

D
000049085
4

UC SOUTHERN REGIONAL LIBRARY FACILITY





THE LIBRARY
OF
THE UNIVERSITY
OF CALIFORNIA
LOS ANGELES



THE HISTORIANS'
HISTORY
OF THE WORLD



GROTE

THE HISTORIANS' HISTORY OF THE WORLD

A comprehensive narrative of the rise and development of nations
as recorded by over two thousand of the great writers of
all ages: edited, with the assistance of a distinguished
board of advisers and contributors,
by

HENRY SMITH WILLIAMS, LL.D.

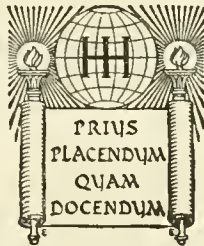

IN TWENTY-FIVE VOLUMES

VOLUME IV—GREECE TO THE ROMAN CONQUEST

The Outlook Company
New York

The History Association
London

1904

COPYRIGHT, 1904,
By HENRY SMITH WILLIAMS.

All rights reserved.

Press of J. J. Little & Co.
New York, U. S. A.

Contributors, and Editorial Revisers.

Prof. Adolf Erman, University of Berlin.

Prof. Joseph Halévy, College of France.

Prof. Thomas K. Cheyne, Oxford University.

Prof. Andrew C. McLaughlin, University of Michigan.

Prof. David H. Müller, University of Vienna.

Prof. Alfred Rambaud, University of Paris.

Prof. Eduard Meyer, University of Berlin.

Dr. James T. Shotwell, Columbia University.

Prof. Theodor Nöldeke, University of Strasburg.

Prof. Albert B. Hart, Harvard University.

Dr. Paul Brönnle, Royal Asiatic Society.

Dr. James Gairdner, C.B., London.

Prof. Ulrich von Wilamowitz Möllendorff, University of Berlin.

Prof. H. Marnali, University of Budapest.

Dr. G. W. Botsford, Columbia University.

Prof. Julius Wellhausen, University of Göttingen.

Prof. Franz R. von Kroncs, University of Graz.

Prof. Wilhelm Soltan, Zabern University.

Prof. R. W. Rogers, Drew Theological Seminary.

Prof. A. Vambéry, University of Budapest.

Prof. Otto Hirschfeld, University of Berlin.

Baron Bernardo di San Severino Quaranta, London.

Prof. F. York Powell, Oxford University.

Dr. John P. Peters, New York.

Dr. S. Rappoport, School of Oriental Languages, Paris.

Prof. Hermann Diels, University of Berlin.

Prof. C. W. C. Oman, Oxford University.

Prof. I. Goldziher, University of Vienna.

Prof. E. C. Fleming, University of West Virginia.

Prof. R. Koser, University of Berlin.

CONTENTS

VOLUME IV

GREECE

	PAGE
INTRODUCTORY ESSAY. THE EVOLUTION OF GREEK PHILOSOPHY. By Dr. Hermann Diels	xiii

CHAPTER XXXVII

THE REIGN OF TERROR IN ATHENS (404-403 B.C.)	1
--	---

Lysander, 2. Cruelties of the Thirty, 3. The Sycophants, 4. The revolt of Thrasybulus, 10.

CHAPTER XXXVIII

THE DEMOCRACY RESTORED (403-400 B.C.)	16
---	----

The end of Alcibiades, 23. Life at Athens, 25. Aristophanes, 27. Euripides, 30.

CHAPTER XXXIX

SOCRATES AND THE SOPHISTS (ca. 425-399 B.C.)	33
--	----

The prosecution of Socrates, 36. Plato's account of the last hours of Socrates, 39. Grote's estimate of Socrates, 45.

CHAPTER XL

THE RETREAT OF THE TEN THOUSAND (404-399 B.C.)	49
--	----

The affairs of Persia, 49. Xenophon's account of Cunaxa, 53. The retreat, 59. Xenophon's picture of the hardships, 61. End of the march, 63. The meaning of Xenophon's feat, 64.

CHAPTER XLI

THE SPARTAN SUPREMACY (480-240 B.C.)	66
--	----

Grote's comparison of Spartan and Athenian rule, 72. Harshness of the Spartan hegemony, 76. Degeneracy of Sparta, 77.

CHAPTER XLII

	PAGE
SPARTA IN ASIA (400-394 B.C.)	82

War of Laedæmon and Elis, 86. Cinadon's plot, 90. Agesilaus in Asia, 91. Persian gold, 95. War rises in Greece, 96. Lysander's plot, 99. Agesilaus recalled, 101.

CHAPTER XLIII

THE CORINTHIAN WAR (394-387 B.C.)	104
---	-----

Battle of Cnidus, 107. Battle of Coronea, 108. Land affairs of the Corinthian War, 111. The great deeds of Conon, 115. Conon rebuilds the Long Walls, 117. The embassy of Antalcidas, 119. The King's Peace, 123.

CHAPTER XLIV

THE RISE OF THEBES (387-371 B.C.)	126
---	-----

Mantineia crushed, 127. The Olynthian War, 129. The surprise of Thebes, 130. Fate of Evagoras and the Asiatic Greeks, 133. The revolt of Thebes, 135. The second Athenian League, 140. Corcyra, 144. The trial of Timotheus, 148. The congress at Sparta, 151. Athens abandons Thebes, 153.

CHAPTER XLV

THE DAY OF EPAMINONDAS (371-367 B.C.)	154
---	-----

Sparta invades Bœotia, 156. Battle of Leuctra, 157. Significance of Leuctra, 159. Jason of Thessaly, 160. Von Stern on the Theban policy, 165. A congress at Athens, 167. Mantineia restored, 167. The Arcadian Revolution, 169. Spartan intolerance of cowardice, 171. The Thebans in the Peloponnesus, 172. Founding of Messene, 175. Athens in league with Sparta, 177. Second invasion of Peloponnesus, 177. Expedition into Thessaly, 180. An embassy to Persia and a congress at Thebes, 182.

CHAPTER XLVI

WHEN THEBES WAS SUPREME (368-360 B.C.)	185
--	-----

Joint work of Epaminondas and Pelopidas, 185. The end of Pelopidas, 189. Battle of Mantineia and death of Epaminondas, 191. Xenophon's account of how Epaminondas fought, 194. Grote's estimate of Epaminondas, 196. Confusion following Epaminondas' fall, 199.

CHAPTER XLVII

THE TYRANTS IN SICILY (410-337 B.C.)	202
--	-----

CHAPTER XLVIII

	PAGE
THE RISE OF MACEDONIA (490-357 B.C.)	208

Early history of Macedonia, 210. Philip, the organiser, 215. Military discipline, 216. Macedonian culture, 217. Olympias, mother of Alexander, 219. The Macedonian phalanx, 220. The waxing of Philip, 221.

CHAPTER XLIX

THE TRIUMPHS OF PHILIP (359-336 B.C.)	222
---	-----

Demosthenes, the orator, 222. Æschines, the rival of Demosthenes, 223. The unpopularity of Demosthenes, 224. Philip's better side, 225. The Sacred War, 227. The First Philippic, 227. Philip and Athens, 229. A treaty of peace, 231. Punishment of the Phocians, 232. The attitude of the Athenians, 232. The Macedonian party, 233. The patriotic party, 234. Philip's intrigues and the outbreak of war, 235. The Third Philippic, 236. Philip returns to the fray, 237. Siege of Perinthus and Byzantium, 238. Decline of Philip's prestige; the Scythian expedition, 238. The crusade against Amphissa, 239. Alliance between Athens and Thebes, 241. The armies in the plain of Chæronea, 243. Battle of Chæronea, 245. Philip takes Thebes, 247. Peace of Demades, 248. Philip in Peloponnesus, 249. Political schemes; family broils, 250. The death of Philip, 251. A summing-up of Philip's character, 253. Grote's estimate of Philip, 254.

CHAPTER L

ALEXANDER THE GREAT (336-335 B.C.)	256
--	-----

Philip and Alexander compared by Justin, 257. Alexander's youth according to Quintus Curtius, 258. Aristotle as his teacher, 261. Bucephalus, 263. Alexander's first deeds, 263. Demosthenes ridicules Alexander, 265. Alexander dashes through Greece, 267. Alexander winnows the North, 268. The revolt of Thebes, 269. The fate of Thebes, 271.

CHAPTER LI

ALEXANDER INVADES ASIA (334 B.C.)	274
---	-----

Schemes of conquest, 274. The problem and the troops, 276. The size of the army, 277. The phalanx and the cavalry, 278. The light troops, 280. The condition of the Persian Empire, 281. The entry into Asia, according to Arrian, 283. Battle of the Granicus, 284. Courage and danger of Alexander, 287. Effects of Alexander's victory, 289.

CHAPTER LII

ISSUS AND TYRE (334-332 B.C.)	290
---	-----

Halicarnassus, 292. Gordium, 295. Darius musters a new host, 297. Darius at Issus, 299. Preparing for battle, 301. Battle of Issus, 302. Flight of Darius, 303. From Issus to Tyre, 305. The siege of Tyre, 307.

CHAPTER LIII

	PAGE
FROM GAZA TO ARBELA (332-331 B.C.)	312

The siege of Gaza according to Arrian, 312. Incidents from Quintus Curtius, 314. Alexander in Egypt, 315. The visit to Ammon, 317. Alexander leaves Egypt, 318. Battle of Arbela, 320.

CHAPTER LIV

THE FALL OF PERSIA (331-327 B.C.)	329
---	-----

The entry into Babylon described by Quintus Curtius, 329. At the border of Persia, 331. A shepherd guide, 332. The released captives; sacking Persepolis, 334. Curtius tells of the enormous loot, 335. Curtius describes an orgy and the burning of Persepolis, 336. The new meaning of the conquest, 338. The pursuit of Darius, 338. Conspiracies against Alexander, 342. Capture of Bessus, 346. Limit of Alexander's progress northward, 348. Alexander murders his friend, 348. Remorse of Alexander, 350. Conspiracy of the royal pages, 353.

CHAPTER LV

THE CONQUEST OF INDIA (327-324 B.C.)	355
--	-----

The war with Porus, 358. The eastern limit, 360. The march to the West, 362. The brave Mallians, 363. Alexander's severe wound and the army's grief, 365. The desert march, 367. Excesses and cruelties described by Curtius, 369. The return of Nearchus, 371.

CHAPTER LVI

THE END OF ALEXANDER (324-323 B.C.)	375
---	-----

His projects, 375. The marriage of Greece with Persia, 377. The mutiny, 379. The last expedition, 383. Grief for Hephæstion, 384. To Babylon, 386. Last illness, 390. The death-bed of Alexander, 391.

CHAPTER LVII

VARIOUS ESTIMATES OF ALEXANDER	393
--	-----

His vices and virtues (Arrian), 393. His favour with fortune (Ælianus), 394. If Alexander had attempted Rome (Livy), 395. A patriotic estimate of Rome's greatness, 398. His invincibility (Grote), 399. His meanness (Ménard and Rollin), 401. His evil influence (Niebuhr), 403. His motives (Droysen), 405. His effect on federalisation (Pöhlmann), 407. His heritage (Hegel), 408. Alexander's true glory (Wheeler), 409.

CHAPTER LVIII

GREECE DURING THE LIFE OF ALEXANDER (333-323 B.C.)	410
--	-----

Confederacy against Macedonia, 411. War in Greece, 412. Affairs at Athens, 413. Demosthenes and Æschines, 414. Deification of Alexander; the gold of Harpalus, 416.

CHAPTER LIX

	PAGE
THE SUCCESSORS OF ALEXANDER (323-232 B.C.) . . .	420

Council at Babylou after Alexander's death, 422. Perdiccas, Meleager, Eumenes, and the puppet king, 425. The compact, 426. The partition, 427. Alexander's posthumous plans, 428. Alexander's funeral described by Diodorus, 430. Alexander's heirs, 431. Arrhidæus, the imbecile, 431. The Diadochi, 432. The women claimants, 433. Death of Perdiccas, 435. The feats of Eumenes, 436. The empire of Antigonus, 437. Polysperchon *versus* Cassander, 438. Lysimachus, 441. Cassander in power, 442. The name of "king" assumed, 446. The siege of Rhodes, 447. The fall of Antigonus, 449. Demetrius at large, 450. Death of Cassander; Demetrius wins and loses, 452. Lysimachus, Arsinoe, and Agathocles, 454. Seleucus; Antigonus; the Ptolemies, 455. Ptolemy Ceraunus in Macedonia, 457. Anarchy in Macedonia, 458. Antigonus Gonatas, 459. The Chremonidean War, 460. Pyrrhus' son takes Macedonia, 461.

CHAPTER LX

AFFAIRS IN GREECE PROPER AFTER ALEXANDER'S DEATH (323-318 B.C.) .	463
---	-----

The Lamian War, 463. Return of Demosthenes; death of Leosthenes, 466. Leonnatus, 467. Death of Leonnatus; naval war; war in Thessaly, 468. Dissolution of the league, 469. The capitulation, 470. The end of Demosthenes, 470. Grote's estimate of Demosthenes, 472. Antipater in Greece, 474. The deaths of Antipater and of Demades, 476. Polysperchon and Cassander, 477. Olympias and Eumenes, 478. Imperial edict recalling exiles, 479. Contest at Athens, 480. Intrigues of Phocion, 481. Phocion's disgrace, 482.

CHAPTER LXI

THE FAILURE OF GRECIAN FREEDOM (318-279 B.C.) . . .	486
---	-----

Hellas at peace, 487. Athens under Demetrius; Sparta behind walls, 488. The last acts of Olympias' power, 490. Ptolemy in Greece, 493. Athens passive and servile, 494. Success of Demetrius in Greece, 497. Battle of Ipsus, 498.

CHAPTER LXII

THE EXPLOITS OF PYRRHUS (<i>ca.</i> 360-272 B.C.) . . .	502
--	-----

The antecedents of Pyrrhus, 503. The last adventures of Demetrius, 504. The end of Lysimachus, king of Macedon, 505. Death of Seleucus, 506. Invasion of the Gauls, 506. Defence of the temple at Delphi, 507. Pyrrhus and the Romans, 508. Pyrrhus summoned by the Tarentines, 508. Pyrrhus in Sicily; his return to Italy, 510. Magna Græcia subdued by the Romans, 511. Return of Pyrrhus to Macedonia, 512. Expedition of Pyrrhus against Sparta, 512. Death of Pyrrhus, 513. Antigonus Gonatas, 514.

CHAPTER LXIII

	PAGE
THE LEAGUES AND THEIR WARS (249-167 B.C.)	516

The Ætoliains, 516. The Ætolian League, 517. The Achæan League and Aratus of Sicyon, 518. Aratus controls the league, 520. Aratus takes Corinth, 521. Sparta under Cleomenes, 523. Antigonos called in, 524. The Social War, 526. Alliance with Rome, 528. Greek freedom proclaimed, 531. The Ætoliains crushed, 531. Greece at the mercy of "friendly" Rome, 533. Rome against Philip, 535. Perseus, king of Macedonia, 537. The humiliation of Greece, 538.

CHAPTER LXIV

THE FINAL DISASTERS (156 B.C.-540 A.D.)	540
---	-----

The Macedonian insurrection, 542. The Achæan War, 542. The destruction of Corinth, 545. Greece under the Romans, 546.

CHAPTER LXV

THE KINGDOM OF THE SELEUCIDÆ (323-65 B.C.)	552
--	-----

Seleucus, 553. Antiochus Soter, 555. Seleucus Philopator, 559.

CHAPTER LXVI

THE KINGDOM OF THE PTOLEMIES (323-30 B.C.)	562
--	-----

Ptolemy Philadelphus, 568. Ptolemy Euergetes, 570. Ptolemy Philopator, 572. Epiphanes, 573. Philometor and Physcon, 573. Roman Interference, 575. Ptolemy Auletes ; Cleopatra and the end, 576.

CHAPTER LXVII

SICILIAN AFFAIRS (317-216 B.C.)	578
---	-----

Agathocles, 578. Pyrrhus and the Romans, 583.

CONCLUDING SUMMARY

THE DEVELOPMENT OF THE HELLENIC SPIRIT. By Dr. Ulrich von Wilamowitz-Möllendorff	587
BRIEF REFERENCE-LIST OF AUTHORITIES BY CHAPTERS	614
A GENERAL BIBLIOGRAPHY OF GRECIAN HISTORY	617

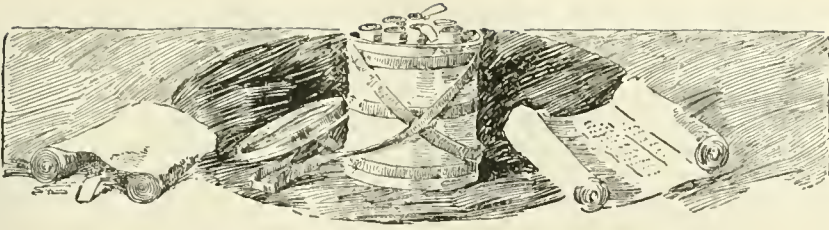

THE EVOLUTION OF GREEK PHILOSOPHY

WRITTEN SPECIALLY FOR THE PRESENT WORK

BY DR. HERMANN DIELS

Professor in the University of Berlin.

It is a primary law of development that each generation should supplant and supersede that which preceded it. The parents bring forth the child, and when the child has advanced to full maturity they themselves lapse into oblivion ; and the same fate overtakes their children and children's children.

So it is with nations. One civilisation rises above the level of the rest, then sinks, yielding place to the fresh vigour of younger nations, to which it bequeaths its heritage of culture. For a while the elder mother-nation is held in remembrance as a teacher and model ; but ultimately — when the new generation of nations has grown strong enough to maintain an independent existence — the elder vanishes to return no more.

Such a stage we ourselves seem to have reached. The peoples of the Classic Age have long passed away, but in the Renaissance the culture of their time rose again from the dead. A bevy of daughters entered upon the heritage of this mother — Italy, France, England, Germany, and many others — and added to it, each after her own fashion. Then they outgrew the imitation and mere echo of the antique, passing on to express in act an independent culture of their own ; and now the time seems to have come when the modern spirit claims absolute liberty of action in every sphere, without the slightest reference to the traditions of antiquity. For the modern technician, the modern naturalist, the modern historian, the modern artist, the modern poet, the ancient world has no message. It is dead — dead past recovery, as we may say.

There is, however, one sphere in which it is not dead, where it still imparts fresh stimulus to the minds of men from day to day, in which it is still recognised as the guide to every fresh enterprise. This sphere is philosophy.

The last and loftiest height to which thinking humanity can climb is that comprehensive vision of all things which we Germans call *Weltanschauung*, and which the Greeks called *Philosophia*. In speculation of this illimitable range we have made but little advance upon the Greeks ; nay, even those most modern of philosophers who, on the basis of biological knowledge, have built up the most modern of all conceptions of the world, are in unconscious

THE HISTORY OF GREECE

agreement with the rudiments of Greek natural science in the sixth century B.C. Let anyone compare the "cosmological perspective" to which Ernest Haeckel has attained in his book *Die Welträthsel* [*The Riddle of the Universe*] (1900) p. 15, "from the highest point of monistic science yet reached," with what Anaximandros taught in the reign of Cyrus, and he will perceive with amazement that modern times have hardly gone further by a single step. The eternity, infinity, and illimitability of the Cosmos; the substance thereof, with its attributes of matter and energy, which in perpetual motion occupy the boundless space; perpetual motion itself in its periodic changes of becoming and ceasing to be; the constant progress of decay and destruction in the innumerable celestial bodies which give place to fresh formations of a similar character; the process of biogenesis on our own planet, by which in the course of æons animal life was brought forth, and by which, through gradual metamorphoses, the vertebrates were evolved from its earliest forms, the mammalia from vertebrates, the primary apes from mammalia, and lastly, through progressive evolution, man was brought into being towards the end of the tertiary period — all these propositions had already been recognised and stated in germ by the Greek thinker who lived during the first generation of Greek philosophy. The sum total of the progress made in twenty-five hundred years, that what was then surmised from, rather than disclosed by, an empiric consideration of some few facts, has now been demonstrated in detail by scientific observation.

But these main propositions, which the modern scientist regards as his own gains, because he has had to win them afresh by his own toil from the errors of the ancient and mediæval world, are of no great significance when compared with the far greater residuum of questions that still remain unanswered. Du Bois-Raymond, as is well known, described these "world riddles" in the year 1880 as in part unsolved, in part insoluble. They are seven in number: (1) The nature of matter and force; (2) the origin of motion; (3) the first beginning of life; (4) the adaptation of nature to certain ends; (5) the rise of sensation and consciousness; (6) the origin of thought and speech; (7) freedom of will.

It is easy to see that, compared with these fundamental questions, which may be summed up in the great question of all, "God and the world," the whole sequence of cosmic research from Anaximander to Haeckel is merely of secondary importance. It is, as it were, the surface of the matter; and even if, with Goethe, we feel the inadequacy of the apothegm of Haller, the poet and naturalist, "Into the heart of nature no created spirit may penetrate," yet we cannot but see that as yet we poor mortals are only nibbling at the rind, and that centuries more of labour are needed to penetrate its diamond hardness.

Thus everything that has hitherto been achieved is, as it were, a mere prelude to the abstract presentment of cosmic principles, and consequently the rudimentary beginnings of study in this sphere are far less remote from its present condition than is the case in any other department of the intellectual activity of mankind. And hence, even at the present day, the consideration of Greek philosophy is not only the most interesting, but also by far the most directly profitable part of the study of antiquity. No man who has not thoroughly studied the systems of Democritus, Plato, and Aristotle can become a profound philosopher in our own time.

"The love of wisdom" was the name which, from the fifth century B.C. onwards, the Greeks bestowed on any kind of intellectual endeavour which was diverted from the practice and directed to the theory of life. The scope

of this striving naturally varied in different periods. In the infancy of Greek speculation, *i.e.*, in the sixth and fifth centuries B.C., men pored with wide, childlike eyes over the marvels of nature that lay about them and tried to find in natural science the solution of the riddle of existence. Philosophy was then mainly the embodiment of scientific and mathematical research, that is to say, it was what we nowadays call "Science."

A troublous period followed, represented by the Sophists, a time of youthful storm and stress, out of which the mature philosophy of ideas developed towards the end of the fifth century. The term "philosopher" begins to acquire a professional meaning. Side by side with the Sophist, who supplied "culture" in return for money, stood the philosopher, who directed the course of education without remuneration. At first, it is true, this education was confined to morals. But in Plato it proceeded to expand into a study that comprised mathematics, logic, physics, and ethics, as well as politics, forming a pyramid built on the broadest of possible bases and culminating in the idea of Good. By that time a "philosopher" had come to mean one who is capable of grasping the eternal idea (Plato, *Rep.* VI, 484 A). Next, in the Universal Encyclopædia of Aristotle, this platonic structure is completed and made habitable within and fitted to human requirements. Under him the idea and the term "philosopher" attained its maximum extension. Thereafter both begin to narrow down. The end of the fourth century witnessed the collapse of the Greek state, to the insecure structure of which the philosophers had never been blind.

With the fall of the Hellenic municipal system and the rise of the Macedonian sovereignty a new world comes into being, in which the leaders are monarchs and no longer individual citizens. The outlook and sphere of action of the individual is restricted. Men grow to be eminent in practical affairs, experts in the art of living, less eager to solve the riddle of the universe than that of the personal Ego, by withdrawing men from the tumult of external affairs and guiding them into the imperturbable calm of philosophic conviction as into a sure haven. Hence in the systems of the Stoa and of Epicurus and Pyrrho the designation of philosopher assumes the meaning of a counsellor in the conduct of life, who, in the lack of political liberty then prevailing, held up an ideal of liberty within, which no tyrant could menace.

In proportion as the sphere of philosophy in the Hellenistic world narrowed to the consideration of the Useful and the Practicable, the sphere of its influence widened. Alexander's expedition had thrown the East open to Greek civilisation, and the assiduous and subjective temperament of the youth of the Semitic peoples was drawn to the wisdom of the Greeks. An active process of endosmosis and exosmosis set in between the countries of the West and East. During the period from the third to the first century B.C. this interchange created a new civilisation, destined to form the basis of the *Imperium Romanum* in matters temporal and the *Imperium Christi* in matters spiritual. But at this period the clear outlines of development tend to become blurred.

As the Hellenic nation expands into the Hellenistic peoples, as the national language of Greece becomes the common medium of the East, nay, of the whole civilised world, the eclecticism which had been formed out of certain elements of the old Greek philosophy under the dominant influence of the Stoa gained ground on all sides. In the time of Christ, Greek philosophy is an indispensable requisite of the higher culture, and the university of Athens, with its professors, whose appointment the state soon took upon

itself, is the one where the educated Roman and Cappadocian alike must have studied. The Greek private tutor, recommended by the head of some school or other at Athens, becomes a standing institution in Roman families of distinction, and is treated with the contempt due to such a *Græculus*, ranking first among the slaves of the household.

Times soon change, however. Under the philosopher Marcus, philosophy gained admission to courtly circles, and presently became indispensable in the conflict with the increasing might of Christianity. After the Christian conception of the world had conquered under Constantine, the university of Athens became the bulwark of Paganism. Neo-Platonism, a new philosophy bred of the enthusiastic temperament of the East, the congenial philosophy of Plato and the erudition of Aristotle, fought the last fight with the courage of despair. But though its champions were, for the most part, superior in courage, moral character, and scientific learning to the bishops whom they withstood, philosophy and the ancient world had played out their part. In the latter end of the period of antiquity the overseer of any craft (as, for example, the overseer of the quarrymen in the *Passio Sanctorum IV Coronatorum*) was called in popular parlance *philosophus* to distinguish him from the artisans. *Sic transit gloria mundi*.

I

With the term "philosophy" as our guide, we have made a rapid superficial survey of the progress of the studies it included in these eleven hundred years of development (585 B.C.—529 A.D.). We will now consider in somewhat fuller detail the three phases which cover the Greek epoch proper, *i.e.*, the first three centuries, from Thales to Pyrrho (585—270), with a special view to the study of their internal evolution.

The Greek nation is almost the last of all the civilised peoples of the ancient world to enter upon the scene of history and bulk largely in the minds of men. The long period during which the Greeks dwelt among their Aryan kindred, fruitful in intellectual progress as their language proves it to have been, has passed utterly out of the historic memory of the race. And yet the beginnings of scientific knowledge must have fallen within this period, in so far as the dim prevision of eternal and perpetual motion dawned upon men's minds from the observation of the moon (*mēnē*, from the root *mē*, to measure), from chronology, and the consequent observation of cosmic laws. Nor have any other than mythical records come down to us from the first thousand years in which the Hellenes dwelt in the Balkan peninsula, their future home, side by side with the original inhabitants and other migratory tribes; but from the buildings and monuments which the earth has yielded to Schliemann's and Evans' spades we can form some conception of the might of these rulers and the splendour of the knightly life they led.

A faint reflection of the Middle Age of Greece has been preserved in the epic poetry of Homer, the most ancient portions of which date back to the year 1000 B.C., while the latest bring us down to the time of Thales, that is to say, to the sixth century. The Homeric bards do not philosophise as the Stoics fancied they did, they look upon life with living eyes in the true artist spirit, and reproduce it "not sicklied o'er with the pale cast of thought." Only in a few later passages of the *Iliad* and the *Odyssey* do we catch strange notes that harmonise ill with that *joie de vivre* which is the keynote of the epics. We see that in those strenuous days, when the Greeks were

bent upon carrying their commerce to the uttermost ends of the earth and satisfying the ever increasing clamour of the populace for food and power, the nation begins to pass over from the light-hearted carelessness of the epic of chivalry to the harsher and more reflective didactic poetry of Hesiod. Indeed, in one of the later passages of the *Odyssey* (*Nekyia*) we note an evident reflex of the Orphic cosmologies, in which, under the name of a Thracian bard of remote antiquity, a mournful and pessimistic strain of poetry, dealing with sin and penitence, stands contrasted with the optimistic acceptance of the existing order of things which is characteristic of Homer.

The forces which brought philosophy, properly so called, to the birth at the beginning of the sixth century were three in number. First, the poetry then extant, which had cast into artless shape a number of speculative observations on the subject of the Cosmos — such as the conceptions of Oceanus encircling the earth, of Zeus dwelling in ether above it, of Tartarus beneath it, and so forth. Nothing but a cool head and a turn for systematisation was needed to convert these images into “ideas” and to combine the latter into a homogeneous and coherent conception. Another service was rendered by the study of geography, mathematics, and astronomy, developed as it had been by the long voyages of Milesians and Phœceans in the Mediterranean after they had supplanted the Phœnicians. A school of navigation came into being at Miletus, which city had successfully opened up the Euxine in the seventh century; and both Thales and Anaximander were trained in it. Miletus, where the trade with Egypt was started about the same time and the establishment of permanent factories like Naucratis taken in hand, likewise constituted the meeting-place of the geometry and astronomy of the Egyptians, whose learning was formerly much over estimated, with the far superior astronomical science of the Babylonians. The reports of mariners, charts, the catalogue of the stars, all combined with Oriental tradition and the unbiassed perspicacity of the Greeks to give the world the first science, *i.e.*, research built upon a basis of empiricism, tested by the methods of mathematics and logic, and aiming at a harmonious interpretation of the Cosmos. To give a name to this study the Ionians evolved the idea of *Historia*, which in the sixth century took the place of *Philosophia*; the latter not coming into use until the fifth century.

In this place I must mention the third element, although it is not in evidence in the earliest exponents of Ionian philosophy. It is the tendency to mysticism, to abstraction from the world, then beginning to develop in the Orphic school, which has left traces of its influence with ever-increasing distinctness in Anaximander, Pythagoras, Heraclitus, and Empedocles. It favoured the rise of a transcendental idealism which, although we do not find it matured into immaterial conceptions in these first natural philosophers, yet contains the germ of Plato’s dualistic idea of the universe. Not that the curve of development runs in smooth ascent from Thales to Plato; it exhibits the spiral windings inseparable from historic processes, since every new tendency calls forth the antagonistic principle to that which has spent its force, and thus brings about the necessity of reaction in a retrospective sense.

Thales, who enjoyed great repute in his native city of Miletus and throughout Asia Minor at the commencement of the sixth century, calls water the beginning of all things. This was no new idea. For before his time poets had spoken of Oceanus, of the origin of the gods, and of the deluge from which the world was born anew. And the infinite sea could not but lie close to the thoughts of a seafaring nation.

The novel and genuinely philosophic element in this proposition is rather the monistic endeavour to refer all phenomena to a single cause, to be sought not in heaven but on earth. For that which is taken as the beginning is not Oceanus, or, it may be, Poseidon, as in the older cosmogonies, but this palpable substance of water, out of which all things come and to which they all return. This original matter is indeed supposed to be animated by a divine spirit, but this divinity is not a person. There is no place for it on Olympus. Rather is it the expression of the immanent force which this philosopher recognised in the incomprehensible properties of the magnet, and there called "soul." This enduing of nature with a soul is characteristic of the infancy of speculation, and hence this Ionic philosophy has also been called Hylozoism (the doctrine of living matter). The monistic impulse, which would bind the world and this single and supposed divine primeval force together, is diametrically opposed to the polytheistic tendency of the popular religion of Greece. Even in the first Greek philosophers this aspiration after unity points forward to monotheism, which was preached by Xenophanes, the Ionian, at the end of this same century.

Of all the achievements of Thales his prediction of the eclipse of the sun (May 28, 585) is that which caused the greatest amazement, although its scientific significance is the most trifling of any. For, as the history of astronomy proves beyond controversy, Thales and his whole generation lacked the rudiments of knowledge necessary for the calculation of eclipses, and had not the faintest notion of how they came about. Hence he can only have employed according to a fixed method some such formula as the Chaldeans had gained from empiric observation in calculating their eclipse period of eighteen years and eleven days (*Saros*). The rule only suffices for approximate predictions. As a matter of fact, Herodotus, the earliest witness to this event, states that Thales allowed a margin of a whole year for the occurrence of the eclipse.

Thales himself left no written works, and this Ionic *Historia* first emerges into the full light of day with Anaximander of Miletus, who founded the Ionic school about a generation later. In him the three forces are strongly marked and defined — first the scientific spirit, which impelled him to give visible expression to the geographical ideas of his countrymen by means of a map of the earth's surface, and to make a systematic description of the heavens with the stationary and revolving celestial bodies. With him originated the conception of the constellations as a system of spheres rotating through and within one another, and it was his mathematical imagination that led him to assume the existence of certain fixed intervals between the revolving spheres, arbitrarily determined as to number, but expressing in their proportion the idea of harmony.

Here we have the germ of the speculations of Pythagoras, on which, as is well known, the laws of Copernicus and Kepler are founded. The vein of poetry in the Ionian character is manifest not only in this intuitive perception but in the aptness of his imagery, when he calls these spheres "chariot-wheels," from the rim of which the fiery flames of the sun, moon, etc., start out like felloes. The scientific element in his system is evident in the manner in which he follows out biologically the idea of Thales concerning water. If all things have at one time been water, then organisms cannot originally have been created as land animals. Hence man, who now comes into the world utterly helpless, has been gradually evolved from pisciform creatures — the first germ of Darwinism.

Lastly the pessimistic mysticism which had lately arisen is clearly manifest in him. When he regards the origin of all individual existences as a

wrong committed by them in separating themselves from the All-One, we can only understand him by referring to Orphic religious ideas, in which birth is looked upon as a decline and fall from the blissful seats of the gods and earthly life is represented as a vale of misery. Death is consequently the penalty which the individual pays for his presumption, whether the individual be a man or a celestial body. For the earth and all other Cosmoi are doomed to extinction in an "Infinite" which corresponds to the ancient idea of Chaos, and, like that, is not conceived of as a vacuum but as matter in an undefined form. This alternation of creation and annihilation, this perpetual motion, anticipates the eternal flux of Heraclitus of Ephesus, who at the end of the sixth century and the beginning of the fifth, transformed the teaching of Anaximander into keener dialectics.

In comparison with this Ephesian thinker the successors of Anaximander at Miletus and whatsoever following they had down to the end of the fifth century sink into total obscurity. Before turning our attention to Heraclitus, however, we must first consider the man who transplanted the Ionic *Historia* from Ionia to Italy and there elaborated both the scientific and mystic side of it with marvellous assiduity — that is, Pythagoras.

Pythagoras left Samos about the year 530, and turned his steps towards Croton in lower Italy, where he found virgin soil for his labours. The mathematical foundation upon which the Ionic school is based attains an excessive predominance with Pythagoras. Epoch-making maxims are associated with his name, and probably not without good reason. But the speculative tendency of the Ionic mind prompted him to set up number itself as a principle; the Infinite of Anaximander being conceived of arithmetically as the Uneven, *i.e.*, that which cannot be divided by two. Since the Even and Uneven alone co-exist, the sacred Three is compounded of Unity and Duality, as is also the Four (*tetraktys*), the root of Being. By simply adding these first four numbers together the Decas ($1 + 2 + 3 + 4 = 10$) is obtained. The cosmos is made to consist of ten celestial bodies, corresponding to this Decas, by the addition of the heaven of the fixed stars as an outermost crust, and the earth and the "anti-earth" (*antichthon*) containing the central fire, at the heart of it. The earth and other stars moved round this centre, and here we have the first glimpse of the modern conception which explains the apparent diurnal motion of the heavens by the rotation of the earth. This rudimentary idea, as elaborated by later Pythagoreans, and particularly by Aristarchus of Samos in the Alexandrine period, constitutes the first starting-point we can assign to the Copernican system of the universe.

Pythagoras made the astounding discovery that the harmonic intervals of the seven-stringed lyre can be reduced to simple rational proportions (the octave = 1:2, the fifth 2:3, the fourth 3:4, the whole tone 8:9). He then sought for a like scheme in the harmony of the spheres, and, as the geometric habit of the Greek mind converted these arithmetical relations into lines and planes, the whole process by which the universe came into existence seemed to be a sum in arithmetic.

The strong tinge of mysticism which Pythagoras had brought with him from the Orphic influences of his native land to his new home in Italy served as a wholesome corrective to this exaggerated rationalism. Every religious sect thrives better in a colony than in the mother-country, as is demonstrated in the case of William Penn and many others. The aristocratic and religious league which Pythagoras founded at Croton prospered mightily, and presently the whole of lower Italy and Sicily was covered with branches of

the order. Its religious ideas, particularly that of the transmigration of souls, were not new, although they have been claimed as peculiarly Pythagorean. Orphic mysticism had adopted in precisely the same fashion the notion of the fall of the spirit and its purification by transmigrations of all kinds into the bodies of men and animals. But the earnestness with which noble-minded men lived conformably to these ideas in matters of practice and brought them into connection with the results of scientific research strongly impressed the ancient world; and the close freemasonry which linked Pythagoreans from every quarter with one another set forth an ideal of manly friendship which served as a model for the institution of the Academy and similar philosophic societies.

But the too strongly marked political complexion of these Pythagorean societies contained the seed of their destruction. At the end of the sixth century and the beginning of the fifth the aristocratic principle was everywhere on the decline, and in Italy itself the Pythagoreans were attacked on democratic grounds by Xenophanes of Colophon, who ridiculed the aristocratic physical sports in which even distinguished Pythagoreans (such as Milo) indulged, and vaunted the intellectual sport of his own *Sophia*. The said wisdom, it must be confessed, was of a negative rather than a positive character.

Xenophanes attacked Homer, the Bible of the ancients, in verses of fierce satire, showing the gods as there depicted to be examples of every kind of immorality. By the unparalleled vigour with which he transferred the monistic tendency of Ionic rationalism to the religious problem, he, first of all Greeks, originated the monotheistic conception of the Deity, which none of the later philosophers ventured to maintain with such unflinching boldness in face of the polytheism of the vulgar herd. To the aristocratic submission to authority in matters of belief required by the Pythagoreans this democratic philosopher opposed the prerogative of doubt, and he has consequently been lauded by the sceptics of all ages as their standard-bearer. At this stage of physical observation, indeed, doubt sets in concerning natural objects. Xenophanes discovers that the rainbow is an optical illusion. He promptly generalises in his scepticism; the sun and the other stars are nothing but fiery exhalations. This assumption will lead to further results among his Eleatic friends.

Meanwhile in the mother-country speculation advanced with huge strides. Heraclitus, a descendant of the royal dynasty of Ephesus, withdrew from his democratic fellow-citizens into haughty isolation. Instead of concerning himself with the scientific gossip which tended to make the Ionic *Historia* lose itself in detail, he laid stress upon the vast concatenation of things. He made the fundamental laws of thought his starting-point, in place of the principles of mathematics. The selection of physical propositions which he deduced poetically from his observations of nature are far more than mere natural symbolism. Fire, constantly transformed into water and earth and as constantly exhaling upwards to the celestial fire, is to him a type of the perpetual change of phenomena that veils the eternal and immutable Law (*logos*), identical in everything but name with the Harmony of the Pythagoreans, which expresses itself in numbers eternally the same. The law of man feeds, he says, upon the divine law manifesting itself in fire.

Here we have the germ of the vast scheme of law which binds God and the world, physics and morals, into a compact entity in the Pantheism of the Stoic philosophy. Since he places fire and soul upon the same footing, it follows that human physiology and psychology are explicable by the same

formula, to which he likewise ingeniously adapts the Orphic ideas. Thus Heraclitus has exercised great influence upon succeeding generations, and Hegel's system avowedly leans upon him.

Equally great is the influence of Parmenides, the Kant of the ancient world. Descended from an Ionian family of rank which had taken refuge at Elea in Italy at the time of the occupation of Phocæa (560), he carries on the tradition of the philosophic poetry of Xenophanes, whose Pantheistic Monism he defends in acute polemics against the "two-headed" Heraclitus. Being — one, eternal, indivisible, immutable, unchangeable — is alone intellectually conceivable. All beside — multiplicity, divisibility, mobility, variability — is logically inconceivable and therefore non-existent. Reason (*logos*) is consequently the measure of all things. His system is abstract and logical to absurdity, but his postulate that this monistic Being must be bounded like a globe that is equally closed in all directions reminds us that we are still in the age of physics. In him the scepticism of Xenophanes hardens into the assertion that everything which contravenes his logical postulate of the Sole Existent — such as multiplicity, colour, motion, becoming and ceasing to be — is mere illusion.

The logical and sceptical bias of the Eleatics is surpassed by the hair-splitting dialectics of Zeno, whose evidences against motion and multiplicity still perplex the thinkers of to-day. On the one hand this precise manipulation of the laws of thought which represents the culminating point of Ionic rationalism redeems the negative Sophism which was beginning to deny the actuality and perceptibility of things themselves (Protagoras, Gorgias), while on the other hand the positive result of this strict definition of the highest conception of Being was to call forth a series of systems which came into existence almost simultaneously, though subject in part to reciprocal influence, a little before the middle of the fifth century. Such was the Doctrine of the Elements taught by Empedocles of Agrigentum, who once more found the idea of the imperishable principle in the fourfold root of Being (the four elements) and brought about the Heraclitic alternation of the external world by the introduction of the two polar forces of love and hate.

The idea of the Element in endless subdivision (which could not be evaded in the world-process of Empedocles) and in endless diversity of quality was strongly brought out by Anaxagoras the Ionian in his *homoiomere*. To this chaos he opposed the thinking and directing reason (*nous*) as a distinct existence, thus definitely breaking with the idea of a hylozoistic union of matter and force, which had already threatened to go to pieces in the systems of Heraclitus and Parmenides, and setting forth the positive dualism of God and the world, *i.e.*, of the Universal Reason working towards predetermined ends and the blind chaotic mass of matter.

More important than either of these two is Leucippus of Miletus, the founder of the atomistic theory, who, as Theophrastus rightly asserts, starts from the position of Parmenides. For he finds the homogeneous, eternal, complete, and indivisible, unchangeable Existence, to which no quality can be ascribed, in the "atom," and solves the difficulties which arose for the Eleatics out of the idea of multiplicity by assuming the existence of an infinite number of such units. Hence results a mechanical interpretation of nature, which proved of all ancient systems the most serviceable for the elucidation of physical and physiological facts. By explaining sensory impressions by mechanical transmission from object to subject, he propounds the first theory of sensory perception, and since, in consequence of this as-

sumption, he regards such qualities as colour, taste, etc., as subjective sensory impressions to which atoms in different arrangements correspond objectively, he lays the foundation of a distinction between primary and secondary qualities which has not been rightly appreciated until modern days.

Generally speaking, the value of the Leucippic theory has only been recognised since the Renaissance. For although Democritus of Abdera extended his master's admirable system to fresh departments of knowledge, established it more firmly by combating the sensualism of Protagoras and other theories arising from a misunderstanding of Leucippus, and, above all, brought it to a high pitch of mathematical and notional exactitude, yet the atomistic school which continued to exist at Abdera till into the fourth century has passed almost utterly out of mind. Plato ignored it, although he adopted many of its theories indirectly; Aristotle alone made use of it, though not as regards the main points of its teachings; and Epicurus, who borrowed from it almost the whole of his theoretical science, by this very absorption played the chief part in the destruction of the Abderite writings, the greatest loss that science has ever suffered.

How can we explain this astounding disregard of atomistic philosophy? In some degree by the fact that Leucippus settled in the barbarous north, far away from Athens, which had grown since the Persian wars to be more and more the *prytaneion*, or central focus of warmth to Hellas, and drew all talent to itself from every quarter; and further, from the fact that the natural science which was dominant in the sixth century and the beginning of the fifth — and was regarded, indeed, as the only legitimate kind of scientific thought — lost its hold on men's minds towards the middle of the fifth century. We have evidence of this in Eleatism, which, with Zeno and Melissus, devoted itself to purely dialectical questions and abandoned the interpretation of nature. We have evidence of it, again, in Empedocles, who in his second series of didactic poems (*Katharmoi*) flings himself into the arms of Orphic mysticism; and in his pupil, Gorgias, who proceeded from physics to nihilism and thence to mere superficial rhetoric. We have the strongest proof of all in Democritus himself, who embraced inductive logic, æsthetics, grammar, and ethics within the range of his studies as well as the old questions of physics. Thus during the Peloponnesian War the way was prepared for the new epoch which was performed with Athens for a stage, and Socrates, Plato, and Aristotle for heroes.

II

Socrates, the Athenian, brought philosophy, as Cicero says, from heaven to earth; that is to say, in place of one-sided speculation upon nature he pursued an equally one-sided study of ethics. In his practical, matter-of-fact way he availed himself of what Eleatic ontology had acquired in order to settle the fundamental ideas of morality and to demonstrate the possibility of scientific proof in face of the nihilistic fallacies of sophistry which despaired of both. So much we may accept as certain from received accounts. All the details of his teaching are wrapped in doubt, for we possess no historical account of it, but merely works of an apologetic character, in which liberal and justifiable advantage is taken of the prerogatives of fiction. Neither Plato nor Xenophon (the latter of whom did not take up his pen until after a superabundant crop of Socratic literature had come into being) can be accepted as historic evidence without further ado. Never-

theless both the disciples of Socrates and his opponents, Aristophanes and Spintharus (the father of Aristoxenus), bear witness to the extraordinary personality of the man.

The rights of the individual were not recognised until the fifth century. The atomistic theory of Leucippus and Democritus sees the Eternal and Constant not in the All-One of Xenophanes and Parmenides, but in the individual. The philosophy of the Sophists breaks the bonds of authority, and in the motto "Man (the individual) is the measure of all things," Protagoras sets up the charter of subjective inclination. This charter Socrates adopts, but he opposes to the liberty of the individual will the counteracting force of obedience to the dictates of the individual conscience. But conscience, as the German and Latin name for it alike imply, means knowledge. A man should therefore act upon his own judgment, but only in so far as his action is founded upon norms scientifically determined. Thus Socrates reads a deeper meaning into the admonition of the Delphic god, "Know thyself," by recognising the independence of the will.

Inasmuch as traditional usage and the law of the state are thus tacitly set aside (and on this point Aristophanes judged more correctly in his caricature than the apologists Plato and especially Xenophon will admit) Socrates is the preacher of a new private morality which traverses the public morality of classic antiquity. His death sentence is so far intelligible, though it remains an act of crude, reactionary violence. The greatness of soul, so far beyond the ordinary level of mankind, which, according to all accounts, the philosopher displayed at the near prospect of death, wrought upon a far wider circle than that of his disciples and contemporaries. His martyrdom set the seal upon the victory of the Ideal philosophy in Athens.

Socrates himself represents a complete individuality, hence his method of education has been of service to individualities the most dissimilar. What contrasting types do we find in Xenophon, the bigoted and stupid cavalry officer; and Plato, the witty and profound thinker; the cynic Antisthenes full of the pride of beggary, and the frivolous courtier Aristippus! They all portrayed themselves rather than their master in their writings, and yet each one of them has in some way or other his part in him.

Of all these disciples of Socrates, two only have influenced the after-world, Antisthenes and Plato, Athenians both, the former a plebeian and founder of the philosophy of the proletariat, the latter, sprung from an old and noble family, an aristocrat of the purest water in all his philosophic ideas. Antisthenes carried the practical and matter-of-fact temper of his master to extremes. Virtue with him is a question of character, and therefore scorns empty words and learning. Logic and mathematics are superfluous, virtue is the only good, vice the only evil; everything else is a matter of indifference. This meagreness of theory is made good by strength of will. Force of character, freedom from the prejudices of conventional custom, conventional religion or conventional government — these are what distinguish the true freeman, the man free in soul, from the slave.

The impression produced by this king in rags in the midst of that age of decadence was striking beyond belief. He with his barking voice seemed to be the warning cry of the proletarian admonishing men to return to nature and to simplicity of life. His acute and witty writings were gladly read. His school, which can show one disciple of world-wide celebrity in the person of Diogenes, was gradually merged into the Stoa, which owes to Cynicism the popular tone of its influential system of ethics. Since the birth of Christ, the Cynic has come to life again, as of old in the guise of the mendi-

cant preacher, proclaiming the gospel of renunciation and holding up the mirror to the corruption of the age. This new Cynicism was one of the most important precursors of the Christian apostolate. It awoke once more in the age of the Renaissance, finding its wittiest exponent in Montaigne, in whose steps J. J. Rousseau afterwards trod. In him we have the best typical example of the strength and weakness of this anti-scientific movement.

Plato, the antithesis of Antisthenes, continued in a direct line the thread of Athenian philosophy. He accomplished, in the widest sense of the term, the task which Socrates had only begun — that of establishing science, now discredited by the Sophist, on a new basis.

We are but imperfectly acquainted with the life of Plato and the phases of his development, for the chronology of his dialogues has not been determined up to this time, either absolutely or relatively, and it is a matter of doubt how far their artistic intention admits of a complete exposition of his system. For Plato's true work was not his literary productions, which he himself regarded as of secondary importance and which obviously reproduce only a fraction of his researches and speculations, but his Academy, in which, from the eighties of the fourth century onwards, he gathered together the ablest scholars from amongst the youth of Greece for study and life in community. If all the transactions of this Academy had been preserved (like the information Aristotle gives us concerning the latter years), it may be that we should be able to trace distinctly the development of this wonderful man. For Plato is both the most gifted and the most complicated personality of Greek antiquity, and the depths and recesses of his nature were not wholly penetrated by his intimate friends, not even by Aristotle; how much less by us of this latter day. What we do possess is, however, amply sufficient to indicate at least his place in this summary.

If from the ranks of the Greek thinkers we have so far considered, we choose out the most eminent leaders and mark the lines of connection between them, we shall see how they all converge to Plato. He is the focus of ancient philosophy, whither all that went before him tends, and whence bright light and warmth stream forth upon posterity down to our own day.

The range of his achievements alone is enough to make this evident. Like the Ionians his grasp embraces cosmology, physics, and anthropology. Like the Pythagoreans he pursues the study of mathematics with ever increasing devotion, presumably as the basis of his speculations. Like Xenophanes he enters the school of the ancient Orphic Mysticism, and in the *Timæus* exalts it into a theology culminating in Monotheism. Like the Eleatics he ponders the problems of ontology. Like Heraclitus he inquires into the eternal flow of genesis; he ponders on the ideals of culture and the political theories of the Sophists, he wrestles with the ideal method of Socrates, he strives with hostile philosophers of the Socratic school on this hand and on that (Aristippus, Euclides, and Antisthenes), and, lastly, he strives with himself as his speculation develops more and more along theological and mathematical lines. For, as the genuine servant of Truth, Plato regards himself up to old age as in process of growing and learning. Nothing is so hateful to him as Dogmatism. Nevertheless there are so many opinions to which he held with unwavering constancy that we are probably justified in speaking of the system of Plato.

At the centre of it lies what has crystallised in more living shape out of the dry conceptions of the Socratic method — the domain of ideas. Even as Parmenides perceived Being in the eternal All-Existent, accessible to Reason alone, so Plato sees the being of individual things in that which pertains to

them in common and as such can be grasped by the Reason. But even as the Eleatic "One" exists even apart from its recognition as an objective being, so these eternal and unchangeable archetypes (*ideai*) live in and by themselves as objective essences which exist wholly apart from the individual objects which partake of their form. These archetypes, like the Eleatic All-Existent, bear the name of unit (monad), only in Plato's scheme there are many such monads, and their unchangeableness does not exclude the idea of causation. Thus his "ideas" are the "units" of Parmenides in multiplicity and the "conceptions" of Socrates endued by metaphysics with the breath of life.

To Socrates the idea of Good and of Virtue lay at the heart of his teaching, and thus the preponderance of the idea of Good is confirmed to his pupil, and in its theological elaboration this abstract idea is converted into the Supreme Reason, the first cause of Being, which is identical with the Deity.

As to the Eleatics, the external world was an illusion of the senses, and in any case a thing irrational, so matter and the world of phenomena which occupies the middle place between matter and ideas is hard to grasp, and Plato's notion of the World-Soul which hovers between the two is as contradictory and obscure as that of the human soul. For with this gifted poet-philosopher there is much that tarries on the threshold of consciousness, and fails to struggle into clear light, a circumstance that harmonises with his own teachings, which find clearness and singleness of purport in the Eternal and Divine alone, obscurity and ambiguity in the intermediate terrestrial sphere of genesis, and utter darkness and inconceivability in the lower sphere of matter and non-existence. These three stages are repeated in his theory of the soul, which from desire rises to courage and ultimately to reason. His ethics and politics, which according to his Hellenic ideas are one and the same, are calculated for three classes of humanity — the iron, the silver, and the golden. The last two, the military and learned classes, are the only ones taken into account in the educational system of his ideal state; for the proletariat there is no need to be concerned, although Antisthenes and his successors regarded this very class as the only one capable of genuine philosophy. But Plato, like the aristocrat he was, has in view an elect type of humanity, exalted by exceptional intelligence above the brute multitude and the solid middle-class element and called by philosophy, *i.e.*, the doctrine of ideas, to the helm of the ideal state.

The teaching of the Sophists had abolished law. Plato likewise knows no law on the lofty level of his ideal state. But the constraint of law seems superfluous where each individual is trained to be the ideal man. Forced by bitter experience to moderate his demands upon human nature and the state towards the end of his life, he sketched in the *Laws*, a model state on the basis of the old established system of government. But this system, like the metaphysics of his old age, seems, as it were, a desertion of his ideals. All that Plato achieved was the education of a race of pupils in his Academy who far surpassed the common standard of learning and morals, and who, though unable to save the state, yet maintained a high standard of knowledge and an ideal of morality for mankind in the midst of a corrupt society.

The greatest of these Academicians is Aristotle of Stagira, who displayed a versatility and thoroughness of research which appears absolutely incomprehensible in our eyes. Like Plato, he steadfastly held that knowledge is never complete, but that truth is to be found by unremitting persistence in

inquiry. This is probably the reason why he gave the world some dialogues adapted to the public taste, and with the help of some of his pupils accumulated and published collections of historico-philological and scientific matter in an unpretentious form; but the systematic lectures in which he propounded to the more advanced followers of his school the results of his speculations and of his wide empirical observation, together with a critical treatment of his predecessors, were never published by him. He worked at these papers his whole life long, and many of the didactic writings which were edited by his pupils after his death, and which are all we possess of the whole body of Aristotle's works, bear evident traces of gradual growth, correction, and amplification.

In a sketch like the present it is impossible to give so much as a summary of the contents of this admirably arranged encyclopædia, which ranked as the richest storehouse of every kind of empiric and speculative science from the beginning of the Christian era down to modern times. The essential points in which his life-work makes an advance on that of Plato are as follows:

Plato never went so far as to reduce his great discoveries and intuitions in every department of science to a complete and connected whole, being averse, on scientific and ethical grounds alike, from the dogmatic definition inseparable from any systematic treatise. This Aristotle did, dividing the whole body of philosophy under three principal heads (theoretical, practical, and poetical) and distinguishing subdivisions (logic, physics, metaphysics, ethics, and politics, and so forth) within these divisions by strongly marked lines of demarcation and methods rigorously exact. He is a Platonist in all things and feels himself so to be. Even where he displays most independence, as in the development of syllogisms or in biology, it is impossible to overlook his indebtedness to the bold speculations of the master.

If the whole work of Plato's life and of his scholars between 388 and 348 had been preserved to us, the ultimate connection between Aristotle and the researches of the Academy would probably be even more evident than it is. Nevertheless there is a marked difference between the speculations of these two great philosophers. Plato wholly dis severed the Universal and Essential in things from the Terrestrial and placed it in a heaven beyond the earth.

Aristotle repudiates this transcendentalism all along the line. The Universal cannot exist without the archetype, the essence must be immanent in it. Hence the individual is the only true Substantive, containing Substance and Matter. This opposition of opinion concerning "Universalia" is, as is well known, the starting-point of mediæval Scholasticism (Nominalism, Realism).

The motion of passive substance towards the active form, *i.e.*, the realisation of the Possible, leads up to the idea of development, of genesis (though not, indeed, in the modern sense) on which Plato's speculations had made shipwreck, and passes over Plato's rigid Eleatism to join hands with Heraclitus, the philosopher of change, with whom Aristotle sees the ultimate cause of all motion and all things in the Deity, itself as eternal as the world, which "yearns towards It as the bridegroom towards the bride." Thus soul, too, is the pattern of the body, hence the purpose of its being. The body is but the instrument (*organon*) of the soul. Thus Aristotle first coins the name and idea of organic being and draws a sharp distinction between these animate creatures (plants, animals, and man) and inanimate nature. In ethics and politics his speculation treads in the footsteps of Plato, save that, in this

province of thought also, he mitigates the uncompromising rigourism of the master by his innate bias towards the historically-established and practically-possible, and turns it to more profitable uses. The ethico-political speculations of both are, however, adapted to the aristocratic class at that time dominant in Greece. Alexander, the pupil of Aristotle, conquered the East during his master's life-time, but the philosopher's opinion that the newly acquired continent should be governed by other laws than those of Hellas was not practically feasible. His ethics failed him utterly in face of the new political situation thus created.

III

At this juncture the cosmopolitan Cynicism, which had outgrown the narrow particularism of Hellenism as early as the time of Antisthenes, and the Stoicism which was built upon its foundation later on, proved the form best fitted to the times. Zeno, sprung of Phœnician blood and brought up in Cyprus, that is on semi-Asiatic soil, elaborated this theory of life at Athens, whither he came shortly after the death of Aristotle (about 320). After the dualism that had prevailed from Anaxagoras to Plato and Aristotle, in which God and the World were set over against one another as antagonistic principles, Zeno's theory harks back to the monistic tendency of the Ionic period. Like that, it is realistic, nay, grossly materialistic, in contrast to the Idealism of Athenian philosophy. The result is a consistent Pantheism in which soul and body represent the analogon to God and the World. Both are of the same essential nature, and only temporarily divided by transitory differentiation of manifestation. Zeno's morality is rigorous, and aims not at the moderation of the passions (like that of Plato and Aristotle) but at their extirpation. The inexorable law that holds the world and man in bonds from which there is no escape, exacts obedience, and to render it voluntarily is virtue.

Since the main object of the Stoic school is the training of the will, and since wisdom as such is only a means to an end, the dogmatic form that corresponds to Oriental modes of thought and the despotic system of contemporary government prevails throughout its teachings. Hence we can understand how this somewhat coarse, wire-drawn, as it were, but effective form of philosophy dominates the whole world from this time forward till about the second century A.D. In essentials it represents a revival of Heraclitism, just as the antithetical philosophy of Epicureanism, which prevailed for the same length of time, is in essence reminiscent of the Abderitic system.

Epicurus (born 342) was the son of an Athenian, but born at Samos. Thus he had opportunities of making himself acquainted with the philosophy of Democritus, which was more highly esteemed in Ionia than at Athens. He did not care for learning for its own sake, however, but for the sake of its practical application. In this respect, as also in his consistent materialism, he is closely akin to the Stoic school.

In dogmatic positiveness and immutability Epicurus far surpasses even the Stoic philosophy. With him the main consideration is a mode of life which induces a tranquil cheerfulness of temper by the refusal to admit all disquieting thoughts (as of death, immortality or divine punishment) and troublesome passions, and by which his followers, while here below, become partakers of the felicity of the gods. This quietist philosophy harmonised

with the ideals of life which obtained at that period, and the ardent exaltation of friendship among this free-thinking fellowship and their ideal of human freedom and dignity atone in some degree for the hollowness of their theory of life.

Finally Scepticism takes the form of a school in Greece with Pyrrho, who died in the same year as Epicurus, 270 B.C. He, too, is only solicitous for tranquillity of mind, but he does not win it by dogmatic faith in this system of doctrine or that, but in believing nothing whatever, in thinking nothing right and nothing important. This thoroughgoing scepticism is bound to doubt even itself. As a result it neutralises itself and thus marks the spontaneous dissolution of Hellenic philosophy.





THE ACROPOLIS OF ATHENS

CHAPTER XXXVII. THE REIGN OF TERROR IN ATHENS

Desolate Athens ! though thy gods are fled,
Thy temples silent, and thy glory dead,
Though all thou hast of beautiful and brave
Sleep in the tomb, or moulder in the wave,
Though power and praise forsake thee, and forget,
Desolate Athens, thou art lovely yet !

— WINTHROP MACKWORTH PRAED.

IN the capitulation on which Athens surrendered, so far as its terms are reported by Xenophon, no mention appears to have been made of any change which was to take place in its form of government; and, if we might believe Diodorus, one article expressly provided that the Athenians should enjoy their hereditary constitution. This is probably an error; but if such language was used in the treaty it was apparently designed rather to insult than to deceive the people; and the framers of the article, who were also to be its expounders, had in their view not the free constitution under which the city had flourished since the time of Solon, but some ancient form of misrule, which had been long forgotten, but might still be recovered from oblivion by the industry of such antiquarians as Nicomachus. It is at least not to be doubted that the Spartan government, if it did not stipulate for the subversion of the democracy, looked forward to such a revolution as one of the most certain and important results of its victory. But it may have believed that its Athenian partisans would be strong enough to effect it without its interference. And we gather from a statement of Lysias, that Lysander, after he had seen the demolition of the walls begun, leaving his friends to complete their work, sailed away to Samos, now the only place in the Ægean where the authority of Sparta was not acknowledged.

If this was the case, he had scarcely laid siege to Samos before his presence was required at Athens. Theramenes, Critias, and their associates, wished to give a legitimate aspect to the power which they meant to usurp, and to overthrow the constitution in the name of the people. But they did not think it safe to trust to their own influence for the first step; and though Agis was still at hand, he might not enter so cordially into their

views, and did not possess so much weight as Lysander. When therefore a day had been fixed for an assembly to consider the question of reforming the constitution, Lysander was sent for to attend the discussion. Theramenes had undertaken the principal part in the management of the business. He proposed that the supreme power should for the present be lodged with thirty persons, who should be authorised to draw up a new code of laws, which however was to be conformable to the ancient institutions, according to a model framed by Dracontides.

LYSANDER

The presence of Lysander, and the nearness of the Peloponnesian troops, deterred the friends of liberty from expressing their sentiments on this proposition. But its nature and tendency were clear, and a murmur of disapprobation ran through the assembly. Theramenes treated it with contemptuous defiance; but Lysander silenced it by a graver argument. He bade the malcontents take notice, that they were at his mercy, and were no longer protected by the treaty. The fortifications had not been demolished within the time prescribed, and therefore in strictness of right the treaty was void. Their lives were forfeited and might be in jeopardy, if they should reject the proposition of Theramenes. It was adopted without further hesitation; and a list of the Thirty, of whom ten were named by Theramenes, ten by the Athenian ephors, and ten were nominally left to the choice of the assembly, was received with equal unanimity. The names which it comprised, some of which soon became infamously notorious were: Polyarches, Critias, Melobius, Hippolochus, Euclidas, Hiero, Mnesilochus, Chremo, Theramenes, Aresias, Diocles, Phædras, Chærilans, Anætius, Piso, Sophocles (not the poet, who was now dead), Eratosthenes, Charicles, Onomacles, Theognis, Æschines, Theogenes, Cleomedes, Erasistratus, Phido, Dracontides, Eumathes, Aristoteles, Hippomachus, Mnesithides. Besides these a board of Ten was appointed — perhaps by Lysander himself — to govern Piræus. As soon as this affair was despatched, Lysander departed with his fleet to Samos, and the Peloponnesian army evacuated Attica.

The Samians, blockaded by land and by sea, were forced to capitulate before the end of the summer; they were permitted to leave the city, but not to carry away any part of their property, except the clothes they wore.

These terms might be thought lenient, had they been guilty of any ferocious outrage; but perhaps Lysander did not view their conduct in that light. He was however probably anxious to return home and to exhibit the fruits of his victory to his admiring countrymen, and may have been therefore the more willing to treat with the besieged. When they had withdrawn, he supplied their place with the exiles who had been expelled at various times in the civil feuds of the island, put them in possession of all the property of the vanquished party and appointed a council of Ten, to govern them, and secure their obedience. He then dismissed the allies to their homes, and himself with the Lacedæmonian squadron returned to Laconia.

He brought with him the Athenian galleys surrendered in Piræus, the last fragments of that maritime power which he had broken, trophies from the prizes taken at Ægospotami, and 470 talents [£94,000 or \$470,000], the remainder of the tribute which he had collected from the Asiatic cities during the absence of Cyrus. But we are inclined to conclude from a story which, though it is not mentioned by Xenophon, is related by several later writers,

[404 B.C.]

with circumstances too minute and probable to be rejected, that he had previously sent a larger sum — perhaps not much less than a thousand talents — which he is said to have entrusted to the care of Gylippus, the hero of Syracuse. Gylippus was subject to the same infirmity which had occasioned the disgrace of his father Cleandridas. He could not resist the temptation of embezzling a part of the treasure, was detected and banished, and put an end to his own life by fasting. But even the sum mentioned by Xenophon was probably the largest that had ever been carried at one time to Sparta. To this were added crowns, and various other presents, which had been bestowed upon Lysander by many cities, which were eager to testify their gratitude and admiration, or to gain the favour of the conqueror.

This influx of wealth was viewed with jealousy by several Spartans, who dreaded the effect it might produce both on their foreign policy, and their domestic institutions: the example of Gylippus, though by no means an extraordinary case, might seem to confirm their views: and it appears that a proposal was made to dedicate the whole to the Delphic god. But Lysander and his friends strenuously resisted this measure, and prevailed on the ephors or the people to let the treasure remain in the public coffers. A part was employed to commemorate the triumph of Sparta, and the merits of the individuals who had principally helped to achieve it. Lysander himself adorned one of the Spartan temples with memorials of his two victories, of Notium and Ægospotami; and the first might indeed justly be considered as having opened the way for the last. Tripods of extraordinary size were dedicated at Amyclæ; and at Delphi the statues of the tutelary twins, Zeus, Apollo, Artemis, and Poseidon, forming part of a great group, which comprised those of Lysander, who was represented receiving a crown from Poseidon, his soothsayer Abas, Hermon the Megarian, the master of his galley, and upwards of twenty-nine other persons, Spartans or natives of other cities, who had distinguished themselves at Ægospotami, long attested the gratitude of Sparta towards gods and men.

CRUELTIES OF THE THIRTY

In the meanwhile the party which had usurped the supreme authority at Athens, had been unfolding the real character of its domination. The first care of the Thirty was to provide themselves with instruments suited to their purposes; they filled all important posts with their creatures. The ephoralty seems to have merged in their own office. The council was already for the most part composed of their own partisans, and needed but few purifying changes; it was now to become the sole tribunal for state-trials.

It might be inferred from the language of Xenophon's history, that the legislative functions which they professed to assume were merely nominal; but we collect from a hint which he drops elsewhere, that they availed themselves from time to time of this branch of their authority, to promulgate laws, or regulations of police, either by way of precaution or of pretext; and that they exercised a censorial control over the occupations and conduct of their subjects. But it is probable that they never intended to publish any code, much less any constitution which might limit their power. Their main object, in which they seem to have been unanimous, was to reverse the policy of Themistocles and Pericles: to reduce Athens to the rank of a petty town, cut off from the sea, without colonies or commerce, incapable of resisting the will of Sparta, or of exciting her jealousy. It seems to have been with the design

of signifying this leading maxim of their administration in a sensible manner, that they altered their position of the bema from which the orators addressed the assembly in the Pnyx, so that it might no longer command a view of the sea and of Salamis. They still more distinctly intimated their intention, while they took a step towards carrying it into effect, by selling the materials of the magnificent arsenal, which it had cost a thousand talents to build, for three, to a contractor who undertook to demolish and clear it away. It was perhaps at a later period, and for their own security, that they destroyed the fortresses on the borders of Attica. If they had succeeded in their aims, the history of Athens might now have been said to have closed; for it would have ceased materially to affect the course of events in the rest of Greece, and could have possessed no interest but such as might belong to the internal changes or quarrels of the oligarchy.

THE SYCOPHANTS

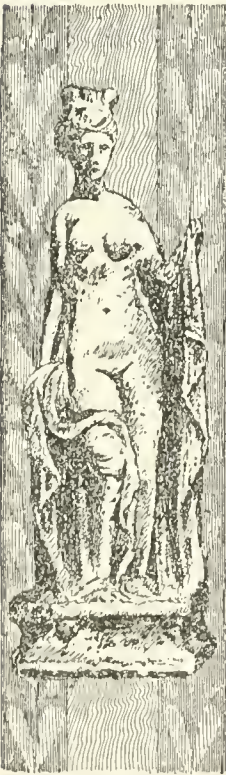

GREEK TERRA-COTTA
(In the British Museum)

Happily for their country the diversity of their characters was too great to be reconciled even by the sense of their common interest, and proved a source of dissension which became fatal to their power. The men whose ability and energy gave them the predominance over the rest, were hurried by the violence of their passions into excesses from which their more prudent and moderate associates recoiled, but which they were unable to prevent. For some time they preserved a show of decency in their proceedings, and some of their acts were so generally acceptable, that the means, though contrary to law and justice, might to many seem to be sanctified by the end. The first prosecutions were directed chiefly against a class of men who were universally odious, and had contributed more than any others to involve the state in the evils from which they themselves now justly suffered, the informers, or sycophants as they were called at Athens, who had perverted the laws, corrupted the tribunals, and had gained an infamous livelihood by the extortion which they were thus enabled to practise on wealthy and timid citizens, but more especially on foreigners subject to Athenian jurisdiction, who were thus, more than by any other grievance, alienated from the sovereign state. The most notorious of these pests of the commonwealth were eagerly condemned by the council; and their punishment was viewed with pleasure by all honest men. Yet the satisfaction it caused must have been a little allayed in some minds by the reflection, that the form of proceeding by which they were condemned was one under which the most innocent might always be exposed to the same fate.

According to the new regulation the Thirty presided in person over trials held by the council: two tables were placed in front of the benches which they occupied, to receive the balls, or tokens, by which the councillors declared their verdict, and which instead of being dropped secretly into a box, were now to be openly deposited on the board, so that the Thirty might see

[404-403 B.C.]

which way every man voted. These however were not the only cases which they brought before the council, even in the early part of their reign. The persons who before the surrender of the city had been arrested on information, partly procured by bribery, and partly extorted by fear, or by the rack, charging them with a conspiracy against the state, but who had really been guilty of no offence but that of expressing their attachment to the constitution which was now abolished, were soon after brought to a mock trial, and judicially murdered.

Even such executions might be considered as among the temporary evils incident to every political revolution: and there were some of the Thirty who did not wish to multiply them more than was necessary to their safety. But the greater number, and above all Critias, did not mean to stop here: and perhaps some signs of discontent soon became visible, which gave them a pretext for insisting on the need of stronger measures, and of additional safeguards. Two of their number, Æschines and Aristoteles, were deputed by common consent to Sparta, to obtain a body of troops to garrison the citadel. The ground alleged was that there were turbulent men whom it was necessary to remove before their government could be settled on a firm basis; and they undertook to maintain the garrison as long as its presence should be required. Xenophon's language seems to imply that Lysander had by this time returned to Sparta; if so, upwards of six months had now elapsed from the surrender of the city. Lysander, whether present or absent, exerted his influence in their behalf, and induced the ephors to send the force which they desired, under the command of Callibius, who was invested with the authority of harmost. His arrival released Critias and his colleagues from all the restraints hitherto imposed on them by their fears of their fellow citizens. They courted him with an obsequiousness proportioned to the wantonness of the tyranny which they hoped to exercise with his sanction and aid.

The footing on which they stood with him is well illustrated by a single fact. An Athenian named Autolyceus, of good family and condition, who in his youth had distinguished himself by a gymnastic victory, had in some way or other offended Callibius, who, according to the Spartan usage, raised his truncheon to strike him. But Autolyceus, not yet inured to such discipline, prevented the blow by bringing him to the ground. Lysander, it is said, when Callibius complained of this affront, observed that he did not know how to govern freemen. He however understood the men with whom he had principally to deal; for the Thirty soon after gratified him by putting Autolyceus to death.

In return for such deference he placed his troops at their disposal, to lead whom they would to prison: and now the catalogue of political offences was on a sudden terribly enlarged. The persons who were now singled out for destruction, were no longer such only as had made themselves odious by their crimes, or had distinguished themselves on former occasions by their opposition to the ruling party, but men of unblemished character, without any strong political bias, who had gained the confidence of the people by their merits or services, and might be suspected of preferring a popular government to the oligarchy under which they were living. Xenophon seems to believe that Critias was inflamed with an insatiable thirst for blood by the remembrance of his exile. But it would appear that ambition and cupidity, rather than resentment, were the mainsprings of his conduct, and that he calculated with great coolness the fruits of his nefarious deeds. Nor was it merely political jealousy that determined his choice of his victims; the immediate profit to be derived from the confiscation of their property

was at least an equally powerful inducement. It is uncertain to which of these motives we should refer the execution of Niceratus, the son of Nicias, who shared his uncle's fate, but may have been involved in it more by his wealth than by his relation to Eurates. It was perhaps on the like account, rather than because of the services which he had rendered to the people, that Antiphon,¹ who during the war had equipped two galleys at his own expense, was now condemned to death. And it was most probably with no other object than Leon, an inhabitant of Salamis, who seems to have been universally respected, and a great number of his townsmen, were dragged from their homes and consigned to the executioner. The case of Leon is particularly remarkable for the light it throws on the policy of the oligarchs. After the arrival of the Lacedæmonian garrison they had begun to dispense with the assistance of the council; and Leon was put to death without any form of trial. But they did not think it expedient always to employ the foreign troops on their murderous errands; they often used Athenians as their ministers on such occasions, and men who did not belong to their party, for the purpose of implicating them in the guilt and odium of their proceedings. When they had resolved on the destruction of Leon, they sent for Socrates and four other persons, and ordered them to go and fetch him from Salamis. As his innocence was no less notorious than the fate which awaited him, Socrates, on leaving the presence of the Thirty, instead of obeying their commands, returned home. The rest executed their commission.

These atrocities soon began to spread general alarm; for no one could perceive any principle or maxim by which they were to be limited for the future; there was on the contrary reason to apprehend that they would be continually multiplied and aggravated. Theramenes, who was endowed with a keen tact which enabled him readily to observe the bent of public opinion, was early aware of the danger into which his colleagues were rushing; and he remonstrated with Critias on the imprudence of creating themselves enemies by putting men to death for no other reason than because they had filled eminent stations, or performed signal services, under the democracy; for it did not follow that they might not become peaceful and useful subjects of the oligarchy, since there had been a time when both Critias and himself had courted popular favour. But Critias contended that they were now in a position which they could only maintain by force and terror; and that every man who had the means of thwarting their plans, and who was not devoted to their interest, must be treated as an enemy.

This argument seems for the time to have satisfied Theramenes. But as deeds of blood followed each other with increasing rapidity, and the murmurs of all honest citizens, though stifled in public, began to find vent in private circles, Theramenes again warned his colleagues, that it would be impossible for the oligarchy to subsist long on its present narrow basis. He wished that they might be able to dispense with the foreign garrison, and foresaw that, if they persisted in their present course, they could never safely dismiss it. His advice now produced some effect on them; but they seem to have been alarmed not so much by the danger which he pointed out as by the warning itself. They knew that he was a man who had never adhered to any party which he believed to be sinking, and suspected that he might be meditating to put himself at the head of a new revolution, as in the time of the Four Hundred. And though his character was so generally understood that he had acquired a homely nickname,² which expressed the

¹ This Antiphon has been confounded with the celebrated orator.

² *Cothurnus* — a shoe which fitted either foot.

[404-403 B.C.]

readiness with which he shifted his side, and the dexterity with which he adapted himself to every change of circumstances, still he might again become a rallying-point for the disaffected. To guard against this danger they determined to strengthen themselves by an expedient similar to that which had been adopted by the former oligarchy. They made out a list of three thousand citizens, who were to enjoy a kind of franchise which perhaps was never exactly defined; but one of its most important privileges was, that none of them should be put to death without a trial before the council. All other Athenians were outlawed, and left to the mercy of the Thirty, who might deal as they thought fit with their lives and property.

Theramenes objected to the new constitution, both on account of the small number of the privileged body, and its arbitrary limitation, which would show that the selection did not proceed upon any ground of merit.

Since they meant to govern by force, it was impolitic, he said, to establish such a disproportion between their strength and that of the governed. His objections were overruled, but not wholly neglected. They perhaps suggested the precaution which was immediately afterwards adopted. Under pretext of a review all the citizens were deprived of their arms, except the knights, and the Three Thousand, who were thus enabled to cope with the rest. The Thirty now believed themselves completely secure, and grew more and more reckless in the indulgence of their rapacity and cruelty. In the low state to which the Athenian finances were reduced, the maintenance of the garrison was a burden which they found it difficult to support; and, among other extraordinary means of raising supplies, it appears that they resorted to the spoliation of the temples. But this was an expedient which probably required some caution and secrecy, and which could not be carried beyond certain limits. One which perhaps appeared both safer and more productive was suggested by Piso and Theognis, two of their number, who observed that several of the resident aliens were known to be ill-affected to the oligarchy, and thus afforded a pretext for plundering the whole class.

They therefore made the proposition that each of the Thirty should have one of the wealthy aliens assigned to him, should put him to death, and take possession of his property. Theramenes very truly remarked, that the sycophants who had rendered the democracy odious to many, had never done anything so iniquitous as what was now contemplated by the persons who were used to style themselves the best sort of people, for they had never taken away both money and life; and he apprehended with good reason that this measure would render the aliens generally hostile to the government. But his colleagues, after what they had already done, were not disposed to view this question on the moral side, and, having braved the hatred of their fellow-citizens, they were not afraid of provoking the aliens. The proposition was adopted; and Theramenes was invited to single out his prey with the rest: but he refused to stain his hands with this innocent blood. It was however resolved to begin by taking ten lives; and, for the sake of covering the real motive, two of the victims were to be poor men, who would therefore be supposed to have suffered for some political offence.

Men who were capable of perpetrating such actions could not long endure the presence of an associate who refused to take his full share of their guilt and odium. The colleagues of Theramenes resolved to rid themselves of a troublesome monitor who might soon prove a dangerous opponent. They first endeavoured to communicate their distrust of his designs to the members of the council in private conversation, and then concerted a plan for an open attack on him. But to insure its success they surrounded the council-

chamber with a band of the most daring of their younger followers, armed with daggers, which they did not take much pains to conceal. Critias then came forward to accuse Theramenes, who was present.

Theramenes made a defence, which, with respect to the charges of Critias, was in most points a satisfactory vindication of his conduct. A murmur of approbation, which ran through the assembly, warned Critias that he could not safely rely on its subserviency for the condemnation of Theramenes; and, after having conferred a few moments with his colleagues, he called in his armed auxiliaries, and stationed them round the railing within which the council sat. He then told the councillors, that he thought he should be wanting in the duty of his station, if he suffered his friends to be misled; and that the persons whom they now saw round them, also declared that they would not permit a man who was manifestly aiming at the ruin of the oligarchy to escape with impunity. Now by virtue of the new constitution none of the Three Thousand could be put to death except by a sentence of the council; but all who were not included in that list might be sent to execution without any form of trial by the Thirty. He therefore declared that, with the unanimous consent of his colleagues, he struck out the name of Theramenes from the list, and condemned him to death.^b

Xenophon gives a vivid picture of the scene that followed: "On hearing this, Theramenes sprang upon the altar of Vesta, and said, 'But I, gentlemen, entreat you for what is most strictly legal—that it may not be in the power of Critias to strike off me, or any of you whom he pleases; but according to the law which these men passed respecting those in the list, according to that may be the decision, both for you and for me. And of this, indeed,' said he, 'by the gods, I am not ignorant, that this altar will be no protection to me; but what I wish to show is, that these men are not only most unjust with regard to mankind, but also impious with regard to the gods. At you, however, who are good and honourable men, I am astonished if you do not come forward in your own defence; knowing moreover, as you do, that my name is not at all more easy to strike off than each of yours.' Upon this, the herald of the Thirty ordered the Eleven to come for Theramenes; and when they had entered with the officers, led by Satyrus the boldest and most shameless of their number, Critias said, 'We deliver up to you this Theramenes here, condemned according to law: do ye, Eleven, seize, and lead him off to the proper place, and do your duty with him.' When he had thus spoken, Satyrus dragged the condemned man from the altar, aided by the other officers. Theramenes, as was natural, called both on gods and men to look on what was doing. But the council kept quiet, seeing both the fellows of Satyrus at the bar, and the space before the council-house filled with guards, and not being ignorant they had come with daggers. So they led off the man through the market-place, while he declared with a very loud voice how he was being treated. And this one expression also is told of him. When Satyrus said that he would rue it if he were not silent; he asked, 'And shall I not then rue it, if I am?'

"Moreover, when he was compelled to die, and drank the hemlock, they said that he flung out on the floor what was left of it, saying, 'Let this be for the lovely Critias.' Now I am aware that these sayings are not worth mentioning: but this I consider admirable in the man, that when death was close at hand, neither his good sense nor his pleasantry deserted his soul."^c

In Theramenes we find much to condemn, and nothing to approve, except that he shrank from following his profligate associates in their career of wickedness. If he had reason to complain that they did not spare the author

[403 B.C.]

of their elevation, the other victims of their tyranny had much more cause to rejoice in his fate. He seems to have died unpitied by either of the parties whom he had alternately courted and abandoned.

His death released the Thirty — among whom it is probable that Satyrus was immediately chosen to supply his place — from the last restraints of fear or shame which had kept them within any bounds of decency ; and they now proceeded to bolder and more thorough-going measures. They emulated the ancient tyrants, who had often removed the lowest class of the commonalty, for whom it was difficult to find employment, from the capital into the country, and prohibited all Athenians who were not on the list of the Three Thousand from entering the city.

But by the oligarchs this step seems not to have been adopted so much with a view to their safety, as to increase the facility of rapine and murder. They continued to send out their emissaries to seize the persons and confiscate the property of the citizens, who were now scattered by their decree over Attica. The greater part of the outcasts took refuge in Piræus ; but when it was found that neither the populous town, nor their rural retreats, could shelter them from the inquisition of their oppressors, numbers began to seek an asylum in foreign cities ; and Argos, Megara, and Thebes, were soon crowded with Athenian exiles.

The oligarchs, notwithstanding their Lacedæmonian garrison, and their reliance on Spartan protection, began to be alarmed at the state to which they had reduced themselves, and to dread the vengeance of their exiled enemies, who were waiting so near at hand for an opportunity of attacking them ; and they applied to the Spartan government to interpose for the purpose of averting the danger. The Spartans, instigated perhaps by Lysander, issued an edict, which showed to what a degree they were intoxicated by prosperity. It empowered the Athenian rulers to arrest the exiles in every Greek city, and under a heavy penalty, forbade any one to interfere in their behalf.

But this decree was no less impolitic than inhuman ; it disclosed a domineering spirit, which could not but produce general alarm and disgust ; but its object was beyond the reach of the Spartan power. At Argos and Thebes, and probably in other cities, the injunction and the threat were disregarded ; the exiles continued to find hospitable shelter. The Thebans more particularly took pains to manifest their contempt for the Spartan proclamation by a counter decree, directing that the persecuted Athenians should be received in all the Bœotian towns ; that if any attempt should be made to force them away, every Bœotian should lend his aid to rescue them ; and that they should not be obstructed in any expedition which they might undertake against the party now in possession of Athens.

This measure, though the spirit it breathes is so different from that in which the Theban commander had voted for the extirpation of the Athenian people, was not dictated either by justice or compassion towards Athens, but by jealousy and resentment towards Sparta. Very soon after the close of the war causes had arisen to alienate the Thebans from their old ally. They were always disposed to set a high value on the services which they had rendered to the Peloponnesian cause and now conceived that they had not been properly requited. They put forward some claims relating to the spoil collected at Decelea, and likewise to the treasure carried to Sparta by Lysander, which, chiefly it seems at his instance, had been resisted or neglected. Hence they could not without great dissatisfaction see Athens in the hands of Lysander's creatures.

THE REVOLT OF THRASYBULUS



OFFICER'S HELMET

Thrasybulus, like Alcibiades, had been formally banished by the Thirty; though it is not certain that he was at Athens when their government was established. He was however at Thebes when their furious tyranny began to drive the citizens by hundreds into exile; and the temper now prevailing at Thebes encouraged him to undertake the deliverance of his country. Having obtained a small supply of arms and money from his Theban friends, he crossed the border with a band of about seventy refugees, and seized the fortress of Phyle, which stood on an eminence projecting from the side of Mount Parnes, with which it was connected by a narrow ridge with precipitous sides, twelve or thirteen miles from Athens. The fortifications had either escaped when the other Attic

strongholds were demolished by the Thirty, or were soon restored to a defensible state. The oligarchs, confident that they should soon be able to crush so feeble an enemy, marched against them with the Three Thousand and their equestrian partisans.^b

On their arrival, some of the young men, in a foolhardy spirit, immediately assaulted the place, producing, however, no effect upon it, but retiring with many wounds. When the Thirty were desirous of surrounding it with works, that they might reduce it by cutting off all supplies of provisions, there came on during the night a very heavy fall of snow, covered with which they returned the next day into the city, after losing very many of their camp followers by an attack of the men from Phyle. Knowing, however, that they would also plunder the country, if there were no watch to prevent it, they despatched to the frontiers, at the distance of fifteen furlongs from Phyle, all but a few of the Lacedæmonian guards, and two squadrons of horse. These having encamped on a rough piece of ground, proceeded to keep watch. There were by this time assembled at Phyle about seven hundred men, whom Thrasybulus took, and marched down by night; and having grounded arms about three or four stades from the party on guard, remained quietly there. When it was towards daybreak, and the enemy now began to get up and retire from their post on necessary purposes, and the grooms were making a noise in currying their horses — at this juncture the party with Thrasybulus took up their arms again, and fell upon them at a run. Some of them they despatched, and routed and pursued them all for six or seven furlongs; killing more than a hundred and twenty of the infantry; and of the cavalry, Nicostratus (surnamed The Handsome) and

[403 B.C.]

two others also, whom they surprised while yet in their beds. After returning and erecting a trophy, they packed up all the arms and baggage they had taken, and withdrew to Phyle. And now the horsemen in the city came out to the rescue, but found none of the enemy any longer on the spot; having waited, therefore, till their relatives had taken up the dead, they returned into the city.

Upon this the Thirty, no longer thinking their cause safe, wished to secure for themselves Eleusis, that they might have a place of refuge, if required. Having sent their orders to the cavalry, Critias and the rest of the Thirty came to Eleusis; and having held a review of the horse in the place, alleging that they wished to know what was their number, and how much additional garrison they would require, they ordered them all to write down their names, and as each one wrote it down in his turn, to pass out through the postern to the sea. On the beach they had posted their cavalry on both sides, and as each successively passed out, their attendants bound him. When all were arrested, they ordered Lysimachus, the commander of the cavalry, to take them to the city and deliver them up to the Eleven. The next day they summoned to the Odeum the heavy-armed in the list, and the rest of the cavalry; when Critias stood up, and said: "It is no less for your advantage, gentlemen, than for our own, that we are establishing the present form of government. As then you will share in its honours, so too you ought to share in its dangers. You must give your votes therefore against the Eleusinians here arrested, that you may have the same grounds with us both of confidence and of fear." And pointing out a certain spot, he ordered them openly to deposit their votes in it. At the same time the Lacedæmonian guard under arms occupied half of the Odeum; and these measures were approved by such of the citizens also as only cared for their own advantage.

After this, Thrasybulus took those at Phyle, who had now gathered together to the number of about a thousand, and came by night into Piræus. The Thirty, on this intelligence, immediately went out to the rescue with both the Lacedæmonians, and the cavalry, and the heavy-armed; and then advanced along the cart-way that leads to Piræus. The force from Phyle for some time attempted to stop their approach; but when the great circuit of the wall appeared to require a large body to guard it, and they were not a large one, they marched in close order into Munychia. The troops from the city drew themselves up so as to fill up the road, being not less than fifty shields deep. In this order they marched up the hill. The force from Phyle also filled up the road, but were not more than ten deep in their heavy-armed; behind whom, however, there were posted both targeteers and light dart-men, and behind them the slingers. These indeed formed a numerous body; for the inhabitants of the place had joined them. While the enemy were coming on, Thrasybulus ordered his men to ground their shields, and having grounded his own, but keeping the rest of his arms, he took his stand in the midst of them, and spoke thus:

"My fellow-citizens, I wish to inform some of you, and to remind others, that of the men who are coming against us, those on the right wing are they whom you routed and pursued five days ago; and those on the extreme left are the Thirty, who both deprived us of our country when guilty of nothing, and expelled us from our houses, and prosecuted the dearest of our relatives. But now truly they have come into a position, where they never thought of being, but we have always been praying that they might be. For we are posted against them with arms in our hands; and seeing that in former days

we were arrested both when at our meals, and asleep, and in the market-place, while others of us were banished, when, so far from being guilty of any offence, we were not even in the country ; for these reasons the gods are now clearly fighting on our side. For even in fair weather they raise a storm, when it is for our advantage ; and when we make an attack, though our enemies are many, they grant to us, who are but few, to erect trophies. And now, too, they have brought us into a position, in which our opponents can neither hurl their spears nor their darts beyond those who are posted before them, through its being up-hill ; whereas we, discharging down-hill both spears, and javelins, and stones, shall both reach them, and mortally wound many of them. And one might perhaps have thought that the first ranks, at any rate, must fight on equal terms ; but as it is, if you only discharge your weapons with spirit, as suits your character, no one will miss, since the road is filled up with them, and standing on their guard they will all the time be skulking under their shields ; so that we shall be able both to strike them when we please, like blind men, and to leap on and overturn them. But, sirs, we must act in such a way that each of us may have the consciousness of having been most instrumental towards the victory. For that (if God will) will now restore to us both country, and houses, and freedom, and honours, and children (such as have them), and wives. O blessed, then, those of us who, as victors, may see that sweetest day of all ! And happy, too, he who falls ! For no one, however rich he may be, shall enjoy so glorious a monument. I, then, when the time is come, will begin the pæan ; and when we have called on Mars to help us, then let us all with one heart avenge ourselves on these men for the insults we have suffered."

Having thus spoken, he faced about towards the enemy, and remained still. For their prophet gave them orders not to make the onset before some one on their side had either fallen, or been wounded : "When, however," said he, "that has happened, I will lead the way, and there will be victory for you who follow, but death to me, as I, at least, believe." And he spoke no falsehood ; but when they had taken up their arms, he himself, as though led by some destiny, was the first to bound forward, and falling on the enemy was killed, and is buried by the passage of the Cephisus ; but the rest were victorious, and pursued them as far as the level ground. There were slain there, of the Thirty, Critias and Hippomachus ; of the ten commanders in Piræus, Charmides, son of Glaucou ; and of the rest about seventy. The conquerors took the arms, but plundered the clothes of none of their fellow-citizens. And when this was done, and they were returning the dead under a truce, many on both sides came up and conversed together. And Cleocritus, the herald of the initiated,¹ being gifted with a very fine voice, hushed them into silence and thus addressed them :

"Fellow-citizens, why are you driving us from our country ? Why do you wish to kill us ? For we have never yet done you any harm ; but have shared with you both the most solemn rites, and the noblest sacrifices and festivals ; and have been your companions in the dance, and in the schools, and in war ; and have faced many dangers with you by land and by sea, for the common safety and liberty of both parties. In the name of our fathers' and our mothers' gods, in the name of kindred, and affinity, and fellowship (for all these things have we in common with one another), cease sinning against your country, and be not persuaded by those most impious Thirty, who, for the sake of their own gain, have killed almost more of the Athenians

[¹ That is, one of the communicants in the Eleusinian mysteries.]

[403 B.C.]

in eight months than all the Peloponnesians in ten years' warfare. And when we might live together in peace, these men inflict on us that war which of all is the most disgraceful, and grievous, and impious, and most hateful both to gods and men — war with one another. But, however, be well assured, that for some of those now slain by us, not only you, but we also, have shed many tears." Such was his speech. The rest of the enemy's commanders, from the very fact of their hearing such fresh appeals to them, led back their men into the city.

The next day the Thirty, quite dejected and solitary, sat together in council: while the Three Thousand, wherever they were severally posted, were at variance with one another. For as many as had acted in a more violent manner, and were therefore afraid, vehemently maintained that they ought not to submit to those in Piræus: while such as were confident that they had done no wrong, both reflected themselves, and were persuading the rest, that there was no necessity for these troubles: and they said that they ought not to obey the Thirty, nor suffer them to ruin the state. At last they voted for deposing them, and choosing others: and accordingly they chose ten, one from each tribe.

So the Thirty departed to Eleusis; while the Ten, together with the commanders of the cavalry, directed their attention to those in the city, who were in a state of great confusion and distrust of each other. The cavalry also bivouacked in the Odeum, with both their horse and their shields; and owing to their want of confidence, they kept going their rounds along the walls, after evening had set in, with their shields, and towards morning with their horses, being constantly afraid that some of those in Piræus might attack them. They, being now many in number, and men of all sorts, were making themselves arms, some of wood, others of wickerwork, and were whitening them over. Before ten days had elapsed, after giving pledges that whoever joined in the war, even though they were strangers, should have equal privileges, they marched out, with many heavy-armed and many light-armed. They had also about seventy horse; and making forays by day, and carrying off wood and corn, they slept again in Piræus. Of those in the city none else came out under arms, but the cavalry sometimes secured plunderers from the force in Piræus, and annoyed their phalanx.

And now the Thirty from Eleusis, and those in the list from the city, sent ambassadors to Lacedæmon, and urged them to come to their support, as the people had revolted from the Lacedæmonians. Lysander, calculating that it was possible quickly to reduce those in Piræus, when besieged both by land and by sea, if once they were cut off from all supplies, joined in getting a hundred talents lent them, and himself sent out as harmost, with his brother Libys as admiral. And having himself proceeded to Eleusis, he raised a large force of Peloponnesian heavy-armed; while the admiral kept guard that no provisions should go in for them by sea; so that those in

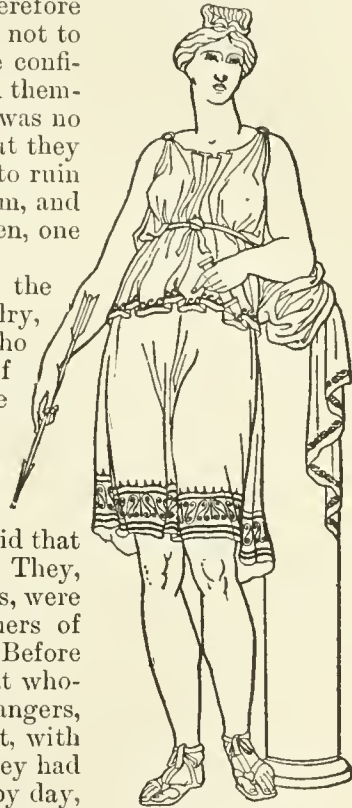

STATUE OF DIANA

Piræus were soon in a strait again, while those in the city, on the other hand, were elated again with confidence in Lysander.

When things were progressing in this way, Pausanias the king, filled with envy at the thought of Lysander's succeeding in these measures, and so at once winning reputation and making Athens his own, gained the consent of three of the ephors, and led out an expedition.¹ All the allies also joined him, except the Bœotians and Corinthians.

Pausanias encamped on a spot called Halipedum, near Piræus, himself occupying the right wing, and Lysander, with his mercenaries, the left. And he sent ambassadors to those in Piræus, telling them to go away to their own homes; but when they did not obey his message, he made an assault (so far, at least, as noise went), that he might not openly appear to wish them well. When he had retired with no result from the assault, the day following he took two brigades of the Lacedæmonians, and three squadrons of the Athenian cavalry, and went along to the Mute Harbour, reconnoitring in what direction Piræus was most easy to circumvallate.

On his retiring, a party of the besieged ran up and caused him trouble; annoyed at which, he ordered the horse to charge them at full speed, and such as had passed the period of youth ten years to accompany them, while he himself followed with the rest. And they slew about thirty of the light-armed, and pursued the rest to the theatre in Piræus. There all the targeteers and heavy infantry of the party in Piræus happened to be arming themselves. And now the light-armed immediately running forward began darting, throwing, shooting, slinging. The Lacedæmonians, when many were being wounded, being very hard pressed, began slowly to retreat; and upon this their opponents threw themselves on them much more vigorously. Seeing this, Thrasybulus and the rest of the heavy-armed went to the support of their men, and quickly drew themselves up in front of the others, eight deep. Pausanias, being very hard pressed, and having retired about four or five furlongs to a hill, sent orders for the Lacedæmonians and the rest of the allies to advance and join him. There having formed his phalanx very deep, he led it against the Athenians. They received his charge, but then some of them were driven into the mud at Hala, and the rest gave way, about a hundred and fifty of them being slain. Pausanias erected a trophy, and withdrew.

Not even under these circumstances was he exasperated with them, but sent secretly, and instructed those in Piræus, with what proposals they should send ambassadors to him and the ephors who were there. They complied with his advice. He also set those in the city at variance, and advised that as many as possible should collect together and come to the Spartan officers, alleging that they did not at all want to be at war with the men in Piræus, but to be reconciled together, and both parties to be friends of the Lacedæmonians. The ephors and the committee appointed to consider the question having heard all their statements, despatched fifteen men to Athens, and ordered them, in concert with Pausanias, to effect the best reconciliation of the parties they could. So they reconciled them on condition of their making peace with one another, and returning to their several homes, with the exception of the Thirty, the Eleven, and the Ten who had commanded in

[¹This curious method of intervention for Athens' sake has been variously interpreted. Thirlwall makes quite a drama of benevolent duplicity about it. According to others, Pausanias was simply moved by a desire to nip Lysander's ambition and to put an end to further cruelties by the Thirty who were already winning general sympathy for the common people and the democratic cause of Athens.]

[403 B.C.]

Piræus. If any of those in the city should feel afraid of remaining there, it was determined that they should establish themselves at Eleusis.

These arrangements being effected, Pausanias disbanded his army, and the party from Piræus went up under arms to the Acropolis, and sacrificed to Athene. But some time afterwards, hearing that the party at Eleusis were hiring mercenaries, they took the field *en masse* against them; and when their commanders had come to a conference, they put them to death; but sent in to the others their friends and relatives, and persuaded them to a reconciliation. And having sworn not to remember past grievances, they lived together under the same government, the popular party abiding by their oaths.^c

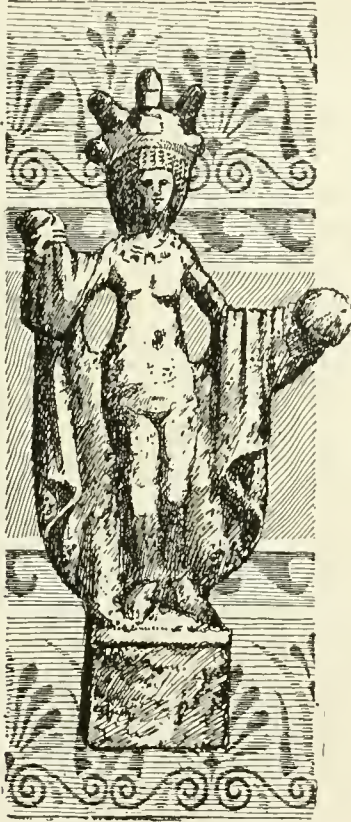

GREEK TERRA-COTTA FIGURE
(In the British Museum)

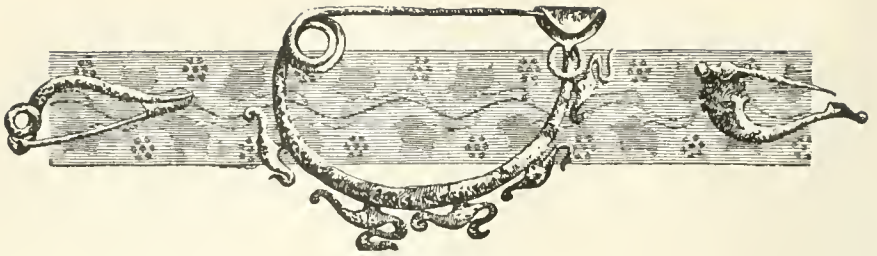

GRECIAN BUCKLES
(In the British Museum)

CHAPTER XXXVIII. THE DEMOCRACY RESTORED

THE period intervening between the defeat of Ægospotami (October. 405 B.C.), and the re-establishment of the democracy as sanctioned by the convention concluded with Pausanias (some time in the summer of 403 B.C.), presents two years of cruel and multifarious suffering to Athens.

After such years of misery, it was an unspeakable relief to the Athenian population to regain possession of Athens and Attica; to exchange their domestic tyrants for a renovated democratical government; and to see their foreign enemies not merely evacuate the country, but even bind themselves by treaty to future friendly dealing. In respect of power, indeed, Athens was but the shadow of her former self. She had no empire, no tribute, no fleet, no fortifications at Piræus, no long walls, not a single fortified place in Attica except the city itself.

Of these losses, the Athenians made little account at the first epoch of their re-establishment; so intolerable was the pressure which they had just escaped, and so welcome the restitution of comfort, security, property, and independence at home. The very excess of tyranny committed by the Thirty gave a peculiar zest to the recovery of the democracy. In their hands, the oligarchical principle (to borrow an expression from Burke) "had produced in fact and instantly, the grossest of those evils with which it was pregnant in its nature"; realising the promise of that plain-spoken oligarchical oath, which Aristotle mentions as having been taken in various oligarchical cities—to contrive as much evil as possible to the people. So much the more complete was the reaction of sentiment towards the antecedent democracy, even in the minds of those who had been before discontented with it. To all men, rich and poor, citizens and metics, the comparative excellence of the democracy, in respect of all the essentials of good government, was now manifest. With the exception of those who had identified themselves with the Thirty as partners, partisans, or instruments, there was scarcely any one who did not feel that his life and property had been far more secure under the former democracy, and would become so again if that democracy were revived.

It was the first measure of Thrasybulus and his companions, after concluding the treaty with Pausanias and thus re-entering the city, to exchange solemn oaths of amnesty for the past, with those against whom they had just been at war. Similar oaths of amnesty were also exchanged with those in Eleusis, as soon as that town came into their power. The only persons excepted from this amnesty were the Thirty, the Eleven who had presided over the execution of all their atrocities, and the Ten who had governed in Piræus. Even these persons were not peremptorily banished: opportunity

[403 B.C.]

was offered to them to come in and take their trial of accountability (universal at Athens in the case of every magistrate on quitting office); so that if acquitted, they would enjoy the benefit of the amnesty as well as all others. We know that Eratosthenes, one of the Thirty, afterwards returned to Athens; since there remains a powerful harangue of Lysias invoking justice against him as having brought to death Polemarchus (the brother of Lysias).

We learn moreover from the same speech, that such was the detestation of the Thirty among several of the states surrounding Attica, as to cause formal decrees for their expulsion or for prohibiting their coming. The sons, even of such among the Thirty as did not return, were allowed to remain at Athens, and enjoy their rights as citizens unmolested; a moderation rare in Grecian political warfare.

The first public vote of the Athenians, after the conclusion of peace with Sparta and the return of the exiles, was to restore the former democracy purely and simply, to choose by lot the nine archons and the senate of Five Hundred, and to elect the generals — all as before. It appears that this restoration of the preceding constitution was partially opposed by a citizen named Phormisius, who, having served with Thrasybulus in Piræus, now moved that the political franchise should for the future be restricted to the possessors of land in Attica. His proposition was understood to be supported by the Lacedæmonians, and was recommended as calculated to make Athens march in better harmony with them. It was presented as a compromise between oligarchy and democracy, excluding both the poorer freemen and those whose property lay either in movables or in land out of Attica; so that the aggregate number of the disfranchised would have been five thousand persons. Since Athens now had lost her fleet and maritime empire, and since the importance of Piræus was much curtailed not merely by these losses, but by demolition of its separate walls and of the Long Walls — Phormisius and others conceived the opportunity favourable for striking out the maritime and trading multitude from the roll of citizens. Many of these men must have been in easy and even opulent circumstances; but the bulk of them were poor; and Phormisius had of course at his command the usual arguments, by which it is attempted to prove that poor men have no business with political judgment or action. But the proposition was rejected; the orator Lysias being among its opponents, and composing a speech against it which was either spoken, or intended to be spoken, by some eminent citizen in the assembly.

Unfortunately we have only a fragment of the speech remaining, wherein the proposition is justly criticised as mischievous and unseasonable, depriving Athens of a large portion of her legitimate strength, patriotism, and harmony, and even of substantial men competent to serve as hoplites or horsemen — at a moment when she was barely rising from absolute prostration. Never certainly was the fallacy which connects political depravity or incapacity with a poor station, and political virtue or judgment with wealth, more conspicuously unmasked than in reference to the recent experience of Athens. The remark of Thrasybulus was most true — that a greater number of atrocities, both against person and against property, had been committed in a few months by the Thirty, and abetted by the class of horsemen, all rich men, than the poor majority of the demos had sanctioned during two generations of democracy. Moreover we know, on the authority of a witness unfriendly to the democracy, that the poor Athenian citizens, who served on shipboard and elsewhere, were exact in obedience to their commanders; while the richer citizens who served as hoplites and horsemen and who laid claim to higher individual estimation, were far less orderly in the public service.

The motion of Phormisius being rejected, the antecedent democracy was restored without qualification, together with the ordinances of Draco, and the laws, measures, and weights of Solon. But on closer inspection, it was found that the latter part of the resolution was incompatible with the amnesty which had been just sworn. According to the laws of Solon and Draco, the perpetrators of enormities under the Thirty had rendered themselves guilty, and were open to trial. To escape this consequence, a second psephism or decree was passed, on the proposition of Tisamenus, to review the laws of Solon and Draco, and re-enact them with such additions and amendments as might be deemed expedient. Five hundred citizens had just been chosen by the people as *nomothetæ* or law-makers, at the same time when the senate of Five Hundred was taken by lot; out of these *nomothetæ* the senate now chose a select few, whose duty it was to consider all propositions for amendment or addition to the laws of the old democracy, and post them up for public inspection before the statues of the Eponymous Heroes, within the month then running. The senate, and the entire body of five hundred *nomothetæ*, were then to be convened, in order that each might pass in review, separately, both the old laws and the new propositions; the *nomothetæ* being previously sworn to decide righteously. While this discussion was going on, every private citizen had liberty to enter the senate, and to tender his opinion with reasons for or against any law. All the laws which should thus be approved (first by the senate, afterwards by the *nomothetæ*), but no others — were to be handed to the magistrates, and inscribed on the walls of the portico called *Pœcile*, for public notoriety, as the future regulators of the city. After the laws were promulgated by such public inscription, the senate of Areopagus was enjoined to take care that they should be duly observed and enforced by the magistrates. A provisional committee of twenty citizens was named, to be generally responsible for the city during the time occupied in this revision. As soon as the laws had been revised and publicly inscribed in the *Pœcile* pursuant to the above decree, two concluding laws were enacted which completed the purpose of the citizens.

The first of these laws forbade the magistrates to act upon, or permit to be acted upon, any law not among those inscribed; and declared that no psephism, either of the senate or of the people, should overrule any law. It renewed also the old prohibition (dating from the days of Clisthenes and the first origin of the democracy), to enact a special law inflicting direct hardship upon any individual Athenian apart from the rest, unless by the votes of six thousand citizens voting secretly.

The second of the two laws prescribed, that all the legal adjudications and arbitrations which had been passed under the antecedent democracy should be held valid and unimpeached — but formally annulled all which had been passed under the Thirty. It further provided that the laws now revised and inscribed, should only take effect from the archonship of Euclides; that is, from the nominations of archons made after the recent return of Thrasylbulus and the renovation of the democracy.

By these ever memorable enactments, all acts done prior to the nomination of the archon Euclides and his colleagues (in the summer of 403 B.C.) were excluded from serving as grounds for criminal process against any citizen. To insure more fully that this should be carried into effect, a special clause was added to the oath taken annually by the senators, as well as to that taken by the heliastic dicasts. The senators pledged themselves by oath not to receive any impeachment, or give effect to any arrest, founded on any fact prior to the archonship of Euclides, excepting only against the

[403 B.C.]

Thirty and the other individuals expressly shut out from the amnesty, and now in exile. To the oath annually taken by the heliasts, also, was added the clause: "I will not remember past wrongs, nor will I abet any one else who shall remember them; on the contrary, I will give my vote pursuant to the existing laws": which laws proclaimed themselves as only taking effect from the archonship of Euclides.

By additional enactments, security was taken that the proceedings of the courts of justice should be in full conformity with the amnesty recently sworn, and that, neither directly nor indirectly, should any person be molested for wrongs done anterior to Euclides. And in fact the amnesty was faithfully observed: the re-entering exiles from Pireus, and the horsemen with other partisans of the Thirty in Athens, blended again together into one harmonious and equal democracy.

Eight years prior to these incidents, we have seen the oligarchical conspiracy of the Four Hundred, for a moment successful, and afterwards overthrown; and we have had occasion to notice, in reference to that event, the wonderful absence of all reactionary violence on the part of the victorious

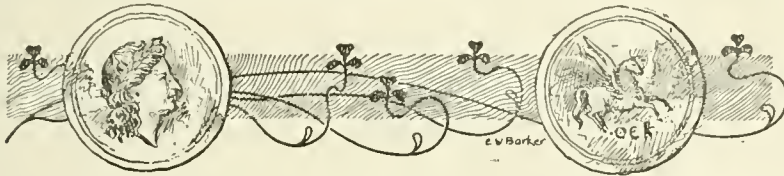

GREEK SEALS

people, at a moment of severe provocation for the past and extreme apprehension for the future. We noticed that Thucydides, no friend to the Athenian democracy, selected precisely that occasion — on which some manifestation of vindictive impulse might have been supposed likely and natural — to bestow the most unqualified eulogies on their moderate and gentle bearing. Had the historian lived to describe the reign of the Thirty and the restoration which followed it, we cannot doubt that his expressions would have been still warmer and more emphatic in the same sense. Few events in history, either ancient or modern, are more astonishing than the behaviour of the Athenian people, on recovering their democracy, after the overthrow of the Thirty: and when we view it in conjunction with the like phenomenon after the deposition of the Four Hundred, we see that neither the one nor the other arose from peculiar caprice or accident of the moment; both depended upon permanent attributes of the popular character. If we knew nothing else except the events of these two periods, we should be warranted in dismissing, on that evidence alone, the string of contemptuous predicates, — giddy, irascible, jealous, unjust, greedy, etc. — one or other of which have been so frequently pronounced by unsympathetic or hostile critics respecting the Athenian people. A people, whose habitual temper and morality merited these epithets, could not have acted as the Athenians acted both after the Four Hundred and after the Thirty. Particular acts may be found in their history which justify severe censure; but as to the permanent elements of character, both moral and intellectual, no population in history has ever afforded stronger evidence than the Athenians on these two memorable occasions.

If we follow the acts of the Thirty, we shall see that the horsemen and the privileged three thousand hoplites in the city had made themselves

partisans in every species of flagitious crime which could possibly be imagined to exasperate the feelings of the exiles. The latter on returning saw before them men who had handed in their relatives to be put to death without trial; who had seized upon and enjoyed their property; who had expelled them all from the city, and a large portion of them even from Attica; and who had held themselves in mastery not merely by the overthrow of the constitution, but also by inviting and subsidising foreign guards. Such atrocities, conceived and ordered by the Thirty, had been executed by the aid, and for the joint benefit (as Critias justly remarked) of those occupants of the city whom the exiles found on returning. Now Thrasylbulus, Anytus, and the rest of these exiles, saw their property all pillaged and appropriated by others during the few months of their absence: we may presume that their lands—which had probably not been sold, but granted to individual members or partisans of the Thirty—were restored to them; but the movable property could not be reclaimed, and the losses to which they remained subject were prodigious.

The men who had caused and profited by these losses—often with great brutality towards the families of the exiles, as we know by the case of Lysias—were now at Athens, all individually well known to the sufferers. In like manner, the sons and brothers of Leon and the other victims of the Thirty, saw before them the very citizens by whose hands their innocent relatives had been consigned without trial to prison and execution. The amount of wrong suffered had been infinitely greater than in the time of the Four Hundred, and the provocation, on every ground, public and private, violent to a degree never exceeded in history. Yet with all this sting fresh in their bosoms, we find the victorious multitude, on the latter occasion as well as on the former, burying the past in an indiscriminate amnesty, and anxious only for the future harmonious march of the renovated and all-comprehensive democracy. We see the sentiment of commonwealth in the demos, twice contrasted with the sentiment of faction in an ascendant oligarchy; twice triumphant over the strongest counter-motives, over the most bitter recollections of wrongful murder and spoliation, over all that passionate rush of reactionary appetite which characterises the moment of political restoration.

“Bloody will be the reign of that king who comes back to his kingdom from exile”—says the Latin poet: bloody indeed had been the rule of Critias and those oligarchs who had just come back from exile: “harsh is a demos (observes Æschylus) which has just got clear of misery.” But the Athenian demos, on coming back from Piræus, exhibited the rare phenomenon of a restoration after cruel wrong suffered, sacrificing all the strong impulse of retaliation to a generous and deliberate regard for the future march of the commonwealth. Thucydides remarks that the moderation of political antipathy which prevailed at Athens after the victory of the people over the Four Hundred, was the main cause which revived Athens from her great public depression and danger. Much more forcibly does this remark apply to the restoration after the Thirty, when the public condition of Athens was at the lowest depth of abasement, from which nothing could have rescued her except such exemplary wisdom and patriotism on the part of her victorious demos. Nothing short of this could have enabled her to accomplish that partial resurrection—into an independent and powerful single state, though shorn of her imperial power—which will furnish material for the subsequent portion of our history.

If we wanted any further proof of their capacity for taking the largest and soundest views on a difficult political situation, we should find it in

[403-402 B.C.]

another of their measures at this critical period. The Ten who had succeeded to oligarchical presidency of Athens after the death of Critias and the expulsion of the Thirty, had borrowed from Sparta the sum of one hundred talents [£20,000 or \$100,000] for the express purpose of making war on the exiles in Piræus. After the peace, it was necessary that such sum should be repaid, and some persons proposed that recourse should be had to the property of those individuals and that party who had borrowed the money. The apparent equity of the proposition was doubtless felt with peculiar force at a time when the public treasury was in the extreme of poverty. But nevertheless both the democratical leaders and the people decidedly opposed it, resolving to recognise the debt as a public charge; in which capacity it was afterwards liquidated, after some delay arising from an un-supplied treasury.

The necessity of a fresh collection and publication (if we may use that word) of the laws, had been felt prior to the time of the Thirty. But such a project could hardly be realised without at the same time revising the laws, as a body, removing all flagrant contradictions, and rectifying what might glaringly displease the age either in substance or in style. Now the psephism of Tisamenus, one of the first measures of the renewed democracy after the Thirty, both prescribed such revision and set in motion a revising body; but an additional decree was now proposed and carried by Archinus, relative to the alphabet in which the revised laws should be drawn up. The Ionic alphabet, that is, the full Greek alphabet of twenty-four letters, as now written and printed, had been in use at Athens universally, for a considerable time — apparently for two generations; but from tenacious adherence to ancient custom, the laws had still continued to be consigned to writing in the old Attic alphabet of only sixteen or eighteen letters. It was now ordained that this scanty alphabet should be discontinued, and that the revised laws, as well as all future public acts, should be written up in the full Ionic alphabet.

Partly through this important reform, partly through the revising body, partly through the agency of Nicomachus, who was still continued as Anagrapheus [“Writer-up” of the old laws], the revision, inscription, and publication of the laws in their new alphabet was at length completed. But it seems to have taken two years to perform — or at least two years elapsed before Nicomachus went through his trial of accountability. He appears to have made various new propositions of his own, which were among those adopted by the nomothetæ: for these he was attacked, on a trial of accountability, as well as on the still graver allegation of having corruptly falsified the decisions of that body — writing up what they had not sanctioned, or suppressing that which they had sanctioned.

The archonship of Euclides, succeeding immediately to the Anarchy (as the period of the Thirty was denominated), became thus a cardinal point or epoch in Athenian history. We cannot doubt that the laws came forth out of this revision considerably modified, though unhappily we possess no particulars on the subject. We learn that the political franchise was, on the proposition of Aristophon, so far restricted for the future, that no person could be a citizen by birth except the son of citizen parents on both sides; whereas previously, it had been sufficient if the father alone was a citizen. The rhetor Lysias, by station a metie, had not only suffered great loss, narrowly escaping death from the Thirty (who actually put to death his brother Polemarchus) but had contributed a large sum to assist the armed efforts of the exiles under Thrasybulus in Piræus. As a reward and compensation

for such antecedents, the latter proposed that the franchise of citizen should be conferred upon him; but we are told that this decree, though adopted by the people, was afterwards indicted by Archinus as illegal or informal, and cancelled. Lysias, thus disappointed of the citizenship, passed the remainder of his life as an *isoteles*, or non-freeman on the best condition, exempt from the peculiar burdens upon the class of metics.

Such refusal of citizenship to an eminent man like Lysias, who had both acted and suffered in the cause of the democracy, when combined with the decree of Aristophon above noticed, implies a degree of augmented strictness which we can only partially explain. It was not merely the renewal of her democracy for which Athens had now to provide. She had also to accommodate her legislation and administration to her future march as an isolated state, without empire or foreign dependencies. For this purpose material

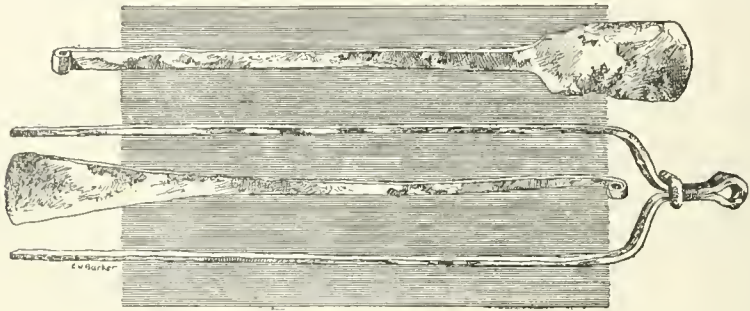

GREEK FIRE IRONS
(In the British Museum)

changes must have been required: among others, we know that the Board of Hellenotamiae (originally named for the collection and management of the tribute at Delos, but attracting to themselves gradually more extended functions, until they became ultimately, immediately before the Thirty, the general paymasters of the state) was discontinued, and such among its duties as did not pass away along with the loss of the foreign empire, were transferred to two new officers—the treasurer at war, and the manager of the theoricon, or religious festival-fund.

While the Athenian empire lasted, the citizens of Athens were spread over the Ægean in every sort of capacity—as settlers, merchants, navigators, soldiers, etc., which must have tended materially to encourage inter-marriages between them and the women of other Grecian insular states. Indeed we are even told that an express permission of *connubium* with Athenians was granted to the inhabitants of Eubœa—a fact (noticed by Lysias) of some moment in illustrating the tendency of the Athenian empire to multiply family ties between Athens and the allied cities. Now, according to the law which prevailed before Euclides, the son of every such marriage was by birth an Athenian citizen; an arrangement at that time useful to Athens, as strengthening the bonds of her empire—and eminently useful in a larger point of view, among the causes of Panhellenic sympathy. But when Athens was deprived both of her empire and her fleet, and confined within the limits of Attica—there no longer remained any motive to continue such a regulation, so that the exclusive city-feeling, instinctive in the Grecian mind, again became predominant. Such is perhaps the explanation of the new restrictive law proposed by Aristophon.

[405-403 B.C.]

Thrasybulus and the gallant handful of exiles who had first seized Phyle received no larger reward than a thousand drachmæ [£40 or \$200] for a common sacrifice and votive offering, together with wreaths of olive as a token of gratitude from their countrymen. The debt which Athens owed to Thrasybulus was indeed such as could not be liquidated by money. To his individual patriotism, in great degree, we may ascribe not only the restoration of the democracy, but its good behaviour when restored. How different would have been the consequences of the restoration and the conduct of the people, had the event been brought about by a man like Alcibiades, applying great abilities principally to the furtherance of his own cupidity and power!

THE END OF ALCIBIADES

At the restoration of the democracy, Alcibiades was already no more. Shortly after the catastrophe at Ægospotami, he had sought shelter in the satrapy of Pharnabazus, no longer thinking himself safe from Lacedæmonian persecution in his forts on the Thracian Chersonesus. He carried with him a good deal of property, though he left still more behind him in these forts: how acquired we do not know. But having crossed apparently to Asia by the Bosphorus, he was plundered by the Thracians in Bithynia, and incurred much loss before he could reach Pharnabazus in Phrygia. Renewing the tie of personal hospitality which he had contracted with Pharnabazus four years before, he now solicited from the satrap a safe conduct up to Susa. The Athenian envoys—whom Pharnabazus, after his former pacification with Alcibiades, 408 B.C., had engaged to escort to Susa, but had been compelled by the mandate of Cyrus to detain as prisoners—were just now released from their three years' detention, and enabled to come down to the Propontis; and Alcibiades, by whom this mission had originally been projected, tried to prevail on the satrap to perform the promise which he had originally given, but had not been able to fulfil. The hopes of the sanguine exile, reverting back to the history of Themistocles, led him to anticipate the same success at Susa as had fallen to the lot of the latter: nor was the design impracticable, to one whose ability was universally renowned, and who had already acted as minister to Tissaphernes.

The court of Susa was at this time in a peculiar position. King Darius Nothus, having recently died, had been succeeded by his eldest son Artaxerxes Mnemon; but the younger son Cyrus, whom Darius had sent for during his last illness, tried after the death of the latter to supplant Artaxerxes in the succession—or at least was suspected of so trying. Cyrus being seized and about to be slain, the queen-mother, Parysatis, prevailed upon Artaxerxes to pardon him, and send him again down to his satrapy along the coast of Ionia, where he laboured strenuously, though secretly, to acquire the means of dethroning his brother; a memorable attempt, of which we shall speak more fully hereafter. But his schemes, though carefully masked, did not escape the observation of Alcibiades, who wished to make a merit of revealing them at Susa, and to become the instrument of defeating them. He communicated his suspicions as well as his purpose to Pharnabazus; whom he tried to awaken by alarm of danger to the empire, in order that he might thus get himself forwarded to Susa as informant and auxiliary.

Pharnabazus was already jealous and unfriendly in spirit towards Lysander and the Lacedæmonians (of which we shall soon see plain evidence)—and perhaps towards Cyrus also, since such were the habitual relations of

neighbouring satraps in the Persian empire. But the Lacedæmonians and Cyrus were now all-powerful on the Asiatic coast, so that he probably did not dare to exasperate them, by identifying himself with a mission so hostile, and an enemy so dangerous, to both. Accordingly he refused compliance with the request of Alcibiades; granting him nevertheless permission to live in Phrygia, and even assigning to him a revenue. But the objects at which the exile was aiming soon became more or less fully divulged to those against whom they were intended. His restless character, enterprise, and capacity, were so well known as to raise exaggerated fears as well as exaggerated hopes. Not merely Cyrus, but the Lacedæmonians, closely allied with Cyrus, and the decarchies, whom Lysander had set up in the Asiatic Grecian cities, and who held their power only through Lacedæmonian support—all were uneasy at the prospect of seeing Alcibiades again in action and command, amidst so many unsettled elements. Nor can we doubt that the exiles whom these decarchies had banished, and the disaffected citizens who remained at home under their government in fear of banishment or death, kept up correspondence with him, and looked to him as a probable liberator. Moreover the Spartan king Agis still retained the same personal antipathy against him, which had already (some years before) procured the order to be despatched, from Sparta to Asia, to assassinate him. Here are elements enough, of hostility, vengeance, and apprehension, afloat against Alcibiades—without believing the story of Plutarch, that Critias and the Thirty sent to apprise Lysander that the oligarchy at Athens could not stand so long as Alcibiades was alive.

A special despatch (or *seytale*) was sent out by the Spartan authorities to Lysander in Asia, enjoining him to procure that Alcibiades should be put to death. Accordingly Lysander communicated this order to Pharnabazus, within whose satrapy Alcibiades was residing, and requested that it might be put in execution. Pharnabazus therefore despatched his brother Magæus and his uncle Sisamithres, with a band of armed men, to assassinate Alcibiades in the Phrygian village where he was residing. These men, not daring to force their way into his house, surrounded it and set it on fire. Yet Alcibiades, having contrived to extinguish the flames, rushed out upon his assailants with a dagger in his right hand, and a cloak wrapped around his left to serve as a shield. None of them dared to come near him; but they poured upon him showers of darts and arrows until he perished, undefended as he was either by shield or by armour. A female companion with whom he lived—Timandra—wrapped up his body in garments of her own, and performed towards it all the last affectionate solemnities.

Such was the deed which Cyrus and the Lacedæmonians did not scruple to enjoin, nor the uncle and brother of a Persian satrap to execute; and by which this celebrated Athenian perished before he had attained the age of fifty. Had he lived, we cannot doubt that he would again have played some conspicuous part—for neither his temper nor his abilities would have allowed him to remain in the shade—but whether to the advantage of Athens or not is more questionable. Certain it is that, taking his life throughout, the good which he did to her bore no proportion to the far greater evil. Of the disastrous Sicilian expedition, he was more the cause than any other individual; though that enterprise cannot properly be said to have been caused by any individual: it emanated rather from a national impulse. Having first, as a counsellor, contributed more than any other man to plunge the Athenians into this imprudent adventure, he next, as an exile, contributed more than any other man (except Nicias) to turn that adventure into ruin,

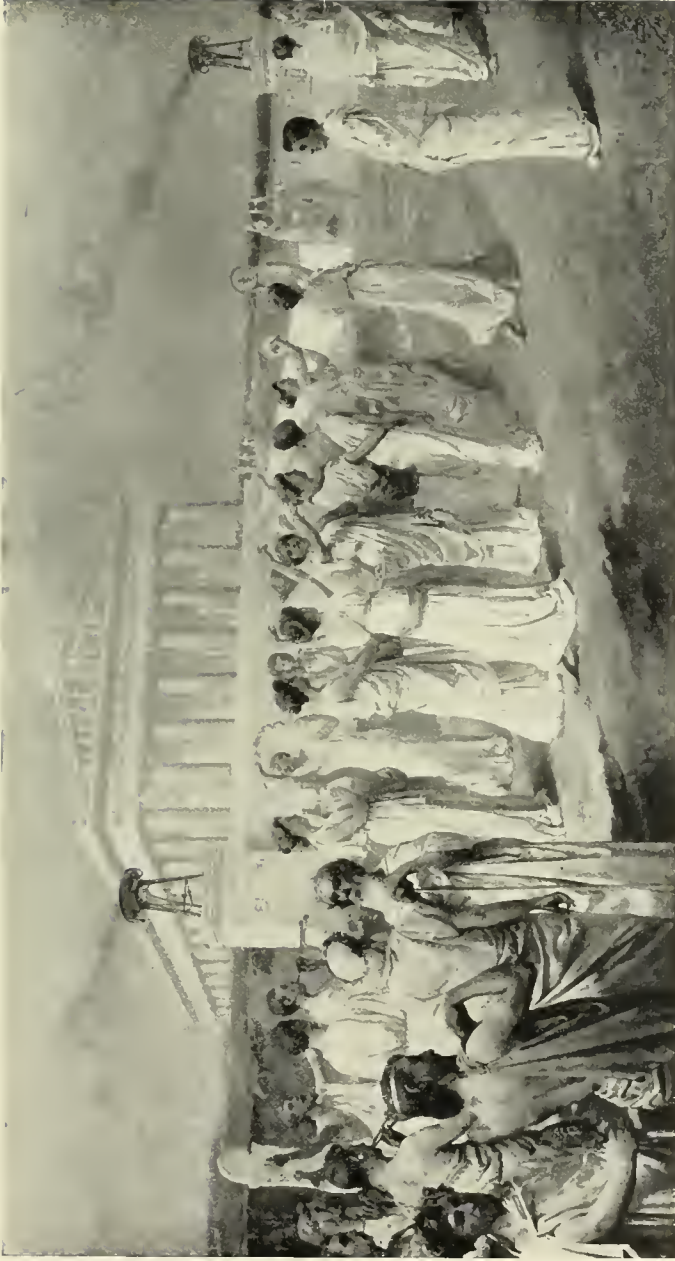

A GREEK RELIGIOUS PROCESSION

[404-403 B.C.]

and the consequences of it into still greater ruin. Without him, Gylippus would not have been sent to Syracuse, Decelea would not have been fortified, Chios and Miletus would not have revolted, the oligarchical conspiracy of the Four Hundred would not have been originated. Nor can it be said that his first three years of political action as Athenian leader, in a speculation peculiarly his own — the alliance with Argos, and the campaigns in Peloponnesus — proved in any way advantageous to his country. On the contrary, by playing an offensive game where he had hardly sufficient force for a defensive, he enabled the Lacedæmonians completely to recover their injured reputation and ascendancy through the important victory of Mantinea. The period of his life really serviceable to his country, and really glorious to himself, was that of three years ending with his return to Athens in 407 B.C. The results of these three years of success were frustrated by the unexpected coming down of Cyrus as satrap: but just at the moment when it behoved Alcibiades to put forth a higher measure of excellence, in order to realise his own promises in the face of this new obstacle — at that critical moment we find him spoiled by the unexpected welcome which had recently greeted him at Athens, and falling miserably short even of the former merit whereby that welcome had been earned.

If from his achievements we turn to his dispositions, his ends, and his means — there are few characters in Grecian history who present so little to esteem, whether we look at him as a public or as a private man. His ends are those of exorbitant ambition and vanity; his means rapacious as well as reckless, from his first dealing with Sparta and the Spartan envoys, down to the end of his career. The manœuvres whereby his political enemies first procured his exile were indeed base and guilty in a high degree. But we must recollect that if his enemies were more numerous and violent than those of any other politician in Athens, the generating seed was sown by his own overweening insolence and contempt of restraints, legal as well as social. On the other hand, he was never once defeated either by land or sea. In courage, in ability, in enterprise, in power of dealing with new men and new situations, he was never wanting; qualities which, combined with his high birth, wealth, and personal accomplishments, sufficed to render him for the time the first man in every successive party which he espoused — Athenian, Spartan, or Persian — oligarchical or democratical. But in none of them did he ever inspire any lasting confidence; all successively threw him off. On the whole, we shall find few men in whom eminent capacities for action and command are so thoroughly marred by an assemblage of bad moral qualities as Alcibiades.^b

LIFE AT ATHENS

The state of Athens after the expulsion of the Thirty was in some respects apparently less desolate than that in which she had been left after the battle of Plataea. It is possible indeed that the invasions of Xerxes and Mardonius may have inflicted less injury on her territory than the methodical and lingering ravages of the Peloponnesians during the Deceleian war. But in 479 the city, as well as the country, had been, for a part of two consecutive years, in the power of an irritated enemy. All that it required both for ornament and defence was to be raised afresh from the ground. Yet the treasury was empty: commerce had probably never yet yielded any considerable supplies, and it had been deeply disturbed by the war; the state pos-

essed no dependent colonies or tributary allies, and was watched with a jealous eye by the most powerful of its confederates.

Commeree had not only been interrupted by the blockade, but had sustained still greater detriment from the tyranny of the Thirty, which had crushed or seared away the most opulent and industrious of the aliens : and the cloud which continued to hang over the prospects of the state, even after freedom and tranquillity had been restored, tended to discourage those who might have been willing to return. The public distress was such that it was with the greatest difficulty the council could provide ways and means

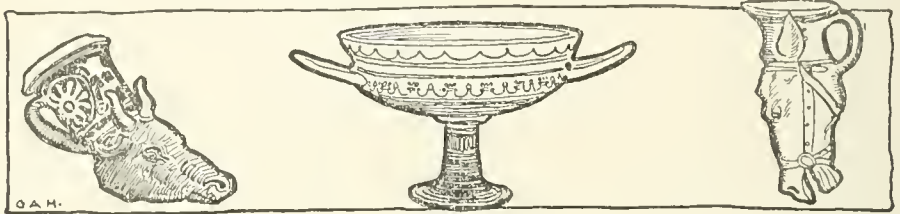

DRINKING HORNS

for the ordinary expenses. Even the ancient sacrifices prescribed by the sacred canons were intermitted, because the treasury could not furnish three talents [£600 or \$3000] for their celebration : and the repayment of a loan of two talents which had been advanced by the Thebans, probably in aid of the exiles, was so long delayed through the same cause, that hostilities were threatened for the purpose of recovering the debt. The navy of Athens had now sunk to a fourth of that which she had maintained before the time of Solon, and it was limited to this footing by a compact which could not be broken or eluded without imminent danger ; Piræus was again unfortified : the arsenal was in ruins : even the city walls needed repairs, which could not be undertaken for want of money ; and on all sides were enemies who rejoiced in her humiliation, and were urged both by their passions and interests to prevent her from again lifting up her head.

The corruption of the Athenian courts of justice probably began with that great extension of their business which took place when the greater part of the allies had lost their independence and were compelled to resort to Athens for the determination of all important causes. At the same time the increase of wealth and the enlargement of commerce, multiplied the occasions of litigation at home. The taste of the people began to be more and more interested in forensic proceedings, even before it was attracted towards them by any other inducement. The pay of the jurors introduced by Pericles strengthened this impulse by a fresh motive, which, when Cleon had tripled its amount, acted more powerfully, and on a larger class. A considerable number of citizens then began to look to the exercise of their judicial functions as a regular source both of pleasure and profit.

But the prevalence of this frivolous habit was not the worst fault of the Athenian courts. In the most important class of cases, the criminal prosecutions, they were seldom perfectly impartial, and their ordinary bias was against the defendant. The juror in the discharge of his office did not forget his quality of citizen, and was not indifferent to the manner in which the issue of a trial might affect the public revenue, and thus he leaned towards decisions which replenished the treasury with confiscations and pecuniary penalties, while they also served to terrify and humble the wealthy class,

[ca. 425-400 B.C.]

which he viewed with jealousy and envy. On this notorious temper of the courts was grounded the power of the infamous sycophants who lived by extortion, and generally singled out, as the objects of their attacks, the opulent citizens of timid natures and quiet habits, who were both unable to plead for themselves, and shrank from a public appearance. Such persons might indeed procure the aid of an advocate, but they commonly thought it better to purchase the silence of the informer, than to expose themselves to the risk and the certain inconvenience of a trial. The resident aliens were not exempt from this annoyance; and, though they were not objects of fear or jealousy, they were placed under many disadvantages in a contest with an Athenian prosecutor. But the noble and affluent citizens of the subject states, above all, had reason to tremble at the thought of being summoned to Athens, to meet any of the charges which it was easy to devise against them, and to connect with an imputation of hostile designs or disloyal sentiments, and were ready to stop the mouths of the orators with gold.

There is no room for doubt as to the existence of the evils and vices we have been describing, though the most copious information we possess on the subject is drawn not from purely historical sources, but from the dramatic satires of Aristophanes. But there may still be a question as to the measure of allowance to be made for comic exaggeration, or political prejudices, in the poet; and it seems probable that the colours in which he has painted his countrymen are in some respects too dark. That the mass of the people had not sunk to this degree of depravity, may we think be inferred from the grief and indignation which it is recorded to have shown on some occasions, where it had been misled into an unjust sentence, by which it stained itself with innocent blood: as Callixenus, who however was not worse than other sycophants, though he was among those who returned after the expulsion of the Thirty, and enjoyed the benefit of the amnesty, died, universally hated, of hunger.



FORTUNE
(After Hope)

ARISTOPHANES

The patriotism of Aristophanes was honest, bold, and generally wise. He was still below the age at which the law permitted a poet to contend for a dramatic prize, and was therefore compelled to use a borrowed name, when, in the year after the death of Pericles, he produced his first work, in which his chief aim seems to have been to exhibit the contrast between the ancient and the modern manners. In his next, his ridicule was pointed more at the defects or the perversion of political institutions, and perhaps at the democratical system of filling public offices by lot. In both, however, he had

probably assailed many of the most conspicuous persons of the day, and either by personal satire, or by attacks on the abuses by which the demagogues thrived, he provoked the hostility of Cleon, who endeavoured to crush him by a prosecution. Its nominal ground was, it seems, the allegation, that the poet, who in fact according to some accounts was of Dorian origin, was not legally entitled to the franchise. But the real charge was that in his



ARISTOPHANES

recent comedy he had exposed the Athenian magistracy to the derision of the foreign spectators. Cleon, however, was baffled; and though the attempt was once or twice renewed, perhaps by other enemies of Aristophanes, it failed so entirely, that he seems to have been soon left in the unmolested enjoyment of public favour; and he not only was encouraged to revenge himself on Cleon by a new piece, in which the demagogue was exhibited in person, and was represented by the poet himself, — who it is said could not find an actor to undertake the part, nor even get a suitable mask made for it, — but he at the same time ventured on an experiment which it seems had never been tried before on the comic stage.

The people had been accustomed to see the most eminent Athenian statesmen and generals brought forward there and placed in a ludicrous light; but it had never yet beheld its own image set before its eyes as in a mirror, which reflected the principal features of its character, not indeed without the exaggeration which belonged to the occasion, but yet with a truth which could not be mistaken or evaded. This was done in the same

play which exposed Cleon's impudence and rapacity; and the follies and faults of the assembled multitude, which appears under its proper name of Demos, as an old dotard, not void of cunning, though incapable of governing himself, are placed in the strongest relief by the presence of its unworthy favourite, who is introduced, not indeed by name, but so as to be immediately recognised, as a lying, thievish, greedy, fawning, Paphlagonian slave. The poet's boldness was so far successful, that instead of offending the audience he gained the first prize: but in every other respect he failed of attaining his object; for Cleon, as we have seen, maintained his influence unimpaired to the end of his life, and the people showed as little disposition to reform its habits, and change its measures, as if the portrait it had seen of itself had been no less amiable than diverting. But the issue of this attempt did not deter him from another, which, but for the applause which had crowned the first, might have appeared equally dangerous. As in the *Knights* he had levelled his satire against the sovereign assembly; in the *Wasps*, which he exhibited in the year before Cleon's death, he attacked the other stronghold of his power, the courts of justice, with still keener ridicule.

The vehicles in which Aristophanes conveyed his political lessons, strange as they appear to us, were probably judiciously chosen, as well with the view of pointing the attention of the audience more forcibly to his practical object, as of relieving the severity of his admonitions and censures. As time has spared only a few fragments of the earlier and the contemporary productions of the comic drama, it is only from the report of the ancient critics that we

[ca. 425-400 B.C.]

can form any notion of the relation in which he stood to his theatrical competitors. He is said not only to have introduced several improvements in the structure of the old political comedy, by which he brought it to its highest perfection, but to have tempered the bitterness and the grossness of his elder rival Cratinus, who is described as the comic Æschylus. It is not quite clear in what sense this account is to be understood, for it is difficult to conceive that the satire of Cratinus can have been either freer or more licentious. But the difference seems to have consisted in the inimitable grace with which Aristophanes handled every subject which he touched. We are informed, indeed, that even in this quality he was surpassed by Eupolis, who is also said to have shown more vigour of imagination in the invention of his plots. Yet another account represents Eupolis as more nearly resembling Cratinus in the violence and homeliness of his invectives; and the testimony of the philosopher Plato, who in an epitaph called the soul of Aristophanes a sanctuary of the Graces, studied his works as a model of style for the composition of his own dialogues, and honoured him with a place in one of his masterpieces, seems sufficient to prove that at least in the elegance of his taste, and the gracefulness of his humour, he had no equal.

How much Aristophanes was in earnest with his subject, how far he was from regarding it merely as an occasion for the exercise of his art, and how little he was swayed by personal prejudices, which have sometimes been imputed to him, is proved less by the keenness of his ridicule than by the warmth of his affection for Athens, which is manifest even under the comic mask. In his extant plays he nowhere intimates a wish for any change in the form of the Athenian institutions. He only deplores the corruption of the public spirit, points out its signs and causes, and assails the persons who minister to it. It is indeed the Athens of another age that he heartily loves; but that age is no remote antiquity; it is, if not within his own memory, near enough to be remembered by the elder part of his audience. He looks back indeed to the days of Miltiades and Aristides, as the period when the glory of Athens was at its height. But those of Myronides and Thucydides, the rival of Pericles, likewise belong, in his view, to the good old times, which he sighs for; and the evils of his own are of still more recent origin. He traces them to the measures of Pericles; to the position in which he had placed Athens with regard to the subject states, and above all to the war in which he had involved her.

The Peloponnesian War he treats as entirely the work of Pericles, and he chooses to ascribe it to his fears for his own safety, or to the influence of Aspasia; and to consider the quarrel with Megara as only the occasion or colour for it. The war he regards as the main foundation of the power of such demagogues as Cleon and Hyperbolus. If peace were only restored, he hopes that the mass of the people would return to its rural occupations and to its ancient tastes and habits; that the assembly and the courts of justice would no longer hold out the same attractions; that litigation would abate, and the trade of the sycophants decay. Cleon is reproached in the *Knights* with having caused the Spartan overtures to be rejected, because he knew that it was by the war he was enabled to plunder the subject cities, and that if the people were released from the confinement of the city walls, and once more to taste the blessings of peace and of a country life, he should no longer find it subservient to his ends. Hence we may perhaps conclude that when, at the end of the same play, Demos (the personified people) is introduced as newly risen out of a magic cauldron, restored to the vigour and comeliness of youth, in a garb and port worthy of the companion of

Aristides and Miltiades, his eyes opened to his past errors, and with the purpose of correcting them, the poet did not conceive the change thus represented as hopeless, and still less meant to intimate that it was impossible.

It was not without reason that Aristophanes, in common with all Athenians who loved and regretted the ancient times, regarded the sophistical circles with abhorrence, not only as seminaries of demagogues and sycophants, but as schools of impiety and licentiousness. That the attention of the Athenian youth should be diverted from military and athletic exercises, from the sports of the field, and from the enjoyment of that leisure which had once been esteemed the most precious privilege of a Greek freeman, to sedentary studies, which at the best only inflated them with self-conceit, and stimulated them to lay aside the diffidence which befitted their age, and come forward prematurely in public, to exhibit their new acquirements and to supplant the elder and graver citizens on the bema, or to harass them before the popular tribunals: this in itself he deemed a great evil.

In the last scene of the *Knights*, one of the resolutions which Demos adopts is that he will bar the agora and the Pnyx against the beardless youths who now pass so much of their time in places of public resort, where they amuse themselves with discussing the merits of the orators in technical language, and will force them to go a-hunting, instead of making decrees. But it was a still more alarming evil, that, by way of preparation for this pernicious result, the religious belief of the young Athenians should be unsettled, their moral sentiments perverted, their reverence for the maxims and usages of antiquity extinguished; that subjects which had never before been contemplated but at an awful distance—the being and nature of the gods, the obligations arising from domestic and civil relations—should be submitted to close and irreverent inspection. It was according to the view of Aristophanes a matter of comparatively little moment, what turn such discussions happened to take, or what was the precise nature of the sophistical theories. The mischief was already done, when things so sacred had once been treated as subjects for inquiry and argument. But he perceived the evil much more clearly than the remedy. He would fain have carried his countrymen half a century backward, and have forced them to remain stationary at the stage which they had then reached in their intellectual progress; and it seems as if he wished to see the schools of the new philosophy forcibly suppressed, and with this view attempted to direct popular indignation against them. The only case in which this attempt succeeded was one in which the poet himself, if he had been better informed, must have desired it should fail.

EURIPIDES

Aristophanes closely watched all the workings of the sophistical spirit, and was sagacious enough to perceive that they were not confined to any particular sphere, but pervaded every province of thought and action. He was naturally led to observe its influence with peculiar attention in the branches of literature or art which were most nearly allied to his own. He was able to trace it in the innovations which had taken place in music and lyrical poetry, but above all in the tragic drama: and Euripides, the last of the three tragic poets who are known to us by their works, appeared to him as one of the most dangerous sophists, and was on this account among the foremost objects of his bitterest ridicule. The earnestness with which Aristophanes

[ca. 425-400 B.C.]

assailed him seems to have increased with the growth of his reputation; for of the three comedies in which he is introduced, the last, which was exhibited after his death, contains by far the most severe as well as elaborate censure of his poetry. It is not however quite certain that Euripides, even in the latter part of his career, was so popular as Sophocles. In answer to a question of Socrates, in a conversation which Xenophon probably heard during the latter part of the Peloponnesian War, Sophocles is mentioned as indisputably the most admirable in his art.

It has often been observed, that the success of Euripides, if it is measured by the prizes which he is said to have gained, would not seem to have been very great: and perhaps there may be reason to suspect, that he owed much of the applause which he obtained in his life-time to the favour of a party, which was strong rather in rank and fortune than in numbers; the same which is said to have been headed by Alcibiades, and to have deprived Aristophanes of the prize.

Alcibiades employed Euripides to celebrate his Olympic victories; and his patronage was sufficient to spread the poet's fame at home and abroad. The anecdote about the celebrity which he had acquired in Sicily is perfectly consistent with this view; as is the invitation which he received a little before his death from Archelaus of Macedonia, at whose court he ended his life; and the admiration which Dionysius of Syracuse expressed for him, by buying his tablets and pen at a high price, to dedicate them in the temple of the Muses.

Aristophanes was so far from being blind to the poetical merits of Euripides, that he was himself charged by his rivals with borrowing from him, and in one of his lost plays acknowledged that in his dietion he had imitated the terseness of the tragic poet, but asserted that his thoughts were less vulgar. How accurately he had studied the works of the tragic drama, how vividly he perceived the genuine character of Greek tragedy, and the peculiar genius of each poet, is sufficiently proved by the mode in which he has conducted the contest which he feigns between Æschylus and Euripides. But his criticism would probably have been less severe, if he had not considered Euripides less in his poetical character than in his connection with the sophistical school. Euripides had in fact been a hearer of Anaxagoras, and probably both of Protagoras and Prodicus. In his house Protagoras was said to have read one of his works by which he incurred a charge of atheism. He was also on intimate terms with Socrates, who was therefore reported to have aided him in the composition of his tragedies, and perhaps may have done so, in the same way as Prodicus and Anaxagoras; and this connection was, as we shall see, of itself a sufficient ground with Aristophanes for suspicion and aversion. The strength of Euripides lay in passionate and moving scenes, and he sought like other poets for situations and characters which afforded the best opportunity for the display of his powers. But he was too frequently tempted to work upon the feelings of his audience by an exhibition of sufferings which were quite foreign to the heroic dignity of the persons who endured them, who were therefore degraded by the pity they excited. The misery of his heroes often consisted chiefly in bodily privations, which could only awaken the sympathy of the spectator's animal nature.

His irreligion is contrasted with the piety of Æschylus, who invokes the goddess of the Eleusinian mysteries; a hint which, after the prosecution of Alcibiades, was easily understood, as to the party to which Euripides belonged. It was probably in the same point of view that Aristophanes considered the plays which he founded on tales of criminal passion.

Euripides was undoubtedly induced to select such subjects, some of which were new to the Greek stage, chiefly by the opportunity they afforded him of displaying his peculiar dramatic talent. But in his hands they seldom failed to give occasion for a sophistical defence of conduct repugnant to Greek usages and feelings, which to Aristophanes would appear much more pernicious than the example itself. But his plays were likewise interspersed with moral paradoxes, which in more than one instance are said to have excited the indignation of the audience. A line in which the most pious of his heroes distinguishes between the oath of the tongue and that of the mind, in terms which might serve to justify any perjury, became very celebrated, and Aristophanes dwells upon it, apparently as a striking illustration of the sophistical spirit. It seems clear that these, and others of the novelties just mentioned, cannot have been designed to gain the general applause of the audience. Though we must reject a story told by some of his Greek biographers, which indeed is at variance with chronology, that the fate of his master Anaxagoras deterred him from philosophical pursuits, and led him to turn his thoughts to the drama, we might still wonder at his indiscretion, if it had not appeared probable that he aimed at gratifying the taste, not so much of the multitude, as of that class of persons which took pleasure in the new learning, and was in fact the favourite poet, not so much of the common people, as of a party, which was growing more and more powerful throughout his dramatic career.

Euripides, however, occupies only a subordinate place among the disciples and supporters of the sophistical school, whom Aristophanes attacked. The person whom he selected as its representative, and on whom he endeavoured to throw the whole weight of the charges which he brought against it, was Socrates. In the *Clouds*, a comedy exhibited in 423, a year after the *Knights* had been received with so much applause, Socrates was brought on the stage under his own name, as the arch-sophist, the master of the free-thinking school. The story is of a young spendthrift, who has involved his father in debt by his passion for horses, and having been placed under the care of Socrates is enabled by his instructions to defraud his creditors, but also learns to regard filial obedience and respect, and piety to the gods, as groundless and antiquated prejudices; and it seems hardly possible to doubt that under this character the poet meant to represent Alcibiades, whom it perfectly suits in its general outline, and who may have been suggested to the thoughts of the spectators in many ways not now perceived by the reader. It seems at first sight as if in this work Aristophanes must stand convicted either of the foulest motives or of a gross mistake. For the character of Socrates was in most points directly opposed to the principles and practice which he attributes here and elsewhere to the sophists and their followers. Yet in the *Clouds* this excellent person appears in the most odious as well as ridiculous aspect; and the play ends with the preparations made by the father of the misguided youth to consume him and his school.^c

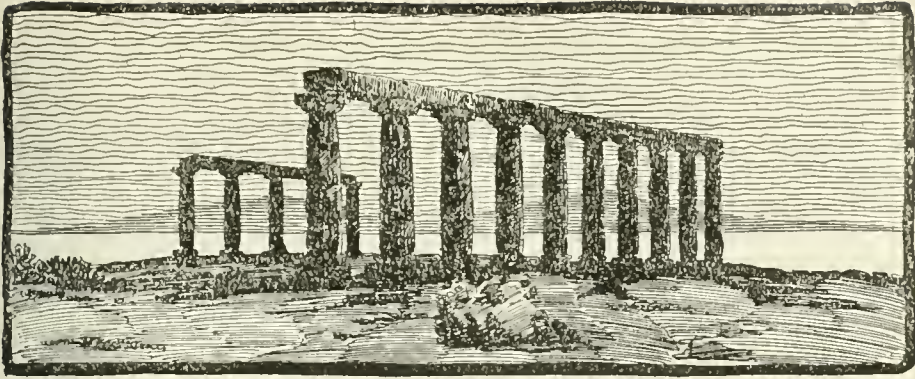

REMAINS OF A TEMPLE AT METAPONTUM

CHAPTER XXXIX. SOCRATES AND THE SOPHISTS

It was not till the superior talents of Pericles had quieted the storms of war and faction that science, which had in the interval received great improvement among the Asian Greeks, revived at Athens with new vigour. Anaxagoras of Clazomenæ, the preceptor and friend of Pericles, bred in all the learning of the Ionian school, is said first to have introduced what might properly be called philosophy there. To him is attributed the first introduction in European Greece of the idea of one eternal, almighty, and all-good Being, or, as he is said, after Thales, to have expressed himself, a perfect mind, independent of body, as the cause or creator of all things. The gods received in Greece, of course, were low in his estimation; the sun and moon, commonly reputed divinities, he held to be mere material substances, the sun a globe of stone, the moon an earth, nearly similar to ours. A doctrine so repugnant to the system on which depended the estimation of all the festivals, processions, sacrifices, and oracles, which so fascinated the vulgar mind, was not likely to be propagated without reprehension. Even the science which enabled men to calculate an eclipse was offensive, inasmuch as it lowered the importance, and interfered with the profits, of priests, augurs, interpreters, and seers. An accusation of impiety was therefore instituted against Anaxagoras; the general voice went with the prosecutors; and all that the power and influence of Pericles could do for his valued friend, was to procure him means of escape from Attica.

But while physical and metaphysical speculation engaged men of leisure, other learning had more attraction for the ambitious and needy. Athens always was the great field for acquiring fame and profit in this line; yet those who first attained eminence in it were foreigners there, Gorgias of Leontini in Sicily, Prodicus of the little island of Ceos, and Hippias of Elis. All these are said to have acquired considerable riches by their profession. Their success invited numbers to follow their example; and Greece, but far more especially Athens, shortly abounded with those who, under the name of sophists, professors of wisdom, undertook to teach every science. The scarcity and dearness of books gave high value to that learning which a man with a well-stored mind, and a ready and clear elocution could communicate. None, without eloquence, could undertake to be instructors; so that the sophists, in giving lessons of eloquence, were themselves the example. They

frequented all places of public resort, the agora, the public walks, the gymnasium, and the porticos; where they recommended themselves to notice by an ostentatious display of their abilities, in disputation among one another, or with whoever would converse with them.

The profession of sophist had not long flourished, and no Athenian had acquired fame in any branch of philosophy, when the singular talents, and singular manners and pursuits, of Soerates, son of Sophroniscus, engaged public attention. The father was a statuary, and is not mentioned as very eminent in his profession; but, as a man, he seems to have been respected among the most eminent of the commonwealth: he lived in particular intimacy with Lysimachus, son of the great Aristides. Socrates, inheriting a very scanty fortune, had a mind wholly intent upon the acquisition and communication of knowledge. The sublime principles of theology, taught by Anaxagoras, made an early impression upon his mind. They led him to consider what should be the duty owed by man to such a Being as Anaxagoras described his Creator; and it struck him that, if the providence of God interfered in the government of this world, the duty of man to man, little considered by poets or priests as any way connected with religion, and hitherto almost totally neglected by philosophers, must be a principal branch of the duty of man to God. It struck him further that, with the gross defects which he saw in the religion, the morality, and the governments of Greece, though the favourite inquiries of the philosophers, concerning the nature of the Deity, the formation of the world, the laws of the heavenly bodies, might, while they amused, perhaps also enlarge and improve the minds of a few speculative men, yet the investigation of the social duties was infinitely more important, and might be infinitely more useful, to mankind in general. Endowed by nature with a most discriminating mind, and a singularly ready eloquence, he directed his utmost attention to that investigation; and when, by reflection, assisted and proved by conversation among the sophists and other able men, he had decided an opinion, he communicated it, not in the way of precept, which the fate of Anaxagoras had shown hazardous, but by proposing a question, and, in the course of interrogatory argument, leading his hearers to the just conclusion.

We are informed by his disciple Xenophon how he passed his time. He was always in public. Early in the morning he went to the walks and the gymnasium: when the agora filled, he was there; and, in the afternoon, wherever he could find most company. Generally he was the principal speaker. The liveliness of his manner made his conversation amusing as well as instructive, and he denied its advantages to nobody. But he was nevertheless a most patient hearer; and preferred being the hearer whenever others were present able and disposed to give valuable information to the company. He did not commonly refuse invitations, frequently received, to private entertainments; but he would undertake no private instruction, nor could any solicitation induce him to relieve his poverty by accepting, like the sophists and rhetoricians, a reward for what he gave in public.

In the variety of his communication on social duties he could not easily, and perhaps he did not desire entirely to avoid either religious or political subjects; hazardous, both of them, under the jealous tyranny of democracy. It remains a question how far he was subject to superstition; but his honesty is so authenticated that it seems fairer to impute to him some weakness in credulity than any intention to deceive. If we may believe his own account, reported by his two principal disciples, he believed himself divinely impelled to the employment to which he devoted his life, inquiring and

[ca. 425-400 B.C.]

teaching the duty of man to man. A divine spirit, in his idea, constantly attended him; whose voice, distinctly heard, never expressly commanded what he was indisposed to do, but frequently forbade what he had intended. To unveil the nature of Deity was not among his pretensions. He only insisted on the perfect goodness and perfect wisdom of the Supreme God, the creator of all things, and the constant superintendence of his providence over the affairs of men. As included in these, he held that everything done, said, or merely wished by men, was known to the Deity, and that it was impossible he could be pleased with evil. The unity of God, though implied in many of his reported discourses, he would not in direct terms assert; rather carefully avoiding to dispute the existence of the multifarious gods acknowledged in Greece; but he strongly denied the weaknesses, vices, and crimes commonly imputed to them. Far however from proposing to innovate in forms of worship and religious ceremonies, so various in the different Grecian states, and sources of more doubt and contention than any other circumstances of the heathen religion, he held that men could not, in these matters, do wrong if they followed the laws of their own country and the institutions of their forefathers. He was therefore regular in sacrifice, both upon the public altars and in his family. He seems to have been persuaded that the Deity, by various signs, revealed the future to men; in oracles, dreams, and all the various ways usually acknowledged by those conversant in the reputed science of augury. "Where the wisdom of men cannot avail," he said, "we should endeavour to gain information from the gods; who will not refuse intelligible signs to those to whom they are propitious." Accordingly he consulted oracles himself, and he recommended the same practice to others, in every doubt on important concerns.

The circumstances of the Athenian government, in his time, could not invite a man of his disposition to offer himself for political situations. He thought he might be infinitely more useful to his country in the singular line, it might indeed be called a public line, which he had chosen for himself. Not only he would not solicit office, but he would take no part in political contest. In the several revolutions which occurred he was perfectly passive. But he would refuse nothing: on the contrary, he would be active in everything that he thought decidedly the duty of a citizen. When called upon to serve among the heavy-armed, he was exemplary in the duties of a private soldier; and as such he fought at Potidæa, Amphipolis, and Delium. We find him mentioned in civil office; at one time president of the general assembly, and at another a member of the council of Five Hundred. In each situation he distinguished himself by his unbending uprightness. When president, he resisted the violence of the assembled people, who voted a decree, in substance or in manner, contrary to the constitution. Neither entreaties nor threats could move him to give it the necessary sanction of his office. As a member of the council we have already seen him, in the office of prytanis, at the trial of the six generals, persevering in resistance to the injustice of popular tyranny, rendered useless through the want of equal constancy in his colleagues, who yielded to the storm. Under the Thirty again we have seen him, not in office indeed, but daring to refuse office, unworthy and illegal office, which the tyranny of the all-powerful Critias would have put upon him.

We are not informed when Socrates first became distinguished as a sophist; for in that description of men he was in his own day reckoned. When the wit of Aristophanes was directed against him in the theatre he was already among the most eminent, but his eminence seems to have been then recent. It was about the tenth or eleventh year of the Peloponnesian

War, when he was six or seven and forty years of age, that, after the manner of the old comedy, he was offered to public derision upon the stage, by his own name, as one of the persons of the drama, in the comedy of Aristophanes, called the *Clouds*, which is yet extant. The audience, accustomed to look on defamation with carelessness, and to hold as lawful and proper whatever might amuse the multitude, applauded the wit, and even gave general approbation to the composition; but the high estimation of the character of Socrates sufficed to prevent that complete success which the poet had looked for. The crown, which rewarded him whose drama most earned the public favour, and which Aristophanes had so often won, was on this occasion refused him.

Two or three and twenty years had elapsed since the first representation of the *Clouds*; the storms of conquest suffered from a foreign enemy and from four revolutions in the civil government of the country, had passed; nearly three years had followed of that quiet which the revolution under Thrasybulus produced, and the act of amnesty should have confirmed, when a young man, named Meletus, went to the king-archon, delivered, in the usual form, an information against Socrates, and bound himself to prosecute. The information ran thus: "Meletus, son of Meletus, of the borough of Pitthos, declares these upon oath against Socrates, son of Sophroniscus, of the borough of Alopece: Socrates is guilty of reviling the gods whom the city acknowledges, and of preaching other new gods: moreover he is guilty of corrupting the youth. Penalty, death."



GRECIAN TERRA-COTTA
(In the British Museum)

THE PROSECUTION OF SOCRATES

Xenophon begins his *Memorabilia* of his revered master with declaring his wonder how the Athenians could have been persuaded to condemn to death a man of such uncommonly clear innocence and exalted worth. Ælianus, though for authority not to be compared with Xenophon, has nevertheless, we think, given the solution. "Socrates," he says, "disliked the Athenian constitution. For he saw that democracy is tyrannical, and abounds with all the evils of absolute monarchy." But though the political circumstances of the times made it necessary for contemporary writers to speak with caution, yet both Xenophon and Plato have declared enough to show that the assertion of Ælianus was well founded; and further proof, were it wanted, may be derived from another early writer, nearly contemporary, and deeply versed in the politics of his age, the orator Æschines. Indeed, though not stated in the indictment, yet it was urged against Socrates by his prosecutors before the court, that he was disaffected to the democracy; and in proof

[399 B.C.]

they affirmed it to be notorious that he had ridiculed what the Athenian constitution prescribed, the appointment to magistracy by lot. "Thus," they said, "he taught his numerous followers, youths of the principal families of the city, to despise the established government, and to be turbulent and seditious; and his success had been seen in the conduct of two, the most eminent, Alcibiades and Critias. Even the best things he converted to these ill purposes: from the most esteemed poets, and particularly from Homer, he selected passages to enforce his anti-democratical principles."

Socrates, it appears indeed, was not inclined to deny his disapprobation of the Athenian constitution. His defence itself, as it is reported by Plato, contains matter on which to found an accusation against him of disaffection to the sovereignty of the people, such as, under the jealous tyranny of the Athenian democracy, would sometimes subject a man to the penalties of high treason. "You well know," he says, "Athenians, that, had I engaged in public business, I should long ago have perished, without procuring any advantage either to you or to myself. Let not the truth offend you: it is no peculiarity of your democracy, or of your national character; but wherever the people is sovereign, no man who shall dare honestly to oppose injustice, frequent and extravagant injustice, can avoid destruction."

Without this proof indeed we might reasonably believe that, though Socrates was a good and faithful subject of the Athenian government, and would promote no sedition, no political violence, yet he could not like the Athenian constitution. He wished for wholesome changes by gentle means; and it seems even to have been a principal object of the labours to which he dedicated himself, to infuse principles into the rising generation that might bring about the desirable change insensibly. His scholars were chiefly sons of the wealthiest citizens, whose easy circumstances afforded leisure to attend him; and some of these, zealously adopting his tenets, others merely pleased with the ingenuity of his arguments and the liveliness of his manner, and desirous to emulate his triumphs over his opponents, were forward, after his example, to engage in disputation upon all the subjects on which he was accustomed to discourse. Thus employed and thus followed, though himself avoiding office and public business, those who governed or desired to govern the commonwealth through their influence among the many, might perhaps not unreasonably consider him as one who was, or might become, a formidable adversary; nor might it be difficult to excite popular jealousy against him.

Meletus, who stood forward as his principal accuser, was, according to Plato, not a man of any great consideration. He was soon joined by Lycon, one of the most powerful speakers of his time, and the avowed patron of the rhetoricians, who, as well as the poets, thought their interest injured by the moral philosopher's doctrine. But Anytus, a man scarcely second to any in the commonwealth in rank and general estimation, who had held high command with reputation in the Peloponnesian War, and had been the principal associate of Thrasybulus in the war against the Thirty and the restoration of the democracy, declared himself a supporter of the prosecution. Nothing in the accusation could, by any known law of Athens, affect the life of the accused. In England no man would be put upon trial on so vague a charge: no grand jury would listen to it. But in Athens, if the party was strong enough, it signified little what was the law. When Lycon and Anytus came forward, Socrates saw that his condemnation was already decided.

By the course of his life, however, and by the turn of his thoughts for many years, he had so prepared himself for all events, that the probability of his condemnation, far from being alarming, was to him rather matter for

rejoicing, as, at his age, a fortunate occurrence. Xenophon says that, by condescending to a little supplication, Socrates might easily have obtained his acquittal. It was usual for accused persons, when brought before the court, to bewail their apprehended lot, with tears to supplicate favour, and by exhibiting their children upon the bema, to endeavour to excite pity. No admonition or entreaty of his friends however could persuade him to such an unworthiness. He thought it, he said, more respectful to the court, as well as more becoming himself, to omit all this; however aware that

their sentiments were likely so far to differ from his that judgment would be given in anger for it. Accordingly, when put upon his defence, he told the people that he did not plead for his own sake, but for theirs, wishing them to avoid the guilt of an unjust sentence.

Condemnation pronounced wrought no change upon him. He again addressed the court, declared his innocence of the matters laid against him, and observed that, even if every charge had been completely proved, still altogether did not, according to any known law, amount to a capital crime. "But," in conclusion he said, "it is time to depart: I to die, you to live: but which for the greater good, God only knows."

It was usual at Athens for execution very soon to follow condemnation; commonly on the morrow. But it happened that the condemnation of Socrates took place on the eve of the day appointed for the sacred ceremony of crowning the galley which carried the annual offerings to the gods worshipped at Delos: and immemorial tradition forbade all executions till the sacred vessel's return. Thus the death of Socrates was respited thirty days,



SOCRATES IN PRISON

while his friends had free access to him in the prison. During all that time he admirably supported his constancy. Means were concerted for his escape; the jailer was bribed, a vessel prepared, and a secure retreat in Thessaly provided. No arguments, no prayers could persuade him to use the opportunity. He had always taught the duty of obedience to the laws, and he would not furnish an example of the breach of it. To no purpose it was urged that he had been unjustly condemned: he had always held that wrong did not justify wrong. He waited with perfect composure the return of the sacred vessel, reasoned on the immortality of the soul, the advantage of virtue, the happiness derived from having made it through life his pursuit, and, with his friends about him, took the fatal cup, and died.

[399 B.C.]

Writers who, after Xenophon and Plato, have related the death of Socrates, appear to have held themselves bound to vie with those who preceded them in giving pathos to the story. The purpose here has been rather to render it intelligible: to show its connection with the political history of Athens; to derive from it illustration of the political history. The magnanimity of Socrates, the principal factor of the pathos, surely deserves admiration; yet it is not that in which he has most outshone other men. The singular merit of Socrates lay in the purity and the usefulness of his manners and conversation; the clearness with which he saw, and the steadiness with which he practised, in a blind and corrupt age, all moral duties; the disinterestedness and the zeal with which he devoted himself to the benefit of others; and the enlarged and warm benevolence, whence his supreme and almost only pleasure seems to have consisted in doing good. The purity of Christian morality, little enough indeed seen in practice, nevertheless is become so familiar in theory that it passes almost for obvious, and even congenial to the human mind. Those only will justly estimate the merit of that near approach to it which Socrates made, who will take the pains to gather, as they may from the writings of his contemporaries and predecessors, how little conception was entertained of it before his time; how dull to a just moral sense the human mind has really been; how slow the progress in the investigation of moral duties, even where not only great pains have been taken, but the greatest abilities zealously employed; and, when discovered, how difficult it has been to establish them by proofs beyond controversy, or proofs even that should be generally admitted by the reason of men.

It is through the light which Socrates diffused by his doctrine enforced by his practice, with the advantage of having both the doctrine and the practice exhibited to highest advantage in the incomparable writings of disciples such as Plato and Xenophon, that his life forms an era in the history of Athens and of man.^b

It is our great good fortune to possess a long and sympathetic description of the closing scenes of his life in the unsurpassed prose of his disciple Plato. Though told in the form of a dialogue and much too long for quotation in full, the presentation of Socrates is so vivid and veracious that a part of it must be given.^a

PLATO'S ACCOUNT OF THE LAST HOURS OF SOCRATES

When we entered, we found Socrates just freed from his bonds, and Xantippe, you know her, holding his little boy and sitting by him. As soon as Xantippe saw us, she wept aloud and said such things as women usually do on such occasions, as "Socrates, your friends will now converse with you for the last time and you with them." But Socrates, looking towards Crito, said, "Crito, let some one take her home." Upon which some of Crito's attendants led her away, wailing and beating herself.

But Socrates sitting up in bed, drew up his leg, and rubbed it with his hand, and as he rubbed it, said: "What an unaccountable thing, my friends, that seems to be, which men call pleasure; and how wonderfully is it related towards that which appears to be its contrary, pain, in that they will not both be present to a man at the same time, yet, if any one pursues and attains the one, he is almost always compelled to receive the other, as if they were both united together from one head.

“And it seems to me,” he said, “that if Æsop had observed this he would have made a fable from it, how the Deity, wishing to reconcile these warring principles, when he could not do so, united their heads together, and from hence whomsoever the one visits the other attends immediately after; as appears to be the case with me, since I suffered pain in my leg before from the chain, but now pleasure seems to have succeeded.

“A bypath, as it were, seems to lead us on in our researches undertaken by reason, because as long as we are encumbered with the body, and our soul is contaminated with such an evil, we can never fully attain to what we desire; and this, we say, is truth. For the body subjects us to innumerable hindrances on account of its necessary support, and moreover if any diseases befall us, they impede us in our search after that which is; and it fills us with longings, desires, fears, all kinds of fancies, and a multitude of absurdities, so that, as it is said in real truth, by reason of the body it is never possible for us to make any advances in wisdom.

“For nothing else but the body and its desires occasion wars, seditions, and contests; for all wars amongst us arise on account of our desire to acquire wealth; and we are compelled to acquire wealth on account of the body, being enslaved by its service; and consequently on all these accounts we are hindered in the pursuit of philosophy. But the worst of all is, that if it leaves us any leisure, and we apply ourselves to the consideration of any subject, it constantly obtrudes itself in the midst of our researches, and occasions trouble and disturbance, and confounds us so that we are not able by reason of it to discern the truth. It has then in reality been demonstrated to us, that if we are ever to know anything purely, we must be separated from the body, and contemplate the things themselves by the mere soul. And then, as it seems, we shall obtain that which we desire, and which we profess ourselves to be lovers of, wisdom, when we are dead, as reason shows, but not while we are alive. For if it is not possible to know anything purely in conjunction with the body, one of these two things must follow, either that we can never acquire knowledge, or only after we are dead; for then the soul will subsist apart by itself, separate from the body, but not before. And while we live, we shall thus, as it seems, approach nearest to knowledge, if we hold no intercourse or communion at all with the body, except what absolute necessity requires, nor suffer ourselves to be polluted by its nature, but purify ourselves from it, until God himself shall release us. And thus being pure, and freed from the folly of the body, we shall in all likelihood be with others like ourselves, and shall of ourselves know the whole real essence, and that probably is truth; for it is not allowable for the impure to attain to the pure. Such things, I think, Simmias, all true lovers of wisdom must both think and say to one another. Does it not seem so to you?”

“Most assuredly, Socrates.”

“If this, then,” said Socrates, “is true, my friend, there is great hope for one who arrives where I am going; there, if anywhere, to acquire that in perfection for the sake of which we have taken so much pains during our past life; so that the journey now appointed me is set out upon with good hope, and will be so by any other man who thinks that his mind has been as it were purified.”

“Certainly,” said Simmias.

“But does not purification consist in this, as was said in a former part of our discourse, in separating as much as possible the soul from the body, and in accustoming it to gather and collect itself by itself on all sides apart

[399 B.C.]

from the body, and to dwell, as far as it can, both now and hereafter, alone by itself, delivered as it were from the shackles of the body?"

"Certainly," he replied.

"Is this then called death, this deliverance and separation of the soul from the body?"

"Assuredly," he answered.

"But, as we affirmed, those who pursue philosophy rightly, are especially and alone desirous to deliver it, and this is the very study of philosophers, the deliverance and separation of the soul from the body, is it not?"

"It appears so."

"Then, as I said at first, would it not be ridiculous for a man who has endeavoured throughout his life to live as near as possible to death; then, when death arrives, to grieve? Would not this be ridiculous?"

"How should it not?"

"In reality then, Simmias," he continued, "those who pursue philosophy rightly study to die; and to them of all men death is least formidable. Judge from this. Since they altogether hate the body and desire to keep the soul by itself, would it not be irrational if, when this comes to pass, they should be afraid and grieve, and not be glad to go to that place, where on their arrival they may hope to obtain that which they longed for throughout life; but they longed for wisdom; and to be freed from association with that which they hated? How many of their own accord wished to descend into Hades, on account of human objects of affection, their wives and sons, induced by this very hope of there seeing and being with those whom they have loved; and shall one who really loves wisdom, and firmly cherishes this very hope, that he shall nowhere else obtain it in a manner worthy of the name, except in Hades, be grieved at dying, and not gladly go there? We must think that he would gladly go, my friend, if he be in truth a philosopher; for he will be firmly persuaded of this, that he will nowhere else but there attain wisdom in its purity; and if this be so, would it not be very irrational, as I just now said, if such a man were to be afraid of death?"

"Very much so, by Jupiter," he replied.

"But it is right, my friends," he said, "that we should consider this, that if the soul is immortal, it requires our care not only for the present time, which we call life, but for all time; and the danger would now appear to be dreadful, if one should neglect it. For if death were a deliverance from everything, it would be a great gain for the wicked, when they die, to be delivered at the same time from the body, and from their vices together with the soul: but now, since it appears to be immortal, it can have no other refuge from evils, nor safety, except by becoming as good and wise as possible. For the soul goes to Hades, possessing nothing else but its discipline and education, which are said to be of the greatest advantage or detriment to the dead, on the very beginning of his journey thither.

"When the dead arrive at the place to which their daemon leads them severally, first of all they are judged, as well those who have lived well and piously, as those who have not. And those who appear to have passed a middle kind of life, proceeding to Acheron, and embarking in the vessels they have, on these arrive at the lake, and there dwell, and when they are purified, and have suffered punishment for the iniquities they may have committed, they are set free, and each receives the reward of his good deeds, according to his deserts: but those who appear to be incurable, through the magnitude of their offences, either from having committed many and great

sacrileges, or many unjust and lawless murders, or other similar crimes, these a suitable destiny hurls into Tartarus, whence they never come forth. But those who appear to have been guilty of curable, yet great offences, such as those who through anger have committed any violence against father or mother, and have lived the remainder of their life in a state of penitence, or they who have become homicides in a similar manner, these must of necessity fall into Tartarus, but after they have fallen, and have been there for a year, the wave casts them forth, the homicides into Cocytus, but the parricides and matricides into Pyriphlegethon: but when, being borne along, they arrive at the Acherusian lake, there they cry out to and invoke, some those whom they slew, others those whom they injured, and invoking them, they entreat and implore them to suffer them to go out into the lake, and to receive them; and if they persuade them, they go out, and are freed from their sufferings, but if not, they are borne back to Tartarus, and thence again to the rivers, and they do not cease from suffering this until they have persuaded those whom they have injured, for this sentence was imposed on them by the judges. But those who are found to have lived an eminently holy life, these are they, who, being freed and set at large from these regions in the earth, as from a prison, arrive at the pure abode above, and dwell on the upper parts of the earth. And among these, they who have sufficiently purified themselves by philosophy shall live without bodies, throughout all future time, and shall arrive at habitations yet more beautiful than these.

“On account of these things, then, a man ought to be confident about his soul, who during this life has disregarded all the pleasures and ornaments of the body as foreign to his nature, and who, having thought that they do more harm than good, has zealously applied himself to the acquirement of knowledge, and who having adorned his soul not with a foreign but its own proper ornament, temperance, justice, fortitude, freedom, and truth, thus waits for his passage to Hades, as one who is ready to depart whenever destiny shall summon him. You then,” he continued, “Simmias and Cebes, and the rest, will each of you depart at some future time; but now destiny summons me, as a tragic writer would say, and it is nearly time for me to betake myself to the bath; for it appears to me to be better to drink the poison after I have bathed myself, and not to trouble the women with washing my dead body.”

When he had thus spoken, Crito said, “So be it, Socrates, but what commands have you to give to these or to me, either respecting your children, or any other matter, in attending to which we can most oblige you?”

“What I always say, Crito,” he replied, “nothing new; that by taking care of yourselves you will oblige both me and mine, and yourselves, whatever you do, though you should not now promise it; but if you neglect yourselves, and will not live as it were in the footsteps of what has been now and formerly said, even though you should promise much at present, and that earnestly, you will do no good at all.”

“We will endeavour then so to do,” he said; “but how shall we bury you?”

“Just as you please,” he said, “if only you can catch me, and I do not escape from you.” And at the same time smiling gently, and looking around on us, he said; “I cannot persuade Crito, my friends, that I am that Socrates who is now conversing with you, and who methodises each part of the discourse; but he thinks I am he whom he will shortly behold dead, and asks how he should bury me. But that which I sometime argued at length, that when I have drunk the poison I shall no longer remain with

[399 B.C.]

you, but shall depart to some happy state of the blessed, this I seem to have urged to him in vain, though I meant at the same time to console both you and myself. Be ye then my sureties to Crito," he said, "in an obligation contrary to that which he made to the judges; for he undertook that I should remain; but do you be sureties that, when I die, I shall not remain, but shall depart, that Crito may more easily bear it, and when he sees my body either burnt or buried, may not be afflicted for me, as if I suffered some dreadful thing, nor say at my interment that Socrates is laid out, or is carried out, or is buried. For be well assured," he said, "most excellent Crito, that to speak improperly is not only culpable as to the thing itself, but likewise occasions some injury to our souls. You must have a good courage then, and say that you bury my body, and bury it in such a manner as is pleasing to you, and as you think is most agreeable to our laws."

When he had said thus he rose, and went into a chamber to bathe, and Crito followed him, but he directed us to wait for him. We waited, therefore, conversing among ourselves about what had been said, and considering it again, and sometimes speaking about our calamity, how severe it would be to us, sincerely thinking that, like those who are deprived of a father, we should pass the rest of our life as orphans. When he had bathed, and his children were brought to him, for he had two little sons and one grown up, and the women belonging to his family were come, having conversed with them in the presence of Crito, and given them such injunctions as he wished, he directed the women and children to go away, and then returned to us.

And it was now near sunset; for he spent a considerable time within. But when he came from bathing he sat down, and did not speak much afterwards; then the officer of the Eleven came in, and standing near him, said, "Socrates, I shall not have to find that fault with you that I do with others, that they are angry with me, and curse me, when, by order of the archons, I bid them drink the poison. But you, on all other occasions during the time you have been here, I have found to be the most noble, meek, and excellent man of all that ever came into this place; and, therefore, I am now well convinced that you will not be angry with me—for you know who are to blame—but with them. Now, then, for you know what I came to announce to you, farewell, and endeavour to bear what is inevitable as easily as possible." And at the same time, bursting into tears, he turned away and withdrew.

And Socrates, looking after him, said, "And thou, too, farewell; we will do as you direct." At the same time turning to us, he said, "How courteous the man is; during the whole time I have been here he has visited me, and conversed with me sometimes, and proved the worthiest of men; and now how generously he weeps for me. But come, Crito, let us obey him, and let some one bring the poison, if it is ready pounded; but if not, let the man pound it."

Then Crito said, "But I think, Socrates, that the sun is still on the mountains, and has not yet set. Besides, I know that others have drunk the poison very late, after it had been announced to them, and have supped and drunk freely, and some even have enjoyed the objects of their love. Do not hasten then, for there is yet time."

Upon this Socrates replied, "These men whom you mention, Crito, do these things with good reason, for they think they shall gain by so doing, and I too with good reason shall not do so; for I think I shall gain nothing by drinking a little later, except to become ridiculous to myself, in being so

fond of life, and sparing of it when none any longer remains. Go, then," he said, "obey, and do not resist."

Crito having heard this, nodded to the boy that stood near. And the boy having gone out, and stayed for some time, came, bringing with him the man who was to administer the poison, who brought it ready pounded in a cup.

And Socrates, on seeing the man, said, "Well, my good friend, as you are skilled in these matters, what must I do?"

"Nothing else," he replied, "than, when you have drunk it walk about, until there is a heaviness in your legs, then lie down; thus it will do its purpose."

And at the same time he held out the cup to Socrates. And he having received it very cheerfully, neither trembling, nor changing at all in colour or countenance, but, as he was wont, looking steadfastly at the man, said, "What say you of this potion, with respect to making a libation to any one, is it lawful or not?"

"We only pound so much, Socrates," he said, "as we think sufficient to drink."

"I understand you," he said, "but it is certainly both lawful and right to pray to the gods, that my departure hence thither may be happy; which therefore I pray, and so may it be." And as he said this, he drank it off readily and calmly. Thus far, most of us were with difficulty able to restrain ourselves from weeping, but when we saw him drinking, and having finished the draught, we could do so no longer; but in spite of myself the tears came in full torrent, so that, covering my face, I wept for myself, for I did not weep for him, but for my own fortune, in being deprived of such a friend. But Crito, even before me, when he could not restrain his tears, had risen up.

But Apollodorus even before this had not ceased weeping, and then bursting into an agony of grief, weeping and lamenting, he pierced the heart of every one present, except Socrates himself. But he said, "What are you doing, my admirable friends? I, indeed, for this reason chiefly, sent away the women, that they might not commit any folly of this kind. For I have heard that it is right to die with good omens. Be quiet, therefore, and bear up."

When we heard this we were ashamed, and restrained our tears. But he, having walked about, when he said that his legs were growing heavy, lay down on his back; for the man so directed him. And at the same time he who gave him the poison, taking hold of him, after a short interval examined his feet and legs; and then having pressed his foot hard, he asked if he felt it; he said that he did not. And after this he pressed his thighs; and thus going higher, he showed us that he was growing cold and stiff. Then Socrates touched himself, and said, that when the poison reached his heart he should then depart. But now the parts around the lower belly were almost cold; when, uncovering himself, for he had been covered over, he said, and they were his last words, "Crito, we owe a cock to Æsculapius; pay it, therefore, and do not neglect it."

"It shall be done," said Crito, "but consider whether you have anything else to say."

To this question he gave no reply; but shortly after he gave a convulsive movement, and the man covered him, and his eyes were fixed; and Crito perceiving it, closed his mouth and eyes.

This was the end of our friend, a man, as we may say, the best of all of his time that we have known, and moreover, the most wise and just.^c

GROTE'S ESTIMATE OF SOCRATES



GREEK VASE

Thus perished the "*parens philosophiæ*" — the first of ethical philosophers; a man who opened to science both new matter, alike copious and valuable, and a new method, memorable not less for its originality and efficacy, than for the profound philosophical basis on which it rests. Though Greece produced great poets, orators, speculative philosophers, historians, etc., yet other countries, having the benefit of Grecian literature to begin with, have nearly equalled her in all these lines, and surpassed her in some. But where are we to look for a parallel to Socrates, either in or out of the Grecian world? The cross-examining elenchus, which he not only first struck out, but wielded with such

matchless effect, and to such noble purposes, has been mute ever since his last conversation in the prison; for even his great successor Plato was a writer and lecturer, not a colloquial dialectician. No man has ever been found strong enough to bend his bow; much less, sure enough to use it as he did. His life remains as the only evidence, but a very satisfactory evidence, how much can be done by this sort of intelligent interrogation; how powerful is the interest which it can be made to inspire, how energetic the stimulus which it can apply in awakening dormant reason and generating new mental power.

It has been often customary to exhibit Socrates as a moral preacher, in which character probably he has acquired to himself the general reverence attached to his name. This is, indeed, a true attribute, but not the characteristic or salient attribute, nor that by which he permanently worked on mankind. On the other hand, Arcesilaus, and the New Academy, a century and more afterwards, thought that they were following the example of Socrates (and Cicero seems to have thought so too) when they reasoned against everything — and when they laid it down as a system, that against every affirmative position, an equal force of negative argument might be brought up as counterpoise. Now this view of Socrates is, in my judgment, not merely partial, but incorrect. He entertained no such systematic distrust of the powers of the mind to attain certainty. He laid down a clear (though erroneous) line of distinction between the knowable and the unknowable. About physics, he was more than a sceptic; he thought that man could know nothing: the gods did not intend that man should acquire any such information, and therefore managed matters in such a way as to be beyond his ken, for all except the simplest phenomena of daily wants; moreover, not only man could not acquire such information, but ought not to labour after it. But respecting the topics which concern man and society, the views of Socrates were completely the reverse. This was the field which the gods had expressly assigned, not merely to human practice, but to human study and acquisition of knowledge; a field, wherein, with that view, they managed phenomena on principles of constant and observable sequence, so that every man who took the requisite pains might know them.

Nay, Socrates went a step further — and this forward step is the fundamental conviction upon which all his missionary impulse hinges. He thought

that every man not only might know these things, but ought to know them; that he could not possibly act well, unless he did know them; and that it was his imperious duty to learn them as he would learn a profession; otherwise, he was nothing better than a slave, unfit to be trusted as a free and accountable being. Socrates felt persuaded that no man could behave as a just, temperate, courageous, pious, patriotic agent, unless he taught himself to know correctly what justice, temperance, courage, piety, patriotism, etc., really were. He was possessed with the truly Baconian idea, that the power of steady moral action depended upon, and was limited by, the rational comprehension of moral ends and means. But when he looked at the minds around him, he perceived that few or none either had any such comprehension, or had ever studied to acquire it—yet at the same time every man felt persuaded that he did possess it, and acted confidently upon such persuasion. Here, then, Socrates found that the first outwork for him to surmount, was, that universal “conceit of knowledge without the reality,” against which he declares such emphatic war; and against which, also, though under another form of words and in reference to other subjects, Bacon declares war not less emphatically, two thousand years afterwards—“*Opinio copie inter causas inopie est.*”

If then the philosophers of the New Academy considered Socrates either as a sceptic, or as a partisan of systematic negation, they misinterpreted his character, and mistook the first stage of his process—that which Plato, Bacon, and Herschel call the purification of the intellect—for the ultimate goal. The elenchus, as Socrates used it, was animated by the truest spirit of positive science, and formed an indispensable precursor to its attainment.

Though negative in his means, Socrates is strictly positive in his ends; his attack is undertaken only with distinct view to a positive result; in order to shame them out of the illusion of knowledge, and to spur them on and arm them for the acquisition of real, assured, comprehensive, self-explanatory, knowledge—as the condition and guarantee of virtuous practice. Socrates was indeed the reverse of a sceptic; no man ever looked upon life with a more positive and practical eye; no man ever pursued his mark with a clearer perception of the road which he was travelling; no man ever combined, in like manner, the absorbing enthusiasm of a missionary, with the acuteness, the originality, the inventive resource, and the generalising comprehension, of a philosopher.

His method yet survives, as far as such method can survive, in some of the dialogues of Plato. It is a process of eternal value and of universal application. That purification of the intellect, which Bacon signalled as indispensable for rational or scientific progress, the Socratic *elenchus* affords the only known instrument for at least partially accomplishing. However little that instrument may have been applied since the death of its inventor, the necessity and use of it neither have disappeared, nor ever can disappear. There are few men whose minds are not more or less in that state of sham knowledge against which Socrates made war: there is no man whose notions have not been first got together by spontaneous, unexamined, unconscious, uncertified association—resting upon forgotten particulars, blending together *disparates* or inconsistencies, and leaving in his mind old and familiar phrases, and oracular propositions, of which he has never rendered to himself account: there is no man, who, if he be destined for vigorous and profitable scientific effort, has not found it a necessary branch of self-education, to break up, disentangle, analyse, and reconstruct, these ancient mental compounds—and who has not been driven to it by his own lame and solitary efforts, since

the giant of the colloquial elenchus no longer stands in the market-place to lend him help and stimulus.

To hear of any man, especially of so illustrious a man, being condemned to death on such accusations as that of heresy and alleged corruption of youth, inspires at the present day a sentiment of indignant reprobation, the force of which I have no desire to enfeeble. The fact stands eternally recorded as one among the thousand misdeeds of intolerance, religious and political. But the sentiment now prevalent is founded upon a conviction that such matters as heresy and heretical teaching of youth are not proper for judicial cognisance. Even in the modern world, such a conviction is of recent date; and in the fifth century B.C. it was unknown. Socrates himself would not have agreed in it; and all Grecian governments, oligarchical and democratical alike, recognised the opposite. The testimony furnished by Plato is on this point decisive. When we examine the two positive communities which he constructs, in the treatises *De Republica* and *De Legibus*, we find that there is nothing about which he is more anxious, than to establish an unresisted orthodoxy of doctrine, opinion, and education. A dissenting and free-spoken teacher, such as Socrates was at Athens, would not have been allowed to pursue his vocation for a week, in the Platonic republic. Plato would not indeed condemn him to death; but he would put him to silence, and in case of need, send him away. This, in fact, is the consistent deduction, if you assume that the state is to determine what is orthodoxy, and orthodox teaching—and to repress what contradicts its own views. Now all the Grecian states, including Athens, held this principle of interference against the dissenting teacher. In any other government of Greece, as well as in the Platonic republic, Socrates would have been quickly arrested in his career, even if not severely punished; in Athens, he was allowed to talk and teach publicly for twenty-five or thirty years, and then condemned when an old man. Of these two applications of the same mischievous principle, assuredly the latter is at once the more moderate and the less noxious.

Secondly, the force of this last consideration, as an extenuating circumstance in regard to the Athenians, is much increased, when we reflect upon the number of individual enemies whom Socrates made to himself in the prosecution of his cross-examining process. Here were a multitude of individuals, including men personally the most eminent and effective in the city, prompted by special antipathies, over and above general convictions, to call into action the dormant state-principle of intolerance against an obnoxious teacher. If, under such provocation, he was allowed to reach the age of seventy, and to talk publicly for so many years, before any real Meletus stood forward—this attests conspicuously the efficacy of the restraining dispositions among the people, which made their practical habits more liberal than their professed principles.

Thirdly, whoever has read the account of the trial and defence of Socrates, will see that he himself contributed quite as much to the result as all the three accusers united. Not only he omitted to do all that might have been done without dishonour, to insure acquittal—but he held positive language very nearly such as Meletus himself would have sought to put in his mouth. He did this deliberately—having an exalted opinion both of himself and his own mission—and accounting the cup of hemlock, at his age, to be no calamity. It was only by such marked and offensive self-exaltation that he brought on the first vote of the dicastery, even then the narrowest majority, by which he was found guilty: it was only by a still

more aggravated manifestation of the same kind, even to the pitch of something like insult, that he brought on the second vote, which pronounced the capital sentence. Now it would be uncandid not to allow for the effect of such a proceeding on the minds of the dicastery. They were not at all disposed, of their own accord, to put in force the recognised principle of intolerance against him. But when they found that the man who stood before them charged with this offence, addressed them in a tone such as dicasts had never heard before and could hardly bear with calmness, they could not but feel disposed to credit all the worst inferences which his accusers had suggested, and to regard Socrates as a dangerous man both religiously and politically, against whom it was requisite to uphold the majesty of the court and constitution.

In appreciating this memorable incident, therefore, though the mischievous principle of intolerance cannot be denied, yet all the circumstances show that that principle was neither irritable nor predominant in the Athenian bosom; that even a large body of collateral antipathies did not readily call it forth against any individual; that the more liberal and generous dispositions, which deadened its malignity, were of steady efficacy, not easily overborne; and that the condemnation ought to count as one of the least gloomy items in an essentially gloomy catalogue.

Let us add, that as Socrates himself did not account his own condemnation and death, at his age, to be any misfortune, but rather a favourable dispensation of the gods, who removed him just in time to escape that painful consciousness of intellectual decline, which induced Democritus to prepare the poison for himself — so his friend Xenophon goes a step further, and while protesting against the verdict of guilty, extols the manner of death as a subject of triumph; as the happiest, most honourable, and most gracious way, in which the gods could set the seal upon an useful and exalted life.

It is asserted by Diodorus, and repeated with exaggerations by other later authors, that after the death of Socrates the Athenians bitterly repented of the manner in which they had treated him, and that they even went so far as to put his accusers to death without trial. I know not upon what authority this statement is made, and I disbelieve it altogether. From the tone of Xenophon's *Memorabilia*, there is every reason to presume that the memory of Socrates still continued to be unpopular at Athens when that collection was composed. Plato, too, left Athens immediately after the death of his master, and remained absent for a long series of years: indirectly, I think, this affords a presumption that no such reaction took place in Athenian sentiment as that which Diodorus alleges; and the same presumption is countenanced by the manner in which the orator Æschines speaks of the condemnation, half a century afterwards. I see no reason to believe that the Athenian dicasts, who doubtless felt themselves justified, and more than justified, in condemning Socrates after his own speech, retracted that sentiment after his decease.^d

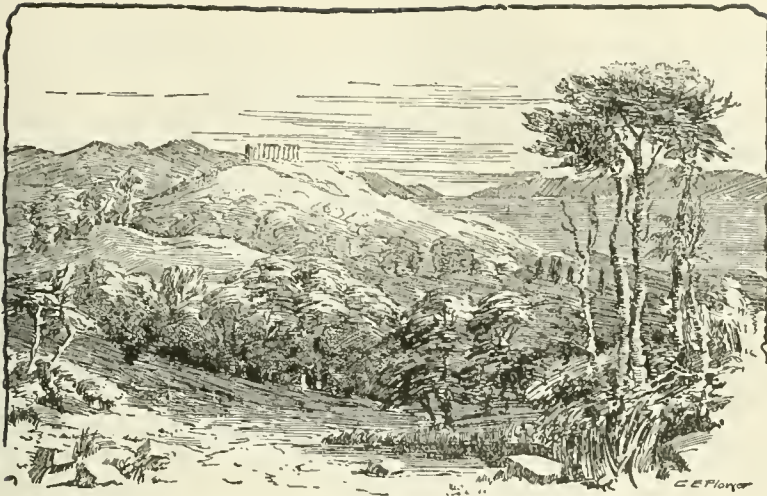

RUINS OF A TEMPLE OF ZEUS

CHAPTER XL. THE RETREAT OF THE TEN THOUSAND

IN the latter years of the Peloponnesian War the affairs of Greece became more than formerly implicated with those of Persia; and, during the short calm which succeeded the long troubles of the former country, some events in the later will require attention. The detail will lead far from Greece; but, beside involving information of Grecian affairs not found elsewhere, it has a very important connection with Grecian history through the insight it affords into circumstances which prepared a revolution effected by Grecian arms, one of the greatest occurring in the annals of the world.

THE AFFAIRS OF PERSIA

By the event of the Peloponnesian War the Asian Greeks changed the dominion of Athens, not for that of Lacedæmon, the conquering Grecian power, but of a foreign, a barbarian master, the king of Persia, then the ally of Lacedæmon. Towards the end of the same year in which a conclusion was put to the war, by the taking of Athens, Darius, king of Persia, the second of the name, died. He was succeeded by his eldest son, Artaxerxes, also the second of his name, and, for his extraordinary memory, distinguished among the Greeks by the addition of Mnemon, "the Mindful." The old king, in his last illness, desirous to see once more his favourite son Cyrus, sent for him from his government in Lydia. The prince, in obeying his father's requisition, travelled in the usual manner of the Eastern great, with a train amounting almost to an army; and, to exhibit in his guard the new magnificence of troops so much heard of in the upper provinces, but never yet seen, he engaged by large pay the attendance of three hundred heavy-armed Greeks, under the command of Xenias of Parrhasia in Arcadia. As a friend and counsellor, he took with him Tissaphernes, satrap of Caria.

On the decease of Darius, which followed shortly, a jealousy, scarcely separable from a despotic throne, but said to have been fomented by the

unprincipled Tissaphernes, induced the new monarch to imprison his brother ; whose death, it was supposed, in course would have followed, but for the powerful intercession of the queen-mother, Parysatis. Restored, through her influence, not only to liberty but to the great command entrusted to him by his indulgent father, Cyrus nevertheless resented highly the indignity he had suffered.

He seems indeed to have owed little to his brother's kindness. Jealous of the abilities and popular character of Cyrus, apprehensive of his revenge, and perhaps not unreasonably also of his ambition, Artaxerxes practised that wretched oriental policy of exciting civil war between the commanders of his provinces, to disable them for making war against the throne. Orontes, a person related to the royal family, governor of the citadel of Sardis was encouraged by the monarch's councils to rebel against that superior officer, under whose immediate authority, by those very councils, he was placed, and ostensibly still required to act. Cyrus subdued and forgave him. A second opportunity occurring, Orontes again rebelled ; again found himself, notwithstanding the secret patronage of the court, unable to support his rebellion ; and, soliciting pardon, obtained from the generosity of Cyrus, not pardon only, but favour. But according to report, to which Xenophon gave credit, the queen-mother herself, Parysatis, whether urged by the known enmity of Artaxerxes to Cyrus, or by whatever other cause, incited her younger son to seek the throne and life of the elder. Thus much, however, appears certain, that, very soon after his return into Asia Minor, Cyrus began preparations with that criminal view. For a pretence, it must be allowed, he seems not to have been totally without what the right of self-defence might afford ; yet his principal motives evidently were ambition and revenge.

The disjointed, tottering, and crumbling state of that empire, which, under the first Darius, appeared so well compacted, and really was so powerful and flourishing, favoured his views. Egypt, whose lasting revolt had been suppressed by the first Artaxerxes, was again in rebellion, and the fidelity of other distant provinces was more than suspected. Within his own extensive vice-royalty, the large province of Paphlagonia, governed by its own tributary prince, paid but a precarious obedience to the Persian throne ; the Mysian and Pisidian mountaineers made open war upon the more peaceful subjects of the plains ; and the Lycaonians, possessing themselves of the fortified places, held even the level country in independency, and refused the accustomed tribute. A large part of Lesser Asia was thus in rebellion, more or less avowed. Hence, on one hand, the attention of the king's councils and the exertion of his troops were engaged ; on the other, an undeniable pretence was ready for Cyrus to increase the military force under his immediate authority.

Cyrus, on his first arrival in the neighbourhood of the Grecian colonies, became, as we have seen, partial to the Grecian character.

As soon as the design against his brother's throne was decided, the younger Cyrus, with increased sedulity, extended his connections among the Greeks. They alone, among the nations of that time, knew how to train armies so that thousands of men might act as one machine. Hence their heavy-armed had a power in the shock of battle that no number of more irregular troops, however brave, could resist. Through the long and extensive war lately concluded, Greece abounded with experienced officers, and with men of inferior rank, much practised in arms, and little in any peaceful way of livelihood. Opportunity was thus ready for raising a force of Grecian mer-

[404-401 B.C.]

cenaries, almost to any amount. What required circumspection was to avoid alarming the court of Susa; and this the defective principles and worse practice of the Persian administration made even easy. Cyrus therefore directed his Grecian commanders, in the several towns, to enlist Greeks, especially Peloponnesians, as many as they could; with the pretence of strengthening his garrisons against the apprehended attempts of Tissaphernes. In Miletus, so the popularity of his character prevailed, a conspiracy was formed for revolting to him; but before it could be carried into effect, it was discovered; and, by the satrap's order, the ringleaders were executed, and many of their adherents banished. Cyrus not only protected the fugitives, but besieged Miletus by land and sea; and this new war furnished an additional pretence for levying troops.

Notwithstanding the character of frankness, honour, and strict regard for truth which Cyrus generally supported, the candour of Xenophon, his friend and panegyrist, has not concealed from us that he could stoop to duplicity when the great interest of his ambition instigated. So far from acknowledging any purpose of disobedience to the head of the empire, he condescended to request from that brother, against whose throne and life his preparations were already directed, the royal authority for adding Ionia to his immediate government. The request was granted; at the instance, it was said, of Parysatis, who preserved much influence with her elder son, while she incited the nefarious views of the younger against him.

Among the many Greeks admitted to the conversation and to the table of Cyrus, was Clearchus, a Lacedæmonian; who, after serving in the armies of his own commonwealth, through the Peloponnesian War, found himself, at the age of fifty, still uneasy in rest. Seeking opportunity for military employment, he thought he had discovered it in the Thracian Chersonesus, where the Greek settlers were harassed by incursions of the neighbouring barbarians; and he persevered in representation and solicitation to the ephors till he obtained a commission for a command there. Hastening his departure, at Corinth an order of recall overtook him. The disappointment was more than he could bear; he resolved to disobey the revered scytale; and proceeded, in defiance of it, to act in pursuance of his commission received. For this he was, in absence, condemned to death; a sentence operating to his banishment for life.

What fair hope now remained to Clearchus does not appear; but the need of military talents, continually and extensively occurring among the various warring commonwealths and scattered colonies of the Greeks, always offered some prospect for adventurers of any considerable military reputation; and, in the moment, a still more inviting field, possibly always in his view, appeared in the court of Cyrus. Thither he went, and, under a forbidding outside, a surly countenance, a harsh voice, and rough manners, the prince discovering in him a character he wanted, after short intercourse, made him a present of ten thousand darics, near eight thousand pounds sterling.

Clearchus did not disappoint this magnificent generosity. Employing the whole of the prince's present in raising troops, he offered, as an individual adventurer, that protection to the Chersonesites which, as a general of the Lacedæmonian forces, he had been commissioned to give, but which the Lacedæmonian government, though claiming to be the protecting power of the Grecian name, had finally refused to afford. His service was accepted; and his success against the barbarians, together with the uncommon regularity and inoffensiveness of his troops in the friendly country, so gratified, not the Chersonesites only, but all the Hellespontine Greeks, that,

while he generally found subsistence at the expense of the enemy, they provided large pay for his army by voluntary contribution. Hence, with a discipline severe sometimes to excess, he preserved the general attachment of those under him; and thus a body of troops was kept in the highest order, ready for the service of Cyrus.

The circumstances of Thessaly afforded another opportunity. Aristippus, a Thessalian of eminence, probably banished by faction, had been admitted to the prince's familiarity. Returning afterwards to his own country, and becoming head of his party, divisions were still such that civil war followed. Then Aristippus thought he might profit from that claim which the ancient doctrine of hospitality gave him upon the generosity of Cyrus. He requested levy-money for two thousand men, with pay for three months. Cyrus granted them for four thousand, and six months; only stipulating that without previous communication with him no accommodation should be concluded with the adverse party. Thus another body of troops, unnoticed, was maintained for Cyrus.

Proxenus, a Theban of the first rank and highest connections, happy in his talents, cultivated under the celebrated Gorgias, of manners to win, and character to deserve esteem, dissatisfied with the state of things in his own city, passed, at the age of towards thirty, to the court of Cyrus, with the direct purpose of seeking employment, honour, and fortune; and, in Xenophon's phrase, of so associating with men in the highest situations that he might earn the means of doing, rather than lie under the necessity of receiving favours. Recommended by such advantages, Proxenus not only obtained the notice, but won the friendship of Cyrus, who commissioned him to raise a Grecian force, pretended for a purpose which the Persian court could not disapprove, the reduction of the rebellious Pisidians.

Thus engaged in the prince's service, it became the care of Proxenus to obtain in his foreign residence the society of a friend, of disposition, acquirements, and pursuits congenial to his own. With this view he wrote to a young Athenian, with whom he had long had intimacy, Xenophon, son of Gryllus, a scholar of Socrates, warmly urging him to come and partake of the prince's favour, to which he engaged to introduce him. In the actual state of things at Athens enough might occur to disgust honest ambition. Xenophon therefore, little satisfied with any prospect there, accepted his friend's invitation; and to these circumstances we owe his beautiful narrative of the ensuing transactions, which remains, like the *Iliad*, the oldest and the model of its kind.

For a Grecian land-force Cyrus contented himself with what might be procured by negotiation with individuals and the allurements of pay. But he desired the co-operation of a Grecian fleet, which, in the existing circumstances of Greece, could be obtained only through favour of the Lacedæmonian government. By a confidential minister therefore, despatched to Lacedæmon, he claimed a friendly return for his assistance in the war with Athens. The ephors, publicly acknowledging the justness of his claim, sent orders to Samius, then commanding on the Asiatic station, to join the prince's fleet, and follow the directions of his admiral, Tamos, an Egyptian.

Preparation being completed, and the advantageous season for action approaching, all the Ionian garrisons were ordered to Sardis, and put under the command of Xenias, the Arcadian, commander of the Grecian guard which had attended Cyrus into Upper Asia. The other Grecian troops were directed to join; some at Sardis, some at places farther eastward. A very large army of Asiatics, whom the Greeks called collectively Barbarians, was

[401 B.C.]

at the same time assembled. The pretence of these great preparations was to exterminate the rebellious Pisidians ; and, in the moment, it sufficed for the troops. It could, however, no longer blind Tissaphernes ; who, not choosing to trust others to report what he knew or suspected, set off, with all the speed that the way of travelling of an Eastern satrap would admit, with an escort of five hundred horse, to communicate personally with the king. Meanwhile Cyrus marched from Sardis, with the forces already collected, by Colossæ to Celænæ in Phrygia, a large and populous town, where he halted thirty days. There he was joined by the last division of his Grecian forces, which now amounted to about eleven thousand heavy-armed, and two thousand targeteers. His Asiatics or barbarians were near a hundred thousand.^b

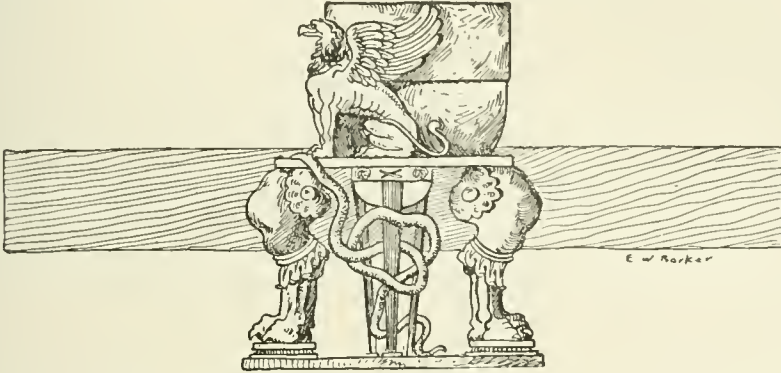

GREEK MARBLE CHAIR

XENOPHON'S ACCOUNT OF CUNAXA

Of the following famous battle-picture, Plutarch wrote glowingly : "Many historians have described this battle ; but Xenophon has done it with such life and energy that we do not read an account of it — we see it and feel all the danger." The praise is not undeserved, and yet as an illuminating example of the mental attitude of the ancient historian with his love of long digressions, it should be noted that in the very midmost of the battle, Xenophon pauses to insert a whole chapter reviewing the life of Cyrus. This chapter is omitted here, the rest of the description being given in the antiquated translation made in 1749 by Edward Spelman.^a

From thence Cyrus proceeded through the Country of Babylon, and in three days' march made twelve Parasangs.¹ When they were arrived at the end of the third day's march, Cyrus reviewed his Forces, both Greeks and Barbarians in a Plain about Midnight (for he expected the King would appear the next Morning, at the Head of his Army, ready to give him Battle), and gave to Clearchus the Command of the right Wing, and to Menon the Thessalian that of the left, while he himself drew up his own Men. After the Review, and as soon as the Day appear'd, there came Deserters from the Great King, who brought Cyrus an account of his Army : then Cyrus, having called together the Generals and Captains of the Greeks, advis'd with them concerning the Order of Battle ; when he encourag'd them by the following Persuasions :

[¹ A parasang was equal to about 3½ English miles.]

“O Greeks! it is not from any want of Barbarians, that I make use of you as my Auxiliaries, but because I look upon you as superior to great Numbers of them; for that reason I have taken you also into my Service: Shew yourselves therefore worthy of that Liberty you enjoy, in the possession of which I think you extremely happy; for be assur'd that I would prefer Liberty before all things I possess. But, that you may understand what kind of Combat you are going to engage in, I shall explain it to you: Their Numbers are great, and they come on with mighty Shouts, which if you can withstand, for the rest I am almost asham'd to think what kind of Men you will find our Country produces. But you are Soldiers; behave yourselves with Bravery, and, if any one of you desires to return home, I will take care to send him back the Envy of his Country; but I am confident that my Behaviour will engage many of you rather to follow my Fortunes, than return home.”

Here Gaulites, a banish'd Samian, a Man of Fidelity to Cyrus, being present, spoke thus: “It is said by some, O Cyrus! that you promise many things now, because you are in such imminent Danger, which, upon any Success, you will not remember; and by others, that, though you should remember your Promises, and desire to perform them, it will not be in your power.”

Cyrus hearing this, said: “Gentlemen! my paternal Kingdom to the South, reaches as far as those Climates that are uninhabitable through Heat, and to the North, as far as those that are so through Cold: Every thing between is under the Government of my Brother's Friends; and, if we conquer, it becomes me to put you, who are my Friends, in possession of it; so that I am under no apprehension, if we succeed, lest I should not have enough to bestow on each of my Friends; I only fear, lest I should not have Friends enow on whom to bestow it. But to each of you Greeks, besides what I have mention'd, I promise a Crown of Gold.” The Officers, hearing these things, espous'd his Cause with greater Alacrity, and made their Report to the rest. After this the Greek Generals, and some of the private Men came to him to know what they had to expect, if they were victorious; all whom he sent away big with hopes: and all who were admitted, advis'd him not to engage personally, but to stand in the Rear. And then it was that Clearchus put this Question to Cyrus: “Are you of Opinion, O Cyrus! that your Brother will hazard a Battle?” “Certainly,” answered Cyrus: “If he is the Son of Darius and Parysatis, and my Brother. I shall never obtain all this without a stroke.”

While the Soldiers were accomplishing themselves for the Action, the number of the Greeks was found to amount to ten thousand four hundred heavy-arm'd Men, and two thousand four hundred Targeteers; and that of the Barbarians in the Service of Cyrus, to one hundred thousand Men, with about twenty Chariots armed with Scythes. The Enemy's Army was said to amount to twelve hundred thousand Men, and two hundred Chariots armed with Scythes: they had besides six thousand Horse, under the Command of Artagerses. These were drawn up before the King. The King's Army was commanded by four Generals, Commanders and Leaders, who had each the Command of three hundred thousand Men; these were Abrocomas, Tissaphernes, Gobryas, and Arbaces. But of this Number nine hundred thousand only were present at the Battle, together with one hundred and fifty Chariots arm'd with Scythes: For Abrocomas coming out of Phœnicia, arriv'd five Days after the Action. This was the Account the Deserters gave to Cyrus before the Battle, which was afterwards confirm'd by the Prisoners. From

[401 B.C.]

thence Cyrus, in one day's March, made three Parasangs, all his Forces, both Greeks and Barbarians, marching in Order of Battle; because he expected the King would fight that day: for in the middle of their March there was a Trench cut five Fathom broad, and three deep. This Trench extended twelve Parasangs upwards, traversing the Plain as far as the Wall of Media. In this Plain are the Canals deriv'd from the River Tigris; they are four in number, each one hundred Feet in breadth, and very deep, and barges laden with Corn sail in them: These Canals fall into the Euphrates; they are distant from one another one Parasang, and have Bridges over them.

Close to the Euphrates, there was a narrow Pass, between the River and the Trench, about twenty Feet in breadth. This Trench the Great King, as soon as he heard Cyrus was marching against him, caus'd to be made by way of Fortification; through this Pass Cyrus and his Army march'd, and were now within the Trench. That day the King did not engage, but many Tracks appear'd both of Horses and Men that retreated. Here Cyrus, sending for Silanus, the Soothsayer of Ambracia, gave him three thousand Daries,¹ because the eleventh Day before that, when he was offering Sacrifice, he told Cyrus that the King would not fight within ten Days: Upon which Cyrus said, "If he does not fight within ten Days, he will not fight at all: And, if what you say proves true, I'll give you ten Talents;" which Sum, the ten Days being expir'd, he then paid him. Since therefore the King had suffer'd the Army of Cyrus to march through this Pass unmolested, both Cyrus and the rest concluded that he had given over all Thoughts of fighting: so that the next Day Cyrus march'd with less Circumspection; and the third day he rode on his Car, very few marching before him in their Ranks, great part of the Soldiers observ'd no Order, many of their Arms being carried in Waggons, and upon sumpter Horses.

It was now about the time of Day, when the Market is usually crowded, the Army being near the place, where they propos'd to encamp, when Patagyas, a Persian, one of those whom Cyrus most confided in, was seen riding towards them full speed, his Horse all in a Sweat, and immediately called to every one he met, both in his own Language, and in Greek, that the King was at hand with a vast Army, marching in Order of Battle. Upon this there was great Confusion, the Greeks and all the rest expecting he would charge them, before they had put themselves in Order: and Cyrus leaping from his Car, put on his Corslet, then mounting his Horse, took his Javelins in his Hand, and order'd all the rest to arm, and every Man to take his Post: They quickly form'd themselves, Clearchus on the right Wing, close to the Euphrates, and next to him Proxenus, and after him the rest: Menon and his Men were posted upon the left of the Greek Army. Of the Barbarians a thousand Paphlagonian Horse, with the Greek Targeteers, stood next to Clearchus on the right. Upon the left Ariæus, Cyrus' Lieutenant-General, was plac'd with the rest of the Barbarians. Cyrus put himself in the Center with six hundred Horse: they had large Corslets, and Cuisses, and all of them Helmets, but Cyrus, who stood ready for the Charge, with his Head unarm'd; they say it is also customary for the rest of the Persians to expose themselves in a day of Action in the same manner: All the Horses in Cyrus' Army had both Frontlets and Breast-plates, and the Horsemen Greek Swords.

[¹ A daric, named after Darius, was a gold coin of about the weight of a sovereign, or five dollars. An Attic talent was valued at about £200 or \$1000.]

It was now the middle of the Day, and no Enemy was yet to be seen. In the Afternoon there appear'd a Dust like a white Cloud, which not long after spread itself like a Darkness over the Plain; when they drew nearer, immediately the brazen Armour flash'd, and their Spears and Ranks appear'd: The Enemy had on their left a Body of Horse arm'd in white Corslets (these were said to be commanded by Tissaphernes), next came those with Persian Bucklers, and next to them heavy-arm'd Men with wooden Shields, reaching down to their Feet (these were said to be Egyptians); then other Horse and other Archers. All these marched according to their respective Countries, each Nation being drawn up in a solid oblong Square: And before them were disposed the Chariots arm'd with Scythes, at a considerable distance from one another. These Chariots had Scythes fix'd aslant at the Axle-Trees, with others under the Body of the Chariot, pointing downwards, that so they might cut asunder every thing they encounter'd. The Design of these Chariots was to break the Ranks of the Greeks.

It now appear'd that Cyrus, when he had exhorted the Greeks to withstand the Shouts of the Barbarians, was mistaken; for they did not come on with Shouts, but as silently and quietly as possible, and in an equal and slow March. Here Cyrus, riding along the Ranks with Pigres the Interpreter, and three or four others, called to Clearchus to bring his Men over-against the Center of the Enemy, because the King was there: And if we break that, says he, our Work is done. But Clearchus observing their Center, and understanding from Cyrus that the King was beyond the left Wing of the Greek Army (for the King was so much superior in number, that, when he stood in the Center of his own Army, he was beyond the left Wing of that of Cyrus) Clearchus, I say, would not however be prevail'd on to withdraw his right from the River, fearing to be surrounded on both sides: but answer'd Cyrus, He would take care that all should go well.

Now the Barbarians came regularly on: and the Greek Army standing on the same Ground, the Ranks were form'd, as the Men came up. In the mean time Cyrus, riding at a small distance before the Ranks, survey'd both the Enemy's Army and his own: Whom Xenophon, an Athenian, observing from the Greek Army, he rode up to him, and ask'd him, whether he had any thing to command; Cyrus, stopping his Horse, order'd him to let them all know, that the Sacrifices and Victims promis'd success. While he was saying this, he heard a Noise running through the Ranks, and ask'd him what Noise it was; Xenophon answer'd, that the Word was now giving for the second time; Cyrus wonder'd who should give it, and ask'd him what the Word was; the other replied, Jupiter the Preserver, and Victory: Which Cyrus hearing, said, I accept it, let That be the Word. After he had said this, he return'd to his Post.

The two Armies being within three or four Stadia of each other, the Greeks sung the Pæan, and advanced: As this Motion occasion'd a small Fluctuation in the Line of Battle, those who were left behind, hasten'd their march, and at once they gave a general Shout, as their Custom is when they invoke the God of War, and all ran on. Some say they struck their Shields with their Pikes to frighten the Enemy's Horses. But the Barbarians, before they came within the Reach of their Darts, turn'd their Horses and fled, and the Greeks pursued them as fast as they could, calling out to one another not to run, but to follow in their Ranks. Here some of the Chariots were borne through their own People without their Charioteers, others through the Greeks, some of whom seeing them coming, divided; while others being amaz'd, like Spectators in the Hippodrome, were taken unawares; but even

[401 B.C.]

these were reported to have received no harm, neither was there any other Greek hurt in the Action, except one upon the left Wing, who was said to have been wounded by an Arrow.

Cyrus seeing the Greeks victorious on their side, and in pursuit of the Enemy, rejoic'd, and was already worshipp'd as King by those about him; however, he was not so far transported as to leave his Post, and join in the Pursuit; but, keeping his six hundred Horse in a Body, he observ'd the King's Motions; well knowing that he was in the Center of the Persian Army: for in all Barbarian Armies, the Generals ever place themselves in the Center, looking upon that Post as the safest, on each side of which their Strength is equally divided, and, if they have occasion to give out any Orders, these are receiv'd in half the time by the Army. The King therefore being at that time in the Center of his own Battle, was, however, beyond the left Wing of Cyrus; and, when he saw none oppos'd him in front, nor any Motion made to charge the Troops that were drawn up before him, he wheel'd to the left, in order to surround their Army. Upon this Cyrus, fearing he should get behind him, and cut off the Greeks, advanc'd against the King, and charging with his six hundred Horse, broke those who were drawn up before him, put the six thousand Men to flight, and, as they say, killed with his own Hand Artagerses, their Commander.

These being broken, the six hundred also belonging to Cyrus dispers'd themselves in the Pursuit, very few being left about him, and those almost all Persons who used to eat at his Table; being accompanied with these, he discovered the King, and those about him, and, unable to contain himself, immediately cried out, I see the Man; then ran furiously at him, and, striking him on the Breast, wounded him through his Corslet, as Ctesias the Physician says, who affirms that he cur'd the Wound. While he was giving the Blow, somebody threw a Javelin at him with great force, and wounded him under the Eye: and now the King and Cyrus engag'd hand to hand, and those about them, in defence of each. In this Action Ctesias (who was with the King) informs us how many fell on his side; on the other, Cyrus himself was killed, and eight the most considerable of his Friends lay dead upon him. When Artapates, who was in the greatest Trust with him of any of his scepter'd Ministers, saw Cyrus fall, they say, he leap'd from his Horse, and threw himself about him: some say, the King order'd Artapates to be slain upon the Body of Cyrus; others, that, drawing his Scimitar, he slew himself: for, he wore a golden Scimitar, a Chain, Bracelets, and other Ornaments, which are worn by the most considerable Persians; and was held in great esteem by Cyrus, both for his Affection and Fidelity.

When Cyrus was dead, his Head and right Hand were cut off upon the spot, and the King, with his Men, in the Pursuit, broke into his Camp; while those with Ariæus, no longer made a stand, but fled through their own Camp to their former Post, which was said to be four Parasangs from the Field of Battle. The King, with his Forces, among many other things, took Cyrus' Mistress, a Phocæan, who was said to be a Woman of great Sense and Beauty. The other, a Milesian, who was the younger of the two, was also taken by the King's Troops, but escap'd naked to the Quarter of the Greeks, who were left to guard the Baggage. These, forming themselves, kill'd many of those who were plundering the Camp, and lost some of their own Men; however, they did not fly, but sav'd the Milesian, with the Men and Effects, and, in general, every thing else that was in their Quarter. By this time the King and the Greeks were at the distance of about thirty Stadia from one another, these pursuing the Enemy that were

opposite to them, as if they had gain'd a complete Victory; and the King's Troops plundering the Camp of the Greeks, as if they also had been every where victorious. But, when the Greeks were inform'd, that the King, with his Men, was among their Baggage, and the King, on his side, heard from Tissaphernes, that the Greeks had put those before them to flight, and were gone forward in the Pursuit, he then rallied his Forces, and put them in order. On the other side, Clearchus consulted with Proxenus, who was nearest to him, whether they should send a Detachment, or should all march to relieve the Camp.

In the mean time the King was observ'd to move forward again, and seem'd resolv'd to fall upon their Rear; upon which the Greeks faced about, and put themselves in a posture to march that way, and receive him. However, the King did not advance that way; But, as before, he pass'd beyond their left Wing, so now he led his Men back the same Way, taking along with him those who had deserted to the Greeks during the Action, and also Tissaphernes with his Forces: for Tissaphernes did not fly at the first Onset, but penetrated with his Horse, where the Greek Targeteers were posted, quite as far as the River: However, in breaking through, he killed none of their Men, but the Greeks, dividing, wounded his People both with their Swords and Darts. Episthenes of Amphipolis commanded the Targeteers, and shewed great conduct upon this occasion.

Tissaphernes, therefore, sensible of his Disadvantage, departed, then; coming to the Camp of the Greeks, he found the King there, and reuniting their Forces, they advanc'd. When they came opposite to the left of the Greeks, these were afraid they should attack their Wing, and, by wheeling to the right and left, annoy them on both sides; to avoid which, they resolv'd to open that Wing, and cover the Rear with the River. While they were consulting upon this, the King marched by them, and drew up his Army opposite to theirs, in the same Order in which he first engag'd. When the Greeks saw them draw near in Order of Battle, they again sung the Pæan, and went on with much more Alacrity than before. However, the Barbarians did not stay to receive them, but fled sooner than the first time: and the Greeks pursued them to a Village. There they halted; for there was an Eminence above the Village, upon which the King's Forces fac'd about. He had no Foot with him, but the Hill was cover'd with Horse in such a manner, that it was not possible for the Greeks to see what was doing: However, they said they saw the royal Ensign there, which was a golden Eagle with its Wings extended, resting upon a Spear.

When the Greeks advanc'd towards them, the Horse quitted the Hill, some running one way, and some another: However, the Hill was clear'd of them by degrees, and at last they all left it. Clearchus did not march up the Hill with his Men, but, halting at the Foot of it, sent Lyeius the Syracusan, and another, with Orders to reconnoitre the place, and make their Report; Lyeius rode up the Hill, and, having view'd it, brought Word that the Enemy fled in all haste. While these things were doing, it grew near Sunset. Here the Greeks halted, and lying under their Arms, rested themselves. In the mean time they wonder'd that neither Cyrus appear'd any where, nor any one from him; for they did not know he was dead; but imagin'd, that he was either led away by the Pursuit, or had rode forward to possess himself of some Post. Hereupon they consulted among themselves, whether they should stay where they were, and send for their Baggage, or return to their Camp. At last they resolv'd to return: And arriv'd at their Tents about Supper-time; And this was the end of that

[401 B.C.]

Day. There they found the greatest part of their Baggage plunder'd, with all the Provisions, and also the Carriages full of Flour and Wine, which Cyrus had prepar'd, in order to distribute them among the Greeks, if at any time his Army should labour under the want of Necessaries. It was said these Carriages amounted to four hundred: which were then all rifled by the King's Troops, so that the greatest part of the Greeks had no Supper, neither had they eaten any Dinner; for, before the Army could halt in order to dine, the King appear'd. And in this Manner they passed the Night.^c



GREEK SEALS

THE RETREAT

When the battle of Cunaxa was over, the Greeks, whose camp meanwhile had been pillaged, rejected the Persian king's demand for unconditional surrender, and, although their numbers by this time were reduced to ten thousand, determined to fight their way through to Asia Minor, a task which involved marching through a hostile country for a distance which measured 1850 miles by the route they had taken from Ephesus to Cunaxa.

Xenophon, one of their leaders, has made this march of the Greeks, which is commonly known as the Retreat of the Ten Thousand, the subject of a separate work. It is one of the most famous military exploits of antiquity and sets the superiority of Greece in the most brilliant light, for the bold and successful enterprise of these ten thousand Greeks does not redound to their glory alone. It is the common possession of their age, their nation, and the culture which it had attained; and marks in the most striking fashion the contrast of the relative values of Persian and Greek civilisation and political institutions. A handful of Greeks bid splendid defiance to the sovereign of the enormous Persian empire, to the sheer bulk of his army, and to all the intrigues of his satraps. It was the victory of Greek subtlety and skill over the rigid and mechanical organisation of Persia, of Greek science over the intellectual poverty of the East, of Greek tactics over Persian confusion; finally, of a genuine sense of honour and patriotic pride over craft, cowardice, and servility.

The route which the Ten Thousand took was not the same by which they had marched to Cunaxa; it lay through Mesopotamia, Media, Armenia, and along the southern shore of the Black Sea to Thrace. The valiant Greeks did not know their way through these countries; they had neither maps nor any trustworthy guide; they had to march through desert and wilderness, to cross mountains and ravines, to pass through barbarous tribes and whole provinces in arms; nevertheless they succeeded in reaching the frontier of their own land with comparatively slight loss.

Soon after they had begun their march, Artaxerxes concluded a treaty with them through the mediation of the satrap Tissaphernes, who had succeeded to the satrapy of Cyrus, in virtue of which they were to be allowed to proceed home undisturbed, escorted by the latter at the head of a Persian

army, and supplied with the requisite provisions by the way. But Tissaphernes kept the Greeks waiting for more than twenty days before he returned from the king's camp, and when at length he did return and set forth with them on their way through Media, he showed himself of so suspicious a temper and fostered such constant and increasing friction between the Greek troops and his own, that at last Clearchus, the Greek commander, begged for an interview with the satrap. This was granted, and Clearchus, confiding in the honour of the hostile leader, went to the Persian camp accompanied by all the twenty-four officers who composed his military council. As soon as they reached it they were treacherously taken prisoners and their guard cut down. They were presently carried off to the royal capital and there put to death together.

The Persians hoped to throw the Greeks into confusion by this treacherous blow, and so vanquish them without much trouble; but they were not a little amazed when (in striking contrast to the spirit and organisation of their own army) a new body of generals and new subordinate officers sprang immediately and, as it were, spontaneously into being from the ranks of the Greek privates and subalterns. For in the Greek army fresh appointments to all posts were made every year; there was no regular promotion and no officer held permanent rank; on the contrary, the man who one year occupied the position of an officer frequently served as a private soldier the next. By this means almost every private soldier was qualified to step into the place of an officer, and it was an easy matter to appoint fresh leaders to the large and small divisions of the army. Xenophon, who had hitherto accompanied the march, neither in the capacity of private nor officer, but merely as a friend and comrade of one of the generals, was the first after the treacherous act of Tissaphernes to urge his countrymen not to yield to the Persian demand for submission, but to fight their way sword in hand through the enemy's country. Only one of the colonels and captains who gathered about him demurred to his proposal. This aroused the suspicions of the rest, and, marking him more narrowly, they perceived by his pierced ears that he was by birth no Greek but a Persian. He was promptly expelled, and Xenophon and four others were appointed to succeed the generals captured by the Persians.

From that day forward Xenophon was the soul of the Greek army, which owed its ultimate deliverance to him and in whom it rightly reposed absolute confidence. He was prudent enough not to command in his own name, but in that of Chirisophus of Sparta, though the latter was wholly devoid of the capacity and knowledge requisite for leading his countrymen home through the heart of the Persian empire. Xenophon's motive in this was, on the one hand, to avoid making himself obnoxious to the Spartans, who had become masters of Greece by the Peloponnesian War, and on the other, to keep his own people under stricter discipline through the terror of a Spartan leader. Directed by an admirable tactical skill, which was equal to every fresh demand of place or circumstance, the Greeks continued their march, perpetually pursued and harassed by the Persians, to the rugged and inhospitable mountain country about the Upper Tigris. Here they came in contact with the fierce and warlike tribe of the Carduchi, who, like the Kurds of to-day who may be their descendants, had never been conquered, and who rejected all overtures for permission to pass through their territory in peace. The Persians, not daring to venture farther, now gave up the pursuit of the Ten Thousand, and the latter marched into the rugged and precipitous country of the Carduchi, and in spite of the constant attacks of the inhab-

[401 B.C.]

itants succeeded by the superiority of their military discipline and experience in reaching the other side of the mountain range and the frontiers of Armenia in seven days. This march through the country of the Carduehi was the most arduous part of their journey and cost them more loss and suffering than all the attacks of the Persian army.^e We turn again to the vivid description in Xenophon's own words as Englished by Spelman.

XENOPHON'S PICTURE OF THE HARDSHIPS

In the country of the Taochians, their Provisions began to fail them : For the Taochians inhabited Fastnesses, into which they had convey'd all their Provisions. At last the army arriv'd at a strong Place, which had neither City nor Houses upon it, but where great Numbers of Men and Women with their Cattle were assembled. This Place Chirisophus order'd to be attack'd the Moment he came before it, and, when the first Company suffer'd another went up, and then another ; for the Place being surrounded with Precipices, they could not attack it on all Sides at once. When Xenophon came up with the Rear-Guard, the Targeteers and heavy-arm'd Men, Chirisophus said to him, "You come very seasonably, for this Place must be taken, otherwise the Army will be starved."

Upon this they call'd a Council of War, and Xenophon demanding, what could hinder them from carrying the Place ; Chirisophus answer'd, "there is no other Access to it but This, and, when any of our Men attempt to gain it, they roll down Stones from the impending Rock, and those they light upon are treated as you see"; pointing at the same time to some of the Men, whose Legs and Ribs were broken. "But," says Xenophon, "when they have consum'd all the Stones they have, what can hinder us then from going up? For I can see nothing to oppose us, but a few Men, and of these not above two or three that are arm'd. The Space, you see, through which we must pass expos'd to these Stones, is about one hundred and fifty Feet in Length, of which that of one hundred Feet is cover'd with large Pines, growing in Groups, against which, if our Men place themselves, what can they suffer, either from the Stones that are thrown, or rolled down by the Enemy? The remaining Part of this Space is not above fifty Feet, which, when the Stones cease, we must dispatch with all possible Expedition." "But," says Chirisophus, "the Moment we offer to go to the Place that is cover'd with the Trees, they will shower down Stones upon us." "That," replies Xenophon, "is the very Thing we want, for by this Means they will be consum'd the sooner. However," continues he, "let us, if we can, advance to that Place, from whence we may have but a little Way to run, and from whence we may also, if we see convenient, retreat with Ease."

Upon this, Chirisophus and Xenophon, with Callimachus of Parrhasia, one of the Captains, advanced (for the last had the command that Day of the Captains in the Rear), all the rest of the Officers standing out of Danger. Then about seventy of the Men advanc'd under the Trees, not in a Body, but one by one, each sheltering himself as well as he could : While Agasias the Stymphalian and Aristonymus of Methyria, who were also Captains belonging to the Rear, with some others, stood behind, without the Trees, for it was not safe for more than one Company to be there. Upon this Occasion Callimachus made Use of the following Stratagem. He advanc'd two or three Paces from the Tree under which he stood ; but, as soon as the Stones began to fly, he quickly retir'd, and, upon every Excursion, more than

ten Cart-Loads of Stones were consum'd. When Agasias saw what Callimachus was doing, and that the Eyes of the whole Army were upon him, fearing lest he should be the first Man who enter'd the Place, he, without giving any Notice to Aristonymus, who stood next to him, or to Eurylochus, of Lusias, both of whom were his friends, or to any other Person, advanc'd alone, with a Design to get before the rest. When Callimachus saw him passing by, he laid hold of the Border of his Shield. In the mean Time Aristonymus, and, after him, Eurylochus ran by them both: For all these were Rivals in Glory, and in constant Emulation of each other. And, by contending thus, they took the Place: For, the Moment one of them had gain'd the Aseent, there were no more Stones thrown from above.

And here followed a dreadful Spectacle indeed; for the Women first threw their Children down the Precipice, and then themselves. Then Men did the same. And here Æneas the Stymphalian, a Captain, seeing one of the Barbarians, who was richly dress'd, running with a Design to throw himself down, caught hold of him, and the other drawing him after, they both fell down the Precipice together, and were dashed to Pieces. Thus we made very few Prisoners, but took a considerable Quantity of Oxen, Asses, and Sheep.

From thence the Greeks advanc'd, through the Country of the Chalybians, and, in seven Marches, made fifty Parasangs. These being the most valiant People they met with in all their March, they came to a close engagement with the Greeks. They had linen Corslets that reach'd below their Navel, and, instead of Tassels, thick Cords twisted. They had also Greaves and Helmets, and at their Girdle a short Faulehion, like those of the Lacedæmonians, with which they cut the Throats of those they over-power'd, and afterwards, cutting off their Heads, carried them away in Triumph. It was their Custom to sing and dance, whenever they thought the Enemy saw them. They had Pikes fifteen Cubits in length, with only one Point. They staid in their Cities till the Greeks march'd past them, and then followed harassing them perpetually. After that they retir'd to their strong Holds, into which they had conveyed their Provisions: So that the Greeks could supply themselves with nothing out of their Country, but liv'd upon the Cattle they had taken from the Taoehians.

They now came to the River Harpasus, which was four hundred Feet broad. And from thence advanc'd through the Country of the Seythinians, and, in four Days' March, made twenty Parasangs, passing through a Plain into some Villages; in which they staid three Days, and made their Provisions. From this Place they made, in four Days' March, twenty Parasangs, to a large and rich City well inhabited: It was called Gymnias. The Governour of this Country sent a Person to the Greeks, to conduct them through the Territories of his Enemies. This Guide, coming to the Army, said he would undertake, in five Days, to carry them to a Place, from whence they should see the Sea. If not, he consented to be put to death. And, when he had conducted them into the Territories belonging to his Enemies, he desired them to lay waste the Country with Fire and Sword. By which it was evident that he came with this View, and not from any Good-will he bore to the Greeks. The fifth Day they arriv'd at the holy Mountain called Theches. As soon as the Men, who were in the Vanguard, ascended the Mountain, and saw the Sea, they gave a great Shout, which, when Xenophon and those in the Rear, heard, they concluded that some other Enemies attack'd them in Front, for the People belonging to the Country they had burn'd, follow'd their Rear, some of whom those who had Charge of it, had

[401-399 B.C.]

killed, and taken others Prisoners in an Ambuscade. They had also taken twenty Bucklers made of raw Ox-hides with the hair on.

The Noise still increasing as they came nearer, and the Men, as fast as they came up, running to those who still continued Shouting, their Cries swelled with their Numbers, so that Xenophon, thinking something more than ordinary had happen'd, mounted on Horse-back, and, taking with him Lyeius and his Horse, rode up to their Assistance: And presently they heard the Soldiers calling out "The Sea! The Sea!" and cheering one another. At this they all set a running, the Rear-guard as well as the rest, and the Beasts of Burden, and Horses were driven forward. When they were all come up to the Top of the Mountain, they embraced one another, and also their Generals and Captains with Tears in their Eyes. And Immediately the Men, by whose Order it is not known, bringing together a great many Stones, made a large Mount, upon which they plac'd a great Quantity of Shields made of raw Ox-hides, Staves, and Bucklers taken from the Enemy. The Guide himself cut the Bucklers in Pieces, and exhorted the rest to do the same. After this the Greeks sent back their Guide, giving him Presents out of the publick Stock, these were a Horse, a silver Cup, a Persian Dress, and ten Daries. But, above all Things the Guide desir'd the Soldiers to give him some of their Rings, many of which they gave him. Having therefore shewn them a Village, where they were to Quarter, and the Road that led to the Maconians, when the Evening came on, he departed, setting out on his Return that Night.^c

END OF THE MARCH

At length, four months after the battle of Cunaxa, they entered Trapezus, the first Greek city they came to, and celebrated their safe arrival among their kindred with sacrifices and games. From this point they continued their retreat, some by sea and some by land. But when the air of Greece breathed upon them once more and the fear of the barbarians was overpast, discord and greed crept in amongst them, and they proved such troublesome guests that even the inhabitants of the Greek colonies along the southern shore of the Black Sea tried to get rid of them as speedily as possible. Making many raids in search of booty and suffering no small loss on the way, they came through Bithynia to Byzantium, and thence proceeded to the interior of Thrace, where Seuthes, who then ruled the country, engaged the rude and bellicose adventurers into whom the remnant of the Ten Thousand had degenerated. For some months they assisted him to extend his sovereignty over various Thracian tribes. Finally they were enlisted by the Spartans, who were then at war with the Persian empire, and so went back to Asia.

The remnant of the whole force amounted to six thousand men, the distance they had traversed from the battle-field of Cunaxa to about the middle of the south coast of the Black Sea to not less than two thousand miles. This they had done in eight months. But the whole march, from Ephesus to Cunaxa and thence to this region on the Black Sea, occupied fifteen months (from February, 401, to the beginning of June, 400 B.C.), and the march from the latter place to the spot where they joined the Spartan army in Asia Minor (March, 399 B.C.) took nine months.

Xenophon, who had rendered the most conspicuous service on this memorable march, returned to Greece after he had led the remnant of the Ten Thousand to the Spartan army in Asia Minor. Some years later he took

part in the expedition against the Persians conducted by his friend the Spartan king, Agesilaus, and after the return of the latter fought at the battle of Coronea. While he was in Asia with Agesilaus he was banished from his native city by a vote of the people, because he had taken part in a war against the Persian king, who was at that time an ally of Athens, and because his aristocratic opinions and his preference for the political system of Sparta had earned him the hatred of the demagogues and the jealousy of the populace. After the battle of Coronea he accompanied Agesilaus to Sparta and remained there for a while, and then settled on a country estate in the neighbourhood of Olympia, which he had either received as a gift from the Spartans or bought with the great wealth he had amassed in Asia. Here and in Corinth he wrote some part of his works. The sentence of banishment from Athens was soon repealed, but it does not seem probable that he ever returned to his native city, though at a later time he induced his son Gryllus to take part in one of the military expeditions of the Athenians. Gryllus fell at the battle of Mantinea, and the story goes that the news of his death was brought to his aged father as he was standing by an altar, sacrificing to the gods. Xenophon was crowned with a garland, in accordance with the Greek custom of wearing wreaths upon festal occasions. He immediately took it from his head, but received the news of his son's death with the utmost composure, saying that he knew he had only begotten a mortal. When he was told that Gryllus had fought with great valour, he put the garland on again, finished his sacrifice, and added to it a prayer in which he gave thanks to the gods for his son's worthiness. Xenophon died at Corinth in (355 B.C.) the ninetyeth year of his age.^e

THE MEANING OF XENOPHON'S FEAT

The world has never ceased to thrill with a sympathetic memory of that glad cry of Xenophon's Ten Thousand, "*Thalatta! Thalatta!*" (The sea! The sea!) It has a kinship with the feelings of the foot-sore and heart-sore children of Israel reaching the edge of the Promised Land. It stands out from above the usual crises of history as a temple dome above a town. It takes its place among such peaks of emotion as the view that Attila took of Rome, and the crusaders of the minarets of Jerusalem, the cry of "Land ho!" on the ships of Columbus. It finds a strangely modern parallel in the first ocean-glimpse of the American soldiers in Sherman's march to the sea.

Like all these picturesque incidents, it meant more than a merely dramatic moment to the history of mankind. It was a prelude in Greek history to the triumph of Alexander. It showed to the Greeks that their ambitions need not be confined to the small parishes they had dwelt in. It revealed the fact that the great realm of the Persian monarch, whom the Greeks always referred to as "The King," was like Dead Sea fruit: brilliant in its shell, and hollow corruption at core. The only impetus the Greeks had felt towards a Panhellenic spirit had been inspired by the imminence of the Persian danger. They had with small bands of patriots dispersed the droves of oriental subjects brought against them, and yet they could not have dreamed that their success in an offensive war would be equal to the glory of the defensive struggle.

But here was a lessening body of ten thousand Greeks, bound together by no common sentiment except a desire for money — which they did not get. And this comparative handful of mercenaries had ransacked the very

[401-399 B.C.]

innermost recesses of the Persian empire, and had never found an army great enough or brave enough to withstand it in open assault. The conquest of such an empire seemed to be within the grasp of any Greek commander. The first to attempt it was a second-rate Spartan king, Agesilaus, who failed. And the Persian empire resisted attack for five generations more, till the new blood of Macedonia and the unlimited ambitions of Alexander made the attempt. Until he came, the blows of the others were only so much callisthenies. When he came he was not loath to acknowledge, on the eve of the battle of Issus, the inspiration he owed to the feat of the Ten Thousand.

Meanwhile, without reference to its remote bearings, the anabasis and catabasis of Xenophon's army stand forth glorious in themselves. He himself sums up the achievement baldly at the conclusion of his work.

"The governors of The King's country, as much of it as we went through, were these: of Lydia, Artemas; of Phrygia, Artacamas; of Lycaonia and Cappadocia, Mithridates; of Cilicia, Syennesis; of Phœnicia and Arabia, Dernes; of Syria and Assyria, Belesys; of Babylon, Rhoparas; of Media, Arbaces; of the Phasiani and Hesperitæ, Tiribazus; the Carduchi, the Chalybes, the Chaldeans, the Macrones, the Colchians, the Mosynœci, the Cœtæ, and the Tibareni, were independent nations; of Paphlagonia, Corylas; of the Bithynians, Pharnabazus; and of the Thracians in Europe, Seuthes.

"The computation of the whole journey, the anabasis and catabasis, was 215 days' march, 1155 parasangs, 34,650 stadia. The length of time occupied in the anabasis and catabasis was one year and three months."

Reckoning the parasang at three and two-fifths miles, the total distance covered would therefore be 3927 miles in the course of fifteen months. The manuscripts do not all agree with regard to the numbers, but the total march may be accepted as nearly four thousand miles, through a country bristling with hostility and treachery, a country unmapped and unknown to the Greeks. This exploit of what might well be termed a pack of desperadoes looms high in history, both as an absolute feat of bravado and as a finger-post for Grecian ambition.^a

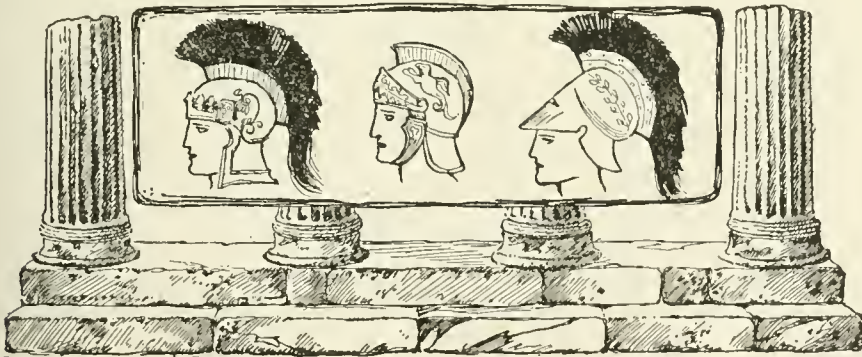



GREEK MEDAL

CHAPTER XLI. THE SPARTAN SUPREMACY

THERE is an inevitable bias in the minds of most people towards the brilliant and refined ideals of Athens as opposed to the obstinate and barren creed of the Spartans. We have heard, therefore, more of the Athenian side than of the Spartan in their wars together. As we approach a period of Spartan glory, it is well to make a quick review and summary of her ideals and achievements down to this period, when, as the Spartophile Müller notes, Sparta won her advancement by discarding her venerable creeds. What follows must be read with the knowledge that it is from the pen of a Spartan partisan.^a

Sparta, by the conquest of Messenia and Tegea, had obtained the first rank in the Peloponnese, which character she confirmed by the expulsion of the tyrants, and the overthrow of Argos. From about the year 580 B.C. she acted as the recognised commander, not only of the Peloponnese, but of the whole Greek name. The confederacy itself, however, was formed by the inhabitants of that peninsula alone, on fixed and regular laws; whereas the other Greeks only annexed themselves to it temporarily. The order of precedence observed by the members of this league may be taken from the inscription on the footstool of the statue of Jupiter, which was dedicated at Olympia after the Persian War, the Ionians, who were only allied for a time, being omitted. It is as follows: Lacedæmon, Corinth, Sicyon, Ægina, Megara, Epidaurus, Tegea, Orchomenos, Phlius, Trœzen, Hermione, Tiryns, Mycenæ, Lepreum, and Elis; which state was contented with the last place, on account of the small share which it had taken in the war.

The defenders of the isthmus are enumerated as follows: Lacedæmonians, Arcadians, Eleans, Corinthians, Sicyonians, Epidaurians, Phliasians, Trœzenians, and Hermionians, nearly agreeing with the other list, only that the Arcadians, having been present with their whole force, and also the Eleans, occupy an earlier place; and the Megarians and Æginetans are omitted, as having had no share in the defence. This regular order of precedence is alone a proof of a firm union. The Tegeatæ, since they had joined the side of Lacedæmon, enjoyed several privileges, and especially the place of honour at the left wing of the allied army. Argos remained excluded from the nations of the Peloponnesus, as it never would submit to the command of Sparta; the Achæans, indifferent to external affairs, only joined themselves momentarily to the alliance: but the Mantineans, though latterly they followed the policy of Argos, were long attached to the Peloponnesian league; for at the end of the Persian War they sent an army, which arrived too late for the battle of Plataea: having before, together with the other Arcadians, helped to defend the isthmus; they had also been engaged in the first days

[480-432 B.C.]

of the action at Thermopylæ, and they were at this time still the faithful allies of the Lacedæmonians. Their subsequent defection from Sparta may be attributed partly to their endeavours to obtain the dominion of Parrhasia, which was protected by Lacedæmon, to their hostility with Tegea, which remained true to Sparta after the great war with Arcadia, which began about 470 B.C., and to the strengthening of their city, and the establishment of a democratic government, through the influence of Argos.

The supremacy of Sparta was exercised in the expeditions of the whole confederacy, and in transactions of the same nature. In the first, the Spartan king — after it had been thought proper never to send out two together — was commander-in-chief, in whose powers there were many remains of the authority of the ancient Homeric princes. Occasionally, however, Sparta was compelled to give up her privilege to other commanders, especially at sea, as, for instance, the fleet at Salamis to Eurybiades. When any expedition was contemplated, the Spartans sent round to the confederate states, to desire them to have men and stores in readiness. The highest amount which each state could be called on to supply was fixed once for all, and it was only on each particular occasion to be determined what part of that was required. In like manner the supplies in money and stores were regularly appointed; so that an army, with all its equipment, could be collected by a simple summons. But agricultural labour, festivals, and the natural slowness of the Doric race, often very much retarded the assembling of this army. The contributions, chiefly perhaps voluntary, both of states and individuals, were registered on stone: and there is still extant an inscription, found at Tegea, in which the war-supplies of the Ephesians, Melians, etc., in money and in corn, are recorded. But the Lacedæmonians never exacted from the Peloponnesian confederacy a regular annual contribution, independent of circumstances; which would have been, in fact, a tribute: a measure of this kind being once proposed to King Archidamus, he answers, "that war did not consume according to rule."

Pericles, however, properly considers it as a disadvantage to the Peloponnesians that they had no paid troops, and that they had amassed no treasure. The object of an expedition was publicly declared: occasionally, however, when secrecy was required, it was known neither to the states nor to their army. The single allied states, if necessity demanded it, could also immediately summon the army of the others; but it is not clear to what extent this call was binding upon them. The Spartan military constitution, which we will explain hereafter, extended to the whole allied army; but it was doubtless variously combined with the tactics of the several nations. To the council of war, which, moreover, only debated, and did not decide, the Spartan king summoned the leaders of the several states, together with other commanders, and generally the most distinguished persons in the army.

According to the constitution of the Peloponnesian league, every common action, such as a declaration of war, or the conclusion of a peace or treaty, was agreed on at a congress of the confederates. But, as there was no regular assembly of this kind, the several states sent envoys (*ἄγγελοι*), like the deputies (*πρόβουλοι*), of the Ionians, who generally remained together only for a short time. All the members had legally equal votes (*ισόψηφοι*); and the majority sometimes decided against a strong opposition; Sparta was often outvoted, Corinth being at all times willing to raise an opposition. We have, however, little information respecting the exact state of the confederacy; it is probable, from the aristocratic feelings of the Peloponnesians,

that, upon the whole, authority had more weight than numbers; and for great undertakings, such as the Peloponnesian War, the assent of the chief state was necessary, in addition to the agreement of the other confederates. When the congress was summoned to Sparta, the envoys often treated with a public assembly of the Spartans.

But upon the internal affairs, laws, and institutions of the allied states, the confederacy had legally no influence. It was a fundamental law that every state should, according to its ancient customs, be independent and supreme; and it is much to the credit of Sparta, that, so long as the league was in existence, she never, not even when a favourable opportunity offered, deprived any Peloponnesian state of this independence. Nor were disputes between individual states brought before the congress of the allies, which, on account of the preponderance of Sparta, would have endangered their liberty; but they were commonly either referred to the Delphian oracle, or to arbitrators chosen by both states. For disputes between citizens of different states there was an entirely free and equal intercourse of justice. The jurisdiction of the states was also absolutely exempt from foreign interference. These are the chief features of the constitution of the Peloponnesian confederacy; the only one which in the flourishing times of Greece combined extensive powers with justice, and a respect for the independence of its weaker members.

Sparta had not become the head of this league by agreement, and still less by usurpation; but by tacit acknowledgment she was the leader, not only of this, but of the whole of Greece; and she acted as such in all foreign relations from about the year 580 B.C. Her alliance was courted by Cræsus: and the Ionians, when pressed by Cyrus, had recourse to the Spartans, who, with an amusing ignorance of the state of affairs beyond the sea, thought to terrify the king of Persia by the threat of hostilities. It is a remarkable fact, that there were at that time Scythian envoys in Sparta, with whom a great plan of operations against Persia is said to have been concerted. In the year 520 B.C. the Platæans put themselves under the protection of Cleomenes, who referred them to Athens; a herald from Sparta drove the Alcæonidæ from their city: afterwards Aristagoras sought from the protector of Greece aid against the national enemy: and when the Æginetans gave the Persians earth and water, the Athenians accused them of treachery before the Spartans: and lastly, during the Persian War, Greece found in the high character of that state the only means of effecting the union so necessary for her safety and success.

In this war a new confederacy was formed, which was extended beyond the Peloponnese; the community of danger and of victory having, besides a momentary combination, also produced a union destined for some duration. It was the assembly of this league—a fixed congress at Corinth during, and at Sparta after, the war—that settled the internal differences of Greece, that invited Argos, Coreyra, and Gelo to join the league, and afterwards called upon Themistocles to answer for his proceedings. So much it did for the present emergency. But at the same time Pausanias, the regent of Sparta, after the great victory of Platæa, prevailed upon the allies to conclude a further treaty. Under the auspices of the gods of the confederacy, particularly of the Eleutherian (or Grecian) Jupiter, they pledged themselves mutually to maintain the independence of all states, and to many other conditions, of which the memory has been lost. To the Platæans in particular security from danger was promised. The Ionians also, after the battle of Mycale, were received into this confederacy.

[479-465 B.C.]

The splendid victories over the Persians had for some time taken Sparta, which was fitted for a quiet and passive existence, out of her natural sphere; and her king, Pausanias, had wished to betray his country for the glitter of an Asiatic prince. But this state soon perceived her true interest, and sent no more commanders to Asia, "that her generals might not be made worse": she likewise wished to avoid any further war with the Persians, thinking that Athens was better fitted to carry it on than herself. If the speech were now extant in which Hetoëmaridas the Heraclid proved to the councillors that it was not expedient for Sparta to aim at the mastery of the sea, we should doubtless possess a profound view, on the Spartan side, of those things which we are now accustomed to look on with Athenian eyes. Nor is it true that the supremacy over the Greeks was in fact transferred at all from Sparta to Athens, if we consider the matter as Sparta considered it, however great the influence of this change may have been on the power of Athens. But Sparta continued to hold its pre-eminence in the Peloponnese, and most of the nations of the mother-country joined themselves to her: while none but the Greeks of Asia Minor and the islands, who had previously been subjects of Persia, and were then only partially liberated, perhaps

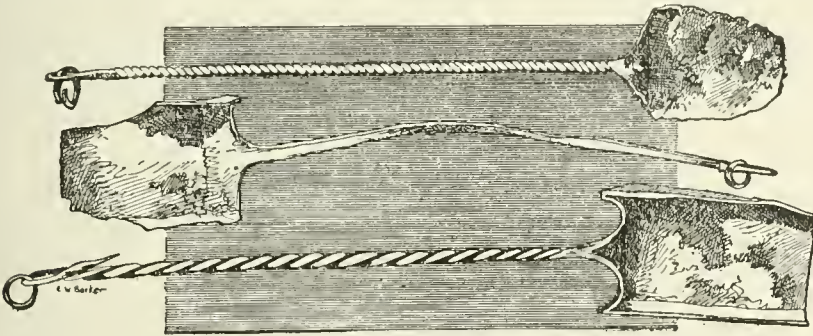

GREEK SHOVELS
(In the British Museum)

too much despised by Sparta, put themselves under the command of Athens. But the complete liberation of Asia Minor from the Persian yoke, which has been considered one of the chief exploits of Athens, was in fact never effected. The Athenian empire did not prevent the vassals and subjects of the king of Persia from ruling over the Greeks of Asia Minor, even down to the very coast. We need not go any further to prove the entire falsehood of the account commonly given by the panegyrical rhetoricians of Athens.

The Peloponnese took the less concern in these proceedings, as internal differences had arisen from some unknown cause, which led to an open war between Sparta and Arcadia. We only know that, between the battle of Platea (in which Tegea, as also later still, showed great fidelity towards Sparta) and the war with the Helots (*i.e.* between 479 and 465 B.C.), the Lacedæmonians fought two great battles, the one against the Tegeatæ and Argives at Tegea, the other against all the Arcadians, with the exception of the Mantineans, at Dipæa (*ἐν Διπαιέσιν*), in the Mænalian territory. Tisamenus, an Elean, of the family of the Iamidæ, was in both battles in the Spartan army; and in both Sparta was victorious.

This war had not been brought to a termination, when, in the year 465 B.C., a tremendous earthquake destroyed Sparta, and a sudden ruin threatened to

overwhelm the chief state of Greece. For, in the hope of utterly annihilating their rulers, many helots revolted, and the war was called the Third Messenian War. Upon this the Lacedæmonians, foreseeing a tedious siege, called in the aid of their allies; and this call was answered among others by the Athenians; the Spartans, however, dismissed them, as we have seen, before the fortress was taken.

Immediately after the dismissal of the Athenians from Ithome, the injured people of Athens annulled the alliance with Sparta, which had subsisted since the Persian War. Then followed the war with the maritime towns of Argolis, in which Athens, after many reverses, at length succeeded in destroying the fleet of Ægina, and subjugating that island (457 B.C.). The inactivity of Sparta during these astonishing successes of her enemy (for when she concluded the armistice with Athens she must have partly foreseen its consequences) seems to prove that she was entirely occupied with the final capture of Ithome, and the settlement of her interests in Arcadia.

The five years' truce in 451 B.C. was only an armistice between Athens and the Peloponnesian confederacy, which left Bœotia to shake off the Athenian yoke by her own exertions. At the end of these five years Megara revolted from the Athenians, and in consequence an invasion of Attica by the Peloponnesians took place, which, though it did not produce any immediate result, was soon followed by the Thirty Years' Truce, in which Athens ceded her conquests in Megaris and the Peloponnese, and on the mainland returned within her ancient boundaries.

If now we consider the events which have been briefly traced it will be perceived, that the principle on which the Lacedæmonians constantly acted was one of self-defence, of restoring what had been lost, or preserving what was threatened with danger; whereas the Athenians were always aiming at attack or conquest, or the change of existing institutions. While the Spartans during this period, even after the greatest victories, did not conquer a foot of land, subjugate one independent state, or destroy one existing institution; the Athenians, for a longer or for a shorter time, reduced large tracts of country under their dominion, extended their alliance (as it was called) on all sides, and respected no connection when it came in conflict with their plans of empire.

But the astonishing energy of the Athenians, which from one point kept the whole of Greece in constant vibration, almost paralysed Sparta; the natural slowness of that state became more and more apparent: which having been, as it were, violently transplanted into a strange region, only began by degrees to comprehend the policy of Athens. It is manifest that the maxims of the Athenian policy were directly at variance with the general feeling of justice entertained by the Greeks, and especially to the respect for affinity of blood; and this fundamental difference was the true cause of the Peloponnesian War. In the first place then, Dorians were opposed to Ionians; and hence in the well-known oracle it was called the Doric War. It was a union of the free Greeks against the evil ambition of one state: of land forces against sea forces: the fleet of the Peloponnesians was at the beginning of the war very inconsiderable. Hence it was some time before the belligerent parties even so much as encountered one another; the land was the means of communication for one party, the sea for the other: hence the states friendly to Athens were immediately compelled to build Long Walls for the purpose of connecting the chief city with the sea, and isolating it from the land. Large bodies of men practised in war fought against

[460-405 B.C.]

wealth: the Peloponnesians carried on the war with natives; whereas Athens manned her fleet — the basis of her power — chiefly with foreign seamen; so that the Corinthians said justly that the power of Athens was rather purchased than native. It was the main principle of Pericles' policy, and it is also adopted by Thucydides in the famous introduction to his *History*, that it is not the country and people, but moveable and personal property in the proper sense of the word, which make states great and powerful. The war meant the maintenance of ancient custom as opposed to the desire for novelty: the former was the chief feature of the Doric, the latter of the Ionic race. The Dorians wished to preserve their ancient dignity and power,



GRECIAN TERRA-COTTA STATUETTE

(In the British Museum)

as well as their customs and religious feelings: the Ionians were commonly in pursuit of something new. It was a union of nations and tribes against one arbitrarily formed: aristocracy was pitted against democracy: this difference was manifested in the first half of the war by Athens changing, while Sparta only restored governments; for in this instance also the power of Sparta was in strictness only employed in upholding ancient establishments, as an aristocracy may indeed be overthrown, but cannot be formed in a moment.

These obvious points of difference are sufficient to substantiate the result which we wish to arrive at. The "honesty and openness" of the Doric character, the noble simplicity of the ancient times of Greece, soon disappeared in this tumultuous age. Sparta therefore and the Peloponnesians emerge from the contest, altered, and as it were reversed; and even before its termination appear in a character of which they had before probably contained only the first seeds.

But in the second half of the war, when the Spartans gave up their great armaments by land, and began to equip fleets with hired seamen; when they had learnt to consider money as the chief instrument of warfare, and begged it at the court of Persia; when they sought less to protect the states joined to them by affinity and alliance, than to dissolve the Athenian confederacy; when they began to secure conquered states by harlots of their own, and by oligarchs forced upon the people, and found that the secret management of the political clubs was more to their interest than open negotiation with

the government; we see developed on the one hand an energy and address, which was first manifested in the enterprises of the great Brasidas, and on the other a worldly policy, as was shown in Gylippus, and afterwards more strongly in Lysander; when the descendants of Hercules found it advisable to exchange the lion's for the fox's skin. And since the enterprises conducted in the spirit of earlier times either wholly failed or else remained fruitless, this new system, though the state had inwardly declined, brought with it, by the mockery of fate, external fame and victory.^b

Whatever nobility of creed the Sparta-loving Müller has, as above, claimed for Sparta up to this time, it is certain that the sudden accession of vast and unforeseen power changed her to a mood in which, as Bury says, "she cynically set aside her high moral professions and yielded to a lust for oppression." Grote was no lover of Sparta and yet he substantiates well his accusations against her.^a

GROTE'S COMPARISON OF SPARTAN AND ATHENIAN RULE

The Spartan empire began with the decisive victory of Ægospotami in the Hellespont (September or October 405 B.C.). The whole power of Athens was thus annihilated, and nothing remained for the Lacedæmonians to master except the city itself and Piræus; a consummation certain to happen, and actually brought to pass in April 404 B.C., when Lysander entered Athens in triumph, dismantled Piræus, and demolished a large portion of the Long Walls. With the exception of Athens herself — whose citizens deferred the moment of subjection by an heroic, though unavailing, struggle against the horrors of famine — and of Samos, no other Grecian city offered any resistance to Lysander after the battle of Ægospotami; which in fact not only took away from Athens her whole naval force, but transferred it all over to him, and rendered him admiral of a larger Grecian fleet than had ever been seen together since the battle of Salamis.

The allies, especially Thebes and Corinth, not only relented in their hatred and fear of Athens, now that she had lost her power — but even sympathised with her suffering exiles, and became disgusted with the self-willed encroachments of Sparta; while the Spartan king Pausanias, together with some of the ephors, were also jealous of the arbitrary and oppressive conduct of Lysander.

We have learned from dark, but well-attested details, to appreciate the auspices under which that period of history called the Lacedæmonian empire was inaugurated. Such phenomena were by no means confined within the walls of Athens. On the contrary, the Year of Anarchy (using that term in the sense in which it was employed by the Athenians) arising out of the same combination of causes and agents, was common to a very large proportion of the cities throughout Greece. The Lacedæmonian admiral Lysander, during his first year of naval command, had organised in most of the allied cities factious combinations of some of the principal citizens, corresponding with himself personally. By their efforts in their respective cities he was enabled to prosecute the war vigorously, and he repaid them, partly by seconding as much as he could their injustices in their respective cities, partly by promising to strengthen their hands still further as soon as victory should be made sure.

In the greater number of cities, he established an oligarchy of ten citizens, or a decarchy, composed of his own partisans; while he at the same

[405-404 B.C.]

time planted in each a Lacedæmonian harmost or governor, with a garrison, to uphold the new oligarchy. The decarchy of ten Lysandrian partisans, with the Lacedæmonian harmost to sustain them, became the general scheme of Hellenic government throughout the Ægean, from Eubœa to the Thracian coast towns, and from Miletus to Byzantium. Lysander sailed round in person with his victorious fleet to Byzantium and Chalcedon, to the cities of Lesbos, to Thasos, and other places — while he sent Eteonicus to Thrace for the purpose of thus recasting the governments everywhere. Not merely those cities which had hitherto been on the Athenian side, but also those which had acted as allies of Sparta, were subjected to the same intestine revolution and the same foreign constraint. Everywhere the new Lysandrian decarchy superseded the previous governments, whether oligarchical or democratical.

In what spirit these new decarchies would govern, consisting as they did of picked oligarchical partisans distinguished for audacity and ambition — who, to all the unscrupulous lust of power which characterised Lysander himself, added a thirst for personal gain, from which he was exempt, and were now about to reimburse themselves for services already rendered to him — the general analogy of Grecian history would sufficiently teach us, though we are without special details. But in reference to this point, we have not merely general analogy to guide us; we have further the parallel case of the Thirty at Athens, the particulars of whose rule are well known and have already been alluded to.

Isocrates, who speaks with indignant horror of these decarchies, while he denounces those features which they had in common with the triacontarchy at Athens — extrajudicial murders, spoliations, and banishments — notices one enormity besides, which we do not find in the latter: violent outrages upon boys and women. Nothing of this kind is ascribed to Critias and his companions; and it is a considerable proof of the restraining force of Athenian manners, that men who inflicted so much evil in gratification of other violent impulses, should have stopped short here. The decemvirs named by Lysander, like the decemvir Appius Claudius at Rome, would find themselves armed with power to satiate their lusts as well as their antipathies, and would not be more likely to set bounds to the former than to the latter. Lysander, in all the overweening insolence of victory, while rewarding his most devoted partisans with an exaltation comprising every sort of licence and tyranny, stained the dependent cities with countless murders, perpetrated on private as well as on public grounds. No individual Greek had ever before wielded so prodigious a power of enriching friends or destroying enemies, as in this universal reorganisation of Greece; nor was there ever any power more deplorably abused.

Taking all these causes of evil together — the decarchies, the harmosts, and the overwhelming dictatorship of Lysander — and construing other parts of the Grecian world by the analogy of Athens under the Thirty, we shall be warranted in affirming that the first years of the Spartan empire, which followed upon the victory of Ægospotami, were years of all-pervading tyranny, and multifarious intestine calamity, such as Greece had never before endured. The hardships of war, severe in many ways, were now at an end, but they were replaced by a state of suffering not the less difficult to bear because it was called peace. And what made the suffering yet more intolerable was, that it was a bitter disappointment and a flagrant violation of promises proclaimed, repeatedly and explicitly, by the Lacedæmonians themselves.

For more than thirty years preceeding — from times earlier than the commencement of the Peloponnesian War — the Spartans had professed to interfere only for the purpose of liberating Greece, and of putting down the usurped ascendancy of Athens. Like the allied sovereigns of Europe in 1813, who, requiring the most strenuous efforts on the part of the people to contend against the Emperor Napoleon, promised free constitutions, and granted nothing after the victory had been assured — the Lacedæmonians held out the most emphatic and repeated assurances of general autonomy in order to enlist allies against Athens; disavowing, even ostentatiously, any aim at empire for themselves.

The victory of *Ægospotami*, with its consequences, cruelly undeceived every one. The language of Brasidas, sanctioned by the solemn oaths of the Lacedæmonian ephors, in 424 B.C., and the proceedings of the Lacedæmonian Lysander in 405-404 B.C., the commencing hour of Spartan omnipotence, stand in such literal and flagrant contradiction, that we might almost imagine the former to have foreseen the possibility of such a successor, and to have tried to disgrace and disarm him beforehand. There was no present necessity for conciliating allies — still less for acting up to former engagements; so that nothing remained to oppose the naturally ambitious inspirations of the Spartan ephors, who allowed the admiral to carry out the details in his own way. But former assurances, though Sparta was in a condition to disregard them, were not forgotten by others; and the recollection of them imparted additional bitterness to the oppressions of the *deceuvirs* and *harmosts*. In perfect consistency with her misrule throughout eastern Greece, too, Sparta identified herself with the energetic tyranny of Dionysius at Syraeuse, assisting both to erect and to uphold it; a contradiction to her former maxims of action which would have astounded the historian Herodotus.

The empire of Sparta, thus constituted at the end of 405 B.C., maintained itself in full grandeur for somewhat above ten years, until the naval battle of *Cnidus* in 394 B.C. That defeat destroyed her fleet and maritime ascendancy, yet left her in undiminished power on land, which she still maintained until her defeat by the Thebans, at *Leuctra* in 371 B.C. Throughout all this time, it was her established system to keep up Spartan *harmosts* and garrisons in the dependent cities on the continent as well as in the islands. Even the Chians, who had been her most active allies during the last eight years of the war, were compelled to submit to this hardship; besides having all their fleet taken away from them. But the native *decarchies*, though at first established by Lysander universally throughout the maritime dependencies, did not last as a system so long as the *harmosts*. Composed as they were to a great degree of the personal nominees and confederates of Lysander, they suffered in part by the reactionary jealousy which in time made itself felt against his overweening ascendancy. After continuing for some time, they lost the countenance of the Spartan ephors, who proclaimed permission to the cities (we do not precisely know when) to resume their pre-existing governments. Some of the *decarchies* thus became dissolved, or modified in various ways, but several probably still continued to subsist, if they had force enough to maintain themselves; for it does not appear that the ephors ever systematically put them down as Lysander had systematically set them up.

Such then was the result throughout Greece when that long war, which had been undertaken in the name of universal autonomy, was terminated by the battle of *Ægospotami*. In place of imperial Athens was substituted, not

[405-403 B.C.]

the promised autonomy, but yet more imperial Sparta. An awful picture is given by the philo-Laconian Xenophon, in 399 B.C., of the ascendancy exercised throughout all the Grecian cities, not merely by the ephors and the public officers, but even by the private citizens, of Sparta.

We have more than one picture of the Athenian empire in speeches made by hostile orators who had every motive to work up the strongest antipathies in the bosoms of their audience against it. We have the addresses of the Corinthian envoys at Sparta when stimulating the Spartan allies to the Peloponnesian War; that of the envoys from Mytilene delivered at Olympia to the Spartan confederates, when the city had revolted from Athens and stood in pressing need of support; the discourse of Brasidas in the public assembly at Acanthus; and more than one speech also from Hermocrates, impressing upon his Sicilian countrymen hatred as well as fear of Athens. Whoever reads these discourses, will see that they dwell almost exclusively on the great political wrong inherent in the very fact of her empire, robbing so many Grecian communities of their legitimate autonomy, over and above the tribute imposed. That Athens had thus already enslaved many cities, and was only watching for opportunities to enslave many more, is the theme upon which they expatiate. But of practical grievances—of cruelty, oppression, spoliation, multiplied exiles, etc., of high-handed wrong committed by individual Athenians—not one word is spoken. Had there been the smallest pretext for introducing such inflammatory topics, how much more impressive would have been the appeal of Brasidas to the sympathies of the Aeanthians! How vehement would have been the denunciations of the Mytilenean envoys, in place of the tame and almost apologetic language which we now read in Thucydides! Athens extinguished the autonomy of her subject-allies, and punished revolters with severity, sometimes even with cruelty. But as to other points of wrong, the silence of accusers, such as those just noticed, counts as a powerful exculpation.

The case is altered when we come to the period succeeding the battle of Ægospotami. Here indeed also, we find the Spartan empire complained of (as the Athenian empire had been before), in contrast with that state of autonomy to which each city laid claim, and which Sparta not merely promised to ensure, but set forth as her only ground of war. Yet this is not the prominent grievance—other topics stand more emphatically forward. The decemvirs and the harmosts (some of the latter being helots), the standing instruments of Spartan empire, are felt as more sorely painful than the empire itself; as the language held by Brasidas at Acanthus admits them to be beforehand. At the time when Athens was a subject city under Sparta, governed by the Lysandrian Thirty and by the Lacedæmonian harmost in the Acropolis—the sense of indignity arising from the fact of subjection was absorbed in the still more terrible suffering arising from the enormities of those individual rulers whom the imperial state had set up. Now Athens set up no local rulers—no native Ten or native Thirty—no resident Athenian harmosts or garrisons. This was of itself an unspeakable exemption, when compared with the condition of cities subject, not only to the Spartan empire, but also under that empire to native decemvirs like Critias, and Spartan harmosts like Aristarchus or Aristodemus. A city subject to Athens had to bear definite burdens enforced by its own government, which was liable in case of default or delinquency to be tried before the popular Athenian dicastery. But this same dicastery (as is distinctly stated by Thucydides) was the harbour of refuge to each subject city; not less against individual Athenian wrong-doers than against misconduct from other cities. In no

one point can it be shown that the substitution of Spartan empire in place of Athenian was a gain, either for the subject cities or for Greece generally ; while in many points it was a great and serious aggravation of suffering. And this abuse of power is the more deeply to be regretted, as Sparta enjoyed after the battle of Ægospotami a precious opportunity—such as Athens had never had, and such as never again recurred—of reorganising the Grecian world on wise principles, and with a view to Panhellenic stability and harmony.

She now stood without competitor as leader of the Grecian world, and might at that moment have reasonably hoped to carry the members of it along with her to any liberal and Panhellenic organisation, had she attempted it with proper earnestness. Unfortunately she took the opposite course, under the influence of Lysander ; founding a new empire far more oppressive and odious than that of Athens, with few of the advantages, and none of the excuses, attached to the latter. As she soon became even more unpopular than Athens, *her* moment of high tide, for beneficent Panhellenic combination, passed away also—never to return.^c

HARSHNESS OF THE SPARTAN HEGEMONY



GREEK URN
(In the British Museum)

The Peloponnesian War had been disastrous in its consequences to public morals. Its long duration and peculiarly bloody character, arousing everywhere mistrust, exciting passions, deifying brute force, had wrought a deterioration in the Greek nature from which it never fully recovered. There was ferocity on the battle-field, a ferocity in the party contests. "This," says Aristotle, "is the oath administered to-day in several cities by the oligarchy : 'I will be the enemy of the people and will do them all the evil I can.'" We may indeed place against this homicidal oath that taken by the heliasts of Athens after the tyranny : "I will forget all past ills and will permit no one else to remember and give them mention." But Athens even in its decadence was always Athens liberal and generous, even as its mutilated

statues remain beautiful in all their degradation.

The system of warfare had also changed. We have shown how one military revolution had already occurred ; the replacing of the aristocratic army of former times by the democratic army of the fifth and sixth centuries. And now the age of mercenaries was being ushered in by the employment, in all Greek cities, of hired soldiers to fight beside their citizen troops. But to pay these hirelings money was required, and Greece applied to Persia, who alone had money ; hence her mendicant attitude towards the Great King, and the continual intervention of Xerxes' successors in Hellenic affairs.

[405-353 B.C.]

This dependence on a foreign power and harshness of the public temper were first observed during the last years of the war; they are found again in the year after peace was concluded, the Year of Anarchy, as the Greeks called the commencement of the Spartan dominion.

Blood flowed everywhere because everywhere were established oligarchical governments. A massacre occurred at Thasos. At Miletus eight hundred citizens belonging to the popularist party were lured from their retreats by Lysander and put to death. At Byzantium, Cetea, and the greater part of the towns of Asia Minor similar outrages were committed. At Samos the inhabitants were all banished, with the privilege of taking away but a single garment. The defection of Chios and its navy had assured Sparta's triumph; as a reward its most prominent citizens were sent into exile and all its triremes were seized. Lycophron, a Phœrean, made himself master of the province of Thessaly after desperate battles. "Thereafter," relates Xenophon, "a Lacedæmonian's lightest word was obeyed; even a citizen in private life could arrange everything to his will." Xenophon himself appears to have shared this terror, since after the retreat of the Ten Thousand he refused the title of general-in-chief that his companions wished to bestow upon him, fearing that Sparta might view with disfavour the placing of command in the hands of an Athenian. The islanders, especially those who had betrayed the cause of Athens, hoped that with the accession to power of Lacedæmonia who was an ally of the Great King the duties established by Aristides and Pericles to protect their commerce would be removed. But they found they had simply changed masters, Sparta continuing to levy the former tribute, which amounted annually to 1000 talents [£200,000 or \$1,000,000].

Athens, more adroit in establishing her empire, had proceeded without cruelty, violence, or spoliation, hence had not known, even in her time of greatest misfortune, the falling-off of her supports. Sparta was not so wise in the formation of kingdoms; force was the only instrument of which she knew the use, and with her the use of it was the abuse of it. Athens had also made use of force, but had always associated with it justice. Athens had made itself the political, military, and judiciary centre of the empire, and further, it was the metropolis of arts and letters for all Hellas. Nothing great or glorious, nothing useful or full of promise, could proceed from the Lacedæmonian dominion; it threatened to topple over in the hour of its erection. A thousand causes were at work to bring about a rapid dissolution; many of these were in Sparta or Greece, the rest in other lands.

DEGENERACY OF SPARTA

The results of Lycurgus' institutions continued to be made manifest. The Spartan city diminished in population from day to day, as though worn away by the friction of its iron institutions. The narrow circle, which it had drawn round itself, never widening but always growing smaller, finally came to enclose but an insignificant number of Spartans. Great numbers had perished in the wars, others cast by poverty into the lower classes could no longer take their seats at the public tables. Aristotle says, "Whoever is without means to contribute to the expense of these tables must forfeit his political rights." The Spartans knew that they were menaced with destruction through lack of citizens; the cry that arose when the four hundred and twenty Spartan soldiers were imprisoned on the island of Sphaacteria, still rang in every ear. Aristotle further states: "The ter-

ritory of Sparta that is capable of providing sustenance for fifteen hundred cavalry and thirty thousand hoplites, to-day barely supports a thousand warriors." In the assemblies of four thousand, there were scarcely to be seen forty Spartans; moreover, inequality of conditions grew as the people decreased in number.

Gold and silver currency had for a long time ceased to be proscribed and the disinterestedness of the Lacedæmonians to be extolled. Numerous examples of their venality were known; Eurybiades had been bought by Themistocles, Plistoanax and Cleandridas by Pericles, Leotychides by the Aleuadæ, the admiral and captains of the fleet by Tissaphernes. The kings, the senators, the ephors, all had repeatedly received bribes, and Gylippus, the liberator of Syracuse, who had been charged to carry to Sparta the plunder of Athens, kept back for his own use thirty talents [£6000 or \$30,000]. Hence the remark of an interlocutor in the *Alcibiades*: "There is more gold and silver in Lacedæmonia than in all the rest of Greece; money flows to it from all parts and once there remains; the country is like a lion's cave, one sees the footprints of those who enter, but of footsteps leaving there is no trace." The commanders who returned from ports in Asia brought with them great wealth, and more than that a taste for luxury and ease, in a word, corruption; every one plunged into wild extravagance and the vices engendered by the possession of riches.

After the Peloponnesian War, the ephor Epitadeus had passed a law authorising citizens to dispose of their property and land. The effects of this rhetra were so prompt to appear that Aristotle was given cause to write: "The land has passed into the hands of a few." In the time of Agis IV the entire territory was owned by a hundred Spartans. Thus the government had become more and more oligarchical. All the national affairs were carried on by the ephors and the senate, even the general assembly was rarely consulted, and in consequence the rulers, being few in number, were all the more jealous of the privileges of their station and less disposed to suffer them to be curtailed. To open their ranks, moreover, for the readmission of families that poverty had driven forth would have been to expose themselves, by relinquishing the majority, to some territorial reform tending toward a fresh division of the immense domains now concentrated in the possession of a few. Public interest might point this way but private interest decidedly opposed it, and private interest won.

There resulted from this a violent hatred between the privileged and the lower classes; the latter being formed of Spartans degraded from their ranks, enfranchised helots, Laonians to whom had been accorded certain rights, and the children of Spartan fathers of the higher order and alien mothers. These classes were given denominations that kept them separate and distinct; there was doubtless also a wide difference in conditions. Below the Equals, who formed a restricted oligarchy, were the Inferiors, or Spartans, who were excluded from the public tables, and the *neodamodes* or helots enfranchised for services rendered the state, and lastly the *periæci*. Though they had no share in the actual government of their country these men estimated highly the value of their services to the state; and at different times many prominent figures, sons of Spartan fathers and helot mothers, such as Lysander, Gylippus, and Callicratidas had issued from this class. In a vindictive address against Lacedæmon the Thebans at Athens declared that the Spartans recruited their military governors from among men who had helot blood in their veins; and indeed many of these people had amassed competencies that gave them the ambition to leave the inferior station in

[405-240 B.C.]

which custom held them. When Cleomenes III promised liberty to those among the helots who could pay into the public treasury the sum of five minæ [£21 or \$108], six thousand presented themselves.

Lacedæmon's two royal houses, however, had been retained, and it should have been the function of these to maintain discipline in the state. But the newly-acquired wealth of Sparta, coupled with the growing authority of the ephors, appreciably diminished the power of the kings. Reduced to the rôle of hereditary generals these monarchs could never depart on an expedition without being accompanied by ten supervisors, who, under the name of councillors, in reality directed all the military operations. During the last years of the Peloponnesian War the decisive battles had been fought on sea, and the fleets were commanded, captives sold, cities ransomed and subsidies received from the Great King by men who were not of pure Spartan blood. Aristotle in his *Politics* calls the office of admiral among them "a second royalty."

Lysander was not obeying the dictates of ambition when, as Sparta's leading citizen, he undertook to reform for his own advantage the political system of the city. "He could not," says Plutarch, "see without regret a city whose glory he had done so much to increase governed by kings who had no more ability to rule than he, so he formed the plan of depriving the reigning houses of their dignity to make it the common appanage of all the Heraclids." The discovery of the plot of Cinadon [described later] revealed an abyss of hatred yawning beneath the social system of Sparta, and at the same time an alarming unanimity of feeling between the inferior classes, both free and slaves. A civil war could easily have resulted from the situation; but Sparta, with that vigilance which continued distrust arouses in all oligarchies, discovered and baffled all the plots that were formed against her.

Yet in spite of this hostility between the classes, in spite of many other difficulties, such as strife between the kings on the one hand and the senators and the ephors on the other, in which the kings were reduced almost to the condition of subjects, and rivalry between the kings themselves, the Spartan government, by reason of concentration of authority in a few hands, was powerful enough for action against other states. At home and abroad the ephors and the harmosts, those so-called conciliators, exercised a permanent dictatorship, maintaining garrisons at Megara, Ægina, Tanagra, Pharsalus, Heraclea in Trachina, at the entrance of Thermopylæ; also Dionysius of Syracuse was Sparta's ally. But this power, wide-spread as it was, was scarcely more than an influence, and an influence that was already on the wane, since the nation that lacks citizens has no resources within itself.

Sparta's exactions offended those who still loved liberty and had not, to console them for its loss, the advantages offered by Athens to her subjects—extensive commerce, and the splendour of public festivals, of arts and of poetry. Sparta, equally grasping and more oppressive, robbed her subjects of everything. She levied on them an annual tribute of one thousand talents [£200,000 or \$1,000,000] which vanished in Lacedæmon never to be seen again, and those who had furnished her with troops, like the Achæans and Arcadians, or with vessels, like the Corinthians, or auxiliaries, like the Thebans, received nothing in return.

The weight of this heavy Dorian rule began shortly to be felt, and many regretted the Athenian supremacy that was kindly even in its excesses. That the Greeks from the coasts of Thrace or Asia, those people who had

never known how to say "No," should tremble at sight of a Spartan mantle or wand of office, was in no way remarkable, since they had been accustomed to obey. Not that a double servitude, that of the oligarchs, friends of Lysander, and that of the Lacedæmonian harmosts was not a great burden to bear, even for them. But Sparta must not count on such docility in the mother-country. She had not hesitated to speak as sovereign in the matter of the Athenian exiles, nor to make decrees, as sole authority, for all Greece. We have seen how Thebes responded.

Thebes, a continental power, had long aspired to play in central Greece the part played by Sparta in the Peloponnesus. Between this state and Athens there might be jealousy, but not necessarily a clash of interests as in her relations with Lacedæmonia. In the intoxication of victory Sparta had believed prudence no longer necessary, and, incensed that the Thebans should have taken at Decelea the tithe belonging to Apollo, had scornfully rejected their claims to a share in the spoils and treasures brought back by Lysander, fourteen hundred and seventy talents, the remainder of the advances made by Cyrus. Corinth, no better received, made common cause with Thebes, and this formed another ground of complaint to Sparta against that state. The Argives, in a discussion relative to the fixing of boundaries, maintained their reasons to be superior to those of their adversaries. "He who is strongest with this argument," said Lysander, drawing his sword, "reasons best about boundary limits." A Megarian, in conference, spoke in a very loud voice. "My friend," said Lysander, addressing him, "your words need a city to make them good." Still more unceremoniously Sparta dealt with the Eleans, as we shall see later.

To the imperious demands of the Spartan government were added individual acts of violence, which are often more odious because a single victim, even though obscure, excites more pity than a whole people bowed under defeat; and there is less peril in attacking public liberty which is the property of all, than in endangering, by contempt of truth and right, the honour or the life of an individual.

A kind and hospitable man of Leuctra, Scedadus, received in his house one day two young Lacedæmonians, who were greatly struck with the beauty of their host's two daughters. Returning from a voyage to Delphi, whither they had gone to consult the oracle, these two Lacedæmonians found the daughters alone in the house and violated them, after which they murdered them and threw their bodies into the well. When Scedadus returned next day his daughters did not, to his surprise, come forth to meet him, and his dog, howling plaintively, ran back and forth from his master to the well. Alarmed, Scedadus looked into the well, discovered the crime, and learned from his neighbours who were its perpetrators. He departed at once for Lacedæmon. In Argolis he fell in with a man as unfortunate as himself, whose son had fallen a victim to the brutality of a Spartan. This father had believed in Lacedæmonian justice, but had had none accorded him. Nevertheless Scedadus continued on his journey, and when he arrived in Sparta, told his story to the ephors, to the kings, to all the citizens he met, but no one would give it heed. Then wishing to call the divine anger down upon Sparta he invoked all the gods of heaven and earth, especially the furies of revenge, and put an end to his life. A tomb was later erected at Leuctra to his unfortunate daughters.

As against the few facts of this nature that have come to our knowledge how many have escaped us? We realise this more fully when we reflect on the hatred Sparta everywhere inspired even in the Peloponnesus.

[405-240 B.C.]

The Arcadians and the Achæans served her from motives of fear alone; she was, they declared, a citadel placed upon their flank to keep guard over the whole peninsula. At Lacedæmon their sentiments were well known. On his return from an expedition in which a whole Spartan corps had been lost, in the Corinthian War which we shall treat of shortly, Agesilaus entered the towns only at night, leaving them at break of day, that his men might not witness the joy exhibited by the inhabitants at this disaster.



GREEK PHILOSOPHER
(After Hope)



CHAPTER XLII. SPARTA IN ASIA

WHEN the Lacedæmonians put an end to the Athenian empire, they neither claimed any dominion on the continent of Asia, nor asserted the freedom of the Grecian republics there: the allegiance of the Asian Greeks was transferred from the Athenian people to the Persian king; and, under him, to the satraps, Pharnabazus and Tissaphernes. We have seen that, among the Greeks of Asia, Cyrus was popular, and Tissaphernes unpopular; insomuch that by a kind of rebellion against the satrap, the Ionians had attached themselves to the prince. The event therefore of the expedition against the king, and the appointment of Tissaphernes to the great command which Cyrus had held, could not but be highly alarming to them. But, on the other hand, the glorious retreat of the Greeks who had accompanied the prince, and the clear evidence which their return in safety bore to the superiority of the Grecian arms, afforded ground of encouragement. If the patronage of Lacedæmon could be obtained, whose councils commanded the united arms of Greece, little, it was hoped, need be apprehended from the satrap's vengeance. Refusing therefore to acknowledge his authority, the Ionians sent ministers to Lacedæmon to solicit protection.

The Lacedæmonian government, less expecting friendship from the king and from Tissaphernes on account of their connection with Cyrus, and valuing it less as the fame of the actions of the Cyrean army taught to despise their enmity, resolved that the Ionians should be protected. Possibly circumstances at home might contribute to this determination. It might be desirable to employ a part of their people on foreign service; and for service against an enemy so famed for wealth, and so little for bravery and military skill, volunteers would be numerous among the poor commonwealths of Peloponnesus. Four thousand men were required from the allies. Only one thousand were added from Lacedæmon: and they were all of those called neodamodes, who, owing their elevation from the condition of slaves into the rank of citizens to the necessities of war, were, on the return of peace, looked upon with so invidious an eye, that occasion for sending them on foreign service would be acceptable, both to the government and to themselves. Cavalry was very desirable for war in Asia: but the utmost force that Peloponnesus could raise was very small; and the principal citizens of the wealthiest republics, who alone composed it, would not be the most willing partakers in distant adventure. Application was therefore made to Athens; where recent disorders, extreme political jealousy, and a total want of protection against any momentary caprice of the people, made the situation of

[400-399 B.C.]

men of rank and fortune so precarious that the offer of pay for three hundred horse found ready acceptance there. Thimbron was appointed commander in chief in Asia, with the title of harmost.

From their attachment to the cause of Cyrus, and consequent dread of the king's vengeance, apparently arose the revolt of those Grecian subjects of the Persian empire, which otherwise would mark gross ingratitude to a beneficent government. For the testimony here given by Xenophon, remarkably corresponding with all remaining from Herodotus and Thucydides, strongly confirms what has been heretofore observed, that there was uncommon liberality in the despotism of the Persian empire. Public faith was kept; property was not without security; it was not then, as under the present wonderfully barbarian government of the same fine country, a crime to be rich. Large estates, given even to foreigners, passed to their late posterity; and, instead of the tyranny which now depopulates towns and provinces, and against which the remaining subjects recur to the patronage of some foreign ambassador, the Persian government so extended liberal protection to all, that Grecian cities could prefer the dominion of the Persian king to that of the Athenian or Lacedæmonian commonwealths, and flourish under it. But the Persian government, though generally mild and liberal, had been, since the reign of Xerxes, always weak, and verging to dissolution. The Lacedæmonian general Thimbron, who, with comparatively a small force, had been making conquests against it, showed no considerable abilities in the field, and in camp and in quarters his discipline was very deficient. The allies suffered from the licentiousness of his army; and complaints were in consequence so urged at Lacedæmon that, on the expiration of his year, he was sentenced to banishment.

Dercyllidas, who succeeded him, was more equal to a great and difficult command. Having already served in Asia, under Lysander, he knew the characters of the two satraps, who divided between them, in almost independent sovereignty, the dominion of the western provinces. The instructions of the ephors directed him to lead the army into Caria, the hereditary government of Tissaphernes. But the desire of revenging a disgrace he had formerly incurred, when harmost of Abydos, in consequence of an accusation from Pharnabazus, assisted at least, according to the contemporary historian, his friend, in determining him to act otherwise. He negotiated with Tissaphernes; and that dastardly satrap, ill-disposed towards Pharnabazus, and always readier for negotiation than battle, instead of exerting the great power with which he was vested for the general defence of the empire, bargained for a particular peace for his own provinces, and consented that the Grecian arms should, without opposition from him, be carried into the Bithynian satrapy. Dercyllidas, having thus provided for the safety of the rich fields of Ionia, which would otherwise have been liable, in his absence, to suffer from the Persian cavalry, hastened his march northward; and, in the length of way from Caria to the borders of Æolis, he maintained an exactness of discipline that gained him the greater credit with the allies as it was contrasted with the licentiousness from which the country had suffered while Thimbron commanded.

The circumstances of Æolis might reasonably have invited the attention of the general, though revenge had not instigated him. According to that liberal policy, more than once already noticed as ordinary among the Persians, Pharnabazus had appointed Zenis, a Greek of Dardanus, to be governor, or, according to Xenophon's phrase, satrap of that fine country, so interesting, in earliest history, as the kingdom of Priam, and the seat of the

Trojan War. Zenis died young, leaving a widow, Mania, also a Dardanian. This extraordinary woman solicited the succession to her late husband's command; and supported her solicitations with presents so agreeable to the satrap's fancy, and proofs so pregnant of her own talents and spirit, that she obtained her suit. Being accordingly vested with the government, she did not disappoint, but, on the contrary, far exceeded, the satrap's expectation. She not only held all in due obedience, but, raising a body of Grecian mercenaries, she reduced the maritime towns of Larissa, Hamaxitus, and Colonæ, which had hitherto resisted the Persian dominion. Herself attended the sieges, viewing the operations from her chariot, and by praises and presents judiciously bestowed she excited such emulation that her army acquired repute superior to any other body of mercenaries in Asia. Pharnabazus requiring troops for suppressing the incursions of the rebellious Mysians and Pisidians, she attended in person. In consequence of her able conduct and high reputation, he always treated her with great respect, and sometimes even desired her assistance in his council.

Mania was another Artemisia; and the weighty authority of Xenophon for the history of the Dardanian satrapess not a little supports the account given by Herodotus of the Halicarnassian queen. But, though Mania could govern provinces and conduct armies, yet, amid the encouragement which the gross defects, both of Grecian and Persian government, offered for daring villainy, she could not secure herself against domestic treachery. Scarcely had she passed her fortieth year when she was murdered in her palace by Midias, who had married her daughter. But a single murder would not answer the execrable villain's purpose. Her son, a most promising youth of seventeen, was cut off. The assassin had then the impudence to ask of the satrap the succession to the government held by the deceased Mania, supporting his solicitation by large presents. But he seems to have founded his hopes on a knowledge rather of the general temper and practice of the Persian great than of the particular character of Pharnabazus. He, with a generous indignation, refused the presents, and declared he would not live unless he could revenge Mania. Midias prepared to support himself by force or intrigue, as circumstances might direct. He had secured Gergis and Scepsis, fortified towns in which Mania's treasures were deposited: but the other towns of the province, with one consent, refusing to acknowledge his authority, adhered to Pharnabazus.

Dercyllidas arrived upon the borders in this critical conjuncture. The satrap was unprepared; the Lacedæmonian name was popular; and the towns of Larissa, Hamaxitus, and Colonæ, in one day opened their gates. A declaration was then circulated, that the purpose of Dercyllidas and the Lacedæmonian government was to give perfect independency to the Æolian cities; desiring only alliance defensive and offensive, with quarters for the army within their walls whenever it might become requisite in that service whose object was the common liberty of all Grecian people. The garrisons were composed mostly of Greeks, attached to Mania, but indifferent to the interest of Pharnabazus. The towns of Neandria, Ilium, and Cocylium acceded to the Spartan general's invitation. Hope of large reward for his fidelity induced the governor of Cebrene to adhere to the satrap; but, upon the approach of the army, the people soon compelled him to surrender.

Dercyllidas then marched towards Scepsis. The assassin Midias, fearful, at the same time, of the Spartan general, the Persian satrap, and the Scepsian citizens, conceived his best hope to lie in accommodation with the former. He proposed a conference, to which Dercyllidas consented. Acquitting

[399-398 B.C.]

himself then of that miscreant by restoring all his private property, with liberal allowance for all his claims, he seized the wealth of Mania, as now belonging to the satrap, the common enemy; and it was his boast, a grateful boast to the army, that he had enriched the military chest with a twelvemonth's pay for eight thousand men.

Having thus, according to Xenophon's expression, in eight days, taken nine cities, he sent proposals of truce to Pharnabazus. That generous satrap, unassisted from the capital of the empire, and deserted and betrayed by the great neighbouring officer whose more peculiar duty it was to afford him assistance, readily accepted them. Xenophon indeed says, that he was little disturbed with the loss of Æolis; esteeming that province, under Lacedæmonian protection, while he had himself peace with Lacedæmon, rather a useful barrier against other enemies. The meaning of this apparently is to be collected only from what follows. The Bithynians, though as tributary subjects of the empire he had assisted them against the Cyrean army, were always licentious, sometimes perhaps rebellious, and they frequently carried hostile depredation among the more peaceful and settled inhabitants of his satrapy. Among these people Dercyllidas resolved to take his winter quarters, as in a hostile territory, and Pharnabazus expressed no dissatisfaction.

Since he had been in Asia, Dercyllidas had fought no great battle, nor taken any town by assault; but, in an army which, under his predecessor, had been so lawless as to be a terror more to friends than enemies, he had restored exact discipline, and yet was the favourite of that army. With that army then he had awed the two great satraps, each commanding a province equal to a powerful kingdom, and both together acting under the mightiest empire in the world; so that, after having given independency and security to the long line of Ionian and Æolian colonies, he could direct his views another way for the benefit of the Grecian name.

The Thracian Chersonese, once the principality of the renowned Miltiades, lately, in large proportion, the property of another great and singular character, Alcibiades, and by its fertility, its many harbours, and its advantageous situation for trade, always a great object for industrious adventurers from Greece, was however always subject to dreadful incursions from the wild hordes of Thracians, who made it their glory to live by rapine. The Chersonesites, in a petition to Lacedæmon for protection, declared that, unless it were granted, they must abandon the country. Dercyllidas, informed of this, before orders could come to himself from Lacedæmon, or another could be sent with the commission, resolved to execute the service. He sent to Pharnabazus a proposal for prolonging the existing truce, which was immediately accepted; and, having so far provided tranquillity for Asia, he transported his army to the European shore. Immediately he visited the Thracian prince Seuthes, by whom he was very hospitably entertained; and having arranged, apparently to his satisfaction, those matters in which his commonwealth and that prince had a common concern, he marched to the Chersonese. There he employed his army, not in plunder and destruction, but in raising a rampart across the isthmus, to secure the peace of the rich country and industrious people within. Begun in spring, it was completed before autumn, and the army was reconveyed into Asia. Dercyllidas then made a progress through the Asiatic cities, to inspect the state of things, and had the satisfaction to find everywhere peace, prosperity, and general content.

Now the ephors sent orders for war to be carried into Caria; for the army under Dercyllidas to march thither; and for the fleet, then commanded by Pharax, to co-operate with it. The first effect of these ill-concerted

measures appears to have been to produce, or at least to hasten, a union between the two satraps, Tissaphernes and Pharnabazus; whose long variance had in no small degree contributed to those great successes which the Greeks, with a force otherwise inadequate to contention with the Persian empire, had been enabled to obtain. Pharnabazus, unsupported by the court of Susa, and basely deserted, or worse than deserted, by Tissaphernes, his immediate superior in command, had acquiesced under the loss of Æolis. But, as soon as the threatened attack of Caria afforded a probability that Tissaphernes would be disposed to change his conduct, Pharnabazus went to him, and declared his readiness to co-operate zealously in measures for driving the Greeks out of Asia. This proposal, to which the jealousy and pusillanimity of Tissaphernes otherwise would scarcely have listened, was made acceptable by the indiscreet violence of the Spartan government. The two satraps went together into Caria, and, having arranged matters for the defence of that country, returned to take the command of an army which threatened Ionia with destruction.

Dercyllidas was already marching for Caria, when information reached him that all his hitherto successful labours for the welfare of the colonies were upon the point of being rendered utterly vain. In these alarming circumstances the interested pusillanimity of Tissaphernes relieved him. Pharnabazus was desirous of engaging; but Tissaphernes already more than half satisfied, since his property in Caria was no longer in immediate danger, would first try the effect of a conference. A herald was therefore sent to the Grecian general. The conference being held accordingly, Dercyllidas insisted on the simple proposition, "that all Grecian cities should be independent." To this the satraps consented, with the conditions, "that the Grecian army should quit the king's territory" (by which seems to have been meant Asia, including the Grecian colonies), "and that the Lacedæmonian governors should quit the Grecian towns." Upon these terms a truce was concluded, to hold till the pleasure of the king and of the Lacedæmonian government could be known.

This was the first treaty, reported on any authentic or even probable testimony, by which, since the early times of the Lydian monarchy, it was provided that the Asian Greeks should be completely emancipated from foreign dominion. All the Ionian and Æolian cities, it appears, thus gained immediate enjoyment of independency in peace: the Carian seem to have waited the confirmation of the treaty by the king of Persia and the Lacedæmonian government. But it was a quiet revolution: no great battle gave it splendour; none of those striking events attended which invite the attention of the writer in proportion as they are fitted to impress the fancy of the reader. It forms, nevertheless, a memorable and interesting era in Grecian history; and the fame of Dercyllidas, less brilliant, but far purer, than that of most of the great men of Greece, though, being recorded by the pen of Xenophon, it is indeed secured against perishing, yet deserves to have been more generally and more pointedly noticed, than we find it, by writers whose theme has been Grecian history, or panegyric of the Grecian character.

WAR OF LACEDÆMON AND ELIS

In that system, if it may be so called, by which the various members of the Greek nation were in some degree held together, we find a strange mixture of undefined, and sometimes repugnant claims, more or less generally

[420-399 B.C.]

admitted. While the Lacedæmonians presided, with authority far too little defined, over the political and military affairs of Greece, the Eleans asserted a prescriptive right to a kind of religious supremacy; also too little defined; universally allowed nevertheless, in a certain degree, but, like the Lacedæmonian supremacy, not always to the extent to which the claimants pretended. In the schism of Peloponnesus, which occurred during the Peloponnesian War, we have seen the imperial state of Lacedæmon summoned to the Elean tribunal, as a British corporation might be summoned to the courts at Westminster; a fine imposed, its citizens interdicted the common games and sacrifices of the nation, an opprobrious punishment publicly inflicted upon an aged and respectable Spartan, who, but by implication, offended against the Elean decrees; and, finally, these measures supported by avowed hostilities, and alliance with the enemies of Sparta. The necessity of the times induced the Lacedæmonians to make peace with these affronts unrevenged; but their smothered resentment had been revived and increased by what they esteemed a new indignity. Before the conclusion of the Peloponnesian War, Agis, king of Lacedæmon, had been sent, in pursuance of a supposed prophetic direction, to perform a sacrifice to Jupiter at Olympia. The Eleans forbade the ceremony, alleging that, according to ancient law, no oracle should be consulted for success in wars between Greeks and Greeks, and they would allow no prayer for victory in such a war. There is a beneficence, a liberal and extended patriotism in this idea, so consonant to the spirit with which Iphitus is said to have founded the Olympian festival, and so opposite to the tenets afterwards generally prevailing in Greece, that they seem to mark the law for ancient and genuine. The Lacedæmonians however were not the less offended with the Eleans for bringing forward, upon such an occasion, what, if those maxims only were considered which had prevailed through succeeding ages, would carry much the appearance of a complete novelty.

The judgment passed against the Lacedæmonians and the fine imposed, the interdiction of the games, the punishment of Lichas, the confederacy with Athens and Argos, the hostilities ensuing, and finally the refusal of permission for sacrifice at Olympia, are stated by the contemporary historian as the motives which disposed the Lacedæmonians to war. We gather from him however that others existed; the democratical party at this time governed Elis, and Elis held many towns of Elea in subjection. The Lacedæmonians did not absolutely require oligarchy in every state of Greece; for they had lately permitted the restoration of democracy in Athens; and even their own government had a mixture of democracy: but they always beheld, with peculiar jealousy, dominion exercised by a democratical commonwealth.

In pursuance of this resolution, ministers were sent to Elis with a declaration that "the Lacedæmonians deemed it just and proper that the towns held in subjection by the Eleans be restored to independency." The Eleans, alleging the right of conquest, refused to resign their sovereignty; and upon this the ephors ordered the king, Agis, to march into their country. The usual ravage of Grecian armies presently followed, but an earthquake, imagined



GREEK VASE

a divine admonition, alarming the aged prince and his superstitious people, they retired out of Elea,¹ and the troops were dismissed to their several homes. Whether as marking the favour of the gods or the weakness of their enemies, this conduct greatly encouraged the Eleans. In either view it improved the hope of gaining to their cause many Grecian states, known to be disaffected towards Lacedæmon. But if the Lacedæmonian sovereignty was tyrannical, theirs apparently was not less so; and while they were cherishing the hope of foreign assistance, they did not take wiser precautions than other Grecian states for securing the attachment of their subjects. In the next spring Agis again entered Elea with an army to which all the allies had contributed, excepting Corinth and Bœotia. Immediately Lepreum revolted to him; Macistus and Epitalium quickly followed the example; and these were imitated, as he advanced into the country, by Leprine, Amphidolia, and Marganeæ. In this defection of their towns, the Eleans were utterly unable to face the Lacedæmonian army in the field. Agis proceeded unopposed to Olympia and sacrificed, now unforbidden, on the altar of Jupiter. The territories of the revolting towns of course had been spared; but rapine and devastation marked the way from Olympia to Elis, whither the king next directed his march. Nor did the country suffer only from the conquering army. The opportunity of freebooting invited the neighbouring Arcadians and Achæans; and slaves and cattle and corn were carried off to such an amount that all the markets of Peloponnesus were glutted with Elean plunder. It was supposed that Agis would not, rather than that he could not, take Elis itself, which was unfortified. After destroying many fair buildings of the outskirts he proceeded to Cyllene, the principal sea-port of the Eleans, and ravage was extended from the mountains to the sea.

Occasion has already frequently occurred to remark, that scarcely any misfortune could befall a Grecian state which would not bring advantage, or at least the hope of advantage, to some considerable portion of its subjects. The aristocratical party in Elis, oppressed by the demagogue Thrasydæus, looked to the present sufferings of their country as the means of relief; but with no better consideration of any political or moral principle than might have guided the wildest savages, or the most profligate among the lowest populace in civilised nations. They proposed to assassinate Thrasydæus, with a few of his confidential friends; and then, in the name of the commonwealth, to open a negotiation with Lacedæmon. The people, they trusted, deprived of their leader, and dreading the arms of the Lacedæmonians, would acquiesce; and thus the principal power in the state would of course come into their hands. The plot failed through a mistake, by which another was murdered for Thrasydæus. The people, however, supposing their favourite killed, rested in silent dejection: but, while the conspirators were arming, and stationing their party, the demagogue awoke, where drunkenness and supervening sleep had overnight checked his way. The people immediately flocked about him; a battle followed, and the conspirators, overpowered, fled to the Lacedæmonian camp.

The conduct of the war was such as we have so often seen in Greece. When plunder no longer remained to employ the Lacedæmonian army profitably, Agis marched home, leaving only a garrison in Epitalium on the Alpheus, where he established the Elean fugitives. Hence rapine was occasionally prosecuted through the autumn and winter. Elis could not, like Athens, support itself under the continual ravage of its territory. In

[¹ Elea is used here to denote the district of which the city of Elis was the capital.]

[398 B.C.]

spring therefore Thrasydæus opened a negotiation with Lacedæmon, and at once offered the independency of all the towns over which the Eleans claimed sovereignty by right of conquest; proposing only to keep Epium, whose territory they had purchased from the inhabitants for thirty talents fairly paid. The Lacedæmonians however, considering, or affecting to consider, the purchase as forced, required that Epium should be free like the rest. The disposition thus apparent in the Lacedæmonians to depress Elis encouraged the villagers of the Pisan territory to assert their claim to the superintendency of the Olympian temple, violently taken from their ancestors, as they contended, by the Eleans, when their city was destroyed. But, whatever might have been the ancient right, the Lacedæmonian administration, thinking those uneducated pretenders unfit for an office of much solemnity and dignity in the eyes of all Greece, would not interfere. Upon the condition therefore that every town of Elea should be, as a free republic, a separate member of the Lacedæmonian confederacy, which was, in effect,



THE SHORES OF ELIS

to be subjects of Lacedæmon, peace was made; and Elis, according to the Lacedæmonian decree preceding the war, humbled and chastened, was itself also restored to its place in that confederacy.

The imputation of impiety, under which the Lacedæmonians began the war, perhaps urged them to a more ostentatious display of respect for the gods at the end of it. Agis himself was deputed to offer, at Delphi, the tenth of the spoil. On his return, he was taken ill at Heræa, and he died soon after his arrival at Lacedæmon. In the magnificence of his funeral the Lacedæmonians probably meant also to exhibit their own piety, as well as to testify their opinion of the deceased prince's merit. They failed however in their estimate of the prevailing prejudices of the Grecian people. Honour to the gods indeed was supposed to be best shown, and religion principally to consist, in pompous processions and expensive spectacles; but general opinion condemned the splendour of the funeral of Agis, as greater than could become the most illustrious mortal.^b

When the days for the funeral solemnities were past and it was necessary for another king to be appointed, Leotychides, who said that he was the son of Agis, and Agesilaus his brother, stood forward as competitors for the throne. Leotychides saying, "The law, Agesilaus, directs, not that the brother, but that the son of the king is to reign; though if there happen to be no son, the brother may in that case become king," Agesilaus rejoined,

"Then I must be king." "How," said Leotychides, "when I am alive?" "Because," returned Agesilaus, "he whom you call your father, said that you were not his son."¹ "But my mother, who knows much better than he, still declares that I am." "Neptune, however," said Agesilaus, "showed that what you assert is false, as he drove your father abroad by an earthquake from her chamber; and time, which is said to be the truest of witnesses, gives testimony with him to the same effect; for you were born in the tenth month after he fled from her, and was never after seen in her chamber." In this manner they disputed. But Diopithes, a man who paid great attention to oracles, supported Leotychides, and said that there was an oracle of Apollo enjoining them "to beware of a halting reign." Lysander however said in reply to him, on behalf of Agesilaus, that "he did not think the god desired them to beware lest their king should stumble and halt, but rather lest one who was not of the royal family should reign; for that the royal power would assuredly be lame whenever men not descended from Hercules should rule the state." The people, after hearing such arguments from both sides, chose Agesilaus for their king.

CINADON'S PLOT

Agesilaus had not yet been a year on the throne, when, as he was offering one of the sacrifices appointed for the city, the augur told him that the gods indicated some conspiracy of the most dangerous kind. Within five days after the conclusion of this sacrifice, somebody gave information to the ephors of a conspiracy, and said that "Cinadon was leader in the affair." Cinadon was a man of vigorous frame, and of powerful mind, but not one of the Equals. When the ephors asked the informer what account he could give of the way in which the plot would be carried into effect, he said that "Cinadon, having conducted him to the outside of the forum, desired him to count how many Spartans there were in the forum; and I," continued he, "having counted the king, the ephors, the senators, and about forty others, asked him, 'And why, Cinadon, have you told me to count them?' 'Consider these,' he replied, 'as enemies, and all the rest now in the forum, who are more than four thousand, as allies.'" He said also that Cinadon pointed out to him in the streets sometimes one, and sometimes two, that were enemies, and said that all the other people were auxiliaries, and that whatever Spartans were on their estates in the country, one, namely the master, was an enemy, while on every estate there were numbers of allies. The ephors then inquiring how many Cinadon said were privy to the plot, he replied that he told him, as to that point, that "there were not very many in concert with the principal agents, but that they were trustworthy, and declared that they were in communication with all the helots, the newly-enfranchised, the inferior citizens, and the people in the parts about the city; for whenever any mention of the Spartans was made among them, no one could forbear from showing that he would willingly eat them up alive." When the ephors further asked "whence they said they would get arms," he answered, that Cinadon had stated to him, "Those of us who are already united, say we have arms enough;" and for the multitude, he said that Cinadon, conducting him into the iron-market, had pointed out numbers of daggers, swords, spits, axes, hatchets, and scythes, and added that "all the instruments with

[¹ It was commonly believed that Alcibiades was the father of Leotychides.]

[397 B.C.]

which men cultivate the ground, or hew wood or stone, would serve as weapons, while the greater part of the artificers had sufficient tools to fight with, especially against unarmed enemies." The informer being finally interrogated "at what time the scheme was to be carried into execution," replied that "directions had been given him to be in readiness at home."

The ephors, after listening to his statement, were of opinion that he had given information of a well-concerted plot, and were greatly alarmed; nor did they summon even what was called the lesser assembly, but some of the senators, conferring together here and there, resolved to send Cinadon to Aulon, accompanied by some others of the younger men, with directions to bring back with him certain inhabitants of that place, and some helots, whose names were written on his scytale. They desired him also to bring with him a certain woman, who was said to be the handsomest in the place, and was thought to corrupt all the Lacedæmonians, old as well as young, that went thither. Cinadon had executed similar commissions for the ephors before; and they now delivered to him the scytale on which were written the names of the persons that were to be apprehended. As he asked "which of the young men he should take with him," they said to him, "Go, and desire the eldest of the *hippagretæ* to send with you six or seven of such of his men as may be at hand." They had previously taken care that the *hippagretæ* should know whom he was to send, and that those who were sent should be apprized that they were to secure Cinadon. They moreover acquainted Cinadon that they would send three carriages, that they might not bring away their prisoners on foot, concealing from him as carefully as possible that they sent them with a view to his security alone. They did not apprehend him in the city, because they were uncertain how far the plot might have spread, and wished first to hear from Cinadon himself who were his accomplices in it, before they themselves should be aware that information was given against them, lest they should make their escape. The party who took him were to keep him prisoner, and when they had learned from him the names of his accomplices, were to send them in writing to the ephors as speedily as possible. So intent indeed were the ephors on effecting their object, that they even despatched a troop of horse to support the party that was gone to Aulon.

As soon as Cinadon was secured, and a horseman arrived with the names of those whom he had put on his list, they instantly apprehended Tisamenus the soothsayer, and the other principal conspirators; and when Cinadon was brought back and examined, and had made a full confession and specified his accomplices, they at last asked him "with what object he had engaged in such a scheme." He replied, "in order that he might be inferior to no man in Lacedæmon." Soon after he was fastened, arms and neck, in a wooden collar, and scourged and pricked with lances; and in this condition he and his accomplices were led round the city. Thus they suffered the penalty of the law.^c

AGESILAUS IN ASIA

Not long after this event news was brought to Sparta by a Syracusan named Herodes, who had just returned from Phœnicia, of preparations which he had witnessed in the Phœnician ports for a great armament, which he had learned was to consist of three hundred galleys. He had not been able to ascertain its object, but it had induced him to quicken his departure, that he might bear the tidings to Greece. The Spartan government was alarmed,

and called a congress of the allies to deliberate on preventive measures. But to Lysander the intelligence afforded a highly welcome opportunity of resuming his ambitious plans, and recovering his influence among the Asiatic Greeks. He seems however to have been aware that he was himself viewed with jealousy at home, and that a proposal coming directly from himself, and immediately tending to his own aggrandisement, would probably be ill received. He resolved therefore to make use of his friend Agesilaus, to accomplish his purpose, and easily prevailed on him to undertake, with a small force, to give such employment to the Persian arms in Asia, as would secure Greece from the threatened invasion.

Agesilaus, who was in the prime of life, was no less eager to display his military talents in such a brilliant field, than Lysander to renew his intrigues, and to replace his creatures in the posts from which they had been dislodged. He therefore offered to take the command of an expedition to Asia, for which he required no more than two thousand neodamode troops, and six thousand of the allies, and desired to be accompanied by a council of thirty Spartans—which he probably knew would, according to usage, be forced upon him—and by Lysander among them. His offer was accepted, and all his requests granted, with the addition of six months' pay for the army. Corinth, Thebes, and Athens, were called upon to contribute their forces, but they all refused.

It was the first time since the expedition of Menelaus that a king of Sparta had undertaken to invade Asia; and Agesilaus, partly perhaps for the sake of the omen, and partly for the sake of his own renown, was willing to associate his enterprise with the recollection of that heroic adventure. He therefore stopped at Aulis, to sacrifice there after the example of Agamemnon. But before he had completed the rite, the Bœotarchs sent a party of horse to enjoin him to desist, and the men did not merely deliver the message, but scattered the parts of the victim which they found on the altar. He however stifled his resentment, and embarked again for Geræstus, where he found the bulk of his armament assembled, and sailed with it to Ephesus.

Soon after his arrival he received a message from Tissaphernes, calling on him to explain the design of his coming. Agesilaus replied, that his object was to restore the Asiatic Greeks to the independence which their brethren enjoyed on the other side of the Ægean. The satrap on this proposed a truce until the king's pleasure could be taken on this demand; he engaged himself to support it with all the credit he possessed, and professed to believe that the court would comply with it. Agesilaus consented to the proposal, only requiring security for the observance of the engagement, and even this security was no more than the oath of Tissaphernes, which he pledged with due solemnity to Dercyllidas, and two other Spartan commissioners, who were sent to ratify the convention. Nothing however was farther from the mind of either party than the thought of peace. Tissaphernes, as soon as he had taken the oath, sent to the king for a reinforcement to enable him to take the field; and Agesilaus, who was well aware of his intentions, and probably would not otherwise have granted the truce, though he observed it with strict fidelity, undoubtedly did not suffer the time to be lost with regard to the progress of his own preparations.

During this interval a breach, which the characters and views of the two men rendered almost inevitable, rose between him and Lysander. The rumour of the expedition, and of the part which Lysander was to take in it, seems to have rekindled the flames of discord in the Asiatic cities, which after the expulsion of his creatures had for a time been kept tranquil by the wise forbearance of the ephors and the prudent administration of Dercyllidas.

[396 B.C.]

When he came to Ephesus, his door was immediately besieged by a crowd of petitioners, who desired a license to oppress their countrymen under his patronage. After the victory of Ægospotami, Lysander, as the man who for the time wielded the irresistible power of Sparta, had been courted with extravagant servility by the Asiatic Greeks. They did not content themselves with the ordinary honours of golden crowns and statues, but raised altars and offered sacrifices, and sang pæans, and consecrated festivals to him as a god: the first example of that grossest kind of adulation, which afterwards became common among the Greeks, and was reduced to a system by the Romans. When he now appeared again in Asia, though in the train of a Spartan king, it was still supposed that the substance of power resided with him, and that he would direct the exercise of the royal authority, as he thought fit. He did not discountenance this persuasion, for he shared it himself. He had calculated on the subserviency of Agesilaus, whom he considered as mainly indebted to his friendship, first for the throne, and then — an obligation little inferior — for the command in Asia. But his colleagues, the rest of the Thirty, felt that the homage paid to him by the allies was derogatory, not only to the royal dignity, but to their own; and they complained to Agesilaus of his presumption.

The king himself had been hurt by it, and resolved to check it, not by a friendly remonstrance, but in a way the most grating to Lysander's feelings. He rejected all applications which were made to him in reliance on Lysander's interest; and his purpose at length became so evident, that Lysander was obliged to inform his clients, that his intercession, instead of furthering, would only obstruct their suits. He had however sufficient self-command to stifle or disguise his resentment; and, after a very mild expostulation with Agesilaus on the harshness of his conduct, requested to be removed from the scene of his humiliation to some other place, where he might still be employed in the public service. The king very willingly complied, and sent him to the Hellespont, where not long after he achieved an acquisition of some moment to the Spartan arms. He prevailed on a Persian of high rank, named Spithridates, who had been offended by Pharnabazus, to revolt, and come with his family, his treasures, and two hundred horse, to Cyzicus, and thence sailed with him and his son to Ephesus, and presented them to Agesilaus, who received them with great pleasure, and took this opportunity of gaining information about the state of Pharnabazus. This incident produced an apparent reconciliation between him and Lysander; but we shall see reason to suspect that on one side, at least, it was not sincere.

Tissaphernes had no sooner received such an addition to his forces, as appeared to him sufficient to overpower Agesilaus, than he threw aside the mask, and sent a message to the Spartan king, bidding him immediately quit Asia, or prepare for war. The council and the allies were somewhat daunted by his arrogant tone, and apparent strength; but Agesilaus, who had expected this result, and desired no other, told the envoys to carry back his thanks to their master, for the advantage he had given the Greeks by his perjury. He then ordered his troops to put themselves in readiness for a long march; sent



PROWS OF GREEK GALLEYS

word to the towns which lay on the road to Caria to lay in provisions for the use of his army; and called on the cities of Ionia, Æolis, and the Hellespont, for their contingents. Agesilaus had reckoned upon this effect of the satrap's selfish fears, and, instead of seeking him in Caria, marched in the opposite direction toward the residence of Pharnabazus. As this invasion was quite unexpected, he found the towns on his road unprepared for resistance, and collected an immense booty. He penetrated nearly to Dascylium without encountering an enemy. But in that neighbourhood he fell in with a body of Persian horse, and, by the issue of a skirmish which ensued, was made to feel its superiority in equipments and training over his own. The next day when he sacrificed, observes Xenophon — as if he was relating a providential warning, not a human contrivance — the victims were found imperfect; and Agesilaus advanced no farther, but retreated towards Ephesus.

There he spent the winter in preparations for the next campaign, and more particularly applied himself to the raising of a body of cavalry, which he perceived would be indispensable to the success and the safety of his future operations. For this purpose he made a list of the most opulent men in the Greek cities, and compelled each of them, as the condition of his exemption from personal service, to furnish a trooper. In the spring he collected his forces at Ephesus, and put them into an active course of training, rousing their emulation by the prizes which he proposed for the most gallant show, and the highest degree of expertness, in every department of the service. Xenophon, as an old soldier, is delighted with the recollection of the military bustle which prevailed during this season at Ephesus; where the wrestling schools and the hippodrome were constantly enlivened by the exercises of the men, the market was abundantly supplied with horses, and arms of every kind, and all the trades subservient to war were kept in full employment. Among other devices for raising the spirits of his troops, Agesilaus borrowed a hint, it would seem, from one of Cimon's stratagems, and ordered his Persian prisoners to be exposed to sale naked, that the Greeks might contrast the delicacy of their persons with the robustness of frames hardened by the exercises of the palæstra.

Before he took the field again, a year having now elapsed from the commencement of his expedition, Lysander and his colleagues were superseded by a new body of councillors, and returned home. Agesilaus then gave public notice, that he meant to take the shortest road into the richest part of the enemy's country. The notice was designed not more for the preparation of his own troops, than for Tissaphernes, who concluded that if this had been the intention of Agesilaus, he would not have disclosed it, and that now Caria was certainly his real mark. He therefore repeated the dispositions of the preceding summer. But while he waited for the enemy with his cavalry in the vale of the Mæander, Agesilaus directed his march towards the plains of Sardis, the richest of Western Asia. During three days he traversed them without seeing an enemy; but on the fourth the Persian cavalry, which Tissaphernes seems to have sent forward as soon as he heard of the movements of Agesilaus, suddenly came up, and cut off many of the followers of the camp, as they were ranging over the country in quest of plunder.

Tissaphernes had already arrived at Sardis; and his countrymen, many of whom had probably suffered considerable loss from the invasion, bitterly censured him for leaving them unprotected, and even it seems charged him with treachery. The complaints were carried up to the court, where he had one implacable and powerful enemy in the fiendish Parysatis, who thirsted to revenge herself on him for his enmity to her favourite son. She had already

[395 B.C.]

found that Artaxerxes was weak enough to sacrifice his most faithful servants to her resentment, even when he knew that it was inflamed by the very services which they had rendered to himself; and according to the most probable account, it was in compliance with her request that he now ordered Tissaphernes to be put to death. The execution of the sentence was committed to Tithraustes, who was appointed to succeed Tissaphernes in his satrapy, and was instructed to open a negotiation with Agesilaus. Accordingly, after executing the first part of his commission, which he did in the Turkish style by the hands of an underling, who surprised Tissaphernes in his bath, Tithraustes sent envoys to treat with the Spartan king. He affected to consider Tissaphernes as the author of the quarrel between his master and the Greeks, and, as if the end of their expedition was now answered by their enemy's death, proposed that Agesilaus should return home. As to the Asiatic Greeks, Artaxerxes was willing to acknowledge their independence, on condition that they would pay their ancient tribute. Agesilaus replied, that he had no authority to conclude peace without the sanction of the government at home: but he would transmit the Persian overtures to Sparta. In the meanwhile Tithraustes was very anxious that hostilities should be suspended in his province, and, pleading his own merits in the execution of Tissaphernes, begged Agesilaus, while he waited for an answer to the terms proposed, to turn his arms against the satrapy of Pharnabazus. To this Agesilaus consented on condition that Tithraustes would defray the expense of the march; and he received thirty talents [£6000 or \$30,000] on that score. This was a step beyond former precedents: for even Tissaphernes, though he had not scrupled to conclude a separate truce, had not paid the enemy a subsidy for invading another part of his master's dominions.

On his march towards the territories of Pharnabazus, Agesilaus received a flattering testimony of the approbation with which his proceedings were viewed at Sparta, and of the disposition which prevailed there to support him in the prosecution of the war. By a despatch which reached him as he lay near Cyme, he learned that he had been invested with the administration of naval affairs, that he was empowered to appoint whom he would to the office of admiral, and still to regulate the operations of the fleet at his discretion. Thus to unite the supreme command of the army and of the navy in one person, was an unexampled mark of confidence, and a striking indication of the new energy which ambition had infused into the Spartan counsels. Agesilaus immediately took measures for raising a fleet; and by a judicious distribution of the burden among the maritime allies, and his influence with wealthy individuals, collected 120 new galleys. But he was less prudent and fortunate in the choice of an admiral, and instead of seeking the highest qualifications, consulted his private affection in the appointment of his wife's brother Pisander. When this business was despatched, he continued his march to the satrapy of Pharnabazus.

PERSIAN GOLD

These preparations, combined perhaps with other tokens, convinced Tithraustes that Agesilaus had no intention of withdrawing from Asia, but was inclined rather to extend than contract his views, and cherished strong hopes of effecting the conquest of the empire. He perceived that he had only purchased a temporary relief, and bethought himself how he might employ the gold, which was his last remaining stay, to greater advantage.

The history of the contest between Greece and Persia afforded several instructive lessons, which were now peculiarly applicable. At the time when the first Artaxerxes was embarrassed by the success of the Athenians in Egypt, he sent an agent, as we have seen, with bribes to Sparta, to procure a diversion in his favour. Tithraustes now resorted to a similar expedient. He sent a Rhodian named Timocrates to Greece, with a sum of fifty talents, which he was charged to distribute, with proper precautions, among the leading persons in the states which might be most easily induced to interrupt the progress of Agesilaus by kindling a war against Sparta at home. Not only was this mission itself a notorious and unquestionable fact; but Xenophon professes an equal degree of certainty as to the names of the persons who received the money. We may at least venture to believe that, though it may have roused them to greater activity, it produced no change in their political sentiments: and we even doubt whether it gave rise to any events which would not have occurred nearly as soon without it. It was indeed natural enough for Agesilaus and his friends to attribute the disappointment of his hopes to the venality of their adversaries. But Xenophon himself observes that the Athenians, though they did not receive any share of the gold, were eager for war in the hope of recovering their independence. And it is clear from his own narrative that similar feelings of jealousy or resentment towards Sparta already prevailed at Thebes, Corinth, and Argos, and were only waiting for an opportunity of displaying themselves in open hostility, but needed no corrupt influence to excite them.

The anti-Laconian party at Thebes—the same no doubt which had sheltered the Athenian exiles, and had contrived the affront offered to Agesilaus at Aulis, and which had therefore reason to dread his resentment if he should ever return to Europe as the conqueror of Asia—set the first springs of hostility in motion. The disposition to war they found already existing; a pretext only was wanting, and this they easily devised. Means were found to induce the Locrians of Opus to make an inroad upon a tract of land which had been long the subject of contention between them and their neighbours the Phocians. The Phocians retaliated by the invasion of the Opuntian Locris, and the Thebans were soon persuaded to take part with the Locrians, and invade Phocis. The Phocians, as was foreseen, applied for succour to Sparta, where, as Xenophon admits, there was the utmost readiness to lay hold on any pretence for a war with Thebes; and the present season of prosperity seemed to the Spartan government the most favourable for humbling a power which had given so many proofs of ill-will towards it.

WAR RISES IN GREECE

War therefore was decreed, and Lysander was sent into Phocis with instructions to collect all the forces he could raise there, and among the tribes seated about Mount Œta, and to march with them to Haliartus in Bœotia, where Pausanias, with the Peloponnesian troops, was to join him on an appointed day. Lysander discharged his commission with his usual activity, and besides succeeded in inducing Orchomenos, which was subject to Thebes, to assert its independence. Pausanias, having crossed the Laconian border, waited at Tegea for the contingents which he had demanded from the allies. They seem to have come in slowly, and Corinth refused to take any part in the expedition. The Thebans, seeing themselves threatened with invasion, sent an embassy to prevail on the Athenians to make common cause with

[395 B.C.]

them against Sparta. There were many feelings to be overcome at Athens, before this resolution could be adopted: recollections of a long hereditary grudge, of the animosity displayed by Thebes during the last war, and especially at its close; the sense of weakness, and the dread of provoking a power, by which Athens had so lately been brought to the brink of destruction. The Athenians desired to recover their pre-eminence in Greece, and their readiest way to that end was to declare themselves the protectors of all who suffered under Spartan tyranny. If they were inclined to dread the enemy's power, they had only to reflect by what means their own had been overthrown. Sparta likewise now ruled over unwilling subjects, and offended allies, who only wanted a leader to encourage them to revolt from her. Indeed she had not one sincere friend left. Argos had always been hostile; Elis had just been deeply wronged. Corinth, Arcadia, and Achaia saw the services which they had rendered in the war requited with insolent ingratitude, and were subject to the control of harmosts, who were not even citi-

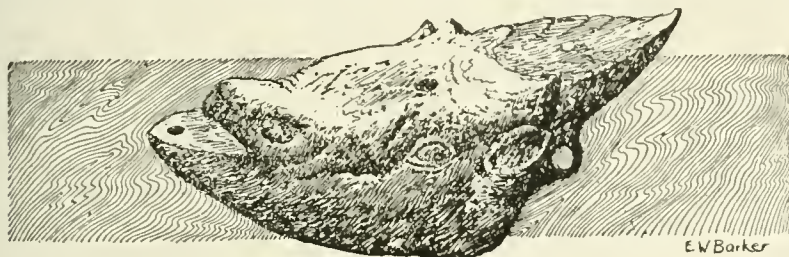

GREEK TERRA-COTTA LAMP

zens of Sparta, but helots; bondmen at home, masters abroad. The cities once subject to Athens, which had been tempted to revolt by the prospect of liberty, found themselves cheated of their hopes, and groaned under the double yoke of a foreign governor, and a domestic oligarchy. The Persian king, to whom Sparta mainly owed her victory, she had immediately afterwards treated as an enemy. Athens might now place herself at the head of a confederacy much more powerful than the empire which she had lost; and the Spartan dominion would be more easily overthrown than the Athenian had been, in proportion as the allies of Sparta were stronger than the subjects of Athens.

These arguments found a willing audience; they were seconded by many voices, and the assembly was unanimous in favour of the alliance with Thebes. Thrasybulus, who moved the decree, reminded the Thebans that Athens was about to repay the obligation which they had laid on her when they refused to concur in riveting her chains, by active exertions, and at a great risk. For she would have to face the enmity of Sparta while Piræus remained still unfortified. Both states prepared for war.

Lysander, having collected all the forces he could raise in the north, marched to Haliartus; but he found that Pausanias had not yet arrived there. It was not in his character to remain anywhere inactive, and he was desirous of making himself master of the town. He first tried negotiation to engage it to revolt. But there were some Theban and Athenian troops in the place, whose presence overawed the disaffected; and he then resolved to venture on an assault. A battle took place close to the walls, in which Lysander was slain. It seems clear from a comparison of all accounts, that he was intercepted between the main body of the Thebans and

the garrison, which made a sally; and he was known to have fallen by the hand of a citizen of Haliartus. His troops were put to flight, and betook themselves to the hills—a branch of the range of Helicon—which rose at no great distance behind the town. The conquerors pursued with great vigour, and incautiously pressed forward up the rising ground, until the difficulties of the ground brought them to a stand, and the fugitives, perceiving their perplexity, turned upon them, assailed them with a shower of missiles, rolled down masses of rock on their heads, and finally drove them in disorder, with the loss of more than two hundred men, into the plain. The dejection caused by this disaster was relieved the next day by the discovery that the remains of Lysander's army had dispersed during the night.

But the exultation of the Thebans at this fruit of their victory was damped in the course of a few hours by the appearance of Pausanias, who had received the news of the battle on the road from Plataea to Thespieæ, and had hastened his march to Haliartus. Yet, according to Diodorus, he brought with him no more than six thousand men; but so small a force could scarcely have produced the alarm described by Xenophon, who, with a slight touch of humour, exhibits the Theban camp as fluctuating between the extremes of presumption and despondency. For the next day their spirits were again raised by the arrival of Thrasybulus and an Athenian army; and their confidence was heightened when they perceived that Pausanias showed no disposition to seek an engagement. His situation was extremely embarrassing. According to Greek usage it was absolutely necessary for him to recover the bodies of the slain, who are said to have amounted to a thousand, either by force or by consent of the victors. The greater part lay so near to the town walls that the attempt to carry them away by force would be one of great difficulty and danger, even if he should gain a victory; and the enemy was so strong in cavalry, that the event of a battle would be very uncertain, especially as his own troops had engaged in the expedition with reluctance. He therefore held a council of war; and after mature deliberation the majority came to the decision—if indeed it was not unanimous—to apply for permission to carry away the dead. The Thebans however were not satisfied with this confession of their superiority, and refused to grant a truce, except on condition that the invaders should withdraw from Bœotia. These terms were gladly accepted by Pausanias and his council, though they were felt by the troops as a degradation, such as a Lacedæmonian army had never before experienced. The general dejection and ill-humour which prevailed in the retreat, were heightened by the insulting demeanour of the Thebans, who accompanied them on their march through Bœotia, and drove back all who deviated in the least from the line, with blows, into the road.

The conduct of Pausanias appears to have been in the whole of this affair perfectly blameless. He had failed indeed to reach Haliartus by the preconcerted day, but he arrived the day after; and when it is considered that he had to collect his army from many quarters, and that the allies were generally averse to the expedition, he may seem rather to have deserved praise, for bringing it up so nearly within the appointed time. The disastrous issue could only be attributed to Lysander's imprudence; and the decision of the council of war with regard to the recovery of the slain, even if it was not clearly required by the circumstances of the case, could not reasonably be imputed as a crime to Pausanias. Yet on his return to Sparta he was capitally impeached; and the nature of the charges brought against him showed that he could not expect a fair trial, but was foredoomed to be sacrificed to public prejudice or to private passion; for the accusation embraced not

[404-395 B.C.]

merely his conduct in his last expedition, but the indulgence which he had granted to the Athenian refugees in Piræus; though his measures on that occasion seem to have been viewed with general approbation at the time, and had only been proved to be impolitic by the event. But under the irritation produced by the recent shame and disappointment, the Spartan senate was no more capable of listening to reason and justice, than the Athenian assembly on some similar occasions; and it is probable that Lysander's friends did the utmost to inflame the public feelings against his old adversary. Pansanias did not appear at the trial; he was condemned to death, and was obliged to seek shelter in the venerated sanctuary of Athene Alca at Tegea, where he ended his days. His son Agesipolis succeeded to the throne.

Lysander left his family in a state of poverty, which proved that his ambition was quite pure from all sordid ingredients. But, if we may believe a story which became current after his death, and is related upon such authority, that we can scarcely suppose it to have been without foundation, he was not satisfied either with fame, or with the substance of power. He is said to have conceived the project of levelling the privileges of the two royal houses, and of making the kingly office elective, and open to all Spartans, no doubt with the hope of obtaining it for himself.^d

LYSANDER'S PLOT

The melodramatic scheme to secure the throne, which has been credited to Lysander, was discredited by Thirlwall, and Mitford, but Grote, Bury, and others accept it, and it is curious enough to deserve chronicle here:

When the Heraclidæ mixed with Dorians, and settled in Peloponnesus, there was a large and flourishing tribe of them at Sparta. The whole, however, were not entitled to the regal succession, but only two families, the Eurytionidæ and the Agidæ; while the rest had no share in the administration on account of their high birth. For as to the common rewards of virtue, they were open to all men of distinguished merit. Lysander, who was of this lineage, no sooner saw himself exalted by his great actions, and supported with friends and power, but he became uneasy to think that a city which owed its grandeur to him, should be ruled by others no better descended than himself. Hence he entertained a design to alter the settlement which confined the succession to two families only, and to lay it open to all the Heraclidæ. Some say, his intention was to extend this high honour not only to all the Heraclidæ, but to all the citizens of Sparta; that it might not so much belong to the posterity of Hercules, as to those who resembled Hercules in that virtue which numbered him with the gods. He hoped, too, that when the crown was settled in this manner, no Spartan would have better pretensions than himself.

At first he prepared to draw the citizens into his scheme, and committed to memory an oration written by Cleon of Halicarnassus for that purpose. But he soon saw that so great and difficult a reformation required bolder and more extraordinary methods to bring it to bear. And as in tragedy machinery is made use of, where more natural means will not do, so he resolved to strike the people with oracles and prophecies; well knowing that the eloquence of Cleon would avail but little, unless he first subdued their minds with divine sanctions and the terrors of superstition. Ephorus tells us, he first attempted to corrupt the priestess of Delphi, and afterwards those of Dodona by means of one Pherecles; and having no success in either

application, he went himself to the oracle of Ammon, and offered the priests large sums of gold. They too rejected his offers with indignation, and sent deputies to Sparta to accuse him of that crime. When these Libyans found he was acquitted, they took their leave of the Spartans in this manner: "We will pass better judgments, when you come to live among us in Libya." It seems there was an ancient prophecy, that the Lacedæmonians would some time or other settle in Africa. This whole scheme of Lysander was of no ordinary texture, nor took its rise from accidental circumstances, but was laid deep and conducted with uncommon art and address: so that it may be compared to a mathematical demonstration, in which, from some principles first assumed, the conclusion is deduced through a variety of abstruse and intricate steps. We shall, therefore, explain it at large, taking Ephorus, who was both an historian and philosopher, for our guide.

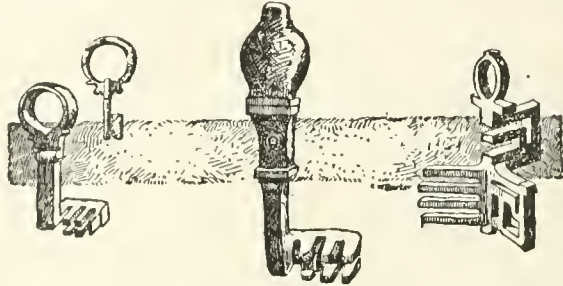

GREEK DOOR KEYS

There was a woman in Pontus who gave it out that she was pregnant by Apollo. Many rejected her assertion, and many believed it. So that when she was delivered of a son, several persons of the greatest eminence took particular care of his education, and for some reason or other gave him the name of Silenus. Lysander took this miraculous birth for a foundation, and raised all his building upon it. He made choice of such assistants, as might bring the story into reputation, and put it beyond suspicion. Then he got another story propagated at Delphi and spread at Sparta, that certain ancient oracles were kept in the private registers of the priests, which it was not lawful to touch or to look upon, till in some future age a person should arise, who could clearly prove himself the son of Apollo, and he was to interpret and publish these oracles. The way thus prepared, Silenus was to make his appearance, as the son of Apollo, and demand the oracles. The priests, who were in combination, were to inquire into every article, and examine him strictly as to his birth. At last they were to pretend to be convinced of his divine parentage, and to show him the books. Silenus then was to read in public all those prophecies, particularly that for which the whole design was set on foot; namely, that it would be more for the honour and interest of Sparta to set aside the present race of kings, and choose others out of the best and most worthy men in the commonwealth. But when Silenus was grown up, and came to undertake his part, Lysander had the mortification to see his piece miscarry by the cowardice of one of the actors, whose heart failed him just as the thing was going to be put in execution. However, nothing of this was discovered while Lysander lived.

Lysander's poverty, which was discovered after his death, added lustre to his virtue. It was then found, that notwithstanding the money which had passed through his hands, the authority he had exercised over so

[395 B.C.]

many cities, and indeed the great empire he had been possessed of, he had not in the least improved his family fortune. Ephorus tells us that, afterwards, upon some disputes between the confederates and the Spartans, it was thought necessary to inspect the writings of Lysander, and for that purpose Agesilaus went to his house. Among the other papers he found that political one, calculated to show how proper it would be to take the right of succession from the Eurytionidæ and Agidæ, and to elect kings from among persons of the greatest merit. He was going to produce it before the citizens, and to show what the real principles of Lysander were. But Lacratides, a man of sense, and the principal of the ephors, kept him from it, by representing how wrong it would be to dig Lysander out of his grave, when this oration, which was written in so artful and persuasive a manner, ought rather to be buried with him.

Among the other honours paid to the memory of Lysander, that which we shall mention is none of the least. Some persons who had contracted themselves to his daughters in his lifetime, when they found he died poor, fell off from their engagement. The Spartans fined them for courting the alliance while they had riches in view, and breaking off when they discovered that poverty which was the best proof of Lysander's probity and justice. It seems, at Sparta there was a law which punished, not only those who continued in a state of celibacy, or married too late, but those that married ill; and it was levelled chiefly at persons who married into rich rather than good families.^e

AGESILAUS RECALLED

While these movements were taking place in Greece, Agesilaus was carrying on the war in Asia, with an activity and success which might well have alarmed the Persian court, and proved the wisdom of the precautions adopted by Tithraustes. On his march into the province of Pharnabazus, he was accompanied by Spithridates, who urged him to advance into Paphlagonia, and undertook to make Cotys, the king of that country, his ally. Cotys, who is elsewhere named Corylas, was one of those powerful hereditary vassals of the Persian king, whose subjection had become merely nominal, and he had lately renounced even the appearance of submission. Artaxerxes, imprudently or insidiously, had put his obedience to the test, by summoning or inviting him to court. But the Paphlagonian prince was too wary, and knew the character of the Persian government too well, to trust himself in its power, and he had openly refused to obey the royal command. It would add nothing to his offence, though something to his security, to treat with the enemies of Artaxerxes. Nothing could be more agreeable to Agesilaus than the opportunity of gaining so powerful an ally; he gladly accepted the mediation of Spithridates, who not only fulfilled his promise, and engaged Cotys to come to the Greek camp, and conclude an alliance with Sparta in person, but prevailed on him, before his departure, to leave a reinforcement of one thousand cavalry, and two thousand targeteers, with the army of Agesilaus.

To reward Spithridates for this important service, in a manner which would strengthen the Greek interest in Asia, Agesilaus, with great address, negotiated a match between Cotys and the daughter of Spithridates, so as to lead each party to consider himself as under obligations to the other, and both to look upon him as their benefactor. As the season was too far advanced for a journey by land across the Paphlagonian mountains, the young

lady was sent by sea, under the charge of a Spartan officer, to the dominions of her intended consort; and Agesilaus returned to take up his winter quarters in the territories of Pharnabazus, and in the satrap's own residence of Dascylium. Here were parks, chases, and forests abounding in game of every kind, and round about were many large villages plentifully stocked with provisions for the ordinary supply of the princely household. The domain was skirted by the windings of a river, full of various kinds of fish. Here therefore the Greek army passed the winter in ease and plenty, making excursions, as occasion invited, into the surrounding country far and wide, while Pharnabazus was forced to range over it as a houseless fugitive, carrying with him his family and his treasures, for which he could find no place of permanent shelter, and, even in this Scythian mode of life, never free from apprehensions for his personal safety.

Sometimes, however, he hovered in the neighbourhood of the Greeks, and once surprised them in one of their marauding excursions; and though he had with him only two scythic-chariots, and about four hundred cavalry, he dispersed a body of seven hundred Greek horse with his chariots, and drove them, with the loss of one hundred men, to seek shelter from their heavy infantry. A few days after this skirmish Spithridates learned that the satrap was encamped in the village of Cava, about twenty miles off, and communicated the discovery to Herippidas. Herippidas, who loved a brilliant enterprise, was immediately fired with the hope of making himself master of the satrap's camp and person, and requested Agesilaus to grant him, for this purpose, two thousand heavy infantry, as many targeteers, the Paphlagonian cavalry, and those of Spithridates, and as many of the Greek horse as might be willing to take part in the adventure. He obtained all he asked; but at night, at the hour of departure, he found that not half of his volunteers appeared at the appointed place. Nevertheless, fearing the raillery of his colleagues, if he should desist, he persevered in his undertaking, and after marching all night, arrived at daybreak at the encampment of Pharnabazus. He overpowered a body of Mysians at the outpost; but their resistance afforded time for the escape of Pharnabazus and his family, who however left the camp, with a great treasure of drinking vessels and costly furniture, in the possession of the assailants. But Herippidas, being anxious, for the sake of his own honour, to deliver the whole booty into the hands of the officers who in the Spartan army answered to the Roman quæstors, took precautions to exclude his allies from all share in it; and he thus deprived the Spartan arms of an advantage much more important than the value of the spoil. For Spithridates and the Paphlagonians, indignant at this treatment, deserted the camp the next night, and repairing to Sardis entered the service of Ariæus, who had again revolted, and was at war with the king: Agesilaus was more deeply affected by this loss than by any mischance that he met with in the course of his expedition: and he seems to have regretted it still more on private than on public grounds.

Not long after, a prospect seemed to be opened to him of gaining a much more valuable ally. A Greek of Cyzicus, who was connected by ties of hospitality with Pharnabazus, and had recently entered into the same relation with Agesilaus, proposed to him to bring about an interview between him and the satrap. The preliminaries were arranged, and a place of meeting appointed in the open air, to which Agesilaus came accompanied by the Thirty, and they seated themselves on the grass to wait for Pharnabazus. He came attended by a train of servants, who, according to the Persian fashion, proceeded to lay down a carpet and cushions for their master. But the

[395-394 B.C.]

intelligent Persian, struck by the contrast of the Spartan simplicity, in a fortune at present so much more prosperous than his own, ordered these instruments of luxury to be removed, and, in his splendid attire, took his seat without ceremony on the green-sward by the side of Agesilaus.

After the forms of a friendly greeting had been interchanged, Pharnabazus opened the conference with an expostulation on the hard treatment which he had suffered. He reminded his hearers of the zeal and constancy with which he had espoused the cause of Sparta in the war with Athens. Nevertheless Spartan hostility had now reduced him to such a condition that even in his own territory he did not know how to find a meal, except such as he could collect, like a dog, from the orts and leavings of their rapine; while his fair patrimonial mansions, his pleasant woods and parks, had been all burned, and felled, and spoiled. If, he concluded, it was his ignorance that made him unable to reconcile such conduct with the obligations of justice and gratitude, he desired that the Spartans would enlighten him.

This address, Xenophon says, struck the Thirty with shame, and it was some time before Agesilaus broke the silence that ensued. Private friendship, he said, must give way to reasons of state. The Spartans, being at war with the king of Persia, were compelled to treat all his subjects as their enemies; and Pharnabazus among the rest, however glad they might be to gain him for their friend. And what they had now to propose was not that he should exchange one master for another, but that he should at once become their ally, and independent of every superior. Nor was it a poor or barren independence that they held out to him, but a rich addition to his hereditary possessions, which their aid would enable him to make at the expense of his fellow subjects, who would then be forced to own him as their master. Pharnabazus, in answer to these overtures, said that he would frankly declare his mind to them. If the king should attempt to place any other general in authority over him, he would renounce his allegiance, and ally himself to Sparta; but if his master entrusted him with the supreme command in that part of his domains, he would do his best to defend them. Agesilaus grasped his hand, and assured him of his warmest regard, and, under the excitement of a generous feeling, forgetting the excuse he had just before made for his past conduct, promised to withdraw immediately from his territories, and, though they should continue at war, to abstain from invading them, as long as there was any other quarter in which he could employ his forces. So the interview ended.

Agesilaus kept his word, and withdrew his forces from the satrapy of Pharnabazus, where indeed it is probable he would not otherwise have stayed much longer, as the spring was coming on, and he was meditating a new expedition, in which he meant to advance as far as he could into the interior. By this movement, if he gained no more decisive advantage, he expected that he should at least separate all the provinces which he left behind him from the Persian empire. With this design he proceeded to the plain of Thebe, where he encamped, and began to collect all the forces he could raise from the allied cities. He was in the midst of these preparations, when he received a message from the ephors, which was brought by a Spartan named Epieydidus, who apprised him of the new turn which affairs had taken in Greece, and summoned him to march with the utmost speed for the defence of his country. Agesilaus received this intelligence with fortitude, though it stopped him at the outset of the most brilliant career that had ever yet been opened by a Greek, and obeyed the command of the ephors with as much promptness as if he had been present in their council-room at Sparta.^d



GREEK VASES

CHAPTER XLIII. THE CORINTHIAN WAR

Two cares principally engaged Agesilaus before his departure ; to provide security for the Asian Greeks in his absence, and to have a numerous and well-appointed army to lead into Greece. For the former purpose, naming Euxenus to preside, with the title of harmost, he placed a body of four thousand men under his orders. With the latter view, he proposed prizes for the cities which should furnish the best troops ; and for commanders of mercenaries, horse, heavy-armed, bowmen, and targeteers, whose bands should be the best chosen, best appointed, and best disciplined. The prizes were mostly arms, elegantly wrought ; but, for higher merit, or the merit of those of higher rank, there were some golden crowns ; and Xenophon mentions it, as a large sum for the occasion, that the expense amounted to four talents, less than a thousand pounds sterling. Three Lacedæmonians, with one officer from each Asiatic city, were named for judges ; but the decision, or the declaration of it, was judiciously referred to the arrival of the army in the Thracian Chersonesus.

Unable as the leading men in the Lacedæmonian administration were, either to conduct a war against the powerful confederacy formed against them, or, upon any tolerable terms, to prevent it, the recall of Agesilaus seems to have been a necessary measure. The army assembled by their enemies was such as had not often been seen in wars within Greece. Argos furnished seven thousand heavy-armed ; Athens had already recovered strength to send six thousand, and add six hundred horse ; Bœotia, Corinth, Eubœa, and Locris made the whole of the army twenty-four thousand heavy-armed, with above fifteen hundred cavalry ; to which was added a large body of the best light-armed of Greece, Acarnanians, Ozolian Locrians, and Malians. The fighting men of all descriptions must have amounted to fifty thousand. The avowed purpose was to invade Laconia. "The Lacedæmonian state," said the Corinthian Timolaus, in a debate on the plan of operations, "resembles a river, which, near the source, is easily forded, but the farther it flows, other streams joining, the depth and power of the current increases. Thus the Lacedæmonians always march from home with their own troops only ; but as they proceed, being reinforced from other cities, their army swells and grows formidable. I hold it therefore advisable to

[394 B.C.]

attack them, if possible, in Lacedæmon itself ; otherwise, the nearer to Lacedæmon the better."

Against so powerful a league, the allies, whom the Lacedæmonians could now command, were principally from the smaller Grecian cities, and none beyond Peloponnesus. Marching themselves six thousand foot and six hundred horse, and being joined by the Mantineans and Tegeans, whose numbers are not reported, they were farther reinforced by no more than seven thousand five hundred heavy-armed, from Epidaurus, Hermione, Trœzen, Sicyon, Achaia, and Elis. Aristodemus, of the blood royal, as regent, commanded for the king, Agesipolis, yet a boy.

Circumstances commonly occur to render confederate armies less efficacious, in proportion to their strength, than those under a single authority. A dispute about the command in chief, with some difference of opinion about their order of battle, some of the generals being for deeper, others for more extended phalanges, gave opportunity for the Lacedæmonians to collect their forces, and march far beyond their own frontier, so as to meet the enemy near Corinth. In the account of the preparatory sacrifices there drops from Xenophon a remarkable confession, that those ceremonies were sometimes engines of policy. While the Bœotians, he says, held the left of their army, they were in no haste to engage ; but, as soon as they had prevailed to have their situation in the line changed, so that the Athenians would be opposed to the Lacedæmonians, and themselves to the Achæans, then they declared that the symptoms of the victims were favourable. They saved themselves perhaps some slaughter by this disingenuous artifice. In the battle which ensued the Achæans fled, and all the allies of Lacedæmon equally yielded to those opposed to them. But the Athenians were defeated with considerable slaughter ; and the superior discipline of the Lacedæmonians so prevailed against superior numbers that, with the loss of only eight of their own body, they remained finally masters of the field ; in which, if we may trust Xenophon's panegyric of Agesilaus for what he has omitted to state in his general history, no less than ten thousand of the confederate army fell.¹ Probably however, though the Lacedæmonians themselves suffered little, their allies suffered much ; for the victory seems to have been little farther decisive than to prevent the invasion of Peloponnesus.

Meanwhile Agesilaus was hastening his march from Asia. He crossed the Hellespont about the middle of July. At Amphipolis he met Dercyllidas, who had been sent to inform him of the victory obtained near Corinth. Immediately he forwarded that able and popular officer into Asia, to communicate the grateful news among the Grecian cities there, and to prepare them for his early return, of which there seemed now fair promise.

Through Thrace and Macedonia the country was friendly, or feared to avow hostility. Thessaly, inimically disposed, and powerful through population and wealth resulting from the natural productiveness of the soil, was however too ill-governed to give any systematical opposition. The defiles of the mountains against Macedonia, where a small force might efficaciously oppose a large one, seem to have been left open. But the influence of the principal towns, Larissa, Cranon, Scotussa, and Pharsalus, in close alliance with the Bœotians, decided the rest, and as the Lacedæmonian army crossed the plain a body of horse, raised from the whole province, infested the march. It was singularly gratifying to Agesilaus that, with his horse,

[¹ This statement of Xenophon is, according to Grote, either a mis-reading or a wild exaggeration. Diodorus says that the Spartans lost 1100 ; the allies 2800.]

promiscuously collected, and entirely formed by himself, supporting it judiciously with his infantry, he defeated and dispersed the Thessalian, the most celebrated cavalry of Greece.

On the day after this success he reached the highlands of Phthia; and thence the country was friendly quite to the border of Bœotia. But there news met him, unwelcome for the public, unwelcome on his private account, and such as instantly almost to blot out his once bright prospect, which, as the historian, his friend and the companion of his march, shows, he had thus far been fondly cherishing, of conquest in Asia, and glory over the world. While the misconduct of the Lacedæmonian administration had excited a confederacy within Greece, which proposed to overwhelm Lacedæmon by superiority of land-force, and, with that view, to carry war directly into Laconia, a hostile navy had arisen in another quarter, powerful enough to have already deprived her, by one blow, of her new dominion of the sea.

The train of circumstances which had produced this event, though memorials fail for a complete investigation of it, will require some attention.



A CORINTHIAN VASE
(In the Museum of Napoleon III)

We have seen Cyprus, at a very early age, from a Phœnician, become a Grecian island, and Salamis the first Grecian city founded there. We have then observed the Cyprian Greeks yielding to the Persian power. The ruin of the marine, the inertness of the court, and the distraction in the councils of Persia, which followed, would afford opportunity and temptation for the Cypriots, beyond other subjects of the empire, again to revolt; and the Persian interest, and the Greek, and the Phœnician, and the tyrannic, and the oligarchal, and the democratical, would be likely to fall into various contest. Such, as far as may be gathered, was the state of things which first invited Athenian ambition to direct its view to Cyprus, when the Athenian navy, rising on the ruins of the Persian, was extending dominion for Athens on all sides, under the first administration of Pericles. This view, quickly diverted to other objects, was however, after a change

in the Athenian administration, resumed; and Cimon, as we have seen, died in command in Cyprus. The policy of Athens would of course propose to hold dominion, there as elsewhere, through support given to the democratical interest. But after the death of Cimon wars so engaged the Athenian government as to prevent the extension of any considerable exertion to such a distance; and the Cyprian cities were mostly governed by their several princes or tyrants, under the paramount sovereignty of Persia.

Among the fugitive Greeks was Evagoras, a youth who claimed descent from the ancient princes of Salamis, of the race of Teucer. Informed of the state of things, this young man formed the bold resolution, with only about fifty fellow-sufferers in exile, devoted to his cause, to attempt the recovery of what he claimed as his paternal principality. From Soli in Cilicia, their place of refuge, they passed to the Cyprian shore, and proceeded to Salamis by night. Knowing the place well, they forced a small gate, probably as in peace, unguarded, marched directly to the palace, and, after a severe conflict, overcoming the tyrant's guard, while the people mostly kept aloof, they remained masters of the city, and Evagoras resumed the sovereignty.

[394 B.C.]

This little revolution, in a distant island, became, through a chain of events out of all human foresight, a principal source of great revolutions in Greece. An extraordinary intimacy grew between the Athenian democracy and the tyrant of Salamis (for that was the title which Evagoras commonly bore among the Greeks), insomuch that the tyrant was associated among the Athenian citizens. In the ruin of Athens, impending from the defeat of Ægospotami, Conon fled thither with eight triremes, saved from the general destruction of the fleet. Conon had previous acquaintance with Evagoras; and eight triremes at his orders, equipped and ably manned, would enable him, in seeking refuge, to offer important service. The Athenian refugee became the most confidential minister of the Cyprian prince, or rather his associate in enterprise. Undertaking negotiation with Pharnabazus, he conciliated that satrap's friendship for Evagoras; which so availed him that, without resentment from the court, or opposition from other satraps, he could add several towns of the island to his dominion.

While Agesilaus was threatening the conquest of Asia, and Pharnabazus, having obtained, in a manner from his generosity and mercy, a respite from the pressure upon himself, was nevertheless apprehensive that this satrapy, separated from the body of the empire, might become dependent upon the Lacedæmonian commonwealth, Conon suggested that the progress of the Lacedæmonian arms, which seemed irresistible by land, would be most readily and efficaciously checked by a diversion by sea. A considerable fleet of Phœnician ships was at the satrap's orders: Evagoras had a fleet which might co-operate with it; the Athenian interest, still considerable in the island and Asiatic Grecian cities, would favour the purpose; and Conon himself had consideration among those cities, and especially among their seamen. Even before Agesilaus left Asia, a project, founded on these suggestions, seems to have been in forwardness. Soon after his departure, through the combined exertions of Pharnabazus, Evagoras, and Conon, a fleet very superior to the Lacedæmonian was assembled; and the generous Pharnabazus formed the resolution, extraordinary for a Persian satrap, to take the nominal command in person, having the good sense apparently to leave the effective command to the superior abilities and experience of Conon.

BATTLE OF CNIDUS

Near Cnidus they met the Lacedæmonian fleet, and the brave but inexperienced Pisander, brother-in-law of Agesilaus, would not avoid a battle. Conon and Evagoras led the Grecian force against him: Pharnabazus took the particular command of the Phœnician, forming a second line. The Grecian force alone, according to report, though Xenophon does not speak of it as certain, outnumbered the Lacedæmonian fleet. The allies in the left of the Lacedæmonian line, alarmed at the view of the enemy's great superiority, presently fled. Pisander was then quickly overpowered. His galley being driven on the Cnidian shore, the crew mostly escaped; but, refusing himself to quit his ship, he was killed aboard. The victory of Conon was complete: according to Diodorus fifty ships were taken.

Such was the disastrous event, the news of which met Agesilaus on his arrival on the confines of Bœotia. The first information struck him with extreme anguish and dejection. Presently, however, the consideration occurring how disadvantageous, in the existing circumstances, the communication of it might be, he had command enough of himself to check all

appearance of his feelings. His army consisted mostly of volunteers, attached indeed to his character, but more to his good fortune; and bound, as by no necessity, so by no very firm principle, to partake in expected distress. With such an army he was to meet, within a few days, the combined forces of one of the most powerful confederacies ever formed in Greece. To support, or, if possible, raise, the confidence and zeal of his troops, though by a device of efficacy to be of short duration, might be greatly important. He therefore directed report to be authoritatively circulated that Pisander, though at the expense of his life, had gained a complete victory; and, to give sanction to the story, he caused the ceremony of the evangelical sacrifice to be performed, and distributed the offered oxen among the soldiers.

Resuming then his march, in the vale of Coronea he met the confederate army, consisting of the flower of the Bœotian, Athenian, Argive, Corinthian, Eubœan, Locrian, and Ænian forces. Expecting this formidable assemblage, he had been attentive to all opportunity for acquiring addition to his own strength. Some he had gained from the Grecian towns on his march through Thrace. On the Bœotian border he was joined by the strength of Phocis, and also of the Bœotian Orchomenos, always inimical to Thebes. A Lacedæmonian mora had been sent from Peloponnesus to reinforce him, with half a mora which had been in garrison in Orchomenos. The numbers of the two armies were thus nearly equal; but the Asiatic Grecian troops, which made a large part of that under Agesilaus, were reckoned very inferior to the European. It was in the spirit of the institutions of Lycurgus that Agesilaus, otherwise simple, even as a Spartan, in his dress and manner, paid much attention to what our great dramatic poet has called "the pomp and circumstance of war"; aware how much it attaches the general mind, gives the soldier to be satisfied with himself, and binds his fancy to the service he is engaged in. Scarlet or crimson appears to have been a common uniform of the Greeks, and the army of Agesilaus appeared, in Xenophon's phrase, all brass and scarlet.

THE BATTLE OF CORONEA

According to the usual manner of war among the Greeks, when the armies approached a battle soon followed. On the present occasion both quitted advantageous ground; Agesilaus moving from the bank of the Cephissus, and the confederates from the roots of Helicon, to meet in a plain. Perfect silence was observed by both armies till within nearly a furlong of each other, when the confederates gave the military shout, and advanced running. At a somewhat smaller distance the opposite army ran to meet the charge. The Lacedæmonians, on its right, where Agesilaus took post, instantly overthrew the Argives, their immediate opponents, who, scarcely waiting the assault, fled toward Helicon. The Cyreans supported in Greece the reputation they had acquired in Asia; and were so emulated by the Ionians, Æolians, and Hellespontines, from whom less was expected, that, all coming to push of spear together, they compelled the centre of the confederate army to retreat. The victory seemed so decided that some of the Asiatics were for paying Agesilaus the usual compliment of crowning on the occasion; when information was brought him, that the Thebans had routed the Orchomenians, who held the extreme of his left wing, and had penetrated to the baggage. Immediately changing his front, he proceeded toward them.

[394 B. C.]

The Thebans perceived they were cut off from their allies, who had already fled far from the field. It was a common practice of the Thebans to charge in column, directing their assault, not against the whole, but a chosen point of the enemy's line. Thus they had gained the battle of Delium against the Athenians, in the eighth year of the Peloponnesian War. To such a formation their able leaders had recourse now; resolving upon the bold attempt to pierce the line of the conquering Lacedæmonians; not any longer with the hope of victory, but with the view to join their defeated allies in retreat. Xenophon praises the bravery, evidently not without meaning some reflection on the judgment, of Agesilaus; who chose to engage them, he says, front to front, when, if he had opened his line and given them passage, their flanks and rear would have been exposed to him.

A most fierce conflict ensued. Shield pressed against shield, stroke was returned for stroke; amid wounds and death no clamour was heard; neither, says the historian, who accompanied the Spartan king, was there complete silence, for the mutterings of rage were mixed with the din of weapons. The perseverance, the discipline, and the skill in arms of the Thebans were such, and such the force of their solid column, that, after many had fallen, a part actually pierced the Lacedæmonian line, and reached the highlands of Helicon; but the greater part, compelled to retreat, were mostly put to the sword. In this obstinate action Agesilaus was severely wounded. His attendants were bearing him from the field when a party of horse came to ask orders concerning about eighty Thebans, who, with their arms, had reached a temple. Mindful, amid his suffering, of respect due to the deity, he commanded that liberty should be granted to them to pass unhurt, whithersoever they pleased. In the philosopher-historian's manner of relating this anecdote is implied that, among the Greeks, in such circumstances, revenge would have prompted an ordinary mind; and, even in Agesilaus, the generous action is attributed, not to humanity, but to superstition; not to an opinion of the deity's regard for mercy and charity among men, but to the fear, unless it were rather the desire of inculcating the fear, of his resentment for any want of respectful attention to himself. When pursuit ended, the victorious army anxiously employed itself in dragging the enemy's slain within its own lines: a remarkable testimony, from the same great writer, to the prevalence still, in a degree that may surprise us, of that barbarism in war, which in Homer's description is striking, though in his age less a matter for wonder.



RUINS OF ANCIENT WALL, AT CORA
(With Modern Structure Superimposed)

C. E. Flower

Next morning early the troops were ordered to parade with arms, all wearing chaplets. Agesilaus himself being unable to attend, the polemarch Gylis commanded at the ceremony of raising the trophy; which was performed with all the music of the army playing, and every circumstance of pomp, that might most inspire, among the soldiery, alacrity and self-satisfaction.

Why then no measures were taken to profit from the advantages, which victory apparently should have laid open, is not shown. The Thebans sending, in usual form, for permission to bury their dead, a truce was granted them, evidently for a longer time than for that purpose alone, could be wanted. Meanwhile the Lacedæmonian army withdrew into Phocis, a country friendly or neutral, to perform a ceremony to which Grecian superstition indeed attached much importance, the dedication of the tenth of the spoil collected by Agesilaus in his Asiatic command. It amounted to a hundred talents; perhaps something more than twenty thousand pounds.

After this second triumphal rite the army, committed to the orders of Gylis, proceeded into the neighbouring hostile province of Ozolian Locris, where the object seems to have been little more than to collect plunder, which, according to the Grecian manner, might serve the soldiers instead of pay. Corn, goods, whatever the rapacious troops could find in the villages, were taken. The Locrians, unable to prevent the injury, did nevertheless what they best could to revenge it. Occupying the defiles which, in returning into Phocis, were necessarily to be repassed, they gave such annoyance that Gylis was provoked to take the command of a select body in pursuit of them.

Entangled among the mountains, he was himself killed, and the whole party would have been cut off, had not the officers left with the command of the main body brought seasonable relief. Agesilaus, still from his wounds unfit for fatigue, passed by sea to Laconia, and the army was distributed in quarters.

If any other writer had ever given any authority for the supposition, we might suspect that Xenophon's account of the battle of Coronea was written under the influence of partiality for his friend and patron, and that the victory was less complete than he has described it.¹ Yet we are not without information of circumstances which may have given occasion for the line of conduct which Agesilaus pursued. The defeat of Cnidus produced a great and rapid revolution in Asiatic Greece.

And thus the fabric of the Lacedæmonian empire, seemingly so established by the event of the Peloponnesian War, and since so extended by the ability of the commanders in Asia, was in large proportion almost instantly overthrown.

Most of the principal officers, and many inferior men, of the numerous Asiatic troops under Agesilaus, would be deeply interested in this revolution. The principal sources of pay for all would cease; and hence the plain of Coronea seems to have been the last field of fame for the Cyreans. We find no mention of them afterwards from Xenophon: apparent proof that their following fortunes were not brilliant; not such as he could have any satisfaction in reporting. Probably they dispersed, some to their homes, some to seek new service, and never more assembled.^b

[¹ On this point Bury says: "Though the battle of Coronea, like the battle of Corinth, was a technical victory for the Spartans, history must here again offer her congratulations to the side which was superficially defeated. . . . It was a great moral encouragement to Thebes for future warfare with Lacedæmon."]

[394-392 B.C.]

LAND AFFAIRS OF THE CORINTHIAN WAR

Xenophon was no such student of the accurate arrangement of events as was Thucydides, and the history recounted hereafter is differently ordered by different historians; by some the massacre at Corinth is postponed two years, to 392 B.C. The massacre which Xenophon with his Spartan sympathies makes so cold-blooded a butchery is by sober historians credited merely to the government's anticipation of a similar step on the part of the opposition.^a

Corinth still continued to be the theatre of war. A Lacedæmonian garrison occupied Sicyon, and made frequent inroads into the Corinthian territory. The allies of Corinth were well pleased to see themselves thus exempt from the calamities of war at her expense. But the party among the Corinthians which, on political grounds, desired to renew their connection with Sparta, derived new motives from this state of things to encourage them in their designs; and they began to hold private meetings to concert measures for restoring peace. Their movements were observed by their adversaries, who determined to counteract them by one of those atrocious massacres which so frequently disfigure the pages of Greek history. We do not know what credit may be due to Xenophon, when he intimates that all the principal allies of Corinth, — the Argives, and Bœotians, and Athenians, — had an equal share in the conspiracy, or whether he is only speaking of the foreign garrison. His horror is chiefly excited by the impiety of the murderers, who selected a holiday for the deed, that they might be the more likely to find their enemies out of doors, and in the execution of their purpose paid no regard to the most sacred things and places, but stained even the altars and images of the gods with the blood of their victims.

Unhappily this was no new excess of party rage: but perhaps few scenes of this kind had been planned with more ferocious coolness, or accompanied with a greater number of shocking circumstances; though it must not be forgotten that it is Xenophon who describes it. Suspicions however had been previously entertained of the plot by Pasimelus, one of the persecuted party, and at the time of the tumult a body of the younger citizens was assembled with him in a place of exercise outside the walls. They immediately ran up to seize the Acrocorinthus, where they maintained themselves for a time against the attacks of their enemies. But an unpropitious omen, probably strengthening the consciousness of their weakness, made them resolve to withdraw, and to seek safety in exile. Yet, notwithstanding the impious treachery of their enemies, they were induced by the persuasions of their friends and relatives, and by the oaths of the leading men of the opposite party, to abandon this intention, and return to their homes.

But their fears for their personal safety had no sooner subsided, than the state of public affairs again began to appear insupportable, and they were ready to run any risk for the sake of a change. The opposite party had gone so far in their enmity to Sparta, or in their zeal for democracy, as to do their utmost towards establishing a complete unity, both of civil rights and of territory, between Corinth and Argos. The land-marks which separated the two states had been removed; so that the name either of Corinth or of Argos might be applied to the whole. But since it was Argive influence that had brought about this union, since the Argive institutions had been adopted, and the Argive franchise communicated to the Corinthians, the discontented had some reason to complain, that Corinth had lost her independence and dignity, while Argos had gained an increase of territory by the transaction. But what they bore still more impatiently, was the loss of

their own rank and influence, which were totally extinguished by the union; they no longer enjoyed any exclusive privileges, any rights which they did not share with the whole Argive-Corinthian commonalty; and this was a franchise which they valued no more than the condition of an alien. They therefore resolved on a desperate effort for restoring Corinth to her former station in Greece, and for recovering their own station in Corinth.

Pasimelus and Alcimenes took the lead in this enterprise. They obtained a secret interview with Praxitas, the Spartan commander at Sicyon, and proposed to admit him and his troops within the walls that joined Corinth with Leehæum, her port on the western gulf. He knew the men, and embraced their offer; and at an appointed hour of night came with a mora of Lacedæmonians, and a body of Sicyonians and of Corinthian exiles, to a gate where the conspirators had contrived to get themselves placed on duty. He was introduced without any opposition; but as the space between the walls was large, and he had brought but a small force with him, he threw up a slight entrenchment, to secure himself until the succours which he expected should arrive. During the next day he remained quiet, and was not attacked; though, besides the garrison of the city, there was a body of Bœotians behind him at Leehæum. But aid had been summoned from Argos, and on the day following the Argive forces arrived, and, confident in their numbers, immediately sought the enemy. They were supported by their Corinthian partisans, and by a body of mercenaries commanded by Iphicrates, an Athenian general, who in this war laid the foundation of his military renown.

The superiority of the Lacedæmonian troops over the other Greeks, and the terror they inspired even when they were greatly outnumbered, was again strikingly manifested in the engagement which ensued. The Argives forced their way through the entrenchment, and drove the handful of Sicyonians before them down to the sea. But when the Lacedæmonians came up, they took to flight, without offering any resistance, and made for the city. But, meeting with the Corinthian exiles, who had defeated the mercenaries, and were returning from the pursuit, they were driven back, and those who did not make their escape by ladders over the wall, were slaughtered by the Lacedæmonians like a flock of sheep. Leehæum was taken, and the Bœotian garrison was put to the sword. After his victory Praxitas was joined by the expected contingents of the allies, and he made use of them first to demolish the Long Walls, for a space sufficient to afford a passage for an army. Next, crossing the isthmus, he took and garrisoned the towns of Sidus and Crommyon. On his return he fortified the heights of Epieieea, which commanded one of the most important passes, and then disbanded his army, and returned to Sparta.

Two important consequences of the long series of hostilities in which all the Greek states had been engaged now became apparent. The number of persons who were thrown upon war as a means of subsistence had so much increased, that the contending powers were able to carry on the struggle with mercenary troops. Another result of the long practice of war was, that it had begun to be more and more studied as an art, and cultivated with new refinements.

Thus Iphicrates had been led to devote his attention to the improvement of a branch of the light infantry, which had hitherto been accounted of little moment in the Greek military system. He had formed a new body of targeteers, which in some degree combined the peculiar advantages of the heavy and light troops, and was equally adapted for combat and pursuit.

[392-391 B.C.]

To attain these objects, he had substituted a linen corslet for the ancient coat of mail, and had reduced the size of the shield, while he doubled the length of the spear and the sword. At the head of this corps he made frequent inroads into Peloponnesus, and in the territory of Phlius he surprised the forces of the little state in an ambuscade, and made so great a slaughter of them that the Phliasiens were obliged to admit a Lacedæmonian garrison into their town. But in Arcadia such was the terror inspired by the troops of Iphicrates, that they were suffered to plunder the country with impunity, and the Arcadians did not venture to meet them in the field. On the other hand they were themselves no less in dread of the Lacedæmonians, who had taught them to keep aloof in a manner which proved the peculiar excellence of the Spartan military training.

A Lacedæmonian *mora*, stationed at Lechæum, accompanied by the Corinthian exiles, ranged the country round about Corinth without interruption. Yet it was not able to prevent the Athenians from repairing the breach which Praxitas had made in the Long Walls, which they regarded as a barrier that screened Attica from invasion. The whole serviceable population of Athens, with a company of carpenters and masons, sallied forth to the isthmus, and having restored the western wall in a few days, completed the other at their leisure. Their work, however, was destroyed in the course of the same summer by Agesilaus, on his return from an expedition which he had made into Argolis, for the purpose of letting the Argives taste the fruits of the war which they had helped to stir, and were most forward to keep up. After having carried his ravages into every part of their territory, he marched to Corinth, stormed the newly repaired walls, and recovered Lechæum. Here he met his brother Teleutias, who, through his influence, which in this case was better exerted than in that of Pisander, had been appointed to the command of the fleet, and having come with a small squadron to support his operations, made some prizes in the harbour and the docks.

But the appearance of Teleutias in the Corinthian Gulf was connected with other events, more important than any which took place in Peloponnesus after the return of Agesilaus from Asia. That we exhibit them in an uninterrupted series, together with their consequences, we shall follow Xenophon's order, and return to them after having briefly related how the war was carried on in Greece, in the campaigns which ensued down to its close.

In the spring of 392, Agesilaus made a fresh expedition for the purpose of bringing the Corinthians to terms, by cutting off one of their chief resources, the fortress of Piræum, at the foot of Mount Geranea on the western gulf. The captures and the booty were brought out, and passed in review before Agesilaus, as he sat in an adjacent building on the margin of a small lake. His triumph was heightened by the presence of envoys from various states, among the rest from Thebes, where the party which desired peace had succeeded in procuring an embassy to be sent for the purpose of ascertaining the terms which Sparta would grant. Agesilaus, the more fully to enjoy their humiliation, affected to take no notice of their presence, while Pharax, their proxenus, stood by him, waiting for an opportunity to present them. Just at this juncture a horseman came up, his horse covered with foam, and informed the king of a disaster which had just befallen the garrison of Lechæum, the loss of almost a whole *mora*, which had been intercepted and cut off by Iphicrates and his targeteers. The action was in itself so trifling, that it would scarcely have deserved mention, but for the importance attached to it at the time, and the celebrity which it retained for many generations.

After all, the whole loss of the Lacedæmonians amounted to no more than 250 men. Yet it produced a degree of consternation and dejection on the one side, and of exultation on the other, which is significant in the same proportion that the disaster appears to us slight and the exploit inconsiderable.

Nothing more clearly shows the weakness of Sparta and the power of her name than the importance attributed both by herself and by her enemies to this petty affair. Agesilaus, having accomplished the object of his expedition, now set out homeward. He took with him the remnant of the defeated mora, leaving another in its room at Lechæum. But his march through Peloponnesus was like that of the Roman army on its return from the Caudine Forks. He would only enter the towns, where he was forced to rest, as late as he could in the evening, and left them again at break of day. At Mantinea, though it was dark when he reached it, he would not stop at all, that his men might not have to endure the insulting joy of their ill-affected allies. On the other hand Iphicrates was emboldened by his success to aim at fresh advantages; and he recovered Sidus, Cromnyon, and Cenoë, where Agesilaus had left a garrison.

His achievement so terrorised the Corinthian exiles at Sicyon, that they no longer ventured to repeat their marauding excursions by land, but crossed over the gulf, and landed near Corinth, where they saw opportunity of giving annoyance. Even in later times the destruction of the Lacedæmonian mora, 250 men, continued to be mentioned as the great military action of his life, and was not thought unworthy to be named in the same page with Marathon and Plataea.

It is not improbable that this victory of Iphicrates was attended with another result, which Xenophon has not thought fit to notice. It seems not only to have prevented the Theban envoys from discharging their commission, but to have put a stop to a negotiation which was proceeding at the same time between Athens and Sparta, after it had reached a very advanced stage. Minute as these occurrences are, they are perhaps, both in themselves and for the impression they produced, the most momentous that took place in Greece before the end of the war. We should have been glad indeed to know a little more of the causes which withdrew Iphicrates from this scene of action shortly after his victory: for they would perhaps have thrown some light on the internal state of Corinth. But Xenophon only informs us that he was dismissed by the Argives, after he had put to death some Corinthians of their party; from what motive and on what pretext we do not learn, nor does it appear whether this transaction had any influence on the relations between Athens and Argos.

In the year following no military operations seem to have taken place in Peloponnesus, except the petty combats or alternate inroads between Sicyon and Corinth, which Xenophon himself does not think worth more than a general notice. But the arms of Agesilaus were turned against Acarnania, where he displayed his usual ability, and established the Spartan supremacy almost without bloodshed. An Athenian squadron was lying at Ceniadæ, to intercept him, if, as was expected, he should attempt to cross the gulf from any part of the coast immediately below Calydon. To avoid it he marched to Rhium through the heart of Ætolia, by roads along which, Xenophon observes, no army, great or small, could have passed without the consent of the Ætolians. They permitted his passage, because they hoped to be aided by his influence in recovering Naupaetus. At Rhium he crossed the straits, and returned home.

[394-390 B.C.]

The event proved the policy of the moderation which he had shown against the wish of his allies. The next spring, as he was preparing for a second invasion of Acarnania, the Acarnanians, alarmed by the prospect of again losing a harvest, on which the subsistence of the people, who were but little conversant with arts or commerce, mainly depended, sent envoys to Sparta to treat for peace, and submitted to the terms which Agesilaus had dictated. The same year his young colleague Agesipolis, who had now reached his majority, was entrusted with the command of an expedition against Argos. The expedition yielded no fruits but the plunder, with which he returned to Sparta. In the meanwhile, through the ambition of Sparta and the patriotic efforts of Conon, Athens had been enabled to take some great steps towards securing her independence, and recovering a part at least of her ancient power.^e

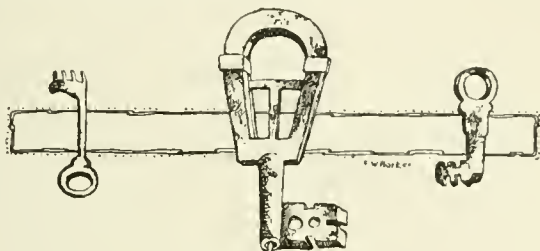

GREEK DOOR KEYS

THE GREAT DEEDS OF CONON

Three great battles had been fought in little more than the space of a month (July and August)—those of Corinth, Cnidus, and Coronea: the first and third on land, the second at sea. In each of the two land-battles the Lacedæmonians had gained a victory: they remained masters of the field, and were solicited by the enemy to grant the burial-truce. But if we inquire what results these victories had produced, the answer must be that both were totally barren. Even the narrative of Xenophon, deeply coloured as it is both by his sympathies and his antipathies, indicates to us that the predominant impression carried off by every one from the field of Coronea was that of the tremendous force and obstinacy of the Theban hoplites—a foretaste of what was to come at Leuctra!

If the two land-victories of Sparta were barren of results, the case was far otherwise with her naval defeat at Cnidus. That defeat was pregnant with consequences following in rapid succession, and of the most disastrous character. As with Athens at Ægospotami—the loss of her fleet, serious as that was, served only as the signal for countless following losses. Pharnabazus and Conon, with their victorious fleet, sailed from island to island, and from one continental seaport to another, in the Ægean, to expel the Lacedæmonian harmosts, and terminate the empire of Sparta. So universal was the odium which it had inspired, that the task was found easy beyond expectation. Conscious of their unpopularity, the harmosts in almost all the towns, on both sides of the Hellespont, deserted their posts and fled, on the mere news of the battle of Cnidus. Everywhere Pharnabazus and Conon found themselves received as liberators, and welcomed with presents of hospitality. They pledged themselves not to introduce any foreign force or governor, nor to

fortify any separate citadel, but to guarantee to each city its own genuine autonomy. This policy was adopted by Pharnabazus at the urgent representation of Conon, who warned him that if he manifested any design of reducing the cities to subjection, he would find them all his enemies; that each of them severally would cost him a long siege; and that a combination would ultimately be formed against him. Such liberal and judicious ideas, when seen to be sincerely acted upon, produced a strong feeling of friendship and even of gratitude, so that the Lacedæmonian maritime empire was dissolved without a blow, by the almost spontaneous movements of the cities themselves. Though the victorious fleet presented itself in many different places, it was nowhere called upon to put down resistance, or to undertake a single siege. Cos, Nisyros, Teos, Chios, Erythræ, Ephesus, Mytilene, Samos, all declared themselves independent, under the protection of the new conquerors. Pharnabazus presently disembarked at Ephesus and marched by land northward to his own satrapy, leaving a fleet of forty triremes under the command of Conon.

To this general burst of anti-Spartan feeling, Abydos, on the Asiatic side of the Hellespont, formed the solitary exception; and it happened by a fortunate accident for Sparta that the able and experienced Dercyllidas was harmost in the town at the moment of the battle of Cnidus. Dercyllidas assembled the Abydenes, heartened them up against the reigning contagion, and exhorted them to earn the gratitude of Sparta by remaining faithful to her while others were falling off; assuring them that she would still be found capable of giving them protection. His exhortations were listened to with favour. Abydos remained attached to Sparta, was put in a good state of defence, and became the only harbour of safety for the fugitive harmosts out of the other cities, Asiatic and European.

Dercyllidas maintained his position effectively both at Abydos and at Sestos; defying the requisition of Pharnabazus that he should forthwith evacuate them. The satrap threatened war, and actually ravaged the lands round Abydos; but without any result. His wrath against the Lacedæmonians, already considerable, was so aggravated by disappointment when he found that he could not yet expel them from his satrapy, that he resolved to act against them with increased energy, and even to strike a blow at them near their own home. For this purpose he transmitted orders to Conon to prepare a commanding naval force for the ensuing spring, and in the meantime to keep both Abydos and Sestos under blockade.

As soon as spring arrived, Pharnabazus embarked on board a powerful fleet equipped by Conon; directing his course to Melos, to various islands among the Cyclades, and lastly to the coast of Peloponnesus. They here spent some time on the coast of Laconia and Messenia, disembarking at several points to ravage the country. They next landed on the island of Cythera, which they captured, granting safe retirement to the Lacedæmonian garrison, and leaving in the island a garrison under the Athenian Nicophemus. Quitting then the harbourless, dangerous, and ill-provided coast of Laconia, they sailed up the Saronic Gulf to the Isthmus of Corinth. Here they found the confederates—Corinthian, Bœotian, Athenian, etc.—carrying on war, with Corinth as their central post, against the Lacedæmonians at Sicyon. The line across the isthmus from Lechæum to Cenchræ (the two ports of Corinth) was now made good by a defensive system of operations, so as to confine the Lacedæmonians within Peloponnesus; just as Athens, prior to her great losses in 446 B.C., while possessing both Megara and Pegræ, had been able to maintain the inland road midway between them.

[393 B.C.]

where it crosses the high and difficult crest of Mount Geranea, thus occupying the only three roads by which a Lacedæmonian army could march from the Isthmus of Corinth into Attica or Bœotia. Pharnabazus communicated in the most friendly manner with the allies, assured them of his strenuous support against Sparta, and left with them a considerable sum of money.

The appearance of a Persian satrap with a Persian fleet, as master of the Peloponnesian Sea and the Saronic Gulf, was a phenomenon astounding to Grecian eyes. And if it was not equally offensive to Grecian sentiment, this was in itself a melancholy proof of the degree to which Panhellenic patriotism had been stifled by the Peloponnesian War and the Spartan empire. No Persian tiara had been seen near the Saronic Gulf since the battle of Salamis; nor could anything short of the intense personal wrath of Pharnabazus against the Lacedæmonians, and his desire to revenge upon them the damage inflicted by Dercyllidas and Agesilaus, have brought him now as far away from his own satrapy. It was this wrathful feeling of which Conon took advantage to procure from him a still more important boon.

Since 404 B.C., a space of eleven years, Athens had continued without any walls round her seaport town Piræus, and without any Long Walls to connect her city with Piræus. To this state she had been condemned by the sentence of her enemies, in the full knowledge that she could have little trade — few ships either armed or mercantile — poor defence even against pirates, and no defence at all against aggression from the mistress of the sea. Conon now entreated Pharnabazus, who was about to go home, to leave the fleet under his command, and to permit him to use it in rebuilding the fortifications of Piræus as well as the Long Walls of Athens. While he engaged to maintain the fleet by contributions from the islands, he assured the satrap that no blow could be inflicted upon Sparta so destructive or so mortifying, as the renovation of Athens and Piræus with their complete and connected fortifications. Sparta would thus be deprived of the most important harvest which she had reaped from the long struggle of the Peloponnesian War. Indignant as he now was against the Lacedæmonians, Pharnabazus sympathised cordially with these plans, and on departing not only left the fleet under the command of Conon, but also furnished him with a considerable sum of money towards the expense of the fortifications.

CONON REBUILDS THE LONG WALLS

Conon betook himself to the work energetically and without delay. He had quitted Athens in 407 B.C., as one of the joint admirals nominated after the disgrace of Alcibiades. He had parted with his countrymen finally at the catastrophe of Ægospotami in 405 B.C., preserving the miserable fraction of eight or nine ships out of that noble fleet which otherwise would have passed entire into the hands of Lysander. He now returned, in 393 B.C., as a second Themistocles, the deliverer of his country, and the restorer of her lost strength and independence. All hands were set to work; carpenters and masons being hired with the funds furnished by Pharnabazus, to complete the fortifications as quickly as possible. The Bœotians and other neighbours lent their aid zealously as volunteers — the same who eleven years before had danced to the sound of joyful music when the former walls were demolished; so completely had the feelings of Greece altered since that period. By such hearty co-operation, the work was finished during the course of the present summer and autumn without any opposition; and Athens enjoyed

again her fortified Piræus and harbour, with a pair of long walls, straight and parallel, joining it securely to the city. The Athenian people not only inscribed on a pillar a public vote gratefully recording the exploits of Conon, but also erected a statue to his honour.

The importance of this event in reference to the future history of Athens was unspeakable. Though it did not restore to her either her former navy, or her former empire, it reconstituted her as a city not only self-determining but even partially ascendant. It reanimated her, if not into the Athens of Pericles, at least into that of Isocrates and Demosthenes: it imparted to her a second fill of strength, dignity, and commercial importance, during the half century destined to elapse before she was finally overwhelmed by the superior

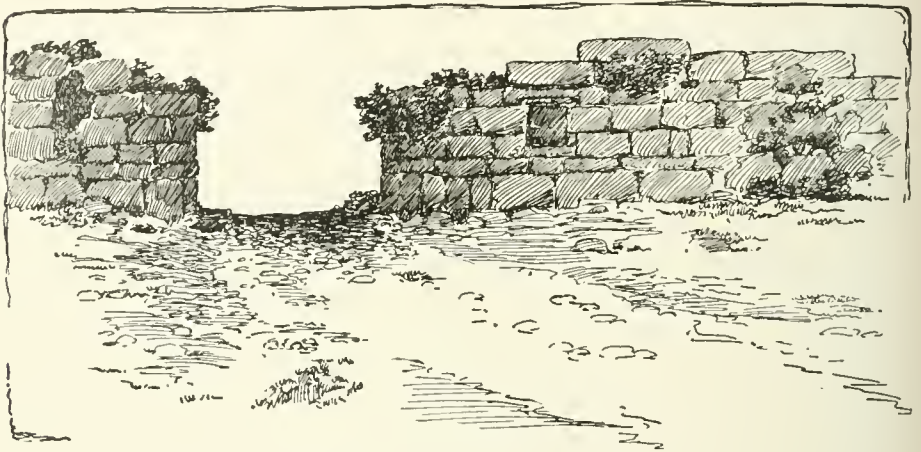

REMAINS OF A GREAT WALL AT MESSENE

military force of Macedon. Those who recollect the extraordinary stratagem whereby Themistocles had contrived (eighty-five years before) to accomplish the fortification of Athens, in spite of the base but formidable jealousy of Sparta and her Peloponnesian allies, will be aware how much the consummation of the Themistoclean project had depended upon accident. Now, also, Conon in his restoration was favoured by unusual combinations such as no one could have predicted. So strangely did events run, that the energy, by which Dercyllidas preserved Abydos, brought upon Sparta, indirectly, the greater mischief of the new Cononian walls. It would have been better for Sparta that Pharnabazus should at once have recovered Abydos as well as the rest of his satrapy; in which case he would have had no wrongs remaining unavenged to incense him, and would have kept on his own side of the Ægean; feeding Conon with a modest squadron sufficient to keep the Lacedæmonian navy from again becoming formidable on the Asiatic side, but leaving the walls of Piræus (if we may borrow an expression of Plato) "to continue asleep in the bosom of the earth."

The presence of Pharnabazus and Conon with their commanding force in the Saronic Gulf, and the liberality with which the former furnished pecuniary aid to the latter for rebuilding the full fortifications of Athens, as well as to the Corinthians for the prosecution of the war — seem to have given preponderance to the confederates over Sparta for that year. The plans

[393-390 B.C.]

of Conon were extensive. He was the first to organise, for the defence of Corinth, a mercenary force which was afterwards improved and conducted with greater efficiency by Iphicrates; and after he had finished the fortifications of Piræus with the Long Walls, he employed himself in showing his force among the islands, for the purpose of laying the foundations of renewed maritime power for Athens.^f

While this work was proceeding, the Corinthians, with the subsidy they had received, fitted out a squadron, with which their admiral Agathinus scoured the Corinthian Gulf. The Spartans sent Polemarchus with some galleys to oppose him: but their commander was soon after slain, and Pollis, who took his place, was compelled by a wound which he received in another engagement, to resign it to Herippidas. Herippidas seems to have driven the Corinthians from their station at Rhium: and Teleutias, who succeeded him, recovered the complete mastery of the gulf, and was thus enabled, as we have seen, to co-operate with Agesilaus at Lechæum.

THE EMBASSY OF ANTALCIDAS

But this partial success did not diminish the alarm with which the Spartan government viewed the operations of Conon, who was proceeding to restore the Athenian dominion on the coasts and in the islands of the Ægean. It perceived that it was necessary to change its policy with regard to the court of Persia, and for the present at least to drop the design of conquest in Asia, and to confine itself to the object of counteracting the efforts of the Athenians, and establishing its own supremacy among the European Greeks. And it did not despair of making the Persian court subservient to these ends. For this purpose Antalcidas, a dexterous politician of Lysander's school, was sent to Tiribazus, who was now occupying the place of Tithraustes in Western Asia, to negotiate a peace. His mission awakened the apprehensions of the hostile confederacy; and envoys [including Conon] were sent from Athens, Bœotia, Corinth, and Argos, to defeat his attempts, and to support the interests of the allies at the satrap's court. Antalcidas however made proposals highly agreeable to Tiribazus, and accompanied them with arguments which convinced the satrap that his master's interest perfectly coincided with that of Sparta. He renounced all claim on the part of his government to the Greek cities in Asia, and was willing that they should remain subject to the king's authority. For the islands, and the other towns, he asked nothing but independence. Thus, he observed, no motive for war between Greece and Persia would be left. The king could gain nothing by it, and would have no reason to fear either Athens or Sparta, so long as the other Greek states remained independent. Tiribazus was perfectly satisfied, but had not authority to close with these overtures, at least against the will of the states which were at present in alliance with his master; and they refused to accede to a treaty on these terms.

But, though the satrap did not venture openly to enter into alliance with Sparta without his master's consent, he did not scruple privately to supply Antalcidas with money for the purpose of raising a navy to carry on the war with the states which were still acknowledged as allies of Persia: and having drawn Conon to Sardis, he threw him into prison, on the pretext that he had abused his trust, and had employed the king's forces for the aggrandisement of Athens. He then repaired to court to report his proceedings and to consult the royal pleasure. It was perhaps rather through some court

intrigue, or vague suspicion, than a deliberate purpose of adopting a line of policy opposite to that of Tiribazus, that Artaxerxes detained him at court, and sent Struthas down to fill his place. Struthas had perhaps witnessed the Asiatic campaigns of Agesilaus, and could not all at once get rid of the impression that the Spartans were his master's most formidable enemies. He therefore immediately made known his intention of siding with the Athenians and their allies.

The Spartan government, perhaps too hastily, concluding that their prospect of amicable dealings with Persia was now quite closed, determined to renew hostilities in Asia, and sent Thimbron — apparently the same officer whom we have already seen commanding there, and who had been fined on his return to Sparta for misconduct — to invade the king's territory. Struthas took advantage of his failings, and, one day that he had gone out at the head of a small party to attack some of the Persian cavalry who had been purposely thrown in his way, suddenly appeared with a superior force, slew him, and a flute-player named Thersander, the favourite companion of his convivial hours, and defeated the rest of his army, as it came up after him, with great slaughter. Diphridas was sent from Sparta to collect the scattered remains of his army, and to raise fresh troops, to defend the allied cities, and carry on the war with Struthas. Teleutias was ordered to sail to Asia with the twelve galleys which he had with him in the Corinthian Gulf, to supersede Ecdicus, and to prosecute the war, in Rhodes or elsewhere, as he found opportunity. His first adventure, after he had taken the command at Cnidus, illustrates the complicated relations and the unsettled state of Greek politics at this period. Teleutias, whose force had been raised, by some additions which it received at Samos, to seven-and-twenty galleys, on his way from Cnidus to Rhodes, fell in with a squadron of ten, sent by the Athenians to aid Evagoras, who had revolted from the king of Persia, their ally, and the enemy of Sparta, whose admiral nevertheless destroyed or captured the whole.

The Athenians now thought it necessary to interpose in defence of their Rhodian friends, and sent Thrasybulus — the hero of Phyle — with forty galleys to check the operations of Teleutias. He thought that he might render more important services to the commonwealth in the north of the Ægean, and the Hellespont, where he would have no enemy to encounter on the sea. Sailing therefore first to the coast of Thrace, he composed the feud of the two Odrysian princes, Amadocus and Seuthes, and engaged them both in a treaty of alliance with Athens. He proceeded to Byzantium, and, throwing his weight into the scale of the democratical party, established its predominance, and with it that of the Athenian interest; and he was thus enabled to restore a main source of the Athenian revenue, the duty of a tenth on vessels coming out of the Euxine. Before he quitted the Bosphorus, he also brought over Chalcedon to the Athenian alliance. Thrasybulus now reduced several of the Lesbian towns, and collected much plunder from the lands of those which refused to submit. He then prepared to return to Rhodes; but first sailed eastward to levy contributions on the southern coast of Asia. Here his career was abruptly terminated. He anchored in the Eurymedon near Aspendus, where he obtained a supply of money. But the Aspendians fell upon him by night, and killed him in his tent. Xenophon's remark, that he died with the reputation of a very good man, may be admitted as sufficient proof that the great services he had rendered to his country were not his only claim to the esteem of his contemporaries, and that the suspicions excited against him were wholly unfounded.



RUINS OF THE TEMPLE OF OLYMPIAN JOVE

[388 B.C.]

The flourishing condition to which Thrasybulus had restored the affairs of Athens in the Hellespont, excited uneasiness at Sparta. Anaxibius obtained three galleys, and a grant of money sufficient to raise one thousand mercenaries. On his arrival in the Hellespont he waged a successful war with the neighbouring towns, subject to Pharnabazus, or allied to Athens, and did much damage to the Athenian commerce. The Athenians were at length induced to send Iphicrates, with eight galleys and about twelve hundred targeteers, mostly those who had served under him at Corinth, to counteract the movements of Anaxibius. Anaxibius was surprised by an ambush. He bade his men seek their safety in flight; for himself, he said, his part was to die there; and, calling for his shield, fought until he fell, with a few of his Spartan companions. The rest fled in disorder to Abydos with the loss of about 250 men.

Notwithstanding the successes of the Athenians in the Hellespont the enemy found means of annoying and threatening them at home. They had hitherto maintained a peaceful intercourse with Ægina; but the Spartans now resolved to make use of the island for the purpose of infesting the coasts of Attica. Teleutias was soon after superseded by Hierax, the new Spartan admiral, and returned home. Hierax sailed to Rhodes, leaving Gorgopas, his vice-admiral, with twelve galleys at Ægina. The Athenians in the fort were soon reduced to greater straits than the Æginetans in the city; and, in the fifth month after their arrival, a strong squadron was sent out from Athens to carry them home. In the meanwhile the Spartan government had resumed its project of attaining its object by means of negotiation, and once more sent out Antalcidas, as the person whose influence with Tiribazus would open the readiest access to the Persian court, as admiral in the room of Hierax. Antalcidas was escorted to Ephesus by Gorgopas and his squadron, and on his arrival sent Gorgopas with ten galleys back to Ægina. The remainder of the fleet which joined him at Ephesus, he placed under the command of his lieutenant Nicolochus, while he himself proceeded on more important business to the court of Artaxerxes.

Gorgopas on his return fell in with the Athenian squadron under Eunomus, and was chased by him into the port of Ægina, where he arrived a little before sunset. Eunomus sailed away soon after dark, with a light in the stern of his galley, to keep his squadron together. Gorgopas, whose men in the meanwhile had landed and refreshed themselves, now embarked again, and pushed across the gulf in the enemy's wake, guided by his light, with every precaution for suppressing or weakening the usual sounds of galleys in motion. At Cape Zoster, as the Athenians were landing, the silence of the night was broken by the sound of the trumpet, and after a short engagement by moonlight, Gorgopas captured four of their galleys; the rest made their escape into Piræus. But not long after, Chabrias, having been sent with a squadron of ten galleys and eight hundred targeteers to the aid of Evagoras, landed by night on Ægina, and posted his targeteers in an ambush. The next day, according to a preconcerted plan, a body of heavy-armed infantry which had come over with him under the command of Demænetus, advanced into the interior of the island. Gorgopas marched to meet them with all the forces he could muster, and passing by the ambuscade was routed and fell in the action, with some other Spartans and between three and four hundred of the other troops. By this victory the Attic commerce was for a time freed from annoyance; for though Eteonicus still remained in Ægina, he had no money to pay the seamen, and therefore could exert no authority.

In this emergency Teleutias was sent to take the command. His arrival was hailed with delight by the men, who had already served under him, and expected an immediate supply of pay. He however called them together, and informed them that he had brought no money with him, and that they had no resource to look to for the relief of their necessities, but their own activity and courage. It was best that they should not depend for subsistence upon the favour either of Greek or barbarian, but should provide for themselves at the enemy's expense. The men expressed entire confidence in his guidance, and promised to obey all his commands. That very night, after they had ended their evening meal, he ordered them to embark with a day's provision, and with twelve galleys crossed the gulf towards Piræus. When they were within about half a mile of the harbour, they rested till daybreak, and then sailed in. He gave orders to strike none but the ships of war which might be lying in the harbour, to capture as many merchant vessels as could be conveniently taken in tow, and to carry away as many prisoners as could be taken from the rest. Not only were these orders executed with alacrity and success, but some of his men, landing on the quay, seized some of the merchants and shipowners who were assembled there, and hurried them on board. While the military force of Athens marched down to the relief of Piræus, which was supposed to have been taken, he made his retreat from the harbour, sent three or four of his galleys with the prizes to Ægina, and with the rest proceeded along the coast as far as Sunium. He made the more captures on his way, as his squadron, having been seen to issue from the port of Athens, was believed to be friendly. At Sunium he found a number of vessels laden with corn, and other valuable cargoes, with which he sailed away to Ægina. The produce of this adventure yielded a month's pay to the men, raised their spirits, and increased their devotion for their commander, who continued to employ them in this predatory warfare: the only kind to which his small force was adequate.

The Athenians however still retained the ascendancy in the Hellespont, where Nicolochus, who after the departure of Antalcidas had sailed northward with five-and-twenty galleys, was blockaded at Abydos by an Athenian squadron of two and thirty, which was stationed on the opposite coast of the Chersonesus, under the command of Diotimus and Iphicrates. But the aspect of affairs was completely changed by the arrival of Antalcidas, who returned in 387 with Tiribazus from the Persian court, where he had been treated with marks of distinguished favour by Artaxerxes, and had fully succeeded in the main object of his mission, having prevailed on the king to aid Sparta in carrying on the war, until the Athenians and their allies should accept a peace to be dictated in the king's name on terms previously arranged between him and the Spartan ambassador. Being informed of the situation of Nicolochus, he proceeded by land to Abydos, and took the command of the blockaded squadron, with which he sailed out in the night. Additions raised his fleet to eighty sail, and gave him the complete command of the sea, so that he was enabled to divert the commerce of the Euxine from Athens into the ports of the allies of Sparta.

The Athenians now saw themselves not only exposed to constant annoyance from Ægina, but in danger of falling again under the power of the enemy, and losing all the benefit of Conon's victory. They were therefore heartily desirous of an honourable peace. Most of the other states were probably still more anxious for the termination of a contest from which they could expect no advantage. When therefore Tiribazus, in his master's name, summoned a congress of deputies to listen to the proposals which he was

[387-386 B.C.]

commissioned to announce, all the belligerents readily sent their ministers to attend it. In the presence of this assembly Tiribazus, having shown the royal seal, read his master's decree, which ran in the following imperial style:

“King Artaxerxes thinks it right that the Greek cities in Asia, and the islands of Clazomenæ and Cyprus, should belong to himself; but that all the other Greek cities, both small and great, should be left independent, with the exception of Lemnos, Imbros, and Scyros, and that these should as of old belong to the Athenians. If any state refuse to accept this peace, I will make war against it, with those who consent to these terms, by land and by sea, with ships and with money.”

THE KING'S PEACE

The treaty founded on these conditions was ratified by all the parties almost without opposition. A little delay arose from the Thebans, who were reluctant to part with the sovereignty they had hitherto exercised over many of the Bœotian towns, and wished, for the sake of at least retaining their pretensions, to ratify in the name of all the other Bœotians. But Agesilaus, who was charged to receive the oath of their ministers, refused to accept it in this form, and required them strictly to conform to the Persian ordinance, and expressly to acknowledge the independence of all other states. One impediment to the general peace still remained. The governments of Corinth and Argos did not consider themselves bound by the treaty to alter the relations which had hitherto subsisted between them; and it was only when Agesilaus threatened them with war, that they consented, the one to dismiss, and the other to withdraw, the Argive garrison from Corinth. Its departure was attended by an immediate reaction in the state of the Corinthian parties. The authors of the massacre, knowing themselves to be generally odious to their fellow citizens, thought themselves no longer safe at home, and left the city. Most of them found refuge at Athens, where they met with a much more honourable reception than they deserved. The exiles of the opposite faction were recalled; and their return dissolved the union with Argos, and restored the influence of Sparta, and the oligarchical institutions.

This treaty, which was long celebrated under the name of the Peace of Antalcidas, was undoubtedly a masterpiece of policy, nor does it appear to deserve the censure which it incurred from the Attic orators and from Plutarch, and which has been repeated by some modern writers, as a breach of political morality. Sparta in her transactions with Persia during the Peloponnesian War, had more than once acknowledged the title of the Persian king to the dominion of the Asiatic Greeks; she had never pledged herself to maintain their independence; and even if she had done so, the revival of the maritime power of Athens, and its union with that of Persia, would have afforded a fair plea for receding from an engagement which she was no longer able to fulfil. The clause in favour of Athens was perhaps only designed to excite jealousy and discord between Athens and the hated Bœotians. It has been attributed to a deeper policy; it has been considered as a device, by which Sparta reserved a pretext for eluding the conditions of the treaty which she rigorously enforced in the case of other states. But it is doubtful whether the exception expressly made concerning the three islands which Athens was allowed to retain, could have been needed, or if needful could have availed, as a colour under which Sparta, while she stripped Thebes of her sovereignty in Bœotia, might keep possession of Messenia and the

subject districts of Laconia. Sparta did not permit a question to be raised on this point. She was constituted the interpreter of the treaty; she expounded it by the rule, not of reason, but of might, with the sword in hand, and the power of Persia at her back.^e

This momentous treaty, which is sometimes called the Peace of Antalcidas after its chief Grecian agent, is nowadays more commonly called the King's Peace, and wisely, since it was the king who chiefly profited by it. Thirlwall, who can always be relied upon to take an impartial view of the question, says of it: "And thus the Peace of Antalcidas, which professed to establish the independence of the Greek states, subjected them more than ever to the will of one. It was not in this respect only that appearances were contrary to the real state of things. The position of Sparta, though seemingly strong, was artificial and precarious; while the majestic attitude in which the Persian king dictated terms to Greece, disguised a profound consciousness, that his throne subsisted only by sufferance, and that its best security was the disunion of the people with whom he assumed so lordly an air." Niebuhr, to whom the Spartans were almost always hypocrites, has this to say: "Painful as this peace was to the feelings of the Greeks, who were obliged to leave the dominion over their countrymen to barbarians, yet the hypocrisy of the Spartans, who, by this peace, allowed the Persians to interfere in the internal affairs of Greece, was worse."

Grote, whose history is a glowing brief for Athens, the type of democracy, as against Sparta, the type of oligarchy, cannot be expected to approve of an agreement leading to such degradation for the Athenians, as well as for all the Greek world. He says: "The peace or convention, which bears the name of Antalcidas, was an incident of serious and mournful import in Grecian history. Its true character cannot be better described than in a brief remark and reply which we find cited in Plutarch. 'Alas, for Hellas (observed some one to Agesilaus) when we see our Laconians *medising!*' 'Nay (replied the Spartan king), say rather the Medes *laconising.*' These two propositions do not exclude each other. Both were perfectly true. The convention emanated from a separate partnership between Spartan and Persian interests. It was solicited by the Spartan Antalcidas, and propounded by him to Tiribazus on the express ground that it was exactly calculated to meet the Persian king's purposes and wishes, as we learn even from the philo-Laconian Xenophon. While Sparta and Persia were both great gainers, no other Grecian state gained anything as the convention was originally framed."

George W. Cox, in his *General History of Greece*, recognises in the treaty a humiliation for Sparta as well as for the rest of Greece, since the peace was not drawn up in the form of an agreement, but rather forced upon Greece by the edict of Persia. It was indeed a fiat "sent down from Susa," like another royal decree to the subjects whom the Persian king looked down upon with oriental disdain. Cox writes thus fervidly:

"The Persian king chose to regard the acceptance of the peace by the Spartans as an act of submission not less significant than the offering of earth and water. In the disgrace which it involved the one was as ignominious as the other; but Sparta had now not even the poor excuse which long ago she had put forward for calling in the aid of the barbarian. She was no longer struggling for self-preservation. In short, by Sparta the Peace of Antalcidas was adopted with the settled resolution to divide and govern; and all of those of her acts, which might seem at first sight to have a different meaning, carry out in every instance this golden rule of despotism. It was the curse of the Hellenic race, and the ruin ultimately of

[387 B.C.]

Sparta itself, that this maxim flattered an instinct which they had cherished with blind obstinacy, until it became their bane. But for Sparta, the consolidation of the Athenian empire would long ago have restrained this self-isolating sentiment within its proper limits. In theory the Spartans by enforcing the Peace of Antalcidas restored to the several Greek states the absolute power of managing their own affairs, and of making war upon one another. In practice Sparta was resolved that their armies should move only at her dictation, that into her treasury should flow the tribute, the gathering of which was denounced as the worst crime of imperial Athens, and that in the government of the oligarchical factions she should have the strongest material guarantee for the absolute submission of the Greek cities. To secure this result the Hellenic states of Lesser Asia were abandoned to the tender mercies of Persian tax-gatherers, and left to feel the full bitterness of the slavery from which Athens had rescued them some ninety years ago."

An outcome which none could have foreseen from the acceptance of this humiliating title-deed to Grecian independence was the sudden and rocket-like rise of the city of Thebes, a city which had heretofore been a second- or third-rate town chiefly distinguished for being on the wrong side of Hellenic questions. Thebes is now about to break forth into flame with a fire-brand named Epaminondas, one of the noblest and most splendid names in all the glitter of Grecian history.^a



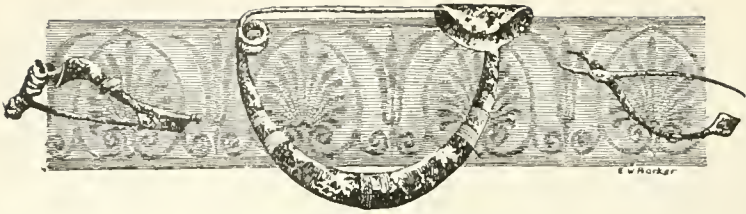

GREEK PINS AND BUCKLE
(In the British Museum)

CHAPTER XLIV. THE RISE OF THEBES

THE brilliant expansion of the power of Sparta after the King's Peace is intimately connected with the name of Agesilaus. Therefore in order rightly to understand the significance and the results of the Peace of Antalcidas, we must first form some idea of the tendencies and political position of this eminent man. Nothing but a just appreciation of his personality will suffice to keep us from tossing rudderless between the Scylla and Charybdis of diametrically opposite views of the object of the peace, and of Sparta's policy at that period.

Agesilaus was from the outset the typical representative of the Sparta of his time. All his thoughts and energies had their root in his own state alone, and to exalt this state to the position of the first power in the world, to gain for it the hegemony of Hellenic affairs, was his object, as it was the object of the whole contemporary policy of Sparta. To this end he laboured with admirable consistency through all his long life, from his first campaign in Asia to his expedition into Egypt, and all his acts, whether as a victorious monarch or an adventurous leader of mercenaries, were directed to one end — to vindicate the authority of Sparta. And when this end could not be attained by force of arms he was equal to compassing it by diplomatic moves. Hence it is certain that the Peace of Antalcidas was not concluded without his knowledge and consent, even if circumstances rendered it desirable for him to keep in the background during the negotiations in Asia.

Lacedæmon found herself incapable of maintaining by mere force of arms the position which had devolved upon her through the events of the Peloponnesian War, and if Sparta were not to abdicate the hegemony of Greece she must perforce try to conclude an advantageous peace and an alliance with Persia. This project was favoured by the ill-timed attempts of Athens to regain her maritime supremacy, and the Spartans, rightly gauging the situation, associated with these attempts their conciliatory negotiations with Persia. That this step, which closed to him henceforth his career of glory in Asia, was an easy one for Agesilaus to take, is unlikely; it was a political necessity, the inevitable consequence of the lines along which Greek policy had developed for the last thirty years.

Persia and Sparta were alike interested in preventing the revival of the sea power of Athens, and both needed peace to regain sway in their own dominions. This was the natural basis of the negotiations. The Great King was appointed supreme arbitrator in the affairs of Greece, and the possession of the Greek cities in Asia Minor was guaranteed to him. The Spartans had never indulged in Panhellenistic sentiments. Their whole

[387-386 B.C.]

political organisation and development made it almost impossible for the fate of their kindred in Asia to rouse any interest in their minds. When once their interests in Ionia were lost by the fortune of war, the documentary recognition of the fact could have roused no scruple in the breast of any true Spartan. And although it was these paragraphs of the peace which stirred the profoundest indignation in such men as Plato and Demosthenes, in the rest of Greece the time of national enthusiasm had gone by. Even in Athens the masses had unlearned their ancient hatred of Persia since they had been indebted to the succour of the Great King for the only bright spot in troublous times of war, and statesmen could not blind themselves to the fact that the political sins of Greece since the year 411, and the constant appeal to Persia for support and mediation which had become habitual since then, had been inexorably conducting her to this end.

The second main paragraph dealt with the internal affairs of Greece. Every state, great or small, was to become autonomous. If the first article contained an important concession to the Great King, this, which decreed the autonomy, was made primarily with a view to the advantage of Sparta. It could have no aim but one, to assert the hegemony of Sparta in Greece. This article, which had so enticing a sound in Greek ears, was the death-warrant of the growing power of the Athenian maritime confederacy, of the supremacy of Thebes in Bœotia, of the union of Argos and Corinth; it destroyed in the germ every power that might have imperilled the position of Sparta. Her own dominion in the Peloponnesus was not compromised by the proclamation of liberty, as her allies were already autonomous in name, while the authority of the hostile coalition was shattered at a blow. Thus the victor of Cnidus shared the spoils with the vanquished foe who had known so well how to avail himself of the right moment for proving an indispensable ally. As suzerain of Hellas, Artaxerxes, who could not suppress the rebels in his own country, dictates peace there, a peace which proclaimed liberty to the states but was nevertheless meant from the outset to enslave them, and Sparta lets herself be appointed to execute the compact which is to procure anew for her the supremacy of Greece. It was not the end of her projects but the beginning.

A glance at the history of the succeeding years shows how she pursued these projects. First of all, the Spartans turned their attention to the internal affairs of the Peloponnesus. The first thing they had to do was to vindicate their authority at home. During the long years of war the old ties between Sparta and her allies had grown looser; here and there the democratic element had taken the helm; there had been attempts to evade the obligation of military service; there had been open rejoicing at Sparta's ill-success. The situation called for energetic measures. We have already seen how a beginning was made with Corinth during the peace negotiations in Sparta. By a threat of armed invasion the Argive garrison was forced to withdraw and the alliance between the two states was dissolved; the Corinthian democrats left the city, the exiles were recalled, and Corinth, more closely linked with Lacedæmon than ever, again became her bulwark against enemies from without.

MANTINEA CRUSHED

The next step was to juggle the government of the other democratic states back into the hands of the oligarchy. Mantinea was the first to suffer. This city had always been an offence in the eyes of Sparta. The

*synoicismus*¹ and the fortification of Mantinea had taken place at the instigation of Argos after the Persian wars, and friendship towards Sparta was hardly likely to have been the leading motive for these proceedings. After the Peace of Nicias the city had joined the league against Sparta founded by Argos, and had taken an active part in the war. The unfavourable issue of the campaign obliged Mantinea to submit to Sparta once more and to conclude peace for thirty years, but nevertheless the democratic government remained in power, and the antagonism against Sparta persisted after, as before. The people made a parade of their animosity, treated the obligation of military service with neglect; and after the defeat of the *mora* on the isthmus Agesilaus had to pass the city under cover of fog and darkness in order to elude the scorn and malicious satisfaction of the inhabitants.

Now the day of reckoning had come. Spartan ambassadors came to Mantinea, bringing a multitude of complaints, together with the demand for the demolition of the walls about the city. This demand being met by a

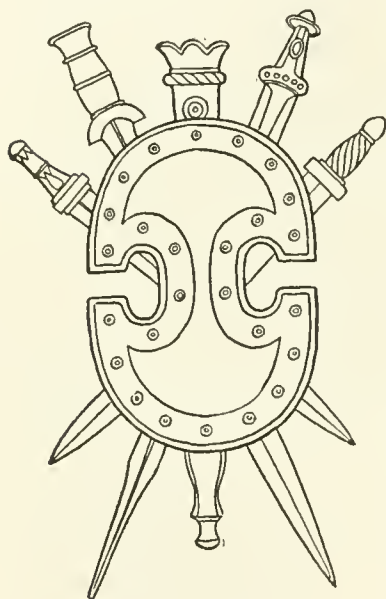

GREEK WEAPONS

refusal, Sparta declared war. Agesilaus begged to be excused from the chief command of the army, as the Mantineans had rendered his father great services during the Messenian War. Agesipolis marched against Mantinea and endeavoured to force the people into compliance by devastating their territory. When this expedient proved fruitless he laid siege to the city. The inhabitants made an obstinate defence, but they were obliged to surrender unconditionally after Agesipolis had dammed the river Ophis, which flowed through the town, and thus caused an inundation which brought about the fall of its walls of unbaked brick. By the intercession of Pausanias, who was living in exile at Tegea, the leaders of the people and the partisans of democracy, sixty in number, were allowed to withdraw in safety, a portion of the population was allowed to inhabit Mantinea as an unfortified place, and the remainder was obliged to settle in four distinct unprotected villages.

To each of these villages a Spartan xenagos was appointed. Xenophon adds that the Mantineans were at first indignant at being removed, but that they afterwards expressed their satisfaction at what had been done, as under an aristocratic government they could lead a quiet life near their estates and free from troublesome demagogues. This is a reproduction of the Spartan and oligarchic view of the matter.

In both ancient and modern times the treatment meted out to Mantinea has invariably been branded as an act of most brutal and barbarous violence and arbitrary cruelty, the outcome of the policy of Agesilaus. In this general and (to a certain extent) just censure of the ruler of the Spartan state at the time, one point has been overlooked. In a democratic constitution the Spartans could see nothing but a reign of revolutionary terrorism which oppressed the peaceful and sober part of the community, their own friends

[¹ That is, the organisation of a group of settlements into one city or capital.]

[385-383 B.C.]

and adherents. To help the latter, to put them in power again, they held to be the duty of the sovereign state. Spartan policy was sure of its aims, and in its consistency lies the secret of Sparta's superiority at this period. And if we are right in assuming that a Spartan must have ceased to be a Spartan before he could conceive otherwise of the state of affairs, there is no justification for heaping personal abuse and scandalous imputations upon a writer who reflects the opinions of his circle.

The punishment of Mantinea produced a profound effect upon the other Peloponnesian cities. With high hopes of an equally energetic interference on their behalf the aristocratic exiles from Phlius immediately turned to Sparta with the entreaty that the Spartans would intercede for their restoration to their homes. A bare admonition from the ephors to the municipal authorities to receive back the friends they had cast out for no sufficient reason, was enough to evoke a decree by which the sentence of banishment was repealed and the exiles were promised the restoration of their property. The spirit of resistance had been broken by the fate of Mantinea.

The Spartans next turned their attention to Bœotia. Although the Bœotian league, not being based on the principle of autonomy, had been broken up by the second paragraph of the peace, they felt the need of taking precautions against any attempt on the part of Thebes—the city which they regarded as the author of the whole ill-starred war and which had defied them to the last to re-establish its authority. Hence, as a first step, a Spartan garrison was retained in the friendly city of Orchomenos, and both Thespiæ and Tanagra were induced to throw in their lot with Sparta. But the most telling stroke at Thebes was the restoration of Plataea. For one thing, the Thebans were thereby deprived of the usufruct of Plataean territory, and for another, the newly founded city, being of course wholly dependent upon Sparta, afforded an excellent base for attack upon Thebes itself. Here again we see the relentless and energetic policy of Sparta in action.

THE OLYNTHIAN WAR

More serious complications in Greek affairs soon gave the Spartans their opportunity for showing themselves masters of Hellas. In the spring of 383 ambassadors from the cities of Apollonia and Acanthus presented themselves in Sparta to beg for support against the increasing power of the Olyntho-Chalcidian league. Their petition was seconded by deputies from Amyntas, king of Macedonia, who felt the security of his dominions imperilled by the encroachments of Olynthus. The Olynthians strove more and more vigorously to assert the authority of the league. They had succeeded in persuading nearly all the cities of the Chalcidice to join their confederacy; they had pushed forward towards Macedonia, and had even brought Pella over to their interests. The league was now in a position to hold the menace of war over any cities which refused adherence, and to meditate far-reaching enterprises. By an agreement with Athens and Thebes it hoped to secure an influence upon middle Greece. By this energetic and well-considered centralisation a federal state was created, admirably calculated to serve as a bulwark of the power of Hellas against Thrace, and as a fresh starting-point for the civilisation of the barbarous North.

As we look back at the lines along which the history of Greece developed, we are inevitably forced upon the conclusion that nothing but strict union, the formation of closely confederated states, could have checked the rapid

process of political decay. This conviction lies at the root of the liberal recognition and sympathy which the majority of modern scholars have accorded to the efforts of the Olynthian league. Whether the brilliant visions of the future which Grote, in particular, sketches for the league would ever have been realised, even if it had not fallen upon the days of Sparta's arbitrary dominion, remains an open question. Centralisation and unification were repugnant to the Greek mind, and every attempt in that direction was bound to go to wreck on the fanatical love of autonomy among the Greek states.

The appeal of Apollonia and Aeanthus, which wished to retain their ancient constitution, and the simultaneous action of the oppressed Amyntas, offered Sparta the desired opportunity for attacking the Chalcidic federation. Doubtless the sea power of Olynthus and the steady expansion of the league had long since attracted general attention there, and had been the subject of anxious reflection. The possibility that this league might grow more powerful still and attain an authoritative position in middle Greece also had to be guarded against at all risks. The policy of Sparta rendered it imperative that every considerable development of power in other states should be repressed. The war against the Olynthians was determined upon, and, by the desire of the ambassadors, Eudamidas was immediately despatched with such forces as could be equipped in haste.

THE SURPRISE OF THEBES

His brother Phœbidas was to follow with the remainder of the troops destined for the campaign in Thraee as soon as the levies were completed, a process which was probably rendered more lengthy by the fact that the new military system was now brought into use for the first time. By the end of summer, 383, Phœbidas was ready to start. He took his way past Thebes. There, as Xenophon tells, party quarrels had reached an extreme point. The office of polemarch was held by Leontiades and Ismenias, who were deadly enemies, each being the leader of a distinct body of partisans. For the moment the anti-Laconian party was in the ascendant. A decree had been promulgated that no man should be allowed to enlist for the campaign against Olynthus. When Phœbidas appeared before the walls of the city, Leontiades, whose family had always maintained close relations with Sparta, endeavoured to gain his favour by every kind of service, and then persuaded the vain and ambitious general to attempt a coup-de-main against the Cadmea. By this means he was to bring the adherents of Sparta into power and secure the active assistance of Thebes in the Olynthian War.

Phœbidas fell in with the proposed plot, and the day of the feast of the Thesmophoria was appointed for its execution. On that day the women of the city celebrated by themselves a festival in the ancient temple of Demeter on the Cadmea. Phœbidas was to make a feint of striking camp and setting out on his march northwards. While the council was assembled in a hall in the market-place and the heat of noon-day kept the rest of the population indoors, Leontiades galloped after the departing general, led him unobserved up to the citadel, and opened the gates to him. He then lied to the council, announced what had taken place, and had Ismenias arrested as a seditious person. The leaders and adherents of the opposition, to the number of three hundred, were obliged to flee for their lives to Athens. The occupation of the Cadmea was a political necessity, the logical consequence of the efforts

[383-380 B.C.]

of Sparta to secure the hegemony. The experiences of the last war had not been suffered in vain.

While Agesilaus was pursuing his victorious career in Asia a coalition against Sparta had been formed in Greece at the instigation of Persia, and Thebes had shown herself most zealous in promoting this anti-Spartan combination which was so grave a menace to the existence of Lacedæmon. This time Sparta was once more undertaking a war on the confines of Greece; if fortune were adverse, if a battle were lost, she had no guarantee against the possibility — the probability even — that hostile Thebes, still barely subdued, might revolt again, bar the way of retreat against the Spartan army, and throw the most serious obstacles in the way of reinforcements. "The Cadmea was the decisive point for the security of the line of march," says Curtius. If a prolonged war were to be waged in the distant north it was essential that this position should be in friendly hands. And the only way of attaining this object was to juggle the reins of government into the hands of the oligarchical party in Thebes and to garrison the citadel with Spartan hoplites for their protection. The success of the expedient proves how well worth while it had been for Phœbidas to take the circuitous route.

This act of violence, the surprise of the Theban citadel in time of peace, called forth a storm of indignation throughout the whole of Greece. Even in Sparta itself a clamour of popular displeasure arose against Phœbidas, because (as Xenophon adds) he had acted without due warrant or command. Apparently the Spartan government found it expedient to cast the odium of the proceeding upon Phœbidas, and therefore, in spite of Xenophon's silence on the subject, there is probably some truth in the story that he was deposed from his command and condemned to pay an exorbitant fine. The wrath of Greece may well have been the reason for this mock sentence. The payment of the fine was never exacted, and in the following year he held the office of a Spartan harmost in Bœotia. For the rest, the remonstrances of Leontiades and Agesilaus, the latter of whom openly maintained that the only point to be considered in judging the case was whether the transgression of Phœbidas were profitable to the state or not, quickly persuaded the Spartans of the propriety and necessity of the coup-de-main. The citadel was not evacuated, and legal proceedings were taken against Ismenias in respect of the league. A solemn tribunal was called together in Thebes, consisting of three Spartan commissioners and a deputy from every town of the league, to pass judgment upon the crimes of Ismenias. He was condemned to death. The most repulsive feature of this judicial murder, which was merely an act of vengeance upon the whilom leader of the anti-Spartan coalition, is the farce of a tribunal which was supposed to represent national ideas and interests.

The road to Thrace was now safe, and the war against Olynthus was prosecuted with the utmost vigour.

It was probably in the spring of 382 that Teleutias, brother of Agesilaus, marched against the city with a large army. He had made up the number of his forces in Thebes, and had received auxiliary contingents from Amyntas and from Derdas, prince of Elimea. This was the beginning of a fierce and prolonged struggle. After some successes which allowed him to press forward to Olynthus itself, devastating the country as he went, he fell in a hotly contested battle, and his death was the signal for a general flight. His whole army was swept away and annihilated. With amazing perseverance the Spartans continued the war; in the spring of 380 another huge army was equipped and the leadership entrusted to the young king, Agesipolis. He

was fortunate in battle, but succumbed to a violent fever the same summer. It was left for Polybiades, his successor in the command, to force the starving city, cut off from access to the sea and robbed of its harvests by the prolonged and desolating war, into surrender. In the year 379 the league was dissolved and the proud city compelled to render military service to the Spartans; the mighty chief city of the Chalcidice became a humble member of the Lacedæmonian alliance.

Meanwhile the Peloponnesus itself had become the scene of a fresh struggle. It has already been mentioned that the exiled aristocrats from Phlius had been allowed to return at the request of Sparta and had been promised the restoration of their property. But here, as everywhere, the attempts at expropriation met with almost insurmountable obstacles. There may have been a lack of good will to push on the proceedings, since it is probable that in many cases the judges themselves were in possession of the estates of the exiles. But in the beginning, at least, there seems to have been no excessive difficulty or delay in giving compensation, and we hear that, in the campaign of Agesipolis, the Phliasians distinguished themselves as zealots of Sparta by the liberality and promptitude of their contributions. After the departure of Agesipolis, as Xenophon relates, the Phliasians hoping to be quit of Spartan intervention, neglected the settlement of the chaotic claims. The returning aristocrats, finding their demands disregarded by an unbiassed court of arbitration, turned with their grievances to Sparta. The authorities of their own city having punished them for this arbitrary proceeding, the ephors, persuaded by exiles and by Agesilaus, the fast friend of the latter, determined upon a campaign against Phlius. The Phliasians sued for peace, but naturally could not accede to the demand of Agesilaus for an unconditional surrender of their citadel.

A tedious siege then began, during which Agesilaus found himself obliged to have recourse to every kind of artifice to allay the wrath of the Lacedæmonians and their allies at making enemies of the large population of the Asopus valley for the sake of a few oligarchs. It was the first note of that discord among the Peloponnesian allies which was destined to exercise such a paralysing effect upon the future military undertakings of the Lacedæmonians. Thanks to the valiant defence of Delphion, to whom Xenophon does not refuse his due meed of praise, the city held out twice as long as had been expected. At last, in the year 379, the lack of provisions constrained the inhabitants to treat for peace, and, unwisely ignoring Agesilaus, they applied direct to Sparta. Sparta committed the sole decision to the king, and the punishment in store for Phlius was naturally not the less severe for the attempt to set Agesilaus aside. A commission was appointed, consisting of fifty oligarchs and fifty of the citizens, and they were empowered to decide the question which of the inhabitants should remain alive and which should not. The further duty of elaborating a constitution was also assigned to them. To safeguard the new order of things a Lacedæmonian garrison was left provisionally in the acropolis. Thus in Phlius, as in Olynthus, Sparta had won the victory.

At this point both Xenophon and Diodorus, with a view to providing a more striking background for subsequent events, give a summary of the expansion of the power and dominion of Sparta up to this time. And truly, from the Peace of Antalcidas to the subjugation of Olynthus the history of Greece is nothing but a history of the extension of Spartan authority. Allied with the king of Persia, the tyrant of Syracuse, and the king of Macedonia, the will of Sparta was "irresistible from the cliffs of Taygetus to

[394-380 B.C.]

Athos." The autonomy-paragraph had broken up all anti-Spartan coalitions. In Corinth, the key of the Peloponnesus, oligarchy was restored, Bœotia had become a vassal of Sparta, the menacing Olynthian league had been annihilated, and the ruins of Mantinea and the sanguinary tribunals at Phlius showed what punishment Sparta was prepared to mete out to any attempt at mutiny or disobedience. The Spartan harmosts with their garrisons commanded the citadels everywhere, and under their protection oligarchic rulers held the populace in fetters. In the time of Lysander, indeed, the Spartan dominions had been more extensive, but Sparta had never borne sway in Hellas with more authority or less restraint. Athens might strive with unflagging perseverance to establish an ascendancy at sea; she might conclude an alliance with Chios directly after the Peace of the King, an alliance which was the precursor of the maritime confederacy presently to be revived; but how insignificant were such things as opposed to the dominant position of Sparta, now at the zenith of her glory! And for the fact that her will and her word were law in Greece, Sparta was mainly indebted to the steady and consistent policy of Agesilaus.

The gray-haired monarch might well look with pride upon the object he had attained. He had reared a mighty structure: though it had been built by harshness and arbitrary power and welded together with blood and cruelty, it is none the less a moving spectacle to see how, before the eyes of its founder, stone after stone was cast down, till nothing but a vast expanse of ruins remained to bear witness to its former greatness.^b

FATE OF EVAGORAS AND THE ASIATIC GREEKS

During the first years of his reign, Evagoras doubtless paid his tribute regularly, and took no steps calculated to offend the Persian king. But as his power increased, his ambition increased also. We find him towards the year 390 B.C., engaged in a struggle not merely with the Persian king, but with Amathus and Citium in his own island, and with the great Phœnician cities on the mainland. By what steps, or at what precise period, this war began, we cannot determine. At the time of the battle of Cnidus (394 B.C.) Evagoras not only paid his tribute, but was mainly instrumental in getting the Persian fleet placed under Conon to act against the Lacedæmonians, himself serving aboard. It was in fact (if we may believe Isocrates) to the extraordinary energy, ability, and power displayed by him on that occasion in the service of Artaxerxes himself, that the jealousy and alarm of the latter against him are to be ascribed. Without any provocation, and at the very moment when he was profiting by the zealous services of Evagoras, the Great King treacherously began to manœuvre against him and forced him into the war in self-defence. Evagoras accepted the challenge, in spite of the disparity of strength, with such courage and efficiency, that he at first gained marked successes. Seconded by his son Pnytagoras, he not only worsted and humbled Amathus, Citium, and Soli, which cities, under the prince Agyris, adhered to Artaxerxes, but he also equipped a large fleet, attacked the Phœnicians on the mainland with so much vigour as even to take the great city of Tyre; prevailing, moreover, upon some of the Cilician towns to declare against the Persians. He received powerful aid from Acoris, the native and independent king in Egypt, as well as from Chabrias and the force sent out by the Athenians. Beginning apparently about 390 B.C., the war against Evagoras lasted something more than ten years, costing the

Persians great efforts and an immense expenditure of money. Twice did Athens send a squadron to his assistance, from gratitude for his long protection to Conon and his energetic efforts before in the battle of Cnidus—though she thereby ran every risk of making the Persians her enemies.

The satrap Tiribazus saw that so long as he had on his hands a war in Greece, it was impossible for him to concentrate his force against the prince of Salamis and the Egyptians. Hence, in part, the extraordinary effort made by the Persians to dictate, in conjunction with Sparta, the Peace of Antalcidas, and to get together such a fleet in Ionia as should overawe Athens and Thebes into submission. It was one of the conditions of that peace that Evagoras should be abandoned; the whole island of Cyprus being acknowledged as belonging to the Persian king. Though thus cut off from Athens, and reduced to no other Grecian aid than such mercenaries as he could pay, Evagoras was still assisted by Acoris of Egypt, and even by Hecatomnus, prince of Caria, with a secret present of money. But the Peace of Antalcidas being now executed in Asia, the Persian satraps were completely masters of the Grecian cities on the Asiatic seaboard, and were enabled to convey round to Cilicia and Cyprus not only their own fleet from Ionia, but also additional contingents from these very Grecian cities.



STATUE OF MINERVA IN A RUINED
TEMPLE AT ATHENS

Evagoras defended himself with unshaken resolution, still sustained by aid from Acoris in Egypt; while Tyre and several towns in Cilicia also continued in revolt against Artaxerxes; so that the efforts of the Persians were distracted, and the war

was not concluded until ten years after its commencement. It cost them on the whole (if we may believe Isocrates) 15,000 talents in money [£3,000,000 or \$15,000,000], and such severe losses in men, that Tiribazus acceded to the propositions of Evagoras for peace, consenting to leave him in full possession of Salamis, under payment of a stipulated tribute.

It was seemingly not very long after the peace, that a Salaminian named Nicoreon formed a conspiracy against his life and dominion, but was detected, by a singular accident, before the moment of execution, and forced to seek safety in flight. He left behind him a youthful daughter in his harem, under the care of a eunuch (a Greek, born in Elis) named Thrasydæus; who, full of vindictive sympathy in his master's cause, made known the beauty of the young lady both to Evagoras himself and to Pnytagoras, the most distinguished of his sons, partner in the gallant defence of Salamis against the Persians. Both of them were tempted, each unknown to the other, to make a secret assignation for being conducted to her chamber by the eunuch: both of them were there assassinated by his hand.

Thus perished a Greek of pre-eminent vigour and intelligence, remarkably free from the vices usual in Grecian despots, and forming a strong con-

[387 B.C.]

trast in this respect with his contemporary Dionysius, whose military energy is so deeply stained by crime and violence. Nicocles, the son of Evagoras, reigned at Salamis after him, and showed much regard, accompanied by munificent presents, to the Athenian Isocrates; who compliments him as a pacific and well-disposed prince, attached to Greek pursuits and arts, conversant by personal study with Greek philosophy, and above all, copying his father in that just dealing and absence of wrong towards person or property which had so much promoted the comfort as well as the prosperity of the city.

We now revert from the episode respecting Evagoras—interesting not less from the eminent qualities of that prince than from the glimpse of Hellenism struggling with the Phœnician element in Cyprus—to the general consequences of the Peace of Antalcidas in Central Greece. For the first time since the battle of Mycale in 479 B.C., the Persians were now really masters of all the Greeks on the Asiatic coast. The satraps lost no time in confirming their dominion. In all the cities which they suspected, they built citadels and planted permanent garrisons. In some cases, their mistrust or displeasure was carried so far as to raze the town altogether. And thus these cities, having already once changed their position greatly for the worse, by passing from easy subjection under Athens to the harsh rule of Lacedæmonian harmosts and native decemvirs, were now transferred to masters yet more oppressive and more completely without the pale of Hellenic sympathy. Both in public extortion, and in wrong-doing towards individuals, the commandant and his mercenaries whom the satrap maintained, were probably more rapacious, and certainly more unrestrained, than even the harmosts of Sparta. Moreover, the Persian grandees required beautiful boys as eunuchs for their service, and beautiful women as inmates of their harems. What was taken for their convenience admitted neither of recovery nor redress. While the Asiatic Greeks were thus made over by Sparta and the Perso-Spartan convention of Antalcidas, to a condition in every respect worse, they were at the same time thrown in, as reluctant auxiliaries to strengthen the hands of the Great King against other Greeks—against Evagoras in Cyprus, and above all, against the islands adjoining the coast of Asia—Chios, Samos, Rhodes, etc. These islands were now exposed to the same hazard, from their overwhelming Persian neighbours, as that from which they had been rescued nearly a century before by the confederacy of Delos, and by the Athenian empire into which that confederacy was transformed. All the tutelary combination that the genius, the energy, and the Panhellenic ardour of Athens had first organised, and so long kept up, was now broken up; while Sparta, to whom its extinction was owing, in surrendering the Asiatic Greeks, had destroyed the security even of the islanders.^e

THE REVOLT OF THEBES

The ambition of making conquests in the East, which it now appeared impossible to retain, had deprived the Lacedæmonians of an authority, or rather dominion in Greece, acquired by the success of the Peloponnesian War, and which they might have reasonably expected to preserve and to confirm. Not only their power, but their safety, was threatened by the arms of a hostile confederacy, which had been formed and fomented by the wealth of Persia. Athens, their rival, their superior, their subject, but always their unrelenting enemy, had recovered her walls and fleet, and aspired to command

the sea. Thebes and Argos had become sensible of their natural strength, and disdained to acknowledge the pre-eminence, or to follow the standard, of any foreign republic. The inferior states of Peloponnesus were weary of obeying every idle summons to war, from which they derived not any advantage but that of gratifying the ambition of their Spartan masters. The valuable colonies in Macedon and Thrace, and particularly the rich and populous cities of the Chalcidic region, the bloodless conquests of the virtuous Brasidas, had forsaken the interest of Sparta, when Sparta forsook the interest of justice. Scarcely any vestige appeared of the memorable trophies erected in a war of twenty-seven years. The eastern provinces (incomparably the most important of all) were irrecoverably lost; and this rapid decline of power had happened in the course of ten years, and had been chiefly occasioned by the fatal splendour of Agesilaus' victories in Asia.

During five years the Spartans maintained, in the Cadmea at Thebes, a garrison of fifteen hundred men. Protected by such a body of foreign troops, which might be reinforced on the shortest warning, the partisans of aristocracy acquired an absolute ascendancy in the affairs of the republic, which they conducted in such a manner as best suited their own interest, and the convenience of Sparta. Without pretending to describe the banishments, confiscations, and murders of which they were guilty, it is sufficient for the purpose of general history to observe, that the miserable victims of their vengeance suffered similar calamities to those which afflicted Athens under the Thirty Tyrants. The severity of the government at length drove the Thebans to despair; and both the persecuted exiles abroad, and the oppressed subjects at home, prepared to embrace any measures, however daring and hazardous, which promised them a faint hope of relief.

Among the Theban fugitives, who had taken refuge in Athens, and whose persons were now loudly demanded by Sparta, was Pelopidas, the son of Hippoclus, a youth whose distinguished advantages might have justly rendered him an object of envy, before he was involved in the misfortunes of his country. He yielded to none in birth; he surpassed all in fortune; he excelled in the manly exercises so much esteemed by the Greeks, and was unrivalled in qualities still more estimable — generosity and courage. He had an hereditary attachment to the democratic form of policy; and, previous to the late melancholy revolution, he was marked out by his numerous friends and adherents as the person most worthy of administering the government. Pelopidas had often conferred with his fellow-sufferers at Athens about the means of returning to their country, and restoring the democracy; encouraging them by the example of the patriotic Thrasybulus, who, with a handful of men, had issued from Thebes, and effected a similar, but still more difficult, enterprise. While they secretly deliberated on this important object, Mellon, one of the exiles, introduced to their nocturnal assembly his friend Phyllidas, who had lately arrived from Thebes; a man whose enterprising activity, singular address, and crafty boldness, justly entitle him to the regard of history.

Phyllidas was strongly attached to the cause of the exiles; yet, by his insinuating complaisance, and officious servility, he had acquired the entire confidence of Leontiades, Archias, and the other magistrates, or rather tyrants, of the republic. In business and in pleasure, he rendered himself alike necessary to his masters; his diligence and abilities had procured him the important office of secretary to the council; and he had lately promised to Archias and Philip, the two most licentious of the tyrants, that he would give them an entertainment, during which they might enjoy the conversation

[379 B.C.]

and the persons of the finest women in Thebes. The day was appointed for this infamous rendezvous, which these magisterial debauchés awaited with the greatest impatience; and, in the interval, Phyllidas set out for Athens, on pretence of private business.

In Athens, the time and the means were adjusted for executing the conspiracy. A body of Theban exiles assembled in the Thriasian plain, on the frontier of Attica, where seven, or twelve, of the youngest and most enterprising, voluntarily offered themselves to enter the capital, and to co-operate with Phyllidas in the destruction of the magistrates. The distance between Thebes and Athens was about thirty-five miles. The conspirators had thirteen miles to march through a hostile territory. They disguised themselves in the garb of peasants, arrived at the city towards evening with nets and hunting poles, and passed the gates without suspicion. During that night, and the succeeding day, the house of Charon, a wealthy and respectable citizen, the friend of Phyllidas and a determined enemy of the aristocracy, afforded them a secure refuge till the favourable moment summoned them to action.

The important evening approached, when the artful secretary had prepared his long-expected entertainment in the treasury. Nothing had been omitted that could flatter the senses, and lull the activity of the mind in a dream of pleasure. But a secret and obscure rumour, which had spread in the city, hung, like a drawn dagger, over the voluptuous joys of the festivity. It had been darkly reported that some unknown strangers, supposed to be a party of the exiles, had been received into the house of Charon. All the address of Phyllidas could not divert the terror of his guests. They despatched one of their lictors or attendants to demand the immediate presence of Charon. The conspirators were already buckling on their armour, in hopes of being immediately summoned to execute their purpose.

But what was their astonishment and terror, when their host and protector was sternly ordered to appear before the magistrates! The most sanguine were persuaded that their design had become public, and that they must all miserably perish, without effecting anything worthy of their courage. After a moment of dreadful reflection, they exhorted Charon to obey the mandate without delay. But that firm and patriotic Theban first went to the apartment of his wife, took his infant son, an only child, and presented him to Pelopidas and Mellon, requesting



CHARON SUMMONED BEFORE THE MAGISTRATES

them to retain in their hands this dearest pledge of his fidelity. They unanimously declared their entire confidence in his honour, and entreated him to remove from danger a helpless infant, who might become, in some future time, the avenger of his country's wrongs. But Charon was inflexible, declaring, "that his son could never aspire to a happier fortune, than that of dying honourably with his father and friends."

So saying, he addressed a short prayer to the gods, embraced his associates, and departed. Before he arrived at the treasury, he was met by Archias and Phyllidas. The former asked him, in the presence of the other magistrates, whose anxiety had brought them from table, "Who are those strangers said to have arrived the other day, and to be now entertained in your family?" Charon had composed his countenance so artfully, and retorted the question with such well-dissembled surprise, as considerably quieted the solicitude of the tyrants, which was totally removed by a whisper of Phyllidas, "that the absurd rumour had doubtless been spread for no other purpose but that of disturbing their pleasures."

They had scarcely returned to the banquet, when Fortune, as if she had taken pleasure to confound the dexterity of Phyllidas, raised up a new and most alarming danger. A courier arrived from Athens with every mark of haste and trepidation, desiring to see Archias, to whom he delivered a letter from an Athenian magistrate of the same name, his ancient friend and guest. This letter revealed the conspiracy; a secret not entrusted to the messenger, who had orders, however, to request Archias to read the despatch immediately, as containing matters of the utmost importance. But that careless voluptuary, whose thoughts were totally absorbed in the expected scene of pleasure, replied with a smile, "Business to-morrow;" deposited the letter under the pillow of the couch, on which, according to ancient custom, he lay at the entertainment; and resumed his conversation with Phyllidas.

Matters were now come to a crisis; Phyllidas retired for a moment; the conspirators were put in motion; their weapons concealed under the flowing swell of female attire, and their countenances overshadowed and hid by a load of crowns and garlands. In this disguise they were presented to the magistrates intoxicated with wine and folly. At a given signal they drew their daggers, and effected their purpose. Charon and Mellon were the principal actors in this bloody scene, which was entirely directed by Phyllidas. But a more difficult task remained. Leontiades, with other abettors of the tyranny, still lived, to avenge the murder of their associates. The conspirators, encouraged by their first success, and conducted by Phyllidas, gained admission into their houses successively, by means of the unsuspected secretary. On the appearance of disorder and tumult, Leontiades seized his sword, and boldly prepared for his defence. Pelopidas had the merit of destroying the principal author of the Theban servitude and disgrace. His associates perished without resistance; men whose names may be consigned to just oblivion, since they were distinguished by nothing memorable but their cruel and oppressive tyranny.

The measures of the conspirators were equally vigorous and prudent. Before alarming the city, they proceeded to the different prisons, which were crowded with the unfortunate victims of arbitrary power. Every door was open to Phyllidas. The captives, transported with joy and gratitude, increased the strength of their deliverers. They broke open the arsenals, and provided themselves with arms. The streets of Thebes now resounded with alarm and terror; every house and family were filled with confusion and uproar; the inhabitants were universally in motion; some providing lights,

[379 B.C.]

others running in wild disorder to the public places, and all anxiously wishing the return of day, that they might discover the unknown cause of this nocturnal tumult.

During a moment of dreadful silence, which interrupted the noise of sedition, a herald proclaimed, with a clear and loud voice, the death of the tyrants, and summoned to arms the friends of liberty and the republic. Among others who obeyed the welcome invitation was Epaminondas, the son of Polymnis, a youth of the most illustrious merit; who united the wisdom of the sage and the magnanimity of the hero, with the practice of every mild and gentle virtue; unrivalled in knowledge and in eloquence; in birth, valour, and patriotism, not inferior to Pelopidas, with whom he had contracted an early friendship. The principles of the Pythagorean philosophy, which he had diligently studied under Lysis of Tarentum, rendered Epaminondas averse to engage in the conspiracy, lest he might imbrue his hands in civil blood. But when the sword was once drawn, he appeared with ardour in defence of his friends and country; and his example was followed by many brave and generous youths who had reluctantly endured the double yoke of domestic and foreign tyranny.

The approach of morning had brought the Theban exiles, in arms, from the Thriasian plain. The partisans of the conspirators were continually increased by a confluence of new auxiliaries from every quarter of the city. Encompassed by such an invincible band of adherents, Pelopidas and his associates proceeded to the market-place; summoned a general assembly of the people; explained the necessity, the object, and the extent of the conspiracy; and, with the universal approbation of their fellow-citizens, restored the democratic form of government.

Exploits of valour and intrepidity may be discovered in the history of every nation. But the revolution of Thebes displayed not less wisdom of design, than enterprising gallantry in execution. Amidst the tumult of action, and ardour of victory, the conspirators possessed sufficient coolness and foresight to reflect that the Cadmea, or citadel, which was held by a Lacedæmonian garrison of fifteen hundred men, would be reinforced, on the first intelligence of danger, by the resentful activity of Sparta. To anticipate this alarming event, which must have rendered the consequences of the conspiracy incomplete and precarious, they commanded the messenger, whom, immediately after the destruction of the tyrants, they had despatched to their friends in the Thriasian plain, to proceed to Athens, in order to communicate the news of a revolution which could not fail to be highly agreeable to that state, and to solicit the immediate assistance of the Athenians, whose superior skill in attacking fortified places was acknowledged by Greeks and barbarians. This message was attended with the most salutary effects. The acute discernment of the Athenians eagerly seized the precious opportunity of weakening Sparta, which, if once neglected, might never return. Several thousand men were ordered to march; and no time was lost, either in the preparation, or in the journey, since they reached Thebes the day after Pelopidas had re-established the democracy.

The seasonable arrival of those auxiliaries, whose celerity exceeded the most sanguine hopes of the Thebans, increased the ardour of the latter to attack the citadel. The events of the siege are variously related. According to the most probable account, the garrison made a very feeble resistance, being intimidated by the impetuous alacrity and enthusiasm, as well as the increasing number of the assailants, who already amounted to fourteen thousand men, and received continual accessions of strength from the neighbouring

cities of Bœotia. Only a few days had elapsed, when the Lacedæmonians desired to capitulate, on condition of being allowed to depart in safety with their arms. Their proposal was readily accepted; but they seem not to have demanded, or at least not to have obtained, any terms of advantage or security for those unfortunate Thebans whose attachment to the Spartan interest strongly solicited their protection. At the first alarm of sedition, these unhappy men, with their wives and families, had taken refuge in the citadel. The greater part of them cruelly perished by the resentment of their countrymen; a remnant only was saved by the humane interposition of the Athenians. So justly had Epaminondas suspected, that the revolution could not be accomplished without the effusion of civil blood.

THE SECOND ATHENIAN LEAGUE

Politics makes strange bedfellows. The petty jealousies of the little Grecian townships, called countries, were as important and as bitter to them as the feuds of empires. Yet, of course, when any two of them fell by the ears they were always ready to accept aid from the bystanding communities, on whatsoever terms they may have recently been. We are now to see a stranger sight than the union of Athens and Sparta, and that is the re-alliance of the polished and haughty Athenians with the citizens of Thebes, although to the Attic mind the very word "Bœotian" had been from time immemorial a synonym for "swine," a by-word of treachery, of Asiatic sympathy, and of backwoods uncouthness.

The immediate effect of the theatrical revolution at Thebes was the death of three of the leading generals concerned. Sparta in disgust executed two of the defeated harmosts with short shrift of trial. The Athenians put to death one of the generals who had gone to the relief of the Thebans, and outlawed the other. They were not yet ready to take a step in renewal of the ancient wars with Sparta. The Thebans felt themselves now quite left at the mercy of the Lacedæmonians, and, indeed, it was only a Spartan who could seemingly have been of aid to them. Sphodrias, a harmost of Thespiæ, was hot-headed enough to dream of taking Athens unawares and seizing the Piræus. He was so slow on the march, however, that daylight found him only at Eleusis. Thereupon, his surprise failing, he retreated, ravaging the country through which he passed. Athens had shown her purpose to keep the peace with Sparta by her punishment of the rash officers who had gone to the relief of Thebes, and yet here was a Spartan general marching against Athens and playing havoc in the vicinity. A prompt disavowal on the part of Sparta was demanded, with the execution of Sphodrias. Sphodrias did not dare return to Sparta for trial, feeling that his doom was certain. And so it would have been had it not been for the influence of Agesilaus who was notably a tender-hearted man and could not resist the pleadings of his son who was on terms of Grecian intimacy with the son of Sphodrias. Acquittal followed, and Athens could not but feel herself insulted and forced into an open declaration for Thebes. War broke out and was busy for six years. It took the form, as usual, of a war between two leagues.

Sparta felt called upon to deal gently with her remaining confederates after she saw Chios, Byzantium, Rhodes, and Mytilene revolt at once to Athens. Sparta divided her league into ten classes: herself the first, the Arcadian states second and third, Elis the fourth, the Achæans the fifth, Corinth and Megara the sixth, Sicyon, Phlius, and the towns of the Argolic

[379-378 B.C.]

Acte the seventh, the Acarnanians the eighth, the Phocians and Locrians the ninth, Olynthus and the other cities on the coast of Thrace the tenth.

To Athens it seemed as if destiny had forced her once more to the forefront of a league against Sparta, a league which should bring her back to her old-time mastery of the seas. This league, which is called by Busolt & others the second Athenian league, is called the third by Beloch,^g who writes of it as follows :

“Meanwhile Athens had striven with zeal to erect again the twice-lost lordship of the seas. Immediately after the King’s Peace the alliance with Chios, Mytilene, Methymna, and Byzantium was renewed : Rhodes also entered into treaty with Athens, as her Asia Minor league had gone to pieces at the death of Glos, about 379. The effort to resume the old relations with the Chalcidians in Thrace had been quickly foiled by the Spartan intervention ; but instead, as we have seen, Thebes had entered into alliance with Athens in the spring of 378. And now, after the breach with Sparta was definite, Athens lifted up to all Hellenes and barbarians, where they were not under Persian rule, the summons to band together in a league against the encroachment of Sparta. The provisions of the King’s Peace should fashion the ground plan. The autonomy of all the states party to it was guaranteed ; the Persian king was to be recognised as lord of the continent of Asia : Athens renounced all claims on her old colonial possessions and for the future the acquisition of houses and lands anywhere in the confederacy should be forbidden to the Athenians. For the administration of affairs a congress (*synedrion*) was established which sat in Athens, and in which delegates from all the allied states had place and vote ; but Athens herself none. For the passing of measures, the consent of both the chief city [Athens] and of the *synedrion* was necessary. The funds for the fleet of the league were defrayed through contributions (*syntaxeis*) whose amount the *synedrion* would fix according to current needs. The management of this fund and the leadership in war belonged to Athens.

“Athens made heavy sacrifices to lay the foundation for the erection of this new league. It was a complete breach with her political practices down to the King’s Peace, a final renunciation of the re-establishment of the empire in its old form, as she had planned since Thrasybulus. And more than that : thousands of Athenian citizens lost their last hope of regaining the property outside Attica, which their fathers had lost through the catastrophe of the year 404. But these sacrifices were not made in vain. The states of Eubœa came at once into the new league, except Oreus, which was held by a Spartan garrison ; also the northern Sporades, Peparethus, Sciathus and Ieus ; Tenedos at the mouth of the Hellespont, Perinthus and Maronea in Thrace ; Paros and other neighbouring isles. Moreover, the previous confederates of Athens, Chios, Mytilene, Mythimna, Byzantium, Rhodes, and Thebes came back.

“Thus at one blow Athens was again the ruling power in the Ægean Sea ; she could now take again in hand the trusteeship of the temple of Delos, which she had lost for some years.

“At the same time the reorganisation of the Attic marine was begun. That was strongly needful : since in the Corinthian War the material had been rendered largely useless, and efforts at its repair had been very insufficiently made. There existed well over one hundred triremes, but most of them old and hardly seaworthy. The building of a great number of new battleships was begun and pushed so skilfully that after the lapse of twenty years (357-6) an array of 289 triremes remained in spite of the great

demands made on the Attic fleet. To cover these expenses and for the payment of the costs of the war an extraordinary tax was levied on the property in Attica."

Thus we find Athens again with an array of allies behind her. She no longer has the prestige of old. The moneys that they entrust to her are contributions (*syntaxeis*), and no longer tribute (*phoros*). So jealous are they, indeed, of Athenian ambition that no citizen of Athens may even acquire property among the allies. The very tablet on which this treaty was carved is still in existence, though broken in a score of fragments. The chief purpose of the league is, it states, to be one of defence, a combination "to compel the Spartans to leave the Greeks in peace and freedom with unviolated lands." The chief agents in the organisation of this confederacy and in the proselyting of allies were the brilliant orator Callistratus, who has been called the Aristides of the second confederacy, and the shrewd generals, Iphicrates, Chabrias, and Timotheus, the worthy son of the great admiral, Conon. The chief fault with the confederacy was that it bound Athens into an unnatural alliance with Thebes, its inveterate enemy, who could serve little further purpose than that of a ladder to be discarded as soon as it had been climbed over. The war, therefore, becomes mainly a war between Sparta and Athens, in which, as Holm^h notes, "Athens played always the rôle of the spectator who sits quiet, saving his strength in order to act as peace-maker over both the antagonists."

Thebes took up the war with a blazing enthusiasm. She had for a controlling spirit the coming man Epaminondas, a military genius of the very first rank, a gifted musician, a philosopher, and an orator. He had the rare qualities of modesty, of pure patriotism, of indifference to money and to partisanship. Allied with him was Pelopidas, who was in command of a new organisation which stood some chance of meeting the famous Spartan hoplite in equal combat. This *Hieros Lochos*, or Sacred Band of sworn friends, was a curious body of three hundred young men fighting in couples and bound together by Grecian ideas of friendship. They were trained to a high degree of gymnastic strength, and while chosen at first merely to serve as front-rank men, later came to be employed as a separate regiment of irresistible momentum in a charge.

Before they had learned the power of this troop the Thebans dug a ditch and built a rampart around the most fertile part of their territory against the invasions of the Spartans. Soon after the revolt of the city, in 378 B.C., the Spartan king Cleombrotus had raided the land, but without result. Later came King Agesilaus for two expeditions, equally fruitless, except for pillage. The Spartan Phœbidas made an inroad in 377 and was killed in a disastrous defeat. To relieve a famine due to the destruction of two harvests, the Thebans sent for two galleys of corn which the Spartan Alcetas captured, putting the crews in prison in the citadel in Oreus in Eubœa. The prisoners captured the fortress and took possession of the town, which now joined the league with Athens. In 376, Agesilaus, who was ill from the bursting of a blood-vessel, on his previous campaign, was compelled to keep his room, and the Spartans sent an army under Cleombrotus, who was repulsed at the passes of Cithæron. The Spartans now sent a fleet to cut off the corn supplies of Athens and put her port under blockade.

Athens, once more able to take the sea, fitted a fleet of eighty galleys which she entrusted to Chabrias. In order to decoy the Spartan fleet under Pollis away from the Piræus, he laid siege to Naxos which was wavering towards the Athenian confederacy. Pollis accepted the challenge, and,

[376-374 B.C.]

though he had only sixty galleys, gave battle between Paros and Naxos. It was a hard fight and the Spartans seem to have lost all their ships except eleven, and these would have been destroyed, says Diodorus, had it not been for the fate of the commanders in the battle of Arginusæ, who, as will be remembered, were in such haste to pursue the defeated enemy that they did not stop to pick up their own wounded and dead on the sinking wrecks of their own fleet. They had been put to death in their hour of triumph, and the lesson was not forgotten by Chabrias in his victory thirty years later.

The glory of Naxos, however, was sufficient. And while it was not so momentous a success as Conon's at the battle of Cnidus, it was more savoury to the Athenians, because it had been won by a fleet not of Asiatics merely commanded by an Athenian, but altogether by Athenian ships and men. In this battle the command of the left wing was given to Phocion, who looms large in later Athenian history. This success at Naxos in the year 376 relieved Athens of famine, re-established her prestige on the sea, and brought seventeen new cities around the Ægean Sea into the confederacy, together with a large contribution. In the same year the Athenians also punished an insurrection at Delos where the renewal of her authority was not entirely welcome. Preparations were now made for a circumnavigation of the Peloponnesus with a fleet under Pinotenus. In 375 he sailed and brought over to the Athenian alliance the islands of Corcyra and Cephallenia, a part of Acarnania, and the king of the Molossians. At Alyzia, Timotheus with his sixty galleys was attacked by the Spartan Nicolochus, with fifty-five galleys. The Athenian won this encounter, but declined a later challenge, and increased his fleet to seventy sail.

The expedition had succeeded in the purpose that had led the Thebans to suggest it, that is, it had prevented Sparta from making her usual incursion into Bœotia. Athens, however, found the fleet a very heavy and irksome expense, and each captain of a trireme was compelled to advance £28 or \$140 towards the payment of his crew. The Athenians now suggested that the Thebans make some payment towards the cost of an expedition which had been of such economy to them; but they declined the opportunity, and Athens, in a not unnatural pique, turned towards Sparta. In 374 a peace was agreed to, but was broken at once owing to the fact that Timotheus interfered at Zacynthus and brought down the wrath of Sparta. So the war went on.

Meanwhile, the year before, the Thebans had been active and growingly successful. They turned against three near-by cities in Bœotia which were old victims of Thebes and had been granted independence under the Peace of Antalcidas. These towns were Plataea, Thespiæ, and Orchomenos. They hated Thebes from bitter memories of former oppressions and held out

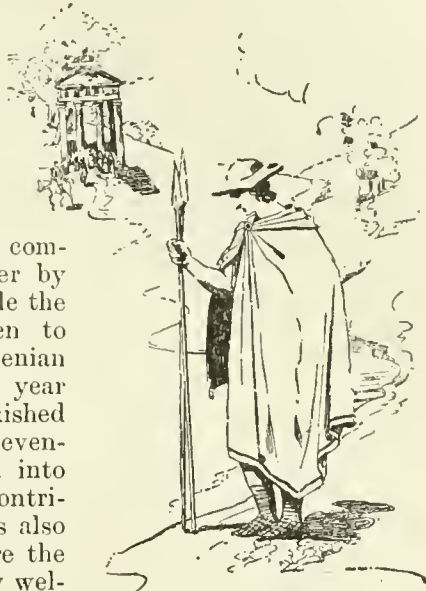

GREEK WARRIOR IN TRAVELLING
COSTUME
(After Hope)

against her increasing presumption, although other Bœotian towns were brought into the league, and although they were themselves heavily assailed. It was 372 before Plataea was taken by surprise and all the inhabitants driven out of it. They took refuge in Athens, whose friendship for Plataea was of old times. Thebes also compelled Thespiæ to tear down her fortifications. These things only revived in Athens the ancient abhorrence of Thebes, but they fed the insolence of the Bœotians. It was probably in 375 B.C., that Pelopidas, at the head of his Sacred Band, unexpectedly fell in with two Spartan moras, each of them equal alone to his three hundred, and each under command of a polemarch. One of his men came flying to Pelopidas, exclaiming :

“ We have fallen into the midst of the enemy.”

“ Why not they into the midst of us ? ” answered Pelopidas. And at once he charged home.

The first onset killed the two Spartan leaders. This threw the two moras into confusion, and Pelopidas, after cutting his way through, instead of retiring, turned and successfully routed each of the moras. So far as the number engaged is concerned, it was hardly more than a serious riot, but, as we have seen before, any blow at the prestige of the Spartan soldier made all Greeks shudder, and here was a new organisation or club from the unheroic city of Thebes destroying a Spartan force of twice its strength. This was a further blow to Spartan pride and new fuel for the increase of Theban self-confidence. In 374 an expedition against Phocis was checked by Spartan troops under Cleombrotus, but about this time the Athenians seem to have regained Oropus, which the Spartans had captured in 411. This year also Lacedæmonian pride was more deeply humbled before Corcyra.^a Of this let Xenophon tell.

CORCYRA

The Lacedæmonians preparing again to send out a fleet, collected vessels to the number of sixty from Lacedæmon itself, from Corinth, Leucas, Ambracia, Elis, Zacynthus, Achaia, Epidaurus, Trœzen, Hermion, and the Halians. Appointing Mnasippus admiral, they instructed him to attend to affairs in that sea in general, and to make an attempt upon Corcyra. They sent also to Dionysius, representing that it was for his interest that Corcyra should not be in the power of the Athenians.

Mnasippus, when his fleet was collected, set sail for Corcyra. He had with him, in addition to the troops from Lacedæmon, a body of mercenaries to the amount of not less than fifteen hundred. When he landed on the island, he at once became master of it, and laid waste the country, which was excellently cultivated and planted, and exhibited, throughout the fields, fine houses and well-constructed wine-vaults ; so that the soldiers, they said, arrived at such a height of luxury, that they would drink no wine but such as was of a fragrant odour. Slaves and cattle in great numbers were carried off from the fields. At length he encamped with his land-forces on a hill, distant about five stadia from the city, and overlooking the country, so that if any of the Coreyræans should come out into the fields, he might cut off their retreat ; his ships he stationed on the opposite side of the city, at a point where he thought that they would observe and stop whatever vessels might approach the coast. In addition to these arrangements, he anchored galleys, when foul weather did not prevent, in front of the harbour. Thus he kept the city in a state of blockade.

[374-373 B.C.]

As the Coreyraens, in consequence, could get no supplies from their grounds, since they were overpowered by land, while nothing could be brought them by sea, because they were inferior in naval force, they suffered greatly from want of provisions, and, sending to the Athenians, entreated aid of them, and represented that "they would lose a very valuable possession if they should be deprived of Coreyra, and would greatly increase at the same time, the strength of their enemies; since from no state in Greece, except Athens, could more ships or money be raised;" they added, also, that "the island of Coreyra was favourably situated with regard to the Gulf of Corinth, and the cities lying upon it, and favourably, too, for ravaging the territory of Laconia, but most favourably of all with reference to the opposite continent, and the passage from Sicily to the Peloponnesus." The Athenians, on hearing these representations, were of opinion that they must pay careful attention to the matter, and sent out Stesicles, as general, with six hundred peltasts, requesting Alcetas to assist in conveying them over the water. These troops were accordingly landed on the coast by night, and made their way into the city of Coreyra.

The Athenians also resolved to fit out sixty additional ships, and elected Timotheus as commander of them. Timotheus, not being able to man these vessels at home, sailed about to the different islands, and endeavoured to complete his crews from thence; thinking it would be no light matter to sail round without due preparation against ships so well disciplined as those of the enemy. But the Athenians, imagining that he was wasting the whole of the season suitable for the expedition, had no patience with him, and, depriving him of his command, appointed Iphicrates in his room. Iphicrates, as soon as he was made commander, manned his vessels with the utmost expedition, and obliged the trierarchs to exert themselves. He took from the Athenians, also, whatever ships were on the coast of Attica, as well as the Paralus and Salaminian ships, observing that "if affairs at Coreyra were successful, he would send them back plenty of ships." His fleet amounted in all to about seventy.

During this time the people of Coreyra were so grievously oppressed with famine, that, in consequence of the number of deserters, Mnasippus made proclamation that "all deserters for the future should be sold as slaves." But when they continued to desert nevertheless, he at last scourged them, and sent them back. The people in the city, however, refused to receive any slaves into the town, and many, in consequence, perished without the walls. Mnasippus, observing this, imagined that he was all but in possession of the city, and began to make new arrangements as to his mercenaries, some of whom he dismissed from his service, while to those who remained he continued in debt two months' pay, though not, as it was said, for want of money, for the greater number of the towns, in consequence of the expedition being over the sea, had sent him money instead of men. But as the people in the city observed from their towers that the lines of the enemy were guarded with less strictness than before, and that the men were straggling over the country, they made a sally upon them, and took some of them prisoners and killed some.

Mnasippus, perceiving what had happened, armed himself, and hastened, with all the heavy-armed troops that he had, to the succour of his men, ordering also the captains and centurions to lead out the mercenaries. Some of the captains observing that "it was not easy for those to have their men obedient who gave them no subsistence," he struck one of them with his staff, and another with the handle of his spear. Thus they all came out without

spirit, and with feelings of hatred towards their general; a state of mind by no means favourable for fighting. However, when he had drawn up his force, he put to flight those of the enemy that were near the gates of the city, and pressed forward in pursuit of them; but the pursued, when they were close to the wall, faced about, and hurled stones and darts at him from the towers; while others, sallying forth from the other gates, fell, in a dense body, upon the extremity of his line. Mnasippus' men there, being formed but eight deep, and thinking their wing too weak, endeavoured to wheel round, but when they began to withdraw from their position, the enemy rushed upon them as if they were going to flee, when they themselves no longer attempted to turn, and those that were nearest to them took to flight. Mnasippus, at the same time, was unable to support the party that were in difficulties, as the enemy were pressing upon him in front, and he was continually left with fewer and fewer men. At last the enemy, collecting in a body, made a general attack upon those remaining with Mnasippus, now reduced to a very small number indeed; while the people from the city, observing how things stood, sallied forth, and, after killing Mnasippus, joined in a general pursuit. The pursuers would probably have taken the camp and entrenchment, had they not observed the crowd in the market, and that of the servants and slaves, and, imagining it an efficient body of defenders, retraced their steps. The Coreyræans however erected a trophy, and restored the dead under a truce.

After this affair, the people in the city grew bolder, while those without were in extreme dejection; for it was said that Iphicrates was almost at hand; and the Coreyræans actually proceeded to fit out their vessels. But Hypermenes, who had been second in command to Mnasippus, manned all the Lacedæmonian ships that were there, and, sailing round to the encampment, loaded them every one with slaves and other effects, and sent them off. He himself, with the marines, and such of the other soldiers as survived, stayed to guard the entrenchment; but at last these also got on board in the utmost disorder and sailed away, leaving behind them a great quantity of corn and wine, and a number of slaves and sick persons; for they were extremely afraid that they would be surprised in the island by the Athenians. However, they arrived in safety at Leucas.

Iphicrates, as soon as he commenced his voyage, continued, while he pursued his way, to prepare everything necessary for an engagement. He left his large sails at home at starting, as standing out for a battle, and of his other sails, even if the wind was favourable, he made little use; but, making his passage with the oar, caused his men, by that means, to keep themselves in better condition, and his ships to pursue their course better. Frequently, too, wherever the crews were going to dine or sup, he would draw off one extremity of the fleet to a distance from the land over against the place, and, when he had turned about, and ranged his vessels in a line with their prows towards it, would start them, at a signal, to race against each other to the shore; when it was a great advantage for such as could first take their water, and whatever else they needed, and first finish their meal; while, to such as came last, it was a great punishment to have the disadvantage in all these respects, since they were all obliged to put out to sea again when he gave the signal; for it was the fortune of those that landed first to do everything at their leisure, but of those that were last, to do all with hurry.

If he landed to take a meal in the enemy's country, he not only posted sentinels, as was proper, on the shore, but also, raising the masts in his ships, kept a lookout from thence. The men stationed on the masts, indeed, saw

[373 B.C.]

much farther than those on the level ground, as they looked down from a higher position. Wherever he supped or slept, he kindled no fire in the camp at night, but kept a light burning in front of the encampment, that no one might approach undiscovered. Often, moreover, if the weather was calm, he would resume his voyage as soon as supper was over; and, if a breeze propelled the vessels, the men reposed as they ran on, but, if it was necessary to use the oar, he made them take rest by turns. In his course by day, he would sometimes, at given signals, lead his ships in a line behind one another, and sometimes in a body side by side; so that, while they pursued their voyage, they practised and acquired whatever was necessary for naval warfare, and thus arrived at the sea which they believed to be occupied by the enemy. They dined and supped, for the most part, on the enemy's territory; but, as they did nothing more there than what was necessary, Iphierates escaped all attacks by the suddenness with which he resumed his voyage, which he soon accomplished. About the time of Mnasippus' death he was at the Sphagiæ in Laconia. Advancing thence to the coast of Elis, and sailing past the mouth of the Alpheus, he came to anchor at the promontory called Icthys. Next day he proceeded from thence to Cephallenia, with his fleet so arranged, and keeping his course in such a manner, that he could, if it should be requisite, get everything needful ready for battle, and engage at once; for as to the fate of Mnasippus, he had heard no account from any eye-witness, and suspected that it might be a report intended to deceive him, and accordingly kept upon his guard. But when he arrived at Cephallenia, he received a full statement of facts, and stopped there to refresh his men.

Having reduced the towns in Cephallenia, he sailed off to Coreyra. Here the first intelligence he received was, that ten galleys were coming from Dionysius to reinforce the Lacedæmonians; and going in person therefore along the coast, and considering from what points it was possible to descry those vessels approaching, and for people making signals to render them visible at the city, he posted sentinels in those places, arranging with them what signals they should give when the enemy sailed up and cast anchor. He then selected twenty of his own captains, who were to be ready to follow him whenever he should send a messenger to them, and gave them notice, that, if any one of them should not follow him, he must not complain of any penalty imposed upon him. As soon as these ships, then, were signalled as approaching, and messengers were sent to the captains, their haste was deserving of admiration; for there was no one, of those that were going to sail, that did not embark with the utmost speed. Standing away to the point where the ships of the enemy were, he found that the men from the rest of them were gone ashore, but that Melanippus, a Rhodian captain, was exhorting the other commanders not to stay there, and, embarking his own crew, was sailing off. Melanippus, in consequence, though he met with the ships of Iphierates, nevertheless escaped, but all the ships from Syracuse were captured, with their crews. Iphierates, cutting off the beaks of the vessels, brought them in tow into the harbour of Coreyra, and settled a fixed sum for each of the prisoners to pay for his ransom, except Crinippus, the chief captain, whom he kept under guard, as if he would exact a vast sum from him, or sell him as a slave. He however died, through grief, by his own hands. The other prisoners Iphierates discharged, taking security from the Coreyreans for the payment of their ransom.

He maintained his sailors, chiefly, by employing them in agriculture in the service of the Coreyreans. With the peltasts, and the heavy-armed

men from the fleet, he passed over to Acarnania, where he afforded aid to the friendly towns, if any required it, and made war upon the Thyreans, a people of great bravery, and occupying a strongly fortified place. Afterwards, fetching the fleet from Coreyra, consisting now of about ninety ships, he proceeded first to Cephallenia and raised contributions there, as well from people that were willing to give them, as from those that were unwilling. He then prepared to commit depredations on the territories of the Lacedæmonians; and, of the cities in those parts attached to the enemy, to receive into alliance such as were willing to join him, and to make war on such as rejected his advances.^c

THE TRIAL OF TIMOTHEUS

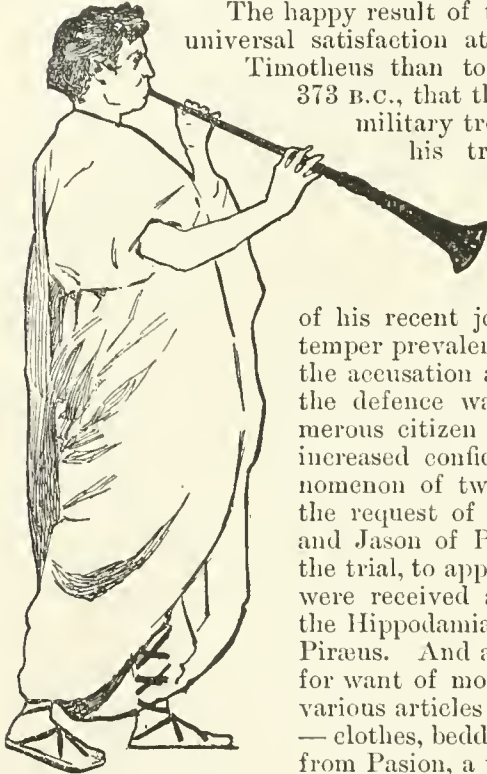

GREEK HERALD

The happy result of the Coreyraean expedition, imparting universal satisfaction at Athens, was not less beneficial to Timotheus than to Iphicrates. It was in November 373 B.C., that the former, as well as his quæstor or military treasurer, Antimachus, underwent each his trial. Callistratus, having returned home, pleaded against the quæstor, perhaps against Timotheus also, as one of the accusers; though probably in a spirit of greater gentleness and moderation, in consequence

of his recent joint success and of the general good temper prevalent in the city. And while the edge of the accusation against Timotheus was thus blunted, the defence was strengthened not merely by numerous citizen friends speaking in his favour with increased confidence, but also by the unusual phenomenon of two powerful foreign supporters. At the request of Timotheus, both Alcetas of Epirus, and Jason of Pheræ, came to Athens a little before the trial, to appear as witnesses in his favour. They were received and lodged by him in his house in the Hippodamian Agora, the principal square of the Piræus. And as he was then in some embarrassment for want of money, he found it necessary to borrow various articles of finery in order to do them honour — clothes, bedding, and two silver drinking-bowls — from Pasion, a wealthy banker near at hand. These two important witnesses would depose to the zealous service and estimable qualities of Timotheus; who

had inspired them with warm interest, and had been the means of bringing them into alliance with Athens; an alliance, which they had sealed at once by conveying Stesicles and his division across Thessaly and Epirus to Coreyra. The minds of the dicastery would be powerfully affected by seeing before them such a man as Jason of Pheræ, at that moment the most powerful individual in Greece; and we are not surprised to learn that Timotheus was acquitted. Although he was now acquitted, his reputation suffered so much by the whole affair, that in the ensuing spring he was glad to accept an invitation of the Persian satraps, who offered him the command of the

[378-373 B.C.]

Grecian mercenaries in their service for the Egyptian war; the same command from which Iphicrates had retired a little time before.

That admiral, whose naval force had been reinforced by a large number of Corcyraean triremes, was committing without opposition incursions against Acarnania, and the western coast of Peloponnesus; insomuch that the expelled Messenians, in their distant exile at Hesperides in Libya, began to conceive hopes of being restored by Athens to Naupactus, which they had occupied under her protection during the Peloponnesian War. And while the Athenians were thus masters at sea both east and west of Peloponnesus, Sparta and her confederates, discouraged by the ruinous failure of their expedition against Coreyra in the preceding year, appear to have remained inactive. With such mental predispositions, they were powerfully affected by religious alarm arising from certain frightful earthquakes and inundations with which Peloponnesus was visited during this year, and which were regarded as marks of the wrath of the god Poseidon. More of these formidable visitations occurred this year in Peloponnesus than had ever before been known; especially one, the worst of all, whereby the two towns of Helice and Bura in Achaia were destroyed, together with a large portion of their population. Ten Lacedaemonian triremes, which happened to be moored on this shore on the night when the calamity occurred, were destroyed by the rush of the waters.

Under these depressing circumstances, the Lacedaemonians had recourse to the same manœuvre which had so well served their purpose fifteen years before, in 388-387 B.C. They sent Antalcidas again as envoy to Persia, to entreat both pecuniary aid and a fresh Persian intervention enforcing anew the peace which bore his name; which peace had now been infringed (according to Lacedaemonian construction) by the reconstitution of the Bœotian confederacy under Thebes as president. And it appears that in the course of the autumn or winter, Persian envoys actually did come to Greece, requiring that the belligerents should all desist from war, and wind up their dissensions on the principles of the Peace of Antalcidas. The Persian satraps, at this time renewing their efforts against Egypt, were anxious for the cessation of hostilities in Greece, as a means of enlarging their numbers of Grecian mercenaries; of which troops Timotheus had left Athens a few months before to take the command.

Apart, however, from this prospect of Persian intervention, which doubtless was not without effect, Athens herself was becoming more and more disposed towards peace. That common fear and hatred of the Lacedaemonians, which had brought her into alliance with Thebes in 378 B.C., was now no longer predominant. She was actually at the head of a considerable maritime confederacy; and this she could hardly hope to increase by continuing the war, since the Lacedaemonian naval power had already been humbled. Moreover, the Athenians had become more and more alienated from Thebes. The ancient antipathy between these two neighbours had for a time been overlaid by common fear of Sparta. But as soon as Thebes had re-established her authority in Bœotia, the jealousies of Athens again began to arise.

During the last three or four years, Plataea, like the other towns of Bœotia, had been again brought into the confederacy under Thebes. Re-established by Sparta after the Peace of Antalcidas as a so-called autonomous town, it had been garrisoned by her as a post against Thebes, and was no longer able to maintain a real autonomy after the Spartans had been excluded from Bœotia in 376 B.C. While other Bœotian cities were glad to

find themselves emancipated from their philo-Laonian oligarchies and rejoined to the federation under Thebes, Plataea — as well as Thespiæ — submitted to the union only by constraint; awaiting any favourable opportunity for breaking off, either by means of Sparta or of Athens. Aware probably of the growing coldness between the Athenians and Thebans, the Plataeans were secretly trying to persuade Athens to accept and occupy their town, annexing Plataea to Attica; a project hazardous both to Thebes and Athens, since it would place them at open war with each other, while neither was yet at peace with Sparta.

This intrigue, coming to the knowledge of the Thebans, determined them to strike a decisive blow. The bæotarch Neocles conducted a Theban armed force immediately from the assembly, by a circuitous route through Hysia to Plataea; which town he found deserted by most of its male adults and unable to make resistance. The Plataeans — dispersed in the fields, finding their walls, their wives, and their families, all in possession of the victor — were under the necessity of accepting the terms proposed to them. They were allowed to depart in safety and to carry away all their movable property; but their town was destroyed and its territory again annexed to Thebes. The unhappy fugitives were constrained for the second time to seek refuge at Athens, where they were again kindly received, and restored to the same qualified right of citizenship as they had enjoyed prior to the Peace of Antalcidas.

It was not merely with Plataea, but also with Thespiæ, that Thebes was now meddling. Mistrusting the dispositions of the Thespians, she constrained them to demolish the fortifications of their town; as she had caused to be done fifty-two years before, after the victory of Delium, on suspicion of leanings favourable to Athens. Such proceedings on the part of the Thebans in Bœotia excited strong emotion at Athens, where the Plataeans not only appeared as suppliants, with the tokens of misery conspicuously displayed, but also laid their case pathetically before the assembly, and invoked aid to regain their town, of which they had been just bereft. On a question at once so touching and so full of political consequences, many speeches were doubtless composed and delivered, one of which has fortunately reached us; composed by Isocrates, and perhaps actually delivered by a Plataean speaker before the public assembly. The hard fate of this interesting little community is here impressively set forth, including the bitterest reproaches, stated with not a little of rhetorical exaggeration, against the multiplied wrongs done by Thebes, as well towards Athens as towards Plataea.

The resolution was at length taken — first by Athens, and next, probably, by the majority of the confederates assembled at Athens — to make propositions of peace to Sparta, where it was well known that similar dispositions prevailed towards peace. Notice of this intention was given to the Thebans, who were moreover invited to send envoys to the Lacedæmonian capital, if they chose to become parties.

In the spring of 371 B.C., at the time when the members of the Lacedæmonian confederacy were assembled at Sparta, both the Athenian and Theban envoys, and those from the various members of the Athenian confederacy, arrived there. Among the Athenian envoys, two at least — Callias (the hereditary *daduch* or torchbearer of the Eleusinian ceremonies) and Autocles — were men of great family at Athens; and they were accompanied by Callistratus, the orator. From the Thebans, the only man of note was Epaminondas, then one of the Bæotarchs.

[371 B.C.]

THE CONGRESS AT SPARTA



GREEK JAR
(In the British Museum)

Of the debates which took place at this important congress, we have very imperfect knowledge; and of the more private diplomatic conversations, not less important than the debates, we have no knowledge at all. Xenophon gives us a speech from each of the three Athenians, and from no one else. That of Callias, who announces himself as hereditary proxenus of Sparta at Athens, is boastful and empty, but eminently philo-Laconian in spirit; that of Antocles is in the opposite tone, full of severe censure on the past conduct of Sparta; that of Callistratus, delivered after the other two — while the enemies of Sparta were elate, her friends humiliated, and both parties silent, from the fresh effect of the reproaches of Antocles — is framed in a spirit of conciliation, admitting faults on both

sides, but deprecating the continuance of war, as injurious to both, and showing how much the joint interests of both pointed towards peace.

This orator, representing the Athenian diplomacy of the time, recognises distinctly the Peace of Antalcidas as the basis upon which Athens was prepared to treat, autonomy to each city, small as well as great: and in this way, coinciding with the views of the Persian king, he dismisses with indifference the menace that Antalcidas was on his way back from Persia with money to aid the Lacedæmonians in the war. Athens and Sparta were to become mutual partners and guarantees; dividing the headship of Greece by an ascertained line of demarcation, yet neither of them interfering with the principle of universal autonomy. Thebes, and her claim to the presidency of Bœotia, were thus to be set aside by mutual consent.

It was upon this basis that the peace was concluded. The armaments on both sides were to be disbanded; the harbours and garrisons everywhere withdrawn, in order that each city might enjoy full autonomy. If any city should fail in observance of these conditions, and continue in a career of force against any other, all were at liberty to take arms for the support of the injured party; but no one who did not feel disposed, was bound so to take arms. This last stipulation exonerated the Lacedæmonian allies from one of their most vexatious chains.

To the conditions here mentioned, all parties agreed; and on the ensuing day, the oaths were exchanged. Sparta took the oath for herself and her allies; Athens took the oath for herself only — her allies afterwards took it severally, each city for itself. Why such difference was made, we are not told; for it would seem that the principle of severance applied to both confederacies alike. Next came the turn of the Thebans to swear; and here the fatal hitch was disclosed. Epaminondas, the Theban envoy, insisted on taking the oath, not for Thebes separately, but for Thebes as president of the Bœotian federation, including all the Bœotian cities. The Spartan authorities, on the other hand, and Agesilaus as the foremost of all, strenuously opposed him. They required that he should swear for Thebes alone, leaving the Bœotian cities to take the oath each for itself. Already in the course of the preliminary debates, Epaminondas had spoken out boldly against the

ascendency of Sparta. While most of the deputies stood overawed by her dignity, represented by the energetic Agesilaus as spokesman, he, like the Athenian Autocles, and with strong sympathy from many of the deputies present, had proclaimed that nothing kept alive the war except her unjust pretensions, and that no peace could be durable unless such pretensions were put aside. Accepting the conditions of peace as finally determined, he presented himself to swear to them in the name of the Bœotian federation. But Agesilaus, requiring that each of the Bœotian cities should take the oath for itself, appealed to those same principles of liberty which Epaminondas himself had just invoked, and asked him whether each of the Bœotian cities had not as good a title to autonomy as Thebes. Epaminondas might have replied by asking why Sparta had just been permitted to take the oath for her allies as well as for herself. But he took a higher ground. He contended that the presidency of Bœotia was held by Thebes on as good a title as the sovereignty of Laconia by Sparta. He would remind the assembly that when Bœotia was first conquered and settled by its present inhabitants, the other towns had all been planted out from Thebes as their chief and mother-city; that the federal union of all, administered by bœotarchs chosen by and from all, with Thebes as president, was coeval with the first settlement of the country; that the separate autonomy of each was qualified by an established institution, devolving on the bœotarchs and councils sitting at Thebes the management of the foreign relations of all jointly.

All this had been pleaded by the Theban orator before the five Spartan commissioners assembled to determine the fate of the captives after the surrender of Plataea; when he required the condemnation of the Plataeans as guilty of treason to the ancestral institutions of Bœotia, and the Spartan commissioners had recognised the legitimacy of these institutions by a sweeping sentence of death against the transgressors. Moreover, at a time when the ascendency of Thebes over the Bœotian cities had been greatly impaired by her anti-Hellenic co-operation with the invading Persians, the Spartans themselves had assisted her with all their power to re-establish it, as a counter-vailing force against Athens. Epaminondas could show that the presidency of Thebes over the Bœotian cities was the keystone of the federation—a right not only of immemorial antiquity, but pointedly recognised and strenuously vindicated by the Spartans themselves. He could show further that it was as old, and as good, as their own right to govern the Lacœonian townships; which latter was acquired and held (as one of the best among their own warriors had boastfully proclaimed) by nothing but Spartan valour and the sharpness of the Spartan sword.

An emphatic speech of this tenor, delivered amidst the deputies assembled at Sparta, and arraigning the Spartans not merely in their supremacy over Greece, but even in their dominion at home, was as it were the shadow cast before by coming events. It opened a question such as no Greek had ever ventured to raise. It was a novelty startling to all—extravagant probably in the eyes of Callistratus and the Athenians, but to the Spartans themselves intolerably poignant and insulting. They had already a long account of antipathy to clear off with Thebes; their own wrong-doing in seizing the Cadmea; their subsequent humiliation in losing it and being unable to recover it; their recent short-comings and failures, in the last seven years of war against Athens and Thebes jointly. To aggravate this deep-seated train of hostile associations, their pride was now wounded in an unforeseen point, the tenderest of all. Agesilaus, full to overflowing of the national sentiment, which in the mind of a Spartan passed for the

[371 B.C.]

first of virtues, was stung to the quick. Had he been an Athenian orator like Callistratus, his wrath would have found vent in an animated harangue. But a king of Sparta was anxious only to close these offensive discussions with scornful abruptness, thus leaving to the presumptuous Theban no middle ground between humble retraction and acknowledged hostility. Indignantly starting from his seat, he said to Epaminondas: "Speak plainly, — will you, or will you not, leave to each of the Bœotian cities its separate autonomy?" To which the other replied, "Will you leave each of the Laconian towns autonomous?" Without saying another word, Agesilaus immediately caused the name of the Thebans to be struck out of the roll, and proclaimed them excluded from the treaty.

Such was the close of this memorable congress at Sparta in June 371 B.C. Between the Spartans and the Athenians, and their respective allies, peace was sworn. But the Thebans were excluded, and their deputies returned home, (if we may believe Xenophon) discouraged and mournful. Yet such a man as Epaminondas must have been well aware that neither his claims nor his arguments would be admitted by Sparta. If, therefore, he was disappointed with the result, this must be because he had counted upon, but did not obtain, support from the Athenians or others.

ATHENS ABANDONS THEBES

The leaning of the Athenian deputies had been adverse rather than favourable to Thebes throughout the congress. They were disinclined, from their sympathies with the Platæans, to advocate the presidential claims of Thebes, though on the whole it was to the political interest of Athens that the Bœotian federation should be maintained, as a bulwark to herself against Sparta. Yet the relations of Athens with Thebes, after the congress as before it, were still those of friendship, nominal rather than sincere. It was only with Sparta, and her allies, that Thebes was at war, without a single ally attached to her. On the whole, Callistratus and his colleagues had managed the interests of Athens in this congress with great prudence and success. They had disengaged her from the alliance with Thebes, which had been dictated seven years before by common fear and dislike of Sparta, but which had no longer any adequate motive to countervail the cost of continuing the war; at the same time the disengagement had been accomplished without bad faith. The gains of Athens, during the last seven years of war, had been considerable. She had acquired a great naval power, and a body of maritime confederates; while her enemies the Spartans had lost their naval power in the like proportion. Athens was now the ascendant leader of maritime and insular Greece, while Sparta still continued to be the leading power on land — but only on land; and a tacit partnership was now established between the two, each recognising the other in their respective halves of the Hellenic hegemony. Moreover, Athens had the prudence to draw her stake, and quit the game, when at the maximum of acquisitions, without taking the risk of future contingencies.⁶

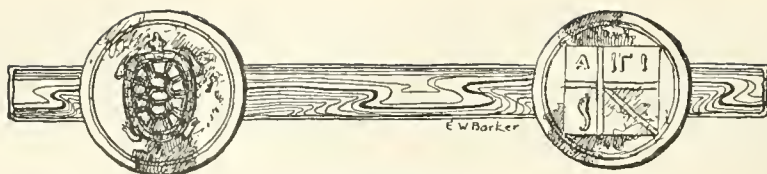

GREEK SEALS

CHAPTER XLV. THE DAY OF EPAMINONDAS

IT was not a new enemy which Sparta had found, but rather an old one which had come to new power, in the city of Thebes. In that city an extraordinary man had come to light, and by his sole influence he raised his people to the head of Grecian affairs. This man was Epaminondas, certainly one of the greatest men — some would have it even the very greatest — that Greece ever produced.

There have been philosophical historians who have doubted the influence of the individual man in moulding the course of human events. According to one point of view it is the events always that make the man, the great man coming forward when he is needed, and because he is needed. But such cases as that of Epaminondas ill accord with this theory. Nothing seems clearer than that Thebes rose into great influence and wrested the sceptre of power from Sparta solely because the great leader Epaminondas chanced to be a Theban. For it is quite beyond dispute, that in all the previous years in which she had constantly participated in the Grecian struggles, Thebes had occupied a subordinate place, and it is equally clear that she sank back at once into relative insignificance the moment that Epaminondas was gone.

It was Epaminondas who led the Thebans in person against the Spartans, in the first engagement in which a Spartan army was ever put to flight in open combat, and the success of Epaminondas was probably due to the fact that his genius had developed a new form of tactics. The method of massing the heavy-armed soldiers in what came afterwards to be famous as the Macedonian phalanx — the weapon with which Alexander won his victories — was, it is said, really due to Epaminondas. Philip of Macedon, who was afterwards to become the master of Greece, was a captive in Thebes during his boyhood, and it is supposed that he there gained the germ of the idea, which afterwards, when put into practice, enabled his Macedonian warriors to scatter the true Greeks as easily as in an earlier day the Greeks had scattered the Persians. What else Philip may have learned through the example of Epaminondas it would be difficult to say, but in this view it is clear that the genius of the great Theban leader may have entered much more potently into the story of the final overthrow of Greece than might at first sight appear.

Such intangible associations aside, however, it is clear that the fame of Epaminondas has suffered through the relative insignificance of the epoch in which he lived. Historians, by common consent, give him a foremost place among the great Greeks; yet to the generality of readers, to whom such names as Themistocles, Pericles, and Alexander are household words, the name of Epaminondas is almost unknown. This neglect was inevitable, for the events in which this latter hero figured were the events of the

[371 B.C.]

declining years of a great nation; events which, far from telling for the up-building of Grecian power, were merely the last preparatory stages for the final overthrow. It seems strange to reflect that the period that intervened between the close of the Peloponnesian War and the final conquest of Greece by Philip of Macedon is a longer period than the entire stretch of the age of Pericles. It was an epoch separated from that golden period of Grecian culture only by the lapse of a single generation; yet how strangely different is the import that it bears to after generations. The proud Athens is now the home of a broken and dispirited people. Sparta, after a brief moment of glory, has been laid in the dust. The ascent of Thebes is no more rocket-like than its descent.

When looking on this period one feels that already Greece has ceased to exist, and yet one may well doubt whether any contemporary citizen, say of Athens, could at all have realised the enormous change that had come over the spirit and status of the Greek race. There were still great men in Athens. Perhaps it may have seemed to the Athenian of that day that great men were as numerous as they had ever been. Euripides and Sophocles had left no worthy successors, to be sure; but Aristophanes lived well on into the later period, and in the field of art Praxiteles may easily have seemed to contemporary judgment the peer of Phidias, while in the field of philosophy and science there were such names as Plato, and Aristotle, and Xenophon, and in oratory there was no name in the previous epoch to rival that of Demosthenes.

Such names as these show that Greek genius did not die out in a single hour. A nation once grown to greatness cannot be overthrown in a single generation, unless its entire population be destroyed or scattered as was that of Nineveh. Yet it is none the less certain that Athenian culture was now in its time of decay, however little patency that fact may have had to the contemporary witness. And in looking back, with all that one has learned of the seemingly fixed limits of national existence through study of other peoples, one is forced to the conclusion that perhaps it did not greatly matter that the sturdy Macedonian from the north should have swept down and stamped out the last spark of Athenian power.^a

The condition of Greece at this time shows that, during the long convulsions, all the old sentiments and associations had been lost, and that Greece had now come to a point at which most of the states could not exist without a protector. It required that fearful training which the Greeks had to submit to for nearly a whole century, before they became capable of living under a really free federal constitution like that of the Achæan League: a firm union into one whole, when the isolated existence of the separate states had become a matter of impossibility. The state of Greece was indescribably sad, and the most atrocious scenes occurred everywhere.

The Spartans might now have enjoyed peace; but they were still incorrigible. When pressed by great difficulties, they always signed the treaties; but when they were out of danger, and the treaties had to be carried into effect, they felt uneasy; they could never prevail upon themselves to exercise self-control, or to give up anything. The Thebans seemed to be ready to accede to the peace; but the Spartans still insisted upon the necessity of Thebes separating from Bœotia, although they had not undertaken the guarantee of the peace; in the Peace of Antalcidas they had done so, but this was not the case now. King Cleombrotus was stationed with an army in Phocis; that army ought now to have been disbanded, and this was the opinion of a few sensible men; but the majority thought that it should be employed in

compelling the Thebans to set the Bœotians free. The ruling party at Sparta now hoped to be able to compel Thebes, which was forsaken by all the other Greeks, without any difficulty, especially as some of the Bœotian towns, such as Orchomenos, sided with Sparta. Orchomenos was still dreaming of her ancient splendour and glory, and of the mythical times when Thebes was separated from Bœotia, when Orchomenos was the most powerful city, and Thebes paid tribute to her. These recollections were cherished by the Orchomenians with great and fond partiality; just as if Amalfi wished at present to re-establish the claims of its ancient greatness.

SPARTA INVADES BŒOTIA

Cleombrotus, therefore, full of hope, entered Bœotia, after the peace had been signed, demanding that Bœotia should carry the terms of the peace into effect, and renounce Thebes, and that every town should assert its independence. The other Bœotian towns, with the exception of Orchomenos and Thespiæ, were reasonable enough to see that their dependence on Thebes, with extensive rights, was far better than independence; and Thebes was supported by far the greater number of the Bœotians. The Thebans, joined by their Bœotian allies, now took the field.^b Cleombrotus, with a degree of military skill rare in the Spartan commanders, baffled all the Theban calculations. Instead of marching by the highway he turned south, defeated a Theban force and captured the port of Creusis with twelve Theban triremes. He then marched north through the mountains into Thespiæ and encamped on the high ground at a place of ever-memorable name — Leuctra.^c

Fortunately for Bœotia, Epaminondas was bœotarch at this time. Pelopidas, likewise bœotarch, commanded the *Hieros Lochos* [Sacred Band], the *élite* of the citizens. If Epaminondas had been an ordinary man, he would have turned back again almost immediately after he had marched out; for the omens, to which the ancients attached so much importance, strangely accumulated to such a degree, that they might have shaken a firm mind which was not altogether proof against superstition. When the army passed out of the gate, for example, they met a herald bringing back a deserter, and uttering ominous words, "You ought not to be led out of the city." Then a high wind rose, carrying off ribbons with which they had adorned themselves for the sacrifice, and these ribbons clung round a pillar on a tomb. Hence an indescribable consternation arose, but Epaminondas recited the magnificent line from the *Iliad*:

εἰς οἰωνὸς ἄριστος ἀμύνεσθαι περὶ πατρῆς!¹

and boldly marched out. It is a pity that we have not a life of Epaminondas by Plutarch; with his Bœotian patriotism, he would certainly have produced a pleasing biography; but how, with his superstitious notions, he would have managed it, we do not know. Every one of the Thebans knew that they should have to fight a battle against the Spartans, and with heavy hearts they set out against an enemy who had never yet been conquered in the field. But the confidence of Epaminondas was unshaken. Although himself armed against all superstition, he willingly allowed his soldiers to

[¹ These are Hector's words in the *Iliad*, XII, 243. The omens having been unfavourable, Polydamas warns him not to fight, but the "crest-tossing Hector" answers scornfully as above, "The best omen of all is to defend the fatherland," and so saying he assailed the Greeks with more than common success.]

[371 B.C.]

fortify themselves with their belief in supernatural signs, and did not oppose the spreading of the rumour among his troops, that the armour of Hercules had disappeared from his temple at Thebes, the birthplace of the god, and that consequently the god himself had taken up his arms to fight for his fellow-citizens. He made his preparations in full confidence, and did what was best under the circumstances. He foresaw that the Spartans would have the belief in their favour that their tactics were superior; for it was the general opinion that their tactics of deep masses were unconquerable, just as it was believed of the drilling regulations of Frederick II after the Seven Years' War, when all the states ordered their troops to be trained according to it, imagining that thereby they could gain battles as he had done. Epaminondas, moreover, had to overcome the pride of the Spartans. Now, in order to meet their tactics and break their pride, he made an excellent disposition, employing the system of defeating masses by still greater masses.

THE BATTLE OF LEUCTRA

The Spartans were drawn up together with their allies. Epaminondas advanced in an oblique line, sending forward the left wing and keeping back the right; but he then ordered the left wing gradually to withdraw to the left, and thus formed on that wing an immense mass. With this he now made a most vigorous attack upon the right wing of the enemy, where the Spartans themselves were stationed. An ordinary general would have done the contrary, directing his force against the part from which no such powerful resistance was to be expected. Pelopidas conducted the attack, and ordered the mass to advance with immense rapidity. We do not know whether the statement is true, that the Thebans advanced fifty men deep. We have only the testimony of Xenophon, but see no reason for denying it. The troops must have been excellently trained, for notwithstanding the dense mass, they advanced with an alacrity as if they had been light troops, just as at present troops advance in an attack with the bayonet, and not according to the fashion of phalangites, who otherwise advanced with deliberate solemnity. The Spartans made a skilful move: in order not to be outflanked, they turned to the right, intending to throw their cavalry upon the right wing of the Bœotians. But the Bœotians made the attack with such precision and quickness, that being beforehand, they routed the Lacedæmonians and Spartans. There Cleombrotus fell, and the Spartans were as decidedly beaten as they well could be. The army did not indeed disperse, but it was absolutely impossible to find any pretext for saying that they had been victorious at any one point, a matter in which the Greeks were otherwise extremely inventive. It requires the partiality of a Xenophon, to leave it undecided as to whether the Spartans were defeated.¹

After the battle, they appear to have remained together for a time, but there was no one among them able to undertake the command. Meantime, as a report had reached Sparta, that the Bœotians offered resistance, another Spartan army, under Archidamus, a son of Agesilaus, had marched across the Isthmus, and was now approaching, but found the Spartans already defeated. All he could do was to collect the remains of the defeated army

[¹ Grote says: "To the discredit of Xenophon, Epaminondas is never named in his narrative of the battle, though he recognises in substance that the battle was decided by the irresistible Theban force brought to bear upon one point of the enemy's phalanx; a fact which both Plutarch and Diodorus expressly referred to the genius of the general."]

and to return with them. They seem to have effected their retreat under the protection of a truce. The only auxiliaries of the Thebans in the battle of Leuctra, had been the Thessalian troops of prince Jason of Pheræ: one of the phenomena of an age, when the old order of things has disappeared, and new institutions have been formed.

If we believe Diodorus, the battle of Leuctra was the direct punishment for perjury: for Cleombrotus, it is said, had concluded a truce with the Thebans, but on the arrival of reinforcements from Peloponnesus, he broke it. One of the narratives must be untrue, either his or that of Xenophon; if the reinforcements under Archidamus arrived before the battle, Xenophon's account must necessarily be given up. Cleombrotus may have had the peculiar misfortune, which happens to many a one who has been unsuccessful; all that is bad and disgraceful is attributed to him. What makes us still more inclined to disbelieve the account of Diodorus is, that if Archidamus had been present at the battle, it could not have been said that after the battle the Spartan army was without a commander. Diodorus probably too eagerly caught up an account which throws the blame upon the Spartans; it was invented either by Ephorus or by Callisthenes.

The loss of the Spartans in the battle is very differently stated. According to one account, it amounted to 4000 men, which would include, besides the Lacedæmonians and Spartans, all the other allies; others mention only 1000 slain, which number would comprise the Lacedæmonians only; others again estimate their number at 1700; but this last number is erroneous, as has been correctly observed by Schneider in a note on Xenophon, and arose from a hasty glance at the numbers written in the characters of the Greek alphabet. We may take it for granted that not less than 1000 Lacedæmonians fell in the battle; but whether this number also comprised the Spartans or not, is a question which cannot be answered at all. But it is a fact, that the number of the Spartans was so extremely small, that the strength of the Spartan citizens as a body was completely paralysed by the loss of this battle. At one time there had been 9000 citizens, subsequently they are said to have amounted to 8000, but at this time there cannot have been 1000 real citizens, and at a still later time there were only 700. At Leuctra several hundreds of them fell. The ancient Spartan citizens were certainly not more numerous than the *nobili* of Venice. They now had to feel the consequences of their wretched selfish policy, which had been so jealous in granting the franchise to the *periceci*, as to exclude a great many excellent men as unfit and unworthy, and had cut them off from every prospect of obtaining it.

All Greece was startled at the news of this victory; it seemed impossible that Sparta should have been beaten in the field. The Spartans themselves were quite dejected. Their allies turned their backs upon them, and in a moment all the states of Peloponnesus, which had hitherto followed their standards, threw up their connection with them, and declared themselves independent; the Phœcians, Loerians, and other allies beyond the Isthmus, immediately concluded a peace and alliance with the Bœotians. Not eighteen months passed away, perhaps it was even in the very winter after the battle of Leuctra, when the Bœotians invaded Peloponnesus. The Spartans were panic stricken and retreated. The Bœotians announced themselves as the protectors of liberty, and there can be no doubt that the personal character and the eminent qualities of Epaminondas everywhere excited great confidence, while the national character of the Thebans would certainly have called forth the opposite feeling.^b

[371 B.C.]

SIGNIFICANCE OF LEUCTRA

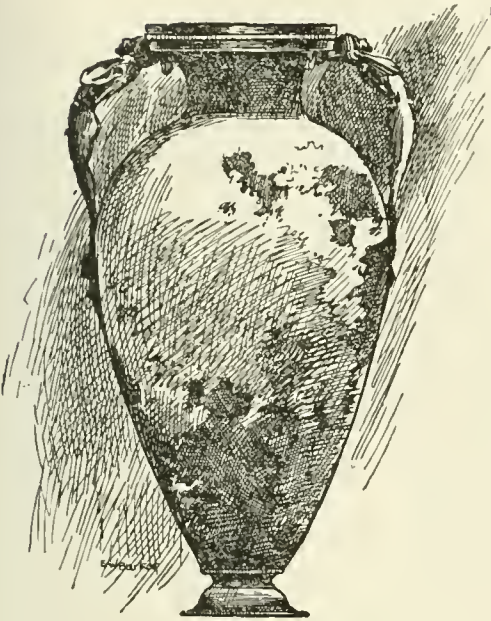

GREEK VASE
(In the British Museum)

The battle of Leuctra was certainly one of those battles which are decisive of the fate of countries and which give history a new turn. It not only brought to the fore a leader of singular magnificence at the head of a new and zealous nation, but it saw the complete collapse of Sparta. It made possible the first invasion of that country which, being without walls, had felt itself girt about with imperishable granite in the brawn of its soldiery. The other nations of Greece for all their hatred of Sparta had never succeeded in invading her. It was considered glory enough to sail around the Peloponnesus or to establish a stronghold upon some portion of the coast. It remained for a Theban newcomer, whom Xenophon does not even mention in his account of the battle of Leuctra, to march into Sparta and prove that her granite

wall of soldiery was only a superstition that crumbled before the onslaught of that new Theban formation which modern foot-ball players have revived and called "the flying-wedge."

The battle of Leuctra is significant in showing that the course of Grecian empire was taking a northward way. In its passage, Thebes was only a stepping-stone to Macedonia. Once out of the little peninsula it had thus far dwelt in, Grecian ambition was to find itself upon an unlimited field of conquest whence it would turn, not logically to the West, where Rome was young and inglorious, but to the East, with its ancient and rotting civilisation and its hoarded opulence.

For the present, however, it is enough to realise that Sparta has fallen never to lift her head again. Remembering all the better side of the Spartan life and the Spartan philosophy, one is disposed to feel a deep sense of regret. It seems to be a moment for elegy. But to certain historians who can see in Sparta at best only a stupid mountain of conservatism, and at worst a monster of hypocrisy, of cruelty and of inertia, it seems to be a time for rejoicing that a blot has been removed from the Grecian escutcheon. No one is more severe and no one more eloquent than Cox who says in his self-defence, "I have been charged with being over-severe to Sparta. I would gladly be convinced that I have been; but until I am so convinced, I cannot modify my words." Then he launches forth into a glowing philippic from which we may quote a portion :

"So ended the fight which left Epaminondas the first general of his age, and so fell a power which had fully earned its title to stability, if grinding tyranny and law-defying oppressiveness could confer such a right. The Lycegean discipline, which crushed all that imparted grace and beauty of

life at Athens, would indeed have been worth little if it had failed to produce the semblance of an unconcern which treated the more generous and tender instincts of humanity as the worst of vices.

“Another act in the great drama had been thus played out; and the whole Hellenic world had at length learned that the promises of freedom made by Sparta had been from beginning to end a lie — a lie scantily veiled at first by the rhetoric of Brasidas, but put forth afterward in the nakedness of unblushing effrontery. Not a single pledge had she redeemed; not a single burden had been removed, not a single abuse redressed. She had hailed the downfall of Athens as the beginning of a golden age for Hellas, and in order to realise it she had aided and abetted her victorious generals in setting up everywhere societies of murderers. Her enemies were prostrate; and she trampled on them without a touch of commiseration. Her allies were too much overpowered by the consciousness of their inferiority really to dispute her will; and she refused to share her spoils with the partners of her robberies. She had put down the Athenian empire with the courts, which, at the least, offered to the free or the subject allies the means of redress for wrongs inflicted or received; and by way of improving matters she had, with gigantic cruelty, let loose upon them a crowd of rapacious and lustful tyrants against whom she would hear no complaint.

“In short the supremacy of Sparta had been from first to last the supremacy of high-handed violence and wanton tyranny. Nor could it have been anything else but what it was. Much has been said of the golden opportunities which the course of events offered to Sparta, and which she deliberately threw away, opportunities presented first in the unlimited freedom of action which followed the seizure of the Athenian fleet at Ægospotami, and again when the return of the Cyrean Greeks placed her at the head of a splendid army in her involuntary conflict with the Persian king. But in truth it is absurd to speak of opportunities of feasting on the loveliest of landscapes, to the man who has extinguished in himself all sense of beauty, of opportunities for generous action to the man whose whole life exhibits nothing but the working of unvarying and consistent selfishness. Whether after Ægospotami, or after the return of the Ten Thousand, it was impossible for Sparta to do anything towards establishing a real Panhellenic union, in other words, a real Greek nation, without reverting in greater or less degree to the works of Athens. To go back to any such system would be for the Spartans what the changing of his skin would be to the Ethiopian, or of his spots to the leopard.”

Before returning to the crescent glory of Epaminondas, it is necessary to pause to note the sudden phenomenon of a singular genius, Jason of Pheræ, who flares up and overawes Greece only to expire at once. He is a striking personage, and important as a forewarning flash of the irresistible storm rising in the North.^a

JASON OF THESSALY

Intelligence of the fatal blow at Leuctra, carried to Lacedæmon, was borne with much real magnanimity, and with all that affectation of unconcern which the institutions of Lycurgus commanded. It happened to be the last day of the festival called the Naked Games; and the chorus of men was on the stage, before the assembled people, when the officer charged with the despatches arrived. The ephors were present, as their official duty required, and to them the despatches were delivered. Without interrupting

[371 B.C.]

the entertainment they communicated the names of the slain to their relations, with an added admonition, that the women should avoid that clamorous lamentation which was usual, and bear the calamity in silence. On the morrow all the relations of the slain appeared as usual in public, with a deportment of festivity and triumph, while the few kinsmen of the survivors, who showed themselves abroad, carefully marked in their appearance humiliation and dejection.

It was a large proportion of the best strength of the commonwealth that, after so great a loss in the battle, remained in a danger not in the moment to be calculated. Every exertion therefore was to be made to save it. Of six moras, into which for military purposes the Lacedæmonian people were divided, the men of four, within thirty years after boyhood (such was the term, meaning perhaps the age of about fourteen), had marched under Cleombrotus; those however being excepted who bore at the time any public office. The ephors now ordered the remaining two moras to march, together with those of the absent moras, to the fortieth year from boyhood, and no longer allowing exception for those in office. The command, Agesilaus being not yet sufficiently recovered to take it, was committed to his son Archidamus. Requisitions were at the same time hastened off for the assistance of the allies: and the Lacedæmonian interest, or the interest adverse to the pretensions and apprehended purposes of Thebes, prevailed so in Tegea, Mantinea, Phlius, Corinth, Sicyon, and throughout the Achæan towns, that from all those places the contingent of troops was forwarded with alacrity.

Meanwhile the leading Thebans, meaning to pay a compliment that might promote their interest in Athens, had hastened thither information of their splendid success. But the impression made by this communication was not favourable to their views: on the contrary, it showed that the jealousy, formerly entertained so generally among the Athenians towards Lacedæmon, was already transferred to Thebes. Thus the incessant quarrels among the Grecian republics, source indeed of lasting glory to some, brought however, with their decision, neither lasting power nor lasting quiet to any; but, proving ever fertile in new discord, had a constant tendency to weaken the body of the nation. Relief to Lacedæmon in its pressing danger came, not from its own exertion, not from the interest which all the Grecian republics had in preventing Thebes from acquiring that overbearing dominion with which in a Lacedæmon had oppressed them, but from a power newly risen, or revived, in a corner of the country whence, for centuries, Greece had not been accustomed to apprehend anything formidable.

Jason of Pheræ in Thessaly was one of those extraordinary men in whom superior powers of mind and body sometimes meet. He was formed to be a hero had he lived with Achilles: and as a politician he could have contended with Themistocles or Pericles. He had the advantage of being born to eminence in his own city, one of the principal of Thessaly; and he appears to have acquired there a powerful popularity. Little informed of the early part of his life, we find him mentioned as general of the Pheræans about six years before the battle of Leuctra, and commanding a force sent to assist Neogenes, chief of Histiaæa in Eubœa. In the contests of faction in Thessaly it was become common to employ mercenary troops. Jason excelled in diligence in training such troops, in courage and skill in commanding them, and in the arts by which he attached them to his interest.

Of the state of Thessaly at this time altogether we may form some judgment from what the contemporary historian [Xenophon] has related of

Pharsalus, one of its most considerable cities. The leaders of the factions by which Pharsalus was torn, weary at length of ruinous contest, came to an extraordinary agreement. Fortunately they had a fellow-citizen, Polydamas, eminent throughout Thessaly for high birth, large possessions, and that splendid hospitality for which the Thessalians were distinguished, but yet more singularly eminent for integrity. To this man the Pharsalians committed the command of their citadel and the exclusive management of their public revenue, giving him altogether a princely authority. In so extraordinary an office Polydamas had the good fortune to succeed in everything, except in opposing the ambition of the too politic and powerful Jason.

Tyrant or patriot, as you will, in his own city of Pheræ, Jason had proceeded to bring most of the Thessalian cities, some by policy, some by arms, under that kind of subjection which so commonly in Greece was entitled confederacy. The strength of Pharsalus, directed by the abilities of Polydamas, was exerted to protect them. But Pharsalus itself was threatened, when Jason sent a proposal for a conference with the chief, which was accepted. In this conference the Pheræan avowed his "intention to reduce Pharsalus, and the towns dependent upon Pharsalus, to dependency upon himself;" but declared that "it was his wish to effect this rather by negotiation than by violence, and with benefit to Polydamas, rather than to his injury. It was in the power of Polydamas," he said, "to persuade the Pharsalians; but that it was not in his power to defend them, the result of all his recent efforts sufficiently showed. For himself, he was resolved to hold the first situation in Greece; the second he offered to Polydamas. What their advantages would be, if a political union took place, Polydamas as well as himself could estimate.

"The cavalry of Thessaly was six thousand strong: the heavy-armed infantry exceeded ten thousand; the numerous inhabitants of the surrounding mountains, subjects of the Thessalian cities, were excellent targeteers. In addition to this force then he had six thousand mercenaries in his pay; a body such as, for choice of men, and perfection of discipline, no commonwealth of Greece possessed. But connection with Athens did not suit his views; for the Athenians affected to be the first maritime power of Greece, and he meant to make Thessaly the first. The three necessities to naval power were timber, hands, and revenue. With the former, Athens was supplied from Macedonia, which lay much more conveniently for the supply of Thessaly. With the second their Penestian subjects were a resource to which Athens had nothing equal." (The Penestæ were a conquered people, reduced to a kind of vassalage under the Thessalians, for whom they performed menial and laborious offices, but were not held in a slavery so severe and degrading as the helots of Laconia, for we find them admitted to that military service, the cavalry, which was generally reckoned among the Greeks to assort only with rank above the lowest citizens.)

It had been a practice of the Thessalian republics, always acknowledging some common bonds of union, to appoint, for extraordinary occasions a common military commander, a captain-general of the Thessalian nation, with the title of Tagus. To this high rank and great command Jason aspired, and the approbation of the Pharsalian government, it appears, was necessary. But he was far from so confining his views. Even the command of all Greece did not suffice for his ambition. "That all Greece might be reduced under their dominion," he observed to Polydamas, "appeared probable from what he had already stated: but he conceived the conquest of the Persian

[371 B.C.]

empire to be a still easier achievement ; the practical proof afforded by the return of the Cyrean Greeks, and by the great progress made with a very small force by Agesilaus, leaving this no longer a matter of mere speculation."

Polydamas, in reply, admitted the justness of Jason's reasoning ; but alleged his own connection with Lacedæmon, which he would at no rate betray, as an objection that appeared to him insuperable. Jason, commending his fidelity to his engagements, freely consented that he should go to Lacedæmon and state his circumstances ; and if he could not obtain succour which might give him reasonable hope of successful resistance, then he would stand clearly excused, both to his allies and to his fellow-citizens, in accepting the proposal offered him. Polydamas, returning then into Thessaly, requested and obtained from Jason, that he should hold under his own peculiar command the citadel of Pharsalus, which had been, in a manner so honourable to him, entrusted to his charge. For security of his fidelity to his new engagements, he surrendered his children as hostages. The Pharsalians, persuaded to acquiesce, were admitted to terms of peace and friendship by Jason, who was then elected without opposition tagus of Thessaly.

The first object of Jason, in his high office, was to inquire concerning the force which the whole country, now acknowledging him its constitutional military commander, could furnish ; and it was found to amount to more than eight thousand horse, full twenty thousand heavy-armed foot, and targeteers enough, in the contemporary historian's phrase, for war with all the world. His next care was the revenue, which might enable him to give energy to this force. Jason was ambitious, but not avaricious, and he desired to have willing subjects. He required therefore from the dependent states around Thessaly only that tribute which had been formerly assessed under the tagus Scopas. At the time of the battle of Leuctra, Jason was already this formidable potentate, and he was then in alliance with Thebes. When therefore the Thebans sent to the Athenian people an account of that splendid action, they did not fail to communicate the intelligence also to the tagus of Thessaly ; and they added a request for his co-operation towards the complete overthrow of the tyranny, so long exercised by the Lacedæmonians over the Greek nation. The circumstances were altogether such as Jason was not likely to look upon with indifference. Having ordered a fleet to be equipped, he put himself at the head of his mercenaries, his standing army, and taking the cavalry in the moment about him, he began his march. He reached Bœotia without loss ; showing, as the contemporary historian observes, how despatch may often do more than force.

Jason, the ally of Thebes, was connected, not indeed by political alliance, but by public and hereditary hospitality, with Lacedæmon. Pleased with the humiliation of his hosts, he was not desirous that his allies should become too powerful. On reaching the Theban camp therefore, demurring to the proposal of the Theban generals for an immediate attack upon the Lacedæmonians, he became the counsellor of peace ; and, acting as mediator, he quickly succeeded so far as to procure a truce. The Lacedæmonians hastened to use the opportunity for reaching a place of safety. Jason, after having thus acted as arbiter of Greece, hastened his return to Thessaly. In his way through the hostile province of Phocis, with leisure to exercise his vengeance, for which he had not before wanted strength, he confined it to the little town of Hyampolis, whose suburbs and territory he wasted, killing many of the people. The Lacedæmonian colony of Heraclea was then to be passed. He had served Lacedæmon at Leuctra because he thought it for his interest ; and he would, without scruple, or fear, injure Lacedæmon, in

its colony of Heraclea, because the prosperity of that colony would obstruct his views. Heraclea was most critically situated for commanding the only easily practicable communication between the countries northward and southward. He therefore demolished the fortifications.

Decidedly now the greatest potentate of Greece, powerful, not by his own strength alone, but by his numerous alliances, while on all sides his alliance was courted, Jason proposed to display his magnificence at the approaching Pythian games. He had commanded all the republics which owned the authority of the tagus of Thessaly to feed oxen, sheep, goats, and swine for the sacrifices; and he proposed the reward of a golden crown for the state which should produce the finest ox to lead the herd for the god. By a very easy impost on them severally, he collected more than a thousand oxen, and ten thousand smaller cattle. He appointed a day, a little before the festival, for assembling the military force of Thessaly; and the expectation in Greece was that he would assume to himself the presidency. Apprehension arose that he might seize the treasure of Delphi; insomuch that the Delphians consulted their oracle for directions from the god on the occasion. The answer, according to report, was similar to what had been given to their forefathers when Xerxes invaded Greece, "that the care of the treasure would be the god's own concern."



GREEK ARCHER

Before the period for the splendid display arrived, this extraordinary man, after a review of the Pheræan cavalry, sitting to give audience to any who might have occasion to speak to him, was assassinated by seven youths, who approached with the pretence of stating a matter in dispute among them. The attending guards, or friends of the tagus, killed one of them on the spot, and another as he was mounting his horse; but the rest so profited from

the confusion of the moment, and the opportunities which circumstances throughout Greece commonly afforded, that they effected their escape. What was the provocation to this murder, or the advantage proposed from it, we are not informed. No symptom appears of any political view: no attempt at a revolution is noticed by the historian; but what he mentions to have followed marks the popularity of Jason among the Thessalians, and also the deficient ideas, equally of morality and true policy, generally prevailing through Greece. The brothers of the deceased, Polydorus and Polyphron, were appointed jointly to succeed to the dignity of tagus: the assassins could find no refuge in Thessaly; but in various cities of other parts of Greece they were received with honour: proof, says the contemporary historian, how vehemently it was apprehended that Jason would succeed in his purpose of making himself sovereign of the country. Such was the unfortunate state of Greece: in the weakness of its little republics men were compelled to

[371 B.C.]

approve means the most nefarious, where other prospect failed, by which their fears were relieved, and present safety procured. Thus assassination became so generally creditable, or at least so little uncreditable, that hope of safety, through speed in flight, was always afforded to the perpetrators.^e

VON STERN ON THE THEBAN POLICY

In Lachmann, Curtius, and others, we are confronted by the notion that Epaminondas began the War of Liberation against Sparta as a Greek, and not in the interest of Bœotia alone, and that the weal or woe of the Greek nation as a whole was the leading motive of all that he did or left undone. Since the Bœotian hegemony (regarded in this aspect as the outcome of the noblest Panhellenic aspirations) is to our historians the pole and focus of their view of the subsequent period, we can easily see the paramount importance of an acceptance or denial of such aspirations for the common good of Greece, in forming an opinion upon this portion of history. It therefore becomes a duty to examine the question more minutely.

It has never been contested that up to the time of the battle of Leuctra the Thebans had never had opportunity or occasion to turn their attention and their energies to a wider field for patriotism. What iron persistency they were compelled to exercise, what struggles they had to endure, in order to maintain their own existence and to realise the local unity for which they strove! It is not probable, not possible, that during these years of wrestling for deliverance from Spartan supremacy, during a struggle of which the issue perpetually hung in suspense, they should have cherished designs for the benefit of Greece as a whole. The deliberate purpose with which they strove straight towards the end in view, without turning aside to the right hand or to the left, proves how keen was the foresight, how determinate the programme, of the Theban leaders, and shows at the same time how little place they gave to idle dreams and illusions, which invariably involve some neglect of the needs of the moment.

The battle of Leuctra, therefore, marks the momentous turning-point in the eyes of the scholars above referred to. "The victory," says Curtius, "was to be regarded as a national act from which all Greeks were to derive benefit,"—hence the embassies sent from the battle-field to Athens and Thessaly. But can the wish to be regarded as the benefactor of all Hellas really have been the true motive of this despatch of heralds? Thebes had won the victory indeed, but the hostile army was far from being annihilated and still occupied the country in formidable numbers. Isolated and without confederates, Thebes could scarcely hope to secure the fruits of her victory unless she could now win powerful allies. The attitude of Athens was naturally of the first importance. It was essential for Thebes to frustrate a conjunction between Sparta and Athens, and, if possible, to assure herself of the support of her powerful neighbour.

The temper of Athens was not propitious to such endeavours. If the knowledge that peace was of the first necessity to themselves rendered the Athenians averse to incurring fresh hardships for the sake of Sparta, they felt even less obligation to take up the cause of Thebes. The embassy was fruitless. The mission to Thessaly was more successful, for Jason of Phæræ promptly prepared to come and render assistance. The Thebans did not dare to attack the enemy's camp before his arrival; and when he appeared in Bœotia with an army they entreated him to undertake the assault in con-

cert with them. Even then the mere mention on his part of the difficulties in the way was enough to divert the Thebans from their project and induce them to accede to his proposals for mediation. We see that they were far from feeling themselves masters of the situation; nothing short of the withdrawal of the Spartan army seemed to them to insure the security of their own position, which was the first-fruits of their victory.

Moreover, Thebes had next to overcome the last resistance to Bœotian unity within her own borders. Thespiæ and Orchomenos had to be coerced before a further advance could be thought of. The next steps were naturally taken with a view to a union amongst the states of middle Greece; and by compacts with Phocis, Loeris, Ætolia, and Aearnania, which acknowledged the right of the conqueror of Leuctra to be the head and chief of the new amphictyony, Thebes strove to attain the position to which her success had given her the best title. But it seems in the highest degree improbable that in all these proceedings Thebes had the interests of the whole of Greece in view, that she cherished the idea of a national uprising against Spartan oppression, that by the extension of dominion for which she strove she desired to make good the wrong done to other Greeks in earlier days by Sparta, and that, as Curtius supposes, the project for the restoration of Messenia had already been definitely conceived. The Theban leaders could not be blind to the fact that the struggle with Sparta had by no means come to an end with the battle of Leuctra, but the political conditions of the time gave them as yet no chance of forming definite resolutions and plans as to how the end was to be brought about. Curtius undoubtedly goes too far when he assumes that at that time Epaminondas was sole master of the situation and controlled the destinies of the Greeks. The Thebans did not even venture to transfer the struggle to Peloponnesian soil and denude Bœotia of her troops, on account of the menacing attitude assumed by Jason of Pheræ in the north.

The tyrant was ostensibly the ally of the Thebans, but his ambitions and independent schemes were coming into ever greater prominence. As he retired from Bœotia after the battle of Leuctra he had surprised Heraclea and destroyed the walls of the city; he would have no one able to bar his free entry into Hellas. Now, in the summer of 370, he was equipping a magnificent army to attend the Pythian games at Delphi. His object in so doing was not merely to make a display of his kingly power. Delphi, the seat and centre of the amphictyones, had always been the connecting link between Thessaly and the other Greek states. By the splendid homage he offered to the god in his sacrificial procession, Jason intended to renew the old obsolete relations; and relying upon the fact that the Thessalian races had a majority in the ancient amphictyonic council, to usurp the guardianship of the oracle and the management of the games, and to secure for himself an influence in Greek politics proportionate to his power. The great body of troops which was to accompany him in this procession sufficiently emphasised these claims and demands. The northern Greeks were not unaware of the danger that threatened them—neither in all likelihood were the Thebans. Xenophon's narrative amply proves with what apprehension they watched his steps, and how great was the disquietude amongst the dwellers in northern Greece. Jason's sudden death was to the Hellenes the deliverance from a nightmare, and the fact that his murderers were honoured as saviours from tyranny and oppression, is an unmistakable token of the temper aroused in Greece by his last enterprise. But it was absolutely impossible for Thebes and the league of middle Greece to wage war upon Sparta

[371-370 B.C.]

in the Peloponnesus while Jason was planning his march to Delphi. They could not withdraw troops from Bœotia without incurring the risk that he would make use of the circumstance to give the fullest scope to his ambitious designs.^g

A CONGRESS AT ATHENS

The ill-humour with which the news of the battle of Leuctra was received at Athens seems to have arisen merely out of the old jealousy and animosity with which the Athenians had been used to regard their northern neighbours, and which revived as soon as the affairs of Thebes became prosperous. For in the event itself, considered with respect to their own interests, they could have seen nothing to deplore. And they proceeded without delay to take advantage of the shock which it had given to the influence of Sparta. It seems to have been the prevailing opinion throughout Greece, and not least at Sparta itself, that the Spartan power had suffered a fatal blow; and Xenophon intimates that the Athenians were surprised to find that any of the Peloponnesian states still adhered to the ancient chief of their confederacy. They believed that the time had now come when Athens might step into the place of Sparta, as guardian of the Peace of Antalcidas, and might transfer all the advantages which her rival had reaped from that title to herself. They therefore assembled a congress in their own city, to which they invited deputies not only from their old allies, but from all the states of Greece which were willing to adopt the Peace of Antalcidas as the basis of their mutual relations. It seems to have been attended by many, if not by most members of the Peloponnesian confederacy; and the resolution to which it came in the oath by which each state was to ratify the compact was thus expressed: "I will abide by the treaty sent down by the king, and by the decrees of the Athenians and their allies, and if an attack be made on any of the states which take this oath, I will succour it with all my might." So that Athens found herself able to obtain better security for the execution of the treaty, than had been given in the last congress held for the like purpose at Sparta, where none of the parties had been bound to enforce its observance by arms: and yet the engagement for mutual defence now involved those who entered into it in danger of a contest both with Sparta and Thebes. Elis would gladly have united herself to an association which would separate, and might protect her, from Sparta; but she would not resign her claims to the sovereignty of the Triphylian towns. The congress on the other hand determined that every town, small or great, should be alike independent, and commissioners were sent round to exact an oath to this effect from the magistrates of each state. It was taken, Xenophon says, by all but the Eleans.

MANTINEA RESTORED

We should have been glad to know which of the Peloponnesian states acceded to this confederacy. But all the information that Xenophon gives as to this point only enables us to conclude that the Mantineans at least were of the number. One of the first effects of the battle of Leuctra seems to have been a revolution which overthrew the Mantinean aristocracy; and the declaration of the congress at Athens—though it expressed the very same principle on which the Spartans had professed to act when they scattered the Mantineans over their four villages—was now interpreted by the

democratical party as a license to restore their political unity, and to rebuild their city; and the work was immediately begun. The Spartan government felt that the restoration of Mantinea would prove to all Greece that it was no longer formidable even to its nearest neighbours; but, in its anxiety to escape this humiliation, it resorted to a step which still more clearly betrayed its weakness, and showed how much it was dispirited by its recent reverse. Agesilaus, who had now recovered from his illness, was sent to use all his hereditary influence at Mantinea to stop the work; and he was instructed to undertake that, if it was only deferred for the present, he would procure the consent of the Spartan government, and even some help towards defraying the expense of the building. He was not allowed to lay this proposal before the popular assembly, but was informed that the decree of the people rendered it necessary to proceed without delay. Though he felt this repulse as a personal affront, and though it set the power of the state at defiance, it was not thought expedient at Sparta to have recourse to arms, and the treaty last concluded with Athens served as a plea for acquiescence. For it was now admitted that the independence of Mantinea had been violated, when it was dismembered for the sake of the aristocratical party. Some of the other Arcadian towns sent workmen to assist the Mantineans, and Elis contributed three talents [£600 or \$3000] to the cost of the fortification. The new city was so constructed as to be secure from such attacks as had proved fatal to that which it replaced.

Peloponnesus had for some years been violently agitated by political convulsions, and had been the scene of incessant struggles between the two leading parties, the friends of aristocratical and of democratical institutions. It seems that the principles on which the Peace of Antalcidas was professedly founded had encouraged the partisans of democracy to hope that they might establish their ascendancy, wherever they were the strongest, without any obstruction from Sparta. Her conduct towards Phlius and Mantinea must have checked these hopes; yet they seem to have revived when the new confederacy between Thebes and Athens, after the recovery of the Cadmea and the revolt of several maritime states compelled Sparta to observe more moderation towards her remaining allies. In many places the aristocratical party was overpowered, and suffered severe retaliation for the oppression it had exercised during the period of its domination. But these triumphs were only the beginning of a series of fierce and bloody contests. The exiles were continually on the watch for an opportunity of regaining what they had lost, and the attempt, whether it succeeded or failed, commonly ended in a massacre. The oligarchical exiles of Phigalea, having seized a fortress near the town, surprised it during a festival, while the multitude was assembled in the theatre, and made a great slaughter among the defenceless crowd, though they were at last forced to retreat, and take refuge in Sparta. The Corinthian exiles, who had found shelter at Argos, were baffled in a similar enterprise, and killed one another to avoid falling into the hands of the opposite party, which immediately instituted a rigorous inquiry at Corinth, and condemned numbers to death or exile on the charge of abetting the conspiracy. Like scenes took place at Megara, Sicyon, and Phlius. The confluence of democratical exiles from other cities tended to keep up a state of constant unnatural excitement at Argos; and there were demagogues who took advantage of it to instigate the multitude against the wealthier citizens into a conspiracy for self-defence.

Arrests were multiplied, until the number of the prisoners amounted to twelve hundred; and the populace, impatient of legal delays, arming itself

[371-370 B.C.]

with clubs, rose upon them, and massacred them all: this bloody execution became memorable under the name of the *scytalism*.¹ The demagogues who had excited the frenzy now endeavoured to restrain it from further excesses; but the attempt only turned it against themselves, and most of them shared the fate of their victims. Their blood seemed to propitiate the infernal powers: the flame, no longer supplied with fuel, expired; and tranquillity was restored. It must be considered as an indication of a remarkable superiority in the Athenian character and institutions over those of Argos, that under similar circumstances, in the affair of the Hermes busts, when religious and political fanaticism combined their influence to madden the people, no such spectacle was witnessed at Athens.

THE ARCADIAN REVOLUTION

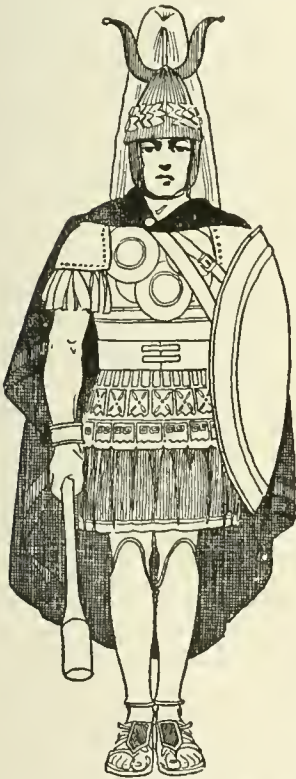

GREEK SOLDIER WITH MACE

With a territory more extensive than any other region of Peloponnesus, peopled by a hardy race, proud of its ancient origin and immemorial possession of the land, and of its peculiar religious traditions, Arcadia — the Greek Switzerland — had never possessed any weight in the affairs of the nation; the land only served as a thoroughfare for hostile armies, and sent forth its sons to recruit the forces of foreign powers — Greek or barbarian — and to shed their blood in quarrels in which they had no concern. The battle of Leuctra opened a prospect of carrying it into effect. A Mantinean named Lycomedes, a man of large fortune and of the highest birth in his native city, seems to have been either the author or the most active mover of the project which was now formed, and which was at least partly executed in the course of the same year (371). The object was to unite the Arcadian people in one body, yet so as not to destroy the independence of the particular states; and with this view it was proposed to found a metropolis, to institute a national council which should be invested with supreme authority in foreign affairs, particularly with regard to peace and war, and to establish a military force for the protection of the public safety. And though there is no reason to doubt that Lycomedes and those who shared his views were chiefly desirous of rescuing their country from a degrading subjection to her imperious neighbour, and of elevating her to an

honourable station among the Greek commonwealths, they undoubtedly did not overlook the accession of strength which would result from this event to their party, in its contest with its domestic adversaries. Their plan could not fail to be agreeable to the Thebans, just in proportion as it was alarming to Sparta; and it was very early communicated to Epaminondas. Within a few months after the battle of Leuctra, a meeting of Arcadians from all

[¹ σκυταλισμός — from the weapon (σκυτάλη) a club which seems to have been principally used.]

the principal towns was held, to deliberate on the measure; and under its decree a body of colonists, collected from various quarters, proceeded to found a new city, which was to be the seat of the general government, and was called Megalopolis, or Megalopolis (the Great City).

The city was designed on a very large scale, and the magnitude of the public buildings corresponded to its extent; the theatre was the most spacious in Greece. The population was to be drawn from a great number of the most ancient Arcadian towns. Pausanias gives a list of forty which were required to contribute to it. The greater part of them appear to have been entirely deserted by their inhabitants; others retained a remnant of their population, but in the condition of villages subject to Megalopolis. Trapezus made an obstinate resistance; and its citizens who survived the struggle preferred quitting their native land to changing their abode in it, and having found means for embarking for the Euxine, were hospitably received as kinsmen in the city of the same name. Lycosura — which boasted of being the most ancient city under the sun — was spared out of respect for the sanctity of one of its temples. The districts which were thus drained of their population never recovered it, and were left in a great measure uncultivated.

The most interesting subject connected with this event, the constitution under which Arcadia was to be united, is unfortunately involved in the greatest obscurity. Megalopolis was the place appointed for the deliberation of the supreme council of the Arcadian body. But of this council we only know that it was commonly described by the name of the Ten Thousand — an appellation which raises a number of perplexing questions. For that it was a representative assembly, and was not intended to consist only of Megalopolitans, is clear both from the terms in which it is spoken of, and from the nature of the case: this would have been a privilege which the other cities would never have conceded to a colony formed out of the most insignificant townships. On the other hand, that so numerous a body should have been collected, either at stated times or as often as occasion required, from the other parts of Arcadia, is scarcely less hard to understand.

Ten commissioners were appointed to superintend the first settlement of the colony, and were honoured with the title of founders. Two of them, Lycomedes and Opeleas, were Mantineans; two, Timon and Proxenus, were leaders of the democratical party at Tegea. Of the rest, two came from Clitor, two from Mænalus, and as many from the Parrhasian cantons. As there was reason to apprehend that Sparta might attempt to interrupt the work in its beginning, Epaminondas sent Pammenes, one of his ablest officers, with one thousand choice troops, to guard and assist the colonists; and hence he also might be looked upon as one of the founders; but it does not appear that he had the foremost, much less, as was sometimes contended, an exclusive claim to that title. It was not however at Megalopolis that any opposition was offered to the undertaking; but in other places violent contests arose between the advocates and the adversaries of the new measure.

It was at Tegea, the chief seat of Spartan and aristocratical influence in Arcadia, that the hardest struggle took place. Though Proxenus and Timon had been deputed as founders of Megalopolis, Stasippus and his partisans did not cease to exert their utmost efforts to counteract the plan of the union, and to keep Tegea in its ancient state of subserviency to Sparta, — or, as Xenophon expresses it, probably in their language, in the enjoyment of its hereditary institutions. Proxenus and another democratical leader named Callibius, — conscious, though they were outvoted in the oligarchical

[370 B.C.]

councils, that the majority of the citizens was on their side, — appealed to arms. Stasippus and some of his party were overtaken. Their enemies having induced them to surrender, conveyed them bound on a wagon to Tegea, where, after a mock trial, in which the Mantineans assisted as judges, they put them all to death. Their surviving partisans, to the number of eight hundred fled to Sparta.

The safety of Sparta seemed to require that she should not passively submit to the blow thus struck at the last remains of her influence in Arcadia, and among the Tegean refugees were several private friends of Agesilaus, and probably of other leading Spartans, who solicited redress and revenge against the Mantineans and their political adversaries. The interference of Mantinea in the civil feuds of Tegea was construed as a violation of the principle which had been recognised in all the treaties concluded since the Peace of Antalcidas, and therefore afforded a fair colour for taking up arms: and war was accordingly declared against Mantinea on this ground. But the strongest motive by which the Spartan government was urged to this step, appears to have been the necessity which it felt for some effort which should restore confidence and cheerfulness at home. For notwithstanding the heroic countenance with which the news of the battle of Leuctra had been received, it had made an impression of deep despondency from which the city had not yet recovered. After the return of the defeated army, a grave question had arisen as to the manner in which the soldiers should be treated.

SPARTAN INTOLERANCE OF COWARDICE

According to the precedents of earlier times, the Spartan who saved his life by flight was subject to the loss of all civil privileges, and to marks of ignominy; and we have seen that it was thought necessary to inflict a temporary degradation on the prisoners who had surrendered — with the permission of their superiors — at Sphacteria. There were some who held that the dishonour which the Spartan arms had incurred at Leuctra could only be effaced by a rigorous enforcement of the ancient martial law. But Agesilaus, and probably most other members of the government, saw that such severity would be now very ill-timed; and according to Plutarch he was empowered to frame some new regulations on this head; but instead of any formal innovation, simply proposed that the law should be suffered to sleep for this once, without prejudice to its application on future occasions. It was, however, on this account the more desirable to divert the thoughts of the people from the recent disaster by a fresh expedition; and Agesilaus was now sufficiently recovered from his illness to take the command.

Xenophon says that he marched with one mora, probably meaning only the Spartan division of his forces. Neither side however was willing to fight: Agesilaus, because his first care was to husband the strength of Sparta; the Arcadians, because they expected soon to be joined by a Theban army, for they were informed by the Eleans that Thebes had borrowed ten talents from Elis for the purpose of the meditated expedition. Perhaps the same intelligence increased the anxiety of Agesilaus to return home. But that his retreat might not appear to be the effect of fear, he remained three days before Mantinea, and ravaged the plain; and then marched back with the utmost speed. Still the honour of Sparta had been vindicated, and the fallen spirits of his countrymen were cheered by the outcome of the events in the vicinity of Mantinea.

THE THEBANS IN THE PELOPONNESUS

The Thebans were in fact advancing with a powerful army, and not long after joined the Arcadians — who employed the interval after the retreat of Agesilaus in an inroad into the Heræan territory — at Mantinea. The victory of Leuctra had so completely changed their position, that they had now the forces of almost all northern Greece, except Attica, at their command. Even Phocis, though as hostile as ever, was compelled to aid them against her late allies. All the Eubœan towns, the Locrians both of the east and west, the Acarnanians, the Trachinian Heraclea and the Malians, contributed to the army; and Thessaly furnished cavalry and targeteers.

The whole force assembled at Mantinea amounted according to Diodorus to fifty thousand, according to Plutarch to seventy thousand men, of whom forty thousand were heavy-armed. The professed object of the expedition was to protect Mantinea, and as it now was no longer in danger, and the season — it was mid-winter — was unfavourable to military operations, several of the Theban commanders proposed to return. They expected to find all the passes, which were naturally difficult, strongly guarded, and could not at once reconcile themselves to the thought of seeking an enemy, who till lately had been deemed almost invincible, in his own country, where he would be animated by the strongest motives to extraordinary exertions. Their apprehensions were only overcome when they received invitations and assurances of support from Laconia itself, and were encouraged by some of the provincials, who came for that purpose to the camp, to expect that the appearance of their army would produce a general revolt of the subject population, which it was said had already refused to obey the orders of the government when it was summoned to the defence of Sparta. They were also informed that one of the principal passes, which led through Caryæ and Sellasia into the vale of the Eurotas, was quite unguarded; and some of the inhabitants of Caryæ offered themselves as guides, and were ready to pledge their lives for the truth of their assertions. The invasion was then unanimously resolved upon.

To distract the enemy's attention, and to accelerate their own movements, the invaders divided their forces so as to penetrate into Laconia simultaneously by different routes. Sellasia was the place of rendezvous appointed for all the four divisions. The Thebans and the Eleans appear to have met with no resistance. The Argives found the passes guarded by a body of troops consisting partly of Bœotian refugees, commanded by a Spartan named Alexander who, however, was overpowered, and fell with two hundred of his men. The pass of the Sciritis might also have been occupied, and from its natural strength it was believed that the Arcadians would never have been able to force it; but Ischolaus, a Spartan who was posted near it at the village of Iuma with a garrison of neodamode troops, and about four hundred of the exiled Tegeans, instead of securing the pass, determined to make his stand in the village, where he was surrounded by the enemy, and slain with almost every one of his men. The four divisions then effected their junction without further opposition, and after having plundered and burnt Sellasia, descended to the banks of the Eurotas, and encamped in a sanctuary of Apollo at the entrance of the plain of Sparta. The next day they pursued their march along the left bank of the river, which was swollen by the winter rains, until they reached the bridge which crossed it directly over against the city. A body of armed troops which appeared on the other side deterred them from attempting the passage; and they proceeded, still

[370 B.C.]

keeping the left bank, to plunder and destroy the dwellings which were thickly scattered in the neighbourhood of the capital, and which from Xenophon's description, who says they were full of good things, seem to have been chiefly villas of the more opulent Spartans, and were probably better stored and furnished than their houses in the town.

It was the first time that fires kindled by a hostile army had ever been seen from Sparta, since it had been in the possession of the Dorian race; and the grief and consternation excited by the spectacle in the women, and the elder part of the men, were proportioned not merely to its strangeness, but to the pride and confidence with which the traditions of so many centuries had taught them to regard their soil as inviolate, and their city, though unwall'd, as impregnable.

In this emergency all eyes were turned upon Agesilaus. As he was fully aware of the danger, so he clearly perceived the course which could alone afford a prospect of deliverance. To remain strictly on the defensive, and in case of an attack to take advantage of the inequalities of the ground, and of the position of the streets and buildings in the outskirts of the town, and in the meanwhile to maintain tranquillity and obedience within, was all that was left to be done; and this, with the means at his disposal, demanded all his abilities. The Spartans, when distributed over the wide range which they had to defend, made so poor a show that the government thought it necessary to resort to an expedient which had been adopted before on less urgent occasions: to arm as many of the helots as could be induced to enlist by a promise of emancipation. And notwithstanding the atrocious purpose which had been cloaked by a similar proposal in former times, more than six thousand volunteers now presented themselves. Their services were accepted with trembling, and employed with continued distrust, until the arrival of some foreign auxiliaries gave a little more security to the government. Not many days after, a small force, probably less than six thousand strong, collected from Corinth, Sicyon, Pellene, Epidaurus, Trœzen, Hermione, and Halia, having been transported in succession over the Argolic Gulf to Brasiaë on the coast of Laconia, crossed the mountains, and, though the enemy was encamped only two or three miles off, made its way into the city.

In the meanwhile the invading army, having ravaged the eastern side of the plain till it came over against Amyclæ, then crossed the river, and turned its front toward Sparta. As the greatest breadth of the plain lies between the river and the foot of Taygetus, still more spoil was found here than on the other side, and this with the greater part of the allies was the single object of attention. The Theban generals alone appear to have been able to prevent their troops from ranging at large in quest of plunder, and to have taken precautions against a surprise from the city. What Epaminondas most desired was to draw the enemy into an engagement, and he is said to have tried the effect of a taunting challenge on Agesilaus, whose temper was not always proof against provocation. But on this occasion he controlled his own feelings, and calmed the general excitement by his authority and example. The Spartans had a small body of cavalry, very inferior, not only in numbers but in condition, to that of the allies; it was however drawn up on the level south of the city. Its appearance served rather to heighten than to check the confidence of the assailants. But an adjacent building, which was consecrated by tradition as the house of the tutelary twins, concealed about three hundred of the young Spartan infantry, who, when the enemy drew near, started from their ambush to support the charge which was made at the same time by their own cavalry. This unexpected attack threw the advancing

squadrons into confusion, and though they were pursued but to a short distance, they did not stop till they reached the Theban phalanx, and even a part of the infantry were so much alarmed by their flight, as to retreat.

It was perhaps on this occasion, while the allies were advancing, that a band of about two hundred men, who had for the most part been long suspected by the government, occupied the Issorium, one of the heights on the skirt of the town towards the river. As they had received no orders, it was evident that they were acting with treasonable designs; and some proposed that they should be forthwith dislodged by force. Agesilaus, however, thought it more prudent, as the extent of the conspiracy was not known, to try a milder course; and going up to the place with a single attendant, affected to believe that they had mistaken his orders, and directed them to station themselves in different quarters. They obeyed, thinking that they had escaped detection; but fifteen of them were arrested by the orders of Agesilaus, and put to death without form of trial, in the night. The suppression of this attempt may have led to the discovery of another more dangerous conspiracy, in which a number of Spartans were implicated. They were arrested in a house where they held clandestine meetings. The clearer their guilt, the more dangerous it probably appeared to bring them to trial; yet there was no power in the state which could legally put a Spartan to death without one. Even the authority of the ephors had never yet been carried so far. They determined however, after a consultation with Agesilaus, to dispense with legal forms, and the prisoners were delivered to a secret execution. The desertions which took place among the helots and the Laconian troops were carefully concealed from public knowledge; but this may not indicate their frequency, so much as the vigilance of Agesilaus.

The reports brought to the camp of the allies, as to the state of things in Sparta, did not encourage Epaminondas to repeat the attempt in which the cavalry had been repulsed, or to prolong his stay in the neighbourhood of the capital. He directed his march southward, and ravaged the whole vale of the Eurotas as far as the coast. Some unwallied towns were committed to the flames, and an assault was made for three successive days on Gythium, the naval arsenal of Sparta, but without success. If it was the design of Epaminondas to take advantage of the discontent which was supposed to prevail in the subject population towards the government, to effect a permanent revolution, the devastation committed by his allies, which he was probably unable to restrain, must have tended to counteract it. He was joined, Xenophon says, by some of the provincials; but the majority must have looked upon the invaders as enemies. Their stay was protracted for some weeks. At length the Peloponnesian troops began to withdraw with their booty, leaving the country almost exhausted. The growing scarcity of provisions and diminution of numbers, combined with the hardships of the season, would have admonished Epaminondas to retire, even if, as Xenophon would lead his readers to suppose, his only business, after recrossing the border, had been to march homeward. But the historian has carefully suppressed the main object which Epaminondas had in view, and which he accomplished during his stay in the peninsula.

He meditated a blow much more destructive to the power and prosperity of Sparta than the invasion of her territory. His design was to deprive her of Messenia, to collect the Messenians in the land of their forefathers, and to found a new city, where they might maintain their independence. He had already sent to the various regions in which the remains of the heroic people were scattered, to invite them to return to their ancient home.

[369 B.C.]

FOUNDING OF MESSENE

Ithome was recommended, at once by the most animating recollections, and by the advantages of its strong and central position ; and the western slope of the ridge on which the ancient stronghold stood, was selected for the new city, Messene. The foundations were laid with the utmost solemnity ; and if we may trust Pausanias, Epaminondas on this occasion did not disdain to practise a pious fraud, for the purpose of showing that the undertaking was sanctioned by the will of the gods. The name of Aristomenes was invoked with peculiar veneration, not only by the Messenians, but by the Greeks of every race who took part in the founding of the city : and the victory of Leuctra was, now perhaps for the first time, ascribed to his supernatural interposition. But though Epaminondas did not neglect the aid to be derived

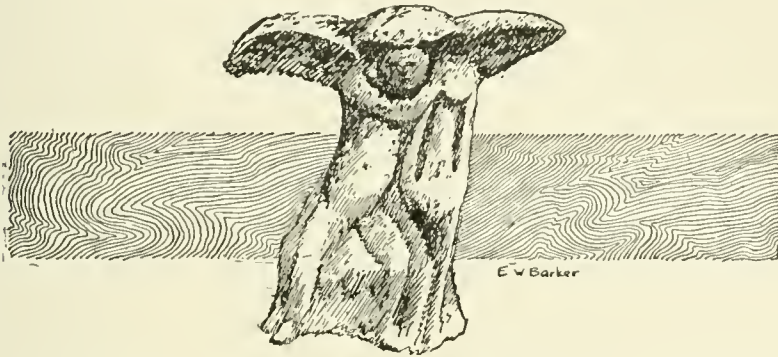

GREEK TERRA-COTTA FIGURE
(In the British Museum)

from pious and patriotic enthusiasm, he at least paid equal attention to all the material means of securing the duration of his work. The most judicious use was made of the natural advantages of the site ; the most approved architects of the day were employed upon the plan, and the most skilful workmen in the execution ; and the fortifications of Messene, which some centuries later excited the admiration of Pausanias, are still found to justify his praise by the solid and beautiful masonry of the remains which are even yet in existence.

When the fortifications of Messene had been carried so far that the presence of the army was no longer needed, Epaminondas, leaving a garrison there, began his march homeward. The building of Messene is so coupled with that of Megalopolis in the accounts of Diodorus and Pausanias, that we may perhaps infer that he did not pass through Arcadia without contributing some important assistance to the latter work, on which the people of Megalopolis were still engaged.

An enemy however still awaited him at the isthmus. In their distress the Spartans had applied for succour to Athens : and their ambassadors were accompanied by envoys from the Peloponnesian states which still adhered to them, among whom those of Corinth and Phlius appear to have supported their request with the greatest earnestness. They appealed to the generosity, to the jealousy, to the fears, and the hopes of the Athenians.

There was already a general disposition among the people, if not in favour of Sparta, yet strongly adverse to Thebes. The assembly, after having

heard the ambassadors, would not listen to any arguments on the other side, but decreed that the whole force of the commonwealth should march to the relief of Sparta, and appointed Iphicrates to the command. An army was immediately raised; and the troops are described by Xenophon as so zealous in the cause, that they murmured because Iphicrates halted for a few days at Corinth. But when they resumed their march, expecting, the historian says, to be led to some glorious action, no such result ensued. It seems that Iphicrates had no wish to seek the enemy, and, perhaps having heard that Sparta was freed from immediate danger, he contented himself with attacking some places in Arcadia, either for the sake of plunder or in the hope that this diversion might hasten the enemy's retreat from Laconia. But it does not appear that his operations produced any effect on those of the Theban army. When Epaminondas began to move towards the isthmus, he posted himself there to guard the passes at the southern extremity: but through some oversight which Xenophon notices with evident surprise, as an extraordinary failure of his military skill, he left the most convenient of them — that on the side of Cenebræ — open; and the Thebans penetrated without any opposition to the isthmus. A body of cavalry, which was sent to observe their movements, and which, Xenophon says, was larger than that purpose required, though insufficient for any other, approached so near as to be drawn into a skirmish, and lost some men in its retreat. With this little advantage over one of the greatest captains of the age, who commanded the forces of the only power which could now be considered as a rival to Thebes, Epaminondas concluded this memorable campaign.

The services which he had rendered to his country were in general duly appreciated by his fellow-citizens; but they excited, and did not disarm, the envy of some inferior minds, and the expedition itself, successful as it had been, afforded them a pretext for assailing him. The yearly term for which he held his office of Bœotarch had expired, it seems, soon after he entered Peloponnesus, and he and his colleagues had retained their command, without any express sanction, three or four months longer. On this ground he and Pelopidas were separately charged with a capital offence. It was merely an experiment to try the strength of their popularity; for their conduct, though perhaps it infringed the letter of the law, was manifestly in accordance with the will of the people. It is indeed somewhat surprising that their adversaries should have ventured on such an attempt, and still more that the issue, as we learn from Plutarch, was considered doubtful, because Pelopidas was first brought to trial. Epaminondas, it is said, declared himself willing to die, provided the names of Leuctra, Sparta, and Messene, and the deeds by which his own was connected with them, might be inscribed upon his tomb. Both, however, were acquitted in the most honourable manner; and Pelopidas, less magnanimous or more irritable than his philosophic friend, who would have forgiven the harmless display of malice, afterwards employed the forms of law to crush their principal accusers.^h

Niebuhr remarks that the re-establishment of Messene "is an imperishable monument to Epaminondas," but draws therefrom a somewhat disconcerting moral:

"In the restoration of Messene, Epaminondas obeyed the dictates of prudence and of his own noble heart; and he could not have acted otherwise even if he had foreseen the consequences. It must be observed that this is again one of those cases in which the accomplishment of justice was not followed by happy results. The restoration of Messene produced at a later period of Greek history, terrible consequences. The Messenians being,

[369 B.C.]

by their peculiar situation, the implacable enemies of Sparta, were obliged to seek support against her; and they preferred doing so at the greatest distance, which made them the humble servants of Macedonia, and the perpetual enemies and traitors of Greece. There was no people so devoted body and soul to King Philip, as the Messenians. The death of Philopœmen is an example of the mischief which Messenia created in Greece, an ineffaceable brand on the name of Messenia. Things which every honest man must desire, are in the end often followed by the saddest consequences." *b*

ATHENS IN LEAGUE WITH SPARTA

In the existing pressure upon Lacedæmon, and upon the states whose interest yet bound them to the Lacedæmonian cause, it was of great importance to hold, and, if possible, improve, their connection with Athens. Ministers accordingly were therefore sent thither, fully empowered to agree upon the system of command and the plan of operations for the next campaign. The former alone made any difficulty. The Athenian council, at this time swayed apparently by wise and moderate men, had agreed with the Peloponnesians, that, all circumstances considered, it would be most for the interest of the confederacy, and most equitable, that the Athenians should direct operations by sea, and the Lacedæmonians by land. But a party in Athens, with Cephisodotus for their orator, thought to earn popular favour by opposing this arrangement. When the proposal of the council was laid before the general assembly (for by that tumultuary meeting, in the degenerate state of Solon's constitution, all the measures of executive government were to have their ratification), Cephisodotus persuaded the ill-judging multitude that they were imposed upon. In the Lacedæmonian squadron, he said, the trierarchs would be Lacedæmonians, and perhaps a few heavy-armed; but the body of the crews would be helots or mercenaries. Thus the Athenians would command scarcely any but slaves and the outcast of nations in the Lacedæmonian navy, whereas, in the Athenian army, the Lacedæmonians would command the best men of Athens. If they would have a partition of military authority really equal, according to the fair interpretation of the terms of the confederacy, the command equally of the sea and of the land forces must be divided. Popular vanity was caught by this futile argument; and the assembly voted that the command, both by sea and by land, should be alternately five days with the Athenians, and five with the Lacedæmonians. In this decision of the petulant crowd, singularly adapted to cripple exertion both by sea and land, the Lacedæmonians, pressed by circumstances, thought it prudent to acquiesce.

SECOND INVASION OF PELOPONNESUS

In spring an army was assembled at Corinth to prevent the passage of the Thebans and their northern allies into Peloponnesus. But the superior abilities of the Theban leaders prevailed. They surprised an outpost. Doubting still their means for forcing their way over the rough descent of the Oean Mountains, they communicated with the Lacedæmonian polemarch commanding, and, whether through his treachery or his weakness, they obtained a truce, under favour of which they safely joined the forces of their Peloponnesian allies, the Arcadians, Argives, and Eleans. This junction being effected, they found

themselves far superior to the army of the Lacedæmonian confederacy. Without opposition then they punished the attachment of the Epidaurians to the Lacedæmonian interest by ravage of their lands. They attempted then one of the gates of Corinth; but, the Corinthians submitting themselves to the able direction of the Athenian general, Chabrias, who was there with a body of mercenaries, they were repulsed with some slaughter. Against so great a superiority of force however the abilities of Chabrias could not prevent the ravage of the Corinthian territory. All Peloponnesus now seemed open to the Thebans, when the pressure of the Thessalian arms, under the tagus, Alexander of Phæræ, upon their northern allies, and apprehension of its extending to Bœotia itself, called the Thebans suddenly out of the peninsula. All the Peloponnesians of the confederacy then, assuming leave of absence, parted to their several homes.

The dissolution of the army of the Theban confederacy gave a most fortunate relief to Lacedæmon. All the leisure it afforded seems to have been wanted for composing troubles within Laconia itself. Offensive operations were left to the auxiliaries sent by Dionysius, then ruling in Syracuse; a body remarkable enough, both in itself and for its actions, to deserve notice. The infantry were Gauls and Spaniards; the cavalry, apparently Sicilian Greeks, so excellent that, though scarcely exceeding fifty horsemen, they had given more annoyance to the Thebans, while laying waste the Corinthian lands, than all the rest of the army. After the other troops, on both sides, were withdrawn, this transmarine force alone undertook the invasion of Sicyonia, defeated the Sicyonians in battle, and took a fort in their territory by assault. Gratified then with glory and plunder they embarked, and, with twenty triremes, their convoy, returned to Syracuse.

Thus far the able leaders of the Theban councils, profiting from the animosity so extensively prevailing against Lacedæmon, had kept their confederacy unanimous and zealous, under the supremacy of Thebes. But it was little likely that, by any management, so many states could be long retained in patient submission to so new a superiority. The long deference of the Grecian republics to Lacedæmonian command, amounting, in many instances, to a zealous, and sometimes extending to a general, loyalty towards the superior people, is a political phenomenon perhaps singular in the history of mankind. But that deference was paid to a superiority, not suddenly obtained, but growing from the extraordinary institutions under which the Lacedæmonians lived; which made them really a superior people, obviously fittest, in the divided and tumultuary state of the Greek nation, to command in war and to arbitrate in peace: whence even still, when the political power of Lacedæmon was so declining, the estimation of the Lacedæmonian people, we are told, was such that at the Olympian and other national meetings a Lacedæmonian was an object of curiosity and admiration for strangers, more even than the conquerors in the games. The superiority of Athens, also, though in few instances, or for a short time only, supported by a loyalty like that which Lacedæmon enjoyed, accruing suddenly, yet had resulted from long preparation. Legislation more perfected, talents and manners more cultivated, and an extraordinary succession of able men at the head of affairs, gave to the Athenians an effectual superiority which the people of other republics saw and felt. But Thebes, without any advantage of ancient prejudice in favour of her pretensions, without any public institutions to be admired, recently emerged from political subjection, possessing indeed a large and disciplined population which might infuse some terror, was yet become so suddenly eminent only through the blaze of talents of a few, and princi-

[368 B.C.]

pally of one extraordinary man, leading her councils, and commanding her armies. If therefore, in any other state of the confederacy, where military force was not very inferior, a similar blaze of character should occur, that state would presently feel itself equal to Thebes, and be prepared to break a connection involving an admission of her superiority.

Such a character had been for some time rising among the Arcadians in Lycomedes of Mantinea, a man inferior to none of his country in birth, superior to most in property, one who had already distinguished himself in council as a principal promoter of the Arcadian union, and in arms at the head of the Arcadian forces. Lycomedes apparently already saw, what afterwards became abundantly notorious, that, if any view to the general good of Greece influenced the Theban councils, it was wholly subordinate to the ambition of making Thebes supreme over the Greek nation. This ambition he resolved to oppose. In the general assembly therefore of the Arcadian states, convened in the new city of Megalopolis, he represented that "Peloponnesus, among all its various present inhabitants, was the proper country of the Arcadians alone; the rest were really strangers. Nor were the Arcadians the most ancient only, they were the most powerful of the Grecian tribes; they were the most numerous, and they excelled in strength of body. It was notorious that the troops of no other Grecian people were in equal request. The Lacedæmonians knew their value: they had never invaded Attica without Arcadian auxiliaries; nor would the Thebans now venture to invade Laconia without them. If therefore the Arcadians knew their own interest, they would no longer obey the Thebans, but insist upon equality in command. They had formerly raised Lacedæmon; they were now raising Thebes; and shortly they would find the Thebans but other Lacedæmonians."

Flattering thus alternately, and stimulating the Arcadian people, Lycomedes obtained the effective command of them; and the natural consequence of the submission of the multitude's caprice to an able man's control resulted: the Arcadians were successful, and their successes were brilliant. The Argives invaded Epidauria. The renowned Athenian general Chabrias, at the head of the Athenian and Corinthian forces, intercepted their retreat. The Arcadians were in alarm for their allies; an assembly was held; the interest of Lycomedes decided the choice of commanders, and the Arcadian army, against great disadvantage of ground, brought off the Argives without loss. An expedition was then undertaken into Laconia; the territory of Asine was ravaged, and the Lacedæmonian polemarch Geranor, who commanded there, was defeated and killed. Many predatory incursions, in the common way of Grecian warfare, followed; and when any object invited, neither night, says the contemporary historian, nor weather, nor distance, nor difficulty of way deterred; insomuch that the Arcadians acquired the reputation of being the best soldiers of their time.

Disposed as the Arcadians showed themselves no longer to admit the superiority of Thebes, their strength, their discipline, and their successful activity in arms, though exerted in the cause of the confederacy, could scarcely fail to excite some jealousy and apprehension in the Theban government. No direct breach ensued, but friendship cooled and became precarious. Meanwhile the new energy of the Arcadian government attracted the regard of the humble and oppressed; always an extensive description of men, and sometimes of states, among the Grecian republics. The people of Elis had long claimed, and generally maintained, a sovereignty over the people of several towns of Elis, and of the whole district called Triphylia,

on the border against Messenia. In a strong situation in Triphylia, called Lasion, to assist in curbing the inhabitants they had allowed some Arcadian exiles to establish themselves. They at length made common cause with their neighbouring fellow-subjects, particularly the Marganeans and Scilluntines, in opposition to the Elean government. For support then they turned their view to the new union of Arcadia : they claimed to be Arcadians ; and by a petition addressed to the new united government they desired to be taken under its protection. At the same time the Eleans were pressing for assistance from their allies of Arcadia, to recover their former dominion over the towns which the Lacedæmonians had restored to independency. The Arcadians slighted this application, and declared by a public resolution that the petition of the Triphylians was well founded, and that their kinsmen should be free. Elis became in consequence still more alienated from Arcadia than Arcadia from Thebes.

The growing schism in the opposing confederacy promised great advantage to Lacedæmon. Meanwhile, though, through vices in their civil constitution and ill-management in their administration, the Lacedæmonians had lost the best half of their territory, their negotiations abroad still carried weight, and were conducted ably and successfully. It was at this critical time that Philiseus, a Greek of Abydos, arrived as minister from the satrap of Bithynia, Ariobarzanes, professedly charged to mediate in the king of Persia's name a general peace among the Grecian republics. This new interference of Persia in Grecian affairs was produced by Lacedæmonian intrigue. Philiseus proposed a congress at Delphi ; and deputies from Thebes and from the states of the Theban confederacy readily met deputies from Lacedæmon there. No fear of Persia, so the historian, not their friend, testifies, influenced the Thebans ; for Philiseus requiring, as an indispensable article, that Messenia should return under obedience to Lacedæmon, they positively refused peace but upon condition that Messenia should be free.

This resolution being firmly demonstrated, the negotiation quickly ended, and both sides prepared for war. Philiseus then gave ample proof of his disposition to the Lacedæmonian cause, by employing a large sum of money, entrusted to him by the satrap, in levying mercenaries for the Lacedæmonian service. Meanwhile a body of auxiliaries from Dionysius of Syracuse, chiefly Gauls and Spaniards, as in the former year, had joined the Lacedæmonian army ; and, while the Athenians were yet but preparing to march, a battle was fought under the command of Archidamus son of Agesilaus. The united forces of Argos, Arcadia, and Messenia were defeated, with slaughter, if Diodorus may be believed, of more than ten thousand men, and, as all the historians report, without the loss of a single Spartan. After a series of calamities the intelligence of this extraordinary success made such impression at Lacedæmon that tears of joy, says the contemporary historian, beginning with Agesilaus himself, fell from the elders and ephors, and finally from the whole people. Among the friends of the Lacedæmonians nevertheless, as no tear of sorrow resulted, this action became celebrated with the title of the "Tearless Battle" of Midea.

EXPEDITION INTO THESSALY

The war with Thessaly now pressed upon Thebes. Still urging Lacedæmon by her confederates and dependents in Peloponnesus, she not only could afford protection to her northern subjects and allies against the successor of the most formidable potentate of the age, but she could aim at

[368 B.C.]

dominion, or influence which would answer the purpose of dominion, among the populous and wealthy, but ill-constituted cities of Thessaly. While the rapacity and ambition of the tagus, Alexander of Pheræ, occasioned a necessity for measures of protection and defence, the disposition to revolt, which his tyranny had excited among those over whom his authority extended, gave probability to views of aggrandisement for those who might support the revolt. Accordingly Pelopidas was sent into Thessaly with an army under a commission to act there at his discretion; for the advantage however, not of the Thessalians, who had solicited protection, but of the Bœotian people, who pretended to be common protectors: a kind of commission which it has been usual in all ages for the barefaced ambition of democracies to avow, while the more decent manners of the most corrupt courts, from which such commissions may have issued, have generally covered them with a veil. Pelopidas penetrated to Larissa, and with the co-operation of its people, expelled the tyrant's garrison. Extending negotiations then into Macedonia, he concluded a treaty with Alexander, king of that country, who desired alliance with Thebes, the better to resist the oppression which he felt or feared from the naval power and ambitious policy of Athens, which were continually exerted to extend dominion or influence over every town on every shore of the Ægean. His younger brother, Philip, then a boy, afterwards the great Philip, father of the greater Alexander, is said to have accompanied Pelopidas in his return to Thebes; whether for advantage of education and to extend friendly connection, or, as later writers have affirmed, as a hostage to insure the performance of stipulated conditions.

Pelopidas returning to his command in Thessaly, his usual success failed him. According to Diodorus and Plutarch, venturing as voluntary negotiator for his country within the power of the profligate tagus, he was seized and imprisoned. But Polybius imputes his misfortune to positive imprudence, and an expression of Demosthenes

would imply that he was made prisoner in battle. Nor were the exertions of the Theban government to avenge him fortunate. The Bœotarchs, who had ventured far into Thessaly with an army said to have been eight thousand foot and six hundred horse, not finding the support expected from the Thessalian people, were reduced to retreat before the greater force of the tagus; and, in traversing the Thessalian plain pursued by a superior cavalry, they suffered severely. It is attributed to the ability of Epaminondas, serving in an inferior station, but called forth by the voices of the soldiers to supply the deficiencies of the generals, that the army was not entirely cut off. Negotiation, supported



GREEK OFFICER SACRIFICING ON THE
EVE OF BATTLE

probably by arms, yet not without some concession, procured at length the release of Pelopidas, early in 367.

AN EMBASSY TO PERSIA AND A CONGRESS AT THEBES

The cordial support of Athens, the force of mercenaries to be added by Philiscus, the growing aversion among the Arcadians to the Theban cause, and the troubles in the northern provinces, with the pressure of the Thessalian arms upon the Theban confederacy, together seemed likely to restore a decisive superiority to Lacedæmon, at least within her peninsula; and then, judging from experience, it was not likely to be confined there. But the able directors of the Theban councils had observed that the first and perhaps the most powerful efficient of this change in circumstances had been negotiation with Persia; and they resolved to direct also their attention to Persia, and try if they could not foil the Lacedæmonians by negotiation still more effectually than by arms. A minister from Lacedæmon, Euthycles, was actually resident at the Persian court. Upon this ground a congress of the confederacy was summoned, and, in pursuance of a common resolution, Pelopidas was sent to Susa on the part of Thebes, accompanied by ministers, from Argos, Elis, and Arcadia. The Athenians, jealous of the measure, sent their ministers also, Timagoras and Leon.

Pelopidas was treated by the Persian court with distinguishing honour. A Persian of rank was appointed to accompany Pelopidas back to Greece, bearing a rescript from the king in which the terms of his friendship were declared. It required that "the Lacedæmonians should allow the independence of Messenia; that the Athenians should lay up their fleet; that war should be made upon them if they refused; and that, if any Grecian city denied its contingent for such war, the first hostilities should be directed against that city; that those who accepted these terms would be considered as friends of the king, those who refused them as enemies."

If we compare the style and spirit of this rescript, and the manner in which it was offered to united Greece, with the terms and circumstances of the Peace of Antalcidas, we shall hardly discover what has been the ground of distinction between them; why one has been so much reprobated, while the other, little indeed applauded, has in a manner been thrown out of observation by the imposing abundance of panegyric which the consent of ancient and modern writers has bestowed on the magnanimous patriotism of Pelopidas, and of his great associate in politics as in arms, Epaminondas. But we may perhaps be led to think that political principle has been out of view, both in the panegyric and in the reproach; that the merit of individuals has considerably swayed the general mind; yet that the great distinction has rested on party-spirit. If however, leaving the political principles of Pelopidas in that obscurity which we seem without means very satisfactorily to illuminate, we look to his political abilities, we shall see them exhibited in their fairest light, in real splendour, not by his professed panegyrists, but by the candid contemporary historian, not his friend. They are evident in the success of his Persian negotiation, to which that historian has borne full testimony; and that negotiation must unquestionably have been a business abounding with difficulties, and requiring much discernment to conduct and bring to so advantageous a conclusion.

But the Thebans appear to have been too much elated by their success, in this extraordinary and very important affair, for perfect prudence to hold

[367 B.C.]

through their political conduct; whether their able chiefs now erred, or rather popular presumption, in the badness of their constitution, to which Polybius bears testimony, was not to be restrained. They assumed immediately to be arbiters of Greece. Their summonses for a congress of deputies from the several republics to meet in Thebes were generally obeyed. The Persian who had accompanied the return of Pelopidas, attended, with the king's rescript in his hand. This was read and interpreted to the congress, while the king's seal appendant was ostentatiously displayed. The Thebans proposed, as the condition of friendship with the king and with Thebes, that the deputies should immediately swear to the acceptance of the terms, in the names of their respective cities. Readily however, as the congress had met in Thebes, the deputies did not come so prepared to take the law from Thebes.

Not simply objecting to the proposed oath, Lycomedes insisted that "Thebes was not the place in which the congress should have been assembled." The Thebans exclaiming, with marks of resentment, that he was promoting discord in the confederacy, he declared his resolution to hold his seat in the congress no longer; and, the other Arcadian deputies concurring with him, they all retired together. The result seems to have been that the congress broke up without coming to any resolution.

Disappointed and thwarted thus, the Thebans could not yet resolve to abandon their project of arrogating that supremacy over the Greek nation which Lacedæmon had so long held; long indeed by the voluntary concession of a large majority of it. They sent requisitions separately to every city to accede to the terms proposed; expecting that the fear of incurring the united enmity of Thebes and of the king, says the contemporary historian, would bring all severally to compliance. The Corinthians, however, setting the example of a firm refusal, with the added observation, that "they wanted no alliance, no interchange of oaths with the king," it was followed by most of the cities. And thus, continues Xenophon, this attempt of Pelopidas and the Thebans to acquire the empire of Greece finally failed.

If we refuse to Thebes the credit of a glory genuine and pure for her first successful struggle against the tyranny of Lacedæmon, we have Epaminondas himself with us, who would take no part in the revolution till the business of conspiracy, treachery, and assassination was over, and the affair came into the hands of the people at large, ready for leaders, and wanting them. We may have more difficulty to decide upon the merit or demerit of that obstinacy with which the Thebans afterwards persisted in asserting dominion over the cities of Bœotia, and thus denying peace to Greece, when proposed upon a condition which might seem, on first view, all that true Grecian patriotism could desire — universal independency. For where was to be found the sanction of that peace? Unfortunately the efficacy of any great interest pervading the country was overborne and lost in the multitude of narrow, yet pressing interests, of parties and of individuals, dividing every little community. No sooner would the independency of the Bœotian towns have been established than a revolution would have been made, or attempted in every one of them. The friends of Thebes once overpowered, and the friends of Lacedæmon prevailing among those towns, how long might Thebes itself have been secure against a second subjection to Lacedæmon, more grievous than the former? As far, then, as these considerations may apologize for the refusal of accession to the treaty of Athens, so far it may also justify the Persian embassy; though scarcely the haughtiness which success in that negotiation seems to have inspired. But what should have been the farther

conduct of Thebes to secure her own quiet, without interfering in the affairs of surrounding states, or how to insure quiet among those states, without the possession and the use of power to control them, is not so easy to determine. For the business of the honest statesman, amid the seldom failing contention of factions within, and the ambition of interested neighbours without, is not so easy and obvious as presumptuous ignorance is commonly ready to suppose, and informed knavery often, with interested purposes, to affirm. How ill prepared Greece was at this time for internal quiet, what follows will but concur with all that has preceded of its history to show.^e





CHAPTER XLVI. WHEN THEBES WAS SUPREME

JOINT WORK OF EPAMINONDAS AND PELOPIDAS

THE Thebans had every inducement to husband their strength and guard their commonwealth against civil divisions, for the number of their adversaries increased with their good fortune. If they could look back with pride on what had been accomplished, still their future was by no means secure. They had indeed baffled the unjustifiable designs of their enemies. The Spartans, who eighteen months before had cherished the hope of decimating the divided Thebans for the benefit of the god, were now reduced to complete impotence, while they were threatened by the Thebans with almost the same fate by which the latter had themselves been confronted; the foundation of a city which offered a safe refuge to all oppressed and outlawed inhabitants of Laconia, had inflicted a mortal wound on the ruling Dorian state; the annihilation of the Peloponnesian league had permanently broken the Spartan supremacy.

But the very rapidity with which the fetters had been shaken off had created many difficulties which the Thebans had to face when they came to reunite the dismembered limbs into a new whole. The hegemony of Sparta, like that of Athens, rested on the foundation of ancient popular tradition; each had its justification in the eminent qualities of the respective states, in the exclusive military training and bravery of the Spartans, in the cultivation and democratic judicial life of the Athenians; all the Greek commonwealth had been pledged to one or the other of these states for a shorter or longer period; consequently subordination to one of them was no disgrace to any town, since the ancestors of its inhabitants had already stood in a similar relation.

The position was quite different in the case of Thebes, which neither by her historical past, nor by the greatness and importance of her intellectual and moral progress and civil institutions, seemed justified and qualified for the assumption of so eminent a position. Much as the Peloponnesians admired the bravery, the discipline, and the excellent disposition of the Theban troops, their military reputation was too recent to allow of its measuring itself in the eyes of the Hellenes with the glory of Sparta's arms and her military practice; and yet warlike courage and bodily dexterity were the only merits which the Thebans could bring forward to support their claim to supremacy in Hellas. They had neglected navigation, though the favourable situation of the country, with its extensive coast on both shores and the excellent roadsteads, especially at Aulis, offered

many advantages; they had at all times shown a disinclination and contempt for commerce and industry, and were consequently often in distress for money; in intellectual and artistic progress, they had not only remained behind Athens and the Hellenes of Asia Minor, but the Dorian states of Sparta, Corinth, Sicyon, and Ægina had also developed a richer culture; the composition of lyrics and the art of playing on the flute were the only accomplishments in which the Bœotians had attained to any skill.

The sense of justice and humanity were little cultivated; savage and cruel in their disposition, they pursued their enemies and their rivals with bloodthirsty passion, so that on his second expedition into the Peloponnesus Epaminondas only saved a number of aristocratic fugitives from Bœotia from an agonising death by denying their origin. Beside this, the inclination of the Thebans to sensual pleasures and their delight in luxurious feasts and banquets, formed a striking contrast to Athenian simplicity and moderation, and to the stern and joyless lives of the Spartans.

It has been already remarked that Epaminondas was free from all these defects and vices and did all in his power to remove them; but he stood so far above his fellow-citizens that his influence was diminished by that very fact. Judging his countrymen by himself, and assuming in them the same virtue and morality, the same enthusiasm for the glory and greatness of their native land as he felt in his own great soul, he drew them into undertakings to which neither their strength nor their capacity was equal; he entered on courses which they, with their defective political training, could not pursue with safety. Consequently it has been justly said that with the corpse of Epaminondas the glory of Thebes was also carried to the grave.

When the period of his command in the field expired, Epaminondas returned home, where he was once more to experience the ingratitude of his fellow-citizens. Not only did the people, now again roused against him, pass him over in the election of the Bœotarchs; it is related that the deluded mob appointed him overseer of roads and canals (*telearchus*), but that by his conscientious administration he gave importance to this insignificant office. Alike in the highest and in the lowest position, this magnanimous man endeavoured to work for the good of his country; his soul was free from the petty human weaknesses which so often cling, like a dark shadow, to talent and worth. This was exhibited in another scene in the year which followed.

From his expedition in Thessaly he, to save Pelopidas, returned joyfully home too late to preserve the Theban state from a disgraceful act of bloodshed. In the interval, armed mobs, stirred up by passionate demagogues, had marched against Orchomenos, where an aristocratic conspiracy was said to have been discovered, had destroyed the detested city, murdered the nobles and chief citizens, and sold the rest into servitude, together with their wives and children. Thus the ancient and famous city of Orchomenos, once the wealthy seat of the Minyæ, disappeared from the number of Greek towns. "Had I been at home," Epaminondas lamented, "this atrocity would never have been committed."

At Susa, in spite of his refusal to bend the knee, Pelopidas had won such high favour with the king, by reason of the fame of his deeds and the recollection of the ancient brotherhood in arms so long subsisting between Thebes and Persia, that the conditions of peace which Artaxerxes declared to the envoys proved to be entirely in accordance with the ideas and interests of Thebes and her skilful representative.

But this award whose fulfilment, and with it the supremacy over Hellas, was entrusted to the Thebans, provoked indignation and resistance in the

[368-365 B.C.]

other states. At Athens, the envoy, Timagoras, was condemned to death for his intimacy with Pelopidas; at Sparta, exception was taken to the recognition of the rebellious Messenians; in Arcadia, the people resented the recognition of the Elean claims to suzerainty over the district of Triphylia, which had joined the Arcadian confederacy, and the deputy, Antiochus, famous as a pugilist and wrestler, vented his anger at home in ridicule of the Persians: "The king," he said, "had bakers, cooks, cup-bearers, and door-keepers in large numbers, but in spite of a zealous search he had not been able to find men who should be able to stand against the Hellenes in a fight; abundance of money and wealth was a vain show; the celebrated golden plane tree could hardly give shade to a locust."

Such being the state of opinion, it is not surprising that the acceptance of the peace should have encountered insuperable difficulties. The ambassadors summoned to Thebes in the ensuing spring had refused to swear to it, and the Arcadian deputy, Lycomedes, even took exception to the place of assembly, by means of which the Thebans would have invested their town with their pre-eminence, and went away in anger. The endeavours to win the concurrence of the separate states were not more successful, so the general war resumed its course and with it sanguinary party strifes in every city, and flight and pursuit for the defeated. In vain Epaminondas, on his third Peloponnesian expedition, endeavoured to bring the principles of mildness and civil tolerance into effect in Achaia: the Theban commonwealth, stirred up by the Arcadian democrats, abolished his institutions and sent magistrates into the country, who countenanced the expulsion of the oligarchs and the erection of unrestricted popular governments, until the refugees assembled together, forcibly compelled their recall, and once more carried Achaia over to the Spartan alliance, whereupon the persecution assumed a different form.

In Sicyon, Euphron, a rich and influential citizen, supported by Arcadian and Argive auxiliaries, placed the new commonwealth under the protection of Thebes, and with the confiscated property of his expelled enemies he obtained mercenaries, with whose aid he made himself ruler of his native city in the capacity of demagogue and tyrant. By wiles and treachery, robberies and crimes, he maintained himself in the government for a long time until, having at last been overpowered and put to flight by an aristocratic army, he was slain in Thebes, whither some of his enemies had followed him, under the eyes of the council. The perpetrator of the deed managed to defend himself so skilfully that he got away unpunished; but the townspeople of Sicyon honoured Euphron, who had freed them from the yoke of the aristocrats, as the second founder of their city.

Thus throughout the Peloponnesus the most terrible party rage was the order of the day; communities and individuals, prompted by passion and revenge, perpetrated wild misdeeds and crimes. Isocrates, in his oration called *Archidamus*, thus paints the situation in the Peloponnesus:

"Every town has its adversaries about it and therefore we have devastation of the country, destruction of the towns, subversion of governments, disregard of laws. Men fear their enemies less than their own fellow-citizens. The rich would rather throw their property into the sea than give to the poor; on the other hand the poor desire nothing better than to rob the rich. The sacrifices are suspended; men slay each other at the altars. There are more exiles from a single city than formerly in the whole of Peloponnesus."

The laws had no longer any general application, since Sparta's ancient supremacy had collapsed and the pre-eminence of Thebes was not yet

established; all common interests vanished, and in alliances and secessions nothing but the momentary advantage was kept in view. Even religious awe was extinguished in men's minds; votive offerings and temple treasures were seized to pay hired troops. The greatest feats of arms were performed for no purpose; valour and military spirit were squandered in adventurous combats and enterprises. Yet in spite of this distracted state of affairs, Sparta could not recover her power and consideration: the want of a free citizenship and the restoration of Messenia ceased to be spoken of. With the help of Syracusan mercenaries, whom the younger Dionysius had sent them, the generals did, indeed, succeed in bringing the town of Sellasia with the passes into Arcadia again under their power; but on the other hand they had to permit not only the Corinthians, but the Phliasians also, the most faithful of the allies of Sparta, who had executed many brave deeds and conducted so many expeditions against the Sicyonians and Argives, to conclude a separate peace with Thebes. They themselves refused to accede

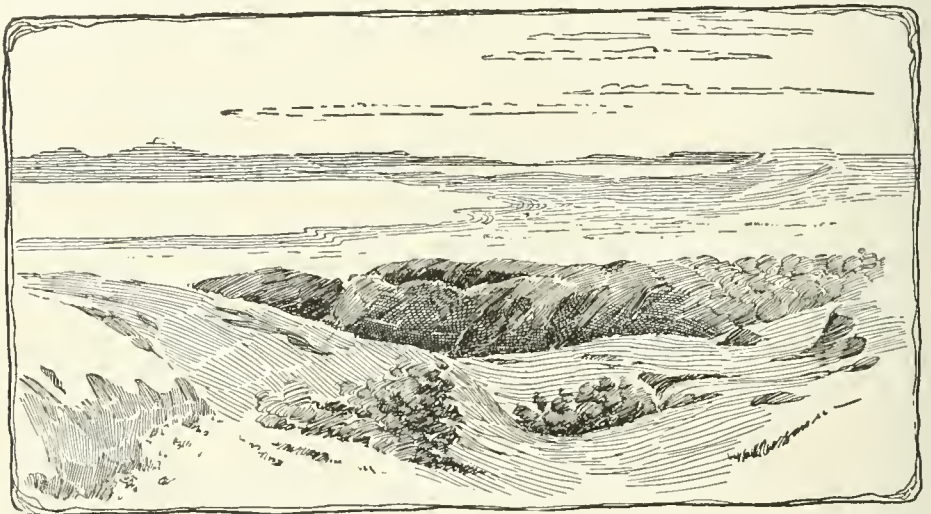

LOOKING TOWARDS CORINTH FROM ARCADIA

to it, notwithstanding the persuasions of their friends, because they could not make up their minds to the recognition of the independence of the Messenians, which was demanded.

As Corinth, Phlius, Epidaurus, and other cities now allied themselves with Thebes, Arcadia drew up an offensive and defensive treaty with Athens, which Epaniondas, in his capacity of ambassador, vainly endeavoured to counteract by a speech against Callistratus before the national council of the Ten Thousand. But Lycomedes, the creator of this union, was not to reap the fruit of his labours. On his way home he met with a violent death at the hands of some Arcadian refugees. The dream of an Arcadian hegemony was buried with him. No other statesman had it in his power to lead that uncultivated, divided nation of soldiers and shepherds, strangers as they were to any sort of common action, to higher and patriotic aims. Petty border feuds again claimed the whole attention of the Arcadians, and the increasing estrangement between Mantinea and Tegea, and the jealousy of both in regard to Megalopolis, stood in the way of the strengthening

[365-364 B.C.]

and development of a united state. Soon disputes with Elis led to other complications fraught with consequences which necessitated a new military expedition on the part of the Thebans.

After the battle of Leuctra, the Eleans had again taken possession of the territory of Triphylia, which had once been wrested from them by the Spartans; but the inhabitants, dissatisfied with the rule of the Eleans, had turned to the Arcadians, and, appealing to the ancient connection between the races, had requested and obtained admission into the Arcadian confederacy. The suzerainty of Elis over Triphylia had indeed, as it seems, been recognised in the peace prescribed by Persia, but the latter's dispositions received as little acceptance here as elsewhere; both sides were therefore prepared to vindicate their claims by force of arms.

To strengthen their position the Eleans concluded an alliance with Sparta, and vacated the border town of Lasion on the western slope of Erymanthus in favour of a flock of oligarchical refugees from Arcadia. In this settlement the government of Megalopolis saw a hostile intention, for from thence the oligarchs had no difficulty in forming traitorous connections with those who thought with them, and they seized the occasion to visit the peaceful little country with a devastating war. They carried robbery and destruction up to the very capital, excited a sanguinary civil war between the popular party and the oligarchical families, and reduced the inhabitants to a state of despair. In vain the Eleans brought about an invasion of the friendly Spartans into the territory of Megalopolis; after an heroic struggle the Arcadians forced the Lacedæmonian king, Archidamus, to surrender the strong hill town of Cromnus, which he had occupied by a rapid movement, and forced him to a disastrous retreat during which a hundred Lacedæmonian citizens fell into the hands of the victors. And as it chanced that the time of the Olympic games was approaching, they took possession of the holy site and bestowed the office of judge of the contests on the Pisatans.

The Eleans, furious at this infringement of their rights, marched up with their collected forces, and on the sacred ground, before the eyes of those assembled for the festival, they delivered a sanguinary battle which was finally decided against them. The Eleans had to give place to the Arcadians and content themselves with omitting the festival from the series of Olympic years, on the grounds of its having been celebrated contrary to law and order. The confederate government of Arcadia laid hands on the temple treasure, and in spite of the protests of the Mantineans, they used it to defray the cost of the war and the pay of the national levies and *epariti*. This was the means of widening the schism and the difference of opinion which had for some time divided the Arcadian confederacy into two camps and which now developed into a breach destined to lead to serious consequences. The Mantineans, outnumbered in the federal government and national council, again turned to the Spartans, while the democrats of Tegea, who then had the upper hand in the guidance of united Arcadia, adhered to the alliance with Thebes.

THE END OF PELOPIDAS

The Thebans had taken no part in these events in the Peloponnesus, beyond keeping provincial governors (harmosts) and garrisons in Tegea, Sicyon, and other towns, for the purpose of guarding their own interests and upholding the cause of democracy. The complications in Thessaly and the

attempts to wrest the command of the sea from the Athenians claimed the whole energies of their statesmen. Soon after the retreat of Epaminondas and Pelopidas after the latter's rescue, Alexander, the cruel tyrant of Pheræ, had renewed his plans of conquest in the mountain country, had subdued the cities of the Aebæans, Phthiotæ, and Magnetes, and extended his military despotism over the whole country. Then the oppressed and threatened people turned once more for help to the Thebans, who now fitted out an army of seven thousand hoplites to take stern vengeance on the disturber of the peace. But on the day fixed for its departure, an eclipse of the sun occurred and spread so much terror among the superstitious people that the march had to be put off.

Pelopidas, the Bœotarch who had been selected to conduct the enterprise, was not deterred by the agitation, and determined to carry out the project by himself at the head of two hundred horsemen, in the conviction that on his appearance the Thessalian soldiers and volunteers would join him in crowds. And his expectation was not disappointed. Even at Pharsalus he found himself in command of such forces that he ventured on storming the line of hills called the "Dogs' heads" (*Cynoscephalæ*), which Alexander held with a far superior army. The ranks of the enemy were already giving way, when Pelopidas, in the passion of victory and revenge, rushed impetuously on the flying tyrant, and, becoming separated from his own men, met his death at the spears of the bodyguard. Maddened by the fall of their brave leader, the Thebans and their companions in arms put renewed energy into the attack and won a complete victory. And as if the honour of this success belonged solely to the dead general, they piled the spoils and weapons of the slaughtered foes beside his corpse, as a monument of the victory, and abandoned themselves to the deepest grief. Many cut off their hair or their horses' manes, many spent the day in their tents without eating or lighting a fire. And as the body was being conducted to Thebes, all the towns along the route manifested their sympathy by mourning celebrations, and in his own native city the great funeral solemnities bore witness to the deep love and honour of the Thebans for the fellow-citizen who had served them so well, who from the glorious days of the Liberation had been always included in the number of the Bœotarchs, whose name was associated with the most famous deeds and the proudest memories, and who had been no less eminent for his chivalrous and magnanimous character than for his heroic spirit and pure patriotism.

The whole army now took the field to avenge his death, and, in conjunction with the Thessalian allies, they soon reduced the tyrant to such straits that he sued for peace, which the victors with more magnanimity than foresight granted him. He had to abandon the towns he had occupied, to confine his dominion to Pheræ and the surrounding district, and to render military service to the Thebans; a compact which neither provided satisfactory security against the repetition of similar encroachments, nor secured a powerful alliance for the Thebans. As in the Peloponnesus, so now there prevailed in Thessaly a condition of distraction and dissolution which was eventually to prepare for the northern conqueror a way into the heart of Hellas.

For seven years longer Alexander continued his nefarious practices, henceforth turning his attention to piracy and the plunder of the islands and coast towns. In the general confusion his audacity went so far that he is said to have once surprised the Piræus in an unguarded hour and carried off a rich booty. Finally, at the instigation of his wife, Thebe, who on a former

[366-362 B.C.]

occasion had excited the imprisoned Pelopidas against her cruel husband, he was murdered by her brothers.

The piratical expeditions with which Alexander afflicted the northern waters, were probably carried out with the knowledge and connivance of Thebes, for the purpose of annoying the Athenians. The latter, especially since their alliance with Sparta, had made the most eager efforts to re-establish their influence over the maritime states, though their means and forces were small and the mercenaries and peltasts who manned their ships little fitted to supply the place of the old citizen army. Iphicrates cruised in the northern waters for the space of three years, attempted to bring back the Greek cities in Thrace and Macedon to their old relation with Athens and made repeated attacks on Amphipolis, but without being able to win back this ancient colony; Timotheus brought Samos into subjection, and, with the help of the revolted Persian governor Ariobarzanes, acquired Sestos and Crithote on the Thracian Chersonesus, whereby the relations with Byzantium were restored, and also won a firm footing in Chalcidice and the Gulf of Thermæ by taking Potidæa and Torone, as well as Methone and Pella. These successes of Athens, though small in comparison with her former dominion over the sea and coasts, and insecure as they were in face of the impossibility of permanently providing the hired troops with pay and maintenance, nevertheless awakened the jealousy of Thebes.

The keen eye of Epaminondas did not fail to perceive that his native city could only attain to the hegemony of Greece if the dominion of the sea were snatched from the Athenians, and being as bold and enterprising as he was sagacious, he endeavoured to persuade his countrymen to build a fleet. Thebes must become a sea power, in order, as he declared before the people, "to place the Propylæa of the Athenian Acropolis under the superintendence of the Cadmea"; not that he wished to accustom the powerful national forces to the seductive life on the sea and thus weaken the heavily-armed militia; the old manner of warfare, which rested on custom, education, and tradition, was to continue to prevail; but for the foundation of a secure ascendancy in Hellas a fleet was indispensable. And so influential was the voice of this great general, that in spite of the remonstrance of the popular orator Meneclidas, the Theban people immediately resolved on the building and equipment of a hundred triremes and the establishment of shipyards of their own.

He undertook the command of the fleet himself, and on his advent the islands of Chios and Rhodes and the important city of Byzantium were induced to fall away from Athens. It was the fatal destiny of Thebes and her patriotic leader, that her appearance had everywhere the effect of simply loosening such federal bonds as still existed and dissolving every force, but without enabling her to herself attain to the height of a great power. No foreign enemy could have found a means so well adapted to break up and enfeeble the Hellenic nation as was the disorganising and disintegrating policy of the Theban general.

THE BATTLE OF MANTINEA AND THE DEATH OF EPAMINONDAS

The Athenians, bitterly incensed against the Thebans by this attack on their maritime supremacy and by the occupation of the town of Oropus on the northeastern frontier, soon found an opportunity to give expression to their resentment by force of arms. In Arcadia the enmity of the supporters

of a democratic state unity, with the Tegeans at their head, against the defenders of the ancient federative organisation on oligarchical principles under the standard of the Mantineans, had reached a high pitch of excitement. This was further aggravated when the Theban governor arrested a number of citizens from Mantinea who were of Laconian sympathies, and were, at Tegea, celebrating the peace recently concluded with Elis, and intended so it was said to take advantage of the opportunity for executing a stratagem which would place the city in the hands of the Spartans: frightened by the threatening attitude of their sympathisers, the governor again set them at liberty; but on complaint being made to Thebes, the aggrieved Arcadians were not granted the desired satisfaction for this breach of the peace, but on the contrary the release of the prisoners was disapproved. On this the Mantineans allied themselves with the Lacedæmonians, Athenians, Achæans, and Eleans and prepared for a struggle against the popular party in Tegea and Megalopolis, and against the Thebans who were approaching for the protection of the latter and the preservation of the frontier against Lacedæmon.

In the spring of 362 Epaminondas and a considerable army, composed of allied Bœotians, Eubœans, Thessalians, etc., marched through Nemea without opposition to Tegea, where he collected around him the troops of the Arcadian, Argive, and Messenian allies, whilst the opposing side assembled its forces in Mantinea. When the Theban general learned that Agesilaus and the Lacedæmonian host were on the way to the meeting-place of their party, and had already reached the town of Pellana on the Arcadian and Laconian frontier, he hastily resolved to advance on Sparta by a night march, and seize the enemy's capital, thus denuded of its defenders "like an empty nest."

The plan would doubtless have succeeded, since only a small number of the citizens had remained behind, had not Agesilaus, hearing of the project from a deserter, despatched a messenger to his son Archidamus, with the command immediately to put the town in a state of defence, while he himself at once set out to return with the cavalry. Thus when Epaminondas approached the banks of the Eurotas, almost at the same time as Agesilaus, he found the town so well watched and guarded that, after a hotly contested battle, he was obliged to retreat with loss. It is true that he managed to penetrate to the market-place, but when he attempted to storm the upper parts of the town, he encountered an obstinate resistance. The inhabitants had torn down their houses and thrown up barricades to bar the approaches. Protected by these dispositions and filled with patriotic enthusiasm, the Spartan citizenship under the guidance of the old king and his son performed prodigies of valour, and gave evidence, as Xenophon says, that no one can easily maintain his ground against despairing men. Even women and children did their part by hurling down stones, utensils, and missiles from the roofs. Isadas, the handsome son of Phœbidas, specially distinguished himself by his heroism and his bold courage. Disappointed in his expectation of surprising Sparta undefended, Epaminondas desisted from the attack, the more readily when he learned that the whole united army of the enemy had started from Mantinea and was hastening to the assistance of the beleaguered town.

He now formed a plan to make up for the failure of the undertaking against Sparta by seizing the town of Mantinea, now denuded of its troops, or at least to make spoil of the stores of grain and herds of cattle collected there. Deceiving the enemy by means of watchfires and a simulated attack, he led the army back to Tegea by a difficult night march. Here he accorded

[362 B.C.]

a brief rest to the wearied infantry, whilst the mounted troops proceeded towards Mantinea. But Epaminondas now learned that fate was against him. The Thebans had already advanced to within seven stadia [nearly a mile] of the town, when they saw the Athenian auxiliaries entering the gates from the opposite side. Hegesilaus, the leader of the Athenian cavalry, was assailed by the prayers of the Mantineans, in alarm for their property; and he at once marched against the enemy, to whom he gave battle under the walls of the town, in a sharp cavalry action, from which the Athenians eventually retired victorious. In this preliminary skirmish at Mantinea fell the brave Athenian leaders, Cephisodorus, and Gryllus, the son of Xenophon. Their memory continued to be held in honour by their fellow-citizens. Gryllus was represented by the painter Euphron in the act of slaying a Theban with his spear, and this circumstance, by a confusion of the previous encounter with the main battle, may have given rise to the story that Epaminondas was slain by Gryllus.

The whole forces of both sides now concentrated in the plain of Mantinea and Tegea, determined to settle the future destiny of Greece by a decisive battle. Epaminondas had pressing reasons for desiring this settlement. The two unsuccessful enterprises, with the strenuous and fruitless marches, were not calculated to enhance his reputation as a general; while a long delay would necessarily weaken the spirit of his soldiers, who adhered to him with such great devotion, and would undermine the prestige of Thebes. Moreover his followers were superior in number to those of the adversary. The size of his army is set down at thirty thousand heavy-armed troops and three thousand cavalry; the enemy's force was smaller by ten thousand hoplites and one thousand mounted men. Faith in Epaminondas had inspired his soldiers with the greatest enthusiasm for the conflict; they eagerly polished their helmets and shields and sharpened their swords and lances, while the Arcadian club-men assumed the Theban ensign.

In the disposition and order of his line of battle, Epaminondas followed much the same plan which had been found to answer so well at Leuctra, only that in order to deceive and make sure of the foe, he caused the troops ranged for the conflict to make a feint of retreating towards the western heights; then, when the enemy, fancying that the encounter would be delayed, began to break up their order of battle, he suddenly made a rapid and vehement attack, so that at the first onset his left wing, where the Thebans and the bravest of the allies had their place, broke the enemy's left, composed of the Spartans and Mantineans. Already the whole wing had begun to waver and plunge into a confused flight; when, at the very moment that he was about to win a complete victory, Epaminondas, pressing boldly forward, was struck in the breast by a spear thrown from the hostile ranks, and with such force that the shaft broke off and the iron remained fixed in the wound.

He was still living when he was carried out of the mêlée; but the fall of their leader shook the spirit and confidence of the troops, and produced such dismay that the advancing column stood still as if paralysed and did not take advantage of its victory. The right wing, composed of the cavalry and peltasts, was overthrown by the opposing Athenians, and thus the battle remained without any decisive issue, though the Thebans retained possession of the field and the Spartans were the first to seek the usual truce for the burial of the dead, a request always looked upon as a token of defeat. Both sides, however, set up memorials of victory. Epaminondas was sorely wounded and the physicians had declared to him that the

withdrawal of the spear would result in his death. From a wooded height he watched the battle, covering the wound with his hand, till his shield, which had been lost in the press, was brought to him and he was informed of the victory of the Thebans. Then he said, "Now it is time to die." He asked for his two brave colleagues, Daiphantus and Iolaidas, and when he learned that they, too, had lost their lives in the battle he advised his fellow-citizens to make peace; and then with a quiet and serene countenance he drew the iron from his breast and delivered up his heroic spirit. His beloved Cephisodorus had fallen at his side and was buried by him on the field of battle. When the friends who stood round him lamented that he left no children, he is reported to have said jestingly, "Am I not leaving you two noble daughters — the battles of Leuctra and Mantinea?"^b

In the last chapter of his *Hellenics*, Xenophon does tardy justice to the genius of Epaminondas, whom he did not even name in his account of Leuctra. In this splendid and Panhellenic struggle at Mantinea, Xenophon lost a son who died bravely and was honoured with a monument by the Mantineans. The father, himself a soldier, has left a less perishable monument in his history, the conclusion of which we quote as follows: ^a



SANDALS WORN BY GREEK SOLDIERS

XENOPHON'S ACCOUNT OF HOW EPAMINONDAS FOUGHT

Epaminondas now reflecting that he must quit Tegea in a few days — as the time allotted for the expedition would soon expire — and that, if he should leave those undefended to whom he came as an ally, they would be besieged and reduced by their enemies and he himself would suffer greatly in reputation — having been repulsed at Sparta with a numerous body of heavy-armed troops, by a handful of men; having been defeated in a cavalry engagement at Mantinea, and having been the cause, by his hostile expedition into the Peloponnesus, of the Lacedæmonians, Arcadians, Achæans, Eleans, and Athenians, forming a union — judged it, on these accounts, impossible for him to withdraw without fighting; for he thought that, if he should conquer, he should cause all his previous failures to be forgotten, and conceived that, if he should die, his death would be glorious in the endeavour to leave the sovereignty of the Peloponnesus to his country. That he should have reasoned thus, appears to me by no means surprising, for such are the reasonings of men ambitious of honour; but that he had so disciplined his army that they sank under no toil, either by night or day, shrank from no danger, and, though they had but scanty provisions, were yet eager to obey, seems to me far more wonderful. For when at last he gave them orders to prepare for battle, the cavalry, at his word, began eagerly to polish their helmets; the heavy-armed troops of the Arcadians marked the clubs on their shields as if they were Thebans, and all the men sharpened their spears and swords, and brightened their bucklers.

[362 B.C.]

After he had led them out thus prepared, it is well to consider how he acted. First of all, as was to be expected, he drew up his forces, and in doing so appeared to give manifest indications that he was preparing for a battle. When his army however was drawn up as he wished, he did not lead it the shortest way towards the enemy, but conducted it towards the mountains on the west and over against Tegea — so as to produce a notion in the enemy that he would not fight that day ; for when he came near the hills, after his main body was drawn out to its full extent, he ordered his men to file their arms at the foot of the heights, so that he appeared to be encamping. By acting in this manner, he slackened the determination for engaging which was in the hearts of most of the enemy, and caused them to quit their posts on the field. But when he had brought up to the front the companies which on the march had been in the wings, and had made the part in which he was posted strong and in the shape of a wedge, he immediately gave orders for his troops to resume their arms, and began to advance, while they followed him. As for the enemy, when they saw the Thebans advancing, contrary to what they had expected, not one of them could remain quiet, but some ran to their posts, some formed themselves in line, others bridled their horses, others put on their breastplates ; yet all were more like men going to suffer some harm than to inflict any on others.

Epaminondas led on his army like a ship of war with its beak directed against the enemy, expecting that wherever he assailed and cut through their ranks he would spread disaster among their whole force ; for he was prepared to settle the contest with the strongest part of his troops ; the weaker he had removed to a distance, knowing that if they were defeated they would cause dismay among his own men and confidence in the enemy. The enemy, on their part, had drawn up their cavalry like a body of heavy-armed infantry, of a close depth, without any foot to support them ; but Epaminondas, on the contrary, had formed of his cavalry a strong wedge-like body, and had posted companies of foot to support them, judging that when he had broken through the cavalry of the enemy, he would have defeated their whole force, since it is hard to find men that will stand when they see some of their own party in flight ; and that the Athenians might not send succour from their left wing to the part of the enemy nearest them, he posted over against them, upon some high grounds, parties of horse and heavy-armed foot, wishing to inspire them with the apprehension that if they stirred to aid others his own troops would attack them in the rear.

Such was the mode in which he commenced the engagement ; nor was he deceived in his expectations ; for, being successful in the part on which he made his attack, he forced the whole body of the enemy to take to flight. But when he himself fell, those who survived him could make no efficient use of their victory ; for though the main body of the enemy fled before them, his heavy-armed troops killed none of them, nor even advanced beyond the spot where the charge took place ; and though the cavalry also retreated, his own cavalry did not pursue, or make any slaughter either of horse or foot, but, like men who had been conquered, slipped away in trepidation amidst their fleeing adversaries. The other parties of foot, indeed, and the peltasts, who had shared in the success of the cavalry, advanced up to the enemy's left wing, as if masters of the field, but there the greater part of them were put to the sword by the Athenians.

When the conflict was ended, the result of it was quite contrary to what all men had expected that it would be ; for as almost the whole of Greece was assembled on the occasion, and arrayed in the field, there was no one

who did not suppose that, if a battle took place, one side would conquer and be masters, and the other be conquered and become subjects; but the divine power so ordered the event, that both parties erected trophies as being victorious, neither side hindering the other in the erection; both parties, as conquerors, restored the dead under a truce, and both parties, as defeated, received them under truce; and neither party, though each asserted the victory to be its own, was seen to gain any more, either in land, or towns, or authority, than it possessed before the battle took place. Indeed there was still greater confusion and disturbance in Greece after the conflict than there had been before it.^c

GROTE'S ESTIMATE OF EPAMINONDAS

Scarcely any character in Grecian history has been judged with so much unanimity as Epaminondas. He has obtained a meed of admiration — from all, sincere and hearty; from some, enthusiastic. Cicero pronounces him to be the first man of Greece. The judgment of Polybius, though not summed up so emphatically in a single epithet, is delivered in a manner hardly less significant and laudatory. Nor was it merely historians or critics who formed this judgment. The best men of action, combining the soldier and the patriot, such as Timoleon and Philopœmen, set before them Epaminondas as their model to copy. The remark has been often made, and suggests itself whenever we speak of Epaminondas, though its full force will be felt only when we come to follow the subsequent history — that with him the dignity and commanding influence of Thebes both began and ended. His period of active political life comprehends sixteen years, from the resurrection of Thebes into a free community, by the expulsion of the Lacedæmonian harmost and garrison, and the subversion of the ruling oligarchy — to the fatal day of Mantinea, 379–362 B.C. His prominent and unparalleled ascendancy belongs to the last eight years, from the victory of Leuctra, 371 B.C. Throughout this whole period, both all that we know and all that we can reasonably divine, fully bear out the judgment of Polybius and Cicero, who had the means of knowing much more. And this too, let it be observed, though Epaminondas is tried by a severe canon; for the chief contemporary witness remaining is one decidedly hostile. Even the philo-Laonian Xenophon finds neither misdeeds nor omissions to reveal in the capital enemy of Sparta — mentions him only to record what is honourable, and manifests the perverting bias mainly by suppressing or slurring over his triumphs. The man whose eloquence bearded Agesilaus at the congress immediately preceding the battle of Leuctra — who in that battle stripped Sparta of her glory, and transferred the wreath to Thebes, who a few months afterwards, not only ravaged all the virgin territory of Laonia, but cut off the best half of it for the restitution of independent Messene, and erected the hostile Arcadian community of Megalopolis on its frontier — the author of these fatal disasters inspires in Xenophon such intolerable chagrin and antipathy, that in the first two he keeps back the name, and in the third, suppresses the thing done. But in the last campaign, preceding the battle of Mantinea, whereby Sparta incurred no positive loss, and where the death of Epaminondas softened every predisposition against him, there was no such violent pressure upon the fidelity of the historian. Accordingly, the concluding chapter of Xenophon's *Hellenica* contains a panegyric, ample and unqualified, upon the military merits of the Theban general; upon his

[379-362 B.C.]

daring enterprise, his comprehensive foresight, his care to avoid unnecessary exposure of soldiers, his excellent discipline, his well-combined tactics, his fertility of aggressive resource in striking at the weak points of the enemy, who content themselves with following and parrying his blows (to use a simile of Demosthenes) like an unskilful pugilist, and only succeed in doing so by signal aid from accident.

The effort of strategic genius — then for the first time devised and applied, of bringing an irresistible force of attack to bear on one point of the hostile line, while the rest of his army was kept comparatively back until the action had been thus decided — is clearly noted by Xenophon, together with its triumphant effect, at the battle of Mantinea; though the very same combination on the field of Leuctra is slurred over in his description, as if it were so commonplace as not to require any mention of the chief with whom it originated. Compare Epaminondas with Agesilaus — how great is the superiority of the first — even in the narrative of Xenophon, the earnest panegyrist of the other! How manifestly are we made to see that nothing except the fatal spear-wound at Mantinea prevented him from reaping the fruit of a series of admirable arrangements, and from becoming arbiter of Peloponnesus, including Sparta herself!

The military merits alone of Epaminondas, had they merely belonged to a general of mercenaries, combined with nothing praiseworthy in other ways, would have stamped him as a man of high and original genius, above every other Greek, antecedent or contemporary. But it is the peculiar excellence of this great man that we are not compelled to borrow from one side of his character in order to compensate deficiencies in another. His splendid military capacity was never prostituted to personal ends — neither to avarice, nor ambition, nor overweening vanity. Poor at the beginning of his life, he left at the end of it not enough to pay his funeral expenses; having despised the many opportunities for enrichment which his position afforded, as well as the richest offers from foreigners. Of ambition he had so little, by natural temperament, that his friends accused him of torpor. But as soon as the perilous exposure of Thebes required it, he displayed as much energy in her defence as the most ambitious of her citizens, without any of that captious exigence, frequent in ambitious men, as to the amount of glorification or deference due to him from his countrymen. And his personal vanity was so faintly kindled, even after the prodigious success at Leuctra, that we find him serving in Thessaly as a private hoplite in the ranks, and in the city as an ædile or inferior street magistrate, under the title of Telearchus. An illustrious specimen of that capacity and good-will, both to command and to be commanded, which Aristotle pronounces to form in their combination the characteristic feature of the worthy citizen. He once incurred the displeasure of his fellow-citizens for his wise and moderate policy in Achaia, which they were ill-judged enough to reverse. We cannot doubt also that he was frequently attacked by political censors and enemies — the condition of eminence in every free state; but neither of these causes ruffled the dignified calmness of his political course. As he never courted popularity by unworthy arts, so he bore unpopularity without murmurs, and without any angry renunciation of patriotic duty.

The mildness of his antipathies against political opponents at home was undeviating; and, what is even more remarkable, amidst the precedents and practice of the Grecian world, his hostility against foreign enemies, Bœotian dissentients, and Theban exiles, was uniformly free from reactionary vengeance. Sufficient proofs have been adduced in the preceding pages of this

rare union of attributes in the same individual—of lofty disinterestedness, not merely as to corrupt gains, but as to the more seductive irritabilities of ambition, combined with a just measure of attachment towards partisans, and unparalleled gentleness towards enemies. His friendship with Pelopidas was never disturbed during the fifteen years of their joint political career—an absence of jealousy signal and creditable to both, though most creditable to Pelopidas, the richer, as well as the inferior man of the two. To both, and to the harmonious co-operation of both, Thebes owed her short-lived splendour and ascendancy. Yet when we compare the one with the other, we not only miss in Pelopidas the transcendent strategic genius and conspicuous eloquence, but even the constant vigilance and prudence, which never deserted his friend. If Pelopidas had had Epaminondas as his companion in Thessaly, he would hardly have trusted himself to the good faith, nor tasted the dungeon, of the Pheræan Alexander; nor would he have rushed forward to certain destruction, in a transport of frenzy, at the view of that hated tyrant in the subsequent battle.

In eloquence, Epaminondas would doubtless have found superiors at Athens; but at Thebes, he had neither equal, nor predecessor, nor successor. Under the new phase into which Thebes passed by the expulsion of the Lacedæmonians out of the Cadmea, such a gift was second in importance only to the great strategic qualities; while the combination of both elevated their possessor into the envoy, the counsellor, the debater, of his country, as well as her minister at war and commander-in-chief. The shame of acknowledging Thebes as leading state in Greece, embodied in the current phrases about Bœotian stupidity, would be sensibly mitigated, when her representative in an assembled congress spoke with the flowing abundance of the Homeric Ulysses, instead of the loud, brief, and hurried bluster of Menelaus. The possession of such eloquence, amidst the uninspiring atmosphere of Thebes, implied far greater mental force than a similar accomplishment would have betokened at Athens. In Epaminondas, it was steadily associated with thought and action—that triple combination of thinking, speaking, and acting which Isocrates and other Athenian sophists set before their hearers as the stock and qualification for meritorious civic life. To the bodily training and soldier-like practice, common to all Thebans, Epaminondas added an ardent intellectual impulse and a range of discussion with the philosophical men around, peculiar to himself.

He was not floated into public life by the accident of birth or wealth, nor hoisted and propped up by oligarchical clubs, nor even determined to it originally by any spontaneous ambition of his own. But the great revolution of 379 B.C., which expelled from Thebes both the Lacedæmonian garrison and the local oligarchy who ruled by its aid, forced him forward by the strongest obligations both of duty and interest; since nothing but an energetic defence could rescue both him and every other free Theban from slavery. It was by the like necessity that the American Revolution, and the first French Revolution, thrust into the front rank the most instructed and capable men of the country, whether ambitious by temperament or not. As the pressure of the time impelled Epaminondas forward, so it also disposed his countrymen to look out for a competent leader wherever he was to be found; and in no other living man could they obtain the same union of the soldier, the general, the orator, and the patriot. Looking through all Grecian history, it is only in Pericles that we find the like many-sided excellence; for though much inferior to Epaminondas as a general, Pericles must be held superior to him as a statesman. But it is alike true of both,

[362-361 B.C.]

and their mark tends much to illustrate the sources of Grecian excellence — that neither sprang exclusively from the school of practice and experience. They both brought to that school minds exercised in the conversation of the most instructed philosophers and sophists accessible to them — trained to varied intellectual combinations and to a larger range of subjects than those that came before the public assembly, familiarised with reasonings which the scrupulous piety of Nicias forswore, and which the devoted military patriotism of Pelopidas disdained.

On one point, the policy recommended by Epaminondas to his countrymen appears of questionable wisdom — his advice to compete with Athens for transmarine and naval power. One cannot recognise in this advice the same accurate estimate of permanent causes — the same long-sighted view of the conditions of strength to Thebes and of weakness to her enemies, which dictated the foundation of Messene and Megalopolis. These two towns, when once founded, took such firm root, that Sparta could not persuade even her own allies to aid in effacing them; a clear proof of the sound reasoning on which their founder had proceeded.

What Epaminondas would have done — whether he would have followed out maxims equally prudent and penetrating, if he had survived the victory of Mantinea — is a point which we cannot pretend to divine. He would have found himself then on a pinnacle of glory, and invested with a plenitude of power, such as no Greek ever held without abusing. But all that we know of Epaminondas justifies the conjecture that he would have been found equal, more than any other Greek, even to this great trial; and that his untimely death shut him out from a future not less honourable to himself, than beneficial to Thebes and to Greece generally.^d

CONFUSION FOLLOWING EPAMINONDAS' FALL

So died Epaminondas — the ablest commander, the noblest citizen, the most stainless character, even if not the greatest statesman, of the Hellenic world. The combination of military ability with civic virtue, of physical prowess with intellectual culture and eloquence, of manly daring with humane feeling, of practical capacity with ideal aspirations, of merit with modesty, of glory with humility, of power with simplicity, has won for him the admiration of succeeding generations as of the whole ancient world. He fell a victim to a deplorable fratricidal war; and cities and citizens, instead of weeping and beating their breasts in penitence over the corpse of the high-hearted man, disputed jealously among themselves the honour of having transfixed his breast with the fatal thrust. But so great was his influence even in death that soon afterwards all the Greek states followed the counsel he had given, and concluded a peace based upon the recognition of the *status quo*. They all needed time for coming to fresh resolutions and collecting fresh forces. Sparta alone held aloof, refusing with obstinate consistency to acknowledge the political independence of Messenia.

Agésilas did not long survive his opponent. A year after the battle of Mantinea he marched to Egypt with an army of mercenaries, accompanied by thirty Spartan citizens, to fight in the service of the rebellious kings Tachus and Nectanebo against the Persians, out of revenge for Messenia's having been declared independent by Artaxerxes. But he obtained little glory. Instead of being appointed commander-in-chief of the fighting forces, as he had hoped, he had to be contented with the position of a

captain of mercenaries. The Egyptians were very much disappointed in their expectations to behold, instead of a knightly king, crowned with glory, an old man of eighty years, infirm, of small stature and poorly dressed, who, devoid of oriental royal dignity and the pomp and ceremonious state of oriental sovereigns, sat down on the grassy ground with his followers, to partake of a meagre repast. After some time he took his departure from the country of the Nile to return by way of Cyrene to his own country, having been royally rewarded by Nectanebo, but without having met the Persians in combat. He died however en route. His mourning companions took the corpse of Agesilaus to bury it in Sparta, the city of his fathers, whose highest power and decline he had witnessed. As regards generalship and magnanimity of disposition, the Spartan king stood far below the Theban citizen, but he equalled him in simplicity of habits and manner of living, in voluntary poverty, in disdain of earthly possessions, and in incorruptible rectitude and ardent patriotism. These were the last bright stars in free Hellas; but while Epaminondas shone forth to the following generations as the model of a high-hearted patriotic general, Agesilaus pointed out to his countrymen the adventurous path of foreign travel and accustomed them to the dishonourable vocation of a mercenary, to which henceforth Sparta's rude citizens abandoned themselves more and more.

The Athenians made better use of their opportunities. As long as Epaminondas lived, their enterprises on the sea were without success; so that several of their generals were condemned to death (as Leosthenes and Callisthenes), or a mulct was imposed upon them (as on Cephisodotus) because they had caused losses to the state on account of their negligence and their unsuccessful undertakings. But after the battle of Mantinea they not only succeeded in driving the Thebans completely away from the sea, but they were again successful in uniting the greatest part of the islands of the Ægean Sea (Eubœa, Chios, Samos, Rhodes, etc.) under their sea-hegemony; in strengthening their sovereignty in Chalcidice and Macedonia and on the Gulf of Thermæ; and, after the murder of the Thracian sovereign Cotys by two youths who had been brought up in Athens, in again bringing the Thracian Chersonesus under their power and opening the sea-route to the fertile coast of the Pontus by way of the Hellespont. As the murderers of a tyrant, the young men of Ænus, who executed this "divine" deed on the person of Cotys, were honoured by the Athenians with the rights of citizens and golden wreaths. But with the good fortune of the Athenians there also returned the old abuses. The dissolute mercenaries, poorly paid, committed acts of extortion and oppression; the sovereign assembly often violated the treaties based on equality of rights, imposed taxes and aids upon the allied cities, divided territories among Attic colonists (cleruchs) and forgot the principles of clemency and moderation which had won so many willing members to their second maritime confederation. Besides, there was a scarcity of able leaders to replace the aging generals, such as Iphicrates, Chabrias, and Timotheus, and there was also a waning of patriotic feeling. Having their own advantage more in mind than the greatness of their city, the generals tried to acquire independent possessions and dominions, an effort which was assisted by the increasing number of the mercenaries, who were taking the place of all the citizen levies. These conditions, combined with the secret intrigues of the Thebans, caused new dissatisfaction and brought about the deplorable social war, which led to the dissolution of the second Athenian maritime confederation at a time when the latter already

[360 B.C.]

comprised about seventy cities, as the disasters of the last years of the Peloponnesian War were the cause of the dissolution of the first.^b

Great changes have taken place in the history of Greece since we left the Athenian soldiers and sailors rotting in the mines of Sicily. A greater change is about to take place. Of this it is only necessary to say the word "Macedonia." Before we trace the rise of these northerners it will be well to glance briefly at the busy circumstances of Sicily.^a



E. W. Barker

GREEK TERRA-COTTA
(In the British Museum)

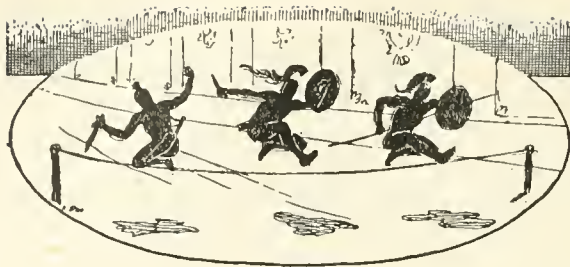

CHAPTER XLVII. THE TYRANTS IN SICILY

THE absence of federation which, in spite of the military superiority of the Greeks, had enabled the king of Persia to become master of Asiatic Greece and arbitrator of European Greece, was about to deliver the whole of Sicily into the hands of the Carthaginians. Segesta, constantly at war with Selinus, called them to its assistance in 410 B.C., as some years previously it had called the Athenians. Carthage was then at the height of its power; it raised an army of one hundred thousand mercenaries, and sent them into Sicily under the command of Hannibal, grandson of that Hamilcar who had been killed in the battle of Himera seventy years before this time. He began by taking possession of Segesta in the name of Carthage, then besieged Selinus, which was taken in 409, after a heroic resistance. All the inhabitants, men and women, old and young, were slain. The town was razed to the ground; the scattered ruins of its temples are still to be seen. Himera was also entirely destroyed. The greater number of the inhabitants had succeeded in escaping before the last assault; about three thousand were left, whom Hannibal put to death by torture in the very spot where his grandfather had fallen.

Two years later he again came to Sicily with Himilco, at the head of 180,000 mercenaries, Libyans, Numidians, Iberians, and Campanians, and laid siege to the large commercial town of Agrigentum, the most important in Sicily, after Syracuse. He caused the tombs to be destroyed for the construction of an embankment; the plague which spread through his army, and of which he himself died, was considered a vengeance of the gods. His colleague, Himilco, offered up children to Moloch as an expiatory sacrifice. The Syracusans, who had come to the help of Agrigentum, completely defeated a body of forty thousand Iberians and Campanians. But the town began to suffer from famine; a large convoy of corn was seized by the Carthaginians. The inhabitants of Agrigentum, spoilt by luxury and incapable of supporting the fatigues of military life, had taken mercenaries into their service; these latter betrayed them and passed over to the enemy. At the end of a siege of six months, most of the inhabitants left the town by night and escaped to Gela. Himilco immediately entered the town and gave it up to pillage, massacred all the inhabitants who were left, and destroyed the buildings which had been erected by the Carthaginian prisoners after the battle of Himera. Magnificent ruins still bear witness to the splendour of Agrigentum, the richest of the Greek cities and one of the most beautiful in the world (406).

Since her victory over the Athenian armies and fleets, Syracuse had become the capital of Sicily. A new code of laws, drawn up by Diocles, had

[410-405 B.C.]

made her constitution still more democratic; magistrates were chosen by vote. Little is known of this legislation, which is said to have been adopted by other Siceliot towns. The chief of the aristocratic party, Hermocrates, who had distinguished himself in the war against the Athenians, commanded the fleet sent by Syracuse to the help of the Peloponnesians and was defeated with them at Cyziens. The Syracusans withdrew from a war in which they had nothing to gain and exiled Hermocrates. He tried to return to his country by armed force and perished in the attempt. Among those who had fought with him was a scribe named Dionysius, who was wounded and left for dead; this circumstance enabled him to escape the sentence of exile which was pronounced on the followers of Hermocrates.

The invasion of the Carthaginians was a cause of fresh dissensions in Syracuse; the destruction of Agrigentum awoke alarm. In the assembly of the people Dionysius accused the generals of having caused, either through incapacity or treason, the misfortunes of Sicily. He was condemned to a fine for factiousness; but a rich townsman, the historian Philistus, promised to pay all the fines laid upon him. He continued to stir up the people and persuaded them to choose a new government, of which he himself was a member. The only thing still wanting was to get rid of his colleagues. "They also are betraying the republic," he said, "and have sold themselves to the Carthaginians." He recalled the exiles in order to make partisans of them. He was sent to Gela to rescue the people from the oppression of the rich; he condemned certain of the nobles to death and distributed their wealth among his soldiers. On his return to Syracuse he saw the people coming out of the theatre: "It is thus that you are deceived," he exclaimed, "they keep you amused by entertainments while the soldiers are without the necessaries of life and the enemy is at our gates. Take back the power you have confided to me; I will not share it with traitors." His friends said: "What honesty! He is the only upright man!" And he was made generalissimo of the troops, whose pay he immediately doubled. Then, as Pisistratus and so many others had done, he declared that there were plots to kill him because he loved the people. A bodyguard was given him of six hundred men; these he increased to a thousand and chose them from among the poorest of the people. He enlisted mercenaries, set the slaves free, filled all the government appointments with men who were devoted to his fortune, and settled in the isle of Ortygia where were situated the arsenals, and which commanded the great port (405).

Now that he had become tyrant through the folly of the people, Dionysius fought the Carthaginians with no more success than the generals whom he had accused of treason. He was able to save neither Gela nor Camarina, and the entire population of these two towns sought refuge in Syracuse. Displeased by these defeats, the Syracusans tried, but all too late, to rise against him. Supported by his mercenaries; he stifled the rebellion, caused some of his enemies to be put to death, drove the others from the town, and maintained his power by fear. A plague stopped the advance of the Carthaginians and induced them to make peace, but they kept all their conquests, that is to say, more than two-thirds of Sicily, in exchange for a clause of the treaty recognising Dionysius as tyrant of Syracuse. He fortified the isle of Ortygia, of which he made a citadel, after driving out the inhabitants so as to make room for his mercenaries. Then he gave the best part of the Syracusan territory to his friends and to the magistrates; the rest was distributed in equal shares between the citizens, the freed slaves and resident foreigners. This alteration of property caused a rebellion; he shut himself up in his fortress of

Ortygia and his mercenaries re-established his authority. Some days later, while the inhabitants were in the fields, busy gathering in the harvest, he had all the houses searched and all weapons removed. When he believed himself absolute master of Syracuse, he wished to extend his rule over the whole of the eastern coast of Sicily. He seized Ætna and Enna, destroyed Naxos and Catana which had been delivered to him by traitors, and sold their inhabitants in order to give their land to the Sicels of the surrounding country and to his Campanian mercenaries. The terrified Leontines opened their gates to him, and were carried to Syracuse. The Rhegians, uneasy at his advance, sent an army into Sicily; but, abandoned by the Messenians, who had at first joined them, they made peace with Dionysius and returned to Italy.

In the meanwhile Dionysius was preparing to revenge himself on the Carthaginians. Syracuse was surrounded by ramparts which made it impregnable. Workmen from all the neighbouring countries, attracted by lure of high wages, were employed to make large supplies of arms and implements of war; it was at this time that the catapult was invented to cast stones and arrows. Numerous warships were built, some of them on a new model with four or five benches of rowers. When these preparations were completed, and mercenaries collected from all sides, Dionysius declared war on the Carthaginians, and, at the head of an army of eighty thousand men, successively re-captured all the towns which they had conquered seven years previously, Gela, Camarina, Agrigentum, Selinus, and Himera, besieged their principal fortress in the isle of Motya on the western point of Sicily, and took it by means of his implements of war (397). But the following year, Himilco landed at Panormus with one hundred thousand men, regained Motya and all the conquests of Dionysius, destroyed Messana, and after a naval victory in sight of Catana, besieged Syracuse by land and sea. Dionysius was obliged to restore to the citizens the arms which he had taken from them, and soon signs of rebellion were again perceived. But once more plague broke out in the Carthaginian army. Himilco paid three hundred talents [£60,000 or \$300,000] for permission to withdraw with the Carthaginian citizens who were in his army, abandoning all his mercenaries who were taken and sold as slaves. Hostilities continued for two years longer and the Carthaginians finally made peace by giving up Tauromenium (392).

This treaty gave Dionysius the opportunity to turn his arms against Magna Græcia, the conquest of which he had long meditated. He took Caulonia, Hipponium, Scylacium, and gave their lands to the Locrians who had made an alliance with him. Croton also fell into his power in spite of a vigorous resistance. Rhegium, which he had besieged for eleven months, finally surrendered; he destroyed the town and sold all the inhabitants. The Syracusan exiles sought refuge on the Adriatic Sea and settled at Ancona (387). Dionysius then ravaged the coasts of Latium and Etruria, where he stole a thousand talents from the temple of Agylla, made alliance with the Gauls who had just taken Rome, enlisted a large number of them among his mercenaries and sent them to the assistance of Sparta which had lately renewed its alliance with Syracuse and was now at war with the Thebans. He founded the town of Lissus in Illyria, and re-established an exiled prince in Epirus. In 383 he made a third war against the Carthaginians; after an alternation of victories and defeats, a treaty was made which fixed the limits of their possessions at the river Ialycus. In a fourth war he took Selinus, Entella, and Eryx, but, his fleet being destroyed opposite Lilybæum, he did not succeed in driving them from the island, and the war again ended in a treaty.

[368-357 B.C.]

In the opinion of the ancients, Dionysius was a type of the godless, avaricious, and suspicious tyrant. In the temple of Zeus, in Syracuse, he replaced by a woollen coat the god's golden coat, which, he said, was too cold in winter and too warm in summer. He stole the gold beard of Æsculapius, saying that the son ought not to have a beard when his father, Apollo, had none. As he was returning with a favourable wind from an expedition in which he had pillaged the temples: "See," he said, "how the gods protect the ungodly."

Numerous anecdotes have been told concerning his perpetual fear: he always wore armour under his clothes; his room was surrounded by a moat which could only be crossed by a drawbridge; when he addressed the people it was from the summit of a tower; he did not dare to be shaved, and his daughters singed off his beard for him with red-hot nutshells; the prisons of the quarries were so arranged that he could hear the least sound. One of his courtiers named Damocles was vaunting the happiness of kings: Dionysius said that he would allow him to enjoy it for one hour; he let him lie on a couch of purple and gold before a well-spread table, and suddenly Damocles perceived above his head a sword suspended by a single hair. This anecdote has all the appearance of a philosophic parable. Those which have been related concerning the literary pretensions of Dionysius are scarcely more trustworthy. It is said that he sent Philoxenus, who found fault with his verses, to the quarries; some time later he had him brought back and read him other verses which he thought better; Philoxenus stood up and said, "Let them take me back to the quarries."

Dionysius had often sent tragedies to the Athenian competitions, but had had little success; however, at the time of the Theban war he had sent mercenaries to the help of the Spartans, then the allies of the Athenians; the latter, therefore, gave the prize to one of his tragedies called *Hector's Ransom*. He celebrated this success by a magnificent feast at which he drank to excess. He was seized with a fever from which he died. Some say that he was poisoned by his son. He had reigned thirty-eight years (367).

Dionysius was a bigamist; he married on the same day a Locrian and a Syracusan, the latter the daughter of one of his most active partisans. The son of the former, named like himself Dionysius, and who is called Dionysius the Younger, succeeded him without difficulty. Dion, the brother of his second wife, had no trouble in taking the direction of the government, for the new tyrant had no thought for anything but pleasure. Dion, a great admirer of Plato, had caused him to come to Sicily during the lifetime of Dionysius the Elder, who received the philosopher somewhat badly and even, it is said, had him sold as a slave. This should have taught Plato that a king's court is not the place for a philosopher; however, after the death of Dionysius and the accession of his son, he returned at the request of Dion, and was very well received by Dionysius the Younger, who took lessons in geometry, and decreased the magnificence of the table, but made no attempt to carry out Plato's communistic theories in Syracuse. After a short time, however, he imagined that Dion was only interesting him in philosophy to distract his attention from public affairs. He intercepted a letter which Dion had written to the Carthaginian generals asking them to address their communications only to himself. Dionysius showed the letter to Dion, accused him of treason, and made him embark for Italy. Plato was unable to obtain his friend's recall. Dionysius even forced his sister Arete, the wife of Dion, to

marry some one else (360). Dion returned three years later with eight hundred men whom he had recruited in Greece and appeared before Syracuse during the absence of Dionysius. The inhabitants received him enthusiastically, but he was unable to seize the citadel of Ortygia (357). Dionysius, defeated in a naval fight, retired to Locris with his riches, but his son Apollocrates remained in the citadel whose garrison held out for a long time. There were disputes in the town; an agrarian law was demanded. Dion was driven away, then recalled, and famine having forced the garrison of Ortygia to surrender, he remained master of Syracuse. Now was the time to re-establish the republic as he had promised; but his love of philosophy did not carry him to the point of renouncing power. He even caused a demagogue to be put to death for having demanded the destruction of the fortress of Ortygia which had been built for the sole purpose of protecting tyranny against the people. A short time after this, he, himself, was assassinated by the Athenian Callippus, his intimate friend (354).

After a reign of two years Callippus was overthrown by Hipparinus and Nysæus, brothers of Dionysius and nephews of Dion. They reigned successively. Then Dionysius, after ten years' absence, seized the city by surprise. But Hicetas, tyrant of the Leontines, forced him to take refuge in the isle of Ortygia. In the midst of this anarchy, and threatened, moreover, by an attack of the Carthaginians, the Syracusans implored help from Corinth, who sent one of her citizens, Timoleon, to the aid of her colony. Timoleon had previously saved the life of his brother Timophanes in a battle. Later on Timophanes had tried to usurp the tyranny at Corinth, and Timoleon joined his brother's murderers. Haunted by his mother's curse and troubled by his conscience, he was living in retirement when the Corinthians entrusted him with the mission of delivering Syracuse from tyranny. He set out with twelve hundred men, and after escaping the Carthaginian fleet, landed at Tauromenium, on the east coast of Sicily. When he reached Syracuse, Dionysius was besieged in his fortress by Hicetas; seeing that he could not defend himself against two enemies at the same time, rather than make terms with Hicetas, he offered to deliver Ortygia up to Timoleon on condition that he should be sent to Corinth with his riches. He lived there for several years, and is said to have opened a school for children, to have at least a similitude of royalty.

Timoleon occupied Ortygia; but his position was difficult, for Hicetas had called the Carthaginians to his assistance, and, under command of Mago, they filled the port with one hundred and fifty vessels and the town with six thousand men. Fortunately Timoleon received from Corinth a reinforcement of ten vessels filled with troops. Catana and other Greek towns along the coast declared for him. Mago, on learning that the Corinthian garrison had succeeded in seizing Achradina, the principal suburb of Syracuse, believed that Hicetas had betrayed him, and feared lest all the Greeks should unite against him. He embarked his soldiers and set sail for Carthage. Hicetas, left with only his own troops, could no longer resist: he returned to Leontini with his army, and Timoleon, without the loss of a single man, was master of Syracuse.

He began by doing what Dion had refused to do; he destroyed the fortress of Ortygia, built on its site courts of justice and restored to power the democratic legislation of Diocles. The town was half deserted; he recalled the exiles, and caused it to be proclaimed at the public games in Greece that Syracuse required colonists. Sixty thousand men answered this appeal. In order to relieve public poverty, he distributed the unoccupied lands to the

[343-337 B.C.]

poor, and sold the statues of the tyrants, except that of Gelo, the conqueror of the Carthaginians. He then turned his attention to the overthrow of tyranny in the other Siceliot towns, and began by forcing Hicetas to live simply as a private citizen. Leptines, tyrant of Engyum, consented to go to the Peloponnesus, as Dionysius had done, for Timoleon was anxious to show the Greeks the tyrants whom he had driven from Sicily. He also seized Apollonia and Entella and restored them their freedom. All the Greek towns sided with him, because he allowed them self-government according to their own inclination. Following their example, several Sicilian and Siceliot towns asked to be admitted into alliance with him.

Terrified by this commencement of a league between the towns, and by the increasing prosperity of Syracuse, the Carthaginians landed seventy thousand men at Lilybæum. Timoleon, who had only succeeded in collecting an army of eleven thousand men, advanced nevertheless against the enemy, whom he surprised on the banks of the brook Crimisus on Selinuntine territory. He established himself in a strong position, attacked the Carthaginians as they were crossing the river, and killed ten thousand of them, of whom three thousand were Carthaginian citizens. He imposed no onerous conditions, for Syracuse was not in a position to carry on a prolonged war: the limits of their territory were fixed at the river Halycus, to the west of Agrigentum, and they agreed to give no more help to the tyrants (338). Timoleon overcame those who were still left; Hicetas, who had again seized the power, was put to death, as were also Mamercus, tyrant of Catana, Hippon, tyrant of Messana, and some others. Timoleon then helped in the rebuilding and re-peopling of the towns destroyed by the Carthaginians, Gela and Agrigentum, for instance, drove from Ætna a band of Campanians, Dionysius' former mercenaries, who had made the town into a retreat for brigands. At last, his work being complete, he abdicated the power. But he always retained the great moral authority; towards the end of his life he became blind, and whenever there was an important discussion he was carried into the market place and his advice was always followed. He died eight years after his arrival in Sicily (337), and the expenses of his funeral were paid from the public treasury. The Syracusans instituted annual games in his honour, "because," said the decree, "he drove away the tyrants, defeated the barbarians, re-peopled the towns, and restored to the Siceliot their laws and institutions." ^b



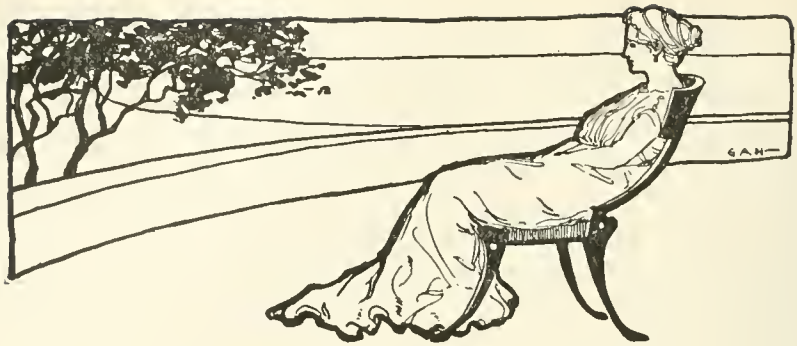

CHAPTER XLVIII. THE RISE OF MACEDONIA

WE have seen that Greece was never a unified nation. There was even dispute, throughout the history of the Greeks as a people, as to just who were included under the caption "Greek." In particular the question rose in reference to the Macedonians when they came to power under the leadership of King Philip, father of Alexander the Great. The Macedonians spoke a dialect of the Greek language, and Philip ardently contended that he and his people were entitled to be considered as true Greeks. The claim was hotly contested so long as the people of Greece, in the narrower sense, had the power to hold out against the man whom they regarded as a usurper; but in the end the claim of Philip received official recognition, and his subjugation of Greece was not regarded as the conquest of a foreigner, but merely as establishing the hegemony of one Greek state over the others, Macedonia now taking that leadership which had been held in turn by Athens, Sparta, and Thebes.

In the broadest view this way of regarding the Macedonians as really Greeks was, perhaps, not illogical. The question of the exact origin of the Hellenes is still much in doubt, but the more the matter is investigated, the more certain it becomes that this wonderful people was a mixed race. Throughout history everywhere, the ethnologist points out that it is the mixed race which develops the greatest potentialities; and the case of Greece is no exception to the rule. One speaks of the Greeks as Aryans, and, therefore, naturally associates them with the Persians and Indians on the one hand and the Germanic races on the other. Yet, in point of fact, it is probably only in relation to their speech that any such close affinity exists. If the theory of the "Mediterranean race" with its central African origin be true, then the Greeks considered ethnologically were much more closely associated with the so-called Hamitic Egyptians and the so-called Semitic Hebrews, Babylonians, Assyrians and Phœnicians, than they were with the other so-called Aryan races.

All discussion of this exact point is still somewhat problematical, but it is quite clear to the most casual physical inspection that the Greek is of a physical type much more closely akin to the dark-skinned and dark-eyed Mediterranean races than to the fair-skinned, blue-eyed, Indo-Germanic tribes. Yet the language of the Greeks is unequivocally of the Indo-Germanic family. Quite possibly, the explanation of this anomaly may be found in the theory of a prehistoric invasion of Greece by a Germanic race from

the north, which mingled with the Mediterranean race already in possession of the soil, and gave to it the elements of the Indo-Germanic language, yet failed to stamp the traits of its physical personality upon the original occupants of the little peninsula. Whoever will, for a moment, consider the known history of the English people as an ethnic race contrasted with the history of the language which they speak, will at once see how very misleading may be any inferences as to racial status based solely upon the English language, were not such checked by other historical sources of information. This is but one case of many that might be given illustrating how philologists have slowly awakened to the fact that inferences based solely upon philological evidence must not be made too confidently in their application to questions of ethnology pure and simple. And so with the case of the Greeks, the fact of their Aryan speech must not blind us to the probability that, as a race, the Hellenes were not closely akin in recent times to the other races speaking Indo-Germanic languages. That the Greeks came to their favoured land from some unknown region and that they found a population there before them which gradually disappeared, presumably by intermingling with the invaders, we have already viewed as a current tradition.

But this is only one item of the evidence which makes it clear that when one uses the word "Greek" he is speaking of a mixed race with no certain proof of common lineage and often with no stronger bond than that supplied by a common language. In one sense, then, whoever spoke the Greek language as his mother tongue was a Greek, whether the place of his nativity were the little peninsula of Greece proper, or an Ægean island, or the coast of Asia Minor, or the island of Sicily, or southern Italy, or Macedonia.

Yet, from another point of view, it is quite clear that the Macedonians were in some respects different in temperament from the typical Greeks and, in particular, from the typical Athenians. One can hardly imagine a Philip or an Alexander as being of Athenian birth. We have learned to revere the Athenian for his culture, his love of the beautiful, his artistic instincts, and exceptionally for his abstract philosophy. But with all this one cannot escape the feeling that, in some sense, the Athenian even of the most brilliant period was a child. He was vain, arrogant, emotional, vacillating; in short, the reverse of all that usually goes to make a great leader or a great political people. The Spartan, to be sure, was more akin to the Macedonian, but rarely indeed did any Spartan show that breadth of political view which characterised Philip and Alexander, and at least the germs of which were latent in a considerable company of their associates and generals. And, indeed, in viewing the Macedonian race as a whole one is forced to the conclusion that here was a sturdier race, of firmer fibre, if also, and perhaps inevitably, of a lower æsthetic plane and a less elaborated culture.

In accordance then as one views the case from one point of view or another, it might be made to appear that Philip was right in claiming that his kingdom was a part of Greece; or that the Athenians were right in combating that claim. But, whatever the theoretical right of the matter, here, as always in the history of nations, Might made the practical or political Right, and the Might lay with Philip. He was a great soldier, and he came at a time when the power of Greece proper had been almost utterly shattered by internal dissensions. Still, it was his desire to effect a peaceful conquest; he sought to rule Greece, but to rule it by diplomacy rather than by the sword, and he well-nigh succeeded. But for the stubborn resistance of Athens, urged on by Demosthenes, he would probably have gained all that he sought without striking a single warlike

blow against the people whom he was pleased to regard as his fellow-Greeks ; but the hostility of Athens at last made an appeal to arms inevitable, and on the field of Charonea Philip proved the sword to be mightier than voice or pen, and effected the utter subjugation of all Greece.

This accomplished, Philip was ready for that invasion of Persia which he had long planned. But, just as his preparations were completed, he was struck down by the hand of an assassin. His ambition was thus cut short, his life-work left unfinished. What he would have accomplished had he lived remains, of course, problematical. He was only in middle life when he fell, and he had already demonstrated that his powers were of the first order, and it is not improbable, had he been permitted to undertake the Asiatic invasion, which he planned, that he would have carried it out successfully. But all comment on such a question as this is, of course, idle. As the case stands, Philip's glory has been almost eclipsed by that of his more brilliant son, and the history of the rise of Macedon seems important to after ages, not so much because it is the history of the overthrow of the Grecian independence, as because it is the history of the preparation for Alexander. The narrative of this preparation we must now view in some detail before passing on to the events of that extraordinary period which has been stamped in history for all time as the Age of Alexander the Great.^a

EARLY HISTORY OF MACEDONIA

Æschylus attributes to King Pelasgus of Argos the statement that the dwellings of his people, named Pelasgians after him, extended to the clear waters of the Strymon, enclosing in their sweep the highlands of Dodona, the district about Pindus, and the wide region of Pæonia. According to the old soldier of Marathon, the inhabitants of the lands watered by the Haliacmon and the Axius were of the same race as those ancient populations which occupied the regions extending from Olympus to the Tænarum, and to the west of Pindus. This high mountain that separates Thessaly from Epirus and the highlands of Dodona forms in its northwestern slope, as far as the Schar-Dagh of ancient Scardus, the wall that divides Macedonia and Illyria, then turns eastward to the source of the Strymon and continues at the left of the river southeastward under the name of Orbelus, till it reaches the coast, thus forming a natural boundary between Macedonia and Pæania, and keeping off the Thracian populations in the east and north. Within this enclosed territory, crossed by the Haliacmon, the Axius with its tributaries, and the Strymon, are a second and third mountain chain which, concentric like that of Pindus-Scardus-Orbelus, enclose the inner coast lands, Pella and Thessalonica. Hemmed in this double circle of valleys, through which break three streams, those of Haliacmon and Axius making their way side by side to the sea, the inhabitants of this district are set apart by nature as forming a sort of hermit race with the lowlands of the coast as their common territorial centre.

According to Herodotus the people, called Dorians at a later period, were crowded out of Thessaly and established themselves near Pindus in the Haliacmon valley, being known there under the name of Macedonians. According to other accounts Argæus, from whom the Macedonians are supposed to descend, came from Argos in Orestis and settled in the region about the source of the Haliacmon, which explains the origin of the name, Argead, given to the house of the king. There are other traditions, widely

received at that time, which assert that three brothers, Heraclidæ of the princely Argive race that sprang from Temenus, travelled north to Illyria, then penetrated into Macedonia and settled at Edessa, close to the mighty falls which mark the entrance of the waters into the fruitful coast lands. In Edessa, also called Ægæ, Perdiccas, youngest of the three brothers, founded the kingdom that was to include in its steady growth and unite in the name of Macedonia the neighbouring districts of Emathia, Mygdonia, Bottia, Pieria, and Amphaxitis.

They belonged to the same Pelasgic race that once peopled all the Hellenic land; but were looked upon by the Hellenes, to whose degree of cultivation they by no means attained, as nothing more than barbarians or semi-barbarians. The religion of the Macedonians and their customs, attest this common origin; and although on the frontiers there was some intermingling with Thracians and Illyrians, the Macedonian speech resembled strongly the older Hellenic dialects.

Up to a very late day the *hetæri* were retained in the Macedonian system of warfare. Entering the land, as they indubitably did, with the founding of the kingdom, the Macedonian Heraclidæ met the same fate as their forerunners in the Peloponnesus, who, immigrants in a foreign land, were under the necessity of establishing right and might for themselves by the complete overthrow of the native

power; with the only difference that here, more than in other Doric lands, the mingling of old and new traits formed a whole, which, retaining the vigour as well as the rough moroseness of the forefathers, presented a picture of heroic times in its least poetic aspect. Certain of the customs were like those of the ancient Franks; the warrior who had never slain a foe must wear the halter about his neck; the hunter who had never brought down a wild boar on the run must sit at the banquet, not recline. At the burning of a dead body the daughter of the deceased was the one designated to extinguish the flames of the pyre after the corpse was consumed; it is also related that the trophies won by Perdiccas in his first victory over the native tribes were torn, in obedience to the will of the gods, by a lion as a sign that friends had been gained, not enemies defeated; and it ever after remained a Macedonian custom never to erect trophies on defeating a foe, whether Hellenic or barbarian, a custom observed by both Philip after Chæronea, and Alexander after the conquest of the Persians and Hindus.

The throne belonged by hereditary right to the reigning race, but the succession was not always so clearly fixed as to exclude all doubt or dispute. The greater the power wielded by royalty, the greater were the wisdom and ability made necessary on the part of those in whom it was vested, and it only too frequently happened that an indolent, incapable minor had to yield the throne in favour of his able brother or cousin.

There was still another danger. Numerous examples show that to the younger sons of kings, also to aliens, portions of the land were yielded over



MEDALLION OF PHILIP II

to become hereditary possessions, under suzerainty of the king, it is true, but with such princely privileges and control that the owners were at liberty to maintain troops of their own. Arrhidæus, the younger brother of the first Alexander, had thus come into possession of the principality of Elymiotis in the upper part of the country, which descended from generation to generation of his race; and to Perdiccas' brother Philip was given an estate on the upper Axius. The kingdom could not gain in power so long as these princely lines were not under complete subjection, and so long as the Pæones, the Agrians, and the Lyncestæ supported them by establishing independent princes on their borders. Alexander I appears to have been the first to force the Lyncestæ, the Pæones, the Orestæ, and the Tymphæi to recognise the Macedonian supremacy, but the princes of those races retained their rank and all their princely possessions.

Of the constitution and administration of Macedonia too little has been handed down to enable us to judge accurately of the extent of the king's power; but when we are told that King Archelaus, during the last decade of the Peloponnesian War, brought into use an entire new set of regulations, that Philip II, in order to make uniform the currency of his realm, instituted throughout an improved system of coinage and also brought about a complete reform in military affairs, we cannot but conclude that to the kingdom belonged a power both great and widespread. Certainly habit and custom had a great deal to do with establishing right and made up for the deficiencies of the constitution. It can be said of the Macedonian rule that it as little resembled that of Asiatic despotism as its people were far removed from the bondage of slavery. "Macedonians are free men," says an ancient writer. Not penestæ like the mass of the populations of Thessaly, not helots like the Spartans, they were a peasant race, holding independent and hereditary property and possessing a common system of laws and local courts, but all bound to give military service when called upon by the king of the land. Even at a later period the military forces were still held to be a union of the general population, with a place in the public assemblies, councils, and courts of law.

In this army a numerous aristocracy came prominently to the front under the name of *hetæri*, or "companions of war," as they are called in the songs of Homer. The members of this class can scarcely be designated as nobles, since the distinguishing marks of their condition were simply large possessions, noble origin, and a close connection with the person of the king, who always rewarded their faithful service with presents and honours. Neither did the families of those princely lines that formerly held independent possessions in the upper country and retained them even after coming under the suzerainty of the more powerful Macedonian kingdom hold aloof, but with their followers submitted themselves to the conditions that prevailed in the kingdom. Large cities, in the Hellenic sense of the word, were not to be found in these lands peopled by aristocrats and peasants; the settlements of the coast were independent Hellenic colonies, in striking contrast to the settlements of the interior.

About the time of the Persian War, under the reign of the first Alexander, there began to appear unmistakable signs of an understanding between Macedonia and Greece. Already Alexander's father had given refuge to Hippias, son of Pisistratus, after his flight from Athens, and had bestowed upon him lands in the Macedonian domain. Alexander himself, being obliged to follow the Persian army into Hellas, had exerted every means in his power—notably at the battle of Plataæ—to assist the Greeks; and by reason of

[479-390 B.C.]

his descent from the Teminedians of Argos, which procured him admission to the Olympian games, had been declared a Hellene.

Like him, Alexander's immediate successors applied themselves with varying energy and ability to bringing their country into the closest possible touch with the trade, the political life, and the culture of the Greeks. The proximity of the rich commercial colonies of Chalcidice, that brought them into close and frequent relations with the main powers of Hellas, who, continually at war with each other, sought or feared the Macedonian influence; the almost constant, internal strife with which Hellas herself was torn and which drove many distinguished men from home to seek peace and honour at the wealthy court of Pella — were causes which acted powerfully to promote Macedonia's advance.

Particularly rich in progress and events was the reign of Archelaus. Though the rest of Hellas was torn and distracted by the Peloponnesian War, under his able guidance Macedonia made constant strides forward. He built fortresses, which the land had previously lacked, laid out streets, and developed the organisation of the army, "accomplishing," says Thucydides, "more for the good of Macedonia than all the eight kings that had preceded him." He founded festival games patterned after those of Hellas at Dion, not far from the grave of Orpheus, at which homage was paid to Olympian Zeus and the Muses. His court, the rallying-point of poets and artists and the common centre for all the Macedonian aristocracy, was a model for the growth of the entire race, and Archelaus himself passed in the eyes of his contemporaries for the richest and most fortunate of men.

Upon the reign of Archelaus followed a period of intensified internal strife, brought about probably by a reaction against the innovations introduced by the growing royal power and directed against the new customs and culture instituted by the court. These modern tendencies found, as was natural, their chief supporters among the princely families and a portion of the *hetæri*, and were furthered by the politics of the leading Hellenic states, whereas the mass of the people, it appears, were quite indifferent to the advantages they offered.

Even in King Archelaus' time there had been an uprising led by the Lyncestian prince Arrhibæus, in concert with the Elymean Sirrhas, either to avenge the removal of the rightful heir to the throne, or to support the claim of Amyntas, the son of Arrhidæus who was grandson to the Amyntas whom Perdiccas caused to disappear. Archelaus had obtained peace by giving his elder daughter in marriage to Sirrhas, and his younger to Amyntas. He was killed, according to tradition, while on a hunting expedition. His son Orestes, who was a minor, succeeded him under the regency of Æropus, but the regent murdered Orestes, and himself became king. Æropus was undoubtedly the son of that Arrhibæus who belonged to the Bacchiadæ line of Lyncestians settled on the borders of Illyria that had so frequently aided his forefathers in their uprisings against the Macedonian kings. The conduct of Æropus and of his sons and grandsons during the next sixty years shows them to have persistently opposed the new monarchical tendencies of the royal house, and to have steadily upheld the laxer system of former times. The constant succession of revolts and the frequent changes of sovereigns that followed are proof of the struggles that were constantly being waged between the members of the royal line and the particularist party.

Æropus was well able to uphold the dignity of his rank, but at his death in 392 Amyntas took possession of the throne; he was murdered by Derdas in 391 and Æropus' son, Pausanias, became king. He was deposed in his

turn by that Amyntas, son of Arrhidæus (390-369 B.C.), in whose person the oldest line of the royal house came again into its rights.

The years of his reign were marked by internal disorders that made Macedonia ready to fall an easy prey to any attack. Summoned possibly by the Lyncestians, the Illyrians broke into the land and devastated it, defeated the army of the king, and forced the king himself to take flight beyond the borders. Argæus had been on the throne two years, whether he was Pausanias' brother or a Lyncestian remains undecided. But aided by Thessaly Amyntas returned, and regained the kingdom, which he found in wretched plight, all the cities and coast lands being in the power of the Olynthians, while even Pella had shut its doors against the king.

There followed as a result of the Peace of Antalcidas, the expedition of the Spartans against Olynthus, which was joined by Amyntas, also by Derdas, prince of Elimeia, with four hundred horsemen. But success was not so easy as had been anticipated, and Derdas was taken prisoner. When Olynthus was finally subdued (380 B.C.), Thebes rose in revolt, and Sparta was defeated at Naxos and at Leuctra. Olynthus renewed the Chalcidian alliance; and Jason of Pheræ, uniting the Thessalian powers, compelled Amyntas III to enter his alliance. On the threshold of a brilliant success Jason was assassinated (370 B.C.). The irresolute Amyntas had not succeeded in upholding his sovereignty, and a little later he died. He was succeeded by the oldest of his three sons, Alexander II, who was soon brought by his mother, the Elymean, to an untimely end. She had for long been carrying on a secret love intrigue with Ptolemæus, of uncertain lineage, who was the husband of her daughter. She persuaded him, during an absence of Alexander in Thessaly, to take up arms against Alexander on his return, and the Thebans rushed to join the movement, it being necessary to impair Macedonia's power before she could gain further victories in Thessaly. Pelopidas arranged a compromise whereby thirty of Alexander's pages were placed as hostages and Ptolemæus received a part-principality, the name of which he assumed. This compromise seemed to be effected only to hasten the downfall of the king, who was assassinated during the course of a festival dance. His mother bestowed her hand upon the murderer, also the throne, to which he acceded under the name of guardian over the two younger sons, Perdicas and Philippus (368-365 B.C.).

Summoned from Chalcidice Pausanias, called "of the kingly line," though to which branch of the royal family he belonged cannot be ascertained, commenced a vigorous campaign against the regent. His success was immediate; Eurydice fled with her two sons to Iphicrates, who was stationed with an Attic fleet in neighbouring waters, and he finally put down the revolt. Still Ptolemæus' position had not been rendered more secure; the murder of Alexander was a breach of the agreement with Thebes, and the friends of the murdered king applied to Pelopidas, who advanced with a hastily gathered army. But Ptolemæus' gold brought disaffection in the ranks, and Pelopidas was obliged to content himself with making a new agreement with the king. Ptolemæus placed his son Philoxenus and fifty hetæri as hostages for his good faith; this was perhaps the motive that brought Philippus to Thebes.

When he reached manhood Perdicas III avenged the death of his brother by causing the assassination of the usurper. To escape the influence of Thebes he devoted himself to the cause of Athens, fighting bravely against the Olynthians by the side of Timotheus. But about this time the Illyrians, doubtless at the instigation of the Lyncestians, came pouring over the borders. Perdicas made a successful stand against this invasion, but in

[360-350 B.C.]

a desperate battle he and four hundred others lost their lives. The whole country was now devastated by the Illyrians, and laid open to the invasion of the Pæonians on the north.

This was the situation when Philip, representing Perdiccas' son Amyntas, who was not yet of age, took command of the army in 359. He had been established in Macedonia since the death of Ptolemæus, having received a part-principality in consequence of a compromise to which Perdiccas had been advised by Plato, and the troops he already had about him formed a nucleus of support. The Illyrians and the Pæonians had already entered the land, and added to them were the former pretenders to the throne, Argæus, and Pausanias from Athens, with the support of the Thracian princes, and three illegitimate sons of his father, who also advanced claims to the throne. Backed by the sympathy and support of the entire country, Philip was equal to the first great emergencies; by the exercise of foresight, skill, and resolution, he rescued the land from the invaders, the throne from its false claimants, and the royal line from fresh intrigues and disasters. And when the Athenians, who had committed the folly of turning their back on him as thanks for his recognition of their claims on Amphipolis, became alarmed at his successes and formed with Grabos the Illyrian, Lyppæus, the Pæonian, and Cetriporis, the Thracian, an offensive and defensive alliance aiming to break Macedonia's might before it became thoroughly established, Philip—having already taken Amphipolis and won over its inhabitants—proceeded rapidly to the frontiers and soon brought the barbarians, who were by no means ready for the conflict, under subjection.

About 356, the frontiers were made secure against barbarian invasion for many years to come. Not long after this all the different intriguing parties had vanished from the court. Of the Lyncestians, Ptolemæus and Eurydice were dead; one of Æropus' sons, Alexander, later became established at court by reason of his marriage with the daughter of the faithful Antipater; the remaining two sons, Heromenes and Arrhibæus, were received into favour by others high in station, and Arrhibæus' two sons, Neoptolemus and Amyntas, were brought up at court. The two pretenders, Argæus and Pausanias, disappear about this time from historical accounts. The rightful heir to the throne, Perdiccas' son Amyntas, in whose name Philip had at first carried on the sovereignty, was secured to Philip's cause by marriage to his daughter, Cynane.

PHILIP THE ORGANISER

Thus Macedonia, under the rule of a prince who had dexterously and systematically developed and employed her resources, had risen to the height where at last she might entertain the thought of issuing forth, and, at the head of united Greece, entering the lists against the Persian might. In the historical accounts that lie before us the forces that were actually at work to produce Philip's astonishing success seem curiously to be lost sight of. Though the writers follow, through all its cleverly planned movements, the hand that seized and drew into its owner's possession all the Greek states one after another, they leave us in the dark as to every detail concerning the personality to which that hand belonged, and to which it owed its strength and firmness. Gold which they always show the hand to dispense at exactly the right moment, seems to be about the only means of effecting his purposes that they attribute to Philip.

On looking closely into the inner life of the state two events stand forth that, arising from earlier causes, were made to yield their full significance by Philip, and in reality formed the basis of his power.

"My father," said Arrian's Alexander to the mutinous Macedonians at Opis in 324, "took you under his protection when he was king, and you, destitute and clad in skins, wandered here from your mountains where you had tended your flocks of sheep that you could with difficulty protect against the Illyrians, the Thracians, and the Triballi; he gave you the chlamys of the soldiers and led you down into the plain, where he trained you to be the equal of the barbarian in the fight." Every man capable of bearing arms had always indeed come forward in time of war, but only to return to his hearth or plough when the need of his services was at an end. The dangers by which Philip was beset when he first assumed the rule, the attacks against which he had to protect a land that was menaced on all sides, gave rise to a measure that, already set on foot in Archelaus' reign, might have averted much of the subsequent internal strife, had it been brought to full development. On the basis of the duty owed by every man to his country in time of war, Philip brought into existence a standing army of native forces that, constantly increasing in size and strength, finally came to number forty thousand men.

MILITARY DISCIPLINE

Not only did Philip form this army, but he brought it up to a high standard of discipline and efficiency. It is related that, to the great displeasure of the lazy, he did away with the baggage-wagon of the foot-soldiers, and allowed but one groom to each horseman; also that he often, even in the heat of summer, organised marches of twenty-five miles or more, carrying provisions and accoutrements for several days. So severe was Philip's discipline that in the war of 338 two officers of high rank who introduced a lute-player into the camp were immediately cashiered. In the service itself the strictest obedience was demanded from subordinates to superiors, and the system of advancement was based solely on the recognition of experience and merit.

The benefits of this military constitution soon became apparent. A feeling was aroused in the various provinces and dependencies of the realm that they formed part of an organic whole, and that Macedonia had risen to the dignity of a nation. Above all, in their unity and the confidence inspired by this military system, the Macedonian races had the consciousness of possessing great efficiency in war, and an ethical strength resulting from a firm social organisation at the head of which was the king himself. The peasant population of this kingdom provided the king with hardy, tractable material from which to form his soldiers, and the nobility furnished in the *hetæri* higher military officials that were distinguished for zeal and a sense of the dignity of their calling. It was natural that an army of this kind should prove vastly superior to the bodies of mercenaries, or even the citizen troops employed by the Hellenic states; and that a people of this physical freshness and vigour should possess a decided advantage over Greek populations whose powers had deteriorated through too close a study of democracy, or from the evil effects of city life. Favoured by fortune in this respect, Macedonia had been enabled to retain her earlier qualities until such time as they should be needed for some great task; and in the conflicts between the king and the aristocracy she had, contrary to the example given by Hellas



F. B. MASTERS

PHILIP AND HIS SOLDIERS

[380-356 B.C.]

centuries before, let the victory fall to the king. Indeed, this sovereignty over a free and powerful peasant race, this military monarchy, guided the people in the direction, and made them assume the form and power, marked out by the democrats in Hellas, who had not, however, been able to bring their plans to realisation.

MACEDONIAN CULTURE

On the other hand education, the most marked result of Hellenic civilisation, must now be made a part of the life of the Macedonian people, thus completing the work already begun by former rulers. In this endeavour the example offered by the court was of utmost importance, the nobility naturally forming the class of highest culture in the land. The demarcation thus made had no parallel elsewhere, inasmuch as the Spartans were all uncultured, and yet had supremacy over the inferior classes of their nation; the free Athenians held themselves all to be without exception of the highest culture; while other states, having given up the ruling class or the introduction of a democracy, had, by emphasising the difference between rich and poor, reduced still lower the general intellectual standard.

In the time of Epaminondas, Philip had lived in Thebes, where a pupil of Plato, Euphræus of Oreus, had exercised a potent influence over his future life. Isocrates calls Philip himself a friend of literature and education, and this esteem is proved by his appointment of Aristotle to the post of tutor to his son. He endeavoured by instructive lectures, instituted especially for the pages and young men about his court, to strengthen their attachment to his person, and to prepare them for the duties devolving upon nobles in their high position. The members of the aristocracy, first as pages, then as hetæri, or bodyguard of the king, and finally as commanders of the different divisions of the army, or as ambassadors to the Hellenic states, had frequent enough occasion to distinguish themselves and receive the reward due to faithful service; but a lack of that polish admired by the king and possessed by him in a high degree was everywhere noticeable. His bitterest adversary must admit that Athens herself could scarcely show his equal in social qualities; and whatever might be the tendency to perpetuate at his court the old Macedonian habits of brawling and drunkenness, the court festivals, receptions to foreign ambassadors, and celebration of national games, were all characterised by that splendour and magnificence dear to the Hellenic taste. The extent of the royal domains, the revenues from land taxes and shipping duties, the mines of Pangea, which yielded one thousand talents annually, and above all the order and economy introduced by Philip into the management of public affairs, elevated his kingdom to a position never before attained by any Hellenic state, save perhaps Athens in the time of Pericles.

Even the Attic envoys were impressed by the character of the nobility gathered at the court of Pella, and by the opulence and military splendour that prevailed. Most of the noble families, such as the Bacchiadæ of Lyncestis, or the house of Polysperchon, or of Orontes, to whom the district of Orestis seems to have belonged, were of princely origin. To Perdicas, the oldest son of Orontes, was given the command of the Orestian phalanx, which when he became hipparch passed over to his brother Alcetas. The most important of these princely houses was that of Eliinea, which was founded by Derdas in the time of the Peloponnesian War. In the year 380, a second Derdas came into possession of the land and joined Amyntas

of Macedonia and the Spartans in their attack on Olynthus; later he is mentioned as having been taken captive by the Olynthians. Philip's motive for taking Derdas' sister, Phila, to wife was either to bind Derdas' interests faster to his own or to arrange some dispute that had arisen between them. The brothers of Derdas, Machatas and Harpalus, were given high offices at court. Yet the breach between Philip and this family was never completely healed, being kept open doubtless by the king, for the purpose of keeping the different members at a distance and in uncertainty as to his favour. Scarcely could Machatas be sure of a just decision in the court presided over by the king, and Philip took advantage of a fault committed by a single member of Derdas' family to turn it to the public confusion of the rest, repulsing with considerable sharpness all Harpalus' pleas in his kinsman's favour.

Among the noble families gathered about the court of Pella, two from their prominence deserve especial mention; these were the houses of Iollas and Philotas. Philotas' son was that wise and faithful general, Parmenion, to whose command Philip repeatedly entrusted the most difficult expeditions. To him Philip owed his victory over the Dardanians in 356, and later his possession of Eubœa. Parmenion's brothers, Asander and Agathon, as also his sons, Philotas, Nicanor, and Hector, carried on the glory of his name, and his daughters contracted marriages with the highest families of the land; one with Cœnus, the leader of the Phalanx, and the other with Attalus, the uncle of a later wife of the king. That a no less honourable and influential post was assigned to Iollas' son, Antipater, or as he was called by the Macedonians, Antipas, is attested by the king's words, "I have slept in peace — Antipas was on guard." The tried fidelity of this statesman, his clear, cool judgment in military as well as political affairs, seemed to single him out as particularly qualified for the high position of viceregent he was soon to fill. He gave his daughter in marriage to the son of a noble Lyncestian family, as being the surest means of gaining their support; his sons, Cassander, Archias, and Iollas, did not attain prominence till later.

Similar to the development of the court was that of the Macedonian nation under Philip's rule; but to this statement we will add that, owing as much to the position formerly held by the state as to the power of Philip's personality, the monarchical element of necessity predominated in the political life of the country. We must first consider all the facts in their relation to each other before we can fully understand Philip's character and methods of procedure. At the centre of a mass of contradictions and disparities of the most unusual nature, a Greek in his relations to his own people, a Macedonian to the Greeks, he exceeded the latter in Hellenic craft and perfidy, and the former in directness and vigour, while he was superior to both in grasp of purpose, in the logical pursuance of his plans, in reticence, and in rapidity of execution. He was proficient in the art of embarrassing his adversaries, always presenting himself before them under a different aspect, and advancing upon them from a different direction from that expected. By nature voluptuous and pleasure-loving, he was as reckless in the indulgence of his appetites as he was inconstant, remaining withal perfect master of himself even when seeming most under the sway of passion; indeed, it is to be questioned whether it was in his virtues or his faults that his true nature was most prominently displayed. In him are united, as are the physical features of a portrait, all the different characteristics of his time — the shrewdness, the polish, the frivolity, coupled with great suppleness and versatility, and the capacity for high thoughts.

[359-336 B.C.]

OLYMPIAS, MOTHER OF ALEXANDER

In striking contrast to that of Philip was the character of Olympias, his wife. She was the daughter of Neoptolemus, the Epirot king, and having known her in his youth at Samothrace, Philip had married her with the consent of her uncle and guardian, Arymbas. Beautiful, reserved, passionate, Olympias was a devotee of the secret rites of Orpheus and Bacchus, and practised in the magical arts of Thracian women. During nocturnal orgies, it is related, she was frequently to be seen rushing through mountain paths with the thyrsus and winding serpents in her hand; and in her dreams were repeated the fantastic pictures with which her brain was filled. The night before her marriage she dreamed, according to tradition, that she was exposed to the fury of a terrific storm, during which a burning thunder-bolt fell into her lap which, flaming up ever higher and higher, finally disappeared in its own wild blaze.

When tradition further relates that among other signs given on the night of Alexander's birth the temple of Artemis in Ephesus, which, with

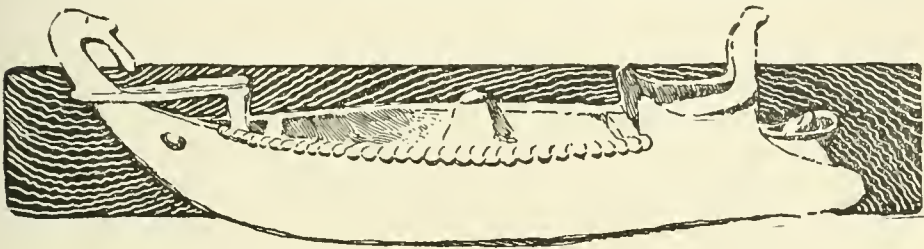

BRONZE MODEL OF A GRECIAN BOAT

Megabyzus and his eunuchs and the hieroduli of the Hellenes formed a striking example of true oriental heathenism, was burned to the ground; and that simultaneously with the information of the birth of his son, Philip received the news of a triple victory — it simply expresses in popular form the significance of a hero's entrance into the world, and the great thoughts associated with such an event.

Theopompus says of Philip, "Everything considered, Europe has never produced a man that could equal the son of Amyntas." Yet the work that he had set as the aim of his existence was not accomplished by the scheming, resolute, tenacious king. He may have used this aspiration, it having root in the very nature of Greece's history and culture, to bring into union the whole Greek world; but he was compelled rather by the exigencies of the situation in which he was placed than by the inherent power of the inspiration itself, and failed to follow it out to full fruition. Beyond the sea was the land wherein lay greatness and the future of Macedonia; but the glance that he strained towards this land would often become dimmed, and the solid structure of his plans be obscured under the airy figures of his desire. Philip's ambition to accomplish a great work was shared by all about him, both the aristocracy and the common people; it was the undertone that was heard through every phrase of Macedonian life, the alluring possibility that was continually beckoning out of the future. The Macedonian armies fought against the Thracians and gained victories over the Greeks; but the Orient was the real object for which they fought and conquered.^b

THE MACEDONIAN PHALANX

The Spartans had created a system of tactics, that is, a military ordinance, which was adopted by all the other Greeks. The Thebans added to it the system of compact masses, the advantage of which was demonstrated by the victory of Leuctra. Philip, formed in the school of Epaminondas, perfected this system and made of it the Macedonian phalanx, which Plutarch compared to a monstrous beast bristling with iron. It was a mass of hoplites, sixteen files deep, pressed close against each other and armed with a sort of pike seven yards long, called *sarissa*. The men in the first five ranks held this weapon in both hands, their faces turned to the enemy. The pikes of the first rank extended five yards beyond the line of battle, those of the second, four, and so on to the fifth, whose lance ends were also a yard beyond the breasts of the men next behind. The remaining ranks pressed forward against the first and prevented their retreating, holding their *sarissæ* with the points upward, resting upon the shoulders of the men in front, and this wilderness of spears effectually warded off the darts of the enemy. Irresistible on level ground, but without ability to make a quick change of front or a rapid evolution, this cumbersome body of infantry was supported in the rear and on the flanks by the light infantry of peltasts, who commenced the conflict.

Before and at the sides ran the archers and frondeurs, an irregular troop composed of strangers, who, when need came, closed in behind the wings. The cavalry of the *hetæria*, or companions of the king, armed with a javelin and a sabre and formed of young men belonging to the highest nobility, constituted, with the phalanx, the principal force of the Macedonian armies. There was further a body of light cavalry and a corps of engineers attached to the service of the siege artillery, which consisted of balists and catapults, recently invented machines for the purpose of firing darts at the enemy and boulders against the ramparts of towns. The establishment of a permanent army was Philip's most important military innovation. Under Philip's weak predecessors the multiplicity of pretenders to the throne had rendered the nobles fractious and virtually independent; but they had under them neither *penestæ* as in Thessaly, nor a *helot* as in Sparta.

Without openly abolishing the ancient privileges, Philip contrived to make them inoffensive by transferring them to the army, where there was always a military and political council. The nobles were little by little induced to leave their estates, and were held permanently at court by the attraction of pleasure and high appointments. It was held an honour among them to have their sons received in the corps of the *hetæria*, and these young members of the king's bodyguard, fulfilling domestic offices about his person, were in reality hostages delivered over into his hands. "Never," says Titus Livius, "were seen slaves so servile in the presence of the master, so arrogant elsewhere."

As regards the common people, nothing whatever was changed in their condition. They had never, as in Greece, formed a political body, and there was no Macedonian city. Apparently everything took place by popular consent, but the army was the Macedonian people. Philip frequently harangued his troops; a proceeding that offered no danger, since the soldiers of a bellicose chief never withhold from him their approbation. Macedonia was a nation of soldiers; hence its government, maintaining a permanent army and engaged in perpetual wars, could be none other than a military monarchy.

[358-357 B.C.]

THE WAXING OF PHILIP

As soon as he had made his kingdom safe from the attacks of barbarians, Philip wished to extend his dominion to the sea, access to which was closed by the Grecian colonies. Some of these had ranged themselves under the protection of Athens, others under that of Olynthus. Amphipolis was independent; Olynthus and Athens had an equal interest in preserving this independence and Philip himself had formally recognised it; nevertheless it was decided not to hold to this obligation, but to seize Amphipolis. It was necessary to prevent the Olynthians and Athenians from uniting for its defence, and in this endeavour Philip made use of wile, he possessing, even in a greater degree than Lysander, the combined qualities of the fox and the lion. He persuaded the Athenians that his only desire in taking Amphipolis was to deliver it to them in exchange for Pydna, a Macedonian town which had placed itself under their protection. At the same time he made sure of the neutrality of the Olynthians, and even obtained help from them by delivering to them Anthemus, and by promising them Potidæa, which belonged to the Athenians. The latter, over-confident of his good faith, did not respond to the appeal of Amphipolis for help. Philip took the town, and afterwards treacherously entered and took Pydna, keeping them both. The Athenians had been outdone, but they could not seek vengeance for this perfidy, as they were engaged at the time in the war of the allies, and had need of all their forces to carry it to an end. This encouraged Philip to take another step; he seized Potidæa, which was occupied by an Athenian garrison, politely sent back the garrison to Athens, and delivered the town to the Olynthians, whom he wished to place in a position of conflicting interests towards the Athenians (357).

Master of Amphipolis, Philip crossed the Strymon with the intention of possessing himself of the mining region of Mount Pangea. He founded there upon the site of the ancient Thasian city Crenides, a new town which he called Philippi, upon the money of which was imprinted the head of Hercules, ancestor of the Macedonian kings. The city of Philippi was at once a military post, the entrance to Thrace, and a centre of exploitation for the mines of Mount Pangea. These mines, far better operated than they had been by the Thasians and Athenians, furnished Philip with an annual revenue of a thousand talents, [£200,000 or \$1,000,000] out of which he made the handsome gold coins which bear his name. This source of riches which enabled him to support his army and to buy traitors in the Greek cities, contributed to his greatness at least as much as the phalanx. He declared that no city was impregnable into which could be driven a mule laden with gold pieces.^c



GREEK MASKS

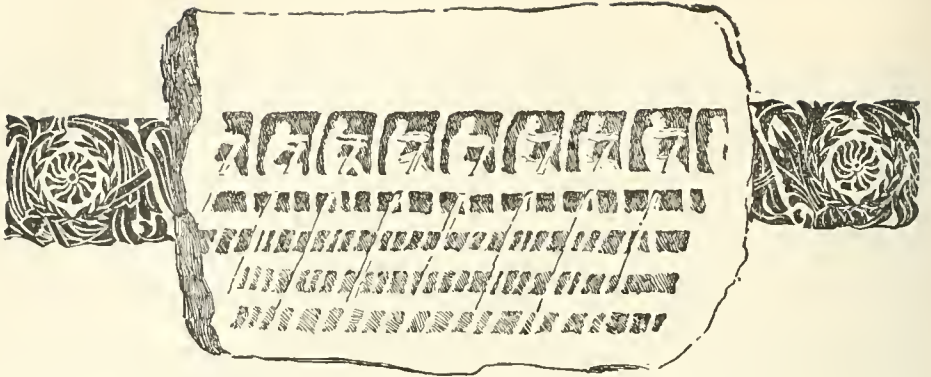

FRAGMENT OF SCULPTURE, SHOWING OARSMEN IN GALLEY

CHAPTER XLIX. THE TRIUMPHS OF PHILIP

DEMOSTHENES, THE ORATOR

THE trite proverb that "the pen is mightier than the sword," like all other proverbs, expresses hardly half the truth. Never was there a more definite combat between the two sharp instruments than in the history of Greece at this period, for that history becomes hardly more than a pitched battle between a splendid organiser of armies and a splendid captain of arguments, and the parallel is the closer inasmuch as Demosthenes, though commonly thought of as an orator, was much more distinctly a writer; for he was decidedly inferior as a speaker to his great rival Æschines, and his orations are chiefly valuable for their logic and their cautious reasoning. Unlike the perishable glories of the art of oratory pure and simple, the art of Demosthenes has come down to us in considerable completeness, and forms a text-book whose eloquence is little appreciated by the students that reluctantly unravel its close-knit fabric.

As this duel between the king of Macedonia and the manufacturer's son of Athens was so nearly a combat of equals, it will be well to cast a brief look at the biography of Demosthenes, since we have given so much attention to the formation of Philip's character.^a

The father of this great orator was an Athenian by birth, and exercised the trade of an armourer, by which he acquired considerable wealth. He married the daughter of one Gylon who had settled upon the borders of the Euxine Sea and contracted an alliance with a rich heiress of the country.¹ At the age of seven Demosthenes was deprived of his father, who left him a fortune which entitled him to rank with the wealthiest citizens. Though guardians had been appointed to manage his estate and direct his education, they seem to have dilapidated the one, and neglected the other. Left at an early age entirely to himself, he launched out into expenses with all the extravagance and vanity of youth, acted as choregus or president of theatrical entertainments, and equipped a ship of war for the service of the republic. He spent the first part of his life without any fixed purpose or aim, indulging

[¹ This made Demosthenes part Scythian.]

in such a state of indolence and effeminacy, as to have his name stigmatised by a term of reproach [Batalos]. But the seeds of genius, being either allowed to shoot up in wild luxuriance or to lie dormant through neglect, were soon to spring up with amazing vigour. He determined thenceforth to devote himself wholly to the study of eloquence. At that time learning of all kinds, but particularly philosophy and the art of rhetoric, was cultivated with great eagerness by the Athenian youth. Plato had established his school in the Academy, and was attended by a vast concourse. Demosthenes attended it with great assiduity, as well as that of Isæus the rhetorician. After these preparatory studies, he tried his strength against his guardians, whom he obliged to refund a part of his property. Emboldened by this success, he mounted the tribunal to harangue the people upon the state of affairs, but was heard with very little attention, and no signs of approbation. Not discouraged by this unfavourable reception, he made a second attempt and was equally unsuccessful.

As he retired, exceedingly depressed by his ill-success, and determined in his mind to relinquish a pursuit for which nature seemed to have rendered him unfit, by denying him the free use of the organs of speech, and a sufficient quantity of breath to articulate distinctly a sentence of moderate length, he was met by one of his friends, a comedian, who exhorted him to conquer the natural and acquired defects under which he laboured. He instantly set about correcting, with the greatest perseverance and most extraordinary means, his rapid and inarticulate pronounciation, ungraceful and awkward gestures in declaiming, and several natural defects under which he laboured.^c

The anecdotes of Demosthenes' struggle with his defects are remembered by many people to whom the very name of King Philip is obscure. These anecdotes rest upon the orator's own authority. The reader need hardly be reminded of the hours he spent talking with his mouth full of pebbles, shouting against the roar of the stormy ocean, practising his gestures before a mirror, expanding his lungs by running and by declaiming as he climbed the steep hills of which Greece is made, shaving half his head to compel himself to keep indoors at his studies, and shutting himself up for months at a time in an underground room where he copied all Thucydides eight times, and polished his own phrases to incandescence.

Thus prepared, he undertook a losing battle in defence of that system of municipal isolation and jealousy which he thought of as freedom, but which had brought on Greece innumerable crimes and sorrows and kept the little peninsula always under the shadow of complete disaster before a larger foe. In a sense, Demosthenes may be compared with the advocates of States' Rights in the United States before the Civil War, except that the Americans never dreamed of carrying their theories to such an extent. To put the two instances on a par, it would be necessary to imagine the Southerners of America demanding not merely that the states have no federation whatsoever, but that even the smallest town of each state should go its own petty way.

ÆSCHINES, THE RIVAL OF DEMOSTHENES

Heroic as the figure of Demosthenes is in many respects one must not forget to do justice to the opposition he met, not only from Macedonia but from within his own city. Posterity is likely to generalise too vigorously, and Æschines has suffered more than his due from the fact that he happened to be the opponent of Demosthenes. It is customary to think of Æschines

as a traitor, a hypocrite, and the paid attorney of Philip in Athens. Yet it might be well to remember that if his advice had been taken and the Macedonians treated with welcome instead of warfare as preached by Demosthenes, the result would have been exactly the same except that much bloodshed would have been saved and a loathsome amount of intrigue and villainy avoided. When Demosthenes is praised for his determination and persistence in his one idea, Æschines must be praised for the same to the same degree. When sympathy is felt for Demosthenes in the enmity he met, it must be remembered that Æschines suffered exile and suffered it with dignity. Æschines was never proved guilty of accepting money from Macedonia, while Demosthenes gloated over the poverty of Æschines and boasted of his own riches. On the other hand it is known that Demosthenes accepted money from Persia. And, if one may be permitted to distinguish between degrees of guilt in bribery, one might feel that Persian money was far dirtier for a Grecian to handle than the semi-Grecian gold of Macedonia, coming from the hand of a king whose great ambition was to organise Greece into a federated monarchy and lead her against Persia.

Æschines claimed to have been of distinguished blood, and, while Demosthenes declared him to be of the lowest possible origin, and that dishonest, he certainly represented the aristocratic party. His friendship for Philip's cause cannot be imputed to a cowardly desire for peace at any price, since he proved himself a brave soldier, while Demosthenes threw away his shield and fled from the very battle-ground of Charonea to which his eloquence had summoned the Greeks. Æschines was a writer of great skill and the three of his orations still extant are rated almost as high as those of Demosthenes. Æschines seems to have had a far better voice and presence than the effeminate student whom posterity thinks of as a majestic thunderer. The good and ill in the character of the latter have been nowhere more briskly summarised than by Prévost-Paradol^d:

THE UNPOPULARITY OF DEMOSTHENES

“Demosthenes was never entirely popular. He had nothing grand in him but his eloquence and will. Dignity of character was wanting. Is it to be said that the highest virtues were necessary in Athens for the popularity of a political man? By no means. Virtue was a title, but the contrary of virtue had also its influence when it was joined to elegance. For Demosthenes, who owed a ridiculous surname [Batalos] to hidden debauches, and who devoted the rest of his youth to an ungrateful work, had neither the graces of vice nor the dignity of virtue. He was neither Aristides nor Alcibiades. Nor had he the easy levity of Cleon and many other demagogues. He was a man of anxiety and toil. He had not the good-natured and happy insolence of a popular orator, who plays with the people and himself, and enlivens the tribune: neither did he possess that which was the contrary, that is to say, natural dignity, the majestic calm which made Pericles the organ of divine reason, a kind of medium between Athens and its destiny, between the people and the spirit of the republic. Demosthenes was violent and laborious. His discourses smelt of oil, but smoothness was absent from them. It was premeditated vehemence, the result of art as much as of inspiration. In short, the people had seen this orator raise himself slowly from mediocrity, and buy his power with long night studies; he inoculated himself patiently with genius. They had hissed at Demosthenes and had seen him

come back stronger; they had hissed again and he had returned all-powerful. The mob is wrong in rarely pardoning such marvels. The mob, with eternal injustice, more willingly gives its approbation to the idleness of genius than to the fertile preparation of work; it adds its partiality in favour of destiny, and the glory which gives itself is more brilliant in its eyes than that which must be conquered. The conduct of Demosthenes, as haughty as his eloquence, would often have irritated a less suspicious democracy. This energetic spirit, nourished by contests, which struggle and effort had alone rendered fruitful, never distrusted its natural impetuosity. Demosthenes applied to political difficulties the same violence he had so happily used against his natural difficulties; he treated his adversaries like the obstacles which had prevented his becoming eloquent. One day an accomplice of Philip, Antiphon, arraigned before the assembly of the people, is sent away acquitted. Demosthenes snatched away the benefit of the popular sentence, arraigned him before the Areopagus, and never rested until he was condemned to death. When has a democracy patiently allowed itself to be thus defended against itself and its judgments broken?

“Demosthenes was of the aristocracy; the aristocracy of money, it is true, but it is sufficient to read Aristophanes to feel that this aristocracy was the heaviest to bear, when one had the misfortune to belong to it. Demosthenes was rich, the son of riches, and he boasted about it with perilous intemperance. In the *Discourse on the Crown* he opposed his fortune to the poverty of Æschines, with a disgust and hardness contrary to the Athenian spirit.

“Add to so many causes of unpopularity, the natural inconsistency of the people, the sacrifices Demosthenes claimed from them, the dangers and the reverses of his politics, and one will be surprised at the lasting power of this great man. The explanation thereof is entirely in the strength and clearness of his wonderful genius. Every day he showed his prodigious eloquence, which consisted in raising his audience above its ordinary intelligence, communicated for a moment to the crowd the generosity of a great soul and the divination of a superior mind. He made the people capable of feeling what was noble in politics, and understanding what was necessary. He showed them in this policy the natural result of the Athenian destiny. He identified his work with the work of that superior power against which all complaint is useless and all anger ridiculous, the work of Necessity.”

But perhaps the most satisfactory claim Demosthenes has on the memory of all time is to be found in that inevitable beauty which surrounds a losing battle fought to the end. Professor Jebbe has said, “As a statesman, Demosthenes needs no epitaph but his own words in the speech *On the Crown*: ‘I say that, if the event had been manifest to the whole world beforehand, not even then ought Athens to have forsaken this course, if Athens had any regard for her glory, or for her past, or for the ages to come.’”

PHILIP'S BETTER SIDE

But finally, while we are endeavouring to be judicial, it is appropriate to think of the better side of King Philip. He, too, had obstacles to overcome, and he suffers from the pathetic consequences of success; for we forgive the weaknesses and vices and the underhand measures of the one who fails, but we are prone to impute the success of the man who succeeds, purely to the evil of his ways. Once more we may quote Prévost-Paradol ^d:

“ Philip had closely observed Greece, with its incurable and daily augmenting weaknesses, and he had foreseen, as a magnificent future, the reunion of these powerless and divided people, under his sovereign authority. He had understood that the Grecian empire, defended by mercenaries and void of citizens, belonged to those who could put in the ranks the greatest number of trained soldiers, and that patriotism had no longer any part to play in this supreme struggle. The instinct and passion of craftiness, patience, the art of bribery, made him eminently suitable for those corrupting and lying manœuvres, which divide the enemy and prepare victory. And to these precious gifts were added an unrestrained ambition, sufficiently strong so as not to draw back in the face of any danger, sufficiently enlightened

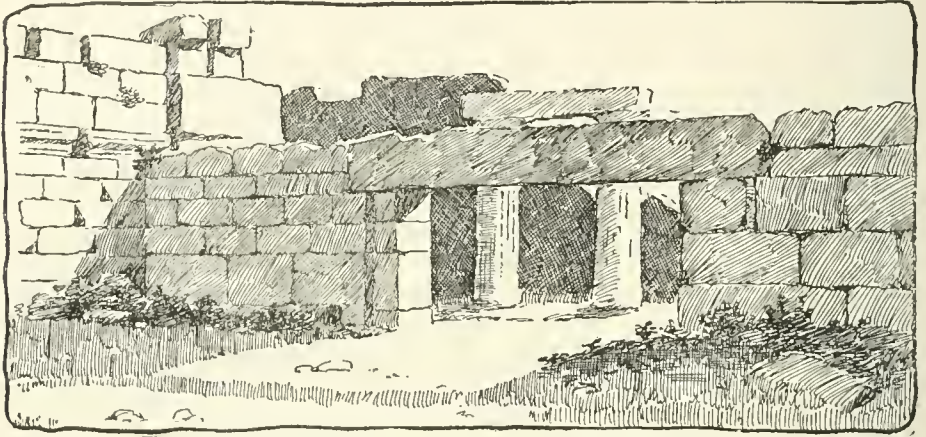

RUINS OF THE GATE OF THE PROPYLEA OF ATHENS

only to seek opportune contests, and to become great only through success. It is because Philip always saw ahead of his actions, and hoped for great things, that they were always appropriate and useful, and that he did them with such terrible activity. He gave himself up entirely to intrigues, to battles, to the formation of his army, to the subjection of Greece, and to vast hopes.

“ It is with a sort of terror that Demosthenes saw and described him as being consumed by desires always greater, and carried away by a hidden strength from enterprise to enterprise. ‘ I saw Philip with one eye put out, one shoulder broken, a crippled hand, a wounded thigh, abandon to fortune without ceremony or hesitation all that it wished to take of his body, provided the rest remained powerful and honoured.’ Who does not see that his unchecked activity followed a more elevated aim than the submission of Greece and that this great man, in a hurry to have finished, was afraid of seeing life suddenly fail his ambition? What could Greece do to such a genius, sustained by such a character ? ”

Professor Bury^f is even more direct in Philip’s praise and in blame for Demosthenes : “ To none of the world’s great rulers has history done less justice than to Philip. The overwhelming greatness of a son greater than himself has overshadowed him and drawn men’s eyes to achievements which could never have been wrought but for Philip’s life of toil.” He also notes that we have no information of Philip’s stupendous conquest of Thrace, and that what we know of him at all has come through Athenian mouths and

[359-351 B.C.]

chiefly from "the malignant eloquence" of Demosthenes, on which account the Greek history of Philip's time has often been regarded "as little more than a biography of Demosthenes," whose policy Professor Bury finds retrograde and retarding, unrelieved by any new ideas. The time needed an Athenian statesman of adaptability and judgment. In the long look, Æschines was more nearly that man than Demosthenes.^a

THE SACRED WAR

Alexander, the tyrant of Pheræ, was assassinated in 359 by his brothers-in-law, at the instigation of his wife, Thebe, she having taken care to deprive him of his sword while he slept and to remove the dogs which guarded the entrance to his chamber. She then introduced her brothers, and on their hesitating to deal the blow she threatened to awake her husband. The murderers assumed Alexander's tyranny, and one of them, Lycophron, was on the throne when Philip was summoned to oppose him by the powerful family of the Aleuadæ of Larissa, who, like the Macedonian kings, pretended to descend from Hercules. Philip was then besieging Methone, the only city of the Thermaic Gulf which still formed part of the Athenian federation. After having received a wound which cost him one eye, he took the city, razed it to the ground, and seized the occasion which then offered to enter Thessaly. Lycophron having made an alliance with the Phocians, Phayllus, brother of Onomarchus, came to his aid with seven thousand men. Philip defeated Phayllus, but was himself defeated by Onomarchus, who forced him back into Macedonia while he, Onomarchus, returned to Bœotia to gain possession of Coronea. But Philip reappeared shortly with a new army: his forces united to those of Thessaly amounted to twenty thousand men and three thousand horses. Against the Phocians, who had stolen the treasure of the temple of Delphi, he appeared as an avenger of Apollo, and all his soldiers wore crowns made of laurel leaves from Tempe.

The encounter took place near the Gulf of Pagasæ, where was stationed an Athenian fleet. Philip obtained a complete victory, due principally to the Thessalian cavalry. The Phocians lost six thousand men; of those made prisoners three thousand were cast into the sea as being sacrilegious, but many of them were able to reach the Athenian vessels by swimming. Onomarchus had been killed in battle, and his body crucified. Lycophron obtained by bribes permission to retire to the Peloponnesus with his troops, delivering the city of Pheræ over to Philip, who seized the port of Pagasæ and the fleet constructed by Alexander. Philip caused to be paid over to him by his Thessalian allies, as war indemnity, a large part of the revenues of the country. He wished to penetrate farther, and under pretext of entering Phocia marched towards Thermopylæ in order to take up his position on a spot that was the key to all Greece. But an Athenian corps commanded by Diophantus occupied the pass, and Philip was obliged to turn back (352).

THE FIRST PHILIPPIC

It was at this epoch that Demosthenes pronounced, before the people of Athens, his first Philippic. So absorbed had been the Greeks by their private rivalries that they had paid no heed to the rapid and increasing

progress made by the Macedonian monarchy. One man alone saw the danger; he had no other arms than his patriotism and his eloquence, but with these he fought valiantly, and though he could not preserve to his country liberty, he at least preserved its honour. The unequal conflict which was about to take place between Demosthenes and Philip was not alone a duel between the ablest of politicians and the greatest of orators; it was a duel to the death between two principles, monarchism and republicanism.



DEMOSTHENES

These two principles had once before, in the reign of Xerxes, been arrayed against each other; but at that time the Greeks were able to forget their private differences in the common danger, and to superiority of numbers they had opposed, not alone heroism, which does not always suffice to conquer, but military tactics. Now conditions were different; Philip had borrowed of the Greeks their tactics, which he brought to perfection, and he managed to turn to his own advantage the condition of the land, now more than ever divided. It was never again to have that unity of military command so necessary in the face of the enemy. The hegemony of Sparta which Athens nobly accepted in the Median War was forever destroyed, and Sparta, which struggled vainly under its double burden, Megalopolis and Messene, took no notice of the progress of Philip. Thebes, which had broken Sparta's power, was not strong enough to take its place, and foolishly inviting the approach of the enemy, repented too late and died in expiation of its fault. Athens remained, but how fallen from its former condition of active energy. In vain Demosthenes tried to awaken it; it asked but to sleep the long sleep of worn-out races. "When, Athenians," cried the great demagogue, "will you rouse and do your duty? What new event, what pressing need, do you await? What contingency more urgent for free men than the danger of dishonour? Will you always assemble in the public

squares to ask each other, 'Well, what is new?' What can be newer than a man from Macedonia making himself victor of Athens and master over all Greece? Is Philip dead? No, he is only ailing. But what matter to you if he be sick or dead; if heaven were to deliver you from him to-day, to-morrow you would cause another Philip to arise, for his victorious advance is far less a result of his own power than of your inertia."

The war of the allies had exhausted Athens' principal source of revenue, and, as frequently happens in the case of spendthrifts who are obliged to economise, the city preferred to do without necessities rather than deny itself the superfluous; the sovereign people refused absolutely to curtail its civil list. Pericles in instituting the public funds could not foresee that the day was to come when the Athenians would prefer amusement to the preservation of the nation's safety. "Why be surprised at Philip's success," asks Demosthenes, "when all the sums formerly allotted to defray the cost of war are now squandered in useless festivity, a decree, furthermore, menacing

[351-349 B.C.]

with pain of death any one who undertakes to restore them to their former purpose?" He reverts frequently to this incurable propensity of Athenian dilettantism, citing the extreme punctuality with which public feast days were observed as against the tardiness of the administration in all that concerned marine matters, or war. "Tell me why your pompous feasts of Panathenæa or of Dionysia, which cost more than the armament of a fleet, are always celebrated on the day set, while your fleets, as at Methone, Pagasæ, and Potidæa, arrive too late? In the observance of your feasts all has been regulated by law; each of you knows in advance the choregus, the gymnasiarch of his tribe; he knows just what he is to receive and the exact moment when he is to receive it; nothing is uncertain, unexpected, neglected. In time of war, with all the preparations war demands, there is no order, no foresight, nothing but confusion on all sides. At the first alarm trierarchs are named, exchanges are made, subsidies are demanded. Then, to the ships are summoned first the metœci, then the freedmen, then the citizens, then — but pending all this work of preparation, that which our fleet should save has perished. All this, citizens, is doubtless very disagreeable to hear, but if in leaving out of a discourse all that offends we exclude the matter itself, what need to speak save for the mere pleasure of your ears?" And this was virtually true; the people listened to Demosthenes because he spoke well, then went to hear the orators of the opposite side, and in the enjoyment of this fine oratorical display were as royally amused as though they had visited the theatre or the Odeum.

PHILIP AND ATHENS

Philip endeavoured by apparent inaction to make the Athenians forget the attack on Thermopylæ by which he justified Demosthenes' fears. But his time was not wasted; he employed it in making partisans, even drawing around himself certain of the pillagers of the Delphic temple. He received their money in trust, thus attaching them firmly to his interests. He had established or was maintaining tyrants in the island of Eubœa, two of whom, feigning treachery to him, called the Athenians to their aid, only to betray them as soon as they had responded to this appeal; it was with difficulty that Phocion could save the Athenian army from destruction. To obtain possession of Amphipolis, Philip had caused the Olynthians to withdraw from the Athenian alliance by ceding to them Potidæa; they, however, regretted this step as soon as they saw their independence menaced. Philip accused them of having given refuge to Macedonian conspirators, and took successively several cities of the Olynthian federation, Apollonia, Stagira, Mecyberna, Torone. The Olynthians asked help of Athens, and Demosthenes, in support of their appeal, delivered three of his most celebrated discourses called the *Olynthiæcs*. The first showed the Athenians the danger they were in, since if Philip were to become master of Olynthus he would not fail to fall upon Athens with all his forces. He then indicated the remedy: a better use of public moneys. Unable to attack the Theorica directly, he evaded the difficulty by demanding a reform in the laws governing its use.

"Be not surprised, Athenians, if I speak contrary to the opinion of the majority. Establish nomothetes, not to create new laws, but to abolish such as work you harm, and these I will designate clearly. They are the laws regulating the theatre and military service. One set sacrifices to the

idlers of the town the funds set apart for war, the other assures impunity to cowards. We stood formerly without a rival, rulers at home, arbiters in foreign lands. Sparta was crushed, Thebes occupied abroad, confronting us was no power that could dispute our empire. What have we done? We have lost our provinces, and uselessly dissipated fifteen hundred talents. War restored to us our allies; in time of peace wise counsellors caused us to lose them, and our enemy has waxed great and powerful. Can any one deny that it is through us that Philip has risen? Undoubtedly you will reply, things on the outside are not favourable to us, but within, what marvels have been accomplished! Name them! Walls restored, roads repaired, fountains rebuilt, and a hundred other trifling matters. Look upon the authors of these splendid works; formerly poor, they are now rich, and in proportion to the rise in their fortunes has been the decline of the state's. The power to pardon is in their hands, nothing is accomplished save through them; and you, Athenians, suffer everything to be taken from you, allies as well as money. Great in numbers, you are treated like menials, happy when your masters throw you your daily pittance, the price of admission to the theatre. The shame of such a condition! They give you your own, and you render thanks as though for a mercy shown you! I know well that it may cost me dear to place your disgrace so clearly before you; but dearer still will it cost those who have brought that disgrace about."

Only in a democracy could a ruler be found who would accept reproaches so severe. The Athenians knew that Demosthenes was right, but to give up the theatre—that was very hard; to reform the administration of the finances—that would take a long, long time! The most urgent need was attended to first: two armies were sent to succour the Olynthians, who were struggling bravely in their own defence. But these armies were formed of mercenaries, commanded by Chares, an indifferent general who was in the pay of every land. The presence of such troops had for effect to create disturbance among the besieged without rendering them the slightest aid. It was finally decided to send an army of citizens; but it was already too late; two traitors had delivered over the city to the enemy (347).

There was stupefaction in Athens and in all Greece when it was learned that Philip had destroyed Olynthus and sold its inhabitants. But pity was of short duration: "Each people," says Demosthenes, "seemed to look upon as gained the time spent by Philip in destroying another." Nevertheless the possession of Chalcidice made him master over the Ægean Sea and brought him nearer to the Thracian Chersonesus, ceded to the Athenians by the king, Cersobleptes. His fleet, already greater than that of Athens, threatened Imbros, Seyros, Lemnos, and Eubœa, made a descent on Attica, carried off the Paralian galley, and tore down the trophies at Marathon. The Athenians, tired of carrying on the struggle alone, tried to form against Philip a general alliance, but his liberality had created for him a numerous faction. Even at Athens little was spoken of but the good intentions of the king. Among those who upheld him were many who had been bought over, notably the orator Demades, possibly also Æschines; but some of the dupes were honest, among them the rhetorician Isocrates, who was dazzled by Philip's success, and many resembling Phocion, who always looked on the dark side, preaching peace because he believed victory impossible, although he was the best general Athens possessed. "Have military greatness," he advised the Athenians, "or make those who have it your friends." When Demosthenes saw this man arise to reply to him, "There," he said, "is the axe of my discourse."

[352-346 B.C.]

The Sacred War still continued. After the death of Onomarchus his brother Phayllus succeeded him in command. With the aid of the Delphic treasure he got together a large army of mercenaries. The Spartans furnished him one thousand men, the Achæans two thousand, the Athenians five thousand and four hundred horses; thus Sparta and Athens participated indirectly in the pillage, Phayllus paying for the maintenance of the troops sent to him. He invaded Bœotia and took the greater part of the cities of Epienemidian Locris; but falling ill he died and his place was taken by Phalæcus, son of Onomarchus. The command of this army of bandits came to be a sort of hereditary royalty. Phalæcus being still very young a tutor was given him in the person of Mnaseas, who was shortly after killed. Phalæcus continued the war; but ten thousand talents, the last of the treasure of Delphi, had been expended and the Phocians were clamouring for a reckoning. The Thebans were also at the end of their resources, in spite of the three hundred talents they had obtained from the king of Persia. They called on Philip for assistance, but he not being willing to risk again finding the pass of Thermopylæ, guarded by Athenians, they were obliged to drop out of the contest. The Athenians were in reality glad to discontinue a war which had lasted ten years without bringing them any profit, and desired a reconciliation with the Thebans.

It even seemed possible to establish a general peace among the Grecian states, for all were equally tired of the long and fruitless war. Philip indirectly gave the Athenians to understand that he was disposed to treat for peace. It being difficult to divine their motive these advances were looked upon as suspicious. Still at Philocrates' proposal it was voted to send off ten ambassadors, among whom was Philocrates himself, the rival orators, Demosthenes and Æschines, and the actor Aristodemus. Æschines later reproached Demosthenes with having failed in eloquence before Philip, a fact which had in it nothing extraordinary, since only Alcibiades or Lysander could compete with Philip in guile, and Demosthenes was used to speaking his thoughts openly to a free people. He was at least, contrary to many of his colleagues, proof against fine speeches, banquets, and gifts.

A TREATY OF PEACE

The ambassadors returned without having obtained anything from Philip save a vague promise to respect the Athenian possessions in Thrace. Three Macedonian envoys followed them; the terms of a treaty of peace were decided upon and another embassy, similar probably to the first, was charged to obtain Philip's signature. Contrary to the advice of Demosthenes, this embassy travelled by short stages on land, and waited a month for Philip at Pella, giving him time to wage war upon the king of Thrace, Athens' ally. He at last returned and persuaded the ambassadors to accompany him as far as Pheræ, under the pretext of desiring their mediation between two Thessalian cities. At Pheræ he signed the treaty but refused to inscribe upon it the name of the Phocians. The ambassadors having left he marched rapidly upon Thermopylæ and took possession of the pass which this time he found unguarded. This had been the aim of all his hesitation and delay. The Athenians were outwitted, and their ambassadors either dupes or accomplices; later Demosthenes even accused Æschines of having sold himself to Philip.

Phalæcus' treason is still more apparent. Before peace was concluded he had refused the assistance first of the Athenians, then of the Spartans, who

offered to occupy the fortresses. The Phocians were left to their fate. Philip presented himself and the fortresses were delivered up to him on the sole condition that Phalæcus be permitted to retire to Peloponnesus with ten thousand mercenaries. In such fashion this chieftain of a robber band, finding nothing more to steal at Delphi, abandoned without a struggle his country to the enemy. The Phocians were at the mercy of Philip who delivered them over to the hatred of the Thebans.^b

The king occupied the country without striking a blow and then summoned the Amphictyonic council to Delphi, that he might hold a trial of the Phocians and their allies and re-order the affairs of the national sanctuary.

PUNISHMENT OF THE PHOCIANS

The sentence was sufficiently severe. The court, attended only by representatives of the peoples which, like the Thebans, Locrians, and Thessalians, had taken part in the Sacred War, followed the dictates of revenge and passion. The Phocians, as being accursed, were expelled from the Amphictyonic league and the two votes which they had hitherto possessed were transferred to Philip and his successors; all the towns, twenty-two in number, were (with the exception of Abæ) to be destroyed and the inhabitants to settle in villages of not more than fifty inhabitants. The fugitives were to be accursed and outlawed wherever they were encountered; those who remained were to pay Apollo a yearly tribute of fifty talents [£10,000 or \$50,000] and to be despoiled of their arms and horses until the stolen treasure should be made up. Philip was in future to preside at the Pythian games. The desire for vengeance went so far that the Ætæans even made a suggestion that the whole male population, exclusive of the boys and the old men, should be thrown down from the rock as temple robbers: an inhuman proposal which Philip rejected with anger. In contrast with such unbridled fury the Macedonian king, who had little mercy for his own enemies, appeared as a mild ruler.

The execution of the sentence was undertaken with relentless severity; ancient towns like Hyampolis, Panopeus, Daulis, Likea disappear henceforth from history; their former inhabitants either wandered homeless in foreign countries or lived out their days in mournful servitude. Many joined the bands of mercenaries which Timoleon the Corinthian conducted to Syracuse in the following year; others passed over with Phalæcus into Crete, where some time afterwards the leader met his death at the siege of Cydonia. All the Phocians who had taken part in the robbing of the temple met with a fearful end, but the lot of those who remained behind was not more enviable. Some years later, when Demosthenes went to Delphi, he beheld a picture of misery: "houses torn down, walls in ruins, the country emptied of men of vigorous age, and a few mourning women and children and old people; such wretchedness as admits of no description in words."

THE ATTITUDE OF THE ATHENIANS

The tidings of these events fell on the betrayed Athenians like a thunderbolt out of a clear sky. Relying on the royal grace and mercy, they had delivered the Phocians to their enemies with their hands tied, and how had that trust been rewarded! In Athens consequently, no one joined in the songs of rejoicing which pealed through Delphi when the Amphictyonic

[346 B.C.]

council and the Greek envoys who hailed Philip as the protector of the venerable sanctuary were entertained by him at a banquet and sacrifices, and libations and prayers were offered in favour of Apollo; on the contrary there was great excitement among the citizens and a mingled feeling of sorrow, indignation, and fear. Men fancied that they already saw the Macedonian king in Attica. On the suggestion of Callisthenes they decided to bring the women and children into the city from the country, to hide their possessions and make preparations for defence. In defiance of the Amphictyonic ban the fugitive Phocians were assured of welcome and protection.

Still when Philip, by an embassy of his own, unfolded his peaceful intentions, but at the same time remained in the neighbourhood with his army in readiness, the position began to be considered more calmly. Nevertheless in the first assembly the people clamoured so that the orators could not make themselves heard, and Æschines called out to Philip's messengers: "The criers are many, the fighters few." But when in view of the pressure of circumstances, even Demosthenes raised his voice "for the peace," and warned the general assembly against inconsiderate action, since it would after all be "foolish and sheer nonsense" to engage in a general war over the "shadow at Delphi," they submitted to the inevitable and recognised the *fait accompli*. A new embassy, with Æschines at its head, carried to the Macedonian ruler the consent of Athens to the decision of the Amphictyons and to her own entrance into the temple union. Satisfied with this result, the king now arranged for the Pythian games with unusual magnificence, and then returned to Macedonia, leaving a garrison behind him in Phocis.

THE MACEDONIAN PARTY

During the years which followed while Philip made his hereditary kingdom more compact and extended its borders by successful contest with the Illyrians and Triballians, with the Epirots and Molossians, and with the eastern Thracians, and while the land of Hellas lay ruined and broken, the Athenians made use of the time to revive their trade, strengthen and equip their fleet, and erect new and magnificent buildings for public purposes. But the civil breach became more and more clearly apparent, and prevented the lasting healing and cure of the sick commonwealth from the severe wounds of the past years. Since the fraudulent embassy the Macedonian faction which adhered to Æschines and Philocrates and the patriots who honoured Demosthenes, Lysurgus, and Hyperides as their leaders had occupied a hostile position towards one another.

If Æschines had at first placed himself on Philip's side from a natural inclination because he was dazzled by the royal personality, and he was able to deceive himself concerning his intentions, he was now on personal grounds the warmest supporter of the king, since the latter had called him his friend and enriched him with presents. He who had once made so poor and modest an appearance, now carried his head proudly, walked about in long flowing garments, and showed by his liberal expenditures the alteration in the means at his disposal. The man of practical wisdom had long since recognised the Macedonian's deceitful game, but he continued to "tread the bridge for him."

Philocrates flaunted his dishonour still more shamelessly. He openly acknowledged that Philip had royally rewarded him, and his prodigality, his dissolute life, and the careless fashion in which he abandoned himself to

sensual pleasures and vices were evidence of the great gifts of his wealthy patron. But among all the partisans of Macedon the greatest zeal was shown by Demades, the son of a poor mariner whose rough wit and popular style of eloquence still revealed the ex-sailor. Round these men, to whom must be added the clever but unprincipled Pytheas, swarmed the mass of people who desired peace at any price that they might enjoy life in ease and comfort and such base spirits as set gold and pleasures above honour and their native country.

THE PATRIOTIC PARTY

This party had its roots and its support in the selfish and pleasure-loving nature of the multitude, and in proportion as it gained in power and adherents the greater was the merit of the men whom no favours and no profit could shake in their fidelity to their country, who looked with suspicious eyes on all Philip's undertakings and intrigues and recognised the preservation of the liberty they had received from their fathers as the worthy aim of all struggle and effort. Amongst these men, besides Demosthenes, who in these years developed a marvellous activity, sought to thwart Philip's plans in every direction, and in especial endeavoured to prevent the intriguing interference of Macedonia in the Peloponnesus by pacification and reconciliation, the noble orator Lycurgus was distinguished in the first rank of the patriots by his unassuming simplicity and austerity. Like Socrates and Phocion an enemy to all sensual pleasures and effeminacy, he effected more through his worth and noble disposition than through his somewhat awkward eloquence. Hyperides was a frank and energetic defender of the interests of his country, but also much addicted to the joys of this world, the pleasures of the table, and fair women. His love affair with the charming courtesan Phryne was notorious. Talented, sprightly, and cultivated, he enchained his listeners by the fresh and natural charm of his oratory. Moreover the "curly-headed" Hegesippus and Timarchus belonged to the patriotic party, but they damaged it in the eyes of the people by their ill repute.

The position of parties was first revealed in the action against Timarchus who in union with Demosthenes had brought before the court of auditors (*logistæ*) an accusation against Æschines on the subject of the fraudulent embassy (344). To defeat this accusation Æschines endeavoured to represent that Timarchus was absolutely disqualified from taking such proceedings by his shameless life and notorious character, and he demonstrated this so effectually that his adversary was punished with the loss of civil rights while his own integrity was shown in a most favourable light. If Æschines had taken up arms in moral indignation at his opponent's vicious conduct, we could only approve his action; but far from appearing as a defender of virtue he treats vice and the prevailing immorality with the greatest leniency and only lifts the veil as much as may serve his party aims. A more successful accusation was that which Hyperides brought in the next year against Philocrates. Conscious of his guilt, the accused went into exile even before judgment was pronounced. Demosthenes might feel encouraged by this result to launch a second documentary accusation against Æschines respecting the treachery and bribery in connection with the fraudulent embassy; but thanks to the skilful defence of the accused and the support of the peace-party, this famous contest also ended with the acquittal of the orator (343).

[344-341 B.C.]

PHILIP'S INTRIGUES AND THE OUTBREAK OF WAR

Philip employed the deceitful peace to form alliances for himself by means of bribery and intrigues in all the Hellenic states; and to acquire partisans and supporters and nourish the civil divisions. He took especial pains to make his own profit out of the internal dissensions in the Peloponnesian states and the irreconcilable hatred of Arcadians, Messenians, and Argeians against Sparta; to win a reputation for himself as the protector of the weak and thus gradually to bring the power of chief arbitrator into his own hands. The fact that these intrigues were not completely successful and that the Athenians, forewarned and filled with distrust, rendered the task of the Macedonian negotiators much more difficult, may be considered as an effect of the *Second Philippic* of Demosthenes. Philip's ill will was consequently especially directed against the Athenians, in whom he recognised the sole opponents of his thirst for dominion, and he sought to damage them in every way without directly violating the peace.

He expelled the pirates from the Attic island of Halonesus and retained the isle as his own property, and when the Athenians complained, he offered it to them as his personal gift; with his newly created naval power he injured Athenian trade and also brought the dominion of the sea more and more into his own hands, and instead of his restoring Eubœa to the Athenians, as had once been hoped, he strengthened his own power by maintaining a secret understanding with his partisans to secure them the supremacy in Eretria and Oreus; in Thessaly he abolished the office of tagus, or chief of the confederation, and set over the four districts four tetrarchs on whom he could rely, a government which was calculated "to break all efforts at union and make the divided forces of the country completely subservient to his aims."

Above all a great stir was created among the Athenians when Philip again turned his arms against the princes Cersobleptes and Teres, with whom they were on friendly terms. In this it was evidently his intention to secure himself a passage into Asia by the subjection of the Thracian coast lands and at the same time to cut the main arteries of Athenian maritime trade, namely the entrance to the Pontus. A royal document with some conciliatory proposals and the offer to lay the disputed points before an impartial tribunal, was designed to divert the attention of the Athenians from their possessions on the Chersonesus, but its suggestions and demands were opposed by Demosthenes or, as the newer criticism has convincingly shown, by Hegesippus, in the *Speech On Halonesus*. And in order to cover their Thracian possessions with the old and new cleruchs, the Athenians sent the general Diopithes with a squadron and mercenary troops. By two successful campaigns Philip now overcame the Thracians in several encounters after a brave resistance and dethroned their princes; he took one town after another on the Middle Hebrus where his soldiers wintered in earth-holes (in "mud-pits"), and secured his new dominions by planting several colonies (Philippopolis, Berea, Cabyle, etc.); meantime Diopithes cruised in the Pontic waters, compelled the cities to purchase a safe voyage for their merchant vessels either by a tribute or, as the commander of the fleet expressed it, of good will, and undertook a military expedition in the Macedonian coasts along the Propontis.

When Philip lodged complaints at Athens at this breach of the peace, and threatened reprisals, the Macedonian party was of opinion that they ought to endeavour to conciliate the king by the recall and punishment of

the general. Then Demosthenes demonstrated, in the sublime speech *The Affairs of the Chersonesus*, that the peace had actually been broken long ago by Philip himself, and that the Athenians, instead of punishing their bold leader, as the corrupt servants of the king and the cowardly advocates of peace demanded, ought to supply him with new troops and munitions of war before Philip could bring all his plans to maturity and fall upon Athens herself.

THE THIRD PHILIPPIC



GREEK MIRROR
(In the British Museum)

After this "act in words," which had the desired effect, Demosthenes in the *Third Philippic*, made clear to the Athenians the necessity of concluding an alliance with the rest of the Hellenic towns for the furnishing of mutual aid so that a check might be given to the insolent and mischievous disposition of the Macedonian, who was perpetrating acts of war and violence under cover of a pretended peace.

"In former days, when any Hellenes abused their power for the oppression of others," so ran this remarkable, wise, and energetic speech, "all Hellas rose to guard the right, and now we permit a 'good-for-nothing Macedonian,' a 'barbarian of the most abandoned character,' to destroy Greek cities and hold the Pythian games, or cause them to be held by his servants. The Hellenes look on this and do nothing, 'as a man regards a shower of hail, praying it may not hit him'; his power is allowed to continue growing, no step being taken against it, each reckoning the moment at which another is shipwrecked to his own gain instead of thinking how to save the existence of Hellas and being active in its cause, though none can help knowing that the evil will attain even the most remote. Once the man who allowed himself to be corrupted by the ambitious and malevolent enemies of his country, fell a victim to the general hate, and was visited with the severest punishment as a grievous criminal; now all this is as it were done away and in its stead is introduced that of which

Greece lies sick unto death, jealousy of him to whom aught has been given, laughter when he confesses to it, hatred of whoever shall rebuke."

In the *Third Philippic* Demosthenes rebukes the indolence and degeneracy of the people with more cutting sarcasm; and although all faith had not disappeared from his soul, yet it is not without reason that the piece has been called "a study in shadows, in whose gloomy colours is revealed a saddened spirit and far from joyful anticipations, whilst through the speech on the Chersonesus, which was written under the influence of bright hopes, there breathes a fresher air."

The tempestuous eloquence of the *Third Philippic* made a powerful impression. Now at the eleventh hour the assembly was roused to decisive action; it placed the conduct of business for a time chiefly in the hands of

[341-340 B.C.]

the patriotic party and made energetic preparations for defence. Whilst Hyperides brought the islands of Chios and Rhodes over to the side of Athens, Demosthenes went himself to the scene of the war, persuaded Byzantium, abandoning her ancient jealousy, to reconcile herself with Athens and conclude an offensive and defensive alliance (341), and acquired Abydos and with it the undisturbed navigation of the Hellespont. Meanwhile the Persian governors, who for a long time past had looked with anxiety and uneasiness on the rise and extension of the Macedonian kingdom, were requested to give assistance, and several states in the Peloponnesus were induced to join in "the Hellenic alliance against Philip." This was a free confederation under the leadership of Athens, with fixed contributions in money and men. Eubœa was also won over to the alliance after the Macedonian governors in Eretria and Oreus had been, the one killed, the other expelled by Phocion. In recognition of these services a golden wreath was awarded to Demosthenes and set on his head in the theatre at the Dionysia.

To make the members of the alliance more ready for sacrifices Athens herself set a magnanimous example of patriotic devotion. It was not only that, on Demosthenes' suggestion, a change had been effected in the organisation of the trierarchy and thus the less wealthy were secured from oppressive tradition and the rich constrained to make greater efforts in proportion to their resources; the people also agreed that the sums which it had hitherto been customary to apply to festival expenses, entertainments, and dramatic representations should be utilised for military operations. "The people," says Niebuhr, "whose poverty was dominant in the assembly and refused the gifts by which alone they obtained the luxury of eating meat on certain festival days since all the rest of the year they ate only olives, cabbages, and onions with dry bread and salt fish,—they who made this sacrifice to provide for the honour of their country; this people has my whole heart and my deepest veneration."

PHILIP RETURNS TO THE FRAY

The warlike impulse in Athens did not long remain unknown to the Macedonian king. He concealed his anger so long as the Thracian War was still in progress; but when he had destroyed the once powerful Odrysian kingdom and secured the Thracian districts by means of colonies and garrisons, when he had led his army across the Hæmus to the Getæ and had won over the colonies on the western shore of the Pontus by conciliation or force, he proceeded to send the Athenians a defiant letter, full of complaints and accusations, and added to them such insults by marching into their possessions on the Chersonesus and seizing Athenian merchantmen, that the assembly of the people declared the peace to have been violated, threw down the peace column, and took measures to furnish substantial aid to the Byzantines whom Philip was even then threatening with a siege.

There was no delusion in Athens as to the importance of the step. When Hegesippus recommended the refusal of Philip's last proposals, there was a cry "Thou art bringing war upon us," whereupon he answered: "Not war alone, but early death and mourning garments and public burials and funeral orations if ye will give yourselves in earnest to free the Hellenes and win back the hegemony which your fathers maintained."

Thus ended the hollow Peace of Philocrates which had lasted seven years, and although from the aspect of affairs and the previous course of

events there could be no hope of a successful struggle of divided Hellas against the advancing power of the Macedonian kingdom, now in the youthful vigour of its military strength; yet we cannot but feel the deepest respect for the manly impulse, the resolution which defied death, and preferred to fall gloriously and honourably under the feet of hostile armies, rather than be any longer a prey to the deceitful trickery of the king and his purchased satellites, or hover any longer in the undignified and ruinous state between war and peace. It was not a question of preserving "a piece of finery which had grown old-fashioned," but of saving liberty and the popular government handed down from their forefathers, of passing on unimpaired to their successors the institutions and political forms for which former generations had staked their property and their blood, and of avoiding the break with the great historical past as long as possible.

SIEGE OF PERINTHUS AND BYZANTIUM

And that there was still strength and courage in the Greek people, Philip to his great chagrin soon received sensible evidence before Perinthus, a maritime city, built in terrace fashion on the high ridge of a tongue of land on the Propontis, with rows of houses crowded thickly together and which he failed to take after a long siege by land and sea. Supported by the Byzantines and the Persian governor, the brave citizens repelled storm and attack with spirit. And now encouraged by the example of the Perinthians, and with the co-operation of the Athenians who sent first Chares, then Phocion, with ships and men to the aid of their hard-pressed ally, the Byzantines offered a manful resistance; so that here too Philip had to raise the siege and it was only by a stratagem that he succeeded in bringing off his fleet from the Black Sea through the Bosphorus and the Hellespont.

The feeble Byzantines would hardly have held out so long against the siege which Philip conducted in similar fashion with battering-rams, machines for flinging projectiles and saps, but Chares, the Athenian, and his squadron drove the Macedonian fleet to the Pontus in a victorious combat, and from his advantageous position at Chrysopolis protected the entrance to the sea, while the valiant Phocion did his utmost to aid in the defensive measures of the Byzantine commander Leon, whom he had previously known in Plato's school. So here too Philip failed to attain his object, in spite of the skill of his engineers and the bravery of his troops, who once even won an entrance into the town on a rainy, moonless night, but were beaten back in a hot fight by the citizens, who ran up hastily, considerably aided by the appearance of an aurora borealis.

DECLINE OF PHILIP'S PRESTIGE; THE SCYTHIAN EXPEDITION

The golden wreath and votes of gratitude with which the rescued Perinthians and Byzantines and the Attic cleruchs on the Chersonesus expressed their thanks to the Athenian state, were especially due to the orator Demosthenes, who by his disinterested and patriotic activity had been mainly instrumental in bringing about this revival of energy. On the news of Philip's failures at Perinthus and Byzantium, the national party reared its head more proudly. Relying on Athens—whose ships again ruled the Pontus as far as Thessaly, barred the coasts and impeded Macedonian trade

[339 B.C.]

and maritime commerce — the patriotic party, in which the spirit of independence, freedom, and national honour was not yet extinct, again bestirred itself in all the Hellenic cities. Even at Thebes evidences appeared which showed how great was the indignation and suspicion against Philip. The partisans of Macedon and the supporters of the peace were thrust into the background; the Hellenic alliance received new members and adherents. Philip's consideration was manifestly on the wane, the more as during this time he was with his army in the distant regions of the Danube. For in order to compensate his troops for their fruitless toil by means of a raiding expedition and restore his military reputation by a brilliant feat, Philip led his army from Byzantium against the Scythians on the Lower Danube. Here he did indeed win the victory in a great pitched battle, took many prisoners, and made spoil of a number of valuable horses and live stock; but on the return march through the country of the Triballi the greater part of this booty was lost; it was only with great difficulty, and when he himself had been sorely wounded, that he led back the army through the pass of Hæmus to his own country.

THE CRUSADE AGAINST AMPHISSA

Nothing but a brilliant feat of arms could restore Philip his declining prestige in Hellas, and to this his partisans paved the way. They contrived to kindle fresh dissensions amongst the Hellenes and managed so skilfully that Philip was afforded an excuse for the invasion of Greece and could hide his personal objects under an honourable pretext. He was able to appear a second time as the protection of the Pythian sanctuary and to overthrow his adversaries.

The Locrians of Amphissa had utilised considerable portions of that accursed "Crissæan plain" as corn and meadow land, had set up brick kilns and farmyards and in the walled haven had erected a toll house where pilgrims journeying to the place of the holy oracle had to pay an impost for shelter and guidance. The Delphians had left the Amphissians in peace to do as they would, especially as the latter paid the usual tithe for the ground they occupied, as well as a ground rent. After the Phocian War, in which the Locrians exhibited so much zeal for the honour of the temple, they would not be likely to become more neglectful in the fulfilment of their tasks; and probably also, as a suitable reward for their services, they acquired new tracts of land which they cultivated. But the sanctuary itself probably now stood in a different position as regards the Hellenic people, since a foreign king had assumed the office of its protector and the Pythia was credited with "philippising."

Æschines, as assistant Athenian deputy (Pylagoras), was at Delphi for the spring meeting of the Amphictyonic council. He had a grudge against the Amphissians because they sided with the patriotic party and he now made use of their position to bring an accusation against them. Pointing, from the height on which the sitting was held, at the harbour and cultivated ground, he made a solemn address to the assembly, and threw it into such a state of excitement by reciting the ancient statutes and oaths, that the envoys, seized with an extravagant religious zeal, marched next morning into the Crissæan plain, accompanied by the citizens and slaves of Delphi, destroyed the harbour, set fire to the houses, and demolished the works. Furious at a proceeding so sudden and carried into effect without any inquiry, the

Amphissians fell on the "crusaders" with arms in their hands, and wounded some while others saved themselves by a hasty flight to Delphi.

Here a meeting of the council and the citizens, under the presidency of Cottyphus of Pharsalus, passed a resolution that at the next regular meeting to be held at Pylæ the punishment of the Amphissians for their crime against the god and the sacred plain should be determined on, and for this purpose the deputies were to obtain special powers from their states.

When Æschines made his report to the Athenian people, Demosthenes cried out to him: "Thou bringest war into Attica — an Amphictyonic war"; and his warning words were of force enough to restrain the Athenians from sending delegates to the appointed tribunal. The Thebans also held aloof, although Timolaus, "the greatest slave of his pleasures" and others of Philip's partisans zealously bestirred themselves. However, the assembly was held, a heavy money-fine was imposed on the Amphissians and when

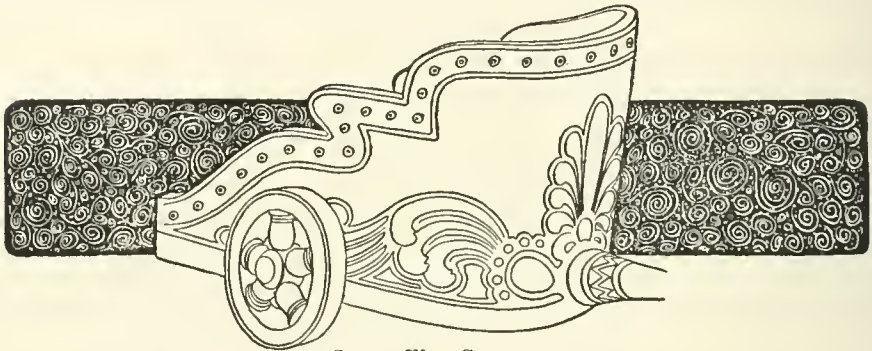

GREEK WAR CHARIOT

they refused payment it was resolved to make war against them. But the small army which Cottyphus himself led against them effected nothing; there was so little zeal that several tribes did not send their contingents, and the others went to work very sluggishly. Consequently at the next autumn meeting the leaders of the Macedonian party were able to make use of the opportunity to elect the Macedonian king as commander in the Sacred War.

Philip had returned from the Scythian expedition only a short time before, but he did not long delay. With an army which gradually increased to thirty thousand foot and twenty thousand horsemen, he broke into Phocis through the pass of Thermopylæ, won possession by a stratagem of the defiles at Parnassus which had been occupied by the generals Chares and Proxenus, and, after some brief contests with the mercenaries, took Amphissa. The city was razed to the ground, the inhabitants expelled, and the consecrated land restored to the Delphian sanctuary. When Philip had further conquered Naupactus and handed it over to the Ætolians, he went back across the mountains, occupied the Phocian frontier town of Elatea in the fertile plain of the Cephissus valley which, commanding the entrance to Locris and Bœotia, offered an excellent base for further operations. When Elatea had been hastily fortified by a stockade and provided with a strong garrison, it became a military camp which threatened immediate danger to Bœotia and Attica.

Demosthenes has painted in lively colours the impression made on the council and citizens of Athens by the news of the occupation of Elatea:

[339-338 B.C.]

“It was evening when a messenger came to the prytanes with the announcement that Elatea was taken. They immediately rose from table; some drove the market people from their booths and lighted the trellis work in order by this fiery signal to summon the people from the country to the town; others sent to the generals and had the alarm sounded: and the city was in the greatest excitement. At daybreak the next morning the prytanes summoned the great council to the council house; the citizens gathered in the popular assembly, and before the council had consulted and come to a decision the whole community was assembled on the Pnyx. And when the council appeared and the prytanes repeated the news received and had introduced the messenger and the latter had communicated his report, the herald asked: ‘Who will speak?’ but no one came forward; and as often as the herald repeated the question none rose although all the strategi were present and all the public orators.”

Then Demosthenes arose and first opposed the idea that Philip was acting in accordance with an understanding with Thebes:

“Whoever indulges in an exaggerated anxiety as though Philip were sure of the Thebans, mistakes the position, for I am convinced that if it were so we should not hear that he is at Elatea but on our frontiers. But it is quite true that in taking this step he had the design of winning Thebes for himself. He has already brought many over to his side by money and craft, but those who have withstood him from the beginning he will not now be able to win. In what intention has he now occupied Elatea? In order that by displaying his power in the neighbourhood and by the threatening aspect of his weapons he may encourage his friends to a bold stroke and intimidate his enemies, so that they will yield from fear or be coerced by the rest. If then we now remember our former quarrels with the Thebans and then distrust them, we shall first of all accomplish Philip’s dearest wish and then drive those who have hitherto been his adversaries over to his side, and there will be a general attack on Attica in conjunction with him.”

To avoid this Demosthenes made the following suggestions to his fellow-citizens: first to banish this present terror, and next to fear for the Thebans, since they were much nearer the object of dread and it was to them that the danger was most threatening; then they should march to Eleusis with their whole forces and with the cavalry, to show that they were themselves under arms, and by this means the party of liberty in Thebes would be encouraged to make a stand for the right, as those sold to Philip had a supporter at Elatea; finally they might choose ten envoys who in conjunction with the strategi should make the necessary arrangements for the march, and then going to Thebes declare there that the Athenians were ready with assistance if the Thebans wished and demanded it.

“If they accept the offer and join us we shall have attained our end without compromising the dignity of our state; if we are not successful the Thebans will have only themselves to blame if they meet with misfortune, but we shall have done nothing shameful or base.”

ALLIANCE BETWEEN ATHENS AND THEBES

The words of the patriot were a ray of light in the gloom of confusion and uncertainty. His suggestions were adopted without a dissentient word and himself placed at the head of an embassy which was to negotiate

the alliance with the Thebans and arrange with the generals as to the measures needed for the war. Demosthenes and his companions set out immediately whilst the army took up its post at Eleusis. When the envoys reached Thebes they immediately encountered those of Philip and his Thessalian allies who, aided by the Macedonian party, were zealously endeavouring by the most seductive promises to persuade the Thebans to conclude a military alliance with the king, or at least to remain neutral and allow his troops a passage to Attica. The witty, eloquent Python of Byzantium showed much skill in enumerating all the acts of benevolence which the king had performed for their city, and in exhibiting the advantages to Thebes which a united attack on Attica would bring in its train, and reminding the people of all the injuries and acts of hostility which Athens had ever inflicted upon them and for which they might now take vengeance. Nor did he forget the participation in the spoils of victory in case of their joining their arms with Macedon and the sufferings and horrors of the war if they stood by Athens. The Theban assembly wavered. But when Demosthenes implored the meeting to forget for the moment all former dissensions and injuries, and only think of saving their native Hellas and preserving liberty and honour; when he made it clear to them that the common danger could only be averted by their firm cohesion — then all doubts vanished before his fiery words. In the enthusiasm with which his speech filled them, they forgot self interest, fear, and favour; they determined to renounce the king and to make an offensive and defensive alliance with Athens. It was the last flicker of the fire which had shone so bravely in the days of the Persian War. At this time Demosthenes' opinion was decisive, not less in the newly erected confederate council at Thebes than before the popular assembly at Athens.

The provisions of the treaty are not positively known. Thebes was recognised as the head of Bœotia, each side secured in its possessions, and the restoration of the Phocian commonwealths determined on. Two-thirds of the cost of the war was to be borne by Athens, one-third by Thebes. On the other hand the assertion of Æschines that Thebes was to have the sole command by land, and by sea was to share it with Athens, lies under justifiable suspicion.

The newly awakened military spirit and the union of the arms of the two most powerful Hellenic states, by no means promised well for Philip's enterprises. He therefore again had recourse to negotiation. His friends and ambassadors protested that he had no hostile intentions against Greece, he had only come to fulfil the decrees of the Amphictyons. Even in Thebes and Athens there were notable men whose voices counselled peace, appealing to the evil signs and presages which were forthcoming in great numbers.

“The Pythia announced heavy misfortunes and old Sibylline utterances were in circulation which pointed to unfortunate battles and bloody fields of corpses, a prey to ravens and vultures: the vanquished weeps, ruin strikes the victor.”

It required all the energy and decision of Demosthenes to overcome these impressions. He went himself to Thebes and confirmed the Bœotarchs and the assembly of the people in their resolution; in Athens, where even Phocion spoke against the war, he is said to have threatened, to “drag into a cell by the hair of his head the first man who suggested peace with Philip.” Demosthenes carried his point. His popularity ran so high that the Athenians honoured him with the award of a golden crown twice in one year.

In the first days of spring the citizen army of Athens set out for Thebes and encamped before the city; but the Thebans brought them in and enter-

[338 B.C.]

tained them in their houses until the two allied armies marched together into the Phocian country. The two first encounters with the Macedonian troop at the Cephissus and in the "wintry" mountain country were favourable to the Hellenes. In Thebes and Athens thanks were rendered to the gods with sacrifices and solemn processions for the successful "river and winter battles." The Athenian army had especially distinguished itself by its discipline, equipment, and military ardour. Such men in Phocis as were capable of bearing arms joined the allies who now occupied the defiles leading into Bœotia. In order to drive them from this advantageous position and open a passage for himself, Philip again had recourse to a stratagem. He sent a division of his army into Bœotia by another mountain road and caused the villages and hamlets to be set on fire. This determined the Bœotian leaders to leave their position and protect their own country. Philip had been waiting for this; he quickly recalled that division and then marched through the passes with his whole army on Chæronea in the plain of the Cephissus, where the wide level offered a favourable battle-field.

THE ARMIES IN THE PLAIN OF CHÆRONEA

Here he was met by the army of the Hellenic allies. To the Thebans and Athenians who formed the kernel, the Eubœans, Megarians, Corinthians, Achæans, and Coreyraens had added their manhood, so that on the whole the Greeks had perhaps the advantage in numbers over their opponent. On the other hand they were far behind him in everything else. Their hastily summoned troops, composed of various nationalities, were no match either in training and discipline or in the use of weapons and military experience for the well-equipped and seasoned hosts of the Macedonians — who had lately been through the Thracian War, crossed the Hæmus and fought with the Seythians and Triballi in the steppes of the Danube — or for the Thessalian horsemen, who were renowned and feared throughout antiquity. And this efficient, practised force was guided by a single will of acknowledged mastery, and led into the battle by experienced generals like Antipater and others; whilst on the side of the Greeks there was no commander of name and consideration. The Athenian Stratocles and the Theban Theagenes were brave and conscientious, but in no way distinguished leaders; and the two other Athenian generals, Lysicles and Chares, the profligate and little regarded captain of mercenaries, could not in any way be compared with Philip.

Under these circumstances it was to be expected that the battle of Chæronea would end in a defeat of the Greeks. But they fought and fell with honour. It was the last test of the strength of the Hellenic people; only a few hired soldiers were to be found in the ranks, the great majority consisting of citizen levies. The heavy infantry of the Thebans, amongst whom the "Sacred Band" of the Three Hundred occupied the place of honour, maintained the reputation for bravery and discipline which they had borne since the days of Epaminondas; and the Athenians, in whose ranks Demosthenes served with the hoplites as a common soldier, were no unworthy members of the league. They formed the left wing whilst the Thebans fought on the right; the rest of the Hellenes and the mercenaries filled the centre. Philip, recognising the importance of the battle, made his dispositions with great wariness. He himself took command of the wing opposite to the Athenians; the other he entrusted to his son Alexander, a youth of

eighteen, who, surrounded by the most experienced warriors, was consumed with eagerness to begin his heroic career of fame and victory in this decisive battle. The oak-tree on the left bank of the Cephissus where his tent stood was still pointed out in Plutarch's time.²

It is among the accusations urged by Æschines against Demosthenes, that in levying mercenary troops he wrongfully took the public money to pay men who never appeared; and further, that he placed at the disposal of the Amphissians a large body of ten thousand mercenary troops, thus withdrawing them from the main Athenian and Bœotian army; whereby Philip was enabled to cut to pieces the mercenaries separately, while the entire force, if kept together, could never have been defeated. Æschines affirms that he himself strenuously opposed this separation of forces, the consequences of which were disastrous and discouraging to the whole cause.

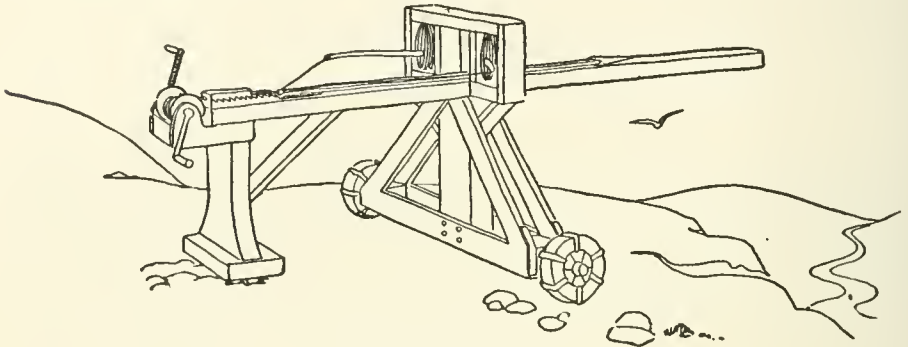

GREEK CATAPULT

It was in August, 338 B.C., that the allied Grecian army met Philip near Charonea, the last Bœotian town on the frontiers of Phocis. He seems to have been now strong enough to attempt to force his way into Bœotia, and is said to have drawn down the allies from a strong position into the plain by laying waste the neighbouring fields. His numbers are stated by Diodorus at thirty thousand foot and two thousand horse; he doubtless had with him Thessalians and other allies from northern Greece, but not a single ally from Peloponnesus. Of the united Greeks opposed to him, the total is not known. We can therefore make no comparison as to numbers, though the superiority of the Macedonian army in organisation is incontestable. The largest Grecian contingents were those of Athens, under Lysicles and Chares, and of Thebes, commanded by Theagenes; there were, besides, Phocians, Achæans, and Corinthians — probably also Eubœans and Megarians. The Lacedæmonians, Messenians, Arcadians, Eleans, and Argives, took no part in the war. All of them had doubtless been solicited on both sides, by Demosthenes as well as by the partisans of Philip. But their jealousy and the fear of Sparta led the last four states rather to look towards Philip as a protector against her, though on this occasion they took no positive part.

The command of the army was shared between the Athenians and the Thebans, and its movements were determined by the joint decision of their statesmen and generals. As to statesmen, the presence of Demosthenes at least insured to them sound and patriotic counsel powerfully set forth; as to generals, not one of the three was fit for an emergency so grave and terrible.

[338 B. C.]

It was the misfortune of Greece that, at this crisis of her liberty, when everything was staked on the issue of the campaign, neither an Epaminondas nor an Iphicrates was at hand. Phocion was absent as commander of the Athenian fleet in the Hellespont or the Ægean. Portents were said to have occurred, oracles and prophecies were in circulation, calculated to discourage the Greeks; but Demosthenes, animated by the sight of so numerous an army, hearty and combined in defence of Grecian independence, treated all such stories with the same indifference as Epaminondas had shown before the battle of Leuctra, and accused the Delphian priestess of philippising. Nay, so confident was he in the result (according to the statement of Æschines), that when Philip, himself apprehensive, was prepared to offer terms of peace, and the Bœotarchs inclined to accept them, Demosthenes alone stood out, denouncing as a traitor anyone who should broach the proposition of peace, and boasting that if the Thebans were afraid, his countrymen the Athenians desired nothing better than a free passage through Bœotia to attack Philip single-handed.

THE BATTLE OF CHERONEA

In the field of battle near Chæronea, Philip himself commanded a chosen body of troops on the wing opposed to the Athenians; while his youthful son Alexander, aided by experienced officers, commanded against the Thebans on the other wing. Respecting the course of the battle, we are scarcely permitted to know anything.¹ It is said to have been so obstinately contested that for some time the result was doubtful. The Sacred Band of Thebes, who charged in one portion of the Theban phalanx, exhausted all their strength and energy in an unavailing attempt to bear down the stronger phalanx and multiplied pikes opposed to them. The youthful Alexander here first displayed his great military energy and ability. After a long and murderous struggle, the Theban Sacred Band were all overpowered and perished in their ranks, while the Theban phalanx was broken and pushed back. Philip on his side was still engaged in undecided conflict with the Athenians, whose first onset is said to have been so impetuous, as to put to flight some of the troops in his army; insomuch that the Athenian general exclaimed in triumph, "Let us pursue them even to Macedonia." It is farther said that Philip on his side simulated a retreat, for the purpose of inducing them to pursue and to break their order. We read another statement — more likely to be true; that the Athenian hoplites, though full of energy at the first shock, could not endure fatigue and prolonged struggle like the trained veterans in the opposite ranks. Having steadily repelled them for a considerable time, Philip became emulous on witnessing the success of his son, and redoubled his efforts: so as to break and disperse them. The whole Grecian army was thus put to flight with severe loss.

The Macedonian phalanx, as armed and organised by Philip, was sixteen deep; less deep than that of the Thebans either at Delium or at Leuctra. It had veteran soldiers of great strength and complete training in its front ranks; yet probably soldiers hardly superior to the Sacred Band, who formed the Theban front rank. But its great superiority was in the length of the

[¹ Niebuhr,² commenting on our scant information, says, "It is as if the muse of Greece had grown dumb on the death-day of Greek liberty, and had thrown her veil over the death blow." Later he notes the remarkable coincidence that the battle of Chæronea was fought in the same year in which Rome conquered the Volscians and Latins "and laid the foundation of her sovereignty over all Italy."]

Macedonian pike or sarissa, in the number of these weapons which projected in front of the foremost soldiers, and the long practice of the men to manage this impenetrable array of pikes in an efficient manner. The value of Philip's improved phalanx was attested by his victory at Chæronea.

But the victory was not gained by the phalanx alone. The military organisation of Philip comprised an aggregate of many sorts of troops besides the phalanx — the bodyguards, horse as well as foot; the hypaspistæ, or light hoplites; the light cavalry, bowmen, slingers, etc.

One thousand Athenian citizens perished in this disastrous field; two thousand more fell into the hands of Philip as prisoners. The Theban loss is said also to have been terrible, as well as the Achæan. But we do not know the numbers; nor have we any statement of the Macedonian loss. Demosthenes, himself present in the ranks of the hoplites, shared in the flight of his defeated countrymen. He is accused by his political enemies of having behaved with extreme and disgraceful cowardice; but we see plainly from the continued confidence and respect shown to him by the general body of his countrymen, that they cannot have credited the imputation. The two Athenian generals, Chares and Lysicles, both escaped from the field. The latter was afterwards publicly accused at Athens by the orator Lysurgus. Lysicles was condemned to death by the dicastery. What there was to distinguish his conduct from that of his colleague Chares — who certainly was not condemned, and is not even stated to have been accused — we do not know.

Unspeaking was the agony at Athens on the report of this disaster, with a multitude of citizens as yet unknown left on the field or prisoners, and a victorious enemy within three or four days' march of the city. The whole population, even old men, women, and children, were spread about the streets in all the violence of grief and terror, interchanging effusions of distress and sympathy, and questioning every fugitive as he arrived about the safety of their relatives in the battle. The flower of the citizens of military age had been engaged; and before the extent of loss had been ascertained, it was feared that none except the elders would be left to defend the city. At length the definite loss became known: severe indeed and terrible — yet not a total shipwreck, like that of the army of Nicias in Sicily.

As on that trying occasion, so now: amidst all the distress and alarm, it was not in the Athenian character to despair. The mass of citizens hastened unbidden to form a public assembly, wherein the most energetic resolutions were taken for defence. Decrees were passed enjoining every one to carry his family and property out of the open country of Attica into the various strongholds; directing the body of the senators, who by general rule were exempt from military service, to march down in arms to Piræus, and put that harbour in condition to stand a siege; placing every man without exception at the disposal of the generals, as a soldier for defence, and imposing the penalties of treason on every one who fled; enfranchising all slaves fit for bearing arms, granting the citizenship to metics under the same circumstances, and restoring to the full privilege of citizens those who had been disfranchised by judicial sentence. This last-mentioned decree was proposed by Hyperides; but several others were moved by Demosthenes, who, notwithstanding the late misfortune of the Athenian arms, was listened to with undiminished respect and confidence. Not only he, but also most of the conspicuous citizens and habitual speakers in the assembly, came forward with large private contributions to meet the pressing wants of the moment. Every man in the city lent a hand to make good the defective points in the

[338 B.C.]

fortification. Materials were obtained by felling the trees near the city, and even by taking stones from the adjacent sepulchres — as had been done after the Persian War when the walls were built under the contrivance of Themistocles. The temples were stripped of the arms suspended within them, for the purpose of equipping unarmed citizens. By such earnest and unanimous efforts, the defences of the city and of Piræus were soon materially improved. At sea Athens had nothing to fear. Her powerful naval force was untouched, and her superiority to Philip on that element incontestable. Envoys were sent to Trœzen, Epidaurus, Andros, Ceos, and other places, to solicit aid and collect money; in one or other of which embassies Demosthenes served, after he had provided for the immediate exigences of defence.

PHILIP TAKES THEBES

Such were the precautions taken at Athens after this fatal day. But Athens lay at a distance of three or four days' march from the field of Chæronea; while Thebes, being much nearer, bore the first attack of Philip. Of the behaviour of that prince after his victory, we have contradictory statements. According to one account, he indulged in the most insulting and licentious exultation on the field of battle, jesting especially on the oratory and motions of Demosthenes; a temper from which he was brought round by the courageous reproof of Demades, then his prisoner as one of the Athenian hoplites.¹ At first he even refused to grant permission to inter the slain, when the herald came from Lebadæa to make the customary demand. According to another account, the demeanour of Philip towards the defeated Athenians was gentle and forbearing. However the fact may have stood as to his first manifestations, it is certain that his positive measures were harsh towards Thebes and lenient towards Athens. He sold the Theban captives into slavery; he is said also to have exacted a price for the liberty granted to bury the Theban slain — which liberty, according to Grecian custom, was never refused, and certainly never sold, by the victor. Whether Thebes made any further resistance, or stood a siege, we do not know. But presently the city fell into Philip's power, who put to death several of the leading citizens, banished others, and confiscated the property of both. A council of Three Hundred — composed of philippising Thebans, for the most part just recalled from exile — was invested with the government of the city, and with powers of life and death over every one. The state of Thebes became much the same as it had been when the Spartan Phœbidas, in concert with the Theban party headed by Leontiades, surprised the Cadmea. A Macedonian garrison was now placed in the Cadmea, as a Spartan garrison had been placed then. Supported by this garrison, the philippising Thebans were uncontrolled masters of the city; with full power, and no reluctance, to gratify their political antipathies. At the same time, Philip restored the minor Bœotian towns — Orchomenos, and Plateæ, probably also Thespiæ and Coronea — to the condition of free communities instead of subjection to Thebes.

At Athens also, the philippising orators raised their voices loudly and confidently, denouncing Demosthenes and his policy. New speakers, who

[¹ According to Diodorus,² he said, "Since Fortune, O King, has represented thee like Agamemnon, art thou not ashamed to act the part of Thersites?" With this sharp reproof Philip was so startled, they say, that he wholly changed his former course, and with admiration released the man that had reprehended him and advanced him to places of honour.]

would hardly have come forward before, were now put up against him. The accusations however altogether failed; the people continued to trust him, omitting no measure of defence which he suggested. Æschines, who had before disclaimed all connection with Philip, now altered his tone, and made boast of the ties of friendship and hospitality subsisting between that prince and himself. He tendered his services to go as envoy to the Macedonian camp; whither he appears to have been sent, doubtless with others, perhaps with Xenocrates and Phocion. Among them was Demades also, having been just released from his captivity. Either by the persuasions of Demades, or by a change in his own dispositions, Philip had now become inclined to treat with Athens on favourable terms. The bodies of the slain Athenians were burned by the victors, and their ashes collected to be carried to Athens; though the formal application of the herald, to the same effect, had been previously refused. Æschines (according to the assertion of Demosthenes) took part as a sympathising guest in the banquet and festivities whereby Philip celebrated his triumph over Grecian liberty. At length Demades with the other envoys returned to Athens, reporting the consent of Philip to conclude peace, to give back the numerous prisoners in his hands, and also to transfer Oropus from the Thebans to Athens.

PEACE OF DEMADES

Demades proposed the conclusion of peace to the Athenian assembly, by whom it was readily decreed. To escape invasion and siege by the Macedonian army was doubtless an unspeakable relief; while the recovery of the two thousand prisoners without ransom was an acquisition of great importance, not merely to the city collectively but to the sympathies of numerous relatives. Lastly, to regain Oropus—a possession which they had once enjoyed, and for which they had long wrangled with the Thebans—was a further cause of satisfaction. Such conditions were doubtless acceptable at Athens. But there was a submission to be made on the other side, which to the contemporaries of Pericles would have seemed intolerable, even as the price of averted invasion or recovered captives. The Athenians were required to acknowledge the exaltation of Philip to the headship of the Grecian world, and to promote the like acknowledgment by all other Greeks, in a congress to be speedily convened. They were to renounce all pretensions to headship, not only for themselves, but for every other Grecian state; to recognise not Sparta nor Thebes, but the king of Macedon, as Panhellenic chief; to acquiesce in the transition of Greece from the position of a free, self-determining, political aggregate, into a provincial dependency of the kings of Pella and Æge. It is not easy to conceive a more terrible shock to that traditional sentiment of pride and patriotism, inherited from forefathers who, after repelling and worsting the Persians, had first organised the maritime Greeks into a confederacy running parallel with and supplementary to the non-maritime Greeks allied with Sparta; thus keeping out foreign dominion and casting the Grecian world into a system founded on native sympathies and free government. Such traditional sentiment, though it no longer governed the character of the Athenians nor impressed upon them motives of action, had still a strong hold upon their imagination and memory, where it had been constantly kept alive by the eloquence of Demosthenes and others. The Peace of Demades, recognising Philip as chief of Greece, was a renunciation of all this proud historical past, and the ac-

[338 B.C.]

ceptance of a new and degraded position, for Athens as well as for Greece generally.

If Philip had not purchased the recognition of Athens, he might have failed in trying to extort it by force. For though, being master of the field, he could lay waste Attica with impunity, and even establish a permanent fortress in it like Decelea — yet the fleet of Athens was as strong as ever, and her preponderance at sea irresistible. Under these circumstances, Athens and Piræus might have been defended against him, as Byzantium and Perinthus had been, two years before; the Athenian fleet might have obstructed his operations in many ways; and the siege of Athens might have called forth a burst of Hellenic sympathy, such as to embarrass his further progress. We may see therefore that, with such difficulties before him if he pushed the Athenians to despair, Philip acted wisely in employing his victory and his prisoners to procure her recognition of his headship. His political game was well played, now as always; but to the praise of generosity bestowed by Polybius he has little claim.

Besides the recognition of Philip as chief of Greece, the Athenians, on the motion of Demades, passed various honorary and complimentary votes in his favour; of what precise nature we do not know. Immediate relief from danger, with the restoration of two thousand captive citizens, was sufficient to render the peace generally popular at the first moment; moreover, the Athenians, as if conscious of failing resolution and strength, were now entering upon that career of flattery to powerful kings which we shall hereafter find them pushing to disgraceful extravagance. It was probably during the prevalence of this sentiment, which did not long continue, that the youthful Alexander of Macedon, accompanied by Antipater, paid a visit to Athens. Meanwhile the respect enjoyed by Demosthenes among his countrymen was noway lessened. Though his political opponents thought the season favourable for bringing many impeachments against him, none of them proved successful.

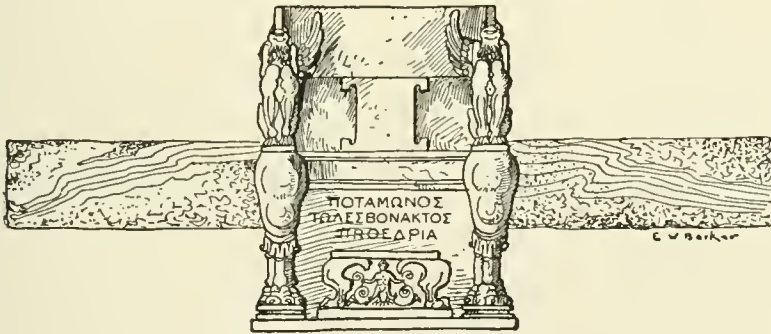

GREEK MARBLE CHAIR

PHILIP IN PELOPONNESUS

Having thus subjugated and garrisoned Thebes, having reconstituted the anti-Theban cities in Bœotia, having constrained Athens to submission and dependent alliance, and having established a garrison in Ambracia, at the same time mastering Acarnania, and banishing the leading Acarnanians who were opposed to him, Philip next proceeded to carry his arms into Peloponnesus. He found little positive resistance anywhere, except in the territory of

Sparta. The Corinthians, Argives, Messenians, Eleans, and many Arcadians, all submitted to his dominion; some even courted his alliance, from fear and antipathy against Sparta. Philip invaded Laconia with an army too powerful for the Spartans to resist in the field. He laid waste the country, and took some detached posts; but he did not take, nor do we know that he even attacked, Sparta itself. The Spartans could not resist; yet would they neither submit nor ask for peace. It appears that Philip cut down their territory and narrowed their boundaries on all the three sides; towards Argos, Messene, and Megalopolis. We have no precise account of the details of his proceedings; but it is clear that he did just what seemed to him good, and that the governments of all the Peloponnesian cities came into the hands of his partisans. Sparta was the only city which stood out against him; maintaining her ancient freedom and dignity, under circumstances of feebleness and humiliation, with more unshaken resolution than Athens.

POLITICAL SCHEMES; FAMILY BROILS

Philip next proceeded to convene a congress of Grecian cities at Corinth. He here announced himself as resolved on an expedition against the Persian king, for the purpose both of liberating the Asiatic Greeks and avenging the invasion of Greece by Xerxes. The general vote of the congress nominated him leader of the united Greeks for this purpose, and decreed a Grecian force to join him, to be formed of contingents furnished by the various cities. The total of the force promised is stated only by Justin, who gives it at two hundred thousand foot, and fifteen thousand horse; an army which Greece certainly could not have furnished, and which we can hardly believe to have been even promised. The Spartans stood aloof from the congress, continuing to refuse all recognition of the headship of Philip. The Athenians attended and concurred in the vote; which was in fact the next step to carry out the peace made by Demades. They were required to furnish a well-equipped fleet to serve under Philip; and they were at the same time divested of their dignity of chiefs of a maritime confederacy, the islands being enrolled as maritime dependencies of Philip, instead of continuing to send deputies to a synod meeting at Athens. For several years afterwards, the naval force in the dockyards of Athens still continued large and powerful; but her maritime ascendancy henceforward disappears.

This scheme—the invasion of Persia—had now ceased to be an object of genuine aspiration throughout the Grecian world. The Great King, no longer inspiring terror to Greece collectively, might now be regarded as likely to lend protection against Macedonian oppression. To emancipate the Asiatic Greeks from Persian dominion would be in itself an enterprise grateful to Grecian feeling, though all such wishes must have been gradually dying out since the Peace of Antalcidas. But emancipation, accomplished by Philip, would be only a transfer of the Asiatic Greeks from Persian dominion to his. The synod of Corinth served no purpose except to harness the Greeks to his car, for a distant enterprise lucrative to his soldiers and suited to his insatiable ambition.

It was in 337 B.C. that this Persian expedition was concerted and resolved. During that year preparations were made of sufficient magnitude to exhaust the finances of Philip; who was at the same time engaged in military operations, and fought a severe battle against the Illyrian king Pleurias. In the spring of 336 B.C., a portion of the Macedonian army

[337-336 B.C.]

under Parmenion and Attalus, was sent across to Asia to commence military operations; Philip himself intending speedily to follow.

Such however was not the fate reserved for him. Not long before, he had taken the resolution of repudiating, on the allegation of infidelity, his wife Olympias; who is said to have become repugnant to him, from the furious and savage impulses of her character. He had successively married several wives, the last of whom was Cleopatra, niece of the Macedonian Attalus. It was at her instance that he is said to have repudiated Olympias; who retired to her brother, Alexander of Epirus. This step provoked violent dissensions among the partisans of the two queens, and even between Philip and his son Alexander, who expressed a strong resentment at the repudiation of his mother. Amidst the intoxication of the marriage banquet, Attalus proposed a toast and prayer, that there might speedily appear a legitimate son, from Philip and Cleopatra, to succeed to the Macedonian throne. Upon which Alexander exclaimed in wrath, "Do you then proclaim me as a bastard?"—at the same time hurling a goblet at him. Incensed at this proceeding, Philip started up, drew his sword, and made furiously at his son; but fell to the ground from passion and intoxication. This accident alone preserved the life of Alexander, who retorted, "Here is a man, preparing to cross from Europe into Asia, who yet cannot step surely from one couch to another." After this violent quarrel the father and son separated. Alexander conducted his mother into Epirus, and then went himself to the Illyrian king. Some months afterwards, at the instance of the Corinthian Demaratus, Philip sent for him back, and became reconciled to him; but another cause of displeasure soon arose, because Alexander had opened a negotiation for marriage with the daughter of the satrap of Caria. Rejecting such an alliance as unworthy, Philip sharply reproved his son, and banished from Macedonia several courtiers whom he suspected as intimate with Alexander; while the friends of Attalus stood high in favour.

THE DEATH OF PHILIP

Such were the animosities distracting the court and family of Philip. A son had just been born to him from his new wife Cleopatra. His expedition against Persia, resolved and prepared during the preceding year, had been actually commenced. But Philip foresaw that during his absence danger might arise from the furious Olympias, bitterly exasperated by the recent events, and instigating her brother Alexander, king of Epirus, with whom she was now residing. He now deemed it essential to conciliate him still further, by a special tie of alliance; giving to him in marriage Cleopatra, his daughter by Olympias. For this marriage, celebrated at Ægæ in Macedonia in August 336 B.C., Philip provided festivals of the utmost cost and splendour, commemorating at the same time the recent birth of his son by Cleopatra. Banquets, munificent presents, gymnastic and musical matches, tragic exhibitions—among which Neoptolemus the actor performed in the tragedy of Cinyras, etc., with every species of attraction known to the age—were accumulated, in order to reconcile the dissentient parties in Macedonia, and to render the effect imposing on the minds of the Greeks; who, from every city, sent deputies for congratulation. Statues of the twelve great gods, admirably executed, were carried in solemn procession into the theatre; immediately after them, the statue of Philip himself as a thirteenth god.

Amidst this festive multitude, however, there were not wanting discontented partisans of Olympias and Alexander, to both of whom the young queen with her new-born child threatened a formidable rivalry. There was also a malcontent yet more dangerous — Pausanias, one of the royal body-guards, a noble youth born in the district called Orestis in upper Macedonia, who, from causes of offence peculiar to himself, nourished a deadly hatred against Philip. The provocation which he had received is one which we can neither conveniently transcribe, nor indeed accurately make out, amidst discrepancies of statement. It was Attalus, the uncle of the new queen Cleopatra, who had given the provocation, by inflicting upon Pausanias an outrage of the most brutal and revolting character. Even for so monstrous an act, no regular justice could be had in Macedonia against a powerful man. Pausanias complained to Philip in person. According to one account, Philip put aside the complaint with evasions, and even treated it with ridicule; according to another account, he expressed his displeasure at the act, and tried to console Pausanias by pecuniary presents. But he granted neither redress nor satisfaction to the sentiment of an outraged man. Accordingly Pausanias determined to take revenge for himself. Instead of revenging himself on Attalus — who indeed was out of his reach, being at the head of the Macedonian troops in Asia — his wrath fixed upon Philip himself, by whom the demand for redress had been refused. That the vindictive Olympias would positively spur on Pausanias to assassinate Philip, is highly probable. Respecting Alexander, though he also was accused, there is no sufficient evidence to warrant a similar assertion; ¹ but that some among his partisans — men eager to consult his feelings and to insure his succession — lent their encouragements, appears tolerably well established.

Unconscious of the plot, Philip was about to enter the theatre, already crowded with spectators. As he approached the door, clothed in a white robe, he felt so exalted with impressions of his own dignity, and so confident in the admiring sympathy of the surrounding multitude, that he advanced both unarmed and unprotected, directing his guards to hold back. At this moment Pausanias, standing near with a Gallic sword concealed under his garment, rushed upon him, thrust the weapon through his body, and killed him. Having accomplished his purpose, the assassin immediately ran off, and tried to reach the gates, where he had previously caused horses to be stationed. Being strong and active, he might have succeeded in effecting his escape — like most of the assassins of Jason of Pheræ under circumstances very similar — had not his foot stumbled amidst some vine-stocks. The guards and friends of Philip were at first paralysed with astonishment and consternation. At length, however, some hastened to assist the dying king, while others rushed in pursuit of Pausanias. Leonnatus and Perdiccas overtook him and slew him immediately.

In what way, or to what extent, the accomplices of Pausanias lent him aid, we are not permitted to know. It is possible that they may have posted themselves artfully so as to obstruct pursuit, and favour his chance of escape; which would appear extremely small, after a deed of such unmeasured audacity. Three only of the reputed accomplices are known to us by name — three brothers from the Lyncestian district of upper Macedonia, Alexander, Heromenes, and Arrhibæus, sons of Æropus; but it seems that there were others besides. The Lyncestian Alexander whose father-in-law, Antipater,

[¹ But Niebuhr^h is less negative. He exclaims, "Alexander was no doubt deeply implicated in this murder. A jury would have condemned him as an accomplice. But he was prudent enough to make away with the participators in the conspiracy, who might have betrayed him."]

[336 B.C.]

was one of the most conspicuous and confidential officers in the service of Philip, belonged to a good family in Macedonia, perhaps even descendants from the ancient family of the princes of Lyncestis. It was he who, immediately after Pausanias had assassinated Philip, hastened to salute the prince Alexander as king, helped him to put on his armour, and marched as one of his guards to take possession of the regal palace.⁹

A SUMMING UP OF PHILIP'S CHARACTER

His character was always to be without character in disposition and action; his principles, to have no principles and everywhere to dissemble his aims; his habits, to accustom himself to nothing, but solely to follow the inspirations of the moment; his strength, to remain master of himself in every condition and proceeding, and, in a thousand other causes and consequences of weakness, to follow his chief plan unchanged, and to lead everything around him, whilst to the short-sighted he appeared to be led by all.

He possessed wit, sagacity, and eloquence, and made use of them. He was insinuating and condescending when it was a question of winning or deluding; merciful when he hated; irritating when he loved; compassionate when he himself had dealt the wounds; ready to comfort, when he had decided to strike the heart more deeply; poor, so as to soften the rage of the plundered rich, so as to reward his helpers; liberal with promises when he saw the people were credulous; full of respect for the gods only when he had a mind to; unconcerned as to the lawfulness of the means, provided they led to the end.

"Philip," says Pausanias, "accomplished the greatest deeds of all the Macedonian kings who reigned before and after him, and also broke more oaths and violated more covenants."

The new politics which Philip established, arose entirely out of his genius, and the master understood his work and knew how to use it. When Philip as a statesman formed something new with cleverness and vigour, the old must therefore have succumbed to it. The old methods were no longer suitable; the means failed the end, the roads no longer led to the goal; danger then took another form, and was threatened on another side. That which could have saved the Greeks from imitating the new methods of the opponent, and of seizing the spirit of them, and throwing themselves quickly into another kind of transaction, they were no longer capable of. By the side of politics he placed an improved war department, but one spirit drifted into both. Philip possessed the talents especially required by a general. In the greatest danger, full of presence of mind, he never doubted his safety; his most terrible deliberation in the field was quiet deliberation and stratagem. The Bœotians learned this when they had cut him off and already thought him caught, and the Chalcidians whose cleverly contrived perfidy was wrecked by his cunning. He anticipated all his enemies; they admitted that on this account he always had advantage over them.

Demosthenes says to the Athenians: "You wage war with Philip in the same way as the barbarians carry on a boxing match; when some one is hit he tries to protect the place, and if he is struck on another part his hands go to it; but to prevent the blow or to foresee it, they cannot and will not. It is thus with you; when you hear Philip is in Chæronea, you decide to send an army there, when in Pydna, also there, so that he is truly your commanding

officer." He maintained a standing army and was therefore always ready to strike; this gave him a great superiority, because as monarch he could at once use his fighting forces, without losing time in consultation.

When he attacked the Greeks, his army had already been trained through fighting the surrounding barbarians; it had to learn how useful and necessary it was, and realise to what purpose he made them persevere in peace. He often made them march three hundred stadia encumbered with their weapons, with helmet, shield, and splints, and in addition to this, food and clothing and utensils. They had to observe the strictest discipline. A distinguished Tarentine was dismissed from the service because he had helped himself to a warm bath; Æropus and Damasippus were dismissed because they brought singers into the camp. In the same manner as Epaminondas, in whose school Philip had learned, beat the Lacedæmonian mora by a new formation of the army and deprived them of the efficiency of their firm, quiet movements — so Philip formed the Macedonian phalanx.

Even Æmilius Paulus acknowledged that nothing ever terrified them. They stood the test at Charonea, where the sacred troops of the Thebans were defeated, and the Athenians, also in the last fight for their freedom, did not prevail against them.‡

GROTE'S ESTIMATE OF PHILIP

Thus perished the destroyer of freedom and independence in the Hellenic world, at the age of forty-six or forty-seven, after a reign of twenty-three years. Our information about him is signally defective. Neither his means, nor his plans, nor the difficulties which he overcame, nor his interior government, are known to us with exactness or upon contemporary historical authority. But the great results of his reign, and the main lines of his character, stand out incontestably. At his accession, the Macedonian kingdom was a narrow territory round Pella, excluded partially, by independent and powerful Grecian cities, even from the neighbouring sea coast. At his death Macedonian ascendancy was established from the coasts of the Propontis to those of the Ionian Sea, and the Ambracian, Messenian, and Saronic gulfs. Within these boundaries, all the cities recognised the supremacy of Philip; except only Sparta, and mountaineers like the Ætolians and others defended by a rugged home.

Good fortune had waited on Philip's steps; but it was good fortune crowning the efforts of a rare talent. Indeed the restless ambition, the indefatigable personal activity and endurance, and the adventurous courage of Philip were such as, in a king, suffice almost of themselves to guarantee success, even with abilities much inferior to his. That among the causes of Philip's conquests, one was corruption, employed abundantly to foment discord and purchase partisans among neighbours and enemies; that with winning and agreeable manners, he combined recklessness in false promises, deceit and extortion even towards allies, and unscrupulous perjury when it suited his purpose — this we find affirmed, and there is no reason for disbelieving it. Such dissolving forces smoothed the way for an efficient and admirable army, organised, and usually commanded, by himself. Its organisation adopted and enlarged the best processes of scientific warfare employed by Epaminondas and Iphicrates. Begun as well as completed by Philip, and bequeathed as an engine ready-made for the conquests of Alexander, it constitutes an epoch in military history. But the more we extol the genius of Philip as a conqueror, formed for successful encroachment

and aggrandisement at the expense of all his neighbours — the less can we find room for that mildness and moderation which some authors discover in his character. If, on some occasions of his life, such attributes may fairly be recognised, we have to set against them the destruction of the thirty-two Greek cities in Chalcidice, and the wholesale transportation of reluctant and miserable families from one inhabitancy to another.

Besides his skill as a general and politician, Philip was no mean proficient in the Grecian accomplishments of rhetoric and letters. Isocrates addresses him as a friend of letters and philosophy; a reputation which his choice of Aristotle as instructor of his son Alexander tends to bear out. Yet in Philip, as in the two Dionysii of Syracuse and other despots, these tastes were not found inconsistent either with the crimes of ambition or the licenses of inordinate appetite. The contemporary historian Theopompus, a warm admirer of Philip's genius, stigmatises not only the perfidy of his public dealings, but also the drunkenness, gambling, and excesses of all kinds in which he indulged — encouraging the like in those around him. His Macedonian and Grecian bodyguard, eight hundred in number, was a troop in which no decent man could live; distinguished indeed for military bravery and aptitude, but sated with plunder, and stained with such shameless treachery, sanguinary rapacity, and unbridled lust, as befitted only centaurs and Læstrygons. The number of Philip's mistresses and wives was almost on an oriental scale; and the innumerable dissensions thus introduced into his court through his offspring by different mothers, were fraught with mischievous consequences.

In appreciating the genius of Philip, we have to appreciate also the parties to whom he stood opposed. His good fortune was nowhere more conspicuous than in the fact, that he fell upon those days of disunion and backwardness in Greece (indicated in the last sentence of Xenophon's *Hellenics*) when there was neither leading city prepared to keep watch, nor leading general to take command, nor citizen-soldiers willing and ready to endure the hardships of steady service. Philip combated no opponents like Epaminondas, or Agesilaus, or Iphicrates. How different might have been his career, had Epaminondas survived the victory of Mantinea, gained only two years before Philip's accession! To oppose Philip, there needed a man like himself, competent not only to advise and project, but to command in person, to stimulate the zeal of citizen-soldiers, and to set the example of braving danger and fatigue. Unfortunately for Greece, no such leader stood forward. In counsel and speech Demosthenes sufficed for the emergency. Twice before the battle of Chæronea — at Byzantium and at Thebes — did he signally frustrate Philip's combinations. But he was not formed to take the lead in action, nor was there any one near him to supply the defect. In the field, Philip encountered only that "public inefficiency," at Athens and elsewhere in Greece, of which even Æschines complains; and to this decay of Grecian energy, not less than to his own distinguished attributes, the unparalleled success of his reign was owing. We shall find during the reign of his son Alexander the like genius and vigour exhibited on a still larger scale, and achieving still more wonderful results; while the once stirring politics of Greece, after one feeble effort, sink yet lower, into the nullity of a subject province. 9



CHAPTER I. ALEXANDER THE GREAT

THE world has seen many great conquerors, but certainly not more than two or three who have stamped their names so indelibly upon the pages of history and appealed to the imagination of so wide an audience as the hero of Macedonia. The young soldier's meteoric career, which Appian, the great Roman historian, justly likened to a flash of lightning, had all the elements of dramatic picturesqueness. Alexander was the wonder of the age in which he lived, and no less a wonder to each succeeding generation. A myth soon grew up about his name, but the myth was scarcely more wonderful than the bald facts of his history. The main outlines of that history are familiar to every school-boy, yet it is a curious fact that no contemporary record of the achievements of Alexander has come down to us. We have the account of the Persian Wars written by Herodotus who was born before their close. We have the record of the Peloponnesian War written by Thucydides who participated in it, and by Xenophon who must have known personally many of its greatest actors. Xenophon has also left us a biography of Agesilaus, who so nearly anticipated Alexander in an Asiatic conquest, and, in so doing, he writes not merely as a contemporary but as a personal friend. But the oldest extant writings that give us an account of the deeds of Alexander were not penned until some three centuries after that hero lived and died. It is true that contemporary records of the history of Alexander were written in numbers, but by some curious chance no copy of any one of these records has been preserved.

Fortunately, however, the histories of Alexander that have come down to us are all based more or less on the contemporary records that are lost. There are five of these important histories, all written, perhaps, almost in the same century—the works namely of Diodorus, Justin, Plutarch, Curtius, and Arrian. The most ancient of these is the history of Diodorus, which dates from somewhere about the age of Julius Cæsar; the latest, that of Arrian, was written probably about the time of the reign of Adrian. There are, of course, numerous other classical authors who make reference to Alexander, but these five are the only ones who have given us anything like a complete history of his doings.

Of these histories, by common consent, the most authoritative is that of Arrian.ⁱ This work is based upon the writings of two of Alexander's

[336 B.C.]

generals, Ptolemy and Aristobulus. The point of view from which the work is written cannot be better described than in the author's own words:

"I have admitted into my narrative as strictly authentic all the statements relating to Alexander and Philip which Ptolemy, son of Lagus, and Aristobulus, son of Aristobulus, agree in making; and from those statements which differ I have selected that which appears to me the more credible, and at the same time the more deserving of record. Different authors have given different accounts of Alexander's actions; and there is no one about whom more have written, or more at variance with each other; but in my opinion the narratives of Ptolemy and Aristobulus are more worthy of credit than the rest—Aristobulus, because he served under King Alexander in his expedition, and Ptolemy's, not only because he accompanied Alexander in his expedition, but also because, being a king himself, the falsification of the facts would have been more disgraceful to him than to any other man. Moreover they are both more worthy of credit, because they compiled their histories after Alexander's death, when neither compulsion was used nor reward offered to them to write anything different from what really occurred. Some statements also made by other writers I have incorporated in my narrative, because they seemed to me worthy of mention and not altogether improbable; but I have given them merely as reports of Alexander's proceedings. And if any man wonders why, after so many other men have written of Alexander, the compilation of this history came into my mind, after perusing the narratives of all the rest, let him read this of mine, and then wonder—if he can."

When one reflects on the library of volumes that have been written in recent times on Alexander and his doings, it is curious to consider how meagre are the original materials on which all this elaboration is based. The entire accounts of Diodorus, Justin, Plutarch, Curtius, and Arrian if printed together in full would make but a comparatively small volume. Nor can it be said that any recent discoveries have greatly altered the point of view from which the history of Alexander is to be regarded, or largely added to our knowledge of the subject. The reader who has mastered these five classical authorities has learned practically all that is specifically known regarding the deeds of Alexander, and every modern historian who treats of the subject must bear these original authorities constantly in mind.^a

Before taking up Alexander's deeds in detail, it may be well to quote, by way of transition from father to son, the epigrammatic comparison made by Justin, between Philip and Alexander, using Brown's translation of 1712:

PHILIP AND ALEXANDER COMPARED BY JUSTIN

"Philip was killed in the Forty-Seventh Year of his Age, after he had Reigned Twenty-Five Years. He had a Son by an Actress of Larissa, whose Name was Aridæus, who reign'd after Alexander. He had, as 'tis usual with Princes, several other Sons by several Wives, some of whom died a Natural, and others fell by a violent Death. He was a Prince that took more Delight in Arms than in Feasting. His greatest Riches consisted in his Military Stores. He was more dexterous at getting Money than at keeping of it, which was the Reason that he was everlastingly Poor and Necessitous, amidst all his Rapines and Plunders. He was naturally inclined neither to Mercy nor Pity, but used both indifferently, as his Affairs required.

"He thought no Way dishonourable to overcome an Enemy. In his Discourse he was Free and Courteous, but always designing. He would promise

infinitely more than he intended to perform. He was equally excellent at Railery and serious Discourse. He measured Friendship not by Fidelity, but the Advantages it brought. His principal Talents were to pretend Love where he hated most, to excite Animosities and Distrusts between Friends, and at the same time to curry Favour with both. Among his other Qualities, Eloquence was none of the least, his Conversation was sprightly and subtle and neither did the Easiness of it exclude its Elegance, nor its Elegance Adulterate the Beauty of its Easiness.

“He was succeeded by his Son Alexander, who surpassed his Father both in his Virtues and his Vices. Their Methods of Conquering were extremely different. The Son carried on his Wars by open Force, the Father by Artifice and Stratagem. One loved to trick an Enemy underhand, the Other to defeat them gallantly in the Field by Bravery. One was more subtle in Council, the Other more Magnificent in his Temper.

“The Father could dissemble, and for the most part overcome his Anger. The Son, when he was thoroughly inflamed, neither knew how to allay, nor Moderate his Revenge. Both of them were over-greedy of Wine, but the Vices of their Drunkenness were different. The Father would run from an Entertainment to go and engage with an Enemy and rashly expose himself to Danger. The Son quarrelled with his friends in his Wine, and treated them like Enemies. Thus we find that Philip has frequently returned from Battels Wounded, and Alexander came from a Banquet stained with the Blood of his Friends. One would rule in Conjunction with his Friends, the Other would reign over them. The Father rather chose to make himself beloved, the Son to be fear’d. Both of ’em were equal Encouragers and Lovers of Learning. The Father had more Cunning, the Son more Honour. Philip was more moderate in his Conversation, Alexander in his Actions, which he show’d by being more Merciful and Generous to the Conquer’d. The Father loved Frugality, the Son was more inclined to Luxury. With these Qualifications the Father laid a Foundation for the Conquest of the World, which the Son most Gloriously accomplished.”^d

ALEXANDER’S YOUTH ACCORDING TO QUINTUS CURTIUS

The kings of Macedon derived their pedigree from Hercules; and Olympias, Alexander’s mother, reckoned the origin of her family from Achilles. From his very infancy he wanted neither allurements or examples to excite him in the pursuit of glory, nor masters to teach him virtue, nor exercise to accustom him to it. For his father, Philip, did by his continual wars raise the reputation of the Macedonians, who, till then were accounted despicable, and by his conquest of Greece, made them formidable everywhere. In fine, he not only laid the foundations of the great things which were done after his death, but even a little before his decease, having resolved to carry the war into Persia, he had levied men, gathered provisions, raised money, and, in short, had an army ready for that expedition; and had actually opened a passage into Asia, by the means of Parmenion.

But in this very juncture he was taken away, as if to leave to his son so great forces to carry on the war, and reap the full glory of it, when it was finished; which seems to have been the contrivance of fortune, who always yielded entire obedience to Alexander alone. This prince was so much in the admiration of all men, not only after he had done so great things, but even at his first setting out, that it was a question whether it were not more

[356-336 B.C.]

reasonable to ascribe the divine original of so great a man immediately to Jupiter himself, rather than mediately to the same god by the *Æacidae* and *Hercules*.

When he went himself to visit the temple of *Ammon* in *Libya*, nothing less would content him than to be called his son, as we shall shew in the sequel. Moreover, it was the opinion of many that *Alexander* was the offspring of a serpent which had been seen in his mother's bed-chamber, and into which *Jupiter* had transformed himself; that the credit of his divine pedigree was advanced by dreams and prophecies; and that when *Philip* sent to *Delphi* to consult about it, he was admonished by the oracle, to pay the greatest reverence to *Ammon*. On the other hand, there are those who affirm, "That all this is mere fiction; and that there was reason to suspect *Alexander's* mother was guilty of adultery: for that *Nectanebus*, king of *Egypt*, who was driven from his kingdom, did not go to *Ethiopia*, as was commonly believed, but went to *Macedonia*, in hopes of receiving succours from *Philip* against the power of the *Persians*. That he deceived *Olympias* by the force of magical enchantments, and defiled his landlord's bed. That from that time *Philip* had a jealousy of her, and that it afterwards appeared this was the chief cause of their divorce. That the very day that *Philip* brought *Cleopatra* into his house, *Attalus*, his wife's uncle, took the liberty to reproach *Alexander* with the baseness of his birth, while the king himself disowned him for his son. In fine, that the constant rumour of *Olympias's* adultery was entertained not only in that part of the world, but even among the nations which he conquered. That the fiction of the serpent was derived from ancient fables, on purpose to conceal the ignominy of that princess. That the *Messenians* had formerly given out the same story concerning *Aristomenes*, and the *Sicyonians* concerning *Aristodemus*."

In reality the same report was spread abroad concerning *Scipio*, who was the first that ruined *Carthage*; and the birth of *Augustus* was in like manner thought to have had something divine in it. For as to *Romulus*, the founder of *Rome*, there is no occasion to say anything of him; since there is no nation so contemptible, but derives its origin either from some god, or the offspring of a god. After all, the flight of *Nectanebus* does not agree with those times; for *Alexander* was six years of age, when that prince was vanquished by *Ochus*, and lost his kingdom and inheritance; but for all this, the tale which is reported of *Jupiter*, is not the less likely to be false. It is affirmed, that *Olympias* herself, having nothing to fear after her husband's death, laughed at the vanity of her son, who would needs have it believed that he was sprung from *Jupiter*; and begged him in a letter, "not to expose her to *Juno's* indignation, seeing that she had been guilty of nothing that deserved that punishment." However, before that time, she is thought to have been the person that took the most pains to gain credit to this fable, and is said to have admonished *Alexander* upon his expedition into *Asia*, "To be mindful of his origin, and do nothing that was unworthy of so great a father."

But it is generally agreed, that between the conception and birth of that prince, it was signified both by prodigies and divers presages, how considerable a person should be born. *Philip* saw in his sleep the womb of *Olympias* sealed up with a ring, on which the picture of a lion was engraved; the memory whereof was preserved by the city of *Alexandria* in *Egypt*, which was for a long time called *Leontopolis*. *Aristander*, the ablest diviner of that time, who afterwards accompanied *Alexander*, and was his chief priest, interpreted the dream, and said it signified the magnanimity and courage of the infant. The same night that *Olympias* was brought to bed, the temple of *Diana* in

Ephesus, the most famous of all Asia, was burnt to ashes. This was done by a profligate villain, who being apprehended and put to the torture, confessed he had no other view in doing it, but to preserve his memory by some great and memorable act of impiety. Wherefore the Magi, who were then at Ephesus, not reckoning so great a misfortune from the loss of the temple alone, but looking upon it as a presage of greater destruction, filled the whole city with mournful exclamations; "That there was a torch kindled somewhere, which, on the like account, and from the same motive, should one day consume all the East."

Philip being blessed with a son, of whom so many happy omens made him conceive the highest hopes, turned all his thoughts towards his education. For being a wise man, and a lover of his country, he easily perceived that all his endeavours would be to no purpose, if he should leave an ignorant and slothful prince behind him, to govern Macedonia, while things were in an unsettled state everywhere: and that his glory could not be long-lived, if the great things he had begun should be lost and ruined by the weakness or negligence of a successor. Among his letters, that discreet and elegant one which he wrote to Aristotle, who was then at Athens with Plato, is yet extant, and is conceived in words much to this purpose:

"Philip to Aristotle wisheth Health.

"I am to acquaint you, that a son is born to me; nor do I thank the gods so much for his birth, as for his being born in your time. I hope that when he shall have been educated and instructed by you, he shall be worthy of us, and fit to succeed to so great a kingdom. For I think it much better to be without children, than to beget them for a punishment, and educate them to the shame and dishonour of their ancestors."

Nor was Philip mistaken; for having been long under the direction of Aristotle, the effect was, that the instructions he received from that great master, laid a foundation for, and enabled him to perform all the great exploits which he executed from that time.

When he grew up, there appeared a perfect symmetry in his members, his joints were strong and firm; and being but of a middle stature, he was really stronger than he appeared to be. His skin was white, only his cheeks and his breast were dyed with an agreeable red; his hair was yellow, and went into a gentle curl; his nose was aquiline, and his eyes of different colours: for his left eye is said to have been blue, and his right very black. There was a certain secret virtue in them; insomuch that nobody could look on his countenance without veneration and fear. He could run with wonderful swiftness, which he often practised, even when he was king, as esteeming it of great use in expeditions; and he was often seen to run for a prize with the swiftest persons about him. He bore fatigue with a patience and firmness that even passes belief; and by this one virtue he oftentimes saved both himself and his armies in the greatest extremities. By frequent exercises, and a very warm constitution, he did so purge off any bad humours which commonly lodge under the skin, that not only his breath, but also what he perspired through the pores of his body were sweet, and his very clothes had a fragrant smell; and this was the cause, as some think, why he was so much inclined to wine and passion. Pictures and statues of him are yet to be seen, which were the performances of the best artists. For lest the comeliness of his face should suffer any thing from the unskilfulness of vulgar sculptors or painters, he strictly forbade any to draw his picture without his order, and threatened to punish any one that should disobey it. In consequence whereof, though there was abundance of good workmen, yet Apelles

[356-336 B.C.]

was the only person who had his consent to draw his picture ; Pyrgoteles to grave him on precious stones, and Lysippus and Polyclitus to represent him in medals.

His governor Leonidas is said to have walked too fast, which Alexander learnt of him ; and never was able to help it afterwards by all his endeavours. I am not ignorant that very much is owing to education, but I am inclined to impute this rather to the temper of that young prince, than to his accustoming himself to it ; for it was impossible for one of his ardour and impetuosity of spirit, not to have the motions of his body answerable to it. And this hastiness of his was so far from being accounted an imperfection by his successors, that they studiously affected it, and imitated him therein ; as they did in his wry neck, which leaned to his left shoulder, in his piercing look and high voice, being incapable to copy the virtues of his mind. In reality, there were many of them whose long lives had scarce anything in them that deserved to be compared to his childhood. Nor did he ever say or act anything that was mean or base, but all his words and actions were equal to, or even surpassed, his fortune. For though he was most ambitious of praise, yet he did not affect to draw it indifferently from every thing, but would have it arise from things that were most praise-worthy ; being sensible that the praise which arises from mean actions is inglorious and dishonourable, and that that victory which is gained over the meanest enemy, is so much the more noble and illustrious. Therefore when some persons told him, "that seeing he was an excellent runner, he ought to list himself among those who were to contend for the prize at the Olympic games, after the example of a king of his name ; and that thereby he should acquire a great fame all over Greece" : he answered, "I would certainly do so, if I were to run against kings."

As often as Philip obtained any signal victory, or reduced any rich and strong place, he could not conceal his grief, amidst the rejoicing of others ; and he was heard to complain amongst boys of his own age, "that his father would leave nothing for him and them to do when they came to be men." For he looked upon every accession of power and riches to be a diminution to his glory, and had a stronger passion for honour than for wealth. He was naturally disposed to sleep but little, and increased his watchfulness by art. If anything happened to him that required serious thought, he put his arm out of the bed, holding a silver ball in his hand, which by its fall into a basin might make a noise, and so disperse that heaviness which was inclining him to slumber. From his very infancy he loved to worship the gods splendidly ; and one day as they were sacrificing, he flung so much incense into the fire, that Leonidas, who was a severe and parsimonious man, not being able to bear that profusion, cried out, "You may burn incense in this manner when you conquer the countries where it grows." Remembering this saying afterwards, when he settled the affairs of Arabia, which produces incense, he sent Leonidas a vast quantity of this perfume, ordering him withal, "to be more liberal for the future, in paying honour to the gods, since he was now convinced that they did plentifully repay the gifts that had been cheerfully made them."

Aristotle as His Teacher

That he understood the more sublime sciences, is evident from his letter to Aristotle, wherein he complains, "That he had profaned their dignity by divulging their principles." Upon which, Aristotle excused himself by

answering, "That those books were published in such a manner, as that they might be reckoned not published; for that no body would be able to understand the meaning of them, but such as had already been instructed in the principles which they contained." When Alexander demanded his books of rhetoric, he strictly forbade him to let them come to the hands of any other; for he was no less desirous to excel others in arts and sciences, than in power and greatness; nor could he endure that men of the lowest rank should share that glory with him. Besides, it appears from his letters that he



ARISTOTLE

studied physic under one Aristotle, who was the son of a physician, of the race of Æsculapius. But he studied that part of philosophy so well, which teaches a man to command both himself and others, that he is thought to have undertaken the supervision of that vast weight and power of the Persian empire, rather by his magnanimity, prudence, temperance, and fortitude, than by his arms and riches. He frankly owned, "That he owed more to Aristotle than to Philip; for that he was indebted to the one for his life; to the other for that life's being formed upon the principles of honour and virtue." Nevertheless, it has been believed by some, not without ground, that his mind, which was so fired with ambition, was yet more inflamed by the too great value which Aristotle set upon honour and glory, which he placed in the rank of things that may be called goods; so that he not only multiplied wars upon wars, in order to extend his dominions, but would needs be looked upon as a god.

Of all the monuments of antiquity, he had the greatest esteem for Homer, who, he thought, was the only person that had perfectly described that wisdom by which empires subsist; and such a passion for him, that he was called Homer's Lover. He was wont to carry his books always along with him; and even when he went to bed, he put them and his sword under his pillow, calling them "his military viaticum, and the elements of warlike virtue." He esteemed Achilles to have been happy in finding so great a man to celebrate his virtues.

Having found a most curious casket, both for matter and workmanship, amongst the plunder of Damaseus, and his friends having asked him "What use it was most proper for?" he answered, "We will dedicate it to Homer, since it is but reasonable that the most precious monument of human wit should be preserved in the finest piece of workmanship." From hence the most correct edition of that poet, which Alexander was at much pains to get, was called the "edition of the casket"; because in that casket the Persians had used to keep odours and perfumes. One day as a certain messenger of good news ran towards him, in all haste stretching out his right hand, with the highest marks of joy on his countenance; "What news can you tell me," says he, "that's worthy of so much joy, unless that Homer is alive again?" He was then arrived to such a degree of happiness, that he thought there wanted nothing to complete his glory, but one capable to trumpet his praise. By frequent reading of him, he had got almost all by heart; so that no person could quote him more readily or familiarly, or judge of him more justly.

[356-336 B.C.]

Bucephalus

He showed an extraordinary courage and dexterity, to the great astonishment of his father and others, in managing the horse Bucephalus, which name was given him from his being marked with the figure of an ox's head. Thessaly was very much famed at that time for fine horses, and great numbers of them were bred in that country, but none of them was to be compared to Bucephalus either for mettle or beautifulness; for which reason Philoniscus a Pharsalian, thinking him worthy of the greatest prince in those parts, brought him to Philip, and proposed to sell him for sixteen talents. But when they came to try his speed and management, by riding him out into the fields, there was none of the king's friends or attendants that durst venture to manage him; for he rose upon them, and frightened all that essayed to mount him, by his fierceness: so that he was now looked upon as unmanageable and useless, upon the account of his wildness: at which Alexander sighing said, "What a fine horse those people lose through their ignorance and cowardice." After having repeated these words over and over, his father chid him "for finding fault with horsemen that were both older and more skilful than himself, as if he could manage that horse better than they." To which he answered, "I will manage him better than they, father, if you will give me leave." Upon this, the father asked him, "What he would forfeit if he could not execute what he had undertaken?" "I will forfeit the price of the horse," replied he. At this every body smiled, and agreed, "That if he won, his father should buy the horse for him; but if he lost, he should lay down the money himself." Then Alexander, taking the horse by the bridle, turned him directly to the sun, that so he might not see his shadow; for he had observed, that this frightened him, and made him more untractable. Finding his fury not much abated notwithstanding this, he stroked his mane, laid his cloak aside gently, and jumped upon him at once, though he was foaming with rage. Then Bucephalus, that was not used to obey, began to fling with his heels, and throw about his head, and very obstinately refuse to be guided by the bridle; then he essayed to get loose, and run away full speed. He was then in a spacious plain that was fit for riding in: wherefore Alexander, giving him the rein, and setting his spurs to his sides, rode shouting with all the vigour and fury imaginable. And after he had traversed a vast space of ground, till he was weary, and willing to stop, he spurred him on till such time as his mettle was exhausted, and he became tame; after which he brought him back very gentle and tractable. When Alexander alighted, his father embraced him with tears of joy, and kissing him, said, "He must seek out a larger empire for himself, for that the kingdom of Macedon was too small for so vast a spirit." Afterwards Bucephalus continued the same fierceness towards others, while he obeyed Alexander alone with a wonderful submission; and after he had been his companion in many labours and dangers, he was at last killed in a battle against Porus.^e

ALEXANDER'S FIRST DEEDS

From the remotest ages of Pelasgian antiquity down to the time of the Roman empire, the holy island of Samothrace, the seat of an awfully mysterious worship, was accounted equal to Delphi in sanctity. Here it is said Philip first saw Olympias, when they partook at the same time in the Cabirian mysteries, and resolved to seek her hand. Olympias loved the fanatical

orgies celebrated by the Thracian and Macedonian women in honour of their Dionysus ; and is even said to have introduced some of the symbols of this frantic worship, — the huge tame snakes, which the Bacchanals wreathed round their necks and arms, — into her husband's palace. It is a stroke which agrees well with the other features of her wild, impetuous character. Who can estimate the degree in which this irritable, uncontrollable nature may have contributed one element towards that combination of ardent enthusiasm with the soberest forethought which distinguishes Alexander, perhaps above every man that ever filled a like station ?

The anecdotes related of Alexander's boyhood are chiefly remarkable as indicating what may be fitly called a kingly spirit, which not only felt conscious that it was born to command, and was impatient of all opposition to its will, but also studied how it might subject all things and persons around it to its own higher purposes. This inborn royalty of soul could hardly have failed to find its way to fame, had it even been originally lodged in an obscure corner. But the prince, who was destined to effect so great a change in the state of the world, was to be committed to the care of the man whose spirit was not less active and ambitious, who also in the range of his intellectual conquests had never been equalled, and who founded a much more lasting empire in the sphere of thought. Never, before or since, have two persons so great in the historical sense of the word, been brought together — above all in the same relation — as Alexander and Aristotle.

Alexander was but thirteen years old when he became the philosopher's pupil. This relation appears to have subsisted between them for no more than three successive years. Alexander was only sixteen when Philip set out on his expedition to Thrace, from which he only returned in the autumn of 339, and he was entrusted with the regency of the kingdom — probably under the direction of a council — during his father's absence. He was then of course occupied with affairs of state ; and in the course of this time, a revolt of one of the conquered tribes, probably on the Illyrian frontier, afforded an occasion for his first essay in the art of war. He reduced the insurgents, took their chief city, expelled its inhabitants, and planted a new colony there, to which he gave the name of Alexandropolis. In the interval between the battle of Charonea and his father's death, he was engaged in transactions quite alien from philosophical or literary pursuits. It is very doubtful whether he saw Aristotle again before he came to the throne. Their personal intercourse must at least have been confined to occasional interviews.

It is pleasing to find it recorded that still he wrote a book on the office of a king expressly for Alexander. Nevertheless we have unquestionable proof that even on this head the force of nature was stronger than that of education. Aristotle's national prejudices led him into extravagant notions as to the superiority of the Hellenic race over the rest of mankind: as if the distinction between Greek and barbarian was nearly the same as between man and brute, person and thing : hence slavery appeared to him not a result of injustice and cruelty, but an unalterable law of nature, a relation necessary to the welfare of society.

Hence too he deduced a practical maxim, which he endeavoured to inculcate upon the future conqueror of Asia, that he should treat the Greeks as his subjects, the barbarians as his slaves. The advice was contrary to Alexander's views and sentiments : it did not suit the position which his consciousness of his own destiny led him to assume. He acted, we know, on a directly opposite principle.

[356-336 B.C.]

We have at least reason to believe that Alexander, though he was but twenty years old at his father's death, had learned, thought, seen, and done more to fit him for the place he was to fill, than many sovereigns in the full maturity of their age and experience. Like his father, he found himself, on his accession to the throne, in a situation which called forth all the powers of his mind and all the energies of his character. Macedonia, though nominally at peace with all its European neighbours, was surrounded by enemies, who might be expected eagerly to seize the opportunity, which seemed to offer itself now that the crown had devolved on a stripling, to shake off a yoke which they had endured with ill-disguised impatience. In the kingdom itself there were powerful families, which had not forgotten the times when they aspired to independence, if not to the possession of the throne. Amyntas, too, the son of Perdicas, was still living, and might be tempted to assert his claim. It was known that the court of Persia was on the watch.

The young king's first object was to secure himself at home : the next to overawe his hostile neighbours, and to extort from them such an acknowledgment of his superiority, as would place him in the position which his father was occupying at the time of his death. In Macedonia, though there might be some ambitious and disaffected nobles, the mass of the people both recognised his title and were attached to his person. Amyntas, son of Perdicas, was put to death on a charge of a plot against Alexander's life. After the last honours had been paid to his father, the king showed himself in a general assembly of his people, and declared his intention of prosecuting his predecessor's undertakings with like vigour, and, it is said, granted a general immunity from all burdens except military service.

The news of Philip's death had excited a general ferment throughout Greece. The gloomy prospect which, since the battle of Chæronea, must have saddened so many hearts — the thought that the flower of the Grecian youth were henceforth to shed their blood for the execution of projects which threatened their country with perpetual subjection — was suddenly exchanged for the liveliest hopes of deliverance from the foreigner's power. In all the principal states language was heard, and preparations were seen, denoting a disposition to take advantage of the unexpected opportunity. Ambracia expelled the Macedonian garrison, and re-established its democratical institutions. The Acarnanian exiles who had taken refuge in Ætolia prepared to return, and the Ætolians in their congress voted succours to reinstate them. Athens took the lead in these movements, and indeed seems to have been the centre from which they proceeded.

DEMOSTHENES RIDICULES ALEXANDER

Among the Athenian envoys who had been sent to congratulate Philip was Charidemus; being at Ægæ at the time of Philip's death, he lost no time in despatching a courier, who was directed to carry the news to Demosthenes before he communicated it to any one else. It happened that the orator was at this juncture mourning the loss of an only daughter, who had died but seven days before; but his private sorrow gave way to public cares. He immediately laid aside his weeds, came out dressed in white, with a festive wreath on his head, and a joyful countenance, and was seen performing a solemn sacrifice at one of the public altars. In order to give greater effect to the momentous tidings, the orator appears to have resorted to a stratagem

which proves that he knew his countrymen to be still superstitious, and credulous. He appeared before the council of Five Hundred, and declared that it had been revealed to him in a dream by Zeus and Athene, that some great good was about to happen to the commonwealth. Messengers soon after arrived with the news which fulfilled the divine announcement. It was apparently the object of Demosthenes, by this artifice, to impress the people with his own view of the change which Philip's death had made in the situation and prospects of Athens. It was at least as harmless an imposture as was ever practised; and, if fraud could ever be pious, might deserve that epithet.¹



BUST OF ALEXANDER
(In the Capitoline Museum, Rome)

He now moved moreover that religious honours should be decreed to the memory of Pausanias.

This conduct of Demosthenes was strongly censured by his contemporaries on various grounds; though not on those which render it most repugnant to the maxims and feelings of civilised society in modern times. Yet we know that even under the better light which we enjoy, not only the massacre of the Huguenots was celebrated with public rejoicings and thanksgivings in the capital of Christian Europe, but the assassination of the prince of Orange, and that of Henry III of France, were openly applauded, and Balthasar Gérard and Clément treated as heroes.

Phocion objected to the proposed demonstrations of joy on two accounts: first, because such exultation over an enemy's death was dastardly, and then, because the force which had won the day at Charonea had only been diminished by the loss of a single life. That the loss which Macedonia had sustained by

Philip's death, was only to be reckoned as that of a single soldier, was manifestly false; and the best excuse that can be offered for Demosthenes is, that he wished to place the event in a different light — one which he might well believe to be the true one. We cannot indeed be sure that he entertained so low an opinion of Alexander's abilities as he thought it expedient to profess; though it appears that the impression made on him by the young prince when he saw him at his father's court was not favourable, and on his return from his embassy he turned his boyish performance into ridicule. It was true that Alexander had at least acted the part of a man better than himself at Charonea; but his real character, and the promise of greatness which he held out, could not yet be known at Athens. Perhaps some report of his multifarious studies and attainments had been heard there, which afforded a handle for Demosthenes to compare him with Margites, the hero of a burlesque poem attributed to Homer, who knew many things, but none well; and the orator now ventured to assure the Athenians, that they had nothing to fear from the young king, who would never stir from Macedonia, but would remain at Pella, dividing his time between his peaceful studies and the inspection of victims, which would never permit him to undertake any dangerous expedition.

¹ It is a bishop and a doctor of divinity, Thirlwall, who justifies this mummery. If it is "excusable" and almost "pious," the trickeries of Philip merit the same tender consideration.]

[336 B.C.]

There were beside engines which the orator was able to set at work against him, which were known only to himself, and which he was obliged to keep secret, but which might reasonably strengthen his confidence. He was in correspondence with the Persian court, and had, it seems, already received sums of money from it to be distributed at his discretion for the purpose of thwarting Philip's enterprise against Asia. The conduct of Demosthenes in this transaction — if we consider that he was carrying on a clandestine negotiation with a foreign state against which his own had declared war, to injure a prince who was the ally of Athens — cannot be vindicated on the principles which regulate the intercourse of civilised nations in modern times. But how little were such scruples heeded when Napoleon's disasters opened a prospect for restoring the independence of Germany!

The people, however, seem to have retained too lively a recollection of the consternation which had followed the battle of Chæronea, to pledge themselves hastily to a renewal of the contest with Macedonia. The language of Æschines inclines us to believe that they did not adopt the motion of Demosthenes with respect to Pausanias. But he prevailed on them to send envoys to many of the Greek states, with secret instructions. The Persian gold, or the promise of subsidies, may have overcome many obstacles. There was another quarter in which the Athenian emissaries might still more safely reckon on a friendly reception. Attalus, Alexander's personal enemy, was commanding a body of troops in Asia. A negotiation was opened with him by means of a letter from Demosthenes, and nothing probably but want of time prevented its success.

ALEXANDER DASHES THROUGH GREECE

But all these plans and preparations were disconcerted and suppressed by the rapidity of Alexander's movements. It seems as if his elder counsellors, who had been long used to Philip's cautious policy, advised him to leave the Greeks for the present to themselves, and not to make any attempt to force them to obedience, until he had established a good understanding with the barbarian tribes on his northern frontier, which after Philip's death had begun to assume a threatening aspect. Alexander, however, saw that, if he should adopt such a course, the work of his father's reign might be undone in a few months: he saw that his presence was immediately necessary in Greece, and he set his forces in motion without delay. In his passage through Thessaly, he endeavoured to conciliate the ruling families by promises. All the concessions that had been made to Philip were renewed to him: their revenues and troops were placed at his disposal. At Thermopylæ he assembled the Amphictyonic council, perhaps before the ordinary time of the autumnal meeting with a view to secure the adherence of the northern tribes which had votes in it; and from them it seems he received the title [Leader of the Greeks] which had been conferred on his father in the Sacred War. He then advanced by rapid marches to Thebes, where, as no preparations had yet been made to execute the resolution which had been precipitately adopted, his presence awed the disaffected into entire submission.

His approach produced a like effect at Athens. The people hastened to appease him by an embassy, which they sent to apologise for their late proceedings, and to offer him all the honours they had conferred on Philip. Demosthenes himself was appointed one of the envoys — perhaps through the

intrigues of his adversaries; and he even proceeded as far as Cithæron, on his way to the Macedonian camp. We do not know whether it was his own reflections on the dangers of his mission, or some hints which he received as to Alexander's intentions, that induced him to find some excuse for turning back. The rest of the ambassadors, however, found the king ready to accept their excuses and promises, perhaps were led to believe that he had never suspected the commonwealth of any hostile designs. He despatched a trusty officer, named Hecataeus, over to Asia, with orders either to arrest Attalus and convey him to Macedonia, or to put him to death. It seems that Attalus had so won the affections of his troops, that Hecataeus thought it safest to have him secretly killed.

Alexander had sent envoys before him to summon a fresh congress at Corinth. He found this assembly as obsequious as that which had been called by his father; and was invested by it with the same title and authority for the prosecution of the war with Persia, as had been bestowed on Philip. Sparta alone either refused to send deputies to the congress, or instructed them to disavow its proceedings. She had been used—such was still her language—herself to take the lead among the Greeks, and would not resign her hereditary rank to another. Alexander perhaps smiled at these pretensions of a state which was hardly able to protect itself, but did not think it worth while to put its resolution to the test, by an invasion of its territory. So too the revolt of Ambracia did not appear to him important enough to detain him so long as would have been necessary to crush it. He even condescended to assure the Ambracians that they had only forestalled his intentions: that he should of his own accord have restored their democratical institutions. It was a concession which his commanding posture enabled him to make with dignity, and therefore without danger. Having thus in the course of a few weeks settled the affairs of Greece, he returned to Macedonia, with the hope that in the following spring he might be able to embark for Asia.

ALEXANDER WINNWS THE NORTH

But when the season for military operations drew near in 335, reports were heard of movements among the Thracian tribes and the Triballians, which seemed to render it necessary, for the security of his kingdom during his absence, that he should spread the terror of his arms in that quarter, before he began an expedition which would carry him so far away from it. Early in the spring Alexander set out on his march toward the Danube. A small squadron of ships of war was ordered to be fitted out at Byzantium, and to sail up the river to meet the army. In ten days, having crossed the Hebrus at Philippopolis, it reached the foot of the Balkan. Here the Thracians had collected their forces to guard the defiles, and were seen entrenched behind their wagons on the summit of the pass. As the road which led up to it was extremely steep, they had formed the plan of rolling their wagons down on the enemy as they advanced, and then falling on their broken ranks. Alexander perceived the object of their preparations, and provided against the danger. The heavy infantry were ordered, where the ground permitted, to open their files and make way for the wagons: where this was not practicable, to throw themselves forward on the ground, and link their shields together over their heads, so that the descending masses might bound over them. The shock came and passed in a few

[335 B.C.]

moments, leaving the men unhurt; they closed their ranks, and rose from the ground with heightened courage. The enemy were soon dislodged from their position by a skilful and vigorous charge, leaving fifteen hundred slain: the fugitives easily escaped; the camp, in which were their wives and children, fell into the hands of the victors.

Having crossed the mountains without further interruption, Alexander now resumed his march, and in three days reached the right bank of the Danube, where he found the galleys which he expected from Byzantium. Under favour of night they crossed over unmolested, and landed in fields of standing corn. This the phalanx levelled, as it marched through, with its spears, the cavalry following until they reached the open ground, where the enemy, astonished and dismayed by their unexpected appearance, did not even wait for the first charge of the horse, but took refuge in their town which lay but a few miles off. Even this—for it was poorly fortified—they abandoned at Alexander's approach, and taking as many as they could of the women and children on their horses, retreated into the wilderness. The town was sacked and razed to the ground, and Alexander having sacrificed on the right bank of the Danube to the gods who had granted him a safe passage, returned to his camp on the other side. Here he received embassies, with submissive or at least pacific overtures, from Syrmus, and from many of the independent nations bordering on the river. His chief object was attained in the proof thus afforded of the terror inspired by his arms.

He now turned his march westward, to reach the borders of Illyria, through the country of the Agrianians and Pæonians, on the western side of the mountains which contain the springs of the Hebrus and the Nestus. The king however was enabled to pursue his march without obstruction up the valley of the Erigon, towards the fortress of Pelium. It stood on high ground in the midst of lofty wooded hills, which were also guarded by Illyrian troops, so as to command all the approaches of the place; and the barbarians had sought an additional safeguard against the assaults of the Macedonians, in a sacrifice, which they celebrated on the hill tops, of three boys, three girls, and as many black rams. Yet all these precautions proved fruitless; and Alexander, after he made himself master of the adjacent hills—where he found the victims of those horrid rites—was proceeding to invest Pelium itself, when the arrival of Glaucias with a numerous army compelled him to retire, that he might provide for his own safety. We shall not dwell on the evolutions by which he extricated himself from a most perilous position. It is sufficient to mention that he first penetrated through a difficult defile, and crossed a river in the presence of an enemy greatly superior in numbers; and three days afterwards, having suddenly returned, fell upon the allies, whose camp was carelessly guarded, in the night, and broke up their host. Glaucias fled towards his home, and was pursued by Alexander with great slaughter as far as the mountains which protected his territories. Clitus at first took shelter in Pelium; but soon despairing of his own resources, set fire to the fortress, and retreated into the dominions of Glaucias.

THE REVOLT OF THEBES

The accounts which reached Greece of Alexander's operations in these wild and distant regions, were, it may be supposed, very imperfect and confused; and at length, during an interval in which no news was heard of

him, a report of his death sprang up, or was studiously set afloat. The report seems to have encouraged a party of Theban exiles to enter the city by night, and attempt a revolution. They began in an unhappy spirit with the massacre of two officers of the Macedonian garrison. They then summoned an assembly, and prevailed on the people to rise in open insurrection, and lay siege to the Cadmea. The citizens who were still in exile were recalled, the slaves enfranchised, the aliens won by new privileges. Demosthenes furnished them with a subsidy which enabled them to procure arms, and induced the Athenians to enter into an alliance with them, and emboldened the people to decree an expedition in aid of the Thebans. This decree, however, was not carried into effect. Elis, too, openly espoused the cause of the Thebans so far as even to send their forces as far as the isthmus, where they were joined by those of some Arcadian states. But here their generals were induced to halt, by the tidings which reached them of Alexander's return.

He was still at Pelium when he heard of the revolt of Thebes. He knew that unless it was crushed in time it would probably spread, and he was anxious about the garrison of the Cadmea. He therefore set out immediately for Bœotia. In seven days, having traversed the upper provinces of Macedonia and crossed the Cambunian range towards its junction with Pindus, he reached Pelinna in Thessaly. Six days more brought him into Bœotia. So rapid were his movements that, before the Thebans had heard that he had passed Thermopylæ, he had arrived at Onchestus. The authors of the insurrection would not at first listen to the news of his approach; they gave out that it was Antipater who commanded the Macedonian army: and then that Alexander, the son of Æropus, had been taken for his royal namesake. But when the truth was ascertained, they found the people still willing to persevere in the struggle which had now become so hopeless.

Alexander, on the other hand, wishing to give them time for better counsels, now moved slowly against the city; and even when he had encamped near the foot of the Cadmea, which they had encompassed with a double line of circumvallation, waited some time for proposals of peace, which he was ready to grant on very lenient terms. There was a strong party within which was willing to submit to his pleasure, and urged the people to cast themselves on his mercy: but the leaders of the revolt, who could expect none for themselves, resisted every such motion; and as beside their personal influence they filled most places in the government, they unhappily prevailed. It was their object to draw matters to extremities. When Alexander sent to demand Phœnix and Prothyas, two of their chiefs, they demanded Philotas and Antipater in return; and when he proclaimed an offer of pardon to all who should surrender themselves to him and share the common peace, they made a counter proclamation from the top of a tower, inviting all who desired the independence of Greece to take part with them against the tyrant. These insults, and especially the animosity and distrust which they implied, put an end to all thoughts of peace, and Alexander reluctantly prepared for an assault.

The fate of Thebes seems after all to have been decided more by accident than by design. Perdiccas, who was stationed with his division in front of the camp, not far from the Theban entrenchments, without waiting for the signal, began the attack, and forced his way into the space between the enemy's lines, and was followed by Amyntas son of Andromenes, who commanded the next division. Alexander was thus induced to bring up the

[335 B.C.]

rest of his forces. Yet at first he only sent in some light troops to the support of the two divisions which were engaged with the enemy. When however Perdicas had fallen, severely wounded, as he led his men within the second line of entrenchments, and the Thebans, who at first had given way, rallied and in their turn put the Macedonians to flight, he himself advanced to the scene of combat with the phalanx, and fell upon them in the midst of the disorder caused by the pursuit. They were instantly routed, and made for the nearest gates of the city, in such confusion that the enemy entered with them, and being soon joined by the garrison of the Cadmea, made themselves masters of the adjacent part of the city. The besieged made a short stand in the market-place; but, when they saw themselves threatened on all sides, the cavalry took to flight through the opposite gates, and the rest as they could find a passage. But few of the foot combatants effected their escape; and the conquerors glutted their rage with unresisted slaughter.

It was not however so much from the Macedonians, as from some of their auxiliaries, that the Thebans suffered the utmost excesses of hostile cruelty. Alexander had brought with him a body of Thracians among his light troops, and he had been reinforced by the Phocians and by all the Bœotian towns hostile to Thebes — more especially by Orchomenos, Thespiæ, and Plataea. The Thracians, impelled by their habitual ferocity, of which they had shown so fearful a specimen many years before, at the capture of Mycalessus; the Bœotians, eager to revenge the wrongs they had endured from Thebes in the day of her prosperity — revelled in the usual license of carnage, plunder, and wanton outrages on those whose age and sex left them most defenceless. The bloodshed, however, was restrained by cupidity, that the most valuable part of the spoil might not be lost. The number of the slain was estimated at six thousand; that of the prisoners at thirty thousand. The Macedonians lost about five hundred men.

THE FATE OF THEBES

It only remained to fix the final doom of the conquered city. Alexander, who had probably made up his mind on it, referred it to a council of his allies, in which the representatives of the Bœotian towns took a leading part. The issue of their deliberation might be easily foreseen, and did not want plausible reasons to justify it. There was a sentence which had been hanging over Thebes ever since the Persian War in which she had so recklessly betrayed the cause of Grecian liberty. It had never been forgotten, and calls had been heard from time to time for its execution. And the city which had so long been permitted by the indulgence of the Greeks to retain a forfeited existence, had nevertheless been distinguished by her merciless treatment of her conquered enemies. In the case of Plataea she had not only instigated the Spartans to a cold-blooded slaughter, forbidden by the usages of Greek warfare, but she had destroyed a city which by its heroic patriotism had earned the gratitude of the whole nation, and was itself a monument of the national triumph. Nor was it forgotten that when Athens was at the mercy of its enemies she alone had proposed to sweep it from the face of Greece.

It seems that these old offences were placed in the foreground, while little notice was taken of the later acts of violence and oppression towards the Bœotian towns, which were the real grounds of their implacable resentment.

The decree of the council was that the Cadmea should be left standing, to be occupied by a Macedonian garrison; that the lower city should be levelled with the ground, and the territory, except the part which belonged to the temples, divided among the allies: the men, women, and children, sold as slaves, all but the priests and priestesses, and some citizens who stood in a relation of hospitality to Philip or Alexander, or held the office of proxenus to the state of Macedonia. Under this head were probably included most of the conqueror's political adherents. He made one other exception, which was honourable rather to his taste than his humanity. He bade spare the house of Pindar, and as many as were to be found of his descendants. The council likewise decreed that Orchomenos and Plataea should be rebuilt. The demolished buildings of Thebes may have furnished materials for the restoration of Plataea.

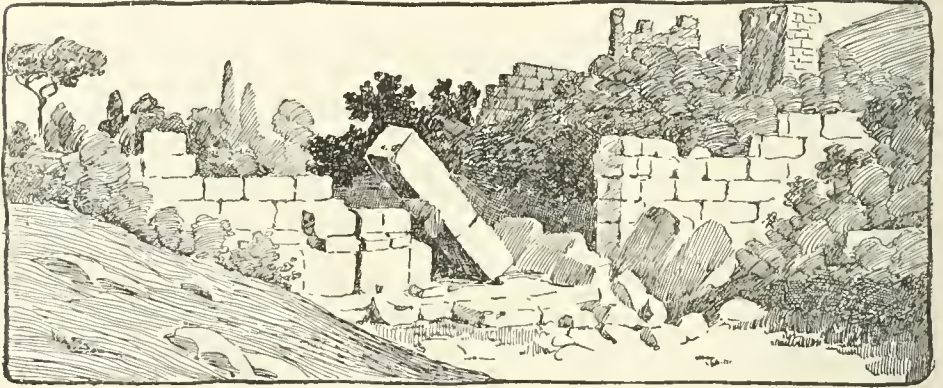

RUINS OF THE GREAT-GATE IN THE WALLS OF MESSENE

It can hardly be doubted that policy had a large share in this rigorous measure, and that Thebes was destroyed chiefly because it would not have been safe to leave it standing, and that the example of its fate might strike the rest of Greece with a wholesome awe. Alexander himself in his subsequent treatment of individual Thebans tacitly acknowledged that his severity had been carried to an extreme which bordered upon cruelty. But the harshness which he displayed in this case enabled him to assume the appearance of magnanimity and gentleness in others. All the Greek states which had betrayed their hostility towards him, now vied with one another in apologies, recantations, and offers of submission. A reaction immediately took place at Elis in favour of the Macedonian party; and in the Arcadian towns which had sent succours for the Thebans, the authors of this imprudent step were condemned to death. The Ætoliens too who had shown some symptoms of disaffection sent an embassy to deprecate the king's displeasure.

Athens, however, had most reason to dread his anger, and strove to avert it by a servile homage, which at once marks the character of the man who proposed it and the depth to which the people had fallen since the battle of Cheronea. When the first fugitives arrived from Thebes, the Athenians were celebrating their great Eleusinian mysteries. All fled in consternation to the city, and removed their property out of the country within the walls. An assembly was immediately called, in which, on the motion of Demades, it was decreed that ten envoys, the most acceptable that could be found,

[335 B.C.]

should be sent to congratulate Alexander on his safe return from his northern expedition, and on the chastisement which he had inflicted on Thebes. The king discovered no displeasure at this piece of impudent obsequiousness, but in reply sent a letter to the people demanding nine of the leading anti-Macedonian orators and generals — Demosthenes, Lycurgus, Hyperides, Polyenctus, Chares, Charidemus, Ephialtes, Diotimus, and Mærocles, whom he charged both with the transactions which had led to the battle of Charonea, and with all the hostile measures that had since been adopted at Athens towards his father and himself, particularly with the principal share in the revolt of Thebes.

In the assembly which was held to consider this requisition, Phocion, it is said, both counselled the people to surrender the objects of the conqueror's resentment or apprehensions, and exhorted the elected victims to devote themselves spontaneously for the public weal. Demosthenes is reported to have quoted the fable of the wolf who called on the sheep to give up their dogs. The people wavered between fear and reluctance, till Demades stepped in to remove the difficulty. He undertook — it was commonly believed for a fee of five talents — to appease Alexander, and save the threatened lives. He found the king satiated with the punishment of the Thebans, and disposed for an exercise of mercy which might soften the impression it had produced on the minds of the Greeks. He remitted his demand with respect to all except Charidemus, who perhaps had incurred his peculiar displeasure by his conduct at Ægæ after Philip's death, and who now embarked for Asia, and proceeded to the Persian court.

The conqueror celebrated his return to Macedonia with an Olympic festival at Ægæ, and with games in honour of the Muses at Dium in Pieria. The inhabitants of Dium held the memory of Orpheus in great reverence, and boasted of the possession of his bones. At the time of the games it was reported that a statue of the ancient bard, which perhaps adorned his monument near the town, had been seen bathed in sweat. Alexander's Lycian soothsayer, Aristander of Telmessus, bade him hail the omen: it signified that the masters of epic and lyric poetry should be wearied by the tale of his achievements. These achievements will now for some time claim our undivided attention.^h

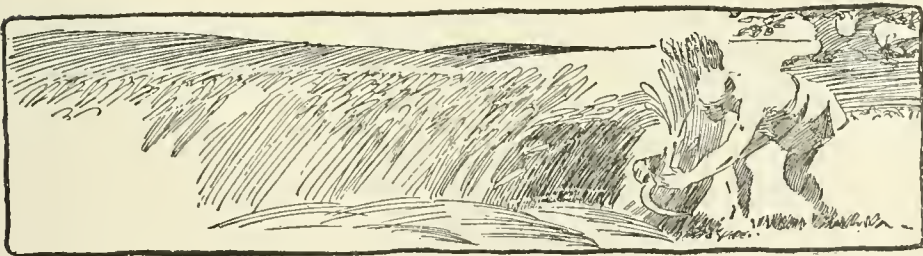

GREEK HARVESTING



APOLLO AND MERCURY

CHAPTER LI. ALEXANDER INVADES ASIA

SCHMES OF CONQUEST

A YEAR and some months had sufficed for Alexander to make a first display of his energy and military skill, destined for achievements yet greater; and to crush the growing aspirations for freedom among Greeks on the south, as well as among Thracians on the north, of Macedonia. The ensuing winter was employed in completing his preparations; so that early in the spring of 334 B.C., his army destined for the conquest of Asia was mustered between Pella and Amphipolis, while his fleet was at hand to lend support.

The whole of Alexander's remaining life — from his crossing the Hellespont in March or April 334 B.C., to his death at Babylon in June 323 B.C., eleven years and two or three months — was passed in Asia, amidst unceasing military operations, and ever-multiplied conquests. He never lived to revisit Macedonia; but his achievements were on so transcendent a scale, his acquisitions of territory so unmeasured, and his thirst for further aggrandisement still so insatiate, that Macedonia sinks into insignificance in the list of his possessions. Much more do the Grecian cities dwindle into outlying appendages of a newly grown oriental empire. During all these eleven years, the history of Greece is almost a blank, except here and there a few scattered events. It is only at the death of Alexander that the Grecian cities again awaken into active movement.

The Asiatic conquests of Alexander do not belong directly and literally to the province of an historian of Greece. They were achieved by armies of which the general, the principal officers, and most part of the soldiers, were Macedonian. The Greeks who served with him were only auxiliaries, along with the Thracians and Pæonians. Though more numerous than all the other auxiliaries, they did not constitute, like the Ten Thousand Greeks in the army of the younger Cyrus, the force on which he mainly relied for victory. His chief secretary, Eumenes of Cardia, was a Greek, and probably most of the civil and intellectual functions connected with the service were also performed by Greeks. Many Greeks also served in the army of Persia against him, and composed indeed a larger proportion of the real force (disregarding mere numbers) in the army of Darius than in that of Alexander. Hence the expedition becomes indirectly incorporated with the stream of Grecian history by the powerful auxiliary agency of Greeks on both sides — and still more, by its connection with previous projects, dreams, and legends, long antecedent to the aggrandisement of Macedon — as well as by the character

[334 B.C.]

which Alexander thought fit to assume. To take revenge on Persia for the invasion of Greece by Xerxes, and to liberate the Asiatic Greeks, had been the scheme of the Spartan Agesilaus and of the Phœrean Jason; with hopes grounded on the memorable expedition and safe return of the Ten Thousand. It had been recommended by the rhetor Isocrates, first to the combined force of Greece, while yet Grecian cities were free, under the joint headship of Athens and Sparta; next, to Philip of Macedon as the chief of united Greece, when his victorious arms had extorted a recognition of headship, setting aside both Athens and Sparta. The enterprising ambition of Philip was well pleased to be nominated chief of Greece for the execution of this project. From him it passed to his yet more ambitious son.

Though really a scheme of Macedonian appetite and for Macedonian aggrandisement, the expedition against Asia thus becomes thrust into the series of Grecian events, under the Panhellenic pretence of retaliation for the long-past insults of Xerxes. We call it a pretence, because it had ceased to be a real Hellenic feeling, and served now two different purposes: first, to ennoble the undertaking in the eyes of Alexander himself, whose mind was very accessible to religious and legendary sentiment, and who willingly identified himself with Agamemnon or Achilles, immortalised as executors of the collective vengeance of Greece for Asiatic insult; next, to assist in keeping the Greeks quiet during his absence. He was himself aware that the real sympathies of the Greeks were rather adverse than favourable to his success.

Apart from this body of extinct sentiment, ostentatiously rekindled for Alexander's purposes, the position of the Greeks in reference to his Asiatic conquests was very much the same as that of the German contingents, especially those of the confederation of the Rhine, who served in the grand army with which the emperor Napoleon invaded Russia in 1812. They had no public interest in the victory of the invader, which could end only by reducing them to still greater prostration. They were likely to adhere to their leader as long as his power continued unimpaired, but no longer. Yet Napoleon thought himself entitled to reckon upon them as if they had been Frenchmen, and to denounce the Germans in the service of Russia as traitors who had forfeited the allegiance which they owed to him. We find him drawing the same pointed distinction between the Russian and the German prisoners taken, as Alexander made between Asiatic and Grecian prisoners. These Grecian prisoners the Macedonian prince reproached as guilty of treason against the proclaimed statute of collective Hellas, whereby he had been declared General and the Persian king a public enemy.

Hellas, as a political aggregate, has now ceased to exist, except in so far as Alexander employs the name for his own purposes. Its component members are annexed as appendages, doubtless of considerable value, to the Macedonian kingdom. Fourteen years before Alexander's accession, Demosthenes, while instigating the Athenians to uphold Olynthus against Philip, had told them: "The Macedonian power, considered as an appendage, is of no mean value; but by itself, it is weak and full of embarrassments." Inverting the position of the parties, these words represent exactly what Greece herself had become, in reference to Macedonia and Persia, at the time of Alexander's accession. Had the Persians played their game with tolerable prudence and vigour, his success would have been measured by the degree to which he could appropriate Grecian force to himself, and withhold it from his enemy.

Alexander's memorable and illustrious manifestations, on which we are now entering, are those, not of the ruler or politician, but of the general

and the soldier. In his character his appearance forms a sort of historical epoch. It is not merely in soldier-like qualities—in the most forward and even adventurous bravery, in indefatigable personal activity, and in endurance as to hardship and fatigue—that he stands pre-eminent; though these qualities alone, when found in a king, act so powerfully on those under his command, that they suffice to produce great achievements, even when combined with generalship not surpassing the average of his age. But in generalship, Alexander was yet more above the level of his contemporaries. His strategic combinations, his employment of different descriptions of force conspiring towards one end, his long-sighted plans for the prosecution of campaigns, his constant foresight and resource against new difficulties, together with rapidity of movement even in the worst country—all on a scale of prodigious magnitude—are without parallel in ancient history. They carry the art of systematic and scientific warfare to a degree of efficiency, such as even successors trained in his school were unable to keep up unimpaired.^b

THE PROBLEM AND THE TROOPS

At a first glance Alexander's projects appear to bear no slight disproportion to the resources at his disposal. In superficial extension his kingdom (even inclusive of Greece) was barely equal to one-fiftieth of the Persian empire, and the numerical proportion of his fighting power to that of Persia by sea and land was even less in his favour. If we add that at Philip's death the Macedonian treasury was exhausted, that the greater part of the royal domain had been given away; that most of the imposts and tributes had been remitted; and finally that, while enormous stores of gold and silver lay amassed in the treasuries of the Persian empire, Alexander, on the completion of his armaments, which cost him eight hundred talents [about £160,000 or \$800,000] had no more than seventy talents [£14,000 or \$70,000] left to begin the war with Asia—the enterprise does in truth appear foolhardy and almost chimerical.

But a closer study of the circumstances shows that Alexander's projects, though certainly bold, were not rash, but came within the compass of the forces and expedients at his command. To realise the possibility and necessity of their success, to understand the organisation of his army and the character of its operations, we must forget the analogies of modern campaigns, since war—as little dependent as anything else in history on normal laws and conditions—changes its theory and purpose with the change of the local and historical conditions involved. The armies which conquered the East were unable to withstand the legions of Rome.

With reference to the financial considerations we must first bear in mind that Alexander invaded an enemy's country, where he might reasonably expect to find treasure and stores of all sorts. When once his host was armed and provided with money and food enough to last till they encountered the foe, he had no further need of a large war-fund; the wars of his time not being rendered costly by expensive ammunition and elaborate transport. Thus the lack of money did not hamper Alexander, while the vaunted treasures of the Great King and the Persian satraps made them all the more welcome as the adversaries to the Macedonian soldiery.

The disproportion of the Macedonian sea-power seems a more serious matter. The Persian king could command four hundred sail, his fleet was that of the Phœnicians, the best seamen of the ancient world, and, in their



STATUE OF ALEXANDER



[334 B.C.]

last sea-fight at least, they had defeated the Hellenes. The Macedonian sea-power, founded by Philip but never yet put to the test, was insignificant, and the fleet which was to sail against the Persians consisted mainly of the triremes of the Greek confederacy, from whom an extreme devotion was naturally not to be expected. Alexander's plans were based entirely upon the excellence of his land forces, and the only use of the fleet was to insure the safety of these in their first movements. When this object had been achieved it became a burden, and Alexander therefore soon took the opportunity of dismissing it.

Lastly, to turn to the Macedonian army, we cannot but recognise in its organisation a rare combination of fortunate circumstance and great military talent. The moral superiority of the Greek army, as opposed to the material superiority of the Persians, had been more and more gloriously proven in almost every war for the last two centuries. The more highly the art of war was developed among the Greeks by civil and foreign strife, the more formidable did they become to the troops of the Persian empire; Alexander's army, full of martial ardour and proud memories, skilled in all the technicalities of the military profession, and notable by reason of its thoroughly practical organisation as the first strategic body known to history, bore in itself the certainty of victory.

The armies of Asia have always been characterised by the vehemence of their onslaught, their overwhelming numbers, and their wild rushes hither and thither, which make them formidable even in flight. In addition to this there were many thousands of Greeks in Persian pay, so that Alexander could not reckon on having to wage war merely on barbarians, but had to look for Hellenic arms, courage, and military skill, on the part of the enemy. Finally, in accordance with the natural scope of his great enterprise, the mobility necessary for taking offensive, and the stability essential to military occupation, had both to be considered in the constitution of his army.

THE SIZE OF THE ARMY

In Philip's time the Macedonian forces had consisted of thirty thousand infantry and from three to four thousand horsemen. Alexander had led about the same number of troops against Thebes. On his departure for Asia he left twelve thousand foot-soldiers and fifteen hundred mounted men in Macedonia under the command of Antipater, and their place was taken by eighteen hundred Thessalian knights, five thousand Greek mercenaries, and seven thousand heavy-armed troops furnished by the Greek states. Besides these he had in his following five thousand Triballians, Odrysians, Illyrians, etc., from one to two thousand archers and Agrianian light infantry, Greek cavalry to the number of six hundred, Thracian and Pæonian to the number of nine hundred. The sum total of his troops therefore amounted to not much over 30,000 infantry and a little more than 5,000 horse. This, with slight divergencies suggested by the details of the narrative, is the estimate of Diodorus. Ptolemy Lagi gives the same figures in his *Memorabilia*, and Arrian repeats them after him. When Anaximenes reckons thirty-four thousand men on foot and five thousand five hundred on horseback he perhaps includes the corps which had already been despatched to Asia by Philip. The estimate of Callisthenes, 40,000 infantry, is obviously too high.

The whole body of infantry and cavalry was not divided into legions or brigades, but into troops bearing the same weapons and, to some extent,

recruited from the same district. The very advantages of a Macedonian army rendered necessary an arrangement which would be unsatisfactory under present conditions; the phalanx would have been no phalanx if it had fought with cavalry, light infantry, and Thracian slingers all combined into a complete army in miniature. It is the general use of small fighting units which has made it necessary for the parts of an army to be self sufficient, and to repeat on a small scale the organisation of the whole. Against such an enemy as the Asiatic hordes—collected together for a pitched battle without previous discipline or training, giving up all for lost after a single defeat, and gaining nothing but renewed danger by a victory over organised troops—against such an enemy, solid and homogeneous masses have the advantage of simplicity, weight, and internal stability, and in the same region where Alexander's phalanx overpowered the army of Darius the Roman legions succumbed to the vehement onslaught of the Parthians. On the whole, Alexander's army was well adapted for such pitched battles, and hence the bulk of it consisted of his phalanxes and heavy cavalry.

THE PHALANX AND THE CAVALRY



A SOLDIER OF ALEXANDER'S
PHALANX

The peculiar character of the phalanx was due to the weapons and co-ordination of the individual members. They were heavily armed according to Greek ideas, equipped with helmets, armour, and a shield which protected the whole body, and their chief weapons were the Macedonian sarissa, a lance more than twenty feet long, and the short Greek sword. Intended solely for close fighting in the mass, they had to be so arranged as to be able, on the one hand, calmly to await the fiercest onset of the enemy, and on the other, to be sure of breaking through the opposing ranks with a rush. They therefore usually stood sixteen deep, the lances of the first five files projecting beyond the front, an impenetrable and indeed unassailable barrier to the advancing enemy; the hinder files laid their sarissa on the shoulders of those in front, so that the charge of the phalanx was irresistible from the double force of weight and motion. Nothing but the thorough gymnastic training of the individual members of the phalanx rendered possible the unity, precision, and rapidity necessary for the very difficult evolutions of a body of men crowded into so small a space. Alexander had about eighteen thousand of these heavy-armed soldiers, the so-called foot-guards, and at the beginning of the campaign they were divided into six divisions under the generals Perdicas, Cœnus, Craterus, Amyntas the

son of Andromenes, Meleager, and Philip the son of Amyntas. The nucleus of these troops at least was Macedonian, and the divisions were named after the Macedonian districts from which they were recruited;

[334 B.C.]

thus the division under Cœnus came from Elimea, that under Perdicas from Orestis and Lyncestis, that of Philip (afterwards led by Polysperchon) from Stymphæa, etc.

What the phalanx was among the infantry, the Macedonian and Thessalian *ilai* were among the cavalry. Both were composed of heavy-armed soldiers and consisted of the nobility of Macedonia and Thessaly; equal in arms, in birth, and in fame, they vied with each other in distinguishing themselves in the eyes of the king, who usually fought at their head. The importance of this arm to Alexander's enterprise was proved in almost every fight; terrible alike in single combat and in charges in the mass, their discipline and armour rendered them superior to the light Asiatic cavalry, however great their numbers, and their onslaught on the enemy's foot was generally decisive. According to the estimate of Diodorus, the knighthood of Macedonia and Thessaly each consisted of five hundred knights; but he, like Callisthenes, sets the cavalry of the Macedonian army at no more than four thousand five hundred men, while the best authorities place it at over five thousand. The two bodies of knights were armed alike — Calas, the son of Harpalus, had command of the Thessalians; Philotas, the son of Parmenion, of the Macedonians.

The latter naturally took the highest rank of the whole Macedonian army, and bore the name of the "guards" or the "king's guards." It consisted of eight *ilai* or squadrons, which were called indifferently by the names of their districts or of their *ilarchoi* (colonels). That under Clitus called the royal *ile*, held the first rank among the Macedonian knighthood and formed the *agema* or royal guard. Besides these knights from Macedonia and Thessaly, there were six hundred more Greek horsemen in the army; they were usually attached to the Thessalian squadron, and seemed to have been similarly armed and drilled. They were commanded by Philip, the son of Menelaus.

Next in rank comes that peculiarly Macedonian body, the hypaspists. The Athenians under Iphicrates had already instituted, under the name of peltasts, a corps with linen corslets, and lighter shields and longer swords than those carried by the hoplites, in order to have a force swifter in attack than the latter and heavier than the light-armed troops. This new kind of corps was received with great approval in Macedonia; the soldier of the phalanx was too heavily armed for service about the person of the king, the light armed soldier was neither dignified nor serviceable enough. This intermediate force was selected for the purpose, and received the name of hypaspists from the long shield, the *aspis*, as it was called, which they had adopted from the phalanx. This force was of enormous value in a war against Asiatic tribes, for the lie of the land hampered only too often the full use of the phalanx, and it was often essential to attempt surprises, quick marches, and strokes of all sorts for which the phalanx was not sufficiently mobile nor the light troops sufficiently steady. For occupying heights, forcing the passage of rivers, and supporting and following up cavalry charges, these hypaspists were admirably adapted. Their numbers amounted to six thousand men. The whole corps was led by Nicanor, whose brother, Philotas, commanded the knights of the guard, and whose father, Parmenion, is described as general of the phalanxes. The first chiliarchy was that of Seleucus; it bore the title of "royal hypaspists," and in its ranks the sons of noble families saw their first military service as pages of the king. The second bore the title of "royal escort of hypaspists," and kept guard over the king's tent.

THE LIGHT TROOPS

The light troops of the Macedonian army were of peculiar importance. They came from the countries of the Odrysians, Triballians, Illyrians, Agrians, and from upper Macedonia; they were armed with their national weapons of offence and defence, and exercised by the hunting and raiding to which they were accustomed at home and the countless petty wars of their chieftains, they were of extreme value in skirmishing, covering the line of march, and for all the purposes served by Pandours, Croats, and Highlanders in modern warfare. The most famous among them are the Agrian chasseurs and the Macedonian archers, who may have formed together a corps of about two thousand men. There is hardly a battle in which they do not play a prominent part, and the devotion with which they fought is testified by the circumstance that the post of toxarch had to be filled afresh three times in one year. At the opening of the campaign it was held by Clearchus, Attalus being in command of the Agrians. The strength of the other light troops, usually known by the general designation of Thracians, was five thousand men, under the command of the Thracian prince Sitalces.

It is obvious that in these troops Alexander brought into use a strategic element hitherto practically non-existent. At all events, the light troops of the Greek armies before his time had been of no great importance, either by numbers or by the uses which they served; nor had they escaped a certain amount of contempt—a natural result of the Greek preference for sword-play, rendered more natural by the fact that their light infantry was composed partly of the off-scouring of the people and partly of barbarian mercenaries. There now appeared on the scene light troops whose national characteristics proved advantageous in this particular kind of fighting, and whose strength and glory lay in those arts of surprise, alarm, and retreat in apparent confusion, which seemed purposeless and questionable to Greek warriors. The famous Spartan general Brasidas himself confessed that the onset of these tribes—with their loud war-cries and the menacing waving of their weapons—had in it something alarming; their capricious transition from attack to flight, and from disorder to pursuit something terrible, against which nothing but the strict discipline of a Hellenic regiment could make it proof. As a matter of fact, these bands were able to fulfil their object to perfection because, being light troops by nature, they needed, when combined with the serried masses of the army, to be used for no purpose except that for which they were naturally fit.

The fundamental principle of the battle array of the Macedonian army was as follows. The army formed two wings, the left under Parmenion, and the right (which usually made the main attack) under Alexander. The infantry of both wings, four divisions of the phalaxes on the right and two, with the corps of hypaspists, on the left, formed the main line, to which were attached the light and heavy cavalry and the light infantry; the invariable order being that the Macedonian guards were on the right, with the Pæonian cavalry and skirmishers, the Agrianian chasseurs and the archers; and the Thessalian guards on the left, with the Greek cavalry, Agathon's Odrysian Thracians, and, lastly, the light infantry, which was often detached from the fighting-line to protect the camp and baggage. In the closest formation, when the phalanx was covered by its shields and stood sixteen deep, and the cavalry eight deep, the line of battle required a plain of at least half a mile in breadth to deploy in, as a rule the phalaxes alone forming a line nearly five thousand paces long.

[334 B.C.]

Such was the army with which Alexander proposed to conquer the East. Though relatively small in numbers it had every prospect of success by reason of its organisation, the excellent discipline of the several corps, the moral force of all, and finally, the personal character of the king and his generals. The Persian empire was not in a position to offer resistance; in its extent, the condition of its subject races, and the inefficiency of its government it contained the elements of its inevitable ruin.

THE CONDITION OF THE PERSIAN EMPIRE

If we consider the condition of the Persian empire at the time Darius Codomannus ascended the throne, we see plainly how, completely it was disintegrated and ripe for dissolution. The cause did not lie in the moral corruption of the court, of the ruling race, and of the peoples it ruled. This corruption, the invariable accompaniment of despotism, is never prejudicial to despotic power; and the greatest empire of modern times gives proof that in the midst of the most shocking profligacy at court, of constant cabals and scandals among the nobles, violent changes of dynasty and unnatural cruelty to the party all-powerful up to the moment of change, despotism enlarges its borders more and more. Persia's misfortune was to have a succession of weak rulers, who were unable to hold the reins of power as firmly as was essential in the interests of the cohesion of the empire; and the consequence was that the people lost the slavish fear, the satraps the blind obedience, the whole empire the only unity which held it together. Thence there grew in the subject peoples, all of whom retained their old religion, laws, and customs, and some their native princes, the longing for independence; in the satraps, too, powerful vicegerents of large and remote districts, the lust of independent power; in the ruling race—which had forgotten in the possession and habit of command the very conditions of its establishment and continuance—indifference to the Great King and the stock of the Achæmenides. In the hundred years of almost complete inaction which followed Xerxes' invasion of Europe, a singular development of the art of war had taken place, and Asia had lost the capacity for coping with it; Greek weapons seemed more powerful than the immense hordes of Persia the satraps trusted to in their rebellions and King Ochus in his campaign to suppress the revolt in Egypt; so that the empire founded by the victories of Persian arms was forced to protect itself by the help of Greek mercenaries.

It is true that Ochus had succeeded in restoring the external unity of the empire and in asserting his power with the fanatical severity proper to despotism; but it was too late. He sank into inaction and impotence, the satraps retained their too lofty station, and in the revival of oppression the subject peoples, particularly those of the western satrapies, did not forget that they had all but thrown it off.

Finally, after fresh and frightful complications, Darius came to the throne. To save the empire he should have been energetic rather than virtuous, cruel rather than mild, arbitrary rather than honourable. He gained the respect of the Persians, all the satraps were devoted to him; but that could not save Persia. He was not feared but loved, and time was soon to show that the nobles of the empire preferred their own advantage to the favour or the service of a master in whom they could admire all but his imperial qualities.

The empire of Darius extended from the Indus to the Hellenic Sea, from the Jaxartes to the Libyan desert. His rule, or rather, the rule of his satraps, did not vary with the character of the various races they ruled; it was nowhere a national form of government, nor had it anywhere the guarantee of a dependent organisation; their power was limited to the satisfaction of arbitrary caprice, the exaction of perpetual impositions, and a kind of hereditary tenure which had grown customary under weak princes. Thus the Great King had hardly any authority over them except the force of arms or such as they chose to recognise for personal reasons. The conditions which existed everywhere within the Persian empire merely rendered the mouldering colossus less capable of rising in its own defence.

The tribes of Iran, Turania, and Ariana were indeed warlike, and happy under any rule which led them to battle and plunder, and horsemen from



A GREEK GENERAL
(After Hope)

Hyrcania, Bactria, and Sogdiana formed the standing army of the satraps in most provinces, but there was no great attachment to the Persian empire to be found among them, and terrible as their onslaught had been in the armies of Cyrus and Cambyses, they were wholly incapable of a serious and prolonged defence, especially when opposed to Greek prowess and military skill.

And as for the western tribes, which were held in subjection only by force, and often with difficulty, they were certain to abandon the Persian cause if a victorious enemy approached their borders.

The Greeks on the coast of Asia Minor were barely kept in subjection by tyrants who depended for their existence on the empire and its satraps, and the inland tribes of the peninsula, after two centuries of stern oppression, had neither the power nor the will to rise in the cause of Persia. They had not even taken part in the previous rebellions of the satrapies of Asia Minor, they were dull, indolent, and forgetful of their past. The same held good of the two Syrias on either side of

the water; long centuries of slavery had reduced the inhabitants to the lowest stage of enervation, and with repulsive indifference they submitted to whatever fate overtook them. On the coast of Phœnicia alone the old versatile life survived, and with it more danger than devotion to Persia; and nothing but private interest and jealousy of Sidon kept Tyre faithful to the Persians. Lastly, Egypt had never relaxed or disguised her hatred of the foreigners, and the devastations of Ochus might cripple but could never subdue her. All the countries conquered to its own perdition by the Persian empire were to all intents and purposes lost at the first attack from the West.^e

[334 B.C.]

THE ENTRY INTO ASIA, ACCORDING TO ARRIAN

In the spring of 334 B.C., Alexander completed his preparations and moved towards the Hellespont (leaving the administration of the affairs in Greece in Antipater's hands), and carried an army of foot, consisting of archers and light-armed soldiers, about thirty thousand, and a little above five thousand horse. He first directed his march to Amphipolis, by way of the lake Cercynites, and thence to the mouths of the river Strymon, which having crossed, he passed by Mount Pangea, along the road leading to Abdera and Maronea, maritime cities of Greece. Thence he marched to the river Hebrus, which being easily forded, he proceeded through the country of Pletis to the river Melas, and thence, on the twentieth day after his departure from Macedon, he arrived at Sestos, whence marching to Elæus, he sacrificed upon the tomb of Protesilaus, because he, of all the Greeks who accompanied Agamemnon to the siege of Troy, set his foot first on the Asiatic shore.

The design of this sacrifice was, that his descent into Asia might be more successful to him, than the former was to Protesilaus. Then having committed to Parmenion the care of conveying the greatest part both of the horse and foot from Sestos to Abydos, they were accordingly transported in 160 trireme galleys, besides many other vessels of burden. Several authors report, that Alexander sailed from Elæus, another port in Greece, himself commanding the flag-ship; and also, that when he was in the middle of the Hellespont, he offered a bull to Neptune and the Nereids; and poured forth a libation into the sea from a golden cup. He is moreover said first of all to have stepped on shore in Asia completely armed, and to have erected altars to Jupiter Descensor, and to Pallas and Hercules. When he came to Ilium, he sacrificed to Pallas Iliaca, and having fixed the arms he then wore in her temple, he took down from thence some consecrated armour, which had remained there from the time of the Trojan War. This armour, some targeteers were always wont to bear before him, in his expedition. He is also said to have sacrificed to Priam upon the altar of Jupiter Hecceios, that he might thereby avert the wrath of his manes from the progeny of Pyrrhus, whence he deduced his pedigree.

When he arrived at Ilium, Menetius, the governor, crowned him with a crown of gold; the same did Chares the Athenian, who came for that purpose from Sigeum; and several others, as well Greeks as Asiatics, followed their example. He then encircled the sepulchre of Achilles with a garland (as Hephæstion did that of Patroclus) and pronounced him happy, who had such a herald as Homer to perpetuate his name; and indeed he was deservedly so styled, because that single accident had raised him to the highest pitch of human glory. As to his

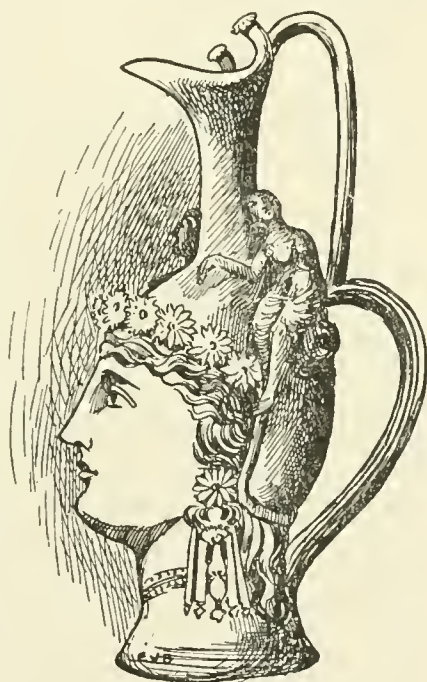

GREEK WINE JUG
(Bardon)

actions, none had hitherto described them in a suitable manner, either in prose or verse, neither had any attempted them in a lyric strain, as the poets had, heretofore, done those of Hiero, Gelo, Theron, and many more, whose exploits were no ways comparable to his; for which reason his greatest acts are less known than the least and most inconsiderable of many ancient generals.^e

THE BATTLE OF THE GRANICUS

The army, when reviewed on the Asiatic shore after its crossing, presented a total of thirty thousand infantry, and forty-five hundred cavalry, thus distributed:

INFANTRY

Macedonian phalanx and hypaspists	12,000
Allies	7,000
Mercenaries	5,000
Under the command of Parmenion	24,000
Odrysians, Triballi (both Thracians), and Illyrians	5,000
Agrianes and archers	1,000
Total infantry:	30,000

CAVALRY

Macedonian heavy — under Philotas son of Parmenion	1,500
Thessalian (also heavy) — under Calas	1,500
Miscellaneous Grecian — under Erigyius	600
Thracian and Pæonian (light) — under Cassander	900
Total cavalry	4,500

Such seems the most trustworthy enumeration of Alexander's first invading army. There were, however, other accounts, the highest of which stated as much as forty-three thousand infantry with four thousand cavalry. Besides these troops, also, there must have been an effective train of projectile machines and engines, for battles and sieges, which we shall soon find in operation. As to money, the military chest of Alexander, exhausted in part by profuse donatives to his Macedonian officers, was as poorly furnished as that of Napoleon Bonaparte on first entering Italy for his brilliant campaign of 1796. According to Aristobulus, he had with him only seventy talents [$\pounds 14,000$ or $\$70,000$]; according to another authority, no more than the means of maintaining his army for thirty days.

Previously the Macedonian generals Parmenion and Calas had crossed into Asia with bodies of troops. Parmenion, acting in Æolis, took Grynias, but was compelled by Memnon to raise the siege of Pitane; while Calas, in the Troad, was attacked, defeated, and compelled to retire to Rhœteum.

We thus see that during the season preceding the landing of Alexander, the Persians were in considerable force, and Memnon both active and successful even against the Macedonian generals, on the region northeast of the Ægean. This may help to explain that fatal imprudence, whereby the Persians permitted Alexander to carry over without opposition his grand army into Asia, in the spring of 334 B.C. They possessed ample means of guarding the Hellespont, had they chosen to bring up their fleet, which, comprising as it did the force of the Phœnician towns, was decidedly superior to any naval armament at the disposal of Alexander. The Persian fleet actually came into the Ægean a few weeks afterwards. Now Alexander's designs, preparations, and even intended time of march, must have been well

[334 B.C.]

known not merely to Memnon, but to the Persian satraps in Asia Minor, who had got together troops to oppose him. These satraps unfortunately supposed themselves to be a match for him in the field, disregarding the pronounced opinion of Memnon to the contrary, and even overruling his prudent advice by mistrustful and calumnious imputations.

At the time of Alexander's landing, a powerful Persian force was already assembled near Zelia in the Hellespontine Phrygia, under command of Arsites the Phrygian satrap, supported by several other leading Persians, Spithridates (satrap of Lydia and Ionia), Pharnaces, Atizyes, Mithridates, Rheomithres, Niphates, Petines, etc. Forty of these men were of high rank (denominated kinsmen of Darius), and distinguished for personal valour. The greater number of the army consisted of cavalry, including Medes, Bactrians, Hyreanians, Cappadocians, Paphlagonians, etc. In cavalry they greatly outnumbered Alexander; but their infantry was much inferior in number, composed, however, in large proportion, of Grecian mercenaries. The Persian total is given by Arrian as twenty thousand cavalry, and nearly twenty thousand mercenary foot; by Diodorus as ten thousand cavalry, and one hundred thousand infantry; by Justin even at six hundred thousand. The numbers of Arrian are the more credible; in those of Diodorus the total of infantry is certainly much above the truth — that of cavalry probably below it.

Memnon, who was present with his sons and with his own division, earnestly dissuaded the Persian leaders from hazarding a battle. Reminding them that the Macedonians were not only much superior in infantry, but also encouraged by the leadership of Alexander, he enforced the necessity of employing their numerous cavalry to destroy the forage and provisions, — and if necessary, even towns themselves, — in order to render any considerable advance of the invading force impracticable. While keeping strictly on the defensive in Asia, he recommended that aggressive war should be carried into Macedonia; that the fleet should be brought up, a powerful land-force put aboard, and strenuous efforts made, not only to attack the vulnerable points of Alexander at home, but also to encourage active hostility against him from the Greeks and other neighbours.

Had his plan been energetically executed by Persian arms and money, we can hardly doubt that Antipater in Macedonia would speedily have found himself pressed by serious dangers and embarrassments, and that Alexander would have been forced to come back and protect his own dominions; perhaps prevented by the Persian fleet from bringing back his whole army. At any rate, his schemes of Asiatic invasion must for the time have been suspended. But he was rescued from this dilemma by the ignorance, pride, and pecuniary interests of the Persian leaders. Unable to appreciate Alexander's military superiority, and conscious at the same time of their own personal bravery, they repudiated the proposition of retreat as dishonourable, insinuating that Memnon desired to prolong the war in order to exalt his own importance in the eyes of Darius. This sentiment of military dignity was further strengthened by the fact, that the Persian military leaders, deriving all their revenues from the land, would have been impoverished by destroying the landed produce. Arsites, in whose territory the army stood, and upon whom the scheme would first take effect, haughtily announced that he would not permit a single house in it to be burned. Occupying the same satrapy as Pharnabazus had possessed sixty years before, he felt that he would be reduced to the same straits as Pharnabazus under the pressure of Agesilaus — “of not being able to procure a dinner in his own

country." The proposition of Memnon was rejected, and it was resolved to await the arrival of Alexander on the banks of the river Granicus.

This unimportant stream, commemorated in the *Iliad*, and immortalised by its association with the name of Alexander, takes its rise from one of the heights of Mount Ida near Scepsis, and flows northward into the Propontis, which it reaches at a point somewhat east of the Greek town of Parium. It is of no great depth: near the point where the Persians encamped, it seems to have been fordable in many places; but its right bank was somewhat high and steep, thus offering obstruction to an enemy's attack. The Persians, marching forward from Zelia, took up a position near the eastern side of the Granicus, where the last declivities of Mount Ida descend into the plain of Adrastea, a Greek city, situated between Priapus and Parium.

Meanwhile Alexander marched onward towards this position, from Arisbe (where he had reviewed his army) — on the first day to Percote, on the second to the river Practus, on the third to Hermotus; receiving on his way the spontaneous surrender of the town of Priapus. Aware that the enemy was not far distant, he threw out in advance a body of scouts under Amyntas, consisting of four squadrons of light cavalry and one of the heavy Macedonian (companion) cavalry. From Hermotus (the fourth day from Arisbe) he marched towards the Granicus, in careful order, with his main phalanx in double files, his cavalry on each wing, and the baggage in the rear. On approaching the river, he made his dispositions for immediate attack, though Parmenion advised waiting until the next morning. Knowing well, like Memnon on the other side, that the chances of a pitched battle were all against the Persians, he resolved to leave them no opportunity of decamping during the night.

Alexander himself took the command of the right, giving that of the left to Parmenion; by right and left are meant the two halves of the army, each of them including three *taxeis* or divisions of the phalanx with the cavalry on its flank — for there was no recognised centre under a distinct command. On the other side of the Granicus, the Persian cavalry lined the bank. The Medes and Bactrians were on their right, under Rheomithres — the Paphlagonians and Hyrcanians in the centre, under Arsites and Spithridates — on the left were Memnon and Arsamenes with their divisions. The Persian infantry, both Asiatic and Grecian, were kept back in reserve; the cavalry alone being relied upon to dispute the passage of the river.

In this array, both parties remained for some time, watching each other in anxious silence. There being no firing or smoke, as with modern armies, all the details on each side were clearly visible to the other; so that the Persians easily recognised Alexander himself on the Macedonian right from the splendour of his armour and military costume, as well as from the respectful demeanour of those around him. Their principal leaders accordingly thronged to their own left, which they reinforced with the main strength of their cavalry, in order to oppose him personally. Presently he addressed a few words of encouragement to the troops, and gave the order for advance. He directed the first attack to be made by the squadron of companion-cavalry whose turn it was on that day to take the lead (the squadrons of Apollonia, of which Soerates was captain, commanded on this day by Ptolemæus son of Philippus), supported by the light horse or Lancers, the Pæonian darters (infantry), and one division of regularly armed infantry, seemingly hypaspists. He then himself entered the river, at the head of the right half of the army, cavalry and infantry, which advanced under sound of trumpets and with the usual war-shouts. As the occasional

[334 B.C.]

depths of water prevented a straightforward march with one uniform line, the Macedonians slanted their course suitably to the fordable spaces; keeping their front extended so as to approach the opposite bank as much as possible in line, and not in separate columns with flanks exposed to the Persian cavalry. Not merely the right under Alexander, but also the left under Parmenion, advanced and crossed in the same movement and under the like precautions.

The foremost detachment under Ptolemy and Amyntas, on reaching the opposite bank, encountered a strenuous resistance, concentrated as it was here upon one point. They found Memnon and his sons with the best of the Persian cavalry immediately in their front; some on the summit of the bank, from whence they hurled down their javelins — others down at the water's edge, so as to come to closer quarters. The Macedonians tried every effort to make good their landing, and push their way by main force through the Persian horse, but in vain. Having both lower ground and insecure footing, they could make no impression, but were thrust back with some loss, and retired upon the main body which Alexander was now bringing across. On his approaching the shore, the same struggle was renewed around his person with increased fervour on both sides. He was himself among the foremost, and all near him were animated by his example. The horsemen on both sides became jammed together, and the contest was one of physical force and pressure by man and horse; but the Macedonians had a great advantage in being accustomed to the use of the strong close-fighting pike, while the Persian weapon was the missile javelin. At length the resistance was surmounted, and Alexander, with those around him, gradually thrusting back the defenders, made good their way up the high bank to the level ground. At other points the resistance was not equally vigorous. The left and centre of the Macedonians, crossing at the same time on all practicable spaces along the whole line, overpowered the Persians stationed on the slope, and got up to the level ground with comparative facility. Indeed no cavalry could possibly stand on the bank to offer opposition to the phalanx with its array of long pikes, wherever this could reach the ascent in any continuous front. The easy crossing of the Macedonians at other points helped to constrain those Persians, who were contending with Alexander himself on the slope, to recede to the level ground above.

Courage and Danger of Alexander

Here again, as at the water's edge, Alexander was foremost in personal conflict. His pike having been broken, he turned to a soldier near him — Aretis, one of the horse-guards who generally aided him in mounting his horse — and asked for another. But this man, having broken his pike also, showed the fragment to Alexander, requesting him to ask some one else; upon which the Corinthian Demaratus, one of the companion-cavalry close at hand, gave him his weapon instead. Thus armed anew, Alexander spurred his horse forward against Mithridates (son-in-law of Darius), who was bringing up a column of cavalry to attack him, but was himself considerably in advance of it. Alexander thrust his pike into the face of Mithridates, and laid him prostrate on the ground: he then turned to another of the Persian leaders, Rhœsaces, who struck him a blow on the head with his scimitar, knocked off a portion of his helmet, but did not penetrate beyond. Alexander avenged this blow by thrusting Rhœsaces through the body with his pike. Meanwhile a third Persian leader, Spithridates, was actually close behind

Alexander, with hand and scimitar uplifted to cut him down. At this critical moment, Clitus son of Dropides — one of the ancient officers of Philip, high in the Macedonian service — struck with full force at the uplifted arm of Spithridates and severed it from the body, thus preserving Alexander's life. Other leading Persians, kinsmen of Spithridates, rushed desperately on Alexander, who received many blows on his armour, and was in much danger. But the efforts of his companions near were redoubled, both to defend his person and to second his adventurous daring. It was on that point that the Persian cavalry was first broken. On the left of the Macedonian line, the Thessalian cavalry also fought with vigour and success; and the light-armed foot, intermingled with Alexander's cavalry generally, did great damage to the enemy. The rout of the Persian cavalry, once begun, speedily became general. They fled in all directions, pursued by the Macedonians.

But Alexander and his officers soon checked this ardour of pursuit, calling back their cavalry to complete his victory. The Persian infantry, Asiatics as well as Greeks, had remained without movement or orders, looking on the cavalry battle which had just disastrously terminated. To them Alexander immediately turned his attention. He brought up his phalanx and hypaspists to attack them in front, while his cavalry assailed on all sides their unprotected flanks and rear; he himself charged with the cavalry, and had a horse killed under him. His infantry alone was more numerous than they, so that against such odds the result could hardly be doubtful. The greater part of these mercenaries, after a valiant resistance, were cut to pieces on the field. We are told that none escaped, except two thousand made prisoners, and some who remained concealed in the field among the dead bodies.

In this complete and signal defeat, the loss of the Persian cavalry was not very serious in mere number, for only one thousand of them were slain. But the slaughter of the leading Persians, who had exposed themselves with extreme bravery in the personal conflict against Alexander, was terrible. There were slain not only Mithridates, Rhœsaces, Spithridates, whose names have been already mentioned, but also Pharnaces, brother-in-law of Darius, Mithrobarzanes satrap of Cappadocia, Atizyes, Niphates, Petines, and others; all Persians of rank and consequence. Arsites, the satrap of Phrygia, whose rashness had mainly caused the rejection of Memnon's advice, escaped from the field, but died shortly afterwards by his own hand, from anguish and humiliation. The Persian or Perso-Grecian infantry, though probably more of them individually escaped than is implied in Arrian's account, was as a body irretrievably ruined. No force was either left in the field, or could be afterwards reassembled in Asia Minor.

The loss on the side of Alexander is said to have been very small. Twenty-five of the companion-cavalry, belonging to the division under Ptolemy and Amyntas, were slain in the first unsuccessful attempt to pass the river. Of the other cavalry, sixty in all were slain; of the infantry, thirty. This is given to us as the entire loss on the side of Alexander. It is only the number of killed; that of the wounded is not stated; but assuming it to be ten times the number of killed, the total of both together will be 1265. If this be correct, the resistance of the Persian cavalry, except near that point where Alexander himself and the Persian chiefs came into conflict, cannot have been either serious or long protracted. But when we add farther the contest with the infantry, the smallness of the total assigned for Macedonian killed and wounded will appear still more surprising. The total of the Persian infantry is stated at nearly twenty thousand, most part of them Greek mercenaries.

[334 B.C.]

Of these only two thousand were made prisoners; nearly all the rest (according to Arrian) were slain. Now the Greek mercenaries were well armed, and not likely to let themselves be slain with impunity; moreover Plutarch expressly affirms that they resisted with desperate valour, and that most of the Macedonian loss was incurred in the conflict against them. It is not easy therefore to comprehend how the total number of slain can be brought within the statement of Arrian.

After the victory, Alexander manifested the greatest solicitude for his wounded soldiers, whom he visited and consoled in person. Of the twenty-five companions slain, he caused brazen statues, by Lysippus, to be erected at Dium in Macedonia, where they were still standing in the time of Arrian. To the surviving relatives of all the slain he also granted immunity from taxation and from personal service. The dead bodies were honourably buried, those of the enemy as well as of his own soldiers. The two thousand Greeks in the Persian service who had become his prisoners, were put in chains, and transported to Macedonia there to work as slaves; to which treatment Alexander condemned them on the ground that they had taken arms on behalf of the foreigner against Greece, in contravention of the general vote passed by the synod at Corinth. At the same time, he sent to Athens three hundred panoplies selected from the spoil, to be dedicated to Athene in the Acropolis with this inscription, "Alexander, son of Philip, and the Greeks except the Lacedæmonians (*present these offerings*), out of the spoils of the foreigners inhabiting Asia." Though the vote to which Alexander appealed represented no existing Grecian aspiration, and granted only a sanction which could not be safely refused, yet he found satisfaction in clothing his own self-aggrandising impulse under the name of a supposed Panhellenic purpose: which was at the same time useful as strengthening his hold upon the Greeks, who were the only persons competent, either as officers or soldiers, to uphold the Persian empire against him. His conquests were the extinction of genuine Hellenism, though they diffused an exterior varnish of it, and especially the Greek language, over much of the oriental world. "True Grecian interests," says Grote, "lay more on the side of Darius than of Alexander."

EFFECTS OF ALEXANDER'S VICTORY

No victory could be more decisive or terror-striking than that of Alexander. There remained no force in the field to oppose him. The impression made by so great a public catastrophe was enhanced by two accompanying circumstances: first, by the number of Persian grandees who perished, realising almost the wailings of Atossa, Xerxes, and the Chorus, in the *Persæ* of Æschylus, after the battle of Salamis; next, by the chivalrous and successful prowess of Alexander himself, who, emulating the Homeric Achilles, not only rushed foremost into the mêlée, but killed two of these grandees with his own hand. Such exploits, impressive even when we read of them now, must at the moment when they occurred have acted most powerfully upon the imagination of the contemporaries.†

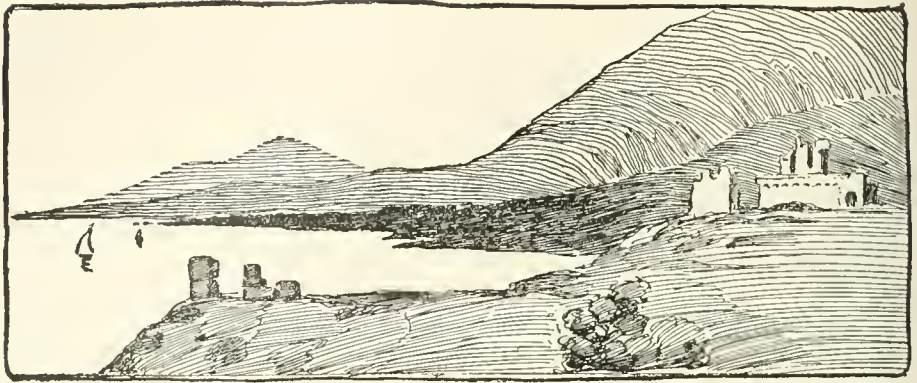

BATTLE-FIELD OF ISSUS

CHAPTER LII. ISSUS AND TYRE

ARSITES had fled after the battle into Phrygia; but there, it was said, overpowered by grief and shame by the disaster, which he attributed to his own counsels, laid violent hands on himself. Alexander bestowed his satrapy on Calas; encouraged the barbarians, who had fled to the mountains, to return to their homes; and ordered the tribute to remain on its ancient footing. Parmenion was detached to take possession of the satrap's residence Dascylium. The king himself, bending his march southward, advanced towards Sardis. The news of his victory produced such an effect in the capital of Lydia, that when he had come within eight or nine miles of it, Mithrines, the commander of the garrison, accompanied by the principal inhabitants, met him, with a peaceable surrender of the city, the citadel, and the treasure. He retained Mithrines on an honourable footing near his person, and committed the command of the citadel to Pausanias, an officer of his guard. To conciliate the Lydians, he restored their ancient laws; that is, abolished the restraints which the policy of the Persian government had imposed on them, when it crushed their rebellion after the first conquest: while, perhaps to make them more familiar with Greek usages, he ordered a temple to be built on the citadel to Olympian Zeus. A body of cavalry and light troops and the Argive contingent were left as a garrison.

Four days after, Alexander arrived at Ephesus. There too, as soon as the tidings of the battle arrived, a body of mercenaries who had been stationed there by Memnon took ship with Amyntas, son of Antiochus, a Macedonian emigrant, who had fled his country to avoid the effects of the king's displeasure, or because he was conscious of a share in some of the plots formed against him. Ephesus was divided between an oligarchical and a democratical faction, which seem nearly to have balanced each other. The oligarchy had been sustained by the power of Persia: their adversaries therefore looked forward with hope to the impending invasion, and had probably received promises of support from Philip. Violent tumults had taken place, in which the oligarchs, aided by Memnon's troops, had prevailed, forced many of their opponents to leave the city, threw down a statue of Philip which stood in the temple, committed other acts of sacrilege there, and broke open the tomb of Heropythes, a great popular leader, who had been buried in the market place. A complete reaction ensued on Alexander's

[334 B.C.]

arrival: democracy was formally restored, the exiles returned to their homes, and the triumphant party became eager for revenge on their vanquished oppressors. Alexander interfered to prevent bloodshed, and forbade any proceedings to be instituted for the punishment of political offences. The city was permitted to expend the tribute which it had before paid to the Persian government on its new temple, which was not yet finished. At a later period he offered to defray the whole expense of the building, on condition that his own name should be inscribed on it as its founder—an offer which the Ephesians declined with ingenious flattery. Before his departure he celebrated a great sacrifice to the goddess, with a solemn procession of his whole army in battle array. By like measures, especially by the establishment of democracy, and remission of tribute, he endeavoured to gain the goodwill of all the other Greek cities on the coast, which was of great importance to him at this juncture, while the naval power of Persia was still formidable.

In the meanwhile he had received offers of submission from Magnesia and Tralles, in the vale of the Mæander, and had sent Parmenion forward to take possession of them. He had also at first reason to hope that Miletus would be as quietly surrendered to him; for Hegesistratus, who commanded the garrison, had made him like offers by letter. But the approach of a Persian armament, which was on its way from Phœnicia, encouraged Hegesistratus to change his intention, and defend his post. Nicanor, however, Alexander's admiral, got the start of the barbarians, and arrived with his fleet of 160 galleys at Lade, before they appeared: and Alexander forthwith secured the island, which commanded the entrance to the port of Miletus, with a detachment of four thousand men. The Persians, finding themselves shut out, came to anchor at Mycale. Their fleet amounted to four hundred sail. Yet, notwithstanding this great inequality, Parmenion advised the king to hazard a sea-fight. A victory, he thought, would be attended with the greatest advantages, while defeat would not make the state of his naval affairs much worse—since, as it was, the enemy were masters of the sea. An omen too, which he had observed, confirmed him in his opinion. Alexander pointed out to him that it might be otherwise interpreted, and that his arguments were not sounder than his rules of divination. The Macedonian fleet was inferior, not only in number, but in nautical skill and training to the Phœnician and Cyprian galleys. It would be mere foolhardiness to seek a battle under such disadvantages; and a defeat, far from leaving him in nearly the same condition as he now stood in, might involve consequences no less important and disastrous than a general insurrection in Greece. The eagle which had been seen to perch on the beach behind the royal galley, signified that he was destined to overcome the Persian navy by his operations on land.

Miletus was divided into two distinct cities by an inner wall, which appears to have been much stronger than the outer one; if indeed what was called the outer city was not a mere open suburb. Alexander had taken it by assault on his first arrival, and then prepared to besiege the other. The townsmen came to a compromise with the garrison, and by mutual consent they deputed one of the most eminent citizens to the king, with an offer of neutrality, which he rejected, bidding them prepare to sustain an immediate attack. His enginery soon made a breach in the wall, which his troops mounted before the eyes of the Persians, who were unable to relieve their friends; for, to cut off all chance of succour, Nicanor had moved up to the mouth of the inner harbour, and laid some galleys across it side by side, so as effectually to bar entrance or escape. The citizens and the garrison, when the besiegers began to pour in through the breach, fled toward the sea; some

put off in boats, but found the harbour's mouth closed before they reached it; about three hundred of the mercenaries swam to a rocky islet within the harbour, and prepared to defend themselves there, until Alexander, admiring their courage, permitted them to purchase their lives by entering into his service. The Persian fleet continued for some time moored at Mycale, in the hope of drawing the enemy into an action; but as it was forced to fetch its water from the mouth of the Mæander, Alexander ordered Philotas to proceed to the place, with a body of infantry and cavalry, and to hinder the crews from landing. The fleet was consequently obliged to go over to Samos for provisions: it returned shortly after, and attempted to surprise the Macedonians in the harbour; but having been foiled in this attempt, withdrew from the coast of Miletus.

Alexander now perceived that his fleet would be of little service to him, while the state of his finances was such that he could ill bear the cost of it. On the other hand, he hoped to shut out the Persians from all the ports of Asia, and thus to disable them from continuing their naval operations. He therefore resolved to dismiss his fleet, retaining only a small squadron, which included the Athenian galleys, for the transport of his besieging machines, and to confine his attention to the prosecution of the war on the southern coast.

HALICARNASSUS

His first object was the reduction of Halicarnassus, where the enemy had now collected almost all the strength which he had remaining in this quarter. Memnon, who after the battle of the Granicus sent his wife and children as pledges of his fidelity to Darius, and had been invested by him with supreme authority in the west of Asia, and with the command of all his naval forces, had been long making preparations for the defence of the place, where he himself, with the Persian Orontobates, satrap of Caria, a numerous garrison of Greeks and barbarians, awaited the invader's approach. They were animated by the presence of two Athenians, Ephialtes and Thrasylbulus, who had come to offer their services against the common enemy. The fleet too, lying at the mouth of the harbour, was capable of rendering good service during a siege. The city, built on heights which rise abruptly in the form of a theatre from the sea, was naturally strong, and had been elaborately fortified, both with walls and a ditch forty-five feet in width, and about half as many in depth. Alexander, on his march from Miletus, made himself master of all the towns that lay between that city and Halicarnassus; and on his entrance into Caria, he was met by Ada, the widow of Idrieus, who surrendered her fortress of Alinda to him, begged leave to adopt him as her son, and placed herself under his protection. He then advanced towards Halicarnassus, and encamped at about half a mile from the walls.

He began by filling up the ditch, so as to enable his engines and wooden towers to approach the walls. The besieged made many vigorous sallies for the purpose of setting fire to the machines, but were always repulsed, and sometimes with great loss. Once a mad attempt of two Macedonian soldiers, who, having challenged one another over their cups to a trial of valour, undertook to storm the citadel on the land side alone, brought on an engagement, which was near becoming general, and might have ended in the capture of the city. For two towers and the intervening wall had been battered down by the engines; but before advantage was taken of the breach, the besieged built another brick wall in the form of a crescent behind it. Twice they

[334 B.C.]

made a desperate attempt to destroy the engines which Alexander brought to play on this new wall — the second time, at the instigation of Ephialtes, with their whole force; but they were defeated with great slaughter, in which Ephialtes himself fell, and it was believed that Alexander might then have stormed the place, but was induced to spare it by the hope that it would soon surrender. In fact, Memnon and Orontobates now despaired of defending it much longer, and resolved to abandon it. In the dead of the night they set fire to a wooden tower, and to some of the houses and magazines near the wall, and while the conflagration spread, made their escape, and crossed over to Cos, where it seems they had previously deposited their treasures. The garrison took refuge, some in the citadels, some in Arconessus. Alexander immediately entered the city, and checked the progress of the flames. But as soon as he had become master of it, he razed it to the ground. He did not however think it worth while to stay, until he had dislodged the enemy from their remaining strongholds; but having committed the province to Ada, he left her, with about three thousand foot and two hundred horse, under a Macedonian officer, to reduce them. He himself pursued his march along the south coast of Asia Minor, to make himself master of the ports which might harbour the Persian fleet.

But as winter was now approaching, he determined, before he left Caria, to send a part of his troops, who had lately married when he set out on his expedition, back to Macedonia, to pass the winter at home. He gave the command of them to three of his generals, who were themselves in the same case; directing them on their return to bring with them as many fresh troops as they could raise. The measure was politic, as well as gracious; for his army had been much weakened to supply so many garrisons as were required for the conquered cities; and nothing was more likely to promote the levies in Macedonia, than the presence of the victorious warriors, whose return attested at once his success and his liberality. Another officer was sent to collect all the troops he could in Peloponnesus. Parmenion was ordered to proceed with the greater part of the cavalry and the baggage to Sardis, and thence into Phrygia, where he himself, after he should have traversed the coast of Lycia and Pamphylia, designed to meet him in the spring.

In his march through Caria he met with a short resistance from the garrison of the strong fortress Hyparna; and turned aside to punish the insolence of the inhabitants of Marmora in Peræa. After he had crossed the Xanthus, he received the submission of most of the Lycian towns. Phaselis even presented him with a golden crown; and the motive which led it to pay him this honour may help to account for the ready submission of the other Lycians. The people of Phaselis had suffered much from the incursions of their neighbours, the Pisidian mountaineers, who had even taken up a fortified position in their territory, for the purpose of continual molestation. They hoped that Alexander would deliver them from this annoyance, and they were not disappointed.

He was still in the neighbourhood of Phaselis, when he was apprised of a plot which had been formed against his life, by his namesake, the son of Æropus, whom he had appointed to command the Thessalian cavalry in the place of Calas, the new satrap of the Hellespontine Phrygia. It appears that, notwithstanding this favour, the Lyncestian either could not forgive the king for the execution of his two brothers, or could not forget the ancient pretensions of his family to royal dignity. He had entered into a negotiation with the Persian court through the fugitive Amyntas, and Darius had sent down an agent named Asisines, to obtain a secret interview with

him, and to offer, if he killed his sovereign, to raise him to the throne of Macedonia, or at least to aid him in the attempt to secure it, with a thousand talents. The Persian emissary had fallen into the hands of Parmenion, and revealed his business; and Parmenion had sent him to the king. Alexander held a council on the subject, and by its advice despatched orders to Parmenion to arrest the Lyncestian and keep him in custody.

Between Phaselis and the maritime plains of Pamphylia, the mountains which form the southern branch of Taurus descend abruptly on the coast,



A PERSIAN NOBLE
(After Bardon)

leaving only a narrow passage along the beach, and this never open but in calm weather, or during the prevalence of a northerly wind. The promontory was called Mount Climax. At the time when Alexander was about to resume his march eastward, the wind was blowing from the south, and the waves washed the foot of the cliffs. He therefore sent the main body of his army over the mountains to Perga, by a circuitous and difficult road, which however he had ordered to be previously cleared by his Thracian pioneers. But for himself he determined with a few followers to try the passage along the shore; danger and difficulty had a charm for him which he could scarcely resist. Perhaps the wind had already subsided; soon after it shifted to the north—a change in which he recognised a special interposition of the gods. Yet, according to Strabo's authors, he found the water still nearly breast high, and had to wade through it for a whole day. As he advanced from Perga, he was met by an embassy from the neighbouring town of Aspendus, which lay a little further eastward near the mouth of the Eurymedon, offering to acknowledge his authority, but praying that they might not be compelled to receive a Macedonian garrison. This request he granted, requiring one hundred talents and

yearly tribute, and exacting hostages for their performance. Then he began his march towards Phrygia.

His road led through the heart of Pisidia, where he was the more desirous of striking terror, as its fierce and lawless inhabitants, secure in their mountain barriers and almost impregnable fortresses, had constantly defied the power of the Persian government. Yet he could not spare the time which would have been necessary to reduce all its strongholds. Termessus, situated on a steep rock, commanding a narrow pass which led from Pisidia into Phrygia, appeared to him too strong to be attempted, though he had dislodged the barbarians from the position which they had taken up without the walls, and made himself master of the pass. But the resistance of Termessus procured for him offers of alliance from its enemy Selge, another of the principal cities, which proved very useful to him. He stormed Sagalassus, though besides its natural strength its inhabitants were accounted the most warlike of the Pisidians; and this success was followed by the submission of most of the smaller towns. He then advanced by the lake Ascania

[334-333 B.C.]

to Celænæ, where the citadel, on an almost inaccessible rock, was guarded by a garrison of one thousand Carians, and one hundred Greeks, placed there by the satrap of Phrygia. It however offered to surrender unless it should be relieved within sixty days; and Alexander thought it best to accept these conditions; and having left a body of fifteen hundred men to observe it, and appointed Antigonus, son of Philip, to the important satrapy of central Phrygia, he prosecuted his march to Gordium, where he had ordered Parmenion to meet him.

GORDIUM

Arrian does not expressly state the object of this movement, which, as Alexander designed next to make for the coast of Syria, involved an enormous circuit. It is hardly credible that he was deterred from advancing directly into Cilicia by the difficulty of passing through the mountain region (the Rugged Cilicia), which immediately follows Pamphylia. He probably thought it necessary to establish his authority in the central provinces, so far at least as to break off their relations with the Persian government, and thus to secure the Greek cities on the western coast from the attacks which might have been made on them from this quarter, if the peninsula, east of Lydia, had remained subject to Darius. The central situation of Gordium also afforded means of easier communication with Macedonia, which the movements of the Persian fleet in the Ægean rendered very desirable, while it enabled him to negotiate on a more advantageous footing with the satraps of the provinces on the Euxine, who, when they saw him so near, might apprehend an immediate invasion. Accordingly, it seems to have been from Gordium that he sent Hegelochus to the coast, with orders to equip another fleet to protect the islands which were threatened by the Persians.

Here he was rejoined by the troops he had sent to winter by their own hearths, accompanied by the new levies, 3000 Macedonian infantry and 650 horse, 300 from Macedonia, 200 from Thessaly, the rest from Elis. Here also he received an embassy from Athens, which came to request that he would release the Athenian prisoners who had been taken among the mercenaries in the battle of the Granicus, and had been sent to Macedonia. Alexander did not think it prudent, while he was on the eve of a decisive contest with Darius, to relax his severity towards the Greeks who took part with the barbarians, but he gave the Athenians leave to renew their application at a more seasonable juncture.

Gordium had been in very early times the seat of the Phrygian kings, and was supposed to have derived its name from Gordius, the father of the more celebrated Midas. In the citadel was preserved with religious veneration a wagon, in which, according to the tradition of the country, Midas with his father and mother entered the town, at a time when the people, who were distracted by civil discord, were holding an assembly. They had been informed by an oracle that a wagon should bring them a king who should compose their strife. The sudden appearance of Midas convinced them that he was the king destined for them; and when he had mounted the throne, he dedicated the wagon in the citadel, as a thank-offering to the king of the gods, who, before his birth, had sent an eagle to alight upon its yoke, while Gordius was ploughing, as a sign of the honour reserved for his race.

This legend had given rise to a prophecy that whoever untied the knot of bark by which the yoke was fastened to the pole, must become lord of Asia. Alexander did not leave Gordium before he had proved that this

prophecy related to himself. He went up to the citadel, and separated the yoke from the pole. Whether he loosened the knot by drawing out a peg,¹ or cut it with his sword, his own followers were not agreed. But all the spectators were convinced that he had legitimately fulfilled the prophecy, and a storm of thunder and lightning which took place the same night, removed every shadow of doubt on the subject (333).

He now resumed his march eastward, and at Ancyra received an embassy from Paphlagonia, promising obedience on the somewhat ambiguous condition that he should abstain from entering their country. The subjugation of this extensive and very mountainous region would have detained him much too long from the more important objects which he had in view, and he therefore contented himself with this show of submission, which at least heightened, while it proved, the terror inspired by his name, and annexed Paphlagonia to the satrapy of Calas. As he advanced through Cappadocia towards the passes of Taurus, he met with no resistance; and his authority was at least nominally acknowledged to a great distance beyond the Halys, so that he could appoint a satrap of Cappadocia. On his way he received tidings from Tarsus, that the satrap Arsames, having heard that he had passed the Gates, was about to quit the city, which at first he meant to defend, and, it was feared, would plunder it before his departure. Hereupon Alexander pushed forward with his cavalry and the lightest part of the infantry at full speed for Tarsus, and Arsames, whatever his intention may have been, fled, leaving the city unhurt, to join the army of Darius.

Alexander, on his arrival at Tarsus, while his blood was still violently heated by these extraordinary exertions, had been tempted to plunge into the clear and limpid waters of the Cydnus, which flowed through the city. This imprudence was generally supposed to have been the cause of a fever which seized him immediately after, and which soon became so threatening in its symptoms that most of his physicians despaired of his life. One however, an Acarnanian named Philippus, who stood high in his confidence, undertook to prepare a medicine which would relieve him. In the meanwhile, a letter was brought to the king from Parmenion, informing him of a report that Philippus had been bribed by Darius to poison him. Alexander, it is said, had the letter in his hand, when the physician came in with the draught, and, giving it to him, drank while he read — a theatrical scene, as Plutarch unsuspectingly observes, but one which would not have been invented but for such a character, and which Arrian was therefore induced, though doubtfully, to record. The remedy, or Alexander's excellent constitution, prevailed over the disease; but it was long before he had regained sufficient strength to resume his march.

In the meanwhile, he sent Parmenion forward with about a third of the army, to occupy the nearest of the maritime passes leading out of Cilicia into Syria. He himself, when sufficiently recovered, proceeded westward with the rest of his forces to Anchialus, where he beheld the statue of its reputed founder Sardanapalus, the voluptuous king, who judged so differently from himself — as the Assyrian inscription on his monument and the figure itself attested — of the value and use of life. At Soli, where he arrived next, he found a strong leaning to the Persian interest, which induced him to place a garrison there, and afforded him a fair ground for demanding a con-

¹ As Aristobulus related, according to Arrian. Droysen observes that the other version is much more appropriate to the character and destiny of the conqueror, and would have been more readily believed by the army. But, critically considered, this is a reason for preferring the account of Aristobulus, whom Droysen elsewhere, as if in dispraise, styles "the sober."

[333 B.C.]

tribution of two hundred talents. Yet it seems to have been only an oligarchical party that had favoured the Persians, and perhaps the penalty was levied on them alone; for he established a democratical government, and the garrison may have been needed for its security. Before he returned to Tarsus, he made an inroad with a division of his forces into the mountains of the rugged Cilicia, and in the course of seven days reduced their wild inhabitants by force or terror to submission. On his return to Soli, he received the agreeable intelligence that Orontobates had been defeated in a hard-fought battle by Ptolemy and Asander, and that the citadel of Halicarnassus, and the other places which he had retained on the coast of Caria, had fallen.

Darius had previously suffered a much greater loss in the death of Memnon, who was carried off by a sudden illness while engaged in the siege of Mytilene, which, after having made himself master of Chios through treachery, and of the rest of Lesbos, he had invested closely by sea and land. Alexander, before he left Soli, celebrated the victory of his generals and at the same time testified his gratitude for his own convalescence by a solemn sacrifice to Æsculapius, with a military procession, a torch race, and musical and gymnastic contests.

He then marched back to Tarsus, and, sending Philotas forward with the bulk of cavalry across the Aleian plain, himself took a more circuitous route along the coast through Magarsus to Mallus, a town which claimed the Argive hero Amphilochus, as its founder. On this ground, as himself descended from the Heraclids of Argos, he both healed its intestine disorders, and exempted it from the tribute which it had paid to the Persian government. At Mallus for the first time he heard of the approach of the great Persian army commanded by Darius in person.^b

DARIUS MUSTERS A NEW HOST



PHRYGIAN WEAPONS AND HELMET

If Alexander was a gainer in respect to his own operations by the death of the eminent Rhodian [Memnon], he was yet more a gainer by the change of policy which that event induced Darius to adopt. The Persian king resolved to renounce the defensive schemes of Memnon, and to take the offensive against the Macedonians on land. His troops, already summoned from the various parts of the empire, had partially arrived, and were still coming in. Their numbers became greater and greater, amounting at length to a vast and multitudinous host, the total of which is given by some as six hundred thousand men; by others as four hundred thousand infantry and one hundred thousand cavalry.

The spectacle of this showy and imposing mass, in every variety of arms, costume, and language, filled the mind of Darius with confidence; especially as there were among them between twenty thousand and thirty thousand Grecian mercenaries. The Persian courtiers, themselves elate and sanguine, stimulated and exaggerated the same feeling in the king himself, who became confirmed in his persuasion that his enemies could never resist him.

From Sogdiana, Bactria, and India, the contingents had not yet had time to arrive ; but most of those between the Persian Gulf and the Caspian Sea had come in — Persians, Medes, Armenians, Derbices, Boreanians, Hyrcanians, Cardaces, etc. ; all of whom, mustered in the plains of Mesopotamia, are said to have been counted, like the troops of Xerxes in the plain of Doriscus, by piling off a space capable of containing exactly ten thousand men, and passing all the soldiers through it in succession. Neither Darius himself, nor any of those around him, had ever before seen so overwhelming a manifestation of the Persian imperial force. To an oriental eye, incapable of appreciating the real conditions of military preponderance — accustomed only to the gross and visible computation of numbers and physical strength — the king who marched forth at the head of such an army appeared like a god on earth, certain to trample down all before him just as most Greeks had conceived respecting Xerxes, and by stronger reason Xerxes respecting himself, a century and a half before. Because all this turned out a ruinous mistake the description of the feeling, given in Curtius and Diodorus, is often mistrusted as baseless rhetoric. Yet it is in reality the self-suggested illusion of untaught men, as opposed to trained and scientific judgment.

But though such was the persuasion of orientals, it found no response in the bosom of an intelligent Athenian. Among the Greeks now near Darius, was the Athenian exile Charidemus ; who having incurred the implacable enmity of Alexander, had been forced to quit Athens after the Macedonian capture of Thebes, and had fled together with Ephialtes to the Persians. Darius, elate with the apparent omnipotence of his army under review, and hearing but one voice of devoted concurrence from the courtiers around him, asked the opinion of Charidemus, in full expectation of receiving an affirmative reply. So completely were the hopes of Charidemus bound up with the success of Darius, that he would not suppress his convictions, however unpalatable, at a moment when there was yet a possibility that they might prove useful. He replied (with the same frankness as Demaratus had once employed towards Xerxes), that the vast multitude now before him were unfit to cope with the comparatively small number of the invaders. He advised Darius to place no reliance on Asiatics, but to employ his immense treasures in subsidising an increased army of Grecian mercenaries. He tendered his own hearty services either to assist or to command. To Darius, what he said was alike surprising and offensive ; in the Persian courtiers, it provoked intolerant wrath. Intoxicated as they all were with the spectacle of their immense muster, it seemed to them a combination of insult with absurdity, to pronounce Asiatics worthless as compared with Macedonians, and to teach the king that his empire could be defended by none but Greeks. They denounced Charidemus as a traitor who wished to acquire the king's confidence in order to betray him to Alexander. Darius himself, stung with the reply, and still further exasperated by the clamours of his courtiers, seized with his own hands the girdle of Charidemus, and consigned him to the guards for execution. "You will discover too late," exclaimed the Athenian, "the truth of what I have said. My avenger will soon be upon you."

Filled as he now was with certain anticipations of success and glory, Darius resolved to assume in person the command of his army, and march down to overwhelm Alexander. From this moment, his land-army became the really important and aggressive force, with which he himself was to act. Herein we note his distinct abandonment of the plans of Memnon — the turning-point of his future fortune. He abandoned them, too, at the pre-

[333 B.C.]

cise moment when they might have been most safely and completely executed. In the first place, there was the line of Mount Taurus, barring the entrance of Alexander into Cilicia; a line of defence nearly inexpugnable. Next, even if Alexander had succeeded in forcing this line and mastering Cilicia, there would yet remain the narrow road between Mount Amanus and the sea, called the Amanian Gates, and the Gates of Cilicia and Assyria—and after that, the passes over Mount Amanus itself—all indispensable for Alexander to pass through, and capable of being held, with proper precautions, against the strongest force of attack. A better opportunity, for executing the defensive part of Memnon's scheme, could not present itself; and he himself must doubtless have reckoned that such advantages would not be thrown away.

The momentous change of policy, on the part of the Persian king, was manifested by the order which he sent to the fleet after receiving intelligence of the death of Memnon. Confirming the appointment of Pharnabazus (made provisionally by the dying Memnon) as admiral, he at the same time despatched Thymodes (son of Mentor and nephew of Memnon) to bring away from the fleet the Grecian mercenaries who served aboard, to be incorporated with the main Persian army. Here was a clear proof that the main stress of offensive operations was henceforward to be transferred from the sea to the land.

It is the more important to note such desertion of policy, on the part of Darius, as the critical turning-point in the Greco-Persian drama—because Arrian and the other historians leave it out of sight, and set before us little except secondary points in the case. Thus, for example, they condemn the imprudence of Darius, for coming to fight Alexander within the narrow space near Issus, instead of waiting for him on the spacious plains beyond Mount Amanus. Now, unquestionably, granting that a general battle was inevitable, this step augmented the chances in favour of the Macedonians. But it was a step upon which no material consequences turned; for the Persian army under Darius was hardly less unfit for a pitched battle in the open plain; as was afterwards proved at Arbela. The real imprudence—the neglect of the Memnonian warning—consisted in fighting the battle at all. Mountains and defiles were the real strength of the Persians, to be held as posts of defence against the invader.

DARIUS AT ISSUS

Darius had marched out of the interior his vast and miscellaneous host, stated at six hundred thousand men. His mother, his wife, his harem, his children, his personal attendants of every description, accompanied him, to witness what was anticipated as a certain triumph. All the apparatus of ostentation and luxury was provided in abundance, for the king and for his Persian grandees. The baggage was enormous: of gold and silver alone, we are told that there was enough to furnish load for six hundred mules and three hundred camels. A temporary bridge being thrown over the Euphrates, five days were required to enable the whole army to cross. Much of the treasure and baggage, however, was not allowed to follow the army to the vicinity of Mount Amanus, but was sent under a guard to Damascus in Syria.

At the head of such an overwhelming host, Darius was eager to bring on at once a general battle. It was not sufficient for him simply to keep back

an enemy, whom, when once in presence, he calculated on crushing altogether. Accordingly, he had given no orders (as we have just seen) to defend the line of the Taurus; he had admitted Alexander unopposed into Cilicia, and he intended to let him enter in like manner through the remaining strong passes — first, the Gates of Cilicia and Syria, between Mount Amanus and the sea — next, the pass, now called Beylan, across Amanus itself. He both expected and wished that his enemy should come into the plain to fight, there to be trodden down by the countless horsemen of Persia.

But such anticipation was not at once realised. The movements of Alexander, hitherto so rapid and unremitting, seemed suspended. We have already noticed the dangerous fever which threatened his life, occasioning not only a long halt, but much uneasiness among the Macedonian army. All was doubtless reported to the Persians, with abundant exaggerations; and when Alexander, immediately after recovery, instead of marching forward towards them, turned away from them to subdue the western portion of Cilicia, this again was construed by Darius as an evidence of hesitation and fear. It is even asserted that Parmenion wished to await the attack of the Persians in Cilicia, and that Alexander at first consented to do so. At any rate, Darius, after a certain interval, contracted the persuasion, and was assured by his Asiatic councillors and courtiers, that the Macedonians, though audacious and triumphant against frontier satraps, now hung back intimidated by the approaching majesty and full muster of the empire, and that they would not stand to resist his attack. Under this impression Darius resolved upon an advance into Cilicia with all his army.

Thymodes indeed, and other Grecian advisers — together with the Macedonian exile Amyntas — deprecated his new resolution, entreating him to persevere in his original purpose. They pledged themselves that Alexander would come forth to attack him wherever he was, and that, too, speedily. They dwelt on the imprudence of fighting in the narrow defiles of Cilicia, where his numbers, and especially his vast cavalry, would be useless. Their advice, however, was not only disregarded by Darius, but denounced by the Persian councillors as traitorous. Even some of the Greeks in the camp shared, and transmitted in their letters to Athens, the blind confidence of the monarch. The order was forthwith given for the whole army to quit the plains of Syria and march across Mount Amanus into Cilicia. To cross, by any pass, over such a range as that of Mount Amanus, with a numerous army, heavy baggage, and ostentatious train (including all the suite necessary for the regal family), must have been a work of no inconsiderable time; and the only two passes over this mountain were, both of them, narrow and easily defensible. Darius followed the northernmost of the two, which brought him into the rear of the enemy.

Thus at the same time that the Macedonians were marching southward to cross Mount Amanus by the southern pass, and attack Darius in the plain, Darius was coming over into Cilicia by the northern pass to drive them before him back into Macedonia. Reaching Issus, seemingly about two days after they had left it, he became master of their sick and wounded left in the town. With odious brutality, his grandees impelled him to inflict upon these poor men either death or amputation of hands and arms. He then marched forward, along the same road by the shore of the gulf which had already been followed by Alexander, and encamped on the banks of the river Pinarus.

The fugitives from Issus hastened to inform Alexander, whom they overtook at Myriandrus. So astonished was he, that he refused to believe the news, until it had been confirmed by some officers whom he sent north-

[333 B.C.]

ward along the coast of the gulf in a small galley, and to whom the vast Persian multitude on the shore was distinctly visible. Then, assembling the chief officers, he communicated to them the near approach of the enemy, expatiating on the favourable auspices under which a battle would now take place. His address was hailed with acclamation by his hearers, who demanded only to be led against the enemy.

PREPARING FOR BATTLE

His distance from the Persian position may have been about eighteen miles. By an evening march, after supper, he reached at midnight the narrow defile (between Mount Amanus and the sea) called the Gates of Cilicia and Syria, through which he had marched two days before. Again master of that important position, he rested there the last portion of the night, and advanced forward at daybreak northward towards Darius. On approaching near to the river Pinarus (which flowed across the pass), he adopted his order of battle. On the extreme right he placed the hypaspists, or light division of hoplites; next (reckoning from right to left), five taxeis or divisions of the phalanx, under Cœnus, Perdiccas, Meleager, Ptolemy, and Amyntas. The breadth of plain between the mountains on the right, and the sea on the left, is said to have been not more than fourteen stadia, or somewhat more than one English mile and a half. From fear of being outflanked by the superior numbers of the Persians, he gave strict orders to Parmenion to keep close to the sea. His Macedonian cavalry, the companions, together with the Thessalians, were placed on his right flank; as were also the Agrianians, and the principal portion of the light infantry. The Peloponnesian and allied cavalry, with the Thracian and Cretan light infantry, were sent on the left flank to Parmenion.

Darius, informed that Alexander was approaching, resolved to fight where he was encamped, behind the river Pinarus. He, however, threw across the river a force of thirty thousand cavalry, and twenty thousand infantry, to insure the undisturbed formation of his main force behind the river. He composed his phalanx, or main line of battle, of ninety thousand hoplites; thirty thousand Greek hoplites in the centre, and thirty thousand Asiatics armed as hoplites (called Cardaces), on each side of these Greeks. These men — not distributed into separate divisions, but grouped in one body or multitude — filled the breadth between the mountains and the sea. On the mountains to his left, he placed a body of twenty thousand men, intended to act against the right flank and rear of Alexander. But for the great numerical mass of his vast host, he could find no room to act; accordingly they remained useless in the rear of his Greek and Asiatic hoplites; yet not formed into any body of reserve, or kept disposable for assisting in case of need. When his line was thoroughly formed, he recalled to the right bank of the Pinarus the thirty thousand cavalry and twenty thousand infantry, which he had sent across as a protecting force. A part of this cavalry were sent to his extreme left wing, but the mountain ground was found unsuitable for action, so that they were forced to cross to the right wing, where accordingly the great mass of the Persian cavalry became assembled. Darius himself in his chariot was in the centre of the line, behind the Grecian hoplites. In the front of his whole line ran the river or rivulet Pinarus; the banks of which, in many parts naturally steep, he obstructed in some places by embankments.

THE BATTLE OF ISSUS

As soon as Alexander, by the retirement of the Persian covering detachment, was enabled to perceive the final dispositions of Darius, he made some alteration in his own, transferring his Thessalian cavalry by a rear movement from his right to his left wing, and bringing forward the lancer-cavalry or sarrissophori, as well as the light infantry, Pæonians and archers, to the front of his right. The Agrianians, together with some cavalry and another body of archers, were detached from the general line to form an oblique front against the twenty thousand Persians posted on the hill to outflank him. As these twenty thousand men came near enough to threaten his flank, Alexander directed the Agrianians to attack them, and to drive them farther away on the hills.

Having thus formed his array, after giving the troops a certain halt after their march, he advanced at a very slow pace, anxious to maintain his own front even, and anticipating that the enemy might cross the Pinarus to meet him. But as they did not move, he continued his advance, preserving the uniformity of the front, until he arrived within bowshot, when he himself, at the head of his cavalry, hypaspists, and divisions of the phalanx on the right, accelerated his pace, crossed the river at a quick step, and fell upon the Cardaces or Asiatic hoplites on the Persian left. Unprepared for the suddenness and vehemence of this attack, these Cardaces scarcely resisted a moment, but gave way as soon as they came to close quarters, and fled, vigorously pressed by the Macedonian right. Darius, who was in his chariot in the centre, perceived that this untoward desertion exposed his person from the left flank. Seized with panic, he caused his chariot to be turned round, and fled with all speed among the foremost fugitives. He kept to his chariot as long as the ground permitted, but quitted it on reaching some

rugged ravines, and mounted on horseback to make sure of escape; in such terror that he cast away his bow, his shield, and his regal mantle. He does not seem to have given a single order, nor to have made the smallest effort to repair a first misfortune. The flight of the king was the signal for all who observed it to flee also; so that the vast host in the rear were quickly to be seen trampling one another down, in their efforts to get through the difficult ground out of the reach of the enemy. Darius was himself not merely the centre of union for all the miscellaneous contingents composing the army, but also the sole commander; so that after his flight there was no one left to give any general order.

This great battle—we might rather say, that which ought to have been a great battle—was thus lost, through the giving way of the Asiatic hoplites on the Persian left, and the immediate flight of Darius within a



PHRYGIAN WEAPONS AND HELMET

few minutes after its commencement. But the centre and right of the Persians, not yet apprised of these misfortunes, behaved with gallantry. When Alexander made his rapid dash forward with the right, under his own immediate command, the phalanx in his left centre (which was under

[333 B.C.]

Craterus and Parmenon) either did not receive the same accelerating order, or found itself both retarded and disordered by greater steepness in the banks of the Pinarus. Here it was charged by the Grecian mercenaries, the best troops in the Persian service. The combat which took place was obstinate, and the Macedonian loss not inconsiderable; the general of division, Ptolemy, son of Seleucus, with 120 of the front-rank men or choice phalangites, being slain. But presently Alexander, having completed the rout on the enemy's left, brought back his victorious troops from the pursuit, attacked the Grecian mercenaries in flank, and gave decisive superiority to their enemies. These Grecian mercenaries were beaten and forced to retire. On finding that Darius himself had fled, they got away from the field as well as they could, yet seemingly in good order. There is even reason to suppose that a part of them forced their way up the mountains or through the Macedonian line, and made their escape southward.

Meanwhile on the Persian right, towards the sea, the heavy-armed Persian cavalry had shown much bravery. They were bold enough to cross the Pinarus and vigorously to charge the Thessalians; with whom they maintained a close contest, until the news spread that Darius had disappeared, and that the left of the army was routed. They then turned their backs and fled, sustaining terrible damage from their enemies in the retreat.

The rout of the Persians being completed, Alexander began a vigorous pursuit. The destruction and slaughter of the fugitives were prodigious. Amidst so small a breadth of practicable ground, narrowed sometimes into a defile and broken by frequent watercourses, their vast numbers found no room, and trod one another down. As many perished in this way as by the sword of the conquerors; insomuch that Ptolemy (afterwards king of Egypt, the companion and historian of Alexander) recounts that he himself in the pursuit came to a ravine choked up with dead bodies, of which he made a bridge to pass over it. The pursuit was continued as long as the light of a November day allowed; but the battle had not begun till a late hour. The camp of Darius was taken, together with his mother, his wife, his sister, his infant son, and two daughters. His chariot, his shield, and his bow also fell into the power of the conquerors; and a sum of three thousand talents [£600,000 or \$3,000,000] in money was found, though much of the treasure had been sent to Damascus. The total loss of the Persians is said to have amounted to ten thousand horse and one hundred thousand foot; among the slain moreover were several eminent Persian grandees: Arsames, Rheomithres, and Atizyes, who had commanded at the Granicus, and Sabaces, satrap of Egypt. Of the Macedonians we are told that 300 foot and 150 horse were killed. Alexander himself was slightly wounded in the thigh by a sword.

Flight of Darius

When Alexander returned at night from the pursuit, he found the Persian regal tent reserved for him. In an inner compartment of it he heard the tears and wailings of women. He was informed that the mourners were the mother and wife of Darius, who had learned that the bow and shield of Darius had been taken, and were giving loose to their grief under the belief that Darius himself was killed. Alexander immediately sent Leonatus to assure them that Darius was still living, and to promise further that they should be allowed to preserve the regal title and state — his war against Darius being undertaken not from any feelings of hatred, but as a

fair contest for the empire of Asia. Besides this anecdote, which depends on good authority, many others, uncertified or untrue, were recounted about his kind behaviour to these princesses; and Alexander himself, shortly after the battle, seems to have heard fictions about it, which he thought himself obliged to contradict in a letter. It is certain (from the extract now remaining of this letter) that he never saw, nor ever entertained the idea of seeing, the captive wife of Darius, said to be the most beautiful woman in Asia; moreover he even declined to hear encomiums upon her beauty.

How the vast host of fugitives got out of the narrow limits of Cilicia, or how many of them quitted that country by the same pass over Mount Amanus as that by which they had entered it—we cannot make out. It is probable that many, and Darius himself among the number, made their escape across the mountain by various subordinate roads and bypaths; which, though unfit for a regular army with baggage, would be found a welcome resource by scattered companies. Darius managed to get together four thousand of the fugitives, with whom he hastened to Thapsacus, and there recrossed the Euphrates. The only remnant of force, still in a position of defence after the battle, consisted of eight thousand of the Grecian mercenaries under Amyntas and Thymodes. These men, fighting their way out of Cilicia (seemingly towards the south, by or near Myriandrus), marched to Tripolis on the coast of Phœnicia, where they still found the same vessels in which they had themselves been brought from the armament of Lesbos. Seizing sufficient means of transport, and destroying the rest to prevent pursuit, they immediately crossed over to Cyprus, and from thence to Egypt.

With this exception, the enormous Persian host disappears with the battle of Issus. We hear of no attempt to rally or re-form, nor of any fresh Persian force afoot until two years afterwards. The booty acquired by the victors was immense, not merely in gold and silver, but also in captives for the slave-merchant. On the morrow of the battle, Alexander offered a solemn sacrifice of thanksgiving, with three altars erected on the banks of the Pinarus; while he at the same time buried the dead, consoled the wounded, and rewarded or complimented all who had distinguished themselves.

No victory recorded in history was ever more complete in itself, or more far-stretching in its consequences, than that of Issus. Not only was the Persian force destroyed or dispersed, but the efforts of Darius for recovery were paralysed by the capture of his family. Portions of the dissipated army of Issus may be traced, reappearing in different places for operations of detail, but we shall find no further resistance to Alexander, during almost two years, except from the brave freemen of two fortified cities. Everywhere an overwhelming sentiment of admiration and terror was spread abroad, towards the force, skill, or good fortune of Alexander, by whichever name it might be called—together with contempt for the real value of a Persian army, in spite of so much imposing pomp and numerical show; a contempt not new to intelligent Greeks, but now communicated even to vulgar minds by the recent unparalleled catastrophe.

Both as general and as soldier, indeed, the consummate excellence of Alexander stood conspicuous, not less than the signal deficiency of Darius. The fault in the latter was that of fighting the battle, not in an open plain, but in a narrow valley, whereby his superiority of number was rendered unprofitable. But this (as we have already observed) was only one among many mistakes, and by no means the most serious. The result would have been the same, had the battle been fought in the plains to the eastward of Mount Amanus. Superior numbers are of little avail on any

[333 B.C.]

ground, unless there be a general who knows how to make use of them ; unless they be distributed into separate divisions ready to combine for offensive action on many points at once, or at any rate to lend support to each other in defence, so that a defeat of one fraction is not a defeat of the whole. The faith of Darius in simple multitude was altogether blind and childish ; nay, that faith, though overweening beforehand, disappeared at once when he found his enemies did not run away, but faced him boldly — as was seen by his attitude on the banks of the Pinarus, where he stood to be attacked instead of executing his threat of treading down the handful opposed to him. But it was not merely as a general that Darius acted in such a manner as to render the loss of the battle certain. Had his dispositions been ever so skilful, his personal cowardice in quitting the field and thinking only of his own safety, would have sufficed to nullify their effect. Though the Persian grandees are generally conspicuous for personal courage, yet we shall find Darius hereafter again exhibiting the like melancholy timidity, and the like incompetence for using numbers with effect, at the battle of Arbela, though fought in a spacious plain chosen by himself.

FROM ISSUS TO TYRE

Happy was it for Memnon that he did not live to see the renunciation of his schemes, and the ruin consequent upon it! The fleet in the *Ægean*, which had been transferred at his death to Pharnabazus, though weakened by the loss of those mercenaries whom Darius had recalled to Issus, and disheartened by a serious defeat which the Persian Orontobates had received from the Macedonians in Caria, was nevertheless not inactive in trying to organise an anti-Macedonian manifestation in Greece. While Pharnabazus was at the island of Siphnos with his one hundred triremes, he was visited by the Lacedæmonian king Agis, who pressed him to embark for Peloponnesus as large a force as he could spare, to second a movement projected by the Spartans. But such aggressive plans were at once crushed by the terror-striking news of the battle of Issus. Apprehending a revolt in the island of Chios, as a result of this news, Pharnabazus immediately sailed thither with a large detachment. Agis, obtaining nothing more than a subsidy of thirty talents and a squadron of ten triremes, was obliged to renounce his projects in Peloponnesus, and to content himself with directing some operations in Crete, to be conducted by his brother Agesilaus ; while he himself remained among the islands, and ultimately accompanied the Persian Autophradates to Halicarnassus. It appears, however, that he afterwards went to conduct the operations in Crete, and that he had considerable success in that island, bringing several Cretan towns to join the Persians.^c

The spoil of Damascus was not the most important advantage which Alexander reaped from the battle of Issus. It averted a danger which, notwithstanding Memnon's death, had continued to give him occasion for much uneasiness ; for he was still threatened with a diversion in his rear — a general rising of the Greeks and an invasion of Macedonia — which might have interrupted, even if it did not finally defeat, his enterprise.

Thus then Alexander had nothing more to fear on this side for the present. But it was not the less his foremost object to guard against the recurrence of this danger, and to deprive the Persian government of all means of aiding the Greeks in their attempts for the recovery of their independence. He saw that if he once made himself master of Phœnicia and *Égypt*, the

Persians would be deserted by the best part of their galleys, which were furnished by the Phœnician cities, and would be unable to repair the loss. His authority would then be undisputed in all the provinces of the empire west of the Euphrates.

Darius had continued his flight without intermission until he had crossed the river at Thapsacus, where he arrived with about four thousand fugitives, who had successively joined his train; and then first felt himself out of immediate peril. Amyntas [the Greek mercenary general who had escaped from Issus], it seems, conceived the bold project of making himself master of Egypt. Sabaces, the satrap of Egypt, had fallen in the battle; and Amyntas, pretending that he had a commission from Darius, gained admittance at Pelusium. He then dropped the mask, and calling on the Egyptians to shake off the hated yoke of Persia, marched against Memphis. Mazaces, the Persian commander of Memphis, was defeated, and forced to take shelter behind the walls. But the victors suffered themselves to be surprised by Mazaces, and Amyntas was slain, with almost all his men.

Darius indeed had the force of the greater part of his empire still entire, and at his command. The troops of the eastern satrapies, including some of the most warlike in his dominions, had already been summoned to the royal standard; and he might expect, in the course of a few months, to see himself at the head of a still more numerous host than he had commanded at Issus. It was perhaps partly with the view of gaining time, that he no sooner reached a place of safety, than he began to sound Alexander's temper by overtures of negotiation. He sent two envoys to Alexander. He assumed the tone of remonstrance, as one who had suffered an unprovoked aggression. He was now reduced, by the chance of war, to make a request: such however as one king might becomingly address to another—that Alexander would restore his mother, wife, and children. He himself was willing to become Alexander's friend and ally, and desired that he would send ministers with the two Persian envoys, to treat with him.

The Persian envoys had been instructed to urge the request contained in their master's letter by word of mouth. Alexander sent Thersippus along with them, charged with a letter to Darius, but with orders to abstain from oral communications on the subject. The letter was a kind of manifesto, in which he vindicated the justice of his proceedings by various reasons, as good, at least, as the strong are usually able to find for attacking the weak. He began like the wolf in the fable. The ancestors of Darius had invaded Macedonia and Greece, and he had been appointed by the Greeks their general, and had come over to Asia, to avenge their wrongs and his own. Ochus had furnished succours to Perinthus and the Thracians against Philip. It was through the machinations of the Persian court that Philip had been murdered; and his death had been made a subject of boastful exultation in its public letters. Darius himself had been the accomplice of Bagoas in the murder of Arses, and had usurped the throne of Persia: he had endeavoured to excite the Greeks to war against Macedonia, and had offered subsidies to Sparta, and to other states, which indeed had been accepted only by Sparta; but his agents had succeeded in corrupting many private persons, and had been incessantly labouring to disturb the tranquillity of Greece. His invasion therefore had been undertaken on just grounds. But since the gods had crowned his arms with victory, none of those who had trusted themselves to his clemency had found reason to regret their choice. He therefore invited Darius himself to come to him, as to the lord of Asia. He might beforehand receive pledges of his personal safety, and might then

[333-332 B.C.]

ask with confidence for his mother, wife, and children, and for whatever else he could desire. In future, he must address Alexander as the King of Asia, in the style, not of an equal, but of a subject, or must expect to be treated as an enemy. If, however, he disputed his claim to sovereignty, let him wait for his coming, and try the event of another contest. He might rest assured that Alexander would seek him, wherever he might be found.

On his road to Phœnicia, Alexander had been met by Straton, son of the king of Aradus, Gerostratus, whose territory included Marathus and several other towns on the main. Gerostratus himself, with all the other Phœnician and Cypriote princes, was serving in the Persian fleet, under Autophradates. Yet Strato brought a golden crown to the conqueror, and surrendered all the cities in his father's dominions into his hands. As he advanced from Marathus, Byblus capitulated to him, and Sidon, where every heart burned with hatred of Persia, hailed him as her deliverer. Thus he proceeded without resistance towards Tyre. And even from this great city he received a deputation on his way, composed of the most illustrious citizens, among whom was the king's son, bringing a golden crown, and a present of provisions for the army, and announcing that the Tyrians had resolved to obey all his commands.

THE SIEGE OF TYRE

It seems that the language in which this message was conveyed intimated something as to the limits of that obedience which the Tyrians were willing to pay. It was not meant that it should extend so far as totally to resign their independence. This Alexander probably understood, and nothing could satisfy him short of absolute submission, and full possession of so important a place. But he met the offers of the Tyrians, as if they had been made in the sense which he required; and bade the envoys apprise their fellow-citizens that it was his intention to cross over to their island, and offer a sacrifice to Melkarth, the Phœnician Hercules, whom he chose to consider as one with the hero of Argos and Thebes. This was perhaps the least offensive way of bringing the matter to an issue; and it obliged the Tyrians to speak their mind more plainly. They now informed him that in all other points he should find them ready to submit to his pleasure, but that they would not admit either a Persian or a Macedonian within their walls; and they begged that he would celebrate the sacrifice which he wished to offer in Old Tyre, which lay on the coast opposite to their island city, where their god had another, and probably a much more ancient, sanctuary.

Alexander indignantly dismissed their ambassadors, and called a council of his officers, in which he declared his intention of besieging Tyre, and explained the reasons which rendered this undertaking necessary, arduous as it was. He observed that it would be unsafe to invade Egypt, so long as the Persians commanded the sea, and that to advance into the interior against Darius, while Tyre remained neutral or vacillating, and while Cyprus and Egypt were in the enemy's hands, would be to let the war be transferred to Greece, where Sparta was openly hostile, and Athens only withheld from the avowal of her enmity by fear. On the other hand the reduction of Tyre would be attended with the submission of all Phœnicia; and the Phœnician fleet, the strength of the Persian navy, would soon pass over to the power which possessed the cities by which it had been equipped, and to which the crews belonged. Cyprus would then speedily fall, and there would be no further obstacle to the conquest of Egypt. They might then set out

for Babylon, leaving all secure on the side of Greece, and with the proud consciousness that they had already severed all the provinces west of the Euphrates from the Persian empire.

The motives which induced Alexander to undertake the siege of Tyre are more evident than those which led the Tyrians to defy his power, after so many of the other Phœnician cities had submitted to him. The main ground of their conduct seems to have been more in the nature of a commercial calculation of expediency. The issue of the contest between Alexander and Darius was still doubtful; notwithstanding his past success the Macedonian conqueror might meet the fate of the younger Cyrus in some future field of battle. In any case the Tyrians believed their city to be impregnable so long as they were superior at sea. It was thought necessary, either for the purpose of detaining the god, or of quieting the popular uneasiness, to adopt an expedient similar to that which many years before had been employed by the Ephesians in a like emergency—to fasten the statue of Apollo, who was denounced as a friend of Alexander, by a golden chain to the altar of Melkarth. On the other hand Alexander seems to have thought it prudent to raise the spirits of his troops by assurances of divine assistance, in an enterprise which appeared to surpass human ability. He too related that he had seen Hercules in a dream taking him by the hand, and leading him within the walls of his city—a sign, as Aristander interpreted it, of success, though in a Herculean labour.

An ordinary conqueror might indeed himself have needed such assurances to encourage him, when he was about to attack a place so prepared for defence as Tyre at this time was, both by nature and art. The island on which the city stood was separated from the main by a channel half a mile broad, through which, in rough weather, the sea rushed with great violence. This strait was indeed shallow on the side of the Phœnician coast, but near the island became three fathoms deep. The walls, which rose from the edge of the cliffs, were 150 feet high on the land side, and composed of huge blocks of stone, cemented with mortar. The city was abundantly stocked with provisions and military stores, contained a number of copious springs; was filled with an industrious and intelligent population, expert in all the arts of naval warfare, and possessed mechanics and engineers, not inferior, it seems, to any that were to be found in the Macedonian camp. Though the greater part of the Tyrian fleet was absent in the Persian service, there still remained a sufficient number of galleys of war, and of smaller craft, both for the defence of the harbours—for there were two, one on the north, the other on the south side of the island—and for the annoyance of the enemy.

Alexander had no naval force which he could immediately oppose to this. His plan was soon formed: he resolved to carry a causeway through the channel, and when it had reached the foot of the walls, to batter them from it with his engines. The real difficulty of the undertaking was not perceived until the dam had been carried halfway across the water. But as the depth increased, while the work itself became more and more laborious and difficult, it now came within reach of the missiles discharged from the top of the walls; and the Tyrian galleys, taking their station at a short distance, incessantly annoyed the workmen, who were not armed to sustain these attacks. Alexander however ordered two wooden towers erected both to shelter the workmen and repel the assailants.

The Tyrians now prepared a more formidable mode of attack. A horse transport was filled with dry twigs and other combustibles, over which they poured pitch and brimstone. In the forepart an additional space was

[332 B.C.]

enclosed, so as to form a huge basket for the reception of these materials, in the midst of which were fixed two masts, which at the ends of their yard-arms supported two cauldrons filled with an inflammable liquid. The stem was raised high above the water by means of ballast heaped near the stern. The besieged, having waited for a favourable breeze, towed the ship behind two galleys towards the mole, and when it came near set it on fire, and, seconded by the wind, ran it on the end of the mole between the towers. The flames soon caught them; but the conflagration did not reach its full height, until the masts gave way and discharged the contents of the cauldrons on the blazing pile. To render it the more effectual, the men on board the galleys from a convenient distance plied the towers with their arrows, so as to defeat every attempt that was made to extinguish the fire.

A shoal of boats now came off from the harbours filled with people, who soon tore up the piles, and set fire to all the machines which had not been overtaken by the flames of the burning ship. The ruin of the work which had cost so much time and labour was completed in a few hours. Alexander, however, was not disheartened; he gave orders that a new mole should be begun, of greater breadth, so as to be capable

of receiving more towers, and that new engines should be constructed. But as he now became aware that, without some naval force to oppose to the Tyrians, he should find the difficulties of the siege insurmountable, he repaired at once in person to Sidon, with a detachment of light troops, to collect as many galleys as he could.

Gerostratus, king of Aradus, and Enylus of Byblus, as soon as they heard that he had become master of their cities, quitted the Persian fleet, with their squadrons, and with a part of the Sidonian galleys; so that Alexander was joined at Sidon by eighty sail of Phœnician ships. About the same time came in ten from Rhodes, as many from Lycia, three from Soli and Mallus, and his own victorious captain, Proteas, from Macedonia. And these were followed not long after by the Cypriote princes with 120 galleys. He had now an armament of nearly 250 sail at his orders. While it went through a course of training for a sea-fight, and while the machines were in preparation, he made an excursion, with some squadrons of horse and a

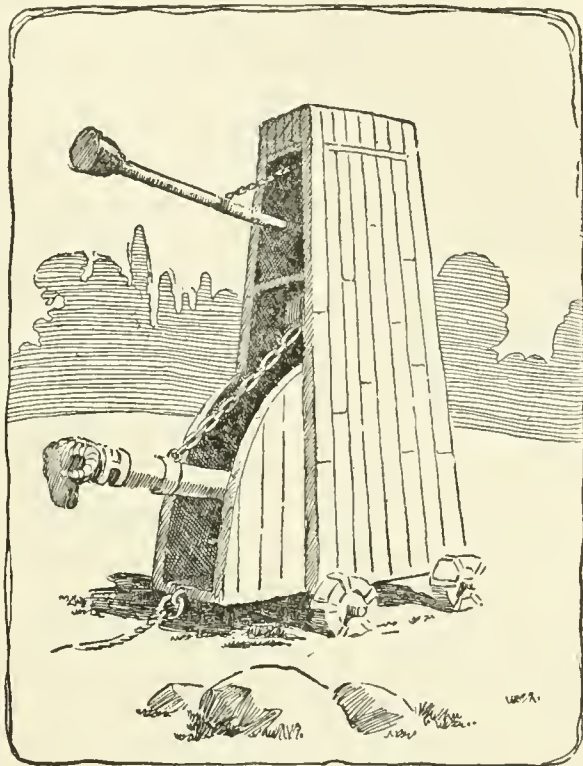

GREEK BATTERING RAM

body of light troops, into the range of Anti-Libanus, and having reduced the mountaineers to submission, within eleven days returned to Sidon, where he found a reinforcement of four thousand Greek soldiers, who had been brought by Cleander from Peloponnesus. He then set sail for Tyre in line of battle, himself, as on shore, commanding the right wing, and Craterus the left. The Tyrians, it seems, expected his approach and were prepared to meet him; when they saw the numbers which he brought with him, they gave up all thoughts of resistance, and only used their galleys to block up the mouths of their harbours. Alexander, when he came up, found the northern harbour too well secured to be attacked, though he sank three of the enemy's galleys which were moored on the outside, and captured one which was consecrated to the tutelary god. The next day he stationed the Cypriotes under the command of Andromachus near the entrance of this harbour, and the Phœnicians near the other, in the same quarter where his own tent was pitched.

In the meanwhile the mole had been restored, and was actively carried forward; mechanics had been collected in great numbers from Phœnicia and Cyprus, and had constructed abundance of engines, which were planted, some on the mole, others on transports and on the heavier galleys. These vessels at first found the approach very much impeded by a bed of stones which the besieged had carried out into the sea from the foot of the cliffs; and the attempts which the Macedonians made to remove this obstacle were for some time thwarted by the dexterity and boldness of the Tyrian divers, who cut the cables of the ships which were anchored for the purpose of drawing up the stones. Chain cables were at length substituted, and the passage was then rapidly cleared by machines, which raised the stones out of their bed, and hurled them into the deep water. The walls were now assailed by the engines on every side, and the contest grew closer and hotter than it had ever been. Every contrivance that ingenuity quickened by fear could suggest was tried by the besieged to ward off these attacks.

Very famous in particular was one, which is not the less credible because Arrian's authors seem to have passed it over in silence: the invention of shields filled with heated sand, which they were made to discharge on the assailants, and which, penetrating between their armour and their skin, inflicted indescribable tortures. Still the means of attack kept growing on the resources of defence. Dejection began to spread within the walls; and there were some who proposed to renew a horrid rite, which had long fallen into disuse—the sacrifice of a boy of good family to Moloch. It does honour to the Tyrian government, that it did not either humour this bloody superstition, or give way to despair; it was policy perhaps to check all thoughts of capitulation rather than ferocity that induced it to execute its Macedonian prisoners on the top of the walls, and to cast their bodies, in the sight of the besiegers, into the sea; but it directed the energy of the people to better expedients. It made a vigorous attempt to surprise the Cypriote squadron stationed near the northern harbour, and would have gained a complete victory over it; but Alexander, having received timely notice of the sally, sailed round unobserved, turned the fortune of the day, and sunk or took most of the enemy's ships. All hopes from offensive measures were crushed by this blow; the safety of the city now rested chiefly in the strength of its walls.

Even these, after several fruitless attempts had been made in other quarters, began to give way on the south side; and a breach was opened, which Alexander tried, but did not find immediately practicable. Three days after,

[332 B.C.]

however, when a calm favoured the approach of the vessels, he gave orders for a general attack. It was to be made on all sides at once, to distract the attention of the besieged; and the fleet was at the same time to sail up to both the harbours, in the hope that in the midst of the tumult it might force an entrance into one of them. But the main assault was to be directed against the breach that had been already formed. The vessels which bore the engines were first brought up to play upon it; and when it had been sufficiently widened, were followed by two galleys, with landing boards and the men who were to mount it. One was commanded by Admetus, and was filled with troops of the guard, and in this Alexander himself embarked. Admetus and his men were the first to effect a landing, animated by the immediate presence of their king, who, after he had paused awhile to observe and animate the exertions of his warriors, himself mounted the breach.

When the Macedonian had once gained a firm footing, the issue of the conflict did not long remain doubtful. Admetus indeed, who led the way, was slain; but Alexander soon made himself master of two towers and the intervening curtain, through which the troops from the other vessel poured in after him, and he then advanced along the walls to the royal palace, which stood on the highest ground, that he might descend from it with the greater ease into the heart of the city. The Tyrians, seeing the wall taken, abandoned their fortifications, and collected their forces in one of the public places, where they gallantly made head against their assailants. But in the meanwhile both the harbours had been forced, their ships sunk or driven ashore, and the besiegers landed to join their comrades in the city. It soon became a scene of unresisted carnage and plunder. The Macedonians, exasperated by the length and labours of the siege, which had lasted seven months, and by the execution of their comrades, spared none that fell into their hands. The king — whom the Greeks call Azemileus — with the principal inhabitants, and some Carthaginian envoys who had been sent with the usual offerings to Melkarth, took refuge in his sanctuary: and these alone, according to Arrian, were exempted from the common lot of death or slavery. It was an act of elemency, by which the conqueror at the same time displayed his piety to the god. Of the rest, eight thousand perished in the first slaughter, and thirty thousand, including a number of foreign residents, were sold as slaves. But if we may believe Curtius, fifteen thousand were rescued by the Sidonians, who first hid them in their galleys, and afterwards transported them to Sidon — not, it must be presumed, without Alexander's connivance or consent. It seems incredible, that he should have ordered two thousand of the prisoners to be crucified; though he might have inflicted such a punishment on those who had taken the leading part in the butchery of the Macedonians. But, after the king and the principal citizens had been spared, it is not easy to understand why any others should have suffered on this account.

So fell Tyre, the rich, and beautiful, and proud, in arts and arms the queen of merchant cities. The conqueror celebrated his victory with a solemn military and naval procession, sacrifice, and games, in honour of the tutelary god who had thus fulfilled his promise and, though after the labour of so many months, had at length brought him into his city. He dedicated the engine which had first shattered the wall, and the sacred galley, in the sanctuary of Melkarth.^b



CHAPTER LIII. FROM GAZA TO ARBELA

WHILE Alexander was yet besieging Tyre, ambassadors arrived from Darius, telling him that Darius would bestow upon him ten thousand talents of silver, if he would set his mother, his wife, and children at liberty; as also all the country between the Euphrates and the Hellespont; and if he would take his daughter in marriage, he should be styled his friend and confederate. Which embassy being debated in council, Parmenion is said to have told him that if he were Alexander, he would accept the terms, and, when the end of war was gained, no longer tempt the hazard thereof. To which the other is said to have replied, "So would I if I were Parmenion; but as I am Alexander, I must act worthily of Alexander." He therefore answered the ambassador that he neither wanted Darius' money, nor would accept of part of his empire, instead of the whole—since all the treasure, and the country, were his; that he would marry his daughter, if he pleased, without his consent: but if Darius had a mind to try his humanity, let him come to him.

This answer being carried to Darius, he, despairing of peace, made fresh preparations for war. Alexander then resolved upon an expedition into Egypt, all the cities of that part of Syria called Palestine being surrendered peaceably into his hands, except Gaza, which was kept by a certain eunuch, named Batis, who, foreseeing this, had already hired many troops of Arabians, and laid up vast stores of provisions, to serve for a long siege. He also entirely trusted to the strength of the place, which he looked upon as impregnable; for which reason, he was resolved that, whenever Alexander approached, he should be denied entrance.

THE SIEGE OF GAZA ACCORDING TO ARRIAN

Gaza is only twenty furlongs distant from the seashore, and exceeding difficult of access, because of the depth of the sand, and the neighbouring sea, which is, everywhere, shallow. The city itself is large and populous, seated on a high hill, and surrounded with a strong wall. It is also the last inhabited place which travellers meet with in their way from Phœnicia to Egypt, and borders upon a vast desert. Alexander, immediately after his arrival there, encamped over against that part of the wall which seemed most subject to an assault, and ordered his engines to be brought thither; and notwithstanding the opinion of some of his engineers, that the wall was not possible to be taken by force, by reason of the height of the bulwarks,

[332 B.C.]

he thought fit to declare his sentiments to the contrary ; and that the more difficult the attempt was, the more necessary it was to be undertaken ; for that the very suddenness and briskness of their assault would strike their enemies with no small terror. He added that, if he were unable to reduce the city, it would abundantly redound to his dishonour, when the news should be carried to Greece, as well as to Darius.

He therefore ordered a rampart to be run round it, of such a height that the engines placed thereupon might be upon a level with the top of the wall, which rampart he then built over against the south part of the wall, because it seemed, there, the least difficult to be assaulted. And when the work was now brought to its full height, the Macedonian engines were immediately placed thereon. About this time, as Alexander was sacrificing, with a crown of gold upon his head, according to the custom of Greece, and just entering upon the office, a certain bird of prey hovered over the altar and let fall a stone from his claws upon his head. Alexander immediately sent to consult Aristander, the soothsayer, what this prodigy could portend. He returned answer : "Thou shalt indeed take the city, O King ; but beware of danger from thence, on the day it is taken." He, hearing this, retired out of the reach of their darts to the engines on the rampart.

But when Alexander saw the Arabians make a furious sally out of the city, and set fire to the engines, and, having the advantage of the higher station, gall the Macedonians below and beat them from the rampart which they had built — then, either forgetful of the divine warning, or moved with the danger of his soldiers, he called his targeteers together and hastened to succour the Macedonians where they were most exposed, and by his presence kept them from betaking themselves to flight and abandoning the rampart : but while he was thus pushing forward, an arrow from an engine pierced his shield and breastplate and wounded him in the shoulder ; which, when he perceived, and thereby knew that Aristander's prediction was true, he rejoiced, because, by the same prediction, he was to take the city.

In the meantime other engines, which had been used at the siege of Tyre, arriving by sea, he ordered the rampart to be run quite round the city, two stadia in breadth, and 250 feet in height. The engines then being prepared, and planted thereupon, the wall was vehemently shaken, and the miners in many places, working privately underneath the foundations thereof and conveying the rubbish away, it fell down. The besiegers then plying the citizens with their darts, beat them out of their towers ; yet thrice they sustained the Macedonian shocks, with the loss of abundance, slain and wounded. But at the fourth attack, when Alexander had called his men thither, he so levelled the wall, which had been undermined in some places, and widened the breaches made by the engines in others, that it seemed then a matter of no difficulty to the Macedonians to fix their ladders to the ruins thereof and storm the city. As soon as the ladders were fixed there arose a great emulation among the besiegers who should first mount the breach. This honour was gained by Neoptolemus of the race of the *Æacidæ*, one of his friends ; and after him, other captains and others still entered with their forces ; and when many of the Macedonians were now within the walls, they forced open the gates, one after another, and gave entrance to the whole army. The citizens, notwithstanding they saw the place thus taken by storm, were resolved to fight to the last ; and gathering together in a body, every one lost his life where he stood, after a brave resistance. Alexander sold the wives and children for slaves ; and a colony being drawn thither from the neighbourhood, the city was afterwards made use of as a garrison.^b

The following incidents, not mentioned by Arrian, are characteristic enough to be quoted from Quintus Curtius, IV. 6. The treatment of Batis, who was in command at Gaza, if correctly reported, — which, however, is by no means certain, — is one of those spasms of barbarity which now and then marred a career otherwise full of dignity.^a

INCIDENTS FROM QUINTUS CURTIUS

“A certain Arabian, one of Darius’ soldiers, ventured upon an action above his fortune, and covering his sword with his buckler, fell upon his knees before the king, as if he had deserted to him; whereupon the king bid him rise, and ordered him to be received into his service; but the barbarian, taking his sword courageously into his right hand, made at the king’s head; who having declined the blow, at the same time cut off the disappointed hand of the barbarian, and flattered himself that he was now cleared of the danger of the day. However, fate, as I take it, is unavoidable, for as he was fighting gallantly among the foremost he was wounded with an arrow, which passed through his armour, and struck in his shoulder, from whence Philip, his physician, drew it. Now the blood began to run in a great quantity, and all that stood by were frightened, never having known an arrow penetrate so deep through armour before.

“As for Alexander, he did not so much as change his countenance, but bid them stop the bleeding, and tie up the wound. Thus he remained some time at the head of the army, either dissembling or overcoming the pain; but when the blood that had been stopped by an application began to run afresh in a larger quantity, and the wound (which by reason of its newness did not at first pain him) upon the cooling of the blood began to swell, then he fainted and fell on his knees. They that were next to him took him up, and carried him into his tent, and Batis concluding him dead, returned into the town in a triumphing manner; but the king, impatient of delay (before his wound was cured), gave orders for a terrace to be raised as high as the city walls, which he commanded to be undermined.

“The besieged, on their part, were not idle, for they had erected a new fortification of equal height with the old wall, but that, however, did not come upon the level with the towers which were planted on the terrace, so that the inward parts of the town were exposed to the enemies’ darts; and to complete their hard fate, the walls were now overthrown by the mines, and gave the Macedonians an opportunity of entering the city at the breaches. The king was at the head of the foremost, and while he carelessly entered the place, his leg was hurt with a stone; notwithstanding which, leaning on his weapon, he fought among the first, though his old wound was not yet healed; his resentment was the greater on account of his having received two wounds in the siege.

“Batis, having behaved himself gallantly, and received several wounds, was at last forsaken by his men, yet this did not hinder him from fighting on, though his arms were grown slippery with his own and his enemies’ blood: but being attacked on all sides, he was taken alive, and being brought before the king, who was overjoyed that he had him in his power, insomuch that he used to admire virtue, even in an enemy, giving way this time to revenge, told him:

“‘Thou shalt not, Batis, die as thou wouldst, but expect to undergo whatever torments ingenuity can invent.’

[332 B. C.]

“At which threats Batis, without making any reply, gave the king not only an undaunted, but an insolent look; whereupon Alexander said, ‘Do you take notice of this obstinate silence? Has he either offered to kneel down, or made the least submission? However, I’ll overcome his taciturnity, if by no other means, at least by groans.’ This said, his anger turned to rage, his fortune having already corrupted his manners, so that he ordered cords to be run through Batis’ heels and tied to the hinder part of a cart, and in that manner had him dragged alive round the city, valuing himself for having imitated Achilles (from whom he descended) in punishing his enemy.”^c

ALEXANDER IN EGYPT

The sieges of Tyre and Gaza, occupying together nine months, were, says Grote, the hardest fighting that Alexander ever encountered.¹

The siege of Gaza had occupied, it seems, three or four months; and it was perhaps not before December 332, that Alexander began his expedition to Egypt. Here he might safely reckon not merely on an easy conquest, but on an ardent reception, from a people who burned to shake off the Persian tyranny, and had even welcomed and supported the adventurer Amyntas. Mazaces himself, as soon as he heard of the battle of Issus, became aware that all resistance to Alexander would be useless, and met him with a voluntary submission. At Pelusium he found the fleet, and having left a garrison in the fortress, ordered it to proceed up the Nile as far as Memphis, while he marched across the desert. Near Heliopolis he crossed the river, and joined the fleet at Memphis. Here he conciliated the Egyptians by the honours which he paid to all their gods, especially to Apis, who had been so cruelly insulted by the Persian invaders; but at the same time he exhibited a new spectacle to the natives—a musical and gymnastic contest, for which he had collected the most celebrated artists from all parts of Greece. He then embarked, and dropt down the western or Canopic arm of the river to Canopus, to survey the extremity of the Delta on that side; and having sailed round the lake Mareotis, landed on the narrow belt of low ground which parts it from the sea, and is sheltered from the violence of the northern gales, which would otherwise desolate and overwhelm it, by a long ridge of rock, then separated from the main land by a channel, nearly a mile (seven stadia) broad, and forming the isle of Pharos. On this site stood the village of Racotis, where the ancient kings of Egypt had stationed a permanent guard to protect this entrance of their dominions from adventurers, especially Greeks, who might visit it for the sake either of plunder or commerce; while for greater security they granted the adjacent district to a pastoral tribe, which regarded all strangers as enemies.

Alexander’s keen eye was immediately struck by the advantages of this position for a city, which should become a great emporium of commerce, and a link between the East and the West—one of the great objects which already occupied his mind—while it secured the possession of Egypt to his empire, and transmitted the name of its founder to distant ages. He immediately gave orders for the beginning of the work, himself traced the outline, which was suggested by the natural features of the ground itself,² and

[¹ Somewhere about this period belongs a picturesque tradition which Grote, Bury, Holm, and others do not mention at all, even to deny; and that is, Alexander’s reception in Palestine as described by Josephus. While it is disbelieved, even by such Jewish historians as Ewald and Milman, it is not entirely impossible. Thirlwall, unlike Mitford, found it credible.]

[² “The city was, in form, like unto a soldier’s coat,” says Diodorus.]

marked the sites of some of the principal buildings, squares, palaces, and temples. The two main streets, which intersected each other at right angles in a great public place, one traversing the whole length of the city, and forming a series of magnificent edifices, provided for health and enjoyment by a free current of air; and the inundations of the Nile secured it from the pernicious effects which would otherwise have arisen from the vicinity of the lake. A causeway connected the island — on which it is said Alexander at first thought of building the city — with the main, and divided the intervening basin into two harbours, which were only joined together by a canal near either end. By the continual accumulation of sand, this isthmus has been so enlarged that it now forms the site of the modern Alexandria. Still there were two defects to counterbalance so many advantages of situation. The harbour was on both sides difficult of entrance, and there was no



GREEK JUG

other within a great distance either on the east or the west. This inconvenience could never be wholly remedied, though the danger of the approach from the sea was afterwards much lessened by the erection of a magnificent beacon-tower, on a rock, near the eastern point of Pharos, which threw out its light to the distance, it is said, of nearly forty miles. The other defect was the want of water; and for this ample provision was made by a new canal, branching from the Nile, which brought a constant supply into the cisterns over which the houses were built. Yet Alexandria was thus placed at the mercy of every enemy who could make himself master of the canal and deprive it of a main necessary of life. It was a part of Alexander's plan to people the city with a mixed colony of Greeks and Egyptians, in which the prejudices of the two races might be effaced by habitual intercourse, though Grecian arts and manners were to give their character to the whole; and therefore, among the temples of the Grecian gods, he ordered one to be founded for the worship of Isis.

A favourable omen is said to have afforded a presage of the prosperity which awaited the new city. When he was about to trace the course of the walls, no chalk was at hand for the purpose, and it was found necessary instead to make use of flour, which soon attracted a large flock of birds from all sides to devour it. Aristander — who was never at a loss — construed this incident as a sign of the abundance which the city should enjoy and diffuse. That indeed probably far exceeded its founder's most sanguine hopes; but still less could he have foreseen or calculated all the elements of a new intellectual life, which were to be there combined, and the influence which it was to exert over the opinions and condition of a great part of the world.

He was still thus engaged when Hegelochus arrived with the news that the Persians had been dislodged from the last holds of their power in the Ægean. Tenedos had revolted from them, as soon as it became sure of Macedonian protection. At Chios the democratical party had risen against the government established by the Persian satraps, and had taken Pharnabazus himself prisoner: and soon after Aristonicus, the tyrant of Methymna, having sailed into the harbour, before he had heard of the recent revolution,

[331 B.C.]

with some pirate ships, fell into their hands. The crews were all put to death; he himself, together with the oligarchical leaders, who had betrayed the city to the Persians, was sent to Alexander to receive his sentence. Mytilene, too, where Chares, the Athenian general, commanded the garrison, had been forced to capitulate, and the whole of Lesbos had been recovered. Hegelochus had likewise left his colleague Amphoterus in possession of Cos, which the islanders had freely surrendered. There Pharnabazus had made his escape; but he had brought the other prisoners with him, among whom, beside Aristonicus, were several tyrants who had ruled under Persian patronage. These Alexander abandoned to the mercy of the cities which they had governed, and they all suffered a cruel death; the Chians, as both enemies and traitors, he sent under a strong guard to a wretched exile in the stifling island prison of Elephantine.

He was now on the confines of Egypt and Libya. In the region which lay not many days' march to the west, as some Greek legends told, Hercules and Perseus had pursued their marvellous adventures: both, it was believed, had consulted the oracle of Ammon in the heart of the Libyan wilderness. Alexander may have been desirous of emulating the achievements of his two heroic ancestors; or, if he had not heard of them, might still have been attracted by the celebrity of the oracle, and by the difficulty of reaching it. That he was impelled by curiosity about its answers, is very doubtful; but it is highly probable that he did not overlook the advantage which he might derive from them, however they might run, and the mysterious dignity with which the expedition itself might invest him in the eyes of his subjects. If however to these motives for the enterprise it should be thought necessary to add any others of a more intelligible policy, it might be conjectured that he also wished to impress Cyrene with respect for his power, and to show that even her secluded situation did not place her beyond the reach of his arms. On his march to Parætonium he was met at about midway by envoys from Cyrene, who brought a crown and other magnificent presents. After a march of about two hundred miles along the coast — perhaps nearly as far as the eastern frontier of the territory of Tripoli — he appears to have taken the direction toward the southeast, which leads, in five or six days for a private caravan, to the oasis.

THE VISIT TO AMMON

It was now for the first time that the Macedonians became acquainted with the face of the Libyan desert — its pathless sands, naked rocks, burning sky, and delusive images. That the journey should have furnished numberless stories for the entertainment of the camp, may easily be supposed. It is more difficult to understand how Alexander could have been at a loss for guides well acquainted with the way, as both Ptolemy and Aristobulus represented — though the one related that the perplexity of the wanderers was relieved by two great serpents, which pointed out the track, and were heard even when they could not be seen; the others described two ravens as performing the same office. Whether these are mere fictions of an idle fancy, or cover some fact which we are not able to ascertain, it is hardly worth while to inquire.¹ That the army was refreshed with the extraordinary occurrence of a shower of rain, in which it saw a manifest interposition

¹ As to the ravens, there is no reason to doubt the literal fact. It appears that these birds are looked upon as indicating the vicinity of a well in the African desert. Two ravens met Belzoni, as he was approaching the oasis El Wak. Ritter, *Afrika*, p. 969.

of the gods, cannot reasonably be doubted. At length it descended safely into the green, well-watered, and richly cultivated valley, where, embosomed in thick woods, stood, within the same enclosure, the palace of the ancient priestly kings, and close by the temple of Ammon.

It was a visit such as Ammon had probably never before received, and the priests no doubt did their utmost, both to welcome the royal pilgrim with due honours, and to impress him with the highest veneration for their oracle. It was not, it seems, always in the temple itself that answers were given. The god chose the place of his revelations for himself. His visible symbol, a round disc formed of precious stones, was placed in a golden ship, from which, on each side, hung sacred vessels of silver; and borne on the shoulders of eighty priests, attended by a train of virgins and matrons, who accompanied the procession with sacred chants, in which they implored a propitious and certain answer, according to the secret impulse of the deity which directed their steps. By such a procession Alexander seems to have been met, as he approached at the head of his army, and to have been conducted into the temple, where his questions were answered by the chief priest. What these questions and answers were, was perhaps never known to any but the interlocutors. It is indeed in itself by no means improbable that the priest saluted him as a hero of divine origin, and promised him the empire of the world: the address would not have been more flattering, nor the prophecy bolder, than those which the Greek oracles, less safe from exposure, had sometimes ventured on. But it is well attested that Alexander did not, at least at the time, disclose what he had heard; but merely declared to his followers that he had received such answers as he had desired, and showed his satisfaction by his offerings and donations.

ALEXANDER LEAVES EGYPT

Aristobulus perhaps only expressed himself carelessly when he said that the army returned by the same route: we cannot hesitate to prefer Ptolemy's statement, that it took the direct road to Memphis; unless indeed we should adopt a supposition which might render the two accounts more consistent — that Alexander struck across the desert in a third direction, which leads directly to the lake Mareotis. At Memphis he received reinforcements which had been sent to him by Antipater, and embassies to present congratulations or petitions from several states of Greece: among them, it seems, one which brought a golden crown, that had been decreed by a congress assembled at the isthmus on the occasion of the Isthmian games. It now only remained for him to settle the mode of administration by which Egypt was to be governed in his absence. It was his object at once to gain the good-will of the Egyptians, and to secure a province so important, and so easily defended, from the ambition of his own officers. The system which he established served in some points as a model for the policy of Rome under the emperors. He retained the ancient distribution of the country into the districts called *nomes*, and not only permitted them to be still governed by the native magistrates, the *nomarchs*, but placed them all under the authority of two Egyptians. Garrisons were stationed at Memphis and Pelusium. The country on the western side of the Delta was committed to the care of Apollonius; that on the east, towards Arabia, to Cleomenes, an Egyptian Greek of Naueratis, who afterwards became unhappily celebrated for his rapacity and financial stratagems. An army was left under the command of

[331 B.C.]

Peucestas and Balacrus, and a fleet under that of Polemon. The mutual jealousy of these officers was a sufficient pledge for their loyalty.

In the spring of 331 he set out from Memphis on his return to Phœnicia. At Tyre he found his fleet arrived, and celebrated another sacrifice to Melkarth, and received an embassy which had been brought over from Athens in the *Paralus*. Its chief object was to obtain the release of the Athenian prisoners taken at the battle of the Granicus; and this Alexander now granted, with several other requests which were urged by the crew of the *Paralus*, who accompanied the envoys in a body. The accounts which came from Peloponnesus indicated that it was threatened with a commotion through the restlessness of Sparta; and Amphoterus was ordered to lead a squadron to the aid of the Peloponnesians, who were well affected towards the Macedonian interest and the war with Persia, and to recover Crete from the Spartans. A new fleet of one hundred sail was ordered to be fitted out in the ports of Phœnicia and Cyprus to follow and reinforce Amphoterus. Whether on this occasion Alexander visited Jerusalem is doubtful; but it seems that he made an expedition into Samaria, to punish the Samaritans, who — goaded perhaps by ill-treatment — had revolted against Andromachus, had taken him prisoner, and burnt him alive. On Alexander's approach, the authors of this atrocity were delivered up to him, and tranquillity was restored. He then began his march towards the Euphrates, and before the end of August arrived at Thapsacus.

A body of troops had been sent forward to throw a bridge across the river. When he had crossed, Alexander did not follow the route which Cyrus had taken through the Mesopotamian desert, but directed his march towards the northeast, through a country which afforded a more abundant supply of food, and where the army had less to suffer from the heat. On the road some Persian scouts fell into his hands, from whom he learnt that Darius, with an army far greater than he had before brought into the field, lay on the left bank of the Tigris, prepared to guard the passage against him. He now advanced at full speed towards the Tigris: but when he reached it found neither Darius himself nor any hostile force, and met with no other obstacle than the rapidity of the stream. On the left bank he gave his troops a few days' rest after their forced march, during which there occurred an eclipse of the moon. Aristander expounded it as a sign that, during that month, the Persian monarchy was destined to lose its power and glory; and when Alexander sacrificed to the moon, the sun, and the earth, as the powers which concurred to produce the portent, the victims were found to announce a victory. He then marched southward along the river, and four days after his reconnoitring parties brought word that a body of cavalry was in sight. They fled at his approach, but some were overtaken, and slain or made prisoners. From these he learned that Darius with his whole army was encamped at no great distance.



COSTUME OF A PERSIAN
MAGISTRATE
(After Bardon)

The Persian king had employed the long interval allowed him by Alexander's operations after the battle of Issus, to collect the remaining strength of his empire; and he had assembled a host with which, if superiority of numbers could have ensured success, he might reasonably have hoped to crush his adversary. It was also composed for the most part of more warlike troops. The division which was most formidable, both for numbers and martial qualities, consisted of the hardy tribes which inhabited the plains on the eastern side of the Caspian, and the valleys above Cabul on the borders of India. They were led by Bessus, the powerful satrap of Bactria; and he was also followed by a body of horse-bowmen, furnished by the Sacee, who wandered in the valleys east of Transoxiana, and though they did not acknowledge his authority, willingly joined him as allies for the sake of pay and plunder. All the provinces between the Caspian Sea and the Persian Gulf, and from Syria and Cappadocia to the mountains west of the Indus, had poured forth their choicest warriors.

The whole amount was stated by some authors at a million of foot and forty thousand horse; this may be a great exaggeration, but it was probably reduced as much too low by those who reckoned no more than two hundred thousand infantry. There were beside two hundred scythed chariots, and fifteen elephants brought from the west of India. With this host Darius had encamped in one of the wide plains between the Tigris and the mountains of Kurdistan, near the Bumadus, a tributary of the Lycus, and a village named Gaugamela (the camel's house), which should have given its name to the battle fought near it, but was forced, through a caprice of which we have many examples, to surrender this distinction to the town of Arbela, which lay more than twenty miles off, where Darius had left his baggage and his treasure. He had been persuaded by his courtiers that his defeat at Issus was entirely owing to the disadvantage of the ground, and he had therefore chosen a field on which he might fully display his forces, and where the enemy would have neither sea nor mountains to cover his flanks; and he had ordered a large tract of the plain to be cleared and levelled for the evolutions of his cavalry and chariots.^d

THE BATTLE OF ARBELA

The position of the Persian king near Mesopotamia was chosen with great military skill. It was certain that Alexander on his return from Egypt must march northward along the Syrian coast, before he attacked the central provinces of the Persian empire. A direct eastward march from the lower part of Palestine across the great Syrian desert was then, as now, utterly impracticable. Marching eastward from Syria, Alexander would, on crossing the Euphrates, arrive at the vast Mesopotamian plains. The wealthy capitals of the empire, Babylon, Susa, and Persepolis, would then lie to his south; and if he marched down through Mesopotamia to attack them, Darius might reasonably hope to follow the Macedonians with his immense force of cavalry, and, without even risking a pitched battle, to harass and finally overwhelm them. We may remember that three centuries afterwards a Roman army under Crassus was thus actually destroyed by the oriental archers and horsemen in these very plains; and that the ancestors of the Parthians who thus vanquished the Roman legions, served by thousands under King Darius. If, on the contrary, Alexander should defer his march against Babylon, and first seek an encounter with

[331 B.C.]

the Persian army, the country on each side of the Tigris in this latitude was highly advantageous for such an army as Darius commanded; and he had close in his rear the mountainous districts of northern Media, where he himself had in early life been satrap, where he had acquired reputation as a soldier and a general, and where he justly expected to find loyalty to his person, and a safe refuge in case of defeat.

His great antagonist came on across the Euphrates against him, at the head of an army which Arrian, copying from the journals of Macedonian officers, states to have consisted of forty thousand foot, and seven thousand horse. In studying the campaigns of Alexander, we possess the peculiar advantage of deriving our information from two of Alexander's generals of division, who bore an important part in all his enterprises. In fact, in reading Arrian, we read General Aristobulus and General Ptolemy on the campaigns of the Macedonians; and it is like reading General Jomini or General Foy on the campaigns of the French.

The estimate which we find in Arrian of the strength of Alexander's army, seems reasonable when we take into account both the losses which he had sustained, and the reinforcements which he had received since he left Europe. Indeed, to Englishmen, who know with what mere handfuls of men their own generals have, at Plassy, at Assaye, at Meeanee, and other Indian battles, routed large hosts of Asiatics, the disparity of numbers that we read of in the victories won by the Macedonians over the Persians presents nothing incredible. The army which Alexander now led, was wholly composed of veteran troops in the highest possible state of equipment and discipline, enthusiastically devoted to their leader, and full of confidence in his military genius and his victorious destiny.

The celebrated Macedonian phalanx formed the main strength of his infantry. His men were veterans; and he could obtain from them an accuracy of movement and steadiness of evolution, such as probably the recruits of his father would only have floundered in attempting, and such as certainly were impracticable in the phalanx when handled by his successors: especially as under them it ceased to be a standing force, and became only a militia. The main strength of his cavalry consisted in two chosen corps of cuirassiers, one Macedonian, and one Thessalian, each of which was about fifteen hundred strong. They were provided with long lances and heavy swords, and horse as well as man was fully equipped with defensive armour. Other regiments of regular cavalry were less heavily armed, and there were several bodies of light horsemen, whom Alexander's conquests in Egypt and Syria had enabled him to mount superbly.

The Persian king availed himself to the utmost of every advantage in his power. He caused a large space of ground to be carefully levelled for the operation of his scythe-armed chariots; and he deposited his military stores in the strong town of Arbela, about twenty miles in his rear. The rhetoricians of after ages have loved to describe Darius Codomannus as a second Xerxes in ostentation and imbecility; but a fair examination of his generalship in this his last campaign, shows that he was worthy of bearing the same name as his great predecessor, the royal son of Hystaspes.

On learning that Darius was with a large army on the left of the Tigris, Alexander hurried forward and crossed that river without opposition. He was at first unable to procure any certain intelligence of the precise position of the enemy, and after giving his army a short interval of rest, he marched for four days down the left bank of the river. A moralist may pause upon the fact, that Alexander must in this march have passed

within a few miles of the remains of Nineveh, the great city of the primeval conquerors of the human race. Neither the Macedonian king nor any of his followers knew what those vast mounds had once been. They had already become nameless masses of grass-grown ruins; and it is only within the last century that the intellectual energy of Layard has rescued Nineveh from its long centuries of oblivion.

On the fourth day of Alexander's southward march, his advanced guard reported that a body of the enemy's cavalry was in sight. He instantly formed his army in order for battle, and directing them to advance steadily, he rode forward at the head of some squadrons of cavalry, and charged the Persian horse whom he found before him. This was a mere reconnoitring party, and they broke and fled immediately; but the Macedonians made



GREEK SOLDIER, TIME OF ALEXANDER
THE GREAT

some prisoners, and from them Alexander found that Darius was posted only a few miles off, and learned the strength of the army that he had with him. On receiving this news, Alexander halted, and gave his men repose for four days, so that they should go into action fresh and vigorous. He also fortified his camp, and deposited in it all his military stores, and all his sick and disabled soldiers; intending to advance upon the enemy with the serviceable part of his army perfectly unencumbered. After this halt, he moved forward, while it was yet dark, with the intention of reaching the enemy, and attacking them at break of day. About halfway between the camps there were some undulations of the ground, which concealed the two armies from each other's view. But, on Alexander arriving at their summit, he saw by the early light the Persian host arrayed before him; and he probably also observed traces of some engineering operation having been carried on along part of the ground in front of them. Not knowing that these marks had been caused by the Persians having levelled the ground for the free use of their war-chariots, Alexander suspected that hidden pitfalls had been prepared with a view of disordering the approach of his cavalry. He summoned a council of war forthwith. Some of the officers were for attacking instantly at all hazards, but the more prudent opinion of Parmenion prevailed, and it was determined not to advance farther till the battle-ground had been carefully surveyed.

Alexander halted his army on the heights; and taking with him some light-armed infantry and some cavalry, he passed part of the day in reconnoitring the enemy, and observing the nature of the ground which he had to fight on. Darius wisely refrained from moving from his position to attack the Macedonians on the eminences which they occupied, and the two armies

[331 B.C.]

remained until night without molesting each other. On Alexander's return to his headquarters, he summoned his generals and superior officers together, and telling them that he well knew that their zeal wanted no exhortation, he besought them to do their utmost in encouraging and instructing those whom each commanded, to do their best in the next day's battle. They were to remind them that they were now not going to fight for a province, as they had hitherto fought, but they were about to decide by their swords the dominion of all Asia. Each officer ought to impress this upon his subalterns, and they should urge it on their men. Their natural courage required no long words to excite its ardour; but they should be reminded of the paramount importance of steadiness in action. The silence in the ranks must be unbroken as long as silence was proper; but when the time came for the charge, the shout and the cheer must be full of terror for the foe. The officers were to be alert in receiving and communicating orders; and every one was to act as if he felt that the whole result of the battle depended on his own single good conduct.

Having thus briefly instructed his generals, Alexander ordered that the army should sup, and take their rest for the night. Darkness had closed over the tents of the Macedonians, when Alexander's veteran general, Parmenion, came to him, and proposed that they should make a night attack on the Persians. The king is said to have answered, that he scorned to fileh a victory, and that Alexander must conquer openly and fairly. Arrian justly remarks that Alexander's resolution was as wise as it was spirited. Besides the confusion and uncertainty which are inseparable from night engagements, the value of Alexander's victory would have been impaired, if gained under circumstances which might supply the enemy with any excuse for his defeat, and encourage him to renew the contest. It was necessary for Alexander not only to beat Darius, but to gain such a victory as should leave his rival without apology for defeat, and without hope of recovery.

The Persians, in fact, expected, and were prepared to meet, a night attack. Such was the apprehension that Darius entertained of it, that he formed his troops at evening in order of battle, and kept them under arms all night. The effect of this was, that the morning found them jaded and dispirited, while it brought their adversaries all fresh and vigorous against them.

The written order of battle, which Darius himself caused to be drawn up, fell into the hands of the Macedonians after the engagement, and Aristobulus copied it into his journal. We thus possess, through Arrian, unusually authentic information as to the composition and arrangement of the Persian army. On the extreme left were the Bactrian, Dahean, and Arachosian cavalry. Next to these Darius placed the troops from Persia proper, both horse and foot. Then came the Susians, and next to these the Cadusians. These forces made up the left wing. Darius' own station was in the centre. This was composed of the Indians, the Carians, the Mardian archers, and the division of Persians who were distinguished by the golden apples that formed knobs of their spears. Here also were stationed the bodyguard of the Persian nobility. Besides these, there were in the centre, formed in deep order, the Uxian and Babylonian troops, and the soldiers from the Red Sea. The brigade of Greek mercenaries, whom Darius had in his service, and who were alone considered fit to stand in the charge of the Macedonian phalanx, was drawn up on either side of the royal chariot. The right wing was composed of the Cælo-Syrians and Mesopotamians, the Medes, the Parthians, the Sacians, the Tapurians, Hyrcanians, Albanians, and Saccesinæ.

In advance of the line on the left wing were placed the Scythian cavalry, with a thousand of the Bactrian horse, and a hundred scythe-armed chariots. The elephants and the fifty scythe-armed chariots were ranged in front of the centre; and fifty more chariots, with the Armenian and Cappadocian cavalry, were drawn up in advance of the right wing.

Thus arrayed, the great host of King Darius passed the night, that to many thousands of them was the last of their existence. The morning of the first of October dawned slowly to their wearied watching, and they could hear the note of the Macedonian trumpet sounding to arms, and could see King Alexander's forces descend from their tents on the heights, and form in order of battle on the plain.

There was deep need of skill, as well as of valour, on Alexander's side; and few battle-fields have witnessed more consummate generalship than was now displayed by the Macedonian king.¹ There were no natural barriers by which he could protect his flanks; and not only was he certain to be overlapped on either wing by the vast lines of the Persian army, but there was imminent risk of their circling round him and charging him in the rear, while he advanced against their centre. He formed, therefore, a second or reserve line, which was to wheel round, if required, or to detach troops to either flank, as the enemy's movements might necessitate: and thus with their whole army ready at any moment to be thrown into one vast hollow square, the Macedonians advanced in two lines against the enemy, Alexander himself leading on the right wing, and the renowned phalanx forming the centre, while Parmenion commanded on the left.

Such was the general nature of the disposition which Alexander made of his army. But we have in Arrian the details of the position of each brigade and regiment; and as we know that these details were taken from the journals of Macedonian generals, it is interesting to examine them, and to read the names and stations of King Alexander's generals and colonels in this the greatest of his battles.

The eight troops of the royal horse-guards formed the right of Alexander's line. Their captains were Clitus (whose regiment was on the extreme right, the post of peculiar danger), Glaucias, Ariston, Sopolis, Heraclides, Demetrias, Meleager, and Hagelochus. Philotas was general of the whole division. Then came the shield-bearing infantry; Nicanor was their general. Then came the phalanx, in six brigades. Cœnus' brigade was on the right, and nearest to the shield-bearers; next to this stood the brigade of Perdicas, then Meleager's, then Polysperchon's; and then the brigade of Amyntas, but which was now commanded by Simmias, as Amyntas had been sent to Macedonia to levy recruits. Then came the infantry of the left wing, under the command of Craterus. Next to Craterus' infantry was placed the cavalry regiments of the allies, with Erigyius for their general. The Thessalian cavalry, commanded by Philippus, were next, and held the extreme left of the whole army. The whole left wing was entrusted to the command of Parmenion, who had round his person the Pharsalian troop of cavalry, which was the strongest and best amid all the Thessalian horse-regiments.

The centre of the second line was occupied by a body of Phalangite infantry, formed of companies, which were drafted for this purpose from each of the brigades of their phalanx. The officers in command of this corps were

[¹ "In so far as we can follow the dispositions of Alexander they appear the most signal example recorded in integrity of military genius and sagacious combination," says Grote.^b "He had really as great an available force as his enemy, because every company in his army was turned to account."]

[331 B.C.]

ordered to be ready to face about, if the enemy should succeed in gaining the rear of the army. On the right of this reserve of infantry, in the second line, behind the royal horse-guards, Alexander placed half the Agrianian light-armed infantry under Attalus, and with them Brison's body of Macedonian archers, and Cleander's regiment of foot. He also placed in this part of his army Menidas' squadron of cavalry, and Arctes' and Ariston's light horse. Menidas was ordered to watch if the enemy's cavalry tried to turn the flank, and if they did so, to charge them before they wheeled completely round, and so take them in flank themselves. A similar force was arranged on the left of the second line for the same purpose. The Thracian infantry of Sitalees was placed there, and Cœranus' regiment of the cavalry of the Greek allies, and Agathon's troops of the Odrysian irregular horse. The extreme left of the second line in this quarter was held by Andromachus' cavalry. A division of Thracian infantry was left in guard of the camp. In advance of the right wing and centre was scattered a number of light-armed troops, of javelin-men and bowmen, with the intention of warding off the charge of the armed chariots.¹

Conspicuous by the brilliancy of his armour, and by the chosen band of officers who were round his person, Alexander took his own station, as his custom was, in the right wing, at the head of his cavalry; and when all the arrangements for the battle were complete, and his generals were fully instructed how to act in each probable emergency, he began to lead his men towards the enemy.

It was ever his custom to expose his life freely in battle, and to emulate the personal prowess of his great ancestor, Achilles. Perhaps in the bold enterprise of conquering Persia, it was politic for Alexander to raise his army's daring to the utmost by the example of his own heroic valour; and, in his subsequent campaigns, the love of the excitement, of "the rapture of the strife," may have made him, like Murat, continue from choice a custom which he commenced from duty. But he never suffered the ardour of the soldier to make him lose the coolness of the general; and at Arbela, in particular, he showed that he could act up to his favourite Homeric maxim of being

*Ἀμφότερον, βασιλεύς τ' ἀγαθὸς κρατερός τ' αἰχμητής.*²

Great reliance had been placed by the Persian king on the effects of the scythe-bearing chariots. It was designed to launch these against the Macedonian phalanx, and to follow them up by a heavy charge of cavalry, which it was hoped would find the ranks of the spearmen disordered by the rush of the chariots, and easily destroy this most formidable part of Alexander's force. In front, therefore, of the Persian centre, where Darius took his station, and which it was supposed the phalanx would attack, the ground had been carefully levelled and smoothed, so as to allow the chariots to charge over it with their full sweep and speed. As the Macedonian army approached the Persian, Alexander found that the front of his whole line barely equalled the front of the Persian centre, so that he was outflanked on his right by the entire left wing of the enemy, and by their entire right wing on his left. His tactics were to assail some one point of the hostile army, and gain a decisive advantage, while he refused, as far as possible, the encounter along

¹ Kleber's arrangement of his troops at the battle of Heliopolis, where, with ten thousand Europeans, he had to encounter eighty thousand Asiatics in an open plain, is worth comparing with Alexander's tactics at Arbela. See Thiers' *Histoire du Consulat*, etc., vol. ii. book v.

² "Both a good king and a valiant warrior."

the rest of the line. He therefore inclined his order of march to the right, so as to enable his right wing and centre to come into collision with the enemy on as favourable terms as possible, though the manœuvre might in some respects compromise his left.

The effect of this oblique movement was to bring the phalanx and his own wing nearly beyond the limits of the ground which the Persians had prepared for the operations of the chariots; and Darius, fearing to lose the benefit of this arm against the most important parts of the Macedonian force, ordered the Scythian and Bactrian cavalry, who were drawn up on his extreme left, to charge upon Alexander's right wing, and check its further lateral progress. Against these assailants Alexander sent from his second line Menidas' cavalry. As these proved too few to make head against the enemy, he ordered Ariston also from the second line with his light horse, and Cleander with his foot, in support of Menidas. The Bactrians and Scythians now began to give way, but Darius reinforced them by the mass of Bactrian cavalry from his main line, and an obstinate cavalry fight now took place. The Bactrians and Scythians were numerous, and were better armed than the horsemen under Menidas and Ariston; and the loss at first was heaviest on the Macedonian side. But still the European cavalry stood the charge of the Asiatics, and at last, by their superior discipline, and by acting in squadrons that supported each other instead of fighting in a confused mass like the barbarians, the Macedonians broke their adversaries, and drove them off the field.



SCYTHE-BEARING CHARIOT

(Showing the Attachment of the Scythe to the Axle)

Darius now directed the scythe-armed chariots to be driven against Alexander's horse-guards and the phalanx; and these formidable vehicles were accordingly sent rattling across the plain, against the Macedonian line. When we remember the alarm which the war-chariots of the Britons created among Cæsar's legions, we shall not be prone to deride this arm of ancient warfare as always useless. The object of the chariots was to create unsteadiness in the ranks against which they were driven, and squadrons of cavalry followed close upon them, to profit by such disorder. But the Asiatic chariots were rendered ineffective at Arbela by the light-armed troops whom Alexander had specially appointed for the service, and who, wounding the horses and drivers with their missile weapons, and running alongside so as to cut the traces or seize the reins, marred the intended charge; and the few chariots that reached the phalanx passed harmlessly through the intervals which the spearmen opened for them, and were easily captured in the rear.

[331 B.C.]

A mass of the Asiatic cavalry was now, for the second time, collected against Alexander's extreme right, and moved round it, with the view of gaining the flank of his army. At the critical moment, Aretes, with his horsemen from Alexander's second line, dashed on the Persian squadrons when their own flanks were exposed by this evolution. While Alexander thus met and baffled all the flanking attacks of the enemy with troops brought up from his second line, he kept his own horse-guards and the rest of the front line of his wing fresh, and ready to take advantage of the first opportunity for striking a decisive blow. This soon came. A large body of horse, who were posted on the Persian left wing nearest to the centre, quitted their station, and rode off to help their comrades in the cavalry fight that still was going on at the extreme right of Alexander's wing against the detachments from his second line. This made a huge gap in the Persian array, and into this space Alexander instantly dashed with his guard; and then pressing towards his left, he soon began to make havoc in the left flank of the Persian centre. The shield-bearing infantry now charged also among the reeling masses of the Asiatics; and five of the brigades of the phalanx, with the irresistible might of their sarissas, bore down the Greek mercenaries of Darius, and dug their way through the Persian centre. In the early part of the battle, Darius had shown skill and energy; and he now for some time encouraged his men, by voice and example, to keep firm. But the lances of Alexander's cavalry and the pikes of the phalanx now gleamed nearer and nearer to him. His charioteer was struck down by a javelin at his side; and at last Darius' nerve failed him; and, descending from his chariot, he mounted on a fleet horse and galloped from the plain, regardless of the state of the battle in other parts of the field, where matters were going on much more favourably for his cause.

Alexander's operations with his right and centre had exposed his left to an immensely preponderating force of the enemy. Parmenion kept out of action as long as possible; but Mazæus, who commanded the Persian right wing, advanced against him, completely outflanked him, and pressed him severely with reiterated charges by superior numbers. Seeing the distress of Parmenion's wing, Simmias, who commanded the sixth brigade of the phalanx, which was next to the left wing, did not advance with the other brigades in the great charge upon the Persian centre, but kept back to cover Parmenion's troops on their right flank; as otherwise they would have been completely surrounded and cut off from the rest of the Macedonian army. By so doing, Simmias had unavoidably opened a gap in the Macedonian left centre; and a large column of Indian and Persian horse, from the Persian right centre, had galloped forward through this interval, and right through the troops of the Macedonian second line. Instead of then wheeling round upon Parmenion, or upon the rear of Alexander's conquering wing, the Indian and Persian cavalry rode straight on to the Macedonian camp, overpowered the Thracians who were left in charge of it, and began to plunder. This was stopped by the phalangite troops of the second line, who, after the enemy's horsemen had rushed by them, faced about, countermarched upon the camp, killed many of the Indians and Persians in the act of plundering, and forced the rest to ride off again. Just at this crisis, Alexander had been recalled from his pursuit of Darius, by tidings of the distress of Parmenion, and of his inability to bear up any longer against the hot attacks of Mazæus. Taking his horse-guards with him, Alexander rode towards the part of the field where his left wing was fighting; but on his way thither he encountered the Persian and Indian cavalry on their return from his camp.

These men now saw that their only chance of safety was to cut their way through; and in one huge column they charged desperately upon the Macedonians. There was here a close hand-to-hand fight, which lasted some time, and sixty of the royal horse-guards fell, and three generals, who fought close to Alexander's side, were wounded. At length the Macedonian discipline and valour again prevailed, and a large number of the Persian and Indian horsemen were cut down; some few only succeeded in breaking through and riding away. Relieved of these obstinate enemies, Alexander again formed his horse-guards, and led them towards Parmenion; but by this time that general also was victorious. Probably the news of Darius' flight had reached Mazæus, and had damped the ardour of the Persian right wing; while the tidings of their comrades' success must have proportionally encouraged the Macedonian forces under Parmenion. His Thessalian cavalry particularly distinguished themselves by their gallantry and persevering good conduct; and by the time that Alexander had ridden up to Parmenion, the whole Persian army was in full flight from the field.¹

It was of the deepest importance to Alexander to secure the person of Darius, and he now urged on the pursuit. The Upper Zab was between the field of battle and the city of Arbela, whither the fugitives directed their course, and the passage of this river was even more destructive to the Persians than the swords and spears of the Macedonians had been in the engagement. The narrow bridge was soon choked up by the flying thousands who rushed towards it, and vast numbers of the Persians threw themselves, or were hurried by others, into the rapid stream, and perished in its waters. Darius had crossed it, and had ridden on through Arbela without halting. Alexander reached that city on the next day, and made himself master of all Darius' treasure and stores; but the Persian king had fled too fast for his conqueror.

A few days after the battle Alexander entered Babylon, "the oldest seat of earthly empire" then in existence, as its acknowledged lord and master. There were yet some campaigns of his brief and bright career to be accomplished. Central Asia was yet to witness the march of his phalanx. He was yet to effect that conquest of Afghanistan in which England since has failed. His generalship, as well as his valour, were yet to be signalled on the banks of the Hydaspes, and the field of Chillianwallah; and he was yet to precede the queen of England in annexing the Punjab to the dominions of a European sovereign. But the crisis of his career was reached; the great object of his mission was accomplished; and the ancient Persian empire, which once menaced all the nations of the earth with subjection, was irreparably crushed, when Alexander had won his crowning victory at Arbela.^j

[¹ The Persian dead were 300,000 according to Arrian, 90,000 according to Diodorus; 40,000 according to Curtius. Arrian says the Macedonians lost 100; Curtius, 300; Diodorus, 500.]

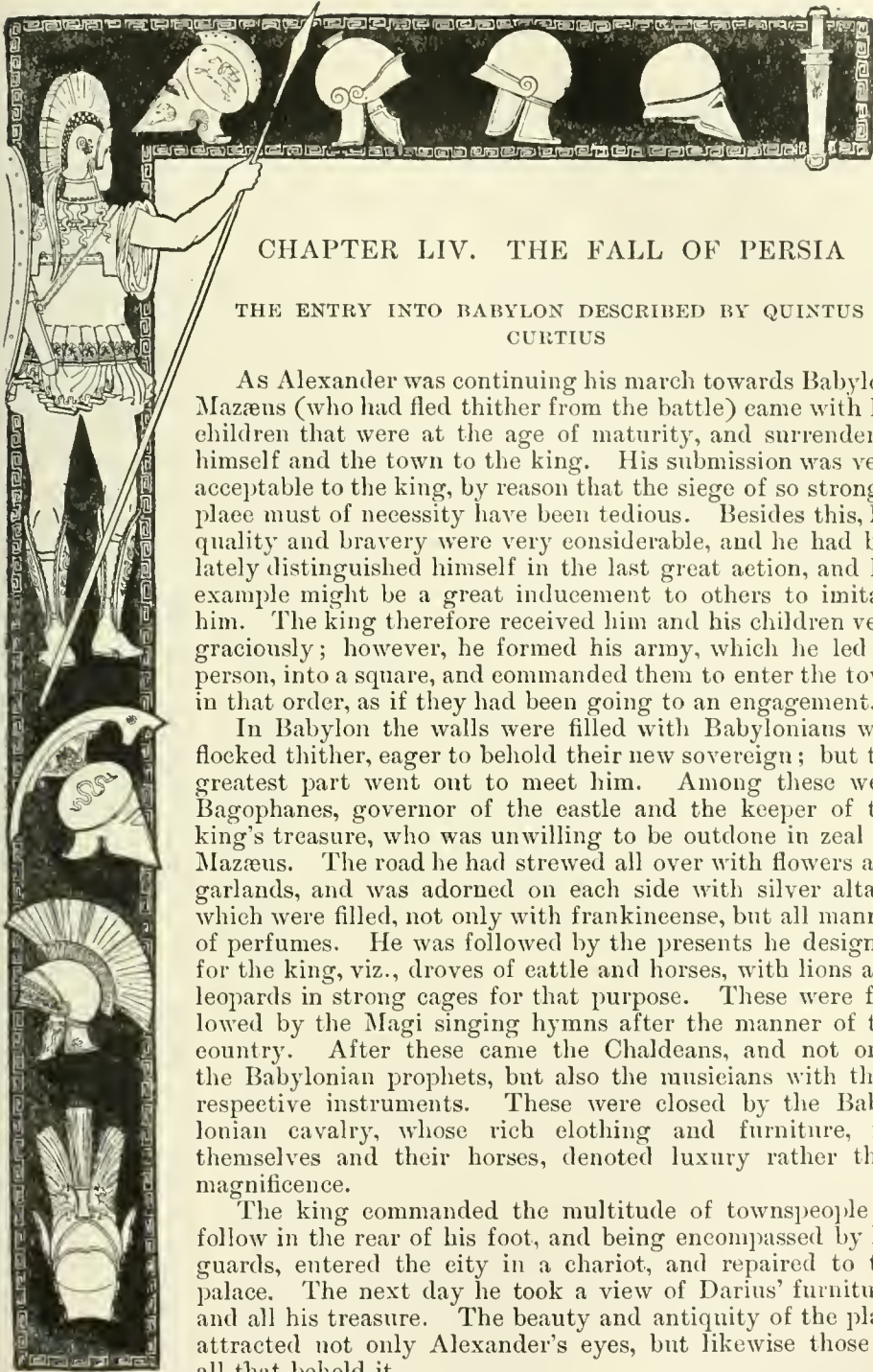

CHAPTER LIV. THE FALL OF PERSIA

THE ENTRY INTO BABYLON DESCRIBED BY QUINTUS
CURTIUS

As Alexander was continuing his march towards Babylon, Mazæus (who had fled thither from the battle) came with his children that were at the age of maturity, and surrendered himself and the town to the king. His submission was very acceptable to the king, by reason that the siege of so strong a place must of necessity have been tedious. Besides this, his quality and bravery were very considerable, and he had but lately distinguished himself in the last great action, and his example might be a great inducement to others to imitate him. The king therefore received him and his children very graciously; however, he formed his army, which he led in person, into a square, and commanded them to enter the town in that order, as if they had been going to an engagement.

In Babylon the walls were filled with Babylonians who flocked thither, eager to behold their new sovereign; but the greatest part went out to meet him. Among these were Bagophanes, governor of the castle and the keeper of the king's treasure, who was unwilling to be outdone in zeal by Mazæus. The road he had strewed all over with flowers and garlands, and was adorned on each side with silver altars, which were filled, not only with frankincense, but all manner of perfumes. He was followed by the presents he designed for the king, viz., droves of cattle and horses, with lions and leopards in strong cages for that purpose. These were followed by the Magi singing hymns after the manner of the country. After these came the Chaldeans, and not only the Babylonian prophets, but also the musicians with their respective instruments. These were closed by the Babylonian cavalry, whose rich clothing and furniture, for themselves and their horses, denoted luxury rather than magnificence.

The king commanded the multitude of townspeople to follow in the rear of his foot, and being encompassed by his guards, entered the city in a chariot, and repaired to the palace. The next day he took a view of Darius' furniture, and all his treasure. The beauty and antiquity of the place attracted not only Alexander's eyes, but likewise those of all that beheld it.

“The king resided longer here,” Curtius continues, “than he had done anywhere; nor could any place be more destructive of discipline. Nothing

can be more corrupt than the manners of this city,¹ nor better provided with all the requisites to stir up and promote all sorts of debauchery and lewdness: for parents and husbands suffer their children and wives to prostitute themselves to their guests, if they are but paid for the crime. The kings and noblemen of Persia take great delight in licentious entertainments: and the Babylonians are very much addicted to wine, and the consequences of drunkenness. The women, in the beginning of their feasts, are modestly elad; then after some time, they lay aside their upper garment, and violate their modesty by degrees; at last (without offence be it spoken) they fling away even their lower apparel: nor is this the infamous practice of the courtesans only, but likewise of the matrons and their daughters, who look upon this vile prostitution of their bodies as an act of complaisance.

“It is reasonable to think, that that victorious army, which had conquered Asia, having wallowed thirty-four days in all kinds of lewdness and debauchery, would have found itself much weakened, for any following engagements, if an enemy had presented itself; but that the damage might be less sensible, it was from time to time as it were renewed with fresh recruits, for Amyntas, the son of Andromenes, brought from Antipater 6000 Macedonian foot, and 500 horse of the same nation; and with these 600 Thracian horse, and 3500 foot of that country. There came also from Peloponnesus 4000 mercenary foot, and 380 horse. The said Amyntas likewise brought him 50 young gentlemen of the nobility of Macedonia, to serve as guards of his person.”

The king having appointed Agathon governor of the castle of Babylon, assigning him seven hundred Macedonians and three hundred mercenaries for that purpose, left the government of the territory and city to Menes and Apollodorus, allotting them a garrison of two thousand foot, and one thousand talents, commanding both to make new levies to recruit the army. He gave to Mazæus who came over to him, the superintendency of Babylon, and ordered Bagophanes, who had surrendered the castle to him, to follow him. He gave the government of Armenia to Mithrenes, who had yielded up Sardis. Out of the money found in Babylon, he ordered every Macedonian trooper six hundred denarii [about £20 or \$100], and five hundred to every foreign trooper, and to every foot soldier two hundred.

Alexander having settled things after this manner, marched into the country called Satrapene.

As the king was on his march to Susa, Abulites, who was governor of that province, sent his son to meet him on the road, and assure him he was ready to surrender the town. It is uncertain whether he did this of his own accord, or by Darius' order, thereby to amuse Alexander with the booty. Having entered the town, Alexander took out of the treasury a prodigious sum, viz., fifty thousand talents of silver, not coined, but in the wedge and bar.² Several kings had been a long time heaping up these vast treasures, as they thought, for their children, and posterity, but one single hour put them all into the hands of a foreign prince.

He then seated himself in the regal throne, which, being much too high for his stature, his feet could not reach the ground; one of his pages therefore brought a table and set it under his feet. Hereupon one of Darius'

[¹ Curtius is obviously speaking of the Babylon of his own day (the early part of the first century A.D.), and assuming, no doubt correctly, that the venerable city had not greatly changed since the time of Alexander. The reader will recall the tales of Babylon quoted from Herodotus in our first volume.]

[² Grote values this at £11,500,000 which amounts to about \$55,000,000. Reckoned as Æginetan talents the sum would be far greater. Grote says it would seem incredible were it not that the treasures of Persepolis were found far greater.]

[331-330 B.C.]

eunuchs sighed, which the king observing, enquired into the cause of his grief. Then the eunuch told him, "That Darius was used to eat upon that table; and that he could not behold, without shedding tears, the table, which was consecrated to his master's use, applied in a manner so insulting and contemptuous." At these words, the king began to be ashamed to violate the gods of hospitality, and commanded it to be taken away: but Philotas entreated him by no means to do so, but on the contrary to take it as a good omen, that that table, off of which his enemy used to eat, was now become his footstool.

Alexander designing now to pass into Persia, gave the government of Susa to Archelaus, leaving him a garrison of three thousand men; Xenophilus had the charge of the castle, having with him for garrison the superannuated Macedonians. The care of the treasury was committed to Callicrates, and the lieutenancy of the county of Susa was restored to Abulites. Darius' mother and children were likewise left here.

Alexander having passed the river with nine thousand foot, the Agrianes, mercenary Greeks, and three thousand Thracians, came into the country of the Uxians; it borders upon the territory of Susa, and extends itself as far as the frontier of Persia. He afterwards united the Uxian nation to the government of Susa; then having divided his army with Parmenion, he commanded him to march through the flat country, while he, with the light-armed forces, took his way along the mountains, which run in a perpetual ridge into Persia.

AT THE BORDER OF PERSIA

Having ravaged all this country, he arrived the third day on the borders of Persia, and on the fifth he entered the straits Pylæ Susidæ. Ariobarzanes, with twenty-five thousand foot, had taken possession of these rocks, which were on all sides steep and craggy, on the tops whereof the barbarians kept themselves, being there out of the cast of the darts. Here they remained quiet on purpose, and seemed to be afraid till the army was advanced within the narrowest part of the straits; but when they perceived them to continue their march, as it were in contempt of them, they rolled down stones of a prodigious bigness upon them, which rebounding often from the lower rocks, fell with the greater force, and not only crushed single persons, but even whole companies.

They likewise plied their slings and bows from all parts; even this did not seem a hardship to these brave men, save that they were forced to perish unrevenged, like beasts taken in a pitfall: upon this, their anger turning into rage, they caught hold of the rocks, and helping one another up, did all they could to get to the enemy; but the parts they laid hold on giving way to the strength of so many hands, fell upon those that loosened them. In these sad circumstances they could neither stand still nor go forward, nor protect themselves with their bucklers, by reason of the great size of the stones the barbarians pushed upon them. The king was not only grieved, but ashamed he had so rashly brought his army into these straits. Till this day he had been invincible, having never attempted anything in vain. He had entered the straits of Cilicia without damage, and had opened himself a new way by sea into Pamphylia; but here that happiness which had always attended him, seemed to be at a stand, and there was no other remedy but to return the same way he came. Having there-

fore given the signal for a retreat, he commanded the soldiers to march in close order, and to join their bucklers over their heads, and so retire out of these straits, after they had advanced thirty furlongs within them.

A SHEPHERD GUIDE

The king, at his return from the straits, having pitched his camp in a plain open ground, not only held a council on the present juncture of affairs, but also was so superstitious as to consult the prophets concerning what was the most advisable to be done: but what, in such a case, could Aristander (who was then in greatest esteem) pretend to foretell? Laying aside therefore the unseasonable sacrifices, he gave orders to bring to him such men as were well acquainted with the country; these men told him of a way through Media, which was safe and open, but the king was ashamed to leave his soldiers unburied, for there was no custom more religiously observed amongst the Macedonians, than that of burying their dead: he therefore commanded the prisoners he had lately taken to be brought before him; among these, there was one who was skilled in both the Greek and Persian languages; this man told him, it was in vain for him to think of leading his army into Persia, over the tops of the mountains; that the narrow ways lay all among woods, and were hardly passable to single persons; that he had been a shepherd, and knew all those byways perfectly well: and that he had been twice taken prisoner; once by the Persians in Lycia, and now by himself.

This answer put the king in mind of the oracle that had told him, "a Lycian should be his guide into Persia;" having therefore made him large promises, suitable to the present necessity, and the prisoner's condition, he ordered him "to be armed after the Macedonian manner, and in the name of fortune to lead the way." Then having committed the guard of the camp to Craterus, with the foot which he commanded, and the forces under Meleager, and a thousand horse archers, he ordered him "to observe the same form of encampment, and to keep a great many fires, that the barbarians might by that think the king was there in person; but if he found Ariobarzanes got intelligence of his march through the winding narrow ways, and thereupon made detachments to oppose his passage; that then Craterus should use his utmost efforts to terrify him, and oblige him to keep his troops together to oppose the present danger; but if he (the king) deceived the enemy, and gained the wood, that then, upon the alarm among the enemies endeavouring to pursue the king, he should boldly enter the straits they had been repulsed in the day before, since he might be sure they were undefended, and the enemy turned upon himself."

At the third watch, he broke up in great silence, without so much as the signal from the trumpet, and followed his guide towards the narrow way. Every light-armed soldier had orders to carry with him three days' provision. But besides the steepness of the rocks, and the slipperiness of the stone that often deceived their feet, the driven snow very much incommoded them; for it sometimes swallowed them up as if they had fallen into pits; and when their fellow-soldiers endeavoured to help them out, they themselves were pulled down into the same pits. Moreover, the night, and unknown country, besides the uncertainty whether the guide was faithful or not, very much increased their fear: for if he deceived the guards, and made his escape, they were liable to be taken like wild beasts: so that the king's

[330 B.C.]

and their safety depended on the fidelity and life of one prisoner. At length they gained the top of the mountain.

Having there refreshed his men both with food and sleep, at the second watch he continued his march, without any great difficulty. However, by reason of the declivity of the mountains towards the plain, there was a great gulf (occasioned by the meeting of several torrents that had worn away the earth) which stopped their further progress. Besides, the branches of the trees were so entangled one within the other, and joined so close, that it opposed their passage like a thick hedge. This cast them into the utmost despair, and they had much ado, to retain their tears: the darkness of the night also increased their terror, for if any stars appeared, they were intercepted by the close contexture of the boughs. The very use of their ears was also taken away; for the wind was high, and by blowing against the interfering branches of the trees, its noise was greatly increased. At last, the long-expected light lessened the terrors which the night had enhanced; for by fetching a small compass, they avoided the gulf: and now every one began to be a guide to himself. Having therefore gained the top of a hill, from whence they could discover the enemy's out-guards, they resolutely showed themselves at the back of the enemy, who mistrusted no such thing. Those few who dared engage, were killed; and the groans of those that were dying, together with the dismal appearance of those that fled to their main body, struck such a terror amongst them, that they took to their heels without so much as trying their fortune.

The noise having reached Craterus' camp, he presently advanced to take possession of those straits where they had been baffled the day before. At the same time, Philotas with Polysperchon, Amyntas, and Cœnus, who had been ordered to march another way, gave a fresh surprise to the barbarians, who were now surrounded on all sides by the Macedonians; notwithstanding which, they behaved themselves gallantly. Oftentimes despair is the cause of hope: for naked as they were, they closed in with those that were armed, and by the bulk of their bodies, brought them down to the ground, and then stuck several of them with their own weapons. However, Ariobarzanes with forty horse, and about five thousand foot, broke through the Macedonian army (a great many falling on both sides) and endeavoured to possess himself of Persepolis, the chief city of the country. But being denied entrance by the garrison, and the enemy pursuing him closely, he renewed the fight, and was slain with all his men. By this time Craterus marching with the utmost expedition, also joined the king.

The king fortified his camp in the same place where he had defeated the enemy: for notwithstanding that he had gained a complete victory, yet the large and deep ditches in many places retarded his march, and so he thought it more advisable to proceed leisurely; not suspecting so much any attempt from the barbarians, as the treachery of the ground.

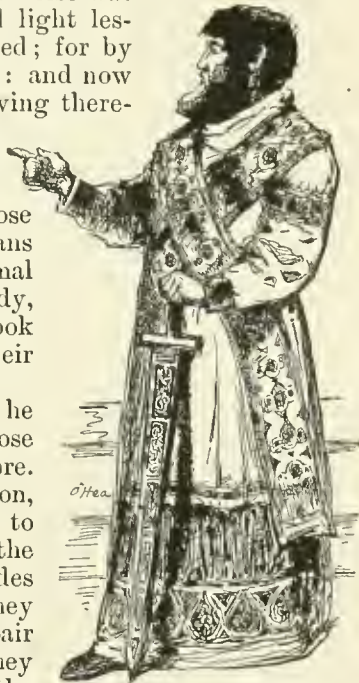

PERSIAN NOBLE IN CIVIL
COSTUME

In his march he received letters from Tiridates (keeper of the royal treasure at Persepolis) notifying him, "that upon advice of his approach, the inhabitants would have rifled the treasury; wherefore he desired him to hasten his march, and come and take possession of it; that the way was safe, although the river Araxes ran across." No other virtue of Alexander's is so admirable as his expedition in all actions. Leaving therefore his foot behind, he marched all night with his cavalry, notwithstanding their late fatigues, and arrived by break of day at the Araxes. There were several villages in the neighbourhood, which having pillaged and demolished, he made a bridge of the materials.

THE RELEASED CAPTIVES; SACKING PERSEPOLIS

The king was not far from Persepolis, when so sad a spectacle presented itself to his eyes, as can hardly be paralleled in history. It consisted of four thousand Greek captives, whom the Persians had mangled after a miserable manner. For some had their feet cut off, others their hands and ears, and all their bodies were burnt with barbarous characters, and thus reserved for the cruel diversion of their inhuman enemies; who now finding themselves under foreign subjection, did not oppose their desire to go out and meet Alexander. They resembled some strange figures more than men, being only distinguishable as such by their voice. They drew more tears from their spectators, than they shed themselves; for in so great a variety of calamities, notwithstanding they were all sufferers, yet their punishment was so diversified, that it was a difficult matter to determine which of them was most miserable. But when they cried out, that at last Jupiter the revenger of Greece had opened his eyes, all the beholders were so moved with compassion, that they thought their sufferings their own. Alexander having dried his eyes (for he could not forbear weeping at so sad an object) bade them "have a good heart," and assured them, "they should see their native country, and their wives again."

Some few accepted, but the remainder were overcome by a long habit, which is stronger than nature; they agreed therefore "to desire the king to assign them some place for their habitation"; and chose a hundred out of their body, to prefer their petition. Alexander, thinking they would ask what he himself intended for them, told them, he had "ordered every one of them a horse, and a thousand denarii [£34 or \$170]; and that when they should come to Greece, he would so provide for them that (except for the calamities they had experienced in their captivity) none should be happier than they." At these words, they fell to weeping, and being dejected, could neither look up, nor speak; which made the king inquire into the cause of their sadness. Then Euthymon made an answer suitable to what he had said to his companions. Hereupon the king, moved with their misfortune and resolution, ordered three thousand denarii [£102 or \$510] to be distributed to every one of them, besides ten suits of clothes, with cattle, sheep, and such a quantity of corn, as was sufficient to cultivate the land that was assigned them.

The next day, having called together all his generals, he represented to them, "that no city had been more mischievous to the Greeks than this seat of the ancient kings of Persia: from hence came all those vast armies: from hence Darius first, and then Xerxes, made their impious wars upon Europe: it was therefore necessary to raze it, to appease the Manes of their

[330 B.C.]

ancestors." The inhabitants had abandoned it, and were fled some one way, and some another; so that the king led the phalanx into it without further delay. He had before this made himself master of many towns of regal wealth and magnificence, some by force, and some by composition, but the riches of this exceeded all the rest. Hither the Persians had brought all their substance; gold and silver lay here in heaps: of clothes there was a prodigious quantity; the furniture of the houses seemed not only designed for use, but for luxury and ostentation. This gave occasion to the conquerors to fight among themselves, each taking for an enemy his companion that had got the richest spoils: and as they could not carry off all they found, they were now no longer employed in taking, but in picking and choosing.

They tore the royal garments, every one being willing to have his share of them: with axes they cut in pieces vessels of exquisite art; in fine, nothing was left untouched, nor carried away entire; the images of gold and silver were broken in pieces, according as every one could lay hold on them. Avarice did not only rage here, but cruelty likewise; for being loaded with gold and silver, they would not be troubled to guard their prisoners, but inhumanly killed them, and now barbarously murdered those they had at first shown mercy to in hopes of gain. This occasioned a great many to give themselves over to a voluntary death, so that putting on their richest apparel, they cast themselves headlong from the walls, with their wives and children; some set fire to their houses (which they thought the enemy would do) and perished, with their families, in the flames. At last the king gave orders, not to injure the persons of the women, nor meddle with their apparel.

CURTIUS TELLS OF THE ENORMOUS LOOT

The immense treasures taken here exceeded all belief: but we must either doubt of all the rest, or believe that in the exchequer of this place was found 120,000 talents,¹ which the king, designing for the use of the war, caused "horses and camels to be brought from Susa to Babylon, to carry it off for that purpose." This sum was afterwards increased, by taking Pasargada, wherein were found six thousand talents. Cyrus had built this city; and Gobares, who was governor thereof, surrendered it to Alexander.

The king made Nearchides governor of the castle of Persepolis, leaving with him a garrison of three thousand Macedonians; he also continued Tiridates (who had delivered up the treasure) in the same honours he had enjoyed under Darius.

Alexander left here the greatest part of his army, with the baggage, under the command of Parmenion and Craterus; and taking with him a thousand horse, and part of the light-armed foot, penetrated farther into the country of Persia about the beginning of winter. On his way he was very much incommoded with storms of rain, and tempests that seemed intolerable; notwithstanding which, he pursued his intended progress. He was now in a country covered over with snow and ice: the sad view of the

[¹ This sum, which Grote reckons at £27,600,000 or \$138,000,000, need not be considered impossible, viewing the extent and the extortion of Persian despotism; the soldiers were paid by the provinces that contributed them; the servants of the government had no salaries in cash from above; and the royal disbursements for necessary expenses were accordingly small. Grote notes that when Nadia-Shah took Delhi in 1739, he found a treasure stated as £32,000,000—even more than Alexander's loot. A pride, too, was taken in vast hoards of precious metal by the oriental despots. Prof. Bury *d* notes how the sudden circulation of such an amount would "perturb the markets of the world."]

place, and the impassable wastes and solitudes, struck the tired soldier with horror; he now began to think he was at the end of the world. They beheld with astonishment the frightful solitudes, which had not the least signs of human culture; they therefore required him to return, "before the very light and heavens failed them." The king forebore chastising them in the amazement they were in, but leaping from his horse, marched on foot before them through the snow and ice. They were ashamed not to follow him; therefore first his friends, then the captains, and at last the soldiers marched after him.

The king was the first that with a pickaxe broke the ice, and made himself a passage; then the rest imitated his example. At length, having made their way through woods almost impassable, they began to discover here and there some tokens that the place was inhabited, as also flocks of sheep wandering up and down. The inhabitants lived in cottages, and thought themselves sufficiently secured by the impracticableness of the country. At the sight of the enemy, they presently killed those who could not follow them, and fled to the remotest mountains, which were covered with snow; but after some conferences with the prisoners, their fright abated, and they surrendered themselves to the king, who was no way severe to them.

CURTIVS DESCRIBES AN ORGY AND THE BURNING OF PERSEPOLIS

Alexander having ravaged the country of Persia, and reduced several towns under his obedience, came at last into the country of the Mardians, who were a warlike nation, and very different from the rest of the Persians in their manner of living. "They dig themselves caves in the mountains,"



RUINS OF PERSEPOLIS

says Curtius, "where they dwell, feeding on their flocks, or wild beasts. The women are not of a softer nature than the men; they have bushy hair, and their garments hardly reach their knees. They bind their forehead with a sling, which serves them both for ornament and weapon." However, the same torrent of fortune bore down this nation, as it had done the rest; so that on the thirteenth day after he departed from Persepolis, he returned thither again.

Then he made presents to his friends, and to the rest according to their respective merit, distributing amongst them almost all that had been taken in the town.

But the excellent endowments of his mind, that noble disposition whereby he surpassed all kings, that manly constancy in surmounting dangers, that unparalleled celerity in undertaking and executing the greatest designs, his inviolable faith to those who submitted to him, his wonderful clemency

[330 B.C.]

towards the prisoners, and his temperance in allowable and usual pleasures, were all sullied by his excessive love of wine: for notwithstanding his enemy and rival, for the empire was at this very instant making the greatest preparations to renew the war, and the late conquered nations were yet uneasy under his new government, yet he would spend the day-time in revelling and feasting; to which entertainments the women were also admitted; not such whom it was a crime to violate, but such as were common, and whose conversation was a disgrace to a man in arms. One of these, whose name was Thais, being heated with wine, told him, he could not do anything that would more oblige all the Greeks, than if he burnt the palace of the kings of Persia; that they expected this by way of reprisal for those towns of theirs the barbarians had destroyed. This drunken harlot had no sooner spoken her opinion in a matter of so great a consequence, but presently some of the company (who were also loaded with wine) applauded the proposal: and the king not only heard it with patience, but, eager to put it in execution, said:

“Why do we not revenge Greece? Why do we delay setting fire to the town?” They were all heated with wine, and in that drunken condition immediately rose to burn that city they had spared when armed. The king showed them the example, and was the first that set fire to the palace, after which his guests, servants, and concubines did the same. There being a great deal of cedar in this noble structure, it presently took fire, and communicated the flames. The army, which was encamped not far from the town, perceived the conflagration, and imagining it to be casual, ran to help to quench it; but being come to the entrance of the palace, and seeing the king himself carrying fresh flambeaux to increase the fire, they flung down the water they had brought, and fed the flames with dry materials.

This was the end of the noblest city of the East, from whence so many nations received their laws; which had been the birth-place of so many kings; formerly the chief terror of Greece; had fitted out a fleet of a thousand sail of ships, and sent out armies, which, like an inundation, almost covered all Europe, had laid bridges over the sea, and hollowed mountains to make the sea a passage; and in so long a time as has elapsed since its destruction, never was rebuilt: for the Macedonian kings made choice of other towns for their residence, which are now in the possession of the Parthians. The ruin of this city was so complete, that were it not for the river Araxes, we should hardly know where it stood. This river ran at no great distance from the walls of this town, which (as the neighbouring inhabitants rather conjecture than certainly know) was situate about twenty furlongs from it.

The Macedonians were ashamed so famous a city should be destroyed by their king in a drunken humour. They therefore made a serious matter of it, and persuaded themselves, “it was expedient it should be consumed this way.” But as for Alexander, as soon as rest had restored him to himself, it is certain he repented of what he had done; and he said, the Persians “would have made more ample satisfaction to Greece had they been necessitated to behold him sitting in Xerxes’ throne in his royal city.”

The next day he ordered thirty talents to be given to the Lyeian who had been his guide into Persia. From hence he passed into the country of Media, where he was met by new recruits from Cilicia. They consisted of five thousand foot, and one thousand horse, both the one and the other were under the command of Plato the Athenian. Having received this reinforcement, he resolved to pursue Darius.^b

THE NEW MEANING OF THE CONQUEST

From this time (330 B.C.) forward to the close of Alexander's life, a period of about seven years, his time was spent in conquering the eastern half of the Persian empire, together with various independent tribes lying beyond its extreme boundary. But neither Greece, nor Asia Minor, nor any of his previous western acquisitions, was he ever destined to see again.

Now in regard to the history of Greece, the first portion of Alexander's Asiatic campaigns (from his crossing the Hellespont to the conquest of Persia, a period of four years, March 334 B.C. to March 330 B.C.), though not of direct bearing, is yet of material importance. Having in his first year completed the subjugation of the Hellenic world, he had by these subsequent campaigns absorbed it as a small fraction into the vast Persian empire, renovated under his imperial sceptre. He had accomplished a result substantially the same as would have been brought about if the invasion of Greece by Xerxes, destined, a century and half before, to incorporate Greece with the Persian monarchy, had succeeded instead of failing. Towards the kings of Macedonia alone, the subjugation of Greece would never have become complete, so long as she could receive help from the native Persian kings, who were perfectly adequate as a countervailing and tutelary force, had they known how to play their game. But all hope for Greece from without was extinguished, when Babylon, Susa, and Persepolis became subject to the same ruler as Pella and Amphipolis — and that ruler too, the ablest general, and most insatiate aggressor, of his age, to whose name was attached the prestige of success almost superhuman. Still, against even this overwhelming power, some of the bravest of the Greeks at home tried to achieve their liberation with the sword: we shall see presently how sadly the attempt miscarried.

But though the first four years of Alexander's Asiatic expedition, in which he conquered the western half of the Persian empire, had thus an important effect on the condition and destinies of the Grecian cities, his last seven years, on which we are now about to enter, employed chiefly in conquering the eastern half, scarcely touched these cities in any way. The stupendous marches to the rivers Jaxartes, Indus, and Hyphasis, which carried his victorious armies over so wide a space of Central Asia, not only added nothing to his power over the Greeks, but even withdrew him from all dealings with them, and placed him almost beyond their cognisance. To the historian of Greece, therefore, these latter campaigns can hardly be regarded as included within the range of his subject. They deserve to be told as examples of military skill and energy, and as illustrating the character of the most illustrious general of antiquity — one who, though not a Greek, had become the master of all Greeks.

THE PURSUIT OF DARIUS

About six or seven months had elapsed from the battle of Arbela to the time when Alexander prepared to quit his most recent conquest — Persia proper. During all this time, Darius had remained at Ecbatana, the chief city of Media, clinging to the hope, that Alexander, when possessed of the three southern capitals and the best part of the Persian empire, might have reached the point of satiation, and might leave him unmolested in the more barren East. As soon as he learned that Alexander was in movement towards

[330 B.C.]

him, he sent forward his harem and his baggage to Hyrcania, on the south-eastern border of the Caspian Sea. Himself, with the small force around him, followed in the same direction, carrying off the treasure in the city, 7000 talents [£1,400,000 or \$7,000,000] in amount, and passed through the Caspian Gates into the territory of Parthyene. His only chance was to escape to Bactria at the eastern extremity of the empire, ruining the country in his way for the purpose of retarding pursuers. But this chance diminished every day, from desertion among his few followers, and angry disgust among many who remained.

Eight days after Darius had quitted Ecbatana, Alexander entered it. How many days had been occupied in his march from Persepolis, we cannot say: in itself a long march, it had been further prolonged, partly by necessity of subduing the intervening mountaineers called Paratacene, partly by rumours exaggerating the Persian force at Ecbatana, and inducing him to advance with precaution and regular array. Possessed of Ecbatana, the last capital stronghold of the Persian kings and their ordinary residence during the summer months, he halted to rest his troops, and establish a new base of operations for his future proceedings eastward. He made Ecbatana his principal depot; depositing in the citadel, under the care of Harpalus as treasurer, with a garrison of six thousand or seven thousand Macedonians, the accumulated treasures of his past conquests, out of Susa and Persepolis; amounting we are told, to the enormous sum of 180,000 talents [£36,000,000 sterling \$180,000,000]. Parmenion was invested with the chief command of this important post, and of the military force left in Media; of which territory Oxodates, a Persian who had been imprisoned at Susa by Darius, was named satrap.

At Ecbatana, Alexander was joined by a fresh force of six thousand Grecian mercenaries, who had marched from Cilicia into the interior, probably crossing the Euphrates and Tigris at the same points as Alexander himself had crossed. Hence he was enabled the better to dismiss his Thessalian cavalry, with other Greeks who had been serving during his four years of Asiatic war, and who now wished to go home. He distributed among them the sum of two thousand talents [£400,000 or \$2,000,000] in addition to their full pay, and gave them the price of their horses, which they sold before departure. The operations which he was now about to commence against the eastern territories of Persia were not against regular armies, but against flying corps and distinct native tribes, relying for defence chiefly on the difficulties which mountains, deserts, privation, or mere distance, would throw in the way of an assailant. For these purposes he required an increased number of light troops, and was obliged to impose even upon his heavy-armed cavalry the most rapid and fatiguing marches, such as none but his Macedonian companions would have been contented to execute; moreover he was called upon to act less with large masses, and more with small and broken divisions. He now therefore for the first time established a regular taxis, or division of horse-bowmen.

Remaining at Ecbatana no longer than was sufficient for these new arrangements, Alexander recommenced his pursuit of Darius. He hoped to get before Darius to the Caspian Gates, at the north-eastern extremity of Media; by which gates was understood a mountain pass, or rather a road of many hours' march, including several difficult passes stretching eastward along the southern side of the great range of Taurus towards Parthia. He marched to Rhagæ, about fifty miles north of the Caspian Gates; which town he reached in eleven days, by exertions so severe that many men as

well as horses were disabled on the road. But in spite of all speed, he learned that Darius had already passed through the Caspian Gates. After five days of halt at Rhagæ, indispensable for his army, Alexander passed them also. A day's march on the other side of them, he was joined by two eminent Persians, Bagistanes and Antibelus, who informed him that Darius was already dethroned and in imminent danger of losing his life.

The conspirators by whom this had been done were: Bessus, satrap of Bactria; Barsaentes, satrap of Drangiana and Arachosia; and Nabarzanes, general of the regal guards. The small force of Darius having been thinned by daily desertion, most of those who remained were the contingents of the still unconquered territories, Bactria, Arachosia, and Drangiana, under the orders of their respective satraps. The Grecian mercenaries, fifteen hundred in number, and Artabazus, with a band under his special command, adhered inflexibly to Darius, but the soldiers of Eastern Asia followed their own satraps. Bessus and his colleagues intended to make their peace with Alexander by surrendering Darius, should Alexander pursue so vigorously as to leave them no hope of escape; but if they could obtain time to reach Bactria and Sogdiana, they resolved to organise an energetic resistance, under their own joint command, for the defence of those eastern provinces—the most warlike population of the empire. Under the desperate circumstances of the case, this plan was perhaps the least unpromising that could be proposed. The chance of resisting Alexander, small as it was at the best, became absolutely nothing under the command of Darius, who had twice set the example of flight from the field of battle, betraying both his friends and his empire, even when surrounded by the full force of Persia. For brave and energetic Persians, unless they were prepared at once to submit to the invader, there was no choice but to set aside Darius; nor does it appear that the conspirators intended at first anything worse. At a village called Thara in Parthia, they bound him in chains of gold, placed him in a covered chariot surrounded by the Bactrian troops, and thus carried him onward, retreating as fast as they could; Bessus assuming the command. Artabazus, with the Grecian mercenaries, too feeble to prevent the proceeding, quitted the army in disgust, and sought refuge among the mountains of the Tapyri bordering on Hyrcania towards the Caspian Sea.

On hearing this intelligence, Alexander strained every nerve to overtake the fugitives and get possession of the person of Darius. At the head of his companion cavalry, his light horse, and a body of infantry picked out for their strength and activity, he put himself in instant march, with nothing but arms and two days' provisions for each man; leaving Craterus to bring on the main body by easier journeys. A forced march of two nights and one day, interrupted only by a short midday repose (it was now the month of July), brought him at daybreak to the Persian camp which his informant, Bagistanes, had quitted. But Bessus and his troops were already beyond it, having made considerable advance in their flight; upon which Alexander, notwithstanding the exhaustion both of men and horses, pushed on with increased speed through all the night to the ensuing day at noon. He there found himself in the village where Bessus had encamped on the preceding day. Yet learning from deserters that his enemies had resolved to hasten their retreat by night marches, he despaired of overtaking them unless he could find some shorter road. He was informed that there was another shorter, but leading through a waterless desert. Setting out by this road with his cavalry, he got over no less than forty-five miles during the night, so as to come on Bessus by complete surprise.

[330 B.C.]

The Persians, marching in disorder without arms, and having no expectation of an enemy, were so panic-stricken at the sudden appearance of their indefatigable conqueror, that they dispersed and fled without any attempt to resist. In this critical moment, Bessus and Barsaentes urged Darius to leave his chariot, mount his horse, and accompany them in their flight. But he refused to comply. They were determined however that he should not fall alive into the hands of Alexander, whereby his name would have been employed against them, and would have materially lessened their chance of defending the eastern provinces; they were moreover incensed by his refusal, and had contracted a feeling of hatred and contempt to which they were glad to give effect. Casting their javelins at him, they left him mortally wounded, and then pursued their flight. His chariot, not distinguished by any visible mark, nor known even to the Persian soldiers themselves, was for some time not detected by the pursuers. At length a Macedonian soldier named Polystratus found him expiring, and is said to have received his last words; wherein he expressed thanks to Alexander for the kind treatment of his captive female relatives, and satisfaction that the Persian throne, lost to himself, was about to pass to so generous a conqueror. It is at least certain that he never lived to see Alexander himself.

Alexander had made the prodigious and indefatigable marches of the last four days, not without destruction to many men and horses, for the express purpose of taking Darius alive. It would have been a gratification to his vanity to exhibit the Great King as a helpless captive, rescued from his own servants by the sword of his enemy, and spared to occupy some subordinate command as a token of ostentatious indulgence. Moreover, apart from such feelings, it would have been a point of real advantage to seize the person of Darius, by means of whose name Alexander would have been enabled to stifle all further resistance in the extensive and imperfectly known regions eastward of the Caspian Gates. The satraps of these regions had now gone thither with their hands free, to kindle as much Asiatic sentiment and levy as large a force as they could, against the Macedonian conqueror; who was obliged to follow them, if he wished to complete the subjugation of the empire. We can understand therefore that Alexander was deeply mortified in deriving no result from this ruinously fatiguing march, and can the better explain that savage wrath which we shall hereafter find him manifesting against the satrap Bessus.

Alexander caused the body of Darius to be buried, with full pomp and ceremonial, in the regal sepulchres of Persis. The last days of this unfortunate prince have been described with almost tragic pathos by historians; and there are few subjects in history better calculated to excite such a feeling, if we regard simply the magnitude of his fall, from the highest pitch of power and splendour to defeat, degradation, and assassination. But an impartial review will not allow us to forget that the main cause of such ruin was his own blindness—his long apathy after the battle of Issus, and abandonment of Tyre and Gaza, in the fond hope of repurchasing queens



HEAD-DRESSES, ANCIENT PERSIA
(After Bardon)

whom he had himself exposed to captivity — lastly, what is still less pardonable, his personal cowardice in both the two decisive battles deliberately brought about by himself. If we follow his conduct throughout the struggle, we shall find little of that which renders a defeated prince either respectable or interesting. Those who had the greatest reason to denounce and despise him, were his friends and countrymen, whom he possessed ample means of defending, yet threw those means away. On the other hand, no one had better grounds for indulgence towards him than his conqueror; for whom he had kept unused the countless treasures of the three capitals, and for whom he had lightened in every way the difficulties of a conquest, in itself hardly less than impracticable.

The recent forced march, undertaken by Alexander for the purpose of securing Darius as a captive, had been distressing in the extreme to his soldiers, who required a certain period of repose and compensation. This was granted to them at the town of Hecatompylos in Parthia, where the whole army was again united. Alexander now began to feel and act manifestly as successor of Darius on the Persian throne; to disdain the comparative simplicity of Macedonian habits, and to assume the pomp, the ostentatious apparatus of luxuries, and even the dress, of a Persian king.

To many of Alexander's soldiers, the conquest of Persia appeared to be consummated and the war finished, by the death of Darius. They were reluctant to exchange the repose and enjoyments of Hecatompylos for fresh fatigues; but Alexander, assembling the select regiments, addressed to them an emphatic appeal which revived the ardour of all. His first march was across one of the passes into Hyrcania, the region bordering the south-eastern corner of the Caspian Sea. Here he found no resistance. Alexander undertook an expedition into the mountains of the Mardi, and reduced the remnant of the half-destroyed tribes to sue for peace.

After repose and festivity at Zendracarta, the chief town of Hyrcania, Alexander marched eastward with his united army through Parthia into Aria. A few days enabled him to crush the Arians. He then marched southward into the territory of the Drangi, or Drangiana (the modern Seistan), where he found no resistance.

CONSPIRACIES AGAINST ALEXANDER

In the chief town of Drangiana occurred the revolting tragedy, of which Philotas was the first victim, and his father Parmenion the second. Parmenion, now seventy years of age, and therefore little qualified for the fatigue inseparable from the invasion of the eastern satrapies, had been left in the important post of commanding the great depot and treasure at Ecbatana. His long military experience, and confidential position even under Philip, rendered him the second person in the Macedonian army, next to Alexander himself. His three sons were all soldiers. The youngest of them, Hector, had been accidentally drowned in the Nile, while in the suite of Alexander in Egypt; the second, Nicanor, had commanded the hypaspists or light infantry, but had died of illness, fortunately for himself, a short time before; the eldest, Philotas, occupied the high rank of general of the companion cavalry, in daily communication with Alexander, from whom he received personal orders.

A revelation came to Philotas, that a soldier named Dimnus had made boast to Nicomachus, his intimate friend or beloved person, under vows of

[330 B.C.]

secrecy, of an intended conspiracy against Alexander, inviting him to become an accomplice. Nicomachus, at first struck with abhorrence, at length simulated compliance, asked who were the accomplices of Dimnus, and received intimation of a few names; all of which he presently communicated to his brother Cebalinus, for the purpose of being divulged. Cebalinus told the facts to Philotas, entreating him to mention them to Alexander. But Philotas, though every day in communication with the king, neglected to do this for two days; upon which Cebalinus began to suspect him of connivance, and caused the revelation to be made to Alexander through one of the pages named Metron. Dimnus was immediately arrested, but ran himself through with his sword, and expired without making any declaration.

Of this conspiracy, real or pretended, everything rested on the testimony of Nicomachus. Alexander indignantly sent for Philotas, demanding why he had omitted for two days to communicate what he had heard. Philotas replied that the source from which it came was too contemptible to deserve notice—that it would have been ridiculous to attach importance to the simple declarations of such a youth as Nicomachus, recounting the foolish boasts addressed to him by a lover. Alexander received, or affected to receive, the explanation, gave his hand to Philotas, invited him to supper, and talked to him with his usual familiarity.

But it soon appeared that advantage was to be taken of this incident for the disgrace and ruin of Philotas, whose free-spoken criticisms on the pretended divine paternity—coupled with boasts, that he and his father Parmenion had been chief agents in the conquest of Asia—had neither been forgotten nor forgiven.

Some of the generals around Alexander, especially Craterus the first suborner of Antigone, fomented these suspicions from jealousy of the great ascendancy of Parmenion and his family. There was not a tittle of evidence against him, except the fact that the deposition had been made known to him, and that he had seen Alexander twice without communicating it. Upon this single fact, however, Craterus and the other enemies of Philotas worked so effectually as to inflame the suspicions and the pre-existing ill-will of Alexander into fierce rancour. He resolved on the disgrace, torture, and death of Philotas—and on the death of Parmenion besides.

To accomplish this, however, against the two highest officers in the Macedonian service, one of them enjoying a separate and distant command, required management. Alexander was obliged to carry the feelings of the soldiers along with him, and to obtain a condemnation from the army, according to an ancient Macedonian custom, in regard to capital crimes, though, as it seems, not uniformly practised. He not only kept the resolution secret, but is even said to have invited Philotas to supper with the other officers, conversing with him just as usual. In the middle of the night, Philotas was arrested while asleep in his bed, put in chains, and clothed in an ignoble garb. A military assembly was convened at daybreak, before which Alexander appeared with the chief officers in his confidence. Addressing the soldiers in a vehement tone of mingled sorrow and anger, he proclaimed to them that his life had just been providentially rescued from a dangerous conspiracy organised by two men hitherto trusted as his best friends—Philotas and Parmenion—through the intended agency of a soldier named Dimnus, who had slain himself when arrested. The dead body of Dimnus was then exhibited to the meeting, while Nicomachus and Cebalinus were brought forward to tell their story. A letter from Parmenion to his sons Philotas and Nicanor, found among the papers seized on the arrest, was

read to the meeting. Its terms were altogether vague and unmeaning; but Alexander chose to construe them as it suited his purpose.

We may easily conceive the impression produced upon these assembled soldiers by such denunciations from Alexander himself — revelations of his own personal danger, and reproaches against treacherous friends. Amyntas, and even Cœnus, the brother-in-law of Philotas, were yet more unmeasured in their invectives against the accused. They, as well as the other officers with whom the arrest had been concerted, set the example of violent manifestation against him, and ardent sympathy with the king's danger. Philotas was heard in his defence, which, though strenuously denying the charge, is said to have been feeble. It was indeed sure to be so, coming from one seized thus suddenly, and overwhelmed with disadvantages; while a degree of courage, absolutely heroic, would have been required for any one else to rise and presume to criticise the proofs. The royal pages began the cry, echoed by all around, that they would with their own hands tear the parri-icide in pieces.

It would have been fortunate for Philotas if their wrath had been sufficiently ungovernable to instigate the execution of such a sentence on the spot. But this did not suit the purpose of his enemies. Aware that he had been condemned upon the regal word, with nothing better than the faintest negative ground of suspicion, they determined to extort from him a confession such as would justify their own purposes, not only against him, but against his father Parmenion — whom there was as yet nothing to implicate. Accordingly, during the ensuing night, Philotas was put to the torture. Hephæstion, Craterus, and Cœnus — the last of the three being brother-in-law of Philotas — themselves superintended the ministers of physical suffering. Alexander himself, too, was at hand, but concealed by a curtain. It is said that Philotas manifested little firmness under torture, and that Alexander, an unseen witness, indulged in sneers against the cowardice of one who had fought by his side in so many battles. All who stood by were enemies, and likely to describe the conduct of Philotas in such manner as to justify their own hatred. The tortures inflicted, cruel in the extreme and long continued, wrung from him at last a confession, implicating his father along with himself. He was put to death; and at the same time, all those whose names had been indicated by Nicomachus, were slain also — apparently by being stoned, without preliminary torture. Philotas had serving in the army a numerous kindred, all of whom were struck with consternation at the news of his being tortured. It was the Macedonian law that all kinsmen of a man guilty of treason were doomed to death along with him. Accordingly, some of these men slew themselves, others fled from the camp, seeking refuge wherever they could. Such was the terror and tumult in the camp, that Alexander was obliged to proclaim a suspension of this sanguinary law for the occasion.

It now remained to kill Parmenion, who could not be safely left alive after the atrocities used towards Philotas; and to kill him, moreover, before he could have time to hear of them, since he was not only the oldest, most respected, and most influential of all Macedonian officers, but also in separate command of the great depot at Ecbatana. Alexander summoned to his presence one of the companions named Polydamas; a particular friend, comrade, or *aide-de-camp*, of Parmenion. Every friend of Philotas felt at this moment that his life hung by a thread; so that Polydamas entered the king's presence in extreme terror, as he was ordered to bring with him his two younger brothers. Alexander addressed him, denouncing Parmenion

[330 B.C.]

as a traitor, and intimating that Polydamas would be required to carry a swift and confidential message to Ecbatana, ordering his execution. Polydamas was selected as the attached friend of Parmenion, and therefore as best calculated to deceive him. Two letters were placed in his hands, addressed to Parmenion; one from Alexander himself, conveying ostensibly military communications and orders; the other, signed with the seal-ring of the deceased Philotas, and purporting to be addressed by the son to the father. Together with these, Polydamas received the real and important despatch, addressed by Alexander to Cleander and Menidas, the officers immediately subordinate to Parmenion at Ecbatana; proclaiming Parmenion guilty of high treason, and directing them to kill him at once. Large rewards were offered to Polydamas if he performed this commission with success, while his two brothers were retained as hostages against scruples or compunction. He promised even more than was demanded — too happy to purchase this reprieve from what had seemed impending death. Furnished with native guides and with swift dromedaries, he struck by the straightest road across the desert of Khorasan, and arrived at Ecbatana on the eleventh day — a distance usually requiring more than thirty days to traverse. Entering the camp by night, without the knowledge of Parmenion, he delivered his despatch to Cleander, with whom he concerted measures. On the morrow he was admitted to Parmenion, while walking in his garden with Cleander and the other officers marked out by Alexander's order as his executioners. Polydamas ran to embrace his old friend, and was heartily welcomed by the unsuspecting veteran, to whom he presented the letters professedly coming from Alexander and Philotas. While Parmenion was absorbed in perusal, he was suddenly assailed by a mortal stab from the hand and sword of Cleander. Other wounds were heaped upon him as he fell, by the remaining officers — the last even after life had departed.

The soldiers in Ecbatana, on hearing of this bloody deed, burst into furious mutiny, surrounded the garden wall, and threatened to break in for the purpose of avenging their general, unless Polydamas and the other murderers should be delivered to them. But Cleander, admitting a few of the ringleaders, exhibited to them Alexander's written orders, to which the soldiers yielded, not without murmurs of reluctance and indignation. Most of them dispersed, yet a few remained, entreating permission to bury Parmenion's body. Even this was long refused by Cleander, from dread of the king's displeasure. At last, however, thinking it prudent to comply in part, he cut off the head, delivering to them the trunk alone for burial. The head was sent to Alexander.

Among the many tragical deeds recounted throughout the course of this history, there is none more revolting than the fate of these two generals. Alexander, violent in all his impulses, displayed on this occasion a personal rancour worthy of his ferocious mother Olympias, exasperated rather than softened by the magnitude of past services. When we see the greatest officers of the Macedonian army directing in person, and under the eye of Alexander, the laceration and burning of the naked body of their colleague Philotas, and assassinating with their own hands the veteran Parmenion, we feel how much we have passed out of the region of Greek civic feeling into that of the more savage Illyrian warrior, partially orientalised. It is not surprising to read, that Antipater, viceroy of Macedonia, who had shared with Parmenion the favour and confidence of Philip as well as of Alexander, should tremble when informed of such proceedings, and cast about for a refuge against the like possibilities to himself. Many other officers were

alike alarmed and disgusted with the transactions. Hence Alexander, opening and examining the letters sent home from his army to Macedonia, detected such strong expressions of indignation, that he thought it prudent to transfer many pronounced malcontents into a division by themselves, parting them off from the remaining army. Instead of appointing any substitute for Philotas in the command of the companion cavalry, he cast that body into two divisions, nominating Hephæstion to the command of one, and Clitus to that of the other.

CAPTURE OF BESSUS

The autumn and winter (330-329 B.C.) were spent by Alexander in reducing Drangiana, Gedrosia, Arachosia, and the Paropamisadæ, the modern Seistan, Afghanistan, and the western part of Kabul, lying between Ghazna



NORTH PERSIAN WARRIOR
(After Bardon)

on the north, Kandahar or Kelar on the south, and Furrah in the west. He experienced no combined resistance, but his troops suffered severely from cold and privation. Near the southern termination of one of the passes of the Hindu-Kush (apparently northeast of the town of Kabul) he founded a new city, called Alexandria ad Caucasum, where he planted seven thousand old soldiers, Macedonians, and others as colonists. Towards the

close of winter he crossed over the mighty range of the Hindu-Kush; a march of fifteen days through regions of snow, and fraught with hardship to his army. On reaching the north side of these mountains, he found himself in Bactria.

The Bactrian leader Bessus, who had assumed the title of king, could muster no more than a small force, with which he laid waste the country, and then retired across the river Oxus into Sogdiana, destroying all the boats. Alexander overran Bactria with scarcely any resistance; the chief places, Bactra (Balkh) and Aornus, surrendering to him on the first demonstration of attack. Having named Artabazus satrap of Bactria, and placed Archelaus with a garrison in Aornus, he marched northward towards the river Oxus, the boundary between Bactria and Sogdiana. It was a march of extreme hardship; reaching for two or three days across a sandy desert destitute of water, and under very hot weather. The Oxus, six furlongs in breadth, deep, and rapid, was the most formidable river that the Macedonians had yet seen. Alexander transported his army across it on the

[329 B.C.]

tent-skins inflated and stuffed with straw. It seems surprising that Bessus did not avail himself of this favourable opportunity for resisting a passage in itself so difficult; he had however been abandoned by his Bactrian cavalry at the moment when he quitted their territory. Some of his companions, Spitamenes and others, terrified at the news that Alexander had crossed the Oxus, were anxious to make their own peace by betraying their leader. They sent a proposition to this effect; upon which Ptolemy with a light division was sent forward by Alexander, and was enabled, by extreme celerity of movements, to surprise and seize Bessus in a village. Alexander ordered that he should be held in chains, naked, and with a collar round his neck, at the side of the road along which the army were marching. On reaching the spot, Alexander stopped his chariot, and sternly demanded from Bessus, on what pretence he had first arrested, and afterwards slain, his king and benefactor Darius. Bessus replied, that he had not done this single-handed; others were concerned in it along with him, to procure for themselves lenient treatment from Alexander. The king said no more, but ordered Bessus to be scourged, and then sent back as prisoner to Bactra.¹

In his onward march, Alexander approached a small town, inhabited by the Branchidæ; descendants of those Branchidæ near Miletus on the coast of Ionia, who had administered the great temple and oracle of Apollo on Cape Posidium, and who had yielded up the treasures of that temple to the Persian king Xerxes, 150 years before. This surrender had brought upon them so much odium, that when the dominion of Xerxes was overthrown on the coast, they retired with him into the interior of Asia. Delighted to find themselves once more in commerce with Greeks, they poured forth to meet and welcome the army, tendering all that they possessed. Alexander, when he heard who they were and what was their parentage, gave orders to massacre the entire population—men, women, and children. They were slain without arms or attempt at resistance, resorting to nothing but prayers and suppliant manifestations. Alexander next commanded the walls to be levelled, and the sacred groves cut down, so that no habitable site might remain, nor anything except solitude and sterility. Such was the revenge taken upon these unhappy victims for the deeds of their ancestors in the fourth or fifth generation before. Alexander doubtless considered himself to be executing the wrath of Apollo against an accursed race who had robbed the temple of the god. The Macedonian expedition had been proclaimed to be undertaken originally for the purpose of revenging upon the contemporary Persians the ancient wrongs done to Greece by Xerxes; so that Alexander would follow out the same sentiment in revenging upon the contemporary Branchidæ the acts of their ancestors—yet more guilty than Xerxes, in his belief. The massacre of this unfortunate population was in fact an example of human sacrifice on the largest scale, offered to the gods by the religious impulses of Alexander, and worthy to be compared to that of the Carthaginian general Hannibal, when he sacrificed three thousand Grecian prisoners on the field of Himera, where his grandfather Hamilcar had been slain seventy years before.

[¹ Later he was brought forth and Alexander had his nose and ears cut off. Mutilation was abhorrent to the Greeks, and even Arrian (IV, 7) rebukes his hero for this atrocity. Bessus was then turned over to the Medes and Persians who, according to Diodorus, f. XVII, 9, "after they had put him to all manner of torments, and used him with all the despite and disgrace imaginable, cut his body into small pieces and hurled every part here and there away out of their slings." Plutarch, *g* however, says that two straight trees were bent together, and one of Bessus' legs fastened to each so that when they were released and sprang apart, his body was torn asunder.]

LIMIT OF ALEXANDER'S PROGRESS NORTHWARD

Alexander then continued his onward progress, first to Maracanda (Samarcand), the chief town of Sogdiana — next to the river Jaxartes, which he and his companions, in their imperfect geographical notions, believed to be the Tanaïs, the boundary between Asia and Europe. In his march, he left garrisons in various towns, but experienced no resistance, though detached bodies of the natives hovered on his flanks.

Here, on the river Jaxartes, Alexander projected the foundation of a new city to bear his name; intended as a protection against incursions from the Scythian nomads on the other side of the river. He planted in it some Macedonian veterans and Grecian mercenaries, together with volunteer settlers from the natives around. An army of Scythian nomads, showing themselves on the other side of the river, piqued his vanity to cross over and attack them. Carrying over a division of his army on inflated skins, he defeated them with little difficulty, pursuing them briskly into the desert. But the weather was intensely hot, and the army suffered much from thirst; while the little water to be found was so bad, that it brought upon Alexander a diarrhœa which endangered his life. This chase of a few miles on the right bank of the Jaxartes (seemingly in the present Khanat of Khokand), marked the utmost limit of Alexander's progress northward.

Shortly afterwards, a Macedonian detachment, unskillfully conducted, was destroyed in Sogdiana by Spitamenes and the Scythians: a rare misfortune, which Alexander avenged by overrunning the region near the river Polytimetus (the Kohik), and putting to the sword the inhabitants of all the towns which he took. He then recrossed the Oxus, to rest during the extreme season of winter at Zariaspa in Bactria, from whence his communications with the West and with Macedonia were more easy, and where he received various reinforcements of Greek troops.

Alexander, distributing his army into five divisions, traversed the country and put down all resistance, while he also took measures for establishing several military posts, or new towns, in convenient places. After some time the whole army was reunited at the chief place of Sogdiana, Maracanda, where some halt and repose was given.

ALEXANDER MURDERS HIS FRIEND

During this halt at Maracanda (Samarcand), 328-327 B.C., the memorable banquet occurred wherein Alexander murdered Clitus. Clitus had saved his life at the battle of the Granicus, by cutting off the sword arm of the Persian Spithridates, when already uplifted to strike him from behind. Since the death of Philotas, the important function of general of the companion cavalry had been divided between Hephæstion and Clitus. Moreover, the family of Clitus had been attached to Philip, by ties so ancient, that his sister, Lanice, had been selected as the nurse of Alexander himself when a child. Two of her sons had already perished in the Asiatic battles. If, therefore, there were any man who stood high in the service, or was privileged to speak his mind freely to Alexander, it was Clitus.

In this banquet at Maracanda, when wine, according to the Macedonian habit, had been abundantly drunk, and when Alexander, Clitus, and most of the other guests were already nearly intoxicated, enthusiasts or flatterers heaped immoderate eulogies upon the king's previous achievements. They

[327 B.C.]

exalted him above all the most venerated legendary heroes; they proclaimed that his superhuman deeds proved his divine paternity, and that he had earned an apotheosis like Hercules, which nothing but envy could withhold from him even during his life. Alexander himself joined in these boasts, and even took credit for the later victories of the reign of his father, whose abilities and glory he depreciated. To the old Macedonian officers, such an insult cast on the memory of Philip was deeply offensive. But among them all, none had been more indignant than Clitus, with the growing insolence of Alexander—his assumed filiation from Zeus Ammon, which put aside Philip as unworthy—his preference for Persian attendants, who granted or refused admittance to his person—his extending to Macedonian soldiers the contemptuous treatment habitually endured by Asiatics, and even allowing them to be scourged by Persian hands and Persian rods. The pride of a Macedonian general in the stupendous successes of the last five years, was effaced by his mortification, when he saw that they tended only to merge his countrymen amidst a crowd of servile Asiatics, and to inflame the prince with high-flown aspirations transmitted from Xerxes or Oechus. But whatever might be the internal thoughts of Macedonian officers, they held their peace before Alexander, whose formidable character and exorbitant self-estimation would tolerate no criticism.

At the banquet of Maracanda, this long-suppressed repugnance found an issue, accidental, indeed, and unpremeditated, but for that very reason all the more violent and unmeasured. The wine, which made Alexander more boastful, and his flatterers fulsome to excess, overpowered altogether the reserve of Clitus. He rebuked the impiety of those who degraded the ancient heroes in order to make a pedestal for Alexander. He protested against the injustice of disparaging the exalted and legitimate fame of Philip, whose achievements he loudly extolled, pronouncing them to be equal, and even superior, to those of his son. For the exploits of Alexander, splendid as they were, had been accomplished, not by himself alone, but by that unconquerable Macedonian force which he had found ready made to his hands; whereas those of Philip had been his own—since he had found Macedonia prostrate and disorganised, and had to create for himself both soldiers and a military system. The great instruments of Alexander's victories had been Philip's old soldiers, whom he now despised, and among them Parmenion, whom he had put to death.

Remarks such as these, poured forth in the coarse language of a half-intoxicated Macedonian veteran, provoked loud contradiction from many, and gave poignant offence to Alexander; who now for the first time heard the open outburst of disapprobation, before concealed and known to him only by surmise. But wrath and contradiction, both from him and from others, only made Clitus more reckless in the outpouring of his own feelings, now discharged with delight after having been so long pent up. He passed from the old Macedonian soldiers to himself individually. Stretching forth his right hand towards Alexander, he exclaimed, "Recollect that you owe your life to me; this hand preserved you at the Granicus. Listen to the outspoken language of truth, or else abstain from asking freemen to supper, and confine yourself to the society of barbaric slaves." All these reproaches stung Alexander to the quick. But nothing was so intolerable to him as the respectful sympathy for Parmenion, which brought to his memory one of the blackest deeds of his life—and the reminiscence of his preservation at the Granicus, which lowered him into the position of a debtor towards the very censor under whose reproof he was now smarting.

At length wrath and intoxication together drove him into uncontrollable fury. He started from his couch, and felt for his dagger to spring at Clitus; but the dagger had been put out of reach by one of his attendants. In a loud voice and with the Macedonian word of command, he summoned the bodyguards and ordered the trumpeter to sound an alarm. But no one obeyed so grave an order, given in his condition of drunkenness. His principal officers, Ptolemy, Perdicas, and others, elung round him, held his arms and body, and besought him to abstain from violence; others at the same time tried to silence Clitus and hurry him out of the hall, which had now become a scene of tumult and consternation. But Clitus was not in a humour to confess himself in the wrong by retiring; while Alexander, furious at the opposition now, for the first time, offered to his will, exclaimed that his officers held him in chains as Bessus had held Darius, and left him nothing but the name of a king. Though anxious to restrain his movements, they doubtless did not dare to employ much physical force; so that his great personal strength, and continued efforts, presently set him free. He then snatched a pike from one of the soldiers, rushed upon Clitus, and thrust him through on the spot, exclaiming, "Go now to Philip and Parmenion."

REMORSE OF ALEXANDER

No sooner was the deed perpetrated than the feelings of Alexander underwent an entire revolution. The spectacle of Clitus, a bleeding corpse on the floor—the marks of stupefaction and horror evident in all the spectators, and the reaction from a furious impulse instantaneously satiated—plunged him at once into the opposite extreme of remorse and self-condemnation. Hastening out of the hall, and retiring to bed, he passed three days in an agony of distress, without food or drink. He burst into tears and multiplied exclamations on his own mad act; he dwelt upon the names of Clitus and Lanice with the debt of gratitude which he owed to each, and denounced himself as unworthy to live after having requited such services with a foul murder. His friends at length prevailed on him to take food, and return to activity. All joined in trying to restore his self-satisfaction. The Macedonian army passed a public vote that Clitus had been justly slain, and that his body should remain unburied; which afforded opportunity to Alexander to reverse the vote, and to direct that it should be buried by his own order. The prophets comforted him by the assurance that his murderous impulse had arisen, not from his own natural mind, but from a maddening perversion intentionally brought on by the god Dionysus, to avenge the omission of a sacrifice due to him on the day of the banquet, but withheld. Lastly, the Greek sophist or philosopher, Anaxarchus of Abdera, revived Alexander's spirits by well-timed flattery, treating his sensibility as nothing better than generous weakness; reminding him that in his exalted position of conqueror and Great King, he was entitled to prescribe what was right and just, instead of submitting himself to laws dictated from without. Callisthenes the philosopher was also summoned, along with Anaxarchus, to the king's presence, for the same purpose of offering consolatory reflections. But he is said to have adopted a tone of discourse altogether different, and to have given offence rather than satisfaction to Alexander.

To such remedial influences, and probably still more to the absolute necessity for action, Alexander's remorse at length yielded. Like the other emotions of his fiery soul, it was violent and overpowering while it lasted.

[327 B.C.]

But it cannot be shown to have left any durable trace on his character, nor any effects justifying the unbounded admiration of Arrian; who has little but blame to bestow on the murdered Clitus, while he expresses the strongest sympathy for the mental suffering of the murderer.

After ten days, Alexander again put his army in motion, to complete the subjugation of Sogdiana. He found no enemy capable of meeting him in pitched battle; yet Spitamenes, with the Sogdians and some Scythian allies, raised much hostility of detail, which it cost another year to put down. Alexander underwent the greatest fatigue and hardships in his marches through the mountainous parts of this wide, rugged, and poorly supplied country, with rocky positions, strong by nature, which his enemies sought to defend. One of these fastnesses, held by a native chief named Sisymithres, seemed almost unattackable, and was indeed taken rather by intimidation than by actual force. The Scythians, after a partial success over a small Macedonian detachment, were at length so thoroughly beaten and overawed, that they slew Spitamenes, and sent his head to the conqueror as a propitiatory offering.

After a short rest at Nautaca during the extreme winter, Alexander resumed operations, by attacking a strong post called the Sogdian Rock, whither a large number of fugitives had assembled, with an ample supply of provision. It was a precipice supposed to be inexpugnable; and would seemingly have proved so, in spite of the energy and abilities of Alexander, had not the occupants altogether neglected their guard, and yielded at the mere sight of a handful of Macedonians who had scrambled up the precipice. Among the captives taken by Alexander on this rock, were the wife and family of the Bactrian chief Oxyartes; one of whose daughters, named Roxane, so captivated Alexander by her beauty that he resolved to make her his wife. He then passed out of Sogdiana into the neighbouring territory Parætacene, where there was another inexpugnable site called the Rock of Choriènes, which he was also fortunate enough to reduce.

From hence Alexander went to Bactra. Sending Craterus with a division to put the last hand to the reduction of Parætacene, he himself remained at Bactra, preparing for his expedition across the Hindu Kush to the conquest of India. As a security for tranquillity of Bactria and Sogdiana during his absence, he levied thirty thousand young soldiers from those countries to accompany him.

It was at Bactra that Alexander celebrated his marriage with the captive Roxane, in the spring of 327 B.C. Amidst the repose and festivities connected with that event, the oriental temper which he was acquiring displayed itself more forcibly than ever. He could no longer be satisfied without obtaining prostration, or worship, from Greeks and Macedonians as well as from Persians; a public and unanimous recognition of his divine origin and superhuman dignity. Some Greeks and Macedonians had already rendered to him this homage. Nevertheless the greater number, in spite of their extreme deference and admiration for him, it was repugnant and degrading. Even the imperious Alexander shrank from issuing public and formal orders



GREEK URN

on such a subject; but a manœuvre was concerted, with his privity, by the Persians and certain compliant Greek sophists or philosophers, for the purpose of carrying the point by surprise.

During a banquet at Bactra, the philosopher Anaxarchus, addressing the assembly in a prepared harangue, extolled Alexander's exploits as greatly surpassing those of Dionysus and Hercules. He proclaimed that Alexander had already done more than enough to establish a title to divine honours from the Macedonians; who, he said, would assuredly worship Alexander after his death, and ought in justice to worship him during his life, forthwith.

This harangue was applauded, and similar sentiments were enforced, by others favourable to the plan; who proceeded to set the example of immediate compliance, and were themselves the first to tender worship. Most of the Macedonian officers sat unmoved, disgusted at the speech. But though disgusted, they said nothing. To reply to a speech doubtless well-turned and flowing, required some powers of oratory; moreover, it was well known that whoever dared to reply stood marked out for the antipathy of Alexander. The fate of Clitus, who had arraigned the same sentiments in the banquetting hall of Maracanda, was fresh in the recollection of every one. The repugnance which many felt, but none ventured to express, at length found an organ in Callisthenes of Olynthus.

This philosopher, whose melancholy fate imparts a peculiar interest to his name, was nephew of Aristotle, and had enjoyed through his uncle an early acquaintance with Alexander during the boyhood of the latter. At the recommendation of Aristotle, Callisthenes had accompanied Alexander in his Asiatic expedition.

On occasion of the demonstration incited by Anaxarchus at the banquet, Callisthenes had been invited by Hephæstion to join in the worship intended to be proposed towards Alexander; and Hephæstion afterwards alleged, that he had promised to comply. But his actual conduct affords reasonable ground for believing that he made no such promise; for he not only thought it his duty to refuse the act of worship, but also to state publicly his reasons for disapproving it; the more so, as he perceived that most of the Macedonians present felt like himself. He contended that the distinction between gods and men was one which could not be confounded without impiety and wrong. Alexander had amply earned — as a man, a general, and a king — the highest honours compatible with humanity; but to exalt him into a god would be both an injury to him and an offence to the gods. Anaxarchus, he said, was the last person from whom such a proposition ought to come, because he was one of those whose only title to Alexander's society was founded upon his capacity to give instructive and wholesome counsel.

Callisthenes spoke out what numbers of his hearers felt. The speech was so warmly applauded by the Macedonians present, especially the older officers, that Alexander thought it prudent to forbid all further discussion upon this delicate subject. Presently the Persians present, according to Asiatic custom, approached him and performed their prostration; after which Alexander pledged, in successive goblets of wine, those Greeks and Macedonians with whom he had held previous concert. To each of them the goblet was handed, and each, after drinking to answer the pledge, approached the king, made his prostration, and then received a salute. Lastly, Alexander sent the pledge to Callisthenes, who, after drinking like the rest, approached him for the purpose of receiving the salute but without any prostration. Of this omission Alexander was expressly informed by one of the companions; upon which he declined to admit Callisthenes

[327 B.C.]

to a salute. The latter retired, observing, "Then I shall go away, worse off than others as far as the salute goes."

Callisthenes certainly would have done well to withdraw earlier (if indeed he could have withdrawn without offence) from the camp of Alexander, in which no lettered Greek could now associate without abnegating his freedom of speech and sentiment, and emulating the servility of Anaxarchus. But being present, as Callisthenes was, in the hall at Bactra when the proposition of Anaxarchus was made, and when silence would have been assent—his protest against it was both seasonable and dignified for being fraught with danger to himself.

Callisthenes knew that danger well, and was quickly enabled to recognise it in the altered demeanour of Alexander towards him. He was, from that day, a marked man in two senses: first, to Alexander himself, as well as to the rival sophists and all promoters of the intended deification—for hatred, and for getting up some accusatory pretence such as might serve to ruin him; next, to the more free-spirited Macedonians, indignant witnesses of Alexander's increased insolence, and admirers of the courageous Greek who had protested against the motion of Anaxarchus. By such men he was doubtless much extolled; which praises aggravated his danger, as they were sure to be reported to Alexander. The pretext for his ruin was not long wanting.

CONSPIRACY OF THE ROYAL PAGES

Among those who admired and sought the conversation of Callisthenes, was Hermolaus, one of the royal pages—the band, selected from noble Macedonian families, who did duty about the person of the king. It had happened that this young man, one of Alexander's companions in the chase, on seeing a wild boar rushing up to attack the king, darted his javelin, and slew the animal. Alexander, angry to be anticipated in killing the boar, ordered Hermolaus to be scourged before all the other pages and deprived him of his horse. Thus humiliated and outraged—for an act not merely innocent, but the omission of which, if Alexander had sustained any injury from the boar, might have been held punishable—Hermolaus became resolutely bent on revenge. He enlisted in the project his intimate friend Sostratus, with several others among the pages; and it was agreed among them to kill Alexander in his chamber, on the first night when they were all on guard together. The appointed night arrived, without any divulgence of their secret; yet the scheme was frustrated by the accident, that Alexander continued till daybreak drinking with his officers, and never retired to bed. On the morrow, one of the conspirators, becoming alarmed or repentant, divulged the scheme to his friend Charicles, with the names of those concerned. Eurylochus, brother to Charicles, apprised by him of what he had heard, immediately informed Ptolemy, through whom it was conveyed to Alexander. By Alexander's order, the persons indicated were arrested and put to the torture; under which they confessed that they had themselves conspired to kill him, but named no other accomplices, and even denied that anyone else was privy to the scheme. In this denial they persisted, though extreme suffering was applied to extort the revelation of new names. They were then brought up and arraigned as conspirators before the assembled Macedonian soldiers. There the confession was repeated. It is even said that Hermolaus, in repeating

it, boasted of the enterprise as both legitimate and glorious; denouncing the tyranny and cruelty of Alexander as having become insupportable to a freeman. Whether such boast was actually made or not, the persons brought up were pronounced guilty, and stoned to death forthwith by the soldiers.

The pages thus executed were young men of good Macedonian families, for whose condemnation accordingly Alexander had thought it necessary to invoke — what he was sure of obtaining against any one — the sentence of the soldiers. To satisfy his hatred against Callisthenes — not a Macedonian, but only a Greek citizen, one of the remnants of the subverted city of Olynthus — no such formality was required. In his case, therefore, as in that of Philotas before, it was necessary to pick up matter of suspicious tendency from his reported remarks and conversations. He was alleged to have addressed dangerous and inflammatory language to the pages, holding up Alexander to odium, instigating them to conspiracy, and pointing out Athens as a place of refuge; he was moreover well known to have been often in conversation with Hermolaus. For a man of the violent temper and omnipotent authority of Alexander, such indications were quite sufficient as grounds of action against one whom he hated.

On this occasion, we have the state of Alexander's mind disclosed by himself, in one of the references to his letters given by Plutarch. Writing to Craterus and to others immediately afterwards, Alexander distinctly stated that the pages throughout all their torture had deposed against no one but themselves. Nevertheless, in another letter addressed to Antipater in Macedonia, he used these expressions: "The pages were stoned to death by the Macedonians; but I myself shall punish the sophist, as well as those who sent him out here, and those who harbour in their cities conspirators against me." The sophist Callisthenes had been sent out by Aristotle, who is here designated; and probably the Athenians after him. Fortunately for Aristotle, he was not at Bactra, but at Athens. That he could have had any concern in the conspiracy of the pages, was impossible. In this savage outburst of menace against his absent preceptor, Alexander discloses the real state of feeling which prompted him to the destruction of Callisthenes — hatred towards that spirit of citizenship and free speech, which Callisthenes not only cherished, in common with Aristotle and most other literary Greeks, but had courageously manifested in his protest against the motion for worshipping a mortal.

Callisthenes was first put to the torture and then hanged. His tragical fate excited a profound sentiment of sympathy and indignation among the philosophers of antiquity.

The halts of Alexander were formidable to friends and companions; his marches, to the unconquered natives whom he chose to treat as enemies.^c



CHAPTER LV. THE CONQUEST OF INDIA

AFTER the conquest of the Bactrian satrapy, there remained only one province of the Persian empire into which Alexander had not yet carried his arms. Already, indeed, before he crossed the Paropamisus, he had made himself master of a great part of the country which the Persians called India, and perhaps had very nearly reached the utmost limits within which the authority of the Great King was acknowledged in the latter years of the monarchy. But the power of the first Darius had certainly been extended much farther eastward. At the battle of Arbela the Greeks for the first time saw elephants, which they heard had been brought from the banks of the Indus. To Alexander and his companions India appeared from a distance as a new world, of indefinite extent, and abounding in wonders and riches. Even without any other inducement, he must eagerly have desired to explore and subdue it.

The king of Taxila [or Takshasila] had offered his alliance to Alexander, and sought aid from him against a powerful neighbour; and thus Alexander ascertained that the state of things in this part of India was highly favourable to his projected invasion. Through some revolutions, no record of which has been preserved, a great part of it had in Alexander's time fallen under the dominion of three princes, Taxiles and two who were kinsmen and bore the name of Porus. The most powerful of these was the immediate neighbour of Taxiles; his territories lay to the east of the Hydaspes. It was against him that the king of Taxila sought to strengthen himself by an alliance with the Macedonian conqueror.

Alexander marched into India at the head of 120,000 foot and 15,000 horse. We must suppose that at least 70,000 of these were Asiatic troops. The summer of 327 had scarcely begun, when he crossed the mountains and advanced to the banks of the Cophen, the river formed by the confluence of the Kabul river with the Panjshir, a larger stream, which meets it from the northwest. Here, in conformity to his summons, he was met by Taxiles, and by several chiefs from the country west of the Indus, bringing presents, such as were accounted the most honourable; and as he expressed a wish for elephants, they promised all they possessed, which however amounted to no more than five-and-twenty.

Alexander now divided his forces. He sent Hephæstion and Perdicas, with a strong division, accompanied by the Indian chiefs, down the vale of the Cophen to the Indus, to prepare a bridge for the passage of the army, while he himself directed his march into the mountains north of the Cophen, and included between it and the Indus. Here lay the territories of three warlike tribes—the Aspasians or Hippasians, Guræans, and Assaceniens. The operations of this campaign, which occupied the rest of the year, do not require to be related here with all the military details. He ascended the rugged vale of the Choës; and gathered a vast booty, including forty thousand captives, and between three and four hundred thousand head of cattle, from which he selected some of the finest to be sent into Macedonia. He then, with some difficulty, effected the passage of the deep and rapid Guræus, and entered the territory of the Assaceniens. Alexander accepted the surrender of Massaga, the capital, on the condition that the mercenaries should join his army. But they discovered a degree of patriotism which he had not looked for. They were so averse from the thought of turning their arms against their countrymen, that, having marched out, and encamped on a hill by themselves, they meditated making their escape in the night. Alexander was apprised of their design, and, though they had not begun to execute it, with less generosity than might have been expected from him, even if mercy was out of the question, surrounded the hill with his troops, and cut them all to pieces. Then, holding the capitulation to have been broken, he stormed the defenceless city, where the chief's mother and daughter fell into his hands.

The inhabitants of Bazira fled to a place of refuge, which was deemed impregnable, and soon became crowded with fugitives from all parts of the country. This was a hill fort on the right bank of the Indus, not far above its junction with the Cophen. Its Indian name seems to have been slightly distorted by the Greeks, according to their usual practice, into that of Aornus, which answered to its extraordinary height, as above the flight of a bird. It was precipitous on all sides, and accessible only by a single path cut in the rock, though in one direction it was connected with a range of hills. But its summit was an extensive plain of fruitful soil, partly clothed with wood, and containing copious springs. The traditions of the country concerning its insurmountable strength seem to have given occasion to the fable, which spread through the Macedonian camp, that Hercules himself had assailed it without success. Alexander did not need this inducement to excite him to the undertaking. It had been a principle, to which he owed most of his conquests, to show that he was not to be deterred by any natural difficulties; and he resolved to make the Aornus his own.

He had not long arrived at it, before he received information of a rugged and difficult track that led up to the top of a hill, separated by a hollow of no great depth, though of considerable width, from the rock. By this path he sent Ptolemy, with a body of light troops, who reached the summit before he was noticed by the garrison, and immediately, as he had been ordered, threw up an entrenchment, and by a fire-signal announced his success to the camp below. The Indians attempted in vain to dislodge him from his position: and the next day Alexander, by a hard struggle, notwithstanding their vigorous resistance, joined him there with the rest of the army. He now availed himself of his superior numbers, and began to carry a mound across the hollow. He took part in the work with his own hands, and the whole army, animated by his example and exhortations, prosecuted it with restless assiduity. But the Indians, astonished at the intrepidity with which

[326 B.C.]

a handful of men had seized this vantage-ground, and alarmed by the progress of the work, began to despair of resistance, and to meditate flight. But while they were stealing out of the place, Alexander scaled the deserted wall with a part of his guard, entered the fortress, and chased the fugitives with great slaughter into the plains below. The capture of the rock which had baffled the assaults of Hercules was celebrated with solemn sacrifices, and supplied a fresh theme for the eloquence of Agis and Anaxarchus.

It was in the course of the campaign in the highlands between the Cophen and the Indus, and, it seems, in the territory of the Guræans, that the Macedonians were struck with some appearances in the productions of the soil, and the manners of the natives, and probably also by the sound of some names which reminded them of the legends of Dionysus, whose fabulous conquests were now so often mentioned by Alexander's flatterers, for the purpose of exalting the living hero, whom they proposed to deify, above the god. And so we read that Alexander came to a city called Nysa, which boasted of Dionysus as its founder, and, as evidence of the fact, showed the ivy and laurel which he had planted—a sight new to the Macedonians, since they had left their native land. Alexander, Arrian observes, was gratified by their story, and wished it to be believed that he was then treading in the steps of Dionysus; for he hoped that the Macedonians, roused by emulation, would be the more willing to bear the fatigues of the expedition in which he purposed to pass the utmost distance that had been reached by the divine conqueror. If we may depend on this observation, it would prove that he had not yet thought of any limit to his own progress, within the farthest bounds of the eastern world.

It cannot have been later than March 326 when he crossed the Indus, probably a little above its junction with the Cophen. He celebrated his arrival on the eastern bank by a solemn sacrifice, and soon after met Taxiles, who had come out, with his army and his elephants, to greet him, and conduct him to his capital, with professions of the most entire devotion. It seems to have been during his stay at Taxila, that Alexander was first enabled to gratify his curiosity concerning the doctrines and practices of the Indian ascetics. He had already witnessed something similar at Corinth, where he found Diogenes living in habits of simplicity not unworthy of the Eastern gymnosophists—as the Greeks called the sages who exposed themselves almost naked to the inclemency of the Indian sky. He is reported to have said that, had he not been Alexander, he would have been Diogenes. The independence of a man who had nothing to ask of his royal visitor but that he would not stand between him and the sun, struck him as only less desirable than the conquest of the world; and he conceived a like admiration for the Indian quietists, who manifested a kindred spirit. He was desirous of carrying away with him some of the Indian sophists as companions of Anaxarchus.

After solemn sacrifices and games, Alexander resumed his march. He was informed that Porus had collected his forces on the left bank of the Hydaspes, to defend the passage; and he therefore sent Cœnus back to the Indus, with orders to have the vessels in which the army had crossed sawed each into two or three pieces, and transported to the Hydaspes. He left all his invalids at Taxila, and strengthened his army with five thousand Indians, who were commanded by Taxiles in person. Having arrived on the right bank of the Hydaspes, he beheld the whole army of Porus, with between two hundred and three hundred elephants, drawn up on the other side.

To distract the attention of Porus, he divided his army into several columns, with which he made frequent excursions in various directions, as if uncertain where he should attempt a passage.

THE WAR WITH PORUS

At the distance of a day's march above the camp, at a bend of the river towards the west, where the projecting right bank was covered with wood, an island, also thickly wooded, parted the stream. This was the spot which Alexander fixed upon for his attempt. He ordered the vessels brought in pieces from the Indus to be carried to it—the shelter of the wood enabled the workmen to put them together again unobserved. Skins also were provided to be stuffed with straw. Night after night he sallied forth with his cavalry, as noisily as possible, and pushed up or down the river, as if to attempt a passage. Porus at first drew out his elephants, and moved towards the quarter from which the clamour proceeded. But when the feint had been often repeated, he ceased to attend to it, and did not stir his elephants for any noise that he might hear on the other side.

Alexander himself set out with the flower of his Macedonian cavalry, and the Bactrian, Sogdian, and Scythian auxiliaries, in all about five thousand, and a select division of heavy and light infantry, which included the hypaspists and the brigades of Clitus and Cœnus. He directed his march at a sufficient distance from the river to be concealed from the enemy's view, and about sunset arrived over against the island. During the night a violent fall of rain, accompanied by a terrible thunderstorm, a little impeded the labours of the men; but the noise also served to drown the clatter of the axes and hammers, and all the din of preparation, which might otherwise have reached the post on the opposite bank.

With the return of light the rain had ceased, and the storm was hushed: and the troops were immediately embarked. The king himself, with Ptolemy, Perdiceas, Lysimachus, and Seleucus, the founder of the Syrian dynasty, went on board a small galley, with a part of the hypaspists. The woody island concealed their movements, until, having passed it, they were within a short distance of the left bank. Then first they were perceived by the Indians stationed there; who immediately rode off at full speed to carry the tidings. Porus was not of a spirit to be so easily overpowered. His first thought, when he received the intelligence, was that there might still be time to come up with the enemy, before they had completed their landing; and he immediately sent one of his sons, with two thousand cavalry, and 120 chariots, towards the place. Alexander charged with all his cavalry. The Indians scarcely waited for the shock of this greatly superior force. Four hundred of them were slain, and among them the prince himself.

Even this disaster did not bow the courage of Porus; leaving a part of his elephants to check Craterus, he advanced to the decisive conflict, with two hundred of them, the whole of his cavalry (about four thousand), three hundred chariots, and the bulk of his thirty thousand men.

Alexander, when he came in sight of the enemy, made his cavalry halt, to allow time for the infantry to come up, and recover breath, after their long and quick march, while he himself, observing the disposition of the hostile army, decided on his plan of attack. He posted himself, as usual, in the right wing, with the main body of the cavalry; but stationed Cœnus, with two squadrons, on the left. With his wonted sagacity he anticipated that



SURRENDER OF PORUS

[326 B.C.]

an attack on the enemy's left wing would draw out the cavalry on the right to protect it; and he ordered Cœnus in this case to fall on their rear. The horse-bowmen were first ordered to advance, and threw the enemy into some disorder by a shower of arrows. Alexander then led up the rest of his cavalry to the charge. The Indian cavalry of the right wing was brought up to the relief of their left, and was at the same time taken in the rear by Cœnus, and charged by Alexander in front. The whole body, in disorder, sought

shelter in the line of the elephants, and the Macedonian phalanx then advanced to take advantage of the confusion, and to support their cavalry. Yet the shock of the huge animals, as long as they were under control, made havoc even in the ranks of the phalanx, and afforded time for the Indian cavalry to rally. But when they were driven in by a second charge of the Macedonian horse, and the engagement was crowded within a nar-

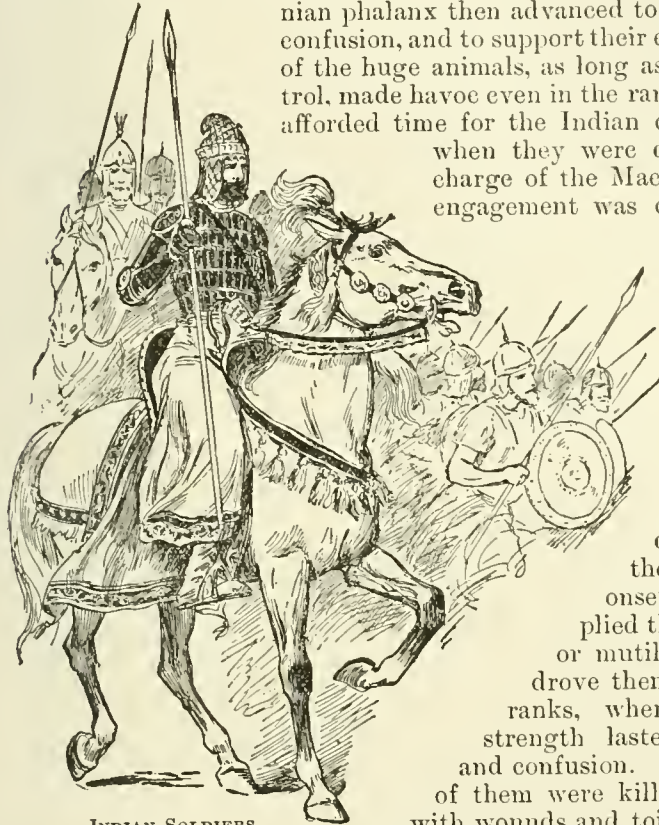

INDIAN SOLDIERS

rower space, the elephants, pressed on all sides, began to grow unmanageable; many lost their drivers, and, maddened by wounds, turned their fury indiscriminately against friend and foe. The phalanx then opened a large space for them and eluded their onset, while the light troops plied them with their missiles, or mutilated their trunks, and drove them back upon their own ranks, where, as long as their strength lasted, they spread havoc and confusion. At length, when many of them were killed, and the rest, spent with wounds and toil, ceased to be formidable, Alexander ordered another general charge

of horse and foot; and the Indians, routed at all points, betook themselves to flight. By this time Craterus, and the divisions on the right bank, had effected their passage; and engaging in the pursuit with all the vigour of fresh troops, made dreadful slaughter among the fugitives.

The number of the slain on the side of the Indians amounted, according to the more moderate account in Diodorus, to about twelve thousand. Among them were two other sons of Porus, and the greater part of his principal officers. Nine thousand prisoners were taken, and eighty elephants. The loss of the Macedonians is estimated, as usual, at only a few hundreds.

Porus himself, mounted on an elephant, had both directed the movements of his forces, and gallantly taken part in the action. He had received a wound in his shoulder — his body was protected by a corselet of curious workmanship, which was proof against all missiles — yet, unlike Darius, as long

as any of his troops kept their ground he would not retire from the field. When, however, he saw all dispersed, he too turned his elephant for flight. He was a conspicuous object, and easily overtaken. All he would ask of Alexander, was to be treated as a king; and when Alexander observed that this was no more than a king must do for his own sake, and bade him make some request for himself, his reply was still that all was included in this. His expectations could scarcely have equalled the conqueror's munificence. He was not only reinstated in his royal dignity, but received a large addition of territory. Yet it was certainly not pure magnanimity, or admiration for his character, that determined Alexander to this proceeding. He was conscious that his forces were not sufficient to enable him to displace the native princes east of the Indus, and to annex their territories, in the form of a satrapy, to his empire. Hence the generosity he had shown to Taxiles. But Taxiles himself might have become formidable without a rival; and the only way to secure the Macedonian ascendancy in the Punjab, was to trim the balance of power.

Alexander, after he had buried his slain, and solemnised his victory with his usual magnificence, allowed the main body of his army a month's rest, perhaps in the capital of Porus. The continuance of the rains was probably the chief motive for this delay. But before he quitted the scene of his triumph, he founded two cities near the Hydaspes — one, which he named Nicæa, near the field of battle, the other near the place where he had crossed the river; this he named Bucephala, after his gallant steed, which had sunk either under fatigue or wounds in the hour of victory.

THE EASTERN LIMIT

Before he resumed his march eastward, Alexander ordered a great quantity of ship timber to be felled in the forests on the upper course of the Hydaspes, which abound in fir and cedar, and floated down the stream to his new cities, and a fleet to be built for the navigation of the Indus. Alexander, on his march up the river Hydraotes, received or extorted the submission of some other smaller tribes. As he approached Sangala, he found the Cathæans strongly entrenched on an insulated hill near the city, behind a triple barrier of wagons. A bloody carnage ensued; for the besieged made a vigorous resistance, and more than twelve hundred of the besiegers, including several general officers, were wounded. In revenge seventeen thousand of the barbarians were massacred; seventy thousand were made prisoners. Alexander then continued his march towards the southeast and arrived on the banks of the Hyphasis, or rather of the stream formed by the junction of the Hyphasis (Bias) with the Hesidrus (Sutlej).

Here he had at length reached the fated term of his progress towards the east. Alexander had, no doubt, long been undeceived as to the narrow limits which, according to the geography of his day, he had at first assigned to India, and to the eastern side of the earth. The ocean, which he had once imagined to be separated by no very vast tract from the banks of the Indus, had receded, as he advanced, to an immeasurable distance. He had discovered that, beyond the Hyphasis, a desert more extensive than any he had yet crossed parted the plains of the Five Streams from the region watered by the tributaries of the Ganges, a river mightier than the Indus: that the country east of the Ganges was the seat of a great monarchy, far more powerful than that of Porus, the land of the Gangarides and Prasians,

[326 B.C.]

whose king could bring into the field two hundred thousand foot, twenty thousand horse, and several thousands of elephants. That this information rather served to inflame Alexander's curiosity and ambition than to deter him, could scarcely be doubted by any one who has fully entered into his character, even if it had not been expressly stated by the ancients.

But the accounts which kindled his ardour, plunged the Macedonians into sullen dejection, which at length broke out into open murmurs. It is possible that, if they had seen any distinct and certain goal before them, they would not have shrunk from the dangers and difficulties of a last enterprise, however arduous. But to set out from a region which had once appeared to them as the verge of the habitable world on a new series of conquests, to which they could foresee no termination, was enough to appal the most adventurous spirits.¹ Their thoughts began to revert with uncontrollable force to their homes in the distant west, as they had reason to fear that they were on the point of being torn from them forever. For even of those who might escape the manifold dangers of a fresh campaign, how many might be doomed to sit down as colonists, and to spend the rest of their lives in that strange land! India was a still more hopeless place of exile than Bactria and Sogdiana, where the Greeks, who had been planted by violence, were only detained by terror. The wish to return became universal, and was soon transformed into a firm resolution not to proceed.

It is difficult to guess how far the arguments by which Alexander endeavoured to overcome the repugnance of his troops, and to animate them with his own spirit, resembled any of those which are attributed to him by Arrian and Curtius. The threat which Curtius puts into his mouth, that, if the Macedonians would not follow him, he would throw himself on his Bactrian and Scythian auxiliaries and make the expedition with them alone, most likely misrepresents the tone which he assumed. But it may easily be supposed that he expressed his wishes, and urged the army to compliance, with passionate eloquence. Not only, however, the feelings of the troops, but the judgment of his officers was adverse to the proposed enterprise; and Cœnus, in a speech which has either been better written or more faithfully reported than the king's, exhorted him to abandon his design. Alexander retired to his tent in displeasure.

The next day he again assembled the army, and made another attempt to overpower their reluctance, declaring that he would force no Macedonian to accompany him; he was sure that there would be volunteers enough among them for his purpose; the rest might return home and say that they had left their king in the midst of his enemies. But even this appeal produced no effect. For three days he kept within his tent, where not even his chief officers were admitted to his presence, waiting for a change in the disposition of the men. But the stillness which prevailed in the camp convinced him, more strongly than words could have done, that their determination was fixed. He then felt that it was time to yield — not perhaps without some pride in the reflection that there was not a man in the army who was capable of his own contempt for difficulties and dangers. He had however gone too far, it seems, to recede without some other pretext. The sacrifices easily supplied one. When they were found unpropitious to the passage of the river, he called his council and declared his resolution to retreat.

It was received with tears of joy and grateful shouts by the army. Before he quitted the Hyphasis, he ordered twelve colossal altars to be built

[¹ "Their very horses' hoofs were worn away by their continual marches," says Diodorus *d* xvii.]

on its banks, and dedicated to the gods who had led him thus far victorious; then, after a solemn sacrifice and games, he began to retrace his steps. On the Acesines he found the city, which Hephæstion had been ordered to build, ready to receive a colony; and there he left the disabled mercenaries, and as many natives of the neighbouring districts, as were willing to settle there.

The fleet on the Hydaspes was now nearly ready, but the two new cities had suffered so much from the rains that the army was for some time employed in restoring them. In the meanwhile, Alexander made his final arrangement of the affairs of the northern Punjab, by which Porus gained a fresh addition of territory, so that his dominions included, it is said, seven nations and above two thousand cities, with, it seems, a title which established his superiority over all the chiefs east of the Indus.

THE MARCH TO THE WEST

The fleet, which was probably for the most part collected from the natives, numbered, according to Ptolemy, nearly two thousand vessels of various kinds, including eighty galleys of war. The command of the whole fleet was entrusted to Nearchus. Alexander divided his forces into four corps. The main body, with about two hundred elephants, was to advance along the eastern bank under the command of Hephæstion. Craterus was to lead a smaller division of infantry and cavalry on the opposite side of the river. Philippus, with the troops of his satrapy, was ordered to take a circuitous route towards the point where the two other generals were to wait for the fleet, in which the king himself was to embark with the hypaspists, the bowmen, and a division of his horseguard — in all, eight thousand men. On the morning of the embarkation, Alexander himself, under the direction of his soothsayers, offered the libations and prayers which were deemed fittest to propitiate the powers of the Indian streams, Hydaspes and the impetuous Acesines, which was soon to join it, and the mighty Indus, which was afterwards to receive their united waters. Among the gods of the west, Hercules and Ammon were invoked with especial devotion; then, at the sound of the trumpet, the fleet began to drop down the river.

It was a spectacle such as the bosom of the Hydaspes had never before witnessed, nor has it since. Its high banks were crowded with the natives, who flocked from all quarters with eager curiosity to gaze, and accompanied the armament in its progress to some distance before they could be satiated with the sight of the stately galleys, the horses, the men, the mighty mass of vessels gliding down in unbroken order; and as the adjacent woods rang with the signals of the boatswains, the measured shouts of the rowers, and the plash of numberless oars, keeping time with perfect exactness, the Indians too testified their delight in strains of their national music.

Alexander, as he proceeded, landed his troops wherever he found a display of force necessary to extort submission from the neighbouring tribes, though it was with reluctance that he spent any time in these incursions; he was anxious, as soon as possible, to reach the frontiers of the Malli, a warlike race, from whom he expected a vigorous resistance, and whom he therefore wished to surprise before they had completed their preparations and had been joined by their allies, particularly their southern neighbours the Oxydracæ or Sudracæ. In five days he arrived at the second place of rendezvous, the confluence of the Hydaspes and the Acesines. His Indian pilots had warned him of the danger which the fleet would have to encounter

[326-325 B.C.]

at this point; yet it did not escape. The united rivers were at that time pent into a narrow space, where their conflicting waters roared and chafed in eddies and waves. Several of the long galleys lost a great part of their oars, and were much shattered; two were dashed against each other, and entirely wrecked, and many of the crews perished. According to some accounts, Alexander himself at one time thought his own galley so much in danger, that he was on the point of jumping overboard. As the stream widened, and spent its violence, a headland on the right bank afforded shelter to the fleet.

While it was undergoing the necessary repairs, Alexander made an expedition inland against the Sibas, or Sivaites, so called undoubtedly from the Indian deity, who was the chief object of their worship. On his return to the fleet, he was rejoined by his three generals, and immediately made his dispositions for the subjugation of the Malli.

There can be little doubt that the name of this people has been preserved in that of the modern city of Multan. The united forces of the Malli and the Sudracæ are estimated in the accounts of Diodorus and Curtius, on the most moderate calculation, at eighty thousand foot, ten thousand horse, and seven hundred chariots; and from the manner in which they are coupled together, we are led to presume that in this respect there was no inequality between them. But the two races were composed of widely different elements: for the name of the one appears to have been derived from that of the Sndra caste; and it is certain that the Brahmans were predominant in the other. As it was on the side of the desert that they might be expected to feel most secure, Alexander resolved to strike across it himself with one division of his army, into the heart of their country, while two other corps traversed it in other directions, to intercept the retreat of those whom he might drive before him.^b

It was with a wonderful ease and enthusiasm that Alexander and his troops captured citadel after citadel and routed horde after horde, slaying ruthlessly those who fought and those who fled. But it is not with equal ease and enthusiasm that the modern reader peruses a catalogue of victories so long as to grow monotonous. We therefore omit the accounts of the various successes of the Macedonians, and hasten to the picturesque climax before the chief Mallian city as told by Arrian.^a

THE BRAVE MALLIANS

When the defendants were unable to endure the violence of his assault they retired into the castle. Alexander with his forces, having burst open one of the gates of the city, entered, and took possession thereof, a long time before the rest. Perdicas and his party no sooner mounted the walls (for many of them had not yet recovered their ladders) than they perceived the city taken, because the walls were left defenceless.

However, the besieged, entering the castle, and being resolutely bent to hold it, some of the Macedonians endeavoured to undermine the walls, others to scale them, and accordingly busied themselves in fixing their ladders, wherever they could, with design to storm the place. But Alexander, not brooking their slow proceedings, snatched a ladder out of the hands of one of the soldiers, and applying it to the wall, immediately mounted, having guarded his body with his shield. Peucestas followed his steps, bearing the consecrated shield, which Alexander had taken from the temple of the Trojan

Pallas, and had ordered to be borne before him in all his battles; after him, Leonnatus ascended by the same ladder, and Abreas (one who received a double stipend, on account of former services) by another. And now Alexander, having gained the top of the battlements, and fixed his shield for defence, drove some of the defendants headlong down into the castle, and slew others with his sword, clearing the place where he stood.

But the royal targeteers being solicitous and endeavouring to ascend in too great numbers, broke the ladders, and thereby not only fell down themselves, but hindered others from mounting. Alexander, in the meantime, stood as a mark for all the Indians, who were in the adjacent towers, for none of them durst venture to come so near him as to fight hand to hand; and those within the castle also cast their darts at him, but at some distance (for the Indians had thrown up a rampart there within the wall, where they stood, and they easily perceived who he was, both by the brightness of his armour, and the greatness of his courage). However, he resolved, rather than to continue exposed in that station, where nothing was to be done worthy notice, to cast himself directly into the castle, imagining that such an action would strike a terror into the besieged, or at least it would add greatly to his glory, and if he died there, he should gain the admiration and applause of posterity; upon which he immediately leaped down into the castle, where, fixing himself against the wall, some of the enemy who rushed forwards upon him he slew with his sword, and among the rest, the Indian general. Others, as they advanced towards him, he smote with stones, and beat them back; but upon their second, and higher approach, he slew them also with his sword, so that the barbarians durst now no more attempt to come within his reach, but gathering about him, at some distance, threw their darts, and such other weapons, at him, as they had, or could find, from that station.

Peucestas, Abreas, and Leonnatus were the only three persons of the whole Macedonian army who mounted the castle wall before the ladders broke, and they leaped down on the inside and valiantly fought to save their king. Abreas was wounded in the face with an arrow, and fell down dead. Alexander's breastplate was pierced through with an arrow, whereby he received a wound in the breast, which Ptolemy says, was so dangerous that, by the vast effusion of blood, his life was despaired of: nevertheless, so long as he was hot, he retained his innate courage, and defended himself valiantly; but the blood streaming from him, and his spirits sinking, he was seized with a dizziness in his head, and a chillness throughout his limbs, whereupon he fell forward upon his shield. Peucestas then, with the sacred shield of Pallas, stood by the king, and protected him from the enemies' darts on the one side, as did Leonnatus on the other; but they were also sore wounded, and Alexander was very nigh losing his blood and life together.

The Macedonians without were in the utmost anxiety to decide how they should ascend the walls, and get to the inside of the castle, fearing lest their king, who had rashly exposed himself by scaling the walls, and leaping down among the enemy, should be in danger; and their ladders being broken, they used all their skill to contrive other ways to mount: whereupon some of them drove large iron pins into the wall (which was built with brick), and taking hold of those, hoisted themselves up with great difficulty; others mounted upon the shoulders of their companions, and so gained the top; however, he who ascended first leaped down on the other side, and saw the king lying prostrate; and afterward, others following, with dreadful

[325 B.C.]

shouts and lamentations, a sharp battle ensued, they endeavouring with all their might to save their king, by covering him with their shields. In the meanwhile, others having torn off the bars, and forced open a gate between two towers, made way for their companions to enter, and a part of the wall giving way to the violent shocks of some others, opened a new passage into the castle.

ALEXANDER'S SEVERE WOUND AND THE ARMY'S GRIEF

A mighty slaughter of the Indians then ensued, every individual found being cut off, and not so much as the women or children spared. The Macedonians then turned their thoughts on their king, whom they bore away upon his shield, not knowing whether he would die or live. Some authors relate that Critodemus, a physician of Cos, laid open his wound and drew out the arrow; others, that Perdicas performed that task, no physician being present and the case urgent: for Alexander commanded that the wound should be opened, though with a sword, and the dart drawn out of his body. However, he lost abundance of blood in the operation, and again fainted away.

While the king lay there, to wait for the healing of his wound, news was carried to the camp, from whence he set out on that expedition, that he was dead; upon which a sudden cry run throughout the camp, as the report spread from one to another: and when they came a little to themselves, and began to set bounds to their grief, they were strangely perplexed, and in great doubt, who should be chosen to head the army (for many seemed to have equal pretence to that dignity, by their merit, not only in Alexander's opinion, but also in that of the Macedonians), and how they should be led safe into their own country, being surrounded with so many fierce and warlike nations; some whereof, whom they had not yet visited, would, in all probability, fight stoutly for their liberty, and others, whom they had, would revolt, when they were freed from the fear of Alexander. Besides, when they begun to consider how many vast rivers were between them and their country, which they were in no ways able to pass over, they were almost driven to despair; and indeed everything seemed terrible to them, when they wanted their king: and even when the former accounts were contradicted, and news came of his being still alive, the messenger could hardly find credit, for they had before heard that there were but small hopes of his life — nay, when letters arrived signifying that he would return to the camp in a short while, the news seemed incredible to many, for they supposed that the letters had been no more than a contrivance of his bodyguards and the generals of his army.



AN INDIAN PRINCE, TIME OF ALEXANDER

When Alexander came to the knowledge of this, he began to fear that an insurrection might happen, for which reason, as soon as his health would admit, he ordered himself to be conveyed to the banks of the river Hydraotes, and from thence, down the stream, to the camp, which was nigh the confluence of the Hydraotes and Acesines, where Hephaestion had the command of the army, and Nearchus of the navy. When the ship, which had the king on board, approached in view of the camp, he ordered the cover of his royal pavilion to be hoisted upon the poop thereof, to be seen by the whole army. But neither yet did many believe him to be alive, thinking the ship was bringing his dead body, until at last he drew near the shore, and stretched out his right hand to the multitude.

Then a loud shout was raised for joy, some holding up their hands to heaven, others to their king; and many, who despaired of his life, melting into tears, by such a sudden and unexpected joy. And when, upon his coming on shore, they brought the bed or litter, whereon he had been carried before, he refused it, and ordered his horse to be made ready, which having mounted, he again received the joyful acclamations of the whole army; the banks and neighbouring woods, echoing with the sound. When he approached his tent, he leaped from his horse, and showed himself also to his army on foot, to give them the greater certainty of his health. Then arose a general emulation among them, and they strove which should approach nighest to him, and some were ambitious to touch his hands, others, his knees, others aspired no nigher than his garment; and some were even satisfied with the sight of him, and with wishing him health and happiness; some brought garlands, and others, flowers such as the country produced to strew in his way; and when some of his friends reproved him for exposing himself to such dangers for the army, and told him, it was not the business of a general, but of a common soldier, Nearchus tells us he took their reproofs ill, and the reason why he was offended at the liberty they used, seems to be, because their reproofs were just, and he was conscious he deserved them. However, his fortitude in battle, and his thirst after glory, hurried him so far, that he could not contain himself, nor keep out of the midst of danger.^e

While Alexander was convalescent from his grievous wound, such of the Malli and Sudraee as remained alive sent ambassadors and made submission with what tattered pride they could muster. They were banqueted and then attached to the satrapy of Philippus, and a thousand of their best troops required to follow Alexander down the river. At the juncture of the Acesines with the Indus he bade Philippus build a city. His father-in-law Oxyartes, bringing news of the misconduct of Tyriaspes the satrap of Paropamisus, was given the satrapy for his own. Craterus was sent westward into Carmania with the bulk of the land-forces. The opulent principedom of Musicanus submitted gracefully, but later revolted, and Musicanus was hanged upon a cross as an example. The prince of Pattala surrendered without struggle and Alexander sailed on to the ocean. Here the Macedonians first saw a real oceanic tide, and many of their vessels, after being stranded, were later shattered by the swift reflux of that coast, till the frightened troops as Quintus Curtius says "neither dared trust themselves on the land, nor remain on board," and there followed the usual result of panic, for as old John Digby in 1747 quaintly translated Curtius "in all tumultuary assemblies, haste is of pernicious consequence."

Nearchus, the admiral, was now left to conduct the fleet from the Indus to the Tigris by way of the Persian Gulf, a marvellous feat of seafaring in

[325 B.C.]

that early day. Alexander about August moved westward by land, soon striking the desert of Gedrosia, where the horrors of the march deserve fuller description.^a

THE DESERT MARCH

He himself then marched forward to Pura, the capital city of the Gedrosi, where he arrived the sixtieth day, after his departure from the country of the Oritæ. Many of the writers of Alexander's life tell us that all the hardships which his army endured in his expedition through Asia were not to be compared with those they underwent in that march. And Nearchus assures us that though he could not possibly be ignorant of the difficulties they must struggle with in such a country, yet nevertheless he was resolved to go forwards.

He tells us the inhabitants informed him that no general was ever able to conduct an army safe through these deserts; that Semiramis entering them with great numbers of men in her flight from India, carried no more than twenty through out of her whole army: and that Cyrus, the son of Cambyses, who also attempted to invade India, but miscarried, lost the greatest part of his forces in those dangerous wastes, himself and seven of his followers only escaping; that these stories being told to Alexander were so far from damping his resolutions that he was thereupon the rather excited to attempt to conduct his army through these parts, where both Cyrus and Semiramis had failed of success, to show that no country was impassable to such soldiers, led on by such a general.

For these reasons, as also that he might be nigh the seacoast to provide necessaries for his fleet, he chose to return that way. However, the heats were so vehement and their want of water so much, that many of his men and most of their beasts of burden died—some by being smothered in the deep scorching sands, but the greatest part of thirst; for they found many little tumuli or hillocks of sand which they were obliged to ascend, and where no firm footing could be had, but they sank deep into it, as they would into clay or new-fallen snow; and their horses and mules were no less harassed and wearied out by the excessive heats and intolerable fatigues of such a march than the men. The great distance of their resting-places was one occasion of the army's hardship, for their want of water caused them oftentimes to continue their march much farther than otherwise they would. Then the length of the march, with the excessive heats and raging thirsts they endured, despatched many of them.

The soldiers then began to slay many beasts of burden for their own use; for when provisions failed they consulted together, and killed both horses and mules, and ate their flesh, and afterwards excused themselves, by pretending that they died of heat or thirst, and there was none who took the pains to inquire thoroughly into the affair: even Alexander himself, it is said, was not ignorant of it; but as their necessities pleaded in their behalf, he deemed it prudence rather to conceal his knowledge thereof, than to seem to authorise it, by suffering the guilty persons to escape punishment. And now, to such straits were they reduced, that neither the sick, nor those who were weary with travel, could be drawn any further, partly for want of beasts, and partly for want of carriages—which the soldiers themselves, because they could not easily drag them through the sands, broke in pieces. Many also broke their wagons, before they began this march, through fear that they should be forced to leave the shorter

and nearer path, and take that which was farther about, only because it was more convenient for carriages.

On this account, many were left behind — some by reason of sickness — some of heat and weariness, and others of thirst; and none took care, either to restore them to health again, or to help them forwards; for the army moved apace, and the whole was so much in danger that they were obliged to neglect the care of particular persons. If any chanced to fall asleep, by reason of the vast fatigues of a hard night's march, when they awaked, if they had strength they followed the army by the track of their footsteps, though few of them ever came up with it, the far greatest part sinking into the sands, like sailors into the ocean, and so perishing.

Another accident also happened, which equally affected man and beast; for the Gedrosian country, like the Indies, is subject to rains while the Etesian winds blow; but these rains fall not in the plains, but among the mountains, where the clouds, not reaching their tops, are, as it were, pent up by the winds and dissolved into showers. When the army therefore, encamped nigh a small brook, for the sake of the water, the same, about the second watch of the night (being swelled with sudden rains, which none of them perceived), poured down such a dreadful inundation, that many women and children, who followed the camp, with the royal furniture, and the baggage mules, which were left alive, were swept away. Nay, so furious was the deluge, that the soldiers were hardly able to save themselves, many of them losing their arms, and some few their lives; many also, who had long endured the utmost extremities of heat and thirst, finding plenty of water, at their first coming here, drank to excess, and died. And hence it was, that Alexander would never, after that time, suffer them to encamp near a torrent, but at the distance of twenty furlongs, at least, to hinder his men from rushing too violently forwards, and drinking too large draughts, to their own destruction; he also took care, that those who came first should not run into the water with their feet, and thereby render it unwholesome to the rest of the army.

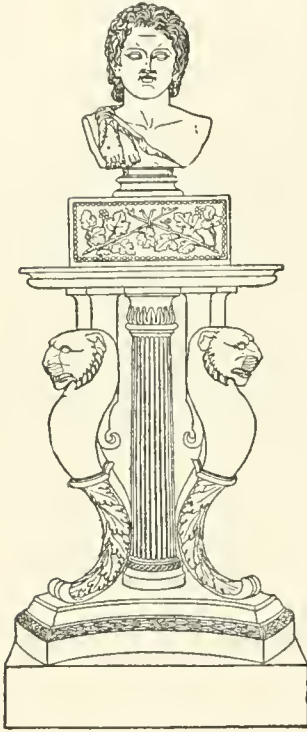

GREEK TRIPOD AND BUST

While the army laboured under the most dreadful inconveniences of heat and thirst in this desert, Alexander performed one gallant act, which we can by no means pass over in silence, though some authors affirm it was not done here, but in the desert of Paropamisus. As the forces continued their march through these sands, which reflected the burning rays of the sun upon them, it was necessary that they should send out parties daily to seek for water; the king, though ready to faint away with thirst, marched on foot, at the head of his troops, that his officers and soldiers (as is usual in such cases) might the more patiently endure those hardships which their general shared in common with them. In the meanwhile, some light-armed soldiers, who were despatched to search for water, found a small quantity, not far from the army, in the channel of a brook, almost dried up, but it was very muddy; however, they

[325 B.C.]

drew it up, and bringing it in a shield, presented it to the king, as a choice gift.

He received it, and returning due thanks to those who brought it, poured it immediately upon the ground, in presence of the army. This action of his encouraged the soldiers, as much as if every man had drunk a share of that water which he refused to taste; and his extraordinary self-denial is no less praiseworthy, than the noble example he showed of a wise and consummate general.

Another accident happened here, which, if it had not been speedily remedied, might have occasioned the loss of the whole army; for the sands being moved to and fro, by the winds, and all the surface reduced to a level, their guides themselves were at a loss how to conduct the army any further: for no sign of any track appeared to point out the path; nor was there so much as a tree, nor a shrub, nor any certain hillock, to be seen to direct them. Besides, they were unacquainted with the manner of observing the motions of the sun by day, and the stars by night, to regulate their march, as mariners at sea to their course by the two Bears, the Phœnicians by the Lesser, but most other nations by the Greater. In this difficulty, Alexander was forced to proceed as chance directed him. However, he ordered his army to turn to the left, and himself, with a few choice horse, went before to point out the road; but their horses, quite spent with heat, were most of them left behind — insomuch, that only he, with five of his followers, passed through the sands, to the seashore, safe on horseback. However, on their arrival there, they dug nigh the coast, and found plenty of water, sweet, and clear; whereupon he ordered the army thither, and, after that travelled seven days along the seacoast, and always found plenty of water. Then, his guides assuring him they knew the way again, they left the sea, and led the army into the inland parts again.^e

EXCESSES AND CRUELTIES DESCRIBED BY CURTIUS

By these means the army came at last upon the frontiers of the Gedrosians, whose territory was very fruitful. Here he stayed some time to refresh his harassed troops; in the interim he received letters from Leonnatus, importing “that he had fought and overcome eight thousand foot, and five hundred horse of the Oritæ.” Craterus likewise sent him advice “that he had seized and put into custody Ozines and Zariaspes, two noblemen of Persia, who were contriving a rebellion.” The king afterwards appointed Siburtius governor of that province, in the room of Memnon, who was lately dead, and then marched into Carmania. Aspastes had the government of this nation, and was suspected to aim at innovations during the king’s abode in India; but as he came to meet the king, his majesty thought fit to dissemble his resentment, and kept him in the same station till he could get a clearer information of the crimes he was accused of.

The governor of India having sent him by this time (according to his orders) a great number of horses and draught cattle out of the respective countries subject to his empire, he remounted, and gave fresh equipages to those who wanted. He also restored their arms to their former splendour, for they were not now far from Persia, which was not only in a profound peace, but vastly rich.

As therefore he not only rivalled the glory Bacchus had gained by the conquest of these countries, but also his fame, he resolved (his mind being

elevated above mortal grandeur) to imitate him in his manner of triumph, though it be uncertain whether it was at first intended by Bacchus as a triumph, or only the sport and pastime of the drunken crew. Hereupon he caused all the streets through which he was to pass to be strewn with flowers and garlands, and large vessels and cups filled with wine to be placed before the doors of the houses. Then he ordered wagons to be made of a sufficient largeness to contain a great many, which were adorned like tents, some with white coverings, and some with precious furniture.

The king's friends and the royal band went first, wearing on their heads chaplets made of variety of flowers, in some places the flutes and hautboys were heard, in others the harmonious sound of the harp and lute; all the army followed, eating and drinking after a dissolute manner, everyone setting off his wagon according to his ability, their arms (which were extraordinarily fine) hanging round about the same. The king, with the companions of his debauchery, was carried in a magnificent chariot laden with gold cups, and other large vessels of the same metal. After this manner did this army of bacchanals march for seven days together, a noble as well as certain prey to those they had conquered, if they had had but courage enough to fall upon them in this drunken condition: nay, it had been an easy matter for a thousand men (provided they were but sober) to have made themselves masters of this riotous army, in the midst of its triumph, as it lay plunged in the surfeits and excesses of a seven days' debauch; but fortune, that sets the price and credit of things, turned this military scandal into glory. The then present age and posterity since have with reason admired, how they could, in that drunken condition, with safety pass through nations hardly yet sufficiently subdued; but the barbarians interpreted the rankest temerity imaginable for a well-grounded assurance. However, all this pomp and splendour had the executioner at its heels, for the satrap Aspastes, of whom we before made mention, was ordered to be put to death. Thus we see that luxury is no obstacle to cruelty, nor cruelty to luxury.

About this time Cleander and Sitalces, with Agathon and Heracon (who had killed Parmenion by the king's orders), came to him, having with them five thousand foot and one thousand horse; but they were followed by their accusers out of the respective provinces of which they had had the prefecture; and indeed it was impossible for them to atone for so many enormous crimes which they had committed, though they had been instruments in an execution altogether grateful to the king; for they were not contented to pillage the public, but even plundered the temples, and left the virgins and chief matrons to bewail the violation of their honour. In fine, by their avarice and lust, they had rendered the very name of the Macedonians odious to the barbarians; but Cleander's fury exceeded all the rest, for he was not contented to defile a noble virgin, but gave her afterwards to his slave for a concubine.

The major part of Alexander's friends did not so much regard the grievousness of the crimes that were now publicly laid to their charge, as the memory of Parmenion, who had been killed by their hands, which perhaps might secretly plead for them in the king's breast; and they were overjoyed to see those ministers of his anger experience the dire effects of it themselves, and "that no power that is injuriously acquired can be of long duration."

The king having heard their accusation, said "that their adversaries had forgot one thing, and the greatest of all their crimes, which was their despairing of his safety; for they would never have dared to be guilty of such villainies, if they had either hoped or believed he should have returned

[325 B.C.]

safe from India." He therefore committed them to custody, and ordered "six hundred soldiers who had been the instruments of their cruelty to be put to death." The same days also the authors of the Persian revolt (whom Craterus had brought along with him) were executed.^f

Still cruelty, in the most odious sense of the word, wanton injustice, was always foreign to his nature; nor have we any proof that his temper had become in other respects harsher, or less even, than before his Indian expedition.

THE RETURN OF NEARCHUS

In the meanwhile he was in painful uncertainty, and was giving way more and more to gloomy thoughts, as to the fate of Nearchus and the fleet. They were at length dispelled by tidings that Nearchus had landed on the coast of Carmania, within a few days' march of the camp. The bearer of the news was the governor of the maritime district in which the event had occurred. Some of the men belonging to the fleet, in an excursion up the country, had fallen in with one of Alexander's soldiers, and learned from him that the king was encamped only five days' march from the sea; by him Nearchus was brought to the governor, who hastened to the camp with the joyful tidings. Alexander sent party after party with means of conveyance for Nearchus. Some of his messengers proceeded but a short distance, and returned without intelligence. Others went further, but lost the road. He began to suspect that he had been deceived, and ordered the governor to be arrested. Meanwhile Nearchus had hauled up his vessels on shore, and had fortified a naval camp, where he left the greater part of his men, and set out, with Archias, his second in command, and five or six companions, to seek the king. On their way they met one of the parties which had been sent with horses and carriages in search of them. But so great was the change made in their appearance by the hardships of the voyage, that, even when they inquired the road to the camp, they were not recognised by their countrymen, until, on the suggestion of Archias, they made themselves known. Some now hastened to inform Alexander of their approach. When he heard of the smallness of their number, he concluded that the fleet was lost, and that they were the only survivors. But their arrival cleared up all mistakes, and diffused universal joy.

The details of the voyage would be foreign to our purpose. Nearchus had been forced to begin it, before the winds had become favourable, by the hostility of the Indians at Pattala; and though he waited four-and-twenty days on the Arabite coast, he afterwards lost three of his vessels in the adverse monsoon. On the coast of Oritis he met Leonnatus, who, after Alexander's departure, had been obliged to defend himself against the combined forces of the natives and their allies. He had gained a great victory with the loss of few men; the satrap Apollophanes was among the slain. From Leonnatus, according to the king's orders, Nearchus received a supply of corn sufficient for ten days, and exchanged some of his least active sailors for better men from the camp; but it does not appear that he lighted upon any of the magazines destined by Alexander for his use. After manifold hardships and perils, from the monsters of the deep, the barrenness of the coast, the hostility of the barbarians, and from the timidity and despondency of his own crews, he at length, with the aid of a Gedrosian pilot, reached the mouth of the Persian Gulf. When they came in sight of Arabia, Onesicritus — with what view is not perfectly clear — urged the admiral

to strike across, and steer to the south. Nearchus however prudently refused to deviate from the king's instructions, and finally landed near the mouth of the river Anamis (Ibrahim), not far to the east of the isle of Ormuz.^b

Now Alexander, having conceived vast designs, had resolved after he had conquered all the eastern coast, to pass out of Syria into Africa, being very much incensed against the Carthaginians, and from thence marching through the deserts of Numidia, to direct his course towards Cadiz; for it was generally reported that Hercules had there planted his pillars. From hence he proposed to march through Spain, which the Greeks call Iberia, from the river Iberus; and having passed the Alps to come to the coast of Italy, from whence it was but a short cut to Epirus. He therefore gave orders to his governors in Mesopotamia "to cut down timber in Mount Libanus, and convey it to Thapsacus, a town in Syria, where it was to be employed to build large vessels, which were afterwards to be conducted to Babylon. The kings of Cyprus were also commanded to supply them with copper, hemp and sails."

While he was doing these things he received letters from the kings Porus and Taxiles, to acquaint him with the death of Abisares by sickness, and that Philip his lieutenant was dead of his wounds; as also that the persons concerned in that action had been punished. Hereupon he substituted Eudæmon (who was commander of the Thracians) in the room of Philip, and gave Abisares' kingdom to his son. From thence he came to Pasargada, which is a city of Persia, and whose satrap's name was Orxines, who in nobility and riches far exceeded all the barbarians; he derived his pedigree from Cyrus, formerly king of Persia; his predecessors had left him a great deal of wealth, which he had very much increased by the long enjoyment of his authority. This nobleman came to meet the king, with all sorts of presents, as well for himself as for his friends; he had with him whole studs of horses ready broke, chariots adorned with gold and silver, rich furniture, jewels, gold plate to a great value, purple garments, and four thousand talents of coined silver. However, this excessive liberality proved the cause of his death; for having presented all the king's friends with gifts far beyond their expectation, he took no notice of Bagoas the eunuch, who had endeared Alexander to him by his abominable compliance; and being informed by some who wished him well, that he was very much in Alexander's favour, he made answer, "that he honoured the king's friends, but not his eunuchs, it not being the custom of the Persians." The eunuch was no sooner acquainted with this answer, than he employed all the power and interest he had so shamefully procured himself to ruin this innocent nobleman.

It happened that Alexander caused Cyrus' tomb to be opened, in order to pay his ashes the funeral rites; and whereas he believed it to be full of gold and silver, according to the general opinion of the Persians, there was nothing found in it but a rotten buckler, two Scythian bows and a scimitar. However, the king placed a crown of gold upon his coffin, and covered it with the cloak he used to wear himself, and seemed to wonder "that so great a prince, who abounded in riches, was not more sumptuously interred than if he had been a private person." Hereupon Bagoas, who stood next to the king, turning to him said: "What wonder is it to find the royal tombs empty, when the satrap's houses are not able to contain the treasures they have taken from thence? As for my own part, I must confess, I never saw this tomb before, but I remember I have heard Darius say that there were three thousand talents buried with Cyrus. From hence

[325-324 B.C.]

proceeds Orxines' liberality to you, that what he knew he could not keep with impunity might produce him your favour, when he presented you with it."

Having thus stirred up the king's anger, those whom Bagoas had entrusted with the same affair came in, so that he on one side, and the suborned witnesses on the other so possessed the king's ears, that Orxines found himself in chains before he had the least suspicion of his being accused. This vile eunuch was not satisfied with the death of this innocent prince, but had the impudence to strike him as he was going to be executed; whereupon Orxines looking at him said: "I had heard indeed, that formerly women reigned in Asia, but it is altogether new, that a eunuch should be a king." This was the end of the chiefest nobleman of Persia, who was not only innocent, but had likewise been profusely liberal to the king.¹ At that time Phradates was put to death, being suspected to aim at the regal dignity. "Now," says Curtius, "Alexander began to be too apt to give credit to false informations; from whence it is plain that prosperity is able to change the best nature, it being a rarity to find anyone sufficiently cautious against good fortune. Thus he who a little before could not find in his heart to condemn Lyncestes Alexander, though accused by two witnesses; and who had suffered several prisoners of a mean condition to be acquitted, even contrary to his own inclination, only because they seemed innocent to the rest, and had restored kingdoms to his conquered enemies, at last so degenerated from himself as even against his own sentiment to bestow kingdoms on some at the pleasure of an infamous catimite, and deprive others of their lives."



GREEK WINE JUG

Much about the same time he received letters from Cœnus concerning the transactions in Europe and Asia, whilst he was subduing India — *viz.*, that Zopirio his governor of Thrace, in his expedition against the Getae, had been surprised with a sudden storm, and perished therein with the whole army; and that Sceuthes being informed thereof had solicited the Odrysians his countrymen to revolt, whereby Thrace was almost lost, and Greece itself in danger; for Alexander having punished the insolence of some of the satraps (who during his wars in India, had exercised all manner of crimes in their respective provinces) had thereby terrified others, who being guilty of the same foul practices, expected to be rewarded after the same manner, and therefore took refuge with the mercenary troops, designing to make use of their hands in their defence, if they were called to execution; others, getting together what money they could, fled. The king being advised hereof, despatched letters to all the governors throughout Asia, whereby they were commanded upon sight to disband all the foreign troops within their respective provinces.

Harpalus was one of these offenders; Alexander had always a great confidence in him, because he had upon his account formerly been banished by Philip, and therefore when Mazæus died, he conferred upon him the satrapship of Babylon, and the guard of the treasures. This man having, by the extravagance of his crimes, lost all the confidence he had in the king's favour, took five thousand talents out of the treasury, and having hired six thousand mercenaries, returned into Europe. He had for a considerable time followed the bent of his lust and luxury, so that despairing of the

[¹ Arriane says, however, that Orxines was proved clearly guilty of defacing and plundering the tomb of Cyrus and of other acts of sacrilege.]

king's mercy, he began to look about for foreign means to secure himself against his anger; and as he had all along cultivated the friendship of the Athenians — whose power was no way contemptible, and whose authority he knew was very great with the other Greeks, as well as their private hatred to the Macedonians — he flattered those of his party that, as soon as the Athenians should be informed of his arrival, and behold the troops and treasure he brought with him, they would immediately join their arms and counsels to his; for he thought that by the means of wicked instruments whose avarice set everything to sale, he might by presents and bribes compass his ends with an ignorant and wavering people.

The king being informed of these things, was equally incensed against Harpalus and the Athenians, and immediately ordered a fleet to be got ready, resolving to repair immediately to Athens; but while he was taken up with these thoughts he received letters of advice that Harpalus had indeed entered Athens, and by large sums gained the chief citizens; notwithstanding which, in an assembly of the people, he had been commanded to leave the town, whereupon he retired to the Greek soldiers, who seized him, and that he was afterwards treacherously killed by a certain traveller.¹ Being pleased with this account, he laid aside his thoughts of passing into Europe; however, he ordered all the cities of Greece to receive their respective exiles, excepting such who had defiled their hands with the blood of their fellow-citizens.

The Greeks not daring to disobey his commands (although they looked upon them as a beginning of the subversion of their laws), not only recalled them, but also restored to them all their effects that were in being. The Athenians were the only people who on this occasion asserted both their own and the public liberty; for, looking upon it as an insupportable grievance (as not being used to monarchical government, but to their own laws and customs of their country), they forbade the exiles entering their territories, being resolved to suffer anything rather than grant admittance to those former dregs of their own town, and now the refuse of the places of their exile.^f

[¹ For a fuller account of the affairs of Harpalus and the exile decree, see Chapter LVIII.]



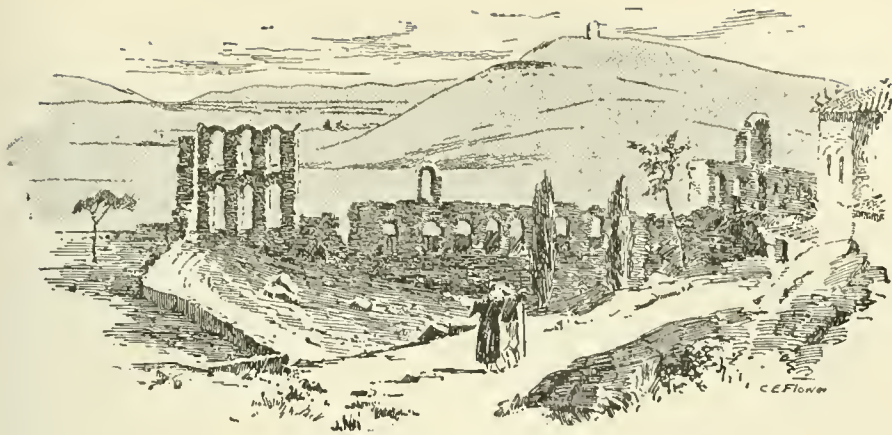

RUINS OF THE THEATRE OF ATTICUS, ATHENS

CHAPTER LVI. THE END OF ALEXANDER

HIS PROJECTS

ALEXANDER might now be said to have returned into the heart of his dominions; since the Indus, the Jaxartes, and the Nile, had become Macedonian rivers. It was a question at that time of great importance to the whole civilised world, what were the plans now floating in the imagination of the youthful conqueror, if not yet reduced to a settled purpose.

It was believed by many that he designed to circumnavigate Arabia to the head of the Red Sea, and afterwards Africa; then, entering the Mediterranean by the Pillars of Hercules, to spread the terror of his arms along its western shores, and finally to explore the northern extremity of the Lake Mæotis, and, if possible, discover a passage into the Caspian Sea. These reports were not altogether without a visible foundation. They seem to have arisen out of the simple fact that Alexander, on his return from India, prepared to equip a fleet on the Euphrates, and sent orders to Phœnicia for vessels to be built there and transported to Thapsacus; thence to fall down the river to Babylon, where a harbour was to be formed, capable of containing one thousand galleys of war.

That a great armament therefore was to be collected, for some operations which were to begin in the Persian Gulf, was sufficiently certain; and Alexander also gave proofs that his views were directed toward Arabia, for he sent three expeditions to survey its coasts: first, a vessel under the command of Archias, the companion of Nearchus, who, however, did not even venture to cross over to the Arabian side of the Persian Gulf, but stopped short at one of the islands. Androstenes, who was afterwards sent out with another vessel, did a little more — he sailed for a short distance along the coast. The boldest of the adventurers was a Cilician, named Hiero, who advanced much farther in the same direction; but his courage and perseverance were at length overcome by the vast range of the coast, which exceeded all his expectations, and on his return he reported that Arabia was nearly as large as India. Yet it would seem, from Arrian's account, that even he had not doubled the cape seen by Nearchus.

It can hardly be supposed that Alexander had resolved to attempt the conquest of Arabia, while he was conscious that he knew so little about the nature and extent of the country, especially as the information which he might obtain as to the interior cannot have been encouraging. But it is not the less probable that discovery and conquest in this quarter were the objects which, henceforth to his death, chiefly occupied his thoughts; for the spirit of discovery was here stimulated by a clear prospect of great advantages to be derived from a maritime communication between Egypt and India. To ascertain whether it was possible to open one, and to secure it, if not by conquests at least by colonies planted on the Arabian coast, was a design certainly suited to Alexander's genius, and worthy of his ambition; and this appears to have been the first destination of the new armament. On any other projects which he may have entertained, it would be still more idle to speculate.

For some time after his return, his attention was engrossed by different cares. From every side he continued to receive fresh complaints of the excesses committed by his satraps and other officers, during his absence, and fresh proofs that many of them aimed at establishing an independent authority. The indignation of the people was especially provoked by the spoliation of the sacred buildings. It is probable, that in almost every case such outrages on the national feelings proceeded from the reckless cupidity of the Macedonians, though the native governors may have abused their powers as grossly in other matters. Not unfrequently perhaps they had connived at the misconduct of the Macedonian officers under their command, we may suspect to have been the case with Orxines and Polymachus. So Abulites, the satrap of Susa, and his son Oxathres, were put to death, it is said, for neglect of duty — it would seem too hastily, for Alexander ran Oxathres through the body with his own sarissa; but it was the Macedonian Heracon who had plundered the temple at Susa. Such proceedings may have been the main cause of an insurrection which had broken out in Media, but was suppressed by the satrap Atropates, who brought its author, a Median named Baryaxes, and several of his partisans, to Pasargadæ, where they suffered death. Baryaxes had assumed the erect *cidaris*, and the title of king of the Medes and Persians, a step to which he was probably encouraged by the popular discontent which had been excited by the extortion and insolence of the strangers.

But such precautions as these were barely sufficient to maintain tranquillity for the present; much more was needed for the future. All that he had observed since his return appears to have strengthened his previous conviction that his empire, to be permanent, must be established on a new basis. And at Susa he began a series of measures, tending, in their remote consequences, to unite the conquerors with the conquered, so as to form a new people out of both, and, in their immediate effects, to raise a new force, independent alike of Macedonian and of Persian prejudices, and entirely subservient to his ends. The first of these measures was a great festival, in which he at the same time celebrated his own nuptials with Statira, the eldest daughter of Darius (who now, it seems, took the name of Arsinoe) and those of his principal officers with Persian and Median ladies of the noblest families. We find an intimation that some address was needed, before the preliminaries could be arranged; and this, from the known temper and views of the Macedonian generals we can easily believe. The king's example had no doubt the greatest weight in overcoming the aversion which they must have felt to such an alliance. The liberality with

[324 B.C.]

which he portioned their brides out of his treasure also had its effect; and their pride was flattered by the condescension with which he placed them on a level with himself in the ceremony.

THE MARRIAGE OF GREECE WITH PERSIA

Hephæstion received the hand of Drypetis, Statira's sister; it was Alexander's express wish that his friend's children should be related to his own. Craterus was wedded to Amastris, a niece of Darius; Perdicas to a daughter of the satrap Atropates; Ptolemy and Eumenes, to two daughters of Artabazus. For Nearchus, Alexander chose the daughter of Mentor by Barsine, a mark of distinguished favour, since he himself had admitted the mother to his bed, and already had a son by her, on whom he had bestowed the name of Heracles, and who afterwards became a competitor for the throne. To Seleucus he gave a daughter of the Bactrian chief Spitamenes. These are the only names recorded by Arrian, but the whole number of the officers who followed the king's example amounted to nearly a hundred. It was not less important for his object that above ten thousand of the private Macedonians had either already formed a connection, or were now induced to enter into one, with Asiatic women. To render it solemn and binding, a list was taken of their names, and a marriage portion was granted to each.

The wealth of Asia and the arts of Greece were combined to adorn the spectacle with a splendour and beauty worthy of the occasion. A gorgeous pavilion was erected, probably on a plain near the city, capable of containing not only the bridal party but the guests whom the king had invited to the banquet. It was supported by pillars sixty feet high, glittering with gold, silver, and precious stones, and was hung and spread with the richest tissues. Ninety-two chambers, magnificently furnished, were annexed to the building: and an outer court appears to have been enclosed by a partition, likewise hung with costly tapestry, for the reception of the ten thousand newly-married soldiers, each of whom received a golden vessel for his libation; and of the strangers who had been drawn by business or curiosity to the court. In the foreground without, tables were spread for the rest of the immense multitude. The nuptials were solemnised according to Persian usage. A separate seat was assigned to each pair: all were ranged in a semicircle, to the right and left of the royal throne. When the last libation had been announced by a flourish of trumpets to the multitude without, the brides entered the banquet hall, and took their places. The king first gave his hand to Statira, and saluted her as his consort; and his example was followed by the rest. This, it seems, completed the nuptial ceremony. The festivities lasted five days, which were filled up with a variety of entertainments; among the rest, musical and dramatic performances of Greek artists, and feats of Indian jugglers. Alexander's subjects from all parts of the empire vied with each other in the magnificence of their offerings to the king, and the value of the crowns which he received on this occasion is said to have amounted to fifteen thousand talents [£3,000,000 or \$15,000,000].

The nuptial festival was a concession gained from the Macedonians in favour of the ancient masters of Asia. Notwithstanding the king's liberality and condescension, murmurs were excited by the preference which had been given to the Persian ceremonial. Alexander now endeavoured to conciliate them by another act of royal munificence, and by the distribution of rewards

to those who had distinguished themselves in the late expeditions. He declared his intention to pay the debts of every Macedonian in the army; and directed that all who wished to share his bounty should give in their names to be registered. The offer was at first very coldly received, and awakened a suspicion, which indicated an unsound state of feeling, though it arose in part from a reproving conscience, and might also be considered as occasioned by the incredible amount of the proffered donative. It was generally believed that the king's object was chiefly to gain information as to the state of their private affairs, and, from the debts which they had contracted, to form a judgment which could not fail to be often unfavourable on the habits and character of each. Few therefore presented themselves to enter their names.

Alexander, as soon as he discovered the cause of this general backwardness, reproved them for their unworthy distrust, with the remark that it was no more fit that subjects should suspect their king of falsehood, than that he should practise it; and immediately ordered tables to be set in the camp, with heaps of gold, where each might receive the amount of his debts without registering his name. This generous confidence removed all doubts; men of all ranks flocked in with their claims, and the secrecy was felt as a greater favour than the relief.

The sum expended on this largess is said to have been no less than twenty thousand talents. Other rewards were conferred on a great number of persons in proportion to their rank and services. But the popularity which the king gained by these measures was soon to be subjected to a hard trial. For it was not long after that the satraps, who had the charge of the Asiatic youth, selected some years before to be taught the Greek language, and to be trained to war according to the Macedonian system, came to Susa, with a body of thirty thousand young soldiers formed in these schools, equipped and armed in the Macedonian fashion. Alexander himself was delighted with their fine persons and martial bearing, and with the manner in which they executed their manœuvres, and immediately proceeded to incorporate them with his army. The infantry, it seems, was for the present kept distinct from the Macedonian troops; but the cavalry, which was drawn from Bactria and Sogdiana, and other eastern provinces, was admitted into the same ranks with the flower of the Macedonian nobility. A fifth division of horse was formed to receive them; and, at the same time, several of the young Asiatic nobles were enrolled in the escort, a body hitherto selected from the first families of Macedonia.

These changes roused the jealousy and resentment of the old troops, in a much higher degree than any of the king's previous acts. His adoption of the dress and usages of the conquered people had displeased them, because it indicated a purpose which they disliked; the late alliances created perhaps still greater discontent, because they still more clearly and directly tended to the same point. But the new organisation of the army was more than a tendency — it was not a mere indication, but the first step in the execution of the purpose which had alarmed them; it was a beginning of destruction to all the privileges they most valued. Alexander, it was plain, wished to be considered only as their sovereign, no longer as their countryman.

The murmurs of the camp probably did not escape his notice, and may have induced him to set out the earlier from Susa, on a march which, by the new occupation it afforded, would perhaps make the army forget its supposed grievances. He therefore ordered Hephæstion to lead the main body down to the coast, while he himself embarked on board the fleet.^b

[324 B.C.]

THE MUTINY

When he arrived at Opis, he called his forces together, and issued a declaration, that "all of them, who by age, infirmity, or loss of limbs, found themselves unable to undergo the fatigues of war, should be freely discharged, and at full liberty to return home. But whoever were inclined to stay with him, should taste so largely of his royal bounty as to become the envy of those who tarried at home, and excite other Macedonians freely to share their toils and dangers with them."

This declaration was made by Alexander with a design to please the Macedonians, but it had a contrary effect; for they interpreting it as if they were despised, or deemed useless in any further warlike enterprise, were vehemently enraged, and took that discourse as levelled against them, which was designed for the army in general. Howbeit, upon this occasion, all their former complaints were renewed — namely, his compliance with the Persians in their habit; his allowing the Macedonian habit to be worn by youths who were barbarians, and styling them their successors; and his admission of strange horse into the auxiliary forces; wherefore they were no longer able to contain themselves, but all of them entreated to be absolved from their military oath. Nay, some proceeded so far as to insult him, by telling him that he and his father Ammon, might, for the future, join their forces and wage war against their enemies. Alexander no sooner heard these words (for he was now much more subject to wrath than heretofore) but leaping instantly from his seat where his captains surrounded him, he commanded the chief of those who endeavoured to excite the multitude to sedition, to be seized, and pointed with his hand to his targeteers, to show them whom they should seize. These were thirteen in number, all whom he commanded immediately to be put to death; whereat, while the rest stood amazed, and kept silence, he again mounted his tribunal, and spoke to this effect.

"Far be it from me, O my Macedonians, to endeavour to divert you from your desires of returning home (you having a free liberty to go whenever you think convenient), but I will, that you understand before your departure, how much you are changed from what once you were. And first to begin, as I ought, with my father Philip: he received you into his protection, a poor, wandering, and unsettled people; many of you clothed with skins, and feeding small flocks of sheep, upon the mountains, which yet you could not keep without continual skirmishes with the Illyrians, Triballi, and Thracians, your neighbours, in which you were often unsuccessful. For shepherds' coats of skins, my father arrayed you in the choicest garments; from the barren mountains, he led you down into the fruitful plains, and instructed you in military discipline, so that you had no more occasion to place your safety in rough and inaccessible mountains, but in your own valour.

"He gave you cities to dwell in, and excellent laws and statutes to be governed by. He gained you also the sovereignty over those barbarians who, aforesaid, continually harassed and insulted you, and from a state of slavery, made you free. He added a great part of Thrace to Macedonia, and by reducing the towns upon the seacoast, set open the gate to commerce. He it was that subdued the Thessalians, who were formerly so terrible to you, and made them your servants; and having overcome the Phocians, opened a wide and convenient entrance for you into Greece, instead of one narrow and difficult. The Athenians and Thebans, who had joined in confederacy against you, he so humbled (myself being present to assist him) that whereas we were, before that time, tributaries to the former, and slaves to the latter,

on the contrary, now, both these cities are under our protection. He entered Peloponnesus, and composing matters there, was constituted general of all the Grecian forces, in the intended expedition against the Persians, and thereby acquired, not only glory to himself, but also to the Macedonian name and nation.

“Those were my father’s bounties to you—great ones indeed, if considered by themselves, but small if compared with mine. For when I succeeded to my father’s kingdom I found some golden and silver cups indeed, but scarce sixty talents in his treasury, though I was charged with a debt of his, of five hundred. However, not discouraged by this, I contracted a fresh debt



THE DYING ALEXANDER
(From the bust in the Uffizi gallery)

of eight hundred talents. I marched out of Macedonia, which was scarce able to sustain you, and led you safe over the Hellespont, though the Persians then held the sovereignty of the sea. Then having beaten Darius’ generals in battle, I thereby added Ionia, Æolis, both Phrygias, and Lydia, to the Macedonian empire. I afterwards took Miletus by assault, and received the voluntary homage of many other people and nations, who submitted themselves, and consented to become tributaries. The treasures of Egypt and Cyrene, which we obtained without blows, helped to fill your coffers; Cœle-

Syria, Palestine, and Mesopotamia, are in your possession. Babylon, Bactria, and Susa, are in your power. The wealth of Lydia, the treasure of Persia, the riches of India, and the ocean, are yours. You are constituted deputies of provinces. You are made captains, princes, and generals of armies.

“What, I beseech you, have I reserved to myself, for all the toils I have undergone, except this purple robe and diadem? I have withheld nothing from you; neither can any mortal show a treasure in my custody, besides what is either yours or preserved for your use. I have no private desires to gratify, that I should hoard up wealth on that account, for I observe the same diet with yourselves, and am satisfied with the same portion of rest. Nay, I have been contented with coarser food than many among you, who live deliciously; and I have often watched for you, that you might sleep in ease and safety.

[324 B. C.]

“Some may, perhaps, insinuate that all these were acquired by your own toils and dangers, in which I, your general, bore no part; but who dares affirm that he has run greater hazards for me, than I have for him?”

“See, which of you has received wounds, let him open his bosom and show the scars, and I will show mine, for there is none of the forepart of my body free; nor is there any kind of weapon which is either thrust forwards by hand, or darted, the marks whereof are not plainly to be traced upon this breast of mine; for I have been wounded with swords in close fight, and with darts and arrows at a distance; besides, I have been beat to the ground with stones from the enemies’ engines; and notwithstanding I have suffered so much for your sakes, by stones, and clubs, and swords, and missive weapons, yet have I led you victorious through all lands, over all seas, rivers, hills, and plain countries. I solemnised your nuptials with my own, that your children might claim affinity with mine.

“The debts of my whole army I freely discharged, without examining too strictly how they were contracted; and notwithstanding the vast stipends you then received, you made no small advantage of the plunder of such cities as you took by storm. Add to this, that I bestowed crowns of gold on many of you, as eternal monuments of your valour, and my esteem for you; and whoever chanced to fall in battle, valiantly fighting, he, over and above the glory which he then acquired by death, was usually honoured with a sumptuous monument. Nay, brazen statues are erected, as testimonies of the valour of some of them in Macedonia, and honours decreed their parents, with a full immunity from all public taxes and impositions; for none of you, fighting under my banner, had ever any occasion to turn his back upon an enemy.

“And now I had determined to release such of you as are unable any longer to endure the fatigues of war, and send you home, so laden with honours and rewards that your countrymen and fellow citizens should deem you, above measure, fortunate and happy. But since ye are all one mind, and since the same notion of returning has possessed all of you, go all, and report at home that your king Alexander, who had subdued the Persians, Medes, Bactrians, and Sacæ; who had tamed the Uxii, Arachoti, and Drangæ; who had reduced the Parthians, Chorasmians, and Hyrcanians, and penetrated as far as the Caspian Sea; who had forced his way over Mount Caucasus, and through the Caspian Straits; who had passed the rivers Oxus, and Tanais, and Indus (which last was never passed before, unless by Bacchus); who had ferried over the rivers Hydaspes, Acesines, and Hydrates; and had also led you beyond the Hyphasis, if you had not refused to follow him; who entered the ocean by both the mouths of the river Indus, and afterwards, marching through the barren and sandy country of the Gedrosi (where none ever carried an army safe before) subdued the Carmanians and Oritæ; who lastly, having conveyed his fleet from the coasts of India, to the Persian Sea, brought you safe and victorious to Susa — tell your countrymen, I say, that after all these great and glorious acts, done for you, you have forsaken him, departed from him, and left him in the hands and under the care of the barbarians, whom he had conquered. When you shall have told all these things, your glory among men, and the notion of your piety towards the gods, will receive a mighty betterment.”

Having thus spoke, he leaped suddenly from his seat, and retiring into the palace, neither put on his royal robes, nor admitted any of his friends to see him that day, nor the next; and on the third having called the Persiau nobility round him, he distributed the command of the several troops among them, and as many of them as he had made his relations, he suffered to kiss

him. But the Macedonians, moved with their king's speech, stood before the tribunal, like people astonished, and kept a profound silence; nor did one of their number offer to accompany the king when he retired to his palace, except his friends and bodyguards, who surrounded him. However, many stood still before the tribunal, and refused to depart, though they neither knew what they should do, nor say, there.

But when they came to understand what he had bestowed upon the Medes and Persians — namely, the several commands of the army; and that the barbarians were distributed into several ranks and orders; that the Persian agema was to be called by a Macedonian name; and the troops of auxiliary foot, and others, to be made up of Persians; that the companions, and all the royal cohort of horse, were to consist of Persians; and that the regiment of Persians was to be nominated the royal regiment — they were no longer able to contain themselves, but running straight, in a body, to the palace, they laid down their arms before the gate, as a sign of submission and repentance: then standing without, they begged to be admitted into the king's presence, promising that they would deliver up the authors of the late tumult, and those who had stirred them to sedition; and withal protesting that they would never stir from his gate, day nor night, unless they could move him to take compassion upon them.

When Alexander came to understand this, he immediately came forth to them, and perceiving them humble and dejected, was so much moved with their sorrow and lamentation, that he wept, and stood some time, as though he would have spoke; but they remained in the same suppliant posture. However, at last, Callines, belonging to the auxiliary troop of horse, a man of much esteem, as well for his age as the command he bore, spoke to this effect:

“Thy Macedonians, O king, are grieved and discontented, because thou hast made some of the Persians thy relations, honoured them with the title of thy kindred, and sufferest them to kiss thee; when, at the same time, they are excluded.” Then Alexander interrupting him, replied, “I now make you all my kindred, and shall, henceforth, style you so.” With that Callines stepped forward and kissed him, and such others, as pleased, followed his example. Whereupon they again took up their arms, and with shouts of joy, and songs, returned to the camp. After this, he sacrificed to the gods, according to the custom of his country, and prepared a royal banquet, which he graced with his presence, where the Macedonians were placed nearest his person; next these the Persians, and then those of all other nations, according to their dignity, or the post they held in the army.

Then the king, and all his guests, drank out of the same cup; the Grecian augurs, as well as the Persian magi, pronouncing their decrees, wishing prosperity to the king and the army, and praying for eternal concord and unanimity between the Macedonians and Persians, for the common benefit of both nations. Nine thousand guests are said to have been present at this entertainment, who all drank out of the same cup, and all joined in the same songs, for the peace and safety of the army.

Then such of the Macedonians as were unable to follow the army, by reason of age, or loss of limbs, were freely discharged, to the number of about ten thousand, who were not only paid their full stipends, according to the time they had served, but each had a talent [£200 or \$1000] given him to defray the expenses of his journey. Those among them who had married Asiatic wives, and had children by them, were ordered to leave their sons

[324 B.C.]

behind, lest they should be the cause of a sedition in Macedonia, if both the sons and their mothers were sent together. However, he took care to instruct them in the Macedonian manners, and to teach them their military discipline, that so, when they arrived at manhood, he might bring them home, and deliver them, thus accomplished, to their parents.

These uncertain and precarious things he promised them at their departure; but he added one sure and undoubted mark of his good will towards them, by appointing Craterus (whom he found ever faithful to him, and whom he loved as his life) to be their captain, to conduct them safe into their own country; wherefore, wishing them all health and happiness, and weeping to behold them weep, he dismissed them, ordering Craterus, when he had finished his task of conducting them safe home, to take upon him the government of Macedonia, Thrace, and Thessaly, and preside over the liberties of Greece. He moreover ordered Antipater to come to him, and bring with him other Macedonians, young and vigorous, instead of those who were dismissed. He dispatched Polysperchon away with Craterus, and gave him the next command under him, for fear any accident should happen to Craterus by the way (he being somewhat indisposed at his setting forward) and they should be destitute of a leader.

It was said that Alexander, overcome with the calumnies wherewith his mother had loaded Antipater, was willing to remove him from Macedonia. But perhaps this call of Antipater was not designed for his disgrace; but rather to prevent any mischief arising from their quarrels, which he might not be able to compose. Many letters had been carried to the king, wherein Antipater accused Olympias of arrogance, cruelty, and meddling with what did not become the mother of Alexander; insomuch, that the king is said to have complained, that he was forced to pay her very dear for the ten months she carried him in her womb. Olympias, on the other hand, exclaimed against Antipater, as insolent, by reason of the command he bore, and the people's obedience to him; that he began to be altogether unmindful from whence he received his authority, and judged himself fit for the sovereignty over Macedonia, and all Greece, where he ought only to act as deputy.

Thus was the king continually wearied out with these complaints insomuch, that at last he began to incline to the opinion of those who were for disgracing Antipater, as one who was more to be feared than the other, if the report were just. However, he neither by word nor action, gave the least intimation that his affections were any way estranged.^c

THE LAST EXPEDITION

After the departure of Craterus, Alexander set out for Ecbatana. The state of the treasure, and the country, which had been so long in such hands as those of Cleander and Sitalces, demanded his attention. It was also a point where he might collect information, and concert measures, with regard to the regions which bounded his dominions on the north along the coasts of the Caspian Sea, concerning which his knowledge was hitherto very imperfect. But no doubt one of his main objects was to gratify the Medians by a residence of some months in their splendid capital, one of the proudest cities of the ancient world, where his Persian predecessors had been used to hold their court during a part of the year. Alexander's presence was everywhere felt as a blessing. In his progress through Media he viewed the pastures

celebrated — it seems, under the name of the Nisean plain — for the number and excellence of the horses bred in them. The number had amounted to 150,000; but, through a series of depredations, which mark the disordered state of the province, it had been reduced by nearly two-thirds. Here he was met by Atropates, the satrap of the northwest part of Media, who, it seems, entertained him with a masquerade of a hundred women, mounted, and equipped with hatchets and short bucklers, according to the popular notion of the Amazons. Such is Arrian's conjecture. The fact, whatever it may have been, gave rise to a story, that Alexander here received an embassy from the queen of the Amazons, and promised to pay her a visit. There were several other objects on this road to attract his attention in a leisurely march: a Bœotian colony planted by Xerxes, which still retained a partial use of the Greek language, and the garden and monuments of Baghistane, which tradition ascribed to Semiramis.

At Ecbatana, after he had despatched the most important business which awaited him there, he solemnised the autumnal festival of Dionysus with extraordinary magnificence. The city was crowded with strangers, who came to witness the spectacle; and three thousand artists are said to have been assembled from Greece, to bear a part in it. The satrap Atropates feasted the whole army; and the Macedonian officers seem to have vied with each other in courtly arts. They put proclamations into the mouths of the heralds, breathing, it is said, a strain of flattery, such as had scarcely been heard by the Persian kings. One of these, which was preserved as a specimen of insolent servility, but is more remarkable as an indication of Alexander's sentiments, was made by Gorgus, the master of the armoury, who presented him with a crown worth three thousand gold pieces, and undertook to furnish ten thousand complete suits of armour, and as many missiles of every sort proper for the attack of a town, whenever he should lay siege to Athens.

GRIEF FOR HEPHÆSTION

Among the theatrical exhibitions there was one which, through the singularity of the subject, has been in part preserved from the oblivion, in which the rest, with numberless better things, have been lost. It was a little drama of the satirical class, entitled *Agên*, the work, as was generally believed, of one Python, possibly the Byzantian, Philip's secretary; but there was also a singular report, that it was written by Alexander himself. If he did not even suggest the subject, or any of the scenes, the passages which have been preserved were certainly designed to gratify his feelings. They allude to the flight of Harpalus, who is mentioned both by his own name, and by a nickname significant of his most notorious vice; to the monument which he had erected at Babylon in honour of Pythonice, and to the largess of corn by which he had obtained the Athenian franchise. The wretched state of Athens, as if it needed such benefactions, is described in a tone of bitter sarcasm, which passes into that of earnest hostility, when one of the speakers observes, that the corn was Glycera's, but might perhaps prove a fatal pledge of friendship to those who had received it. There can be no doubt that in these words the poet meant to speak Alexander's mind.

But the festival was interrupted by an event, which Alexander felt as the greatest calamity of his life. Hephæstion had been attacked some days before by a fever, which at first did not show any alarming symptoms. Trusting to his youth and strong constitution, he had, it appears, neglected

[324 B.C.]

the directions of his physician, and by his imprudence so inflamed the disease, that it carried him suddenly off. It was a day which was to have been devoted to the gymnastic exercises of the boys. Alexander was witnessing a footrace, when a message was brought to him that Hephæstion was worse. He instantly hurried to his friend's bedside, but before he arrived Hephæstion had expired.

Alexander's grief, though not embittered by self-reproach, was passionate and violent, as that which he showed at the death of Clitus. There is no evidence that Hephæstion possessed any qualities that deserved the preference with which Alexander distinguished him: and indeed there are intimations that, even in Alexander's judgment, his chief merit was the devotion and obsequiousness with which he requited his master's partiality. Perhaps if the attachment had been more considerably formed, the loss would have been less keenly felt. After the first transports of anguish had subsided, Alexander sought consolation in the extravagant honours which he paid to his departed favourite, and in the vain semblance of grief, which he forced all persons and things around him to put on.

We may refuse, with Arrian, to believe that he was so barbarous and frantic, as to put the innocent physician to death, and to pull down the temple of Æsculapius, if there was one, at Ecbatana. But there is no reason why we should question Plutarch's statement, that he ordered the horses and mules to be shorn, and the town walls to be dismantled of their battlements.¹ These were probably among the customary signs of a general mourning on the death of the Persian kings: and it is certain that he directed one to be observed throughout his Asiatic dominions. He also commanded that, as was usual on the same occasions, the sacred fire should be quenched in all the Persian sanctuaries until the funeral was over. For this, preparations were made on a scale of more than royal magnificence. He ordered Perdicas to convey the corpse to Babylon, where a pile was to be built at the expense of ten thousand talents [£2,000,000 or \$10,000,000], and funeral games were to be celebrated with a splendour never before witnessed: for which purpose all the artists assembled at Ecbatana were to repair to the capital. The courtiers, especially those who might be suspected to entertain very different feelings, endeavoured to prove their sympathy with the king by extraordinary tokens of veneration for the departed favourite. Eumenes, who had lately had a violent quarrel with him, which was only composed by the royal authority, dexterously set the example, and dedicated himself and his arms to the deceased; perhaps anticipating Alexander's wish, that Hephæstion should receive sacred honours. He was anxious that this should be done under the sanction of religious authority, and therefore sent to consult the oracle of Ammon on the question, whether Hephæstion should be worshipped as a hero or a god. In the meanwhile, it is said, he ordered the sound of music to cease in the camp. The division of the cavalry which had been commanded by Hephæstion, was to retain his name, and the officer to whom it was committed was to be regarded only as his lieutenant.

These fantastic cares, however, served but to cherish his melancholy, and his officers endeavoured to divert him by some fitter occupation, which might draw him from Ecbatana, where he was constantly reminded of his bereave-

¹ Droysen^d rejects these reports with the utmost contempt; perhaps forgetting what Herodotus (IX, 24) relates of the mourning for Masistius, in which the Persians shaved themselves, and the horses, and the beasts of burden: a precedent, which at least proves that there is nothing absurd or incredible in Plutarch's account; if it does not render it certain that the same marks of grief were a necessary part of the general mourning ordered by Alexander.

ment. He at length began to rouse himself, and complied with their wishes. An object opportunely presented itself, which called him again into action, and in the manner most suited to the present temper of his soul. The Kossæans, who inhabited the highlands on the confines of Media and Persia, were still unsubdued; and, relying on their mountain strongholds, continued from time to time to make predatory inroads on their neighbours. Though it was now the depth of winter, Alexander set out to punish and quell them. He divided his forces into two columns, and gave the command of one to Ptolemy. The obstacles opposed by the country and the season were such as he was used to overcome: the barbarians could do little to bar his progress. They were hunted like wild beasts into their lairs, and every man taken capable of bearing arms was put to the sword. It was a sacrifice to the shade of Hephæstion, in which Alexander might see another resemblance to Achilles. He then crossed the mountains, and, coming down upon the Tigris, took the direct road to Babylon.

TO BABYLON



GREEK URN

At the distance of some days' march from the city, he was met by presages of impending calamity. A deputation of the Chaldean priests came to the camp, and requested a private audience, in which they informed him that their god Belus had revealed to them that some danger threatened him, if he should at that time enter Babylon. Alexander is said to have replied with a verse of Euripides, expressing disbelief in divination. But it is certain that the warning sank deep into his mind. The state of his feelings was apt for gloomy forebodings: and there was a strange harmony between the words of the Chaldeans, and an intimation which he had lately received from a Greek soothsayer, named Peithagoras.

Still the priests found that they could not induce the king to give up his intention of visiting the capital of his empire, where many important affairs were to be transacted, and embassies from remote parts of the world were awaiting his arrival. They then urged him at least not to enter the city by the eastern gate, so as to have his face turned towards the dark west. This mysterious advice struck Alexander's fancy; he altered the course of his march, and proceeded some distance along the bank of the Euphrates. But he then found that the lakes and morasses formed by the inundations of the river to the west of Babylon would prove an insurmountable obstacle. He was still reluctant to neglect the warning of the Chaldeans, but yet not now indisposed to listen to Anaxarchus, and the other philosophical Greeks about him, who treated the occult science, and especially its Babylonian professors, with contempt. There was however another motive for distrust, a suspicion that his priestly counsellors were less concerned about his safety than their own. Alexander, before he left Babylon, had ordered the great temple, which Xerxes had demolished, to be rebuilt under the superintendence of the

[323 B.C.]

priests. The revenues which had been assigned by the Assyrian kings, for the maintenance of the temple-worship, were also managed by the priests, and, while the temple lay in ruins, had been applied by them to their own use. They knew that Alexander's presence would soon put an end to such abuses.

Thus then he at length entered Babylon, not without a secret misgiving, by the ominous quarter.¹ The Great City had probably never before witnessed so stirring a scene as was exhibited by the crowds now assembled for various purposes within its walls. Nearchus had brought in the fleet from Opis: the vessels transported over land from Phœnicia had come down from Thapsacus: the harbour was in progress, and other ships were on the stocks in the arsenals of Babylon itself. Another crowd of workmen and artists were busied with Hephæstion's funeral pile, and with the preparations for his obsequies. And never before had Alexander's imperial greatness been so conspicuously displayed as in the embassies from foreign states, which were now in attendance at his court.² It seems indeed that there was a disposition among some of his historians to exaggerate the number and variety of those embassies. We must perhaps pass over as doubtful those which are said to have come—surprising the Macedonians and the Greeks by the novelty and strangeness of their names and garb—from the European Seythians, from Celtic and Iberian tribes, from Ethiopia, from Carthage, from Libya, and from at least three of the Italian nations, the Bruttians, Lucanians, and Tyrrenians.

The object of the Italian embassies is not mentioned: those of the Bruttians and Lucanians may be easily accounted for, since, only six or seven years before, the conqueror's kinsman and namesake, Alexander of Epirus, had perished in war with them. We are prepared to accept the testimony that they were met at Babylon by envoys from Rome, and though the scene may appear to us so memorable as to have afforded temptation for fiction, the fact was recorded before the greatness of the Roman name could have suggested the thought. Strabo mentions an occasion which might have led to this embassy. Alexander—we know not precisely when—had sent remonstrances to the Romans on account of injuries which his subjects had suffered from the pirates of Antium, which was subject to Rome. Alexander would probably have been satisfied with such a supremacy in Italy as he had acquired in Greece: that no general confederacy would have been formed against him by the Italian states: and Rome, single-handed, could not long have withstood such an army as he could have brought against her, backed by the forces and treasure of Greece, Asia, and Africa.

Among the embassies were several from Greek cities. He gave precedence according to the dignity of their temples. So Elis took the lead, and was followed by Delphi and Corinth: but the shrine of Ammon was recognised as second to Olympia. The Epidaurians received an offering for their god, though Alexander added the remark, that Æsculapius might have treated him better, than to suffer him to lose his dearest friend.

The honours designed for Hephæstion continued to share his earnest attention with graver business. The funeral pile was at length completed, and was a marvel of splendour, such as the gorgeous East had never beheld.

¹ That Alexander's return to Babylon took place early in 323, may now be considered as sufficiently certain.

² Niebuhr compares this period with Napoleon's stay in Dresden before he made his fatal march to Moscow. He was similarly surrounded by embassies in crowds.]

A part of the wall of Babylon, to the length of about a mile, was thrown down to furnish materials for the basement, and the shell of the building. It was a square tower, and each side, at least at the foot, measured a stade in breadth: the height was about two hundred feet, divided into thirty stories, roofed with the trunks of palm trees. The whole of the outside was covered with groups of colossal figures, and other ornaments, all of gold, ivory, and other precious materials, and it was surmounted by statues of sirens, so contrived as to emit a plaintive melody. All who courted the king's favour contributed their offerings to the work, or to the obsequies. As to the magnificence of the concluding ceremony, of the funeral games and banquet, nothing more need be said than that it corresponded to the richness of this astonishing work of art, which was raised at an expense about ten times exceeding that of the Parthenon, merely to be devoured by the flames.

Alexander was not of a character to continue long brooding over melancholy thoughts.¹ He appears now to have resumed his great plans with his wonted energy. It was about this time, that he sent out three expeditions to explore the coast of Arabia. He was impressed with the belief, that the Caspian Sea was connected by some outlet at its northern extremity with the ocean which girded the earth, and perhaps hoped that a passage might be found through this channel to the coast of India. With this view he sent Heraclides, with a party of shipwrights, to the shores of the Caspian, to build a fleet, which might survey its coasts, and ascertain its limits. In the meanwhile, he undertook an excursion from Babylon on the Euphrates, to inspect the canal called the Pallacopas, which branched from it to the south-west. He then sailed down the Pallacopas into the lakes which received its waters, and examined the channels by which they were connected with each other. On a part of the shore his eye was struck by a point, which seemed to him well adapted for the site of a city, and he ordered one to be built there, which he afterwards peopled with a colony of Greek mercenaries. The circuit was large, and the passages so intricate, that he was once separated for some time from the main body of the squadron. On his return through this maze of waters, an accident occurred, trifling in itself, but sufficiently ominous, it seems, to revive the uneasy feelings with which he had entered Babylon, and which had subsided when he saw himself once more out of it, and the prediction of the Chaldeans apparently belied. As the royal galley, which Alexander steered himself, passed over the lake, a sudden gust of wind carried away his *causia* into the water, and lodged the light diadem which circled it on one of the reeds that grew out of a tomb. One of the sailors immediately swam off to recover it, and, to keep it dry, placed it on his own head. Alexander rewarded him with a talent, but at the same time ordered him to be flogged, for the thoughtlessness with which he had assumed the ensign of royalty. The diviners, it is said, took the matter more seriously, and advised the king to avert the omen by the infliction of death on the offender.

On his return he found all the preparations for his intended expedition nearly complete. Fresh troops had arrived from the western provinces, and Peucestas had brought an army of twenty thousand Persians, and a body of mountaineers from the Kossæan and Tapurian highlands. The Persians Alexander incorporated with his Macedonian infantry; so as in every file of sixteen to combine twelve Persians, armed with bows or javelins, with four

[¹ Here again, Droysen's *d* picture of Alexander's dejection: "With Hephæstion his youth had sunk into the grave: and, though scarcely beyond the threshold of manhood, he began fast to grow old," seems violently overcharged.]

[323 B.C.]

heavy-armed Macedonians. And now the envoys whom he had sent to the oracle of Ammon returned with the answer, that Hephæstion was to be worshipped as a hero. This was probably as much as Alexander had desired. He immediately proceeded to give effect to the injunction, and sent orders to his satrap Cleomenes, to erect two temples to the new hero, one in Alexandria, the other on the isle of Pharos.

Fresh envoys had also arrived from Greece—from what states we are not informed—to render him the divine honours which he had demanded. They came crowned, according to the custom of persons sent on a sacred mission to a temple, offered golden crowns to him, and saluted him with the title of a god. But, Arrian observes with emphatic simplicity, he was now

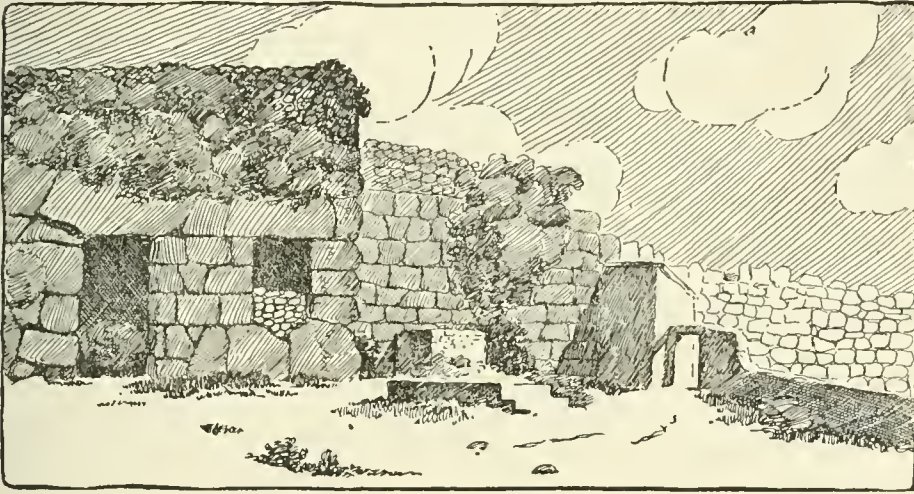

RUINS OF GREEK WALL AT ALATRIUM

not far from his end. It seemed to be announced by another sinister omen. The king had been busied with the enrolment of the newly-arrived troops, in council with his officers, who were seated on each side of the throne. Feeling thirst, he withdrew to refresh himself; the council rose for a time, and none were left in the hall but the attendant eunuchs. Before he returned, a man entered the apartment, mounted the steps of the throne, and seated himself on it. The slaves had probably been kept motionless by amazement, when they should have prevented him: but when the deed was done, the etiquette of the Persian court forbade them to lay their hands on one who occupied the seat of royalty, and they rent their clothes and beat their breasts in helpless consternation. The man was examined, and put to the torture, by Alexander's orders, who suspected a treasonable design. According to some accounts, he was a Messenian, named Dionysius, who had been a long time in prison, and had just made his escape. We may infer, that he was out of his senses. He could give no explanation of his act, but that it had come into his mind. Hence it seemed the more manifest to the soothsayers, that it must be viewed as a sign of impending evil. Alexander himself probably so considered it, and it was the more alarming, as it followed so many others. That he was haunted by his gloomy forebodings, and superstitious fancies, to the degree which Plutarch describes, is hardly credible, unless he was already unconsciously affected by the disorder which

proved fatal to him: as on the other hand it seems probable that its secret germs may have been cherished by the dejected state of his spirits.

From the presence of the disease, before its symptoms had become manifest, we may perhaps best explain the behaviour which Plutarch attributes to him in the interview which he had with Antipater's son, Cassander, shortly before his death; a scene which appears to have been attended with very important consequences. Alexander confronted Cassander with Antipater's accusers: and when Cassander treated their charges as groundless calumnies, sternly interrupted him, and asked whether men who had suffered no wrong would have travelled so far to prefer a calumnious charge. Cassander pleaded, that the greater the distance from the scene of the alleged injury, the safer was the calumny. But the king indignantly replied that Cassander showed how well he had studied Aristotle's sophistry, by which every argument might be turned two opposite ways, but that it should avail nothing, if the complaints proved to be in any degree well-founded. So far indeed we only see a proof that Alexander retained the full vigour of his mind and character. Plutarch however adds, what is more difficult to believe, that because Cassander, at his first audience, could not keep his countenance at the sight of the Persian ceremonial, which was entirely new to him, Alexander seized him by the hair, and dashed his head against the wall. This may be a gross exaggeration; but that Cassander's reception was so harsh and violent as to leave an indelible impression of fear and hatred on his soul, is confirmed, as strongly as such a fact can be, by his subsequent conduct.

LAST ILLNESS

The preparations for the projected campaign were now so far advanced, that Alexander celebrated a solemn sacrifice for its success. He at the same time entertained his principal officers at a banquet, and continued drinking with them to a late hour of the evening. As he was retiring to rest, he was invited by Medius — who it seems had of late been admitted to an intimacy with him something like Hephæstion's — to a revel, which was to be followed by a fresh drinking-bout. He complied, and the greater part of the night seems to have been thus spent. The next evening he again banqueted at the house of Medius, and again the carousal was prolonged.

It was at the close of this banquet, after he had refreshed himself with a bath, that he felt the symptoms of fever so strongly as to be induced to sleep there. The grasp of death was on him, though his robust frame yielded only after a hard struggle to the gradual prevalence of the malady.

We have a minute and seemingly complete account of his last illness, in an official diary which Arrian transcribed. Nevertheless various reports, which it does not sanction, were current in ancient times, and one of them, which ascribed his death to gross intemperance, has always been very generally believed. Another, which has been as generally rejected, attributed it to a dose of poison,¹ contrived by Aristotle, conveyed by Cassander, and administered by Iollas, another of Antipater's sons, who filled the office of cup-bearer to the king. As this report was undoubtedly invented by Cassander's enemies, so the other may have been first circulated by him and his partisans. It represents Alexander as having drained an enormous

[¹ Niebuhr thinks that Alexander could hardly have been poisoned as the poisons of that day always acted within twenty-four hours. This is, however, by no means certain. Aratus, the hero of the Achaean League, died of slow poisoning, according to the high authority of Polybius.]

[323 B.C.]

cup, a bowl of Hercules, as it was called, and as having instantly sunk as from a sudden blow. This incident certainly would not have appeared on the face of the journal; but neither does it seem quite consistent with Alexander's habits, who, according to Aristobulus, drank chiefly for the sake of prolonging conversation, nor with other details which have been preserved concerning the banquet. If he had been in his usual state of health, the debauch described in the journal would probably have produced no effect on him. It may however both have hastened the outbreak of the fever, and have rendered it fatal. Aristobulus related another fact, which the journal passed over in silence; that in a paroxysm of the fever, the patient quenched his thirst with a large draught of wine.^b

THE DEATH-BED OF ALEXANDER

On the morning of the first of June Alexander awoke very ill. The varied emotions of the last few days, with the rapid succession of banquets, had made him only too susceptible to illness, and the fever took strong hold on him. He had to be carried in his bed to the altar for the morning sacrifice which he was wont to offer daily. He then lay on a couch in the great hall, receiving his generals and giving them the necessary orders for the start: the army was to set out on the fourth of June; the fleet, with which he was going in person, on the following day. He was then carried on his couch to the Euphrates, got into a ship and crossed to the gardens on the farther side, where he took a bath and passed the night shivering with chill. After the bath and sacrifice the next morning, he went into his private apartment and lay on a couch there all day. Medius was there and tried to cheer him by conversation. The king commanded the leaders to appear before him next morning, and having taken a little supper he went to bed.

The fever increased, his condition grew worse, and he passed the whole night without sleep. After the bath and sacrifice next morning Nearchus and the other leaders of the fleet were admitted; the king informed them that their departure must be postponed for a day on account of his illness, but that he hoped to be sufficiently recovered by that time to embark on the sixth. He remained in the bathroom; Nearchus was commanded to sit by his bed and tell him of his voyage. Alexander listened with great pleasure, rejoicing that he too should presently experience similar perils. Meanwhile his condition changed for the worse, the fever was higher every night. Nevertheless on the morning of the fourth of June he called the officers of the fleet together after the bath and morning sacrifice, and commanded them to have everything in readiness for his reception and for the sailing of the fleet on the sixth. After the evening bath the fever set in more violently than ever, the king's strength diminished visibly, and a night of sleepless torment ensued.

Next morning he was carried in a high fever to the great reservoir and offered sacrifice with difficulty; he then gave audience to the officers, issued some orders concerning the sailing of the fleet, discussed the appointments to certain posts with his generals, and left the selections of the officers to be promoted, to them, with the admonition to make a strict examination. The sixth came, the king was prostrated by sickness, nevertheless he had himself carried to the altar, offered sacrifices and prayers, and gave orders for the departure of the fleet to be postponed. A melancholy night followed, and the next morning the king was hardly able to offer sacrifice. He commanded

the generals to assemble in the anteroom of the palace and the captains and officers to keep together in the courtyard. He had himself carried back from the gardens to the palace. He grew weaker every moment; when the leaders were admitted he recognised them but was not able to speak. The fever continued through the night, and through the following day and night the king lay speechless.

The impression produced by the king's illness in both the army and the city was beyond description; the Macedonians thronged round the palace, they begged to see their king, they feared that he was dead already and that his death was kept secret; they did not cease their lamentations, threats, and entreaties until the doors were opened to them. Then they filed past their king's bed, and Alexander raised his head slightly, gave his hand to each and looked his silent farewell to his veterans. On the following day (it was the tenth of June) Pithon, Peucestas, Seleucus, and others went to the temple of Serapis and inquired of the god whether the king would be better if he were carried into his temple and prayed to him. The answer was "Bring him not, if he remains where he is he will soon be better." And on the day after, towards the evening of the eleventh of June, Alexander died.^d



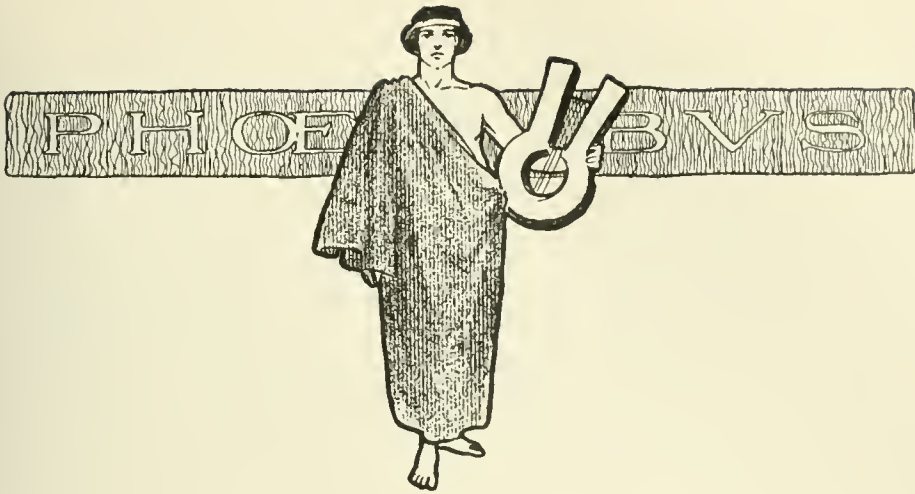

CHAPTER LVII. VARIOUS ESTIMATES OF ALEXANDER

Now that we have compassed the so great deeds of a life so short, it is inevitable that the sum total of the man's varied activity should be reckoned up into a brief statement of the value of his career to civilisation. The sums arrived at in Alexander's case have been as various as the minds that have made them up. A brief collection of them is full of contrast and illumination.^a

HIS VICES AND VIRTUES (ARRIAN)

His body was beautiful, and well proportion'd; his Mind brisk and Active; his Courage wonderful. He was strong enough to undergo Hardships, and willing to meet Dangers; ever ambitious of Glory, and a strict observer of Religious Duties. As to those Pleasures which regarded the Body, he shewed himself indifferent; as to the Desires of the Mind, insatiable. In his Counsels he was sharp-sighted, and cunning; and pierc'd deep into doubtful Matters, by the Force of his natural Sagacity. In marshalling, arming, and governing an Army, he was thoroughly skill'd; and famous for exciting his Soldiers with Courage, and animating them with Hopes of Success, as also in dispelling their private Fears, by his own Example of Magnanimity. He always enter'd upon desperate Attempts with the utmost Resolution and Vigour, and was ever diligent in taking any Advantage of his Enemies' Delay, and falling upon him unawares. He was a most strict observer of his Treaties; notwithstanding which he was never taken at a Disadvantage, by any Craft or Perfidy of his Enemies. He was sparing in his Expenses, for his own Private Pleasures, but in the distribution of his Bounty to his Friends, Liberal and Magnificent.

If anything can be laid to Alexander's Charge, as committed in the heat and violence of Wrath, or if he may be said to have imitated the Barbarian Pride a little too much, and bore himself too haughtily, I cannot think them such vast Crimes; and especially when one calmly considers his green Years, and uninterrupted Series of Success, it will appear no great Wonder if Court

Sycophants, who always flatter Princes to their Detriment, sometimes led him away. But this must be said, in his behalf, that all Antiquity has not produced an Example of such sincere Repentance, in a King, as he has shewed us. I cannot condemn Alexander for endeavouring to draw his Subjects into the Belief of his Divine Original, because 'tis reasonable to imagine he intended no more by it, than to procure the greater Authority among his Soldiers. Neither was he less famous than Minos, or Æacus, or Rhadamanthus, who, all of them challeng'd Kindred with Jove; and none of the ancients condemn'd them for it; nor were his glorious Actions any way inferior to those of Theseus, or Ion, tho' the former claim'd Neptune, and the latter Apollo, for his Father. His assuming and wearing the Persian Habit, seems to have been done with a political View, that he might appear not altogether to despise the Barbarians, and that he might also have some Curb to the Arrogance and Insolence of his Macedonians. And for this Cause, I am of Opinion, he plac'd the Persian Melophori among his Macedonian Troops, and Squadrons of Horse, and allow'd them the same share of Honour. Long Banquets, and deep Drinking, Aristobulus assures us, were none of his Delights; neither did he prepare Entertainments for the sake of the Wine (which he did not greatly love, and seldom drank much of) but to Rub up a mutual Amity among his Friends.

Whoever therefore attempts to condemn, or calumniate Alexander, does not so much ground his Accusation upon those Acts of his, which really deserve Reproof, but gathers all his Actions as into one huge Mass, and forms his Judgment thereupon: But let any Man consider seriously who he was, what Success he always had, and to what a pitch of Glory he arrived; who, without Controversy, reigned King of both Continents, and whose Name has spread through all Parts of the habitable World; and he will easily conclude, that in comparison of his great and laudable Acts, his Vices and Failings are few and trifling, and which, in so prodigious a Run of Prosperity, if they could be avoided, (considering his Repentance and Abhorrence of them afterwards) may easily be overlooked, and are not of Weight sufficient to cast a Shade upon his Reign.

I am persuaded there was no Nation, City, nor People then in being whither his Name did not reach, for which Reason, whatever Origin he might boast of or claim to himself, there seems to me to have been some Divine Hand presiding both over his Birth and Actions, insomuch, that no mortal upon Earth either excel'd or equal'd him.^b

HIS FAVOUR WITH FORTUNE (ÆLIANUS)

Commendable and renowned be the actes of Alexander which he dyd at Granicus and Issus. His foughten field at Arbeles, the taking of Darius, the subduing of the Persians to the Macedonians, the conquering of al Asia, the bringyng of the Indians under his owne dominion, etc. Lawdible be his feats of armes donne at Tyrus, and Oxydaeris: But what meane we to comprehend in a skantlyng of lynes the puisaunce of so incomparable a Prince? let it be as some envyouys varlets and backbiting tonges woulde have it, that the prosperous successe of his adventures is to be attributed to Fortune, what of that? yet is he notable and praiseworthy notwithstanding, insomuch as his fortune never fainted nor fayled, and in that hee was lulled in the lappe of so loving a Lady that she never withdrew her favour from him.^c

IF ALEXANDER HAD ATTEMPTED ROME (LIVY)

[When the historian of Rome, old Livy, was writing of the comparatively obscure general, Papirius Cursor, the fact that he was contemporary with Alexander and would have had to meet him had he come against Italy, led Livy to breathe so Roman a defiance to the world-conqueror that we must needs quote it here, preferably in the old-fashioned garb of the anonymous translation of 1686.]

Without doubt in that Age, which yielded as great plenty of gallant Captains as any, there was not a Person on whom the State of Rome did more rely and depend, insomuch, as some Writers have concluded, that he [Papirius Cursor] would have been an equal match to the Great Alexander, if after the Conquest of Asia, he had bent his Arms against Europe.

Now although from the beginning of this Work it may sufficiently appear, that I have sought nothing less than Digressions from the just order and series of the Story; nor have at all endeavored, by extravagant Varieties, to garnish it, or with pleasant Sallies to divert the Reader and refresh myself; yet happening upon the mention of so great a King, and so renowned a Captain, I could not but be moved to disclose and set down those thoughts which have oft occur'd to my mind, and inquire a little, What event would probably have succeeded to the Roman Affairs, had they happened to have been engaged with this Illustrious Conqueror. As the Roman State bore up against other Kings and Nations, so it might have prov'd to him also Invincible. To begin with ballancing the Commanders one against another, I do not deny but Alexander was an excellent Leader, but that which enhance'd his Fame, was, That he was a sole and Sovereign Commander; a young Man, his Sails always full blown with prosperous Gales, and one who dyed before ever he had labored under any of the frowns of Fortune. For to omit other glorious Princes and renowned Captains, illustrious Examples of the uncertainty of Humane Grandeur: What was it that exposed Cyrus (whom the Greeks so highly magnific) or our great Pompey of late, to the turning Wheel of Fortune, but only this, That they lived long? On the other side, Let us take a review of the Roman Commanders, I mean not through all Ages, but such as being Consuls or Dictators about those times, Alexander must have engaged with, if he had spread his Ensigns this way; there were M. Valerius Corvinus, C. Marcius Rutilus, C. Sulpicius, T. Manlius Torquatus, Q. Publilius Philo, L. Papirius Cursor, Q. Fabius Maximus, the two Decii, L. Volumnius, Manlius Curius, besides abundance of prodigious Warriors that succeeded afterwards; if he had first set upon the Carthaginians, (as he was resolv'd to have done, if he had not been prevented by Death) and so had arriv'd in Italy when well stricken in years. Each one of these was master of as good Parts and natural Abilities, as Alexander, and had the advantage of being train'd up in an incomparable Military Discipline, which having been delivered from hand to hand ever since the foundation of their City, was now by continual Precepts arriv'd to the perfection of an Art. And whereas, Alexander often hazarded his Person, and underwent all Military toils and dangers (which was one thing that not a little added to his Glory :) can it be thought, that if Manlius Torquatus, or Valerius Corvinus, had chanc'd to meet him at the head of his Troops, either of them would not have prov'd a Match for him, who were both of them famous for stout Soldiers before ever they had Commands? Would the Decii, that rush'd with devoted Bodies into the midst of the Enemy, have been afraid of him? Would Papirius Cursor, that mighty Man both for strength of Body and gallantry of Mind, have declined to cope

with him? Was it likely that a single young Gentleman should out-wit or manage his Affairs with greater prudence than that Senate which he only, whoever he was, had a right Idea of, that said, "It consisted altogether of Kings"?

Here, forsooth, was the danger, lest he should more advantageously choose his Ground to Encamp on, provide Victuals more carefully, prevent Surprizes and Stratagems more warily, know better when to venture a Battel, range his Army more Soldier-like, or strengthen it with Reserves and Recruits, better than any of those whom I have named knew how to do: Alas! in all these matters, he would have confess'd he had not to deal with a Darius, over whom, being attended with a vast Train of Women and Eunuchs, softened with wearing gold and Purple, and clogg'd with the superfluous Furniture of his luxurious Fortune, he did indeed obtain an unbloody Victory, meeting rather with a Booty than an Enemy, and had only this to boast of, That he durst handsomely contemn such an abundance of Vanity.

He would have had another kind of prospect in Italy than in India, through which he march'd at his ease with a drunken Army, Feasting and Revelling all the way: But here he must have met with the thick woody Forrest, and almost unpassable Streights of Apulia; the lofty Mountains of Lucania, and fresh Tokens of a late Defeat that happen'd to his own Name and Family, where his Uncle Alexander, King of the Epirotes, was hewn to pieces.

We speak hitherto of Alexander, not yet debauch'd with excess of good Fortune, wherein never any Man had less command of himself than he: But if we consider him in his new Habit, and that new Nature, (if I may call it so) which he took up after he had a while been flush'd with Victories, we may avow he would have come into Italy, more like a Darius than an Alexander, and brought with him a bastard Army, altogether degenerated from the Macedonian courage and manners, into the debauches and effeminacies of the Persians. I am asham'd, in so great a Monarch as he was, to relate his proud humors of changing so oft his Garb; his excessive vain-glory, in expecting that Men should adore him by casting themselves prostrate at his feet, when-ever they approached him; his barbarous Cruelties and Butcheries of his nearest Friends amongst his Cups and Banquets, and that ridiculous Vanity of forging a Divine Pedigree, and boasting himself the Son of Jupiter. Nay more, since his Drunkenness and Greediness of wine, his savage Passions and choleric Phrensies did every day increase (I report nothing but what all Authors agree in), shall we not think that his Abilities, as a General, must quickly have decayed and been wonderfully impaired?

But here perhaps was the danger (which some little trifling Greeks who would cry up the glory even of the Parthians, to depress the Roman name, are often wont to alledge) That the People of Rome would never have been able to endure the very Majesty and dread of Alexanders Name (whom indeed I am apt to think they then scarce ever heard of:) Let us conceit as magnificently as may be of this Prince, yet still it will be but the Grandeur of one Man, acquir'd in little more than twelve Years continued Felicity; and whereas some extol it highly on his Account, That the Romans, though never worsted in any War, have yet been defeated in divers Battels, whereas Fortune was never wanting to Alexander in any one encounter, they do not consider that they are comparing the Exploits of one particular Man, and he too but a Youth, with the achievements of a People that have now been involv'd in Wars eight hundred years.

You ought rather to compare Man with Man, Captain with Captain, than

the Fortune of one with the other. How many Roman Generals may I name, that never suffer'd a Repulse in their days? We can run over whole Pages in the Annals of our Magistrates, full of Consuls and Dictators, whose Success as well as Virtue, was such, as they never gave the Common-wealth so much as one days grief or discontentment. And that which makes them yet to be more admired than Alexander, or any other King in the World; some of them held their Office of Dictator not above ten or twenty days, and none the Consulship beyond a year: Their Levies were often obstructed by the Tribunes of the Commons, so that they set forth too late; and sometimes for holding the Court for Elections, they were sent for home too soon: In the hurry of Affairs the Year was apt to be wheel'd about, and then they must leave all to new Instruments; now the rashness, another time the dishonesty of a Colleague, was either a great hindrance to their Success, or perhaps occasion'd a mischief. Many times they succeeded after the defeat of their Predecessors, or receiv'd a raw and undisciplin'd Army: From all which inconveniences Kings are not only free, but absolute Masters both of their Enterprizes, and the times and means they will take to accomplish them, leading all things by their Councils, and not following them. Had therefore this unconquered Alexander been engaged against these unconquered Captains, he would have hazarded all those past pleasures of Fortunes favor; nay, in this the danger would have been greater, that the Macedonians had but one Alexander, and he not only obnoxious to many Casualties, but voluntarily exposing himself to frequent Dangers. But the Romans had many that were Alexanders equals, both for Glory and the grandeur of their Achievements, each of whom, might according to his peculiar Fate, either live or dye, without at all endangering the Publick.



GRECIAN COSTUME
(After Hope)

It remains now to ballance the Forces on each side, and that neither in respect of numbers, quality of the Soldiers, or the multitude of their Allies and Auxiliaries. There were numbered of Romans in the Surveys taken by the Censors of that Age, two hundred and fifty thousand Polls; and therefore in all the revolts of the Latines, they were able to levy Ten Legions, and that too almost wholly in the City; and frequently in those times, four or five distinct Armies were kept on foot at once, which maintained Wars in Etruria, in Umbria, with the Gauls (Confederates with the Enemy) in Samnium and in Lucania: On the other side, he must have cross'd the Sea, having of old Macedonian Bands not above Thirty thousand Foot, and four thousand Horse, and those most of them Thesalians; for this was the total of his Force when he appeared most formidable. If he should have added to these, Persians, Indians, or others out of his

new Conquests, they would but more encumber rather than assist him. Then the Romans had Supplies at hand to reinforce them presently from home upon any accident; whereas Alexander (as it happened afterwards to Annibal), Warring in a remote foreign Country, his Army would have mouldered away apace, and could not readily have Recruits. The Macedonians had for their Arms, a Shield and a Spear like a Pike; the Romans, a large Target that skreen'd almost the whole Body, and a Javelin, a Weapon not a little more serviceable than the Spear, both to strike and push with, near hand, and also to be lanced at a distance. The Soldiers of each side were wont to stand firm, and keep their Ranks; the Macedonian Phalanx was immovable and uniform; but the Roman Battalions more distinct, and consisting of several Divisions, more ready to separate and close again upon any occasion.

A Patriotic Estimate of Rome's Greatness

To speak now of labour and travel, What Soldier is comparable to the Roman? Who better able to hold out and endure all the fatigues of War? Alexander, worsted in one Battel, had been utterly undone: But what Power could have broken the Roman courage, whom neither the shameful disgrace at Caudium nor the fatal defeat at Cannæ, could in the least daunt or dispirit? Undoubtedly Alexander, although his first attempt should have prov'd prosperous, would often here have missed his Persians and his Indians; he would have wish'd to have been dealing again with the soft and cowardly Nations of Asia and confest, That before he only fought with Women, as King Alexander of Epirus is reported to have said, when he had here received his Death wound, reflecting upon those easie Occurents of War, which this young Prince (his Nephew) met with in Asia, in respect to those difficulties he himself had to struggle with in Italy.

And truly, when I consider that the Engagements at Sea between the Romans and Carthaginians in the first Punick War, took up no less than four and twenty years' space, I am inclinable to conjecture, that the whole age of Alexander would not have been enough to have finish'd a War with either a one of those States. And since by antient Leagues they were then at Amity and in Alliance with each other, 'tis probable an equal apprehension of danger might have united them against the common Enemy: And what less could he then expect but to have been utterly overwhelm'd and crush'd by the joint Arms of two the most potent Republicks in the World? The Romans, though not indeed in the days of Alexander, or when the Macedonian Power was at heighth, have yet since try'd the courage of the Macedonians, under the conduct of Antiochus, Philip, and Perses, and came off not only without loss, but even without any danger or hazard.

It may seem a proud word, but without arrogance it is spoken, Let there be no Civil Wars amongst us; never can we be distressed by any Enemy, Horse or Foot; never in set Battel, never in plain equal ground, or places disadvantageous, outdone in Courage or Resolution. The Soldier I confess in heavy Armour, may be apprehensive of the Enemies Cavalry in a Champion Country, or be incommoded with Arrows shot from a distance, or embarrass'd in unpassable Woods, or Quarters, where provisions cannot be brought to them; but still let there be a thousand Armies greater and stronger than that of Alexander and his Macedonians, so long as we hold together, and continue that love of Peace, and prudent care of civil Concord, wherein we live at this day, we are able, and ever shall be, to rout and put them all to flight.^d

HIS INVINCIBILITY (GROTE)

[Against Livy's confidence in the Roman bulwark must be placed Grote's trust in Alexander's genius.]

Exalted to this prodigious grandeur, Alexander was at the time of his death little more than thirty-two years old — the age at which a citizen of Athens was growing into important commands; ten years less than the age for a consul at Rome; two years younger than the age at which Timur first acquired the crown, and began his foreign conquests. His extraordinary bodily powers were unabated; he had acquired a large stock of military experience; and what was still more important, his appetite for further conquest was as voracious, and his readiness to purchase it at the largest cost of toil or danger, as complete, as it had been when he first crossed the Hellespont. Great as his past career had been, his future achievements, with such increased means and experience, were likely to be yet greater. His ambition would have been satisfied with nothing less than the conquest of the whole habitable world as then known; and if his life had been prolonged, he would probably have accomplished it. Nowhere (so far as our knowledge reaches) did there reside any military power capable of making head against him; nor were his soldiers, when he commanded them, daunted or baffled by any extremity of cold, heat, or fatigue.

The patriotic feelings of Livy dispose him to maintain that Alexander, had he invaded Italy would have failed and perished like his relative, Alexander of Epirus. But this conclusion cannot be accepted. If we grant the courage and discipline of the Roman infantry to have been equal to the best infantry of Alexander's army, the same cannot be said of the Roman cavalry as compared with the Macedonian companions. Still less is it likely that a Roman consul, annually changed, would have been found a match for Alexander in military genius and combinations; nor, even if personally equal, would he have possessed the same variety of troops and arms, each effective in its separate way, and all conspiring to one common purpose; nor the same unbounded influence over their minds in stimulating them to full effort. I do not think that even the Romans could have successfully resisted Alexander the Great; though it is certain that he never throughout all his long marches encountered such enemies as they, nor even such as Samnites and Lucanians — combining courage, patriotism, discipline, with effective arms both for defence and for close combat.

Among all the qualities which go to constitute the highest military excellence, either as a general or as a soldier, none was wanting in the character of Alexander. Together with his own chivalrous courage — sometimes indeed both excessive and unseasonable, so as to form the only military defect which can be fairly imputed to him — we trace in all his operations the most careful dispositions taken beforehand, vigilant precaution in guarding against possible reverse, and abundant resource in adapting himself to new contingencies. Amidst constant success, these precautionary combinations were never discontinued. His achievements are the earliest recorded evidence of scientific military organisation on a large scale, and of its overwhelming effects. Alexander overawes the imagination more than any other personage of antiquity, by the matchless development of all that constitutes effective force — as an individual warrior, and as organiser and leader of armed masses; not merely the blind impetuosity ascribed by Homer to Ares, but also the intelligent, methodised, and all-subduing compression which he personifies in Athene. But all his great qualities were fit for use only against

enemies ; in which category indeed were numbered all mankind, known and unknown, except those who chose to submit to him. In his Indian campaigns, amidst tribes of utter strangers, we perceive that not only those who stand on their defence, but also those who abandon their property and flee to the mountains, are alike pursued and slaughtered.

Apart from the transcendent merits of Alexander as a soldier and a general, some authors give him credit for grand and beneficent views on the subject of imperial government, and for intentions highly favourable to the improvement of mankind. I see no ground for adopting this opinion. As far as we can venture to anticipate what would have been Alexander's future, we see nothing in prospect except years of ever-repeated aggression and conquest, not to be concluded until he had traversed and subjugated all the inhabited globe. The acquisition of universal dominion — conceived not metaphorically, but literally, and conceived with greater facility in consequence of the imperfect geographical knowledge of the time — was the master passion of his soul.

The Persian empire was a miscellaneous aggregate, with no strong feeling of nationality. The Macedonian conqueror who seized its throne was still more indifferent to national sentiment. He was neither Macedonian nor Greek. Though the absence of this prejudice has sometimes been counted to him as a virtue, it only made room, in my opinion, for prejudices yet worse. The substitute for it was an exorbitant personality and self-estimation, manifested even in his earliest years, and inflamed by extraordinary success into the belief in divine parentage ; which, while setting him above the idea of communion with any special nationality, made him conceive all mankind as subjects under one common sceptre to be wielded by himself. To this universal empire the Persian king made the nearest approach, according to the opinions then prevalent. Accordingly Alexander, when victorious, accepted the position and pretensions of the overthrown Persian court as approaching most nearly to his full due. He became more Persian than either Macedonian or Greek. While himself adopting, as far as he could safely venture, the personal habits of the Persian court, he took studied pains to transform his Macedonian officers into Persian grandees, encouraging and even forcing intermarriages with Persian women according to Persian rites. At the time of Alexander's death, there was comprised, in his written orders given to Craterus, a plan for the wholesale transportation of inhabitants both out of Europe into Asia, and out of Asia into Europe, in order to fuse these populations into one by multiplying intermarriages and intercourse. Such reciprocal translation of peoples would have been felt as eminently odious, and could not have been accomplished without coercive authority. It is rash to speculate upon unexecuted purposes ; but, as far as we can judge, such compulsory mingling of the different races promises nothing favourable to the happiness of any of them, though it might serve as an imposing novelty and memento of imperial omnipotence.

In respect of intelligence and combining genius, Alexander was Hellenic to the full ; in respect of disposition and purpose, no one could be less Hellenic. Instead of hellenizing Asia, he was tending to asiatise Macedonia and Hellas. His temper and character, as modified by a few years of conquest, rendered him quite unfit to follow the course recommended by Aristotle towards the Greeks — quite as unfit as any of the Persian kings, or as the French Emperor Napoleon, to endure that partial frustration, compromise, and smart from free criticism, which is inseparable from the position of a limited chief.^e

Cox^f in his *General History of Greece* sees a degeneration already set in foreshadowing his future, had he lived, and agrees with Grote^e as to his asiatising tendency. "It may almost be said that the results which he had achieved were precisely those which would have followed if Xerxes had been the conqueror at Salamis, Platæa, and Mycale."

HIS MEANNESS (MÉNARD AND ROLLIN)

"So ended he," says Ménard, "whom they call Alexander the Great. Let the name stand; but he owed his greatness not to his personal qualities, to his own efforts, or to his genius, but, as Plutarch admitted, to Fortune. Never was there an example of a prosperity so infallible and so little deserved. But Fame is feminine; she measures merit by success. Alexander created a school; his personality encumbers history and usurps an enormous space. The decadence of Greece and the Roman decadence are filled up with pastiches and caricatures of him; even in modern times he has remained the type and the ideal of all warrior tyrants down to Louis XIV and Napoleon.

"The literature that makes his fame is for the most part of poor stuff. The Greeks of the imperial epoch, in order to console themselves for the grandeur of Rome, did their best to inflate the glory of Alexander. This theatrical hero is worth more to the rhetorician than a legislator like Solon or a statesman like Pericles. Men of letters of all countries and times have been overwhelmed by him and found in him the god of monarchic idolatry. Thanks are due to Rollin for having made some reservations. He who lived in the snulight of royalty was not afraid to say that it was a poor compliment for a king to be compared to Alexander, 'the least estimable of Plutarch's great men.' We hardly read Rollin nowadays and his judgments have little authority; they say that he lacked the power of historic criticism. Perhaps he did, but he had a right conscience, which is worth still more. He made history a school of moral instruction, and it is thus that later generations are formed strong and sane. Our grandfathers, who learned their history from Rollin, achieved the French Revolution." *g*

It is interesting to refer directly to the pages of Rollin alluded to by Ménard. Rollin divides Alexander's life into two distinct halves, the former all beautiful and brilliant; the latter in hideous contrast. We quote from his resumé of the latter and uglier half.^a

His uninterrupted felicity, that never experienced adverse fortune, intoxicated and changed him to such a degree, that he no longer appeared the same man; and I do not remember that ever the poison of prosperity had a more sudden or more forcible effect than upon him.

Was ever enterprise more wild and extravagant, than that of crossing the sandy deserts of Libya; of exposing his army to the danger of perishing with thirst and fatigue; of interrupting the course of his victories, and giving his enemy time to raise a new army, merely for the sake of marching so far, in order to get himself named the son of Jupiter Ammon; and purchase, at so dear a rate, a title which could only render him contemptible?

It appears to me that to the battle of Issus and the siege of Tyre inclusive, it cannot be denied, but that Alexander was a great warrior and an illustrious general. But I much doubt, whether, during these his first exploits, he ought to be set above his father; whose actions, though not so dazzling, are however as much applauded by good judges, and those of the military profession. Philip, at his accession to the throne, found all things unsettled. He himself was obliged to lay the foundations of his own fortune, and was not supported by the least foreign assistance. He alone raised himself to the power and grandeur to which he afterwards attained. He was obliged to train up, not only his soldiers, but his officers; to instruct them in all the military exercises; to inure them to the fatigues of war; and to his care and abilities alone, Macedonia owed the rise of the celebrated phalanx, that is, of the best troops the world had then ever seen, and to which Alexander owed all his conquests. How many obstacles stood in Philip's way before he could possess himself of the power which Athens, Sparta, and Thebes had successively exercised over Greece! The Greeks,

who were the bravest people in the universe, would not acknowledge him for their chief, till he acquired that title by wading through seas of blood, and by gaining numberless conquests over them. Thus we see, that the way was prepared for Alexander's executing his great design; the plan whereof, and most excellent instructions relative to it, had been laid down for him by his father. Now, will it not appear a much easier task to subdue Asia with Grecian armies, than to subject the Greeks who had so often triumphed over Asia?

It must be confessed, that the actions of this prince diffuse a splendour that dazzles and astonishes the imagination, which is ever fond of the great



MERCURY
(From a vase)

and marvellous. His enthusiastic courage raises and transports all who read his history, as it transported himself. But ought we to give the name of bravery and valour to a boldness that is equally blind, rash, and impetuous; a boldness void of all rule, that will never listen to the voice of reason, and has no other guide than a senseless ardour for false glory, and a wild desire of distinguishing itself at any price? This character suits only a military robber, who has no attendants; whose own life is alone exposed; and who, for that reason, may be employed in some desperate action; but the case is far otherwise with regard to a king, who owes his life to all his army and his whole kingdom. True valour is not desirous of displaying itself, is no ways anxious about its own reputation, but is solely intent on preserving the army.

Do any of these characteristics suit Alexander? When we peruse his history and follow him to sieges and battles, we are perpetually alarmed for his safety, and that of his army; and conclude every moment that they

are upon the point of being destroyed. Here we see a rapid flood, which is going to draw in and swallow up this conqueror: there we behold a craggy rock, which he climbs, and perceives round him soldiers, either transfixed by the enemy's darts, or thrown headlong by huge stones from precipices. We tremble when we perceive in a battle the axe just ready to cleave his head; and much more when we behold him alone in a fortress, whither his rashness had drawn him, exposed to all the javelins of the enemy. Alexander was ever persuaded, that miracles would be wrought in his favour, than which nothing could be more unreasonable, as Plutarch observes; miracles do not always happen; and the gods at last are weary of guiding and preserving rash mortals, who abuse the assistance they afford them.

Alexander seems possessed of such qualities only as are of the second rank, I mean those of war, and these are all extravagant; are carried to the rashest

and most odious excess, and to the extremes of folly and fury; whilst his kingdom is left a prey to the rapine and exactions of Antipater; and all the conquered provinces abandoned to the insatiable avarice of the governors, who carried their oppressions so far, that Alexander was forced to put them to death.

Nor do his soldiers appear to be better regulated; for these, having plundered the wealth of the East, after the prince had given them the highest marks of his beneficence, grew so licentious, so disorderly, so debauched and abandoned to vices of every kind, that he was forced to pay their debts by a largess of £1,500,000.

What strange men were these! how depraved their school! how pernicious the fruit of their victories! ^h

HIS EVIL INFLUENCE (NIEBUHR)

Alexander is for the East, what Charlemagne is for the West; and, next to Rustam, he is the chief hero of the Persian fairy tales and romances. To us also he is a man of extraordinary importance, inasmuch as he gave a new appearance to the whole world. He began what will now be completed, in spite of all obstacles—the dominion of Europe over Asia; he was the first that led the victorious Europeans to the East. Asia had played its part in history, and was destined to become the slave of Europe. He has also become the national hero of the Greeks, although he was as foreign to them as Napoleon was to the French, notwithstanding that he traced his family to the mythical heroes of Greece.

But his personal character will appear to us in a different light. Many a rhetorician, even in antiquity, formed a correct judgment of him. Who does not know the story of the pirate, who was condemned to death by Alexander, and, on being brought before him, said, that there was no difference between them! The Orientals still call him, “Alexander the robber.” I will not judge of him from this point of view, for the whole history of the world turns upon war and conquest; I speak only of his personal character. But, without agreeing with the declamations which have so often been made about him, I unhesitatingly declare, that I have formed a very unfavourable opinion of him. When I behold a young man, who, in his twentieth year, ascends the throne, after having conspired against his father—who then displays in his policy a cruelty like that of the house of the Medici in the sixteenth century, like Cosmo de Medici and his two sons—who not only sacrifices his step-mother to Olympias, but causes the innocent infant of the unhappy Cleopatra, as well as several other near relatives, to be murdered (we do not know their names, as Arrian skilfully evades mentioning them)—who despatched all that knew anything of his complicity, as well as those who had previously offended him—such a young man is condemned for all time to come.

Plutarch shows a foolish and unfounded partiality towards him, and such was universally the case among the Greeks. His drunkenness cannot be denied, and with it they excuse his murders, as, for example, that of Clitus; and, in order poetically to complete the indescribable folly committed by later Greeks, they compare him with Dionysus. But his drunkenness does not account for all he did. He caused the most innocent and most faithful servant, the best general of his father, to be maliciously assassinated in a truly oriental manner; the man had been frank and open, and knew that

Alexander was what he was through him. The murder of his friend Clitus, who told him the truth, was a fearful act. I do not comprehend how persons can excuse Alexander by saying, that he was an unusually great man; if he was so, was he not then responsible for his unusually great powers? All his actions, which are praised as generous, are of a theatrical nature and mere ostentation. His friendship for Aristotle did not save Callisthenes. His attachment to Hephæstion was not friendship, but a disgrace. His generosity towards the captive Persian princesses is nothing extraordinary; if it be not ostentation, it is something quite natural, and of everyday occurrence; but it is mere ostentation.

It must, indeed, be acknowledged that Alexander is a most remarkable phenomenon; but the praise bestowed on him can apply only to his great intelligence and his talents. He was altogether an extraordinary man, with the vision of a prophet, a power for which Napoleon also was greatly distinguished; when he came to a place, he immediately perceived its capability and its destination; he had the eye which makes the practical man. If we had no other example of the keenness of his judgment, the fact that he built



WRAPPING THE DEAD IN INFLAMMABLE SHEETS

Alexandria would alone furnish sufficient evidence; he discovered the point which was destined, for fifteen hundred years, to form the link between Egypt, Europe, and Asia. It is impossible not to concede to him the praise of a great general. Nay, a most competent judge, Hannibal, declared him to be the greatest general. It must not, however, be forgotten, that he had most excellent instruments—distinguished generals, and a splendid army. If he had had to create his army, his undertaking would not have succeeded so well. Parmenion, Philotas, Ptolemy, Seleucus, and Antigonus were all distinguished captains, all proceeded from the school of his father, and had acquired great reputation even under him; and, if we except the single Eumenes, we may assert, that no great commander was trained under Alexander. In like manner, King Frederick II inherited an army already trained by his father; and most of his generals had served in the army before his time.

Alexander undertook the Asiatic expedition as a true adventurer. He himself adopted the most contemptible pomp of eastern despotism, and took pleasure in the vanities and follies of the Persians; the Orientals, who were accustomed to prostrate themselves before him, were his darlings. He forgot the respect due to his old soldiers, and demanded of them, who were free men, the prostration of the Persians.

His worthless friend Hephæstion died; and Alexander celebrated his burial in a manner which showed utter senselessness and absurdity, in his prodigality and in his perpetration of oriental horrors. In order to offer to the deceased a worthy sacrifice, he undertook an expedition against a free people of mountaineers, and extirpated the whole nation; and according to a truly eastern fashion, he slaughtered all the prisoners in honour of his deceased friend. All that is related of this period is disgraceful; insensible to all that is good, and dissatisfied with himself, he abandoned himself more and more to frightful drunkenness. He offered prizes for the best drinkers, and an ἀγὼν πολυποσίας ended with some thirty persons drinking themselves to death: a proceeding which we can contemplate only with the most complete disgust.

Perhaps no man has personally exercised a greater historical influence than Alexander; this cannot be questioned. But what influence he exercised, and whether it was beneficial, is a question on which opinions are divided. In regard to Greece, his conquests were altogether injurious. Through him the Greek nation was, as it were, seized with consumption, for he reduced its numbers immensely. A vast number of recruits must have gone from Greece and Macedonia to India and Upper Asia, whom he forever withdrew from their country by assigning to them settlements in those countries. It lay in the nature of things, that Greece should be lost, and should fall into a state of complete weakness, when a new wealthy and military state arose by the side of it. Even the good which arose from the establishment of this Macedonio-Asiatic empire, was injurious to Greece. Commerce was transferred to Alexandria; and Athens ceased to be spoken of as a commercial city. Alexander's influence upon the nearer and remoter parts of conquered Asia was different in different countries. Upon Egypt it was beneficial, for that country was evidently better off under the Ptolemies than it had been under the Persians. The first three Macedonian kings of Egypt were excellent princes, and raised the country to a degree of prosperity, which it never enjoyed either before or after: and that period was sufficient for such a country to heal its ancient wounds.

Alexander's contemporaries among the Greeks were not mistaken as to the influence which he exercised. He died detested and cursed by Greece and Macedonia. If he had lived longer, he would perhaps himself have seen the downfall of the structure he had reared. He could not be otherwise than active and stirring, and he could not have gone on without bringing ruin upon himself. His intention was not to hellenise Asia, but to make Greece Persian; hence if he had longer remained in Asia, we should have seen the formation of a Græco-Persico-Macedonian empire. As he wanted to arm the Greeks and Macedonians in the Persian fashion, those nations would afterwards probably have revolted and put him to death. The only means by which Greece might have been saved, and have recovered its liberty, would have been, if Alexander had passed through the natural course of his life, and had fallen with the glory of his exploits.²

HIS MOTIVES (DROYSEN)

[Bishop Thirlwall² sees great benefits from Alexander's conquests, but doubts if they were all intentional with him, or largely the accidents of his success. Droysen feels no doubt as to the presence of sharply definite motives and large policies in Alexander's mind.]

“That the soul of this king was built on a scale that surpassed human measure,” Polybius says, “is an opinion in which all agree.” His strength of

will, his wide vision, his intellectual pre-eminence are proved by his deeds and the strict, the rigid, logic of their consistency. What his desire was, and what his conception of his work (a fair judge will wish no other measure), this is something one can approximately learn only from such parts of his work as he was allowed to realise. Alexander was versed in the highest culture and knowledge of his time; he would have cherished no meaner opinion of a king's calling than the "master of those who know." But for him, unlike his great teacher, the thought of what monarchy was



ARISTOTLE TEACHING THE YOUTHFUL ALEXANDER

(See p. 262)

and the "monarch's duty as watchman" did not logically lead to the necessity of treating barbarians like animals and plants. Nor would it have been his opinion that his Macedonians had been trained to arms from his father's time in order that they might be, in the philosopher's language, "masters over those who were fitly slaves"; still less that first his father, and then he himself, had forced the Greeks into the Corinthian federation, that they might plunder defenceless Asia, squeeze it dry with their exquisite selfishness and their shameless intrigues.

He had dealt Asia a terrible blow. He would remember the spear of his ancestor Achilles. He would recognise that the grace of the true spear of royalty lay in its power to heal the wounds it made. With the annihilation of the old kingdom, with the death of Darius, he became heir to the empire over unnumbered peoples who had been govern-

ed till then as slaves. A labour it was, worthy of a king indeed, to free them so far as they could understand or learn of freedom, to preserve and further them in whatever they enjoyed of laudable and sound, to respect and spare them in whatever was sacred in their eyes and whatever was their very own. He must know how to propitiate, how to win them, that they too may be made to share the burden of the empire which is gradually to unite them with the Greek world. Such a monarchy could permit no mention of conquerors and conquered when once the victory was won; it must wipe out from men's memory the distinction between Greek and barbarian,

There lay on this road difficulties immeasurable — much that was arbitrary, much that was violent, unnatural — they seemed to make the undertaking impossible. But him they did not stop nor perplex; they only heightened the vehemence of his will, and stiffened the rigid and conscious assurance of his dealings. The work which he had undertaken in the exaltation of youth possessed him; gathering like an avalanche it swept him on; ruin, devastation, fields of dead, marked his progress; with the world that he conquered, there came a change over his army, over his surroundings, over the man himself. He passed on like a tempest, he saw only his aim, and in that his justification.

The majority misunderstood and disapproved of what the king did or left undone. While Alexander tried all means to win the conquered and make them forget their conquerors in the Macedonians, many of his followers in their insolence and their selfishness calmly claimed the conquerors' ruthless right of violence. While Alexander received with the same graciousness the genuflexions of Persian magnates and the congratulatory missions with which Greece honoured him, accepting alike the worship which the orientals considered they owed him, and the military acclamations of his phalanxes, they would have liked to see themselves as the equal of their king, and everything else far below them in the dust of humility. And while they themselves yielded to all the luxuriousness and licentiousness of Asiatic life, so far as the camp and the vicinity of their openly disapproving king permitted — yielded with no other object besides the gratification of appetites run mad — they took it ill of their king that he wore the Median dress and affected the Persian court functions, wherein the millions of Asia recognised and worshipped him as their god and king.¹

HIS EFFECT ON FEDERALISATION (PÖHLMANN)

[Every one admits that the lack of unity among the Greek towns was the cause of evils innumerable, and that some form of federation was vitally needed. Many have felt that Alexander furnished the needed unifaction by his centralised empire; but Pöhlmann is of contrary mind.]

Droysen's peculiar way of seeing history has led him greatly to overrate the blessings of the new federal régime. It is true that in Hellas, under the old party names of aristocrat and democrat, the hostile interests of rich and poor were engaged in a pitiless and passionate struggle, and, if we consider the decomposition that was killing the life of communities, a monarchy would appear to be exactly what was needed to exercise a levelling and reconciliatory influence. But a kingdom of this national character, whose first aim would be to satisfy the most vital interests of the nation and create a true internal peace — such a kingdom was not at all the ideal of the Macedonian monarchy. So far from standing superior to party warfare, the monarchy supported itself by favouring the particular interests of that party which came over to the Macedonian camp. The immense emigration produced by the consequent oppression of those who belonged to the opposition, is proof enough that the new order did not produce a citizenship of inner peace, but, on the contrary, gave new food to the differences from which the communities suffered. So far as the policy of Philip was concerned, the object of the bond was attained when it brought the power of the Greek people into its own service; and even if the war against Persia had its national and Hellenic side, yet so early an authority as Polybius rightly and soberly judged that

the Macedonian king was chiefly acting in the matter to satisfy a personal end. It is an illusion of Droysen's to imagine that this subjection of Greece to a policy which was, by its nature, bound to serve dynastic and personal interests, at the same time secured to the Greeks a common national policy.

The consolidation of the new world power was a consequence of Alexander's irresistible and victorious progress through the heart of the Persian kingdom. His policy was to bring about a new "Hellenistic" régime which should lead to a peaceful blending of Greek and barbarian, and the object was to be gained by putting the oriental and the Græco-Macedonian elements on an equality in army and administration — setting Asiatics, for example, as satraps beside European military governors and treasury officers. He triumphed over opposition, which he encountered chiefly in the army.

This policy was certainly an inevitable consequence of his undertaking and of the conditions which were necessary to its success; but need he have so exaggerated it as to make a complete return to the traditions of oriental despotism? This is a question we do not find so easy to answer in the affirmative, as Droysen does, for he sees nothing but "prejudice" in the resistance which Alexander's claims to apotheosis and genuflexion encountered in the old Macedonian spirit and the Greek love of freedom.

As Ranke rightly declared, it meant a complete break with their entire national history that the Greeks as well should be subjected to the sway of an authority which was no other than that against which they had warred for centuries. Certainly the "city" had outlived its time as the final political unit. The needs of the day called for "an ascent from the city constitution to state constitutions," in which the cities themselves would enjoy only a communal independence. But then they must, to use Droysen's own words, "find in the universal bond their right and their safeguard." And this safeguard could be offered by no orientalising despotism.ⁿ

HIS HERITAGE (HEGEL)

Alexander had the good fortune to die at the proper time — *i.e.*, it may be called good fortune, but it is rather a necessity. That he may stand before the eyes of posterity as a youth, an early death must hurry him away. Achilles begins the Greek world, and his antitype Alexander concludes it: and these youths not only supply a picture of the fairest kind in their own persons, but at the same time afford a complete and perfect type of Hellenic existence. Alexander finished his work and completed his ideal; and thus bequeathed to the world one of the noblest and most brilliant of visions, which our poor reflections only serve to obscure. For the great world-historical form of Alexander, the modern standard applied by recent historical "Philistines" — that of virtue or morality — will by no means suffice. And if it be alleged in depreciation of his merit, that he had no successor, and left behind no dynasty, we may remark that the Greek kingdoms that arose in Asia after him are his dynasty. The Græco-Bactrian kingdom lasted for two centuries. Thence the Greeks came into connection with India, and even with China. The Greek dominion spread itself over northern India. Other Greek kingdoms arose in Asia Minor, in Armenia, in Syria, and Babylonia. But Egypt especially, among the kingdoms of the successors of Alexander, became a great centre of science and art; for a great number of its architectural works belong to the time of the Ptolemies, as has been made out from the deciphered inscriptions. Alexandria became the chief centre of

commerce — the point of union for Eastern manners and tradition with Western civilisation. Besides these, the Macedonian kingdom, that of Thrace, stretching beyond the Danube, that of Illyria, and that of Epirus, flourished under the sway of Greek princes.^m

ALEXANDER'S TRUE GLORY (WHEELER)

If a man's life-work is to be judged only by what he erects into formal organisation, then we must pronounce the career of Alexander a failure, and more than a failure. He had dismantled what he found, and built nothing sure in its place. His dream of fusing the East and the West had been fulfilled and embodied in no visible institution, no form of government or law, of state or church. Greece, Egypt, and the Orient were still in government asunder.

No wonder that historians have written the story of Greece — among them great names like Niebuhr and Grote — and seen nothing more in the career of Alexander than a brilliant disturbance of the world's order, an enthronement of militarism, an annihilation of Greek liberty, and an undoing of Greece in all that makes her life of interest to the world. It is another thing that their blindness could see in Alexander himself only a mad opportunist and greedy conqueror, whose life, had it been spared, could have wrought no more than further conquest; for Alexander was of all things an idealist, and they who have not read that in the story of his life, may as well not have read it at all. Grote and Demosthenes are, each in his way, types of historians and statesmen who have spent their strength in deploring the waste of goodly seed-corn scattered on the fields, their eyes turned towards the former harvest, not the next. The old maxims, the old creeds, and the good old times are reasserted, defended, and bewailed long after they have passed to their larger fruitage in the unfolding of a larger life.

When Alexander's career began, the culture of the world, fixed in two main types, the feminine and the masculine, if we may broadly characterise them so, was still centralised and located, on the one hand in the wealth and settled industrial life of the Mesopotamian and the Egyptian river valleys, on the other in the free energy of the old Greek city communities. When his career ended, the barrier separating these domains had been broken down, never to be raised again.

Man as a base line for measuring the universe, man as a source of governing power, arose in Greece; it was Greece that shaped the law of beauty from which came the arts of form, the law of speculative truth from which by ordered observations came the sciences, and the law of liberty from which came the democratic state. This was what the old Greece held in keeping for the world. Alexander was the strong wind that scattered the seed; again, he was the willing hand of the sower.

The story of Alexander has become a story of death. He died, himself, before his time. With his life he brought the old Greece to its end; with his death, the state he had founded. But they all three, Alexander, Greece, the Grand Empire, each after its sort, set forth, as history judges men and things, the inner value of the saying, "Except a grain of wheat fall into the earth and die, it abideth alone."^o



CHAPTER LVIII. GREECE DURING THE LIFE OF ALEXANDER

THE great conqueror is so much more of a cosmopolitan than a Greek that it has been possible and advisable to trace his career as a unit almost without alluding to the little territory his father had been so anxious to acquire and appease. But Greece, never quiet, was not stagnant during the absence of Alexander; and before taking up the tangle of the successors of Alexander, it will be well to glance at the activities of the Grecians and their futile restiveness.^a

The springs of that policy among the Grecian republics, which produced war against Alexander in Greece itself while he was prosecuting the war of the Grecian confederacy against Persia—nowhere declared by ancient writers, but seeming rather studiously involved in mist by some of them—may nevertheless, by a careful examination of information remaining, in a great degree be traced.

Nothing in ancient history remains more fully ascertained than that, under the Macedonian supremacy, the Grecian republics enjoyed, not only more liberty and independency than under the Athenian or Lacedæmonian supremacy, but, as far as appears, all that could be consistent with the connection of all as one people. Nor did it rest there; Demosthenes, in the Athenian assembly, reviled the Macedonian monarchs, the allies of his commonwealth, the heads of the Grecian confederacy, in a manner that in modern times would be reckoned highly indecent towards an enemy; and he avowed and even boasted of treasonable practices against the general confederacy, of which his commonwealth was a member. "I," he said, "excited Lacedæmon against Alexander: I procured the revolt against him in Thessaly and Perrhæbia." In fact the government of Athens, described, as we have formerly seen, by Xenophon and Isocrates as in their time verging towards anarchy, is largely shown, in the extant works of following orators, and especially in the celebrated contest between Æschines and Demosthenes, to have been still advancing in corruption and degradation. During the whole time that Alexander was in Asia, the struggle of parties was violent—one, under Demosthenes, with the support of Persia, contended ably and indefatigably for the mastery of Athens and of Greece; the other, after Isocrates, looking to Phocion as their leader, desired peace under the established supremacy of Macedonia, and above all things dreaded the ascendancy of Demosthenes and his associates.

[333-331 B.C.]

Of the domestic politics of Lacedæmon information rarely comes to us but through transactions with other states. Agis, the reigning king of the Proclidean family, whom we have seen already active in enmity to Macedonia, appears to have been a man of character to suit the purposes of Demosthenes. Possibly he was not much grieved, nor perhaps was Demosthenes, at the death of Memnon. Had Memnon lived, either could have been but second of the Greeks of the party; which could no way maintain itself but through the patronage of Persia. By Memnon's death indeed great advantages were lost, and a contest of far less hope for the party altogether remained. But in that contest Demosthenes reckoned, by his talents and his extensive political communication, to hold the first importance among the Greeks, while Agis reckoned himself effectually first, by his regal dignity and the old eminence of the Lacedæmonian state; both trusting that they should still not fail of support from Persia. Till the battle of Issus the hopes of both might reasonably run high; and evidently they were not abandoned on the adverse event of that battle.

Looking to facts acknowledged by all, we find the half-ruined state of Lacedæmon never ceasing to avow a political opposition, at length growing into open hostility to the confederacy of republics, constitutionally established under the lead of Macedonia; as constitutionally, it appears, as ever before under the lead of Lacedæmon, Athens, or Thebes. In Athens itself an opposition to the Macedonian interest was always openly maintained. Negotiation was carried on by Lacedæmon among the other republics with avowed hostile purpose, and adverse intrigue from Athens appears to have been no secret. Against this open political hostility no interference of force has been even pretended to have been used; and, in all appearance, hardly so much opposition of influence as honest prudence might require. Negligence, inertness, short-sightedness, may seem, with more reason, to be imputed; yet they never have been imputed to Antipater, to whom the government of Macedonia and the protection of the Macedonian party in Greece were committed. While then the Macedonian supremacy, if not remissly, was liberally exercised, the party interests in every Grecian state, the inveterate hatred everywhere of fellow-citizens to fellow-citizens, and the generally active and restless temper of the Grecian people afforded ground for that league against the confederacy of the Greek nations acknowledging the lead of Macedonia, which Demosthenes and Agis succeeded in forming.

CONFEDERACY AGAINST MACEDONIA

It is beyond question that Persian gold, imputed by all writers, greatly promoted the Persian interest. It appears to have been after the disastrous battle of Arbela, when the Persian monarch's hope even of personal safety depended on opportunity to raise new enemies to Alexander, that he found means to make remittances to Greece. Æschines, uncontradicted by Demosthenes, stated before the assembled Athenian people, as a matter publicly known and not to be gainsaid, that a present to them of three hundred talents (about sixty thousand pounds) was offered in the name of the king of Persia. The prevalence of Phocion's party however at the time sufficed to procure a refusal of the disgraceful offer.

But in Peloponnesus the Persian party, under the lead of the king of Lacedæmon, for whom there was no difficulty in taking subsidies from the Persian court, obtained superiority. Argos and Messenia were inveterately

hostile to Lacedæmon, and were indeed neither by bribes nor threats to be gained. But all Elis, all Arcadia, except Megalopolis, and all Achaia, one small town only refusing, renounced the confederacy under the lead of Macedonia, and joined Lacedæmon in war, equally against Macedonia and all Grecian republics which might adhere to the confederacy. Beyond the peninsula the opposite politics generally prevailed; though in Athens Phocion's party could do no more than maintain nominal adherence to engagement, and a real neutrality; the weight of the party of Demosthenes sufficing to prevent any exertion against the Lacedæmonian league.

That league however was not of such extent that it could be hoped, with the civic troops only of the several states, to support war against the general confederacy under the lead of Macedonia; and those states were not of wealth to maintain any considerable number of those, called mercenaries, ready to engage with any party. Nevertheless mercenary troops were engaged for that league, to the number, if the contemporary orator Dinarchus should be trusted, of ten thousand — Persia supplying the means, as Æschines, still uncontradicted by Demosthenes, affirms; and another source is hardly to be imagined. With such preparation and such support Agis ventured to commence offensive war. A small force of the opposing Peloponnesian states was overborne and destroyed or dispersed; siege was laid to the only adverse Arcadian city, Megalopolis, and its fall was expected daily.

Alexander was then in pursuit of Darius. Accounts of him received in Greece of course would vary: some reported him in the extreme north of Asia; others in India. Meanwhile revolt in Thessaly and Perrhæbia, excited by the able intrigues of Demosthenes, and, according to Diodorus,^e also in Thrace, distressed Antipater; while it was a most imperious duty upon him, as vicegerent of the head of the Grecian confederacy, to protect the members of that confederacy, apparently the most numerous part of the nation, against the domestic enemy, supported by the great foreign enemy who threatened them.

WAR IN GREECE

Accounts remaining, both of the circumstances of the Macedonian kingdom at the time, and of following events, are very defective. But it appears indicated that no Macedonian force, that could be spared for war southward, would enable Antipater to meet Agis; and it was long before he could excite the republican Greeks, adverse to the Lacedæmonian and Persian interest, however dreading its prevalence, to assemble in arms in sufficient numbers. His success however in quelling the disturbances in Thessaly and Thrace, encouraging the zeal of that portion of the Greek nation which dreaded republican empire, whether democratical under Demosthenes or oligarchical under Agis, enabled him at length to raise superior numbers.

Megalopolis had resisted beyond expectation. Antipater, entering Peloponnesus to relieve that place, was met by Agis. A sanguinary battle ensued. The Lacedæmonians are said to have fought with all the obstinacy which their ancient institutions required, and which their ancient fame was adapted to inspire. But they were overborne: Agis, fighting at their head, with the spirit of a hero rather, apparently, than with the skill of a general, received a wound which disabled him, so that it was necessary to carry him out of the field. His troops, unable to resist superior numbers, directed by superior skill, took to flight. Diodorus relates that, pressed by the pursuing enemy, he peremptorily commanded his attendants to save themselves, and

[331 B.C.]

leave him with his arms; and that, disabled as he was, refusing quarter and threatening all who approached him, he fought till he was killed.

The conduct of the victor then was what became the delegate of the elected superintendent and protector of the liberties of Greece. The Lacedæmonian government, feeling its inability to maintain the war in which it was engaged, and the principal instigator being no more, sent a deputation to Antipater to treat for peace. Antipater, as deputy of the captain-general and vicegerent of the Greek nation, took nothing further upon himself than to summon a congress of the several republics to Corinth, to which he referred the Lacedæmonian ministers. There matters were much debated and various opinions declared. The decision at last, in the historian's succinct account, appears not what might best become the wisdom and dignity of a nation accustomed to appreciate its ascertained privileges, or what ought to be such. Unable to agree upon a measure to afford precedent for future times, the resource was to decree that the Lacedæmonian state, submitting itself to the mercy of their great and magnanimous captain-general, should send fifty principal Spartans into Macedonia, as hostages to insure obedience to his decision. We owe to Curtius the additional probable information that the assembly set a fine of 120 talents [about £24,000 or \$120,000] upon the Eleans and Achæans, to compensate to the Megalopolitans the damages done in the hostile operations against them.

It seems likely the Lacedæmonians rejoiced in a sentence which, in so great a degree, secured them against the usual virulence of party animosity among the Greeks, and the result of which they had reason to hope would be liberal and mild. It does not appear that anything more was required than to acknowledge error in hostile opposition to the general council of the nation, and to send, thus late, the Lacedæmonian contingent of troops for maintaining the Grecian empire, already acquired, in Asia.^b

This blow riveted the chains forged at Chæroneia, which however were still destined to be burst by more than one gallant struggle, though never to be finally shaken off. Alexander, when he heard of Antipater's success, is said to have spoken contemptuously of "the battle of mice," which his lieutenant had been fighting, while he had been slaughtering myriads, and overrunning kingdoms; and while the event continued unknown, it did not in the slightest degree interfere with his operations. Yet Antipater's victory was perhaps not much less hardly won than either of his own over Darius. But from the distance at which he now stood, Greece and Macedonia began to appear very diminutive objects. His little kingdom was now chiefly valuable to him as a nursery of soldiers; and the most important advantage which he reaped from the establishment of his power in Greece, was that it insured a constant succession of recruits for his army.

AFFAIRS AT ATHENS

It is rather surprising that when Agis — encouraged by the great distance which separated Alexander from Europe, by perhaps exaggerated rumours of the dangers that threatened him in Asia, and by the disasters which had befallen the Macedonian arms at home — ventured on his ill-fated struggle Athens remained neutral. It was afterward made a ground of accusation against Demosthenes, that he had taken no advantage of this occasion to display the hostility which he always professed towards Alexander. The event proves that he took the most prudent course; but his motives must



URNS AND VASES

remain doubtful. He was perhaps restrained, not by his opinion of the hopelessness of the attempt, but by the disposition to peace, which he found prevailing at home, whether the effect of fear or of jealousy, or of any other cause. Had the people been ready to embark in the contest, an orator probably would not have been wanting to animate them to it. But Demosthenes may still have given secret encouragement and assistance to the Peloponnesian confederates, and may have alluded to this, when, according to his adversary's report, he boasted that the league was his work. The issue of that struggle, and the news which arrived soon after, of the great victory by which Alexander had decided the fate of the Persian monarchy at Gaugamela [Arbela], must have crushed all hope at Athens, except one, which might have been suggested by domestic experience, that the conqueror's boundless ambition might still lead him into some enterprise beyond his strength.

DEMOSTHENES AND ÆSCHINES

There was however a party there, which did not dissemble the interest it felt in the success of the Macedonian arms. Before the battle of Issus, when Alexander was commonly believed to be in great danger, and Demosthenes was assured by his correspondents that he could not escape destruction, Æschines says, that he was himself continually taunted by his rival, who exultingly displayed the letters that conveyed the joyful tidings, with the dejection he betrayed at the prospect of the disaster which threatened his friends. Æschines was the active leader of the macedonising party: all his hopes of a final triumph over his political adversaries were grounded on the Macedonian ascendancy. But Phocion, though his motives were very different, added all the weight of his influence to the same side. His sentiments were so well known, that Alexander himself treated him as a highly honoured friend; addressed letters to him from Asia, with a salutation which he used to no one else except Antipater, and repeatedly pressed him to accept magnificent presents. Phocion indeed constantly rejected them; and when Alexander wrote that their friendship must cease if he persisted to decline all his offers, was only moved to intercede in behalf of some prisoners, whose liberty he immediately obtained.

The disaster of Chæronea (337 B.C.) had held out a signal to the enemies of Demosthenes at Athens, to unite their efforts against him. He had been

[337-325 B.C.]

assailed in the period following that event until Philip's death, by every kind of legal engine that could be brought to bear upon him ; by prosecutions of the most various form and colour. All these experiments had failed ; the people had honoured him with more signal proofs of its confidence than he had ever before received : he had never taken a more active part, or exercised a more powerful sway, in public affairs. Yet it seems that after the Macedonian arms had completely triumphed, both in Asia and in Greece, Æschines thought the opportunity favourable for another attempt of the same nature. This trial, the most celebrated of ancient pleadings, the most memorable event in the history of eloquence throughout all past ages, deserves mention here, chiefly for the light it throws on the character and temper of the Athenian tribunals, at a time when the people is supposed to have been verging towards utter degeneracy, so as to be hardly any longer an object of historical interest — a time, it must be remembered, when the rest of Greece was quailing beneath the yoke of the stranger, and his will, dictated to the so-called national congress at Corinth, was sovereign and irresistible.

The occasion of this prosecution arose out of two offices with which Demosthenes had been entrusted, in the year, it seems, after that of the battle of Chæronea. He had been appointed by his tribe to superintend the repairs which, according to a decree proposed by himself, the city walls were to undergo, the work being equally distributed among the ten tribes. At the same time he filled another post — the treasurership of the theoric fund, which involved a large share in the general control and direction of the finances. In both offices he had made a liberal contribution out of his own property to the service of the state. On this ground, but more especially as a mark of approbation for his public conduct on all occasions, a decree was passed, on the motion of his friend Ctesiphon, that he should be presented with a golden crown. For this decree Æschines had indicted Ctesiphon as having broken the law in three points : first, because it was illegal to crown a magistrate before he had rendered an account of his office ; next, because it was forbidden to proclaim such an honour, when bestowed by the people, in any other place than the assembly-ground in the Pnyx, but particularly to proclaim it, as Ctesiphon had proposed ; and, lastly, because the reason assigned in the decree, so far as related to the public conduct of Demosthenes, was false, inasmuch as he had not deserved any reward. The question at issue was, in substance, whether Demosthenes had been a good or a bad citizen. Hence the prosecutor, after a short discussion of the dry legal arguments, enters, as on his main subject, into a full review of the public and private life of Demosthenes ; and Demosthenes, whose interest it was to divert attention from the points of law, which were not his strong ground, can scarcely find room for them in his defence of his own policy and proceedings, which, with bitter attacks on his adversary, occupies almost the whole of his speech.

His boast is that throughout his political career he had kept one object steadily in view : to strengthen Athens within and without, and to preserve her independence, particularly against the power and the arts of Philip. He owned that he had failed ; but it was after he had done all that one man in his situation — a citizen of a commonwealth — could do. He had failed in a cause in which defeat was more glorious than victory in any other, in a struggle not less worthy of Athens than those in which her heroic citizens in past ages had earned their fame. In a word, the whole oration breathes the spirit of that high philosophy which, whether learned in the schools or

from life, has consoled the noblest of our kind in prisons, and on scaffolds, and under every persecution of adverse fortune, but in the tone necessary to impress a mixed multitude with a like feeling, and to elevate it for a while into a sphere above its own. The effect it produced on that most susceptible audience can be but faintly conceived. The result was that Æschines not only lost his cause, but did not even obtain a fifth part of the votes, and consequently, according to law, incurred a small penalty. But he seems to have felt it insupportable to remain at the scene of his defeat, where he must have lived silent and obscure. He quitted Athens, and crossed over to Asia, with the view it is said of seeking protection from Alexander, through whose aid alone he could now hope to triumph over his adversaries.

When this prospect vanished, he retired to Rhodes, where he opened a school of oratory, which produced a long series of voluble sophists, and is considered as the origin of a new style of eloquence, technically called the Asiatic, which stood in a relation to the Attic not unlike that of the composite capital to the Ionic volute, and was destined to prevail in the East wherever the Greek language was spoken, down to the fall of the Roman Empire. He died at Samos, about nine years after Alexander, having survived both his great antagonist and his friend Phocion.

DEIFICATION OF ALEXANDER; THE GOLD OF HARPALUS

In the course of the year preceding Alexander's death, the stillness and obscurity of Athenian history were broken, partly by the new measures adopted by the conqueror on his return from India with respect to Greece, and partly by the adventures of Harpalus.

Alexander's claim of divine honours could not be viewed in Greece with the same feelings which it had excited among the victorious Macedonians. To the people bowed down by irresistible necessity under a foreign yoke, it was not a point of great moment under what form or title the conqueror, in the plenitude of his power, chose to remind them of their subjection. They might consider the demand as a wanton insult; but it was in no other sense an injury. There might not be many base enough to recommend it, but there were perhaps still fewer so unwise as to think it a fit ground for resistance. It involved no surrender of religious faith, even in those who were firmly attached to the popular creed; and the ridicule for which it afforded so fair a mark was, with most, sufficient revenge for its insolence. The Spartan answer to the king's envoys was perhaps the best: "If Alexander will be a god, let him." At Athens there was something more of debate on the question; yet it hardly seems that opinions were seriously divided on it. It was opposed by a young orator, named Pytheas. It was observed by the more practical statesmen, that he was not yet of an age to give advice on matters of such importance. He replied that he was older than Alexander, whom they proposed to make a god. Lycurgus appears to have spoken, with the severity suited to his character, of "the new god, from whose temple none could depart without need of purification." But it does not follow that he wished to see the demand rejected. At least Demades and Demosthenes were agreed on the main point, and their language, as far as it is reported, seems to have been very similar. Demades warned the people not to lose earth while they contested the possession of heaven; and Demosthenes advised them not to

[324 B.C.]

contend with Alexander about celestial honours. The assembly acquiesced in the king's demand.¹

But the order relating to the return of the exiles awakened very much stronger feelings, partly of fear, and partly of indignation. It appears that Alexander, before he set out on his expedition, when it was his object to conciliate the Greeks, had engaged by solemn compact with the national congress at Corinth — perhaps only confirming one before made by Philip — not to interfere with the existing institutions of any Greek state, but to preserve them inviolate. The tendency of Alexander's new measure was to effect a revolution, wherever Macedonian influence was not yet completely predominant, throughout Greece. Nicanor, a Stagirite, had been sent down by Alexander to publish his decree during the games at Olympia. There were some thousands of the exiles and their friends collected there, who listened to the proclamation with joy. It was in the form of a letter addressed to them in a style of imperial brevity: "King Alexander to the exiles from the Greek cities. We were not the author of your exile, but we will restore you to your homes, all but those who are under a curse [for sacrilege or murder]. And we have written to Antipater on the subject, that he may compel those cities which are unwilling to receive you."

Great alarm ensued at Athens among those who had reason to dread the execution of the decree. The people would not comply with it, but still did not venture openly to reject it. A middle course was taken, by which time at least was gained. An embassy was sent to Alexander, to deprecate his interference; and at Babylon the Athenian envoys met those of several other Greek states, who had come on the same business. In the meanwhile there prevailed at home not only great anxiety about the issue of the embassy, but fears for the immediate safety of the city.

Such was the state of affairs at Athens, when the appearance of Harpalus gave rise to fresh perplexity and uneasiness. The precise time when he arrived on the coast of Attica is difficult to ascertain. But it seems most probable that it was after the return of Demosthenes from Olympia. Harpalus, as we have seen, carried away some five thousand talents, and had collected about six thousand mercenaries. He must therefore have crossed the Ægean with a little squadron; and it is probable that the rumour of his approach reached Athens at least some days before him. He had reason to hope for a favourable reception. He came with his Athenian mistress, for whose sake he had conferred a substantial benefit on her native city; and he had already gained at least one friend there, on whose influence he may have founded great expectations: Charicles, Phocion's son-in-law, who had descended so low as to undertake the erection of the monument in honour of Pythionice, and had received thirty talents by way of reimbursement.

[¹ We insert here a defence of Alexander's act from the pen of his chief biographer, Droysen: *d* "Neither sacred history nor dogma were grounded on the firm basis of doctrinal writings, revealed once for all as of divine origin; for religious things there was no other rule or form than the experience and opinion of men as it was and developed itself in life, also perhaps the instructions of the oracles and the many interpretations of signs. If the oracle of Zeus Ammon, although ridiculed, in the end still designated the king as Zeus' son; if Alexander, sprung of the race of Hercules and Achilles, had conquered and reorganised a world; if in reality he had accomplished greater things than Hercules and Dionysus; if the long established enlightening of minds disaccustomed to the deepest religious wants had left from the honour and feasts of the gods only the diversions, the outer ceremonies, and the calendar; — then one can realise that for Greece, the thoughts of divine honour and deification of man did not lie too far off. Alexander was only the first to claim for himself that which after him the most miserable princes and the most infamous men could justly receive from Hellenes and Greeks, above all from Athenians." The apotheosis of Alexander must then be regarded as a move not altogether due to vanity, and of political rather than religious or personal meaning.]

He might calculate still more confidently on the force of the temptation which his treasure and his troops held out to the people, if they were already disposed to risk an open quarrel with Alexander, and on the ample means of corruption he possessed. These hopes were disappointed, and at first he certainly met with a total repulse. It seems most probable — though our authors leave this doubtful — that his squadron was not permitted to enter Piræus. We know that a debate took place on his first arrival, that Demosthenes advised the people not to receive him, and that Philocles, the general in command at Munychia, was ordered to prevent his entrance. Philocles indeed appears afterwards to have disobeyed this order; but it is probable that he did not immediately allow Harpalus to land. The fullest account we have of the proceedings of Harpalus on his first appearance in the roads of Munychia, is contained in the few words of Diodorus; that, “finding no one to listen to him, he left his mercenaries at Tænarus, and with a part of his treasure came himself to implore the protection of the people.” The sum which he brought with him was a little more than 750 talents: enough certainly to buy the greater part of the venal orators; and many yielded to the temptation.

Whether Demosthenes was one of those who accepted a bribe from Harpalus, has been a disputed point from his own day to ours. It will appear from the following narrative that the evidence cannot be considered as quite conclusive on either side; all that can be proved in his favour is that, the more fully the facts of the case are stated, the more glaring are the absurdities and contradictions involved in the suppositions of his guilt, while the few facts which tend that way may be very easily reconciled with the supposition of his innocence.

The part which he took in the public debates on the affair, is known from good authority — mostly from that of his contemporaries and accusers. It is universally admitted that he was one of those who at the first opposed the reception of Harpalus. After the return of Harpalus to Athens, when he had gained over several of the orators to his side, envoys came from several quarters — from Antipater, from Olympias, and it seems also from Philoxenus, a Macedonian, who filled a high office in Asia Minor — to require that he should be given up. Demosthenes and Phocion both resisted this demand; and Demosthenes carried a decree, by which it was directed, that the treasure should be lodged in the citadel, to be restored to Alexander, and he himself was empowered to receive it. Its amount was declared by Harpalus himself; but, out of the 750 talents no more than 308 remained in his possession. It was clear that nearly 450 had found their way into other hands. Demosthenes now caused another decree to be passed, by which the Areopagus was directed to investigate the case, and he proposed that instead of the ordinary penalty — tenfold the amount of the bribe — capital punishment should be inflicted on the offenders. A very rigid inquiry was instituted; the houses of all suspected persons — with the single exception of one who had been just married — were searched: the Areopagus made its report against several, and among them was Demosthenes himself. He was the first who was brought to trial, was found guilty, and condemned to pay fifty talents. Being unable to raise this sum, he was thrown into prison, but soon after made his escape and went into exile.

One point is indisputably clear: that Demosthenes, whether bribed or not, did not change sides. Harpalus, notwithstanding the efforts of Demosthenes and Phocion in his behalf, was committed to prison, to await Alexander's pleasure. He however made his escape, returned to Tænarus, and

[324-323 B.C.]

thence crossed over with his troops, and the rest of his treasure, to Crete. Here he was assassinated by Thimbron, one of his confidential officers. His steward fled to Rhodes, where he was seized by order of Philoxenus, and forced to disclose the names of those who had accepted bribes from his master. The list was sent to Athens, and the name of Demosthenes — though Philoxenus is said to have been his personal enemy — did not appear in it.

It is a question, which the meagre accounts that have been preserved leave in great obscurity, whether any preparations for war had actually been made at Athens before Alexander's death. It can hardly be supposed that any such measures were taken until the envoys who had been sent to remonstrate with him returned from Babylon; and the interval between their return and the arrival of the news of his death, cannot have been very long. Yet that in this interval at least something was done with a view to a war which was believed to be impending, may be regarded as nearly certain. For it was at this time that a division of the mercenaries who had been disbanded by the satraps, in compliance with Alexander's orders, was brought over to Europe by the Athenian Leosthenes. Leosthenes himself had been for a time in Alexander's service, and though still young, had gained a high reputation: but it seems that he had quitted it in disgust, and had already returned to Athens, and that he went over to Asia, to collect as many as he could of the disbanded troops, whom he landed at Cape Tænarus. It can hardly be supposed that he did this without some ulterior object; and his connection with Hyperides — the chief of the anti-Macedonian party after Demosthenes had withdrawn — and his subsequent proceedings, scarcely leave room to doubt that the object was to have a force in readiness to resist Antipater, if he should attempt to enforce Alexander's edict.

When the news of Alexander's death reached Athens, Phocion and Demades professed to disbelieve the report. Demades bade the people not to listen to it: such a corpse would long before have filled the world with its odour. Phocion desired them to have patience; and when many voices asseverated the truth of the report, replied, "If he is dead to-day, he will still be dead to-morrow, and the next day, so that we may deliberate at our leisure, and the more securely." But their remonstrances were disregarded. The council of Five Hundred held a meeting with closed doors; and Leosthenes was commissioned immediately to engage the troops at Tænarus, about eight thousand men, but secretly, and in his own name, that Antipater might not suspect the purpose, and that the people might have the more time for other preparations. Confirmation of the fact was received shortly after from the mouth of eye-witnesses, who had been present at Babylon when it took place.^e

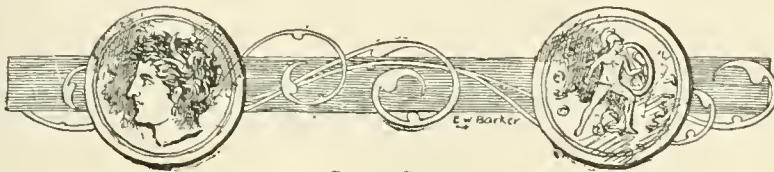

GREEK SEALS

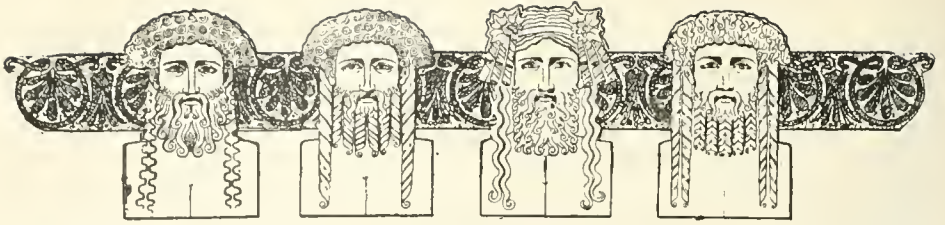

CHAPTER LIX. THE SUCCESSORS OF ALEXANDER

SOME of the most important histories of Greece, notably those of Mitford and of Grote, have terminated with the death of Alexander; and in point of fact one feels some logic in the contention that Greece as a factor in civilisation disappeared with the close of the Alexandrian epoch. Yet as far as mere chronology goes Greece continued a nation, and in some respects a more closely unified nation than ever before, for a period after the death of Alexander as long as the period of her prominence before that event. It was in the year 500 B.C. that the Ionian cities of Asia Minor revolted against the Persian power, and precipitated that conflict which had for its chief result the bringing of the Greek nation, for the first time, into prominence as a world power. From this memorable date to the death of Alexander in 323 B.C., is a period of 177 years; and, as it happened, another period of exactly the same length intervened between the death of Alexander and the final overthrow of Greece by the Romans, culminating in the destruction of Corinth in the year 146 B.C.

But while equally extended in point of time, how utterly different are these two periods in world-historic import! Into the first of them were crowded the events which have made the name of Greece famous for all time; the second was a mere period of senility, in which a once powerful and still proud people struggled in vain to regain its former status, and finally collapsed utterly under the blows of a superior power. Yet in mere geographical extent the Greece of this later period was far larger than Greece proper of the earlier time, for now it included, in addition to the original Hellas, the territories of Macedonia and Epirus; but this was never an harmonious coalition.

The old Greeks of the classical territory were never reconciled to the domination of their northern neighbours, whom they preferred to consider as barbarians, but they were obliged for much of the time to accept that domination, however unwillingly; for the kings of Macedonia, though their power fluctuated from time to time, always had more or less influence over the entire territory of the new Greece.

The meteoric career of Alexander had been cut short at a time when that hero, though he had accomplished conquests without precedent in history, had not yet entered upon the full prime of manhood. It is known that his ever active brain was teeming with plans for fresh conquests, and it is hardly to be doubted that, had he lived, some of these would have been put into almost immediate execution. What the final result would have been, is one of those problems that must ever puzzle the mind of the thoughtful student of history. Such conjectures are utterly futile; yet one cannot escape them. Would the conqueror of the East have spread his power to the West also, subjugating Europe as he had already subjugated Asia? Would he have

[323-301 B.C.]

gone on throughout another half century, had that stretch of life been granted to him, ruling with a firm hand the wide territories that he had conquered, and holding his mighty empire under one unified government with himself at its summit — or would his mighty ambition presently have overstepped the bounds of reason, and would some reverse have presently dashed him headlong from his pinnacle of power? As to this no man can say, and all moralisings on the subject are but idle dreams.

But turning from such visions to the realities, one is presented with an extraordinary picture of a mighty empire, built up by a mere youth, held for the moment, as it were, in the grasp of his hand, and then dashed suddenly into fragments as that hand fell stricken by death. In twelve years the youth Alexander had made himself absolute master of wider territories than were probably ever ruled before by any one man in recorded history; but, almost before the breath of life had left his body, and literally before that body had been laid in the tomb, a strife had begun among the followers of the great captain, which was to lead to almost immediate dismemberment of his empire.

It is one of the surest tests of a great leader of men to be able to gather about him great men as his assistants. Judged by this test Alexander looms large indeed, for he had among his generals, as after events were to prove, a whole company of men, each of whom acknowledged himself subordinate to Alexander, but declined to bow to any lesser power; each of whom, indeed, believed himself worthy to be a king, and determined to make that belief good in practice, now that the great king was no more. Antipater and Craterus, and Antigonus, and Cassander, and Ptolemy, and Eumenes — these are but a few of the leaders among the men who at once began to quarrel about Alexander's possessions, even to the neglect of the burial of Alexander's body. It seems that Alexander had foreseen the inevitable faction, for the story was told that on his death-bed, he had been asked to whom he wished his empire to fall, and he had feebly answered, "to the best man!"

There was, indeed, a pretence of preserving the empire for Alexander's son, borne by Roxane after his death, and given the name of Alexander the Younger; but a score of years is long to wait for a ruler of a newly formed empire, which has within it so many elements of discord as were to be found in the empire of Alexander; and, however sincere a certain number of the leaders may have been, their original intentions of holding the empire for the heir of its founder had vanished from the minds of every one almost before that heir was born. There was indeed a royalist party, which for a time attempted, perhaps in good faith, to uphold the rights of the royal family of Macedonia; but, in the course of the intricate series of revolts and wars in which the entire empire was soon involved, it became difficult, if not impossible, to trace the motives that influenced the various principal actors. But, whatever these motives, the results were very tangible and unmistakable. Alexander's heir was never destined to reach manhood. Both he and his mother were ruthlessly killed by Cassander. Olympias, the mother of Alexander, who, for a time, took an active part in the contests, evincing qualities which explained many of the traits of her great son, met a like fate.

The work of destruction went on until the royal family of Macedon, which Philip and Alexander had made illustrious, was routed out to its last member, and finally, after some twenty-two years of incessant warfare, the vast empire of Alexander was divided into three chief parts: Macedonia, including Greece proper, under the Antigonidæ, the descendants of

Antigonus; the Asiatic kingdom, under the Seleucidæ; and Egypt, under the Ptolemies. The subsequent history of each of these three kingdoms must be considered by itself, but first we must make a brief survey of that great conglomerate struggle through which this dismemberment of the empire of Alexander was brought about.^a Of this Niebuhr says:

“The disputes among the generals of Alexander are to me the most confused events in history. I have very often read them attentively, in order to gain a clear insight into them; but, although I have had a tenacious memory from my early youth, I never was able to gain a distinct recollection of the detail of those quarrels and disputes: I always found myself involved in difficulties. And such is the case still; I find it impossible to group the events in such a manner as to afford an easy survey. This confusion arises from the fact that we have to deal with a crowd of men among whom there is not one that stands forth prominently on account of his personal character. The question always is, whether one robber or another is to be master, and it is impossible to take pleasure in any one of them. One is, indeed, better than another, and Ptolemy is, in my opinion, the best: he was a blessing to Egypt, which under him became happy and prosperous, for his government was rational; but still he is morally a man in whom we can take little interest. His personal character leaves us quite indifferent, when we have once formed a notion of him. Eumenes is the only one who is important on account of his personal character; all the rest are imposing through their deeds of arms alone.

“In the earlier history of Greece we like to follow the great men step by step; but all these Macedonians leave us perfectly indifferent; we feel no interest whether the one is defeated or the other; not even the tragic fall of Lysimachus can make an impression upon us; I look upon it with greater indifference than I should feel at a bull-fight, in which a noble animal defends itself against the dogs that are set at it. I could wish that the earth had opened and swallowed up all the Macedonians. Everyone intimately acquainted with ancient history will share this feeling of indifference with me. And when we are under the influence of such a feeling, it is not easy to dwell upon a history like this; it does not impress itself upon our mind.

“It would be most easy to relate the history of the successors of Alexander as minutely as it was given by Trogus Pompeius, and as we still have it in Diodorus; but there would then be before us only a vast chaos. Even where we have ample information, we must advance rapidly.

“Whoever wishes to investigate this history, must study the eighteenth, nineteenth, and twentieth books of Diodorus; but he ought not to forget that there are many gaps in Diodorus. The eighteenth book, in particular is very much mutilated, and some of the gaps are concealed; for the manuscripts of Diodorus were made with the intention to conceal the fact that they are not complete. The student, however, must compare also the *Excerpts* in Photius from Arrian’s lost work.”^g

COUNCIL AT BABYLON AFTER ALEXANDER’S DEATH

The Macedonians passed the night after the king’s death under arms, as if feeling themselves surrounded by enemies. The peaceable inhabitants of Babylon, perhaps with better reason, dreaded lest their wealthy city should become the scene of military tumult and licence. They hardly ventured to

[323 B.C.]

creep out of their houses to gather news; lighted no lamps in the evening, but watched for the morning in darkness and silence, eagerly listening, and trembling at every sound they caught. The great officers on whom the care of the state chiefly devolved, probably spent the same interval, together or apart, in no less anxious deliberation. By Hephæstion's death the number of those who bore the title of somatophylax was reduced to seven: Leonnatus, Lysimachus, Aristonous, Perdicas, Ptolemy (the reputed son of Lagus, but, according to a report rather widely spread, one of Philip's bastards, his mother having been the king's mistress), Pithon, and Peucestas. When Alexander died, they were all in Babylon.

The next day they summoned a council of the other Macedonian officers, some of whom were but little inferior to them in rank and influence, to confer on the great question of the succession. The soldiers wished to take part in it also; and, though forbidden, forced their way into the palace, and filled the avenues of the council hall, so that many witnessed the proceedings. There a mournful object met their eyes, and revived the consciousness of their loss—the vacant throne, on which had been laid the diadem, with the royal robes and armour. The sight called forth a fresh burst of lamentation, which however was hushed into deep silence, when Perdicas came forward to address the assembly. First he placed the ring, which he had received from Alexander in his last moments, on the throne. "The ring," he said, "was the royal signet, which Alexander had used for the most important state business; it had been committed to him by the dying king, but he placed it at their disposal. It was however absolutely necessary for their own safety that they should forthwith elect a chief, capable of guarding them against the dangers to which they would be exposed without a head in a hostile land. It was to be hoped that, in a few months, Roxane would give them an heir to the throne. In the meanwhile it was for them to choose, by whom they would be governed." He had probably hoped that the wish which he so modestly dissembled would have been anticipated by general acclamation. But the meeting waited for advice.

Nearchus had a different plan to propose. He, as we have seen, had married a daughter of Mentor's widow, Barsine; and Barsine was also the mother of a son by Alexander. He therefore pointed out to the Macedonians "that there was no need to wait for the uncertain issue of Roxane's pregnancy; there was an heir to the throne already born—Hercules, the son of Barsine: to him the diadem belonged." But Nearchus was the only man present who had any interest in this choice. The soldiers clashed their spears and shields together, in token of vehement dissent; and Ptolemy gave utterance to their feelings on this point: "Neither Barsine, nor Roxane, could be mother of a prince whom the Macedonians would acknowledge as their sovereign. Was it to be borne, that the conquerors of Asia should become subject to the son of a barbarian captive? It was better that the throne should remain vacant, and that the persons who had formed Alexander's council of state should continue to have the supreme management of affairs, deciding all questions by a majority of votes." This motion however gained few partisans; its effect would have been permanently to exclude the royal family from the succession: a step for which few were prepared.

Thus most minds were turned towards the advice of Perdicas; for there was a clear distinction between Barsine, and Roxane, Alexander's beloved wife, who was then in the palace, while Mentor's widow had been left with her son at Pergamus. It was now the right time for some friend of Per-

diccas to come forward in his behalf, and Aristonous, perhaps according to previous concert, undertook the task. He observed "that Alexander himself had already decided who was worthiest to command, when, having cast his eyes round all his friends who were at his bedside, he gave his royal signet to Perdicas. They had only to ratify Alexander's choice." Still the assembly was not inclined to invest Perdicas alone, under any title, with supreme power. The result of the whole deliberation was a sort of compromise between the proposals of Ptolemy and Aristonous. It seems to have been decided, but not without clamorous opposition, that, if Roxane should bear a son, he should succeed to the throne; and that in the meanwhile four guardians should be appointed for the future prince to exercise the royal authority in his name. Perdicas and Leonnatus were to be regents in Asia, Antipater and Craterus in Europe.

The cavalry — the aristocratical portion of the army — acquiesced in the resolution of their chiefs. But it was very ill received by the whole body of the infantry. No motive appears for their dissatisfaction, except that they had not been consulted on the question, and that they wished to dispose of the crown. Still it is not clear whether they acted quite of their own accord, or were excited to resistance by Meleager, who seems to have been impelled, partly by ambition, and partly by personal enmity to Perdicas. The accounts remaining of his conduct are contradictory as to details, but agree in representing him as the leader and soul of the opposition. According to some authors, he quitted the council of the officers after bitter invectives against Perdicas, declaring that the people was the true heir of the monarchy, and alone could rightfully dispose of it, and hastened to instigate the soldiery to insurrection and plunder. According to others, he was deputed to appease their discontent, but took the opportunity to inflame it, and placed himself at their head. We are left equally in doubt whether it was he who first proposed another competitor for the throne, whose name was soon mentioned in the popular assembly.

This was Arrhidæus, a son of Philip, by Philinna, a Thessalian woman, who is commonly described as of low condition. Arrhidæus was either naturally deficient in understanding, or had never recovered from the effects of a potion, said to have been administered to him by Olympias, whom jealousy rendered capable of every crime. It seems that Alexander, either through prudence or compassion, had removed him from Macedonia, though he had not thought him fit to be trusted with any command; and he was now in Babylon. Most probably Meleager, perceiving that whoever should raise such a prince to the throne would reign under his name, was the foremost to recommend him as the sole legitimate heir. To the army Arrhidæus must have been personally indifferent; but he was Philip's son, without any mixture of barbarian blood, and, which probably weighed more with them, he would be purely their creature. The proposal therefore was agreeable to their pride and their prejudices, which were stronger than their regard for Alexander now, as they had been in his lifetime. After a short pause — perhaps of surprise that a name so seldom heard should have been put forward on such an occasion — all, as if some happy discovery had been made, broke out into loud acclamations in favour of Arrhidæus; and Pithon, who, it seems — having apparently been sent by the council to soothe them — endeavoured to show the folly of their choice, only incurred their resentment. Meleager was deputed to bring the prince into the assembly; and, when he came, they saluted him as king, under the new name of Philip. He immediately proceeded to the palace, accompanied by Meleager, and escorted

[323 B.C.]

by the troops. The officers, it seems, were still in council there, and when Arrhidæus appeared, some attempt was made to terminate the affair by discussion. But as the chiefs refused to sanction the choice of the infantry, they soon found themselves threatened with violence, and obliged to retire. Arrhidæus mounted the throne, and was invested with the royal robes.

PERDICCAS, MELEAGER, EUMENES, AND THE PUPPET KING

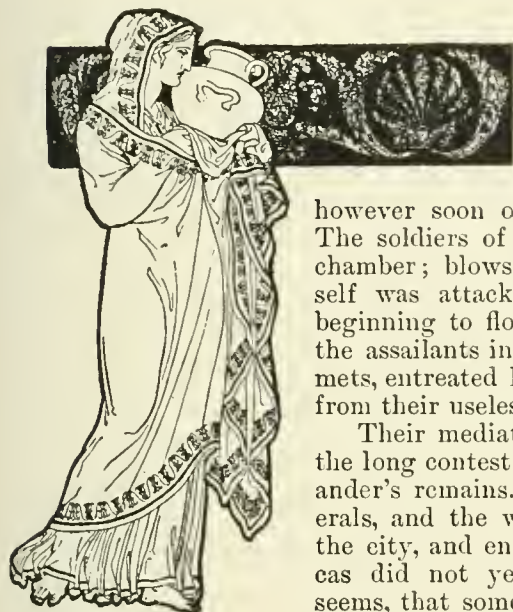

WATER CARRIER
(After Hope)

Perdiccas had ordered the door of the room where Alexander's body lay to be locked, and prepared to guard it with six hundred chosen men; he was joined by Ptolemy at the head of the royal pages. They were

however soon overpowered by superior numbers. The soldiers of the adverse party broke into the chamber; blows were interchanged, Perdiccas himself was attacked with missiles, and blood was beginning to flow, when some of the elder among the assailants interposed, and, taking off their helmets, entreated Perdiccas and his followers to desist from their useless resistance.

Their mediation put an end to this prelude of the long contest which was to take place for Alexander's remains. But the greater part of the generals, and the whole body of the cavalry, quitted the city, and encamped outside the walls. Perdiccas did not yet accompany them; he hoped, it seems, that some change might happen in the disposition of the multitude, which he might more easily turn to his own advantage, if he stayed.

But Meleager, probably apprehending the same thing, and eager to satisfy his hatred, urged the king to give an order for the execution of Perdiccas. This he could not obtain; Arrhidæus was perhaps too timid to strike so great a blow. Meleager therefore was forced to interpret the silence of his royal puppet as consent, and sent an armed band to the house of Perdiccas, with directions to bring him to the palace, or to kill him if he should resist. Perdiccas had only about sixteen of the royal pages with him, when his door was beset. He however appeared on the threshold with a firm countenance, and overawed those who came to arrest him by the severe dignity of his looks and his words. They probably did not think Meleager's authority a sufficient warrant for the murder of a man of such high rank. When they had withdrawn, he and his attendants mounted their horses, and hastened to the camp of their friends.

One eminent person of their party however remained in the city: Eumenes the Cardian, who had already decided on the course which his own interests required, and on this occasion gave proof of the sagacity and dexterity, which afterwards carried him through so many dangers and even brought him so near to the highest fortune. Eumenes, in his boyhood, had attracted Philip's notice by his promising talents; he was brought up at the Macedonian court, and was employed by Alexander both as his principal secretary and keeper

of the records, and in military commands. He had risen so high in favour with the king, that he could even venture on more than one occasion to quarrel with Hephæstion; but, after the favourite's death, he laboured, by ingenious contrivances and profuse expense in honour of his memory, to remove all suspicion that he viewed the event with pleasure. In this liberality, he showed the greater self-command, as he was habitually parsimonious.

Such a man was formed for the times which followed Alexander's death. Eumenes felt that he could only be safe in the strife of parties, as long as he could guard against the jealousy to which a foreigner in high station was exposed among the Macedonians. He remained, as we have observed, in Babylon after the flight of Perdiccas, under the pretext that he had no right to take a part in disputes concerning the succession; secretly however purposing to promote the interests of Perdiccas, as far as he could; for he probably foresaw that this side would finally prevail. He assumed the character of a peacemaker; and his seeming neutrality gave great weight to his mediation. It was seconded by vigorous measures on the part of the seceders. They began to stop the supply of provisions, and to threaten the Great City with famine. Meleager found his condition growing every day more embarrassing. He had been called to account by his own troops for the attempt he had made against the life of Perdiccas, and could only shelter himself under the royal authority. At length the soldiers came in a body to the palace, and demanded that an embassy should be sent to the cavalry, with overtures of peace. Three envoys were accordingly despatched: and it is remarkable, that one of them was a Thessalian, another an Arcadian of Megalopolis; so that probably the third, Perilaus, whose country is not mentioned, was not a Macedonian. The negotiations which followed are reported too obscurely to be described. It is said that the party of Perdiccas refused to treat, until the authors of the quarrel had been given up to them; and that this demand excited a violent tumult in the city, which was only calmed when Arrhidæus, displaying more vigour than he had been believed to possess, offered to resign the crown. Yet it does not appear that this condition was granted.

THE COMPACT

The terms on which the treaty was concluded were, according to the most authentic account, that Arrhidæus should share the empire with Roxane's child, if it should be a boy; that Antipater should command the forces in Europe; that Craterus should be at the head of affairs in the dominions of Arrhidæus; but that Perdiccas should be invested with the command of the horseguards, the chiliarchy, before held by Hephæstion, in which Alexander would permit no one to succeed him. This, it seems, was a post which, at the Persian court, had been equivalent to that prime minister, or grand vizier of the whole empire. It was however stipulated that Meleager should be associated with Perdiccas in the regency, though with a subordinate rank. Of Leonnatus we hear no more as a member of the government. The compact was ratified by a solemn reconciliation between the contending parties. The cavalry returned to the city; the phalanx marched out to meet them; Perdiccas and Meleager advanced between the lines to salute each other as friends. The troops on each side followed their example, and were once more united in one body.

It was however impossible, after what had happened, that Perdiccas and Meleager should ever trust each other. Meleager probably relied on the

[323 B.C.]

infantry for protection. But Perdicas had now taken possession of the imbecile king, who was as passive in his hands as he had been in his rival's, and had resolved to strike the first blow. Before he directly attacked his enemy, he thought it necessary to deprive him of the support which he might find in the army; and he seems to have devised a very subtle plan for this end. He suborned emissaries to complain among the foot-soldiers that by the recent arrangement Meleager had been elevated to an equality with himself — not apparently for the purpose of exciting discontent, or of gaining a party among these troops, but to lead Meleager himself blindfold into a snare. Meleager was soon informed of the language that had been used against him in the camp, and indignantly complained of it to Perdicas, whom he probably suspected to be its secret author. But Perdicas was so great a master of dissimulation, that he completely lulled his suspicions. He affected to sympathise deeply with his resentment, and proposed to arrest the agitators. It was agreed between them, the more safely and surely to effect their object, that the whole army should be drawn out in the adjacent plain, under the pretext of a solemn lustration, to be celebrated with the old Macedonian rites, to purify it from the blood shed in the late quarrel. The usage on such occasions was to kill a dog, and to carry its entrails, divided into two parts, to opposite extremities of the field, so that the army might be drawn up between them, the phalanx on one side, the cavalry on the other. Such at least was the order now adopted by the two chiefs.

On the appointed day Perdicas, with the king at his side, placed himself at the head of the cavalry and the elephants, facing the infantry, which was commanded by Meleager. After a short pause, he ordered them to advance. Meleager's troops were alarmed at the sight of this movement, for they now observed that the ground was favourable for the operations of the cavalry, and that, if they were attacked, they should not be able to make good their retreat without great loss. But, as they received no orders from their chief, and were quite uncertain as to the design of Perdicas, they remained motionless, until a very narrow interval was left between the two lines. The king then rode up with a single squadron, and, having been previously instructed by the regent, demanded that the authors of the late dissensions should be given up to punishment; threatening, if they refused, to charge with the whole force of the cavalry and the elephants.

The men were dismayed by the suddenness of the proceeding; and Meleager, who now perceived his own danger, had not sufficient presence of mind to make any attempt at self-defence. Perdicas took advantage of their consternation, to select about three hundred of those who had most distinguished themselves as his adversary's partisans, and immediately caused them to be trampled to death by the elephants in the sight of the whole army, and with the apparent consent of the king whose cause they had maintained. After this execution Meleager could have no hope of safety but in flight. He was not arrested on the field, but soon after took refuge in a temple at Babylon, where he was despatched by order of Perdicas.

THE PARTITION

By this blow the regent's authority was firmly established, as far as related to the king and the army. A more difficult task remained. He was still surrounded by rivals as ambitious as Meleager, and more formidable from their ability and influence. His next care was to satisfy their pre-

tensions, so as least to weaken himself. A new distribution of the satrapies was settled by general consent, but probably in most points under his direction; in some at least we clearly trace his hand. It was not necessary for any purpose to make a total change; and the general principle adopted seems to have been to retain as many as possible of the satraps appointed by Alexander in their governments. The provinces which lay near the eastern and northeast frontier of the empire, were probably the least coveted, and in these scarcely any alteration was made. There were others from which, as they were more desirable, it might have been more difficult to displace their actual occupants.

The most important part of the new arrangement was that which related to the governments west of the Euphrates. Ptolemy, who was not only honoured on account of his reputed connection with the royal family, but also much beloved for his personal qualities, by the army, had fixed his eyes on Egypt, and obtained it with the adjacent regions of Arabia and Libya. Cleomenes was not removed, but placed under his orders. Laomedon remained in Syria, Philotas in Cilicia, Asander in Caria, Menander in Lydia, and Antigonus in the great province which included Phrygia proper, Lycia, and Pamphylia. But since Lycia and Pamphylia are also said to have been given to Nearchus, we may infer that he held these provinces with a subordinate rank — a suspicion which is confirmed by his subsequent relations with Antigonus. The Hellespontine Phrygia was assigned to Leonnatus — perhaps as a compensation for his share in the regency, or for the sake of removing him from court; and Eumenes, whom Perdicas regarded as his steady adherent, was rewarded with the title of satrap over Paphlagonia and Cappadocia. But these countries, which Alexander had never subdued, were still to be won by the sword from their native ruler, Ariarathes, who had held them as an hereditary vassal of Persia.

In Europe the government of Macedonia and Greece, together with that of the western countries on the coast of the Adriatic, which might afterwards be annexed to the empire, was to be divided between Antipater and Craterus — a partition in which Perdicas may have seen a prospect of collision between them likely to promote his ascendancy. Thrace, or the whole maritime region to the northeast of Macedonia, a province which had never been reduced to tranquil submission, and where the Odrysians had lately been roused to revolt by their chief Seuthes, was committed to Lysimachus, a warrior of iron frame and unflinching hardihood. There are two other names which might have been looked for in this list. Aristonous might have been expected to occupy a prominent place in it, since he had shown himself a decided partisan of Perdicas; yet we hear of no provision made for him. Hence it has been conjectured that Perdicas retained him near his person, as one of his staunchest friends. It was perhaps for a like reason that he entrusted Seleucus — who was destined to act so great a part in the history of the ensuing period — with the chiliarchy which had been assigned to himself — a highly honourable and important post indeed, but one which he might safely part with, as it could add little or nothing to the power he possessed as regent.

ALEXANDER'S POSTHUMOUS PLANS

There still remained a question on which he felt it necessary to consult the army, that he might relieve himself from a dangerous responsibility. Papers had been found in Alexander's cabinet, containing the outlines of

[323 B.C.]

some vast projects. It would seem that they might easily have been suppressed; but it was known that they corresponded in part with the instructions which had been given to Craterus, and therefore they could not safely be neglected without the general consent. Some related to the equipment of a great armament — a thousand galleys, it is said, of the largest size — destined for the conquest of Carthage, and of the whole coast of Africa on the Mediterranean as far as the Straits, and those of Spain and the adjacent maritime regions, as far as Sicily: for which end a road was to be made along the African shore. Others were plans for new colonies, to be planted in Asia with Europeans, and in Europe with Asiatics. There were also directions for six new temples to be built in Europe — at Delos, Delphi, Dodona, Dium, Amphipolis, and Cyrrhus — each at the cost of fifteen hundred talents, beside one of extraordinary magnificence to the goddess of Ilium, and for a monument to his father in Macedonia, which was to equal the largest of the Egyptian pyramids in its dimensions.

It must be owned, that there are some points in these schemes which look suspicious, and which, even if they had crossed Alexander's mind, we should not have expected he would have committed to writing. But the part relating to the temples can scarcely have been fabricated, and was probably contained in the instructions given to Craterus. The plan for an interchange of population between Europe and Asia is also quite conformable to the views which Alexander disclosed in his life-time. This however, and that of the expedition to Africa, could not any longer have entered into any one's thoughts, and might have been silently dropped. But perhaps Perdicas apprehended that the sums destined for the other objects might be demanded from him by his colleagues, and therefore deemed it advisable formally to annul the whole by the highest authority. That he forged the project of the expedition, to render the real contents of the papers the less acceptable to the Macedonians, seems a very improbable conjecture. All were laid before a military assembly, and rejected as impracticable or useless.

During the tumultuous scenes which followed Alexander's death, his body had lain in the palace unburied. There are various reports as to the place selected for its interment. According to one, it was to have been transported to the sanctuary of Ammon. But the more probable is, that it was determined it should be deposited in the sepulchre of his ancestors at Ægæ. And Aristander the soothsayer is said to have declared that it had been revealed to him, the land where it rested was destined to be ever prosperous and secure from invasion: which however was no more than an ancient Greek superstition as to the virtue of a hero's relics. Orders were now given to construct a funeral car worthy of these precious remains, and



PRIESTESS
(After Hope)

the general Arrhidæus was appointed to escort them towards the western coast.^b

The description by Diodorus (XVIII, 3) of this funeral pomp is so gorgeous that as a farewell sunset of Alexander's day it merits insertion here: *a*

ALEXANDER'S FUNERAL DESCRIBED BY DIODORUS

“First was provided a Coffin of beaten Gold, so wrought by the Hammer as to answer to the Proportion of the Body; it was half fill'd with Aromatick Spices, which serv'd as well to delight the Sense as to preserve the Body from Putrefaction. Over the Coffin was a Cover of Gold, so exactly fitted, as to answer the higher part every way: Over this was thrown a curious Purple Coat embroider'd with Gold, near to which were plac'd the Arms of the Deceas'd, that the whole might represent the Acts of his Life. Then was provided the Chariot, in which the Body was to be convey'd, upon the top of which was rais'd a Triumphant Arch of Gold, set thick and studded over with preeious Stones eight Cubits in breadth, and twelve in length: Under this Roof was plac'd a Throne of Gold, join'd to the whole Work, foursquare, on which were carv'd the Heads of Goat-Harts, and to these were fastened Golden Rings of two Hands breadth in the diameter; at which hung, for Show and Pomp, little Coronets of various beautiful Colours, which, like so many Flowers, gave a pleasant Prospect to the Eye. Upon the top of the Arch was a Fringe of Network, where hung large Bells, that the Sound of them might be heard at a great distance.

“On both sides the Arch at the Corners stood an Image of Victory in Gold, bearing a Trophy: A Peristthylum, of Gold supported the Arch-work, the Chapiters of whose Pillars were of Ionian Workmanship: Within the Peristthylum, by a Network of Gold of a finger's thickness in the Workmanship, hung four Tablets one by another equal to the Dimensions of the Wall, whereupon were portray'd all sorts of living Creatures. At the entrance into the Arch stood Lions in Gold, with their Faces towards them that approach'd to enter. From the middle of every Pillar an Achanthus in Gold, sprouted up in Branches spiring in slender Threads to the very Chapiters: Over the Arch about the middle of the Roof on the outside was spread Purple Carpet in the open Air, on which was plac'd a vast Golden Crown, in form of an Olive Coronet, which by the reflection of the Sun-Beams darted such an amazing Splendor and Brightness, that at a distance it appear'd as a Flash of Lightning. Under the Seats or Bottom of the whole Work ran two Axle-trees, about which mov'd four Persian Wheels, whose spokes and Nathes were over-laid with Gold, but the Felloes were shod with Iron: The Ends of the Axes were of Gold, representing the Heads of Lions, every one holding a Dart in his Mouth. There were four Draught-Trees, to every one of which were fix'd four Courses of Yoaks, and to every Course were bound four Mules, so that the Mules were sixty four in number, the choicest for Strength and Largeness that could be got: Every Mule was adorn'd with a Crown of Gold, and Bells of Gold on either side their Heads; and on their Necks were fitted Rich Collars set and beautified with precious Stones. And suitable to so stately a Show, a vast Company of Workmen and Pioneers (that plain'd the Ways for its Passage) attended it.

“And thus Arrhidæus (who had spent two Years in Preparations) brought the King's Body from Babylon to Ægypt. Ptolemy, in Honour of the King met the Corps with his Army as far as Syria, where he receiv'd it,

[323 B.C.]

and accompany'd it with great Care and Observance : For he had resolv'd not as yet to conduct it to the Temple of Hammon, but to keep the Body in the City which Alexander himself had built, the most Famous almost of any City in the World. To this end he built a Temple in Honour of Alexander in Greatness and Stateliness of Structure becoming the Glory and Majesty of that King; and in this Repository he laid the Body, and honour'd the Exequies of the Dead with Sacrifices and magnificent Shows, agreeable to the State of a Demi-God." ^c

ALEXANDER'S HEIRS

While such honours were paid to the conqueror's corpse, two of the living objects of his affection fell victims to the revenge of Roxane and the ambition of Perdicas. Roxane, with the agent's concurrence, invited Statira and her sister Drypetis to Babylon by a friendly letter, and when they came she caused them to be assassinated and secretly buried. In the course of time Roxane was delivered of a boy, who was acknowledged as partner of Philip Arrhidæus in the empire, and bore the name Alexander (Ægus). ^b

Arrhidæus, the Imbecile

The sham government of Arrhidæus was now to commence. He must have been staying with the army. The phalanx no doubt did not believe that Arrhidæus was an idiot, but probably considered him to be a wise ruler who was only calumniated : just as even in Denmark, no one would believe that Christian VII was mad, from fear of wronging the king's majesty. The king's madness was in Holstein such a secret that persons at the utmost whispered it to one another, and to believe it appeared to the people like a culpable act; there is something mystic in the belief that such royal aberration is not madness, but profundity of thought. This may have been the feeling of the phalangites.

The cavalry were satisfied, as soon as they had him in their power. Perdicas was chiliarchus or administrator, and Craterus was to take care of the king's person, as the queen took care of the person of King George III, while the successor managed the government. Craterus was assigned to him as a kind of tutor, who took care of him, and always kept him in order; this shows how imbecile he must have been. Arrhidæus disappears altogether from history, and he was no more king than his nephew Alexander, the son of Roxane, and is mentioned only as a name. But in order to understand many coins and some inscriptions, we must bear in mind that Arrhidæus assumed the name of Philip.

The satrapies were now distributed afresh.

But before proceeding to the history of the satraps, or governors, we must relate the first of the horrible scenes of that time — viz., the insurrection of the unfortunate Greeks in the *ἀνω σατραπείαι* (323 B.C.) — a term comprising Khorasan in its widest extent, partly the province, properly so called, and partly the whole of Persia, east of the great Median desert. There Alexander had settled the captive Greeks, who had served as mercenaries under Darius, as well as other Greeks from among his own allies; he formed them into military colonies. These people were driven by despair to revolt, probably when they heard the report of the Lamian War; they assembled and determined to force their way to Greece. A Macedonian army under Pithon was sent against them. The fearful demoralisation

among the mercenaries became manifest on that occasion ; he would probably have been unable to do anything against them, if he had not bribed one of their commanders, who during the engagement deserted his post. Being overpowered, they now capitulated. Pithon had received orders from Perdiccas to put them all to the sword, that they might no longer be troublesome to him. But Pithon had formed a different plan: he wanted to employ those Greeks as a force, with the aid of which he hoped to play a prominent part; he was a Macedonian, and had claims upon the empire which was already beginning to be torn in pieces. Accordingly he spared their lives; but now his Macedonians rebelled against him—here we see the effects of the national hatred existing between the Greeks and Macedonians—for they found that it would be much more advantageous to kill the Greeks and seize the booty they had collected. They therefore made a general massacre among them, and took their property. After this was done, Pithon returned as if he had executed the orders of Perdiccas. It is as if we read a history of Ali Pasha. Soon afterwards, the hostilities among the governors broke out.

The Diadochi

The generals and satraps of Alexander, called in Greek the Diadochi [*διάδοχοι*, or “successors”], were about twenty in number; none of them was inclined to play a subordinate part, but a great many could not entertain the thought of assuming supreme power. Some of them, therefore, at first kept aloof from the disputes; these were the men who had no great expectations for themselves. The great rupture at the beginning was between Perdiccas on the one hand, and Antipater and Ptolemy on the other.

Perdiccas claimed the supreme power, because Alexander, by giving him his seal-ring, had conveyed it to him; and Antipater claimed it as regent of Macedonia, because he looked upon himself in that capacity as the representative of the nation. He was joined by Ptolemy because he was far off, for if they had been near each other, Antipater and Ptolemy could never have become allies. But as it was, Ptolemy in a distant and inaccessible kingdom considered himself safe, and Antipater could have no inclination to deprive him of his kingdom.

Ptolemy showed himself as a very practical and intelligent man; for he never thought for one moment of making himself master of the whole of Alexander's empire, while the others were more or less harbouring such notions; but he was satisfied with the enormous prize he had carried off from the lottery, the possession of Egypt; and he only sought such provinces as could be maintained from his own kingdom, that is, Syria, Cyprus, and the countries on the opposite coast of Asia, which formed the monarchy under Philadelphus and Euergetes, who were masters of the opposite coast. This was very natural, as he could not but wish to secure himself on all sides.

Antipater aimed at power, but despised the diadem, still having the feelings of a soldier of Philip. He was already very far advanced in years, being the oldest of the generals; and Philip had had none who surpassed him in ability, and he had honoured him more than any other, as, for example, by the embassy to Athens. We recognise Antipater and Parmenion as the greatest among Philip's generals. Antipater was a man of the old school, and affected great simplicity. While the other generals appeared in purple chlamydes, he used the common Macedonian garment, and a stick, so that no one could distinguish him from an ordinary Macedonian. Such an

affectation, combined with internal rudeness, is very often found in men of a blood-thirsty disposition. Not even Plutarch is able to conceal his cruelty.

Perdiccas was the worst of all. He seems to have been a Macedonian noble. Although we read little of a nobility and the like among the Macedonians, and yet he appears in all circumstances as a person of great pretensions. He was guilty of every license, even the greatest cruelties, without being blood-thirsty like Antipater, who was another Duke of Alva. Perdiccas was a purely oriental and unprincipled character; a man of very moderate talents, to whom nothing was sacred.

He had no friends; Eumenes of Cardia alone was in connection with him, and drew close to him. As Craterus was the most chivalrous and gallant among the Macedonians, so Eumenes was the cleverest, and very much distinguished by his great talents: he would have been a distinguished man at any time. He is the only man of that period (if we except Craterus, who fell early) in whom we can take a personal interest; he was a true Odysseus, inexhaustible in resources. He never sacrificed a friend to his own interests. He always obeyed the dictates of humanity, and whenever in his life there occur actions which would be deplored in better times, still they are praiseworthy in comparison with what others did at the time. Being inexhaustible in counsel, he also had quite different ideas from those of the Macedonians. Had he been a Macedonian, he would unquestionably have gained the inheritance of Alexander, as far as it was possible, and as far as it could be concentrated in one man's hand. But he was a stranger, a native of Cardia in Chersonesus, and this circumstance placed him in a position among the Macedonians, which prevented his ever rising to the height which he might otherwise have attained.

Eumenes had not risen, like the rest, by his military talents alone, but more especially as a statesman. At the age of twenty he had entered the cabinet of King Philip, and was employed by him for seven years as secretary; he had then, without interruption, been with Alexander until the king's death, so that for twenty years he had been the organ of the royal government. But he was by no means unfit for the calling, by which men at that time rose to greatness, for he was also a good soldier. Alexander had a horse-guard consisting of two squadrons, and one of them was commanded by Eumenes. If he had been a native of Macedonia, he would unquestionably have eclipsed all others. He afterwards displayed the very greatest talent as a general, which is the more wonderful, as in the time of Alexander he had never commanded an army: he had only acted the part of a looker-on. He was then forty years old, but he was like the men of the revolution who displayed their military skill, although no one had suspected that they possessed any. Eumenes was appointed governor of Cappadocia and Pontus, but had first to conquer them. Perdiccas, feeling that Eumenes was very useful to him, assisted him in his conquests.

The Women Claimants

While Perdiccas was aiding Eumenes, the women of the family of Alexander began a commotion with a view of taking possession of the reins of government. Even during the life-time of Alexander, his sister, Cleopatra, the widow of the Molossian, ambitious like her mother, Olympias, and her whole race, had tried to interfere in the affairs of Macedonia. Even before Alexander's death, Olympias quarrelled with Antipater, and went to her family in Epirus. Cleopatra now endeavoured to obtain influence with

Antipater, but he would not allow her any; it would, however, seem that she acted on the authority of her brother, who wished to prevent Antipater establishing himself too firmly, and therefore allowed her some influence along with Antipater. She seems to have been the spy of her brother. After Alexander's death, Olympias remained in Epirus for several years, until

she unfortunately returned after Antipater's death. Cleopatra, fearing Antipater, who was master in Macedonia, went to Sardis, where she kept a princely court, which became the centre of the intrigues and endless complications of the time.

As Queen Elizabeth continued to deceive many by allowing them to believe that they might hope for her hand, so Cleopatra held out hopes to several of the generals, partly because she had no confidence in her own situation, and partly because she expected brilliant results from her marrying one of the commanders. Thus she contrived to keep up a hope especially in the aged Perdiccas. This was a cause of great alarm to Antipater, who endeavoured to counteract the scheme, and to connect Perdiccas with himself by offering him his daughter, Nicæa, in marriage. This double intrigue was quite in the spirit of all the transactions of that time; it has all its meanness and untruth. The result was, that Perdiccas, through these negotiations, was placed in great difficulties. He thought it dangerous to offend Antipater; but the latter was not in earnest, wishing only to put off Perdiccas and to gain time, and thus both negotiations came to nothing.



FEMALE COSTUME

About the same time there appeared in Asia Minor another daughter of Philip, who is called by some Cyna, and by others Cynane, a Barbaro-Macedonian name. She was a daughter of Audata, an Illyrian woman, for King Philip, according to Macedonian custom, had lived in polygamy, like other barbarian kings. The fate of this Cyna was very tragic. The fact that no one has ever made the last misfortunes of the family of Alexander the subject of a historical tragedy, shows how little the history of that time is known; we have here a most excellent subject for a tragedy, and if Shakespeare had known the fate of that princess and of Olympias, he would unquestionably have seized it as a subject for his muse.

Cyna had been married to the pretender Amyntas a cousin of Alexander, and she had remained behind in Macedonia with her only daughter, Adeia, who afterwards adopted the Greek name Eurydice, which had also been assumed by her grandmother, the mother of Cyna, whose Illyrian name was Audata; Eurydice was a common name in the family of Philip (his mother also bore it), just as Laudice or Laodice was common in the family of the Syrian dynasty. The names of the Macedonians are very often confounded; it is remarkable, that among the Macedonian princes sometimes

[323-321 B.C.]

even brothers have the same name; two brothers of Antigonus Gonatas, *e.g.*, were called Demetrius.

Cynaë was an Amazon character, having accompanied her father on his last expedition, and she educated her daughter in the same way. She went to Asia Minor for the purpose of creating a revolution; she belonged to Antipater's faction, and it was, no doubt, according to a preconcerted plan with Cleopatra, that Perdiccas caused her to be murdered by his brother Alcetas; she died like a heroine. This made a terrible impression upon the Macedonians, and was the main cause of the fall of Perdiccas.

DEATH OF PERDICCAS

Soon afterwards, hostilities broke out between Perdiccas and Antigonus, the satrap of Phrygia, during which Eumenes declared in favour of Perdiccas. This was followed by a general contest in which Perdiccas was joined by Eumenes alone; all the rest, not only Ptolemy, Antipater, and Antigonus, but also Lysimachus and Craterus, were arrayed against Perdiccas.

Perdiccas, who was under the necessity of undertaking something, in order to maintain himself, now (321) undertook an expedition against Ptolemy, whom he wanted to drive out of Egypt, while Eumenes was defending himself in Asia Minor.

This undertaking, which was indeed very difficult, failed; Ptolemy had very prudently fortified himself behind the Nile, and made excellent preparations for defending himself. The army followed Perdiccas very reluctantly, and after having tried in vain for weeks and months to break through the lines of Ptolemy, a rebellion broke out among his men, and he was murdered by his own troops¹ (321). His power had lasted three years, beginning with the death of Alexander; and during that period he had always carried Arrhidæus with him. Antipater, who had even before gone to Asia Minor, now came forward in the camp. The generals of Perdiccas gladly concluded peace with Ptolemy.

Antipater now assumed the supreme power in the empire, which had been possessed by Perdiccas, and all acquiesced in it, because he was at the greatest distance.

The show-kings were now handed over to Antipater. The unfortunate Philip Arrhidæus was married to Eurydice, the daughter of Cyna—a circumstance which is of interest only in the tragic fate of the house of Philip. Eurydice, on account of her ambition, now endeavoured to throw matters into confusion, but Antipater took her and Arrhidæus, as well as Roxane and her child, to Europe with him, and compelled them, as long as he lived, to be more humble. It may in some respects have been disagreeable to the ambitious Macedonian rulers in Asia, that the members of the royal family were in Macedonia in the hands of Antipater; but at the same time this very circumstance paved the way for their independence.

A new distribution of the satrapies also was then undertaken, which, however, was soon set at nought by Ptolemy, who by force made himself master of Phœnicia and Syria, and expelled the governors of these provinces.

[¹ Diodorus describes vividly how Perdiccas tried to cross the Nile; part of his army crossing safely trod away the sand and hundreds who followed were lost. Perdiccas then recalled the vanguard and they were drowned by hundreds. Enraged at this loss of two thousand lives "without a stroke stricken," a body of knights killed him in his tent.]

THE FEATS OF EUMENES

In the meantime, there had been going on in Asia Minor the war between Eumenes, the satrap of Cappadocia, and Antigonus, the satrap of Phrygia, with the party of Antipater; and in that war Craterus had fallen. He had come to the assistance of Antigonus, but Eumenes gained a brilliant victory over him, and Craterus lost his life. But now a storm was rising against Eumenes: a superior force, for which he was no match, was assembling against him. He was sometimes successful, but he succumbed in the end.

The facts are these. After the death of Perdiccas, Eumenes, together with the other partisans of Perdiccas, especially his brother Alcetas of Pisidia, was declared an outlaw in an assembly of the Macedonian army, which on such occasions represented the nation. Antigonus was commissioned to carry the sentence into effect, and he also received the means necessary for this object — but he employed them for the purpose of establishing for himself a larger dominion.

Eumenes, after having lost a battle in Cappadocia, in the face of Antigonus, shut himself up with five hundred men, in the mountain fortress of Nora in Cappadocia, and disbanded his whole army, in the hope that if circumstances should improve, his soldiers would be drawn towards him as towards a magnet. He sustained the siege for half a year. Then, after having been besieged in vain during the winter, he escaped from the besiegers, having kept them engaged, until he had collected strength in other parts. He fled into Syria, and then to the upper satrapies (which had taken no part in the earlier war) to Antigonus of Susa, and Peucestas of Persia. A second war then broke out between Eumenes and Antigonus.

The death of Antipater, which had taken place in the meantime, had greatly altered all circumstances. He had appointed Polysperchon regent, and the latter called upon Olympias to come forward again. Antigonus, Cassander, and Ptolemy (though the last did not do so actively), declared against him; Polysperchon, on the other hand, put himself in connection with Eumenes, on behalf of Olympias and her grandson, and called upon him to take the family of Alexander under his protection.

Eumenes now appeared in upper Asia with full authority from Olympias. The *argyraspidæ* and most of Alexander's veterans were likewise in those parts, for what reason, we know not. They looked upon themselves as a station of invalids, were in the enjoyment of perfect leisure, and lived in the greatest abundance, like the followers of the Normans in England. They were all *seigneurs*. They had hitherto joined no party, and lived like a nation of Mamelukes, almost in the forms of a republic. Eumenes, provided with the authorisation of Olympias, now applied to them, and gained them over to his side. The satraps also declared themselves in his favour, and he obtained possession of the royal treasures. With these means at his command, Eumenes for years carried on the war on behalf of Olympias and young Alexander. For years he overcame the jealousy of the Macedonian commanders, who hated him as a foreigner, and controlled those old faithless men of the sword. He induced them to quit their merry quarters for the objects he stated to them, to follow him, and to risk their own existence for his personal objects; he guided them all by assuming the appearance that they were all equal, and by erecting a symbolical throne of Alexander.

All the Macedonian world was now divided into two masses, which fought against each other both in Europe and in Asia. Cassander was engaged in Greece against Polysperchon, and Antigonus in Asia against Eumenes, still

[321-301 B.C.]

pretending that he was obliged to carry into effect the decrees of the Macedonian army against Eumenes.

The power of Antigonus, however, increased immensely through the war with which he was commissioned: he not only made himself master of Eumenes' satrapy of Cappadocia in western Asia, and of other satrapies in Asia Minor, such as Pisidia and Lycia, but he also occupied Media and the intermediate provinces, so that his rule extended from the Hellespont to Persia. He took his headquarters at Ecbatana, whence he made war upon the southern provinces. In order to attack them he had to pass through the desert of Rhei and Kom, which separates Fars and Kerman from Media. Antigonus there undertook the celebrated expedition through the desert, in order to attack the allies in their winter quarters; but the manner in which Eumenes discovered and thwarted his march, is much more brilliant, for he deceived his enemy, and induced him to give up his plan, which could not have failed, and to make his retreat. In the eighth year after Alexander's death, Antigonus concluded the war against Eumenes, by attacking him with a far superior force. Peucestas had displayed a miserable character, but Antigonus had conducted the war in a most able manner. In the end (316 B.C.), he defeated the allies, and conquered the immense oriental train and their harems, which they carried about with them; and in order to recover these, they concluded peace with Antigonus. This was the price for which the unfortunate Eumenes was delivered up by his own troops, as Charles I was delivered up by the Scotch. Antigonus would willingly have saved him, but he was obliged to sacrifice him to the national hatred of the Macedonians against the Greeks.

THE EMPIRE OF ANTIGONUS

This war established the dominion of Antigonus, who through his victory over Eumenes and the satraps under him, obtained the supremacy over their provinces, and now was in possession of a large empire. He was the first who was courageous enough to drop all hypocrisy, and in 306 B.C. assumed the diadem and the kingly title. No one had as yet ventured to do this, just as Napoleon hesitated for a long time to assume the imperial title. Antigonus was already advanced in years, being of about the same age as Perdicas, and somewhat younger than Antipater (who was the oldest among the generals) if we take into consideration the age at which he died in 301 B.C. He was one of the old officers of Philip, and a good one too. He was, indeed, like most of them, nothing beyond a soldier, but in ability he was superior to most of them. Among those who contended for the empire (if we except Eumenes the stranger and Craterus who fell early), he and Lysimachus were probably the best. Besides Antipater and his son Cassander, they alone were true generals. Ptolemy distinguished himself only by his skilful defence of Egypt against Perdicas; subsequently in the war against Antigonus, not much is to be said of him.

In the meantime great changes had taken place in Macedonia. Antipater had been quiet during the latter years: he reigned in the name of Arrhidæus, and of the little son of Alexander, who at his death was not yet seven years old. Heracles was older, but illegitimate, and was regarded as incapable of succeeding his father: he too was in Macedonia with his mother Barsine. Antipater kept the royal family at Pella in a state of splendid captivity, while he himself lived in the greatest simplicity.

But when his end was approaching, he made a singular arrangement concerning the regency (319 B.C.). Two of his sons were still alive : the one, Iollas, who was said to have poisoned Alexander, was dead, but Cassander and Philip were still living. Antipater did not give the regency and his power to either of them, but to a petty Epirot prince of the name of Polysperchon or Polysperchon.

POLYSPERCHON VERSUS CASSANDER

This arrangement made Cassander and Polysperchon enemies. As soon as the father had closed his eyes, and Polysperchon had entered upon the administration, Cassander quitted Macedonia, went to Ptolemy in Egypt, assembled troops, and prepared to attack Polysperchon. He was conscious of his own superiority : he was a man who in great difficulties knew how to extricate himself ; he was a general who undertook little, but was very cautious in what he did undertake, and a remarkable instrument in taking revenge for Alexander's cruelty against the Greeks. Antigonus and Ptolemy, as we have already mentioned, joined him ; though the latter took no active part in the war, being desirous firmly to establish his own dominion in the interior.

A war now arose which was carried on with the most fearful devastation of unhappy Greece ; the ravages were constantly repeated, until the country was brought down so completely, that it was entirely annihilated.

This war between the two pretenders to the crown of Macedonia, and to the guardianship of the unfortunate royal family, however, inflicted even more suffering upon Macedonia than upon poor Greece.

Polysperchon favoured Olympias, with whom he was already connected by his nationality. She was still living among her countrymen in Epirus, whither she had gone even in the reign of Alexander. The fact that Æacides, a petty prince of the Molossians, who had been expelled by her, now supported her, and on this account brought great misery upon his family, shows that national ties were stronger than those arising from family connection. Polysperchon, as we said before, connected himself with Olympias, and called upon her to return to Macedonia, and undertake the government as the guardian of her grandson, Alexander, the son of Roxane. She readily accepted this proposal, and both now formed connections with Eumenes.

The latter obtained from Olympias full power to act as he thought fit, as if he were *Lieutenant du Roi*, and this induced the argyraspidæ and the satraps of Upper Asia to declare in his favour. Olympias, however, appears still to have remained in Epirus. Eurydice, on the other hand, joined the party of Cassander, and the feud between the two queens became the cause of the civil wars in Macedonia. Polysperchon seems to have had less ambition, and was satisfied with being the first general.

At the same time, however, Polysperchon also endeavoured to secure the assistance of the Greeks, and in the name of the king he issued a proclamation to them in which he declares, in the name of King Philip Arrhidæus, employing the language of hearty sympathy, that the Greeks ought not to impute the harsh cruelties which they had experienced from the generals (Antipater and Craterus) to the king ; that he had neither approved nor known of them ; that he disapproved of the change in their constitutions, and that they should be restored just as they had been under

[317 B.C.]

Philip and Alexander. All the exiled Greeks, moreover, with the exception of a few, were to return. For the purpose of carrying this measure into effect, Polysperchon proceeded to Greece.

Cassander appeared with a few thousand soldiers, whom he had collected in Asia. With this small force he commenced the war elsewhere described, in which he recovered the dominion of his father and a great deal more. When Cassander had established himself there, Polysperchon no longer attacked him, but turned to Peloponnesus, to carry his decrees into effect.

While Polysperchon and Cassander were thus arrayed against each other in Greece, Olympias ruled in Macedonia with a tragic fury. The Macedonians hated and despised her both personally and because she was a foreigner; and she knew this quite well. She remembered that the old national party in Macedonia had regarded Alexander as the son of a foreigner; that on the other hand, the marriage of Philip with Cleopatra, the niece of Attalus, had been hailed with general rejoicings, and that she had been obliged to withdraw with Alexander. She therefore looked upon the real Macedonians as her personal enemies, and the more terrible her natural disposition was, the more she felt irritated, and the more she abandoned herself to acts of infuriated cruelty. The accounts of them are certainly not exaggerated, for we are moving during this period on perfectly historical ground, though it is indeed a barren and exhausted ground, which does not produce a single blossom of poetry. The history of that time is quite authentic, but we may rejoice that we have no very minute accounts of it.

Among the victims of Olympias, we find her step-son, the poor Arrhidæus, and his unfortunate wife Eurydice, the daughter of Cynane. This Cynane was persecuted by her in every way as a mortal enemy, and Eurydice was looked upon by her as the granddaughter of a rival. In early life, Philip had loved Olympias, but afterwards he was shocked at her, and withdrew from her; she had become detestable to him. He lived in wild polygamy, and his mistresses were to her the objects of a truly oriental hatred. Eurydice, the granddaughter of such a rival, was young, lively, and equally ambitious. Olympias cherished against her the hatred of fading age and a malign disposition against the freshness of youth. It must also be borne in mind, that Eurydice's mother had been married to Amyntas, the champion of the party which drove Olympias from Macedonia. Her mother, Cynane, was a bold woman, and Eurydice was a person of the same character; she wanted to rule in the name of her husband.

While Polysperchon was forming a connection with Olympias, Eurydice entered into a relation with Cassander. Olympias seems still to have been staying in Epirus at the time when Polysperchon went to Phocis and thence into Peloponnesus. He took Arrhidæus with him on this expedition, but he must afterwards have sent him back to Pella. Olympias now returned to Macedonia with an army of Epirots and Ætolians, which was opposed by

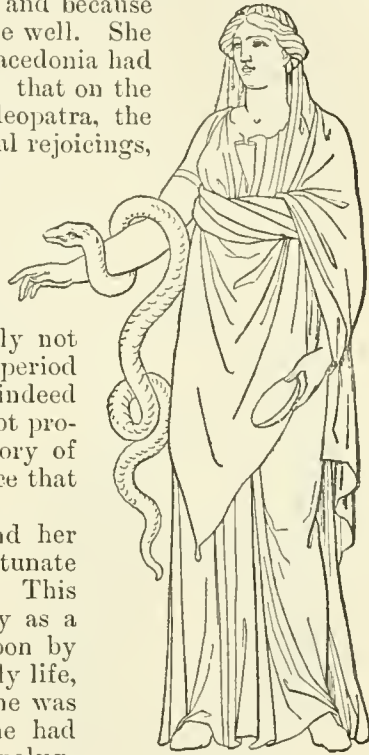

HYGEIA
(After Hope)

Eurydice and a Macedonian force. Olympias made use of the influence of her own name and of that of her son, for the purpose of gaining over the followers of Eurydice. The Macedonians were extremely untrustworthy, and they seem to have been induced to desert to their opponents not only by bribery, but often by mere caprice; and it is not till the time when the dominion of the Antigonidæ had become established, that this faithlessness ceases. Eurydice and Arrhidæus accordingly being deserted by the Macedonians, fell into the hands of Olympias, who now ordered them to be put to death. Wishing to enjoy their death, she first intended to kill them by hunger, and ordered them to be walled up in a dungeon — and a little food to be given to them. But as this lasted too long, Olympias becoming impatient, and fearing lest a tumult should arise, ordered the dungeon to be broken open and the harmless idiot to be murdered by Thracians. Eurydice was obliged to choose the manner in which she was to die, and died with great firmness. Olympias now put forward her little grandson Alexander with his mother Roxane. In the same manner she raged against the whole house of Antipater, one of whose sons was likewise killed.

But the cruelties of Olympias excited discontent and rebellion among the restless and mutinous Macedonians. When Polysperchon was obliged to retreat from Megalopolis, most of the Greek cities declared for Cassander. Cassander thus gained a firm footing in Greece; and, while Polysperchon retreated, Cassander followed him into Macedonia, where the people declared for him, Pella, Pydna, and Amphipolis alone declaring against him. Olympias, with her grandson Alexander, Roxane, and others, had fled to Pydna. Polysperchon was deserted by his troops, who were bribed by Cassander, and was obliged to flee with a few faithful adherents into Ætolia.

Olympias was thus shut up in Pydna; it was situated quite close to the sea, and there was no one inclined to afford her assistance. Eumenes was then in Upper Asia, engaged in the war against Antigonus. If Antigonus, as he himself wished, had become reconciled to Eumenes, the latter would have been able to act as mediator on behalf of Olympias; but, at all events, the assistance from that quarter would have come too late. The party blockaded at Pydna were suffering from the most terrible famine, and Olympias was compelled to surrender. She stipulated for her life, and Cassander promised to spare her, but had no intention of keeping his word. The widows and orphans of those who had been murdered by Olympias brought charges

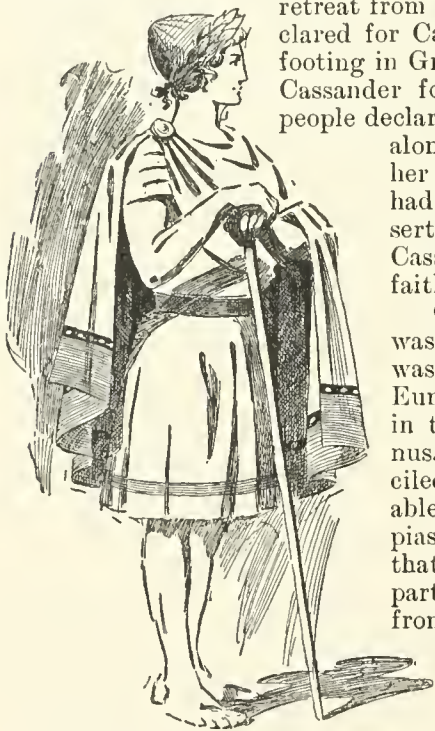

COSTUME OF A YOUTH OF THE UPPER CLASSES

against her before the Macedonians, who again formed a *champ de Mars*. Olympias did not appear, and was sentenced to death. Afterwards, she declared her willingness to appear before a court of Macedonians; but Cassander ordered her to be executed, saying, that he must obey the will of the nation.⁹ Olympias received warning that she must prepare for death.

[316 B.C.]

She put on her royal robes and came forward, leaning on two of her women, to meet the soldiers. Even they were so overpowered by the majesty of her presence, and by the numberless great recollections attached to her name, that they could not bring themselves to execute Cassander's order. He was obliged to commit the deed of blood to the persons who had accused her, and who were eager enough for revenge to undertake it themselves. She submitted to her fate with unbending firmness, neither shrinking from their swords nor uttering a word unworthy of her birth and fortunes.^b

Young Alexander, and his mother, Roxane, were sent to Amphipolis, where, for a time, they were kept in close confinement, and afterwards put to death. Hercules, the son of Barsine, was likewise murdered, and that too by Polysperchon; but when this happened cannot be accurately determined. Polysperchon now disappears from history. His son, Alexander, continued to play a part for some time, but it did not last long.

After the fall of Olympias, all the other places, which had till then held out, opened their gates to Cassander; and he now was king of Macedouia, without having the regal title.

About the same time Antigonus, by his conquest of Eumenes, became master of all Asia, while Lysimachus ruled in Thrace, and Ptolemy in Egypt. We need hardly observe, that Antigonus' dominion in the most eastern satrapies was merely nominal, or did not exist at all; but, in regard to Babylonia, Persia, and other interior provinces, the case was different, for there he really ruled as master. But none of the princes had yet assumed the kingly title. This was the state of things in 316 B.C.

In the feuds which henceforth arise among the rulers, a younger generation of men already appears on the stage, and they can in no way be compared with the older men who had gone forth from the school of Philip. Seleucus was one of these younger men; he had not yet distinguished himself, but may have become acquainted with war as early as the time of Philip. He was of about the same age as Alexander, and in every sense an *enfant de la fortune*, who rose only through his extraordinary good fortune. [His realm and his followers, known as the Selencidæ, will be treated in a later chapter.] Antigonus had conquered for himself an empire by campaigns, labours, and hardships; he lost one eye, and, in the end, his life. Ptolemy had been a companion in arms of Philip, and had greatly distinguished himself under Alexander. Of Cassander we have already spoken; and Lysimachus had been obliged to conquer Thrace, the possession of which he was now enjoying.

It had been given to him to be conquered, for it was not a satrapy, having been under the administration of Antipater. The country had become tributary as early as the time of Philip, but had retained its ancient dynasties. The princes of the Odrysians, though dependent on, and weakened by Philip, still existed; and, in the reign of Alexander, Thrace was always united with Macedonia. But, after his death Perdicas separated the two countries, for the purpose of weakening Antipater, and changed Thrace into a satrapy, which he gave to Lysimachus, and which Lysimachus subdued.

LYSIMACHUS

It is uncertain whether Lysimachus was a Thessalian or a Macedonian. He was captain of the king's bodyguard, and very distinguished, especially for his lion-like bravery. When Callisthenes was tortured by Alexander,

Lysimachus, on seeing his frightful condition, gave him poison out of compassion—a bold thing to do under a tyrant of Alexander's temperament. This story shows that Lysimachus was considered as a man of independence of mind, who preserved his free and proud spirit, when Alexander had already become an eastern despot.

He established his empire with small means, and for the greater part of his life he was reasonable enough to be satisfied with his dominion. It was not till his old age that ambition overcame him and carried him away, though, perhaps, not without some deeper motive and the desire to save himself. He once crossed the Danube in the vain attempt to make conquests in the country beyond the river; this may, perhaps, have been only an attempt to keep off the invading nations of the north. He had a difficult problem to solve, to conquer the wild and warlike Thracians, whose country appears to us northern people as a fair southern sort of paradise, but was terrible to the Greeks on account of the severe arctic cold; and the terror was increased by the savage manners of the inhabitants. On the coast, however, there were large and magnificent Greek cities, and the beautiful Chersonesus. We know little of the reign of Lysimachus, and we are not even informed whether he resided at Byzantium or elsewhere. In later times, during the war against Antigonus, his residence seems to have been in Asia, at Sardis or at Ephesus.

CASSANDER IN POWER

When Cassander was once in possession of Macedonia, he extirpated the family of Alexander, without a hand being raised in their defence. Aristobulus, who wished to interfere, was delivered up and sacrificed. Hence it is remarkable that he married Thessalonice, the only surviving daughter of Philip; but this may have arisen from the pride of the usurper, or from the hope of thereby establishing his dominion. His government of Macedonia was at the same time a perfect dominion over Greece, with very few exceptions, one of which was Sparta.

Thebes had been restored by Cassander immediately after the conquest of Macedonia (316 B.C.), for, in his hatred of Alexander, he undid all that Alexander had done. By their possession of the Theban territory the Bœotians were so much bound up with the interests of Macedonia, that it became a question as to whether it was prudent to restore Thebes. It is not certain whether they had incurred the suspicion of Cassander. It was a matter of great difficulty to induce the Bœotians to consent to the restoration; in all of the rest of Greece it was regarded as an act of the greatest justice, and it seems to have been a general national consolation.

About the same time Cassander founded Cassandrea, a remarkable proof that he was a man of practical sagacity. Philip had extirpated or sold the Greek population on the Macedonian coast, with the exception of that of Amphipolis and Pydna. One of these destroyed cities was Potidæa, which had at first been a Corinthian colony, but afterwards belonged to Athenian cleruchi. Now, on that site, Cassander assembled, not only many strangers, but all the Greeks, especially those Olynthians who were still surviving from the destruction of their city, and built Cassandrea. On the site of the insignificant town of Therma, he founded Thessalonica, which he called after the name of his wife. This act also shows great practical wisdom. Thessalonica, situated on a fine harbour, and in a fertile district, being now extended, became the chief commercial place in Macedonia, a

[316-307 B.C.]

rank which it has maintained down to the present day. Cassandrea (now Cassandra) soon became great and powerful ; it has often been destroyed, but was always restored again ; and its situation was so happily chosen, that it naturally always recovered.

This was the condition of Greece at the time when the appearance of Demetrius Poliorcetes, the son of Antigonus (307 B.C.), stirred up everything without doing any good. He had even before been actively engaged in a war against Ptolemy.

The defeat and death of Eumenes put Antigonus in possession of a vast monarchy, extending from the Hellespont as far as India. According to the early invented principle of the balance of power, the others now demanded that he should give up a part of his conquests ; they even thought it necessary, for the sake of justice and for the balance of power, that the countries of upper Asia should form a separate state.

Seleucus, the child of fortune, was destined to obtain that empire ; a man who was the pet of fortune, but in no way distinguished as a hero or statesman. In the same year (316 B.C.) in which Cassander had conquered Macedonia, and Antigonus, after the conquest of Eumenes, returned from Upper Asia, Antigonus intended to order Seleucus to be arrested at Babylon. But he escaped, and the Chaldeans now foretold Antigonus, that the fate of his family was involved in the affair. It was easy to foretell the beginning, but not the end, for the Seleucidæ did not overthrow Antigonus. Seleucus now went to Ptolemy whom he urged on to wage war against Antigonus.

Thus arose, in 316 B.C., the second or third great internal war among the Macedonian princes — we say the second or third, because the recommencement of the war in 318 B.C. may either be regarded as a continuation of the first or as a second war. In this war, Antigonus fell out with Cassander, and Ptolemy allied himself with Cassander and Lysimachus against Antigonus. Lysimachus, however, was cunning enough to keep aloof as much as he could, and Cassander, too, at first took much less part in it than Ptolemy. In the beginning it was, properly speaking, only Antigonus and Ptolemy that were arrayed against each other.

The war was at first carried on especially in Syria and Cyprus. Ptolemy had taken possession of Cœle-Syria and southern Phœnicia. Antigonus now directed his arms against him, and at first generally with success, so that he made himself master of Syria and a great part of Cyprus ; until, in the fourth year of the war, Demetrius Poliorcetes lost the battle of Gaza against Ptolemy, of which we shall speak hereafter.

In the meantime, however, the generals of Antigonus were carrying on a war in Greece against Cassander, from 315 B.C. till the end of 312 B.C. It is worthy of remark that both Antigonus and Ptolemy considered the Greeks of sufficient importance, to endeavour to gain their favour by proclaiming the struggle a war of independence for the Greeks ; neither of them, however, had any serious intention of this kind. In the very first year of the war, Antigonus sent Aristodemus of Miletus with a fleet and large sums of money to Greece, probably with no other intention than to make a diversion against Cassander and prevent him from crossing over into Asia.

This brought unspeakable misery upon Greece. Each city was too weak, and also but little inclined to defend itself ; each threw itself into the arms of the party that happened to be at its gates. Alexander, the son of Polysperchon, had remained in Peloponnesus, establishing himself mainly at Corinth and Sicyon ; he now joined Antigonus, from whom he received money and troops. He and Aristodemus also enlisted soldiers in Greece,

and the war now broke out, especially in Peloponnesus. Cassander, forcing his way into the peninsula, conquered Cenchreæ, the port of Corinth.

But all on a sudden, Alexander deserted Antigonus, and faithlessly concluded a peace with Cassander in his own name and that of his father. By this means, Aristodemus was driven out of Peloponnesus, and now went to Ætolia, whence he carried on the war against the opposite countries of Peloponnesus, Achaia, and Elis. The watchword always was, "Liberty and Autonomy for Greece;" but the towns were, notwithstanding, treated in a most terrible manner. During the first campaign, the principal scene of operations was Arcadia and Argolis, and in the second, Elis and Achaia.

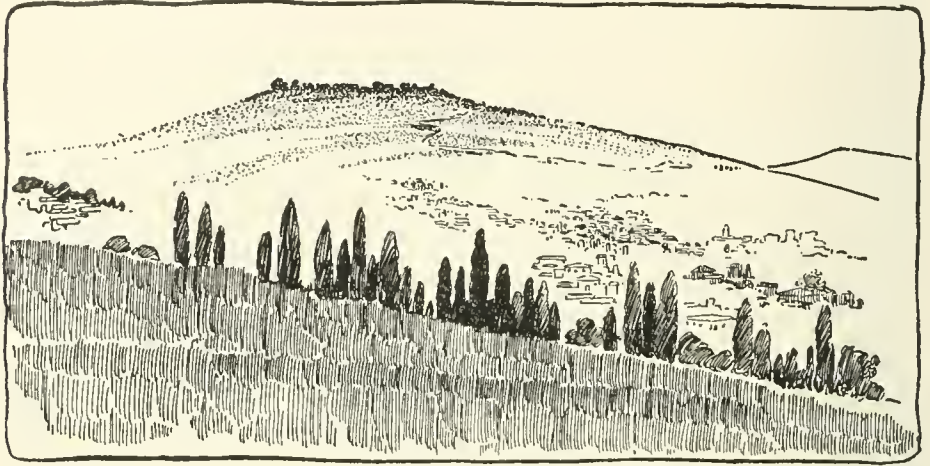

A SCENE IN SYRIA

Almost the whole of Achaia was laid waste during this campaign, and Patræ and Ægium were taken. Alexander was then murdered, and Cratesipolis, his widow, keeping possession of Corinth and Sicyon, ruled there almost as an absolute queen.

But Cassander transferred the war into Ætolia; these occurrences rendered the conflict more and more important, and the Acarnanians, therefore, beginning to be apprehensive, threw themselves into the arms of Cassander and the Macedonians. Being now supported by Cassander, they endeavoured to rid themselves of their connection with the Ætolians. The year following saw the commencement of the war of Cassander against Ætolia.

In 312 B.C., Antigonus made great preparations, and under the command of Ptolemy, a son of his sister, sent an army into Greece, more especially into Bœotia, which was exasperated against Cassander, for having been obliged by him to give up the territory of Thebes. In conjunction with them, Ptolemy conquered Chalcis, and wherever they went, they were successful in expelling the garrisons of Cassander, who had no other city in Greece left that sided with him except Athens. But while Antigonus was victorious there, he was losing ground in other parts; and thus he found himself obliged, in 311 B.C., to conclude a peace with his opponents.

In Syria, Antigonus had entrusted the supreme command against Ptolemy and Seleucus to his son Demetrius, who was then still a very young man. This Demetrius plays a very prominent part in history. He has the honour of having his life described among the biographies in Plutarch — an

[312-308 B.C.]

honour which we might reasonably grudge Demetrius, for he is a despicable person. We know him, partly from Plutarch's biographies, and partly from a number of anecdotes in Athenæus, to have been the most unprincipled and most detestable man in existence: the acts of faithlessness which he committed against Alexander, the son of Cassander, are not the only things for which he deserves our detestation. He was also a voluptuary of the vulgarlest and most abject description; the lowest crapule was the element in the filth of which he revelled; and he was quite a heartless man, who knew no friendship; the basest creatures, the companions of his lusts, were his only friends. Cassander was, after all, capable of distinguishing persons deserving of respect, as he showed in the selection of Demetrius Phalereus; and so also was Ptolemy; but we know that Demetrius Poliorcetes lived at Athens in intimacy with the most abject and abandoned persons of the time. He also showed towards his soldiers an ingratitude and a heartlessness, which are quite revolting; they were perfectly indifferent to him, and he regarded them only as his tools. They accomplished great things for him, but he always sacrificed them without any scruple, leaving to destruction on the morrow those who had saved his life the day before. In addition to this, he was a gambler, whose dull torpor could be excited only by great changes of fortune, and who staked everything upon a card. He is remarkable for his enormous good fortune: "fortune raised him beyond all conception, and then deserted him, but when he seemed entirely lost, she again held out her hand to him," says Plutarch, in a verse which he applies to him.

Such a man would deserve no attention at all, were it not that he acted a great part, and that nature had endowed him with great abilities, especially in mechanics, according to the leaning of that age toward the mechanical sciences. In this respect, as in many others, we may compare him with a modern person, the regent Philip of Orleans, who, however, was a far better man. Demetrius was a great inventor in mechanics, and he did much for the improvement of military engineering: this is a merit which he did not unfairly assume, but he is fully entitled to his reputation in this respect. A short time before, a great impulse had been given to mechanics in the affairs of war, and machines of every description were improved. Engines, which for centuries had remained unchanged, were now, partly through the progress of mathematics, and partly through the increased wealth that could be employed upon them, improved in one year, more than they were formerly in the course of centuries.

Demetrius was eighteen years old when Antigonus commissioned him to undertake the command of an army against Ptolemy. The first attempt failed, for at Gaza he was completely defeated, and Ptolemy again took possession of Cœle-Syria. Ptolemy carried on the war in a generous spirit, for, declaring it to be a civil war between Macedonians, he set the prisoners free without ransom, whereby he gained the good will of the Macedonians. Antigonus now undertook the command himself, and Ptolemy again evacuating the towns of Cœle-Syria, ravaged them.

Peace was then concluded, but it lasted only for a short time. Cassander succeeded in inducing Ptolemy, the nephew of Antigonus, who was stationed in Bœotia, as well as another general on the Hellespont, to revolt. Yet Antigonus soon recovered those countries. In the same year Ptolemy took Cyprus and extended his power on the coast of Asia Minor.

In the year following Ptolemy appeared with a fleet in Greece, having until then been the ally of Cassander. It was probably the Bœotians and Peloponnesians that called in his assistance against Polysperchon, and he

had a fair opportunity of being able to say that he was coming to avenge the murder of Roxane and Alexander. Cratesipolis surrendered to him her principality of Argos and Sicyon, being unable to maintain those cities any longer; but it was not without difficulty that the mercenaries were prevailed upon to surrender: it was effected only by stratagem. The Peloponnesians afterwards were slow in doing what they had promised, and Ptolemy himself probably did not care much about the conquest. Hence he concluded a treaty with Cassander, whereby he obtained possession of Peloponnesus with the exception of Argos and Sicyon.

Antigonus now sent his son Demetrius with a fleet to Greece. No one there was willing to sacrifice himself for Cassander, who had no fleet, so that he was unable to undertake anything against Demetrius. The latter appeared unexpectedly before Piræus: the harbour not being closed, he landed and quickly took Piræus, before the posts could be occupied. He immediately proclaimed that the expedition had been undertaken for the purpose of restoring to Athens her freedom and autonomy, and he was accordingly received with enthusiasm. The Macedonian garrison under Dionysius shut itself up in Munychia, and negotiations were commenced between Demetrius Poliorcetes and the city. Demetrius Phalereus was sent as ambassador down to the camp in Piræus; Demetrius promised the Athenians an amnesty, the city was declared free, and the ancient democratic constitution was restored; but Demetrius Phalereus was sent into exile.

Demetrius Poliorcetes now besieged the Macedonians in Munychia. He would not go to Athens till he had taken that fortress; it was at first blockaded, while the preparations for a siege were going on. While the engines were building, Demetrius marched against Megara, where there was a garrison of Cassander. The town was taken by storm and plundered, and it was only at the urgent request of the Athenian ambassadors, that its inhabitants were saved and not dragged away into slavery. He then returned to Piræus, where he attacked Munychia, until the feeble garrison being exhausted, was obliged, after several days, to surrender, and then departed. The fortifications were razed to the ground, and the place given up to the Athenians. Athens was now free, but Demetrius, for the protection of the Athenians, gave them a garrison of his own troops. After this he stayed for a time at Athens, where he was received with enthusiasm, as elsewhere described.

If Demetrius had remained at Athens, and continued the war against Cassander, he might easily have conquered all Greece; but he was called away by his father Antigonus, because Ptolemy had made himself master of Cyprus. About the month of Hecatombæon, Demetrius sailed to Cyprus; and now, by a brilliant victory of Demetrius over Menelaus, the brother of Ptolemy, near Salamis in Cyprus, Antigonus and Demetrius gained the mastery at sea. Cyprus was reconquered. Menelaus, with all his forces in the island, was obliged to capitulate; and thus the sea far and wide was in the power of Antigonus and his son. But an expedition which the two undertook against Egypt proved a failure.

THE NAME OF KING ASSUMED

Until now, none of the princes had assumed the title of king, but after the victory of Salamis, Antigonus took the diadem for himself and his son. Immediately afterwards, Ptolemy, Cassander, Lysimachus, and Seleucus did

[307-305 B.C.]

the same; and the years were now counted from their accession (306 B.C.): these are what are called the Macedonian Eras.

Demetrius now remained absent from Athens for a period of three or nearly four years; during this time the city was left to itself, and a hard time it was. We may easily imagine that Cassander was not idle, and endeavoured to recover Athens, which was of such importance to him. He was in possession of Panactum and Phyle, and inflicted the severest sufferings upon the city. This war must unquestionably be regarded as one of the chief causes of the terrible poverty in which we afterwards find Athens, for there can be no doubt that the whole territory was laid waste during the incursions from Panactum and Phyle. In this war, Demochares was strategus of Athens, and with her resources alone he operated against Cassander for four years in a most able manner, until Demetrius returned.

According to the order observed by Trogus Pompeius—though not according to that of Justin, who has here quite without judgment omitted many things—we now come to the expedition of Demetrius against Rhodes, one year after the unsuccessful undertaking against Egypt.

THE SIEGE OF RHODES

The salted and dried fish of the Euxine were articles of great consumption in Egypt, and it was for this trade that Rhodes was the natural entrepôt. The consequence of this was, that the Rhodians and the Ptolemies were natural friends and allies, and that Rhodes would on no account separate itself from Egypt; its whole existence depended upon the commercial advantages, which even the first Ptolemy conceded to them. Rhodes, therefore, was a weak place, in which Demetrius Poliorcetes and Antigonus might attack the Egyptians; and it would have been an immense loss to Egypt, if the two princes had conquered the island, the possession of which was to them of equal importance.

Hostilities commenced by Demetrius capturing the Rhodian merchant vessels, which were sailing to Egypt; the first example in antiquity of neutral vessels being seized upon. The Rhodians paying in equal coin, captured the ships of Antigonus, who now declared this measure to be an act of open hostility; and Demetrius was commissioned to lay siege to Rhodes. While Antigonus was engaged in preparations, the Rhodians, seeing that Ptolemy's fleet had been defeated, made an attempt to obtain peace; but the terms which were offered to them were such as to prevent their accepting them. Antigonus demanded one hundred hostages, whom he himself was to select, the right freely to use the harbour of Rhodes for his ships of war, and an unconditional alliance against Ptolemy. These terms were rejected by the Rhodians.

Demetrius then landed at Rhodes. His preparations were immense: the determination of the Rhodians to defend themselves manfully could not be doubted, and hence every effort was made to compel them by force. Demetrius appeared with two hundred ships of war, one hundred and seventy transports, and many small vessels; he is said to have embarked no less than forty thousand men, partly sailors and partly soldiers. He assembled his forces at Loryma, opposite to Rhodes, and during his passage across, the sea between Caria and Rhodes was covered with his ships. He landed without opposition, made a harbour for his ships of war, and approached with besieging engines. The whole island was in the meantime overrun, the

country was laid waste, and all who had not fled into the city, were led away into slavery.

While Demetrius was thus encamped before the walls of the city, the Rhodians were making the most extraordinary preparations. Their citizens were called to arms; in their enumeration only six thousand were found capable of bearing arms, and not more than one thousand metæci and strangers, who were willing faithfully to undertake the defence. At first they do not appear to have employed mercenaries; but they allowed their slaves to take up arms, and after the close of the war they rewarded them with freedom and the franchise.

This siege is as interesting and as important as the siege of Rhodes under Soliman against the noble Grand Master de l'Isle Adam in 1522, which was

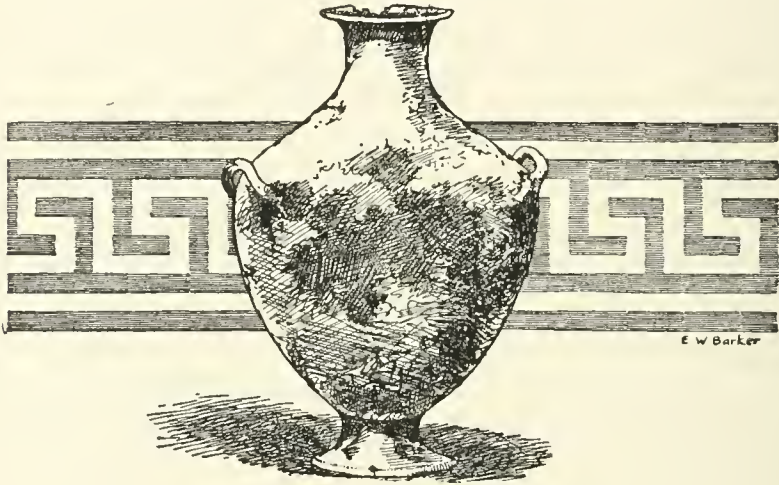

TERRA-COTTA URN
(In the British Museum)

one of the most heroic defences in modern history. In like manner, the siege of ancient Rhodes is one of the most glorious achievements in the later history of Greece.

Demetrius at last became tired, observing that the game was not worth the chase. The siege would have lasted a few months longer, and this prospect made him impatient, as he was losing immense numbers of men and ships. In addition to this, Cassander was completely gaining the upper hand in Greece, and Antigonus found that all around, everybody was rising against him. Demetrius accordingly, on the mediation of Athens and several other Greek cities, concluded a peace, by which he hoped to save his honour. It was based on the terms which the Rhodians had been willing to accept from the first: they were to assist Antigonus and Demetrius in all other wars, but not against Ptolemy, "and as the wars of the two princes were chiefly directed against Ptolemy, the Rhodians had neutrality guaranteed to them." They were further to retain their city with perfect freedom, as well as all their subjects.

Demetrius now returned to Greece. Cassander had been blockading Athens, while Demetrius was besieging Rhodes; and the latter now appeared with a very considerable fleet to relieve Athens. He landed at Aulis on the

[304-301 B.C.]

Euripus, between Oropus and Chalcis, to come upon the rear of Cassander and compel him to withdraw from Athens. Demetrius had a good harbour at Aulis. Chalcis was in the hands of Cassander, and had a Bœotian garrison; but it was a large, desolate place, and was easily taken. In order not to be cut off, Cassander was obliged to break up, and proceeded through Bœotia towards Thessaly. He succeeded in reaching Thermopylæ; Demetrius pursued him, and Heraclea surrendered to him; while six thousand Macedonian troops declared in his favour.

Demetrius, then entering to Attica, conquered Panactum and Phyle, which had been occupied by Cassander, and through which he had had Attica under his control. The Athenians received Demetrius with enthusiasm, as their benefactor. All that impertinent flattery could devise had been exhausted; and what was done now had the character of caricature.

From Athens, Demetrius made several expeditions in different directions, but the city remained his headquarters. During these expeditions, the desolation of the country increased more and more, and it is surprising that Attica did not become a complete wilderness as early as that time.

In the spring of 303 Demetrius entered Peloponnesus, which was in the hands of Cassander and Ptolemy; and he again showed himself in the field as an excellent and active commander. He conquered Corinth, Sicyon, Bura, and Ægium. Then he undertook an expedition with his fleet to Leucas and Coreyra. The Coreyreans were enemies of Cassander. While Demetrius was engaged in those parts, the Romans had advanced to the extreme point of Messapia, and accordingly were very near to Demetrius.

From thence Demetrius returned to Corinth, where he convened a congress of the Greeks, the first after the time of Alexander. He was there proclaimed hegemon of the Greeks, and in the spring, he proceeded to Athens, where he was received as a god with incense and processions by the Athenians, who, being adorned with wreaths, came out to meet him.

Afterwards Athens had to pay a war contribution of 250 talents, which Demetrius under the very eyes of the people gave to his courtesans while he ridiculed the Athenians. Things like these naturally goaded the people into madness.

Demetrius was now master of the greater part of Greece. In the following year he assembled a large army of his allies, and proceeded by way of Chalcis into Thessaly with fifty-six thousand men, to meet Cassander. He took from him a great part of Thessaly, and then after both had dragged each other about without anything being decided, they separated, Demetrius being called to Asia by his father, because a great coalition had there been formed against him. In order, therefore, to withdraw honourably, Demetrius concluded a peace with Cassander, in which Greece was declared free, and then crossed over into Asia.

THE FALL OF ANTIGONUS

Seleucus who was now master of Babylon and the upper satrapies, after having subdued all Iran as far as India without any effort, had formed, together with Ptolemy, Cassander, and Lysimachus, a coalition against Antigonus. This is the first instance known in history, of a great coalition of princes of equal rank and equal independence. Antigonus, who now possessed only Asia Minor, Cyprus, a portion of Syria and the greater part of Greece, was thus opposed by all the rest of the Macedonian world; and

it was against this coalition that Demetrius led his army into Asia Minor. We know very little about the details of the war, but it appears that the enemies pressed into Asia Minor from all sides. The decisive battle was fought near Ipsus in Phrygia; it was decided especially by the admirable infantry of Lysimachus and Cassander. Seleucus had only Asiatics; the phalanx of Ptolemy was of little importance, and only his mercenaries fought bravely; but the truth is that in reality he had no talent as a commander. Antigonus fell in the battle, and the defeat was so complete, that his whole empire was destroyed. Demetrius escaped with a small band to the maritime towns of Ionia, but behaved in a praiseworthy manner.

The empire of Antigonus was now cut up: the western provinces were divided between Cassander and Lysimachus, the upper provinces were assigned to Seleucus, and Cyprus and Syria to Ptolemy, who, however, did not maintain upper Syria, but confined himself to Phœnicia and Cyprus. Plistarchus, a brother of Cassander obtained Cilicia as a special indemnification for Cassander, who himself received Caria and Pamphylia, while Lysimachus acquired Lydia, Ionia, Phrygia, and the north coast of Asia Minor.

DEMETRIUS AT LARGE

After the battle of Ipsus, Demetrius had escaped with a few thousand men to Ephesus, where he had a fleet; and he did not altogether despair of the success of his cause. Cyprus, Sidon, and Tyre, as well as several of the Ionian towns and islands, were still in his possession, and he was anything but an insignificant man. He now displayed great skill, and drew all his forces together, with a view to establish himself in Greece, and there again to try his fortune. For he saw well, that the coalition of the generals who had invaded his father's empire must soon break up, and that then his assistance would probably be sought by one or other of them, which was, in fact, afterwards done by Seleucus and Ptolemy. He sent the great Pyrrhus first as negotiator, and afterwards as hostage, to Ptolemy. Pyrrhus had been his companion in arms; he had lost his kingdom through Cassander, and was now wandering about in the world in the hope of conquering a kingdom for himself. The expedition of the adventurer Cleonymus also belongs to this time, or, rather, to a somewhat earlier one; he was a pretender to the throne of Sparta, from which he was, perhaps unjustly, excluded.

From Ephesus, Demetrius sailed through the Cyclades to Athens, where he wanted to establish himself first. But the Athenians were determined to avail themselves of the jealousy of the princes among each other, to secure their independence; and accordingly they sent an embassy to meet Demetrius, and declare to him, that they would not receive him.

Athens was now spared for a time, and Demetrius, before attacking the city, undertook several other expeditions. He first directed his course, with his squadron, towards the coast of Thrace, gained a footing in the Thracian Chersonesus, and made war upon Lysimachus, who, in the meantime, had taken possession of Lydia, Caria, and Phrygia. Lysimachus was not supported by the other princes, nor was it necessary, and Demetrius made no conquests there. Meantime, however, a new lucky star was rising for him through Seleucus, who, having fallen out with Ptolemy, and being dissatisfied with his share, was ready to form a friendship with Demetrius. He sued for the hand of Stratonice, a daughter of Demetrius, whom, however, he afterwards gave up to his son, Antiochus. Demetrius now sailed with his

[300-295 B.C.]

fleet to Cilicia and Syria, and, in passing, made himself master of Cilicia, and the treasures which Plistarchus, the son of Cassander, was guarding there, and then began to quarrel with Seleucus. For when Cilicia and the Phœnician cities were in the power of Demetrius, Seleucus in vain asked that they should be given up to him; and it was not without difficulty that Demetrius escaped from his plots: a formal rupture, however, did not take place. Demetrius then became reconciled with Ptolemy also, and that as we have already mentioned, through the mediation of Pyrrhus. He now again appeared in Greece, with increased forces. He gained a firm footing in Peloponnesus, though it is uncertain how many towns he subdued there.

In the mean time, Cassander died, and Demetrius, supported by a newly-increased fleet, began the siege of Athens. He had then again fallen out with Ptolemy, who now sent a fleet to assist the Athenians.

Demetrius blockaded the city by land and by sea, and the Athenians, being cut off from the sea, were visited by a fearful famine. They fed upon all kinds of animals, upon indigestible herbs, and the grass which grew on the Acropolis. An Egyptian fleet, attempting to introduce provisions into Piræus, was repelled by Demetrius. At length, after an obstinate defence, they were compelled by the famine to surrender. Every catastrophe brought the city nearer its downfall, though Demetrius, considering that he was the conqueror, displayed great mildness. He convened the Athenians, without their arms, in the theatre, and surrounded the building with his hoplites. But he was satisfied with having struck them with the horrors of death, and, having reproached them for their ingratitude, he declared that he pardoned them. The Athenians were obliged at once to concede to him the right to keep garrisons at Munychia and Piræus, but otherwise they fared better under him now, than at the time when as their friend he had revelled in his excesses. He even fed the Athenians, giving them grain and other necessaries of life.

Demetrius now returned to Peloponnesus. During this expedition, he was on the point of making himself master of Sparta. The Spartans, ever since the battle of Megalopolis, had taken no part in the struggle of the Greeks for independence. Sparta had during that period become more and more powerless, although she was in the enjoyment of peace. That which now emboldened and induced her to declare against Macedonia, is left unnoticed by the historians of the time; and it would be inexplicable, if we did not know that Ptolemy and Lysimachus continued the war against Demetrius. We also know that down to the time of Cleomenes, there existed a constant connection between Sparta and Alexandria; whence we may suppose, that that alliance already existed, and that all the Lacedæmonians received pay from Alexandria. Acts of hostility had indeed occurred between Sparta and Demetrius, but they were not of any importance. It is unknown what forces Archidamus possessed, and what occasioned him to commence the war. All we know is that Archidamus was defeated near Mantinea, that Demetrius advanced as far as Laconia, and that Sparta was now surrounded for the second time with palisades and trenches, and in some parts also with a wall: Pausanias at least places the fortifications at this time. He also calls the defeat of Mantinea, the third great blow to Sparta after the battle of Leuctra and that of Agis. Demetrius might, no doubt, easily have crossed those fortifications, if he had not at the moment received intelligence that all his affairs were in a bad condition, and if he had not for this reason given up the war with Sparta.

For Ptolemy had taken possession of all the places in Cyprus, with the exception of Salamis, which city he was besieging, and which contained the children of Demetrius. Lysimachus was making himself master of the Ionian and other maritime Greek towns in Asia Minor, which had hitherto been under the dominion of Demetrius. The Egyptian fleet seems to have gained the ascendancy; probably because Ptolemy had become master of Tyre and Sidon, whereby Demetrius lost the means of obtaining timber and troops. The Asiatic province henceforth disappears from the history of Demetrius, and he was again in great difficulties.

DEATH OF CASSANDER ; DEMETRIUS WINS AND LOSES

But the death of Cassander, and the misfortunes of his family, opened fresh prospects for Demetrius. Cassander died of dropsy in 297. His eldest son Philip appears to have been his sole heir, but he died soon afterwards at Elatea, 296; two other sons, Antipater and Alexander, then divided the empire between themselves. Both were very young, and their mother Thessalonice, a daughter of King Philip, was the only surviving member of the family; they can scarcely have been more than grown up boys, if the time of Cassander's marriage with Thessalonice is correctly stated in Diodorus. Thessalonice was appointed guardian, or she was commissioned to divide the empire between her two sons. To do this fairly, was a difficult task.

Antipater, the elder, thinking himself wronged by his mother in the division, murdered her; and applying to Lysimachus, his father-in-law, he was supported by him. But Alexander, who was confined to western Macedonia, applied to Pyrrhus, who in the meantime had returned to his paternal kingdom, to obtain his assistance; for this purpose he ceded to him the possessions which the Macedonian kings had in Epirus, together with Ambracia and Acarnania. But distrusting Pyrrhus, he applied at the same time to Demetrius. As Pyrrhus sold his assistance, we may suppose that Demetrius did not give his without some selfish motive either; he evidently caused Thessaly to be ceded to him, the whole of which had belonged to Cassander. Demetrius now entering Thessaly, met Alexander at Larissa. Both intrigued against each other, and aimed at each other's life. After many attempts, and repeated snares, Demetrius struck the blow and caused Alexander to be murdered.

The Macedonian troops of the latter now had no king; Demetrius came forward with a proclamation, in which he declared that he had acted only in self-defence; that his life had been in danger (which was really true, but all the Macedonian princes were equally bad); and called upon the Macedonians to submit to him. The troops submitted to Demetrius and he was proclaimed king. Lysimachus having put himself in possession of the dominion of Antipater, his son-in-law, gave up his new Macedonian possession and made peace with Demetrius, who thus became master of all Macedonia. He now ruled over Macedonia, Thessaly, Attica, Megara, and most of the towns of Peloponnesus. The Spartans, however, continued the war against him.

During these struggles, Demetrius wanted to take from Pyrrhus that portion of Macedonia which Alexander had ceded to him, and thus he began to quarrel with his most faithful friend. During his residence in Alexandria, Pyrrhus had married Antigone, a daughter of Ptolemy by his first wife; and

[286-285 B.C.]

as long as he lived, he was sure of the friendship of the Alexandrian court. The detail of the wars between Pyrrhus and Demetrius cannot form a part of this history, for they are petty and insignificant. Pyrrhus was allied with the Ætolians, and defended himself with great skill against an immensely superior force; and after a few years he was victorious. It was fortunate for him that Demetrius was just then planning greater things; for he was thinking of recovering the empire of his father—a senseless idea under the circumstances of the time. He built an enormous fleet, and enlisted an army which is said to have amounted to one hundred thousand men. His empire comprised not only Macedonia and Thessaly, for nominally he was also hegemon of the Greeks, as Philip and Alexander had been before, and possessed a number of coast towns in Asia; the parts of his kingdom were very much scattered about. But he collected his army with immense exertions; his subjects were fearfully oppressed, and all his dominion was in a state of ferment. His government was on the whole unbearable to the Macedonians on account of his pride and his cruelty; they were not a nation to allow themselves to be governed in the Asiatic fashion. He showed himself very rarely and accepted no petitions; but once he behaved with unusual kindness, receiving all petitions and throwing them into the folds of his garment. Everybody was highly delighted; but when he rode over the bridge of the Axius, he threw them all into the river. Such things naturally exasperated all the people against him.

In the end Pyrrhus, called upon by the more distant kings, and being no doubt invited by the Macedonians themselves, availed himself of the ferment, and invaded Macedonia with a small force. Demetrius marched against him; Pyrrhus manœuvred and negotiated with the Macedonians, until they rose in a general insurrection, refusing obedience to Demetrius and ordering him to withdraw. He was glad to get away, and went, we believe, to Demetrias in Magnesia, which he himself had built on the Gulf of Pagasæ, near the ancient town of Ioleus, and which we afterwards find in the hands of his son Antigonus. Thence he proceeded into Greece. He was a great general; his keen discernment as a military commander is attested by the foundation of Demetrias and of New-Sicyon: the fortress of Demetrias exercised an important influence upon the fate of Greece. Demetrius had reigned over Macedonia five or six years.

Demetrius soon concluded peace with Pyrrhus, and if he had waited patiently, he would have been certain of his restoration; but he could not wait, he wanted to decide everything at once, and thus in his restlessness he crossed over into Asia. He left behind him in Greece his son Antigonus, surnamed Gonatas, who remained master of a great part of Greece. His father had retained possession of Thessaly and of some Greek towns, in which he had garrisons, and the fortress of Demetrias, where he had estab-



GRECIAN OIL BOTTLE

lished arsenals and wharfs for ships of war, commanded Thessaly and Eubœa. Demetrius landed in Asia Minor, wishing to undertake an expedition into the interior of Asia, like a man who has no more to lose; heaven knows what dreams he may have indulged in of overthrowing the empire of Lysimachus and Seleucus. It was impossible for him to conceive anything else but a successful result of his scheme. He accordingly first appeared with his troops in the Asiatic provinces of Lysimachus, where he was met by Agathocles, a son of Lysimachus, who successfully manœuvred him out of those provinces, so that he was obliged to proceed to the interior. In this manner he dragged his army into Armenia, just as Charles XII dragged his into the Ukraine. His desponding troops at length delivered him up to Seleucus, who had surrounded him and cut him off from the sea. He was accordingly taken prisoner, but Seleucus treated him with great clemency. He continued to live for a time very contentedly and happily as a perfectly reckless man; Seleucus, who formed a correct estimate of him, having given him a large Persian palace with hunting grounds, etc., in Syria. Seleucus would perhaps have made use of him against Lysimachus, but Demetrius died in the meantime.

LYSIMACHUS, ARSINOË, AND AGATHOCLES

Lysimachus had, during this period, after the murder of Antipater, his son-in-law, and the last heir of the elder Antipater (perhaps as a punishment for an attempt upon his own life), been in possession of a portion of Macedonia; but he had afterwards given it up to Demetrius. The Macedonians now recognised Pyrrhus as their king; but Lysimachus invaded his kingdom, and after having reigned alone for seven months, Pyrrhus was obliged to divide his empire between himself and Lysimachus. The Macedonians deserting him as a stranger, surrendered to Lysimachus, whom they honoured as an ancient companion of Alexander, and whom they regarded as being nearly related to themselves, being either a Thessalian or a Macedonian. The division, however, between Lysimachus and Pyrrhus did not last for any length of time; for shortly after Lysimachus drove Pyrrhus out of his kingdom. He had reigned over Macedonia altogether five years and six months, partly in conjunction with Lysimachus and partly alone.

The empire of Lysimachus had been gradually extended and consolidated. Greece did not become subject to him; Antigonus Gonatas, who had received the greater part of his father's fleet, maintained himself there with the remnants of his father's forces, and from Demetrius he ruled over a part of Greece, although many Greek cities asserted their independence. Besides Macedonia proper and Thrace, Lysimachus ruled over Lydia, Mysia, Ionia, Caria, and, no doubt over Phrygia Major also—an empire as beautiful as he could have wished, “and just of that extent which Alexander ought to have given to his empire in order to insure its stability.” His real residence seems to have been Lysimachia in Chersonesus, in the neighbourhood of the ancient Cardia. With the exception of Thessalonice, all those Macedonian princes built new capitals for themselves; Alexandria was at least enlarged by Ptolemy.

Previously to the conquest of Macedonia, Lysimachus had undertaken an expedition across the Danube, against Dromichaetes, a king of the Getæ. In the plain of Bessarabia his retreat was cut off, and he, with all his army, was taken prisoner. The generous conduct of the Dacian king,

[283-282 B.C.]

Dromichætes, is celebrated in the collection of anecdotes; Lysimachus was set free, and his power was not weakened by this defeat.

But the royal house was soon to become the scene of a terrible tragedy, the occasion of which came from the family of Ptolemy. Ptolemy had divorced his first wife Eurydice, the daughter of Antipater; and his second wife, the intriguing Berenice, employed every means to cajole Ptolemy, who was enfeebled by age, and to get the succession decided in favour of her own son. She succeeded so well that the aged Ptolemy, two years before his death, resigned his throne to his younger son Ptolemy Philadelphus, and himself took the oath of allegiance to him. The first-born Ptolemy, surnamed Ceraunus, betook himself to Lysimachus, whose eldest son, Agathocles, was married to his sister Lysandra, likewise a daughter of Ptolemy Soter, by his first wife Eurydice. Lysimachus, who received him in a friendly manner, was himself married to Arsinoë, a daughter of Ptolemy by his second wife, by whom he had two sons. This Arsinoë now had recourse to the same intrigues in the house of Lysimachus. His eldest son, Agathocles, was already a man of very mature age (Lysimachus was seventy-four years old at his death) and of great eminence. In many a campaign he had successfully commanded his father's armies; he was very popular throughout the country, and it was he that was destined to succeed his father. But Arsinoë hated him as the husband of her half-sister, against whom she entertained a deadly enmity; and also because he was an obstacle in the way of her own children. She accordingly determined to deprive him of both his throne and his life. It must be borne in mind, that in case of Lysimachus' death she had reason to fear for her own life, and that according to the practice of the age, the step-mother and her children would have been murdered by Agathocles as soon as he had ascended the throne.

Arsinoë, therefore, calumniously informed Lysimachus that his life was threatened by his son Agathocles. The latter was at first treated with insult and persecuted by his father, and soon afterwards killed by poison. As this made a great impression, Lysimachus caused several others of his sons to be put to death, and began to rage against all whom Arsinoë pointed out as partisans of Agathocles. These things produced a complete state of anarchy both in the house of Lysimachus and in his kingdom. As everyone felt that his life was in danger, his nobles began to apply for protection to Seleucus, to whom Lysandra, the wife of Agathocles, had fled with one of her husband's brothers. Seleucus had no objection to being thus called upon to interfere. He marched from Babylon across Mount Taurus down into Western Asia, and, though chiefly by treachery, gained a decisive victory over the aged king in Lower Phrygia. Lysimachus, as at all other times, showed great valour, but fell in the battle. With the exception of Cassandrea, where the widow Arsinoë resided with her children, the whole of the Macedonian state surrendered to Seleucus.

SELEUCUS ; ANTIGONUS ; THE PTOLEMIES

The whole of Alexander's empire, with the exception of Egypt, southern Syria, a portion of Phœnicia, and Cyprus, was thus united under the sceptre of Seleucus. As he had not seen his native country since the beginning of Alexander's expedition, Seleucus now crossed the Hellespont to take possession of his native land, perhaps with the intention of there closing his days in peace. But while sacrificing in the neighbourhood of Lysimachia, he was

murdered by Ptolemy Ceraunus, whom he had protected in his misfortunes with the view, according to the policy of the time, of having a dangerous pretender against Ptolemy Philadelphus. The state of dissolution was such that Ptolemy, without any difficulty, was recognised as king by the Macedonian troops of Seleucus, and by all Macedonia. He accordingly took possession of the empire. There was no hereditary family—that was the misfortune. Ptolemy Ceraunus had paved his way to the throne by murder and ingratitude; but he was in himself no insignificant man: he was very brave and resolute. What his morality was will be seen hereafter.

The Asiatic provinces of Lysimachus were quite united with the Syrian empire, of which Antiochus remained in undisturbed possession, Seleucus, even in his lifetime, having assigned to him the upper provinces. Antiochus endeavoured to avenge the death of his father; and a war broke out between Ptolemy Ceraunus and this Antiochus, who is surnamed Soter, for all the Macedonian kings bearing the same name are distinguished by surnames. He was called Soter, for having conquered the Gauls in Asia Minor. Ptolemy Ceraunus was also at war with Antigonus.

The war with Antiochus did not last long; for Antiochus was wise enough to confine himself to Asia, and not to extend his power further. He would not come to Europe, because he would have been unable to defend his possessions there. He therefore soon listened to proposals of peace.

No definite peace seems to have been concluded with Antigonus; he was too weak to effect anything against Macedonia, and seems to have been reasonable enough to avoid everything which might have called forth greater efforts against him.

Ptolemy endeavoured to establish his power firmly by treaties; and here our guide passes on to the history of Pyrrhus: Ptolemy tried to form alliances, renounced his claims to Egypt, became reconciled with his brother Ptolemy Philadelphus, and tried to win the friendship of Pyrrhus.

Throughout this period, Antigonus Gonatas was at war with Ptolemy Ceraunus, Antiochus Soter, and Ptolemy Philadelphus, and carried on a petty maritime war with them. But during the same period a general Greek war was carried on against him “with the aid of Egypt.” This war is mentioned only in a chapter of Justin, by means of which we must find our way by a careful interpretation; and for this reason the war has been overlooked by all who have written on the Amphictyons. It had its origin in the Amphictyony. Justin, who mentions its date, 281, however, does not call it an Amphictyonic war. The fact is that the Greeks sought a pretext for uniting their forces, in order to rid themselves of the dominion of Antigonus, and therefore engaged in a war against the Ætolians, who were allied with Antigonus.

It is not difficult to understand that, under the Amphictyonic pretext, the Spartans again obtained the assistance of the allies, and recovered the supremacy. Sparta had the supreme command of the army. Areus (or as the Latins call him, Arcas), who was then king of Sparta, as well as his son Acrotatus, was very different from the earlier Spartan kings. In his reign Sparta again became a state of some importance, not through his power but through his name, and perhaps more particularly through his good fortune. The war was carried on with Egyptian money; with it Areus raised the armies which he commanded, and the wars continued for a long time. Egypt assisted with her fleet, but gave no land forces, which were furnished by Areus.

[281-280 B.C.]

This war forms the beginning of another interference of Egypt in the affairs of Greece, for since the time when Demetrius Poliorcetes removed the garrisons of Ptolemy Soter from Corinth and Sicyon, the Egyptian kings do not seem to have interfered in the affairs of Greece. This new interference tore Greece to pieces, and owing to the subsidies which Sparta received, the power of that state rose again.

PTOLEMY CERAUNUS IN MACEDONIA

After the Amphyctyonic War, Justin passes on to Ptolemy Ceraunus and the affairs of Macedonia. He reigned two years, or one year and a half, and during that period he committed crime upon crime. His sister Arsinoe, the widow of Lysimachus, was living with two sons at Cassandrea; the Macedonian princesses had such towns as places in which they resided as widows, and in which, in case of a change of dynasty, they might be safe against any hostile machinations. Cassandrea quickly rose to prosperity, and its possession had an immense charm for her brother. If Arsinoe had placed herself under the protection of Ptolemy Philadelphus, her step-brother, the latter would have had a very strong place in Macedonia, where his fleet might have been stationed, and her sons might then have placed themselves at the head of the malcontents in Macedonia, and have come forward as pretenders. The simplest way for Ptolemy Ceraunus now was to cause his sister and her sons to be murdered, and the question as to whether this should be done or not could not excite any scruples, according to the principles of that time; the only doubt was, how it should be done.

In order to carry out his plan, Ptolemy sued for the hand of his own sister, according to the notions of the family of the Lagidæ, who had adopted the Egyptian views about marriage with a sister. Arsinoe was at first very timid, and her eldest son, though still a child, foresaw what was to come, and warned his mother, saying that the whole was a treacherous scheme. But Arsinoe was a silly woman, who allowed herself to be deceived by the prospect of becoming a queen, just as afterwards Nicæa allowed herself to be gained over by Antigonus Gonatas. She confided in him, opened the gates of the fortress, and admitted him into the town. But now the clouds vanished from her eyes, and she discovered too late what his intentions were. Ptolemy treacherously took possession of the gates of the town, and the first thing he did was to murder the two boys before the eyes of their mother; Arsinoe herself was stripped of all her ornaments (for the avarice of those men was as great as their other vices), and ignominiously sent to Samothrace. She afterwards returned to Egypt, where she spent the remainder of her life. The history of that period reveals to us an interesting but horrible spectacle; it is by no means as monotonous or as unimportant as we are easily tempted to imagine.



GREEK JUG

This crime of Ptolemy Ceraunus was soon followed by its punishment — the arrival of the Gauls as previously described.

Ptolemy drew his forces together, but foolishly declined the auxiliaries offered to him by the Dardanians, and thoughtlessly ventured upon a battle, the result of which was the same as that of the battle on the Allia. No army could resist the vehemence of the Celts, without having been previously accustomed to their appearance and their horrid war cries, and without having learned to sustain the shock with which the intoxicated and infuriated Celts rushed to battle. Familiarity with these things alone rendered resistance possible. Ptolemy, with all his crimes, was an able warrior; he fought bravely, until being severely wounded, he fell into the hands of the Gauls who murdered him.

ANARCHY IN MACEDONIA

We know nothing of the consequences of this victory, except that there followed a state of anarchy in Macedonia, which lasted four years. A panic spread over the whole country, and even a number of towns no doubt succumbed to the Gauls; the open country was thoroughly inundated by the Gauls, and all the population was put to the sword or dragged into slavery, as is usually done by the Tartars and Turks, the latter of whom, in 1683, carried away from Austria no less than two hundred thousand men. There was no heir to the throne, for Ptolemy had left no issue; the families of Cassander and Lysimachus were extirpated, and Pyrrhus happened to be in Italy; civil disturbances breaking out among the Macedonians, whom the death of their king had left to themselves, completed the misfortune. One Meleager, a brother of Ptolemy Ceraunus, came forward as king, and then Antipater, a son of Philip, the brother of Cassander; but neither was able to maintain himself on account of the divisions among the Macedonians. What became of Meleager is uncertain, but Antipater afterwards appears again.

In these circumstances, Sosthenes, as we have seen, assembled an army, and successfully resisted the enemy. His exploits attracted so much attention that the Macedonians proclaimed him their king. But he did not accept the royal title for himself, but only demanded that they should take the oath of allegiance to him as a strategus; he is, however, enumerated among the kings of Macedonia. His modesty does him honour. When the barbarians had murdered and plundered to their hearts' content, they gradually retreated, and Sosthenes restored a portion of Macedonia. But two years later, there followed a fresh invasion of the barbarians on their expedition to Delphi; he met them with all his forces, but the battle was lost, and the brave and worthy man died in consequence of illness, 279.

There now followed again a state of anarchy. Several pretenders arose against one another, who are mentioned in the fragments of Porphyrius on Macedonian history; Antipater came forward again, then Ptolemy a son of Lysimachus, Arrhidæus, and Antigonus. Antipater appears for a time to have had the upper hand, at least he was in possession of Macedonia at the time when Antigonus Gonatas gained the sovereignty. Among the pretenders we also find Eurydice, the daughter of Lysimachus, and widow of Antipater, the son of Cassander; she, being in possession of Cassandrea, restored its inhabitants to freedom. This must have happened after 280, when it was yet in the hands of Ptolemy Ceraunus, and before 277, in which year Antigonus Gonatas overpowered his competitors. We should scarcely know anything

[277 B.C.]

about that period, had not fortunately a kind providence preserved some isolated statements here and there, and in Eusebius the excerpts from Porphyrius on the chronology of the Macedonian kings.

Four years of perfect misery thus passed away, until Antigonus Gonatas, after having concluded peace with Antiochus Soter, proceeded from Greece and Thessaly to the coast of Macedonia, and was readily recognised by the Macedonians (277). He restored the kingdom of Macedonia. From a Greek point of view, as well as from that of common humanity, we can only detest him; but, as far as the Macedonian nation is concerned, he was a benefactor—a real Camillus, and he was even more to Macedonia than Camillus was to Rome.

The expedition of the Gauls against Delphi was contemporary with the second campaign of Pyrrhus against the Romans, and for years he did not allow himself to be induced by these dangers to return across the Adriatic, although he became more inclined to make peace. During that period Antigonus made himself master of the vacant throne of Macedonia.

The reign of Antigonus Gonatas is quite obscure; there is scarcely any other period in history which is equally so. It is a remarkable period, and the long reign of thirty-six years was not without great events.

ANTIGONUS GONATAS

He was the son of Demetrius Poliorcetes and Phila, the daughter of Antipater, so that through his mother he was a grandson of Antipater, and a step-brother of Craterus, the son of Craterus. Antigonus had not recovered Macedonia till after the lapse of ten years. In the interval he had ruled over a very scattered empire, and he seems to have resided at Demetrias in Magnesia. Whether during that period he was still in possession of Corinth and Chalcis, or whether they were already in the hands of Craterus, we cannot say with certainty. He was, however, master of a part of Thessaly. It was not till 277 that he became king of Macedonia. Chronology here is in the most terrible confusion.

Even his conquest of Macedonia has not come down to us in any connected narrative, and we can only guess the connection. Macedonia was overcome by Gauls, and had no legitimate ruler, Antipater being only a usurper. Antigonus must have come by sea, and have offered himself as king to the Macedonians. After he was landed and was encamped near Lysimachia, he came in contact with the Gauls, who were in possession of the open country. While still encamped on the coast, he tried to conclude peace with them; but they were as faithless as they were uncivilised, and at the most critical moment he learned that they were treacherously marching against him. Abandoning his camp, he withdrew to his ships, while a part of his army remained concealed in a forest; they then fell upon his camp, intoxicated themselves, and when they, engaged in plunder, had fallen into disorder, and were overladen with food and drink, Antigonus attacked and defeated them. This victory at once raised him very high in public estimation, and gained for him great repute. He then conquered Antipater, and established himself as king of Macedonia, though assuredly not of Macedonia in its whole extent. The interior at first did not belong to him, and was still occupied by the Gauls.

To Macedonia he was a very beneficent ruler, and he showed himself to be an extremely prudent, thoughtful, and resolute character.

At the very beginning of his reign there occurred a war, which Antigonus, for the recovery of Macedonia, carried on against Apollodorus, the tyrant of Cassandrea, a man whose name is interesting at a time when Greek history cannot point to any other person of importance.

This was the first success of Antigonus, and he also extended his dominion in Greece; but the Athenians maintained themselves against him.

Pyrrhus then returned from Italy after an absence of seven years; he was highly indignant at Antigonus, of whom he had demanded assistance against Italy, and who had imprudently refused it. Antigonus went to meet Pyrrhus as far as the passes of the Aous — where afterwards Antigonea was founded. Pyrrhus defeated him in a battle of some importance; during his retreat, the Gauls who were to protect Antigonus were nearly all cut to pieces, and the Macedonian phalanx, deserting Antigonus, proclaimed Pyrrhus king. Pyrrhus was thus, for a time, king of Macedonia, and Antigonus was confined to a few places on the seacoast, Thessalonica, Cassandrea, and Thessaly.

Pyrrhus now marched into Greece, and perished at Argos whither Antigonus had followed him with an army.

Antigonus was then stationed in the heart of Peloponnesus with an armed force. He availed himself of the opportunity of making himself master of the peninsula and of constituting it anew according to his own mind. Not being able to place garrisons everywhere, he gave the government in all towns which surrendered to him, to his partisans, and established tyrants who were ready to exert their power for his interests. Hence rebellions sometimes occurred when Antigonus was absent. We may mention particularly the overthrow of Aristotimus of Elis, which was brought about by a heroic conspiracy headed by a childless old man; this is one of the noble occurrences in dying Greece.

THE CHREMONIDEAN WAR

Athens, and Sparta under its king, Areus, were apparently allied with the Ætolians and with king Ptolemy against Antigonus. The friendship which the war of Pyrrhus had brought about between Antigonus and the Spartans, was of short duration; the Antigonids and Ptolemies were and remained mortal enemies, and thus the Spartans, being the allies of Ptolemy, became again involved in a war against Antigonus. We do not know how Athens was drawn into this war, whether she had imprudently formed an alliance with Ptolemy, or whether Antigonus had sought a quarrel with her. But an alliance did exist between Athens and Ptolemy, and an Egyptian fleet was stationed near Attica to support Athens by sea. Attica was cruelly ravaged by incursions from Bœotia, and Athens itself was besieged and often blockaded. This war lasted for many years, and completed the misery of Athens, as much as the siege and conquest of Totila completed the destruction of Rome.

This war in Attica is called the Chremonidean War, because Chremonides, an Athenian, was the soul of it.

We know only very little about this war. Ptolemy sent a fleet under the admiral Patroclus to the assistance of the Athenians; and while he was to land and relieve Athens from the sea side, Areus, with the Spartans and his allies, was to attack the Macedonians and oblige them to raise the siege on the land side. But Areus was too slow. The two parties thus being

[265-239 B.C.]

unable to come to an understanding, returned home without having effected anything. After a very long siege, during which Ptolemy Philadelphus, with all his good intentions, effected nothing, Athens being completely exhausted and helpless, was obliged to capitulate.

PYRRHUS' SON TAKES MACEDONIA

Among the various changes of that period, we may mention the transitory conquest of Macedonia by Alexander II, of Epirus, during the Chremonidean war. This Alexander was the only one of the three sons of Pyrrhus that survived his father, of whom he was not unworthy. After his father's death, he remained in the undisturbed possession of the country. He greatly resembled his father, and was, in fact, almost a copy of him, although with feebler features. He also possessed the intellectual culture of his father, and was, like him, an author. Alexander had the same restlessness as his father, but he was not a gambler in the same degree as his father, who staked everything on one throw. While Antigonus was deeply involved in the war with Greece, Alexander invaded Macedonia, which was then still so weak (and it was not yet so much attached to the new dynasty as it was afterwards under Philip, the grandson of Antigonus) that the Macedonian troops deserted to him, and Alexander was recognised as king without difficulty. But he did not maintain the new acquisition. Demetrius, the son of Antigonus, who was then still very young, assembled a fresh army, attacked him, and recovered Macedonia from him, just as Charles XII, in his youth, so brilliantly repelled a similar attack. Demetrius pursued Alexander himself into Epirus, so that the latter was obliged to take refuge in Acarnania, and returned to his kingdom only with the assistance of the Ætolian towns. Afterwards, Alexander of Epirus observed indeed a hostile policy towards Macedonia, but took care not to become involved in a war with it. His kingdom of Epirus was consolidated, and had the same extent in which Pyrrhus had left it to him, and he was allied with the Ætolians.

Trogus says that after the subjugation of Athens, about 264, and after the death of Areus, Antigonus had to carry on a war with Alexander, the son of his brother. This Alexander was the son of Craterus, a half-brother of Antigonus, by Phila.

We will not decide whether the statement that Antigonus poisoned Alexander, is true or not; but there can be no doubt that he gained possession of Corinth by treachery and gained a secure footing in the Peloponnesus. But through the carelessness of the aged Antigonus, whose thoughts turned away from Greece to the restoration of Macedonia, the league of the Achæan towns was revived and gained fresh strength. Antigonus became the second founder of the Macedonian kingdom, but the more he strengthened his own country the more he neglected Greece. Aratus of Sicyon, as we have already seen, surprised Corinth and expelled the Macedonian garrison. The loss of Corinth was a death-blow to Antigonus, for through it he lost his dominion over Peloponnesus. The Ætolians, thinking themselves thus endangered, allied themselves with Antigonus. The Achæans had received considerable support from Ptolemy Euergetes. Antigonus died at the age of seventy-three and was succeeded by his son Demetrius, whose reign was inglorious and unfortunate for Macedonia. The greatest event of the reign of Demetrius is his great war for the possession of Epirus which he fought with the Ætolians.

Alexander of Epirus, the son of the great Pyrrhus, left behind him five children—two sons, Pyrrhus and Ptolemy, and three daughters. At his death his sons were yet very young, and his widow Olympias, who was at once his sister and his wife, according to the detestable custom of the Ptolemies, acted as guardian of the children. Alexander's kingdom comprised all Epirus to the extent which his father had possessed, and the part of Acarnania which had fallen to his share at the time when the country was divided between him and the Ætolians. But his relation to the Ætolians was insecure, and Olympias was not without apprehensions; it is possible that symptoms may have already been visible in Epirus of the ferment which afterwards manifested itself in so fearful a manner, and it is not unlikely that the malcontents may have applied to the Ætolians. Olympias alone being unable to offer any resistance to the Ætolians, sought the protection of the Macedonians by endeavouring to effect a marriage between one of her daughters (whose name is misspelt Ptia; we must no doubt read Phthia) with Demetrius of Macedonia. Demetrius accepted the offer, although he was already married to the Syrian princess Stratonice, a sister of Antiochus Theos, whom he now divorced in order to marry Phthia.

Stratonice, leaving Demetrius, went to Asia Minor, as Justin, our only authority, relates; the divorce, however, did not lead to a war between Macedonia and Syria, because the latter country was too weak. But in Syria itself that fury of a woman created great mischief. She proceeded to the court at Antioch, offering her hand to Seleucus Callinicus; and when he rejected the offer, she induced the restless Antiochians by her intrigues to recognise her as their queen. Seleucus happened to be engaged in an expedition against the upper satrapies, and when he returned, he conquered Stratonice. Being now deserted by the Antiochians, she was taken prisoner and put to death.

The marriage of Phthia with Demetrius then became the occasion of great confusion and misfortune, by dragging him into the war with the Ætolians. The latter availed themselves of the forlorn state of Epirus for the purpose of attacking the Epirot portion of Acarnania, and making themselves masters of the whole country. Demetrius hastened to support the Epirots, and thus arose a war between the Macedonians and Ætolians, in which the latter joined the Achæans, against whom they otherwise entertained an invincible aversion. This is the most brilliant war that was ever carried on by the Greeks against the Macedonians, but we know nothing of its separate occurrences. Whether the war was brought to a close by the conclusion of a truce or otherwise, is unknown.

There never was a moment since the Lamian war, at which the recovery of the national independence of the Greeks was so near at hand as after the death of Demetrius. He died during an expedition against the Dardanians, after a reign of ten years, leaving behind him Philip, a boy of between five and six years old, just at the time when the Romans, for the first time, appeared with their armies on the eastern coast of the Adriatic.⁹

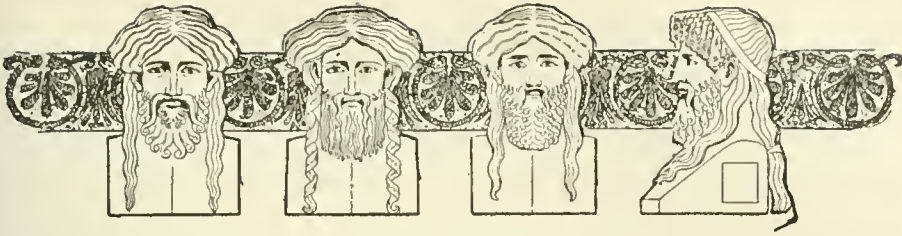

CHAPTER LX. AFFAIRS IN GREECE PROPER AFTER ALEXANDER'S DEATH

THE preceding chapter has dealt with the affairs of the post-Alexandrian epoch, with chief reference to the outlying territories of the disrupting empire. We must now take up the trend of affairs in Greece proper, and from the Grecian standpoint. Something of this has necessarily been dealt with incidentally in the preceding chapter, but a certain amount of repetition is essential to clearness. We are now back in Greece, and are to witness the effect produced at Athens by the death of Alexander.

THE LAMIAN WAR

We have seen that the report of the great conqueror's demise was at first disbelieved. The hearers hoped, but doubted. When the report was confirmed, the effect was electric.^a At once there was an end of hesitation and secrecy. The popular feeling burst forth, like a flood long pent up. Phocion, and the orators of the Macedonian party, endeavoured in vain to stem it. Their influence was gone — as Demades, before long, experienced to his cost. None were listened to but those who recommended the most decided and vigorous measures. It was resolved without delay to send a supply of arms and money to Leosthenes for his levies at Tanarus, with directions no longer to make a secret of the object for which they were destined. The remainder of the treasure of Harpalus, and the penalties which had been recovered, furnished the means.

It was very important, now that a prospect was once more opened of a general confederacy among the Greeks for a national cause, that Athens should immediately make her determination known as widely as possible. By another decree, the people declared itself ready to assert the liberty of Greece, and to deliver the cities which were held by Macedonian garrisons; for this purpose a fleet was to be equipped of forty trireme galleys, and two hundred of the larger size, with four banks of oars. All the citizens under forty years of age were to arm: those of seven tribes to prepare for foreign service, the rest to remain at home for the defence of Attica. Lastly, envoys were appointed to the principal states of Greece, to announce that Athens was again, as in the days of her ancient glory, about to place herself in the front of the battle with the common enemy, and to set her last resources, men, money, and ships, on the venture; and to exhort all who wished for independence, to follow her example.

The success of the Athenian negotiations appears not to have been so great in Peloponnesus as in the northern states, though these were exposed

to the enemy's first attacks. Sparta, Arcadia, and Achaia kept aloof from the struggle to the end — whether restrained by jealousy of Athens, or by the remembrance of the last unfortunate contest with Macedonia. Messene, Elis, Sicyon, Phlius, Epidaurus, Trœzen, and Argos joined the confederacy; but even of these, several appear to have held back until they were encouraged by the first success of the other allies. In northern Greece, Leosthenes himself was one of the most active and successful envoys. As soon as he had completed the equipment of his levies at Tœnarus, leaving them, it seems, under the command of an inferior officer, he went over to Ætolia. He found the Ætolians, who had been alarmed and incensed by Alexander's threats about Cœniadæ, heartily inclined to the national cause, and obtained a promise of seven thousand men. He then proceeded to solicit aid from Locris, Phocis, and others of the neighbouring states. Almost everywhere, from the borders of Macedonia to Attica, a good spirit prevailed. The Dolopians, the mountaineers of Cœta, all the towns of Doris, Carystus in Eubœa, the Locrians and Phocians, many of the tribes in the western valleys of Pindus, as the Ænianians, Alyzæans, and Athamantians, the Leucadians, and a part at least, it seems, of the Acarnanians, sent their contingents. Even from beyond the borders of Greece, the allies received some auxiliaries: from the Molossian chief, Aryptæus, who, however, afterwards deserted and betrayed them, and in very small number from Illyria and Thrace. But the policy by which Thebes had been destroyed, and its territory divided among the Bœotian towns, was now attended with an effect more disastrous to Greece than the conqueror could have foreseen. It was known that the success of the Greeks would be followed by the restoration of Thebes — the Theban exiles probably formed a strong body in the Greek army; and hence the Bœotians, though surrounded on all sides by the forces of the confederacy, zealously adhered to the Macedonian cause, which was that of their private interest, and their inveterate hatred to the fallen city.

Antipater received the tidings of Alexander's death — to him no mournful event — nearly at the same time with those of the movements in Greece. His situation was one of great difficulty and danger. The whole force immediately at his disposal was small, and, if he marched against Greece, it would be necessary to leave a part of it for the protection of Macedonia. Nevertheless Antipater determined not to wait for reinforcements nor to remain on the defensive, but to seek the enemy. The force which he was able to bring into the field amounted to no more than thirteen thousand foot, and six hundred horse. It might seem that he, rather than the Athenians, was acting rashly, when, with so small an army, he ventured to invade Greece: and perhaps he relied somewhat too confidently on the superiority of the Macedonian discipline and tactics, and on the recollection of his victory over Agis. It must however be observed, that he calculated on the support of the Thessalians, and probably of some other northern states; and he might hope by a rapid movement to crush the confederacy, before it had collected its forces, or at least to prevent it from receiving fresh accessions of strength. He had also ordered Sippas, whom he left to supply his place in Macedonia, to levy troops with the utmost diligence, and may have expected to be speedily reinforced by these recruits. His coffers were well filled, for he had received a large supply of treasure from Alexander; and the fleet which had brought it over, consisting of 110 galleys, remained with him, and was now ordered to attend the operations of the army.

Leosthenes was elected commander-in-chief, not more in honour of Athens than on account of the confidence which was reposed in his abilities.

[323 B.C.]

The Athenians could spare no more than five thousand infantry, and five hundred cavalry, of Attic troops ; to these they added two thousand mercenaries. But now the Bœotians, encouraged perhaps by the tidings of Antipater's approach, collected their forces to oppose the passage of this little army, and encamped near Plataea, no doubt in very superior numbers, to watch the passes of Cithæron. Leosthenes, apprised of their movement, hastened with a division of his troops to the relief of his countrymen, effected a junction with them, and gave battle to the enemy. He gained a complete victory, raised a trophy, and returned, with this happy omen of more important success, to his camp.

Antipater was joined on his march by a strong body of Thessalian cavalry, under Menon of Plarsalus, which gave him, in this arm, a decided advantage over the allies. He drew up his forces, it seems, in the vale of the Sperchius, and offered battle. Leosthenes did not wait to be attacked. It is possible that he may have had a secret understanding with the Thessalian general. But his army was thirty thousand strong, and it may have been the sight of his superior force that fixed Menon's wavering inclination. The fortune of the day was decided by the Thessalian cavalry, which went over in the heat of the battle to the Greeks. We are not informed what loss Antipater suffered, but he did not think it safe to attempt to retreat through Thessaly. He looked about for the nearest place of refuge, and threw himself into the town of Lamia — which stood in a strong position on the south side of Mount Othrys, about three miles from the sea — began to repair the fortifications, and laid in a supply of arms and provisions furnished perhaps by the fleet. His only remaining hope was that he might be able to sustain a siege, until succours should arrive. Leosthenes immediately proceeded to fortify a camp near the town, and after having in vain challenged the enemy to a fresh engagement, made several attempts to take it by assault. But the place was too strong, the garrison too numerous : the assailants were repulsed with the loss of many lives ; and at length he found himself obliged to turn the siege into a blockade.

It was the first advantage that had been gained for many years over the Macedonian arms, which were beginning perhaps to be thought invincible ; and it had certainly reduced an enemy, late the master of Greece, to a state of extreme distress and danger. The confidence of the people was raised to its utmost height by an embassy from Antipater, by which he sued for peace. We are not informed what terms he proposed, but his overtures were probably treated as a sign of despair. The people looked upon him as already in their power, and demanded that he should surrender at discretion. Yet they did not relax their efforts, but made use of the advantage they had gained to procure additional strength for the common cause. Polyæctus was sent with other envoys into Peloponnesus, to rouse the states which had hitherto remained neutral, to action. Here he was opposed by some of the traitors whom Athens had lately cast out from her bosom ; but he was seconded by the voluntary exertions of his old colleague Demosthenes.

As soon as Alexander's death released the Athenians from the restraint which his power had imposed on them, the orators of the Macedonian party sank under the contempt and indignation of the people, and several of them paid the penalty of their former insolence and baseness. Demades was perhaps most mildly treated in proportion to his offences. Yet he was brought to trial on several indictments — among others, as the author of the decree which conferred divine honours on Alexander, for which he was condemned to a fine of ten talents [£2000 or \$10,000]. But he was partially disfran-

chised, so as to be made incapable of taking part in public affairs. The bronze statues also, with which he had been honoured, and the city disgraced, were melted down, and applied to purposes the most expressive of contempt and loathing for the original. He however remained at Athens in the enjoyment of his ill-gotten wealth, waiting till the accomplishment of Phocion's denunciations should raise him once more out of his ignominious obscurity, and should compel the people to listen to his voice. The time-serving Pytheas, the prosecutor of Demosthenes, and the witty glutton Callimedon, who had been accused by Demosthenes of a treasonable correspondence with the exiles at Megara, were also convicted, we know not on what charges, and were obliged, either by sentence of banishment, or to escape worse evils, to quit Athens. They now threw aside the mask, openly entered into the service of Macedonia, and were employed by Antipater to counteract the influence of the Athenian envoys in Peloponnesus with all the power of their oratory.

RETURN OF DEMOSTHENES; DEATH OF LEOSTHENES

Demosthenes had not resigned himself so contentedly as Æschines to perpetual exile. It was perhaps a weakness, but one which does not lower him in our esteem, that he met the thought of it with less courage than that of death. But when he heard of the successes of Leosthenes, when he learned that an Athenian embassy was making the circuit of Peloponnesus to advocate the cause of national independence, and that it was thwarted at every step by Antipater's hirelings, his despondency and resentment vanished; he quitted his retreat, joined the envoys, and accompanied them to the end of their mission. To him it owed its most important results. Sicyon, Argos, and even Corinth are mentioned among the states which were brought over to the league by his eloquence. His kinsman Demon took advantage of the general feeling to propose a decree for his recall. It was passed, and not in the form of an act of grace, but of a respectful invitation. A vessel was sent by public authority, to bring him over from the place of his sojourn. When it returned with him to Piræus, a solemn procession, headed by the magistrates and the priests, came down to greet him, and to escort him back to the city. He now again raised his hands — perhaps to the goddess whom he had unjustly reproached — and congratulated himself on a return so much happier than that of Alcibiades, as it was the effect of the free good will of his fellow-citizens, not extorted from their fears. It was indeed a day of glory so pure — not to be effaced by a thousand scandalous anecdotes — that he might gladly have consented to the price which he afterwards paid for it. The penalty to which he had been condemned still remained to be discharged, and it was one of those obligations which it seems could not be legally cancelled. But Demon carried a decree by which fifty talents were assigned to Demosthenes from the treasury, nominally to defray the cost of an altar which was annually adorned at the public expense for one of the festivals.

But these bright gleams of joy and hope were soon to be overcast. Antipater's fortune had sunk to the lowest point; it was now to be gradually gaining the ascendant. The first disaster which befell the Greek cause was the death of Leosthenes. Antipater had directed a sally against the besiegers, who were employed in the work of circumvallation. A sharp combat took place; and Leosthenes, hastening up to the support of his men, was struck on the head by a stone from an engine, fell senseless, and was carried back to the camp, where he died, the third day after.

[322 B.C.]

It remained to be considered, who should take the place of Leosthenes. The choice, we find, was left without dispute to Athens. Antiphilus, a young man who had acquired high reputation for courage and military skill, received the command.

LEONNATUS

But in the meanwhile succours were approaching for the relief of Antipater. Leonnatus had come down to take possession of his satrapy, with instructions from Perdicas, to aid Eumenes in the conquest of Cappadocia. But, if he was ever in earnest about this enterprise, he was soon diverted from it by other projects. He had entered into a secret correspondence

with Olympias, who, being in open enmity with Antipater, and very much dissatisfied with the recent arrangements, desired to form an alliance, through her daughter Cleopatra, the widowed queen of Epirus, with some one powerful enough to protect her interests. The history of such negotiations is seldom accurately known; it only appears that Leonnatus received a letter from Cleopatra, in which she promised him her hand — if he came to Pella with a sufficient force, it must be supposed, to overpower Antipater, and to secure the throne of Macedonia for himself. He was a man of sanguine temper, as well as of towering ambition, and eagerly grasped at the offer. While he was occupied with this scheme, he received a message from Antipater, now blocked up in Lamia, to implore his speediest succour. Antipater's envoy was empowered to offer the hand of one of Antipater's daughters to Leonnatus. Eumenes endeavoured to dissuade Leonnatus from compliance with this request, and professed to consider his own life as in danger from the enmity of Antipater and

Hecataeus. Leonnatus therefore thought he might safely trust him with the secret, let him see Cleopatra's letters, and assured him that his intentions were nothing less than friendly to

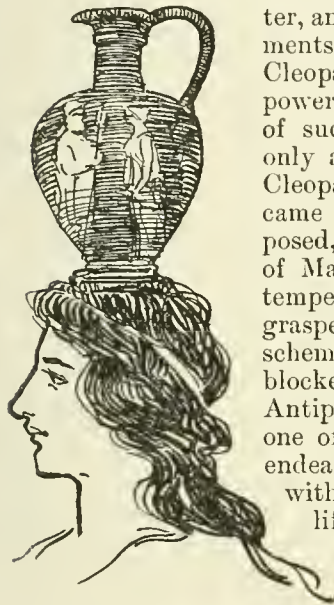

WATER CARRIER

Antipater. But the project did not at all suit the views of Eumenes, who saw that he should probably forfeit his satrapy with the patronage of Perdicas, and felt no confidence in the impetuous character of Leonnatus. He therefore made his escape by night, accompanied only by three hundred horse and two hundred armed slaves, with his treasure, which amounted to five thousand talents, and fled to Perdicas, whose favour he secured by this proof of fidelity.

Leonnatus had now no choice left. It was in Macedonia alone that he could hope to establish himself. But it seems that he thought it necessary for his own sake, first to quell the insurrection of the Greeks, and then to rid himself of Antipater. He therefore crossed over to Europe, and marched towards the theatre of war. In Macedonia, he added a large body of troops to his army, which then numbered no less than twenty thousand foot and twenty-five hundred horse. When Antiphilus heard of the approach of this formidable force, he immediately perceived that the siege must be raised; and he seems to have taken his measures with great judgment and energy. He fired his camp, sent the baggage and all his useless

people to Melitæa, a town on the Enipeus, which lay near his road, and himself, crossing the chain of Othrys, advanced with his unencumbered troops to meet Leonnatus, before he could be joined by Antipater.

DEATH OF LEONNATUS; NAVAL WAR; WAR IN THESSALY

Leonnatus charged with his wonted valour; but after a sharp combat, his troops were broken, and put to flight, and driven into the marsh, where he himself fell, pierced with many wounds. The Greeks remained masters of the field, and erected their trophy, the third which they had won since the beginning of the war.

To Antipater however the loss which he suffered through the defeat of Leonnatus was more than compensated by the advantage he gained from the death of a formidable rival; though he may not have known the whole extent of his danger. He had followed the march of the Greeks, and it seems was at no great distance when the battle took place; for the next day he effected a junction with the army of Leonnatus, which immediately acknowledged him as its chief. He now saw himself at the head of a force, before which the allies, but for the superiority of their cavalry, would not have been able to stand. Still, such was the terror inspired by the Thessalian horse, that he did not venture to descend into the plain; and he had probably already received intelligence of the approach of Craterus. He therefore advanced along the higher ground on the skirts of the plain towards the borders of Macedonia. Antiphilus and Menon could only watch his movements, and made no attempt to obstruct them; but remained in the central vale of Thessaly.

In the meanwhile the Athenians, who had undertaken the whole burden of the war on the sea, had been defeated on what they were used to consider as their own element. The Macedonian admiral Clitus, with his 240 sail, gained two victories over the Athenians, who were commanded by Ection, and destroyed a great number of their ships. Soon after, when the Macedonians had become masters of the sea, a squadron was sent, with a strong body of troops, Macedonians as well as mercenaries, under the command of Micion, to invade Attica. Phocion led as strong a force as could be mustered to meet the enemy, who had landed on the eastern coast, not far from Marathon, and was overrunning the country. But the enemy was defeated, and driven back to his ships with great loss, and Micion was left among the slain. So that even this naval war, though it probably inflicted a severe injury on the Athenians, terminated in a manner which reminded them of better days.

Not long after, the aspect of affairs in Thessaly was again changed by the arrival of Craterus. He had brought, beside the veterans, four thousand heavy-armed, one thousand Persian bowmen and slingers, and fifteen hundred cavalry. He probably entered Thessaly by one of the western passes, as this was the direction which Antipater had taken. When they had joined their forces, Craterus resigned the supreme command to his colleague. They then marched down into the plain, where the allies were posted, and encamped near the banks of the Peneus. The Macedonian army now amounted to between forty thousand and fifty thousand heavy infantry, three thousand light troops, and five thousand cavalry. The Greeks were little more than half as numerous; for the Ætolians had not returned to the camp. It became evident to Antiphilus and Menon that they must hazard a battle or soon be deserted by the greater part of their troops. The engagement took place on the plain of Crannon, a little to the west of

[322 B.C.]

the road between Larissa and Pharsalus, not far from the foot of a range of low hills which stretch across from the Enipeus to the Peneus. It began, as before, with the cavalry. That of the Macedonians was probably commanded by Craterus, but it was still unable to cope with the Thessalians; and the event of the day might have been similar to that in which Leonnatus fell, if the Macedonians had not now had the advantage of two able and experienced generals. Antipater, who was at the head of the phalanx, when he saw his horse giving way, fell upon the enemy's infantry. They were quite unable to sustain the shock, but still were so ably commanded that they retreated in good order to the adjacent high ground, and there took up a position from which the Macedonians vainly attempted to dislodge them. We seem to collect from this fact that Alexander was still more fortunate in his enemies than in his officers. But Menon, perceiving the retreat of his infantry, did not venture to prolong the combat, in which he was on the point of gaining a decided victory; he drew off his troops, and the Macedonians remained everywhere masters of the field.

DISSOLUTION OF THE LEAGUE

The Greeks had not lost more than five hundred men; but though the loss was trifling, it was the result of a defeat; and this, in such circumstances, was inevitably fatal to their cause. Antiphilus and Menon thought themselves forced to negotiate. Antipater at once saw that an opportunity was presented to him of dissolving the confederacy without another blow. When the Greek heralds came to him with proposals of peace, he declared that he would enter into no treaty with the confederacy, but was willing to receive envoys from the allied states separately. He knew that this would be an irresistible temptation to each to renounce the common cause, that it might make the better terms for itself. But to hasten their resolution, he and Craterus laid siege to some of the Thessalian towns, among the rest to Pharsalus, which the allies were compelled to abandon to their fate. This proof of weakness, and the danger which extorted it, overpowered all reluctance in the inferior states of the confederacy. One after another sent its envoys to the Macedonian camp, and submitted to the terms dictated by Antipater, which were unexpectedly mild. Their lenity attracted those who still hesitated, and in a short time all had laid down their arms.

The two states which had excited and guided the insurrection, now remained exposed to the conqueror's vengeance, unable to afford any help to one another — unable, had their forces been united, to offer any resistance to him. Phocion now had the melancholy pleasure of exerting the influence he had gained by his long connection with the enemies of his country, in her behalf. For the readiness he showed on this occasion, we may well forgive his gentle reproach — that if she had followed his counsels, she would not have needed his aid; as in truth if she had followed those of Lycidas in the Persian War, she would not have become an object of envy and hatred, and would perhaps never have been subject to a Macedonian master. The honour of his mediation he shared with Demades, to whom the eyes of all were first turned in this emergency. While the storm of war was rolling towards the frontiers of Attica, Demades sat aloof, like Achilles, an unconcerned spectator, brooding over his dishonour, and could only be induced to interpose by entreaties and gifts. He was a disfranchised man, who had no right to offer his advice. But he was not inexorable; and when his

franchise was restored to him, proposed a decree, which was immediately carried, to send envoys, Phocion and himself in the number, with full powers to Antipater. They found the Macedonian army encamped on the site of Thebes, and preparing to invade Attica. Antipater would be satisfied with nothing but absolute submission.

The terms finally granted were, that they should deliver up a number of their obnoxious orators, including Demosthenes and Hyperides; that they should limit their franchise by a standard of property; that they should receive a garrison in Munychia, and pay a sum of money for the cost of the war. All the articles were accepted by the plenipotentiaries, and ratified by the people; and soon after the Macedonian garrison marched into Munychia, to settle the interpretation of those which had not been precisely defined.

THE CAPITULATION

We conclude that the Athenians had been induced to expect a revival of the ancient limited democracy, perhaps as it existed in the time of Solon; by which the poorest would indeed have been excluded from several offices, but not from the privileges which they exercised in the assembly and the courts of justice. Hopeless as the condition of the people was, it seems doubtful whether they would have ratified the treaty, if they had known beforehand how Antipater understood it on this point. The new regulation which he decreed sounded very moderate, if not necessary or just; but its practical effect was that nearly two-thirds of the citizens were disfranchised, and many transported out of Greece. It provided that a qualification of two thousand drachmæ should be required from every citizen, and this has been commonly understood as the entire amount of property of every kind to be possessed by each. If this was the case, it remains an inexplicable mystery that out of twenty-one thousand persons then exercising the franchise, no more than nine thousand could be found possessing that sum [£80 or \$400].

To the disfranchised citizens Antipater offered a town and district in Thrace. A great number of a higher class were formally banished.

It seems that the contribution which had been mentioned in the treaty was not immediately exacted; perhaps was purposely reserved as an additional security for their good behaviour. The question about Samos was referred to the king's council, and, by order of Perdicas, the Athenian colonists were soon after expelled from their possessions. The republic, it appears, was also deprived of Lemnos, Imbros, and Seyros.

THE END OF DEMOSTHENES

Demosthenes and his partners in misfortune had retired from the city before the Macedonian garrison arrived, yet hardly so soon as it was heard that Antipater was on his march against Athens. Demades proposed a decree condemning Antipater's victims to death. They had certainly escaped, before they could be arrested under this decree; and their first place of refuge was Ægina.

As the danger grew more pressing, the friends parted, seeking separate asylums. Aristonicius and Himeræus took shelter in the Æaceum. Hyperides, it seems, first sought refuge at the altar of Poseidon in the same island, but afterwards passed over to Peloponnesus, and fled to the temple of Demeter at Hermione, once deemed a shrine of awful sanctity. Demos-

[322 B.C.]

thenes chose the sanctuary of Poseidon in the isle of Calauria near Trœzen. There remained no hope of safety for the fugitives, but in the protection of the gods. But Antipater had taken his measures to render even this safeguard unavailing.

It was not in Athens alone that Antipater pursued the friends of liberty to death. To carry out his purpose, he had engaged the services of a band of men, who, from their infamous occupation, acquired the title of the Exile-Hunters. The leader of this pack was an Italian Greek of Thurii, named Archias. He had been a player, and afterwards, it seems, had studied, perhaps practised, rhetoric; but we find no trace that he was connected with any political party in Greece — where indeed, as a foreigner, he could scarcely have been admitted into one. He served probably for nothing but his hire; yet he displayed as much zeal in his commission, as if he had been instigated by private enmity. He was attended on his circuit by a guard of Thracians, and with their assistance dragged most of the Athenian exiles — whom, as the prey for which his master most longed, he had undertaken to seize himself — from the altars to which he found them clinging. Aristonicus, Himeræus, and Hyperides were conveyed to Antipater, who was then at Corinth or Cleonæ, and the first two at least were immediately put to death. Hyperides, according to the more authentic report, was reserved to be executed in Macedonia. But all seem to have agreed that Antipater was not satisfied with his blood, but ordered his tongue to be first cut out, and his remains to be cast to the dogs. His bones however were secretly rescued by one of his kinsmen, and carried to Athens, where they were buried in the grave of his fathers.

Demosthenes calmly awaited the coming of Archias in the temple at Calauria, well knowing that he would not be sheltered by the sanctity of the place, and prepared for his end. He had dreamed, it is said, the night before, that he was contending with Archias in a tragic part; that the judgment of the spectators was in his favour, but that he lost the prize, because he had not been furnished with the outward requisites of the exhibition — an apt illustration at least of his failure in the real contest, which was the task of his life. When Archias came to the door of the temple with his satellites, he found Demosthenes seated. He at first addressed him in the language of friendly persuasion, to inveigle him out of his retreat, and offered to intercede with Antipater in his behalf.

Demosthenes listened for a time in silence to his bland professions, but at length replied: "Archias, you never won me by your acting, nor will you now by your promises." When the player found that he was detected, he flung away the mask, and threatened in earnest. "Now," said Demosthenes, "you speak from the Macedonian tripod; before you were only acting: wait a little, till I have written a letter to my friends at home." And he took a roll, as to write, and as was his wont, when he was engaged in composition, put the end of the reed to his mouth, and bit it; he then covered his face with his robe, and bowed his head. According to another report, he was seen to take something out of a piece of linen, and put it into his mouth; the Thracians imagined that it was gold. In one way or other, he had swallowed a poison which he had kept for this use. When he had remained some time in this attitude the barbarians, thinking that he was lingering through fear, began to taunt him with cowardice; and Archias, going up to him, urged him to rise, and repeated his offers of mediation.

Demosthenes now felt the poison in his veins; he uncovered his face, rose, and fixing his eyes on the dissembler, said, "It is time for you, Archias, to

finish the part of Creon, and to cast my body to the dogs. I quit thy sanctuary, Poseidon, still breathing; though Antipater, and the Macedonians, have not spared even it from pollution." So saying, he moved with faltering step towards the door, but had scarcely passed the altar, when he fell with a groan, and breathed his last.

His end would undoubtedly have been more truly heroic, though not in the sight of his own generation, if he had braved the insults and torture which awaited him. But he must not be judged by a view of life which had never been presented to him; according to his own, it must have seemed base to submit to the enemy whom he had hitherto defied, for the sake of a few days more of ignominious wretchedness. And even on the principles of a higher philosophy he might think that the gods, who were not able to protect him, had discharged him from their service, and permitted him to withdraw from a post which he could no longer defend.

The ancients saw the finger of Heaven in the fate of the vile instruments of his destruction. That of Demades will be afterwards related; Archias ended his days in extreme indigence, under the weight of universal contempt. It was later before Athens was permitted to do justice to the services of her great citizen, who indeed had never lost her esteem. The time at length came when his nephew Demochares might safely propose a decree, by which the honours of the prytaneum and of the foremost seat at public spectacles, were granted to his descendants, and a bronze statue was erected in the agora to himself. It bore an inscription, corresponding in its import to the dream which he was said to have had at Calaura: "Had but the strength of thy arm, Demosthenes, equalled thy spirit, never would Greece have sunk under the foreigner's yoke." The statue itself was believed in Plutarch's time to have confirmed the general persuasion of his innocence as to the only charge which ever threw a shade on the purity of his political character.¹ The honours paid to his memory were not confined to Athens. A monument was erected to him in the sanctuary where he died, and both at Calaura and in other parts of Greece he continued, down to the age of Hadrian and probably as long as the memory of the past survived there, to receive marks of public reverence approaching to the worship of a hero.^b

GROTE'S ESTIMATE OF DEMOSTHENES

The violent deaths of these illustrious orators, the disfranchisement and deportation of the Athenian demos, the suppression of the public dicasteries, the occupation of Athens by a Macedonian garrison, and of Greece generally by Macedonian Exile-Hunters — are events belonging to one and the same calamitous tragedy, and marking the extinction of the autonomous Hellenic world. Of Hyperides as a citizen we know only the general fact, that he maintained from first to last, and with oratorical ability inferior only to Demosthenes, a strenuous opposition to Macedonian dominion over Greece; though his prosecution of Demosthenes respecting the Harpalian

[¹ Plutarch tells this story: "A certain soldier being sent for to come unto his captain, did put such pieces of gold as he had into the hands of Demosthenes' statue, which had both his hands joined together: and there grew hard by it a great plane tree, divers leaves whereof either blown off by wind by chance, or else put there of purpose by the soldier, covered so this gold, that it was there a long time, and no man found it: until such time as the soldier came again, and found it as he left it. Hereupon this matter running abroad in every man's mouth, there were divers wise men that took occasion of this subject to make epigrams in the praise of Demosthenes, who in his life was never corrupted." But the same story was told of other statues.]



THE DEATH OF DEMOSTHIENES

treasure appears (so far as it comes before us) discreditable. Of Demosthenes, we know more — enough to form a judgment of him both as citizen and statesman. At the time of his death he was about sixty-two years of age, and we have before us his first *Philippic*, delivered thirty years before (352–351 B.C.). We are thus sure that even at that early day he took a sagacious and provident measure of the danger which threatened Grecian liberty from the energy and encroachments of Philip. He impressed upon his countrymen this coming danger, at a time when the older and more influential politicians either could not or would not see it; he called aloud upon his fellow-citizens for personal service and pecuniary contributions, enforcing the call by all the artifices of consummate oratory, when such distasteful propositions only entailed unpopularity upon himself. At the period when Demosthenes first addressed these earnest appeals to his countrymen, long before the fall of Olynthus, the power of Philip, though formidable, might have been kept perfectly well within the limits of Macedonia and Thrace; and would probably have been so kept, had Demosthenes possessed in 351 B.C. as much public influence as he had acquired ten years afterwards.

Throughout the whole career of Demosthenes as a public adviser, down to the battle of Chæronea, we trace the same combination of earnest patriotism with wise and long-sighted policy. During the three years' war which ended with the battle of Chæronea, the Athenians in the main followed his counsel; and disastrous as were the ultimate military results of that war, for which Demosthenes could not be responsible, its earlier periods were creditable and successful, its general scheme was the best that the case admitted, and its diplomatic management universally triumphant. But what invests the purposes and policy of Demosthenes with peculiar grandeur, is, that they were not simply Athenian, but in an eminent degree Panhellenic also. It was not Athens only that he sought to defend against Philip, but the whole Hellenic world. In this he towers above the greatest of his predecessors for half a century before his birth — Pericles, Archidamus, Agesilaus, Epaminondas; whose policy was Athenian, Spartan, Theban, rather than Hellenic. He carries us back to the time of the invasion of Xerxes and the generation immediately succeeding it, when the struggles and sufferings of the Athenians against Persia were consecrated by complete identity of interest with collective Greece. The sentiments to which Demosthenes appeals throughout his numerous orations are those of the noblest and largest patriotism — trying to inflame the ancient Grecian sentiment of an autonomous Hellenic world, as the indispensable condition of a dignified and desirable existence; but inculcating at the same time that these blessings could only be preserved by toil, self-sacrifice, devotion of fortune, and willingness to brave hard and steady personal service.

From the destruction of Thebes by Alexander in 335 B.C., to the Lamian War after his death, the policy of Athens neither was nor could be conducted by Demosthenes. But condemned as he was to comparative inefficacy, he yet rendered material service to Athens, in the Harpalian affair of 324 B.C.



DECORATION, FROM A VASE

If, instead of opposing the alliance of the city with Harpalus, he had supported it as warmly as Hyperides, the exaggerated promises of the exile might probably have prevailed, and war would have been declared against Alexander. The Lamian War was not of his original suggestion, since he was in exile at its commencement. But he threw himself into it with unrestrained ardour, and was greatly instrumental in procuring the large number of adhesions with it obtained from so many Grecian states. In spite of its disastrous result, it was, like the battle of Charonea, a glorious effort for the recovery of Grecian liberty, undertaken under circumstances which promised a fair chance of success. There was no excessive rashness in calculating on distractions in the empire left by Alexander; on mutual hostility among the principal officers and on the probability of having only to make head against Antipater and Macedonia, with little or no reinforcement from Asia. Disastrous as the enterprise ultimately proved, yet the risk was one fairly worth incurring, with so noble an object at stake; and could the war have been protracted another year, its termination would probably have been very different. We shall see this presently when we come to follow Asiatic events. After a catastrophe so ruinous, extinguishing free speech in Greece, and dispersing the Athenian demos to distant lands, Demosthenes himself could hardly have desired, at the age of sixty-two, to prolong his existence as a fugitive beyond sea.

Of the speeches which he composed for private litigants, occasionally also for himself, before the dicastery, and of the numerous stimulating and admonitory harangues on the public affairs of the moment, which he had addressed to his assembled countrymen, a few remain for the admiration of posterity. These harangues serve to us, not only as evidence of his unrivalled excellence as an orator, but as one of the chief sources from which we are enabled to appreciate the last phase of free Grecian life, as an acting and working reality.

ANTIPATER IN GREECE

The death of Demosthenes, with its tragical circumstances, is on the whole less melancholy than the prolonged life of Phocion, as agent of Macedonian supremacy in a city half depopulated, where he had been born a free citizen, and which he had so long helped to administer as a free community. The dishonour of Phocion's position must have been aggravated by the distress in Athens, arising both out of the violent deportation of one-half of its free citizens, and out of the compulsory return of the Athenian settlers from Samos — which island was now taken from Athens, after she had occupied it forty-three years, and restored to the Samian people and to their recalled exiles, by a rescript of Perdiccas in the name of Arrhidæus. Occupying this obnoxious elevation, Phocion exercised authority with his usual probity and mildness. Exerting himself to guard the citizens from being annoyed by disorders on the part of the garrison of Munychia, he kept up friendly intercourse with its commander Menyllus, though refusing all presents both from him and from Antipater.

Throughout Peloponnesus, Antipater purged and remodelled the cities, Argos, Megalopolis, and others, as he had done at Athens; installing in each an oligarchy of his own partisans — sometimes with a Macedonian garrison — and putting to death, deporting, or expelling hostile, or intractable, or democratical citizens. Having completed the subjugation of Peloponnesus, he passed across the Corinthian Gulf to attack the Ætoliens, now the only

[322-321 B.C.]

Greeks remaining unsubdued. It was the purpose of Antipater, not merely to conquer this warlike and rude people, but to transport them in mass across into Asia, and march them up to the interior deserts of the empire. His army was too powerful to be resisted on even ground, so that all the more accessible towns and villages fell into his hands. But the Ætolians defended themselves bravely, withdrew their families into the high towns and mountain tops of their very rugged country, and caused serious loss to the Macedonian invaders. Nevertheless, Craterus, who had carried on war of the same kind with Alexander in Sogdiana, manifested so much skill in seizing the points of communication, that he intercepted all their supplies and reduced them to extreme distress, amidst the winter which had now supervened. The Ætolians, in spite of bravery and endurance, must soon have been compelled to surrender from cold and hunger, had not the unexpected arrival of Antigonos from Asia communicated such news to Antipater and Craterus, as induced them to prepare for marching back to Macedonia, with a view to the crossing of the Hellespont and operating in Asia. They concluded a pacification with the Ætolians — postponing till a future period their design of deporting that people — and withdrew into Macedonia; where Antipater cemented his alliance with Craterus by giving to him his daughter Phila in marriage.

Another daughter of Antipater, named Nicæa, had been sent over to Asia not long before, to become the wife of Perdiccas. That general, acting as guardian or prime minister to the kings of Alexander's family (who are now spoken of in the plural number, since Roxane had given birth to a posthumous son, called Alexander, and made king jointly with Philip Arrhidæus), had at first sought close combination with Antipater, demanding his daughter in marriage. But new views were presently opened to him by the intrigues of the princess at Pella (Olympias, with her daughter Cleopatra, widow of the Molossian Alexander) — who had always been at variance with Antipater, even throughout the life of Alexander — and Cynane (daughter of Philip by an Illyrian mother, and widow of Amyntas, first cousin of Alexander, but slain by Alexander's order) with her daughter Eurydice. It has been already mentioned that Cleopatra had offered herself in marriage to Leonnatus, inviting him to come over and occupy the throne of Macedonia; he had obeyed the call, but had been slain in his first battle against the Greeks, thus relieving Antipater from a dangerous rival. The first project of Olympias being thus frustrated, she had sent to Perdiccas proposing to him a marriage with Cleopatra. Perdiccas had already pledged himself to the daughter of Antipater; nevertheless he now debated whether his ambition would not be better served by breaking his pledge, and accepting the new proposition. To this step he was advised by Enmenes, his ablest friend and coadjutor, steadily attached to the interest of the regal family, and withal personally hated by Antipater. But Alcetas, brother of Perdiccas, represented that it would be hazardous to provoke openly and immediately the wrath of Antipater. Accordingly Perdiccas resolved to accept Nicæa for the moment, but to send her away after no long time, and take Cleopatra; to whom secret assurances from him were conveyed by Enmenes. Cynane also (daughter of Philip and widow of his nephew Amyntas), a warlike and ambitious woman, had brought into Asia her daughter Eurydice for the purpose of espousing the king Philip Arrhidæus. Being averse to this marriage, and probably instigated by Olympias also, Perdiccas and Alcetas put Cynane to death. But the indignation excited among the soldiers by this deed was so furious as to menace their safety, and they were forced to permit the marriage of the king with Eurydice.

All these intrigues were going on through the summer of 322 B.C., while the Lamian War was still effectively prosecuted by the Greeks. About the autumn of the year, Antigonus (called Monophthalmus), the satrap of Phrygia, detected these secret intrigues of Perdiccas; who, for that and other reasons, began to look on him as an enemy, and to plot against his life. Apprised of his danger, Antigonus made his escape from Asia into Europe to acquaint Antipater and Craterus with the hostile manœuvres of Perdiccas; upon which news, the two generals, immediately abandoning the Ætolian War, withdrew their army from Greece for the more important object of counteracting Perdiccas in Asia.

In the spring of 321 B.C., Antipater and Craterus, having concerted operations with Ptolemy governor of Egypt, crossed into Asia and began their conflict with Perdiccas; who himself, having the kings along with him, marched against Egypt to attack Ptolemy.

By the death of Perdiccas, and the defection of his soldiers, complete preponderance was thrown into the hands of Antipater, Ptolemy, and Antigonus. Antipater was invited to join the army, now consisting of the forces both of Ptolemy and Perdiccas united. He was there invested with the guardianship of the persons of the kings, and with the sort of ministerial supremacy previously held by Perdiccas. He was however exposed to much difficulty, and even to great personal danger, from the intrigues of the princess Eurydice, who displayed a masculine boldness in publicly haranguing the soldiers; and from the discontents of the army, who claimed presents, formerly promised to them by Alexander, which there were no funds to liquidate at the moment. At Triparadisus in Syria, Antipater made a second distribution of the satrapies of the empire; somewhat modified, yet coinciding in the main with that which had been drawn up shortly after the death of Alexander. To Ptolemy was assured Egypt and Libya, to Antigonus the Greater Phrygia, Lycia, and Pamphylia—as each had had before.

Antigonus was placed in command of the principal Macedonian army in Asia, to crush Eumenes and the other chief adherents of Perdiccas; most of whom had been condemned to death by a vote of the Macedonian army. After a certain interval, Antipater himself, accompanied by the kings, returned to Macedonia, having eluded by artifice a renewed demand on the part of his soldiers for the promised presents. The war of Antigonus, first against Eumenes in Cappadocia, next against Alcetas and the other partisans of Perdiccas in Pisidia, lasted for many months, but was at length successfully finished. Eumenes, beset by the constant treachery and insubordination of the Macedonians, was defeated and driven out of the field. He took refuge with a handful of men in the impregnable and well-stored fortress of Nora in Cappadocia, where he held out a long blockade, apparently more than a year, against Antigonus.

THE DEATHS OF ANTIPATER AND OF DEMADES

Before the prolonged blockade of Nora had been brought to a close, Antipater, being of very advanced age, fell into sickness, and presently died. One of his latest acts was to put to death the Athenian orator Demades, who had been sent to Macedonia as envoy to solicit the removal of the Macedonian garrison at Munychia. Antipater had promised, or given hopes, that if the oligarchy which he had constituted at Athens maintained unshaken adherence to Macedonia, he would withdraw the garrison. The Athenians

[319 B.C.]

endeavoured to prevail on Phocion to go to Macedonia as solicitor for the fulfilment of this promise; but he steadily refused. Demades, who willingly undertook the mission, reached Macedonia at a moment very untoward for himself. The papers of the deceased Perdiccas had come into possession of his opponents; and among them had been found a letter written to him by Demades, inviting him to cross over and rescue Greece from her dependence "on an old and rotten warp"—meaning Antipater. This letter gave great offence to Antipater—the rather, as Demades is said to have been his habitual pensioner—and still greater offence to his son Cassander; who caused Demades with his son to be seized, first killed the son in the immediate presence and even embrace of the father, and then slew the father himself, with bitter invective against his ingratitude. All the accounts which we read depict Demades, in general terms, as a prodigal spendthrift and a venal and corrupt politician. We have no ground for questioning this statement; at the same time, we have no specific facts to prove it.

POLYSPERCHON AND CASSANDER

Antipater by his last directions appointed Polysperchon, one of Alexander's veteran officers, to be chief administrator, with full powers on behalf of the imperial dynasty; while he assigned to his own son Cassander only

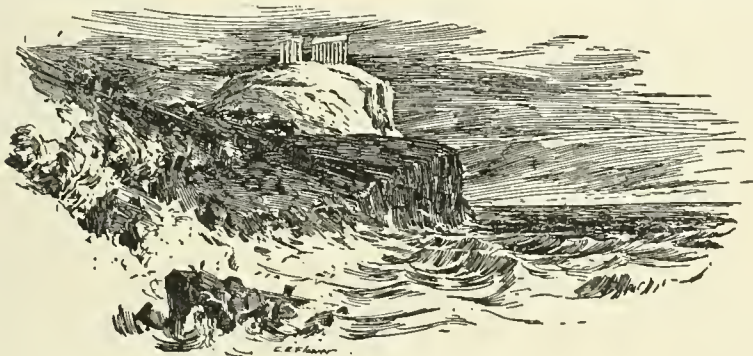

PROMONTORY OF SUNIUM

the second place, as chiliarch, or general of the bodyguard. He thought that this disposition of power would be more generally acceptable throughout the empire, as Polysperchon was older and of longer military service than any other among Alexander's generals. Moreover, Antipater was especially afraid of letting dominion fall into the hands of the princesses; all of whom—Olympias, Cleopatra, and Eurydice—were energetic characters; and the first of the three (who had retired to Epirus from enmity towards Antipater) furious and implacable.

But the views of Antipater were disappointed from the beginning, because Cassander would not submit to the second place, nor tolerate Polysperchon as his superior. Immediately after the death of Antipater, but before it became publicly known, Cassander despatched Nicanor with pretended orders from Antipater to supersede Menyllus in the government of Munychia. To this order Menyllus yielded. But when after a few days the Athenian public came to learn the real truth, they were displeased with Phocion for having

permitted the change to be made — assuming that he knew the real state of the facts, and might have kept out the new commander. Cassander, while securing this important post in the hands of a confirmed partisan, affected to acquiesce in the authority of Polysperchon, and to occupy himself with a hunting-party in the country. He at the same time sent confidential adherents to the Hellespont and other places in furtherance of his schemes; and especially to contract alliance with Antigonus in Asia and with Ptolemy in Egypt. His envoys being generally well received, he himself soon quitted Macedonia suddenly, and went to concert measures with Antigonus in Asia. It suited the policy of Ptolemy, and still more that of Antigonus, to aid him against Polysperchon and the imperial dynasty. On the death of Antipater, Antigonus had resolved to make himself the real sovereign of the Asiatic Alexandrine empire, possessing as he did the most powerful military force within it.

Even before this time the imperial dynasty had been a name rather than a reality; yet still a respected name. But now, the preference shown to Polysperchon by the deceased Antipater, and the secession of Cassander, placed all the real great powers in active hostility against the dynasty. Polysperchon and his friends were not blind to the difficulties of their position. The principal officers in Macedonia having been convened to deliberate, it was resolved to invite Olympias out of Epirus, that she might assume the tutelage of her grandson Alexander (son of Roxane); to place the Asiatic interests of the dynasty in the hands of Eumenes, appointing him to the supreme command; and to combat Cassander in Europe, by assuring of themselves the general good will and support of the Greeks. This last object was to be obtained by granting to the Greeks general enfranchisement, and by subverting the Antipatrian oligarchies and military governments now paramount throughout the cities.

OLYMPIAS AND EUMENES

The last hope of maintaining the unity of Alexander's empire in Asia, against the counter-interests of the great Macedonian officers — who were steadily tending to divide and appropriate it — now lay in the fidelity and military skill of Eumenes. At his disposal Polysperchon placed the imperial treasures and soldiers in Asia; especially the brave, but faithless and disorderly Argyraspides. Olympias also addressed to him a pathetic letter, asking his counsel as the only friend and saviour to whom the imperial family could now look. Eumenes replied by assuring them of his devoted adherence to their cause. But he at the same time advised Olympias not to come out of Epirus into Macedonia; or if she did come, at all events to abstain from vindictive and cruel proceedings. Both these recommendations, honourable as well to his prudence as to his humanity, were disregarded by the old queen. She came into Macedonia to take the management of affairs; and although her imposing title — of mother to the great conqueror — raised a strong favourable feeling, yet her multiplied executions of the Antipatrian partisans excited fatal enmity against a dynasty already tottering. Nevertheless Eumenes, though his advice had been disregarded, devoted himself in Asia with unshaken fidelity to the Alexandrine family, resisting the most tempting invitations to take part with Antigonus against them. His example contributed much to keep alive the same active sentiment in those around him; indeed, without him, the imperial family would have had no sincere or

[319 B.C.]

commanding representative in Asia. His gallant struggles for two years against the greatly preponderant forces of Ptolemy, Antigonus, and Seleucus, and against the never-ceasing treachery of his own officers and troops are among the most memorable exploits of antiquity. While even in a military point of view, they are hardly inferior to the combinations of Alexander himself, they evince, besides, a flexibility and aptitude such as Alexander neither possessed nor required, for overcoming the thousand difficulties raised by traitors and mutineers around him. To the last, Eumenes remained unsubdued; he was betrayed to Antigonus by the base and venal treachery of his own soldiers, the Macedonian *Argyraspides*.

IMPERIAL EDICT RECALLING EXILES

On learning the death of Antipater, most of the Greek cities had sent envoys to Pella. To all the governments of these cities, composed as they were of his creatures, it was a matter of the utmost moment to know what course the new Macedonian authority would adopt. Polysperchon, persuaded that they would all adhere to Cassander, and that his only chance of combating that rival was by enlisting popular sympathy and interests in Greece, or at least by subverting these Antipatristic oligarchies — drew up in conjunction with his counsellors a proclamation which he issued in the name of the dynasty.

This proclamation directed the removal of all the garrisons, and the subversion of all the oligarchies, established by Antipater after the Lamian War. It ordered the recall of the host of exiles then expelled. It revived the state of things prevalent before the death of Alexander — which indeed itself had been, for the most part, an aggregate of macedonising oligarchies interspersed with Macedonian garrisons. To the existing Antipatristic oligarchies, however, it was a death-blow; and so it must have been understood by the Grecian envoys — including probably deputations from the exiles, as well as envoys from the civic governments — to whom Polysperchon delivered it at Pella. Not content with the general edict, Polysperchon addressed special letters to Argos and various other cities, commanding that the Antipatristic leading men should be banished with confiscation of property, and in some cases put to death; the names being probably furnished to him by the exiles. Lastly, as it was clear that such stringent measures could not be executed without force — the rather as these oligarchies would be upheld by Cassander from without — Polysperchon resolved to conduct a large military force into Greece; sending thither first, however, a considerable detachment, for immediate operations, under his son Alexander.

To Athens, as well as to other cities, Polysperchon addressed special letters, promising restoration of the democracy and recall of the exiles. At Athens, such change was a greater revolution than elsewhere, because the multitude of exiles and persons deported had been the greatest. To the existing nine thousand Athenian citizens, it was doubtless odious and alarming; while to Phocion, with the other leading Antipatristics, it threatened not only loss of power, but probably nothing less than the alternative of flight or death. The state of interests at Athens, however, was now singularly novel and complicated. There were the Antipatristics and the nine thousand qualified citizens, there were the exiles, who, under the new edict, speedily began re-entering the city, and reclaiming their citizenship as well as their property. Polysperchon and his son were known to be

soon coming with a powerful force. Lastly, there was Nicanor, who held Munychia with a garrison, neither for Polysperchon, nor for the Athenians, but for Cassander; the latter being himself also expected with a force from Asia. Here then were several parties — each distinct in views and interests from the rest, some decidedly hostile to each other.

CONTEST AT ATHENS

The first contest arose between the Athenians and Nicanor respecting Munychia; which they required him to evacuate, pursuant to the recent proclamation. Nicanor on his side returned an evasive answer, promising compliance as soon as circumstances permitted, but in the meantime entreating the Athenians to continue in alliance with Cassander, as they had been with his father Antipater. He seems to have indulged hopes of prevailing on them to declare in his favour — and not without plausible grounds, since the Antipatrian leaders and a proportion of the nine thousand citizens could not but dread the execution of Polysperchon's edict. And he had also what was of still greater moment — the secret connivance and support of Phocion: who put himself in intimate relation with Nicanor, as he had before done with Menyllus — and who had greater reason than any one else to dread the edict of Polysperchon.



GREEK PEASANT
(After Ilupe)

Foreseeing the gravity of the impending contest, Nicanor had been secretly introducing fresh soldiers into Munychia. Presently, making an unexpected attack from Munychia and Salamis, he took Piræus by surprise, placed both the town and harbour under military occupation, and cut off its communication with Athens by a ditch and palisade. On this palpable aggression, the Athenians rushed to arms. But Phocion as general damped their ardour, and even declined to head them in an attack for the recovery of Piræus before Nicanor should have had time to strengthen himself in it.

The occupation of Piræus in addition to Munychia was a serious calamity to the Athenians, making them worse off than they had been even under Antipater. Piræus, rich, active, and commercial, containing the Athenian arsenal, docks, and muniments of war, was in many respects more valuable than Athens itself — for all purposes of war, far more valuable. Cassander had now an excellent place of arms and base, which Munychia alone would not have afforded, for his operations in Greece against Polysperchon; upon whom therefore the loss fell hardly less severely than upon the Athenians. Now Phocion, in his function as general, had been forewarned of the danger, might have guarded against it, and ought to have done so. This was a grave dereliction of duty, and admits of hardly any other explanation except that of treasonable connivance. It seems that Phocion, foreseeing his own ruin and that of his friends in the

[319 B.C.]

triumph of Polysperchon and the return of the exiles, was desirous of favouring the seizure of Piræus by Nicanor, as a means of constraining Athens to adopt the alliance with Cassander; which alliance indeed would probably have been brought about, had Cassander reached Piræus by sea sooner than the first troops of Polysperchon by land. Phocion was here guilty, at the very least, of culpable neglect, and probably of still more culpable treason, on an occasion seriously injuring both Polysperchon and the Athenians; a fact which we must not forget, when we come to read presently the bitter animosity exhibited against him.

The news that Nicanor had possessed himself of Piræus, produced a strong sensation. Presently arrived a letter addressed to him by Olympias herself, commanding him to surrender the place to the Athenians, upon whom she wished to confer entire autonomy. But Nicanor declined obedience to her order, still waiting for support from Cassander. The arrival of Alexander (Polysperchon's son) with a body of troops, encouraged the Athenians to believe that he was come to assist in carrying Piræus by force, for the purpose of restoring it to them. Their hopes, however, were again disappointed. Though encamped near Piræus, Alexander made no demand for the Athenian forces to co-operate with him in attacking it; but entered into open parley with Nicanor, whom he endeavoured to persuade or corrupt into surrendering the place. When this negotiation failed, he resolved to wait for the arrival of his father, who was already on his march towards Attica with the main army.

INTRIGUES OF PHOCION

It was Phocion and his immediate colleagues who induced Alexander to adopt this insidious policy; to decline reconquering Piræus for the Athenians, and to appropriate it for himself. To Phocion, the reconstitution of autonomous Athens — with its democracy and restored exiles, and without any foreign controlling force — was an assured sentence of banishment, if not of death. Not having been able to obtain protection from the foreign force of Nicanor and Cassander, he and his friends resolved to throw themselves upon that of Alexander and Polysperchon. They went to meet Alexander as he entered Attica, represented the impolicy of his relinquishing so important a military position as Piræus, while the war was yet unfinished, and offered to co-operate with him for this purpose, by proper management of the Athenian public. Alexander was pleased with these suggestions, accepted Phocion with the others as his leading adherents at Athens, and looked upon Piræus as a capture to be secured for himself. Numerous returning Athenian exiles accompanied Alexander's army. It seems that Phocion was desirous of admitting the troops, along with the exiles, as friends and allies into the walls of Athens, so as to make Alexander master of the city; but that this project was impracticable in consequence of the mistrust created among the Athenians by the parleys of Alexander with Nicanor.

The strategic function of Phocion, however — so often conferred and re-conferred upon him — and his power of doing either good or evil, now approached its close. As soon as the returning exiles found themselves in sufficient numbers, they called for a revision of the list of state officers, and for the re-establishment of the democratical forms. They passed a vote to depose those who had held office under the Antipatrian oligarchy, and who still continued to hold it down to the actual moment. Among these Pho-

cion stood first: along with him were his son-in-law Charicles, the Phalerean Demetrius, Callimedon, Nicocles, Thudippus, Hegemon, and Philocles. These persons were not only deposed, but condemned — some to death, some to banishment and confiscation of property. Demetrius, Charicles, and Callimedon sought safety by leaving Attica; but Phocion and the rest merely went to Alexander's camp, throwing themselves upon his protection on the faith of the recent understanding. Alexander not only received them courteously, but gave them letters to his father Polysperchon, requesting safety and protection for them, as men who had embraced his cause, and who were still eager to do all in their power to support him. Armed with these letters, Phocion and his companions went through Bœotia and Phocis to meet Polysperchon on his march southward. They were accompanied by Dinarchus and by a Platean named Solon, both of them passing for friends of Polysperchon.

The Athenian democracy, just reconstituted, which had passed the recent condemnatory votes, was disquieted at the news that Alexander had espoused the cause of Phocion and had recommended the like policy to his father. It was possible that Polysperchon might seek, with his powerful army, both to occupy Athens and to capture Piræus, and might avail himself of Phocion (like Antipater after the Lamian War) as a convenient instrument of government. It seems plain that this was the project of Alexander, and that he counted on Phocion as a ready auxiliary in both. Now the restored democrats, though owing their restoration to Polysperchon, were much less compliant towards him than Phocion had been. Not only would they not admit him into the city, but they would not even acquiesce in his separate occupation of Munychia and Piræus. On the proposition of Agnonides and Archestratus, they sent a deputation to Polysperchon accusing Phocion and his comrades of high treason; yet at the same time claiming for Athens the full and undiminished benefit of the late regal proclamation — autonomy and democracy, with restoration of Piræus and Munychia free and ungarrisoned.

As the sentiment now prevalent at Athens evinced clearly that Phocion could not be again useful to him as an instrument, Polysperchon heard his defence with impatience, interrupted him several times, and so disgusted him that he at length struck the ground with his stick, and held his peace. Hegemon, another of the accused, was yet more harshly treated. The sentence could not be doubtful. Phocion and his companions were delivered over as prisoners to the Athenian deputation, together with a letter from the king, intimating that in his conviction they were traitors, but that he left them to be judged by the Athenians — now restored to freedom and autonomy.

PHOCION'S DISGRACE

The Macedonian Clitus was instructed to convey them to Athens as prisoners under a guard. Mournful was the spectacle as they entered the city; being carried along the Ceramicus in carts, through sympathising friends and an embittered multitude, until they reached the theatre, wherein the assembly was to be convened.

The common feeling of antipathy against him burst out into furious manifestations. Agnonides the principal accuser, supported by Epicurus and Demophilus, found their denunciations welcomed and even anticipated, when they arraigned Phocion as a criminal who had lent his hand to the subver-

[318 B.C.]

sion of the constitution, to the sufferings of his deported fellow-citizens, and to the holding of Athens in subjection under a foreign potentate; in addition to which, the betrayal of Piræus to Nicanor constituted a new crime — fastening on the people the yoke of Cassander, when autonomy had been promised to them by the recent imperial edict. After the accusation was concluded, Phocion was called on for his defence; but he found it impossible to obtain a hearing. Attempting several times to speak, he was as often interrupted by angry shouts; several of his friends were cried down in like manner; until at length he gave up the case in despair, and exclaimed:

“For myself, Athenians, I plead guilty; I pronounce against myself the sentence of death for my political conduct; but why are you to sentence these men near me, who are not guilty?”

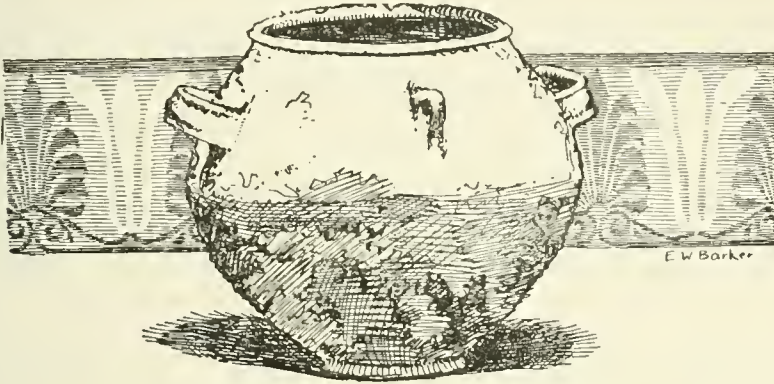

GREEK TERRA-COTTA JAR
(In the British Museum)

“Because they are your friends, Phocion,” was the exclamation of those around. Phocion then said no more; while Agnonides proposed a decree, to the effect that the assembled people should decide by show of hands, whether the persons now arraigned were guilty or not; and that if declared guilty, they should be put to death. Some persons present cried out that the penalty of torture ought to precede death: but this savage proposition, utterly at variance with Athenian law in respect to citizens, was repudiated not less by Agnonides than by the Macedonian officer Clitus. The decree was then passed; after which the show of hands was called for. Nearly every hand in the assembly was held up in condemnation; each man even rose from his seat to make the effect more imposing; and some went so far as to put on wreaths in token of triumph.

After sentence, the five condemned persons, Phocion, Nicocles, Thudippus, Hegemon, and Pythocles, were consigned to the supreme magistrates of Police, called the Eleven, and led to prison for the purpose of having the customary dose of poison administered. Hostile bystanders ran alongside, taunting and reviling them. It is even said that one man planted himself in the front, and spat upon Phocion; who turned to the public officers and exclaimed, “Will no one check this indecent fellow?” This was the only emotion which he manifested; in other respects, his tranquillity and self-possession were resolutely maintained, during this soul-subduing march from the theatre to the prison, amidst the wailings of his friends, the broken spirit of his four comrades, and the fiercest demonstrations of antipathy from

his fellow-citizens generally. One ray of comfort presented itself as he entered the prison. It was the day on which the Knights celebrated their festal procession with wreaths on their heads in honour of Zeus. Several of these horsemen halted in passing, took off their wreaths, and wept as they looked through the gratings of the prison.

Being asked whether he had anything to tell his son Phocion, Phocion replied: "I tell him emphatically, not to hold evil memory of the Athenians." The draught of hemlock was then administered to all five — to Phocion last. Having been condemned for treason, they were not buried in Attica; nor were Phocion's friends allowed to light a funeral pile for the burning of his body; which was carried out of Attica into the Megarid, by a hired agent named Conopion, and there burned by fire obtained at Megara. The wife of Phocion, with her maids, poured libations and marked the spot by a small mound of earth; she also collected the bones and brought them back to Athens in her bosom, during the secrecy of night. She buried them near her own domestic hearth, with this address: "Beloved Hestia, I confide to thee these relics of a good man. Restore them to his own family vault, as soon as the Athenians shall come to their senses."¹

After a short time (we are told by Plutarch) the Athenians did thus come to their senses. They discovered that Phocion had been a faithful and excellent public servant, repented of their severity towards him, celebrated his funeral obsequies at the public expense, erected a statue in his honour, and put to death Agnonides by public judicial sentence; while Epicurus and Demophilus fled from the city and were slain by Phocion's son.

These facts are ostensibly correct; but Plutarch omits to notice the real explanation of them. Within two or three months after the death of Phocion, Cassander, already in possession of Piræus and Munychia, became also master of Athens; the oligarchical or Phocionian party again acquired predominance; Demetrius the Phalerean was recalled from exile, and placed to administer the city under Cassander, as Phocion had administered it under Antipater.

We cannot indeed read without painful sympathy the narrative of an old man above eighty, — personally brave, mild, and superior to all pecuniary temptation, so far as his positive administration was concerned, — perishing under an intense and crushing storm of popular execration. But when we look at the whole case — when we survey, not merely the details of Phocion's administration, but the grand public objects which those details subserved, and towards which he conducted his fellow-citizens — we shall see that this judgment is fully merited. In Phocion's patriotism — for so doubtless he himself sincerely conceived it — no account was taken of Athenian independence; of the autonomy or self-management of the Hellenic world; of the conditions, in reference to foreign kings, under which alone such autonomy could exist. He had neither the Panhellenic sentiment of Aristides, Callieratidas, and Demosthenes, nor the narrower Athenian sentiment, like the devotion of Agesilaus to Sparta, and of Epaminondas to Thebes.

¹ Plutarch, *Phocion*, 36, 37. Two other anecdotes are recounted by Plutarch, which seem to be of doubtful authenticity. Nicocles entreated that he might be allowed to swallow his potion before Phocion; upon which the latter replied: "Your request, Nicocles, is sad and mournful; but as I have never yet refused you anything throughout my life, I grant this also."

After the first four had drunk, all except Phocion, no more hemlock was left; upon which the jailer said that he would not prepare any more, unless twelve drachmæ of money were given to him to buy the material. Some hesitation took place, until Phocion asked one of his friends to supply the money, sarcastically remarking that it was hard if a man could not even die *gratis* at Athens.

[318 B.C.]

To Phocion it was indifferent whether Greece was an aggregate of autonomous cities, with Athens as first or second among them, or one of the satrapies under the Macedonian kings. Now this was among the most fatal defects of a Grecian public man.

It was precisely during the fifty years of Phocion's political and military influence, that the Greeks were degraded from a state of freedom, into absolute servitude. In so far as this great public misfortune can be imputed to any one man—to no one was it more ascribable than to Phocion. He was strategus during most of the long series of years when Philip's power was growing; it was his duty to look ahead for the safety of his countrymen, and to combat the yet immature giant. He heard the warnings of Demosthenes, and he possessed exactly those qualities which were wanting to Demosthenes—military energy and aptitude. Had he lent his influence to inform the short-sightedness, to stimulate the inertia, to direct the armed efforts, of his countrymen, the kings of Macedon might have been kept within their own limits, and the future history of Greece might have been altogether different. Unfortunately, he took the opposite side. He acted with Æschines and the Philippisers; without receiving money from Philip, he did gratuitously all that Philip desired—by nullifying and sneering down the efforts of Demosthenes and the other active politicians. After the battle of Charonea, Phocion received from Philip first, and from Alexander afterwards, marks of esteem not shown towards any other Athenian. This was both the fruit and the proof of his past political action—anti-Hellenic as well as anti-Athenian.

Having done much, in the earlier part of his life, to promote the subjugation of Greece under the Macedonian kings, he contributed somewhat, during the latter half, to lighten the severity of their dominion; and it is the most honourable point in his character that he always refrained from abusing their marked favour towards himself, for purposes either of personal gain or of oppression over his fellow-citizens. Alexander not only wrote letters to him, even during the plenitude of imperial power, in terms of respectful friendship, but tendered to him the largest presents—at one time the sum of one hundred talents [£20,000 or \$100,000]; at another time the choice of four towns on the coast of Asia Minor, as Xerxes gave to Themistocles. He even expressed his displeasure when Phocion, refusing everything, consented only to request the liberation of three Grecian prisoners confined at Sardis. The intense and unanimous wrath of the people against him is an instructive, though a distressing spectacle. It was directed, not against the man or the administrator—for in both characters Phocion had been blameless, except as to the last collusion with Nicanor in the seizure of the Piræus—but against his public policy. It was the last protest of extinct Grecian freedom, speaking as it were from the tomb in a voice of thunder, against that fatal system of mistrust, inertia, self-seeking, and corruption, which had betrayed the once autonomous Athens to a foreign conqueror.^e

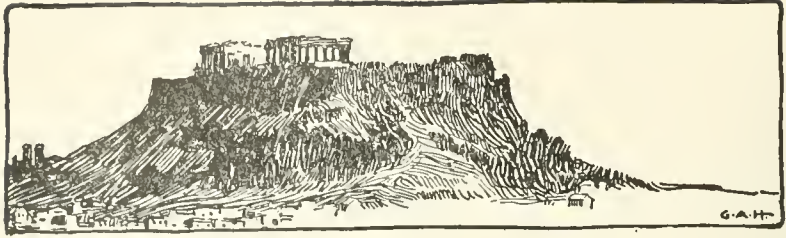

CHAPTER LXI. THE FAILURE OF GRECIAN FREEDOM

WE have already mentioned that Polysperchon with his army was in Phocis when Phocion was brought before him, on his march towards Peloponnesus. Before he reached Attica, Cassander arrived at Piræus to join Nicanor with a fleet of thirty-five ships and four thousand soldiers obtained from Antigonus. On learning this fact, Polysperchon hastened his march also, and presented himself under the walls of Athens and Piræus with a large force of twenty thousand Macedonians, four thousand Greek allies, one thousand cavalry, and sixty-five elephants; animals which were now seen for the first time in Greece. He at first besieged Cassander in Piræus, but finding it difficult to procure subsistence in Attica for so numerous an army, he marched with the larger portion into Peloponnesus, leaving his son Alexander with a division to make head against Cassander. Either approaching in person the various Peloponnesian towns, or addressing them by means of envoys, he enjoined the subversion of the Antipatrian oligarchies, and the restoration of liberty and free speech to the mass of the citizens. In most of the towns, this revolution was accomplished; but in Megalopolis, the oligarchy held out, not only forcing Polysperchon to besiege the city, but even defending it against him successfully. His admiral Clitus was soon afterwards defeated in the Propontis, with the loss of his whole fleet, by Nicanor (whom Cassander had sent from Piræus) and Antigonus.

After these two defeats, Polysperchon seems to have evacuated Peloponnesus, and to have carried his forces across the Corinthian Gulf into Epirus, to join Olympias. His party was greatly weakened all over Greece, and that of Cassander proportionally strengthened. The first effect of this was the surrender of Athens. The Athenians in the city, including all or many of the restored exiles, could no longer endure that complete severance from the sea, to which the occupation of Piræus and Munychia by Cassander had reduced them. Athens without a port was hardly tenable; in fact, Piræus was considered by its great constructor, Themistocles, as more indispensable to the Athenians than Athens itself. It was agreed that they should become friends and allies of Cassander; that they should have full enjoyment of their city, with the port Piræus, their ships and revenues; that the exiles and deported citizens should be readmitted; that the political franchise should for the future be enjoyed by all citizens who possessed one thousand drachmæ of property and upwards; that Cassander should hold Munychia with a governor and garrison, until the war against Polysperchon was brought to a close; and that he should also name some one Athenian citizen, in whose hands the supreme government of the city should be vested. Cassander named Demetrius the Phalerean (*i.e.*, an Athenian of the deme Phalerum), one of the colleagues of Phocion.

[318-311 B.C.]

This convention restored substantially at Athens the Antipatrian government; yet without the severities which had marked its original establishment, and with some modifications in various ways. It made Cassander virtually master of the city (as Antipater had been before him), by means of his governing nominee, upheld by the garrison, and by the fortification of Munychia; which had now been greatly enlarged and strengthened, holding a practical command over Piræus, though that port was nominally relinquished to the Athenians. But there was no slaughter of orators, no expulsion of citizens; moreover, even the minimum of one thousand drachmæ, fixed for the political franchise, though excluding the multitude, must have been felt as an improvement compared with the higher limit of two thousand drachmæ prescribed by Antipater. Cassander was not, like his father, at the head of an overwhelming force, master of Greece. He had Polysperchon in the field against him with a rival army and an established ascendancy in many of the Grecian cities; it was therefore his interest to abstain from measures of obvious harshness towards the Athenian people.^b

HELLAS AT PEACE

Subsequent events, in Greece itself first of all, offer sufficient explanation of what the Peace of 311 meant, so far as the freedom of the Grecian states was concerned. And yet it appears the old magic of the word did not cease to delude the mind and inflame the heart—for did not that word comprehend everything they thought they now lacked and had once enjoyed?

Free their city republics could yet certainly be, or become—free after a certain fashion; but independent, scarce one of them. Powers far superior stood round on every side; and although full of active men ready to be hired for fighting, these little states were too poor to bring up considerable armies, too jealous and bitter about one another to make a reliable alliance, and lastly the public spirit of their citizens was too decayed to permit any possible hope of a radically better state of things. Their day was over. Only the forms of a great monarchy could have held together this restless life which was fretting itself away; but whatever attempt had been made in this direction had taken no root among a people who were entirely separatist, and whose ideas of citizenship never went beyond the limits of their various cities. The very qualities that so peculiarly fitted the Greek spirit to serve as the fermenting leaven that should work through the peoples of Asia and forward their development, incapacitated it for the work of retaining its independent politics and keeping pace with the new developments of the time.

The situation of Sparta in these times is a strange one. The laws of Lycurgus and the old forms still linger there, but the old spirit has gone out, even to the last trace. It is a reign of the basest immorality. The citizens have dwindled to a few hundreds, the constitution of Lycurgus, formally observed, is a lie. The narrower the intellectual circle in which thought may move, the cruder must be the notions that obtain. Literature and science, the comfort and hope of the rest of Greece, were still, even to this day, proscribed in Sparta. Sparta had no other interest in the situation except that in her dominion was the universal recruiting ground for all parties—the peninsula of Tænarus—and distinguished Spartans were always glad to take the field as mercenaries. Even the son of the aged king Cleomenes II, Acrotatus, led a mercenary army to Tarentum and Sicily in 315, revolting those in whose pay he fought by his bloodthirsty savagery and his

unnatural passions. He came home to Sparta dishonoured, and died before he could inherit from his father.

At the death of Cleomenes (309), Cleonymus, a worthy brother to Acrotatus in dissoluteness and arrogance, demanded the kingdom; the Gerousia decided in favour of the young son of Acrotatus, Areus, and after a few years Cleonymus entered the service of Tarentum with a force of mercenaries, to bring the name of Sparta into ignominy by behaving even worse than his brother. At home the power of the kings, since the state no longer existed for its business of war, was as good as gone. The ephorate ruled as an oligarchy, and the oligarchy wanted nothing but quiet and pleasure, wrapped up in the dead laws of Lycurgus; nothing was further from their thoughts than the idea of winning again their old hegemony, at least in the Peloponnese—an idea which might now have been justified by the distraction of Greece and the strife of parties that was bursting afresh into flames.

ATHENS UNDER DEMETRIUS; SPARTA BEHIND WALLS

Athens affords us the most vivid glimpse into this unhappy time. How often had the ruling party and the policy of the city changed since the battle of Chæronea. At last in the autumn of 318, after the victory of Cassander, the state was given a form which was anything but a democracy. The man whom the people chose, and Cassander confirmed, as state administrator, was Demetrius, the son of Phanostratus of Phalerus. He had grown up in the house of Timotheus and had been educated in science and for a political life by Theophrastus. He was a man as talented as he was vain, as versatile in the realm of letters as he was politically characterless—for the rest, a man of the world and its pleasures, who fell on his feet wherever he was.

It may be that in his early years he had lived like a philosopher, that his table was laid very frugally, "only with olives in vinegar and cheese from the islands." And then too, when he became master of the state he showed himself, according to some, a humane, clear-sighted, excellent statesman; while others declare that he spent but a small proportion of the city's income (which with subsidies from Egypt and Macedonia he had raised to twelve hundred talents) in administration and in keeping the city well prepared for war; the rest went partly in public festivities and splendour, and partly in his own riotous and dissolute living. He that would pose in his ordinances as a reformer of Athenian morals, corrupted morals by his more than doubtful example. Every day, it was said, he gave splendid dinners to which a great number of guests were always invited; in his expenditure on his table he surpassed even the Macedonians, in his elegance he outdid Cyprians and Phœnicians; spikenard and myrrh were sprinkled for perfume, the floor was strewn with flowers, costly carpets and paintings decorated the rooms; he kept so extravagant, so luxurious, a table, that his cook, who had what was left over, was able to buy three properties in two years out of the profits he made by his sales. Demetrius spent the greatest care upon his choice of dress, he dyed his hair fair, painted his face, anointed his head with precious oils; he always showed a smiling countenance, he wanted to please every one.

The most dainty and unbridled wantonness side by side with that subtle, gracious, and witty culture, which has ever since been described by the epithet Attic—both are characteristic of the life of Athens in those days. It was the fashion to attend the schools of philosophy.

[318-317 B.C.]

Such words as home, chastity, modesty, were no longer heard in the Athens of that time, or they were only words. Life had all become phrases and epigrams, ostentation and occupied idleness. Athens distributed flattery and entertainment to the mighty ones of the earth, and permitted herself to receive in return their gifts and gratuities. She grew more servile as she grew more oligarchic. She played as a state the rôle of parasite to kings and such as held power, a sponging flatterer not at all ashamed to buy admiration and pleasures at the price of dignity. There were only two things her people were afraid of; they were afraid of being bored, and they were afraid of being ridiculous — and there were rich occasions for being both. Religion had disappeared, and with the indifference of enlightenment superstition came in — magic witchcraft, astrology. Moral conduct, out of an old habit (for morality like the laws had been reasoned away), was theoretically handled in the schools and made a theme for debate and literary duels. The two standard philosophies of the next centuries, the Stoic and the Epicurean, were evolving in Athens at this period.

It was, of course, a proud thing for Demetrius that the city was much and profitably frequented. Trade itself was probably livelier in Athens during these years than at any other time and rivalled that of Rhodes, Byzantium, and Alexandria. According to a census which was probably undertaken during the year Demetrius was archon (309), the population of Attica amounted to 21,000 citizens, 10,000 strangers, 400,000 slaves — certainly a great number of inhabitants for a territory of little more than forty square miles.^c

The acquisition of Athens by Cassander, followed up by his capture of Panactum and Salamis, and seconded by his moderation towards the Athenians, procured for him considerable support in Peloponnesus, whither he proceeded with his army. Many of the cities, intimidated or persuaded, joined him and deserted Polysperchon; while the Spartans, now feeling for the first time their defenceless condition, thought it prudent to surround their city with walls. This fact, among many others contemporaneous, testifies emphatically how the characteristic sentiments of the Hellenic autonomous world were now dying out everywhere. The maintenance of Sparta as an unwallied city was one of the deepest and most cherished of the Lycurgean traditions; a standing proof of the fearless bearing and self-confidence of the Spartans against dangers from without. The erection of the walls showed their own conviction, but too well borne out by the real circumstances around them, that the pressure of the foreigner had become so overwhelming as hardly to leave them even safety at home.



GRECIAN HEAD-DRESSES.

THE LAST ACTS OF OLYMPIAS' POWER

The warfare between Cassander and Polysperchon became now embittered by a feud among the members of the Macedonian imperial family. King Philip Arrhidæus and his wife Eurydice, alarmed and indignant at the restoration of Olympias, which Polysperchon was projecting, solicited aid from Cassander, and tried to place the force in Macedonia at his disposal. In this however they failed.

Olympias, assisted not only by Polysperchon, but by the Epirot prince Æacides, made her entry into Macedonia out of Epirus, apparently in the autumn of 317 B.C. She brought with her Roxane and her child—the widow and son of Alexander the Great. The Macedonian soldiers, assembled by Philip Arrhidæus and Eurydice to resist her, were so overawed by her name and the recollection of Alexander, that they refused to fight, and thus insured to her an easy victory. Philip and Eurydice became her prisoners; the former she caused to be slain; to the latter she offered only an option between the sword, the halter, and poison. The old queen next proceeded to satiate her revenge against the family of Antipater. One hundred leading Macedonians, friends of Cassander, were put to death, together with his brother Nicanor; while the sepulchre of his deceased brother Iollas, accused of having poisoned Alexander the Great, was broken up.

During the winter, Olympias remained thus completely predominant in Macedonia; where her position seemed strong, since her allies the Ætoliæ were masters of the pass at Thermopylæ, while Cassander was kept employed in Peloponnesus by the force under Alexander, son of Polysperchon. But Cassander, disengaging himself from these embarrassments, and eluding Thermopylæ by a maritime transit to Thessaly, seized the Perrhæbian passes before they had been put under guard, and entered Macedonia without resistance. Olympias, having no army competent to meet him in the field, was forced to shut herself up in the maritime fortress of Pydna, with Roxane, the child Alexander, and Thessalonice daughter of her late husband Philip, son of Amyntas.

Here Cassander blocked her up for several months by sea as well as by land, and succeeded in defeating all the efforts of Polysperchon and Æacides to relieve her. In the spring of the ensuing year (316 B.C.), she was forced by intolerable famine to surrender. Cassander promised her nothing more than personal safety, requiring from her the surrender of the two great fortresses, Pella and Amphipolis, which made him master of Macedonia. Presently however the relatives of those numerous victims, who had perished by order of Olympias, were encouraged by Cassander to demand her life in retribution. They found little difficulty in obtaining a verdict of condemnation against her from what was called a Macedonian assembly. Nevertheless, such was the sentiment of awe and reverence connected with her name, that no one except these injured men themselves could be found to execute the sentence. She died with a courage worthy of her rank and domineering character. Cassander took Thessalonice to wife, confined Roxane with the child Alexander in the fortress of Amphipolis—where (after a certain interval) he caused both of them to be slain.

While Cassander was thus master of Macedonia, and while the imperial family were disappearing from the scene in that country, the defeat and death of Enmenes (which happened nearly at the same time as the capture of Olympias) removed the last faithful partisan of that family in Asia. But at the same time it left in the hands of Antigonus such overwhelming

[317-315 B.C.]

preponderance throughout Asia, that he aspired to become vicar and master of the entire Alexandrine empire, as well as to avenge upon Cassander the extirpation of the regal family. His power appeared indeed so formidable that Cassander of Macedonia, Lysimachus of Thrace, Ptolemy of Egypt, and Seleucus of Babylonia, entered into a convention, which gradually ripened into an active alliance against him.

During the struggles between these powerful princes, Greece appears simply as a group of subject cities, held, garrisoned, grasped at, or coveted, by all of them. Polysperchon, abandoning all hopes in Macedonia after the death of Olympias, had been forced to take refuge among the Ætolians, leaving his son Alexander to make the best struggle that he could in Peloponnesus; so that Cassander was now decidedly preponderant throughout the Hellenic regions. After fixing himself on the throne of Macedonia, he perpetuated his own name by founding, on the isthmus of the peninsula of Pallene and near the site where Potidæa had stood, the new city of Cassandrea.

Passing through Bœotia, he undertook the task of restoring the city of Thebes, which had been destroyed twenty years previously by Alexander the Great, and had ever since existed only as a military post on the ancient citadel called Cadmea. The other Bœotian towns, to whom the old Theban territory had been assigned, were persuaded or constrained to relinquish it; and Cassander invited from all parts of Greece the Theban exiles or their descendants. From sympathy with these exiles, and also with the ancient celebrity of the city, many Greeks, even from Italy and Sicily, contributed to the restoration. The Athenians, now administered by Demetrius Phalereus under Cassander's supremacy, were particularly forward in the work; the Messenians and Megalopolitans, whose ancestors had owed so much to the Theban Epaminondas, lent strenuous aid. Thebes was re-established in the original area which it had occupied before Alexander's siege; and was held by a Cassandrian garrison in the Cadmea, destined for the mastery of Bœotia and Greece.

After some stay at Thebes, Cassander advanced towards Peloponnesus. Alexander (son of Polysperchon) having fortified the isthmus, he was forced to embark his troops with his elephants at Megara, and cross over the Saronic Gulf to Epidaurus. He dispossessed Alexander of Argos, of Messenia, and even of his position on the isthmus, where he left a powerful detachment, and then returned to Macedonia. His increasing power raised both apprehension and hatred in the bosom of Antigonus, who endeavoured to come to terms with him, but in vain. Cassander preferred the alliance with Ptolemy, Seleucus, and Lysimachus—against Antigonus, who was now master of nearly the whole of Asia, inspiring common dread to all of them. Accordingly, from Asia to Peloponnesus, with arms and money Antigonus despatched the Milesian Aristodemus to strengthen Alexander against Cassander; whom he further denounced as an enemy of the Macedonian name, because he had slain Olympias, imprisoned the other members of the regal family, and re-established the Olynthian exiles. He caused the absent Cassander to be condemned by what was called a Macedonian assembly, upon these and other charges.

Antigonus further proclaimed, by the voice of this assembly, that all the Greeks should be free, self-governing, and exempt from garrisons or military occupation. It was expected that these brilliant promises would enlist partisans in Greece against Cassander; accordingly Ptolemy, ruler of Egypt, one of the enemies of Antigonus, thought fit to issue similar proclamations a

few months afterwards, tendering to the Greeks the same boon from himself. These promises, neither executed nor intended to be executed, by either of the kings, appear to have produced little or no effect upon the Greeks.

The arrival of Aristodemus in Peloponnesus had re-animated the party of Alexander (son of Polysperchon), against whom Cassander was again obliged to bring his full forces from Macedonia. Though successful against Alexander at Argos, Orehomenos, and other places, Cassander was not able to crush him, and presently thought it prudent to gain him over. He offered to him the separate government of Peloponnesus, though in subordination to himself; Alexander accepted the offer—becoming Cassander's ally—and carried on war, jointly with him, against Aristodemus, with varying success, until he was presently assassinated by some private enemies. Nevertheless his widow Cratesipolis, a woman of courage and energy, still maintained herself in considerable force at Sicyon.

Cassander's most obstinate enemies were the Ætolians, of whom we now first hear formal mention as a substantive confederacy. These Ætolians became the allies of Antigonus as they had been before of Polysperchon, extending their predatory ravages even as far as Attica. Protected against foreign garrisons, partly by their rude and fierce habits, partly by their mountainous territory, they were almost the only Greeks who could still be called free. Cassander tried to keep them in check through their neighbours the Acarnanians, whom he induced to adopt a more concentrated habit of residence, consolidating their numerous petty townships into a few considerable towns,—Stratus, Sauria, and Agrinium,—convenient posts for Macedonian garrisons. He also made himself master of Leucas, Apollonia, and Epidamnus, defeating the Illyrian king Glaucias, so that his dominion now extended across from the Thermaic to the Adriatic Gulf. His general Philippus gained two important victories over the Ætolians and Epirots, forcing the former to relinquish some of their most accessible towns.

The power of Antigonus in Asia underwent a material diminution, by the successful and permanent establishment which Seleucus now acquired in Babylonia; from which event the era of the succeeding Seleucidæ takes its origin. In Greece, however, Antigonus gained ground on Cassander. He sent thither his nephew Ptolemy with a large force to liberate the Greeks, or in other words, to expel the Cassandrian garrisons; while he at the same time distracted Cassander's attention by threatening to cross the Hellespont and invade Macedonia. This Ptolemy (not the Egyptian) expelled the soldiers of Cassander from Eubœa, Bœotia, and Phœcis; having taken Chalcis, Oropus, Eretria, and Carystus, he entered Attica and presented himself before Athens. So much disposition to treat with him was manifested in the city, that Demetrius the Phalerean was obliged to gain time by pretending to open negotiations with Antigonus, while Ptolemy withdrew from Attica. Nearly at the same epoch, Apollonia, Epidamnus, and Leucas, found means, assisted by an armament from Coreyra, to drive out Cassander's garrisons, and to escape from his dominion. The affairs of Antigonus were now prospering in Greece, but they were much thrown back by the discontent and treachery of his admiral Telesphorus, who seized Elis and even plundered the sacred treasures of Olympia. Ptolemy presently put him down, and restored these treasures to the god.

In the ensuing year, a convention was concluded between Antigonus, on one side, and Cassander, Ptolemy (the Egyptian) and Lysimachus, on the other, whereby the supreme command in Macedonia was guaranteed to Cassander, until the maturity of Alexander son of Roxane; Thrace being at

[312-308 B.C.]

the same time assured to Lysimachus, Egypt to Ptolemy, and the whole of Asia to Antigonus. It was at the same time covenanted by all, that the Hellenic cities should be free. Towards the execution of this last clause, however, nothing was actually done. Nor does it appear that the treaty had any other effect, except to inspire Cassander with increased jealousy about Roxane and her child; both of whom (as has been already stated) he caused to be secretly assassinated soon afterwards, by the governor Glaucias, in the fortress of Amphipolis, where they had been confined. The forces of Antigonus, under his general Ptolemy, still remained in Greece. But this general presently (310 B.C.) revolted from Antigonus, and placed them in co-operation with Cassander; while Ptolemy of Egypt, accusing Antigonus of having contravened the treaty by garrisoning various Grecian cities, renewed the war and the triple alliance against him.

Polysperchon — who had hitherto maintained a local dominion over various parts of Peloponnesus, with a military force distributed in Messene and other towns — was now encouraged by Antigonus to espouse the cause of Heracles (son of Alexander by Barsine), and to place him on the throne of Macedonia in opposition to Cassander. This young prince Heracles now seventeen years of age, was sent to Greece from Pergamus in Asia, and his pretensions to the throne were assisted not only by a considerable party in Macedonia itself, but also by the Ætolians. Polysperchon invaded Macedonia, with favourable prospects of establishing the young prince; yet he thought it advantageous to accept treacherous propositions from Cassander, who offered to him partnership in the sovereignty of Macedonia, with an independent army and dominion in Peloponnesus. Polysperchon, tempted by these offers, assassinated the young prince Heracles, and withdrew his army towards Peloponnesus. But he found such unexpected opposition, in his march through Bœotia, from Bœotians and Peloponnesians, that he was forced to take up his winter quarters in Locris (309 B.C.). From this time forward, as far as we can make out, he commanded in southern Greece as subordinate ally or partner of Cassander.

The assassination of Heracles was speedily followed by that of Cleopatra, sister of Alexander the Great, and daughter of Philip and Olympias. She had been for some time at Sardis, nominally at liberty, yet under watch by the governor, who received his orders from Antigonus; she was now preparing to quit that place, for the purpose of joining Ptolemy in Egypt, and of becoming his wife. She had been invoked as auxiliary, or courted in marriage, by several of the great Macedonian chiefs, without any result. Now, however, Antigonus, afraid of the influence which her name might throw into the scale of his rival Ptolemy, caused her to be secretly murdered as she was preparing for her departure; throwing the blame of the deed on some of her women, whom he punished with death.

All the relatives of Alexander the Great (except Thessalonice wife of Cassander, daughter of Philip by a Thessalian mistress) thus successively perished, and all by the orders of one or other among his principal officers. The imperial family, with the prestige of its name thus came to an end.

PTOLEMY IN GREECE

Ptolemy of Egypt now set sail for Greece with a powerful armament. He acquired possession of the important cities — Sicyon and Corinth — which were handed over to him by Cratesipolis, widow of Alexander son of

Polysperchon. He then made known by proclamation his purpose as a liberator, inviting aid from the Peloponnesian cities themselves against the garrisons of Cassander. From some he received encouraging answers and promises; but none of them made any movement, or seconded him by armed demonstrations. He thought it prudent therefore to conclude a truce with Cassander and retire from Greece, leaving however secure garrisons in Sicyon and Corinth. The Grecian cities had now become tame and passive. Feeling their own incapacity of self-defence, and averse to auxiliary efforts — which brought upon them enmity without any prospect of advantage — they awaited only the turns of foreign interference and the behests of the potentates around them.

The Grecian ascendancy of Cassander, however, was in the following year exposed to a graver shock than it had ever yet encountered, by the sudden invasion of Demetrius called Poliorcetes, son of Antigonus. This young prince, sailing from Ephesus with a formidable armament, contrived to conceal his purposes so closely, that he actually entered the harbour of Piræus (on the 26th of the month Thargelion — May) without expectation, or resistance from any one; his fleet being mistaken for the fleet of the Egyptian Ptolemy. The Phalerean Demetrius, taken unawares, and attempting too late to guard the harbour, found himself compelled to leave it in possession of the enemy, and to retire within the walls of Athens; while Dionysius, the Cassandrian governor, maintained himself with his garrison in Munychia, yet without any army competent to meet the invaders in the field. This accomplished Phalerean, who had administered for ten years as the viceroy and with the force of Cassander, now felt his position and influence at Athens overthrown, and even his personal safety endangered. He obtained permission to retire to Thebes, from whence he passed over soon after to Ptolemy in Egypt. The Athenians in the city declared in favour of Demetrius Poliorcetes; who however refused to enter the walls until he should have besieged and captured Munychia, as well as Megara, with their Cassandrian garrisons. In a short time he accomplished both these objects. Indeed energy, skill, and effective use of engines in besieging fortified places, were among the most conspicuous features in his character; procuring for him the surname whereby he is known to history. He proclaimed the Megarians free, levelling to the ground the fortifications of Munychia, as an earnest to the Athenians that they should be relieved for the future from all foreign garrison.

ATHENS PASSIVE AND SERVILE

After these successes, Demetrius Poliorcetes made his triumphant entry into Athens. He announced to the people, in formal assembly, that they were now again a free democracy, liberated from all dominion either of soldiers from abroad or oligarchs at home. He also promised them a further boon from his father Antigonus and himself — 150,000 medimni of corn for distribution, and ship-timber in quantity sufficient for constructing one hundred triremes. Both these announcements were received with grateful exultation. The feelings of the people were testified not merely in votes of thanks and admiration towards the young conqueror, but in effusions of unmeasured and exorbitant flattery. Stratocles (who has already been before us as one of the accusers of Demosthenes in the Harpalian affair) with others exhausted their invention in devising new varieties of compliment and

[307 B.C.]

adulation. Antigonus and Demetrius were proclaimed to be not only kings, but gods and saviours; a high priest of these saviours was to be annually chosen, after whom each successive year was to be named (instead of being named after the first of the nine archons, as had hitherto been the custom), and the dates of decrees and contracts commemorated; the month Munychion was re-named as Demetrian; two new tribes, to be called Antigonias and Demetrias, were constituted in addition to the preceding ten; the annual senate was appointed to consist of six hundred members instead of five hundred; the portraits and exploits of Antigonus and Demetrius were to be woven, along with those of Zeus and Athene, into the splendid and voluminous robe periodically carried in procession, as an offering at the Panathenaic festival; the spot of ground where Demetrius had alighted from his chariot, was consecrated with an altar erected in honour of Demetrius Catabates or the Descender. Several other similar votes were passed, recognising, and worshipping as gods, the saviours Antigonus and Demetrius. Nay, we are told that temples or altars were voted to Phila-Aphrodite, in honour of Phila wife of Demetrius; and a like compliment was paid to his two mistresses, Leæna and Lamia. Altars are said to have been also dedicated to Adimantus and others, his convivial companions or flatterers. At the same time the numerous statues which had been erected in honour of the Phalerean Demetrius during his decennial government, were overthrown, and some of them even turned to ignoble purposes, in order to cast greater scorn upon the past ruler. The demonstrations of servile flattery at Athens, towards Demetrius Poliorcetes, were in fact so extravagantly overdone, that he himself is said to have been disgusted with them, and to have expressed contempt for these degenerate Athenians of his own time.

The most fulsome votes of adulation proposed in honour of Demetrius Poliorcetes by his partisans, though perhaps disapproved by many, would hardly find a single pronounced opponent. One man, however, there was, who ventured to oppose several of the votes — the nephew of Demosthenes, Demochares; who deserves to be commemorated as the last known spokesman of free Athenian citizenship. We know only that such were his general politics, and that his opposition to the obsequious rhetor Stratocles ended in banishment, four years afterwards. He appears to have acted as a general during this period, and to have been active in strengthening the fortifications and military equipment of the city.

The altered politics of Athens were manifested by impeachment against Demetrius Phalereus and other leading partisans of the late Cassandrian government. He and many others had already gone into voluntary exile; when their trials came on, they were not forthcoming, and all were condemned to death. But all those who remained, and presented themselves for trial, were acquitted; so little was there of reactionary violence on this occasion.

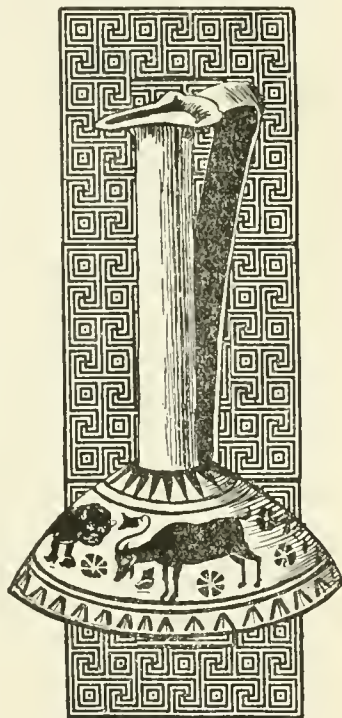

GREEK JUG

The friendship of this obnoxious Phalerean, and of Cassander also, towards the philosopher Theophrastus, seems to have been one main cause which occasioned the enactment of a restrictive law against the liberty of philosophising. It was decreed, on the proposition of a citizen named Sophocles, that no philosopher should be allowed to open a school or teach, except under special sanction obtained from a vote of the senate and people. Such was the disgust and apprehension occasioned by the new restriction, that all the philosophers with one accord left Athens. This spirited protest, against authoritative restriction on the liberty of philosophy and teaching,

found responsive sympathy among the Athenians. The celebrity of the schools and professors was in fact the only characteristic mark of dignity still remaining to them — when their power had become extinct, and when even their independence and free constitution had degenerated into a mere name.

Athenian envoys were despatched to Antigonus in Asia, to testify the gratitude of the people, and communicate the recent complimentary votes. Antigonus not only received them graciously, but sent to Athens, according to the promise made by his son, a large present of 150,000 medimni of wheat, with timber sufficient for one hundred ships. He at the same time directed Demetrius to convene at Athens a synod of deputies from the allied Grecian cities, where resolutions might be taken for the common interests of Greece. It was his interest at this moment to raise up a temporary self-sustaining authority in Greece, for the purpose of upholding the alliance with himself, during the absence of Demetrius — whom he was compelled to summon into Asia with his army, requiring his services for the war against Ptolemy in Syria and Cyprus.

The following three years were spent by Demetrius: (1) In victorious operations near Cyprus, defeating Ptolemy and making himself master of that island; after which Antigonus and Demetrius assumed the title of kings, and the example was followed by Ptolemy, in Egypt, by Lysimachus, in Thrace, and by Seleucus in Babylonia, Mesopotamia, and Syria; thus abolishing even the titular remembrance of Alexander's family. (2) In an unsuccessful invasion of Egypt by land and sea, repulsed with great loss. (3) In the siege of Rhodes. The brave and intelligent citizens of this island resisted for more than a year the most strenuous attacks and the most formidable siege-equipments of Demetrius Poliorectes. All their efforts however would have been vain had they not been assisted by large reinforcements and supplies from Ptolemy, Lysimachus, and Cassander. Such are the conditions under which alone even the most resolute and intelligent Greeks can now retain their circumscribed sphere of autonomy. The siege



CERES
(From a vase)

[304-302 B.C.]

was at length terminated by a compromise; the Rhodians submitted to enrol themselves as allies of Demetrius, yet under proviso not to act against Ptolemy. Towards the latter they carried their grateful devotion so far as to erect a temple to him, called the Ptolemæum, and to worship him (under the sanction of the oracle of Ammon) as a god. Amidst the rocks and shoals through which Grecian cities were now condemned to steer, menaced on every side by kings more powerful than themselves, and afterwards by the giant republic of Rome—the Rhodians conducted their political affairs with greater prudence and dignity than any other Grecian city.

Shortly after the departure of Demetrius from Greece to Cyprus, Cassander and Polysperchon renewed the war in Peloponnesus and its neighbourhood. We make out no particulars respecting this war. The Ætolians were in hostility with Athens, and committed annoying depredations. The fleet of Athens, repaired or increased by the timber received from Antigonus, was made to furnish thirty quadriremes to assist Demetrius in Cyprus, and was employed in certain operations near the island of Amorgos, wherein it suffered defeat. But we can discover little respecting the course of the war, except that Cassander gained ground upon the Athenians, and that about the beginning of 303 B.C., he was blockading or threatening to blockade Athens. The Athenians invoked the aid of Demetrius Poliorcetes, who, having recently concluded an accommodation with the Rhodians, came again across from Asia, with a powerful fleet and army, to Aulis in Bœotia. He was received at Athens with demonstrations of honour equal or superior to those which had marked his previous visit. He seems to have passed a year and a half, partly at Athens, partly in military operations carried successfully over many parts of Greece. He celebrated, as president, the great festival of the Heræa at Argos; on which occasion he married Didamia, sister of Pyrrhus, the young king of Epirus. He prevailed on the Sicyonians to transfer to a short distance the site of their city, conferring upon the new city the name of Demetrias. At a Grecian synod, convened in Corinth under his own letters of invitation, he received by acclamation the appointment of leader or emperor of the Greeks, as it had been conferred on Philip and Alexander. He even extended his attacks as far as Leucas and Corcyra. The greater part of Greece seems to have been either occupied by his garrisons, or enlisted among his subordinates.

So much was Cassander intimidated by these successes, that he sent envoys to Asia, soliciting peace from Antigonus; who, however, elate and full of arrogance, refused to listen to any terms short of surrender at discretion. Cassander, thus driven to despair, renewed his applications to Lysimachus, Ptolemy, and Seleucus. All these princes felt equally menaced by the power and dispositions of Antigonus, and all resolved upon an energetic combination to put him down.

SUCCESS OF DEMETRIUS IN GREECE

After uninterrupted prosperity in Greece, throughout the summer of 302 B.C., Demetrius returned from Leucas to Athens, about the month of September, near the time of the Eleusinian mysteries. He was welcomed by festive processions, hymns, pæans, choric dances, and bacchanalian odes of joyous congratulation. One of these hymns is preserved, sung by a chorus of ithyphalli—masked revellers, with their heads and arms encircled by wreaths—clothed in white tunics, and in feminine garments.

Effusions such as these, while displaying unmeasured idolatry and subservience towards Demetrius, are yet more remarkable, as betraying a loss of force, a senility, and a consciousness of defenceless and degraded position, such as we are astonished to find publicly proclaimed at Athens. It is not only against the foreign potentates that the Athenians avow themselves incapable of self-defence, but even against the incursions of the Ætolians, — Greeks like themselves, though warlike, rude, and restless. When such were the feelings of a people — once the most daring, confident, and organising, and still the most intelligent, in Greece, we may see that the history of the Greeks as a separate nation or race is reaching its close; and that from henceforward they must become merged in one or other of the stronger currents that surround them.

After his past successes, Demetrius passed some months in enjoyment and luxury at Athens. He was lodged in the Parthenon, being considered as the guest of the goddess Athene. But his dissolute habits provoked the louder comments, from their being indulged in such a domicile; while the violences which he offered to beautiful youths of good family led to various scenes truly tragical. The subservient manifestations of the Athenians towards him, however, continued unabated. It is even affirmed that, in order to compensate for something which he had taken amiss, they passed a formal decree, on the proposition of Stratocles, declaring that everything which Demetrius might command was holy in regard to the gods, and just in regard to men. The banishment of Demochares is said to have been brought on by his sarcastic comments upon this decree. In the month Munychion (April) Demetrius mustered his forces and his Grecian allies for a march into Thessaly against Cassander; but before his departure, he was anxious to be initiated in the Eleusinian mysteries. It was however not the regular time for this ceremony; the Lesser Mysteries being celebrated in February, the Greater in September. The Athenians overruled the difficulty by passing a special vote, enabling him to be initiated at once, and to receive in immediate succession the preparatory and the final initiation, between which ceremonies a year of interval was habitually required. Accordingly, he placed himself disarmed in the hands of the priests, and received both first and second initiation in the month of April, immediately before his departure from Athens.

BATTLE OF IPSUS

Demetrius conducted into Thessaly an army of fifty-six thousand men: of whom twenty-five thousand were Grecian allies — so extensive was his sway at this moment over the Grecian cities. But after two or three months of hostilities, partially successful, against Cassander, he was summoned into Asia by Antigonus to assist in meeting the formidable army of the allies — Ptolemy, Seleucus, Lysimachus, and Cassander. Before retiring from Greece, Demetrius concluded a truce with Cassander, whereby it was stipulated that the Grecian cities, both in Europe and Asia, should be permanently autonomous and free from garrison or control. This stipulation served only as an honourable pretext for leaving Greece; Demetrius had little expectation that it would be observed. In the ensuing spring was fought the decisive battle of Ipsus in Phrygia (300 B.C.), by Antigonus and Demetrius, against Ptolemy, Seleucus, and Lysimachus; with a large army and many elephants on both sides. Antigonus, completely defeated,

[301-294 B.C.]

was slain ; his age was more than eighty years. His Asiatic dominion was broken up, chiefly to the profit of Seleucus, whose dynasty became from henceforward ascendant, from the coast of Syria eastward to the Caspian Gates and Parthia ; sometimes, though imperfectly, farther eastward, nearly to the Indus.

The effects of the battle of Ipsus were speedily felt in Greece. The Athenians passed a decree proclaiming themselves neutral, and excluding both the belligerent parties from Attica. Demetrius, retiring with the remnant of his defeated army, and embarking at Ephesus to sail to Athens, was met on the voyage by Athenian envoys, who respectfully acquainted him that he would not be admitted. At the same time, his wife Didamia, whom he had left at Athens, was sent away by the Athenians under an honourable escort to Megara, while some ships of war which he had left in the Piræus were also restored to him. Demetrius, indignant at this unexpected defection of a city which had recently heaped upon him such fulsome adulation, was still further mortified by the loss of most of his other possessions in Greece. His garrisons were for the most part expelled, and the cities passed into Cassandrian keeping or dominion. His fortunes were indeed partially restored by concluding a peace with Seleucus, who married his daughter. This alliance withdrew Demetrius to Syria, while Greece appears to have fallen more and more under the Cassandrian parties. It was one of these partisans, Lachares, who, seconded by Cassander's soldiers, acquired a despotism at Athens such as had been possessed by the Phalæcean Demetrius, but employed in a manner far more cruel and oppressive.

Various exiles from his tyranny invited Demetrius Poliorettes, who passed over again from Asia into Greece, recovered portions of Peloponnesus, and laid siege to Athens. He blocked up the city by sea and land, so that the pressure of famine presently became intolerable. Lachares having made his escape, the people opened their gates to Demetrius, not without great fear of the treatment awaiting them. But he behaved with forbearance, and even with generosity. He spared them all, supplied them with a large donation of corn, and contented himself with taking military occupation of the city, naming his own friends as magistrates. He put garrisons, however, not only into Piræus and Munychia, but also into the hill called Museum, a part of the walled circle of Athens itself (298 B.C.).

While Demetrius was thus strengthening himself in Greece, he lost all his footing both in Cyprus, Syria, and Cilicia, which passed into the hands of Ptolemy and Seleucus. New prospects however were opened to him in Macedonia by the death of Cassander (his brother-in-law, brother of his wife Phila) and the family feuds supervening thereupon. Philippus, eldest son of Cassander, succeeded his father, but died of sickness after something more than a year. Between the two remaining sons, Antipater and Alexander, a sanguinary hostility broke out. Antipater slew his mother Thesalonice, and threatened the life of his brother, who in his turn invited aid both from Demetrius and from the Epirotic king Pyrrhus. Pyrrhus being ready first, marched into Macedonia, and expelled Antipater; receiving as his recompense the territory called Tymphæa (between Epirus and Macedonia) together with Acarnania, Amphilochia, and the town of Ambracia, which became henceforward his chief city and residence. Antipater sought shelter in Thrace with his father-in-law Lysimachus ; by whose order, however, he was presently slain. Demetrius, occupied with other matters, was more tardy in obeying the summons ; but, on entering into Macedonia, he found himself strong enough to dispossess and kill Alexander (who had

indeed invited him, but is said to have laid a train for assassinating him), and seized the Macedonian crown; not without the assent of a considerable party, to whom the name and the deeds of Cassander and his sons were alike odious.

Demetrius became thus master of Macedonia, together with the greater part of Greece, including Athens, Megara, and much of Peloponnesus. He undertook an expedition into Bœotia, for the purpose of conquering Thebes; in which attempt he succeeded, not without a double siege of that city. But Greece as a whole was managed by Antigonus (afterwards called Antigonus Gonatas) son of Demetrius, who maintained his supremacy unshaken during all his father's life-time; even though Demetrius was deprived of Macedonia by the temporary combination of Lysimachus with Pyrrhus, and afterwards remained (until his death in 283 B.C.) a captive in the hands of Seleucus. After a brief possession of the crown of Macedonia successively by Seleucus, Ptolemy Ceraunus, Meleager, Antipater, and Sosthenes—Antigonus Gonatas regained it in 277 B.C. His descendants, the Antigonid kings, maintained it until the battle of Pydna in 168 B.C.; when Perseus, the last of them, was overthrown, and his kingdom incorporated with the Roman conquests.

Of Greece during this period we can give no account, except that the greater number of its cities were in dependence upon Demetrius and his son Antigonus—either under occupation by Macedonian garrisons, or ruled by local despots who leaned on foreign mercenaries and Macedonian support. The spirit of the Greeks was broken, and their habits of combined sentiment and action had disappeared. The invasion of the Gauls indeed awakened them into a temporary union for the defence of Thermopylæ in 279 B.C. But this burst of spirit did not interrupt the continuance of the Macedonian dominion in Greece, which Antigonus Gonatas continued to hold throughout most of a long reign. He greatly extended the system begun by his predecessors, of isolating each Grecian city from alliances with other cities in its neighbourhood—planting in most of them local despots, and compressing the most important by means of garrisons. Among all Greeks, the Spartans and the Ætoliens stood most free from foreign occupation, and were the least crippled in their power of self-action. The Achæan League too developed itself afterwards as a renovated sprout from the ruined tree of Grecian liberty, though never attaining to anything better than a feeble and puny life, nor capable of sustaining itself without foreign aid.^b

At this point Grote ends his immortal work and takes farewell of Grecian history in the following words:

“With this after-growth, or half-revival, I shall not meddle. It forms the Greece of Polybius, which that author treats, in my opinion justly, as having no history of its own, but as an appendage attached to some foreign centre and principal among its neighbours—Macedonia, Egypt, Syria, Rome. Each of these neighbours acted upon the destinies of Greece more powerfully than the Greeks themselves. The Greeks to whom these volumes have been devoted—those of Homer, Archilochus, Solon, Æschylus, Herodotus, Thucydides, Xenophon, and Demosthenes—present as their most marked characteristic a loose aggregation of autonomous tribes or communities, acting and reacting freely among themselves, with little or no pressure from foreigners. The main interest of the narrative has consisted in the spontaneous grouping of the different Hellenic fractions, in the self-prompted co-operations and conflicts, the abortive attempts to bring about something like an effective federal organisation, or to maintain two permanent rival confederacies, the

energetic ambition and heroic endurance of men to whom Hellas was the entire political world. The freedom of Hellas, the life and soul of this history from its commencement, disappeared completely during the first years of Alexander's reign. After following to their tombs the generation of Greeks contemporary with him — men like Demosthenes and Phocion, born in a state of freedom — I have pursued the history into that gulf of Grecian nullity which marks the succeeding century; exhibiting sad evidence of the degrading servility, and suppliant king-worship, into which the countrymen of Aristides and Pericles had been driven, by their own conscious weakness under the overwhelming pressure from without.

“I cannot better complete that picture than by showing what the leading democratical citizen became, under the altered atmosphere which now bedimmed his city. Demochares, the nephew of Demosthenes, has been mentioned as one of the few distinguished Athenians in this last generation. He was more than once chosen to the highest public offices; he was conspicuous for his free speech, both as an orator and as an historian, in the face of powerful enemies; he remained throughout a long life faithfully attached to the democratical constitution, and was banished for a time by its opponents. In the year 280 B.C., he prevailed on the Athenians to erect a public monument, with a commemorative inscription, to his uncle Demosthenes. Seven or eight years afterwards, Demochares himself died, aged nearly eighty. His son Laches proposed and obtained a public decree, that a statue should be erected, with an annexed inscription, to his honour. We read in the decree a recital of the distinguished public services whereby Demochares merited this compliment from his countrymen. All that the proposer of the decree, his son and fellow-citizen, can find to recite, as ennobling the last half of the father's public life (since his return from exile), is as follows: (1) He contracted the public expenses, and introduced a more frugal management. (2) He undertook an embassy to King Lysimachus, from whom he obtained two presents for the people — one of thirty talents, the other of one hundred talents. (3) He proposed the vote for sending envoys to King Ptolemy in Egypt, from whom fifty talents were obtained for the people. (4) He went as envoy to Antipater, received from him twenty talents, and delivered them to the people at the Eleusinian festival.

“When such begging missions are the deeds for which Athens both employed and recompensed her most eminent citizens, an historian accustomed to the Grecian world as described by Herodotus, Thucydides, and Xenophon, feels that the life has departed from his subject, and with sadness and humiliation brings his narrative to a close.”^b

A kindred feeling seems to have actuated most of the other prominent historians of Greece, with the notable exception of Thirlwall. Yet from a slightly altered point of view, there is much of interest in the story of the later struggles of this wonderful people, against a seemingly predestined fate. Even were it not so, our present purpose, which regards Greece not as an isolated entity but as a part of the scheme of world history, requires that we should follow the tragic drama to its close.^a

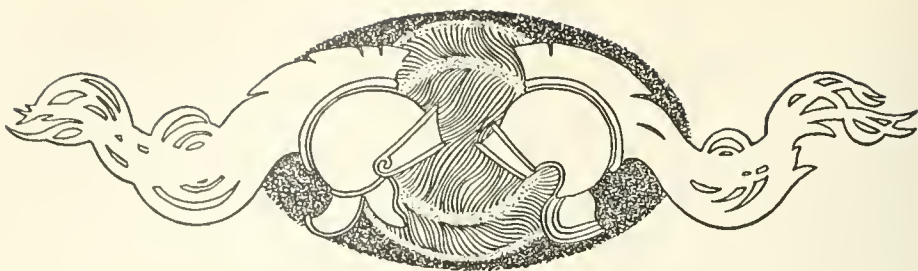

CHAPTER LXII. THE EXPLOITS OF PYRRHUS

WE now approach that dramatic moment when Greek first met Roman in battle array. Into the tangled web of the history of this period there flashes the scarlet thread of the life of Pyrrhus of Epirus. Though a fuller account of his war against Italy must be deferred to the Roman history, it will be briefly sketched here, together with a short account of his country and his ancestors.^a

Epirus, in spite of its distance from the chief centres of Greek thought and action, and the fact that its inhabitants were hardly regarded as other than barbarians, exerted even at an early period no small influence on Greece, by means more especially of the oracle of Dodona. One of the earliest and most flourishing settlements of the Greeks proper in Epirus was the Corinthian colony of Ambracia, which gave its name to the neighbouring gulf. The happy results of the experiment appear to have tempted other Greek states to imitate the example, and Elatria, Bucheta, and Pandosia bore witness to the enterprise of the people of Elis. Phœnice, still so called, was the wealthiest of all the native cities of Epirus, and after the fall of the Molossian kingdom the centre of an Epirotic league.

The kings or rather chieftains of the Molossians, who ultimately extended their power over all Epirus, claimed to be descended from Pyrrhus, son of Achilles, who, according to the legend, settled in the country after the sack of Troy, and transmitted his kingdom to Molossus, his son by Andromache. The early history of the dynasty is very obscure; but Admetus, who lived in the fifth century B.C., has become famous for his hospitable reception of the banished Themistocles, in spite of the grudge that he must have harboured against the great Athenian, who had persuaded his countrymen to refuse the alliance tardily offered by the Molossian chief when their victory against the Persians was already secured. He was succeeded about 429 B.C. by his son or grandson, Tharymbas or Arymbas I, who being placed by a decree of the people under the guardianship of Sabylinthus, chief of the Atintanes, was educated at Athens, and thus became at a later date the introducer of a higher kind of civilisation among his subjects. Alcetas, the next king mentioned in history, was contemporary with Dionysius of Syracuse (about 385 B.C.) and was indebted to his assistance for the recovery of his throne. His son Arymbas II (who succeeded by the death of his brother Neoptolemus) ruled with prudence and equity, and gave encouragement to literature and the arts. To him Xenocrates of Chalcedon dedicated his four books on the art of governing; and it is specially mentioned that he bestowed great care on the education of his brother's children. Troas, one of his nieces, became his own wife; and Olympias, the other, was married

[ca. 360-288 B.C.]

to Philip of Macedonia, and had the honour of giving birth to Alexander the Great. On the death of Arymbas, his nephew Alexander, the brother of Olympias, was put in possession of the throne by the assistance of Philip, who was afterwards assassinated on occasion of the marriage of the youthful king with Philip's daughter Cleopatra. Alexander was the first who bore the title of king of Epirus, and he raised the reputation of his country amongst foreign nations. His assistance having been sought by the Tarentines against the Samnites and Lucanians, he made a descent, 332 B.C., at Paestum, near the mouth of the river Silarus, and reduced several cities of the Lucani and Bruttii; but in a second attack upon Italy he was surrounded by the enemy, defeated, and slain, near the city Pandosia, in the Bruttian territory.

Æacides, the son of Arymbas II, succeeded Alexander, and espoused the cause of Olympias against Cassander; but he was dethroned by his own soldiers, and had hardly regained his position when he fell, 313 B.C., in battle against Philip, brother of Cassander. He had, by his wife Pthia, the celebrated Pyrrhus, and two daughters Didamia and Troas, of whom the former married Demetrius Poliorcetes. His brother Alcetas, who succeeded him, continued the war with Cassander till he was defeated; and he was ultimately put to death by his rebellious subjects, 295 B.C. The name of Pyrrhus, who next ascended the throne, gives to the history of his country an importance which it would otherwise never have possessed.

THE ANTECEDENTS OF PYRRHUS

Born about the year 318, and claiming descent from Pyrrhus, the son of Achilles, connected also with the royal family of Macedonia through Olympias, the mother of Alexander the Great, he became when a mere stripling king of the wild mountain tribes of Epirus, and learned how to fight battles in the school of Demetrius Poliorcetes and of his father Antigonus. He fought by their side in his seventeenth year at the memorable battle of Ipsus in Phrygia, in which they were decisively defeated by the combined armies of Seleucus and Lysimachus. Soon afterwards he was sent to the court of Ptolemy of Egypt at Alexandria as a pledge for the faithful carrying out of a treaty of alliance between Ptolemy and Demetrius, as his sister Didamia was the wife of the latter. Through Ptolemy, whose step-daughter Antigone he married, he was enabled to establish himself firmly on the throne of Epirus, and he became a formidable opponent to Demetrius, who was now king of Macedonia and the leading man in the Greek world.^e

Demetrius had not renounced the project of resuming his father's kingdom. He made immense preparations. The other kings renewed their league in which they included Pyrrhus, who had long been the friend of Demetrius but was now to become his rival. This rivalry was the more dangerous to Demetrius since he had made himself hated by his insolence. One day when, contrary to his custom, he had received all the petitions which were presented to him, he was seen to throw them into a river as he was crossing the bridge.

All the kings of that day made an endeavour to imitate Alexander, but it was said that Demetrius represented him as an actor on the stage, bowing his head to right and left, assuming majestic airs, adorning himself with a double diadem and a purple mantle on which he had caused the sun, the moon, and the stars to be embroidered in gold.

Pyrrhus, on the contrary, recalled Alexander by his fire and his boldness. He was the type of the soldier and the adventurer. He loved war for itself and despised all else. He came to the assistance of the Ætolians when they were attacked by Demetrius, but the two kings did not meet, having both missed their way. Whilst Demetrius ravaged Epirus, Pantarchus, one of his lieutenants, gave battle to Pyrrhus, and during the fight provoked him to single combat. Both were wounded, but Pyrrhus overthrew his adversary; the Epirots, excited by the courage of their king, carried the victory, and the Macedonians, having been conquered by him, admired him more and more.

Whilst Ptolemy raised the Greek towns against Demetrius, Lysimachus entered Macedon by Thrace, and Pyrrhus by Epirus. Demetrius thought it prudent to turn first against Pyrrhus, who was a foreigner, but he was not slow to repent his action. Desertions were numerous and soon a general mutiny broke out in the army. The soldiers had not forgiven Demetrius for permitting the capture of Beroëa, where most of them had left their wives and their money. They went over to Pyrrhus in crowds to ask for his commands as their general. Demetrius returned to his tent, took off his crown and his royal mantle, assumed a dark dress and a Macedonian cap and left the camp unnoticed. He had scarcely gone when his tent was pillaged.

Pyrrhus was proclaimed king of Macedon; but Lysimachus appeared on the scene and demanded his share. Pyrrhus was not sufficiently certain of the Macedonians to enter into a contest with one of Alexander's lieutenants, and he agreed to divide the towns and provinces of Macedonia with Lysimachus. As Antipater, who had murdered his own mother, protested against this arrangement and complained that he was being despoiled of his inheritance, Lysimachus had him put to death; in him the family of Alexander became extinct.

THE LAST ADVENTURES OF DEMETRIUS

Demetrius withdrew first to Cassandrea, a town which Cassander had founded on the site of Potidæa. Then he passed into Greece to endeavour to retrieve his fortunes. The Athenians, under the command of Olympiodorus, had expelled the Macedonian garrison from the Museum and resumed possession of the Piræus and of Munychia. They had summoned Pyrrhus, who, after having aided them to liberate themselves, gave them the excellent advice to receive no more kings into their city. Demetrius would have besieged Athens, but the philosopher Crates, being sent to him, dissuaded him in his own interest. Corinth and some portions of the Peloponnesus still remained to him; there he left his son, Antigonus Gonatas, and set out for Asia with such vessels as he had and about twelve thousand soldiers. Most of the towns surrendered and several he took by force, amongst others the town of Sardis. A few officers and soldiers passed into his camp. But Agathocles, son of Lysimachus, appeared with a numerous army. Demetrius, pursued across the desert, soon found himself confronted by Seleucus. The latter presented himself unarmed before his enemy's troops and exhorted them to quit a brigand leader who had not even the means of paying them. The soldiers saw the wisdom of the advice and went over to him.

Demetrius attempted to flee, but was soon dying of hunger and obliged to give himself up to Seleucus. Lysimachus offered a large sum to have him put to death; Antigonus Gonatas implored Seleucus to release his father, offering to abandon all he possessed as his ransom and to surrender himself as hostage.

[285-281 B.C.]

Seleucus repulsed both proposals. He contented himself with preventing this incorrigible adventurer from again trying his fortune. He gave him a palace, park, and all the comforts of life. The besieger developed a taste for hunting and then for games of chance. He soon accustomed himself to this easy life, became very fat, and died of over-eating (283).

THE END OF LYSIMACHUS, KING OF MACEDON

As soon as Lysimachus had nothing more to fear from Demetrius, he turned against Pyrrhus and tried to corrupt his officers. He reproached them for having selected for themselves an Epirot king whose ancestors had been the slaves of Macedon, and for having preferred him to an old comrade of Alexander. Pyrrhus could not struggle against the desertion of his troops. A caprice of the soldiers had given him Macedon; a new caprice took it away from him, and he withdrew to Epirus. We might think we were reading the history of the Lower or Byzantine Empire — the fruits of military government are everywhere the same. Macedonia was united with the kingdom of Thrace (286); but it had not yet come to the end of the revolutions which had continued to shake it ever since the death of Alexander. These revolutions, always provoked by personal ambition and never by a question of principle or national interest, refute the Utopia of monarchical stability in a striking manner.

The polygamy practised by the Macedonian kings multiplied the rivalries so common in royal families. Agathocles, the eldest of the sons of Lysimachus, who had established his father's throne on a firmer basis by his combats with the independent Thracians and with Demetrius, died of poison administered at the instigation of his step-mother Arsinoe, the daughter of Ptolemy. This murder was followed by many others, for Agathocles had numerous friends. His widow, Lysandra, who was also a daughter of Ptolemy, took refuge with Seleucus and demanded that he should avenge her. She had with her one of her brothers who, like all the members of the royal family of Egypt, bore the name of Ptolemy and was surnamed Ceraunus, the thunder, on account of his violent character. He was the eldest of the children of Ptolemy Soter, but the intrigues of Berenice, one of his step-mothers, caused him to be deprived of the throne. Ptolemy Soter abdicated in favour of the son he had had by Berenice, and who reigned under the name of Ptolemy Philadelphus (285). The eldest at first went to Lysimachus, then to Seleucus, whom he endeavoured to interest in his favour.

Seleucus, who nourished the hope of reconstituting Alexander's monarchy, had an opportunity to intervene in Macedonia to avenge Lysandra and in Egypt to support Ptolemy Ceraunus. He was undecided when Lysimachus forestalled him by declaring war against him. The two octogenarians, in whom age had not extinguished ambition, once more measured their forces in a last battle at Corupedion in Phrygia.¹ Lysimachus was slain; for some days his body was sought for in vain; it was discovered through his dog who had guarded it and kept off the birds of prey. They buried him in the town of Lysimachia which he had founded near Cardia on the European bank of the Hellespont (281). The ranks of the veterans are thinning rapidly; and little wonder, — forty troublous years had passed since Alexander died.

[¹ "This," says Justin, "was the last contest between the fellow-soldiers of Alexander; Lysimachus was seventy-four years old; Seleucus seventy-seven."]

DEATH OF SELEUCUS

Seleucus assumed the title of Nicator, the conqueror. The defeat and death of Lysimachus made him master of Asia Minor, Thrace, and Macedonia. In the east he had extended his sway over Upper Asia as far as the Indus, but he had given his son Antiochus the crown of the provinces beyond the Euphrates. Antiochus might thus think that after the death of his father he would unite under his authority all the possessions of Alexander with the exception of Egypt. It is said that at the time when Seleucus was serving as a common soldier in the army of the conqueror of Asia, the oracle of the Didymean Apollo had announced to him the greatness of his future, while advising him never to return to Europe. Nevertheless, six months after the battle of Corupedion, he wished to take possession of Macedonia and to end his days in his own country. He disembarked at Lysimachia and at once offered a sacrifice. Then Ptolemy Ceraunus who had come to him as a suppliant and had been received by him as a friend, stabbed him before the altar (280).

The death of the last of Alexander's companions-in-arms was not avenged. The army which had proved faithful to none of its chiefs, proclaimed the murderer king of Thrace and Macedon. He had no difficulty in getting rid of his rivals. Antiochus, to whom he abandoned Asia Minor, had to subdue the towns on the Hellespont which had revolted; Antigonus Gonatas, involved in a struggle with a league of cities in the Peloponnesus, could not assert his claims to Macedonia. Pyrrhus was more dangerous, but at this moment the Tarentines, who were at war with Rome, summoned him to their aid. Ptolemy Ceraunus furnished him with troops, elephants, and ships to pass over into Italy, gave him his daughter in marriage, and undertook to protect Epirus so long as he should be absent. Pyrrhus set out at once and the assassin might fancy that he was to enjoy his usurped throne in peace. He did not enjoy it long; the very next year a formidable invasion of barbarians swooped down on Macedonia and Greece.

INVASION OF THE GAULS

Numerous tribes of Gauls, or Galatæ, as the Greeks called them, had been established, for how long is not known, on the banks of the Danube, when a fresh migration of Belgic Tectosages, starting from Toulouse, set in motion those populations which, having little knowledge of the art of cultivating the ground, found all regions too narrow for them. Two or three hundred thousand men, divided into three bands descended like clouds of locusts on Thrace, Macedonia, and Greece. Ptolemy Ceraunus, who in his presumption had refused the assistance of the Dardani, was overwhelmed with his whole army. His head was stuck on the end of a pike and paraded about the country. The fields were laid waste, the towns closed their gates, and the inhabitants, accustomed to rely on the protection of the soldiers, could do nothing but groan and invoke the names of Philip and Alexander. A Macedonian named Sosthenes urged them to defend themselves, collected the young men and succeeded in repelling the enemy. He was offered the crown, which he refused, desiring only the title of general. But very soon his little army, weak and inexperienced as it was, succumbed with him to the invasion of a new horde of barbarians which, after completing the devastation of Macedonia turned in the direction of Greece,

[279-278 B.C.]

The Athenians, though weakened by their struggles with the Macedonian kings, resolved to arrest the barbarians at the pass of Thermopylæ. The peoples of central Greece responded to their summons, but the Peloponnesians, believing themselves to be sufficiently protected by the Isthmus of Corinth, did not stir. The Ætolians furnished the largest number of soldiers, but the command was conferred on the Athenians, who had taken the initiative in resistance. Their ships were of much service to the Greek army; they approached the shore, in spite of the difficulty of navigating amongst the morasses, and sent a shower of arrows against the enemy. It was a deadly fight for the barbarians; their superiority in numbers was of no advantage to them in this narrow passage. Then, in order to compel the Ætolians to return home, Brennus¹ detached forty thousand men who recrossed the Sperchius and deluged Ætolia with fire and blood. It was the warfare of savages; nothing was spared, neither age nor sex. As Brennus had anticipated, the Ætolians immediately quitted Thermopylæ to rescue or avenge their wives and children. But already a corps of troops from Patræ, the only town in the Peloponnesus which had thought of coming to the rescue of the Ætolians, had encountered the barbarians and inflicted such slaughter upon them that less than half returned to the camp at Thermopylæ.

DEFENCE OF THE TEMPLE AT DELPHI

The Ænians and Heracleans, ridding themselves of the neighbourhood of the barbarians by an act of treachery, showed Brennus the path by which in the old days the Persians had turned Mount Ceta. The Phocians who guarded it were thrown into confusion and the army of the Greeks would have suffered the same fate as the soldiers of Leonidas, if it had not been fortunate enough to take refuge on the Athenian vessels. The Galatæ immediately proceeded towards Delphi; they had heard of the riches of the temple and it was primarily for this that they had invaded Greece. The Delphians demanded of the oracle whether they should put the sacred treasure in a place of safety: "The god," answered the Pythia, "ordains that the votive offerings be left where they are; he will himself protect his sanctuary by means of the White Virgins." It was thus that the Pythia indicated Artemis and Athene, the moon and the light. It was indeed the terrors of the night which triumphed over the barbarians. The noise of thunder, repeated by the great echoes of Parnassus, struck them with fear. Enormous fragments of rock detached themselves from the mountain and crushed them by thousands. Amidst the awe of the sacred woods, a prey to the mysterious terror which was ascribed to Pan, they rushed against one another. Enveloped in a whirlwind of hail and snow they fled



A SOLDIER OF GAUL

[¹ This name Brennus seems to be merely a military title, having been referred to the Cymric *brenhin*—king, though others believe it a proper name like the Welsh "Bran"; some historians refer to Brennus simply as "the brenn."]

in confusion, pursued like wild beasts through the deep gorges under the irresistible arrows of the archer who strikes from afar. Brennus ordered them to burn their chariots and kill their ten thousand wounded who were hindering their flight. He himself, after taking copious draughts of wine, stabbed himself with his sword. What remained of this countless army succumbed to hunger, fatigue, and the attacks of the Ætolians and Dardani. According to Justin, Diodorus, and Pausanias, not one escaped.¹

Other bands of Galatæ were destroyed about the same time by Antigonus Gonatas who since the death of Sosthenes had returned to Macedonia. He had left them his camp after having distributed his soldiers in the woods and on ships. When the barbarians were filled with wine and meat he fell unexpectedly upon them and effected a great slaughter. As these Galatæ were strong and brave he took many of them into his pay and soon had occasion to employ them. On the coins struck in memory of this victory we see the god Pan, the originator of panic fears, bearing a trophy (278).

PYRRHUS AND THE ROMANS

The absence of any federal link between the Greek cities of Italy rendered them incapable of resisting the native peoples of the Samnites, Lucanians, and Bruttians. They were thus naturally led to demand the support of the great Roman republic, which alone could protect them. Rome never refused her protection to those who asked for it, even if they were at a distance from Italy, — like Marseilles which, thanks to her alliance with the Romans, was able to extend her commerce without any fear of her barbarian neighbours, the Ligurians and the Gauls. Rome's first relations with the Greek towns of Italy were those of friendship: Loeri, Thurii, and Rhegium, asked and obtained her alliance and protection. Tarentum alone preferred to have the Romans as enemies rather than friends.

She had never had to suffer either from the tyrants of Syracuse or from the Lucanians or the Samnites, for she was separated from them by less powerful and less warlike populations. Under the influence of democratic institutions she had achieved, says Strabo, an amazing prosperity. She aspired to play a dominant part in the peninsula of Italy similar to that which Syracuse had acquired in Sicily; it was therefore with anxiety and jealousy that she watched the progress of the Roman power. By a mad act of provocation the Tarentines put themselves entirely in the wrong and rendered war with Rome inevitable. Then, according to their custom, they called in the assistance of a foreign prince, and though on this occasion they had chosen the bravest and most skilful captain of the day, the struggle on which they embarked resulted in the final establishment of the dominion of the Romans over all Italy.

PYRRHUS SUMMONED BY THE TARENTINES

They summoned Pyrrhus, king of Epirus, promising him the support of the Lucanians and Samnites. He eagerly seized the opportunity to renew the attempt of his great-uncle, Alexander the Molossian. Ptolemy Cerau-

[¹ It would hardly be necessary to add a rational explanation of this supernatural defence of Delphi, were it not desirable that the credit should not be denied the gallant 4000 Delphians and other soldiers who made so brave a stand for their gods and altars and after rolling down rocks upon the Gauls until they were in confusion, charged them and broke them into panic, pursuing them even through a night of bitter storm.]

[280-279 B.C.]

nus, in order to rid himself of a dangerous competitor, furnished him with soldiers and elephants. Pyrrhus founded great hopes on this expedition.

No sooner had he arrived than he caused the theatre, the gymnasiums, and the gardens where they met to discuss politics, to be closed, forbade festivals and all unseasonable diversions, enrolled all the citizens and had them drilled. There were many who sought to escape but he had the doors guarded. When this produced murmuring he took some of the malcontents and sent them to Epirus.

Soon he heard that the Roman army was approaching. He would have liked to await the arrival of the Lucanians and Samnites, and offered his mediation to the consul Lævinus, but was answered that the Romans did not accept him as arbitrator and did not dread him as a foe. The battle was fought near the river Siris in the neighbourhood of Heraclea. The king had his horse killed under him, and, according to Justin, was even wounded. He sent his elephants forward; the Romans, who had never seen any, called them the Lucanian oxen. It was they that gave Pyrrhus the victory. When he saw the dead bodies of the Romans, all wounded in front and with their hands on their arms: "With such men," he said, "I should have soon conquered the world." He caused them to be buried in like manner with his own soldiers (280).

Pyrrhus marched into Campania, but did not manage to surprise Capua and was not more successful in an attempt on Naples. He went as far as Præneste and came within sight of Rome; but the Romans had now raised a new army; he saw the legions being restored to life like the heads of the hydra, and fearing to be surrounded he returned to Tarentum. An embassy was sent to him; he hoped that he was about to dictate terms of peace but it merely came to discuss the ransom of the captives. Pyrrhus offered to restore the prisoners without payment. Knowing that Fabricius, the chief ambassador, was poor, he thought to win him over by proposing to repair the errors of fortune. Fabricius answered simply that his poverty did not trouble him and did not prevent his being highly considered in his own country. Pyrrhus sent Cineas to Rome with presents for the wives of the senators; it is said that these presents were refused; this is not impossible though very extraordinary. Historians are not agreed as to the conditions proposed. The senate would have accepted them, but a lofty speech of the blind old Appius Claudius so worked on the assembly as to lead to its returning Pyrrhus the answer that it would not be possible to treat with him until he had left Italy. Cineas, on his return from Rome, told Pyrrhus that the senate seemed to him an assembly of kings; politically speaking, the heads of families who composed the Roman city, may indeed be compared with the Homeric kings; but if Cineas meant to refer to the successors of Alexander, the comparison was by no means flattering to honourable men like Curius and Fabricius.

There was nothing for it but to continue the war. A fresh encounter took place near Asculum, Pyrrhus, whose Italian auxiliaries were armed in the Roman fashion, had skilfully combined the formation of the legion with that of the phalanx. But a Roman soldier cut off the trunk of an elephant: the Lucanian oxen were not, then, invulnerable. According to the *Építome* of Titus Livius the result of the battle was doubtful. According to Plutarch the Romans had the advantage on the first day, but on the morrow Pyrrhus, having contrived to decoy them to ground on which he was able to manipulate his forces, put them to flight and obliged them to take refuge in their camp. He had lost his best soldiers, and when he was congratulated

on his success: "Another such victory," he said, "and I shall have to return to Epirus." One of his followers offered to poison him for the Romans: Fabricius denounced the treachery to him, advising him to choose his friends better. He sent back the Roman prisoners without ransom; the senate sent him an equal number of Greek and Italian prisoners. An armistice was concluded and he took advantage of it to pass into Sicily (278).

PYRRHUS IN SICILY; HIS RETURN TO ITALY

Since the death of Agathocles Sicily had been continuously troubled by the acts of brigandage perpetrated by the Mamertines established at Messana, and by the wars of Hicetas, tyrant of Syracuse, against Phintias, tyrant of Agrigentum. After having reigned nine years, Hicetas was dethroned by Thynion who took his place and occupied the island of Ortygia whilst Sosistratus was master of the rest of the town. The Carthaginians, taking advantage of the dissensions of these two leaders, besieged Syracuse. It was then that the two parties implored the aid of Pyrrhus. He had some claims to Sicily as son-in-law of Agathocles. He could not pass through Messana for the Mamertines had made a league with the Carthaginians against him. He disembarked at Tauromenium, whither he had been summoned by the tyrant Tyndarion and from there he proceeded to Catana and thence to Syracuse where he was received as a deliverer. He reconciled Thynion and Sosistratus and joining the forces of the Syracusans to those which he had brought with him, he expelled the Mamertines and forced them to retire to Messana. Agrigentum, Leontini, Selinus, Segesta, and many other towns opened their gates to him. He took Eryx, leading the assault himself, and in the same way made himself master of Panormus the principal port of the Carthaginians, to whom, of all their Sicilian possessions, only Lilybæum remained (277).

After two months' siege he judged that this place was impregnable so long as the Carthaginians were masters of the sea. He then decided to make a descent on Africa, after the example of Agathocles. But as he needed sailors he required the cities to supply them and grew angry at their tardiness and resistance; his yoke began to weigh as heavily as that of the Carthaginians and Mamertines. He had had enough of Sicily and used the reiterated appeals of the Tarentines and Samnites as an excuse for departure. With great difficulty he escaped from the Carthaginian fleet, which sank seventy of his ships, and he then fell in with a band of Mamertines who were waiting for him on the coast of Italy. He lost his rear-guard and two of his elephants; he was hurt and as he was retiring to dress his wound a tall soldier came and attacked him. But Pyrrhus had a strong arm and a well-tempered sword: he hit him a blow on the head and cut it in two. The barbarians, struck with admiration, allowed him to continue his route. He stopped at Locri to punish the inhabitants who had expelled his garrison, then, as he was in want of money to pay his troops, he pillaged the temple of Core, one of the most celebrated in Italy. But the vessels which were carrying off the sacred treasure were thrown on the shore by a tempest. Pyrrhus, struck with fear, replaced all the money in the treasury of the goddess and continued his route to Tarentum.

In his absence the Romans had retaken Crotona, admitted Heraclea to their alliance and several times defeated the Bruttians, Lucanians, and Samnites. Weakened by these defeats the allies of Pyrrhus sent him but few

[275 B.C.]

soldiers. Nevertheless he hastened to take the field to prevent the junction of two Roman armies sent against him — the one by Samnium, the other by Lucania. Near Beneventum he encountered the consul Curius, who was compelled to give battle before the arrival of his colleague. But the Romans no longer dreaded the elephants; they flung flaming tow at them. Some were killed and others reserved for the triumph. The victory of the Romans was complete (275). They took the camp of Pyrrhus who re-entered Tarentum with a small number of riders. He was compelled to renounce his projects in the west. The whole scheme had failed and he made haste to embark on another. He told the Tarentines he had written to the kings of Macedon and Asia for their help, and that he was going away to collect a fresh army. He left them a garrison. The Tarentines summoned the Car-

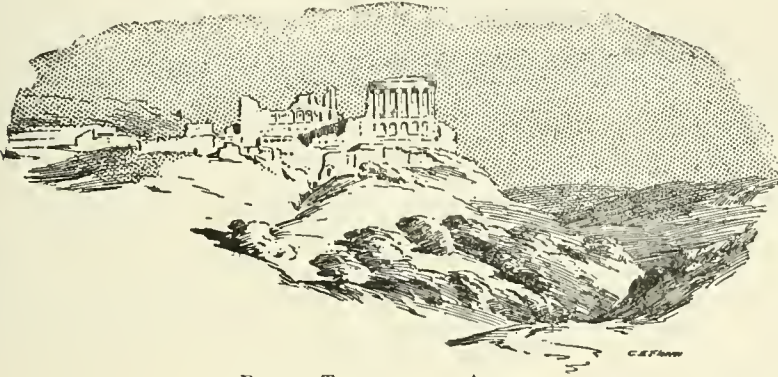

RUINED TEMPLE NEAR ATHENS

thaginians who sent their fleet to the harbour. But Milon, the commander of the Epirot garrison, surrendered the citadel to the Romans. They entered the town, declared it tributary to Rome and disarmed the inhabitants.

MAGNA GRÆCIA SUBDUED BY THE ROMANS

All the native peoples of southern Italy, who had welcomed Pyrrhus as a deliverer were finally subdued to the dominion of Rome. It was a deliverance for such Greek cities as still existed, but they were no more than the shadow of their former selves. Although free under the protection of Rome, they disappear obscurely from history. In the time of Strabo the name of Magna Græcia was already an ancient memory and the Greek language was no longer spoken save at Naples, Rhegium, and Tarentum. For want of a federal bond between the autonomous cities, the Hellenic race with its brilliant civilisation had gradually disappeared from the soil of Italy. The Romans were about to enter into its inheritance that they might eventually transmit it to Gaul and Spain. They re-peopled some of the ancient Greek colonies which had lapsed into barbarism, notably Posidonia and Hipponium which had long been peopled, the one by the Campanians, the other by the Bruttians and which changed their Greek names for those of Pæstum¹ and Vibo Valentia.

[¹ At Pæstum, most interesting ruins of three Greek temples are still to be seen. Two of these are in a relatively fine state of preservation; and one — the temple of Poseidon — is among the most imposing structures in existence. It is probably as old as the Parthenon, and is much better preserved.]

RETURN OF PYRRHUS TO MACEDONIA

The sole advantage which Macedonia had derived from Alexander's conquest was the barren honour of furnishing royal dynasties to Egypt and Asia. No part of the conqueror's heritage had been more disputed between ambitious rivals. Within the space of fifty years ten kings had succeeded each other on the throne in consequence of as many military revolutions. After the invasion of the Galatæ, Antigonus Gonatas, the son of Demetrius, fancied he had secured himself in the possession of devastated Macedonia by making a treaty with his competitor Antiochus Soter, whose daughter he married. But military anarchy had not yet reached its term. Pyrrhus, returning from Italy and at a loss how to pay his troops, sought an occasion for war. He entered Macedonia simply for the purpose of collecting spoil. Having won a few successes he remembered that he had been king of this country, marched against Antigonus, cut to pieces the Galatæ whom he employed as mercenaries, and took his elephants. Then he approached the phalanx, recognised some of the captains who commanded it, addressed them by their names and extended his hand to them. All the soldiers went over to him. Proud of his victory over the Galatæ, he consecrated their shields in the temple of the Itonian Athene, enlisted the barbarians, whose value he had recognised, and put them as garrisons in the Macedonian cities. At Ægæ they pillaged the royal tombs and scattered the bones. This called forth complaints from the Macedonians; but Pyrrhus, as an Epirot, took little interest in the ancient kings of Macedonia. He had no time to punish his mercenaries, and he was soon to stand in need of their services. An opportunity of conquering Greece had presented itself to him and he desired to take advantage of it.

EXPEDITION OF PYRRHUS AGAINST SPARTA

This opportunity was offered to him by Cleonymus of Sparta, the same who had been before him in making an expedition to Tarentum. He requested Pyrrhus to support the rights which he pretended to have to the throne of Sparta. The ephors had set him aside in favour of Areus, the son of his eldest brother; and to complete his chagrin his wife Chelidonis, who was much beloved by him, did not conceal her aversion, and showed her preference for the son of Areus, named Acrotatus.

This seemed to Pyrrhus a sufficient pretext for invading the Peloponnesus with twenty-five thousand footmen, two thousand horses, and twenty-four elephants. He declared, moreover, that his sole object was to restore liberty to the towns which Antigonus was keeping in subjection. As to the Spartans, far from wishing them ill, he proposed, he said, to confide his younger sons to their care, that they might be educated in the discipline of Lyeurgus. When his soldiers began pillaging, the Spartans reproached him with his breach of faith. He answered, "Neither are you in the habit of saying beforehand what you will do." There had been nothing to give warning of this aggression in time of peace and the town was not in a state of defence: the whole army had followed the king Areus to Crete whither he had been summoned by the Gortynians. Cleonymus would have liked to attack immediately; but Pyrrhus preferred to wait for a capitulation which seemed inevitable. He established his camp before Sparta believing himself certain of being able to enter whenever he might wish.

[272 B.C.]

Sparta was saved by the women. It had been proposed to send them to Crete, a suggestion which roused their indignation. Archidamia, mother of Acrotatus and the richest heiress in Sparta, entered the senate, sword in hand, and protested in the name of the women against their being thought capable of surviving the ruin of their country. The walls raised in preceding wars left the town exposed at several points: the night was spent in digging a great ditch parallel with the enemy's camp, and barricades were formed on each side by means of chariots with their wheels buried in the ground. The women undertook a third of the work and obliged those who were to fight next day to rest. In the morning they armed the young men and exhorted them to die under the eyes of their mothers. During the fight, which lasted all day, they kept close to them, handing them weapons, carrying them food and drink and tending the wounded. But as Rollin has pointed out, if the women of Sparta practised masculine virtues they sometimes forgot the virtues of their sex: seeing the young Acrotatus who had fought like a lion return covered with blood and dust, they envied the lot of Chelidonis. Plutarch adds a detail which shows how far the Spartans carried the sacrifice of the family to the city: the old men, he says, cried out: "Bravo, Acrotatus. Retain Chelidonis, and may she give the country children as brave as thou." As to Chelidonis herself, not wishing to fall into the hands of her husband, she had prepared a rope to hang herself if the town were taken.

The combat began again the next day. The Macedonians endeavoured to fill up the trench with branches. Pyrrhus even succeeded in crossing it and galloped towards the town; but his horse was killed and threw him on a steep slope; his friends had great difficulty in rescuing him. Almost all the Spartans were killed or wounded, and the town was on the verge of being taken when a lieutenant of Antigonus brought help. Almost at the same time Areus arrived from Crete with two thousand Spartans. Pyrrhus decided to raise the siege. He turned in the direction of Argos, where one party had summoned him to oppose another faction supported by Antigonus. Areus pursued him as he retreated, harassing him in the defiles and destroying his rear-guard composed of Galatæ and Molossians. To avenge the death of his son Ptolemy, who had been killed in this fight, Pyrrhus destroyed almost the whole Spartan army and then continued his route towards Argos.

DEATH OF PYRRHUS

Antigonus was occupying the heights. Pyrrhus proposed to him to settle their quarrel in a single combat, but Antigonus answered that if Pyrrhus was weary of life he might find many roads to death. The Argives begged the two kings to withdraw and to permit them to remain friends of both. They consented to do so, but during the night the partisans of Pyrrhus admitted him into the town. The members of the opposite party immediately summoned Antigonus. At the same time Areus arrived with the relics of his army. Fighting went on in the streets all night in the midst of a general confusion. Pyrrhus would have retired, but his Galatæ, coming to his assistance, blocked the narrow streets. One of his elephants had fallen across the gateway, another whose driver was wounded was overturning friends and enemies indiscriminately. Pyrrhus received a blow from the javelin of an Argive soldier and turned against the man who had wounded him; the soldier's mother, who, with some other women, was watching the fight from the top of the roofs, seeing her son in danger seized

a tile and flung it at the king's head. He fell from his horse. Though he had removed the plume from his helmet he was recognised: his head was cut off and taken to Antigonus. At this example of the mutability of fortune the latter was reminded of his father Demetrius and caused a search to be made for the body of Pyrrhus, which he burned, with the head, on a funeral pyre. He sent the ashes to Pyrrhus' son Helenus who returned to Epirus (272).

ANTIGONUS GONATAS

The history of the twenty years which followed the death of Pyrrhus is little known. We have no guide but Justin *g* who is not always very reliable, and some scanty indications in Polybius *h* and Pausanias. *i* All we know is that these twenty years were not an epoch of repose for Greece, and still less of liberty. The death-blow of Greek liberty had been struck at Chæronea, and the weapon had been left in the wound. The Macedonian monarchy clung to Greece like the shirt of Nessus. Though they had been compelled to renounce Alexander's heritage the kings of Macedon were still the heirs of Philip and determined to continue his work of subjugating Greece. This policy was persistently followed by Antigonus Gonatas, who bequeathed it to his successors. After the death of Pyrrhus he had no competitors for the throne of Macedon. The greater part of the army of the king of Epirus was composed of Macedonians and Galatæ who passed without difficulty into Antigonus' service. His rule in Greece extended over Thessaly and Eubœa, over Corinth and a part of the Peloponnesus, exactly which part is not known: Justin says vaguely that the Peloponnesians were delivered into his hands by treachery. Sometimes he put garrisons into the cities, sometimes he set up tyrants: "Most of the tyrants in Greece," says Polybius, "date from this Antigonus." The isolation of the cities, their mutual jealousies and the rivalry of the political factions, everywhere raised up interested accomplices for the Macedonian usurpation.

Following the example of his predecessors, Antigonus Gonatas was especially eager for the conquest of Athens. He burned the temple of Poseidon at Colonus and the sacred wood which surrounded it. The war lasted six or seven years. A revolt of Antigonus' hired Galatæ scarcely interrupted hostilities; Areus, king of Sparta, and a lieutenant of Ptolemy Philadelphus who had been sent to the aid of Athens and might have taken advantage of this diversion, remained inactive and the Athenians, deserted by their allies, were obliged to receive a Macedonian garrison (268). Antigonus also sent garrisons to Megara, Salamis, and Cape Sunium.

But about the same time Alexander, king of Epirus, made an incursion into Macedonia to avenge the death of his father Pyrrhus, and the phalanx went over to him, thus giving a fresh example of the facility with which military monarchies change masters. Antigonus was absent; his son Demetrius, who was still very young, soon recovered possession of Macedonia. Alexander, in his turn despoiled of Epirus, took refuge amongst the Acarnanians, who subsequently reinstated him in possession of his kingdom. This did not prevent him from treating with the Ætolians for the partition of Acarnania, for gratitude is by no means a royal virtue. Antigonus kept the throne of Macedonia till his death in 243, and his dynasty maintained itself there for more than a century, prosecuting the conquest of Greece up to the last, till that country, exhausted by the ceaseless struggle, finally threw itself into the arms of the Roman people. *b*

[272 B.C.]

Inglorious as was this termination of a career like that of Pyrrhus, the closing scene of his life was not without some points of resemblance to its general character. He was undoubtedly one of the nobler spirits of his age, though it would seem that it could have been only in one which was familiar with atrocious crimes, that he could have gained the reputation of unsullied virtue, more particularly of probity, which we find attached to his name. With extraordinary prowess, such as revived the image of the heroic warfare, he combined many qualities of a great captain, and was thought by some to be superior even to Alexander in military art. But his whole life was not only a series of unconnected, mostly abortive, enterprises, but might be regarded, with respect to himself, as one ill-concerted, perplexed, and bootless adventure. From beginning to end he was the sport, not so much of fortune, as of desires without measure or plan, of an impetuous, but inconstant will. His ruling passion was less ambition than the love of action; and he seems to have valued conquest chiefly because it opened new fields of battle. But viewed as subservient to higher ends, both his life and his death were memorable and important. He contributed to adjust the balance of power among Alexander's successors in the West. He exercised the Roman arms with a harder trial than they had ever before undergone; and inspired the people with a confidence in its own strength which nerved it for the struggle with Carthage, and prepared it for the mastery of the world. His death forms a momentous epoch in Grecian history, as it left the field clear for the final contest between the liberty of Greece and the power of Macedon, a contest which was only terminated by the ruin of both. *f*



GREEK BOTTLES

(From the Museum of Napoleon III)

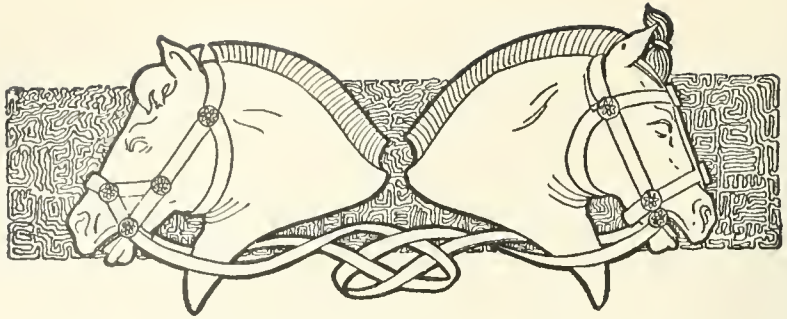

CHAPTER LXIII. THE LEAGUES AND THEIR WARS

WHILST the cultured Greeks of the long-established cities and confederacies were being gradually absorbed into the Macedonian kingdom, and the spirit of liberty was dying out amidst luxury and the fleeting pleasures of sense, amidst theatrical shows and festivals, and amidst the philosophy and culture of the day; two races, as yet little affected by the influences of Hellenic life and culture, emerged into the foreground of effective action. These were the Ætolians and the Achæans.

THE ÆTOLIANS

For centuries the Ætolian mountaineers, a branch of the Æolian race but with a great admixture of foreign (barbarian) blood, had led in peasant simplicity a quiet and unnoted existence in the open country, dwelling in villages and scattered homesteads, remote from the culture and refinement, as from the ostentation and luxury of other Hellenic peoples. Inured to a life of hardship by the character of their country, which, bounded on the west by the torrent stream of the Achelous and on the east by the Evenus, offered no fertile land for cultivation except along the southern coast — the inland tracts being fit for nothing but pasture and the chase — the Ætolians had preserved intact the warlike spirit and savage freedom of primitive times “when the law ran just as far as the sword could reach, and honourable pillage by sea and land was every brave man’s trade.” Out of sheer valour and love of fighting they undertook venturesome freebooting voyages under their native captains and chiefs, penetrating even to the distant coasts of Italy and Asia Minor, or entered the service of foreign states as mercenaries; while those who remained at home provided for the few needs of their rude and simple existence by field labour, cattle-tending, horse-breeding, and the chase.

Weapons were the pride and ornament of the free man, and he hardly ever laid them aside. When the Ætolians took the field, armed with slings and spears, and ranged, sometimes in serried phalanx, sometimes in irregular hordes, their strength, agility, and desperate courage made them formidable to all their enemies. Their national dress included the *kausia* or broad-brimmed white hat, the tunic, girded high and leaving the arms free, and the high Cretan shoe. The right foot was left bare in climbing or going uphill, “to insure a firmer foothold.” In culture and learning they were far behind other Greeks, who avoided and despised the rude, haughty, and boastful “mountain peasants” in consequence. Yet even they in time developed

some artistic feeling and talent, for as their power increased, Thermus the capital of their league, was richly adorned with public buildings and temples, pictures and statues. In this unfortified town, encircled by mountains and tracts of fertile country, the districts belonging to the league celebrated their annual festival and assembly with fairs, games, and feasts, for they were as ready to enjoy life in every sort of turbulent and unbridled pleasure as to hazard it in any bold venture.

THE ÆTOLIAN LEAGUE

From very early times the townships and districts under democratic government had been united in some sort of loose confederacy, which imposed but a very slight curb upon the independent action of each community; but it was not until the Macedonian period, when the power of other states was impaired by civil wars and their energy paralysed by the effects of a higher state of civilisation, that the several confederacies of kindred tribes united to form a general Ætolian League, its purpose being rather to safeguard their predatory excursions than to strengthen a political system based on moral or legal principles.¹ For although the germ of a vigorous federal and communal life might lie dormant in this hardy and primitive race, yet it was wanting in moral discipline, the authority of law, and the habit of obedience. The first result of the fresh unity and order brought into Ætolian enterprise by this closer union was the extension of Ætolian supremacy westward over the Cœniades and eastward over Naupactus.

From this time forth we find the Ætolians mentioned in every military achievement of importance; they manfully withstood the Macedonian greed of domination; we see them defending Hellenic liberty and independence against Antipater and Cassander; they formed the nucleus of the force which checked the wild hordes of the Celts at Thermopylæ and overthrew Brennus and his robber bands on the sacred soil of Delphi. Everywhere we find their strong hand and resolute energy at work on the destinies of the Greek nation in the mournful period of its decline and fall, staving off and delaying the complete subjugation of Greece to the best of their ability.

The supreme authority of the federated states was vested in the *Panætolium*, or Diet of the League, which assembled in council regularly every year at the autumnal equinox in the mountain city of Thermus, and at which every free-born Ætolian was entitled to appear and vote. In cases of urgency this assembly was sometimes held at other times and places. The Diet of the League declared war and peace, concluded alliances and treaties, and sent and received ambassadors. Its proceedings were directed by a president (*strategus*) who was elected annually. In administrative and judicial matters the supreme authority was the Council called the *Apocleti*, the members or "assessors" (*synedri*) of which were elected annually from amongst the members of the Diet and the noble families of the several districts. Under the presidency of the *strategus* the Council managed the ordinary course of business and judicature for the league as a whole as well as for the several districts or cantons, maintained the rights of the League and the several confederated districts against attacks from within and from

[¹ Freemanⁱ comparing the two great Leagues says: "The political conduct of the Achæan League with some mistakes and some faults, is, on the whole, highly honourable. The political conduct of the Ætolian League is, throughout the century in which we know it best, simply infamous."]

without, and in certain cases appointed commissions consisting of not more than thirty members.

At first all members of the League enjoyed full civil rights within it, and accordingly might settle anywhere within its territory, acquire landed property, contract marriages, take part in the public assemblies, vote, and hold public office. These privileges of citizenship were shared not only by all Ætolians, but by all other Greeks who joined the League, whether voluntarily or under compulsion, such as the inhabitants of certain towns and districts in Thessaly, Phocis, Locria, Messenia, and others. Since the expulsion of Aristotimus, governor of Elis, the Eleans had occupied a relation of independent defensive alliance with the Ætolians; they gave and received help at need, but retained their political autonomy. It was otherwise with the Cephallenians, who paid tribute as Ætolian subjects, and were obliged to sue for justice in the Ætolian law courts.

THE ACHÆAN LEAGUE AND ARATUS OF SICYON

In natural contrast with the Ætolian "peasant league," the league of the Achæan cities arose in the reign of Antigonus Gonatas. It was the last vigorous shoot that sprang from the decaying root of the Hellenic tree of liberty.

From primitive times the twelve towns of the coast of Achaia had been joined in a loose confederacy for which the sanctuary of Zeus Homagyrus or Homorius in the district of Helice served as a place of assembly and council. It was a religious association based upon kinship — ancient Greece has many such to show — a free union for the worship of tribal divinities under traditional forms, and involved no restraint upon the political independence of its members. Without exercising any great influence upon the political and military life of Greece, Achaia was notable for unostentatious virtues, for order, unity, and a patriarchal form of government; while Croton, Sybaris, and other flourishing colonies in lower Italy bore eloquent witness to the culture and creative energy of the Achæan race. In so great honour were the uprightness and public virtue of the simple and industrious coast dwellers held by the rest of Greece that after the battle of Leuctra the great Hellenic states besought them to arbitrate in their internal quarrels. This old-time confederacy was broken up and destroyed by the Macedonian rulers, who craftily sowed the seeds of discord, and then made use of the ensuing dissensions to subjugate and oppress the several cities by foreign garrisons and governors. But despotism could not obliterate the memory of the happy past. Favoured by the weakness and confusion which followed upon the Celtic invasion of Macedonia, four towns, Dyme, Patræ, Tritæa, and Pharæ, having expelled their garrisons and tyrants, renewed the confederacy, vowed mutual aid against external and internal enemies, and pledged themselves faithfully to observe the decrees of the League. Five years later they were joined by Ægium, thenceforth the capital. Others soon followed: Bura, where the tyrant had been slain, Cerynea, where the governor had voluntarily abdicated in fear of a like fate, Pellene, Leontium, and Ægira.

But even in its rejuvenated form the Achæan League remained for years in provincial isolation, until Aratus of Sicyon¹ induced his native city to join it, and set before it a loftier aim in the deliverance of Greece from the

[¹ Freeman *i* praises Marcus of Cerynea, as the probable founder or "Washington of the original League," though obscured later by Aratus.]

[249 B.C.]

dismemberment and chaos due to the exclusive regard of local interests, and the awakening of national spirit, unity, and vigour.

Even in the days of Macedonian rule Sicyon had not forfeited her ancient glories. Her gardens, fruitful fields, and flourishing villages, her magnificent buildings and art collections, and the merchant vessels in her sheltered harbour, bore testimony to the wealth, culture, and busy trade of her citizens. But internal discord, fostered by Macedonian guile, undermined the foundations of her prosperity. Party strife arose, bringing revolutions and tyrannies. Clinias, a citizen of noble birth, great wealth, and patriotic spirit, perished in the struggle against the tyrant Abantidas. With difficulty his son Aratus, a child of seven years old, was rescued and brought to Argos, where he grew up sound in body and mind under the fostering care of friends, while his native city fell under tyranny after tyranny, until, broken in spirit and shorn of her noblest citizens, she ultimately came under the sway of the wicked and violent Nicocles. For thirteen years Aratus dwelt in Argos, in the society of the wealthy and cultured friends of his family, and in intercourse with the numerous Sicyonians who sought refuge in this neighbouring town from the wrath and persecution of their own tyrant, and who turned eyes full of hope upon the vigorous and able youth who combined courage with discretion and burned with desire to deliver his native place and avenge his father's murder. He contrived cunningly to deceive the tyrant's spies, to whom he seemed to spend all his days in thoughtless gaiety with courtesans and boon companions.

When the auspicious moment seemed to have come, Aratus left Argos in company with some fugitives and a band of mercenaries. They climbed the walls during the night, surprised and disarmed the tyrant's bodyguard, and at daybreak summoned the citizens to rise for their liberties. Nicocles escaped in the tumult, his palace was sacked and given to the flames, his property confiscated to the commonwealth. Thus without bloodshed was the liberation of Sicyon effected. But fresh disorders and disturbances soon threatened, when some six hundred fugitives, who had once been wealthy men, returned and demanded the restoration of property which had long since passed into other hands. In order that he might not be left without support in this difficult situation Aratus induced the Dorian city, wealthy still in spite of all, to join the Achæan League on an equality of laws and privileges, and then, by the help of a large sum of money granted to him by the friendly king of Egypt, Ptolemy, upon his personal application in Alexandria, he effected a settlement and reconciliation among his contentious fellow-citizens.

The fame which he won by this prudent and patriotic act, combined with the great service he had rendered to the League by inducing such an important seaport to join it, smoothed the young commander's way to the highest office; but he modestly chose to work his way up. He first enrolled himself in the Achæan cavalry, but by the end of six years he had attained the dignity of strategus which was thenceforth seldom conferred upon another until his death. Clear-minded, far-sighted, and steeped in the philosophic and patriotic culture of his time, Aratus soon turned his energies towards the great end of uniting all Peloponnesians under the hegemony of Achaia. Without interfering with the autonomy and freedom of the several states he established the principle of equal rights for all members of the League. The road to office and honours lay open to every man within it, without distinction of wealth or social standing; and, though some towns or districts of those which were gradually won over to the League might favour

a different form of government, yet the constitution of the Achaean confederacy, as it developed by degrees under Aratus, retained the character of a moderate democracy. Moreover, careful as he was to avoid rousing local jealousies or wounding local self-esteem and prejudices by meddling with internal administration, traditional privileges and customs, or the religious peculiarities of different places or communities, he awakened the sense of a common civilisation by introducing uniformity of weights and measures, a common coinage, and equality of commercial rights, and secured it by the bond of religion.

ARATUS CONTROLS THE LEAGUE

The government of the Achaean League which was formed under Aratus was vested in the free Diet of the people, which met twice a year (in spring and autumn) at their ancient place of council, not far from

Ægium, and at which every free citizen who had attained his thirtieth year was qualified to appear and give his opinion and his vote. In spring, the beginning of the civil year, the officers of the League were elected by the Diet, the president, the secretary or chancellor, and the senate, which, in concert with the demiurgi, or representatives of the ten Achaean towns which originally composed the League, formed the supreme executive authority, managing political affairs in conformity with the decrees and ordinances of the Diet and under its control, directing the discussion and voting of the great assemblies of the League, and making the necessary preparations when they were to be held. In urgent cases the strategus and senate acted on their own initiative, without the authorisation of the Diet but subject to the obligation of rendering account to it. There was a League Court, likewise appointed by the great assembly, for the settlement of internal disputes.

The strategus presided at the Diet as in the greater and lesser council, and confirmed decrees and ratified documents by his signature and the seal of the League. Possessed of executive powers in external and internal affairs, he had charge of the treasury, called in the contributions of the confederates in money, ships, and men, and held supreme command of the army and fleet, subject to the obligation of rendering account of his actions. In war he was assisted by the captain of the cavalry (hipparch), and in home affairs by the chancellor or secretary (grammateus).

This admirable constitution was in the main the work of Aratus, always the "moving spirit" of the League, and though his later years are in many respects open to reproach, yet this practical application of his philosophic and patriotic ideas is worthy of the highest commendation. He is one of those characters whose portraits, distorted by the favour and enmity of partisans, are but uncertainly discerned in history. Strenuously as he strove in his *Memorabilia* (the essentials of which Plutarch has preserved in his biography) to guard his actions and motives from misconception and to truly exhibit himself to his contemporaries and to posterity, his record is

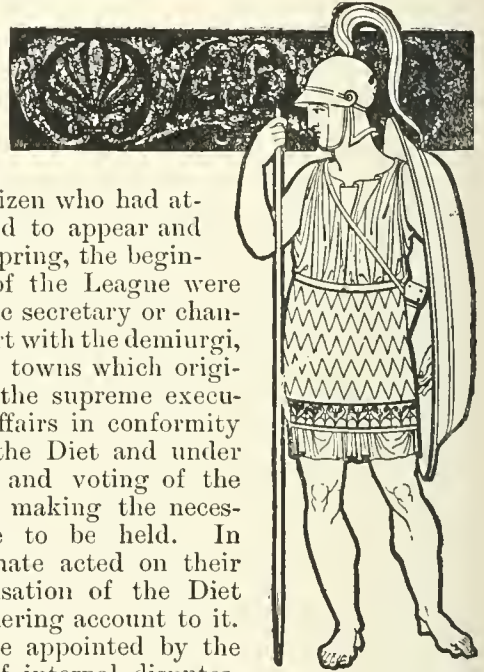

A SHIELD BEARER

[249-242 B.C.]

nevertheless darkened by many shadows and charged with many blunders. "Aratus had not a great Hellenic soul," is the verdict of Schorn, "his soul was narrow and Achæan." As a man he was distinguished by many fine and amiable qualities, as a citizen he merits respect for his great love of his country, to which he dedicated his life with an absolute devotion, and to the aggrandisement of which all his efforts were directed with rare perseverance. To the state he sacrificed himself without reserve, giving up his property, friendships, enmities, and even the implacable hatred of tyrants with which he had been imbued from his youth up; everything, indeed, except the ambition which cast a doubt even upon his patriotism. He desired to shine on the Achæan horizon alone, and he used his influence to keep down any who attempted to shine beside him.

He regarded the Ætolian peasant-league, with its raids and savage feuds, and the revolutionary attempts of the Spartan kings Agis and Cleomenes with equal abhorrence; and by turning his arms against them alternately he played into the hands of the common national foe, Macedonia. As strategus his military talents were of a very inferior order. He was admirably skilled in arranging sudden attacks and ambushes, and in the carrying out of military surprises his boldness and daring were equal to his subtlety and cunning, but as a commander his capacity was small, and in his first campaign he proved diffident, timorous, and faint-hearted. It was not his strong point to look danger boldly in the face, in battle he lost self-control and presence of mind; and he consequently preferred the privy and crooked ways of stratagem, dissimulation, and deceit to a direct and valiant attack.

In his second period of office as strategus, Aratus increased the reputation he had gained by the liberation of Sicyon, but had impaired by a profitless campaign against the Ætolians in the first year of his command, by his successful stratagem at Corinth. With mingled craft and daring he succeeded in ridding the impregnable citadel of Acrocorinthus of its Macedonian garrison, and persuaded this important city, one of the three "fettlers of Greece," to join the League.^e

ARATUS TAKES CORINTH

Three brothers, Syrian Greeks, had pilfered from the royal treasure at Corinth, and one of them named Erginus, came to Sicyon from time to time to exchange their plunder at the house of a banker well known to Aratus. Through this channel Aratus learned that there was an accessible point in the wall of the citadel; and Erginus, having engaged the concurrence of a fourth brother who served in the garrison, undertook to conduct Aratus to the place, where the wall was no more than fifteen feet high. The brothers demanded a large reward. Sixty talents [£12,000 or \$60,000] were to be deposited with the banker, to be paid to them in the event of success; and even in the case of failure, if they escaped, each was to receive a house and a talent. Aratus could not immediately raise so large a sum, and was forced to pledge his plate and his wife's ornaments, purchasing, as Plutarch observes, the privilege of a perilous adventure for the good of his country, at a price which it would have been accounted magnanimous to reject, if it had been offered as a bribe. When the time came which had been fixed for the attempt, leaving the main body of his forces under arms, he proceeded with four hundred men, few of whom were in the secret, towards Corinth. As they approached the wall, the light of

the full moon, which would have rendered concealment almost impossible, was intercepted by clouds which rose from the sea. Several other propitious circumstances contributed to his success, though he fully earned it by his courage. Erginus with seven others, disguised as wayfarers, gained entrance at a gate and overpowered the guard, while Aratus, with only a hundred of his men, scaled the wall, and advanced towards the citadel with the scaling-ladders, ordering the rest to follow. But on his way through the town he fell in with a patrol, one of whom escaped, and soon raised a general alarm.

Aratus, again favoured by the moon which broke through the clouds as he was entangled in the most intricate part of the ascent, reached the wall of the citadel safely, and was soon engaged in a hard combat with the garrison. As soon as the alarm was raised, Archelaus, finding that the citadel was attacked, hastened with all his forces in that direction. But he chanced to light on three hundred Achæans, who, unable to find the track of their comrades, had covered behind a projection of the rock. They now sprang out as from an ambuscade, and completely routed and dispersed his troops. But they were recalled from the pursuit by Erginus to the succour of Aratus, and their arrival decided the struggle. By sunrise he was in possession of the fortress, and the forces which had followed him from Sicyon, making their appearance at the same time, were joyfully admitted into the lower town by the Corinthians, who helped to capture the royal soldiers.^d

By this act, in which he generously hazarded his private fortune, Aratus gained such a degree of popular confidence that the Achæans thenceforth committed the conduct of public affairs to his hands, and followed his counsel even in the years when he was by law excluded from the office of strategus. The towns of Trœzen, Epidaurus, Cleonæ, and Megara, presently revolted from Macedonia and joined the Achæan League.

The rise of the Achæans stirred up the jealousy of other states, and incited the Macedonians to fresh exertions to recover what they had lost. The old king Antigonus concluded an alliance with the Ætolians for a joint attack on Achaia, on the basis of a partition of the territory to be acquired. But Aratus, who had chosen Ptolemy as patron of the League, and thus secured the protection of Egypt in the event of possible disaster, repulsed the Ætolian marauders before they could join hands with the Macedonians, and dissuaded King Antigonus from the proposed campaign by promising him the remaining dominions of the Peloponnesus. The aged Antigonus Gonatas died soon afterwards, and his son and heir, Demetrius II, was kept fully occupied by an invasion of his own country by the Dardans.

Aratus contrived to make use of these circumstances for fresh acquisitions. Secured from attack in the rear by an offensive and defensive alliance with the Ætolians, he induced most of the states of the Peloponnesus by force or subtlety to join the League. Thus Lydiades, the young and accomplished prince who reigned at Megalopolis, was prevailed upon to join, and the rich and extensive territory of that city was won for the League. The tyrants, abandoned by Macedonia, were no longer able to withstand the power of Achaia; they yielded voluntarily or under compulsion to the tide of democracy; so that when Demetrius II sank into his grave after ten years of feeble sovereignty, and Antigonus Doson (the Promiser) undertook the government of Macedonia during the minority of King Philip III, the Achæans ruled over Hermione, Phlius, and the greater part of Arcadia, counted the rich island of Ægina among their possessions, had induced Argos to join the League after a long struggle with three successive tyrants, and had entered into an alliance with Athens (whence, by the

[232-227 B.C.]

assistance of Aratus, the Macedonian garrisons had been forced to withdraw) on equal terms though without reciprocal civil rights. Mantinea, Tegea, Orchomenos, and Elis were the only towns that remained subject to the Ætolians, who, however, had meanwhile extended their dominion over part of Thessaly; and Sparta, just awakened from her long trance and invigorated by a new birth from within, was striving to regain the ascendancy which had been hers in the glorious days of old. Out of these elements was bred the fatal conflict which broke all that was left of the strength of Greece at the very moment when the Romans began to intermeddle in the domestic concerns of warring states.^e

SPARTA UNDER CLEOMENES

Lacedæmon had, by this time, exchanged poverty and hardy discipline for opulence and voluptuous manners. The public meals, that last pledge of Spartan frugality and temperance, were discountenanced by the rulers of the state, and fell into disrepute and disuse. One or two princes, who endeavoured to stem the torrent of corruption, suffered deposition, exile, and even death. The laws of Lycurgus were totally disregarded. The lands were all in possession of a few families, who lived in the greatest splendour, whilst the rest of the Spartans, stripped of their patrimony, were doomed to the greatest indigence. The efforts of Agis IV, the king, to enforce the sumptuary laws, to cancel all debts, and to make a new division of lands, were opposed by the rich, and at last punished with death, on pretence of a design to alter the government.

In such a situation of affairs, Cleomenes ascended the Spartan throne, a prince who united integrity of heart with martial spirit and a love of glory. He found, on his accession, both the internal constitution and the public affairs of Sparta in the utmost confusion. Domestic distress, with its concomitant despondency of spirit, had caused throughout Laconia a universal depopulation. Instead of natives sufficient to occupy the thirty-nine thousand shares into which Lycurgus had originally divided the land, only seven hundred families of the Spartan race were now to be found; and, of these, about six hundred, sunk into abject penury and wretchedness, were incapable of exerting any degree of vigour in the public service. The slaves, too, had many of them perished through want of employment and subsistence, while others had been carried off, in great numbers, by the enemies of Sparta. Such was the miserable decay of both public and private virtue! Cleomenes, actuated by his natural disposition to arms, as well as by the representations already mentioned of the Ætolians, in order to revive the martial spirit of the Spartans, attacked Tegea, Mantinea, and Orchomenos, cities of Arcadia. Having reduced these under his obedience, he marched without delay against a certain castle in the district of Megalopolis, which commanded on that side the entrance into Laconia.

Immediately upon this act of hostility, the Achæan states declared war against the Spartans. The Spartan king forthwith took the field, with what troops he could muster, and ravaged the territories of the cities in alliance with Achaia. With five thousand men he advanced against the Achæan general Aratus, who, perceiving the resolution of the Spartans, declined an engagement, though at the head of twenty thousand. The retreat of Aratus, determined the Eleans, who had never been steady in the interests of Achaia, openly to declare against her. The Achæans attempted to

chastise this defection; but they were routed by Cleomenes at Lycæum, near the Elean borders; and totally overthrown by him in the ensuing campaign, near Leuctra. Pursuing his good fortune, he reduced several of the towns of Arcadia, which he garrisoned with his Lacedæmonian troops.

He returned to Sparta with the mercenaries only, and cut off the ephori, whom he considered as troublesome to himself, and oppressive to the Spartan subjects, by assassination; a course which he endeavoured to justify, by arraigning the unconstitutional establishment of this order of magistrates, and a recital of several acts of iniquity. He now seized on the administration of justice, and re-established the agrarian and sumptuary laws of Lyeurgus, which he enforced by his own example. Having thus made himself master of Sparta, he diverted that energy to foreign enterprises, which might otherwise have broken out in domestic sedition. He plundered the territories of Megalopolis, forced the Achæan lines at Hecatombæum, and obtained a complete victory. The Achæan army, composed of the flower of their nation, were almost all cut off. The Mantineans, having slaughtered the Achæan garrison stationed in their city, put themselves under the protection of the Spartans. The same spirit of defection and revolt appeared in most of the other cities of Peloponnesus. In this extremity, they sued for peace to Cleomenes; but Aratus, who had for some time declined to take the lead in the public affairs of Achaia, now resumed his authority; and, by insisting on such terms as the high-spirited Cleomenes could not accept, contrived to prevent that peace which his countrymen wished for.

Both Aratus and Cleomenes wished to unite all the nations of Peloponnesus into one commonwealth, and by that means to form such a bulwark for the liberties of Greece, as might set all foreign power at defiance. But to what people the supreme direction of the common affairs should belong, was the question. Even Aratus, so much above the love of money, showed himself, on this occasion, the slave of ambition; and, rather than see a superior in power, determined to involve everything in confusion.

The interruption of the negotiations for peace raised a general ferment throughout Peloponnesus; the conduct of Aratus fired the martial ardour of Cleomenes, and excited jealousies in different states; nor could the Achæans obtain any assistance from the Athenians, the Ætoliens, or the Argives. Corinth was on the point of surrendering to the Spartan king; and even Sicyon must have been lost, had not a timely discovery prevented an intended conspiracy. Here we may remark the extreme quickness with which the Grecian states entered into any confederacy that was formed for humbling whatever power preponderated in Greece: a proof, that, however their manners were corrupted, their sentiments of liberty and the balance of power were not yet wholly subverted.

ANTIGONUS CALLED IN

Resentment against Cleomenes induced Aratus to entertain the project of calling in, for the destruction of Sparta, the aid of Antigonus of Macedon. But in Greece this attempt was generally odious, and Antigonus was averse from all interference in Grecian affairs, not being easily dazzled by the splendour of ambition. But the last and greatest of these difficulties Aratus surmounted by various artifices, and entered into a compact with Antigonus, the conditions whereof were that the citadel of Corinth should be delivered

[223-221 B.C.]

into the hands of the king; that he should be at the head of the Achaean confederacy, superintend their councils, and direct their operations; that his army should be supported at their expense. From these articles it is evident, that the liberties of Achaia were now no more, and that the sovereign of this country was Antigonus.¹

This transaction roused the indignation of the Peloponnesian states: they looked to Cleomenes as the only protector of their liberties. That hero, upon hearing that the Macedonians were in motion, took possession of a pass on the Oean Mountains, which commanded the Corinthian Isthmus; but the Achaeans having surprised Argos, he was forced to

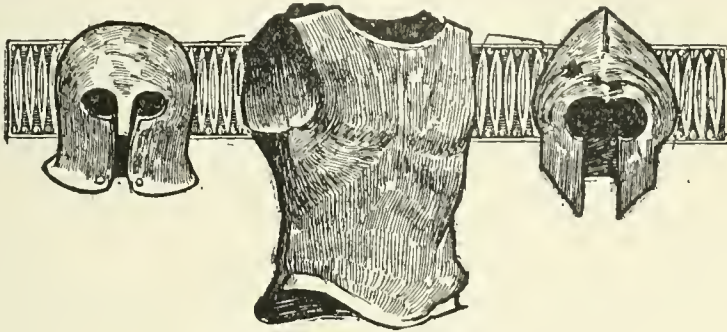

GREEK CUIRASS AND HELMETS

(In the British Museum)

abandon it, and to leave it open for the Macedonians. The Achaeans now resumed their superiority in Peloponnesus, and most of the cities in that peninsula were constrained to submit to their power. The efforts of Cleomenes to restore the liberties of Peloponnesus, and to protect, of course, those of the rest of Greece, equal the most famed exploits of antiquity. But the wary Antigonus, rich in treasure, artfully protracted the war, and suffered his impetuous adversary to waste his force in vain. Cleomenes was forced to retreat to Sellasia, in order to cover Sparta.

Antigonus, therefore, encamped at a distance, on the plain below, in order to watch the motions of the enemy, and to act according to circumstances. Cleomenes, reduced to the greatest distress for want of provisions, was forced to throw open his entrenchments, and, without further delay, to come to an engagement. All his skill and valour, which were eminently displayed on this occasion, could not save him from a complete defeat (221 B.C.). He fled first to Sparta, and from thence to Egypt; where, after various adventures, the loftiness of his spirit, which could not brook the indignities offered to him by the ministers of Ptolemy Philopator, brought him to an honourable but untimely end.^f

Having eluded the vigilance of his guards he made a sally with his friends, thirteen in number, all with drawn swords, and raised the cry of liberty. The Alexandrian populace stared and applauded, as at a scene on the stage, but with as little thought of taking any part in the action. The Spartans killed the governor of the city, and another courtier, but after an ineffectual attempt

[¹ Freemanⁱ calls Aratus "the Creator, the Preserver, and the Destroyer" of the League and bitterly compares his surrender of Corinth with Cavour's delivery of Savoy and Nice to Napoleon III.]

to break open the prison in the citadel, finding themselves universally shunned, they abandoned their forlorn hope, and turned their swords against their own hearts. Panteus, the dearest of the king's friends, consented at his request to survive until he saw that the others had breathed their last. Ptolemy, as soon as he had learned what had happened, ordered all the women and children belonging to the deceased to be put to death; and the young wife of Panteus is said to have paid the like pious offices to Cratesiclea, who was forced to witness the butchery of her two grandsons, as Cleomenes had received from her husband. The body of Cleomenes was flayed and hung on a cross, until, if we may believe Plutarch, an extraordinary occurrence awakened Ptolemy's superstitious fears, gave occasion for new expiatory rites in the palace, and induced the Alexandrians to venerate Cleomenes as a hero.

Such indeed he was, when measured with them. As we turn from them to the proper subject of this history, we feel, as it were, that we are beginning again to breathe a healthier atmosphere: and we carry away a strengthened conviction, that great as were the evils which Greece suffered from the ill-regulated passion for liberty, it was still better to live there, than under the sceptre of the Ptolemies—among a people who can hardly be said to have a history, in any higher sense than a herd of animals, always prone, unless when goaded into fury.^d

During the absence of Antigonus, a multitude of Illyrians, and other barbarians, made an irruption into Macedon, and committed great devastation. This irruption hastened his return into his own dominions. In a decisive battle, the barbarians were defeated; but the Macedonian king, by straining his voice during the engagement, burst a blood-vessel. The consequent effusion of blood threw him into a languishing state, and he died in the space of a few days, lamented by all Greece.

Antigonus II succeeded by Philip, the son of Demetrius, the last of the Macedonian kings of that name; a prince only in the seventeenth year of his age, intelligent, affable, munificent, and attentive to all the duties of the royal station. This excellent character was formed by a good natural disposition, cultivated by the instructions and example of Antigonus, who appointed him his successor on the Macedonian throne.

THE SOCIAL WAR

The jealousy which the Ætoliens had long entertained of the Achæan states, was increased by the importance which they had assumed from their alliance with Macedon. No sooner were they relieved from the dread of Antigonus, than they ravaged the Achæan coast, and committed depredations on all the neighbouring countries. Aratus having opposed to them the Achæan forces in vain, invoked and obtained the aid of the king of Macedon. Philip promised that as soon as he should have settled the affairs of his own kingdom, he would repair to Corinth, in order to meet the convention of the states in alliance with Achaia, that he might have an opportunity of settling with them a plan of future operations. In the meantime, the Ætoliens, making a fresh irruption into Peloponnesus, sacked Cynætha, a city of Arcadia, put most of the inhabitants to the sword, and laid the place in ruins. The convention of the Achæan confederates, now assembled at Corinth, unanimously agreed that unless the Ætoliens should make reparation, war should be declared against them, and the direction of it committed to the king of Macedon. Hence the origin of the Social War, so called

[221-216 B.C.]

from the association entered into by the several states engaged against Ætolia.

Philip commenced his operations with the siege of Ambracas, a fortress which commanded an extensive territory, belonging of right to Epirus, but now in the hands of the Ætolians. Having reduced this fortress, he restored it to the Epirots, and prepared to carry the war into Ætolia. The Ætolian spirit was not daunted either by the loss of Ambracas or the threats of Philip. They invaded Macedon, and made incursions into Achaia, which they reduced to the greatest distress. The mercenaries in the Achæan service had mutinied for want of pay; the Peloponnesian confederates became spiritless or disaffected; even the Messenians, in whose cause chiefly Achaia, had, at the beginning, taken up arms, were afraid to act against the Ætolians: whilst the Spartans, notwithstanding their engagements, at the late conventions, to Achaia, had now massacred, or sent into exile, all such of their own citizens as were in the interest of the Achæans, and openly declared against them. For the Spartans, amidst their greatest humiliation, had ever been impatient of the domination of Achaia, to which the haughtiness of that republic had, in all probability, very much contributed.

A year had elapsed since the alliance had been formed against Achaia, when Philip of Macedon, in the depth of winter, set out with the utmost secrecy to Corinth, where a part of his forces were stationed. He surprised a party of Eleans, who had gone forth to ravage the Sicyonian territories, and reduced Psophis, a stronghold within the confines of Arcadia, of which the Eleans had taken possession. He plundered Elis, one of the finest regions in Greece, in respect to cultivation, and rich in every kind of rural wealth. He next subdued under his power Triphylia, a district of Peloponnesus to the southward of Elis, and wrested the Ætolian yoke from the necks of the Messenians. Philip made a temperate use of all his victories. He granted peace to all who sued for it; and the whole of his conduct seemed to be directed by the same generous motives which had formerly directed that of Antigonus. But in the midst of these fair appearances, Philip began to manifest latent seeds of ambition. He restrained the pride and power of his ministers, who had been appointed to their offices by his predecessor Antigonus; and supported Eperatus in the election of general of Achaia, in opposition to Aratus. In order to counterbalance this unpopular measure, and to strengthen himself in the affections of the Achæan people, he besieged Teichos, and having taken that fortress, restored it to the Achæans, to whom it belonged. He also made an inroad into Elis, and presented the Dymeans and the cities in the neighbourhood with all the plunder. He now imagined that the wealth and vigour of the Achæan republic were at his disposal; but the new general had not provided any magazines, and the treasury was exhausted. Philip now affected to place great confidence in Aratus. By the advice of this statesman, he made an attempt on the island of Cephallenia, an island in the Ionian Sea, near the coast of Peloponnesus, and the great resort of the Ætolian pirates. His attempt, after it had been carried on almost to success, was baffled by the treachery of his ministers.

He now, following the advice of Aratus, invaded and ravaged Ætolia itself, returned into Peloponnesus, laid waste Laconia, and, flushed with success, meditated the subjection of all Greece, and a junction with Hannibal against the Romans. Aratus in vain attempted to dissuade him from this project. He sent ambassadors to the Carthaginian general, but they were intercepted, soon after their landing in Italy: as they gave out, however, that they were going to Rome, they, in a little time, obtained their release, and

made their way to Hannibal, with whom they concluded a treaty. On their return they were again intercepted, and sent with all their papers to Rome. But Philip despatched other ambassadors, and a ratification of the treaty was obtained. It was stipulated that Philip should furnish a fleet of two hundred ships, to be employed in harassing the Italian coasts; and that he should also assist Hannibal with a considerable body of land-forces. In return for this assistance, when Rome and Italy should be finally reduced, which were to remain in the possession of the Carthaginians, Hannibal was to pass into Epirus at the head of a Carthaginian army, to be employed as Philip should desire; and, having made a conquest of the whole country, to give up to him such parts of it as lay convenient for Macedon.

In consequence of this agreement, the Macedonian king entered the Ionian Gulf, with a large fleet, fell down to the coast of Epirus, took Oricum, on the coast of Epirus, a defenceless seaport, but from which there was a short passage to Italy, and laid siege to Apollonia; but surprised and defeated by the Romans, secretly retreated homeward across the mountains.

ALLIANCE WITH ROME

The Romans, humbled by the victorious arms of Hannibal, were not in a condition in which they might prosecute a war with Macedon; they therefore determined, if possible, to raise up enemies against Philip in Greece, that he might be employed at home in the defence of his own dominions. They accordingly made overtures for this purpose to the Ætoliens, who, confiding in the flattering declarations of the Roman ambassador, hastened to conclude a treaty, of which the following were the principal conditions: That the Ætoliens should immediately commence hostilities against Philip by land, which the Romans were to support by a fleet of twenty galleys; that whatever conquests might be made, from the confines of Ætolia to Corcyra, the cities, buildings, and territory, should belong to the Ætoliens, but every other kind of plunder to the Romans. The Spartans and Eleans, with other states, were included in this alliance; and the war commenced with the reduction of the island of Zacynthus, which, as an earnest of Roman generosity and good faith, was immediately annexed to the dominions of Ætolia. These transactions were dated about 208 B.C.

It has already been observed, that Philip aimed at the subjection of all Greece. Aratus, who would have opposed him in this design, he took off by poison.¹ His interest in Greece was now strengthened by the introduction of the Romans: he was regarded by the Greeks as the champion of freedom, and as their defence against the Romans, whom they still considered and denominated barbarians. Not only the Greeks northward

[¹ "This infamous action," says Polybius,^b "was not for some time discovered to the world; for the poison was not of that kind which procures immediate death; but was one of those which weaken the habit of the body, and destroy life by slow degrees. Aratus himself was very sensible of the injury that he had received. 'Such, Cephalo,' he said to a favourite servant, 'is the reward of the friendship which I have had for Philip.' So great and excellent a thing is moderation, which disposed the sufferer, and not the author of the injury, to feel the greatest shame when he found that all the glorious actions which he had shared with Philip, in order to promote the service of that prince, had been at last so basely recompensed.

"Such was the end of this magistrate, who received after his death, not from his own country alone, but from the whole republic of the Achæans, all the honours that were due a man who had so often held the administration of their government, and performed such signal services for the State. For they decreed sacrifices to him, with the other honours that belong to heroes, and, in a word, omitting nothing that could serve to render his name immortal."]

[208-205 B.C.]

of the Corinthian isthmus, but even the Achaean League, prepared to take up arms in his support. Encouraged by these allies, he acted with uncommon vigour: he carried the war into Illyricum with success; marched to the relief of the Aearnians, who were threatened by the Ætolians, and fortified himself in Thessaly. The Ætolians, notwithstanding these advantages gained over them by Philip, and that they were afterwards defeated by him in two hot engagements, remained undaunted, and prosecuted the war with an amazing obstinacy. The neighbouring states, now jealous of the successes of Philip, endeavoured to mediate a peace; nor did the Macedonian show himself unwilling to treat for that purpose.

A peace was ready to be concluded, when the Romans, deeply interested in the prolongation of war, sent their fleet to support the Ætolians; who, encouraged also by the prospect of acquiring another ally, Attalus, king of Pergamus, boldly set Philip at defiance, and talked of terms to which they knew he would not submit. The moderation of Philip strengthened the indignation of his Greek confederates against the Ætolians; a disposition which he soon found an opportunity of calling forth into action. Intelligence being brought to him, whilst he was assisting at the Nemean games, that the Romans had landed, and were laying waste the country from Corinth to Sicyon, he instantly set out, attacked and repulsed the enemy, and, before the conclusion of the games, returned again to Argos; an achievement which greatly distinguished him in the eyes of all Greece, assembled at that solemnity. After other vigorous, though unsuccessful, exertions against the Romans, he was called back, by domestic insurrections, to Macedon.

The Achaean states, though deprived of the powerful aid of the Macedonian king, still carried on their military operations under the conduct of Philopœmen of Megalopolis, in Arcadia, an enthusiast in the cause of liberty from his earliest years, and one who had been active in bringing over several of the Arcadians to join the Achaean League. Soon after the death of Aratus, to whom he was as much superior in military, as he was inferior in political abilities, he attained the chief sway in the Achaean councils. He saw with concern the humiliating condition to which a foreign yoke had reduced his countrymen, and conceived the noble resolution of relieving them from it. In the character of general of Achaia, he improved their discipline, inured them to hardship and toil, and gave them weightier armour, and more powerful weapons. The effect of this discipline soon appeared: the armies of Ætolia and Elis, which attacked them in Philip's absence, were totally defeated. In the meantime, the Romans, supported by Attalus, attacked Eubœa, of all the provinces of Greece, though an island, one of the most considerable for fertility of soil, extent of territory, and advantage of situation. Philip, on his part, kept a watchful eye on his enemies: his military preparations were vigorous, and not without success. The war was prolonged, with various success, for six years, when the Romans and Attalus retired from Greece. A peace was now concluded between the Ætolians and Romans, on the one part, and Philip on the other, whose successful ambition led him, by a natural progress, to attack the dominions of the king of Egypt.

The Romans, whose policy it was never to have more enemies on their hands than one at a time, had consented to a peace with Macedon, because they were involved in a war with Carthage; but that war being now at an end, they eagerly embraced the first pretexts they could find for a rupture with the prince, whose successes had excited a jealousy of his growing

power. Complaints being brought before that political and powerful people from Attalus, from the Rhodians, from the Athenians, and from Egypt, they readily determined to improve so favourable a juncture. And first, they declared themselves the guardians of the young king of Egypt. Marcus Æmilius was despatched from Rome, to announce to Philip the intentions of the Roman senate. The ambassador found the king before Abydos, at the head of an army flushed with victory. Philip was not insensible of the advantage of his situation; yet the Roman, undaunted by the deportment of the monarch, charged him with dignity and firmness, not to attack the possessions of the crown of Egypt; to abstain from war with any of the Grecian states; and to submit the matters in dispute between him, Attalus, and the Rhodians, to fair arbitration. "The boastful inexperience of youth," said the king, "thy gracefulness of person, and, still more, the name of Roman, inspire thee with this haughtiness. It is my wish, that Rome may observe the faith of treaties; but should she be inclined again to hazard an appeal to arms, I trust that, with the protection of the gods, I shall render the Macedonian name as formidable as that of the Roman." These things, with the cruel destruction of the city and inhabitants of Abydos, happened about 199 B.C.

Philip, like other ambitious princes, was now on terms of hostility with most of the neighbouring nations. Rome, on the contrary, was in a situation the most favourable that could be imagined to her ambition: Carthage was subdued; in Italy, all remains of insurrection had subsided; Sicily, in fertility and opulence, at that time the pride of the western world, with most of the adjacent islands, was annexed to her dominions; and even those nations which had not yet felt the force of her arms, heard, with terror, the fame of a people not to be subdued even by a Hannibal. About three years, therefore, after peace had been made with Philip, the Romans despatched a fleet, under the conduct of the consul Sulpicius, for the relief of Athens, then besieged by the Macedonians.

Philip was moved with resentment, and attempted to wreak his vengeance on Athens. Disappointed in his hope of surprising that city, he laid waste the country around it, destroying even the temples, which he had hitherto affected to venerate, and mangling and defacing every work of art in such a manner, that there scarcely remained, according to the Roman historian Livy, a vestige of symmetry or beauty. Here we have an opportunity of remarking the contrast between the genius of Athens, in the times of Philip, the father of Alexander, and that Philip who now filled the throne of Macedon. The Athenians harassed by the arms of this last mentioned prince, had recourse to the only weapons with which they were now acquainted—the invectives of their orators, and the acrimony of their popular decrees. It was resolved, that "Philip should forever be an object of execration to the Athenian people; that whatever statues had been raised to him, or to any of the Macedonian princes, should be thrown down; that whatever had been enacted in their favour should be rescinded; that every place in which any inscription, or memorial, had been set up in praise of Philip, should be thenceforth held profane and unclean; that in all their solemn feasts, when their priests implored a blessing on Athens and her allies, they should pronounce curses on the Macedonian, his kindred, his arms by sea and land, and the whole Macedonian name and nation: in a word, that whatever had been decreed in ancient times against the Pisistratidæ, should operate in full force against Philip; and that whoever should propose any mitigation of the resolutions now formed, should be adjudged a

[200-193 B.C.]

traitor to his country, and be punished with death." The flatteries of the Athenians to their allies were in proportion to their impotent execrations of the Macedonian monarch. Such is the connection between meanness of spirit and the loss of freedom!

GREEK FREEDOM PROCLAIMED

A languid and indecisive war had been carried on for the space of two years between the Macedonians and Romans, during the consulship of Sulpicius and that of his successor Villius, not much to the honour of these commanders, when the command of the Roman army devolved to the new consul, Titus Quintius Flaminius, not indeed unacquainted, being a Roman, with the science of war, but more remarkable for his skill and address in negotiation than for military genius. The Roman consul, by the vigour of his arms, but still more by the dexterity with which he carried into execution the profound policy of his nation, brought Greece to the lowest state of humiliation. By detaching the most considerable of the Grecian states, particularly the Ætolians and the Achæans, from their connection with Macedonia; by ingratiating himself with the Grecian states, whom he managed, after they had become his confederates, with infinite artifice; by making a pompous but insidious proclamation of their freedom at the Isthmian and Nemean games, he reduced the Macedonian king to the necessity of first seeking a truce, and afterwards of accepting peace on these mortifying conditions, which were entirely approved by the Roman senate:

"That all the Greek cities, both in Asia and in Europe, should be free, and restored to the enjoyment of their own laws.

"That Philip, before the next Isthmian games, should deliver up to the Romans all the Greeks he had in any part of his dominions, and evacuate all the places he possessed either in Greece or in Asia.

"That he should give up all the prisoners and deserters.

"That he should surrender all his decked ships of every kind; five small vessels, and his galley of sixteen banks of oars, excepted.

"That he should pay the Romans a thousand talents [£200,000 or \$1,000,000], one half down, the rest in ten equal annual payments.

"And that, as a security for the performance of these regulations, he should give hostages, his son Demetrius being one." The date of this peace was 193 B.C.

Flaminius having made various decrees in favour of the several Grecian communities in confederacy with the Romans; having expelled Nabis, the tyrant of Sparta, from Argos; and having obtained the freedom of the Roman slaves in Greece, returned to Rome, to the great satisfaction of all Greece; and withdrew, as he had promised, all the Roman garrisons.

THE ÆTOLIANS CRUSHED

Antiochus, king of Syria, was renowned for the magnificence of his court, great treasures, numerous armies, military talents, and political wisdom. He had visited the coasts of the Hellespont, formerly subject to the kings of Syria; he had even passed over into Thrace, where he had likewise claims; and he was preparing to rebuild Lysimachia, in order to make it again the seat of government in the countries anciently possessed by Lysimachus.

The pretensions of so powerful and politic a prince to countries which the Romans had already marked as their own, excited the jealousy of that ambitious people. They gave him repeated notification, that, "by the treaty with Macedon, the Grecian cities in Asia, as well as Europe, had been declared free: that Rome expected he would conform to that declaration"; and further, "that henceforth Asia was to be the boundary of his dominions; and that any attempt to make a settlement in Europe, would be considered by Rome as an act of hostility." Antiochus, at first, manifested a disposition to peace, and, in order to obtain it, would have made large concessions, could anything less than the humiliation of the crown of Syria have satisfied Roman ambition.

But Hannibal, the sworn enemy of Rome, no sooner heard of his meditating a war against the Romans, than he made his escape from Carthage to the Syrian court, and urged him to arms. The Ætoliens, too, solicited him to vindicate the cause of Greece, notwithstanding the delusive show of liberty granted by Rome, more enthralled in reality than at any former period. Hannibal recommended an invasion of Italy, where alone, in his judgment, Rome was vulnerable. With only eleven thousand land-forces, and a suitable naval armament, he offered to carry the war into the heart of that country; provided Antiochus would, at the same time, appear at the head of an army on the western coast of Greece, that, by making a show of an intended invasion from that quarter, he might divert the attention and divide the strength of the Romans. The Ætoliens, on the other hand, told him, that if Greece were made the seat of war, there would be, throughout all that country, a general insurrection against the power of the Romans. Antiochus, having adopted the plan of the Ætoliens in preference to that of Hannibal, entered Greece with a small force, and being disappointed in his expectations of succour from the Grecian states, was defeated at the straits of Thermopylæ; by Manlius Acilius Glabrio, the Roman consul. He escaped with only five hundred men to Chalcis, from whence he retreated with precipitation to his Asiatic dominions, 187 years before the Christian era.

The Ætoliens having rejected the terms of peace offered to them by the Romans, the consul pressed forward the siege of Heraclea, which soon surrendered at discretion. He was preparing to besiege Naupactas, a seaport on the Corinthian Gulf, of the greatest importance to the Ætolian nation, who now decided to submit themselves to the faith of the Roman people, and sent deputies to intimate this determination to the Roman consul. Acilius, catching the words of the deputies, said, "Is it then true, that the Ætoliens submit themselves to the faith of Rome?" Phœneas, who was at the head of the Ætolian deputation, replied, that they did. "Then," continued the consul, "let no Ætolian, from henceforth, on any account, public or private, presume to pass over into Asia; and let Dicæarchus, with all who have had any share in his revolt, be delivered into my hands."

"The Ætoliens," interrupted Phœneas, "in submitting to the faith of the Romans, meant to rely upon their generosity, but not to yield themselves up to servitude: neither the honour of Ætolia, nor the customs and laws of Greece, will allow us to comply with your requisition." "It is insolent prevarication," answered the consul, "to mention the honour of Ætolia and the customs and laws of Greece; you ought even to be put in chains." The Ætoliens, exasperated even to madness at this imperious treatment of their deputies and nation, were encouraged in their disposition to vindicate their liberties by arms, by the expectation of succours from Asia and from Macedon; but this expectation was disappointed, and they

[190-188 B.C.]

were reduced to the necessity of sending ambassadors to Rome, to implore the clemency of the Roman senate. The only conditions they could obtain were, either to pay a thousand talents [£200,000 or \$1,000,000], a sum which, they declared, far exceeded their abilities, and to have neither friend nor foe, but with the approbation of Rome, or to submit to the pleasure of the senate. The Ætolians desired to know, what they were to understand by "submitting to the pleasure of the senate": an explanation being refused, they were obliged to return uncertain of their fate. The war with Rome was renewed; but the Roman vigour and policy prevailed in the unequal contest, and the Ætolians were again obliged to apply to the consul, in the most submissive manner, for mercy. The conditions granted to them were extremely hard: they were heavily fined, obliged to give up several of their cities and territories to the Romans, and to deliver to the consul forty hostages, to be chosen by him, none under twelve, or above forty years of age. But one express condition comprehended everything that imperious power might think fit to impose: the Ætolians were to "pay observance to the empire and majesty of the Roman people."

The predominant power of the Achæans in the Peloponnesus, now became the object of Roman jealousy and ambition. Though confederated with Achaia, the Peloponnesian cities retained each of them peculiar privileges, and a species of independent sovereignty. No sooner was peace concluded with Ætolia, than Marcus Fulvius Nobilior, to whom the conduct of the Ætolian War had been committed on the expiration of the consulship of Acilius, took up his residence in the island of Cephallenia, that he might be ready, upon the first appearance of any dispute in Achaia, to pass over into Peloponnesus, and improve every dissension, for the aggrandisement of the Roman Republic. Such an opportunity soon presented itself: the congress of the Achæan states had always been held at Ægium; but Philopœmen, now the Achæan general, having determined to divide among all the cities of the League the advantages of a general convention, had named Argos for the next diet. This innovation the inhabitants of Ægium opposed, and appealed to the Roman consul for his decision. Another pretext for passing over into Greece was also soon offered to Fulvius. The Lacedæmonian exiles, who had been banished in the days of the tyrants, and never restored, resided in towns along the coast of Laconia, protected by Achæan garrisons, cut off the inhabitants of Lacedæmon from all intercourse with the seacoast. One of those maritime towns was attacked by the Spartans in the night-time, but defended by the exiles, with the assistance of the Achæan soldiery. Philopœmen represented this attempt of the Spartans as an insult on the whole Achæan body. He obtained a decree in favour of the exiles, commanding the Lacedæmonians, on pain of being treated as enemies, to deliver up the authors of that outrage. This decree the Lacedæmonians refused to obey. They dissolved their alliance with Achaia, and offered their city to the Romans. In revenge of this, Philopœmen, notwithstanding the advanced season, laid waste the territories of Lacedæmon. /

GREECE AT THE MERCY OF "FRIENDLY" ROME

The bond which had formerly existed between Macedonia and Greece, giving the history of both, after the time of Philip and the Great Alexander, a common road to travel, had in the course of time disappeared. The Greeks had not desired this bond with Macedonia, though nothing else

could possibly have won the townships their independence. For, while the kings of Macedonia proceeded rigorously in carrying out their desire of building for themselves a suzerainty in Greece, yet for all that the ultimate end of pursuit was not the enslaving of Greece, but her amalgamation with Macedonia. The Greeks would have been as free as the Macedonians were under the monarchy, and it was no mean degree of freedom they enjoyed.

An Asiatic despotism could take no root on this soil, it could not spring up spontaneously. Rome certainly was capable of exercising such power, since she commanded forces such as would not have been at the disposal of a king of Macedonia and Greece. But the Greeks had worked against the amalgamation with Macedonia as though it had been the worst of all fates. Now, as a reward, they accepted the rule of the cruel Romans, who revealed their character even more and more clearly through the veiling cloud of their friendship, their alliance, and their altruistic enthusiasm for freedom.

There is a silence come over the land of Greece, since the result of the Roman war against Syria, the silence of bondage. Zacynthus, Apollonia, Epidamnus, and certain other points in the Greek world, might thereafter at once be considered and treated as subject lands. Altogether the Romans during this time moved nearer. Istria was conquered and made a province. Even Ætolia was not talked of in Philip's last years; here too, stillness had come. Not one of the many little leagues, which now divided Greece dared or could dare to refuse anything the Romans demanded—if, that is to say, the Romans attached any importance to it. And of what kind these commands were one may still judge from isolated facts appearing in the detached fragments from which we have to construct the history of Greece during this period. Thebes had to receive again within her walls the murderer of the Bœotarch, Brachyllas, because he murdered for Rome's sake and was a friend of Rome.

From only one quarter of Greece did there sound any note of life and activity—from Achaia; and the Romans did, for an exception, think it worth while to concern themselves about Achaia somewhat, and to take action, when occasion offered, that her dissolution might be hastened.

But such life or activity as may still stir in the Achæan League is no longer a cheering spectacle in any way. Those of its men who are best calculated to win respect, because they are not in the pay of the Romans, and still cherish thoughts of independence, prove themselves to be, if not without real worth, yet certainly without caution or insight. Philopœmen and Lycortas stand highest among them. Philopœmen himself is said to have perceived that extinction under the Roman rule was become altogether inevitable, and that the only thing left to do was to endeavour to put it off as long as possible. That was the right view for a man to take, unless he had determined to evade bondage by a voluntary death. But Philopœmen, it would appear, did not hold the view attributed to him. He thought the bond might grow stronger again some day, and, if it were necessary, assert itself in arms against the Romans. For why else, if this were not his idea, should there have been that madness and murder in Sparta? The old Spartan life had to be stamped out, the new citizens must be strangled, because the old Sparta and the strong Sparta would not join the Achæans and so the Peloponnese remained divided. With the idea that the unity of the Peloponnese was gained at last, and that the bond was solid and complete, Philopœmen and his friends may have rested from the festival of murder in Sparta, which now found herself once more forced into the Achæan League.

[189-183 B.C.]

Obviously the heads of the League thought they might move more freely. They ventured to mention the League's independence, they continued to disobey Roman commands. In this they made one of two mistakes. Either they thought the senate really desired their independence, or else they imagined that they also were still something considerable and were capable, if necessary, of defending themselves in arms. It would not have suited the Romans just then to appear again in Greece with an army, and so, for a time, though only a very short time, they permitted the high and empty words of the Achæans. And in the end the sword was not in the least required to bring them back to heel, only a stern command from the senate, and at once the liberty craze of the Achæans tumbled pitifully into nothing.

The trifling differences which sprang from the endeavours of the Achæans and the counter endeavours of the Spartans, would be insignificant did they not conduce to our knowledge of the Roman method. The arts which were employed against Macedonia were also employed against the Achæans. The small should be stricken like the great, so that in the end both might be completely and easily taken. The Romans must have seen with pleasure the perverse measures to which Philopœmen and the Achæans resorted in order to force the Peloponnesus to the unity of the League.⁹

The Romans, thus invited to act as umpires in Greece, found means to break the strength of the commonwealth of Achaia, by seducing its confederate states — a conduct which, in the eyes of pure morality, must appear enormously treacherous; but which if, in the ambitious designs of states and princes, the certain attainment of the end be considered as a sufficient justification of the means, must be deemed refined policy. By the intrigues of Roman emissaries, too, a party of Messenians took up arms against the Achæans; and Philopœmen, hastening to suppress the insurgents, fell into their hands, and was put to death.



BACCHUS
(After Hope)

ROME AGAINST PHILIP

During these transactions in Greece, the Romans, jealous of the increasing power of their ally, Philip of Macedon, sought an occasion of quarrelling with him, and, agreeably to their usual policy, encouraged every complaint, and supported the pretensions of his enemies; prepared to plunder them, too, in their turns, when the Macedonian power should no longer be formidable. The small cantons or communities of Thessaly, in which he had re-established his authority, were now encouraged to assert their independence; and the Macedonian king was called to account for those very outrages which he had committed on the side of the Romans. Commissioners were appointed for the settlement of differences. Philip was

required by them to evacuate Ænus and Maronea, which were claimed by Eumenes. These were cities on the Hellespont, which, from their maritime situation, afforded many advantages. The complexion and designs of the Roman commissioners were obvious; and Philip, judging it vain to keep measures with men determined at any rate to take part with his adversaries, expostulated with them with great boldness on the injustice, treachery, and ingratitude of their nation.

In this temper of mind he wreaked his revenge on the Maroneans, whose solicitations, he supposed, had been employed against him. A body of his fiercest Thracian mercenaries being introduced into Maronea, on the night before the Macedonian garrison was to march out, on pretence of a sudden tumult, put to the sword all the inhabitants suspected of favouring the Roman interest, without distinction of condition, age, or sex, and left the place drenched in the blood of its citizens. The Romans threatened to revenge this massacre, and Philip was obliged to send his second son, Demetrius, to Rome, to make an apology. The Roman senate, with a view to debauch the filial affection of Demetrius and to draw him over to the interests of Rome, told him that, on his account, whatever had been improper in his father's conduct should be passed over; and that, from the confidence they had in him, they were well assured Philip would, for the future, perform everything that justice required: that ambassadors should be sent to see all matters properly settled: and that, from the regard they bore to the son, they were willing to excuse the father. This message excited in the breast of Philip a suspicion of the connection formed between Rome and Demetrius; which suspicion was inflamed by the insinuations and dark artifices of his eldest son Perseus, a prince, according to the Roman writers, of an intriguing and turbulent disposition, sordid, ungenerous, and subtle.

Perseus and Demetrius were both in the bloom of life; the former aged about thirty years when Demetrius returned from Rome, but born of a mother of mean descent, a seamstress of Argos, and of so questionable a character, as to make it doubtful whether he was really Philip's son. Demetrius was five years younger, born of his queen, a lady of royal extraction. Hence Perseus had conceived a jealousy of his brother, and was insidiously active to undermine him in the royal favour. He accused Demetrius to the king of a design to assassinate him. Philip, familiarised as he was to acts of blood, was struck with horror at the story of Perseus. Retiring into the inner apartment of his palace, with two of his nobles, he sat in solemn judgment on his two sons, being under the agonising necessity, whether the charge could be proved or disproved, of finding one of them guilty. Distracted by his doubts, Philip sent Philocles and Apelles, two noblemen, to proceed as his ambassadors to Rome, with instructions to find out, if possible, with what persons Demetrius corresponded, and what were the ends he had in view.

Perseus, profoundly artful, and having the advantage of being the heir apparent to the Macedonian crown, secretly gained over to his interest his father's ambassadors, who returned to the king with an account that Demetrius was held in the highest estimation at Rome, and that his views appeared to have been of an unjustifiable kind; delivering, at the same time, a letter, which they pretended to have received from Quintus Flaminius. The handwriting of the Roman, and the impression of his signet, the king was well acquainted with; and the exactness of the imitation induced him to give entire credit to the contents, more especially as Flaminius had formerly

[179-168 B.C.]

written in commendation of Demetrius. The present letter was written in a different strain. The author acknowledged the criminality of Demetrius, who indeed, he confessed, aimed at the throne; but for whom, as he had not meditated the death of any of his own blood, he interceded with the monarch. The issue of this atrocious intrigue was truly tragical: Demetrius, found guilty of designs against the crown and the life of his father, was put to death. Philip, when too late, discovered that he had been imposed upon by a forgery, and died of a broken heart.

PERSEUS, KING OF MACEDONIA

Perseus succeeded his father on the throne of Macedon, a hundred and seventy-nine years before the birth of Christ. The first measures of his government appeared equally gracious and political. He assumed an air of benignity and gentleness. He not only recalled all those whom fear or judicial condemnation had, in the course of the late reign, driven from their country; but he even ordered the income of their estates, during their exile, to be reimbursed. His deportment to all his subjects was happily composed of regal dignity and parental tenderness. The same temper which regulated his behaviour to his own subjects, he displayed in his conduct towards foreign states. He courted the affections of the Grecian states, and despatched ambassadors to request a confirmation of the treaties subsisting between Rome and Macedon. The senate acknowledged his title to the throne, and pronounced him the friend and ally of the Roman people. His insinuations and intrigues with his neighbours were the more effectual, that most of them began to presage what they had to expect, should the dominion of Rome be extended over all Greece; and looked upon Macedon as the bulwark of their freedom from the Roman yoke.

The only states that stood firm to the Roman cause, were Athens and Achaia. But in this all of them now agreed, that foreign aid was on all occasions necessary to prop the tottering remains of fallen liberty, which, by this time, was little else than a choice of masters. Besides all those advantages which Perseus might derive from the well-grounded jealousy of Roman ambition, he succeeded to all those mighty preparations which were made by his father. But all this strength came to nothing: it terminated in discomfiture, and the utter extinction of the royal family of Macedon. He lost all the advantages he enjoyed, through avarice, meanness of spirit, and want of real courage. The Romans, discovering or suspecting his ambitious designs, sought and found occasion of quarrelling with him. A Roman army passed into Greece. This army, for the space of three years, did nothing worthy of the Roman name; but Perseus, infatuated, or struck with a panic, neglected to improve the repeated opportunities which the incapacity or the corruption of the Roman commanders presented to him. Lucius Æmilius Paullus, elected consul, restored and improved the discipline of the Roman army, which, under the preceding commanders, had been greatly relaxed. He advanced against Perseus, drove him from his entrenchments on the banks of the river Enipeus, and engaged and defeated him under the walls of Pydna.

On the ruin of his army, Perseus fled to Pella. He gave vent to the distraction and ferocity of his mind, by murdering with his own hand two of his principal officers, who had ventured to blame some parts of his conduct. Alarmed at this act of barbarity, his other attendants refused to

approach him; so that, being at a loss where to hide himself, or whom to trust, he returned from Pella, which he had reached only about midnight, before break of day. On the third day after the battle he fled to Amphipolis. Being driven by the inhabitants from thence, he hastened to the seaside, in order to pass over into Samothrace, hoping to find a secure asylum in the reputed holiness of that place. Having arrived thither, he took shelter in the temple of Castor and Pollux. Abandoned by all the world, his eldest son Philip only excepted, without a probability of escape, and even destitute of the means of subsistence, he surrendered to Octavius, the Roman prætor, who transported him to the Roman camp. Perseus approached the consul with the most abject servility, bowing his face to the earth, and endeavouring with his suppliant arms to grasp his knees. "Why, wretched man," said the Roman, "why dost thou acquit Fortune of what might seem her crime, by a behaviour which evinces that thou deservest not her indignation? Why dost thou disgrace my laurels, by showing thyself an abject adversary, and unworthy of having a Roman to contend with?" He tempered, however, this humiliating address, by raising him from the ground, and encouraging him to hope for everything from the clemency of the Roman people. After being led in triumph through the streets of Rome, he was thrown into a dungeon, where he starved himself to death. His eldest son, Philip, and one of his younger sons, are supposed to have died before him. Another of his sons, Alexander, was employed by the chief magistrates of Rome in the office of a clerk.

THE HUMILIATION OF GREECE

Within the space of fifteen days after Æmilius had begun to put his army in motion, all the armament was broken and dispersed; and, within two days after the defeat at Pydna, the whole country had submitted to the consul. Ten commissioners were appointed to assist that magistrate in the arrangement of Macedonian affairs. A new form of government was established in Macedon, of which the outlines had been drawn at Rome. On this occasion the Romans exhibited a striking instance of their policy in governing by the principle of division. The whole kingdom of Macedon was divided into four districts; the inhabitants of each were to have no connection, intermarriages, or exchange of possessions, with those of the other districts, but every part to remain wholly distinct from the rest. And among other regulations tending to reduce them to a state of the most abject slavery, they were inhibited from the use of arms, unless in such places as were exposed to the incursions of the barbarians. Triumphal games at Amphipolis, exceeding in magnificence all that this part of the world had ever seen, and to which all the neighbouring nations, both European and Asiatic, were invited, announced the extended dominion of Rome, and the humiliation not only of Macedon, but of Greece; for now the sovereignty of Rome found nothing in that part of the world that was able to oppose it.

The Grecian states submitted to various and multiplied acts of oppression, without a struggle. The government which retained the longest a portion of the spirit of ancient times, was the Achaean. In their treatment of Achaia, the Romans, although they had gained over to their interests several of the Achaean chiefs, were obliged to proceed with great circumspection, lest the destruction of their own creatures should defeat their designs. They endeavoured to trace some vestiges of a correspondence

[168-167 B.C.]

between the Achaean body and the late king of Macedon; and when no such vestiges could be found, they determined that fiction should supply the place of evidence. Caius Claudius, and Cneius Domitius Ahenobarbus, were sent as commissioners from Rome, to complain that some of the first men of Achaia had acted in concert with Macedon. At the same time they required, that all who were in such a predicament should be sentenced to death: promising that, after a decree for that purpose should be enacted, they would produce the names of the guilty. "Where," exclaimed the assembly, "would be the justice of such a proceeding? First name the persons you accuse, and make good your charge." "I name, then," said the commissioner, "all those who have borne the office of chief magistrate of Achaia, or been the leaders of your armies." "In that case," answered Xenon, an Achaean nobleman, "I too shall be accounted guilty, for I have commanded the armies of Achaia; and yet I am ready to prove my innocence, either here, or before the senate of Rome." "You say well," replied one of the Roman commissioners, laying hold on his last words, "let the senate of Rome then be the tribunal before which you shall answer."

A decree was framed for this end, and above a thousand Achaean chiefs were transported into Italy, a hundred and sixty-seven years before Christ.^f Among these was Polybius,^b who afterwards became famous as the historian of the Roman Conquest, and whose work, though preserved only in fragments beyond the fifth book of the original forty, is the chief reliable source of information regarding some of the events of the period we have just considered. Had fortune spared us the later books of Polybius, our knowledge of the history of the Leagues would have been far different from what it is; for this Greek of the "degenerate" Hellenistic age is universally admitted to be the most philosophical and reliable of all historical writers among his countrymen of any age, Thucydides alone excepted. We shall see more of his work when we come to the history of the Punic wars, where he is again the chief authority.^a

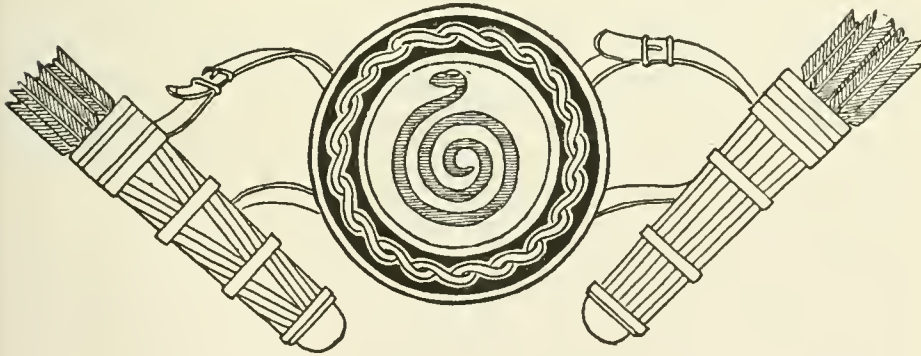



THE PLAIN OF ARGOS

CHAPTER LXIV. THE FINAL DISASTERS

THE condition of Achaia during this period of the Roman dominion, from B.C. 172 to 152, was peculiar and is very obscure. The government was in a very sad condition; Callierates and Andronidas tyrannised over the Achæans, although they had no followers, and although the people were so enraged against the former that he was publicly hissed, and everybody shunned him. "He is a man who stands forth branded in every respect with everlasting infamy; he was never invited by a Greek either to dinner or to a wedding;" but still it was impossible to change the direction he gave to the state. "He was regarded as a demon, whose existence could not be controlled." No consideration was shown towards foreign powers; it was a state of utter inactivity and leisure, but at the same time of material prosperity. Commerce and agriculture were thriving, as is mentioned several times by Polybius; the taxes were not very heavy, the laws were suited to the circumstances, and hence it was a period of general material well-being. But at the same time, it is evident that the number of regular marriages decreased immensely, and consequently that of persons who were born citizens also; it was just the same as towards the end of the Roman Republic and under the Roman emperors, when people generally lived in concubinage. It was a deplorable condition.

There was not a trace of intellectual life; literature no longer existed, except that a few philosophers still lived at Athens. Poetry was confined to little poems, and was cultivated in Asia more than in Peloponnesus; the new comedy had entirely died away. In spite of the material prosperity, nothing was done for the arts and for monuments. The Achæans preserved the Greek name until the end, but the Romans need not have been jealous of them. There were still some places to be subdued to complete the supremacy of Rome, as Carthage, for example; and so long as that city existed, the Romans turned their eyes towards those who might be an obstacle to their subduing those places.

At the middle of the second century B.C., Achaia embraced the whole of Peloponnesus; it must have extended its dominion even beyond it, for not to mention Megara, which had belonged to it before, it now also comprised Pleuron and Calydon, which were originally Ætolian towns, but are called both Ætolian and Achæan. In general people had become accustomed to the Achæan League; Sparta alone bore the connection reluctantly.

The disputes which, in the end, led to the fatal war, arose out of the intrigues of Menalcidas, a Lacedæmonian, who even rose to the dignity of strategus. This Menalcidas, with a remarkable versatility in his wickedness, jumped from one party to another. The quarrels between the Achæans and Lacedæmonians are said to have arisen from his villainy and that of Diæus of Megalopolis, on the occasion of a quarrel between Athens and Oropus.



THE LAST DAYS OF CORINTH

[156-150 B.C.]

The town of Oropus, of which, ever since the Peloponnesian War, the Athenians had wanted to take possession, which was often subdued by them, but each time taken from them again, had, according to Pausanias, been assigned to them by Philip after the Macedonian War, that is, he had made the town tributary to Athens. The Athenians, it is said, plundered the town, because they were suffering from severe poverty — but they had probably imposed too heavy taxes upon the Oropians, and levied them too rigorously, so that the Oropians applied to the Romans for redress. A great quantity of existing Athenian tetradrachmæ still attests the poverty prevailing at that time in Athens, for they consist of copper only covered over with a thin coat of silver. The Athenians were then compelled to pay to the Oropians one hundred talents as an indemnification ; but they contrived to become reconciled with them, and induced them not to exact the money, to return to their former relation, and admit a garrison into their town. The conduct of this garrison, however, induced the Oropians to demand its withdrawal. As the Athenians refused, the Oropians applied to the Achæans, and bribed Menalcidas, who happened to be strategus, with ten talents ; Menalcidas again prevailed upon Callierates to persuade the popular assembly to compel Athens to pay the one hundred talents. But the Athenians were beforehand with them : they completely plundered Oropus, and Menalcidas also exacted the promised sum with the greatest insolence, while he himself refused to pay to Callierates the sum he had promised him. The latter charged him with high treason, and Menalcidas retaliated. The former repaired to Rome, and Menalcidas is said to have saved his life only by bribing Diæus, who was strategus.

The manner in which out of this unrelated quarrel the disputes between the Achæans and Lacedæmonians arose is not clear. But they gave rise to a war, and a wretched war it was. Diæus, with an army of the Achæan confederates, entered Laconia, demanding the condemnation of the recalitrants. A Spartan senator proposed, that the twenty-four whose condemnation was demanded by Diæus, should of their own accord go into exile. This was done, and according to a preconcerted plan, all were condemned to death. But these exiles were kindly received by the Roman senate, and Diæus and Callierates were sent to Rome to counteract their influence. The latter died on his journey, having apparently somewhat changed his conduct during the latter part of his life. Diæus and Menalcidas vehemently disputed before the senate, which simply commanded them to return and wait, until a Roman embassy should bring over a decisive answer. The Achæans, however, did not wait, and Damocritus, who had in the meantime succeeded Diæus as strategus, invaded Laconia, before the Roman ambassadors arrived, defeated the enemy, and advanced as far as Sparta. He had no intention to pursue them farther, and the Achæans accordingly accused and condemned him, thinking that he had been bribed ; and he went into exile. This happened probably in 150 B.C. ; and Diæus now became strategus in the place of Damocritus.

In the meantime the great drama throughout the world came to a crisis. The Romans had undertaken the destruction of Carthage, but did not find it so easy as they had imagined. In the provinces, the most contemptible side of the character of the Romans was seen ; they were beheld as plunderers and oppressors ; it was known that they were hated by all the world, and it was expected that a general insurrection would break out, extending from Spain to the extreme East. And it was believed that Rome could not stand against it. It is possible that the nations may have heard of the internal decay of Rome, of the ferment of Italy, and of the discontent of the allies.

Under these circumstances, an insurrection first broke out in Macedonia. The Romans had torn that country asunder in four parts, as Napoleon wanted to divide Poland into three states — an attempt which proved fatal to him. The Romans in Macedonia had not left together those masses which, in language and origin, as well as geographically, were united; but with a diabolic and calculating policy they had torn the country to pieces, and it was divided in such a manner as to have as little connection as possible, one tribe being mixed up with others. All the respectable people of Macedonia, under the pretext of their being hostages, had been carried away with their families into Italy, where they amalgamated with the inhabitants and disappeared. In this manner all persons of mark had been removed. Moreover, the *commercium* and *connubium* among those four provinces had been abolished, so that no Macedonian was allowed to possess land in two different provinces, every one being confined to his own district. But still Macedonia was in a condition of great prosperity, especially in consequence of its mines and commerce, as we must infer from the immense quantity of Macedonian money of that period, which has come down to us. The limbs which had been torn asunder, longed to be reunited as one whole.

THE MACEDONIAN INSURRECTION

At this time there appeared among them a man of about forty years, calling himself Philip, and declaring himself to be a son of Perseus, and to have escaped from his father's misfortunes. It is possible that he was a pseudo-Philip, that his real name was Andriscus, and that he was a native of Thrace: there were several such impostors at that time. Philip defeated the Romans, and in a very short time made himself master of all Macedonia, which recognised him. He even penetrated into Thessaly, where he gained advantages, and successfully maintained himself against the untrained troops of the Romans. All sided with him; but the Achæans very inconsistently sent auxiliaries to the Romans, although at the time all nations were harbouring designs of revolt, but the Achæans thought that they were not yet ripe for it. The Achæan auxiliaries came very opportunely to the Romans; it was only through these, who were commanded by a Roman legate, that they succeeded in defending Thessaly, and with their assistance they repelled the Macedonians, until Metellus came with the Roman legion. He defeated this Philip, whom the Romans call Andriscus, in several battles. Macedonia now became a Roman province, under the absolute power of an imperator; the senate coolly ordered them to dismiss from the confederacy not only Lacedæmon, but all the other places which had not belonged to Achaia at the time when the Achæans concluded the treaty with Rome in the first (or more correctly the second) Macedonian War. C. Aurelius Orestes, together with other ambassadors, brought these orders to Corinth, whither he summoned the allies of the Achæans.

THE ACHÆAN WAR

This very unjust and insolent demand threw the Achæans into a state of frenzy; even before Orestes had finished his speech, the council hastened to the market-place, calling upon the people to assemble, and it cannot excite wonder, though it is a proof of the utter want of common sense among the

[147-146 B.C.]

Achæans, that they fell upon the Roman ambassadors, and insultingly drove them out of the theatre. All the Lacedæmonians who happened to be in the city were arrested. After this the Achæans again marched into Laconia, where Menalcidas had, in the meantime, made away with himself, because he had broken a truce which he had been ordered to observe by the Romans.

At this time the Macedonian insurrection was not yet quelled, and fortune was still undecided. Metellus had not yet come over. Simultaneously the Third Punic War was going on; the Spaniards and Iberians were stirring; Masinissa's family was suspected, and in short the Romans were pressed on all sides. Their cunning policy therefore was mildness: they said that they were willing to pardon the Achæans, if they would but acknowledge their guilt, and apologise. But almost the whole nation was now in a state of intoxication, "according to the words of Scripture, that God makes the nations intoxicated for their own destruction." Critolaus the strategus, played the part of a hero, and inflamed the minds of the people—especially of the populace, which was already in commotion at Corinth. When the Roman ambassadors commenced speaking no one listened to them; they were obliged to stop, and as the tumult became too great, they went away. Critolaus, and still more, Diæus, now goaded the Achæans into the madness of declaring war against the Romans, and marching towards Thermopylæ. The war was decreed nominally against the Lacedæmonians, but in reality against the Romans.

We have only very scanty information about the course of this war; but the *Excerpts* of Porphyrogenitus from Polybius^c will throw light upon it. "Posterity can form no conception," says Polybius, "of the madness with which the war was carried on; it was as if men rushed into it for the purpose of perishing."

Critolaus assembled a considerable army. The Bœotians, headed by the Thebans under the wretched Pytheas, and the Chalcidians, were the only Greeks that sided with the Achæans; the Ætolians and the other nations were neutral; the Lacedæmonians, on the other hand, were hostile towards the Achæans, for which reason all of the Achæans could not leave their country. The allied army advanced as far as Heraclea near Mount Ceta, and laid siege to that town in order to protect Thermopylæ. But everything was there managed so senselessly, that when Metellus, who on being informed of this, without waiting for orders, had broken in from Macedonia with the rapidity of lightning, came to its relief, the Achæans under Diæus and Critolaus hastily fled back through the pass of Thermopylæ.

Metellus overtook them near Scarphe, attacked and defeated them so completely that within a few hours the Achæan army was utterly annihilated; many were slain, many were taken prisoners, and many dispersed in flight. Diæus fled, Critolaus was not to be found, having perhaps perished in a marsh. The whole army was scattered. An Arcadian contingent of one thousand men, which arrived too late, was carried away by the flight of the others, and a few days later, in the neighbourhood of Chæronea, it was partly taken and partly cut to pieces by the Romans. The Achæans fled in disorder into Peloponnesus. In Bœotia all the people, quitting the towns, took refuge in the mountains; Thebes was deserted; many made away with themselves from despair, and many implored the Romans to kill them, declaring themselves to be the authors of all the misfortunes.

Diæus succeeded Critolaus in the command of the army; he was a person of the utmost incapacity, and formidable only to those who obeyed him.

He had recourse to the most extreme measures; he decreed that all judicial trials for debts should be stopped, all imprisoned debtors should be set free, and that no debt should become due before the close of the war — a sad decree



GREEK WATER VESSEL
(Berlin Museum)

for the wealthy, but it made him popular among the rabble. Twelve thousand slaves were to be manumitted and armed (they are called *παράτροφοι* — *i.e.*, milk-brothers, the children of female slaves or nurses); and heavy war contributions were levied. Four thousand men were sent to Megara to defend that place, and Diæus himself assembled the army on the isthmus. When Metellus appeared, those four thousand soon evacuated Megara, and all the forces were concentrated on the isthmus close to the walls of Corinth.

Metellus now appeared before Corinth. Animated by a feeling of humanity he wished to spare the city; such a magnificent ancient city was indeed something venerable to many a Roman, and the idea of destroying it was terrible to Metellus. It is also possible that he grudged the consul Mummius, who was already advancing in quick marches, the honour of

bringing the war to a close. Once more Metellus sent some Greeks to the Achæan army, according to Roman notions, fair terms, if they would but lay down their arms, and requesting them to put confidence in him. What else could he have done? But Diæus, who knew that his life was forfeited, goaded the poor people to madness. The Achæans, believing that Metellus had offered peace from a feeling of weakness, nearly killed the ambassadors, and Diæus did not set them free until a ransom of ten thousand drachmæ was paid; this is a characteristic feature of the man who showed his avarice to the very last minute. The hypostrategus, who was favourable to the Romans, was tortured.

In the meantime Mummius arrived and took the place of Metellus. He had no such feelings towards the Achæans as his predecessor, who returned to Rome. Mummius now had an army of twenty-three thousand foot and three thousand horse, while the Achæans had only fourteen thousand foot and a few hundred horse. The Achæans were encamped on the isthmus in a strong position, but this was of no avail. The Romans had a fleet furnished by their allies, while the Greeks had no ships, and the Roman fleet cruised along the whole coast of Peloponnesus, landing everywhere, and ravaging the country with the most fearful cruelty. What Themistocles had said to the Peloponnesians, when they wanted to fortify themselves on the isthmus, now came to pass; the contingents, especially those of the Elceus, dispersed in all directions in order to protect their own towns, without being able to do so.

A somewhat favourable engagement, in which they defeated a detachment of the Romans, which had ventured too far and was not duly supported, made the Achæans completely mad, and being thus encouraged they

[146 B.C.]

thoughtlessly attacked the Roman army. But their small advantage was immediately neutralised by a fatal blow; for in a great and decisive battle, the Achæans were so completely routed, that they were not even able to throw themselves into Corinth. The cavalry fled immediately; the infantry maintained its ground better, but in the end all fled in different directions into the mountains, and Diæus to Megalopolis, where he first murdered his wife and then took poison. All the population of Corinth deserted the city and took refuge in the mountains, as the Romans had done on the arrival of the Gauls, and were hunted by the Romans like wild beasts.^b

THE DESTRUCTION OF CORINTH

Mummius had not expected so easy a conquest, and, though informed that the gates were open, suspecting some stratagem, suffered an entire day to pass before he marched into the city. Though no resistance was offered, all the men found within the walls were put to the sword; the women and children were reserved for sale; and when all its treasures had been carried away, on a signal given by blast of the trumpet the city was consigned to the flames. So it is said the senate had expressly decreed. But vengeance for the insults offered to the Roman envoys was probably more the pretext than the motive for this cruelty. It was at least no less a crime in the eyes of the Roman soldiers that Corinth was the richest city of Greece. Scarcely any other was adorned with so many precious works of art. Mummius himself had as little eye for them as any of his men, who made dice-boards of the finest masterpieces of painting; but he knew that such things were highly valued by others, and he therefore preserved those which were accounted the choicest to embellish his triumph.

Before the arrival of the ten commissioners, who were sent in the autumn to regulate the state of Greece, he made a circuit in Peloponnesus to inflict punishment on the cities and persons that had taken an active share in the war. The walls of all such towns were dismantled, and their whole population disarmed. The adherents of Diæus were sentenced to death or exile, and their property confiscated; and the Achæans—that is, the cities which had contributed to the war—were condemned to pay two hundred talents [£40,000 or \$200,000] to Sparta. The greater part of the Corinthian territory was annexed to Sicyon. Mummius afterwards marched northward to deal like retribution among the insurgents of Bœotia and Eubœa. He razed Thebes and Chalcis—or at least their walls—to the ground; condemned the Bœotians and Eubœans—or more probably those cities alone—to pay one hundred talents to Heraclea, which they had helped to besiege; and at Chalcis he shed so much blood of the principal citizens, that Polybius himself can only reconcile his conduct with the supposed mildness of his character by the suggestion that he was urged by his council to unwonted severity.

It remained for the ten commissioners, according to the instructions of the senate, to fix the future condition of the conquered nation. All Greece, as far as Macedonia and Epirus, was constituted a Roman province: and Achaia enjoyed the melancholy distinction of giving its name to the whole. But the senate's jealousy was not satisfied with the formal establishment of its sovereignty; it had also decreed a series of regulations tending as much as possible to restrict every kind of union and intercourse among the Greeks, and to reduce them to the lowest stage of weakness and degradation. All federal assemblies, all democratical polities, were abolished, and the govern-

ment of each city committed to a magistracy, for which a certain amount of property was required as a qualification. No one might acquire land in any part of the province but that in which his franchise lay. The details of this outline, and all temporary measures for the settlement of the country, were left to the discretion of Mummius and the Ten; and Polybius, who appears to have arrived in Greece soon after the fall of Corinth, was now able in some degree to alleviate the calamity which he had found it impossible to avert; and perhaps it would not have been equally in his power to render such services to his countrymen if he had been previously less alienated, at least in appearance, from the national cause. As the intimate friend of the conqueror of Carthage, he was treated with the highest respect and confidence; and he employed his influence so as to win the esteem and gratitude of his fellow-citizens. Mummius himself, when sated with bloodshed and rapine, showed a disposition to conciliate the vanquished. Before his departure, though he had removed the statue of the Isthmian Poseidon, to dedicate it—in gross violation of religious propriety—in the temple of Jupiter at Rome, he repaired the damage which had been done to the public buildings on the Isthmus, adorned the temples of Olympia and Delphi, and made a circuit round the principal Greek cities to receive tokens of their gratitude.

The political institutions were of course, according to the senate's decree, strictly oligarchical. And in this respect no alteration seems ever to have been granted by the Roman government. But in some other points the rigour of its original regulations was a few years afterward greatly relaxed. The fines imposed on the Achæans, and on the Bœotians and Eubœans, were remitted; the restraints on intercourse and commerce were withdrawn; and the federal unions which had been abolished were revived. The Romans in their official language seem to have described this renewal of the old forms as a restoration of liberty to Greece. But even if the monument in which this sounding phrase appears to be applied to it, did not itself illustrate the vigilance with which the exercise of political freedom was checked by the provincial government, we might be sure that these revived confederations answered no other purpose than that of affording an occasion for some periodical festivals, and some empty titles, soothing perhaps to the feelings of the people, but without the slightest effect on their welfare. The end of the Achæan War was the last stage of the lingering process by which Rome enclosed her victim in the coils of her insidious diplomacy, covered it with the slime of her sycophants and hirelings, crushed it when it began to struggle, and then calmly preyed upon its vitals.

GREECE UNDER THE ROMANS

We have brought the political history of ancient Greece down to a point which may be fitly regarded as its close; since in the changes which afterwards befell the country the people remained nearly passive. The events of the Mithridatic War—in which the Achæans and Lacedæmonians, and all Bœotia, except Thespieæ, are said to have declared themselves against Rome, and the royal army in Greece received a reinforcement of Lacedæmonian and Achæan troops—might serve to indicate that the national spirit was not wholly extinct, or that the Roman dominion was felt to be intolerably oppressive. But Athens certainly no more deserved Sulla's bloody vengeance for the resistance into which she was forced by the tyranny of Athenion, than for the credulity with which she had listened to his lying promises.

[146 B.C.-540 A.D.]

No historical fact is more clearly ascertained than that from this epoch the nation was continually wasting away. Strabo,^e who visited Greece but a little more than a century later (B.C. 29), found desolation everywhere prevailing. Beside his special enumeration of ruined towns and deserted sites, and his emphatic silence as to the present, while he explores the faint vestiges or doubtful traditions of the past, the description of almost every region furnishes occasion for some general remark illustrating the melancholy truth. Messenia was for the most part deserted, and the population of Laconia very scanty in comparison with its ancient condition; for beside Sparta it contained but thirty small towns in the room of the hundred for which it had once been celebrated. Of Arcadia it was not worth while to say much, on account of its utter decay. There was scarcely any part of the land in tillage, but vast sheep-walks, and abundant pasture for herds of cattle, especially horses; and so the solitude of Ætolia and Acarnania had become no less favourable to the rearing of horses than Thessaly. Both Acarnania and Ætolia — he repeats elsewhere — are now utterly worn out and exhausted; as are many of the other nations. Of the towns of Doris scarcely a trace was left; the case was the same with the Ænians. Thebes had sunk to an insignificant village; and the other Bœotian cities in proportion — that is, as he elsewhere explains himself, they were reduced to ruins and names, all but Tanagra and Thespiæ, which, compared with the others, were tolerably well preserved.

It has been usual in modern times to attribute this decline of population to the loss of independence, to the withering influence of a foreign yoke — in a word, to Roman misrule. And it would be bold and probably an error, to assert, that it was wholly unconnected with the nature of the government to which Greece was subject as a Roman province. It is too well known what that government was — how seldom it was uprightly administered, how easily, even in the purest hands, it became the instrument of oppression. The ordinary burdens were heavy. The fisherman of Gyaros, who was sent ambassador to Augustus, to complain that a tax of 150 drachmæ was laid upon his island which could hardly pay two-thirds of that sum, afforded but a specimen of a common grievance. Greece was not exempt from those abuses which provoked the massacre of the Romans in Asia at the outbreak of the Mithridatic War. And even if we had no express information on the subject, we might have concluded that it did not escape the still more oppressive arbitrary exactions of corrupt magistrates, and their greedy officers. “Who does not know,” Cicero asks, “that the Achæans pay a large sum yearly to L. Piso?” It was notorious that he had received one hundred talents from them, beside plunder and extortion of other kinds. The picture which Cicero draws of the evils inflicted by L. Piso upon Greece is no doubt rhetorically overcharged; but it is one of utter impoverishment, exhaustion, and ruin. And here we may remark that the privileges of the free cities included in the province afforded no security against the rapacity and oppression of a Piso or a Verres. The Lacedæmonians, Strabo observes, were peculiarly favoured, and remained free, paying nothing but voluntary offerings. But these were among the most burdensome imposts; and so Athens, which enjoyed the like immunity, was nevertheless, according to Cicero’s phrase, torn to pieces by Piso. To this it must be added that the oligarchical institutions everywhere established — and even Athens was forced so to qualify her democracy that little more than the name seems to have been left — tended to promote the accumulation of property in few hands; as we read that the whole island of Cephallenia was subject to C. Antonius as his private estate.

Nevertheless it seems certain, that when these are represented as the main causes of the decline of population in Greece, which followed the loss of her independence, their importance has been greatly exaggerated, while others much more efficacious have been overlooked or disparaged. For on the one hand it is clear that this decline did not begin at that epoch, but had been going on for many generations before. A comparison of the forces brought into the field to meet the Celtic invasion by the states of northern Greece with those which they furnished in the Persian War, would be sufficient to prove the fact with regard to them; the evil lay deeper than the ravages of war. And we have now the evidence of Polybius, that in the period either

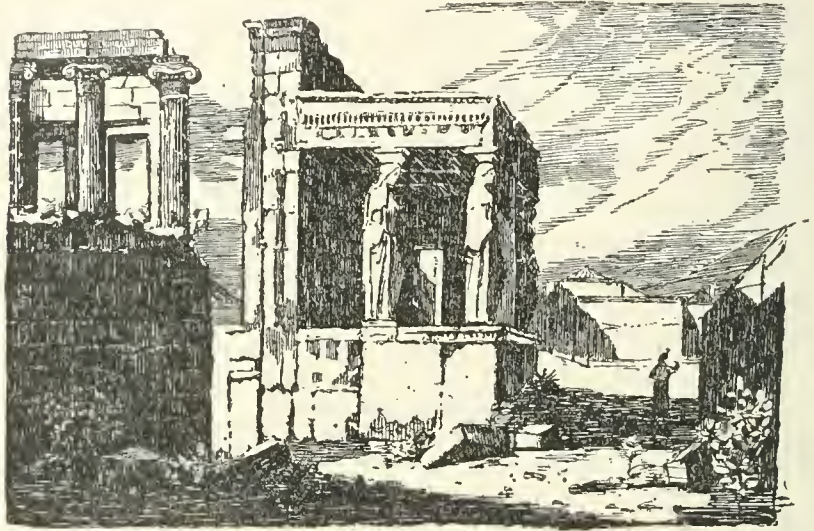

RUINS OF THE ERECHTHEUM, ATHENS

immediately preceding, or immediately subsequent to the establishment of the Roman government — a period which he describes as one of concord and comparative prosperity, when the wounds which had been inflicted on the peninsula were beginning to heal—even then the population was rapidly shrinking, through causes quite independent of any external agency, and intimately connected with the moral character and habits of the society itself.

The evil was not that the stream of population was violently absorbed, but that it flowed feebly, because there was an influence at work which tended to dry up the fountain-head. Marriages were rare and unfruitful through the prevalence of indifference or aversion toward the duties and enjoyments of domestic life. The historian traces this unhealthy state of feeling to a taste for luxury and ostentation. But this explanation, which could only apply to the wealthy, seems by no means adequate to the result. The real cause struck deeper, and was much more widely spread. Described in general terms, it was a want of reverence for the order of nature, for the natural revelation of the will of God; and the sanction of infanticide was by no means the most destructive, or the most loathsome form in which it manifested itself. This was the cancer which had been for many generations eating into the life of Greece.

How little the vices of the Roman government had to do with the decrease of population in Greece, becomes still more apparent as we follow its

[146 B.C.—540 A.D.]

course through the history of the empire. The change from republican to monarchical institutions was in general beneficial to the provinces, and especially to Greece, which was not only exempt from the danger of arbitrary oppression, but was distinguished by many marks of imperial favour. Within the space of a few years, about the beginning of this period, three new colonies animated the south coast of the Corinthian Gulf. Pompey planted a settlement of pirates in the solitude of Dyme. His great rival restored Corinth, and, if he had lived longer, would perhaps have opened a canal through the Isthmus. Though the commerce, which at the fall of Corinth had been diverted to Delos, and afterwards dispersed by the Mithridatic War, may not have wholly returned into its ancient channel, still there can be no question that the advantages of this restoration were very largely felt throughout Greece. Augustus founded another populous Roman colony at Patrae, which enjoyed the privileges of a free city. Nicopolis indeed was rather designed as a monument of his victory, than to promote the prosperity of Greece : for it was peopled from the decayed towns of the adjacent regions, and the effect was to turn Acarnania and Aetolia into a wilderness.

Athens too had soon repaired the loss it suffered through Sulla's massacre, though Piræus did not rise out of its ruins. But the Athenian population was recruited, as it had long been, by the lavish grant or cheap sale of the franchise. It was like the galley of Theseus, retaining nothing but the name and semblance of the old Athenian people, without any real natural identity of race ; so that it was no exaggeration, when Piso called it a jumble of divers nations. The poverty indeed of the city, which had been a main cause of its unfortunate accession to the side of Mithridates, still continued, and was but slightly relieved by the bounty of benefactors like Pomponius and Herodes Atticus, or even by the growing influx of wealthy strangers who came to pursue rhetorical or philosophical studies there.

While its splendour was increased by the magnificent structures added to it by Hadrian and Herodes, perhaps the larger part of the freemen was never quite secure of their daily meal. Still the good will of the early emperors was unequivocally manifested. They seem always to have lent a favourable ear to the complaints and petitions of the province, and Nero went so far as to reward the Greeks for their skilful flattery of his musical talents by an entire and general exemption from provincial government, which may have compensated for the presents he exacted from them. The Greeks, it is said, abused their new privileges by discord and tumults, and Vespasian restored the proconsular administration, and above all the tribute — which was perhaps his real motive — with the remark that they had forgotten the use of liberty. But it is evident that on the whole, from the reign of Augustus to that of Trajan, the increase of the population was not checked by oppression or by any calamity. Yet at the end of this period we find Plutarch declaring, that Greece had shared more largely than any other country in the general failure of population which had been caused by the wars and civil conflicts of former times over almost all the world, so that it could then hardly furnish three thousand heavy-armed soldiers — the number raised by Megara alone for the Persian War ; and his assertion is confirmed by the pictures drawn by another contemporary witness.

In times when the present was so void and cheerless, the future so dark and hopeless, it was natural that men should seek consolation in the past, even though it had been less full, than was the case among the Greeks, of power and beauty, prosperity and glory. Nor was it necessary then to evoke its images by learned toil out of the dust of libraries or archives. The whole

land was covered with its monuments in the most faultless productions of human genius and art. There was no region so desolate, no corner so secluded, as to be destitute of them. Even the rapacity of the Romans could not exhaust these treasures. Though Mummius was said to have filled Italy with the sculptures which he carried away, it is probable that in the immense multitude which remained, their absence, in point of number, might be scarcely perceived. If Nero robbed Delphi of five hundred statues, there might still be more than two thousand left there.

The expressive silence of these memorials was interpreted by legends which lived in the mind and the heart of the people; and so long as any inhabitants remained in a place, a guide was to be found thoroughly versed in this traditional lore. The town of Panopeus at the northern foot of Parnassus, though celebrated by Homer as a royal residence, had been reduced, when it was visited by Pausanias, to a miserable assemblage of huts, in which the traveller could find nothing to deserve the name of a city, as it contained neither an archive, nor a gymnasium, nor a theatre, nor a market-place, nor a fountain; but the people remembered that they were not of Phocian, but of Phlegyan origin: they could show the grave which covered the vast bulk of the great Tityus, and the remnants of the clay out of which Prometheus had moulded the human race. Relics of like antiquity were at the same period reverently treasured in most parts of Greece. The memory of the past was still more effectually preserved by a great variety of festivals, games, public sacrifices, and other religious solemnities. After the extinction of the national independence, the battle of Plataea did not cease to be commemorated by the Feast of Liberty; as notwithstanding the absence of all political interests, the forms of deliberation were kept up in the Amphictyonic, the Achæan, Phocian, and Bœotian councils. The heroes both of the mythical and the historical age were still honoured with anniversary rites — Aratus and Demosthenes, and the slain at Marathon, no less than Ajax and Achilles, Temenus, Phoroneus, and Melampus.

The religion of the Greeks, which was so intimately associated with almost all their social pleasures and their most important affairs, had never lost its hold on the great body of the nation. We hear much of the change wrought in the state of religious feeling by the speculations of the sophists, and the later kindred philosophical schools, by the frequent examples of sacrilegious violence, by the progress of luxury, and the growing corruption of manners. But the effect seems to have been confined to a not very large circle of the higher classes. With the common people paganism continued, probably as long as it subsisted at all, to be not a mere hereditary usage, but a personal, living, breathing, and active faith. In the age of the Antonines the Attic husbandmen still believed in the potent agency of their hero Marathon, as the Arcadian herdsmen fancied that they could hear the piping of Pan on the top of Mænalus. The national misfortunes, as they led the Greeks to cling the more fondly to their recollections of the past, tended to strengthen the influence of the old religion, and rendered them the less disposed to admit a new faith which shocked their patriotic pride and dispelled many pleasing illusions, while it ran counter to all their tastes and habits, and deprived them of their principal enjoyments. Accordingly, it seems that Christianity, notwithstanding the consolations it offered for all that it took away, made very slow progress beyond the cities in which it was first planted; and its ascendancy was not firmly established long before the beginning of a period in which a series of new calamities threatened the very existence of the nation.

[146 B.C.—540 A.D.]

The result of the Persian invasion in the mind of the victorious people had been a feeling of exulting self-confidence, which fostered the development of all its powers and resources. The terror of the Celtic inroad was followed by a sense of security earned in a great measure by an honourable struggle. Far different was the impression left by the irruption of Alaric, when Greece was at length delivered from his presence. The progress of the barbarians had been stopped by no resistance before they reached the utmost limits of the land. They retreated indeed before Stilicho, but not broken or discomfited, carrying off all their booty to take undisturbed possession of another, not a distant province. It was long indeed before the Greeks experienced a repetition of this calamity, but henceforth they lived in the consciousness that they were continually exposed to it. They neither had strength to defend themselves, nor could rely on their rulers for protection.

The safety of Greece was one of the last objects which occupied the attention of the court of Constantinople. In the utter uncertainty how soon a fresh invader might tread in the steps of Alaric, every rumour of the movements of the hordes which successively crossed the Danube, might well spread alarm, even in the remotest corners of Peloponnesus. The direction which they might take could be as little calculated as the course of lightning. Who could have foreseen that Attila and Theodoric would be diverted from their career to fall upon other prey — that Genseric after his repulse before Tanarus would not renew his invasion — that the Bulgarians would be so long detained by the plunder of the northern provinces? In the reign of Justinian the advances of the barbarians became more and more threatening, and in the year 540 northern Greece was again devastated by a mixed swarm of Huns and other equally ferocious spoilers, chiefly of the Slavonic race.

The strengthened fortifications of the Isthmus indeed withstood this flood, though they could not shelter the Peloponnesians from the earthquakes and the pestilence, which during this unhappy period were constantly wasting the scanty remains of the Hellenic population which had escaped or survived the inroads of the barbarians. Justinian's enormous line of fortresses revealed the imminence of the danger, but could not long avert it. In the course of the seventh and eighth centuries the worst forebodings were realised; after many transient incursions the country was permanently occupied by Slavonic settlers. The extent of the transformation which ensued is most clearly proved by the number of the new names which succeeded to those of the ancient geography. But it is also described by historians in terms which have suggested the belief that the native population was utterly swept away, and that the modern Greeks are the descendants of barbarous tribes which subsequently became subject to the empire, and received the language and religion which they have since retained from Byzantine missionaries and Anatolian colonists; and such is the obscurity which hangs over the final destiny of the most renowned nation of the earth, that it is much easier to show the weakness of the grounds on which this hypothesis has been reared, than to prove that it is very wide of the truth.^d

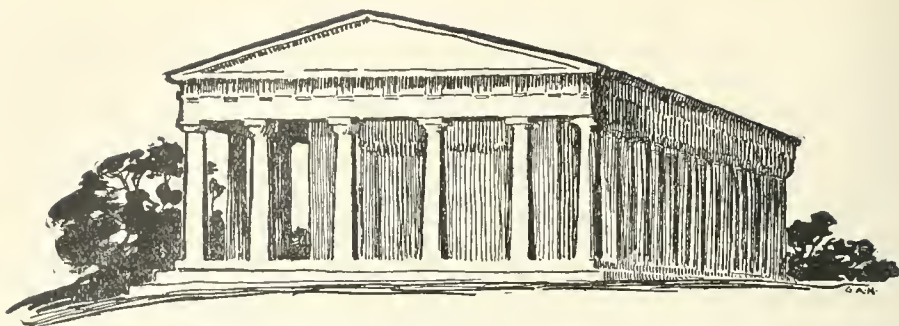

CHAPTER LXV. THE KINGDOM OF THE SELEUCIDÆ

IN the final tripartite division of Alexander's empire, the largest part, geographically speaking, fell to Seleucus, known as Nicator, or the Conqueror, who gave his name to the kingdom which was destined for many generations to play a more or less important part in Asiatic history. Seleucus had his capital first at Babylon and re-established the power of Grecian or Macedonian arms over a large part of the Asiatic territory of Alexander's empire. Subsequently the seat of the kingdom was shifted to the newly founded city of Antioch on the coast of Asia Minor, which became one of the most important capitals in the world, at times almost rivalling Alexandria. The territory and power of the Seleucidæ were early curtailed owing to the advance of outlying nations, notably the Parthians, and gradually disintegrated rather by slow stages than by the sudden shock of a single conquest. Chiefly because of the shifting of progress far to the west, it was not destined to play any really important part in the building of world history. In name, at least, the kingdom continued in independent existence long after Greece proper had been overthrown; but the Parthians and Sassanians in turn had largely shorn it of its glory, and it was these powers, rather than the Seleucidæ proper, that came into rivalry and conflict with the Roman might when that new mistress of the world extended her influence to the eastward. We must think therefore of the kingdom of the Seleucidæ rather as a link in time and place between great powers, than as a thing of really intrinsic importance. A brief summary of its history is, therefore, all that need detain us. Here again for the sake of clearness — if clearness be possible in this chaotic period — some repetition is unavoidable.^a

The kingdom of Syria was not confined to that country alone, but also comprehended those vast and fertile provinces of upper Asia, which formed the Persian empire; being, in its full extent, bounded by the Mediterranean on one side, and the river Indus on the other. These wide-spreading dominions are commonly called the kingdom of Syria, because Seleucus, the first of the Syro-Macedonian kings, having built the city of Antioch in that province, chose it, as did likewise his successors, for the usual place of his residence. Here his descendants, from him styled Seleucidæ, reigned, according to Eusebius, for the space of 251 years, that is, from the 117th Olympiad, when Seleucus recovered Babylon, to the third year of the 180th, when Antiochus Asiaticus, the last of the race of Seleucus, was driven out by Pompey, and Syria reduced to a Roman province. Before we proceed to the history of the Seleucidæ, we shall exhibit a series of the kings of that race, with the years of their respective reigns.

[323-312 B.C.]

A TABLE OF THE KINGS OF SYRIA, FROM THE FOUNDATION OF THAT MONARCHY TO ITS BEING REDUCED BY THE ROMANS, WITH THE YEARS OF THEIR RESPECTIVE REIGNS.

	YEARS		YEARS	
Selencus Nicator	32		Tryphon	4
Antiochus Soter	19		Antiochus Sidetes	11
Antiochus Theos	15		Alexander Zebina	13
Selencus Callinicus	20		Antiochus Grypus	19
Selencus Ceraunus	3		Antiochus Cyzicenus	21
Antiochus the Great	36		Selencus Epiphanes	7 months
Selencus Philopator	11		Antiochus Eusebes	1
Antiochus Epiphanes	11		Demetrius Eucærus	2
Antiochus Eupator	12		Philip	3
Demetrius Soter	12		Antiochus Epiphanes	4
Alexander Balas	5		Antiochus Dionysus	7
Demetrius Nicator	6		Tigranes	14
Antiochus Theos	3		Antiochus Asiaticus	4

Selencus, the founder of the Syro-Macedonian empire, was the son of Antiochus, one of the chief captains of Philip, the father of Alexander. He served under Alexander from his tender years, attended him in his expedition into Asia, and was by him honoured with the chief command of the elephants, a commission of great trust and reputation. After the death of that conqueror, Perdiccas, whom the officers had unaniously appointed regent of the empire, placed Selencus at the head of the cavalry of the allies; in which command he acquitted himself with such reputation that Antipater, who succeeded Perdiccas in his regency, raised him to the government of Babylon and its territory.

SELEUCUS

In this post he was tempted, by the example of the other captains of Alexander, who aspired to the supreme power in their respective allotments, to betray his trust, and entertain thoughts of setting up for himself; whence, when Eumenes, on his march into Susiana, pressed him to join the governors of the upper provinces against Antigonus, who had openly revolted, he not only refused to lend them any assistance, but even attempted to destroy both Eumenes and his army, by cutting the sluices of the Euphrates, and laying the whole plain where they were encamped under water. Eumenes, however, though thus surprised, reached an eminence with his troops, before the waters rose to any height, and the next day, by diverting their course, found means to escape the danger, without the loss of a single man. Selencus made a truce with Eumenes, granting him a free passage through his province. But when Antigonus demanded an account of the revenues of his government, the answer he gave him so exasperated Antigonus that he thought it advisable to abandon his province, and put himself under the protection of Ptolemy, governor of Egypt.

Selencus meeting with a friendly reception from Ptolemy, in Egypt, represented so effectually to that prince, as also to Lysimachus and Cassander, the formidable power and ambitious views of Antigonus, that he engaged them all three in a league against him. This war put an end both to the life and reign of Antigonus. After the victory which Ptolemy gained over Demetrius at Gaza, Selencus, having obtained of the conqueror a thousand foot and two hundred horse, took his route towards Babylon, in order to attempt the recovery of that city. This undertaking was looked upon as a desperate enterprise, even by his friends, but was attended with all the success he wished for.

Seleucus being now master of the city and castle, judged it necessary to raise what forces he could, not doubting that Antigonus would soon send an army to drive him from these acquisitions. Accordingly, while he was busy in recruiting his army and disciplining his new-raised troops, news was brought him that Nicanor, governor of Media under Antigonus, was advancing against him, at the head of ten thousand foot, and seven thousand horse. Upon this intelligence Seleucus marched out to meet him with three thousand foot and four hundred horse only, and passing the Tigris, concealed his men, as the enemy drew near, in the fens hard by the river, with a design to attack Nicanor unexpectedly; who not having had any intelligence of Seleucus' march, encamped in a disadvantageous post, where he was the following night surprised, and his army, after great slaughter, put to the rout. Such of the soldiers as survived the slaughter declared for Seleucus—a circumstance which enabled him to pursue his conquests, and reduce in a short time all Media and Susiana, with many of the adjacent provinces. Having, by this victory, established his interest and power in Babylon, he daily improved them by the clemency of his government, and by his justice, equity, and humanity, to such a degree that, from so low a beginning, he became, in a few years, the greatest and most powerful of all Alexander's successors.

And now Seleucus, seeing himself in quiet possession of Babylon and its territory, advanced at the head of a considerable army into Media, where he engaged and slew with his own hand Nicanor, or, as others call him, Nicator, whom Antigonus had sent against him. Having reduced all Media, he pursued his march into Persia, Bactria, Hyrcania, etc., subjecting to his new empire these and all the other provinces on this side the Indus, which had been formerly conquered by Alexander. In the meantime Antigonus and Demetrius having assumed the title of king, Seleucus imitated their example, styling himself king of Babylon and Media.

Having therefore no enemy to fear on this side the Indus, he resolved to cross that river, and, by a sudden irruption, make himself master of those vast provinces which were known by the name of India. These Alexander had formerly subdued; but after his death, while his successors were engaged in mutual wars with each other, one Sandrocottus, or, as others call him, Androcottus, an Indian of mean extraction, under the specious pretence of delivering his country from the tyranny of foreigners, had raised a powerful army, and having driven out the Macedonians, seized the Indian provinces for himself. To recover these provinces Seleucus crossed the Indus: but finding that Sandrocottus had made himself absolute master of all India and drawn into the field an army of six hundred thousand men, with a prodigious number of elephants, he did not judge it advisable to provoke so great a power; and therefore entering into a treaty with him, he agreed to renounce all his pretensions to that country, provided Sandrocottus furnished him with five hundred elephants—which proposal the Indian prince willingly agreeing to, a peace was concluded between them.

Seleucus marching into the upper Syria, made himself master of that rich province, and built on the river Orontes the city of Antioch, which soon became, and continued to be for many ages, the metropolis of the East; for the Syrian kings, and afterwards the Roman governors, who presided over the affairs of the eastern provinces, chose it for their place of residence; and afterward in the Christian times, it was the see of the chief patriarch of Asia. Besides Antioch, Seleucus built in the same country several other cities of less importance.

[283-273 B.C.]

A few months after the decease of Demetrius, died also Ptolemy Soter, king of Egypt, so that two only of Alexander's captains survived, — viz., Lysimachus and Seleucus. As they were each upwards of seventy, it was expected that they should have closed the scene of life in the union which had subsisted so long between them, for they had ever been closely united, and, to the utmost of their power, supported each other; but it happened quite otherwise; a war, which proved fatal to both, soon breaking out between them.

Seleucus was easily persuaded to engage in this war, being already sufficiently inclined to it on other accounts; but before he embarked in so great an undertaking, he not only resigned to his son Antiochus a considerable part of his empire, but also, by an unparalleled example, his favourite queen Stratonice. Seleucus having, without much difficulty, prevailed upon Stratonice to accept of a young prince for her husband instead of an old king, the nuptials were solemnised with the utmost pomp and magnificence; after which Antiochus and Stratonice were crowned king and queen of upper Asia, Seleucus willingly resigning to them all those provinces.

Seleucus advanced into Asia Minor, where he easily reduced all the places belonging to Lysimachus. The city of Sardis was soon obliged to capitulate. Lysimachus met the enemy at Corupedion in Phrygia. The engagement was very bloody, and the victory long doubtful; but at last Lysimachus, who had fought the whole time at the head of his troops with incredible bravery, being run through with a spear by Malacon of Heraclea, and killed on the spot, his soldiers betook themselves to flight, and left Seleucus master of the field and all their baggage. Thus died Lysimachus, after having seen the death of fifteen of his children; and as he was, to use the expression of Memnon, the last stone of his house to be pulled down, Seleucus, without opposition, made himself master of all his dominions.

What gave him most pleasure on this occasion was that he now was the only survivor of all the captains of Alexander; and that, by the event of this battle, he was become, as he styled himself, the Conqueror of Conquerors. This last victory, which he looked upon as the effect of a peculiar providence in his favour, gave him the best title to the name of Nicator, or conqueror, by which historians commonly distinguish him from other kings of the same name, who afterwards reigned in Syria.

His triumph on this occasion did not last long; for, seven months after, as he was marching into Macedon, to take possession of that kingdom, with a design to pass the remainder of his life in his native country, he was treacherously slain by Ptolemy Ceraunus, on whom he had conferred innumerable favours. Such was the end of Seleucus, the greatest general in the opinion of Arrian, and the most powerful prince, after Alexander, in the age he lived in. He died in the forty-third year after the death of Alexander, in the thirty-second of the Grecian or Seleucian era, and seventy-third or, as Justin will have it, seventy-eighth of his age.

ANTIOCHUS SOTER

On the death of Seleucus, Antiochus, surnamed Soter, his son by Apama, the daughter of Artabazus the Persian, took possession of the empire of Asia, and held it for the space of nineteen years.

Sosthenes, who had reigned some years in Macedon, being dead, Antiochus Soter, and Antigonus Gonatas, the son of Demetrius, laid claim to

that kingdom, their fathers having held it, one after the other ; but Antigonus, who had already reigned ten years in Greece, being nearest, first took possession of those dominions ; but neither daring to attack the other, the two kings came to an agreement ; and Antigonus having married Phila, the daughter of Stratonice by Seleucus, Antiochus renounced his pretensions to the crown of Macedon. In consequence of this renunciation, Antigonus not only quietly enjoyed the kingdom of Macedon, but transmitted it to his posterity, who reigned there for several generations.

Antiochus now marched against the Gauls, who having, by the favour of Nicomedes, got settlements in Asia, harassed, with frequent incursions, the neighbouring princes. Antiochus defeated them with great slaughter, and delivered those provinces from their oppressions ; and hence he acquired the title of Soter, or "saviour."

Not long after this successful expedition against the Gauls, Antiochus, hearing of the death of Philetærus, prince of Pergamus, seized that oppor-



RUINS OF ANTIOCH

tunity to invade his territories, with a view to add them to his own dominions ; but Eumenes, nephew and successor of the deceased prince, having raised a considerable army, encountered him near Sardis, overthrew him in battle, and thereby not only secured himself in the possession of what he had already enjoyed, but enlarged his dominions with several new acquisitions. After his defeat, Antiochus returning to Antioch there put to death one of his own sons for raising disturbances in his absence, and at the same time proclaimed the other, called also Antiochus, king of Syria. He died soon after, leaving his son in the sole possession of his dominions. The young prince was his son by Stratonice.

Antiochus, on his accession to the throne, assumed the surname of Theos, — that is, god ; and by this he is distinguished from the other kings of Syria who bore the name of Antiochus.

In the third year of the reign of Antiochus Soter, a bloody war had broken out between him and Ptolemy Philadelphus, king of Egypt. While Antiochus was thus engaged in a war with the king of Egypt, great commotions and revolts happened in the eastern provinces of his empire, which, as he was not at leisure to suppress them immediately, increased to such a degree that he could never afterwards re-establish quiet ; by which means Antiochus lost all the provinces of his empire lying beyond the Euphrates.

[261-223 B.C.]

These troubles and commotions in the East made Antiochus Theos weary of his war with Ptolemy; a treaty of peace was therefore concluded on the following terms: that Antiochus should divorce his former wife Laodice, who was his own sister by the father, marry Berenice, the daughter of Ptolemy, and settle the crown upon the male issue of that marriage. Two years after this marriage Ptolemy Philadelphus died — an event which Antiochus Theos, his son-in-law, no sooner understood than he removed Berenice from his bed, and recalled Laodice, with her children Seleucus Callinicus, and Antiochus Hierax; but Laodice being well acquainted with his fickle temper, and fearing lest he might again abandon her and receive Berenice, resolved to improve the present opportunity and secure the succession to her son, for by the late treaty with Ptolemy, her children were disinherited and the crown settled on the son of Berenice. To effect this design, she caused Antiochus to be poisoned; when she saw him expiring, she ordered him to be privately conveyed away, and one Artemon, who greatly resembled him, as well in features as in the tone of his voice, to be placed in his bed. Artemon acted his part with great dexterity, and personating Antiochus, tenderly recommended his dear Laodice and her children to the lords that visited him. In the name of Antiochus, whom the people believed still alive, orders were issued, enjoining all his subjects to obey his beloved son Seleucus Callinicus, and acknowledge him for their lawful sovereign. The crown being by this infamous contrivance secured to Callinicus, the death of the king was publicly declared, and Callinicus without any opposition ascended the throne. Antiochus Hierax, the other son of Laodice, had at this time the government of the provinces of Asia Minor, where he commanded a considerable body of troops.^c

Hardly had Seleucus to some extent recovered from the severe defeats inflicted upon him by Ptolemy the “benefactor” during the three years’ war of vengeance, when his younger brother Antiochus, surnamed “the hawk” (Hierax) on account of his rapacity, raised the standard of revolt in conjunction with Mithridates of Pontus, and (Seleucus having been routed by Galatian mercenaries in a terrible battle at Ancyra) made himself master of a large part of Asia Minor, but was forced to pay tribute for it to the hordes of Celtic robbers, who overran the provinces after their victory, ravaging and pillaging with impunity. Not until Seleucus had effected a reconciliation with his brother and made a peace by which he resigned to the latter his dominions in Asia Minor, was he able gradually to reunite the lost or rebellious provinces and to restore tranquillity and order in his kingdom. Both brothers were brave and energetic; but the sanguinary quarrels of their house, and the crimes which were handed down from generation to generation to beget fresh acts of revenge, had imbruted their minds. Alike in vigour, restlessness, and violence, they persecuted each other to the death. Antiochus died a fugitive in a Thracian city under the blows of Celtic assassins, and his royal brother fell in the following year in an unsuccessful fight with Attalus I, the conqueror of the Galatians and ruler of the kingdom of Pergamus.

The son and successor of Seleucus, who bore the same name as his father with the surname of “the thunderbolt” (Ceraunus), entered on the heritage of the kingdom and the war with Attalus, but after a reign of three years met his death in battle at the hands of Nicanor and the Galatian captain Apaturius. The Syrian army then bestowed the crown upon his younger brother, Antiochus III. He, being occupied with the eastern provinces, delegated the conduct of the war in Asia Minor to his maternal uncle

Achæus. They both fought with good fortune and success. While the king led an expedition into Media and Persia, defeated the rebellious satraps Molon and Alexander in the field and constrained them to commit suicide, and compelled the Bactrians, Parthians, and Indians to acknowledge the suzerainty of the Syrian king, Achæus drove his adversary Attalus back over the frontiers of his own principality, pressed hard upon him in his own capital, and, by a policy of mingled conciliation and coercion, prevailed upon the Greek cities of the western coast to submit to annexation. But, rendered presumptuous by success, he next attempted to set up an independent kingdom in Asia Minor, and thus again prevented the complete restoration of the Seleucid dominion. Antiochus, involved in a fresh war with Egypt, from which country he was scheming to wrest the intermediate Syrian territory of the Lebanon, was obliged to let his uncle have a free hand for a while. But he had hardly concluded peace with Ptolemy after the disastrous battle of Raphia in the ancient country of the Philistines, and abandoned his claim to the Syrian coast, before he took the field against the traitorous Achæus. The latter, deserted by most of his troops, took refuge in the fortified city of Sardis, where he was closely besieged by Antiochus, and, having been treacherously betrayed into his hands, was put to a painful death.

Antiochus, whom the flattery of contemporary historians styles "the great," then conceived the design of restoring the empire of the Seleucids to its pristine expansion. For this purpose he undertook an adventurous campaign of several years' duration in eastern Iran and India, constrained the revolting princes and states to do homage to him, and extorted a recognition (more apparent than real) of Syrian supremacy.

Just as Antiochus returned to Asia Minor the fourth Ptolemy, the voluptuous Philopator, died, and his son Ptolemy Epiphanes, a minor, succeeded to the kingdom. The consequent disorders, factions, and weakness of Egypt inspired the enterprising king of Syria with the hope that he might after all acquire the coast land of the Lebanon. Reinforced by a treaty of partition with Philip of Macedonia, who himself coveted the Egyptian possessions in Asia Minor, Thrace, and the islands, Antiochus invaded Judea with an army, overthrew the Ætolian leader, Scopas, commander of the Egyptian forces, at Paneas near the sources of the Jordan, and subjugated the coast, including the fortified town of Gaza. The inhabitants of Jerusalem and Judea gladly welcomed the rule of Syria, which was at first mild and conciliatory, though it soon became even more oppressive than that of Egypt. The guardians of the Egyptian king hastened to prevent an attack upon Egypt itself by concluding a treaty of peace in which they renounced all claim to the conquered territory and betrothed their ward to Cleopatra, daughter of Antiochus. Meanwhile Philip had been waging successful war in Asia Minor, the Hellespont, and the islands, though all his conquests were rendered nugatory by the disastrous fight with the Romans at Cynoscephalæ.

Instead of manfully supporting his ally against the mighty adversary from the west, Antiochus endeavoured to turn the withdrawal of the Macedonian army to his own profit. He laid claim to all the territory west of the Taurus and on both shores of the Hellespont which his ancestor Seleucus had acquired by his victory over Lysimachus; and, not content with mastering the Greek cities on the Asiatic coast and the independent kings of Pergamus, Bithynia, Cappadocia, Pontus, and Armenia, he crossed the Hellespont, occupied the city of Lysimachia which had been rebuilt, together with other places on the Thracian peninsula, and threatened Lampsacus, Byzantium,

[196-170 B.C.]

and Heraclea. Apprehensive for their independence, the princes and cities he menaced followed the example set by the rich and powerful commercial city of Rhodes, and placed themselves under the protection of the Romans. The latter, by repeated embassies, required "the great" king to desist from hostilities against their allies, and to liberate all the Greek cities in Asia and Europe. Antiochus haughtily declined Roman intermeddling with his affairs, saying that as he did not trouble himself about the concerns of Italy and the western world, so he forbade the Romans to curtail his prerogatives in Asia and Thrace, stigmatising their demands as contrary to justice and honour. [He also gave the Carthaginian Hannibal his protection and support against Rome.] Further negotiations by embassies and epistles delayed the outbreak of war for some years, but could not divert the fatal blow from the Syrian empire. The battle of Magnesia broke the might of the Seleucid kingdom for evermore; Syria made no second appeal to arms. Antiochus "the great" was slain at Elymais, south of the Caspian Sea, by the inhabitants of the city, while he was engaged in plundering the temple of Baal to fill his empty coffers with its treasures.^b

SELEUCUS PHILOPATOR

He was succeeded by Seleucus, surnamed Philopator, or, as Josephus^d styles him, Soter, which indeed was the surname of his son Demetrius. This prince reigned eleven years and some months; but made a very poor figure, by reason of the low state to which the Syrian empire had been reduced by the Romans, and the exorbitant sum of a thousand talents he was obliged to pay annually, by virtue of the treaty of peace between the king his father and that republic. It was under this prince that the famous accident happened concerning Heliodorus, which is mentioned in the second book of Maccabees, and described in the History of Israel. Later Heliodorus poisoned Seleucus and put the crown on his own head.

Antiochus, brother of Seleucus, being arrived at Athens on his return from Rome, received there the news of his brother's death, and was at the same time told that Heliodorus had seized the crown and was supported by a strong party; but that another was forming in favour of Ptolemy, who claimed the kingdom of Syria, in right of his mother, the deceased king's sister. Hereupon Antiochus had recourse to Eumenes, king of Pergamus, and to Attalus, the king's brother, who conducted him into Syria, at the head of a powerful army, drove out the usurper, and seated him on the throne. On his being settled on the throne he assumed the name of Epiphanes, that is, "the illustrious," which title was never worse applied. His odd and extravagant conduct made his subjects look upon him as a madman; whence, instead of Epiphanes, or "the illustrious," they used to style him Epimanes, that is, "the madman."

Antiochus having, ever since the return of Apollonius from the Egyptian court, been making the necessary preparations for the war with Ptolemy, was met by the forces of Ptolemy, between Mount Casius and Pelusium. Hereupon an engagement ensued, in which the Egyptians were routed at the first onset. Antiochus, having spent the whole winter in making fresh preparations for a second expedition into Egypt, gained a second victory over the forces of Ptolemy, took Pelusium, and led his army into the very heart of the kingdom. In this last overthrow it was in his power to have cut off all the Egyptians to a man; but, instead of pursuing his advantage, he took

care to put a stop to the slaughter, riding about the field in person, forbidding his men to put any more to death. This clemency gained him the hearts of the Egyptians so completely, that when he advanced into the country all the inhabitants voluntarily submitted to him; by which means he made himself master of Memphis, and all the rest of Egypt, except Alexandria, which still held out against him. In his second invasion Ptolemy fell into the hands of the conqueror; but whether he was taken prisoner, or surrendered himself voluntarily, is uncertain. It was at this time that Antiochus took Jerusalem, and profaned the temple.

The Alexandrians, seeing Ptolemy Philometor in the hands of Antiochus, whom he suffered to govern his kingdom as he pleased, looked upon him as lost to them, and therefore placed his younger brother on the throne, giving him the name of Euergetes, which was afterwards changed into that of Physcon, or "great-bellied," his luxury and gluttony having made him remarkably corpulent, and by this name he is most commonly mentioned in history.

Antiochus, being informed of what was transacting in Egypt, took occasion from this to return a third time into that country, upon the specious pretence of restoring the deposed king; but in reality he made himself master of the kingdom. Having therefore defeated the Alexandrians in a sea-fight near Pelusium, he again entered that unhappy country at the head of a powerful army, and advanced directly to Alexandria to besiege it.

In this extremity Ptolemy Euergetes and Cleopatra his sister, who were in the city, sent ambassadors to Rome representing their situation, and imploring the assistance of that powerful republic. The Roman ambassadors obliged Antiochus to quit Egypt. On his return, being highly provoked to see himself thus obliged to quit a kingdom which he looked upon as his own, Antiochus vented his rage upon the city of Jerusalem, which had given him no offence. But the desolations he caused in Judea, and the bloody war which he carried on against the Jews, with the generous resistance made first by Mattathias, and afterwards by his son, the brave Judas Maccabæus, are recorded in the history of that people.^c

On the death of Antiochus, his favourite Philip was left as regent during the minority of Antiochus Eupator. Philip was however put to death by a rival, Lysias. Meanwhile Demetrius, the son of Seleucus Philopator, who had been at Rome as hostage for many years, escaped and seized the throne, taking the surname of Soter, "saviour." The Romans acknowledged him, but with so little enthusiasm that when an alleged impostor, Alexander Balas, claiming to be the son of Antiochus, appeared, the Romans favoured him, and he defeated Demetrius, who fell in battle 150 B.C. He left a son, also named Demetrius, who, with the aid of Ptolemy Philometor of Egypt, defeated Alexander Balas, and put him to death. Demetrius, called Nicator, was overthrown by a general named Tryphon acting for Antiochus, the son of Alexander Balas, who was crowned as Antiochus Theos, only to be put to death later by Tryphon, who claimed the crown. Tryphon was dispossessed by the brother of Demetrius Nicator, who took the name of Antiochus Sidetes, a monarch of many good qualities, and reigned nine years, winning praise even from the Jews who had suffered so much from Syrian kings. He was killed in battle with the Parthians, and Demetrius Nicator, who had remained in captivity all these nine years, recovered the throne, but was slain by a new pretender, Alexander Zebina, who was put to death by a son of Demetrius Nicator, called Antiochus Grypus, who is said to have made his mother Cleopatra—a past mistress of intrigue—drink a bowl of poison she had prepared for him.

[125-65 B.C.]

After a reign of eight years he was opposed by his half-brother, Antiochus Cyzicenus, who compelled him to share the kingdom. Grypus being assassinated, Syria was again made one under a Seleucus Epihanes, who defeated Cyzicenus only to be expelled in seven months by Antiochus Eusebes, who in turn, after a year, fell before Grypus' fourth son, Demetrius Eucerus. He was driven out by his own brother Philip, and Philip by a younger brother, Antiochus Dionysius.

By this time the kaleidoscopic feuds of the Seleucidæ had weakened Syria till it was ripe for a foreigner, and the Armenian king, Tigranes, made prey of it. A last claimant, Antiochus Asiaticus, held out for a time: then called in the Romans, who under Pompey absorbed Syria into the empire, and put an end to the race of Seleucus, which had ruled from about 312 B.C. to 65 B.C.^a



GREEK BOTTLES

(In the Museum of Napoleon III)



CHAPTER LXVI. THE KINGDOM OF THE PTOLEMIES

WHEN the empire of Alexander was parcelled out among his generals, the most desirable lot perhaps was that which fell to the share of Ptolemy. That astute general chose Egypt for his portion, and despite the efforts of his rivals, he was able, thanks in part to the isolated geographical position, to retain it, and ultimately to become its recognised sovereign and the founder of a dynasty of kings which was to hold unbroken sway there for the long period of three hundred years.

Ptolemy, besides being an excellent general, was evidently a man of rather wide culture and varied attainments. His capacities have been sometimes accounted for by the suggestion that he was probably in fact the half-brother of Alexander the Great, as his mother had been a concubine of Philip; though his royal paternity, if indeed a fact, was never officially recognised. Be that as it may, Ptolemy was a man of great ability as a ruler, and his general culture is evidenced by the fact that he wrote a history of the life and campaigns of Alexander, which work, as we have already seen, was one of the two chief sources from which the history of Arrian was compiled.

The first Ptolemy founded, and his successors enlarged and extended, the famous Alexandrian library, which came to be by far the most important collection of books that had probably been gathered together anywhere in the world up to that time, comprising, it is said, no fewer than half a million manuscripts. In connection with the library was an institution which was virtually a college, where the most distinguished scholars of the day studied and taught. The language and the entire official life thus transplanted into Old Egypt were of course Grecian. All official connection with the mother country was soon utterly broken; the kingdom of the Ptolemies, as a political factor, was a thing quite apart; but in the broader sense the new Egyptian power was essentially Greek. Alexandria, the new Athens, became the centre of Greek life, thought, and influence; it was there, rather than to Athens itself, that the youth flocked from the provinces to drink at that fount of Grecian culture which still maintained its influence in the world for generations after the original Hellas had been shattered in power and shorn of all political significance.

But the time came when the Egyptian empire also was to come in conflict with the Romans. The tragic romance of Cleopatra, the last daughter of the Ptolemies, is known to every one, though curiously enough the patent fact is often overlooked that this "daughter of the Nile" was in no proper sense an Egyptian, but to the last drop of her blood a Macedonian Greek, bearing the name even of one of the wives of the father of Alexander the

[323-321 B.C.]

Great. It was this Egyptian empire of the Ptolemies, then, which served as the direct channel of transit of the old Grecian culture to Rome, somewhat as Persia had been the channel of transit of Egyptian and Babylonian culture to Greece. It was a curious and interesting revival through which Egypt, which for some centuries had ceased to play an important part in the great game of the nations, came to be again the centre of culture of the entire world, even though this time it bore an exotic and not an indigenous culture.

But though this empire of the Ptolemies had thus a vastly greater importance than the other portions of Alexander's dismembered empire, we shall treat its history somewhat briefly here, since we must necessarily return to some phases of it more in detail in pursuing the history of that Roman power by which the kingdom of the Ptolemies was finally overthrown.^a

THE KINGDOM OF THE PTOLEMIES: THE THIRTY-THIRD EGYPTIAN DYNASTY

	YEARS	BEGAN B.C.
Lagus or Soter reigned	38	323
Philadelphus	38	285
Euergetes	25	247
Philopator	17	222
Epiphanes	24	204
Philometor	35	181
Physcon or Euergetes II	29	146
Soter II or Lathyrus	10	117
Alexander I (Soter deposed)	18	107
Soter II restored	7	89
Berenice	6 months	81
Alexander II	6 months	80
Neus Dionysus or Auletes	14	80
Ptolemy the Elder	4	51
Ptolemy the Younger	3	48
Cleopatra	14	44
Egypt a Roman province		30 ^a

When Egypt was given to Ptolemy by the council of generals, Cleomenes was at the same time and by the same power made second in command, and he governed Egypt for one year before Ptolemy's arrival, that being in name the first year of the reign of Philip Arrhidæus, or, according to the chronologer's mode of dating, the first year after Alexander's death. The first act of Ptolemy was to put Cleomenes to death.

Perdiccas, in the death of Cleomenes and the seizure of the body of Alexander, had seen quite enough proof that Ptolemy, though too wise to take the name of king, had in reality grasped the power; and he now led the Macedonian army against Egypt, to enforce obedience and to punish the rebellious lieutenant.

Perdiccas attempted to cross the Nile at the deep fords below Memphis. Part of his army passed the first ford, though the water was up to the men's breasts. But they could not pass the second ford in the face of Ptolemy's army. After this check, whole bodies of men, headed by their generals, left their ranks; and among them Pithon, a general who had held the same rank under Alexander as Perdiccas himself, and who would no longer put up with his haughty commands. Upon this the disorder spread through the whole army, and Perdiccas soon fell by the hand of one of his own soldiers.

On the death of their leader, all cause of war ceased. Ptolemy sent corn and cattle into the camp of the invading army, which then asked for orders from him who the day before had been their enemy. The princes, Philip Arrhidæus and the young Alexander, both fell into his hands; and he might

then, as guardian in their name, have sent his orders over the whole of Alexander's conquests. But, by grasping at what was clearly out of his reach, he would have lost more friends and power than he would have gained; and when the Macedonian phalanx, whose voice was law to the rest of the army, asked his advice in the choice of a guardian for the two princes, he recommended to them Pithon and Arrhidæus; Pithon, who had just joined him, and had been the cause of the rout of the Macedonian army, and Arrhidæus, who had given up to him the body of Alexander.

The Macedonian army, accordingly, chose Pithon and Arrhidæus as guardians, and as rulers with unlimited power over the whole of Alexander's



BACCHANALIAN FIGURE
(After Illope)

conquests; but though none of the Greek generals who now held Asia Minor, Syria, Babylonia, Thrace, or Egypt, dared to acknowledge it to the soldiers, yet in reality the power of the guardians was limited to the little kingdom of Macedonia. With the death of Perdicas, and the withdrawal of his army, Phœnicia and Cœle-Syria were left unguarded, and almost without a master; and Ptolemy, who had before been kept back by his wise forethought rather than by the moderation of his views, sent an army under the command of Nicanor, to conquer those countries. Jerusalem was the only place that held out against the Egyptian army; but Nicanor, says the historian Agatharchides, seeing that on every seventh day the garrison withdrew from the walls, chose that day for the assault, and thus gained the city. What used to be Egypt was an inland kingdom, bounded by the desert; but Egypt under Ptolemy was a country on the seacoast;

and on the conquest of Phœnicia and Cœle-Syria he was master of the forests of Libanus and Antilibanus, and stretched his coast from Cyrene to Antioch, a distance of twelve hundred miles.

The wise and mild plans which were laid down by Alexander for the government of Egypt, when a province, were easily followed by Ptolemy when it became his own kingdom. The Greek soldiers lived in their garrisons or in Alexandria under the Macedonian laws; while the Egyptian laws were administered by their own priests, who were upheld in all the rights of their order and in their freedom from land tax.

While Egypt under Ptolemy was thus enjoying the advantages of its insulated position, and was thereby at leisure to cultivate the arts of peace, the other provinces were being harassed by the unceasing wars of Alexander's generals, who were aiming like Ptolemy at raising their own power.

Antigonus, in his ambitious efforts to stretch his power over the whole of the provinces, had by force or treachery driven Seleucus out of Babylon, and forced him to seek Egypt for safety, where Ptolemy received him with the kindness and good policy which had before gained so many friends. No arguments of Seleucus were wanting to persuade Ptolemy that Antigonus was aiming at universal conquest, and that his next attack would be upon Egypt. He therefore sent ambassadors to make treaties of alliance with

[316-311 B.C.]

Cassander and Lysimachus, who readily joined him against the common enemy.

Ptolemy crossed over to Cyprus to punish the kings of the little states on that island for having joined Antigonus; for now that the fate of empires was to be settled by naval battles the friendship of Cyprus became very important to the neighbouring states. He landed there with so large a force that he met with no resistance. He added Cyprus to the rest of his dominions. He banished the kings, and made Nicoreon governor of the whole island. From Cyprus, Ptolemy landed with his army in upper Syria, and then marching hastily into Asia Minor he took Mallus, a city of Cilicia. Having rewarded his soldiers with the booty there seized, he again embarked and returned to Alexandria. This inroad drew off the enemy from Coele-Syria.

Ptolemy, on reaching Alexandria, set his army in motion towards Pelusium, on its way to Palestine. He was met at Gaza by the young Demetrius with an army of eleven thousand foot and twenty-three hundred horse, followed by forty-three elephants and a body of light-armed barbarians, who, like the Egyptians in the army of Ptolemy, were not counted. But the youthful courage of Demetrius was no match for the cool skill and larger army of Ptolemy; the elephants were easily stopped by iron hurdles, and the Egyptian army, after gaining a complete victory, entered Gaza, while Demetrius fled to Azotus. Ptolemy, in his victory, showed a generosity unknown in ancient warfare; he not only gave leave to the conquered army to bury their dead, but sent back the whole of the royal baggage which had fallen into his hands, and also those personal friends of Demetrius who were found among the prisoners. By this victory the whole of Phœnicia was again joined to Egypt, and Seleucus regained Babylonia.

When Antigonus, who was in Phrygia on the other side of his kingdom, heard that his son Demetrius had been beaten at Gaza, he marched with all his forces to give battle to Ptolemy. Ptolemy did not choose to risk his kingdom against the far larger forces of Antigonus. Therefore, with the advice of his council of generals, he levelled the fortifications of Acca, Joppa, Samaria, and Gaza, and withdrew his forces and treasure into Egypt, leaving the desert between himself and the army of Antigonus. Antigonus then led his army northward, leaving Egypt unattacked.

This retreat was followed by a treaty of peace between these generals, by which it was agreed that each should keep the country that he then held; that Cassander should govern Macedonia until Alexander Ægus, the son of Alexander the Great, should be of age; that Lysimachus should keep Thraee, Ptolemy Egypt, and Antigonus Asia Minor and Palestine; and each wishing to be looked upon as the friend of the soldiers by whom his power was upheld and the whole of these wide conquests kept in awe, added the very unnecessary article that the Greeks living in each of these countries should be governed according to their own laws.

All the provinces held by these generals became more or less Greek kingdoms, yet in no one did so many Greeks settle as in Lower Egypt. Though the rest of Egypt was governed by Egyptian laws and judges, the city of Alexandria was under Macedonian law. It did not form part of the nome of Hermopolites in which it was built. It scarcely formed a part of Egypt, but was a Greek state in its neighbourhood, holding the Egyptians in a state of slavery. In that city no Egyptian could live without feeling himself of a conquered race. He was not admitted to the privileges of Macedonian citizenship; while they were at once granted to every Greek, and soon to every Jew, who would settle there.

By the treaty just spoken of, Ptolemy, in the thirteenth year after the death of Alexander, was left undisputed master of Egypt. During these years he had not only gained the love of the Egyptians and Alexandrians by his wise and just government, but had won their respect as a general by the skill with which he had kept the war at a distance. He had lost and won battles in Syria, in Asia Minor, in the island of Cyprus, and at sea; but since Perdiceas marched against him, before he had a force to defend himself with, no foreign army had drunk the sacred waters of the Nile.

The next year Ptolemy, finding that his troops could hardly keep their possessions in Cilicia, carried over an army in person to attack the forces of Antigonus in Lycia. He gained the whole southern coast of Asia Minor.

While Ptolemy was busy in helping the Greek cities of Asia to gain their liberty, Menelaus, his brother and admiral, was almost driven out of Cyprus by Demetrius. On this Ptolemy got together his fleet, to the number of 140 long galleys and two hundred transports, manned with not less than ten thousand men, and sailed with them to the help of his brother. This fleet under the command of Menelaus was met by Demetrius with the fleet of Antigonus, consisting of 112 long galleys and a number of transports; and the Egyptian fleet, which had hitherto been master of the sea, was beaten near the city of Salamis in Cyprus by the smaller fleet of Demetrius. This was the heaviest loss that had ever befallen Ptolemy. Eighty long galleys were sunk, and forty long galleys with one hundred transports and eight thousand men were taken prisoners. He could no longer hope to keep Cyprus, and he sailed hastily back to Egypt, leaving to Demetrius the garrisons of the island as his prisoners, all of whom were enrolled in the army of Antigonus, to the number of sixteen thousand foot and six hundred horse.

This naval victory gave Demetrius the means of unburdening his proud mind of a debt of gratitude to his enemy; and accordingly, remembering what Ptolemy had done after the battle of Gaza, he sent back to Egypt, unasked for and unransomed, those prisoners who were of high rank, that is to say, the whole that had any choice about which side they fought for; and among them were Leontiscus the son, and Menelaus the brother of Ptolemy.

Antigonus was overjoyed with the news of his son's victory. By lessening the power of Ptolemy, it had done much to smooth his own path to the sovereignty of Alexander's empire, which was then left without an heir; and he immediately took the title of king, and gave the same title to his son Demetrius. In this he was followed by Ptolemy and the other generals, but with this difference—that while Antigonus called himself king of all the provinces, Ptolemy called himself king of Egypt; and while Antigonus gained Syria and Cyprus, Ptolemy gained the friendship of every other kingdom and of every free city in Greece; they all looked upon him as their best ally against Antigonus, the common enemy.

The next year Antigonus mustered his forces in Cœle-Syria, and got ready for a second attack upon Egypt. The pride of Antigonus would not let him follow the advice of the sailors, and wait eight days till the north winds of the spring equinox had passed; and by this haste many of his ships were wrecked on the coast, while others were driven into the Nile and fell into the hands of Ptolemy. Antigonus himself, marching with the land forces, found all the strong places well guarded by the Egyptian army; and, being driven back at every point, discouraged by the loss of his ships and by seeing whole bodies of his troops go over to Ptolemy, he at last took the advice of his officers and led back his army to Syria, while Ptolemy

[306-280 B.C.]

returned to Alexandria, to employ those powers of mind in the works of peace which he had so successfully used in war.

Antigonus then turned the weight of his mighty kingdom against the little island of Rhodes. The galleys of Ptolemy, though unable to keep at sea against the larger fleet of Demetrius, often forced their way into the harbour with the welcome supplies of corn. Month after month every stratagem and machine which the ingenuity of Demetrius could invent were tried and failed; and after the siege had lasted more than a year he was glad to find an excuse for withdrawing his troops; and the Rhodians in their joy hailed Ptolemy with the title of Soter or "saviour." This name he ever afterwards kept, though by the Greek writers he is more often called Ptolemy the son of Lagus, or Ptolemy Lagus.

The next of Ptolemy's conquests was Cœle-Syria; and soon after this the wars between these successors of Alexander were put an end to by the death of Antigonus, whose overtowering ambition was among the chief causes of quarrel. This happened at the great battle of Ipsus in Phrygia, where they all met, with above eighty thousand men in each army. Antigonus king of Asia Minor was accompanied by his son Demetrius, and by Pyrrhus king of Epirus; and he was defeated by Ptolemy king of Egypt, Seleucus king of Babylon, Lysimachus king of Thrace, and Cassander king of Macedonia; and the old man lost his life fighting bravely. After the battle, Demetrius fled to Cyprus, and yielded to the terms of peace which were imposed on him by the four allied sovereigns. He sent his friend Pyrrhus as a hostage to Alexandria; and there this young king of Epirus soon gained the friendship of Ptolemy and afterwards his step-daughter in marriage. Ptolemy was thus left master of the whole of the southern coast of Asia Minor and Syria — indeed of the whole coast of the eastern end of the Mediterranean, from the island of Cos on the north to Cyrene on the south.

During these formidable wars with Antigonus, Ptolemy had never been troubled with any serious rising of the conquered Egyptians; and perhaps the wars may not have been without their use in strengthening his throne.

Ptolemy's first children were by Thais the noted courtesan, but they were not thought legitimate. Leontiseus, the eldest, we afterwards hear of, fighting bravely against Demetrius; of the second, named Lagus after his grandfather, we hear nothing. He then married Eurydice the daughter of Antipater, by whom he had several children. The eldest son, Ptolemy, was named Ceraunus, "the thunderbolt," and was banished by his father from Alexandria. In his distress he fled to Seleucus, by whom he was kindly received; but after the death of Ptolemy Soter he basely plotted against Seleucus and put him to death. He then defeated in battle Antigonus the son of Demetrius, and got possession of Macedonia for a short time. He



GREEK VASE
(In the British Museum)

married his half-sister Arsinoe, and put her children to death; he was soon afterwards put to death himself by the Gauls, who were either fighting against him or were mercenaries in his own army. His Macedonian coins, with the name of Ptolemy Ceraunus, prove that he took the name himself, and that it was not a nickname given to him for his ungovernable temper, as has been sometimes thought.

Another son of Ptolemy and Eurydice was put to death by Ptolemy Philadelphus, for plotting against his throne, to which, as the elder brother, he might have thought himself the best entitled. Their daughter Lysandra married Agathocles the son of Lysimachus; but when Agathocles was put to death by his father, she fled to Egypt with her children, and put herself under Ptolemy's care. Next he married Berenice, a lady who had come into Egypt with Eurydice, and had formed part of her household. She was the widow of a man named Philip; and she had by her first husband a son named Magas, whom Ptolemy made governor of Cyrene, and a daughter, Antigone, whom Ptolemy gave in marriage to Pyrrhus, when that young king was living in Alexandria as hostage for Demetrius.

With Berenice Ptolemy spent the rest of his years without anything to trouble the happiness of his family. He saw their elder son Ptolemy, whom we must call by the name which he took late in life, Philadelphus, grow up everything that he could wish him to be; and, moved alike by his love for the mother and by the good qualities of the son, he chose him as his successor on the throne, instead of his eldest son Ptolemy Ceraunus, who had shown, by every act in his life, his unfitness for the trust. His daughter Arsinoe married Lysimachus in his old age, and urged him against his son Agathocles, the husband of her own sister. She afterwards married her half-brother Ptolemy Ceraunus; and lastly we shall see her the wife of her brother Philadelphus. Argæus, the youngest son of Ptolemy, was put to death by Philadelphus, on a charge of treason. Of his youngest daughter Philotera we know nothing, except that her brother Philadelphus afterwards named a city on the coast of the Red Sea after her.

After the last battle with Demetrius, Ptolemy had regained the island of Cyprus and Cœle-Syria, including Judea; and his throne became stronger as his life drew to an end.

His last public act, in the thirty-eighth year of his reign, was ordered by the same forbearance which had governed every part of his life. Feeling the weight of years press heavily upon him, that he was less able than formerly to bear the duties of his office, and wishing to see his son firmly seated on the throne, he laid aside his diadem and his title, and without consulting either the army or the capital, proclaimed Ptolemy, his son by Berenice, king, and contented himself with the modest rank of somatophylax, or satrap, to his successor.

PTOLEMY PHILADELPHUS

One of the chief troubles in the reign of Philadelphus was the revolt of Cyrene. The government of that part of Africa had been entrusted to Magas, the half-brother of the king, a son of Berenice by her former husband. Berenice, who had been successful in setting aside Ceraunus to make room for her son Philadelphus on the throne of Egypt, has even been said to have favoured the rebellious and ungrateful efforts of her elder son Magas to make himself king of Cyrene.

[285-247 B.C.]

After the war between the brothers had lasted some years, Magas made an offer of peace, which was to be sealed by betrothing his only child Berenice to the son of Philadelphus. To this offer Philadelphus yielded; as by the death of Magas, who was already worn out by luxury and disease, Cyrene would then fall to his own son. Magas, indeed, died before the marriage took place; but, notwithstanding the efforts made by his widow to break the agreement, the treaty was kept, and on this marriage Cyrene again formed part of the kingdom of Egypt.

But the black spot upon the character of Philadelphus, which all the blaze of science and letters by which he was surrounded cannot make us overlook, is the death of two of his brothers.

Philadelphus had, when young, married Arsinoe the daughter of Lysimachus of Thrace, by whom he had three children—Ptolemy, who succeeded him, Lysimachus, and Berenice; but, having found that his wife was intriguing with Amyntas, and with his physician Chrysippus of Rhodes, he put these two to death, and banished the queen Arsinoe to Coptos in the Thebaid.

He then took Arsinoe his own sister as the partner of his throne. She had married first the old Lysimachus king of Thrace, and then Ceraunus her half-brother, when he was king of Macedonia. As they were not children of the same mother, this second marriage was neither illegal nor improper in Macedonia; but her third marriage, with Philadelphus, could only be justified by the laws of Egypt, their adopted country. They were both past the middle age, and whether Philadelphus looked upon her as his wife or not, at any rate they had no children. Her own children by Lysimachus had been put to death by Ceraunus, and she readily adopted those of her brother with all the kindness of a mother. This seeming marriage, however, between brother and sister did not escape blame with the Greeks of Alexandria. The poet Sotades, whose verses were as licentious as his life, wrote some coarse lines against the queen, for which he was forced to fly from Egypt, and being overtaken at sea he was wrapped up in lead and thrown overboard.

In the Egyptian inscriptions Ptolemy and Arsinoe are always called "the brother-gods"; on the coins they are called Adelphi, "the brothers"; and afterwards the king took the name of Philadelphus, or "sister-loving," by which he is now usually known.

The wars between Philadelphus and his great neighbour Antiochus Theos seem not to have been carried on very actively, though they did not wholly cease till Philadelphus offered as a bribe his daughter Berenice, with a large sum of money under the name of a dowry. Antiochus was already married to Laodice, whom he loved dearly, and by whom he had two children, Seleucus and Antiochus; but political ambition had deadened the feelings of his heart, and he agreed to declare this first marriage void and his two sons illegitimate, and that his children, if any should be born to him by Berenice, should inherit the throne of Babylon and the East. The peace between the two countries lasted as long as Philadelphus lived, and was strengthened by kindnesses which each did to the other.

Philadelphus was of a weak frame of body, and had delicate health; and though a lover of learning beyond other kings of his time, he also surpassed them in his unmeasured luxury and love of pleasure.

He reigned over Egypt, with the neighbouring parts of Arabia; also over Libya, Phœnicia, Cœle-Syria, part of Ethiopia, Pamphylia, Cilicia, Lycia, Caria, Cyprus, and the isles of the Cyclades. The island of Rhodes and many of the cities of Greece were bound to him by the ties of friendship,

for past help and for the hope of future. The wealthy cities of Tyre and Sidon did homage to him, as before to his father, by putting his crowned head upon their coins. The forces of Egypt reached the very large number of two hundred thousand foot and twenty thousand horse, two thousand chariots, four hundred Ethiopian elephants, fifteen hundred ships of war, and one thousand transports. Of this large force, it is not likely that even one-fourth should have been Greeks; the rest must have been Egyptians and Syrians, with some Gauls.

These large forces were maintained by a yearly income, equally large, of fourteen thousand eight hundred talents, or two millions and a quarter pounds sterling, besides the tax on corn, which was taken in kind, of a million and a half of artabas, or about five millions of bushels. To this we may add a mass of gold, silver, and other valuable stores in the treasury, which were boastfully reckoned at the unheard-of sum of seven hundred and forty thousand talents, or above one hundred million pounds sterling.

The trade down the Nile was larger than it had ever been before; the coasting trade on the Mediterranean was new; the people were rich and happy; justice was administered to the Egyptians according to their own laws, and to the Greeks of Alexander, according to the Macedonian laws; the navy commanded the whole of the eastern half of the Mediterranean; the schools and library had risen to a great height upon the wise plans of Ptolemy Soter; in every point of view Alexandria was the chief city in the world. Athens had no poets or other writers during this century equal in merit to those who ennobled the Museum. Philadelphus, by joining to the greatness and good government of his father the costly splendour and pomp of an eastern monarch, so drew the eyes of after ages upon his reign that his name passed into a proverb.

Needless to say, the civilisation of this time was essentially Greek. The main body of writers and scholars of the period naturally gave the stamp of this culture to the epoch. Yet the old civilisation of Egypt must have reacted upon the intruders in many ways.

Philadelphus died in the thirty-eighth year of his reign, leaving the kingdom as powerful and more wealthy than when it came to him from his father; and he had the happiness of having a son who would carry on, even for the third generation, the wise plans of the first Ptolemy.

PTOLEMY EUERGETES

Ptolemy, the eldest son of Philadelphus, succeeded his father on the throne of Egypt, and after a short time took the name of Euergetes. He began his reign with a Syrian war; for no sooner was Philadelphus dead than Antiochus, who had married Berenice only because it was one of the articles of the treaty with Egypt, sent her away together with her young son. Antiochus then recalled his first wife, Laodice, and she, distrusting her changeable husband, had him at once murdered to secure the throne to her own children. Seleucus, the eldest, seized the throne of Syria; and, urged on by his mother, sent a body of men after Berenice, with orders to put her to death, together with her son, who by the articles of marriage had been made heir to the throne.

The cities of Asia Minor hastily sent help to the queen and her son, while Ptolemy Euergetes, her brother, who had just come to the throne of Egypt, marched without loss of time into Syria. But it was too late to

[245-222 B.C.]

save them ; they were both put to death by the soldiers of Seleucus. Many of the cities, moved by hatred of their king's cruelty, opened their gates to the army of Euergetes ; and, had he not been recalled to Egypt by troubles at home, he would soon have been master of the whole of the kingdom of Seleucus. As it was, he had marched beyond the Euphrates, had left an Egyptian army in Seleucia the capital of Syria, and had gained a large part of Asia Minor. On his march homeward, he laid his gifts upon the altar in the temple of Jerusalem, and there returned thanks to heaven for his victories. He had been taught to bow the knee to the crowds of Greek and Egyptian gods ; and, as Palestine was part of his kingdom, it seemed quite natural to add the god of the Jews to the list.

No sooner had Euergetes reached home than Seleucus, in his turn, marched upon Egypt, and sent for his brother Antiochus Hierax, to bring up his forces and to join him. But before Antiochus could come up the army of Seleucus was already beaten ; and Antiochus, instead of helping his brother in his distress, strove to rob him of his crown. Instead of leading his army against Euergetes, he marched upon Seleucus, and by the help of his Gallic mercenaries beat him in battle. But the traitor was himself soon afterwards beaten by Eumenes, king of Bithynia, who had entered Syria in the hope that it would fall an easy prey into his hands after being torn to pieces by civil war. Antiochus, after the rout of his army, fled to Egypt, believing that he should meet with kinder treatment from Euergetes, his enemy, than after his late treachery he could hope for from his own brother. But he was ordered by Euergetes to be closely guarded, and when he afterwards made his escape he lost his life in his flight by the hands of Celtic assassins, as already related.

Euergetes, finding himself at peace with all his neighbours on the coasts of the Mediterranean, then turned his arms towards the south. He easily conquered the tribes of Ethiopia, whose wild courage was but a weak barrier to the arms and discipline of the Greeks ; and made himself for the moment master of part of the highlands of Abyssinia, the country of the Hexumitæ.

Euergetes did not forget his allies in Greece, but continued the yearly payment to Aratus, the general of the Achæan League, to support a power which held the Macedonians in check ; and when the Spartans under Cleomenes tried to overthrow the power of the Achæans, Euergetes would not help them. Euergetes had married his cousin Berenice, who, like the other queens of Egypt, is also called Cleopatra ; by her he left two sons, Ptolemy and Magas, to the elder of whom he left his kingdom, after a reign of twenty-five years of unclouded prosperity. Egypt was during this reign at the very height of its power and wealth. It had seen three kings, who, though not equally great men, not equally fit to found a monarchy or to raise the literature of a people, were equally successful in the parts which they had undertaken. Euergetes left to his son a kingdom perhaps as large as the world had ever seen under one sceptre, and though many of his boasted victories were like letters written in the sand, of which the traces were soon lost, yet he was by far the greatest monarch of his day.

But here the bright pages in the history of the Ptolemies end. Though trade and agriculture still enriched the country, though arts and letters did not quit Alexandria, we have from this time forward to mark the growth of only vice and luxury, and to measure the wisdom of Ptolemy Soter by the length of time that his laws and institutions were able to bear up against the misrule and folly of his descendants.

PTOLEMY PHILOPATOR

Nothing is known of the death of Ptolemy Energetes, and there is no proof that it was by unfair means. But when his son began a cruel and wicked reign by putting to death his mother and brother, and by taking the name of Philopator, or father-loving, the world seems to have thought that he was the murderer of his father, and had taken this name to throw a cloak over the deed. Unfortunately history is not free from acts of successful wickedness. By this murder of his brother, and by the minority both of Antiochus king of Syria and of Philip king of Macedonia, Philopator found

himself safe from enemies either at home or abroad, and he gave himself up to a life of thoughtlessness and pleasure. The army and fleet were left to go to ruin, and the foreign provinces, which had hitherto been looked upon as the bulwarks of Egypt, were only half guarded; but the throne rested on the virtues of his forefathers, and it was not till his death that it was found to have been undermined by his own vices.^e



G. HARTNER.

A GREEK MAIDEN

At the instigation of his minister, Sosibius, he caused his brother Magas to be murdered, lest he might endeavour to secure the kingdom to himself. The death of Cleomenes, the exiled king of Sparta, who had been protected and provided for by the preceding king, soon followed. Antiochus the Great, who at this time ruled in Syria, perceiving the disorder and licentiousness which prevailed in the court of Egypt, thought it a favourable time to declare war against that country. Ptolemy, who seems not to have lacked courage, roused himself for the emergency, collected a great army, and proceeded to meet the enemy. In the beginning of the war, Antiochus obtained some advantages over the Egyptian troops: but shortly after, in a great battle fought at Raphia near Gaza, he was completely defeated, with great loss; and Ptolemy obtained a large extension of influence in Palestine and Syria. Humbled by this de-

feat, and alarmed at the progress of Achaëus in Asia Minor, Antiochus was anxious to make peace with Ptolemy; and the Egyptian king, although he had every inducement to prosecute the war, being equally anxious to return to his licentious pleasures, was ready to receive his overtures. A peace was in consequence concluded, by which Cœle-Syria and Palestine were confirmed as belonging to Egypt. This being done, Ptolemy went to Jerusalem, where he was well received, and treated the inhabitants kindly, until, having made a fruitless attempt to enter the inner sanctuary, he retired from the city threatening the whole nation of the Jews with extermination. It does not appear that he dared to assail the sacred city; but, on returning to Egypt, he published a decree which he caused to be engraved on a pillar erected at the gate of his palace, excluding all those who did not sacrifice to the gods whom he worshipped. By this means the Jews were virtually outlawed,

[216-170 B.C.]

being prevented from suing to him for justice, or from claiming his protection. But this was not the extent of his infliction. By another decree he reduced them from the first rank of citizens, to which they had been raised by the favour of Alexander, to the third rank. They were in consequence degraded so far as to be enrolled among the common people of Egypt.

During this reign the Romans, being again at war with Carthage, sent ambassadors to Egypt, to renew their ancient friendship, who brought magnificent presents to Ptolemy and his queen.

EPIPHANES

At the death of Philopator, 204 B.C., Ptolemy Epiphanes, being then a child of five years old, ascended the throne. In the early part of his reign another Roman embassy visited Egypt, when the king's counsellors took the opportunity of placing the young prince under the guardianship of the powerful republic. The senate of Rome accepted the charge, and sent Marcus Lepidus to act as guardian—a trust which, after a short stay in Egypt, he conferred upon Aristomenes, an Aearnanian, who discharged the duties of this important office with integrity and ability for several years, until the king had attained the age of fourteen, when, according to the usage of the country, he was entitled to take the administration of the kingdom into his own hands. The folly of investing a person so young with absolute power, was in this instance made fully apparent. The youth, who had been universally popular whilst under the direction of Aristomenes, was no sooner enthroned than he placed himself under the influence of worthless men, by whose advice he was led to the adoption of measures through which great disorders were introduced into every branch of the government; and at length his former able and honest minister was put to death.

Epiphanes married Cleopatra, daughter of Antiochus the Great. This marriage appears to have taken place when the young king was about seventeen years old. It is generally supposed that he was taken off by poison, administered by his nobles, to prevent him from entering on a war with Syria to which he had committed himself, when the national finances were so low that they feared they should have to contribute largely towards the expenses of the contest. He left two sons, Philometor and Physeon; and a daughter, Cleopatra, who was successively married to her two brothers.

PHILOMETOR AND PHYSCON

Philometor, the elder of the two sons, then but six years old, was placed on the throne under the guardianship of his mother Cleopatra, who for eight years conducted the affairs of the kingdom with great judgment and success. After her death, Lenæus, a nobleman of distinction, and Eulæus, a eunuch, were charged with the government of the country. One of their earliest measures was to insist on the restoration of Cœle-Syria and Palestine to Egypt,—these provinces having been wrested from the dominion of Egypt by the power of Antiochus the Great. This demand led to a violent contest, which tended more than any preceding event to demonstrate the rapid decline of Egyptian power, and the rising sway of Rome.

The Syrian army, under the command of Antiochus Epiphanes, prosecuted the war with such vigour and success that it penetrated to the walls of Alexandria, and actually secured the person of the Egyptian king. Whether he was taken in war, or placed himself willingly in the hands of the Syrian king, does not clearly appear. But, however this may be, the Syrian monarch gained little by his acquisition. For although he induced Philometor to enter into a treaty with him, this was instantly disallowed by the nation, who, regarding a sovereign in the power of an enemy as lost to his country, immediately raised Physcon, the king's brother, to the throne. This led to a second Syrian invasion, which resulted in the expulsion of Physcon; Antiochus restoring Philometor to the government, but retaining Pelusium, the key to the country, in the possession of Syrian troops. From this and other indications of the Syrian king's intentions, Philometor rightly judged that it was his design, by setting the two brothers in continued collision with each other, to retain Egypt virtually in his own power. Acting on this judgment, Philometor invited his brother to terms of reconciliation, which, by the aid of their sister Cleopatra, was happily effected.

The measures adopted by the two brothers to restore Egypt to an independent and prosperous condition, induced Antiochus again to march an army into that country. He was on this occasion, however, compelled, by the prompt and energetic interference of the Romans, to abandon the enterprise. By agreement between the two brothers, they were to reign jointly; but they were no sooner freed from the danger of foreign aggression, than they began to quarrel between themselves. This quickly produced an open rupture, in which Physcon succeeded in driving his brother out of the kingdom. He was, however, soon after restored by the power of Rome, which at the same time assigned Libya and Cyrene to Physcon. New disputes arose, and various contests took place between them, in all of which Rome regarded herself as entitled to act as the paramount ruler of Egypt, and to award the sovereignty according to her will.

Philometor was soon after provoked into a war with Alexander Balas, who had been raised to the throne of Syria mainly by his support. In the prosecution of this contest, the king of Egypt marched into Syria, where he completely routed the army of Alexander near Antioch, but died, a few days after, from wounds received in the battle. He left behind him a high reputation for wisdom and clemency. It was in his reign, and by his favour and that of his queen Cleopatra, that the Jews under Onias were permitted to build the famous Jewish temple at Heliopolis.

On the death of her husband, Cleopatra endeavoured to secure the crown for their son; but some of the leading men inclined towards Physcon, and invited him from Cyrene, where he then reigned, into Egypt. The queen raised an army to oppose him, and a civil war was imminent, when an accommodation was arranged, through the mediation of Rome, by which Physcon married Cleopatra, who was his sister and his brother's widow, on the understanding that they were to reign with joint authority, and that Cleopatra's son by Philometor should be declared next heir to the crown. This agreement was no sooner completed than it was violated. On the day of his marriage Physcon murdered the son of Philometor in the arms of his mother, and commenced a career of iniquity and slaughter of which this was a fitting prelude. He indeed assumed the name of Euergetes, "benefactor," which the Alexandrians changed into Kakergetes, "the evil-doer"—an epithet which he justly merited; for he was the most cruel and wicked, most despicable and vile, of all the Ptolemies. To the Jews he evinced unmitigated

[146-107 B.C.]

enmity and cruelty, because they had espoused the cause of Cleopatra. He then divorced Cleopatra, his wife, and married her daughter, of the same name, who was his own niece; but not before he had subjected the young princess to the vilest indignity.

Such conduct excited the disgust of his subjects, and, accompanied as it was with excessive cruelty, produced a revolt which drove him from the kingdom. He, however, succeeded in recovering his position, and at length died in the sixty-seventh year of his age, having reigned twenty-nine years.

It is a fact as singular as unaccountable, that this most licentious and bloody prince, whose name is infamous, as associated with almost every crime, is notwithstanding celebrated by the most respectable ancient writers as a great restorer of learning, a patron of learned men, and withal an author of some celebrity himself. Physcon left three sons—Apion, by a concubine, and Lathyrus and Alexander by his wife Cleopatra. By his will he left the kingdom of Cyrene to Apion, and the crown of Egypt to his widow in conjunction with either of her sons whom she should choose. In the exercise of this discretionary power the queen would have preferred Alexander, the younger son; but this was so distasteful to the people that she was compelled to admit Lathyrus to the joint sovereignty, and place Alexander in the kingdom of Cyprus. After reigning ten years, the former prince was obliged to leave Egypt, to which his brother immediately returned; Lathyrus repairing to Cyprus, and taking upon himself the government of that country. It was at this period that Lathyrus invaded Judea, then governed by Alexander Jannæus, and obtained such advantages over him that the Jewish state was only saved from ruin by the aid sent to it by Cleopatra from Egypt.

In the meantime the younger brother, Alexander, having for nearly eighteen years, while bearing the name of "king," submitted as a slave to the violent and capricious will of his mother, became quite weary of her intolerable tyranny, and put her to death. This fact being made public, he was driven from the throne, and Lathyrus, or Soter II, restored; he reigned seven years longer. During this period the ruin of Thebes took place. Lathyrus, freed from the power of his rival, undertook to restore the government of the kingdom to its former state. This led to an insurrection, of which Thebes was the centre. That ancient city not only refused to submit to the prescribed laws, but even struggled to regain its lost independence. The effort was vain. The king, having defeated the rebels in several battles, besieged Thebes, which, having held out for three years, was at length subdued, and so devastated that this noble capital was never afterwards repaired, and consequently sank into ruin.

ROMAN INTERFERENCE

Lathyrus was succeeded by his only legitimate child, Cleopatra, whose proper name was Berenice. This princess, however, had scarcely assumed the sovereignty, when she was called to submit to the dictation of Roman



HEAD-DRESSES

power. Sulla, then perpetual dictator of the imperial city, no sooner heard of the death of Lathyrus, than he conferred the crown of Egypt on Alexander, a son of the king of that name who had been driven out of the country for having murdered his mother. The Alexandrians succeeded in persuading Alexander to marry Berenice, and reign jointly with her. This he did, but in nineteen days afterwards caused her to be murdered. He, however, continued on the throne, and reigned fifteen years in a manner which might be expected from the atrocity of the commencement. At length the people, worn out by his exactions and goaded to desperation by his cruelties, rose with common consent, and drove him from the throne. He made some fruitless efforts to induce Pompey to aid him to recover his crown, but died a few months after his expulsion, in banishment at Tyre.

PTOLEMY AULETES; CLEOPATRA AND THE END

The Egyptians, having driven out this tyrant, selected a natural son of Ptolemy Lathyrus to fill the vacant throne. This prince, by a gift of six thousand talents (£1,200,000 or \$6,000,000) to Julius Cæsar and Pompey, was recognised as king of Egypt in alliance with Rome. He was named Ptolemy Auletes, "the Flute-player"; but took on himself the title of Neus Dionysus, "the new Bacchus." He was a fit representative of the fallen condition of the Egyptian state. More effeminate than any of his predecessors, priding himself on dancing in a female dress in religious processions, he was at the same time equal to his grandfather Physcon in the violence and viciousness of his conduct. After some time he was, like his predecessor, expelled from the throne. He succeeded, however, by immense gifts, in inducing Gabinius, the Roman governor of Syria, to attempt his restoration, which was at length accomplished; Archelaus, who had been invested with the government, having been defeated and slain by the Romans. Auletes was thus restored to the throne, and died in peaceable possession of his dignity about four years after his restoration.

Auletes on his restoration had put to death his daughter Berenice; and at his demise left two daughters, Cleopatra and Arsinoe, and two sons. The first of these, Ptolemy the elder, otherwise called Dionysus II, was, according to his father's will, married to his eldest sister, then about seventeen years old; and the juvenile couple were invested with the sovereignty of Egypt, under the protection of the Roman republic. It appears that this most celebrated Egyptian princess evinced considerable vigour and talent, even at that early age. So clever, indeed, was she, that the ministers who had been placed in charge of the national affairs were very anxious to get rid of her, and at length deprived her of her share in the sovereignty, and expelled her from the kingdom. Cleopatra, however, had a spirit equal to the occasion. She retired into Syria, raised an army, and in a short time marched upon Pelusium, prepared to dispute with her brother the sovereignty of the nation. It was while the hostile armies of the brother and sister lay within sight of each other, that Pompey, after the loss of the battle of Pharsalia, reached Egypt, expecting protection and support, but was put to death by the ministers of Ptolemy. Soon after this event, Julius Cæsar arrived in pursuit of his rival, and was presented with Pompey's head and his ring.

Cleopatra, whose licentiousness was quite equal to her talent and energy, caused herself to be secretly conveyed to Cæsar's quarters, where she succeeded in captivating that mighty conqueror, and commenced an intimacy

[48-30 B.C.]

which resulted in the birth of a son, called, after his father, Neocæsar. The scandal of this conduct enabled Ptolemy and his ministers to rouse the public spirit of the Alexandrians, and of Lower Egypt generally, against the mighty Roman, to such an extent that he was placed in most imminent peril. Cæsar, however, disposed the handful of soldiers which he had with him in such a manner as to keep the Egyptians in check, until the arrival of Mithridates with large reinforcements, when he defeated the Egyptian forces with great slaughter. In the course of this conflict Ptolemy was drowned in the Nile.

Cæsar soon adjusted the affairs of Egypt to his own mind, placing Cleopatra on the throne. But as the Egyptians had a great antipathy to female sovereignty, he compelled Cleopatra to submit to the farce of marrying her younger brother, a lad eleven years old. She, however, held the power in her own hand until he reached the age of fourteen, when by the laws of the country he was entitled to enter upon the joint administration of affairs. She then caused him to be poisoned. Arsinoe, who had been carried to Rome by Julius Cæsar, and compelled to walk, bound in chains of gold, before his triumphal chariot, was also assassinated at the instigation of Cleopatra.

The death of Cæsar convulsed the whole empire of Rome and all its dependencies, and swept away the last feeble remnant of Egyptian monarchy and independence. On this occasion Cleopatra instantly decided to support the triumvirs against the murderers of Julius. On a charge of being unfaithful to this purpose, she was summoned to appear before Antony at Tarsus. Confident in the power of her charms, she obeyed, and effectually seduced that great captain. In fact, so besotted was he by this intercourse, that he neglected his affairs, and at length was so completely ruined that, having inflicted on himself a mortal wound, he died in the arms of his wanton mistress. Cleopatra had two sons by Antony, and soon after his decease she shared the fate which she had brought on him. To avoid being made a spectacle at the triumph of Augustus, as he was proof against her seductive charms, she procured her own death in some unknown way; tradition says by the bite of an asp. Egypt then became a province of the Roman empire, and continued in this state until the birth of Christ, and long afterwards.^d

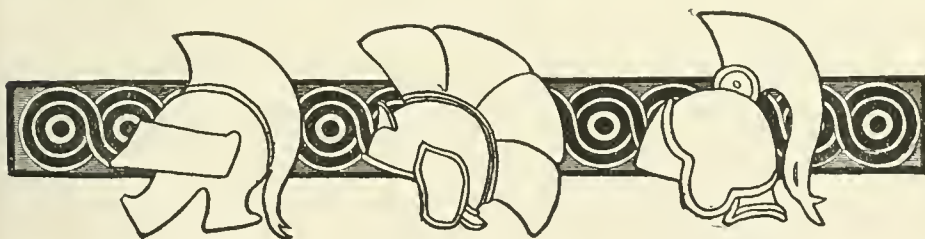



CHAPTER LXVII. SICILIAN AFFAIRS

AGATHOCLES

WHILE Greece and Macedonia were torn by the disputes of Alexander's successors, Sicily was a prey to a tyrant who for energy, audacity, and complete absence of moral sense, is worthy to be ranked amongst them. It was the age of adventurers and soldiers of fortune. Agathocles, the son of a working potter, became famous in his youth by his beauty, strength, and courage, and also by his immoral life. He enlisted as a soldier, and men were amazed by his height and the weight of his weapons. He obtained a command through the influence of a powerful citizen who liked him, and whose widow he married shortly after. This marriage brought him riches, but his ambition was not limited by wealth. He wished to gain the approval of the people by his eloquence, as he had obtained the affection of the soldiers by his daring.

Tyranny, the natural result of class antagonism in a city, had reappeared at Syracuse after the death of Timoleon. The tyrant, Sosistratus, was supported by the aristocrats; Agathocles became the advocate of the claims of the people. He had also a personal grievance against Sosistratus, who, after an expedition against the Bruttians, had refused him the prize for courage which he deserved. Being driven from Syracuse, he recruited an army among the exiles, whose number was always very great by reason of the continual revolutions of Sicily and Magna Græcia. He tried in vain to seize Croton, then served with the Tarentines, who, a short time after, drove him away because he wished to direct their government.

Some time later, a revolution broke out at Syracuse. Sosistratus was exiled with six hundred men of his faction and asked help of the Carthaginians. Agathocles returned, distinguished himself in the war by his courage and skill, and became so popular that the Corinthian Acestorides, general of the republic, suspected him of aspiring to the tyranny and wished to have him murdered. He escaped the danger by changing clothes with a

[317-310 B.C.]

slave and soon after they heard that he was raising troops. Peace was made with the Carthaginians, who brought back Sosistratus and his partisans. Agathocles obtained permission to return also, and swore in the temple of Demeter to respect the constitution.

Soon after, the people, fascinated by his speeches, named him protector of peace, and charged him with the re-establishment of harmony between the factions. According to Justin, who seldom agrees with Diodorus, Agathocles' usurpation was the result of a treaty with Hamilcar, the Carthaginian general, who supplied him with African soldiers. Whatever may be the truth in regard to this, the first use which he made of his power was to massacre the six hundred senators, their relatives, and friends. The town was given up to the soldiers, who pillaged the houses, carried off the women, and killed without discrimination. Those partisans of the oligarchy who succeeded in escaping the massacre, took refuge at Agrigentum. Then Agathocles called the people together and declared that his only wish had been to restore their freedom and that he now intended retiring to private life. His followers, especially those who had taken part in the pillage, begged him to remain in power. He consented, but on condition that he should govern alone, for the colleagues who might be given him would perhaps attempt to violate the laws, and he would not be responsible except for his own acts. Votes were taken, and as the rich were paralysed by fear, and he had promised the poor to cancel debts and divide lands, he obtained all the votes. But he took neither the crown nor any of the external signs of power: the reality sufficed; he would not even have a bodyguard. Having no further enemies to fear, he allowed himself the luxury of clemency, tactics imitated later by Augustus and recommended by Machiavelli. He then administered the finances, attended to the necessities of the army and the navy, and added to the dominion of Syracuse some of the towns and territory of the interior.

The Syracusan exiles who had taken refuge at Agrigentum stirred up the people to make war on Agathocles before his rule extended over the whole of Sicily. The Agrigentines recognised the danger, and joining with the inhabitants of Gela and Messana sent to Sparta to ask for a general, for they feared to entrust the command to one of their own citizens who might make use of it to usurp the tyranny. Acrotatus, son of King Cleomenes, was detested at Sparta; he seized the opportunity of fighting abroad. But when he came to Agrigentum, he made himself universally disliked on account of his insolence, his waste of public funds, his dissolute life, and his luxury more worthy of a Persian than a Lacedæmonian. He murdered Sosistratus, the chief of the Syracusan exiles, at a banquet. He was driven away, they even wished to stone him, but he escaped by night. The Agrigentines made peace with Agathocles who, having no further foreign hostility to fear, was able to strengthen and extend his authority. The Syracusan exiles, being forced to leave Agrigentum, took refuge at Messana, but the Messanians feared the anger of Agathocles; he offered to make alliance with them, and persuaded them to grant the freedom of the city to these exiles. Men were astonished by such noble sentiments, but some time later he found means to entice them from Messana, to the number of more than six hundred, and had them put to death. He succeeded in making his government recognised in most of the towns of Sicily, and on all sides he caused the death of all who inspired him with fear.

The ever increasing progress of Agathocles awoke the fears of the Carthaginians and they sent a large army into Sicily under the command of

Hamilcar the son of Gisco. A battle took place near the river Himera between Gela and Agrigentum. It was said to have been on this spot that a former tyrant of Agrigentum, Phalaris, put his enemies to death by shutting them up in a bronze bull under which a fire was lighted; the hill on which Phalaris' castle stood was still called Ecnomus. Agathocles seemed to have won the battle, when unexpected help came to the Carthaginians and gave them the victory. Then the towns which had accepted or suffered Syracusan suzerainty submitted successively to the Carthaginians, and Hamilcar, master of all the rest of Sicily, laid siege to Syracuse. Agathocles repaired the fortifications of the town and put it in a state of defence, but these precautions could only delay certain ruin, for no outside help could be expected. Agathocles then conceived a singularly daring plan: he resolved to carry the war into Africa. It was what Scipio did at a later date, but in less difficult circumstances, for in Agathocles' case it was first necessary to leave a town besieged by land and sea.

He had few soldiers; he set free and enlisted the slaves, and made them take an oath of fidelity. Although he had been pitiless towards his political adversaries, he knew that some were still alive, and that they were ready to capitulate with the enemy. He spoke of his plan to no one. He told the Syracusans that all he asked of them was a little patience, and that he had sure means of saving them. In the town he only left the soldiers requisite for its defence and embarked all the rest, being careful to take as hostages a member of each of the families which he mistrusted. He persuaded the rich to avoid the fatigues and privations of the siege by retiring to their estates, and when they were scattered he had them killed by his soldiers, and took their money. The port was blockaded by the Carthaginian fleet; but merchant vessels were seen bringing provisions to the besieged. The Carthaginians advanced to capture them. Agathocles seized the opportunity to leave the port, and the merchant vessels were able to enter while the Carthaginians pursued Agathocles' fleet. He escaped by dint of hard rowing and landed with his army on the coast of Africa.

Then, having offered a sacrifice, he told his soldiers that he had made a vow if his vessels escaped the enemy to make torches of them for the principal goddesses of Sicily, Demeter and Core, and taking a brand from the altar he set fire to his fleet. The soldiers, losing all hope of return, had no other resource than victory. This act of temerity, which has become proverbial, was perhaps necessary. Agathocles had too few soldiers to employ some in protecting the fleet; it would have been taken by the Carthaginians, who were masters of the sea. They seized a pleasure town which Diodorus calls the Great Town and the White Tunis. Agathocles had not sufficient soldiers to leave garrisons; he razed it to the ground and encamped under the walls of Carthage.

The Carthaginians, seeing their country pillaged, thought that their army in Sicily had been destroyed. They had no time to collect mercenaries; they armed to the number of forty thousand and placed Hanno and Bomilcar at their head. These chiefs belonged to two rival families. The Carthaginians often took this precaution as a guarantee against usurpation. But this multitude of new and badly disciplined soldiers could not resist Agathocles' little army. Hanno was killed, and Bomilcar, who aspired to the tyranny, led the troops back to the town. The terrified Carthaginians attributed their misfortune to the anger of the gods. For a long time they had sacrificed to Moloch only children whom they bought; they thought that he demanded more precious victims, and offered him two hundred chil-

[310-307 B.C.]

dren from the most wealthy families. Three hundred citizens offered themselves to complete the sacrifice. They were placed on the hands of the bronze statue, and a large fire was lighted; the victims fell into the burning flames. Diodorus believes that these human sacrifices, customary among Phœnician nations, possibly gave rise to the fable of Cronos devouring his children, for the Greeks identified their Cronos with the Phœnician Moloch.

The Carthaginians ordered Hamilcar to send them some of his troops; but not wishing to abandon Sicily, they announced the complete ruin of Agathocles and, as a proof, sent to Syracuse the beaks of his burnt vessels. Antander, Agathocles' brother, wished to surrender; the Ætolian Eurymedon persuaded him not to despair, and a short time later they received news of the success of the Greeks. The courage of the besieged was renewed; Hamilcar wished to attempt an assault; he was taken, his head was cut off and sent to Agathocles, who threw it into the Carthaginian camp. His success won him the alliance of the Libyan and Numidian nations. He wrote to Ophellas, governor of Cyrene, who had fought under Alexander, entreating him to invade the Carthaginian territory, which should be shared after the victory; he would leave Africa to Ophellas, and would be content to keep Sicily. This plan tempted Ophellas; he was in communication with the Athenians, because he had married a descendant of Miltiades. He raised mercenaries in Greece and set out to cross the desert with a numerous army, carrying along with it women and children, for they hoped to found colonies. The army suffered much from the heat, from thirst, and from the bites of serpents. Agathocles received his allies warmly, gave them food, then murdered Ophellas and incorporated his soldiers in his own army; the women and children were sent to Sicily and perished in a tempest. Cyrene became part of the dominions of Ptolemy.

About the same time, the Carthaginians put Bomilcar to death for attempting to seize the tyranny. Agathocles might have profited by the confusion which this event caused in Carthage, but he had received alarming news. The Agrigentines had endeavoured to profit by Hamilcar's death to free Sicily from both Carthaginian and Syracusan rule. Agathocles, leaving the command of his army to Archagathus, his eldest son, embarked on open boats which had been hastily built. On landing at Selinuntium, he was told that his officers had just defeated the Agrigentine army. He reduced to submission Heraclea, Thermæ, Centuripæ, Cephalædium, and Apollonia. It was about this time that, following the example of the successors of Alexander, he took the title of king, and had it put on his coins (307). However, he wore no crown, and instead of imitating the mistrust of Dionysius the Elder, he went to the assembly without a guard. When he gave banquets, he was often served in an earthen bowl, and willingly recalled the time when he had begun life as a working potter. He was easy tempered and gay, so as to encourage his guests to talk freely, but he took note of all that he heard, and when, by this means, he had discovered which men were not to be trusted, he invited them separately and put them to death.

In Africa, his son Archagathus was at first successful; but he found his army weakened by desertions, in need of the necessities of life, and inclined to revolt. The soldiers complained of not being paid. He risked a battle

GREEK CANDLE
STICK

and was defeated. Then he resolved to leave the army, as Bonaparte did in later times in Egypt. The soldiers, furious at finding themselves abandoned by their general, murdered his two sons and surrendered to the Carthaginians, who enrolled them in their army.

On his return to Sicily, Agathocles first of all gave vent to his anger against Segesta, which had refused him subsidies. This expedition was marked, according to Diodorus, by atrocious cruelty: men were burned alive, pregnant women made to miscarry, young girls and children sold to the Brutians, and the town of Segesta, peopled by new inhabitants, received the name of Dicæopolis — city of vengeance. At the same time Agathocles commanded his brother Antander to slay the parents, wives, and children of the soldiers of the African army, to revenge the murder of his sons. Diodorus adds that these savage executions produced such horror that Agathocles, despairing of keeping the power, proposed to Dinocrates, the general of the exiles, to re-establish the republic at Syracuse. But Dinocrates had no desire to do so; in the twenty years during which he had been leader of armed bands, he had acquired a taste for this kind of regal dignity. Unsuccessful in forming this alliance, Agathocles purchased Carthaginian help by yielding up certain towns to them, and beat Dinocrates whose troops surrendered. He had them massacred but spared Dinocrates, and as they were worthy of each other, he made him his lieutenant.

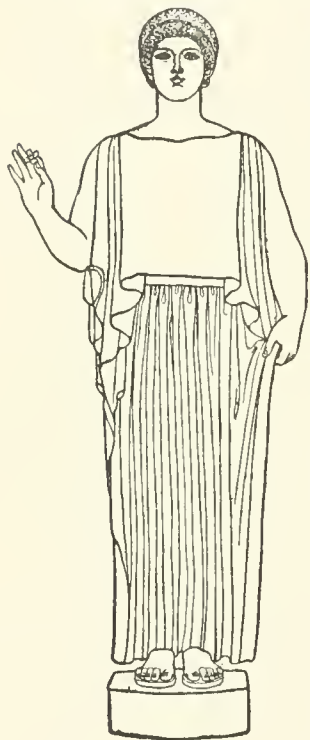

NYPH
(From a statue)

He undertook, following Dionysius' example, the conquest of southern Italy. He began by seizing the Æolian Isles, in order to obtain the treasure consecrated to Core and to Hephæstus in the prytaneum of Lipara; then he prepared to cross into Italy. His preparations excited the fears of the Tarentines, who were already menaced in another direction by the native populations. They applied to the Spartans, whose king, Cleonymus, enrolled mercenaries at Cape Tænarum. He formed a considerable army by uniting with them the forces of Tarentum and the Messapians, with whom he made an alliance immediately on his arrival. The Lucanians in alarm made peace with Tarentum, and Cleonymus, not wishing to have come in vain, turned

against Metapontum, which town, however, he had entered as an ally. He imposed on the town a tribute of six hundred talents, and took two hundred young girls as hostages, which caused him to be looked on with suspicion, for, although he was a Spartan, he had the reputation of a man of dissolute character; however, he was punished later on by the wicked behaviour of his wife Chelidonis. Then, instead of delivering Sicily from the tyranny of Agathocles, as he had announced the intention of doing, he attacked Coreyra, which appeared to him a convenient post for watching Greek affairs, raised a tribute, and established a garrison. Then, returning to Italy, without troubling either about the Tarentines who had summoned him, or about the Messapians whose alliance he had demanded, he began to fight and pillage indiscriminately, under pretext of punishing those whom he called rebels.

[300-289 B.C.]

He carried on this piratical war to the remotest part of the Adriatic Sea. The Italians killed some of his troops, a tempest destroyed part of his fleet, but he escaped and wound up his series of adventures by calling Pyrrhus against his country to avenge his matrimonial troubles.

Agathocles conducted an expedition against Coreyra, in pursuit of Cleonymus, but found Cassander besieging the town by land and by sea. He burned the Macedonian fleet, and seized Coreyra, which he gave as a dowry to his daughter Lanassa, whom he married to Pyrrhus, king of Epirus. On his return he found that a number of his mercenaries were in revolt against his grandson Archagathus, who had not given them their pay; he had two thousand of them killed. According to Diodorus, they were Ligurians and Etruscans, but it seems probable that there were Bruttians among them, for this punishment led to a war between the Bruttians and Agathocles. He was defeated and revenged himself on the inhabitants of Croton, who had done him no injury. He told them not to be troubled by his advance, he was only travelling through the country to take his daughter into Epirus. They made no preparations for defence; he took the town, sacked it, and massacred the inhabitants. Then he attacked Hipponium, which was in the hands of the Bruttians, took it, and placed a garrison there which was massacred a short time later.

In his old age he suffered from a very painful illness of the joints, and his son and grandson disputed his succession during his life-time. The latter caused him to be poisoned by his favourite, Mænon, by means of a corrosive placed in a toothpick. This Mænon was a Segestan and had become the tyrant's slave; in this manner he avenged his country's ruin. It is said that Agathocles, to put an end to the torture he was suffering, had himself placed, while still alive, on the funeral pyre; this was believed to be a punishment for the sacrilege which he had committed in the Æolian Isles in stealing the sacred treasure of Hephestus.

After the death of Agathocles, his son and grandson were killed by Mænon, who tried to seize the power with the help of the Carthaginians. The Syracusans chose Hicetas for their general, and it was agreed that they should give hostages and recall the exiles. But at the first election of the magistrates Agathocles' mercenaries claimed that they were wronged, the citizens armed, a fight was imminent; at last it was agreed that the mercenaries should leave Sicily. They were mostly Campanians, known by the name of Mamertines.

Agathocles had taken a great number into his pay. When it was agreed that they were to leave Sicily, they went to Messina to embark, and were hospitably received; but during the night they killed the inhabitants and seized their wives and possessions. This settlement of Mamertines at Messina was a fresh element of trouble for Sicily, and later on became the cause of the first war between the Romans and the Carthaginians.

PYRRHUS AND THE ROMANS

The absence of federal union between the Greek cities of Italy made them incapable of resisting the native populations, the Samnites, Lucanians, and Bruttians. They were therefore naturally induced to ask aid of the great Roman Republic, which alone was able to protect them. The earliest relations which Rome had with the Greek towns of Italy were friendly. Tarentum alone preferred having the Romans as enemies to having them as

friends. By an act of mad provocation the Tarentines put themselves entirely in the wrong and caused war with Rome to become inevitable. Then, as was their custom, they called to their assistance a foreign prince, and although this time they chose the bravest and most skilful captain of the period, the struggle in which they engaged had as a consequence the final establishment of Roman government over all Italy.

The Lucanians and the Bruttians having attacked the town of Thurii, the ally of Rome, an army, commanded by the consul Fabricius was sent to its rescue, while at the same time a squadron of ten galleys cruised in the Gulf of Tarentum. The Tarentines, assembled in the theatre which overlooked



HYGEIA
(From a statue)

the sea, perceived some of these vessels at the entrance of the port. Immediately an orator named Philochares, who was known by the name of the famous courtesan Thais because of his shameful immorality, exclaimed that the presence of these ships was an act of hostility, and that by the terms of a treaty, the Romans were not allowed to pass Cape Lacinium. The people hurried to the port, sank or captured the vessels, the *dux* who commanded them was killed, the rowers were reduced to slavery. The Roman senate sent an embassy to demand reparation. The ambassadors had scarcely entered the theatre where the people were assembled than they were greeted by insulting laughter. They wished to speak, but their pronunciation of Greek was ridiculed and they were driven out. A drunkard soiled the toga of the principal ambassador; the laughter increased. The Roman turned round and said: "Laugh! you will soon weep, for my robe shall be washed in your blood."

They summoned Pyrrhus, king of Epirus, promising him the support of the Lucanians and Samnites. An account of his exploits and death has previously been given.

All the natives of southern Italy who had greeted Pyrrhus as a saviour, were finally subdued to Roman rule. It was the rescue of the Greek towns which were still in existence, but they were only shadows of their former selves. Although free under the protection of Rome, they vanished obscurely from history. In the time of Strabo the name of Magna Græcia was already an ancient recollection, and the Greek language was only spoken at Naples, Rhegium, and Tarentum. For want of federal union between the autonomous cities, the Hellenic race with its brilliant civilisation had disappeared gradually from Italian soil. The Romans were about to reap its inheritance and transmit it to Gaul and Spain. They repopled some of the former Greek colonies which had become barbarous, especially Posidonia and Hipponium, which had long been inhabited, the latter by the Campanians, the former by the Bruttians, and which had changed their Greek names for those of Pæstum and Vibo-Valentia.

The Roman peace did not restore to the Greek towns of Italy the glory which had radiated from their art and literature during the stormy period

[272-216 B.C.]

of their political independence. The innumerable painted vases which are admired in our museums, and the coins of infinite variety suffice to mark their place in the history of civilisation. Not rich Tarentum only, but towns of no importance, Terina, Velia, Metapontum, Heraclea in Lucania, made coins of inimitable perfection. The production of these works of art ceased abruptly with that communal autonomy of which the coin was the visible symbol. In 268, Rome, who, till then, had only had moulded copper coinage, for the first time made silver coins, and at the same time withdrew the right of coining from all her Italian subjects. Few laws have been more disastrous to art.

The beautiful iconic coins of King Hiero and his wife, Queen Philistis, mark the last period of Sicilian autonomy. After a victory gained over the Mamertines of Messina, Hiero was proclaimed king by the Syracusans who no longer felt capable of supporting the disturbances of freedom (269). On leaving Sicily Pyrrhus had said: "What a fine battle-field we leave the Romans and Carthaginians!" The fulfilment of this prophecy was not delayed, and the First Punic War, which broke out in 263, had Sicily for a stage. At the beginning Hiero, the ally of Carthage, was defeated by the Romans, and passed over to their side. His reign, a long and peaceful one, was a transition for the Syracusans between their stormy autonomy and the inevitable dominion of Rome.^b



GREECE

Clime of the unforgotten brave !
Whose land from plain to mountain-cave
Was Freedom's home or Glory's grave !
Shrine of the mighty ! can it be
That this is all remains of thee ?
Approach, thou craven, crouching slave ;
Say, is not this Thermopylæ ?
These waters blue that round you lave,
O servile offspring of the free,
Pronounce what sea, what shore is this ?
The gulf, the rock of Salamis !
These scenes, their story not unknown,
Arise and make again your own ;
Snatch from the ashes of your sires
The embers of their former fires ;
And he who in the strife expires
Will add to theirs a name of fear
That Tyranny shall quake to hear,
And leave his sons a hope, a fame,
They too will rather die than shame ;
For Freedom's battle once begun,
Bequeathed by bleeding sire to son,
Though baffled oft is ever won.
Bear witness, Greece, thy living page,
Attest it, many a deathless age :
While kings, in dusty darkness hid,
Have left a nameless pyramid,
Thy heroes, though the general doom
Have swept the column from their tomb,
A mightier monument command,
The mountains of their native land !
There points thy muse to stranger's eye
The graves of those that cannot die !
'Twere long to tell, and sad to trace,
Each step from splendour to disgrace :
Enough, — no foreign foe could quell
Thy soul, till from itself it fell ;
Yes ! self-abasement paved the way
To villain-bonds and despot sway.

— BYRON; *The Giaour*.

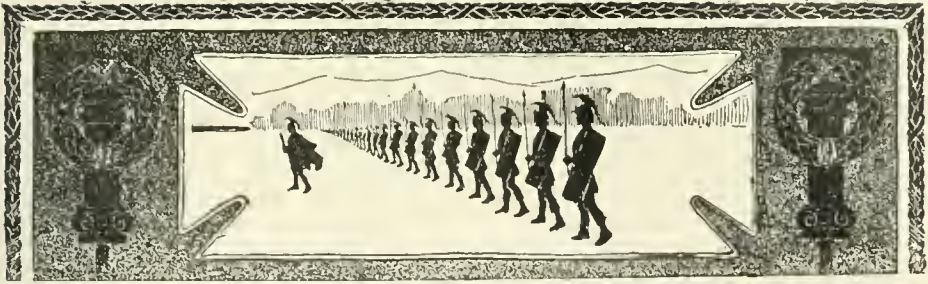

CONCLUDING SUMMARY

THE DEVELOPMENT OF THE HELLENIC SPIRIT

WRITTEN SPECIALLY FOR THE PRESENT WORK

BY DR. ULRICH VON WILAMOWITZ MÖLLENDORFF

PROFESSOR OF CLASSICAL PHILOLOGY IN THE UNIVERSITY OF BERLIN, ETC.

HOMER stands at the beginning of Greek history; nothing before him, nothing beside him, a great gulf fixed between him and everything after; yet there is nothing Greek on which his light or shadow does not fall. Homer is a world in himself, and what a world he is! In the eyes of many, even to this day, he stands for the sum total of the Greek spirit; in the eyes of some, for the whole body of poetry. What the two epics set before us is so complete, so individual, that in spite of all concessions in detail, the oneness of the poem and of the author is constantly obtruding itself upon our notice anew. Homer is so little antiquated that he seems to be of no age; we place him in a sunnier morning-time of mankind, that is all; but to range him in the sequence of history, to conceive of him as under conditions of time and place seems like profanation; this, like so much else, he has in common with the Old Testament. And yet to classify him thus is the first necessity of real comprehension. The Greeks themselves have not done much to help us. About the time of Socrates a school of æsthetic criticism restricted the sacred name of the poet Homer, certainly not without some show of reason, to the *Iliad* and the *Odyssey*; and thus these poems have come down to us, but the price we pay is the loss of all others of equally Homeric origin; and hence Homer stands more than ever alone. The last word of the philology of antiquity was that Homer ought to be explained only by himself. Modern philology seemed on the way to the same conclusion.

By the discoveries of the last generation the ban of this isolation has been broken. Only by wilful blindness can the Ilium of Homer be dissociated from the Ilium restored to light on Hissarlik, though the remains of the latter go far back beyond the time of Homer and Priam. Not the age of the Homeric poets alone, but the age of the Homeric heroes rises up before us from these strongholds and tombs. The links that bind it to the older civilisation of Asia and of Egypt lie revealed, positive chronological data already enable us to determine the certainty of this or that. From these

actual remains we begin to gain some conception of the history and the peoples whose poetic reflection shines for us in the *Iliad* and the *Odyssey*.

On the shores of the Ægean Sea, in the second half of the second thousand years before Christ, there existed a sumptuous civilisation which had received impulses from the East and from the South, but in which we nevertheless recognise the spirit of the Greece immortalised in the Homeric poems; and in the Asiatic home of Homer the connecting threads do not break off short as we trace them back. In the mother-country, on the other hand, other savage Greek tribes, whom we name after the Dorians, forced their way in; they destroyed the ancient superior civilisation, reduced some of its representatives to slavery, and drove the rest over into Asia. There was another immigration into Asia, this time of the Phrygio-Thracian tribes, the ancestors of the Armenians; such of the earlier population as were not reduced to slavery being driven south. These tribes we are wont to call after the Carians. There was a time when they reached out towards Europe, and in a few islands they continued for centuries to struggle against the Hellenising influence to which in the long run they completely succumbed. But as the study of this long and important period is still in its infancy, our main object should still be the collection of material; it will be one of the principal tasks of the next generation to sift and elaborate what has been accumulated. At the present time it is more important than any amount of detail for us to understand what is the historic background both for the subject-matter of the Homeric epics and for the practice of this form of poetry and the existence of the poets who used it.

The Homeric poems are a legacy from the first great period of Greek history. We may approximately fix the year 800 B.C. as their latest possible date. The subject-matter of the Epos, the Heroic legend, is the deposit of historical reminiscences of that earlier time. It was wholly fit that men should see in the epic heroes the founders of their own nation and of their own civilisation; but in point of fact it was through Homer that the Greek nation first acquired consciousness of itself, of its individuality and of the common blood in its veins. Not in the time of the heroes alone, but in that of the poets of the Epos, the Greeks had no national unity and less than no national feeling, and the same holds good of their civilisation. The tales which Homer tells are laid to a great extent in Argos, Thebes, and Sparta; all the heroes come from the country which we call Hellas and distinguish from Asia as their mother-country. Nearly all the Homeric gods have their homes there likewise. But now gods and heroes, like Agamemnon's Achæan host, are taken across to the northwestern angle of Asia. Achilles has conquered Lesbos; the descendants of Agamemnon rule in Mytilene and Cyme. Cyme, Smyrna, and Chios are the reputed birth-places of Homer. Here, where later the Æolian dialect comes into collision with the mightier Ionian, was perfected the artificial dialect of the epic,—a dialect spoken in this form at no time and in no place,—and the heroic verse that was at no time and in no place a really popular form, and was first imported into Lesbos itself by the Ionian Epos. Here, side by side with the ruling class which claimed descent from the Homeric gods and heroes, was evolved a class of professional bards, and amongst them arose the gifted poets whose names have been forgotten in the fame of the one and only Homer. Let us hope that the real Homer was worthy of this pre-eminence. By these Homerides the Epos, first sung to the lute, and then recited, was carried farther and farther among the islands and along the coast. The subject-matter awakened interest everywhere; being, as it were, national history, the form won for

itself an ever widening circle of appreciation. Gradually in the mother-country there were found native bards who learned from wandering rhapsodists the art of making poetry in the Homeric style, that is to say, of using a foreign language and a foreign art-form, but to express new matter, which was nevertheless invariably linked in some fashion with the world of Homeric heroes. Accordingly, the production of epic poems, ever based upon Homeric legend, was maintained in the mother-country for centuries after it had died out in Ionia, continuing into the sixth century. It is through these circles, in the main, that Homer has been preserved.

The cardinal point was that, in the Homeric Epos, the Greeks acquired an organ of speech capable of expressing all that men could say and hear. It was a well-defined and yet highly elastic style, not by any means exclusively adapted to narrative; on the contrary they never abandoned the practice of casting instruction of all kinds into this form, which was popularised and made generally intelligible by the school from the time there were schools at all. It was also used in incantations, in monumental inscriptions, and in the fleeting jest. The most abstract philosophy, the description of the starry heavens, the dogmatic side of astrology, nay even the Psalms and the Gospel of St. John, have been clothed in Homeric garb. In like manner it is characteristic of the genius of Greece that it begins its evolution by creating such a mode of expression, and for a thousand years does not grow weary of it. The instinct for form and the adherence to a form once discovered are likewise Greek; their combination begets at first an unparalleled achievement, but for centuries long it has to drudge in the service of imitative facility and orthodox formalism.

Homer, moreover, created for the Greeks their heroic legend. The whole wealth of scattered and desultory reminiscence and tradition among the various tribes and families, combined with all that occupied the memory and imagination of man, was gathered together in one by the art of the Epic poets. Thus another and more beautiful domain was built up in the imaginations of men, from which a light fell on the present so brilliant that the present paled before it, while even as children men began to make themselves at home in that domain. Here it was that the Greeks found their common fatherland, proud and united, whilst they were still at daggers drawn with one another upon earth, and once more when they were all subject to foreign lords; to this day all those of us who have drunk a draught from Homer's spring, feel at home in this region. Their gods the Greeks, likewise, received from Homer; not the faith by which the heart is made heavy and light, rendered contrite and redeemed, but the names and the histories, the relations and the amours of their celestial host—that is to say, their mythology.

The name itself implies how far it was from anything like divine revelation and holiness. The muse has much to say that is untrue but resembles truth. Homeric art, however, understood the secret of humanising the stories of the gods as effectually as the stories of tribes and kings. And this Homeric art took captive the fancy of the listeners, that is, the fancy of the whole nation as soon as it gave ear to the poetry of Homer. Homer gave to the Greek his gods, and all the Greek gods turned into men with the gift. He gives us a complete picture of nature too, he teaches us to see what surrounds us, and the sorrows and joys that condition our brief life under the sun. The roseate flush of dawn, the twinkling of the dog-star, the rush of the hurricane, the babble of the mountain stream, the tops of the fir trees in the highland forest, and the clumps of asphodel on untilled ground; the lions and wolves in the Asiatic mountain country, the horse and the hound, the

companions of man, he sees everything, shows everything, loves everything; above all, the sea, eternal, ever new, that has become a home to the Ionian in lieu of mother-earth. In the light in which he viewed Nature and set her forth the Greeks accustomed themselves to look upon her. Not only so, but whole generations took pleasure in the reproduction of what had once been done, and turned their eyes aside from the contemplation of the Real, the infinitude whereof no Homer can exhaust.

In fine, the judgment passed upon Homer by Horace, who repeats the verdict of the stoics, contains a large measure of truth:

*“Qui, quid sit pulcrum, quid turpe, quid utile, quid non,
Planius ac melius Chrysippo et Crantore dicit.”*

He gives us a complete picture of the doings of man, shows us princes and beggars, old men and boys, the budding maiden and the perfection of dæmonic beauty. So rich is this completeness, so profound the poet's knowledge of life, that the thing we most clearly realise is the utter preposterousness of any attempt to compare Homer with any popular poetry whatsoever. Rather does Plato rightly name him the grandsire of tragedy, and only one picture of the world can claim a birthright equal to that of Homer—the picture set forth on the stage of William Shakespeare.

In this Homeric delineation of mankind, which includes immortal men, to wit, the gods, and has the portrayal of nature for its complement, lies that specifically Homeric quality which casts a spell over every unspoilt mind, and which the finest art-critics of all times and nations never grow weary of praising. It bears witness to a high psychological culture in both poets and listeners. No state of primitive barbarism such as Tacitus depicts in the Germani, none but an old and richly developed civilisation, could lead up to this. The fresh observation of nature in the pictures of Knossos, the rigid stylistic convention of the euttle-fish on the golden platter of Mycenæ, for example, the bold ornament on painted vessels, like the pitcher of Marseilles, the architecture of the beehive tombs, show the Homeric sense of art in other regions and at a pre-Homeric period.

This Homeric art is certainly in the main Hellenic. But for all that, it is only one side of the Hellenic spirit, which is not even remotely understood by those who identify it with Homer. A great danger is already threatening this form of art in the shape of conventionalism, of stereotyped beauty. It grows too easy to be a Homerides, and he who rests satisfied with such an achievement thereby renounces all aspiration to become a Homer. And the life depicted by Homer conceals beneath its brilliant surface much not only of hollowness but of evil. There is a total lack of national sentiment; there is no state; properly speaking there is no religion. These gods will vanish into thin air like vapours at the advent of a true god who wins men's hearts to serve him. These men and women enjoy and suffer—to what end? To blossom and wither like the leaves of the woodland. What is the end of this brilliant world? The horrors of devastation for Ilium, and for the Achæans, returning home in their fleet—shipwreck.

The Ionians had just been torn from their native mountains and springs, from their ancestors and from their gods; in dire distress they had fought for and conquered new settlements on a foreign coast and among foreign races. They had been constrained to turn away from their mother-earth: the sea cannot take its place, for the earth alone is *θεσμοφόρος*. So it is that the legitimate heirs of the Homeric poets are the very men who shake off Homeric ideals—the Milesian merchant who traverses all seas, founds

factories and cities, mingles with all nations, gathers information and wealth from all sides; the Ionian artist who abandons the exereescences of conventional style with the conventional Heroic legend, in his search for what is characteristic and individual; the subjective thinker of Ionia who seeks in his own breast the solution of the world's enigma, and whether he discovers cosmic law there or in the contemplation of the heavens, ruthlessly thrusts away from him the fair illusions of Homer.

Meanwhile, in obscurity and gloom another Greece slowly arose in the mother-country. The immigrants, before whom the peoples of Agamemnon, Achilles, and Nestor—in so far as they were not enslaved by their rough masters—fled across the sea, had to begin from the beginning. The remains of the old civilisation stood in their midst, uncomprehended and mysterious as the Roman strongholds in the countries inundated by the flood of the Germani of the great migration. Where, as in Sparta, the forms of life fitted for migratory conditions were preserved in art, that primitive rudeness survived which (to take an instance) permitted the use of the axe only and not of the plane in the fashioning of a door-post. We recognise everywhere the oldest and lowest forms of religion—fetich-worship, totemism, a gloomy form of ancestor-worship; human sacrifice is frequent. Ornament has lost the sensuous delight in form proper to the Heroic period; it begins with lines and dots. The influence of the East must for a while have been totally arrested. How ill at ease an Asiatic Greek must have felt in this world is shown by Hesiod, who inveighs against his Helieonian village-home. He was the son of an immigrant Æolian. A large part of the country, not only the whole of the west coast, but also Thessaly the home of Hellen, *i. e.*, of the whole nation, never again played an active part in civilisation. This, of course, had to come from the Greeks of Asia; and the cities of the eastern border in which the remains of the original population preponderated, Athens and Eubœa, to which the maritime city of Corinth was added from the Dorian cities, were the entrance gates to this civilisation. But the process of receiving and assimilating it was carried on in the main under the pressure of new modes of life, which we name after the Dorians. With regard to the older period we lack not direct evidence merely but credible information at almost every step: not till the beginning of the sixth century does it become possible to some extent to grasp this civilisation; but the institutions, their reflection in Heroic legend, and the character of the religion (not mere mythology) permit of a few inferences. The times were hard; for the most part a ruling class alone raised itself above the miserable, restless, joyless struggle for daily bread, and below it bondmen in many cases wore out a wretched existence. Not until the end of the period do men advance beyond the stage of primitive husbandry, and then not everywhere. Agriculture and cattle rearing remain the chief means of livelihood. The ruling class is warlike; where the mountains permit it, they pursue the sport of horse-racing, but for purposes of war horsemen are of little account. Highest in public esteem stands the physical exercise which in time of peace takes the place of military service; Greek gymnastics, of which Homer knows little, become hallowed by the competitive games which by degrees not only become the culminating moments of life but also evoke the first glimmer of public spirit.

The umpires at the Olympian games are the first to apply the name of Hellenes to the nation—more exactly speaking, to the class. For here it has come to pass that, though politically divided into numberless cantons, though involved in perpetual feuds and irreconcilable local animosities, the

members of this class recognise one another, intermarry, call a truce for the festivals, and find a common interest in maintaining their class supremacy against the encroachments of the lower orders. The protection of the patriarchal organisation places Sparta at the head of a loose federation. The spirit of the age is masculine. The loin-cloth is laid aside at gymnastic exercises, the nude male form is the fairest of objects. The love of boys becomes not only a national institution but the sole province in which love claims the co-operation of the soul. Everything presents the sharpest contrast to Homer. Gymnastics require self-control and training; military service requires obedience; class supremacy is not favourable to the predominance of the individual man, but demands his subordination to the class. Thus, then, these men trained themselves strictly and austere, and gained control over themselves, body and soul. They set up an ideal of the perfect man, who by training and obedience earns the right to be free and to rule. And they held out to him the prospect of becoming equal with the gods, even as Hercules entered heaven; but on earth they kept him within bounds by raising above him the other Greek ideal, that of the free self-governing community—the aggregate of equally worthy and therefore equally privileged free men. However much the reality may have altered, these two ideals remained inviolate, and they are the specifically European element which the Greeks have to show as against the East—the Greeks of the mother-country, be it understood, for Homer knows of nothing but an unbridled individualism; he does homage to the hero who, in good and evil alike, knows no bounds. These nobles are not licensed to aspire beyond the limits of their class nor do they wish to do so. They invented an ideal of happiness that could be realised on earth; all that was required was to keep within bounds. Hercules, the ideal hero of this society, had nothing but toil upon earth, but in return he made the step from human to divine by his own strength. This grand conception betrays the lengths to which Doric self-reliance believed itself able to go.

The free man has come into being; the power above him, which we call society or the state, has also come; at that time it was called Law or Custom—*Nomos*; and this power is sanctified by the existence of an exponent of the divine revelation, the god (*i.e.* the Apollo) of Delphi. The authority of this god, and of the oracles by which he answers through his priests, is undisputed. He addresses the mortal with the warning "Know thyself," that is, as a creature that is mortal. He enjoins self-control and self-restraint; the numerous Greek adages recommending moderation, the praise of the mean and of equality, the encomiums on *sophrosyne*, belong to this period and to this world. No doubt, so much would not have been said of this virtue if it had not been so rare, but erroneous as it is to conceive of the Greeks as examples of the virtues they recommend, the establishment of this moral ideal is significant; a complement to their faith in the power of man to gain admittance into heaven by force. Under Apollo's direction music takes its place by the side of gymnastics; music also masters the wild instincts; it includes every kind of intellectual culture known to this society. The boy learns to sing, to strike the lute, to keep time in the dance; and the consecration of worship rests upon it all. Harmony must reign in the deportment and movement of the body, and of the soul likewise. The piper takes his place in the column on the march; it marks an important advance that the line of battle now marches to meet the enemy in step and in serried ranks; it is thought a fit subject for the painter's art, and not without justice. The ruling caste does not often produce a poet

who is a musician at the same time; the poets are for the most part brought from the East: but the nobles must be able to sing the songs, to dance, and even to improvise a verse to a set tune over the wine. The female sex also takes its part in music; choirs of maidens are popular, and native poetesses occur more frequently than native poets. Side by side with solemn gravity we get, at stated times of the ceremonial year, the most unbridled enjoyment, ecstatic revelry, the grossest kind of burlesque; but this is curbed; it appeals more to the lower social strata, and does not find expression in art until a late period.

Like all institutions, this worship and the whole system of the cult of Apollo was not established without fierce struggles; and it incorporated into itself, and thus rendered innocuous, many things which it was unable to cast forth. This was true more particularly of ecstasy. There had been a time when the nation was thrilled by a mighty religious movement having its source in the Phrygio-Thracian religions: the great god Dionysus came, he who walks the earth demanding faith and followers, who possesses men with his spirit and enables a man to experience what he himself experienced, and is ever experiencing afresh — divine madness, death and resurrection. The movement naturally laid hold upon the Greeks of the East also, but it did not take souls captive there; the Homeric Greeks have no appreciation of mysticism. Here, on the contrary, within the religion that was gradually being Homerised, a counter-current set in, capable, indeed, of becoming a sub-current, but only if its course were directed into the bed of the official religion, and if Apollo effected a compromise with Dionysus. In narrower circles, outside the state religion, this doctrine and practice based upon the ecstasy, the redemption of man, have always held their own; the old religion of Demeter passed through similar crises, and the incorporation into the state cult of secret rites such as were practised at Eleusis, did not suffice to stifle the longing for an individual religion. But for the time the Apolline system is triumphant.

Doric architecture is now added to the solemn rendering of Doric music. The temple, the house of the image of the god, made, not for congregational worship, but for solemn procession or devout meditation, is the consummate expression of this piety. That the gods should take the form of men is an outcome of the Homeric temper; but Zeus as a naked man hurling lightning, Apollo as a naked youth, the calm, majestic matrons and maidens — these are the Doric ideal of divinity. In addition to these we get the statues of men, the male image (*ἀνδρικός*) and the virginal image (*κόρη*). The inspiration of these arts certainly came from the East, but what interests and delights us in archaic sculpture and in those very examples which seem to us typical, as so genuinely Greek, is the Doric element; it reveals itself to us not only in the *Æginetæ* and the statues of nude youths who are just as much gods as men, but also in the *Idolino* and the *Delphic charioteer*, the *Hestia Giustiniani* and the female prize-runner, in the works of *Polyclitus* and again in those of *Myron*; for Athens long shares in this culture, the chief prophet of which at the twelfth hour was the *Theban Pindar*, with his gift for showing us both its splendour and its remoteness from modern sentiment. To this day Homer and the Athenians produce a vivid impression on every unsophisticated mind; Pindar requires arduous historical study, like *Virgil*, *Dante*, and *Calderon*.

By its situation, and the close ties of consanguinity between its population and the Ionians, Athens was destined to unite the civilisations of East and West. The comparatively large peninsula of Attica, so shut off that it

is almost insular, had already developed into a political unit at an earlier stage. Aristocratic rule had, it is true, reduced the less wealthy of the peasant population to a condition of servitude, but by introducing the olive it had made agriculture profitable; and, like the Dorians in Corinth, it had recognised trade as an occupation not derogatory to men of rank. Material conditions for amelioration were far more favourable than in the neighbouring island of Ægina, where commerce concerned only the ruling class, who farmed their lands with purchased slaves. But the rapid rise of Athens from obscurity to the first rank is due to one man, in whom the union of East and West was first consummated—the wise Solon. Of noble birth and in sympathy with Dorian modes of life, he had, for all that, travelled to distant shores as a merchant, had laid aside among the Ionians all prejudice, superstition, and mysticism; above all, had acquired the power of using poetry not only for political but also for moral exhortation. He was inspired by the fullest confidence in the might, wisdom, and justice of God, and in the goodness of human nature; all it needed was liberty to exercise itself without let or hindrance,—a need which found its complement in the social order,—that other men might likewise obtain the liberty that was their right. His people had faith in him, and placed the organisation of the state in his hands. He gave the power to the whole people, *i.e.*, to the changing majority of free and upright Athenians, and he gave them all access to the national assembly, to the executive committee, the deliberative council, and the national court of justice. In principle, democracy was established. And the principle of freedom and of equality can be obscured neither by abuse nor by inadequate use; the only limitation to which it is subject is due to the higher principle which Solon himself placed above it, and which never disappears, at least, in theory, from the politics of the Greeks—the principle of justice. Whatever modification it underwent, with Solon there came into existence the municipal constitution, not of Athens alone, but of Greece, which endures as long as the Greek spirit can be traced in historical continuity—the free state of free men. At the time, as a matter of fact, freedom could not be maintained in Athens. But the struggles of the great families, which for another hundred years wrestled together for supremacy, only gave the city time to absorb the Ionian spirit more fully, to develop industry and trade side by side with agriculture, to exploit that economic freedom which was never again encroached upon, and so to accumulate strength in every direction for the decisive moment. This came with the question whether Europe was to be swallowed up in the despotic world-empire of Asia, to which Homeric Greece had already ingloriously succumbed. The issue was not a question of national differences, but simply one of freedom or servitude; a servitude, too, such as the wise man often accepts, because it does not seem to threaten individual liberty. But the free state or class, the democracy of Athens, no less than the Peloponnesian aristocracy, refused to brook it. The Athenian line of battle won the victory at Marathon—it was the triumph of the Doric element. The weapon for the maritime victory of Salamis had been rapidly forged by the genius of Themistocles, a modern Ionian in every sense of the word. In defiance of all human calculations, Xerxes was defeated and compelled to renounce his pretensions to the whole of Europe.

The spirit of Greece now became a national idea; the kinsmen of the Greeks in Asia not only came over, but they made Athens,—Sparta being so tardy,—the presidial centre of a confederation unprecedented in power and extent by anything Greek; the conception of a vast Greek empire in

the future, a national confederation, seemed capable of realisation at that moment, since it was possible for the first thought of it to take shape. Politically, too, Athens seemed destined to unite the Greeks of the East and of the West; and if she did so, the Greeks were bound to possess the world.

Under the auspices of these great times Attic tragedy arose as the most perfect expression of the union of Western with Eastern Hellenism, stamped with the features of the great period of its birth; for not until Æschylus, the warrior of Marathon, took the Homeric Heroic legend for the groundwork of the ancient ecstatic Dionysian festivals; not until he substituted the solemn Doric chorus for the satyrs, and reduplicated the Ionian reciter, was the drama discovered which, sublime beyond the scope of mere humanity, and still remaining a part of the worship of the god, yet bore within it the germ of development into a picture of human life, making an appeal more direct and more effective than the narrative of the rhapsodist or the song of the bard. An abundance of talent turned to this new form, which remained Athenian even when the poets came from abroad, and became more and more Athenian, human, and modern. Yet no one ventured to abandon the Homeric subject-matter and go direct to contemporary life for material. And so it continued to be, although with the decay of the Attic empire and its great poets, tragedy (whether as Attic drama or as a part of worship), no longer had any intrinsic claim to the subject-matter of the Heroic legend. Here again the authority of a great achievement condemned posterity to the depths of imitation. The form of drama known at Athens as comedy was regarded as quite another thing; and it had certainly gone far from its source in the same masquerade and the same Dionysian ecstasy by the time it was cast into shape by witty Athenian poets, and promoted to be species of literature. Comedy became drama, and followed the lines of tragedy by centring about a definite action; it was no less wonderful than the latter so long as it served the purpose of the moment and of the necessarily circumscribed circle of Athenian society; but for this very reason it exercised no universal influence, and was destined to fall to pieces with the collapse of the political and social fabric. The last literary achievement of Athens was to transform it, about the time of Alexander, into a refined, purely recitative play which occupied exactly the same relation to contemporary life as later tragedy occupied to the Heroic legends. This new comedy deserved and received the same classic *imprimatur* as tragedy; but the same slavish subjection to a model ensued; the figures of Menander, so infinitely commonplace and provincial, alas! were doomed to make their appearance on the comic stage, like Medea and Orestes on the tragic, whether the play were written and acted in Rome or Alexandria. In this petrified and haphazard form the theory rather than the poetry of the drama was conveyed to the West. Aristotle, in particular, failed to advance from the chance illustration of actual performances to a formulated statement of the truth, and modern writers have still an unwholesome habit of tossing about the terms "tragedy" and "comedy," at all events in theory. We have the will to admire and the capacity to understand both what has been achieved by the Athenians and the causes that led inevitably to that achievement: but the foundation of modern dramatic art is Shakespeare — or Plato, who recognised in theory that tragedians and comedians are anything but contradictory terms, and who, like Shakespeare, combined both in himself.

In the Athenian art of the fifth century, as in Æschylean tragedy, the elements of Eastern and Western Greece interpenetrate, and each heightens

the effect of the other. The Parthenon is a Doric temple with an Ionic frieze. To Ionic monumental fresco painters is given the task of painting Homeric stories on the broad surfaces of Athenian and Delphic porticoes; the capacity to immortalise the deeds of contemporary life is its own contribution. From the devout spirit that inspires the poet of the *Oresteia*, Phidias, with all the wealth and all the art at his command, tries to create images of the gods that will satisfy the religious feeling of his time. To the Greeks they were the greatest for all time. Precisely as in the case of tragedy, such a high strain of endeavour lasts but a short time. Then the Ionic element becomes preponderant; the human, subjective aspect thrusts itself into prominence. It is inevitable, and the thing it created is worthy of admiration. But in the *pathos* and *ethos* of the divine types created by Praxiteles and Scopas there is nothing but the mythological character of Homer's gods; they are immortal men, and no more; to Scopas and Praxiteles they were nothing higher than this. And it was right that it should be so; for in the meantime the comprehension of the truly divine had so far progressed that its circumscription in a person was merely symbolical, and implied no idea of physical incarnation.

Ionia's greatest and most important contribution was that provided by the audacity of the great thinkers and observers of the sixth century, that indeed which, by setting the whole conception of the world on a new basis, was bound to destroy the fair illusion of gods in the form of men which Æschylus and Phidias might still have regarded as a truth. It was only on Ionian soil, on the soil of Homer, that man had courage and strength to fling aside all convention, all tradition, to step into the centre of the universe himself and say "Thou art naught but what I recognise as thee, thou signifyest what I discover in thee." The idea was not at the outset formulated with this precision, but such is the spirit in which the Ionians early went to work — not the philosophers alone, but the reckless natures who in the world of action took themselves for the standard of conduct — men like Archilochus the poet, whose subjectivism combined with his brutal outspokenness and license aroused the delight and horror of his contemporaries and of posterity. A terrible moral danger lurked in this attitude, and Ionia, which changed nothing but its masters, brought an infection into the mother-country which neither the state nor society availed to overcome. But for strong natures it also provided the remedy, and the world, for its part, owes to this Ionic element the best of what the Greeks have bequeathed to her — science, philosophy, natural science, and history, though it is true that they had first to be ennobled by the Athenians. This is most easily seen in the case of history.

Historia is subjective inquiry; Herodotus, not a man of powerful intellect, gives us, as he himself says, the sum of his own investigations. This includes what he has seen, heard, read, and thought, all in close juxtaposition. The subjective mind determines how and what he can and may narrate. Thucydides, the Athenian, on the other hand, writes the war of the Peloponnesians and Athenians; here it is the object which is the determining factor. The writer renders both himself and the reader account of his subject and of his method, indicates the degree of credibility for his various statements and adds his own interpretations and conclusions for what they are worth; the scientific method has thus been reached. Man has not lost his independence, but he consciously places his whole strength at the service of an idea, in this case the idea of truth; and, clear as it is to him that he cannot reach the point of presenting it pure and complete, he has no doubt that an objective truth exists and is accessible to human knowledge.

Natural science had begun, at a stroke, to explain genesis (*das Werden*) in general and particular by a bold hypothesis. The investigator made the laws. Natural science, in its turn, came to test its laws by a thousand patient, minute, independent observations of nature, to accumulate the facts from which the rule might be deduced in its turn. Most important for this purpose is the cultivation of that domain in which pure abstraction permits of an unbroken series of proofs, the domain of numbers and geometrical concepts. Here we have a genuine process of learning from which, in time, mathematics takes its name; here the deceptive character of sensuous perceptions is as clear as the existence of knowable laws; here are revealed the necessity and possibility of many to collaborate and continue the work. It was not by means of his religious brotherhood, which, if it had lasted, would have ultimately become a sect, that Pythagoras exercised a beneficent influence, but by the methodical organisation of study, which became scientific in so far as it turned its attention to mathematics. At the same time, in spite of all premature hypotheses, medicine, the branch of observation most closely in touch with actual life, discovered by keen observation and continuous experiment the right way to gain a knowledge of the human body, its nature, its sufferings, how to keep it healthy, or if necessary how to cure it. In astronomy and medicine we have the difference between the East and Hellas most clearly manifest. Thousands of years before, the Babylonians had already observed the heavens; thousands of years before, the Egyptians had compounded prescriptions from all kinds of drugs and simples. But this was sorcery, and even the Greeks had to pay for allowing themselves to be imposed upon by it.

In the sphere of morals the breach with that *Nomos* of which we have spoken was a great danger: the whole edifice of the Apolline organisation fell to pieces. Democracy fairly challenged man to translate his theory into practice, and the mental attitude of the time was so political that people thought Anaxagoras a crank, because of his own free will he devoted himself to the *vita contemplativa* and refused to mingle in the political hurly-burly. They declined to believe in his good faith, and political suspicion allied with the principle of established authority, which always naturally opposes a tendency so novel, banished him from Athens. And from the very fact that, in all other fields, this principle was so strong among the Greeks, the age that dared express and pursue every thought that rose in the mind acquires its peculiar significance. The activity, inventiveness, and audacity of the period of the sophists, with its superabundance of talent, sowed seeds without number, many of which, unproductive at the time, have been left for the modern world rightly to appreciate. Thus a science of jurisprudence would have been developed, had not the fall of the empire destroyed the sphere in which alone a uniform system of law could prevail: the practice of the legal profession thus falling into the hands of pettifoggers, while the theory of jurisprudence was left to philosophers, who were honest in their quest of the principle of justice.

Modern speculation has gradually outgrown the tendency to regard the sophists through the eyes of Plato, and to impute to them moral and intellectual indifferentism. One thing, however, is incontestable: the whole movement, coming, as it does, from Ionia, is rationalistic through and through; the intellect will acknowledge nothing on a par with itself. A prophet like Empedocles, who was a doctor, a philosopher, and a poet to boot, besides cherishing the proud conviction of being as good a sophist as any other, could go about extolling his revelation in the Peloponnesus; in

Athens he would have found no place. The port of Athens, on the other hand, was laid out by a Milesian diagrammatically in the dreary chess-board style then in vogue for buildings on new sites, although it can only be satisfactory on paper, inasmuch as it neither takes account of the character of the landscape nor consists with the artistic feeling of the Greeks. Rationalistic in his teaching, again, was the only Athenian whose sophist doctrines gave offence to his compatriots, especially because instead of making a fortune like the teachers of wisdom from abroad, he neglected his affairs. We, ourselves, should hardly except Socrates from the category of sophists on account of his merits as a dialectician, had not the reactionary democracy of the restoration executed him as a person dangerous to the common weal. He chose to die rather than do the least thing that ran counter to his conscientiousness of rectitude, his Logos, the belief in the reality of the Good which he was not able to demonstrate by rationalistic methods; and the moral grandeur of his death has reared for the faith of the human race an image which bears eternal witness that man is free and happy if he can but base his actions on belief in the Good; he needs no future world of punishment and reward. This eccentric Silenus-faced Athenian did not aspire to become a god like Hercules, he would have been more at home in a pedantic than a heroic atmosphere: he merely did nothing which he did not think right. The claim that the will obeys the reason—in most cases such a pitiful brag!—was a truth with him. Socrates was Athenian to the core, and therefore a loyal citizen of the democratic state; but, like Solon, he combines the Ionian and the Doric temperament; and, in common with the law-giver, he is devoid of feeling for mysticism and the whole sphere of the Unknown. His life is only intelligible as an outgrowth of the history of Athens; his death makes him a type of man as he can and should be. So long as the human race survives on our planet it will be a master experience of our moral education to live through the dying hours of this old and ugly plebeian.

That we can so do, that we can have Socrates as our master, we owe wholly and solely to the loyalty and poetic genius of the man (Plato) who set himself in the days of that agony to show that—hard as it may be to define uprightness, courage, piety and what other virtues there may be—the upright and courageous and therefore happy man has demonstrated in his own person the reality of these abstractions. This alone would have sufficed to make Plato a benefactor to mankind; but this is only a small part of his labours. With all that Socrates and the school of sophistry taught him, he combines mathematics and the mysticism of Pythagoras. He founded the school which was destined to serve the purposes of organised scientific work for nearly a thousand years, and which is the prototype of all such organisations. He lays down the fundamental lines of every philosophical science, constructing, and, where he thinks he has found a better way, demolishing the foundations he himself has laid. Many of his intuitions have only been verified after the lapse of centuries and tens of centuries; others still await verification. The force inherent in him is best proved by the energy of those who assure us that he has had his day. He has set Eros as the mediator between heaven and earth; this Eros has no worthier abode than the writings of Plato; through them, even to-day, Psyche is learning the road heavenwards. But Plato is a Greek in every fibre, he can only be understood through his people, and his people through him.

Plato was a poet; and though he fixed his mind wholly on the eternal type, unduly despising the individual phenomenon, and thrusting his own individuality completely into the background, yet this individuality with its

poetic genius cast light and shade in bewildering alternation over every field of contemplation, like the full moon as she fleets over the mountains and plains of Attica.

Science needed the cool judgment and caution of the systematiser. She found it in the person of Aristotle, the master-builder among men (*baumeisterlicher Mann*), as Goethe calls him. At his hands science first received systematic treatment and method — the tools of her craft. The existence of the man and his work attest for all time the unnatural character of a division of the one and indivisible body of science though it be only into natural and abstract sciences. For even in the collection of material, he laboured for all branches alike. It is idle to inquire which were the greater, his personal achievements or those which owed their birth to his example. For his successors carried on the work in his spirit, even more truly when, often after vehement controversy, they advanced beyond him, than when they rested content with merely working out the plan of the master-builder. Sprung of a family of physicians, and endowed with the Ionian temperament, the natural science of Ionia is the most substantial contribution he made to the legacy bequeathed by Plato. But he had likewise made himself familiar with all the accepted tricks of oratory at Athens, he speaks with authority on logic, rhetoric, and poetry, and he is capable of treating all literary forms with the hand of a master. Yet he did not discover his own peculiar style until he combined the bald simplicity of Ionian scientific phraseology with Attic balance and Attic elegance. Thus he became the father of scientific prose, of the text-book no less than the lecture and the practical investigation. Even in halting translations he afforded nutriment to powerful intellects. His own words will have a modern ring to the end of time.

It is a characteristic distinction between the two philosophers that Plato, the incomparable artist in words, fiercely attacked rhetoric, while Aristotle made it a cardinal item in his programme of education. It was a power and he reckoned with it accordingly, not without yielding more to contemporary taste than we can approve. To the modern mind rhetoric is the least congenial element in the culture and literature of antiquity. We can understand that in the political agitation which pervaded the Attic empire, oratory, which was a daily necessity in parliamentary debate and in the law courts, was bound to develop into an art, and that a literature should have arisen corresponding to that of our daily press. So, too, we can understand that the manifold intellectual activity of the age of the sophists, and the tentative efforts of science, needed an organ which should not only convey practical information but have an eye to effect. That this prose should become Attic, in spite of the fact that the language of Athens had barely passed through its first phase of development in tragedy, was inevitable from the time when Athens took the lead in Greece. In the sphere of language, at all events, the country attained to national unity. But to us there is at first sight something monstrous in the fact that in the age of Pericles a set form of oratory should arise which not only consciously competes with poetry but seeks to supplant it — and which actually succeeded in preventing the development of any new poetic method. The whole classic world, including the Latins, devoted no trifling labour and skill to this art of eloquence, and its art-theory ended by making poetry a mere subdivision of it. We are now coming to recognise more and more how much modern poetry in particular owes to this prose-poetry and its methods: the modern connecting-link of the rhyme was discovered beyond all dispute by that Gorgias whom Plato attacked as the champion of rhetoric; the intermediate links lie before us

in an unbroken chain. Our astonishment subsides, if we so far rid ourselves of prejudice as to realise how arbitrary is every line of demarcation between poetry and prose. Not only the poems of Walt Whitman, but a great many of Goethe's finest poems would be regarded by every Greek art-critic as prose. Prose really implies that the language proceeds on foot; the reverse, — that it soars aloft by means of this device or that, — applies to every conventionalised form of speech; whether it is cast into a regular measure or not is irrelevant in comparison with the fact that it is informed by measure. The Hellenic bias towards style manifests itself here in the creation of a definite form, and we cannot question the fact that the development of the period demanded a new style and one unhampered by the laws of metre. For at such a high point of civilisation the poetic form does not suffice for what the world has to say and wishes to hear. Empty and conventional jingle, relying on tricks of style, undoubtedly attained a bad eminence in Greek and Latin oratory; but a similar spectacle has been afforded by poetry and the arts of chisel and brush. If a man had something to say, like Aristotle, Polybius, and Plutarch, it did him no harm to clothe his thoughts in a form, the effect of which we perceive agreeably even without understanding the art to which it is due. It is the same artistic conventionality which to this day lends to French prose, whether it be that of literature or of polite conversation, the charm which the Teuton does not possess in equal measure. And the French have attained to it by a rhetorical schooling traditionally derived from the method of antiquity. That elegance is not an inborn quality with them is shown by the formlessness of so great a writer as Rabelais. Were we in a position to read the laws of Solon we should perceive that Attic elegance was likewise no gift of heaven. An art which we find still dominant in the sermons and hagiography of the Byzantines is a power not to be despised, even apart from its historical value.

Again, it was not to these conventional tricks, in the first instance, that Plato was averse. He was logician enough to appreciate the high educational value of making thought move in regulated periods (a thing that many people overlook nowadays); but the heaven-born poet felt that this intellectual mechanism was antagonistic to the direct unconscious self-revelation of emotional experience. The thing that roused him to passionate protest was the claim laid by rhetoric to the formation of youth. This had to be begun on a fresh system, the old training in music and gymnastics being no longer adequate. The question was between a scientific and philosophical education (Plato was thinking particularly of mathematics, to which we also devote attention) and a conventional and mechanical training of the mind. There is no question that the rhetoricians provided the latter. It is rhetoric that our own schools desire to achieve by the practice of speaking and writing in the mother-tongue, and rhetoric that they formerly aimed at by speaking and writing in Latin. This Plato repudiated because it was no genuine knowledge, while the fact that the rhetorician took upon himself to talk of everything, irrespective of how much he knew of his subject, and never attempted to conceal that he aimed at effect and nothing else, appeared to the disciple of Socrates wantonly immoral. And when Isocrates, the most successful and systematic teacher of rhetoric, called his form of instruction philosophy, it must have sounded like mockery in the ears of the genuine philosopher. In youth, Plato had experienced in his own case that no poetic form was suited to portray what was to him the noblest of all visions — Socrates in converse with his pupils and with the sophists. He felt within himself the capacity to embody this vision directly by the reproductive power



THE ACROPOLIS TO-DAY

of imagination without any other stylistic conventionality than that of his own poetic fire. Thus in the divine madness of the poet, of which he speaks later in his *Phædrus*, he found the form to suit him. This form he perfected, and created, in the height of his power, works in which we find all the merits of all kinds of poetry and rhetoric, but which are, nevertheless, something utterly apart and unique. In his old age he probably felt that the form was no longer adequate to the substance; but he did not care to abandon it; and he who has glowed with enthusiasm with the youthful Plato, in his elder years willingly gives ear to the style of his old age, because the soul within has not grown old. Great writers like Aristotle and Cicero, having safely stored this characteristic form, which was natural to one period and one person alone, in the pigeon-holes of their æsthetic system, have indeed produced admirable dialogues. They are counterfeits none the less, and it is a wholly anti-Platonic classicism which holds or would hold the dialogue to be the true, or even a particularly good, method of scientific investigation and statement. Plato's dialogue is a miracle which will edify the world to the end of time, like Athenian tragedy and the comedy of Aristophanes; but it is specifically Athenian. This is why Aristotle at his best abandoned dialogue in favour of a plain statement of ideas. Had the efforts of Aristotle been attended with success, the quarrel between rhetoric and philosophy would have been adjusted, inasmuch as rhetorical training would have received its proper and subordinate place in the philosophical education of youth. But the unforeseen expansion of Hellenic civilisation did not allow of such root-growth, and at a later period the power was wanting. In the dialogue *De Oratore*, that work which has most of the Platonic character, Marcus Cicero, though himself of the rhetorical school, renews the attempt to subordinate rhetoric to scientific training. In so doing he reproduced the ideas of his contemporaries, the successors of Plato in the Academy. The attempt succeeded neither in Rome nor in Greece. One of the strongest signs of decadence in the time of the empire is the fact that philosophy, except where it holds its own in narrow scholastic circles, has to yield precedence to rhetoric. Where the Latin language prevailed more especially, philosophy becomes no more than a part of general education; while rhetoric, thanks to an adherence to Attic models of style that grows ever closer and more difficult, becomes more and more an empty game of words that only serves to mask the internal decay which it precipitates. And yet the sight of the clinging ivy on the trunk of the dead oak is a fair one.

For centuries the great model of all rhetoricians was Demosthenes. His inimitable greatness is most plainly manifest in their imitations, even though they be those of Cicero. He, too, is intelligible only in connection with his age and his city, the only time and place which could have brought him forth as their natural fruit. The statesmen of the great epoch of Athens had wrought with the living word, prisoned in no written document — thus, Pericles. Gradually the political pamphlet began to make its way, choosing amongst other forms that of the *δημηγορία*, or parliamentary speech. The leading statesmen, indeed, wrote very seldom; but the literati, whom they made their mouthpiece, in time became a power in the formation of public opinion. Pre-eminent among these was Isocrates; he too made use of the form of the *δημηγορία* amongst others, his studied arts of speech giving it a character which must have formed a singular contrast to the words dictated by the passion of the moment in the Pnyx. It was a result of existing conditions that the speech in the law courts was sometimes suited to produce its effect as a pamphlet pretty much in the form in which it had

been delivered. The popularity of rhetoric also preserved many speeches in the courts which had no particular tendency, and thus, curiously enough, special pleading made its way into literature. But Demosthenes was the first to rise to the position of a leading statesman by the publication of orations to the people or to the courts which he had either actually made or else had reduced to this form. Simultaneously his works took their place among the most distinguished classics of his nation. His only education had been that of an advocate, which included, it must be admitted, all the arts of speech; nothing that may even remotely be called science ever touched him. In our moral judgment of him we should apply no standard but that which he recognised; he took the license which had been taken by patriotic Athenian statesmen even in the days of Themistocles. Possibly this did not tally with the Platonic standard, but then, neither did the state of Athens. The charm of Demosthenes lies in his faith in the democratic imperialistic ideals of the Athens of Pericles. That these had long been past hope, was the key to his fate; he himself was ruined by the fact. That by the power of the spoken word and the faith that alone makes the word powerful, he almost succeeded in inspiring his worn-out and selfish nation with his own patriotism, and, that in spite of everything, Athens once again entered the arena to champion liberty against Philip with the lives of her citizens—therein lies his greatness. The tragic side of this greatness heightens its fascination for one who sees through the illusions of Demosthenes and perceives the better right, historically speaking, on the side of Philip; but the fire of the passion of Demosthenes will carry even such a one away. This is not the charm to which the rhetoricians were susceptible. What held them spell-bound is what at first alienates our sympathies. Hellenic art restrained all wildness and passion, reducing it to the smoothest, most harmonious form. Demosthenes did not speak like this, of that we are sure. As a writer he practises the art of conventionalisation with the soundest judgment and the most cautious intelligence—we discover that this speaker can do whatever he pleases, his power knows no bounds; but he himself defines the narrow limits consistent with the growth of harmonious beauty; beauty, if you will, of the style in which contemporary art adorned its mausoleums; for in the case of Scopas and Leochares, too, vast pathos slumbers beneath the sweep of the beautiful line.

Athenian independence and power and that Greek liberty in opposition to which Philip looked a barbarian and a tyrant in the eyes of Demosthenes, had in truth long been but a phantom. The attempt made by Athenian statesmen, from Aristides to Pericles, to transform into an Athenian empire the confederation of cities which the repulse of the Persians had called into existence, was the greatest act of the Hellenes in the sphere of politics. The concentration of their civilisation into a unit under the hegemony of Athens was achieved. But the issue which the young Thucydides foresaw when, at the outbreak of the Peloponnesian war, he determined to write his history, fell out otherwise than he perhaps anticipated or than was in all human probability to be anticipated. Athens had not strength to subdue the Peloponnesus; Sparta subdued Athens and destroyed the empire—but with the help of the Persians, who were the real victors. The result was not only the desolation and brutalisation incident to a long civil war, but a despair of any kind of favourable issue—indeed of any issue at all. The restoration of the Athenian democracy, the catastrophe of Sparta, which after Leuctra has as much as it can do in fighting for its own existence, the ephemeral rise of Thebes, due to the pre-eminence of a single man, all this

has no further significance in the history of the nation except to emphasise the fact that none of these little cities could maintain a sovereignty either at home or over their neighbours; that they existed only in virtue of the general weakness. Even the Persian might, which imposes its will on the Greeks so frequently even without the aid of armed force, subsists only because no one attacks it. What this whole world lacks is a dominant will to coerce it to its own advantage. It lacks a master. Many are aware of this, many give voice to it; that state in particular, — founded in violence and yet powerful, — which Dionysius of Syracuse carved out for himself by overcoming the Carthaginians in the hour of their need, widely disseminated this feeling. The fall of his dynasty brought about a reaction, and the spirit of ancient municipal independence owed its power to the fact that the monarchy seemed to place even the personal freedom of the individual in jeopardy. How Philip would have solved the problem put in his hands on the day of Chæronea, it is idle to speculate. Long before that, the aged Isocrates had called upon him to take his place as general of the Hellenic confederacy against the Persians. And now it came to pass that his son was confronted with this same problem. He it was who solved it. He is and was the master of whom the Hellenic nation stood in need.

Demosthenes and all those who were pledged to the old ideals of sovereign cities, whether oligarchies or democracies, were naturally incapable of understanding the great king and his empire, but even Aristotle seems to have thought much as they did, although he had been Alexander's tutor and saw clearly the need of reform in society and the petty states, and was strongly inclined to translate his political theories into practice. His historical compilations ignore the Macedonian monarchy, and his theories reveal no suspicion of what Alexander designed and executed. This ought not to astonish us, even if we see in Alexander the crowning figure of Hellenic civilisation. For all truly great men in history seem to the reflective eye of posterity like providential agents appearing at the right moment to accomplish what has long ago been augured as a need, prophesied and prepared for. As a matter of fact they accomplish the result in quite another fashion, a fashion of their own, often contrary to all anticipation, filled as they justly are with the sense that they are contributing something new and original. But contemporaries who have no power of reading history backwards from the event (even if their interpretation were likely to be sound), experience the clash of this novel contribution with all the more violence the higher they stand over the common herd, which after all only takes up the catchword, crying, "Hosannah!" on Sunday, and on Friday, "Crucify!" Even now it counts itself singularly sage for taking its catchword from Demosthenes or Aristotle for the condemnation of Alexander.

Alexander went to Asia with the intention of seizing upon the empire of the Persian king. This he accomplished, not in a wild orgy of victory but with the tenacious perseverance which took three years for the conquest and organisation of the Eastern provinces, but did not overleap itself by extravagant ambitions. It is only legend that makes him the conqueror of the world. He was a Macedonian, the hereditary king of a feudal state which the energy of his father had transformed into a military monarchy. He was a Greek in the sense which even the journalists had long since learned to express by saying that it was not race but education that made the Greek. But he was also recognised as the legitimate successor of the Achæmenides, and was himself willing to employ the Persians, side by side with Macedonians and Hellenes, in the service of the empire. His empire was accordingly

not to be based on nationality, it was to rear itself over the heads of nations and states. He granted self-government in the widest interpretation of the term to kingdoms, half-civilised tribes, Hellenic and other towns; he not only respected all local peculiarities of manners and religion, he even went so far in this direction as to deliver peoples from a foreign yoke—as for instance in the case of the Egyptians. But his empire was to be more than a confederacy, it was to be an effective entity with the imperial rule supreme over all, with the imperial army a ready instrument of war in the hands of the sovereign, to compel the Universal Peace, as he called his empire, and with the king's officers able to exercise sufficient authority for the protection, not only of the constituent parts of the empire against one another but also of the individual against the arbitrary action of the individual community. Finally, he realised the civilising mission of the state as fully as any prince has ever realised it; he took in hand the irrigation of Mesopotamia, founded cities, built harbours, and set about the scientific exploration of his newly discovered world in a style to which even the present furnishes few parallels.

The imperial government, like the imperial army, was centred, head and heart, in the king. On his person everything depended. Absolute monarchy was the only possible form for the empire. The founder of this empire, who bore as many wounds on his body as anyone among his veterans, who commanded in all battles in person, who himself, by ceaseless toil, carried on the business of administration, might well regard himself as the true king whose right to rule, even his master, Aristotle, did not dispute, though he questioned the possibility of such a man's existence. But Alexander in no way regarded himself as a sovereign because he had the power. He regarded himself as a king by the grace of God, not in the sense of a more or less dubious legitimacy, which many great and petty sovereigns are apt to advance as sole proof of their title, but in the sense in which the genuine artist and the prophet may claim to be the depositaries of the divine spirit. It was the reverse of presumption when Alexander set the divine element in himself in the foreground. During his lifetime he exhibited the most scrupulous piety, and it is contemptible to tax him with hypocrisy; he had far more faith in miracles and oracles than we are willing to ascribe to the pupil of Aristotle, though we can readily understand it in the Macedonian and the soldier. To him it was a revelation from heaven when the Libyan god greeted him as his son. Had not his ancestor, Heracles, been the son of Zeus and of Amphitryon? For him personally it was the confirmation of his faith in his own mission, and the divinity of its ruler gave his empire a religious consecration. It was consistent with this idea that the worship of Alexander took its place above the innumerable special cults of tribes and towns, of families and communities, as the religion of the empire as a whole. There are many instances of the worship of the sovereign being assigned a place in the pantheon, side by side with that of the godhead figured under a thousand different names and shapes; for the worship of defunct monarchs, the ancient and hallowed practice of ancestor-worship offers a precedent. The adoration paid to Plato and Epicurus was of a precisely similar character. Thus, the abuses of which weaklings and miscreants on the throne, and flatterers and sycophants among subjects, have been guilty, must not be allowed to neutralise the historical and spiritual authority of the institution of the worship of the sovereign, which is inseparably bound up with the institution of the monarchy of Alexander. This monarchy is the highest phase of political and social organisation attained

by antiquity. For the much-lauded Roman Empire is nothing else than this kind of monarchy, *imperium et libertas*. Caesar actually grasped at the crown of the Greek king. So far as Italy and the West were concerned, Augustus certainly wished to be the first citizen and no more — the confidential agent of the sovereign people. But to the Greek half of his empire he was from the first both king and god, and he owed his victory not least to his own belief and that of others in the divinity of his adoptive father. From the time of Hadrian the Augustan theory was in the main exploded even in the West.

This Hellenistic state allowed Alexander's scheme to drop; he would have granted the Persians full rights of citizenship. From henceforth these rights pertain only to the man who has been Hellenised — the legal stamp of such a condition being membership of an Hellenic community. This is clearly manifest in Egypt, where even the Roman emperor bestows Roman citizenship on no Egyptian who has not been adopted into one of the Greek cities of the country. (In this connection we may leave institutions specifically Roman out of account.) For the rest, the king strives to preserve the ideals of the elder age of Greece, the free man and the free state. Personal and economic liberty, legal redress, and liberty of emigration are for the most part secured, not only to the subjects of a single kingdom, but to all Greeks. In like manner the cities enjoy a very considerable liberty of action, in degrees ranging from nominal sovereignty down to the government by royal officials which is presently established in Alexandria. The ancient Greek municipalities of Asia, in particular, enjoyed as subjects much greater privileges than, for example, the cities of Latin countries at the present day. The country, on the contrary, was almost everywhere allotted to some municipal community; that tendency with which we are familiar in the Roman Empire, to convert nations which did not take kindly to town settlements (like the Celts, for instance) from tribes into towns, if only on paper, is equally perceptible in Syria. Egypt remained "the country," *Chora*, but likewise remained barbarous and enslaved. One of the rocks on which the civilisation of antiquity made shipwreck was the fact that the farmer was kept in tutelage or even in bondage by the city, and that he lagged behind it in education. Slavery, as an institution, has to be reckoned with only in the western half of the empire; not in Egypt, Palestine, and large districts of Asia. A community which holds property of its own, imposes its own taxes, which has its own laws and law courts, its own constitution and elective magistrates, is free to all intents and purposes; the fact that it pays a fixed tribute to the king, and leaves to his decision or award all questions of peace and war, intercourse with foreign states, or even with communities of its own political status, and is in many respects practically subject to his control, does not materially detract from its liberty. The danger of such a situation lurks in the circumstance that it minimises interest in their own city among the most capable of its citizens. It offers no career for effective political action. Worse still, the citizen ceases to bear arms. The army consists of the royal troops, official rank goes by royal appointment, and the monarchy alone has great resources at its command. To this centre, and to courts and capitals, the stir of life and every kind of talent is drawn. Very few of the free cities, mainly those which still retained their sovereign rights, like Rhodes, remained centres of civilisation. Not one of the new settlements became such, unless it was a royal capital. Doubtless there can be no genuine patriotism when the citizen takes no part in public life either by counsel or act. Doubtless a government which rests

entirely upon the capacity of the sovereign can neither be stable, nor in the long run endure. But, on the whole, we must confess that the Hellenes lived at ease under this kind of government. The ancient petty states alone chose rather to bleed to death than to forego the empty name of liberty. We may regard with sympathy the attempts at confederacies made by Crete, the Peloponnesus and Ætolia; but we cannot deny that politically they are of little importance; they are matters of no moment in the history of civilisation.

About the year 330 there were three men who stood forth as the representatives of the great ideals of life—Alexander, Aristotle, and Demosthenes. Demosthenes perishes; the time is gone by for his kind of Greek liberty and greatness; the future is for the heroes of the *vita activa* and the *vita contemplativa*, men of action who passionately assail the Doric ideal of the *sophrosyne*, as Alexander did in taking the Achilles of Homer for his model. In many cases they are inspired solely by personal ambition, and the lust of pleasure joins hands with the love of power. The end is contempt for man and the nausea of satiety. Of such are Demetrius, the conqueror of cities, and Pyrrhus. But not a few have learned from Aristotle and Alexander what the duty of a king is. The first sovereigns of the dynasties of the Seleucids and the Ptolemies, Antigonus Gonatas and Hiero of Syracuse, devoted a lifetime of toil and pains to the high duty of sovereignty. Cleomenes of Sparta, the socialistic dreamer on the throne, perishes in the attempt to renew the youth of Sparta and the Peloponnesus.

The men of contemplative life vanish from public and often from social life; they make a habit of living celibate lives in small circles and communities; doctrine alone, and that often esoteric, takes its place side by side with research. Those who translate into action what they have learned from the masters generally contribute little to scientific inquiry. Philosophy is compelled to an inevitable step, the several sciences disengage themselves from her. What remains,—metaphysical and logical speculation,—nevertheless maintains its supreme ascendancy in virtue of the fact that from this time forward the active, effective potency of philosophy shines forth, the potency which she exercises as *magistra vitæ*, as the religion of the heart and the assurance of the intellect in life and conduct. This power extends its sway over ever widening circles even though it cannot reach down to the lower classes; and the gulf between the cultured and the illiterate grows broader and broader. Athens remains the capital city of this philosophy; this is its only title to distinction. Wide as are the differences between the schools, they are agreed in this, that their ideal is the sage, the man apart, who takes his stand not only above the world but outside it—the reverse of the kingly type. The historic continuity of the ancient ideals, Ionian no less than Dorian, is unmistakable.

The various sciences flourish where the necessary means are at their disposal, that is to say, at the courts. This does not make them courtly in character, although Eratosthenes and Aristarchus were tutors of princes; not mathematics alone but all serious learning knows no royal road for kings. The library, the observatory, the scientific collections, and the medical school of Alexandria, which far surpass all others, must be looked upon as directly due to the school of Aristotle; the first two Ptolemies honoured learning, and for that reason gave it nothing but means and liberty. In the second century, their unworthy successors banished the company of scholars, who then found liberty at least in Rhodes. By tracing the course of mathematics and astronomy we can see how the scholars of the few places where

they laboured with enthusiasm keep in constant touch with one another by their writings; but splendid as is the progress made by individuals, the number of those who can really follow is very small, and we feel that a general stagnation must set in if this correspondence were to die out and the few scientific institutions perish. Without the study of pure science that of the applied sciences will never make progress; it will soon lose ground. Thus it was, even in the department in which observation and practice most go hand in hand, in medicine. From his geographical, botanical, and zoological survey, Alexander had left behind an enormous mass of material which was at first augmented by many additions. Eratosthenes, in his map of the world, could use some of the astronomical definitions of locality which had evidently been made for the purpose. This is the origin of the network of degrees with which the globe is overlaid, and one would have thought that other scholars would have hastened to verify and complete it by further measurements of shadows. Not so. True, Eratosthenes stands at the end of the third century, when the great period of advance is over, and the evil genius of Greece gathers strength to rest satisfied with the great things achieved and, by canonising them, to put a stop to further progress. The criticism of Hipparchus, well grounded as it was in the abstract, contributed something to this end by repudiating the good attained and setting hindrances in the way of a greater attainable good, for the sake of a greatest good that was unattainable. Every department of natural science presents much the same spectacle. What has been gained by the labours of the third century, is here and there carried farther by the few (in many cases, as was inevitable, by quantitative amplification), but in the main the scientific thinking had been done; and by no means all the old ideas were transmitted, even in this petrified form. It was left for the nineteenth century, which in its own strength has advanced to an incomparable height of knowledge, to look back and appreciate at its just value the achievements and intuitions of the earlier age.

In the department of abstract science the accumulation of material, — not only of the whole heritage of literature, but also of all that was preserved in the memory of man, — was taken in hand on a scale amazingly vast. The Ionians had already taken note of the traditions of barbarous nations; the study was prosecuted in the spirit of Alexander, and presently Hellenised barbarians, such as Manetho, Berosus, and Apollonius of Caria, took part in it. Grammar, with philology, lexicography, textual criticism, and minute exegesis, likewise becomes a genuine science, the importance of which, again, the nineteenth century has been the first to realise, when, in the pride of its own strength, it soared beyond the achievements of this early period. Towards a real science of history, however, no step had been taken, even in dealing with Homer, who constituted the centre and culminating point of these studies. Nor did the Greeks attempt to gain a scientific conception of any foreign language, not even of Latin. This one-sided view hampered their historical judgment. Not one of them tried to see from the point of view of another mind, and their philology and their science of history have therefore remained rationalistic.

The students in the sphere of language and literature were principally poets, men whose interest was æsthetic; and the poetry of the time, in so far as it has come down to us, is either actually erudite or has the airs and graces of erudition, in that it employs the art-forms of an earlier period, particularly those of the Ionic school. It displays a vast amount of taste and elegance; it twines about the stately life of the courts and the seats of

learning, the quiet peristyles of the town houses and country villas by shore and stream; as rich and ornate as the grotesques of the loggias in the Vatican and the frescoes of the Farnesina, obtrusively magnificent as the allegories of the Doges' palace and of the Luxembourg. But it no longer brought forth anything that fired the spirit of the whole nation, and spoke to all mankind. Moreover, it disdained to seek new forms, and soon prohibited the search for them. No doubt in the lower and numerically larger classes of society there continued to exist a poetry which satisfied their needs, a poetry which would probably have a powerful charm for us by reason of its popular character; but the fatal evil was that the nation was now altogether incapable of renewing its youth by the upspringing of fresh elements.

Prose was more national in character and more lucid. Our terminology is incommensurable with that of the period, and the works themselves have all fallen victims to the later tendencies of style, but when we see that the historical novel, the love-story, the *roman comique*, the romance of travel, and so forth, are Hellenic products, we suspect that intellectual activity was no less marked in this sphere than in others.

In the third century the bias towards mysticism seems to have been completely repressed, we find no trace of a popular religious movement that seizes upon the hearts of men and takes their senses captive. The Ionian spirit prevails throughout. The gorgeous ritual of worship, the temple-building and festivals, all bear the stamp of superficiality. Even the disciples of Plato hark back to Socratic criticism: the result being the most important scientific work of the age, though to the uninitiated it looks like pure scepticism. It has its complement, however, in Plato's own writings and in the practical recognition of his moral idealism. The deficiency is none the less unmistakable. Even with the noblest representatives of active as of intellectual life we breathe a thin rationalistic air. In the second century mysticism begins to come slowly to the surface, frequently associated with the ancient name of Pythagoras, not seldom heralding the irruption of the barbarian element and barbarian religions. And astrology, with its vain superstitions, has already made its appearance, having tortured into its service a hideously shallow pseudo-science.

Even the man in whom the intellectual culture of the Hellenistic period as a whole is once more grandly embodied at its close does not escape the contagion of this false doctrine; I mean Posidonius, who, in the spirit of Aristotle, strove, by voyages of discovery, observations, and calculations of his own, to unite that side of philosophy which touched upon natural science with metaphysics and ethics, primarily and mainly on the basis of the old Stoic school, though strongly influenced by Plato and Aristotle. Apart from these merits, he was a brilliant portrayer of manners and chronicler of contemporary history, a loyal adherent of the Roman oligarchy, even though he preferred to live in Rhodes, the most independent of free cities. By his monotheism, which was a heart-felt religion with him, by the mixture of mysticism and reason, the abundance of his encyclopædic learning and his advocacy of encyclopædic education, he affected the succeeding age more powerfully than any other man; especially among the Romans, for Varro and Cicero, Sallust and Seneca are under his influence. For all our admiration we must confess that he himself is not free from gross superstition, and that scholarship with him is in danger of being attenuated to general culture. We can judge of the change when we remember that he was the pupil of Panætius, the shallow and shrewd-minded friend of Scipio Æmilianus, who drew up for the Romans a handbook of the Ciceronian doctrine of duty,

afterwards compiled by Cicero in his *Di Officiis*, and who athetised the *Phædo*, because the doctrine of immortality appeared to him unworthy of the admired dialectician.

Posidonius came from Apamea in Syria, and countries in which the bulk of the population was Semitic furnish a large number of contemporary poets and writers of all sorts. But the best witness to the power of Hellenism is supplied by those circles which oppose it, in the front rank the Jews, concerning whom we have the fullest information. Their independence in matters of detail is of far less importance than their community of thought and feeling. In writings like Proverbs, Ecclesiastes, and Wisdom, the influence of Greek thought is unmistakable. Before and during the Maccabæan reaction the subject-matter of the Old Testament was worked up by Greek methods into novels, epics, and dramas. Prophecy and apocalypse linked themselves with the poetic oracles of Greece, and the nationalist movement, the leaders of which soon became Hellenistic princes themselves, goes but a little way towards severing the threads of connection. In the early days of the empire, Philo is no less subject than Cicero to the influence of Posidonius and of Plato. The Pharisees of Jerusalem, and, still more, the populations of mixed districts, could not disown the Hellenistic atmosphere they breathed. Without Alexander, without Hellenism, we cannot imagine the Gospels coming into existence.

The great task of Hellenism was the education of the nation that ruled it. This was begun in times out of mind, when the Greek character and Greek weights and measures were adopted on the Tiber, and the first temples in the Greek style arose in Roman market-places to the gods of Greece. The Latins had nevertheless preserved their national characteristics and had tolerated no Greek settlement on their shores. Now the question was no longer one of ousting the Greek language, but rather of adopting the whole of Greek civilisation. Greek scholars, hearing Marcus Cicero speak, lamented that the last advantage of their nation had been taken from them, not without justice. And yet through the winning of this soul the West was won for Greek civilisation, even though it was no less determined that the Hellenes should one day be called Romæi.

It was of cardinal importance to the history of the world that the Hellenistic kingdoms were too weak to enter into the decisive struggle carried on between Rome and Carthage, first for Sicily, (which was utterly lost to the Greeks,) and then for the mastery of the West.

Rome had already banished Greek influence from Italy. This momentous fact of the weakness of Greece was the result of Alexander's untimely death and of the impossibility of maintaining the unity of the empire, the struggle for which had lasted fifty years and allowed of the rise of three great powers which mutually held one another in check. By the time Rome had overcome Hannibal, Egypt had been so enfeebled by misgovernment that it put itself, ingloriously but prudently, under the protection of the Roman republic. Macedonia succumbed, not without honour. The king of Asia no longer had the power to extend his influence to Europe; he forfeited to Rome the countries to which he owed that title. But the fall of the empire, now called Syria, involved the strengthening of that nationality which Alexander, rightly estimating its value, had desired to gain over by a share in the government. With the Arsacid monarchy, Philhellenes though they called themselves, a foreign nationality and an intolerant religion flung Hellenism back beyond the Euphrates. The Roman senate undertook the government of the Greek provinces reluctantly, rightly thinking that the

result would be as detrimental to their own people as to the subject provinces. It is none the less true that a more ruthless set of blood-suckers has hardly ever fallen upon a defenceless prey. Despair made the Asiatics see a deliverer even in that savage Cappadocian Mithridates, thus bringing disaster upon disaster. Rome herself was utterly out of joint, and finally Greece had to furnish a stage for the decisive struggles of the Roman revolution. Rhodes, the last city that had enjoyed some degree of immunity, was pillaged by the liberators who had murdered Cæsar. How hardened men were to such catastrophes we have recently learnt when it became known that, in the time of Sulla, northern barbarians burned the temple at Delphi; a thing that had been entirely forgotten in the traditions handed down to us. It has also come to light that probably at that time the whole amount of capital accumulated and secured in countless institutions was lost, the festivals of the gods, the games, the banquets all came to an end; the guilds collapsed, even those of the musicians and actors, who had provided themselves with charters from all the powers; wide stretches of the country lay desolate. Some few individuals acquired property which in the sequel became enormously valuable, and this fact in itself was a hindrance to any healthy revival.

Augustus was the deliverer who ultimately brought peace and order: and the Greeks did extravagant homage to their saviour. He deserved it, no doubt, but fresh sap could no longer rise in the decrepit and mutilated tree. Hellenism had seen everything perish that fire and sword could destroy; the sole thing left intact was the intellectual heritage of her forefathers. With them she took refuge, they proved themselves victorious even over the Romans, her lords. Thus was consummated the process which determined the future of the world, the process by which the nation not only resigned all political aspirations, but blotted out the whole of the last three centuries, insisted on speaking as Plato or Demosthenes spoke, or even like Herodotus and Lysias, forgot even the deeds of Alexander in contemplating Salamis and Marathon, and actually went so far as to dispute the possibility of progress in poetry and philosophy (inclusive of the several sciences) beyond that of the classic age, which it chose to conclude with the Attic period. Imitation was now the only safe way, the very principle of progress was challenged. This was the case even more in theory than in practice; the plastic arts, for example, still continued to do original work, because artists are seldom burdened with literary culture. But in the whole sphere of language the results could not fail to be disastrous, for the gulf between the educated classes, — who, by virtue of schooling and study, could twist their speech into the mode of three centuries ago and more, — and the populace, — whose speech, thus deprived of all ennobling influences, rapidly degenerated, — presently became so wide that they hardly attempted to arrive at a common understanding. The difficulty of artificial modes of speech made it necessary for rhetoric and the art of style to take the first place in the schools, and words gradually stifled ideas. Nor was novelty in the latter thought desirable, they were all the more welcome if they were as classic as the words. The whole object of life was really nothing more than a repetition of forms, and of substance (so far as there was any substance), hallowed by antique usage. Even so obsolete an institution as the gymnastic games was revived, the old religious worship was laboriously restored; in the second century after Christ, Apollo began once more to dispense oracles in verse. The authority of Homer was exalted to an extravagant pitch; every one knew him who had been to school at all. In extensive circles the use of Homeric phrases passed for poetry, the Homeric Olympus for religion, and now, for the first time, he took the

place held to-day by the Old Testament among those who have no other book. This is most plainly manifest in Christian polemics.

Under the liberal and Philhellenic government of the dynasty that came to the throne with Nerva, the world prospered; in a material sense Asia has never been happier. The age could boast of orators who spoke like Demosthenes and Plato in one. A certain amount of philosophical training prevailed among educated men; lovable and able individuals are not lacking; such men as Plutarch, who paints that copy of real Hellenism which the heroes of the French revolution adopted instead of the original, and who transmits to Montaigne, for example, a large portion of the worldly wisdom of the Greeks. The work of compilation by which astronomy and geography are summed up by Ptolemy, grammar by Herodian, and medicine by Galen, is of the utmost value from the standpoint of history. A shallow Semitic pamphleteer like Lucian copies the graceful forms of antiquity with such skill, that in the Renaissance and the days of the *Éclaircissement* he passes for a leading representative of the Greek spirit. But the age is in its dotage for all that; there is natural science without experiment, abstract science without unbiassed examination, knowledge without philosophy. The deeper souls have reached a point at which their strength lies in resignation. Hope, the only treasure of all those in Pandora's box to remain with man in the youth of the nation, has now fled. None have now a living faith save those who renounce the world. The Platonic Eros is no longer a force, and the Agape is known only to those to whom Paul has revealed it. Men's souls are weary; presently their bodies too begin to sicken. *Æsculapius* is the only god of heaven whose worship flourishes side by side with that of the emperors, the gods of the empire; the feeble health of the individuals of whom we hear most becomes a disquieting factor; under Marcus Aurelius the first great wave of mortality sweeps over the empire. From this point the downward course is rapid, especially when, with Severus, the empire falls into the hands of barbarian generals. Nor must it be forgotten that Augustus greatly circumscribed the eastern half of the empire, which he permitted to remain Greek. He romanised the Danube provinces, Illyria, Africa, and even Sicily. Every year the East sent a strong contingent to the West, and though the fact contributed the largest share to the assimilation of Greek culture by the West (in Rome, for example, the language of the Christian congregations was Greek until some time after this), these emigrants were none the less permanently lost to the Greek nation. In the East the ancient nations were astir; as early as the second century an Aramaic literature begins, in Phrygia inscriptions appear in the vulgar tongue; in spite of Longinus, the Palmyra of Zenobia is not a Greek city any more; there is an alarming increase of spiritual force in barbarian religions; even in that which came across the frontier from the Parthians. In those circles into which Gnosis, so-called, leads us, which did not consist wholly of ignorant persons, the Greek element is only one of many. The imperial army becomes more and more a force that makes for barbarism. No wonder that civilisation collapses, with the empire out of joint, and the ravages of the Germans — whom the classicism of the age dubs Scythians, in the phrase of Herodotus — just beginning. By their misdeeds at this period the Goths and Vandals richly earned the secondary sense attached to their name, though it has been mistakenly associated with the devastation of Italy and Africa. They reduced Greece to a desert, they destroyed Olympia; worse still, they annihilated the prosperity of Asia. The athletic games which had taken the place of the gymnastic contests of antiquity, but had always retained

something of the spirit of the latter, practically came to an end. All that peace had allowed to come into being — temples, monuments, and theatres — was destroyed to build inadequate walls. Far and wide the thin stratum of the educated classes that overlaid a people half estranged from civilisation perished entirely. Some sort of order was restored by Diocletian and Constantine, but the place of the Greek king had now been taken by the oriental sultan; the free man had died out. Then came the church, which presently forbade freedom of thought. Origen was a thinker and philological student almost without peer among his contemporaries. Eusebius had no equal among the scholars of his day. It was therefore not the fault of Christianity if these two men had no successors, but gave place to the purblind, and barely honest superstition of Athanasius and the vulgar abuse of Epiphanius. On the contrary, Christianity showed its affinity with Hellenic civilisation by the very fact that they withered together. Its earthly victory should dazzle the eyes of those least of all who believe in the kingdom of God that Jesus preached. Of this there is hardly a trace at the council of Nicaea.

The qualities that were at work in the decay of civilisation were essentially Greek — satisfaction in present achievement, and reverence for authority. The classicist movement allowed them to gain exclusive sway. Hand in hand with them went a fine sense of form; the imitative faculty has never attained greater triumphs. Christianity also submitted to the yoke of classicist rhetoric; the impressive sermons of the great Cappadocians bear witness to this, no less than the childish *Symposium of the Virgins* of Methodius. In league with the church, this formal culture has the great merit of having preserved a large portion of the literature of antiquity as an aid to education. The Greek faculty of abstract thought showed itself mighty for good and evil. In the midst of the terrible third century, it was able to take refuge in the purer air of immaterial conceptions, though at the cost of the delight in the visible world characteristic of the Ionic school.

There was little of Plato but his name and the mysticism of his old age in this last great philosophical movement which called itself after him; and it was never more alien to the Greek spirit than when it tried by fantastic necromancy to hold fast the ancient system of religion. The same mode of thought practically prevailed to the same extent on Christian soil, not only in the many circles which the church had repudiated; orthodox dogma is itself but one of these systems, though one that was canonised and preserved for centuries together with the whole body of classical civilisation. This torpor is naturally repellent to us, especially when we contrast it with the active progress of the Roman church which takes the task of civilising the West out of the hands of imperial Rome and surpasses all she has done. Nevertheless, there is a certain grandeur in the spectacle of this ancient and mummified civilisation preserving the Greek nation from utter wreck, in the face, ultimately, of enslavement to a barbarous race and a stern and aggressive religion. But if such a great political and intellectual future as we should wish them is ever to smile upon the Greeks, or rather, the Romæi, it will not come by way of the repristination of any obsolete form whatsoever, it will not be brought about directly by the spirit of antiquity, whether Greek or Christian; but the whole nation must become new by the assimilation of the modern culture of the West. The West, it must be borne in mind, did not imitate the Hellenes, it made a right use of its heritage from them to liberate itself and renew its youth. This service they still render, and will continue to render, to the individual man. By lifting their eyes to the glory of Greece, whether it be Homeric or Doric, Athenian or Hellen-

istic, men will evermore gain strength to be free and to enter willingly into the service of the Idea, and thus, if they have strayed from the right path, will learn to find their way back to nature and to God.

Politically the Greeks did not gain the mastery of the world, they did not even attain to national unity; but a homogeneous civilisation for the whole world, nevertheless, came into being through them. In such a civilisation for the future we too believe, and we labour to realise it because we desire and advocate the fellowship and concord of many nations, countries, and languages. But the civilisation of the world knows no stronger tie than the groundwork common to all genuine civilisations; and that is our heritage from Greece.

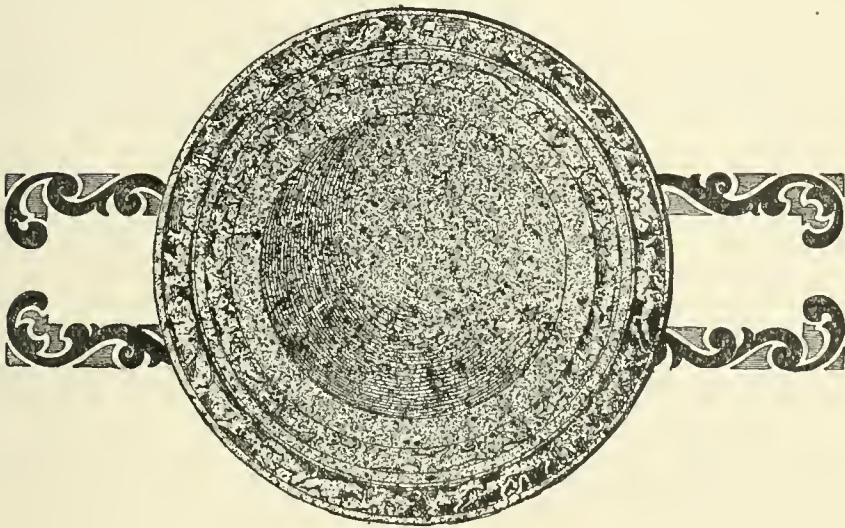

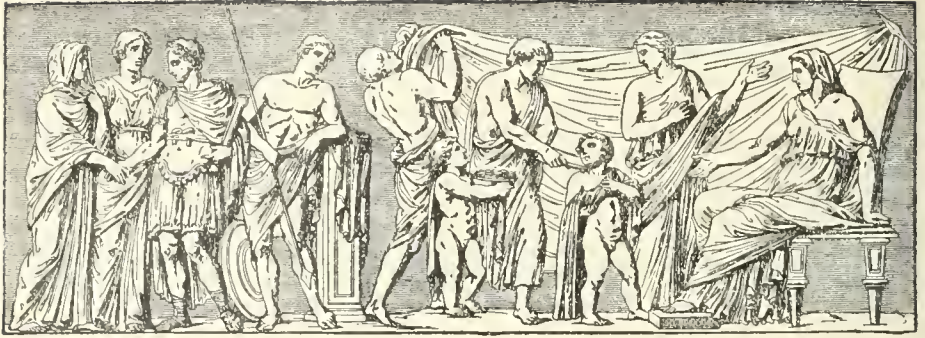

BRIEF REFERENCE-LIST OF AUTHORITIES BY CHAPTERS

[The letter *a* is reserved for Editorial Matter.]

CHAPTER XXXVII. THE REIGN OF TERROR IN ATHENS

^b CONNOP THIRLWALL, *History of Greece*. — ^c XENOPHON, *Hellenics*.

CHAPTER XXXVIII. THE DEMOCRACY RESTORED

^b GEORGE GROTE, *History of Greece*. — ^c CONNOP THIRLWALL, *op. cit.* — ^d ARISTOPHANES' *Plays*. — ^e EURIPIDES' *Plays*. — ^f LYSIAS' *Orations*. — ^g THUCYDIDES, *History of the Grecian War*. — ^h PLUTARCH, *Lives of Illustrious Men*.

CHAPTER XXXIX. SOCRATES AND THE SOPHISTS

^b WILLIAM MITFORD, *History of Greece*. — ^c PLATO'S *Phaedo* (translated by Henry Carey). — ^d GEORGE GROTE, *op. cit.* — ^e XENOPHON, *Memorabilia and Apologia Socrates*. — ^f CLAUDIUS AELIANUS, *Varia Historia* (translated by A. Fleming). — ^g DIODORUS SICULUS, *Historical Library*.

CHAPTER XL. THE RETREAT OF THE TEN THOUSAND

^b WILLIAM MITFORD, *op. cit.* — ^c XENOPHON, *Anabasis and Catabasis*. — ^d PLUTARCH, *op. cit.* — ^e FRIEDRICH D. SCHLOSSER, *Weltgeschichte*.

CHAPTER XLI. THE SPARTAN SUPREMACY

^b KARL O. MÜLLER, *The History and Antiquities of the Doric Race* (translated by Tuffnell and Lewis). — ^c GEORGE GROTE, *op. cit.* — ^d JOHN B. BURY, *History of Greece*. — ^e ARISTOTLE, *Politics*. — ^f VICTOR DURUY, *Histoire des Grecs*.

CHAPTER XLII. SPARTA IN ASIA

^b WILLIAM MITFORD, *op. cit.* — ^c XENOPHON, *op. cit.* — ^d CONNOP THIRLWALL, *op. cit.* — ^e PLUTARCH, *op. cit.*

CHAPTER XLIII. THE CORINTHIAN WAR

^b WILLIAM MITFORD, *op. cit.* — ^c XENOPHON, *op. cit.* — ^d DIODORUS SICULUS, *op. cit.* — ^e CONNOP THIRLWALL, *op. cit.* — ^f GEORGE GROTE, *op. cit.* — ^g GEORGE W. COX, *The Athenian Empire*. — ^h JOHN B. BURY, *op. cit.* — ⁱ BARTHOLD G. NIEBUHR, *Lectures on Ancient History*.

CHAPTER XLIV. THE RISE OF THEBES

^b ERNST VON STERN, *Geschichte der Spartanischen und Thebanischen Hegemonie* — ^c XENOPHON, *op. cit.* — ^d DIODORUS SICULUS, *op. cit.* — ^e GEORGE GROTE, *op. cit.* — ^f JOHN GILLIES, *History of Ancient Greece*. — ^g JULIUS BELOCH, *Griechische Geschichte*. — ^h ADOLF HOLM, *History of Greece*. — ⁱ JOHN B. BURY, *op. cit.* — ^j GEORGE W. COX, *op. cit.* — ^k GEORG BUSOLT, *Griechische Geschichte*.

CHAPTER XLV. THE DAY OF EPAMINONDAS

^b BARTHOLD G. NIEBUHR, *op. cit.* — ^c GEORGE GROTE, *op. cit.* — ^d GEORGE W. COX, *op. cit.* — ^e WILLIAM MITFORD, *op. cit.* — ^f ERNST CURTIUS, *Griechische Geschichte.* — ^g ERNST VON STERN, *op. cit.* — ^h CONNOP THIRLWALL, *op. cit.* — ⁱ PLUTARCH, *op. cit.* — ^j DIODORUS SICULUS, *op. cit.* — ^k XENOPHON, *op. cit.* — ^l PAUSANIAS, *A general description of Greece.*

CHAPTER XLVI. WHEN THEBES WAS SUPREME

^b GEORG WEHER, *Weltgeschichte.* — ^c XENOPHON, *op. cit.* — ^d GEORGE GROTE, *op. cit.* — ^e ISOCRATES, *Archidamus.* — ^f CICERO, *Tusculanarum Disputationum Libri V. and De Oratore.* — ^g POLYBIUS, *General History.* — ^h PLUTARCH, *op. cit.*

CHAPTER XLVII. THE TYRANTS IN SICILY

^b LOUIS MÉNARD, *Histoire des Grecs.*

CHAPTER XLVIII. THE RISE OF MACEDONIA

^b JOHANN G. DROYSEN, *Geschichte Alexanders des Grossen.* — ^c L. MÉNARD, *op. cit.* — ^d DEMOSTHENES, *Orations.* — ^e HERODOTUS, *History.* — ^f THUCYDIDES, *op. cit.* — ^g ARRIAN, *The Anabasis of Alexander.* — ^h THEOPOMPUS, *Philippica.* — ⁱ TITUS LIVIUS, *Annales.*

CHAPTER XLIX. THE TRIUMPHS OF PHILIP

^b L. MÉNARD, *op. cit.* — ^c JOHN POTTER, *Antiquities of Greece.* — ^d L. A. PRÉVOST-PARADOL, *Revue de l'histoire universelle.* — ^e R. C. JEBB, in an article on "Demosthenes" in the Ninth Edition of the *Encyclopædia Britannica.* — ^f J. B. BURY, *op. cit.* — ^g GEORGE GROTE, *op. cit.* — ^h B. G. NIEBUHR, *op. cit.* — ⁱ DIODORUS SICULUS, *op. cit.* — ^j WILHELM DRUMANN, *Verfall der griechischen Staaten.* — ^k PLUTARCH, *op. cit.* — ^l PAUSANIAS, *op. cit.* — ^m XENOPHON, *op. cit.* — ⁿ GEORG WEHER, *op. cit.*

CHAPTER L. ALEXANDER THE GREAT

^b APPIANUS ALEXANDRINUS, *The History of Appian of Alexandria* (translated from the Greek by J. Dancer). — ^d JUSTIN, *History of the World* (the abridgment of the *Philippic History* of Trogus Pompeius) — ^e QUINTUS CURTIUS, *The Wars of Alexander* (translated by William Young, 1747). — ^f DIODORUS SICULUS, *op. cit.* — ^g PLUTARCH, *op. cit.* — ^h CONNOP THIRLWALL, *op. cit.* — ⁱ ARRIAN *op. cit.* — ^j PTOLEMY LAGI, and ARISTOBULUS, as quoted by Arrian, Diodorus, etc.

CHAPTER LI. ALEXANDER INVADES ASIA

^b GEORGE GROTE, *op. cit.* — ^c J. G. DROYSEN, *op. cit.* — ^d JURIEU DE LA GRAVIÈRE, *Les campagnes d'Alexandre.* — ^e ARRIAN, *op. cit.* — ^f GEORGE GROTE, *op. cit.* — ^g PTOLEMY LAGI, ARISTOBULUS, ANAXIMENES, and CALLISTHENES, as quoted by Arrian, Diodorus, etc.

CHAPTER LII. ISSUS AND TYRE

^b CONNOP THIRLWALL, *op. cit.* — ^c GEORGE GROTE, *op. cit.* — ^d J. G. DROYSEN, *op. cit.*

CHAPTER LIII. FROM GAZA TO ARBELA

^b ARRIAN, *op. cit.* — ^c QUINTUS CURTIUS, *op. cit.* — ^d CONNOP THIRLWALL, *op. cit.* — ^e GEORG H. A. EWALD, *The History of Israel.* — ^f HENRY H. MILMAN, *The History of the Jews.* — ^g DIODORUS SICULUS, *op. cit.* — ^h GEORGE GROTE, *op. cit.* — ⁱ WILLIAM MITFORD, *op. cit.* — ^j EDWARD S. CREASY, *Fifteen Decisive Battles of the World.* — ^k JOHN B. BURY, *op. cit.* — ^l ADOLF HOLM, *op. cit.* — ^m FLAVIUS JOSEPHUS, *Antiquities of the Jews* — ⁿ KARL RITTER, *Afrika* (in *Die Erdkunde, etc.*). — ^o LOUIS A. THIERS, *Histoire du Consulat et de l'Empire.*

CHAPTER LIV. THE FALL OF PERSIA

^b QUINTUS CURTIUS, *op. cit.* — ^c GEORGE GROTE, *op. cit.* — ^d JOHN B. BURY, *op. cit.* — ^e ARRIAN, *op. cit.* — ^f DIODORUS SICULUS, *op. cit.* — ^g PLUTARCH, *op. cit.*

CHAPTER LV. THE CONQUEST OF INDIA

^b CONNOP THIRLWALL, *op. cit.* — ^c J. G. DROYSEN, *op. cit.* — ^d DIODORUS SICULUS, *op. cit.* — ^e ARRIAN, *op. cit.* — ^f QUINTUS CURTIUS, *op. cit.*

CHAPTER LVI. THE END OF ALEXANDER

^b CONNOP THIRLWALL, *op. cit.* — ^c ARRIAN, *op. cit.* — ^d J. G. DROYSEN, *op. cit.* — ^e PLUTARCH, *op. cit.* — ^f BARTHOLD G. NIEBUHR, *op. cit.* — ^g HERODOTUS, *op. cit.* — ^h POLYBIUS, *op. cit.* — ⁱ ARISTOBULUS, quoted by Plutarch, Arrian, etc.

CHAPTER LVII. VARIOUS ESTIMATES OF ALEXANDER

^b ARRIAN, *op. cit.* — ^o CLAUDIUS ÆLIANUS, *op. cit.* — ^d TITUS LIVIUS, *Roman History* (translated 1686). — ^c GEORGE GROTE, *op. cit.* — ^f GEORGE W. COX, *op. cit.* — ^g L. MÉNARD, *op. cit.* — ^h CHARLES ROLLIN, *Ancient History*. — ⁱ BARTHOLD G. NIEBUHR, *op. cit.* — ^k CONNOP THIRLWALL, *op. cit.* — ^l J. G. DROYSEN, *op. cit.* — ^m GEORG W. F. HEGEL, *Philosophy of History*. — ⁿ R. PÖHLMANN, in Müller's *Handbuch der classischen Alterthumswissenschaft*. — ^o BENJAMIN IDE WHEELER, *Alexander the Great*.

CHAPTER LVIII. GREECE DURING THE LIFE OF ALEXANDER

^b WILLIAM MITFORD, *op. cit.* — ^o DIODORUS SICULUS, *op. cit.* — ^d J. G. DROYSEN, *op. cit.* — ^c CONNOP THIRLWALL, *op. cit.* — ^f PLUTARCH, *op. cit.*

CHAPTER LIX. THE SUCCESSORS OF ALEXANDER

^b CONNOP THIRLWALL, *op. cit.* — ^o DIODORUS SICULUS, *op. cit.* — ^d J. G. DROYSEN, *op. cit.* — ^e JUSTIN, *op. cit.* — ^f ARRIAN, *op. cit.* — ^g B. G. NIEBUHR, *op. cit.* — ^h WILLIAM MITFORD, *op. cit.* — ⁱ GEORGE GROTE, *op. cit.* — ^j PHOTIUS, Excerpts from Arrian's *Bithynica*.

CHAPTER LX. AFFAIRS IN GREECE PROPER AFTER ALEXANDER'S DEATH

^b CONNOP THIRLWALL, *op. cit.* — ^c PLUTARCH, *op. cit.* — ^d J. G. DROYSEN, *Geschichte des Hellenismus* — ^e GEORGE GROTE, *op. cit.* — ^f DIODORUS SICULUS, *op. cit.*

CHAPTER LXI. THE FAILURE OF GRECIAN FREEDOM

^b GEORGE GROTE, *op. cit.* — ^o J. G. DROYSEN, *op. cit.* — ^d PAUSANIAS, *op. cit.* — ^e JUSTIN *op. cit.* — ^f DIODORUS SICULUS, *op. cit.* — ^g PLUTARCH, *op. cit.* — ^h POLYBIUS, *op. cit.* — ⁱ CONNOP THIRLWALL, *op. cit.*

CHAPTER LXII. THE EXPLOITS OF PYRRHUS

^b L. MÉNARD, *op. cit.* — ^o TITUS LIVIUS, *op. cit.* — ^d PLUTARCH, *op. cit.* — ^e Article on "Epirus," in the Ninth Edition of the *Encyclopædia Britannica*. — ^f CONNOP THIRLWALL, *op. cit.* — ^g JUSTIN, *op. cit.* — ^h PAUSANIAS, *op. cit.* — ⁱ POLYBIUS, *op. cit.*

CHAPTER LXIII. THE LEAGUES AND THEIR WARS

^b POLYBIUS, *General History* (translated by Sir H. Spears). — ^c W. SCHORN, *Geschichte Griechenlands von der Entstehung des ätol. und ächäischen Bundes bis auf die Zerstörung von Korinth* — ^d CONNOP THIRLWALL, *op. cit.* — ^e GEORG WEBER, *op. cit.* — ^f OLIVER GOLDSMITH, *History of Greece*. — ^g L. FLATHE, *Geschichte Macedoniens und der Reiche welche von macedonischen Königen beherrscht wurden*. — ^h PLUTARCH, *op. cit.* — ⁱ EDWARD A. FREEMAN, *History of Federal Government in Greece and Italy* (edited by John B. Bury).

CHAPTER LXIV. THE FINAL DISASTERS

^b BARTHOLD G. NIEBUHR, *op. cit.* — ^c POLYBIUS, *op. cit.* — ^d CONNOP THIRLWALL, *op. cit.* — ^e STRABO, *Geographica*. — ^f PAUSANIAS, *op. cit.* — ^g L. FLATHE, *op. cit.* — ^h W. SCHORN, *op. cit.* — ⁱ CONSTANTINE VII, PORPHYROGENITUS, Excerpts from POLYBIUS.

CHAPTER LXV. THE KINGDOM OF THE SELEUCIDÆ

^b GEORG WEBER, *op. cit.* — ^c *An Universal History*, compiled from original authors, 1799. — ^d FLAVIUS JOSEPHUS, *op. cit.* — ^e DIODORUS SICULUS, *op. cit.* — ^f APPIAN, *Roman History*. — ^g JUSTIN, *op. cit.* — ^h ARRIAN, *op. cit.*

CHAPTER LXVI. THE KINGDOM OF THE PTOLEMIES

^b J. G. DROYSEN, *op. cit.* — ^c S. SHARPE, *History of Egypt*. — ^d G. SMITH, *The Gentile Nations*. — PAUSANIAS, *op. cit.* — DIODORUS SICULUS, *op. cit.* — JOSEPHUS, *op. cit.* — ARRIAN, *op. cit.* — PLUTARCH, *op. cit.* — JUSTIN, *op. cit.* — EUTROPIUS, *Epitome of Roman History*.

CHAPTER LXVII. SICILIAN AFFAIRS

^b L. MÉNARD, *op. cit.* — DIODORUS SICULUS, *op. cit.* — STRABO, *op. cit.* — PLUTARCH, *op. cit.* — EDWARD A. FREEMAN, article on "Sicily," in the Ninth Edition of the *Encyclopædia Britannica*. — ADOLF HOLM, *Geschichte Siciliens im Alterthum*.



A GENERAL BIBLIOGRAPHY OF GRECIAN HISTORY

A BRIEF SURVEY OF THE SOURCES

IN a previous part of this work reference has been made to the large number of historians of Greece and to the fragmentary condition in which their works have come down to us. Attention has also been called to the comparatively small aid which the historian of Greece receives from epigraphical inscriptions. There are, to be sure, various inscriptions that give an incidental aid; as, for example, the famous inscription on the leg of the statue of Ramses II at Abu-Simbel; an Athenian inscription referring to the work on the Erechtheum; inscriptions from the walls of the temples at Ephesus, at Priene, and the like. All of these, however, give but incidental glimpses; taken together they would make but a most meagre and fragmentary historical record. There is, however, one inscription extant of far greater importance. This is the so-called Parian marble or Parian chronicle, which was found originally at Paros, was brought to England in 1627 at the instance of the earl of Arundel, and was subsequently presented to the University of Oxford, where it forms part of the collection of Arundel marbles.

This inscription originally comprised an epitome of the chief events in Grecian history (with various notable omissions) from the alleged reign of Cecrops, 1318 B.C., to the archonship of Diognetus, 264 B.C. At present, however, the last part of the record is lost, so that the extant portion comes only to the time of Diotimus, 354 B.C. Various parts of the inscription are more or less illegible, and there are, as just noted, numerous very noteworthy omissions, particularly as regards political events. Moreover, the entire record, as pointed out by Clinton,¹ is everywhere one year out of the way. Nevertheless, as a guide to the sequence of events in Grecian history and as a check on the other sources, the Parian chronicle is of the very greatest importance. It is not known just when or by whom this inscription was made, but it is apparently based on earlier sources that are in the main fairly reliable.

¹ *Fasti Hellenici*.

As the entire inscription of the Parian chronicle is contained on a slab of marble only about three and a half feet in length, it is obvious that its record must be of the most epitomised character; in short, a mere sequence of names. For a fuller record of the events of Grecian history we must turn to the usual sources, the manuscripts of the historians proper. Non-historical writings are not to be altogether ignored, to be sure. In many cases they furnish us important aids in filling in gaps or in supplying details. In particular the dramatists and the orators furnish important historical data; among the former, Æschylus, Euripides, Aristophanes; among the orators, Isæus, Isocrates, Æschines, and Demosthenes. The works of Plato and Aristotle and, to a less extent, of other philosophers are also to be looked to here and there. But all of these, let it be repeated, are of meagre importance compared with the records of the historians proper.

Something has been said in another place of the large number of Greek historians. Mr. Clinton lists forty-seven by name who flourished prior to 306 B.C.; and this without including the historians of Alexander. Among these are such more or less familiar names as Cadmus of Miletus, Hecateus, Hellanicus, Ctesias, Ephorus, Theopompus, Dinon, and Anaximenes. But of the entire list of earlier writers only three are represented by extant works in anything but the most fragmentary condition. These three bear the famous names Herodotus, Thucydides, and Xenophon. All of these lived within the same century; and each of them left a detailed account of a relatively brief but highly significant period of Grecian history. The story of Herodotus closes with the year 478 B.C.; Thucydides deals with twenty-one years of the Peloponnesian War, though taking an incidental glance at earlier history; Xenophon, taking up the account of the Peloponnesian War where Thucydides leaves off, continues the record to the death of Epaminondas in the year 362 B.C.

Curiously enough, there is no Greek historian after Xenophon, for about two centuries, whose works have been preserved; and the records of Grecian history for all other periods than those covered by Herodotus, Thucydides, and Xenophon are mostly preserved in the writings of authors who lived long after Greece had ceased to have importance as an autonomous nation. But of course these writings drew upon contemporary records; and being made at a time when it was possible to check their accounts with numerous histories that are now lost, they have almost the same significance as if they were themselves contemporary sources. These later writings are comparatively few in number. By far the most important of them is the general history of Diodorus, to which reference has so frequently been made. Justin's abridgment of Trognus Pompeius is also of value; as are the biographies of Plutarch and of Cornelius Nepos. The chronicle of Eusebius supplies many gaps in the record, particularly as regards the earlier periods of Grecian history; and the same is true of the work of Pausanias, which, though dealing primarily with geography, makes important historical allusions here and there; as, for example, in regard to the Messenian wars. The lives of Alexander the Great by Arrian and by Quintus Curtius, based on the now lost works of Alexandrian contemporaries, furnish us full records of the age of the Macedonian hero. For the post-Alexandrian epoch the fragments of Polybius are the chief source for the periods which they cover. But these are so meagre that our main reliance must be placed upon the general historians Diodorus and Justin, here as for so many other periods.

Oddly enough, no single work except the general histories has come down to us that deals with the history of Greece as a whole; that history

can be reconstructed only by piecing together the various fragmentary records, and he who would know Grecian history at first hand has chiefly to attend to the authorities just mentioned. When one has read Diodorus and Justin, Plutarch and Nepos, and Herodotus, Thucydides, Xenophon, Arrian, and Curtius, one has appealed to the chief among first-hand sources of Grecian history. We have already had occasion to refer to some of these at considerable length, and fuller notes concerning them will be found in the present bibliography; but there is one of them whose work is so important and whose position as a factor in the history of literature is so unique that we are justified in giving more extended attention to him here. This is, of course, the oldest and in some respects the most remarkable of all, Herodotus; an author whom we encounter almost everywhere in the old Orient and who serves as almost our sole witness for the great events through which Greece attained a dominant place among the nations,—the events, namely, of the so-called Persian or Median Wars.

Herodotus, the celebrated father of history, or, as K. O. Müller styles him, the father of prose, was born at Halicarnassus, in Asia Minor, about 484 B.C., and died at Thurii, Italy, about 424 B.C. Halicarnassus was a colony of Doric Greece, and therefore Herodotus was related in his ancestry rather to the Spartans than to the Athenians. His work, however, was not written in the Doric dialect but in the Ionic, which at that time was the accepted vehicle of literary productions in Greece, being the dialect generally employed by Homer, Hesiod, and the long line of logographers. The style of Herodotus has been recognised by critics of all succeeding ages as almost perfect of its kind.

As to the life of the man himself, comparatively little is known. A wealth of fable is associated with his name, as with that of most celebrities of antiquity, but the part of this which may be accepted as historically accurate is almost infinitesimal. Certain ideas, however, have gradually clustered about the name of Herodotus that by common consent are accepted as representing his biography, in default of more accurate information, which latter, presumably, will never be forthcoming. Thus it is accepted that he was born at Halicarnassus of parents named Lyxes and Dryo, and that he was the nephew of Panyasis, a famous epic poet, from which latter circumstance it may be inferred that he came of a literary lineage. It is further alleged that he left Halicarnassus owing to the tyranny of Lygdamis, the ruler of the colony, who had put to death his uncle Panyasis. It is believed that Herodotus went to the island of Samos and lived there for several years; whether he made his extensive journeys in search of knowledge thence, or at a later period, is not ascertained. In either event it is held that he subsequently returned from Samos to Halicarnassus, and personally assisted in the overthrow of the tyrant Lygdamis. Even after this event, however, it would appear that Herodotus did not find Halicarnassus a satisfactory place of residence, as he subsequently migrated to the Greek colony of Thurii, in Italy, where his last days were spent, and where it is presumed he repolished and completed his history. The colony in Thurii was first established in the year 443, but whether or not Herodotus was a member of the first company that went out to it is in dispute; that he finally went there, however, seems to be accepted without reserve.

These meagre facts, some of them by no means too well authenticated, constitute practically all that is known from outside authority regarding the actual life of Herodotus. There are, to be sure, numerous other traditions current, some of which were doubtless founded upon fact, and a few of

which are almost inseparably associated with the name of Herodotus. Such, for example, is the story that Herodotus read the books of his great history before the people of Athens, and created such popular enthusiasm thereby that the sum of ten talents (£2,000, \$10,000) was voted him from the public treasury. If this be taken as true to fact, it would appear that the business of literature was not ill paid even in that early day. Another tale, or possibly an elaboration of the same one, alleges that Herodotus desired to make his history known to the Greek world, and decided that this could best be accomplished by reading it before the assembled multitudes at Olympia. Just when this reading was held is not clear, but, notwithstanding this lack of date, it is alleged that the reading created the greatest enthusiasm, and that Herodotus divided the honours of the occasion with the winners of the Olympic games.

Another elaboration of the tale, which one would fain believe true, asserts that the youthful Thucydides, listening to the recital of Herodotus, was moved to tears, and fired with the ambition to follow in the footsteps of the great writer. The cold hand of modern scepticism has been laid rudely on this tradition, it being asserted that the date of the birth of Thucydides is too near that of Herodotus to lend authenticity to the story. But, be that as it may, this tale is probably as near the truth as most of the others which we have associated with the name of the father of history.

The work of Herodotus is remarkable, among other things, as being the oldest complete prose composition that has come down to us from classical antiquity. It must not be inferred from this that Herodotus was the first Greek who wrote prose. The fact is far otherwise. The so-called father of prose was, as is well known, preceded by a long line of Greek writers, who composed not merely prose compositions, but compositions on history. The names of many of these men are known, but their works have come down to us only in meagre fragments. As such, however, they serve to prove the wide gap which separated the best of them from their successor Herodotus. Indeed it is doubtless because of the surpassing excellence of the history of Herodotus that his work lived on through the labours of successive copyists, while the works of his predecessors were permitted to disappear through slow decay like the works of so many other and later writers of antiquity.

If it be true that the style is the man, then we may feel that after all, despite the meagre contemporary records as to his life, the man Herodotus is well known to us; for his great work, possibly the only one that he ever composed, has come down to us intact. Not indeed that the actual manuscript of his own production has been preserved. No author of classical Greece has come down to us directly in this sense. But in that day the individual copyist did in a small way what the printing-press to-day accomplishes on a larger scale. And of the numerous copies that were made of Herodotus in succeeding ages down to the period of the Renaissance, something less than a score are still preserved. Most of these date only from the fifteenth, fourteenth, or, at the earliest, the tenth century. There are, however, two or three that are undoubtedly still more ancient, though probably none that was written within a thousand years after the death of the author himself. The fact of numerous copies made in different ages by different hands being available for comparison, however, makes it reasonably sure that we have in the carefully edited editions of modern scholarship a fairly accurate representation of what Herodotus actually wrote.

This work, then, is commonly spoken of as the *History of the Persian War*. It is really much more than that. Starting with the idea of the Persian

War as a foundation, Herodotus has built a structure which might, perhaps with more propriety, be termed a history of the world as known in his day. The work itself makes it clear that, in acquiring material for its composition, the author travelled extensively in Asia and in Egypt. He visited Babylon, and gives us the description of an eye-witness of the glories of that famous capital; and he sojourned long in Egypt, saw with his own eyes the Pyramids and other monuments of that wonderful civilisation, and heard from the priests fabulous tales of the past history of their country.

When one reflects what must have been the range of observation of the average stay-at-home Greek of that day, one readily understands how much of what Herodotus saw in these foreign lands had the charm to him of absolute novelty. He had but to recount what he had seen and heard—a fair degree of literary skill being of course presupposed—to produce a narrative which would have all the charm for his compatriots of a fascinating romance. The marvels of his actual observation in Babylon and in Egypt must have seemed to him more wonderful than anything he could conceivably invent. Therefore, even had his sole object been—as quite probably it was—merely to make an entertaining narrative, he had no inducement to depart from the recital of the truth as he saw and heard it. That, in point of fact, he did thus cling to the truth is admitted to-day on all hands. There were periods, however, within a few hundred years of his own epoch, when Herodotus was considered by even the best authorities of the time as a bald romancer. The Greeks and Romans of about the beginning of our era, with Plutarch—or a “false Plutarch”; the question of authenticity is an open one—at their head, did not hesitate to stigmatise Herodotus as a writer of fables. “Plutarch” even went further and asserted that he was a malignant perverter of the truth as well.

Such detractions, however, did not at all alter the fact that the story of Herodotus had an abiding interest for each succeeding generation of readers, and it is one of the curious results of modern exploration and investigation to prove that very often where Herodotus was supposed to have invented fables he was, in point of fact, merely narrating, in the clearest manner possible, what he had actually seen.

Mixed with these recitals of fact, to be sure, there is much that is really fabulous, but this is chiefly true of those things which Herodotus reports by hearsay, and explicitly labels as being at second hand. Whether fact or fable, however, the entire story of Herodotus has at once the fullest interest and the utmost importance for the historian of to-day. For where it tells us facts about the nations of antiquity, these are very often facts that would otherwise be shut out absolutely from our view; and where he relates fables, he at least preserves to us, in a vivid way, a picture of the mental status and the intellectual life of a cultivated Greek in the period of the greatest might of that classical nation.

Our present concern is with the part of Herodotus that deals explicitly with the affairs of Greece. This has particular reference to the Persian Wars, although giving many incidental references to other periods of history. For this period of the Persian invasions Herodotus is practically our sole source, and we have drawn on him largely at first hand. His narrative here may be paraphrased and in some slight details modified, but can never be supplanted. The account of Herodotus closes with the year 478—the definitive year in which the Persians were finally expelled from Greece. As Herodotus was six years old in 478, he must have had personal recollections of the effect produced upon his elders by the accounts of the battles of

Thermopylæ, Salamis, and Plataea; must indeed all his life have been associated with men who participated in these conflicts; his account, therefore, has all the practical force of the report of a contemporary witness.

As we have said, the period following the Persian wars—the age of Pericles—found no contemporary historian, though the writings of the poets and the orators to some extent make amends for the deficit; and the art treasures that have been preserved are more eloquent than words in their testimony to the culture of the time. The general historians and biographers supply us with the chief details of the political events of the time and bridge for us the gap between the Persian and the Peloponnesian wars.

When we reach the Peloponnesian War itself we come upon the work of the master historian Thucydides. A critical estimate of his writings has already been given and need not be repeated here. Neither need we take up at length the work of Xenophon, who, as already noted, explicitly continued the history of Thucydides. We have previously had occasion to point out that Xenophon did not equal his great predecessor in true historical sense, or in breadth and impartiality of view. His partiality for Sparta and his friendship for Agesilaus led him to do scant justice to the great Theban Epaminondas, and we have previously noted how the record of Diodorus, rather than the contemporary account of Xenophon, is our best source for the history of the Theban hero. Nevertheless Xenophon remains an important source for the period of which his *Hellenica* treats. His more popular work, the *Anabasis*, describes a picturesque incident in Grecian history, which was important rather as an adumbration of possible future events than because of its intrinsic interest.

Coming to the Macedonian epoch we find, as might be expected, that the picturesque life of Alexander called forth a multitude of chroniclers; all of which, as has been said, were superseded by the later works of Arrian and Curtius.

Recapitulating in a few words what has just been said of the original sources of Grecian history, it would appear that the reader who has before him the works of Diodorus, Justin, Plutarch, Nepos, Herodotus, Thucydides, Xenophon, and Arrian will have access to the chief fountain-heads upon which modern historians have drawn. But it will be clear to anyone who considers these authors in their entirety that the idea of Grecian history to be gained by reading these classical writers alone would be a somewhat disjointed and unsatisfactory one. Many points of chronology would remain obscure; there would be many gaps in the story. Yet, the view thus to be gained was the only one accessible until about a century ago. The revival of interest in the classical authors that came about along with the general intellectual advance in the time of Elizabeth, had led to the translation of many classical authors by such men as Thomas North, Philemon Holland, and Arthur Golding. It had led also, as we have noted, to the production of Sir Walter Raleigh's general history, which was complete for the period during which Greece was an important nation. But there was no other attempt to unify the story of Grecian history and give it a modern garb until more than a century later.

Then the stimulus given to historical investigation by the success of Gibbon's splendid work, led to an attempt to treat the history of Greece in a manner equally comprehensive. The man who first undertook the task in England was William Mitford. The work that he produced was an epochal one, replete with scholarship, yet it had certain limitations which

led directly to the production by another hand of a yet more monumental work on the same subject. For, as is well known, the history of Grote was written with the explicit intention of combating the conception of Grecian civilisation that Mitford's book had made current.

There are two quite different points of view from which the history of a foreign nation may be regarded. One of these may be called the "sympathetic," the other the "antipathetic" view. It was the latter of these which Mitford chose, or rather to which he was impelled by temperament, in dealing with those phases of Athenian life which are the central facts in the political history of Greece. It may be laid down almost as an axiom that it is impossible to write a truly great history of a great people from the antipathetic standpoint. At best, one can obtain only a surface knowledge of a foreign people—it is hard enough to gain a correct knowledge of one's own race. Every people, like every individual, is a strangely inconsistent organism. The deeds of its diverse moods never seem to harmonise; they are as different as the two sides of a shield or medal, and in proportion as we seize on one phase or another of the inconsistencies, we change utterly the type of the picture. Of course the great historian must see all sides and properly adjust them; but the difficulty is this: it is much easier to detect the inconsistencies than the underlying consistencies, which, after all, are necessary to national life. Hence the antipathetic historian makes out a strong case against the nation with relative ease, while quite overlooking the better side; whereas the sympathetic historian, while searching for the better side, cannot by any possibility overlook the obvious inconsistencies.

To illustrate from the case in hand: Mitford was an ardent tory, and he insisted on weighing Greek conduct in his own balance. He never failed to sneer at the democratic tendency of Athens, and to point out the inconsistencies in Athenian life. And he found ample material. Nothing is more startling to the student who undertakes a careful survey of the history of Greece than the glaring defects of this people. Take two or three illustrations: The Athenians contended all along for equality of rights, yet (1) the majority of their co-residents were slaves; (2) they frequently denied to their best citizens the privilege of living in Athens, banishing them, without even the charge of crime, by ostracism; and (3) they strove all along to establish imperial power for Athens over other cities—strove so fiercely for it that the final result was the utter overthrow of Greece itself.

Again, the Athenian is said to have worshipped the æsthetic and the beautiful. His poetry and art attest the truth of the claim. Yet at table he ate with his fingers; in the streets he committed indescribable vulgarities without concealment; and in his relations with his fellows he indulged in practices of the most revolting kind so commonly that to "love after the manner of the Greeks" became an opprobrious by-word among nations. Herodotus himself records that the Greeks taught these practices to the Persians, who to this day are reproached with them.

To go no further, here is plenty of material for the antipathetic historian. Yet even a very brief analysis might serve to modify the first judgment which would tend to denounce the Greeks as the most inconsistent and disreputable of mortals.

Thus, as to the slaves, a sympathetic historian would not forget that slavery had existed almost everywhere in antiquity, among Hamitic, Semitic, and Aryan races alike; and that modern nations did not throw it off for more than two thousand years after the downfall of Greece. Nor will he forget

that the last great nation to discard it was the United States, the most advanced of democracies; and that, when the great struggle came through which it was at last rooted out there, practically all Europe sympathised in spirit with the slave-holder, and not with the party that strove to free their fellow-men. These are grotesque inconsistencies; but with the later history in mind we can scarcely hold up the matter of slavery as an essentially Greek inconsistency.

Then consider the question of ostracism. At first sight it surely seems difficult to bring within the pale of reason this fact of the banishment from Athens of one great citizen after another — of Themistocles, the hero of Salamis, of Aristides the Just, of the brilliant Alcibiades, of Xenophon, and of Thucydides. But consider the matter a little further. Here was a little people, numerically insignificant, who had got hold of a unique principle. They had experienced the pleasures of personal liberty, of free “government of, for, and by the people,” and all the world about them looked jealously on their experiment. Always the gold of Persia was at hand to help on an aristocratic party at home in the effort to overthrow the democratic party by whatever means, fair or foul.

What then must necessarily be the attitude of the best citizens of Athens toward any one of their number who gained very great popularity and influence, and who seemed ambitious to use his power autocratically? Why, such a person, however respected, however loved even — indeed just in proportion to the respect and affection that he inspired — must be regarded with apprehension. And the ballot for ostracism solved the problem, after a fashion. It required no charge against the citizen. It accused him of no crime. It merely gave official expression to a popular belief that it were better for the state that this citizen should retire for a time from its precincts. It was a confession of governmental weakness, to be sure. A powerful unified democracy like the United States in modern times has no need of such a law; but a weak government like that of France still thinks itself obliged sometimes to resort to it in case of political offenders, who are feared for exactly the same reason that led to ostracism in Athens — as witness the case of Déroulède and his allies. In this view then the practice of ostracism, which very probably preserved the democratic government of Athens long after it would otherwise have been overthrown, is not the grotesque inconsistency it at first seems.

As to the factions of the cities, which led to what Ruskin calls the “suicide of Greece,” they come to seem as natural as human nature itself when one stops to reflect that Hellas was never a united country under unified government. The Greek had, to be sure, a prejudice in favour of his race against outside barbarians. But his keenest prejudice was for his own city. The idea of liberty was too new for the conception of a federation of cities to be grasped all at once. Even now, after more than twenty-five hundred years of experiment and effort, that idea has only in a few instances been successfully realised and practised on a large scale for considerable periods of time — by the Greek cities themselves at a later period; by the north Italian cities late in the Middle Ages; and by the Anglo-Saxon race in our own day. It is not strange then that the Athenian regarded the Spartan as a political foreigner; and the struggles between the two were not different from the struggles that have gone on ever since between different neighbouring states all over the world. The appalling fact of universal carnage inconsistently disturbing the dreams of the brotherhood of man is one of the saddest evidences of the restricted

civilisation of our race. But with all recent history in our minds, we can hardly hold it too much against the Greek that he was not more advanced in this regard in the year 400 B.C. than is all the rest of the world in the year 1900 A.D.

Without going further it must be clear how very different the points of view are from which the "sympathetic" and the "antipathetic" historian will respectively regard a people, in particular a people of high genius like the Greeks. And, to return to Mitford, it is hardly an unjust criticism which has said of him that his ponderous work, despite its learning, "is scarcely more than a huge party pamphlet." And this is true precisely because he viewed the Greek always from the standpoint of his own narrow prejudice. Yet this must not be taken to imply that Mitford's history is valueless. The fact is far otherwise. With due allowance for its bias, it may be read with full profit by everyone, and there are many passages of it that are unprejudiced and authoritative, while the merits of its style commend it so highly that we have had occasion to return to it again and again.

But the greatest distinction of Mitford was to call forth the work of Grote; for it was through indignation aroused by Mitford's attitude toward Grecian affairs that the London banker, whose recreation was the study of the classics, was led to present a different view of Grecian history. The intentions to combat Mitford developed finally the conception of a comprehensive history, and when this history was completed, a definitive presentation of Grecian affairs had been put forward. Next to Gibbon's *Rome*, perhaps the greatest historical work ever produced in England is Grote's *History of Greece*. Unfortunately, Grote did not continue his history beyond the time of Alexander, so we must seek other guides for the period of the decline and fall of Grecian power. The earliest epochs of Grecian history also have been opened up by the work of Schliemann and his successors since the day of Grote. Nor need it be denied that in various details Grote's theories have been modified by later investigations. But, in the main, his work was based upon such secure foundations, and was conceived and carried out in such a broad and philosophical spirit, that it must stand indefinitely, like the work of Gibbon, as a finished historical structure.

If one were to single out for particular reference the part of Grote's work which was most revolutionary and at the same time most satisfactory, one would cite perhaps the earliest portion, that which deals with the myths and traditions of Greece. It is almost a matter of course that the chief authoritative investigators of such a subject as this are usually scholars by profession; closet students of that type of mind which can give years of enthusiastic devotion to the investigation of a few pages of an obscure manuscript, and which can devote pages of polemics to the establishment of the correct reading of a disputed text the subject-matter of which is perhaps altogether trivial. This type of mind is in many ways admirable, and the work which it accomplishes is entitled to full respect, but it is not the kind of intellect one would willingly follow as a rule in the decision of questions of more practical import. And it is because this is the sort of intelligence which has chiefly attacked this problem, that the discussion of it has usually evinced so little of practicality. Moreover, another set of persons of even more visionary cast, the poets, namely, have added their modicum of argument along equally visionary lines, prejudiced in their view by love of the great literature in which the mythical tales are embalmed. But Grote combined in his own mind the qualities of secure and profound scholarship with a full appreciation of the beauties of literature and a rare practical

knowledge of the world of everyday affairs, which gave him perhaps a keener critical view and a clearer historical perspective than had been vouchsafed anyone who had before attempted to deal with the subject.

Grote was a practical banker and successful financier, turned historian through sheer love of his subject. He applied to the subject of Greek mythology the rules of what may be best described as sound common-sense. He recognised that a myth is not the growth of a day, but the accretion of perhaps many generations, or even centuries of legendary history. He fully recognised two very essential basal principles of practical psychology, namely, first, that quite the rarest feat of the human mind is anything approaching pure invention; but that, secondly, scarcely less rare is a recital, however securely founded in history, which does not contain some elements of invention. He recognised, in other words, the full truth of the homely saying that "where there is much smoke there must be some fire"; but he recognised also the truth that no two persons could ever be found who, after viewing the smoke, would agree as to the exact proportion which it bore to the fire.

Making the application to the case in hand, Grote was convinced that every important myth and legend must have had the prototype of at least its outline in the actual history of some human beings in some period. He combined with this conviction the no less certain one that in our day it is utterly impossible to say what people or what time furnished this historical basis of the tradition, or just what proportion of fact is mingled with the enshrouding cloud of fable. When, therefore, Grote came to write his history of Greece, he adopted a compromise regarding the mythical period, which is one of the most striking illustrations of his practical sagacity. He recited the fables as fables, labelling the legendary period as such, and making no attempt whatever to determine what relation any specific incident among these legends might bear to the actual experiences of the people of prehistoric Greece. Grote's decision in this matter was at once received with acclaim by a large number of readers; and though of course it by no means silenced the champions of other views, it may fairly be said that after more than half a century there is no other manner of treating this period which can justly supplant that which the great historian established.

Our estimate of Grote in other fields is well illustrated by the liberal use we have made of his work. Notes on other historians of Greece — many of them by no means unimportant in themselves, but no one of them quite to be compared with this master historian — will appear in the following bibliography. It will be sufficient here to recall the names of Thirlwall and Curtius among the general historians of Greece of the earlier generation, and the names of Holm, Beloch, Busolt, and Bury among the more recent writers; while for special periods the names of Droysen, Müller, Schliemann, and Finlay have particular prominence.

LIST OF AUTHORS QUOTED, CITED, OR CONSULTED; WITH CRITICAL AND BIOGRAPHICAL NOTES

Abbot, E., *History of Greece*, London, 1892-1893. — Ælianus Claudius, *ποικίλη ἱστορία*, edited by Perizonius, Leyden, 1701, the *Variable History of Ælianus* (trans. by A. Fleming), London, 1576. — Alfieri, V., *Tragedy on Agis IV, King of Sparta*. — Allcroft, A. H., *Decline of Hellas, 371-323 B.C.*, London, 1894; (in collaboration with W. F. Masom), *Synopsis of Grecian History to 495 B.C.*, London, 1891. — *Annual of the British School at Athens*. — Anonymous, *Der Griechisch-türkische Krieg des Jahres 1897*, Berlin, 1898; *Seven Essays*

on the Social Condition of the Ancient Greeks, Oxford, 1832. — **Aristobulus**, as quoted by Plutarch, Arrian, etc. (in Müller's *Fragmenta*). — **Aristotle**, *Ἠθικὰ*, edited by Zell, Heidelberg, 1820, 2 vols; *Πολιτικὰ*, edited by Barthélemy St. Hilaire, with Fr. trans., Paris, 1837; *Ethics, Politics* (trans. by Gillies), London, 1804. — **Arrianus**, Flavius, *Ἀνάβασις Ἀλεξάνδρου*, edited by F. Schneider, Leipzig, 1798; *The Anabasis of Alexander*, London.

L. Flavius Arrianus, born at Nicomedia about 100 A.D., died at an advanced age during the reign of Marcus Aurelius.

In considering a career so romantic as that of Alexander, it is quite impossible that the historian should remain a calm, unmoved spectator of the incidents which he describes. We find, therefore, that the numerous biographers of Alexander have for the most part placed themselves explicitly on one or another of opposite sides. Either, on the one hand, they have considered Alexander as the greatest of heroes and most wonderful of men, or, on the other hand, have regarded him as merely the greatest of adventurers. It is tolerably easy, accordingly as one emphasises one side or another of the facts of Alexander's history, to make out a seemingly good case from either of these points of view. But what we have elsewhere said about the sympathetic historian applies with full force here, and it is not to be expected that anyone can have written a really satisfactory biography of Alexander who has not been appreciative of those points of his genius which lie quite without the range of the ordinary adventurer. Thus it is not surprising to find that the really great biographies of Alexander, both those of antiquity and those of modern times, have been written from the sympathetic point of view.

The biography of Arrian, which, by common consent, far exceeds in importance all other writings on Alexander that have come down to us, is certainly most judicious in spirit, and probably as impartial as such a production could possibly be. Arrian does not spare the faults of Alexander nor hesitate to give them full expression, but he fully appreciates the greatness of his hero, and he undertook to write his life, as he himself explicitly states, because he felt that no one before him had done full justice to his subject. Arrian frankly states his opinion that his own production will be found not unworthy, and that, in virtue of it, he, himself, must be entitled to be regarded as one of the great writers of Greece. All things considered, it is, perhaps, strange that posterity should have declined to accede to this claim. The work of Arrian is indeed admitted on all hands to be a production of sterling merit — certainly one of the most impartial and judicial historical productions of antiquity. Yet, notwithstanding the extreme importance of his subject, the name of Arrian is comparatively little known to the general public, whereas the name of Xenophon, whom Arrian to some extent took for his master, is familiar to everyone, though the subject of his chief work was of such relative insignificance.

This anomaly is, perhaps, partly explained in the fact that Arrian did explicitly follow Xenophon as a master, since one never expects to rank the follower on a par with the originator. But the truer explanation is probably that Arrian lived at a late period, after the glory of Greece, as the literary centre of the world, had quite departed; and it has been customary to regard all works of this later period, with their necessary alterations of style, representing the time of degeneracy of the Greek language, as things to be looked at askance by lovers of that language in its purity. Then, too, perhaps, the very importance of Arrian's subject may have been detrimental to the permanent popularity of his work. There was no possible reason why any other writer should take up in great detail the story of the *Anabasis* of the Ten Thousand after Xenophon, since that story, much as if it had been a mere romance, owed its importance almost entirely to the qualities of style of the original narrator. But the case of Alexander was quite different. Numberless writers, as was most natural, had told his story in the times immediately after his death. It was inevitable that so amazing a history should continue to excite the interest of mankind throughout all time and should be retold again and again by countless generations of historians. Even had the biography of Arrian proved in all respects comprehensive and satisfactory, later generations must have demanded that the story should be retold after the manner of their own times, but in point of fact, the biography of Arrian, important as it is, is by no means altogether comprehensive. It contains, to be sure, all incidents which its author was satisfied were authentic, but it explicitly omitted various other incidents, which, whether true or false, must have an abiding interest from the very fact of having been associated with the name of Alexander.

Each succeeding generation of historians must then judge for itself, as is the prerogative of the critic, among the various contradictory stories that have come down to us, and must weigh anew the evidence of this side or that, and make for itself a new story of Alexander.

Assmann, W., *Handbuch der Allgemeinen Geschichte*, Brunswick, 1853.

Bachelet, J. A. F., *Histoire ancienne grecque*, Paris, 1883. — **Baraibar** (in collaboration with **Menendez Pelayo**) *Poetas liricos Griegos*, Madrid, 1884. — **Becker, Wilhelm A.**,

Charicles, or Illustrations of the Private Life of the Ancient Greeks (translated by Frederick Metcalfe), London, 1854. — **Beloch**, J., Griechische Geschichte, Strasburg, 1893-1899, 2 vols. — **Bent**, J. T., The Cyclades: Life among the Insular Greeks, London, 1885. — **Berens**, E. M., Myths and Legends of Ancient Greece, London, 1879. — **Berg**, van den, Petite Histoire des Grecs, Paris, 1880. — **Bergk**, T., Griechische Litteraturgeschichte, Berlin, 1872-1891. — **Bernhardy**, G., Grundriss der Griechischen Litteratur, Halle, 1836, rev. ed. 1876-92. — **Berthelot**, A., Les grandes scènes de l'histoire grecque, Paris, 1889. — **Blackie**, J. S., Horæ Hellenicæ, London and Edinburgh, 1874. — **Blanchard**, Th., Les Mavroyeni, Paris, 1893. — **Bluemner**, Hugo, Home Life of Ancient Greeks (trans. by A. Zimmern), London, 1895; Technologie und Terminologie der Gewerbe und Künste bei Griechen u. Römern, Leipsic, 1887. — **Boeckh**, A., Public Economy of the Athenians (trans. by A. Lamb), Boston, 1857.

August Boeckh, born at Carlsruhe, November 24, 1785; died in Berlin, August 3, 1867. He published an edition of Pindar with a continuous commentary, a Latin translation, and a treatise on Greek Versification, (1811); also *Metrological Investigations concerning the Weights, Coins, and Measures of Antiquity* (1835); *A Dissertation on the Silver Mines of Laurium in Attica*, and other treatises. He began the *Corpus Inscriptionum Grecarum*, continued by his pupil Franz and still unfinished. His most important work on the *Public Economy of the Athenians*, while necessarily somewhat antiquated, retains its original importance in many features, and as a repository of knowledge drawn from the classical writers has not been superseded.

Bonnet, M., Le Philologie classique, Paris, 1892. — **Bougault**, Alfred, Hist. des lett. étrangères, Paris, 1876. — **Bougot**, A., Rivalité d'Eschine et Demosthènes, Paris, 1891. **Brequigny**, L. G. O. F. de, Vie des anciens orateurs grecs, Paris, 1752. — **Bronwer**, P. v. L., Histoire de la Civilisation Morale et Religieuse des Grecs. — **Brown**, J. B., Stoics and Saints. Lectures on Later Heathen Moralists, Glasgow, 1893. — **Budge**, E. A. W., The Life and Exploits of Alexander the Great, London, 1896. — **Bulwer**, H. L. E., An Autumn in Greece, London, 1826. — **Bulwer Lytton**, E. G. E. L. See Lytton. — **Burgess**, G., and others, Greek Anthology, London, 1854. — **Burnouf**, E., Mémoires sur l'antiquité, Paris, 1879; La légende athénienne, Paris, 1872; The Science of Religions (trans. by Julie Liebe), London, 1888; Histoire de la littérature grecque, Paris, 1869. — **Bury**, J. B., History of Greece, London, 1900; The Double City of Megalopolis (in Journal of Hellenic Studies), London, 1898.

John B. Bury, born 1861; was educated at Trinity College, Dublin, became professor of modern history in Dublin University in 1893; regius professor of Greek in 1898; and regius professor of modern history in the University of Cambridge, 1903. Professor Bury is well known for his *History of the Later Roman Empire* and for his edition of Gibbon's *Decline and Fall*. In preparing the history of Greece he wavered, as his preface tells us, between an elaborate work and the more difficult task of presenting a well-balanced epitome of Greek history in a single volume. He was probably wise in choosing the latter; and in so doing he has produced a work which, while brief, may properly be styled comprehensive and authoritative and which is also entertaining. It does not attempt to supplant the more elaborate works of the older writers, nor does it enter quite the same field with the recent German productions; but it is almost the only work which, in a single volume, gives the reader any clear idea of the latest developments of Mycenaean history, while carrying the story of Grecian history in general through the age of Alexander.

Busolt, G., Die Griechische Gesch. bis zur Schlacht bei Chæroneia, Gotha, 1893; (in Müller's Handbuch der klassischen Alterthumswissenschaft, Munich, 1892).

Caillemer, E., Études sur les antiquités juridiques d'Athènes, Paris, 1880. — **Carraroli**, D., Di leggenda di Allessandro Magno, Mondovi, 1892. — **Church**, A. J., Heroes and Kings, London, 1883; London, 1900; The Fall of Athens, London, 1894; Nicias and the Sicilian Expedition, London, 1899; Pictures from Greek Life and Story, 1893. — **Cicero**, Tusculanarum Disputationum Libri V. and De Oratore, Rome, 1469. — **Clarke**, E. D., Travels in Various Countries of Europe, Asia, and Africa, London, 1810. — **Clinton**, Fynes H., Fasti Hellenici, London, 1851. — **Collins**, W. L., Ancient Classics for English Readers, London, 1870. — **Conitolas**, B., La Grèce apres la faillite, Paris, 1895. — **Constantine VII.**, Flavius Porphyrogenitus, Έκλογαί περί Προσβειών (Excerpta de Legationibus), περί ἀρετῆς καὶ κακίας (Excerpta de Virtutibus et Vitiis), edited by Valesius, 1634; περί γνωμῶν (Excerpta de Sententiis), Rome, 1827. — **Corner**, J., History of Greece, London, 1885, 8 vols. — **Costard**, G., Dissertation on Uses of Astronomy in History, etc., London, 1764. — **Coulange**, F. de, Nouvelles recherches sur quelques problèmes d'histoire, Paris, 1891. — **Cox**, G. W., A History of Greece, London, 1874, 2 vols.; General History of Greece, London, 1876; The Athenian Empire, London, 1876; The Tale of the Great Persian War, London, 1861; The Greeks and the Persians, London, 1877; Lives of Greek Statesmen, London, 1885.

George W. Cox, born at Benares, January 10, 1827; vicar of Bekesbourne, 1881, rector of Scrayingham, 1881-1897. His various historical works have had great popularity, to which the excellence of their style eminently entitles them. They are scholarly as regards their treatment of facts, but are essentially artistic in their presentation of these facts. No one has treated the mythological period in a more satisfactory way. Obviously, considering the date of their publication, they are not to be looked to for the latest phases of Mycenaean investigation.

Cramer, J. A., *A Geographical and Historical Description of Ancient Greece*, Oxford, 1828.—**Creasy**, Edward S., *Fifteen Decisive Battles of the World*, London, 1852.—**Curtius**, A. M., *Rise of the Macedonian Empire*, London, 1877.—**Curtius**, E. von, *Griechische Geschichte*, Berlin, 1887, 3 vols.

Ernst Curtius was born at Lübeck, Germany, September 2, 1814; died July 12, 1896. When K. O. Müller undertook that tour of Greece which began so auspiciously and ended so disastrously, he had as an assistant a young German of kindred genius to his own, afterwards to be known perhaps even more widely than himself as an historian of Greece, in the person of Ernst Curtius. The work which Müller was not permitted to complete was carried on by Curtius, who devoted his entire life to the study of classical antiquities as his master had done before him. It was Curtius who, many years later, conceived the idea of making excavations at the famed site of Olympia. Curtius himself, acting as envoy for the German government, secured to that country the monopoly of excavating there. The results of these excavations which Curtius for a time personally conducted are full of importance and interest, and were given to the world in a series of ponderous volumes.

Much of the work of Curtius had this technical character, but the one book through which he became best known, and by which he will probably be longest remembered, was an essentially popular history of Greece—by far the most popular exposition of the subject that has ever been written in Germany. It is a work essentially un-German, so to say, in its plan of execution. It is a condensed running narrative of the events of Grecian history, and, what is strange indeed in a German work, it is quite unmarred by footnotes: notes there are, to be sure, but these are relatively few in number and are placed by themselves at the end of each volume, where they may be easily found by the few who care to seek them out, without marring the interest and distracting the attention of the mass of readers of the text. It is interesting to note that this most delightful and popular history was written at the instance of a publisher as a companion work to Professor Mommsen's equally famous history of Rome. The similarity of treatment and general identity of plan of these two famous works suggest that the publisher perhaps had no small share in predetermining their character and scope; if so, the world owes him two of the most important histories that have come out of the land of historians.

Professor Curtius' personal point of view may be described at once as sympathetic and critical; he had the ripest scholarship, and he early imbibed much of Müller's enthusiasm, but he perhaps brought to his subject a shade more of practicality than his great master. The combination of traits made him almost a perfect historian. As a teacher he was long regarded as one of the most successful in the land of great teachers. Professor Boyesen, in a popular article on the Berlin University, written for an American magazine some years ago, described at some length a seminar of Professor Curtius, and expressed his surprise and admiration at the ease and fluency with which Professor Curtius carried on what might be styled a familiar conversation in classical Latin. Such an incident is far less novel in Germany than it would be in France, or England, or America; for in Germany the student is still taught to speak Latin—after a fashion—in the Gymnasium, and the scholars are not few who learn to handle it with relative ease as a spoken language. In the case of Professor Curtius, then, this mastery of classical languages is perhaps less remarkable than his practical mastery of his mother-tongue; for there are many German professors who can speak Latin fluently where there is one who can write German that anyone who is not a German can read with pleasure.

Curtius, Quintus, *De Rebus Gestis Alexandri Magni*, Venice, 1471; *The Wars of Alexander* (trans. by William Young), London, 1747.

Dahlmann, F. C., *Forschungen auf dem Gebiete der Gesch.*, Altona, 1822-1824.—**Dar-
enberg**, C. V., and **Saglio**, E., *Dictionnaire des antiquités grecques et romaines*, Paris, 1873; *La Médecine dans Homère*, Paris, 1865.—**Dares**, the Phrygian, *Daretis Phrygii de Excidio Trojæ Historia*, L'hist. véritable de la guerre des Grecs et des Troyens, faite française par Ch. de Bourgueville, 1893.—**Daubau**, C. A., *Extraits des auteurs anciens sur l'hist. grecque*, Paris, 1888.—**Deltour**, N. F., *Histoire de la littérature grecque*, Paris, 1885.—**Diodorus**, Siculus, *Βιβλιοθήκη ἱστορική*, edited by L. Dindorf, Leipsic, 1828, 6 vols. *The Historical Library*, London, 1700.—**Diogenes**, Laertius, *φιλόσοφοι βίοι*, edited by H. G. Hübner, Leipsic, 1828, 6 vols.—*Lives and Opinions of the Most Eminent Philosophers*

(trans. by C. D. Yonge), London, 1848. — **Dodge**, T. A., *Great Captains; History of Origin and Growth of Art of War*, Boston, 1890. — **Donaldson**, J., *Modern Greek Grammar*, Edinburgh, 1853. — **Dragoumes**, N., *Souvenirs historiques*, Paris, 1890. — **Droysen**, J. G., *Geschichte Alexanders des Grossen*, Gotha, 1892; *Gesch. des Hellenismus*, Gotha, 1877-1878.

Johann Gustav Droysen was born at Treptow, Pomerania, Prussia, July 6, 1808; died at Berlin, June 19, 1884. His history of Alexander was written before any of the really great modern histories of Greece were undertaken, and it far surpassed any preceding effort in the fullness with which it drew upon all sources of antiquity and in the critical acumen with which it analysed the material thus gathered. It had, moreover, the merit of a style of more than average lucidity, and this, added to its other qualities, gave it at once a wide popularity and an authoritative position which it has continued to hold to this day. Indeed, it is only very recently that anyone has attempted to write a history of Alexander which could be regarded as competing in the same field with that of Droysen, except such extended sketches as form part of such comprehensive Grecian histories as those of Grote, Thirlwall, and Curtius.

Droysen treats his subject from a truly sympathetic point of view. For him Alexander is a very great hero; he is thoroughly in sympathy with the monarchical idea, and he regards Alexander as a great benefactor of his kind, who, had he lived, would have put the stamp of his genius still more firmly upon the most important epoch in the history of human evolution. Even such debatable points as Alexander's demand that divine honours should be paid him by the Greeks, after the oriental manner, are made by Droysen, as we have seen, to appear altogether favourable to his hero. It must not be supposed from this, however, that the history of Droysen is a fulsome eulogy. It is, on the other hand, the work of a candid critic of broad views and clear insight, who is by no means blind to the defects of his hero, but who believes that, in spite of these defects, the hero was not merely one of the greatest military geniuses, but one of the greatest men of any age.

Having treated the age of Alexander, it was not unnatural that Droysen should go on to the study of later Greek life. His treatment of the Hellenic age remains perhaps the most comprehensive and scholarly contribution to this difficult subject.

Droysen, H., (in *Hermann's Lehrbuch d. griechischen Antiquitäten*) Freiburg, 1889; *Untersuchungen über Alexanders des Grossen Heerwesen und Kriegführung*, Freiburg, 1885; *Athen und Westen vor der Sicilischen Expedition*, Berlin, 1882. — **Drumann**, W., *Verfall der Griechischen Staaten*, Berlin, 1815. — **Dujon**, E., *Problèmes de Mythologie*, Auxerre, 1887. — **Du Mesnil**, A., *Politik des Epaminondas*, Munich, 1863. — **Dunbar**, G., in *Potter's Antiquities of Greece*, Edinburgh, 1820. — **Duncker**, M., *Abhandlungen aus der griech. Geschichte*, Leipsic, 1887; *History of Greece to the End of the Persian War* (trans.), London and Edinburgh, 1883. — **Duruy**, V., *Histoire des Grecs*, Paris, 1887-1889. — **Dyer**, L., *Studies of the Gods in Greece at Certain Sanctuaries*, London, 1891.

Elser, C., *Die Lehre des Aristoteles über das Wirken Gottes*, Münster, 1893. — **Ely**, T., *Olympus, Tales of the Gods of Greece*, London, 1891. — **Eugamon**, *Τηλεγονία*, (Telegonia).

Falke, J. von, *Greece and Rome, their Life and Art* (trans. by W. H. Browne), New York, 1882. — **Farfar**, J. A., *Paganism and Christianity*, London, 1891. — **Fellows**, C., *An Account of Discoveries in Lycia*, London, 1841. — **Finlay**, G., *History of Byzantine and Greek Empires from 716 to 1453*, Edinburgh, 1853; *History of Greece from Conquest by Crusaders, 1204-1461*, Edinburgh and London, 1851; *History of Greek Revolution*, Edinburgh and London, 1861; *History of Greece under Ottoman and Venetian Domination*, Edinburgh and London, 1856; *Greece under the Romans*, Edinburgh, 1844. Most of Finlay's works, dealing with the later period of Grecian history, are properly without the scope of the present bibliography. They treat the Byzantine epoch from a Greek point of view and are thus complementary to Gibbon's work. We shall have occasion to return to them when dealing with the later Roman Empire. — **Flathe**, J. L. F. F., *Geschichte Macedoniens*, Leipsic, 1832-1834. — **Floigl**, V., *Cyrus und Herodot*, Leipsic, 1881. — **Fraenkel**, A., *Die Quellen der Alexander Historiker*, 1884, 8 vols. — **Françillon**, R. E., *Gods and Heroes*, Edinburgh, 1892. — **Freeman**, E. A., *History of Federal Government in Greece and Italy*, London, 1893; *History of Sicily*, Oxford, 1891; article on "Sicily" in the Ninth Edition of the *Encyclopædia Britannica*. The first edition of Professor Freeman's work on federal government, cited above, bore the following title: *The History of Federal Government from the Foundation of the Achæan League to the Dissolution of the United States*; a title which suggests the difficulties an historian may encounter when his enthusiasm leads him to enter the fields of prophecy. For obvious reasons the author was not able to complete his work in accordance with the original title. Unfortunately, he did not move as far towards its completion as he might have done, as a second volume was never published. The fragment

that he has given us, however, retains great importance in its application to that late and futile effort of the Greeks to harmonise the relations of their antagonistic cities. — **Furtwängler** (in collaboration with **Löschke**), *Mykenische Vasen*, Berlin, 1886.

Gardner, Percy, *New Chapters in Greek History*, London, 1892; *Manual of Greek Antiquities*, London, 1895. — **Garnett**, R., *A Chaplet from the Greek Anthology*, London, 1892. — **Geddes**, William D., *The Problem of the Homeric Poems*, London, 1878, 8 vols. — **Geldart**, E. M., *Modern Greek Language*, Oxford, 1866. — **Gell**, W., *Itinerary of Greece*, with Commentary on Pausanias and Strabo, London, 1810. — **Gerard**, P., *L'Éducation athénienne au cinquième et quatrième siècles b.c.*, Paris, 1889. — **Gerhard**, E., *Griechische Mythologie*, Berlin, 1854. — **Gervinus**, G. G., *Gesch. des Neunzehnten Jahrhunderts*, Leipsic, 1853. — **Gibbon**, E., *Decline and Fall of Roman Empire*, London, 1853. — **Gilbert**, G., *Beiträge zur inneren Gesch. Athens*, Leipsic, 1877; *Handbuch der Griechischen Staatsalterthümer*, Leipsic, 1893. — **Gillies**, J., *History of Ancient Greece*, London, 1825. — **Gladstone**, W. E., *Studies on Homer and the Homeric Age*, Oxford, 1858. — **Glover**, R., *Leonidas (poem)*, London, 1737. — **Godkin**, E. L., *Historical Educator*, London, 1854. — **Goldsmith**, O., *History of Greece*, London, 1825.

Oliver Goldsmith was born at Pallas, County Longford, Ireland, November 10, 1728; died at London, April 4, 1774. The name of Goldsmith has been everywhere a household word for more than a century, but probably comparatively few of the multitude of readers of *The Deserted Village* and *The Vicar of Wakefield* are aware that the famous poet and novelist was also a writer of histories. And, in point of fact, it would be going much too far to claim for Goldsmith any such rank in the field of history as, by common consent, he is accorded in these other walks of literature. Indeed it might almost be said that Goldsmith was not a historian at all in the modern sense of the word; he did not prepare himself by any extended series of intimate personal researches; he did not attempt to ferret out any new facts, or bring any novel lights to bear upon the subject. To put the matter briefly, he took up the writing of history as pure hack-work for whatever monetary recompense it would bring at the moment, with probably little thought beyond that. Nevertheless Goldsmith had some of the inherent instincts of the scholar, and, moreover, he was too great an artist not to know that truth lies at the foundation of all art; hence, even though he wrote in one sense carelessly, he could not do less than ground himself in at least the main outlines of the story that he had to tell, and it would be quite a mistake to suppose that his history of Greece is utterly despicable as a mere narrative of facts. Generally speaking, on the contrary, it may be depended on as to mere statement of fact, while its manner of presentation is, it goes almost without the saying, such as to give it a place quite aside from the ordinary.

There are indeed times when the spirit of the writer seems somewhat to flag, and one misses here and there that felicity of expression and charm of narrative which one is wont to associate with the name of Goldsmith; but, in the main, the story, as a story of Grecian life, is told in a manner not unworthy of the author of *The Vicar*, which is equivalent to saying that the mere story of Greek history has rarely elsewhere been told so well. The skill of the trained writer is shown, however, perhaps even more in the selection and massing of materials than in the mere matter of verbal style in the narrower sense. In particular Goldsmith has followed out the tangled web of post-Alexandrian history and woven it into something like a continuous and uniform texture with a facility of literary resource that is rare indeed among writers of history. Of course matter, rather than manner, is the *sine qua non* with the historian, and it was not to be expected that the history of Goldsmith could retain the prestige which it once enjoyed, after such writers as Mitford, Thirlwall, Grote, and Curtius had devoted years of effort to a more extended treatment of the same subject. Nevertheless the history of Goldsmith still has its utility for a certain class of readers. Judicious selections from it are fully entitled to stand beside the best that has been written on the subject. If, on the whole, one regrets that Goldsmith did not take the time to give his work greater authority, one cannot but regret also that some of the later writers, and notably Grote, were not able to add to their more ponderous productions something of the charm of style which is the chief merit of Goldsmith's history.

Goll, H., *Kulturbilder aus Hellas und Rom*, Leipsic, 1878. — **Gosselin**, P. F., *Géographie des Grecs analysée*, Paris, 1790. — **Grant**, A., *Greece in the Age of Pericles*, London, 1893. — **Grote**, G., *History of Greece*, London, 1846–1856; *Plato*, London, 1865.

George Grote was born near Beckenham in Kent, November 17, 1794; died at London, June 18, 1871. He was educated for a commercial life, and as a banker became a partner in the firm of Prescott, Grote & Co. He continued in active business until 1843, and he three times represented the city of London in parliament, retiring from public life in 1841. The first two volumes of his *History of Greece* were published in 1846, the remaining volumes appearing successively between 1847 and 1856. His *Plato and the other Companions of*

Socrates, in three volumes, appeared in 1865. In politics Grote was greatly influenced by his friend James Mill, accepting his theories upon church establishment and government. Years before the passage of the reform bill, Grote was one of the earnest reformers who strove to further the views of Mill and Bentham. His work as a politician, however, was quite subordinate to his importance as a historian, for the latter work was taken up at first as a mere labour of love, and only carried to completion, it is said, at the instigation of his wife. We have already commented at length upon Grote's work in the introduction to this bibliography.

Grundy, G. B., *The Persian War*. 1901. — **Guerber, H. A.**, *The Story of the Greeks*, London, 1898. — **Guhl, E.**, and **Koner, W.**, *The Life of the Greeks and Romans described from Antique Monuments* (trans. by F. Hueffer), London, 1877.

Hadley, J., *Philological Essays*, New York, 1873. — **Hahn, J. G. von**, *Folk Lore of Modern Greece*, London, 1884. — **Hall, H. R.**, *The Oldest Civilisation of Greece*. — **Hammond, B. E.**, *Political Institutions of the Ancient Greeks*, London, 1895; *Greek Constitutions*, Cambridge, 1896. — **Harrison, J. E.**, *Mythology and Monuments of Ancient Athens*, London, 1890. — **Harrison, J. A.**, *The Story of Greece*, New York, 1885. — **Hase, H.**, *The Public and Private Life of the Ancient Greeks*, London, 1836. — **Hegel, G. W. F.**, *Lectures on the Philosophy of History*, London, 1857. — **Heine, H.**, *Gesammelte Werke* (Zweiter Cyklus), Berlin, 1857. — **Helbig, W.**, *Die Italiker in der Po-Ebene*, Leipsic, 1879. — **Hermann, K. F.**, *Lehrbuch Griechischer Antiquitäten*, Freiburg, 1880; *Kulturgeschichte der Griechen und Römer*, Göttingen, 1857. — **Herodotus**, *Heroditi Historiæ*, ed. Schweighäuser, Strasburg, 1816, 5 vols.; *History of Herodotus*, translated by Wm. Beloe, London, 1806. — **Hertzberg, G. F.**, *Gesch. der Griechen im Alterthum*, Berlin, 1885; *Geschichte von Hellas und Rom*, 1879; *Geschichte Griechenlands unter der Herrschaft der Römer*, Halle, 1866–1875; *Gesch. Griechenlands seit dem Absterben des antiken Lebens bis zur Gegenwart*, Hamburg, 1876–1879. Professor Hertzberg's works have the merit of pleasant presentation, and may be depended upon as a representative presentation of the most authoritative views. They make no claim to any such amount of original investigation as characterises the standard works of Grote and Curtius. — **Hogarth, D. G.**, article on "Mycenæan Civilisation" in the *New Volumes of the Ninth Edition of the Encyclopædia Britannica*, London. — **Holm, A.**, *Gesch. Siciliens im Alterthum*, Leipsic, 1870–1874; *Griechische Gesch.*, Berlin, 1893; *History of Greece*, London, 1898.

Adolf Holm was born in 1830 at Lübeck; he is at present professor of history at Palermo, Sicily. Professor Holm's work, combining original investigation with a fair grade of popularity of treatment, is one of the most important of recent contributions to the subject.

Hopf, Carl, *Gesch. Griechenlands vom Beginn des Mittelalters* (in *Ersch und Gruber's Encyclopædie*), Leipsic, 1818. — **Huellmann, C. D.**, *Würdigung des Delphischen Orakels*, Bonn, 1837; *Anfänge der griech. Geschichte*, Königsberg, 1814. — **Hullmann, L. D.**, *Primi tempi della storia graeca*, 1894. — **Hume, D.**, *On the Populousness of Ancient Nations*, Edinburgh, 1753. — **Hutton, C. A.**, *Greek Terra-cotta Statuettes*, London, 1899.

Isocrates, Archidamus, ed. by G. S. Dobson, London, 1828, 2 vols.

Jäger, O., *Geschichte der Griechen*, Gütersloh, 1896. — **Jahn, O.**, *Ans der Alterthums-wissenschaft*, Bonn, 1868. — **Jebb, R. E.**, in an article on "Demosthenes" in the Ninth Edition of the *Encyclopædia Britannica*. — **Jevons, F. B.**, *Athenian Democracy*, London, 1895. — **Josephus, F.**, *Ἰουδαϊκὴ ἀρχαιολογία*, ed. by Dindorf, Paris, 1845 (trans. by W. Whiston, "The Jewish Antiquities," London, 1737); *περὶ τοῦ Ἰουδαϊκοῦ πολέμου ἢ Ἰουδαϊκῆς ἱστορίας περὶ ἀλώσεως*, ed. by Hudson, Oxford, 1720 (trans. by Whiston, London, 1737). — **Jurien de la Gravière, J. P. E.**, *Les campagnes d'Alexandre*, Paris, 1884; *La marine des anciens*, Paris, 1880. — **Justinus**, *Justini Historiarum Philippicarum Libri XLIV*; *History of the World*, London, 1853.

Kellner, G. C., *Edle Griechen*, Leipsic, 1802. — **Kertenensis, R.**, *Voyage to Dalmatia, Greece, and Asia*. — **Kingsley, Charles**, *Hyppatia*, London, 1858. — **Kolster, W. H.**, *Alexander der Grosse*, Berlin, 1866. — **Kortum, J. C.**, *Gesch. Griechenlands von der Urzeit bis zum Untergang des achäischen Bundes*, Heidelberg, 1854. — **Kruse, F. C. R.**, *Hellas*, Leipsic, 1826.

Lake, W. M., *A Historical Outline of the Greek Revolution*, London, 1825. — **Lang, Andrew**, *Homer and the Epic*, London, 1893. — **Larcher, P. H.**, *Traduction d'Hérodote*, Paris, 1786. — **Lardy, E.**, *La Guerre Greco-Turque* (see *Modern Greece*), Paris, 1899. — **Larocque, J.**, *La Grèce au siècle de Périclès*, Paris, 1883. — **Laurent, T.**, *Études sur l'histoire de l'humanité*, Brussels, 1861–1870. — **Leake, W. M.**, *Researches in Greece*, London, 1814; *Topography of Athens*, London, 1821. — **Lebeau, Charles**, *Hist. du Bas-Empire*,

Paris, 1757-1786.—**Lecky**, W. E. H., *Rationalism in Europe*, London, 1870.—**Lenormant**, F., *La Grande Grèce*, Paris, 1881.—**Lerminier**, E., *Histoire des législatures et des constitutions de la Grèce*, Paris, 1882.—**Letronne**, J. A., *Fragments inédits d'anciens poètes grecs*, Paris, 1838.—**Livius**, Titus, *Annales*, Rome, 1469; ed. by Drakenborch, Leyden, 1738-1746, 7 vols. (trans. by Philemon Holland, "History of Rome," London, 1600; by D. Spillan, C. Edmunds, and W. A. McDevitte, London, 1849, 4 vols).—**Lloyd**, W. W., *Sophoclean Telogy* (in *Journal Hellenic Studies*), London, 1884.—**Lytton**, E. G. E. L. Bulwer, Athens: *Its Rise and Fall*, London, 1837.

Edward George Earle Lytton Bulwer-Lytton was born at London, May 25, 1803; died at Torquay, January 18, 1873. It has happened more than once that the achievements of a man's later life have quite eclipsed the renown of his earlier years. It was so in the case of Bulwer-Lytton. In mature life he came to be so universally known as a politician and novelist that perhaps comparatively few of his readers are aware that he ever wrote a history. Part of this neglect is perhaps due to the fact that he never finished the important work on Athens which at one time was very widely and favourably known. Possibly his success as a novelist led him to abandon his early project, or, more likely, the distractions of other activities prevented him from returning to a work which he must have abandoned with reluctance. In any event the two volumes which he published on Athenian history remain a valuable fragment. They are written from the standpoint of an ardent admirer of all phases of Grecian life, and his judgment must, therefore, sometimes be accepted with a certain reserve. Yet, as a whole, his work so far as it was carried has hardly been supplanted as an estimate of the Athenian people and their life. It is the work of a man who, though pre-eminent as a writer, had also large attainments as a scholar and investigator. Whoever turns to the volumes before us must leave them with regret that the fascinating story which they tell was never completed. Such as they are, however, they constitute a most valuable estimate of an artistic people by a man who was himself an artist.

Macaulay, G. C., *Translation of the History of Herodotus*, London, 1890.—**MacDermott**, T. B., *Outlines of Grecian History*, Dublin, 1889.—**Mahaffy**, J. P., *Problems in Greek History*, London, 1892; *Alexander's Empire*, London, 1877; *The Greek World under Roman Sway*, London, 1890; *Greek Life and Thought from Alexander to Roman Conquest*, London, 1887; *Introduction to Duruy's History of Greece*, Boston, 1890; *Rambles and Studies in Greece*, London, 1876; *A History of Classical Greek Literature*, London, 1883; *The Empire of the Ptolemies*, London, 1895.

John Pentland Mahaffy was born at Chaponnaire, near Vevey, Switzerland, February 26, 1839.

The student of history has occasion to deplore, over and over, the fact that the greatest scholars so generally fail utterly to master a lucid style of writing. It is a real pleasure therefore, as well as a surprise, when, now and again, one comes across a man of recognised scholarship who has also real distinction as a writer. Such a man is Professor Mahaffy. As a scholar, and particularly as an investigator of Grecian life in all its phases, including prominently the age of the Ptolemies, Professor Mahaffy has long had an established reputation. And it requires but the most casual inspection of any of his books to show that his capacity as a writer is of a high order.

The explanation of what might almost be said to be an anomaly such as this is found, seemingly, in the wide sweep of Professor Mahaffy's interests and in the sound fund of common sense which he brings to bear on any problem of scholarship. Too many students of antiquity have been carried away with the beauties of the Greek language, and brought utterly under the spell of the classical literature, until all critical acumen that they might once have possessed focalises and wastes itself solely on verbal questions, leaving none for application to practicalities. Thus it has happened that all manner of myths have grown up in the minds of men about the word "Greek."

Some of these myths Professor Mahaffy has made it his business to attempt to dispel. We have already had occasion to refer to his criticism on the eulogists of Thucydides. Again, in a matter of much broader scope, Professor Mahaffy long ago pointed out that the popular notion which regarded the Greek as the type of brave man was a most palpable illusion. He called attention to the fact that in some of the most important of Grecian battles—as, for example, that in which the Spartans won against the Corinthians, in the time of Agesilaus—the total death roll was sometimes only half a dozen men. He noted the childish way in which the Greek leaders were wont to keep up the courage of their men by harangues and bombast, and the way in which each side strove to frighten the other by loud shoutings and clashing of arms as it advanced. "These," he said, "are not the characteristics of men who are brave in the modern sense of the word." Again, he asked if it is conceivable that a modern body of warriors would have been repelled year after year by the walls of Athens, when only a handful of men, so to say, were within to defend them.

Advancing still further in the same iconoclastic spirit, Professor Mahaffy pointed out that some of the dearest traditions of Grecian history had been interpreted and foisted on the world through the minds of prejudiced participants, rather than in a spirit of fairness and equity. Thus the battle of Marathon, which we are accustomed even now to hear spoken of as the great decisive contest between the East and the West, will with difficulty bear this interpretation if one will consider it without prejudice. At the best, it was certainly a far less important and decisive battle than that of Plataea, but it chanced that the Athenians were the victorious combatants at Marathon, whereas at Plataea the Spartans bore the honours of the day; and since the Athenians, through their literature, served as the mouthpiece of Greece, it is not strange that the event in which they chiefly figured should have been unduly magnified, and the memory of it transmitted in distorted proportions to posterity. It is vastly to the credit of modern scholarship that it should be able to revise certain judgments on such matters as these, that have come down to us with all the accumulated inertia of generations of repetition.

It must not be supposed, however, from what has just been said, that Professor Mahaffy's task in dealing with the history of Greece is altogether, or even chiefly, iconoclastic. The fact is quite otherwise. Critical as he can be on occasion, Professor Mahaffy nevertheless is, on the whole, an ardent and sympathetic admirer of the people who have furnished the theme of his life studies; but his laudatory judgments may be accepted with the more confidence because of the evidence he has given us that in considering the Greeks he does not allow himself to be carried utterly away by his enthusiasm, nor to forget that the Greeks, despite their national genius, were after all very human, and only properly to be understood when judged by some such practical standard as we apply to peoples of our own generation.

Professor Mahaffy knows his Greece of to-day at first hand quite as well as he knows ancient Greece through studies of the classics. He has described most charmingly his rambles in Greece proper; and latterly he has made the Ptolemaic epoch peculiarly his own, and his writings on this period take rank as among the most important contributions to a subject which most students of Grecian history have distinctly neglected.

Mannert, C., *Geographie der Griechen und Römer, Nürnberg, 1788-1792.* — **Manso, J. C. F.**, *Sparta, Leipzig, 1800-1805.* — **Martin, H.**, *Les Cavaliers Athéniens, Paris, 1886.* — **Masom, W. F.**, *Synopsis of Grecian History, London, 1888.* — **Maspero, G.**, *Hist. ancienne des peuples de l'orient, Paris, 1886.* — **Mela, Pomponius, De Situ Orbis Libri III, ed. by Vinetus, Paris, 1572; (trans. by Arthur Golding, *Rare and Singular Works of Pomponius Mela, London, 1590.*) — **Melingo, P. v.**, *Griechenland in unseren Tagen, Vienna, 1892.* — **Ménard, L.**, *Histoire des Grecs, Paris, 1893, 2 vols.* — **Merivale, Charles**, *History of the Romans under the Empire, London, 1850-1851.* — **Meyer, E.**, *Geschichte des Alterthums, Stuttgart, 1884-1893.* — **Milchoefer, A.**, *Anfänge der Kunst in Griechenland, Leipzig, 1883.* — **Milligan, W.**, *Religion of Ancient Greece, Edinburgh, 1882.* — **Mitford, W.**, *History of Greece, London, 1841.* — **Monceaux, P.**, *La Grèce avant Alexandre, Paris, 1892.* — **Müller, I.**, *Handbuch der klassischen Alterthumswissenschaft, Nördlingen, 1885, etc., 9 vols. in progress.* — **Müller, A.** (in Hermann's *Lehrbuch der Griechischen Antiquitäten*), *Freiburg, 1880.* — **Müller, H. D.**, *Historisch-mythologische Untersuchungen, Göttingen, 1892.* — **Müller, Karl**, *Fragmenta Historicorum Græcorum, Paris, 1841-1870, 5 vols.; new edition, 1883.* — **Müller, K. O.**, *History of the Literature of Ancient Greece, London, 1858; History and Antiquities of the Doric Race, London, 1830; Handbuch der Archäologie der Kunst, Stuttgart, 1878.***

Karl Otfried Müller was born at Brieg, Prussia, August 28, 1797; died at Athens, August 1, 1840. If to be sympathetic with the genius of a people is a prerequisite for the great historian, Müller was eminently qualified to write a history of the Greek people. He was a man of essentially poetical and artistical temperament, and combined with these qualities a profound scholarship. An incident of his early manhood will illustrate perfectly his temperament. The incident occurred during his visit to the famous art gallery in Dresden. In itself it was nothing more than the fact of his becoming entranced by the celebrated Raphael there. Before this picture, as he himself writes, he stood quite enchanted, and he could scarcely bring himself to leave it long enough to visit other portions of the gallery. Now, of course, to any person of less impressionable temperament who has seen the picture, it will be quite clear that Müller, standing thus entranced before the Madonna, saw with the inner eye of his own enthusiasm, rather than with the more tangible organ of sense. Doubtless, in his half-hypnotic trance, he would have been equally delighted had the veriest chromo been substituted in the canvas for the original picture. He had gone to see the Raphael full of enthusiastic expectancy, and he was sure not to be disappointed. He did not see the awkward, mechanical, old-fashioned grouping; he was quite unmindful of the defect of drawing which had given unequal legs to the kneeling figure at the right. He did not know that, if he had come across this same painting unlabelled and before unheard of, he would scarcely have given it a second thought; he only knew that it represented an ideal — an

ideal that had lingered fondly in his mind since his earliest youth. To stand before that picture and see it with his own eyes was to realise that ideal. Many another person has had that same sensation before that same canvas, and for the same reason; and with them, as with him, it was a test of personal temperament, and not a test of the excellence of the picture itself.

Gifted with this impressionable artistic temperament, it was not strange that Müller's ambitions early looked in the direction of Greece. From his earliest youth the study of classical times became his one absorbing passion, and long before he had reached middle age he had come to be known to scholars everywhere as a member of that inner circle who have made classical lore their own. Naturally he wrote as well as studied, and his works on Greece became classical from the moment of their issue. His especial interest during those early years, which were to represent the largest portion of his working life, was directed towards the early history of the Greeks as a nation and towards the effort to solve the riddles of that period. In particular, his studies of the Doric race became famous, and remain to this day practically the last word that has been said on the subject. One must, perhaps, sometimes make allowance for Müller's enthusiasm and favourable prejudice, just as for Mitford's opposite point of view; but generally speaking, Müller's work is distinguished above all things, next to its scholarship, for its fairness and the breadth of view from which the subject is contemplated.

Oddly enough, all Müller's important works were written before he himself had ever visited the land of which he treated. Needless to say, a desire to visit Greece was ever with him, but it was long before the desire was realised. At last, however, the opportunity came to visit Greece in a semi-official capacity; the government granted him leave of absence from his university work, and provided him with a draftsman to make sketches in Greece under his direction. In the autumn of 1839 he started on this memorable and, as it proved, fatal tour. A story is told of his entry into Greece which will illustrate the power and charm of his personality. A friend of Finlay, the English historian of the later period of Greece, chanced to be on the same boat with Müller, and, after landing, he at once reported to Finlay that a most extraordinary man had come to Greece—a man whose name and nationality were unknown to him, but who had surprised everyone on the boat by seeming to speak all languages with equal facility and to discuss all topics with a like affluence of erudition. "I don't know who he is," said the narrator, "but he is somebody quite out of the common." Needless to say, Finlay was not left long in doubt as to who this "somebody quite out of the common" really was.

With what enthusiasm and energy Müller began his investigations in the land, every part of which was so dear to him and at once so familiar and so novel, may be easily imagined, but his labours were not destined to reach the results that had been hoped; for, partly perhaps through over-exertion and fatigue, he was stricken with a fever, was brought back to Athens unconscious and delirious, and died there on the 1st of August, 1840. His work was thus cut short while he was yet in his prime, but even so he will always be remembered as one of the most prominent contributors to Grecian history of any age.

Muuro, Observations on Persian Wars, London, 1898; article in the *Journal of Hellenic Studies*. — **Mure**, William, *Grecian Literature*, London, 1854. — **Murray**, A. S., *Greek Bronzes*, London, 1898.

Nagiotte, E., *Histoire de la littérature grecque*, Paris, 1883. — **Nepos**, C., *De Viris Illustribus*, Venice, 1471 (ed. by Dionysius Lambinus, Paris, 1569); *Lives of Illustrious Men*, London, 1723. — **Nicolai**, R., *Griechische Litteraturgeschichte*, Leipsic, 1876. — **Niebuhr**, B. G., *Lectures on Ancient History*, London, 1852; *Stories of Greek Heroes*, London, 1887. — **Niese**, B., *Gesch. der Griechischen und Macedonischen Staaten*, Gotha, 1893. — **Nitzsch**, C. W., *Die Römische Annalistik von ihren ersten Anfängen bis auf Valerius Antias*, Berlin, 1873.

Oman, C. W. C., *History of Greece to Macedonian Conquest*, London, 1890; *History of Greece to Death of Alexander*, London, 1891. — **Oncken**, W., *Athen und Hellas*, Leipsic, 1866. — **Osborn**, H. F., *From the Greeks to Darwin*, New York, 1894. — **Overbeck**, J., *Gesch. der Griechischen Plastik*, Leipsic, 1857.

Paley, F. A., *An Inquiry into the Origin of Bookwriting among the Greeks*, London, 1881. — **Papathegopoulos**, K., *Histoire de la civilisation hellénique*, Paris, 1875. — **Pausanias**, *Ἑλλάδος Περιήγησις*, ed. by Kühn, Leipsic, 1696; (translation by Thomas Taylor), *A Description of Greece*, London, 1794. — **Perry**, W. C., *Greek and Roman Sculpture*, London, 1882. — **Peter**, C., *Zeittafeln der Griechischen Geschichte*, Halle, 1886. — **Perrot**, G., in collaboration with C. Chipiez, *Histoire de l'art dans l'antiquité*, Paris, 1881. — **Philippson**, A., *Thessalien und Epirus*, Berlin, 1897. — **Philostephanus Timæus, Sosibius**

and **Demetrius Phalereus** as quoted by Plutarch. — **Philostratus**, *Tὰ ἐς τὸν Τιανέα Ἀπολλώνιον*, Venice, 1502; *Life of Apollonius*, London, 1809. — **Photius**, Excerpts from Arrian's *Bithynica* (in Müller's *Fragmenta*). — **Pigorini**, in *Atti dell' Accademia de Lincei*. — **Plato**, *Republic* (trans. by Henry Cary), London, 1861. — **Pliny**, *Historia Naturalis* (trans. by J. Bostock and H. T. Riley), London, 1848. — **Ploix**, C., *La nature des dieux*, Paris, 1888. — **Plutarch**, *Βίοι Παράλληλοι*, Rome, 1470, 2 vols. (ed. by C. Sintenis, Leipsic, 1839–1846, 4 vols.); *Lives*, London, 1579; *Lives of Illustrious Men*, London, 1829, etc. — **Pocock**, E., **Talfourd**, T., **Rutt**, J., and **Ottley**, *A History of Greece*, London, 1851. — **Poestion**, J. C., *Hellas, Rom, und Thule*, Leipsic, 1882. — **Pohlmann**, R. (in Müller's *Handbuch der klassischen Alterthumswissenschaft*, Nördlingen, 1885, etc., 9 vols. in progress). — **Pollard**, A., *True Stories from Greek History*, London, 1892. — **Polyænus**, *Στρατηγήματα*, Lyons, 1589; *Stratagems of War* (trans. by R. Shepherd), London, 1793. — **Polybius**, *Καθολικὴ κοινὴ ἱστορία*, Paris, 1609; *The History of* (trans. by E. Grimston), London, 1693; *The History of* (trans. by Sir H. Spears), Oxford, 1823 (Fragmentary but very valuable for later period). — **Pomeranz**, B., *La Grèce et la Judée dans l'antiquité*, London, 1891. — **Potter**, J. J., *Antiquities of Greece*, Edinburgh, 1820. — **Poynter**, E. J., *On a Bronze Leg from Italy* (in *Journal of Hellenic Studies*), London, 1886. — **Preller**, L., *Griechische Mythologie*, Berlin, 1899. — **Prévost-Paradol**, L. A., *Essai sur l'histoire universelle*, Paris, 1890. — **Purper**, L., *La résurrection de la mythologie*, Paris, 1894.

Quinet, E., *De la Grèce dans ses rapports avec l'antiquité*, Paris, 1830.

Radet, S. T. G., *La déification d'Alexandre*. — **Rangabe**, A. R., *Greece: Her Former and Present Position*, New York, 1867; *Hist. lit. de la Grèce moderne*, Paris, 1877. — **Ranke**, L. v., *Weltgeschichte*, Leipsic, 1883–1886, 8 vols. — **Redesdale**, Lord (in *Mitford's Greece*), *Biography of William Mitford*, London, 1822. — **Renan**, E., *Études d'histoire religieuse*, Paris, 1857. — **Rennell**, J., *Geographical System of Herodotus*, London, 1800. — **Ridgeway**, W., *The Early Age of Greece*, Cambridge, 1901, 2 vols.; *What People produced Objects called Mycenaean* (in *Journal of Hellenic Studies*), London, 1886. — **Ritter**, Karl, *Die Erdkunde im Verhältniss zur Natur und zur Geschichte des Menschen*, Berlin, 1817–1818, 2 vols. — **Roberts**, W. R., *The Ancient Bœotians; their Character, etc.*, Cambridge, 1895. — **Robinson**, W. S., *Short History of Greece*, London, 1895. — **Robion**, F., *Les Institutions de la Grèce antique*, Paris, 1882. — **Rodd**, J. R., *Customs and Lore of Modern Greece* (see *Modern Greece*), London, 1892. — **Rollin**, C., *Ancient History of the Greeks and Macedonians*, London, 1881; *Ancient History of the Egyptians, Carthaginians, etc.*, London, 1841. — **Rose**, D., *Popular History of Greece*, London, 1888. — **Ruskin**, J., *Præterita*, London, 1886–1900, 2 vols.; *Modern Painters*, London, 1843.

Sardagua, V., *Storia della Grecia Antica*, Verona, 1881. — **Sathas**, C. N., *Documents inédits relatifs à l'histoire de la Grèce en Moyen Age*, Paris, 1880. — **Sayce**, A. H. (in his preface to *Schliemann's Troja*, London, 1884); (in *J. P. Mahaffy's A History of Classical Greek Literature*, London, 1883); *On the Language of the Homeric Poems*, London, 1881. — **Schäfer**, A., *Demosthenes und seine Zeit*, Leipsic, 1885–1886; *Abriss der Quellenkunde der griech. und röm. Gesch.*, Leipsic, 1889. — **Schliemann**, H., *Troja*, London, 1884; *Ilios*, Leipsic, 1881; *Mycenæ*, London, 1878; *Tiryns: The Prehistoric Palace of the Kings of Tiryns*, London, 1886.

Heinrich Schliemann was born at Neu-Buckow, Mecklenburg-Schwerin, January 6, 1822; died at Naples, December 27, 1890. He was in many ways a most extraordinary man. He was largely denied the advantages of an early liberal education, as it became necessary for him to earn his way in the world while yet a boy, but he made amends for this by putting into practice a most amazing system of self-education, through which he had been able to acquire an entire mastery of a list of languages only limited by his own desires. French, Italian, Spanish, English, Russian, — he learned one after another in periods of only a few months for each; but not till relatively late in life, at thirty-five namely, did he take up the study of Greek. The reason for this delay, as he himself explained it, was that his interest in Grecian history had always been so intense that he dared not take up the study of the language lest it should prove a distraction detrimental to his business. But now he had followed out that business so persistently that he had become a wealthy man and could afford to do as he wished. He acquired Greek as quickly and as completely as he had acquired other languages, beginning with the modern Greek and passing back in inverse chronological order to the various classical authors. He learned not merely to read the language, but to write it with facility and speak it fluently, so that he could express himself in either modern or ancient Greek almost as readily as in his native tongue.

This accomplished, he had prepared the way for an attempt which, as he believed in later years, had been an ambition with him all his life, — the search, namely, for the site of

Ancient Troy. Having amassed a fortune, the income from which was more than sufficient for all his needs, he retired from active participation in business and devoted the remainder of his life to a self-imposed task. How well he succeeded, all the world knows. In opposition to the opinions of many scholars here picked on the hill of Hissarlik as the site of ancient Ilium, and his excavations there soon demonstrated that at least it had been the site, not of one alone, but of at least seven different cities in antiquity — one being built above the ruins of another at long intervals of time. One of these cities, the sixth from the top, — or, to put it otherwise, the most ancient but one, — was, he became firmly convinced, Ilium itself.

The story of his achievements has already been told. But it is necessary here to point the warning that Dr. Schliemann's excavations — wonderful as are their results — do not, perhaps, when critically viewed, demonstrate quite so much as might at first sight appear. There is, indeed, a high degree of probability that the city which he excavated was really the one intended in the Homeric descriptions, but it must be clear, to anyone who scrutinises the matter somewhat closely, that this fact goes but a little way towards substantiating the Homeric narrative as a whole. The city of Ilium may have existed without giving rise to any such series of events as that narrated in the *Iliad*. Dr. Schliemann himself was led to realise this fact, and to modify somewhat, in later years, the exact tenor of some of his more enthusiastic earlier views, yet the fact remains that the excavations at Hissarlik must be reckoned with by whoever in future discusses the status of the Homeric story.

If they did not prove as much as some could wish, they at least were enormously suggestive. Had they done nothing else, they at least furnished a mass of authentic documents bearing upon the life of the prehistoric period of Grecian antiquity. Even more important in this regard were the excavations of Dr. Schliemann subsequently made at the sites of the old Greek cities of Mycenæ and Tiryns. Ilium was not located on Grecian soil, and its relation with Grecian history was only conjectural, but these other cities were in Greece itself, and inspection of their ruins has brought within the historic period some centuries of Grecian life that hitherto were utterly obscure, or only known through incidental references of the Homeric poems.

Schlosser, F. C., Weltgeschichte, Frankfurt, 1844.

Friedrich Christoph Schlosser, born at Jever, Germany, November 17, 1776; died at Heidelberg, September 23, 1861, the Nestor of German historians has been spoken of — not unjustly — as the German Tacitus. More than almost any other man, perhaps, at the beginning of the nineteenth century, he was influential in establishing the school of what may be called scientific history, not merely through his writings but through his personal influence on a coterie of pupils who included many of the distinguished historians of the middle of the nineteenth century.

Professor Schlosser was a beautiful character as well as a scholarly mind. The historical sweep of his mind was of the widest, as evidenced in the subjects which he selected, while the force of his personality is equally demonstrated by the results that he achieved. His *Universal History* and his *History of the Eighteenth Century* immediately took place as the greatest authorities in the field at the time of their publication, and the latter work was early translated into English.

The work on *Universal History* was the first attempt of its kind, of anything like a corresponding comprehensiveness, in modern times. As originally written by Schlosser himself it had a largely technical character, yet it so clearly contained the elements of a great popular work that it was soon elaborated under Schlosser's own direction by his pupil, Dr. G. L. Kriegk, and in this popularised form, though a bulky work of nineteen volumes, it soon achieved a wide circulation throughout Germany. This was about the middle of the century. Since then there have been numerous new editions of Schlosser's popular history, and, even to-day, its sale probably exceeds in Germany that of any other similar work. It occupies, indeed, a place of its own which no other universal history exactly rivals. It has fullest authority, yet it is essentially popular in character. It is the narrative of the sweep of world-historic events. Its style, though less eloquent than that of Weber, is reasonably lucid, and the sentiments which actuate it throughout are those of which every reader in the main approves. We shall have occasion to recur again and again to its pages, and each such recurrence will tend to increase one's surprise that a work of such comprehensive merit should never, hitherto, have been made accessible to the reader of English.

Schneider, E., Les Pélasges et leurs descendants, Paris, 1884. — **Schorn, W.**, Geschichte Griechenlands von der Entstehung des ätol. und achaischen Bundes bis auf die Zerstörung von Korinth. — **Schrader, O.**, Die älteste Zeittheilung des indogerman. Volks, Berlin, 1878. — **Schrammen, T.**, Tales of the Gods of Ancient Greece, London, 1894. — **Schuchardt, C.**, Schliemann's Excavations (trans. by E. Sellers), London, 1891 (an admirable summary of archaeological results). — **Seignobos, C.**, Hist. narrative et descriptive de la Grèce ancienne, Paris, 1891. — **Sergeant, L.**, Greece, London, 1880. — **Serre, P.**, Études sur l'histoire

militaire et maritime des Grecs, Paris, 1885. — **Simpson**, W., Mycenæ, Troy and Ephesus, London, 1878. — **Sittl**, C., Gesch. der griechischen Litteratur, Munich, 1884. — **Smith**, A., The Wealth of Nations, London, 1891. — **Smith**, George, The Gentile Nations. — **Smith**, J., Voyage and Shipwreck of St. Paul, London, 1848. — **Smyth**, W., History of Greece, London, 1851. — **Stengel**, P. (in Müller's Handbuch der Classischen Alterthumswissenschaft, Nördlingen, 1876-1888). — **Strabo**, Γεωγραφικά, Venice, 1516, The Geography of Strabo (trans. from the Greek by H. C. Hamilton and W. Falconer), London, 1851, 3 vols. — **Stern**, E. von, Gesch. d. Spart. Hegemonie, Dorpat, 1884. — **Symonds**, J. A., The Greek Poets, London, 1893.

Taine, H., The Philosophy of Art in Greece, New York, 1889; Lectures on Art, New York, 1889. — **Tarbell**, F. B., A History of Greek Art, London, 1896. — **Taylor**, T., The Eleusinian and Bacchic Mysteries, New York, 1891. — **Terzetti**, A., La Grèce ancienne et moderne considérée sous l'aspect religieux, Paris, 1884. — **Theognis**, Ἐλέγεια (Poems), Venice, 1495; edited by Bekker, Leipsic, 1815. — **Theopompus**, φιλιππικά (Philippica), Theopompī Chii fragmenta, collegit, disposicvit et explicavit, R. H. E. Wichers, Leyden, 1829. — **Thiers**, L. A., Histoire du Consulat et de l'Empire, Paris, 1845-1862, 20 vols. — **Thirlwall**, C., A History of Greece, London, 1845.

Connop Thirlwall was born at Stepney, London, January 11, 1797; died at Bath, July 27, 1875. Bishop Thirlwall was one of those extraordinary men who are, perhaps, much more numerous than the world generally imagines, of whom it may be justly said that he never accomplished half that he might have done had he focalised his energies, and more persistently applied his capabilities. He was almost a prodigy of learning as a child, and in adult life he showed how the capacity to acquire knowledge was still retained by making himself master of the Welsh tongue, and preaching in that language when called to a Welsh pulpit. But his efforts were never focalised for a long period on any particular field, and it was almost by accident, and certainly by outside influence, that he was led to produce the one work which will transmit his name to posterity. This work of course is his history of Greece.

Such criticism as this is not intended in any sense to be a disparagement of that history, nor indeed of Thirlwall's accomplishments as a whole. Applied in that sense criticism would be absurd, for it may be doubted, even to this day, whether Thirlwall's is not the best general history of Greece that has ever been written. Certainly, for the general reader, it combines in a larger measure authority with a popular interest of presentation than any other in the English language. But the work was written to meet a popular demand, and while it was in no sense a hurried or careless production, the friends of Thirlwall always thought that it might have been given a somewhat more authoritative cast, had it been undertaken through different motives.

After all, however, perhaps the world is better for the work as it stands. Ponderous histories of Greece are no novelty, whereas readable histories of any country are never a drug on the market. The frequency with which we have had occasion to recur to the pages of Thirlwall in treating the history of Greece has been an earnest of our estimate of the position which his history holds after two or three generations of workers have searched for fresh material in the same field.

Thonvenal, E. A., La Grèce du Roi Othon, Paris, 1890. — **Thucydides**, Συγγραφή, Venice, 1502; The History of the Grecian War (trans. by Henry Dale), London, 1852; Of the Peloponnesian Wars, London, 1856, 2 vols. — **Timayenis**, T. T., Greece in the Times of Homer, New York, 1885; A History of Greece from Earliest Times to Present, New York, 1881. — **Tozer**, H. F., The Islands of the Ægean, Oxford, 1890; Researches in the Highlands of Turkey, 1869. — **Tsountas**, C., and J. I. **Manatt**, The Mycenaean Age, Boston and New York, 1897. — **Tyrtaeus**, Εὐνομία, edited by Klotz, Bremea, 1764, Fragments 5, 6.

Virchow, R. (in Schliemann's Ilios, Leipsic, 1881).

Wachsmuth, C., Die Stadt Athen im Alterthum, Leipsic, 1874. — **Waddington**, W. H. (in collab. with Le Bas), Voyage Archéologique en Grèce et en Asie Mineure, Paris, 1847-1877, 6 vols. — **Walton**, A., The Cult of Asklepios, Ithaca, N.Y., 1894. — **Watkins**, L., The Age of Pericles. — **Weber**, G., Weltgeschichte, Leipsic, 1857-1880; A History of Philosophy, London, 1896. — **Wheeler**, Benjamin Ide, Alexander the Great: The Merging of East and West in Universal History, New York and London, 1902.

Benjamin Ide Wheeler was born at Randolph, Mass., July 15, 1854. President of the University of California since 1899. President Wheeler's earlier publications were chiefly concerned with Greek philology, but his interest in other phases of Greek life is evidenced by the work above cited. As a matter of course this work is scholarly; but it is also popular in the best sense of the word: indeed, no more readable and satisfactory account of the life of Alexander exists in any language.

Wilamowitz-Möllendorf, W., von, *Homerische Untersuchungen*, Berlin, 1881. — **Winterton**, R., *Poetae Minores Græci*, Cambridge, 1684. — **Witt**, C., *The Retreat of the Ten Thousand*, London, 1891; *The Trojan War*, London, 1884. — **Wolf**, F. A., *Prolegomena ad Homerum*, Halle, 1795. — **Wordsworth**, C., *Athens and Attica*, London, 1836. — **Wyse**, T., *Impressions of Greece*, London, 1871.

Xanthus, *Λυδικὰ Βιβλία δ'*, *Lydiaca* (in C. Müller's *Fragmenta Historicorum Græcorum*, pp. xx-xxiii, 36-41). — **Xenophon**, *Κύρου Ἀναβάσις*, ed. by Krüger, Leipsic, 1888, 7th ed.; *Anabasis of Cyrus*, London, 1881; *Ἀπομνημονεύματα Σωκράτους*, ed. by Kühner, Leipsic, 1882, 4th ed.; *Memorabilia*, edited by J. R. King, Oxford, 1874; *Ἑλληνικά*, *The Hellenics*, London, 1855.

Zeller, E., *History of Greek Philosophy*, London, 1881.



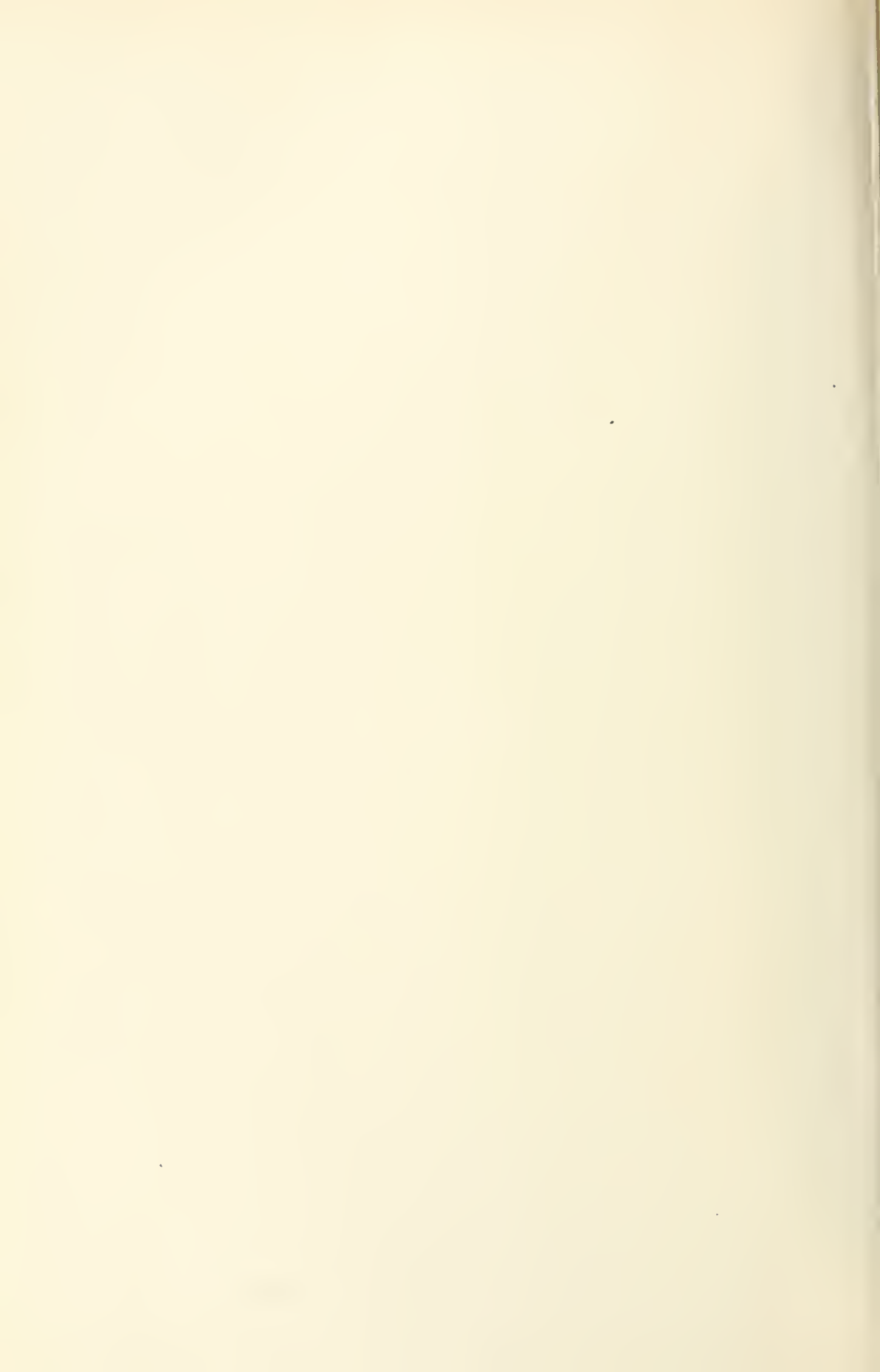

UNIVERSITY OF CALIFORNIA LIBRARY

Los Angeles

This book is DUE on the last date stamped below.

50m-7,'69(N296s4)--C-120



D 000 049 085 4

