

HAMPTON & SON'S

BOOK OF DESIGNS

LONDON.





Wm. Williams

Mrs. Williams

The Grange

1870

Wm. Williams

The Grange





Mrs Englands

38 Hill street.

Franklin Square

London

W

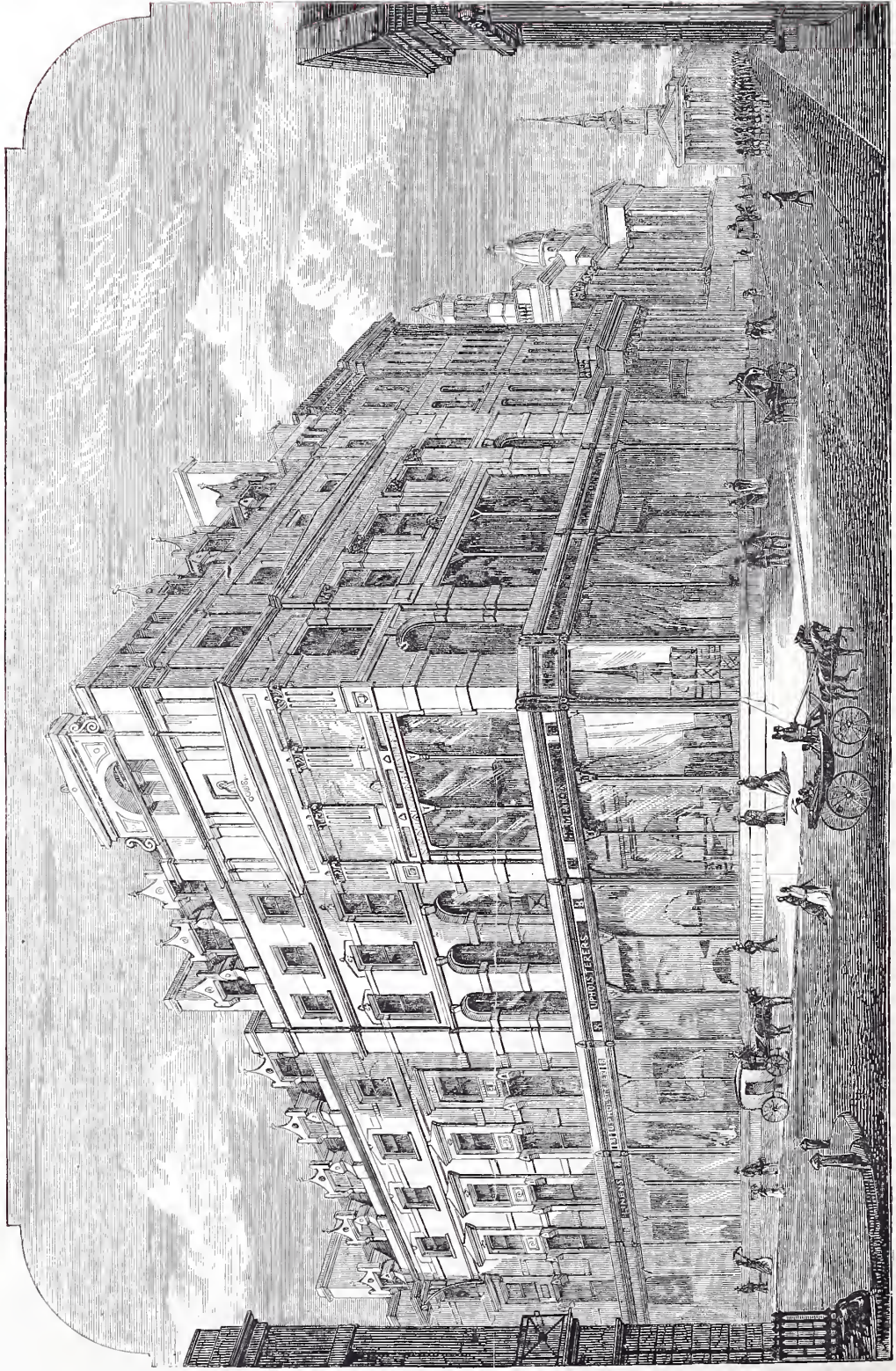

HAMPTON AND SONS, 8, PALL MALL EAST, & 1, 2, 3, PORSET PLACE, CHARING CROSS.



ESTABLISHED 1830.

HAMPTON & SONS

Illustrated Designs

OF

CABINET FURNITURE

ENGRAVED FROM PHOTOGRAPHS OF STOCK

AT THEIR

NEW PREMISES AND MANUFACTORY,

8, PALL MALL EAST,

AND

1, 2, 3, DORSET PLACE, CHARING CROSS,

LONDON.

THE KEY TO THIS WORK CONTAINS PRICES AND DESCRIPTION TO THE  
NUMBERS ATTACHED TO EACH ARTICLE, ALSO ESTIMATES FOR  
FURNISHING 8, 12, & 16 ROOMED HOUSES, TOGETHER WITH A  
NEW PRICE LIST OF BEDDING MANUFACTURED  
ON THE PREMISES.

*Entered at Stationers' Hall.*



Digitized by the Internet Archive  
in 2016

<https://archive.org/details/hamptonsonsillus00hamp>

*Mrs Williams*  
*The Garth*

**HAMPTON AND SONS,** in submitting to the Public the following Book of Designs, illustrating Cabinet and Upholstered Furniture, photographed and engraved by eminent artists, from their Stock, wish to draw attention to the fact that they undoubtedly must be true to form and scale, thus avoiding the possibility of customers being disappointed on receipt of goods, and enabling every one either in town, country, or abroad, to make a selection.

The accompanying Key to this Work contains the description and price of every article, together with carefully drawn up Estimates for Furnishing 8, 12, and 16-roomed Houses, by which intending Purchasers can arrive at the exact cost, and at the same time have a correct representation of each article by referring to the corresponding number in this Book of Designs.

All Cabinet Goods are marked in plain figures at the lowest possible price, which can only be maintained by a large sale; the quality of every article can be thoroughly relied on as to manufacture, all being made by or for themselves, thereby trusting to obtain the full confidence of all customers.

The Upholstery Department is composed of English, French, and German cutters-out and stuffers, therefore they are enabled for style and taste to compete with any House in the Trade.

Interior Decorations, Painting, Paper Hanging, Gilding, and Gas Fitting executed. A large Stock of British and Foreign Paper Hangings always on hand. Experienced and competent persons sent to any distance to take instructions and give Estimates for furnishing and decorating in any style and to any extent required.

In the Bedding Department all goods are manufactured on the Premises under their superintendence, and can be guaranteed as to purity and quality.

A large Stock of Fenders, Fire-irons, Coal Scoops, and General Furnishing Ironmongery in Show Rooms devoted to that purpose.

HAMPTON AND SONS beg to call attention to their Carpet Department, especially as they are manufacturers, it comprises the best productions of British and Foreign Looms, as well as their own in Axminster, Wilton, Turkey, Aubusson, Velvet-Pile, Brussels, Tapestry, Kidderminster, Felt, and other Carpets; also Floor Cloths, Kamptulicon, Linoleum, Matting, and great varieties of Rugs and Mats.

The Drapery Department is replete with every description of Silk, Tapestry, Silk and Wool Repts and Damasks, French Tournay, Cretonne and Chintz Hangings, Lace and other Curtains, together with a large stock of Table and Household Linens, Blankets, Counterpanes, Eiderdown Quilts, outside and inside Blinds of every kind, &c.

Furniture Repaired, Re-stuffed, and Re-covered, Bedding purified.

Removals effected with the greatest care.

No charge made for Packing, or use of Cases and Materials, but require them to be returned, Carriage paid.

---

### TERMS.

Cash on delivery, without discount or abatement. Orders from the country to contain a remittance or reference.

Goods for Exportation must be paid for before Shipment.

Goods delivered within seven miles of Charing Cross by our own Vans carriage free.

Bankers, LONDON AND WESTMINSTER,  
St. James' Square.

POST-OFFICE ORDERS made payable at Charing Cross.



*Contents*

## CONTENTS.

Title and Preface.	
Bagatelle Boards and Stands .. .. .	121
Baths .. .. .	563, 665, 675, 682, 683, 684
Bedsteads, Iron .. .. .	453 to 484
"    Chair, Cabinet, and Folding .. .. .	453, 454, 455
"    Cots, and Cribs .. .. .	457, 458, 459, 460
"    Wood Arabian .. .. .	485 to 493, 567, 574
Bedstep Commodes .. .. .	558, 559, 560, 561
Bidets .. .. .	563
Blinds .. .. .	449, 450, 451, 452
Bookcases .. .. .	146, 149, 151, 154, 157, 161, 162, 163
Bookshelves .. .. .	144, 145
Bookslides and Bookrests .. .. .	155, 156
Brackets .. .. .	152, 153
Cabinets .. .. .	393, 395, 397, 399, 400, 401, 402, 403, 404, 405, 406, 407, 445
Cabinet Nest of Drawers .. .. .	119, 164
Canterburys .. .. .	303, 305, 307
"    Whatnots .. .. .	308, 309, 310, 311, 312
Chairs, Bedroom .. .. .	183, 188, 203, 218, 219, 220, 221, 222, 573, 575, 587, 592, 600, 608, 620 to 646
"    Children's .. .. .	631 to 640
"    Dining-room, Library, and Parlour .. .. .	35 to 67
"    Drawing-room .. .. .	168 to 197
"    Dining-room and Library Easy .. .. .	68 to 83, 90, 91, 93, 94, 96, 97, 99, 100
"    Drawing-room Easy, 223 to 239, 249, 250, 252, 253, 255, 256, 258, 259, 261, 262, 264, 265, 267, 268, 270 to 277	
"    Folding .. .. .	216, 217, 644, 645, 646
"    Hall .. .. .	1 to 10, 21
"    Kitchen or Windsor .. .. .	642, 645, 646, 667, 668, 670, 672
"    Library and Office .. .. .	47, 48, 52, 57, 58, 59, 60, 64, 65, 181, 222, 629, 641, 642, 643
"    Nursing .. .. .	226, 227, 639, 640, 667
"    Occasional and Fancy .. .. .	198 to 207, 208, 209, 210, 211, 212, 213, 214, 215, 216, 217, 218, 219, 220, 221, 222
"    "    Gilt .. .. .	193, 196, 197, 198, 199, 200, 201
"    Prie Dieu .. .. .	223, 224, 225
"    Reading and Smoking .. .. .	77, 80, 81, 82, 83, 641, 642, 643, 644, 645, 646
"    Rocking .. .. .	226, 227, 667
"    Shop .. .. .	630
Chamber Pedestals .. .. .	562, 566, 570, 578, 584, 588, 596, 604, 612
Cheffoniers .. .. .	114, 389, 390, 391, 392, 394, 396, 398
Clothes-horses .. .. .	663
Coal Scuttles .. .. .	688, 689, 690, 691, 692, 693, 694
Commodes and Bedsteps .. .. .	558, 559, 560, 561, 565
Couches and Settees, Dining-room, and Library .. .. .	84, 85, 86, 87, 88, 89, 92, 95, 98, 100
"    "    Drawing-room .. .. .	240 to 248, 251, 254, 257, 260, 265, 266, 269, 272, 275, 278, 286, 287
Cornices and Poles .. .. .	408 to 420, 447, 448
Davenportes .. .. .	352, 353, 355, 356
Desk Slope .. .. .	147
Dinner Waggon .. .. .	128 to 135
Door Scrapers .. .. .	29, 30
Drawers, Chest of .. .. .	497, 498, 499, 500, 504, 515, 594, 610, 612, 618, 651, 652
Dumb Waiter, revolving .. .. .	123
Fenders and Fire-irons .. .. .	674, 701 to 715
Fire Guards .. .. .	685, 686, 687
Flap Stands .. .. .	34
Flower Stands and Jardinières .. .. .	318 to 326, 328, 330, 332, 338, 446
Girandoles .. .. .	429, 431, 432, 434, 437, 438

## CONTENTS.

Glasses, Cheval .. .. .	553, 555, 557
„ Chimney .. .. .	421 to 446
„ Console .. .. .	441, 442, 443, 444
„ Pier .. .. .	441
„ Rising Dressing .. .. .	552, 554
„ Toilet and Dressing .. .. .	544 to 557, 583, 589, 597, 605, 613
Hall Benches .. .. .	16, 20
Hat and Umbrella Stands .. .. .	14, 15, 18, 19, 22, 23, 26, 27, 31, 32
Hat Rails .. .. .	25
Linen Press .. .. .	669
„ Baskets .. .. .	654
Music Stools and Stands .. .. .	297, 298, 299, 329
Ottomans Box .. .. .	296, 304
„ Centre .. .. .	279 to 285
„ Fender .. .. .	292, 294
„ Foot .. .. .	283, 289, 290, 291, 293, 295
„ Seat .. .. .	285, 296, 300, 302, 304
Pedestals, with Drawers and Secretary .. .. .	119, 164
Plate Carrier .. .. .	124
Portfolio Stand .. .. .	316
Reading Easel .. .. .	148, 331
Screens, Dining-room, Cheval and Folding .. .. .	136, 137, 138
„ Drawing-room, Cheval and Banner .. .. .	137, 327, 333, 335, 336, 337
„ Table .. .. .	327
„ Wicker Washback .. .. .	660
Secretaires .. .. .	142, 143, 151, 154, 164
Sideboards .. .. .	115, 116, 117, 120, 122, 125, 126, 127
Tables, Bed-room .. .. .	338, 357, 513, 515
„ Camp .. .. .	118
„ Card .. .. .	334, 373, 374, 375, 376, 377
„ Centre or Loo .. .. .	378 to 386
„ Coffee .. .. .	338, 357
„ Console .. .. .	441, 442, 443, 444
„ Dining .. .. .	104, 106, 108, 109, 110, 111, 112, 113
„ Drawing-room Writing .. .. .	363, 364, 365, 366, 369, 370, 372, 379
„ Dressing and Toilet .. .. .	521, 523, 524, 525, 526, 528, 529, 530, 532, 535, 536, 538, 540, 542, 572, 577, 585, 593, 601, 609, 617, 648, 657, 658
„ Fancy .. .. .	301, 326, 327, 328, 331, 332, 334, 338, 339, 340, 341, 342, 343, 345, 354, 359
„ Hall .. .. .	24, 28, 33, 34
„ Kitchen .. .. .	662, 664, 671, 673
„ Library and Office .. .. .	108, 139, 140, 141, 142, 143
„ Nursery .. .. .	664
„ Occasional .. .. .	354, 367, 361, 362, 363, 364, 365, 366, 367, 368, 369, 370, 371, 372, 379
„ „ Card .. .. .	375, 376, 377
„ Pembroke .. .. .	102, 662
„ Rising Side .. .. .	132
„ Sutherland .. .. .	358, 359, 360
„ Work .. .. .	344, 346, 347, 348, 349, 350, 351
Trays, Luncheon and Butler .. .. .	103, 105, 107
„ Stand .. .. .	107, 118
„ Tea .. .. .	695 to 700
Towel Horses .. .. .	501, 502, 506, 507, 510, 511, 571, 580, 586, 595, 603, 611, 619, 659
Umbrella Stands .. .. .	11, 12, 13, 17
Wardrobes .. .. .	503, 507, 508, 512, 514, 516, 517, 518, 519, 520, 568, 576, 582, 590, 598, 606, 614, 649, 650, 653
Washstands .. .. .	165, 166, 167, 521, 522, 523, 525, 527, 531, 533, 534, 537, 539, 541, 543, 569, 579, 581, 591, 599, 607, 615, 647, 656, 665, 679, 680, 681
Whatnots .. .. .	150, 301, 306, 368, 309, 310, 311, 312, 313, 314, 315, 317, 387, 388, 435
„ Cheffonier .. .. .	387, 388
Waterclosets, portable .. .. .	565
Watercans .. .. .	677, 678

HAMPTON & SONS

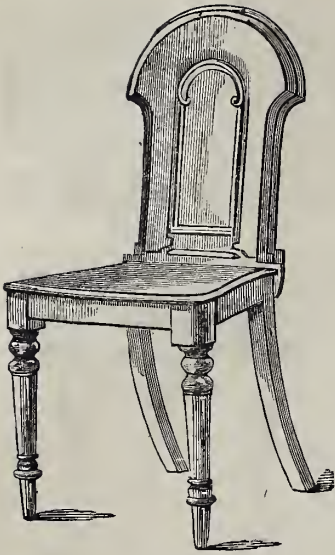

1



2

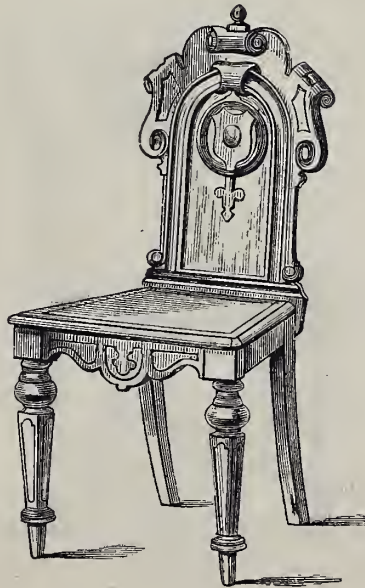

3

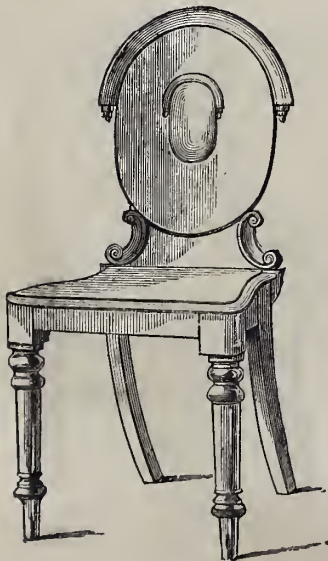

4

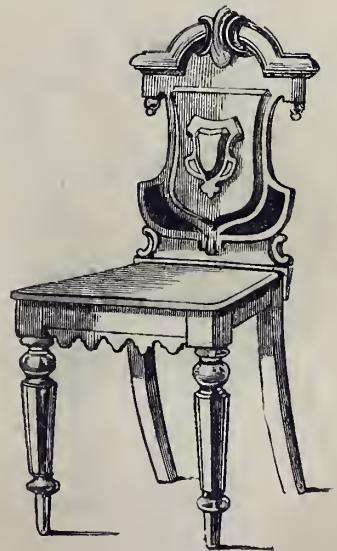

5

HAMPTON & SONS



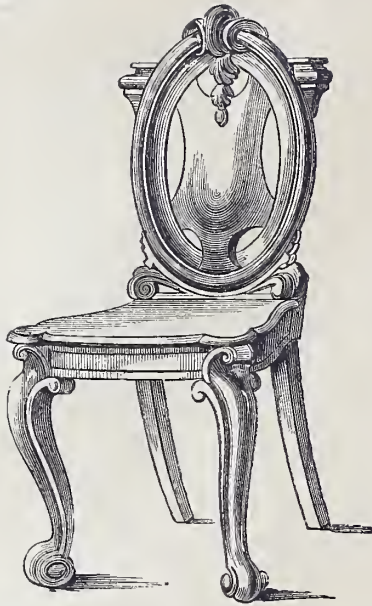

6

HAMPTON & SONS

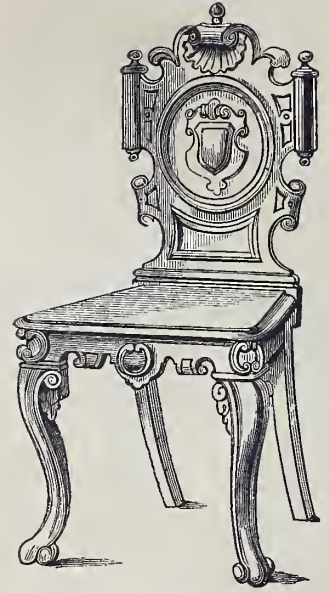

7

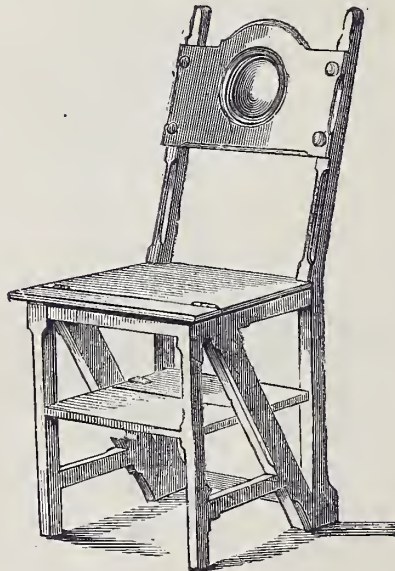

8

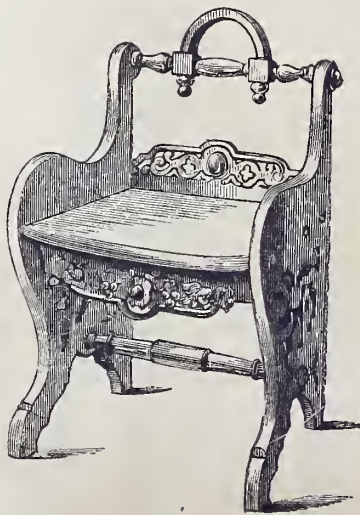

9

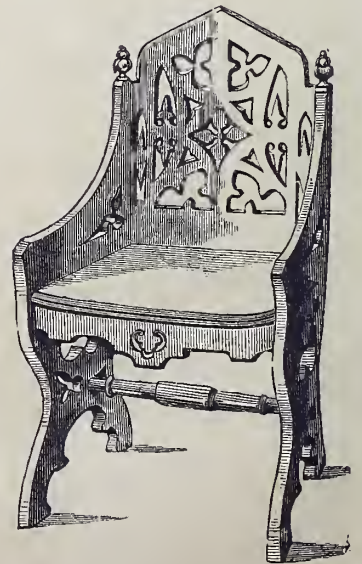

10

HAMPTON & SONS

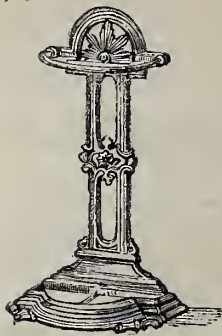

11

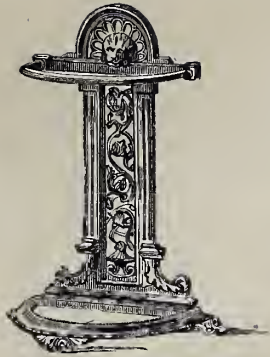

12



13

HAMPTON & SONS

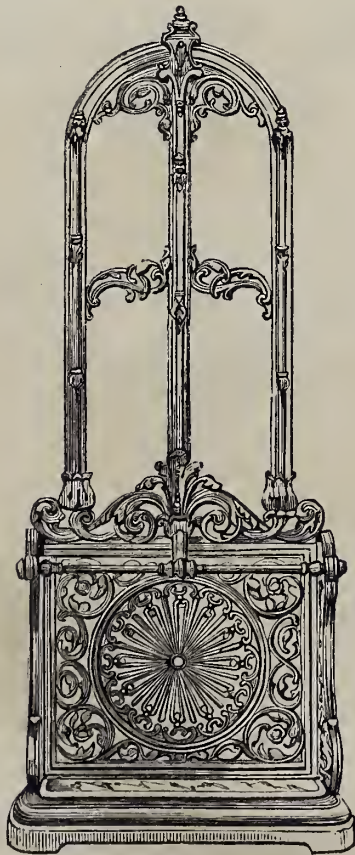

14

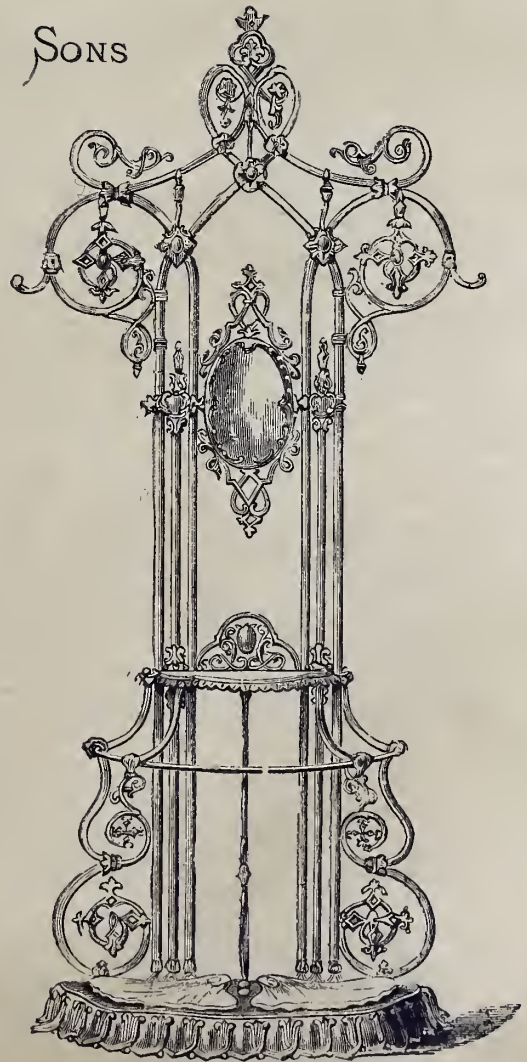

15

HAMPTON & SONS



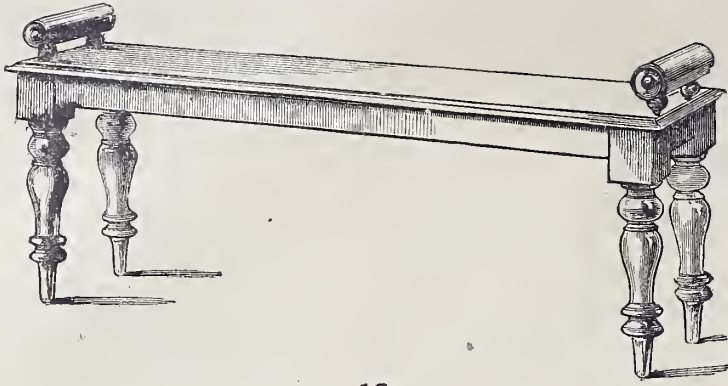

16



17

HAMPTON & SONS

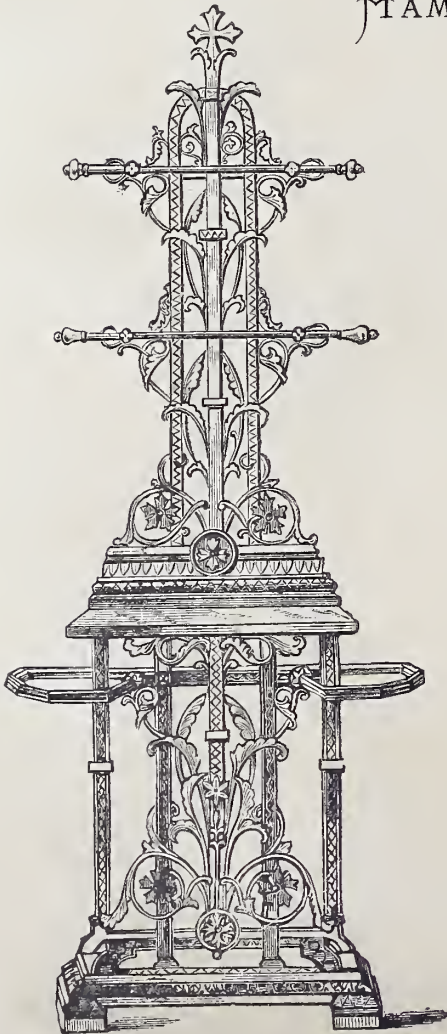

18

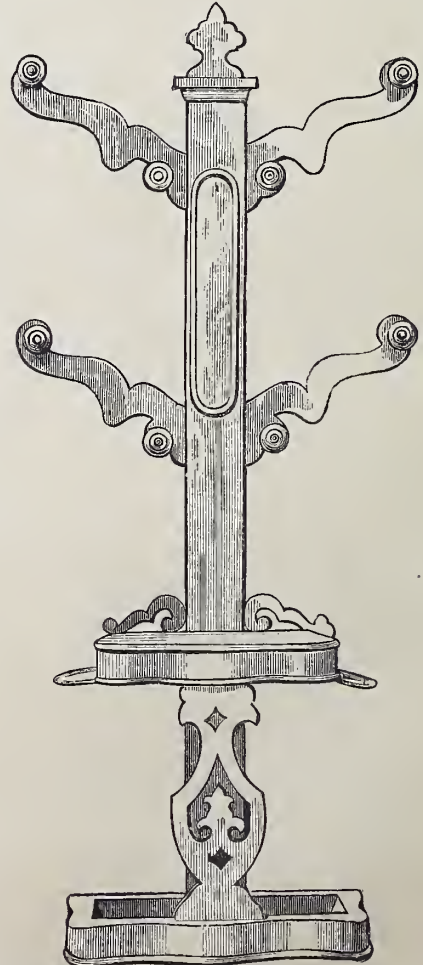

19

HAMPTON & SONS



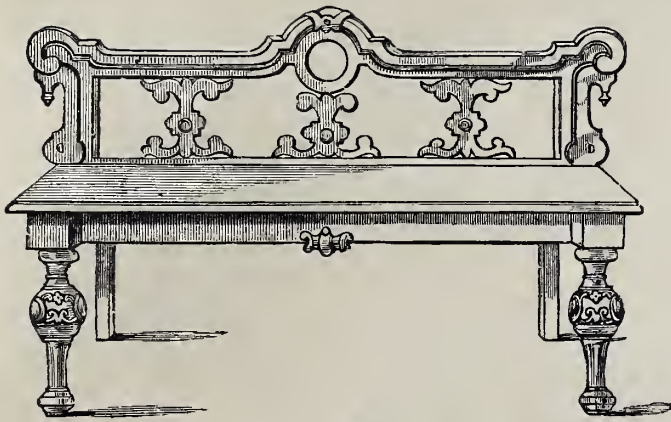

20

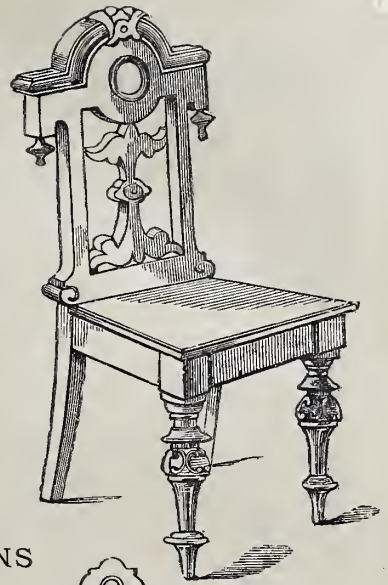

21

HAMPTON & SONS

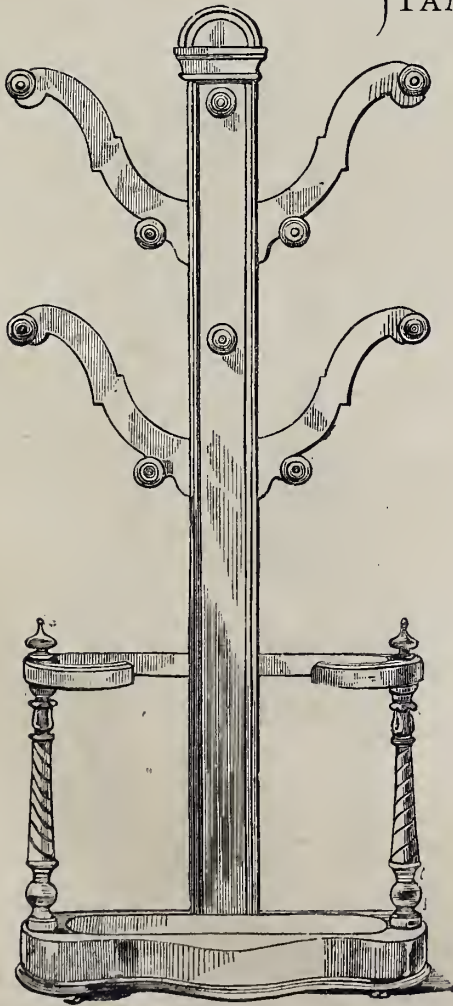

22

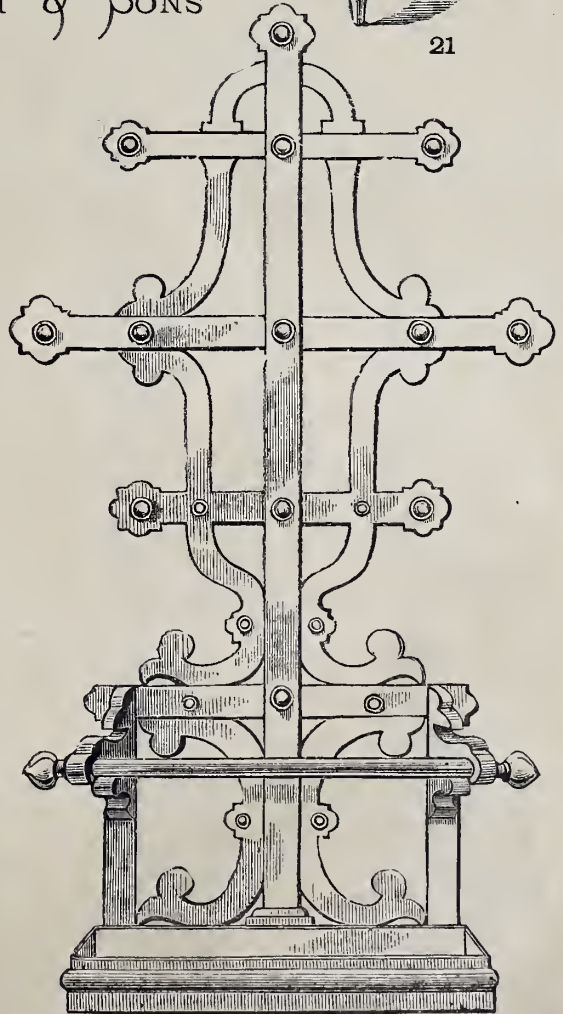

23

HAMPTON & SONS

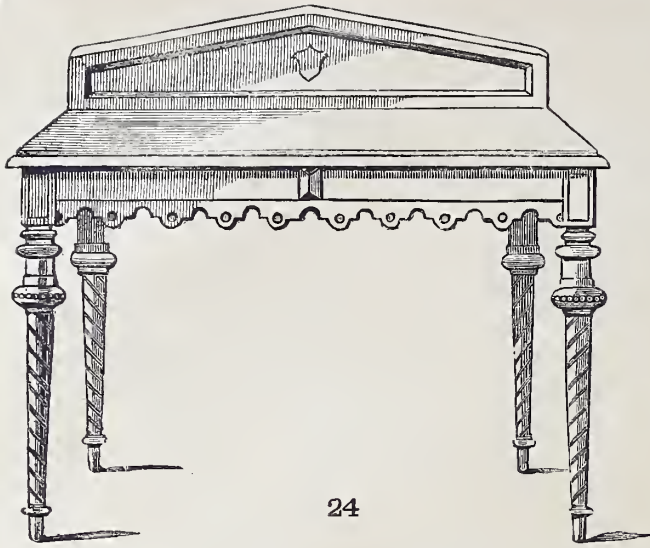

24

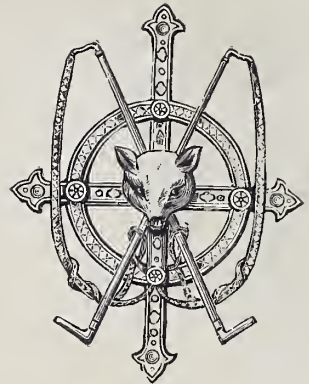

25

HAMPTON & SONS

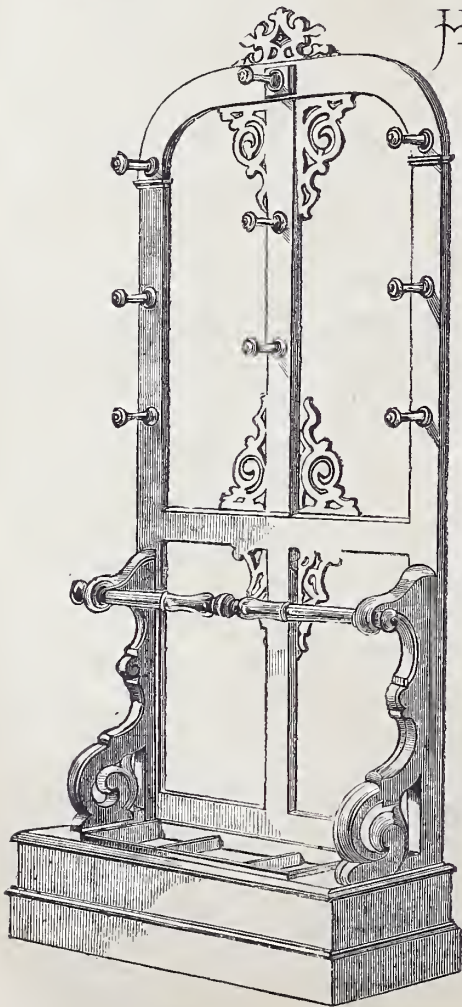

26

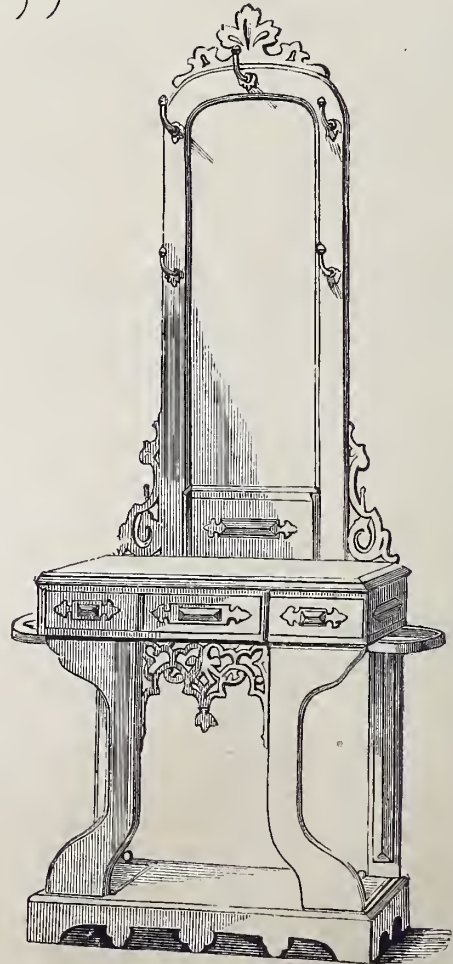

27

HAMPTON & SONS



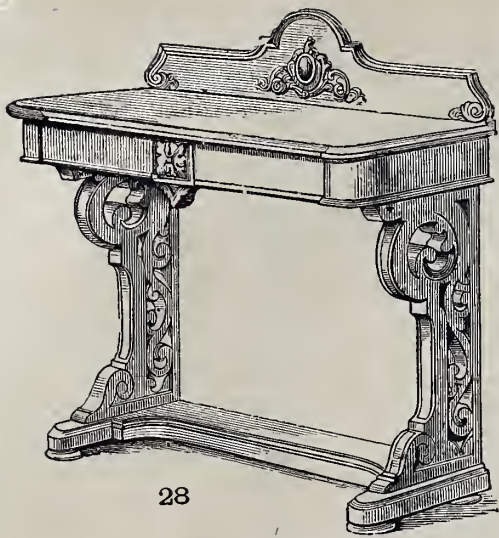

28

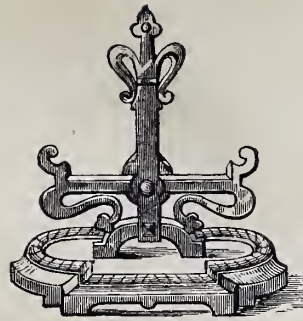

29

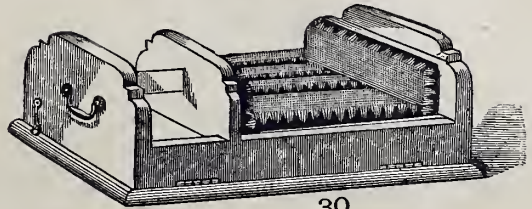

30

HAMPTON & SONS

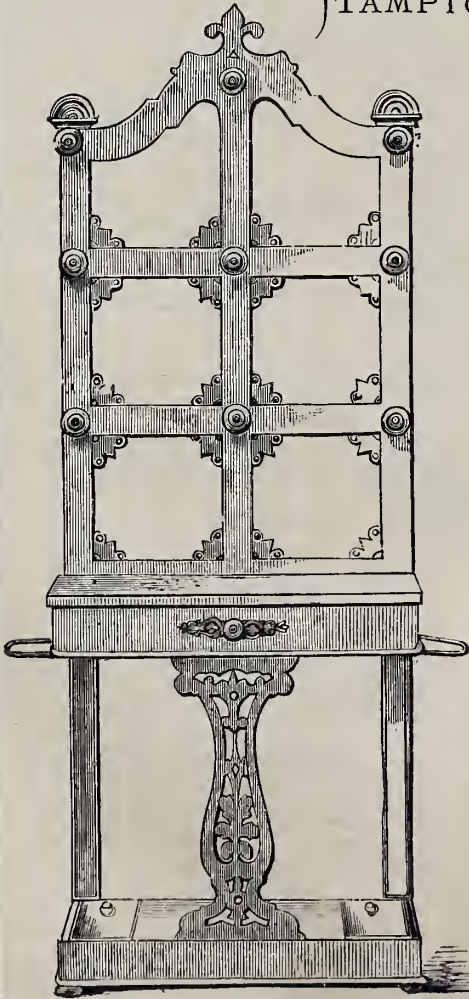

31

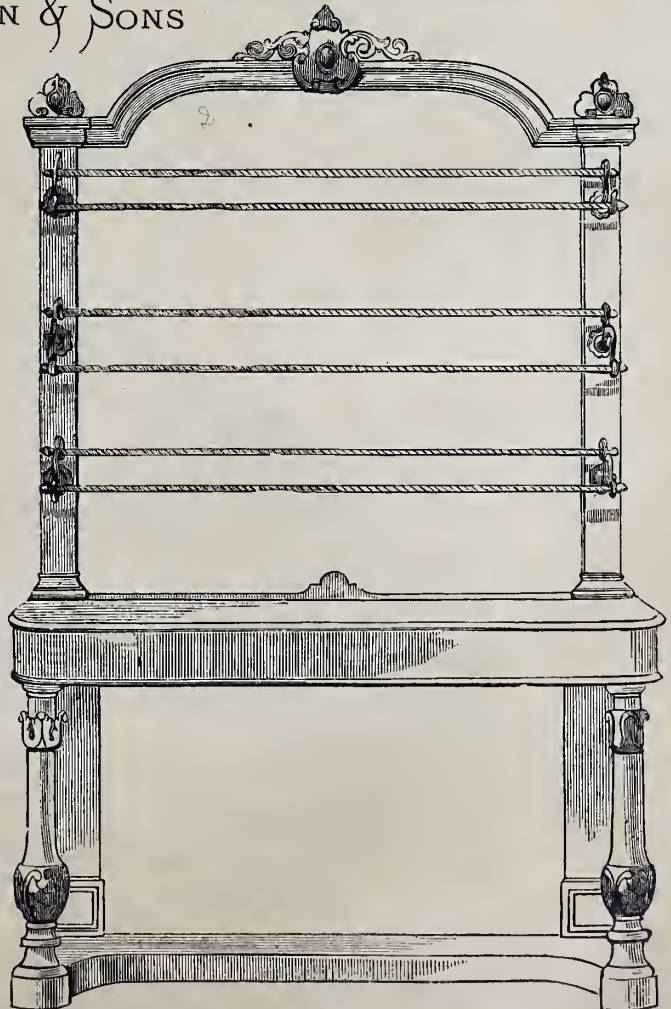

32

HAMPTON & SONS

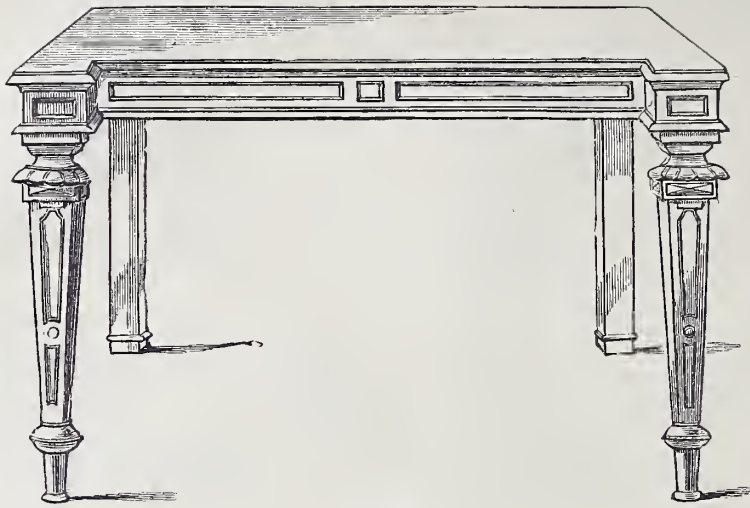

33

HAMPTON & SONS

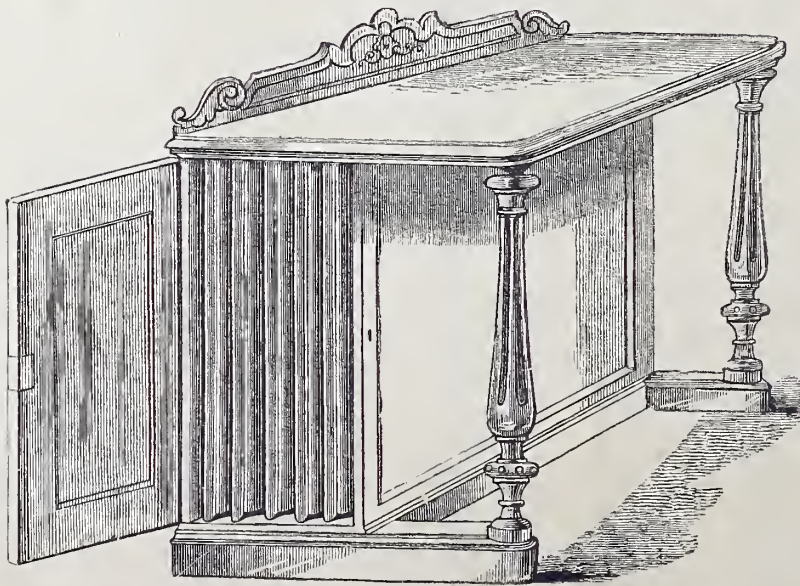

34

HAMPTON & SONS





35

HAMPTON & SONS

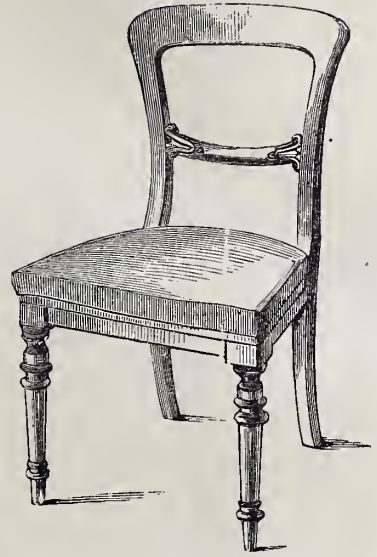

36

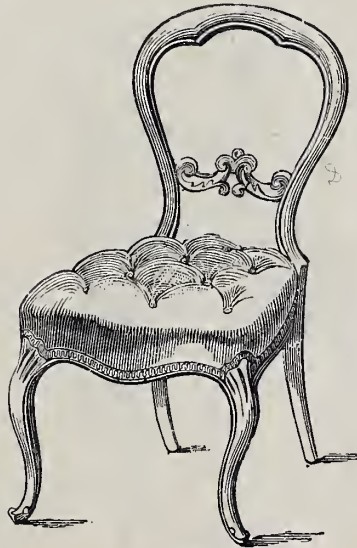

37

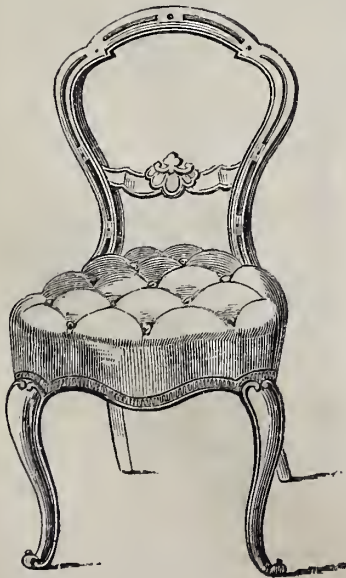

38

HAMPTON & SONS



39



40

HAMPTON & SONS



41



42



43

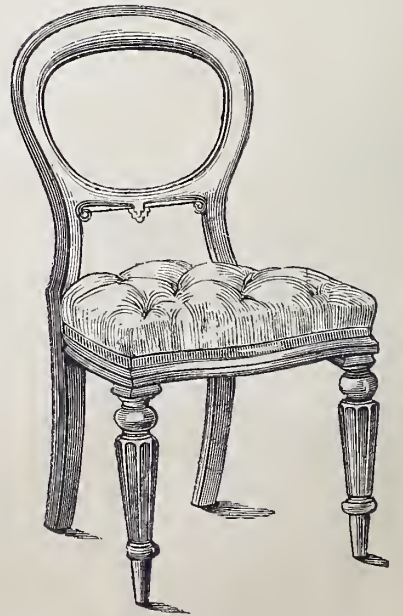

44

HAMPTON & SONS



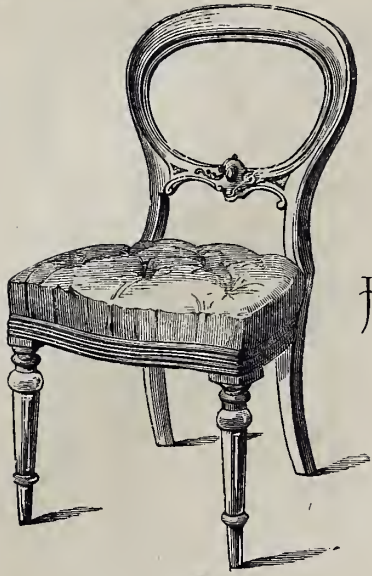

45

HAMPTON & SONS



46

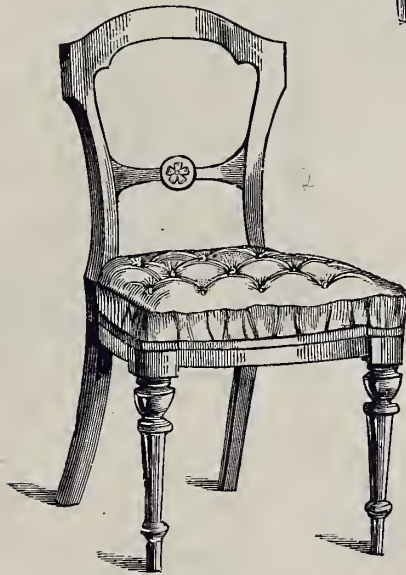

47

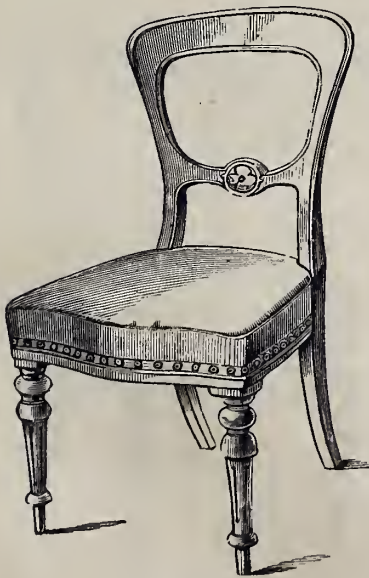

48

HAMPTON & SONS



49

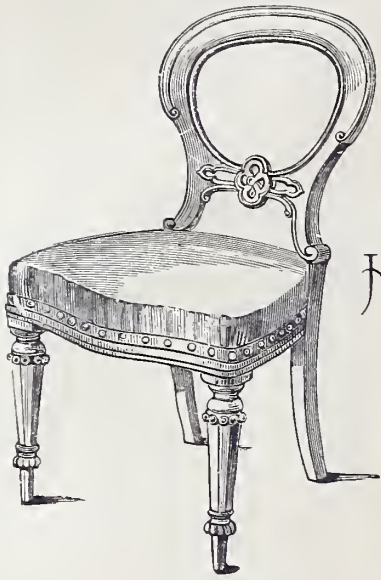

50

HAMPTON & SONS



51



52



53



54

HAMPTON & SONS





55

HAMPTON & SONS

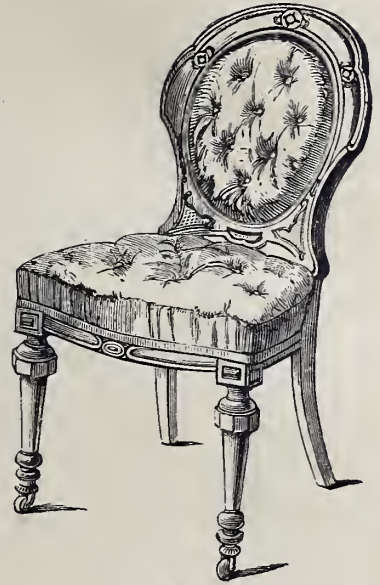

56



57

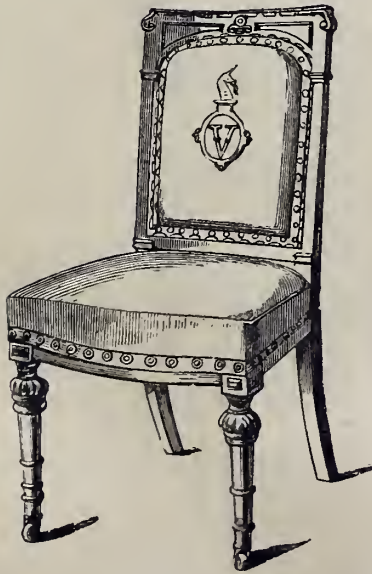

58

HAMPTON & SONS

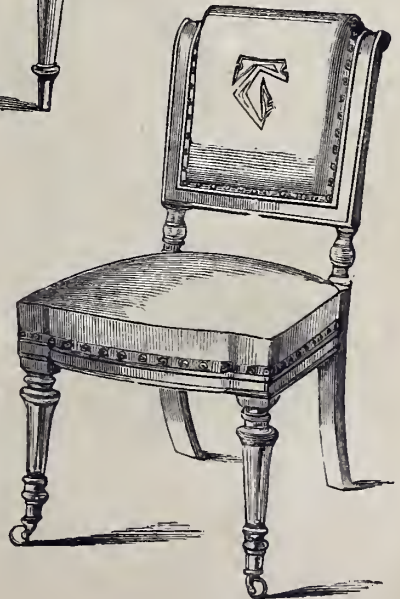

59



60

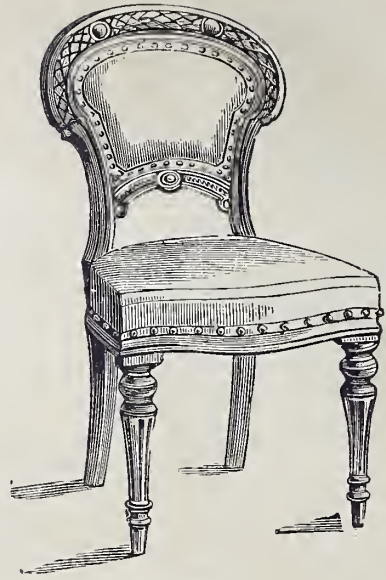

61

HAMPTON & SONS

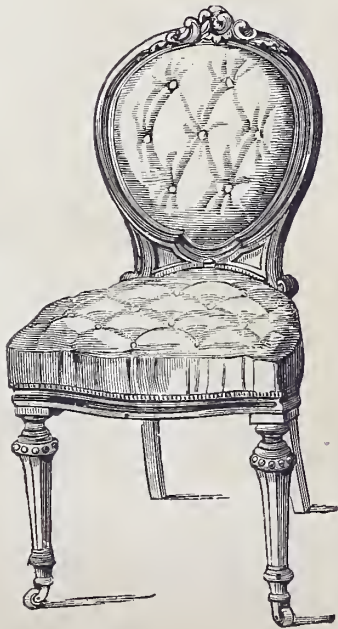

62



63

HAMPTON & SONS



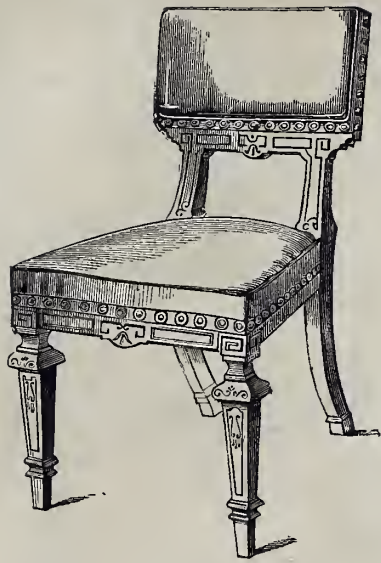

64

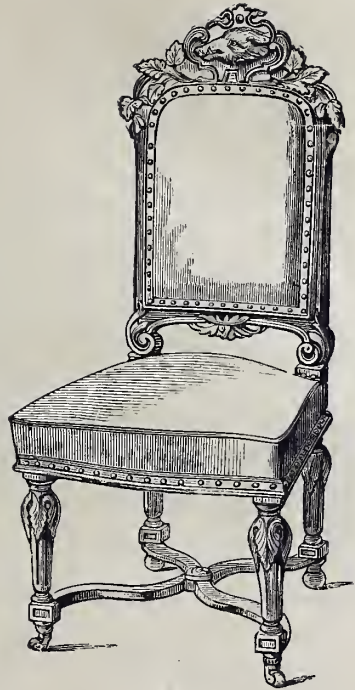

65

HAMPTON & SONS

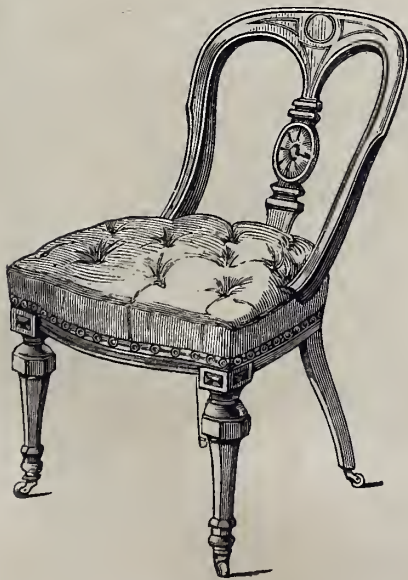

66

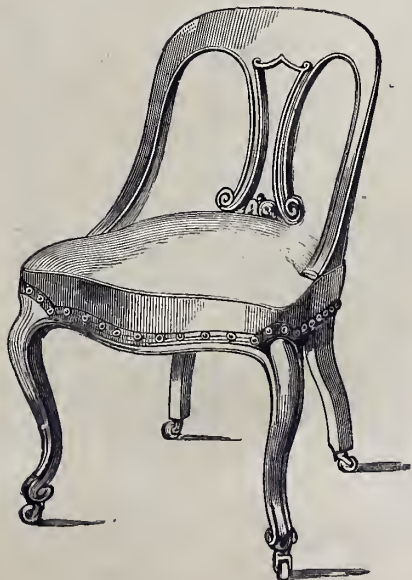

67

HAMPTON & SONS



68



69

HAMPTON & SONS

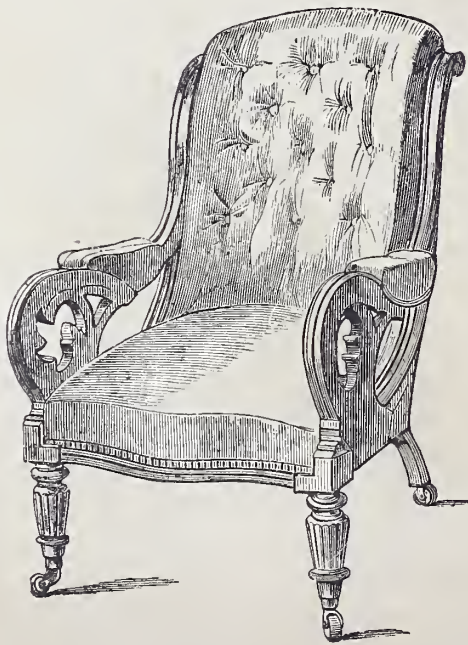

70

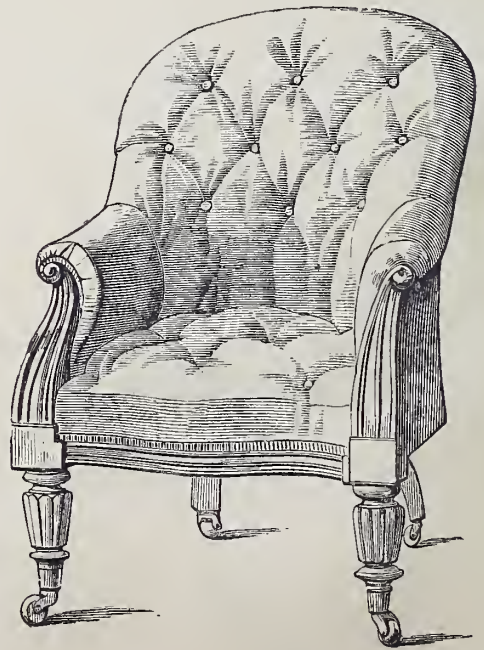

71

HAMPTON & SONS





72



73

HAMPTON & SONS



74



75

HAMPTON & SONS

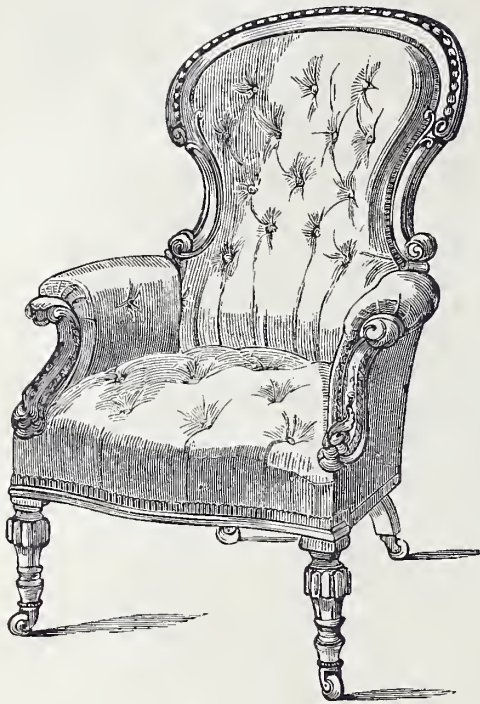

76

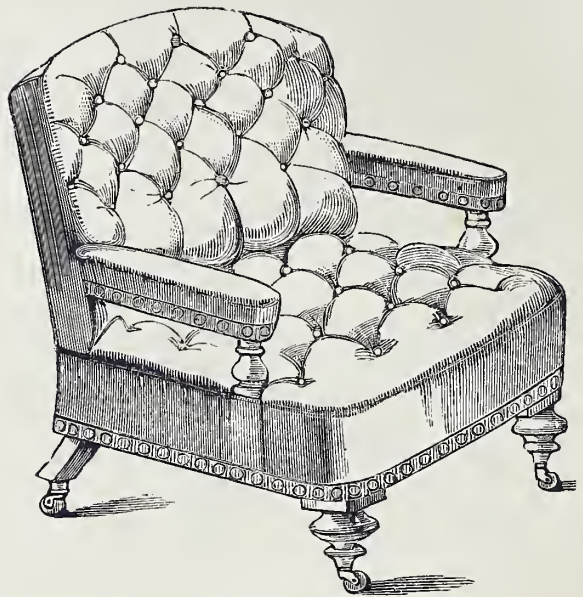

77

HAMPTON & SONS



78

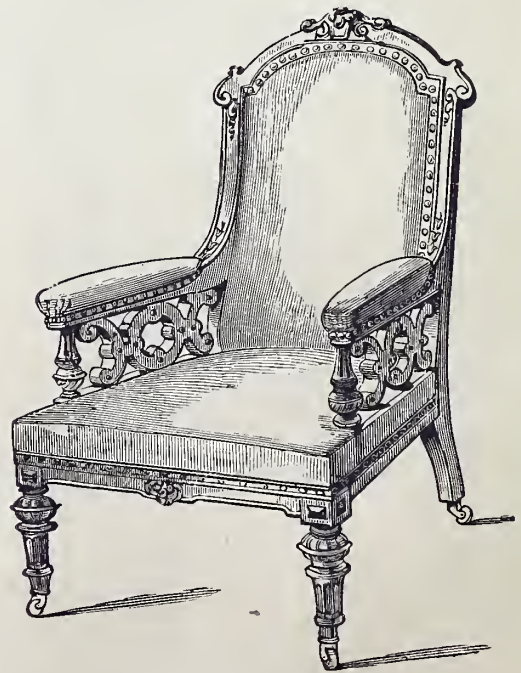

79

HAMPTON & SONS



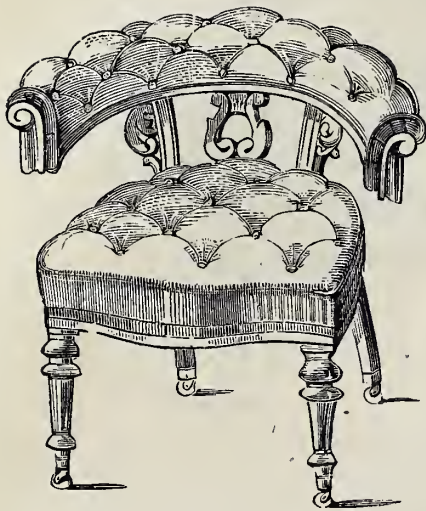

80



81

HAMPTON & SONS

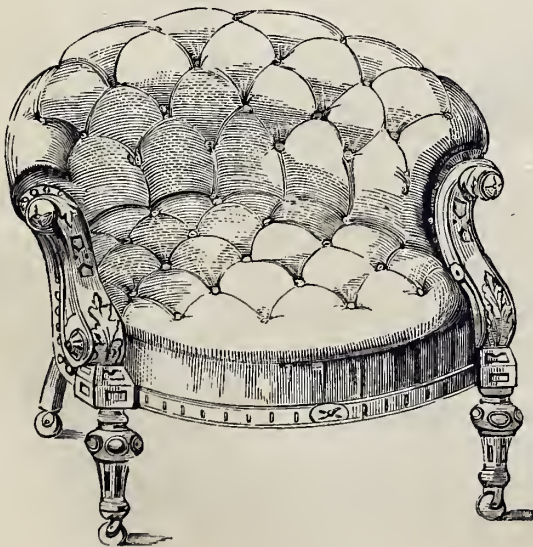

82

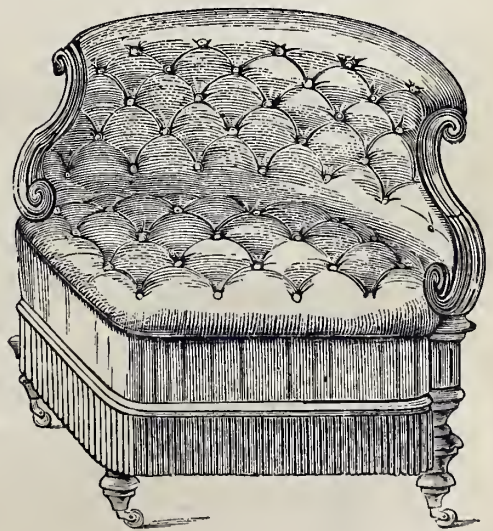

83

HAMPTON & SONS



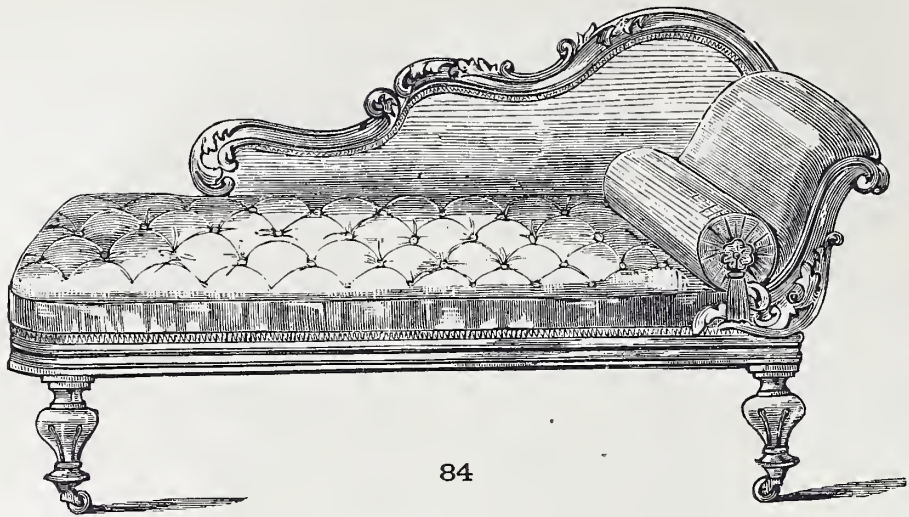

84

HAMPTON & SONS

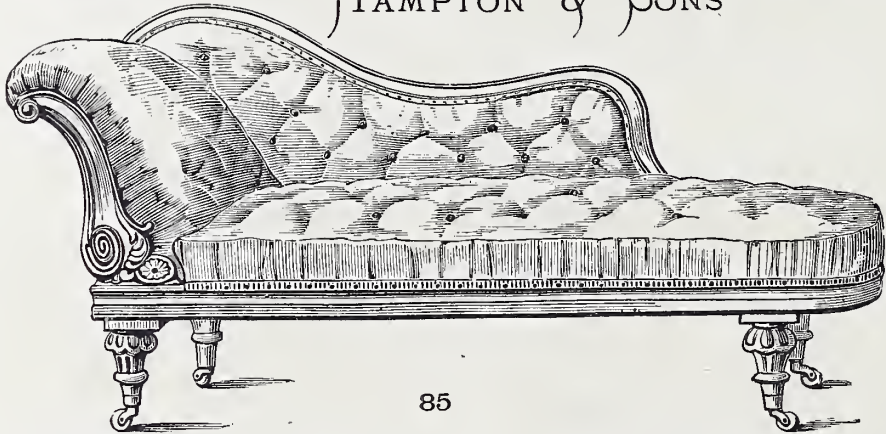

85

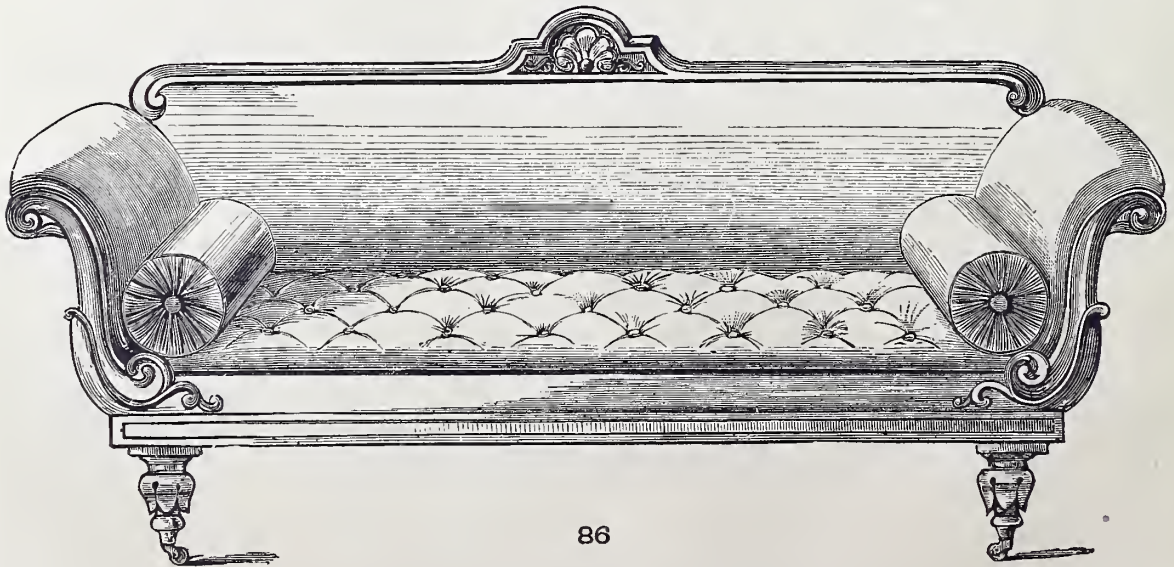

86

HAMPTON & SONS



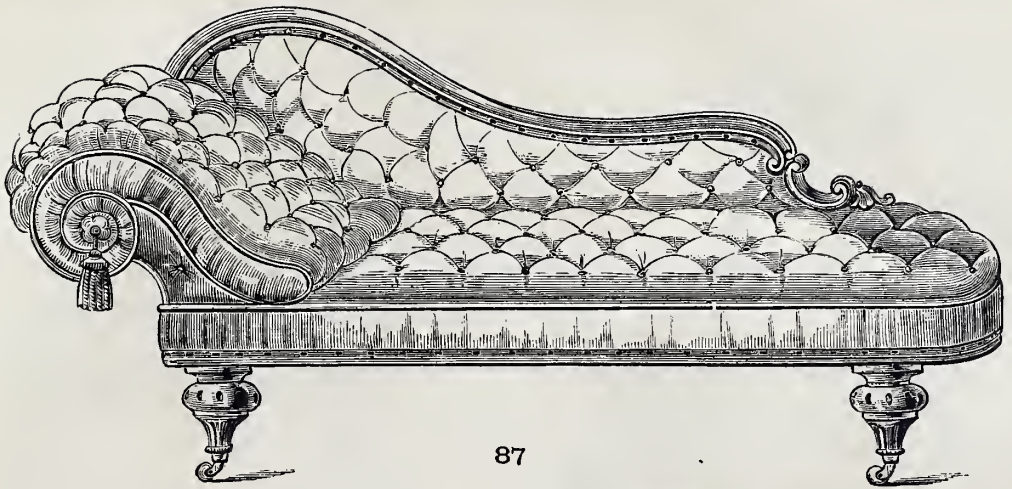

87

HAMPTON & SONS

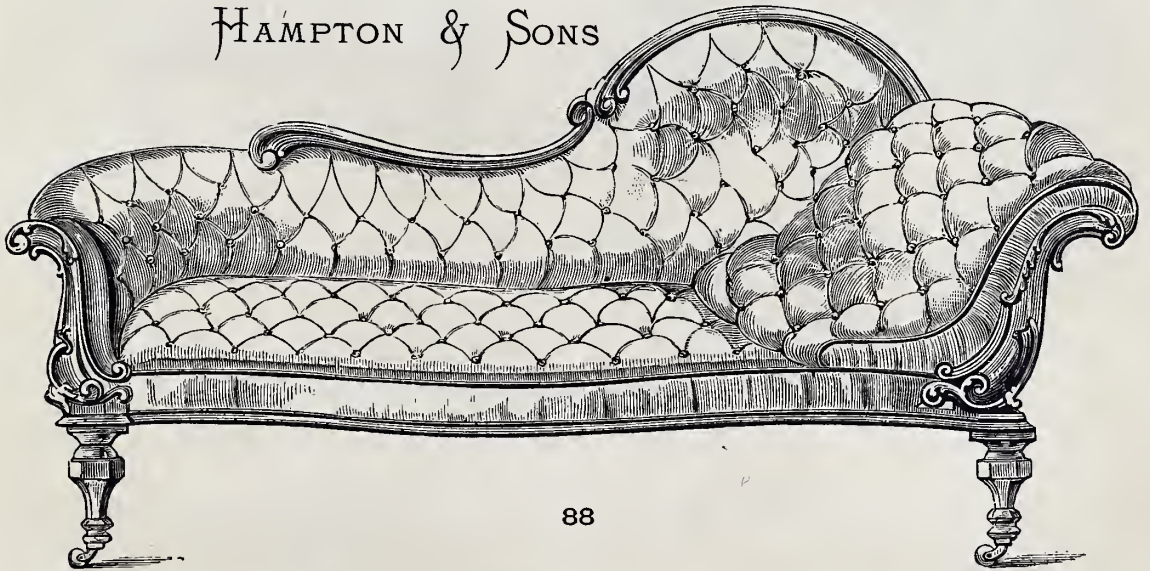

88

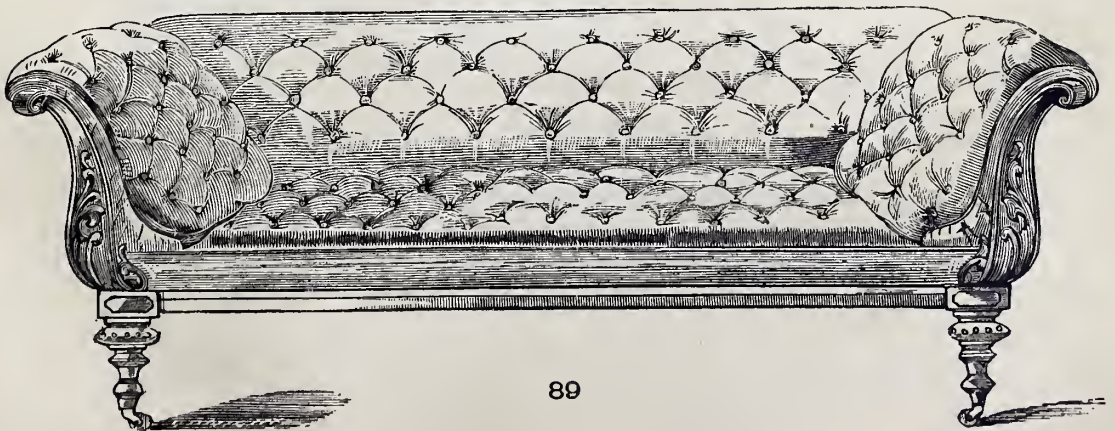

89

HAMPTON & SONS



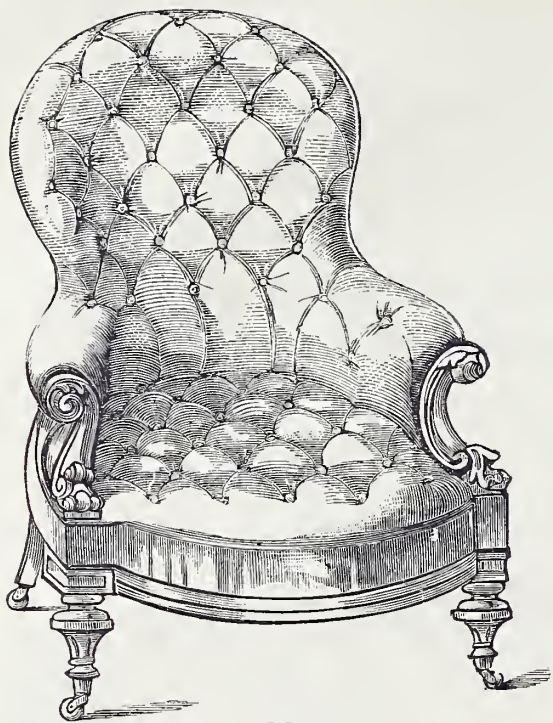

90

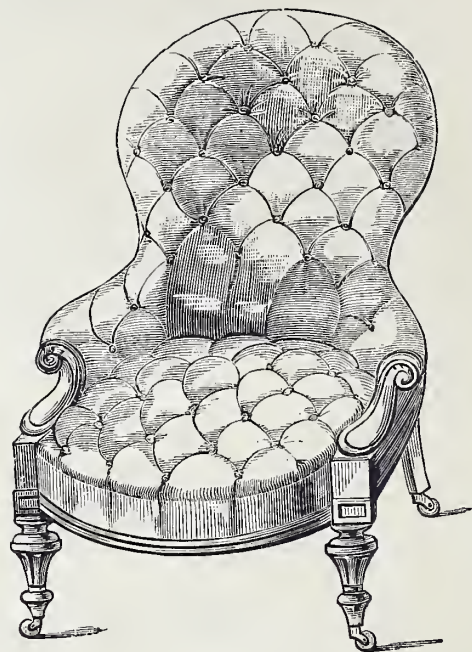

91

HAMPTON & SONS

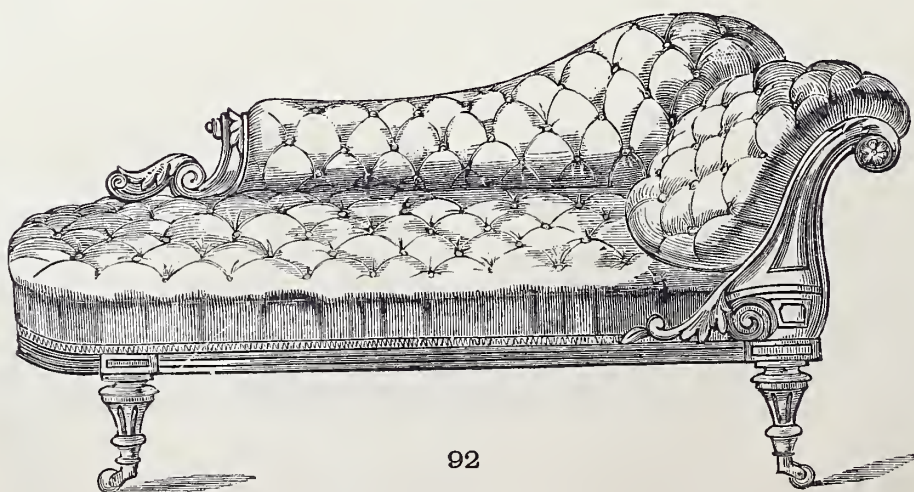

92

HAMPTON & SONS





93



94

HAMPTON & SONS

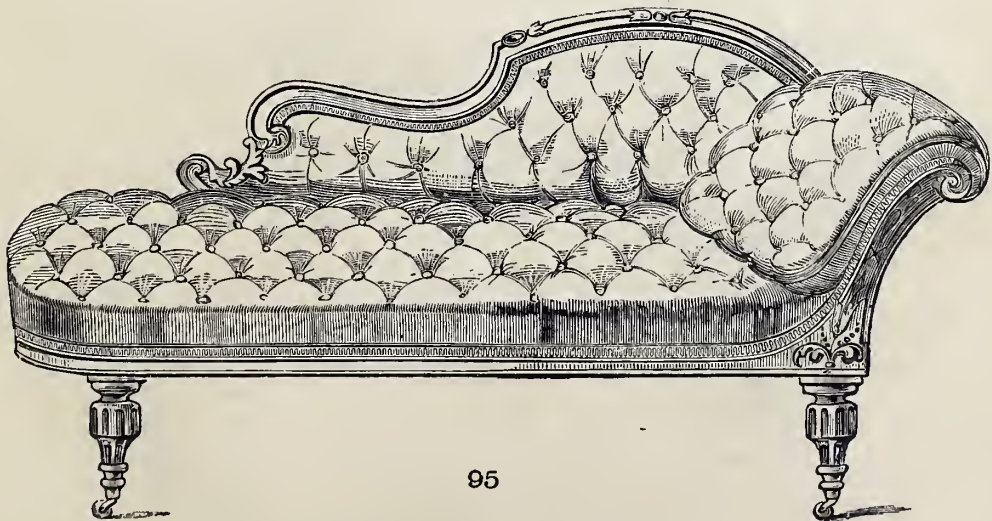

95

HAMPTON & SONS

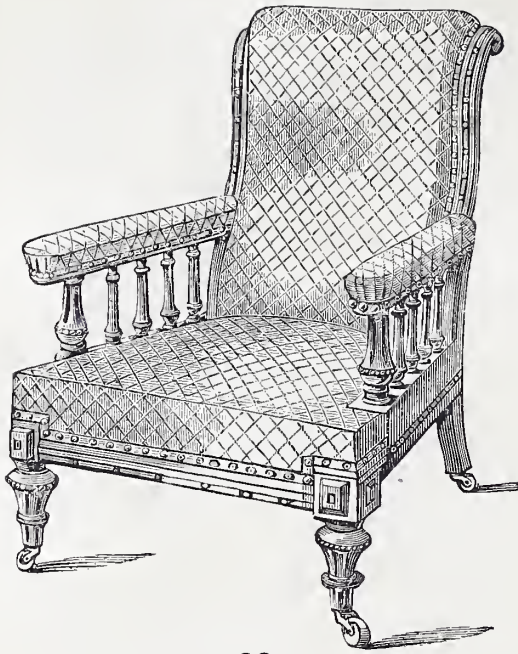

96



97

HAMPTON & SONS

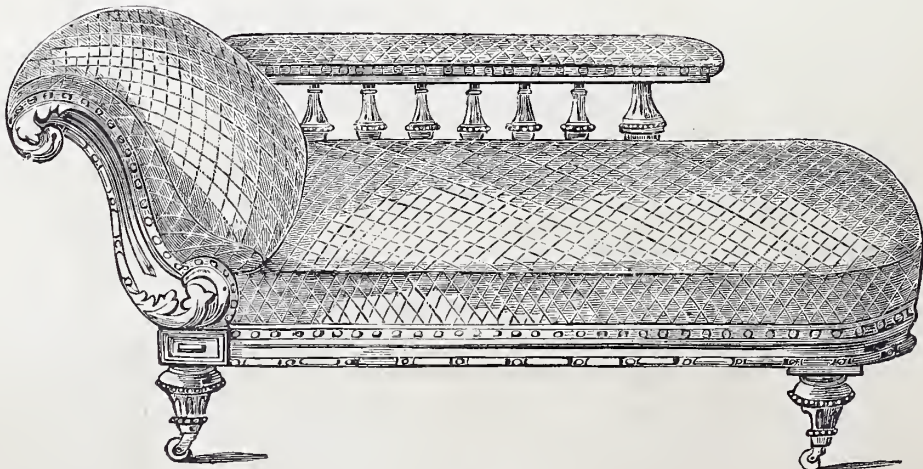

98

HAMPTON & SONS



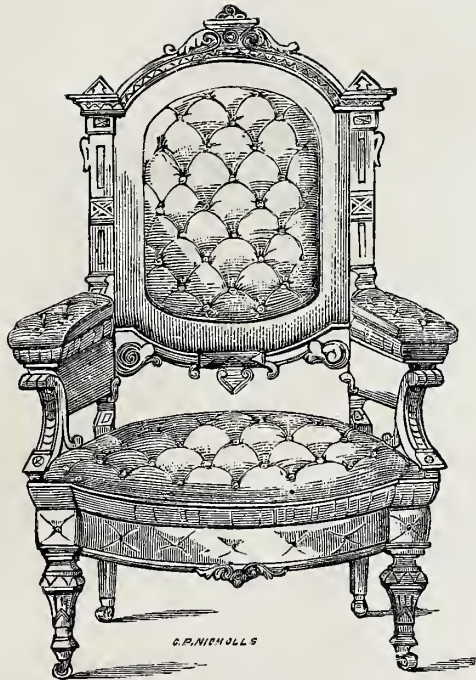

99

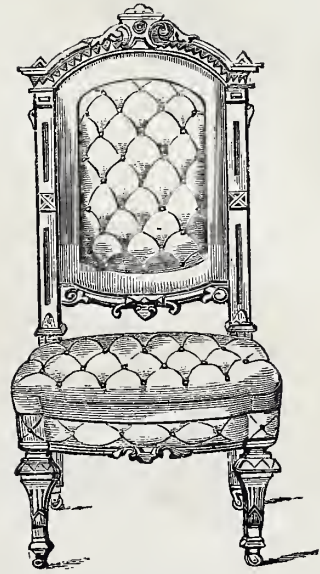

100

HAMPTON & SONS

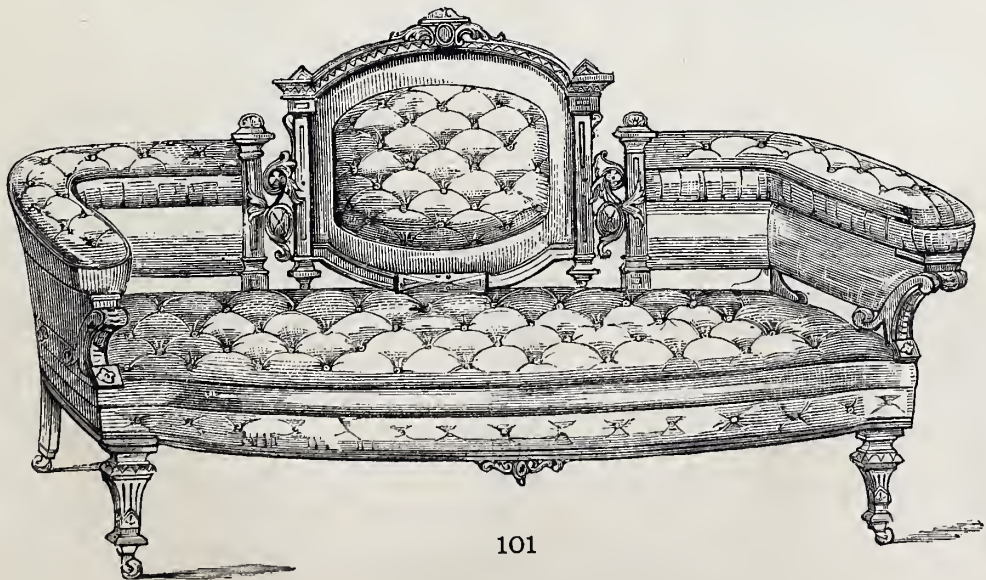

101

HAMPTON & SONS



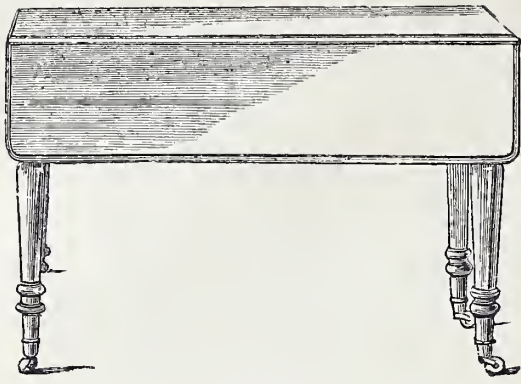

102

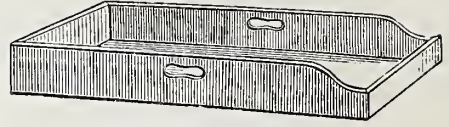

103

HAMPTON & SONS

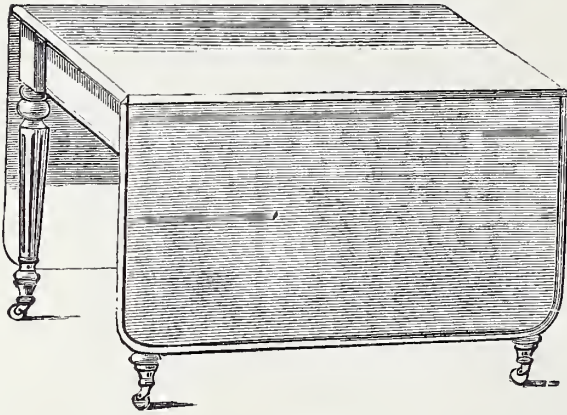

104



105

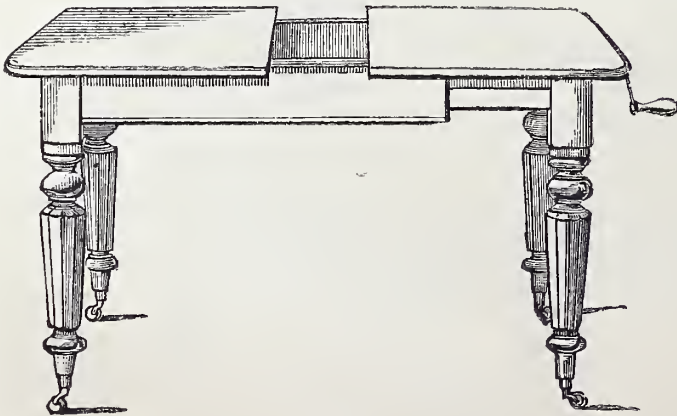

106



107

HAMPTON & SONS

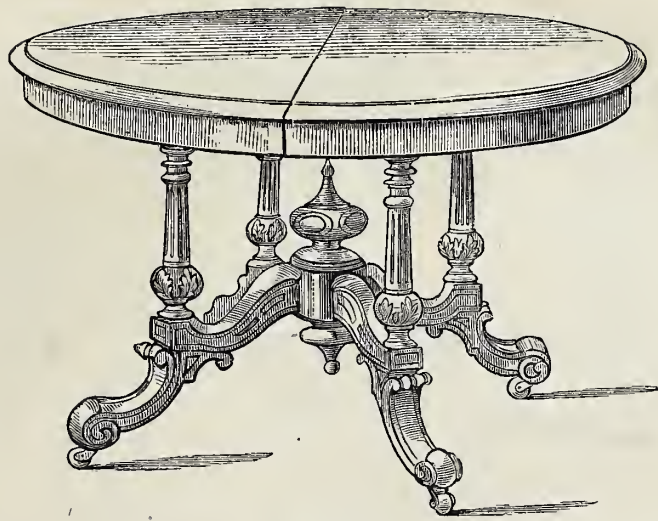

108

HAMPTON & SONS

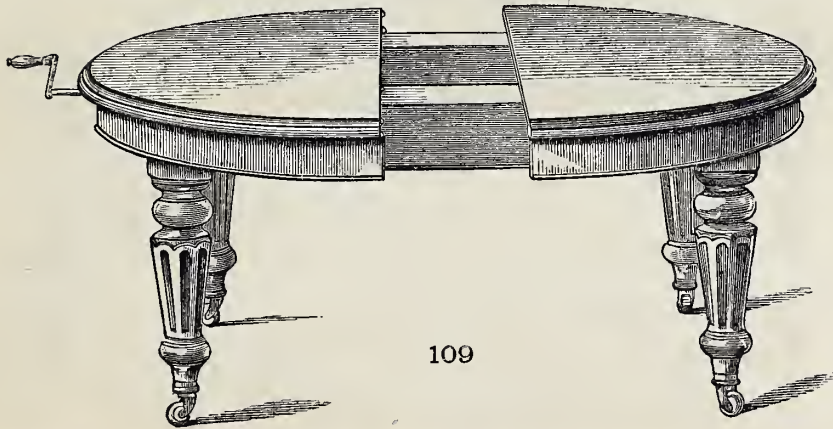

109

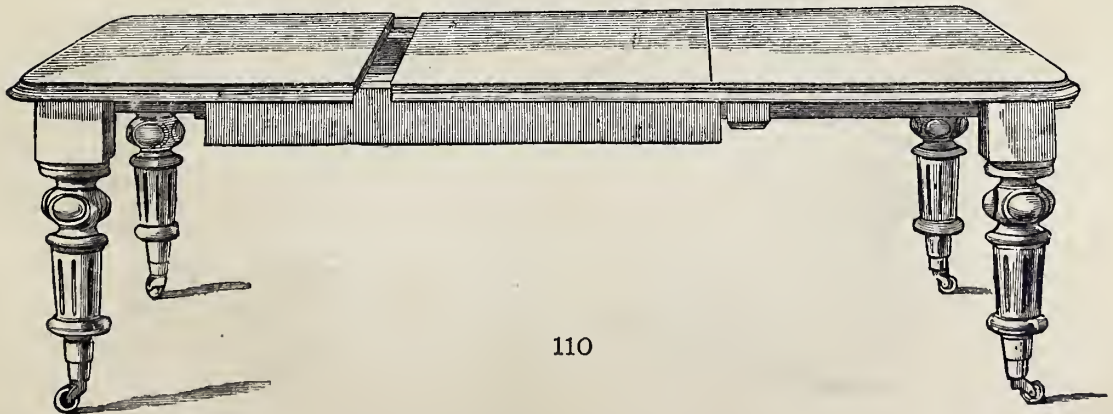

110

HAMPTON & SONS

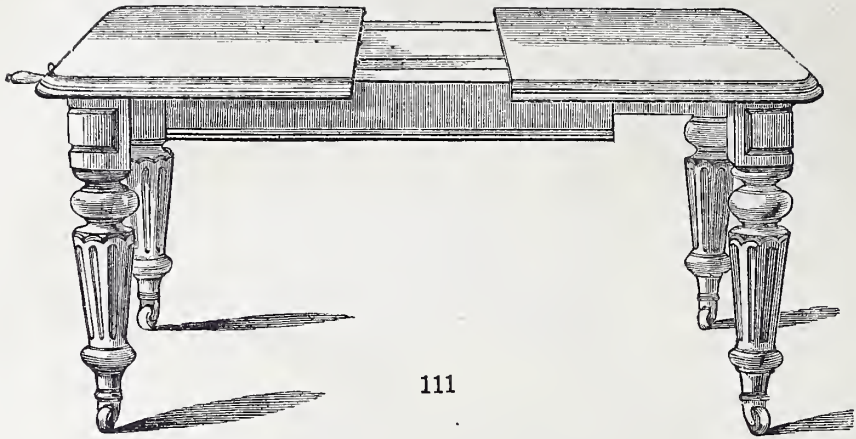

111

HAMPTON & SONS

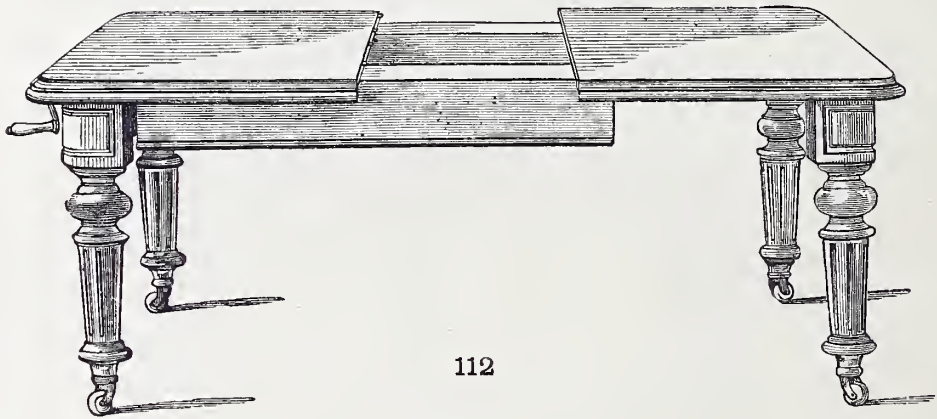

112

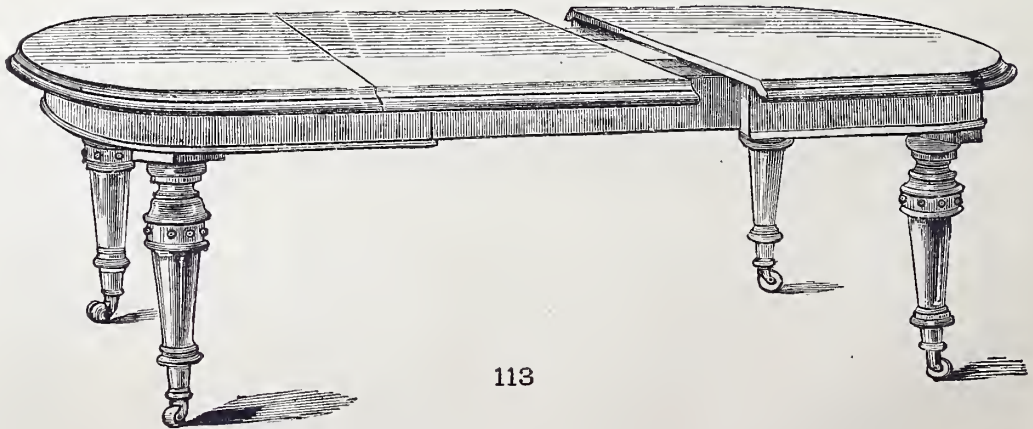

113

HAMPTON & SONS



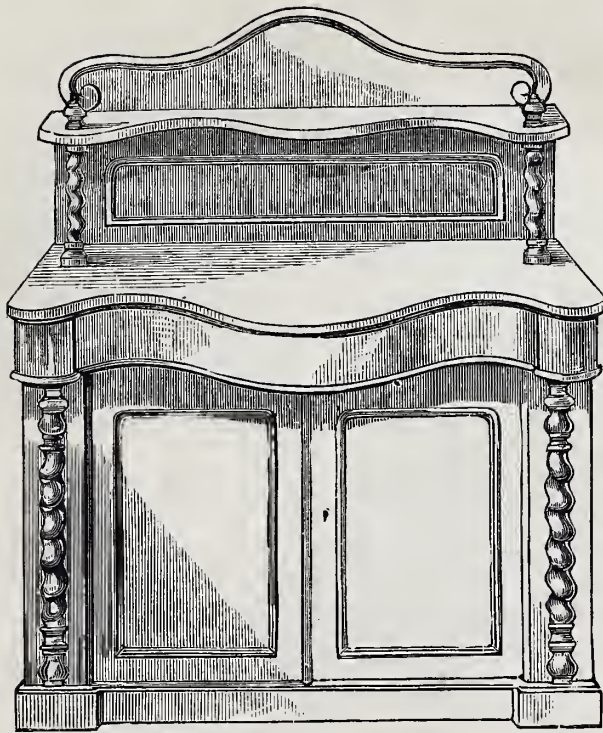

114

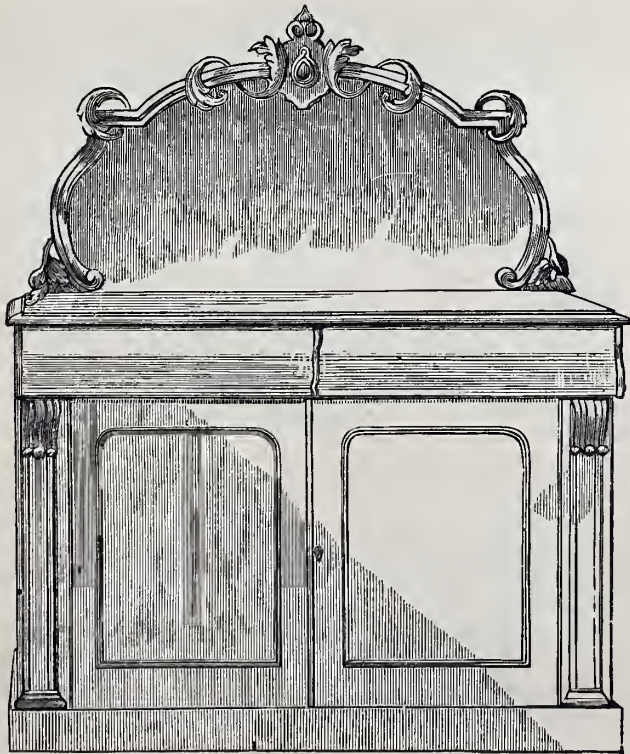

115

HAMPTON & SONS

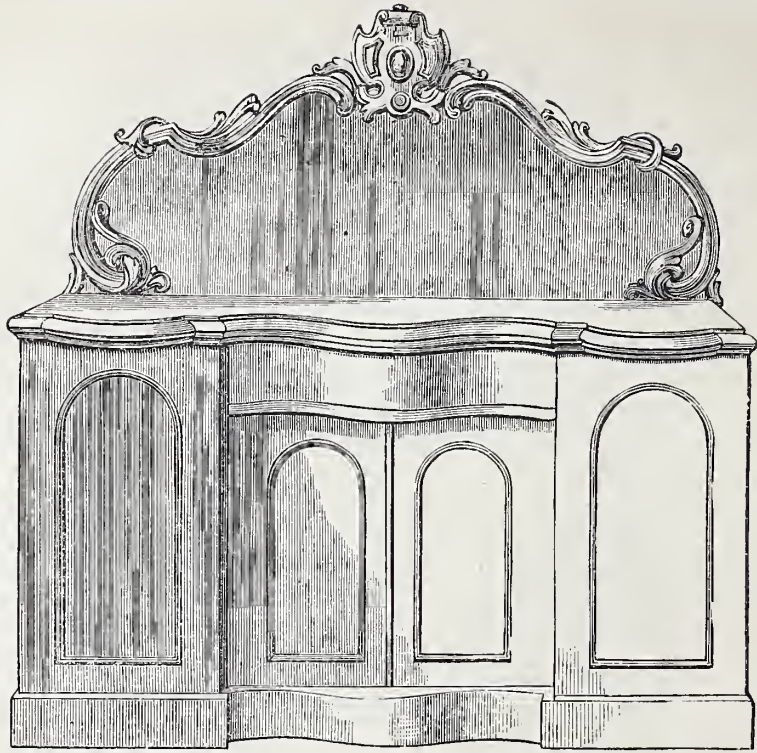

116

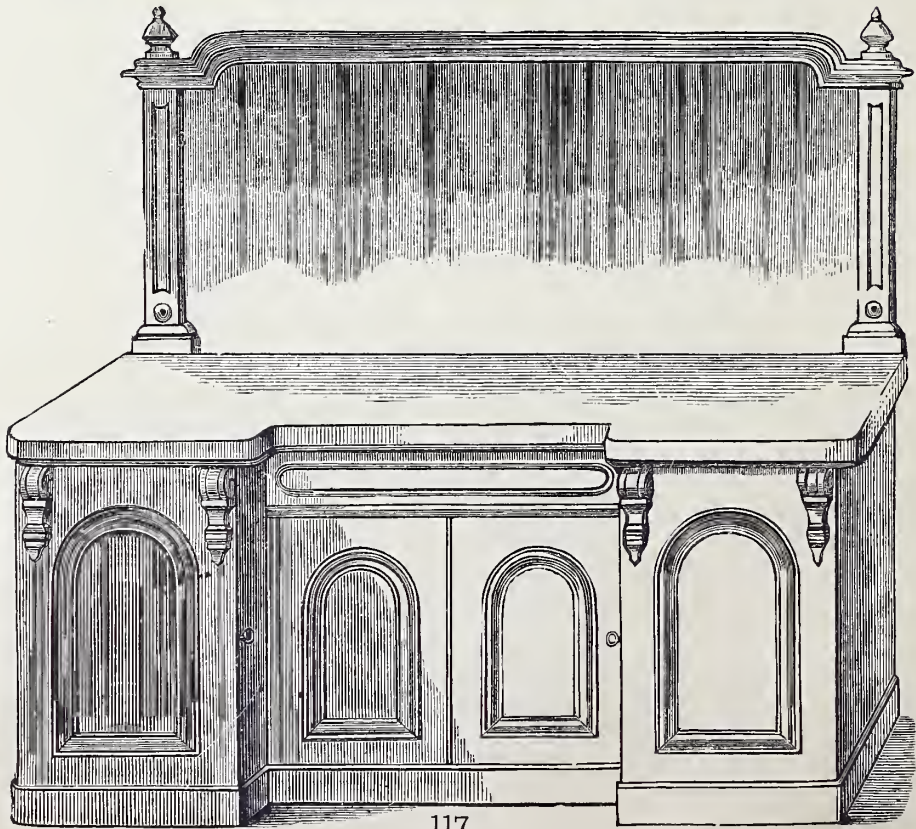

117

HAMPTON & SONS



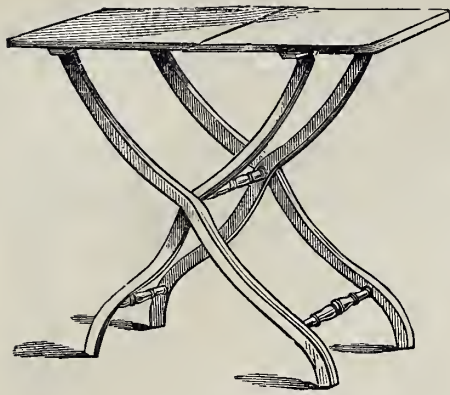

118

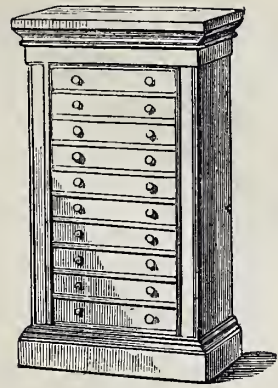

119

HAMPTON & SONS

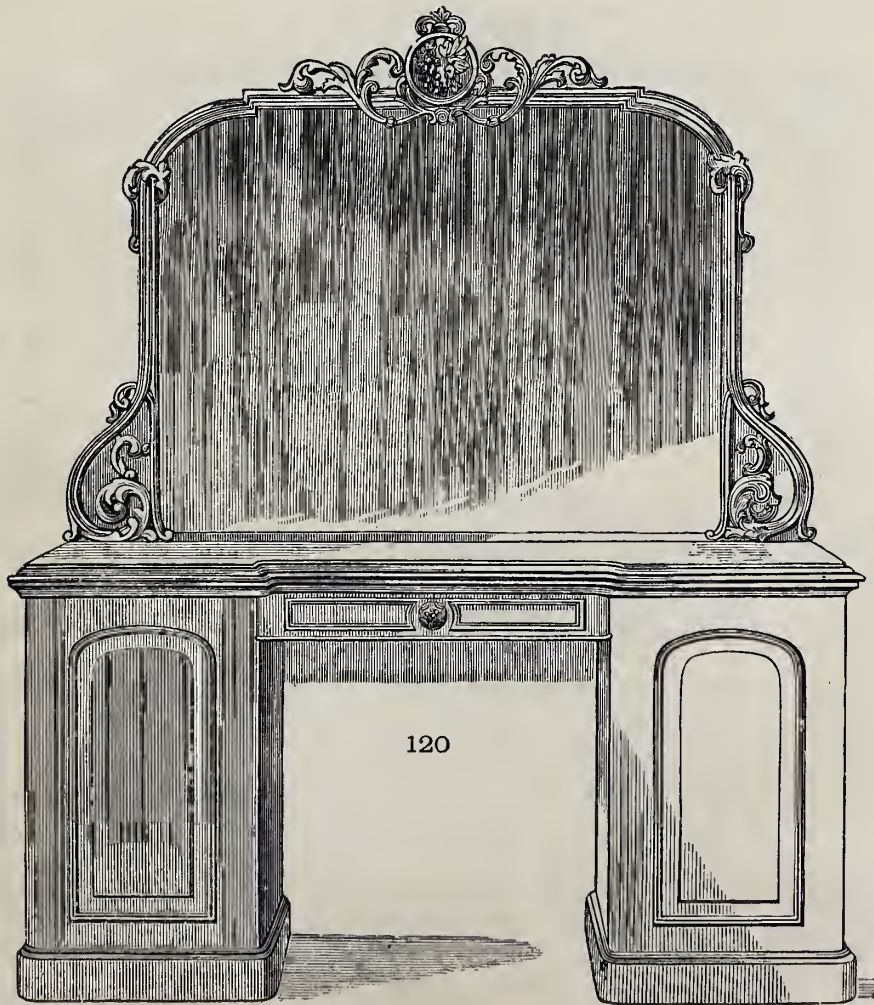

120

HAMPTON & SONS

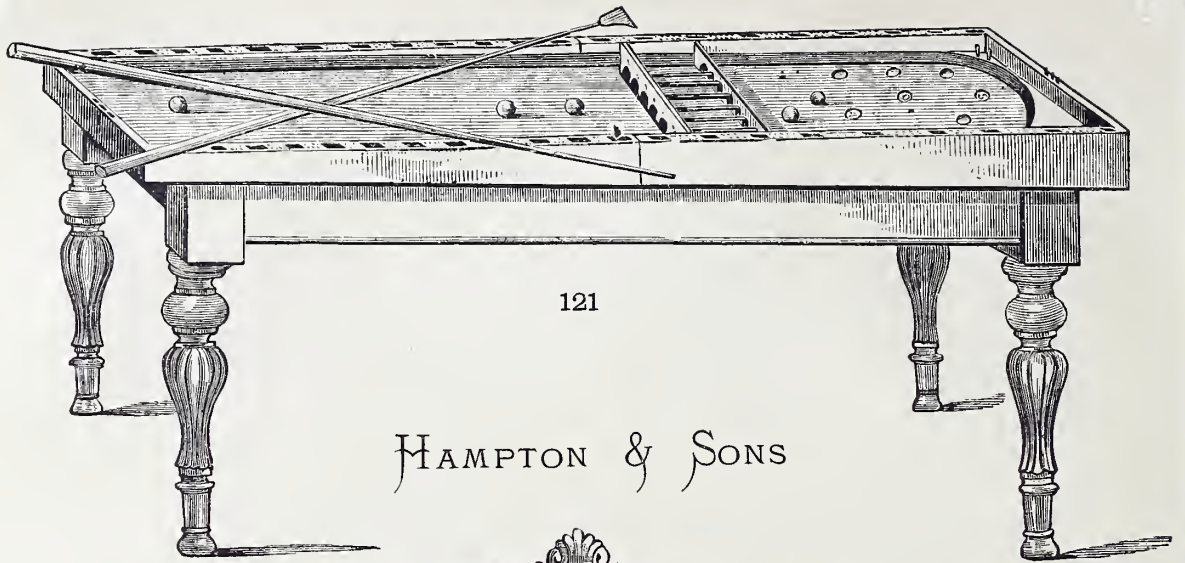

121

HAMPTON & SONS

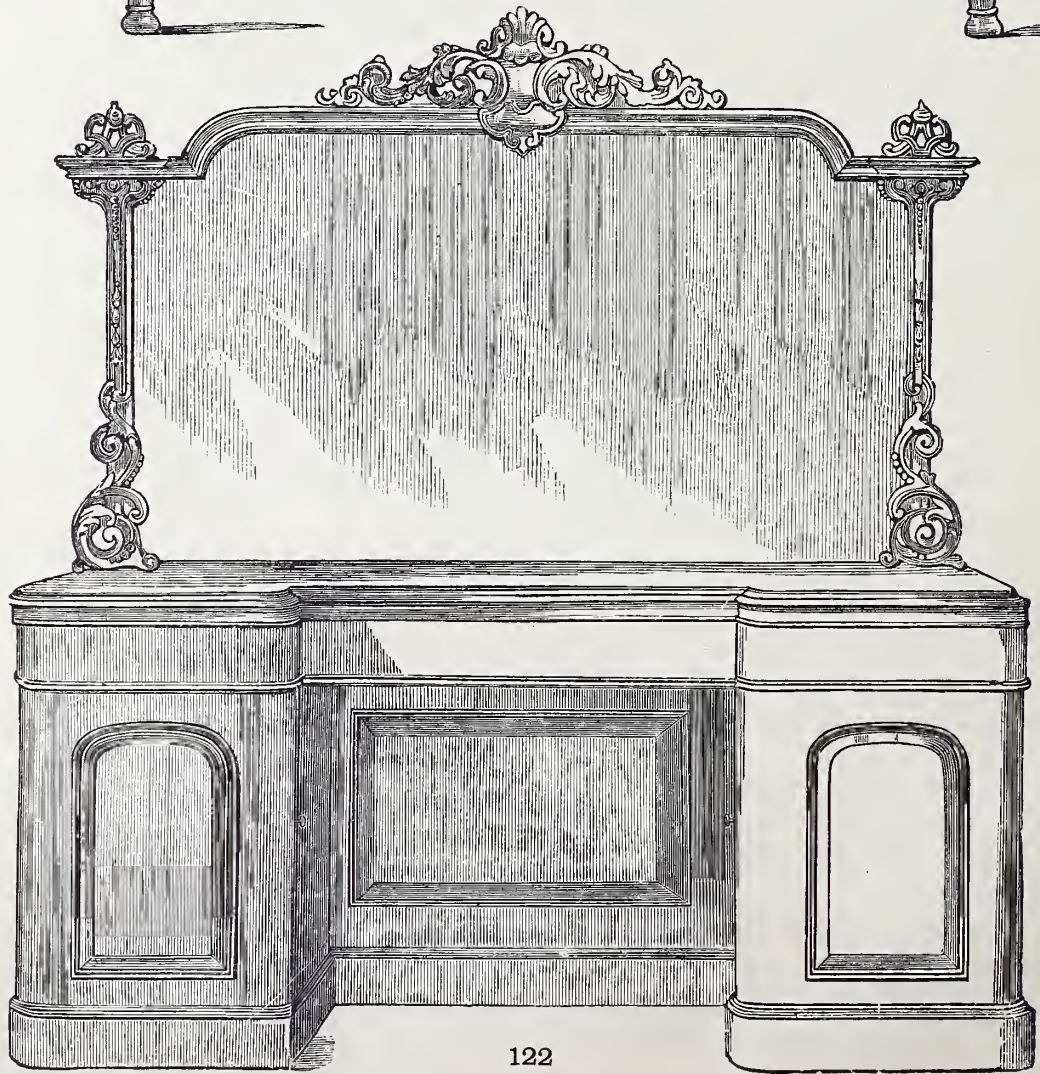

122

HAMPTON & SONS



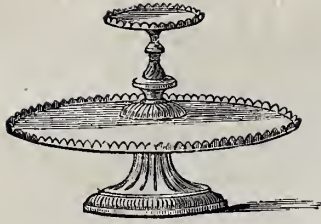

123

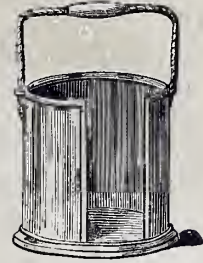

124

HAMPTON & SONS

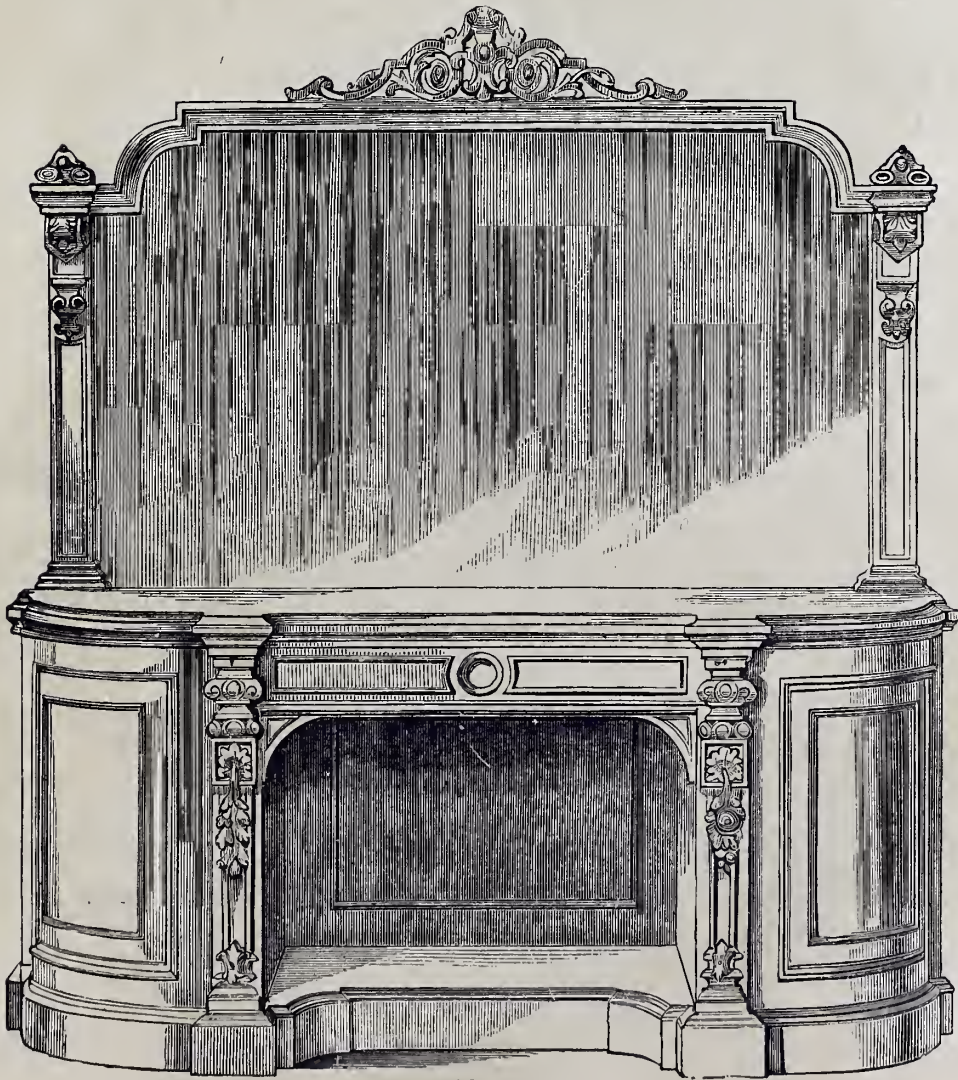

125

HAMPTON & SONS

HAMPTON & SONS



126

HAMPTON & SONS



HAMPTON & SONS

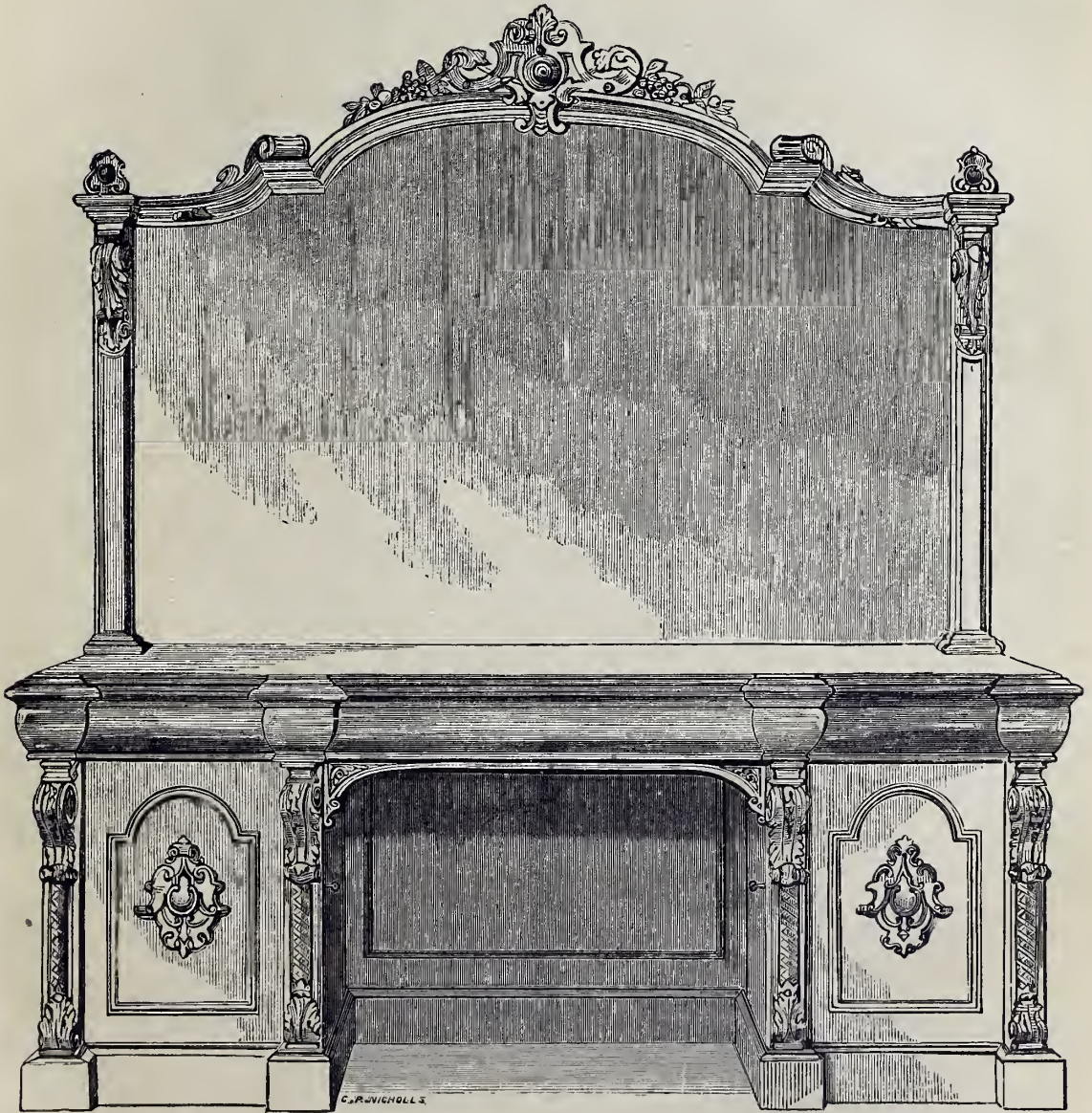

C. R. VICKHOLL'S

127

HAMPTON & SONS

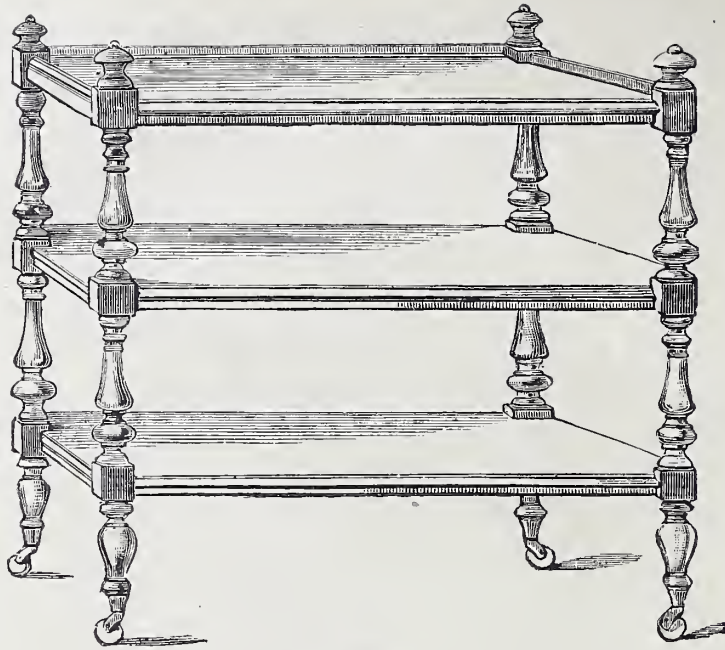

128

HAMPTON & SONS

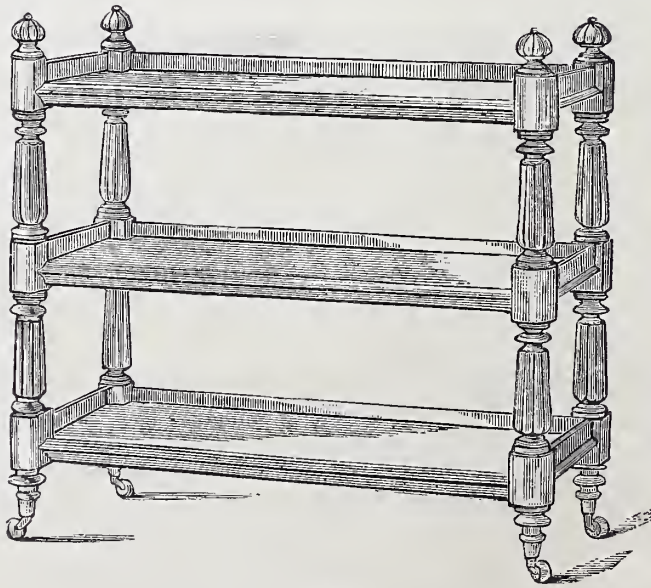

129

HAMPTON & SONS



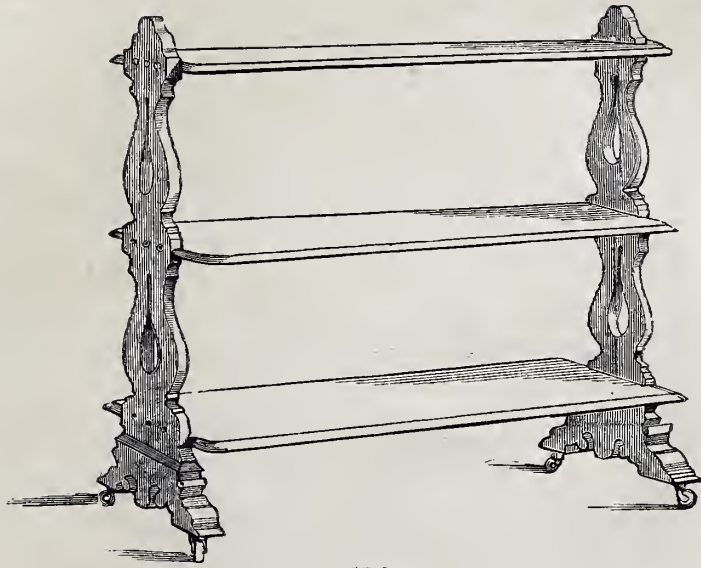

130

HAMPTON & SONS

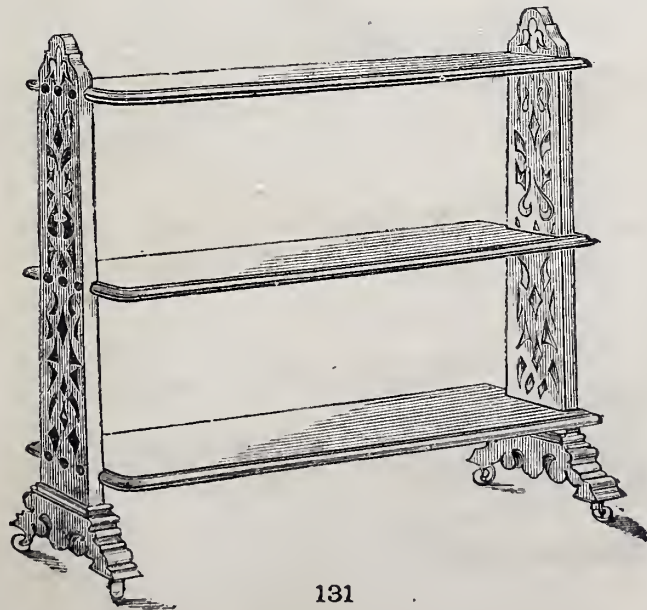

131

HAMPTON & SONS

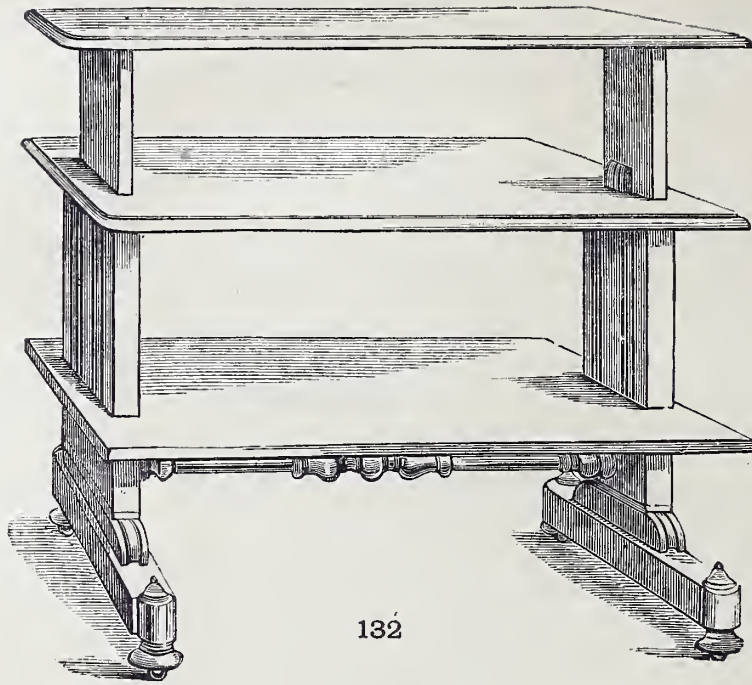

132

HAMPTON & SONS

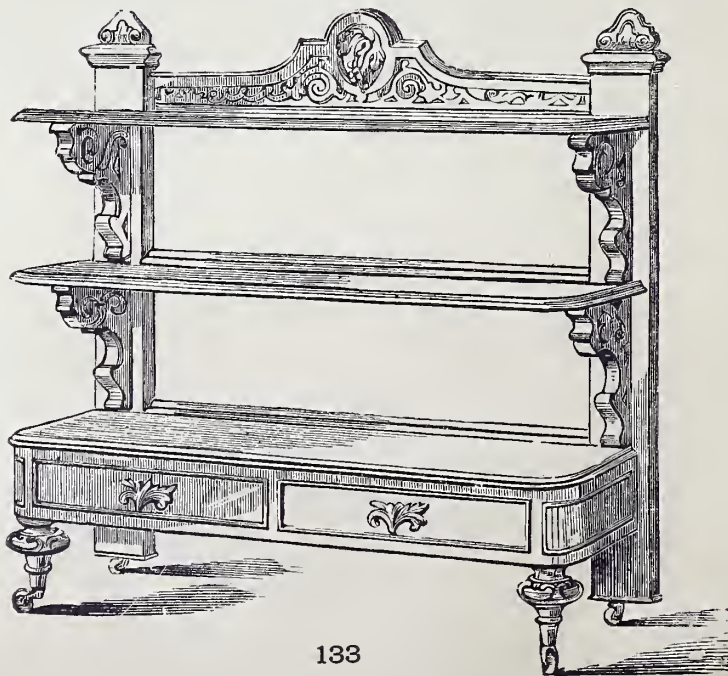

133

HAMPTON & SONS



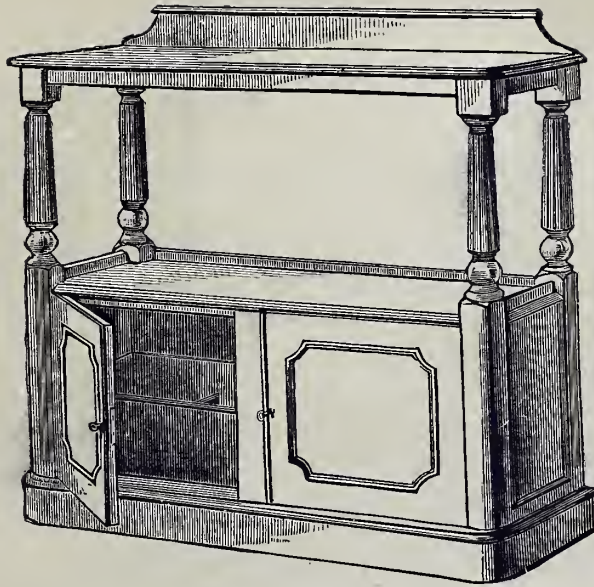

134

HAMPTON & SONS

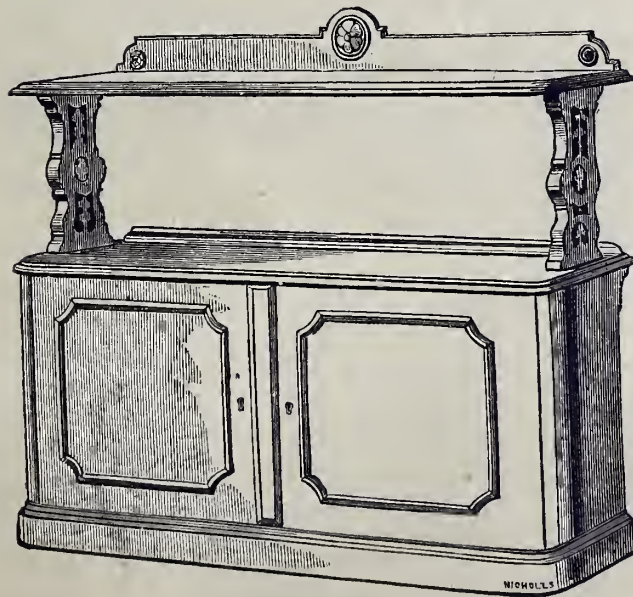

135

HAMPTON & SONS

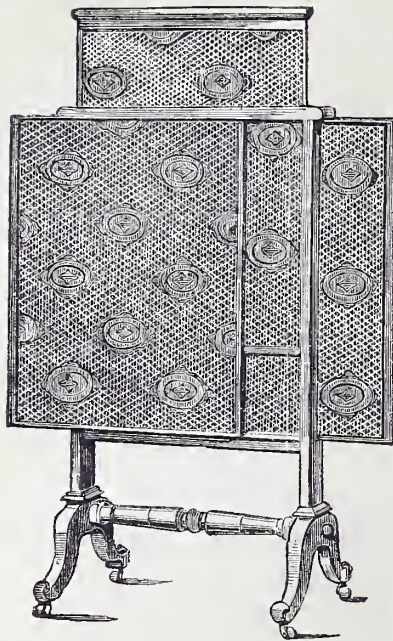

136

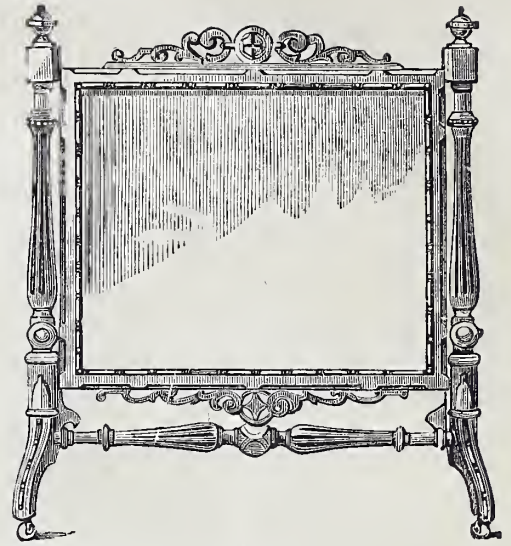

137

HAMPTON & SONS

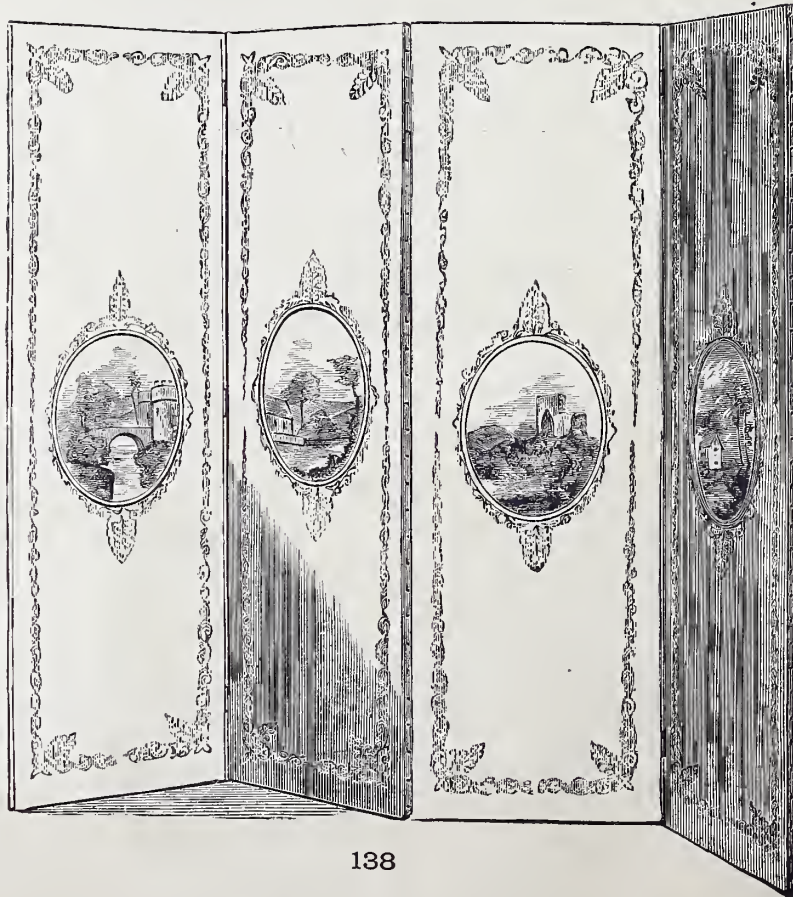

138

HAMPTON & SONS



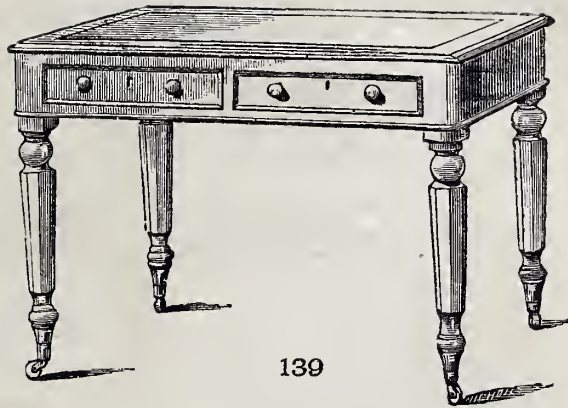

139

HAMPTON & SONS

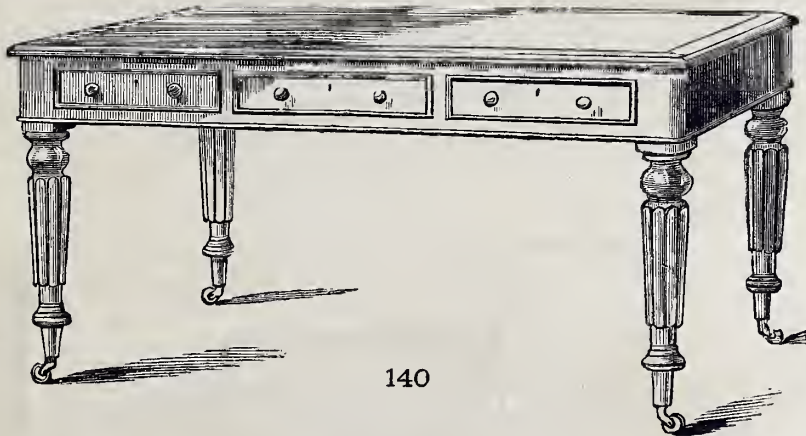

140

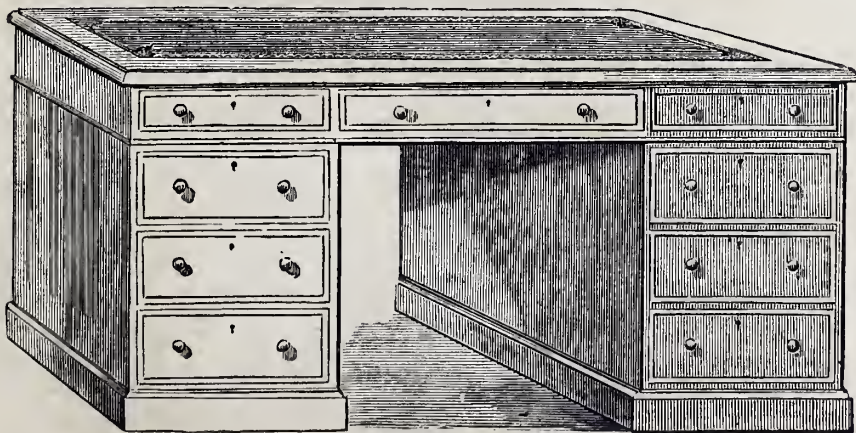

141

HAMPTON & SONS

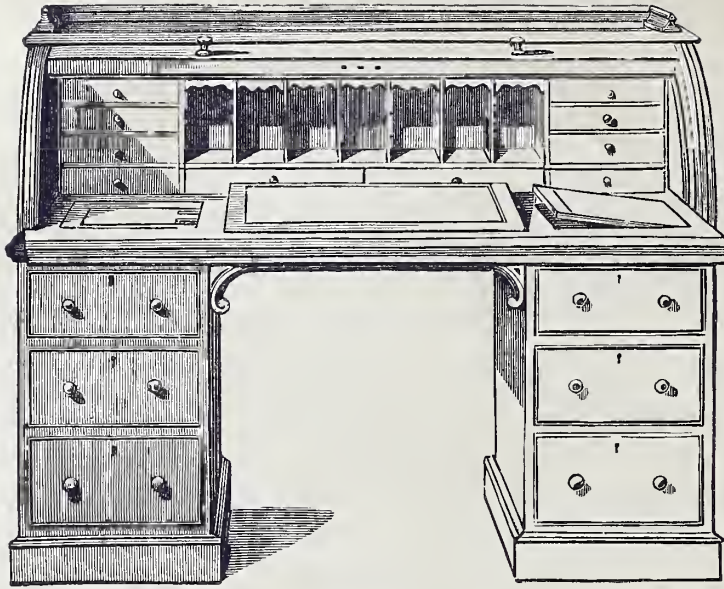

142

HAMPTON & SONS

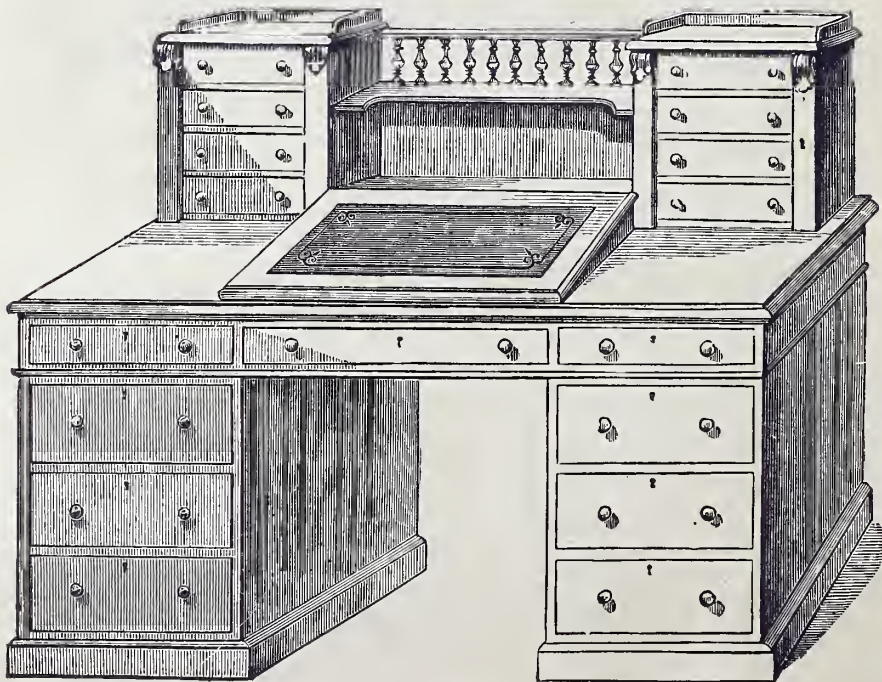

143

HAMPTON & SONS



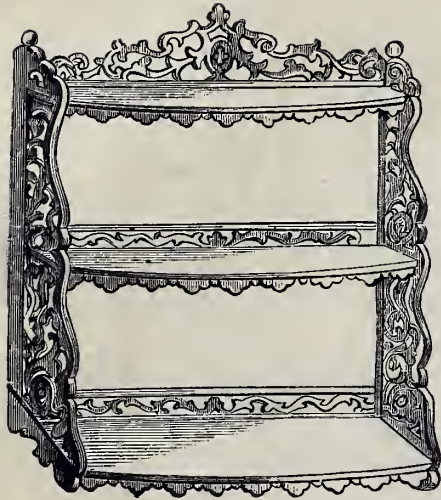

144

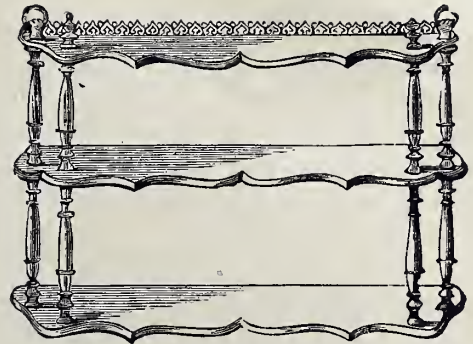

145

HAMPTON & SONS

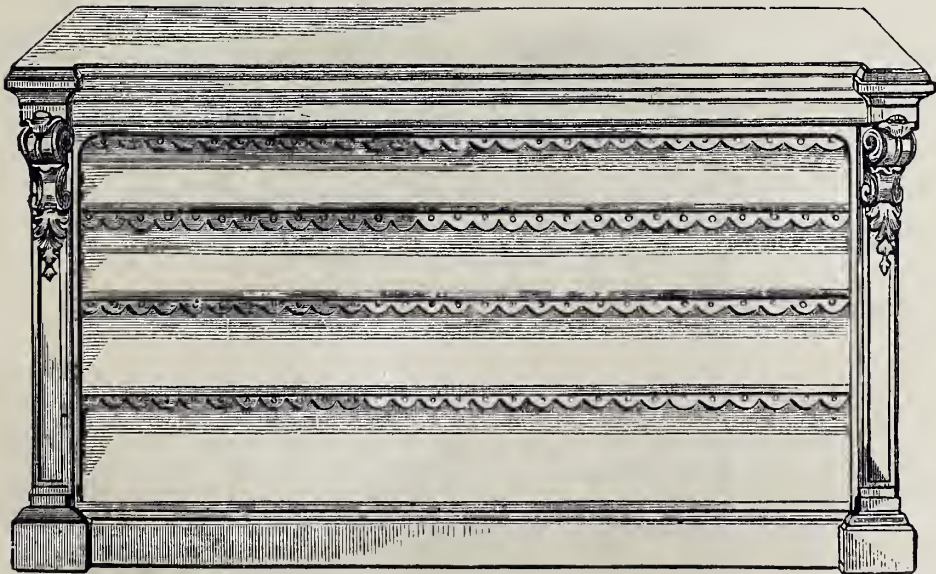

146

HAMPTON & SONS

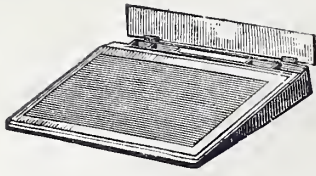

147

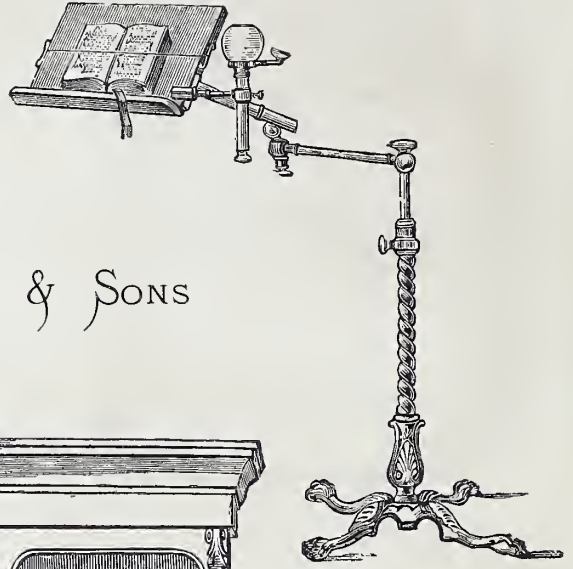

148

HAMPTON & SONS

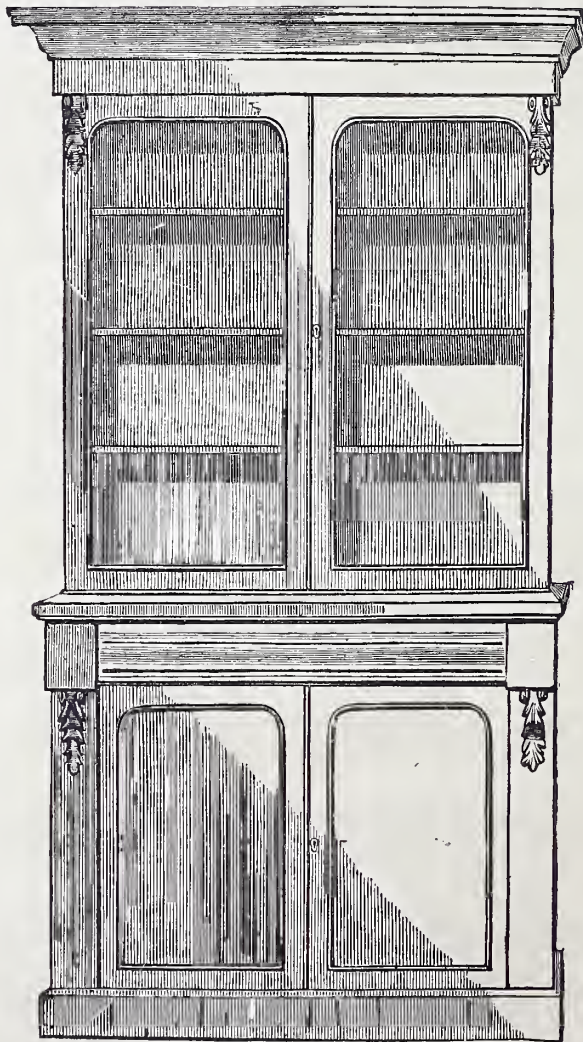

149

HAMPTON & SONS





150

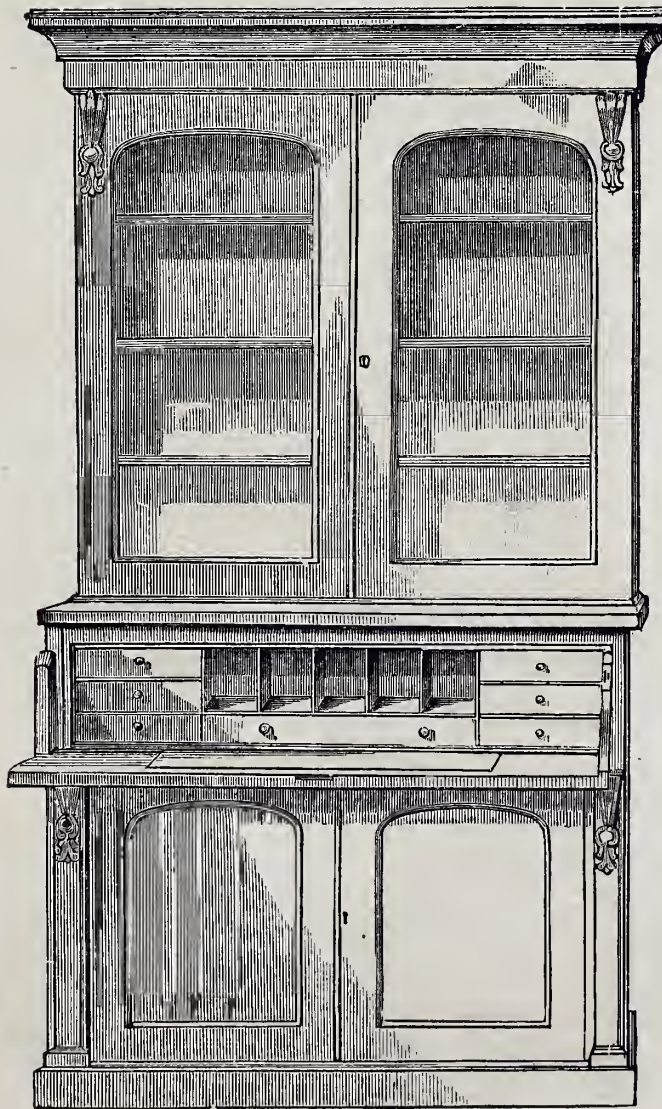

151

HAMPTON & SONS.



152

HAMPTON & SONS.



153

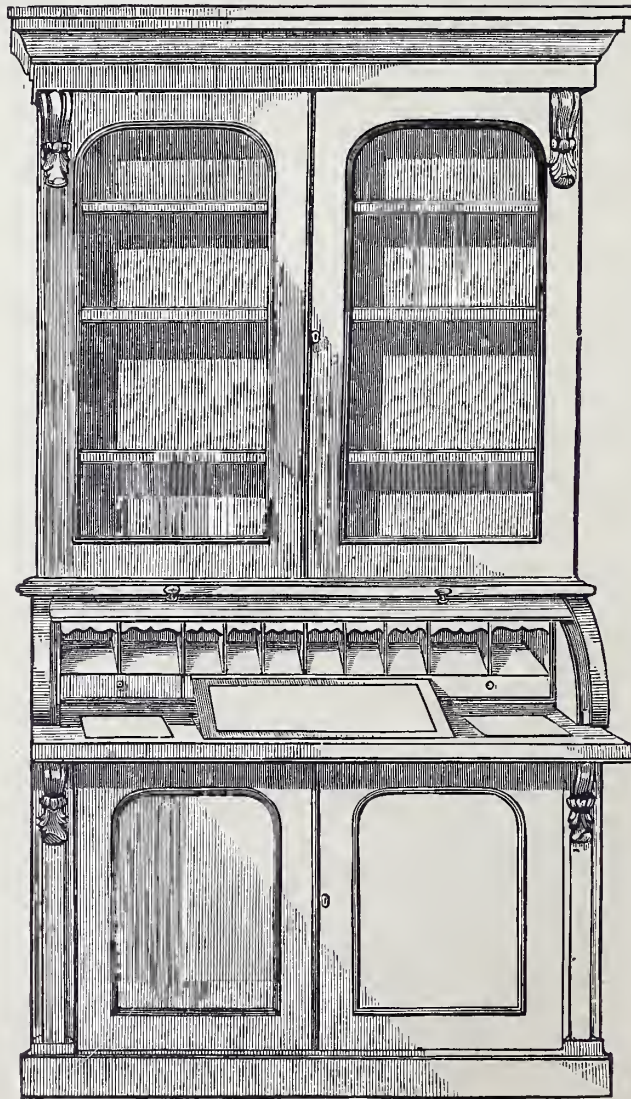

154

HAMPTON & SONS



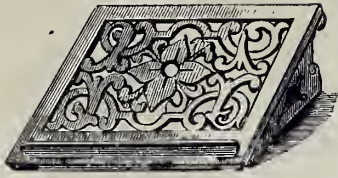

155

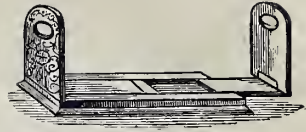

156

HAMPTON & SONS

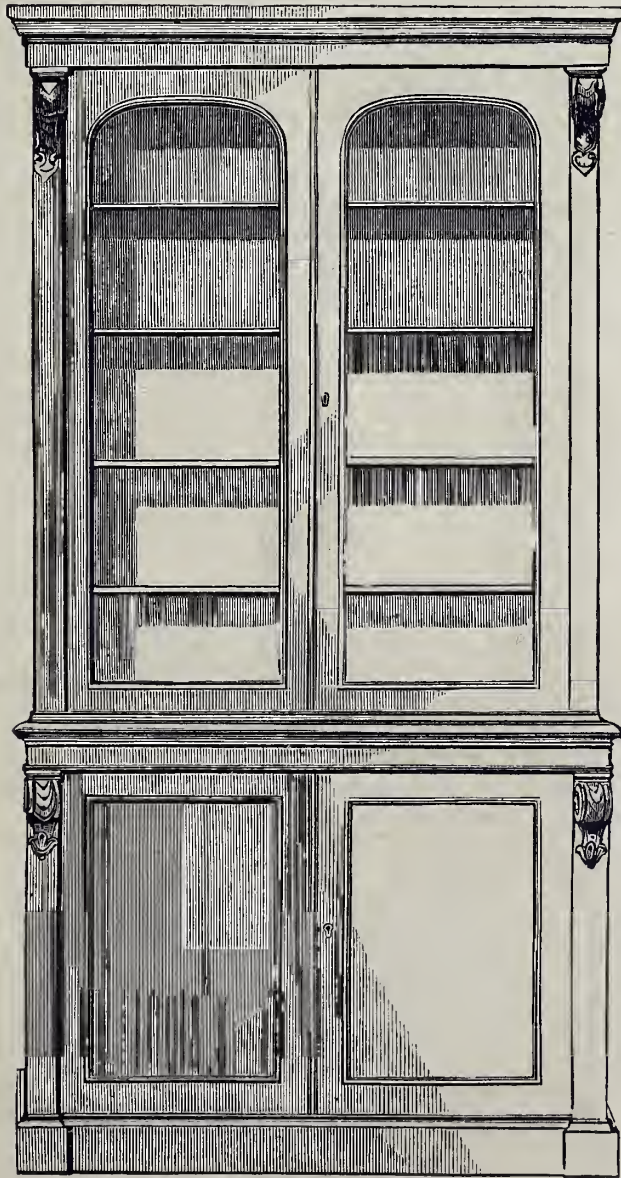

157

HAMPTON & SONS



158

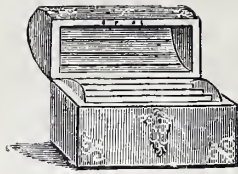

159



160

HAMPTON & SONS

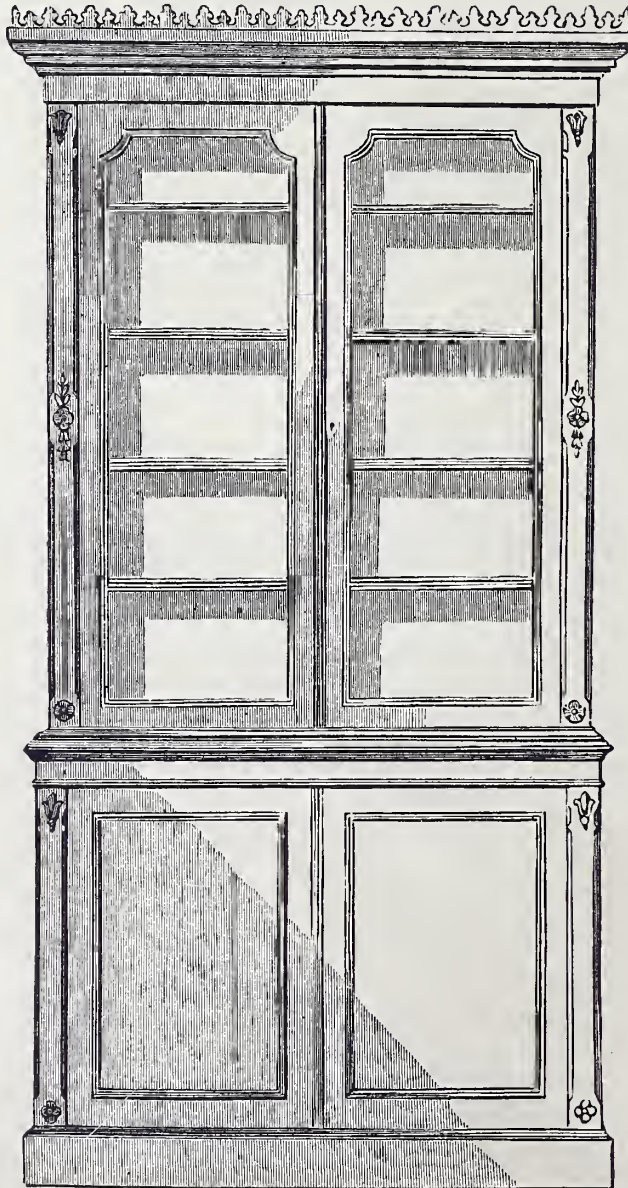

161

HAMPTON & SONS



HAMPTON & SONS

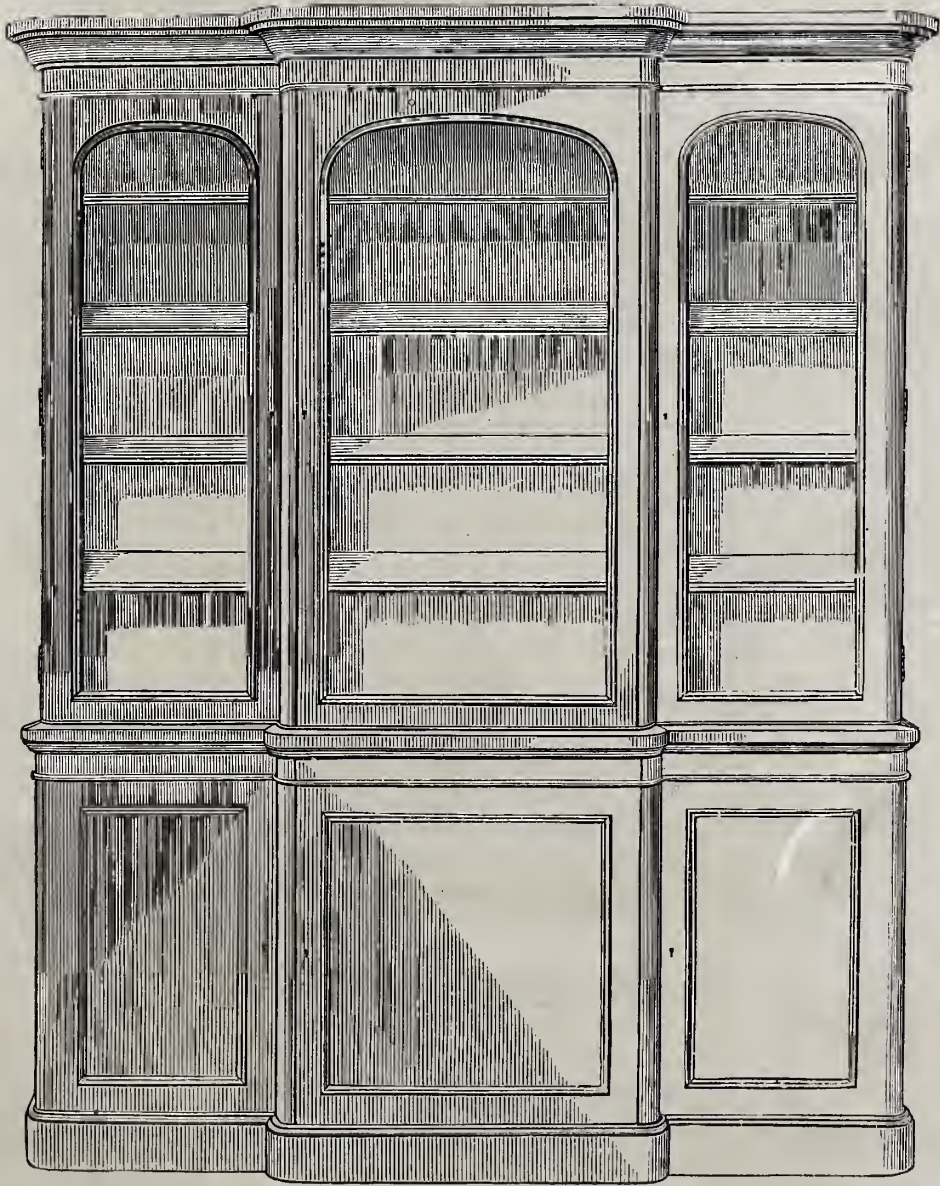

162

HAMPTON & SONS



HAMPTON & SONS

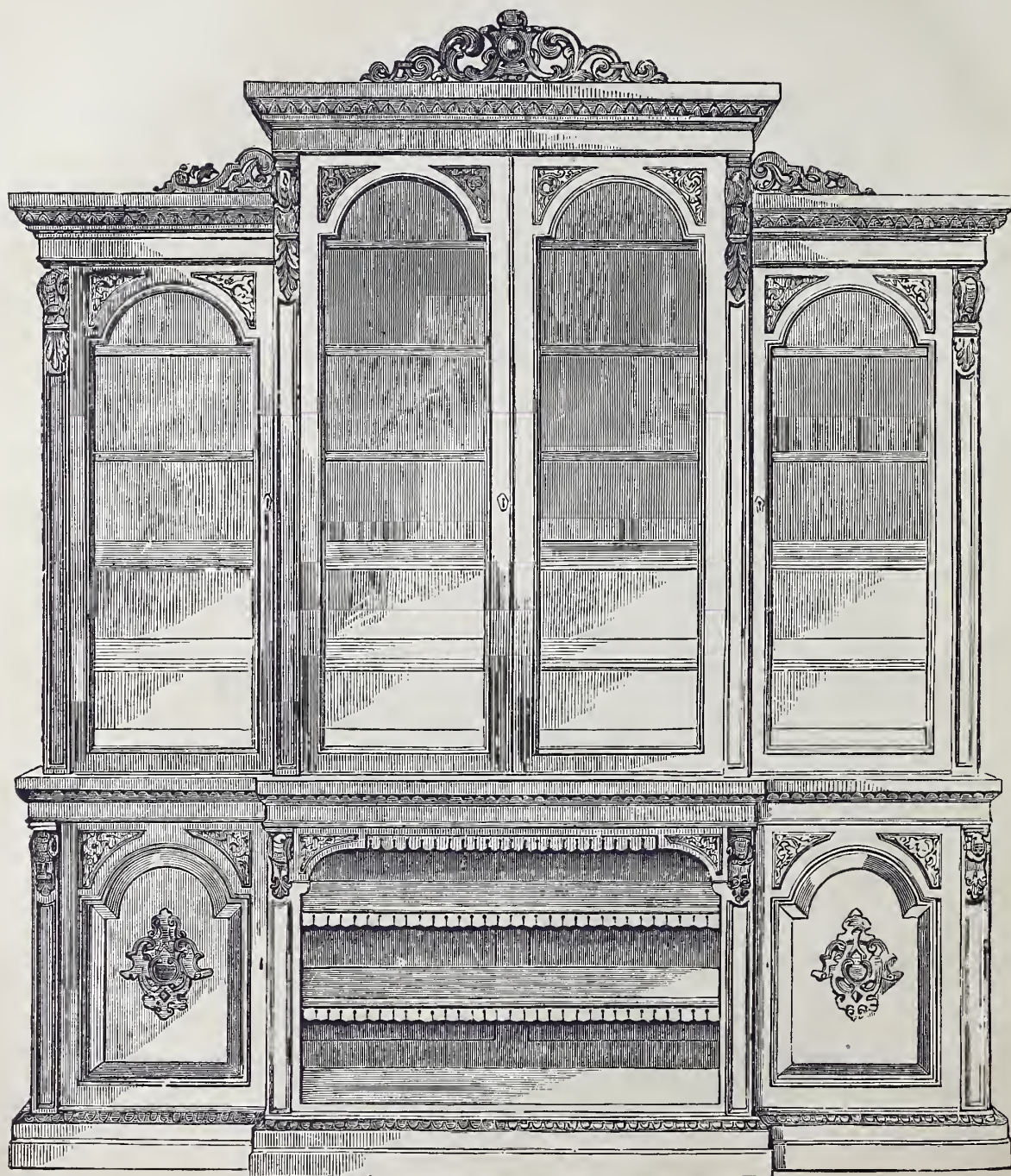

163

HAMPTON & SONS



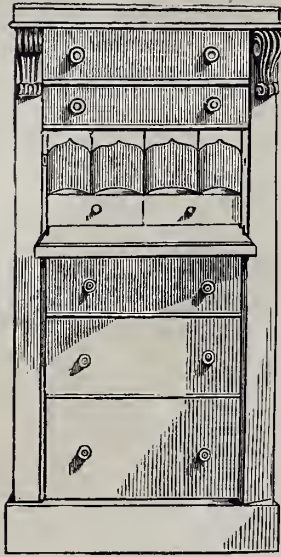

164

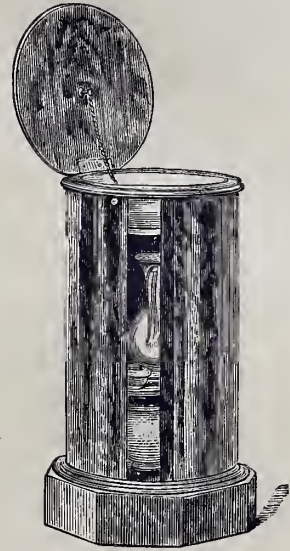

165

HAMPTON & SONS

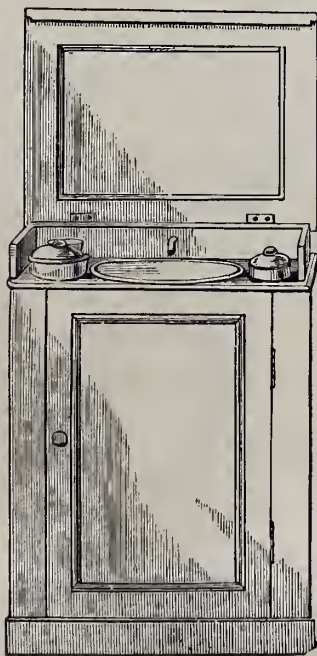

166



167

HAMPTON & SONS

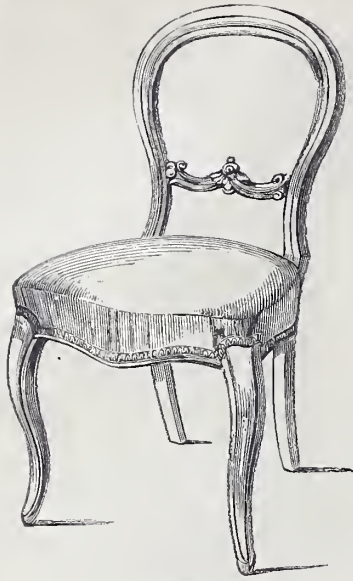

168

HAMPTON & SONS



169



170



171

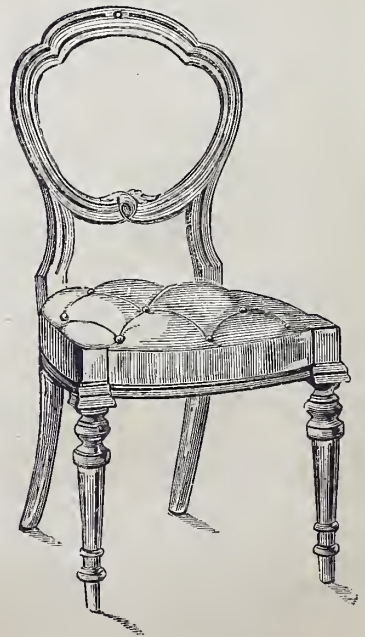

172

HAMPTON & SONS



HAMPTON & SONS

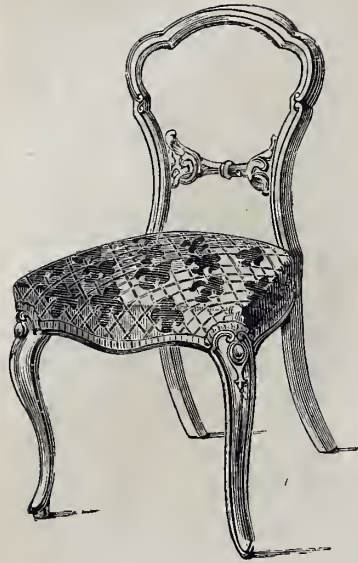

173



174



175



176



177

HAMPTON & SONS

HAMPTON & SONS



178



179

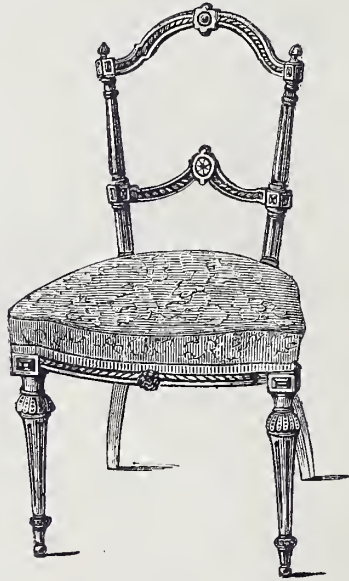

180

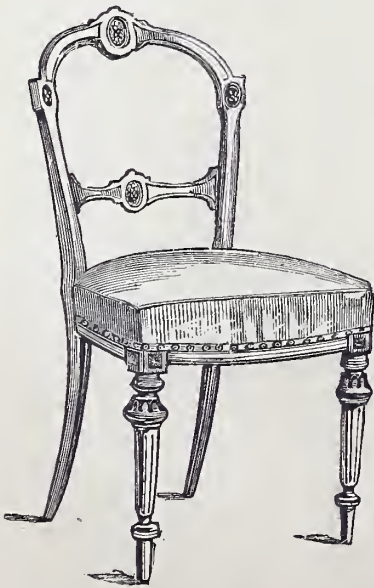

181

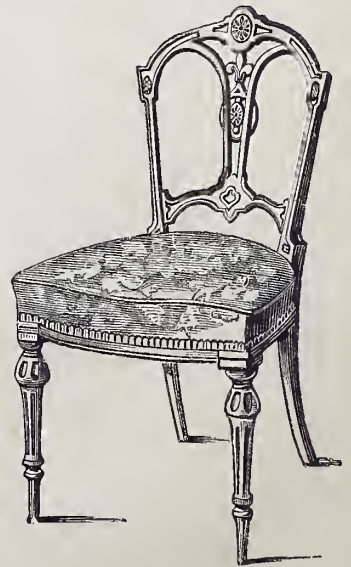

182

HAMPTON & SONS





183

HAMPTON & SONS



184



185



186



187

HAMPTON & SONS



188



189



190



191



192

HAMPTON & SONS

HAMPTON & SONS



HAMPTON & SONS



193



194



195

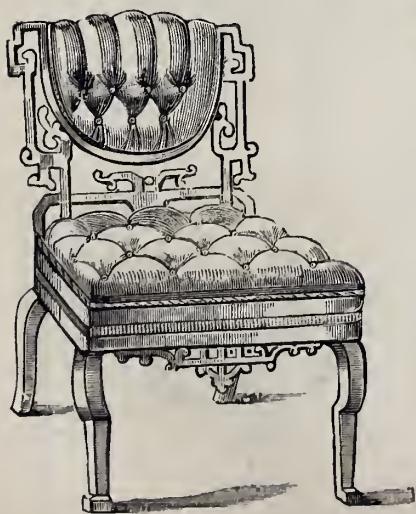

196

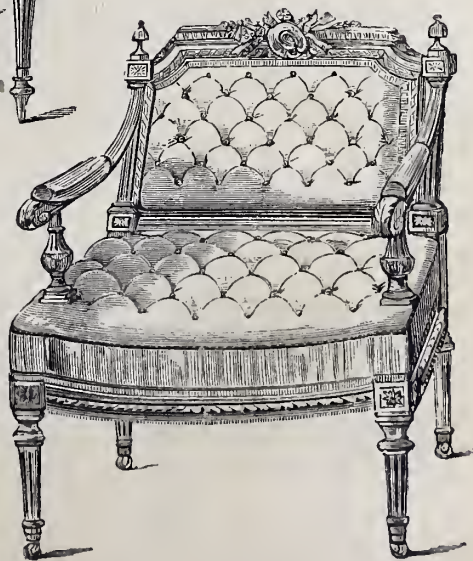

197

HAMPTON & SONS



198

HAMPTON & SONS



199

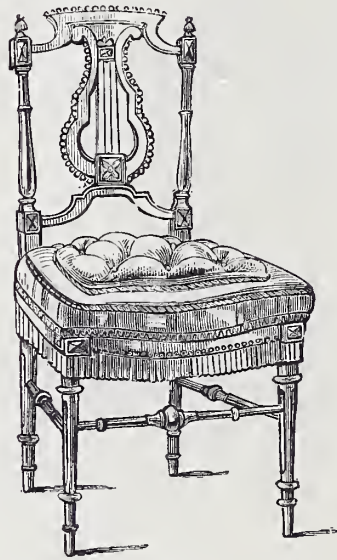

200



201



202

HAMPTON & SONS





203

HAMPTON & SONS



204



205



206



207

HAMPTON & SONS

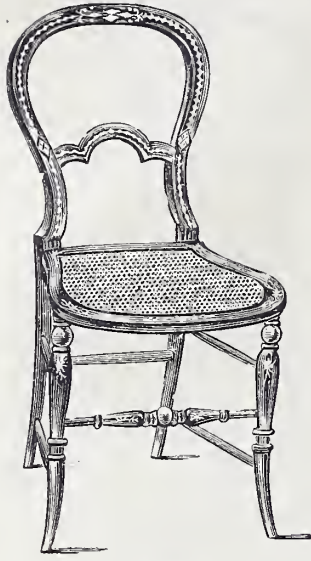

208

HAMPTON & SONS

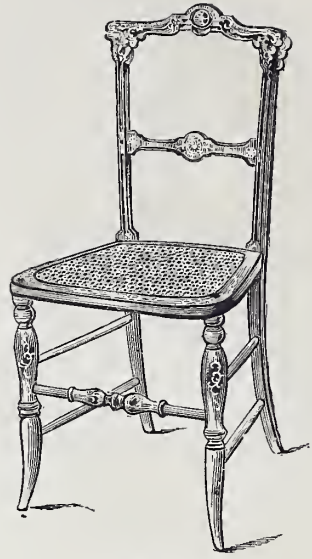

209

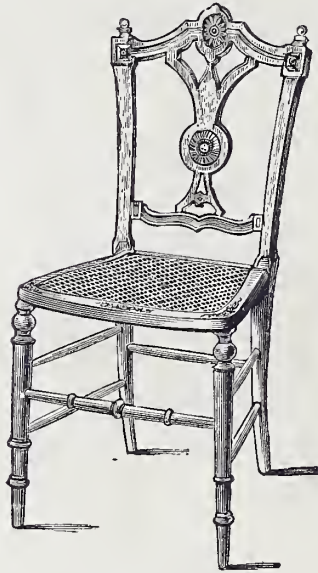

210

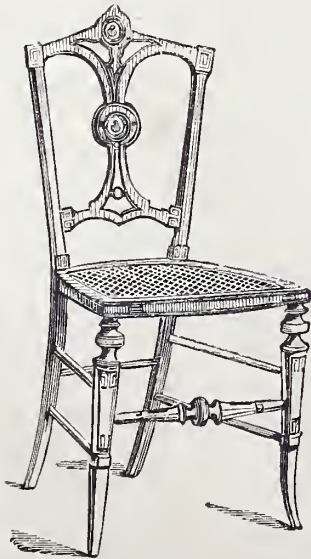

211

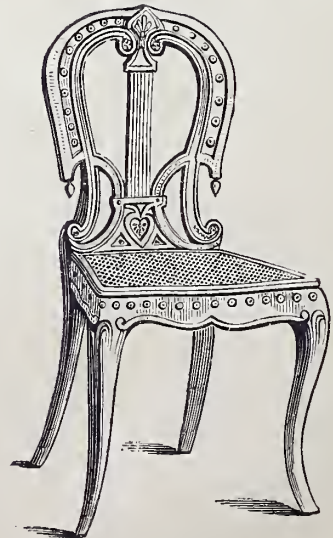

212

HAMPTON & SONS





213

HAMPTON & SONS

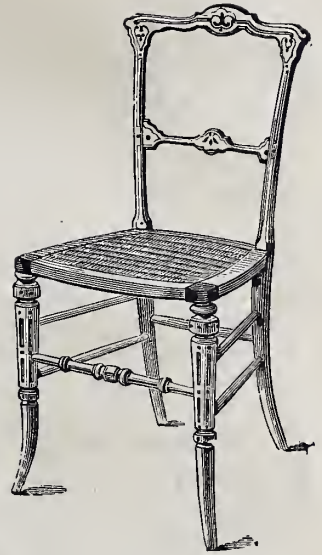

214



215

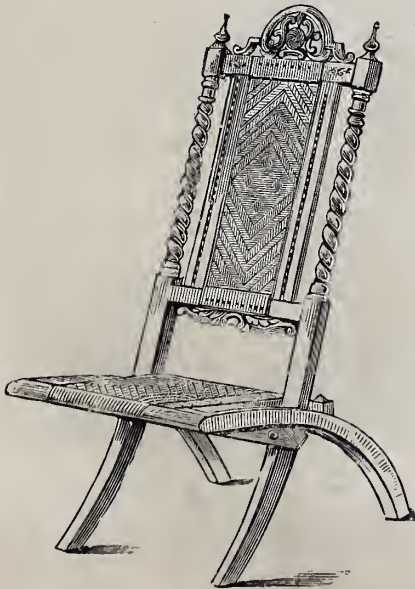

216

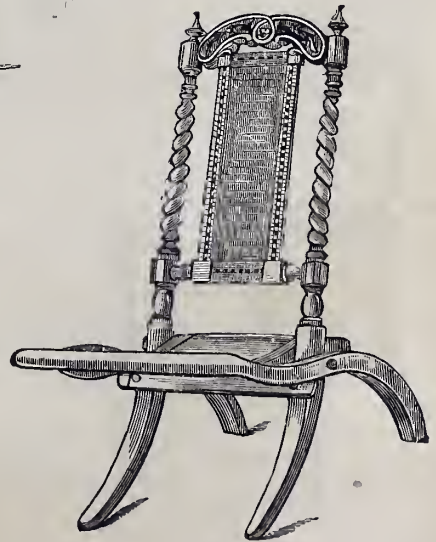

217

HAMPTON & SONS



218

HAMPTON & SONS



219



220



221



222

HAMPTON & SONS



HAMPTON & SONS



223

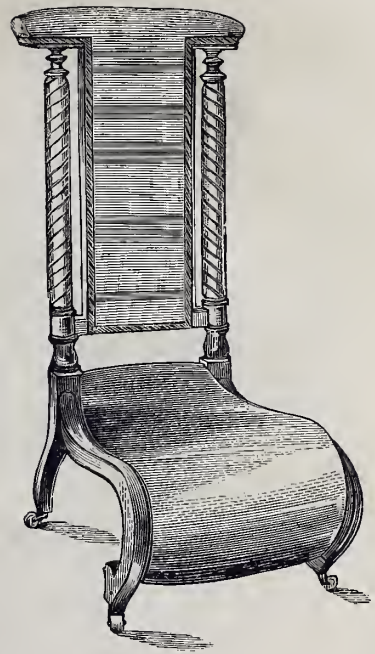

224

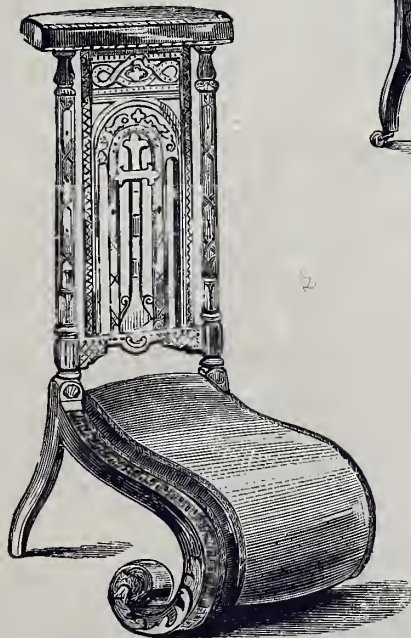

225

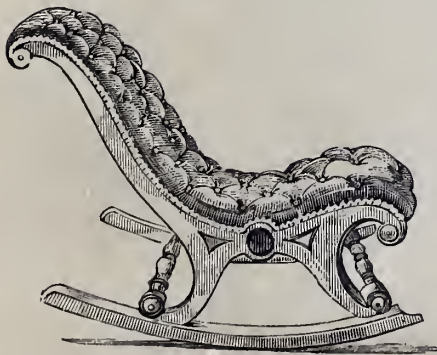

226



227

HAMPTON & SONS



228



229

HAMPTON & SONS



230

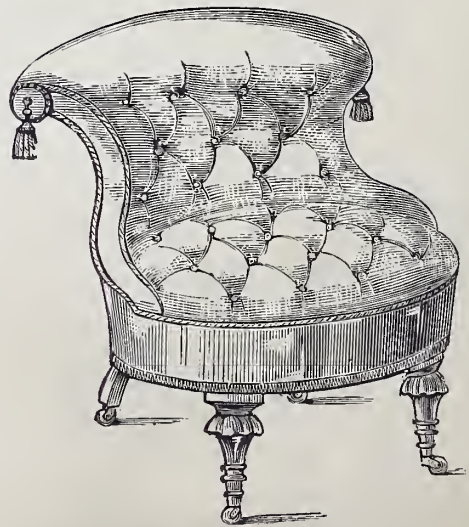

231

HAMPTON & SONS





232



233

HAMPTON & SONS

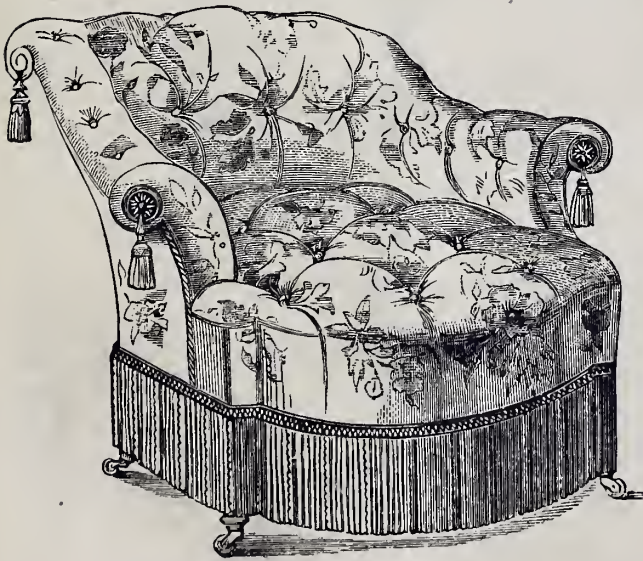

234



235

HAMPTON & SONS



236



237

HAMPTON & SONS

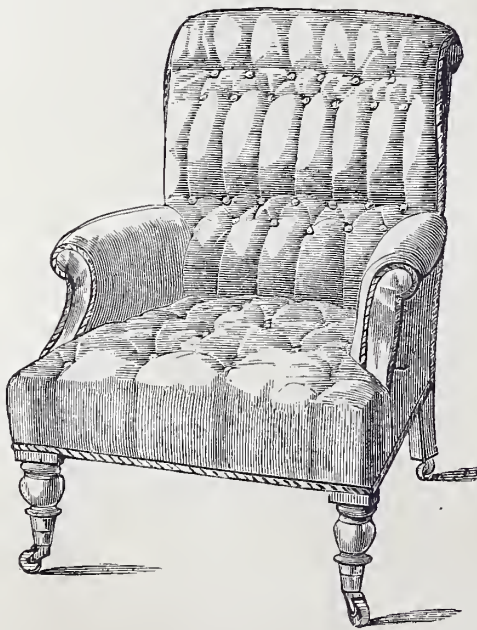

238

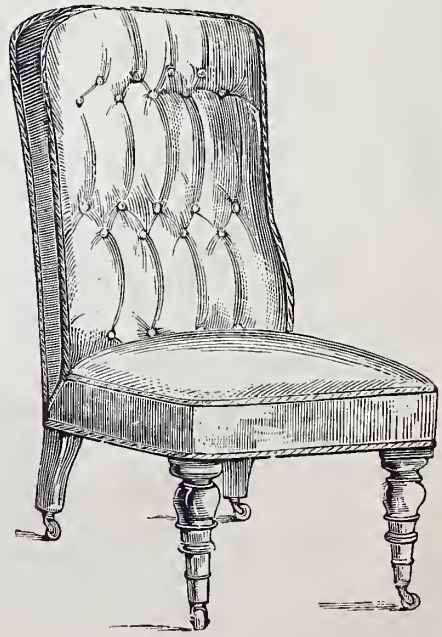

239

HAMPTON & SONS



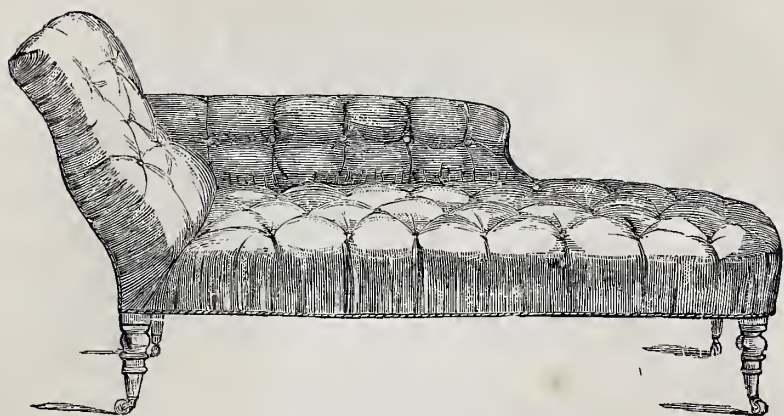

240

HAMPTON & SONS

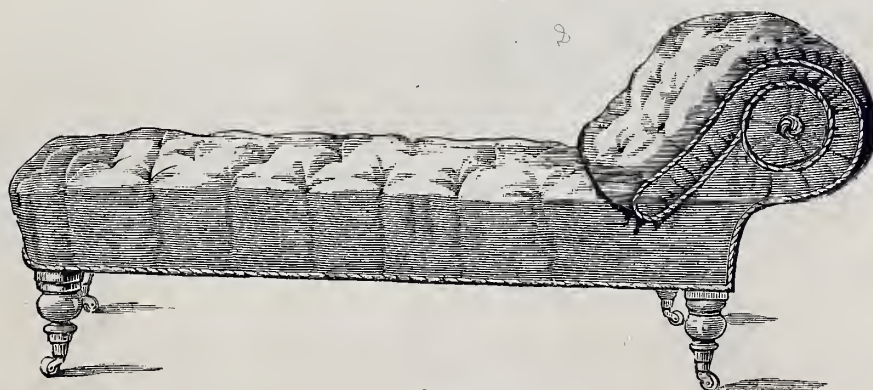

241

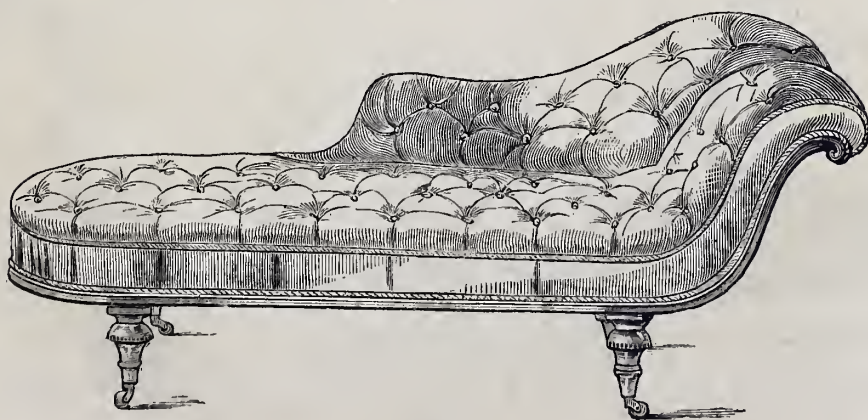

242

HAMPTON & SONS

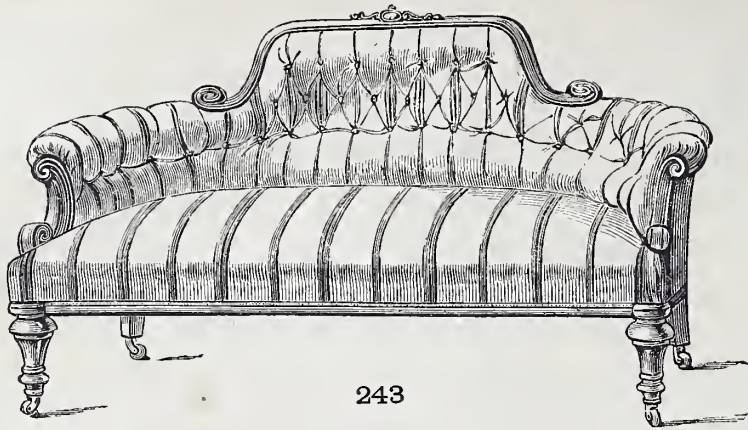

243

HAMPTON & SONS

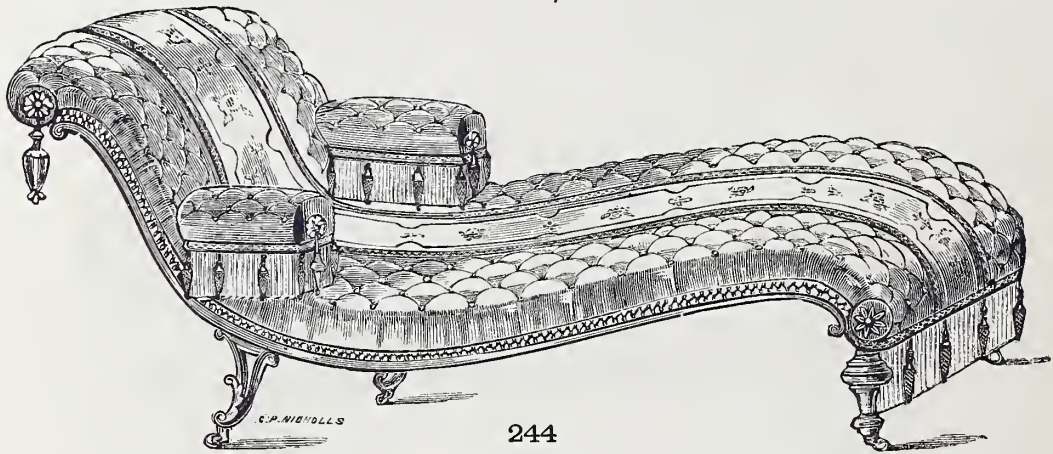

244

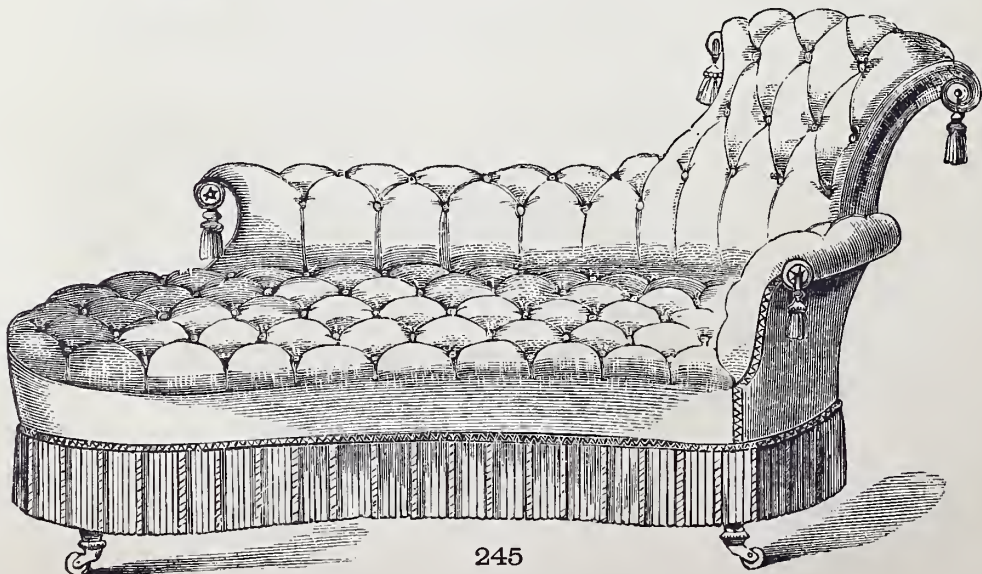

245

HAMPTON & SONS





246

HAMPTON & SONS

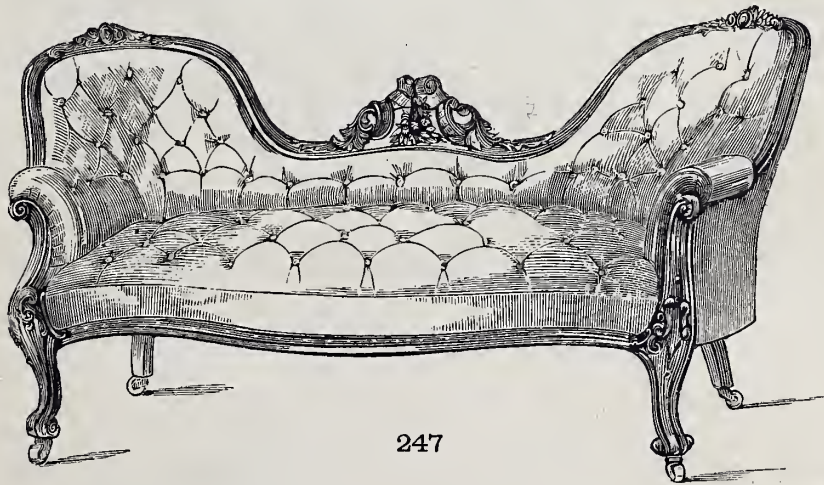

247

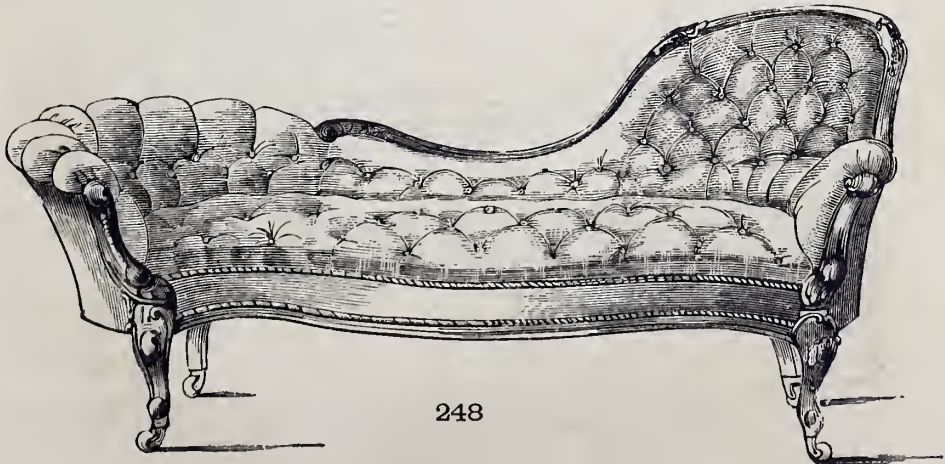

248

HAMPTON & SONS

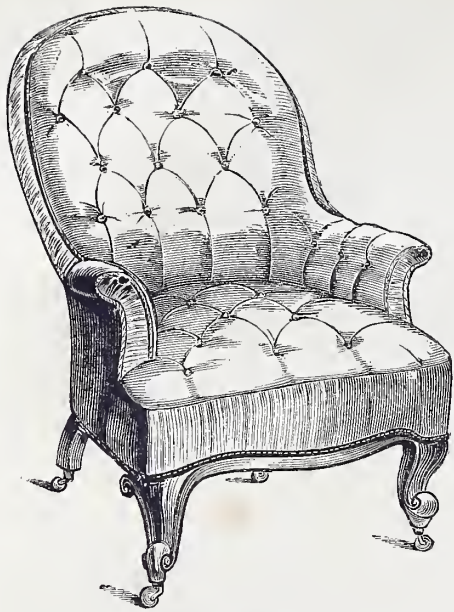

249

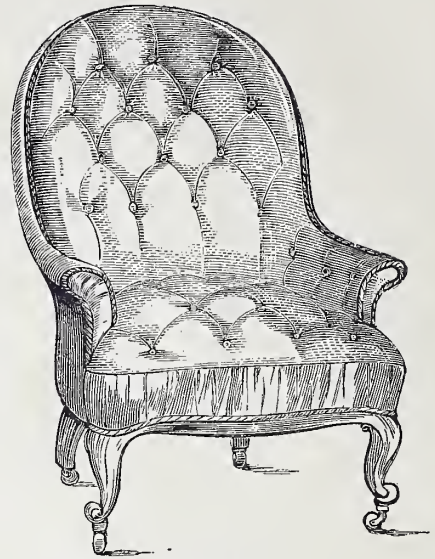

250

HAMPTON & SONS

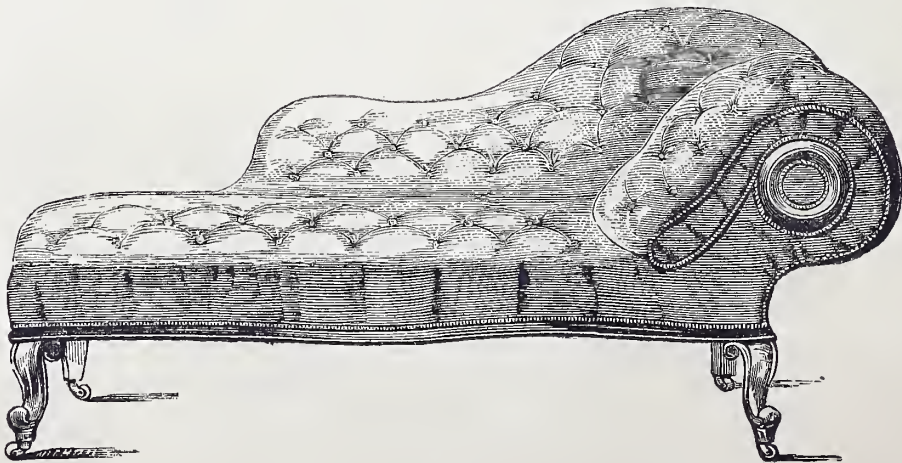

251

HAMPTON & SONS



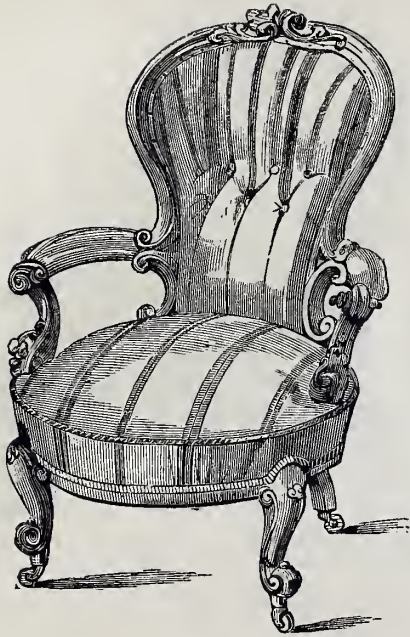

252



253

HAMPTON & SONS

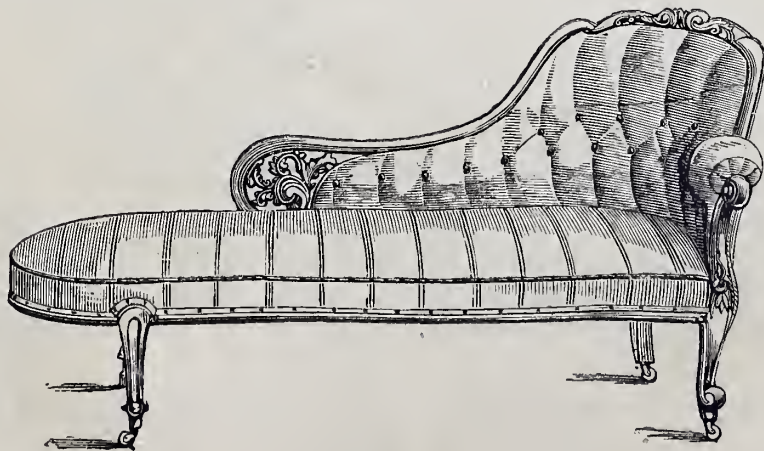

254

HAMPTON & SONS

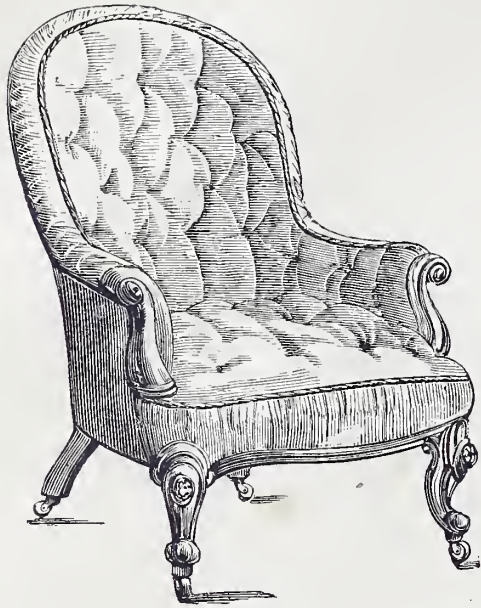

255

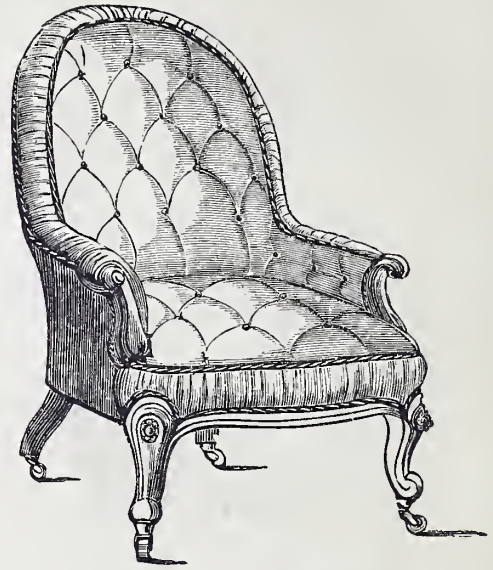

256

HAMPTON & SONS

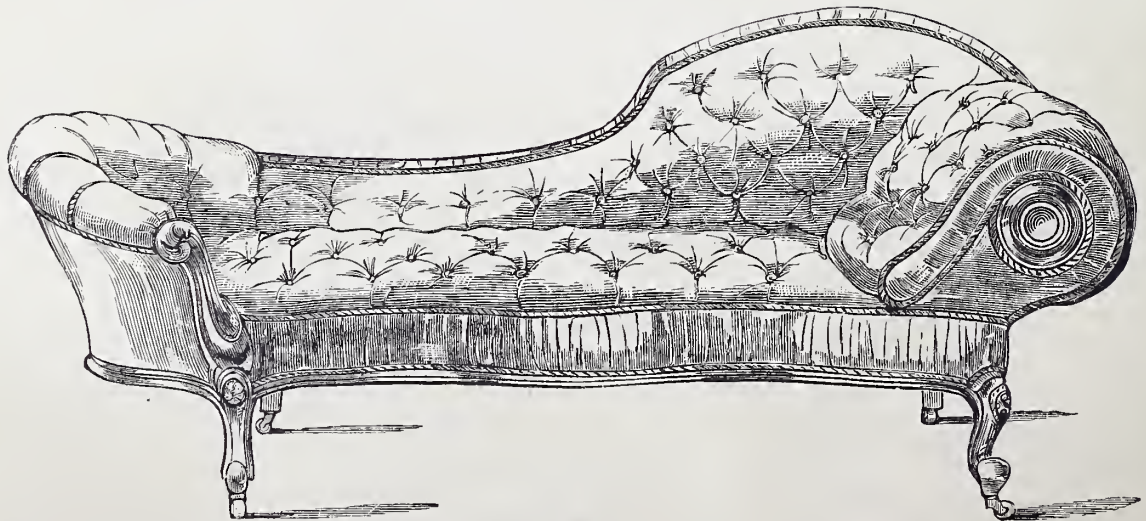

257

HAMPTON & SONS





258



259

HAMPTON & SONS

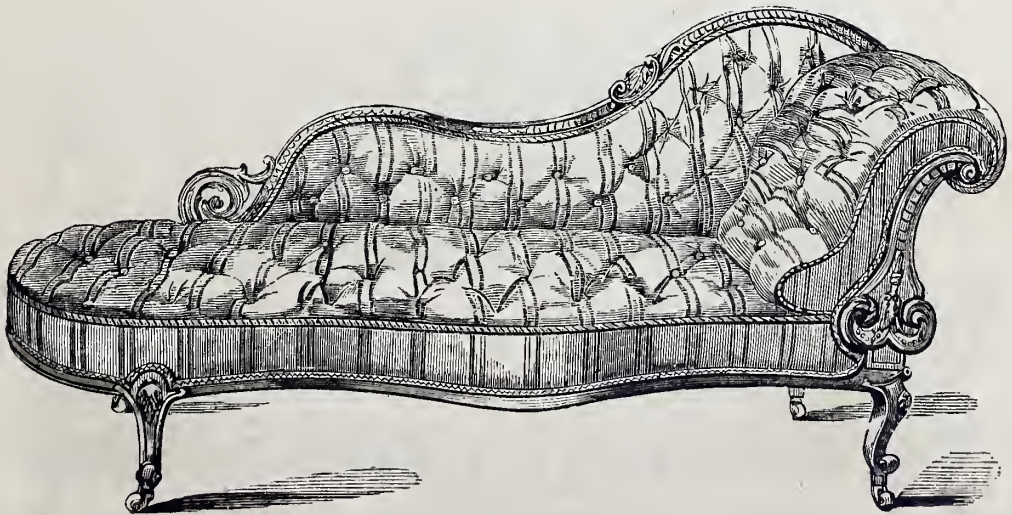

260

HAMPTON & SONS

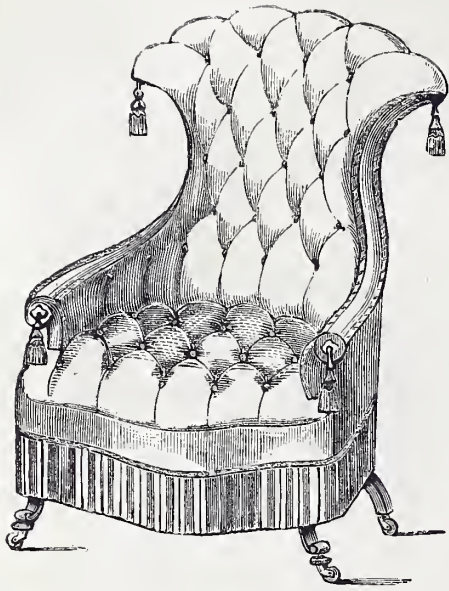

261

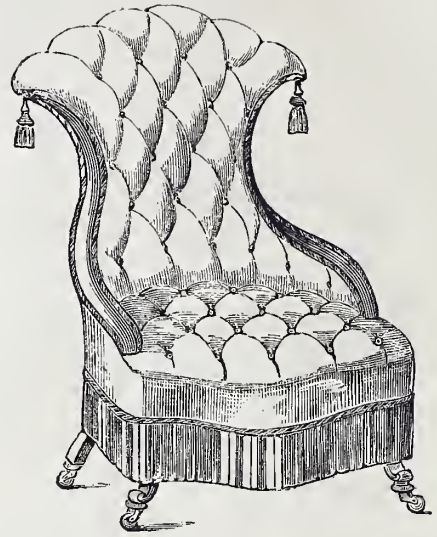

262

HAMPTON & SONS

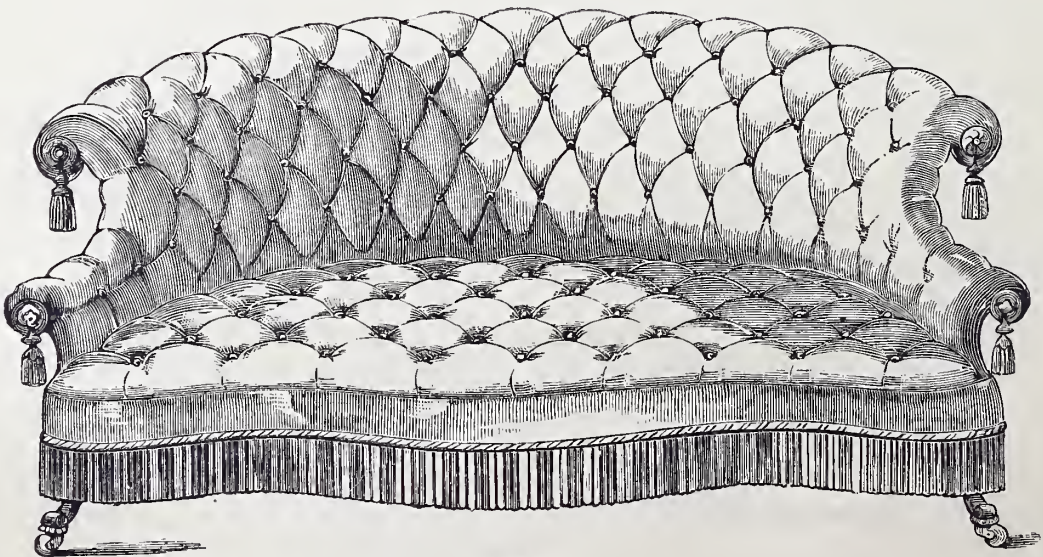

263

HAMPTON & SONS





264



265

HAMPTON & SONS

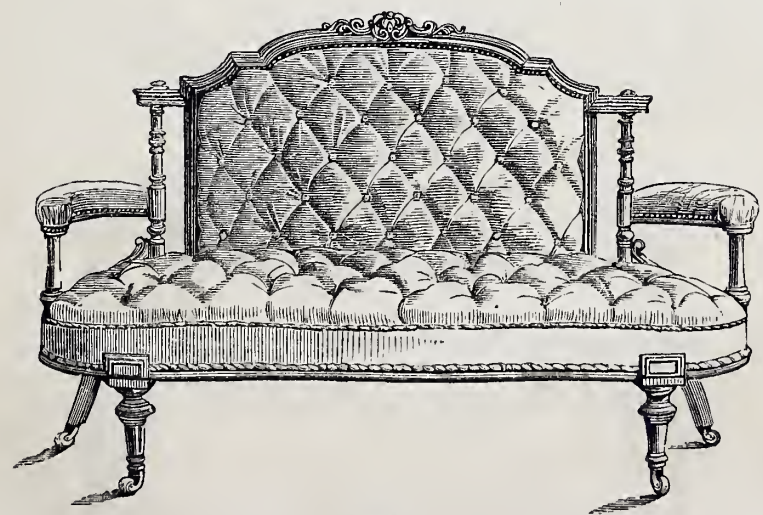

266

HAMPTON & SONS



267



268

HAMPTON & SONS

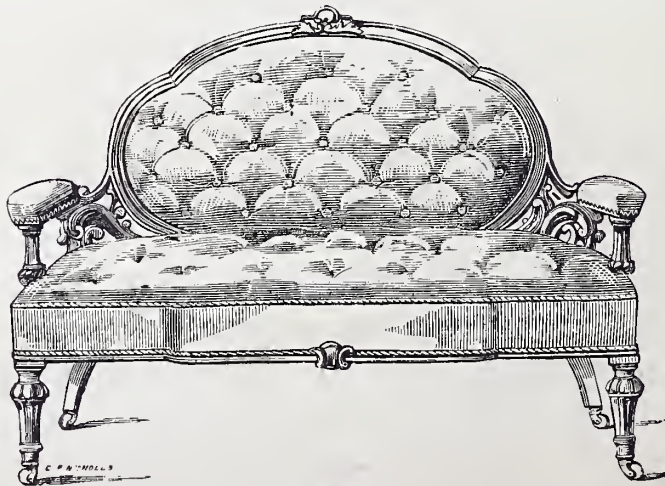

269

HAMPTON & SONS



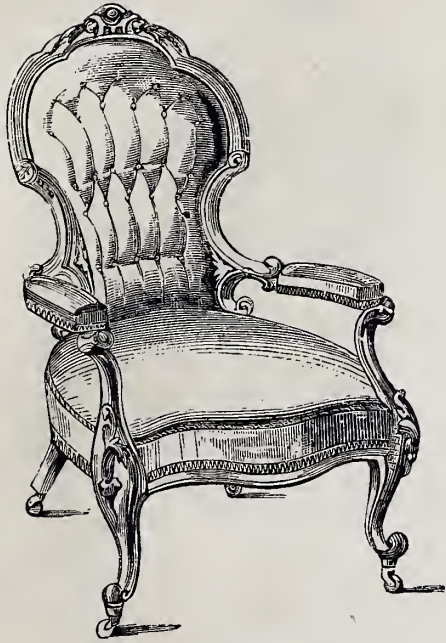

270

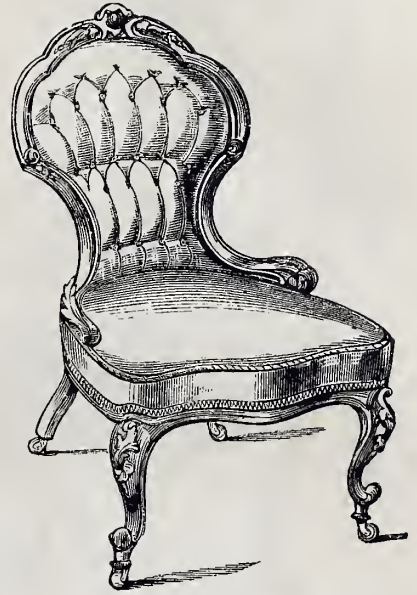

271

HAMPTON & SONS

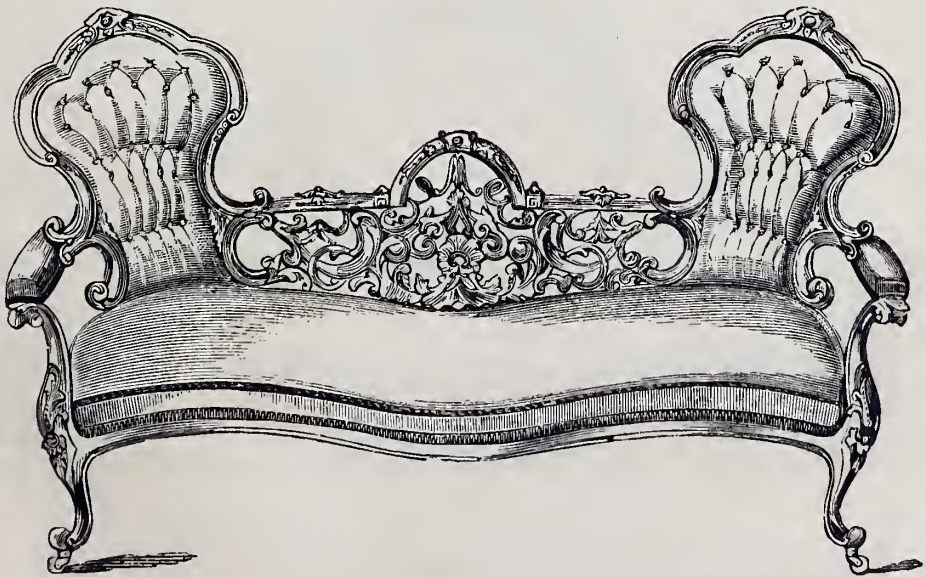

272

HAMPTON & SONS

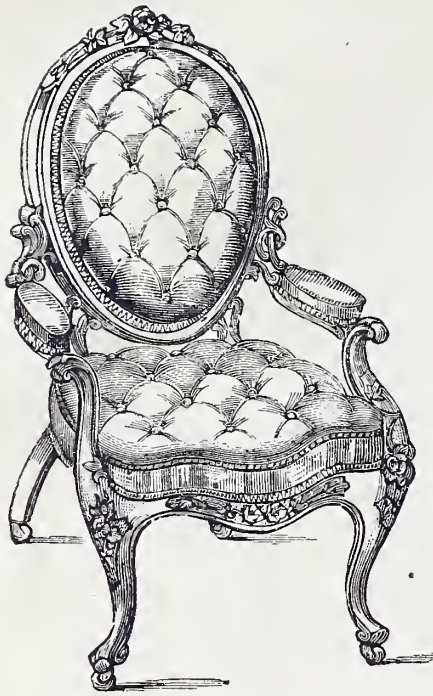

273

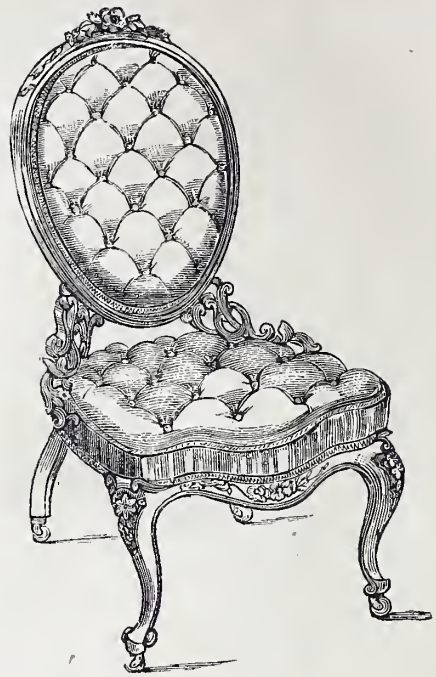

274

HAMPTON & SONS

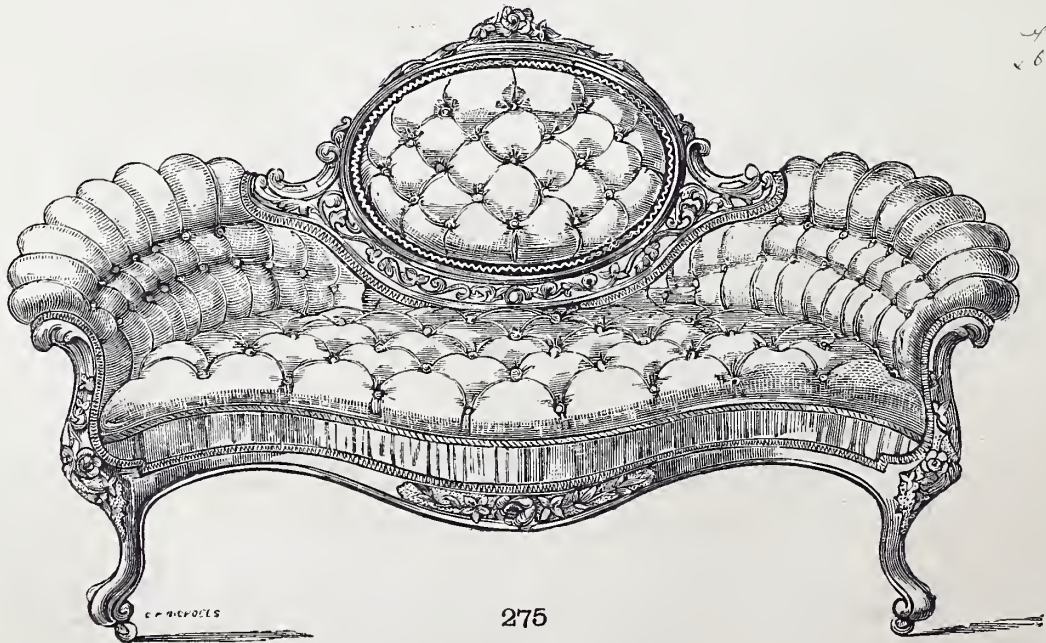

275

HAMPTON & SONS





276

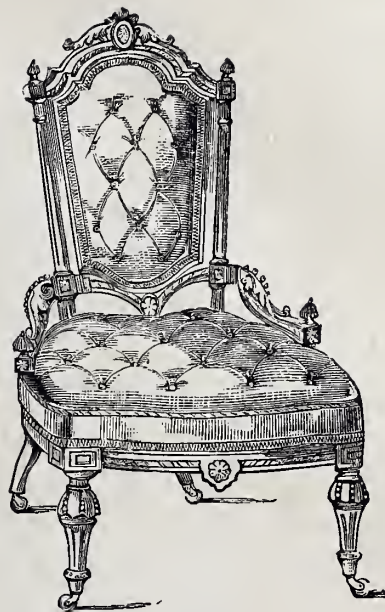

277

HAMPTON & SONS

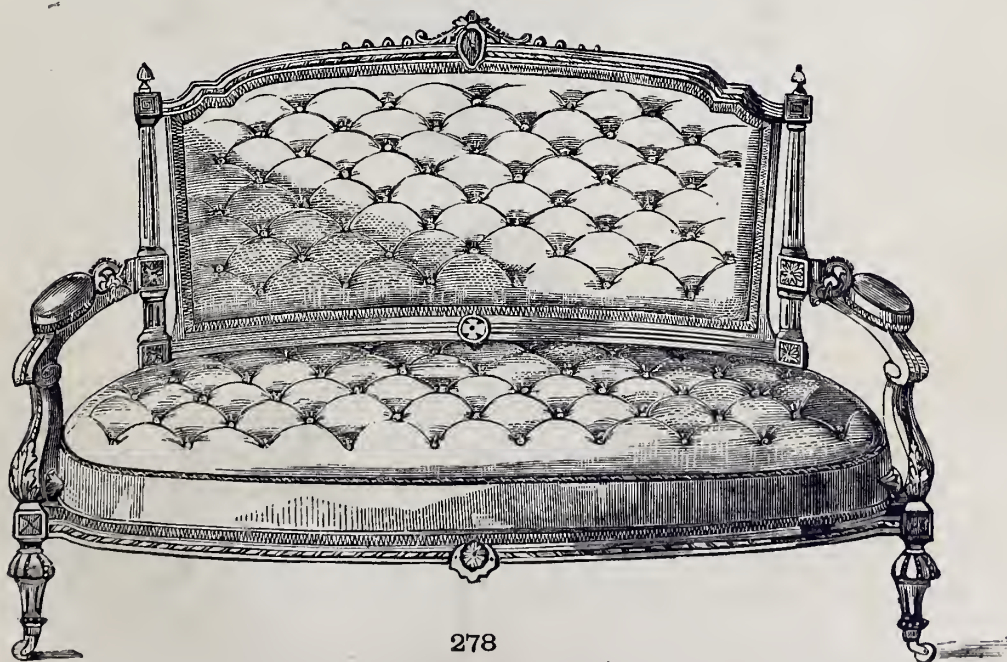

278

HAMPTON & SONS

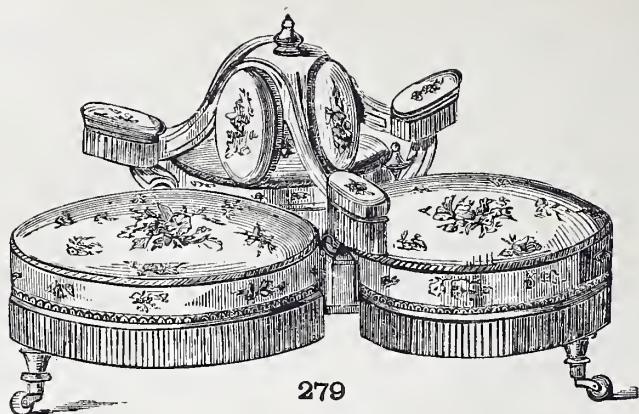

279

HAMPTON & SONS

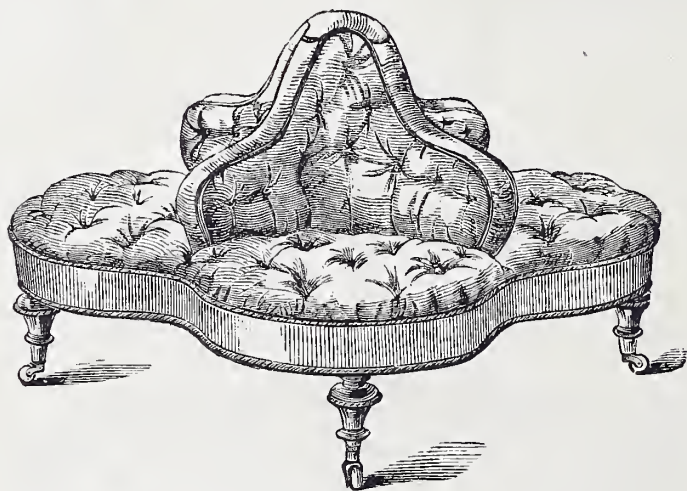

280

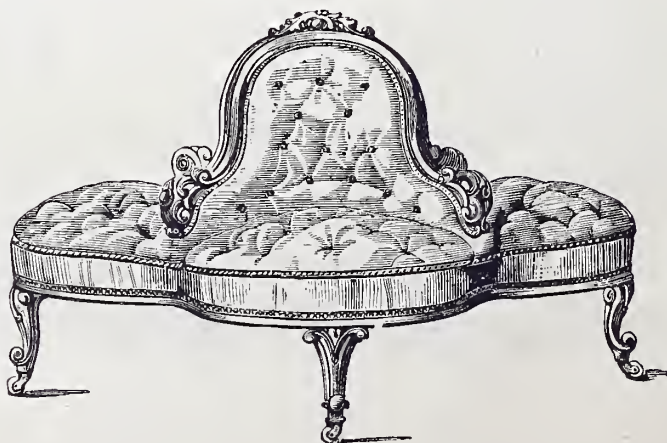

281

HAMPTON & SONS



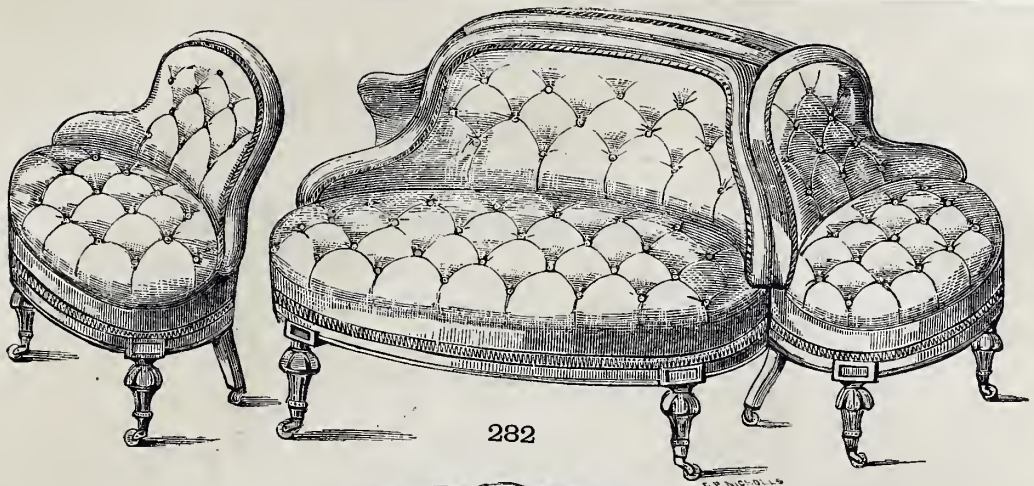

282

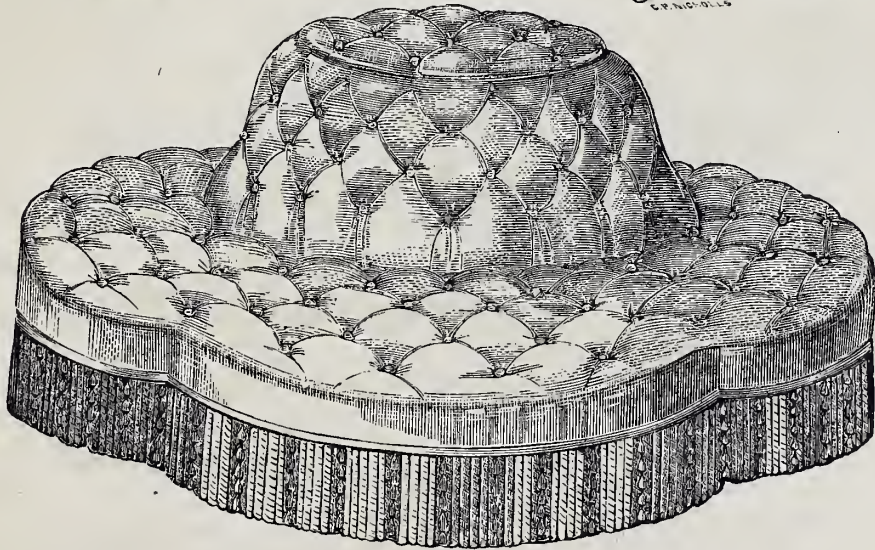

283

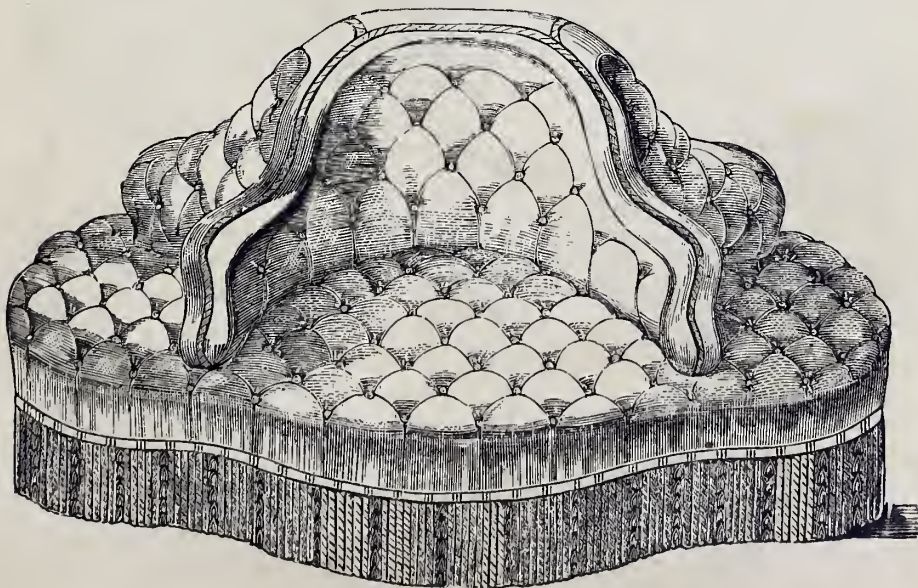

284



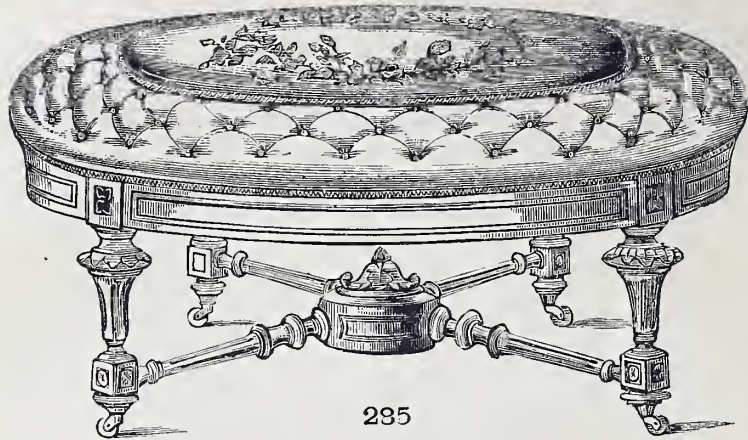

285

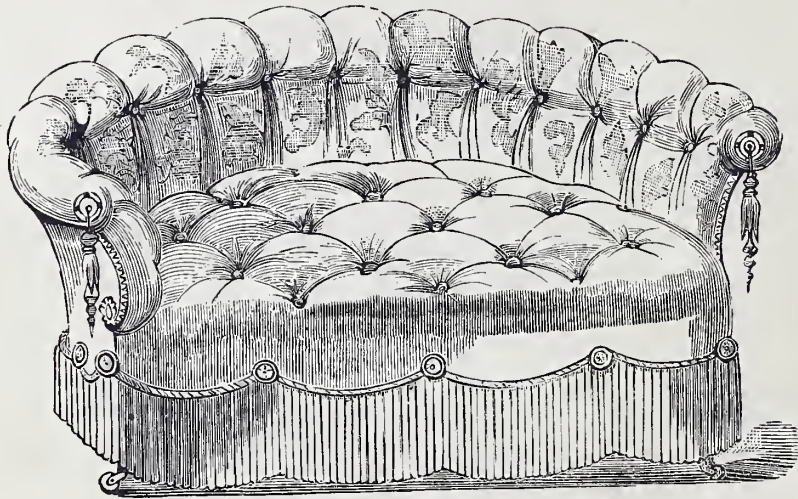

286

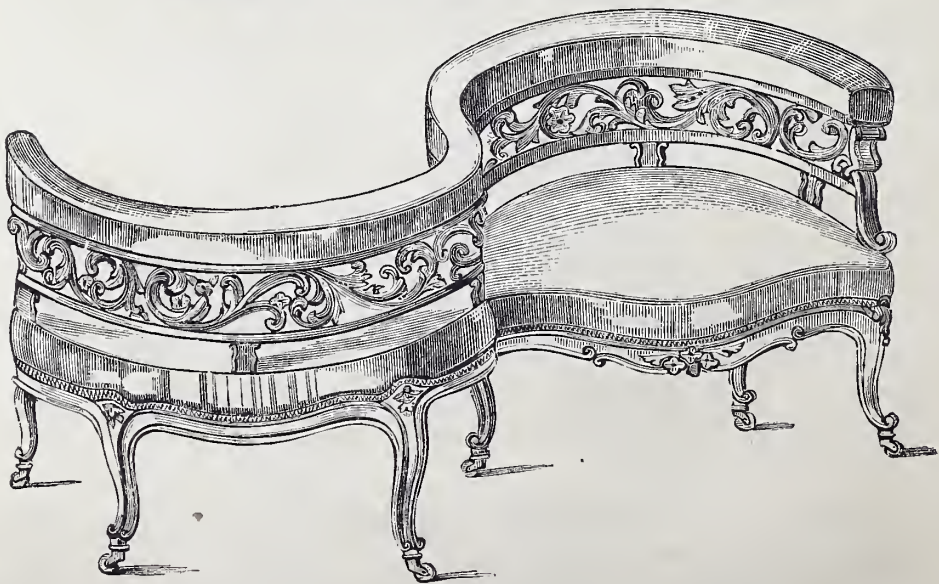

237

HAMPTON & SONS





288



289



290



291



292



293



294

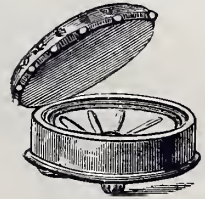

295

HAMPTON & SONS

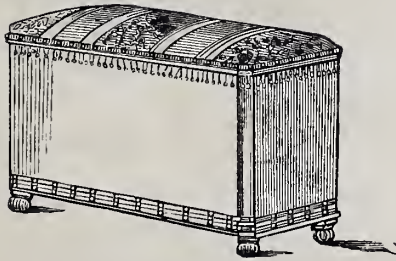

296



297



298



299

HAMPTON & SONS

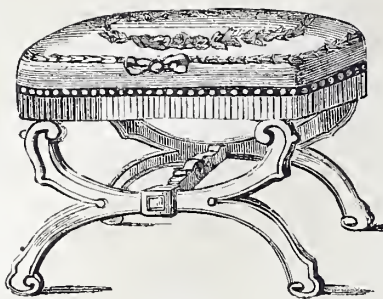

300

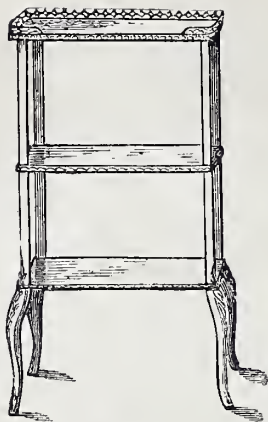

301

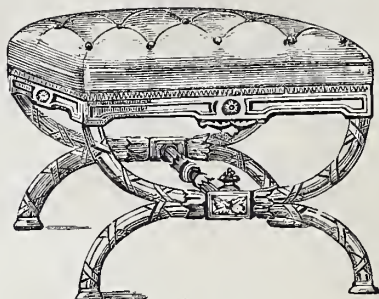

302

HAMPTON & SONS

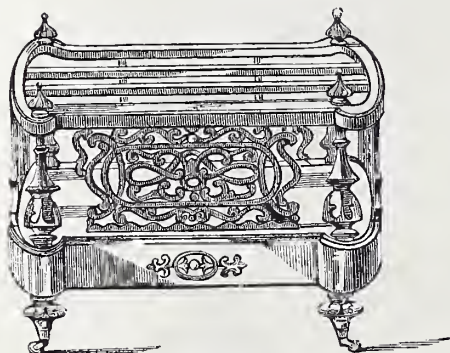

303

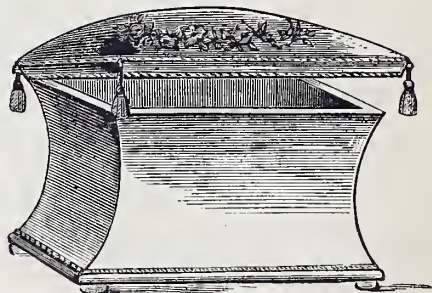

304

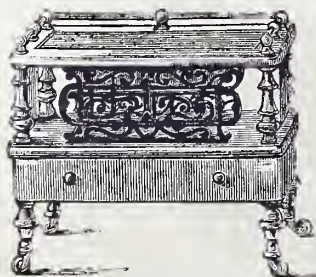

305

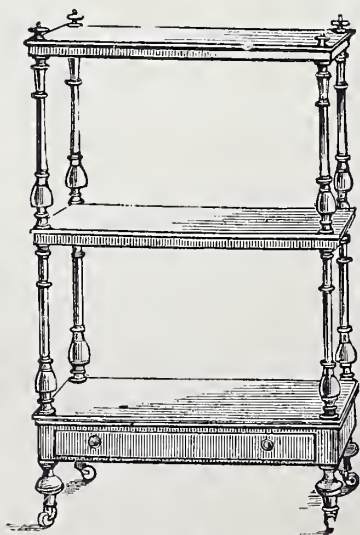

306

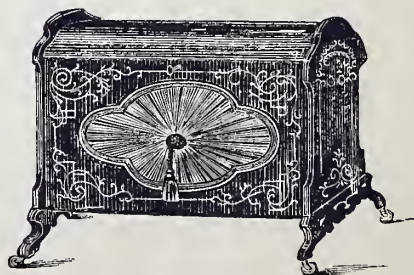

307

HAMPTON & SONS



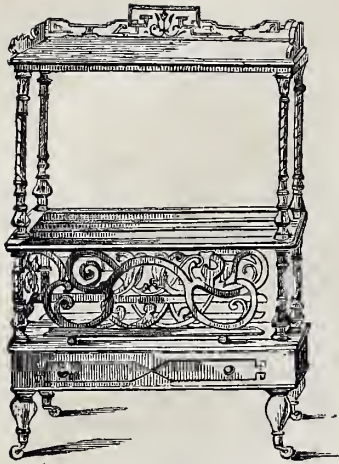

308

HAMPTON & SONS



309

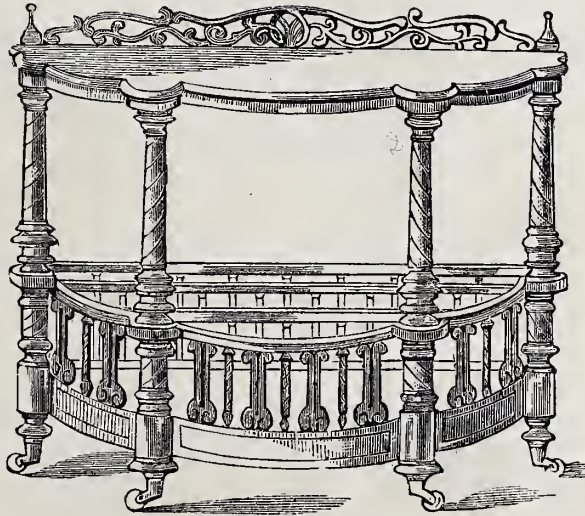

310

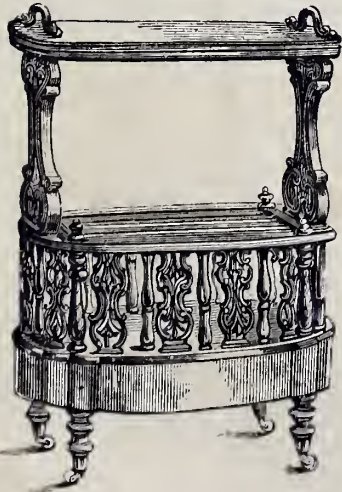

311

HAMPTON & SONS



312



313



314

HAMPTON & SONS

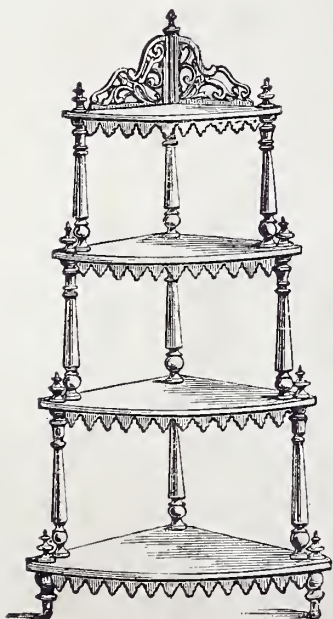

315

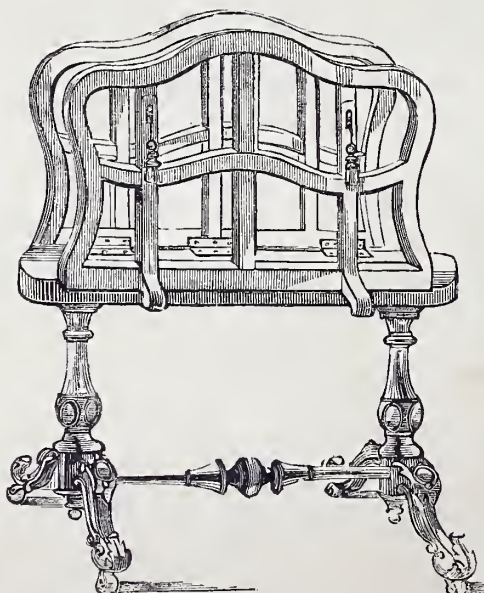

316

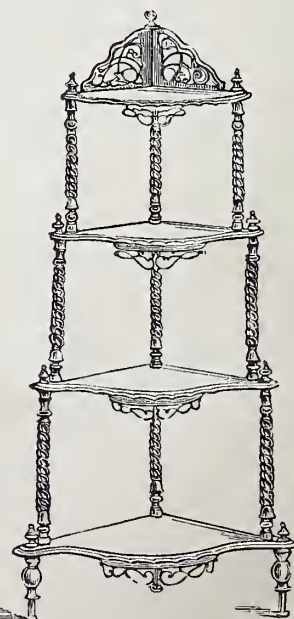

317

HAMPTON & SONS





318



319

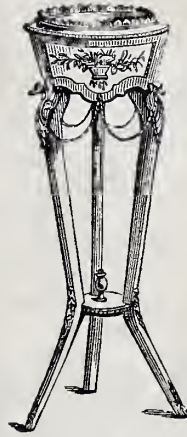

320



321

HAMPTON & SONS



322

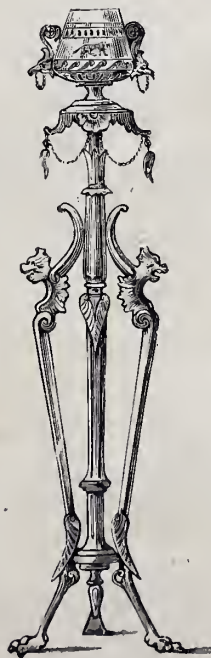

323

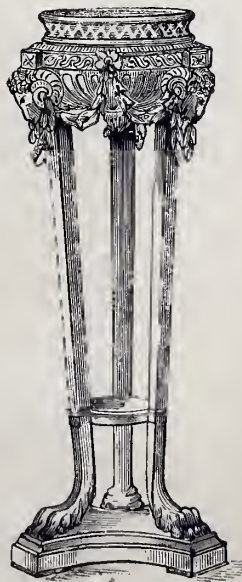

324

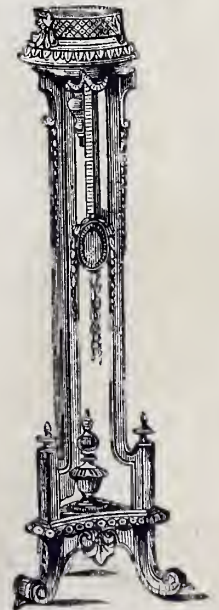

325

HAMPTON & SONS



326



327



328

HAMPTON & SONS

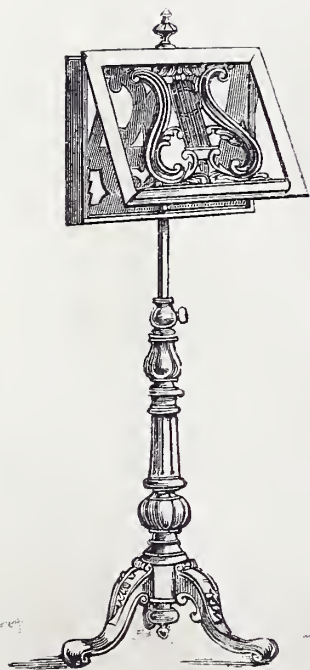

329

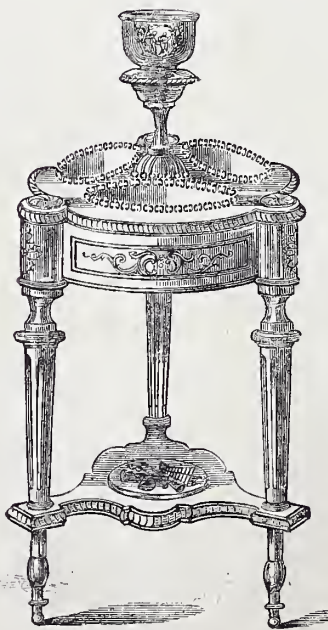

330

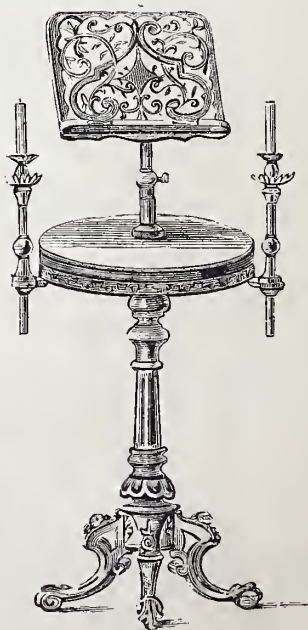

331

HAMPTON & SONS



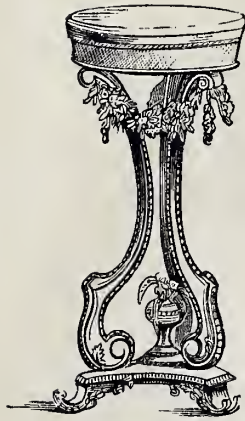

332



333

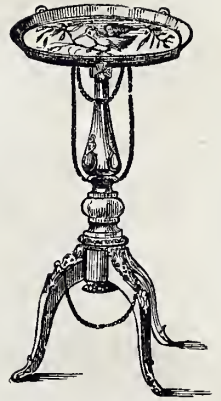

334

HAMPTON & SONS

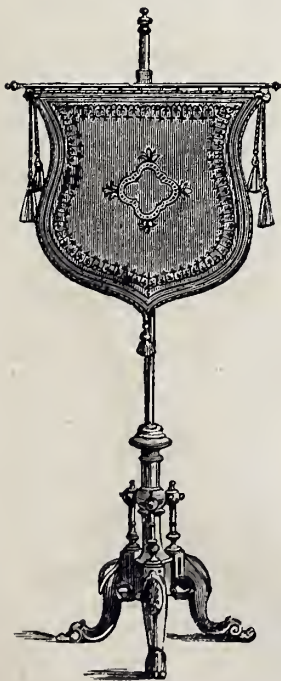

335



336

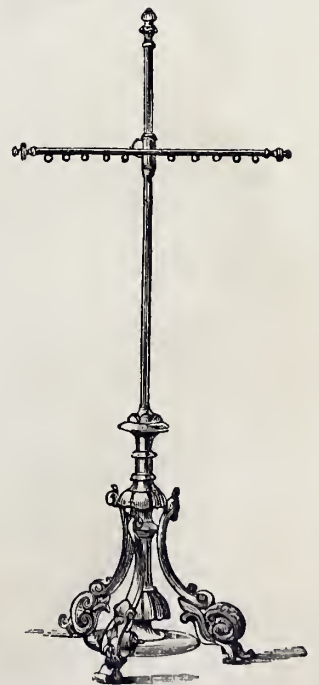

337

HAMPTON & SONS



338



339

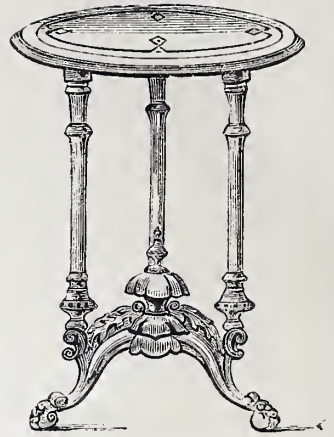

340

HAMPTON & SONS

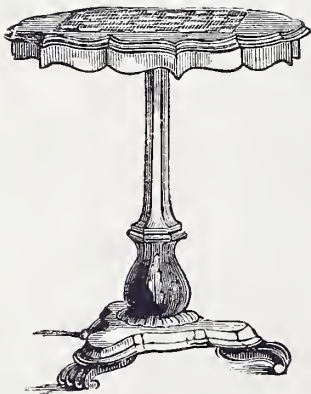

341



342



343



344



345

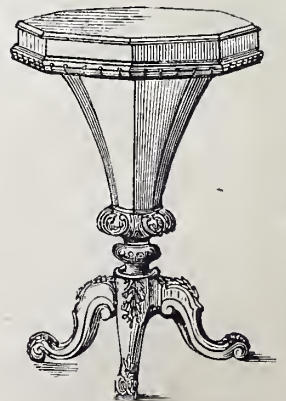

346

HAMPTON & SONS



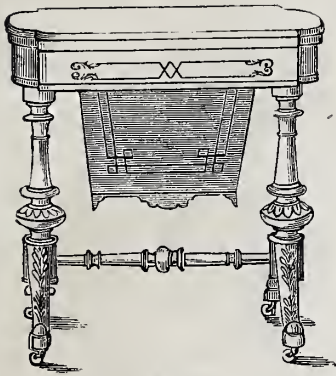

347

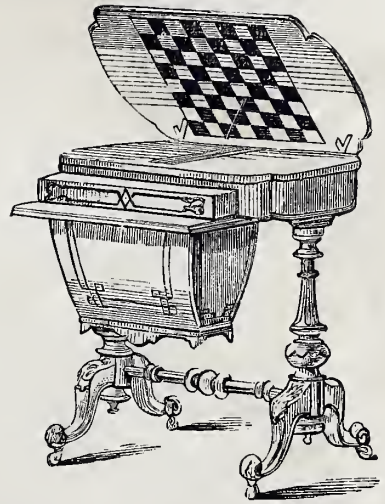

348

HAMPTON & SONS

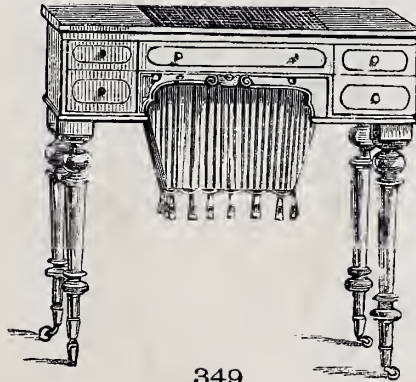

349

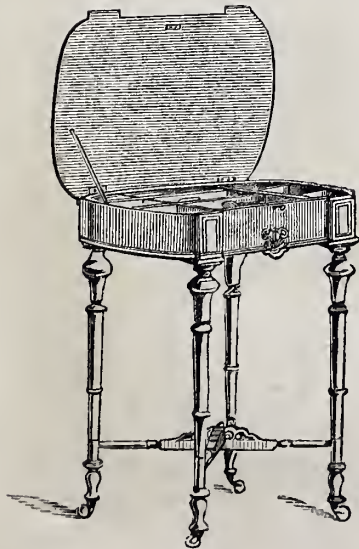

350

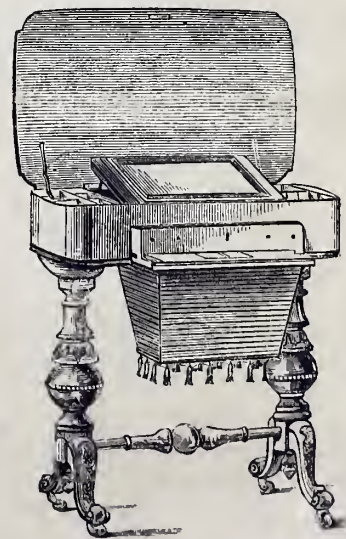

351

HAMPTON & SONS

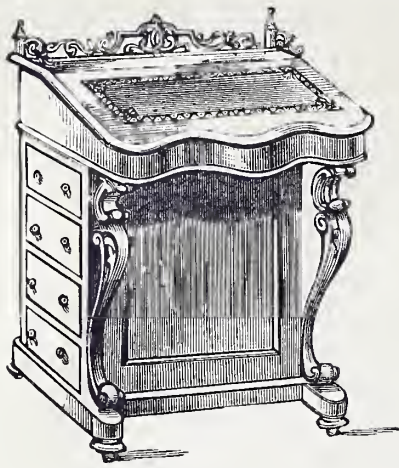

352

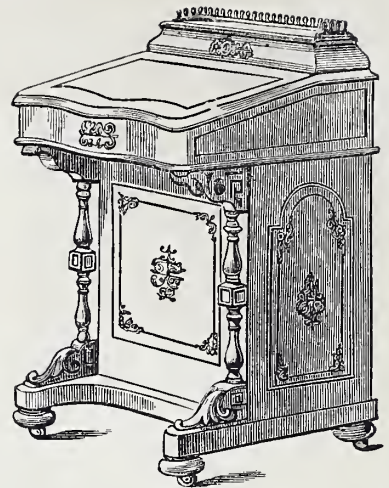

353

HAMPTON & SONS

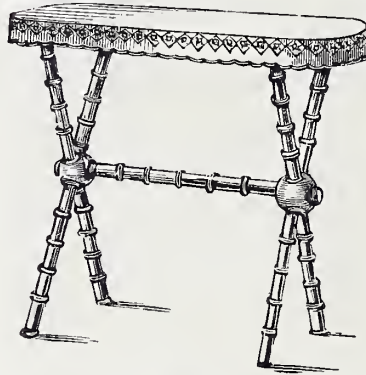

354

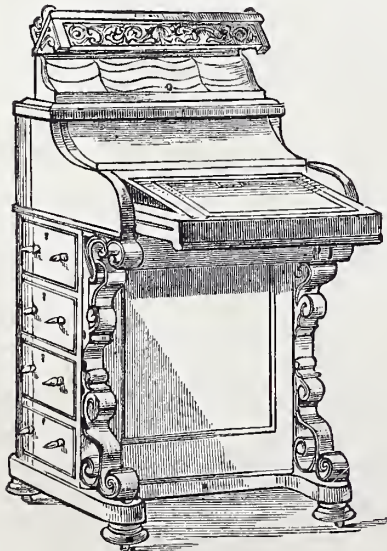

355

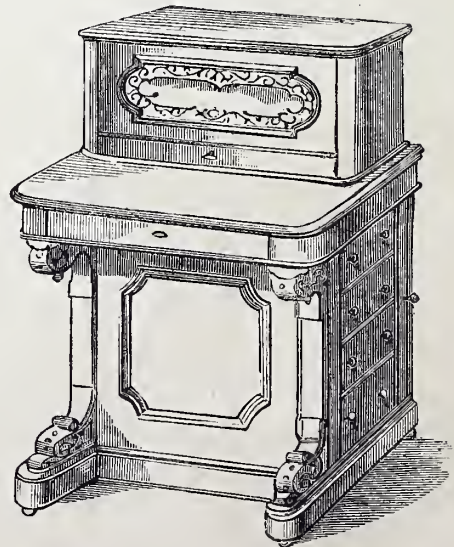

356

HAMPTON & SONS



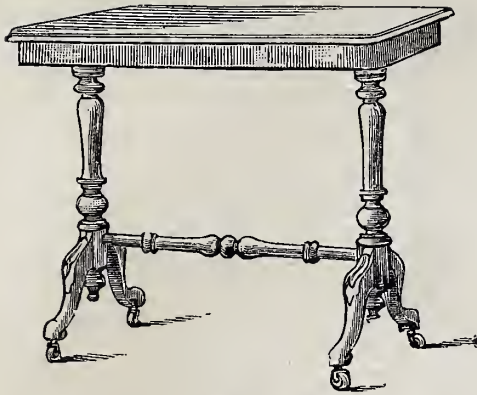

357

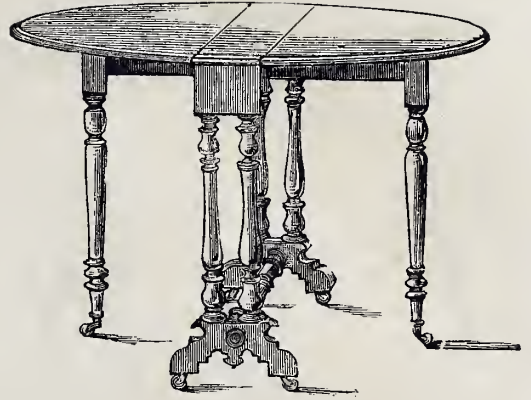

358

HAMPTON & SONS



359

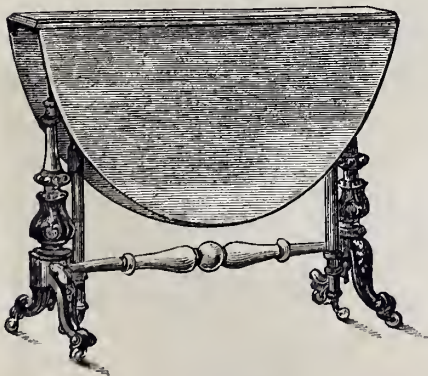

360

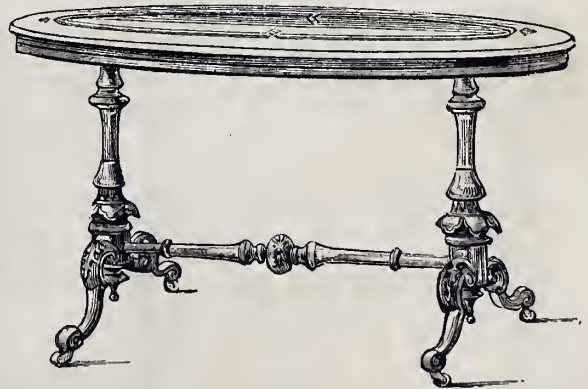

361

HAMPTON & SONS

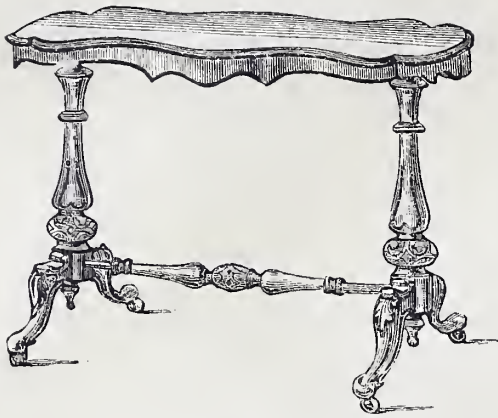

362

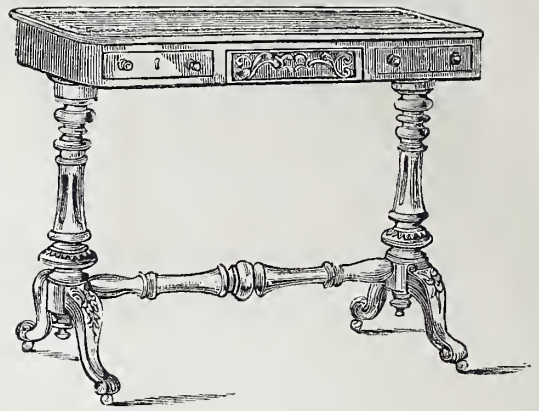

363

HAMPTON & SONS

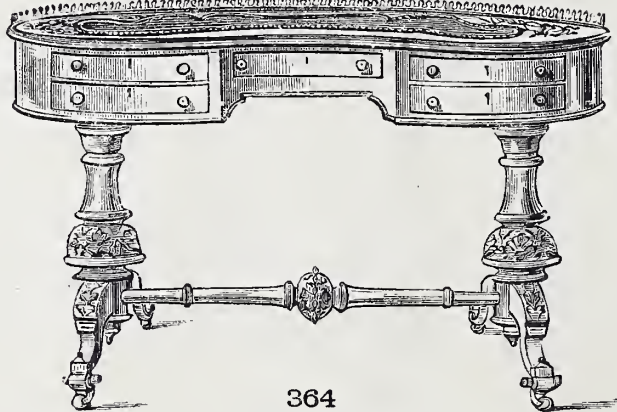

364

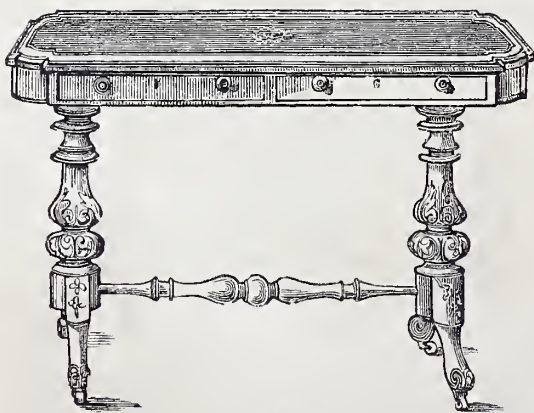

365

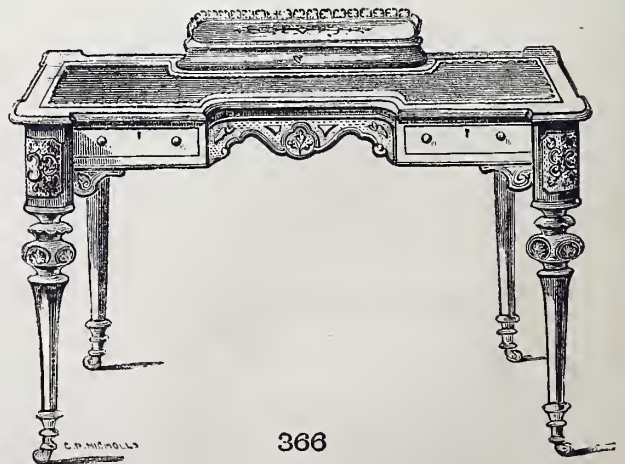

366

HAMPTON & SONS



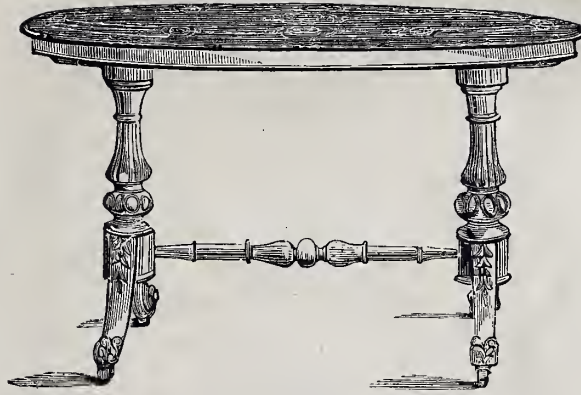

367

HAMPTON & SONS

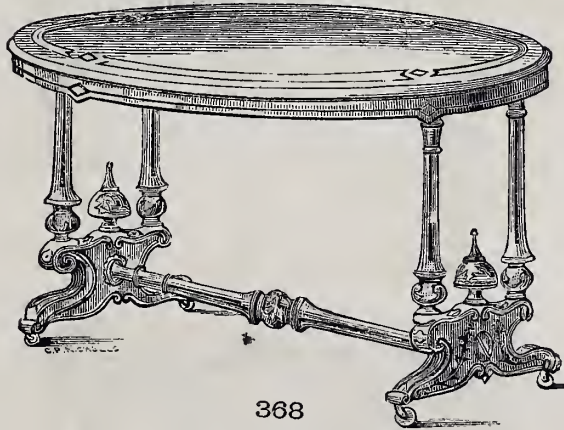

368

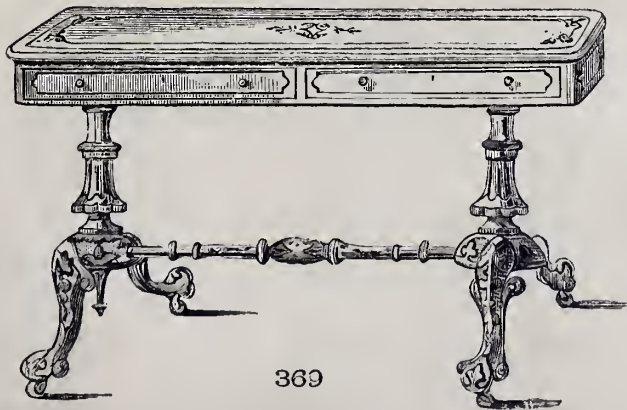

369

HAMPTON & SONS

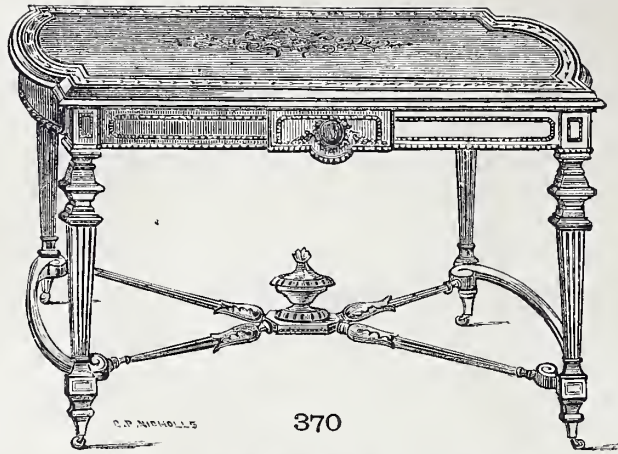

370

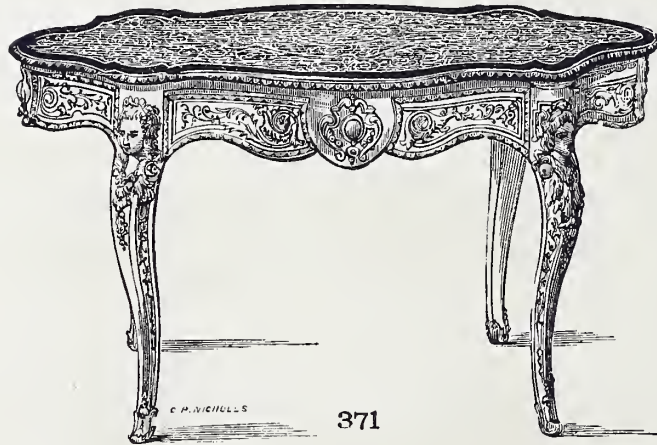

371

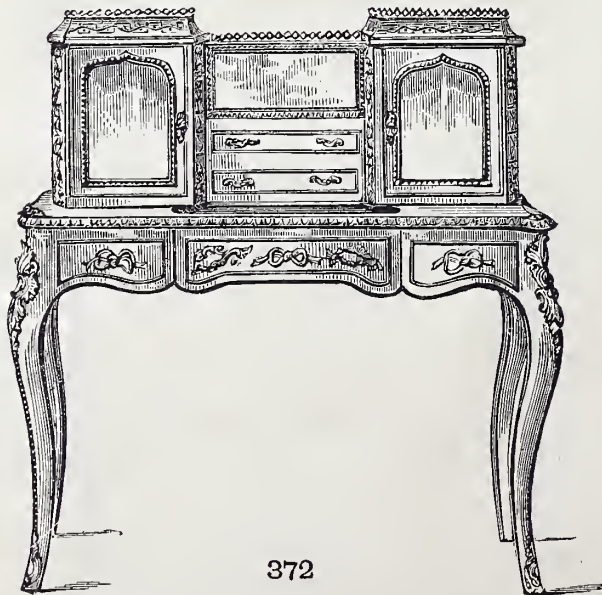

372

HAMPTON & SONS



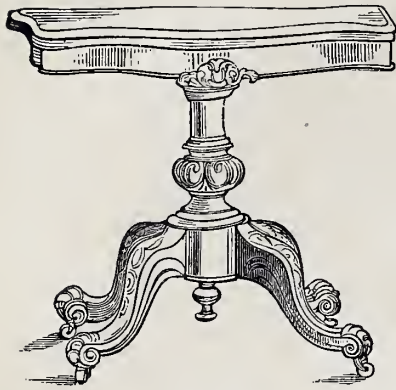

373

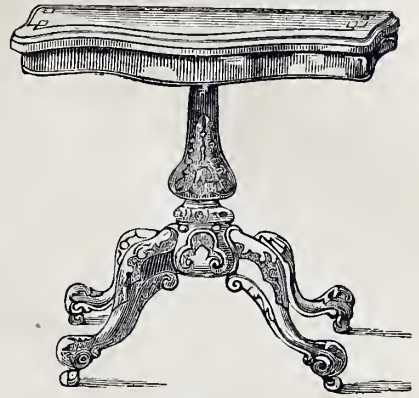

374

HAMPTON & SONS

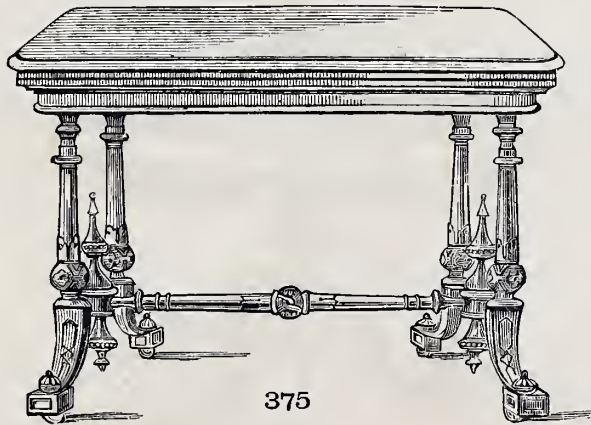

375

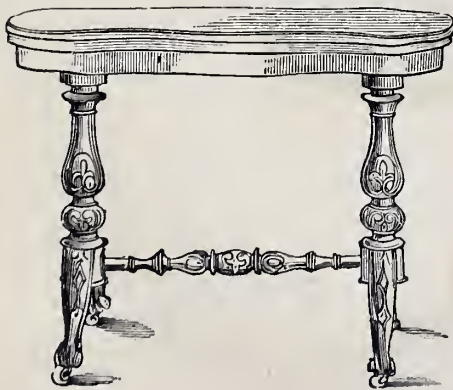

376



377

HAMPTON & SONS



378

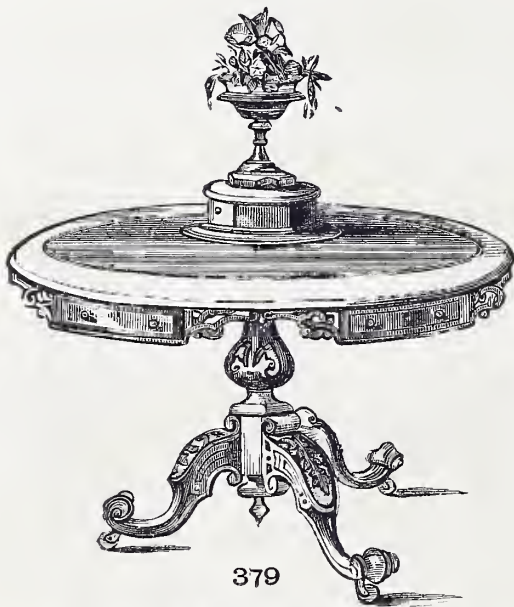

379



380

HAMPTON & SONS



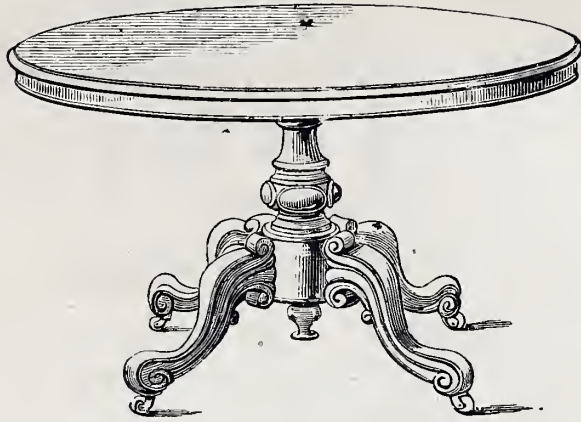

381

HAMPTON & SONS

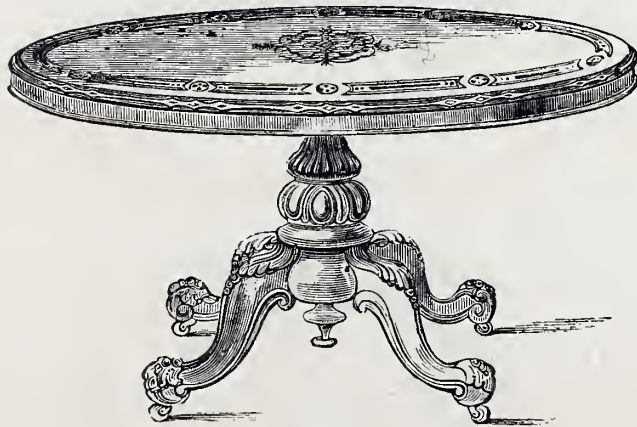

382

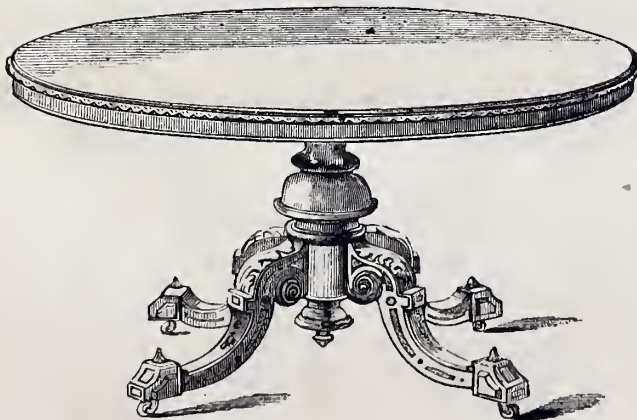

383

HAMPTON & SONS



384

HAMPTON & SONS

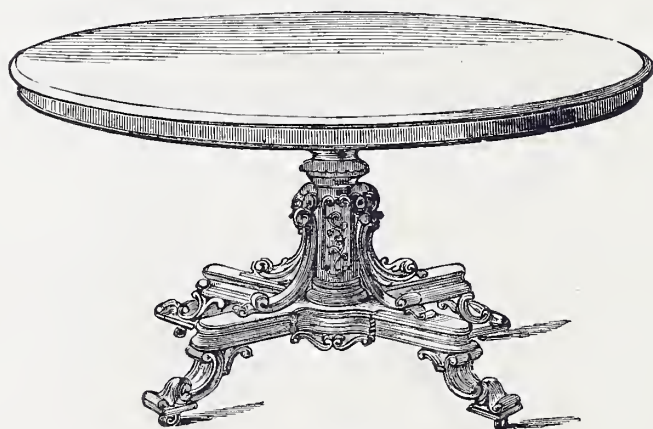

385

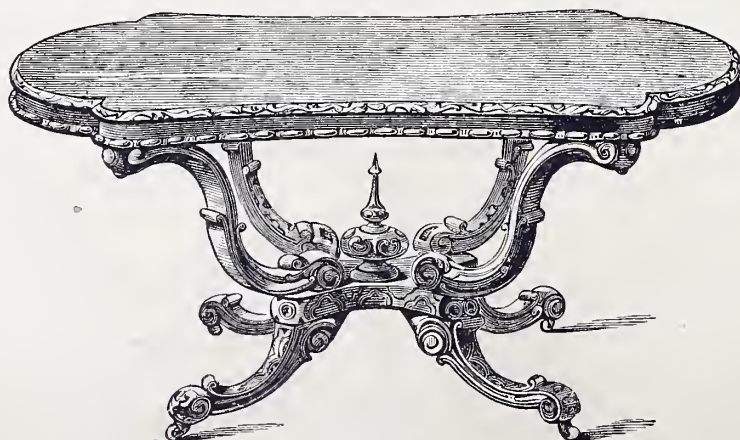

386

HAMPTON & SONS



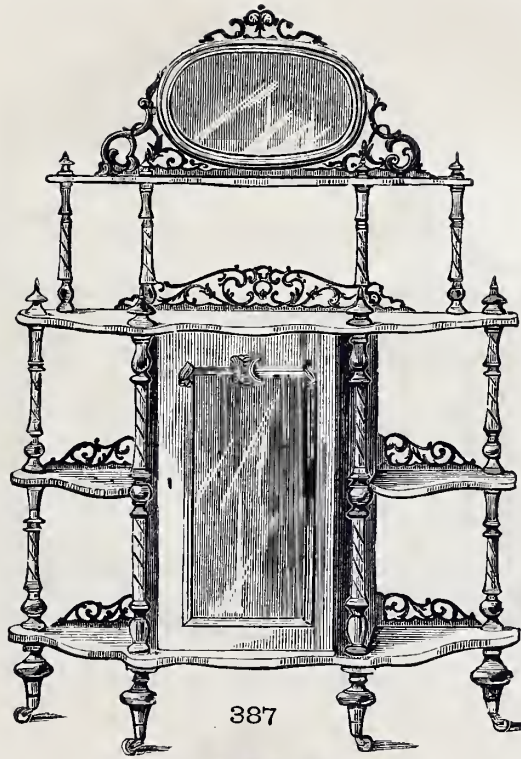

387

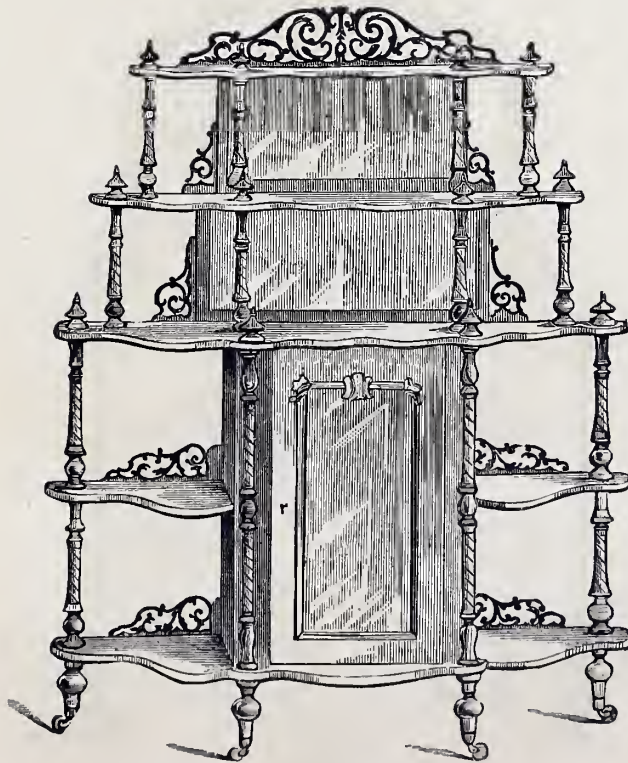

388

HAMPTON & SONS

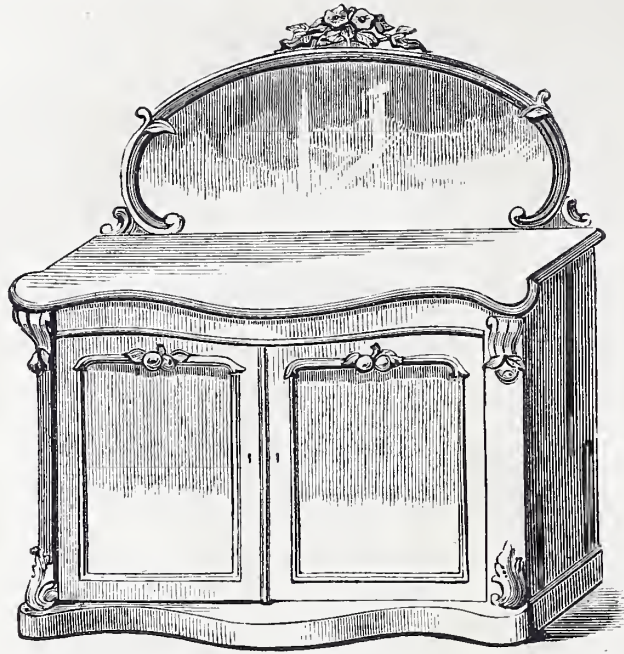

389

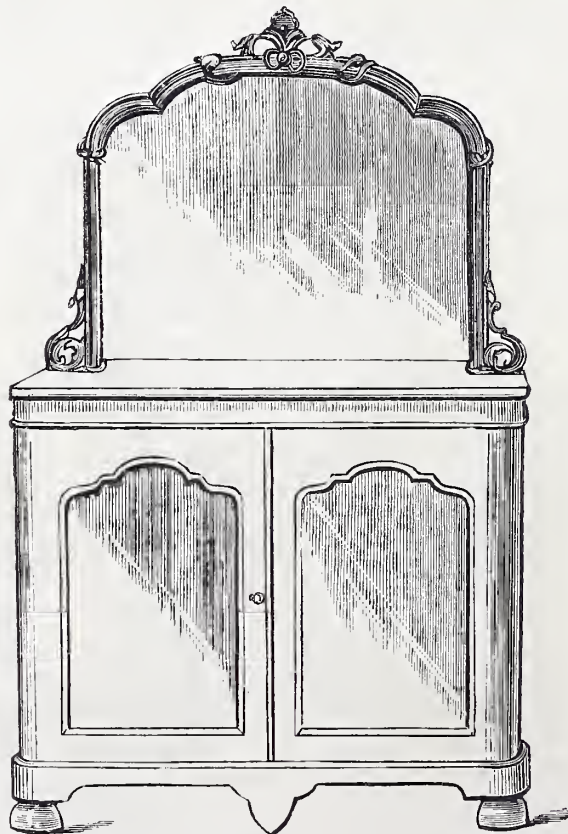

390

HAMPTON & SONS



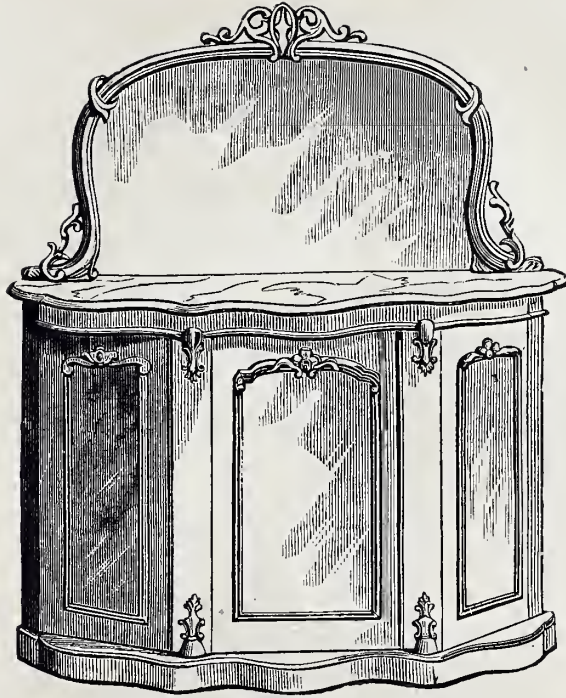

391

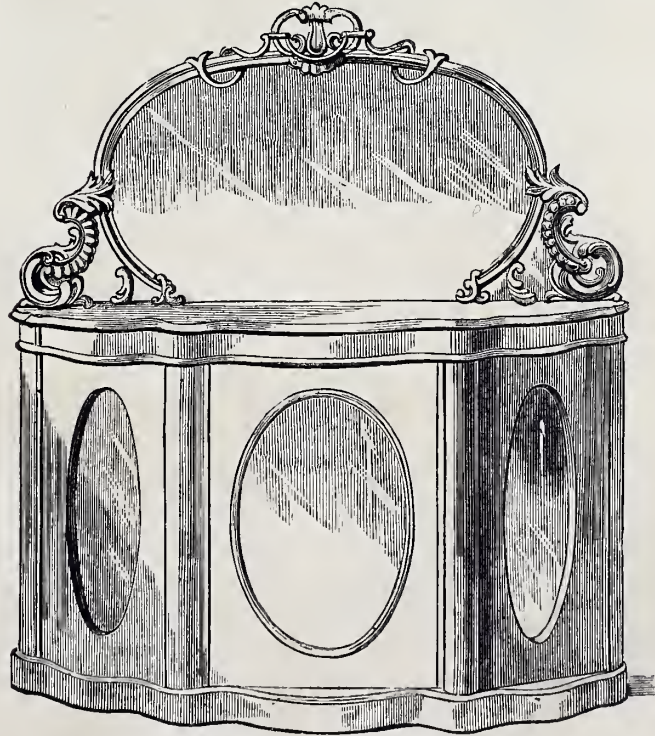

392

HAMPTON & SONS

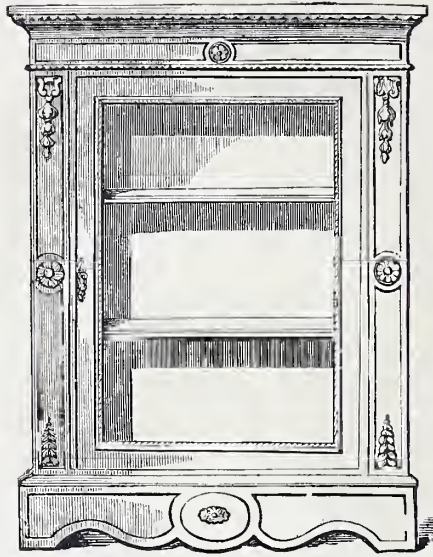

393

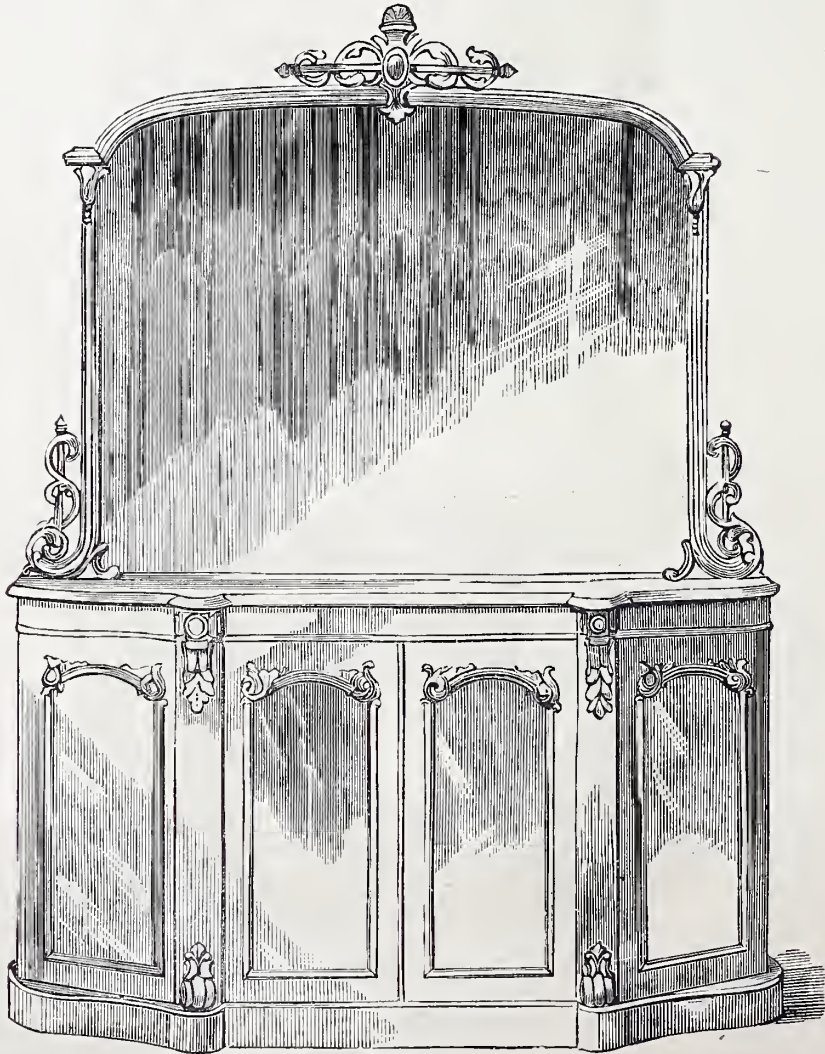

394



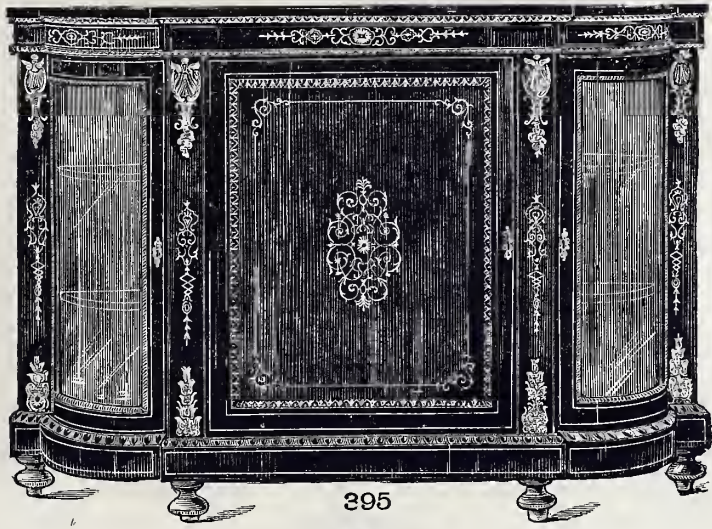

395

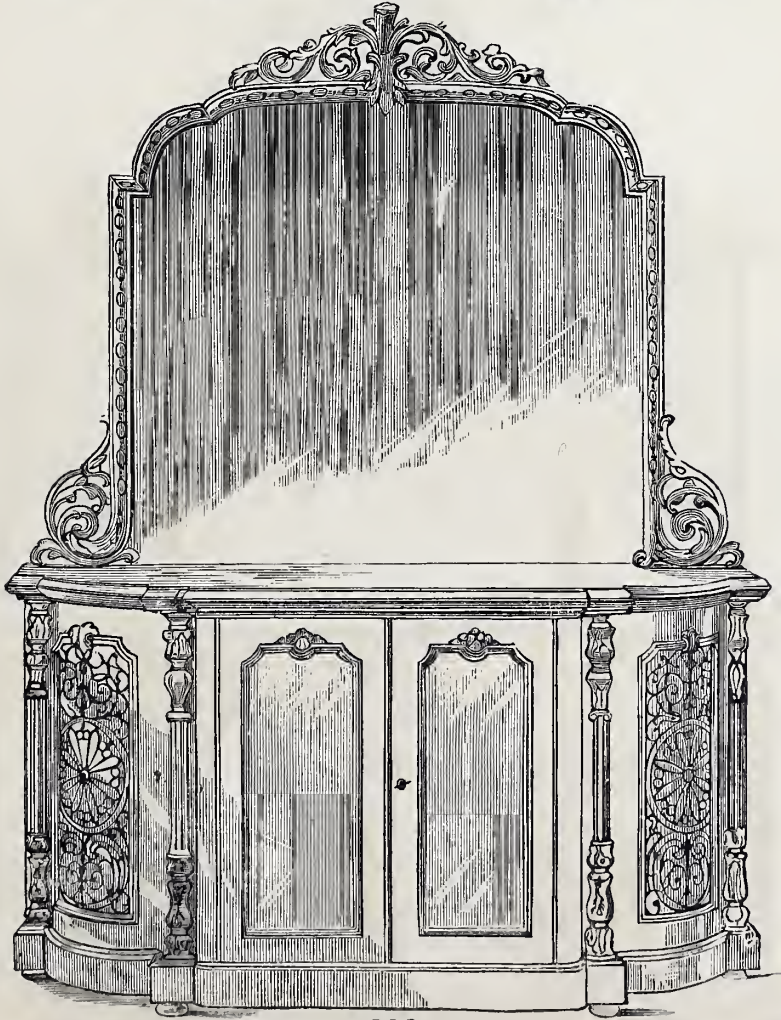

396

HAMPTON & SONS



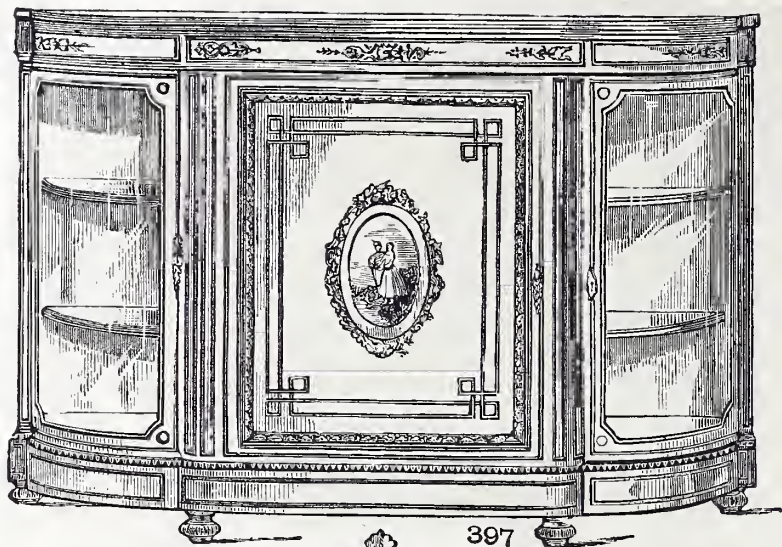

397

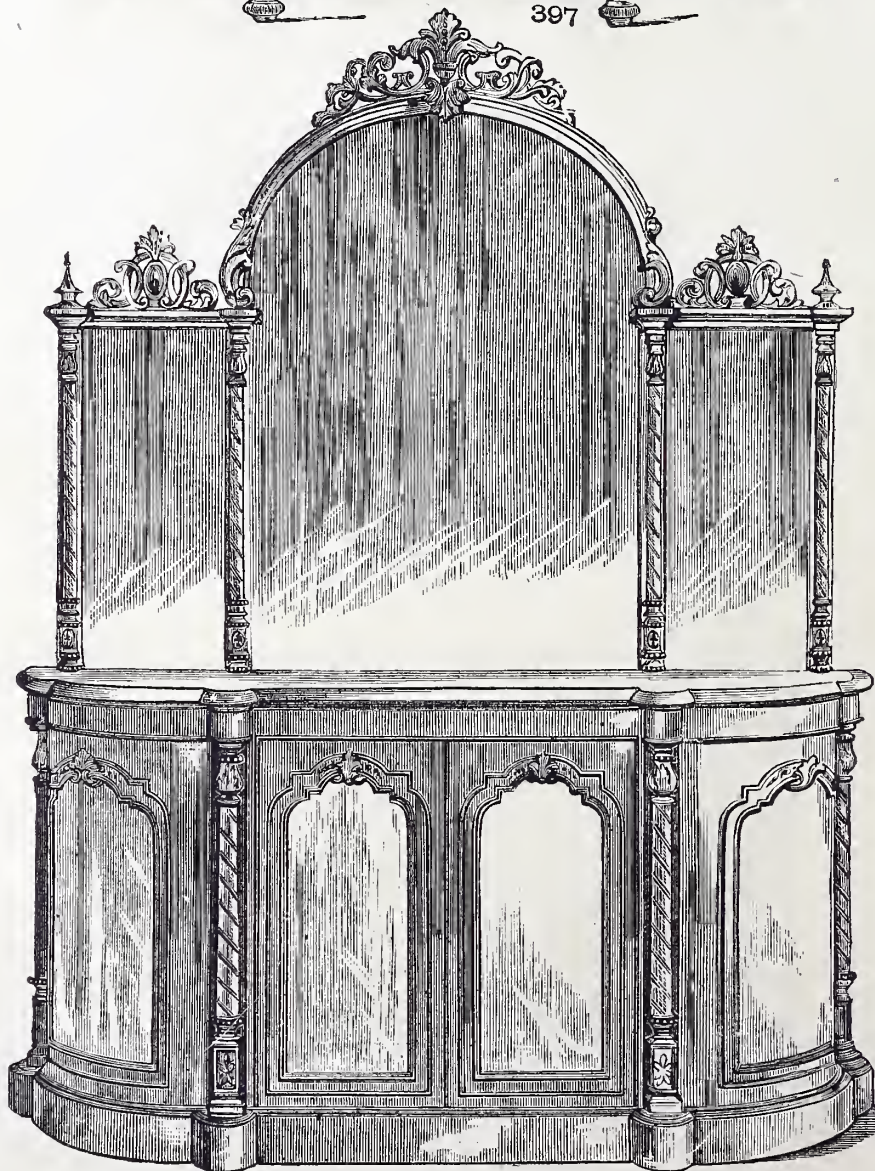

398



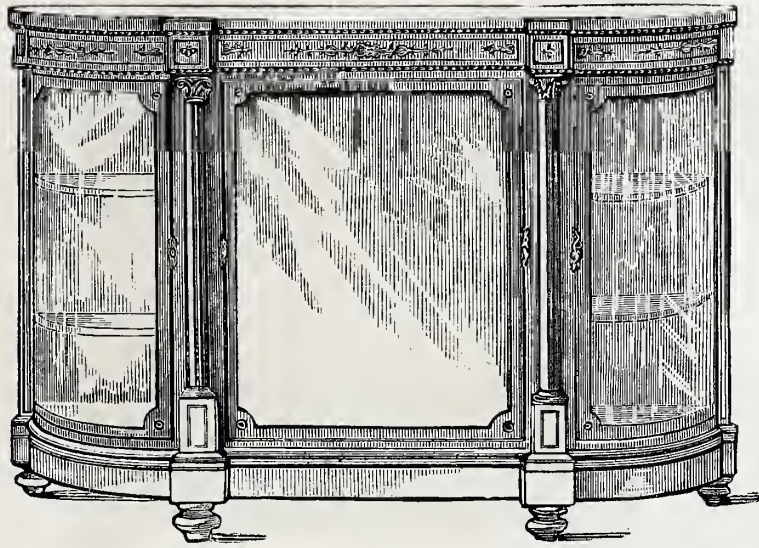

399

HAMPTON & SONS



400

HAMPTON & SONS



401

HAMPTON & SONS

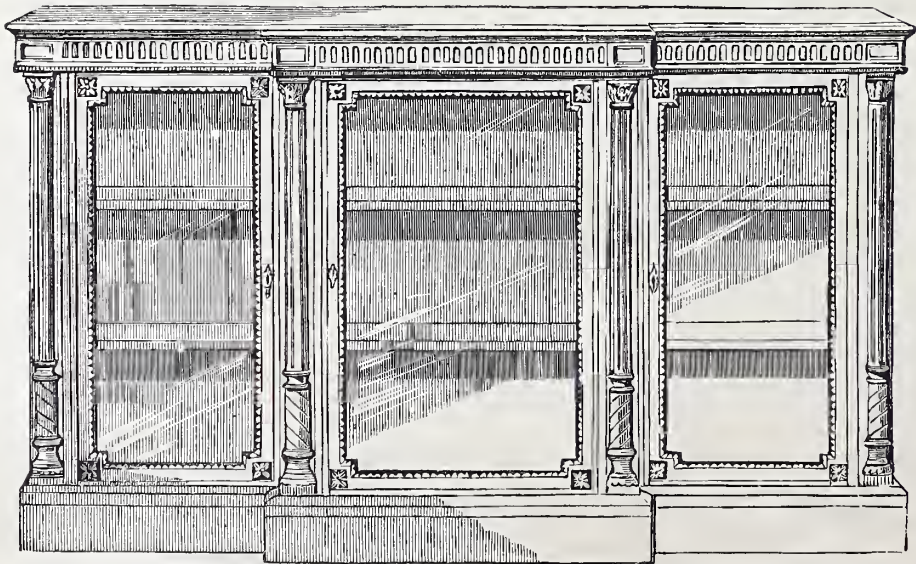

402

HAMPTON & SONS



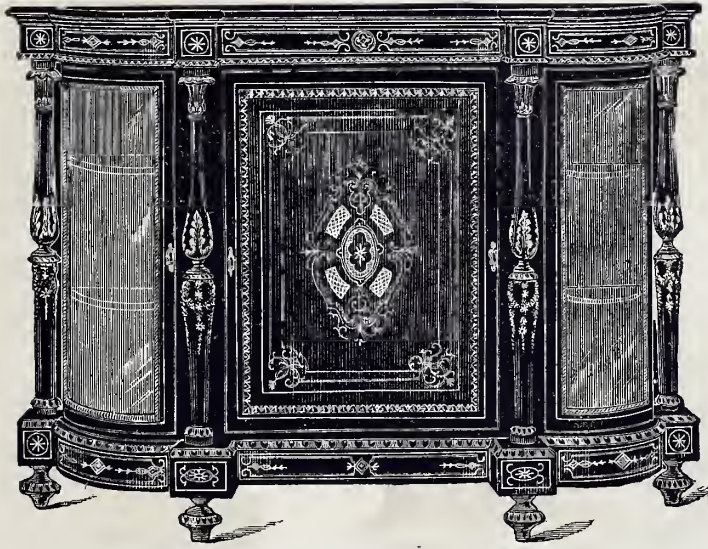

403

HAMPTON & SONS

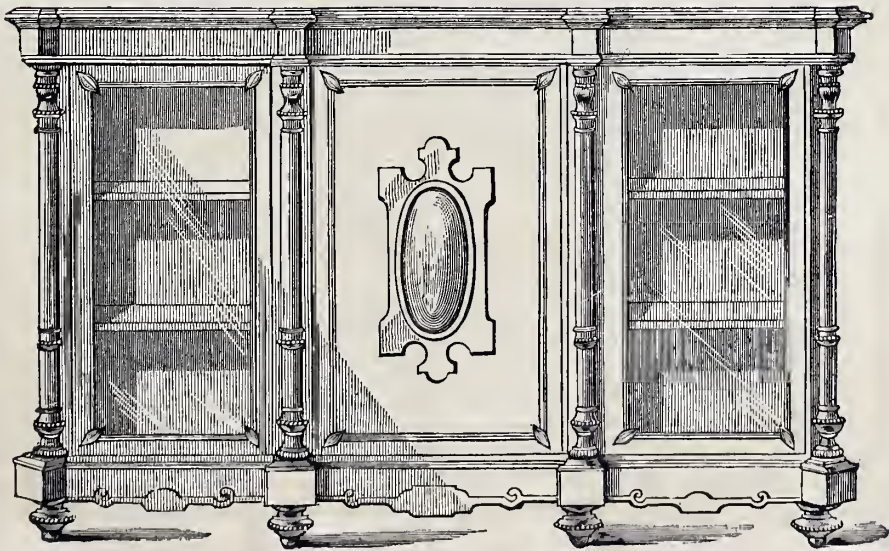

404

HAMPTON & SONS





405

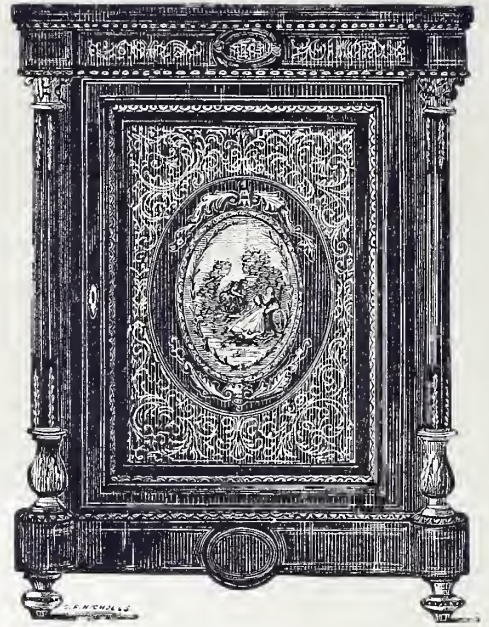

406

HAMPTON & SONS

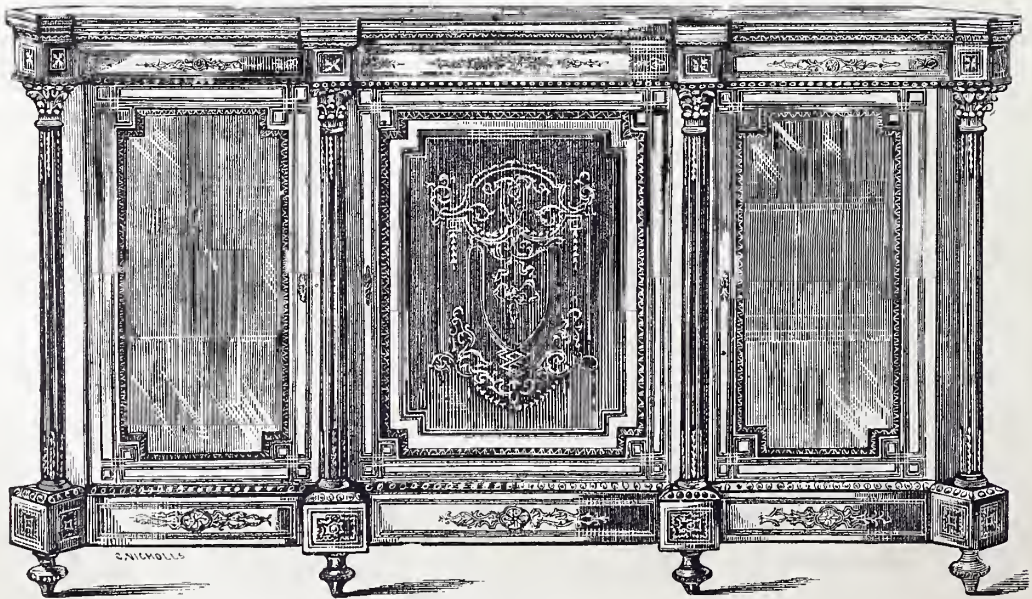

407

HAMPTON & SONS





408

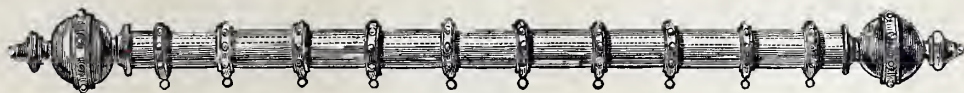

409



410



411



412



413



414



415



416

HAMPTON & SONS



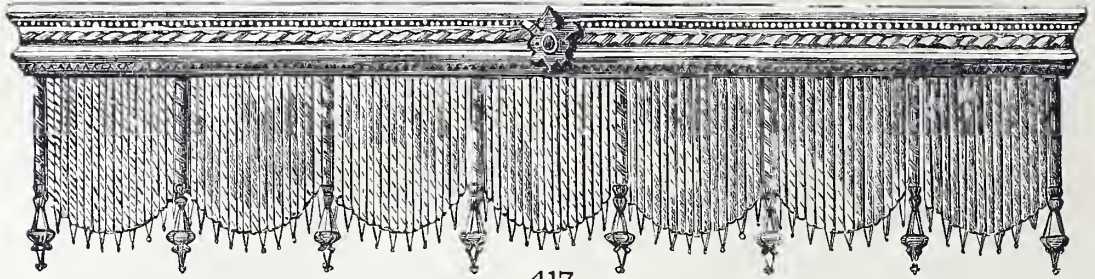

417

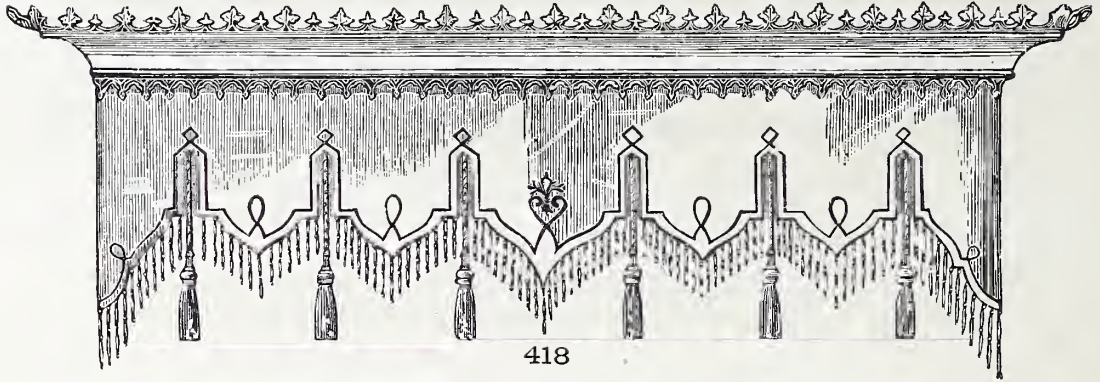

418

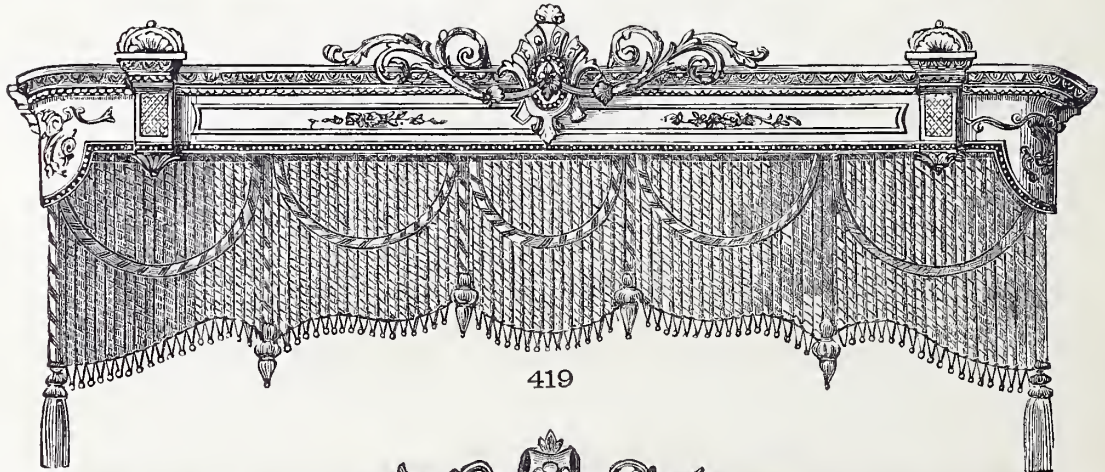

419



420

HAMPTON & SONS



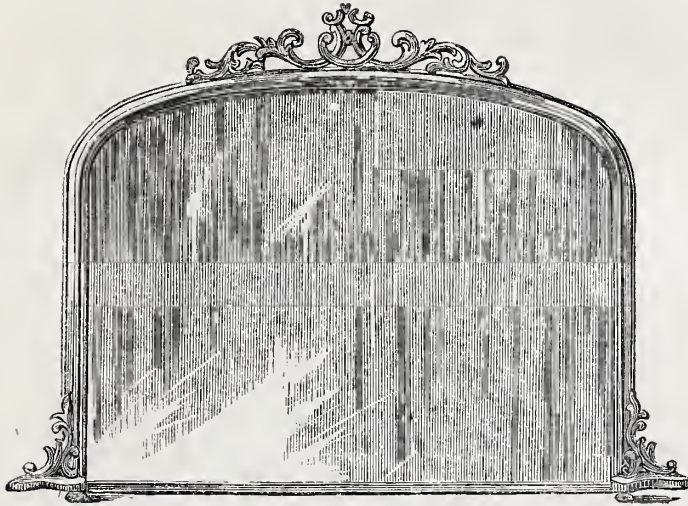

421

HAMPTON & SONS

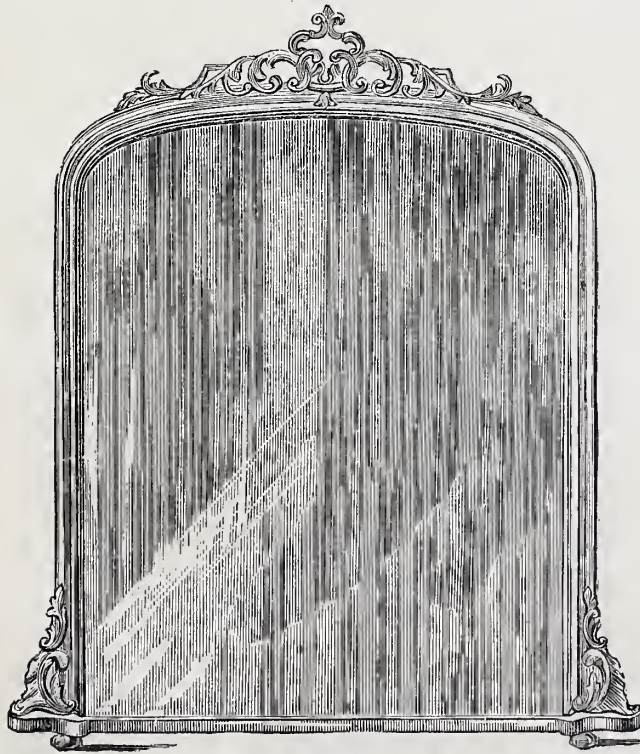

422

HAMPTON & SONS

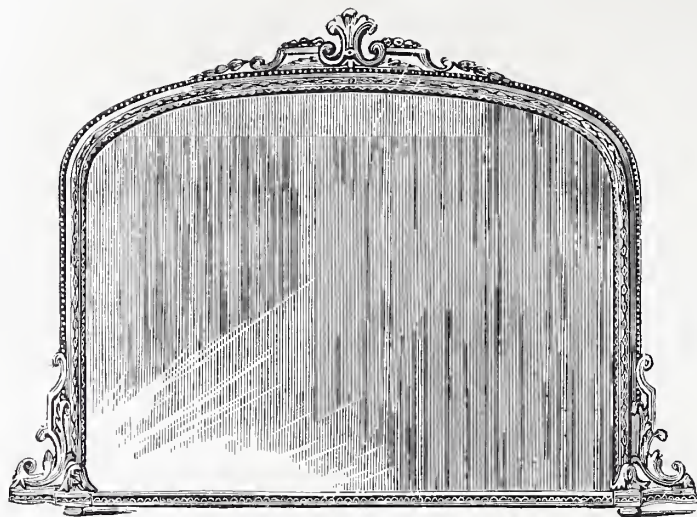

423

HAMPTON & SONS

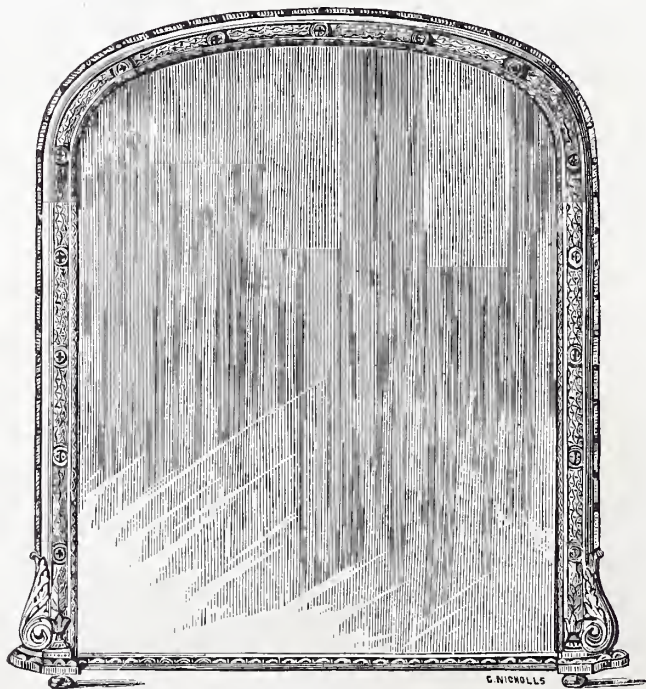

424

HAMPTON & SONS



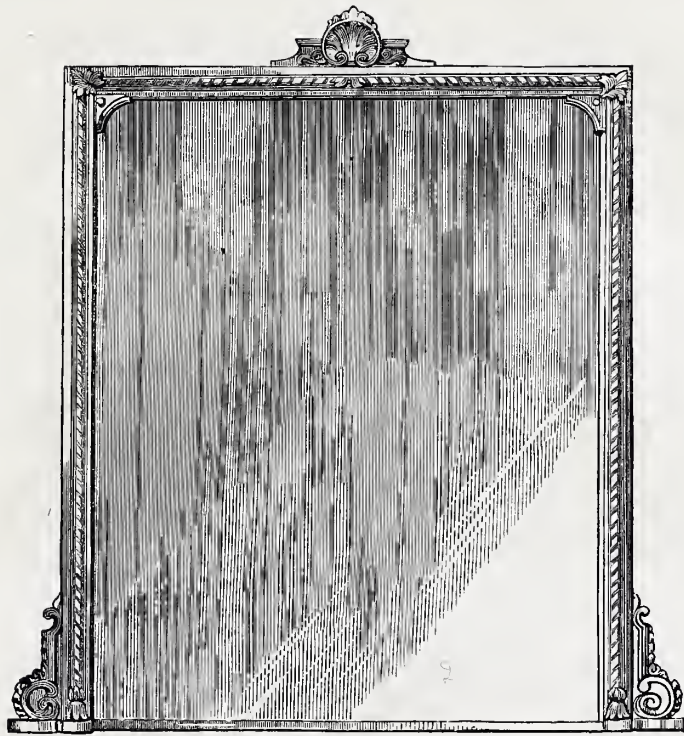

425

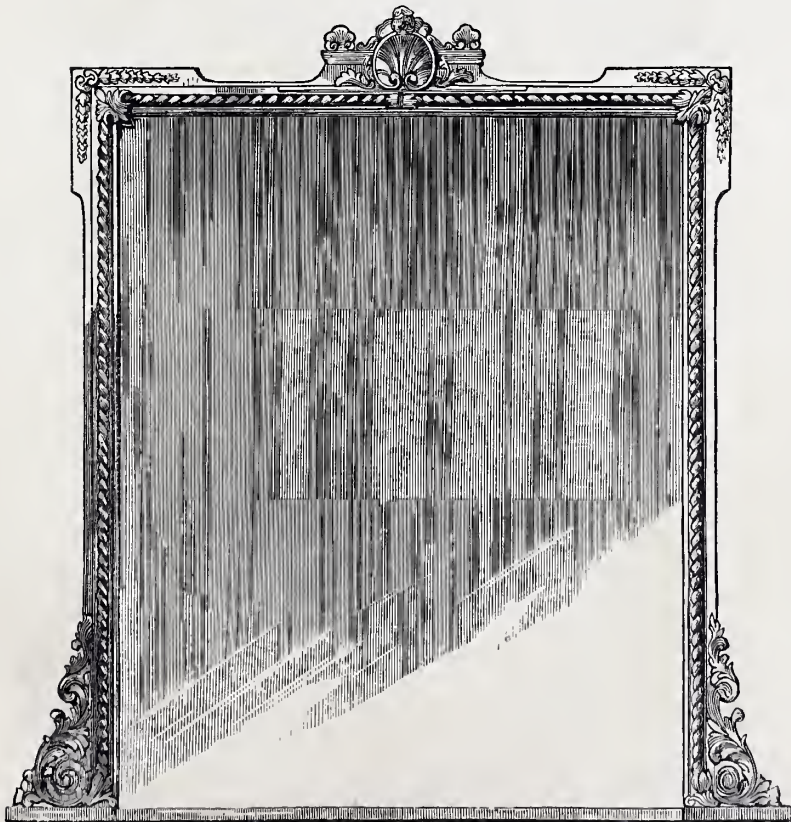

426

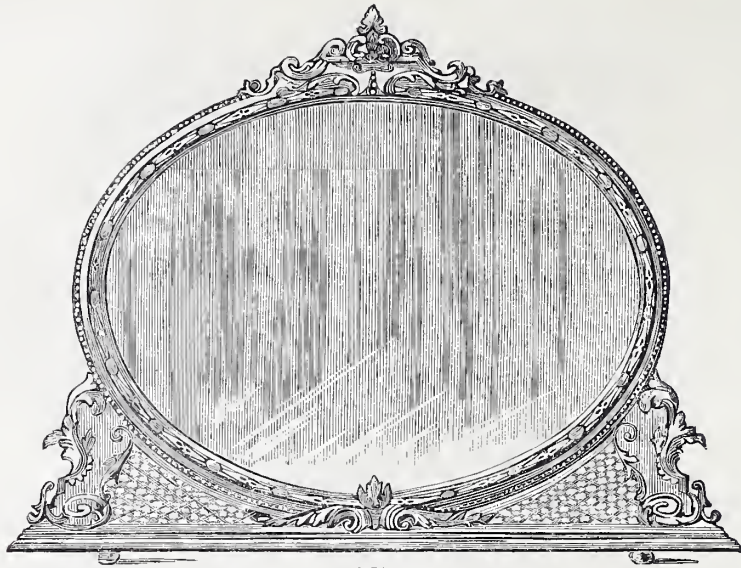

427

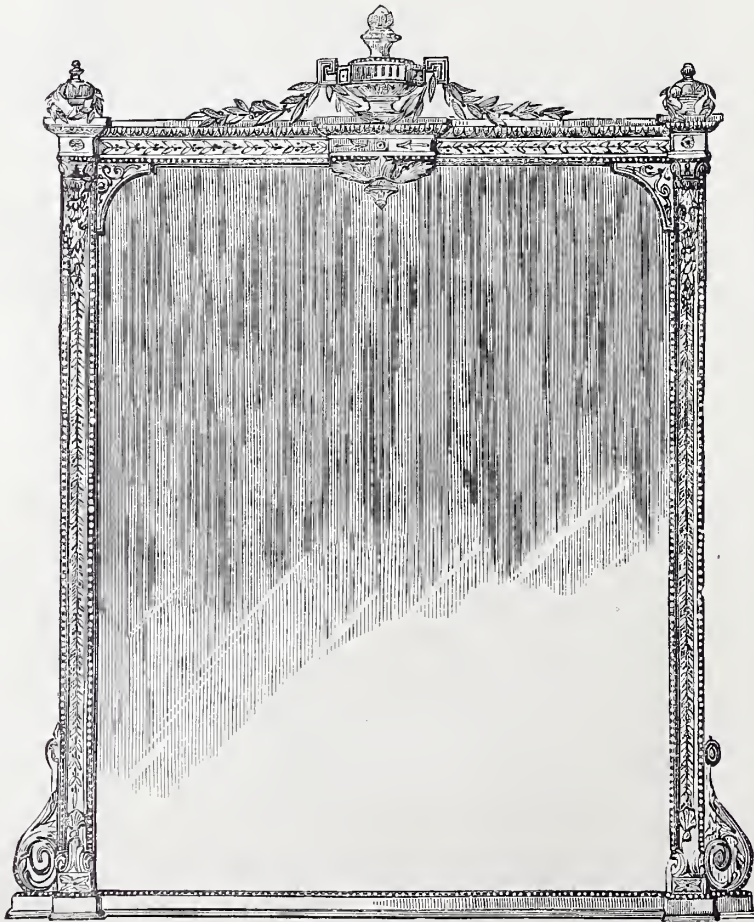

428

HAMPTON & SONS



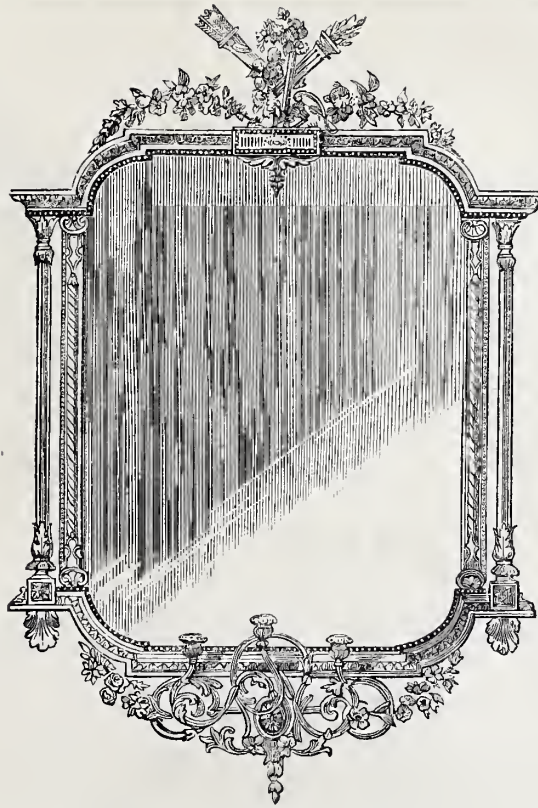

429



430

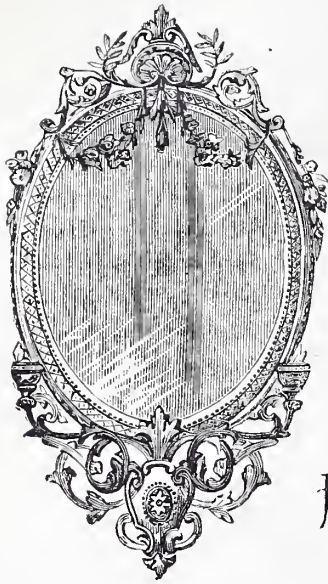

431

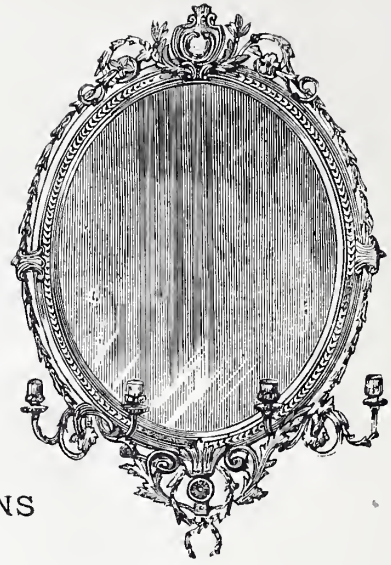

432

HAMPTON & SONS

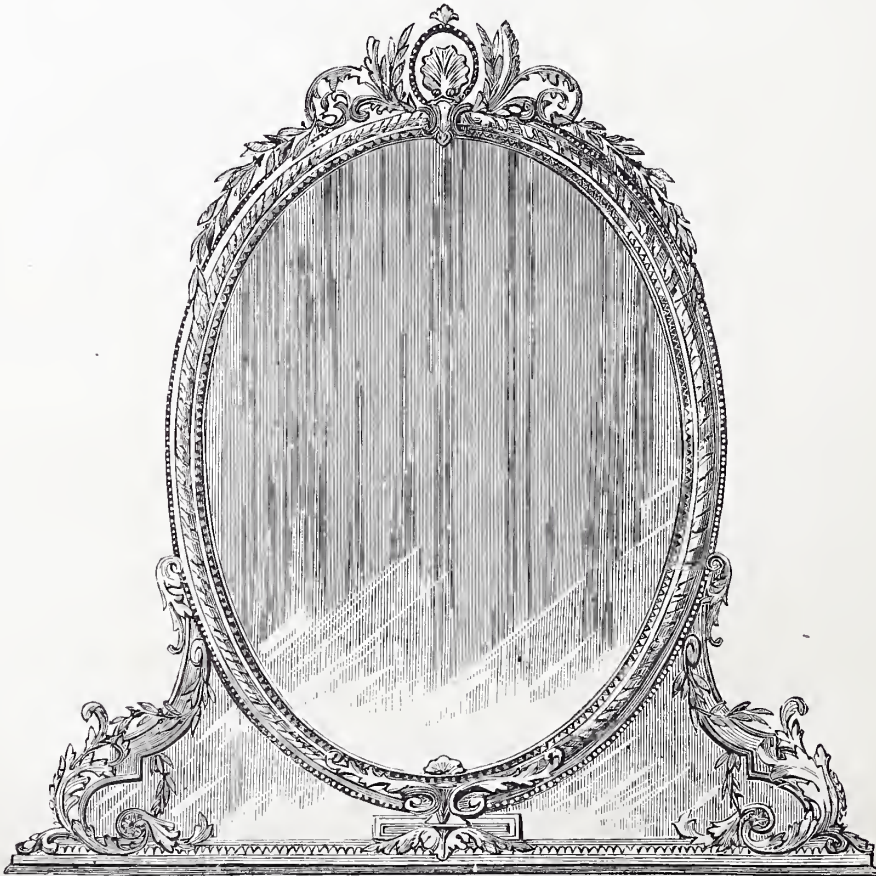

D. NICHOLS

433

HAMPTON & SONS



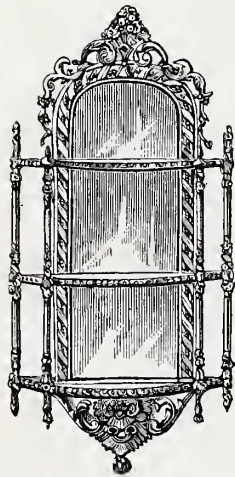

434

HAMPTON & SONS

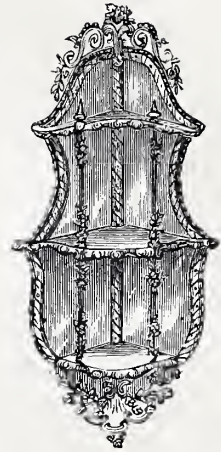

435

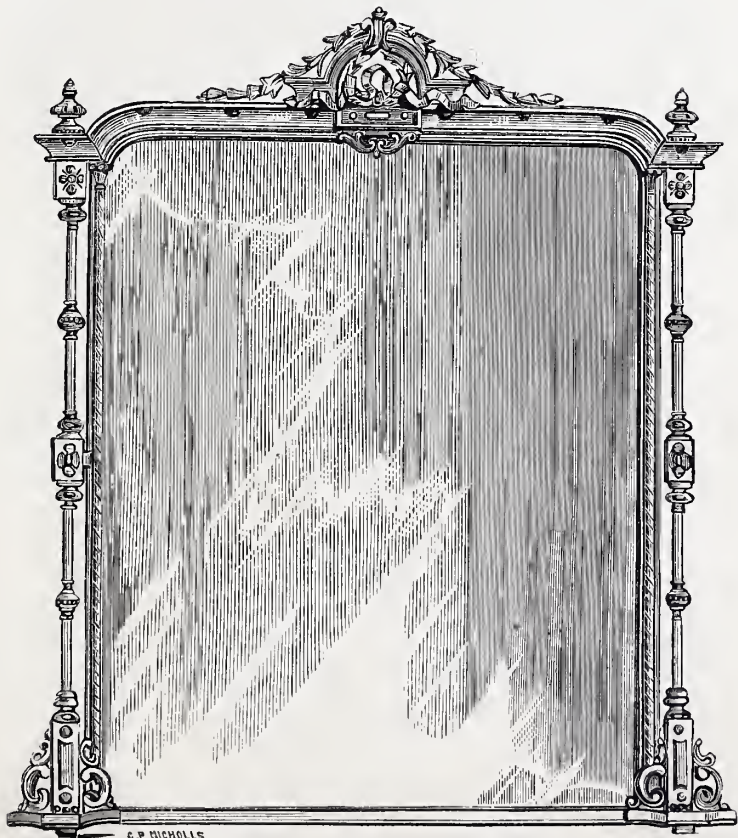

C. P. NICHOLS

436

HAMPTON & SONS



437

HAMPTON & SONS



438



439

HAMPTON & SONS



HAMPTON & SONS

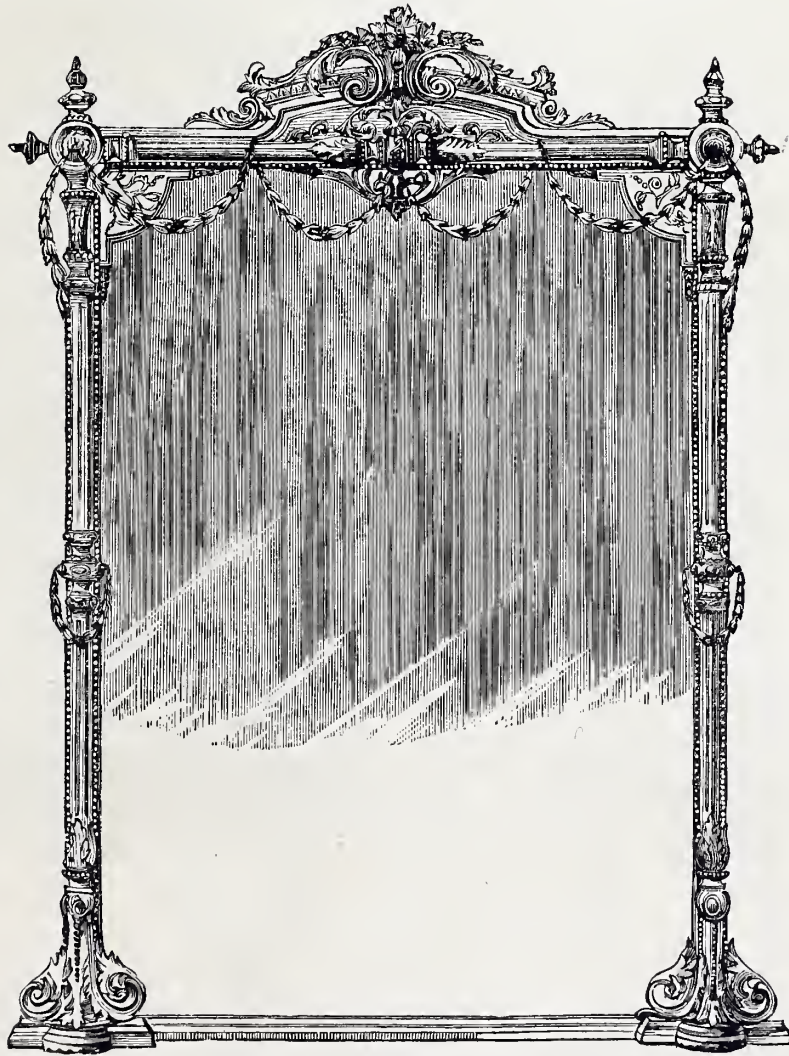

440

HAMPTON & SONS

HAMPTON & SONS

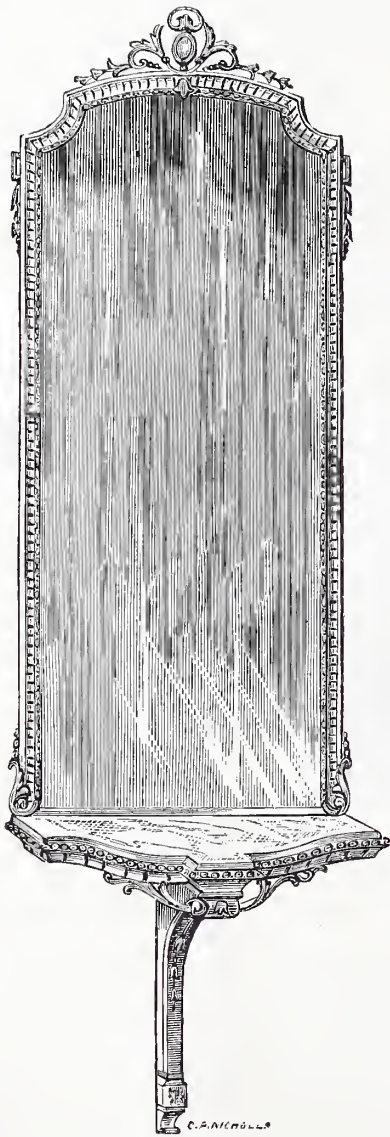

441



442

HAMPTON & SONS



HAMPTON & SONS

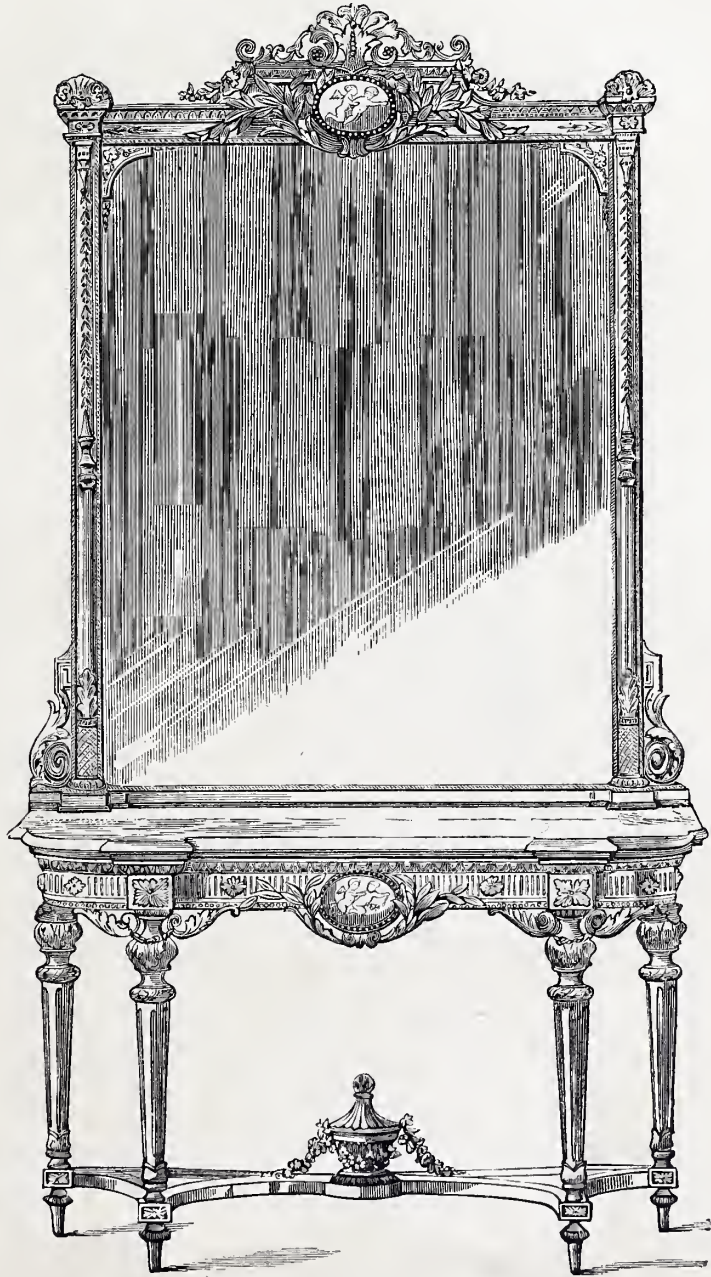

443

HAMPTON & SONS

HAMPTON & SONS

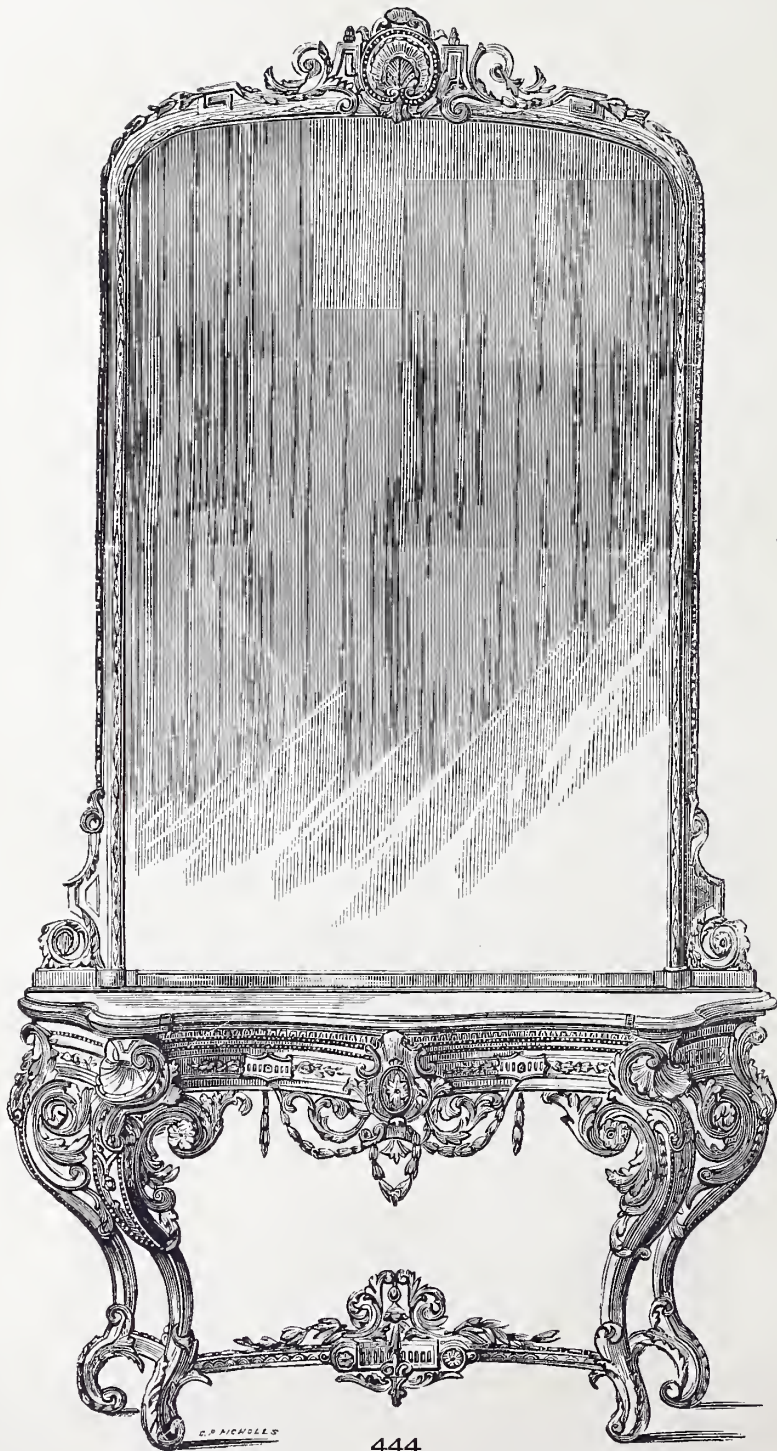

444

HAMPTON & SONS



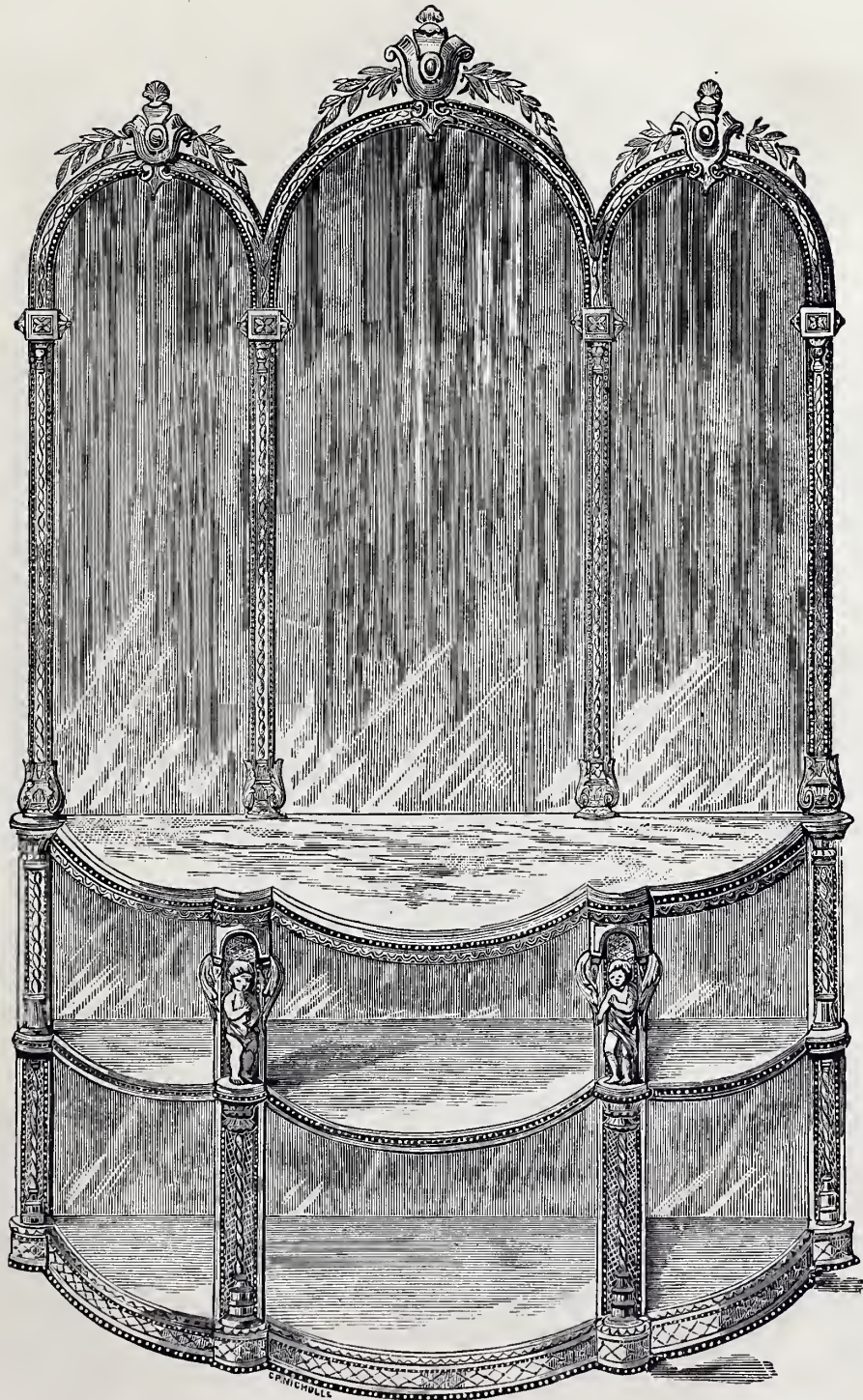

445

HAMPTON & SONS







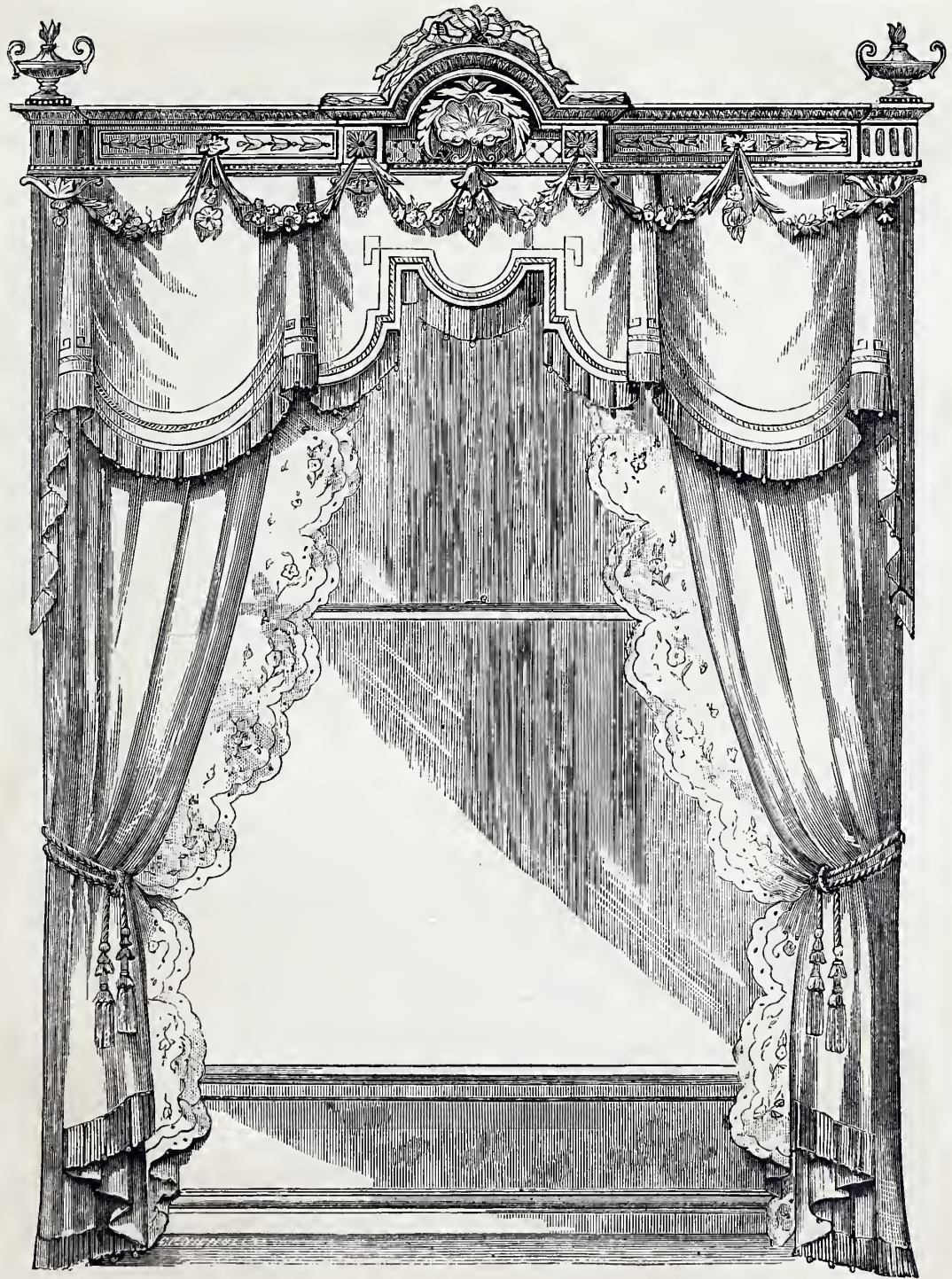

447

HAMPTON & SONS



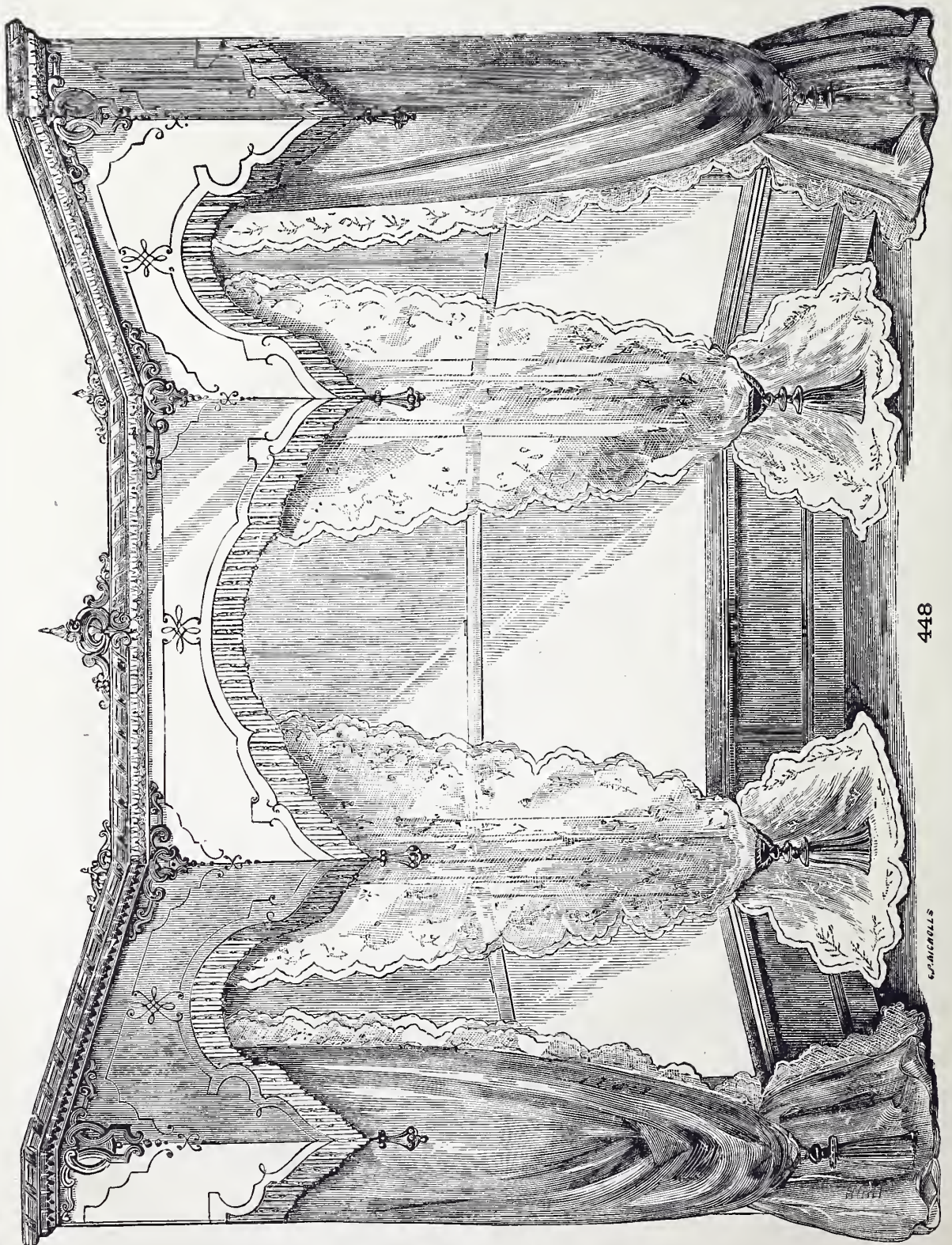

448

W. P. GIBBS

HAMPTON & SONS



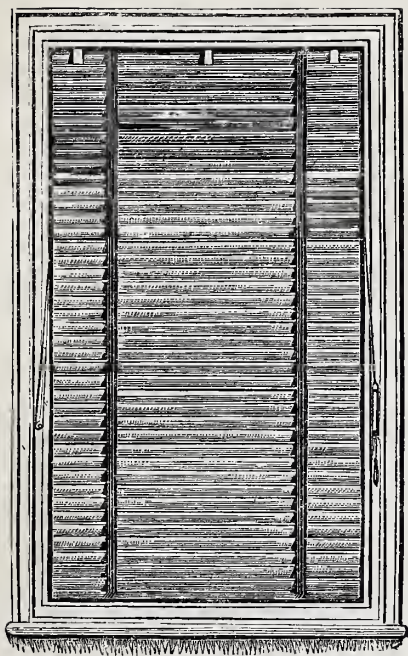

449

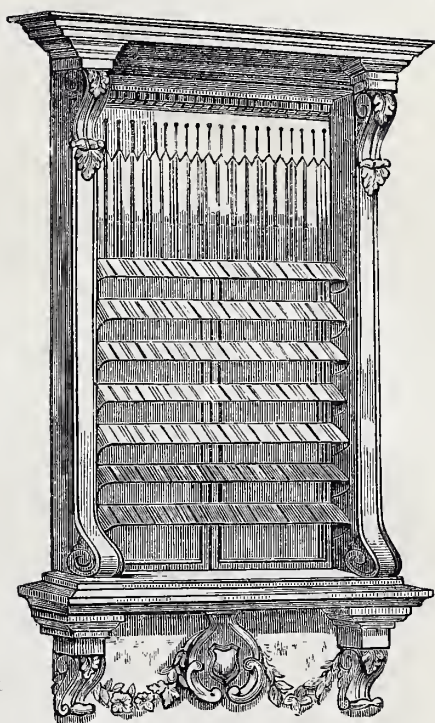

450

HAMPTON & SONS

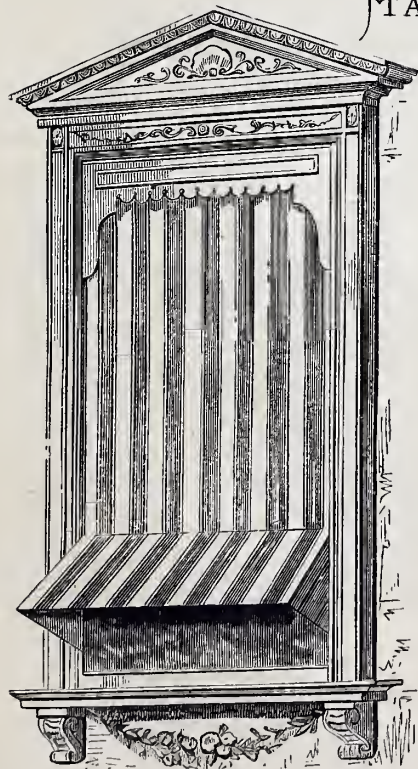

451

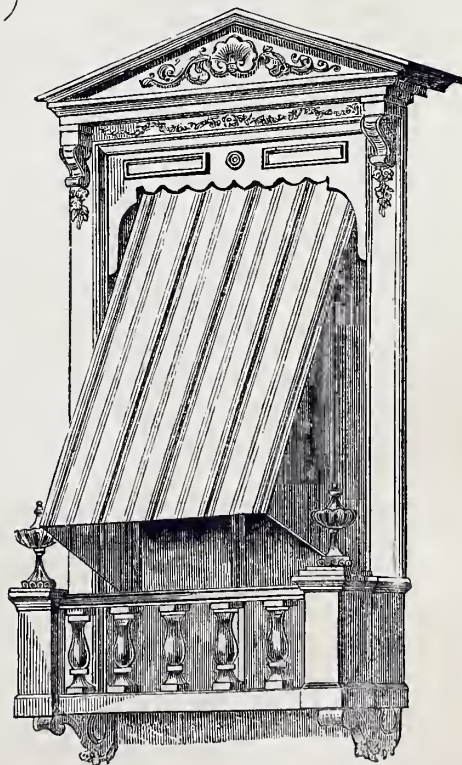

452

HAMPTON & SONS

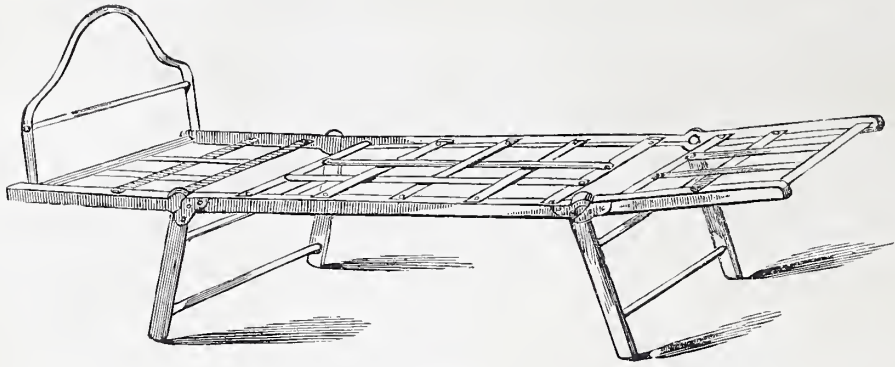

453

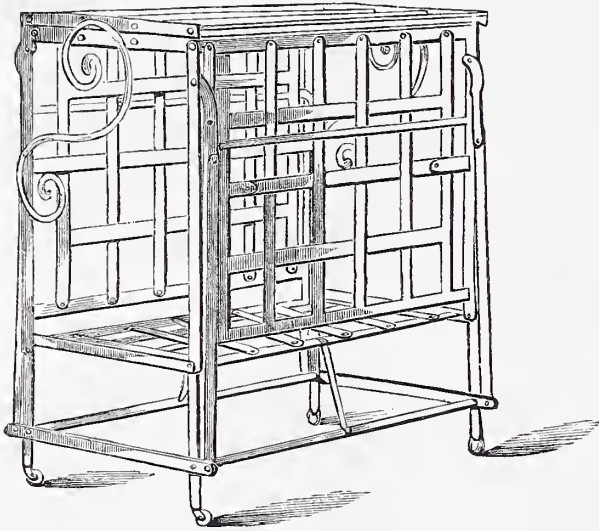

454

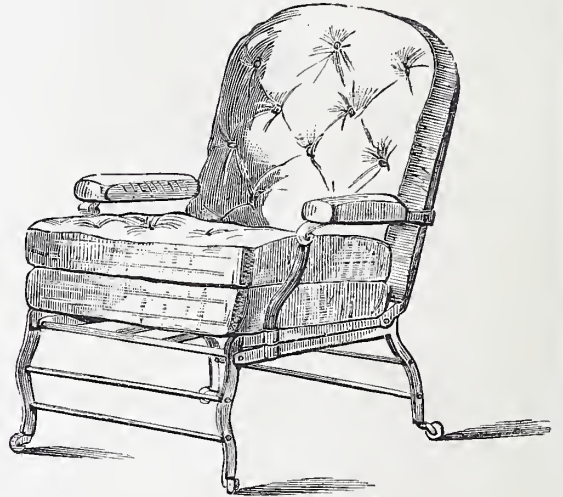

455

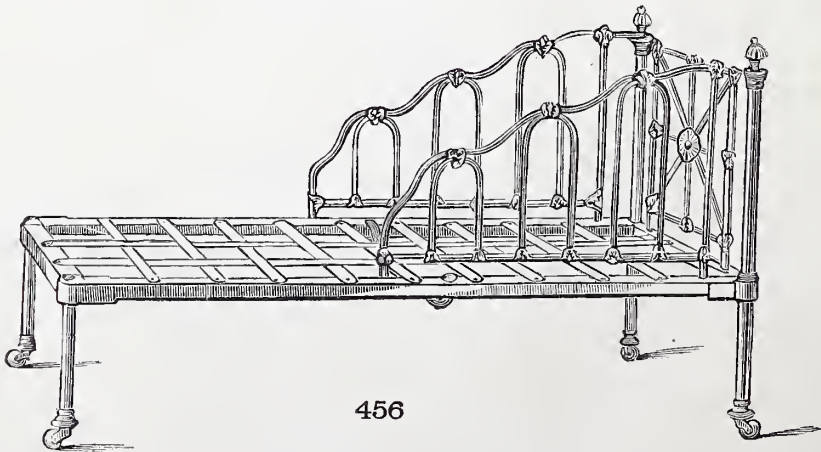

456

HAMPTON & SONS



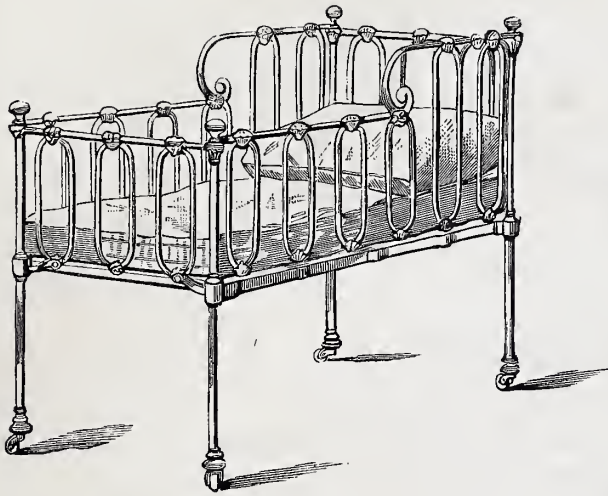

457

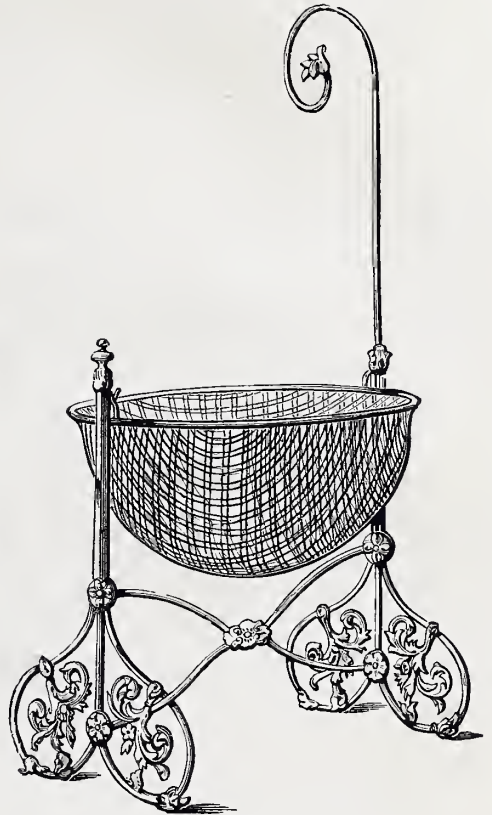

458

HAMPTON & SONS

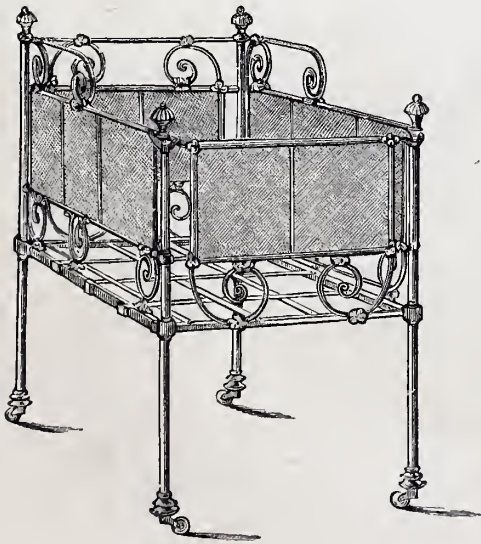

459

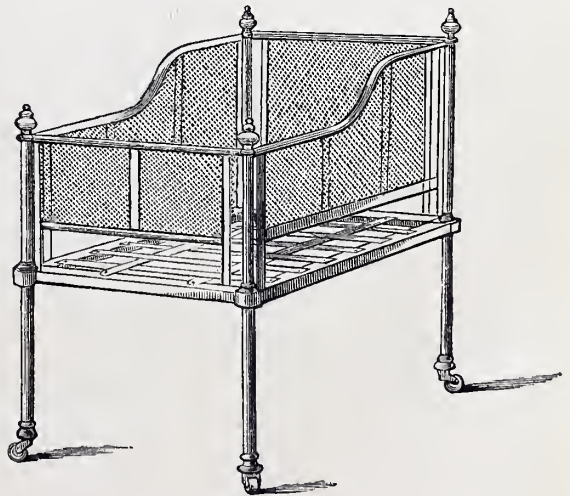

460

HAMPTON & SONS

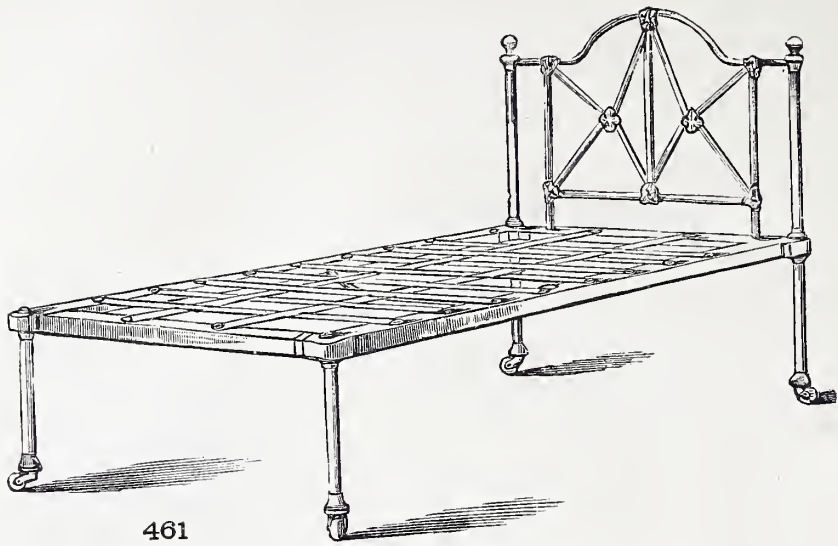

461

HAMPTON & SONS



462

HAMPTON & SONS



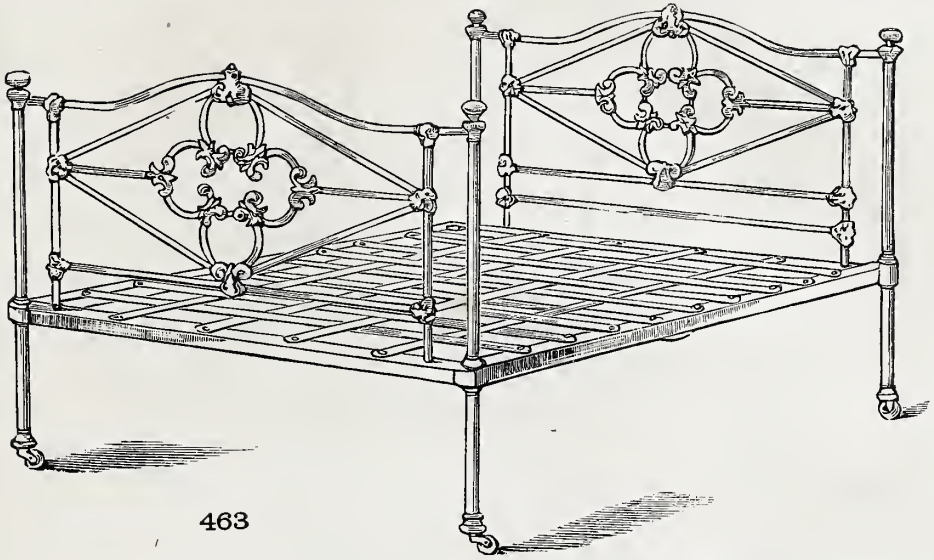

463

HAMPTON & SONS



464

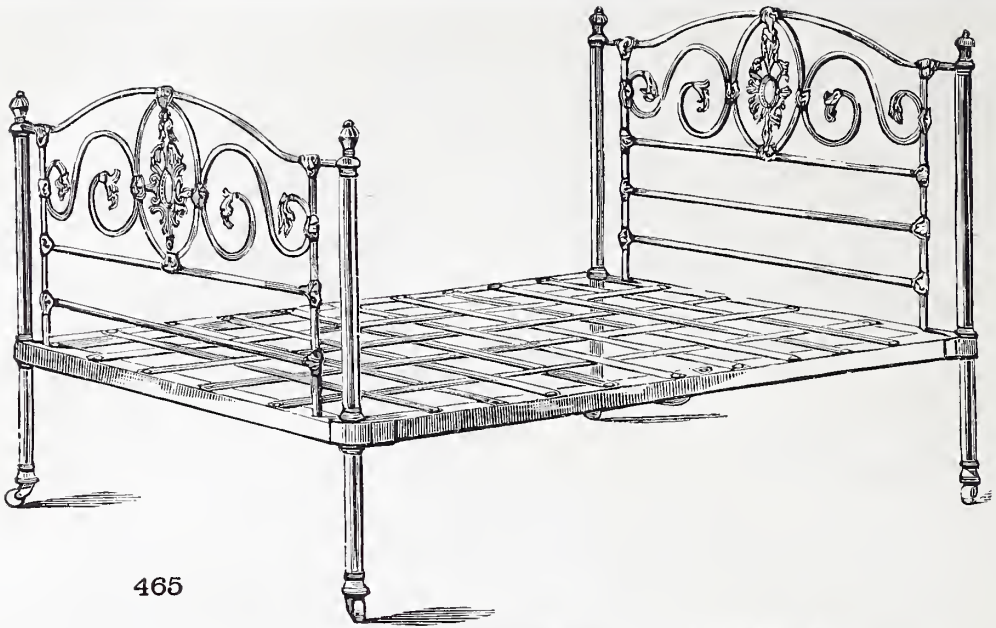

465

HAMPTON & SONS



466



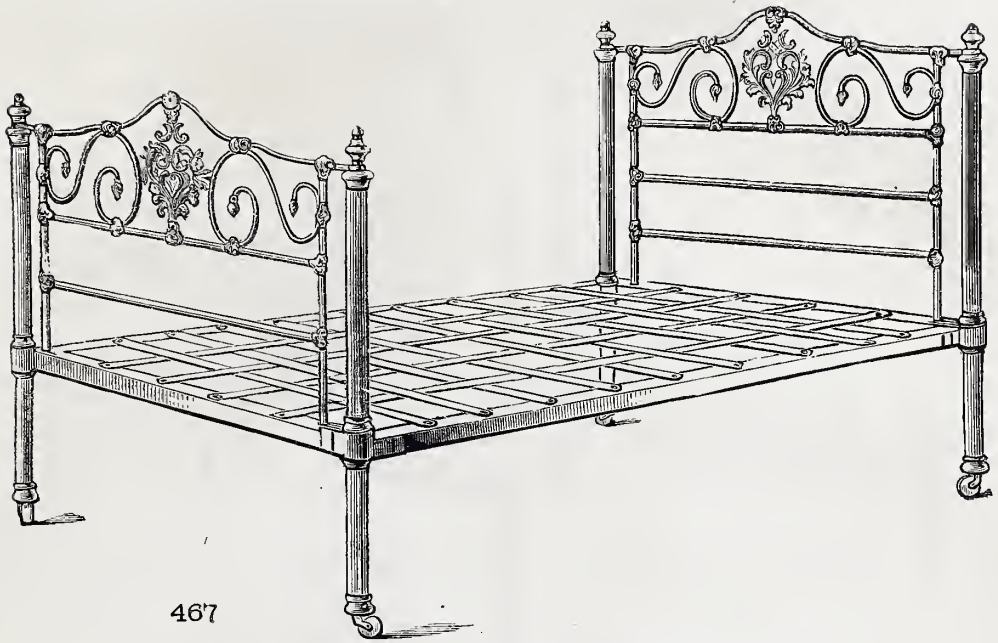

467

HAMPTON & SONS

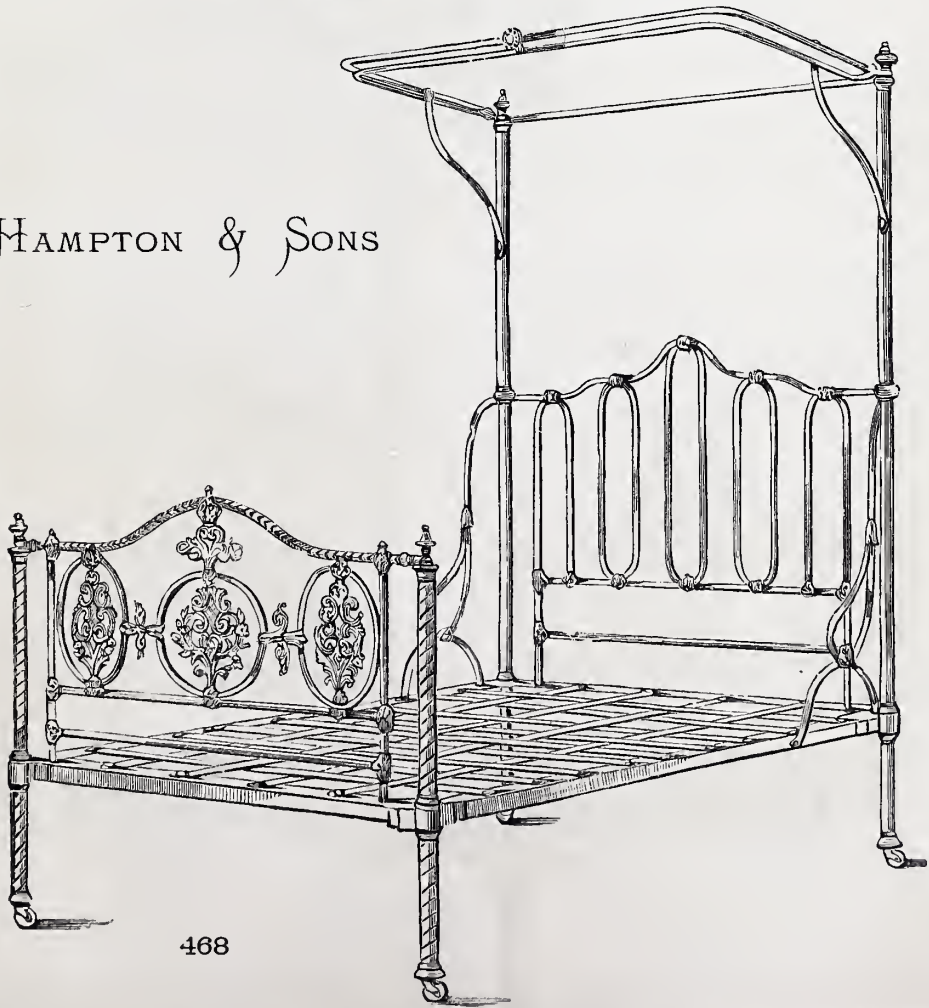

468

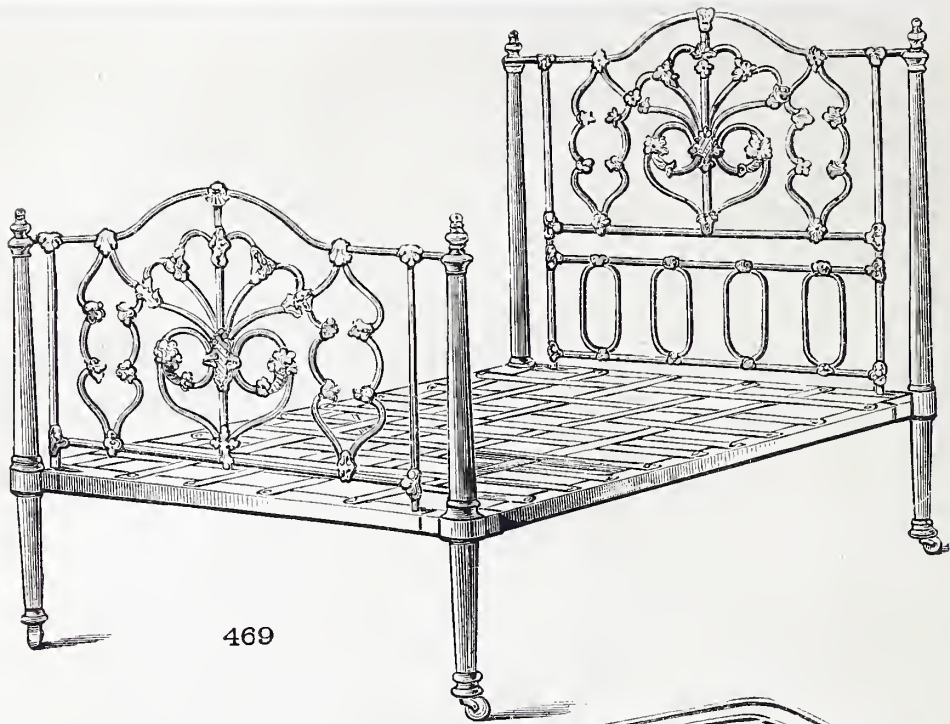

469

HAMPTON & SONS

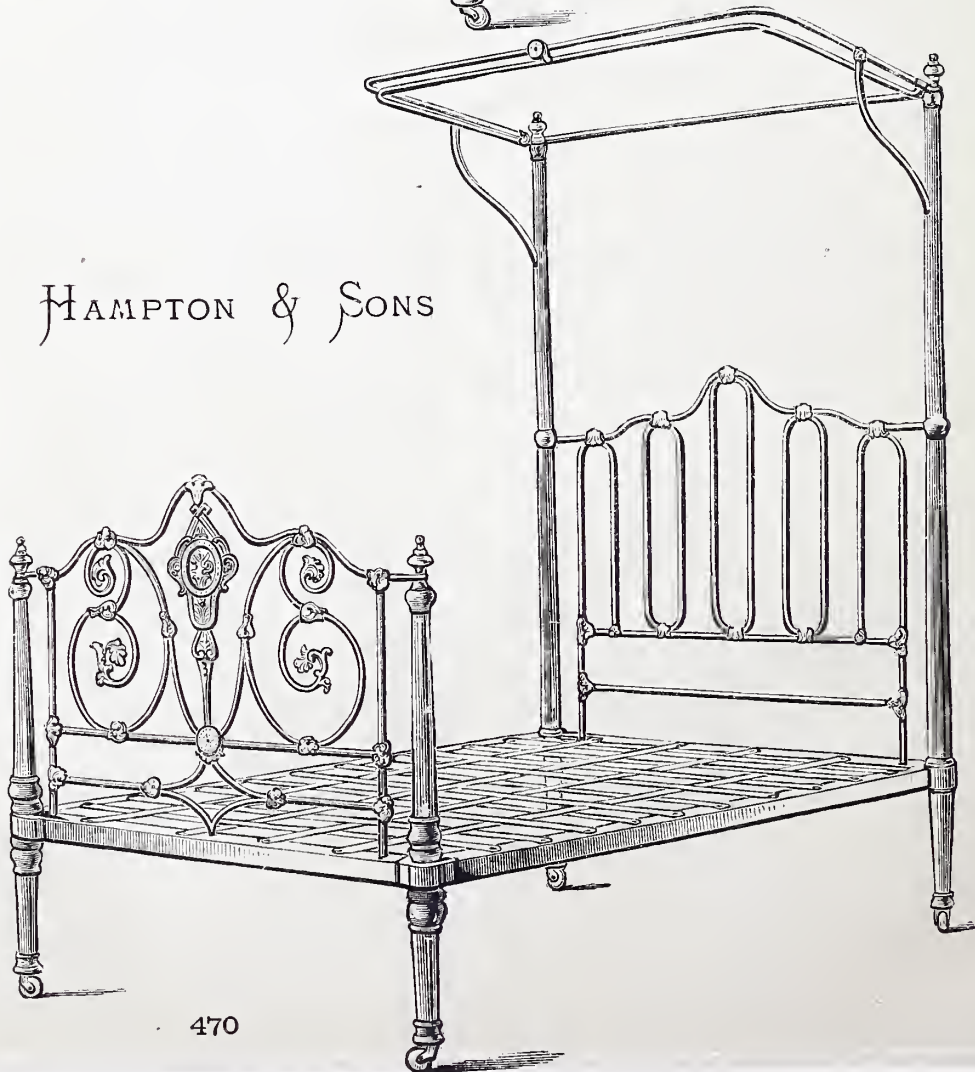

470



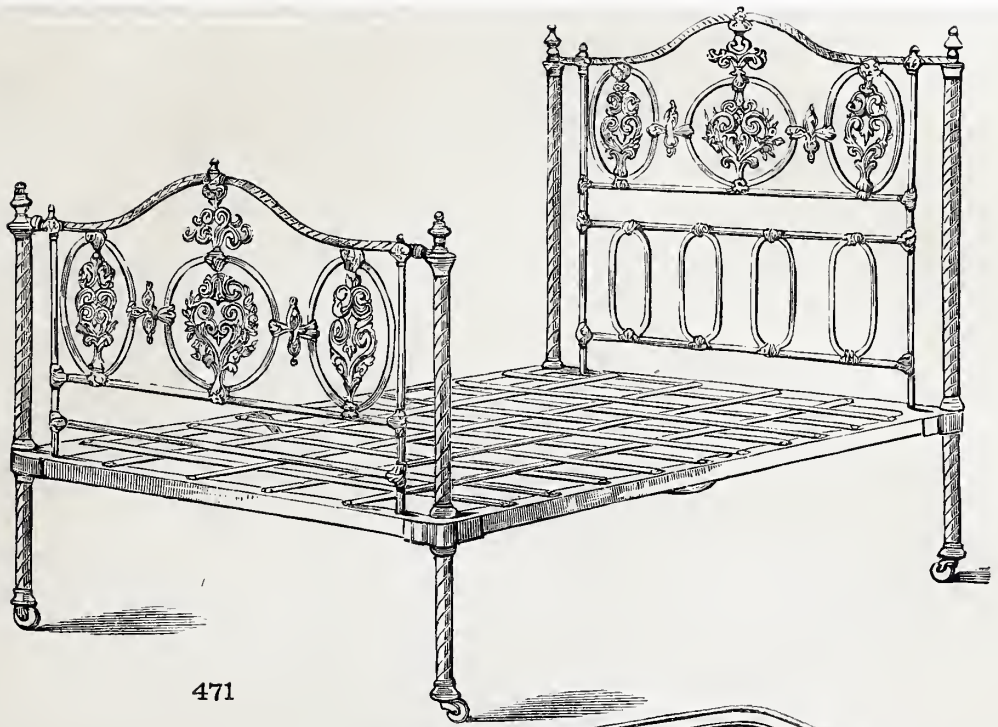

471

HAMPTON & SONS



472

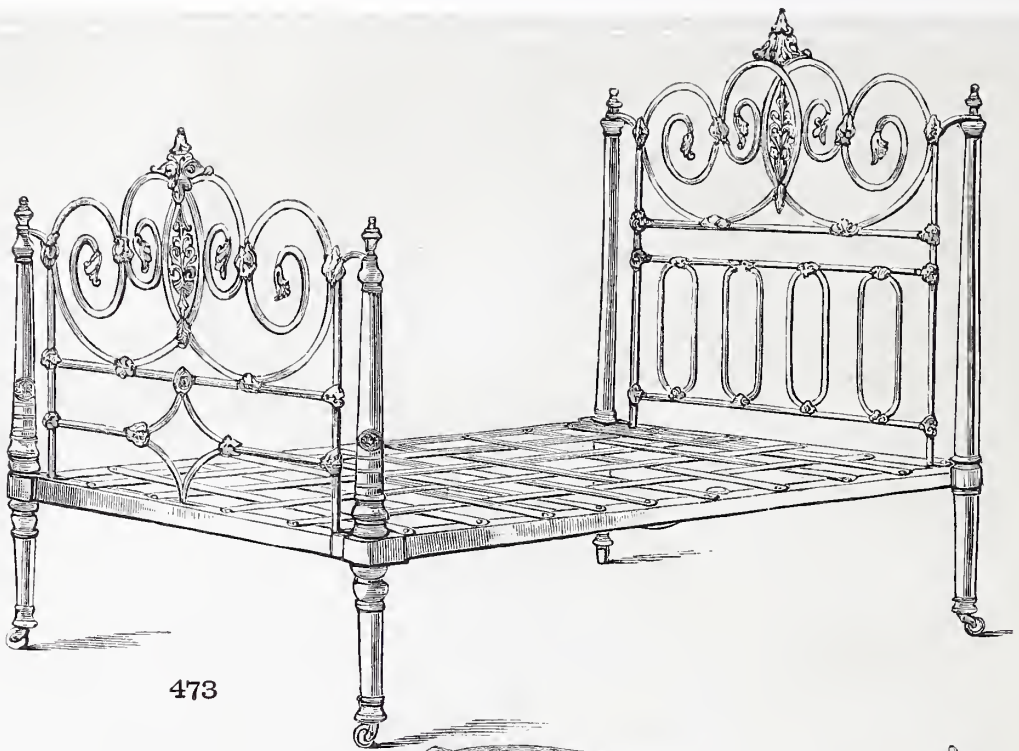

473

HAMPTON & SONS



474



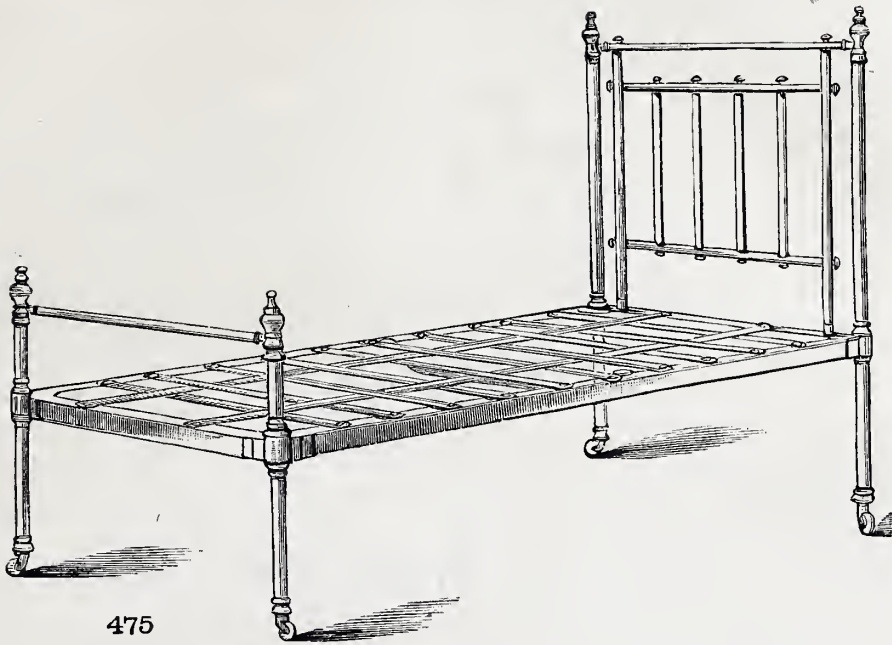

475

HAMPTON & SONS

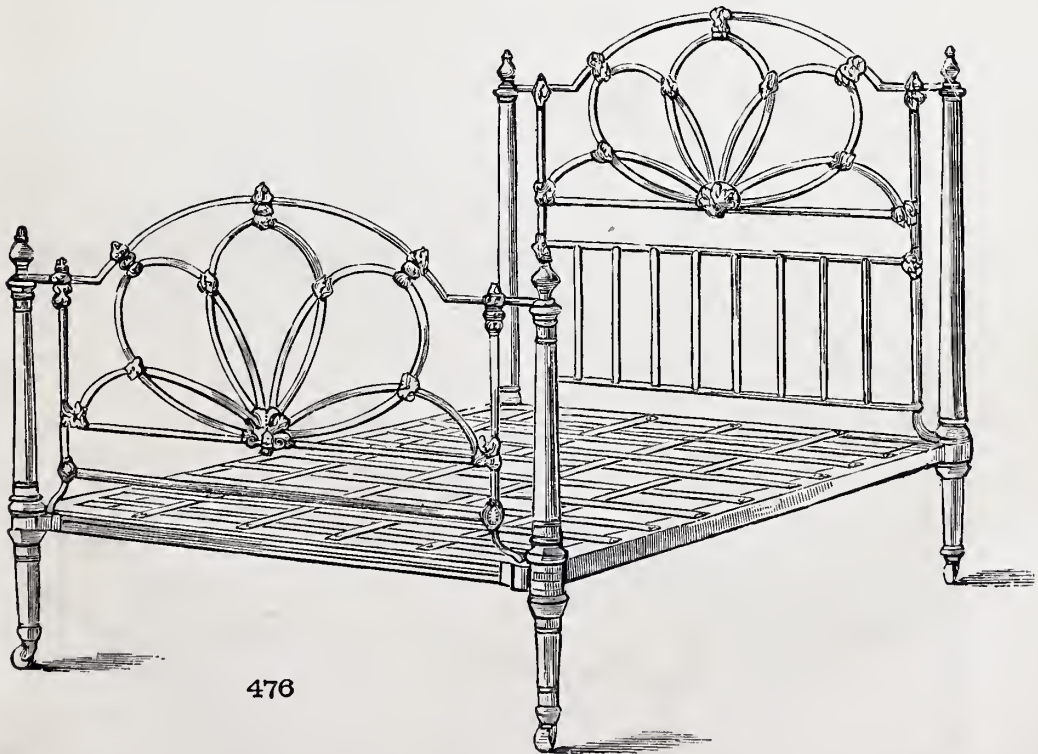

476

HAMPTON & SONS

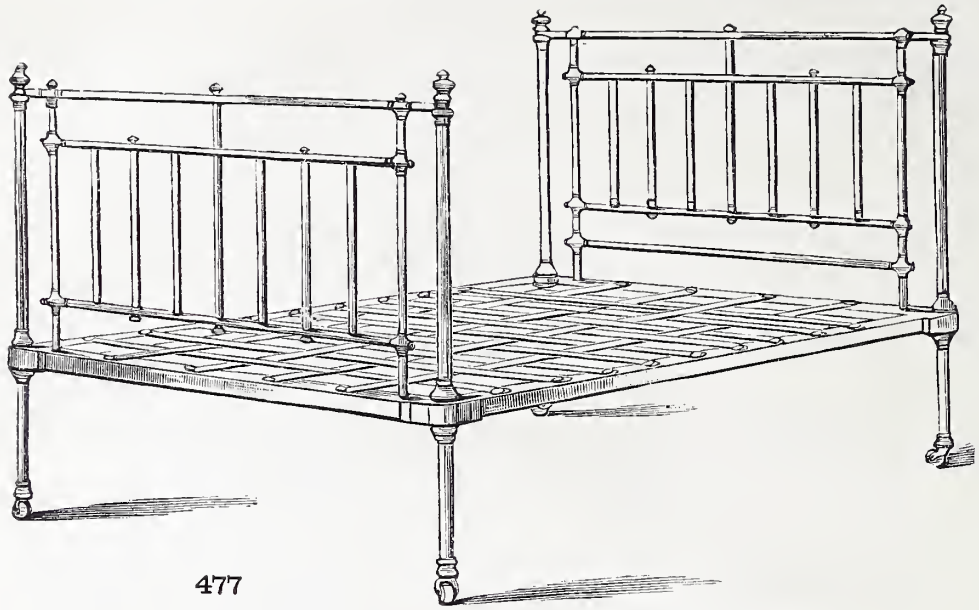

477

HAMPTON & SONS



478



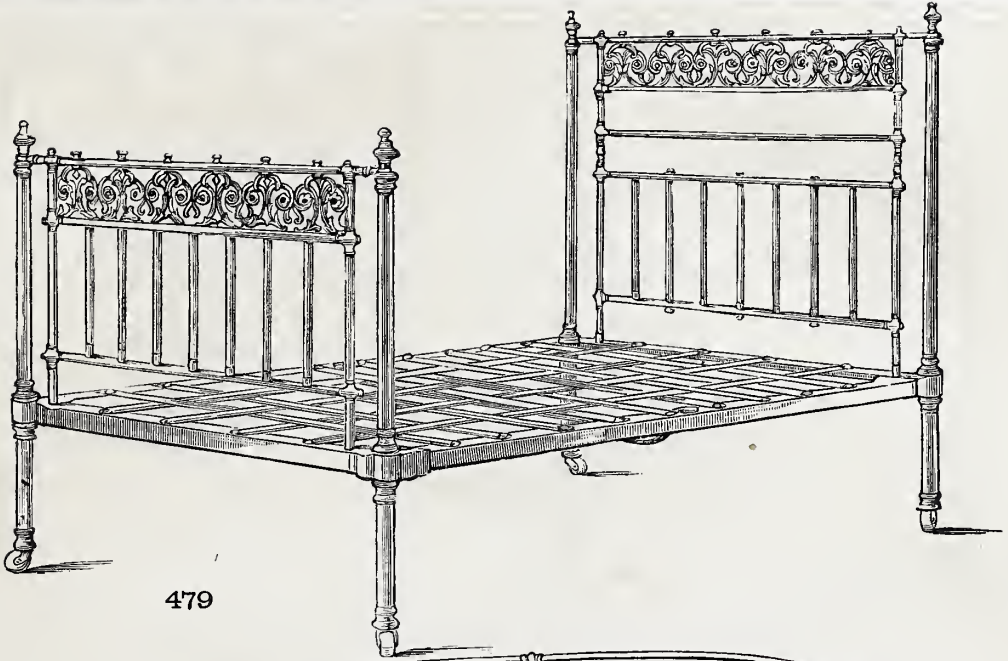

479

HAMPTON & SONS

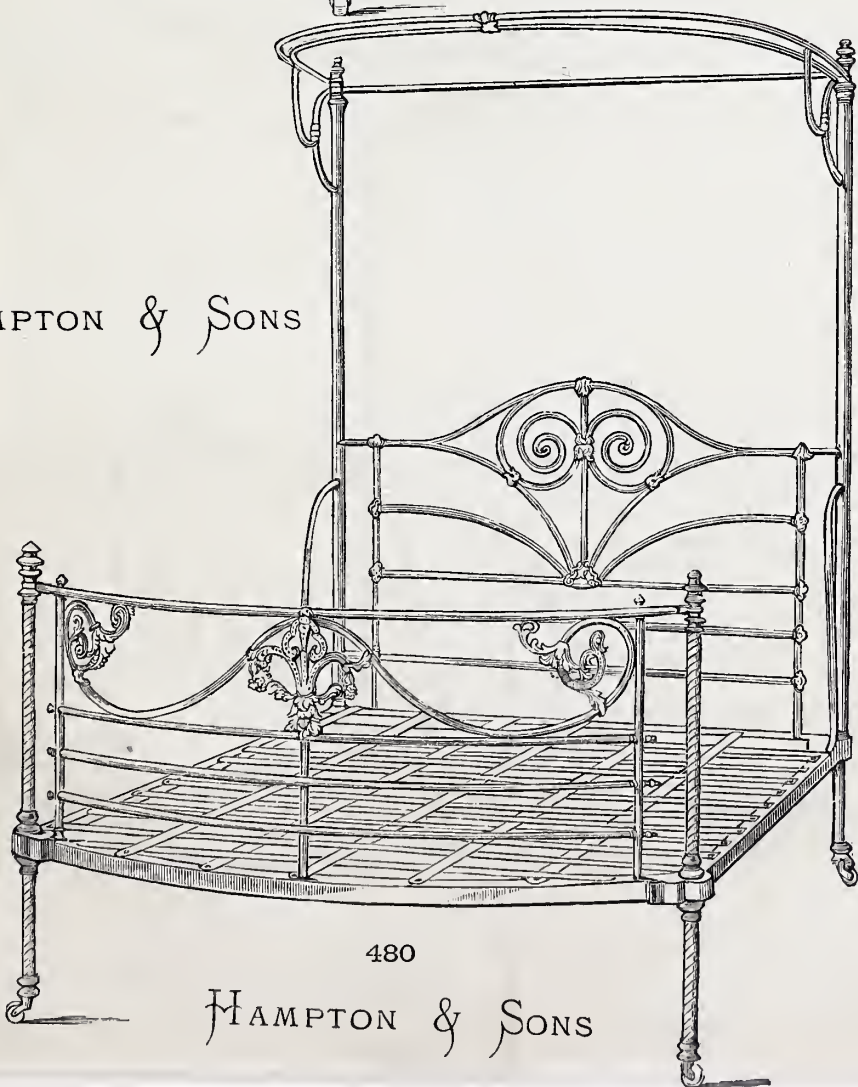

480

HAMPTON & SONS

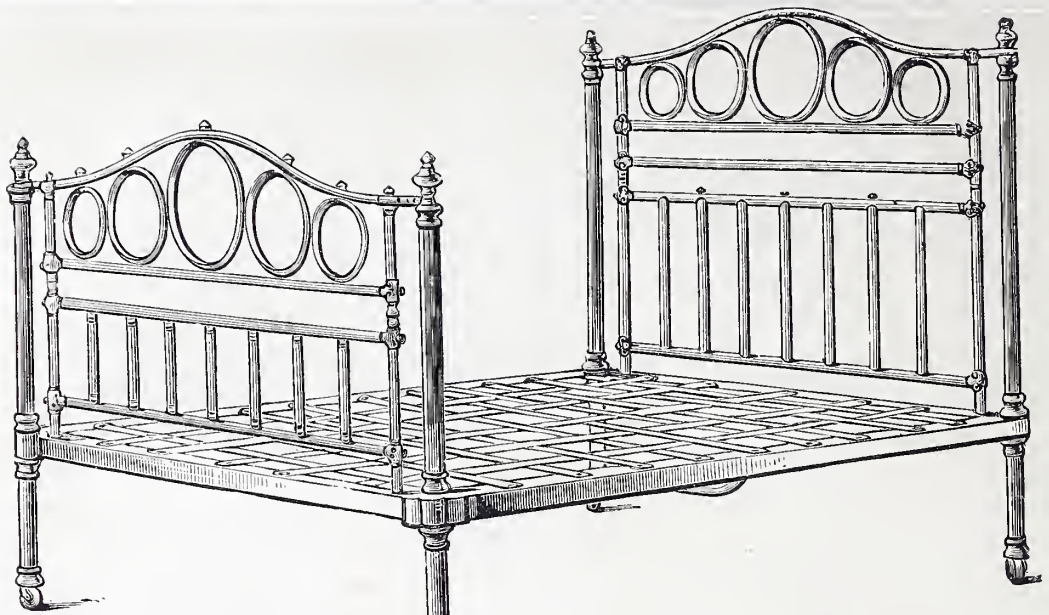

481

C. P. HIGGINS

HAMPTON & SONS

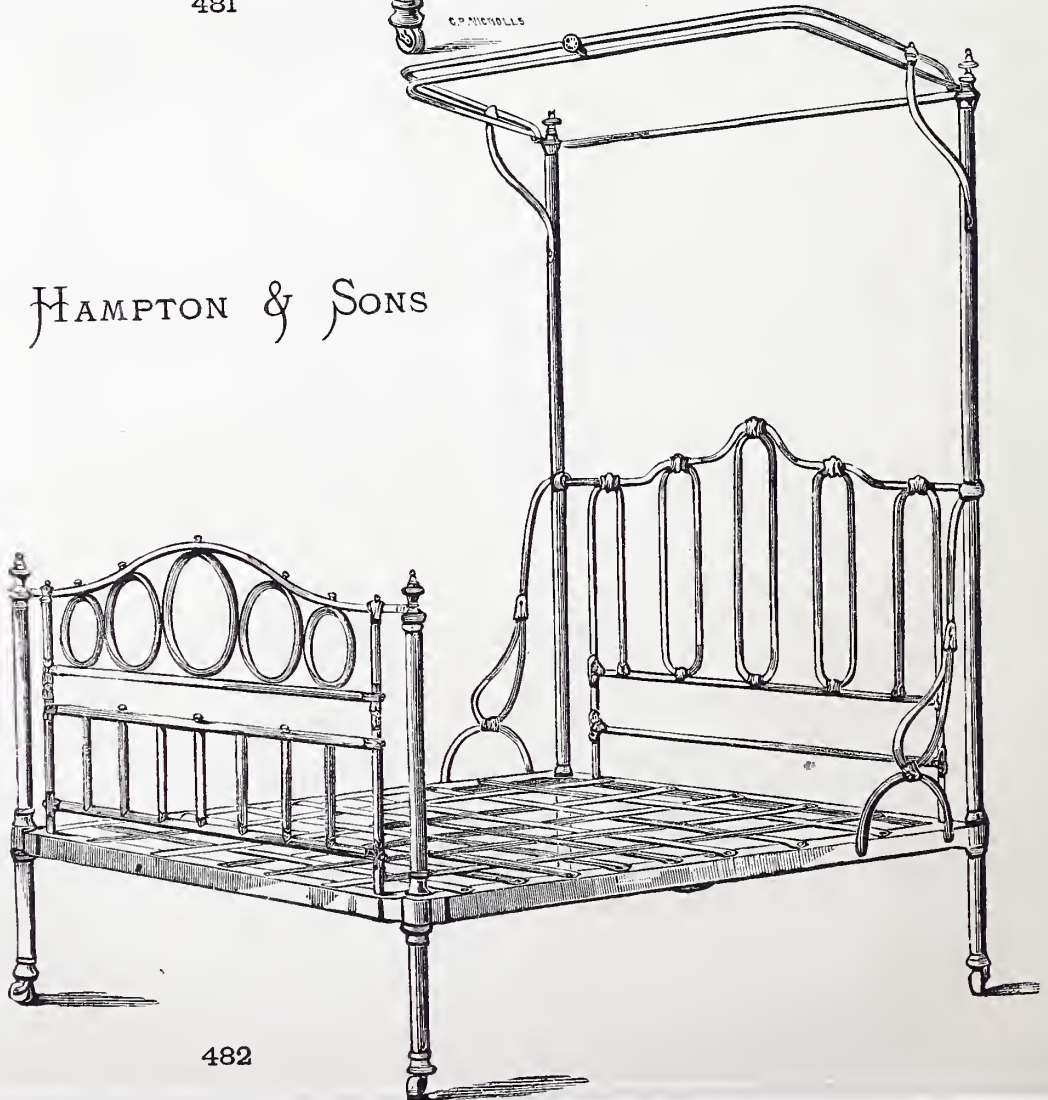

482



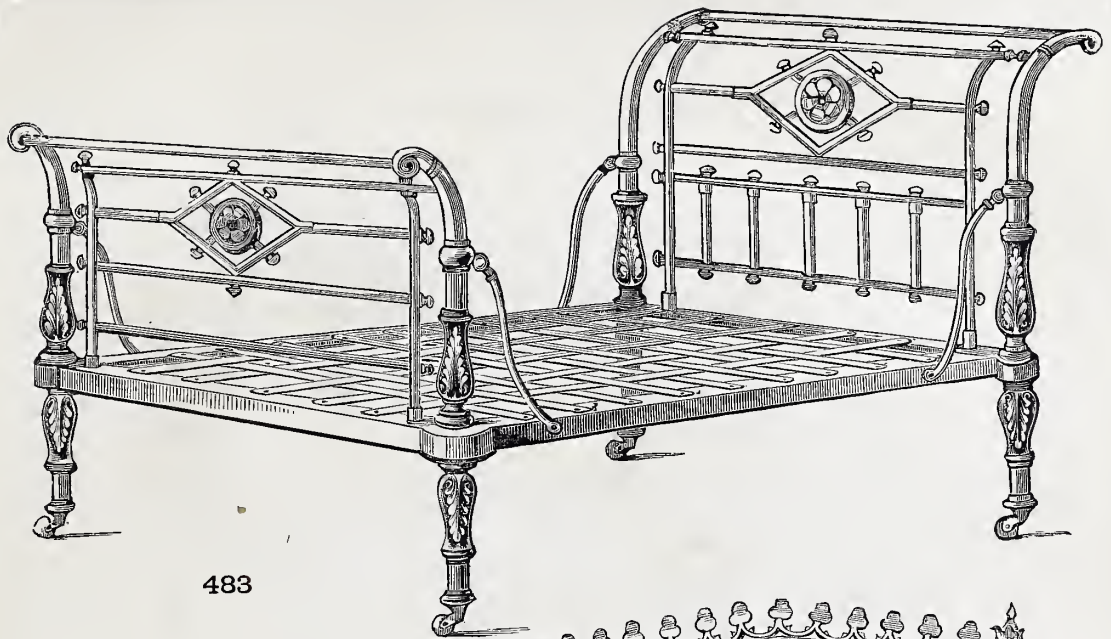

483

HAMPTON & SONS



484

HAMPTON & SONS

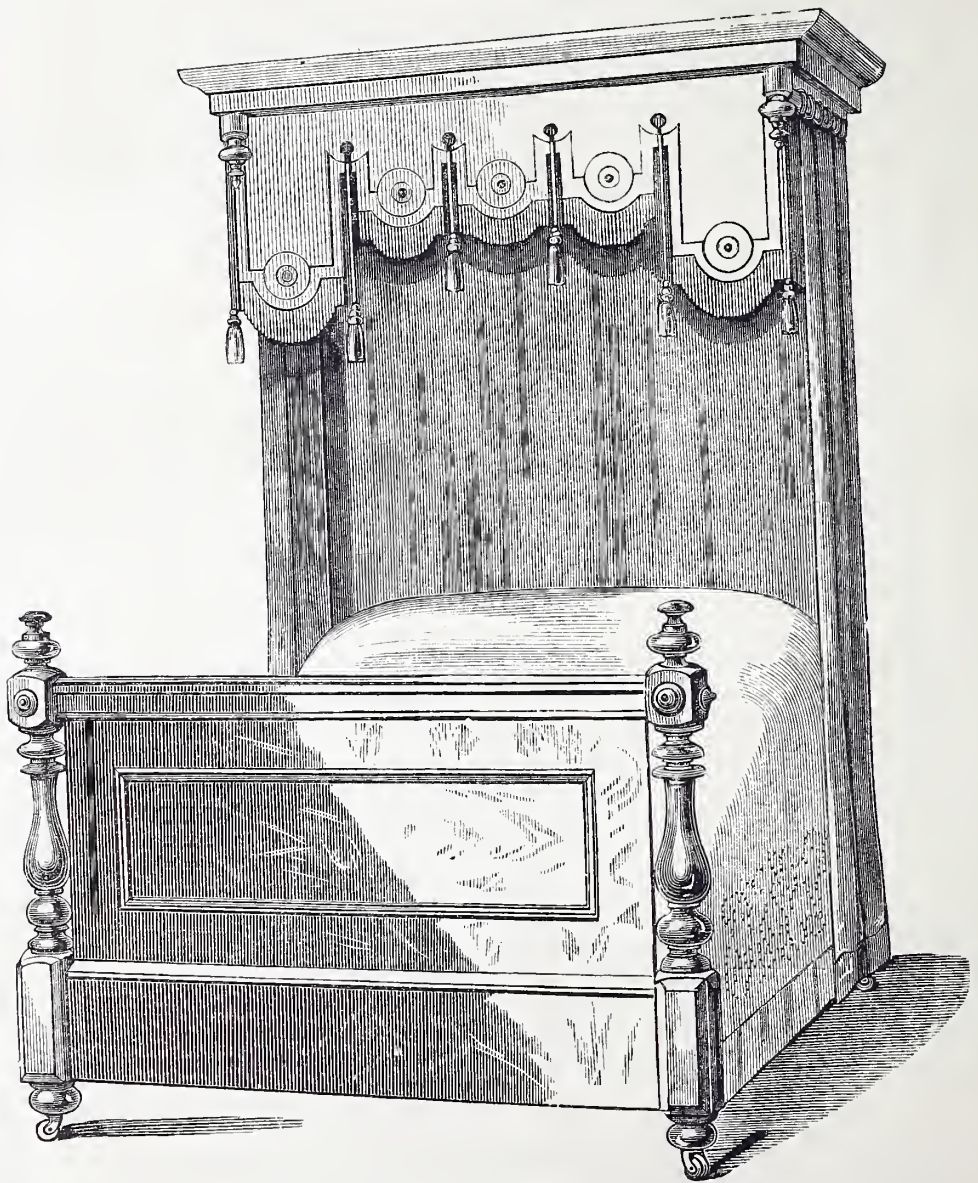

485

HAMPTON & SONS



HAMPTON & SONS

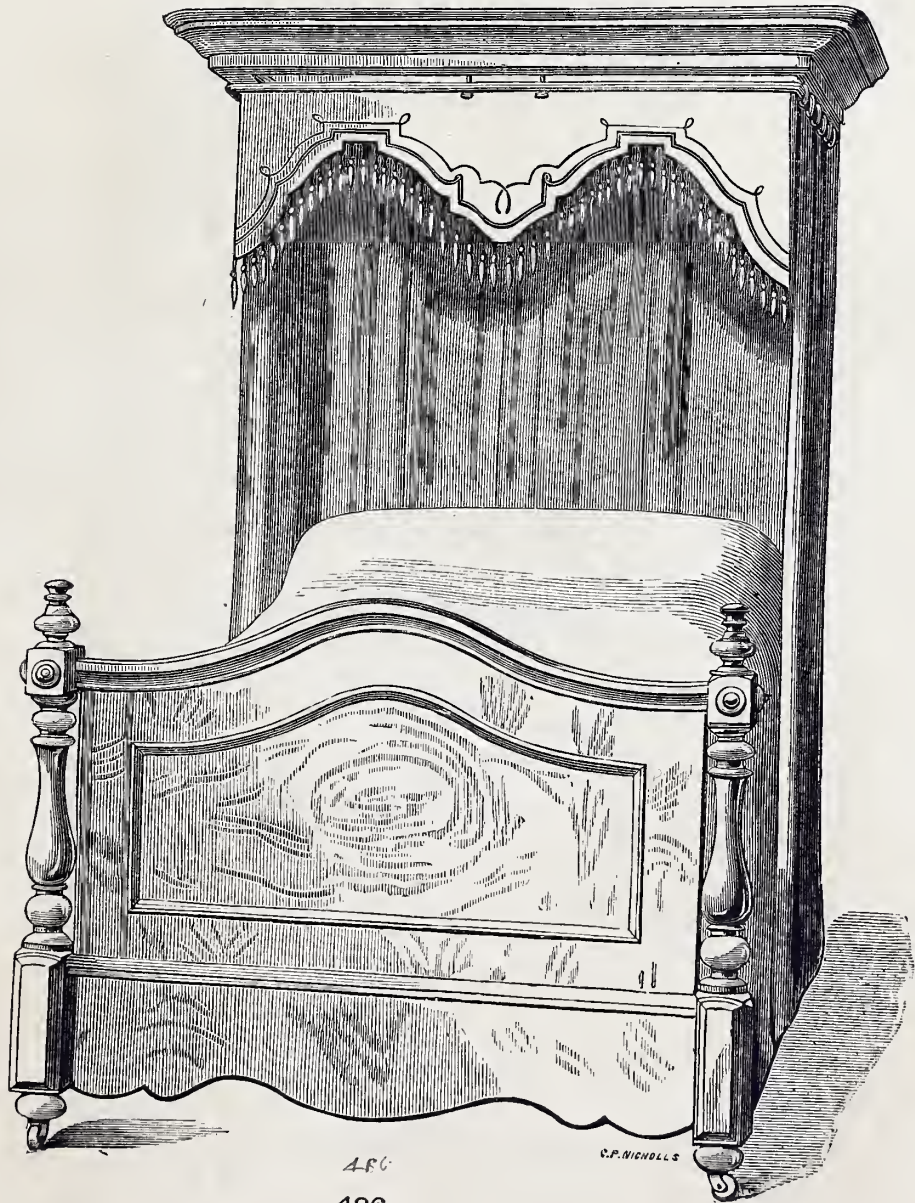

A.F.C.

C.P. NICHOLS

486

HAMPTON & SONS

HAMPTON & SONS

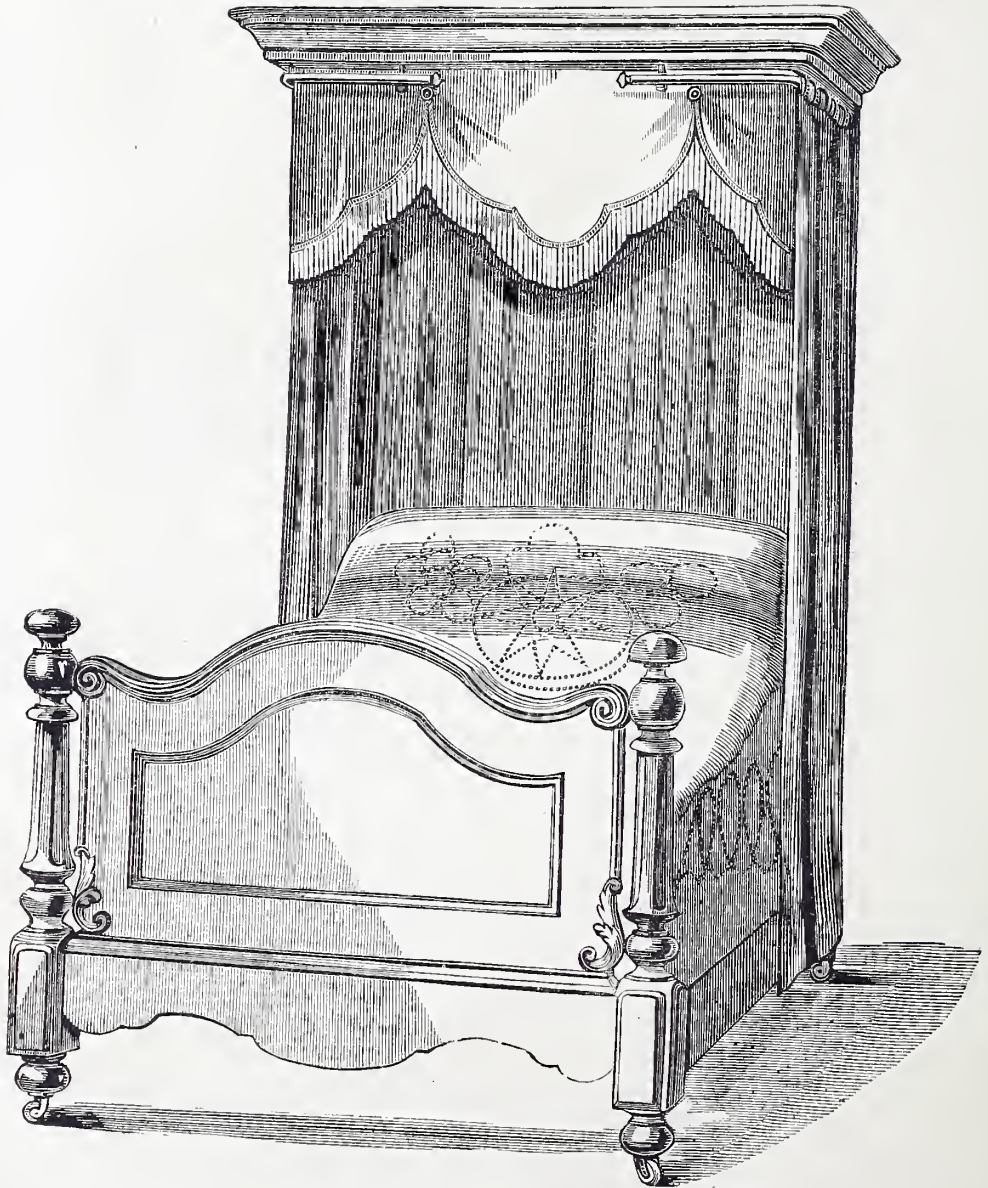

487

HAMPTON & SONS



HAMPTON & SONS

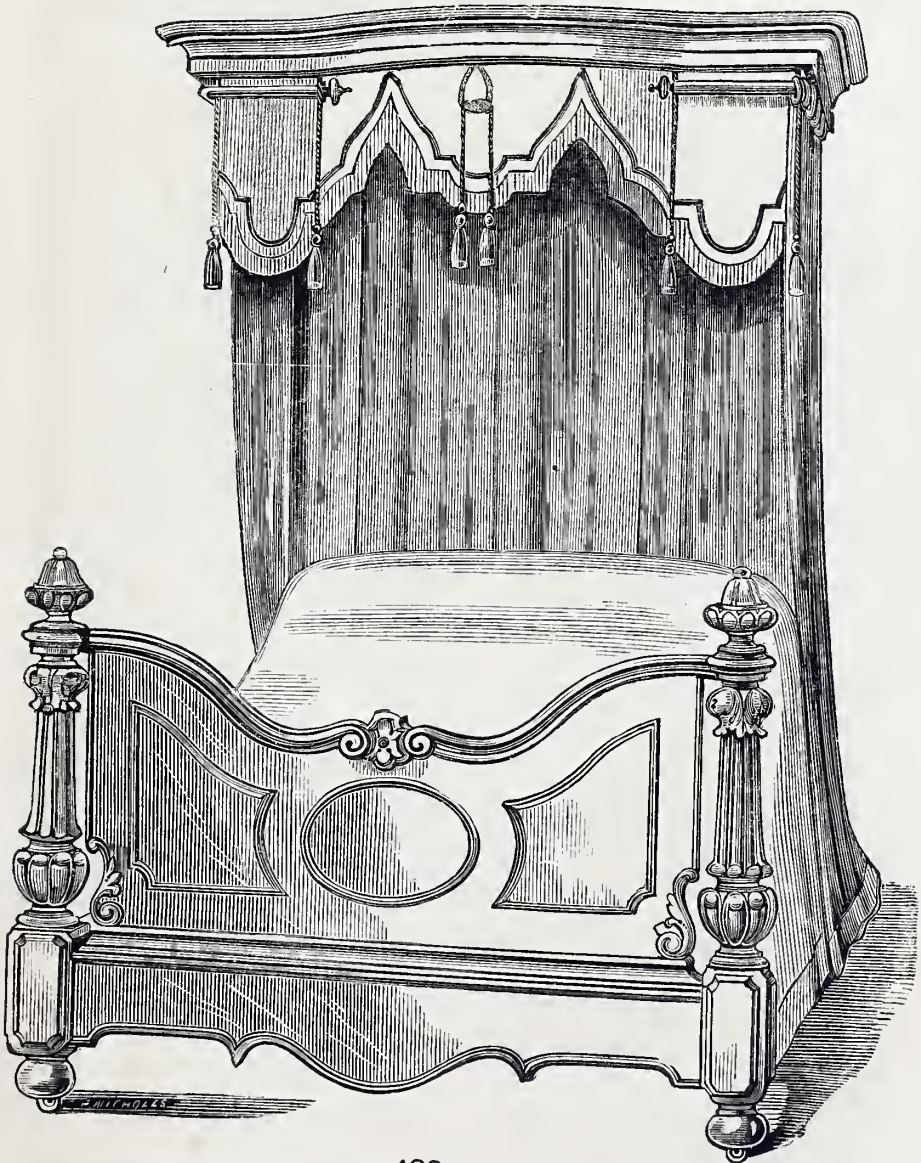

488

HAMPTON & SONS

HAMPTON & SONS

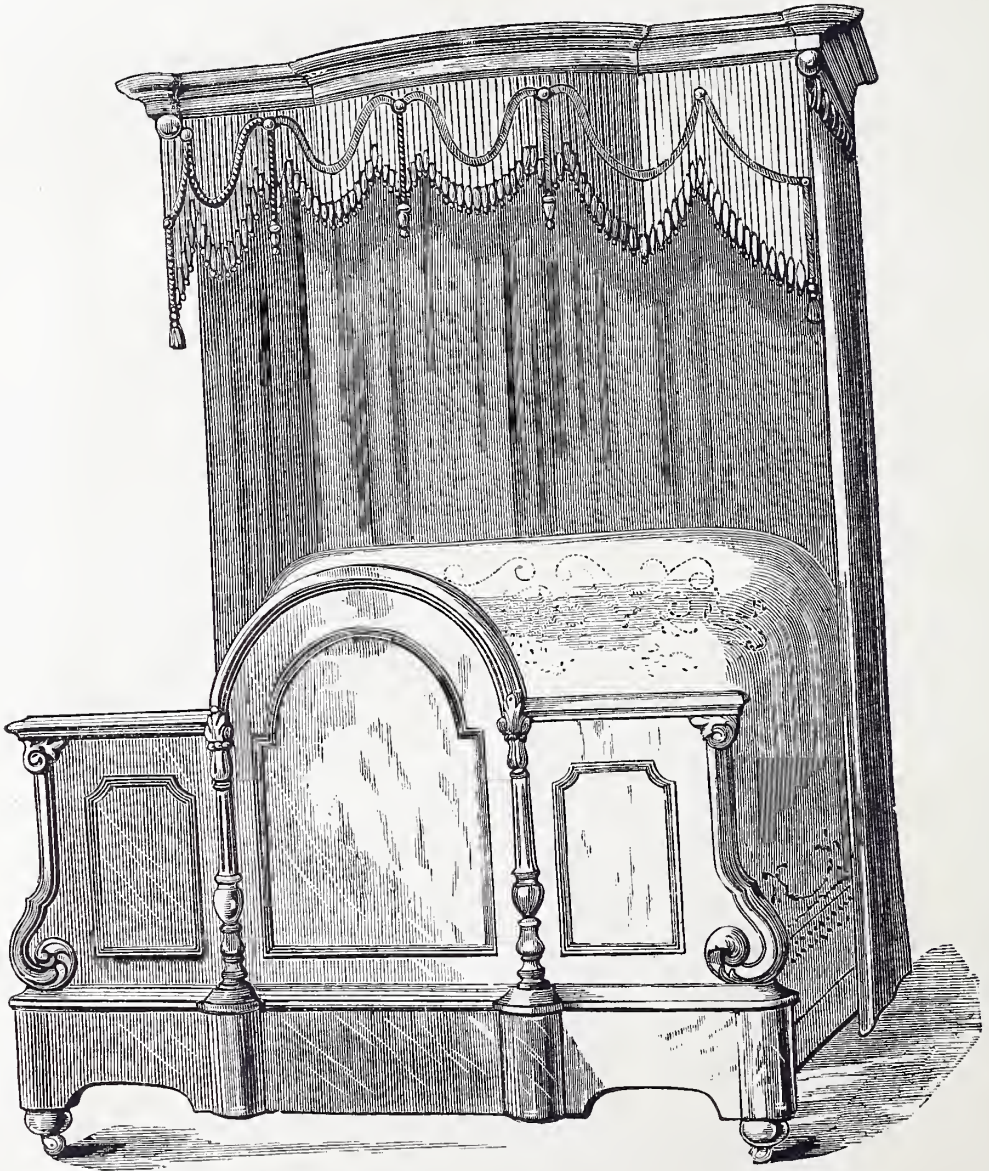

489

HAMPTON & SONS



HAMPTON & SONS

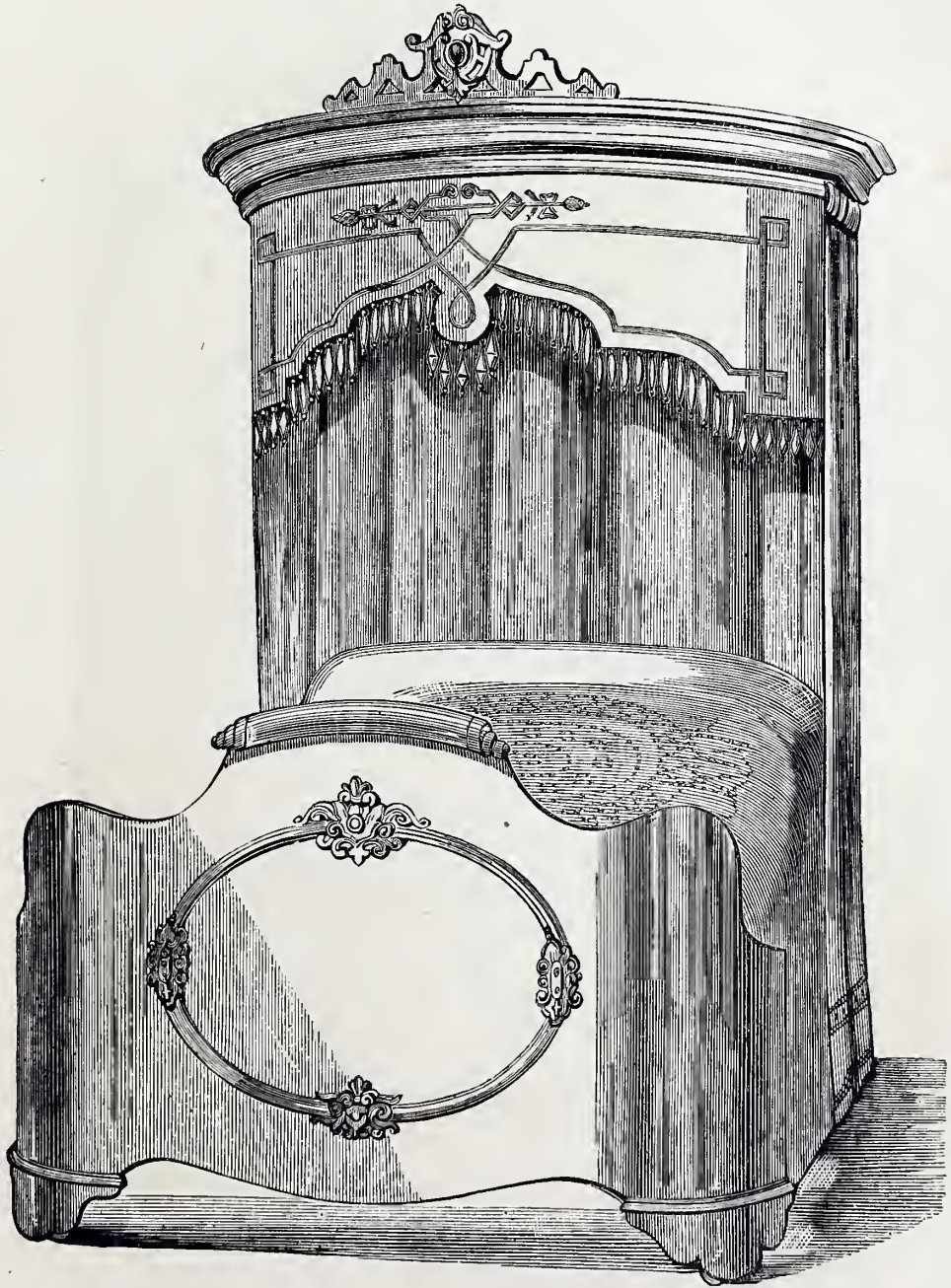

490

HAMPTON & SONS

HAMPTON & SONS

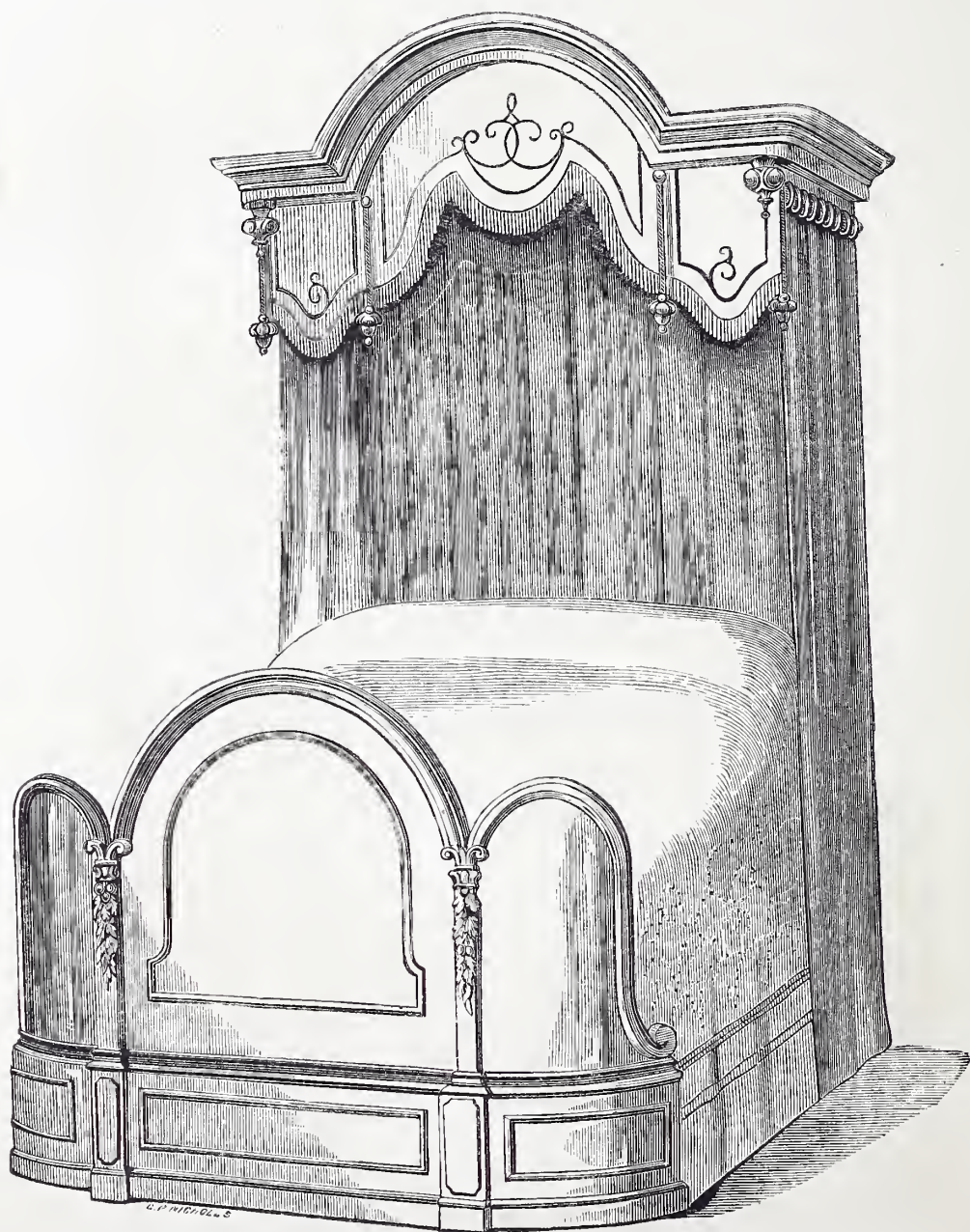

491

HAMPTON & SONS



HAMPTON & SONS



492

HAMPTON & SONS

HAMPTON & SONS

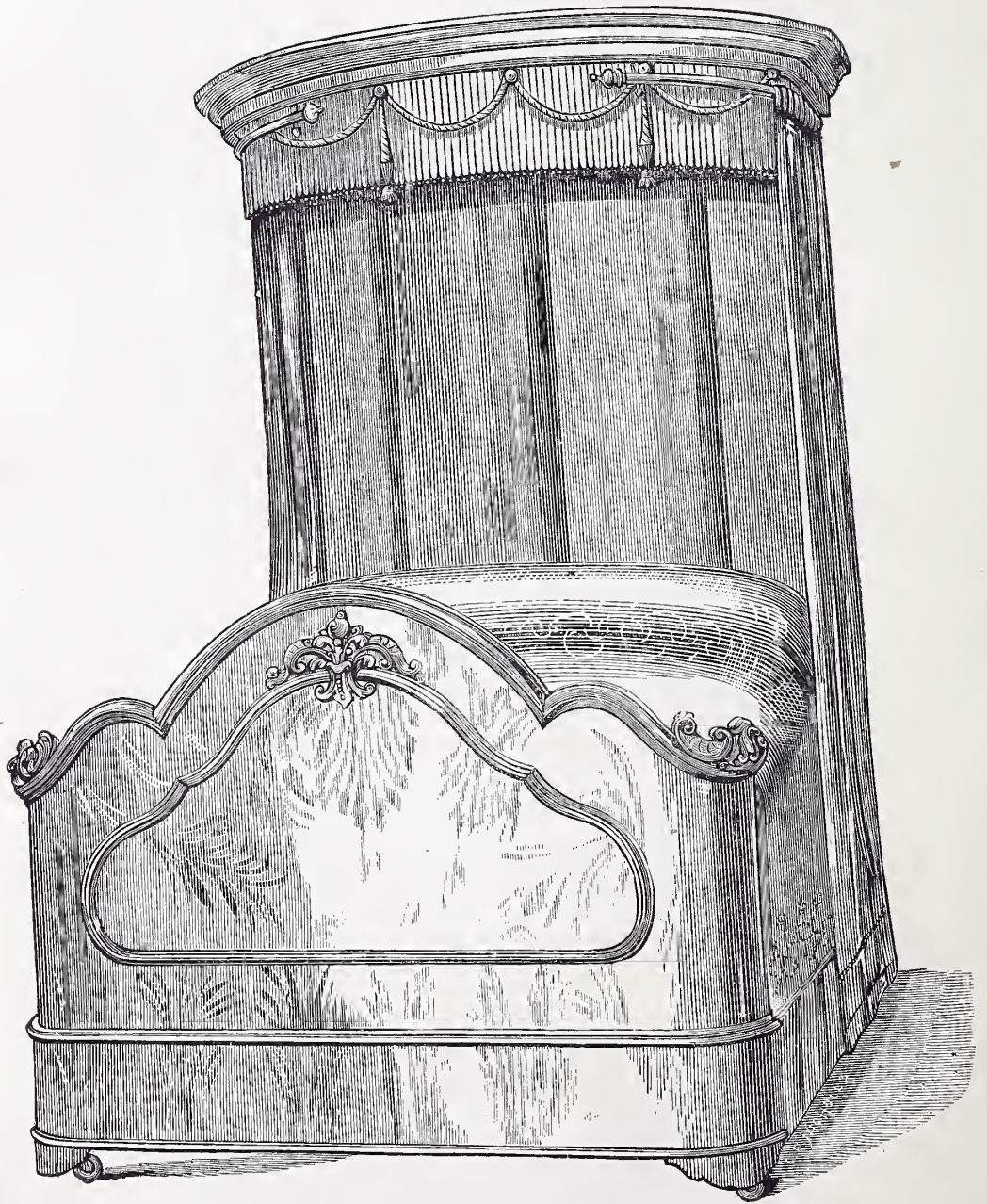

493

HAMPTON & SONS



HAMPTON & SONS

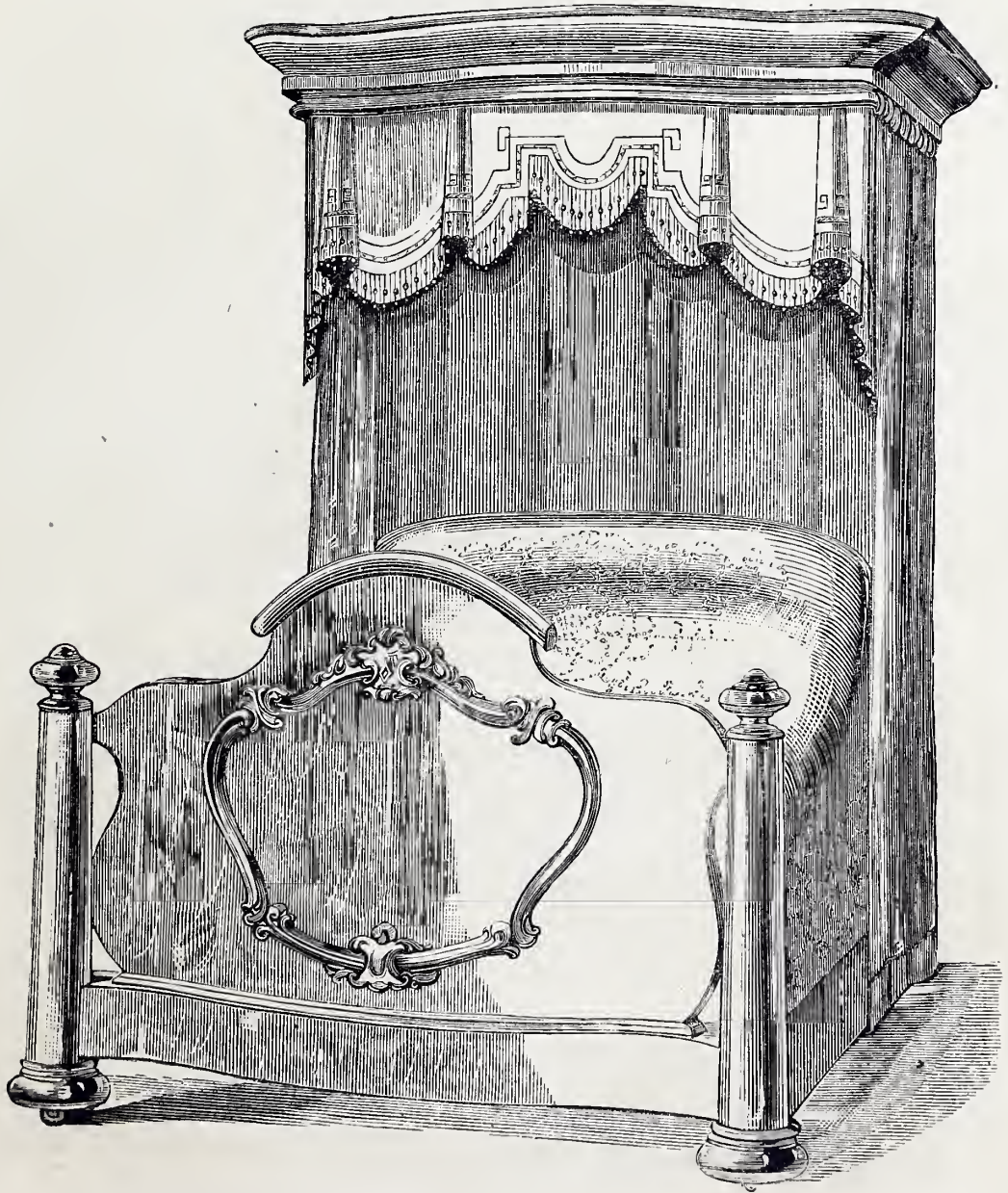

494

HAMPTON & SONS

HAMPTON & SONS

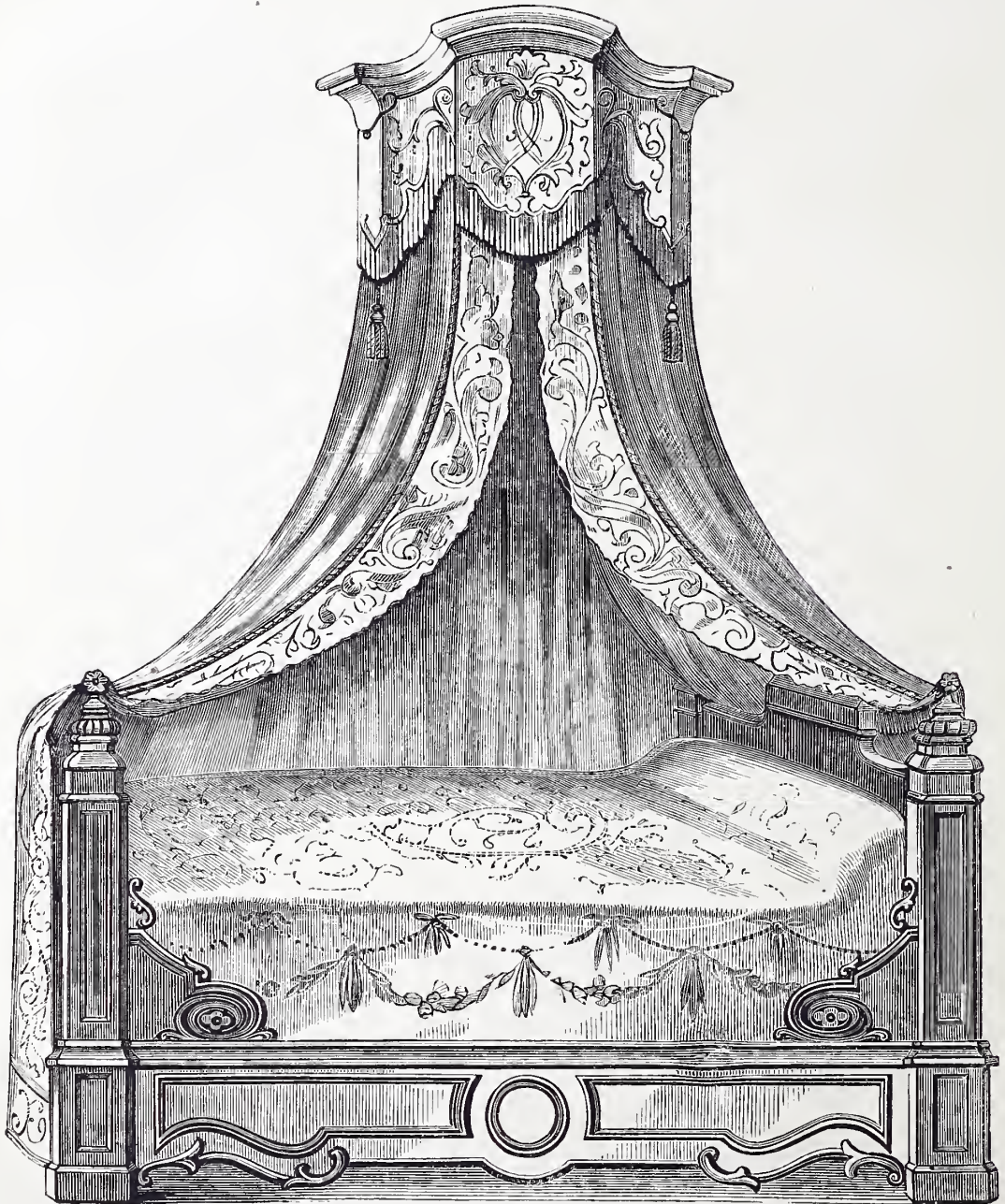

C.P. MCHOLLS

495

HAMPTON & SONS



HAMPTON & SONS

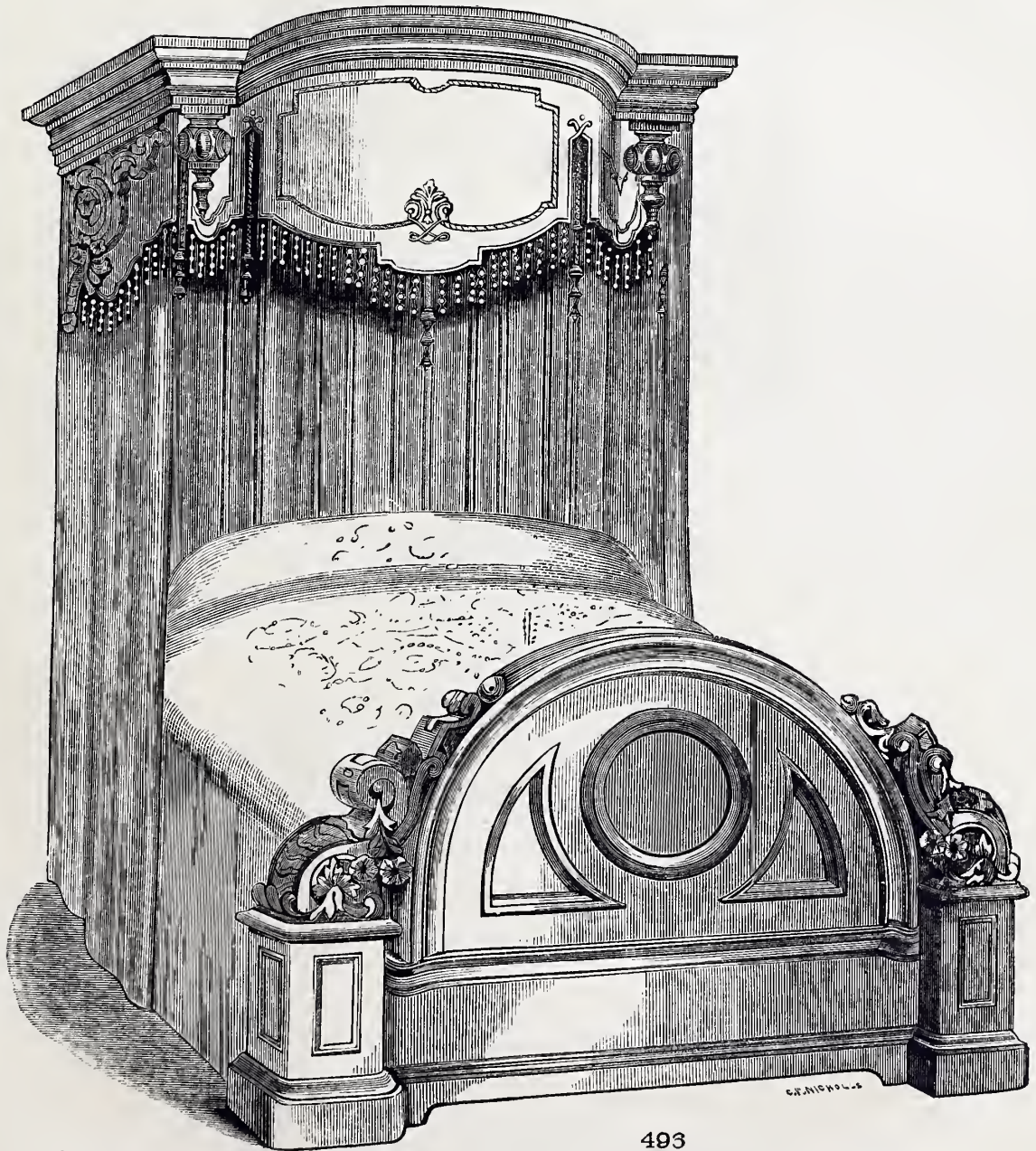

493

HAMPTON & SONS

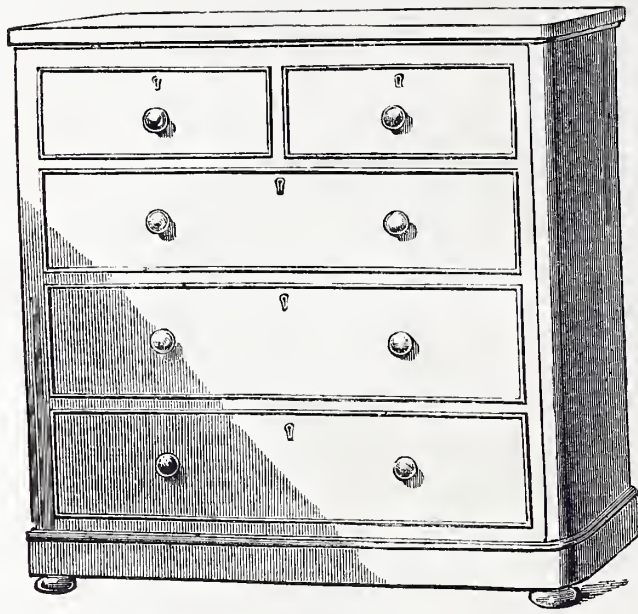

497

HAMPTON & SONS

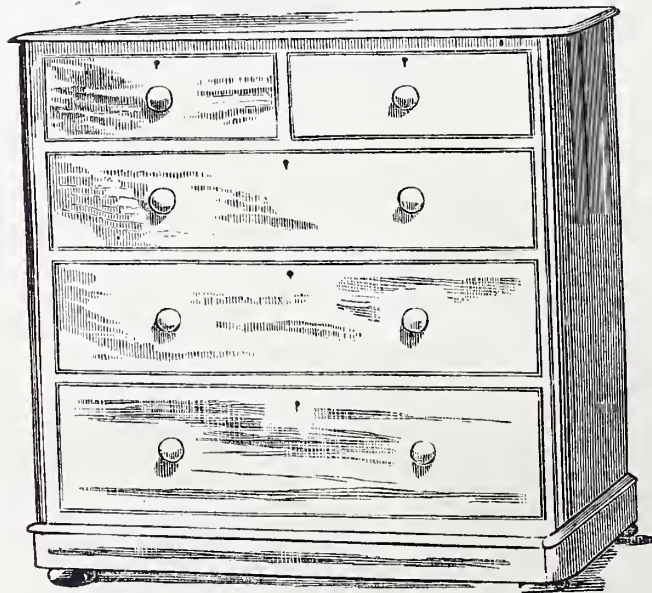

498

HAMPTON & SONS





499

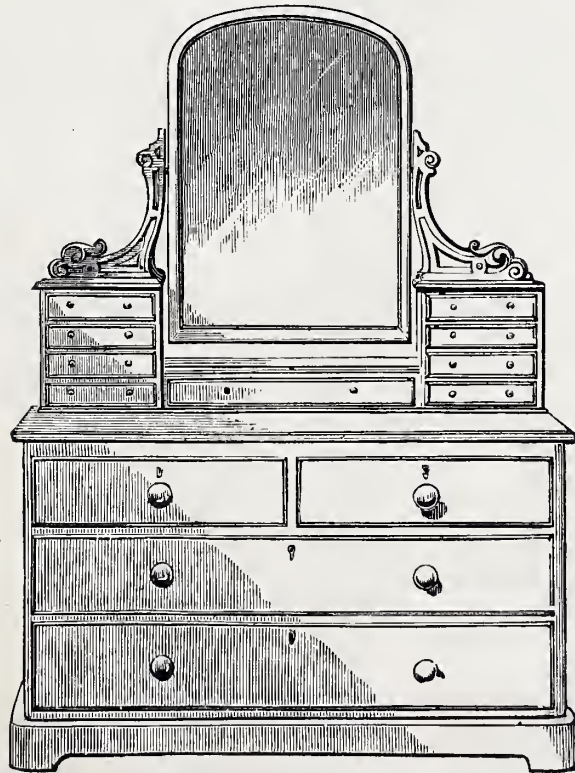

500

HAMPTON & SONS

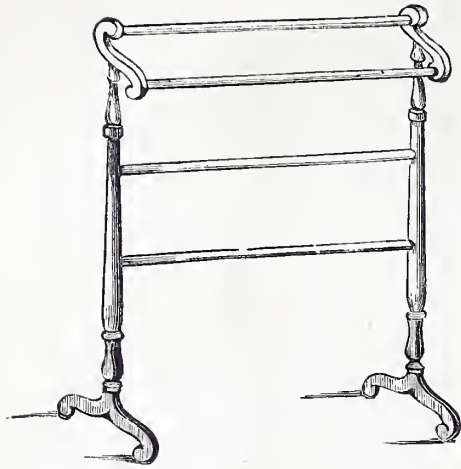

501

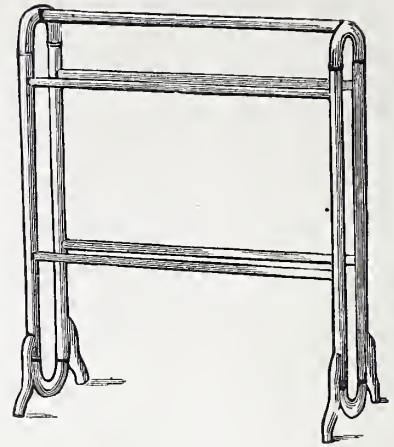

502



503



504

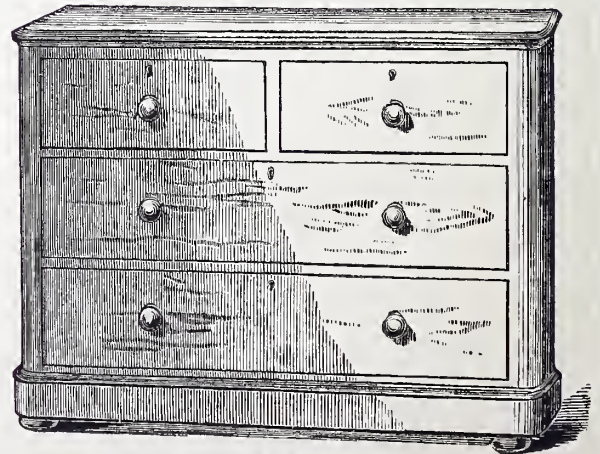

505

HAMPTON & SONS



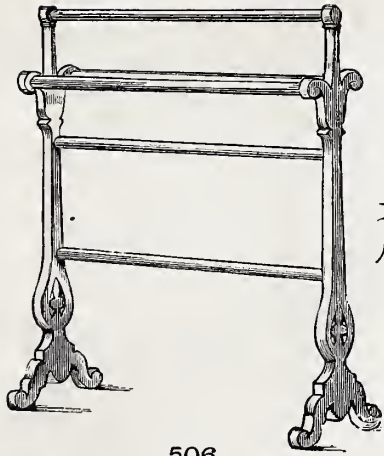

506

HAMPTON & SONS

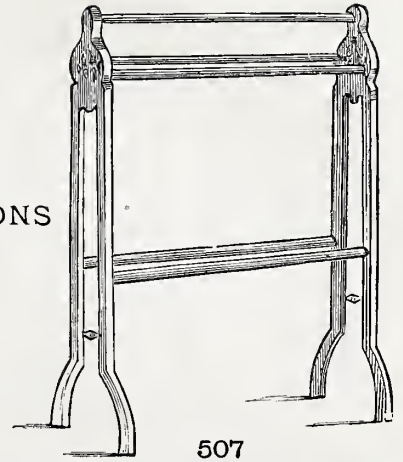

507

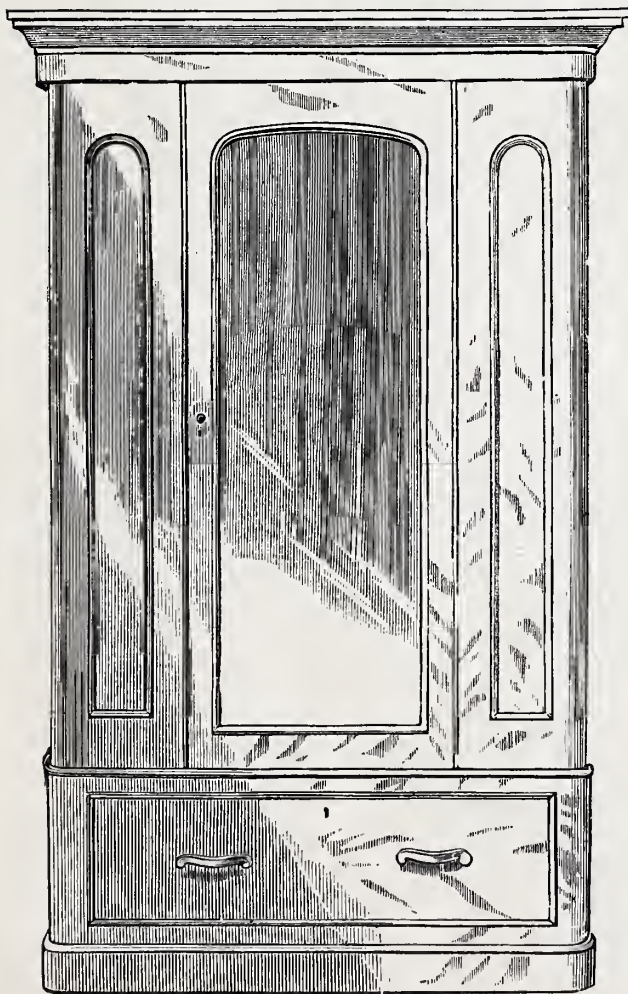

508

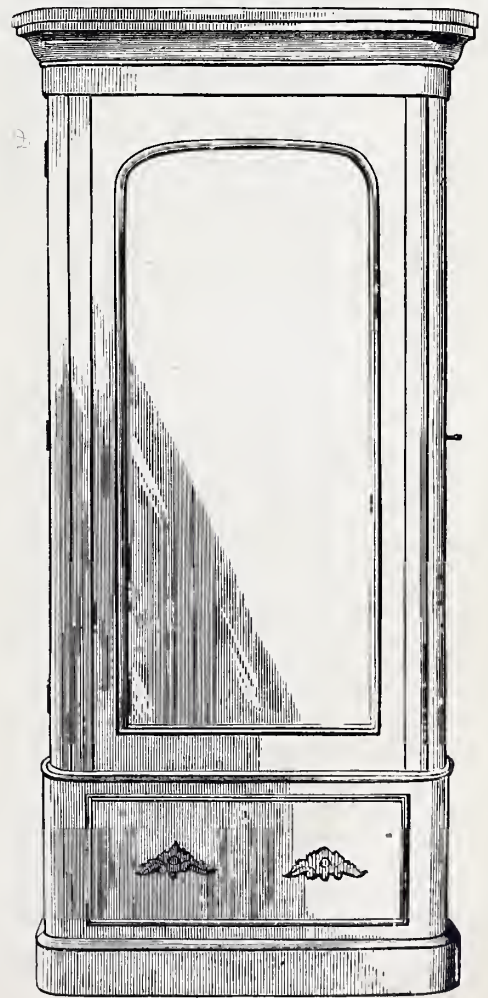

509

HAMPTON & SONS

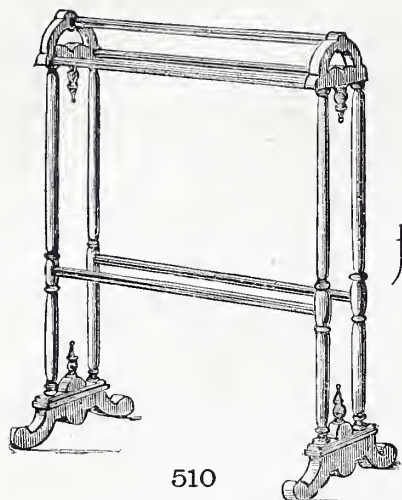

510

HAMPTON & SONS

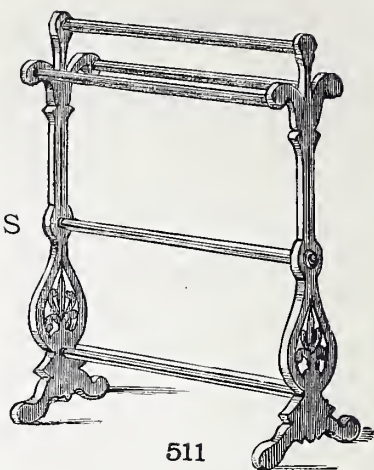

511

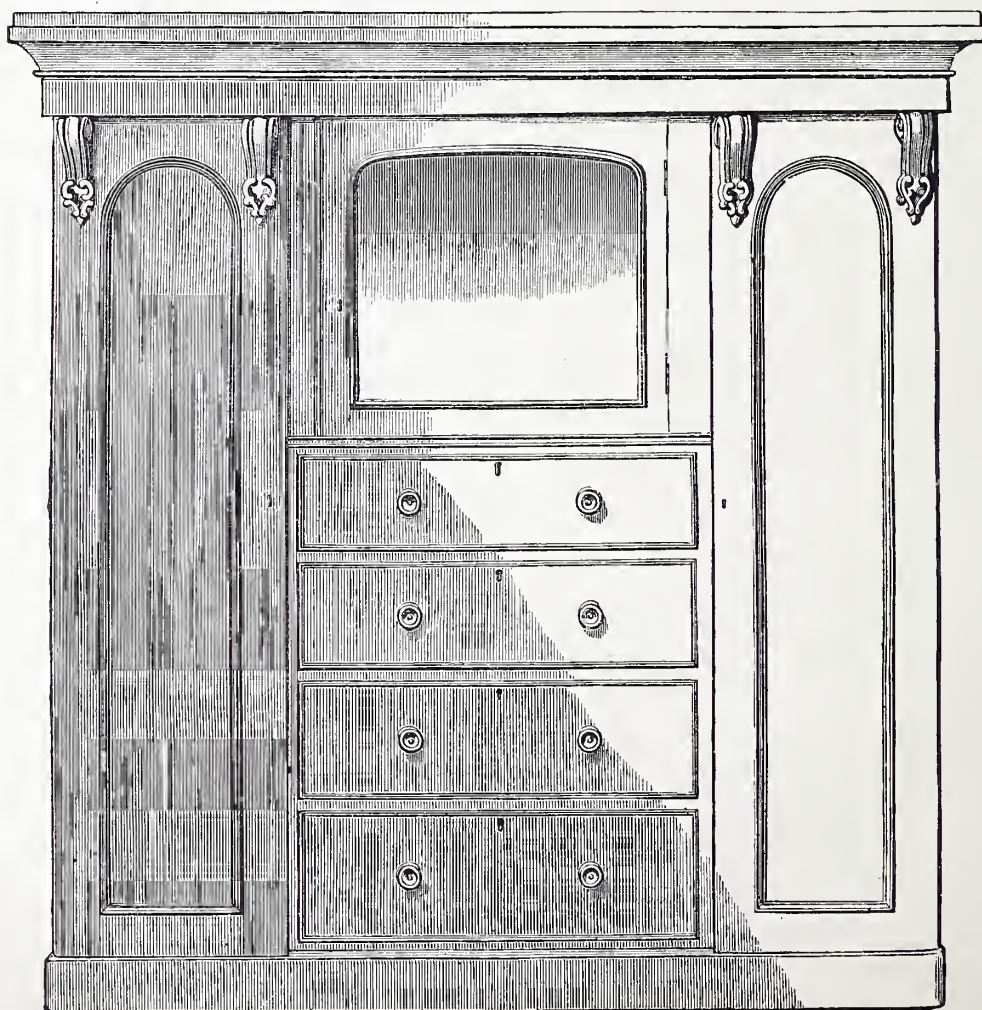

512

HAMPTON & SONS



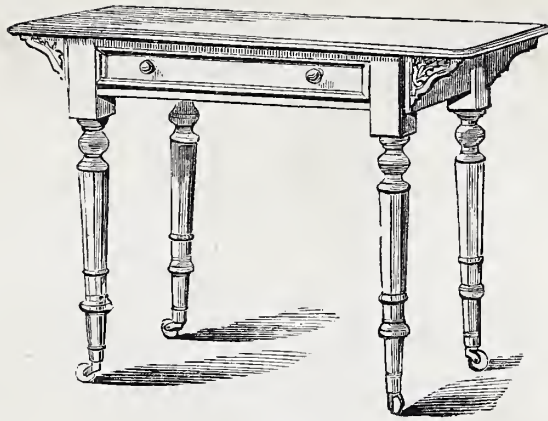

513



514

HAMPTON & SONS

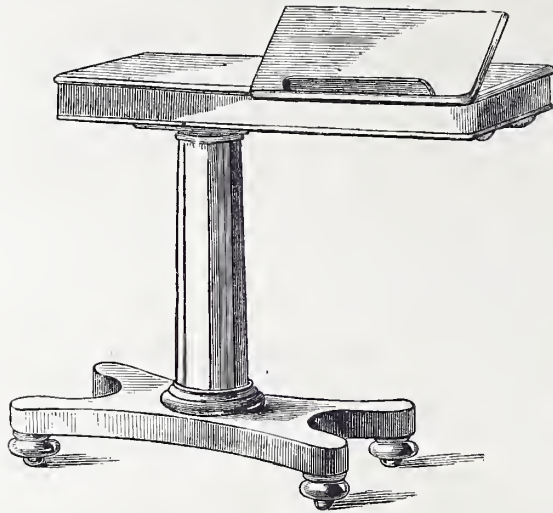

515

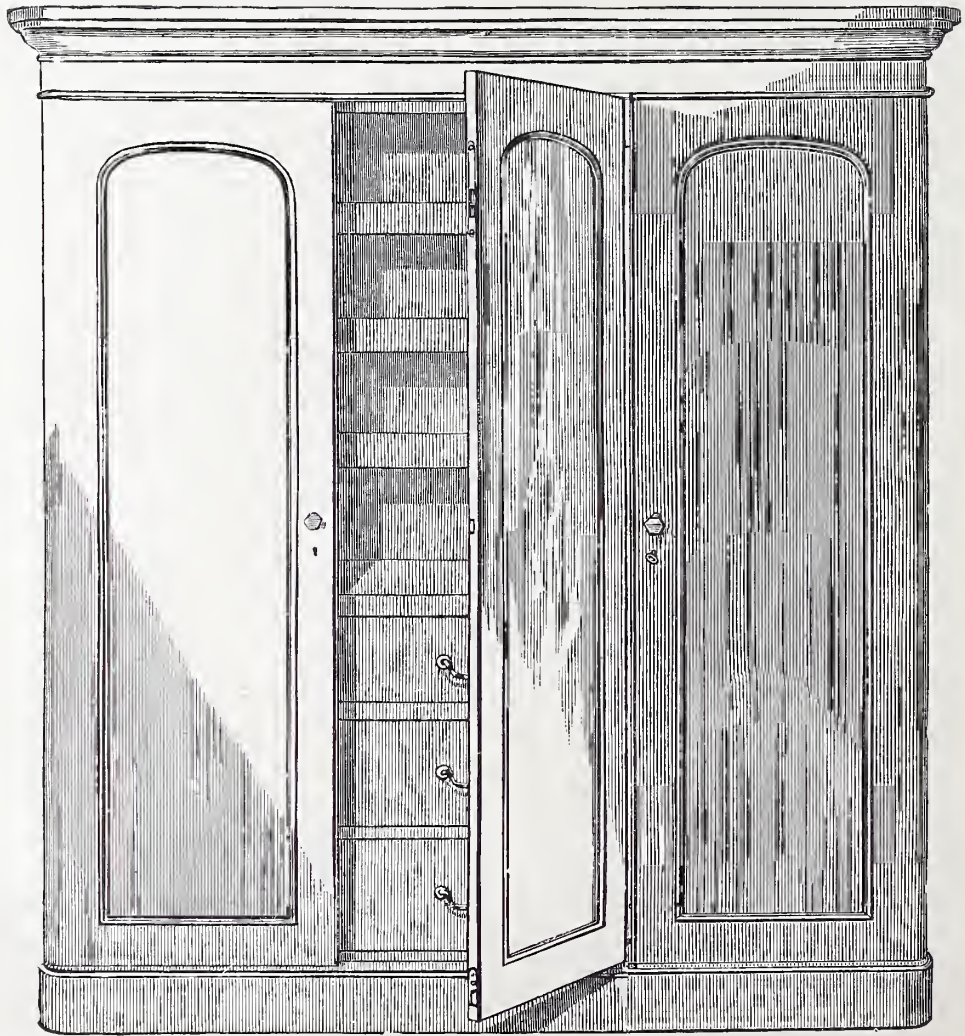

516

HAMPTON & SONS



HAMPTON & SONS

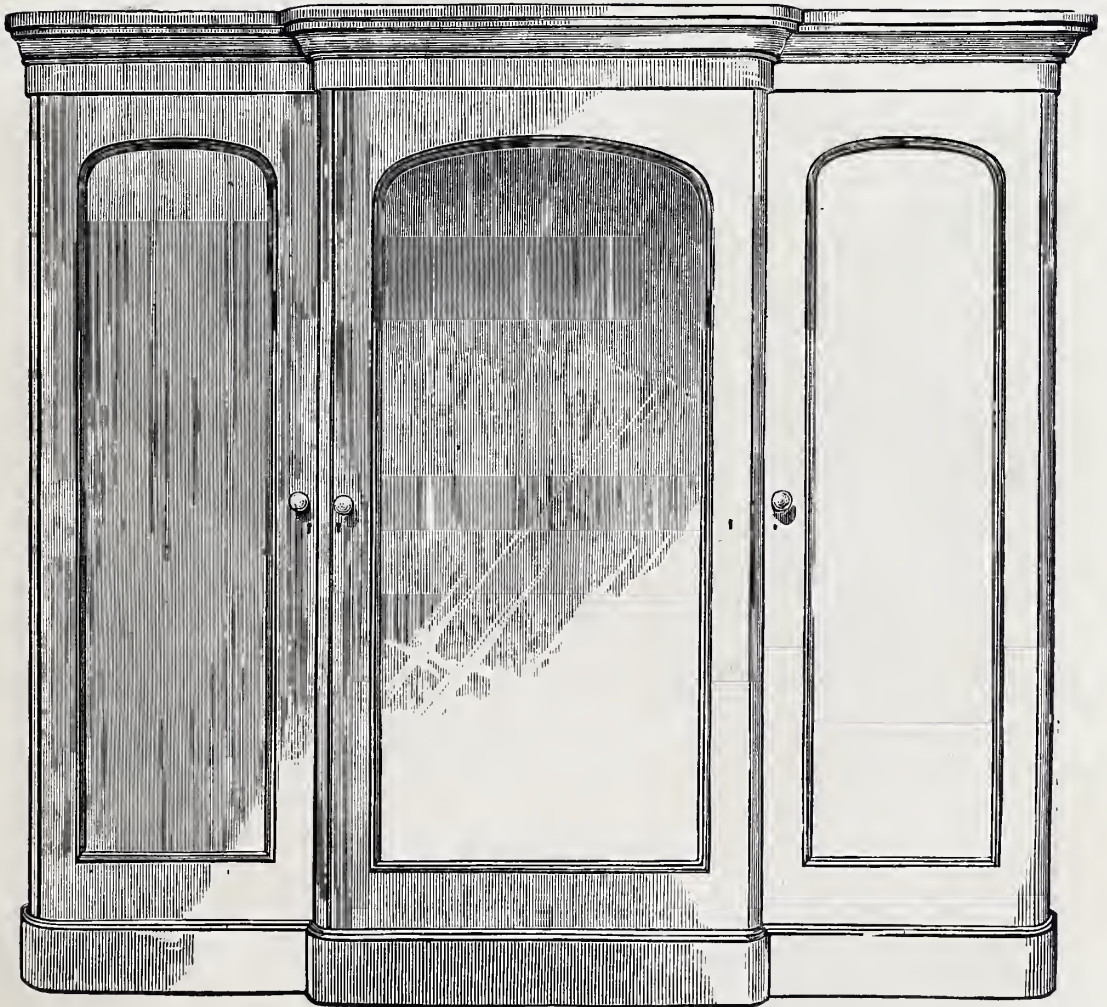

517

HAMPTON & SONS

HAMPTON & SONS

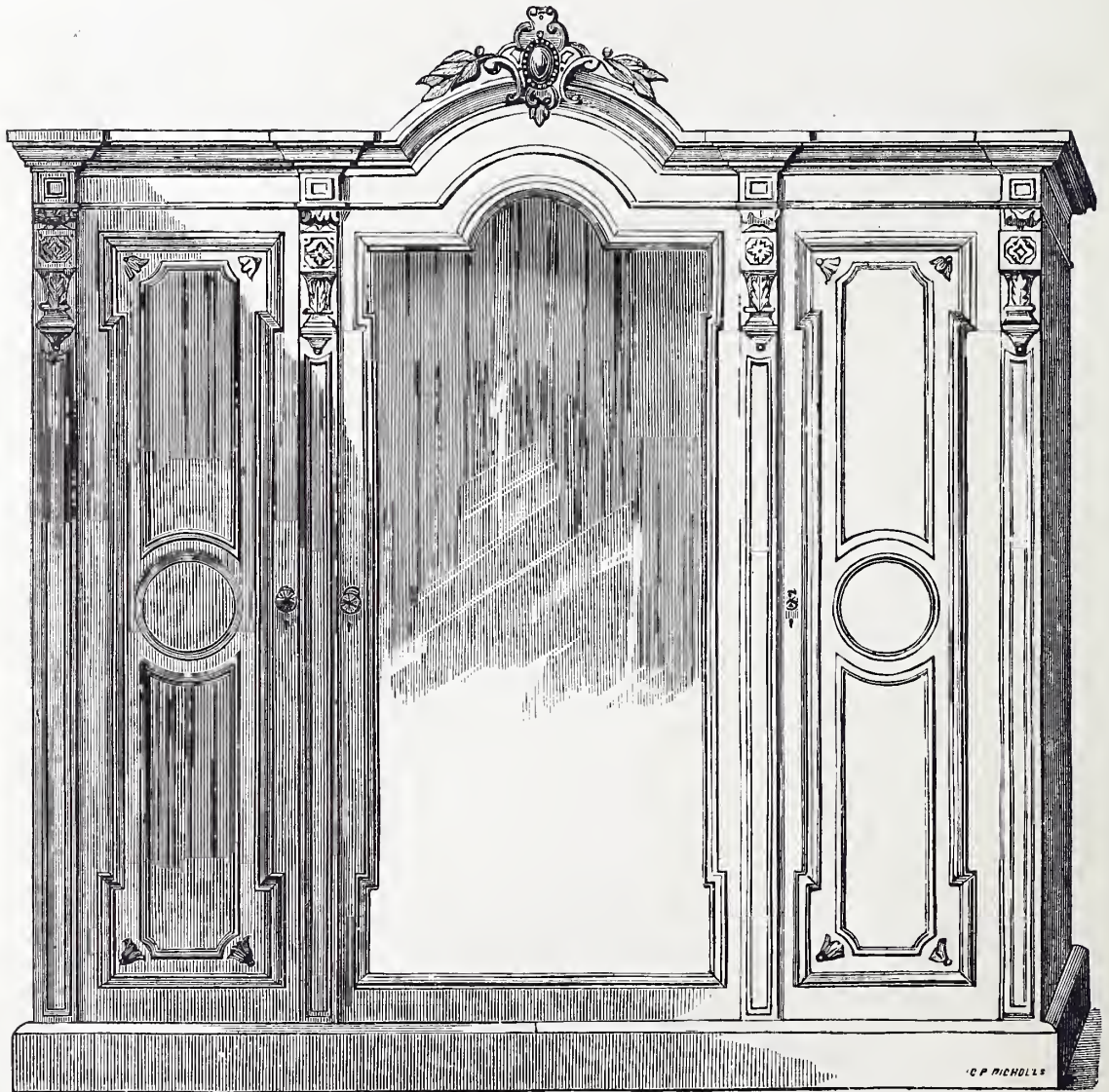

518

HAMPTON & SONS



HAMPTON & SONS

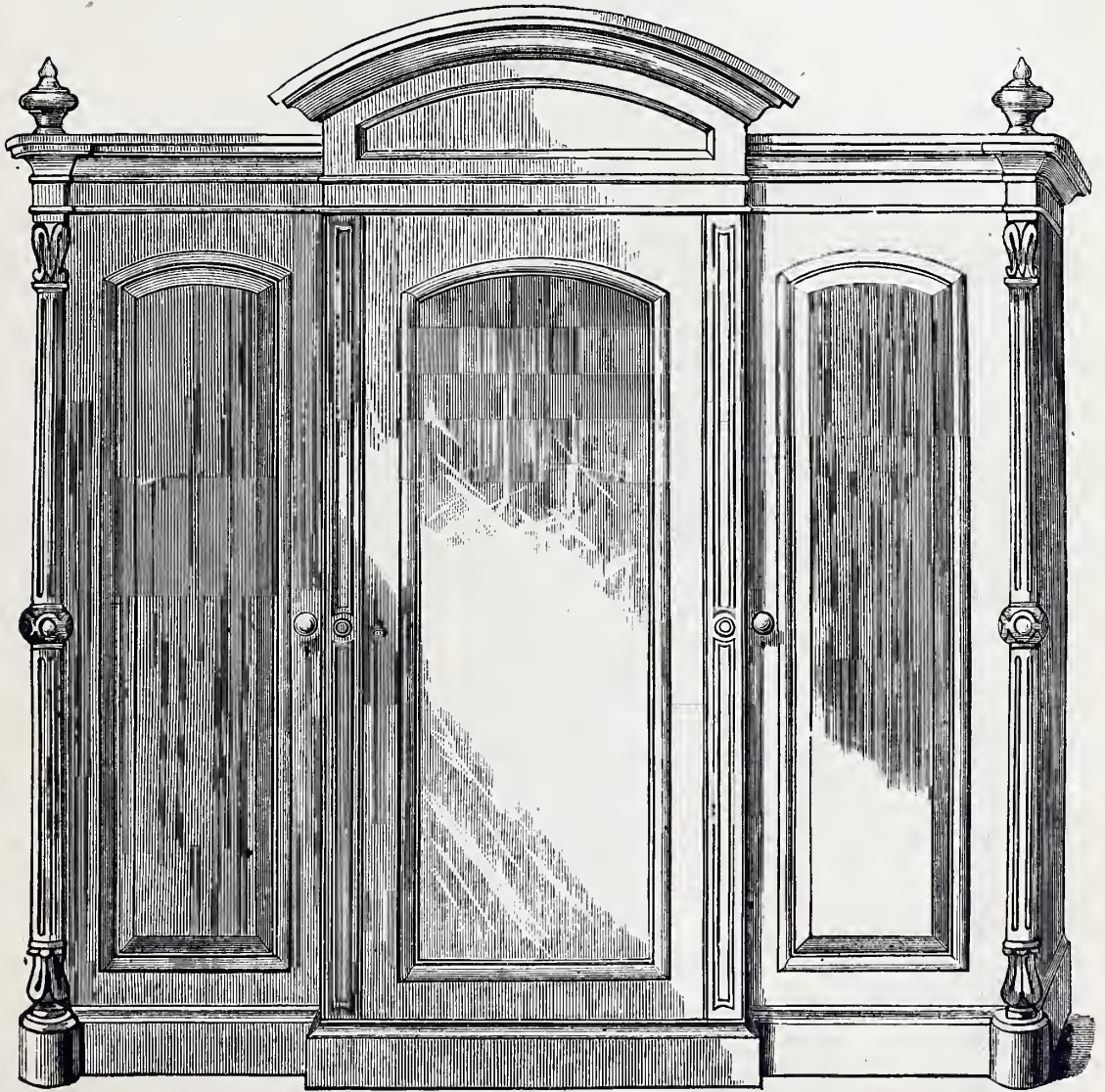

519

HAMPTON & SONS

HAMPTON & SONS

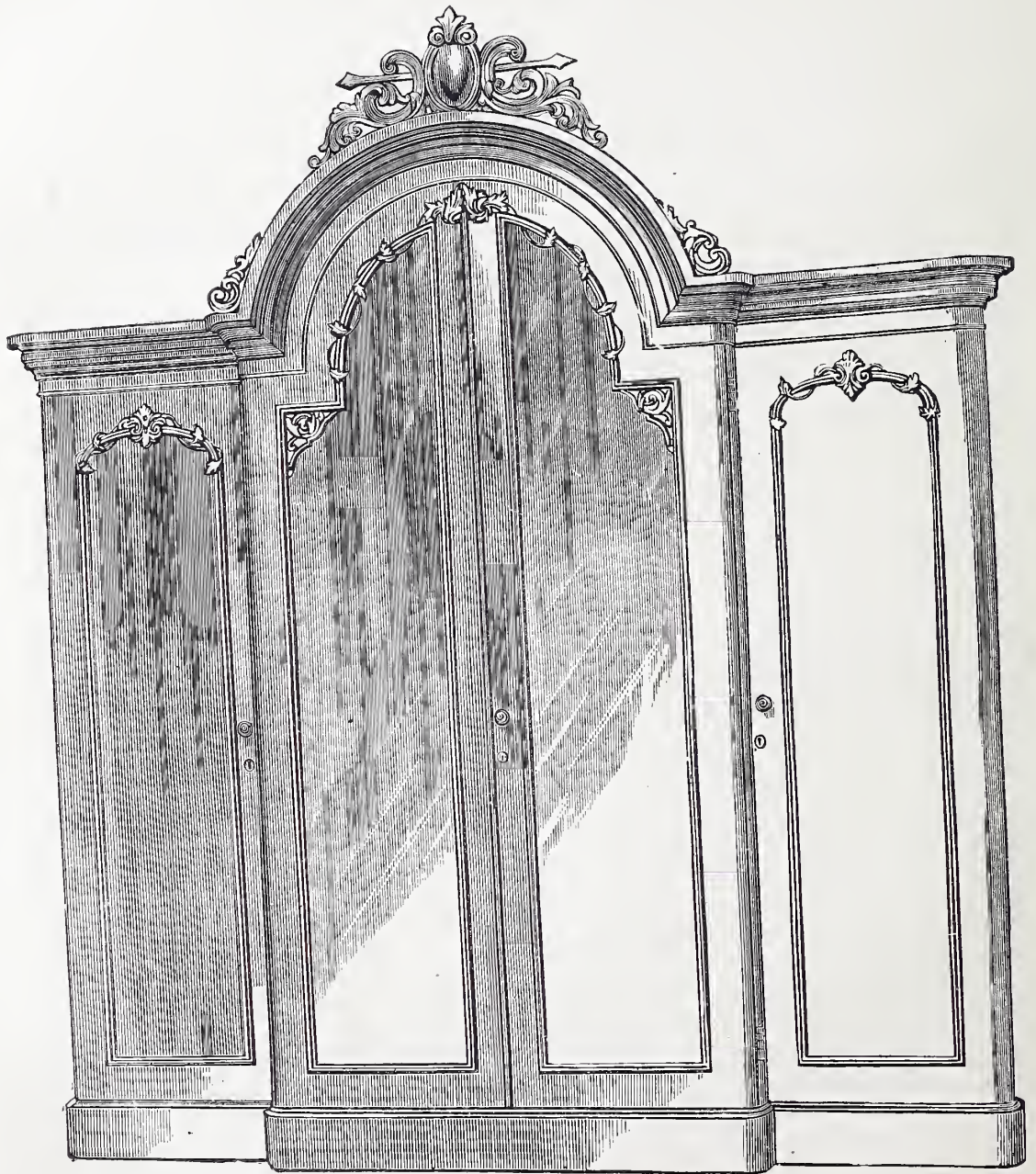

520

HAMPTON & SONS



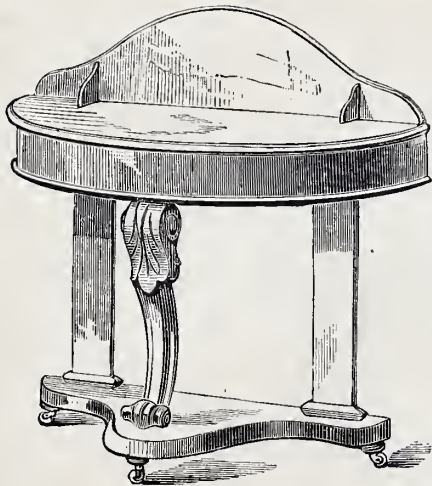

521

HAMPTON & SONS



522

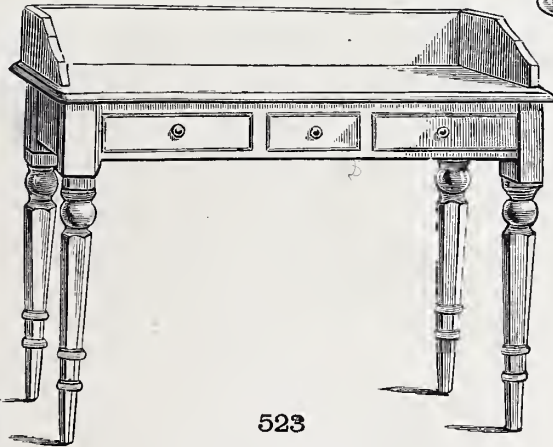

523

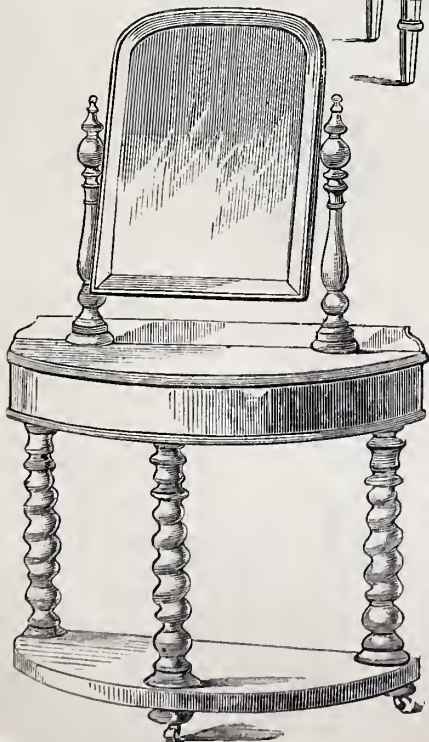

524

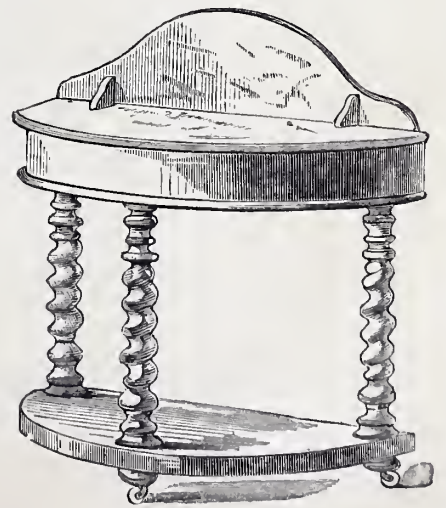

525

HAMPTON & SONS

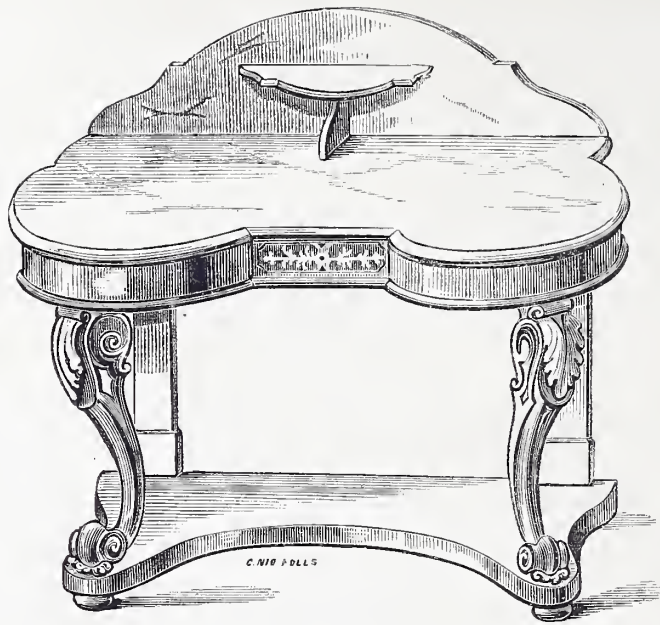

526

HAMPTON & SONS

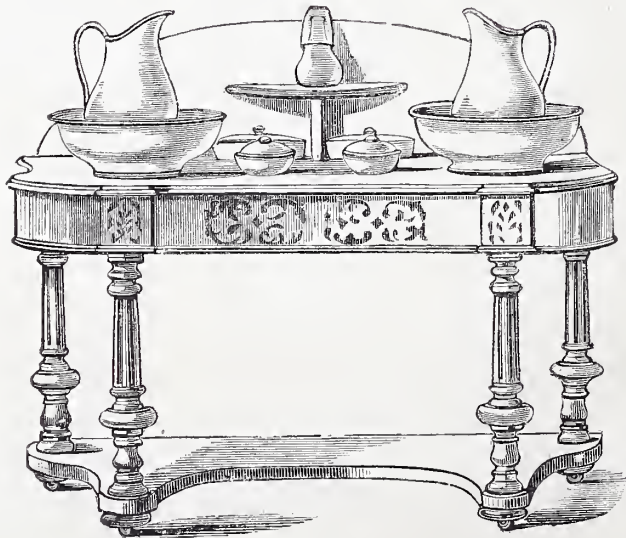

527

HAMPTON & SONS





528

HAMPTON & SONS

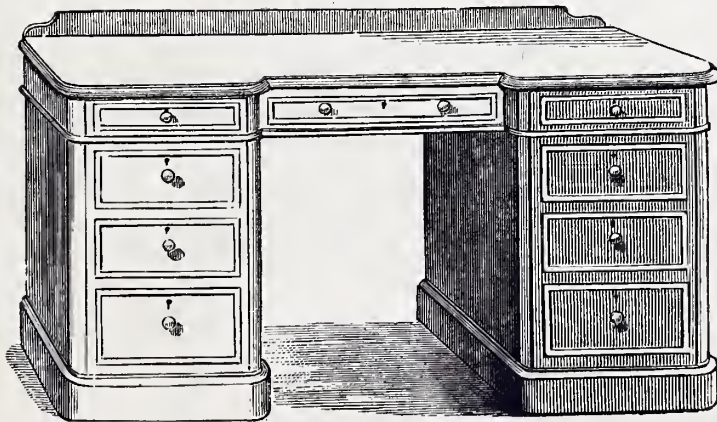

529

HAMPTON & SONS

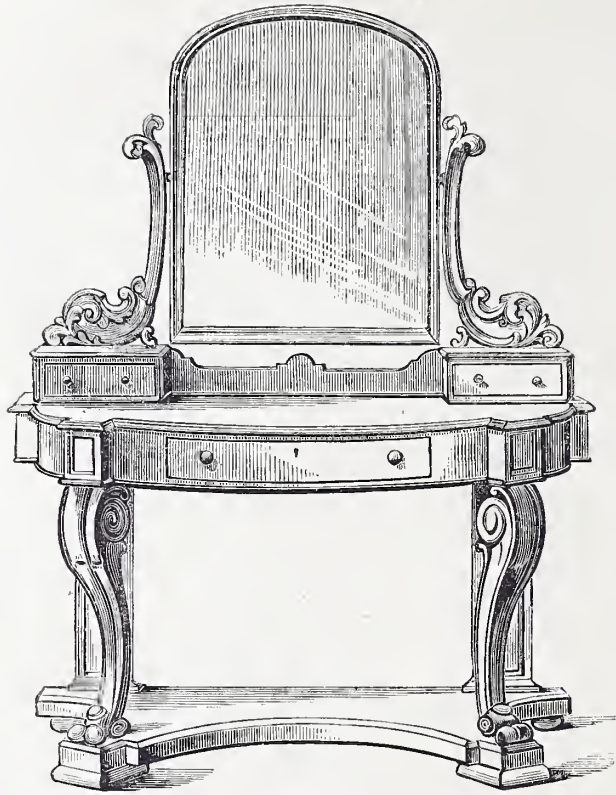

530

HAMPTON & SONS

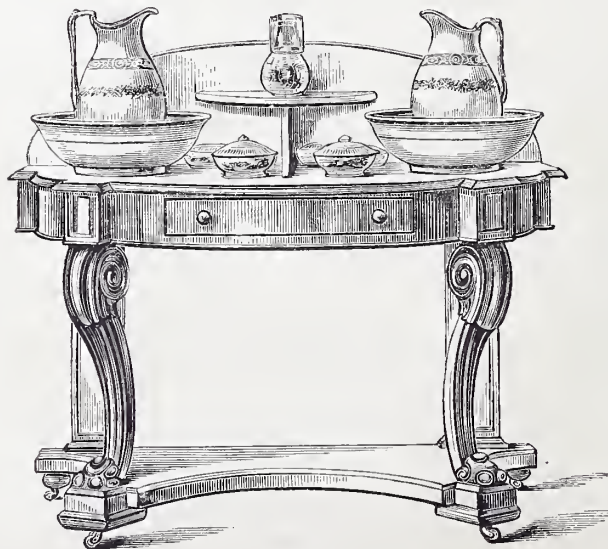

531

HAMPTON & SONS





532

HAMPTON & SONS

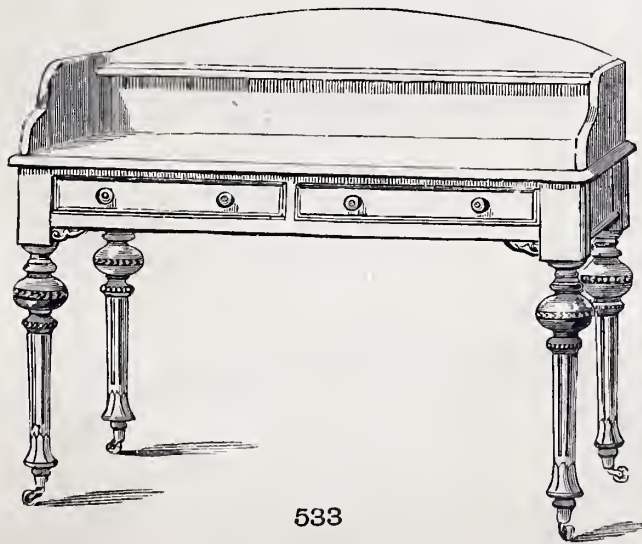

533

HAMPTON & SONS

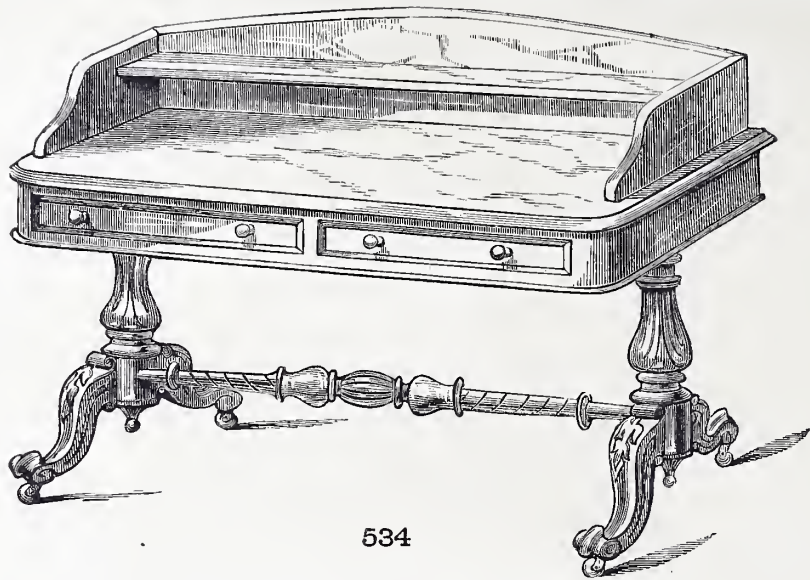

534

HAMPTON & SONS

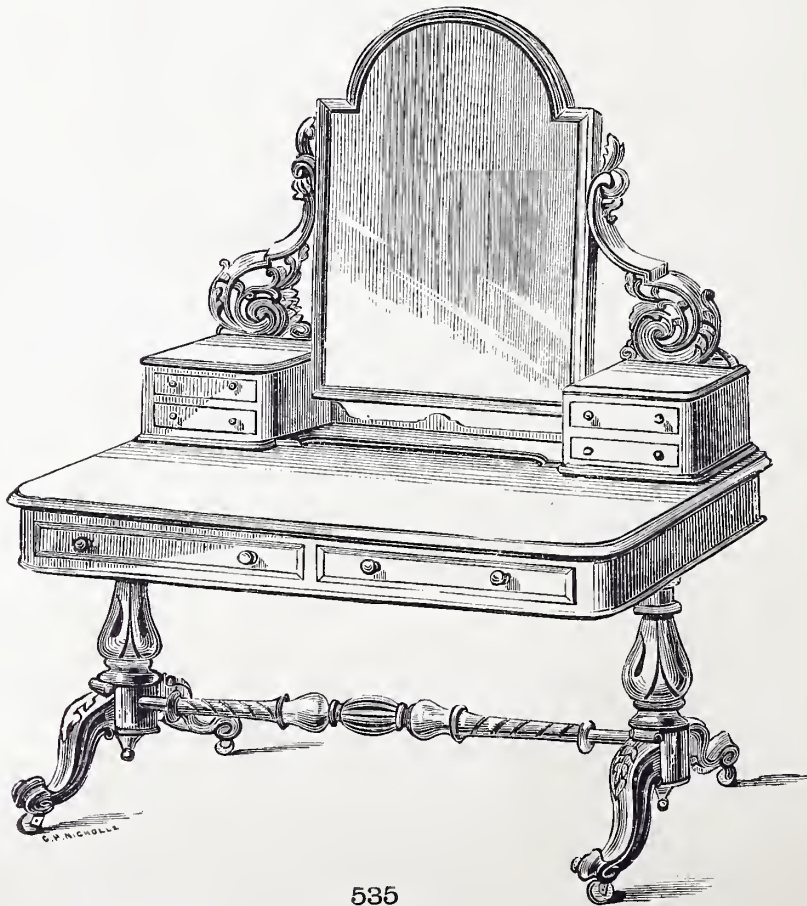

535

HAMPTON & SONS



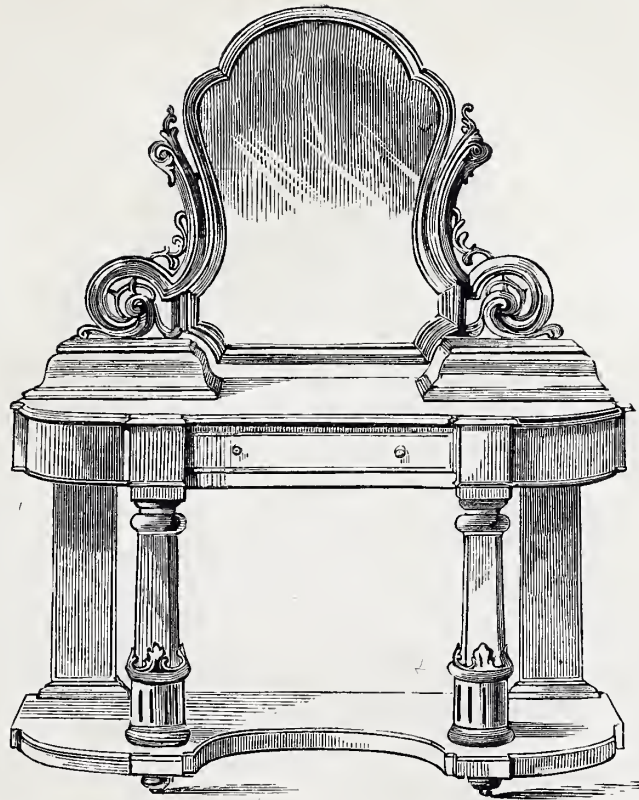

536

HAMPTON & SONS

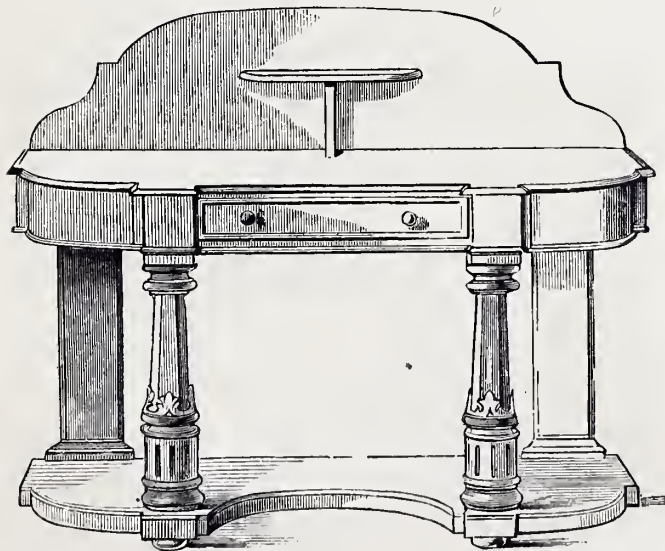

537

HAMPTON & SONS



538

HAMPTON & SONS

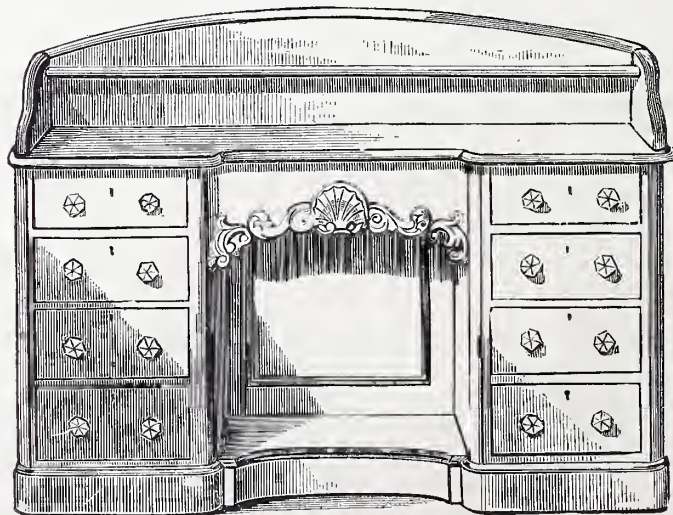

539

HAMPTON & SONS



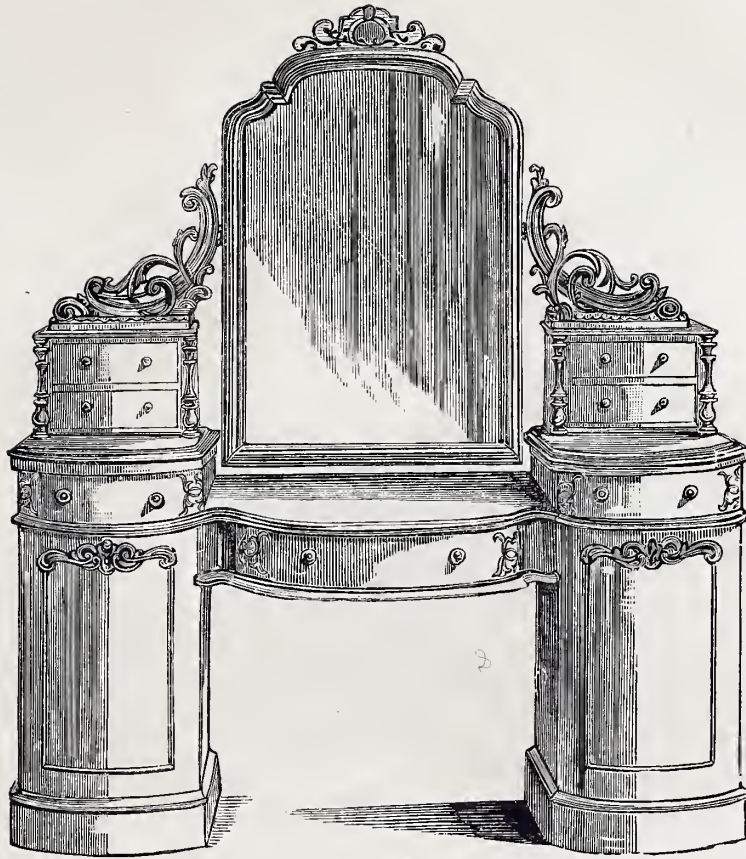

540

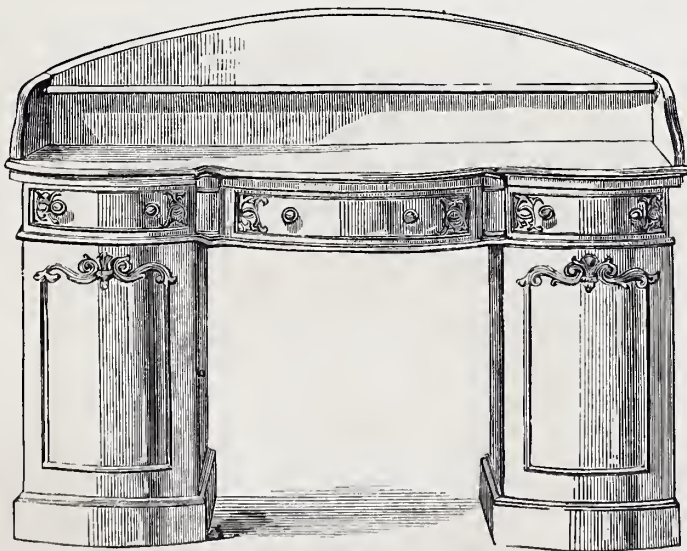

541

HAMPTON & SONS

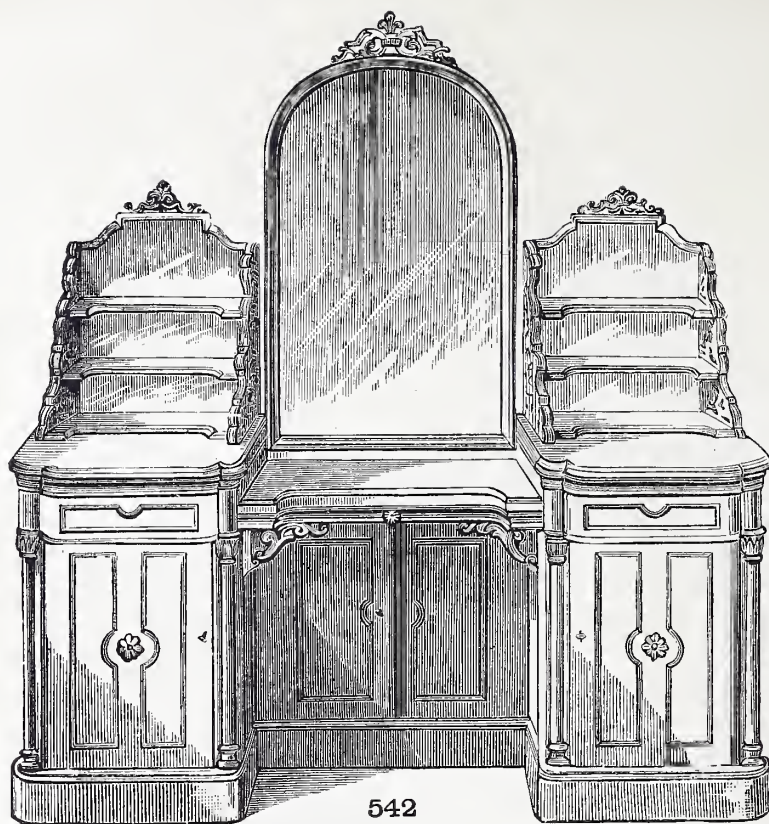

542

HAMPTON & SONS

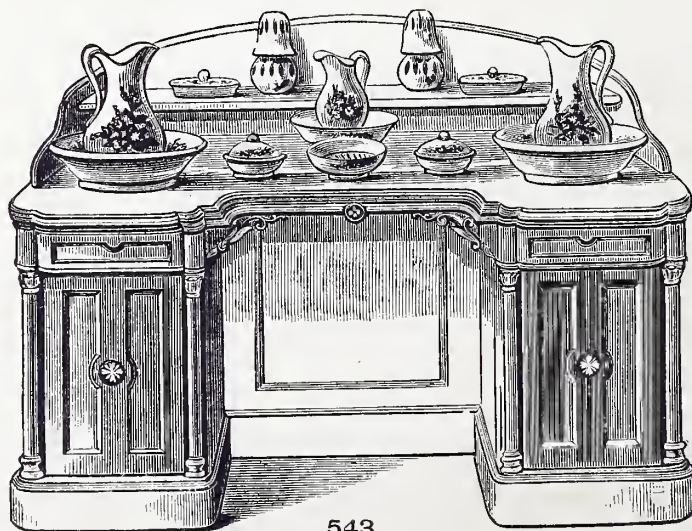

543

HAMPTON & SONS



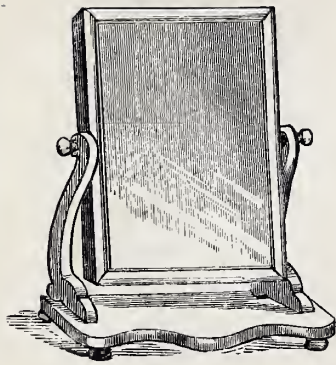

544

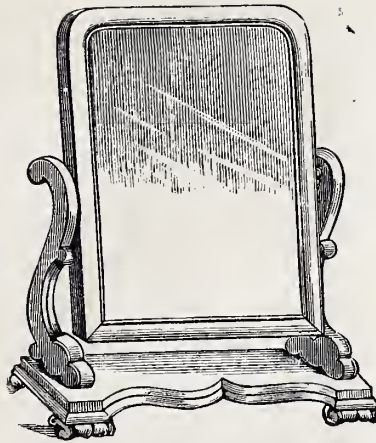

545



546

HAMPTON & SONS

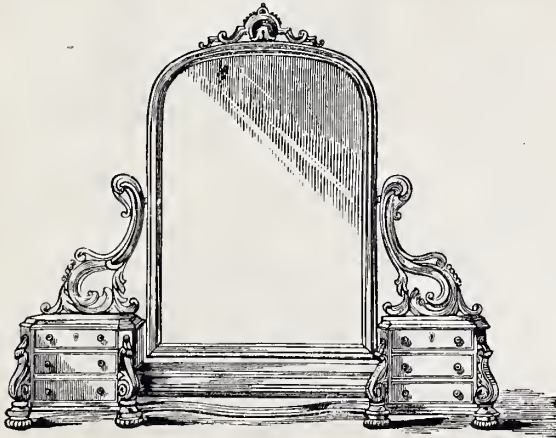

547



548

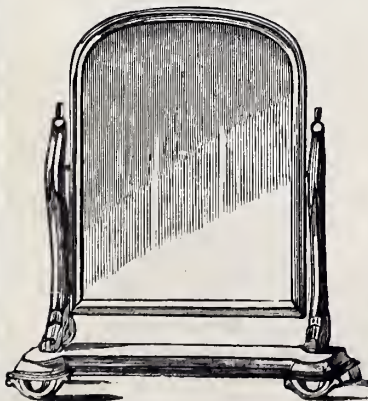

549



550

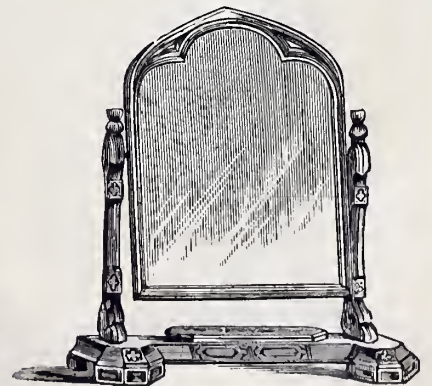

551

HAMPTON & SONS

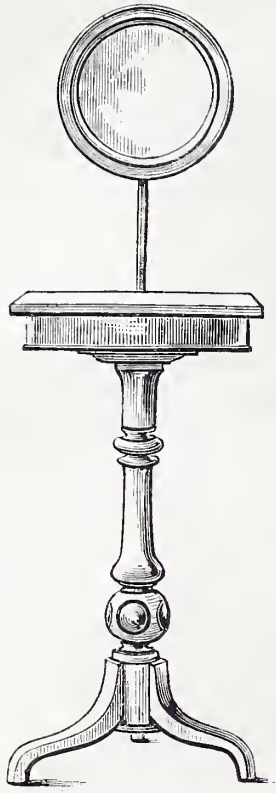

552

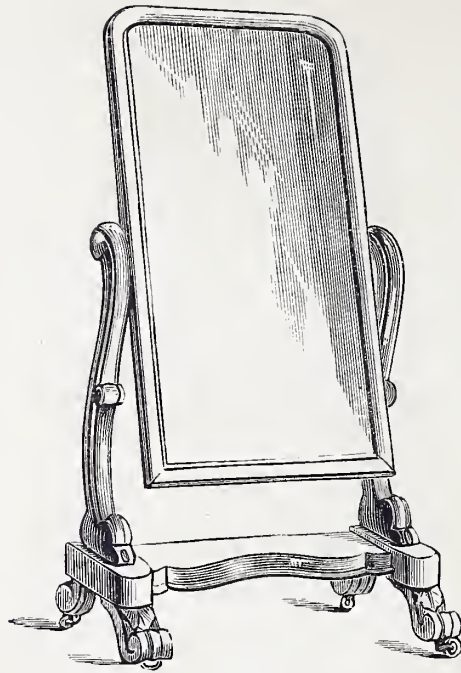

553

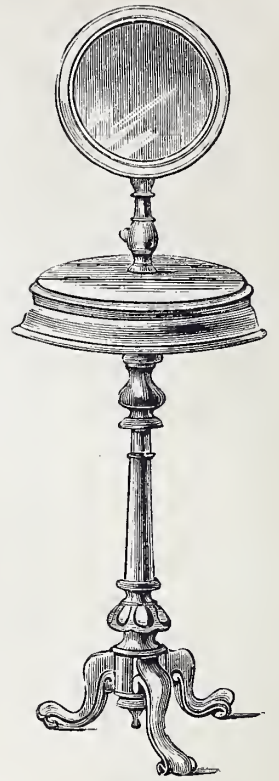

554

HAMPTON & SONS

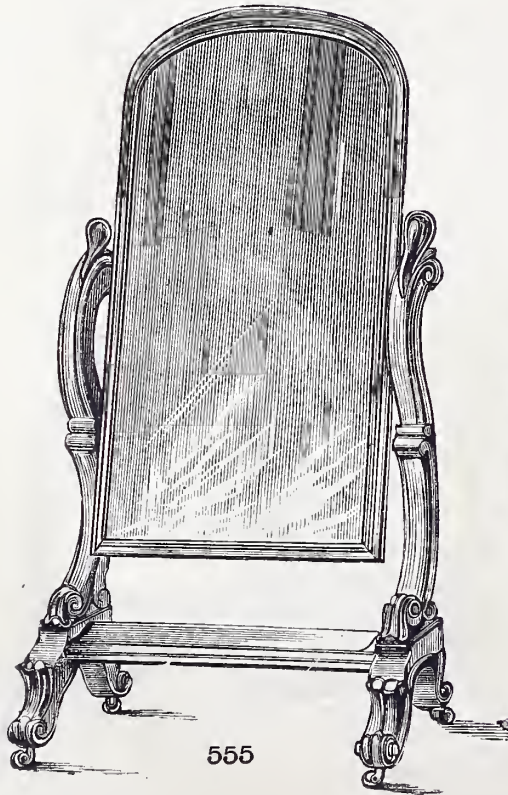

555

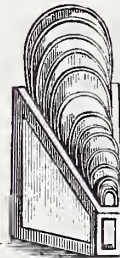

556

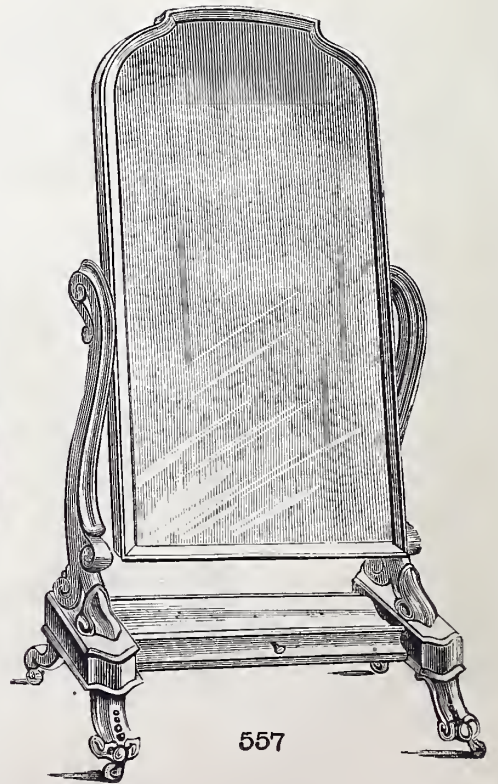

557



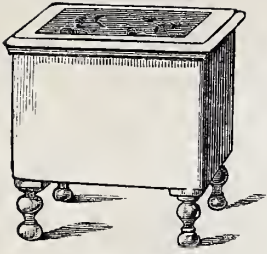

558

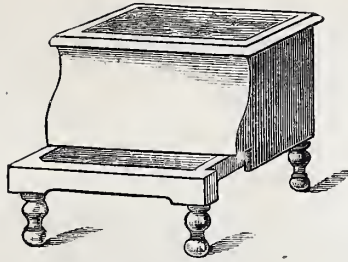

559

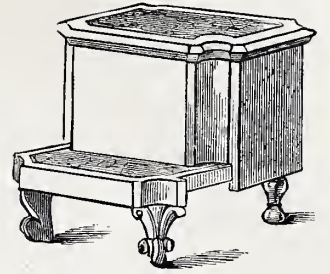

560

HAMPTON & SONS

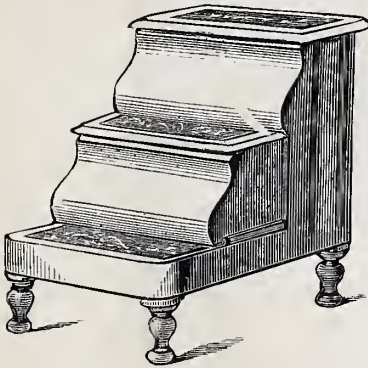

561



562

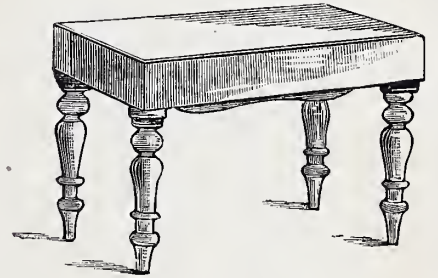

563

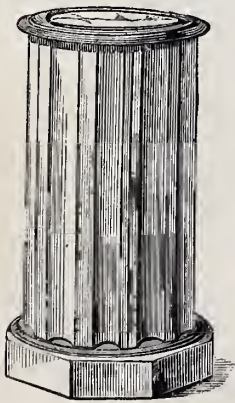

564

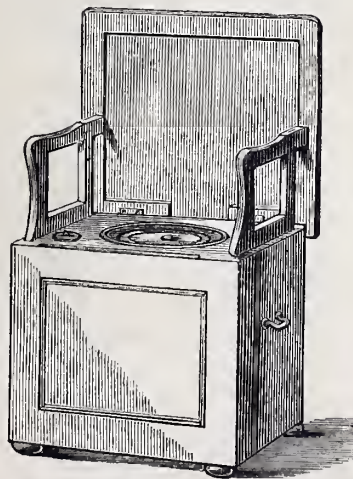

565

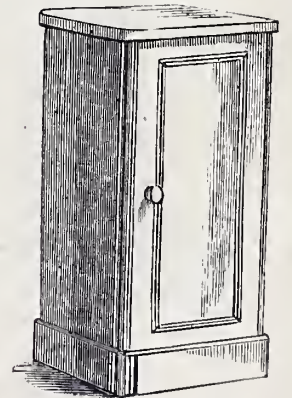

566

HAMPTON & SONS

HAMPTON & SONS

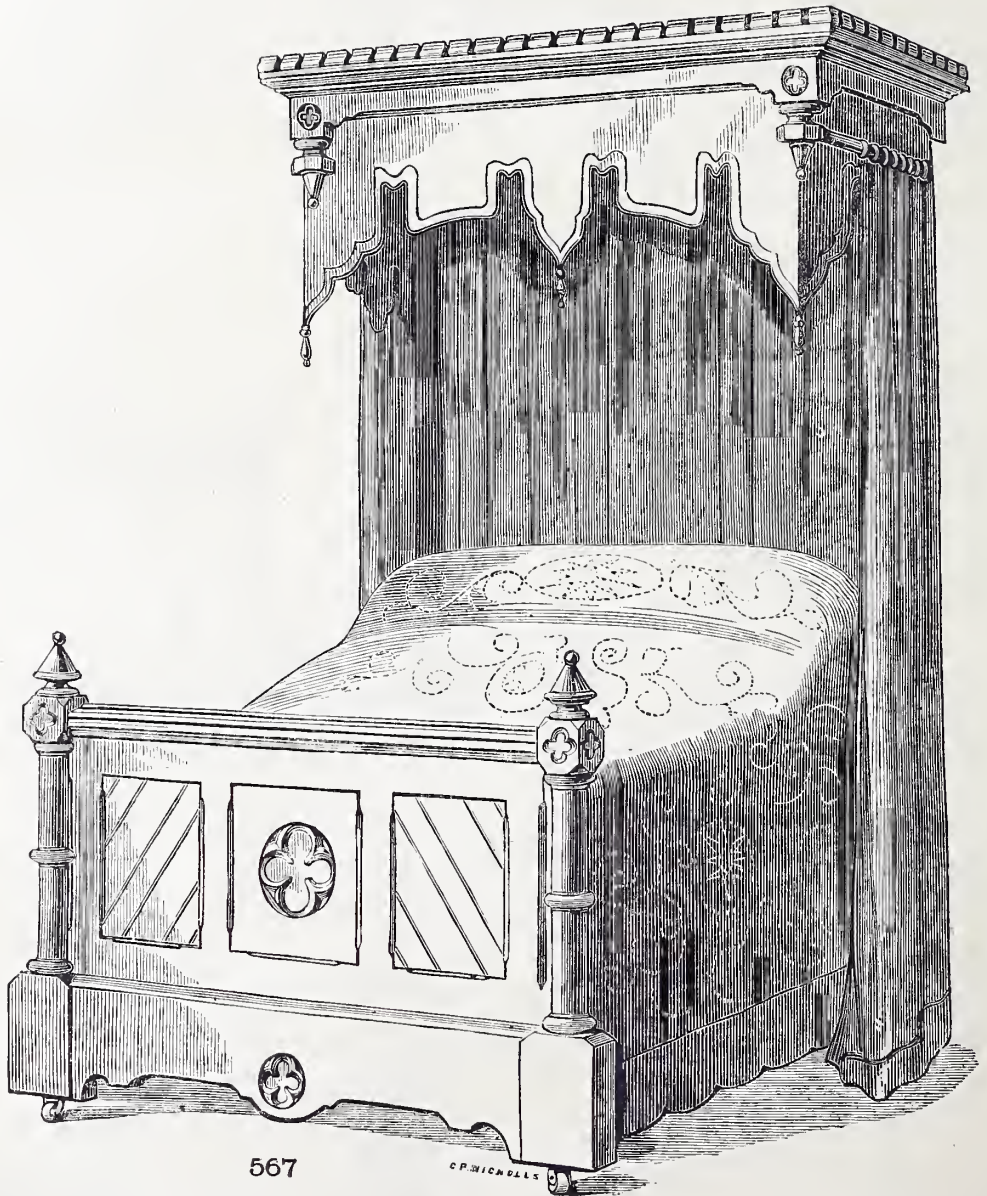

HAMPTON & SONS



HAMPTON & SONS



568

HAMPTON & SONS

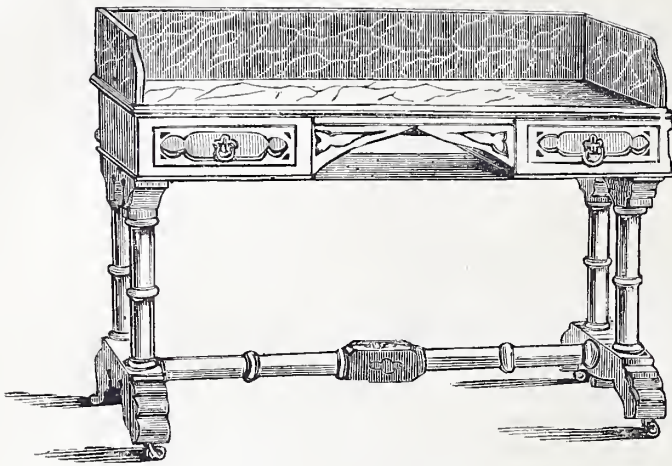

569

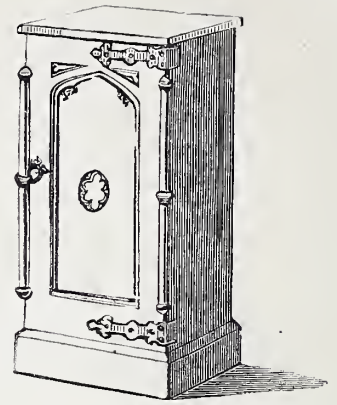

570

HAMPTON & SONS

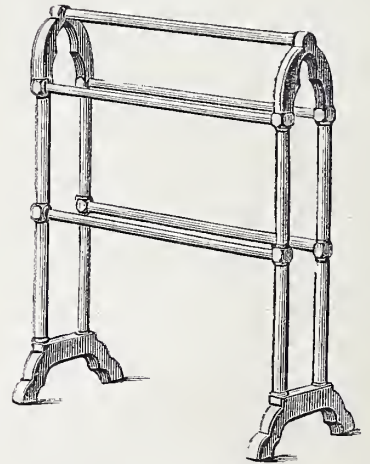

571

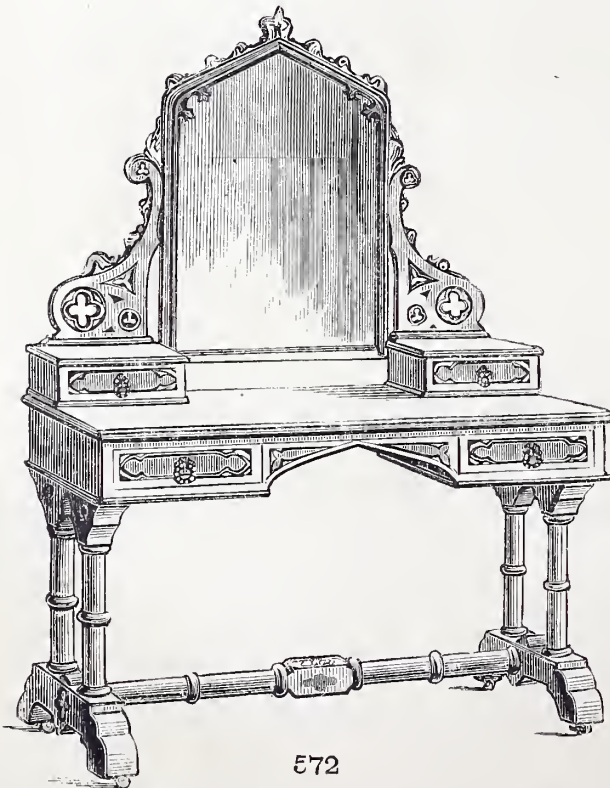

572



573

HAMPTON & SONS



HAMPTON & SONS

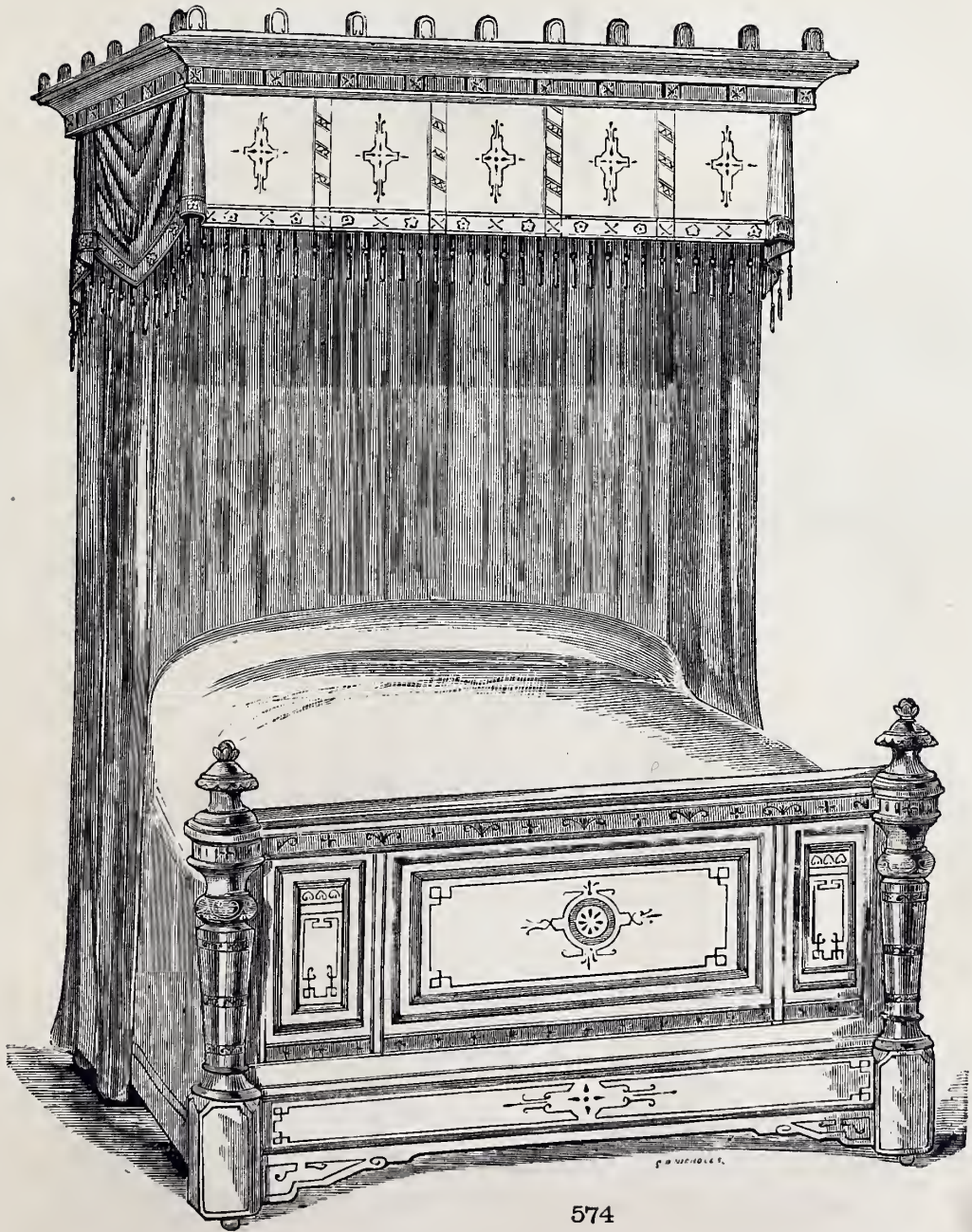

574

HAMPTON & SONS



575

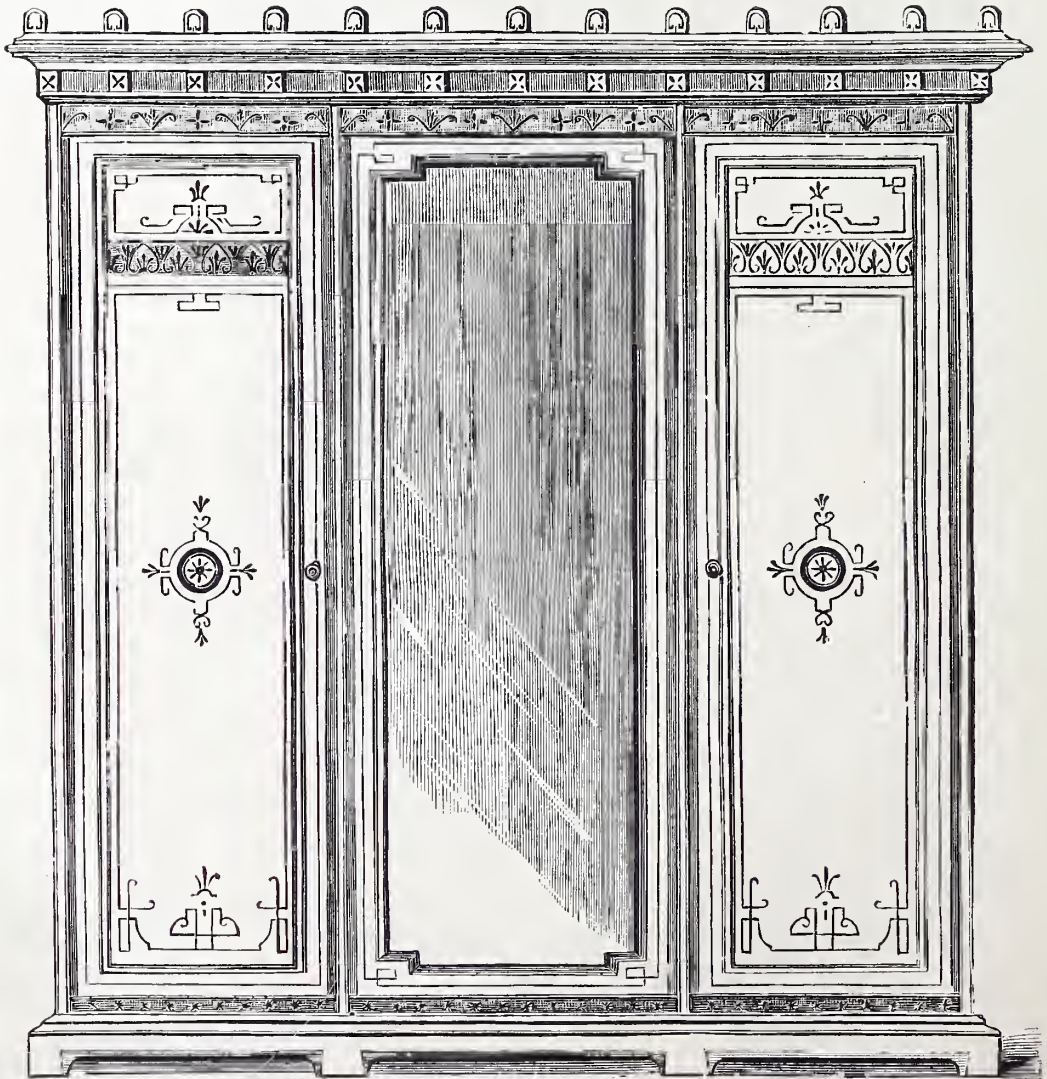

576

HAMPTON & SONS



HAMPTON & SONS

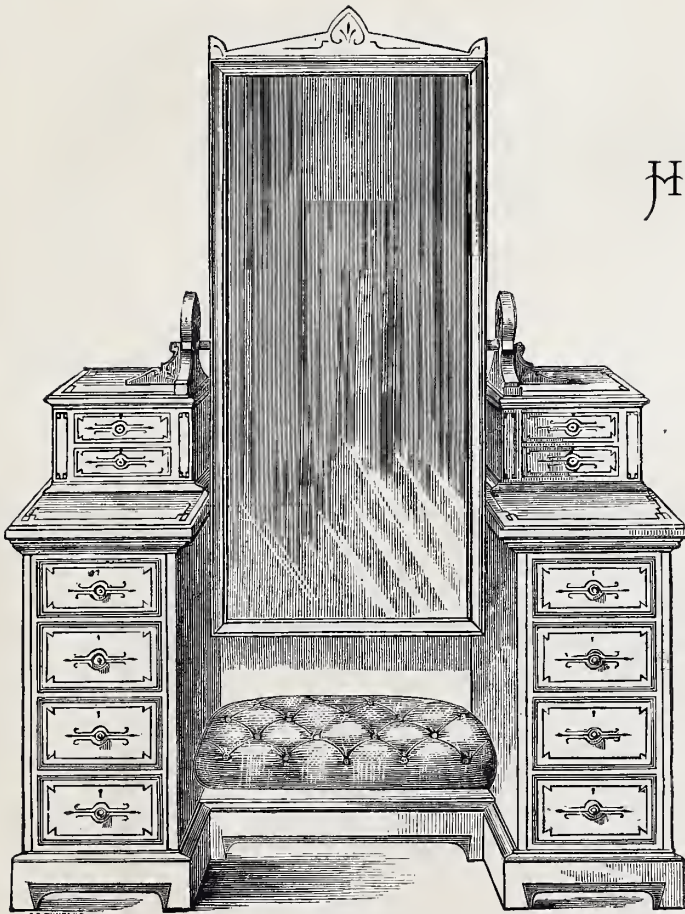

C.F. HOLLIS

577

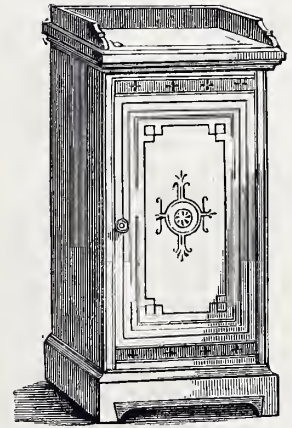

578

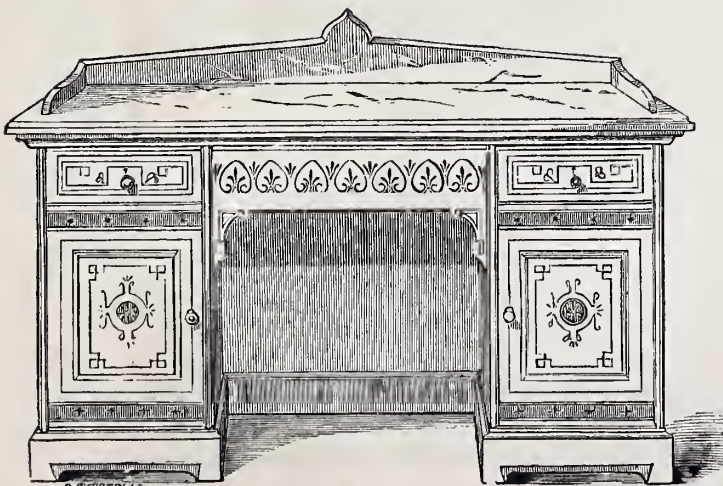

C.F. HOLLIS

579

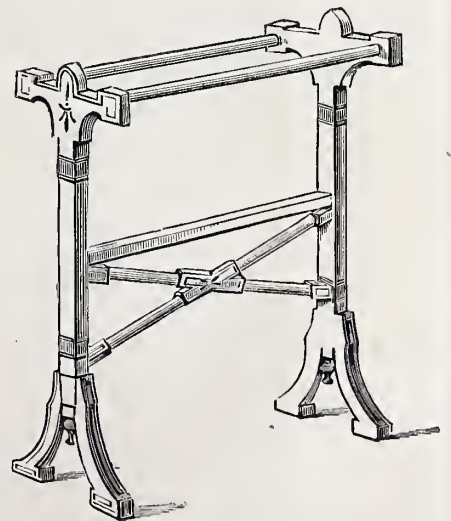

580

HAMPTON & SONS

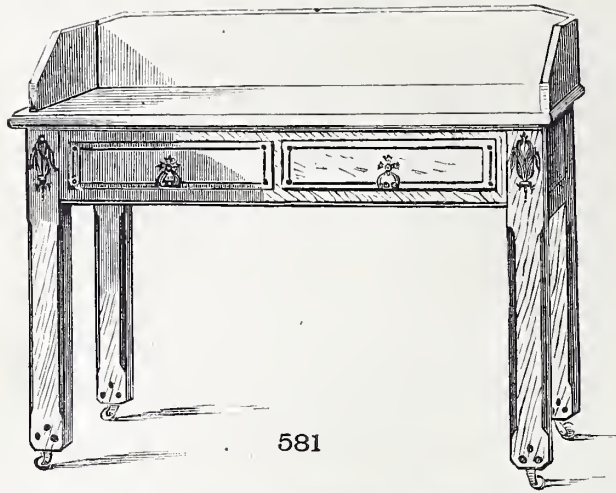

581

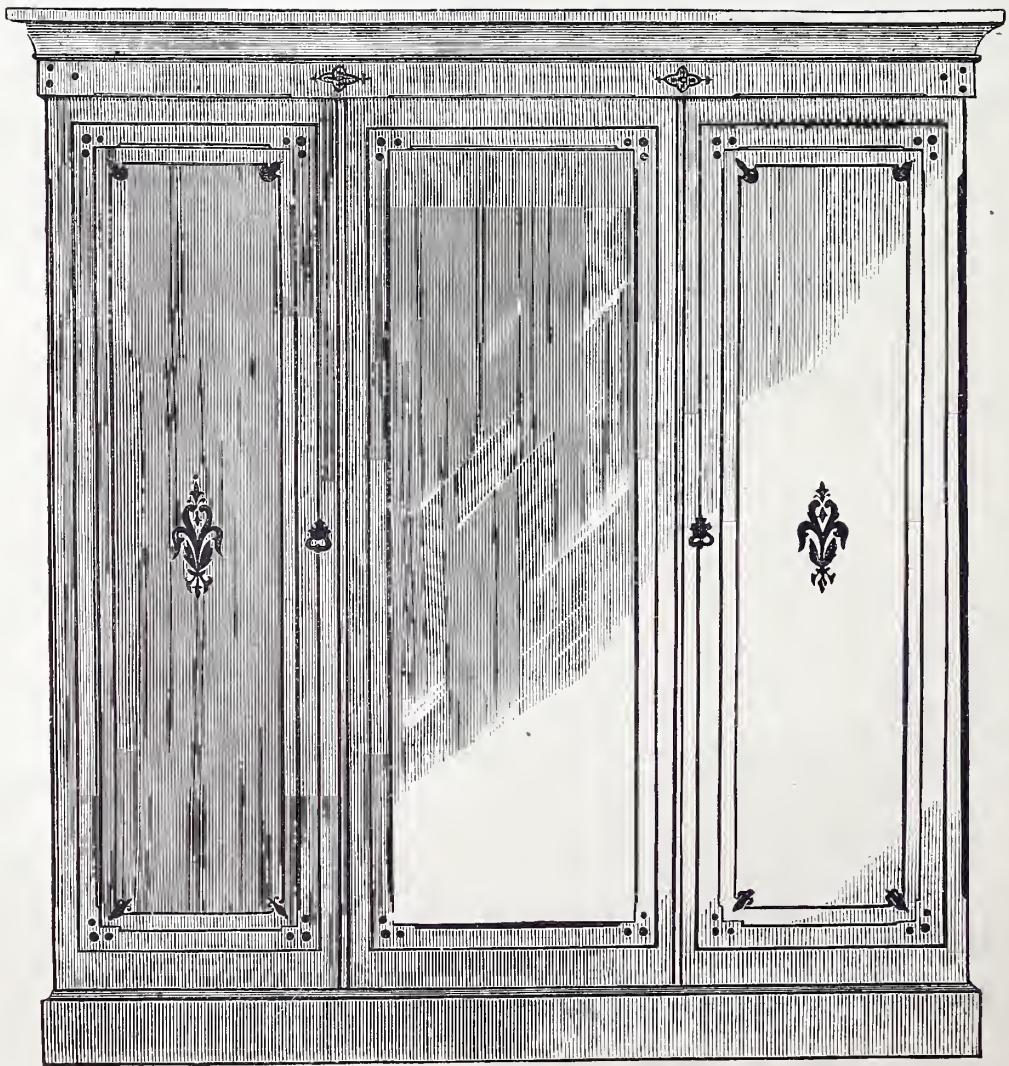

582

HAMPTON & SONS



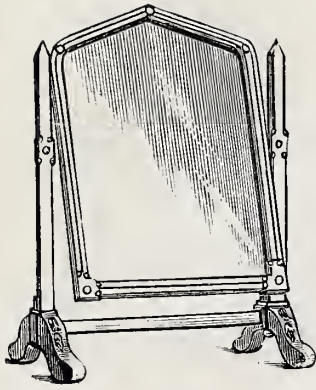

583

HAMPTON & SONS

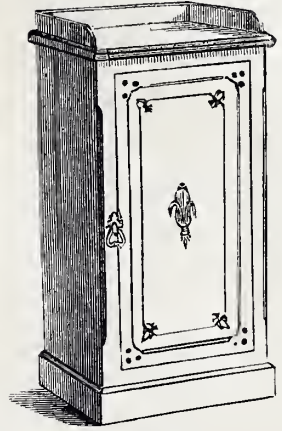

584

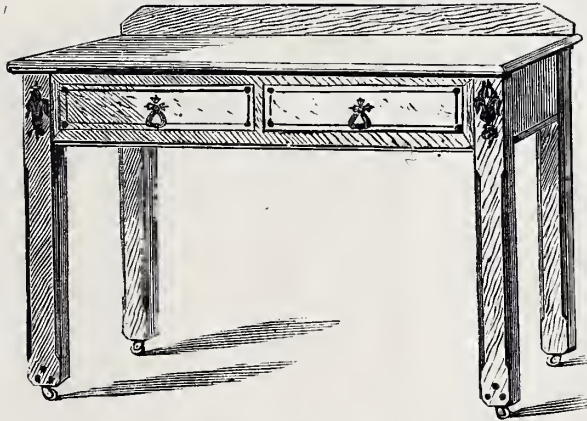

585

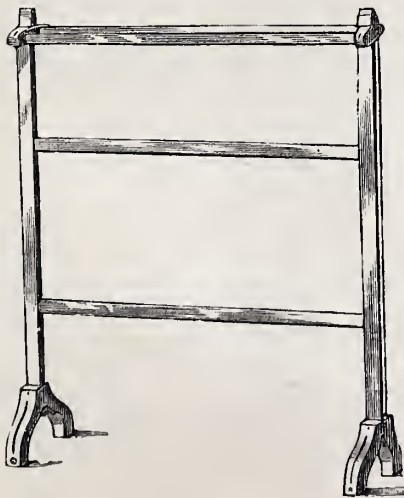

586



587

HAMPTON & SONS

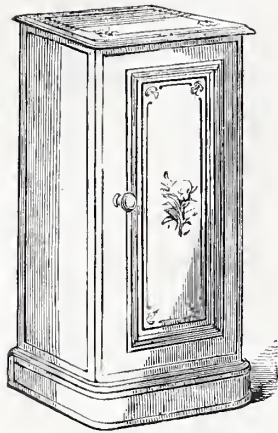

588

HAMPTON & SONS



589

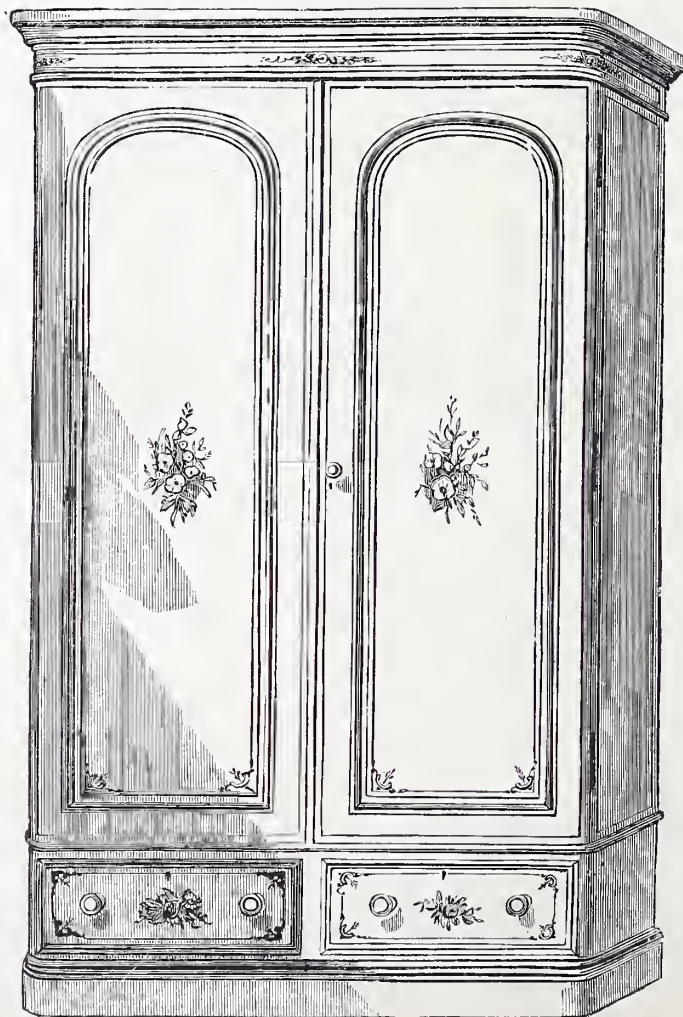

590

HAMPTON & SONS



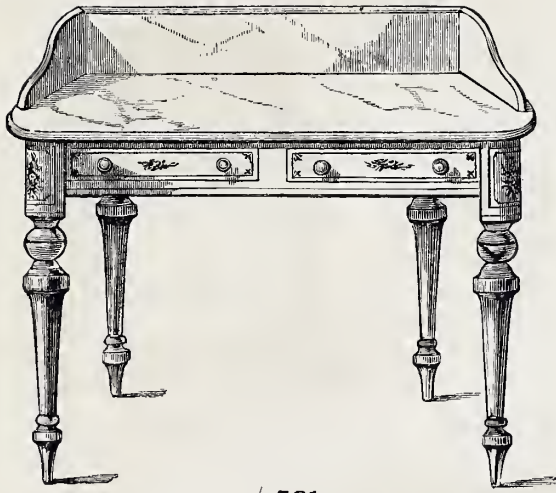

591



592

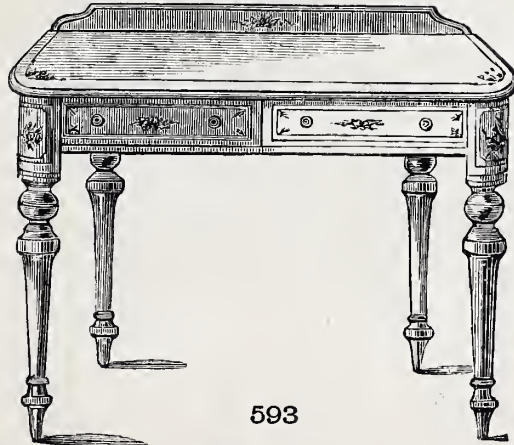

593



594

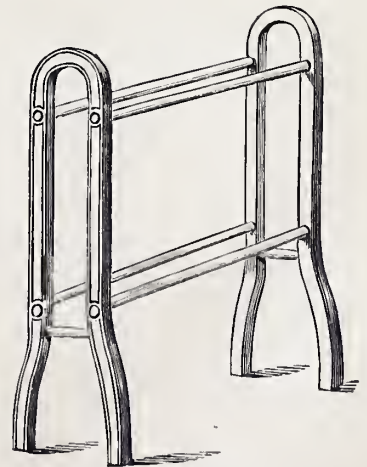

595

HAMPTON & SONS

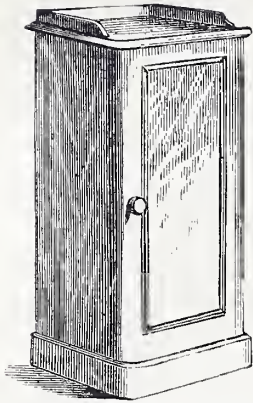

596

HAMPTON & SONS

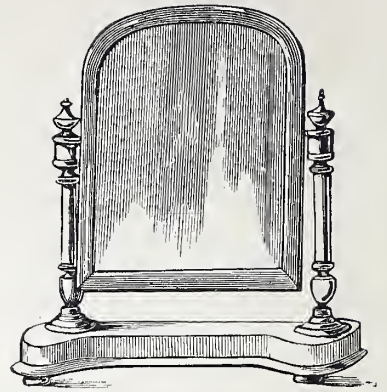

597



598

HAMPTON & SONS



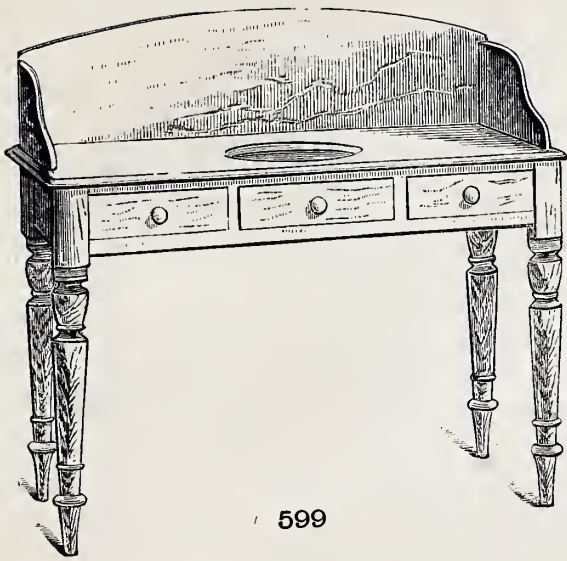

599



600

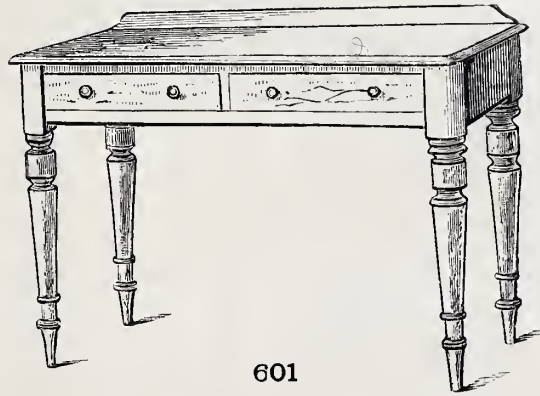

601

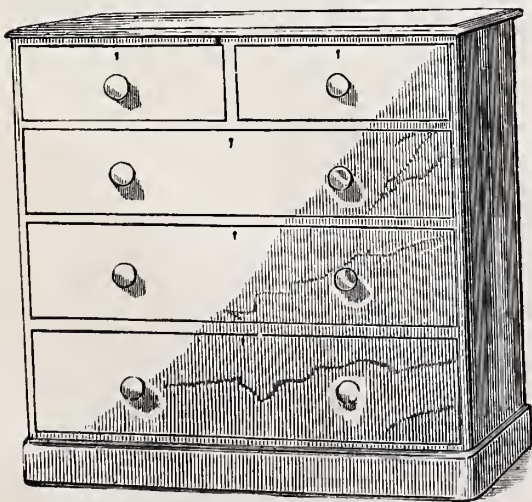

602

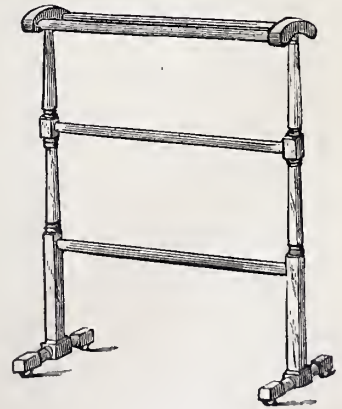

603

HAMPTON & SONS

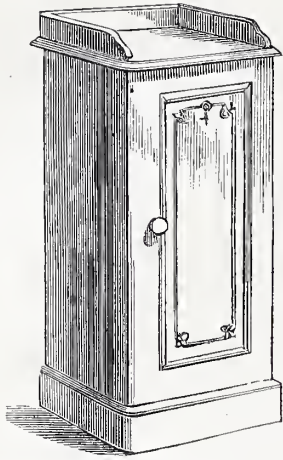

604



605

HAMPTON & SONS

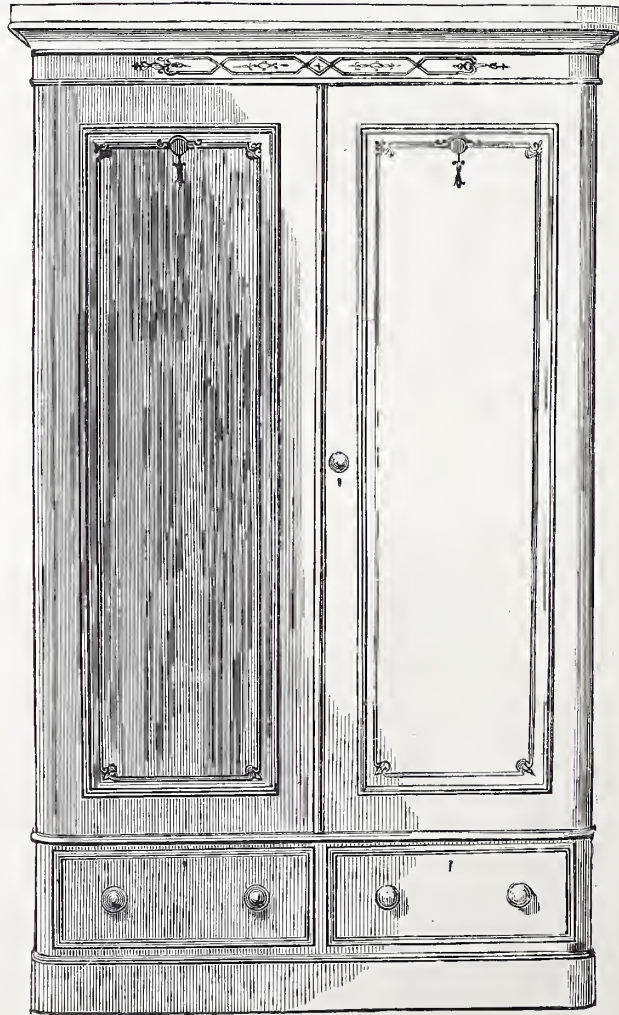

606

HAMPTON & SONS



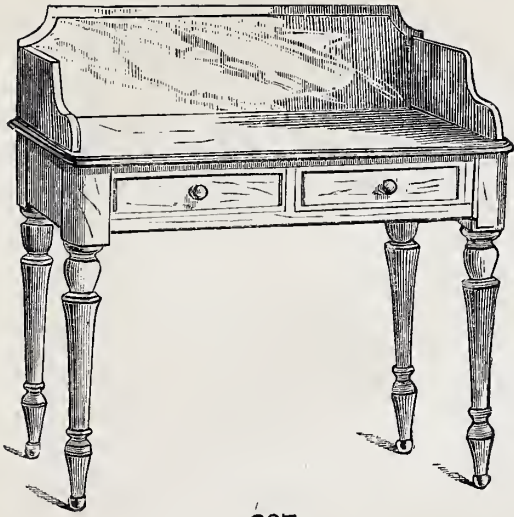

607

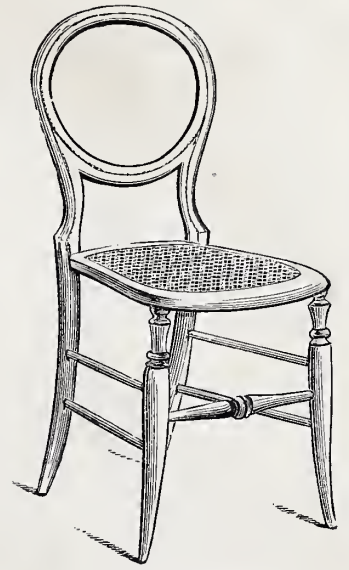

608

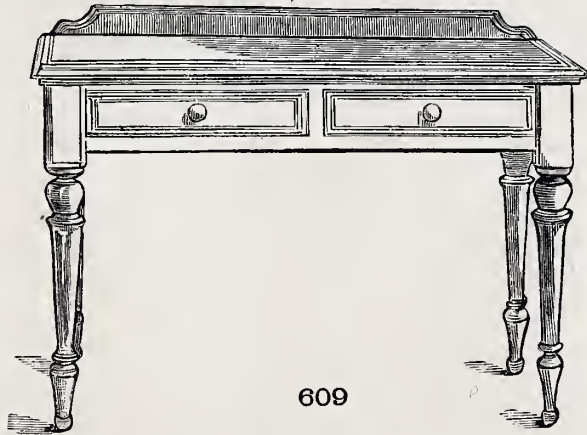

609



610

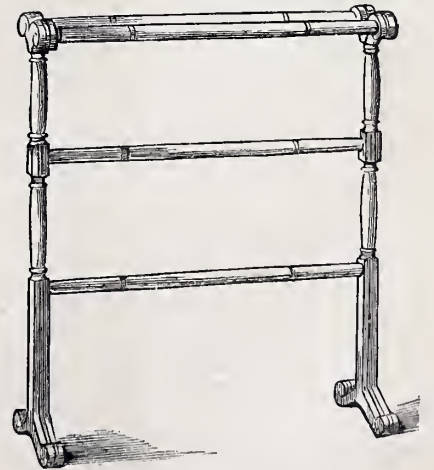

611

HAMPTON & SONS

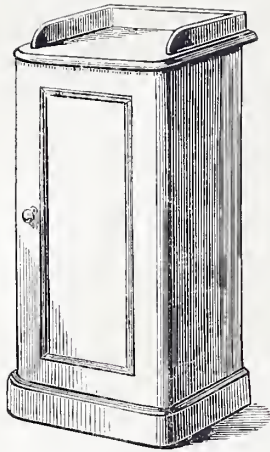

612

HAMPTON & SONS



613

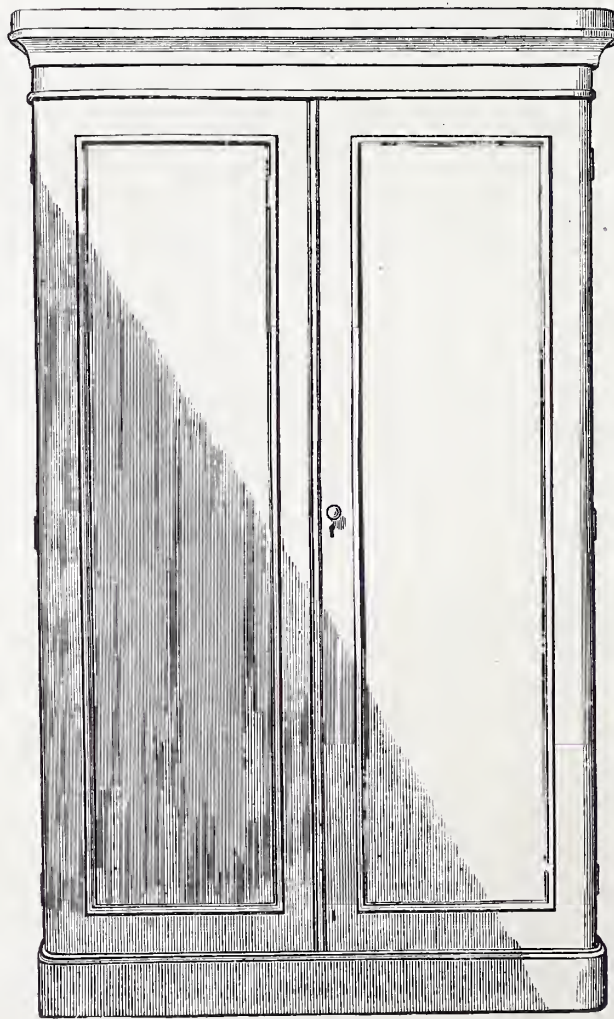

614

HAMPTON & SONS



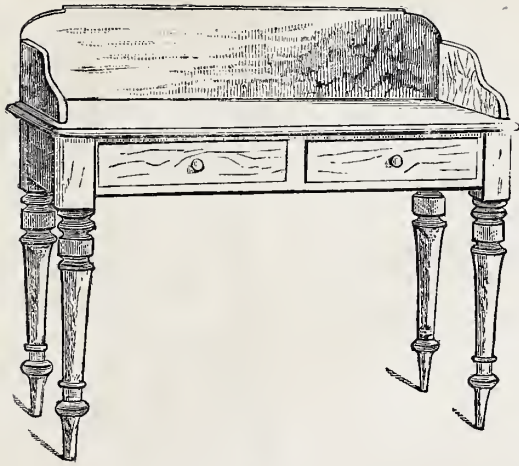

615



616

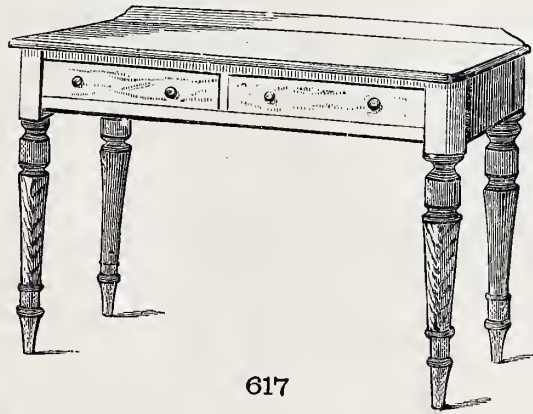

617



618

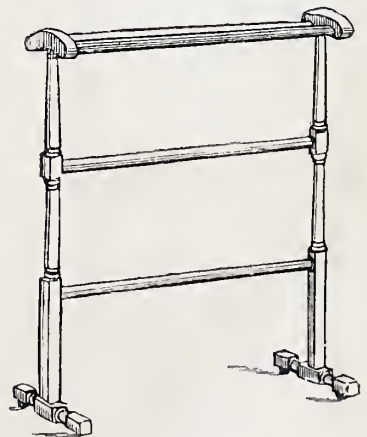

619

HAMPTON & SONS



620

HAMPTON & SONS

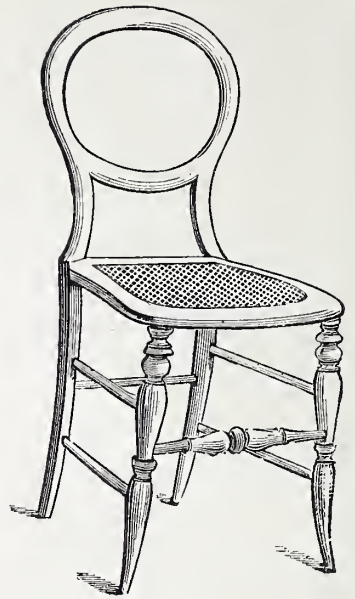

621



622

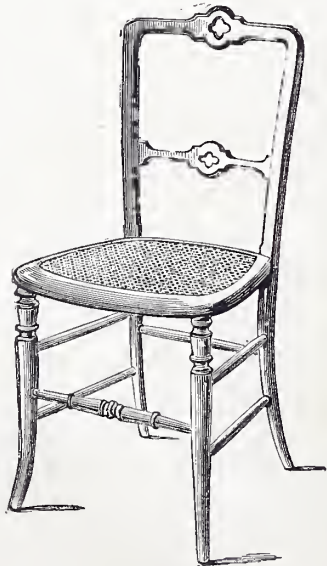

623



624

HAMPTON & SONS





625

HAMPTON & SONS



626

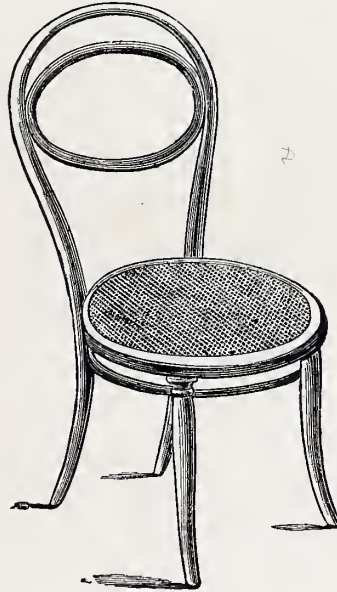

627



628



629

HAMPTON & SONS



630



631

HAMPTON & SONS

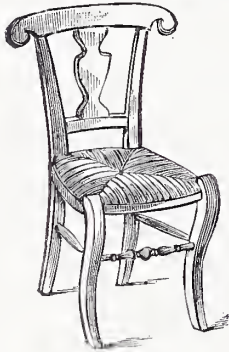

632

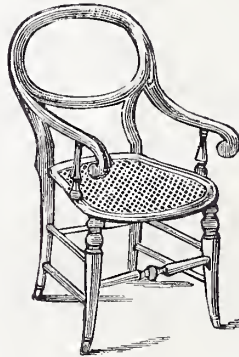

633

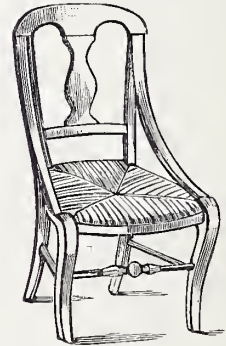

634



635

HAMPTON & SONS



636



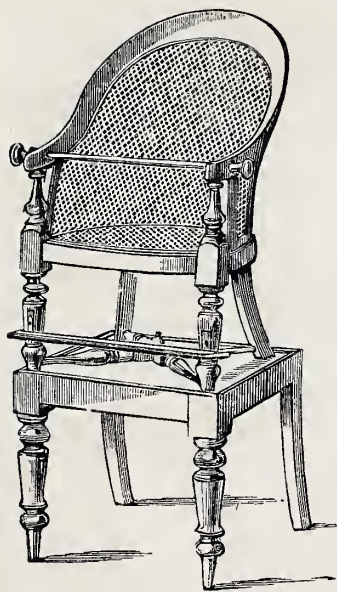

637

HAMPTON & SONS

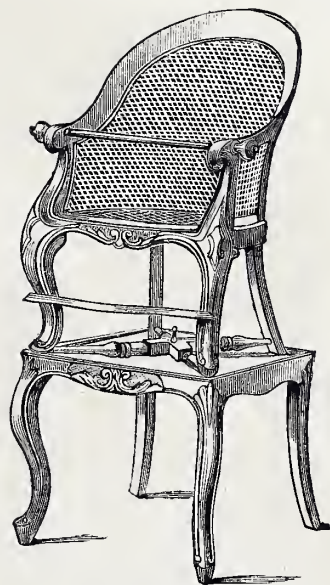

638



639



640

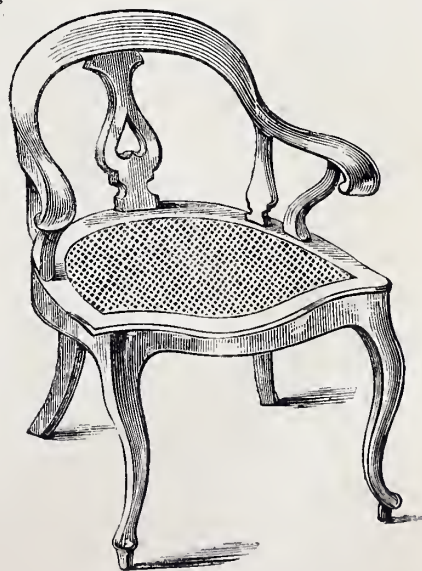

641

HAMPTON & SONS



642

HAMPTON & SONS

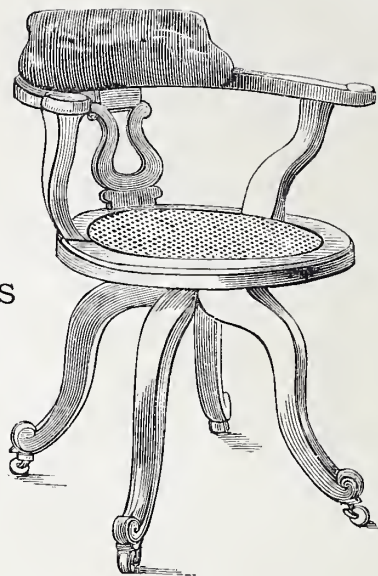

643

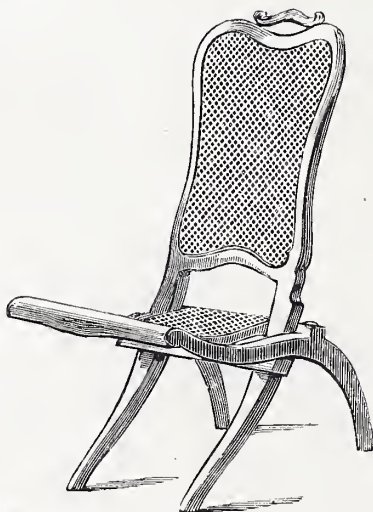

644



645

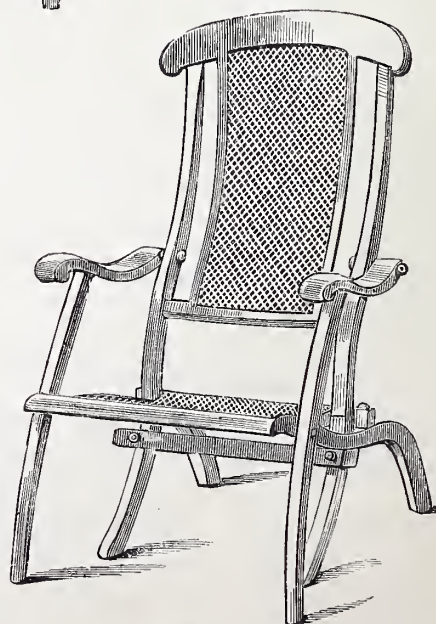

646

HAMPTON & SONS



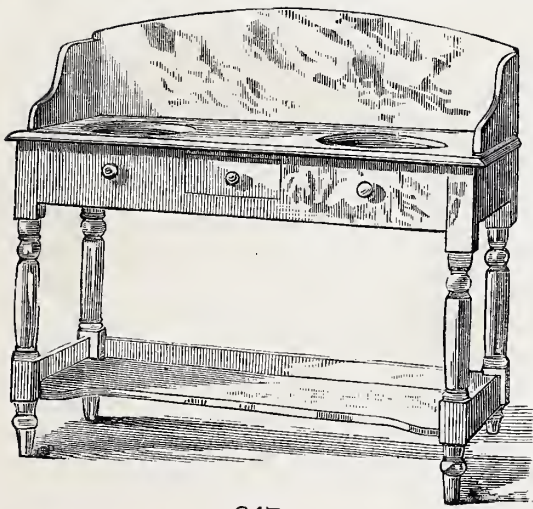

647



648



649

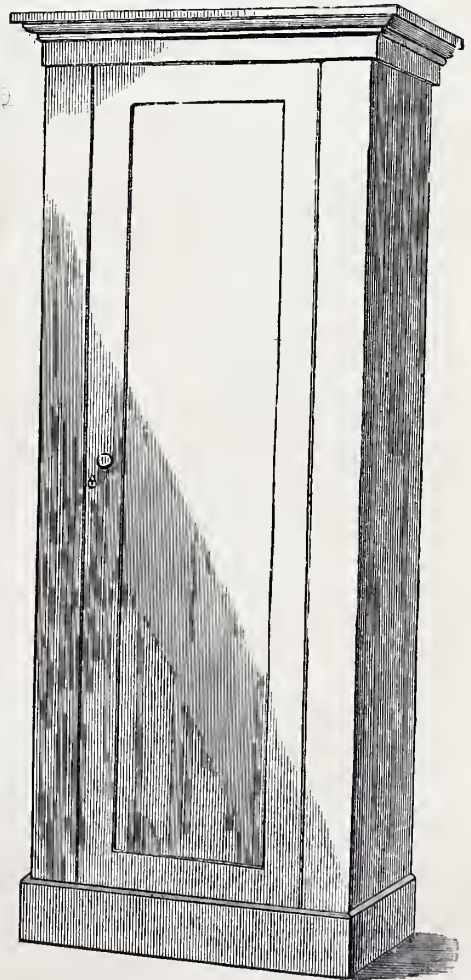

650

HAMPTON & SONS

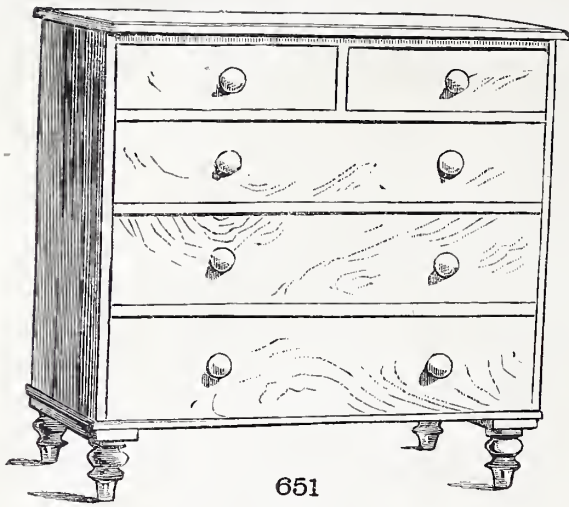

651

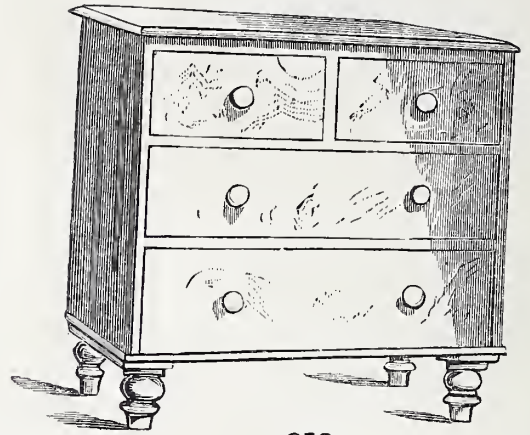

652

HAMPTON & SONS

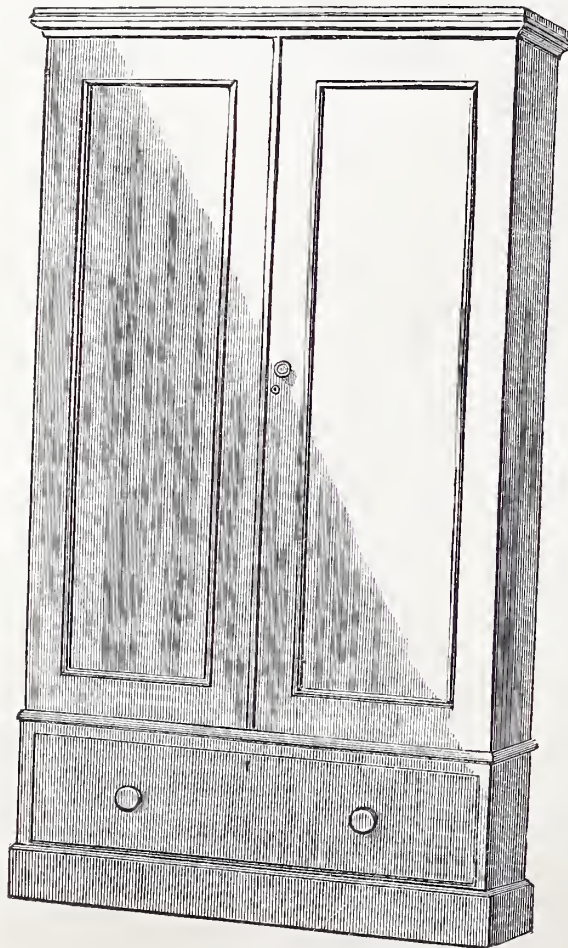

653

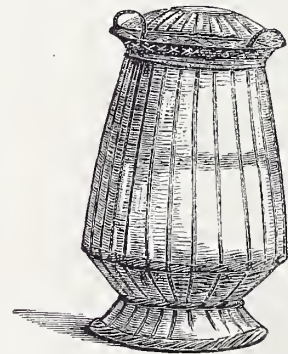

654



655

HAMPTON & SONS



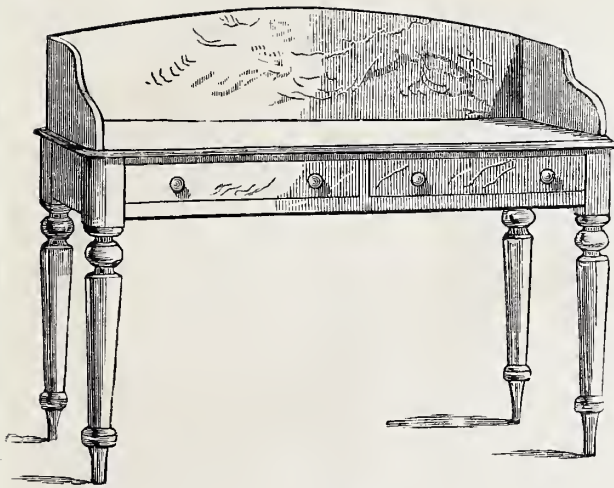

656

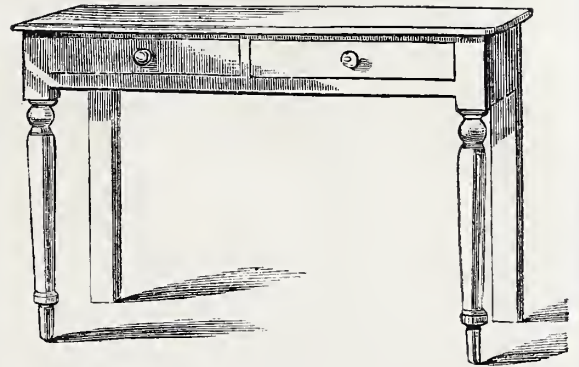

657

HAMPTON & SONS

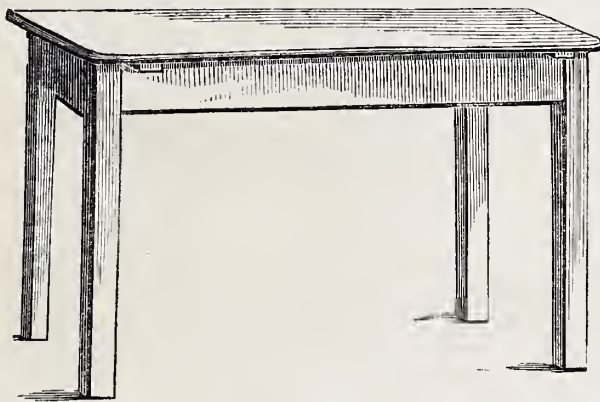

658

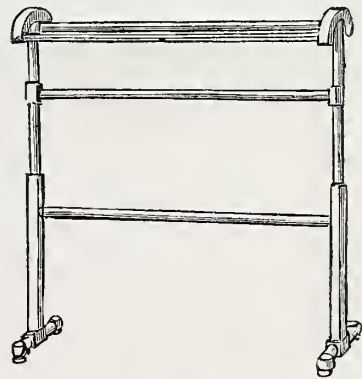

659

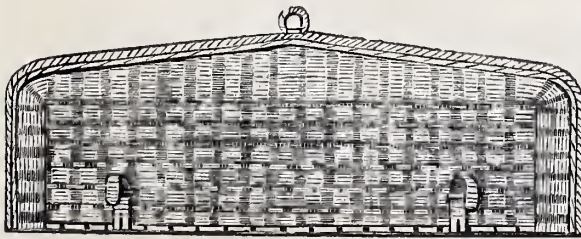

660

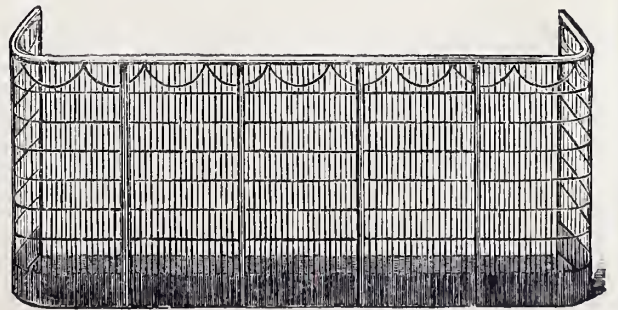

661

HAMPTON & SONS

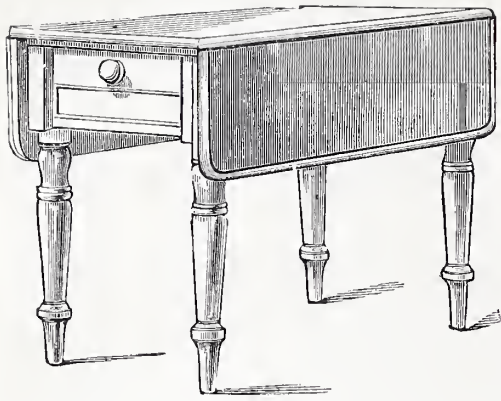

662

HAMPTON & SONS

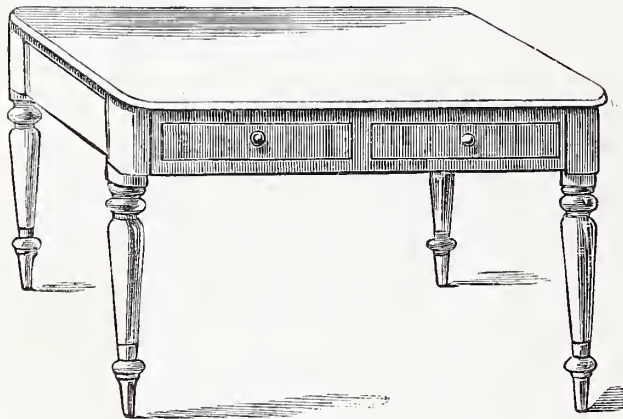

664

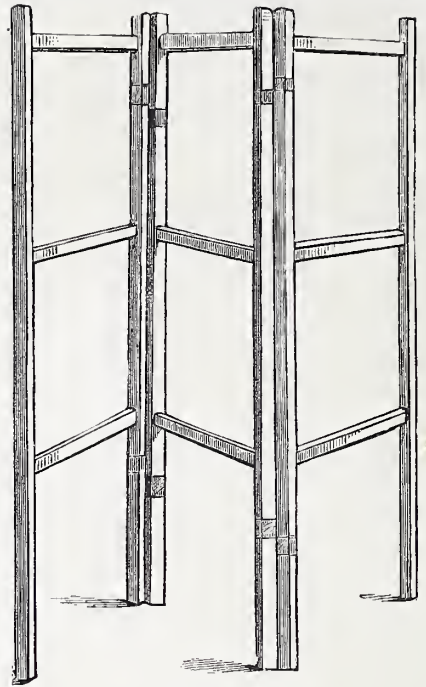

663

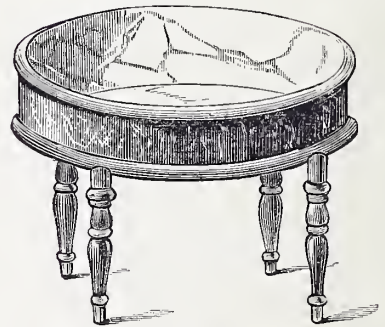

665

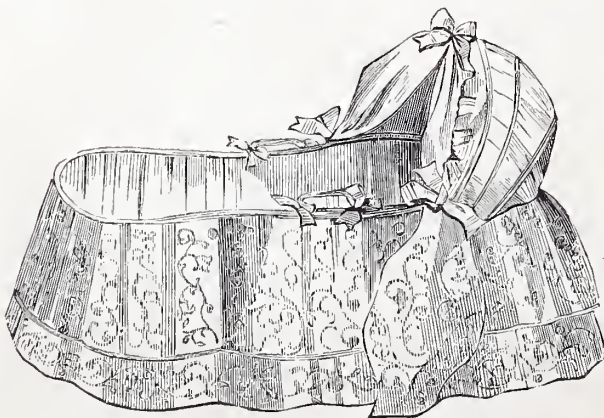

666

HAMPTON & SONS



667



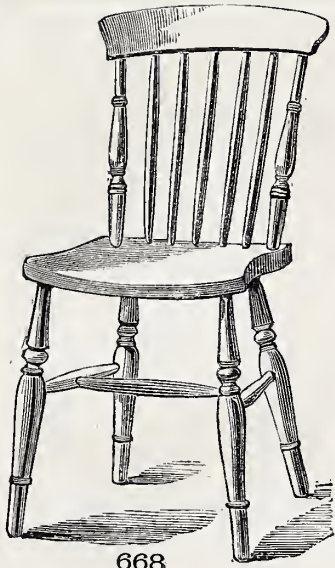

668

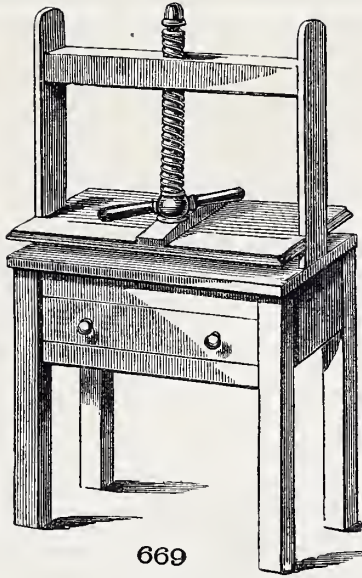

669



670

HAMPTON & SONS

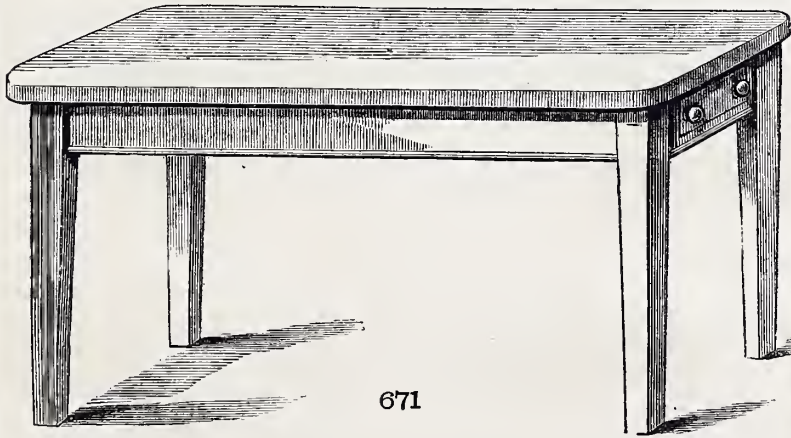

671



672

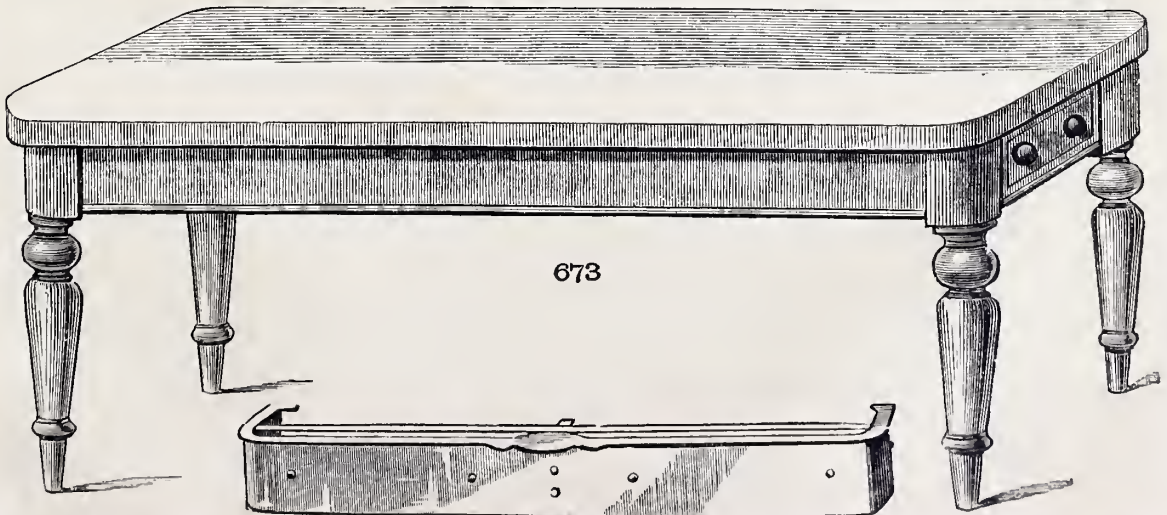

673

674



675



676

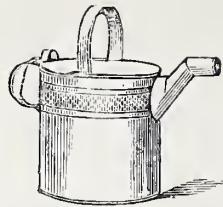

677



678

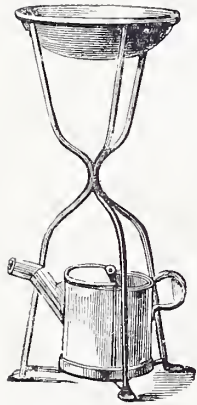

679

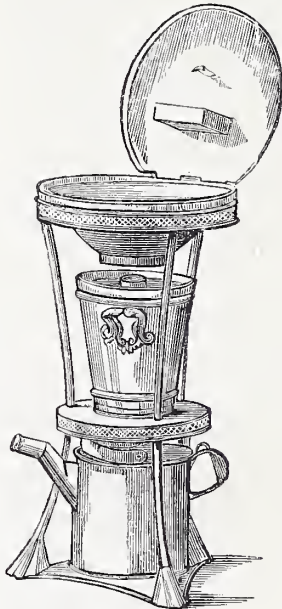

680

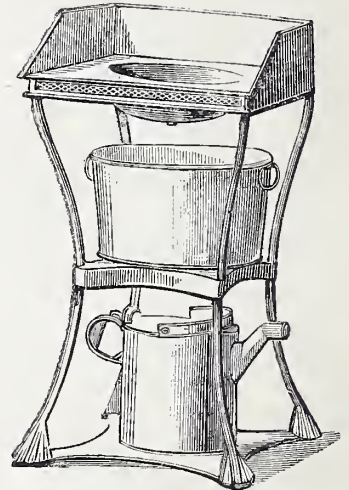

681



682

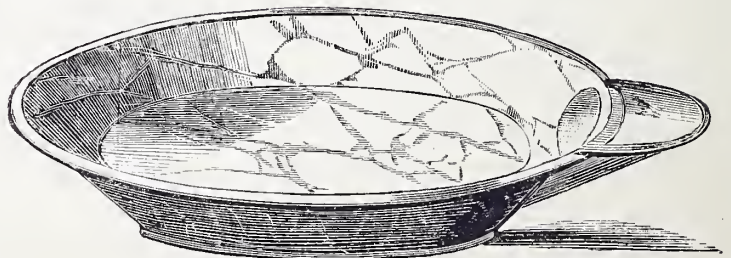

683

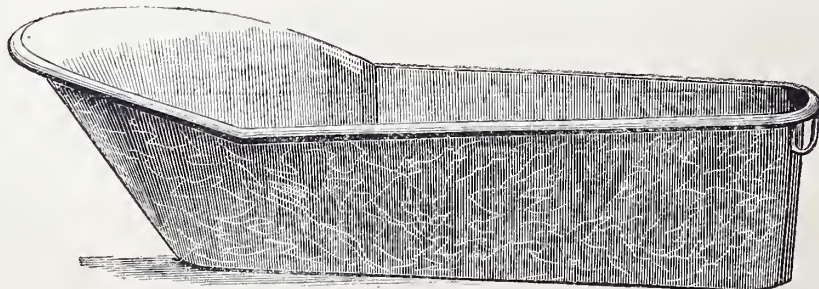

684

C. B. CHOLLS

HAMPTON & SONS



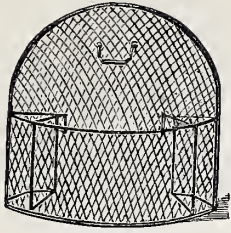

685

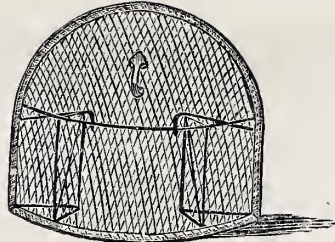

686

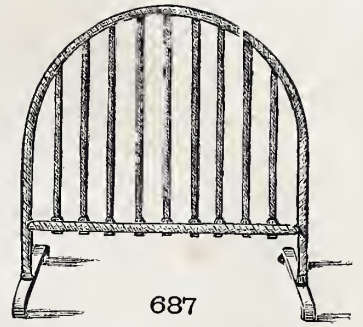

687

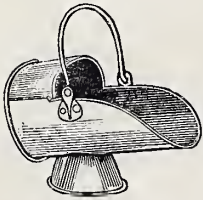

688

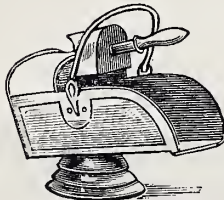

689

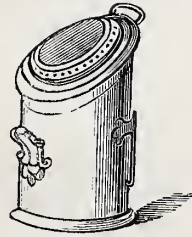

690

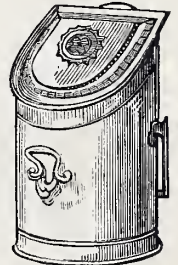

691

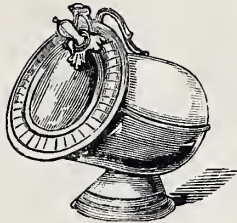

692

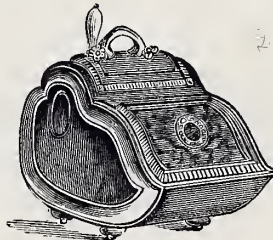

693

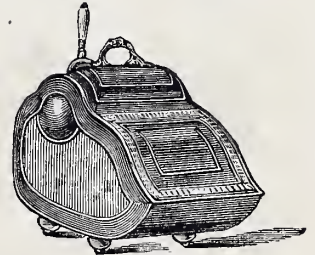

694

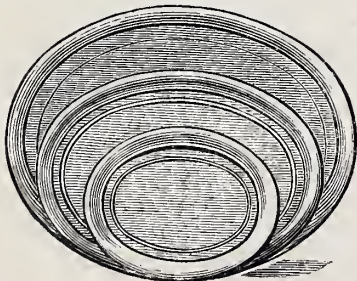

695

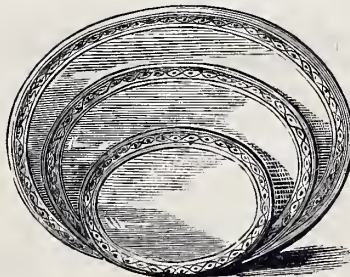

696

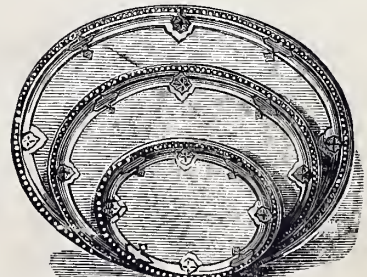

697



698

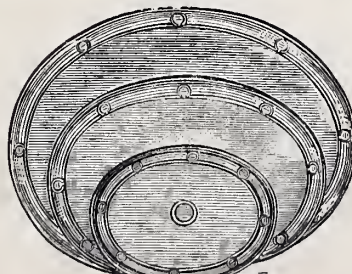

699

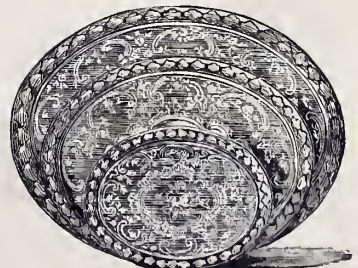

700

HAMPTON & SONS





701



705

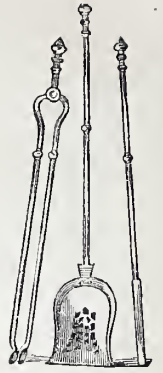

712



706

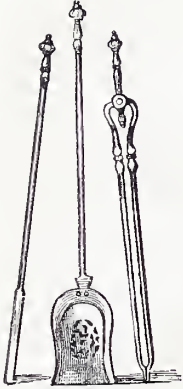

702



707

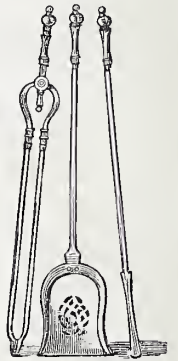

713



708

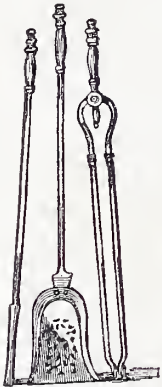

703



709

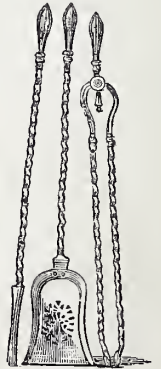

714

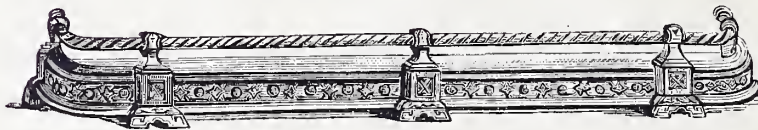

710

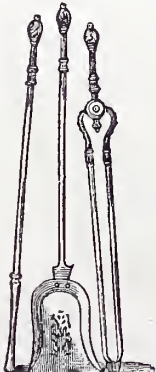

704



711

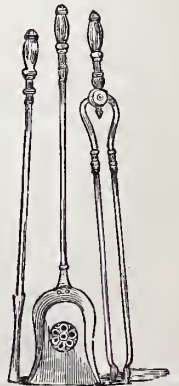

715

HAMPTON & SONS









1/89 KHM =

# 2888





