



# WORLDWIDE EQUIPMENT GUIDE



**TRADOC DCSINT Threat Support Directorate**  
DISTRIBUTION RESTRICTION: Approved for public release; distribution unlimited.

## TABLE OF CONTENTS

	Page		Page
<b>Memorandum, 24 Sep 2001</b> .....	*i	V-150 .....	2-12
<b>Introduction</b> .....	*vii	VTT-323 .....	2-12.1
<b>Table: Units of Measure</b> .....	ix	WZ 551 .....	2-12.2
<b>Errata Notes</b> .....	x	YW 531A/531C/Type 63 Vehicle Series.....	2-13
<b>Supplement Page Changes</b> .....	*xiii	YW 531H/Type 85 Vehicle Series .....	2-14
<b>1. INFANTRY WEAPONS</b> .....	1-1	<b>Infantry Fighting Vehicles</b>	
<b>Small Arms</b>		AMX-10P IFV .....	2-15
AK-74 5.45-mm Assault Rifle .....	1-3	BMD-1 Airborne Fighting Vehicle.....	2-17
RPK-74 5.45-mm Light Machinegun.....	1-4	BMD-3 Airborne Fighting Vehicle.....	2-19
AK-47 7.62-mm Assault Rifle .....	1-4.1	BMP-1 IFV .....	2-20.1
Sniper Rifles.....	1-4.3	BMP-1P IFV .....	2-21
SVD 7.62-mm Sniper Rifle .....	1-4.5	BMP-2 IFV .....	2-23
Barrett .50-Cal Anti-materiel Rifle .....	1-4.6	BMP-3 IFV .....	2-25
PKM 7.62-mm General Purpose MG.....	1-5	Marder 1IFV .....	2-26.1
NSV 12.7-mm Heavy MG .....	1-6	Warrior IFV .....	2-27
AGS-17 30-mm Auto Grenade Launcher .....	1-7	Kliver IFV/APC Turret.....	*2-29
GP-30 40-mm Under-Barrel Grenade Launcher..	1-8		
W-87 35-mm Auto Grenade Launcher.....	*1-8.1	<b>3. RECONNAISSANCE</b> .....	*3-1
Table: Infantry Weapon Night Vision Systems*	1-8.2	<b>Reconnaissance Vehicles</b>	
<b>Recoilless Weapons</b>		AMX-10RC Armored Recon Vehicle .....	3-2.1
Table: Selected Infantry Weapons .....	*1-8.4	BRDM-2 Armored Scout Car .....	3-3
SPG-9 73-mm Recoilless Gun .....	1-9	BRM-1K Armored Recon Command Vehicle.....	3-4
Carl Gustaf M2 84-mm Recoilless Rifle.....	1-10	BRM-3K Combat Reconnaissance Vehicle.....	3-5
RPG-7V 40-mm ATGL.....	1-11	EE-9 Armored Reconnaissance Vehicle.....	3-6
Panzerfaust-3 60-mm ATGL.....	1-13	Fox Armored Reconnaissance Vehicle.....	3-7
M67 90-mm Recoilless Gun .....	1-10.1	Shorland S55 Personnel Carrier.....	3-8
RPG-29 105-mm ATGL .....	1-14	<b>Reconnaissance Systems</b>	
Armbrust 67-mm Disposable ATGL.....	1-15	Horizon Battlefield Surveillance Radar .....	*3-9
RPG-22 72-mm Disposable ATGL.....	1-16		
AT-4 84-mm Disposable ATGL .....	1-17	<b>4. TANKS/ASSAULT VEHICLES</b> .....	4-1
RPO Infantry Rocket Flame Weapon.....	1-18	<b>Light Tanks/Assault Vehicles</b>	
RPO-A Series Infantry Rocket Flame Weapon..	1-19	AMX-13 Light Tank.....	4-3
M40 106-mm Recoilless Rifle .....	1-20	M41A3 Walker Light Tank .....	4-4
B-10 82-mm Recoilless Gun .....	1-21	M1985/PT-85 Light Tank.....	4-4.1
M60 82-mm Recoilless Gun .....	1-22	Type 63A Modernized Light Tank.....	*4-4.3
B-11 107-mm Recoilless Gun .....	1-23	PT-76B Amphibious Tank.....	4-5
		Scorpion Combat Vehicle Recon, Tracked.....	4-6
<b>2. INFANTRY VEHICLES</b> .....	2-1	<b>Main Battle Tanks</b>	
<b>Armored Personnel Carriers</b>		AMX-30.....	4-6.1
BOV-M .....	2-4.1	Challenger 2.....	4-6.3
BTR-152.....	2-4.2	Chieftain Mk 5 .....	4-7
BTR-60PA .....	2-5	Leopard 1A1 .....	4-8.1
BTR-60PB.....	2-6.1	Leopard 2.....	4-9
BTR-80.....	2-7	M60A1/M60A3 .....	4-10.1
BTR-80A.....	2-8	T-34 .....	4-10.3
BTR-D Airborne APC.....	2-9	T-55AMV .....	4-11
M113A1 .....	2-10		
MT-LB Light Armored Multi-purpose Vehicle ..	2-11	* Denotes new equipment sheet	
Pandur .....	2-11.1		

	Page		Page
T-62M .....	4-13	<b>Towed Cannon</b>	
T-64B .....	4-14.1	D-30A 122-mm Towed Howitzer .....	6-5
T-72B .....	4-15	M-46 130-mm Towed Gun .....	6-6
T-72M1 .....	4-17	2A36 152-mm Towed Gun .....	6-6.1
T-80B .....	4-19	D-20 152-mm Towed Gun-Howitzer .....	6-7
T-80U .....	4-21	G-5 155-mm Towed Howitzer .....	6-8
T-90 .....	4-22.1	GH N-45 155-mm Towed Gun-Howitzer .....	6-8.1
Type 59-II .....	4-23		
Type 85-IIM .....	4-25	<b>Self-Propelled Cannon</b>	
<b>5. ANTITANK</b> .....	5-1	2S1 122-mm SP Howitzer .....	6-9
<b>Antitank Guns</b>		2S3 152-mm SP Howitzer .....	6-10
ZIS-3 76-mm Towed Antitank Gun .....	5-3	2S5 152-mm SP Gun .....	6-11
SD-44 85-mm Towed Gun .....	5-4	2S19 152-mm SP Howitzer .....	6-12
M36 90-mm Self-Propelled AT Gun .....	5-4.1	Type 83 152-mm SP Gun-Howitzer .....	6-13
MT-12 100-mm Towed AT Gun .....	5-5	G-6 155-mm SP Howitzer .....	6-15
2A45M 125-mm Towed AT Gun .....	5-6	AU-F1 155-mm SP Howitzer .....	6-17
<b>ATGM Launcher Vehicles</b>		<b>Multiple Rocket Launcher</b>	
9P148 (AT-4/5) ATGM Launcher Vehicle .....	5-7	BM-21 122-mm MRL .....	6-19
9P149 (AT-6/9) ATGM Launcher Vehicle .....	5-9	9A51/Prima 122-mm MRL .....	*6-20
AMX-10 HOT ATGM Launcher Vehicle .....	5-11	9P132 122-mm Rocket Launcher .....	6-20.1
M901/ITOW ATGM Launcher Vehicle .....	5-13	M77 128-mm MRL .....	6-20.3
<b>Antitank Guided Missile Launchers</b>		9P140 220-mm MRL .....	6-21
AT-3 Antitank Guided Missile Launcher .....	5-15	Fadjr-3 240-mm MRL .....	6-22.1
AT-4/5 ATGM Launcher (9P135) .....	5-16	Astros-II 127/180/300-mm MRL .....	6-23
AT-7/13 ATGM Launcher (9P151) .....	5-17	WM-80 273-mm MRL .....	6-25
Eryx ATGM Launcher .....	5-18	9A52-2 300-mm MRL .....	*6-26
Kornet-E ATGM Launcher .....	5-18.1	<b>Mortars/Gun-Mortar Systems</b>	
Milan 2 and 3 ATGM Launcher .....	5-19	MO-120-RT 120-mm Mortar .....	*6-26.1
Red Arrow-8 ATGM Launcher .....	5-20	2S12 120-mm SP Mortar .....	6-27
Tech Report: Gun-Launched ATGMs .....	*5-21	2S23 120-mm SP Combination Gun .....	6-28
<b>6. ARTILLERY</b> .....	6-1	<b>Artillery Ammunition</b>	
<b>Reconnaissance/C<sup>3</sup></b>		OPFOR Special Munitions .....	6-29
1V13 Artillery Command and Recon Vehicle ..	6-2.1	Laser-Guided Projectiles .....	6-30
1V14/15 ACRV .....	6-2.2	Foreign Course Corrected Rockets .....	6-31
1V16 ACRV .....	6-2.3	Foreign Course Corrected Projectiles .....	6-31
1V18/19 ACRV .....	6-2.4	Sensor Fuzed Munitions .....	6-32
1V110 ACRV .....	6-2.5	<b>New Indirect Fire Technologies</b>	
1V111 ACRV .....	6-2.6	TOS-1 220mm Flamethrower Weapon .....	*6-33
1V119 ACRV .....	6-2.7	<b>7. AIR DEFENSE</b> .....	*7-1
PRP-3/PRP-4M Artillery Mobile Recon Vehicle	6-3	<b>Towed Antiaircraft (AA) Guns</b>	
SNAR 10 Battlefield Surveillance Radar .....	6-4	GDF-003 35-mm Towed AA Gun (Skyguard) ..	*7-2
ARK-1M Artillery Locating Radar .....	6-4.1	M1939 37-mm Towed AA Gun .....	7-2.1
BL-904 Artillery Locating Radar .....	6-4.2	KS-19M2 100-mm Towed AA Gun .....	7-3
Cymbeline Artillery Locating Radar .....	6-4.3	S-60 57-mm Towed AA Gun .....	7-4
IL-219 Artillery Locating Radar .....	6-4.5	Type 65 37-mm Towed AA Gun .....	7-4.1
IL-220U Artillery Locating Radar .....	6-4.6	ZPU-4 14.5-mm Heavy Machinegun .....	7-4.2
SORAS 6 Sound Ranging System .....	6-4.7	ZU-23 23-mm Towed AA Gun .....	*7-5

Page	Page
<b>Self-Propelled AA Guns/Combination Guns</b>	
Gepard 35-mm SP AA Gun ..... *7-6	
ZSU-23-4 23-mm SP AA Gun ..... 7-7	
2S6M 30-mm SP AA Gun/Missile System ..... 7-8	
ZSU-57-2 57-mm SP AA Gun ..... 7-8.1	
<b>Manportable Surface-to-Air Missiles (SAMs)</b>	
SA-7b/GRAIL ..... 7-9	
SA-14/GREMLIN ..... 7-10	
SA-16/GIMLET ..... 7-10.1	
SA-18/GROUSE ..... 7-11	
<b>SAM Launcher Systems</b>	
SA-2/GUIDELINE ..... 7-11.1	
SA-3/GOA ..... 7-11.2	
SA-5/GAMMON ..... 7-12	
SA-6/GAINFUL ..... 7-12.1	
SA-8b/GECKO ..... 7-12.2	
SA-10b/GRUMBLE ..... 7-12.4	
SA-10c/GRUMBLE ..... *7-12.5	
SA-11/GADFLY ..... *7-12.6	
SA-12a/GLADIATOR and SA-12b/GIANT ..... *7-12.7	
SA-13b/GOPHER ..... 7-13	
SA-15b/GAUNTLET ..... 7-14	
Aspide Mk 1(Skyguard) ..... *7-14.1	
Crotale 4000 ..... *7-14.2	
Crotale-New Generation ..... *7-14.3	
<b>Air Defense Radars</b>	
Long Track Early Warning Radar ..... 7-15	
Tube Arm Air Defense Radar ..... 7-16	
Giraffe Air Defense Radar ..... *7-17	
<b>8. ENGINEER &amp; LOGISTICS</b> ..... 8-1	
<b>Engineer</b>	
Land Mine Primer ..... 8-2.1	
Mine Table ..... 8-2.7	
TM-62 Land mine ..... 8-2.11	
TM-83 Side-attack mine ..... 8-2.13	
Helkir Antihelicopter mine ..... 8-2.14	
PMR-3 Towed Mechanical Minelayer ..... 8-3	
GMZ-3 Tracked Minelaying Vehicle ..... 8-4	
UMZ Scatterable Minelaying System ..... 8-5	
KMT-5 Tank-Mounted Roller-Plow Set ..... 8-6	
DIM Vehicle-Mounted Mine Detector ..... 8-6.1	
Tables: Line-charge Minebreaching Systems . 8-6.3	
MTK-2 Tracked Mineclearing Vehicle ..... 8-7	
BAT-M Tracked Route-Clearing Vehicle ..... 8-8	
BAT-2 Armored Route-Clearing Vehicle ..... 8-9	
IMR-2M Obstacle-Clearing Vehicle ..... 8-10	
MT-55A Armored Vehicle-Launched Bridge 8-10.1	
MTU-72 Armored Vehicle-Launched Bridge 8-10.2	
PMP Heavy Folding Pontoon Bridge ..... 8-10.3	
TMM Truck-Mounted Scissors Bridge ..... 8-10.5	
<b>Logistics</b>	
UAZ-469 0.6 mt Utility Truck ..... 8-11	
GAZ-66 2 mt Cargo Truck ..... 8-12	
Ural-375D 4.5 mt Cargo Truck ..... 8-13	
KRAZ-255B 7.5 mt Cargo Truck ..... 8-14	
BREM-1 Armored Recovery Vehicle ..... 8-15	
T-54-T Armored Recovery Vehicle ..... 8-16	
<b>9. ROTARY-WING AIRCRAFT</b> ..... *9-1	
<b>Light Helicopters</b>	
BO-105 ..... 9-3	
MD-500/Defender ..... 9-4	
Mi-2/HOPLIGHT ..... 9-5	
SA-341/Gazelle ..... 9-6	
<b>Attack Helicopters</b>	
AH-1F/Cobra ..... 9-7	
AH-1W/Supercobra ..... 9-8	
Ka-50/HOKUM ..... 9-9	
Mi-24/HIND ..... 9-11	
Mi-28/HAVOC ..... 9-12.1	
<b>Utility Helicopters</b>	
AS-532/Cougar ..... 9-13	
Mi-8/HIP ..... 9-14	
Mi-17/HIP ..... 9-15	
<b>Multi-Role Helicopters</b>	
Lynx ..... 9-16	
<b>Transport Helicopters</b>	
Mi-6/HOOK ..... 9-17	
Mi-26/HALO ..... 9-18	
<b>10. FIXED-WING AIRCRAFT</b> ..... 10-1	
<b>Strike Aircraft</b>	
MiG-23/FLOGGER ..... 10-3	
Su-24D/FENCER ..... 10-5	
<b>Ground Attack Aircraft</b>	
Su-17/FITTER ..... 10-7	
Su-25/FROGFOOT ..... 10-9	
<b>Multi-Role Aircraft</b>	
Su-27/FLANKER ..... 10-11	
<b>Transport Aircraft</b>	
An-2/COLT ..... 10-13	
IL-18/COOT ..... 10-14	

	Page		Page
<b>11. COMMAND AND COMMUNICATIONS</b>	11-1	Shmel-1 .....	12-4
		TU-143/DR-3 .....	12-5
		Hermes 450S .....	*12-7
<b>Command Vehicles</b>			
BMP-1KSh Command and Staff Vehicle.....	11-3		
<b>Radios</b>			
Tactical Single Channel Radios.....	11-5		
Tactical Frequency Hopping Radios .....	11-7		
<b>12. UNMANNED AERIAL VEHICLES</b> .....	12-1	<b>13. HEAVY ROCKET/THEATER MISSILE</b> ..	13-1
AT1 .....	12-2.1	Table: Luna-M/SCUD-B .....	13-4
AT2 .....	12-2.2	<b>14. EQUIPMENT UPGRADES</b> .....	*14-1
D-4.....	12-3	Equipment Upgrade Tables.....	*14-1
		Countermeasures .....	*14-9
		<b>Glossary</b> .....	Glossary-1

**DISTRIBUTION RESTRICTION: Approved for public release; distribution is unlimited.**

## Introduction

This Worldwide Equipment Guide (WEG) serves as an interim guide for use in training, simulations, and modeling until the publication of equipment FM. The WEG supports the draft OPFOR FM series (100-7) for the Contemporary Operational Environment (COE). It provides the basic characteristics of selected equipment and weapons systems readily available to the OPFOR, and generally listed in either *FM 100-60, Armor- and Mechanized-Based Opposing Force: Organization Guide* or *FM 100-63, Infantry-Based Opposing Force: Organization Guide*. Selected weapons systems and equipment are included in the categories of infantry weapons, infantry vehicles, reconnaissance vehicles, tanks/assault vehicles, antitank, artillery, air defense, engineer and logistic systems, rotary- and fixed-wing aircraft, and communications equipment.

The pages in this WEG are designed for insertion into loose-leaf notebooks. Since the guide and current updates do not include all possible OPFOR systems identified in the OPFOR FMs, additional equipment sheets for those systems will be published periodically. Systems selected will be keyed directly to baseline equipment contained in the 100-60 series and substitute systems in the appropriate substitution matrix. The WEG is published on the worldwide web for use by authorized government organizations.

### WORLDWIDE OPFOR EQUIPMENT

Due to the proliferation of weapons through sales and resale, wartime capture, and licensed or unlicensed production of major end items, distinctions between equipment as friendly or OPFOR have blurred. Sales of upgrade equipment and kits for application to weapon systems have further blurred distinctions between old or obsolete systems and modern systems. This WEG describes base models listed in the FMs or upgrades of those base models, which reflect current capabilities. Many less common variants and upgrades are also addressed.

### HOW TO USE THIS GUIDE

The WEG is organized by categories of equipment, in chapters. The format of the equipment pages is basically a listing of parametric data. This permits updating on a standardized basis as data becomes available. For meanings of acronyms and terms, see the Glossary. Please note that although most terms are the same as U.S. terminology, some reflect non-U.S. concepts and are not comparable or measurable against U.S. standards. For example, if an OPFOR armor penetration figure does not say RHA (rolled homogeneous armor), do not assume that is the standard for the figure. Please consult the Glossary often. If questions remain, contact this office.

System names refer back to the field manuals. However, they also reflect intelligence community changes in naming methods. Alternative designations include the manufacturer's name, as well as U.S./NATO designators. Note also that the WEG focuses on the complete weapon system (e.g., AT-4/5 antitank guided missile launcher or 9P148 ATGM launcher vehicle), versus a component or munition (9P135 launcher assembly or AT-4/5 ATGM).

Many common technical notes and parameters are used in chapters 2 through 7, since the systems contained in those chapters have similar weapon and automotive technologies. Chapters 1 (Infantry Weapons), and 8 through 12 (Engineer and Logistics, Unmanned Aerial Vehicles) offer systems that have many unique parameters and therefore may not be consistent with those in other chapters.

Please note the updated Threat Support Directorate website. The WEG and other TSD products can be downloaded at: <http://leav-www.army.mil/threats/index/index.htm>.

We solicit your assistance in finding unclassified information which is not copyright-restricted, and which can be certified for use. Questions and comments on systems data should be addressed to the author noted for each chapter. For general questions concerning production, content, and distribution to U.S. government organizations please contact:

**Mr. Tom Redman**

DSN: 552-7925 Commercial (913) 684-7925  
e-mail address: redmant@leavenworth.army.mil

## Units of Measure

The following symbols and abbreviations are used in this guide.

<u>Unit of Measure</u>	<u>Parameter</u>
(°)	degrees of slope/gradient, elevation, traverse
cal	caliber—(tube length in multiples of cannon bore)
GHz	gigahertz—frequency (GHz = 1 billion hertz)
hp	horsepower (kWx1.341 = hp)
Hz	hertz—unit of frequency
kg	kilogram(s) (2.2 lb.)
kg/cm <sup>2</sup>	kg per square centimeter—pressure
km	kilometer(s)
km/h	km per hour
kW	kilowatt(s) (1 kW = 1,000 watts)
liters	liters—liquid measurement (1 gal. = 3.785 liters)
m	meter(s)—if over 1 meter use meters; if under use mm
m <sup>3</sup>	cubic meter(s)
m <sup>3</sup> /hr	cubic meters per hour—earth moving capacity
m/hr	meters per hour—operating speed (earth moving)
MHz	megahertz—frequency (MHz = 1 million hertz)
mach	mach + ( <i>factor</i> ) —aircraft velocity (See Glossary)
mil	milliradian, radial measure (360° = 6400 mils, 6000 Russian)
min	minute(s)
mm	millimeter(s)
m/s	meters per second—velocity
mt	metric ton(s) (mt = 1,000 kg)
rd/min	rounds per minute—rate of fire
RHAe	rolled homogeneous armor (equivalent)
shp	shaft horsepower—helicopter engines (kWx1.341 = shp)
µm	micron/micrometer—wavelength for lasers, etc.



## ERRATA NOTES

The following changes reflect updated information about data in preceding editions of the Worldwide Equipment Guide. We recommend that users note the changes in their copies. In a future edition, we will incorporate changes into published pages.

Page	Change
Chapters 2-5	For all direct-fire guns, or armored fighting vehicles with guns, 100 mm and over, under "MAIN ARMAMENT AMMUNITION", and after "Armor Penetration (mm)", if penetration number is not available for Frag-HE or HE rounds, add: "Can defeat IFVs on impact." NOTE: A near miss can cause collateral damage against IFVs and is likely to cause collateral damage to APCs and most IFVs.
Chapters 2-5	For all direct-fire guns, or armored fighting vehicles with 100-125-mm guns, under "MAIN ARMAMENT AMMUNITION", maximum aimed range for HEAT rounds, unless otherwise stated is limited to no greater than 2,500 m.
2-5	Under VARIANTS, delete: 1V118 Reostat. This vehicle is not artillery-related. See sheet for ACRV 1V119.
2-8, etc.	For the BTR-80A (2-8), BMD-3 (2-20), BMP-2 (2-24), BMP-3 (2-26), and BRM-3K (3-5), change 30-mm APDS round penetration to 25 mm at (60°) and 1,500 m. Ammunition data also applies to 2S6M (7-8), Ka-50/HOKUM (9-9), Mi-24/HIND (9-11), Mi-28/ HAVOC (9-12.1), and Su-25/FROGFOOT (10-9).
2-9	Under VARIANTS, after Artillery command and reconnaissance vehicles: Change to: ACRV 1V18 and 1V19 are battery and battalion command and observation vehicles, respectively.
2-11	For MT-LB Light Multipurpose Vehicle, "Max Swim Speed" is changed.
2-17	For BMD-1 AIFV, under VARIANTS, add: <b>BMD-1KShM:</b> Command and communications vehicle which replaces BMP-1KSh for airborne forces. It has a raised structure vs turret, six road wheels, a CLOTHESLINE radio antenna, and an AGS-17 AGL.
2-18, 5-15	For additional information on the AT-3 ATGM launcher and AT-3 on BMD-1, see sheet for BMP-1 IFV, pg. 2-20.1 in this update, in sections for ATGM launcher, Ammunition data, and NOTES.
2-21 2-23 5-7 5-16	For the AT-4/AT-5 ATGM launcher, for the 9P148 ATGM Launcher vehicle, and for the BMP-1P and BMP-2, add the Indian NAG to the list of ATGMs available for export, and which can be launched from the launcher. The fire-and-forget (IIR-homing) missile has a 5-6 km range and offers a top-attack mode.
2-25	For BMP-3, under FIRE CONTROL, Gunner Night, change to:

1K13-2 II night channel/NAMUT thermal for "Desert BMP-3"

- 2-26 For BMP-3, under VARIANTS, change last entry, "BMP-3: UAE" to:  
**Desert BMP-3:** Improved IFV exported to UAE and Kuwait, with NAMUT thermal sights and other upgrades--the most proliferated version of BMP-3.  
Add: **BMP-3M:** New version of BMP-3 for sale, with improved computer-based integrated and superior stabilized fire control, one of the first IFV gun autotracker, thermal sights with an ATGM channel, an increased capacity autoloader for ATGMs and gun rounds, and other mobility, survivability and lethality upgrades. Other options include ARENA or SHTORA-1 active protection system.
- For all guns or vehicles with guns 76-99 mm, data item "Armor Penetration (mm):", if penetration number is not available for Frag-HE or HE-type rounds, add the following: "Can defeat most IFVs on impact." NOTE: A near miss can cause collateral damage against IFVs and is likely to cause collateral damage to APCs.
- 4-6.1 Add NOTE: For all direct-fire guns, or armored fighting vehicles with 105-mm  
4-8.1 guns which fit NATO standard rifled ammunition, a new option is the Israeli LAHAT gun-launched semi-active laser homing ATGM. For tank-directed fires, this requires a fire control modification to accommodate the laser guidance device, although a remote designator may be used. The ATGM has a 5+ km range, tandem HEAT warhead, and a top-attack mode.
- 4-13 Under line drawing, add the following entry:  
T-62M with Bra Armor
- After Applique Armor (mm): Bra armor..., add  
is common
- 4-15 Under VARIANTS, add the following entry:  
**T-72B1:** Variant introduced in 1986 without ATGM launch capability.
- 4-15 Under VARIANTS, add the following entry:  
**T-72BV:** Under the Russian naming scheme, a T-72B with ERA could be expected to add V to the name.
- 7-1 In Ch 7. AIR DEFENSE, change analyst assigned.
- 7-7 For ZSU-23-4, note clarification of ammunition altitude and fuze data.
- 7-8 For 2S6M, add , gun ammunition, night sight and NOTES on day/night capability.

7-11.1 to 7-12 For SA-2/GUIDELINE, SA-3/GOA, and SA-5/GAMMON, Missile and Space Intelligence Center provided comments which were incorporated in replacement pages.

8-14 Under **VARIANTS**, add the following entry:  
**TZ 8-255B:** POL truck, capacity 8,000 liters.

9-1 In Ch 9. ROTARY-WING AIRCRAFT, change analyst assigned.

10-1 In Ch 10. FIXED-WING AIRCRAFT, change analyst assigned.

G-1 to G-6 In Glossary, new terms and acronyms were added.

## Supplement Page Changes

To Incorporate this supplement into the WEG, please make the page changes as noted below:

<u>System</u>	<u>Page</u>	<u>Change</u>
Memorandum		Replace and change
Enclosure 1	i, ii	Replace and chg
Table of Contents	iii-vi	Replace and chg
Supplement Page Changes	xiii, xiv	Replace and chg
W-87 Automatic Grenade Launcher	1-8.1, 1-8.2	Add
Table: Infantry Weapon Night Vision Systems	1-8.2, 1-8.3	Add
Table: Selected Infantry Weapons	1-8.4 to 1-8.8	Add
Kliver IFV/APC Turret	2-29, 2-30	Add
Ch. 3 Reconnaissance Chapter Introduction	3-1 to 3-2	Replace and page chg
Horizon Battlefield Surveillance Radar	3-9, 3-10	Add
Type 63A Modernized Light Tank	4-4.3, 4-4.4	Add
Technology Report: Gun-Launched ATGMs	5-21 to 5-25	Add
9A51/Prima 122-mm MRL	6-20	*Replace and page chg
9A52-2 300-mm MRL	6-25/6-26	*/Replace and page chg
MO-120-RT 120-mm Mortar	6-26.1, 6-26.2	Add
TOS-1 220-mm Flamethrower Weapon	6-33, 6-34	Add
Ch 7. AIR DEFENSE	7-1	Replace and chg
GDF-003 35-mm Towed AA Gun (Skyguard)	7-2	Add
ZU-23 23-mm Towed AA Gun	7-5	Replace and chg
Gepard 35-mm SP AA Gun	7-6	Add
SA-10b/GRUMBLE	7-12.4	Replace and chg
SA-10c/GRUMBLE	7-12.5	Add
SA-11/GADFLY	7-12.6	Add
SA-12a/GLADIATOR, SA-12b/GIANT	7-12.7	Add
Aspide Mk 1 SAM (Skyguard)	7-14.1	Add
Crotale 4000 SAM	7-14.2	Add
Crotale-New Generation SAM	7-14.3, 7-14.4	Add
Giraffe Air Defense Radar	7-17, 7-18	Add
Tables: Line-Charge Minebreaching System	8-6.3 to 8-6.6	Add
Hermes 450S UAV	12-7, 12-8	Add
Ch 14. EQUIPMENT UPGRADES	14-1 to 14-8	Add
Countermeasures	14-9 to 14-13	Add

\* Also replaces sheet on back page of added sheet



## GLOSSARY

**AA** - anti-aircraft

**acquisition range** - sensor range against a category of targets. Targets are usually categorized as infantry, armored vehicles, or aircraft. Acquisition includes four types (or levels of clarity, in ascending order of clarity): detection, classification, recognition, and identification. Where the type of acquisition is not specified, the acquisition range will be regarded as sufficient for accurate targeting. This range is comparable to the former Soviet term *sighting range*.

**AAM** - air-to-air missile

**AD** - antihandling device (mines)

**ADHPM** - artillery-delivered high-precision munition. This term can be used to describe various

artillery precision munitions, including guided, terminally homing, SAL-homing, and course-corrected mortar and cannon rounds and rockets.

**AGL** - automatic grenade launcher

**AIFV** - airborne infantry fighting vehicle

**aka** - also known as

**ALCM** - air-launched cruise missile

**AL/RDX** - aluminized RDX (ammunition) is an enhanced blast filler with aluminum added to the RDX high explosive, often used in Russian Frag-HE munitions with increased lethality.

**AM** - amplitude modulated (communications)

**antitank** - functional area and class of weapons characterized by destruction of tanks. In the modern context used in this guide, the role has expanded to fit the term "antiarmor" (which includes systems and munitions which can be employed against light armored vehicles)

**AP** - antipersonnel

**APAM** - antipersonnel - anti-materiel (ammunition)

**APE** - armor-piercing explosive (ammunition)

**APERS-T** - antipersonnel - tracer (ammunition)

**APC** - armored personnel carrier

**APC-T** - armor-piercing capped tracer (ammunition)

**AP HE** - armor-piercing high explosive (ammunition)

**API-T** - armor-piercing incendiary tracer (ammunition)

**APERS-T** - antipersonnel tracer (ammunition)

**APT** - armor-piercing tracer (ammunition)

**APU** - auxiliary power unit; auxiliary propulsion unit

**ARM** - anti-radiation missile. The missile homes in on the radar pulse to kill a radar system.

**ASM** - air-to-surface missile

**AT** - antitank

**ATGL** - antitank grenade launcher

**ATGM** - antitank guided missile

**aux** - auxiliary

**average cross-country (speed)** - vehicle speed (km/hr) on unimproved terrain without a road

**AVLB** - armored vehicle-launched bridge

**burst (rate of fire)** - artillery term: the greatest number of rounds that can be fired in 1 minute  
**BW** - biological warfare, including ammunition type.

**cal** - caliber

**caliber** - barrel length to gun bore ratio (for all gun systems), and used as a measure of gun barrel size or as a component of ammunition/gun size; in the case of US-made infantry weapons, diameter of ammunition/gun bore only, measured in inches, and used to describe ammunition/gun size

**canister** - close-range direct-fire ammunition which dispenses a fan of flechettes forward

**C - centigrade**

**CC** - cargo-carrying (ammunition)

**CCD** - cover, concealment, and deception; also charged-coupled device, an imaging sensor which operates in the visual and near-IR bands, with day and limited night capability.

**CCM** - counter-countermeasure

**CE** - chemical energy: the class of ammunition which employs a shaped charge for the lethal mechanism. Ammunition types which employ CE include HEAT and HESH (see below).

**Chem** - chemical (ammunition type)

**CM** - countermeasure

**coax** - coaxial

**CRV** - combat reconnaissance vehicle

**CW** - continuous wave (communications)

**cyclic (rate of fire)** - maximum rate of fire for an automatic weapon (in rd/min)

**decon** - decontamination

**direct-fire range** - maximum range of a weapon, operated in the direct-fire mode, at which the bullet's trajectory will not rise above the height of the intended point of impact on the target. At this range, the gunner is not required to adjust for range in order to aim the weapon. The comparable Russian term is *point blank range*.

**DPICM** - dual-purpose improved conventional munitions (ammunition)

**DPICM-BB** - dual-purpose improved conventional munitions, base-bleed (ammunition)

**DU** - depleted uranium (ammunition)

**DVO** - direct-view optics

**ECM** - electronic countermeasure

**EFP** - explosively-formed penetrator (ammunition); kinetic-energy penetrator which is created by a plate, shaped into a slug by an explosive charge, then propelled by it to a target

**EIOC** - estimated IOC

**EMD** - engineering, manufacture and development. Fielding phase between prototype and IOC.

**EMP** - electro-magnetic pulse, including ammunition type. The pulse can kill electronic microcircuits in a target area.

**EO** - electro-optic, electro-optical

**ERA** - explosive reactive armor

**ERFB** - extended range full-bore (ammunition)

**ERFB-BB** - extended range full-bore, base-bleed (ammunition)

**est** - estimate

**ET** - electronic timing (ammunition fuze type)

**European** - from a consortium of firms located or headquartered in several European countries

**EW** -electronic warfare

**FCS** - fire control system

**FFAR** - folding-fin aerial rockets

**FAE** - fuel-air explosive (ammunition). This munition technology is employed in aerial bombs and artillery munitions, and uses a dispersing explosive fill to produce intense heat, a long-duration high-pressure wave, and increased HE blast area

**flechette** – small steel darts (much like nails) used to fill artillery rounds (and some bombs). Generally thousands of these darts are fired (similar to a shotgun in an anti-personnel role) dispensing the flechettes forward over a wide area. Unlike **canister rounds**, FSU artillery rounds use a time fuze, permitting close-in direct fire, long-range direct fire, and indirect fire.

**FH** - frequency-hopper (radio, communications)

**FLIR** - forward-looking infrared (thermal sensor)

**FLOT** - forward line of own troops

**FM** - frequency modulated (communications)

**FOV** - field of view

**frag-HE** - fragmentation-high explosive (ammunition)

**FSU** - former Soviet Union

**GCS** - ground control station

**gen** - generation. Equipment such as APS and (thermal and II) night sights are often categorized in terms of 1st, 2nd or 3rd generation of development, with different capabilities for each.

**GP MG** - general purpose machinegun

**GPS** - global positioning system

**HE** - high explosive (ammunition)

**HEAT** - high-explosive antitank (also referred to as shaped-charge ammunition)

**HEAT-FS** - high-explosive antitank, fin-stabilized (ammunition)

**HEAT-MP** - high-explosive antitank, multi-purpose

**HEFI** - high-explosive fragmentation incendiary (ammunition)

**HEI** - high-explosive incendiary (ammunition)

**HEP-T** - high explosive plastic-tracer (ammunition)

**HESH** - high-explosive squash head (ammunition)

**HF**- high frequency (communications)

**hps** - hops per second (communications)

**HUD** - head-up display

**HVAP-T** - hypervelocity, armor-piercing tracer (ammunition)

**ICM** - improved conventional munition (ammunition, round containing submunitions/grenades)

**IFF** - identification friend-or-foe

**IFV** - infantry fighting vehicle - improved conventional munition; frag-He bomblet submunition

**II** - image intensification (night sighting system)

**ILS** - instrument landing system

### Glossary-3

**INA** - information not available



**incend** - incendiary

**IOC** - interim operational capability

**IR** - infrared

**IRBM** - intermediate-range ballistic missile (3,001-5,500 km)

**I-T** - incendiary - tracer (ammunition)

**K-kill** - catastrophic kill (simulation lethality data)

**kbits** - kilobites per second (communications)

**KE** - kinetic energy: class of ammunition which transfers energy to the target for the lethal mechanism. Ammunition types which employ KE include AP, APFSDS-T, and HVAP-T.

**LAFV** - light armored fighting vehicle

**LLLTV** - low-light-level television

**LMG** - light machinegun

**LRF** - laser rangefinder

**mach** - speed of sound, based on atmospheric conditions (1160 km/h at sea level)

**max** - maximum

**maximum aimed range** - maximum range of a weapon (based on firing system, mount, and sights) for a given round of ammunition, while aiming at a ground target or target set with sights in the direct-fire mode. The range is not based on single-shot hit probability on a point target, rather on tactical guidance for firing multiple rounds if necessary to achieve a desired lethality effect. One writer referred to this as *range with the direct laying sight*. Even greater ranges were cited for *salvo fire*, wherein multiple weapons (e.g., tank platoon) will fire a salvo against a point target.

**max effective range** - maximum range at which a weapon may be expected to achieve a high single-shot probability of hit (50%) and a required level of destruction against assigned targets. This figure may vary for each specific munition and by type of target (such as infantry, armored vehicles, or aircraft).

**max off-road (speed)** - vehicle speed (km/hr) on dirt roads

**MCLOS** - manual command-to-line-of-sight

**MG** - machinegun

**Mk** - Mark

**MRBM** - medium-range ballistic missile (1,001-3,000 km)

**MRL** - multiple rocket launcher

**MMW** - millimeter wave (sensor mode, band in the electromagnetic spectrum)

**MVV** - muzzle velocity variation (RF tracker for monitoring round-to-round variations in muzzle

velocity variations due to tube wear, or for tracking artillery course-corrected rounds for command course adjustment)

**N/A** - not applicable

**NBC** - nuclear, biological, and chemical

**Nd** - neodymium, type of laser rangefinder

**NFI** - no further information

**normal (rate of fire)** - artillery term: rate (in rd/min) for fires over a 5-minute period

**Nuc** - nuclear (ammunition type )  
**NVG** - night-vision goggle  
**NVS** - night-vision system

**PD** - point-detonating (ammunition fuze type)  
**penaid** - Penetration aid, countermeasure system in the warhead to counter air defense weapons effectiveness.

**Ph** - probability of hit (simulation lethality data)

**PIBD** - point-initiating base-detonating (ammunition fuze type)

**pintel** - post attached to a firing point or vehicle, used to replace the base for a weapon mount

**Pk** - probability of kill (simulation lethality data)

**Poss** - possible

**practical (rate of fire)** - maximum rate of fire for sustained aimed weapon fire against point targets. The rate includes reload time and reduced rate to avoid damage from overuse. Former Soviet writings also refer to this as the **technical rate of fire**.

**RAP** - rocket-assisted projectile (ammunition type)

**ready** - rapid detectability under normal mobility conditions (mines)

**mirecon** - reconnaissance

**rd** - round

**ready rounds** - rounds available for use on a weapon, whether in autoloader or in nearby stowage, which can be loaded within the weapon's stated rate of fire

**RF** - radio frequency

**RHA** - rolled homogeneous armor, often used as a standard armor hardness for measuring penetration of anti-tank munitions

**RHAe** - RHA equivalent, a standard used for measuring penetrations against various type armors

**rpm** - rounds per minute (aircraft)

**RV** - reentry vehicle. That portion of a TBM separating (or multiple separating) warhead which reenters the atmosphere and maneuvers to the target.

**SACLOS** - semiautomatic command-to-line-of-sight

**SAL** - semi-active laser; guidance method used in precision munitions, such as ADHPM, and ATGMs.

**SAM** - surface-to-air missile

**SHF** - super high-frequency (sensors)

**SFM**- sensor-fuzed munition (artillery ammunition)

**shp** - shaft horsepower (aircraft)

**SLAP** - sabot light armor penetrator (ammunition). Small arms/machinegun round with a sub-caliber penetrator guided down a gun bore by sabots, designed to defeat light armor.

**SP** - self-propelled

**SOF** - special operations forces

**SRBM** - short-range ballistic missile (0-1,000 km)

**SSM** - surface-to-surface missile (can include IRBM, MRBM, or SRBM, or cruise missile)

**stadimetric** - in this guide, a method of range-finding using stadia line intervals in sights and target size within those lines to estimate target range

**stowed rounds** - rounds available for use on a weapon, but stowed and requiring a delay greater than that for ready rounds (and cannot be loaded within the weapon's stated rate of fire)  
**sustained (rate of fire)** - artillery term: rate (in rd/min) for fires over the duration of an hour

**tactical AA range** - maximum targeting range against aerial targets, aka: **slant range**

**TAR** - target acquisition radar

**TBM** - theater ballistic missile

**TEL** - transporter-erector-launcher. Vehicle which carries, raises, and launches TBMs.

**TELAR** - transporter-erector-launcher and radar

**thermobaric** - HEI volumetric (blast effect) explosive technology similar to fuel-air explosive and used in shoulder-fired infantry weapons and ATGMs

**TLAR** - transporter-launcher and radar

**TOF** - time of flight (seconds)

**TTP** - tactics, techniques, and procedures

**TTR** - target tracking radar

**TV** - television (sensor mode)

**UAV** - unmanned aerial vehicle, class of unmanned aerodynamic systems which include remotely piloted vehicles and preprogrammed (drone) aircraft

**UHF** - ultra-high frequency (communications)

**UI** - unidentified

**VEESS** - vehicle engine exhaust smoke system

**VHF** - very high frequency (communications)

**volumetric** - class of explosive ammunition fill which produces high long-duration blast and heat (includes thermobaric and FAE)

**vs** - versus

**w/** - with (followed by associated object)

**WMD** - weapons of mass destruction (ammunition type). These generally consist of nuclear, bacteriological, and chemical munitions.

**WP** - white phosphorus (ammunition)



**DEPARTMENT OF THE ARMY**  
TRADOC DCSINT, Threat Support Directorate  
700 Scott Avenue, Bldg 53  
FORT LEAVENWORTH, KS 66027-1323

REPLY TO  
ATTENTION OF

ATIN-L-T (71)

24 Sep 01

MEMORANDUM FOR: See Distribution

SUBJECT: Worldwide Equipment Guide (WEG) Semiannual Update 1-2001

1. This is our fourth supplement to the WEG, the first for the year 2001. This issue is intended to support—
  - FMs 100-60 (Armor- and Mechanized-Based Opposing Force Organization Guide) and 100-63 (Infantry-Based Opposing Force Organization Guide).
  - The draft OPFOR manual series (FM 7-100, posted at the TSD web site), for the Contemporary Operational Environment (COE).
  - The spectrum of worldwide systems, to reflect technological and proliferation trends. These systems also support the expanding scope of U.S. Army training, and ongoing U.S. Army operations.
2. The WEG (Enclosure 2) is organized as a loose-leaf document to permit page changes (see page xiii). Accumulated Errata sheets for all the updates are included, with notes which reflect changes to previous WEG editions. We appreciate comments from users and the intelligence community.
3. The Threat Support Directorate (TSD) would like to remind users that the WEG is not a product of the U.S. Army intelligence community. It was developed to support OPFOR portrayal in training simulations (constructive, virtual, and live) and activities, and is approved for that use.
4. Due to limited budget, TSD asks that users accept only one copy per office and either make xerox copies or download additional copies from the TSD web site. The TSD web site address is: <http://leav-www.army.mil/threats/index/index.htm>. We solicit your questions and comments. For specific comments contact authors noted in chapter introductions. For general comments or questions, requests for distribution, or for address change, contact Tom Redman, DSN 552-7925, commercial (913) 684-7925, e-mail: redmant@leavenworth.army.mil.

2 Encls  
as

A handwritten signature in black ink, appearing to read "Nicholas C. Comer".

NICHOLAS C. COMER  
GS-14, Director  
Threat Support Directorate



## TRADOC DCSINT TSD OPFOR BASELINE DOCUMENTATION

The following tables list TSD products currently available for use in OPFOR development and application. The TSD-produced FM 100-60 series is the most recent documentation, and is posted at the TSD web site: <http://leav-www.army.mil/threats/index/index.htm>.

### TSD-PUBLISHED FIELD MANUALS

Document No.	Document Title	Published	Posted on Web Site
FM 100-60	Armor- and Mechanized-Based Opposing Force: Organization Guide	16 Jul 97	Yes PDF File
	Replaced TP 350-12		
	Replaced TP 350-14		
FM 100-63	Infantry-Based Opposing Force: Organization Guide	18 Apr 96	Yes HTML File
	Replaced TP 350-13		

New OPFOR FMs are currently in review for describing operations and tactics in the Contemporary Operational Environment (COE). Those consist of :

- FM 7-100 OPFOR Doctrinal Framework and Strategy
- FM 7-100.1 OPFOR Operations.
- FM 7-100.2 OPFOR Tactics

Future additions to the series will include a COE organization guide FM. This World-wide Equipment Guide update is the last planned update. In the 2nd Quarter of FY 2002, a COE equipment FM will incorporate and supersede the WEG.

## Chapter 1 Infantry Weapons

This chapter provides the basic characteristics of selected infantry weapons either in use or readily available to the OPFOR and therefore likely to be encountered by U.S. forces in varying levels of conflict. The selection of weapons is not intended to be all inclusive, rather a representative sampling of weapons and equipment supporting various military capabilities.

This chapter is divided into two categories—*small arms* and *recoilless weapons*. *Small arms* covers, in order, assault rifles, under-barrel grenade launchers, light machineguns, general purpose machineguns, heavy machineguns, and automatic grenade launchers. The second category, *recoilless weapons*, contains the US 106-mm Recoilless Rifle M40 and the Russian 73-mm Recoilless Gun SPG-9. This category also covers a rapidly growing segment of shoulder-fired (unguided) infantry weapons. While originally limited to shoulder-fired unguided antitank weapons such as the Russian 40-mm Antitank Grenade Launcher RPG-7, the utility of shoulder-fired weapons has expanded to include multi-purpose systems such as the Swedish 84-mm Recoilless Rifle Carl Gustaf M2. This field of weapons is often labeled “antitank” and also includes “bunker-buster” warheads, and weapons fired from close spaces such as the German 67-mm Disposable Antitank Grenade Launcher Armbrust.

Another emerging battle-tested, lethal, shoulder-fired weapon is the Russian Infantry Rocket Flame Weapon RPO-A Series (RPO-A/D/Z) capable of firing either a smoke, incendiary, or a thermobaric warhead to 600 meters. At 200 meters it is accurate to 0.5 m<sup>2</sup>. The thermobaric warhead has a demolition effect corresponding to a round of 122-mm HE artillery. Due to the relative low cost, availability, versatility, transportability, trainability, and lethality of this category of infantry weapons, trainers should expect to encounter these systems in larger numbers with increasing levels of lethality, penetration, and utility. For information on guided antitank weapon systems see Chapter 5.

Questions and comments on data listed in this chapter should be addressed to:

**Mr. Richard G. McCall**  
DSN: 552-7960 Commercial (913) 684-7960  
e-mail address: mcallr@leavenworth.army.mil





## Russian 5.45-mm Assault Rifle AK-74

	<p><b>Ammunition Types</b></p> <p>5.45-mm cartridge Ball Ball-tracer Incendiary-T AP</p>	<p><b>Typical Combat Load</b></p> <p>300</p>
<p><b>SYSTEM</b></p> <p><b>Alternative Designations:</b> INA  <b>Date of Introduction:</b> 1974  <b>Proliferation:</b> Widespread</p> <p><b>Description:</b>  Weight (kg):      Loaded (with magazine): 3.95      Empty (w/o magazine): 3.4  Length (mm):      Overall: 880 (937 including muzzle brake)      Barrel: 415  Rate of Fire (rd/min):      Cyclic: 600      Practical:          Automatic: 100          Semiautomatic: 40  Operation: Gas  Feed: 30-rd detachable box magazine (40-rd used by RPK-74 LMG is interchangeable)  Fire Mode: Selective, automatic or semi-automatic</p> <p><b>SIGHTS</b></p> <p><b>Name:</b> INA  Type: Fore, pillar; rear, U-notch  Magnification: None  <b>Night Sights Available:</b> Yes. AK-74M N3 mounts an NSPU-3</p>	<p><b>VARIANTS</b></p> <p><b>AKS-74:</b> Folding-stock version with a Y-shaped, tubular stock.  <b>AK-74M:</b> Improves the basic AK-74 design by adding a folding plastic stock, an improved mount for night vision or other sights.  <b>AKS-74U:</b> Submachinegun: modified version with a much shorter barrel (207-mm) and a conical flash suppressor instead of a muzzle break. Its overall length is 492 with stock folded.  <b>AK-101:</b> 5.56x45-mm (NATO) variant of the AK-74M.  <b>AK-102:</b> 5.56x45-mm (NATO) short-barrel (314-mm) variant of the AK-74M.  <b>AK-103:</b> 7.62x39-mm variant of the AK-74M.  <b>AK-104:</b> 7.62x39-mm short-barrel (314-mm) variant of the AK-74M.  <b>AK-105:</b> 5.45x39-mm short-barrel (314-mm) variant of the AK-74M.</p> <p><b>AMMUNITION</b></p> <p><b>Name:</b> 7N6  Caliber/length: 5.45x39-mm  Type: Ball  Range (m):      Effective: 500      Maximum: 800  Armor Penetration: INA  Muzzle Velocity (m/s): 880</p> <p><b>Name:</b> 7N10  Caliber/length: 5.45x39-mm  Type: Armor piercing  Range (m):      Effective: INA for AK-74 (800 for RPK-74)  Armor Penetration (mm): 16 @ 100 m 80% of time  Muzzle Velocity (m/s): INA for AK-74 (960 for RPK-74)</p>	

**NOTES**

The AK-74 is basically an AKM rechambered and rebored to fire a 5.45-mm cartridge. The AK-74 can mount a 40-mm under-barrel grenade launcher and a passive image intensifier night sight. The AK-74 is also the basis for other 5.45-mm infantry weapons including the RPK-74 light machinegun.

## Russian 5.45-mm Light Machinegun RPK-74

	<p><b>Ammunition Types</b></p> <p>5.45-mm cartridge Ball Ball-tracer Incendiary-T AP</p>	<p><b>Typical Combat Load</b></p> <p>320</p>
<p><b>SYSTEM</b></p> <p><b>Alternative Designations:</b> INA <b>Date of Introduction:</b> Late 1970s <b>Proliferation:</b> Widespread</p> <p><b>Description:</b> Weight (kg):   Loaded (with magazine): 5.0   Empty (w/o magazine): 4.6 Length (mm):   Overall: 1.07 m   Barrel: 590 mm (including flash suppresser) Rate of Fire (rd/min):   Cyclic: 600   Practical:     Automatic: 150     Semiautomatic: 50 Operation: Gas Feed: 40-rd detachable box magazine (30-rd used by AK-74 is interchangeable) Fire Mode: Selective, automatic or semi-automatic</p> <p><b>SIGHTS</b></p> <p><b>Name:</b> INA <b>Type:</b> Fore, cylindrical post; rear, tangent leaf with U-notch; adjustable to 1,000 m <b>Magnification:</b> None <b>Night Sights Available:</b> Yes. 1LH51 night sight</p>	<p><b>VARIANTS</b></p> <p><b>RPKS-74:</b> Folding stock</p> <p><b>AMMUNITION</b></p> <p><b>Name:</b> 7N6 Caliber/length: 5.45x39-mm Type: Ball Range (m):   Effective: 800   Maximum: 1,000   Armor Penetration: INA   Muzzle Velocity (m/s): 960</p> <p><b>Name:</b> 7N10 Caliber/length: 5.45x39-mm Type: AP Range (m):   Effective: 800 Armor Penetration (mm): 16 @ 100 m 80% of time Muzzle Velocity (m/s): 960</p>	

**NOTES**

The RPK-74 is the machinegun version of the AK-74, firing the same ammunition. Instead of the prominent muzzle brake used on the AK-74, the machinegun is longer than that normally used with the AK-74, but the magazines are interchangeable. The RPK-74 has a bipod and is compatible with the front firing ports of BMPs. The RPK-74 is the standard squad machinegun in OPFOR infantry units. It generally replaces both the RPK and PKM 7.62-mm weapons.

## Russian 7.62-mm Assault Rifle AK-47/AKM

	<p><b>Ammunition Types</b></p> <p>7.62-mm cartridge Ball Tracer API Tracer Incendiary</p>	<p><b>Typical Combat Load</b></p> <p>120</p>
<p><b>SYSTEM</b></p> <p><b>Alternative Designations:</b> AK, Kalashnikov  <b>Date of Introduction:</b> 1949/1961  <b>Proliferation:</b> Widespread (over 50 million)  <b>Description:</b>  <b>Weight (kg):</b>          Loaded (with magazine): 3.8          Empty (w/o magazine): 4.3/3.14  <b>Length (mm):</b> 870/880  <b>Rate of Fire (rd/min):</b>          Cyclic: 600          Practical:              Automatic: 100              Semiautomatic: 40  <b>Operation:</b> Gas  <b>Feed:</b> 30-round curved box magazine  <b>Fire Mode:</b> Selective, automatic or semi-automatic</p> <p><b>SIGHTS</b></p> <p><b>Name:</b> INA  <b>Type:</b> Fore, pillar; rear, U-notch  <b>Magnification:</b> None  <b>Night Sights Available:</b> Yes</p>	<p><b>VARIANTS</b></p> <p>Numerous. Many countries manufacture clones of the AK-47 or weapons using the basic AK action. Some of these are made in different calibers.</p> <p><b>AKS:</b> Folding stock.  <b>AKM:</b> Improved AK-47, sights, magazine, and stock. Easier to manufacture with stamped receiver.  <b>AKMS:</b> Folding stock variant of AKM.</p> <p><b>AMMUNITION</b></p> <p><b>Name:</b> M1943 (57N231)  <b>Caliber/length:</b> 7.62x39-mm  <b>Type:</b> Ball  <b>Range (m):</b>          Effective: 300          Maximum: 2,500  <b>Armor Penetration:</b> INA  <b>Muzzle Velocity (m/s):</b> 710</p> <p><b>Name:</b> M1943 (T-45)  <b>Caliber/length:</b> 7.62x39-mm  <b>Type:</b> Tracer  <b>Range of Trace (m):</b> 800  <b>Muzzle Velocity (m/s):</b> 718</p>	

### NOTES

Photo is of an AKM. All 7.62-mm Kalashnikov assault rifles are very dependable weapons. They produce a high volume of fire and are simple to maintain and produce. The primary difference between the AK-47 and the improved AKM is the receiver. The receiver of the AK-47 is forged and machined while the receiver of the AKM is stamped metal facilitating easier manufacturing. Both the AK-47 and the AKM can mount a 40-mm under-barrel grenade launcher. The AK-47 and AKM have been replaced in many armies by the newer AK-74. The AK-74 is basically an AKM rechambered to fire a 5.45-mm x 39-mm cartridge. The 7.62-mm RPK light machinegun is based on the AK/AKM design while the RPK-74 is a machinegun version of the AK-74.



## Sniper and Anti-materiel Rifle Threat

Summary: Sniper rifles in 7.62 mm have been used by all armies for many years. The accepted U.S. definition of sniper is a “highly skilled military marksman detailed to spot and pick off enemy troops from a concealed position.” Most of these weapons have limited armor penetration ability (lightly armored vehicles). More recently sniper rifles in 12.7 mm (.50 cal) and above have proliferated to the point that any U.S. force is likely to encounter them in every combat environment. Within the past ten years another trend is to equip armies with anti-materiel rifles (a.k.a. hand cannons) generally in 14.5 to 20 mm. Some of these were designed not to destroy a vehicle but to neutralize a specific capability mounted externally on the vehicle (see Croatia’s RT-20 below).

7.62 mm (.308 cal). The representative rifle in this caliber is the widely proliferated 7.62x54R SVD (Russian and clones). It can penetrate lightly armored vehicles (10 mm @ 200 m).

12.7 mm (.50 cal) Sniper/anti-materiel rifles. These rifles are integral to any modern battlefield. Although generally categorized as sniper rifles (and capable of being used against personnel), they are generally employed as anti-materiel rifles. The most widely proliferated of these rifles, whether labelled as a sniper or anti-materiel rifle, is the U.S. Barrett M82A1/M95 .50 cal semi-automatic rifle, followed by the Croatian MACS M2-1/M3 (12.7-mm bolt action), then the Russian V-94 (12.7-mm semi-auto). The Barrett M82A1 is employed by all U.S. military forces as well as 27 other countries including Belgium, Chile, Denmark, Finland, France, Greece, Italy, Netherlands, Norway, Philippines, Portugal, Saudi Arabia, and UK. The Saboted Light Armor Penetrator (SLAP) round fired from the M82A1 can penetrate 19 mm (.75 in) of armor @ 1,500 m. It can also fire a multi-purpose round (See M82A1 data sheet). Approximately 25 variants of 12.7-mm sniper/anti-materiel rifles are available.

Larger-caliber Anti-materiel Rifles (14.5 to 20-mm). A trend during the past ten years has been towards larger-caliber anti-materiel rifles. Although several are manufactured, the Croatian RT20 20-mm “hand cannon” is the most prevalent (range 1,800 m). It can fire either HE or API. The RT20 was developed primarily to penetrate the armored casing around the thermal sight head on M84 tanks (a 20-mm round was the smallest caliber that could penetrate the casing). During the war in the former Yugoslavia, M84s were frequently deployed to detect Croatian infantry moving at night, so a method of removing their night-vision capability was found with this RT20 “hand cannon”.

Other anti-materiel rifles readily available are:

- South African NTW 20-mm (range 1,500 m)
- NTW 14.5-mm (range 2,300 m)
- Hungary Gepard M3 14.5-mm (range 1,000 m)
- Austria Steyr IWS 2000 15.2-mm (range 1,000 m)



## Russian 7.62-mm Sniper Rifle SVD

	<p style="text-align: center;"><b>Ammunition Types</b></p> <p><b>7.62-mm cartridge</b> Light Ball Heavy Ball Sniper Enhanced Penetration AP-I Tracer</p>	<p style="text-align: center;"><b>Typical Combat Load</b></p> <p style="text-align: center;"><b>40</b></p>
<p><b>SYSTEM</b></p> <p><b>Alternative Designations:</b> Dragunov <b>Date of Introduction:</b> 1967 <b>Proliferation:</b> Widespread</p> <p><b>Description:</b> Weight (kg):   Loaded (with magazine): 4.5   Empty (w/o magazine): 4.3 Length (mm):   Overall: 1,230   With Bayonet: 1,370   Barrel: 620 Rate of Fire (rd/min): 30 Operation: Gas Feed: 10-rd detachable box magazine (15-rd available for the SVD-S) Fire Mode: Semi-automatic only</p> <p><b>SIGHTS</b></p> <p><b>Name:</b> PSO-1 Type: Infrared detection capability for night firing Magnification: 4x Field of View (°): 6</p> <p><b>Night Sights Available:</b> Yes. NSPU-3 . The NSPU-3 increases accuracy to 1,000 m at night or during poor visibility. <b>Sighting Range (m):</b> 1,300</p> <p><b>VARIANTS</b></p> <p><b>SVD-S:</b> Folding stock, 15-rd magazine <b>SVU:</b> Bullpup (trigger forward of magazine) <b>OTs-03AS:</b> SVU w/PSO-1 sight. <b>6V1:</b> SVD with PSO-1 sight. <b>6V1-N3:</b> SVD with NSPU-3 night sight.</p>	<p><b>AMMUNITION</b></p> <p><b>Name:</b> Sniper (7N14) Caliber/length: 7.62x54R-mm rimmed Type: Steel core Range (m):   Maximum: 3,800   With Scope: 1,300   Without Scope: 800 Armor Penetration: INA Muzzle Velocity (m/s): 823</p> <p><b>Name:</b> 7N13 Caliber/length: 7.62x54R-mm rimmed Type: Enhanced penetration Range (m):   Sighting: 2,000 Armor Penetration (mm): INA. (Effective against lightly armored vehicles and crews.) Muzzle Velocity (m/s): INA</p> <p><b>Name:</b> B-32 Caliber/length: 7.62x54R-mm rimmed Type: AP-I Range (m):   Sighting: 2,000 Armor Penetration: 10-mm @ 200 m Muzzle Velocity (m/s): 808</p> <p><b>Name:</b> T-46 Caliber/length: 7.62x54R-mm rimmed Type: Tracer Range of Trace (m): 1,200 Muzzle Velocity (m/s): 798</p>	

### NOTES

The bolt mechanism and gas recovery system of the SVD are similar to those of the AK and AKM. The 7.62x54-mm rimmed cartridge of the SVD is not interchangeable with the 7.62x39-mm rimless round of the AK-47/AKM. The SVD performs best when using target grade ammunition, however standard (PKM/PKT) 7.62x54-mm rimmed rounds may also be fired. One squad in each OPFOR mechanized infantry platoon has an SVD. The platoon leader and sniper normally ride in the first squad vehicle. While the sniper has received centralized training on the SVD he also has an assault rifle (usually AKS-74U) for normal combat. His SVD is carried in the IFV/APC for those instances when he acts as a sniper.

United States M82A1A .50-cal Anti-Materiel Rifle

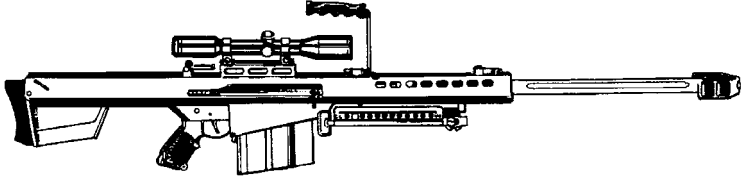
	<p style="text-align: center;"><b>Ammunition Types</b></p> <p><b>.50-cal cartridge</b>          Raufoss Grade A          Ball (M2/M33)          AP (M2)          AP-I (M8)          API-T (M20)          Tracer (M10/21)          SLAP (M903)          MP (MK211 Mod 0)</p>	<p style="text-align: center;"><b>Typical Combat Load</b></p> <p style="text-align: center;">30</p>
<p><b>SYSTEM</b></p> <p><b>Alternative Designations:</b> None  <b>Date of Introduction:</b> Early 1980s  <b>Proliferation:</b> Widespread (27+)</p> <p><b>Description:</b>  <b>Weight (kg):</b>          Empty (w/o magazine): 14.75  <b>Length (mm):</b>          Overall: 1,448          Barrel: 736  <b>Operation:</b> Recoil  <b>Feed:</b> 10-rd detachable box magazine  <b>Fire Mode:</b> Semi-automatic only</p> <p><b>SIGHTS</b></p> <p><b>Name:</b> Unertl  <b>Type:</b> Optical (matches trajectory of .50-cal Raufoss Grade A)  <b>Magnification:</b> 10x</p> <p><b>Name:</b> Swarovski  <b>Type:</b> Optical (with ranging reticle)  <b>Magnification:</b> 10x42</p> <p><b>Night Sights Available:</b> yes</p> <p><b>AMMUNITION</b></p> <p><b>Name:</b> Raufoss Grade A (match)(DODIC A606) (USMC)  <b>Caliber/length:</b> .50-cal BMG/12.7-mm x 99-m (NATO)  <b>Type:</b> Standard operating round  <b>Range (m) (equipment-size targets):</b>          Maximum (w/scope): 1,800  <b>Muzzle Velocity (m/s):</b> 854</p>	<p><b>Name:</b> MP NM140 (Nammo) MK211 Mod 0  <b>Caliber/length:</b> .50-cal BMG/12.7-mm x 99-m (NATO)  <b>Type:</b> Multipurpose  <b>Range (m) (equipment-size targets):</b>          Maximum (w/scope): 1,800  <b>Armor Penetration:</b> 11 mm @45° @1,000 m  <b>Fragmentation:</b> 20 fragments after hitting 2 mm steel  <b>Incendiary Effect:</b> Ignition of JP4 and JP8  <b>Accuracy:</b> &lt;15 cm @ 550 m  <b>Muzzle Velocity (m/s):</b> 915</p> <p><b>Name:</b> AP-S NM173 (Nammo)  <b>Caliber/length:</b> .50-cal BMG/12.7-mm x 99-m (NATO)  <b>Type:</b> Armor piercing  <b>Range (m) (equipment-size targets):</b>          Maximum (w/scope): 1,800  <b>Armor Penetration:</b> 11 mm @30° @1,500 m  <b>Accuracy:</b> &lt;15 cm @ 550 m  <b>Muzzle Velocity (m/s):</b> 915</p> <p><b>Name:</b> M903 (Olin)  <b>Caliber/length:</b> .50 cal BMG/12.7-mm x 99-m (NATO)  <b>Type:</b> Saboted Light Armor Penetrator (SLAP) (actual bullet is tungsten .30 inch penetrator wrapped in a .50-cal plastic sabot)  <b>Range (m) (equipment-size targets):</b>          Maximum (w/scope): 1,500  <b>Armor Penetration:</b> 19 mm (.75 in) @1,500 m  <b>Accuracy:</b> INA  <b>Muzzle Velocity (m/s):</b> 1,014</p> <p><b>VARIANTS</b></p> <p><b>Model 95:</b> Bullpup bolt action, 5-round magazine</p>	

**NOTES**

The M82A1A provides maneuver commanders with the tactical option of employing snipers with an anti-materiel weapon to augment present 7.62-mm anti-personnel sniper rifles. Recoil equals 7.62x51-mm levels. The USMC uses Raufoss Grade A ammunition, but the rifle is capable of firing any standard 12.7x99-mm Browning machinegun ammunition.

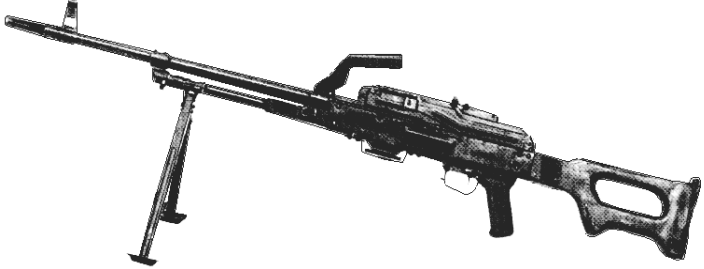

## Russian 7.62-mm General Purpose Machinegun PKM

	<p><b>Ammunition Types</b></p> <p>7.62-mm cartridge Ball Ball-tracer Incendiary-ranging API API-T</p>	<p><b>Typical Combat Load</b></p> <p>INA</p>
<p><b>SYSTEM</b></p> <p><b>Alternative Designations:</b> (see VARIANTS)  <b>Date of Introduction (PKM/PKT):</b> 1971/1968  <b>Proliferation:</b> Widespread</p> <p><b>Description:</b>  Weight (kg):  Empty (w/o magazine) (PKM/PKT) (kg): 8.4/10.66  Loaded (with magazine): Varies with magazine  Ammo box (only) with 100/200-rd belt (kg): 3.9/8.0  Tripod (lightweight) (kg): 4.75  Length (mm):  Overall (PKM/PKT): 1,160/1,080  On tripod (PKS): 1,267  Barrel: 658  Barrel Change: Yes  Mount Type: Pintle, coaxial, bipod or tripod (Stepanov)  Mounted On: (see VARIANTS)  Rate of Fire (rd/min):  Cyclic: 650  Practical: 250  Fire Mode: Automatic  Operation: Gas  Feed: Belt, 100-rd belt carried in a box fastened to the right side of the receiver. 25-rd belts can be joined in several combination lengths (100/200/250)</p>	<p><b>SIGHTS</b></p> <p><b>Name:</b> INA  Type: Open iron sights  Sighting range (PKM/PKT) (m): 1,500/2,000  Magnification: None  <b>Night Sights Available:</b> Yes</p> <p><b>VARIANTS</b></p> <p><b>PKM:</b> Squad machinegun  <b>PKT:</b> Tank-mounted coaxial, lacks stock, sights, bipod, has solenoid electric trigger, longer heavier barrel.  <b>PKS:</b> Lightweight tripod-mounted infantry weapon  <b>PKMS:</b> Lightweight tripod-mounted variant of the PKS  <b>PKB (PKBM):</b> Pintle-mounted on APCs, SP guns, BRDM, BTRs, has butterfly trigger rather than solenoid, double space grips, and front and rear sights</p> <p><b>AMMUNITION</b></p> <p><b>Name:</b> INA  Caliber and Length: 7.62x54-mm rimmed  Type: Ball  Max Range (PKM/PKT) (m): 3,800/4,000  Practical Range (PKM/PKT) (m):  Day: 1,000/2,000  Night: 300/INA  Armor Penetration @ 0° obliquity @ 500 range (mm): 8  Muzzle Velocity (PKM/PKT) (m/s): 825/855</p>	

### NOTES

The 7.62-mm general-purpose machinegun (PKM) is a gas-operated, belt-fed, sustained-fire weapon. The basic PKM is bipod-mounted but can also fit in vehicle firing ports. It is constructed partly of stamped metal and partly of forged steel. Compared to the US M-60, the PK-series machineguns are easier to handle during firing, easier to care for, and lighter. The 7.62x54R is a more powerful cartridge than the US with a slightly shorter effective range.

## Russian 12.7-mm Heavy Machinegun NSV/NSV-T

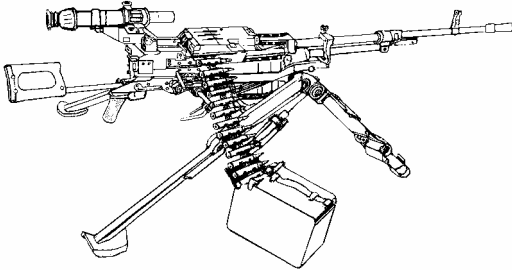
	<p style="text-align: center;"><b>Ammunition Types</b></p> <p><b>12.7-mm cartridge</b>        API (B-32)        API-T (BZT-44)        HEI</p>	<p style="text-align: center;"><b>Typical Combat Load</b></p> <p style="text-align: center;"><b>300</b></p>
<p><b>SYSTEM</b></p> <p><b>Alternative Designations:</b> NSVS (tripod-stand mounted), Utyos  <b>Date of Introduction:</b> Early 1970s  <b>Proliferation:</b> Widespread</p> <p><b>Description:</b>  <b>Weight (kg):</b>        Total System (w/6T7): 43        Empty: 25        Loaded: INA        Tripod (6T7 tripod): 16  <b>Length (mm):</b>        Overall: 1,560        On 6T7 Tripod: 1,900  <b>Width (on 6T7 tripod) (mm):</b> 860  <b>Height (on 6T7 tripod) (mm):</b> 380  <b>Barrel Life (rds):</b> 5,000  <b>Barrel Change Time (sec):</b> 5  <b>Barrel Weight (kg):</b> 9.2  <b>Mount Type:</b> 6T7 (infantry) tripod or 6U6 (w/seat) universal tripod  <b>Mounted On:</b> (see VARIANTS)  <b>Traverse (°):</b> 360  <b>Elevation (°):</b> -5 to +75  <b>Rate of Fire (rd/min):</b>        Cyclic: 680-800        Practical: 100  <b>Fire Mode:</b> Automatic; short bursts (four to six) or long bursts (10 to 15) or continuously  <b>Operation:</b> Gas  <b>Feed:</b> Left or right from metal link belt from 50-rd boxes</p>	<p><b>SIGHTS</b></p> <p><b>Name:</b> INA  <b>Type:</b> Metallic sights, (tangent leaf rear and folding front post)  <b>Sight Range (m):</b> 2,000  <b>Name:</b> 10P50 Optical  <b>Type:</b> Day optical sight  <b>Magnification:</b> 3-6x  <b>Name:</b> 1PN52-1  <b>Type:</b> Night sight  <b>Magnification:</b> 5.3x  <b>Name:</b> 10P80 (used w/ 6U6 mount)  <b>Type:</b> AA collimating sight (aircraft speed to 300 km/h)  <b>Name:</b> 10P81 (used w/ 6U6 mount)  <b>Type:</b> Ground target sight  <b>Name:</b> K10-T (on NSVT for T-72/T-80)  <b>Type:</b> Reflex AA sight</p> <p><b>VARIANTS</b></p> <p><b>NSVT:</b> Tank-mounted, (see NOTES)</p> <p><b>AMMUNITION</b>  <b>Name:</b> B-32  <b>Caliber and Length:</b> 12.7x108-mm  <b>Type:</b> Armor Piercing Incendiary  <b>Max Range (ground) (m):</b> 7,850  <b>Effective Range (m):</b>        AA: 1,000        Ground: 2,000        Armor: 800        Night (w/1PN52-1): 1,000  <b>Armor Penetration @ 0° obliquity @ 500/1,000m range (mm):</b>        20/13.2  <b>Muzzle Velocity (m/s):</b> 860</p>	

**NOTES**

A tripod-mount (6T7) version is available for infantry use in a ground role. However, the NSVT appears more commonly mounted on the turrets of tanks as an anti-aircraft machinegun. On the T-72 and the T-80, it has a rotating mount and can be fired from within the tank. The tank commander employs the K10-T reflex sight to engage aircraft. On the T-72/T-80 mount he engages ground targets with metallic sights on the gun itself. The T-64 tank mounts a modified version with a fixed mount on the commander's cupola. It fires by means of an electrical solenoid when the tank is buttoned up. An optic serves this purpose. Instead of the normal 50-round ammunition belt container, the NSVT on the T-64 may use a larger belt container holding 200 rounds.

## Russian 30-mm Automatic Grenade Launcher AGS-17

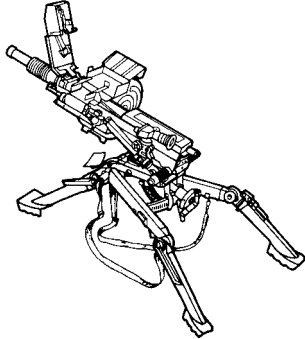
	<p><b>Ammunition Types</b></p> <p>30-mm grenade Frag-HE</p>	<p><b>Typical Combat Load (Dismounted)</b></p> <p>87</p>
<p><b>SYSTEM</b></p> <p><b>Alternative Designations:</b> Plamya (Flame)  <b>Date of Introduction:</b> 1974  <b>Proliferation:</b> At least 12 countries</p> <p><b>Description:</b>  Crew: 3 (see NOTES)  Weight (kg):      Empty (without magazine): 30.71      Loaded (with magazine): 45.05  Launcher: 17.86  Sight: .99  Tripod: 11.86  Magazine (loaded): 14.34  Length (m): 1.28  Height (m): INA  Width (m): INA  Tripod Name: SAG-17  Mounts: Tripod, vehicle, or helicopter  Traverse (°): 30 total  Elevation (°): +7 to +87  Service Life of Barrel (rds): 6,000  Barrel Change Time: Quick disconnect  Rate of Fire (rd/min):      Practical: 60-100      Cyclic: 100-400 Adjustable with a thumb safety. May be fired single shot or in short (<math>\leq 5</math> rds) or long (6-10 rds) bursts.  Operation: Blowback  Feed: Drum magazine containing 29 round belt.  Fire Mode: Selective, automatic and semi-automatic  Loader Type: Manual</p>	<p><b>SIGHTS</b></p> <p><b>Name:</b> PAG-17  Type: Illuminated day optical sight  Sighting Range (m): 1,700  Magnification: 2.7x  Location: Left rear of launcher  <b>Night Sights Available:</b> Yes</p> <p><b>VARIANTS</b></p> <p><b>AG-17:</b> Vehicle mounted.  <b>AG-17A:</b> Helicopter mounted, electric trigger, rate of fire increased to 420-500 rd/min, 300 rd belt.  <b>TKB-722K AGL:</b> Lighter version and possibly the follow-on to the AGS-17, shoots the same ammunition as the AGS-17</p> <p><b>AMMUNITION</b></p> <p><b>Name:</b> VOG-17A, VOG-17M (self-destruct)  Caliber/length: 30x132.8-mm  Type: Frag-HE  Range (m)      Direct Fire Range (m): 700      Effective (m): 1,200      Min Range (m): 50      Max Indirect Range (m): 1,730  Armor Penetration: Lightly armored vehicles.  Accuracy @ 400 m:      Distance: 4.3 m      Deflection: .2 m  Casualty Radius (m): 15 (90% at 7 m)  Complete Round Weight (grams): 350  Grenade Weight (grams): 280  Warhead Explosive Weight (grams): 36  Muzzle Velocity (m/s): 185  Fuze Type: Impact, activates after 25 spins.</p>	

### NOTES

The AGS-17 provides the infantry with an area suppressive capability. One AGL can create a damage zone 15 meters wide. The fire from an AGL platoon covers a sector approximately 90 m across. Although primarily intended for use against personnel, it has a limited capability to engage lightly armored vehicles. The crew consists of a gunner and two riflemen-assistant gunners, and may have an additional ammunition bearer. For ground transport the AGS-17 breaks down into four parts: launcher, sight, tripod, and magazine. When dismounted the gunner carries the sight and launcher, the first assistant carries the tripod and a magazine, and the second assistant carries two additional magazines. It is very accurate in the semiautomatic mode and is quite effective in area coverage in the automatic mode. The 50-meter increments in the range table atop the receiver indicate accuracy against point targets. The AGS-17 is normally organized in a platoon consisting of 6 launchers, carried in pairs in three armored vehicles (they can also be carried in trucks, or by individuals). The AGS-17 is capable of mounting night vision sights.

## Russian 40-mm Under-Barrel Grenade Launcher GP-30

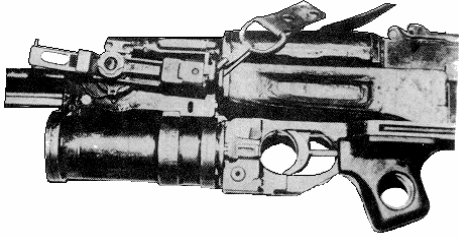
	<p style="text-align: center;"><b>Ammunition Types</b></p> <p><b>40-mm grenade</b>        Frag-HE (impact)        Frag-HE (bounding)        Smoke</p>	<p style="text-align: center;"><b>Typical Combat Load</b></p> <p style="text-align: center;"><b>10</b></p>
<p><b>SYSTEM</b></p> <p><b>Alternative Designations:</b> BG-15 Mukha; GP-25 Koster, GP-30 Obuvka  <b>Date of Introduction:</b> 1980  <b>Proliferation:</b> Widespread</p> <p><b>Description:</b>  <b>Weight (kg):</b>        Loaded: 1.79        Empty: 1.5  <b>Length (mm):</b>        Overall: 323        Barrel: 205  <b>Rate of Fire (rd/min):</b> 4-5  <b>Operation:</b> N/A  <b>Feed:</b> Muzzle-loaded  <b>Fire Mode:</b> Single-shot  <b>Accuracy @ 400 m:</b>        Distance: 6.7 m        Deflection: 3 m  <b>Components:</b> Barrel (w/ mounting bracket and sight), trigger assembly</p> <p><b>SIGHTS</b></p> <p><b>Name:</b> N/A  <b>Type:</b> Front post and rear open U-notched  <b>Location:</b> Left side of mounting bracket  <b>Sighting Range (m):</b> Graduated out to 400</p> <p><b>VARIANTS</b></p> <p><b>BG-15, GP-25:</b> (see NOTES)</p>	<p><b>AMMUNITION</b></p> <p><b>Name:</b> VOG-25  <b>Caliber/length:</b> 40x102-mm  <b>Type:</b> Frag-HE with impact fuze  <b>Weight (kg):</b>        Round: .250        Exposive: .048  <b>Range (m):</b>        Maximum: 400        Minimum: 10-40 (arms itself)  <b>Casualty Radius (m):</b> 6; (90% @ 10)  <b>Self-destruct Time (sec):</b> 14-19  <b>Muzzle Velocity (m/s):</b> 76</p> <p><b>Name:</b> VOG-25P  <b>Caliber/length:</b> 40x122-mm  <b>Type:</b> Bounding Frag-HE, explodes .5 to 1.5 m from impact  <b>Weight (kg):</b>        Round: .278        Exposive: .037  <b>Range (m):</b>        Maximum: 400        Minimum: 10 - 40 (arms itself)  <b>Casualty Radius (m):</b> 6; 90% @ 10  <b>Self-destruct Time (sec):</b> 14 - 19  <b>Muzzle Velocity (m/s):</b> 75</p> <p><b>Name:</b> GRD-40  <b>Caliber/length:</b> 40x150-mm  <b>Type:</b> Smoke  <b>Effective Against:</b> Visual and infrared  <b>Weight (g):</b> 260  <b>Smoke Screening Range (m):</b> 50, 100, 200  <b>Smoke Screen Dispersion (m):</b>        1 sec..... 10x10x10        2 sec..... 20x20x20        3 sec..... 25x25x25  <b>Smoke Screen Duration @ wind speed of 3-5 m/s:</b> At least 60 sec  <b>Muzzle Velocity (m/s):</b> 70-75</p>	

**NOTES**

The GP-30 Obuvka is a widely proliferated, muzzle-loaded, single-shot, detachable, under-barrel grenade launcher. The BG-15, GP-25 and the GP-30 are all basically the same weapon. Variants can be mounted on all models of Kalashnikov assault rifles. The rifleman can fire the launcher only when the complete weapon is attached to the assault rifle.

**Chinese 35-mm Automatic Grenade Launcher W-87**

	<p><b>Ammunition Types</b></p> <p>35-mm grenades        Frag-HE        HEAT</p>	<p><b>Typical Combat Load</b></p> <p>At least 12</p>
<p><b>SYSTEM</b>  <b>Alternative Designations:</b> INA  <b>Date of Introduction:</b> Prior to 1988  <b>Proliferation:</b> At least one  <b>Description:</b>        Weight (kg):          Empty (without magazine): 12          Tripod: 8        Mounts: Bipod (attached) or Tripod        Operation: Blowback        Feed: 6, 9-rd box, 12-rd drum        Fire Mode: Semi or Automatic        Loader Type: Manual        Recoil: Similar to .50 cal rifle</p> <p><b>PERFORMANCE</b>  <b>Range (m)</b>        Direct Fire Range: INA        Effective: 600        Max Range: 1,500        Rate of Fire (rd/min): 400        Muzzle Velocity (m/s): 170</p>	<p><b>AMMUNITION</b>  <b>Name:</b> INA        Caliber/length: 35-mm        Type: Frag-HE        Grenade Fill: HE and 400 3-mm steel balls        Armor Penetration: Penetrates body armor        Lethal Radius (m): 10        Complete Round Weight (grams): 270        Muzzle Velocity (m/s): 170</p> <p><b>Name:</b> INA        Caliber/length: 35-mm        Type: HEAT        Armor Penetration: 80 mm @ 600 m        Lethal Radius (m): 5        Complete Projectile Weight (grams): 270        Muzzle Velocity (m/s): 170</p> <p><b>SIGHTS</b>        Type: Optical</p>	

**NOTES**

The W-87 is significant in that it weighs a little more than a medium 7.62-mm GP MG (PKM 18.5 lbs/U.S. M60 MG 32 lbs). It is smaller and lighter than the AGS-17 but still provides the infantryman with the ability to destroy lightly armored vehicles at 2 to 3 times the range of the majority of infantry light AT systems. Ten 35-mm W-87 rounds weigh less than 100 linked 7.62 rounds. The 35-mm rounds are probably more effective against point targets at medium to long ranges than ball 7.62-mm.



## Infantry Weapon Night Vision Systems

In the past, most military forces reacted to darkness by: (1) reducing combat activities during the period, and (2) using cover of darkness to carry out clandestine activities. A selected number of forces, however, learned to exploit the cover of darkness to execute combat missions. For close combat at night, the most common solution for that vulnerability has been to illuminate the battlefield ("turn night into day"). Illumination technologies include pyrotechnics (flares, white phosphorus rounds, set fires, etc.). Of course, non-military illumination sources, including moonlight, civilian illumination, etc. can be used. Night vision technologies with military applications are: (1) Lights operating in the visual light band, such as vehicle headlights and spotlights. (2) Spotlights and sensors in the the infrared (IR) band (3) Spotlights and sensors which use other bands of the light spectrum. Other sensors for day and night use include infrared laser and radio-frequency radars. A critical vulnerability associated with all of these systems is that they are active systems and emit energy which can be detected, targeted, and engaged with weapons. Some sensors (such as passive sights and some radars) can use energy from other emitters; but they are subject to limitations on range and availability of emitters. They can supplement night vision systems; but they would still permit the majority of the operational area to be concealed in darkness. With the limitations of illumination systems, they concede to the enemy cover of night for widespread clandestine activities.

The need for equipment for commercial and military markets has generated a technology explosion in the night vision field. With these night vision instruments, goggles, and weapon sights in recent decades, higher tier countries were able to "own the night", and execute operations with a clear advantage which often led to decisive battlefield success. Cost and budget considerations excluded many military forces from effective access to these technologies. Most forces worldwide accept the limitations incrementally upgraded night systems (which may technically inferior to most sights in the US and other western countries). However, that separation has narrowed. In most areas of the world today, *no one force owns the night*.

The wide availability of night vision systems and the general consensus for their use in the civilian sector has driven down cost for some technologies and led to proliferation of new technologies. These technologies generally consist of electro-optic (EO) passive systems using the infrared light band. The most numerous type of EO sensors is sights (which combine EO processing with viewing optics); and most sights worldwide employ image intensifier (II) systems. Image intensifiers use ambient light in a portion of the near IR band (0.7-0.9 $\mu$ ) and intensify the image in a microchannel plate or photocathode tube. Most Russian armored vehicle sights are II/IR sights; thus, an II sight can be used in conjunction with an IR searchlight. The sights may be operated passively without the searchlight, with a corresponding range reduction. In the past, many forces used active infrared much of the time, and sensors in the passive mode only part of the time. The current trend is to reduce force vulnerability by eliminating active light sources and to reduce reliance on ambient light sources for II, through widespread use of improved II and thermal sights. Technology improvements in the II field are categorized into generations, now up to 4th generation. Improvements in range, resolution, resistance to blooming from bright light, and weight reductions will continue to make II a competitive night vision option.

With the microcircuit revolution, there has been a corresponding revolution in imaging systems technologies. An immediate product is charged-coupled device (CCD) TV cameras, which operate in both visual and near-IR bands (0.4-0.9) for day TV and low light (dusk and dawn) applications. Another resultant technology is thermal imaging. A thermal imaging system uses a camera which converts a heat (temperature differential) image to a digital electronic signal, then converts the signal back to a display circuit. With a sight system, the signal is sent to a microchannel plate for viewing. For more sophisticated applications, the signal can be converted for transmission over cable to a monitor or to a computer and processed for further exploitation. The signal can also be sent as a TV signal as an RF signal over digital communications nets. Thermal imaging systems (TIS) have seen a variety of technology improvements. Within the 1st generation of thermal imagers (also called Forward Looking Infrared - FLIR), there is a variety of improvements in camera design, processing technologies, application, and display system technologies. Thus, increased capabilities in range, resolution, weight reduction, variety of applications, and operating time (given coolant requirement) can be noted. A recent development is uncooled thermal sensors. Currently, 2nd generation TIS with further improvements in these areas are being fielded. However, due to limited infantry weapons ranges and cost factors, the most numerous military sensors will continue to be II sights.

The following are examples of night sight capabilities for portrayal of the listed OPFOR equipment. Given the wide variety of military and commercial systems which can be used, night vision device capabilities vary widely from older 1 gen II sights to thermal and CCD systems. Although some hand-held and tripod-mounted systems are used, the most proliferated and highest priority systems are weapon sights. The below table provides data for OPFOR applications, reflecting a mix of older and newer night vision systems.

### **Night Vision Capabilities for OPFOR Infantry TOE Weapons**

<b>Weapon</b>	<b>Lowest Unit Level</b>	<b>Description</b>	<b>Range vehicle (m)</b>	<b>Range Man (m)</b>	<b>Ref Comments</b>
GP-30 Grenade Launcher	Squad	3 gen II	300-500	300	Mounts on AK-74
Carl Gustaf Recoilless Rifle	Squad	2 gen II LRF sight	1,000	500+	Ballistic computer sight
RPK-74 Light MG	Squad	4 gen II	1,500	600	Compact and lightweight
BTR-80A APC	Squad	1 gen II	800	<800	Upgrade sight available
SVD Sniper Rifle	Platoon	4 gen II	1,500	600	Compact weapons sight
RPG-29 AT Grenade Launcher	Platoon Wpn Sqd	2 gen II LRF sight	1,000	500+	Ballistic computer sight
PKM General Purpose MG	Platoon Wpn Sqd	2 gen II	1,500	600	Wide variety available
Eryx ATGM Launcher	Platoon Wpn Sqd	Thermal	600+	<600	ATGM range capability
W-87 Automatic Grenade Launcher	Platoon Wpn Sqd	Thermal hand-held 4 gen II on W-87	2,000	700+	Thermal can adjust fires and observe for the platoon
Metis-2 ATGM Launcher	Company AT	Thermal	3,200	>1,000	1st generation thermal
SA-18/GROUSE MANPADS	Company	II gen 2			Against aircraft 4500 m
Kornet ATGM Launcher	Battalion AT	Thermal	4,000+	>1,500	1st generation thermal
AT-5b/Konkurs-M ATGM	Battalion AT	Thermal	3,600	>1,500	Can fit on other launchers.

\* Ranges are based on sensor capabilities (and reflect standard range criteria for: detection, classification, recognition or identification). These are capabilities of representative marketed foreign sensors fielded on systems or available for OPFOR systems upgrades.



## Selected Infantry Weapons

### Automatic Grenade Launchers (AGLs)

Name	Producing Country / Number of Users	Crew/ Combat Load Total Weight (kg)	Munition Nomenclature (Diameter and Type)	Munition Capabilities: Range (m)/ Effectiveness (mm) (HEAT armor penetration)	Sights Day/night	Comments
<b>W-87</b> 35-mm	China	1 12 or more 12.0 (empty)	HEAT Frag-HE	600m/80mm	D: optical N: see comment	Shoulder-fired with bipod, pintel or tripod mount Thermal hand-held or II sights are used to adjust fire.
<b>QLZ-87</b> 35-mm	China	1 15 or more	HEAT Frag-HE	600m/80mm	D: optical N: see comment	Shoulder-fired with bipod, pintel or tripod mount Thermal hand-held or II sights are used to adjust fire.
<b>RAG-30</b> 30-mm	Slovak Rep (development)	1 15 or more 11 empty 13.2 full	VOG-30 (Frag-HE) VOG-17M (Frag-HE self-destruct)	1,200m/AP and soft targets casualty radius 15 m =90% @ 7 m)	D: iron N: INA	Shoulder-fired with bipod
<b>AGS-30</b> 30-mm (aka TKB-722K)	Russia +12	2 90 16.55 less ammo & sight (includes tripod)	VOG-30 (Frag-HE) VOG-17M (Frag-HE self-destruct)	1,200m/AP and light armored vehicles casualty radius 15 m =90% @ 7 m)	D: PAG-17 (2.7x) N: yes	The AGS-30 is a lightweight variant of the AGS-17. Tripod= 6 kg, Mag (30 rd)=13.7 kg Tripod or pintel mount
<b>MK19</b> 40-mm	US widespread	2 48 rd ammo can gun (35kg) tripod (22kg)	HE HE DP Buckshot (HEAT made by Pakistan)	1,500m/55mm max 2,400m	D: open N: yes (AN/TVS-5)	The fire control systems for the Striker and the CIS-40 AGL
<b>Striker</b> 40-mm (aka CG40)	Sweden widespread	2 gun (17.5kg)	Same as MK19 ABM (airburst)	1,500m	D: optical (8x) N: yes (Gen III II)	Integrated fire control with LRF, day/night sight, with video imaging, ballistic computer.  Computer-controlled fire control system manufactured by Saco and Bofors/Carl Gustav/CDC.  ABM = Air bursting munitions
<b>CIS-40 AGL</b> 40-mm	Singapore	2 lighter than Mk 19	Same as MK19 ABM	1,500m	D: optical N: yes	Integrated fire control with LRF, day/night sight, ballistic computer. The ABMS (ABM System made by Singapore Technologies Kinetics -STK) can be retrofitted to any new and current 40mm systems including US MK 19.

1-8.5

Antitank Grenade Launchers (ATRLs)						
Name	Producing Country / Number of Users	Crew/ Combat Load Total Weight (kg)	Munition Nomenclature (Diameter and Type)	Munition Capabilities: Range (m)/ Effectiveness (mm) (HEAT armor penetration)	Sights Day/night	Comments
<b>RPG-7V</b> 40-mm	Russia +40 Variants +7	2 5 7.9 (Empty)	PG-7VL (93mm HEAT) PG-7VR (105mm TandemHEAT) OG-7VM (Frag-HE)  TBG-7V (105mm Thermobaric)	300m/600mm 200m/750+ includes ERA 1000m/rein concrete:+1,500, Log/dirt: +1,000  200m/INA	D: PGO-7 N: NSP-3, NSP-2 (IR), NSPU, PGN-1 (II), 1PN58 (II), others.	In addition to AT role, can be used against personnel and for bunkerbusting and as a side-attack mine system (See Note 2). Other countries have developed rounds for RPG-7V. For TBG-7V see Thermobaric/Bunkerbusters.
<b>Panzerfaust-3</b> 60-mm tube <b>Panzerfaust 3-T</b> <b>(with 3-T grenade)</b>  (Systems aka Pzf-3 or Pzf-3T)  <b>Fire Salamander</b>	German +8	1 INA 12	3-T (110mmTandem HEAT) PZF3 (110 HEAT-original rd) Other munitions include: HEAT-125, HEAT-90, HESH, MZ-110 (Multipurpose-Frag), Illumination, IR Smoke, and Smoke. For BASTEG, see BUNKERBUSTERS.	500m/700+mm 500m/500mm	D: optical. The 3-T uses Simrad IS200 laser N: yes. IR goggles. The 3-T uses Simrad KN205F II night sight	Tube is disposable—the firing post & sight are reusable. System can fire from enclosures. Add 3-T & LRF to convert toPanzerfaust 3-T 600. In addition to AT role, Pzf-3 can be used for AP, bunkerbusting and as a side-attack mine system (See Note 2). Advanced -tripod mount with a SIRA sensor package uses acoustic detection and IR sensor triggering. <b>Fire Salamander</b> is a 4 x Pzf-3 launcher mount on a tripod with remote controlled TV camera, and sensors for auto-launch.
<b>Panzerfaust 3-T 600</b> 60-mm <b>Pzf 3-IT600</b> <b>Pzf-3-LR / RS PZF 3</b>		1 INA 12+sight (+ laser unit for Pzf-3-LR)	3-T (110mmTandem HEAT) Other munitions as noted above. Pzf-N (Tandem HEAT) IT600 (Tandem HEAT) Pzf-3-LR (Tandem SAL-H)	600m/700+mm  600m/700+mm, Netherlands 600m/900+mm 800m/700+mm	D: Simrad IS200 laser rangefinder sight. N: yes. Simrad KN205F II night sight	Same as above. System w/ IT600 grenade is Pzf 3-IT600. The Pzf 3-LR is a developmental semi-active laser homing (SAL-H) system. It requires a CO <sup>2</sup> laser guidance unit and SAL-H grenade.
<b>Carl Gustaf M2/M3 Recoilless Gun</b> 84-mm in-bore round	Sweden +20	1, 2 if ammo bearer INA M2:14.2 M3: 8.5	FFV 551 (HEAT) FFV 751 (Tandem HEAT) FFV 502 (DP-HEAT/HE) FFV 441B (HE) Smoke and illumination	700m/400mm 500m/500+mm 1000m AP-500m AT/150+mm 1100m/INA	D: optical 3x Option is CLASS LRF computerized sight. N: May be used with gen 3 II sight, such as CLASS night channel.	Weapon uses a round with a rocket-propelled grenade, for shorter flight time and better hit probability. In addition to AT role, it can be used against personnel, for smoke/illum support, and for bunker busting. The M3 is a lightweight variant of the M2.
<b>Type 69-1</b> 40-mm tube (similar to RPG-7V)	Chinese widespread	2 5 5.6	Type 84 (85mm HEAT) HE/HEAT (HEAT/Frag-HE)  AP (See comments) HE-Incendiary (76mm) Illumination (75mm) Can fire all RPG-7 ammunition.	350m/180mm at 65° 1,800m AP/20m lethal radius 300m AT/150mm at 60° 1,500m/15m lethal radius 1,500m/15m lethal radius 600m or 1,500m/35 seconds	D: optical N: yes, II and IR.	See Note 2. The AP is an airburst grenade. It strikes the ground and bounds up to explode. *OPFOR could mix Chinese, Russian, and Bulgarian rounds, as well as well as commercial ammunition for these systems marketed by western firms. The G-Law SAL-H guided grenade can be fired from this system.
<b>RPG-29</b> 105-mm in-bore grenade	Russia +15	2 INA 11.5	PG-29V (Tandem HEAT)	500 or 800m/750+mm /reinforced concrete1,500+mm Log/dirt 3,700+mm	D: optical N: avail	A tripod variant has an optical sight, laser rangefinder, and ballistic data computer-increase the range to 800m against stationary target. Launch tube folds in half. See Note 2.
<b>RPG-2</b> 40-mm	Russia widespread	1, 2 if ammo bearer 5/2.8 (empty)	PG-2 (80-mm HEAT)	100m/180mm	D: folding leaf N: yes, NSP-2 IR	
<b>SMAW</b> 83-mm	US (USMC)	1 INA/7.6	HEDP HEAA (antitank)	500, 250 for1x2m target 500, 250 for1x2m target	D: optical N: yes, AN/PVS-4	SMAW (Shoulder-launched Multipurpose Assault Weapon).

NOTES: 1. All weapons can be shoulder fired, as well as other mounts as noted in comments.

2. Generally, the systems can be employed as a side-attack (off-route) mine, with a break wire. Selected systems can be fitted with a multi-sensor unit for conversion into a sensor-fuzed mine.

3. There is no counterpart U.S. system.

Antitank Rocket Launchers ( ATRLs - Disposable)						
Name	Producing Country /Number of Users	Crew Combat Load Total Weight (kg)	Munition Nomenclature (Diameter and Type)	Munition Capabilities: Range (m)/ Effectiveness (mm) (HEAT armor penetration)	Sights Day/night	Comments
<b>RPG-18</b> 64-mm	Russia +15	All have a crew of 1 w/single launchers 2.7	HEAT	200m/Armor: 375	D: Iron N: No	RPG-18, 22, & 26 are copies of the US M72 LAW. Also penetrates reinforced concrete: 500, brick: 1,000
<b>RPG-22</b> 72-mm	Russia +15	2.8	HEAT	250/ Armor: 390	D: Iron N: No	Improved (range) version of the RPG-18 (LAW). Also rein concrete: 1,000 brick: 1,200
<b>RPG-26</b> 72.5-mm	Russia + 15	2.9	HEAT	250/ armor: 400	D: Iron N: No	Improved RPG-22 Also rein concrete: 1,000 brick: 1,500 log & earth: 2,400
<b>RPG-27</b> 105-mm	Russia +15	8	Tandem HEAT	200/ armor: 750	D: Iron N: No	Disposable version of RPG-29. Also rein concrete & brick : 1,500 log & earth: 3,700
<b>RPG-75</b> 68-mm	former Czech +13		HEAT HEDP	300/ 300 300/300	D: Iron N: No	Similar to US M-72 LAW
<b>M-72 LAW</b> 66-mm	US widespread		HEAT	300/300	D: Peep N: Yes, AN/PVS-4	
<b>AT-4 (US M136)</b> 84-mm	Sweden +7	6	AT4 HEAT (HEAT) LMAW (HEDP) AT4 (CS Confined Space) AT4E2 HP-T (High Penetration)	330/420 330/150 330/INA 330/600+	D: popup N: yes, INA	LMAW = Light Multipurpose Assault Weapon Grenade is similar to Carl Gustaf FFV 502. AT4 CS can be fired from confined space.
<b>Armbrust</b> 67-mm	German +7	6.3	HEAT	400/300	D: reflex N: no	Low signature and IR detectability. Does not emit smoke or flash, and no flash can be seen from the rear. Quieter than a pistol shot. Only .8 m clearance is required to fire. Armbrust can be fired from confined space.
<b>APILAS</b> 112-mm	France +15	9	HEAT	330/720 rein concrete: 2,000	D: optical 3x N: yes, (nonexpendable) INA	APILAS-APA mounts on a tripod with break-wire sensor. Can also be used on a tripod with the AJAX sensor package. (see Notes)
<b>C-90-C (M3)</b> 90-mm	Spain +3	3.9	HEAT Smoke Incendiary HE Frag	400/400	D: optical N: yes	Four variants: C-90-CR-RB (M3) = AT C-90-CR-AM (M3) = (DP+ AT & AP) C-90-CR-FIM (M3) = Smoke, incendiary C-90-CR-BK (M3) = Anti-bunker
<b>RBR M80</b> 64-mm	Former Yugo +3	3	HEAT	250/300	D: Iron N: INA	Very similar to US M72 LAW
<b>AT-12-T /</b> 120-mm	Sweden 1	14	Tandem HEAT	300/900	D: popup N: no	
<b>RBR HORNET</b> 120-mm	Former Yugo +2	10	HEAT	400/700-800	D: optical N: INA	A reuseable Hornet-S launcher (which launches this grenade) was in development.
<b>RBR M90</b> 120-mm	Former Yugo +2	10	HEAT	250/800+	D: optical N: INA	

- NOTES: 1. Single disposable ATRLs are issued (to crew of one), as rounds of ammunition. Users are assigned the mission in addition to other duties, to supplement AT fires.  
2. All disposable ATRLs can be shoulder fired, as well as other mounts as noted in comments.  
3. Generally, the systems can be employed as a side-attack (off-route) mine, with a break wire. Selected systems can be fitted with a multi-sensor unit for conversion into a sensor-fuzed mine.  
The AJAX advanced side-attack mine sensor uses acoustic sensors to identify targets and to turn on the IR sensor. When in view of the IR sensor the rocket is fired, destroying the target.

Thermobaric, Flame, and Smoke Weapons						
Name	Producing Country / Number of Users	Crew/ Combat Load Total Weight (kg)	Munition Nomenclature (Diameter and Type)	Munition Capabilities: Range (m)/ Effectiveness (mm) (HEAT armor penetration)	Sights Day/night	Comments
<b>TBG-7V</b> (Grenade on RPG-7V)	See RPG-7V 3	See RPG-7V 4.5 kg	TBG-7V (105-mm HE) See Thermobaric above	200m/2 m radius 200m/AT against light armor	See RPG-7V	The demolitions effect of the TBG-7V equates to that of a 122-mm HE artillery round.
<b>RPO Flame Launcher</b>	Russia +15	1 2 per pack 22 for a pack	RPO (Napalm-type Pyrogel)	190m/10-40m path 3-4m wide	Post sight	Being replaced by RPO-A/Z/D Pack=launcher & 2 rds
<b>RPO-A Thermobaric Launcher (Disposable)</b>	Russia +15	1 2 per package 11	RPO-A (Thermobaric) (encapsulated)	600m/50m lethal radius 600m/AT against light armor	Post sight OPO-1	LMAW (Light Multipurpose Assault Weapon) Can be fired from enclosures.
<b>RPO-Z Flame Launcher (Disposable)</b>	Russia +15	1 2 per package 11	RPO-Z (Incendiary)		Post sight OPO-1	Can be fired from enclosures.
<b>RPO-D Smoke Launcher (Disposable)</b>	Russia +15	1 2 per package 11	RPO-D (Red Phosphorus) (encapsulated)	200m/2 m radius	Post sight OPO-1	Can be fired from enclosures. Smoke screen 55 to 90 m long for 3 to 5 min. Effective against visual & IR.

- NOTES: 1. Disposable ATRLs are issued as rounds of ammunition. Users are assigned the mission in addition to other duties to supplement fires.  
2. All grenades have some incendiary and smoke effects. Thermobaric grenades are sometimes classed within the category HE. They have flame effects, and have demolition effects as noted below.  
3. Note other thermobaric, flame and smoke grenades under ATRL listings.

Multi-Purpose and Bunker Buster Weapons						
Name	Producing Country / Number of Users	Crew/ Combat Load Total Weight (kg)	Munition Nomenclature (Diameter and Type)	Munition Capabilities: Range (m)/ Effectiveness (mm) (HEAT armor penetration)	Sights Day/night	Comments
<b>SMAW HEPD</b> 83-mm	US		HEDP	500, 250 for 1x2m target		See ATRLs
<b>AT8 Bunker Buster</b> 84-mm Disposable	Sweden/US	1 INA-issued as round 7.2	AT8 (HEDP Multi-purpose)	250m/1-m hole in LAV /260+mm in concrete	D: Pop-up sight	Designed to fit in AT-4 launcher. Grenade is same as for SMAW.
<b>C90-CR-BK (M3)</b> 90-mm	Spain	1 INA Fire: 5.1 Trans: 5.4	Tandem HE	350m/70mm /600mm brick wall /300+mm concrete reinforced	D: optical N: yes	Precursor shaped charge for punching a hole and follow-through HE grenade explodes (400 fragments) inside the bunker.
<b>RPO-A</b>			See Thermobaric above			
<b>TBG-7V</b> (Grenade on RPG-7V)	See RPG-7V 3	4.5 kg	TBG-7V (105-mm HE) See Thermobaric above	200m/2 m radius 200m/AT against light armor		The demolitions effect of the TBG-7V equates to that of a 122-mm HE artillery round.
<b>BASTEG</b> (Grenade on Pzf-3, 3-T, 3-T600, 3-IT600) 60-mm	See Pzf-3		BASTEG (HEMP—High Explosive Multipurpose, Tandem 110-mm HEAT/47-mm HE)	/15mm armor at 45° /AP fragmentation		BASTEG is Barricade & Street Encounter Grenade. Other penetrations: 920 mm sand-bag, 256 mm concrete

- NOTES: 1. Disposable weapons are issued as rounds of ammunition. Users are assigned the mission in addition to other duties to supplement fires, or to create a breach.  
2. All shaped charge grenades have some penetration effect for bunker-busting and against structures.  
3. All high-explosive (HE) warheads have some demolition effects against structures. Thermobaric grenades have superior demolition effects against bunkers and structures, as well as personnel inside.

1-8.8

**Russian 73-mm Recoilless Gun SPG-9**

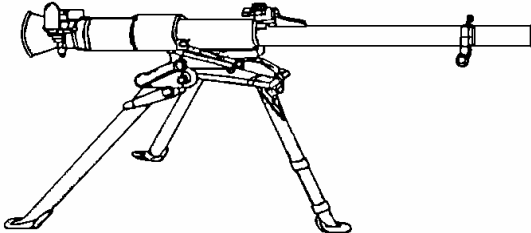
	<p><b>Ammunition Types</b></p> <p>73-mm recoilless gun        RA HEAT        RA HE</p>	<p><b>Typical Combat Load</b></p> <p>INA</p>
<p><b>SYSTEM</b></p> <p><b>Alternative Designations:</b> INA  <b>Date of Introduction:</b> 1970  <b>Proliferation:</b> Widespread</p> <p><b>Description:</b>        Crew: 3        Caliber (mm): 73        Weight (kg):          Firing Position: 47.5          Travel Position: 47.5          Tripod: 12        Length (travel) (m): 2.11        Width (travel) (m): .99        Height (travel) (m): .80        Rifling: None        Breech Mechanism Type: Interrupted screw        Feed: Breech load        Traverse (°): 30 total        Elevation (°): -3 to +7        Rate of Fire (rd/min): 6        Emplacement/displacement time (min): 1        Fire From Inside Building: No</p>	<p><b>SIGHTS</b></p> <p><b>Name:</b> PGO-9        Type: Optical and iron        Magnification: Optical 4x, 10° field of view        Location: Left side        Sighting Range (m): 1,300  <b>Night Sights Available:</b> IR and passive night, PGN-9</p> <p><b>VARIANTS</b></p> <p><b>SPG-9D:</b> Airborne version with detachable wheels</p> <p><b>AMMUNITION</b></p> <p>Range (m):          Maximum Effective:            HEAT: 1,000            HE: 1,300          Minimum: INA        Armor Penetration (mm) @ 1,000 m: 400 (HEAT any range)        Casualty Radius (m): INA        Length (mm): 1,000        Complete Round Weight (kg):          Rocket-Assisted HEAT: 3.5          Rocket-Assisted HE: 4        Muzzle Velocity (m/s): 435        Max Velocity w/rocket assist (m/s): 700</p>	

**NOTES**

The SPG-9 is a recoilless, smooth-bore, single-shot antitank weapon that fires both antiarmor and antipersonnel ammunition. Several generations of night vision equipment are available for the SPG-9. It is manportable, but a truck or APC normally carries it. It must be dismounted and placed on its tripod for firing.

## Swedish 84-mm Recoilless Rifle Carl Gustaf M2

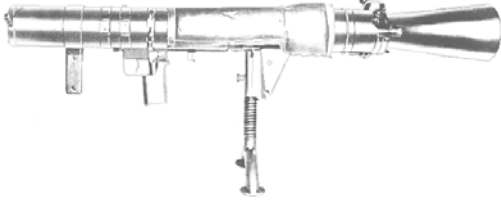
	<p><b>Ammunition Types</b></p> <p><b>84-mm round</b> HEAT (tandem) HEDP HEAT HE Smoke Illumination</p>	<p><b>Typical Combat Load</b></p> <p>INA</p>
<p><b>SYSTEM</b></p> <p><b>Alternative Designations:</b> INA <b>Date of Introduction:</b> INA <b>Proliferation:</b> At least 20 countries <b>Description:</b> Crew: 1 or 2 (see NOTES) Caliber (mm): 84 Weight (kg): Mount: .8 M2: 14.2 M3: 8.5 Length (mm): 1,065 Rifling: 24 lands/progressive twist Breech Mechanism Type: Hinged Rate of Fire (rd/min): 6 Fire From Inside Building: INA</p> <p><b>SIGHTS</b></p> <p><b>Name:</b> INA Type: Iron and telescoped Magnification: 3x Location: Left side Weight (kg): 1 <b>Used With Range Finders:</b> Yes, laser <b>Night Sights Available:</b> May be used with Generation III Image Intensification Systems.</p> <p><b>VARIANTS</b></p> <p><b>M3:</b> Lightweight version of the M2</p> <p><b>AMMUNITION</b></p> <p><b>Name:</b> FFV 751 Type: HEAT (tandem) Range (m): Effective: 500 Minimum: INA Moving: INA Penetration: Armor (mm): +500 Weight (kg): 4</p>	<p><b>Name:</b> FFV 502 Type: HEDP (with dual mode fuze) Range (m): Effective (personnel in open): 1,000 Effective (stationary): 500 Moving: 300 Arming Range: 15-40 Penetration: Armor (mm): +150 Weight (kg): 3.3 Muzzle Velocity (m/s): 230</p> <p><b>Name:</b> FFV 551 Type: HEAT Range (m): Effective: 700 Arming Range: 5-15 Penetration: Armor (mm): 400 Weight (kg): 3.2 Muzzle Velocity (m/s): 255</p> <p><b>Name:</b> FFV 441B Type: HE Range (m): Effective (unprotected troops, soft-skinned vehicles): 1,100 Arming Range: 20-70 Casualty Radius (m): INA Weight (kg): 3.1 Muzzle Velocity (m/s): 240</p> <p><b>Name:</b> FFV 469B Type: Smoke Range (m): Effective: Up to 1,300 Weight (kg): 3.1 Muzzle Velocity (m/s): 240</p> <p><b>Name:</b> FFV 545 Type: Illumination Range (m): Practical: 300-2,100 Burning Time (sec): 30 Illuminated Area, dia: 400-500 Candle Power: 650,000 cd Weight (kg): 3.1 Muzzle Velocity (m/s): 260</p>	

**NOTES**

The 84-mm Carl Gustaf recoilless rifle is a one-man portable, direct-fire, single-shot, breech-loading weapon. Several versions of the Carl Gustaf are produced outside Sweden; however, the ammunition is interchangeable among the variants. While the weapon can be operated by one person it is better to have two—one to fire the gun, and the other to carry and load the ammunition. In addition to its antitank role, the weapon can be used as part of an illumination plan, to provide smoke, or for bunker busting.

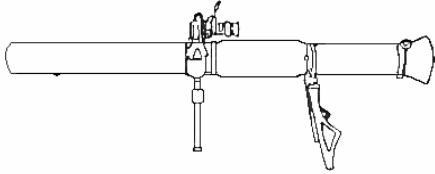

## United States 90-mm Recoilless Rifle M67

	<p style="text-align: center;"><b>Ammunition Types</b></p> <p><b>90-mm recoilless gun</b> HE HEAT APERS Target Practice</p>	<p style="text-align: center;"><b>Typical Combat Load</b></p> <p style="text-align: center;">7</p>
<p><b>SYSTEM</b></p> <p><b>Alternative Designations:</b> INA  <b>Date of Introduction:</b> Late 1940s  <b>Proliferation:</b> At least 11 countries  <b>Description:</b>  Crew: 3 (see Note)  Caliber (mm): 90  Weight (empty) (kg): 16.4  Length (mm): 1.35  Height (ground-mounted) (mm): 432  Mount: Rear bipod and forward monopod  Feed: Manual  Rate of Fire (rd/min):  Maximum: 1 each 6 seconds, not to exceed 5 rounds  Sustained: 1  Fire From Inside Building: No</p> <p><b>SIGHTS</b></p> <p><b>Name:</b> M103  Type: Optical, (graduated in 50 m intervals up to 400 m, every 100 m up to 800 m)  Magnification: x3  Field of View (°): 10  Location: Left center</p> <p><b>VARIANTS (INA)</b></p>	<p><b>AMMUNITION</b></p> <p><b>Name:</b> INA  Type: HE  Range (m):  Effective: 400  Weight (kg): INA</p> <p><b>Name:</b> M371E1  Type: HEAT  Range (m):  Aimed: 800  Effective: 420  Penetration:  Armor (mm): 350  Weight (kg): 4.2  Fuze: Point Detonating  Muzzle Velocity (m/s): 213</p> <p><b>Name:</b> XM590E1  Type: APERS Canister (antipersonnel)  Fill: 2,400 eight-grain flechettes  Range (m):  Effective: 200  Weight (kg): 3.08  Muzzle Velocity (m/s): 381</p> <p><b>Name:</b> XM590E1  Type: Target Practice  Range (m): Ballistically identical to the HEAT M371E1  Weight (kg): 3.08  Muzzle Velocity (m/s): 381</p>	

### NOTES

The M67 90-mm recoilless rifle is a lightweight, portable, direct-fire only, crew-served antitank weapon. It is designed to be fired primarily from the ground using the bipod and monopod, but it may be fired from the shoulder. It is an air-cooled, breech-loaded, single-shot rifle that fires fixed ammunition. Although intended primarily for use as an antitank weapon, the M67 can be used against secondary targets such as gun emplacements and bunkers. It is also very effective in an anti-personnel role. Although no longer produced in the US, the M67 is still in production by South Korea.

The crew consists of a gunner, assistant gunner, and ammo bearer. The M67 can be operated with a crew of only two; however, the third crew member (ammo bearer) is considered necessary for efficient operations. In the absence of an individual to perform the duties assigned to the ammo bearer, the gunner (crew member 1) lays and fires the 90-mm rifle and is the crew leader. He carries the M67 and a pistol. The loader (crew member 2) is responsible for loading the rifle and acts as the gunner when required. He secures ammunition and checks the clearance of the backblast area prior to firing. He carries a pistol, spare parts, cleaning materiel, and 3 rounds of 90-mm. The ammunition bearer (crew member 3) is responsible for securing ammunition and providing security for the recoilless rifle position. He carries an assault rifle and 4 rounds of 90-mm.



## Russian 40-mm Antitank Grenade Launcher RPG-7V

	<b>Ammunition Types</b>  <b>40-mm grenade</b> PG-7V PG-7VM PG-7VS PG-7VL PG-7VR TBG-7V OG-7V OG-7VM	<b>Typical Combat Load</b>  5
<p><b>SYSTEM</b></p> <p><b>Alternative Designations:</b> INA  <b>Date of Introduction:</b> 1962  <b>Proliferation:</b> At least 40 countries</p> <p><b>Description:</b>            Crew: 2            Caliber (launcher ) (mm): 40            Weight (kg):              Empty: 7.9              Loaded: Varies with grenade            Length (mm): 950            Rate of Fire (rd/min): 6            Fire From Inside Building: No  <b>Grenade Components:</b> Warhead, rocket motor, tail assembly</p> <p><b>SIGHTS</b></p> <p><b>Name:</b> PGO-7            Type: Optical w/II            Magnification: 2.7x, 13° field of view            Location: Top of launcher/sight-left side            Sighting Range (m): 500  <b>Night Sights Available:</b> Yes, NSP-3, NSP-2 (IR), NSPU, PGN-1 (II), 1PN58 (II)</p> <p><b>VARIANTS</b>  <b>RPG-7D, RPG-7DV1:</b> Folding variants used by airborne troops</p> <p><b>AMMUNITION</b></p> <p><b>Name:</b> PG-7V            Caliber (mm): 85            Type: HEAT            Range (m):              Effective: 500              Minimum: INA              Moving: 300            Penetration:              Armor (mm): 330            Length (mm): INA            Weight (kg): 2.2</p>	<p><b>Name:</b> PG-7VM            Caliber (mm): 70.5            Type: INA            Range (m):              Effective: 500              Minimum: INA            Penetration:              Armor (mm): 330            Muzzle Velocity (m/s): 140            Length (mm): 950            Weight (kg): 2</p> <p><b>Name:</b> PG-7VS            Caliber (mm): 72            Type: INA            Range (m):              Effective: 500              Minimum: INA            Penetration:              Armor (mm): INA              Brick (m): + 1.5              Reinforced concrete (m): + 1            Casualty Radius (m): INA            Muzzle Velocity (m/s): INA            Length (mm): INA            Weight (kg): 2</p> <p><b>Name:</b> PG-7VL            Caliber (mm): 93            Type: INA            Range (m):              Effective: 300              Minimum: INA            Penetration:              Armor (mm): 600              Brick (m): 1.7              Reinforced concrete (m): + 1.1            Muzzle Velocity (m/s): 112            Length (mm): 980            Weight (kg): 2.6</p>	

### NOTES

The RPG-7V is a recoilless, shoulder-fired, muzzle-loaded, reloadable, antitank grenade launcher. It fires a variety of rocket-assisted grenades from a 40-mm smoothbore launcher tube. It is the standard squad antitank weapon in use by the OPFOR. The RPG-7V is light enough to be carried and fired by one person. However, an assistant grenadier normally deploys to the left of the gunner to protect him from small arms fire. The RPG-7V requires a well-trained gunner to estimate ranges and lead distances for moving targets. Crosswinds as low as 7 miles per hour can complicate the gunner's estimate and reduce first-round hit probability to 50% at ranges beyond 180 meters.

**Russian Antitank Grenade Launcher RPG-7V continued**

---

<p><b>Name:</b> PG-7VR (uses RPG-7V1 launcher sights) Caliber (mm): 105 Type: Tandem Range (m):     Effective: 200     Minimum: INA     Sighting Range: INA Penetration:     Armor (mm): +750 (all armor including reactive armor)     Brick (m): 2     Reinforced concrete (m): +1.5 Muzzle Velocity (m/s): INA Length (mm): 1,306 Weight (kg): 4.5</p> <p><b>Name:</b> TBG-7V (uses RPG-7V1 launcher sights) Caliber (mm): 105 Type: Thermobaric (similar to RPO-A warhead) Range (m):     Effective: 200     Sighting Range: 800 Penetration:     Armor (mm): INA     Brick (m): +1.5     Reinforced concrete (m): + 1.5 Casualty Radius (m): INA Muzzle Velocity (m/s): INA Length (mm): INA Weight (kg): 4.5</p>	<p><b>Name:</b> OG-7V Caliber (mm): 40 Type: Frag-HE Range (m):     Effective: 950 Casualty Radius (m): INA Muzzle Velocity (m/s): 152 Length (mm): 569 Weight (kg): 1.7</p> <p><b>Name:</b> OG-7VM Caliber (mm): 40 Type: Frag-HE Range (m):     Effective: 1,000 Casualty Radius (m): INA Muzzle Velocity (m/s): 145 Length (mm): 595 Weight (kg): 1.7</p>
---	--

## German 60-mm Antitank Grenade Launcher Panzerfaust-3

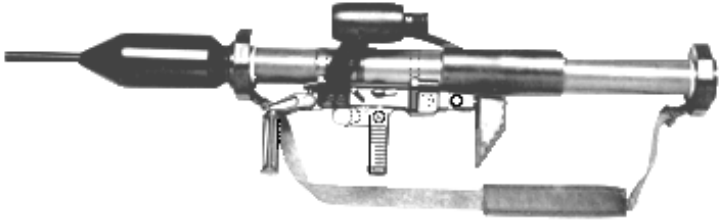
	<p><b>Ammunition Types</b></p> <p>60-mm grenade HEAT Multipurpose-FRAG BASTEG Illumination Smoke Practice</p>	<p><b>Typical Combat Load</b></p> <p>INA</p>
<p><b>SYSTEM</b></p> <p><b>Alternative Designations:</b> Balliste, Pzf 3 <b>Date of Introduction:</b> 1990 <b>Proliferation:</b> At least eight countries</p> <p><b>Description:</b> Crew: 1 Caliber (mm): Launch Tube: 60 Warhead: 110 Weight (kg): 12 Length (mm): Firing Position: 1,200 Travel Position: 1,200 Rifling: None Breech Mechanism Type: N/A Rate of Fire (rd/min): 5 Fire From Inside Building: Yes</p> <p><b>SIGHTS</b></p> <p><b>Name:</b> INA <b>Type:</b> Optical <b>Magnification:</b> INA <b>Location:</b> Left side <b>Used With Range Finders:</b> Yes <b>Night Sights Available:</b> Yes</p> <p><b>VARIANTS</b></p> <p><b>Panzerfaust 3-T 600:</b> Simrad IS2000 laser gun sight with range of moving targets out to 600 m. Can be fitted with Simrad KN205F night sights.</p>	<p><b>AMMUNITION</b></p> <p><b>Name:</b> INA <b>Caliber (mm):</b> 110 <b>Type:</b> HEAT <b>Range (m):</b> Effective (moving): 300 Effective (stationary): 500 <b>Penetration:</b> Armor (mm): + 700 <b>Weight (kg):</b> 3.8 <b>Muzzle Velocity(m/s):</b> 170 <b>Flight Velocity(m/s):</b> 250 <b>Time of Flight to 300 m (sec):</b> 1.3</p> <p><b>Name:</b> BASTEG (Barricade and Street Encounter Grenade) <b>Caliber (mm):</b> 110 <b>Type:</b> Shaped-charge w/stand-off fuze <b>Range (m):</b> INA <b>Penetration:</b> Concrete (mm): INA <b>Weight (kg):</b> INA <b>Muzzle Velocity(m/s):</b> INA <b>Flight Velocity(m/s):</b> INA <b>Time of Flight to 300 m (sec):</b> INA</p> <p><b>OFF-ROUTE MINE SYSTEM</b></p> <p><b>Target Speed range (km/h):</b> 30-60 <b>Effective Range (m):</b> 150 <b>Operational Time (days):</b> 40 <b>Acquisition:</b> Targets detected by acoustic sensor which activates the infra-red sensor. <b>Sensors:</b> IR Sensor: Passive, two-color IR Optics: Double parabolic, off-axis Acoustic: Capacitative microphone.</p>	

### NOTES

The Panzerfaust 3 is a compact, lightweight, shoulder-fired, unguided antitank weapon. It consists of a disposable cartridge with a 110-mm warhead and reusable firing and sighting device. The Panzerfaust can be adapted to serve as an off-route mine.

## Russian 105-mm Antitank Grenade Launcher RPG-29

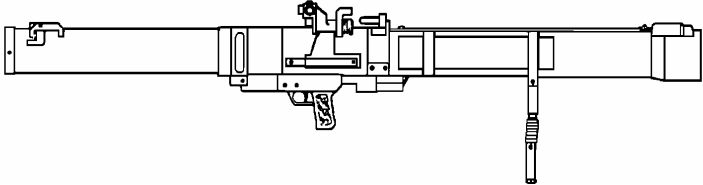
	<p style="text-align: center;"><b>Ammunition Types</b></p> <p>105-mm grenade HEAT (tandem)</p>	<p style="text-align: center;"><b>Typical Combat Load</b></p> <p style="text-align: center;">INA</p>
<p><b>SYSTEM</b></p> <p><b>Alternative Designations:</b> Vampir <b>Date of Introduction:</b> Late 1980s <b>Proliferation:</b> Former Soviet Union</p> <p><b>Description:</b> Crew: 2 Caliber (tube) (mm): 105 Weight (kg): 11.5 Length (mm): 1,000 Life of Tube/barrel: 300 Rate of Fire (rd/min): INA Fire From Inside Building: INA Maximum Target Speed (km/h): INA Emplacement/displacement time (min): (see NOTES)</p> <p><b>SIGHTS</b></p> <p><b>Name:</b> INA Type: Iron, optical, and night Magnification: INA Location: Left side Sighting Range (m): 450 <b>Night Sights Available:</b> Yes, INA</p>	<p><b>VARIANTS</b> (see NOTES)</p> <p><b>AMMUNITION</b> <b>Name:</b> PG-29V Caliber (warhead): 105 Type: HEAT (tandem) Range (m):   Effective: 500   Minimum: INA Penetration (m):   Armor: +750, (650 behind ERA)   Concrete and brick: +1.5 Casualty Radius (m): INA Length (mm): INA Complete Round Weight (kg): 6.7 Muzzle Velocity (m/s): 280</p>	

**NOTES**

For ease of transportation the RPG-29 can be broken down into two parts which one soldier can carry. It can be made ready to fire within a few seconds. A folding bipod is provided to assist aiming during prone firing. An unnamed variant has a tripod mount and guidance and control system. The guidance and control system of the mounted variant includes an optical sight, laser rangefinder and ballistic data computer for firing on moving targets. This increases the effective range of the mounted system to 800 m against a stationary target with a hit probability of 80%.

## German 67-mm Disposable Antitank Grenade Launcher Armbrust

	<p><b>Ammunition Type</b></p> <p>67-mm grenade HEAT</p>	<p><b>Typical Combat Load</b></p> <p>INA</p>
<p><b>SYSTEM</b></p> <p><b>Alternative Designations:</b> Crossbow  <b>Date of Introduction:</b> INA  <b>Proliferation:</b> At least seven countries</p> <p><b>Description:</b>  Crew: 1  Caliber (mm): 67  Weight (kg): 6.3  Length (mm): 850  Rifling: None  Breech Mechanism Type: N/A  Rate of Fire (rd/min): N/A (disposable)  Fire From Inside Building: Yes (see NOTES)</p> <p><b>SIGHTS</b></p> <p><b>Name:</b> N/A  <b>Type:</b> Reflex  <b>Magnification:</b> None  <b>Location:</b> Left side  <b>Sighting Range (m):</b> INA  <b>Night Sights Available:</b> INA</p>	<p><b>VARIANTS (INA)</b></p> <p><b>AMMUNITION</b></p> <p><b>Name:</b> INA  <b>Type:</b> HEAT  <b>Range (m):</b>  Maximum: 1,500  Effective AT: 300  Flight Time (sec) @ 300 m: 1.5  <b>Penetration:</b>  Armor (mm): 300  Reinforced Concrete (m): INA  Muzzle Velocity(m/s): 210</p>	

### NOTES

The Armbrust is a preloaded, disposable, shoulder-fired antitank weapon. It has a low signature and low IR detectability and can be safely fired from small enclosed rooms. The muzzle does not emit smoke or blast and no flash can be seen from the rear. Only .8 m clearance is required between the rear of the weapon and the wall. It is quieter than a pistol shot. The entire weapon is considered a round of ammunition and the launcher is thrown away once the weapon is fired. Manufactured by Singapore.

## Russian 72-mm Disposable Antitank Grenade Launcher RPG-22

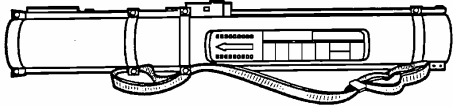
	<p style="text-align: center;"><b>Ammunition Types</b></p> <p style="text-align: center;">72-mm grenade HEAT</p>	<p style="text-align: center;"><b>Typical Combat Load</b></p> <p style="text-align: center;">INA</p>
<p><b>SYSTEM</b></p> <p><b>Alternative Designations:</b> INA  <b>Date of Introduction:</b> 1985  <b>Proliferation:</b> At least three countries</p> <p><b>Description:</b>  Crew: 1  Caliber (mm): 72  Weight (kg): 2.8  Length (mm):      Firing Position: 850      Travel Position: 750  Rifling: None  Breech Mechanism Type: N/A  Rate of Fire (rd/min): N/A (disposable)  Fire From Inside Building: No, backblast out to 30 m behind the weapon.</p> <p><b>SIGHTS</b></p> <p><b>Name:</b> INA  Type: Iron, calibrated for 50, 150, 200 m  Magnification: None  Location: Top of launcher  Sighting Range (m): 250  <b>Night Sights Available:</b> No</p>	<p><b>VARIANTS</b> (None)</p> <p><b>AMMUNITION</b> (see NOTES)</p> <p><b>Name:</b> INA  Caliber (mm): 72  Type: HEAT  Range (m):      Effective: 250      Arming Range: INA  Penetration:      Armor (mm): 390      Brick (m): 1.2      Reinforced Concrete (m): 1  Muzzle Velocity(m/s):      Initial: 133      Maximum: 300  Length (mm): 618  Weight (kg): 1.48</p>	

**NOTES**

The RPG-22 is a lightweight, shoulder-fired, preloaded, disposable antiarmor weapon intended for firing one round, after which the tube is discarded. It is basically a scaled-up version of the RPG-18 (similar to the US LAW) and has no dedicated grenadier; however, all soldiers train to use the squad-level disposable weapon.



## Swedish 84-mm Disposable Light Antitank Weapon AT4

	<p><b>Ammunition Types</b></p> <p>84-mm round HEDP HEAT</p>	<p><b>Typical Combat Load</b></p> <p>INA</p>
<p><b>SYSTEM</b></p> <p><b>Alternative Designations:</b> US M136, Bofors AT 4, FFV AT4  <b>Date of Introduction:</b> INA  <b>Proliferation:</b> At least seven countries</p> <p><b>Description:</b>  Crew: 1  Caliber (mm): 84  Weight (kg): 6  Length (mm):      Firing Position: 1,000      Travel Position: 1,000  Rate of Fire (rd/min): N/A (disposable)  Fire From Inside Building: See AT4 CS</p> <p><b>SIGHTS</b></p> <p><b>Name:</b> INA  Type: Popup, preset to 200 m  Location: Top left  <b>Night Sights Available:</b> Yes, INA</p> <p><b>VARIANTS</b> (see NOTES)</p> <p><b>LMAW:</b> Light Multipurpose Assault Weapon, uses HEDP  <b>AT4 CS:</b> Confined space  <b>AT4 HP:</b> High penetration</p> <p><b>AMMUNITION</b></p> <p><b>Name:</b> AT4 HEAT  Caliber (mm): 84  Type: HEAT  Range (m):      Effective: 300      Arming Range: INA  Penetration:      Armor (mm): 420  Weight (kg): 6.7  Muzzle Velocity(m/s): 285</p>	<p><b>Name:</b> LMAW (see VARIANTS)  Caliber (mm): 84  Type: HEDP, modified Carl Gustaf HEPD FFV 502 (with dual mode fuze)  Range (m):      Effective: 300      Arming Range: INA  Penetration:      Armor (mm): 150      Concrete (m): INA  Casualty Radius (m): INA  Muzzle Velocity (m/s): 235</p> <p><b>Name:</b> AT4 CS (confined space) can fire from confined spaces as small as 22.5 m<sup>3</sup>  Caliber (mm): 84  Type: HEAT or HEDP (LMAW) warheads  Range (m):      Effective: INA      Arming Range: INA  Penetration:      Armor (mm): INA  Weight (kg): INA  Muzzle Velocity(m/s): INA</p> <p><b>Name:</b> AT4 HP (high penetration)  Caliber (mm): 84  Type: HEAT  Range (m):      Effective: INA      Arming Range: INA  Penetration:      Armor (mm): 600  Weight (kg): Less than 7  Muzzle Velocity(m/s): 290</p>	

**NOTES**

The AT4 is a lightweight, preloaded, disposable antiarmor weapon intended for firing one round, after which the tube is discarded. All AT4 systems share the same launcher but may contain different preloaded munitions. The variant selected depends on the intended use. The AT4's average recoil is comparable to the M16 rifle.

## Russian Infantry Rocket Flame Weapon RPO

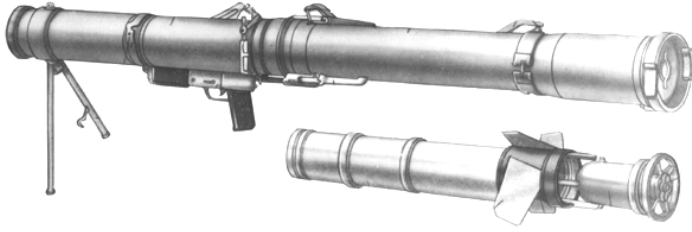
	<p style="text-align: center;"><b>Ammunition Types</b></p> <p><b>Rocket</b> Rocket-propelled encapsulated napalm projectile.</p>	<p style="text-align: center;"><b>Typical Combat Load</b></p> <p style="text-align: center;">2</p>
<p><b>SYSTEM</b>  <b>Alternative Designations:</b> Rys (Lynx)  <b>Date of Introduction:</b> Late 1970s  <b>Proliferation:</b> FSU</p> <p><b>Description:</b>  Crew: 1  Weight (kg):  Empty: 3.5  Pack (launcher and two rounds): 22  Length (ready to fire) (m): 1.44  Rate of Fire (rockets/min): 1  Reaction Time-Travel to Fire (sec): 60  Fire From Inside Building: INA  Tube Life: 100 rounds  <b>Launcher Components:</b> Firing tube, firing mechanism, mechanical sights, collapsing bipod and sling.</p> <p><b>PERFORMANCE</b></p> <p><b>Range (m):</b>  Effective: 190  Maximum: 400  Minimum: INA  <b>Accuracy:</b> INA  <b>Muzzle Velocity (m/s):</b> INA</p>	<p><b>SIGHTS</b></p> <p><b>Name:</b> N/A  Type: Open metal, front and rear  Location: Left side, rear is on-line with rear of grip  Magnification: None  <b>Night Sights Available:</b> INA</p> <p><b>VARIANTS (None)</b></p> <p><b>AMMUNITION</b></p> <p><b>Name:</b> RPO  Type: Incendiary  Warhead Incendiary Fill (liters): 4  Weight of Incendiary in Warhead (kg): 4  Type of Incendiary: Pyrogel  Burn Temperature (°C): 800-1,000  Caliber (mm): 122  Casualty Radius: Fire envelope 10-40 m deep in the direction of the shot with a spray width of 3-4 m.  Components: Container, warhead canister, propulsion unit</p>	

### NOTES

The RPO is a combat-tested, shoulder-fired reusable weapon that fires a rocket-propelled encapsulated napalm warhead. It was designed to replace the LPO-50. The RPO is carried in two parts that must be connected to fire. Squeezing the trigger ignites the rocket with an electric spark. Part of the propellant gas enters the container and pushes the canister, kindling the igniter which in turn, ignites the incendiary mixture. The napalm in the RPO ignites at the initial stage of the flight and upon impact burning pieces are scattered all over the target. Although still in use by the OPFOR Flamethrower Bn (Encapsulated) at Corps or Army level (and other armies), the RPO has generally been replaced by the Infantry Rocket Flame Weapon RPO-A Series (RPO-A/D/Z).

Russian Infantry Rocket Flame Weapon RPO-A Series (RPO-A/Z/D)

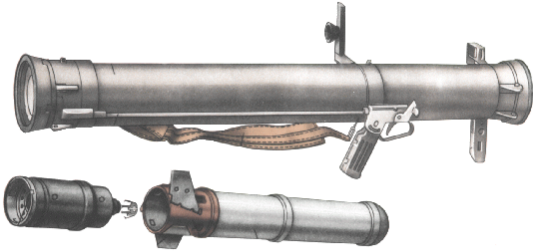
	<p><b>Ammunition Types</b></p> <p><b>Rocket</b> RPO-A: Thermobaric-flammable mixture RPO-Z: Incendiary RPO-D: Smoke</p>	<p><b>Typical Combat Load</b></p> <p>2</p>
<p><b>SYSTEM</b></p> <p><b>Alternative Designations:</b> Shmel (Bumblebee) <b>Date of Introduction:</b> 1984 <b>Proliferation:</b> Widespread</p> <p><b>Description:</b> Crew: 1 Caliber (mm): 93 Number of Weapons in a Package: 2 Weight of Package (kg): 12 Total weapon (1) weight (kg): 11 Length (mm): 920 Rate of Fire (rockets/min): 2 Reaction Time-Travel to Fire (sec): 30 Fire From Inside Building: Yes. It can be fired in enclosures of 60 m<sup>3</sup> or greater or with a barrier behind the weapon. <b>Components:</b> Container, ejection motor, warhead.</p> <p><b>PERFORMANCE</b></p> <p><b>Range (m):</b> Direct Fire: 200 With Optical Sight: 850 Effective: 600 Minimum: 20 Indirect Fire: 1,000 <b>Accuracy @ 200 m:</b> .5 m<sup>2</sup> <b>Muzzle Velocity (m/s):</b> 125</p>	<p><b>SIGHTS</b></p> <p><b>Name:</b> OPO-1 Type: Optical calibrated to 600 m Location: Left, next to grip Magnification: None <b>Night Sights Available:</b> INA</p> <p><b>VARIANTS (None)</b></p> <p><b>AMMUNITION</b></p> <p><b>Name:</b> RPO-A Type: Thermobaric Casualty Radius (m): 50 (personnel in open) Lightly armored materiel kill probability at 400 m: 0.7 Burn Temperature (°C): 800+ Warhead Explosive Type: Trotyl equivalent (kg) -2 Warhead Mixture Weight (kg): 2.1</p> <p><b>Name:</b> RPO-Z Type: Incendiary Warhead Mixture Weight (kg): 2.5</p> <p><b>Name:</b> RPO-D Warhead Weight (kg): 2.3 Smoke-Incendiary Type: Based on red phosphorous. Smokescreen: Time of Formation (min): 2 Length (m): 55 to 90 Depth (m): INA Height (m): INA Duration (min): 3 to 5 Effective Against: Visual and infrared</p>	

**NOTES**

Designed as a follow-on to the RPO, the RPO-A, -Z, and -D are one-shot, disposable, shoulder-fired, combat tested (Afghanistan, Tajikistan, Chechnya), flame weapons. They are reliable and can be ready to fire within 30 seconds. Any soldier, infantryman, or paratrooper can use this close-combat weapon with minimal instruction. The RPO-A comprises three basic components: container, ejection motor, and case which is filled, depending on its purpose, with thermobaric (enhanced blast explosive), smoke or incendiary rockets. At any range the blast effects of the thermobaric munitions are much more serious than the thermal effects. The RPO-A is known as the infantryman's pocket artillery because the demolition effect corresponds to the 122-mm HE artillery, and 120-mm mortar projectile. The RPO series of flame weapons also serves as an extremely effective counter-sniper weapon. The armor- and mechanized -based OPFOR usually issues one RPO-A per BMP (mechanized infantry squad). They are also found in the Flamethrower Bn (Encapsulated) at Corps or Army level. One squad per infantry platoon has a RPO-A in the infantry-based OPFOR. The RPO-A series of flame weapons are issued more along the lines of ammunition rather than a weapon, therefore the BOI may vary.

## United States 106-mm Recoilless Rifle M40

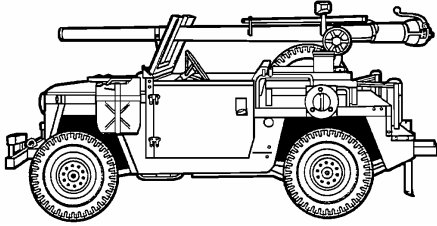
	<p><b>Ammunition Types</b></p> <p><b>106-mm recoilless gun</b> HEAT HEAT-T HEP-T APERS-T HEAP</p>	<p><b>Typical Combat Load</b></p> <p><b>INA</b></p>
<p><b>SYSTEM</b></p> <p><b>Alternative Designations:</b> (see VARIANTS) <b>Date of Introduction:</b> 1953 <b>Proliferation:</b> At least 50 countries</p> <p><b>Description:</b> Crew: 2 Caliber (mm): 106 Weight (kg):     With Spotting Rifle: 130     Gun Only: 113 Length (m):     Total: 3.40     Barrel: 2.85 Width (on M79 mount) (m):     Legs Spread: 1.524     Legs Closed: .8 Height (on M79 mount) (m): 1.3 Bore: Rifled 36 grooves, rh Breech Type: Interrupted thread Recoil System: Vented breech Feed: Manual Traverse (°): 360 Elevation (°) (M79 Mount): -17/+65 Rate of Fire (rd/min): 5 Spotting Rifle: .50 cal M8C Emplacement/displacement time (min): INA Fire From Inside Building: No Complete Round Weight (kg): 13 Muzzle Velocity (m/s): 570</p> <p><b>SIGHTS</b></p> <p><b>Name:</b> INA Type: Optical <b>Name:</b> Bofors modernization package Type: Simrad LP101 laser sight in place of the ranging gun Magnification: INA Location: INA <b>Name:</b> Bofors modernization package Type: Computerized LASer Sight (CLASS) Magnification: INA Location: INA <b>Night Sights Available:</b> Yes, INA</p>	<p><b>VARIANTS</b></p> <p><b>M79 Mount:</b> Tripod, ground, or vehicle <b>M50 Ontos:</b> Six-barrel mount on small tracked vehicle <b>PAK-66:</b> Austrian M40 on two-wheel carriage</p> <p><b>AMMUNITION</b></p> <p><b>Name:</b> M344A1 Type: HEAT Range (m):     Maximum Effective: 1,350     Maximum Range: 2,745 Armor Penetration (mm): INA Complete Round Weight (kg): 16.8 Muzzle Velocity (m/s): 503</p> <p><b>Name:</b> 3/A-HEAT-T (Bofors upgrade) Type: HEAT-Tracer Range (m):     Maximum Effective: 2,000 Armor Penetration (mm): 700 + Complete Round Weight (kg): 14.5 Muzzle Velocity (m/s): 570</p> <p><b>Name:</b> M346A1 Type: HEP-T (HE plastic-tracer) Range (m):     Maximum: 6,870 Complete Round Weight (kg): 16.95 Muzzle Velocity (m/s): 498</p> <p><b>Name:</b> M581 Type: APERS-T (antipersonnel-tracer) (flechette) Fill (.5 g ea): 10,000 flechettes Range (m):     Maximum Effective: 300 Complete Round Weight (kg): 18.73 Muzzle Velocity (m/s): 438</p> <p><b>Name:</b> HEAP M-DN Type: HE antipersonnel (steel pellets) Fill: 1,000 steel pellets Range (m):     Maximum Effective: 1,500     Lethal Radius: 40 Complete Round Weight (kg): 16.4 Muzzle Velocity (m/s): 560</p>	

**NOTES**

The US M40 or M40A1 recoilless rifle is an antitank weapon. It uses a .50 cal spotting rifle mounted along the axis of the barrel to determine proper elevation for the 106-mm barrel. Upgraded systems may have the Simrad laser sight in lieu of the ranging (spotting) gun.

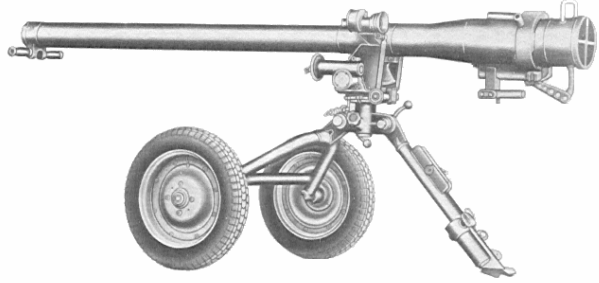

## Former Yugoslavian 82-mm Recoilless Gun M60

	<p><b>Ammunition Types</b></p> <p>82-mm recoilless gun HEAT</p>	<p><b>Typical Combat Load</b></p> <p>36</p>
<p><b>SYSTEM</b></p> <p><b>Alternative Designations:</b> M60A  <b>Date of Introduction:</b> First sighted 1965  <b>Proliferation:</b> At least 2 countries</p> <p><b>Description:</b>  Crew: 2-5  Caliber (mm): 82  Weight (kg):      Firing Position: 122      Travel Position: 122  Tripod: INA  Length (travel) (m): 2.4 approximate  Width (travel) (m): 1.0 approximate, firing position  Height (travel) (m): 0.83 approximate, firing position  Rifling: Yes, 4 with left rotation  Breech Mechanism Type: Vertically hinged with flange rotate lock  Feed: Breech load  Traverse (°): 360  Elevation (°): -20 to +35  Rate of Fire (rd/min): 4  Emplacement/displacement time (min): 0.5/ 0.5  Fire From Inside Building: No</p> <p><b>SIGHTS</b></p> <p><b>Name:</b> INA  Type: Optical telescopic  Magnification: INA  Location: Left side  Sighting Range (m): 1,500  <b>Night Sights Available:</b> INA</p>	<p><b>VARIANTS</b></p> <p>Distinction between M60 and M60A is unknown.</p> <p><b>AMMUNITION</b></p> <p><b>Name:</b> M60  Type: HEAT  Range (m):      Maximum Effective: 500      Maximum Aimed Range: 1,500 stationary target      1,000 moving target      Maximum Range: 4,500  Armor Penetration (mm): 200  Complete Round Weight (kg): 7.2  Muzzle Velocity (m/s): 388</p> <p><b>Name:</b> M72  Type: Rocket-assisted HEAT  Range (m):      Maximum Effective: 1,000      Maximum Aimed Range: 1,500 stationary/ 1,000 moving      Maximum Range: 4,500  Armor Penetration (mm): 220  Complete Round Weight (kg): INA  Muzzle Velocity (m/s): INA</p>	

### NOTES

The M60 is mounted on a two-wheeled carriage with a trailing leg that is used as a tripod leg for firing, as well as a tow bar for towing the gun. The gun can be towed behind a variety of vehicles, then moved into position by hand. Gun height is adjustable based on wheel and leg lock settings. The M60 can also be mounted on a pintel, such as the antitank version of the M-60PB APC, which features two guns. Back-blast safety area is 45 m deep by 25 m wide.

## Russian 107-mm Recoilless Gun B-11

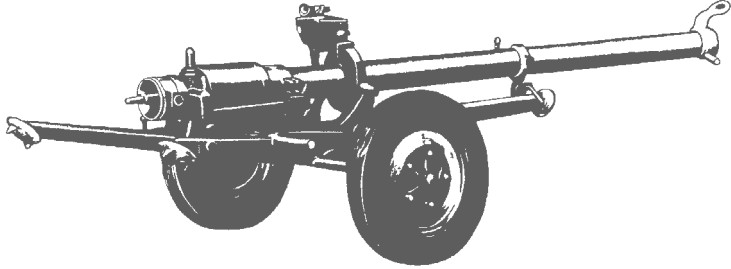
	<p style="text-align: center;"><b>Ammunition Types</b></p> <p><b>107-mm recoilless gun</b> HEAT HE</p>	<p style="text-align: center;"><b>Typical Combat Load</b></p> <p style="text-align: right;"><b>30</b> 10 20</p>	
	<table border="0" style="width: 100%;"> <tr> <td style="width: 50%; vertical-align: top;"> <p><b>SYSTEM</b></p> <p><b>Alternative Designations:</b> RG107  <b>Date of Introduction:</b> 1950s  <b>Proliferation:</b> At least 5 countries</p> <p><b>Description:</b>  Crew: 5  Caliber (mm): 107  Weight (kg):      Firing Position: 304.8      Travel Position: 304.8  Length (m):      Firing Position: 3.54      Travel Position: 3,56  Width (travel) (m): 1.45  Height (m):      Firing Position: 1.19      Travel Position: 0.9  Rifling: None  Breech Mechanism Type: Interrupted screw  Feed: Breech load  Traverse (°): 35 each direction, 360 total with slight move  Elevation (°): -10 to +45  Rate of Fire (rd/min):  Emplacement/displacement time (min): 1/1  Fire From Inside Building: No</p> </td> <td style="width: 50%; vertical-align: top;"> <p><b>SIGHTS</b></p> <p><b>Name:</b> PBO-4 combination (direct/indirect) and iron  Type: Optical, panoramic and iron  Magnification: Optical 5.5x direct/2.5x indirect  Location: Left side  Sighting Range (m):      Direct: 1,800      Indirect: 6,650</p> <p><b>Night Sights Available:</b> Direct and indirect (illuminated)</p> <p><b>AMMUNITION</b></p> <p><b>Name:</b> BK-883  Type: HEAT  Range (m):      Max Effective: 450      Max Aimed Range: 1,400 (est)      Max Range: INA  Armor Penetration (mm): 381 at 0°  Complete Round Weight (kg): 12.5  Muzzle Velocity (m/s): 400</p> <p><b>Name:</b> O-883A  Type: Frag-HE  Range (m):      Max Effective: N/A      Max Aimed Range: 1,300 direct/ 6,650 indirect      Max Range: 6,650  Armor Penetration (mm): N/A  Complete Round Weight (kg): 13.5  Muzzle Velocity (m/s): 375</p> </td> </tr> </table>		<p><b>SYSTEM</b></p> <p><b>Alternative Designations:</b> RG107  <b>Date of Introduction:</b> 1950s  <b>Proliferation:</b> At least 5 countries</p> <p><b>Description:</b>  Crew: 5  Caliber (mm): 107  Weight (kg):      Firing Position: 304.8      Travel Position: 304.8  Length (m):      Firing Position: 3.54      Travel Position: 3,56  Width (travel) (m): 1.45  Height (m):      Firing Position: 1.19      Travel Position: 0.9  Rifling: None  Breech Mechanism Type: Interrupted screw  Feed: Breech load  Traverse (°): 35 each direction, 360 total with slight move  Elevation (°): -10 to +45  Rate of Fire (rd/min):  Emplacement/displacement time (min): 1/1  Fire From Inside Building: No</p>
<p><b>SYSTEM</b></p> <p><b>Alternative Designations:</b> RG107  <b>Date of Introduction:</b> 1950s  <b>Proliferation:</b> At least 5 countries</p> <p><b>Description:</b>  Crew: 5  Caliber (mm): 107  Weight (kg):      Firing Position: 304.8      Travel Position: 304.8  Length (m):      Firing Position: 3.54      Travel Position: 3,56  Width (travel) (m): 1.45  Height (m):      Firing Position: 1.19      Travel Position: 0.9  Rifling: None  Breech Mechanism Type: Interrupted screw  Feed: Breech load  Traverse (°): 35 each direction, 360 total with slight move  Elevation (°): -10 to +45  Rate of Fire (rd/min):  Emplacement/displacement time (min): 1/1  Fire From Inside Building: No</p>	<p><b>SIGHTS</b></p> <p><b>Name:</b> PBO-4 combination (direct/indirect) and iron  Type: Optical, panoramic and iron  Magnification: Optical 5.5x direct/2.5x indirect  Location: Left side  Sighting Range (m):      Direct: 1,800      Indirect: 6,650</p> <p><b>Night Sights Available:</b> Direct and indirect (illuminated)</p> <p><b>AMMUNITION</b></p> <p><b>Name:</b> BK-883  Type: HEAT  Range (m):      Max Effective: 450      Max Aimed Range: 1,400 (est)      Max Range: INA  Armor Penetration (mm): 381 at 0°  Complete Round Weight (kg): 12.5  Muzzle Velocity (m/s): 400</p> <p><b>Name:</b> O-883A  Type: Frag-HE  Range (m):      Max Effective: N/A      Max Aimed Range: 1,300 direct/ 6,650 indirect      Max Range: 6,650  Armor Penetration (mm): N/A  Complete Round Weight (kg): 13.5  Muzzle Velocity (m/s): 375</p>		

**NOTES**

The B-11 is towed on a two-wheeled carriage with an under-slung tripod. The gun can be fired while on two wheels; but due to recoil effect on accuracy, it is usually fired from the tripod.

The gun can easily be moved and repositioned by hand.

A unit of fire is 80 rounds.





## Chapter 2 Infantry Vehicles

Infantry vehicles can vary from general transport assets such as trucks, to specially designed *light armored fighting vehicles (LAFVs)*. The intensity of combat on the modern battlefield requires infantry vehicles that are mobile, survivable, and lethal. Many ground forces have programs underway to field infantry LAFVs for modern requirements. Because of budgetary constraints, many ground forces continue using infantry vehicles which we might consider obsolete, but which are well suited for their environment and military role. A number of forces have aggressive upgrade programs for older systems. The U.S. Army, in its next conflict, is likely to encounter infantry forces with a mix of older and newer infantry vehicles.

### CLASSIFICATION

Infantry LAFVs are generally classed as *armored personnel carriers (APCs)* or *infantry fighting vehicles (IFVs)*. The lighter, less protected and less lethal system is the APC. It is intended to carry soldiers to the close combat zone, then dismount them for their commitment to the fight. An IFV is designed to fight with soldiers onboard, to carry the soldiers forward without dismounting them if possible, and to support them with direct fires if they do dismount. The plethora of upgrade options available is permitting both APCs and IFVs to become more mobile, survivable, and lethal. Thus we see APCs with IFV survivability or IFV lethality, or with both—which transforms them into IFVs. We also see IFVs with vulnerabilities which ill-suit them for their mission requirement. This chapter highlights key infantry vehicles, with an emphasis on their capabilities in mobility, survivability and lethality. Please note that on the modern battlefield, lack of a capability (swim, night sights, etc.) is in fact a vulnerability.

### TRENDS

This chapter highlights infantry LAFV features in terms of mobility, survivability, and lethality. Armies have been looking at ways to balance the need for increased protection with limitations that additional armor brings, such as the need to be amphibious. One solution is to accept a lack of swim capability for a segment of up-armored IFVs, coupled with a distribution of (less armored) amphibious vehicles within the force. Other armies are looking at limited addition of applique armor or active protection systems. Several companies have developed light explosive reactive armor (ERA), which can be used on LAFVs. However, this is a less likely upgrade, because exploding armor fragments are a hazard to dismounted soldiers.

In the past, higher combat power and cost of tanks justified the wide disparity in firepower between tanks and IFVs. However, modern IFVs, when fully manned and equipped, may have equal or higher combat power and similar cost. Therefore, lethality improvements previously afforded to tanks are being added to selected IFVs. A wide variety of lethality upgrades are available for LAFVs. These include larger main weapons and antitank guided missile (ATGM) launchers, and improved fire control systems (FCS), especially night sights. The simplest but sometimes most costly upgrade is improved ammunition.

Improved secondary armaments for aerial targets permit the main weapon to focus more on heavy targets. Thus, several countries are adding remote day sights and night sights and improved ammunition for machineguns (MGs). Others are adding automatic grenade launchers to supplement MG fires.

The aerial threat to AFVs has prompted ground forces to address that threat. One response is proliferation of air defense assets, such as shoulder-fired SAMs. A more direct response which is difficult to counter, is cost-effective, and has long-term benefits for force effectiveness, is to better equip the vehicles for counterair fires. Some infantry vehicles have been fitted with high-angle-of-fire turrets (e.g., BTR-80) and antiaircraft sights (BMP-3). Improved fire control technology has led to more exotic ammunition solutions. The BMP-3 gun-launched ATGM has a higher velocity for use against helicopters. Another new development is ballistic computer-based electronically-fuzed frag-HE rounds, including forward- and side-firing rounds, which can defeat rotary-wing aircraft and ground-based antiarmor positions at stand-off range.

Infantry vehicles offer the most economical armored vehicle chassis for development of combat support and service support vehicles, including air defense vehicles, artillery, C<sup>4</sup>, reconnaissance, etc. Noted variants offer a link to other systems described in the WEG.

This chapter provides a representative sampling of infantry vehicles in use today. The selection is not comprehensive, rather reflects APCs and IFVs currently available to the OPFOR. Within this chapter, other types of infantry vehicles are also noted. These include airborne vehicles and multipurpose transporters. Other armored transport vehicles available to infantry units are armored trucks (e.g., former Soviet BTR-152), amphibious assault vehicles (such as U.S. LVTP7), jeep-type vehicles (e.g., HMMWV), and fast-attack vehicles (based on so-called dune buggy designs). Examples of alternative vehicles will be added in later issues of the WEG.

## **TECHNICAL NOTES**

The following notes apply to infantry LAFVs, and to combat vehicles (in other chapters) that are used for reconnaissance, tank/assault, antitank, air defense, and artillery roles. Weapon, fire control, and munition-related narrative applies to towed and ground weapon systems.

On each equipment sheet, the top of the page provides an illustration (line drawing or photo of the system) and a summary of weapons and munitions. Note that a Typical Combat Load, when available, may be estimated. In actuality, ammunition load depends on specific country holdings, on time frame, and on scenario tactical considerations.

System and Variants sections provide basic data to assist in understanding current system status and proliferation, as well as possible upgrade options. Under Description, to assure comparability on vehicle dimensions, gun tube length is not included in those dimensions.

In the area, Automotive Performance, the figure *max off-road* denotes speed on dirt roads. The figure *average cross-country* is used for true off-road speed; for selected systems, it was measured on an approved course. Although some systems have specified radios, for many OPFOR countries, radios will be replaced to link with their military radio nets.

**Protection** figures for use in simulation applications must be measured by certifying agencies in accordance with specific Army standards. Figures on equipment sheets include published data provided for general information use, and may not coincide with vulnerability data developed by approved agencies. Protection options are available for upgrading systems. The wide variety of supplemental protection packages include active and passive armor, active protection systems and countermeasure systems. Although upgrades are being advertised and are technically possible, that does not mean that they are tactically sound, or that the application fits the OPFOR to be portrayed. Other options are generally available for installation; but, because their applicability has not been noted for specific systems, they were not included. Only a few countermeasure parameters were included. However, specific protection upgrades and systems are noted for selected OPFOR systems.

System lethality is determined by a variety of interrelated functions and considerations in the process of bringing destruction upon enemy forces and equipment. Lethality is addressed on the equipment sheets under the headings of Armament, Fire Control, Sights, and Main Armament Ammunition. Lethal fires can be delivered by *direct fire*, in which weapon systems acquire and observe their targets, or by *indirect fire*, in which weapons use remote acquisition assets to direct their fires. Note that direct-fire systems such as tanks can receive remote acquisition reports and engage targets by indirect fire; and indirect fire systems (such as artillery) can employ direct-fire sights to fire in the direct-fire mode. For the WEG, high-angle fires are not interpreted as indirect fires as long as the firing weapon uses its own sights to acquire and aim.

Factors affecting lethality, which are considered in the WEG, include: rates of fire, various ranges, accuracy and errors, acquisition/fire control capabilities, lethality effects, ammunition, and ability to engage targets on the move. Any of these technical factors, and other more subtle ones, may affect lethality in combat. Note also that various rates of fire are used, with adjusting factors, such as movement status and type of target. Generally automatic weapon use life dictates that, for more than a 3-4 second interval, the number of rounds expended will not exceed the *practical* rate of fire. However, maximum rate is critical against fast-closing targets, such as flying aircraft.

Range is not a fixed figure for most systems. It can be directly affected by four technical factors: gun/launcher configuration, mount (how it is fixed to the system), acquisition capability, and specific munition ballistics. Range is also related to less tangible factors, such as movement status (moving versus stationary, and movement speed), target type, elevation angle (such as for air defense weapons), visibility conditions, and terrain. Each weapon can have different ranges listed by ammunition type and model, where munitions are broken out. Generally, the range of direct-fire frag-HE rounds is greater than munitions designed for point targets, because the effects area is much greater than those of shaped-charge or kinetic-energy rounds. With fragmentation and blast effects, a near miss may be good enough to inflict severe damage. With these considerations, the WEG provides a figure called *maximum aimed range*. This range indicates the farthest range for system-on-system aimed direct fire.

The maximum aimed range is based on a combination of tactics, techniques and procedures (TTPs), and on parameters of the technical factors noted above: gun/launcher, mount, acquisition system, and ammunition ballistics. This direct-fire range significantly exceeds the weapon's *maximum effective range*. The maximum effective range/night denotes the effective range for a round, given available night acquisition capabilities. The TTPs also call for a "salvo range" for armored fighting vehicles, which exceeds other ranges and requires one or more volleys of a platoon against a single point target. These figures are less tangible, are based on TTP, and are not included in the WEG.

Probability of hit data is included for instructional purposes, not for use in simulations and models. Accuracy for weapons, munitions, and acquisition systems decreases with range. Antitank guided missiles are an exception; they usually have a singular probability of hit for all ranges, based on technical precision capability. Limitations, vulnerabilities, and countermeasures can affect actual performance. Several of these factors are noted on equipment pages.

Lethality performance given a hit can be measured in terms of radius of effects for fragmentation/blast effects against soft targets, and penetration distance (through steel) against hard targets. The fragmentation and blast effects of a frag-HE round mean that it is less lethal against hard targets, such as heavily armored vehicles. Another consideration is the level of destruction required. For many possible adversary forces, the critical requirement against armored vehicles is not a 100% or catastrophic kill. A mobility kill or firepower kill may be sufficient to render a system combat-ineffective, and may be counted in lethality data. The OPFOR can employ a mix of lethal and nonlethal methods. Fires of degrading (versus destructive) munitions such as smoke, mines, and radio frequency jammers can be used to suppress units and support the effort. Consult other manuals in the FM 100-60 series and other approved publications for guidance on these tactics, techniques, and procedures.

Questions and comments on data listed in this chapter should be addressed to:

**Mr. Tom Redman**

DSN: 552-7925 Commercial (913) 684-7925  
e-mail address: redmant@leavenworth.army.mil

## Yugoslavian Armored Personnel Carrier BOV-M

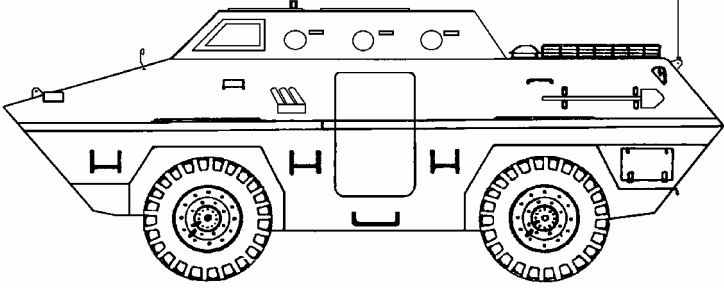
	<p><b>Weapons &amp; Ammunition Types</b></p> <p>7.62-mm MG, M86 Ball-T, API, API-T</p>	<p><b>Typical Combat Load</b></p> <p>(est) 2,000</p>
<p><b>SYSTEM</b>  <b>Alternative Designations:</b> Sometimes referred to as "BOV"  <b>Date of Introduction:</b> 1984  <b>Proliferation:</b> At least 3 countries  <b>Description:</b>          Crew: 2          Troop Capacity: 8          Combat Weight (mt): 7.0 -9.0, depending on the variant          Chassis Length Overall (m): 6.0          Height Overall (m): 2.34 to top of cabin          Width Overall (m): 2.53          Ground Pressure (kg/cm<sup>2</sup>): INA          Drive Formula: 4 x 4</p> <p><b>Automotive Performance:</b>          Engine Type: 148-hp Diesel          Cruising Range (km): 800          Speed (km/h):            Max Road: 95            Max Off-Road: INA            Average Cross-Country: 20            Max Swim: N/A          Fording Depths (m): 1.1</p> <p><b>Radio:</b> INA</p> <p><b>Protection:</b>          Armor, Turret Front (mm): 6-10 mm, defeats 7.62 mm AP at 300 m          Applique Armor (mm): Grill armor over windows, sides on variants          Explosive Reactive Armor (mm): N/A          Active Protective System: N/A          Mineclearing Equipment: N/A          Self-Entrenching Blade: N/A          NBC Protection System: Available          Smoke Equipment: 3 smoke grenade launchers on each side</p> <p><b>ARMAMENT</b>  <b>Main Armament:</b> (See NOTES)          Caliber, Type, Name: 7.62-mm (7.62x 54R) M86 MG          Rate of Fire (rd/min): 250 practical / 650 cyclic, 2-10 round bursts          Loader Type: Belt-feed (100-rd belts)          Ready/Stowed Rounds: INA          Elevation (°): INA          Fire on Move: Yes</p> <p><b>Auxiliary Weapon:</b> N/A</p>	<p><b>ATGM Launcher:</b> N/A  <b>Firing Ports:</b> 3 firing ports on each side, plus 1 for commander</p> <p><b>FIRE CONTROL</b>  <b>FCS Name:</b> N/A  <b>Main Gun Stabilization:</b> N/A  <b>Rangefinder:</b> N/A  <b>Infrared Searchlight:</b> Yes, on MG  <b>Sights w/Magnification:</b>          Gunner:            Day: Optical sight, INA                Field of View (°): INA                Acquisition Range (m): 1,500            Night: IR night sight on MG  <b>Commander Fire Main Gun:</b> No</p> <p><b>VARIANTS</b>  <b>BOV-M:</b> APC was produced in the republic of Slovenia. Some APCs have a 12.7-mm MG.  <b>BOV-VP:</b> Security version with metal grates on the sides which can be swung out to direct crowds.  <b>BOV-1/Polo M-83:</b> ATGM launcher vehicle w/6 x AT-3 launchers.  <b>BOV-3:</b> Air defense variant with 3 turret-mounted 20-mm cannon.  <b>BOV-30:</b> Air defense vehicle with 2 turret-mounted 30-mm cannon.  <b>BOV-SN ambulance:</b> Ambulance variant.  <b>LOV:</b> Croatian APC variant without the raised compartment, with a 12.7-mm MG, and optional increased hull protection. The family of LOV vehicles includes recon and NBC recon vehicles, command vehicle, rocket launcher, EW vehicle, and AA missile vehicle.</p> <p><b>MAIN ARMAMENT AMMUNITION</b>  <b>Caliber, Type, Name:</b>          7.62-mm API, API-T            Maximum Aimed Range (m): 1,500            Max Effective Range (m):              Day: 1,000/400-500 on the move              Night: INA            Tactical AA Range: INA            Armor Penetration (mm): 8 (RHA) at 500 m</p> <p><b>Other Ammunition Types:</b> Light Ball, Ball-T, Heavy Ball, Incendiary</p>	

### NOTES

The M86 MG is a license-built copy of the Russian PKT. Vehicle has central tire inflation system. Many vehicles have steel mesh screen over the windows.

## Russian Armored Transporter BTR-152

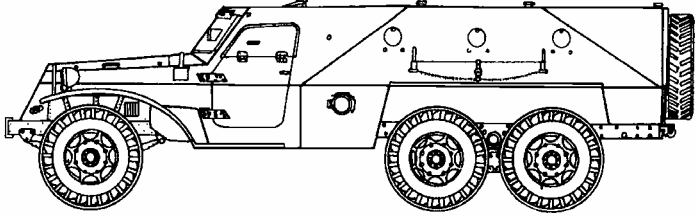
 <p style="text-align: center;">BTR-152V2 Variant</p>	<p><b>Weapons &amp; Ammunition Types</b></p> <p>7.62-mm SGMB MG Lt ball, ball-T, API</p> <p>or 12.7mm MG</p> <p><u>Optional in side mounts</u> 2x 7.62-mm SGMB MG Lt ball, ball-T, API</p>	<p><b>Typical Combat Load</b></p> <p style="text-align: center;">1,250</p> <p style="text-align: center;">1,250-1,750</p>
<p><b>SYSTEM</b>  <b>Alternative Designations:</b> BTR-140, Chinese Type 56  <b>Date of Introduction:</b> 1950  <b>Proliferation:</b> At least 20 countries  <b>Description:</b>  Crew: 2  Troop Capacity: 17  Combat Weight (mt): 9.0  Chassis Length Overall (m): 6.83  Height Overall (m): 2.04  Width Overall (m): 2.32  Ground Pressure (kg/cm<sup>2</sup>): 3.7  Drive Formula: 6 x 6</p> <p><b>Automotive Performance:</b>  Engine Type: 110-hp Gasoline  Cruising Range (km): 650  Speed (km/h):  Max Road: 65  Max Off-Road: INA  Average Cross-Country: INA  Max Swim: N/A  Fording Depths (m): 0.80  <b>Radio:</b> 10RT-12 or R-123</p> <p><b>Protection:</b>  Armor, Turret Front (mm): 11-15 on hull front (no turret)  Applique Armor (mm): Available  Explosive Reactive Armor (mm): N/A  Active Protective System: N/A  Mineclearing Equipment: N/A  Self-Entrenching Blade: N/A  NBC Protection System: N/A  Smoke Equipment: N/A</p> <p><b>ARMAMENT</b>  <b>Main Armament:</b> Note: 12.7-mm MG can be used instead.  Caliber, Type, Name: 7.62-mm (7.62x 54R) machinegun, SGMB  Rate of Fire (rd/min): 250 practical  Loader Type: Belt-fed  Ready/Stowed Rounds: 250 in box, 1,000 ready/0  Elevation (°): -6 to +23.5  Fire on Move: Yes</p> <p><b>Auxiliary Weapon:</b> (Optional)  Caliber, Type, Name: 2x 7.62-mm (7.62x 54R) machinegun, SGMB  Mount Type: Optional MGs on side pintel mounts  Maximum Aimed Range (m): 2,000</p>	<p>Max Effective Range (m):  Day: 1,000/ 400-500 on the move  Night: II sights available  Fire on Move: Yes  Rate of Fire (rd/min): 250 practical each/650 cyclic, 2-10 rd bursts  <b>ATGM Launcher:</b> N/A  <b>Firing Ports:</b> 3 on each side, 2 in rear doors</p> <p><b>FIRE CONTROL</b>  <b>FCS Name:</b> N/A  <b>Main Gun Stabilization:</b> N/A  <b>Rangefinder:</b> N/A  <b>Infrared Searchlight:</b> No  <b>Sights w/Magnification:</b>  Gunner:  Day: Optical sight  Field of View (°): INA  Acquisition Range (m): 2,000  Night: II and IR sights available  <b>Commander Fire Main Gun:</b> No</p> <p><b>VARIANTS</b>  <b>BTR-152:</b> Basic APC; many of which would later be covered and converted for other uses, such as ambulances, radio stations, and engineer vehicles. Versions for AA use include an Egyptian M53 gun (4x 12.7 mm) mount, and PLO-held ZU-23-2 gun mount.  <b>BTR-152A:</b> Anti-aircraft version with twin 14.5-mm MG turret  <b>BTR-152D and E:</b> Anti-aircraft versions with 4x 14.5-mm MGs  <b>BTR-152I:</b> BTR-152V version for artillery command vehicle.  <b>BTR-152K:</b> Version similar to <b>BTR-152V3</b> but with armored roof  <b>BTR-152V:</b> APC variant has central tire inflation system.  <b>BTR-152U:</b> Command vehicle with high rear structure  <b>BTR-152V1:</b> BTR-152V version with winch  <b>BTR-152V2:</b> BTR-152V version without winch  <b>BTR-152V3:</b> BTR-152V with winch and infrared driving lights</p> <p><b>MAIN ARMAMENT AMMUNITION</b>  <b>Caliber, Type, Name:</b>  7.62-mm API  Maximum Aimed Range (m): 2,000  Max Effective Range (m):  Day: 1,000  Night: INA  Tactical AA Range: 1,000  Armor Penetration (mm): 8 at 500 m</p> <p><b>Other Ammunition Types:</b> Light ball, ball-T, hvy ball, API-T, I-T</p>	

**NOTES**

Vehicles are early examples of armored transporters built from converted truck chassis (ZIL-151, and later ZIL-157)

## Russian Armored Personnel Carrier BTR-60PA

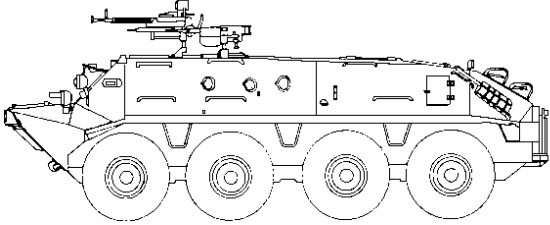
	<b>Weapons &amp; Ammunition Types</b>	<b>Typical Combat Load</b>
<p><b>SYSTEM</b>  <b>Alternative Designations:</b> BTR-60-PK  <b>Date of Introduction:</b> 1963  <b>Proliferation:</b> At least 30 countries (including variants)  <b>Description:</b>            Crew: 2            Troop Capacity: 12            Combat Weight (mt): 10.1            Chassis Length Overall (m): 7.22            Height Overall (m): 2.06            Width Overall (m): 2.82            Ground Pressure (kg/cm<sup>2</sup>): INA            Drive Formula: 8 x 8</p> <p><b>Automotive Performance:</b>            Engine Type: 2 x 180-hp Gasoline            Cruising Range (km): 500            Speed (km/h):                Max Road: 80                Max Off-Road: 60                Average Cross-Country: INA                Max Swim: 10            Fording Depths (m): Amphibious</p> <p><b>Radio:</b> INA</p> <p><b>Protection:</b>            Armor, Turret Front (mm): 7-9mm hull front (no turret)            Applique Armor (mm): N/A            Explosive Reactive Armor (mm): N/A            Active Protective System: N/A            Mineclearing Equipment: N/A            Self-Entrenching Blade: N/A            NBC Protection System: Collective            Smoke Equipment: N/A</p> <p><b>ARMAMENT</b>  <b>Main Armament:</b>            Caliber, Type, Name: 12.7-mm (12.7 x 108) heavy MG, DShK            Rate of Fire (rd/min): 80-100 (practical)            Loader Type: Belt feed            Ready/Stowed Rounds: INA            Elevation (°): -10/+80            Fire on Move: Yes</p> <p><b>Auxiliary Weapons:</b>            Caliber, Type, Name: 2 x 7.62-mm machinegun PKT            Mount Type: Vehicle top            Maximum Aimed Range (m): 1,500            Max Effective Range (m):                Day: 1,000                Night: N/A</p>	<p>12.7-mm DShK MG            APDS, API, API-T,            HE-T, HEI, I-T</p> <p>2 x 7.62-mm PKT MG            Lt Ball, Ball-T            API, API-T</p>	<p>500 250 250</p> <p>3,000</p>
	<p>Fire on Move: Yes            Rate of Fire (rd/min): 250 practical / 650 cyclic, in 2-10 rd bursts</p> <p><b>ATGM Launcher:</b> N/A  <b>Firing Ports:</b> 3 on each side</p> <p><b>FIRE CONTROL</b>  <b>FCS Name:</b> N/A  <b>Main Gun Stabilization:</b> N/A  <b>Rangefinder:</b> N/A  <b>Infrared Searchlight:</b> N/A  <b>Sights w/Magnification:</b>            Gunner:                Day: K10-T                    Field of View (°): INA                    Acquisition Range (m): 1,500 (est)                Night: N/A  <b>Commander Fire Main Gun:</b> No</p> <p><b>VARIANTS</b>            A variety of armament variants for the vehicle were used, including single 7.62-mm PKT MG, or 12.7-mm MG, or no MG.</p> <p>Artillery command and reconnaissance vehicles. ACRV <b>IV18</b> is a command and observation vehicle (COP). ACRV <b>IV19</b> is a fire direction center (FDC).</p> <p><b>BTR-60PB:</b> The most widely fielded variant has a one-man turret, a 14.5-mm KPVT MG, a coaxial 7.62-mm MG and day/night sights.</p> <p><b>BTR-60PBK:</b> Company commander variant with 3 additional radios</p> <p><b>BTR-60 PU:</b> Armored command vehicle (ACV) variant with a 10-m mast radio antenna and front-to-rear rail antenna for mobile use</p> <p><b>BTR-60 PU-12/-12M:</b> Air defense associated ACV and its upgrade</p> <p><b>BTR-60 R-975:</b> Forward air controller turreted variant.</p> <p><b>MTP-2:</b> Armored recovery vehicle</p> <p><b>R-145BM:</b> ACV with R-111, R-123, and R-130M radios and the distinctive Clothesline antenna</p>	

**Russian Armored Personnel Carrier BTR-60PA continued**

---

<p><b>MAIN ARMAMENT AMMUNITION</b> <b>Caliber, Type, Name:</b> 12.7-mm, APDS Chinese, Type 54 Maximum Aimed Range (m): 1,500 Max Effective Range (m): Day: 1,500 vehicles Night: N/A Tactical AA Range: 1,600 Armor Penetration (mm): INA</p> <p>12.7-mm, API/API-T Type 54 Maximum Aimed Range (m): 1,500 Max Effective Range (m): Day: 1,500 unarmored ground / 800 armored Night: N/A Tactical AA Range: 1,000 Armor Penetration (mm): INA</p>	<p><b>Other Ammunition Types:</b> Incendiary-T, HE-T Type MDZ, HEI Type ZP, Russian Duplex, Russian Duplex-T</p>
---	--

**NOTES**

This vehicle is a roofed variant of the BTR-60P open-hatch armored carrier. It is widely fielded in original and modified form. The APC has a top-mounted 12.7-mm MG forward of rectangular gunner's hatch. Where an additional two 7.62-mm MGs are mounted, they are right and left of the hatch. Because of space restriction, no more than one or two gunners can fit in the opening.

A notable vulnerability is that passengers have to exit the vehicle through top hatches, which makes them vulnerable to fires. Also, gunners must be at least shoulder high out of the vehicle to operate the weapons.

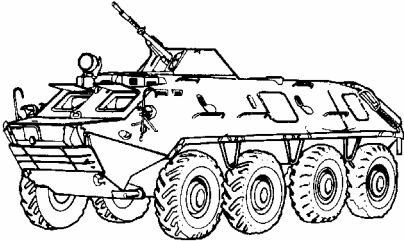

## Russian Armored Personnel Carrier BTR-60PB

	<b>Weapons &amp; Ammunition Types</b>	<b>Typical Combat Load</b>
<p><b>SYSTEM</b>  <b>Alternative Designations:</b> INA  <b>Date of Introduction:</b> 1966  <b>Proliferation:</b> At least 33 countries  <b>Description:</b>            Crew: 2            Troop Capacity: 8            Combat Weight (mt): 10.3            Chassis Length Overall (m): 7.22            Height Overall (m): 2.3            Width Overall (m): 2.82            Ground Pressure (kg/cm<sup>2</sup>): 0.90            Drive Formula: 8 x 8</p> <p><b>Automotive Performance:</b>            Engine Type: 2x 90-hp Gasoline            Cruising Range (km): 500            Speed (km/h): Max Road: 80                Max Off-Road: INA                Average Cross-Country: INA                Max Swim: 10            Fording Depths (m): Amphibious  <b>Radio:</b> R-123</p> <p><b>Protection:</b>            Armor, Turret Front (mm): 7            Applique Armor (mm): Available            Explosive Reactive Armor (mm): N/A            Active Protective System: N/A            Mineclearing Equipment: N/A            Self-Entrenching Blade: N/A            NBC Protection System: Collective            Smoke Equipment: N/A</p> <p><b>ARMAMENT</b>  <b>Main Armament:</b>            Caliber, Type, Name: 14.5-mm (14.5 x 114) heavy MG, KPVT            Rate of Fire (rd/min): 150 practical            Loader Type: Belt-fed            Ready/Stowed Rounds: 50/450            Elevation (°): -5 to +30            Fire on Move: Yes</p> <p><b>Auxiliary Weapon:</b>            Caliber, Type, Name: 7.62-mm machinegun, PKT            Mount Type: Coax</p>	<p><b>14.5-mm turret MG</b> API, API-T</p> <p><b>7.62-mm coax PKT MG</b> Light ball, Ball-T, API, API-T, I-T</p> <p>Maximum Aimed Range (m): 2,000            Max Effective Range (m):                Day: 1,000/ 400-500 on the move                Night: N/A            Fire on Move: Yes            Rate of Fire (rd/min): 250 practical/650 cyclic, 2-10 round bursts</p> <p><b>ATGM Launcher:</b> N/A  <b>Firing Ports:</b> 3 on each side</p> <p><b>FIRE CONTROL</b>  <b>FCS Name:</b> N/A  <b>Main Gun Stabilization:</b> N/A  <b>Rangefinder:</b> N/A  <b>Infrared Searchlight:</b> Yes  <b>Sights w/Magnification:</b>            Gunner:                Day: PP-61AM, 2.6x                    Field of View (°): 23                    Acquisition Range (m): 2,000                Night: N/A  <b>Commander Fire Main Gun:</b> No</p> <p><b>VARIANTS</b>  <b>BTR-60PBK:</b> Command APC variant, with three additional radios.  <b>BTR-60PB FAC:</b> Turreted forward air control variant without gun.</p> <p><b>BTR-60PZ:</b> Final production model, with 1PZ-2 roof-mounted periscope and high angle-of-fire turret.</p> <p><b>BTR-70:</b> Similar design with diesel engines and added side doors.  <b>BTR-80:</b> Similar design with many upgrades, including greater dimensions, larger side doors, high angle-of-fire turret, new radio, single more powerful diesel engine, smoke grenade launchers, etc.</p> <p><b>MAIN ARMAMENT AMMUNITION</b>  <b>Caliber, Type, Name:</b>            14.5-mm API-T                Maximum Aimed Range (m): 2,000                Max Effective Range (m):                    Day: 2,000                    Night: INA                Tactical AA Range: 1,400                Armor Penetration (mm): 20 at 1,000 m/ 30 at 500 m</p> <p><b>Other Ammunition Types:</b> API, I-T</p>	<p>500</p> <p>2,000</p>

### NOTES

The APC has self-sealing tires and a central tire inflation system. A vulnerability is that troops must dismount from the top. In Afghanistan a variety of weapons were used, such as the AGS-17 automatic grenade launcher instead of the main gun. Current options include several one-man turrets, such as the Modular Weapons Station (as on BTR-80A, with a 30-mm gun), or Kliver (with a 30-mm gun, 7.62-mm coax MG, thermal sights, superior day sights, and four Kornet ATGM launchers).

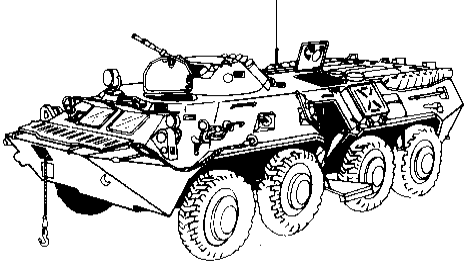

	<p><b>Weapons &amp; Ammunition Types</b></p> <p><b>14.5-mm turret MG</b> API, API-T</p> <p><b>7.62-mm coax PKT MG</b> Light ball, Ball-T, API, API-T, I-T</p>	<p><b>Typical Combat Load</b></p> <p><b>500</b></p> <p><b>2,000</b></p>
<p><b>SYSTEM</b>  <b>Alternative Designations:</b> GAZ-5903  <b>Date of Introduction:</b> 1984  <b>Proliferation:</b> At least 22 countries  <b>Description:</b>  Crew: 2  Troop Capacity: 8  Combat Weight (mt): 13.6  Chassis Length Overall (m): 7.55  Height Overall (m): 2.41  Width Overall (m): 2.95  Ground Pressure (kg/cm<sup>2</sup>): INA  Drive Formula: 8 x 8</p> <p><b>Automotive Performance:</b>  Engine Type: 260-hp Diesel  Cruising Range (km): 600  Speed (km/h): Max Road: 85  Max Off-Road: 60  Average Cross-Country: 40  Max Swim: 10  Fording Depths (m): Amphibious</p> <p><b>Radio:</b> R-173</p> <p><b>Protection:</b>  Armor, Turret Front (mm): Against 12.7mm  Applique Armor (mm): Available  Explosive Reactive Armor (mm): N/A  Active Protective System: N/A  Mineclearing Equipment: N/A  Self-Entrenching Blade: N/A  NBC Protection System: Collective  Smoke Equipment: 6 x 81-mm smoke grenade launchers</p> <p><b>ARMAMENT</b>  <b>Main Armament:</b>  Caliber, Type, Name: 14.5-mm (14.5 x 114) heavy MG, KPVT  Rate of Fire (rd/min): 150 practical  Loader Type: Belt-fed  Ready/Stowed Rounds: 50/450  Elevation (°): -4/+60  Fire on Move: Yes</p> <p><b>Auxiliary Weapon:</b>  Caliber, Type, Name: 7.62-mm machinegun, PKT  Mount Type: Coax  Maximum Aimed Range (m): 1,500</p>	<p>Max Effective Range (m):  Day: 1,000  Night: N/A  Fire on Move: Yes  Rate of Fire (rd/min): 250 practical/650 cyclic, 2-10 round bursts  <b>ATGM Launcher:</b> N/A  <b>Firing Ports:</b> 3 on each side</p> <p><b>FIRE CONTROL</b>  <b>FCS Name:</b> N/A  <b>Main Gun Stabilization:</b> N/A  <b>Rangefinder:</b> N/A  <b>Infrared Searchlight:</b> OU-3GA2M  <b>Sights w/Magnification:</b>  Gunner:  Day: 1P3-6, 1.2x/4x  Field of View (°): 49/14  Acquisition Range (m): 2,000  Night: N/A  <b>Commander Fire Main Gun:</b> No</p> <p><b>VARIANTS</b>  <b>BTR-80A:</b> IFV with a stabilized turret containing a 30-mm 2A42 (BMP-2) automatic gun, coax 7.62-mm MG, and TNP-3 day/night sights. This vehicle is in prototype and offered for export. The drop-in turret package is also offered for export. A BTR-80S variant includes the turret/fire control, but with 14.5-mm versus 30-mm gun.</p> <p><b>BTR-80K:</b> Command variant w/ added R-173, R-173P, and R-159 (portable) radios, R-174 intercom, navigation aids, and an 11-m mast</p> <p><b>1V152:</b> Artillery battalion command vehicle  <b>2S23:</b> 120-mm self-propelled combination gun (howitzer/mortar)  <b>BREM-K:</b> Armored recovery vehicle  <b>RKhM-4:</b> NBC reconnaissance vehicle  <b>UNSh:</b> Standardized expanded chassis for current variants, including <b>Kushetka-B</b> ACRV and BMM vehicle series.</p> <p><b>MAIN ARMAMENT AMMUNITION</b>  <b>Caliber, Type, Name:</b>  14.5-mm API-T  Maximum Aimed Range (m): 2,000  Max Effective Range (m):  Day: 2,000  Night: INA  Tactical AA Range: 1,500-2,000  Armor Penetration (mm): 20 at 1,000 m/ 30 at 500 m</p> <p><b>Other Ammunition Types:</b> API, I-T</p>	

**NOTES**

BTR-80 is superior to BTR-60/70 with a larger chassis, high-angle-of-fire turret, and single more powerful diesel engine (vs gasoline). Options include the Kliver turret with a 30-mm gun, 7.62-mm coax MG, thermal sights, superior day sights, and (four) Kornet ATGM launchers.

## Russian Armored Personnel Carrier BTR-80A

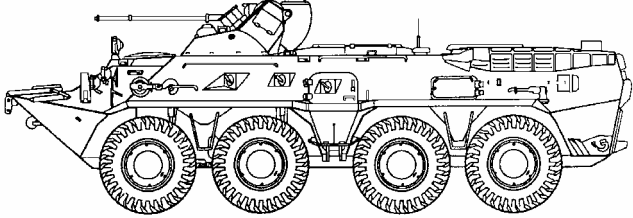
	<p><b>Weapons &amp; Ammunition Types</b></p> <p><b>30-mm automatic gun</b> HEI-T, Frag-HE-T AP-T, APDS-T, APFSDS-T</p> <p><b>7.62-mm coax MG</b></p>	<p><b>Typical Combat Load</b></p> <p><b>300</b></p> <p><b>2,000</b></p>
<p><b>SYSTEM</b> <b>Alternative Designations:</b> GAZ-59034 <b>Date of Introduction:</b> 1994 <b>Proliferation:</b> At least 3 countries <b>Description:</b> Crew: 2 Troop Capacity: 8 Combat Weight (mt): 14.6 Chassis Length Overall (m): 7.65 Height Overall (m): 2.80 Width Overall (m): 2.90 Ground Pressure (kg/cm<sup>2</sup>): INA Drive Formula: 8 x 8</p> <p><b>Automotive Performance:</b> Engine Type: 260-hp Diesel Cruising Range (km): 800 Speed (km/h): Max Road: 90 Max Off-Road: INA Average Cross-Country: INA Max Swim: 10 Fording Depths (m): Amphibious</p> <p><b>Radio:</b> R-163-50U VHF, R-163-UP receiver, R-174 intercom</p> <p><b>Protection:</b> Armor, Turret Front (mm): Can defeat 12.7-mm Applique Armor (mm): N/A Explosive Reactive Armor (mm): N/A Mineclearing Equipment: No Self-Entrenching Blade: N/A Active Protective System: N/A NBC Protection System: Collective Smoke Equipment: 6 x 81-mm smoke grenade launchers</p> <p><b>ARMAMENT</b> <b>Main Armament:</b> Caliber, Type, Name: 30-mm automatic gun, 2A72 Rate of Fire (rd/min): 200-330 variable cyclic in bursts Loader Type: Dual-belt feed Ready/Stowed Rounds: 300/0 Elevation (°): -5 to +70 Fire on Move: Yes</p> <p><b>Auxiliary Weapon:</b> Caliber, Type, Name: 7.62-mm machinegun PKT Mount Type: Coax Maximum Aimed Range (m): 1,500 Max Effective Range (m): Day: 1,000 Night: 800+</p>	<p>Fire on Move: Yes Rate of Fire (rd/min): 250 practical/650 cyclic, 2-10 round bursts</p> <p><b>ATGM Launcher:</b> N/A <b>Firing Ports:</b> 4 right side, 3 left side</p> <p><b>FIRE CONTROL</b> <b>FCS Name:</b> N/A <b>Main Gun Stabilization:</b> 2-plane <b>Rangefinder:</b> INA <b>Infrared Searchlight:</b> OU-5 <b>Sights w/Magnification:</b> Gunner: Day: 1P3-9, 1.2x/4x Field of View (°): 49/14 (est) Acquisition Range (m): 4,000 Night: TPN3-42 II/IR Field of View (°): INA Acquisition Range (m): 800 <b>Commander Fire Main Gun:</b> No</p> <p><b>VARIANTS</b> <b>BTR-80S:</b> APC has the same turret with 14.5-mm vs 30-mm gun.</p> <p><b>MAIN ARMAMENT AMMUNITION</b> <b>Caliber, Type, Name:</b> 30-mm APDS-T Maximum Aimed Range (m): INA Max Effective Range (m): Day: 2,000 Night: INA Tactical AA Range: 2,500 Armor Penetration (mm): 25 (RHA) at 1,500 m</p> <p>30-mm APFSDS-T, M929 Maximum Aimed Range (m): INA Max Effective Range (m): Day: 2,000+ Night: INA Tactical AA Range: 2,500 Armor penetration (mm): 55 (RHA) at 1,000 m/45 at 2,000 m</p> <p>30-mm Frag-HE Maximum Aimed Range (m): 4,000 Max Effective Range (m): Day: 4,000 Night: INA Tactical AA Range: 2,500 Armor Penetration (mm): INA</p> <p><b>Other Ammunition Types:</b> 30-mm AP-T, HEI-T</p>	

**NOTES**

The drop-in gun/turret package (Modular Weapon System) is offered for export, to upgrade a wide variety of vehicles to BTR-80A standard. BTR-80A can mount K1-126 bullet-resistant tires.

## Russian Airborne Armored Personnel Carrier BTR-D

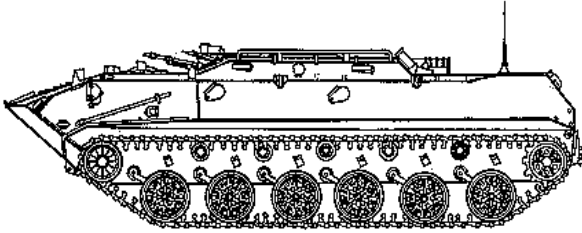
	<p><b>Weapons &amp; Ammunition Types</b></p> <p>2x 7.62-mm hatch MG Lt Ball, Ball-T, API, API-T, In- cendiary</p>	<p><b>Typical Combat Load</b></p> <p>2,000</p>
<p><b>SYSTEM</b>  <b>Alternative Designations:</b> BMD M1979  <b>Date of Introduction:</b> 1974  <b>Proliferation:</b> At least 1 country  <b>Description:</b>  Crew: 1  Troop Capacity: 12 passengers  Combat Weight (mt): 6.7  Chassis Length Overall (m): 5.88  Height Overall (m): 1.67  Width Overall (m): 2.63  Ground Pressure (kg/cm<sup>2</sup>): 0.5</p> <p><b>Automotive Performance:</b>  Engine Type: 240-hp Diesel  Cruising Range (km): 500  Speed (km/h):  Max Road: 61  Max Off-Road: 35  Average Cross-Country: INA  Max Swim: 10  Fording Depth (m): Amphibious</p> <p><b>Radio:</b> R-123</p> <p><b>Protection:</b>  Armor, Turret Front (mm): "Antibullet" (7.62-mm)  Applique Armor (mm): N/A  Explosive Reactive Armor (mm): N/A  Mineclearing Equipment: N/A  Self-Entrenching Blade: N/A  Active Protective System: No  NBC Protection System: Yes  Smoke Equipment: 2x2 forward firing smoke grenade launchers  Vehicle engine exhaust smoke system (VEESS)</p> <p><b>ARMAMENT</b>  <b>Main Armament:</b>  Caliber, Type, Name: 7.62-mm (7.62 x 54R) machinegun, PKT  Rate of Fire (rd/min): 250 practical / 650 cyclic, in 2-10 round bursts  Loader Type: Belt-fed  Ready/Stowed Rounds: INA  Elevation (°): INA  Fire on Move: Yes</p> <p><b>Auxiliary Weapon:</b> N/A</p>	<p><b>ATGM Launcher:</b> N/A  <b>Firing Ports:</b> 2 on each side, 1 in left rear door, permit two 5.45-mm RPK-74 light machineguns to be used.</p> <p><b>FIRE CONTROL</b>  <b>FCS Name:</b> N/A  <b>Main Gun Stabilization:</b> N/A  <b>Rangefinder:</b> N/A  <b>Infrared Searchlight:</b> N/A  <b>Sights w/Magnification:</b> Open, 1x  <b>Commander Fire Main Gun:</b> No</p> <p><b>VARIANTS</b>  <b>1V118 Reostat/1V119 Spektr:</b> Artillery command and observation posts for amphibious and airborne forces.  <b>2S9:</b> 120-mm self-propelled combination gun, with a turreted breech-loaded mortar/howitzer system.  <b>BMD-KShM:</b> Former Soviet regiment or division command and staff variant, with large Clothes-line antenna.  <b>BREM-D:</b> Armored repair and recovery variant.  <b>BTR-RD/Robot:</b> An ATGM variant (AT-4/-5) with 2 launchers, dismounted or mounted on pintles for vehicle launch.  <b>BTR-ZD:</b> Air defense variant with porteeed or towed ZU-23 twin 23-mm air defense gun. Vehicle also carries manpad SAM launchers.  <b>BTR-3D:</b> Air defense variant with a rear-mounted ZU-23 gun.  <b>Sterkh (Malakit/Shmel):</b> UAV transporter and launcher vehicle.</p> <p><b>MAIN ARMAMENT AMMUNITION</b>  <b>Caliber, Type, Name:</b>  7.62-mm API  Maximum Aimed Range (m): 1,500  Max Effective Range (m):  Day: 1,000 m / 400-500 on the move  Night: INA  Tactical AA Range: INA  Armor Penetration (mm): 8 (RHA) at 500 m</p> <p><b>Other Ammunition Types:</b> 7.62-mm Light Ball, Ball-T, Heavy Ball, API, API-T, Incendiary</p>	

### NOTES

BTR-D is a variant of the BMD-1, with an additional road wheel, with the turret removed, and with a raised hatch area. The vehicle can be parachute landed with airborne troops. The BTR-Ds in grenade launcher units will carry one AGS-17 30-mm AGL in the rear. Options include the Kliver turret with a 30-mm gun, 7.62-mm coax MG, thermal sights, superior day sights, and (four) Kornet ATGM launchers.

## US Armored Personnel Carrier M113A1

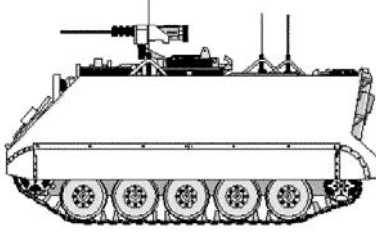
	<p><b>Weapons &amp; Ammunition Types</b></p> <p><b>.50 cal cupola MG</b> Slap, API, API-T, Ball, Ball-T, Incendiary, I-T</p>	<p><b>Typical Combat Load</b></p> <p style="text-align: center;"><b>2,000</b></p>
<p><b>SYSTEM</b>  <b>Alternative Designations:</b> INA  <b>Date of Introduction:</b> 1964  <b>Proliferation:</b> At least 46 countries  <b>Description:</b>  Crew: 2  Troop Capacity: 11 passengers  Combat Weight (mt): 11.20  Chassis Length Overall (m): 4.90  Height Overall (m): 1.80  Width Overall (m): 2.70  Ground Pressure (kg/cm<sup>2</sup>): .55</p> <p><b>Automotive Performance:</b>  Engine Type: 215-hp Diesel  Cruising Range (km): 483  Speed (km/h):      Max Road: 64      Max Off-Road: INA      Average Cross-Country: INA      Max Swim: 5.8  Forcing Depths (m): Amphibious</p> <p><b>Radio:</b> Various, including intercom</p> <p><b>Protection:</b>  Armor, Turret Front (mm): N/A—No turret  Applique Armor (mm): Yes—anti-mine armor on bottom  Explosive Reactive Armor (mm): Available  Active Protective System: N/A  Mineclearing Equipment: N/A  Self-Entrenching Blade: N/A  NBC Protection System: N/A  Smoke Equipment: N/A</p> <p><b>ARMAMENT</b>  <b>Main Armament:</b>  Caliber, Type, Name: .50 cal (12.7 x 99) heavy machinegun, M2HB  Rate of Fire (rd/min): 450-550 cyclic  Loader Type: Belt feed  Ready/Stowed Rounds: 250/1750  Elevation (°): -20/+60  Fire on Move: Yes</p> <p><b>Auxiliary Weapon:</b> N/A  <b>ATGM Launcher:</b> N/A  <b>Firing Ports:</b> None</p> <p><b>FIRE CONTROL</b>  <b>FCS Name:</b> N/A</p>	<p><b>Main Gun Stabilization:</b> N/A  <b>Rangefinder:</b> N/A  <b>Infrared Searchlight:</b> N/A  <b>Sights w/Magnification:</b>  Gunner:      Day: Open ladder sight, 1x          Field of View (°): INA          Acquisition Range (m): 2,000      Night: N/A  <b>Commander Fire Main Gun:</b> No</p> <p><b>VARIANTS</b>  More than 100 variants have been produced in numerous countries, with 7.62-mm MGs, 40-mm automatic grenade launchers, 90-mm recoilless rifles, and turrets with 20-to-76-mm cannons. The following are US variants. Command variants are <b>M577</b> and <b>M114</b> (C&amp;R). Self-propelled mortars are <b>M125</b> (81-mm) and <b>M106A2</b> (4.2-inch). The <b>M901/ITV</b> ATGM launcher vehicle is a common variant. The <b>M163</b> SP air defense gun has a 20-mm Vulcan cannon; and <b>M730</b> is a Chapparral AD missile launcher. Other variants include ambulances, recovery and engineer vehicles.</p> <p><b>M113A2:</b> This multi-national variant features mobility improvements. One version is being developed with the Giat TS90 90-mm cannon. <b>M113A3:</b> Changes for this multi-national variant include a new power train and increased armor protection.</p> <p><b>AIFV:</b> The multi-national IFV variant has M113A3 armor upgrades, a stabilized turret with 25-mm gun, and a 7.62-mm MG.</p> <p><b>VCC-1:</b> Italian M113 copies are supplemented by this variant</p> <p><b>MAIN ARMAMENT AMMUNITION</b>  <b>Caliber, Type, Name:</b>  .50 SLAP (sabot light armor penetrator)      Maximum Aimed Range (m): 2,000      Max Effective Range (m):          Day: 2,000          Night: INA      Armor Penetration (mm): INA</p> <p>.50 Cal Ball      Maximum Aimed Range (m): 2,000      Max Effective Range (m):          Day: 1,000          Night: N/A      Armor Penetration (mm): INA</p> <p><b>Other Ammunition Types:</b> Ball-T, Incendiary, I-T, API, API-T</p>	

**NOTES**

The M113A1 is a variant of the gasoline-powered **M113**. Armors available include Rafael Enhanced Add-on Armor Kit (EAAK), Creusot-Marrel plate armor, and SNPE explosive reactive armor. Thermal and TV sights are also available.

## Russian Light Armored Multi-purpose Vehicle MT-LB

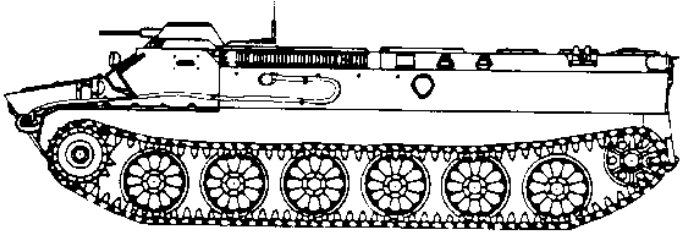
	<p><b>Weapons &amp; Ammunition Types</b></p> <p>7.62-mm Turret MG Lt Ball, Ball-T, API, API-T, Incendiary</p>	<p><b>Typical Combat Load</b></p> <p>2,000</p>
<p><b>SYSTEM</b>  <b>Alternative Designations:</b> MT-LB-T  <b>Date of Introduction:</b> 1970, modernized in 1995  <b>Proliferation:</b> At least 9 countries  <b>Description:</b>  Crew: 2  Troop Capacity: 11 passengers  Combat Weight (mt): 11.9  Chassis Length Overall (m): 6.35  Height Overall (m): 1.87  Width Overall (m): 2.85  Ground Pressure (kg/cm<sup>2</sup>): 0.46 standard track / 0.28 wide track</p> <p><b>Automotive Performance:</b>  Engine Type: 290-hp Diesel  Cruising Range (km): 500  Speed (km/h):      Max Road: 61.5/70 modernized      Max Off-Road: 30/45 modernized      Average Cross-Country: INA      Max Swim: 5-6  Forcing Depth (m): Amphibious</p> <p><b>Radio:</b> R-123 or upgrade to -123M/-173</p> <p><b>Protection:</b>  Armor, Turret Front (mm): 7-14  Applique Armor (mm): N/A  Explosive Reactive Armor (mm): INA  Active Protective System: N/A  Mineclearing Equipment: N/A  Self-Entrenching Blade: Yes  NBC Protection System: Collective  Smoke Equipment: N/A</p> <p><b>ARMAMENT</b>  <b>Main Armament(s):</b>  Caliber, Type, Name: 7.62-mm (7.62x 54R) machinegun, PKT  Rate of Fire (rd/min): 250 practical / 650 cyclic, 2-10 round bursts  Loader Type: Belt-feed  Ready/Stowed Rounds: INA  Elevation (°): -5/ +35  Fire on Move: Yes</p> <p><b>Auxiliary Weapon:</b> N/A  <b>ATGM Launcher:</b> N/A</p>	<p><b>Firing Ports:</b> 1 on each side and 1 in each rear door.</p> <p><b>FIRE CONTROL</b>  <b>FCS Name:</b> INA  <b>Main Gun Stabilization:</b> N/A  <b>Rangefinder:</b> N/A  <b>Infrared Searchlight:</b> N/A  <b>Sights w/Magnification:</b>  Gunner:      Day: PP-61AM, 2.6x          Field of View (°): 23          Acquisition Range (m): 1,500 (est)      Night: N/A  <b>Commander Fire Main Gun:</b> No</p> <p><b>VARIANTS</b>  <b>MT-LB Upgrade:</b> 1995 upgrade includes improved steering and a new engine.  <b>2S1:</b> 122-mm self-propelled howitzer.  <b>9P149/Shturm-S:</b> ATGM launcher vehicle with AT-6 autoloader.  <b>MT-LB "blade":</b> Dozer version with a blade attached to the vehicle.  <b>MT-LBu:</b> Expanded variant for artillery command and reconnaissance vehicles (ACRVs) and other uses.  <b>MT-LBV:</b> Arctic variant with .57m wide track for snow and improved flotation.  <b>MTP-LB:</b> Technical support vehicle.  <b>MT-SON:</b> Ground surveillance radar vehicle with Pork Trough/SNAR-2 radar.  <b>RKhM:</b> Chemical reconnaissance vehicle.  <b>SA-13:</b> Regimental surface-to-air missile launcher vehicle.  <b>SNAR-10:</b> Ground surveillance radar vehicle with Big Fred radar.</p> <p><b>MAIN ARMAMENT AMMUNITION</b>  <b>Caliber, Type, Name:</b>  7.62-mm API, API-T  Maximum Aimed Range (m): 1,500  Max Effective Range (m):      Day: 1,000/400-500 on the move      Night: INA  Tactical AA Range: INA  Armor Penetration (mm): 8 (RHA) at 500 m</p> <p><b>Other Ammunition Types:</b> Light Ball, Ball-T, Heavy Ball, Incendiary</p>	

### NOTES

Russian AG-17 30-mm automatic grenade launcher modification is available for use on MT-LB.

Russian KBP offers a drop-in one-man turret, called Kliver, with a stabilized 2A72 30-mm gun, a 4 Kornet ATGM launcher, thermal sights, and improved fire control system.

**Austrian Armored Personnel Carrier Pandur**

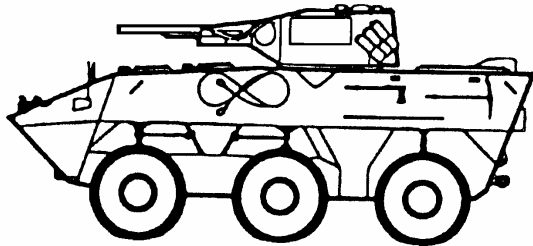
 <p>Sketch of MICV 1/127 APC</p>	<p><b>Weapons &amp; Ammunition Types</b></p> <p><b>12.7mm MG, M2HB</b> SLAP, API, API-T, Ball, Ball-T, Incend, I-T</p> <p><b>7.62-mm MG, FN-MAG</b> Ball-T, API, API-T</p>	<p><b>Typical Combat Load</b></p> <p><b>1,000</b></p> <p><b>1,600</b></p>
<p><b>SYSTEM</b>  <b>Alternative Designations:</b> System featured is MICV 1/127 version  <b>Date of Introduction:</b> 1996  <b>Proliferation:</b> At least 3 countries, 2 more to follow, and the UN  <b>Description:</b>          Crew: 3          Troop Capacity: 8-9          Combat Weight (mt): 11.3          Chassis Length Overall (m): 5.70          Height Overall (m): 2.64 top of cupola          Width Overall (m): 2.50          Ground Pressure (kg/cm<sup>2</sup>): INA          Drive Formula: 6 x 6</p> <p><b>Automotive Performance:</b>          Engine Type: 210-hp Diesel/265-hp in upgrade          Cruising Range (km): 650          Speed (km/h):            Max Road: 105            Max Off-Road: INA            Average Cross-Country: INA            Max Swim: 9/11 with Amphibious Vehicle          Fording Depths (m): 1.2</p> <p><b>Radio:</b> INA</p> <p><b>Protection:</b>          Armor, Turret Front (mm): 12.7-mm on front 30°, 7.62-mm other          Applique Armor (mm): Add-on protection to 14.5 mm available          Explosive Reactive Armor (mm): N/A          Active Protective System: N/A          Mineclearing Equipment: N/A          Self-Entrenching Blade: N/A          NBC Protection System: Yes          Smoke Equipment: 6-12 smoke grenade launchers</p> <p><b>ARMAMENT</b>  <b>Main Armament:</b> Note:          Caliber, Type, Name: .50 cal (12.7 x 99) heavy MG, M2HB          Rate of Fire (rd/min): 450-550 cyclic          Loader Type: Belt-fed          Ready/Stowed Rounds: 250 /750          Elevation (°): -15 to +50          Fire on Move: Yes</p> <p><b>Auxiliary Weapon:</b>          Caliber, Type, Name: 7.62-mm (7.62 x 51) machinegun, FN-MAG          Mount Type: Turret/cupola mount          Maximum Aimed Range (m): 2,000</p>	<p>Max Effective Range (m):          Day: 1,500          Night: II sights available          Fire on Move: Yes          Rate of Fire (rd/min): 250 practical each/650-1000 cyclic, in bursts  <b>ATGM Launcher:</b> N/A  <b>Firing Ports:</b> 2 on each side, for several APC variants.</p> <p><b>FIRE CONTROL</b>  <b>FCS Name:</b> N/A  <b>Main Gun Stabilization:</b> N/A  <b>Rangefinder:</b> N/A  <b>Infrared Searchlight:</b> No  <b>Sights w/Magnification:</b>          Gunner:            Day: Optical sight, Swarovski F-450, 2x            Field of View (°): INA            Acquisition Range (m): 2,000            Night: II and IR sights available, thermal for cannon variants  <b>Commander Fire Main Gun:</b> No</p> <p><b>VARIANTS</b>          Pandur offers a wide variety of configurations on a modern 6x6 vehicle chassis, with weights varying 9-15t. Base vehicle is the APC, with flat hull top and 2- and 3-step hull top configurations. A recent variant is <b>Amphibious Vehicle</b>, stretch flat-hull APC with slab sides and minimal preparation time for amphibious operation. Options include 1-3 cupolas and/or drop-in turrets with weapons: 7.62- and/or 12.7-mm MGs, 25-, 30-, or 35-mm autocannon, 40-mm AGL, and 90-mm cannon. Other variants include recon, fire support, TOW, Hell-fire, and HOT ATGM launchers, engineer, command and control, NBC, ambulance, mortar, and logistics vehicles. A recent 8x8 fire support chassis prototype was displayed with a 105-mm gun.</p> <p><b>MAIN ARMAMENT AMMUNITION</b>  <b>Caliber, Type, Name:</b>          .50 cal SLAP            Maximum Aimed Range (m): 2,000            Max Effective Range (m):              Day: 2,000              Night: INA            Armor Penetration (mm): INA</p> <p>.50 cal Ball            Maximum Aimed Range (m): 2,000            Max Effective Range (m):              Day: 1,000              Night: INA            Armor Penetration (mm): INA</p> <p><b>Other Ammunition Types:</b> Ball-T, API, API-T, Incendiary, I-T</p>	

**NOTES**

A spall liner and mine protection carpet are included on the APC.



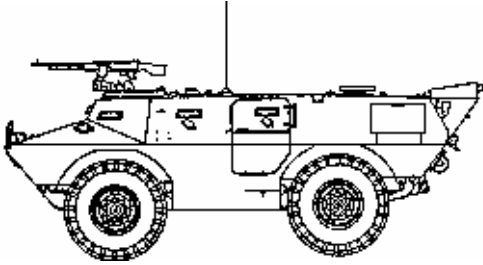

## US Armored Personnel Carrier V-150

	<p><b>Weapons &amp; Ammunition Types</b></p> <p>7.62-mm cupola MG Ball-T, Match API, API-T</p>	<p><b>Typical Combat Load</b></p> <p>3,200</p>
<p><b>SYSTEM</b>  <b>Alternative Designations:</b> Commando  <b>Date of Introduction:</b> 1971  <b>Proliferation:</b> At least 20 countries  <b>Description:</b>          Crew: 3          Troop Capacity: 2          Combat Weight (mt): 9.89          Chassis Length Overall (m): 5.69          Height Overall (m): 1.98          Width Overall (m): 2.26          Ground Pressure (kg/cm<sup>2</sup>): INA          Drive Formula: 4 x 4</p> <p><b>Automotive Performance:</b>          Engine Type: 202-hp Diesel          Cruising Range (km): 643          Speed (km/h):              Max Road: 89              Max Off-Road: INA              Average Cross-Country: INA              Max Swim: 5          Fording Depth (m): Amphibious</p> <p><b>Radio:</b> INA</p> <p><b>Protection:</b>          Armor, Turret Front (mm): Against 7.62-mm ball          Applique Armor (mm): N/A          Explosive Reactive Armor (mm): N/A          Mineclearing Equipment: N/A          Self-Entrenching Blade: N/A          Active Protective System: N/A          NBC Protection System: N/A          Smoke Equipment: Optional</p> <p><b>ARMAMENT</b>  <b>Main Armament:</b>          Caliber, Type, Name: 7.62-mm (7.62 x 51) MG, FN-MAG (example)          Rate of Fire (rd/min): 650-1000 cyclic          Loader Type: Belt feed, box magazines          Ready/Stowed Rounds: INA          Elevation (°): INA          Fire on Move: Yes</p> <p><b>Auxiliary Weapon:</b> N/A</p>	<p><b>ATGM Launcher:</b> N/A  <b>Firing Ports:</b> None</p> <p><b>FIRE CONTROL</b>  <b>FCS Name:</b> N/A  <b>Main Gun Stabilization:</b> N/A  <b>Rangefinder:</b> N/A  <b>Infrared Searchlight:</b> N/A  <b>Sights w/Magnification:</b>          Gunner:              Day: Open ladder sight                  Field of View (°): INA                  Acquisition Range (m): 2,000              Night: N/A</p> <p><b>Commander Fire Main Gun:</b> No</p> <p><b>VARIANTS</b>          Armament options vary widely and include: a turret with 7.62-mm or 12.7-mm MG or turrets with 20-mm, 25-mm, 30-mm, 76-mm, or 90-mm gun. Another turret offers a 12.7-mm MG and 40-mm grenade launcher. An 81-mm self-propelled mortar launcher variant and a TOW ATGM launcher variant are available. Variants include a cargo carrier, police and security vehicles, an air defense variant with 20-mm Vulcan cannon.</p> <p><b>V-100:</b> This earlier 4x4 APC has a gasoline engine.</p> <p><b>V-150S:</b> This slightly larger 4x4 variant has improved drive train and the above variety of turret and gun options. A Commando command variant includes a raised compartment area with external-mount 7.62-mm MG. Taiwan has versions with an open-mount 12.7-mm MG and a 107-mm (4.2 inch) mortar.</p> <p><b>V-200:</b> Variant sold to Singapore with 20-mm turret, 90-mm turret, air defense variant with RBS-70 surface-to-air missile and a recovery variant. Another variant has a 120-mm mortar.</p> <p><b>MAIN ARMAMENT AMMUNITION</b>          Caliber, Type, Name: 7.62-mm Ball, NATO          Maximum Aimed Range (m): 2,000 (est)          Max Effective Range (m):              Day: 1,500              Night: INA          Tactical AA Range: INA          Armor Penetration (mm): INA</p> <p><b>Other Ammunition Types:</b> Ball-T, API, API-T, Match</p>	

**NOTES**

The baseline V-150 is equipped with a variety of pintle-mounted 7.62-mm machineguns. Many MGs are installed by user countries from their inventories. The Belgian FN-MAG general purpose MG is a widely used MG that represents a common capability.

## North Korean Armored Personnel Carrier VTT-323

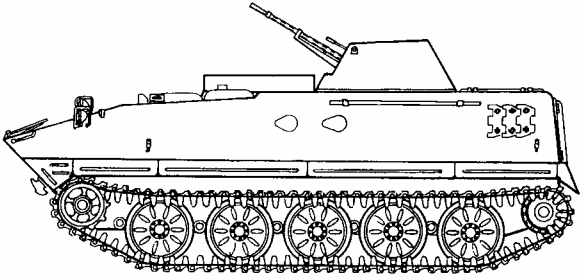
	<table border="1"> <thead> <tr> <th>Weapons &amp; Ammunition Types</th> <th>Typical Combat load</th> </tr> </thead> <tbody> <tr> <td><b>2 x 14.5-mm KPVT MG</b></td> <td><b>1,000</b></td> </tr> <tr> <td>API, API-T</td> <td>500</td> </tr> <tr> <td>HE-T</td> <td>500</td> </tr> <tr> <td>*AT Vehicle</td> <td></td> </tr> <tr> <td><b>AT-3-Type ATGM</b></td> <td><b>4</b></td> </tr> <tr> <td>HEAT</td> <td></td> </tr> <tr> <td>HE</td> <td></td> </tr> <tr> <td><b>SA-7/-14/16 MANPAD</b></td> <td><b>2</b></td> </tr> </tbody> </table>	Weapons & Ammunition Types	Typical Combat load	<b>2 x 14.5-mm KPVT MG</b>	<b>1,000</b>	API, API-T	500	HE-T	500	*AT Vehicle		<b>AT-3-Type ATGM</b>	<b>4</b>	HEAT		HE		<b>SA-7/-14/16 MANPAD</b>	<b>2</b>	
Weapons & Ammunition Types	Typical Combat load																			
<b>2 x 14.5-mm KPVT MG</b>	<b>1,000</b>																			
API, API-T	500																			
HE-T	500																			
*AT Vehicle																				
<b>AT-3-Type ATGM</b>	<b>4</b>																			
HEAT																				
HE																				
<b>SA-7/-14/16 MANPAD</b>	<b>2</b>																			
<p><b>SYSTEM</b>  <b>Alternative Designations:</b> M1973  <b>Date of Introduction:</b> 1973  <b>Proliferation:</b> At least one country</p> <p><b>Description:</b>  Crew: 3  Troop Capacity: 9 passengers  Combat Weight (mt): 13.5  Length Overall (m): 6.20  Height Overall (m): 2.50  Width Overall (m): 3.06  Ground Pressure (kg/cm<sup>2</sup>): 0.58</p> <p><b>Automotive Performance:</b>  Engine Type: 260-hp Diesel  Cruising Range (km): 450  Speed (km/h):      Max Road: 80      Max Off-Road: 70-80      Average Cross-Country: INA      Max Swim: 10  Fording Depths (m): Amphibious  <b>Radio:</b> INA</p> <p><b>Protection:</b>  Armor, Turret Front (mm): 24  Applique Armor (mm): No  Explosive Reactive Armor (mm): No  Active Protective System: No  NBC Protection System: No  Smoke Equipment: No</p> <p><b>ARMAMENT</b>  <b>Main Armament:</b>  Caliber, Type, Name: 2 x 14.5-mm (14.5x114) Heavy MGs, KPVT  Rate of Fire (rd/min): 300 practical (2 x 150)  Loader Type: Belt  Ready/Stowed Rounds: INA  Elevation (°): -5 to +60  Fire on Move: Yes  <b>Auxiliary Weapon:</b> None  <b>Firing Ports:</b> 2 on each side</p> <p><b>ATGM Launcher:</b>  Name: 9P111-type  Launch Method: Rail-launched  Guidance: MCLOS  Command Link: Wire  Launcher Dismountable: Yes</p>	<p><b>FIRE CONTROL</b>  <b>FCS Name:</b> No  <b>Main Gun Stabilization:</b> No (est.)  <b>Rangefinder:</b> No  <b>Infrared Searchlight:</b> No  <b>Sights w/Magnification:</b>  Gunner:      Day: INA      Field of View (°): INA      Acquisition Range (m): 1,500      Night: INA  <b>Commander Fire Main Gun:</b> No</p> <p><b>VARIANTS</b>  North Korean variant of Chinese YW 531A/ Type 63-II APC. An AT variant also mounts an AT-3-type ATGM launcher, and may include a SA-14 or SA-16 manportable air defense launcher.</p> <p>Other vehicles using the chassis are the <b>PT-85</b> light tank, a 120-mm combination gun, a 122-mm SP howitzer, 107-mm MRLs (12/18/24 tubes), a 4-barreled 14.5-mm SP AA Gun, the M1985 (AT-3-type 4-rail) ATGM launcher vehicle, and 82- and 120-mm SP mortars.</p> <p><b>MAIN ARMAMENT AMMUNITION</b>  <b>Caliber, Type, Name:</b> 14.5-mm API-T  Max Aimed Range (m): 2,000 (EST)  Max Effective Range (m):      Day: 1,500      Night: INA  Tactical AA Range: 1,500  Armor Penetration (mm): 20 at 1,000 m/ 30 at 500 m, 38 at muzzle  <b>Other Ammunition Types:</b> API, I-T, HE-T Type MDZ</p> <p><b>ANTITANK GUIDED MISSILES</b> See AT-3 for ATGM types.  <b>Name:</b> AT-3c Imp/ Polk (Slovenian)  Warhead Type: Tandem HEAT  Armor Penetration (mm): 580 (RHA)  Range (m): 3,000</p> <p><b>Name:</b> Red Arrow-73A (Chinese)  Warhead Type: HEAT  Armor Penetration (mm): 500 RHA  Range (m): 3,000</p> <p><b>Name:</b> Red Arrow-73B/C (Chinese)  Warhead Type: HEAT  Armor Penetration (mm): 600 RHA  Range (m): 3,000</p> <p><b>Other ATGMs:</b> I-RAAD (Iranian), Malyutka-2 HE (Russian)</p>																			

### NOTES

Thermal sights are available. Slovenian TS-M ATGM thermal night sight ranges are: detection 4,500 m, recognition 2,000 m. The HE-Blast ATGM is used for killing personnel and destroying bunkers and other fortifications.

## Chinese Armored Personnel Carrier WZ 551

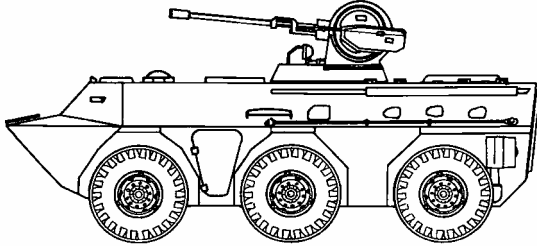
	<p><b>Weapons &amp; Ammunition Types</b></p> <p>25-mm automatic gun API HE</p> <p>7.62-mm coax MG</p>	<p><b>Typical Combat Load</b></p> <p>*400 200 200</p> <p>1,000</p> <p>*mix estimate</p>
	<p>APC w/25-mm gun</p>	
<p><b>SYSTEM</b></p> <p><b>Alternative Designations:</b> M1986/1, M1986/2, Type 86</p> <p><b>Date of Introduction:</b> 1994</p> <p><b>Proliferation:</b> At least 3 countries</p> <p><b>Description:</b></p> <p>Crew: 3</p> <p>Troop Capacity: 10</p> <p>Combat Weight (mt): 15.3</p> <p>Chassis Length Overall (m): 6.63</p> <p>Height Overall (m): 2.89</p> <p>Width Overall (m): 2.80</p> <p>Ground Pressure (kg/cm<sup>2</sup>): INA</p> <p>Drive Formula: 6 x 6</p> <p><b>Automotive Performance:</b></p> <p>Engine Type: 256-hp Diesel</p> <p>Cruising Range (km): 600</p> <p>Speed (km/h):</p> <p>Max Road: 85</p> <p>Max Off-Road: INA</p> <p>Average Cross-Country: INA</p> <p>Max Swim: 8</p> <p>Fording Depths (m): Amphibious</p> <p><b>Radio:</b> INA</p> <p><b>Protection:</b></p> <p>Armor, Turret Front (mm): INA</p> <p>Applique Armor (mm): N/A</p> <p>Explosive Reactive Armor (mm): N/A</p> <p>Mineclearing Equipment: No</p> <p>Self-Entrenching Blade: No</p> <p>Active Protective System: N/A</p> <p>NBC Protection System: Collective</p> <p>Smoke Equipment: 8 smoke grenade launchers</p> <p><b>ARMAMENT</b></p> <p><b>Main Armament:</b></p> <p>Caliber, Type, Name: 25-mm automatic overhead turreted gun</p> <p>Rate of Fire (rd/min): 100/300/500 in bursts, or semi-automatic</p> <p>Loader Type: Drum feed</p> <p>Ready/Stowed Rounds: 200/ 200</p> <p>Elevation (°): -8 to +55</p> <p>Fire on Move: Yes, reduced range (est.)</p> <p><b>Auxiliary Weapon:</b></p> <p>Caliber, Type, Name: 7.62-mm machinegun PKT</p> <p>Mount Type: Coax</p> <p>Max Aimed Range (m): 2,000</p>	<p>Max Effective Range (m):</p> <p>Day: 1,000</p> <p>Night: 800+</p> <p>Fire on Move: Yes</p> <p>Rate of Fire (rd/min): 250 practical/ 650 cyclic, 2-10 round bursts</p> <p><b>ATGM Launcher:</b> N/A</p> <p><b>Firing Ports:</b> 4</p> <p><b>FIRE CONTROL</b></p> <p><b>FCS Name:</b> N/A</p> <p><b>Main Gun Stabilization:</b> INA</p> <p><b>Rangefinder:</b> INA</p> <p><b>Infrared Searchlight:</b> IR sight w/searchlight optional</p> <p><b>Sights w/Magnification:</b></p> <p>Gunner: Day/night sight</p> <p>Day: INA</p> <p>Field of View (°): INA</p> <p>Acquisition Range (m): INA</p> <p>Night: II</p> <p>Field of View (°): INA</p> <p>Acquisition Range (m): INA</p> <p><b>Commander Fire Main Gun:</b> No</p> <p><b>VARIANTS</b></p> <p>Other versions include APCs with other 25-mm guns, and with 12.7-mm machinegun. There are also IFV variants with the Dragar 1-man turret and 25-mm gun, and the BMP-1 turret with 73-mm gun. Other vehicle types include: C3 vehicle, ambulance, and an engineer vehicle. The ATGM launcher vehicle variants launch Red Arrow-8E (HJ-8E), and the new Red Arrow-9 (HJ-9) ATGM.</p> <p><b>MAIN ARMAMENT AMMUNITION</b></p> <p><b>Caliber, Type, Name:</b> 25-mm API</p> <p>Max Aimed Range (m): INA</p> <p>Max Effective Range (m):</p> <p>Day: 2,000 (est.)</p> <p>Night: INA</p> <p>Tactical AA Range: 2,000 (est)</p> <p>Armor Penetration (mm): INA</p> <p><b>Caliber, Type, Name:</b> 25-mm HE</p> <p>Max Aimed Range (m): INA</p> <p>Max Effective Range (m):</p> <p>Day: 2,000+ (est)</p> <p>Night: INA</p> <p>Tactical AA Range: 2,000 (est)</p> <p>Armor penetration (mm): INA</p> <p><b>Other Ammunition Types:</b> INA</p>	

**NOTES**

The tires have run-flat capability.

# Chinese Armored Personnel Carrier YW 531A/531C

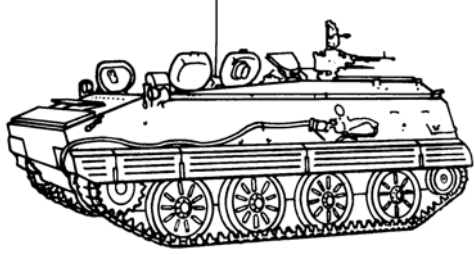
 <p style="text-align: right;">YW 531 Baseline APC</p>	<p><b>Weapons &amp; Ammunition Types</b></p> <p><b>12.7-mm MG</b> APDS, API, API-T, HE-T, HEI</p>	<p><b>Typical Combat Load</b></p> <p><b>1,120</b> 500 620</p>
<p><b>SYSTEM</b> Data is for YW 531A/C where different</p> <p><b>Alternative Designations:</b> Type 63, North Korean M1967</p> <p><b>Date of Introduction:</b> Late 1960s</p> <p><b>Proliferation:</b> At least 9 countries</p> <p><b>Description:</b> Crew: 4 Troop Capacity: 10 passengers Combat Weight (mt): 12.60 Chassis Length Overall (m): 5.48 Height Overall (m): 2.85 Width Overall (m): 2.98 Ground Pressure (kg/cm<sup>2</sup>): 0.44</p> <p><b>Automotive Performance:</b> Engine Type: 260-hp Diesel/320-hp Diesel Cruising Range (km): 500 Speed (km/h): Max Road: 42/66 Max Off-Road: 32/40 Average Cross-Country: INA Max Swim: 6.0 Fording Depths (m): Amphibious</p> <p><b>Radio:</b> Type 889</p> <p><b>Protection:</b> Armor, Turret Front (mm): 14, front glacis Applique Armor (mm): N/A Explosive Reactive Armor (mm): N/A Mineclearing Equipment: N/A Self-Entrenching Blade: N/A Active Protective System: NA NBC Protection System: N/A Smoke Equipment: N/A</p> <p><b>ARMAMENT</b> <b>Main Armament:</b> Caliber, Type, Name: 12.7-mm (12.7 x 108), heavy MG, Type 54 Rate of Fire (rd/min): 80-100 practical/600 air targets in bursts Loader Type: Belt feed Ready/Stowed Rounds: INA Elevation (°): -5 to +85 Fire on Move: Yes</p> <p><b>Auxiliary Weapon:</b> N/A <b>ATGM Launcher:</b> N/A <b>Firing Ports:</b> 2 left side, 1 right, 1 in the rear/1 each side and rear</p> <p><b>FIRE CONTROL</b> <b>FCS Name:</b> N/A</p>	<p><b>Main Gun Stabilization:</b> N/A <b>Rangefinder:</b> N/A <b>Infrared Searchlight:</b> N/A <b>Sights w/Magnification:</b> Gunner: Day: Open ladder sight, optical sight, NFI Field of View (°): INA Acquisition Range (m): 3,300 Night: N/A <b>Commander Fire Main Gun:</b> No</p> <p><b>VARIANTS</b> <b>YW531A/Type 63-II:</b> Upgrade APC with gun shield. Other vehicles with this chassis are: <b>YW 531B</b> and <b>Type 54-1</b> 122-mm SP howitzer, <b>Type 70</b> 130-mm (19-tube) MRL, and a Red Arrow-8 ATGM launcher vehicle with 4-rail launcher and 4 stowed ATGMs.</p> <p><b>YW-531C:</b> Variant APC with gun shield, better vision ports, and ventilation. Other vehicles use this chassis, including <b>YW 750</b> ambulance, and <b>YW 701A/B</b> and <b>YW 702</b> command post vehicles. The <b>C</b>, <b>D</b> and <b>E</b> variants differ in intercom sets and firing ports. Two SP mortar variants are <b>Type YW-304</b> (82-mm M-1937 type, 120 rounds, 3,040 m) and <b>Type YW-381</b> (120-mm, 50 rds, 7,700 m).</p> <p><b>YW-531H/Type 85, Type 89, and Type 90:</b> Expanded 5-road wheel variants. For the <b>-H</b> variant and vehicle series, see sheet.</p> <p><b>VTT-323:</b> North Korean variant, also known as <b>M1973</b> (See sheet).</p> <p><b>MAIN ARMAMENT AMMUNITION</b> <b>Caliber, Type, Name:</b> 12.7-mm, APDS (Tungsten Core), Type 54 Max Aimed Range (m): 2,000 (est) Max Effective Range (m): Day: 1,500 vehicles, 1,600 aircraft Night: INA Tactical AA Range: 1,600 Armor Penetration (mm): INA</p> <p>12.7-mm, API, Type 54 Max Aimed Range (m): 2,000 (est) Max Effective Range (m): Day: 1,500 Unarmored ground, 800 armored vehicles Night: INA Tactical AA Range: 1,600 Armor Penetration (mm): 21 (RHA) at 500 m, 13 at 1,000 m</p> <p><b>Other Ammunition Types:</b> API-T, Russian Duplex, Russian Duplex-T, Incendiary-T, HE-T Type MDZ, HEI Type ZP</p>	

**NOTES**

Type 54 MG is a Chinese copy of former Soviet 12.7-mm DShKM.

## Chinese Armored Personnel Carrier YW 531H and Vehicle Series Type 85

 <p style="text-align: center;">Type 85 ATGM Launcher Vehicle with Red Arrow-8 ATGM</p>	<p><b>Weapons &amp; Ammunition Types</b></p> <p><b>12.7-mm MG</b> APDS, API, API-T, HE-T, HEI</p> <p style="text-align: center;">or</p> <p><b>Missile Launcher</b> (ATGM launcher vehicle) HEAT ATGM</p>	<p><b>Typical Combat Load</b></p> <p style="text-align: right;"><b>1,120</b> 500 620</p> <p style="text-align: right;"><b>8</b></p>
<p><b>SYSTEM:</b> Data is for APC / ATGM vehicle where different</p> <p><b>Alternative Designations:</b> Type 85 is preferred nomenclature</p> <p><b>Date of Introduction:</b> 1986</p> <p><b>Proliferation:</b> At least 4 countries</p> <p><b>Description:</b> Crew: 2 / 4 Troop Capacity: 13 / 0 passengers Combat Weight (mt): 13.6 / 13.8 Chassis Length Overall (m): 5.9 Height Overall (m): 2.85 / INA Width Overall (m): 2.98 Ground Pressure (kg/cm<sup>2</sup>): 0.59</p> <p><b>Automotive Performance:</b> Engine Type: 320-hp Diesel Cruising Range (km): 500 Speed (km/h): Max Road: 65 / 60 Max Off-Road: 46 Average Cross-Country: 35 Max Swim: 6.0 Fording Depths (m): Amphibious</p> <p><b>Radio:</b> Type 889 / Type 889 or VRC 83</p> <p><b>Protection:</b> Armor, Turret Front (mm): 14 front glacis Applique Armor (mm): N/A Explosive Reactive Armor (mm): N/A Mineclearing Equipment: N/A Self-Entrenching Blade: N/A Active Protective System: NA NBC Protection System: N/A Smoke Equipment: 2 x 4 grenade launchers, some versions</p> <p><b>ARMAMENT</b> <b>Main Armament:</b> Caliber, Type, Name: 12.7-mm (12.7 x 108), heavy MG, Type 54 Rate of Fire (rd/min): 80-100 practical/600 air, in bursts / 2-3 Loader Type: Belt feed Ready/Stowed Rounds: 4/4 for ATGM launcher vehicle Elevation (°): -4 to +82 / -7 to +13 Fire on Move: Yes / No</p> <p><b>Auxiliary Weapon:</b> N/A <b>ATGM Launcher:</b> N/A <b>Firing Ports:</b> 6-7 (3 on each side, 1 in rear door, Thai version)</p> <p><b>FIRE CONTROL</b> <b>FCS Name:</b> N/A <b>Main Gun Stabilization:</b> N/A</p>	<p><b>Rangefinder:</b> N/A <b>Infrared Searchlight:</b> N/A <b>Sights w/Magnification:</b> Gunner: Day: Open ladder sight / day periscope Field of View (°): INA Acquisition Range (m): 2,000 / 4,000 Night: INA / Thermal sight optional <b>Commander Fire Main Gun:</b> No</p> <p><b>VARIANTS</b> <b>Type 85:</b> Export vehicle series derived from the C-variant APC but expanded, and with addition of a fifth road wheel. Note: <b>Thai</b> version has .50 cal (12.7-mm) M2HB MG vs Type 54. The -H APC sired a new family of combat and support vehicles. Combat variants include: armored command APC, <b>YW 309</b> IFV (73-mm gun), <b>NVH-1</b> IFV (25- or 30-mm gun), <b>NVH-4</b> IFV (25-mm gun), <b>Type 70-1/ YW 302</b> 122-mm SP howitzers and <b>YW 306</b> 130-mm MRL. Support vehicles include a maintenance engineer vehicle, recovery vehicle, command post vehicle, fire fighting vehicle, and WZ 751 ambulance. Mortars are SP <b>Type 67</b> 82-mm (M1937-type, 120 rounds, 3,040 m max range), and <b>YW 381</b> 120-mm (50 rounds, 7,700 m max range). Each also has a 12.7-mm MG with 540 rounds.</p> <p><b>Type 85 ATGM launcher vehicle:</b> Raised hull variant with 4-rail launcher turret for Red Arrow-8 SACLOS wire-guided ATGM. The ROF is 2-3 rd/min. See launcher sheet for ATGM data.</p> <p><b>Type 89/ YW 534:</b> A 5-wheeled APC, combat, and support vehicle series (250 mm longer and 74 mm wider) for Chinese forces.</p> <p><b>MAIN ARMAMENT AMMUNITION</b> <b>Caliber, Type, Name:</b> 12.7-mm, APDS (Tungsten Core), Type 54 Max Aimed Range (m): 2,000 Max Effective Range (m): Day: 1,500 vehicles / 1,600 aircraft Night: INA Tactical AA Range: 1,600 Armor Penetration (mm): INA</p> <p>12.7-mm, API, Type 54 Max Aimed Range (m): 2,000 Max Effective Range (m): Day: 1,500 Unarmored ground / 800 armored Night: INA Tactical AA Range: 1,000 Armor Penetration (mm): 21 (RHA) at 500 m, 13 at 1,000 m</p> <p><b>Other Ammunition Types:</b> API-T, Russian Duplex, Russian Duplex-T, Incendiary-T, HE-T Type MDZ, HEI Type ZP</p>	

NOTES None

## French Infantry Fighting Vehicle AMX-10P

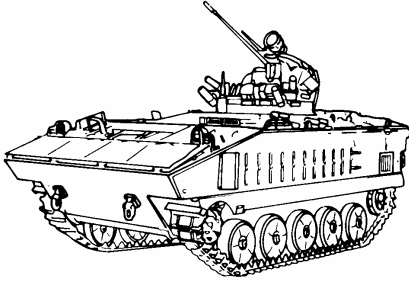
	<p><b>Weapons &amp; Ammunition Types</b></p> <p><b>20-mm Cannon</b> APDS-T, API-T HEI, HEI-T</p> <p><b>7.62-mm coax MG</b> Tracer, AP, API, In- cendiary</p>	<p><b>Typical Combat Load</b></p> <p><b>760</b> (est) 260 500</p> <p><b>2,000</b></p>
<p><b>SYSTEM</b>  <b>Alternative Designations:</b> INA  <b>Date of Introduction:</b> 1973  <b>Proliferation:</b> At least 3 countries  <b>Description:</b>  Crew: 3  Troop Capacity: 8 passengers  Combat Weight (mt): 14.5  Length Overall (m): INA  Height Overall (m): 2.57  Width Overall (m): 2.78  Ground Pressure (kg/cm<sup>2</sup>): 0.53</p> <p><b>Automotive Performance:</b>  Engine Type: 300-hp Diesel  Cruising Range (km): 600  Speed (km/h):      Max Road: 65      Max Off-Road: INA      Average Cross-Country: INA      Max Swim: 7  Fording Depths (m): Amphibious  Mineclearing Equipment: N/A  Self-Entrenching Blade: N/A</p> <p><b>Radio:</b> INA</p> <p><b>Protection:</b>  Armor, Turret Front (mm): 12.7-mm frontal  Applique Armor (mm): N/A  Explosive Reactive Armor (mm): Available  Active Protective System: N/A  NBC Protection System: Yes  Smoke Equipment: 4 smoke grenade launchers</p> <p><b>ARMAMENT</b>  Caliber, Type, Name: 20-mm automatic cannon M693 F1  Rate of Fire (rd/min): 740  Loader Type: Dual belt feed  Ready/Stowed Rounds: INA  Elevation (°): -8/+50  Fire on Move: INA</p> <p><b>Auxiliary Weapon:</b>  Caliber, Type, Name: 7.62-mm (7.62 x 51) MG, AAT 52 NF1  Mount Type: Coax  Maximum Aimed Range (m): INA</p>	<p>Max Effective Range:  Day: INA  Night: INA  Fire on Move: Yes  Rate of Fire (rd/min): INA</p> <p><b>ATGM Launcher:</b> N/A  <b>Firing Ports:</b> None</p> <p><b>FIRE CONTROL</b>  <b>FCS Name:</b> INA  <b>Main Gun Stabilization:</b> INA  <b>Rangefinder:</b> INA  <b>Infrared Searchlight:</b> Yes  <b>Sights w/Magnification:</b>  Gunner:      Day: OB 40 Day/ night sight      Field of View (°): INA      Acquisition Range (m): INA      Night: OB 40 Day/ night sight      Field of View (°): INA      Acquisition Range (m): INA  <b>Commander Fire Main Gun:</b> No</p> <p><b>VARIANTS</b>  <b>AMX-10P:</b> Variant with Milan or HOT ATGM launcher  <b>AMX-10P/Milan:</b> ATGM launcher vehicle, with two launchers  <b>AMX/HOT:</b> ATGM launcher vehicle (Toucan II turret, 4 launchers)  <b>AMX-10 TM:</b> Mortar carrier towing 120-mm RT-61 mortar  <b>AMX-10 PAC 90:</b> Fire support/AT variant with Giat 90-mm gun  <b>AMX-10P Marine:</b> Improved swim variant w/ 12.7/25/90-mm gun  <b>AMX-10 PC:</b> Command variant with varied command stations  <b>AMX-10 RC:</b> Wheeled (6 x 6) fire support vehicle with 90-mm gun  <b>AMX-10 RAC:</b> The same fire support chassis with 105-mm gun</p> <p><b>MAIN ARMAMENT AMMUNITION</b>  Caliber, Type, Name: 20-mm (20x139) APDS-T  Maximum Aimed Range (m): INA  Max Effective Range (m):  Day: 1,300  Night: INA  Tactical AA Range: INA  Armor Penetration (mm): INA</p> <p><b>Other Ammunition Types:</b> API, API-T, HEI, HEI-T</p>	

### NOTES

A French SNPE explosive reactive armor (ERA) kit and others are available for use on the AMX-10P. However, during dismounted troop movement, ERA would be a hazard. Thus, passive armor is more likely; and ERA application is doubtful.



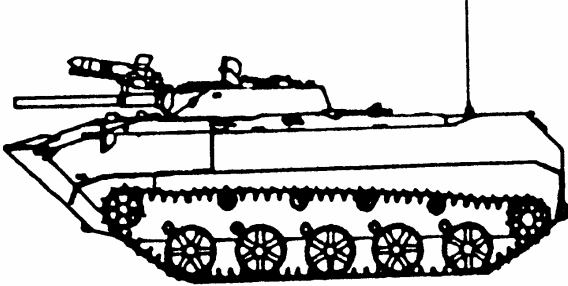

## Russian Airborne Fighting Vehicle BMD-1

	<b>Weapons &amp; Ammunition Types</b>	<b>Typical Combat Load</b>
<p><b>SYSTEM</b>  <b>Alternative Designations:</b>  <b>Date of Introduction:</b> 1969  <b>Proliferation:</b> At least 1 country  <b>Description:</b>            Crew: 2            Troop Capacity: 5 passengers (+1)            Combat Weight (mt): 13.3            Chassis Length Overall (m): 6.74            Height Overall (m): 2.15            Width Overall (m): 2.94            Ground Pressure (kg/cm<sup>2</sup>): 0.57</p> <p><b>Automotive Performance:</b>            Engine Type: 240-hp Diesel            Cruising Range (km): 600            Speed (km/h):                Max Road: 65                Max Off-Road: 40-45                Average Cross-Country: INA                Max Swim: 7            Fording Depth (m): Amphibious</p> <p><b>Radio:</b> R-123M</p> <p><b>Protection:</b>            Armor, Turret Front (mm): 23 or Antibullet            Applique Armor (mm): See NOTES            Explosive Reactive Armor (mm): See NOTES            Active Protective System: N/A            Mineclearing Equipment: N/A            Self-Entrenching Blade: N/A            NBC Protection System: Collective            Smoke Equipment: VEES</p> <p><b>ARMAMENT</b>  <b>Main Armament:</b>            Caliber, Type, Name: 73-mm smoothbore gun, 2A28/Grom            Rate of Fire(rd/min): 7-8            Loader Type: Autoloader            Ready/Stowed Rounds: 40 / 0            Elevation (°): -4/ +33            Fire on Move: Yes, but only 10 km/h or less (est)</p> <p><b>Auxiliary Weapons:</b>            Caliber, Type, Name: 7.62-mm (7.62x 54R) machinegun, PKT            Mount Type: Coax            Maximum Aimed Range (m): 1,300            Max Effective Range (m):                Day: 1,000/400-500 on the move                Night: 800</p>	<p>73-mm gun            HEAT (est) 16            HE 24</p> <p>AT-3/a/b/c/Imp ATGM            HEAT 3            HE 1</p> <p>7.62-mm coax MG 2,000            2x 7.62-mm bow MG 4,000</p> <p>Fire on Move: Yes            Rate of Fire (rd/min): 250 practical / 650 cyclic, 2-10 round bursts            Caliber, Type, Name: 7.62-mm machinegun, PKT            Mount Type: Bow (ball-mounted)            Maximum Aimed Range (m): 1,000            Max Effective Range (m):                Day: 1,000/400-500 on the move                Night: N/A</p> <p>Fire on Move: Yes            Rate of Fire (rd/min): 250 practical / 650 cyclic, 2-10 round bursts</p> <p><b>ATGM Launcher:</b>            Name: 9P111            Launch Method: Rail-launched            Guidance: MCLOS            Command Link: Wire            Launcher Dismountable: Yes</p> <p><b>Firing Ports:</b> 1 on each side, 1 in left rear door</p> <p><b>FIRE CONTROL</b>  <b>FCS Name:</b> INA  <b>Main Gun Stabilization:</b> N/A  <b>Rangefinder:</b> Stadiametric  <b>Infrared Searchlight:</b> Yes  <b>Sights w/Magnification:</b>            Gunner:                Day: 1PN22M1, 8x                    Field of View (°): 15                    Acquisition Range (m):                Night: 1PN22M1, 6.7x                    Field of View (°): 6                    Acquisition Range (m): 800-1,000, based on light</p> <p><b>Commander Fire Main Gun:</b> No</p> <p><b>VARIANTS</b>  <b>BMD-1K:</b> Command IFV (FSU), with added R-126 and R-107.  <b>BMD-1M:</b> Variant with improved ventilation and road wheels.  <b>BMD-1P:</b> Widely fielded IFV with AT-4/5 replacing AT-3.  <b>BMD-1PK:</b> Company commander variant (FSU) of BMD-1P.  <b>BMD-2:</b> Widely fielded variant with a 30-mm automatic gun and with AT-3 ATGM launcher replaced by AT-4/5 ATGM launcher.  <b>BTR-D:</b> Stretched (6-road wheel) armored multipurpose transporter variant, with two 7.62-mm MGs but no turret. This chassis has been used for a variety of other airborne vehicles.</p>	

**Russian Airborne Fighting Vehicle BMD-1 continued**

<p><b>MAIN ARMAMENT AMMUNITION</b>  <b>Caliber, Type, Name:</b>  73-mm HEAT-FS, PG-9  Maximum Aimed Range (m): 1,300  Max Effective Range (m):  Day: 800, but 600 or less on the move  Night: 800  Tactical AA Range: INA  Armor Penetration (mm): 335 (RHA)</p> <p>73-mm HEAT-FS, NFI  Maximum Aimed Range (m): 1,300  Max Effective Range (m):  Day: 1,000, but 600 or less on the move  Night: 800-1,000  Tactical AA Range: INA  Armor Penetration (mm): &gt;400 (RHA)</p> <p>73-mm HE, OG-9  Maximum Aimed Range (m): 1,300, 600 or less on the move  Max Effective Range (m):  Day: 1,300, but 600 or less on the move  Night: 800-1,000  Tactical AA Range: INA  Armor penetration (mm): INA</p> <p>73-mm HE, OG-9M1  Maximum Aimed Range (m): 4,500  Max Effective Range (m):  Day: 1,300, but 600 or less on the move  Night: 800-1,000  Tactical AA Range: INA  Armor Penetration (mm): INA</p> <p><b>Other Ammunition Types:</b> OG-9M</p>	<p><b>Antitank Guided Missiles:</b>  Name: AT-3, -3A, -B  Warhead Type: Tandem HEAT  Armor Penetration (mm): 410 RHA  Range (m): 3,000</p> <p>Name: AT-3C  Warhead Type: Tandem HEAT  Armor Penetration (mm): 520 RHA  Range (m): 3,000</p> <p>Name: AT-3C Imp/ Polk (Slovenian)  Warhead Type: Precursor with HEAT  Armor Penetration (mm): 580 RHA  Range (m): 3,000</p> <p>Name: Malyutka-2 (Russian)  Warhead Type: Tandem HEAT  Armor Penetration (mm): 800 RHA  Range (m): 3,000</p> <p>Name: Malyutka HE (Russian)  Warhead Type: Frag-HE  Armor Penetration (mm): N/A  Range (m): 3,000</p>
---	---

**NOTES**

Vehicle can be parachute landed with airborne troops onboard. Height can be lowered.

Russian KBP offers a drop-in one-man turret, called Kliver, with a stabilized 2A72 30-mm gun, a 4-Kornet ATGM launcher, thermal sights, and improved fire control system. The Russian Volgograd Tractor Plant offers the B30 turret (a drop-in one-man turret with 2A42 30-mm gun, 7.62-mm coax MG, and a 9P135M launcher for AT-4/-5 ATGM). A Russian AG-17 30-mm automatic grenade launcher is available for BMD-1.

Other options are spall liners, air conditioning, and a more powerful engine. A French SNPE explosive reactive armor (ERA) kit and others are available for use on the BMD-1. However, during dismounted troop movement, ERA would be a hazard. Thus, passive armor is more likely; and ERA application is doubtful. For amphibious use, additional armor application is unlikely.

The Slovenian TS-M ATGM thermal night sight has a detection range of 4,500m and a recognition range of 2,000m.

The AT-3 HE-Blast ATGM is used for killing personnel and destroying bunkers and other fortifications.

The AT-3C Polk features a nose probe, an improved motor for increased velocity, lower smoke noise signature and a SACLOS launcher with improved sights.



**Russian Airborne Fighting Vehicle BMD-3 continued**

<p><b>MAIN ARMAMENT AMMUNITION</b></p> <p><b>Caliber, Type, Name:</b>  30-mm AP-T  Maximum Aimed Range (m): 2,500  Max Effective Range (m):  Day: 1,500  Night: INA  Tactical AA Range: 4,000  Armor Penetration (mm): 18 (RHA) at 1,500m</p> <p>30-mm APDS  Maximum Aimed Range (m): 2,500  Max Effective Range (m):  Day: 2,000  Night: INA  Tactical AA Range: 4,000  Armor Penetration (mm): 25 (RHA) at 1,500m</p> <p>30-mm APFSDS-T M929  Maximum Aimed Range (m): 2,500  Max Effective Range (m):  Day: 2,000+  Night: INA  Tactical AA Range: 4,000  Armor penetration (mm): 55 (RHA) at 1,000m, 45 at 2,000m</p>	<p>30-mm Frag-HE  Maximum Aimed Range (m): 4,000  Max Effective Range (m):  Day: 4,000  Night: INA  Tactical AA Range: 4,000  Armor Penetration (mm): INA</p> <p><b>Other Ammunition Types:</b> 30-mm HEI-T</p> <p><b>Antitank Guided Missiles:</b>  Name: AT-5B/Konkurs-M  Warhead Type: Tandem shaped charge (HEAT)  Armor Penetration (mm): 925 (RHA)  Range (m): 4,000</p> <p>Name: AT-5/Spandrel  Warhead Type: Shaped charge (HEAT)  Armor Penetration (mm): 650 (RHA)  Range (m): 4,000</p>
---	--

**NOTES**

BMD-3 has variable height control.

Automatic grenade launcher has 290 ready rounds and 261 in the rack. The ATGM launcher has 3 ready rounds (one on the launcher), and two stowed.

A French SNPE explosive reactive armor (ERA) kit and others are available for use on the BMD-3. However, during dismounted troop movement, ERA would be a hazard. Thus, passive armor is more likely and ERA application is doubtful. For amphibious use, additional armor application is unlikely. Other options are spall liners, air conditioning, and a more powerful engine.

The Russian SANOET-1 thermal gunner's sight is available. Thermal sights are available for the ATGM launcher. The Russian Trakt/IPN65 thermal imaging ATGM night sight is optional. Acquisition range is 2,500 m (NFI). For the ATGM launcher in dismount configuration, the Russian Mulat/IPN86 lightweight thermal ATGM night sight has 3,600 m detection range and 2,000 m identification range.

French-German Flame-V adapter kit permits the BMD-3 to launch Milan, Milan-2 and Milan-3 ATGMs.

Russian KBP offers a drop-in one-man turret, called Kliver, with a stabilized 2A72 30-mm gun, a 4 Kornet ATGM launcher, thermal sights, a coaxial 7.62-mm MG and improved fire control system.

## Russian Infantry Fighting Vehicle BMP-1

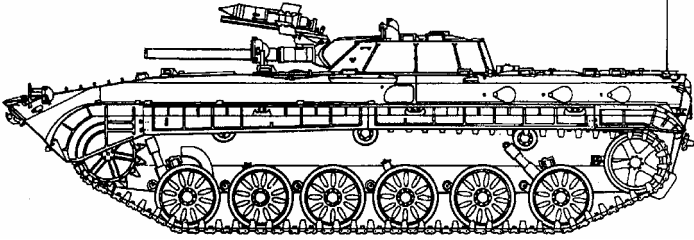
	<b>Weapons &amp; Ammunition Types</b>	<b>Typical Combat load</b>														
<p><b>SYSTEM</b>  <b>Alternative Designations:</b> BMP Model 1970, Korshun  <b>Date of Introduction:</b> 1970  <b>Proliferation:</b> At least 33 countries  <b>Description:</b>            Crew: 3            Troop Capacity: 6 passengers (+2)            Combat Weight (mt): 13.3            Length Overall (m): 6.74            Height Overall (m): 2.15            Width Overall (m): 2.94            Ground Pressure (kg/cm<sup>2</sup>): 0.57</p> <p><b>Automotive Performance:</b>            Engine Type: Diesel            Cruising Range (km): 600            Speed (km/h):                Max Road: 65                Max Off-Road: 40-45                Average Cross-Country: INA                Max Swim: 7            Fording Depths (m): Amphibious            Mineclearing Equipment: KMT-8 or 10 mine plow available            Self-Entrenching Blade: No  <b>Radio:</b> R-123, R-M or R-173</p> <p><b>Protection:</b>            Armor, Turret Front (mm): 19-23            Applique Armor (mm): Available            Explosive Reactive Armor (mm): Available            Active Protective System: No            NBC Protection System: Collective protection            Smoke Equipment: Vehicle engine exhaust smoke system (VEESS)</p> <p><b>ARMAMENT</b>  <b>Main Armament:</b>            Caliber, Type, Name: 73-mm smoothbore gun 2A28/Grom            Rate of Fire: 7-8 rd/min            Loader Type: Autoloader            Ready/Stowed Rounds: 40 / 0            Elevation (°): -4 to +33            Fire on Move: Yes, but only 10 km/h or less (est.)</p> <p><b>Auxiliary Weapon:</b>            Caliber, Type, Name: 7.62-mm (7.62x 54R) Machinegun PKT            Mount Type: Coax            Max Aimed Range (m): 1,300            Max Effective Range (m):                Day: 1,000 / 400-500 on the move                Night: 800            Fire on Move: Yes            Rate of Fire: 250 rpm (practical, in 2-10 round bursts)</p>	<table border="1"> <tbody> <tr> <td><b>73-mm gun</b></td> <td><b>40</b></td> </tr> <tr> <td>    HEAT</td> <td>20</td> </tr> <tr> <td>    HE</td> <td>20</td> </tr> <tr> <td><b>AT-3/a/b/C/Imp ATGM</b></td> <td><b>5</b></td> </tr> <tr> <td>    HEAT</td> <td>3</td> </tr> <tr> <td>    HE</td> <td>2</td> </tr> <tr> <td><b>7.62-mm coax MG</b></td> <td><b>2,000</b></td> </tr> </tbody> </table> <p><b>Firing Ports:</b> 4 on each side, 1 in left rear door</p> <p><b>ATGM Launcher:</b>            Name: 9P111            Launch Method: Rail-launched            Guidance: MCLOS            Command Link: Wire            Launcher Dismountable: Yes</p> <p><b>FIRE CONTROL</b>  <b>FCS Name:</b> INA  <b>Main Gun Stabilization:</b> No  <b>Rangefinder:</b> Laser  <b>Infrared Searchlight:</b> Yes  <b>Sights w/Magnification:</b>            Gunner:                Day: 1PN22M1, 8x                    Field of View (°): 15                    Acquisition Range (m):                Night: 1PN22M1, 6x                    Field of View (°): 6                    Acquisition Range (m): 800-1,000, based on light  <b>Commander Fire Main Gun:</b> No</p> <p><b>VARIANTS</b>            Earlier models, referred to as <b>BMP</b> and <b>BMP-A</b> were produced in small numbers from 1966. The standard BMP-1 (<b>Model 1970</b>) features improved fume venting, NBC protection, and swim features. Copies include: Chinese <b>WZ 501/Type 86</b>, <b>Czech BVP-1</b>, and the Polish <b>BWP-1</b>. A variety of variant IFVs/APCs and support vehicles have been developed using this chassis. For instance, the Chinese <b>WZ 503</b> is a raised hull APC variant replacing the 73-mm gun with a 12.7-mm MG. The <b>WZ 504</b> is an ATGM launcher vehicle with 4-rail AT-3-type ATGM launcher. The <b>WZ 505</b> is an ambulance vehicle; and <b>WZ 506</b> is a regimental command and staff vehicle.</p> <p><b>BMP-1K:</b> Company command IFV, with added R-126 and R-107 transceivers. Firing ports and most periscopes are blocked.</p> <p><b>BMP-1KSh:</b> Former Soviet regiment or division command and staff vehicle, with turret mounted erectable 10-meter radio mast. Radios include R-130, R-111, and R-173.</p> <p><b>BMP-1M:</b> Iranian variant with drop rear gate vs double doors.</p> <p><b>BMP-1P:</b> Widely fielded FSU IFV with an AT-4/5 ATGM launcher and smoke grenade launchers (see pp. 2-21 and 2-22).</p> <p><b>BMP-1PG:</b> Recently offered upgrade similar to BMP-1P with an automatic grenade launcher and other options (see p. 2-21).</p> <p><b>BMP-1PK:</b> Command variant for BMP-1P (see p. 2-21).</p>	<b>73-mm gun</b>	<b>40</b>	HEAT	20	HE	20	<b>AT-3/a/b/C/Imp ATGM</b>	<b>5</b>	HEAT	3	HE	2	<b>7.62-mm coax MG</b>	<b>2,000</b>	
<b>73-mm gun</b>	<b>40</b>															
HEAT	20															
HE	20															
<b>AT-3/a/b/C/Imp ATGM</b>	<b>5</b>															
HEAT	3															
HE	2															
<b>7.62-mm coax MG</b>	<b>2,000</b>															

**Russian Infantry Fighting Vehicle BMP-1 continued**

<p><b>BPzV:</b> Czechoslovakian reconnaissance variant with a TALL MIKE external tripod mounted radar.</p> <p><b>BREM-2:</b> Light recovery and repair vehicle with a light crane.</p> <p><b>BREM-4:</b> Armored recovery vehicle. Czech version is VPV.</p> <p><b>BRM-1, BRM-1K:</b> Reconnaissance command variants with improved sensors and low-profile 2-man turret (see p. 3-4).</p> <p><b>BRM-23:</b> Bulgarian reconnaissance variant with a 23-mm cannon, AT-3 ATGM, navigation system, NBC and artillery reconnaissance devices, and image intensifier night sights.</p> <p><b>IMR:</b> Armored engineer tractor, with crane and dozer blade.</p> <p><b>IRM:</b> Engineer underwater reconnaissance vehicle, with mine detectors and mapping capabilities.</p> <p><b>MLI-84:</b> Romanian APC variant with a 12.7-mm MG.</p> <p><b>MP-31:</b> Modernized command and staff vehicle.</p> <p><b>OT-90:</b> Czech APC variant with 14.5-mm and 7.62-mm MGs.</p> <p><b>PRAM-S:</b> Czechoslovakian self-propelled 120-mm mortar variant.</p> <p><b>PRP-3/PRP-4:</b> Artillery reconnaissance vehicle (see p. 6-3).</p> <p><b>Snezka:</b> Czech stretched version battlefield surveillance vehicle, with a sensor suite (including radar) mounted on a telescoping arm.</p> <p><b>SVO:</b> Czechoslovakian turretless mine clearing variant with 24 large rocket-propelled line charges.</p> <p><b>VP90:</b> Czech reconnaissance vehicle with 14.5 and 7.62-mm MGs</p> <p><b>Main Armament Ammunition:</b>          Caliber, Type, Name: 73-mm HEAT-FS, PG-9          Max Aimed Range (m): 1,300          Max Effective Range (m):              Day: 800, but 600 or less on the move in 2-4 rd bursts              Night: 800          Tactical AA Range: INA          Armor Penetration (mm): 335 (RHA)</p> <p>Caliber, Type, Name: 73-mm HEAT-FS, NFI          Max Aimed Range (m): 1,300</p>	<p>Max Effective Range (m):              Day: 1,000/ 600 or less on the move              Night: 800-1,000          Tactical AA Range: INA          Armor Penetration (mm): &gt;400 (RHA)</p> <p>Caliber, Type, Name: 73-mm HE, OG-9M1          Max Aimed Range (m): 4,500          Max Effective Range (m):              Day: 1,300/ 600-1,000 on the move              Night: 800-1,000          Tactical AA Range: INA          Armor penetration (mm): INA</p> <p><b>Other Ammunition Types:</b> OG-9, OG-9M</p> <p><b>Antitank Guided Missiles:</b>          Name: AT-3 Malyutka/-3a, -b Malyutka-M          Warhead Type: Tandem HEAT          Armor Penetration (mm): 410 (RHA)          Range (m): 800-3,000</p> <p>Name: AT-3c/ Malyutka-P          Warhead Type: Tandem HEAT          Armor Penetration (mm): 520 (RHA)          Range (m): 800-3,000</p> <p>Name: AT-3c Imp/ Polk (Slovenia)          Warhead Type: Tandem HEAT          Armor Penetration (mm): 580 (RHA)          Range (m): 3,000</p> <p>Name: Malyutka-2 (Russian)          Warhead Type: Tandem HEAT          Armor Penetration (mm): 800 (RHA)          Range (m): 3,000</p> <p>Name: Red Arrow-73A (Chinese)          Warhead Type: HEAT          Armor Penetration (mm): 500 RHA          Range (m): 3,000</p> <p>Name: Red Arrow-73B/C (Chinese)          Warhead Type: HEAT          Armor Penetration (mm): 600 RHA          Range (m): 3,000</p> <p>Name: Malyutka-2 HE (Russian)          Warhead Type: Frag-HE          Armor Penetration (mm): INA          Range (m): 3,000</p>
--	--

**NOTES**

Thermal gunner sights are available; however, most upgrades involve adding a thermal sight with an improved gun and improved fire control system. The Slovenian TS-M ATGM thermal night sight has a detection range of 4,500 m and a recognition range of 2,000 m.

Russian BMP-2 2-man turrets with gun and fire control system are being marketed for BMP-1 customers. The Volgograd Tractor Plant offers the BMP-1/B30 package with a B30 turret (a drop-in one-man turret with 2A42 30-mm gun, 7.62-mm coax MG, BMP-2-type fire control system, PZU-8 AA sight, and a 9P135M ATGM launcher for AT-4/-5 ATGM). Russian KBP offers a drop-in one-man turret, called Kliver, with a stabilized 2A72 30-mm gun, a 4-Kornet ATGM launcher, thermal sights, and improved fire control system. A Ukrainian turret is also available.

Russian AG-17 30-mm AGL modification is available for use on BMP-1. A French SNPE ERA kit and others are available for use on the BMP-1. Other options are improved tracks, spall liners, air conditioning, smoke grenade launchers/laser warning receivers, and a more powerful engine (360 hp).

The AT-3-type ATGM can be upgraded by an operator with a new warhead in minutes. Low-mid-level maintenance can upgrade the missile motor. The HE-Blast ATGM is used for killing personnel and destroying bunkers and other fortifications. The AT-3C Polk features a nose probe, an improved motor for increased velocity, lower smoke and noise signature, and a SACLOS launcher with improved sights.

## Russian Infantry Fighting Vehicle BMP-1P

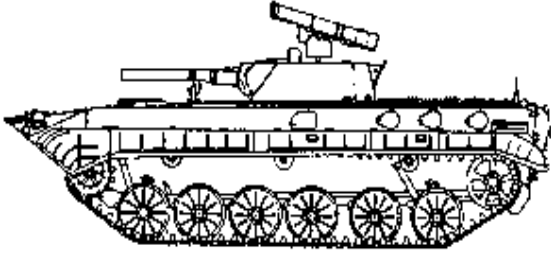
	<b>Weapons &amp; Ammunition Types</b>  <b>73-mm gun</b> HEAT-FS HE  <b>ATGM</b> AT-4/-4B/-5/-5B  <b>7.62-mm coax MG</b>	<b>Typical Combat Load</b>  <b>40</b> (est) 16 24  <b>4</b>  <b>2,000</b>
<p><b>SYSTEM</b></p> <p><b>Alternative Designations:</b> BWP-1 (Poland), see NOTES</p> <p><b>Date of Introduction:</b> 1974</p> <p><b>Proliferation:</b> At least 7 countries</p> <p><b>Description:</b></p> <p>Crew: 3</p> <p>Troop Capacity: 6 passengers</p> <p>Combat Weight (mt): 13.3</p> <p>Chassis Length Overall (m): 6.74</p> <p>Height Overall (m): 2.15</p> <p>Width Overall (m): 2.94</p> <p>Ground Pressure (kg/cm<sup>2</sup>): 0.57</p> <p><b>Automotive Performance:</b></p> <p>Engine Type: 300-hp Diesel</p> <p>Cruising Range (km): 600</p> <p>Speed (km/h):</p> <ul style="list-style-type: none"> <li>Max Road: 65</li> <li>Max Off-Road: 40-45</li> <li>Average Cross-Country: INA</li> <li>Max Swim: 7</li> </ul> <p>Fording Depth (m): Amphibious</p> <p><b>Radio:</b> R-123, or R-173</p> <p><b>Protection:</b></p> <p>Armor, Turret Front (mm): 19-23</p> <p>Applique Armor (mm): N/A</p> <p>Explosive Reactive Armor (mm): Available</p> <p>Active Protective System: N/A</p> <p>Mineclearing Equipment: KMT-8 plow available</p> <p>Self-Entrenching Blade: N/A</p> <p>NBC Protection System: Collective</p> <p>Smoke Equipment: Six 81-mm smoke grenade launchers, VEES</p> <p><b>ARMAMENT</b></p> <p><b>Main Armament:</b></p> <p>Caliber, Type, Name: 73-mm smoothbore gun 2A28/Grom</p> <p>Rate of Fire (rd/min): 7-8</p> <p>Loader Type: Autoloader</p> <p>Ready/Stowed Rounds: 40 / 0</p> <p>Elevation (°): -4/+33</p> <p>Fire on Move: Yes, but only 10 km/h or less (est)</p> <p><b>Auxiliary Weapon:</b></p> <p>Caliber, Type, Name: 7.62-mm (7.62x 54R) machinegun, PKT</p> <p>Mount Type: Coax</p> <p>Maximum Aimed Range (m): 1,300</p> <p>Max Effective Range (m):</p> <ul style="list-style-type: none"> <li>Day: 1,000 / 400-500 on the move</li> <li>Night: 800</li> </ul> <p>Fire on Move: No</p> <p>Rate of Fire (rd/min): 250 practical / 650 cyclic, 2-10 round bursts</p>	<p><b>ATGM Launcher:</b></p> <p>Name: 9P135M2</p> <p>Launch Method: Tube-launched</p> <p>Guidance: SACLOS</p> <p>Command Link: Wire</p> <p>Launcher Dismountable: Yes</p> <p><b>Firing Ports:</b> 4 on each side, 1 in left rear door</p> <p><b>FIRE CONTROL</b></p> <p><b>FCS Name:</b> 1PN22M1</p> <p><b>Main Gun Stabilization:</b> N/A</p> <p><b>Rangefinder:</b> Stadiametric</p> <p><b>Infrared Searchlight:</b> OU-3GK</p> <p><b>Sights w/Magnification:</b></p> <p>Gunner:</p> <ul style="list-style-type: none"> <li>Day: 1PN22M1, 8 x                             <ul style="list-style-type: none"> <li>Field of View (°): 15</li> <li>Acquisition Range (m): 1,300</li> </ul> </li> <li>Night: 1PN22M1, 6.7x                             <ul style="list-style-type: none"> <li>Field of View (°): 6</li> <li>Acquisition Range (m): 800-1,000 based on light</li> </ul> </li> </ul> <p><b>Commander Fire Main Gun:</b> No</p> <p><b>VARIANTS</b></p> <p><b>BMP-1PG:</b> This recently offered Russian upgrade is similar to BMP-1P with an added AG-17 30-mm automatic grenade launcher and other options, including thermal sights.</p> <p><b>BMP-1PK:</b> Command variant, with addition of R-126 and R-107 transceiver. A small telescoping antenna is mounted on right rear. Firing ports and telescopes on right side are blocked off.</p> <p><b>MAIN ARMAMENT AMMUNITION</b></p> <p><b>Caliber, Type, Name:</b></p> <p>73-mm HEAT-FS, PG-9</p> <ul style="list-style-type: none"> <li>Maximum Aimed Range (m): 1,300</li> <li>Max Effective Range (m):                             <ul style="list-style-type: none"> <li>Day: 800, but 600 or less on the move in 2-4 round bursts</li> <li>Night: 800-1,000</li> </ul> </li> <li>Tactical AA Range: INA</li> <li>Armor Penetration (mm): 335 (RHA)</li> </ul> <p>73-mm HEAT-FS, NFI</p> <ul style="list-style-type: none"> <li>Maximum Aimed Range (m): 1,300</li> <li>Max Effective Range (m):                             <ul style="list-style-type: none"> <li>Day: 1,000/ 600 or less on the move</li> <li>Night: 800-1,000</li> </ul> </li> <li>Tactical AA Range: INA</li> <li>Armor Penetration (mm): &gt;400 (RHA)</li> </ul>	

**Russian Infantry Fighting Vehicle BMP-1P continued**

<p>73-mm HE, OG-9M1  Maximum Aimed Range (m): 4,500  Max Effective Range (m):  Day: 1,300/ 600-1,000 on the move  Night: 800-1,000  Tactical AA Range: INA  Armor penetration (mm): INA</p> <p><b>Other Ammunition Types:</b> OG-9, OG-9M</p> <p><b>Antitank Guided Missiles:</b>  Name: AT-5/SPANDREL  Warhead Type: Shaped charge (HEAT)  Armor Penetration (mm): 650 (RHA)  Range (m): 4,000</p>	<p>Name: AT-5B/Konkurs-M  Warhead Type: Tandem shaped charge (HEAT)  Armor Penetration (mm): 925 (RHA)  Range (m): 4,000</p> <p>Name: AT-4/SPIGOT  Warhead Type: Shaped charge (HEAT)  Armor Penetration (mm): 480 (RHA)  Range (m): 2,000</p> <p>Name: AT-4B/Factoria  Warhead Type: Tandem Shaped charge (HEAT)  Armor Penetration (mm): 550 (RHA)  Range (m): 2,500</p>
---	--

**NOTES**

The prototype IFV, known as BMP, was not fielded. Initial BMP production variant, BMP-A, was halted with insignificant numbers. The base-line production IFV, BMP-1, has an AT-3/SAGGER antitank guided missile. The BMP-1P upgrade is widely fielded, with an AT-4/-5 ATGM launcher replacing the AT-3 launcher. The vehicle also added smoke grenade launchers. This variant should generally be portrayed where OPFOR calls for the BMP-1. For applications where a robust and modernized OPFOR is expected, use AT-5B ATGM. The AT-4/-4B ATGMs are less likely to be employed on this vehicle.

Other options are spall liners, air conditioning, and a more powerful engine. A French SNPE explosive reactive armor (ERA) kit and others are available for use on the BMD-1. However, during dismounted troop movement, ERA would be a hazard. Thus, passive armor is more likely; and ERA application is doubtful. Additional armor application may jeopardize amphibious capability.

Russian AG-17 30-mm automatic grenade launcher modification is available for use on BMP-1P. Russian KBP offers a drop-in one man turret, called Kliver, with a stabilized 2A72 30-mm gun, a 4 Kornet ATGM launcher, thermal sights, and improved fire control system.

The Russian Alis thermal gunner's sight is available. The Slovenian TS-F ATGM thermal night sight has a detection range of 4,500 m and a recognition range of 2,000 m.

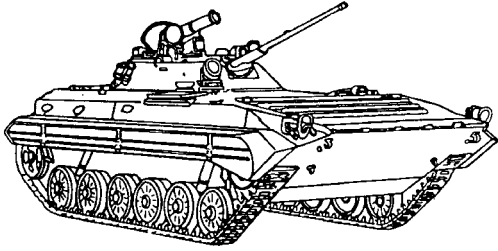

## Russian Infantry Fighting Vehicle BMP-2

	<b>Weapons &amp; Ammunition Types</b>	<b>Typical Combat Load</b>
	<b>30-mm automatic gun</b> HEI-T, Frag-HE AP-T, APDS-T, APFSDS-T  <b>ATGM</b> AT-5/-5B/-4/-4B  <b>7.62-mm coax MG</b>	<b>500</b> 340 160  <b>5</b>  <b>2,000</b>
<p><b>SYSTEM</b>  <b>Alternative Designations:</b> Yozh (Russia), Sarath (India)  <b>Date of Introduction:</b> 1980  <b>Proliferation:</b> At least 20 countries  <b>Description:</b>                      Crew: 3                      Troop Capacity: 7 passengers                      Combat Weight (mt): 14.3                      Chassis Length Overall (m): 6.72                      Height Overall (m): 2.45                      Width Overall (m): 3.15                      Ground Pressure (kg/cm<sup>2</sup>): 0.63</p> <p><b>Automotive Performance:</b>                      Engine Type: 300-hp Diesel                      Cruising Range (km): 600                      Speed (km/h):                          Max Road: 65                          Max Off-Road: 45                          Average Cross-Country: 35                          Max Swim: 7                      Fording Depth (m): Amphibious</p> <p><b>Radio:</b> R-123M transceiver or R-173</p> <p><b>Protection:</b>                      Armor, Turret Front (mm): 23-33                      Applique Armor (mm): On BMP-2D                      Explosive Reactive Armor (mm): Available, see NOTES                      Active Protective System: N/A                      Mineclearing Equipment: KMT-8 mine plow available                      Self-Entrenching Blade: N/A                      NBC Protection System: Collective                      Smoke Equipment: 6 smoke grenade launchers, VEES</p> <p><b>ARMAMENT</b>  <b>Main Armament:</b>                      Caliber, Type, Name: 30-mm automatic gun, 2A42                      Rate of Fire (rd/min): 550 cyclic in bursts/ 200-300 practical                      Loader Type: Dual-belt feed                      Ready/Stowed Rounds: 500/0                      Elevation (°): -5 to +74                      Fire on Move: Yes</p> <p><b>Auxiliary Weapon:</b>                      Caliber, Type, Name: 7.62-mm (7.62x 54R) machinegun, PKT                      Mount Type: Turret coax                      Maximum Aimed Range (m): 2,000</p>	<p>Max Effective Range (m):                      Day: 1,000                      Night: INA                      Fire on Move: Yes                      Rate of Fire (rd/min): 250 practical/650 cyclic, 2-10 round bursts</p> <p><b>ATGM Launcher:</b>                      Name: 9P135M1/M3                      Launch Method: Tube-launched                      Guidance: SACLOS                      Command Link: Wire                      Launcher Dismountable: Yes</p> <p><b>Firing Port:</b> 4 on left side, 3 on right side                      1 in left rear door</p> <p><b>FIRE CONTROL</b>  <b>FCS Name:</b> BPK-1-42 or BPK-2-42  <b>Main Gun Stabilization:</b> 2-plane  <b>Rangefinder:</b> Laser  <b>Infrared Searchlight:</b> Yes  <b>Sights w/Magnification:</b>                      Gunner:                          Day: BPK-1-42 or BPK-2-42                          Field of View (°): 8                          Acquisition Range (m): 2,500-4,000 (est)                          Night: BPK-1-42 or BPK-2-42 II/IR                          Field of View (°): INA                          Acquisition Range (m): INA  <b>Commander Fire Main Gun:</b> No</p> <p><b>VARIANTS</b>  <b>BMP-2D:</b> Variant with add-on plate armor, but which cannot swim  <b>BMP-2E:</b> Variant with 6-mm steel plates added and track skirts  <b>BMP-2K:</b> Command variant with additional radio</p> <p><b>MAIN ARMAMENT AMMUNITION</b>  <b>Caliber, Type, Name:</b>                      30-mm AP-T                          Maximum Aimed Range (m): 2,500                          Max Effective Range (m):                              Day: 1,500                              Night: INA                          Tactical AA Range: 4,000                          Armor Penetration (mm): 18 (RHA, 60°) at 1,500 m</p>	

**Russian Infantry Fighting Vehicle BMP-2 continued**

<p>30-mm APDS  Maximum Aimed Range (m): 2,500  Max Effective Range (m):  Day: 2,000  Night: INA  Tactical AA Range: 4,000  Armor Penetration (mm): 25 (RHA) at 1,500m</p> <p>30-mm APFSDS-T M929  Maximum Aimed Range (m): 2,500  Max Effective Range (m):  Day: 2,000+  Night: INA  Tactical AA Range: 4,000  Armor penetration (mm): 55 (RHA) at 1,000m/45 at 2,000m</p> <p>30-mm Frag-HE  Maximum Aimed Range (m): 4,000/ 2,500 point target  Max Effective Range (m):  Day: 4,000  Night: INA  Tactical AA Range: 4,000  Armor Penetration (mm): INA</p> <p><b>Other Ammunition Types:</b> 30-mm HEI-T</p>	<p><b>Antitank Guided Missiles:</b>  Name: AT-5/SPANDREL  Warhead Type: Shaped charge (HEAT)  Armor Penetration (mm): 650 (RHA)  Range (m): 4,000</p> <p>Name: AT-5B/Konkurs-M  Warhead Type: Tandem shaped charge (HEAT)  Armor Penetration (mm): 925 (RHA)  Range (m): 4,000</p> <p>Name: AT-4/SPIGOT  Warhead Type: Shaped charge (HEAT)  Armor Penetration (mm): 480 (RHA)  Range (m): 2,000</p> <p>Name: AT-4B/Factoria  Warhead Type: Tandem shaped charge (HEAT)  Armor Penetration (mm): 550 (RHA)  Range (m): 2,500</p>
--	--

**NOTES**

A French SNPE explosive reactive armor (ERA) kit and others are available for use on the BMP-2. However, during dismounted troop movement, ERA would be a hazard. Thus, passive armor is more likely and ERA application is doubtful. For amphibious use, additional armor application is unlikely. Other options are spall liners, air conditioning, and a more powerful engine.

Russian AG-17 30-mm automatic grenade launcher modification is offered for BMP-2.

Russian KBP offers a drop-in one-man turret, called Kliver, with a stabilized 2A72 30-mm gun, a 4 Kornet ATGM launcher, thermal sights, a coaxial 7.62-mm MG and improved fire control system.

ATGM load consists of one ready on the launcher and four stowed. They are readily accessible, but require hand loading from an open hatch. The AT-5 and AT-5B are more likely than AT-4 and -4B.

French-German Flame-V adaptor kit permits the BMP-2 system to launch Milan, Milan-2, and Milan-3 ATGMs.

Thermal sights are available. The Russian SANOET-1 thermal gunner's sight is available. The Russian Trakt/IPN65 thermal imaging (TI) ATGM night sight is optional. Acquisition range is 2,500 m (NFI). For the launcher in dismount configuration, the Slovenian TS-F ATGM night sight is available and has a detection range of 4,500 m and recognition range of 2,000 m. The Russian Mulat/IPN86 lightweight TI ATGM thermal sight has 3,600 m detection range and 2,000 m identification range.

## Russian Infantry Fighting Vehicle BMP-3

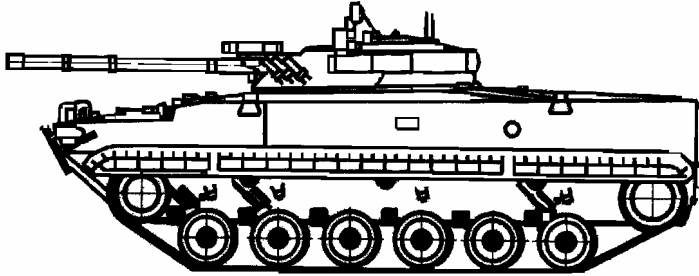
	<b>Weapons &amp; Ammunition Types</b>	<b>Typical Combat Load</b>
<p><b>SYSTEM</b>  <b>Alternative Designations:</b> Soviet ICV M1990/1  <b>Date of Introduction:</b> 1990  <b>Proliferation:</b> At least 7 countries  <b>Description:</b>            Crew: 3            Troop Capacity: 7 passengers            Combat Weight (mt): 18.70            Chassis Length Overall (m): 6.73            Height Overall (m): 2.45            Width Overall (m): 3.15            Ground Pressure (kg/cm<sup>2</sup>): 0.62</p> <p><b>Automotive Performance:</b>            Engine Type: 500-hp Diesel            Cruising Range (km): 600            Speed (km/h):                Max Road: 70                Max Off-Road: 45                Average Cross-Country: 35                Max Swim: 10            Fording Depth (m): Amphibious</p> <p><b>Radio:</b> R-173, R-173P</p> <p><b>Protection:</b>            Armor, Turret Front (mm): 30-35 front glacis            Applique Armor (mm): Yes on turret            Explosive Reactive Armor (mm): Available, see NOTES            Active Protective System: N/A            Mineclearing Equipment: KMT-8 plow available            Self-Entrenching Blade: Yes            NBC Protection System: Collective            Smoke Equipment: 6 smoke grenade launchers, VEES</p> <p><b>ARMAMENT</b>  <b>Main Armaments:</b>            Caliber, Type, Name: 100-mm rifled gun 2A70            Rate of Fire (rd/min): 8-10            Loader Type: Autoloader gun rounds; manual for gun and ATGMs            Ready/Stowed Rounds: 22/18 for rounds, 3/5 for ATGMs            Elevation (°): -5 to +60            Fire on Move: Yes</p> <p>Caliber, Type, Name: 30-mm automatic gun 2A72            Rate of Fire: 350 rd/min (cyclic) in bursts            Loader Type: Dual-belt feed            Ready/Stowed Rounds: 500/0</p>	<p>100-mm rifled gun            Frag-HE 40            AT-10/Imp ATGM 8</p> <p>30-mm automatic gun            HEI-T, Frag-HE 340            AP-T, APDS-T or APFSDS-T 160</p> <p>7.62-mm coax MG 2,000            2 x 7.62-mm bow MG 4,000</p> <p>Elevation (°): -5 to +60            Fire on Move: Yes</p> <p><b>Auxiliary Weapon:</b>            Caliber, Type, Name: 7.62-mm (7.62x 54R) machinegun, PKT            Mount Type: Turret coax            Maximum Aimed Range (m): 2,000            Max Effective Range (m):                Day: 1,000                Night: INA            Fire on Move: Yes            Rate of Fire (rd/min): 250 practical / 650 cyclic, in 2-10 round bursts</p> <p>Caliber, Type, Name: 7.62-mm (7.62x 54R) machinegun, PKT            Mount Type: Bow left and right            Maximum Aimed Range (m): 1,000            Max Effective Range (m):                Day: 1,000/400-500 on the move                Night: N/A            Fire on Move: Yes            Rate of Fire (rd/min): 250 practical / 650 cyclic, in 2-10 round bursts</p> <p><b>ATGM Launcher:</b>            Name: 2A70 100-mm gun            Launch Method: Gun-launched            Guidance: SACLOS, laser-beam rider            Command Link: Encoded infrared laser-beam            Launcher Dismountable: No</p> <p><b>Firing Ports:</b> 2 on each side, 1 in left rear door</p> <p><b>FIRE CONTROL</b>  <b>FCS Name:</b> 1K13-2  <b>Main Gun Stabilization:</b> 2-plane  <b>Rangefinder:</b> Laser  <b>Infrared Searchlight:</b> Yes  <b>Sights w/Magnification:</b>            Gunner:                Day: 1K13-2, 8x ; 1P3-10 antiaircraft, 2.6x; PPD-1 stand-by                Field of View (°): INA                Acquisition Range (m): 5,200                Night: 1K13-2 II night channel, 5.5x                Field of View (°): INA                Acquisition Range (m): INA  <b>Commander Fire Main Gun:</b> Yes</p>	

**Russian Infantry Fighting Vehicle BMP-3 continued**

<p><b>VARIANTS</b></p> <p><b>BMP-3F:</b> Amphibious Armored Combat Vehicle developed for Naval Infantry.</p> <p><b>BMP-3 M1995:</b> ATGM launcher vehicle, with Kornet (AT-14) launcher and autoloader, and thermal sights.</p> <p><b>9P157:</b> ATGM launcher vehicle, with Krizantema (AT-15) ATGM autoloader, MMW and thermal fire control system.</p> <p><b>BMP-3K:</b> Command variant, with electronic round fuze system for 100-mm gun. Bow MGs are removed. Added radios are R-159, R-143 and R-174.</p> <p><b>BREhM-L:</b> Armored recovery vehicle (ARV).</p> <p><b>BRM-3K:</b> Combat recon vehicle with radar and 30-mm gun.</p> <p><b>BMP-3:</b> UAE upgrade improvements including Namut Thermal Night sight.</p> <p><b>MAIN ARMAMENT AMMUNITION</b></p> <p><b>Caliber, Type, Name:</b>  100-mm HE 3UOF17  Maximum Aimed Range (m): 5,000  Max Effective Range (m):  Day: 4,000  Night: INA  Tactical AA Range: 4,000  Armor Penetration (mm): 25 (RHA)</p> <p>Caliber, Type, Name: 100-mm HE-Shapnel (HEF/MOD.96)  Focused-fragmentation, electronically-fuzed  Maximum Aimed Range (m): 5,200  Max Effective Range (m):  Day: 5,200  Night: INA  Tactical AA Range: 4,000  Armor Penetration (mm): INA</p> <p>30-mm APFSDS-T M929  Maximum Aimed Range (m): 2,500  Max Effective Range (m):  Day: 2,000+  Night: INA  Tactical AA Range: 4,000  Armor penetration (mm): 55 (RHA) at 1,000 m, 45 at 2,000 m</p>	<p>30-mm Frag-HE  Maximum Aimed Range (m): 4,000  Max Effective Range (m):  Day: 4,000  Night: INA  Tactical AA Range: 4,000  Armor Penetration (mm): INA</p> <p>30-mm AP-T  Maximum Aimed Range (m): 2,500  Max Effective Range (m):  Day: 1,500  Night: INA  Tactical AA Range: 4,000  Armor Penetration (mm): 18 (RHA, 60°) at 1,500 m</p> <p>30-mm APDS  Maximum Aimed Range (m): 2,500  Max Effective Range (m):  Day: 2,000  Night: INA  Tactical AA Range: 4,000  Armor Penetration (mm): 25 (RHA) at 1,500 m</p> <p><b>Other Ammunition Types:</b> 100-mm HE-I, 30-mm HEI-T</p> <p><b>Antitank Guided Missiles</b></p> <p>Name: AT-10/Basnya  Warhead Type: Shaped charge  Command Link: Encoded laser-beam  Warhead Type: Shaped charge (HEAT)  Armor Penetration (mm): 650 (RHA)  Range (m): 4,000</p> <p>Name: AT-10 Improved  Warhead Type: Tandem shaped charge  Armor Penetration (mm): 700 (RHA) behind ERA  Range (m): 4,000  Launcher Dismountable: No</p>
--	---

**NOTES**

A French SNPE ERA kit and others are available for use on the BMP-3. However, during dismounted troop movement ERA would be a hazard. Thus, passive armor is more likely and ERA application is doubtful. Other options are spall liners and air conditioning.

Russian AG-17 30-mm automatic grenade launcher modification is available for use on BMP-3.

Russian KBP offers a drop-in one-man turret called Kliver, with a stabilized 2A72 30-mm gun, a 4 Kornet ATGM launcher, thermal sights, and improved fire control system.

The Namut thermal gunner's sight is available for use on BMP-3. This uses the French Athos thermal camera. Namut sight has 3x and 10x channels. Night acquisition range: 2,600 m (NFI)

Stowed rounds and ATGMs can be passed from the passenger compartment to the gunner for hand loading. This includes ATGMs.

The "HEF" (or "HE-Shrapnel") round can be employed in indirect fire mode with air burst to 7,000 m.

# German Infantry Fighting Vehicle Marder 1

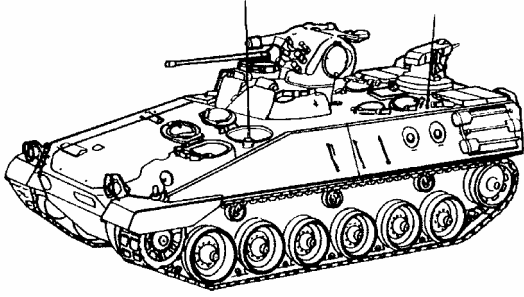
	<p><b>Weapons &amp; Ammunition Types</b></p> <p><b>20-mm automatic cannon</b> HEI/HEI-T API-T or APDS-T</p> <p><b>7.62-mm coax MG</b> coaxial rear/remote turret</p> <p><b>Milan ATGM Launcher</b></p>	<p><b>Typical Combat Load</b></p> <p><b>1,250</b></p> <p><b>5,000</b></p> <p><b>5</b></p>
	<p><b>SYSTEM</b>  <b>Alternative Designations:</b> INA  <b>Date of Introduction:</b> 1971  <b>Proliferation:</b> At least 2 countries  <b>Description:</b>            Crew: 4 (3+1 squad member, who dismounts with the squad)            Troop Capacity: 5            Combat Weight (mt): 29.2/35.0* for Marder 1A3            Chassis Length Overall (m): 6.79/6.88*            Height Overall (m): 2.99/3.02*            Width Overall (m): 3.24/3.38*            Ground Pressure (kg/cm<sup>2</sup>): 0.83/0.94*</p> <p><b>Automotive Performance:</b>            Engine Type: 590-600-hp Diesel            Cruising Range (km): 520            Speed (km/h):                Max Road: 75                Max Off-Road: 65                Average Cross-Country: 35                Max Swim: N/A            Fording Depth (m): 1.5/2.0 with preparation</p> <p><b>Radio:</b> INA</p> <p><b>Protection:</b>            Armor, Turret Front (mm): Against 20 mm/30 mm*            Applique Armor (mm): Available/Standard*            Explosive Reactive Armor (mm): Brenus ERA available            Active Protective System: N/A            Mineclearing Equipment: N/A            Self-Entrenching Blade: N/A            NBC Protection System: Collective            Smoke Equipment: 6 smoke grenade launchers</p> <p><b>ARMAMENT</b>  <b>Main Armaments:</b>            Caliber, Type, Name: 20-mm automatic cannon (92 Cal), Rh202            Rate of Fire (rd/min): 800-1,000            Loader Type: Dual belt feed/manual for Milan            Ready/Stowed Rounds: 345 HE and 75 AP/830 stowed            Elevation (°): -17 to +65            Fire on Move: No</p> <p><b>Auxiliary Weapon:</b>            Caliber, Type, Name: 7.62-mm (7.62x 51) machinegun, MG3            Mount Type: Turret coax            Maximum Aimed Range (m): 2,000            Max Effective Range (m):                Day: INA</p> <p>Night: INA            Fire on Move: Yes            Rate of Fire (rd/min): INA</p> <p><b>ATGM Launcher:</b>            Name: Milan, Milan 2, Milan 3            Launch Method: Tube (from canister)            Guidance: SACLOS            Command Link: Wire            Launcher Dismountable: Yes, with attached folded tripod.</p> <p><b>Firing Ports:</b> Two on each side</p> <p><b>FIRE CONTROL</b>  <b>FCS Name:</b> INA  <b>Main Gun Stabilization:</b> N/A  <b>Rangefinder:</b> Laser  <b>Infrared Searchlight:</b> Yes/removed in later variants  <b>Sights w/Magnification:</b>            Gunner:                Day: PERI Z 11, 2x and 6x                    Field of View (°): INA                    Acquisition Range (m): INA                Night: IR and white light/thermal sight*                    Field of View (°): INA                    Acquisition Range (m): INA</p> <p><b>Commander Fire Main Gun:</b> Yes</p> <p><b>VARIANTS</b>  <b>Marder 1A1:</b> Variant includes PERI Z 59 II gunner night sight, and Milan launcher. <b>Marder 1A1A</b> has original night sight.</p> <p><b>Marder 1A3:</b> Variant includes applique armor package, 7.62-mm MG moved to left side coaxial turret mount, three upper hull doors. In addition the suspension and turret interior were upgraded. Extra armor blocks the firing ports.</p> <p><b>Roland:</b> German air defense missile launcher vehicle with Marder chassis.</p> <p>* Data for Marder 1A3</p>	

**German Infantry Fighting Vehicle Marder 1 continued**

<p><b>VCTP:</b> Argentine Army IFV with a Marder chassis, a 720-hp engine, a 20-mm gun on a two-man turret, and two 7.62-mm MGs.</p> <p><b>TAM:</b> Argentine Army tank uses the Marder chassis and a 105-mm gun.</p> <p><b>MAIN ARMAMENT AMMUNITION</b>  <b>Caliber, Type, Name:</b>  20-mm (20x139) APDS-T, DM43A1  Maximum Aimed Range (m): INA  Max Effective Range (m):  Day: 2,000  Night: INA  Tactical AA Range: INA  Armor Penetration (mm): 32 at 1,000 m</p> <p>20-mm HEI, DM51A2/HEI-T, DM81  Maximum Aimed Range (m): INA  Max Effective Range (m):  Day: 2,000+  Night: INA  Tactical AA Range: INA  Armor Penetration (mm): INA</p>	<p>20-mm Shrapnel, DM111 (canister with forward fragment dispense)  Maximum Aimed Range (m): INA  Max Effective Range (m):  Day: INA  Night: INA  Tactical AA Range: INA  Armor Penetration (mm): INA</p> <p><b>Other Ammunition Types:</b> DM63 APDS-T, canister</p> <p><b>Antitank Guided Missiles</b>  Name: Milan  Warhead Type: Shaped charge (HEAT)  Armor Penetration (mm): 600 (RHA)  Range (m): 25-2,000</p> <p>Name: Milan 2  Warhead Type: Tandem Shaped charge  Armor Penetration (mm): 800 (RHA)  Range (m): 20-2,000</p> <p>Name: Milan 3  Warhead Type: Tandem Shaped charge with precursor charge  Armor Penetration (mm): 880 (RHA)  Range (m): 20-1,920</p>
--	---

**NOTES**

German Brenus ERA and others are available for use on the Marder 1. However, during dismounted troop movement ERA would be a hazard. Thus, passive armor is more likely and ERA application is doubtful.

All Milan launchers will fire all ATGMs. However, Milan 3 countermeasures will only function with the Milan 3 launcher. All Milan launchers can mount (and many are fitted with) the MIRA thermal night sight.

## British Infantry Fighting Vehicle Warrior

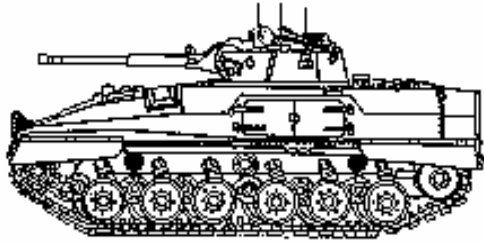
	<p><b>Weapons &amp; Ammunition Types</b></p> <p><b>30-mm auto gun</b> HEI-T APDS-T, APSE-T</p> <p><b>7.62-mm coax MG</b> Ball, Ball-T</p>	<p><b>Typical Combat Load</b></p> <p>228</p> <p>2,200</p>
<p><b>SYSTEM</b>  <b>Alternative Designations:</b> FV 511, MCV-80  <b>Date of Introduction:</b> 1988  <b>Proliferation:</b> At least two countries  <b>Description:</b>  Crew: 3  Troop Capacity: 7 passengers  Combat Weight (mt): 24.00  Chassis Length Overall (m): 6.34  Height Overall (m): 2.79  Width Overall (m): 3.03  Ground Pressure (kg/cm<sup>2</sup>): 0.65</p> <p><b>Automotive Performance:</b>  Engine Type: 550-hp Diesel  Cruising Range (km): 660  Speed (km/h):      Max Road: 75      Max Off-Road: 60      Cross-Country: 48      Max Swim: N/A  Fording Depth (m): 1.3 Unprepared</p> <p><b>Radio:</b> INA</p> <p><b>Protection:</b>  Armor, Turret Front (mm): Against 14.5-mm gun  Applique Armor (mm): Available (see VARIANTS)  Explosive Reactive Armor (mm): N/A  Active Protective System: N/A  Mineclearing Equipment: N/A  Self-Entrenching Blade: N/A  NBC Protection System: Yes  Smoke Equipment: Smoke grenade launchers (4 each side of turret)</p> <p><b>ARMAMENT</b>  <b>Main Armament:</b>  Caliber, Type, Name: 30-mm automatic cannon, RARDEN L21A1  Rate of Fire (rd/min): 80-90 cyclic  Loader Type: Feed tray, clip-fed (3-round clips)  Ready/Stowed Rounds: 228/0  Elevation (°): -10/+45  Fire on Move: INA</p> <p><b>Auxiliary Weapon:</b>  Caliber, Type, Name: 7.62-mm chain gun, L94A1  Mount Type: Turret coax  Maximum Aimed Range (m): INA  Max Effective Range: INA</p>	<p>Fire on Move: Yes  Rate of Fire (rd/min): 520-570</p> <p><b>ATGM Launcher:</b> N/A  <b>Firing Ports:</b> None</p> <p><b>FIRE CONTROL</b>  <b>FCS Name:</b> INA  <b>Main Gun Stabilization:</b> N/A  <b>Rangefinder:</b> INA  <b>Infrared Searchlight:</b> Yes  <b>Sights w/Magnification:</b>  Gunner:      Day: INA          Field of View (°): INA          Acquisition Range (m): INA      Night: SPAV L2A1 II sight          Field of View (°): INA          Acquisition Range (m): INA</p> <p><b>Commander Fire Main Gun:</b> No</p> <p><b>VARIANTS</b>  Command variant is outfitted with radios, mapboards, other staff support equipment, and Vickers Defence Turret.</p> <p><b>Desert Warrior:</b> Variant with the 2-man turret from LAV-25, with a US M242 Bushmaster 25-mm automatic cannon, coaxial MG and 1-2 ATGM launchers. Other modifications are additional passive armor and three periscopes for improved vision. Sold to Kuwait.</p> <p><b>Desert Storm Variant:</b> Changes included passive armor added to hull sides and a pintle mount for a Milan-2 ATGM launcher.</p> <p><b>Mechanized Artillery Observation Vehicle (MAOV):</b> It resembles an IFV, but is fitted with a dummy cannon, improved artillery reconnaissance and automation systems, and land navigation. Options include an Osprey 8-power optical and thermal sight with Nd:YAG laser designator for the observer.</p> <p><b>MAIN ARMAMENT AMMUNITION</b>  <b>Caliber, Type, Name:</b>  30-mm APDS-T, L14      Maximum Aimed Range (m): 4,000      Max Effective Range (m):          Day: 1,100          Night: INA      Armor Penetration (mm): INA</p> <p><b>Other Ammunition Types:</b> 30-mm APSE-T (AP Secondary Effects-T L5, HEI-T L13</p>	

### NOTES

Variants available but not in production include engineer, recovery, mortar vehicles, armored fighting vehicles with 90-mm and 105-mm guns, an APC with 7.62-mm chain gun, ATGM launcher vehicles for Milan, HOT and Trigat, and a low-profile chassis for a reduced signature IFV.





## Russian IFV/APC Turret Kliver

	<p><b>Weapons &amp; Ammunition Types</b></p> <p><b>30-mm automatic gun</b> HEI-T, Frag-HE APDS-T or APFSDS-T</p> <p><b>7.62-mm coax MG</b></p> <p><b>ATGM</b> Kornet-LR Kornet-LR HE</p>	<p><b>Typical Combat Load</b></p> <p><b>300</b></p> <p><b>2,000</b></p> <p><b>4 or 8</b> (See Notes)</p>
<p>BMP-1 with Kliver turret</p>		
<p><b>SYSTEM</b></p> <p><b>Alternative Designations:</b> TKB-799</p> <p><b>Date of Introduction:</b> Displayed first time in 1996</p> <p><b>Proliferation:</b> Prototypes displayed on BTR-80, BMP-1 and -3 chassis. This represents upper tier (higher cost) turret upgrades.</p> <p><b>Description:</b> Turret crew: 1, gunner in 1-man turret Combat Weight (mt): 1.5-2.5 Fording Depths (m): Amphibious vehicle capability retained</p> <p><b>Protection:</b> Armor, Turret Front (mm): INA Smoke Equipment: Not on prototypes, but could be added</p> <p><b>ARMAMENT</b></p> <p><b>Main Armaments:</b> Caliber, Type, Name: 30-mm automatic gun 2A72 Rate of Fire: 350 rd/min (cyclic) in bursts Loader Type: Belt feed Ready/Stowed Rounds: 300/0 Elevation (°): -10 to +60 Fire on Move: Yes</p> <p><b>Auxiliary Weapon:</b> Caliber, Type, Name: 7.62-mm (7.62x 54R) machinegun, PKT Mount Type: Turret coax Maximum Aimed Range (m): 2,000 Max Effective Range (m): Day: 1,500 Night: INA Fire on Move: Yes Rate of Fire (rd/min): 250 practical / 650 cyclic, in 2-10 rd bursts</p> <p><b>ATGM Launcher:</b> Name: Kornet Launch Method: Turret mount launcher, with free-slew elevation Guidance: Laser-beam rider Command Link: Encoded infrared laser-beam Launch Method: 4x tube-launched missiles Launcher Dismountable: No, however Kornet-E spare possible Elevation (°): INA Rate of Launch: (missiles/min): 2-3, depending on range Reaction Time (sec): 1-2 Ready/Stowed Missiles: 4/0 APC or IFV, 4 for DF support role</p>	<p><b>FIRE CONTROL</b></p> <p><b>FCS Name:</b></p> <p><b>Main Gun Stabilization:</b> 2-plane for fire on move</p> <p><b>Rangefinder:</b> Laser, built into sight</p> <p><b>Infrared Searchlight:</b> No</p> <p><b>Sights w/Magnification:</b> Gunner: 1K13-2 12x independent 2-plane stabilized sight Day: TV Field of View (°): INA Acquisition Range (m): 5,500 Night: Thermal sight Field of View (°): INA Acquisition Range (m): 3,500</p> <p><b>Commander Fire Main Gun:</b> No</p> <p><b>VARIANTS</b> Prototypes displayed include BTR-80 and BMP-3 chassis. KBP Tula claims that it can be installed on any vehicle with 1.5-2.5 tonne turret capacity. Hull opening rework for the turret ring would be required. KBP (manufacturer) says that a 2-man turret version is available.</p> <p><b>BMP-1M:</b> IFV with Kliver upgrade. The turret was designed for the BMP-1 turret ring.</p> <p><b>MAIN ARMAMENT AMMUNITION</b></p> <p><b>Caliber, Type, Name:</b> 30-mm APFSDS-T M929 Maximum Aimed Range (m): 2,500 Max Effective Range (m): Day: 2,000+ Night: INA Tactical AA Range: 4,000 Armor penetration (mm): 55 (RHA) at 1,000 m, 45 at 2,000 m</p> <p>30-mm Frag-HE Maximum Aimed Range (m): 4,000 Max Effective Range (m): Day: 4,000 Night: INA Tactical AA Range: 4,000 Armor Penetration (mm): INA</p>	

## Russian IFV/APC Turret Kliver continued

<p>30-mm APDS Maximum Aimed Range (m): 2,500 Max Effective Range (m): Day: 2,000 Night: INA Tactical AA Range: 4,000 Armor Penetration (mm): 25 (RHA) at 1,500 m</p> <p><b>Other Ammunition Types:</b> 100-mm HE-I, 30-mm HEI-T</p>	<p><b>Antitank Guided Missiles</b> Name: Kornet-LR Alternative Designation: 9M133 Missile Weight (kg): 27 Warhead Type: Tandem Shaped Charge (HEAT) Armor Penetration (mm): 1,200 Min/Max Range (m): 100/5,500 Probability of Hit (%): 90 Average Velocity (m/s): 550 Time of Flight to Max Range (sec): 22</p> <p><b>Other Missiles:</b> Kornet-LR HE (thermobaric, 9M133F)</p>
---	--

### NOTES

Force could use a partial maneuver unit upgrade, such as one per platoon, or 3-4 per company, to serve the direct-fire support role in an APC or IFV-based mechanised infantry unit. The cost would be less than conversion of all vehicles, with a significant lethality improvement against armored vehicles (tanks and IFVs) as well as against aircraft. In the DF support role, 4 more ATGMs and MANPADS launcher could be stowed in place of 2-4 troops. Stowed rounds and ATGMs can be passed from the passenger compartment to the gunner for hand loading.

Turret installation would not interfere with NBC system, commander's station, or with onboard ammunition stowage.

## Chapter 3 Reconnaissance

Reconnaissance represents all measures associated with organizing, collecting, and studying information on the enemy, terrain, and weather in area of upcoming battles. Aggressive continuous reconnaissance allows the timely accomplishment of combat missions with minimum losses. Poor reconnaissance can lead to failure. This chapter focuses on the reconnaissance systems of ground maneuver forces and specialized ground reconnaissance troops such as special purpose forces. However, there are also dedicated reconnaissance assets which other chapters in this manual discuss in more detail:

- Artillery target acquisition (Chapter 6).
- Aerial reconnaissance (Chapters 9, 10, & 12).
- Air defense reconnaissance, early warning, and target acquisition (Chapter 7).
- Engineer reconnaissance (Chapter 8).
- Signals reconnaissance (Chapter 13).
- NBC reconnaissance (when published).

As the modern battlefield becomes increasingly mobile and lethal the challenge is to design and deploy reconnaissance systems with the ability to acquire the enemy, transmit intelligence, and survive for the next mission. In this era, the struggle for "information dominance" complements other technological struggles (such as armor/antiarmor and mobility/countermobility) that characterize the modern battlefield. Reconnaissance developments are increasingly utilizing the electromagnetic spectrum, integrating C2, navigation systems, data processing, and fusing technologies, as well as new mobility systems to provide greater situational awareness and forecasting for the combined arms commander in battlefield management. Assets are specially designed for different branches and echelons, from tactical to strategic.

Much of the reconnaissance effort will continue to be executed by assigned maneuver units. This challenge also translates to reconnaissance as a combined arms mission, not solely the business of reconnaissance troops. Most forces employ a mix of maneuver vehicles, including tanks and infantry fighting vehicles, dismounted reconnaissance patrols with ground sensors, aerial reconnaissance, and reconnaissance vehicles.

Ground sensors include optics (sights, binoculars, and telescopes) that operate in the visual light (0.4-0.7 $\mu$ ) bandwidth of the electro-magnetic spectrum. Electro-optical systems, such as laser rangefinders, laser designators, aiming circles or goniometers, and remote cameras can operate in the visual band, as well as in the infrared (0.7-13 $\mu$ +) band. Television (TV) systems employ a camera which transforms an image into RF data which can be linked to a system for processing and transmission. Among current emphases are lightweight hand-held/tripod mounts, weapons optics, and EO sensors for infantry. Sensor systems increasingly use acoustic and seismic sensors, and radars. Acoustic sensors include multi-directional microphones, directional microphones that can be linked for determining azimuth, as well as sound-ranging arrays and vehicles which intersect azimuths to locate sound sources. Acoustic sensors can generate a wake-up signal to actuate sensor suites. Weapon sensors continue to be the preponderant ones for surveillance, target location, and successful reconnaissance operations.

Radars are finding new applications. Battlefield surveillance radars continue to include ground radars on tripod mounts and towed carriages, vehicle mounted systems, and on aerial platforms. Through the use of micro-circuit miniaturization and fire control computer application technology, target acquisition radars are finding new applications on vehicles and weapons carriages, such as antitank guns. Compact radars are being marketed for manportable carry and attachment to weapons, such as automatic grenade launchers. Airborne applications of imaging radar reconnaissance systems use MTI and synthetic aperture radars and doppler processing for tactical and operational-strategic surveillance and target acquisition.

A variety of recent sensor systems are fused into sensor suites, which can employ multiple sensors for day/night integrated detection, location, and target acquisition. The most common sensor suites incorporate day/night cameras and laser rangefinder/designators. More sophisticated suites include radars for long-range detection. Several suites can be mounted on tripods or masts for easy vehicle mounting. Thus, forces are using sensor suites to convert light armored vehicles or wheeled combat support vehicles into reconnaissance sensor vehicles.

Digital communication and graphic display technologies support fused intelligence networks which can incorporate a wide variety of assets, such as reconnaissance vehicles and aircraft, UAVs, operational-strategic intelligence sources (such as satellite data, map data, and links to higher-level assets). Modern commercial products such as imageary, simplified ground station terminals, TV, and internet will contribute to real-time availability of fused intelligence.

Much attention will continue to focus on combat reconnaissance applications. Recent developments include assets for special operations forces that vary from lightweight manportable precision location and laser designators, to semi-submersible infiltration landing craft (SILC) for use by naval special operations forces.

The modern lethal battlefied (increased lethality, mobility, day/night coverage, and longer range of coverage) poses an increasing hazard to reconnaissance assets and personnel. Therefore, two other technology trends are on the increase: remote sensors and robotic sensors. Civilian applications have led to a wide variety of remote cameras, remote mines which can be used as trigger/alert devices for patrols, and unattended ground sensors (including acoustic, IR, seismic, tripwire-electronic, and magnetic). Key technology problems, particularly detectibility, power supply/battery limitations, and signal transmission problems have generally been resolved. Rechargeable batteries, acoustic/IR wake-up, miniaturization, increased sensor sensitivity, and other advances contribute to break-throughs. Robotic chassies permit applications in dangerous areas (e.g., minefields, urban and defilade areas, and open areas without cover).

Questions and comments on reconnaissance for specific BOSs should be addressed to the respective chapter POC. Questions concerning data in this chapter should be addressed to:

**Walt Williams**

DSN: 552-7923 Commercial (913) 684-7923

e-mail address: [williamw@leavenworth.army.mil](mailto:williamw@leavenworth.army.mil)

### *Reconnaissance Vehicles*

The reconnaissance requirement is for a continuous and pervasive effort throughout the battlefield at all phases of operation. To accomplish that effort, ground forces employ a mix of vehicles in areas that vary based on types of threat, and on mobility requirement. Some of the vehicles must act as independent reconnaissance patrols, combat reconnaissance patrols, and combat outposts against high threat forces. Many reconnaissance missions will be executed by maneuver units using organic vehicles, such as APCs, IFVs, tanks, and combat support vehicles.

The spectrum of reconnaissance vehicles currently ranges from older systems ill-suited for modern requirements, to survivable, mobile, and lethal systems, equipped with complex sensor arrays and communications suites. A number of forces fielded *combat reconnaissance vehicles* (CRVs) designed for operations at or beyond the FLOT, not to initiate combat but to survive if engaged. They may operate in combat reconnaissance patrols with heavily armed vehicles such as tanks and IFVs. Swim capability is a valuable asset. Many offer sensors no better than those on other armored vehicles, and use optics for a variety of combat support missions, such as fire support. Examples of these are the British Saladin Armored Car and the Austrian Pandur armored reconnaissance Fire Support Vehicle. Main guns on these vehicles can range up to 105 mm (South African Rooikat). A growing trend is for CRVs with added sensors (such as the Russian BRM-3K). It is a versatile vehicle configured for maneuver reconnaissance with thermal sights and a 30-mm gun, but is also useful for setting up a stationary surveillance position with its Tall Mike radar. As a command (-K type) vehicle, it employs a mix of radios to transmit intelligence across several nets in a combined arms force.

Reconnaissance missions closer to the protection of maneuver units or within the area of responsibility (AOR) still bear some risk. Therefore sensor reconnaissance missions and force security patrol missions require vehicles with some weapons and armor protection. A recent trend is the fielding of *sensor reconnaissance vehicles* with sophisticated multi-sensor arrays specially designed to operate behind or near the FLOT and provide continuous data to combined arms forces. Among these vehicles, addition of an elevating mast or arm permits the crew to use defilade cover yet raise the sensor suite and surveil the battlefield. An example is the Czech Snezka, or the Chinese Type 85 with HJ-62C radar. Vehicles designed to support specific branches are included with those branches (such as PRP-3/4 for artillery).

A class of vehicles widely proliferated for such light patrol duties is the *armored scout car*. With wheels rather than tracks, light armor, and guns generally of 7.62 - 20 mm, they offer low cost but are vulnerable to a wide variety of weapons. Examples include the British Ferret and Russian BRDM-2. A recent category of vehicle which US Army forces will encounter is lightly armored vehicles on truck or jeep-type chassis with very light armor for security, and patrol. Some are unarmed; whereas others employ sophisticated weapons stations and lethal firepower (up to 30-mm guns). Smaller 4x4 scout vehicles (such as French VBL) and ultra-light *fast-attack* vehicles have also been built for light patrol and rapid reconnaissance missions. For site security and other internal security patrol missions, such as MP patrol, *light patrol vehicles* may be fashioned with small arms protection, minimum sensors, and troop carrying capacity.

A critical reconnaissance mission for maneuvering forces is route reconnaissance. The mission requires systems that are highly mobile, with superior sensors as well as superior communications capabilities. Swim capability is generally required. The system should be survivable and avoid a fight when possible, but armed sufficiently to fight and survive when necessary. Specialized capabilities to support the route reconnaissance effort on a complex battlefield include NBC and engineer recon vehicles. They should have comparable mobility and survivability with accompanied vehicles. Engineer vehicles must clear obstacles, and may be required to conduct underwater reconnaissance for prospective water crossings. For information on engineer reconnaissance vehicles, see the Engineer chapter.

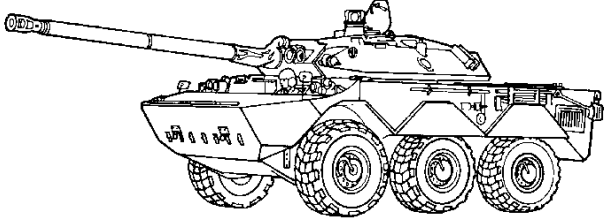
	<p><b>Weapons &amp; Ammunition Types</b></p> <p><b>105-mm rifled gun</b> APFSDS-T HEAT-T HE-T</p> <p><b>7.62-mm coax MG</b></p>	<p><b>Typical Combat Load</b></p> <p><b>38</b> (est) 10 9 19</p> <p><b>4,000</b></p>
<p><b>SYSTEM</b> <b>Alternative Designations:</b> INA <b>Date of Introduction:</b> 1979 <b>Proliferation:</b> At least 3 countries <b>Description:</b> Crew: 4 Troop Capacity: None Combat Weight (mt): 15.8 Chassis Length Overall (m): 6.35 Height Overall (m): 2.29 Width Overall (m): 2.95 Drive Formula: 6 x 6</p> <p><b>Automotive Performance:</b> Engine Type: 260-hp Diesel Cruising Range (km): 1,000 Speed (km/h): Max Road: 85 Max Off-Road: INA Average Cross-Country: INA Max Swim (km/h): 4.5/7.2 with 2 hydrojets Fording Depth (m): INA</p> <p><b>Radio:</b> INA</p> <p><b>Protection:</b> Armor, Turret Front (mm): INA Applique Armor (mm): Available, Desert Storm version Explosive Reactive Armor (mm): N/A Active Protective System: KCBM ATGM IRCM decoy device Mineclearing Equipment: N/A Self-Entrenching Blade: N/A NBC Protection System: Yes Smoke Equipment: 2x2 smoke grenade launchers (16 grenades)</p> <p><b>ARMAMENT</b> <b>Main Armament:</b> Caliber, Type, Name: 105-mm (48 Cal) rifled gun, CN-105-F2 Rate of Fire (rd/min): INA Loader Type: Manual Ready/Stowed Rounds: 12/26 Elevation (°): -8 to +20 Fire on Move: No</p> <p><b>Auxiliary Weapons:</b> Caliber, Type, Name: 7.62-mm MG, INA Mount Type: Coax Maximum Aimed Range (m): 2,000 Max Effective Range (m): Day: INA</p>	<p>Night: INA Fire on Move: Yes Rate of Fire (rd/min): INA <b>ATGM Launcher:</b> N/A <b>Firing Ports:</b> N/A</p> <p><b>FIRE CONTROL</b> <b>FCS Name:</b> COTAC M401 <b>Main Gun Stabilization:</b> No <b>Rangefinder:</b> Cilas APX M550 laser <b>Infrared Searchlight:</b> No <b>Sights w/Magnification:</b> Gunner: Day: APX M504-04, 10x Field of View (°): INA Acquisition Range (m): INA Night: DIVT 13 LLLTV Field of View (°): INA Acquisition Range (m): INA <b>Commander Fire Main Gun:</b> No</p> <p><b>VARIANTS</b> <b>Desert Storm version:</b> Vehicles have applique armor, an ATGM IRCM decoy device, and a DIVT 16 thermal sight, range 4,000 m.</p> <p><b>MAIN ARMAMENT AMMUNITION</b> <b>Caliber, Type, Name:</b> 105-mm APFSDS-T, OFL 105 Mle F3, Giat Maximum Aimed Range (m): 2,000 Max Effective Range (m): Day: 1,500 Night: INA Armor Penetration (mm): Single heavy tank target at 1,000 m</p> <p>105-mm HEAT-T, OCC 105 F3, French Giat Maximum Aimed Range (m): 1,300 Max Effective Range (m): Day: 1,250 Night: INA Armor Penetration (mm): 100 at 70°</p> <p>105-mm HE, OE 105 Mle F3 Maximum Aimed Range (m): 2,500 Max Effective Range (m): Day: 1,000 Night: INA Armor Penetration (mm): INA</p> <p><b>Other Ammunition Types:</b> Smoke</p>	

**NOTES**

The Alis modular thermal sight can be used on AMX-10RC. A 280-hp Baudouin engine replaced the original engine in some upgrades. In 1997 the French army demonstrated a version of the Leclerc Battlefield Management System on the AMX-10RC.



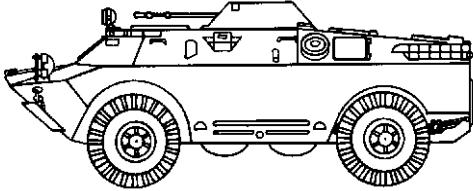

## Russian Armored Scout Car BRDM-2

	<b>Weapons &amp; Ammunition Types</b>  <b>14.5-mm machinegun</b> API, API-T, I-T HE-T  <b>7.62-mm coax MG</b> Heavy ball, I-T, Light ball, Ball-T, API-T	<b>Typical Combat Load</b>  <b>500</b> 160 340  <b>2,000</b>
<p><b>SYSTEM</b>  <b>Alternative Designations:</b> GAZ 41-08  <b>Date of Introduction:</b> 1963  <b>Proliferation:</b> At least 45 countries  <b>Description:</b>  Crew: 4  Troop Capacity: 0 (for this configuration)  Combat Weight (mt): 7.0  Chassis Length Overall (m): 5.75  Height Overall (m): 2.31  Width Overall (m): 2.75  Ground Pressure (kg/cm<sup>2</sup>): INA  Drive Formula: 4 x 4 (+ 4 auxiliary wheels)</p> <p><b>Automotive Performance:</b>  Engine Type: 140-hp Gasoline  Cruising Range (km): 750  Speed (km/h): Max Road: 95  Max Off-Road: INA  Average Cross-Country: INA  Max Swim: 10  Fording Depths (m): Amphibious</p> <p><b>Radio:</b> R-123</p> <p><b>Protection:</b>  Armor, Turret Front (mm): 10  Applique Armor (mm): N/A  Explosive Reactive Armor (mm): N/A  Mineclearing Equipment: N/A  Self-Entrenching Blade: N/A  Active Protective System: N/A  NBC Protection System: Collective  Smoke Equipment: N/A</p> <p><b>ARMAMENT</b>  <b>Main Armament:</b>  Caliber, Type, Name: 14.5-mm Machinegun KPVT  Rate of Fire (rd/min): 150 practical/600 cyclic  Loader Type: Belt feed  Ready/Stowed Rounds: 500/0  Elevation (°): -5 / +30  Fire on Move: Yes</p> <p><b>Auxiliary Weapon:</b>  Caliber, Type, Name: 7.62-mm (7.62x 54R) Machinegun PKT  Mount Type: Coax  Maximum Aimed Range (m): 1,500  Max Effective Range (m):  Day: 1,000m / 400-500 on the move  Night: N/A</p>	<p>Fire on Move: Yes  Rate of Fire (rd/min): 250 practical / 650 cyclic in 2-10 round bursts</p> <p><b>ATGM Launcher:</b> N/A  <b>Firing Ports:</b> INA</p> <p><b>FIRE CONTROL</b>  <b>FCS Name:</b> N/A  <b>Main Gun Stabilization:</b> N/A  <b>Rangefinder:</b> N/A  <b>Infrared Searchlight:</b> INA  <b>Sights w/Magnification:</b>  Gunner:  Day: PP-61AM  Field of View (°): 23  Acquisition Range (m): 2,000  Night: N/A  Field of View (°): INA  Acquisition Range (m): INA  <b>Commander Fire Main Gun:</b> No</p> <p><b>VARIANTS</b>  Polish modernized variant has been offered in five versions, with upgrades such as: 12.7-mm MG, improved PKT MG mount, roof-mounted AT-4 ATGM, surveillance radar, improved fire control, etc.</p> <p>Antitank guided missile launcher vehicles:  <b>9P122</b> variant with 6-rail AT-3 ATGM launcher  <b>9P124</b> variant with 4-rail AT-2 MCLOS ATGM launcher  <b>9P133</b> variant with 6-rail AT-3C SACLOS ATGM launcher  <b>9P137</b> variant with 5-rail AT-5 ATGM launcher  <b>9P148</b> variant with 5-rail AT-4 or AT-5 ATGM launcher.</p> <p><b>BRDM-2Rkh:</b> NBC reconnaissance vehicle</p> <p><b>BRDM-2U:</b> Command variant without a turret</p> <p><b>SA-9:</b> SAM system transporter-erector-launcher vehicle</p> <p><b>MAIN ARMAMENT AMMUNITION</b>  <b>Caliber, Type, Name:</b>  14.5-mm API-T  Maximum Aimed Range (m): INA  Max Effective Range (m):  Day: 2,000  Night: INA  Tactical AA Range: 1,400  Armor Penetration (mm): 20 at 1,000 m/30 at 500 m</p> <p><b>Other Ammunition Types:</b> 14.5-mm API, I-T, HE-T Type MDZ</p>	

### NOTES

Some BRDMs may include an AT-4 launcher and ATGMs for dismounted self-defense.

## Russian Armored Reconnaissance Command Vehicle BRM-1K

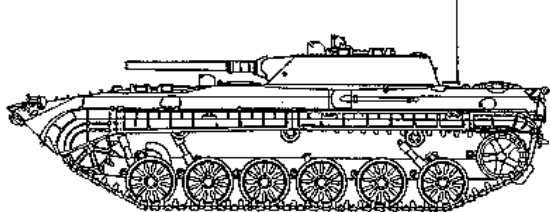
	<p><b>Weapons &amp; Ammunition Types</b></p> <p>73-mm gun HEAT HE</p> <p>7.62-mm coax MG</p>	<p><b>Typical Combat Load</b></p> <p>20 (est) 10 10</p> <p>2,000</p>
<p><b>SYSTEM</b>  <b>Alternative Designations:</b> BMP M1976/2  <b>Date of Introduction:</b> 1976  <b>Proliferation:</b> At least 3 countries  <b>Description:</b>  Crew: 4 (with addition of a navigator)  Troop Capacity: 6 passengers  Combat Weight (mt): 13.3  Chassis Length Overall (m): 6.74  Height Overall (m): 2.15  Width Overall (m): 2.94  Ground Pressure (kg/cm<sup>2</sup>): 0.57</p> <p><b>Automotive Performance:</b>  Engine Type: 300-hp diesel  Cruising Range (km): 600  Speed (km/h):      Max Road: 65      Max Off-Road: 40-45      Average Cross-Country: INA      Max Swim: 7  Fording Depth (m): Amphibious  <b>Radio:</b> R-173, R-130, 2x R-148 manportable, R-014D telegraph</p> <p><b>Protection:</b>  Armor, Turret Front (mm): 19-23  Applique Armor (mm): Available  Explosive Reactive Armor (mm): Available  Active Protective System: N/A  Mineclearing Equipment: N/A  Self-Entrenching Blade: N/A  NBC Protection System: Yes  Smoke Equipment: VEES</p> <p><b>ARMAMENT</b>  <b>Main Armament:</b>  Caliber, Type, Name: 73-mm smoothbore gun, 2A28/Grom  Rate of Fire (rd/min): 7-8  Loader Type: Autoloader  Ready/Stowed Rounds: 20 / 0  Elevation (°): -4/+33  Fire on Move: Yes, but only 10 km/h or less (est)</p> <p><b>Auxiliary Weapon:</b>  Caliber, Type, Name: 7.62-mm (7.62x 54R) machinegun PKT  Mount Type: Coaxial  Maximum Aimed Range (m): 1,300  Max Effective Range (m):      Day: 1,000 / 400-500 on the move</p>	<p>Night: 800  Fire on Move: Yes  Rate of Fire (rd/min): 250 practical / 650 cyclic, in 2-10 round bursts  <b>Firing Ports:</b> 1 on each side, 1 in left rear door</p> <p><b>FIRE CONTROL</b>  <b>FCS Name:</b> INA  <b>Main Gun Stabilization:</b> No  <b>Rangefinder:</b> Laser  <b>Infrared Searchlight:</b> Yes  <b>Sights w/Magnification:</b>  Gunner:      Day: 1PN22M2, 8x          Field of View (°): 15 (est)          Acquisition Range (m): INA      Night: 1PN22M2 II channel, 6x          Field of View (°): 6 (est)          Acquisition Range (m): 800-1,000, based on light</p> <p><b>VARIANTS</b>  <b>BRM-1:</b> Baseline armored reconnaissance vehicle (BMP M1976/1) without smoke grenade launchers, added comms (R-130, R-014D telegraph), and Tall Mike radar but with four more passengers.</p> <p><b>MAIN ARMAMENT AMMUNITION</b>  <b>Caliber, Type, Name:</b>  73-mm HEAT-FS, PG-9      Maximum Aimed Range (m): 1,300      Max Effective Range (m):          Day: 800, 600 on the move          Night: 800      Armor Penetration (mm): 335 (RHA)</p> <p>73-mm HEAT-FS, NFI      Maximum Aimed Range (m): 1,300      Max Effective Range (m):          Day: 1,000, 600 on the move          Night: 800-1,000      Armor Penetration (mm): &gt;400 (RHA)</p> <p>73-mm HE, OG-9      Maximum Aimed Range (m): 1,300      Max Effective Range (m):          Day: 1,300, 1,000 on the move          Night: 1,000      Armor penetration (mm): INA</p> <p><b>Other Ammunition Types:</b> 73-mm HE, OG-9M</p>	

**NOTES**

Derived from BMP-1, the vehicle has a 2-man turret and additional sensors. Two manportable SAM launchers are included. BMP-1 options fit BRM-1 and -1K.  
SENSORS: 1PN22M2 sight, 1D8 laser rangefinder, and Tall-Mike battlefield surveillance radar. Radar characteristics: operating band I (9.0 GHz); detection ranges 30 km personnel, 12 km vehicles. The Russian Alis or Sanoet thermal gunner's sight can be installed. Passengers may dismount from BRM-1K and will dismount from BRM-1 to form an alternate reconnaissance post.

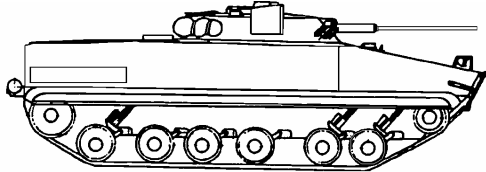

## Russian Combat Reconnaissance Vehicle BRM-3K

	<p><b>Weapons &amp; Ammunition Types</b></p> <p><b>30-mm auto gun</b> HE-I &amp; Frag-HE-T APDS, APFSDS-T</p> <p><b>7.62-mm coax MG</b></p>	<p><b>Typical Combat Load</b></p> <p><b>500</b> 340 160</p> <p><b>2,000</b></p>
<p><b>SYSTEM</b>  <b>Alternative Designations:</b> Lynx, Rys  <b>Date of Introduction:</b> 1990  <b>Proliferation:</b> At least 1 country  <b>Description:</b>  Crew: 6  Combat Weight (mt): 19.6  Chassis Length Overall (m): 6.10  Height Overall (m): 2.65  Width Overall (m): 3.15  Ground Pressure (kg/cm<sup>2</sup>): 0.62</p> <p><b>Automotive Performance:</b>  Engine Type: 500-hp Diesel  Cruising Range (km): 600  Speed (km/h):  Max Road: 70  Max Off-Road: 45  Average Cross-Country: 35  Max Swim: 10  Forcing Depths (m): Amphibious</p> <p><b>Radio:</b> R-163-50U UHF, R-163-50K HF, R-163-10U (dismounts)</p> <p><b>Protection:</b>  Armor, Turret Front (mm): 30-35 mm (front glacis)  Applique Armor (mm): Yes on turret  Explosive Reactive Armor (mm): Available  Mineclearing Equipment: N/A  Self-Entrenching Blade: N/A  Active Protective System: N/A  NBC Protection System: Collective  Smoke Equipment: 6 Smoke grenade launchers, VEES</p> <p><b>ARMAMENT</b>  <b>Main Armament:</b>  Caliber, Type, Name: 30-mm automatic gun, 2A72  Rate of Fire: 350 rd/min (cyclic) in bursts  Loader Type: Dual-belt feed  Ready/Stowed Rounds: 500/ 0  Elevation (°): -5 to + 60  Fire on Move: Yes</p> <p><b>Auxiliary Weapon:</b>  Caliber, Type, Name: 7.62-mm machinegun, PKT  Mount Type: Turret coax  Max Effective Range:  Day: 2,000 m  Night: 1,200-1,500 passive/2,000 active  Fire on Move: Yes</p>	<p>Rate of Fire (rd/min): 250 practical / 650 cyclic, in 2-10 round bursts</p> <p><b>Firing Ports:</b> 1 on each side</p> <p><b>FIRE CONTROL</b>  <b>FCS Name:</b> BPK-2-42  <b>Main Gun Stabilization:</b> 2-plane, 2E52-1  <b>Rangefinder:</b> Laser  <b>Infrared Searchlight:</b> Yes  <b>Sights w/Magnification:</b>  Gunner:  Day: BPK-2-42  Field of View (°): 8  Acquisition Range (m): 4,000 (est)  Night: 1PN61 II/IR sight  Field of View (°): INA  Acquisition Range (m): 1,200-1,500/3,000+ active IR  <b>Commander Fire Main Gun:</b> INA</p> <p><b>VARIANTS</b>  N/A</p> <p><b>MAIN ARMAMENT AMMUNITION</b>  <b>Caliber, Type, Name:</b>  30-mm APDS  Maximum Aimed Range (m): 4,000 (est)  Max Effective Range (m):  Day: 2,500  Night: 1,200-1,500 passive/ 2,500 active  Tactical AA Range: 4,000  Armor Penetration (mm): 25 (RHA) at 1,500 m</p> <p>30-mm APFSDS-T M929  Maximum Aimed Range (m): 4,000 (est)  Max Effective Range (m):  Day: 2,500+  Night: 1,200-1,500 passive/2,500+ active  Tactical AA Range: 4,000  Armor penetration (mm): 55 (RHA) at 1,000 m, 45 at 2,000 m</p> <p>30-mm Frag-HE  Maximum Aimed Range (m): 4,000  Max Effective Range (m):  Day: 4,000  Night: 1,200-1,500 passive/ 3,000+ active  Tactical AA Range: 4,000  Armor Penetration (mm): INA</p> <p><b>Other Ammunition Types:</b> 30-mm HEI-T, AP-T</p>	
<p><b>NOTES</b>  BRM-3K is a variant of BMP-3 with a steel hull.</p>		
<p>ONBOARD SENSORS: The 1PN71 thermal sight (3.7x/11.5x) has an acquisition range against tanks of 3.0 km. The 1D14 laser rangefinder (73x and 18x sights) has a day light only acquisition range of 10.0 km. The 1PN61 passive image intensifier night sight uses a laser illuminator. In the passive mode, the Generation II (7x) sight has a night acquisition range of 1.2-1.5 km. Using the active laser pulse illuminator, the acquisition range can be extended. Tall Mike Radar has an operating band I (9.0 GHz), and detection ranges: 3.0 km against personnel, 12.0 against moving vehicles.</p>		

## Brazilian Armored Reconnaissance Vehicle EE-9

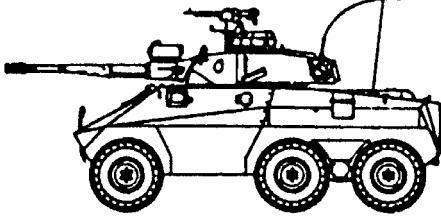
	<b>Weapons &amp; Ammunition Types</b>	<b>Typical Combat Load</b>
<p><b>SYSTEM</b>  <b>Alternative Designations:</b> Cascavel IV  <b>Date of Introduction:</b> 1977  <b>Proliferation:</b> At least 18 countries (all variants)  <b>Description:</b>            Crew: 3            Troop Capacity: None            Combat Weight (mt): 13.4            Chassis Length Overall (m): 5.19            Height Overall (m): 2.36            Width Overall (m): 2.66            Drive Formula: 6 x 6</p> <p><b>Automotive Performance:</b>            Engine Type: 212-hp Diesel            Cruising Range (km): 880            Speed (km/h): Max Road: 100                Max Off-Road: INA                Average Cross-Country: INA                Max Swim: N/A            Fording Depth (m): 1.0 unprepared</p> <p><b>Radio:</b> INA</p> <p><b>Protection:</b>            Armor, Turret Front (mm): 16            Applique Armor (mm): N/A            Explosive Reactive Armor (mm): N/A            Active Protective System: N/A            Mineclearing Equipment: N/A            Self-Entrenching Blade: N/A            NBC Protection System: N/A            Smoke Equipment: 6 smoke grenade launchers</p> <p><b>ARMAMENT</b>  <b>Main Armament:</b>            Caliber, Type, Name: 90-mm gun, Engesa EC-90 (Cockerill-type)            Rate of Fire (rd/min): INA            Loader Type: Manual            Ready/Stowed Rounds: 24/ 20            Elevation (°): -8/+15            Fire on Move: INA</p> <p><b>Auxiliary Weapons:</b>            Caliber, Type, Name: 7.62-mm MG, INA            Mount Type: Coax            Maximum Aimed Range (m): 2,000            Max Effective Range (m):                Day: INA                Night: INA            Fire on Move: Yes            Rate of Fire (rd/min): INA</p>	<p>90-mm cannon            APFSDS-T            HEAT-T, HESH            HE-T</p> <p>7.62-mm coax MG            .50 cal AA MG</p> <p>44            (est) 11            11            22</p> <p>2,000            500</p> <p>Caliber, Type, Name: .50 Cal M2 HB MG            Mount Type: Cupola            Maximum Aimed Range (m): 2,000            Max Effective Range (m):                Day: 2,000                Night: INA            Fire on Move: Yes            Rate of Fire (rd/min): INA</p> <p><b>ATGM Launcher:</b> N/A  <b>Firing Ports:</b> N/A</p> <p><b>FIRE CONTROL</b>  <b>FCS Name:</b> INA  <b>Main Gun Stabilization:</b> N/A  <b>Rangefinder:</b> LV3 laser rangefinder  <b>Infrared Searchlight:</b> N/A  <b>Sights w/Magnification:</b>            Gunner:                Day: SS-123, 10x                    Field of View (°): INA                    Acquisition Range (m): INA                Night: SS-122 II channel, 5.6x                    Field of View (°): INA                    Acquisition Range (m): INA  <b>Commander Fire Main Gun:</b> No</p> <p><b>VARIANTS</b>  <b>Cascavel I:</b> Original vehicle had a US M36 37-mm gun turret.  <b>Cascavel II:</b> Variant with a French 90-mm gun from AML-90.  <b>Cascavel III:</b> Uses the 90-mm Cockerill gun and new transmission.  <b>Cascavel IV:</b> Has a new engine and transmission, improved day and night optics with laser rangefinder, and a 50 cal antiaircraft MG.</p> <p><b>MAIN ARMAMENT AMMUNITION</b>  <b>Caliber, Type, Name:</b>            90-mm APFSDS-T, Engequimica-produced            Maximum Aimed Range (m): INA            Max Effective Range (m):                Day: 2,000+                Night: INA            Armor Penetration (mm): INA</p> <p>90-mm HE-T, Engequimica-produced            Maximum Aimed Range (m): INA            Max Effective Range (m):                Day: 2,200                Night: INA            Armor Penetration (mm): INA</p> <p><b>Other Ammunition Types:</b> HEAT-T, HESH-T, Smoke, Cannister</p>	

**NOTES**

Other ammunition maximum effective ranges are (m): HEAT-T - 1,500, HESH-T - 800.

## British Armored Reconnaissance Vehicle Fox

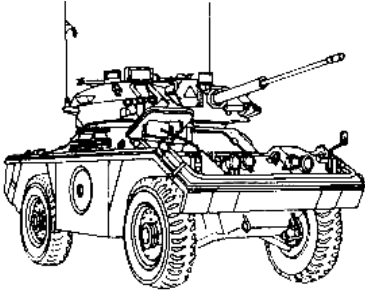
	<p><b>Weapons &amp; Ammunition Types</b></p> <p><b>30-mm auto-cannon</b> HEI-T, APDS-T, APSE-T</p> <p><b>7.62-mm coax MG</b></p>	<p><b>Typical Combat Load</b></p> <p><b>99</b> (est) 66 33</p> <p><b>2,600</b></p>
<p><b>SYSTEM</b> <b>Alternative Designations:</b> FV721 <b>Date of Introduction:</b> 1973 <b>Proliferation:</b> At least 3 countries</p> <p><b>Description:</b> Crew: 3 Troop Capacity: 0 Combat Weight (mt): 6.12 Chassis Length Overall (m): 4.17 Height Overall (m): 2.20 Width Overall (m): 2.13 Ground Pressure (kg/cm<sup>2</sup>): INA Drive Formula: 4 x 4</p> <p><b>Automotive Performance:</b> Engine Type: 190-hp Gasoline Cruising Range (km): 434 Speed (km/h): Max Road: 104 Max Off-Road: INA Average Cross-Country: INA Max Swim: 5.23 Fording Depth (m): 1.0 Unprepared</p> <p><b>Radio:</b> INA</p> <p><b>Protection:</b> Armor, Turret Front (mm): Resistant to heavy MG (NFI) Applique Armor (mm): N/A Explosive Reactive Armor (mm): N/A Active Protective System: N/A Mineclearing Equipment: N/A Self-Entrenching Blade: N/A NBC Protection System: N/A Smoke Equipment: 2 x 4-barrel smoke grenade launchers</p> <p><b>ARMAMENT</b> <b>Main Armament:</b> Caliber, Type, Name: 30-mm auto-cannon, Rarden L21 Rate of Fire (rd/min): 80-90 cyclic (1-6 round bursts) Loader Type: Feed tray, manual clip-fed (3-round clips) Ready/Stowed Rounds: INA Elevation (°): -14/+40 Fire on Move: INA</p> <p><b>Auxiliary Weapon:</b> Caliber, Type, Name: 7.62-mm machinegun L7A2</p>	<p>Mount Type: Coax Maximum Aimed Range (m): INA Max Effective Range (m): INA Fire on Move: Yes Rate of Fire (rd/min): INA</p> <p><b>ATGM Launcher:</b> N/A <b>Firing Ports:</b> None</p> <p><b>FIRE CONTROL</b> <b>FCS Name:</b> INA <b>Main Gun Stabilization:</b> N/A <b>Rangefinder:</b> N/A <b>Infrared Searchlight:</b> N/A <b>Sights w/Magnification:</b> Gunner: Day: SPAV L2A1, 5.8/1.6 x Field of View (°): 8/28 Acquisition Range (m): INA Night: L2A1, II sight Field of View (°): INA Acquisition Range (m): INA</p> <p><b>Commander Fire Main Gun:</b> No</p> <p><b>VARIANTS</b> None of the variants have been fielded.</p> <p><b>MAIN ARMAMENT AMMUNITION</b> <b>Caliber, Type, Name:</b> 30-mm APDS-T, L14A2 Maximum Aimed Range (m): 1,500 Max Effective Range (m): Day: 1,000 Night: INA Tactical AA Range: INA Armor Penetration (mm): 40 (RHA, 45°) at 1,500 meters</p> <p>Caliber, Type, Name: 30-mm HE-T, L13A1 Maximum Aimed Range (m): 2,000 Max Effective Range (m): INA Tactical AA Range: INA Armor Penetration (mm): N/A</p> <p><b>Other Ammunition Types:</b> APSE-T (AP Secondary Effects-T L5A2). The gun can fire the KCB (Oerlikon) family of munitions.</p>	

**NOTES**

These vehicles have been phased out of British service.

## British Personnel Carrier S55

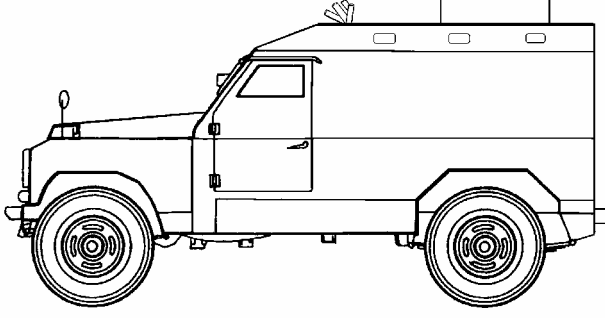
 <p style="text-align: center;">S55 without machinegun turret</p>	<p><b>Weapons &amp; Ammunition Types</b></p> <p><b>7.62-mm Turret MG</b> Ball Ball-T API API-T</p>	<p><b>Typical Combat Load</b></p> <p style="text-align: center;"><b>1,500</b></p>
<p><b>SYSTEM</b> Unless otherwise stated, data is for Mk 5 upgrade.  <b>Alternative Designations:</b> FV18061, S5 Shorland  <b>Date of Introduction:</b> 1963 original, 1990s for Mk 5  <b>Proliferation:</b> At least 21 countries</p> <p><b>Description:</b>  Crew: 3  Troop Capacity: 0, 8 passengers in raised roof personnel carrier  Combat Weight (mt): 3.6  Chassis Length Overall (m): 4.51  Height Overall (m): 1.85, 2.29 for turret  Width Overall (m): 1.80  Drive Formula: 4 x 4, with run-flat tires</p> <p><b>Automotive Performance:</b>  Engine Type: 114-hp Gasoline  Cruising Range (km): 514  Speed (km/h):      Max Road: 105 Mk 5      Max Off-Road: INA      Average Cross-Country: 48      Max Swim: N/A  Fording Depth (m): 0.5  Radio: INA</p> <p><b>Protection:</b>  Armor, Turret Front (mm): 11.0, can defeat 7.62-mm ball at 26 m  Applique Armor (mm): Grass-reinforced plastic flooring  NBC Protection System: No  Smoke Equipment: 2 x 4 smoke grenade launchers + roof mount</p> <p><b>ARMAMENT</b>  <b>Main Armament:</b>  Caliber, Type, Name: 7.62-mm (7.62x 51) GP Machinegun, L7A2  Mount Type: Turret  Rate of Fire: 80-100 (practical)  Loader Type: Belt feed  Ready/Stowed Rounds: INA  Elevation (°): -4 to +82  Fire on Move: Yes  Rate of Fire (rd/min): INA</p>	<p><b>ATGM:</b> N/A  <b>Firing Ports:</b> 3 each side, 2 in the rear doors for personnel carrier</p> <p><b>FIRE CONTROL</b>  <b>Infrared Searchlight:</b> None, visual searchlight only  <b>Sights w/Magnification:</b>  Gunner:      Day: Periscopic sight on turret roof      Night: N/A  <b>Commander Fire Main Gun:</b> No</p> <p><b>VARIANTS</b>  The vehicle is produced in several versions, including armored car (with notchback cab and room for 3), personnel carrier van version.</p> <p><b>Upgrades:</b>  Mk 1: Initial version, with 7.25-mm armor and 67-hp engine.  Mk 2: Variant with 8.25-mm armor and 77-hp engine.  Mk 3: Upgrade with 91-hp engine.  Mk 4: Variant with 11-mm armor and 114-hp engine.  Mk 5: Upgrade with improved suspension, wider wheelbase.</p> <p><b>Special-Purpose Vehicles:</b>  S53 Mobile Air Defense Vehicle: Vehicle with lightweight multiple launcher (3 ready, 6 stowed).  S54 Anti-Hijack Vehicle: Version has special rifle marksman turret.</p> <p><b>MAIN GUN AMMUNITION</b>  <b>Caliber, Type, Name:</b>  Maximum Aimed Range (m): 2,000 (est)  Max Effective Range (m):      Day: 800      Night: INA  Armor Penetration (mm RHA):</p> <p><b>Other Ammunition Types:</b> Ball, Ball-T, API, API-T</p>	

### NOTES

Vehicle is based on British Land Rover chassis. Primary use for the vehicle is for military site security, and internal security vehicle for police and border forces.

Air conditioning is available.

## French Heliborne Battlefield Surveillance Radar HORIZON



### SYSTEM

**Alternative Designations:** Helicoptere d'Observation Radar et d'Investigation sur Zone

**Date of Introduction:** 1994

**Proliferation:** At least 1 country

### Description:

Crew: 4

Platform: Mounted on AS-532UL/Cougar helicopter

Combat Weight (mt): 11.5

Antenna size (m): 3.5 x 5

**Radio:** INA

### RADAR

#### Antenna:

Mount: Vertical post mount pointing downward from left rear.

Radar stows under helicopter tail on take-off and landings, then lowers hydraulically during operation.

Antenna Type: Doppler, with MTI

Mode: Search

Scan Method: Antenna rotates horizontally for azimuth scan. Radar rotates 10°/sec, for a low pulse repetition frequency (PRF). Electronic for elevation.

#### Transmitter:

Transmitter Type: Traveling Wave Tube fully coherent, agile frequency and adaptive burst mode.

Frequency band: I/J

RF maximum (GHz): 12.0

Power (kw): 50

Mode: Doppler MTI radar

### Receiver and Processing Requirements:

Aircraft has onboard processing system. The processor is designed for a low false alarm rate. Ground station is mounted in a 7-mt truck. Each ground station holds 2 work stations. System receives 60° and 90° sector scans, independent of aircraft flight dynamics. Real-time digital data link can be integrated into French RITA communications net. Each moving target is automatically detected, located, analyzed, and classified. System can operate separately or as part of an intelligence network.

### Protection and Electronic Counter-countermeasures:

Radar snapshot mode reduces vulnerability to anti-radiation missiles. Very low sidelobes reduce ECM effects. The aircraft carries flares and decoys.

### VARIANTS

System derived from the **Orchidee** system used in Desert Storm. Orchidee was compatible with the British Astor and US JSTARS systems.

### PERFORMANCE

Surveillance range (km): 200 / 150 in rain clutter

Surveillance rate: 20,000 km<sup>2</sup>every 10 sec

Target location accuracy (m): 40

Datalink range: 120 km, Agatha data link

Surveillance targets: Wheeled or tracked vehicles, moving or hovering rotary wing aircraft, slow-flying FW aircraft, watercraft.

Target speed (km/hr): 4-400, including nap-of-the-earth (NOE)

Flight speed (km/hr): 130

Surveillance altitude (m): 2,000-4,000

Endurance (hrs): 4

### NOTES

The system was designed to operate under army control at division level. HORIZON set consists of 2 aircraft, one ground station, navigation equipment, and Agatha data link.





## Chapter 4 Tanks/Assault Vehicles

The lethality and variety of weapons available to armored, mechanized, and infantry forces for the close fight require a continued and expanded use of heavily armored fighting vehicles (AFVs). This chapter provides a representative sampling of AFVs in use today and designed for combat assault. The selection is not comprehensive, rather reflects a mix of systems currently available for the OPFOR and likely to be encountered in varying levels of conflict. The selection is also used to highlight trends within this field of weapons.

Vehicles used for combat assault in this Guide are divided into two categories—*main battle tanks* and *light tanks/assault vehicles*. Tanks are tracked, heavily armored vehicles with guns of generally 75 mm or more. Among modern trends in AFVs are: increased variety of systems worldwide, and a wider application of these systems for varied roles and missions on the battlefield. As a result, technology sharing and proliferation of upgrade packages have blurred lines among vehicles used for assault, antiarmor, combat reconnaissance and fire support missions. Another trend is increased weight for all types of armored vehicles. With heavier armor protection packages, higher-output engines and larger weapons, a significant proportion of medium tanks have grown into the heavy tank weight category. Therefore, the term *main battle tank* is more relevant than previous weight categories.

There are still *light tanks* on the battlefield, although increased armor and gun size on light armored fighting vehicles such as infantry fighting vehicles and armored reconnaissance vehicles have blurred lines of distinction. A number of AFVs, such as the British Scorpion and French AMX-13 can be characterized as reconnaissance vehicles, tank destroyers, fire support vehicles, or assault vehicles; but they have tracks, armor protection, and guns of 60 mm or greater. Thus, they can also be used for light tank missions. The term *assault vehicle* currently represents a narrow category of older vehicles used by (former) Soviet forces - medium-armored vehicles with medium-heavy guns and no turrets. None of these vehicles were selected for this initial publication. Some representative systems will be included in the next iteration. With blurring of lines among roles and missions for heavier LAFVs and light tanks, the term *assault vehicle* will likely broaden to reflect a variety of modern programs for light - medium armored vehicles with medium to heavy guns, for use in the assault role.

Two notable trends for vehicles in this chapter are a reflection of increasing systems costs and declines or leveling of military budgets - development of variants off of established systems, and use of equipment/packages to extend the use life of systems and enhance their effectiveness. As a result, seemingly old and out-of-date tanks, some of which pre-date World War II, can be a threat to modern armored and mechanized forces. The WEG highlights a variety of upgrades as well as limitations for selected tanks. Systems-related trends can be divided among mobility, survivability, and lethality, as noted on the data sheets.

To improve mobility and compensate for weight increases, many forces have replaced older engines with more powerful diesel engines. Swim capability is limited to a few light tanks.

Within the area of survivability, the most obvious consideration is increasing armor protection levels. A prominent trend is the application of additional armor, such as plate armor or panels on turrets, side-skirts over tracks, and addition of explosive reactive armor (ERA). Additional protection measures include use of entrenching blades for self-emplacment, mine-clearing plows and rollers, nuclear, biological and chemical (NBC) protection, vehicle smoke emission systems, and smoke grenade launchers. To complement these systems are sensors such as mine detectors, laser warning receivers, and radar warning receivers. A trend receiving increasing attention is the use of active measures: electro-optical countermeasures, such as infrared jammers, and active protection systems (also known as defensive aides suites) designed to intercept incoming projectiles and destroy them prior to impact.

The area of lethality has seen a variety of upgrades, including: gun replacement, improved stabilization and fire control systems, additional weapons such as antitank guided missile systems, and improved ammunition. Critical parameters include fire on the move capability, which can be linked to stabilization, rate of fire, integrated sights, acquisition ranges, and weapon range. Note, because weapon range is really a function of sights, gun precision, the type of mount, and specific round ballistics, the WEG will incorporate those factors in the round data, as maximum aimed range. That figure conforms to the OPFOR tactics and accounts for technical capabilities (see Glossary). Maximum effective range is also included (see Glossary).

The WEG notes a variety of new ammunition natures, such as electronically fuzed tank rounds for use against helicopters, and OPFOR availability of western-style HEAT-multipurpose rounds, which can be used as both antitank and antipersonnel rounds, for greater flexibility and lethality. For some systems, the ammunition mix could be determined or estimated. For others, that data was not available. Within each category, the specific round mix will depend on tactical considerations, comparative lethality and the intended targets. A general rule for OPFOR is that tanks will have approximately 50% antitank rounds and 50% rounds for use against soft targets. Because of the relative increase in protection against HEAT rounds vs kinetic energy rounds, mix estimates reflect a bias toward KE rounds. The term *stowed rounds* does not mean rounds which are not in the tank's autoloader. Rounds in ready reach are ready rounds. Stowed rounds are those which are in compartments away from the gunner's or loader's positions, requiring a slower than normal rate of fire (see Glossary). In calculating tank rounds, the figure does not include the tactical possibility of adding an additional round in the breach.

Secondary arms continue to play an important role for OPFOR tanks, because their use permits the main gun to focus fires more on heavy and area targets. Tankers will fire main guns at hovering or slow-flying aircraft; however, the more likely weapon is the antiaircraft machinegun. Similarly, OPFOR tanks will fire main guns at personnel and other soft targets as required; but the more efficient weapon for targets at close range is the coaxial machinegun.

Questions and comments on data listed in this chapter should be addressed to:

**Mr. Tom Redman**

DSN: 552-7925 Commercial (913) 684-7925  
e-mail address: redmant@leavenworth.army.mil

## French Light Tank AMX-13

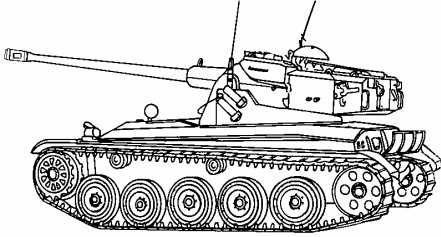
 <p style="text-align: center;">AMX-13 Model 51/75 mm Gun</p>	<p><b>Weapons &amp; Ammunition Types</b></p> <p><b>90-mm rifled gun</b> APFSDS-T HEAT HE Cannister</p> <p><b>7.62-mm coax MG</b></p>	<p><b>Typical Combat Load</b></p> <p style="text-align: center;"><b>34</b></p> <p style="text-align: center;"><b>3,600</b></p>
<p><b>SYSTEM</b>  <b>Alternative Designations:</b> AMX-13/90  <b>Date of Introduction:</b> 1966  <b>Proliferation:</b> At least 15 countries  <b>Description:</b>  Crew: 3  Combat Weight (mt): 15.0  Chassis Length Overall (m): 4.88  Height Overall (m): 2.28  Width Overall (m): 2.51  Ground Pressure (kg/cm<sup>2</sup>): 0.74</p> <p><b>Automotive Performance:</b>  Engine Type: 250-hp Gasoline  Cruising Range (km): 350  Speed (km/h):      Max Road: 60      Max Off-Road: INA      Average Cross-Country: INA      Max Swim: N/A  Forcing Depths (m): 0.6 unprepared, 2.1 with snorkel</p> <p><b>Radio:</b> TR-VP118 and intercom</p> <p><b>Protection:</b>  Armor, Turret Front (mm): 25 at 45° impact angle  Applique Armor (mm): N/A  Explosive Reactive Armor (mm): N/A  Active Protective System: N/A  Mineclearing Equipment: N/A  Self-Entrenching Blade: N/A  NBC Protection System: N/A  Smoke Equipment: 2 smoke grenade launchers each side of turret</p> <p><b>ARMAMENT</b>  <b>Main Armaments:</b>  Caliber, Type, Name: 90-mm rifled gun CN-90-F3  Rate of Fire (rd/min): INA  Loader Type: Autoloader and manual  Ready/Stowed Rounds: 10 in autoloader, 11/13 in hull  Elevation (°): -5.5/+12.5  Fire on Move: N/A</p> <p><b>Auxiliary Weapon:</b>  Caliber, Type, Name: 7.62-mm (7.62x51) MG, AA52  Mount Type: Turret coax  Maximum Aimed Range (m): INA  Max Effective Range (m):      Day: INA</p>	<p>Night: INA  Fire on Move: Yes  Rate of Fire (rd/min): INA</p> <p><b>FIRE CONTROL</b>  <b>FCS Name:</b> INA  <b>Main Gun Stabilization:</b> N/A  <b>Rangefinder:</b> N/A  <b>Infrared Searchlight:</b> Yes  <b>Sights w/Magnification:</b>  Gunner:      Day: L862, 7.5x and 8x          Field of View (°): INA          Acquisition Range (m): INA      Night: OB-11-A, 5x          Field of View (°): INA          Acquisition Range (m): 800-1,000</p> <p><b>Commander Fire Main Gun:</b> No</p> <p><b>VARIANTS</b>  <b>AMX-13 Model 51:</b> Original tank destroyer/recon vehicle, Model 51, w/75-mm gun. Many variants and upgrades have diesel engines and a 7.62-mm AA MG. Two versions were fitted with 2 x SS-11 or 3 x HOT ATGM launchers  <b>AMX-13/90:</b> This is the variant portrayed on this data sheet.  <b>AMX-13/105:</b> Variant with a GIAT 105G1 105-mm gun.  <b>AMX-13 CD Model 55:</b> Armored recovery variant.  <b>AMX-13 DCA:</b> Air defense variant with twin 30-mm guns.  <b>AMX-13 with LAR:</b> Multiple Rocket Launcher System.  <b>AMX 105-mm Mk 61:</b> Self-propelled howitzer variant.  <b>AMX F3:</b> 155-mm self-propelled gun.  <b>AMX-VCI:</b> Variant used as an APC.</p> <p><b>MAIN ARMAMENT AMMUNITION</b>  <b>Caliber, Type, Name:</b>  90-mm APFSDS-T, NFI      Maximum Aimed Range (m): INA      Max Effective Range (m):          Day: 2,000          Night: 800-1,000      Armor Penetration (mm): INA</p> <p>90-mm HEAT, NFI      Maximum Aimed Range (m): INA      Max Effective Range (m):          Day: 1,000          Night: N/A      Armor Penetration (mm): 160 (RHA) at 60° impact angle</p> <p><b>Other Ammunition Types:</b> HE, Cannister, Smoke</p>	

**NOTES**

Israeli EL-OP thermal sights are available for use on the tank.

## US Light Tank M41A3

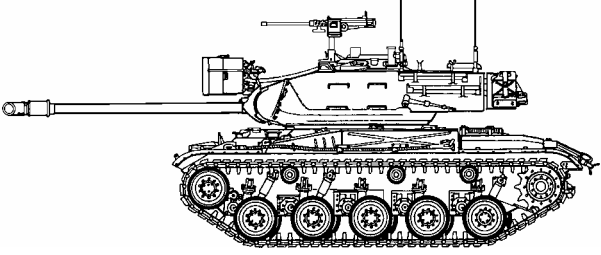
	<table border="1"> <thead> <tr> <th>Weapons &amp; Ammunition Types</th> <th>Typical Combat Load</th> </tr> </thead> <tbody> <tr> <td><b>76-mm rifled gun M32</b></td> <td><b>65</b></td> </tr> <tr> <td>APDS-T/APFSDS-T</td> <td>20</td> </tr> <tr> <td>HEAT -T</td> <td>20</td> </tr> <tr> <td>Frag-HE</td> <td>20</td> </tr> <tr> <td>Cannister</td> <td>5</td> </tr> <tr> <td><b>7.62-mm coax MG</b></td> <td><b>5,000</b></td> </tr> <tr> <td><b>12.7-mm AA MG</b></td> <td><b>2,175</b></td> </tr> </tbody> </table>	Weapons & Ammunition Types	Typical Combat Load	<b>76-mm rifled gun M32</b>	<b>65</b>	APDS-T/APFSDS-T	20	HEAT -T	20	Frag-HE	20	Cannister	5	<b>7.62-mm coax MG</b>	<b>5,000</b>	<b>12.7-mm AA MG</b>	<b>2,175</b>	
Weapons & Ammunition Types	Typical Combat Load																	
<b>76-mm rifled gun M32</b>	<b>65</b>																	
APDS-T/APFSDS-T	20																	
HEAT -T	20																	
Frag-HE	20																	
Cannister	5																	
<b>7.62-mm coax MG</b>	<b>5,000</b>																	
<b>12.7-mm AA MG</b>	<b>2,175</b>																	
<p><b>SYSTEM</b>  <b>Alternative Designations:</b> Walker Tank, Walker Bulldog  <b>Date of Introduction:</b> 1951  <b>Proliferation:</b> At least 18 countries  <b>Description:</b>            Crew: 4            Combat Weight (mt): 23.5            Chassis Length Overall (m): 5.82            Height Overall (m): 2.73            Width Overall (m): 3.20            Ground Pressure (kg/cm<sup>2</sup>): 0.72</p> <p><b>Automotive Performance:</b>            Engine Type: 500-hp Gasoline            Cruising Range (km): 161            Speed (km/h):                Max Road: 72                Max Off-Road: 48                Average Cross-Country: 40                Max Swim: N/A            Forging Depths (m): 1.0 Unprepared, 2.4 prepared</p> <p><b>Radio:</b> INA</p> <p><b>Protection:</b>            Armor, Turret Front (mm): 38            Applique Armor (mm): Available            Explosive Reactive Armor (mm): N/A            Active Protective System: N/A            Mineclearing Equipment: N/A            Self-Entrenching Blade: N/A            NBC Protection System: N/A            Smoke Equipment: N/A</p> <p><b>ARMAMENT</b>  <b>Main Armament:</b>            Caliber, Type, Name: 76-mm rifled gun M32            Rate of Fire (rd/min): INA            Loader Type: Manual            Ready/Stowed Rounds: INA            Elevation (°): -9.75/ +19.75            Fire on Move: No</p> <p><b>Auxiliary Weapon:</b>            Caliber, Type, Name: 7.62-mm (7.62x51) MG, M9194E1            Mount Type: Turret coax            Maximum Aimed Range (m):</p>	<p>Max Effective Range (m):            Day: INA            Night: N/A            Fire on Move: Yes            Rate of Fire: INA</p> <p>Caliber, Type, Name: .50 (12.7 x 99) AA machinegun, M2HB            Mount Type: Cupola AA mount            Maximum Aimed Range (m): INA            Max Effective Range (m):            Day: 2,000            Night: INA            Fire on Move: Yes            Rate of Fire (rd/min): 450-550</p> <p><b>FIRE CONTROL</b>  <b>FCS Name:</b> INA  <b>Main Gun Stabilization:</b> N/A  <b>Rangefinder:</b> N/A  <b>Infrared Searchlight:</b> Available  <b>Sights w/Magnification:</b>            Gunner:                Day: M97A1 and M20A1                Field of View (°): INA                Acquisition Range (m): INA                Night: Available  <b>Commander Fire Main Gun:</b> No</p> <p><b>VARIANTS</b>  <b>M41 DK-1:</b> Danish variant with diesel engine and LRF-based fire control. Other upgrades are side skirts, thermal sights, NBC protection, smoke grenade launchers and 7.62-mm AA MG.  <b>Brazilian M41:</b> Upgrades are similar to DK-1 except for AA MG and change to 90-mm gun using Cockerill Mk III ammunition.  <b>Uruguayan M41:</b> M41A3 fitted with Cockerill Mk III gun.  <b>YUNG HU:</b> Taiwanese upgrade with diesel engine.  <b>M42/Duster:</b> Air defense gun system with twin 40-mm AA cannon.</p> <p><b>MAIN ARMAMENT AMMUNITION</b>  <b>Caliber, Type, Name:</b>            76-mm APFSDS-T, AAI M464            Maximum Aimed Range (m): INA            Max Effective Range (m): INA            Armor Penetration (mm): NATO triple heavy (57°) at 1000 m</p> <p><b>Other Ammunition Types:</b> M33A1 and A2 APDS-T, M319 and M339 AP-T, M496 HEAT-T, HE, Smoke (WP), M363 cannister</p>																	

### NOTES

German Atlas offers the MOLFF 1-plane stabilized laser rangefinder fire control system and retrofit kit. The FCS includes a thermal night sight. Israeli EL-OP offers a FCS for the system. Maximum range for the canister round is 155 meters.

## North Korean Light Tank M1985

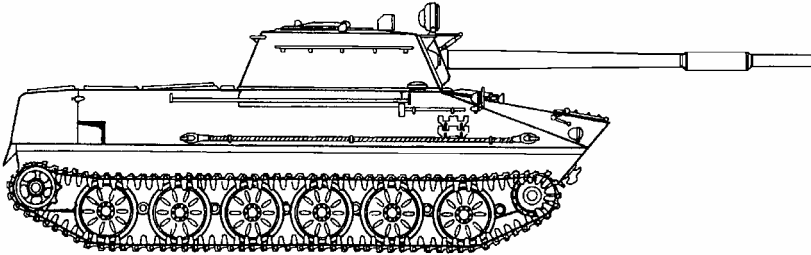
	<p><b>Weapons &amp; Ammunition Types</b></p> <p><b>85-mm rifled gun</b> APC-T/HVAP-T HEAT-FS AP HE Frag-HE, HE</p> <p><b>ATGM Launcher</b> AT-3-type ATGM</p> <p><b>12.7-mm AAMG</b></p> <p><b>7.62-mm coax MG</b></p>	<p><b>Typical Combat load</b></p> <p>47*</p> <p>4*</p> <p>500*</p> <p>*(est) 1,000*</p>
<p><b>SYSTEM</b></p> <p><b>Alternative Designations:</b> Often called <u>PT-85</u></p> <p><b>Date of Introduction:</b> 1985</p> <p><b>Proliferation:</b> At least 1 country</p> <p><b>Description:</b> Crew: 3-4 Combat Weight (mt): 19.0 Chassis Length Overall (m): 7.0 Height Overall (m): 2.6 Width Overall (m): 3.2 Ground Pressure (kg/cm<sup>2</sup>): INA</p> <p><b>Automotive Performance:</b> Engine Type: 320-hp Diesel Cruising Range (km): 500 Speed (km/h): Max Road: 60 Max Off-Road: INA Average Cross-Country: INA Max Swim: 10 Fording Depths (m): Amphibious</p> <p><b>Radio:</b> INA</p> <p><b>Protection:</b> Armor, Turret Front (mm): 30 (est.) Applique Armor (mm): N/A Explosive Reactive Armor (mm): N/A Mineclearing Equipment: N/A Self-Entrenching Blade: N/A Active Protective System: No NBC Protection System: INA Smoke Equipment: INA</p> <p><b>ARMAMENT</b></p> <p><b>Main Armament:</b> 85-mm rifled gun, resembles CH Type 62 and 63 Rate of Fire(rd/min): 8 Loader Type: Manual Ready/Stowed Rounds: INA Elevation (°): -5 to +18 Fire on Move: No (est.)</p> <p><b>Auxiliary Weapons:</b> Caliber, Type, Name: 12.7-mm (12.7 x 108), Type 54/DSHKM Mount Type: Cupola Max Aimed Range (m): 2,000</p>	<p>Max Effective Range (m): Day: 1,600 unarmored ground / 800 armored (est) Night: INA Tactical AA Range: 1,600 (est.) Armor Penetration (mm): 21 at 500 m, 13 at 1,000 m</p> <p>Caliber, Type, Name: 7.62-mm Machine gun PKT Mount Type: Turret coax Max Effective Range (m): Day: 1,000 (400-500 on the move) Night: 800 Fire on Move: Yes Rate of Fire (rd/min): Practical: 250 Cyclic: 650, in 2-10 round bursts</p> <p><b>ATGM Launcher:</b> Name: Similar to 9P111 Launch Method: Rail-launched Guidance: MCLOS Command Link: Wire Launcher Dismountable: Yes</p> <p><b>FIRE CONTROL</b></p> <p><b>FCS Name:</b> INA <b>Main Gun Stabilization:</b> None <b>Rangefinder:</b> None <b>Infrared Searchlight:</b> Yes <b>Sights w/Magnification:</b> Gunner: Day: INA Field of View (°): INA Acquisition Range (m): 1,500-3,000 (est) Night: IR, INA Field of View (°): INA Acquisition Range (m): 800 (est.)</p> <p><b>Commander Fire Main Gun:</b> INA</p> <p><b>VARIANTS:</b> N/A</p> <p><b>MAIN ARMAMENT AMMUNITION</b></p> <p><b>Caliber, Type, Name:</b> 85-mm HVAP-T, BR-365PK Max Aimed Range (m): 1,500 (est) Max Effective Range (m): Day: 1,150 (direct fire range) Night: 800 Armor Penetration (mm): 130 (0°) at 1,000 m</p>	

**North Korean Light Tank M1985 continued**

<p><b>Caliber, Type, Name:</b> 85-mm APC-T, Type 367  Max Aimed Range (m): 1,500 (est)  Max Effective Range (m):  Day: 1,150 (est)  Night: 800  Armor Penetration (mm): 120 (0°) at 1,000 m</p> <p><b>Caliber, Type, Name:</b> 85-mm HEAT-FS (variant of BK-2M)  Max Aimed Range (m): 1,500 (est)  Max Effective Range (m):  Day: 1,500/970 direct fire range  Night: 800  Armor Penetration (mm): 100 at 65°, 300-400 at 0° all ranges</p> <p><b>Caliber, Type, Name:</b> 85-mm, AP HE,  Max Aimed Range (m): 2,000-3,000 (est.)  Max Effective Range (m):  Day: 1,500/950 direct-fire range  Night: 800  Armor Penetration (mm): 102 (0°) at 1,000 m</p> <p><b>Caliber, Type, Name:</b> 85-mm Frag-HE, INA (Copy of O-365K)  Max Aimed Range (m): 4,000 (est)  Max Effective Range (m):  Day: 1,500 (est)  Night: 800  Armor Penetration (mm): Can defeat most IFVs on impact</p> <p><b>Other Ammunition Types:</b> Chinese Smoke, AP HE. Russian BR-365P HVAP-T, BK-2M HEAT-FS</p> <p><b>Antitank Guided Missiles:</b>  Name: AT-3, -3A, -B  Warhead Type: Tandem HEAT  Armor Penetration (mm): 410 RHA  Range (m): 3,000</p>	<p>Name: AT-3C  Warhead Type: Tandem HEAT  Armor Penetration (mm): 520 RHA  Range (m): 3,000</p> <p>Name: AT-3C Imp/ Polk (Slovenian)  Warhead Type: Precursor with HEAT  Armor Penetration (mm): 580 RHA  Range (m): 3,000</p> <p>Name: Red Arrow-73A (Chinese)  Warhead Type: HEAT  Armor Penetration (mm): 500 RHA  Range (m): 3,000</p> <p>Name: Red Arrow-73B/C (Chinese)  Warhead Type: HEAT  Armor Penetration (mm): 600 RHA  Range (m): 3,000</p> <p>Name: Malyutka-2  Warhead Type: Tandem HEAT  Armor Penetration (mm): 800 RHA  Range (m): 3,000</p> <p>Name: Malyutka-2 HE  Warhead Type: Frag-HE  Armor Penetration (mm): N/A  Range (m): 3,000</p>
--	--

**NOTES**

Chassis is derived from North Korean stretched VTT-323 APC chassis.

Main gun is of the family which includes Chinese Type 62 and 63 tank guns, Chinese Type 56/ FSU D-44 field guns, and the T-34/85 tank. Therefore, ammunition options includes the variety of ammunition available for these guns.

The AT-3-type ATGM can be upgraded by an operator with a new warhead in minutes. Low-mid level maintenance can upgrade the missile motor. The HE-Blast ATGM is used for killing personnel and destroying bunkers and other fortifications.

## Chinese Light Tank Type 63A Modernized

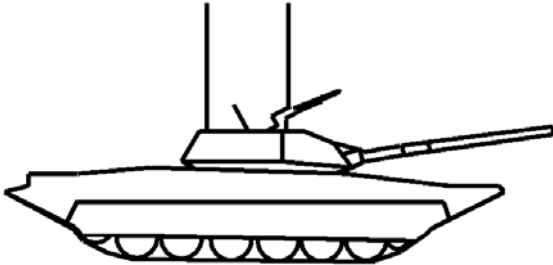
	<b>Weapons &amp; Ammunition Types</b>  <b>105-mm rifled gun</b> New CH APFSDS-T M456 HEAT L35 HESH  <b>7.62-mm coax MG</b>  <b>12.7-mm AA MG</b>	<b>Typical Combat Load</b>  57  2,000  500
<p><b>SYSTEM</b>  <b>Alternative Designations:</b> Type 99, Type ZTS 63A  <b>Date of Introduction:</b> 1999  <b>Proliferation:</b> At least 1 country  <b>Description:</b>                      Crew: 3                      Combat Weight (mt): INA                      Chassis Length Overall (m): 8.15                      Height Overall (m): INA                      Width Overall (m): 3.20                      Ground Pressure (kg/cm<sup>2</sup>): INA</p> <p><b>Automotive Performance:</b>                      Engine Type: 1,000-hp Diesel                      Cruising Range (km): 370                      Speed (km/h):                          Max Road: 64                          Max Off-Road: 28                          Average Cross-Country: 28                          Max Swim: 7, can swim in 1.3-m waves with waveboard                      Fording Depth (m): Amphibious</p> <p><b>Radio:</b> A-220A</p> <p><b>Protection:</b>                      Armor, Turret Front (mm): Against 35-mm AP round at 300 m                      Applique Armor (mm): Added armor defeats 35-mm at 0 m                      Explosive Reactive Armor (mm): Available - degrades swim ability                      Active Protective System: N/A                      Mineclearing Equipment: N/A                      Self-Entrenching Blade: N/A                      NBC Protection System: Probable                      Smoke Equipment: 8 x smoke grenade launchers</p> <p><b>ARMAMENT</b>  <b>Main Armaments:</b>                      Caliber, Type, Name: 105-mm rifled gun, similar to German design                      Rate of Fire (rd/min): 8                      Loader Type: Manual                      Ready/Stowed Rounds: INA                      Elevation (°): -4 to +22                      Fire on Move: Probable</p> <p><b>Auxiliary Weapon:</b>                      Caliber, Type, Name: 7.62-mm (7.62x 54R) Machine gun                      Mount Type: Turret coax                      Maximum Aimed Range (m): 2,000                      Max Effective Range (m):                          Day: 1,000                          Night: 800</p>	<p>Fire on Move: Yes                      Rate of Fire (rd/min): 250 practical, 600 cyclic in 2-10 round bursts</p> <p>Caliber, Type, Name: 12.7-mm (12.7x108) W 85                      Mount Type: Turret cupola                      Maximum Aimed Range (m): 2,000                      Max Effective Range (m):                          Day: 1,500 ground/1,600 for air targets (APDS)                          Night: N/A, II sights available                      Fire on Move: Yes                      Rate of Fire (rd/min): 80-100 practical, 600 air targets 2-10 rd bursts</p> <p><b>FIRE CONTROL</b>  <b>FCS Name:</b> INA  <b>Main Gun Stabilization:</b> Probable  <b>Rangefinder:</b> LRF  <b>Infrared Searchlight:</b> Yes  <b>Sights w/Magnification:</b>                      Gunner: Modern day/night sights improved with ballistic computer                          Day: INA                              Field of View (°): INA                              Acquisition Range (m): INA                          Night: Yes                              Field of View (°): INA                              Acquisition Range (m): 1,650 claimed  <b>Commander Fire Main Gun:</b> No</p> <p><b>VARIANTS:</b>  <b>Type 63:</b> Original amphibious tank with 85-mm gun. Modernized tank is lengthend with boat-shaped hull for improved swim effects, improved lethality and protection, and a welded turret.</p> <p><b>MAIN ARMAMENT AMMUNITION</b>  <b>Caliber, Type, Name:</b>                      105-mm New CH (Chinese) APFSDS-T                      Maximum Aimed Range (m): 3,000                      Max Effective Range (m):                          Day: 2,000-3,000 (est)                          Night: 800-1,300                      Armor Penetration (mm): 460 at 2,000 m</p> <p>105-mm APFSDS, H6/62                      Maximum Aimed Range (m): 3,000                      Max Effective Range (m):                          Day: 2,000-3,000 (est)                          Night: 800-1,300                      Armor Penetration (mm): INA</p>	



## Chinese Light Tank Type 63A Modernized continued

---

<p>105-mm HESH, L35 (UK) Maximum Aimed Range (m): 5,000 Max Effective Range (m): Day: 2,000-3,000 (est) Night: 800-1,300 Armor Penetration (mm): NATO single heavy target</p>	<p>105-mm HEAT, M456 (multinational) Maximum Aimed Range (m): 3,000 Max Effective Range (m): Day: 1,500-2,500 (est) Night: 800-1,300 Armor Penetration (mm): 432, NATO single heavy target</p> <p><b>Other Ammunition Types:</b> Chinese Type 83/ UK L64/ US M735 APFSDS, UK L52 APDS, multinational M393 HEP-T, French OE 105-F1 HE, L39 Smoke, cannister</p>
---	--

### NOTES

Next upgrade mentioned in articles is addition of a "35mm shell launcher" (probably a 35-mm automatic grenade launcher similar to a W-87 - see data sheet this update).

## Russian Amphibious Tank PT-76B

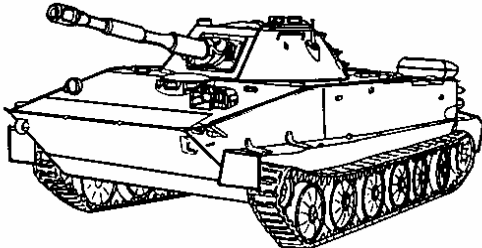
	<p><b>Weapons &amp; Ammunition Types</b></p> <p><b>76-mm rifled gun D-56</b> HVAP, AP-T/API-T HEAT Frag-HE</p> <p><b>7.62-mm coax MG</b></p>	<p><b>Typical Combat Load</b></p> <p><b>40</b> 10 10 20</p> <p><b>1,000</b></p>
	<p><b>SYSTEM</b>  <b>Alternative Designations:</b> INA  <b>Date of Introduction:</b> 1952  <b>Proliferation:</b> At least 21 countries  <b>Description:</b>            Crew: 3            Combat Weight (mt): 14.0            Chassis Length Overall (m): 6.91            Height Overall (m): 2.26            Width Overall (m): 3.14            Ground Pressure (kg/cm<sup>2</sup>): 0.46</p> <p><b>Automotive Performance:</b>            Engine Type: 240-hp Diesel            Cruising Range (km): 260            Speed (km/h):                Max Road: 44                Max Off-Road: INA                Average Cross-Country: 25                Max Swim: 10            Forging Depth (m): Amphibious</p> <p><b>Radio:</b> R-123  <b>Protection:</b>            Armor, Turret Front (mm): 20            Applique Armor (mm): N/A            Explosive Reactive Armor (mm): N/A            Active Protective System: N/A            Mineclearing Equipment: N/A            Self-Entrenching Blade: N/A            NBC Protection System: N/A            Smoke Equipment: VEES</p> <p><b>ARMAMENT</b>  <b>Main Armament:</b>            Caliber, Type, Name: 76-mm rifled gun D-56B            Rate of Fire (rd/min): 6-8            Loader Type: Manual            Ready/Stowed Rounds: INA            Elevation (°): -4/+30            Fire on Move: Yes</p> <p><b>Auxiliary Weapon:</b>            Caliber, Type, Name: 7.62-mm (7.62x54R) machinegun PKT            Mount Type: Coax            Maximum Aimed Range (m): 1,500            Max Effective Range (m):                Day: 1,000/400-500 on the move                Night: 600</p> <p>Fire on Move: Yes            Rate of Fire (rd/min): 250 practical / 650 cyclic, 2-10 round bursts</p> <p><b>FIRE CONTROL</b>  <b>FCS Name:</b> INA  <b>Main Gun Stabilization:</b> 2-plane  <b>Rangefinder:</b> N/A  <b>Infrared Searchlight:</b> Available  <b>Sights w/Magnification:</b>            Gunner: TShK-66            Day:                Field of View (°): INA                Acquisition Range (m): 4,000            Night: TVN-28 IR Available                Field of View (°): INA                Acquisition Range (m): 600  <b>Commander Fire Main Gun:</b> No</p> <p><b>VARIANTS</b>  <b>Polish PT-76:</b> Variant with a separate commander's hatch and 12.7-mm MG.  <b>Type 63:</b> Chinese variant with a new turret, 85-mm gun, and 12.7-mm AA MG.</p> <p><b>MAIN ARMAMENT AMMUNITION</b>  <b>Caliber, Type, Name:</b>            76-mm HVAP-T, BM-354P                Maximum Aimed Range (m): 1,060                Max Effective Range (m):                    Day: 650                    Night: 600                Armor Penetration (mm): 127 at muzzle, 50 at 1,000 m</p> <p>76-mm HEAT, BK-350M                Maximum Aimed Range (m): 1,000                Max Effective Range (m):                    Day: 650                    Night: 600                Armor Penetration (mm): 280 to max range</p> <p>76-mm, Frag-HE, OF-350                Maximum Aimed Range (m): 4,000                Max Effective Range (m):                    Day: INA                    Night: 600                Armor Penetration (mm): INA</p> <p><b>Other Ammunition Types:</b> 76-mm AP-T, BR-350 API-T</p>	

### NOTES

Original PT-76 was produced in limited numbers with a non-stabilized main gun. Some PT-76s are augmented with 12.7-mm AA MGs. Israel offers an upgrade package with a 90-mm gun, LRF fire control and a 300-hp engine.

## British Combat Reconnaissance Vehicle, Tracked Scorpion

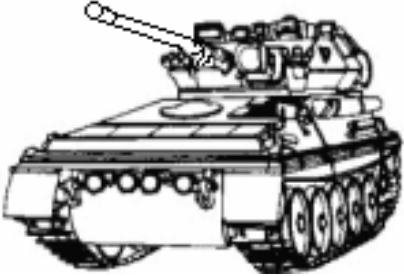
	<p><b>Weapons &amp; Ammunition Types</b></p> <p><b>76-mm rifled gun</b> HESH HE Cannister</p> <p><b>7.62-mm coax MG</b></p>	<p><b>Typical Combat Load</b></p> <p style="text-align: right;"><b>40</b></p> <p style="text-align: right;"><b>3,600</b></p>
<p><b>SYSTEM</b>  <b>Alternative Designations:</b> FV101  <b>Date of Introduction:</b> 1972  <b>Proliferation:</b> At least 18 countries  <b>Description:</b>  Crew: 3  Combat Weight (mt): 8.07  Chassis Length Overall (m): 4.79  Height Overall (m): 2.10  Width Overall (m): 2.24  Ground Pressure (kg/cm<sup>2</sup>): 0.36</p> <p><b>Automotive Performance:</b>  Engine Type: 190-hp Gasoline  Cruising Range (km): 650  Speed (km/h):      Max Road: 80      Max Off-Road: INA      Average Cross-Country: INA      Max Swim: 4/6 with propeller  Fording Depth (m): 1.07, amphibious</p> <p><b>Radio:</b> INA</p> <p><b>Protection:</b>  Armor, Turret Front (mm): Against 14.5-mm projectiles  Applique Armor (mm): N/A  Explosive Reactive Armor (mm): N/A  Active Protective System: N/A  Mineclearing Equipment: N/A  Self-Entrenching Blade: N/A  NBC Protection System: Yes  Smoke Equipment: 4 smoke grenade launchers each side of turret</p> <p><b>ARMAMENT</b>  <b>Main Armament:</b>  Caliber, Type, Name: 76-mm rifled gun L23A1  Rate of Fire (rd/min): 6  Loader Type: INA  Ready/Stowed Rounds: INA  Elevation (°): -10/ +35  Fire on Move: N/A</p>	<p><b>Auxiliary Weapon:</b>  Caliber, Type, Name: 7.62-mm (7.62x51) MG, L8A1  Mount Type: Turret coax  Maximum Aimed Range (m): INA  Max Effective Range (m): INA  Fire on Move: Yes  Rate of Fire (rd/min): INA</p> <p><b>FIRE CONTROL</b>  <b>FCS Name:</b> INA  <b>Main Gun Stabilization:</b> N/A  <b>Rangefinder:</b> Laser rangefinder  <b>Infrared Searchlight:</b> Yes  <b>Sights w/Magnification:</b>  Gunner:      Day: Barr and Stroud Tank Laser Sight, 10x          Field of View (°): INA          Acquisition Range (m): 2,200      Night: GEC Sensors SS100, II, x5.8/1.6          Field of View (°): 8/28          Acquisition Range (m): INA  <b>Commander Fire Main Gun:</b> No</p> <p><b>VARIANTS</b>  <b>Scorpion 90:</b> Variant with a 90-mm Cockerill Mk III gun.</p> <p>A number of vehicles use the same Alvis chassis. They include the <b>Scimitar</b> armored reconnaissance vehicle, <b>Striker</b> armored ATGM launcher vehicle, <b>Spartan</b> armored personnel carrier or Milan ATGM launcher, <b>Stormer</b> modernized APC, <b>Samaritan</b> armored ambulance, and <b>Saber</b> modernized reconnaissance vehicle.</p> <p><b>MAIN ARMAMENT AMMUNITION</b>  <b>Caliber, Type, Name:</b>  76-mm HESH, L29      Maximum Aimed Range (m): 2,200      Max Effective Range (m): INA      Armor Penetration (mm): INA</p> <p><b>Other Ammunition Types:</b> L24A1/2 HE (max effective range--indirect fire: 5,000 meters), L33A1 Cannister (max effective range: 100 meters), L32A5 Smoke (BE), L42 Illumination</p>	

### NOTES

As a reflection of the vehicle's suitability for a variety of roles, in recent times it is referred to as an armored reconnaissance vehicle or combat vehicle reconnaissance (tracked)--CVR (T).

A British upgrade program includes a diesel engine, thermal sights, and secure communications. The Tank Laser Sight and Avimo LV10 Day/Night LRF sight can accept a thermal channel. Thermal sights are available for use on the tank.

## French Main Battle Tank AMX-30

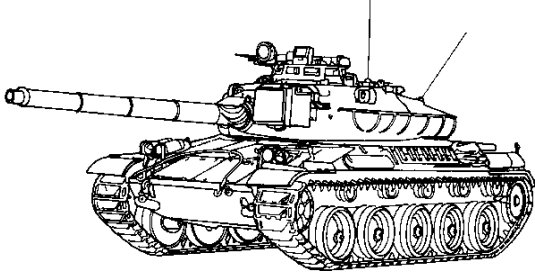
	<b>Weapons &amp; Ammunition Types</b>	<b>Typical Combat Load</b>
<p><b>SYSTEM</b>  <b>Alternative Designations:</b> INA  <b>Date of Introduction:</b> 1967  <b>Proliferation:</b> At least 10 countries  <b>Description:</b>            Crew: 4            Combat Weight (mt): 36.00            Chassis Length Overall (m): 6.59            Height Overall (m): 2.29            Width Overall (m): 3.10            Ground Pressure (kg/cm<sup>2</sup>): 0.77/0.85 for AMX-30B2</p> <p><b>Automotive Performance:</b>            Engine Type: 720-hp Diesel multi-fuel            Cruising Range (km): 500-600            Speed (km/h):                Max Road: 65                Max Off-Road: INA                Average Cross-Country: 35-40                Max Swim: N/A            Fording Depths (m): 1.3, 2.2 prepared, 4.0 with snorkel</p> <p><b>Radio:</b> INA</p> <p><b>Protection:</b>            Armor, Turret Front (mm): 81 KE &amp; CE (RHA) /120 AMX-30B2            Applique Armor (mm): N/A            Explosive Reactive Armor (mm): GIAT Brenus ERA available            Active Protective System: Galix decoys and IR jammer available            Mineclearing Equipment: No            Self-Entrenching Blade: No            NBC Protection System: Yes            Smoke Equipment: 2x2 smoke grenade launchers, VEES</p> <p><b>ARMAMENT</b>  <b>Main Armament:</b>            Caliber, Type, Name: 105-mm (56 Cal) rifled gun CN-105-F1            Rate of Fire (rd/min): 6            Loader Type: Manual            Ready/Stowed Rounds: 19/28            Elevation (°): -8 to +20            Fire on Move: No/Yes, AMX-30B2 with COTAC FCS</p> <p><b>Auxiliary Weapon:</b>            Caliber, Type, Name: 20-mm (20x139) Auto-cannon M693            Mount Type: Turret Coax            Maximum Aimed Range(m): 2,000</p>	<p><b>105-mm rifled gun</b>            APFSDS-T            HEAT-T            HE</p> <p><b>20-mm coaxial cannon</b></p> <p><b>7.62-mm cupola MG</b></p> <p>Max Effective Range (m):            Day: 1,300            Night: INA            Fire on Move: No            Rate of Fire (rd/min): 1,200</p> <p>Caliber, Type, Name: 7.62-mm (7.62x51) Machinegun Giat NF1            Mount Type: Turret Cupola            Maximum Aimed Range(m): 1,200            Max Effective Range (m):            Day: 600            Night: INA            Fire on Move: Yes            Rate of Fire (rd/min): 900</p> <p><b>ATGM Launcher:</b> N/A</p> <p><b>FIRE CONTROL</b>  <b>FCS Name:</b> INA  <b>Main Gun Stabilization:</b> None/stabilization for AMX-30B2  <b>Rangefinder:</b> Optical/APX-550 Laser for AMX-30B2  <b>Infrared Searchlight:</b> PH-8-B  <b>Sights w/Magnification:</b>            Gunner:                Day: M271 telescope, 8x                Field of View (°): 9                Acquisition Range (m): INA                Night: OB-17-A IR periscope                Field of View (°): INA                Acquisition Range (m): 1,000/1,500 white light  <b>Commander Fire Main Gun:</b> No</p> <p><b>VARIANTS</b>  <b>AMX-30S:</b> Export for desert use. The engine is downrated to 620 hp. The FCS is upgraded with Soplelem LRF day/night sight.</p> <p><b>AMX-30B2:</b> System is upgraded with improved transmission, suspension, NBC system, gun stabilization, and COTAC FCS with a thermal night sight. French Army AMX-30s were upgraded to -B2.</p> <p><b>AMX-30EM2:</b> Spanish upgrade program with 850-hp engine, new transmission, Hughes FCS, enlarged ammunition stowage, ERA, and C-437 APFSDS-T ammunition.</p> <p><b>AMX-30 DCA:</b> AD version - 2x30-mm guns on AMX-30 chassis.  <b>GCT/AU-F1:</b> Self-propelled 155-mm howitzer on AMX-30 chassis.  <b>AMX-30D:</b> Armored recovery vehicle.  <b>AMX-30 EBG:</b> Combat engineer tractor.  <b>AMX-30 Bridge Layer:</b> Scissors bridge on AMX-30 chassis.  <b>Pluton:</b> Theater ballistic missile launcher on AMX-30 chassis.</p>	<p>47</p> <p>1,050</p> <p>2,050</p>

**French Main Battle Tank AMX-30 continued**

<p><b>MAIN ARMAMENT AMMUNITION</b></p> <p><b>Caliber, Type, Name:</b>          105-mm APFSDS-T, OFL 105 F1, French Giat          Maximum Aimed Range (m): 3,000          Max Effective Range (m):              Day: 1,800              Night: INA          Armor Penetration (mm): NATO triple heavy target; 5,500 m</p> <p><b>Caliber, Type, Name:</b>          105-mm APFSDS-T, M413, Israeli Military Industries          Maximum Aimed Range (m): 6,000          Max Effective Range (m):              Day: 2,000              Night: INA          Armor Penetration (mm): NATO triple heavy target, 6,000+m</p> <p><b>Caliber, Type, Name:</b>          105-mm HEAT-T, OCC 105 F1, French Giat          Maximum Aimed Range (m): 2,500          Max Effective Range (m):              Day: 2,500              Night: INA          Armor Penetration (mm): 360 at 0°</p>	<p>105-mm HEAT-T, M456A2, Belgian Mecar          Maximum Aimed Range (m): 2,500-8,200          Max Effective Range (m):              Day: INA              Night: INA          Armor Penetration (mm): 432 at 0°</p> <p>105-mm HE, OE 105 F1, French Giat          Maximum Aimed Range (m): 2,500          Max Effective Range (m):              Day: 2,500              Night: INA          Armor Penetration (mm): N/A</p> <p><b>Other Ammunition Types:</b> Any NATO-standard 105-mm ammunition can be used. They include Belgian Mecar M1060, Chinese Norinco 105, German Rheinmetall DM43, Spanish Santa Barbara C-437, British Royal Ordnance L64A4 and H6/6, US M735 and M833 (depleted uranium), and Canadian FP105 APFSDS-T rounds. Other types available are: HE-T, smoke, illuminating, HESH-T, HE plastic tracer (HEP-T), and canister or APERS-T (flechette).</p> <p>A recent round is the Israeli Military Industries APAM round, which over-flies the target and disperses fragmenting submunitions outward and downward over a much wider kill zone.</p>
--	--

**NOTES**

AMX-32: Upgraded tank - did not enter production.  
 AMX-40: Later upgraded tank - did not enter production.

## British Main Battle Tank Challenger 2

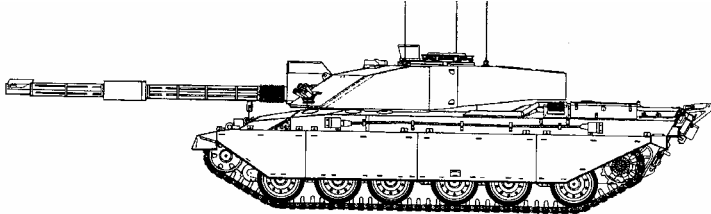
	<b>Weapons &amp; Ammunition Types</b>	<b>Typical Combat Load</b>
<p><b>SYSTEM</b>  <b>Alternative Designations:</b> INA  <b>Date of Introduction:</b> 1994  <b>Proliferation:</b> At least 2 countries  <b>Description:</b>            Crew: 4            Combat Weight (mt): 62.5            Chassis Length Overall (m): 8.33            Height Overall (m): 2.50            Width Overall (m): 3.52            Ground Pressure (kg/cm<sup>2</sup>): 0.97</p> <p><b>Automotive Performance:</b>            Engine Type: 1,200-hp Diesel            Cruising Range (km): 450            Speed (km/h):                Max Road: 59                Max Off-Road: 45 est                Average Cross-Country: 40                Max Swim: N/A            Fording Depths (m): 1.1 Unprepared  <b>Radio:</b> INA</p> <p><b>Protection:</b>            Armor, Turret Front (mm): 500 KE RHA at 2,000 m/800 CE            Applique Armor (mm): INA            Explosive Reactive Armor (mm): N/A            Active Protective System: N/A            Mineclearing Equipment: INA            Self-Entrenching Blade: INA            NBC Protection System: Yes            Smoke Equipment: Smoke grenade launchers (2x5), VEES</p> <p><b>ARMAMENT</b>  <b>Main Armaments:</b>            Caliber, Type, Name: 120-mm rifled gun, L30 CHARM            Rate of Fire (rd/min): INA            Loader Type: Separate-loading manual            Ready/Stowed Rounds: INA            Elevation (°): -10 to +20            Fire on Move: Yes</p> <p><b>Auxiliary Weapon:</b>            Caliber, Type, Name: 7.62-mm McDonnell Douglas Chain Gun            Mount Type: Turret Coax            Maximum Aimed Range (m): INA            Max Effective Range (m):                Day: INA                Night: INA            Fire on Move: Yes            Rate of Fire: INA</p>	<p><b>120-mm rifled gun</b>            APFSDS-T            HESH</p> <p><b>7.62-mm MG</b>            coaxial chain gun            cupola AA MG</p> <p>Caliber, Type, Name: 7.62-mm (7.62x 51) AA Machinegun L37A2            Mount Type: Cupola            Maximum Aimed Range (m): INA            Max Effective Range (m):                Day: 800                Night: INA            Fire on Move: Yes            Rate of Fire (rd/min): INA  <b>ATGM Launcher:</b> None</p> <p><b>FIRE CONTROL</b>  <b>FCS Name:</b> Improved Fire Control System (Marconi IFCS)  <b>Main Gun Stabilization:</b> 2-plane electric  <b>Rangefinder:</b> SAGEM Laser rangefinder  <b>Infrared Searchlight:</b> No  <b>Sights w/Magnification:</b>            Gunner: Thermal Imaging and Gun Sighting System (TOGS-2)                Day: Gunner's Primary Sight                Field of View (°): INA                Acquisition Range (m): 5,000            Night: Barr &amp; Stroud TOGS-2 (with SAGEM thermal imager)                Field of View (°): INA                Acquisition Range (m): INA  <b>Commander Fire Main Gun:</b> INA</p> <p><b>VARIANTS</b>  <b>Challenger 1:</b> Base tank from which Challenger 2 was derived. The latter tank includes 150 improvements, including mobility upgrades, new FCS, guns, and land navigation system, and an APU.  <b>Challenger 2E:</b> The tank has a 1,500-hp engine and L30A1 gun.  <b>Omani Challenger 2:</b> Variant with GPS, air conditioning and additional radiators.</p> <p><b>MAIN ARMAMENT AMMUNITION</b>  <b>Caliber, Type, Name:</b>            120-mm APFSDS-T, CHARM 3, depleted uranium            Maximum Aimed Range (m): 5,000-6,500            Max Effective Range (m):                Day: 3,000+                Night: INA            Armor Penetration (mm): INA</p> <p>120-mm High-Explosive Squash-Head (HESH), L31            Maximum Aimed Range (m): 5,000            Max Effective Range (m):                Day: 3,000                Night: INA            Armor Penetration (mm): INA</p> <p><b>Other Ammunition Types:</b> L15 APDS, L34 WP Smoke</p>	<p><b>52</b>  <b>20</b>  <b>32</b></p> <p><b>4,000</b></p>

NOTES None

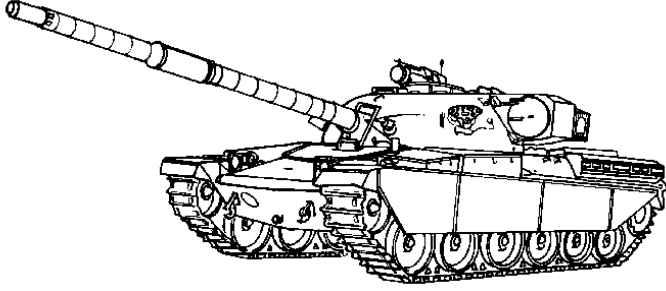

## British Main Battle Tank Chieftain Mk 5

	<b>Weapons &amp; Ammunition Types</b>	<b>Typical Combat Load</b>
<p><b>SYSTEM</b>  <b>Alternative Designations:</b> FV 4201  <b>Date of Introduction:</b> 1967 Original Chieftain  <b>Proliferation:</b> At least 6 countries  <b>Description:</b>            Crew: 4            Combat Weight (mt): 55.00            Chassis Length Overall (m): 7.48            Height Overall (m): 2.90            Width Overall (m): 3.51            Ground Pressure (kg/cm<sup>2</sup>): 0.90</p> <p><b>Automotive Performance:</b>            Engine Type: 750-hp Diesel            Cruising Range (km): 400-500            Speed (km/h):                Max Road: 48                Max Off-Road: INA                Average Cross-Country: 30                Max Swim: N/A            Fording Depths (m): 1.1 Unprepared</p> <p><b>Radio:</b> C42/Larkspur VHF</p> <p><b>Protection:</b>            Armor, Turret Front (mm): 300 (RHA)            Applique Armor (mm): ROMOR applique on turret, side skirts            Explosive Reactive Armor (mm): N/A            Active Protective System: N/A            Mineclearing Equipment: Plow variant, and AVLB/engineer variant            Self-Entrenching Blade: No            NBC Protection System: Yes            Smoke Equipment: Smoke grenade launchers (6 each side of turret)</p> <p><b>ARMAMENT</b>  <b>Main Armaments:</b>            Caliber, Type, Name: 120-mm rifled gun, L11A5            Rate of Fire (rd/min): 8-10 first minute/6 sustained            Loader Type: Separate-loading manual            Ready/Stowed Rounds: INA            Elevation (°): -10 to +20            Fire on Move: Yes</p> <p><b>Auxiliary Weapon:</b>            Caliber, Type, Name: 7.62-mm (7.62x 51) Machine gun L8A1            Mount Type: Turret Coax            Maximum Aimed Range (m): INA            Max Effective Range (m):                Day: 800                Night: INA            Fire on Move: Yes            Rate of Fire: INA</p>	<p><b>120-mm rifled gun</b>            APFSDS-T 20            HESH 44</p> <p><b>7.62-mm MG</b>            6,200</p> <p>--Coaxial and Stowed 6,000</p> <p>--Cupola AA MG 200</p> <p>Caliber, Type, Name: 7.62-mm (7.62x 51) AA Machine gun L37A1            Mount Type: Cupola            Maximum Aimed Range (m): INA            Max Effective Range (m):                Day: 800                Night: INA            Fire on Move: Yes            Rate of Fire (rd/min): INA</p> <p><b>ATGM Launcher:</b> N/A</p> <p><b>FIRE CONTROL</b>  <b>FCS Name:</b> Improved Fire Control System (IFCS)  <b>Main Gun Stabilization:</b> 2-plane  <b>Rangefinder:</b> Laser, Nd-Yag  <b>Infrared Searchlight:</b> Yes  <b>Sights w/Magnification:</b>            Gunner:                Day: Barr and Stroud Tank Laser Sight (TLS), 8x                Field of View (°): 10                Acquisition Range (m): 5,000                Night: 1R18 Thermal sight, 3x                Field of View (°): INA                Acquisition Range (m): INA</p> <p><b>Commander Fire Main Gun:</b> INA</p> <p><b>VARIANTS</b>  <b>Mk 5:</b> Final production variant, with a new engine and NBC system, modified auxiliary weapons and sights. Mk 6-11 are upgrades to earlier models, with addition of IFCS. Mk 12 added ROMOR (aka: Stillbrew) spaced armor boxes. Mk 11 and Mk 12 have Thermal Observation and Gunnery Sight (TOGS).</p> <p>A variety of support vehicles were developed from the tank. They include recovery vehicles, AVLB, dozer, mineclearer, air defense and 155-mm SP artillery systems.</p> <p><b>Khalid/Shir 1:</b> Jordanian variant which has chassis, turret and weaponry of the Chieftain, but which incorporates engine and running gear upgrades of Challenger I. The fire control has seen a number of improvements, including a new ballistic computer.</p> <p><b>MAIN ARMAMENT AMMUNITION</b>  <b>Caliber, Type, Name:</b>            120-mm APFSDS-T, L23A1            Maximum Aimed Range (m): 5,000            Max Effective Range (m):                Day: 3,000                Night: INA            Armor Penetration (mm): INA</p>	



## **British Main Battle Tank Chieftain Mk 5 continued**

---

120-mm High-Explosive Squash-Head (HESH), L31 Maximum Aimed Range (m): 5,000 Max Effective Range (m): Day: 3,000 Night: INA Armor Penetration (mm): INA	<b>Other Ammunition Types:</b> L15 APDS, L34 WP Smoke
--	---

### **NOTES**

Early Chieftains and some later modified tanks mount the 50. Cal M2HB machinegun over the main gun as a ranging gun. Iran and Kuwait retained the .50 Cal MG.

The HESH round is used for antitank chemical-energy (CE) antiarmor missions, and for HE effects against personnel and materiel.

The Iranians claim to employ a snorkel system on Chieftain, for fording to 5 meters depth.

A variety of fire control systems and thermal sights are available for Chieftain. At 324 Chieftains have been upgraded with the Barr and Stroud TOGS thermal sight system. The 1R26 thermal camera can be used with the 1R18 thermal night sight. It has wide (13.6°) and narrow (4.75°) fields of view, and is compatible with TOGS format. GEC Sensors offers a long list of sights including: Multisensors Platform, Tank Thermal Sensor, and SS100/110 thermal night sight. Marconi, Nanoquest, and Pilkington offer day and night sights for the Chieftain.

Charm Armament upgrade program, with the 120-mm L30 gun incorporated in Challenger 1, is available for Chieftain modification programs.

## German Main Battle Tank Leopard 1A1

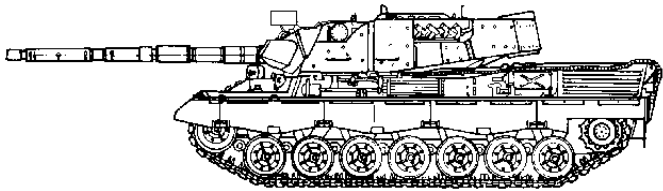
 <p>Leopard 1A1A1 with applique armor</p>	<p><b>Weapons &amp; Ammunition Types</b></p> <p><b>105-mm rifled gun</b> APFSDS-T HESH-T</p> <p><b>7.62-mm MG</b> coaxial cupola</p>	<p><b>Typical Combat Load</b></p> <p><b>60/later 55</b></p> <p><b>5,500</b> 1,250 1,250</p>
<p><b>SYSTEM</b>  <b>Alternative Designations:</b> INA  <b>Date of Introduction:</b> 1965  <b>Proliferation:</b> At least 12 countries  <b>Description:</b>  Crew: 4  Combat Weight (mt): 40/42.4 LA1A1 and after  Chassis Length Overall (m): 7.09  Height Overall (m): 2.61  Width Overall (m): 3.37  Ground Pressure (kg/cm<sup>2</sup>): 0.86/0.88 LA1A1 and after</p> <p><b>Automotive Performance:</b>  Engine Type: 830-hp Diesel multi-fuel  Cruising Range (km): 600  Speed (km/h):      Max Road: 65      Max Off-Road: INA      Average Cross-Country: INA      Max Swim: N/A  Fording Depths (m): 1.2 Unprepared, 2.25 prepared, 4.0 snorkel</p> <p><b>Radio:</b> INA</p> <p><b>Protection:</b>  Armor, Turret Front (mm): 250 RHA, KE/230 CE  Applique Armor (mm): Available, standard on L1A1A1 and after  Explosive Reactive Armor (mm): Brenus available  Active Protective System: N/A  Mineclearing Equipment: No  Self-Entrenching Blade: No  NBC Protection System: Yes  Smoke Equipment: 2x4 76-mm smoke grenade launchers</p> <p><b>ARMAMENT</b>  <b>Main Armament:</b>  Caliber, Type, Name: 105-mm (51 Cal) L7A3 rifled gun  Rate of Fire (rd/min): 10  Loader Type: Manual  Ready/Stowed Rounds: 13/47  Elevation (°): -9 to +20  Fire on Move: No/Yes (to 28 km/h) Leopard 1A1A1 and after</p> <p><b>Auxiliary Weapons:</b>  Caliber, Type, Name: 7.62-mm (7.62x51) Machinegun M3  Mount Type: Turret Cupola  Maximum Aimed Range(m): 1,400  Max Effective Range (m):      Day: INA      Night: INA  Fire on Move: Yes  Rate of Fire (rd/min): INA</p>	<p>Caliber, Type, Name: 7.62-mm (7.62x51) Machinegun MG3  Mount Type: Turret Cupola  Maximum Aimed Range(m): INA  Max Effective Range (m): INA  Fire on Move: Yes  Rate of Fire (rd/min): INA  <b>ATGM Launcher:</b> N/A</p> <p><b>FIRE CONTROL</b>  <b>FCS Name:</b> N/A  <b>Main Gun Stabilization:</b> None/stabilization for -1A1A1 and after  <b>Rangefinder:</b> TEM 2A Optical  <b>Infrared Searchlight:</b> XSW-30-U red/white  <b>Sights w/Magnification:</b>  Gunner:      Day: TZF 1A telescope, 8x      Field of View (°): INA      Acquisition Range (m): 1,400      Night: IR available      Field of View (°): INA      Acquisition Range (m): 1,000/1,500 white light  <b>Commander Fire Main Gun:</b> No</p> <p><b>VARIANTS</b>  <b>Leopard 1</b> was the baseline tank (first production batch) with original tracks, and without track skirts, stabilization or thermal sleeve for gun. The <b>Leopard 1A1</b> version, as featured, can be fitted with applique armor. <b>Leopard 1A1A1</b> is the third production lot, with applique, air filter intakes. Early tanks have been upgraded to this standard.</p> <p><b>Leopard 1A2:</b> Production batch and -1A1 upgrade with a new cast turret, improved NBC system, II night sights, and air conditioning.  <b>Italian Leopard 1A2:</b> Upgrade with Sirio thermal FCS, gun stabilization and turret drive.</p> <p><b>Leopard 1A3:</b> Production system with previous improvements, larger welded spaced armor turret, and improved FCS (by country).</p> <p><b>Leopard 1A4:</b> Final production system, with AEG-Telefunken FCS.</p> <p><b>Leopard 1A5:</b> More than 1,300 -1A1/1A2 tanks have been refitted with an EMES-18 FCS and thermal sights. <b>Leopard 1A5 (BE):</b> Belgian upgraded -1A1/1A2s, with new FCS, FN MAG 7.62-mm MGs, and thermal sights.</p> <p><b>Leopard 1-V:</b> Dutch version, of -1A1A1, with German EMES-12A3 FCS and PZB II night sight.</p> <p>A variety of systems use Leopard 1 chassis. These include Gepard air defense gun, engineer and recovery vehicles, and a bridgelayer.</p>	

**German Main Battle Tank Leopard 1A1 continued**

<p><b>MAIN ARMAMENT AMMUNITION</b>  <b>Caliber, Type, Name:</b>  105-mm APFSDS-T, DM43, German Rheinmetall  Maximum Aimed Range (m): 2,000+  Max Effective Range (m):  Day: 1,400/2,000 Leo 1A1 and later  Night: 1,000 IR/1,500 white light/more with thermal  Armor Penetration (mm): NATO triple heavy target, 5,500 m</p> <p>105-mm APFSDS-T, M413, Israeli Military Industries  Maximum Aimed Range (m): 6,000  Max Effective Range (m):  Day: 2,000  Night: 1,000 IR/1,500 white light/more with thermal  Armor Penetration (mm): NATO triple heavy target, 6,000+m</p> <p>105-mm HEAT-T, OCC 105 F1, French Giat  Maximum Aimed Range(m): 2,500  Max Effective Range (m):  Day: 2,500  Night: INA  Armor Penetration (mm): 360 at 0°</p> <p>105-mm HEAT-T, M456A2, Belgian Mecar  Maximum Aimed Range (m): 2,500-8,200  Max Effective Range (m):  Day: INA  Night: INA  Armor Penetration (mm): 432 at 0°</p>	<p>105-mm HESH-T, DM512, Rheinmetall  Maximum Aimed Range (m): 4,000  Max Effective Range (m):  Day: 1,500  Night: 1,000 IR/1,500 white light/more with thermal  Armor Penetration (mm): N/A</p> <p>105-mm HE, OE 105 F1, French Giat  Maximum Aimed Range (m): 2,500  Max Effective Range (m):  Day: 2,500  Night: INA  Armor Penetration (mm): N/A</p> <p><b>Other Ammunition Types:</b> Any NATO-standard 105-mm ammunition can be used. They include: Chinese Norinco 105, British Royal Ordnance L64A4 and H6/6, Belgian Mecar M1060, French Giat OFL 105 F1, Spanish Santa Barbara C-437, US M735 and M833 (depleted uranium), and Canadian FP105 APFSDS-T rounds. Other types available are: HE-T, smoke, illuminating, HESH-T, HE plastic tracer (HEP-T), and canister or APERS-T (flechette).</p> <p>A recent round is the Israeli Military Industries APAM round, which over-flies the target and disperses fragmenting submunitions outward and downward over a much wider kill zone.</p>
--	--

**NOTES**

More than a dozen fire control systems, many with thermal sights, are available for this tank. A version with LLLTV sights is the Leopard 1A1A2. Improved stabilization systems include US HR Textron, French SAMM, and German FWM. Other options include a front mounted dozer blade, improved air conditioning, a 120-mm smoothbore gun, and other secondary

## German Main Battle Tank Leopard 2

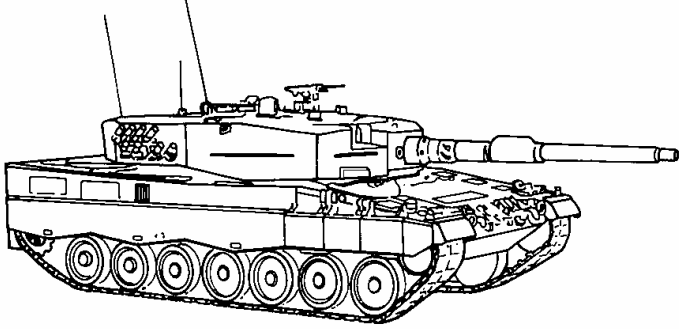
	<p><b>Weapons &amp; Ammunition Types</b></p> <p><b>120-mm smoothbore gun</b> APFSDS-T HEAT-MP-T</p> <p><b>7.62-mm machineguns</b></p> <p>--Coaxial</p> <p>--Cupola MG/stowed</p>	<p><b>Typical Combat Load</b></p> <p>42</p> <p>4750</p> <p>2000</p> <p>2750</p>
	<p><b>SYSTEM</b>  <b>Alternative Designations:</b> Swiss Pz 87, Swedish Strv 121  <b>Date of Introduction:</b> 1979  <b>Proliferation:</b> At least 7 countries  <b>Description:</b>  Crew: 4  Combat Weight (mt): 55.15  Chassis Length Overall (m): 7.69  Height Overall (m): 2.79  Width Overall (m): 3.70  Ground Pressure (kg/cm<sup>2</sup>): 0.83</p> <p><b>Automotive Performance:</b>  Engine Type: 1,500-hp Diesel  Cruising Range (km): 550  Speed (km/h):      Max Road: 72      Max Off-Road: 45      Average Cross-Country: 40      Max Swim: N/A  Forcing Depths (m): 1.0 Unprepared, 4.0 with snorkel</p> <p><b>Radio:</b> INA</p> <p><b>Protection:</b>  Armor, Turret Front (mm): 700 KE/1,000 against HEAT rounds  Applique Armor (mm): Track skirt  Explosive Reactive Armor (mm): N/A  Active Protective System: Galix (See note Strv 122)  Mineclearing Equipment: No  Self-Entrenching Blade: No  NBC Protection System: Yes  Smoke Equipment: Smoke grenade launchers, 8 each side of turret</p> <p><b>ARMAMENT</b>  <b>Main Armaments:</b>  Caliber, Type, Name: 120-mm smoothbore gun M256  Rate of Fire (rd/min): INA  Loader Type: Manual  Ready/Stowed Rounds: 15/27  Elevation (°): -9 to +20  Fire on Move: Yes</p> <p><b>Auxiliary Weapon:</b>  Caliber, Type, Name: 7.62-mm (7.62x 51) Machinegun MG3A1  Mount Type: Turret Coax  Maximum Aimed Range(m): INA  Max Effective Range (m):      Day: INA      Night: INA</p> <p>Fire on Move: Yes  Rate of Fire (rd/min): 1,200</p> <p>Caliber, Type, Name: 7.62-mm (7.62x 51) Machinegun MG3A1  Mount Type: Turret Cupola  Maximum Aimed Range(m): INA  Max Effective Range (m):      Day: INA      Night: INA  Fire on Move: Yes  Rate of Fire (rd/min): 1,200  <b>ATGM Launcher:</b> N/A</p> <p><b>FIRE CONTROL</b>  <b>FCS Name:</b> INA  <b>Main Gun Stabilization:</b> WNA-H22, 2-plane  <b>Rangefinder:</b> Laser neodymium  <b>Infrared Searchlight:</b> Yes  <b>Sights w/Magnification:</b>  Gunner:      Day: Krupp-Atlas EMES-15, 12x / FERO Z18 secondary, 8x      Field of View (°): 5/10      Acquisition Range (m): INA      Night: Zeiss thermal imager      Field of View (°): INA      Acquisition Range (m): INA  <b>Commander Fire Main Gun:</b> Yes</p> <p><b>VARIANTS</b>  A variety of MBT variants from 2A1 to 2A4 denote minor changes, as well as FCS upgrades. Combat support variants include an armored recovery vehicle.</p> <p><b>Pz87:</b> Swiss variant with indigenous machineguns, communications and FCS, and improved NBC equipment.</p> <p><b>Dutch Leopard 2:</b> Uses indigenous equipment as noted above.</p> <p><b>Leopard 2A5/Leopard 2 (Improved):</b> Recent upgrade with spaced armor added to turret front, and increased armor on hull and side skirts. Other improvements include improved stabilization, suspension, navigation, fire control, and hatch design.</p> <p><b>Strv 122:</b> Swedish-licensed variant resembling 2A5 with an indigenous turret and other upgrades. The tank features French Galix active protection system and improved command and control. Sweden developed an HE-T round designed to range 2,000 meters or more for its Leopard-2 and Strv-122 tanks. With additional armor, Strv 122 will weigh 62 mt.</p>	

**German Main Battle Tank Leopard 2 continued**

---

<p><b>MAIN ARMAMENT AMMUNITION</b>  <b>Caliber, Type, Name:</b>  120-mm APFSDS-T, DM43  Maximum Aimed Range(m): 3,500  Max Effective Range (m):  Day: INA  Night: INA  Armor Penetration (mm): 450 at 2,000 meters</p> <p>120-mm APFSDS-T, US Olin GD120  Maximum Aimed Range(m): 3,500  Max Effective Range (m):  Day: 3,000  Night: INA  Armor Penetration (mm): 520 at 2,000 meters</p>	<p>120-mm HEAT-MP-T, DM-12A1/US Olin M830  Maximum Aimed Range(m): INA  Max Effective Range (m):  Day: 2,500  Night: INA  Armor Penetration (mm): INA</p> <p><b>Other Ammunition Types:</b> US-produced M829, M829A1 APFSDS-T; US M830A1 HEAT-MP-T (MPAT), GE DM12A1 (US copy M830) HEAT-MP-T (MPAT)</p>
--	--

**NOTES**

A variety of upgrade programs and options are available for the Leopard 2. These include the Atlas Elektronik Vehicle Integrated Command and Information System (IFIS), a digital command and information system.

A new longer gun barrel (L55 gun barrel, 1.30 meters longer) is available. It permits effective use of a new APFSDS-T round, DM53 (LKE II), with a longer rod penetrator, and which is under development. The German Army has decided not to buy the DM43 APFSDS-T round (aka: LKE 1), rather to wait and upgrade to the DM53.

United States Main Battle Tank M60A1/M60A3

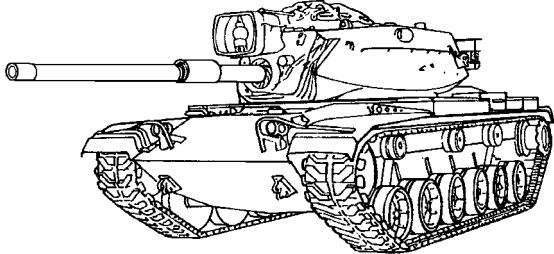
 <p style="text-align: center;">M60A1</p>	<p><b>Weapons &amp; Ammunition Types</b></p> <p><b>105-mm rifled gun</b> APFSDS-T HEAT HE APERS-T/Canister</p> <p><b>.50 cal AA MG</b> <b>7.62-mm coaxial MG</b></p>	<p><b>Typical Combat Load</b></p> <p style="text-align: center;"><b>63</b></p> <p style="text-align: center;"><b>900</b> <b>5,950</b></p>
	<p><b>SYSTEM</b> (M60A1 / M60A3, where their data differs)  <b>Alternative Designations:</b> INA  <b>Date of Introduction:</b> 1963/1979  <b>Proliferation:</b> At least 17 countries  <b>Description:</b>  Crew: 4  Combat Weight (mt): 52.5  Chassis Length Overall (m): 6.95  Height Overall (m): 3.27  Width Overall (m): 3.63  Ground Pressure (kg/cm<sup>2</sup>): 0.87</p> <p><b>Automotive Performance:</b>  Engine Type: 750-hp Diesel  Cruising Range (km): 550  Speed (km/h):  Max Road: 48  Max Off-Road: 45  Average Cross-Country: 35  Max Swim: N/A  Fording Depths (m): 1.2, 2.4 Prepared, 4 with snorkel  <b>Radio:</b> AN/VRC-12, or compatible with army net radios</p> <p><b>Protection:</b>  Armor, Turret Front (mm): 325 KE RHA at 2,000 m/325 CE  Applique Armor (mm): Available, including modular armor  Explosive Reactive Armor (mm): BLAZER and others available  Active Protective System: N/A  Mineclearing Equipment: GDLS mine roller system available  Self-Entrenching Blade: INA  NBC Protection System: Yes  Smoke Equipment: Smoke grenade launchers (2 x 6) on M60A3  VEESS on later M60A3s</p> <p><b>ARMAMENT</b>  <b>Main Armaments:</b>  Caliber, Type, Name: 105-mm 51-cal rifled gun, M68  Rate of Fire (rd/min): 6-8  Loader Type: Manual  Ready/Stowed Rounds: 16/ 47  Elevation (°): -10 to +20  Fire on Move: No</p> <p><b>Auxiliary Weapon:</b>  Caliber, Type, Name: 7.62-mm (7.62x51) Machinegun, M73/M240  Mount Type: Turret coax  Max Aimed Range (m): 2,000 (est)  Max Effective Range (m):  Day: 1,800  Night: INA  Fire on Move: Yes  Rate of Fire (rd/min): 600-950</p> <p>Caliber, Type, Name: .50 cal (12.7-mm) AA Machinegun, M85  Mount Type: Cupola  Max Aimed Range (m): 2,000  Max Effective Range (m):  Day: 2,000 (est)  Night: INA  Fire on Move: Yes  Rate of Fire (rd/min): 450-550 (est)</p> <p><b>FIRE CONTROL</b>  <b>FCS Name:</b> M32E1 day/night periscope / M35 or M36E1 sight  <b>Main Gun Stabilization:</b> Available / poor 2-plane  <b>Rangefinder:</b> M17C coincidence / AN/VVG-2 ruby laser  <b>Infrared Searchlight:</b> Number 2 IR and white light  <b>Sights w/Magnification:</b>  Gunner:  Day: M31, 8x / M35 or M36E1, 8x  Field of View (°): 7.5  Acquisition Range (m): 2,000 / 3,000  Night: None, IR, II available/ None, II, thermal (See NOTES)  Field of View (°): INA / See NOTES  Acquisition Range (m): INA  <b>Commander Fire Main Gun:</b> INA</p> <p><b>VARIANTS</b>  <b>M60:</b> Original tank was derived from M48, but with a 105-mm gun. Vehicles derived from the M60 include <b>M60 AVLB</b>, the <b>M9</b> bulldozer, and <b>M728</b> Combat Engineer Vehicle.</p> <p><b>M60A1:</b> Features a reshaped turret, added ammunition stowage, rangefinder, improved fire control, and improved running gear.</p> <p><b>M60A2:</b> Unique and less successful tank version with a 152-mm gun and Shillelagh ATGM from the M-551/Sheridan.</p> <p><b>M60A3:</b> This version has better engine, fire control, thermal sights, ballistic computer, thermal sleeve, and improved stabilizer. A number of countries have upgraded M60A1s to comparability to the M60A3 standard. These include Israel, Austria, and Saudi Arabia.</p> <p><b>MAGACH-7:</b> Israeli variant with improved engine, track, fire control system, added stabilized sights, modular armor, armor track skirts, thermal sleeve, and with two 7.62-mm only cupola MGs.</p> <p><b>MAIN ARMAMENT AMMUNITION</b>  <b>Caliber, Type, Name:</b>  105-mm APFSDS, UI (New Chinese)  Max Aimed Range (m): 3,000  Max Effective Range (m):  Day: 2,000 / 3,000 (est)  Night: INA  Armor Penetration (mm): 460 at 2,000 m</p>	

**United States Main Battle Tank M60A1/M60A3 continued**

<p><b>Caliber, Type, Name:</b> 105-mm APFSDS, H6/62 (UK)  Max Aimed Range (m): 3,000  Max Effective Range (m):  Day: 2,000 / 3,000  Night: INA  Armor Penetration (mm): NATO single heavy target, 5,000 m</p> <p><b>Caliber, Type, Name:</b> 105-mm APFSDS, DM23 (GE)  Max Aimed Range (m): 3,000  Max Effective Range (m):  Day: 2,000 / 3,000  Night: INA  Armor Penetration (mm): 150, NATO single heavy target, 60° at 2,000 m</p> <p><b>Caliber, Type, Name:</b> 105-mm HEAT, M456 (multinational)  Max Aimed Range (m): 3,000  Max Effective Range (m):  Day: 1,500-2,000 / 1,500-2,500 (est.)  Night: INA  Armor Penetration (mm): 432, NATO single heavy target</p>	<p><b>Caliber, Type, Name:</b> 105-mm HESH, L35 (UK)  Max Aimed Range (m): 3,000  Max Effective Range (m):  Day: 2,000 / 2,000-2,500 (est.)  Night: INA  Armor Penetration (mm): NATO single heavy target</p> <p><b>Caliber, Type, Name:</b> 105-mm HE, HE-OE (FR)  Max Aimed Range (m): 3,000  Max Effective Range (m):  Day: 2,000 / 2,500-3,000 (est.)  Night: INA  Armor Penetration (mm): INA</p> <p><b>Caliber, Type, Name:</b> 105-mm APERS-T, M494 (Flechette)  Max Aimed Range (m): 3,000  Max Effective Range (m):  Day: 2,000 / 3,000  Night: INA  Armor Penetration (mm): N/A</p> <p><b>Other Ammunition Types:</b> Chinese Type 83/ UK L64/ US M735 APFSDS, UK L52 APDS, multinational M393 HEP-T, L39 Smoke, French OBUS 105 F1 Illuminating, Australian TC800 Canister (balls)</p>
---	---

**NOTES**

A variety of day and night sights (including thermal and stabilized), stabilization systems and ballistic computers are available for M60A1 and M60A3. The TTS thermal sight (5x and 10x, FOV 6x4 and 12x8°) was added to US M60A3, and has been widely fielded.

The Swiss 120-mm Compact Tank Gun is available.

Israeli IMI offers the APAM round with submunitions and a time fuze.

Israeli IAI now offers LAHAT gun-launched ATGM, with semi-active laser homing and tandem warhead; but it requires modified fire control.

Israeli IMI offers several upgrade packages, such as SABRA, for the SABRA MBT. This private venture includes extensive upgrades for mobility, lethality, and protection, including a 120-mm main gun.

## Russian Main Battle Tank T-34/85

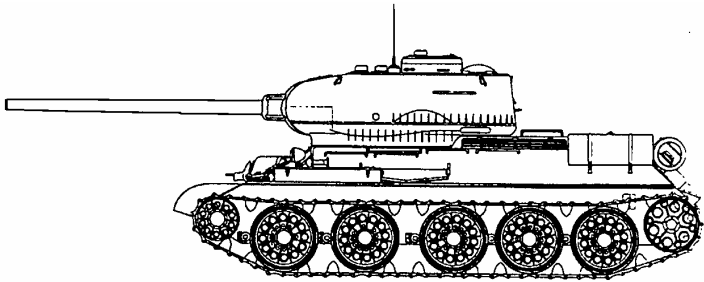
	<p><b>Weapons &amp; Ammunition Types</b></p> <p><b>85-mm rifled gun</b> APC-T/HVAP-T HEAT-FS AP HE Frag-HE, HE</p> <p><b>2 x 7.62-mm MG</b> (7.62x54R)</p>	<p><b>Typical Combat load</b></p> <p><b>55</b></p> <p><b>2,745</b></p>
<p><b>SYSTEM</b>  <b>Alternative Designations:</b> T-34-85 Model 1944  <b>Date of Introduction:</b> 1944  <b>Proliferation:</b> At least 20 countries with T-34 tanks and variants  <b>Description:</b>  Crew: 5  Combat Weight (mt): 32  Chassis Length Overall (m): 6.1  Height Overall (m): 2.7  Width Overall (m): 2.99  Ground Pressure (kg/cm<sup>2</sup>): 0.88</p> <p><b>Automotive Performance:</b>  Engine Type: 500-hp Diesel  Cruising Range (km): 300, 500 with extra tanks  Speed (km/h):      Max Road: 56      Max Off-Road: 35      Average Cross-Country: INA      Max Swim: N/A  Forcing Depths (m): 1.3, 5.5 with snorkel</p> <p><b>Radio:</b> R-113, R-123 in later versions</p> <p><b>Protection:</b>  Armor, Turret Front (mm): 75-85  Applique Armor (mm): No  Explosive Reactive Armor (mm): No  Mineclearing Equipment: Plow, roller, and dozer blade available  Self-Entrenching Blade: N/A  Active Protective System: No  NBC Protection System: No  Smoke Equipment: 2 x BDSH smoke charges</p> <p><b>ARMAMENT</b>  <b>Main Armament:</b> 85-mm rifled gun, D-5T or ZIS-S-53  Rate of Fire(rd/min): 3-4  Loader Type: Manual  Ready/Stowed Rounds: INA  Elevation (°): -5 to +25  Fire on Move: No</p> <p><b>Auxiliary Weapon:</b>  Caliber, Type, Name: 7.62-mm MG, SGMT (early upgrade)  Mount Type: Coaxial  Maximum Aimed Range (m): 2,000  Max Effective Range (m):      Day: 1,000/ 400-500 on the move      Night: N/A</p>	<p>Fire on Move: Yes  Rate of Fire (rd/min): 250 practical /650 cyclic, 2-10 rd bursts</p> <p>Caliber, Type, Name: 7.62-mm MG, SGMB (early upgrade)  Mount Type: Bow  Maximum Aimed Range (m): 2,000  Max Effective Range (m):      Day: 1,000/ 400-500 on the move      Night: N/A  Fire on Move: Yes  Rate of Fire (rd/min): 250 practical/650 cyclic, 2-10 rd bursts</p> <p><b>FIRE CONTROL</b>  <b>FCS Name:</b> INA  <b>Main Gun Stabilization:</b> None  <b>Rangefinder:</b> Stadiametric  <b>Infrared Searchlight:</b> No  <b>Sights w/Magnification:</b>  Gunner:      Day: TSh-15 or TSh-16 articulated telescope, 4.5x      Field of View (°): 15      Acquisition Range (m): 1,500 direct fire, 5,200 indirect fire      Night: N/A      Field of View (°): N/A      Acquisition Range (m): N/A  <b>Commander Fire Main Gun:</b> No</p> <p><b>VARIANTS:</b>  <b>T-34:</b> The baseline tank, also referred to as <b>T-34/76</b>, has a 76-mm main gun. Many T-34s have been modified. Earlier versions use the 7.62-mm DTM MG, and later versions 7.62-mm SGMT or PKT MG. Some countries have replaced 7.62-mm AAMG with a 12.7-mm MG. Some Chinese variants have LRFs. Egyptian variants have rubber skirts and a VEES system. Conversions include 122-mm SP guns, self-propelled AA guns, armored recovery vehicles, bridgelayers, bulldozers, and flamethrowers. Most are no longer in service.</p> <p><b>OT-34-85:</b> Flamethrower version is indistinguishable from the <b>T-34/85</b>, with a ZIS-S-53 gun and 60-70 m flame range.</p> <p>Poland and Czechoslovakia also produced <b>T-34/85</b>.</p> <p><b>MAIN ARMAMENT AMMUNITION</b>  <b>Caliber, Type, Name:</b> 85-mm HVAP-T, BR-365PK  Max Aimed Range (m): 1,500  Max Effective Range (m):      Day: 1,150 (direct fire range)      Night: N/A  Armor Penetration (mm): 130 (0°) at 1,000 m, 167 (0°) at muzzle</p>	



**Russian Main Battle Tank T-34/85 continued**

---

<p><b>Caliber, Type, Name:</b> 85-mm APC-T, BR-367  Max Aimed Range (m): 1,500  Max Effective Range (m):  Day: 1,150 (est)  Night: N/A  Armor Penetration (mm): 120 (0°) at 1,000 m</p> <p><b>Caliber, Type, Name:</b> 85-mm HEAT-FS, BK-2M  Max Aimed Range (m): 1,500 (est)  Max Effective Range (m):  Day: 970 direct fire range  Night: N/A  Armor Penetration (mm): 100 at 65°, 300-400 at 0° all ranges</p> <p><b>Caliber, Type, Name:</b> 85-mm, AP HE,  Max Aimed Range (m): 1,500 (est)  Max Effective Range (m):  Day: 1,150 (est)  Night: N/A  Armor Penetration (mm): 102 (0°) at 1,000 m</p>	<p><b>Caliber, Type, Name:</b> 85-mm Frag-HE, O-365K  Max Aimed Range (m): 5,200  Max Effective Range (m):  Day: INA  Night: N/A  Armor Penetration (mm): Can defeat most IFVs on impact</p> <p><b>Other Ammunition Types:</b> Chinese smoke, Russian HVAP-T BR-365P, Russian AP-T BR-365 and BR-365K, Russian Frag-HE O-365, North Korean APC-T Type 367</p>
---	---

**NOTES**

Main gun is in the family which includes D-44 and SD-44 field guns, KS-12 AA Gun and ASU-85 assault gun. Ammunition options include the variety of ammunition available for these guns.

## Russian Main Battle Tank T-55AMV

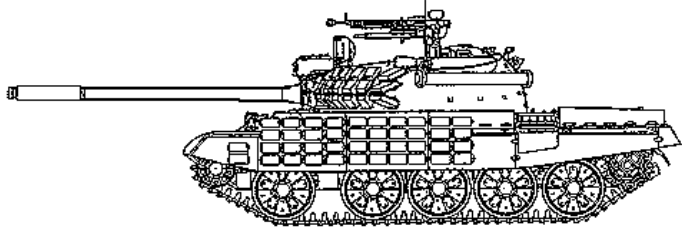
	<b>Weapons &amp; Ammunition Types</b>  <b>100-mm rifled gun</b> APFSDS-T HEAT Frag-HE ATGM  <b>7.62-mm coax PKT MG</b> <b>12.7-mm AA MG</b>	<b>Typical Combat Load</b>  (mix est) <b>43</b> 14 3 21 5  <b>1,250</b> <b>500</b>
<p><b>SYSTEM</b>  <b>Alternative Designations:</b> INA  <b>Date of Introduction:</b> 1983  <b>Proliferation:</b> At least 3 countries  <b>Description:</b>                      Crew: 4                      Combat Weight (mt): 40.5                      Chassis Length Overall (m): 6.20                      Height Overall (m): 2.32                      Width Overall (m): 3.60                      Ground Pressure (kg/cm<sup>2</sup>): 0.89</p> <p><b>Automotive Performance:</b>                      Engine Type: 620-690 hp Diesel                      Cruising Range (km): 390/600 with extra tanks                      Speed (km/h):                          Max Road: 50                          Max Off-Road: 35                          Average Cross-Country: 25                          Max Swim: N/A                      Fording Depths (m): 1.4 Unprepared, 5.5 with snorkel</p> <p><b>Radio:</b> R-173, R-173P, R-124 intercom</p> <p><b>Protection:</b>                      Armor, Turret Front (mm): 200 (base T-55 armor)                      Applique Armor (mm): Rubber screens and box armor                      Explosive Reactive Armor (mm): 1st Gen raises to KE/700-900 against HEAT; 2nd Gen raises to 450-480 KE/700-900 HEAT                      Active Protective System: Russian Drozd APS available                      Mineclearing Equipment: Roller-plow set, and plows available                      Self-Entrenching Blade: No                      NBC Protection System: Yes                      Smoke Equipment: Smoke grenade launchers (4x 81-mm each side of turret), and 24 grenades. Vehicle engine exhaust smoke system</p> <p><b>ARMAMENT</b>  <b>Main Armaments:</b>                      Caliber, Type, Name: 100-mm rifled gun, D-10T2S                      Rate of Fire (rd/min): 5-7                      Loader Type: Manual                      Ready/Stowed Rounds: INA                      Elevation (°): -5 to +18                      Fire on Move: Yes (gun rounds only--ATGMs require a short halt)</p> <p><b>Auxiliary Weapon:</b>                      Caliber, Type, Name: 7.62-mm (7.62x 54R) Machinegun PKT-T                      Mount Type: Turret coax                      Maximum Aimed Range (m): 2,000                      Max Effective Range (m):                          Day: 800</p>	<p>Night: 800                      Fire on Move: Yes                      Rate of Fire (rd/min): 250 rpm practical, 800 cyclic, 2-10 rd bursts</p> <p>Caliber, Type, Name: 12.7-mm (12.7x108) AA MG DShKM                      Mount Type: Turret top                      Maximum Aimed Range (m): 2,000                      Max Effective Range (m):                          Day: 1,500                          Night: N/A                      Fire on Move: Yes                      Rate of Fire (rd/min): 80-100 practical, 600 cyclic, 2-10 rd bursts</p> <p><b>ATGM Launcher :</b>                      Name: D-10T2S gun                      Launch Method: Gun-launched                      Guidance: SACLOS, Infrared laser-beam rider                      Command Link: Encoded laser-beam                      Launcher Dismountable: No</p> <p><b>FIRE CONTROL</b>  <b>FCS Name:</b> Volna  <b>Main Gun Stabilization:</b> M1 Tsiklon 2-plane  <b>Rangefinder:</b> KDT-2 Laser  <b>Infrared Searchlight:</b> L-4  <b>Sights w/Magnification:</b>                      Gunner:                          Day: TShSM-32PV, 3.5x and 7x                              Field of View (°): 18 and 8                              Acquisition Range (m): 4,000                          Night: 1K13                              Field of View (°): INA                              Acquisition Range (m): 800-1,300, gun rounds only  <b>Commander Fire Main Gun:</b> No</p> <p><b>VARIANTS</b>                      More than a dozen countries have produced upgraded T-55 variants with similar capabilities in protection and lethality. Many countries have upgraded to a larger main gun.</p> <p>T-55AMV is derived from a line of variants of T-55 MBT. <b>T-55A</b> added an NBC protection system. <b>T-55M</b> added the Volna fire control system (with ATGM launcher), improved gun stabilization and sights, improved engine, new radio, and increased protection. That included side skirts, smoke grenade launchers, applique armor, and fire protection. <b>T-55AM</b> added bra armor, an armor band around the turret for 180° coverage. The -AMV upgrade means substitution of ERA for the bra armor. Variants ending with -1 denote replacement of the engine w/V-46 engine from T-72 MBT. The Ukraine and Syria will upgrade to the T-55AMV standard.</p>	

**Russian Main Battle Tank T-55AMV continued**

<p><b>T-55AM2B:</b> Czech version of T-55AMV with Kladivo fire control.  <b>T-55AM2:</b> Variant does not have ATGM capability or Volna FCS.  <b>T-55AM2P:</b> Polish version of T-55AMV but with Merida FCS.  <b>T-55AMD:</b> Variant with the Drozd APS instead of ERA.  <b>T-55AD Drozd:</b> Variant with Drozd but not Volna FCS and ERA.</p> <p><b>MAIN ARMAMENT AMMUNITION</b>  <b>Caliber, Type, Name:</b>  100-mm APDS-T, BM-8 Russian  Maximum Aimed Range (m): 2,500  Max Effective Range (m):  Day: 1,500  Night: 800-1,300  Armor Penetration (mm): 200 at 1,000 meters</p> <p>100-mm APFSDS-T, BM-25  Maximum Aimed Range (m): 2,500  Max Effective Range (m):  Day: INA  Night: 800-1,300  Armor Penetration (mm): INA</p> <p>100-mm APFSDS-T, BM-412M, Romanian  Maximum Aimed Range (m): 2,500  Max Effective Range (m):  Day: 2,000+ (est)  Night: 800-1,300  Armor Penetration (mm): 418 at 2,000 m, 380 at 3,000 m</p> <p>100-mm APFSDS-T, M1000, Belgian  Maximum Aimed Range (m): 2,500  Max Effective Range (m):  Day: 2,500 (est)  Night: 800-1,300  Armor Penetration (mm): NATO triple heavy target, 4,500 m</p>	<p>100-mm HEAT, BK-17  Maximum Aimed Range (m): 2,500  Max Effective Range (m):  Day: 1,000 (est)  Night: 800-1,000 (est)  Armor Penetration (mm): 380</p> <p>100-mm Frag-HE, OF-32  Maximum Aimed Range (m): 4,000  Max Effective Range (m):  Day: &lt;2,500  Night: 800-1,300  Armor Penetration (mm): INA</p> <p><b>Other Ammunition Types:</b> A variety of other rounds within the range noted above are available. They include the GIAT NR 322/NR 352 APFSDS-T and Slovak JPrSv AP-T with ranges beyond 2,000 m.</p> <p><b>Antitank Guided Missiles:</b>  Name: AT-10/BASTION  Warhead Type: Shaped charge (HEAT)  Armor Penetration (mm): 650 (RHA)  Range (m): 4,000 (day only, see NOTES)</p> <p>Name: AT-10 Improved  Warhead Type: Tandem shaped charge  Armor Penetration (mm): 700 (RHA) behind ERA  Range (m): 4,000 (day only, see NOTES)</p>
---	---

**NOTES**

The 1K13 sight is both night sight and ATGM launcher sight; however, it cannot be used for both functions simultaneously.

T-55s with "bra armor", semi-circular add-on armor, have turret protection increased to 330 mm (KE) and 400-450 mm (CE). Other improvements available include a hull bottom reinforced against mines, better engines, rubber track pads, and a thermal sleeve for the gun.

Optional sights and fire control systems include the Israeli El-Op Red Tiger and Matador FCS, Swedish NobelTech T-series sight, and German Atlas MOLF. The Serbian SUV-T55A FCS, British Marconi Digital FCS, South African Tiger, and Belgian SABCA Titan offer upgraded function. One of the best is the Slovenian EFCS-3 integrated FCS.

A variety of thermal sights is available. They include the Russian/French ALIS and Namut-type sight from Peleng. There are thermal sights available for installation which permit night launch of ATGMs.



## Russian Main Battle Tank T-62M

<p>115-mm HEAT, BK-4  Maximum Aimed Range (m): 1,500 (est)  Max Effective Range (m):  Day: 1,200  Night: 850-1,200  Armor Penetration (mm): 495 (RHA)</p> <p>115-mm Frag-HE-T, OF-27  Maximum Aimed Range (m): 4,000  Max Effective Range (m):  Day: 1,500-2,000  Night: 850-1,300  Armor Penetration (mm): INA</p> <p><b>Other Ammunition Types:</b> BM-3 APFSDS, BM-4 APFSDS, BK-4M HEAT, BK-15 HEAT, OF-11 Frag-HE, OF-18 Frag-HE</p>	<p><b>Antitank Guided Missiles</b></p> <p>Name: AT-10/Sheksna  Warhead Type: Shaped charge (HEAT)  Armor Penetration (mm): 650  Range (m): 4,000 (day only, see NOTES)</p> <p>Name: AT-10 Improved  Warhead Type: Tandem shaped charge  Armor Penetration (mm): 700 behind ERA  Range (m): 4,000 (day only, see NOTES)</p>
--	--

### NOTES

The 1K13 sight is both night sight and ATGM launcher sight; however, it cannot be used for both functions simultaneously.

Other improvements available include a hull bottom reinforced against mines, rubber track pads, and a thermal sleeve for the gun.

Optional sights and fire control systems include the Israeli El-Op Red Tiger and Matador FCS, Swedish NobelTech T-series sight, and German Atlas MOLF. The British Marconi Digital FCS, South African Tiger, and Belgian SABCA Titan offer upgraded function. One of the best is the Slovenian EFCS-3 integrated FCS.

A variety of thermal sights is available. They include the Russian Agava, French SAGEM-produced ALIS and Namut sight from Peleng. There are thermal sights available for installation which permit night launch of ATGMs.

## Russian Main Battle Tank T-64B

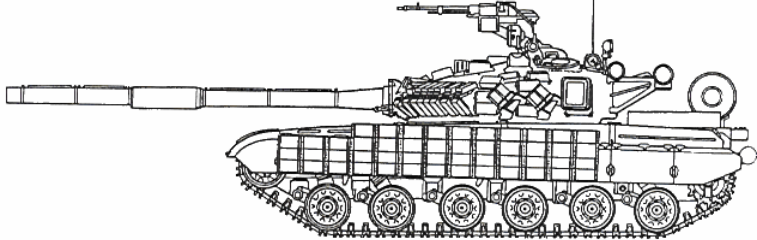
 <p>T-64BV</p>	<p><b>Weapons &amp; Ammunition Types</b></p> <p><b>125-mm smoothbore gun</b> APFSDS-T HEAT Frag-HE ATGM</p> <p><b>7.62-mm coax MG</b> <b>12.7-mm NSVT AA MG</b></p>	<p><b>Typical Combat Load</b></p> <p><b>37</b> (mix est) 12 2 17 6</p> <p><b>1,250</b> <b>300</b></p>
<p><b>SYSTEM</b> <b>Alternative Designations:</b> INA <b>Date of Introduction:</b> 1979 <b>Proliferation:</b> At least 2 countries <b>Description:</b> Crew: 3 Combat Weight (mt): 40.3 Chassis Length Overall (m): 6.45 Height Overall (m): 2.17 Width Overall (m): 3.41 Ground Pressure (kg/cm<sup>2</sup>): 0.86</p> <p><b>Automotive Performance:</b> Engine Type: 720-hp Diesel Cruising Range (km): 500 with extra tanks Speed (km/h):     Max Road: 60     Max Off-Road: INA     Average Cross-Country: INA     Max Swim: N/A Forcing Depths (m): 1.8 Unprepared, 5.0 w/snorkel</p> <p><b>Radio:</b> R-123M, R-124 intercom</p> <p><b>Protection:</b> Armor, Turret Front (mm): 450 KE RHA at 2,000 m/900 CE Applique Armor (mm): N/A Explosive Reactive Armor (mm): Standard on T-64BV Active Protective System: Available Mineclearing Equipment: Mine rollers and plows available Self-Entrenching Blade: Yes NBC Protection System: Yes Smoke Equipment: Smoke grenade launchers (4x 81-mm each side of turret), and 24 grenades. Vehicle engine exhaust smoke system</p> <p><b>ARMAMENT</b> <b>Main Armament:</b> Caliber, Type, Name: 125-mm smoothbore gun 2A46-2 Rate of Fire (rd/min): 6-8 (lower in manual mode) Loader Type: Separate-loading autoloader, ATGMs manual Ready/Stowed Rounds: 24 in carousel, 6 ATGMs manual/7 stowed Elevation (°): -6 to +18 Fire on Move: Yes (30 km/h rounds/low speed or stop ATGMs)</p> <p><b>Auxiliary Weapon:</b> Caliber, Type, Name: 7.62-mm (7.62x 54R) Machinegun PKT Mount Type: Turret coax Maximum Aimed Range (m): 2,000</p>	<p>Max Effective Range (m):     Day: 1,000     Night: 850-1,300 Fire on Move: Yes Rate of Fire (rd/min): 250 practical / 650 cyclic, 2-10 round bursts</p> <p>Caliber, Type, Name: 12.7-mm (12.7x108) AA MG NSVT Mount Type: Turret top Maximum Aimed Range (m): 2,000 Max Effective Range (m):     Day: 1,500 ground/1,600 for air targets (APDS)     Night: 800-1,300 Fire on Move: Yes Rate of Fire (rd/min): 210 practical/ 800 air targets in bursts</p> <p><b>ATGM Launcher:</b> Name: 2A46-2 tank gun Launch Method: Gun-launched Guidance: SACLOS Command Link: Encoded radio frequency Launcher Dismountable: No</p> <p><b>FIRE CONTROL</b> <b>FCS Name:</b> INA <b>Main Gun Stabilization:</b> 2E26M 2-plane <b>Rangefinder:</b> Laser <b>Infrared Searchlight:</b> Yes <b>Sights w/Magnification:</b> Gunner:     Day: 1G42     Field of View (°): INA     Acquisition Range (m): 5,000     Night: TPN-1-49-23     Field of View (°): INA     Acquisition Range (m): 800-1,300 (est) <b>Commander Fire Main Gun:</b> No</p> <p><b>VARIANTS</b> <b>T-64A:</b> Production version of base tank. That tank has a history of reliability problems. It also lacks the high armor protection, track skirts, a FCS and ATGM launch capability of T-64B. <b>T-64BK:</b> Command tank version, with 10-m whip antenna. <b>T-64B1:</b> Version of -B tank without ATGM launch capability. <b>T-64BV:</b> Variant noted in the above line drawing has Kontakt ERA mounted. This variant is more likely for encounter by US forces.</p>	

**Russian Main Battle Tank T-64B continued**

<p><b>MAIN ARMAMENT AMMUNITION</b></p> <p><b>Caliber, Type, Name:</b>  125-mm APFSDS-T, BM-42M  Maximum Aimed Range (m): 3,000-4,000  Max Effective Range (m):  Day: 2,000-3,000  Night: 850-1,300  Armor Penetration (mm): 590-630 at 2,000 meters</p> <p>125-mm Frag-HE-T, OF-26  Maximum Aimed Range (m): 5,000  Max Effective Range (m):  Day: INA  Night: 850-1,300  Armor Penetration (mm): INA</p> <p>125-mm HEAT-MP, BK-29M  Maximum Aimed Range (m): 4,000  Max Effective Range (m):  Day: 2,000-3,000  Night: 850-1300  Armor Penetration (mm): 650-750</p>	<p>125-mm HEAT, BK-27  Maximum Aimed Range (m): 4,000  Max Effective Range (m):  Day: 2,000-3,000  Night: 850-1,300  Armor Penetration (mm): 700-800</p> <p><b>Other Ammunition Types:</b> Giat 125G1 APFSDS-T, Russian BM-42 and BM-32 APFSDS-T. Note: The Russians may have a version of the BM-42M with a DU penetrator.</p> <p><b>Antitank Guided Missile:</b>  Name: AT-8/SONGSTER  Warhead Type: Shaped charge (HEAT)  Armor Penetration (mm): 700 (RHA) conventional  Range (m): 4,000</p>
---	---

**NOTES**

The night sight cannot be used to launch the ATGM. The daysight can be used at night for launching ATGMs if the target is illuminated. A variety of thermal sights is available. They include the Russian Agava-2, French SAGEM-produced ALIS and Namut sight from Peleng. There are thermal sights available for installation which permit night launch of ATGMs.

The more recent BK-27 HEAT round offers a triple-shaped charge warhead and increased penetration against conventional armors and ERA. The BK-29 round, with a hard penetrator in the nose is designed for use against reactive armor, and as an MP round has fragmentation effects. If the BK-29 HEAT-MP is used, it may substitute for Frag-HE (as with NATO countries) or complement Frag-HE. With three round natures (APFSDS-T, HEAT-MP, ATGMs) in the autoloader vs four, more antitank rounds would be available for the higher rate of fire.

## Russian Main Battle Tank T-72B

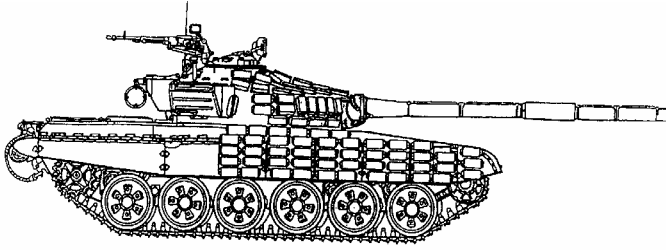
 <p style="text-align: center;">T-72B w/Kontakt ERA</p>	<b>Weapons &amp; Ammunition Types</b>	<b>Typical Combat Load</b>
<p><b>SYSTEM</b>  <b>Alternative Designations:</b> T-72S (export), SMT M1988  <b>Date of Introduction:</b> 1985  <b>Proliferation:</b> At least 2 countries  <b>Description:</b>            Crew: 3            Combat Weight (mt): 44.5            Chassis Length Overall (m): 6.91            Height Overall (m): 2.19            Width Overall (m): 3.58            Ground Pressure (kg/cm<sup>2</sup>): 0.90</p> <p><b>Automotive Performance:</b>            Engine Type: 840-hp Diesel            Cruising Range (km): 500/ 900 with external tanks            Speed (km/h):                Max Road: 60                Max Off-Road: 45                Average Cross-Country: 35                Max Swim: N/A            Fording Depths (m): 1.2 Unprepared/5.0 with snorkel            Radio: R-173 and R-134</p> <p><b>Protection:</b>            Armor, Turret Front (mm): 520/950 against HEAT            Applique Armor (mm): Side of hull over track skirt, turret top            Explosive Reactive Armor (mm): Kontakt or Kontakt-5 ERA            Active Protective System: Arena available            Mineclearing Equipment: Roller-plow set, and plows available            Self-Entrenching Blade: Yes            NBC Protection System: Yes            Smoke Equipment: Smoke grenade launchers (8x 81-mm left side of turret), and 32 grenades. Vehicle engine exhaust smoke system.</p> <p><b>ARMAMENT</b>  <b>Main Armament:</b>            Caliber, Type, Name: 125-mm smoothbore gun 2A46M/ D-81TM            Rate of Fire (rd/min): 4-6/2 in manual mode            Loader Type: Autoloader (separate loading) and manual            Ready/Stowed Rounds: 22/23            Elevation (°): -6 to +14            Fire on Move: Yes, up to 25 km/h. Depending on the road and distance to the target, most crews may halt before firing.</p> <p><b>Auxiliary Weapon:</b>            Caliber, Type, Name: 7.62-mm (7.62x 54R) Machinegun PKT            Mount Type: Turret coax            Maximum Aimed Range (m): 2,000            Max Effective Range (m):                Day: 1,000                Night: 800</p>	<p><b>125-mm smoothbore gun</b>            APFSDS-T (mix est) 15            HEAT 3            Frag-HE 21            ATGM 6</p> <p><b>7.62-mm coax MG</b> 2,000</p> <p><b>12.7-mm AA MG</b> 300</p> <p>Fire on Move: Yes            Rate of Fire (rd/min): 250 practical, 600 cyclic in 2-10 round bursts</p> <p>Caliber, Type, Name: 12.7-mm (12.7x108) AA MG NSVT            Mount Type: Turret top            Maximum Aimed Range (m): 2,000            Max Effective Range (m):                Day: 1,500/1,000 antiaircraft                Night: N/A            Fire on Move: Yes            Rate of Fire (rd/min): 200 practical, 600 cyclic in bursts</p> <p><b>ATGM Launcher:</b>            Name: 2A46M            Launch Method: Gun-launched            Guidance: SACLOS, Laser beam rider            Command Link: Encoded infrared laser beam            Launcher Dismountable: No</p> <p><b>FIRE CONTROL</b>  <b>FCS Name:</b> 1A40-1  <b>Main Gun Stabilization:</b> 2E42-2, 2-plane  <b>Rangefinder:</b> TPD-K1M laser rangefinder  <b>Infrared Searchlight:</b> Yes  <b>Sights w/Magnification:</b>            Gunner:                Day: TPD-K1, 8                Field of View (°): 9                Acquisition Range (m): 3,000 with LRF, 5,000 without            ATGM/Night: 1K13-495 5.6x (8x ATGM)                Field of View (°): 6, 40 min (5 ATGM)                Acquisition Range (m): INA</p> <p><b>Commander Fire Main Gun:</b> No</p> <p><b>VARIANTS</b>  <b>T-72BK:</b> Commander's variant with additional radios</p> <p><b>T-72BM:</b> Version with Kontakt-5 explosive reactive armor. This system is being fielded and is available for export.</p> <p><b>T-72S/Shilden:</b> Russian export T-72A upgraded to be comparable to the T-72BM standard. Although similar to the T-72BM, it may have less turret front protection. The early T-72S tank has Kontakt ERA, as shown above.</p> <p><b>T-90:</b> Successor to T-72BM. This tank has been tentatively approved for production and adoption as a standard tank, alongside the T-80U, for the Russian army. The T-90 uses the gun and 1G46 gunner sights from T-80U, a new engine, and thermal sights. Protective measures include Kontakt-5 ERA, laser warning receivers, and the SHTORA infrared ATGM jamming system.</p>	



**Russian Main Battle Tank T-72B continued**

<p><b>MAIN ARMAMENT AMMUNITION</b></p> <p><b>Caliber, Type, Name:</b>  125-mm APFSDS-T, BM-42M  Maximum Aimed Range (m): 3,000  Max Effective Range (m):  Day: 2,000-3,000  Night: 850-1,300  Armor Penetration (mm): 590-630 at 2,000 meters</p> <p>125-mm Frag-HE-T, OF-26  Maximum Aimed Range (m): 5,000  Max Effective Range (m):  Day: INA  Night: 850-1,300  Armor Penetration (mm): INA</p> <p>125-mm HEAT-MP, BK-29M  Maximum Aimed Range (m): 3,000  Max Effective Range (m):  Day: INA  Night: 850-1300  Armor Penetration (mm): 650-750</p>	<p>125-mm HEAT, BK-27  Maximum Aimed Range (m): 3,000  Max Effective Range (m):  Day: INA  Night: 850-1,300  Armor Penetration (mm): 700-800</p> <p><b>Other Ammunition Types:</b> Giat 125G1 APFSDS-T, Russian BM-42 and BM-32 APFSDS-T. Note: The Russians may have a version of the BM-42M with a DU penetrator.</p> <p><b>Antitank Guided Missiles:</b>  Name: AT-11/SVIR  Warhead Type: Shaped charge (HEAT)  Armor Penetration (mm ): 700 behind ERA/800 conventional  Range (m): 4,000</p> <p>Name: AT-11B/INVAR  Warhead Type: Tandem Shaped charge (HEAT)  Armor Penetration (mm ): 800 behind ERA /870 conventional  Range (m): 4,000</p>
---	---

**NOTES**

The T-72B is the second main variant from the original Russian T-72 tank (after T-72A).

The 1K13-49 sight is both night sight and ATGM launch sight. However, it cannot be used for both functions simultaneously. A variety of thermal sights is available. They include the Russian Agava-2, French SAGEM-produced ALIS and Namut sight from Peleng. Thermal gunner night sights are available which permit night launch of ATGMs.

The more recent BK-27 HEAT round offers a triple-shaped charge warhead and increased penetration against conventional armors and ERA. The BK-29 round, with a hard penetrator in the nose is designed for use against reactive armor, and as an MP round has fragmentation effects. If the BK-29 HEAT-MP is used, it may substitute for Frag-HE (as with NATO countries) or complement Frag-HE. With three round natures (APFSDS-T, HEAT-MP, ATGMs) in the autoloader vs four, more antitank rounds would available for the higher rate of fire.

## Polish/Czechoslovakian Main Battle Tank T-72M1

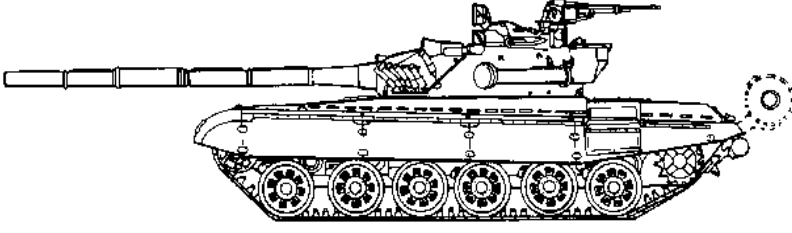
	<b>Weapons &amp; Ammunition Types</b>  <b>125-mm smoothbore gun</b> APFSDS-T HEAT Frag-HE  <b>7.62-mm coax MG</b>  <b>12.7-mm AA MG</b>	<b>Typical Combat Load</b>  <b>44</b> (mix est) 15 7 22  <b>2,000</b>  <b>300</b>
<p><b>SYSTEM</b>  <b>Alternative Designations:</b> Russian T-72A  <b>Date of Introduction:</b> 1975  <b>Proliferation:</b> At least 7 countries</p> <p><b>Description:</b>                      Crew: 3                      Combat Weight (mt): 41.5 (without ERA)                      Chassis Length Overall (m): 6.91                      Height Overall (m): 2.19                      Width Overall (m): 3.59                      Ground Pressure (kg/cm<sup>2</sup>): 0.90</p> <p><b>Automotive Performance:</b>                      Engine Type: 780-hp Diesel                      Cruising Range (km): 460/700 with extra tanks                      Speed (km/h):                          Max Road: 60                          Max Off-Road: 45                          Average Cross-Country: 35                          Max Swim: N/A                      Forging Depths (m): 1.2 Unprepared/5.0 with snorkel</p> <p><b>Radio:</b> R-173M</p> <p><b>Protection:</b>                      Armor, Turret Front (mm): 500/560 against HEAT                      Applique Armor (mm): Side of hull over track skirt, turret top                      Explosive Reactive Armor (mm): 1st or 2nd Gen ERA available                      Active Protective System: Arena or Drozd available                      Mineclearing Equipment: Roller-plow set, and plows available                      Self-Entrenching Blade: Yes                      NBC Protection System: Yes                      Smoke Equipment: Smoke grenade launchers (6x 81-mm each side of turret), and 24 grenades. Vehicle engine exhaust smoke system.</p> <p><b>ARMAMENT</b>  <b>Main Armaments:</b>                      Caliber, Type, Name: 125-mm smoothbore gun 2A46M/ D-81TM                      Rate of Fire (rd/min): 4-6/2 in manual mode                      Loader Type: Autoloader (separate loading) and manual                      Ready/Stowed Rounds: 22/22 (22 in carousel)                      Elevation (°): -6 to +14                      Fire on Move: Yes, up to 25 km/h. Depending on the road and distance to the target, most crews may halt before firing.</p> <p><b>Auxiliary Weapon:</b>                      Caliber, Type, Name: 7.62-mm (7.62x 54R) Machinegun PKT                      Mount Type: Turret coax                      Maximum Aimed Range (m): 1,800</p>	<p>Max Effective Range (m):                      Day: 1,000                      Night: 800                      Fire on Move: Yes                      Rate of Fire (rd/min): 250 practical, 600 cyclic in 2-10 round bursts</p> <p>Caliber, Type, Name: 12.7-mm (12.7x108) AA MG NSVT                      Mount Type: Turret top                      Maximum Aimed Range (m): 2,000                      Max Effective Range (m):                      Day: 1,500, 1,000 AA                      Night: N/A                      Fire on Move: Yes                      Rate of Fire (rd/min): 200 practical, 600 cyclic in bursts</p> <p><b>ATGM Launcher:</b> N/A</p> <p><b>FIRE CONTROL</b>  <b>FCS Name:</b> INA  <b>Main Gun Stabilization:</b> 2E28M, 2-plane  <b>Rangefinder:</b> TPD-K1 laser rangefinder  <b>Infrared Searchlight:</b> Yes  <b>Sights w/Magnification:</b>                      Gunner:                          Day: TPD-K1 laser rangefinder sight, 8 x                          Field of View (°): 9                          Acquisition Range (m): 3,000 with LRF, 5000 without                          Night: TPN-1-49, 5.5 x                          Field of View (°): 6                          Acquisition Range (m): 800  <b>Commander Fire Main Gun:</b> No</p> <p><b>VARIANTS</b>  <b>T-72:</b> Original Russian tank from which T-72 variants were derived.</p> <p><b>T-72M:</b> Original Polish and former-Czechoslovakian T-72-series tank from which Polish/Czechoslovakian T-72M1 was derived. T-72M differs from T-72 in replacing the right-side coincident rangefinder with a centerline-mounted TPD-K1 LRF.</p> <p><b>T-72A:</b> The Russian variant differs from T-72 with the TPD-K1 LRF, added sideskirts, additional armor on the turret front and top, smoke grenade launchers, internal changes, and a slight weight increase. The Russian export version and Polish/Czechoslovakian counterparts are called <b>T-72M1</b>. Versions with Kontakt ERA are known as <b>T-72AV /T-72 M1V</b>. Please note that some countries have inventories of T-72, T-72M and T-72M1, with different versions of each variant. Also, many variants were upgraded or modified. Some T-72M1s do not have smoke grenade launchers or track skirts. Some T-72s/T-72Ms have smoke grenade launchers. More reliable discriminators are armor and rangefinder/FCS.</p>	

Polish/Czechoslovakian Main Battle Tank T-72M1 continued

<p><b>T-72AK/7T-2M1K:</b> Commander's variant with additional radios</p> <p><b>T-72AM/Banan:</b> Ukrainian T-72A upgrade with ERA, a new engine, and additional smoke grenade launchers. The <b>T-72AG</b> upgrade has a 1200-hp engine, Shtora-1 ATGM jammer, and 1G46 (T-80U) FCS with thermal night sights.</p> <p><b>T-72M1M:</b> T-72M1 variant upgraded to T-72B standard.</p> <p><b>T-72M2/Moderna.</b> Slovakian T-72M upgrade with new engine and fire control, SFIM thermal sight, laser warning receiver, ERA, and 2 x 20-mm AA guns on turret</p> <p><b>T-72M4CZ:</b> Czech variant with TURMS FCS with thermal sight, new engine, increased protection ERA, and 48t weight. <b>T72M3CZ</b> is a less radical upgrade-- for instance existing engine is modified.</p> <p><b>T-72MP:</b> Ukrainian upgrade with a 1,000-hp engine, added armor, Shtora-1, and SAGEM FCS and thermal sights.</p> <p><b>T-72S/Shilden:</b> Russian export T-72A upgraded to T-72B standard.</p> <p><b>M-84:</b> Former Yugoslavian tank upgraded to T-72M1 standard, but with indigenous sights. With an upgraded engine, the tank is <b>M-84A</b>. A Croatian improved version of M-84 is <b>M84A4/Sniper</b>, with improved fire control and thermal night sights. A Slovenian upgrade uses the state-of-the-art and the well-marketed EFCS-3 FCS.</p> <p><b>PT-91/Twardy:</b> Polish upgrade tank with ERA, laser warning receiver, smoke grenade launchers, and Tiger fire control system. Sights include a thermal gunner night sight.</p>	<p><b>MAIN ARMAMENT AMMUNITION</b></p> <p><b>Caliber, Type, Name:</b> 125-mm APFSDS-T, BM-42M Maximum Aimed Range (m): 3,000 Max Effective Range (m): Day: 2,000-3,000 Night: 850-1,300 Armor Penetration (mm): 590-630 at 2,000 meters</p> <p>125-mm Frag-HE-T, OF-26 Maximum Aimed Range (m): 5,000 Max Effective Range (m): Day: INA Night: 850-1,300 Armor Penetration (mm): INA</p> <p>125-mm HEAT-MP, BK-29M Maximum Aimed Range (m): 3,000 Max Effective Range (m): Day: INA Night: 850-1300 Armor Penetration (mm): 650-750</p> <p>125-mm HEAT, BK-27 Maximum Aimed Range (m): 3,000 Max Effective Range (m): Day: INA Night: 850-1,300 Armor Penetration (mm): 700-800</p> <p><b>Other Ammunition Types:</b> Giat 125G1 APFSDS-T, Russian BM-42 and BM-32 APFSDS-T. Note: The Russians may have a version of the BM-42M with a DU penetrator.</p>
--	--

**NOTES**

A variety of thermal sights is available. They include the Russian Agava-2, French SAGEM-produced ALIS and Namut sight from Peleng.

The more recent BK-27 HEAT round offers a triple-shaped charge warhead and increased penetration against conventional armors and ERA. The BK-29 round, with a hard penetrator in the nose is designed for use against reactive armor, and as an MP round has fragmentation effects. If the BK-29 HEAT-MP is used, it may substitute for Frag-HE (as with NATO countries) or complement Frag-HE. With three round natures (APFSDS-T, HEAT-MP, ATGMs) in the autoloader vs four, more antitank rounds would be available for the higher rate of fire.

## Russian Main Battle Tank T-80B

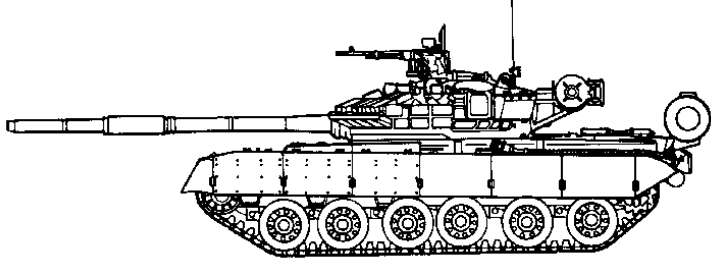
	<b>Weapons &amp; Ammunition Types</b>  <b>125-mm smoothbore gun</b> APFSDS-T HEAT Frag-HE ATGM  <b>7.62-mm coax MG</b> <b>12.7-mm NSVT AA MG</b>	<b>Typical Combat Load</b>  <b>45</b> (mix est) 15 3 21 6  <b>1,250</b> <b>500</b>
<p><b>SYSTEM</b>  <b>Alternative Designations:</b> See NOTES  <b>Date of Introduction:</b> 1978  <b>Proliferation:</b> At least 1 country  <b>Description:</b>                      Crew: 3                      Combat Weight (mt): 44.5                      Chassis Length Overall (m): 6.98                      Height Overall (m): 2.22                      Width Overall (m): 3.58                      Ground Pressure (kg/cm<sup>2</sup>): 0.87</p> <p><b>Automotive Performance:</b>                      Engine Type: 1,000-hp or 1,100-hp Gas turbine (multifuel),                      Cruising Range (km): 370/ 500 with extra tanks                      Speed (km/h):                          Max Road: 70                          Max Off-Road: 48                          Average Cross-Country: 40                          Max Swim: N/A                      Fording Depths (m): 1.8 Unprepared, 5.0 w/snorkel, 12.0 with BROD-M system</p> <p><b>Radio:</b> R-173, R-174 intercom</p> <p><b>Protection:</b>                      Armor, Turret Front (mm): Defeat 120-mm rounds (triple layer)                      Applique Armor (mm): N/A                      Explosive Reactive Armor (mm): 1st Generation ERA available                      Active Protective System: Available                      Mineclearing Equipment: Mine rollers and plows available                      Self-Entrenching Blade: Yes                      NBC Protection System: Yes                      Smoke Equipment: Smoke grenade launchers (4x 81-mm each side of turret), and 24 grenades. Vehicle engine exhaust smoke system</p> <p><b>ARMAMENT</b>  <b>Main Armaments:</b>                      Caliber, Type, Name: 125-mm smoothbore gun 2A46-2                      Rate of Fire (rd/min): 6-8 (lower in manual mode)                      Loader Type: KORZINA separate-loading autoloader and manual                      Ready/Stowed Rounds: 28 in carousel/17 rounds stowed but readily available for manual loading                      Elevation (°): -7 to +20                      Fire on Move: Yes (30 km/h gun rounds/low speed or stop ATGMs)</p> <p><b>Auxiliary Weapon:</b>                      Caliber, Type, Name: 7.62-mm (7.62x 54R) Machinegun PKT                      Mount Type: Turret coax                      Maximum Aimed Range (m): 2,000</p>	<p>Max Effective Range (m):                      Day: 1,000                      Night: 850-1,300                      Fire on Move: Yes                      Rate of Fire (rd/min): 250 practical / 650 cyclic, 2-10 round bursts</p> <p>Caliber, Type, Name: 12.7-mm (12.7x108) AA MG NSVT                      Mount Type: Turret top                      Maximum Aimed Range (m): 2,000                      Max Effective Range (m):                      Day: 1,500 ground/1,600 for air targets (APDS)                      Night: 800-1,300                      Fire on Move: Yes                      Rate of Fire (rd/min): 210 practical/ 800 air targets in bursts</p> <p><b>ATGM Launcher:</b>                      Name: 2A46-2 tank gun                      Launch Method: Gun-launched                      Guidance: SACLOS                      Command Link: Encoded radio frequency                      Launcher Dismountable: No</p> <p><b>FIRE CONTROL</b>  <b>FCS Name:</b> FCS 1A33  <b>Main Gun Stabilization:</b> 2E26M 2-plane  <b>Rangefinder:</b> Laser  <b>Infrared Searchlight:</b> Yes  <b>Sights w/Magnification:</b>                      Gunner:                          Day: 1G42                              Field of View (°): INA                              Acquisition Range (m): 5,000                          Night: 1-4A                              Field of View (°): INA                              Acquisition Range (m): 800-1,300 (est)</p> <p><b>Commander Fire Main Gun:</b> No</p> <p><b>VARIANTS</b>  <b>T-80BV:</b> Variant noted in the above line drawing has ERA mounted. This variant is more likely for encounter by US forces.</p> <p><b>MAIN ARMAMENT AMMUNITION</b>  <b>Caliber, Type, Name:</b>                      125-mm APFSDS-T, BM-42M                      Maximum Aimed Range (m): 3,000-4,000                      Max Effective Range (m):                      Day: 2,000-3,000                      Night: 850-1,300                      Armor Penetration (mm): 590-630 at 2,000 meters</p>	

## Russian Main Battle Tank T-80B continued

<p>125-mm Frag-HE-T, OF-26 Maximum Aimed Range (m): 5,000 Max Effective Range (m): Day: INA Night: 850-1,300 Armor Penetration (mm): INA</p> <p>125-mm HEAT-MP, BK-29M Maximum Aimed Range (m): 4,000 Max Effective Range (m): Day: 2,000-3,000 Night: 850-1300 Armor Penetration (mm): 650-750</p> <p>125-mm HEAT, BK-27 Maximum Aimed Range (m): 4,000 Max Effective Range (m): Day: 2,000-3,000 Night: 850-1,300 Armor Penetration (mm): 700-800</p>	<p><b>Other Ammunition Types:</b> Giat 125G1 APFSDS-T, Russian BM-42 and BM-32 APFSDS-T. Note: The Russians may have a version of the BM-42M with a DU penetrator.</p> <p><b>Antitank Guided Missile:</b> Name: AT-8/SONGSTER Warhead Type: Shaped charge (HEAT) Armor Penetration (mm): 700 (RHA) conventional Range (m): 4,000</p>
---	--

### NOTES

The T-80B and -BV variants are often misidentified as T-80. They are visibly different and bear other distinctions, such as T-80B/-BV capability for launching AT-8/ Songster ATGM.

The night sight cannot be used to launch the ATGM. The daysight can be used at night for launching ATGMs if the target is illuminated. A variety of thermal sights is available. They include the Russian Agava-2, French SAGEM-produced ALIS and Namut sight from Peleng. There are thermal sights available for installation which permit night launch of ATGMs.

The 12.7-mm MG NSVT has both remote electronically operated sight PZU-5 and gun-mounted K10-T reflex sight.

The more recent BK-27 HEAT round offers a triple-shaped charge warhead and increased penetration against conventional armors and ERA. The BK-29 round, with a hard penetrator in the nose is designed for use against reactive armor, and as an MP round has fragmentation effects. If the BK-29 HEAT-MP is used, it may substitute for Frag-HE (as with NATO countries) or complement Frag-HE. With three round natures (APFSDS-T, HEAT-MP, ATGMs) in the autoloader vs four, more antitank rounds would be available for the higher rate of fire.

The ATGM may be launched while moving slowly (NFI). The AT-8 can be auto-loaded with the two halves mated during ramming; but the stub charge is manually loaded.

## Russian Main Battle Tank T-80U

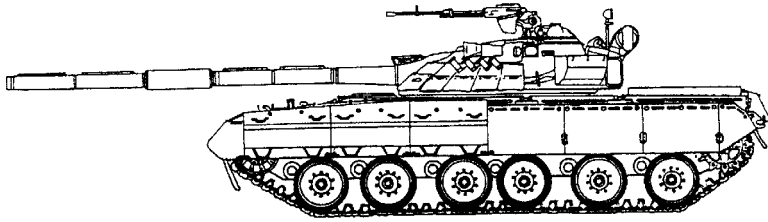
	<b>Weapons &amp; Ammunition Types</b>  <b>125-mm smoothbore gun</b> APFSDS-T HEAT Frag-HE ATGM  <b>7.62-mm coax MG</b> <b>12.7-mm NSVT AA MG</b>	<b>Typical Combat Load</b>  <b>45</b> (mix est) 15 3 21 6  <b>1,250</b> <b>500</b>
<p><b>SYSTEM</b>  <b>Alternative Designations:</b> SMT (Soviet Medium Tank) M1989  <b>Date of Introduction:</b> 1987  <b>Proliferation:</b> At least 3 countries  <b>Description:</b>                      Crew: 3                      Combat Weight (mt): 46.0                      Chassis Length Overall (m): 7.01                      Height Overall (m): 2.20                      Width Overall (m): 3.60                      Ground Pressure (kg/cm<sup>2</sup>): 0.92</p> <p><b>Automotive Performance:</b>                      Engine Type: 1250-hp Gas turbine (multi-fuel), diesel on T-80UD                      Cruising Range (km): 335 km/600 km with extra tanks                      Speed (km/h):                          Max Road: 70                          Max Off-Road: 48                          Average Cross-Country: 40                          Max Swim: N/A                      Fording Depths (m): 1.8 Unprepared, 5.0 w/snorkel, 12.0 with BROD-M system</p> <p><b>Radio:</b> R-173, R-174 intercom</p> <p><b>Protection:</b>                      Armor, Turret Front (mm): Against 120-mm ammunition                      Applique Armor (mm): Side of hull, over track skirt                      Explosive Reactive Armor (mm): Kontakt-5 2nd Generation ERA                      Active Protective System: ARENA is available                      Mineclearing Equipment: Roller-plow set and plows available                      Self-Entrenching Blade: Yes                      NBC Protection System: Yes                      Smoke Equipment: Smoke grenade launchers (4x 81-mm each side of turret), and 24 grenades. Vehicle engine exhaust smoke system.</p> <p><b>ARMAMENT</b>  <b>Main Armaments:</b>                      Caliber, Type, Name: 125-mm smoothbore gun 2A46M-1                      Rate of Fire (rd/min): 7-8 (lower in manual mode)                      Loader Type: KORZINA separate-loading autoloader, and manual                      Ready/Stowed Rounds: 28 in carousel/17 stowed (manual loaded)                      Elevation (°): -4 to +18                      Fire on Move: Yes (gun rounds and ATGMs)</p> <p><b>Auxiliary Weapon:</b>                      Caliber, Type, Name: 7.62-mm (7.62x 54R) Machinegun PKT                      Mount Type: Turret coaxial                      Maximum Aimed Range (m): 2,000</p>	<p>Max Effective Range (m):                      Day: 800                      Night: 800                      Fire on Move: Yes                      Rate of Fire (rd/min): 250 practical / 650 cyclic, 2-10 round bursts</p> <p>Caliber, Type, Name: 12.7-mm (12.7x108) AA MG NSVT                      Mount Type: Turret top                      Maximum Aimed Range (m): 2,000                      Max Effective Range (m):                      Day: 1,500                      Night: 800-1,300                      Fire on Move: Yes                      Rate of Fire (rd/min): 210 practical/ 800 air targets in bursts</p> <p><b>ATGM Launcher:</b>                      Name: 2A46M-1 tank gun                      Launch Method: Gun-launched                      Guidance: SACLOS, Laser-beam rider                      Command Link: Encoded infrared laser-beam                      Launcher Dismountable: No</p> <p><b>FIRE CONTROL</b>  <b>FCS Name:</b> FCS 1A42  <b>Main Gun Stabilization:</b> 2E42, 2-plane  <b>Rangefinder:</b> Laser  <b>Infrared Searchlight:</b> Yes  <b>Sights w/Magnification:</b>                      Gunner:                          Day: 1G46/PERFECT, 3.6/12x                          Field of View (°): INA                          Acquisition Range (m): 5,000 (70%P-hit for ATGM)                          Night: AGAVA-2                          Field of View (°): INA                          Acquisition Range (m): 2,600 (gun rounds only)  <b>Commander Fire Main Gun:</b> Yes</p> <p><b>VARIANTS</b>  <b>T-80UD:</b> Version produced in the Ukraine with a 1000-hp diesel engine instead of the turbine engine, and 1st generation ERA.   <b>T-80UK:</b> Command version with R-163-50K and R-163-U radios, TNA-4 land navigation system, and an electronic fuze-setting device that permits use of Ainet Shrapnel Round. The AGAVA thermal sight provides a 2,600-meter night acquisition range.   <b>T-84:</b> Recent Ukrainian upgrade of T-80UD with a welded turret, a French ALIS thermal sight, a more powerful engine, optional use of ARENA active protection system (APS) and SHTORA-1 active IR ATGM jammer system. Prototypes have been demonstrated, and the tank is available for export.</p>	

**Russian Main Battle Tank T-80U continued**

<p><b>MAIN ARMAMENT AMMUNITION</b>  <b>Caliber, Type, Name:</b>  125-mm APFSDS-T, BM-42M  Maximum Aimed Range (m): 3,000-4,000  Max Effective Range (m):  Day: 2,000-3,000  Night: 800-1,300  Armor Penetration (mm): 590-630 at 2,000 meters</p> <p>125-mm HE-Shapnel Focused-fragmentation, Ainet  Maximum Aimed Range (m): 5,000  Max Effective Range (m):  Day: 4,000  Night: 800-1,300  Tactical AA Range: 4,000-5,000  Armor Penetration (mm): INA</p> <p>125-mm Frag-HE-T, OF-26  Maximum Aimed Range (m): 5,000  Max Effective Range (m):  Day: INA  Night: 800-1,300  Armor Penetration (mm): INA</p> <p>125-mm HEAT-MP, BK-29M  Maximum Aimed Range (m): 4,000  Max Effective Range (m):  Day: INA  Night: 800-1300  Armor Penetration (mm): 650-750</p>	<p>125-mm HEAT, BK-27  Maximum Aimed Range (m): 4,000  Max Effective Range (m):  Day: INA  Night: 800-1,300  Armor Penetration (mm): 700-800</p> <p><b>Other Ammunition Types:</b> Giat 125G1 APFSDS-T, Russian BM-42 and BM-32 APFSDS-T. Note: The Russians may have a version of the BM-42M with a DU penetrator.</p> <p><b>Antitank Guided Missiles:</b>  Name: AT-11/SVIR  Warhead Type: Shaped charge (HEAT)  Armor Penetration (mm): 700 (RHA) behind ERA/800 conventional  Range (m): 5,000</p> <p>Name: AT-11B/INVAR  Warhead Type: Tandem shaped charge  Armor Penetration (mm): 800 (RHA) behind ERA /870 conventional  Range (m): 5,000</p>
--	--

**NOTES**

Line drawing is a T-80UD.

GTA-18A Auxiliary Power Unit is used when the engine is off.

The BK-29 round, with a hard penetrator in the nose is designed for use against reactive armor, and as an MP round has fragmentation effects. The more recent BK-27 HEAT round offers a triple-shaped charge warhead and 50 mm more penetration.

The electronic round fuzing system for Ainet rounds is available for other tanks. This round uses technology similar to that for French Oerlikon's AHEAD round. The round is specially designed to defeat targets by firing fragmentation patterns forward and radially, based on computer calculated settings from the laser rangefinder and other inputs. Targets are helicopters and dug in or defilade priority ground threats, such as ATGM positions. Rate of fire is 4 rd/min.

The 12.7-mm MG NSVT has both remote electronically operated sight PZU-5 and gun-mounted K10-T reflex sight.

The original night sight is the II Buran-PA (800-1300 meters range). The sight cannot be used to launch the ATGM. The daysight can be used at night for launching ATGMs if the target is illuminated. A variety of thermal sights is available. They include the Russian Agava-2, French SAGEM-produced ALIS and Namut sight from Peleng. There are thermal sights available for installation which permit night launch of ATGMs.

## Russian Main Battle Tank T-90

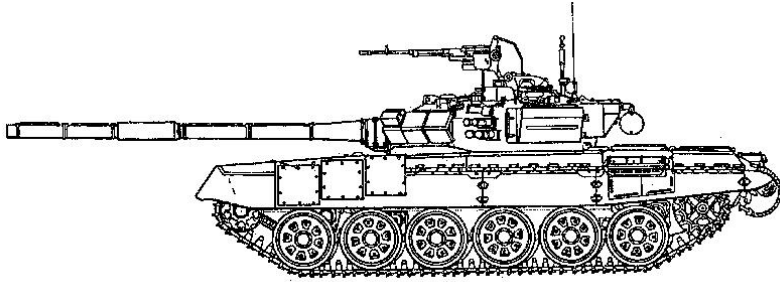
	<b>Weapons &amp; Ammunition Types</b>	<b>Typical Combat Load</b>
<p><b>SYSTEM</b>  <b>Alternative Designations:</b> T-90S, T-90E  <b>Date of Introduction:</b> 1994  <b>Proliferation:</b> At least 1 country  <b>Description:</b>            Crew: 3            Combat Weight (mt): 46.5            Chassis Length Overall (m): 6.86            Height Overall (m): 2.23            Width Overall (m): 3.37            Ground Pressure (kg/cm<sup>2</sup>): 0.87</p> <p><b>Automotive Performance:</b>            Engine Type: 1,000-hp Diesel (See NOTES)            Cruising Range (km): 500 km/650 km with extra tanks            Speed (km/h):                Max Road: 60                Max Off-Road: INA                Average Cross-Country: INA                Max Swim: N/A            Fording Depths (m): 1.2 Unprepared, 5.0 w/snorkel</p> <p><b>Radio:</b> R-163-504 UHF, R-163-UP receiver/R-173 for T-90S</p> <p><b>Protection:</b>            Armor, Turret Front (mm): 780-810 KE, 1,020-1,220 CE            Applique Armor (mm): Turret roof, front of track skirt            Explosive Reactive Armor (mm): Kontakt-5 2nd Generation ERA            Active Protective System: TshU-1-7/Shtora-1 countermeasure suite            Mineclearing Equipment: Roller-plow set and plows available            Self-Entrenching Blade: Yes            NBC Protection System: Yes            Smoke Equipment: 12 x 3D17 smoke grenade launchers, VEES</p> <p><b>ARMAMENT</b>  <b>Main Armaments:</b>            Caliber, Type, Name: 125-mm smoothbore gun 2A46M-1 or -4            Rate of Fire (rd/min): 7-8 (lower in manual mode)            Loader Type: Separate-loading autoloader, and manual            Ready/Stowed Rounds: 22 in carousel, 15 more at hand /6 (est)            Elevation (°): INA            Fire on Move: Yes (gun rounds and ATGMs)</p>	<p><b>125-mm smoothbore gun</b>            APFSDS-T (mix est) 14            HEAT-MP/HEAT 3            HE-Shrapnel/Frag-HE 20            ATGM 6</p> <p><b>7.62-mm coax MG</b> 2,000</p> <p><b>12.7-mm NSVT AA MG</b> 300</p> <p><b>Auxiliary Weapon:</b>            Caliber, Type, Name: 7.62-mm (7.62x 54R) Machinegun PKT            Mount Type: Turret coaxial            Maximum Aimed Range (m): 2,000            Max Effective Range (m):                Day: 800                Night: 800            Fire on Move: Yes            Rate of Fire (rd/min): 250 practical / 650 cyclic, 2-10 round bursts</p> <p>Caliber, Type, Name: 12.7-mm (12.7x108) AA MG NSVT            Mount Type: Turret top            Maximum Aimed Range (m): 2,000            Max Effective Range (m):                Day: 1,500                Night: 800-1,300            Fire on Move: Yes            Rate of Fire (rd/min): 210 practical/ 800 air targets in bursts</p> <p><b>ATGM Launcher:</b>            Name: 2A46M-1 tank gun            Launch Method: Gun-launched            Guidance: SACLOS laser-beam rider, REFLEKS missile launcher            Command Link: Encoded infrared laser beam            Launcher Dismountable: No</p> <p><b>FIRE CONTROL</b>  <b>FCS Name:</b> FCS 1A45T  <b>Main Gun Stabilization:</b> 2E42-4, 2-plane  <b>Rangefinder:</b> Laser sight  <b>Infrared Searchlight:</b> Yes, when II sight employed (See NOTES)  <b>Sights w/Magnification:</b>            Gunner:                Day: 1A43 and 1G46/PERFECT, 3.6/12x                Field of View (°): 20/2.5                Acquisition Range (m): 5,000 detection (70%P-hit for ATGM)            Night: AGAVA-2 (See NOTES)                Field of View (°): INA                Acquisition Range (m): 2,600 (See NOTES)</p> <p><b>Commander Fire Main Gun:</b> Yes</p> <p><b>VARIANTS</b>  <b>T-90E:</b> INA  <b>T-90S:</b> Export variant  <b>T-90SK:</b> Export command variant</p>	



**Russian Main Battle Tank T-90 continued**

<p><b>MAIN ARMAMENT AMMUNITION</b>  <b>Caliber, Type, Name:</b>  125-mm APFSDS-T, BM-42M  Maximum Aimed Range (m): 3,000-4,000  Max Effective Range (m):  Day: 2,000-3,000  Night: 2,000-2,600  Armor Penetration (mm): 590-630 at 2,000 meters</p> <p>125-mm HE-Shapnel Focused-Fragmentation, Ainet  Maximum Aimed Range (m): 5,000  Max Effective Range (m):  Day: 4,000  Night: 2,600  Tactical AA Range: 4,000-5,000  Armor Penetration (mm): INA</p> <p>125-mm Frag-HE-T, OF-26  Maximum Aimed Range (m): 5,000  Max Effective Range (m):  Day: INA  Night: 2,600  Armor Penetration (mm): INA</p> <p>125-mm HEAT-MP, BK-29M  Maximum Aimed Range (m): 4,000  Max Effective Range (m):  Day: INA  Night: 2,600  Armor Penetration (mm): 650-750</p>	<p>125-mm HEAT, BK-27  Maximum Aimed Range (m): 4,000  Max Effective Range (m):  Day: INA  Night: 2,600  Armor Penetration (mm): 700-800</p> <p><b>Other Ammunition Types:</b> French Giat 125G1 APFSDS-T, Russian BM-42 and BM-32 APFSDS-T. Note: The Russians may have a version of the BM-42M with a DU penetrator.</p> <p><b>Antitank Guided Missiles:</b>  Name: AT-11/SVIR  Warhead Type: Shaped charge (HEAT)  Armor Penetration (mm): 700 (RHA) behind ERA/800 conventional  Range (m): 5,000</p> <p>Name: AT-11B/INVAR  Warhead Type: Tandem shaped charge  Armor Penetration (mm): 800 (RHA) behind ERA /870 conventional  Range (m): 5,000</p>
---	---

**NOTES**

The original tank version of the tank has an 840-hp diesel engine. The engine in subsequent models is upgraded. Engine options include 950, 1,000 and 1,100 hp.

The tank may be fielded with the original II sight from the T-80 series (Buran-PA, 800-1300 meters range). However, marketing materials feature the AGAVA-2 thermal sight. There are thermal sights available which permit night launch of ATGMs.

The T-90 may be fielded with full Shtora-1 package (laser warning receiver with auto-slew gun capability, LWR-directed smoke grenade launchers, and EO-IR jammer), with a partial package, or without Shtora-1. Shtora-1 illuminators can be used for night illumination.

An improved gun, 2A46M-4, with improved accuracy and use life is available for fitting to the T-90.

The BK-29 round, with a hard penetrator in the nose is designed for use against reactive armor, and as an MP round has fragmentation effects. The more recent BK-27 HEAT round offers a triple-shaped charge warhead and 50 mm more penetration.

The electronic fuzing system for HE-Shrapnel rounds uses technology similar to that for French Oerlikon's AHEAD round. The round is specially designed to defeat targets by firing fragmentation patterns forward and radially, based on computer calculated settings from the LRF and other inputs. Targets are helicopters and dug in or defilade priority ground threats, such as ATGM positions. Rate of fire is 4 rd/min.

The 12.7-mm MG NSVT has both remote electronically operated sight PZU-5 with vertical stabilization, night acquisition, and a gun-mounted K10-T reflex sight.

## Chinese Main Battle Tank Type 59-II

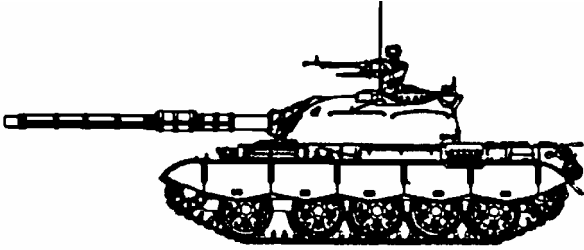
	<b>Weapons &amp; Ammunition Types</b>  <b>105-mm rifled gun L7</b> New CH APFSDS-T M456 HEAT L35 HESH  <b>7.62-mm coax MG</b> <b>7.62-mm bow MG</b> <b>12.7-mm AA MG</b>	<b>Typical Combat Load</b>  <b>34</b> 12 6 16  <b>2,000</b> <b>1,000</b> <b>500</b>
<p><b>SYSTEM</b>  <b>Alternative Designations:</b> WZ 120B  <b>Date of Introduction:</b> 1951  <b>Proliferation:</b> At least 2 countries  <b>Description:</b>                      Crew: 4                      Combat Weight (mt): 36.5-37.0                      Chassis Length Overall (m): 6.04                      Height Overall (m): 2.59                      Width Overall (m): 3.30                      Ground Pressure (kg/cm<sup>2</sup>): 0.8</p> <p><b>Automotive Performance:</b>                      Engine Type: 520-hp Diesel                      Cruising Range (km): 440/600 with external tanks                      Speed (km/h):                          Max Road: 50                          Max Off-Road: 25                          Average Cross-Country: INA                          Max Swim: N/A                      Fording Depths (m): 1.4 Unprepared, 5.5 with snorkel</p> <p><b>Radio:</b> INA</p> <p><b>Protection:</b>                      Armor, Turret Front (mm): 203                      Applique Armor (mm): Track skirts are fitted to some tanks                      Explosive Reactive Armor (mm): N/A                      Active Protective System: N/A                      Mineclearing Equipment: Mine plows and roller-plows available                      Self-Entrenching Blade: N/A                      NBC Protection System: N/A                      Smoke Equipment: 8 x 81-mm smoke grenade launchers                          Vehicle engine exhaust smoke system</p> <p><b>ARMAMENT</b>  <b>Main Armaments:</b>                      Caliber, Type, Name: 105-mm rifled gun, similar to L7                      Rate of Fire (rd/min): 6-10                      Loader Type: Manual                      Ready/Stowed Rounds: INA                      Elevation (°): -5/+18                      Fire on Move: Yes</p> <p><b>Auxiliary Weapon:</b>                      Caliber, Type, Name: 7.62-mm (7.62x 54R) Machine gun Type 59T                      Mount Type: Turret coax                      Maximum Aimed Range (m): 2,000                      Max Effective Range (m):                          Day: 1,000                          Night: 800</p>	<p>Fire on Move: Yes                      Rate of Fire (rd/min): 250 practical, 600 cyclic in 2-10 round bursts</p> <p>Caliber, Type, Name: 7.62-mm (7.62x 54R) Machine gun Type 59T                      Mount Type: Bow ball mount                      Maximum Aimed Range (m): 1,000                      Max Effective Range (m):                          Day: 1,000                          Night: N/A                      Fire on Move: Yes                      Rate of Fire (rd/min): 250 practical, 600 cyclic in 2-10 round bursts</p> <p>Caliber, Type, Name: 12.7-mm (12.7x108) AA MG Type 54                      Mount Type: Turret cupola                      Maximum Aimed Range (m): 2,000                      Max Effective Range (m):                          Day: 1,500 ground/1,600 for air targets (APDS)                          Night: N/A, II sights available                      Fire on Move: Yes                      Rate of Fire (rd/min): 80-100 practical, 600 air targets 2-10 rd bursts</p> <p><b>FIRE CONTROL</b>  <b>FCS Name:</b> UI light spot fire control system  <b>Main Gun Stabilization:</b> 2-plane  <b>Rangefinder:</b> LRF  <b>Infrared Searchlight:</b> Yes  <b>Sights w/Magnification:</b>                      Gunner:                          Day: INA                              Field of View (°): INA                              Acquisition Range (m): INA                          Night: Type DC 1024/00 II sights, x7                              Field of View (°): 6                              Acquisition Range (m): 1,000  <b>Commander Fire Main Gun:</b> No</p> <p><b>VARIANTS:</b>  <b>Type 59:</b> Original model is a copy of the Former Soviet T-54 MBT and has a 100-mm main gun.</p> <p><b>T-72Z/ Safir 74:</b> Iranian variant which constitutes state of the art for upgraded 50s-generation former Warsaw Pact tanks. This tank has a 780-hp diesel engine, track skirts, and smoke grenade launchers. An Iranian ERA package will fit T-72Z. Armament includes an M68 105-mm rifled gun, 7.62-mm Type 59T (PKT) MG, and a 12.7-mm Type 59 (DSHKM) MG. The cannon can launch AT-10/ Bastion ATGMs (to 4000 meters) and fire a broad range of NATO 105-mm ammunition. Fire control includes the robust Slovenian EFCS-3-55 fire control system with stabilization, a laser rangefinder, and a ballistic computer. The FCS includes a commander's independent viewer and target designation system, and II gunner night sights.</p>	

**Chinese Main Battle Tank Type 59-II continued**

<p><b>MAIN ARMAMENT AMMUNITION</b>  <b>Caliber, Type, Name:</b>  105-mm APFSDS, H6/62  Maximum Aimed Range (m): 3,000  Max Effective Range (m):  Day: 2,000-3,000 (est)  Night: 800-1,300  Armor Penetration (mm): INA</p> <p>105-mm APFSDS, UI (New Chinese)  Maximum Aimed Range (m): 3,000  Max Effective Range (m):  Day: 2,000-3,000 (est)  Night: 800-1,300  Armor Penetration (mm): 460 at 2,000 m</p>	<p>105-mm HEAT, M456 (multinational)  Maximum Aimed Range (m): 3,000  Max Effective Range (m):  Day: 1,500-2,500 (est)  Night: 800-1,300  Armor Penetration (mm): 432, NATO single heavy target</p> <p>105-mm HESH, L35 (UK)  Maximum Aimed Range (m): 5,000  Max Effective Range (m):  Day: 2,000-3,000 (est)  Night: 800-1,300  Armor Penetration (mm): NATO single heavy target</p> <p><b>Other Ammunition Types:</b> Chinese Type 83/ UK L64/ US M735 APFSDS, UK L52 APDS, multinational M393 HEP-T, French OE 105-F1 HE, L39 Smoke, cannister</p>
---	--

**NOTES**

GEC-Marconi Centaur fire control system is available. British Barr and Stroud thermal based FCS can be fitted.

## Chinese Main Battle Tank Type 85-IIM

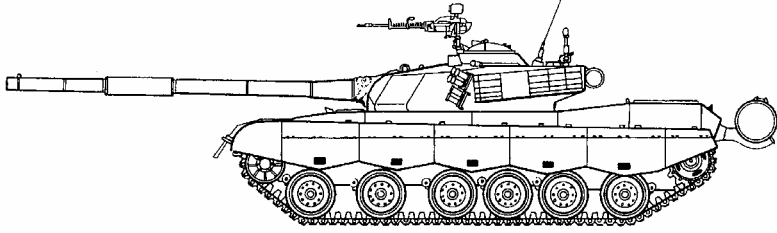
	<b>Weapons &amp; Ammunition Types</b>	<b>Typical Combat Load</b>
<p><b>SYSTEM</b>  <b>Alternative Designations:</b> INA  <b>Date of Introduction:</b> 1991  <b>Proliferation:</b> At least 2 countries  <b>Description:</b>            Crew: 3            Combat Weight (mt): 41.0            Chassis Length Overall (m): 10.28            Height Overall (m): 2.30            Width Overall (m): 3.450            Ground Pressure (kg/cm<sup>2</sup>): 0.771</p> <p><b>Automotive Performance:</b>            Engine Type: 730-hp Diesel            Cruising Range (km): 700/900 with external tanks            Speed (km/h):                Max Road: 57                Max Off-Road: 45                Average Cross-Country: 35                Max Swim: N/A            Fording Depths (m): 1.4 Unprepared, 2.4 with snorkel</p> <p><b>Radio:</b> INA</p> <p><b>Protection:</b>            Armor, Turret Front (mm): INA            Applique Armor (mm): Track skirts. Composite panels available.            Explosive Reactive Armor (mm): N/A            Active Protective System: N/A            Mineclearing Equipment: Mine plows and roller-plow set            Self-Entrenching Blade: N/A            NBC Protection System: Yes            Smoke Equipment: 12x 81-mm smoke grenade launchers                Vehicle engine exhaust smoke system</p> <p><b>ARMAMENT</b>  <b>Main Armament:</b>            Caliber, Type, Name: 125-mm smoothbore gun 2A46M/ D-81TM            Rate of Fire (rd/min): 4-6/2 in manual mode            Loader Type: Autoloader (separate loading) and manual            Ready/Stowed Rounds: 22/23 (22 in carousel)            Elevation (°): -6 to +14            Fire on Move: Yes, up to 25 km/h. Depending on the road and distance to the target, most crews may halt before firing.</p> <p><b>Auxiliary Weapon:</b>            Caliber, Type, Name: 7.62-mm (7.62x 54R) Machine gun Type 59            Mount Type: Turret coax            Maximum Aimed Range (m): 1,800            Max Effective Range (m):                Day: 1,000</p>	<p><b>125-mm smoothbore gun</b>            APFSDS-T            HEAT            Frag-HE</p> <p><b>7.62-mm coax MG</b></p> <p><b>12.7-mm cupola AAMG</b></p> <p>Night: 800            Fire on Move: Yes            Rate of Fire (rd/min): 250 practical, 600 cyclic, 2-10 rd bursts</p> <p>Caliber, Type, Name: 12.7-mm (12.7x108) AA MG Type 54            Mount Type: Cupola            Maximum Aimed Range (m): 2,000            Max Effective Range (m):                Day: 1,500 ground/1600 for air targets (APDS)                Night: N/A            Fire on Move: Yes            Rate of Fire (rd/min): 80-100 practical, 600 air targets, 2-10 rd bursts</p> <p><b>FIRE CONTROL</b>  <b>FCS Name:</b> ISFCS-212 (Image-Stabilized Fire Control System)  <b>Main Gun Stabilization:</b> 2-plane  <b>Rangefinder:</b> LRF  <b>Infrared Searchlight:</b> Yes  <b>Sights w/Magnification:</b>            Gunner:                Day: UI stabilized gunner sight                Field of View (°): INA                Acquisition Range (m): INA                Night: 2nd Generation II sights                Field of View (°): INA                Acquisition Range (m): INA  <b>Commander Fire Main Gun:</b> No</p> <p><b>VARIANTS</b>  <b>Type 85-IIAP:</b> Variant assembled from Type 59s and Type 69-IIs and upgrade kits, or from licensed production in Pakistan.  <b>Type 85-III:</b> Upgraded variant with 1,000-hp engine and composite armor panels. Variant is in prototype stage.</p> <p><b>MAIN ARMAMENT AMMUNITION</b>  <b>Caliber, Type, Name:</b>            125-mm APFSDS-T, BM-42M                Maximum Aimed Range (m): 3,000                Max Effective Range (m):                    Day: 2,000-3,000                    Night: 850-1,300                Armor Penetration (mm): 590-630 at 2,000 meters</p> <p>125-mm Frag-HE-T, OF-26                Maximum Aimed Range (m): 5,000                Max Effective Range (m):                    Day: INA                    Night: 850-1,300                Armor Penetration (mm): INA</p>	<p>42            (mix est) 15            6            21</p> <p>2,000</p> <p>500</p>

## Chinese Main Battle Tank Type 85-IIM continued

---

<p>125-mm HEAT-MP, BK-29M Maximum Aimed Range (m): 3,000 Max Effective Range (m): Day: INA Night: 850-1300 Armor Penetration (mm): 650-750</p> <p>125-mm HEAT, BK-27 Maximum Aimed Range (m): 3,000 Max Effective Range (m): Day: INA Night: 850-1,300 Armor Penetration (mm): 700-800</p>	<p><b>Other Ammunition Types:</b> Giat 125G1 APFSDS-T, Russian BM-42 and BM-32 APFSDS-T. Note: The Russians may have a version of the BM-42M with a DU penetrator.</p>
--	--

### NOTES

GEC-Marconi Centaur fire control system is available. British Barr and Stroud thermal based FCS can be fitted.

The more recent BK-27 HEAT round offers a triple-shaped charge warhead and increased penetration against conventional armors and ERA. The BK-29 round, with a hard penetrator in the nose is designed for use against reactive armor, and as an MP round has fragmentation effects. If the BK-29 HEAT-MP is used, it may substitute for Frag-HE (as with NATO countries) or complement Frag-HE. With three round natures (APFSDS-T, HEAT-MP, ATGMs) in the autoloader vs four, more antitank rounds would be available for the higher rate of fire.

## Chapter 5 Antitank

As armored combat vehicles have ascended in importance on the battlefield, so have the systems designed to stop those vehicles. The umbrella term *antitank* originally denoted systems specifically designed to destroy tanks. But today it is also more broadly constructed. Modern combat is combined arms combat. Mechanized forces include other armored combat vehicles, such as armored reconnaissance vehicles, infantry fighting vehicles, armored personnel carriers, etc. Tanks cannot survive or achieve their tactical objectives without support from other armored systems. The more recent term *antiarmor* may supplant the current term; because anti-tank weapons which cannot penetrate tank armor can still be a formidable threat if they can defeat or damage more lightly armored fighting vehicles. With upgrades and innovative tactics even older, seemingly obsolete, weapons can be used as OPFOR antiarmor weapons.

Antitank weapons can include guns of various sizes, antitank guided missile launcher systems, rocket and grenade launchers, mines and their delivery systems, and other obstacle systems. The rocket and grenade launchers are described in Chapter 1, Infantry Weapons. Mines and other obstacle systems are noted at Chapter 8, Engineer Systems. Because the OPFOR place a high priority on stopping and destroying armored combat vehicles, they will use all other available assets which can doctrinally support the effort. These include fixed and rotary-wing aircraft, artillery, NBC assets, etc. A number of recent systems have been fielded seemingly for other roles, but available for use as antitank weapons: light tanks, heavy armored reconnaissance vehicles with guns of 60 millimeters or more, assault vehicles, fire support vehicles, and artillery/mortar-type combination guns, such as Russian 120-mm 2S9, 2S23, and 2S31. Many OPFOR countries will employ antitank weapons for roles other than antitank, including AT guns against personnel and soft targets, and ATGMs against personnel and rotary-wing aircraft.

*Antitank guns* include towed guns and self-propelled antitank guns (also known as tank destroyers). A number of guns were designed as field guns, with multi-role capability as both artillery and antitank guns. The modern focus on maneuver warfare has brought a slight decline in development of uniquely antitank guns. Thus, the 85-mm D-44 gun, which can be used as artillery, is effective for use in an antitank role. Although recent systems have been developed, the number fielded has not kept pace with production of armored combat vehicles. Nevertheless, their effectiveness and selected armies' continued reliance on linear positional battles and protracted defenses have kept a large number of these systems in inventories. Based on numbers fielded and likelihood of their threat to US forces, only towed antitank guns were included.

A number of upgrades are available. These include night sights, such as passive image intensifier sights and thermal sights for the Russian 100-mm MT-12. This is a robust antitank weapon, with a high rate of fire and rapid mobility. Note the Russian innovation in the MT-12R, an AT gun with a radar-directed all-weather fire control system. Improved ammunition is critical for continued effectiveness of antitank weapons. The MT-12 and its variants can fire a variety of modern ammunition, including the Russian gun-launched ATGM, Kastet.

The *antitank guided missile* (ATGM) is the singular greatest threat to tanks today. These systems are distinguished from other antitank weapons in that they are guided to the target. Most employ SACLOS guidance (see Glossary). An operator holds crosshairs on the target, and the missile tracker directs the missile to that point. There is a wide variety of countermeasures (such as smoke and counterfire, due to long flight time and operator vulnerability) for use against ATGMs. Thus, a 90% probability of hit is a technical figure, and does not mean a 90% probability of success. On the other hand, there is a variety of counter-countermeasures which the ATGMs, launchers, and operators can use to increase the chance for success. Tactics, techniques and procedures within the antitank arena are critical to mission success.

As armor protection levels and antitank weapon lethality levels continue to rise, armor protection for many modern tanks has outpaced most AT weapons. However, ATGMs have been able to increase their size, range, and warhead configurations to threaten even the heaviest tanks. Among notable trends in ATGMs is the worldwide proliferation and variety of manportable and portable *antitank guided missile launchers*. These include shoulder-launched, short-range systems, such as the French Eryx, and a variety of copies of former Soviet systems, such as the AT-3/Malyutka ("Suitcase SAGGER). Another notable trend is in development of upgrade ATGMs, with increased lethality. The most common type of lethality upgrade is addition of a nose precursor or tandem warhead. A more recent lethality upgrade has been the use of warheads that permit the "fly-over, shoot-down" mode. These missiles can over-fly a vehicle behind a hill, and fire an explosively-formed penetrator (EFP, in the shape of a cannon kinetic-energy penetrator round) downward through the relatively soft top of armored vehicles. Other improvements include improved guidance and resistance to countermeasures, reduced smoke and noise signature, and increased range. A fairly common trend has been addition of night sights, including thermal sights for the launcher. As the missiles and launchers have been improved, weight loads have increased. Most of the so-called portable launchers (AT-4 launcher, TOW, and HOT) have outgrown the portability weight limit, and must be carried in vehicles and only dismounted short distances from the carriers.

Although there are unique *ATGM launcher vehicles* with unique ATGMs, most numerous launcher vehicles are military and commercial vehicles adapted with pintel mounts for portable ground launchers, with ATGMs manually loaded and launched. Configurations of those vehicles consist of simply pairing of vehicle and launcher, and can be executed with equipment at hand; therefore, they were not described in this guide. The number of fielded ATGM launcher vehicles specially designed for the mission numbers no more than a few dozen systems. They constitute a high level threat to vehicles and rotary-winged aircraft in the US Army.

Systems selected for this chapter are the more common threat systems, or represent the spectrum of antitank systems which can threaten US Army forces in the world today.

Questions and comments on data listed in this chapter should be addressed to:

**Mr. Tom Redman**

DSN: 552-7925 Commercial (913) 684-7925  
e-mail address: redmant@leavenworth.army.mil

## Russian 76-mm Towed Antitank Gun ZIS-3

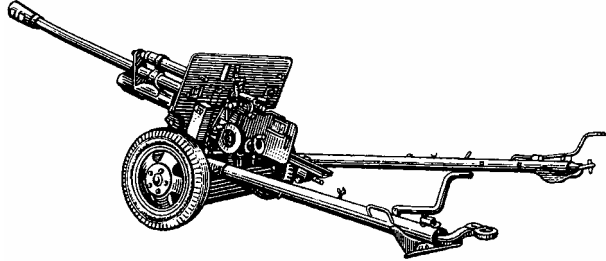
	<p><b>Weapons &amp; Ammunition Types</b></p> <p>76-mm rifled gun HVAP-T HEAT APC-T Frag-HE</p>	<p><b>Typical Combat Load</b></p> <p>INA</p>
<p><b>SYSTEM</b>  <b>Alternative Designations:</b> M1942  <b>Date of Introduction:</b> INA  <b>Proliferation:</b> At least 14 countries</p> <p><b>Description:</b>  Crew: 5-7  Combat Weight (mt): 1.12  Length Overall, Travel (m): 6.10  Height Overall, Travel (m): 1.3  Width Overall, Travel (m): 1.4</p> <p><b>Mobility:</b>  Mount: Two-wheeled carriage with twin trails  Prime mover: AT-P tractor, light trucks  Towed Speed (km/h):      Max Road: INA      Max Off-Road: INA      Average Cross-Country: INA  Fording Depth (m): N/A  Emplace Time (min): INA  Displace Time (min): INA  <b>Radio:</b> N/A  <b>Protection:</b> Gun shield</p> <p><b>ARMAMENT</b>  <b>Main Armaments:</b>  Caliber, Type, Name: 76-mm rifled gun  Rate of Fire (rd/min): 8-10 normal / 15-20 burst indirect fire  Loader Type: Manual  Ready/Stowed Rounds: N/A  Elevation (°): -5/+37  Fire on Move: No</p> <p><b>FIRE CONTROL</b>  <b>FCS Name:</b> N/A  <b>Main Gun Stabilization:</b> N/A  <b>Rangefinder:</b> N/A  <b>Sights w/Magnification:</b>  Gunner:      Day: INA          Field of View (°): INA          Acquisition Range (m): INA      Night: INA          Field of View (°): INA          Acquisition Range (m): INA</p>	<p><b>VARIANTS</b> N/A</p> <p><b>MAIN ARMAMENT AMMUNITION</b>  <b>Caliber, Type, Name:</b>  76-mm HVAP-T, BR-354P      Maximum Aimed Range (m): INA      Max Effective Range (m):          Day: 1,000          Night: INA      Armor Penetration (mm): 58 at 1,000 meters          92 at 500 meters</p> <p>76-mm APC-T , BR-350B      Maximum Aimed Range (m): INA      Max Effective Range (m): INA      Day: 1,000      Night: INA      Armor Penetration (mm): 61 at 1,000 meters</p> <p>76-mm HEAT, BK-354M      Maximum Aimed Range (m): 1,000      Max Effective Range (m): INA      Day: 500      Night: INA      Armor Penetration (mm): 120 (RHA)</p> <p>76-mm Frag-HE, OF-350A      Maximum Aimed Range (m): INA      Max Effective Range (m):          Day: INA          Night: INA      Armor Penetration (mm): INA</p> <p>76-mm Frag-HE      Maximum Aimed Range (m): INA      Max Effective Range (m):          Day: 1,500          Night: INA      Armor Penetration (mm): INA</p> <p><b>Other Ammunition Types:</b> API-T BZR-350B, Smoke (WP)</p>	

### NOTES

Although the ZIS-3 is categorized as an antitank gun, some OPFOR forces will employ it for general support, especially against light targets. Typical combat load is based on the prime mover; and a wide variety of systems can be used as prime movers.



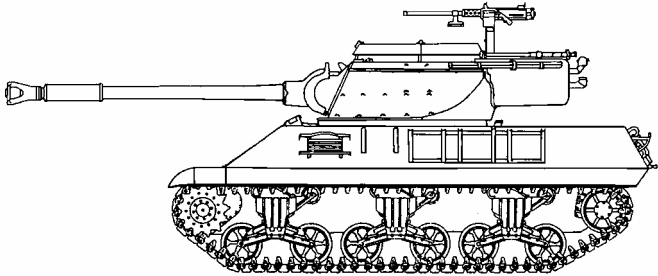

## U.S. Self-Propelled Antitank Gun M36

 <p>M36B2</p>	<p><b>Weapons &amp; Ammunition Types</b></p> <p><b>90-mm gun</b> APFSDS-T, HVAP, HEAT-T or APC HE</p> <p><b>12.7-mm bustle MG</b> API, API-T, APDS-T</p>	<p><b>Typical Combat Load</b></p> <p style="text-align: center;">47</p> <p style="text-align: center;">1,000</p>
<p><b>SYSTEM</b>  <b>Alternative Designations:</b> INA  <b>Date of Introduction:</b> 1944  <b>Proliferation:</b> At least 5 countries  <b>Description:</b>  Crew: 5  Combat Weight (mt): 27.7/30.8 for M36B1/29.9 for M36B2  Chassis Length Overall (m): 5.98  Height Overall (m): 3.19  Width Overall (m): 3.05  Ground Pressure (kg/cm<sup>2</sup>): 0.95/0.86 M36B2</p> <p><b>Automotive Performance:</b>  Engine Type: 500-hp Gasoline/375-hp Diesel for M36B2  Chassis: M-10 tank destroyer  Cruising Range (km): 177  Speed (km/h):      Max Road: 42/40 M36B2      Max Off-Road: INA      Average Cross-Country: 29      Max Swim: N/A  Fording Depth (m): 0.91/1.07 M36B2</p> <p><b>Radio:</b> INA</p> <p><b>Protection:</b>  Armor, Turret Front (mm): 76  Applique Armor (mm): N/A  Explosive Reactive Armor (mm): N/A  Active Protective System: N/A  Mineclearing Equipment: N/A  Self-Entrenching Blade: N/A  NBC Protection System: No  Smoke Equipment: No</p> <p><b>ARMAMENT</b>  <b>Main Armament:</b>  Caliber, Type, Name: 90-mm (50 Cal) rifled gun, M3  Rate of Fire (rd/min): 8 est  Loader Type: Manual  Ready/Stowed Rounds: INA  Elevation (°): -10 to +20  Fire on Move: No</p> <p><b>Auxiliary Weapon:</b>  Caliber, Type, Name: 12.7-mm machinegun, M2HB  Mount Type: Turret bustle</p>	<p>Maximum Aimed Range (m): 2,000  Max Effective Range (m):      Day: 2,000      Night: N/A  Fire on Move: Yes  Rate of Fire (rd/min): 550</p> <p><b>ATGM Launcher:</b> None</p> <p><b>FIRE CONTROL</b>  <b>FCS Name:</b> INA  <b>Main Gun Stabilization:</b> No  <b>Rangefinder:</b> No  <b>Infrared Searchlight:</b> No  <b>Sights w/Magnification:</b>  Gunner:      Day: INA      Night: No  <b>Commander Fire Main Gun:</b> No</p> <p><b>VARIANTS</b>  <b>M36B1:</b> Variant uses an M4A3/Sherman tank chassis.  <b>M36B2:</b> Variant uses an M10 chassis with plate canopy protection.</p> <p><b>MAIN ARMAMENT AMMUNITION</b>  <b>Caliber, Type, Name:</b>  90-mm HVAP, INA      Maximum Aimed Range (m): INA      Max Effective Range (m):          Day: 1,000          Night: N/A      Armor Penetration (mm): 195 at 1,000 m</p> <p>90-mm APFSDS-T, Mecar 90      Maximum Aimed Range (m): 1,000-2,000      Max Effective Range (m):          Day: 1,000+          Night: N/A      Armor Penetration (mm): INA</p> <p>90-mm HEAT-T, Yugoslavian M74      Maximum Aimed Range (m): INA      Max Effective Range (m):          Day: 1,000          Night: N/A      Armor Penetration (mm): 150 (30° impact) at 1,000 m</p> <p><b>Other Ammunition Types:</b> HE M71, APC-T M82</p>	

### NOTES

This type vehicle is historically referred to as a "tank destroyer". The above label is more modern. The baseline vehicle has an open-top turret.

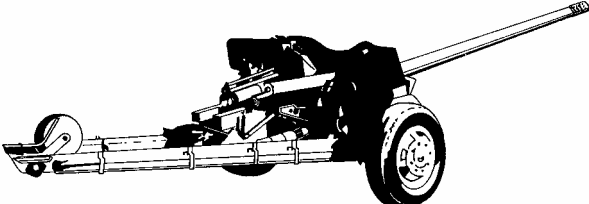

## Russian 100-mm Towed Antitank Gun MT-12

	<table border="1"> <thead> <tr> <th>Weapons &amp; Ammunition Types</th> <th>Typical Combat Load</th> </tr> </thead> <tbody> <tr> <td><b>100-mm smoothbore gun</b></td> <td><b>20</b></td> </tr> <tr> <td>APFSDS-T</td> <td>8</td> </tr> <tr> <td>HEAT</td> <td>4</td> </tr> <tr> <td>Frag-HE</td> <td>4</td> </tr> <tr> <td>AT-10 ATGM</td> <td>4</td> </tr> </tbody> </table>	Weapons & Ammunition Types	Typical Combat Load	<b>100-mm smoothbore gun</b>	<b>20</b>	APFSDS-T	8	HEAT	4	Frag-HE	4	AT-10 ATGM	4
Weapons & Ammunition Types	Typical Combat Load												
<b>100-mm smoothbore gun</b>	<b>20</b>												
APFSDS-T	8												
HEAT	4												
Frag-HE	4												
AT-10 ATGM	4												
<p><b>SYSTEM</b>  <b>Alternative Designations:</b> T-12A, 2A29  <b>Date of Introduction:</b> 1972  <b>Proliferation:</b> At least 12 countries  <b>Description:</b>  Crew: 6  Combat Weight (mt): 3.1  Length Overall, Travel (m): 9.65  Height Overall, Travel (m): 1.6  Width Overall, Travel (m): 2.3</p> <p><b>Automotive Performance:</b>  Mount: Two-wheeled carriage with twin trails and coaster wheel  Prime mover: MT-LB-T, URAL-375D and other trucks  Towed Speed (km/h):  Max Road: 60  Max Off-Road: INA  Average Cross-Country: 25  Forcing Depth (m): INA  Emplace Time (min): 2-3  Displace Time (min): 2-3  <b>Radio:</b> N/A  <b>Protection:</b> Gun shield</p> <p><b>ARMAMENT</b>  <b>Main Armaments:</b>  Caliber, Type, Name: 100-mm smoothbore gun 2A29  Rate of Fire (rd/min): 6-8/up to 15 indirect fire  Loader Type: Manual  Ready/Stowed Rounds: 0/20  Elevation (°): -7/+20  Fire on Move: No</p> <p><b>ATGM Launcher:</b>  Launch Method: Gun-launched, 2A29 smoothbore gun  Guidance: Laser-beam rider  Command Link: Encoded laser-beam  Launcher Dismountable: No</p> <p><b>FIRE CONTROL</b>  <b>FCS Name:</b> N/A  <b>Main Gun Stabilization:</b> N/A  <b>Rangefinder:</b> N/A  <b>Sights w/Magnification:</b>  Gunner:  Day: OP40M-40U direct fire, 5.5x / PG-1M indirect fire  Field of View (°): 11  Acquisition Range (m): 3,000/8,200 indirect fire  Night: APN6-40 II sight, 6.8x</p>	<p>Field of View (°): 7  Acquisition Range (m): 2,000</p> <p><b>VARIANTS</b>  <b>T-12:</b> Original version of Russian gun. MT-12 has changes in carriage and obturator, which do not affect lethality performance.  <b>MT-12R:</b> Russian upgrade with radar-directed fire control system, for use at night and adverse weather.  <b>Topaz:</b> Former-Yugoslav variant of T-12, with the 2A19M gun mounted on a D-30 carriage. Some have AT FCS-1 (see NOTES).</p> <p><b>MAIN ARMAMENT AMMUNITION</b>  <b>Caliber, Type, Name:</b> 100-mm APFSDS-T, BM-412M, Romanian  Maximum Aimed Range (m): 2,500, 3,000 platoon volley  Max Effective Range (m):  Day: INA  Night: INA  Armor Penetration (mm): 418 at 2,000 m/380 at 3,000 m</p> <p><b>Caliber, Type, Name:</b> 100-mm APFSDS-T, M1000, Belgian  Maximum Aimed Range (m): 3,000/platoon volley INA  Max Effective Range (m):  Day: INA  Night: INA  Armor Penetration(mm): Triple heavy target at 4,000 meters</p> <p><b>Caliber, Type, Name:</b> 100-mm HEAT, BK-17  Maximum Aimed Range (m): 2,500, 3,000 platoon volley  Max Effective Range (m):  Day: INA  Night: INA  Armor Penetration (mm): 380</p> <p><b>Other Ammunition Types:</b> Russian BM-2/-20/-25 APFSDS-T; OF-15 Frag-HE; BK-5M HEAT-FS</p> <p><b>Antitank Guided Missiles:</b>  Name: AT-10/Kastet  Warhead Type: Shaped charge (HEAT)  Armor Penetration (mm): 650 (RHA)  Range (m): 5,000</p> <p>Name: AT-10b/Kan  Warhead Type: Tandem Shaped charge (HEAT)  Armor Penetration (mm): 700 (RHA) behind ERA  Range (m): 5,000</p>												

### NOTES

Russian 2nd generation II sights are available. The daysight can be used at night if the target is illuminated. Thermal sights are available. The MT-12R radar FCS can be used for surveillance, acquisition, and tracking. The Serb Iskra AT FCS-1 computerized laser rangefinder FCS is on offer for sale. Range is 500-3,000 meters. The ATGM sight and laser guidance device has a 5,000-meter range and is a day sight only. Ranges (m) for Frag-HE: 8,200 indirect fire/3,000 direct-fire. Rate of fire for indirect fire (Frag-HE) is up to 15 rd/min.

## Russian 125-mm Towed Antitank Gun 2A45M

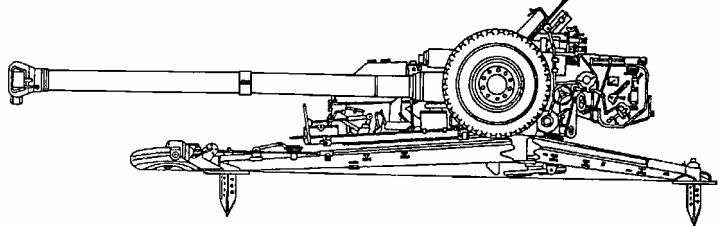
	<p><b>Weapons &amp; Ammunition Types</b></p> <p><b>125-mm smoothbore gun</b></p> <p>APFSDS-T HEAT Frag-HE Invar/Svir ATGM</p>	<p><b>Typical Combat Load</b></p> <p><b>*60</b></p> <p>28 4 20 8</p> <p>* Mix estimate</p>
	<p><b>SYSTEM</b>  <b>Alternative Designations:</b> SPRUT-B (Octopus-B)  <b>Date of Introduction:</b> 1980s  <b>Proliferation:</b> At least 1 country</p> <p><b>Description:</b>  Crew: 7  Combat Weight (mt): 6.5  Length Overall, Travel (m): 7.12  Height Overall, Travel (m): 2.09, 2.35 with APU (0.90 firing)  Width Overall, Travel (m): 2.3</p> <p><b>Automotive Performance:</b>  Mount: Two-wheeled carriage with three trails and coaster wheel  Prime mover: MT-LB, URAL-4320, and other trucks  Towed Speed (km/h):  Max Road: 80  Max Off-Road: INA  Average Cross-Country: 25  Emplace Time (min): 1.5  Displace Time (min): 2.0  <b>Radio:</b> On the prime mover  <b>Protection:</b> Gun shield</p> <p><b>ARMAMENT</b>  <b>Main Armaments:</b>  Caliber, Type, Name: 125-mm smoothbore gun 2A45M  Rate of Fire (rd/min): 6-8  Loader Type: Manual, separate-loading  Ready/Stowed Rounds: 6/60 on prime mover  Elevation (°): -6 to +25  Fire on Move: No</p> <p><b>ATGM Launcher:</b>  Launch Method: Gun-launched  Guidance: Laser-beam rider, with 9S53 guidance device  Command Link: Encoded laser-beam  Launcher Dismountable: No</p> <p><b>FIRE CONTROL</b>  <b>FCS Name:</b> N/A  <b>Main Gun Stabilization:</b> N/A  <b>Rangefinder:</b> N/A  <b>Sights w/Magnification:</b>  Gunner:  Day: OP4M-48A, 5x, direct fire, 5.5x / 2Ts33 iron PG-1M, 4x, indirect fire  Field of View (°): 11 on OP4M-48A, 10 on PG-1M  Acquisition Range (m): 4,000/8,200 indirect fire</p> <p>Night: 1PN53-10 II sight, 6.8x; 1PN80 thermal sight available  Field of View (°): 7  Acquisition Range (m): 800-1,300</p> <p><b>VARIANTS</b>  None</p> <p><b>MAIN ARMAMENT AMMUNITION</b>  <b>Caliber, Type, Name:</b> 125-mm APFSDS-T, BM-42M  Max Aimed Range (m): 3,000  Max Effective Range (m):  Day: 2,000-3,000  Night: 800-1,300 II sight  Armor Penetration (mm): 590-630 at 2,000 meters</p> <p><b>Caliber, Type, Name:</b> 125-mm HEAT, BK-27  Max Aimed Range (m): 2,500  Max Effective Range (m):  Day: INA  Night: 800-1,300 II sight  Armor Penetration (mm): 700-800</p> <p><b>Caliber, Type, Name:</b> 125-mm HEAT-MP, BK-29M  Max Aimed Range (m): 2,500  Max Effective Range (m):  Day: 2,500  Night: 800-1,300 II sight  Armor Penetration (mm): 650-750</p> <p><b>Caliber, Type, Name:</b> 125-mm Frag-HE-T, OF-26  Max Aimed Range (m): 5,000  Max Effective Range (m):  Day: 2,500  Night: 800-1,300 II sight, direct fire  Armor Penetration (mm): Can defeat IFVs on impact</p> <p><b>Other Ammunition Types:</b> Giat 125G1, and BM-42 and BM-32 APFSDS-T. The Russians may have a BM-42M with DU penetrator.</p> <p><b>Antitank Guided Missiles:</b>  Name: AT-11/SVIR  Warhead Type: Shaped charge (HEAT)  Armor Penetration (mm): 700 (RHA) behind ERA/800 conventional  Range (m): 5,000</p> <p>Name: AT-11B/INVAR  Warhead Type: Tandem shaped charge  Armor Penetration (mm): 800 (RHA) behind ERA /870 conventional  Range (m): 5,000</p>	

### NOTES

The ATGM sight and laser guidance device has a 5,000-meter range, day sight only. The day sight can be used at night if the target is illuminated.

## Russian ATGM Launcher Vehicle 9P148

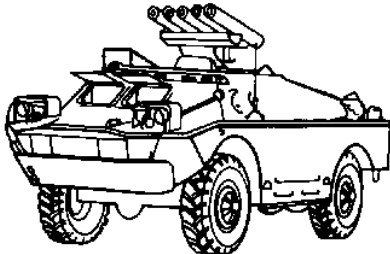
	<table border="1"> <thead> <tr> <th>Weapons &amp; Ammunition Types</th> <th>Typical Combat Load</th> </tr> </thead> <tbody> <tr> <td><b>Launcher</b> AT-5/AT-5B ATGM</td> <td style="text-align: center;"><b>15-20</b> 15</td> </tr> <tr> <td>Mixed (see NOTES) AT-4/AT-4B ATGM AT-5/AT-5B ATGM</td> <td style="text-align: center;">10 10</td> </tr> </tbody> </table>	Weapons & Ammunition Types	Typical Combat Load	<b>Launcher</b> AT-5/AT-5B ATGM	<b>15-20</b> 15	Mixed (see NOTES) AT-4/AT-4B ATGM AT-5/AT-5B ATGM	10 10
Weapons & Ammunition Types	Typical Combat Load						
<b>Launcher</b> AT-5/AT-5B ATGM	<b>15-20</b> 15						
Mixed (see NOTES) AT-4/AT-4B ATGM AT-5/AT-5B ATGM	10 10						
<p><b>SYSTEM</b>  <b>Alternative Designations:</b> BRDM-2/AT-5  <b>Date of Introduction:</b> 1977  <b>Proliferation:</b> At least 6 countries  <b>Description:</b>            Crew: 2            Platform: BRDM-2M/GAZ-41-08            Combat Weight (mt): 7.0            Chassis Length Overall (m): 5.73            Height (m):                Overall: 2.31                In Firing Position: INA            Width Overall (m): 2.26            Drive Formula: 4 x 4 (+ 4 auxiliary wheels)</p> <p><b>Automotive Performance:</b>            Engine Type: 140-hp Gasoline            Cruising Range (km): 750            Speed (km/h):                Max Road: 100                Max Off-Road: INA                Average Cross-Country: INA                Max Swim: 10            Fording Depth (m): Amphibious            Self-Entrenching Blade: N/A</p> <p><b>Radio:</b> R-123</p> <p><b>Protection:</b>            Armor, Turret Front (mm): 10            Applique Armor (mm): N/A            Explosive Reactive Armor (mm): N/A            Active Protective System: N/A            NBC Protection System: Collective            Smoke Equipment: N/A</p> <p><b>ARMAMENT</b>  <b>Antitank Guided Missile Launcher</b>            Name: 9P135M3 (recent upgrade)            Launch Method: tube-launched            Number of missiles on launcher: 5            Elevation (°): INA            Rate of Launch: (missiles/min): 2-3, depending on range            Reaction Time (sec): INA            Emplacement Time (min): INA            Displacement Time (min): INA            Can Launch Missiles Simultaneously : NA            Ready/Stowed Missiles: 15 (launcher + autoloader)/ 0-5 by mix            Loader Type: Automated            Launcher dismountable: No            Auxiliary Launcher: Yes            Fire on the Move: No</p>	<p><b>FIRE CONTROL</b>  <b>FCS Name:</b> N/A  <b>Guidance:</b> SACLOS            Command Link: Wire            Beacon Type: Incandescent bulb            Tracker Type: IR, 9S451M1            Susceptible To Countermeasures: EO jammers, smoke, counterfire            Counter-countermeasures: Electro-optical jamming alarm (See note)  <b>Rangefinder:</b> N/A  <b>Infrared Searchlight:</b> N/A  <b>Sights w/Magnification:</b>            Gunner:                Day: 9Sh119M1                    Field of View (°): INA                    Acquisition Range (m): INA                Night: 1PN65                    Field of View (°): INA                    Acquisition Range (m): 2,500</p> <p><b>VARIANTS</b>  <b>9P137:</b> Original launcher vehicle with 5 AT-5 (only) launch rails</p> <p><b>AMMUNITION</b>  <b>Antitank Guided Missiles:</b>            Name: AT-5/SPANDREL                Alternative Designations: Konkurs                Missile Weight (kg): 25.2 (in tube)                Warhead Type: Shaped Charge (HEAT)                Armor Penetration (mm): 650                Minimum/Maximum Range (m): 75/4,000                Probability of Hit (%): 90                Average Velocity (m/s): 200                Time of Flight to Max Range (sec): 20</p> <p>Name: AT-5B                Alternative Designations: Konkurs-M                Missile Weight (kg): 26.5 (in tube)                Warhead Type: Tandem Shaped Charge (HEAT)                Armor Penetration (mm): 925                Minimum/Maximum Range (m): 75/4,000                Probability of Hit (%): 90                Average Velocity (m/s): 208                Time of Flight to Max Range (sec): 19</p> <p>Name: AT-4/SPIGOT                Alternative Designations: Fagot                Missile Weight (kg): 13.0 (in tube)                Warhead Type: Shaped Charge (HEAT)                Armor Penetration (mm): 480                Minimum/Maximum Range (m): 70/2,000                Probability of Hit (%): 90                Average Velocity (m/s): 186                Time of Flight to Max Range (sec): 11</p>						

## **Russian ATGM Launcher Vehicle 9P148 continued**

---

<p>Name: AT-4B Alternative Designations: Factoria, Konkurs M Missile Weight (kg): 13.4 (in tube) Warhead Type: Shaped Charge (HEAT) Armor Penetration (mm): 550 Minimum/Maximum Range (m): 70/2,500 Probability of Hit (%): 90 Average Velocity (m/s): 180 Time of Flight to Max Range (sec): 13.2-14.0</p>	<p><b>Other Missile Types:</b> N/A</p>
---	--

### **NOTES**

A variety of ATGM mixes have been seen with 9P148, between AT-4 and AT-5-type ATGMS. The primary benefit of adaptability is increased launcher load and adaptability to user countries' inventories of ATGMS. Most common ATGM is AT-5. As AT-5B is produced, it is likely to replace AT-5 in better-budgeted country inventories.

Reload time for the launcher is 25 seconds.

Russian firms have developed countermeasures, such as encoded-pulse beacons for ATGMS and counter-dazzler adjustments to the 9S451M1 guidance box. Filters can be mounted in front of reticles.

The 1PN66 thermal sight is available for the ATGM launcher. Acquisition range is approximately 2,500 meters.

Russian KBP offers a drop-in one-man turret, called Kliver, with a stabilized 2A72 30-mm gun, a 4 Kornet ATGM launcher, thermal sights, and improved fire control system.

## Russian ATGM Launcher Vehicle 9P149

	<p><b>Weapons &amp; Ammunition Types</b></p> <p><b>Launcher</b>          AT-6 HEAT ATGM          AT-9 HEAT ATGM          AT-6 HE ATGM          AT-9 HE ATGM</p>	<p><b>Typical Combat Load</b></p> <p><b>12</b></p>
<p><b>SYSTEM</b>  <b>Alternative Designations:</b> Shturm-S  <b>Date of Introduction:</b> 1990  <b>Proliferation:</b> At least 9 countries  <b>Description:</b>          Crew: 2          Platform: MT-LB          Combat Weight (mt): 12.3          Chassis Length Overall (m): 6.35          Height (m):              Overall: 1.8              In Firing Position: INA          Width Overall (m): 2.85</p> <p><b>Automotive Performance:</b>          Engine Type: 290-hp Diesel          Cruising Range (km): 500 km          Speed (km/h):              Max Road: 65              Max Off-Road: INA              Average Cross-Country: INA              Max Swim: 3-4          Fording Depths (m): Amphibious          Self-Entrenching Blade: Yes</p> <p><b>Radio:</b> R-123M or R-173</p> <p><b>Protection:</b>          Armor, Turret Front (mm): 7-14          Applique Armor (mm): N/A          Explosive Reactive Armor (mm): N/A          Active Protective System: N/A          NBC Protection System: Collective          Smoke Equipment: N/A</p> <p><b>ARMAMENT</b>  <b>Antitank Guided Missile Launcher</b>          Name: INA          Launch Method: tube-launched          Number of missiles on launcher: 1          Elevation (°): -5/+15          Rate of Launch: (missiles/min): 2-3, depending on range          Reaction Time (sec): INA          Emplacement Time (min): INA          Displacement Time (min): INA          Can Launch Missiles Simultaneously: N/A          Ready/Stowed Missiles: 12/ 0          Loader Type: Automated</p>	<p>Launcher dismountable: No          Auxiliary Launcher: No          Fire on the Move: No</p> <p><b>FIRE CONTROL</b>  <b>FCS Name:</b> INA  <b>Guidance:</b> SACLOS          Command Link: Radio frequency          Beacon Type: INA          Tracker Type: IR          Susceptible To Countermeasures: Smoke, counterfire          Counter-countermeasures: 5 encoded frequencies  <b>Rangefinder:</b> INA  <b>Infrared Searchlight:</b> INA  <b>Sights w/Magnification:</b>          Gunner:              Day: INA                  Field of View (°): INA                  Acquisition Range (m): 5,000              Night: Yes                  Field of View (°): INA                  Acquisition Range (m): INA</p> <p><b>VARIANTS</b> N/A</p> <p><b>AMMUNITION</b>  <b>Antitank Guided Missiles</b>          Name: AT-6a/SPIRAL              Alternative Designations: Kokon              Missile Weight (kg): 46.5 (in tube)              Warhead Type: Shaped Charge (HEAT)              Armor Penetration (mm): 750, 600 behind ERA              Minimum/ Maximum Range (m): 400/5,000              Probability of Hit (%): 90              Average Velocity (m/s): 345              Time of Flight to Max Range (sec): 14.5</p> <p>Name: AT-9              Alternative Designations: Ataka              Missile Weight (kg): 48.3 (in tube)              Warhead Type: Tandem Shaped Charge (HEAT)              Armor Penetration (mm): 950, 800 behind ERA              Minimum/Maximum Range (m): 400/6,000, 5,000 ground use              Probability of Hit (%): 90              Average Velocity (m/s): 400              Time of Flight to Max Range (sec): 15.0 (12.5 in ground use)</p> <p><b>Other Missile Types:</b> AT-6 HE thermobaric, AT-9 HE thermobaric</p>	

### NOTES

Other missiles (AT-6b and AT-6c) can be launched from helicopters; but their length exceeds the 1832-mm limit for the Shturm-S autoloader. A modular AT-6 ATGM launcher system with launcher and autoloader is available for installation on vehicles, fixed sites and boats.



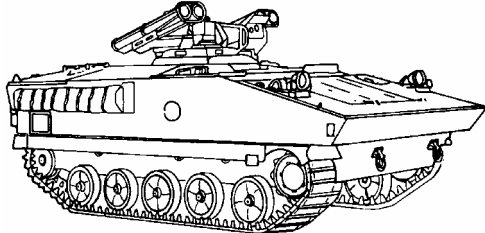

# French ATGM Launcher Vehicle AMX-10 HOT

	<b>Weapons &amp; Ammunition Types</b>  <b>Total</b> HOT/ HOT 2, 2T/ HOT 3	<b>Typical Combat load</b>  <b>18</b>
<p><b>SYSTEM</b>  <b>Alternative Designations:</b> INA  <b>Date of Introduction:</b> INA  <b>Proliferation:</b> At least 1 country  <b>Description:</b>          Crew: 4-5          Platform: AMX-10P          Combat Weight (mt): 14.1          Chassis Length Overall (m): 5.78          Height (m):            Overall: 2.57            In Firing Position: INA          Width Overall (m): 2.78</p> <p><b>Automotive Performance:</b>          Engine Type: 300-hp Diesel          Cruising Range (km): 600 km          Speed (km/h):            Max Road: 65            Max Off-Road: INA            Average Cross-Country: 30-40            Max Swim: 7 (with optional water jets)          Fording Depths (m): Amphibious          Self-Entrenching Blade: N/A</p> <p><b>Radio:</b> VHF and intercom</p> <p><b>Protection:</b>          Armor, Turret Front (mm): 12.7-mm frontal (distance NFI)          Applique Armor (mm): N/A          Explosive Reactive Armor (mm): Available (see NOTES)          Active Protective System: N/A          NBC Protection System: Collective          Smoke Equipment: 3 smoke grenade launchers</p> <p><b>ARMAMENT</b>  <b>Antitank Guided Missile Launcher</b>          Name: Lancelot 3          Launch Method: tube-launched          Number of missiles on launcher: 4          Elevation (°): -12/+18          Rate of Launch: (missiles/min): INA          Reaction Time (sec): INA          Emplacement Time (min): INA          Displacement Time (min): INA          Can Launch Missiles Simultaneously: INA          Ready/Stowed Missiles: 4/14          Loader Type: Manual          Launcher dismountable: No          Auxiliary Launcher: No          Fire on the Move: No</p>	<p><b>FIRE CONTROL</b>  <b>FCS Name:</b> INA  <b>Guidance:</b> SACLOS          Command Link: Wire          Beacon Type: INA          Tracker Type: INA          Susceptible To Countermeasures: Smoke, counterfire          Counter-countermeasures: Infrared CM hardening on later ATGMs  <b>Rangefinder:</b> M427 Laser rangefinder  <b>Infrared Searchlight:</b> INA  <b>Sights w/Magnification:</b>          Gunner:            Day: M509, 3x/12x              Field of View (°): INA              Acquisition Range (m): INA            Night: Castor Thermal Image System available              Field of View (°): INA              Acquisition Range (m): INA</p> <p><b>VARIANTS</b> N/A</p> <p><b>Antitank Guided Missiles</b>          Name: HOT            Alternative Designations: Euromissile            Missile Weight (kg): 32 (in tube)            Warhead Type: Shaped Charge (HEAT)            Armor Penetration (mm): 800            Minimum/ Maximum Range (m): 75/4,000            Probability of Hit (%): INA            Average Velocity (m/s): 233            Time of Flight to Max Range (sec): 17.3</p> <p>Name: HOT 2            Alternative Designations: INA            Missile Weight (kg): 32 (in tube)            Warhead Type: Tandem Shaped Charge (HEAT)            Armor Penetration (mm): 900            Minimum/Maximum Range (m): 75/4,000            Probability of Hit (%): INA            Average Velocity (m/s): 233            Time of Flight to Max Range (sec): 17.3</p> <p>Name: HOT 2T            Alternative Designations: INA            Missile Weight (kg): 32 (in tube)            Warhead Type: Tandem shaped Charge (HEAT)            Armor Penetration (mm): 1250            Minimum/Maximum Range (m): 75/4,000            Probability of Hit (%): INA            Average Velocity (m/s): INA            Time of Flight to Max Range (sec): INA</p> <p><b>Other Missile Types:</b> HOT 3--similar to HOT 2T, but with improved countermeasures</p>	

## **French ATGM Launcher Vehicle AMX-10 HOT continued**

---

### **NOTES**

The HOT Antitank guided missile is produced by a European consortium which includes France and Germany. It can be launched from a ground launcher, the same launcher mounted on a variety of vehicles, from infantry fighting vehicles and ATGM launcher vehicles, and from helicopters. The AMX-10 HOT constitutes a high-end application on that spectrum, and has not been widely proliferated.

The cruciform-based single-tube ground launcher system exceeds the weight limit for the portable class of ATGM launchers. An updated launcher for HOT-2T offers a Thermal Modular System night sight and a dual band tracker. Alternate mounts for the launcher include the ATLAS/Commando lightweight launcher (140 kg) mounted on the Spanish Santana (4 x 4 Land Rover light truck).

The Lancelot turret used on AMX-10 HOT can be mounted on other armored fighting vehicles.

The French-produced VAB HOT uses a Mephisto retractable twin-tube launcher, and has an onboard load of 10 HOT ATGMs.

The UTM800 turret holds four HOT missiles, with a stabilized sight and Castor thermal night sight. The UTM800 is used on two applications. The French VCR/TH employs the turret on a Panhard VCR/TT 6 x 6 APC chassis. The other is the UTM turret on a VAB APC chassis.

The German Jaguar 1 Jagdpanzer is a modified Leopard 1 tank chassis with a single-tube HOT launcher.

French SNPE explosive reactive armor can be employed on AMX-10 type vehicles.

# US ATGM Launcher Vehicle M901

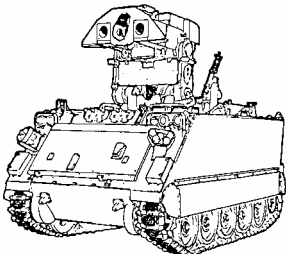
	<p><b>Weapons &amp; Ammunition Types</b></p> <p><b>ATGM Launcher</b> TOW, ITOW, TOW 2, TOW 2A, TOW 2B</p> <p><b>7.62-mm Cupola MG</b></p>	<p><b>Typical Combat Load</b></p> <p style="text-align: center;"><b>12</b></p> <p style="text-align: center;"><b>2,000</b></p>
<p><b>SYSTEM</b>  <b>Alternative Designations:</b> ITV (Improved TOW Vehicle), ITOW  <b>Date of Introduction:</b> 1978  <b>Proliferation:</b> At least 8 countries  <b>Description:</b>  Crew: 4-5  Platform: M113A1  Combat Weight (mt): 11.79  Chassis Length Overall (m): 4.90  Height (m):      Overall: 2.91      In Firing Position: 3.35  Width Overall (m): 2.70</p> <p><b>Automotive Performance:</b>  Engine Type: 212-hp Diesel  Cruising Range (km): 483  Speed (km/h):      Max Road: 64      Max Off-Road: INA      Average Cross-Country: INA      Max Swim: 5.8  Fording Depths (m): Amphibious  Self-Entrenching Blade: N/A</p> <p><b>Radio:</b> Various, including intercom</p> <p><b>Protection:</b>  Armor, Turret Front (mm): INA  Applique Armor (mm): Available. Anti-mine armor on bottom  Explosive Reactive Armor (mm): Available  Active Protective System: No  NBC Protection System: No  Smoke Equipment: 4 smoke grenade launchers on each front corner</p> <p><b>ARMAMENT</b>  <b>Antitank Guided Missile Launcher</b>  Name: M27 cupola with launcher head ("Hammerhead")  Launch Method: Tube-launched  Number of missiles on launcher: 2  Elevation (°): -30/+34  Rate of Launch: (missiles/min): 2  Reaction Time (sec): 4.25  Emplacement Time (min): 0.33  Displacement Time (min): INA  Can Launch Missiles Simultaneously: No  Ready/Stowed Missiles: 2/10  Loader Type: Manual  Launcher dismountable: No  Auxiliary Launcher: No  Fire on the Move: No</p>	<p><b>Auxiliary Weapon:</b>  Caliber, Type, Name: 7.62-mm (7.62x51) MG  Mount Type: Cupola  Direct Fire Range (m): INA  Max Effective Range (m):      Day: INA      Night: INA  Fire on Move: Yes  Rate of Fire: INA</p> <p><b>Firing Ports:</b> INA</p> <p><b>FIRE CONTROL</b>  <b>FCS Name:</b> INA  <b>Guidance:</b> SACLOS  Command Link: Wire  Beacon Type: Xenon (Infrared), thermal on TOW-2 and after  Tracker Type: INA  Susceptible To Countermeasures: Smoke, counterfire  Counter-countermeasures:  <b>Rangefinder:</b> INA  <b>Infrared Searchlight:</b> INA  <b>Sights w/Magnification:</b>  Gunner:      Day: Day sight/tracker, 13x      Field of View (°): 5.5 x      Acquisition Range (m): INA      Night: AN/TAS-4 thermal sight      Field of View (°): INA      Acquisition Range (m): INA</p> <p><b>VARIANTS</b>  <b>ITOW:</b> Launcher variants have been upgraded with new turrets and launcher heads to fit the later TOW variants, such as ITOW, TOW 2, 2A and 2B. <b>M901A2:</b> Launcher vehicle fitted for TOW 2.</p> <p>A variety of M113-based vehicles have incorporated TOW "hammerhead" launcher for use as ATGM launcher vehicles. These include the Italian VCC-1-based launcher vehicle, and the Dutch Armored Infantry Fighting Vehicle (AIFV) -based launcher vehicle.</p> <p><b>AMMUNITION</b>  <b>Antitank Guided Missiles</b>  Name: TOW  Alternative Designations: BGM-71  Missile Weight (kg): 25.5 (in tube)  Warhead Type: Shaped Charge (HEAT)  Armor Penetration (mm): 600  Minimum/ Maximum Range (m): 65/3,750  Probability of Hit (%): INA  Average Velocity (m/s): 179  Time of Flight to Max Range (sec): 21</p>	

**US ATGM Launcher Vehicle M901 continued**

<p>Name: ITOW  Alternative Designations: BGM-71C  Missile Weight (kg): 25.7 (in tube)  Warhead Type: Tandem Shaped Charge (HEAT, short probe)  Armor Penetration (mm): 800  Minimum/ Maximum Range (m): 65/3,750  Probability of Hit (%): INA  Average Velocity (m/s): 179  Time of Flight to Max Range (sec): 21</p> <p>Name: TOW 2  Alternative Designations: BGM-71D  Missile Weight (kg): 28.1 (in tube) / 21.5 (missile only)  Warhead Type: Tandem Shaped Charge (Larger HEAT, long probe)  Armor Penetration (mm): INA  Minimum/ Maximum Range (m): 65/3,750  Probability of Hit (%): 90  Average Velocity (m/s): 179  Time of Flight to Max Range (sec): 21</p>	<p>Name: TOW 2A  Alternative Designations: BGM-71E  Missile Weight (kg): 22.65 (missile only)  Warhead Type: Tandem Shaped Charge (Larger HEAT, long probe)  Armor Penetration (mm): INA  Minimum/ Maximum Range (m): 65/3,750  Probability of Hit (%): INA  Average Velocity (m/s): 188  Time of Flight to Max Range (sec): 20</p> <p>Name: TOW 2B  Alternative Designations: BGM-71F  Missile Weight (kg): 22.60 (missile only)  Warhead Type: Dual explosive-formed penetrators (EFP), top-attack  Armor Penetration (mm): INA  Minimum/ Maximum Range (m): 200/3,750  Probability of Hit (%): INA  Average Velocity (m/s): 179  Time of Flight to Max Range (sec): 21</p> <p><b>Other Missile Types:</b> See NOTES, below</p>
---	---

**NOTES**

The loader has side and overhead protection during loading, which requires 40 seconds.

The Improved Target Acquisition System (ITAS) was developed for TOW 2 and later. It includes a laser rangefinder, increased acquisition range, improved night capabilities (second-generation thermal channel), an automatic boresight and greater hit probability.

The UK-developed Further-Improved TOW (FITOW) program is expected to be similar to TOW 2B, but with two smaller warheads.

The Israeli MAPATS is a TOW missile variant with laser-beam rider guidance and a laser guidance system.

The Israeli TAAS tandem warhead is the same diameter as the warhead on the original TOW missile, and appears to be a candidate for retrofit. The warhead is claimed to be able to penetrate 1,020 mm of armor.

## Russian ATGM Launcher AT-3

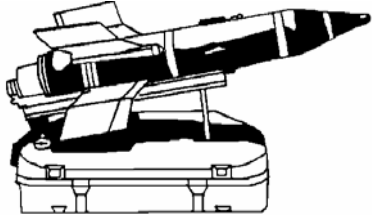
	<p><b>Weapons &amp; Ammunition Types</b></p> <p>ATGM Launcher AT-3 HEAT ATGM AT-3 HE ATGM</p>	<p><b>Typical Combat Load</b></p> <p>4/ 3 Polk Set 1 on launcher</p>
<p><b>SYSTEM</b>  <b>Alternative Designations:</b> Malyutka Complex  <b>Date of Introduction:</b> 1963  <b>Proliferation:</b> At least 45 countries  <b>Description:</b>  Crew: 3  Primary Mount: Ground mount on "suitcase" launcher  Alternate Mounts: Rail on BMP-1, BMD-1, BRDM, BRDM-2 etc.  Weight Overall, Excluding Missile (kg): 30.5 launcher + guidance  Length Overall in Firing Position (m): 0.86 with AT-3/a/b/c  1.02 with Malyutka-2  Height Overall In Firing Position (m): INA  Width Overall In Firing Position (m): INA</p> <p><b>ARMAMENT</b>  <b>Launcher</b>  Name: 9P111 Case launcher  Launch Method: Rail on case  Elevation (°): Fixed for launcher (see NOTES)  Rate of Launch: (missiles/min): 2  Reaction Time (sec): INA  Emplacement Time (min): 1.7 POLK set  Displacement Time (min): INA  Ready/Stowed Missiles: 4/0, 3/0 POLK set</p> <p><b>FIRE CONTROL</b>  <b>FCS Name:</b> 9S415/9S415M/9S415M1 guidance panel  <b>Guidance:</b> MCLOS (9S415/-M panel), SACLOS  Command Link: Wire  Beacon Type: Incandescent infrared bulb (SACLOS)  Tracker Type: N/A for MCLOS, flare tracker for SACLOS  Susceptible To Countermeasures: EO jammers, smoke, counterfire  Counter-countermeasures: Offset guidance panel, laser filters  <b>Rangefinder:</b> INA  Frequency: INA  Counter-countermeasures: INA  <b>Sights w/Magnification:</b>  Gunner:  Day: 9Sh16, 8x  Field of View (°): 22.5 (see NOTES)  Acquisition Range (m): 4000  Night: Available</p>	<p><b>VARIANTS</b>  Copies include North Korean Susong-Po, Taiwanese Kun Wu, and the Chinese copy, Red Arrow-73/HJ-73, with indigenous guidance.</p> <p><b>POLK:</b> Slovenian Portable Anti-armor Launching Set includes a new launcher, guidance panel with binocular sight, and 3 ATGMs similar to AT-3C Improved (nose probes and lower smoke signature). With a nose probe and improved propellant, the MCLOS-guided ATGM can reach maximum range in 25 sec and penetrate 580 mm. A Russian AT-3c/Improved (SACLOS) has similar capabilities.</p> <p><b>AMMUNITION</b>  <b>Antitank Guided Missiles</b>  Name: AT-3, -3a, -3b/SAGGER  Alternative Designations: Malyutka, Malyutka-M  Missile Weight (kg): 10.9  Warhead Type: Shaped Charge (HEAT)  Armor Penetration (mm): 400  Minimum/Maximum Range (m): 500/3,000  Probability of Hit (%): 70 against moving tanks  Average Velocity (m/s): 115  Time of Flight to Max Range (sec): 26</p> <p>Name: AT-3c/SAGGER  Alternative Designations: Malyutka-P  Missile Weight (kg): 11.4  Warhead Type: Shaped Charge (HEAT)  Armor Penetration (mm): 520  Minimum/Maximum Range (m): 500/3,000  Probability of Hit (%): 90 (SACLOS)  Average Velocity (m/s): 115  Time of Flight to Max Range (sec): 26</p> <p>Name: Malyutka-2  Alternative Designations: Malyutka (Modernized)  Missile Weight (kg): 12.5  Warhead Type: Tandem Shaped Charge (HEAT)  Armor Penetration (mm): 800  Minimum/Maximum Range (m): 500/3,000  Probability of Hit (%): 90 (SACLOS)  Average Velocity (m/s): 130  Time of Flight to Max Range (sec): 23</p> <p><b>Other Missiles:</b> Malyutka (Modernized) HE, AT-3c Imp, POLK</p>	

### NOTES

AT-3 is classed by weight as portable (21-40 kg), rather than manportable (<21 kg). The launcher is also a missile carry case. The guidance panel can be located up to 15 meters from the launcher, and can control up to four launchers. If target is <1,000 meters from launcher, the operator can joystick the missile to target without using optics. Guidance elevation (°) is -5/ +10. Because the module is small and can be shifted, elevation and field of view are operationally unlimited. Improved versions can be used on older launchers, but in the MCLOS mode. The Slovenian Iskra TS-M thermal sight is available, with detection at 3,000 meters and recognition at 1,800 meters.

Any AT-3 can be modernized to Malyutka-2 with replacement of warhead and or replacement of specific warhead and motor components.

## Russian ATGM Launcher AT-4/AT-5

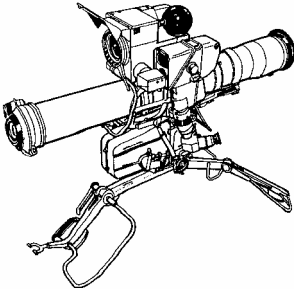
 <p style="text-align: center;">9P135M3 w/AT-5B and thermal sight</p>	<p><b>Weapons &amp; Ammunition Types</b></p> <p><b>ATGM Launcher Total</b> AT-4/AT-4B ATGM</p> <p>AT-5/AT-5B ATGM</p>	<p><b>Typical Combat Load</b></p> <p style="text-align: center;"><b>4 or 8</b> (see NOTES)</p>
<p><b>SYSTEM</b>  <b>Alternative Designations:</b> 9P135M Firing Post, Fagot/Fagot-M  <b>Date of Introduction:</b> 1973  <b>Proliferation:</b> At least 25 countries  <b>Description:</b>          Crew: 3          Primary Mount: Ground mount on folding tripod          Alternate Mounts: Pintel (post) on BMP-1P, BTR-D, UAZ-469, etc.          Weight Overall, Excluding Missile (kg): 22.5          Length Overall in Firing Position (m): 1.1/1.3 AT-4/5 tube          Height Overall In Firing Position (m): INA          Width Overall In Firing Position (m): INA</p> <p><b>ARMAMENT</b>  <b>Launcher</b>          Name: 9P135 (AT-4 only), 9P135M (AT-4/AT-5), -M1, -M2, -M3          Launch Method: Tube-launched          Elevation (°) (-/+): INA          Rate of Launch: (missiles/min): 2-3, depending on range          Reaction Time (sec): INA          Emplacement Time (min): INA          Displacement Time (min): INA          Ready/Stowed Missiles: 4/0 full dismount, 4/4 on or near vehicle</p> <p><b>FIRE CONTROL</b>  <b>FCS Name:</b> 9S451M1 Guidance control box  <b>Guidance:</b> SACLOS          Command Link: Wire          Beacon Type: Incandescent infrared bulb          Tracker Type: IR, 9S451M1          Susceptible To Countermeasures: EO jammers, smoke, counterfire          Counter-countermeasures: EO jamming alarm (see NOTES)  <b>Rangefinder:</b> INA  <b>Sights w/Magnification:</b>          Gunner:              Day: 9Sh119M1, 4x                  Field of View (°): 4.5                  Acquisition Range (m): INA              Night: Available (See NOTES)</p>	<p><b>VARIANTS</b>  <b>P135M3:</b> Konkurs-M Complex. Launcher with 1PN65 thermal sight and AT-5B/Konkurs-M missiles. Night range is 2,500m.</p> <p><b>AMMUNITION</b>  <b>Antitank Guided Missiles</b>          Name: AT-5B/SPANDREL-B          Alternative Designations: Konkurs-M          Missile Weight (kg): 26.5 (in tube)          Warhead Type: Tandem Shaped Charge (HEAT)          Armor Penetration (mm): 925          Minimum/Maximum Range (m): 75/4,000          Probability of Hit (%): 90          Average Velocity (m/s): 208          Time of Flight to Max Range (sec): 19</p> <p>Name: AT-5/SPANDREL          Alternative Designations: Konkurs          Missile Weight (kg): 25.2 (in tube)          Warhead Type: Shaped Charge (HEAT)          Armor Penetration (mm): 650          Minimum/Maximum Range (m): 75/4,000          Probability of Hit (%): 90          Average Velocity (m/s): 200          Time of Flight to Max Range (sec): 20</p> <p>Name: AT-4/SPIGOT          Alternative Designations: Fagot          Missile Weight (kg): 13.0 (in tube)          Warhead Type: Shaped Charge (HEAT)          Armor Penetration (mm): 480          Minimum/Maximum Range (m): 70/2,000          Probability of Hit (%): 90          Average Velocity (m/s): 186          Time of Flight to Max Range (sec): 11</p> <p><b>Other Missiles:</b> AT-4B/Factoria (see NOTES)</p>	

### NOTES

Because of its weight, the Russians categorize the AT-4/4B system as portable (21-40 kg) rather than manportable. For dismounted carry load is divided among three packs. Due to the greater weight, AT-5/-5B fits into the "heavy" class (40+ kg), and should only be carried short distances from vehicles (<500 meters). For crews using both ATGM classes and operating near vehicles, combat load is 8 (4 stowed in the vehicle).

The AT-4B/Factoria is an upgrade ATGM with a 2,500 meter range, 550-mm penetration, and a velocity of 180 m/s (13.2 - 14.0 sec TOF). Russian firms have developed counter-countermeasures, such as encoded-pulse beacons for ATGMs and counter-dazzler adjustments to the 9S451M1 guidance box. Filters can be mounted in front of reticles.

TPVP/1PN65 thermal sight is available, with the range approximately 2,500 meters (see VARIANTS, above). Weight is 13 kg. Slovenian TS-F sight and Russian 1PN86-1/1PN86/Mulat have a 3,600 meter detection range.





## French ATGM Launcher Eryx

	<p><b>Weapons &amp; Ammunition Types</b></p> <p><b>ATGM Launcher</b> Eryx ATGM</p>	<p><b>Typical Combat Load</b></p> <p><b>1</b></p>
<p><b>SYSTEM</b>  <b>Alternative Designations:</b> Anti-Char Courtee Portee (ACCP)  <b>Date of Introduction:</b> 1991  <b>Proliferation:</b> At least 5 countries  <b>Description:</b>  Crew: 1  Primary mount: Ground mount on tripod or shoulder launch  Alternate mounts: Shoulder launch--standing, kneeling or prone  Weight Overall, Excluding Missile (kg): 3, 4 with tripod  Length Overall in Firing Position (m): 0.905  Height Overall In Firing Position (m): INA  Width Overall In Firing Position (m): INA tripod, 0.16 on shoulder</p> <p><b>ARMAMENT</b>  <b>Launcher</b>  Name: Eryx  Launch Method: Tube (disposable canister/ launch tube)  Elevation (°): INA, tripod; unlimited on shoulder launch  Rate of Launch: (missiles/min): INA  Reaction Time (sec): 20-30 (includes emplace time)  Emplacement Time (min): See Reaction Time (above)  Displacement Time (min): &lt; 0.03  Ready/Stowed Missiles: 1/0</p> <p><b>FIRE CONTROL</b>  <b>FCS Name:</b> INA  <b>Guidance:</b> SACLOS  Command Link: Wire  Beacon Type: Infrared laser diode  Tracker Type: Charged couple device (CCD)  Susceptible To Countermeasures: EO jammers, smoke, counterfire  Counter-countermeasures: Flight time less than 4 seconds</p>	<p><b>Rangefinder:</b> INA  <b>Sights w/Magnification:</b>  Gunner:  Day: INA, 3x  Field of View (°): 3.4  Acquisition Range (m): INA  Night: Sopelem OB50 II sight  Field of View (°): INA  Acquisition Range (m): INA</p> <p><b>VARIANTS</b>  N/A</p> <p><b>AMMUNITION</b>  <b>Antitank Guided Missile</b>  Name: Eryx  Alternative Designations: ACCP  Missile Weight (kg): 11 (in tube)  Warhead Type: Tandem Shaped Charge (HEAT)  Armor Penetration (mm): 900  Minimum/Maximum Range (m): 50/600  Probability of Hit (%): 90  Average Velocity (m/s): 162  Time of Flight to Max Range (sec): 3.7</p> <p><b>Other missiles:</b> N/A</p>	

### NOTES

The disposable canister/launch tube is attached to the reusable firing post (which includes sight systems).

Eryx employs a recoil reduction system with reduced back-blast, which permits launch from inside of buildings. Signature reduction includes noise and smoke reduction.

A rest such as a ledge or sandbag is required for launches beyond 350 meters.

The optional French Mirabel thermal night sight is available for use on Eryx. The Mirabel offers an acquisition range of 1,000 meters, but weighs an additional 3.4 kg.

## Russian ATGM Launcher Kornet-E

 <p style="text-align: center;">Kornet-E system (with Kornet-LR missile)</p>		<p><b>Weapons &amp; Ammunition Types</b></p> <p><b>ATGM Launcher Total</b></p> <p>HEAT ATGM HE ATGM</p>	<p><b>Typical Combat Load</b></p> <p style="text-align: center;"><b>3-4</b></p>
<p><b>SYSTEM</b>  <b>Alternative Designations:</b> Kornet, AT-14  <b>Date of Introduction:</b> 1997-98  <b>Proliferation:</b> At least 3 countries  <b>Description:</b>  Crew: 2-3  Primary Mount: Ground mount on tripod  Alternate Mounts: IFV, APC, ATGM launcher vehicle, jeep  Weight Overall, Excluding Missile (kg): 30 with thermal sight (11)  Length Overall in Firing Position (m): 1.21 (missile canister)  Height Overall In Firing Position (m): INA  Width Overall In Firing Position (m): INA</p> <p><b>ARMAMENT</b>  <b>Launcher</b>  Name: 9P163  Launch Method: Tube-launched from carrying canister  Elevation (°): INA  Rate of Launch: (missiles/min): 2-3, depending on range  Reaction Time (sec): 1-2  Emplacement Time (min): 1.0  Displacement Time (min): 1.0  Ready/Stowed Missiles: 2 for 2-man crew, 3-4 for 3-man crew</p> <p><b>FIRE CONTROL</b>  <b>FCS Name:</b> INA  <b>Guidance:</b> Laser beam rider  Command Link: N/A  Beacon Type: N/A  Tracker Type: N/A  Susceptible To Countermeasures: Smoke, counterfire  Counter-countermeasures: Encoded laser beam  <b>Rangefinder:</b> Not included  <b>Sights w/Magnification:</b>  Gunner:  Day: 1P45-1 elbow sight  Field of View (°): INA  Acquisition Range (m): 5,500  Night: 1PN79 / Metis-2 thermal sight  Field of View (°): INA  Acquisition Range (m): 3,500 (ID range 2,500)</p>	<p><b>VARIANTS</b>  <b>Kornet-E:</b> Export version of the Kornet system includes a light-weight launcher tripod, thermal night sight, and Kornet-LR missile. A version of the system is available for use in hot desert climates (to 60° C). Since Russian KBP began development of a medium-range (2,500 m) version, it divided domestic programs into the following:  <b>Kornet-MR:</b> Manportable system with E-type launcher and -MR missile. This missile is not currently fielded.  <b>Kornet-LR.portable:</b> System with the -LR missile.  <b>Kornet-LR self-propelled:</b> ATGM system on BMP-3 chassis with twin launchers, auto-loader, automated dual-track FCS with dual target trackers, Kredo surveillance radar, and improved FLIR.</p> <p><b>Kliver:</b> Missile-gun turret upgrade; 1-man turret with 30-mm gun, 7.62-mm MG, automated FCS and 4-tube Kornet ATGM launcher.</p> <p>KBP displayed a prototype <b>overhead weapons module</b> to mount on a variety of vehicles (displayed on a HMMWV). It has dual twin (4-tube) launcher, and a central module with TV/FLIR sights and MG.</p> <p><b>AMMUNITION</b>  <b>Antitank Guided Missiles</b>  Name: Kornet-LR  Alternative Designation: 9M133  Missile Weight (kg): 27  Warhead Type: Tandem Shaped Charge (HEAT)  Armor Penetration (mm): 1,200  Min/Max Range (m): 100/5,500  Probability of Hit (%): 90  Average Velocity (m/s): 550  Time of Flight to Max Range (sec): 22</p> <p>Name: Kornet-MR  Alternative Designation: INA  Missile Weight (kg): INA  Warhead Type: Tandem Shaped Charge (HEAT)  Armor Penetration (mm): 1,000  Min/Max Range (m): 100/2,500  Probability of Hit (%): 90  Average Velocity (m/s): INA  Time of Flight to Max Range (sec): INA</p> <p><b>Other Missiles:</b> Kornet-LR HE (thermobaric, 9M133F)  Kornet-MR HE (thermobaric).</p>		

### NOTES

By weight, Kornet-MR can be broken down into a portable (marginally manportable) 2-man system, or into a clearly manportable 3-man system. Kornet-LR can be manportable with MR missiles or a larger crew, but generally is only portable (short-distance carry – See AT-3). Medium-range and long-range Kornet missiles are interchangeable among Kornet-LR, -MR, and Kornet-E launcher systems.

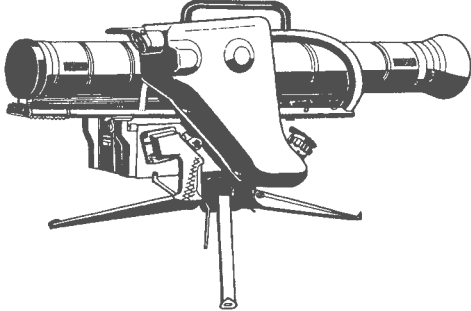

## European ATGM Launcher MILAN 2 /MILAN 3

 <p style="text-align: center;">MILAN 2</p>	<p><b>Weapons &amp; Ammunition Types</b></p> <p><b>ATGM Launcher Total</b></p> <p>HEAT ATGM</p>	<p><b>Typical Combat Load</b></p> <p style="text-align: center;">1 or 2</p>
<p><b>SYSTEM</b> (MILAN 2 / MILAN 3, where their data differs)  <b>Alternative Designations:</b> Missile d'Infanterie Leger Antichar  <b>Date of Introduction:</b> 1985 MILAN 2/1996 MILAN 3  <b>Proliferation:</b> At least 39 countries MILAN/MILAN 2/1 MILAN 3  <b>Description:</b>  Crew: 2, 3 with ammo bearer for second missile  Primary Mount: Ground mount on tripod, including operator prone  Alternate Mounts: IFV, ATGM Launcher Vehicle, jeep, helicopter  Weight Overall, Excluding Missile (kg): 16.5  Length Overall in Firing Position (m): 1.2 (missile canister)  Height Overall In Firing Position (m): 0.6  Width Overall In Firing Position (m): 0.42</p> <p><b>ARMAMENT</b>  <b>Launcher</b>  Name: MILAN 2/MILAN 3  Launch Method: Tube-launched from carrying canister  Elevation (°): INA  Rate of Launch: (missiles/min): 2-3, depending on range  Reaction Time (sec): INA  Emplacement Time (min): INA  Displacement Time (min): INA  Ready/Stowed Missiles:  2-man crew (1 on launcher), 0 stowed  3-man crew (1 on launcher), + 1 ready, 0 stowed</p> <p><b>FIRE CONTROL</b>  <b>FCS Name:</b>  <b>Guidance:</b> SACLOS  Command Link: Wire  Beacon Type: Pyrotechnic flare, MILAN 2/ xenon bulb, MILAN 3  Tracker Type: IR, 2.2 μm/ 0.9 μm MILAN 3  Susceptible To Countermeasures: Smoke, counterfire, moving  Counter-countermeasures: Encoded tracker, counters EOIRCM  <b>Rangefinder:</b> INA  <b>Sights w/Magnification:</b>  Gunner:  Day: Name INA, 7x  Field of View (°): 4.3  Acquisition Range (m): INA  Night: MIRA Thermal sight available  Field of View (°): 3 x 6  Acquisition Range (m): 4,000 detection/ 2,000 recognition</p>	<p><b>VARIANTS</b>  The missile launchers can be pintle-mounted for launch from vehicles, such as the Marder 1A3 IFV. A variety of reconnaissance vehicles, such as the French VBL, are fitted with MILAN launchers.</p> <p><b>MILAN 2T:</b> Improved ATGM with tandem warhead - not fielded</p> <p><b>MILAN 3:</b> Variant with a CCD tracker for the missile beacon. MILAN, MILAN 2, and MILAN 3 missiles can be fired from all three launchers; however, the EOIRCM will only work with both MILAN 3 launcher and MILAN 3 missile.</p> <p><b>MCT:</b> Compact turret w/two launchers for Spartan and other APCs.</p> <p><b>AMMUNITION</b>  <b>Antitank Guided Missiles</b>  Name: MILAN  Missile Weight (kg): 6.7  Warhead Type: Shaped Charge (HEAT)  Armor Penetration (mm): 600 (RHA)  Min/Max Range (m): 25/2,000  Probability of Hit (%): &gt;90  Average Velocity (m/s): 160  Time of Flight to Max Range (sec): 12.5</p> <p>Name: MILAN 2  Missile Weight (kg): 6.7  Warhead Type: Tandem Shaped Charge  Armor Penetration (mm): 800 (RHA)  Min/Max Range (m): 25/2,000  Probability of Hit (%): &gt;90  Average Velocity (m/s): 160  Time of Flight to Max Range (sec): 12.5</p> <p>Name: MILAN 3  Missile Weight (kg): 7.1  Warhead Type: Tandem Shaped Charge with precursor charge  Armor Penetration (mm): 880 (RHA)  Min/Max Range (m): 20/1,920  Probability of Hit (%): &gt;90  Average Velocity (m/s): 160  Time of Flight to Max Range (sec): 12.5</p> <p><b>Other Missiles:</b> N/A</p>	

### NOTES

Although the launcher is portable and has been labeled man-portable, it is too heavy for one-man carry with missile.

A kit is available for retrofit to MILAN and MILAN 2 launchers, to permit firing MILAN 3 ATGM with EOIRCM (jammer countermeasure).

## Chinese ATGM Launcher Red Arrow-8

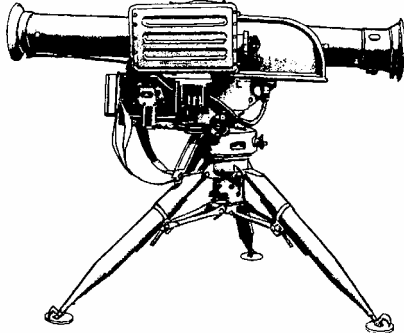
	<p><b>Weapons &amp; Ammunition Types</b></p> <p>ATGM Launcher Total</p> <p>HEAT ATGM</p>	<p><b>Typical Combat Load</b></p> <p>Ground 1-5</p> <p>Vehicle 8-12</p>
<p><b>SYSTEM</b>  <b>Alternative Designations:</b> Hongjian-8, RA-8, HJ-8  <b>Date of Introduction:</b> 1986  <b>Proliferation:</b> At least 4 countries  <b>Description:</b>  Crew: 4  Primary Mount: Ground mount on tripod, including operator prone  Alternate Mounts: APC, ATGM Launcher Vehicle, jeep, helicopter  Weight Overall, Excluding Missile (kg): 63  Length Overall in Firing Position (m): 1.57 (missile canister)  Height Overall In Firing Position (m): INA  Width Overall In Firing Position (m): INA</p> <p><b>ARMAMENT</b>  <b>Launcher</b>  Name: Red Arrow 8  Launch Method: Tube-launched from carrying canister  Elevation (°) (-/+): -7 to +12  Rate of Launch: (missiles/min): 2-3, depending on range  Reaction Time (sec): INA  Emplacement Time (min): INA  Displacement Time (min): INA  Ready/Stowed Missiles: INA</p> <p><b>FIRE CONTROL</b>  <b>FCS Name:</b> INA  <b>Guidance:</b> SACLOS  Command Link: Wire  Beacon Type: Incandescent infrared bulb  Tracker Type: IR  Susceptible To Countermeasures: IR jammer, smoke, counterfire  Counter-countermeasures: Jamming CM (NFI)  <b>Rangefinder:</b> INA</p>	<p><b>Sights w/Magnification:</b>  Gunner:  Day: Name INA, 12x  Field of View (°): INA  Acquisition Range (m): INA  Night: PTI-32 Thermal sight available (copy of Thorn EMI)  Field of View (°): INA  Acquisition Range (m): 4,000 detection/2,000 identification</p> <p><b>VARIANTS</b>  <b>Baktar Shikan:</b> Pakistani variant, also called <b>Green Arrow</b>.  Missile data is similar to Red Arrow-8A</p> <p><b>AMMUNITION</b>  <b>Antitank Guided Missiles</b>  Name: Red Arrow-8A  Alternative Designation: HJ-8A  Missile Weight (kg): 24.5 (in tube), 22.5 ready for launch  Warhead Type: Shaped Charge (HEAT)  Armor Penetration (mm): 800  Min/Max Range (m): 100/3,000  Probability of Hit (%): 90  Average Velocity (m/s): 220  Time of Flight to Max Range (sec): 13.6</p> <p>Name: Red Arrow-8E  Alternative Designation: HJ-8E  Missile Weight (kg): 24.5 (in tube), 22.5 ready for launch  Warhead Type: Tandem Shaped Charge (HEAT)  Armor Penetration (mm): 900  Min/Max Range (m): 100/4,000  Probability of Hit (%): 90  Average Velocity (m/s): 210  Time of Flight to Max Range (sec): 19</p> <p><b>Other Missiles:</b> There may be -8, -8B and -8C versions of the ATGM; however, the above are more likely for encounter.</p>	

### NOTES

Although the launcher is portable, it too heavy for one-man carry. Vehicle mounts are jeeps, such as the Chinese BJ-212 and BJ 2023 C, and APCs such as the Chinese WZ-551 and Type 90 APC. A Chinese four launcher turret has been fitted on ATGM launcher vehicles including the Chinese YW 531, WZ-551, and YW 534, and Chilean Piranha. Helicopter mounts are the Chinese Zhi-9 (license-built SA-354N/Dauphin 2) and French Antelope.

## *Gun-launched Antitank Guided Missiles*

A critical element of modern warfare is the use of "high-precision weapons" to extend the lethal range of ground forces. Maneuver forces can add gun-launched missiles to tanks and anti-tank (AT) guns to increase accuracy and range. Also, these missiles offer a higher missile speed than most other ATGMs for intercepting moving targets. Thus they can engage a wider range of targets (such as fast-moving helicopters or vehicles) at longer ranges in the modern operational environment.

A gun-launched ATGM must be ballistically matched to a stub case with an eject charge, which expels the missile from the gun. For the more common laser beam-riding ATGMs, another requirement is a laser guidance unit/designator in its sight. Application to antitank (AT) guns is even simpler and more cost-effective, with a tripod-mounted laser guidance unit. For semi-active laser homing ATGMs, a laser designator is not required on the vehicle, as long as one is coordinated with the gun to start designating, and is within designation range of the target.

There are attractive advantages to the ATGM upgrade. Few countries are producing or buying significant numbers of modern tanks. Many, however, are upgrading current inventories to approach the lethality (including range, rate of fire, precision, and penetration) of newer tanks. Gun-launched ATGMs provide an easy upgrade for older tanks with addition of the missile and its related FCS. Applications are available for tanks, assault guns, infantry fighting vehicles, and AT guns in any known gun caliber of 100-125 mm. Current estimate is that 10-20% of 140,000 potential OPFOR tanks (about 21,000) are missile-capable. Nearly all operational Russian-made tanks, and close to 1,000 BMP-3 IFVs are either equipped with or can be retrofitted with gun-launched ATGMs.

With upgrade kits available for low-level depot conversion, the task of distinguishing missile-capable vehicles is much more difficult. The most common upgrade uses a 1K13 sight, which replaces the vehicle night sight. Other more capable laser projectors and fire controls are available. Because laser guidance units for AT guns are manportable units, which can be concealed and easily transported, the number of ATGM-launch AT guns cannot be determined.

There are benefits and downsides to this technology. The cost to upgrade a tank for launching six missiles will run \$120,000-\$300,000 (subject to varying negotiable costs). Many modern canister-launch ATGMs currently enjoy a lethality overmatch against certain aspects of even the heaviest tanks. Because gun-launched ATGMs offer penetration inferior to some ATGMs, they may be overlooked in the budget-constrained military markets of today. NOTE: The lethality is limited by gun-caliber which can be expanded using a different attack trajectory (i.e., dive- or top-attack.) As with other ATGMs, range advantage may be of limited utility in selected battlefield environments, such as many cluttered, forested, or uneven terrains of Europe and Asia. However, for many applications in the battlefield environment, such as in urban combat, a gunner can use the increased precision for applications, such as placing the round through the top-left pane of the third window on the right of that fourth floor apartment. Units lacking employment discipline could quickly expend missile allocation, then find themselves out-ranged by enemy guns. For many environments, however, such as in European terrain, limited numbers of missiles could be used to control line-of-sight in open areas. Once the enemy

approaches within his effective range, flight time (vs KE round) and the limited penetration of a bore diameter HEAT warhead can place the firer at risk. Night use and fire-on-the move limitations can reduce opportunities for use of most gun-launched ATGMs.

Ground forces may employ moderate use by balancing selective gun-launched ATGM upgrades with acquisition of newer more conventional ATGMs. Countries with limited budgets may select high-priority units for the gun-launched ATGMs. Others may designate specially-assigned maneuver units for use with the upgrade. Another selective approach would be to configure units with one vehicle per platoon equipped for employing gun-launch ATGMs. Another critical consideration is missile availability. Under shifting wartime conditions, a force may not be able to shift missile-launch units, missiles and laser units to support the main effort.

The first successful gun-launched ATGM application was the 125-mm Kobra (aka AT-8/SONGSTER) radio frequency (RF) guided ATGM, fired from the T-64B Russian tank. Later, Kobra was adopted for the widely fielded T-80B tank, and is still used today.

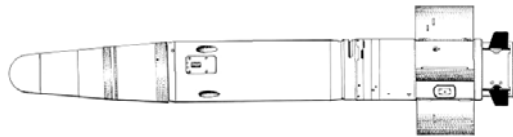

Kobra

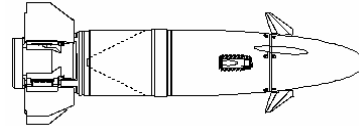

Svir

The Russian SVIR (aka AT-11/SNIPER), for the T-72B tank and other applications has a configuration which permits it to be handled by the autoloader like conventional separate-loading ammunition, with the missile loaded in the first stroke, and a second stroke for the stub case. SVIR uses laser beam-rider (LBR) guidance, which means that the gunner must use the 1K13 sight rather than the daysight.

The T-80U and later tanks use the Refleks fire control system, in which the laser guidance unit is in the day sight rather than the night sight. With this sight, the missile used is called Refleks; and the range is 5,000 meters. The Russians now offer a tandem warhead version, INVAR. A new Ukrainian ATGM, Kombat, is an indigenous design missile produced for use with their T-84 tanks, and for tanks with compatible FCS.

The Russian BASTION missile family (aka AT-10) fits a variety of 100-115 mm guns. It is a single-piece round combining missile and eject charge configured similarly to a unitary round.



Bastion Round Configuration

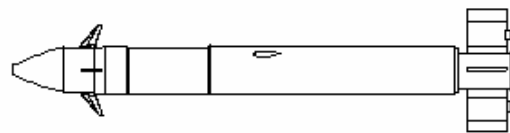

Bastion Flight Configuration

With different chamber configurations and bore diameters on user guns, the different configurations have their own Russian names. Improved versions include the Bastion-M family with





**Past and Current Gun-launched ATGMs**

<b>Designator/Name (Producer Country)</b>	<b>Number Users/ Status</b>	<b>Bore (mm)</b>	<b>Launcher Platform (Tank unless noted)</b>	<b>Range (km)</b>	<b>Shift to Gun Rd (km)*</b>	<b>Penetration (mm)/Type Warhead</b>	<b>Guidance/ P-Hit (%)</b>
US Shillelagh (Obsolete)	At least 1	152	M60A2 M551 recon vehicle	3	1-1.5	500/HEAT Unitary	SACLOS Wire/<80
Russian Kobra	At least 2	125	T-64B T-80B	4	2-2.5	700/HEAT Uni- tary	SACLOS RF/80
Russian Bastion	At least 4	100	T-55AM	4	1.0-2.5	650/HEAT Uni- tary	LBR/ 80-90
		100	T-55AM2V	4	1.0-2.5		80-90
Sheksna		115	T-62D	4	1.0-2.5		80-90
		115	T-62M	4	1.0-2.5		80-90
Basnya		100	BMP-3 IFV	4	.5		80 on move 90 stopped
Kastet		100	MT-12 AT Gun	5	1.0-2.5		90
Russian Bastion-M	At least 1	100	BMP-3 IFV and others	4	.5 1.0-2.5	700/Tandem HEAT	LBR 90
Russian Arkan	At least 1	100	BMP-3 IFV Poss others	5	.5 1.0-2.5	700/Tandem HEAT	LBR 90
Russian Svir Refleks	At least 2 At least 5	125	T-72B/S, 2A45M	4	2-2.5	800/HEAT	LBR/80-90
			T-80U, T-84	5	2-3		80-90
			T-90	5	2-3		80-90
			2A45M AT Gun	5	2-3		80-90
Russian Invar	At least 1	125	T-72B/S	4	2-2.5	870/Tandem HEAT	LBR/80-90
			T-80U, T-84	5	2-3		80-90
			T-90	5	2-3		80-90
			2A45M AT Gun	5	2-3		80-90
Ukrainian Kombat	At least 1	125	T-84	5	2-3	UNK/Tandem HEAT	LBR/80-90
			Poss others	5	2-3		80-90

NOTES: \*Average point of shift from using ATGM to gun round is close to the conventional ammunition's maximum effective range; but the decision involves various factors (Next page).

**Recently Marketed And Future Gun-Launched ATGMs**

<b>Designator/Name (Producer Country)</b>	<b>Number Users/ Status</b>	<b>Bore (mm)</b>	<b>Launcher Platform/ # Missiles</b>	<b>Range (km)</b>	<b>Shift to Gun Rd (km)*</b>	<b>Penetration (mm)/Type Warhead</b>	<b>Guidance/ P-Hit (%)</b>
Russian/German Spear	Near fielding	105	Leopard 1 tank or other NATO type	5	1.4-2	700/Tandem HEAT	LBR 90
Israeli LAHAT	Marketed	105	Merkava or M60 tank or other NATO type, poss M40 recls gun	5-7	1.5-2.5	700+ (est)/ Tandem HEAT Top-Attack	SAL- Homing
		120		5-7	2.0-3.0		
		106		5-7	1.0-1.5		
Israeli Excalibur	In R&D	120	Merkava or M1A1 or other NATO type				Terminal Hom- ing

tandem warheads. ARKAN, has a tandem warhead and a control surface adapted from the SVIR. The initial version fits BMP-3; but it is now being marketed for all variants. A German and Russian R&D effort will produce SPEAR, a 105-mm ATGM for use with NATO guns.

A recent development is the Israeli LAHAT ATGM, which is initially marketed in 105 mm for NATO-standard cannon, and which can be adapted to NATO-standard 120-mm guns.

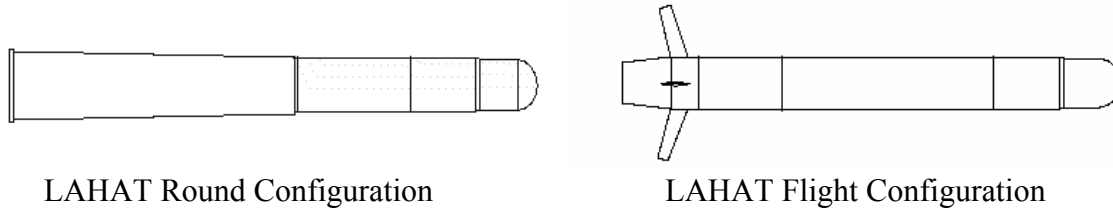

There are reports that the LAHAT missile could possibly be adapted for use with the M40 106-mm recoilless rifle, to extend the usefulness of that well-proliferated older weapon. The LAHAT's semi-active laser-homing guidance means that the ATGM can be designated with the vehicle's designator or launched at a target beyond the line-of-sight and homed to target by a down-range designator. Indirect fire capability allows the option for armored combat vehicles working in a combined arms formation to extend their lethal range and destroy enemy sensors, while reducing the enemy's opportunity to detect them and trigger deadly counter-fires.

Technical capabilities and limitations affect use of the systems. The missiles can be launched at moving targets; but hit probability is highest if the target is stopped or moving slowly. Smoke and dust can degrade the laser beam and the associated optics. However, effects of obscurants on ATGM seeker sensitivity have in some cases been shown to improve the hit performance of certain LBR missiles. Launch rate varies from 2-3 per minute, depending on target range. As target units approach within the gun's maximum effective range (see Glossary), the system should cease launching ATGMs and shift to gun rounds. Given the lethality of modern kinetic energy main gun rounds at 3,000 meters, an ATGM-launch vehicle may not want to risk a missile's 8-second flight time against a 2-second KE round. Determination of the point of shift from ATGM to cannon round is primarily dependent on accuracy of the vehicle's gun sight, and capabilities of specific rounds onboard. For instance, improved KE rounds can range out to 3 km; but most have a max effective range of no more than 2.5 km. The BMP-3 ATGM is the IFV's only true AT round, and can be employed to its minimum range.

Missile proliferation cannot be determined, because ammunition packaged for transport is difficult to track. Basic load is 5-8 rounds per vehicle, with another basic load at battalion re-supply and a half basic load at division. In a gun basic load, the ATGMs substitute for Frag-HE rounds (used beyond KE round range) and a portion of the of HEAT round allocation.

Most gun-launched ATGM fire control systems do not have a night channel which permits observation for launch at night. The few that do are limited by the range (800-1,300 meters) of their infrared sensors. However, with proper battlefield illumination, engagements can take place using its full range. They just need a lot of well-positioned and well-timed

illumination. Recently, thermal night sights have been introduced with thermal sights (FLIRs) which permit launch at night, but with restrictions in range based on the technical capability of the FLIR to detect and recognize targets, and launch on the move.

Laser beam guidance ATGMs have not received as much attention for countermeasures as have semi-active command line-of-sight (SACLOS) systems. Those ATGMs using LBR guidance are not susceptible to interference from electro-optical countermeasures. Even electro-optical jammers operating in the same wavelengths as the laser are ineffective because the missile optical receiver is looking back towards its launch point rather than at the target. Laser decoy devices used against SAL-homing munitions are also ineffective. The ATGM rider laser beam, however, can trigger laser warning receivers. Operator counter-tactics can reduce warning time. Conventional reactions against ATGMs, such as obscuration of optics, can degrade performance of gun-launch missiles. But the longer target range and shorter flight time can reduce a target's awareness and time window in which to react. Explosive reactive armor, stand-off plates, and hard-kill active protection systems can significantly reduce penetration by HEAT (or shaped-charge) warheads, characteristic kill mechanisms on most ATGMs.

Considerations such as tactics, specific deployment, and technology of each gun and upgrade impact on their effectiveness. These upgrades could apply to OPFOR portrayal of numerous systems in this document, especially in chapters for: infantry weapons (Chapter 1), infantry vehicles (Ch 2), tanks and assault vehicles (Ch 4), and antitank guns (Ch 5). Similar upgrades could be added to heavy reconnaissance vehicles (Ch 3). For more information see the subject white paper, which will be added on the TSD website.



## **Chapter 6**

### **Artillery**

This chapter provides the basic characteristics of selected artillery weapon systems either in use or readily available to the OPFOR. Therefore, the artillery systems discussed in this chapter are those likely to be encountered by U.S. forces in varying levels of conflict. The selection of artillery systems is not intended to be all-inclusive, rather a representative sampling of weapons and equipment supporting various military capabilities.

This update is divided into the following categories—artillery reconnaissance, towed artillery systems, mortar/gun-mortar systems, and multiple rocket launchers. Later updates of this guide will include data sheets addressing the aforementioned categories as well as ground mounted mortars, artillery locating radars, sound and flash systems, and surface-to-surface missiles (SSMs).

Questions and comments on data listed in this chapter should be addressed to:

**Mr. Walter L. Williams**

DSN: 552-7923 Commercial (913) 684-7923

e-mail address: [williamw@leavenworth.army.mil](mailto:williamw@leavenworth.army.mil)

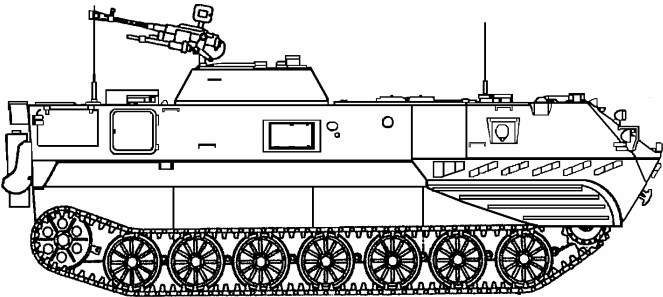

## Russian Artillery Command and Reconnaissance Vehicle 1V13

	<b>Weapons &amp; Ammunition Types</b>  <b>12.7-mm DShK MG</b>	<b>Typical Combat Load</b>  <b>500</b>
<p><b>SYSTEM</b>  <b>Alternative Designations:</b> M1974-1  <b>Date of Introduction:</b> 1974  <b>Proliferation:</b> At least 1 country  <b>Description:</b>  Crew: 6  Platform (chassis): MT-LBu  Combat Weight (mt): 15.7  Chassis Length Overall (m): 7.62  Height Overall (m): 2.72  Width Overall (m): 2.85</p> <p><b>Automotive Performance:</b>  Engine Type: YaMZ-238, 240 hp diesel  Cruising Range (km): 500 km  Speed (km/h):      Max Road: 60      Max Off-Road: 26      Cross-Country: INA      Max Swim: 4.5  Fording Depths (m): Amphibious</p> <p><b>Radio:</b> R-123M radio (3 each)</p> <p><b>Protection:</b>  Armor, Turret Front (mm): 20  Armor Turret Top (mm): INA  Armor Hull (mm): 15  NBC Protection System: Yes  Smoke Equipment: No</p>	<p><b>ARMAMENT</b>  <b>Caliber, Type, Name:</b> 12.7-mm heavy machinegun, DShK  <b>Mount Type:</b> Pintle  <b>Direct Fire Range (m):</b> 1,500  <b>Max Effective Range (m):</b>      Day: 1,500      Night: N/A  <b>Fire on Move:</b> Yes  <b>Rate of Fire (rpm):</b> 80-100 (practical)</p> <p><b>VARIANTS</b>  <b>1V13M:</b> INA</p> <p><b>SENSORS/COMPONENTS</b>  <b>Navigation:</b> 1T121-M Navigation System</p> <p><b>Fire direction:</b>  Automated: APK automated firing data receiver  Manual: PUO-7</p> <p><b>Other equipment:</b> DSP-30 rangefinder, K-1 collimator, roof mounted periscopic aiming circle, VOP-7 vision blocks and driver's periscopes.</p>	

### NOTES

The MT-LBu-based 1V12 *Maschina* ACRV set was first noted in 1974. The set provides the command and control vehicles for SP cannon battalions. The eight vehicle set consists of three 1V13 battery senior officer's vehicles, three 1V14 battery commander's vehicles, one 1V15 battalion commander's vehicle, and one 1V16 battalion FDC/chief of staff's vehicle. The 1V12M *Faltset* ACRV set is a modernized version of the system. The installation of an upgraded electronics package in the vehicles necessitated the requirement for an external-mounted power generator (the 1V12 *Machina* ACRV generator was mounted internally). In addition to freeing a small amount of space inside the vehicle, the external mounting reduces the internal noise level.

The ACRV 1V13 is the battery FDC of the 1V12 ACRV Complex. The battery senior officer, assisted by fire direction and communications personnel mans the vehicle. It has direct radio communications with the battery COP, the battalion COP, and the battalion FDC. The vehicle is equipped with a land navigation system and has a roof mounted periscopic aiming circle. The roof mounted periscopic aiming circle allows the battery senior officer the ability to lay the howitzers for direction from within his vehicle. There is no battlefield observation equipment present on the 1V13.

## Russian Artillery Command and Reconnaissance Vehicle 1V14/1V15

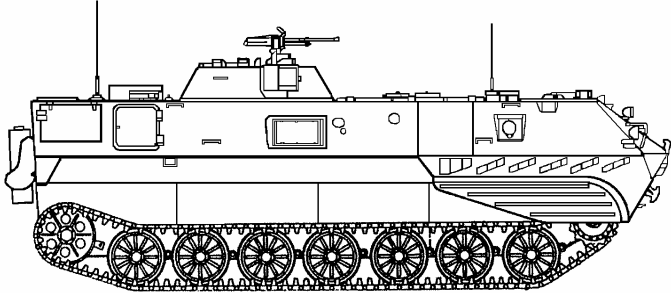
	<p><b>Weapons &amp; Ammunition Types</b></p> <p>7.62-mm MG</p>	<p><b>Typical Combat Load</b></p> <p>2,000</p>
<p><b>SYSTEM</b></p> <p><b>Alternative Designations:</b> M1974-2A (1V14), M1974-2B (1V15)</p> <p><b>Date of Introduction:</b> 1974</p> <p><b>Proliferation:</b> At least 1 country</p> <p><b>Description:</b></p> <p>Crew: 1V14 (6)/1V15 (7)</p> <p>Platform (chassis): MT-LBu</p> <p>Combat Weight (mt): 15.7</p> <p>Chassis Length Overall (m): 7.26</p> <p>Height Overall (m): 2.72</p> <p>Width Overall (m): 2.85</p> <p><b>Automotive Performance:</b></p> <p>Engine Type: YaMZ-238, 240hp diesel</p> <p>Cruising Range (km): 500 km</p> <p>Speed (km/h):</p> <ul style="list-style-type: none"> <li>Max Road: 60</li> <li>Max Off-Road: 26</li> <li>Cross-Country: INA</li> <li>Max Swim: 4.5</li> </ul> <p>Fording Depths (m): Amphibious</p> <p><b>Radios:</b></p> <ul style="list-style-type: none"> <li>1V14: R-123M (3 each), R-107M (1 each)</li> <li>1V15: R-123M (2 each), R-107M (1 each), R-111 (1 each), R-130M (1 each)</li> </ul>	<p><b>Protection:</b></p> <p>Armor, Turret Front (mm): 20</p> <p>Armor Turret Top (mm): INA</p> <p>Armor Hull (mm): 15</p> <p>NBC Protection System: Yes</p> <p>Smoke Equipment: No</p> <p><b>ARMAMENT</b></p> <p><b>Caliber, Type, Name:</b> 7.62-mm machinegun, PKT</p> <p><b>Mount Type:</b> Pintle</p> <p><b>Direct Fire Range (m):</b> 1,500</p> <p><b>Max Effective Range (m):</b></p> <ul style="list-style-type: none"> <li>Day: 1,000</li> <li>Night: N/A</li> </ul> <p><b>Fire on Move:</b> Yes</p> <p><b>Rate of Fire (rpm):</b> 650 (cyclic), 2-10 round bursts</p> <p><b>VARIANTS</b></p> <p><b>1V14M/1V15M:</b> INA</p> <p><b>SENSORS/COMPONENTS</b></p> <p><b>Navigation:</b> 1T121-M Navigation System</p> <p><b>Fire direction:</b></p> <ul style="list-style-type: none"> <li>Automated: 1V520.</li> <li>Manual: PUO-7</li> </ul> <p><b>Other equipment:</b> 1D15 laser rangefinder, DSP-30 rangefinder, 1PN44 day/night sight, PAB-2AM aiming circle, DS-1 stereoscopic rangefinder, VOP-7 vision blocks and driver's periscopes.</p>	

### NOTES

The MT-LBu-based 1V12 *Maschina* ACRV set was first noted in 1974. The set provides the command and control vehicles for SP cannon battalions. The eight vehicle set consists of three 1V13 battery senior officer's vehicles, three 1V14 battery commander's vehicles, one 1V15 battalion commander's vehicle, and one 1V16 battalion FDC/chief of staff's vehicle. The 1V12M *Faltset* ACRV set is a modernized version of the system. The installation of an upgraded electronics package in the vehicles necessitated the requirement for an external-mounted power generator (the 1V12 *Machina* ACRV generator was mounted internally). In addition to freeing a small amount of space inside the vehicle, the external mounting reduces the internal noise level.

The ACRV 1V14 and ACRV 1V15 are the battery and battalion commander's vehicles of the 1V12 ACRV Complex. Both vehicles are equipped with the 1T121 land navigation system, a 1D15 laser rangefinder, and the 1PN44 day/night sight mounted in a basketed turret. The observer uses an analog coordinate converter to translate the polar location data when determining rectangular target coordinates. The 1V14 has an internal power generator. The 1V15 can be distinguished from the 1V14 by the external antenna bracket on the rear of the vehicle. The 1V520 fire direction computer may be transported internally and dismantled at a command observation post. The artillery commander, assisted by target acquisition, fire direction and communications personnel mans the vehicle. The artillery commander decides how to attack targets of opportunity and targets relayed to him by the supported maneuver unit.

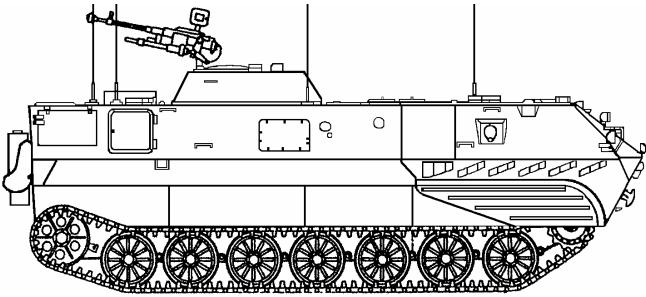

## Russian Artillery Command and Reconnaissance Vehicle 1V16

	<b>Weapons &amp; Ammunition Types</b>  <b>12.7-mm DShK MG</b>	<b>Typical Combat Load</b>  <b>500</b>
<p><b>SYSTEM</b>  <b>Alternative Designations:</b> M1974-3  <b>Date of Introduction:</b> 1974  <b>Proliferation:</b> At least 1 country  <b>Description:</b>  Crew: 7  Platform (chassis): MT-LBu  Combat Weight (mt): 15.7  Chassis Length Overall (m): 7.26  Height Overall (m): 2.72  Width Overall (m): 2.85</p> <p><b>Automotive Performance:</b>  Engine Type: YaMZ-238, 240hp diesel  Cruising Range (km): 500 km  Speed (km/h):      Max Road: 60      Max Off-Road: 26  Cross-Country: INA  Max Swim: 4.5  Forcing Depths (m): Amphibious</p> <p><b>Radios:</b>  R-123M (2 each), R-111M (1 each),  R-130M (1 each, R-326 receiver (1 each)</p>	<p><b>Protection:</b>  Armor, Turret Front (mm): 20  Armor Turret Top (mm): INA  Armor Hull (mm): 15  NBC Protection System: Yes  Smoke Equipment: No</p> <p><b>ARMAMENT</b>  <b>Caliber, Type, Name:</b> 12.7-mm HMG, DShK  <b>Mount Type:</b> Pintle  <b>Direct Fire Range (m):</b> 1,500  <b>Max Effective Range (m):</b>      Day: 1,500      Night: N/A  <b>Fire on Move:</b> Yes  <b>Rate of Fire (rpm):</b> 80-100 (practical)</p> <p><b>VARIANTS</b>  <b>1V16M:</b> INA</p> <p><b>SENSORS/COMPONENTS</b>  <b>Fire direction:</b>  Automated: 9V59  Manual: PUO-7</p>	

### NOTES

The MT-LBu-based 1V12 *Maschina* ACRV set was first noted in 1974. The set provides the command and control vehicles for SP cannon battalions. The eight vehicle set consists of three 1V13 battery senior officer's vehicles, three 1V14 battery commander's vehicles, one 1V15 battalion commander's vehicle, and one 1V16 battalion FDC/chief of staff's vehicle. The 1V12M *Faltset* ACRV set is a modernized version of the system. The installation of an upgraded electronics package in the vehicles necessitated the requirement for an external-mounted power generator (the 1V12 *Machina* ACRV generator was mounted internally). In addition to freeing a small amount of space inside the vehicle, the external mounting reduces the internal noise level.

The 1V16 is the simplest of the vehicles in the 1V12 ACRV Complex and serves as the battalion FDC/chief of staff's vehicle. Normally, the battalion chief of staff, assisted by fire direction and communication personnel mans the vehicle. It has neither battlefield observation optics nor a navigation system. However, the vehicle is equipped with the standard VOP-7 vision blocks and driver's periscopes. It is equipped with extra radios and has an extendable antenna mast mounted on the vehicle rear. The 9V59 fire-direction computer is mounted in the vehicle.

The 9V59 fire-control computer comes in several different models believed to be designated as the 9V59-1, -2, and -3. For example, the 9V59-2 is associated with 152-mm artillery units. The 9V59 fire-control computer is probably a 4-bit computer and, although quite rugged, is assessed to have a low mean time between failures because of a large number of discrete components. The 1V510 is assessed to be a replacement for the 9V59 fire-control computer. The 1V510 is capable of performing survey calculations and technical firing data. The system is assessed to be 33% faster than the 9V59.

## Russian Artillery Command and Reconnaissance Vehicle 1V18/1V19

	Weapons & Ammunition Types	Typical Combat Load
<p><b>SYSTEM</b>  <b>Alternative Designations:</b> M1979-2A (1V17), M1979-2B (1V18)  <b>Date of Introduction:</b> 1979  <b>Proliferation:</b> At least 1 country  <b>Description:</b>            Crew: 6            Platform (chassis): BTR-60PB            Combat Weight (mt): 10.1            Chassis Length Overall (m): 7.22            Height Overall (m): 2.06            Width Overall (m): 2.82</p> <p><b>Automotive Performance:</b>            Engine Type: 2 GAZ-49B 90 hp(180 hp total) in-line, water-cooled gasoline            Cruising Range (km): 500 km            Speed (km/h):                Max Road: 80                Max Off-Road: 60                Cross-Country: INA                Max Swim: 10            Fording Depths (m): Amphibious</p> <p><b>Radio:</b>            1V18: R-123M (3 each), R-107M (1 each)            1V19: R-123M (2 each), R-107M (1 each), R-111 (1 each), R-130M (1 each)</p> <p><b>Protection:</b>            Armor, Turret Front (mm): INA            Armor Turret Top (mm): INA            Armor Hull (mm): INA            NBC Protection System: Yes            Smoke Equipment: No</p>	<p><b>VARIANTS</b> None</p> <p><b>SENSORS/COMPONENTS</b>  <b>Navigation:</b> 1T121-M Navigation System</p> <p><b>Fire direction:</b>            Automated: 1V520            Manual: PUO-7</p> <p><b>Other equipment:</b> 1D15 laser rangefinder, 1PN44 day/night sight, PAB-2AM aiming circle, DS-1 stereoscopic rangefinder</p>	

### NOTES

In 1979, the Soviet Union introduced a similar wheeled ACRV set for multiple rocket launcher and towed cannon units. The eight-vehicle set consists of three 1V110 battery senior officer's vehicles, three 1V18 battery commander's vehicles, one 1V19 battalion commander's vehicle, and one 1V111 battalion chief of staff's vehicle. Early versions of the 1V17 ACRV set included a 1V111 equipped with a modified ZIL-130-mounted 9S77M instead of the ZIL-131. There have been no upgrades to the 1V17 like that of the 1V12 to 1V12M.

The ACRV 1V18 and 1V19 are the battery and battalion commander's vehicles of the 1V17 ACRV Complex. Both vehicles are equipped with the 1T121 land navigation system, a 1D15 laser rangefinder, and the 1PN44 day/night sight. The observer uses an analog coordinate converter to translate the polar location data when determining rectangular target coordinates. The 1V520 fire direction computer may be transported internally and dismantled at a command observation post.

## Russian Artillery Command and Reconnaissance Vehicle 1V110

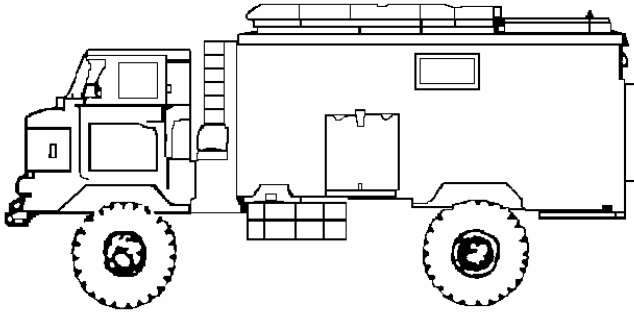
	<b>Weapons &amp; Ammunition Types</b>	<b>Typical Combat Load</b>
<p><b>SYSTEM</b>  <b>Alternative Designations:</b> M1979-1  <b>Date of Introduction:</b> 1979  <b>Proliferation:</b> At least 1 country  <b>Description:</b>  Crew: 5  Platform (chassis): GAZ-66B, 4x4 wheeled, Box Body Van  Combat Weight (mt): 3.6  Chassis Length Overall (m): 5.66  Height Overall (m): 2.44  Width Overall (m): 2.34</p> <p><b>Automotive Performance:</b>  Engine Type: ZMZ-66, 115 hp V-8, water-cooled, gasoline  Cruising Range (km): 875 km  Speed (km/h):      Max Road: 87      Max Off-Road: 35      Cross-Country: INA  Fording Depths (m): .80</p> <p><b>Radio:</b> R-123M radio (3 each)</p>	<p><b>VARIANTS</b>  None</p> <p><b>SENSORS/COMPONENTS</b>  <b>Navigation:</b> See NOTES.</p> <p><b>Fire direction:</b> No computation system is installed. The vehicle is equipped with the APK automated firing data receiver.</p> <p><b>Other equipment:</b> DSP-30 laser rangefinder, K-1 collimator</p>	

### NOTES

In 1979, the Soviet Union introduced a similar wheeled ACRV set for multiple rocket launcher and towed cannon units. The eight-vehicle set consists of three 1V110 battery senior officer's vehicles, three 1V18 battery commander's vehicles, one 1V19 battalion commander's vehicle, and one 1V111 battalion chief of staff's vehicle. Early versions of the 1V17 ACRV set included a 1V111 equipped with a modified ZIL-130-mounted 9S77M instead of the ZIL-131. There have been no upgrades to the 1V17 like that of the 1V12 to 1V12M.

The ACRV 1V110 battery FDC serves the same function as the ACRV 1V13 (1V12 ACRV Complex) and is similarly equipped. However, the land navigation system is a different model.

## Russian Artillery Command and Reconnaissance Vehicle 1V111

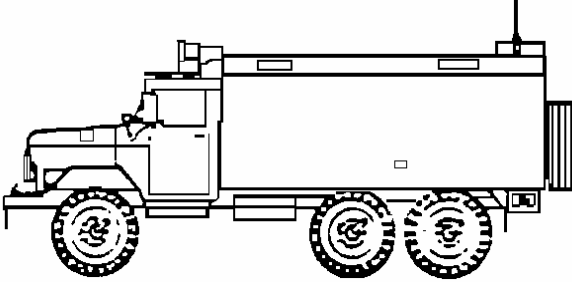
	<p><b>Weapons &amp; Ammunition Types</b></p>	<p><b>Typical Combat Load</b></p>
<p><b>SYSTEM</b>  <b>Alternative Designations:</b> M1979-3  <b>Date of Introduction:</b> 1979  <b>Proliferation:</b> At least 1 country  <b>Description:</b>  Crew: 7  Platform (chassis): ZIL 131 6x6 box body van  Combat Weight (mt): 6.7  Chassis Length Overall (m): 6.90  Height Overall (m): 2.48  Width Overall (m): 2.50</p> <p><b>Automotive Performance:</b>  Engine Type: ZIL 131 61, 150 hp V-8, water-cooled, gasoline  Cruising Range (km): 850 km  Speed (km/h):      Max Road: 80      Max Off-Road: 35      Cross-Country: INA  Fording Depths (m): 1.4</p> <p><b>Radio:</b> R-111M (1 each), R-123M (2 each) radios; R-130M short-wave radio (1 each), and R-326 receiver (1 each)</p>	<p><b>VARIANTS</b> None</p> <p><b>SENSORS/COMPONENTS</b>   <b>Fire direction:</b> 9V59 fire-control computer</p>	

### NOTES

In 1979, the Soviet Union introduced a similar wheeled ACRV set for multiple rocket launcher and towed cannon units. The eight-vehicle set consists of three 1V110 battery senior officer's vehicles, three 1V18 battery commander's vehicles, one 1V19 battalion commander's vehicle, and one 1V111 battalion chief of staff's vehicle. Early versions of the 1V17 ACRV set included a 1V111 equipped with a modified ZIL-130-mounted 9S77M instead of the ZIL-131. There have been no upgrades to the 1V17 like that of the 1V12 to 1V12M.

The ACRV 1V111 battalion FDC/chief of staff's vehicle serves the same function as the ACRV 1V16 (1V12 ACRV Complex) and houses the fire-direction computer. Like the 1V16, it is the simplest of the vehicles in the 1V17 ACRV Complex and lacks a land navigation system.

## Russian Artillery Command and Reconnaissance Vehicle 1V119

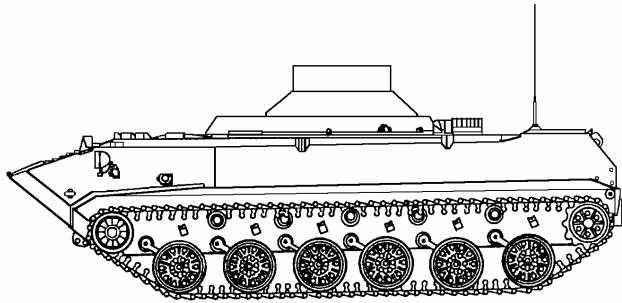
 <p data-bbox="488 617 727 638">Artist Drawing From Photo</p>	<b>Weapons &amp; Ammunition Types</b>	<b>Typical Combat Load</b>
<p><b>SYSTEM</b>  <b>Alternative Designations:</b> 1V119 Spekt  <b>Date of Introduction:</b> 1981  <b>Proliferation:</b> At least 1 country  <b>Description:</b>            Crew: 6            Platform (chassis): BMD-1            Combat Weight (mt): 6.7            Chassis Length Overall (m): 5.88            Height Overall (m): 1.97            Width Overall (m): 2.63</p> <p><b>Automotive Performance:</b>            Engine Type: Type 5D20, 240 hp V-6, liquid-cooled diesel            Cruising Range (km): 500 km            Speed (km/h):                Max Road: 61                Max Off-Road: 35                Cross-Country: INA                Max Swim: 10            Fording Depths (m): Amphibious</p> <p><b>Radio:</b> R-123M (3 each), R-107M (1 each)</p> <p><b>Protection:</b>            Armor, Turret Front (mm): INA            Armor Turret Top (mm): INA            Armor Hull (mm): 15            NBC Protection System: Yes            Smoke Equipment: No</p>	<p><b>VARIANTS</b> None</p> <p><b>SENSORS/COMPONENTS</b>  <b>Navigation:</b> 1T121-M Navigation System</p> <p><b>Fire direction:</b>            Automated: 1V520.            Manual: PUO-7</p> <p><b>Other equipment:</b> 1D15 laser rangefinder, DSP-30 rangefinder, 1PN44 day/night sight, PAB-2AM aiming circle, DS-1 stereoscopic rangefinder, VOP-7 vision blocks and driver's periscopes.</p>	

### NOTES

The ACRV 1V119 is associated with the deployment of the 2S9 Nona-S 120-mm Combination Gun and can be parachute landed with airborne troops. The 1V119's sensor and fire direction package is similar to the ACRV 1V14. The 1V118 Reostat is classified as a command and reconnaissance vehicle and is not associated with an ACRV complex.

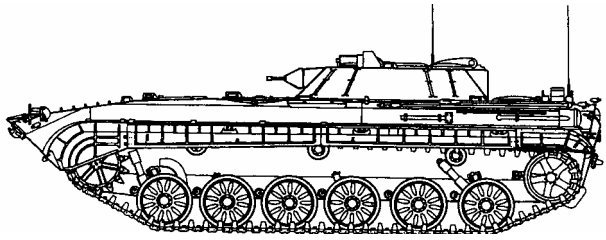

## Russian Artillery Mobile Reconnaissance Vehicle PRP-3/PRP-4M

	<p><b>Weapons &amp; Ammunition Types</b></p> <p>7.62 PKT MG</p>	<p><b>Typical Combat Load</b></p> <p>2,000</p>
<p><b>SYSTEM</b>  <b>Alternative Designations:</b> None  <b>Date of Introduction:</b> 1975  <b>Proliferation:</b> At least 1 country  <b>Description:</b>  Crew: 5  Platform (chassis): BMP-1  Combat Weight (mt): 13.2  Chassis Length Overall (m): 6.73  Height Overall (m): 2.14  Width Overall (m): 2.94</p> <p><b>Automotive Performance:</b>  Engine Type: 293-hp Diesel  Cruising Range (km): 600  Speed (km/h):      Max Road: 60      Max Off-Road: 35      Cross-Country: INA      Max Swim: 7  Forcing Depths (m): Amphibious</p> <p><b>Radio:</b> R-173</p> <p><b>Protection:</b>  Armor, Turret (mm): 23  Armor Hull (mm): 19  Self-Entrenching Blade: No  NBC Protection System: Yes  Smoke Equipment: Vehicle engine exhaust smoke system (VEESS)</p> <p><b>ARMAMENT</b>  <b>Main Armament:</b>  Caliber, Type, Name: 7.62-mm machinegun PKT  Mount Type: coax  Direct Fire Range (m): 1,300  Max Effective Range (m):      Day: 1,000 / 400-500 on the move      Night: 800  Fire on Move: Yes  Rate of Fire (rpm): 600 cyclic in 2-10 round bursts</p>	<p><b>VARIANTS</b>  None</p> <p><b>SENSORS/COMPONENTS</b></p> <p><b>PRP-3 Sensors/Components:</b>  Navigation: 1G25 gyrocompass and 1G13 gyro course indicator  Fire Direction: 1V520 Ballistic Computer  Right Side Sensors: 1PN61 Night Vision sensor and 1D11 Laser Rangefinder  Left Side Sensors: None  Radar: 1RL126 Small Fred Radar      Operating Band: K (36.2 – 37.0 GHz)      Detection Range: 20 km      Tracking Range: 7–12 km</p> <p><b>PRP-4 Sensors/Components:</b>  Navigation: 1G25-1 gyrocompass and 1G13 gyro course indicator  Fire Direction: 1V520 Ballistic Computer  Right Side Sensors: 1PN61 Night Vision sensor and 1D11M-1 Laser Rangefinder  Left Side Sensors: 1PN59 Thermal Imaging Night Vision Device and 1D14 Laser Rangefinder  Radar: 1RL133M-1 Tall Mike Radar      Operating Band: I (9.0 GHz)      Detection Range (personnel): 3.0 km      Detection Range (vehicle): 12 km</p>	

### NOTES

The PRP-4M has improved 1PN71 night vision sensors. The vehicles are also equipped with a NBC filtration and overpressure system.

## Russian Battlefield Surveillance Radar SNAR 10

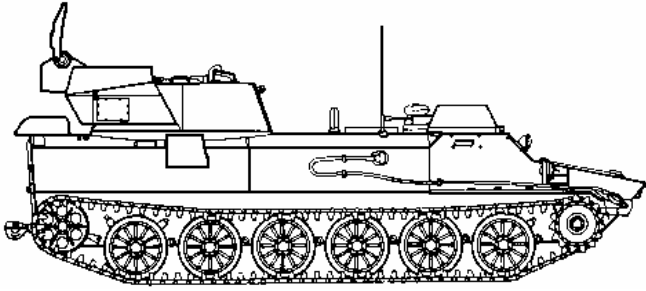
 <p style="text-align: center;">SNAR 10 with radar raised and the turret mounted 7.62 PKT MG pointed to the rear</p>	<p style="text-align: center;"><b>Weapons &amp; Ammunition Types</b></p> <p style="text-align: center;">7.62 PKT MG</p>	<p style="text-align: center;"><b>Typical Combat Load</b></p> <p style="text-align: center;">2,000</p>
<p><b>SYSTEM</b>  <b>Alternative Designations:</b> BIG FRED, 1RL232, 1RL232-1  <b>Date of Introduction:</b> 1975  <b>Proliferation:</b> At least 12 countries  <b>Description:</b>  Crew: 5  Platform (chassis): MT-LBu  Combat Weight (mt): 12.6  Chassis Length Overall (m): 7.62  Height Overall (m): 2.72 (est.)  Width Overall (m): 2.85</p> <p><b>Automotive Performance:</b>  Engine Type: YaMZ-238, 240 hp diesel  Cruising Range (km): 500 km  Speed (km/h):      Max Road: 60      Max Off-Road: 26      Cross-Country: INA      Max Swim: N/A  Forcing Depths (m): INA</p> <p><b>Radio:</b> R-123M radio, 2 each</p> <p><b>Protection:</b>  Armor, Turret Front (mm): 20  Armor Turret Top (mm): INA  Armor Hull (mm): 15  NBC Protection System: Yes  Smoke Equipment: No</p>	<p><b>ARMAMENT</b>  <b>Main Armament:</b>  Caliber, Type, Name: 7.62-mm machinegun PKT  Mount Type: Coax  Direct Fire Range (m): 1,300  Max Effective Range (m):      Day: 1,000 / 400-500 on the move      Night: 800  Fire on Move: Yes  Rate of Fire (rpm): 600 cyclic in 2-10 round bursts</p> <p><b>VARIANTS</b>  None</p> <p><b>RADAR</b>  <b>Performance Capability</b>  Antenna Type: Parabolic  Operating Band: K (34.55 to 35.25 GHz)  Detection Range Against Moving Targets, Without MTI (km):      Vehicles: 16.0      Ships: 30.0      Shell Impact: 10.0  Detection Range Against Moving Targets, With MTI (km):      Vehicles: 10.0  Emplacement Time (minutes): 5.0  Displacement Time (minutes): 5.0</p>	

### NOTES

The primary mission of the Big Fred radar is to detect and track both moving ground and water surface targets. Additionally, the radar can be used to provide friendly fire correction data to artillery units. The SNAR 10 is not capable of amphibious operations (unlike other members of the MT-LBu family) due to the heavy turret. The vehicles are also equipped with a NBC filtration and overpressure system.



## Russian Artillery Locating Radar ARK-1M Rys

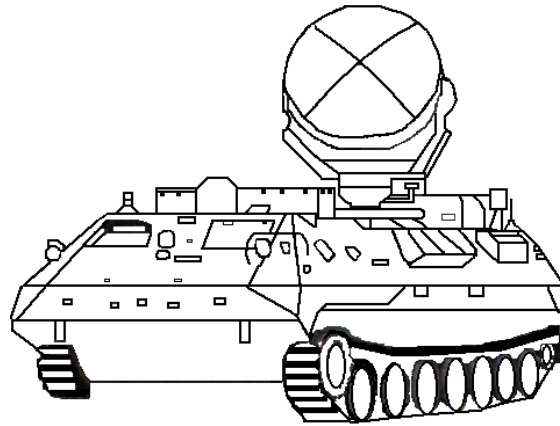

### SYSTEM

**Alternative Designations:** None

**Date of Introduction:** 1986

**Proliferation:** At least 1 country

#### Description:

Crew: 4

Platform (chassis): MT-LBu

Combat Weight (mt): 15.7

Chassis Length Overall (m): 7.62

Height Overall (m): 2.72

Width Overall (m): 2.85

#### Automotive Performance:

Engine Type: YaMZ-238, 240 hp diesel

Cruising Range (km): 500 km

Speed (km/h):

Max Road: 60

Max Off-Road: 26

Cross-Country: INA

Max Swim: 4.5

Fording Depth (m): Amphibious

**Radio:** R-123M radio

### Protection:

Armor, Turret Front (mm): 20

Armor Turret Top (mm): INA

Armor Hull (mm): 15

NBC Protection System: Yes

Smoke Equipment: No

### RADAR

#### Antenna:

Antenna Type: Reflector

#### Receiver:

Noise Figure (dB): 8.0

#### Performance Capability

Detection Range (km):

Mortar: 13.0

Gun/howitzer: 8.0

MLRS: 25.0

Tactical Missile: 30.0

Max Number of Targets (tracks/min): 3

Emplacement Time (minutes): 5.0

Displacement Time (minutes): 5.0

### NOTES

The ARK-1M power supply is located on the rear of the vehicle.

## Chinese Artillery Locating Radar BL-904

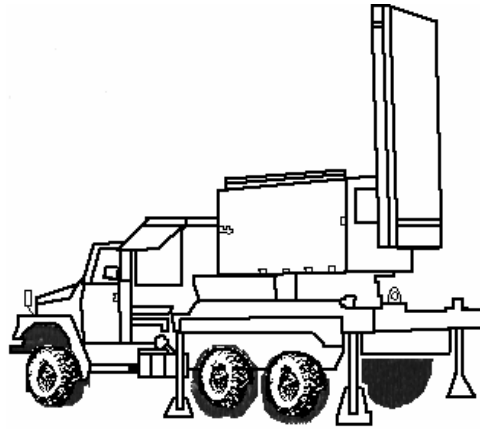

### SYSTEM

**Alternative Designations:** Type 704 and Type 704M

**Date of Introduction:** 1991

**Proliferation:** Ready for production

#### Description:

Crew: 4

Platform (chassis): Dong Feng EQ2100E6D, 2500 kg, 6x6

Combat Weight (mt): 11.5

Chassis Length Overall (m): 6.84 (est.)

Height Overall (m): INA

Width Overall (m): 2.40 (est.)

#### Automotive Performance:

Engine Type: Cummins 6BT5.9 Diesel

Cruising Range (km): INA

Speed (km/h):

Max Road: 85

Max Off-Road: INA

Cross-Country: INA

Max Swim: N/A

Fording Depths (m): 0.9

**Radio:** INA

### RADAR

#### Antenna:

Antenna Type: Phased-Array

Antenna Gain (dBi): 43.3

Mode: Search

Scan Method: Electronic

Scan Type: Sector (azimuth)

Scan Width (deg):

Narrow: 30.0

Wide: 90.0

Mode: Verification

Scan Method: Electronic

Scan Type: Nonperiodic

Mode: Track

Scan Method: Electronic

Scan Type: Nonperiodic

#### Transmitter:

Transmitter Type: Traveling Wave Tube

RF minimum (GHz): 8.0

RF maximum (GHz): 12.0

Mode: All

#### Receiver:

Noise Figure (dB): 8.0

Single Pulse Processing: Coherent

Multiple Pulse Processing: Doppler Filters

#### Performance Capability

Detection Range, Wide Scan Mode (km):

82-mm Mortar: 15.0

122-mm Howitzer: 16.0

155-mm Howitzer: 18.0

Detection Range, Narrow Scan Mode (km):

122-mm Howitzer: 20.0

155-mm Howitzer: 25.0

273-mm Rocket: 30.0

Max Number of Targets (tracks/min): 8

Emplacement Time: 10.0 (2 vehicle configuration)

Displacement Time: 10.0 (2 vehicle configuration)

### NOTES

Versions of the BL-904 have been offered for sale by NORINCO Industries since at least 1991. While China's army is a prime candidate for the deployment of the BL-904, there is no evidence of it being fielded to operational units. Additionally, the system has not been exported. It was initially named the Type 704. Later an improved-performance version was called the Type 704M. The system is similar to the U.S. AN/TPQ-36 in both appearance and performance (as claimed by the manufacturer). The system can be used to track friendly artillery fire. The system calculates the impact error of friendly artillery rounds and provides automatic correction parameters for increased accuracy. The radar system is employed as a two-vehicle set. One vehicle carries the radar while the other vehicle carries the command cabin and the system power supply. The command cabin contains the operation and control panel, data processing equipment, computer monitors/displays, etc.

## British Artillery Locating Radar Cymbeline

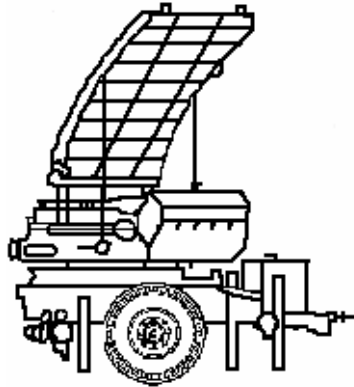

**Alternative Designations:** MUFAR/PIF-518

**Date of Introduction:** 1973

**Proliferation:** At least 3 countries

**Description:**

Crew: 3

Platform (chassis): MK 1 version trailer

Combat Weight (kg): 980

Chassis Length Overall (m): 2.90 (transit)

Height Overall (m): 1.80 (transit)

Width Overall (m): 1.78 (transit)

**Automotive Performance:**

Cruising Range (km): INA

Speed (km/h):

    Max Road: INA

    Max Off-Road: INA

    Cross-Country: INA

    Max Swim: N/A

Fording Depths (m): .75

**Radio:** INA

**RADAR**

**Antenna**

Antenna Type: Reflector

Search Mode:

    Scan Method: Mechanical

    Scan Type: Sector

    Scan Width (°): 40

**Transmitter**

Transmitter Type: INA

RF Minimum (GHz): 8.0

RF Maximum (GHz): 12.0

Mode: Search

**Receiver**

Noise Figure (dB): INA

Multiple Pulse Processing: MTI Optional

**Performance Capability**

Detection Range (km):

    Min: 1.0

    Max: 20.0

Max Number of Targets (tracks/min): 3

Emplacement Time (min): 10.0

Displacement Time (min): 10.0

**NOTES**

The primary power source for the Cymbeline radar is a Wankel-engined driven generator delivering 1.5 kW at 28 volts d.c. The generator is capable of operating for a period of eight hours prior to refueling. Normally, the radar is transported on a two-wheeled trailer towed behind a prime mover like a Land Rover (or similar type vehicle). Four men for short distances can carry the radar. Additionally, the Cymbeline radar may be mounted on a self-propelled vehicle like the British FV432 Armored Personnel Carrier.



## Russian Artillery Locating Radar IL-219

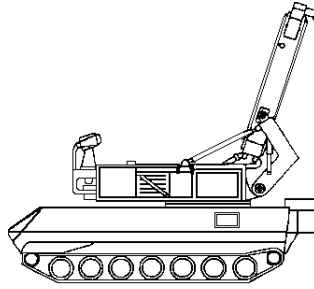

**Alternative Designations:** Zoopark-1

**Date of Introduction:**

**Proliferation:** At least 1 country

**Description:**

Crew: 3

Platform (chassis): MT-Lbu

Combat Weight (mt): INA

Chassis Length Overall (m): 7.62

Height Overall (m): 2.72

Width Overall (m): 2.85

**Automotive Performance:**

Engine Type: YaMZ-238, 240 hp diesel

Cruising Range (km): 500

Speed (km/h):

Max Road: 60

Max Off-Road: 26

Cross-Country: INA

Max Swim: 4.5

Fording Depths (m): Amphibious

**Radio:** R-123M radio

**RADAR**

**Antenna**

Antenna Type: Phased-Array

Antenna Gain (dBi): 40.0

Search Mode:

Scan Method: Electronic

Scan Type: Sector

Scan Width (°): 60

Verification Mode:

Scan Method: Electronic

Scan Type: Nonscanning

Scan Width (°): N/A

Track Mode:

Scan Method: Electronic

Scan Type: Nonperiodic

Scan Width (°): 6 (azimuth - nominal value indicated, equal to 10% of the maximum scan)

Scan Width (°): 4 (elevation - nominal value indicated, equal to 10% of the maximum scan)

**Transmitter**

Transmitter Type: INA

RF Minimum (GHz): 6.0

RF Maximum (GHz): 8.0

Mode: All

**Receiver**

Noise Figure (dB): 5.0

Single Pulse Processing: INA

Multiple Pulse Processing: INA

**Performance Capability**

Detection Range (km):

81-mm Mortar: 12.0

120-mm Mortar: 15.0

105-mm Howitzer: 8.0

155-mm Howitzer: 10.0

122-mm Rocket: 12.0

220-mm Rocket: 20.0

Tactical Missile: 35.0

Max Number of Targets (tracks/min): 12

Emplacement Time (min): 5.0

Displacement Time (min): 5.0

### NOTES

The Zoopark-1 automated multifunctional reconnaissance and control complex consists of the IL259 radar mounted on a MT-LBu chassis, IL30 maintenance van on a URAL-43203 truck, and the trailer-mounted ED30-T230P-1RPM power station. The MT-Lbu engine driven generator allows for autonomous operation. The ED30-T230P-1RPM power station provides power during vehicle and radar maintenance.

The Zoopark-1 is capable of tracking friendly artillery fire. The system calculates the impact error of friendly artillery rounds and provides automatic correction parameters for increased accuracy. Additionally, the system is also capable of controlling (simultaneously) several remote piloted vehicles (RPVs) using an automatic screen indication with a topographic mapping of calculated and real RPV flight routes. The radar is capable of conducting air traffic control around an airfield or operating area. The radar tracks and establishes the current position of aircraft in the operating area of responsibility and provides real-time data transmission of data received to the air control center.

The antenna beam is electronically phase-steered in azimuth and elevation. The reflect-array is composed of 3328 phase shifters, space-fed by a monopulse horn located on the front side of the array and electronics enclosure. After coming into position, and after the array is raised from the travel position, it is rotated so that its boresight is centered in the assigned coverage sector. The search scan elevation angle is probably fixed, nominally at a low angle in the range of 30 to 50 mils. The search mode will be interrupted by verification and track mode scans during periods when targets are detected. Verification is most likely a non-scanning mode, with the beam pointed at the same elevation angle as the search scan. Also, verification may be repeated for some targets. During the track mode, the radar tracks the target by scanning in both azimuth and elevation.

## Ukrainian Artillery Locating Radar IL-220U

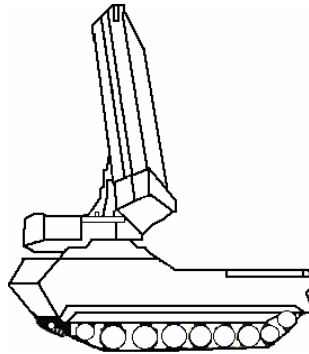

**Alternative Designations:** None  
**Date of Introduction:** Ready for production  
**Proliferation:** At least 1 country  
**Description:**  
Crew: INA  
Platform (chassis): GM-5951 ATV  
Combat Weight (mt): 39.6  
Chassis Length Overall (m): 9.42  
Height Overall (m): 3.35  
Width Overall (m): 3.25

**Automotive Performance:**  
Engine Type: INA  
Cruising Range (km): INA  
Speed (km/h):  
    Max Road: 60  
    Max Off-Road: INA  
    Cross-Country: INA  
    Max Swim: INA  
Fording Depths (m): INA

**Radio:** INA

### RADAR

#### Antenna

Antenna Type: Phased-Array  
Antenna Gain (dBi): INA  
Search Mode:  
    Scan Method: Electronic  
    Scan Type: Sector  
    Scan Width (°): 60

Verification Mode:  
    Scan Method: Electronic  
    Scan Type: Monopulse  
    Scan Width (°): 2.3 (single beam position is assumed)  
Track Mode:  
    Scan Method: Electronic  
    Scan Type: Monopulse  
    Scan Width (°): 6 (10% of the full azimuth sector assumed for a crossing trajectory)

### Transmitter

Transmitter Type: Traveling Wave Tube (TWT)  
RF Minimum (GHz): 3.0  
RF Maximum (GHz): 4.0  
Mode: Pulsed

### Receiver

Noise Figure (dB): 5.0  
Single Pulse Processing: Coherent  
Multiple Pulse Processing: MTI and Doppler Filters

### Performance Capability

Detection Range (km):  
    Mortar: 30.0  
    Tube Artillery: 20.0  
    Rocket: 40.0  
    Tactical Missile: 55.0  
Max Number of Targets (tracks/min):  
Emplacement Time (min): 5.0  
Displacement Time (min): 5.0

**NOTES** None

## Swedish Sound Ranging System SORAS 6

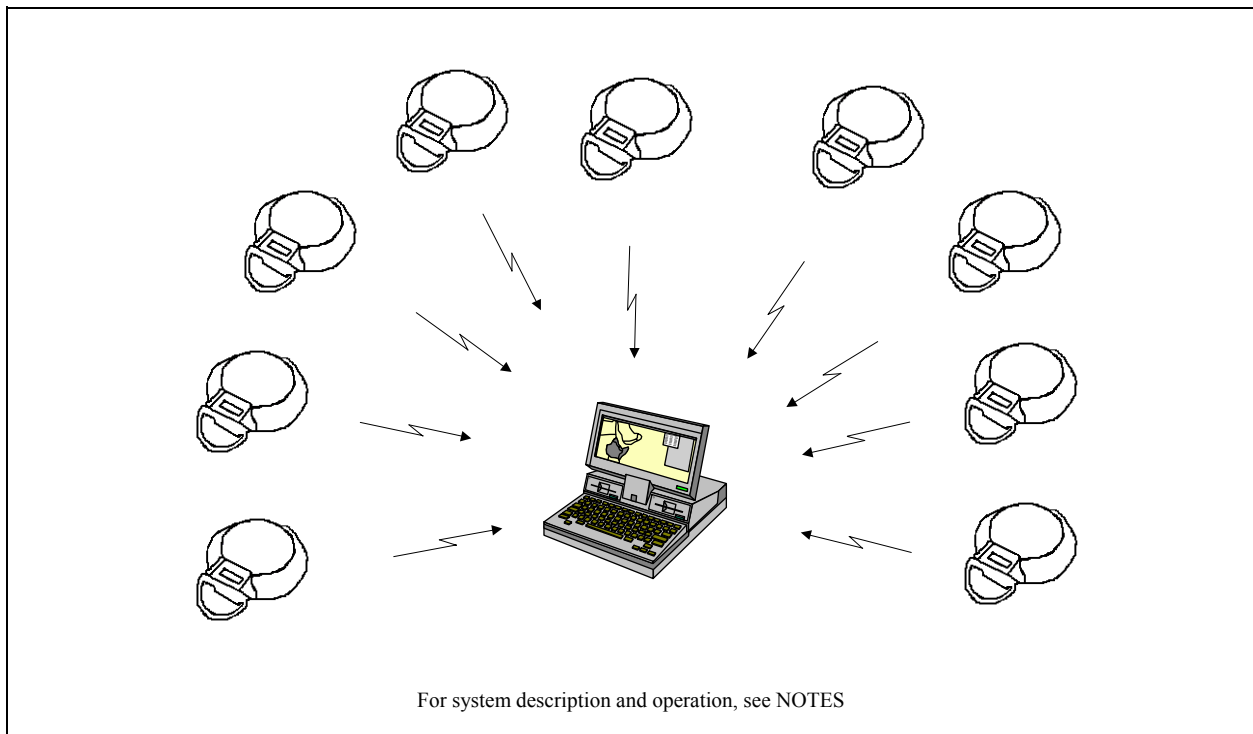

**Alternative Designations:** None  
**Date of Introduction:** INA  
**Proliferation:** At least 3 countries  
**Radio:** INA

**Calculator**

**Dimension:**

Length (mm): 400  
 Width (mm): 535  
 Height (mm): 565

Weight (kg): 52

Memory: 200 targets

Length of microphone cable (km): 1 - 8

Data Output: Display and Paper Strip

**Microphones**

Total Number: 9

**Dimension:**

Circumference (mm): 255  
 Height (mm): 52

Weight (kg): 2.8

Sound Frequency (Hz): 2 to 150

Length of microphone cable (km): 1 - 8

**Meteorological Unit**

Mast height (m): 15

Mast weight (kg): 40

**Performance Capability**

Detection Range (km):

Minimum: INA  
 Maximum: 30.0

Precision:

Under 10 km: 1% of the measured distance  
 Under 30 km: 2% of the measured distance

Emplacement Time (min): Varies

Displacement Time (min): Varies

**NOTES**

SOUND RANGING System (SORAS) 6 is a fully automated, EMP-protected, completely passive sound ranging system capable of accurately locating enemy gun positions. Each microphone is surveyed into position, and acoustically designates an azimuth to each firer. The computer terminal then calculates intersection points with the azimuths, for target locations. The system operates in temperatures ranging from  $-40^{\circ}$  to  $+55^{\circ}$  C. Normally, it takes between 2 and 45 seconds for the calculator to calculate target coordinates. But, the target coordinate calculation time depends on the number of sound sources within the same interval of time. Nine microphones are deployed in an area 8 km wide and 1-2 km deep. The microphone positions are determined by conventional surveying methods or by special equipment. An alarm on the calculator is automatically triggered if contact is broken with any of the microphones. Two people can connect the meteorological unit and raise the mast in 15 to 20 minutes.

The above schematic is representative of the system, and does not reflect the actual Soras 6 computer terminal and associated hardware.



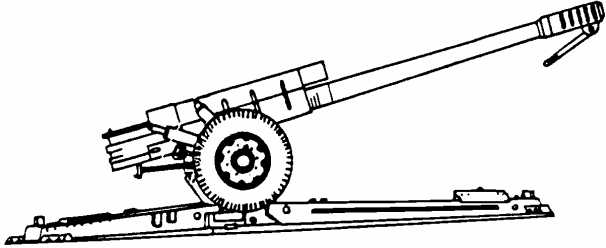

## Russian 122-mm Towed Howitzer D-30A

	<b>Weapons &amp; Ammunition Types</b>  <b>122-mm howitzer</b>  Frag-HE Smoke Illumination	<b>Typical Combat Load</b>
<p><b>SYSTEM</b>  <b>Alternative Designations:</b> 122-mm D-30A Lyagushka  <b>Date of Introduction:</b> 1963  <b>Proliferation:</b> At least 13 countries  <b>Description:</b>                      Crew: 5 (section of 6)                      Carriage: D-30                      Combat Weight (mt): 3.2                      Chassis Length Overall (m):                          Travel Position: 5.4                          Firing Position: INA                      Height Overall (m): 1.6                      Width Overall (m):                          Travel Position: 1.9                          Firing Position: INA                      Towing Speed (km/h):                          Max Road: 60                          Max Off-Road: 25                          Max Cross-Country:                              Fording Depths (m): .5                      Emplacement Time (min): 1.5                      Displacement Time (min): 3.5</p> <p><b>Prime Mover:</b> MT-LB; Ural-375, or equivalent</p> <p><b>ARMAMENT</b>  <b>Main Armament:</b>                      Caliber, Type, Name: 122-mm, 2A18M canon                      Barrel Length (cal): 38 (approximately)                      Rate of Fire (rpm):                          Burst: 8                          Normal: 6                          Sustained: 4                      Loader Type: Semi-automatic                      Breech Type: Vertical sliding wedge                      Muzzle Brake Type: Multi-baffle                      Traverse (°):                          Left: 360                          Right: 360                          Total: 360                      Elevation (°) (-/+): -7/+70°</p>	<p><b>FIRE CONTROL</b>  <b>Indirect Fire:</b> PG-1M Panoramic Telescope (PANTEL)  <b>Direct Fire:</b> OP 4M-45  <b>Collimator:</b> K-1  <b>Gun Display Unit:</b> None  <b>Fire Control Computer:</b> None</p> <p><b>VARIANTS</b>  <b>Saddam:</b> Iraqi produced version of the D-30  <b>D30J:</b> Yugoslavian produced version of the D-30  <b>SP 122:</b> Egyptian self-propelled howitzer (M109A2 chassis and turret with an Egyptian made D-30 howitzer).  <b>Type 85:</b> Chinese self-propelled howitzer (Chinese Type 85 APC chassis and a licensed produced version of the D-30 in a semi-open superstructure.)</p> <p><b>MAIN ARMAMENT AMMUNITION</b>                      Caliber, Type, Name:                      122-mm Frag-HE, OF-81                          Indirect Fire Range (m):                              Minimum Range: 1000                              Maximum Range: 15,300                          Complete Projectile Weight (kg): 21.76 (OF-56)                          Muzzle Velocity: 680 m/s                          Fuze Type: RGM-2 PD</p> <p>122-mm, HEAT-FS                          Direct Fire Range (m):                              Minimum Range: 0                              Maximum Range: 1000                          Armor Penetration (mm): 460 (@ 0° obliquity any range)                          Complete Projectile Weight (kg): 21.58                          Muzzle Velocity: 740 m/s                          Fuze Type: GPV-2 PIBD</p> <p>122-mm Frag-HE Rocket Assisted                          Indirect Fire Range (m):                              Minimum Range: INA                              Maximum Range: 21,900                          Complete Projectile Weight (kg): 21.76 (3OF-56)                          Muzzle Velocity: INA                          Fuze Type: PD</p> <p><b>Other Ammunition Types:</b> Incendiary, Chemical, Flechette, Semi-active laser-guided Kitolov-2M Frag-HE</p>	

### NOTES

The D-30A is a midlife product improvement of the D-30. The original D-30 was fielded in 1963 and the midlife product improvements occurred in the mid to late 1970's. The original D-30 is in use with at least 50 different countries.

## Russian 130-mm Towed Gun M-46

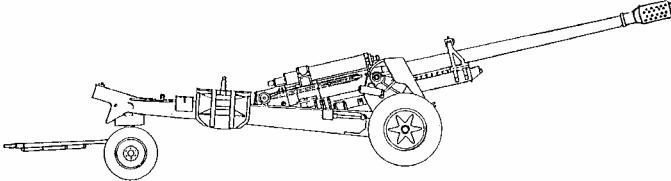
	<p><b>Weapons &amp; Ammunition Types</b></p> <p><b>130-mm howitzer</b></p> <p>Frag-HE Smoke Illumination</p>	<p><b>Typical Combat Load</b></p>
<p><b>SYSTEM</b>  <b>Alternative Designations:</b> None  <b>Date of Introduction:</b> 1954  <b>Proliferation:</b> At least 25 countries  <b>Description:</b>  Crew: 8  Carriage: M-46  Combat Weight (mt): 8.45  Chassis Length Overall (m):  Travel Position: 11.73  Firing Position: 11.10  Height Overall (m): 2.55  Width Overall (m):  Travel Position: 2.45  Firing Position: INA  Towing Speed (km/h):  Max Road: 50  Max Off-Road: 20  Max Cross-Country: 10  Forcing Depths (m): INA  Emplacement Time (min): 6  Displacement Time (min): 7</p> <p><b>Prime Mover:</b> AT-S 59, KrAZ-255 or equivalent</p> <p><b>ARMAMENT</b>  <b>Main Armament:</b>  Caliber, Type, Name: 130-mm, canon  Barrel Length (cal): 52 (approximately)  Rate of Fire (rpm):  Burst: 8  Normal: 6  Sustained: 5  Loader Type: Manual  Breech Type: Horizontal sliding wedge  Muzzle Brake Type: Multiperforated (pepperpot)  Traverse (°):  Left: 25  Right: 25  Total: 50  Elevation (°) (-/+): -2.5/+45°</p>	<p><b>FIRE CONTROL</b>  <b>Indirect Fire:</b> PG-1 Panoramic Telescope (PANTEL)  <b>Direct Fire:</b> OP 4-35  <b>Collimator:</b> K-1  <b>Gun Display Unit:</b> None  <b>Fire Control Computer:</b> None</p> <p><b>VARIANTS</b>  None</p> <p><b>MAIN ARMAMENT AMMUNITION</b>  <b>Caliber, Type, Name:</b>  130-mm Frag-HE, OF44  Indirect Fire Range (m):  Minimum Range: INA  Maximum Range: 22,500  Complete Projectile Weight (kg): 33.40 (OF33)  Muzzle Velocity: 930 m/s  Fuze Type: V-429 PD</p> <p>130-mm, APC-T  Direct Fire Range (m):  Minimum Range: 0  Maximum Range: 1140  Armor Penetration (mm): INA  Complete Projectile Weight (kg): 33.49 (BR-482B)  Muzzle Velocity: INA  Fuze Type: DBR BD</p> <p>130-mm Frag-HE, OF-43  Indirect Fire Range (m):  Minimum Range: INA  Maximum Range: 27,500  Complete Projectile Weight (kg): 33.40 (OF-33)  Muzzle Velocity: 930 m/s  Fuze Type: V-429 PD</p> <p>130-mm Frag-HE, ERFB-BB  Indirect Fire Range (m):  Minimum Range: INA  Maximum Range: 38,000  Complete Projectile Weight (kg): 33.40  Muzzle Velocity: 940 m/s  Fuze Type: ML-5 PD</p> <p><b>Other Ammunition Types:</b> Smoke, Chemical, Illumination</p>	

**NOTES:**

The M-46 gun crew is provided limited frontal protections by virtue of a frontal V-shaped shield (approximately 7-mm thick). Otherwise, the crew, ammunition supply, and equipment are vulnerable to casualties and damage from small arms fire, artillery fire, and bomb shrapnel. The Extended Range Full Bore-Base Bleed round was specifically designed by NORINCO Industries (China) for use with the Chinese 130-mm Type 59 Field Gun. However, this round may be fired by the M-46.

## Russian 152-mm Towed Gun 2A36

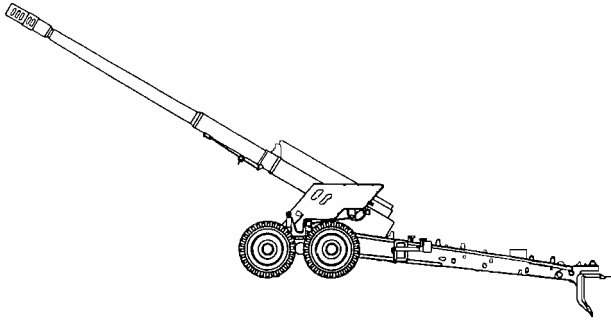
	<p><b>Weapons &amp; Ammunition Types</b></p> <p><b>152-mm gun</b></p> <p>Frag-HE Smoke Illumination</p>	<p><b>Typical Combat Load</b></p>
<p><b>SYSTEM</b>  <b>Alternative Designations:</b> 2A36 Giatsint-B  <b>Date of Introduction:</b> 1981  <b>Proliferation:</b> At least 11 countries  <b>Description:</b>  Crew: 8  Carriage: 2A36  Combat Weight (mt): 9.80  Chassis Length Overall (m):  Travel Position: 12.9  Firing Position: 11.0  Height Overall (m): 2.7  Width Overall (m):  Travel Position: 2.7  Firing Position: 8.7  Towing Speed (km/h):  Max Road: 70  Max Off-Road: 20  Max Cross-Country: 15  Fording Depths (m): .6  Emplacement Time (min): 5  Displacement Time (min): 7</p> <p><b>Prime Mover:</b> KrAZ-4556, KrAZ-255B, or AT-S tractor</p> <p><b>ARMAMENT</b>  <b>Main Armament:</b>  Caliber, Type, Name: 152-mm, cannon  Barrel Length (cal): 49  Rate of Fire (rpm):  Burst: 6  Normal: 5  Sustained: 4  Loader Type: Semi-automatic  Breech Type: Horizontal sliding wedge  Muzzle Brake Type: Multi baffle  Traverse (°):  Left: 25  Right: 25  Total: 50  Elevation (°) (-/+): -2/+57°</p>	<p><b>FIRE CONTROL</b>  <b>Indirect Fire:</b> PG-1M Panoramic Telescope (PANTEL)  <b>Direct Fire:</b> N/A  <b>Collimator:</b> K-1  <b>Gun Display Unit:</b> None  <b>Fire Control Computer:</b> None</p> <p><b>VARIANTS:</b> None</p> <p><b>MAIN ARMAMENT AMMUNITION</b>  <b>Caliber, Type, Name:</b>  152-mm Frag-HE, OF-39 (RAP)  Indirect Fire Range (m):  Minimum Range: 9,100  Maximum Range: 28,400  Complete Projectile Weight (kg): 43.51 (OF-29)  Muzzle Velocity (m/s): 945  Fuze Type: V-429 PD</p> <p><b>Caliber, Type, Name:</b>  152-mm, HEAT, BP-540  Direct Fire Range (m):  Minimum Range: 0  Maximum Range: 1,000  Armor Penetration (mm): INA  Complete Projectile Weight (kg): 27.00  Muzzle Velocity (m/s): 655  Fuze Type: GPV-3 PD</p> <p><b>Caliber, Type, Name:</b>  152-mm Frag-HE, OF-86  Indirect Fire Range (m):  Minimum Range: 0  Maximum Range: 30,500  Complete Projectile Weight (kg): 43.8 (OF-59)  Muzzle Velocity (m/s): 945  Fuze Type: V-429 PD</p> <p><b>Other Ammunition Types:</b> DPICM, DPICM-BB, Incendiary, Chemical, Flechette, Semi-active laser-guided Krasnopol-M Frag-HE</p>	

### NOTES

The most distinguishing feature of the 2A36 is its lower carriage. The large system weight required the use of tandem "walking-beam" axles and four wheels to provide mobility. A hydraulically powered firing pedestal is mounted on the front of the lower carriage and serves as part of the travel lock (similar to the D-20). Although the trails do not have the folding summer spades of the D-20, they do have two large spades similar to those found on the M-46/M-47. The weight of the 2A36 normally requires it to be towed by a heavy truck (like the KrAZ-255B). The KrAZ-255B is equipped with a special winch used to lift the trails in order to attach the gun's lunette to the towing pintle.

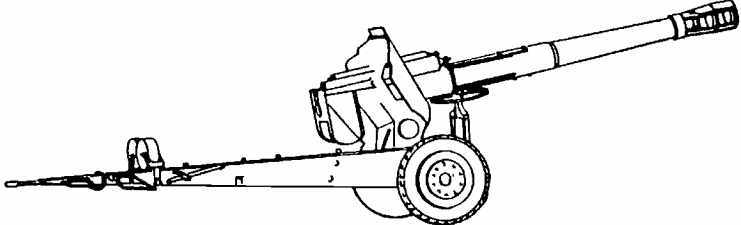

	<p><b>Weapons &amp; Ammunition Types</b></p> <p><b>152-mm howitzer</b></p> <p>Frag-HE Smoke Illumination</p>	<p><b>Typical Combat Load</b></p>
	<p><b>SYSTEM</b>  <b>Alternative Designations:</b> None  <b>Date of Introduction:</b> 1955  <b>Proliferation:</b> At least 13 countries  <b>Description:</b>  Crew: 8  Carriage: 122-mm gun D-74  Combat Weight (mt): 5.7  Chassis Length Overall (m):  Travel Position: 8.10  Firing Position: 8.69  Height Overall (m): 2.52  Width Overall (m):  Travel Position: 2.35  Firing Position: INA  Towing Speed (km/h):  Max Road: 60  Max Off-Road: 30  Max Cross-Country: 15  Fording Depths (m): .5  Emplacement Time (min): 2.5  Displacement Time (min): 2.5</p> <p><b>Prime Mover:</b> AT-S Tracked vehicle; MT-LB; Ural-375; Ural-4320</p> <p><b>ARMAMENT</b>  <b>Main Armament:</b>  Caliber, Type, Name: 152-mm, canon  Barrel Length (cal): 25  Rate of Fire (rpm):  Burst: 5-6  Normal: INA  Sustained: 1 (65 rounds the first hour)  Loader Type: Manual  Breech Type: Vertical sliding wedge  Muzzle Brake Type: Double flared  Traverse (°):  Left: 29  Right: 29  Total: 58  Elevation (°) (-/+):-5/+45°</p> <p><b>FIRE CONTROL</b>  <b>Indirect Fire:</b> PG-1M Panoramic Telescope (PANTEL)  <b>Direct Fire:</b> OP 4M  <b>Collimator:</b> K-1  <b>Gun Display Unit:</b> None  <b>Fire Control Computer:</b> None</p> <p><b>VARIANTS</b>  None</p> <p><b>MAIN ARMAMENT AMMUNITION</b>  <b>Caliber, Type, Name:</b>  152-mm Frag-HE, OF32  Indirect Fire Range (m):  Minimum Range: 4600  Maximum Range: 17,400  Complete Projectile Weight (kg): 43.56 (OF25)  Muzzle Velocity: 655 m/s  Fuze Type: V-90 PD</p> <p>152-mm, HEAT, BP-540  Direct Fire Range (m):  Minimum Range: 0  Maximum Range: 1000  Armor Penetration (mm): INA  Complete Projectile Weight (kg): 27.00  Muzzle Velocity: 655 m/s  Fuze Type: GPV-3 PD</p> <p>152-mm Frag-HE, OF-96  Indirect Fire Range (m):  Minimum Range: INA  Maximum Range: 24,400  Complete Projectile Weight (kg): 43.56 (OF-64)  Muzzle Velocity: INA  Fuze Type: PD</p> <p><b>Other Ammunition Types:</b> DPICM, DPICM-BB, Incendiary, Expendable Jammer, Chemical, Flechette, Semi-active laser-guided Krasnopol-M Frag-HE</p>	

**NOTES**

The D-20 was the first 152-mm cannon system to incorporate a semiautomatic vertical-sliding-wedge breech block. Although the ammunition for the system was not changed, this modification allowed a slightly higher rate of fire to be achieved (6 rounds per minute rather than 4), although the sustained rate of fire was unchanged. Because the carriage is based on that of the 122-mm gun D-74, the D-20 cannot be elevated above 45°.

## South African 155-mm Towed Gun-Howitzer G5

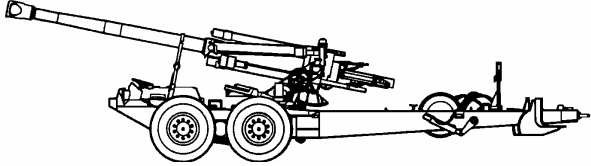
	<b>Weapons &amp; Ammunition Types</b>  <b>155-mm howitzer</b>  Frag-HE Smoke Illumination	<b>Typical Combat Load</b>
<p><b>SYSTEM</b>  <b>Alternative Designations:</b> None  <b>Date of Introduction:</b> 1981  <b>Proliferation:</b> At least 4 countries  <b>Description:</b>  Crew: 8  Carriage: G5  Combat Weight (mt): 13.75  Chassis Length Overall (m):  Travel Position: 12.1  Firing Position: 11.0  Height Overall (m): 2.3  Width Overall (m):  Travel Position: 3.3  Firing Position: 8.7  Towing Speed (km/h):  Max Road: 90  Max Off-Road: 50  Max Cross-Country: 15  Forcing Depths (m): .6  Emplacement Time (min): 2  Displacement Time (min): 1</p> <p><b>Auxiliary Propulsion Unit Performance:</b>  Engine Type: 76 hp air-cooled diesel  Cruising Range (km): 100  Speed (km/h):  Max Road: 16  Max Off-Road: INA  Cross-Country: 3  Max Swim: N/A</p> <p><b>Prime Mover:</b> Samil 100 6x6 artillery tractor or a 10 ton equivalent</p> <p><b>ARMAMENT</b>  <b>Main Armament:</b>  Caliber, Type, Name: 155-mm, canon  Barrel Length (cal): 45  Rate of Fire (rpm):  Burst: 3  Normal: 2  Sustained: 2</p>	<p>Loader Type: Semi-automatic  Breech Type: Interrupted screw  Muzzle Brake Type: Single baffle  Traverse (°):  Left: 41  Right: 41  Total: 82  Elevation (°) (-/+): -3/+75°</p> <p><b>FIRE CONTROL</b>  <b>Indirect Fire:</b> Digital Panoramic Telescope  <b>Direct Fire:</b> Trunnion mounted telescopic sight  <b>Collimator:</b> INA  <b>Gun Display Unit:</b> None  <b>Fire Control Computer:</b> None</p> <p><b>VARIANTS</b>  <b>G-5 MkIII</b> Upgrade of G-5 (see NOTES)</p> <p><b>MAIN ARMAMENT AMMUNITION</b>  <b>Caliber, Type, Name:</b>  155-mm Frag-HE, M1 HE  Indirect Fire Range (m):  Minimum Range: 3000  Maximum Range: 30,000  Complete Projectile Weight (kg): 8.7  Muzzle Velocity: 897 m/s  Fuze Type: PD M841</p> <p>155-mm Frag-HE BB, M1 HE  Indirect Fire Range (m):  Minimum Range: INA  Maximum Range: 39,000  Complete Projectile Weight (kg): 8.7  Muzzle Velocity: 895 m/s  Fuze Type: PD M841</p> <p><b>Other Ammunition Types:</b> See NOTES</p>	

### NOTES

The G5 is fully compatible with NATO standard 155-mm ammunition and has a direct fire range of 3000 meters (using a Frag-HE round). The APU, combined with the tandem walking-beam suspension, gives the G5 excellent self-propelled mobility over short distances. The four wheels are all powered and give the gun excellent traction over most terrain. But, the APU serves purposes other than mobility. It provides power to open and close the trails, raise and lower the trail wheels, and raise and lower the firing platform. However, there is no power traverse or elevation. Although designed for an eight-man section, the South African Defense Force normally operates the G5 with a five-man section. However, the G5 can operate with minimum of two people when all of the powered systems are working. The G-5 MkIII includes 35 reliability modifications and performance improvements. The improvements include the addition of the AS2000 Gun Monitor, an improved braking system, bigger diameter and wider trail wheels (specifically designed for sand), and incorporation of the REUTECH ACV 58 Communications System.

## Austrian 155-mm Towed Gun-Howitzer GH N-45

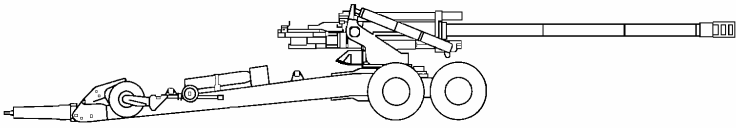
	<b>Weapons &amp; Ammunition Types</b>  <b>155-mm howitzer</b>  Frag-HE Smoke Illumination	<b>Typical Combat Load</b>
<p><b>SYSTEM</b></p> <p><b>Alternative Designations:</b> None</p> <p><b>Date of Introduction:</b> 1980</p> <p><b>Proliferation:</b> At least 9 countries</p> <p><b>Description:</b></p> <p>Crew: 6</p> <p>Carriage: GH N-45</p> <p>Combat Weight (mt):</p> <p>GH N-45: 8.90</p> <p>GH N-45 APU: 11.00</p> <p>Chassis Length Overall (m):</p> <p>Travel Position: 9.06</p> <p>Firing Position: 11.53</p> <p>Travel Position (GH N-45 APU): 9.55</p> <p>Firing Position (GH N-45 APU): 11.53</p> <p>Height Overall (m): (at 0° elevation)</p> <p>Travel Position: 2.15</p> <p>Firing Position: 2.20</p> <p>Travel Position (GH N-45 APU): 2.15</p> <p>Firing Position (GH N-45 APU): 2.20</p> <p>Width Overall (m):</p> <p>Travel Position: 2.50</p> <p>Firing Position: 9.93</p> <p>Travel Position (GH N-45 APU): 2.75</p> <p>Firing Position (GH N-45 APU): 9.93</p> <p>Towing Speed (km/h):</p> <p>Max Road: 90</p> <p>Max Off-Road: 50</p> <p>Max Cross-Country: 15</p> <p>Fording Depths (m): .6</p> <p>Emplacement Time (min): 4</p> <p>Displacement Time (min): 4</p> <p>Auxiliary Propulsion Unit Performance:</p> <p>Engine Type: 125 hp air-cooled diesel</p> <p>Cruising Range (km): 150</p> <p>Speed (km/h):</p> <p>Max Road: 35</p> <p>Max Off-Road: INA</p> <p>Cross-Country: 3</p> <p>Max Swim: N/A</p> <p><b>Prime Mover:</b> 10 ton 6x6 truck or artillery tractor</p>	<p><b>ARMAMENT</b></p> <p><b>Main Armament:</b></p> <p><b>Caliber, Type, Name:</b> 155-mm, cannon</p> <p>Barrel Length (cal): 45</p> <p>Rate of Fire (rpm):</p> <p>Burst: 7</p> <p>Normal: 3</p> <p>Sustained: 2</p> <p>Loader Type: Semi-automatic</p> <p>Breech Type: Interrupted screw</p> <p>Muzzle Brake Type: Multi-baffle</p> <p>Traverse (°):</p> <p>Left: 30</p> <p>Right: 40</p> <p>Total: 70</p> <p>Elevation (°) (-/+): -5/+72°</p> <p><b>FIRE CONTROL</b></p> <p><b>Indirect Fire:</b> Digital Panoramic Telescope</p> <p><b>Direct Fire:</b> Trunnion mounted telescopic sight</p> <p><b>Collimator:</b> INA</p> <p><b>Gun Display Unit:</b> None</p> <p><b>Fire Control Computer:</b> None</p> <p><b>VARIANTS</b></p> <p><b>GH N-45 A1</b> Upgrade of GH N-45 (See NOTES)</p> <p><b>MAIN ARMAMENT AMMUNITION</b></p> <p><b>Caliber, Type, Name:</b></p> <p>155-mm Frag-HE, SN-101</p> <p>Indirect Fire Range (m):</p> <p>Minimum Range: INA</p> <p>Maximum Range: 25,100</p> <p>Complete Projectile Weight (kg): 42.3</p> <p>Muzzle Velocity (m/s): 897</p> <p>Fuze Type: PD</p> <p><b>Caliber, Type, Name:</b></p> <p>155-mm Frag-HE ERFB</p> <p>Indirect Fire Range (m):</p> <p>Minimum Range: INA</p> <p>Maximum Range: 39,600</p> <p>Complete Projectile Weight (kg): 45.4</p> <p>Muzzle Velocity (m/s): 895</p> <p>Fuze Type: PD</p> <p><b>Other Ammunition Types:</b> See NOTES</p>	

### NOTES

The GH N-45 is fully compatible with NATO standard 155-mm ammunition. The APU, combined with the tandem walking-beam suspension, gives the GH N-45 excellent self-propelled mobility over short distances. The four wheels are all powered and give the gun excellent traction over most terrain. But, the APU serves purposes other than mobility. It provides power to open and close the trails, raise and lower the trail wheels, and raise and lower the firing platform. However, there is no power traverse or elevation. The GH N-45 also includes an optional chain system (reducing the ground pressure) to improve cross-country mobility in deep, muddy, or sandy terrain. The GH N-45 A1 includes reliability modifications and performance improvements.



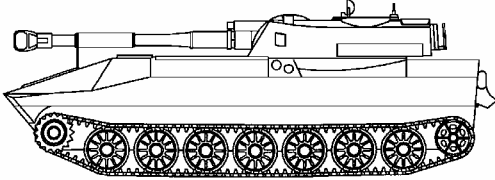

## Russian 122-mm Self-Propelled Howitzer 2S1

	<p><b>Weapons &amp; Ammunition Types</b></p> <p>122-mm howitzer</p> <p>Frag-HE HEAT-FS Smoke Illumination</p>	<p><b>Typical Combat Load</b></p> <p>45</p>
<p><b>SYSTEM</b>  <b>Alternative Designations:</b> 122-mm 2S1 Gvozdika  <b>Date of Introduction:</b> 1974  <b>Proliferation:</b> At least 12 countries  <b>Description:</b>  Crew: 4 (section of 6 with 2 in ammo carrier)  Platform (chassis): MT-LBu  Combat Weight (mt): 15.7  Chassis Length Overall (m): 7.26  Height Overall (m): 2.72  Width Overall (m): 2.85</p> <p><b>Automotive Performance:</b>  Engine Type: V-8, 300 hp, Diesel  Cruising Range (km): 500 km  Speed (km/h):  Max Road: 60  Max Off-Road: 30  Cross-Country: INA  Max Swim: 4.5  Fording Depths (m): Amphibious  Emplacement Time (min): 2  Displacement Time (min): 1</p> <p><b>Radio:</b> R-123M</p> <p><b>Protection:</b>  Armor, Turret (mm): 20  Armor Turret Top (mm): 10  Armor Hull (mm): 15  Self-Entrenching Blade: No  NBC Protection System: Yes  Smoke Equipment: No</p> <p><b>ARMAMENT</b>  <b>Main Armament:</b>  Caliber, Type, Name: 122-mm, canon, 2A31  Barrel Length (cal): 36  Rate of Fire (rpm):  Burst: 5  Normal: 4  Sustained: 1-2  Fire from Ground: INA  Loader Type: Semi-automatic  Breech Type: Horizontal sliding wedge</p>	<p>Muzzle Brake Type: Double baffle  Traverse (°):  Left: 360  Right: 360  Total: 360  Elevation (°) (-/+): -3/+70°</p> <p><b>FIRE CONTROL</b>  <b>Indirect Fire:</b> PG-2 Panoramic Telescope (PANTEL)  <b>Direct Fire:</b> OP 5-37  <b>Collimator:</b> K-1  <b>Gun Display Unit:</b> None  <b>Fire Control Computer:</b> None</p> <p><b>VARIANTS</b>  None</p> <p><b>MAIN ARMAMENT AMMUNITION</b>  <b>Caliber, Type, Name:</b>  122-mm Frag-HE, OF-81  Indirect Fire Range (m):  Minimum Range: 1000  Maximum Range: 15,300  Complete Projectile Weight (kg): 21.76 (OF-56)  Muzzle Velocity: 680 m/s  Fuze Type: RGM-2 PD</p> <p>122-mm, HEAT-FS  Direct Fire Range (m):  Minimum Range: 0  Maximum Range: 1000  Armor Penetration (mm): 460 (@ 0° obliquity any range)  Complete Projectile Weight (kg): 21.58  Muzzle Velocity: 740 m/s  Fuze Type: GPV-2 PIBD</p> <p>122-mm Frag-HE Rocket Assisted  Indirect Fire Range (m):  Minimum Range: INA  Maximum Range: 21,900  Complete Projectile Weight (kg): 21.76 (3OF-56)  Muzzle Velocity: INA  Fuze Type: PD</p> <p><b>Other Ammunition Types:</b> Incendiary, Chemical, Flechette, Expendable Jammer, Semi-active laser-guided Kitolov-2M Frag-HE</p>	

### NOTES

The 2S1's ammunition stowage rack is not mechanized. The 2S1 is manually loaded with a semiautomatic ramming capability. The four-man crew consists of the commander, driver, gunner, and loader.

## Russian 152-mm Self-Propelled Gun-Howitzer 2S3M

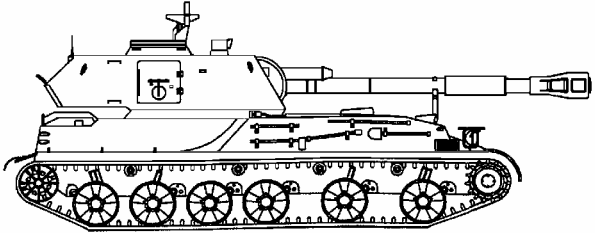
	<p><b>Weapons &amp; Ammunition Types</b></p> <p>152-mm howitzer Frag-HE Smoke Illumination</p> <p>7.62 PKT MG</p>	<p><b>Typical Combat Load</b></p> <p>46</p> <p>1500</p>
<p><b>SYSTEM</b></p> <p><b>Alternative Designations:</b> 152-mm 2S3M Akatsiya <b>Date of Introduction:</b> 1973 <b>Proliferation:</b> At least 8 countries <b>Description:</b> Crew: 4 Platform (chassis): Modified SA-4 Ganef Combat Weight (mt): 27.5 Chassis Length Overall (m): 7.75 Height Overall (m): 3.13 Width Overall (m): 3.21</p> <p><b>Automotive Performance:</b> Engine Type: 520-hpV-59 V-12 multi-fuel diesel Cruising Range (km): 450 km Speed (km/h): Max Road: 60 Max Off-Road: 25 Cross-Country: INA Max Swim: N/A Fording Depth (m): 1.00 Emplacement Time (min): 3 Displacement Time (min): 3</p> <p><b>Radio:</b> R-123M</p> <p><b>Protection:</b> Armor, Turret (mm): 20 Armor Turret Top (mm): 15 Armor Hull (mm): INA Self-Entrenching Blade: Yes NBC Protection System: Yes Smoke Equipment: No</p> <p><b>ARMAMENT</b></p> <p><b>Main Armament:</b> Caliber, Type, Name: 152-mm, 2A33 Barrel Length (cal): 34 Rate of Fire (rpm): Burst: 4 Normal: 3 Sustained: 1 Fire from Ground: INA Loader Type: Semiautomatic Breech Type: Vertical sliding wedge Muzzle Brake Type: Double baffle Traverse: (°): Left: 360 Right: 360 Total: 360 Elevation (°) (-/+): -4/+60°</p>	<p><b>Auxiliary Weapon:</b> Caliber, Type, Name: 7.62-mm machinegun PKT Mount Type: Bow (ball-mounted) Direct Fire Range (m): 1000 Max Effective Range (m): Day: 1000 /400-500 on the move Night: 800 Fire on Move: Yes Rate of Fire (rpm): 650 (cyclic)</p> <p><b>FIRE CONTROL</b></p> <p><b>Indirect Fire:</b> PG-4 Panoramic Telescope (PANTEL) <b>Direct Fire:</b> OP 5-38 <b>Collimator:</b> K-1 <b>Gun Display Unit:</b> None <b>Fire Control Computer:</b> None</p> <p><b>VARIANTS</b></p> <p><b>2S3M1:</b> Upgrade of 2S3M</p> <p><b>MAIN ARMAMENT AMMUNITION</b></p> <p><b>Caliber, Type, Name:</b> 152-mm Frag-HE, OF32 Indirect Fire Range (m): Minimum Range: 4600 Maximum Range: 17,400 Complete Projectile Weight (kg): 43.56 (OF25) Muzzle Velocity: 655 m/s Fuze Type: V-90 PD</p> <p>152-mm, HEAT, BP-540 Direct Fire Range (m): Minimum Range: 0 Maximum Range: 1000 Armor Penetration (mm): INA Complete Projectile Weight (kg): 27.00 Muzzle Velocity: 655 m/s Fuze Type: GPV-3 PD</p> <p>152-mm Frag-HE, OF-96 Indirect Fire Range (m): Minimum Range: INA Maximum Range: 24,400 Complete Projectile Weight (kg): 43.56 (OF-64) Muzzle Velocity: INA Fuze Type: PD</p> <p><b>Other Ammunition Types:</b> DPICM, DPICM-BB, Incendiary, Chemical, Flechette, Semi-active laser-guided Krasnopol-M Frag-HE</p>	

**NOTES**

The 2S3M is an upgrade version of the 2S3. The 2S3M turret contains the 2A33 cannon, fire-control equipment, ammunition storage space, and work positions for commander, gunner, and loader. The cannon extends beyond the vehicle front and has an electrical loader/rammer attached to the cradle. Ammunition is stored in the rear of the chassis and can be replenished through a hatch in the rear panel.

## Russian 152-mm Self-Propelled Gun 2S5

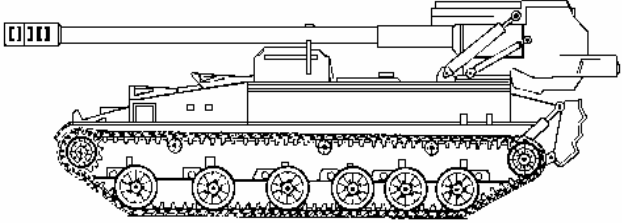
	<p><b>Weapons &amp; Ammunition Types</b></p> <p><b>152-mm howitzer</b> Frag-HE Smoke Illumination</p> <p><b>7.62 PKT MG</b></p>	<p><b>Typical Combat Load</b></p> <p><b>30</b></p> <p><b>1500</b></p>
<p><b>SYSTEM</b>  <b>Alternative Designations:</b> 152-mm 2S5 Giatsint-S  <b>Date of Introduction:</b> 1981  <b>Proliferation:</b> At least 4 countries  <b>Description:</b>  Crew: 5 (section of 7 with 2 in ammo carrier)  Platform (chassis): Modified 2S3  Combat Weight (mt): 28.2  Chassis Length Overall (m): 8.33  Height Overall (m): 2.76  Width Overall (m): 3.25</p> <p><b>Automotive Performance:</b>  Engine Type: 520-hp V-59-V-12 multi-fuel diesel  Cruising Range (km): 500 km  Speed (km/h):  Max Road: 63  Max Off-Road: 25  Cross-Country: INA  Max Swim: 4.5  Forcing Depths (m): 1.05  Emplacement Time (min): 2  Displacement Time (min): 1</p> <p><b>Radio:</b> R-123M</p> <p><b>Protection:</b>  Armor, Turret (mm): INA  Armor Turret Top (mm): 15  Armor Hull (mm): 15  Self-Entrenching Blade: Yes  NBC Protection System: Yes  Smoke Equipment: None</p> <p><b>ARMAMENT</b>  <b>Main Armament:</b>  Caliber, Type, Name: 152-mm, canon, 2A37  Barrel Length (cal): 52  Rate of Fire (rpm):  Burst: 6  Normal: 5  Sustained: 1-2  Fire from Ground: INA  Loader Type: Semi-automatic  Breech Type: Horizontal sliding wedge  Muzzle Brake Type: Multi baffle  Traverse: (°):  Left: 15  Right: 15  Total: 30  Elevation (°) (-/+): -2/+57°</p>	<p><b>Auxiliary Weapon:</b>  Caliber, Type, Name: 7.62-mm machinegun PKT  Mount Type: Bow (ball-mounted)  Direct Fire Range (m): 1000  Max Effective Range (m):  Day: 1000 /400-500 on the move  Night: 800  Fire on Move: Yes  Rate of Fire (rpm): 650 (cyclic)</p> <p><b>FIRE CONTROL</b>  <b>Indirect Fire:</b> PG-1M Panoramic Telescope (PANTEL)  <b>Direct Fire:</b> N/A  <b>Collimator:</b> K-1  <b>Gun Display Unit:</b> None  <b>Fire Control Computer:</b> None</p> <p><b>VARIANTS</b>  None</p> <p><b>MAIN ARMAMENT AMMUNITION</b>  <b>Caliber, Type, Name:</b>  152-mm Frag-HE, OF-39  Indirect Fire Range (m):  Minimum Range: 9100  Maximum Range: 28,400  Complete Projectile Weight (kg): 43.51 (OF-29)  Muzzle Velocity: 945 m/s  Fuze Type: V-429 PD</p> <p>152-mm, HEAT, BP-540  Direct Fire Range (m):  Minimum Range: 0  Maximum Range: 1000  Armor Penetration (mm): INA  Complete Projectile Weight (kg): 27.00  Muzzle Velocity: 655 m/s  Fuze Type: GPV-3 PD</p> <p>152-mm Frag-HE, OF-86  Indirect Fire Range (m):  Minimum Range: INA  Maximum Range: 30,500  Complete Projectile Weight (kg): 43.8 (OF-59)  Muzzle Velocity: 945 m/s  Fuze Type: V-429 PD</p> <p><b>Other Ammunition Types:</b> DPICM, DPICM-BB, Incendiary, Chemical, Flechette, Semi-active laser-guided Krasnopol-M Frag-HE</p>	

### NOTES

The 2S5 is more powerful, has a longer range and a higher rate of fire than the 2S3. However, the 2S5 has a limited main armament traverse and a narrower elevation range than the 2S3.

## Russian 152-mm Self-Propelled Howitzer 2S19

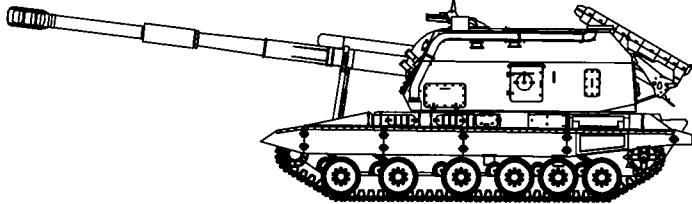
	<p><b>Weapons &amp; Ammunition Types</b></p> <p>152-mm howitzer</p> <p>Frag-HE Smoke Illumination</p> <p>12.7-mm MG</p>	<p><b>Typical Combat Load</b></p> <p>50</p> <p>300</p>
<p><b>SYSTEM</b></p> <p><b>Alternative Designations:</b> 152-mm 2S19 Msta-S</p> <p><b>Date of Introduction:</b> 1989</p> <p><b>Proliferation:</b> At least 4 countries</p> <p><b>Description:</b></p> <p>Crew: 5 (section of 7 with 2 in ammo carrier)</p> <p>Platform (chassis): Modified T-72</p> <p>Combat Weight (mt): 42</p> <p>Chassis Length Overall (m): 11.91</p> <p>Height Overall (m): 2.98</p> <p>Width Overall (m): 3.58</p> <p><b>Automotive Performance:</b></p> <p>Engine Type: 840-hp V84-A diesel</p> <p>Cruising Range (km): 500 km</p> <p>Speed (km/h):</p> <ul style="list-style-type: none"> <li>Max Road: 60</li> <li>Max Off-Road: 25</li> <li>Cross-Country: INA</li> <li>Max Swim: N/A</li> </ul> <p>Fording Depths (m): Unprepared: 1.5</p> <p>Emplacement Time (min): 1-2</p> <p>Displacement Time (min): 1-2</p> <p><b>Radio:</b> R-173</p> <p><b>Protection:</b></p> <ul style="list-style-type: none"> <li>Armor, Turret (mm): 15</li> <li>Armor Turret Top (mm): 15</li> <li>Armor Hull (mm): 15</li> </ul> <p><b>Self-Entrenching Blade:</b> Capable of digging a complete firing pit in 40-60 minutes</p> <p>NBC Protection System: Yes</p> <p>Smoke Equipment: Six Type 902 smoke grenade launchers and Vehicle engine exhaust smoke system (VEESS)</p> <p><b>ARMAMENT</b></p> <p><b>Main Armament:</b></p> <p>Caliber, Type, Name: 152-mm, canon, 2A64</p> <p>Barrel Length (cal): 48</p> <p>Rate of Fire (rpm):</p> <ul style="list-style-type: none"> <li>Burst: 8</li> <li>Normal: 6</li> <li>Sustained: 2</li> </ul> <p>Fire from Ground: 6-7</p> <p>Loader Type: autoloader</p> <p>Breech Type: Vertical sliding wedge</p> <p>Muzzle Brake Type: Double baffle</p> <p>Traverse: (°):</p> <ul style="list-style-type: none"> <li>Left: 360</li> <li>Right: 360</li> </ul>	<p>Total: 360</p> <p>Elevation (°) (-/+): -4/+68°</p> <p><b>Auxiliary Weapon:</b></p> <p>Caliber, Type, Name: 12.7-mm NSVT machinegun</p> <p>Mount Type: PZU-5 AA</p> <p>Direct Fire Range (m): 2000</p> <p>Max Effective Range (m)*:</p> <ul style="list-style-type: none"> <li>Day: 1500 (AA)/1500 (Ground)</li> <li>Night: N/A</li> </ul> <p>Fire on Move: Yes</p> <p>Rate of Fire (rpm): 800 (cyclic)</p> <p><b>FIRE CONTROL</b></p> <p><b>Indirect Fire:</b> 1P22 Panoramic Telescope (PANTEL)</p> <p><b>Direct Fire:</b> 1P23</p> <p><b>Collimator:</b> K-1</p> <p><b>Gun Display Unit:</b> None</p> <p><b>Fire Control Computer:</b> None</p> <p><b>VARIANTS</b></p> <p>None</p> <p><b>MAIN ARMAMENT AMMUNITION</b></p> <p><b>Caliber, Type, Name:</b></p> <p>152-mm Frag-HE, OF-72</p> <ul style="list-style-type: none"> <li>Indirect Fire Range (m):</li> <ul style="list-style-type: none"> <li>Minimum Range: 6500</li> <li>Maximum Range: 24,700</li> </ul> <li>Complete Projectile Weight (kg): 43.56 (OF-45)</li> <li>Muzzle Velocity: 864 m/s</li> <li>Fuze Type: RGM-2 PD</li> </ul> <p>152-mm, HEAT, BP-540</p> <ul style="list-style-type: none"> <li>Direct Fire Range (m):</li> <ul style="list-style-type: none"> <li>Minimum Range: 0</li> <li>Maximum Range: 1000</li> </ul> <li>Armor Penetration (mm): INA</li> <li>Complete Projectile Weight (kg): 27.00</li> <li>Muzzle Velocity: 655 m/s</li> <li>Fuze Type: GPV-3 PD</li> </ul> <p>152-mm Frag-HE BB, OF-91</p> <ul style="list-style-type: none"> <li>Indirect Fire Range (m):</li> <ul style="list-style-type: none"> <li>Minimum Range: 6710</li> <li>Maximum Range: 29,000</li> </ul> <li>Complete Projectile Weight (kg): 42.86 (OF-61)</li> <li>Muzzle Velocity: 828 m/s</li> <li>Fuze Type: KZ-88 PD</li> </ul> <p><b>Other Ammunition Types:</b> All standard 152-mm artillery rounds</p>	

**NOTES**

The 2S19's gun crew can load the gun at any angle of elevation. The 2S19 can also produce a smokescreen by injecting diesel fuel into the exhaust outlet. The 21-hp gas turbine AP-18D Auxiliary Power Unit provides power for turret operations when the vehicle engine is shut down.

## Chinese 152-mm Self-Propelled Gun-Howitzer Type 83

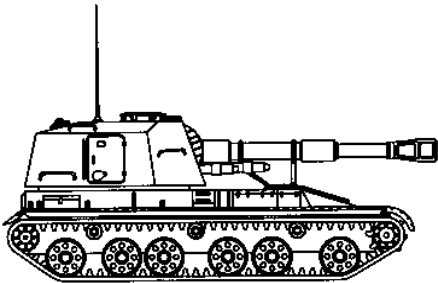
	<table border="1"> <thead> <tr> <th>Weapons &amp; Ammunition Types</th> <th>Typical Combat Load</th> </tr> </thead> <tbody> <tr> <td><b>152-mm howitzer</b></td> <td><b>30</b></td> </tr> <tr> <td>Frag-HE Smoke Illumination</td> <td></td> </tr> <tr> <td><b>12.7-mm MG</b></td> <td><b>650</b></td> </tr> <tr> <td><b>7.62-mm MG</b></td> <td><b>650</b></td> </tr> </tbody> </table>	Weapons & Ammunition Types	Typical Combat Load	<b>152-mm howitzer</b>	<b>30</b>	Frag-HE Smoke Illumination		<b>12.7-mm MG</b>	<b>650</b>	<b>7.62-mm MG</b>	<b>650</b>
Weapons & Ammunition Types	Typical Combat Load										
<b>152-mm howitzer</b>	<b>30</b>										
Frag-HE Smoke Illumination											
<b>12.7-mm MG</b>	<b>650</b>										
<b>7.62-mm MG</b>	<b>650</b>										
<p><b>SYSTEM</b>  <b>Alternative Designations:</b> None  <b>Date of Introduction:</b> 1984  <b>Proliferation:</b> At least 1 country  <b>Description:</b>  Crew: 5  Platform (chassis): Type 83  Combat Weight (mt): 30.0  Chassis Length Overall (m): 7.33  Height Overall (m): 3.50  Width Overall (m): 3.24</p> <p><b>Automotive Performance:</b>  Engine Type: Type 12150L, V-12, 520-hp liquid-cooled diesel  Cruising Range (km): 450 km  Speed (km/h):      Max Road: 55      Max Off-Road: 35      Cross-Country: INA      Max Swim: N/A  Fording Depth (m): 1.3  Emplacement Time (min): 1  Displacement Time (min): 1</p> <p><b>Radio:</b> Type 889D</p> <p><b>Protection:</b>  Armor, Turret (mm): INA  Armor Turret Top (mm): INA  Armor Hull (mm): INA  Self-Entrenching Blade: No  NBC Protection System: No  Smoke Equipment: No</p> <p><b>ARMAMENT</b>  <b>Main Armament:</b>  Caliber, Type, Name: 152-mm, Type 66 cannon  Barrel Length (cal): 29  Rate of Fire (rpm):      Burst: 4      Normal: INA      Sustained: INA      Fire from Ground: INA</p>	<p>Loader Type: Semiautomatic  Breech Type: Vertical sliding wedge  Muzzle Brake Type: Double baffle  Traverse (°):      Left: 360      Right: 360      Total: 360  Elevation (°) (-/+): -5/+65°</p> <p><b>Auxiliary Weapon:</b>  Caliber, Type, Name: 12.7-mm (12.7x108) AA MG Type 54  Mount Type: Turret top  Direct Fire Range (m): 1500  Max Effective Range (m):      Day: 1500 ground/1600 for air targets (APDS)      Night: INA  Fire on Move: Yes  Rate of Fire (rpm): 80-100 practical, 600 for air targets in 2-10 round bursts</p> <p>Caliber, Type, Name: 7.62 (7.62 x 54R) Machinegun Type 59  Mount Type: Turret coax  Direct Fire Range (m): 1800  Max Effective Range (m):      Day: 1000      Night: 800  Fire on Move: Yes  Rate of Fire (rpm): 250 practical, 600 cyclic in 2-10 round bursts</p> <p><b>FIRE CONTROL</b>  <b>Indirect Fire:</b> Panoramic  <b>Direct Fire:</b> INA  <b>Collimator:</b> INA  <b>Gun Display Unit:</b> None  <b>Fire Control Computer:</b> None</p> <p><b>VARIANTS</b>  <b>425-mm Mineclearing Rocket Launcher Type 462:</b> 2-round rocket launcher for use in clearing minefields.</p> <p><b>120-mm SP Anti-Tank Gun:</b> The AT gun is fitted with a 120-mm smoothbore mounted inside a turret on a Type 83 Gun-Howitzer chassis.</p>										

## Chinese 152-mm Self-Propelled Gun-Howitzer Type 83 continued

<p><b>MAIN ARMAMENT AMMUNITION</b></p> <p><b>Caliber, Type, Name:</b> 152-mm Frag-HE, Type 66     Indirect Fire Range (m):         Minimum Range: 9600         Maximum Range: 17,230 Complete Projectile Weight (kg): 43.6 Muzzle Velocity: 655 m/s Fuze Type: Liu-4 PD and Proximity</p> <p>152-mm Frag-HE Rocket Assisted Projectile     Indirect Fire Range (m):         Minimum Range: INA         Maximum Range: 21,880 Complete Projectile Weight (kg): INA Muzzle Velocity: INA Fuze Type: PD</p>	<p>152-mm Frag-HE Type 83     Indirect Fire Range (m):         Minimum Range: INA         Maximum Range: 30,370 Complete Projectile Weight (kg): 46.95 Muzzle Velocity: 955 m/s Fuze Type: Liu-4 PD and Proximity</p> <p><b>Other Ammunition Types:</b> HE-I, Illumination, Smoke</p>
--	---

### NOTES

The Type 83 152-mm SP Gun-Howitzer is capable of firing all standard types of 152-mm rounds. The main armament cannon is based on the Chinese 152-mm Towed Type 66 mounted on a vehicle hull similar to the Russian 152-mm SP Gun-Howitzer 2S3. The crew communicates with each other using the Type 803 intercom system. There are reports of the Type 83 being equipped with an anti-tank rocket launcher referred to as the Type 40. However, it is suspected that the rocket launcher is really the 40-mm anti-tank rocket launcher Type 69-1 (an upgraded variant of the Russian RPG-7).

## South African 155-mm Self-Propelled Howitzer G6

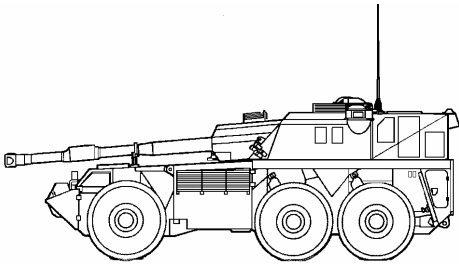
	<b>Weapons &amp; Ammunition Types</b>  <b>155-mm howitzer</b>  Frag-HE Smoke Illumination  <b>.50 Cal. M2 HB MG</b>	<b>Typical Combat Load</b>  45      900
	<p><b>SYSTEM</b>  <b>Alternative Designations:</b> 155-mm G6 Rhino  <b>Date of Introduction:</b> 1988  <b>Proliferation:</b> At least 2 countries  <b>Description:</b>            Crew: 6            Platform (chassis): Purpose built 6x6 wheeled            Combat Weight (mt): 48            Chassis Length Overall (m): 10.4            Height Overall (m): 3.5            Width Overall (m): 3.4</p> <p><b>Automotive Performance:</b>            Engine Type: 525-hp air-cooled diesel            Cruising Range (km): 700 km            Speed (km/h):                Max Road: 85                Max Off-Road: 30                Cross-Country: INA                Max Swim: N/A            Fording Depth (m): 1.00            Emplacement Time (min): 1            Displacement Time (min): 0.5</p> <p><b>Radio:</b> INA</p> <p><b>Protection:</b>            Armor, Turret (mm): See NOTES            Armor Turret Top (mm): See NOTES            Armor Hull (mm): See NOTES            Self-Entrenching Blade: No            NBC Protection System: Yes            Smoke Equipment: 8 81-mm grenade launchers</p> <p><b>ARMAMENT</b>  <b>Main Armament:</b>            Caliber, Type, Name: 155-mm, canon            Barrel Length (cal): 45            Rate of Fire (rpm):                Burst: 3                Normal: 2                Sustained: 1            Fire from Ground: INA            Loader Type: Semi-automatic            Breech Type: Interrupted screw</p> <p>Muzzle Brake Type: Single baffle            Traverse: (°):                Left: 40                Right: 40                Total: 80            Elevation (°) (-/+): -5/+75°</p> <p><b>Auxiliary Weapon:</b>            Caliber, Type, Name: .50 (12.7x99) heavy machinegun, M2HB            Mount Type: Cupola AA mount            Direct Fire Range (m): INA            Max Effective Range (m):                Day: 1000                Night: INA            Fire on Move: Yes            Rate of Fire (rpm): 450-550 (cyclic)</p> <p><b>FIRE CONTROL</b>  <b>Indirect Fire:</b> Digital Panoramic Telescope  <b>Direct Fire:</b> Trunnion mounted telescopic sight  <b>Collimator:</b> INA  <b>Gun Display Unit:</b> None  <b>Fire Control Computer:</b> None</p> <p><b>VARIANTS</b>            None</p> <p><b>MAIN ARMAMENT AMMUNITION</b>  <b>Caliber, Type, Name:</b>            155-mm Frag-HE, M1 HE            Indirect Fire Range (m):                Minimum Range: 3000                Maximum Range: 30,000            Complete Projectile Weight (kg): 8.7            Muzzle Velocity: 897 m/s            Fuze Type: PD M841</p> <p>155-mm Frag-HE BB, M1 HE            Indirect Fire Range (m):                Minimum Range: INA                Maximum Range: 39,000            Complete Projectile Weight (kg): 8.7            Muzzle Velocity: 895 m/s            Fuze Type: PD M841</p> <p><b>Other Ammunition Types:</b> See NOTES</p>	

## **South African 155-mm Self-Propelled Howitzer G6 continued** \_\_\_\_\_

### **NOTES**

The G6 is a three-axle, six-wheeled, heavily armored system mounting a modified version of the G5 cannon. The G6 is fully compatible with NATO standard 155-mm ammunition and has a direct fire range of 3000 meters (using a Frag-HE round). The rigid chassis is actually divided into two parts, a driver's/engine compartment and a crew compartment. In order to distribute its weight and to maintain mobility over sand and soft terrain, the G6 employs large 21x25 run-flat tires. The driver controls a central tire-inflation system to vary the ground pressure. The system can also be used to maintain some degree of tire pressure in case of air leakage from small punctures. The G6 is equipped with an electronically controlled hydraulic flick rammer that provides an initial rate of fire of 3 rounds per minute.

The vehicle hull and turret provide protection against 7.62-mm small arms fire and artillery shrapnel. The frontal 60° arc provides protection against 20-mm type ammunition. Additionally, the shape and armor thickness of the chassis hull allows it to withstand at least three mine detonations (against TM46 antitank landmine or equivalent) before being immobilized. The separation of the driver/engine compartment from the crew compartment also facilitates survival against mines. The connection between the two is perforated with blowout holes to direct the force of the blast upwards, away from any personnel compartments. The separation also allows the driver to be beyond the detonation point before the mine is activated. The driver also has bullet-resistant glass windows that can be further protected by armored shutters, although it limits him to the use of a periscopic viewing port. The vehicle commander has limited steering and braking capability if the driver becomes a casualty. The crew compartment has four firing ports (two each side) so the crew can engage targets without exposing themselves to return fire.

A 45-hp (34 kw) Auxiliary Power Unit (APU) provides power for turret operations, recharging the batteries, and the driver/crew compartment air conditioning system. A wide range of optional subsystems is available to increase the efficiency of the G6 and its crew. They include the following:

- Inertial navigation and laying or back-up laying systems
- Night vision equipment
- Barrel cooling and thermal warning systems
- Fire control computer interface
- Muzzle velocity analyzer
- Explosion control for fuel tanks

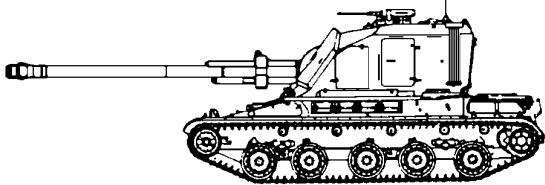

## French 155-mm Self-Propelled Howitzer AU-F1

	<b>Weapons &amp; Ammunition Types</b>  <b>155-mm howitzer</b>  Frag-HE Smoke Illumination  <b>.50 Cal. M2 HB MG</b>	<b>Typical Combat Load</b>          <b>800</b>
	<p><b>SYSTEM</b>  <b>Alternative Designations:</b> 155-mm GCT (Export Version)  <b>Date of Introduction:</b> 1979  <b>Proliferation:</b> At least 4 countries  <b>Description:</b>            Crew: 4            Platform (chassis): Modified AMX-30            Combat Weight (mt): 42.0            Chassis Length Overall (m): 10.25            Height Overall (m): 3.25            Width Overall (m): 3.15</p> <p><b>Automotive Performance:</b>            Engine Type: Hispano-Suiza HS110, 720-hp water-cooled multi-fuel            Cruising Range (km): 450 km            Speed (km/h):                Max Road: 60                Max Off-Road: 40                Cross-Country: INA                Max Swim: N/A            Fording Depth (m): 2.10            Emplacement Time (min): 1-2            Displacement Time (min): 1</p> <p><b>Radio:</b> TRC 559 (VHF-FM)</p> <p><b>Protection:</b>            Armor, Turret (mm): See NOTES            Armor Turret Top (mm): See NOTES            Armor Hull (mm): See NOTES            Self-Entrenching Blade: No            NBC Protection System: Yes            Smoke Equipment: 4 grenade launchers</p> <p><b>ARMAMENT</b>  <b>Main Armament:</b>            Caliber, Type, Name: 155-mm, canon            Barrel Length (cal): 40            Rate of Fire (rpm):                Burst: 8                Normal: 6                Sustained: 2-3 (manual loading)                Fire from Ground: INA            Loader Type: Autoloader            Breech Type: Vertical sliding wedge</p> <p>Muzzle Brake Type: Double baffle            Traverse: (°):                Left: 360                Right: 360                Total: 360            Elevation (°) (-/+): -4/+66°</p> <p><b>Auxiliary Weapon:</b>            Caliber, Type, Name: .50 (12.7x99) heavy machinegun, M2HB            Mount Type: Cupola AA mount            Direct Fire Range (m): INA            Max Effective Range (m):                Day: 1000                Night: INA            Fire on Move: Yes            Rate of Fire (rpm): 450-550 (cyclic)</p> <p><b>FIRE CONTROL</b>  <b>Indirect Fire:</b> M 589 Optical Goniometer  <b>Direct Fire:</b> INA  <b>Collimator:</b> INA  <b>Gun Display Unit:</b> ATILA fire direction system  <b>Fire Control Computer:</b> None</p> <p><b>VARIANTS</b>  <b>AU-FIT:</b> Upgrade of AU-F1</p> <p><b>MAIN ARMAMENT AMMUNITION</b>  <b>Caliber, Type, Name:</b>            155-mm Frag-HE, OE-155-56/69            Indirect Fire Range (m):                Minimum Range: 9600                Maximum Range: 23,000            Complete Projectile Weight (kg): 43.75            Muzzle Velocity: 810 m/s            Fuze Type: PD</p> <p>155-mm Frag-HE Rocket Assisted H3            Indirect Fire Range (m):                Minimum Range: INA                Maximum Range: 31,500            Complete Projectile Weight (kg): INA            Muzzle Velocity: 830 m/s            Fuze Type: PD</p> <p><b>Other Ammunition Types:</b> DPICM, Illumination, Smoke</p>	

### NOTES

The export version of the AU-F1 is known as the GCT (Grande Cadence de Tir or high rate of fire). The AU-FIT is fitted with the Sagem Cita 20 inertial navigation system as well as a 20-24 hp gas turbine auxiliary power unit (APU). A four-man gun crew can reload the AU-F1 in 15 minutes. A two-man gun crew can reload the AU-F1 in 20 minutes. The AU-F1's armor provides crew protection against artillery shrapnel and small arms fire.

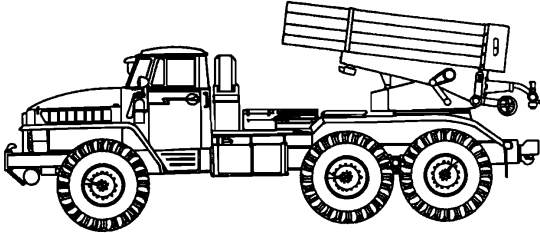

## Russian 122-mm Multiple Rocket Launcher BM-21

	<b>Weapons &amp; Ammunition Types</b>  122-mm rocket  Frag-HE	<b>Typical Combat Load</b>          40
<p><b>SYSTEM</b>  <b>Alternative Designations:</b> BM-21 GRAD (Hail) MRL  <b>Date of Introduction:</b> 1963  <b>Proliferation:</b> At least 50 countries  <b>Description:</b>          Crew: 5 (8 with 9K51 Complex)          Chassis/Carriage: Ural 375-D 6x6 wheeled          Combat Weight (mt): 13.7          Chassis Length Overall (m): 7.35          Height Overall (m): 3.09          Width Overall (m): 2.40</p> <p><b>Automotive Performance:</b>          Engine Type: ZIL 375, 180 hp water-cooled, V-8 gasoline engine          Cruising Range (km): 450 km          Speed (km/h):              Max Road: 75              Max Off-Road: 35              Cross-Country: INA              Max Swim: N/A          Fording Depths (m): Unprepared: 1.5          Emplacement Time (min): 3          Displacement Time (min): 2</p> <p><b>Radio:</b> R-123M</p> <p><b>Protection:</b>          Armor, Front (mm): None          Armor Side (mm): None          Armor Roof (mm): None          Self-Entrenching Blade: No          NBC Protection System: No          Smoke Equipment: No</p> <p><b>ARMAMENT</b>  <b>Launcher:</b>          Caliber, Type, Name: 122-mm, 9P132          Number of Tubes: 40 (4 rows of 10 tubes)          Launch Rate:              Full Salvo Time: 40 rounds in 20 seconds              Single Rocket Interval: .5 seconds per rocket          Loader Type: Manual          Reload Time: 10 minutes          Launcher Drive: Electric          Traverse: (°):              Left: 102              Right: 70              Total: 172          Elevation (°) (-/+): - 0/+55°</p>	<p><b>FIRE CONTROL</b>  <b>Indirect Fire:</b> PG-1M Panoramic Telescope (PANTEL)  <b>Collimator:</b> K-1  <b>Fire Control Computer:</b> None  <b>Position Location System:</b> None</p> <p><b>VARIANTS</b>  <b>BM-21V:</b> Russian 12-tube version for airborne divisions  <b>BM-21B:</b> Russian 36-tube MRL on a 6x6 ZIL-131 chassis  <b>Grad-P:</b> Russian 1 round rocket launcher  <b>BM-11:</b> North Korean 30-tube version  <b>Type 81:</b> Chinese 40- rail-launched version  <b>RM-70:</b> Czechoslovakian 40-tube version  <b>Sakr:</b> Egyptian 40- tube version</p> <p><b>MAIN ARMAMENT AMMUNITION</b>  <b>Caliber, Type, Name:</b>          122-mm Frag-HE, 9M22U  <b>Indirect Fire Range (m):</b>              Minimum Range: 5000              Maximum Range: 20,380          Warhead Weight (kg): 18.4 (M21OF)          Rocket Length: (m): 2.87          Maximum Velocity: INA          Fuze Type: MRV-U (PD)</p> <p>122-mm Frag-HE, 9M28F  <b>Indirect Fire Range (m):</b>              Minimum Range: 1500              Maximum Range: 15,000          Warhead Weight (kg): 21.0          Rocket Length: (m): 2.87          Maximum Velocity: INA          Fuze Type: MRV-U (PD) or AR-6 (proximity)</p> <p>122-mm Frag-HE, Type 90A (Chinese)  <b>Indirect Fire Range (m):</b>              Minimum Range: 12,700              Maximum Range: 32,700          Warhead Weight (kg): 18.3          Rocket Length: (m): 2.75          Maximum Velocity: INA          Fuze Type: PD</p> <p><b>Other Ammunition Types:</b> Smoke, Incendiary, Chemical, RF Jammer, Illumination, Antitank mines, Antipersonnel mines</p>	

### NOTES

The BM-21 is unquestionably the world's most widely used MRL. The launcher with supporting equipment is referred to as the complex 9K51. A special electric generator powers the launcher. The 9V170 firing device is cab mounted. But, the rockets can be fired using a remote-firing device that has a 64-meter-long cable.

	<p align="center"><b>Weapons &amp; Ammunition Types</b></p> <p align="center"><b>122-mm rocket</b></p> <p align="center">Frag-HE</p>	<p align="center"><b>Typical Combat Load</b></p> <p align="center"><b>50</b></p>
<p><b>SYSTEM</b>  <b>Alternative Designations:</b> 9A51  <b>Date of Introduction:</b> 1988  <b>Proliferation:</b> At least 2 countries  <b>Description:</b>  Crew: 3  Chassis/Carriage: Ural 4320 6x6 wheeled  Combat Weight (mt): 13.9  Chassis Length Overall (m): 7.35  Height Overall (m): 2.50  Width Overall (m): 2.50</p> <p><b>Automotive Performance:</b>  Engine Type: KAMAZ-740, 210 hp, diesel engine  Cruising Range (km): 990  Speed (km/h):      Max Road: 85      Max Off-Road: 40      Cross-Country: INA      Max Swim: N/A  Fording Depths (m): 1.5  Emplacement Time (min): 3  Displacement Time (min): 3</p> <p><b>Radio:</b> R-173M FM-VHF</p> <p><b>Protection:</b>  Armor, Front (mm): None  Armor Side (mm): None  Armor Roof (mm): None  Self-Entrenching Blade: No  NBC Protection System: No  Smoke Equipment: No</p>	<p><b>ARMAMENT</b>  <b>Launcher:</b>  Caliber, Type, Name: 122-mm, Prima  Number of Tubes: 50  Launch Rate:      Full Salvo Time: 50 rounds in 30 seconds      Single Rocket Interval: 0.6 seconds per rocket (est)  Loader Type: Transloader, crane hoist  Reload Time: 10 minutes  Launcher Drive: Electric  Traverse (°):      Left: 58      Right: 58      Total: 116  Elevation (°): -0/+55°</p> <p><b>FIRE CONTROL</b>  <b>Indirect Fire:</b> PG-1M Panoramic Telescope (PANTEL)  <b>Collimator:</b> K-1  <b>Fire Control Computer:</b> None  <b>Position Location System:</b> None</p> <p><b>VARIANTS</b>  None</p> <p><b>MAIN ARMAMENT AMMUNITION</b>  <b>Caliber, Type, Name:</b> 122-mm Frag-HE, 9M53F  Indirect Fire Range (m):      Min Range: 5,000      Max Range: 20,500  Warhead Weight (kg): 26  Rocket Length: (m): 3.03  Maximum Velocity: INA  Fuze Type: Prox</p> <p><b>Other Ammunition Types:</b> All standard 122-mm rockets</p>	

**NOTES**

The 9A51 Prima launcher assembly incorporates 50 launch tubes, a thermal shroud, and a remote electronic fuze setter. The remote fuze setter increases the ease with which the crew can adjust to changing target situations. Small boxes on the upper right surface of the exit end of the launcher tube contain the fuze setter for each rocket. The launch tubes are arrayed from top to bottom: 11-11-11-10-7. A 51<sup>ST</sup> tube in the center of the fourth row is blocked and used for electronics. The elevating arms are mounted in the center of the bottom row (like the 9P138) in order to reduce the height of the system. The 9A51 Prima is capable of firing older 122-mm rockets as well as the newer 122-mm rockets. The new rockets are equipped with a separating, parachute-retarded warhead that has more lethality. The launcher vehicle and the 9T232M ammunition resupply vehicle constitute the 9K59 rocket complex.

Both the 9A51 Prima and the 9T232M-ammunition resupply vehicle are based on the same Ural-4320 5-ton, 6x6 truck used for the BM-21-1. The 9A51 Prima is equipped with manually emplaced hydraulic firing jacks to enhance firing stability. The 9T232M ammunition resupply vehicle carries 50 rockets arranged in racks on the vehicle's rear deck. The crew manually reloads the launcher. The 9A51 Prima is capable (under optimum conditions) of firing a 50 rocket salvo that covers an area of 190,000m<sup>2</sup>.

## Russian 122-mm 1-Round Rocket Launcher 9P132

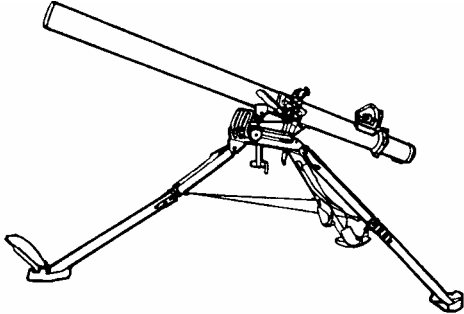
	<p><b>Weapons &amp; Ammunition Types</b></p> <p>122-mm rocket</p> <p>Frag-HE</p>	<p><b>Typical Combat Load</b></p> <p>1</p>
<p><b>SYSTEM</b>  <b>Alternative Designations:</b> DKZ-66, BM-21P, Grad-1P, 9K510  <b>Date of Introduction:</b> Mid to late 1960's  <b>Proliferation:</b> At least 5 countries</p> <p><b>Description:</b>  Crew: 4-5 (includes ammunition bearers)  Combat Weight (kg):  Loaded: 101  Unloaded: 55  Length (m): 2.50  Width (m): 1.53  Height (m): 1.00  Emplacement Time (min): 2.5  Displacement Time (min): 2</p> <p><b>Radio:</b> R-107M</p> <p><b>ARMAMENT</b>  <b>Launcher:</b>  Caliber, Type, Name: 122-mm, 9P132  Number of Tubes: 1  Launch Rate: 1 round per minute  Loader Type: Manual  Reload Time: .67 minutes (approximately 40 seconds)  Traverse(°):  Left: 7  Right: 7  Total: 14  Elevation (°) (-/+): +10/+40°</p>	<p><b>FIRE CONTROL</b>  <b>Indirect Fire:</b> PG-1M Panoramic Telescope (PANTEL)  <b>Collimator:</b> K-1</p> <p><b>VARIANTS</b>  None</p> <p><b>MAIN ARMAMENT AMMUNITION</b>  <b>Caliber, Type, Name:</b>  122-mm Frag-HE, 9M22M  Indirect Fire Range (m):  Minimum Range: 3,000  Maximum Range: 10,800  Warhead Weight (kg): 19.4  Rocket Length (m): 1.90  Maximum Velocity (m/s): 450  Fuze Type: PD</p> <p><b>Caliber, Type, Name:</b>  122-mm Illuminating Rocket Projectile, 9M42  Indirect Fire Range (m):  Minimum Range: 1,000  Maximum Range: 5,000  Rocket Weight (kg): 27  Rocket Length (m): 1.90</p> <p><b>Other Ammunition Types:</b> Smoke</p>	

### NOTES

The 9P132 is a lightweight, man-portable rocket launcher used by guerrilla, special purpose forces, or other light forces. The 9P132 is only effective as a harassment or interdiction weapon. When used to fire a new illumination rocket (9M42) the system has been referred to as the 9K510. The 9P132 is broken down for manpack transport into two one-man loads – the tube (27 kg) and the tripod sight assembly with a remote firing device (27 to 28 kg). The tripod legs also fold for ease of handling. Each 9M22M rocket is broken down into two one-man loads for transport. It takes approximately 2 minutes for assembly of the rocket. When assembled, the launcher has three course elevation positions, with the final elevation set by means of an elevation screw. The crew uses an electrical remote control with an electrical impulse generator and battery to fire the launcher. The 9P132 is incapable of firing the 9 foot version rockets of the BM-21 and similar 122-mm systems.

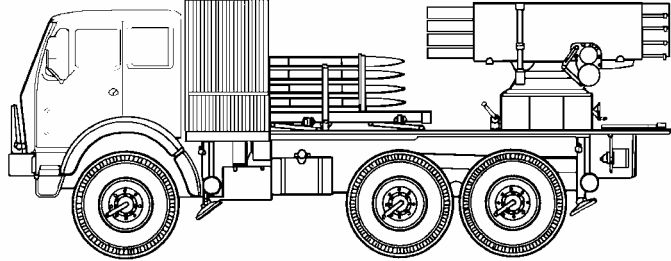

## Yugoslav 128-mm Multiple Rocket Launcher M77

	<p><b>Weapons &amp; Ammunition Types</b></p> <p>128-mm rocket</p> <p>Frag-HE</p>	<p><b>Typical Combat Load</b></p> <p>32</p>
<p><b>SYSTEM</b></p> <p><b>Alternative Designations:</b> M-77 Oganj</p> <p><b>Date of Introduction:</b> Early 1970's</p> <p><b>Proliferation:</b> At least 4 countries</p> <p><b>Description:</b></p> <p>Crew: 5</p> <p>Chassis/Carriage: Modified FAP-2026 BDS/AV 6x6 wheeled</p> <p>Combat Weight (mt): 22</p> <p>Chassis Length Overall (m): 8.40</p> <p>Height Overall (m): 3.10</p> <p>Width Overall (m): 2.50</p> <p><b>Automotive Performance:</b></p> <p>Engine Type: Model 2F/002A, 200 hp water-cooled, 8-cylinder diesel engine</p> <p>Cruising Range (km): 600</p> <p>Speed (km/h):</p> <ul style="list-style-type: none"> <li>Max Road: 80</li> <li>Max Off-Road: 35</li> <li>Cross-Country: INA</li> <li>Max Swim: N/A</li> </ul> <p>Fording Depths (m): Unprepared: 1.2</p> <p>Emplacement Time (min): 3</p> <p>Displacement Time (min): 2</p> <p><b>Radio:</b> R-123M</p> <p><b>Protection:</b></p> <p>Armor, Front (mm): None</p> <p>Armor Side (mm): None</p> <p>Armor Roof (mm): None</p> <p>Self-Entrenching Blade: No</p> <p>NBC Protection System: No</p> <p>Smoke Equipment: No</p>	<p><b>ARMAMENT</b></p> <p><b>Launcher:</b></p> <p>Caliber, Type, Name: 128-mm</p> <p>Number of Tubes: 32 (4 rows of 8 tubes)</p> <p>Launch Rate:</p> <p>Full Salvo Time: 32 rounds in 25.6 seconds</p> <p>Single Rocket Interval: 8 seconds per rocket</p> <p>Loader Type: Hydraulic</p> <p>Reload Time: 2 minutes</p> <p>Launcher Drive: Electric</p> <p>Traverse (°):</p> <ul style="list-style-type: none"> <li>Left: 180</li> <li>Right: 180</li> <li>Total: 360</li> </ul> <p>Elevation (°) (-/+): 0/+50°</p> <p><b>FIRE CONTROL</b></p> <p><b>Indirect Fire:</b> PG-1M Panoramic Telescope (PANTEL)</p> <p><b>Collimator:</b> K-1</p> <p><b>Fire Control Computer:</b> None</p> <p><b>Position Location System:</b> None</p> <p><b>VARIANTS</b></p> <p><b>128-mm Single Tube Launcher</b></p> <p><b>MAIN ARMAMENT AMMUNITION</b></p> <p><b>Caliber, Type, Name:</b></p> <p>128-mm Controlled Frag-HE</p> <p>Indirect Fire Range (m):</p> <ul style="list-style-type: none"> <li>Minimum Range: 1,000</li> <li>Maximum Range: 20,600</li> </ul> <p>Warhead Weight (kg): 20</p> <p>Rocket Length (m): 2.60</p> <p>Maximum Velocity (m/s):: INA</p> <p>Fuze Type: PD</p> <p><b>Other Ammunition Types:</b> DPICM</p>	

### NOTES

The M77 is configured and operated in the same manner as the Czechoslovakian 122-mm (40 round) multiple rocket launcher RM-70. The launcher is mounted over the rear axles with the reloader located behind the cab. During reloading, the launcher is rotated to the rear, two hydraulic cylinders raise the reloader, and then the rockets are pushed into the launcher. Unlike the RM-70, the M77 uses hydraulic cylinders rather than a sprocket and chain drive mechanism. The modified FAP2026 truck has four hydraulically emplaced firing jacks to provide firing stability. The rockets can be fired from inside the cab or with a remote-firing device. The M77 MRL is capable of mounting an antiaircraft machinegun for protection.



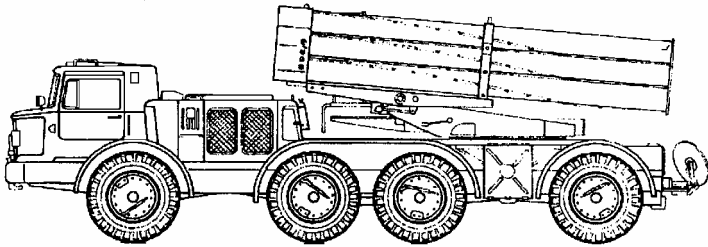

## Russian 220-mm Multiple Rocket Launcher 9P140

	<p><b>Weapons &amp; Ammunition Types</b></p> <p>220-mm rocket</p> <p>Frag-HE</p>	<p><b>Typical Combat Load</b></p> <p>16</p>
<p><b>SYSTEM</b></p> <p><b>Alternative Designations:</b> 9P140 Uragan</p> <p><b>Date of Introduction:</b> 1977</p> <p><b>Proliferation:</b> At least 7 countries</p> <p><b>Description:</b></p> <p>Crew: 4</p> <p>Chassis/Carriage: ZIL-135LM 8x8 wheeled</p> <p>Combat Weight (mt): 20.0</p> <p>Chassis Length Overall (m): 9.3</p> <p>Height Overall (m): 3.2</p> <p>Width Overall (m): 2.8</p> <p><b>Automotive Performance:</b></p> <p>Engine Type: 2 each - 177 hp, 8 cylinder, 4-stroke gasoline engines</p> <p>Cruising Range (km): 500 km</p> <p>Speed (km/h):</p> <ul style="list-style-type: none"> <li>Max Road: 65</li> <li>Max Off-Road: INA</li> <li>Cross-Country: INA</li> <li>Max Swim: N/A</li> </ul> <p>Fording Depths (m): Unprepared: 1.2</p> <p>Emplacement Time (min): 3</p> <p>Displacement Time (min): 3</p> <p><b>Radio:</b> R-123M</p> <p><b>Protection:</b></p> <ul style="list-style-type: none"> <li>Armor, Front (mm): None</li> <li>Armor Side (mm): None</li> <li>Armor Roof (mm): None</li> <li>Self-Entrenching Blade: No</li> <li>NBC Protection System: No</li> <li>Smoke Equipment: No</li> </ul> <p><b>ARMAMENT</b></p> <p><b>Launcher:</b></p> <p>Caliber, Type, Name: 220-mm, 9P140</p> <p>Number of Tubes: 16 (2 rows of 6 tubes and 1 row of 4 tubes)</p> <p>Launch Rate:</p> <ul style="list-style-type: none"> <li>Full Salvo Time: 16 rounds in 20 seconds</li> <li>Single Rocket Interval: 1.25 seconds per rocket</li> </ul> <p>Loader Type: Manual</p> <p>Reload Time: 15-20 minutes</p> <p>Launcher Drive: Electric</p> <p>Traverse (°):</p> <ul style="list-style-type: none"> <li>Left: 30</li> <li>Right: 30</li> <li>Total: 60</li> </ul> <p>Elevation (°) (-/+): -0/+55°</p>	<p><b>FIRE CONTROL</b></p> <p><b>Indirect Fire:</b> PG-1M Panoramic Telescope (PANTEL)</p> <p><b>Collimator:</b> K-1</p> <p><b>Fire Control Computer:</b> None</p> <p><b>Position Location System:</b> None</p> <p><b>VARIANTS</b></p> <p>None</p> <p><b>MAIN ARMAMENT AMMUNITION</b></p> <p><b>Caliber, Type, Name:</b></p> <p>220-mm Frag-HE, 9M27F</p> <ul style="list-style-type: none"> <li>Indirect Fire Range (m): <ul style="list-style-type: none"> <li>Minimum Range: 10,000</li> <li>Maximum Range: 35,000</li> </ul> </li> <li>Warhead Weight (kg): 100</li> <li>Rocket Length (m): 4.8</li> <li>Maximum Velocity: INA</li> <li>Fuze Type: Electronic timing (ET)</li> </ul> <p>220-mm DPICM, 9M27K</p> <ul style="list-style-type: none"> <li>Indirect Fire Range (m): <ul style="list-style-type: none"> <li>Minimum Range: 10,000</li> <li>Maximum Range: 35,000</li> </ul> </li> <li>Warhead Weight (kg): 90</li> <li>Rocket Length (m): 5.1</li> <li>Maximum Velocity: INA</li> <li>Fuze Type: Electronic timing (ET)</li> </ul> <p>220-mm Antitank, 9M27K2</p> <ul style="list-style-type: none"> <li>Indirect Fire Range (m): <ul style="list-style-type: none"> <li>Minimum Range: 10,000</li> <li>Maximum Range: 35,000</li> </ul> </li> <li>Warhead Weight (kg): 90</li> <li>Rocket Length (m): 5.1</li> <li>Maximum Velocity: INA</li> <li>Fuze Type: Electronic timing (ET)</li> </ul>	

## Russian 220-mm Multiple Rocket Launcher 9P140 continued

<b>MAIN ARMAMENT AMMUNITION (continued)</b> <b>Caliber, Type, Name:</b> 220-mm Antipersonnel, 9M27K3 Indirect Fire Range (m): Minimum Range: 10,000 Maximum Range: 35,000 Warhead Weight (kg): 90 Rocket Length: (m): 5.1 Maximum Velocity: INA Fuze Type: Electronic timing (ET)	220-mm Antitank, 9M59 Indirect Fire Range (m): Minimum Range: 10,000 Maximum Range: 35,000 Warhead Weight (kg): 90 Rocket Length: (m): 5.1 Maximum Velocity: INA Fuze Type: Electronic timing (ET)  <b>Other Ammunition Types: None</b>
--	--

### NOTES

The 9P140 Uragan (previously referred to incorrectly as BM-22 or BM-27) is the world's first modern fin and spin-stabilized heavy rocket system. Essentially a scaled-up version of the BM-21, the 9P140 use many of the same design features. The launcher, 9T452 transloader, rockets, and support equipment constitutes the 9K57 complex.

The 9P140 and its transloader are both based on variants of the gasoline-powered ZIL-135LM 8-ton 8x8 chassis. The truck is unusual in that it uses two engines, each driving the wheels on one side of the truck, and only the front and rear axles steer. The 9P140 cab has a blast shield that is raised during firing, and the vehicle is stabilized during firing by two manually emplaced hydraulic jacks at the rear of the chassis.

The launcher has electrically powered traversing and elevating mechanisms. During travel, the launcher assembly is oriented rearward and a light sheet metal cover over the muzzle end of the tubes prevents foreign material from entering the tube. This is a safety feature that is designed for travel when loaded. There is no such cover for the muzzle end of an unloaded launcher.

## Iranian 240-mm Multiple Rocket Launcher Fadjr-3

	<p style="text-align: center;"><b>Weapons &amp; Ammunition Types</b></p> <p>240-mm rocket</p> <p>Frag-HE</p>	<p style="text-align: center;"><b>Typical Combat Load</b></p> <p style="text-align: center;">12</p>
<p><b>SYSTEM</b></p> <p><b>Alternative Designations:</b> INA</p> <p><b>Date of Introduction:</b> 1996</p> <p><b>Proliferation:</b> At least 1 country and Hezbollah Units</p> <p><b>Description:</b></p> <p>Crew: 5</p> <p>Chassis/Carriage: Mercedes Benz 6x6 wheeled</p> <p>Combat Weight (mt): 15.0</p> <p>Chassis Length Overall (m): 10.45</p> <p>Height Overall (m): 3.34</p> <p>Width Overall (m): 2.54</p> <p><b>Automotive Performance:</b></p> <p>Engine Type: 280 hp, V-8 liquid-cooled, diesel engine</p> <p>Cruising Range (km): INA</p> <p>Speed (km/h):</p> <ul style="list-style-type: none"> <li>Max Road: 60</li> <li>Max Off-Road: 25 (est)</li> <li>Cross-Country: INA</li> <li>Max Swim: N/A</li> </ul> <p>Fording Depths (m): INA</p> <p>Emplacement Time (min): INA</p> <p>Displacement Time (min): INA</p> <p><b>Radio:</b> INA</p> <p><b>Protection:</b></p> <p>Armor, Front (mm): None</p> <p>Armor Side (mm): None</p> <p>Armor Roof (mm): None</p> <p>Self-Entrenching Blade: No</p> <p>NBC Protection System: No</p> <p>Smoke Equipment: No</p>	<p><b>ARMAMENT</b></p> <p><b>Launcher:</b></p> <p>Caliber, Type, Name: 240-mm, Fadjr-3</p> <p>Number of Tubes: 12 (2 rows of 6 tubes)</p> <p>Launch Rate:</p> <ul style="list-style-type: none"> <li>Full Salvo Time: 12 rounds in 48 seconds (est)</li> <li>Single Rocket Interval: 4 seconds per rocket (est)</li> </ul> <p>Loader Type: Transloader, crane hoist</p> <p>Reload Time: 12 to 15 minutes (est)</p> <p>Launcher Drive: Manual</p> <p>Traverse: (°):</p> <ul style="list-style-type: none"> <li>Left: 90</li> <li>Right: 100</li> <li>Total: 190</li> </ul> <p>Elevation (°) (-/+): -0/+57°</p> <p><b>FIRE CONTROL</b></p> <p><b>Indirect Fire:</b> INA</p> <p><b>Collimator:</b> INA</p> <p><b>Fire Control Computer:</b> None</p> <p><b>Position Location System:</b> None</p> <p><b>VARIANTS</b></p> <p>None</p> <p><b>MAIN ARMAMENT AMMUNITION</b></p> <p><b>Caliber, Type, Name:</b> 240-mm Frag-HE, Fadjr-3</p> <p>Indirect Fire Range (m):</p> <ul style="list-style-type: none"> <li>Min Range: INA</li> <li>Max Range: 43,000</li> </ul> <p>Warhead Weight (kg): 90</p> <p>Rocket Length: (m): 5.2</p> <p>Maximum Velocity: INA</p> <p>Fuze Type: PD</p> <p><b>Other Ammunition Types:</b> INA</p>	

### NOTES

The system is stabilized by 2 firing jacks mounted on the rear of the vehicle and 2 more located behind the cab. The system has a dedicated resupply vehicle with a crane to assist in reloading. Shahid Bagheri Industries of Iran developed the system with possible technical assistance from North Korea.

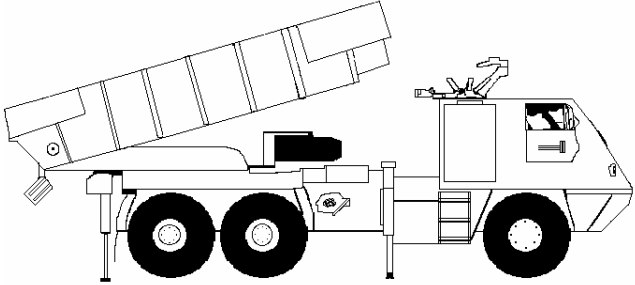

## Brazilian 127-mm, 180-mm, & 300-mm Multiple Rocket Launcher ASTROS II

	<b>Weapons &amp; Ammunition Types</b>	<b>Typical Combat Load</b>
<p><b>SYSTEM</b>  <b>Alternative Designations:</b> ASTROS II AV-LMU  <b>Date of Introduction:</b> 1983  <b>Proliferation:</b> At least 6 countries  <b>Description:</b>            Crew: 3            Chassis/Carriage: TECTRAN 10-ton 6x6 wheeled            Combat Weight (mt): 20.0            Chassis Length Overall (m): 8.0            Height Overall (m): 2.6            Width Overall (m): 2.4</p> <p><b>Automotive Performance:</b>            Engine Type: 280 hp, water-cooled turbocharged, diesel engine            Cruising Range (km): INA            Speed (km/h):                Max Road: 70                Max Off-Road: 40                Cross-Country: INA                Max Swim: N/A            Fording Depths (m): Unprepared: 1.0            Emplacement Time (min): INA            Displacement Time (min): INA</p> <p><b>Radio:</b> INA</p> <p><b>Protection:</b>            Armor, Front (mm): None            Armor Side (mm): None            Armor Roof (mm): None            Self-Entrenching Blade: No            NBC Protection System: No            Smoke Equipment: 6 smoke grenade launchers</p> <p><b>ARMAMENT</b>  <b>Launcher:</b>            Caliber, Type, Name: 127-mm, 180-mm, 300-mm, ASTROS            Number of Tubes: 127-mm (32), 180-mm (16), 300-mm (4)            Launch Rate:                Full Salvo Time: INA                Single Rocket Interval: INA            Loader Type: Manual            Reload Time: INA            Launcher Drive: Electric            Traverse (°):                Left: INA                Right: INA                Total: INA            Elevation (°) (-/+): INA</p>	<p><b>127-mm rocket</b> Frag-HE</p> <p><b>180-mm rocket</b> Frag-HE</p> <p><b>300-mm rocket</b> Frag-HE</p> <p><b>.50 Cal. M2 HB MG</b></p>	<p><b>32</b></p> <p><b>16</b></p> <p><b>4</b></p> <p><b>INA</b></p>
	<p><b>Auxiliary Weapon:</b>            Caliber, Type, Name: .50 (12.7x99) heavy machinegun, M2HB            Mount Type: Cab AA mount            Direct Fire Range (m): INA            Max Effective Range (m):                Day: 1000                Night: INA            Fire on Move: Yes            Rate of Fire (rpm): 450-550 (cyclic)</p> <p><b>FIRE CONTROL</b>  <b>Indirect Fire:</b> INA  <b>Collimator:</b> INA  <b>Fire Control Computer:</b> FIELDGAURD Radar or the FILA System  <b>Position Location System:</b> INA</p> <p><b>VARIANTS:</b> None</p> <p><b>MAIN ARMAMENT AMMUNITION</b>  <b>Caliber, Type, Name:</b>            127-mm Frag-HE, SS-30            Indirect Fire Range (m):                Minimum Range: 9000                Maximum Range: 30,000            Warhead Weight (kg): INA            Rocket Length (m): 3.9            Maximum Velocity: INA            Fuze Type: INA</p> <p><b>Other Ammunition Types:</b> None</p> <p><b>Caliber, Type, Name:</b>            180-mm Frag-HE, SS-40            Indirect Fire Range (m):                Minimum Range: 15,000                Maximum Range: 35,000            Warhead Weight (kg): INA            Rocket Length (m): 4.2            Maximum Velocity: INA            Fuze Type: INA</p> <p><b>Other Ammunition Types:</b> DPICM, HE-Incendiary, Antitank mines, Antipersonnel mines, Runway Denial</p>	

**Brazilian 127-mm, 180-mm, & 300-mm Multiple Rocket Launcher ASTROS II**  
**continued**

---

<p><b>Caliber, Type, Name:</b>  300-mm Frag-HE, SS-60  Indirect Fire Range (m):      Minimum Range: 20,000      Maximum Range: 60,000  Warhead Weight (kg): INA  Rocket Length: (m): 5.6  Maximum Velocity: INA  Fuze Type: INA</p> <p><b>Other Ammunition Types:</b> DPICM, HE-Incendiary, Antitank mines, Antipersonnel mines, Runway Denial</p>	<p>300-mm Frag-HE, SS-80  Indirect Fire Range (m):      Minimum Range: 22,000      Maximum Range: 90,000  Warhead Weight (kg): INA  Rocket Length: (m): 5.6  Maximum Velocity: INA  Fuze Type: INA</p> <p><b>Other Ammunition Types:</b> DPICM, HE-Incendiary, Antitank mines, Antipersonnel mines, Runway Denial</p>
--	---

**NOTES**

The ASTROS (Artillery SaTuration ROcket System) II is a modular multiple rocket launcher capable of firing three different caliber wrap-around fin rockets (for improved accuracy) using several types of warheads. The universal modules enable the system to accomplish fire missions with ranges from 9 to 90 kilometers.

The ASTROS II system consists of the following vehicles:

Universal Multiple Launcher (AV-LMU), Ammunition Supply Vehicle (AV-RMD), Command and Control Vehicle/Fire Control Unit (AV-VCC), Mobile Workshops (for field maintenance), and the Optional Electronic Fire Control Unit (AV-UCF). All of the ASTROS II vehicles use the Tectran Engenharia 10 ton, 6x6, wheeled vehicle chassis.

A typical firing battery consists of six AV-LMU launchers, six AV-RMD ammunition supply vehicles, and one AV-VCC fire control unit. A AV-VCC command and control unit and two mobile workshops are found at battalion level. The battalion level AV-VCC can coordinate and direct fire missions for three ASTROS batteries. The AV-RMD ammunition supply vehicle carries two complete loads for each launcher.

## Chinese 273-mm Multiple Rocket Launcher WM-80

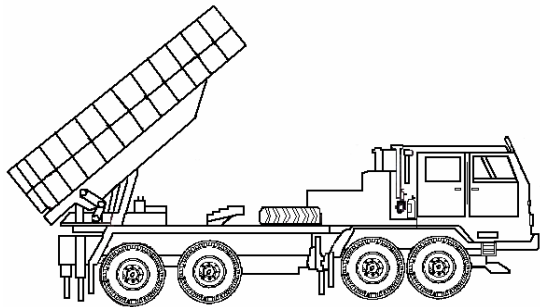
	<p><b>Weapons &amp; Ammunition Types</b></p> <p>273-mm rocket</p> <p>Frag-HE</p>	<p><b>Typical Combat Load</b></p> <p>8</p>
<p><b>SYSTEM</b></p> <p><b>Alternative Designations:</b> None</p> <p><b>Date of Introduction:</b> INA</p> <p><b>Proliferation:</b> Ready for production</p> <p><b>Description:</b></p> <p>Crew: 5</p> <p>Chassis/Carriage: TA 580 8x8 wheeled</p> <p>Combat Weight (mt): 34</p> <p>Chassis Length Overall (m): 9.55</p> <p>Height Overall (m): 3.30</p> <p>Width Overall (m): 3.06</p> <p><b>Automotive Performance:</b></p> <p>Engine Type: 525 hp air-cooled, diesel engine</p> <p>Cruising Range (km): 400 km</p> <p>Speed (km/h):</p> <ul style="list-style-type: none"> <li>Max Road: 70</li> <li>Max Off-Road: INA</li> <li>Cross-Country: INA</li> <li>Max Swim: N/A</li> </ul> <p>Fording Depths (m): Unprepared: INA</p> <p>Emplacement Time (min): 3 to 5</p> <p>Displacement Time (min): 3 to 5</p> <p><b>Radio:</b> INA</p> <p><b>Protection:</b></p> <p>Armor, Front (mm): None</p> <p>Armor Side (mm): None</p> <p>Armor Roof (mm): None</p> <p>Self-Entrenching Blade: No</p> <p>NBC Protection System: No</p> <p>Smoke Equipment: No</p> <p><b>ARMAMENT</b></p> <p><b>Launcher:</b></p> <p>Caliber, Type, Name: 273-mm,</p> <p>Number of Tubes: 8 (2 rows of 4 tubes)</p> <p>Launch Rate:</p> <ul style="list-style-type: none"> <li>Full Salvo Time: 8 rounds in 5 seconds</li> <li>Single Rocket Interval: .5 seconds per rocket</li> </ul> <p>Loader Type: Manual</p>	<p>Reload Time: 5-8 minutes</p> <p>Launcher Drive: Electric</p> <p>Traverse (°):</p> <ul style="list-style-type: none"> <li>Left: 20</li> <li>Right: 20</li> <li>Total: 40</li> </ul> <p>Elevation (°) (+/+): +20/+60°</p> <p><b>FIRE CONTROL</b></p> <p><b>Indirect Fire:</b> INA</p> <p><b>Collimator:</b> INA</p> <p><b>Fire Control Computer:</b> None</p> <p><b>Position Location System:</b> None</p> <p><b>VARIANTS</b></p> <p>None</p> <p><b>MAIN ARMAMENT AMMUNITION</b></p> <p><b>Caliber, Type, Name:</b></p> <p>273-mm Frag-HE, WM-80</p> <p>Indirect Fire Range (m):</p> <ul style="list-style-type: none"> <li>Min Range: 34,000</li> <li>Max Range: 80,000</li> </ul> <p>Warhead Weight (kg): 150</p> <p>Rocket Length (m): 4.58</p> <p>Maximum Velocity (m/s): 1,140</p> <p>Fuze Type: WJ-6A (PD)</p> <p>273-mm DPICM, WM-80</p> <p>Indirect Fire Range (m):</p> <ul style="list-style-type: none"> <li>Min Range: 34,000</li> <li>Max Range: 80,000</li> </ul> <p>Warhead Weight (kg): 150</p> <p>Rocket Length (m): 4.58</p> <p>Maximum Velocity (m/s): 1,140</p> <p>Fuze Type: MD-23A (proximity)</p> <p><b>Other Ammunition Types:</b> None</p>	

### NOTES

The WM-80 is currently being advertised heavily on the open-market by NORINCO Industries. The WM-80 Rocket System is composed of the multiple rocket launcher, the ammunition transloader, fire command and control vehicles, and the maintenance vehicles. The fire command and control is composed of a brigade/regiment command vehicle, battalion command vehicle, surveillance/spotting radar, and meteorological radar.

## Russian 300-mm Multiple Rocket Launcher 9A52-2

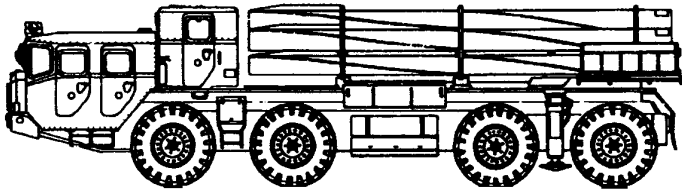
	<p style="text-align: center;"><b>Weapons &amp; Ammunition Types</b></p> <p>300-mm rocket Frag-HE</p>	<p style="text-align: center;"><b>Typical Com- bat Load</b></p> <p style="text-align: center;">12</p>
<p><b>SYSTEM</b>  <b>Alternative Designations:</b> 9A52-2 Smerch-M  <b>Date of Introduction:</b> 1989  <b>Proliferation:</b> At least 4 countries  <b>Description:</b>  Crew: 4 (7 with 9K58 Complex)  Chassis/Carriage: MAZ-543M 8x8 wheeled  Combat Weight (mt): 43.7  Chassis Length Overall (m): 12.1  Height Overall (m): 3.05  Width Overall (m): 3.05</p> <p><b>Automotive Performance:</b>  Engine Type: 518 hp, V-12 diesel engine  Cruising Range (km): 850 km  Speed (km/h):      Max Road: 60      Max Off-Road: 35      Cross-Country: INA      Max Swim: N/A  Fording Depths (m): Unprepared: 1.1  Emplacement Time (min): 3  Displacement Time (min): 3</p> <p><b>Radio:</b> R-123M</p> <p><b>Protection:</b>  Armor, Front (mm): None  Armor Side (mm): None  Armor Roof (mm): None  Self-Entrenching Blade: No  NBC Protection System: No  Smoke Equipment: No</p> <p><b>ARMAMENT</b>  <b>Launcher:</b>  Caliber, Type, Name: 300-mm, 9A52  Number of Tubes: 12 (3 rows of 4 tubes)  Launch Rate:      Full Salvo Time: 12 rounds in 38 seconds      Single Rocket Interval: 3 seconds per rocket  Loader Type: Transloader, crane hoist  Reload Time: 36 minutes  Launcher Drive: Electric  Traverse (°):      Left: 30      Right: 30      Total: 60  Elevation (°) (-/+): -0/+55°</p>	<p><b>FIRE CONTROL</b>  <b>Indirect Fire:</b> PG-1M Panoramic Telescope (PANTEL)  <b>Collimator:</b> K-1  <b>Fire Control Computer:</b> None  <b>Position Location System:</b> None</p> <p><b>VARIANTS</b>  None</p> <p><b>MAIN ARMAMENT AMMUNITION</b>  <b>Caliber, Type, Name:</b> 300-mm Frag-HE, 9M55F  Indirect Fire Range (m):      Min Range: 20,000      Max Range: 90,000  Warhead Weight (kg): 258  Rocket Length (m): 7.6  Maximum Velocity: INA  Fuze Type: Electronic timing (ET)</p> <p><b>Caliber, Type, Name:</b> 300-mm DPICM, 9M55K  Indirect Fire Range (m):      Min Range: 20,000      Max Range: 90,000  Warhead Weight (kg): 235  Rocket Length (m): 7.6  Maximum Velocity: INA  Fuze Type: Electronic timing (ET)</p> <p><b>Caliber, Type, Name:</b> 300-mm Sensor-fuzed (MOTIV-3M), 9M55K1  Indirect Fire Range (m):      Min Range: 20,000      Max Range: 90,000  Warhead Weight (kg): 233  Rocket Length (m): 7.6  Maximum Velocity: INA  Fuze Type: Electronic timing (ET)</p> <p><b>Ammunition Note:</b> All of the above warheads fit on a n inertially course-corrected rocket, with time-fuze adjustment. These provide greatly improved accuracy, with error of 0.019 percent of range.</p> <p><b>Other Ammunition Types:</b> Smoke, Incendiary, Chemical, Leaflet, Fuel Air Explosive (FAE), R-90 expendable miniature UAV (experimental)</p>	

**NOTES**

The 9A52-2 launcher with all supporting equipment, including the 9T234-2 Transloader, and the 1K123 Vivary Fire Control System, is referred to as the complex 9K58.



## French 120-mm Mortar MO-120-RT

	<b>Weapons &amp; Ammunition Types</b>  <b>120-mm mortar</b>  Frag-HE	<b>Typical Combat Load</b>  <b>70</b>
<p><b>SYSTEM</b>  <b>Alternative Designations:</b> RT-61  <b>Date of Introduction:</b> 1961  <b>Proliferation:</b> At least 22 countries  <b>Description:</b>          Crew: 4-6          Prime Mover: VAB M120 4x4 wheeled          Combat Weight (mt): 13.0          Chassis Length Overall (m): 5.98          Height Overall (m): 2.06          Width Overall (m): 2.50          Combat Weight (kg): 582          Wheeled Carriage/Tube Support Mechanism (kg): 220          Baseplate (kg): 194          Length Overall (m): 2.70          Height Overall (m): 1.10          Width Overall (m): 1.55          Bipod (kg): N/A          Ground Clearance (m): 0.35</p> <p><b>Automotive Performance:</b>          Engine Type: Renault VI MIDS, 220 hp, diesel engine          Cruising Range (km): 1,000          Speed (km/h):              Max Road: 92              Max Off-Road: 60 (est)              Cross-Country: 30 (est)              Max Swim: N/A          Fording Depths (m): Amphibious          Emplacement Time (min): 1.5          Displacement Time (min): 2</p> <p><b>Radio:</b> INA</p> <p><b>Protection:</b>          Armor, Front (mm): INA          Armor Side (mm): INA          Armor Roof (mm): INA          Self-Entrenching Blade: No          NBC Protection System: Yes          Smoke Equipment: No</p>	<p><b>ARMAMENT</b>  <b>Main Armament:</b>          Caliber, Type, Name: 120-mm, mortar, MO-120-RT          Rate of Fire (rpm):          Burst: 18          Normal: 10          Sustained: INA          Loader Type: Manual          Traverse (°):              Left: 7.5              Right: 7.5              Total: 15          Elevation (°): +30/+85°</p> <p><b>FIRE CONTROL</b>  <b>Indirect Fire:</b> INA  <b>Collimator:</b> INA  <b>Fire Control Computer:</b> None  <b>Position Location System:</b> None</p> <p><b>VARIANTS</b>  <b>120 2R2M:</b> Mounted in light armored vehicles such as the MOWAG Piranha APC or the Turkish FMC-NUROL mortar vehicle.</p> <p><b>MAIN ARMAMENT AMMUNITION</b>  <b>Caliber, Type, Name:</b> 120-mm Frag-HE, PR14          Indirect Fire Range (m):              Min Range: 1,100              Max Range: 8,135          Complete Projectile (kg): 18.60          Maximum Velocity: INA          Fuze Type: M557 PD</p> <p><b>Caliber, Type, Name:</b> 120-mm HE-RA, PRPA (Rocket Assist)          Indirect Fire Range (m):              Min Range: 1,100              Max Range: 13,000          Complete Projectile (kg): 18.60          Maximum Velocity: INA          Fuze Type: M557 PD</p> <p><b>Other Ammunition Types:</b> All standard 120-mm smoothbore mortar projectiles without fold-out fins</p>	

### NOTES

The RT-61 is a rifled mortar capable of firing pre-engraved spin-stabilized and smoothbore 120-mm mortar projectiles with or without rocket assist. However, it is not capable of firing smoothbore mortar projectiles with fold out fins (spring-loaded tail assemblies with straight fins). The RT-61 is a three-piece mortar system consisting of a rifled tube, a baseplate, and a wheeled carriage. Trigger firing is the normal method of firing for this mortar. Drop firing can be accomplished only with smoothbore mortar projectiles.

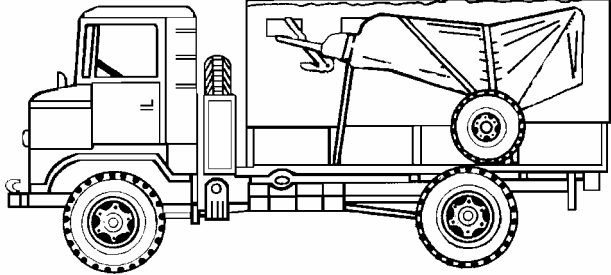

# Russian 120-mm Self-Propelled Mortar 2S12-RT

	<p><b>Weapons &amp; Ammunition Types</b></p> <p><b>120-mm mortar</b></p> <p>Frag-HE Smoke Illumination</p>	<p><b>Typical Combat Load</b></p> <p><b>48</b></p>
<p><b>SYSTEM</b>  <b>Alternative Designations:</b> 120-mm 2S12 Sani (Sled)  <b>Date of Introduction:</b> early 1980s  <b>Proliferation:</b> At least 1 countries  <b>Description:</b>          Crew: 5          Vehicle Platform (chassis): GAZ-66          Combat Weight (mt): 3.64          Chassis Length Overall (m): 5.66          Height Overall (m): 2.44          Width Overall (m): 2.34  <b>2B11 Mortar</b>          Combat Weight (kg): 210 (firing) /297 (traveling)          Wheeled Carriage 2L81 (kg): 87          Baseplate (kg): 80          Bipod (kg): 55</p> <p><b>Automotive Performance:</b>          Engine Type: ZMZ-66, 115 hp V-8 water cooled gasoline          Cruising Range (km): 600          Speed (km/h):              Max Road: 87              Max Off-Road: 35              Cross-Country: INA          Forging Depths (m): .80          Emplacement Time (min): 3 (est)          Displacement Time (min): 3 (est)</p> <p><b>Radio:</b> R-123M</p> <p><b>Protection:</b>          Armor, Turret Front (mm): None          Armor Turret Top (mm): None          Armor Hull (mm): None          NBC Protection System: No          Smoke Equipment: No</p> <p><b>ARMAMENT</b>  <b>Main Armament:</b>          Caliber, Type, Name: 120-mm, mortar, 2B11          Rate of Fire (rpm):          Burst: 15          Normal: 10          Sustained: 4 (est)          Loader Type: Manual</p>	<p>Traverse (°):          Left: 5 (on bipod)/26 (moving the bipod)          Right: 5 (on bipod)/26 (moving the bipod)          Total: 10 (on bipod)/52 (moving the bipod)          Elevation (°) (-/+): +45/+80°</p> <p><b>FIRE CONTROL</b>  <b>Indirect Fire:</b> MPM-44M  <b>Direct Fire:</b> INA  <b>Collimator:</b> K-1  <b>Gun Display Unit:</b> None  <b>Fire Control Computer:</b> None</p> <p><b>VARIANTS</b>          None</p> <p><b>MAIN ARMAMENT AMMUNITION</b>  <b>Caliber, Type, Name:</b>          120-mm Frag-HE (3OF843B)          Indirect Fire Range (m):              Minimum Range: 450              Maximum Range: 7,000          Complete Projectile Weight (kg): 16.8          Muzzle Velocity (m/s):: 325          Fuze Type: GVMZ-7 PD</p> <p>120-mm Smoke          Indirect Fire Range (m):              Minimum Range: 1,000              Maximum Range: 6,800          Complete Projectile Weight (kg): 16.7          Muzzle Velocity (m/s):: INA          Fuze Type: PD</p> <p>120-mm Illumination, S-843          Indirect Fire Range (m):              Minimum Range: 1,000              Maximum Range: 5,300          Complete Projectile Weight (kg): 16.8          Muzzle Velocity (m/s):: INA          Fuze Type: T-1 TSQ</p> <p><b>Other Ammunition Types:</b> All standard 120-mm mortar rounds</p>	

**NOTES**

The 2S12 is a self-propelled version of the towed 120-mm mortar 2B11 (M-120) carried on the bed of GAZ-66 truck. The SP version provides greater mobility for this versatile mortar. The 2S12 has a special safety device to prevent double loading when the mortar round is not fired or removed from the tube. When a round is loaded, it trips a tab on the tube, preventing another round from being loaded. The tab shifts to the "ready" position when the round fires, allowing the 2S12 to be reloaded.

## Russian 120-mm Self-Propelled Combination Gun 2S23

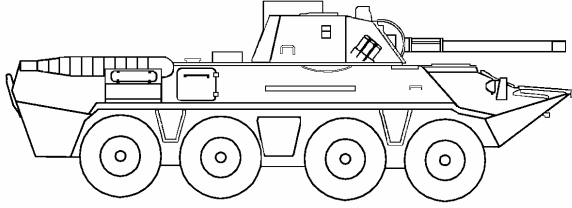
	<p><b>Weapons &amp; Ammunition Types</b></p> <p><b>120-mm mortar</b></p> <p>Frag-HE Smoke Illumination</p> <p><b>7.62-mm MG</b></p>	<p><b>Typical Combat Load</b></p> <p><b>30</b></p> <p><b>2,000</b></p>
<p><b>SYSTEM</b></p> <p><b>Alternative Designations:</b> 120-mm 2S23 Nona-SVK  <b>Date of Introduction:</b> 1990  <b>Proliferation:</b> At least 1 countries  <b>Description:</b>  Crew: 4  Platform (chassis): Modified BTR-80 APC  Combat Weight (mt): 14.5  Chassis Length Overall (m): 7.50  Height Overall (m): 2.75  Width Overall (m): 2.90</p> <p><b>Automotive Performance:</b>  Engine Type: 260 hp V-8 water cooled diesel  Cruising Range (km): 600  Speed (km/h):  Max Road: 80  Max Off-Road: 60  Cross-Country: 40  Max Swim: 10  Fording Depths (m): Amphibious  Emplacement Time (min): 1 (est)  Displacement Time (min): 1 (est)  <b>Radio:</b> R-173</p> <p><b>Protection:</b>  Armor, Turret Front (mm): Against 12.7-mm  Armor Turret Top (mm): INA  Armor Hull (mm): INA  NBC Protection System: Yes  Smoke Equipment: Six 81-mm smoke grenade launchers</p> <p><b>ARMAMENT</b></p> <p><b>Main Armament:</b>  Caliber, Type, Name: 120-mm, gun-mortar, 2A60  Barrel Length (cal): INA  Rate of Fire (rpm):  Burst: 10  Normal: 6  Sustained: 4  Loader Type: autoloader  Breech Type: combined semi-automatic breechblock with wedge locking mechanism and powder gases plastic obturator  Muzzle Brake Type: None  Traverse (°):  Left: 35  Right: 35  Total: 70  Elevation (°) (-/+): -4/+80°</p>	<p><b>Auxiliary Weapon:</b>  Caliber, Type, Name: 7.62-mm machinegun, PKT  Mount Type: Coax  Direct Fire Range (m): 1,500  Max Effective Range (m):  Day: 1,000  Night: N/A  Fire on Move: Yes  Rate of Fire (rpm): 650 (cyclic), 2-10 round bursts</p> <p><b>FIRE CONTROL</b>  <b>Indirect Fire:</b> INA  <b>Direct Fire:</b> INA  <b>Collimator:</b> K-1  <b>Gun Display Unit:</b> None  <b>Fire Control Computer:</b> None</p> <p><b>VARIANTS</b>  None</p> <p><b>MAIN ARMAMENT AMMUNITION</b></p> <p><b>Caliber, Type, Name:</b>  120-mm Frag-HE (3VOF49)  Indirect Fire Range (m):  Minimum Range: 1,000  Maximum Range: 8,850  Complete Projectile Weight (kg): 19.8  Muzzle Velocity (m/s): 367  Fuze Type: B35 PD</p> <p>120-mm, HEAT  Direct Fire Range (m):  Minimum Range: 40  Maximum Range: 1,000  Armor Penetration (mm): INA  Complete Projectile Weight (kg): 13.20  Muzzle Velocity (m/s): 560  Fuze Type: PD</p> <p>120-mm Frag-HE rocket assisted  Indirect Fire Range (m):  Minimum Range: 6,710  Maximum Range: 13,000  Complete Projectile Weight (kg): 19.8  Muzzle Velocity (m/s): 367  Fuze Type: B35 PD</p> <p><b>Other Ammunition Types:</b> All standard 120-mm rifled mortar rds</p>	

**NOTES**

2S23 has a device for loading projectiles from the ground. During traveling the device is externally attached on the right side near the side door.

### OPFOR Special Munitions Chart for Training Simulation

WEAPON	SMOKE (km)	SCATTERABLE MINES (km)	CHEMICAL (km)
122-MM: 2S1 SP, D-30 TOWED HOWITZER	15.3	N/A	15.3
152-MM: 2S3/2S3M SP, D-20 TOWED HOWITZER	17.2	N/A	17.2
152-MM: 2S19 SP, 2A65 TOWED HOWITZER	24.0	N/A	24.0
152-MM: 2S5 SP, 2A36 TOWED GUN	28.4	N/A	28.4
122-MM: BM-21 MRL	20.5	13.4	20.5

REMARKS: Currently, Russia has developed and is testing 122-mm rockets with various warheads (Frag-HE, AT/AP mines, jammers, and sensor-fuzed munitions) achieving firing ranges between 32-35 kilometers. These rockets could be deployed within the next 2-5 years.

## Advanced Artillery Munitions: Laser-Guided Projectiles

NAME	COUNTRY	CALIBER	WEIGHT (kg)	LENGTH (mm)	TYPE WARHEAD	GUIDANCE SYSTEM	TARGET DESIGNATION RANGE (km) <sup>(1)</sup>		RANGE (km)		STATUS / PROLIFERATION
							MIN	MAX	MIN	MAX	
BUSSARD	Germany	120-mm mortar	17	1,050	Tandem (precursor and main charge); 800+ mm RHA penetration	IR Focal plane array (3-5 $\mu$ terminal homing), semi-active laser homing (SAL- 1.06 $\mu$ )	3-5	.8	12	Developmental	
Terminally Guided Mortar Bomb	Ukraine /Poland	120-mm mortar	18	1,200 (+)	HEAT; 550-mm RHA	SAL (1.06 $\mu$ )	3-5	.5	7	Testing	
Kitolov-2	Russia	120-mm mortar, combo gun	25	1,220	Frag-HE	SAL (1.06 $\mu$ )	3-5	.5	9	Limited production/ 1 country	
Smel'chak	Russia	240-mm mortar	134	1,635	Frag-HE	SAL (1.06 $\mu$ )	3-5	3.6	9.2	Limited production/ 1 country	
Kitolov-2M (KM-3)	Russia	122-mm howitzer	27	1,225	Frag-HE	SAL (1.06 $\mu$ )	3-5	.8	14	Limited production/ 2 countries	
Krasnopol	Russia	152-mm howitzer	51	1,300	Frag-HE, 6.5 kg AL/RDX	Inertial (middle stage of flight) SAL (final stage of flight)	3-5	5	20	Full production/ 14 countries	
Krasnopol-M (KM-2)	Russia	155-mm howitzer	43.0	955	Frag-HE, 6.2 kg AL/RDX	Inertial (middle stage of flight) SAL (final stage of flight)	3-5	4	17	Full production/ 2 countries	
Santimeter-1	Russia	152-mm howitzer	49.5	1,195	Frag-HE, 6.5 kg AL/RDX	SAL (1.06 $\mu$ )	3-5	3	18	Limited production/ 3 countries	
Aurora	Russia	152-mm howitzer	47 (+)	955	Frag-HE, 12.0 kg AL/RDX	SAL (1.06 $\mu$ )	3-5	5	25	Ready for production, waiting for export customer	
Ugroza <sup>(2)</sup>	Russia	122-mm rocket	65.5 (est.)	3,037 (est.)	Tandem HEAT dual main charge; 600-mm penetration	SAL (1.06 $\mu$ )	3-5	1	20-32	Limited production/ 2 countries	
Copperhead	United States	155-mm cannon	62	1,370	HEAT	Inertial (middle stage of flight) SAL (final stage of flight)	3-5	4	16	Production complete/1 country	

NOTES:

(1) The Target Designation Range column portrays an engagement of a tank size target moving at 10-15 km/h.

(2) The Ugroza's range is dependent upon the warhead being fitted on a rocket body containing either an older rocket motor (20 km) or new rocket motor (32 km).



### Foreign Course Corrected Rocket Programs

NAME	COUNTRY	CALIBER (mm)	WEIGHT (kg)	LENGTH (mm)	WARHEAD TYPE	GUIDANCE SYSTEM	ACCURACY (CEP, m)	RANGE (km)	STATUS/ PROLIFERATION
9M55-series	Russia	300	~800	7,200	Varies - ICM, SFM, HE, thermo-baric, scatterable mines	Inertial	150 @ max range (0.21% of range)	70	Fielded 2 countries
9M5xx-series	Russia	300	~800	7,200	Varies - ICM, DPICM, SFM, HE, thermobaric, scattererable mines	Inertial	171@ maximum range (.19% of range)	90	Production/ Ex-ported, 2 countries
AccuLAR	Israel/Romania	160	120	3,700	DPICM, SFM	RF Ground Track	90-135	45	Late development IOC 2003
MLRS-TCS	Israel	227	308	3,940	DPICM SFM	RF Ground Track	70-120	32	Late development IOC 2001
Angel-100	China	300	~800	7,200	Varies - ICM, SFM, HE	Inertial	210 @ max range (0.21% of range)	100	Development IOC 2005-7
CORECT	Switzerland-Germany	227	308	3,940	DPICM, AT-4 mines	GPS+Inertial and magnetometer	50 (independent of range)	32	Late development IOC 2003-5
MARS-NAW	Germany	227	308	3,940	DPICM, SMArt-155	GPS+Inertial	50	65-70	Late development IOC 2003-2005
LT-2000 Mk45	Taiwan	227	308	3,940	DPICM	GPS+Inertial	50	75	Development IOC 2008
Diehl RM-70 Upgrade	Germany, France, Slovakia	122	77	3,220	DPICM, Multimode (HEAT, HE, Incendiary)	GPS+Inertial	50	36	Development IOC2008

Other countries with course corrected rocket development programs: Indonesia, South Africa, India, Ukraine, Brazil, Iraq.

### Foreign Course Corrected Projectile Programs

NAME	COUNTRY	CALIBER (mm)	WEIGHT (kg)	LENGTH (mm)	WARHEAD TYPE	GUIDANCE SYSTEM	ACCURACY (CEP, m)	RANGE (km)	STATUS/ PROLIFERATION
TCM	Sweden	155	47	955	Varies (DPICM, SFM, HE)	Inertial+GPS	50-70	60	Development IOC 2006
Diehl GPS Geschoss	Germany	155	47	955	Varies (DPICM, SFM, HE)	Inertial+GPS	10	40	Development IOC 2003-5
Poleaxe	UK	155	54	1,650	DPICM, SFM	Inertial+GPS	50	80	Development IOC 2014
Pelican	France	155	50	1,350	DPICM, HE, SFM	Inertial+GPS	50-80	80	Development IOC 2014
BWB GPS Fin-stabilized	Germany	155	55	1,650	DPICM, SFM, HE	Inertial+GPS	20-50	100	Development IOC 2012
Ramjet Projectile	Holland-Sweden	155	55	1,500	DPICM, SFM	GPS+Inertial	20-50	80	Research IOC 2018
BROMSA	Sweden	105/155	Fuze	N/A	Any Projectile	GPS or MVV RF tracker	2-4X improvement over ballistic projectiles	25-30	Development IOC 2007
SAMPRASS	France	105/155	Fuze	N/A	Any Projectile	GPS	2-6X improvement over ballistic projectile	25-40	Development IOC 2005-7
STAR	UK	105/155	Fuze	N/A	Any Projectile	GPS	2-6X improvement over ballistic projectile	25-40	Development IOC 2005-7

Other countries with course corrected projectile development programs: Israel, South Africa, Ukraine, and others.





### Advanced Artillery Munitions: Sensor-Fuzed Munitions

NAME	COUNTRY	CALIBER DELIVERY SYSTEM	TARGETING SENSOR	SEARCH ALTITUDE	ARMOR PENETRATION	TYPE WARHEAD	RANGE (km)	STATUS/ PROLIFERATION
BONUS	France/ Sweden	155-mm cannon	2-color IR sensor with laser altimeter	175	120-135-mm at 150 meter slant range	Tantalum EFP	27 (39-cal. cannon) 35 (52-cal. cannon)	Full Production
SMArt	Germany	155-mm cannon	94 Ghz MMW Sensor (Active and Passive), 3-5 $\mu$ IR sensor	150	135-mm RHA pene- tration @ 100 meters	Tantalum liner, COMP-B fill with unique waveshaper	25	Full Production
Indian Sensor Fuzed Munition	India	120-mm mortar 155-mm cannon	MMW	100 (est)	50-70-mm RHA penetration @ 100 meters	Copper penetrator	7	EIOC 2002-2003
Israeli Top-Attack Sensing Submunition	Israel	227-mm rocket	Ka-Band (Active and Passive)	100 (est)	100-mm RHA pene- tration @ 100 meters	Copper penetrator	32	Developmental
Meteor	Poland	122-mm rocket	2 color IR sensor with laser diode altimeter	150	80-100-mm RHA penetration @ 100 meters	Copper penetrator	30	EIOC 2003
Motiv-3M	Russia	300-mm rocket	2 color IR sensor	100 (est)	70-mm RHA pene- tration @ 150 me- ters and 30°	Copper penetrator, Ball slug	90	Full Production
Universal Submunition	Russia	120-mm mortar, 122-mm, 220-mm, and 300-mm rockets	W-band MMW Sensor (Active and Passive), 1-2 $\mu$ and 8-14 $\mu$ IR sensor	100 (est)	60-70-mm RHA penetration @ 100 meters and 30°	Copper penetrator, Ball slug	33 (122-mm) 35 (220-mm) 90 (300-mm)	Limited Production
MCS-E1	Russia	152-mm cannon	35 Ghz MMW (Active), 3-5 $\mu$ IR sensor	100 (est)	90-mm RHA pene- tration	Copper penetrator, Ball slug	24	EIOC 2003-2004
MCS-E2, 152-mm	Russia	152-mm cannon	W-band MMW Sensor (Active and Passive), 1-2 $\mu$ and 8-14 $\mu$ IR sensor	150 (est)	80-mm RHA pene- tration @ 125 me- ters and 30°	Copper penetrator, Ball slug	20	Developmental, EIOC 2007-2008
MCS-E2, 155-mm	Russia	155-mm cannon	W-band MMW Sensor (Active and Passive), 1-2 $\mu$ and 8-14 $\mu$ IR sensor	150 (est)	80-mm RHA pene- tration @ 125 me- ters and 30°	Copper penetrator, Ball slug	25	Developmental, EIOC 2007-2008
SADARM	US	155-mm cannon	35 Ghz MMW Sensor (Active and Passive), 8-14 $\mu$ IR sensor	130 (est) 165 (est) P3I	135-mm RHA pene- tration @ 100 meters	INA	24	Limited Production





## Chapter 7 Air Defense

This chapter provides an overview of selected air defense systems either in use or readily available to an OPFOR. The selection of weapons is not intended to be all-inclusive, but rather a representative sampling of weapons and equipment supporting various OPFOR military capabilities.

This chapter is divided into three categories—*towed AA guns*, *self-propelled AA guns/combination guns* and *surface-to-air missiles (SAMs)*. *Towed AA guns* covers, in order, the KS-19M2 100-mm gun, S-60 57-mm gun and the ZU-23 23-mm gun. The next category, *self-propelled AA guns/combination guns*, contains the ZSU-23-4 23-mm gun and the 2S6 30-mm gun/missile system. The final category of *surface-to-air missiles (SAMs)* consists of the SA-7b, SA-8b, SA-14, SA-15b and the SA-18.

Tactical air defense is used to protect ground force units and other potential targets from attack by enemy fixed-wing aircraft and armed helicopters. Due to increases in performance and the sheer number of air defense systems, specifically manportable systems, the selected systems represent some of the most formidable threats to aircraft of all types.

Some trends in air defense development will become more widespread in the near future. These include the production of authorized and unauthorized copies of existing systems and the development of hybrid systems. The sensor package may consist of one or more radars, direct view optics, and electro-optics systems. The sensor package is the single most important aspect of air defense systems since these devices perform the surveillance and tracking functions. As the data classification permits, all attempts have been made to provide the user with as much information as possible in these areas. Radar systems have traditionally been the most popular sensor for air-defense systems, however, with the latest generation weapons they are usually supplemented with a variety of optic or electro-optic sensors such as; TV cameras, night vision sights, and laser rangefinders. As the trends become more defined and more information becomes available, updates to the systems will be produced.

Questions and comments on data listed in this chapter should be addressed to:

**Pamela Senterfitt**

DSN: 552-7983, Commercial (913) 684-7983  
e-mail address: senterfp@leavenworth.army.mil

Swiss 35-mm Towed AA Gun GDF-003 (with Skyguard AA Gun-Missile Battery) \_\_

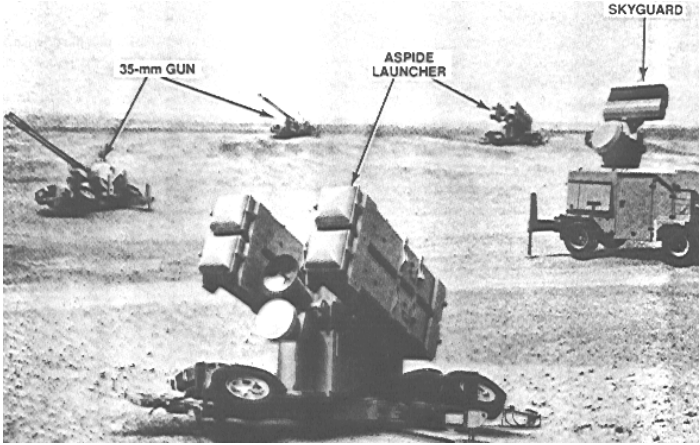
	<p><b>Weapons &amp; Ammunition Types</b></p> <p>35-mm automatic cannon</p>	<p><b>Typical Combat Load</b></p> <p>238</p>
<p><b>SYSTEM</b>  <b>Alternative Designations:</b> Skyguard System  <b>Date of Introduction:</b> Circa 1981-84  <b>Proliferation:</b> At least 3 countries</p> <p><b>Description:</b>  Crew: 3  Carriage: 4-wheeled/2-axle towed chassis  Combat Weight (kg): 6,400  Length Overall (m):      Travel Position: 7.8      Firing Position: 8.83  Length of Barrel (m): INA  Height (m):      Travel Position: 2.6      Firing Position: 1.72  Width Overall (m):      Travel Position: 2.26      Firing Position: 4.49  Prime Mover: Medium (5t 6x6) truck</p> <p><b>Automotive Performance:</b>  Max. Towed Speed (km/h): 60  Emplacement Time (min): 1.5  Battery Emplacement Time: 15  Displacement Time (min): 5</p> <p><b>ARMAMENT</b>  <b>Gun:</b>  Caliber, Type: 35x228 35-mm automatic gun  Number of Barrels: 2  Operation: Gas-operated  Rate of Fire(rd/min):      Cyclic: 1,100 (550/barrel)      Practical: INA, bursts up to 25 rounds  Loader Type: 2x56-rd magazine automatic feed  Reload Time (sec):  Traverse (°): 360  Traverse Rate (°/sec): 120  Elevation (°): -5 to +92</p>	<p>Elevation Rate (°/sec): 60  Reaction time (sec): INA</p> <p><b>FIRE CONTROL</b>  <b>Sights w/magnification:</b>  <b>On-carriage:</b> lead-computing sight or GUN KING electro-optical system  <b>Off-carriage:</b>  SEC-Vidicon TV tracking system  Laser rangefinder  Search and track radars:      Name: Skyguard Mk II (SW)      Function: Fire control tracker      Detection Range (km): INA      Tracking Range (km): 25      Frequency: 8-20 GHz      Frequency Band: I/J doppler MTI      Rotation Rate/min: 60      Mean Power (W): 200      Link: Digital data, virtually invulnerable to ECM, including frequency jumps</p> <p><b>VARIANTS</b>  System used in complex with radar, 2 Aspide missile launchers, and generators. Other radars and missiles can be used with the system. Base radar range was 20 km.</p> <p><b>GDF-001:</b> System has a simple sight.  <b>GDF-002:</b> Add Marconi digital FCS  <b>GDF-005:</b> Upgrade (available for -003 in NDF-C kit) has autonomous sight, onboard power supply, and automatic reloader.</p> <p><b>Skyshield 35-AHEAD</b> gun configuration with Skywhip gun mount is designed for AHEAD ammunition.</p>	<p><b>MAIN ARMAMENT AMMUNITION</b>  <b>Type:</b> HEI-T  Range (m):      Tactical AA range: 4,000 (self-destruct)      Tracer range: 3,100+  Effective Altitude (m): 3,100-4,000  Self-destruct time (sec): 6-12</p> <p><b>Type:</b> Semi-armor-piercing HEI-T (SAPHEI-T)  Range (m): 4,000  Tactical AA range: 4,000 (self-destruct)  Effective Altitude (m): 4,000 (est)  Self-destruct time (sec): 6-12  Penetration (mm, KE): 40 at 1,000 m</p> <p><b>Type:</b> APDS-T  Range (m): 4,000      Tactical AA range: 4,000      Tracer range: 2,000  Effective Altitude (m): 4,000 (est)  Penetration (mm, KE): 90 at 1,000 m</p> <p><b>Type:</b> APFSDS-T  Range (m): 4,000      Tactical AA range: 4,000      Tracer range: INA  Effective Altitude (m): 4,000 (est)  Penetration (mm, KE): 115+ at 1,000 m</p> <p><b>Type: Frangible APDS (FAPDS)</b> - on impact with the target surface, the penetrator breaks into several KE fragments. The round has Frag-HE effects with the higher velocity and flat trajectory of a sabot round.</p> <p><b>AG 35x228/AHEAD</b> (Advanced Hit Efficiency and Destruction) round uses a programmable time fuze and HE charge to dispense a cloud of 152 pellets (3,800 from a 25-round burst) at or in the path of a target helicopter, LAV, or soft target. Other fuze modes include proximity and PD.</p>
<p><b>NOTES</b>  System can also be used against ground targets.</p>		
<p>An upgrade kit (gun computer, software, muzzle velocity sensor, and electronic fuze programmer) permits -003 gun to fire the AHEAD round.</p>		
<p>System uses a wire link among major components.</p>		

## Russian 37-mm Towed AA Gun M-1939

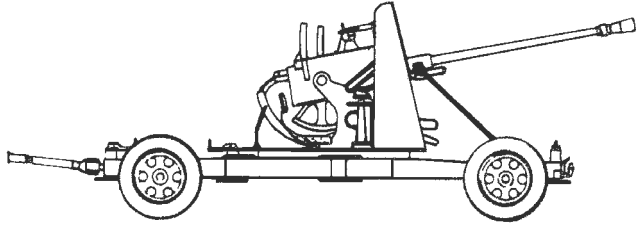
		<b>Weapons &amp; Ammunition Types</b>  <b>1 x 37-mm AA gun</b>  HE HE-FRAG-T AP AP-T HVAP HVAP-T HEI-T	<b>Typical Combat Load</b>  <b>200</b>
<b>SYSTEM</b> <b>Alternative Designation:</b> None <b>Date of Introduction:</b> 1939 <b>Proliferation:</b> At least 50 countries  <b>Description:</b> Crew: 8 Carriage: Four-wheels Combat Weight (kg): 2,050 Length Overall (m): 6.04 Length of Barrel (m): 2.73 Height Overall (m): 2.11 Width Overall (m): 1.95 Prime Movers: Utility, small, medium trucks  <b>Automotive Performance:</b> Max. Towed Speed (km/h): 60 Cross Country (km/h): 25 Fording Depth (m): 0.7 Emplacement Time (sec): 30 Displacement Time (sec): 30	<b>ARMAMENT</b> <b>Gun</b> Caliber, Type: 37-mm rifled Number of Barrels: 1 Breech Mechanism: Rising Block Rate of Fire (rd/min): Cyclic: 180 Practical: 80 Clip Capacity (rds): 5 Feed: Gravity Loader Type: Manual Reload Time (sec): 2 Traverse (°): 360 Traverse Rate (°/sec): 61 Elevation (°) (-/+): -5/+85 Elevation Rate: (°/sec): 22  <b>FIRE CONTROL</b>  <b>Sights w/magnification:</b> AZP-37 Optical sight	<b>AMMUNITION</b> <b>Type:</b> HE, HE-FRAG-T, AP, AP-T, HVAP, HVAP-T, HEI-T <b>Range (m):</b> Max. Range (ground): 9,600 Max. Eff Range (slant): 3,000 Max. Altitude: 6,700 <b>Armor Penetration (mm): 55 @ 500 m</b> <b>Projectile Weight (kg):</b> HE: 0.74 AP: 0.77 HE-FRAG-T: 0.73 HVAP: 0.62 HEI-T: INA <b>Muzzle Velocity (m/s):</b> HE: 880 AP: 880 HVAP: 960 HEI-T: INA HE-FRAG-T: 880 <b>Self-Destruct (sec): 8 to 12</b> <b>Self-Destruct Range (m): 3,700 to 4,700</b>  <b>VARIANTS</b> <b>Type 55:</b> Chinese designation <b>Type 65:</b> Chinese twin barrel Twin barrel exports	

### NOTES

The M-1939 is a towed 37-mm anti-aircraft gun mounted on a four-wheeled carriage. During traveling, it can be fired from wheels at halts or fired while traveling. Normal emplacement however, requires the wheels to be removed and a jack placed under each axle for support prior to firing. The M-1939 is manually loaded with clips of five rounds each. The rounds are gravity fed into the vertically opening sliding breech with the empty cartridges automatically extracted. The M-1939 is a derivative of the BOFORS L60. Because it lacks a radar and powered gun laying motors, the M-1939 is considered to be effective only during daylight and in fair weather.



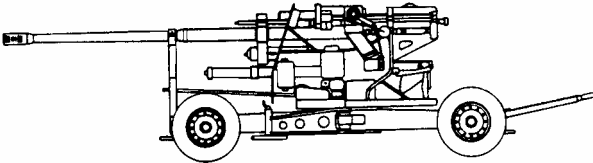

## Russian 100-mm Towed AA Gun KS-19M2

	<p><b>Weapons &amp; Ammunition Types</b></p> <p><b>100-mm gun</b></p> <p>Frag-HE AP-T APC-T</p>	<p><b>Typical Combat Load</b></p> <p><b>100</b></p>
<p><b>SYSTEM</b>  <b>Alternative Designations:</b> None  <b>Date of Introduction:</b> 1949  <b>Proliferation:</b> At least 20 countries</p> <p><b>Description:</b>  Crew: 15  Carriage: Towed 2-axle, 4-wheel carriage  Combat Weight (kg): 11,000  Length Overall (m): 9.3  Travel Position: 9.45  Firing Position: INA  Length of Barrel (m): 5.74  Height (m):  Overall: 2.2  Travel Position: INA  Firing Position: 7.62  Width Overall (m): 2.32  Prime Mover: Towing vehicle AT-S or AT-T</p> <p><b>Automotive Performance:</b>  Max. Towed Speed (km/h): 35  Emplacement Time (min): 7  Displacement Time (min): 6</p>	<p><b>ARMAMENT</b>  <b>Gun:</b>  Caliber, Type: 100-mm gun  Number of Barrels: 1  Service Life of Barrel (rds): 2,800  Rate of Fire (rd/min):  Maximum: INA  Practical: 10-15  Loader Type: Manual  Reload Time (min): INA  Traverse (°): 360  Traverse Rate (°/sec): 20  Elevation (°) (-/+): -3 to 89  Elevation Rate (°/sec): 12  Reaction time (sec): 30</p> <p><b>FIRE CONTROL</b>  <b>On-carriage:</b>  PO-1M telescope  Field of View (°): 14  Power: 5x  PG panoramic telescope:  Field of View (°): 10  Power: 4x  <b>Off-carriage:</b>  Rangefinder: D-49 (off carriage)  Radar:  Name: SON-9/SO-9A (FIRE CAN)  Function: Fire Control  Detection Range (km): 80  Tracking Range (km): 35  Frequency: 2.7-2.9 GHz  Frequency Band: E  Peak Power (kW): 300  PUAZO 6-19 or 6-19M fire control director</p>	<p><b>VARIANTS</b>  <b>Type 59:</b> Chinese variant.</p> <p><b>MAIN ARMAMENT AMMUNITION</b>  <b>Types:</b> Frag-HE, AP-T, APC-T  Range (m):  With on-carriage sight: 4,000  With off-carriage radar: 12,600  Projectile Weight (kg):  Frag-HE: 15.61  AP-T: 15.89  APC-T: 16  Muzzle Velocity (m/s): 900-1,000  Fuze Type: Proximity and Time  Self-Destruct (sec): 30</p>

### NOTES

The KS-19M2 may also be employed in a ground support role.

## Russian 57-mm Towed AA Gun S-60

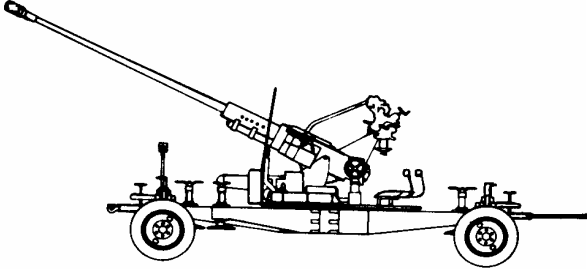
	<p align="center"><b>Weapons &amp; Ammunition Types</b></p> <p>57-mm gun</p> <p>FRAG-T APC-T</p>	<p align="center"><b>Typical Combat Load</b></p> <p align="right">200</p>
<p><b>SYSTEM</b>  <b>Alternative Designs:</b> None  <b>Date of Introduction:</b> 1950  <b>Proliferation:</b> At least 46 countries</p> <p><b>Description:</b>  Crew: 7  Carriage: Four-wheel  Weight (kg): 4,500  Length Overall (m):      Travel Position: 8.50      Firing Position: 8.84  Length of Barrel (m): 4.39  Height (m):      Overall:      Travel Position: 2.37      Firing Position: 6.02  Width Overall (m):      Travel Position: 2.08      Firing Position: 6.9  Prime Mover: Ural-375D</p> <p><b>Automotive Performance:</b>  Max. Towed Speed (km/h): 60  Emplacement Time (min): 1  Displacement Time (min): 3</p>	<p><b>ARMAMENT</b>  <b>Gun:</b>  Caliber, Type: 57-mm automatic cannon  Number of Barrels: 1 each  Service Life of Barrel (rds): INA  Rate of Fire (rd/min):      Cyclic: 105-120      Practical: 70  Loader Type: 4 rd clip, manual  Reload Time (sec): 4-8  Traverse (°): 360  Traverse Rate (°/sec): 40  Elevation (°) (-/+): -4 to +87  Elevation Rate (°/sec): 34  Reaction time (sec): 4.5</p> <p><b>FIRE CONTROL</b>  <b>On-carriage:</b>  Optical mechanical computing sight  AZP-57:      Target Range (m): 5,500  Direct fire telescope</p> <p><b>Off-carriage:</b> (see NOTES)  Rangefinder: D-49  Radar:      Name: SON-9/SON-9A      Function: Fire Control      Detection Range (km): 80      Tracking Range (km): 35      Frequency: 2.7-2.9 GHz      Frequency Band: E      Peak Power (kW): 300  PUAZO 6-60 fire control director</p>	<p><b>VARIANTS</b>  <b>Type 59:</b> Chinese variant  <b>SZ-60:</b> Hungarian license-built variant</p> <p><b>MAIN ARMAMENT AMMUNITION</b>  <b>Type:</b> FRAG-T, APC-T  Range (m):      With on-carriage sight: 4,000      With off-carriage radar: 6,000  Projectile Weight (kg):      FRAG-T: 2.81      APC-T: 2.82  Muzzle Velocity (m/s): 1,000  Fuze Type:      FRAG-T: Point detonating      APC-T: Base detonating  Self-Destruct (sec): 13-17</p>

**NOTES**

Some versions may have the FLAP WHEEL as the primary fire control radar. A S-60 battery will generally consist of six guns, a fire-control radar, and a fire-control director. Four-round clips feed ammunition horizontally into weapon. The S-60 also has an ammunition ready rack that can hold 4 four-round clips near ammunition feed mechanism on left side of the breech. The S-60 can also be used in a ground support role.

## Chinese 37-mm Towed AA Gun Type 65

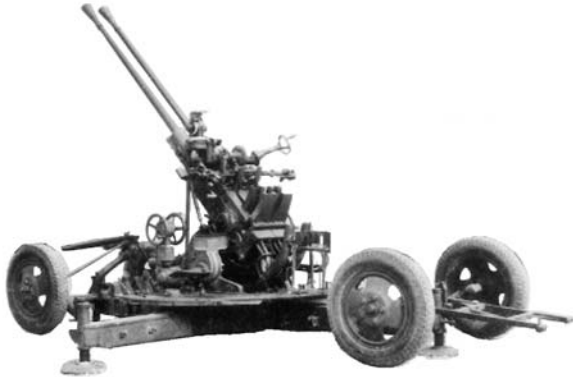
	<p><b>Weapons &amp; Ammunition Types</b></p> <p>37-mm automatic cannons</p>	<p><b>Typical Combat Load</b></p> <p>400</p>
<p><b>SYSTEM</b>  <b>Alternative Designations:</b> INA  <b>Date of Introduction:</b> Circa 1965  <b>Proliferation:</b> At least 7 countries</p> <p><b>Description:</b>  Crew: 5 to 8  Carriage: 4-wheeled/2-axle towed chassis  Combat Weight (kg): 2,700  Length Overall (m): 5.940  Travel Position: 6.036  Firing Position: INA  Length of Barrel (m): 2.729  Height (m): 2.080  Overall: INA  Travel Position: 2.105  Firing Position: INA  Width Overall (m): 1.901  Prime Mover: INA</p> <p><b>Automotive Performance:</b>  Max. Towed Speed (km/h): 60  25 cross-country  Emplacement Time (min): INA  Displacement Time (min): INA  Fording Depth (m): 0.7  Turning Radius (m): 8</p>	<p><b>ARMAMENT</b>  <b>Gun:</b>  Caliber, Type: 37-mm automatic gun  Number of Barrels: 2  Operation: Recoil  Service Life of Barrel (rds): 2,500+  Barrel Change time (min): 2-3  Rate of Fire(rd/min):  Cyclic: 320-360 (160-180/barrel)  Practical: 80  Loader Type: 5-round clip  Reload Time (sec): 4-8  Traverse (°): 360  Traverse Rate (°/sec): INA  Elevation (°): -5 to 85  Elevation Rate (°/sec): INA  Reaction time (sec): INA</p> <p><b>FIRE CONTROL</b>  <b>Sights w/magnification:</b> Optical  mechanical computing sight</p>	<p><b>VARIANTS</b>  Russian twin-barreled variant of M-1939 export version  <b>M1985:</b> NKPA has mounted the 37-mm Type 65 on an open turret APC chassis.</p> <p><b>MAIN ARMAMENT AMMUNITION</b>  <b>Types:</b> AP-T, HE-T, HEI-T  Range (m):  Max Range: 8,500  Tactical AA range: 2,500  Altitude:  Max Altitude: 6,000  Effective (m): 1,768 at 45°  2,865 at 65°  Self-destruct time (sec): 8-12  Self-destruct range (m): 3,700-4,700</p>

### NOTES

Tire Size is 6.50 x 20. The gun can be employed on an SP tracked vehicle mount. A Chinese built direct copy of the Soviet twin barrel export version of the M-1939. The Type 65 consists of two recoil operated automatic cannons mounted on a towed, four-wheeled carriage. All tracking and loading operations are performed manually by a five to eight man gun crew. Because it lacks a radar and powered gun laying motors, the Type 65 is considered to be effective only during daylight and in fair weather.

Ammunition is interchangeable among Types 55, 65, and 74 AA guns.

Strengths: Highly reliable, rugged and simple to operate.

Weaknesses: Short range, small projectile. No organic radar.

## Russian 14.5-mm Heavy Machinegun ZPU-4

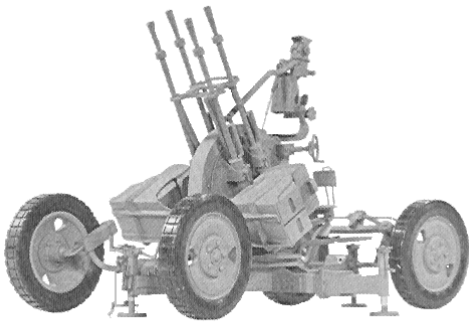
		<b>Weapons &amp; Ammunition Types</b>  <b>4 barreled KPV 14.5-mm heavy machinegun</b> AP-T API API-T HEI HEI-T	<b>Typical Combat Load</b>  <b>4,800 rds</b> (1,200 rds/barrel)
<b>SYSTEM</b>  <b>Alternative Designations:</b> None <b>Date of Introduction:</b> 1949 <b>Proliferation:</b> At least 45 countries  <b>Description:</b> Crew: 5 Carriage: 4 wheeled/2 axle towed chassis Combat Weight (kg): 1,810 Length Overall (m): Travel Position: 4.53 Firing Position: 4.53 Length of Barrel (m): 1.348 Height (m): Overall: INA Travel Position: 2.13 Firing Position: INA Width Overall (m): 1.72 Prime Mover: INA  <b>Automotive Performance:</b> Max. Towed Speed (km/h): 35 Emplacement Time (min): 2 Displacement Time (min): 2	<b>ARMAMENT</b>  <b>Gun:</b> Caliber, Type: 14.5 mm machinegun Number of Barrels: 4 Service Life of Barrel (rds): INA Rate of Fire(rd/min): Max: 2,200-2,400 (600/barrel) Practical: 600 (150/barrel) Loader Type: Belt of 150 rds Reload Time (sec): 15 Traverse (°): 360 Traverse Rate (°/sec): 48 Elevation (°): -8 to +90 Elevation Rate (°/sec): 29 Reaction time (sec): 8  <b>FIRE CONTROL</b>  Optical mechanical computing sight Telescope, ground targets	<b>VARIANTS</b>  <b>Type 56:</b> Chinese and NK variant. <b>MR-4:</b> Romanian single axle variant  <b>MAIN ARMAMENT AMMUNITION</b>  <b>Types:</b> API, API-T, HEI, AP-T, HEI-T Range (m): Max: 8,000 Min: INA Altitude (m): Max: 5,000 Effective: 1,400	

### NOTES

The ZPU-4 can be fired with wheels in travel position if necessary.

The ZPU-4 may also be employed in a ground support role.

Strengths: Highly reliable, rugged and simple to operate. Quick reaction time, widely deployed, explosive round.

Weaknesses: The short-range small projectile requires a direct hit. No organic radar (except the NK Type 56 and M1983).

## Russian 23-mm Towed AA Gun ZU-23

	<p><b>Weapons &amp; Ammunition Types</b></p> <p>2 x 23-mm AA guns</p> <p>HE-I HEI-T API-T TP</p>	<p><b>Typical Combat Load</b></p> <p>2,400</p>
<p><b>SYSTEM</b>  <b>Alternative Designation:</b> ZU-23-2  <b>Date of Introduction:</b> 1962  <b>Proliferation:</b> At least 50 countries</p> <p><b>Description:</b>  Crew: 5  Carriage: Two-wheeled  Combat Weight (kg): 950  Length Overall (m):      Travel Position: 4.57      Firing Position: 4.60  Length of Barrel (m): 2.01  Height Overall (m):      Travel Position: 1.87      Firing Position: 1.28  Width Overall (m):      Travel Position: 1.83      Firing Position: 2.41  Prime Movers: GAZ-69 4 x 4 truck,  MTLB-T, BMD-2</p> <p><b>Automotive Performance:</b>  Max. Towed Speed (km/h): 70  Emplacement Time (sec): 15-20  Displacement Time (sec): 35-40</p>	<p><b>ARMAMENT</b>  <b>Gun:</b>  Caliber, Type: 23-mm, gas-operated gun,  2A14 or 2A14M</p> <p>Number of Barrels: 2  Breech Mechanism: Vertical Sliding Wedge  Rate of Fire (rd/min):      Cyclic: 1,600-2,000      Practical: 400 in 10-30 rd bursts  Feed: 50-rd ammunition canisters fitted on  either side of the upper mount assembly  Loader Type: Magazine  Reload Time (sec): 15  Traverse (<sup>o</sup>): 360  Traverse Rate (<sup>o</sup>/sec): INA  Elevation (<sup>o</sup>) (-/+): -10<sup>o</sup> to +90<sup>o</sup>  Elevation Rate: (<sup>o</sup>/sec): 54  Reaction Time (min): 8 (est.)</p> <p><b>FIRE CONTROL</b></p> <p><b>Sights w/magnification:</b>  Optical mechanical sight for AA fire  Straight tube telescope for ground targets</p> <p><b>VARIANTS</b>  <b>ZU-23M:</b> Egyptian produced ZU-23, also referred to as the SH-23M.</p>	<p><b>BTR-3D:</b> Russian BTR-D APC with ZU-23 mounted on rear deck, for SP AA gun.</p> <p><b>BTR-ZD</b> is BTR-D with towed ZU-23 and MANPADS.</p> <p><b>MAIN ARMAMENT AMMUNITION</b>  <b>Type:</b> HE-I, HEI-T, API-T, TP, APDS-T, FAPDS (frangible APDS)</p> <p>Range (m):      Max. Range: 2,500      Min. Range: 0  Altitude (m):      Max. Altitude: 3,500      Min. Altitude: 0  Projectile Weight (kg):      HE-I: 0.18      HEI-T: 0.19      API-T: 0.189      TP: 0.18  Muzzle Velocity (m/s): 970  Fuze Type:      HE-I: Point detonating      HEI-T: Point detonating      API-T: Base detonating      TP: Dummy  Self-Destruct (sec): 11  Penetration (mm): 19@ 1000 m API-T</p>

### NOTES

Highly mobile air droppable system. Fires the same ammunition as the ZSU-23-4. The reload time will depend on the proficiency of the crew to manually reload. Can fire from the traveling position in emergencies. The ZU-23 can also be used in a ground support role.

## German/Swiss 35-mm SP AA Gun System Gepard

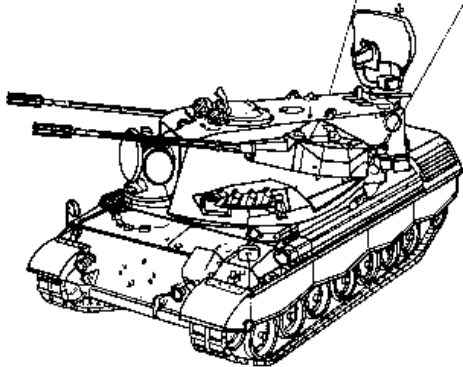
	<p align="center"><b>Weapons &amp; Ammunition Types</b></p> <p>2 x 35-mm cannons HEI-T SAPHEI-T FAPDS APDS-T/APFSDS-T</p>	<p align="center"><b>Typical Combat Load</b></p> <p align="center">680</p>
<p><b>SYSTEM</b> <b>Alternative Designations:</b> 5PFZ-B2L Upgrade variant known as FlakPz 1A2 <b>Date of Introduction:</b> 1976 original <b>Proliferation:</b> At least 5 countries</p> <p><b>Description:</b> Crew: 3 Combat Weight (mt): 46 Chassis: Leopard 1 tank chassis Chassis Length Overall (m): 7.16 Height (m):     Radar up: 4.23     Radar down: 3.01 Width Overall (m): 3.25</p> <p><b>Automotive Performance:</b> Engine Type: 830-hp Diesel Cruising Range (km): 550 Speed (km/h):     Max. Road: 65     Fording Depths (m): 2.25</p> <p><b>Radio:</b> INA</p> <p><b>Protection:</b> Armor (mm): 40 NBC Protection System: Yes Smoke Protection: 8 grenade launchers</p> <p><b>ARMAMENT</b> <b>Gun:</b> Caliber, Type, Name: 35x228 gun, KDA Number of barrels: 2 Rate of Fire (rd/min): 1,100 (550/barrel) Reaction time (sec): 6-10 Ammunition Loader: Twin belt Reload Time (min): INA Elevation (°): -10 to +85° Fire on Move: Yes (est)</p>	<p><b>FIRE CONTROL</b> <b>FC System:</b> EADS digital computer-based <b>Sights w/magnification:</b> Stabilized video sights for -1A2 upgrade Magnification: INA Field of View(°): INA Night sights: Thermal for -1A2 upgrade <b>IFF:</b> Yes, MSR-400 <b>Navigation system:</b> Computerized <b>Laser Rangefinder:</b> ND Yag (1.06μ) <b>Linked to Air Defense Net?:</b> Yes</p> <p><b>Radars:</b> Name: INA, Siemens Manufacture Function: Target Acquisition Detection Range (km): 15 Tracking Range (km): INA Frequency Band: S Search on the Move: Yes</p> <p>Name: INA Function: Target tracking Detection Range (km): 15 Tracking Range (km): 15 Frequency Band: Ku</p> <p><b>VARIANTS</b> <b>Gepard 1A2:</b> Upgrade variant with new FCS, including stabilized thermal sight and video auto-tracker, integrated C<sup>2</sup>, increased range, reduced reaction time, and FAPDS. <b>Gepard CA1:</b> Dutch variant (also called 95 Cheetah) uses Signaal I-band MTI radar and dual I-band K-band tracking radars. <b>PRTL-35mm GWI:</b> Upgrade Dutch variant, with upgrades similar to 1A2 and new radios, but with different radars. Range with FAPDS is claimed to be 3,500-4,500.</p>	<p><b>MAIN ARMAMENT AMMUNITION</b> <b>Type:</b> HEI-T <b>Range (m):</b>     Tactical AA range: 4,000 (self-destruct)     Tracer range: 3,100+ Effective Altitude (m): 3,100-4,000 Self-destruct time (sec): 6-12</p> <p><b>Type:</b> Semi-armor-piercing HEI-T (SAPHEI-T) <b>Range (m):</b> 4,000 Tactical AA range: 4,000 (self-destruct) Effective Altitude (m): 4,000 (est) Self-destruct time (sec): 6-12 Penetration (mm, KE): 40 at 1,000 m</p> <p><b>Type:</b> APDS-T <b>Range (m):</b> 4,000     Tactical AA range: 4,000     Tracer range: 2,000 Effective Altitude (m): 4,000 (est) Penetration (mm, KE): 90 at 1,000 m</p> <p><b>Type:</b> APFSDS-T <b>Range (m):</b> 4,000     Tactical AA range: 4,000     Tracer range: INA Effective Altitude (m): 4,000 (est) Penetration (mm, KE): 115+ at 1,000 m</p> <p><b>Type:</b> Frangible APDS (FAPDS) for upgrades. On impact with the target surface, the penetrator breaks into several KE fragments. The round has Frag-HE effects with the higher velocity and flat trajectory of a sabot round.</p> <p><b>Other Ammunition Types:</b> HEI</p>

**NOTES**

Auxiliary power unit has 90-hp engine.

KMW is developing an upgrade with 2x Stinger MANPADS missile launchers added to a gun, and integrated with the FCS.

## Russian 23-mm SP AA Gun ZSU-23-4

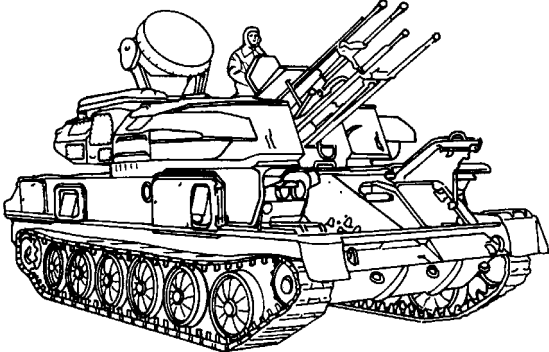
	<p align="center"><b>Weapons &amp; Ammunition Types</b></p> <p>4x 23-mm AA guns</p> <p>HE-I HEI-T API-T</p>	<p align="center"><b>Typical Combat Load</b></p> <p align="center">2,000</p>
<p><b>SYSTEM</b>  <b>Alternative Designation:</b> Shilka  <b>Date of Introduction:</b> 1965  <b>Proliferation:</b> At least 28 countries</p> <p><b>Description:</b>  Crew: 4  Combat Weight (mt): 20.5  Chassis: GM-575 Tracked, six road wheels, no track support rollers  Length (m): 6.5  <b>Height (m):</b>  Radar up: 3.75  Radar down: 2.60  Width (m): 3.1</p> <p><b>Automotive Performance:</b>  Engine Type: V6R-1 diesel  Cruising Range (km): 450  Speed (km/h):  Max. Road: 50</p> <p><b>Radio:</b> R-123</p> <p><b>Protection:</b>  NBC Protection System: Yes</p>	<p><b>ARMAMENT</b>  <b>Gun:</b>  <b>Caliber, Type, Name:</b> 23-mm liquid-cooled AA 2A7/2A7M  <b>Rate of Fire(rd/min):</b>  Practical: INA  Cyclic: 850-1,000  Reload Time (min): 20  Elevation (°): -4° to +85°  Fire on Move: Yes  Reaction Time (sec): 12-18</p> <p><b>FIRE CONTROL</b>  <b>Sights w/magnification:</b>  <b>Day and night vision devices:</b>  Driver periscope: BMO-190  Driver IR periscope: INA  Commander periscope: TPKU-2  Commander IR periscope: TKH-ITC  <b>IFF:</b> INA</p> <p><b>Radar:</b> 1RL33M1  <b>Name:</b> GUN DISH  Function: Search and Tracking  Detection Range (km): 20  Tracking Range (km): 10  Frequency: 14.8 to 15.6 GHz  Frequency Band: J</p> <p>Optical-mechanical computing sight: Part of fire-control subsystem designated as RPK-2</p>	<p><b>VARIANTS</b>  (see NOTES)</p> <p><b>MAIN ARMAMENT AMMUNITION</b>  <b>Types:</b> HE-I, HEI-T, API-T  Range (m):  Max. Effective Range: 2,500  Min. Range: INA  <b>Altitude (m):</b>  Max. Altitude: 5,100  3,500 if self-destruct fuze is included  Min. Altitude: INA  Projectile Weight (kg):  HE-I: 0.18  HEI-T: 0.19  API-T: 0.189  Muzzle velocity (m/s): 950-1,000  Fuze Type:  HE-I: Point detonating, self-destruct option  HEI-T: Point detonating, self-destruct option  APT-T: Base detonating</p>

### NOTES

Ammunition is normally loaded with a ratio of three HE rounds to one AP round. ZSU 23-4 Shilka, is capable of acquiring, tracking and engaging low-flying aircraft (as well as mobile ground targets while either in place or on the move). Resupply vehicles carry an estimated additional 3,000 rounds for each of the four ZSUs in a typical battery. Recent (October 1997) information details ZSU-23-4 updates/modernization being offered by the Ukrainians that include: a new radar system replacing the GUN DISH radar, plus a sensor pod believed to include day/night camera, and a laser rangefinder; and mounted above radar/sensor pod is a layer of six fire-and-forget SAMs, believed to be Russian SA-18/GROUSE.

## Russian 30-mm SP AA Gun/Missile System 2S6M

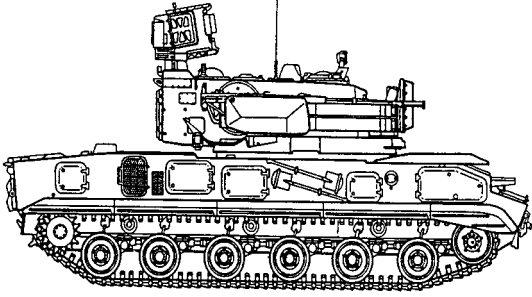
	<p align="center"><b>Weapons &amp; Ammunition Types</b></p> <p><b>2 x 30-mm twin-barrel cannons</b></p> <p>AP-T, APDS Frag-T HE-I APE</p> <p><b>SA-19/GRISON</b></p>	<p align="center"><b>Typical Combat Load</b></p> <p align="right"><b>1,904</b></p> <p align="right"><b>8</b></p>		
	<table border="1"> <tr> <td data-bbox="190 632 560 1608"> <p><b>SYSTEM</b> <b>Alternative Designations:</b> 2K22M, Tunguska-M <b>Date of Introduction:</b> 1990 <b>Proliferation:</b> At least 2 countries</p> <p><b>Description:</b> Crew: 4 Combat Weight (mt): 34 Chassis: GM-352M tracked vehicle Chassis Length Overall (m): 7.93 Height (m):     TAR up: 4.02     TAR down: 3.36 Width Overall (m): 3.24</p> <p><b>Automotive Performance:</b> Engine Type: V-12 turbo diesel Cruising Range (km): 500 Speed (km/h):     Max. Road: 65     Max. Swim: INA Forcing Depths (m): INA</p> <p><b>Radio:</b> R-173</p> <p><b>Protection:</b> NBC Protection System: Yes</p> </td> <td data-bbox="560 632 966 1608"> <p><b>ARMAMENT</b></p> <p><b>Gun:</b> Caliber, Type, Name: 30-mm gun, 2A38M Rate of Fire (rd/min): 4,800 (four gun total) Reload Time (min): gun ammunition and missiles in about 16 min. Elevation (°) (-/+): -10 to + 87° Fire on Move: Yes</p> <p><b>Missile: 9M311</b> Name: SA-19/GRISON Range (m):     Max. Range: 8,000-10,000 (see NOTES)     Min. Range: 2,500 Altitude (m):     Max. Altitude: 3,500     Min. Altitude: 15 Dimensions:     Length (m): 2.83 Weight (kg): 57 (in container) Missile Speed (m/s): 600-900 Guidance: SACLOS Seeker Field of View(°): INA Tracking Rate: INA Warhead Type: Frag-HE Warhead Weight (kg): 9 Fuze Type: Proximity Self-Destruct (sec): INA System Reaction Time (sec): 6-12 Fire on Move: No (must be at a halt to fire the missile)</p> </td> <td data-bbox="966 632 1429 1608"> <p><b>FIRE CONTROL</b> <b>Sights w/magnification:</b> Stabilized optical sight 1A29M Magnification: 8x Field of View(°): 8° Commander's position IR day/night sight Night sight: 1TPP1 thermal available <b>IFF:</b> Yes</p> <p><b>Radars:</b> HOT SHOT radar system Name: 1RL144 (TAR) Function: Target Acquisition Detection Range (km): 18-20 Tracking Range (km): INA Frequency: 2-3 GHz Frequency Band: E</p> <p>Name: 1RL144M (TTR) Function: Target Tracking Detection Range (km): 16 Tracking Range (km): INA Frequency: 10-20 GHz Frequency Band: J</p> <p><b>VARIANTS</b> (see NOTES)</p> <p><b>MAIN ARMAMENT AMMUNITION</b> <b>Type:</b> AP-T, APDS, Frag-T, HE-I, APE Range (m):     Max. Range: 4,000     Min. Range: 200 Altitude (m):     Max. Altitude: 3,000     Min. Altitude: 0 Projectile Weight (kg): INA</p> </td> </tr> </table>		<p><b>SYSTEM</b> <b>Alternative Designations:</b> 2K22M, Tunguska-M <b>Date of Introduction:</b> 1990 <b>Proliferation:</b> At least 2 countries</p> <p><b>Description:</b> Crew: 4 Combat Weight (mt): 34 Chassis: GM-352M tracked vehicle Chassis Length Overall (m): 7.93 Height (m):     TAR up: 4.02     TAR down: 3.36 Width Overall (m): 3.24</p> <p><b>Automotive Performance:</b> Engine Type: V-12 turbo diesel Cruising Range (km): 500 Speed (km/h):     Max. Road: 65     Max. Swim: INA Forcing Depths (m): INA</p> <p><b>Radio:</b> R-173</p> <p><b>Protection:</b> NBC Protection System: Yes</p>	<p><b>ARMAMENT</b></p> <p><b>Gun:</b> Caliber, Type, Name: 30-mm gun, 2A38M Rate of Fire (rd/min): 4,800 (four gun total) Reload Time (min): gun ammunition and missiles in about 16 min. Elevation (°) (-/+): -10 to + 87° Fire on Move: Yes</p> <p><b>Missile: 9M311</b> Name: SA-19/GRISON Range (m):     Max. Range: 8,000-10,000 (see NOTES)     Min. Range: 2,500 Altitude (m):     Max. Altitude: 3,500     Min. Altitude: 15 Dimensions:     Length (m): 2.83 Weight (kg): 57 (in container) Missile Speed (m/s): 600-900 Guidance: SACLOS Seeker Field of View(°): INA Tracking Rate: INA Warhead Type: Frag-HE Warhead Weight (kg): 9 Fuze Type: Proximity Self-Destruct (sec): INA System Reaction Time (sec): 6-12 Fire on Move: No (must be at a halt to fire the missile)</p>
<p><b>SYSTEM</b> <b>Alternative Designations:</b> 2K22M, Tunguska-M <b>Date of Introduction:</b> 1990 <b>Proliferation:</b> At least 2 countries</p> <p><b>Description:</b> Crew: 4 Combat Weight (mt): 34 Chassis: GM-352M tracked vehicle Chassis Length Overall (m): 7.93 Height (m):     TAR up: 4.02     TAR down: 3.36 Width Overall (m): 3.24</p> <p><b>Automotive Performance:</b> Engine Type: V-12 turbo diesel Cruising Range (km): 500 Speed (km/h):     Max. Road: 65     Max. Swim: INA Forcing Depths (m): INA</p> <p><b>Radio:</b> R-173</p> <p><b>Protection:</b> NBC Protection System: Yes</p>	<p><b>ARMAMENT</b></p> <p><b>Gun:</b> Caliber, Type, Name: 30-mm gun, 2A38M Rate of Fire (rd/min): 4,800 (four gun total) Reload Time (min): gun ammunition and missiles in about 16 min. Elevation (°) (-/+): -10 to + 87° Fire on Move: Yes</p> <p><b>Missile: 9M311</b> Name: SA-19/GRISON Range (m):     Max. Range: 8,000-10,000 (see NOTES)     Min. Range: 2,500 Altitude (m):     Max. Altitude: 3,500     Min. Altitude: 15 Dimensions:     Length (m): 2.83 Weight (kg): 57 (in container) Missile Speed (m/s): 600-900 Guidance: SACLOS Seeker Field of View(°): INA Tracking Rate: INA Warhead Type: Frag-HE Warhead Weight (kg): 9 Fuze Type: Proximity Self-Destruct (sec): INA System Reaction Time (sec): 6-12 Fire on Move: No (must be at a halt to fire the missile)</p>	<p><b>FIRE CONTROL</b> <b>Sights w/magnification:</b> Stabilized optical sight 1A29M Magnification: 8x Field of View(°): 8° Commander's position IR day/night sight Night sight: 1TPP1 thermal available <b>IFF:</b> Yes</p> <p><b>Radars:</b> HOT SHOT radar system Name: 1RL144 (TAR) Function: Target Acquisition Detection Range (km): 18-20 Tracking Range (km): INA Frequency: 2-3 GHz Frequency Band: E</p> <p>Name: 1RL144M (TTR) Function: Target Tracking Detection Range (km): 16 Tracking Range (km): INA Frequency: 10-20 GHz Frequency Band: J</p> <p><b>VARIANTS</b> (see NOTES)</p> <p><b>MAIN ARMAMENT AMMUNITION</b> <b>Type:</b> AP-T, APDS, Frag-T, HE-I, APE Range (m):     Max. Range: 4,000     Min. Range: 200 Altitude (m):     Max. Altitude: 3,000     Min. Altitude: 0 Projectile Weight (kg): INA</p>		

### NOTES

Range out to 10 km for hovering aircraft and low flying targets. In addition to the 8 mounted ready missiles two additional missiles can be carried inside. There is a 2S6M1 variant/upgrade, which has improved missile control, range and altitude capabilities of 1.5-10 km, and 0.015-6 km respectively. However, as of November 1997 the 2S6M1 is not known to be fielded.

Main operating mode is radar mode, with day/night capability. The 1TPP1 thermal module is available for mounting on 2S6M. This sight has a range of 4,000-6,000 m.





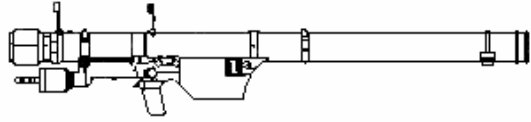

## Russian Manportable SAM System SA-7b/GRAIL

	<b>Weapons &amp; Ammunition Types</b>  ready missile	<b>Typical Combat Load</b>  1
<p><b>SYSTEM</b>  <b>Alternative Designation:</b>                  9K32M Strela-2M  <b>Date of Introduction:</b> 1972  <b>Proliferation:</b> Worldwide</p> <p><b>Description:</b>                  Crew: 1</p>	<p><b>ARMAMENT</b>  <b>Launcher</b>                  Name: 9P54M                  Dimensions:                  Length (m): 1.47                  Diameter (mm): 70                  Weight (kg): 4.71                  Reaction Time (acquisition to fire) (sec): 5-10                  Time Between Launches (sec): INA                  Reload Time (sec): 6-10</p> <p><b>Missile</b>                  Name: 9M32M                  Range (m):                  Max. Range: 5,500                  Min. Range: 500                  Altitude (m):                  Max. Altitude: 4,500                  Min. Altitude: 18                  Dimensions:                  Length (m): 1.40                  Diameter (mm): 70                  Weight (kg): 9.97                  Missile Speed (m/s): 580                  Propulsion: Solid fuel booster and solid fuel sustainer rocket motor.                  Guidance: Passive IR homing device (operating in the medium IR range)                  Seeker Field of View(°): 1.9°                  Tracking Rate(°/sec): 6°                  Warhead Type: HE                  Warhead Weight (kg): 1.15                  Fuze Type: Contact (flush or grazing)                  Self-Destruct (sec): 15</p>	<p><b>FIRE CONTROL</b>  <b>Sights w/Magnification:</b>                  Launcher has sighting device and a target acquisition indicator. The gunner visually identifies and acquires the target.                  Gunner:                  Field of View (°): INA                  Acquisition Range (m): INA</p> <p><b>IFF:</b> Yes (see NOTES)</p> <p><b>VARIANTS</b>  <b>SA-N-5:</b> Naval version  <b>HN-5A:</b> Chinese version  <b>Strela 2M/A:</b> Yugoslavian upgrade  <b>Sakr Eye:</b> Egyptian upgrade</p> <p>Mounted in several types of vehicles in four, six, and eight-tube launcher varieties.                  Can be mounted on several helicopters (Mi-24, S-342 Gazelle)</p>

### NOTES

The seeker is fitted with a filter to reduce the effectiveness of decoying flares and to block IR emissions. This missile is a tail-chasing heat (IR) seeker that depends on its ability to lock on to heat sources of usually low-flying fixed- and rotary-wing aircraft. An identification friend or foe (IFF) system can be fitted to the gunner/operator's helmet. Further, a supplementary early warning system consisting of a passive RF antenna and headphones can be used to provide early cue about the approach and rough direction of an enemy aircraft. The main difference between the SA-7 and SA-7b is the improved propulsion of the SA-7b. This improvement increases the speed and range of the newer version.

Russian Manportable SAM System SA-14/GREMLIN

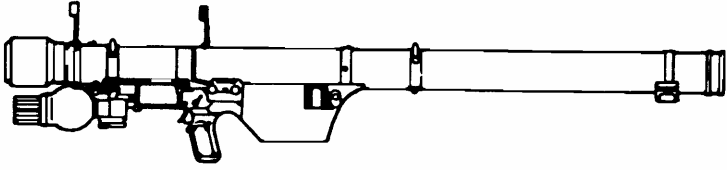
	<p><b>Weapons &amp; Ammunition Types</b></p> <p>ready missiles</p>	<p><b>Typical Combat Load</b></p> <p>1</p>
	<p><b>SYSTEM</b>  <b>Alternative Designation:</b> 9K34 Strela-3  <b>Date of Introduction:</b> 1978  <b>Proliferation:</b> Worldwide</p> <p><b>Description:</b>  Crew: 1</p>	<p><b>ARMAMENT</b>  <b>Launcher</b>  Name: 9P59  Dimensions:  Length (m): 1.40  Diameter (mm): 75  Weight (kg): 2.95  Reaction Time (sec): 14  Time Between Launches (sec): 35-40  Reload Time (sec): 25</p> <p><b>Missile</b>  Name: 9M36 or 9M36-1  Range (m):  Max. Range: 6,000  Min. Range: 600  Altitude (m):  Max. Altitude: 6,000  Min. Altitude: 50  Dimensions:  Length (m): 1.4 m  Diameter (mm): 75 mm  Fin Span (mm): INA  Weight (kg): 10.3  Missile Speed (m/s): 600  Propulsion: 2-stage solid-propellant rocket  Guidance: passive IR homing  Seeker Field of View: INA  Tracking Rate: INA  Warhead Type: Frag-HE  Warhead Weight (kg): 1.0  Fuze Type: Contact/grazing  Self-Destruct (sec): 14-17</p>

## Russian Manportable SAM System SA-16/GIMLET

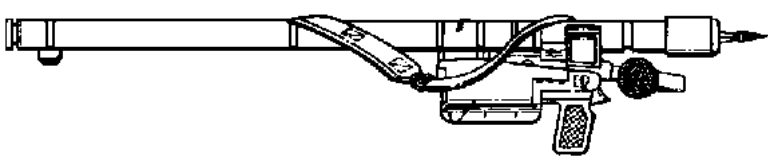
		<b>Weapons &amp; Ammunition Types</b>	<b>Typical Combat Load</b>
		<b>Ground mount</b>	<b>1</b>
		<b>SP Artillery mount</b>	<b>2</b>
		<b>MANPAD transporter</b>	<b>5</b>
<p><b>SYSTEM</b>  <b>Alternative Designation:</b> 9K310 Igla-1  <b>Date of Introduction:</b> 1986  <b>Proliferation:</b> At least 34 countries</p> <p><b>Description:</b>  Crew: 1</p> <p><b>ARMAMENT</b>  <b>Launcher</b>  Name: 9P322 launch tube  9P519 launcher gripstock  Dimensions (m):  Length: 1.708  Diameter: 0.08 tube, 0.33 overall  Weight (kg): 7.1  Reaction Time (sec): 5-7 seconds  Time between launches: INA  Reload time (sec): &lt;60</p>	<p><b>Missile</b>  Name: 9M313  Range (m):  Max. Range: 5,200 receding  4,500 approaching  Min. Range: 600  Altitude (m):  Max. Altitude: 3,500 receding slow  3,000 slow approach  2,500 receding fast  2,000 fast approach  Min. Altitude: 10  Dimensions (mm):  Length: 1,593  Diameter: 72  Weight (kg): 10.8  Missile Speed (m/s): 570  Propulsion: Solid fuel booster and dual-thrust solid fuel sustainer rocket motor.  Guidance: Passive IR homing  Seeker Field of View: 80°  Tracking Rate: INA  Warhead Type: Frag-HE  Warhead Weight (kg): 1.27  Fuze Type: Contact  Self-Destruct (sec): 14-17</p>	<p><b>FIRE CONTROL</b>  <b>Sights w/Magnification:</b>  Front hooded ring, rear optical  Gunner:  Field of View (°): INA  Acquisition Range (m): INA</p> <p><b>IFF:</b> Yes</p> <p><b>VARIANTS</b>  Specialized applications include an LUAZ utility carrier designed for a manpads firing unit. The vehicle has a rack for mounting five 9P322 SA-16 launcher tubes. This rack could be used in other manportable AD unit vehicle applications.</p> <p><b>Djigit:</b> Russian twin launcher complex mounted on a rail frame with operator's seat and tripod. Missiles can be simultaneously launched using centrally mounted sight. A Hungarian mount with this system on a GAZ-630 4x4 truck is called <b>Igla-1E</b>.</p> <p><b>Igla-1E:</b> Russian export variant. Unlike the base system, fuel remnants are not fuzeed with the warhead. IFF interrogator can be tailored to customer specifications.</p> <p><b>Igla-1M:</b> Export variant similar to -1E, but lacks an IFF interrogator.</p>	

### NOTES

Launcher deployment time is 5-13 seconds. Missiles are preloaded in the launch tube for quick loading to the gripstock. A tube can be used up to five times. The missile is cooled by a disposable bottle of refrigerant. The bottle and launcher battery are useable for 30 seconds after activation. The ATGM is more vulnerable to EO/IR decoy countermeasures than is the SA-18. Because the nose extends past the launcher tube, the nose is protected with an extended cap, which is removed before launching.

The unusually wide (80°) FOV seeker permits the missile to respond more quickly to fast-maneuver targets, such as helicopters. Maximum speed for engaged targets varies from 320 m/s rear aspect, receding targets, to 360-400 m/s head-on, approaching targets.

The gunner may have an optional portable electronic plotting board, which warns of location and direction of approaching target(s) with a display range of up to 12.5 km.

## Russian Manportable SAM System SA-18/GROUSE

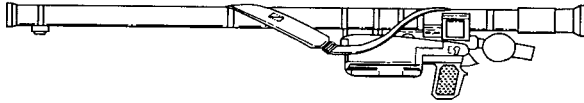
		<b>Weapons &amp; Ammunition Types</b>  ready missiles	<b>Typical Combat Load</b>  1
<p><b>SYSTEM</b>  <b>Alternative Designation:</b> 9K38 Igla  <b>Date of Introduction:</b> 1983  <b>Proliferation:</b> At least 4 countries</p> <p><b>Description:</b>          Crew: 1</p>	<p><b>ARMAMENT</b>  <b>Launcher</b>          Name: 9P39          Dimensions (m):            Length: 1.708            Diameter: INA          Weight (kg): 1.63          Reaction Time (sec): 6-7          Time Between Launches (sec): 16          Reload Time (sec): 10</p> <p><b>Missile</b>          Name: 9M39          Range (m):            Max. Range: 6,000            Min. Range: 500          Altitude (m):            Max. Altitude: 3,500            Min. Altitude: 10          Dimensions (mm):            Length: 1708            Diameter: 70          Weight (kg): 10.6          Missile Speed: Mach 2          Propulsion: Solid fuel booster and dual-thrust solid fuel sustainer rocket motor.          Guidance: Passive IR homing          Seeker Field of View: INA          Tracking Rate: INA          Warhead Type: HE          Warhead Weight (kg): 1.27          Fuze Type: Contact          Self-Destruct (sec): 15</p>	<p><b>FIRE CONTROL</b>  <b>Sights w/Magnification:</b>          Launcher has fore and rear sights          Gunner:            Field of View (°): INA            Acquisition Range (m): INA</p> <p><b>IFF:</b> Yes</p> <p><b>VARIANTS</b>  <b>Igla-V:</b> Air-to-air version  <b>Igla-D:</b> Use in airborne forces  <b>Igla-N:</b> Increased lethality  <b>Igla-S:</b> Improved version of Igla-N</p>	

**NOTES**

The SAM gunner is provided information about location and direction of approaching target(s) using a portable electronic plotting board. Two variants (Igla-D and Igla-N) can be separated in two parts for easier portability, but this adds 60 seconds to the reaction time. Igla-N is heavier due primarily to the warhead mass increased to 3.5 kg.

## Russian SAM System SA-2/GUIDELINE

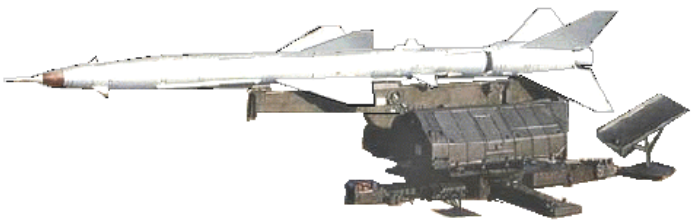
	<b>Weapons &amp; Ammunition Types</b>  <b>Single rail ground mounted</b>	<b>Typical Combat Load</b>  <b>Six launchers per battery</b>
<p><b>SYSTEM</b>  <b>Alternative Designations:</b> V75SM, S-75 Dvina, V-75 Volkhov  <b>Date of Introduction:</b> 1959  <b>Proliferation:</b> At least 41 countries</p> <p><b>ARMAMENT</b>  <b>Launcher</b>  <b>Description:</b> Single-rail, ground- mounted, not mobile but transportable  Name: INA  Dimensions: INA  Weight (kg): INA  Reaction Time (sec): INA  Time Between Launches (sec): INA  Reload Time (min): 10-12  Fire on Move: No  Emplacement Time (min): &lt; 4 hours  Displacement Time (min): &lt; 4 hours  Normal Salvo: 3 missiles at six-second intervals</p> <p><b>Missile:</b> V750K  Name: INA  Range (km):  Max. Range: 35-50 Volga 55, Volga-M 67  Min. Range: 7-9  Altitude (m):  Max. Altitude: 28,000  Volga, Volga-M 30,000  Min. Altitude: 100  Dimensions:  Length (m): 10.70  Diameter (m): 0.70</p>	<p>Weight (kg): 2,300-2,450 at launch  Missile Speed (mach): 4.5  Propulsion:  Solid fuel booster 5 sec duration  Sustainer liquid &lt;70 sec duration  Guidance: Command RF  Warhead Types: HE, Nuc  Bursting Radius (m): 125-135  Kill Radius (m): 65  CEP (m): 76.3  Fuze Type: Proximity or Command  Command destruction at (sec): 115  Warhead Weight (kg): 195 HE</p> <p><b>FIRE CONTROL</b>  <b>Radar:</b>  Name: FAN SONG, A-F variants  Function: Fire Control  Control Range (km): 60-120 A, B  70-145 for C, D, E  INA for F  Frequency Band: E/F for A, B G  for C, D, E, INA for F  Location: Within battery formation</p> <p><b>Radar:</b>  Name: SPOON REST, P-12  Function: Target Acquisition, Early Warning  Detection Range (km): 275  Frequency Band:  A=A (VHF)  B=VHF below A band  Location: Outside battery formation</p>	<p><b>Radar:</b>  Name: FLAT FACE, P-15  Function: Early warning, target acquisition  Detection Range (km): 250  Frequency Band: C  Location: At regimental HQ</p> <p><b>Radar:</b>  Name: SIDE NET, PRV-11  Function: Height Finding Radar  Detection Range (km): 180  Frequency Band: E  Location: At regimental HQs in some cases</p> <p><b>VARIANTS</b>  <b>SA-2a (Mod 0):</b> FAN SONG A  <b>SA-2b (Mod 1):</b> FAN SONG B, longer missile  <b>SA-2c (Mod 2):</b> FAN SONG C, longer range, lower altitude engagement  <b>SA-2d (Mod 3):</b> FAN SONG E, EW enhanced  <b>SA-2e (Mod 4):</b> FAN SONG E nuc variant  <b>SA-2f (Mod 5):</b> FAN SONG F, EW enhanced  Backup optical, home-in on jam-capable missile  <b>SA-N-2:</b> Naval test version, unsuccessful  <b>HQ-2:</b> Chinese variant (CSA-1)  <b>Volga-M upgrade:</b> Mid 90's, digital sub-systems, 41 miles range, less maintenance  <b>Iraqi Mod:</b> Infrared terminal guidance/missile</p>

### NOTES

The SA-2/Guideline is a two-stage medium-to-high altitude, long-range, radar-tracking SAM. The weapon is a national-level asset usually found in the rear area with the mission of defending static assets such as supply and command installations. It is fired from a single-rail ground-mounted launcher that can be moved by a truck. The missiles are carried on a special transloader-semi-trailer towed by a Zil truck. An SA-2 regiment consists of three battalions, each having a single firing battery. Each battery has six launchers arranged in a star formation, a centrally located FAN SONG fire control radar, and a loading vehicle. The two forward batteries usually locate 40 to 50 km behind front lines; the third battery locates approx 80 km behind.

Limitations include limited effectiveness against updated ECM, restricted mobility, and limited effectiveness against low-altitude targets.

## Russian SAM System SA-3/GOA

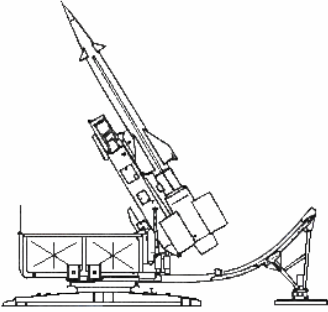
	<b>Weapons &amp; Ammunition Types</b>  <b>Launch rails</b>	<b>Typical Combat Load</b>  <b>2 or 4</b>
<p><b>SYSTEM</b>  <b>Alternative Designations:</b> S-125 Neva, S-125 Pechora (export)  <b>Date of Introduction:</b> Twin launcher 1961/quadraple launcher 1973.  <b>Proliferation:</b> At least 39 countries</p> <p><b>LAUNCHER</b>  <b>Description:</b> Towed twin or quad-rail launcher  Name: INA  Dimensions: INA  Weight (kg): INA  Reaction Time (sec): INA  Time Between Launches (sec): INA  Reload Time (min): 50 (quad launcher)  Fire on Move: No  Emplacement Time (min): 120  Displacement Time (min): 100</p>	<p><b>ARMAMENT</b>  <b>Missile:</b>  Name: 5V24, 5V27  Range (m):  Max. Range: 29,000  Min. Range: 2,400  Altitude (m):  Max. Altitude: 18,300  Min. Altitude: 4.5  Dimensions:  Length (m): 6.10  Diameter (mm): 550  Weight (kg): 946  Missile Speed (m/s): 650-1,150  Velocity (mach): 3.5  Propulsion: Solid fuel booster  Guidance: Command RF  Warhead Type: Frag-HE  Fuze Type: Proximity RF  Warhead Weight (kg): 73</p>	<p><b>FIRE CONTROL</b>  <b>Radar:</b>  Name: LOW BLOW  Function: Tracking/Command guidance  Control Range (km): 85  Detection Range (km): 110  Frequency Band: I  Tracking Capability: 1 target simultaneously (1-2 missiles)</p> <p><b>Radar:</b>  Name: FLAT FACE/P-15  Function: Target Acquisition  Detection Range (km): 250  Frequency Band: C</p> <p><b>Radar:</b>  Name: SQUAT EYE/P-15M  Function: Target Acquisition (low altitude, instead of FLAT FACE)  Detection Range (km): INA  Frequency Band: C</p> <p><b>VARIANTS</b>  <b>SA-3a:</b> Two-rail launcher. Missiles without interstage fins.  <b>SA-3b (GOA Mod 1):</b> Two-rail launcher. Missiles have interstage fins.  <b>SA-3c:</b> Four-rail launcher.  <b>S-125 Pechora:</b> Export version  <b>SA-N-1:</b> Naval version</p>

**NOTES**

The SA-3/GOA is a two-stage, low- to medium-altitude SAM. Two ready missiles travel in tandem on a modified truck or tracked vehicle from which the crew loads the missiles onto a ground-mounted, trainable launcher for firing. The truck-mounted FLAT FACE radar acquires the targets, while the LOW BLOW radar carries out the fire control function. It is principally a point/small area defense weapon. The SA-3 system is not mobile. It is movable, but its displacement time is considerable.

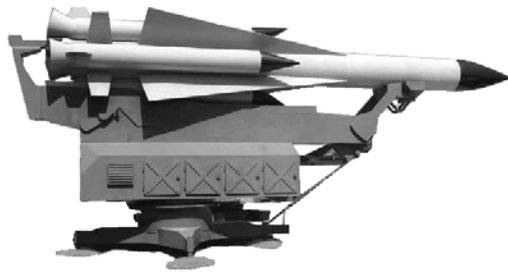

## Russian SAM System SA-5/GAMMON

	<p align="center"><b>Weapons &amp; Ammunition Types</b></p> <p align="center"><b>Single-rail ground mounted</b></p>	<p align="center"><b>Typical Combat Load</b></p> <p align="center"><b>Six launchers per Battalion</b></p>
<p><b>SYSTEM</b>  <b>Alternative Designations:</b> S-200, Vega  <b>Date of Introduction:</b> 1963  <b>Proliferation:</b> At least 15 countries</p> <p><b>ARMAMENT</b>  <b>Launcher:</b>            Description: Single-rail, ground- mounted, not mobile but transportable            Dimensions: INA            Weight (kg): INA            Reaction Time (sec): INA            Time Between Launches (sec): INA            Reload Time (min): INA            Fire on Move: No            Emplacement Time (min): Days            Displacement Time (min): Days</p> <p><b>Missile:</b> (See NOTES)            Name: INA            Range (km):                Max. Slant Range: 300            Effective Range: 250                Min. Range: 17            Altitude (m):                Max. Altitude: 29,000                Effective ceiling: 30,000                Min. Altitude: INA            Dimensions:                Length (m): 10.7                Diameter (mm): 750            Weight (kg): 7,100            Wrap around Boosters:                Length (m): 4.9                Diameter (mm): 500            Missile Speed (m/s): 1,100            Propulsion: 2-stage liquid fuel, four wrap-around solid fuel rockets</p>	<p>Guidance: Semi-active homing            Warhead Type: Conventional (HE) or nuclear            Fuze Type: INA            Warhead Weight (kg): 60 HE            Self-Destruct (sec): INA            Booster separation at (km): 2            Reload Time (min): 5</p> <p><b>FIRE CONTROL</b>  <b>Radar:</b>            Name: SQUARE PAIR            Function: Tracking            Effective Range (km): 350            Frequency (GHz): 6.62-6.94            Frequency Band: H            Located: With firing units</p> <p><b>Associated Radars:</b>            Name: BACK NET initially                BAR LOCK B (P-50) follow-on            Function: Surveillance/ early warning            Range (km): 250/ 390            Frequency Band: E-band (2-2.5 GHz) / E &amp; F bands            Location: Generally with separate early warning or Signals Reconnaissance bns</p> <p>Name: SIDE NET/PRV-11 initially,                ODD PAIR, E-band follow-on            Function: Height Finding Radar            Range: INA            Frequency Band: E-band            Location: Generally with separate early warning or Signals Reconnaissance bns</p>	<p>Name: TALL KING            Function: Very long-range early warning            Effective Range (km): 500-600            Frequency Band: A-band (150-180 MHz)            Location: Generally with separate early warning or Signals Reconnaissance bns</p> <p>Name: BACK TRAP            Function: Very long-range early earning            Effective Range (km): INA            Frequency Band: A-band (172 MHz)            Location: Brigade Level</p> <p>Name: BIG BACK            Function: Very long-range early warning            Effective Range (km): INA            Frequency Band: 3-d L-band            Location: Brigade Level</p> <p><b>VARIANTS</b>            Possibly as many as 5 missiles/variants</p>

### NOTES

The SA-5/Gammon is a long-range, strategic semi-active guided missile system for targeting medium-to-high altitude high-speed aircraft.

The missile has a long cylindrical body with a conical nose, four long chord cruciform delta wings, four small cruciform rectangular control surfaces at the extreme rear, and four jettisonable, wraparound solid-fuel boosters with canted nozzles. It uses a liquid propellant, dual thrust rocket engine, and the missile travels about 2 km before booster separation. The sustainer has four cropped delta wings and steerable rear fins. Control is assisted by ailerons.

## Russian SAM System SA-6/GAINFUL

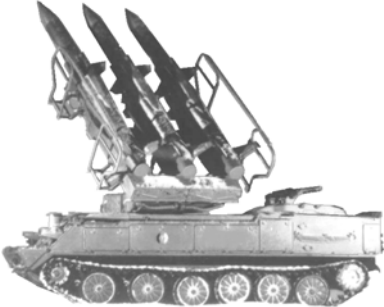
	<b>Weapons &amp; Ammunition Types</b>  <b>Launch rails</b>	<b>Typical Combat Load</b>  <b>3</b>
<p><b>SYSTEM</b>  <b>Alternative Designations:</b> Kub, Kvadral  <b>Date of Introduction:</b> 1966  <b>Proliferation:</b> At least 22 countries</p> <p><b>Description:</b>  Crew: 3  Combat Weight (mt): 14  TEL Chassis: Modified PT-76  Length (m): 6.09  Height (m): 4.45  Width (m): 3.04</p> <p><b>Automotive Performance:</b>  Engine Name, Type: V-6R, 6 cyl diesel  Cruising Range (km): 250  Speed (km/h):      Max. Road: 45      Max. Swim: N/A</p> <p><b>Radio:</b> INA</p> <p><b>Protection:</b>  NBC Protection System: Yes</p>	<p><b>ARMAMENT</b>  <b>Launcher:</b>  Name: 2P25  Reaction Time (min): INA  Time Between Launches (sec): INA  Reload Time (min): 10  Fire on Move: No  Emplacement Time (min): 5 or less  Displacement Time (min): INA</p> <p><b>Missile:</b>  Name: 3M9, 9M9  Range (m):      Max. Range: 25,000      Min. Range: 4,000  Altitude (m):      Max. Altitude: 15,000      Min. Altitude: 50  Dimensions:      Length (m): 6.20      Diameter (mm): 335  Weight (kg): 599  Missile Speed: Mach 2.7  Propulsion: Solid fuel  Guidance: Semi-active radar homing  Warhead Type: Frag HE  Fuze Type: Proximity RF  Warhead Weight (kg): 50</p>	<p><b>FIRE CONTROL</b>  <b>Sights w/Magnification:</b> EO sighting system on vehicle. Commander and driver have IR.</p> <p><b>IFF:</b> Pulse-doppler</p> <p><b>Radar:</b>  Name: STRAIGHT FLUSH  Function: Fire control /target acquisition  Detection Range (km): 60-90  Tracking Range (km): 28  Frequency: I-low altitude (tracking); G/H-med altitude (acquisition); H (detection)</p> <p><b>Radar:</b>  Name: LONG TRACK  Function: Battlefield surveillance/target acquisition  Detection Range (km): 167  Tracking Range (km): 150  Frequency: 2.6 GHz  Frequency Band: E</p> <p><b>Radar:</b>  Name: THIN SKIN  Function: Height Finding  Detection Range (km): 240  Tracking Range (km): INA  Frequency Band: H</p> <p><b>VARIANTS</b>  <b>SA-6b/GAINFUL:</b> Mounted on MT-LB, has integrated radar. The TELAR can operate independently for surveillance.</p>

**NOTES**

The SA-6 is a two-stage, solid-fuel, low-altitude SAM. It has radio-command guidance with semi-active radar terminal homing. Targets are low to medium altitude fixed- and rotary-wing aircraft. Two or more missiles may be launched at a target during an engagement. The associated STRAIGHT FLUSH fire control/target acquisition radar vehicle uses the same chassis as the SA-6a TEL. The LONG TRACK target acquisition radar is also associated with the SA-6 system. The LONG TRACK surveillance radar acquires target data, the STRAIGHT FLUSH missile site radars take over target acquisition and fire control.

SA-6 regiments organic to mechanized and tank divisions consist of 20 TELs in five batteries, 4 TELs to a battery. The SA-6b system includes the FIRE DOME fire control radar. When the SA-6a TEL battery is replaced with an SA-6b TELAR, the battery doubles its capability to acquire and engage targets. Each battery has four triple launchers, one STRAIGHT FLUSH vehicle, and two reload vehicles (3 missiles each). Normally, three of these batteries are deployed approximately 5 km behind the front line; the remaining two are deployed about 10 km farther back, filling the gaps between the three forward batteries.

# Russian SAM System SA-8b/GECKO

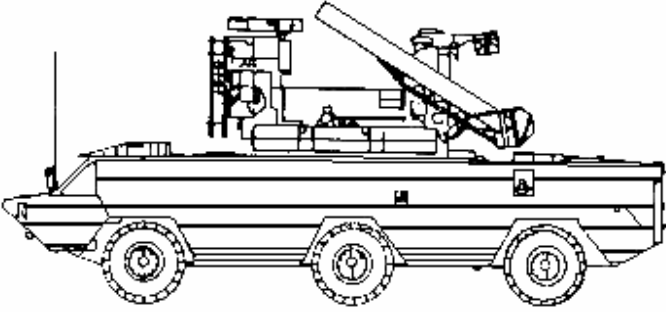
	<b>Weapons &amp; Ammunition Types</b>  SA-8b in canisters	<b>Typical Combat Load</b>  6
<p><b>SYSTEM</b>  <b>Alternative Designations:</b> 9K33M3 Osa-AKM  <b>Date of Introduction:</b> 1980  <b>Proliferation:</b> At least 25 countries</p> <p><b>Description:</b>                  Crew: 3                  Combat Weight (mt): 9                  TELAR: BAZ-5937 6x6 amphibious cross-country capable vehicle                  Length (m): 9.14                  Height (m): 4.2 (with surveillance radar folded down)                  Width (m): 2.75</p> <p><b>Automotive Performance:</b>                  Engine Type: D20K300 diesel                  Cruising Range (km): 500                  Speed (km/h):                      Max. Road: 80                      Max. Swim: 8</p> <p><b>Radio:</b> R-123M</p> <p><b>Protection:</b>                  NBC Protection System: Yes</p>	<p><b>ARMAMENT</b>  <b>Launcher:</b>                  Name: 9P35M2                  Dimensions:                      Length (m): 3.2                      Diameter (mm): INA                  Weight (kg): 35                  Reaction Time (sec): INA                  Time Between Launches (sec): 4                  Reload Time (min): 5                  Fire on Move: No                  Emplacement Time (min): 4                  Displacement Time (min): Less than 4 (est.)</p> <p><b>Missile:</b>                  Name: 9M33M3                  Range (m):                      Max. Range: 15,000                      Min. Range: 200                  Altitude (m):                      Max. Altitude: 12,000                      Min. Altitude: 10                  Dimensions (mm):                      Length: 3158                      Diameter: 209.6                  Weight (kg): 170                  Missile Speed (m/s): 1020                  Propulsion: Solid propellant rocket motor                  Guidance: RF CLOS                  Warhead Type: Frag-HE                  Fuze Type: Contact and proximity                  Warhead Weight (kg): 16                  Self-Destruct (sec): 25-28</p>	<p><b>FIRE CONTROL</b>  <b>Sights w/Magnification:</b> INA                  LLLTV/optical assist (for target tracking in low visibility and heavy ECM)</p> <p><b>IFF:</b> Yes</p> <p><b>Radar:</b>  <b>Name:</b> LAND ROLL  <b>Function:</b> Target Acquisition  <b>Detection Range (km):</b> 20-30  <b>Tracking Range (km):</b> 20-25  <b>Frequency:</b> 6-8 GHz  <b>Frequency Band:</b> H</p> <p><b>Radar:</b>                  Name: Monopulse Target Tracking Radar                  Function: Target Tracking                  Detection Range (km): 20-25                  Tracking Range (km): INA                  Frequency: 14.2-14.8 GHz                  Frequency Band: J</p> <p><b>2 Missile tracking radars:</b>                  Frequency: 10-20 GHz</p> <p><b>VARIANTS</b>  <b>SA-8a:</b> Initial production model that carries four missiles on exposed rails.  <b>4K33 Osa-M (SA-N-4):</b> Naval variant</p>

**NOTES**

The first production version of this system was identified as SA-8a, which only had 4 launcher rails and exposed missiles. The SA-8b typically has two BAZ-5937 resupply/transloader vehicles, carrying 18 missiles each (boxed in sets of three) that supports a battery of four TELARs. A target can be brought under fire both with one missile as well as a volley of two missiles. This system is also air transportable.

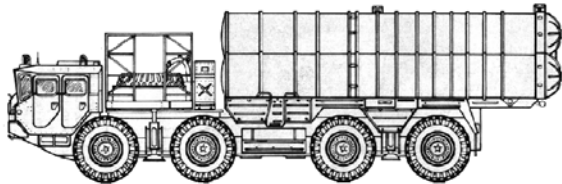

## Russian SAM System SA-10b/GRUMBLE

	<b>Missiles</b>  <b>SA-10b in canisters on-board</b>	<b>Typical Combat Load</b>  <b>4</b>
<p><b>SYSTEM</b></p> <p><b>System Designation:</b> S-300PMU  <b>Alternative Designations:</b> SA-10b GRUMBLE (NATO)  <b>Date of Introduction:</b> 1985  <b>Proliferation:</b> At least 8 countries  <b>Primary Components:</b></p> <ul style="list-style-type: none"> <li>1- Launch vehicle with command shelter (5P85SU)</li> <li>2- Launch vehicles without command shelter (5P58DU)</li> <li>1- FLAP LID B Target engagement radar</li> </ul> <p><b>ARMAMENT</b></p> <p><b>TEL:</b>  Name: 5P85SU or 5P58DU (see NOTES)  Time Between Launches (sec): 3  Reload Time (min): INA  Crew: 6  Fire on Move: No  Emplacement Time (min): 5  Displacement Time (min): &lt; 5  Missiles Fired Simultaneously: 12 (2 per target)  Targets Tracked Simultaneously: 6</p> <p><b>Automotive Performance:</b>  Chassis: MAZ-7910 (8x8)  Engine: D12A-525 V-12 water cooled  Horsepower: 525  Cruising Range (km): 650  Speed (km/h):  Max. Road: 60  Weight (kg): 20,000  Dimensions (m):  Length: 9.4  Width: 3.1  Height: 3.7</p>	<p><b>Missile:</b>  Name: 5V55RUD  Range (km):  Max. Launch Range: 90  Min. Range: 5  Altitude (m):  Max. Altitude: 27,000  Min. Altitude: 25  Speed (m/sec):  Max Target: 1,200  Max SAM: 2,100  Dimensions:  Length (m): 7  Diameter (mm): 450  Weight (kg):  In Canister: 2,100  Guidance: Track-Via-Missile (TVM)  Warhead Type: HE  Fuze Type: Contact  Warhead Weight (kg): 133</p> <p><b>VARIANTS</b></p> <p><b>SA-10a:</b> Semi-fixed version deployed on trailers.  <b>SA-10c:</b> Improved, longer range (150 km), TOMBSTONE radar, expanded C<sup>2</sup>.  <b>HQ-10/HQ-15:</b> Chinese licensed copy of SA-10.  <b>HQ-9/FT2000:</b> Chinese based on S-300PMU (SA-10b).  <b>SA-N-6:</b> Russian naval version.</p> <p>For additional information on variants and options, see SA-10c (next page).</p>	<p><b>ASSOCIATED RADARS</b></p> <p><b>Radar:</b>  Name: 30N6  NATO Designation: FLAP LID B  Function: Target Engagement  Unit Associated With: Firing battery  Detection Range (km): 90 km  Interception Altitude (m): 25 and higher  Target Speed (km/h): 4,200  Targets Engaged Simultaneously: 6  Missiles Guided Simultaneously: 12  Frequency (GHz): 10  Frequency Band: I/J</p> <p><b>Radar:</b>  Name: 76N6  NATO Designation: CLAM SHELL  Function: Low Altitude Search and Acquisition  Unit Associated With: Battalion/regiment  Detection Range (km):  @ 1,500 feet altitude: 93  @ 3,000 feet altitude: 120  Targets Tracked Simultaneously: 180 low level targets  Resolution of Target Radar Cross Section (RCS):  .02 m<sup>2</sup> @ 1,400 kts  Frequency (GHz): INA  Frequency Band: I</p> <p><b>Radar:</b>  Name: INA  NATO Designation: BIG BIRD  Function: Target Detection/Command Guidance  Unit Associated With: Regiment  Frequency (GHz): 3.3  Frequency Band: F</p>

### NOTES

The missiles (5V55R) are in a sealed transport launch canister and do not need to be tested or adjusted during their service life of 10 years. They are launched vertically by the canister without turning the launcher toward the target. Each battery has one 5P85SU launcher vehicle with a command shelter mounted behind the cab and one or two 5P58DU launcher vehicles without the command shelter. Two missiles are normally fired at each target increasing probability of hit. The line drawing is of the 5P58DU TEL (without the command shelter).

Russian SAM System SA-10c GRUMBLE (export variant)

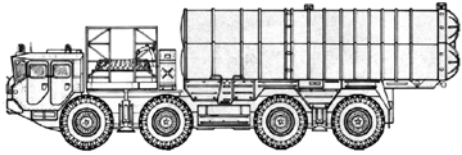
	<p><b>Missiles</b></p> <p>SA-10c in canisters on-board TEL or trailer launcher</p>	<p><b>Typical Combat Load</b></p> <p>4</p>
<p><b>SYSTEM</b>  <b>System Designation:</b> S-300PMU1  <b>Alternative Designations:</b> SA-10c  <b>Date of Introduction:</b> 1990-93  <b>Proliferation:</b> At least 4 countries  <b>Primary Components:</b>              83M6E automated C<sup>2</sup> system, consisting of the Baykal-1E or 54K6E battle management CP vehicle, and 64N6E radar vehicle. The system can control up to 6 missile complexes (72 missiles, against 36 targets). System also has vehicles and technical support facilities.</p> <p>90Zh6E missile complex, with 30N6E radar, battalion CP, and up to 12 5P85SE launcher vehicles or 12 5P85TE trailer launchers. Complex includes vehicles (e.g., trucks, UAZ-452T2 survey vehicle) and equipment.</p> <p>48N6E air defense missile</p> <p><b>ARMAMENT</b>  <b>Trailer Launcher and TEL</b>              Name: 5P85SE TEL, in ground force units              5P85TE trailer launcher for site defense</p> <p>Missiles per launcher: 4              Reaction Time: 8-10 sec              Time Between Launches (sec): 3              Reload Time (min): INA              Crew: 4-6              Fire on Move: No              Emplacement Time (min): 5 TEL              30 trailer launcher              Displacement Time (min): &lt; 5 (est) TEL              INA trailer launcher</p> <p><b>Automotive Performance:</b>              For TEL, see SA-10b.</p> <p>The 5P85TE trailer launcher is normally towed by a KRAZ-260B 6x6 truck.</p>	<p><b>Missile:</b>              Name: 48N6E              Type: Single-Stage, solid-fuel              Launch Mode: Vertical launch              Range (km):              Max. Launch Range: 150              Max Range TBMs: 40              Targets .5-1 km high: 28-38              Min. Range: 5              Altitude (m):              Max. Altitude: 27,000              Min. Altitude: 10              Speed (m/sec):              Max Target: 2,800              Max SAM: 1,900-2,000              Dimensions:              Length (m): 7.5              Diameter (mm): 519              Weight (kg):              In Canister: 2600              Guidance: Track-Via-Missile              Warhead Type: Frag-HE              Fuze Type: radio command              Warhead Weight (kg): 145</p> <p><b>VARIANTS</b>  <b>SA-10b:</b> See previous page.</p> <p><b>SA-10c:</b> Upgrades C<sup>2</sup>, missiles, and radars. It is a more mobile system with an engagement range increase to 150 km. Forces may use a mix of earlier and later assets.</p> <p><b>Favorit:</b> Later improved system with upgraded C<sup>2</sup> (83M6E2 and 90Zh6E2), radars (6N6E2 and 30N6E2), and the 48N6E2 missile. Engagement range is 200 km.</p> <p>Recent <b>L6LE</b> all-altitude target designation upgrade radar vehicle can replace CLAM SHELL.</p>	<p><b>ASSOCIATED RADARS</b>  <b>Radar:</b>              Name: 64N6E              NATO Designator: INA              Function: Surveillance radar              Unit: Brigade, 3-6 90Zh6E complexes (bns), total 18-72 launchers              Mobility: Vehicle-mounted              Detection range (km): 200              Number of Targets detected: up to 200              Targets for Simultaneous Lock and Track: 100              Frequency Band: INA, 3-D phased array</p> <p><b>Radar:</b>              Name: 30N6E              NATO Designation: INA              Function: Multifunction - Illumination, guidance, and automatic tracking              Unit: 90Zh6E complex (battalion), 2-6 fire units, total 6-12 launchers              Mobility: Vehicle-mounted              Detection Range (km): 150              Targets Engaged Simultaneously: up to 6              Missiles Guided Simultaneously: up to 12              Frequency Band: INA 3-D phased array</p> <p><b>Radar:</b>              Name: 76N6 (optional supplement to 90Zh6E)              NATO Designation: CLAM SHELL              Function: Low Altitude Search and Acquisition              Unit Associated With: Battalion              Mobility: Mounted atop 40V6 trailer tower              Antenna station is on a 5T58 truck              Operation: Station can operate 500m from radar.              Emplacement time (hrs): 1-2              Detection Range (km):              @ 500 m altitude: 90              @ 1,000 m altitude: 120              Targets Tracked Simultaneously: up to 180              Target Generation Time/Target (sec): 3              Resolution of Target RCS: .02 m<sup>2</sup> @ 1400 kts              Frequency Band: I-band 3-D radar</p>

**NOTES**

Ground force brigade structure probably differs, with 3-4 battalions and 18-36 total launcher vehicles (vs 36-72 for area defense brigade).

The 83M6E automated C<sup>2</sup> system can be used with other AD missile system complexes, such as SA-5, earlier SA-10, and SA-11. With this C<sup>2</sup> and compatible nets, this system can be used as the base for an integrated air defense system. The 83M6E (Baykal-1E) system can also pass pass detections directly to the Rubezh-2M air intercept control net.

The missiles (48N6E) are launched vertically by the canister without turning the launcher toward the target. Two missiles are normally fired at each target increasing probability of hit.

The Osnova-1E integrated air defense system C<sup>2</sup> vehicle can process 120 targets at a time. It can simultaneously sort out aircraft ECM (with the AKUP-22 system) and pass up to 80 targets to Baikal-1E or other AD missile systems, as well as up to 60 targets to Rubezh-2M.

# Russian SAM System SA-11/GADFLY

	<p align="center"><b>Weapons &amp; Ammunition Types</b></p> <p><b>Launch rails, Total</b>  <b>TELAR</b>  <b>Loader-launcher</b></p>	<p align="center"><b>Typical Combat Load</b></p> <p align="center"><b>4</b> <b>8</b></p>
<p><b>SYSTEM</b>  <b>Alternative Designations:</b> BUK-M1  <b>Date of Introduction:</b> 1979/ 83 for -M1  <b>Proliferation:</b> At least 5 countries  <b>Description:</b>  Crew: 4  Combat Weight (mt): 32.34 for TELAR  36 or less for all  Chassis: For CP, TELARs, launcher-loader, radars, GM-569 armored, tracked  TELAR:  Length (m): 9.3  Height (m): 3.8 travel/7.72 deployed  Width (m): 3.25</p> <p><b>Automotive Performance:</b>  Engine Name, Type: 700-hp diesel  Cruising Range (km): 500  Speed (km/h):  Max. Road: 65  Max with launchers ready: 30  Forcing depth (m): 1  APU: Yes for TELARs, LL, radars, CP  <b>Radio:</b> INA</p> <p><b>Protection:</b>  Amor protection: Small arms (est)  NBC Protection System: INA</p> <p><b>ARMAMENT</b>  <b>Launcher:</b>  Name: 9A310M1  Reaction Time (min): 0.25-0.5  0.1 for low-flyers  Time Between Launches (sec): 3  Reload Time (min): 13  Fire on Move: No  Emplacement time from march (min): 5  Emplace time, reposition (sec): 20 for a 100-200 m survivability move. TEL does not have to be lowered and locked down.  Displacement Time (min): 5</p>	<p><b>Missile:</b>  Name: 9M38M1  Range (m):  Max. Range: 36,000  Min. Range: 3,000  Altitude (m):  Max. Altitude: 22,000  Min. Altitude: 15  Dimensions:  Length (m): 5.55  Diameter (mm): 400  Weight (kg): 690  Max target speed (m/s): 830  Max missile Speed (m/s): 1,200  Propulsion: Solid fuel  Guidance: RF command, inertial correction,  Semi-active radar homing  Warhead Type: Frag HE  Fuze Type: Proximity RF  Warhead Weight (kg): 70  Warhead lethal radius (m): 17</p> <p><b>PROTECTION/COUNTERMEASURES</b>  <b>Jam ECCM:</b> Noise jam 240-330 w/MHz  <b>Passive Jam ECCM:</b> 3 Packets/100m  <b>Measures:</b> One launcher operates radar, while others are passive. Other guidance modes reduce radar illumination time.  <b>IFF:</b> Pulse-doppler</p> <p><b>FIRE CONTROL</b>  <b>Sights:</b> TV optical auto-tracker  Acquisition range (km): 20  Navigation systems: Available on all  <b>Radar:</b>  Name: 9S18M1/SNOW DRIFT  Function: Battery target acquisition radar  Description: Armored tracked chassis with phased array radar and dipole antenna  Detection range (km): 100-160  Range precision (m): 400  Detection altitude (km): 25  Frequency: INA</p>	<p><b>Radar:</b>  Name: FIRE DOME  Function: Launcher tracker, illuminator  Detection Range (km): 80 (2 m<sup>2</sup>)  100 (3 m<sup>2</sup>)  Targets tracked: 1  Frequency: 6-10 GHz  Frequency Band: H/I</p> <p><b>OTHER VEHICLES:</b>  <b>Support:</b>  Name: 9A39M1  Function: Launcher-loader vehicle  Missile load: 8  Reload Time (min): 15  Fire on Move: No  Emplacement Time (min): 5</p> <p><b>C<sup>2</sup> Vehicle:</b>  Name: 9S470M1  Function: Battery Command Post  Data links: Wire and radio AD net, and can link to SA-10/Osnova integrated net.  Targets tracked: 15 (6 assigned to TELs)</p> <p><b>Other support equipment:</b> TM-9T229  Transporter vehicle, maintenance vehicles, mobile test unit.</p> <p><b>VARIANTS</b>  <b>BUK:</b> Original system used unsuccessful TUBE ARM, replaced by SNOW DRIFT  <b>BUK-M1-2:</b> Export-based upgrade with adaptation of SA-17/9M317 SAM to BUK launcher system. Orion passive radar system can also be added. Range extends to 45 km. New 9A310M1-2 launcher vehicle with a phased array radar permits launcher multi-target missions. SNOW DRIFT upgrade available. Software/ECM upgrades are included.</p>

**NOTES**

The 9K37M1 complex consists of a CP vehicle, TA radar, 6 TELARs, 3 launcher-loaders, and 48 missiles. A battery can engage up to 6 targets (up to 12 missiles) simultaneously. Launcher-loader can launch missiles on TELAR command when necessary. The TELARs can be located 5-10 km apart and operate autonomously. Target types include helicopters, fixed-wing aircraft, UAVs, anti-radiation missiles, and cruise missiles.





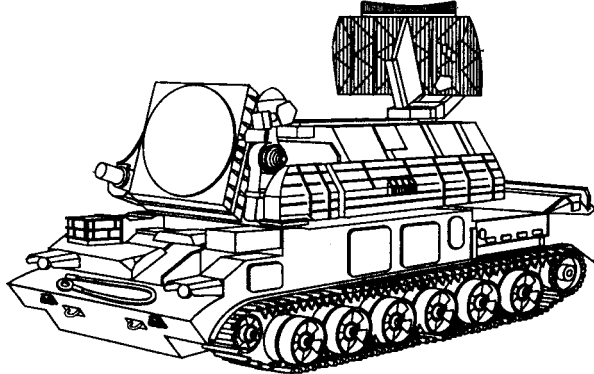

## Russian SAM System SA-15b/GAUNTLET

	<p style="text-align: center;"><b>Weapons &amp; Ammunition Types</b></p> <p style="text-align: center;">ready missiles</p>	<p style="text-align: center;"><b>Typical Combat Load</b></p> <p style="text-align: center;">8</p>
<p><b>SYSTEM</b> Alternative Designations: <b>9K331 Tor-M1</b> Date of Introduction: <b>1990</b> Proliferation: <b>At least 5 countries</b></p> <p>Description: <b>Crew: 3</b> TLAR: 9A331 combat vehicle Chassis: GM-355 Combat Weight (mt): 34 Length (m): 7.5 Height (m): 5.1 (TAR up) Width (m): 3.3</p> <p><b>Automotive Performance:</b> Engine Type: V-12 diesel Cruising Range (km): 500 Speed (km/h):     Max. Road: 65</p> <p>Radio: <b>INA</b></p> <p><b>Protection:</b> NBC Protection System: Yes</p>	<p><b>ARMAMENT</b> <b>Launcher:</b> Name: INA Dimensions: INA     Length (m): INA     Diameter (mm): INA Weight (kg): INA Reaction Time (sec): 5-8 Time Between Launches (sec): (see NOTE) Reload Time (min): 10 Fire on Move: Yes Emplacement Time (min): 5 Displacement Time (min): Less than 5</p> <p><b>Missile:</b> Name: 9M331 Range (m):     Max. Range: 12,000     Min. Range: 100 Altitude (m):     Max. Altitude: 6,000     Min. Altitude: 10 Dimensions (mm):     Length: 2,900     Diameter: 235 Weight (kg): 167 Missile Speed (m/s): 850 Propulsion: INA Guidance: Command Warhead Type: Frag-HE Fuze Type: RF Proximity Warhead Weight (kg): 15 Self-Destruct (sec): INA</p>	<p><b>FIRE CONTROL</b> <b>Sights w/Magnification:</b> Electro-optical (EO) television system:     Range: 20 km</p> <p><b>IFF:</b> Yes</p> <p><b>Radar:</b> Name: INA Function: Target Acquisition Detection Range (km): 25 Tracking Range (km): INA Frequency: INA Frequency Band: H-band Doppler</p> <p><b>Radar:</b> Name: INA Function: Target Tracking and Guidance Detection Range (km): INA Tracking Range (km): 25 Frequency: INA Frequency Band: K-band Doppler, Phased Array</p> <p><b>VARIANTS</b> <b>SA-N-9:</b> Naval version</p>

**NOTES**

SA-15b is designed to be a completely autonomous air defense system (at division level), capable of surveillance, command and control, missile launch and guidance functions from a single vehicle. The basic combat formation is the firing battery consisting of four TLARs and the Rangir battery command post. The TLAR carries eight ready missiles stored in two containers holding four missiles each. The SA-15b has the capability to automatically track and destroy 2 targets simultaneously in any weather and at any time of the day.

## Italian Aspide Mk 1 SAM System (with Skyguard AA Gun-Missile Battery)

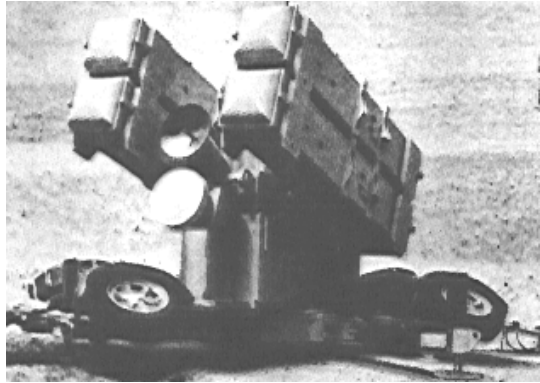
 <p style="text-align: center;">Aspide 4-canister configuration</p>	<p style="text-align: center;"><b>Weapons &amp; Ammunition Types</b></p> <p><b>Launch canisters</b></p> <p><b>Total missiles</b></p>	<p style="text-align: center;"><b>Typical Combat Load</b></p> <p style="text-align: center;">4/6 (depending on configuration)</p> <p style="text-align: center;">12</p>
<p><b>SYSTEM</b>  <b>Alternative Designations:</b> Skyguard system  <b>Date of Introduction:</b> 1986.  <b>Proliferation:</b> At least 18 countries</p> <p><b>LAUNCHER</b>  <b>Description:</b> Towed 4/6 canister launcher  Name: INA  Reaction Time (sec): 11  Time Between Launches (sec): INA  Fire on Move: No  Number of fire channels: 2  Emplacement Time (min): 15</p> <p><b>ARMAMENT</b>  <b>Missile:</b>  Name: Aspide  Range (km):      Max. Range: 15+      Min. Range: 0.75  Altitude (m):      Max. Altitude: 6,000+      Min. Altitude: 10  Dimensions:      Length (m): 3.65      Diameter (mm): 203</p>	<p>Weight (kg): 230  Missile Speed (m/s): 650  Velocity (mach): 2.0  Maneuver capability (Gs): 35-40  Propulsion: Solid fuel booster  Guidance: J-band radar semiactive homing. Seeker also can be used in home-on-jam mode.  Warhead Type: Frag-HE  Fuze Type: Proximity and contact  Warhead Weight (kg): 33</p> <p><b>FIRE CONTROL</b>  <b>Onboard Fire Control:</b> Tracker and illuminator radars, I/J-band  <b>Off-carriage Fire Control</b>  Electro-optical system: SEC-Vidicon TV tracking system  Laser rangefinder</p>	<p><b>Radar:</b>  Name: Skyguard Mk II (SW)  Function: (1) Fire control search and (2) track, I-band, doppler  Detection Range (km): INA  Tracking Range (km): 25  Tracking Capability: 1 target, 1-2 missiles  Frequency: 8-20 GHz  Frequency Band: J, doppler illuminator  Rotation Rate/min: 60  Mean Power (W): 200</p> <p><b>VARIANTS</b>  <b>Amoun:</b> Egyptian Aspide/Sparrow system  <b>Aramis:</b> Brigade SAM system with 6-canister launcher.  <b>Spada:</b> Italian Air Force launcher version.  <b>Sparrow:</b> System from which Aspide is derived, and is interchangeable in the launcher.  <b>LY-60:</b> Chinese ground/naval variant</p>

### NOTES

GPS is used for surveying systems in position. Skyguard connection link is 1,000-m cable link or 5000-m radio link.

The system can also be used with Supergiraffe AD battalion EW radar.

Other missile systems can be used with Skyguard system instead of Aspide. They include ADATS, ASRAD, AIM-7E/Sparrow, SAHV-IR, and Chinese LY-60.

European SAM System Crotale 4000

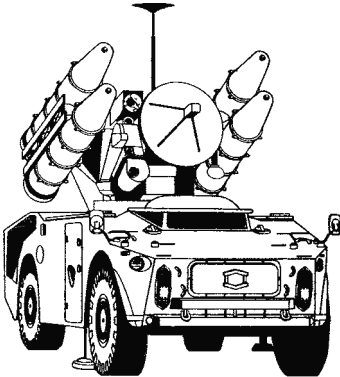
	<p style="text-align: center;"><b>Weapons &amp; Ammunition Types</b></p> <p><b>R440 missile canisters</b></p>	<p style="text-align: center;"><b>Typical Combat Load</b></p> <p style="text-align: center;"><b>4</b></p>
<p><b>SYSTEM</b>  <b>Alternative Designations:</b> TSE 5000  <b>Date of Introduction:</b> 1971, 4000 in 1988  <b>Proliferation:</b> At least 9 countries  <b>Description:</b> Data is for vehicle w/launcher          TELAR: P4R 4x4          Crew: 2 launcher vehicle          Combat Weight (mt): 15.0          Length (m): 6.22          Height (m): 3.41          Width (m): 2.72</p> <p><b>Automotive Performance:</b>          Engine Type: INA          Cruising Range (km): 600          Max. Road Speed (km/h): 70          Fording depth (m): 0.68</p> <p><b>Radio:</b> INA</p> <p><b>Protection:</b>          Armor protection (mm): 3-5          NBC Protection System: No</p> <p><b>ARMAMENT</b>  <b>Launcher:</b>          Name: Crotale          Weight (mt): INA          Set-up time (min): 5          Reaction Time (sec): 6.5          Time Between Launches (sec): 2.5          Reload Time (min): 2          Fire on Move: No</p>	<p><b>Missile:</b>          Name: R440          Range (m):            Max: 10,000            Max, slow movers: 14,600            Min. Range: 500          Altitude (m):            Max. Altitude: 5,000            Min. Altitude: 15          Dimensions (mm):            Length: 2890            Diameter: 150          Weight (kg): 84, 100 with canister          Missile Speed (m/s): 750          Maneuver capability (Gs): 27          Propulsion: Solid propellant motor          Guidance: RF CLOS          Warhead Type: Focused frag-HE          Warhead Weight (kg): 15          Lethal radius (m): 8</p> <p><b>FIRE CONTROL</b>  <b>Sights w/Magnification:</b>          Day Camera: TV tracker, low elevation            Range (km): 14.0          Optical sight: back-up binocular tracker          Day/Night Camera: Thermal, optional v            Field of view (°): 8.1/2.7            Elevation (°): 5.4/1.8            Range (km): 19.0          Missile Tracker: IR, for remote control</p> <p><b>IFF:</b> Yes, on ACU (See Notes)</p>	<p><b>Radar:</b>          Name: Mirador IV pulse doppler          Function: Surveillance          Antenna rotation rate (rpm): 60          Detection Range (km): 18.5          Altitude coverage (m): 0 - 4,500          Target Detection: 30 targets per rotation          Multiple target tracking: 12 targets.          Frequency Band: E</p> <p><b>Radar:</b>          Name: INA, on launcher vehicle          Function: tracking          Targets tracked: 1          Missile guidance, simultaneous: 2          Detection Range (km): 17          Altitude coverage (m): 0 - 5,000          Frequency (GHz): 12-18          Frequency Band: J, monopulse          Associated radar: I-band (8-10 GHz) command</p> <p><b>VARIANTS</b>          System is mounted on vehicles, shelter, ships  <b>Crotale 1000:</b> Initial version with cable link.  <b>Crotale 2000:</b> Variant with TV and IFF.  <b>Crotale 3000:</b> Variant has TV auto-tracker.  <b>Crotale 4000:</b> Variant with radio data link and thermal sight option  <b>Crotale Improved:</b> Has new radar  <b>Cactus:</b> SA variant for SAHV-3 missile.  <b>FM-80/HQ-7:</b> Chinese variant.  <b>Shahine:</b> Upgrade has R460 15-km missile on AMX-30 tank chassis. <b>Shahine 2</b> features radar range increase to 12.0, M3.5 velocity, and 5-m minimum altitude (slow movers).  <b>Thales Crotale:</b> Upgrades for French air force and navy variants and Saudi variants.</p>

**NOTES**

The all-weather system is deployed in platoons. A platoon includes an Acquisition and Coordination Unit (ACU) vehicle and 2-3 "firing units" (launcher vehicles). A battery includes two platoons. Battery reloads are delivered on trucks. An ACU uses the same P4R chassis with the surveillance radar, IFF interrogator, battle management computer, digital RF datalink, and VHF radios. With the RF datalink, interval can be up to 10 km between ACUs, and up to 3 km between ACU and launcher vehicles.

An off-chassis remote control system can be used to guide the missile.

## European SAM System Crotale-New Generation

 <p style="text-align: center;">XA-181 SAM Launcher Vehicle</p>	<p style="text-align: center;"><b>Weapons &amp; Ammunition Types</b></p> <p>VT-1 missile canisters</p>	<p style="text-align: center;"><b>Typical Combat Load</b></p> <p style="text-align: center;">8</p>
<p><b>SYSTEM</b></p> <p><b>Alternative Designations:</b> Crotale-NG, XA-181 (Finnish SAM Launcher vehicle)</p> <p><b>Date of Introduction:</b> 1991-92</p> <p><b>Proliferation:</b> At least 5 countries, all variants</p> <p><b>Description:</b> Data is for vehicle w/launcher TELAR: XA-181 is XA-180 (PASI) 6x6 APC with Crotale NG launcher system</p> <p>Crew: 4</p> <p>Combat Weight (mt): 23.0 launch-ready</p> <p>Length (m): 7.35</p> <p>Height (m): 2.3 for vehicle hull +2-3 m (est)</p> <p>Width (m): 2.9</p> <p><b>Automotive Performance:</b></p> <p>Engine Type: 240-hp diesel</p> <p>Cruising Range (km): 800</p> <p>Max. Road Speed (km/h): 80</p> <p>Swim capability: No</p> <p><b>Radio:</b> INA</p> <p><b>Protection:</b></p> <p>Armor protection: 6-12 mm</p> <p>NBC Protection System: Yes</p> <p><b>ARMAMENT</b></p> <p><b>Launcher:</b></p> <p>Name: VL-VT-1</p> <p>Weight (mt): 4.8</p> <p>Reaction Time (sec): &lt;6</p> <p>Time Between Launches (sec): 1-2</p> <p>Reload Time (min): 10</p> <p>Fire on Move: No</p>	<p><b>Missile:</b></p> <p>Name: VT-1</p> <p>Range (m):</p> <p style="padding-left: 20px;">Max. Range: 11,000</p> <p style="padding-left: 20px;">Min. Range: 500</p> <p>Altitude (m):</p> <p style="padding-left: 20px;">Max. Altitude: 6,000</p> <p style="padding-left: 20px;">Min. Altitude: 5</p> <p>Dimensions (mm):</p> <p style="padding-left: 20px;">Length: 2300</p> <p style="padding-left: 20px;">Diameter: 170</p> <p>Weight (kg): 75</p> <p>Missile Speed (m/s): 1,250</p> <p>Maneuver capability (Gs): 35</p> <p>Propulsion: Solid propellant motor</p> <p>Guidance: RF CLOS</p> <p>Warhead Type: Focused frag-HE</p> <p>Fuze Type: Proximity</p> <p>Warhead Weight (kg): 14</p> <p>Lethal radius (m): 8</p> <p><b>FIRE CONTROL</b></p> <p><b>Sights w/Magnification:</b></p> <p>Day Camera: Mascot, CCD TV</p> <p style="padding-left: 20px;">Field of view (°): 2.4</p> <p style="padding-left: 20px;">Elevation (°): 1.8</p> <p style="padding-left: 20px;">Range (km): 15</p> <p>Night Camera: Castor, thermal</p> <p style="padding-left: 20px;">Field of view (°): 8.1/2.7</p> <p style="padding-left: 20px;">Elevation (°): 5.4/1.8</p> <p style="padding-left: 20px;">Range (km): 19</p> <p>Missile Tracker: IR missile localiser on the CCD camera</p> <p><b>IFF:</b> Yes</p>	<p><b>Radar:</b></p> <p>Name: TRS 2630</p> <p>Function: Surveillance</p> <p>Antenna: Planar</p> <p>Detection Range (km):</p> <p style="padding-left: 20px;">Aircraft: 20</p> <p style="padding-left: 20px;">Hovering rotary wing aircraft: 11</p> <p style="padding-left: 20px;">Altitude coverage (m): 0-5000</p> <p>Multiple target tracking: Automatic track-while-scan for up to 8 targets.</p> <p>Frequency (GHz): 2-3</p> <p>Frequency Band: S</p> <p>ECCM: Low sidelobes, wide-band frequency agility, search on the move capability</p> <p><b>Radar:</b></p> <p>Name: INA</p> <p>Function: Engagement, tracking</p> <p>Detection Range (km): 30</p> <p>Frequency (GHz): 35</p> <p>Frequency Band: Ku</p> <p>ECCM: Wideband frequency agile</p> <p><b>VARIANTS</b></p> <p>System is designed to fit on a modular pod, on ships, and for variety of chassis. They include APCs, e.g., M113, Korean IFV, Piranha 10x10, and the XA-180 as noted</p> <p>Russian Fabel VL-VT-1 launcher upgrade gives VT-1 hypervelocity missile (HVM) vertical 40-m rise before pitch-over to target.</p> <p><b>Pegasus:</b> South Korean system with a different missile</p>

### NOTES

The modular all-weather system includes acquisition, tracking, firing and computer units integrated on one vehicle, for management by a single system operator.

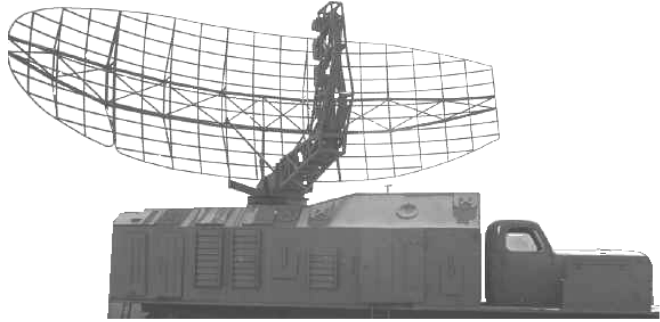

## Russian SAM Radar System LONG TRACK

	
<p><b>SYSTEM</b></p> <p><b>Alternative Designations:</b> INA</p> <p><b>Date of Introduction:</b> IOC 1967</p> <p><b>Description:</b> Twenty-five foot high single conventional parabolic mesh reflector antenna with multiple stacked feeds that is vehicle mounted.</p> <p><b>Functions:</b> Early warning radar, surveillance and target acquisition</p> <p><b>Chassis:</b> A modified version of the AT-T heavy tracked transporter or truck mounted.</p> <p><b>Mobility:</b> On/off road capable mobility is very good. The LONG TRACK was the first highly mobile early warning radar. The antenna is folded for transport.</p> <p><b>ADA Unit Level:</b> Employed at both battalion and brigade levels</p>	<p><b>Frequency Band:</b> E- band, 2.6 GHz</p> <p><b>Sweep Rate (rpm):</b> 15</p> <p><b>Effective Range (km):</b> &gt;150</p> <p><b>Effective Altitude (km):</b> 30</p> <p><b>Track Targets on Move:</b> No</p> <p><b>Emplacement Time (min):</b> INA</p> <p><b>Displacement Time (min):</b> INA</p> <p><b>Associated SAMs:</b> SA-4/GANEF, SA-6/GAINFUL, SA-8/GECKO</p> <p><b>VARIANTS</b> Polish <b>Jawor</b> (circa 1965) and Polish <b>Farm Gate</b> (Truck mounted).</p> <p><b>Exports:</b> Restricted outside of former Warsaw Pact.</p>

**NOTES** None

## Russian SAM Radar System TUBE ARM

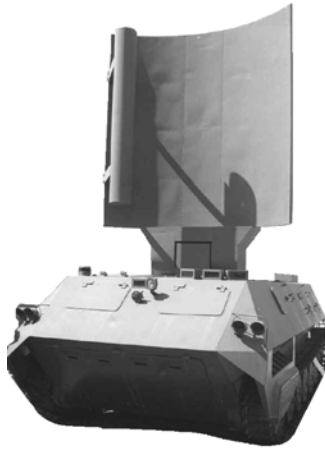

<p><b>SYSTEM</b></p> <p><b>Alternative Designation:</b> INA</p> <p><b>Date of Introduction:</b> Circa 1983</p> <p><b>Description:</b> Eighteen foot high cut parabolic cylindrical antenna that is track vehicle mounted.</p> <p><b>Functions:</b> Acquisition and surveillance</p> <p><b>Chassis:</b> MT-LBu tracked vehicle</p> <p><b>Mobility:</b> On/off road capable mobility is very good.</p> <p><b>Associated SAMs:</b> SA-11 GADFLY</p> <p><b>ADA Unit Level:</b> Employed at both battalion and brigade levels</p> <p><b>Frequency Band:</b> H/I bands</p>	<p><b>Sweep Rate:</b> INA</p> <p><b>Effective Range (km):</b> INA</p> <p><b>Effective Altitude (km):</b> INA</p> <p><b>Track Targets on Move:</b> INA</p> <p><b>Emplacement Time (min):</b> INA</p> <p><b>Displacement Time (min):</b> INA</p> <p><b>VARIANTS</b> None known</p> <p><b>Exports:</b> None known due to problems with entire SA-11 system.</p> <p><b>Follow-on/Replacement systems:</b> 9S18M1 "SNOWDRIFT"</p>
--	--

**NOTES**

This radar was originally developed for the SA-11/GADFLY. As a result of problems with the TUBE ARM surveillance radar, the 9S18M1 SNOWDRIFT radar was developed to replace it.



## Swedish SAM Radar System Giraffe



### SYSTEM

**Alternative Designations:** See Variants

**Date of Introduction:** 1992

**Proliferation:** Various configurations in at least 18 countries

**Description:** Radar has a broadband fully coherent travelling-wave-tube (TWT) transmitter, and a vertically polarized parabolic reflector antenna lifted on an elevating arm. Hydraulic elevating arm height is 13m, 7m for Giraffe 50AT and HARD.

Crew: INA

Chassis: The most mobile systems are Giraffe 50AT and Hard, on a Swedish Haggglunds Bv208 All Terrain Tracked Carrier, with an articulated chassis. It is a diesel-engined variant of Bv206.

#### Data for Giraffe 50AT chassis (Bv208)

Weight (kg): 6.34, INA with arm

Length (m): 6.9, INA with arm

Width (m): 1.9

Height (m): 2.4 for chassis, INA with arm

Engine Type: 125-hp Mercedes Benz OM Diesel

Cruising Range (km): 330

Max. Road Speed (km/h): 50

Mobility: Off road mobility is very good on tracked chassis, off-road speed is slightly reduced due to arm.

Fording Depth (m): Amphibious; however, arm may affect it.

Emplacement Time (min): INA

Displacement Time (min): INA

**Associated AD systems:** RBS70, RBS90, RBS 23/BAMSE, Stinger, Rapier, Mistral, AA guns, and any other air defense systems with compatible C<sup>2</sup> networks.

**ADA Unit Level:** Employed to support short-range and medium-range firing units and air defense and coastal defense networks.

### RADAR CAPABILITY

**Functions:** Early warning, surveillance, acquisition and tracking, and for combat control center

**Features:** Radar is designed to operate in a ground clutter and ECM environment. The signal processor uses digital MTI doppler processing, with current ECCM, such as automatic jumps to avoid jammed frequencies, and extracts jammer bearings from display. Radar has automatic target detection and tracking.

#### Specifications:

Frequency Band: G-band, except for HARD (H/I-band)

Sweep Rate (rpm): Antenna rotates 60 rpm.

Effective Range (km): Number in name denotes range in km. Thus, Giraffe 50AT range is 50 km.

Resolution 0.1 sq m target (km): 20-25

Effective Altitude (km): Low flying targets, up to 12 (depending on target resolution and aspect)

Track Targets on Move: No

#### VARIANTS

**Giraffe (PS-70/R):** Original system for use with RBS70, with 40 km surveillance, 20 km target designation range.

**Giraffe 40:** Truck-mounted system for AA guns and MANPADS support nets.

**Giraffe 50:** System featured above, with reduced detection and reaction time, and better clutter resistance.

**Giraffe 75 (PS-90):** Truck-mounted medium-range system, which can control up to 20 fire units.

**Giraffe 100:** Truck-mounted long-range variant employs the Sea Giraffe 150 radar.

**Coastal Giraffe:** Coastal defense variant.

**Giraffe AD:** Medium-range variant focused on ECCM and C<sup>2</sup>.

**Giraffe CS:** Short-range and coast defense variant.

**HARD (PS-91):** Short-range variant on Bv-208 chassis. The H/I-band operating frequencies provide low probability of intercept (LPI).

### NOTES

It can be mounted in various vehicle configurations, such as tracked vehicle, wheeled APC, or truck, and can be ship-mounted. Fixed site versions are also available.

The radar net can alert the missile firer and assign sector on a plotting board within the sight unit for RBS-70 and RBS-90 MANPADS.



## Chapter 8 Engineer and Logistics

This chapter provides the basic characteristics of selected *engineer equipment* and *logistics vehicles*. *Engineer equipment* covers, in order, obstacle- and route-clearing vehicles, mine-laying systems, and mineclearing systems. It does not include engineer equipment designed primarily for civil engineering or construction in the rear areas. Also not included is dredging and gap crossing equipment. Data sheets addressing some of these systems will be sent with the next supplement to this guide.

The second category—*logistics vehicles*, provides the basic characteristics of selected trucks readily available to the OPFOR. It includes a representative vehicle from the light, utility, medium, and heavy truck categories. Later updates of this guide will include data on a wider selection of trucks, trailers, vans and other logistical equipment.

Questions and comments on data listed in this chapter should be addressed to:

**Mr. Richard G. McCall**  
DSN: 552-7960 Commercial (913) 684-7960  
e-mail address: mcallr@leavenworth.army.mil



## *Land Mine Primer*

The widespread use of landmines on today's battlefields results from a combination of mass production, plastic mines, improved battlefield delivery systems, and development of sophisticated fuzing. Advances in mass-production techniques and the associated reduction in per-item cost along with its simplicity of manufacture and automated production make landmines extremely attractive for terrain denial. Another technological improvement affecting landmines is the widespread use of plastic. Metal detectors are ineffective for locating plastic-cased mines unless the manufacture intentionally places a mass of metal in the mine. Remotely delivered mines have expanded capability for changing the tempo of battle. Development of various fuze arming and triggering options have increased mine usefulness in warfare.

**1. Types of Minefields.** The five basic types of OPFOR minefields are antitank (AT), antipersonnel (AP), mixed, decoy, and antilanding. AT minefields are the primary type of OPFOR engineer obstacle and serve to destroy or disable armored vehicles. They are primarily established in belts consisting of multiple rows on avenues that are favorable for tanks in front of the forward edge and on the flanks. Where difficult terrain is available, minefield belts will be tied into terrain obstacles to reduce the mine requirement. The OPFOR sets up conventional AP minefields on the forward edge of friendly defensive positions, in front of AT minefields, or along dismounted avenues of approach. Mixed minefields consist of both AP and AT mines. Decoy minefields are a significant form of deception to slow movement or deceive as to true unit locations. Antilanding minefields prevent landings by amphibious, airborne, or heliborne assault forces.

Minefields can also be categorized by their technical method of activation—uncontrolled, controlled, and intelligent minefields. Controlled minefields consist of landmines with electronic switches giving the operator (controller) control over the operational status of the minefield. The operator can change the status of the landmines either by a direct hardwire link or by radio. An entire minefield can be emplaced and turned on or off, as necessary to best support friendly operations. On a smaller scale, select passages in a conventional minefield can contain controllable landmines, allowing for the option of clearing safe lanes for friendly use. The addition of selectable anti-removal and self-destruct features to controlled mines enhances flexibility and overall effectiveness.

Intelligent minefields are far-term concepts, with no foreign systems projected for fielding prior to 2008. They are still in the developmental stage and will have all the advantages of controlled landmines but also will use two-way communications. They will be composed of "wide area coverage" mines.

**2. Types of Mines.** Mines may be AT/anti-vehicle, AP, antihelicopter, or area mines. They may also be defined by the manner in which they are emplaced such as scatterable (remote), or side-attack (generally AT or anti-vehicle) or their area coverage. As noted earlier for minefields, the OPFOR makes distinctions between controlled mines (command-operated by hard wire or radio linkage) and uncontrolled mines.

**a. Antitank.** Conventional antitank mines, such as the TM-62 AT mine, are those that are emplaced either by hand or by mechanical means. These will continue to be the primary landmine threat throughout the foreseeable future. They are readily available to armies and insurgency groups worldwide and are cheap and effective. These mines are normally buried just below the surface of the ground but can be surface laid or buried with up to 30 cm of cover.

Antitank mines can vary in size from as small as 1.4 kg for a scatterable mine (PTM-1S) to over 20 kg for a side attack mine (TM-83). The category of antitank mines includes side-attack and anti-vehicle mines.

**(1). Side-attack.** Commonly called “off-route mines”, side-attack mines are an integral part of the adaptive battlefield and date back to the LGM trip-wire AT mines of the Vietnam War era. Today there are at least 18 different side-attack mines in use by 22 countries. Ten more side-attack mines are under development. Within the next few years these weapons will have proliferated to every combat environment.

Side-attack mines are autonomous weapons that attack vehicles from the side as the vehicles pass by. Current developments in side-attack landmines use mature technology from other weapon programs. For example, a shoulder-fired AT weapon placed on a tripod and fitted with an IR sensor can kill moving targets up to 100 meters away. Current warhead technology in these weapons can allow penetration of up to 950 mm of rolled homogeneous armor. Since side-attack landmines have increased areas of coverage, the number required to hinder mobility of enemy forces is greatly reduced. Uses for these landmines include harassment throughout the area of operation and reinforcement of conventional minefields to make "cleared" lanes unsafe. SOF and security patrols can also use these mines to economically cover multiple avenues of approach, alert on enemy encroachments, and trigger time-sensitive kill zones.

**(2). Anti-vehicle.** Many smaller antitank mines, or larger antipersonnel mines, have been developed (or modified) to severely damage or destroy vehicles other than tanks with a few pound of high explosives or fragmentation. These may be either trucks or lightly armored combat support vehicles such as BTRs.

**b. Antipersonnel.** On the battlefield, the modern AP mine is used to:

- Inflict personnel casualties.
- Hinder soldiers in clearing AT minefields.
- Establish defensive positions.
- Deny access to terrain.

Antipersonnel landmines injure by either blast or fragmentation. The small antipersonnel mine contains no more than a pound (usually only a few ounces) of high explosive. Blast injures by the force of the charge. The loss of a foot or a leg is the common result. Fragmentation mines contain hundreds to thousands of pellets. Plastic-cased landmines pepper their victims with small particles of plastic that are not detectable with x-rays, making complete cleansing of wounds extremely difficult and increasing the risk of infection and amputation.

**c. Antihelicopter.** The modern attack helicopter, with increasing agility and weapons payload, is able to bring enormous firepower to bear on enemy forces. To counter this threat, a new type of mine—the antihelicopter mine—is being developed. By borrowing technologies from the side-attack and wide-area landmines, antihelicopter mines may make use of acoustic fuzing to locate and target potential low-flying targets at significant distances. Their multiple-fragment warheads are more than capable of destroying light-skinned, nonarmored targets at closer ranges.

A simple antihelicopter mine can be assembled from an acoustic sensor, a triggering IR sensor, and a large directional fragmentation mine. More advanced mines use a fairly sophisticated data processing system to track the helicopter, aim the ground launch platform, and guide fire the kill mechanism toward the target. As the helicopter nears the mines, the acoustic sensor activates or cues an IR or MMW sensor. This second sensor initiates the mine when the helicopter enters the lethal zone of the mine. A typical large fragmentation warhead is sufficient to damage soft targets, such as aircraft. Alternate warhead designs include high-explosive warheads and single or multiple explosively formed penetrators.

**d. Area Coverage.** The terms “area” and “wide area” mines are often confusing and misleading. Mines classified as area mines range from antipersonnel “bouncing Betty” mines to side-attack mines, directional fragmentation mines “claymores”, and possibly antihelicopter mines. Wide area coverage mines with sophisticated fuzing and possibly a limited communications capability are weapons of the future and have not been fielded.

**3. Emplacement or Delivery Methods.** In the past landmines generally were placed manually one at a time. Mass mine delivery and distribution systems permit the rapid placement of large quantities of mines. Landmine emplacement vehicles are designed to automatically arm and bury a landmine every 3-10 meters. Landmines also may be placed with artillery, rockets, or aircraft at a rate of hundreds, even thousands, of mines per minutes.

Emplacement means may be manual, mechanical, or remote. Manual emplacement is not possible when there is little time or during high-speed maneuver operations. Therefore, mechanical and remote means are more prevalent.

**a. Manual.** The OPFOR manually emplaces minefields when—

- There is no contact with the enemy.
- Mechanical minelayers are unavailable.
- It is inadvisable to use mechanical minelayer because of terrain restrictions.

**b. Mechanical.** OPFOR engineers rely extensively on mechanized minelayers. These can bury or surface-lay AT mines. The layout of mechanically emplaced minefields is the same as those emplaced by hand. Mines can also be emplaced by helicopters or vehicles with the use of chutes (slides). Mine chutes can also be used to assist manual burial emplacement or to surface-lay mines.

**c. Scatterable Mines.** The US calls them “scatterable mines”, other countries call them “remotely-delivered”. Whatever you chose to call them they are landmines, laid without regard to classical patterns, which are designed to be delivered by aircraft, tube artillery, multiple rocket launchers, missiles, ground vehicles, or they can be hand-thrown. Scatterable mines are not a standard item except in well-equipped armies of the world. While the number of countries possessing scatterable mines continue to increase, there will continue to be many areas of the world where scatterable mines are not a threat through the far term.

Minefield emplacement is progressing from manually and mechanically emplaced minefields to the more flexible and dynamic remotely, scatterable minefield. The ability to remotely deliver mines allows a rapid response with thousands of landmines at any point on the battlefield. Since many scatterable landmines feature self-destruct and antidisturbance fuzing, they are well suited for operations that deny terrain for a specific period. After the allotted time has expired, the terrain can once again be used by friendly forces. Scatterable mines may be delivered by the following methods.

**(1) Artillery.** Multiple rocket launchers are the primary means of remote minelaying. The principal advantage of MRL mine delivery is its ability to quickly emplace large minefields in a single volley, while minimizing exposure to enemy targeting and weapon systems. Both AP and AT mines can be delivered by artillery (which may include cannon and mortar rounds).

**(2) Ground Vehicles.** Within recent years the trend has been to mount scatterable-mine dispensers on ground vehicles. Both AP and AT mines can be launched from ground vehicles. This also gives the engineers the ability to re-seed or reinforce an obstacle without entering the minefield itself.

**(3) Infantry.** Lower level OPFOR infantry units may employ man-portable remote mine dispensers. These man-portable dispensers, weighing only a few pounds, are ideal for installing small, defensive, AP or AT minefields. Infantry-fired ground dispensers allow low-level units to remotely emplace minefields to protect their fighting positions, flanks, and boundaries between units, or to cover firing lines and gaps in combat formations. They can quickly close breaches in existing protective minefields and increase the density of mines on armor avenues of approach.

**(4) Aerial.** Both AT and AP minefields can be laid using aerial minelaying systems. Bombers and fighter-bombers can lay remotely delivered minefields in the operational depths. Ground-attack aircraft lay these minefields in the enemy’s tactical depths.

Helicopter minelaying systems are used to emplace small mine belts or large barrier minefields in the execution of army or division offensive or defensive maneuver plans. This type of aerial minelaying is normally conducted over friendly territory—along flanks or in rear areas. When supporting an airborne or air assault landing, helicopters may lay mines on enemy territory. Helicopter mine chutes are a tool available to even low-technology helicopter forces for installation on a variety of helicopters by low echelon maintenance units and rapidly dispensing conventional anti-tank mines in areas inaccessible to even rapidly moving ground vehicles.

Placement of a limited number of side-attack or conventional AT/AP mines along likely movement routes allows the OPFOR to harrass traffic, slow movement rates, cause casualties, and affect enemy morale.



**4. Fuzes.** Some types of fuzes, such as pressure fuzes, are used in both AT and AP mines while other fuzes tend to be linked more to specific types of mines. For example, acoustic sensors are generally used with antihelicopter and advanced off-route mines while magnetic, tilt-rod, or seismic fuzes are used with AT mines. Most AT mines are detonated by the pressure of a vehicle driving over a buried mine or by the movement of a tilt rod attached to the mine. Pressure and tilt-rod AT mine fuzes are being replaced or complemented by mines with magnetic, optical, seismic, and acoustic influence mines.

Some mines have a second fuze well to facilitate the installation of a anti-handling fuze. Conventional antihandling devices and target-sensing fuzes have evolved into sophisticated booby traps, which virtually assure grievous injury or death to the deminer. Some landmines may be detonated by metal detectors; others explode when their fuzes detect light when lifted from the ground. One version of the “Bouncing Betty” is activated by an array of seismic detectors.

Other mines, for example the US M18A1, will accommodate a variety of fuzes, including tripwire and command detonation. Other mines, especially antihelicopter mines use a combination of sensors/fuzes to acquire the helicopter and initiate the mine when the helicopter enters the lethal zone.

**a. Pressure.** The pressure fuze is the most common type of fuzes for both AT and AP mines. It may require only a few ounces pressure to active the mine or as much as several hundred pounds.

**b. Trip Wire.** Also called pressure release, these fuzes may be attached to a thin wire stretched across a path or route. When the victim or vehicle passes and breaks the wire, the mine is detonated. Trip wires are used mainly with AP and side-attack mines.

**c. Magnetic.** Most armored vehicles contain a large quantity of steel and therefore create large magnetic disturbances that signal their presence to a magnetic influence fuzed landmine.

**d. Optical.** An optical fuze, using a small infrared or ultra-violet transmitting diode on a surface-placed landmine, sends a detonation signal with it senses light reflecting from the hull of a tank.

**e. Radar.** A small micro-electronic radar can sense the underside of a tank by the magnitude and location of the radar reflection.

**f. Seismic.** Mines can be equipped with sensors that detect the vibrations caused by the weight and track movement of tanks or by the noise they make.

**g. Acoustic.** When a system approaches, antihelicopter or advanced off-route mines use an acoustic sensor to activate or cue an IR, seismic, or MMW sensor.

**h. Infrared.** IR sensors are generally used against vehicles, ground and aerial.



## Mines the US soldier is "most likely to encounter" on the adaptive battlefield

### Anti-Tank Mines

Name	Country of Manufacture	Number of User Countries	Emplacement Method	Armor Penetration (mm)/ Kill Mechanism	Effective Range (meter)	Detectability/ Composition	Anti-Handling	Fuze Type/ Self Neutralize	Explosive Type & Weight/Total Weight (kg)	Comment
<b>Scatterable</b>										
<b>PTM-3</b>	FSU	12+	remote-surface: UMZ, helicopter, PKM portable	70 mm: penetrates tank belly & destroys running gear		visual mine detectors cause detonation plastic	yes	proximity, magnetic self-destruct: yes-16 to 24 hrs	TG-40: 1.8 kg Total: 5 kg	
<b>PTM-1S/ PGMDM</b>	FSU	17+	remote-surface: UMZ, MRL, aircraft, PKM portable	track breaker on contact/ blast	1	visual plastic	no	contact, pressure neutralize: yes-0 to 24 hrs	PVV-12S liquid plastic: 1.4 kg	similar to German AT-1
<b>Manual, Mechanical, and Chute Emplaced</b>										
<b>TM-62M/ P/B/D</b>	FSU Poland Bulgaria	30+	manual mechanical chute	27 RHAE blast	1	varies: M: metal-easy P: plastic B: caseless D: wood	Not built in	pressure (200 kg) magnetic seismic	Trotyl, RDX & aluminum/7 kg Total: 8.5 kg	
<b>TM-57</b>	FSU Bulgaria China Iraq	29+	manual mechanical chute	blast	1	easy sheet metal	yes	pressure (00/2.5/5-6 kg) delay-armed, tilt rod, pull (booby trap) neutralize: no	TNT or TGA 60/24/16: 6.0 kg Total: 8.47 kg	
<b>TM-46/ TMN-46</b>	FSU Germany Bulgaria Egypt (M/71) Israel (No. 6)	28+	manual mechanical	blast	1	easy sheet metal	TMN-46 yes	pressure (180/132 kg), tilt rod neutralize: no	TNT, amatol/5.7 kg Total: 2.9 kg	
<b>PT-Mi-Ba-III</b>	Czech	17 + terrorist groups	manual mechanical chute	blast defeats known belly armor	1	plastic/bakelite (metal in fuze only-2.9 gr)	yes with RO-4 fuze	pressure (200 kg) self-destruct or neutral: no	TNT/7.2 kg Total: 9.9	
<b>Mk 7</b>	United Kingdom	16+	manual	blast	1	easy metal	yes	pressure (150 kg), tilt rod available	TNT/8.9 kg Total: 13.6	
<b>TMD-B</b>	FSU Namibia	16+	manual	blast	1	difficult with hand held detectors - wood	possible	pressure (200-500 kg) self-destruct or neutral: no	TNT/9.0 kg Total: 9.7	
<b>TMA-3</b>	Former Yugoslavia	13	manual mechanical	blast	1	very difficult with hand held detectors plastic coating	yes	pressure (180 kg) self-destruct or neutral: no	cast TNT/6.5 Total: 7.0	

### Anti-Tank Mines (continued)

Name	Country of Manufacture	Number of User Countries	Emplacement Method	Armor Penetration (mm)/ Kill Mechanism	Effective Range (m)	Detectability/ Composition	Anti-Handling	Fuze Type/ Self Neutralize	Explosive Type & Weight/Total Weight (kg)	Comment
<b>M19</b>	US Chile Iran South Korea Turkey	13	manual	blast	1	difficult with hand held detectors plastic	yes	pressure (182 kg)	COMP B/9.53 kg Total: 12.56	
<b>TMK-2</b>	FSU	13+	manual	250 RHAЕ belly attack plate charge	1	easy metal	possible	tilt rod (8-12 kg) self-destruct or neutral: no	TG-50, TNT Total: 12.5	
<b>PRB M3/ A</b>	Belgium	12	manual	blast	1	very difficult with hand held detectors plastic	yes	pressure (250 kg)	RDX/TNT 6.5 Total: 6.8	
<b>Side-Attack (Antitank and Anti-vehicle) Mines</b>										
Name	Country of Manufacture	Number of User Countries	Emplacement Method	Armor Penetration (mm)/ Kill Mechanism	Effective Range (meter)	Detectability/ Composition	Anti-Handling	Fuze Type/ Self Neutralize	Explosive Type & Weight/Total Weight (kg)	Comment
<b>TM-83</b>	FSU	13+	manual	100 RHAЕ EFP	50	visual case metal	possible	IR & seismic, or breakwire	explosive 9.6 Total: 20.4 kg	
<b>LMG</b>	FSU	13+	manual	rocket propelled shaped-charge	27	visual metal	no	Tension (1 kg), trip-wire neutralize: no	TNT: 3.2 kg Total: 10 kg	
<b>Panzer-faust</b>	Germany	1	manual	700 rocket propelled shaped-charge	150	visual metal	no	IR & acoustic, seismic, breakwire		SIRA sensor package
<b>MIACHAF F1</b>	France UK (L14A1) Netherlands (NR 29)	4+	manual	70 RHAЕ @ 40 m shaped-charge	80	visual metal	no	breakwire, command, IR influence neutralize: no	Hexolite: 7 kg Total: 12 kg	
<b>PARM 1 (DM-12)</b>	Austria Germany UK Sweden Finland	5+	manual	600 rocket propelled shaped-charge	40	visual metal	no	neutralize: 20, 40, 60 days	Total: 10 kg	
<b>PK Mi-PK</b>	Czech	1+	manual	50 RHAЕ 5-EFPs	30	visual metal	possible	contact wire	explosive: 5.5 Total: 12	

## Anti-Personnel Mines

Name	Country of Manufacture	Number of User Countries	Emplacement Method	Kill Mechanism	Effective Range (m)	Detectability/Composition	Anti-Handling	Fuze Type/Self Neutralize	Explosive Type & Weight/Total Weight (kg)	Comments
<b>Scatterable</b>										
<b>PFM-1S</b>	FSU	12+	remote-surface (UMZ, MRL, helicopter, PKM portable)	blast	1	visual plastic	no	pressure (5 kg) Self-destruct: 85% over 40 hr	liquid plastic-VS-6D: 40 g Total: 70 g	copy of US BLU-43B
<b>POM-1S</b>	FSU	12+	remote-surface (UMZ, helicopter, PKM portable)	fragmentation	4	visual	yes	tripwires, Self-destruct	100 g Total: 750 g	copy of US BLU-42B
<b>POM-2S</b>	FSU	12+	remote-surface (UMZ, helicopter, PKM portable)	fragmentation	16	visual, readily	no	tripwires (.2 kg) Self-destruct: 4 to 100 hr	TNT: .14 kg Total: 1.6 kg	
<b>Manual, Mechanical, and Chute Emplaced</b>										
<b>PMN</b>	FSU China Iraq	32+	manual chute	blast	1	readily-plastic case metal in fuze & cover	cannot be disarmed/	pressure plate-very sensitive (8-25 kg) self-neutralize: no	TNT: 237 g Total: .55 kg	most common AP mine
<b>MON 100</b>	FSU Bulgaria	27+	manual	directional fragmentation 400 pieces	100=width of kill zone @ 100 m= 6.5-9.5	metal case	possible but not likely	electric command, tension-release self-neutralize: no	TNT: 2 kg Total: 5 kg	also effective against lightly armored vehicles
<b>OZM-4</b>	FSU	26+	manual	bounding fragmentation (.6-.8 m above ground)	15	readily detectable case cast iron	possible	tripwire (2-5 kg), electrical, pressure, tension release self-neutralize: no	Total: 5 kg	
<b>MON 200</b>	FSU Bulgaria	25+	manual	directional fragmentation 900 pieces	200=width of kill zone @ 200 m= 10.5-14.5	visual metal case	possible but not likely	electrical, self-neutralize: no	TNT: 12 kg Total: 25 kg	also effective against lightly armored vehicles
<b>PMD-6</b>	FSU Namibia Serbia	24+	manual	blast	1	detectable wood metal in fuze	possible	pressure, tripwire (1 kg) self-neutralize: no	TNT: 200 g Total: .4 kg	
<b>MON 50</b>	FSU	23+	manual	directional fragmentation 485 pieces	width of kill zone @ 50 m=45	visual plastic case	possible	electric command, tripwire, tension, tension release self-neutralize: no	RDX: 700 g Total: 2 kg	copy of US M18A1 claymore

Antipersonnel Mines (continued)										
Name	Country of Manufacture	Number of User Countries	Emplacement Method	Kill Mechanism	Effective Range (meter)	Detectability/Composition	Anti-Handling	Fuze Type/Self Neutralize	Explosive Type & Weight/Total Weight (kg)	Comments
<b>POMZ-2M</b>	FSU China (Type 59) North Korea Germany	22+	stake mine manual	fragmentation	4	visual, detector cast iron	possible	tripwire (1 kg force)	TNT: 75 g Total: 1.77 kg	
<b>M18A1/ Claymore</b>	US South Korea (K440) Pakistan (P5 Mark I) Iran Chile South Africa (Shrapnel mine No. 2) FSU (MON-50)	22+	manual	directional steel fragments	50	visual plastic case	possible	electric command, tripwire, tension, tension release	C4: 680 g Total: 1.60 kg	
<b>M14</b>	US India (M-14) Vietnam (MN-79 & MD 82B)	20+	manual	blast	1 contact	very difficult with hand-held detector plastic body (only metal is steel striker tip)	possible	pressure (9-16 kg)	TNT: 29 g Total: .099 kg	

### Antihelicopter

Name	Country of Manufacture	Number of User Countries	Emplacement Method	Armor Penetration (mm)/ Kill Mechanism	Effective Range (meter) Maximum /Minimum	Detectability/Composition	Target Velocity (m/s)	Fuze Type/	Warhead Type/Total Weight (kg)	Status
<b>AHM-200</b>	Bulgaria	1	manual	10 @ 100 m	max 200	visual		combined acoustic & Doppler SHF	Total weight: 35 kg	in production
<b>HELKIR</b>	Austria	1	manual	6 @ 50 m 2 @ 150 m		visual		dual acoustic & IR	Total weight: 43 kg	in production
<b>TEMP-20</b>	Russia	0	manual		detection 1,000 max 200	visual	100	dual acoustic & IR	Total weight: 12 kg	development
<b>AHM</b>	UK	0	manual remote		200/50	visual		dual acoustic & IR	multiple EFP	development

## Russian Antitank Mine TM-62M/P/B/D



<p><b>SYSTEM</b></p> <p><b>Alternative Designations:</b> None  <b>Date of Introduction:</b> 1960  <b>Proliferation:</b> Over 30 countries  <b>Description:</b>          Shape: Circular          Color: Olive Green          Case Material: (see VARIANTS)          Length (mm): 110          Height (mm): 101.8          Diameter (mm): 320          Total Weight (kg): 8.5</p> <p><b>DETECTABILITY</b></p> <p><b>Ready:</b> Varies. The TM-62M (metal case) is readily detectable. Other variants are much more difficult. Of the TM-62 series antitank mines and fuzes, the TM-62P (plastic) is the most difficult to detect.</p> <p><b>EXPLOSIVE COMPOSITION</b></p> <p><b>Type:</b> Trotyl, RDX and aluminum power  <b>Weight:</b> 7.5 to 8.3  <b>Booster:</b> Yes          Type: Pentryt          Weight (gr): 0.75</p> <p><b>FUZE</b></p> <p><b>Types:</b> Pressure, seismic, magnetic  <b>Safety Device:</b> Delay arming, transport clip</p> <p><b>Name:</b> MVCh-62 (most common)  <b>Type:</b> Pressure  <b>Actuation Force (kg):</b> 200 /150 to 550  <b>Resistant to Explosive Neutralization:</b> Yes</p> <p><b>Name:</b> VM-62Z  <b>Type:</b> Seismic</p> <p><b>Name:</b> MVZ-62  <b>Type:</b> INA</p>	<p><b>Name:</b> MVN-62  <b>Type:</b> INA</p> <p><b>Name:</b> MVN-80  <b>Type:</b> Proximity</p> <p><b>Name:</b> MVP-62  <b>Type:</b> Proximity</p> <p><b>PERFORMANCE</b></p> <p><b>Armor Penetration (mm):</b> 27  <b>Effect:</b> Blast  <b>Effective Range (m):</b> 1  <b>Emplacement Method:</b> (see NOTES)              Manual              Mechanical              Chute  <b>Burial Depth:</b>              Maximum: 20              Minimum: None  <b>Techniques of Employment:</b> (see NOTES)  <b>Controllable (remotely detonated):</b> Yes, may use the Russian UMP-2 Controlled AT Minefield Set  <b>Antihandling Device:</b> Possible, however, no secondary fuze well or AD features. A special AD (MS-3) is used under AT mines.  <b>Self-Destruct:</b> No  <b>Detonation Height:</b> N/A  <b>Underwater Emplacement:</b> Limited duration capabilities when used underwater.</p> <p><b>DELIVERY PLATFORMS</b> (examples)</p> <p>Tracked minelaying vehicle GMZ/GMZ-2/3          Towed mechanical minelayer PMR-3 and PMZ-4          Helicopter (with VMP-2 minelayer)</p> <p><b>VARIANTS</b></p> <p><b>TM-62M:</b> Metallic case  <b>TM-62P:</b> Plastic case  <b>TM-62B:</b> Caseless  <b>TM-62D:</b> Wooden</p>
---	--

**NOTES**

TM-62 mines can be emplaced in integrated explosive barriers or in homogeneous minefields. They may be employed singly or in groups as part of an explosive antitank barrier. TM-62 mines are placed in accordance with former Soviet doctrine, which dictates a normal density of one mine per meter of front.





## Russian Side-attack Antitank Mine TM-83

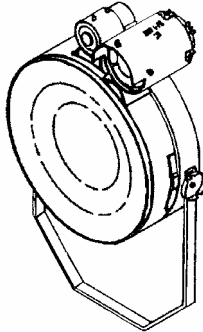

<p><b>SYSTEM</b></p> <p><b>Alternative Designations:</b> None  <b>Date of Introduction:</b> INA  <b>Proliferation:</b> At least 13 countries  <b>Description:</b>          Shape: Cylinder          Color: Olive green          Case Material: Metal          Length (mm): INA          Height (mm): 400          Diameter (mm): 250          Total Weight (kg): 20.4</p> <p><b>DETECTABILITY</b></p> <p><b>Ready:</b> Visual</p> <p><b>EXPLOSIVE COMPOSITION</b></p> <p><b>Type:</b> TG40/60  <b>Weight (kg):</b> 9.6  <b>Booster:</b> INA</p>	<p><b>PERFORMANCE</b></p> <p><b>Armor Penetration (mm):</b> 100  <b>Effect:</b> EFP, side-attack  <b>Effective Range (m):</b> 50  <b>Emplacement Method:</b> Manual  <b>Controllable (remotely detonated):</b> Yes, (100-m cable)  <b>Antihandling Device:</b> Possible  <b>Self Destruct:</b> 30 days</p> <p><b>VARIANTS</b> None</p> <p><b>FUZE</b></p> <p><b>Types:</b> 2-color IR sensor , seismic, or MVZ-7 breakwire  <b>Number of Fuze Wells:</b> 1  <b>Actuation Force (kg):</b> N/A  <b>Resistant to Explosive Neutralization:</b> Yes</p>
---	---

**NOTES**

The TM-83 is a high-explosive antitank mine. It is basically a plate charge mounted on a stand. The mine uses seismic sensors to identify approaching targets and to turn on the dual IR sensor. When a valid target passes into the field of view of the sensor, the warhead is fired. The plate is formed into a slug which is propelled by the explosive, destroying the target. The seismic sensor is stored on the back of the mine and is connected by an electronic cable. It can also be fired electronically. The mine may be mounted on a tripod, the storage box, or tree, etc.

## Austrian Antihelicopter Mine HELKIR

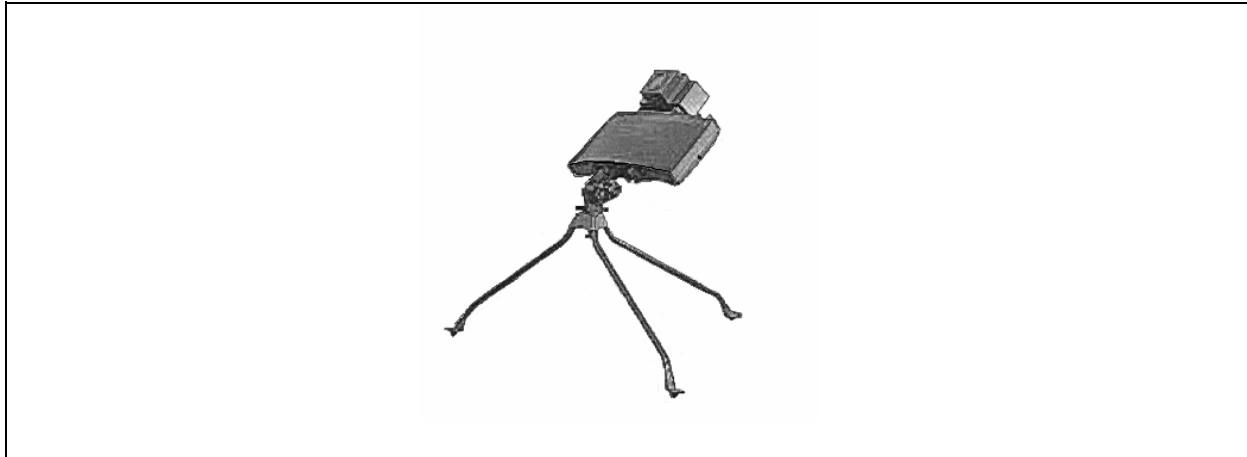

<p><b>SYSTEM</b></p> <p><b>Alternative Designations:</b> None  <b>Date of Introduction:</b> In current production  <b>Proliferation:</b> At least 1  <b>Description:</b>          Shape: Rectangular          Color: Green          Case Material: Metal          Length (mm): INA          Height (mm): INA          Diameter (mm): INA          Total Weight (kg): 43</p> <p><b>DETECTABILITY</b></p> <p><b>Ready:</b> Visual</p> <p><b>EXPLOSIVE COMPOSITION</b></p> <p><b>Type:</b> INA  <b>Weight:</b> 20</p>	<p><b>FUZE/SENSOR</b></p> <p><b>Types:</b> Dual, acoustic, and IR  <b>Number of Fuze Wells:</b> INA  <b>Resistant to Explosive Neutralization:</b> Yes</p> <p><b>PERFORMANCE</b></p> <p><b>Armor Penetration (mm):</b> 6 @ 50 m or 2 @ 150 m  <b>Effect:</b> Directed fragmentation  <b>Effective Range (m):</b> 150  <b>Target Speed (km/h):</b> 250  <b>Emplacement Method:</b> Manual  <b>Controllable (remotely detonated):</b> Yes  <b>Antihandling Device:</b> Yes  <b>Self-Destruct:</b> INA</p> <p><b>VARIANTS</b> None</p>
--	---

### NOTES

The HELKIR antihelicopter mine is designed to engage nap-of-the-earth targets. The sensor is a dual acoustic-IR. The acoustic sensor listens for a valid noise input and turns on the IR sensor. The IR sensor is located coaxially to the warhead. When a hot IR signature is detected, the warhead is functioned.

## Russian Towed Mechanical Minelayer PMR-3

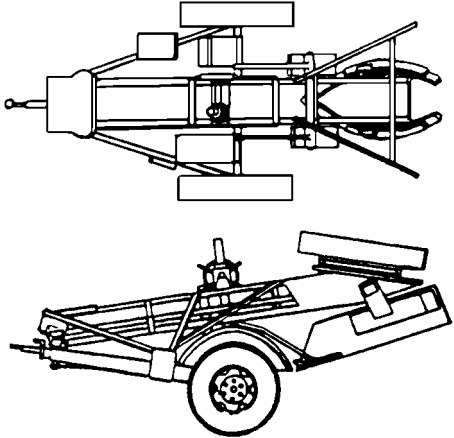
	<p><b>Mine Types</b></p> <p><b>Mines</b>          TM-44          TM-46          TM-57          TM-62 Series          TM-72          TMD-B</p>	<p><b>Typical Combat Load</b></p> <p>(varies, see <b>Prime Mover</b>)</p>
<p><b>SYSTEM</b></p> <p><b>Alternative Designations:</b> INA  <b>Date Of Introduction:</b> INA  <b>Proliferation:</b> At least 17 countries</p> <p><b>Description:</b>          Crew: 6 (commander, driver, four operators)          Weight (mt): 1.3          Length (m): 5.6          Height (m): 2.7          Width (m): 2</p> <p><b>Prime Mover:</b>          6x6 ZIL-131 truck (200 mines) or          4x4 URAL-375D (350 mines) or          BTR-152 (120 mines)</p>	<p><b>MINELAYING EQUIPMENT</b></p> <p><b>Operating Speed (km/h):</b>          Burying: 2 to 3          Surface Laying: 4 to 10          In Snow: INA</p> <p><b>Minelaying Rate (min):</b> 10 to 12  <b>Minelaying Pattern:</b> Straight line  <b>Mine Spacing (m):</b> 3 to 4  <b>Mine Capacity:</b> Prime-mover dependent  <b>Max Burial Depth (cm):</b> 20</p> <p><b>VARIANTS</b></p> <p><b>PMZ-4:</b> Lays controlled minefields; uses the same mines as the PMR-3 with the exception of the controllable minefield and cable-laying options; uses the UMP-2 Controlled AT Minefield Set</p>	

### NOTES

The PMR-3, shown above, (and the similar PMZ-4) consists of a single chute and a plow attachment. Although both systems look similar at first glance, there are significant differences. Most notably, is the addition of a cable layer on the PMZ-4, used for the laying controlled minefields and the absence of the conveyer-belt chain drive on the wheels. Additionally, the PMZ-4 is more automated and must be hand loaded only. The towed-minelayers are used in sections of three or four and operate 20 to 40 meters apart with each minelayer laying a straight-line row. The mines in different rows are staggered with the distance between mines depending on whether the mines are pressure-initiated or full-width attack (influenced or tiltrod fuzed).

## Russian Tracked Minelaying Vehicle GMZ-3

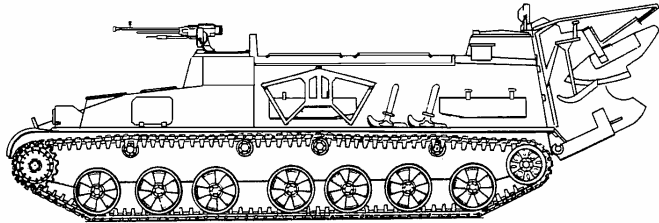
	<p><b>Mine Types</b></p> <p><b>Mines</b>            TM-57 w/fuze MVZ-57            TM-62 series w/fuzes            TM-46            TMD-B            MV4-62            MVP-62 &amp; w/prox fuze            MVN-80</p>	<p><b>Typical Combat Load</b></p> <p>208</p>
	<p><b>7.62-mm PKT MG</b></p>	<p>3,000</p>

<p><b>SYSTEM</b></p> <p><b>Alternative Designations:</b> INA  <b>Date of Introduction:</b> GMZ series-1963  <b>Proliferation:</b> Former Soviet Union</p> <p><b>Description:</b>            Crew: 3 (see NOTES)            Chassis: Based on the SA-4 (GANEF) SAM            Weight (mt): 28.5            Length (m): 8.62            Height (m): 2.7            Width (m): 3.25            Ground Clearance (mm): 470            Gradient (°): 30            Fording Depth (m): 1            Vertical Step (m): .7</p> <p><b>AUTOMOTIVE</b></p> <p><b>Engine:</b> 4 cyl, 513 hp, multi-fuel diesel  <b>Cruising Range (km):</b> 500  <b>Speed (km/h):</b>            On Road: 60            Off Road: 30  <b>Fuel Capacity (liters):</b> INA  <b>Night Driving Equipment:</b> Yes, TVNE-4B for the driver and K-3A for the vehicle commander (and PKT)  <b>Navigation Equipment:</b> (see NOTES)  <b>Radio:</b> R-123  <b>NBC Protection System:</b> Yes  <b>Smoke Screening System:</b> VEES, plus 6 81-mm launchers, 3 on each side.</p>	<p><b>MINELAYING EQUIPMENT</b></p> <p><b>Operating Speed (km/h):</b>            Burying: 6            Surface Laying: 16            In Snow: 10  <b>Minelaying Pattern:</b> Straight line or staggered  <b>Mine Spacing (m):</b> 5 and 10  <b>Burial Depth (mm):</b>            Ground: 120            Snow: 500</p> <p><b>Length of Single-row Minefield (m):</b>            Percussion Fuzes: 1,000            Proximity Fuzes: 2,000</p> <p><b>Mine Capacity:</b> 208  <b>Mine Weight (kg):</b> up to 12  <b>Time Required to Load Minelayer with One Basic Mine Load (min) (7 men):</b> 15 to 20  <b>Men required to Load Minelayer with Mines:</b> 7 (squad)  <b>Time Required to Load Minelayer with Crew Only (m):</b> 60  <b>Time from Travel to Operating Position (min):</b>            Automatic: Up to 2            Manual: Up to 8</p> <p><b>ARMAMENT</b>            Some GMZ may be armed with either the 12.7 or the 14.5 machineguns.</p> <p><b>Main Armament:</b>            Caliber, Type, Name: 7.62-mm PKT MG            Mount Type: Cupola (GMZ-3)            Max Effective Range (m):            Day: 2,000            Night: INA            Fire on Move: Yes            Rate of Fire (rd/min):            Practical: 250            Cyclic: 650</p> <p><b>VARIANTS</b></p> <p><b>GMZ:</b> (shown above)  <b>GMZ-2:</b> (see NOTES)</p>
---	--

### NOTES

The crew of the GMZ-3 consists of three people—the vehicle commander, driver-mechanic, and the minelayer operator. The commander and driver are located in the forward section while the operator compartment is located in the rear portion of the vehicle. The vehicle commander operates the 7.62-mm PKT machinegun. The GMZ-3 has a digital navigation system allowing precise topographic tie-in of the minefield being laid. The previous model minelayer (GMZ-2) was not designed for the employment of mines with proximity fuzes.

## Russian Scatterable Minelaying System UMZ

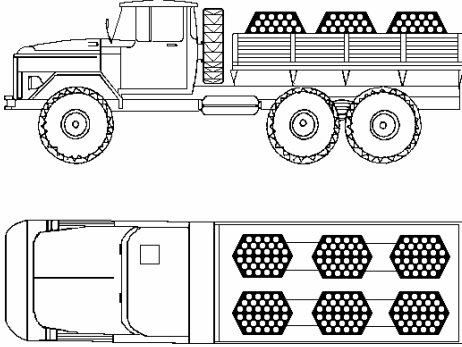
	<p><b>Mine Types</b></p> <p><b>Mines</b> PFM-1 PFM-1/S POM-1 (S) POM-2S PTM-1S (PGMDM) PTM-3</p>	<p><b>Typical Combat Load</b></p> <p>(varies with type of mine—see below)</p>
---	--	---

<p><b>SYSTEM</b></p> <p><b>Alternative Designations:</b> Multipurpose Minelayer <b>Date of Introduction:</b> INA <b>Proliferation:</b> Former Soviet Union</p> <p><b>Description:</b> Crew: 2 (driver and operator ) Chassis: ZIL-131 Truck (see VARIANTS) Weight (mt):     Without Mine Load: 8.3     With Mine Load: 10 Length (m): 7.1 Height (m): 2.5 Width (m): 3 Ground Clearance (mm): 330</p> <p><b>AUTOMOTIVE</b></p> <p><b>Engine:</b> V8, 150 hp, gas <b>Cooling:</b> Water <b>Cruising Range (km):</b> 525 <b>Speed (km/h):</b> 80 <b>Gradient (°):</b> 30 <b>Fording Depth (m):</b> 1.4 <b>Vertical Step (m):</b> .53 <b>Night Vision Equipment:</b> Yes, PNV-57E <b>Navigation Equipment:</b> INA <b>Radio:</b> R-159</p>	<p><b>MINELAYING EQUIPMENT</b></p> <p><b>Operating Speed (km/h):</b> 10 to 40 <b>Distance Mines Launched from Vehicle (m):</b> 30-60 <b>Minefield (m):</b> Length: 1,000 to 1,200 Depth: 30 to 120 <b>Max Length of Minefield with One Basic Load (m):</b>     AP, PFM-1S: 3,200     AP, POM-2: 5,000     AT, PTM-3: 600 <b>Length of Triple-Row Minefield (m):</b> 150 to 1,500 depending on mine type <b>Mine Capacity:</b> From 180 to 11,520 depending on the type of mine <b>Number of Mines in One Basic Load:</b>     AP, PFM-1S: 11,520     AP, POM-2: 720     AT, PTM-3: 180 <b>Time Required to Load Minelayer (hr) (2 men):</b> 1.5 to 2 <b>Time from Travel to Operating Position (min):</b> 5</p> <p><b>VARIANTS</b> Although primarily mounted on the ZIL-131, the UMZ minelaying system has been observed mounted on several different carriers such as a modified MTLB-U chassis or on a PT-S tracked amphibious personnel carrier.</p>
---	---

### NOTES

While the UMZ, scatterable, mine system has been disclosed as the likely replacement for the GMZ-series, mechanical mineplanters, it probably will supplement the role formerly held by the GMZ. The UMZ consists of three launchers mounted on each side of the vehicle for a total of six mine launchers per vehicle. Each full turn launcher is hexagonally shaped and contains 30 launch tubes totaling 180. It can fire the mines to one or both sides, or to the rear. Both AP and AT mines are launched from the 140-mm launch tubes. The UMZ uses the same mine canisters as the PKM system. Depending on the position of the launch tubes, one-, two-, or three-lane mine fields can be laid.

## Russian Tank-Mounted Mineclearing Roller-Plow KMT-5

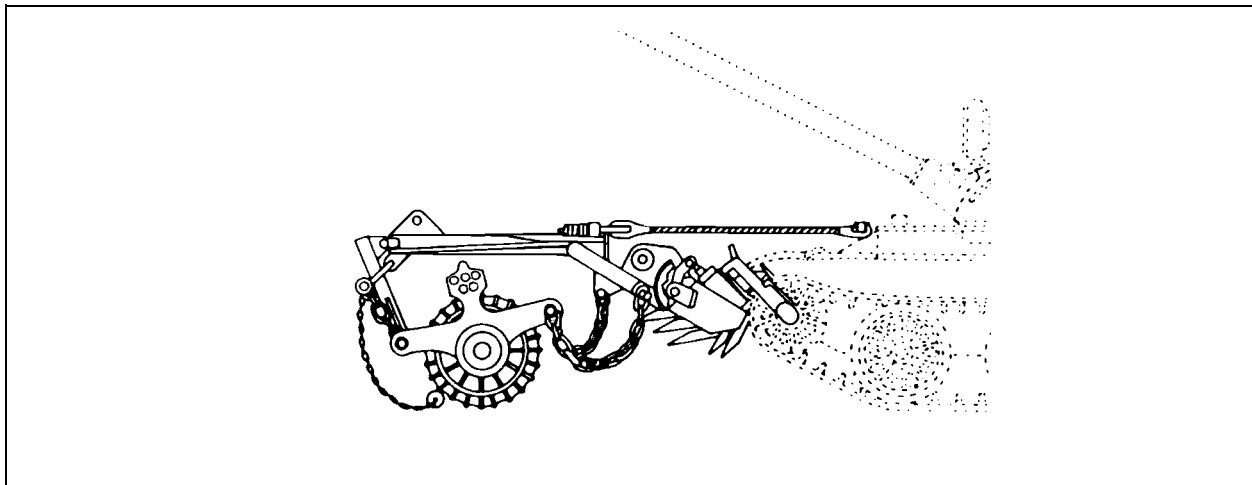

SYSTEM	MINECLEARING EQUIPMENT
<p><b>Alternative Designations:</b> INA  <b>Date of Introduction:</b> 1960s  <b>Proliferation:</b> At least 20 countries</p>	<p><b>Type:</b> Roller and plow  <b>Platform:</b> Mounted on T-54, T-55, T-62, other medium tanks  <b>Form:</b> 3 rollers x 2  <b>Number of Rollers Per Set:</b> 2  <b>Total Number of Rollers:</b> 6  <b>Mine Removal Speed (km/h):</b> 8-12  <b>Cleared Lane Width, each (mm):</b> 810 x 2  <b>Mineclearing Track Width (mm):</b> 810  <b>Installation Time (min):</b> 30 to 45</p>
<p><b>Description:</b>            Weight Total (kg): 7,500            Roller Section: 2,265            Plough: 420            Length (m): 3.2            Width (m): 4            Ditch Crossing (m): 2.5  <b>System Components:</b> Two plows (KMT-4) and two sets of three rollers</p>	

### NOTES

The KMT-5M mine roller-plow is very flexible, since it allows for either the plows or the rollers to be used. The rollers function satisfactorily against mines equipped with simple pressure fuzes, but other mines will defeat this equipment. However, the roller-plow combination also allows the tank to counter more sophisticated fuzes with plows designed to uncover or push mines aside. The plows and rollers cannot work simultaneously.

The KMT-5M also includes a luminous lane-marking device for night operations. Because plows and rollers do not clear the area between them a "dogbone" or light chain with rollers is stretched between the roller sections to defeat tilt-rod mines. Quick disconnects allow the operator to drop either plows or rollers or both; otherwise, the crew can remove the system in 8 to 13 minutes. All current medium tanks have fittings for attaching mineclearing equipment.

There is one plow per tank platoon and one roller per company. For tanks newer than the T-55/62 the plows are no longer carried in the engineer company, but are permanently mounted on the tank. Therefore the engineers need only to transport the rollers. One KrAZ-255B truck (with KM-61 crane) or two ZIL-131 trucks can carry one KMT-5M.

## Russian Vehicle-Mounted Mine Detector DIM

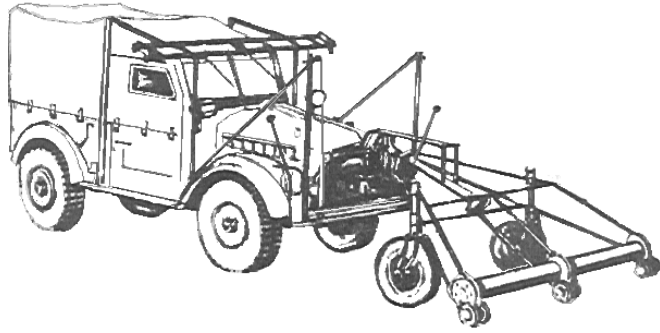
	
<p><b>SYSTEM</b></p> <p><b>Alternative Designations:</b> None  <b>Date Of Introduction:</b> Pre-1975  <b>Proliferation:</b> Widespread</p> <p><b>Description:</b>  Crew: 2  Prime Mover: UAZ-469/69 or other light 4x4 vehicles  Components:      Detection system      Pneumatic system      Electronic system</p>	<p><b>CAPABILITIES</b></p> <p><b>Operating (scan) Speed (km/h):</b> 10  <b>Mounting/dismounting Time (min):</b> Up to 7  <b>Detection Ability:</b> Can detect metallic mines in roadways, airfields, and other flat terrain.  <b>Max Detection Depth (cm):</b> 25  <b>Max Detection Depth While Forging (cm):</b> 70</p> <p><b>VARIANTS</b>  None</p>

### NOTES

The DIM is a large pulse-induction mine-detection device mounted to a light 4x4 truck. The detection element fastens to a frame on the front of the vehicle. When a mine is detected, the vehicle breaking system is engaged and the clutch is disengaged. The full-width detection head, located 2.6 meters from the vehicle's front wheels to provide stopping distance, is divided into six components to pinpoint mine location. The electronic system also displays which component of the mine-detector head the mine is under. It also has attached rollers so that the head does not come in contact with ground objects. Cross-country capability is very limited, therefore the DIM is generally used for clearing prepared surfaces. The detection equipment swings upward to ride on the top of the vehicle cab for traveling. When needed it is swung forward to rest on two wheels.





### Explosive Charge Minefield Breaching Systems

Minefield breaching explosive line charge systems are in use throughout the world. They provide the maneuver commander a method to expeditiously breach antitank or antipersonnel minefields. Once identified on the battlefield however, these systems generally become the priority target. Some systems, single or double line, are mounted on tanks while others are mounted on trailers, armored vehicles, and trucks. Some other systems are man-portable. The larger vehicle-, and trailer- mounted systems are designed to clear lanes through minefields/obstacles, large enough for the passage of ground combat vehicles. Man-portable (infantry) systems clear passage for at least one person to transit. The explosive filled lines are usually connected to a launcher by a cable, fired over a minefield (within which it lands) and then detonated to create a breach through the minefield. Standoff between the explosive charge and launcher varies. For instance, the Japanese CX has a standoff of 800 meters from the launcher.

#### Truck or Trailer Mounted Minebreaching Systems

Motorized and infantry units may have either wheeled or towed antitank minebreaching systems. While some of these systems can be dismantled, most are fired from the back of cargo trucks or from trailers. Minefield beaching systems are organic to the Combat Engineer Company of the Engineer Battalion. See FM 100-63, for additional information. A typical "truck-mounted explosive minefield breaching system" is the FSU UR-83P (below).

Name	Country of Origin	Chassis	System (or Shell) Weight (kg) Overall: Rocket: Explosive Explosive/m	Range (m)	Length (m)	Standoff (m)	Effectiveness Lane Width (m): Lane Length (m) Lane clearing time (min)	Type Launcher / Nr Line Charges	Rocket Diameter (mm)	Operators	Explosive-Type/nr/ Notes
UR-83P	FSU	Truck (ZIL-131) or trailer	<b>Dimensions (m)</b> (ready for launch) Length: 1.5 Width: 1.5 Height: 2.6 <b>Launcher Wt (kg):</b> Total: 230 Packaged: 360 Charge: 1,380	440	114		LL: 115 LW: 6 Assembly time by engr sqd (min): 90	Line UZP-83 charge		2	portable dismountable
Type 81	CH	EQ-240 Truck chassis	Loaded: 5,112 Unloaded: 4,082 Exp: unk Exp/m: unk	3,000	na	2,900 +	LL: 60+ LW: 10+	10 tube	2,530	3	HE, FAE ea round clears 18 m radius in AP.

The Type 81 mineclearing rocket system consists of a 10-tube launcher mounted on the rear of a modified EQ-240 chassis. Rockets are loaded manually by three persons. Although it is uncertain, warheads for this system are filled with conventional HE, FAE or a combination of both. The Chinese have stated that this system is effective against AP mines, but its effectiveness against AT mines is unknown. The range of this system is 3,000 meters, which provides the system with a maximum standoff of approximately 2,900 meters. Each round clears an 18-meter radius within an AP minefield. It is not known whether this is for the FAE or high-explosive warhead. The Type 1987 has 24 launch tubes and is mounted on a Type 59/69 tank chassis.

### Tracked-Vehicle-Mounted Systems

Systems mounted on the rear of tanks increase the survivability of the platform and therefore increase the likelihood that it may be successfully employed prior to its destruction. The use of a tracked chassis as the launch carrier gives the system the same mobility and maneuverability on the battlefield as mechanized units; however, use of these systems does not allow tanks or mechanized vehicles to conduct a "Blitzkrieg" type rush across the minefield. Systems found in armor and mechanized divisions will generally be mounted on tracked vehicles due to mobility requirements. Although these minefield breaching systems may (or may not) be mounted on tanks they do not belong to the maneuver commander. They are engineer assets and are found in rather limited numbers. Two of these systems are in the Mineclearing Platoon, Mine Warfare Company, Division Engineer Company, Engineer Battalion, of a mechanized/armored division, engineer brigade, or Corps. Further information on these elements can be found in FM 100-60.

Tracked-Vehicle-Mounted Systems											
Name	Country of Origin	Chassis	System (or Shell) Weight (kg) Overall: Rocket: Explosive Explosive/m	Range (m)	Length (m)	Standoff (m)	Effectiveness Lane Width (m): Lane Length (m) Lane clearing time (min)	Type Launcher /Nr Line Charges	Rocket Diameter (mm)	Crew	Explosive Type/nr/ Notes
<b>Type 84</b>	CH	Tank or other armored vehicle	OA: 800 Rocket: unk Exp: 400 Exp/m: 5	300	80	200	LL: 60 LW: 5	1	unk	unk	Line charge
The Type 84 mounts in a box on the rear of a tank or other vehicle. Inside the box is a rocket in a launch rail attached to the box lid, an 80-meter-long explosive hose, and a drag chute. The rocket pulls the explosive hose over the minefield or other obstacle, arming the fuze in flight. After a short delay, the hose explodes leaving a cleared path. The box is automatically discarded after firing. With a published range of 300 meters and a length of 80 meters, the standoff of the system is estimated to be approximately 200 meters.											
<b>Type 762</b>	CH	Type 83, 152-mm tracked howitzer	OA: unk Rocket: 760 Exp: 400 Exp/m: 3	1,000	130	800-900	LL: 130 LW: 12-22	2	425	unk	line charge. 32 charges 12 kg ea
The Type 762 is a twin-rail rocket launcher mounted on a Type 83, 152-mm tracked howitzer chassis. It carries two 425-mm GSL 211 mineclearing rockets. The warhead on GSL 211 rockets contain an explosive line charge that is extracted during flight. The line charge is composed of 32 fixed-interval explosive charges, each weighing 12 kg. When the explosive charge is at a specific height above the minefield, specially designed detonation fuzes at the head and tail of the line charge activate and simultaneously detonate the charges. The system is equipped with an ordinary rangefinder with questionable accuracy; it is uncertain how the system will perform when deployed over a minefield.											
<b>SVO</b>	CZ	BMP-1	Shell size: Length (mm): 1,457 Dia (mm): 246 Weight (kg): 42				LL: 100-120 LW: 5 Time btwn rounds (sec): 2.5	24 explosive rockets			fuze initiation rod length (m): .3

The Czech Republics SVO is an armored, tracked, mineclearing vehicle used for combat breaches of AT and mixed minefields. The breach is conducted by the launching of mineclearing shells in a specific pattern in order to detonate all the mines along a pathway through the minefield. The entire system is contained in a modified BMP-1 chassis. The turret on the chassis has been removed and exchanged for a rocket firing platform. The firing platform contains 24 launch rods angled at different elevations and deflections in order to provide full warhead coverage for a path through the minefield. The front half of the compartment is for storing and launching the warheads, the other is the operator's position. The shells fit over the 24 launch rods and are projected into the air by the initiation of explosive cartridges. Piezoelectric fuzes located at the base of the fuze extension rods detonate the shells .3 meters above the ground. The SVO reportedly has a 95% probability of initiating single impulse, nonblast resistant, pressure-fuzed mines.											
<b>UZ-67</b>	FSU	2S1 mod	weight (kg): 2,400		93	200 and 350	LL: 75-80 LW: 6 Time: 3-5	2	unk	2	basic load of 2 line charges
<b>UZ-77</b>	FSU	2S1 mod	unk		93	200 & 500 water: 200	LL: 80-90 LW: 6 Time: 3-5	2	unk	2	basic load of 2 line charges

### Man-Portable Rocket Propelled Line Charges

Many countries and some insurgent groups produce small (1 or 2 man-portable) explosive line charges with a wide variety of capabilities and performance. Mechanized infantry units normally do not have these since the tracked vehicles clear a way for the dismounted infantry. The basis of issue of these systems for use by dismounted (or regular) infantry units is generally three per infantry battalion; nine per brigade/regiment; 27 per division. They are used only in the primary avenue of attack (or as a deception). Battlefield employment dictates that the line is fired and detonated. The infantry then moves as quickly as possible (probably under fire) along the cleared path ensuring they do not step on any uncovered/ unexploded mines. The line charges are usually carried by one or more soldiers therefore the overall weight of the charges is important. The bullet trap line charge delivery methods realizes a significant weight savings by eliminating the additional weight of a rocket. The soldier simply uses his standard issue weapon to deliver the detonating cord/hose across the minefield. This places limitations on the length and weight of the delivered charge. A typical "infantry explosive minefield breaching system" is the FSU ZRP-2. It is a mine demolition charge designed to blast lanes through AP minefields. The ZRP-2 consists of a detonating cable, powder rocket engine, connecting cable, fuze, braking cord, launching table, launching device, anchor and carrying pack. The charge is launched into an AP minefield with the aid of launching device UP-60 from a position prepared on the ground surface. The charge is detonated remotely by a mechanical fuze. The charge is straightened in the minefield manually with the braking cord while the fuze retarder is burning.

<b>ZRP-2 (FSU) Mine demolition charge</b>	
Type	extended, single-line, made of detonating cable DKR-150A
Weight of set (kg)	50 packaged, 34 in pack
Crew, men	1 or 2
Length of charge (m)	60
Charge launching range (m)	140-160
Size of passage through AP minefield (m)	55 length x 0.4 width
Launch preparation time (min)	5

Infantry Line Charges				
Name	Country	Delivery Method	Explosive Weight (kg/m)	Length (m)
Type 73	China	Rocket	2.40	106
Type 74	China	Rocket	2.40	100
Type 81	China	Rocket	0.10	100
Type 84	China	Rocket	0.40	28
ODMIRA-60	Czech Rep	Rocket	NA	60
FATEH-1	Egypt	Rocket	0.42	120
Comet No 3001	Germany	Rocket	0.10	72
Comet No 3010	Germany	Rocket	0.57	53
Ladder 80	Germany	Rocket	NA	70
Unknown	Iraq	Bullet trap	NA	40
POMINS I	Israel	Bullet trap	0.27	50
POMINS II	Israel	Rocket	NA	50
Type 70	Japan	Rocket	1.41	136
Unknown	North Korea	Rocket	NA	180
Clap/M	Pakistan	Rocket	0.05	300
M/60	Sweden	Rocket	NA	150
Unknown	South Africa	Rocket	NA	35
Unknown	South Africa	Rocket	NA	120
RAMBS	UK	Bullet Trap	0.02	40
RAMBS 2	UK	Bullet Trap	unknown	60
ROMANS	UK	Rocket	unknown	50

8-6.6

## Russian Tracked Mineclearing Vehicle MTK-2

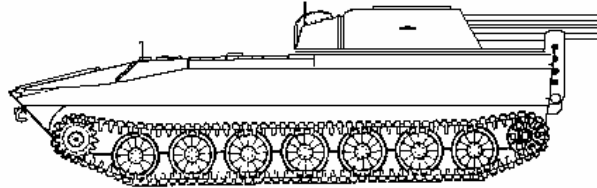

### SYSTEM

**Alternative Designations:** UR-77 mineclearing vehicle, M1979

**Date of Introduction:** 1981

**Proliferation:** FSU and former Warsaw Pact armies

#### Description:

Crew: 2 (commander-operator, driver-mechanic)

Chassis: Based on the 2S1

Weight (mt): 15.5

Length (m): 8.4

Height (m): 3.1

Width (m): 2.8

**System Components:** Vehicle and two mineclearing charges

### AUTOMOTIVE

**Cruising Range (km):** 500

**Speed (km/h):**

On Road: 60

Off Road: 30

Water: 5

**NBC Protection System:** Yes

**Smoke Screening System:** No

### MINECLEARING EQUIPMENT

**Type:** Explosive line

**Charges Used:** UZP-77, UZ-67

**Length of Charge (m):** 93

**Length of Charge Feed (m):**

UZP-77: 200 and 500

UZ-67: 200 and 350

**Size of Lane in AT Minefield (m):**

Width: Up to 6

Length (UZP-77): 80-90

Length (UZ-67): 75-80

**Breaching Time (min):** 3 to 5

### VARIANTS (INA)

### NOTES

The MTK-2 clears lanes in minefields by using rocket propelled charges. The charges are launched onto the minefield and then detonated by the vehicle commander-operator from within the vehicle. The charge can be fired on land or in the water.

## Russian Tracked Route-Clearing Vehicle BAT-M

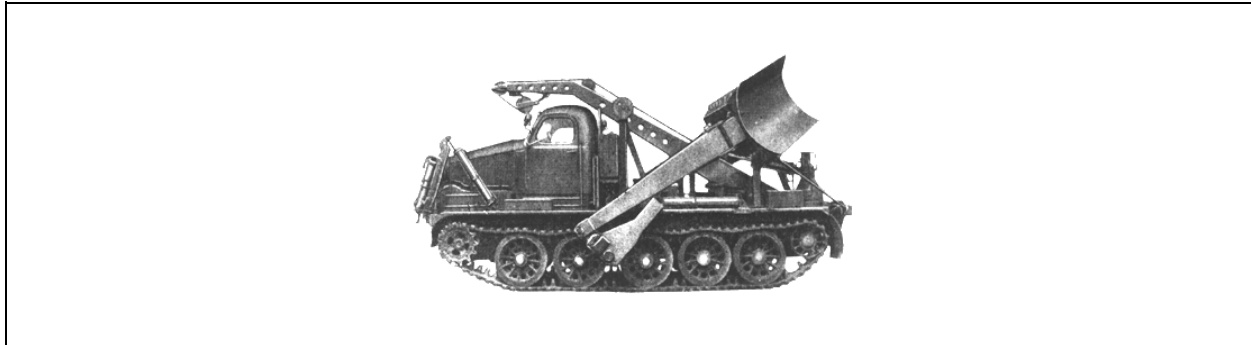

<p><b>SYSTEM</b></p> <p><b>Alternative Designations:</b> Dozer  <b>Date of Introduction:</b> 1967  <b>Proliferation:</b> Widespread</p> <p><b>Description:</b>  Crew: 2  Chassis: AT-T heavy tracked artillery tractor  Weight (mt): 26  Length Overall (m): 10  Height Travel (m): 3.5  Width Overall (m): 4.7  Clearance (mm): 425  Gradient (°): 30  Trench Crossing (m): 1.57  Fording Depth (m): .7  Vertical Step (m): 1  Time from Travel to Operating Position (min): 5 to 7</p>	<p><b>AUTOMOTIVE</b></p> <p><b>Engine:</b> V12, 415 hp, diesel  <b>Cruising Range (km):</b> 500  <b>Speed (km/h):</b> 35  <b>Navigation Equipment:</b> No  <b>NBC Protection:</b> Yes  <b>Radio:</b> INA</p> <p><b>BLADE</b></p> <p><b>Width (m):</b> 4.8  <b>Blade Rate (m<sup>3</sup>/hr):</b> 250  <b>Operating Speed (km/h):</b> 10</p> <p><b>ROTARY CRANE</b></p> <p><b>Capacity (mt):</b> 2</p> <p><b>VARIANTS</b></p> <p><b>BAT</b>  <b>BAT-2:</b> Based on MT-T artillery tractor</p>
--	---

### NOTES

The BAT tractor dozer is a AT-T heavy tractor with a large dozer blade mounted at the front of the hull. It is designed for general engineer use, road and trail clearing and construction. The BAT-M is an improved model (over the BAT) and is electrohydraulic, whereas the BAT is electropneumatic. The BAT-M also has a hydraulic crane, and the dozer blade can be swung to the rear improving the vehicle's load distribution when in travelling mode.

## Russian Armored Route-Clearing Vehicle BAT-2

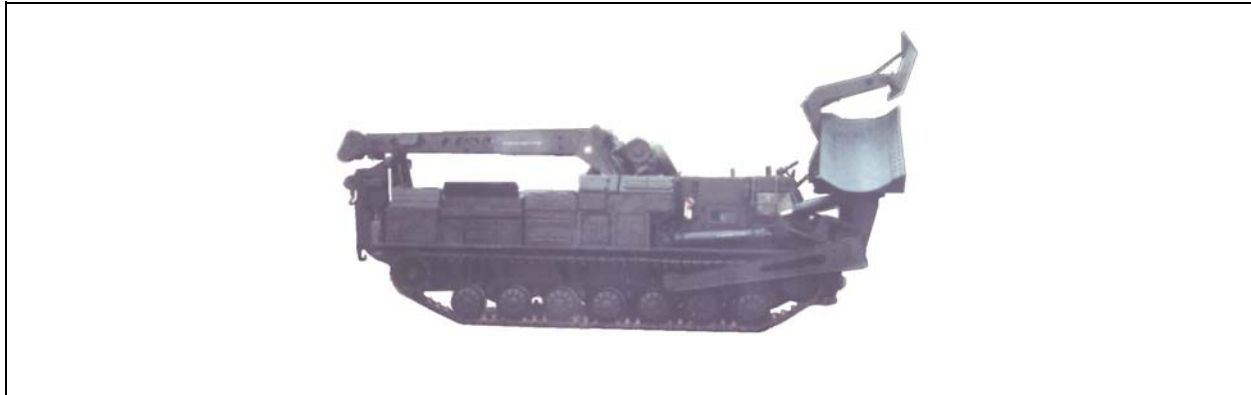

<p><b>SYSTEM</b></p> <p><b>Alternative Designations:</b> None  <b>Date of Introduction:</b> 1981  <b>Proliferation:</b> At least 2 countries.  <b>Description:</b>  Crew: 2+8  Engineer Capacity: 8  Chassis: MT-T  Weight (mt): 39.7  Length Overall (m): 9.64  Height Travel (m): 3.69  Width Overall (m): 4.2  Clearance (mm): 430  Gradient (°): INA  Trench Crossing (m): 2.7  Fording Depth (m): 1.3  Vertical Step (m): .8</p> <p><b>AUTOMOTIVE</b></p> <p><b>Engine:</b> V-64-4 multi-fuel diesel, 700 hp  <b>Cruising Range (km):</b> 500  <b>Speed (km/h):</b> 60  <b>Navigation Equipment:</b> INA  <b>NBC Protection:</b> Yes  <b>Radio:</b> INA</p>	<p><b>BLADE</b></p> <p><b>Width (m):</b> Variable. Mounted vertically in front and over the crew cab when not in use.  Bulldozer Position: 4.5  Road Clearing/building: 4.2  Grading: 4.1-4.35</p> <p><b>Operating Depth</b> (solid and frozen soil) (m): .5</p> <p><b>Operating Speed (km/h):</b>  Road Building:  Ground Unobstructed: 6-8  Ground with Trees ≤ 30 cm: 2-3  Snow: 8-15  Hourly Capacity (m<sup>3</sup>/hr):  Ditch Digging: 200-250  Filling in Ditches, Craters, etc: 350-450</p> <p><b>CRANE</b></p> <p><b>Capacity (mt):</b> 2  <b>Boom Length (m):</b> 7.3</p> <p><b>WINCH</b></p> <p>Capacity (mt): 25  Cable Length (m): 100</p> <p><b>VARIANTS</b>  None</p>
--	---

### NOTES

The BAT-2 is a follow-on to the BAT and BAT-M dozers, but better fits the classification of armored route-clearing vehicle rather than that of a high-speed armored dozer. Its cab is fully armored and it is designed to operate in the forward areas of the battlefield. The windows in the front, sides, and rear are bullet-proof further enhancing battlefield survivability.

The ability to carry an eight-man engineer squad facilitates its role in the movement support detachment. Other BAT-2 missions include road building, obstacle, (stone and wood) removal, and snow removal operations. The vehicle is also designed to operate in urban terrain and as an NBC vehicle. Storage areas for engineer supplies have been designed into the vehicle. The BAT-2 has a crane, a ripper, and a winch.



## Russian Obstacle Clearing Vehicle IMR-2M

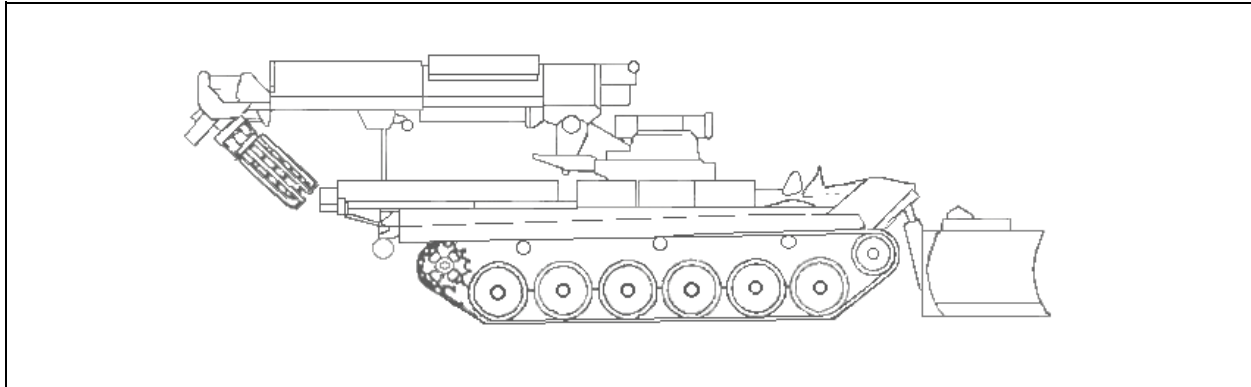

<p><b>SYSTEM</b></p> <p><b>Alternative Designations:</b> N/A  <b>Date of Introduction:</b> 1982  <b>Proliferation:</b> FSU and former Warsaw Pact armies</p> <p><b>Description:</b>  Crew: 2  Chassis: T-72A  Weight (mt): 44.3  Length (traveling) (m): 9.55  Height (traveling) (m): 3.68  Width (traveling) (m): 3.73  Gradient (°): 25  Fording Depth (m): 1.2  <b>System Components:</b> Multipurpose dozer equipment, boom, treadway mine exploder</p> <p><b>AUTOMOTIVE</b></p> <p><b>Engine:</b> 12 cyl, 840 hp, diesel  <b>Cruising Range (km):</b> 500  <b>Speed (km/h):</b> 60  <b>Night Driving Equipment:</b> Yes  Radio: R-173 radio, R-174 intercom  NBC Protection System: Yes  <b>Smoke Screening System:</b> INA</p>	<p><b>BLADE</b></p> <p>Can be used as a dozer, grader and V-blade, vertical plane skew ability.  Operating Speed (bulldozer) (km/h): 8-12  Earth Displacement (m<sup>3</sup>/hr): 300  Lane Clearing Rate (km): .35</p> <p><b>ALL-PURPOSE TOOL</b></p> <p><b>Trench Digging</b> (1.1 to 1.3m deep)(m<sup>3</sup>/hr): 8-10  <b>Pit Digging</b> (up to 2.5m deep) (m<sup>3</sup>/hr): 12-16</p> <p><b>BOOM</b></p> <p><b>Capacity (mt):</b> 2  <b>Reach (m):</b> 8.4</p> <p><b>MINE SWEEPING SPEED (km):</b></p> <p><b>AT pressure mines:</b> 6-15  <b>Tilt Rod mines:</b> 7</p> <p><b>VARIANTS</b></p> <p><b>IMR:</b> The IMR is a NBC-protected, combat engineer vehicle based on the T-54/55 tank chassis. It is fitted with an articulating dozer blade and a telescoping crane that fits a number of attachments.  <b>IMR-2:</b> Equipped with mine sweepers and mine-clearing extended charges. Line drawing is of IMR-2.</p>
---	--

### NOTES

The IMR-2M differs from the IMR-2 in that the IMR-2M has no line-launched mineclearing charge. The IMR-2M has more armor, hydraulic equipment and a scraper-ripper.

## Czechoslovak Armored Vehicle-Launched Bridge MT-55A

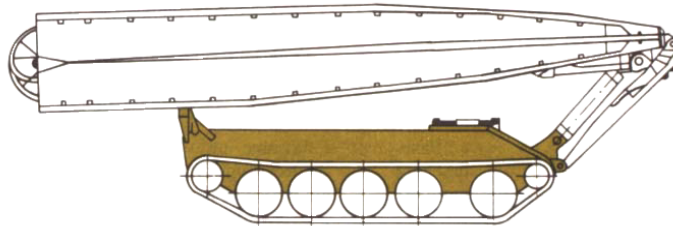

### SYSTEM

**Alternative Designations:** None  
**Date of Introduction:** 1970  
**Proliferation:** At least 20 countries.  
**Description:**  
Crew: 2  
Chassis: T-55A Tank (modified)  
Weight (mt): 36  
Length with Bridge (m): 9.90  
Height with Bridge (m): 3.35  
Width with Bridge (m): 3.30  
Ground Clearance (mm): 425  
Gradient (°): 30  
Fording Depth (m): 1.4  
Vertical Step (m): .7  
Trench (m): 2.7

### VARIANTS

None

### AUTOMOTIVE

**Engine:** V-12 Diesel, 580 hp  
**Cruising Range (km):** 690  
**Speed (km/h):**  
Max Road: 32-35  
Average Cross-Country: 16-20  
**Radio:** R-123  
**Self-Entrenching Blade:** No  
**NBC Protection System:** Yes  
**Smoke Equipment:** Vehicle engine exhaust smoke system.

### BRIDGE

**Type:** Scissors  
**Capacity (mt):** 50  
**Width of Obstacle (m):** 17  
**Width (m):** 3.3  
**Length Opened (m):** 18  
**Weight (kg):** 6.5  
**Emplacement Time (min):** 2  
**Displacement Time (min):** 5-6

### NOTES

The MT-55A has a gap measuring device and infrared equipment for bridge-laying at night. It can also launch the MT-72 bridge.

## Russian Armored Vehicle-Launched Bridge MTU-72

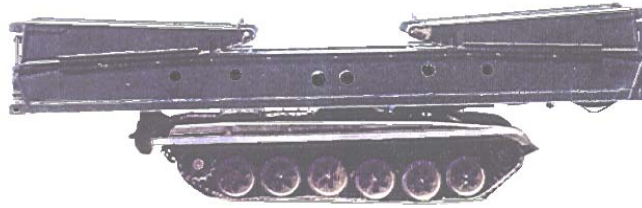

<p><b>SYSTEM</b></p> <p><b>Alternative Designations:</b> None <b>Date of Introduction:</b> 1974 <b>Proliferation:</b> At least one country. <b>Description:</b> Crew: 2, Commander and driver Chassis: T-72S Weight (mt): 40 Length with bridge (m): 11.64 Height with bridge (m): 3.38 Width with bridge (m): 3.46 Ground Clearance (mm): 49 Gradient (°): 31 Side Slope (°): 22 Fording Depth (m): 1.2 Vertical Step (m): .85 Trench (m): 2.8</p> <p><b>VARIANTS</b> None</p>	<p><b>AUTOMOTIVE</b></p> <p><b>Engine:</b> 840 hp Diesel <b>Cruising Range (km):</b> 500 <b>Speed (km/h):</b> Max Road: 60 Max Off-Road: 45 Average Cross-Country: 35 <b>Radio:</b> R-173 and R-134 <b>Self-Entrenching Blade:</b> Yes <b>NBC Protection System:</b> Yes <b>Smoke Equipment:</b> Vehicle engine exhaust smoke system.</p> <p><b>BRIDGE</b></p> <p><b>Type:</b> Cantiliver <b>Capacity (mt):</b> 50 <b>Width of Obstacle (m):</b> 18 <b>Width (m):</b> 3.55 <b>Length Opened (m):</b> 20 <b>Weight (kg):</b> 6,400 <b>Emplacement Time (min):</b> 3 <b>Displacement Time (min):</b> 8</p>
---	--

### NOTES

The crew is armed with a light machine gun, a submachine gun, and hand grenades for protection.

## Russian Heavy Folding Pontoon Bridge PMP

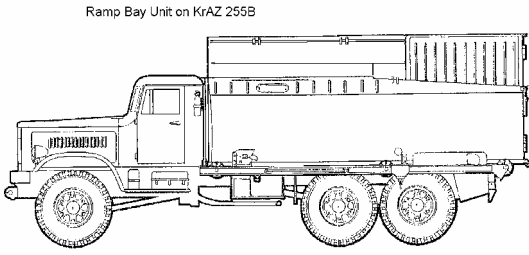
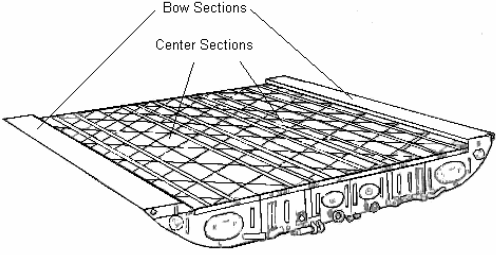
 <p>Ramp Bay Unit on KrAZ 255B</p>	 <p>Bow Sections Center Sections</p>
<p><b>SYSTEM</b></p> <p><b>Alternative Designations:</b> Ribbon bridge  <b>Date of Introduction:</b> 1961  <b>Proliferation:</b> Over 20 countries.  <b>Description:</b>  Crew: See Assembly Data  Chassis: KrAZ-255B</p> <p><b>BRIDGE</b></p> <p><b>Type:</b> Pontoon  <b>Total Length of Bridge (m):</b> 227  <b>Capacity/Load Class (mt):</b> 60  <b>Roadway Width (m):</b> 6.5  <b>Working Party:</b> Varies - approx. 65 for full bridge set. See RAFT ASSEMBLY DATA  <b>Material:</b> SKhL-4 steel  <b>Pontoons in Set:</b> See NOTES  Bridge/center: 32  Ramp/shore: 4  <b>Bridge Pontoons:</b>  Weight (kg): 6,790  Length (m):  Unfolded: 6.75  Folded: 6.75  Width (m):  Unfolded: 8  Folded: 5  Depth Unfolded (m):  Bow Section: .9  Center Section: .7  Folded: 2</p>	<p><b>Ramp Pontoons</b>  Weight (kg): 7,252  Length (m):  Unfolded: 5.6  Folded: 5.6  Width Unfolded (m):  River End: 7.3  Shore End: 7  Folded: 3.1</p> <p><b>RAFT ASSEMBLY DATA</b></p> <p><b>40-Ton Raft-Bridge</b>  Pontoons: 2  Overall Deck Length (m): 13.5  Assembly Time (min): 8  Working Party (est.): 6</p> <p><b>60-Ton Raft-Bridge</b>  Pontoons: 3  Overall Deck Length (m): 20.3  Assembly Time (min): 10  Working Party (est.): 9</p> <p><b>80-Ton Raft-Bridge</b>  Pontoons: 4  Overall Deck Length (m): 27  Assembly Time (min): 12  Working Party (est.): 12</p>

**NOTES**

Although the complete PMP ribbon bridge set consists of 32 center pontoons and 4 ramp pontoons, the normal bridge unit consists of a half-set (one complete bridge) made up of 16 center and 2 ramp pontoons. Each 4-section is launched from the KrAZ-255B. It automatically unfolds upon entering the water. The sections then lock in place to form a bridge unit 6.75 meters long and 8 meters wide. Normally, all the units are launched simultaneously. They join together parallel to the near shore to form a continuous roadway. The roadway then swings across the water obstacle; powerboats (6 per half-set) hold it in place on the designated centerline.

Engineers can use the full 36-pontoon set to construct 227 meters of bridge. They may also configure it as 40- to 170-ton rafts. A half-set gives the capability to construct 119 meters of 60-ton bridge, 191 meters of 20-ton bridge, or rafts. Under ideal conditions assembly speeds of 7 meters of bridge per minute can result. This bridge can be built in streams with a velocity of up to 2 meters a second (approx. 7 km/h).

## Russian Heavy Folding Pontoon Bridge PMP continued

<p><b>RAFT ASSEMBLY DATA continued</b></p> <p><b>110-Ton Raft-Bridge</b> Ramp Pontoon: 1 Bridge pontoons: 5     Overall Deck Length (m): 39.3     Assembly Time (min): 15     Working Party (est.): 18</p> <p><b>170-Ton Raft-Bridge</b> Ramp Pontoon: 1 Bridge pontoons: 8     Overall Deck Length (m): 59.6     Assembly Time (min): 15     Working Party (est.): INA</p> <p><b>AUXILIARY EQUIPMENT</b> Powerboats or tracked amphibians: 12</p> <p><b>LAUNCH SEQUENCE</b></p> <ol style="list-style-type: none"><li>1. The travel locks are disengaged, the pontoon carrier backs to the edge of the water, brakes sharply, and then the pontoon slides over the carrier roller system into the water where it unfolds almost immediately.</li><li>2. The pontoon is then stiffened by activating six locking devices.</li></ol>	<ol style="list-style-type: none"><li>3. Once the pontoons have been launched and stiffened they are interconnected parallel to the near shore to form a continuous strip of roadway.</li><li>4. This roadway is then swung across the water obstacle and held in place by powerboats.</li></ol> <p>Whenever possible the launching operations are done along a continuous shoreline permitting all pontoons to be launched at the same time. If necessary, the bridge can be built on a small frontage using the successive raft system. This slows construction time.</p> <p><b>RETRIEVAL</b></p> <p>For retrieval the launch operation is reversed. The pontoon carrier backs to the water's edge, an integral jib is unfolded from the truck bed, and two cables are strung from the winch (located behind the driver's cab) through the jib pulleys, around the pontoon retrieving guides, and secured to the pontoon retrieval studs. The winch simultaneously folds and lifts the pontoon to the truck bed. The jib is then folded back into the truck bed, and the pontoon is winched over the roller system and secured. The whole procedure takes but a very few minutes.</p>
---	---

## Russian Truck-Mounted Scissors Bridge TMM

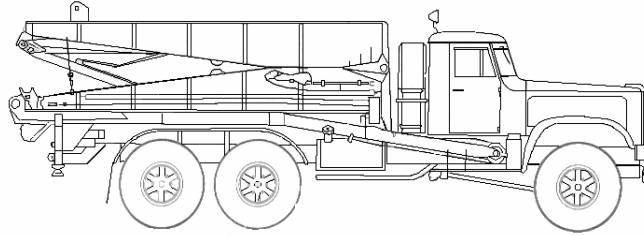

### SYSTEM

**Alternative Designations:** Mechanized Bridge, Scissors Bridge

**Date of Introduction:** 1964

**Proliferation:** At least 20 countries

**Description:**

Crew: See working party

Chassis: Modified KrAZ-214 (6 × 6), 7,000 kg, or KrAZ-255B (6 × 6), 7,500 kg, and KrAZ-260 trucks.

Weight (mt): 19

Length with bridge (m): 9.3

Height with bridge (m): 3.15

Width with bridge (m): 3.2

Ground Clearance (mm): 360

Gradient (°): 0

Fording Depth (m): 1

### BRIDGE

**Type:** Truck-mounted scissors

**Capacity/Load Class (mt):** 60

**Material:** Low alloy steel

**Width (m):**

Unfolded: 3.8

Folded: 3.2

**Weight (kg):** 4.24

**Pier:** (TMM on KrAZ-255)

Height (m):

Min: 1.7

Max: 3.21

Ground Area (m<sup>2</sup>/pier): 2.4

Weight (m): 1.15

Lowering Method: Cable release

Raising Method: Hand winch

Locking Method: Manual

### ASSEMBLY DATA

**Spans in Set:** 4

**Length of 1 Span (m):**

Unfolded: 10.5

Folded: 5.2

**Total Length of Bridge (m):** 42

**Obstacle Span (m):**

Span: 9.4

Depth: 3

**Roadway Width (m):**

Closed: 3.2

Extended: 5.2

**Assembly Time (min):** 20-40

1 Span: 8-15

4 Spans: 30-60

**Recovery Time (min):** Same as assembly

**Working Party:** 3 per span/12 total

### VARIANTS

**TMM-3:** KrAZ-255B 6 × 6 improved bridgelaying mechanism.

**TMM-6:** MAZ-543 8 × 8 truck with 17 m bridge spans (unfolded).

### NOTES

The TMM is a multiple-span, trestle-supported, scissors-type, treadway bridge. One bridge set comprises four 10.5 meter, spans carried on, and launched from specially modified trucks. Spans fold in half for transport. Three of the spans have integral-mounted adjusted (1.7 to 3.2 meters) trestle legs, while the fourth (far-shore) span has none.

During travel, the trestles can fold beneath the scissors plan. A launching girder mounted on the truck bed launches the TMM hydraulically over the tailgate. Assisted by winch cables and pulleys, the girder raises, unfolds, and emplaces the span with the folding trestle legs. If necessary the TMM can be laid underwater. This requires about 50% more emplacement time.

## Russian Truck-Mounted Scissors Bridge TMM continued

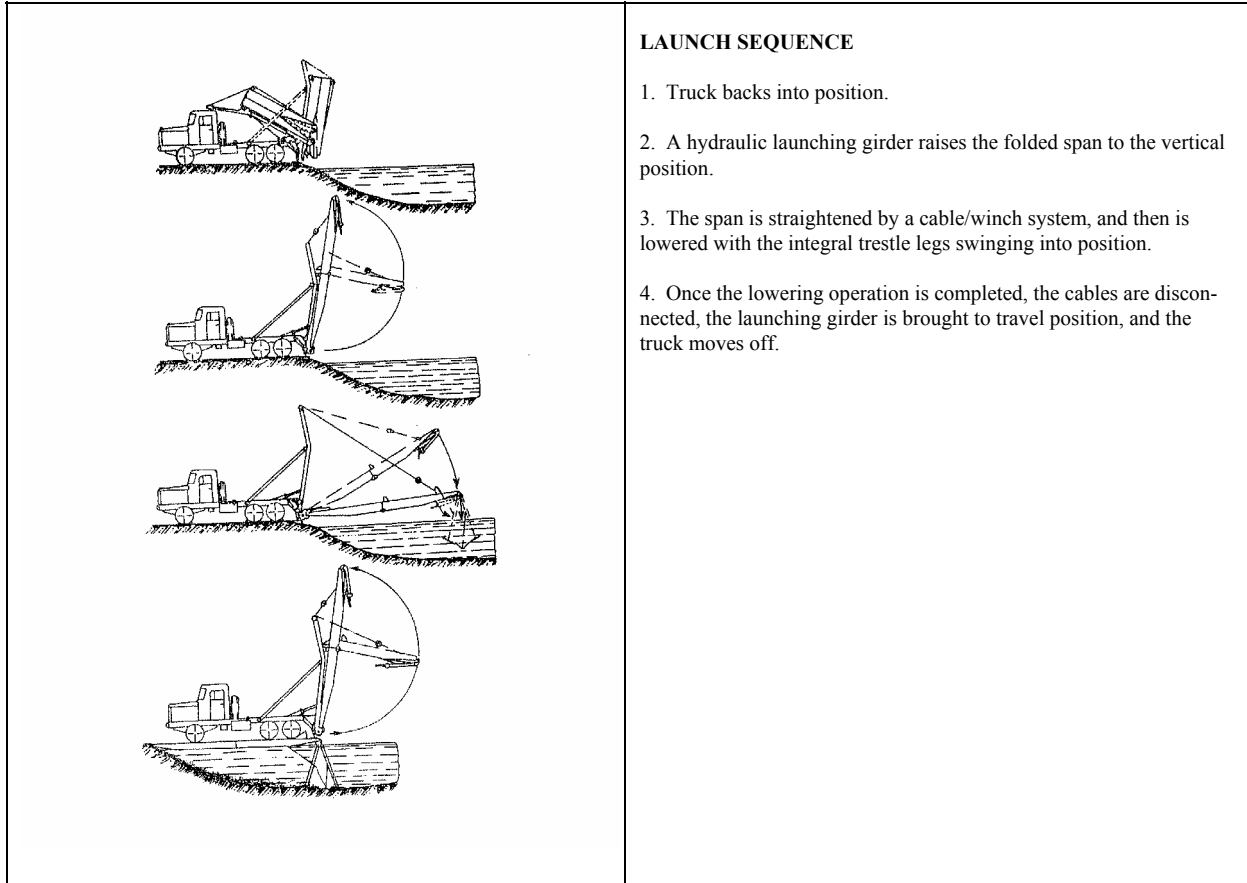

### LAUNCH SEQUENCE

1. Truck backs into position.
2. A hydraulic launching girder raises the folded span to the vertical position.
3. The span is straightened by a cable/winch system, and then is lowered with the integral trestle legs swinging into position.
4. Once the lowering operation is completed, the cables are disconnected, the launching girder is brought to travel position, and the truck moves off.

## Russian 0.6 mt 4 x 4 Utility Truck UAZ-469

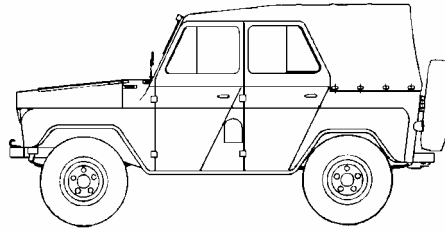

<p><b>SYSTEM</b></p> <p><b>Alternative Designations:</b> INA  <b>Date of Introduction:</b> 1973  <b>Proliferation:</b> Widespread</p> <p><b>Description:</b>  Troop Capacity: 2 in front, 5 in rear  Weight (mt):      Gross Vehicle Weight: 2.4      Curb: 1.6  Length Overall (m): 4  Height Overall (m): 2  Width Overall (m): 1.8  Payload on/off Highway (kg): 600  Number of Axles: 2  Ground Clearance (mm): 300  Turning Radius (m): 6.5  Wheels:      Size (in): 8.40x15      Central Tire Pressure Regulation System: No      Run Flat: No</p>	<p><b>AUTOMOTIVE</b></p> <p><b>Engine:</b> Inline 4, 70 hp, gasoline  <b>Cooling:</b> Water  <b>Cruising Range (road) (km):</b> 730  <b>Speed (km/h):</b> 100  <b>Fuel Capacity (liters):</b>  Left Tank: 39  Right Tank: 39  <b>Towing Capability (kg):</b>  Off Highway: 850  On Highway: 850  <b>Gradient (loaded) (°):</b> 60  <b>Fording Depths (m):</b> .58  <b>Trench Crossing Width (mm):</b> INA</p> <p><b>CARGO SPACE</b></p> <p><b>Height (mm):</b> 400  <b>Width (mm):</b> 1,400  <b>Length (mm):</b> 1,000  <b>Cargo Bed Area (m<sup>2</sup>):</b> 1.6</p> <p><b>VARIANTS</b></p> <p><b>UAZ-469B:</b> Export; lower off-road performance  <b>Ambulance:</b> 1 stretcher patient and 1 attendant</p>
--	--

**NOTES**

The UAZ-469 replaces the earlier UAZ-69.



## Russian 2 mt 4 x 4 Cargo Truck GAZ-66

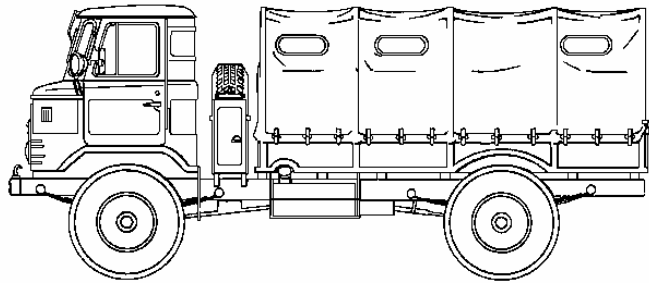

<p><b>SYSTEM</b></p> <p><b>Alternative Designations:</b> INA  <b>Date of Introduction:</b> 1964  <b>Proliferation:</b> Widespread</p> <p><b>Description:</b>  Troop Capacity: 3 in cab, 18 in rear  Weight (mt):      Gross Vehicle Weight: 5.8      Curb: 3.6  Length Overall (m): 5.65  Height Overall (m): 2.44  Width Overall (m): 2.32  Payload on/off Highway (kg): 2,000  Number of Axles: 2  Ground Clearance (mm): 315  Turning Radius (m): 10  Wheels:      Size (in): 12x18      Central Tire Pressure Regulation System: Yes</p>	<p><b>AUTOMOTIVE</b></p> <p><b>Engine:</b> V8, 115 hp, gasoline  <b>Cooling:</b> Water  <b>Cruising Range (road) (km):</b> 875  <b>Speed (km/h):</b> 95  <b>Fuel Capacity (liters):</b>  Left Tank: 105  Right Tank: 105  <b>Towing Capability (kg):</b>  Off Highway: 2,000  On Highway: 2,000  <b>Gradient (loaded) (°):</b> 39  <b>Fording Depths (m):</b> .8</p> <p><b>CARGO SPACE</b></p> <p><b>Height (mm):</b> 890  <b>Width (mm):</b> 2,050  <b>Length (mm):</b> 3,330  <b>Cargo Bed Area (m<sup>2</sup>):</b> 6.8</p> <p><b>VARIANTS</b></p> <p><b>GAZ-66B:</b> Canvas-top cab for air transport or airdrop  <b>GAZ-66A:</b> Steelcab  Numerous other variants for various duties.</p>
--	---

**NOTES**

Besides functioning as a general cargo carries, the GAZ-66 is used as a prime mover for 120-mm mortar. The DDA-66 variant is an NBC decontamination truck.

## Russian 4.5 mt 6 x 6 Cargo Truck Ural-375D

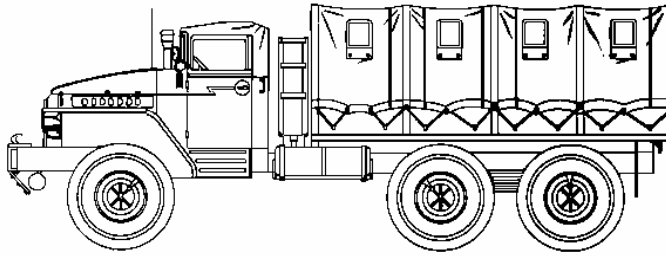

### SYSTEM

**Alternative Designations:** INA

**Date of Introduction:** 1965

**Proliferation:** Widespread

### Description:

Troop Capacity: 3 in cab, 24 in rear

Weight (mt):

Gross Vehicle Weight: 13.2

Curb: 8.4

Length Overall (m): 7.36

Height Overall (m): 2.68

Width Overall (m): 2.67

Number of Axles: 3

Ground Clearance (mm): 410

Turning Radius (m): 10.8

Side Slope (°): 32

Vertical Step (mm): 800

Gradient (loaded) (°): 65

Fording Depths (m): 1.49

Trench Crossing Width (mm): 875

Wheels:

Size (in): 14x20

Central Tire Pressure Regulation System: Yes

Run Flat: INA

### AUTOMOTIVE

**Engine:** V8, 180 hp, gasoline

**Cooling:** Liquid

**Cruising Range (road) (km):** 650

**Speed (km/h):** 75

**Fuel Capacity (liters):**

Main Tank: 300

Aux Tank: 60

**Towing Capability (kg):**

Off Highway: 5,000

On Highway: 10,000

### CARGO SPACE

**Height (mm):** 872

**Width (m):** 2.43

**Length (m):** 3.9

**Cargo Bed Area (m<sup>2</sup>):** 9.5

### VARIANTS

**URAL-375:** Observation hatch and unimproved powertrain

**URAL-375E:** Decontamination vehicle

**URAL-375N:** 2,000 kg additional payload

**URAL-375S:** Truck-tractor

**URAL-375T:** Equipped with winch

### NOTES

Besides functioning as a general cargo carrier, the Ural-375D is used as a prime mover for light and medium artillery. The Ural-375 chassis also serves as a base for the BM-21 MRL, POL tankers, vans, and cranes. The Ural-4320 began to replace the Ural-375D around 1978.

## Russian 7.5 mt 6 x 6 Cargo Truck KrAZ-255B

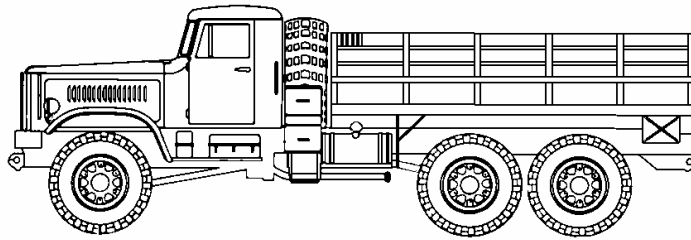

### SYSTEM

**Alternative Designations:** INA  
**Date of Introduction:** 1967  
**Proliferation:** Widespread

#### Description:

Troop Capacity: 3 in cab, 16 in rear  
Weight (mt):  
    Gross Vehicle Weight: 19.7  
    Curb: 12  
Length Overall (m): 8.64  
Height Overall (m): 2.94  
Width Overall (m): 2.75  
Payload (kg): 7,500  
Number of Axles: 3  
Ground Clearance (mm): 360  
Turning Radius (m): 14  
Wheels:  
    Size (in): 20x21  
    Central Tire Pressure Regulation System: Yes  
    Run Flat: INA

### AUTOMOTIVE

**Engine:** V8, 265 hp, diesel  
**Cooling:** Water  
**Cruising Range (road) (km):** 850  
**Speed (km/h):** 70  
**Fuel Capacity (liters):**  
    Right Tank: 165  
    Left Tank: 165  
**Towing Capability (kg):**  
    Off Highway: 10,000  
    On Highway: 50,000  
**Gradient (loaded) (°):** 30  
**Fording Depths (m):** 1

### CARGO SPACE

**Length (m):** 4.56  
**Width (m):** 2.5  
**Height (m):** .92  
**Cargo Bed Area (m<sup>2</sup>):** INA

### VARIANTS

**KrAZ-258:** Tractor-truck  
Numerous other variants for various duties.

### NOTES

Primarily designed as a cargo truck, the KrAZ-255B is also used as a prime mover for various equipment including a tank-transporter trailer and PMP pontoon bridge.

## Russian Armored Recovery Vehicle BREM-1

	<p><b>Weapons &amp; Ammunition Types</b></p> <p>12.7-mm AD MG</p>	<p><b>Typical Combat Load</b></p> <p>840</p>
<p><b>SYSTEM</b></p> <p><b>Alternative Designations:</b> None  <b>Date of Introduction:</b> 1984  <b>Proliferation:</b> At least 5 countries.  <b>Description:</b>  Crew: 3 (see NOTES)  Chassis: T-72 tank  Weight (mt): 41  Length Overall (m): 7.98  Height Travel (m): 2.45  Width Overall (m): 3.46  Clearance (mm): 457  Gradient (°): 30  Trench Crossing (m): 2.8  Fording Depth (m): 1.2  Vertical Step (m): .85</p> <p><b>AUTOMOTIVE</b></p> <p><b>Engine:</b> V-12 Multi-fuel Diesel, 840 hp  <b>Cruising Range w/external tanks (km):</b>  Dirt Road w/o Towed Vehicle: 650  Dirt Road Towing Vehicle: 220-430  Highway w/o Towed Vehicle: 700  <b>Speed (km/h):</b>  Max Highway: 60  Dirt Road: 45  Towing Tank on Dirt Road: 12  <b>Smoke Equipment:</b> Vehicle engine exhaust smoke system (VEESS).  Four smoke grenade launchers may be fitted.  <b>NBC Protection:</b> Yes  <b>Radio:</b> R-123</p> <p><b>BLADE</b></p> <p><b>Width (m):</b> 3.1</p>	<p><b>CRANE</b></p> <p><b>Capacity (mt):</b>  2 m Extension: 19  4.4 m (max) Extension: 3  <b>Boom Length (max) (m):</b> 4.4</p> <p><b>WINCH</b></p> <p><b>Capacity (mt):</b>  Line Pull: 25  With Blocks: 100  <b>Cable Length (m):</b> 200  <b>Auxiliary Winch:</b>  Capacity (line pull) (kg): 530  Cable Length (m): 400</p> <p><b>TOWING</b></p> <p><b>Capacity (mt):</b> 50  <b>Towing Rods:</b>  Two 1.68 m  Two 5.5 m  <b>Hydraulic Jack Capacity (mt):</b> 30</p> <p><b>ARMAMENT</b></p> <p><b>Caliber, Type, Name:</b> 12.7-mm, AD MG NSV-T  Mount Type: Cupola  Max Effective Range (m):  AA: 1,500  Ground: 2,000  Fire on Move: Yes</p> <p><b>VARIANTS</b>  None</p>	

**NOTES**

The BREM-1 is designed to tow damaged tanks from the battlefield to damaged vehicle collection points. It has a crew of three—commander, driver, and mechanic. Instead of a turret it has a rectangular platform on top of the hull for work and loading.

## Russian Armored Recovery Vehicle T-54-T

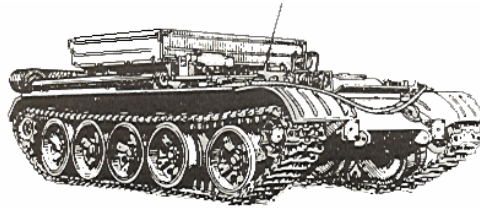

### SYSTEM

**Alternative Designations:** BTS-2 (Medium Tank Towing Vehicle-2)

**Date of Introduction:** 1965

**Proliferation:** At least 50 countries

#### Description:

Crew: 3 to 5

Chassis: T-54

Weight (mt): 36

Length (m): 7.5

Height (m): 1.9

Width (m): 3.27

Clearance (mm) 264

Gradient (°): 31

Trench Crossing (m): 2.7

Fording Depth (m):

Unprepared: 1.4

With Snorkel: 5.5

Vertical Step (m): .8

### AUTOMOTIVE

**Engine:** V-12 Diesel, 520 hp

**Cruising Range (km):** 400

**Speed (km/h):** 48

**Smoke Equipment:** Vehicle engine exhaust smoke system.

**NBC Protection:** No. (see VARIANTS)

**Radio:** INA

**CRANE CAPACITY (mt):** 1

**TOWING CAPACITY (mt):** At least 40

### ARMAMENT

None

### VARIANTS

There are numerous variants based on T-54 and T-55 chassis each with differing equipment modifications.

**T-54 (A):** Former East German manufacture. Push/pull bar at front, 1 mt crane, NBC equipment, no winches or spades.

**T-54 (B):** Former East German manufacture. Similar to T-54 (A). Tow cables brackets at hull rear, hull front protective plate, snorkel. No winch or spade.

**T-54 (C):** Former East German manufacture. Heavy-duty crane, snorkel.

### NOTES

The T-54-T armored recovery vehicles are based on modified chassis of the T-54 medium tank. The recovery vehicle variants have a crane able to lift up to 3 mt, a loading platform, and a spade on the rear of the vehicle. They can mount a snorkel for deep fording. Performance figures are the same for the T-54 (and T-55) tanks. They replaced older tank recovery vehicles based on the T-34 chassis.

## Chapter 9 Rotary-Wing Aircraft

This chapter provides the basic characteristics of selected rotary-wing aircraft readily available to the OPFOR. Both FM 100-60, *Armor- and Mechanized-Based Opposing Force: Organization Guide*, and FM 100-63, *Infantry-Based Opposing Force: Organization Guide*, use descriptors to indicate aircraft capabilities. In each manual, a substitution matrix enables the trainer to structure OPFOR air support requirements as required by capability rather than specific type.

**Rotary-Wing Aircraft**, covers systems classified as light, attack, utility, multi-role, and transport aircraft. Multi-role aircraft are able to support missions across each of the categories. This chapter encompasses many aircraft which may have a dual civil/military history. It does not include however, aircraft designed and used primarily for civil aviation.

The sampling of systems was selected because of wide proliferation across numerous countries or because of already extensive use in training scenarios. Additional data sheets addressing other widely proliferated helicopter systems will be sent with further supplements to this guide.

Because of the increasingly large numbers of variants of each aircraft, only the most common variants produced in significant numbers were addressed. If older versions of helicopters have been upgraded in significant quantities to the standards of newer variants, the older versions were not addressed.

The munitions available to each aircraft are mentioned, but not all may be employed at the same time. The weapon systems inherent to the airframe are listed under armament. The most probable weapon loading options are also given, but assigned mission dictates actual weapon configuration. Therefore, any combination of the available munitions may be encountered.

Questions and comments on data listed in this chapter should be addressed to:

**CPT (P) Blake Burslie**  
DSN: 552-7922, Commercial (913) 684-7922  
e-mail address: burslieb@leavenworth.army.mil

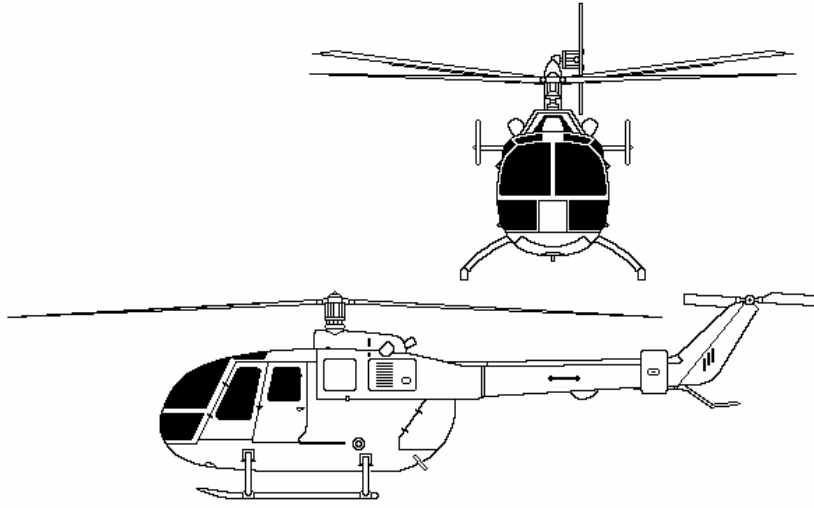

## European Light Helicopter BO-105

	<p><b>Weapon &amp; Ammunition Types</b></p> <p><b>Other Loading Options</b></p> <p>7.62-mm or 12.7-mm MG pods</p> <p>2.75-in rocket pods (7 or 12 ea.)</p> <p>68-mm SNEB rocket pods (12ea)</p> <p>50-mm SNIA rockets (28 ea.)</p> <p>TOW ATGM pods (4 ea.)</p> <p>HOT ATGM</p> <p>AS-12 ASM pods (2 ea.)</p> <p>Stinger AAM pod (4 ea.)</p>	<p><b>Combat Load</b></p> <p>2</p> <p>2</p> <p>2</p> <p>2</p> <p>6</p> <p>2</p> <p>1</p>		
	<table border="1"> <tr> <td data-bbox="190 806 594 1755"> <p><b>SYSTEM</b></p> <p><b>Alternative Designations:</b> INA</p> <p><b>Date of Introduction:</b> 1972</p> <p><b>Proliferation:</b> At least 40 countries</p> <p><b>Description:</b> Variants in “( )”</p> <p>Crew: 1 or 2 (pilots)</p> <p>Blades:</p> <p>    Main rotor: 4</p> <p>    Tail rotor: 2</p> <p>Engines: 2x 420-shp Allison 250-C20B turboshaft</p> <p>Weight (kg):</p> <p>    Maximum Gross: 2,500</p> <p>    Normal Takeoff: 2,000</p> <p>    Empty: 1,301, 1,913 (PAH1)</p> <p>Speed (km/h):</p> <p>    Maximum (level): 242</p> <p>    Cruise: 205</p> <p>Ceiling (m):</p> <p>    Service: 3,050</p> <p>    Hover (out of ground effect): 457</p> <p>    Hover (in ground effect): 1,525</p> <p>Vertical Climb Rate (m/s): 7.5</p> <p>Fuel (liters):</p> <p>    Internal: 570</p> <p>    Internal Aux Tank: 200 ea. (max 2x)</p> <p>Range (km):</p> <p>    Normal Load: 555</p> <p>    With Aux Fuel: 961</p> <p>Dimensions (m):</p> <p>    Length (rotors turning): 11.9</p> <p>    Length (fuselage): 8.8</p> <p>    Width: 2.5</p> </td> <td data-bbox="594 806 1024 1755"> <p>Dimensions continued (m):</p> <p>    Height: 3.0</p> <p>    Main Rotor Diameter: 9.8</p> <p>    Tail Rotor Diameter: 1.9</p> <p>Cargo Compartment Dimensions (m):</p> <p>    Floor Length: 1.9</p> <p>    Width: 1.4</p> <p>    Height: 1.3</p> <p>Standard Payload (kg):</p> <p>    Internal load: 690</p> <p>    External on sling only: 1,200</p> <p>    Transports 3 troops or 2 litters, or cargo.</p> <p><b>Survivability/Countermeasures:</b></p> <p>    Main and tail rotors electrically deiced.</p> <p>    Infrared signature suppressors can be mounted on engine exhausts.</p> <p>    Rotor brake.</p> <p><b>ARMAMENT</b></p> <p><b>Most Probable Armament:</b></p> <p><b>BO-105P/PAH1:</b> Outriggers carry 6x HOT antitank missiles, or rocket pods.</p> <p><b>CASA BO-105/ATH:</b> The Spanish produced variant rigidly mounts 1x Rh 202 20-mm cannon under the fuselage.</p> <p><b>AVIONICS/SENSOR/OPTICS</b></p> <p>The BO-105P has a roof-mounted direct-view, daylight-only sight to allow firing of HOT ATGMs. Options exist to fit a thermal imaging system for night operations, and a laser designator.</p> </td> <td data-bbox="1024 806 1430 1755"> <p><b>Night/Weather Capabilities:</b></p> <p>Available avionics include weather radar, Doppler and GPS navigation, and an autopilot. It is capable of operation in day, night, and instrument meteorological conditions.</p> <p><b>VARIANTS</b></p> <p>The BO 105 was developed initially by Messerschmitt-Bolkow-Blohm in Germany. Others are built in Chile, the Philippines, Indonesia (<b>NBO-105</b>), and Spain (<b>CASA BO-105/ATH</b>).</p> <p><b>BO-105CB:</b> The standard production variant.</p> <p><b>BO-105CBS:</b> VIP version with a slightly longer fuselage to accommodate 6 passengers, some used in a SAR role.</p> <p><b>BO-105LS:</b> Upgraded to 2x 550-shp Allison 250-C28 turboshaft engines for extended capabilities in high altitudes and temperatures. Produced only in Canada.</p> <p><b>BO-105M/VBH:</b> Standard reconnaissance version.</p> <p><b>BO-105P/PAH1:</b> Standard antitank version.</p> </td> </tr> </table>		<p><b>SYSTEM</b></p> <p><b>Alternative Designations:</b> INA</p> <p><b>Date of Introduction:</b> 1972</p> <p><b>Proliferation:</b> At least 40 countries</p> <p><b>Description:</b> Variants in “( )”</p> <p>Crew: 1 or 2 (pilots)</p> <p>Blades:</p> <p>    Main rotor: 4</p> <p>    Tail rotor: 2</p> <p>Engines: 2x 420-shp Allison 250-C20B turboshaft</p> <p>Weight (kg):</p> <p>    Maximum Gross: 2,500</p> <p>    Normal Takeoff: 2,000</p> <p>    Empty: 1,301, 1,913 (PAH1)</p> <p>Speed (km/h):</p> <p>    Maximum (level): 242</p> <p>    Cruise: 205</p> <p>Ceiling (m):</p> <p>    Service: 3,050</p> <p>    Hover (out of ground effect): 457</p> <p>    Hover (in ground effect): 1,525</p> <p>Vertical Climb Rate (m/s): 7.5</p> <p>Fuel (liters):</p> <p>    Internal: 570</p> <p>    Internal Aux Tank: 200 ea. (max 2x)</p> <p>Range (km):</p> <p>    Normal Load: 555</p> <p>    With Aux Fuel: 961</p> <p>Dimensions (m):</p> <p>    Length (rotors turning): 11.9</p> <p>    Length (fuselage): 8.8</p> <p>    Width: 2.5</p>	<p>Dimensions continued (m):</p> <p>    Height: 3.0</p> <p>    Main Rotor Diameter: 9.8</p> <p>    Tail Rotor Diameter: 1.9</p> <p>Cargo Compartment Dimensions (m):</p> <p>    Floor Length: 1.9</p> <p>    Width: 1.4</p> <p>    Height: 1.3</p> <p>Standard Payload (kg):</p> <p>    Internal load: 690</p> <p>    External on sling only: 1,200</p> <p>    Transports 3 troops or 2 litters, or cargo.</p> <p><b>Survivability/Countermeasures:</b></p> <p>    Main and tail rotors electrically deiced.</p> <p>    Infrared signature suppressors can be mounted on engine exhausts.</p> <p>    Rotor brake.</p> <p><b>ARMAMENT</b></p> <p><b>Most Probable Armament:</b></p> <p><b>BO-105P/PAH1:</b> Outriggers carry 6x HOT antitank missiles, or rocket pods.</p> <p><b>CASA BO-105/ATH:</b> The Spanish produced variant rigidly mounts 1x Rh 202 20-mm cannon under the fuselage.</p> <p><b>AVIONICS/SENSOR/OPTICS</b></p> <p>The BO-105P has a roof-mounted direct-view, daylight-only sight to allow firing of HOT ATGMs. Options exist to fit a thermal imaging system for night operations, and a laser designator.</p>
<p><b>SYSTEM</b></p> <p><b>Alternative Designations:</b> INA</p> <p><b>Date of Introduction:</b> 1972</p> <p><b>Proliferation:</b> At least 40 countries</p> <p><b>Description:</b> Variants in “( )”</p> <p>Crew: 1 or 2 (pilots)</p> <p>Blades:</p> <p>    Main rotor: 4</p> <p>    Tail rotor: 2</p> <p>Engines: 2x 420-shp Allison 250-C20B turboshaft</p> <p>Weight (kg):</p> <p>    Maximum Gross: 2,500</p> <p>    Normal Takeoff: 2,000</p> <p>    Empty: 1,301, 1,913 (PAH1)</p> <p>Speed (km/h):</p> <p>    Maximum (level): 242</p> <p>    Cruise: 205</p> <p>Ceiling (m):</p> <p>    Service: 3,050</p> <p>    Hover (out of ground effect): 457</p> <p>    Hover (in ground effect): 1,525</p> <p>Vertical Climb Rate (m/s): 7.5</p> <p>Fuel (liters):</p> <p>    Internal: 570</p> <p>    Internal Aux Tank: 200 ea. (max 2x)</p> <p>Range (km):</p> <p>    Normal Load: 555</p> <p>    With Aux Fuel: 961</p> <p>Dimensions (m):</p> <p>    Length (rotors turning): 11.9</p> <p>    Length (fuselage): 8.8</p> <p>    Width: 2.5</p>	<p>Dimensions continued (m):</p> <p>    Height: 3.0</p> <p>    Main Rotor Diameter: 9.8</p> <p>    Tail Rotor Diameter: 1.9</p> <p>Cargo Compartment Dimensions (m):</p> <p>    Floor Length: 1.9</p> <p>    Width: 1.4</p> <p>    Height: 1.3</p> <p>Standard Payload (kg):</p> <p>    Internal load: 690</p> <p>    External on sling only: 1,200</p> <p>    Transports 3 troops or 2 litters, or cargo.</p> <p><b>Survivability/Countermeasures:</b></p> <p>    Main and tail rotors electrically deiced.</p> <p>    Infrared signature suppressors can be mounted on engine exhausts.</p> <p>    Rotor brake.</p> <p><b>ARMAMENT</b></p> <p><b>Most Probable Armament:</b></p> <p><b>BO-105P/PAH1:</b> Outriggers carry 6x HOT antitank missiles, or rocket pods.</p> <p><b>CASA BO-105/ATH:</b> The Spanish produced variant rigidly mounts 1x Rh 202 20-mm cannon under the fuselage.</p> <p><b>AVIONICS/SENSOR/OPTICS</b></p> <p>The BO-105P has a roof-mounted direct-view, daylight-only sight to allow firing of HOT ATGMs. Options exist to fit a thermal imaging system for night operations, and a laser designator.</p>	<p><b>Night/Weather Capabilities:</b></p> <p>Available avionics include weather radar, Doppler and GPS navigation, and an autopilot. It is capable of operation in day, night, and instrument meteorological conditions.</p> <p><b>VARIANTS</b></p> <p>The BO 105 was developed initially by Messerschmitt-Bolkow-Blohm in Germany. Others are built in Chile, the Philippines, Indonesia (<b>NBO-105</b>), and Spain (<b>CASA BO-105/ATH</b>).</p> <p><b>BO-105CB:</b> The standard production variant.</p> <p><b>BO-105CBS:</b> VIP version with a slightly longer fuselage to accommodate 6 passengers, some used in a SAR role.</p> <p><b>BO-105LS:</b> Upgraded to 2x 550-shp Allison 250-C28 turboshaft engines for extended capabilities in high altitudes and temperatures. Produced only in Canada.</p> <p><b>BO-105M/VBH:</b> Standard reconnaissance version.</p> <p><b>BO-105P/PAH1:</b> Standard antitank version.</p>		

### NOTES

Available munitions are shown above; not all will be employed at the same time, mission dictates weapons configuration. External stores are mounted on weapons “outriggers” or racks on each side of the fuselage. Each rack has one hardpoint. This helicopter is produced by the Eurocopter Company. It was formed as a joint venture between Aerospatiale of France, and Daimler-Benz Aerospace of Germany. Other missions include: direct air support, antitank, reconnaissance, search and rescue, and transport. Clamshell doors at rear of cabin area open to access cargo area. Cargo floor has tiedown rings throughout.

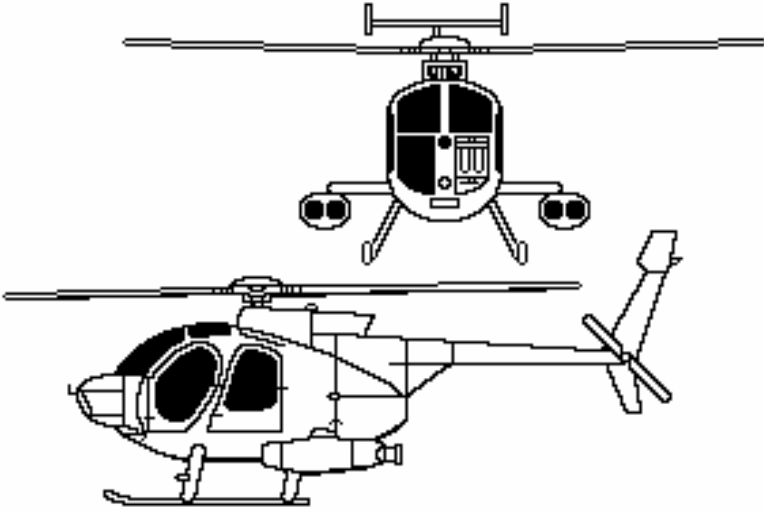

United States Light Helicopter MD-500/Defender

	<p><b>Weapon &amp; Ammunition Types</b></p> <p><b>Other Loading Options</b></p> <p>M134 7.62-mm 6x barrel, Gatling type twin MG pods</p> <p>M260 2.75-in Hydra 70 rocket pods (7 or 12 each)</p> <p>.50 cal MG pods</p> <p>M75 40-mm grenade launchers</p> <p>MK19 40-mm grenade launcher</p> <p>TOW missile pods (2 each)</p> <p>Hellfire ATGM</p> <p>Stinger AAM</p>	<p><b>Combat Load</b></p> <p><b>2000</b></p> <p><b>2</b></p> <p><b>2</b></p> <p><b>2</b></p> <p><b>2</b></p> <p><b>2</b></p> <p><b>2</b></p>
<p><b>SYSTEM</b></p> <p><b>Alternative Designations:</b> Hughes model 369, Cayuse, Loach</p> <p><b>Date of Introduction:</b> 1977 (MD-500 MD)</p> <p><b>Proliferation:</b> At least 22 countries</p> <p><b>Description:</b> Variants in “( )”</p> <p>Crew: 1 or 2 (pilots)</p> <p>Blades:</p> <p>    Main rotor: 4 or 5 (see VARIANTS)</p> <p>    Tail rotor: 2 or 4 (see VARIANTS)</p> <p>Engines: (see VARIANTS)</p> <p>Weight (kg):</p> <p>    Maximum Gross: 1,361 (500), 1,610 (530)</p> <p>    Normal Takeoff: 1,090</p> <p>    Empty: 896</p> <p>Speed (km/h):</p> <p>    Maximum (level): 241 (500), 282 (530)</p> <p>    Cruise: 221 (500), 250 (530)</p> <p>Ceiling (m):</p> <p>    Service: 4,635 (500), 4,875 (530)</p> <p>    Hover (out of ground effect): 1,830 (500), 3,660 (530)</p> <p>    Hover (in ground effect): 2,590 (500), 4,360 (530)</p> <p>Vertical Climb Rate (m/s): 8.4 (500), 10.5 (530)</p> <p>Fuel (liters):</p> <p>    Internal: 240</p> <p>    Internal Aux Tank: 80</p> <p>Range (km):</p> <p>    Normal Load (est.): 485 (500), 430 (530)</p> <p>Dimensions (m):</p> <p>    Length (rotors turning): 9.4 (500), 9.8 (530)</p> <p>    Length (fuselage): 7.6 (500), 7.3 (530)</p> <p>    Width: 1.9</p> <p>    Height: 2.6 (500), 3.4 (530 over mast-mounted sight)</p>	<p>Dimensions continued (m):</p> <p>    Main Rotor Diameter: 8.0 (500), 8.3 (530)</p> <p>    Tail Rotor Diameter: 1.4</p> <p>Cargo Compartment Dimensions (m):</p> <p>    Floor Length: 2.4</p> <p>    Width: 1.3</p> <p>    Height: 1.5</p> <p>Standard Payload (kg):</p> <p>    Internal load: INA</p> <p>    External load: 550</p> <p>    Transports 2 or 3 troops or cargo internally, or 6 on external platforms in lieu of weapons.</p> <p><b>Survivability/Countermeasures:</b></p> <p>Some models have radar warning receivers. Chaff and flare systems available. Infrared signature suppressors can be mounted on engine exhausts.</p> <p><b>ARMAMENT</b></p> <p><b>Most Probable Armament:</b> (MD-500D pictured)</p> <p><b>MD-500MD/Scout Defender:</b> Fitted with guns, rockets, grenade launchers, or a combination on 2x fuselage hardpoints.</p> <p><b>MD-500MD/TOW Defender:</b> Twin TOW missile pods on 2x fuselage hardpoints; mounts missile sight in lower-left front windshield.</p> <p><b>AVIONICS/SENSOR/OPTICS</b></p> <p>The MD-500 allows for the mounting of a stabilized, direct-view optical sight in the windshield. Options exist to fit a mast-mounted, multiple field of view optical sight, a target tracker, a laser rangefinder, thermal imager, a 16x FLIR for night navigation and targeting, and autopilot.</p>	<p><b>Night/Weather Capabilities:</b></p> <p>Optional avionics include GPS, ILS and full instrument weather conditions packages. The more advanced variants are fully capable of performing all missions under any conditions.</p> <p><b>VARIANTS</b></p> <p><b>OH-6A/Cayuse:</b> Developed initially by the Hughes Aircraft company (later McDonnell Douglas Helicopter Company) in the mid-1960s for the US Army. Fitted with 1x 253-shp Allison T63-A-5A turboshaft, 4 bladed main rotor, and an offset “V” tail.</p> <p><b>Hughes 500M:</b> Military export version of OH-6 in mid-1970s with upgraded 278-shp Allison 250-C18 turboshaft engine, “V” tail.</p> <p><b>MD-500MD/Scout and TOW Defender:</b> Improved military version of the model 500 with 5 main rotor blades, 375-shp Allison 250-C20B turboshaft engine, and T-tail.</p> <p><b>MD-500E/MD-500MG/Defender II:</b> Had a more elongated nose for streamlining, and an optional 4x blade tail rotor for reduced acoustic signatures. Possible mast-mounted sight.</p> <p><b>OH-6A/MD-530F Super Cayuse/Lifter:</b> Upgraded engine to a 425-shp Allison 250-C30 turboshaft, and avionics in 1988 for the US Army.</p> <p><b>MD-530MG/Defender:</b> Has a mast-mounted sight, and incorporated upgrades of all previous variants.</p> <p><b>AH/MH-6J:</b> US Army Special Operations variant derived from the MD-530MG.</p>

**NOTES**

Available munitions are shown above; not all will be employed at the same time, mission dictates weapons configuration. External stores are mounted on weapons racks on each side of the fuselage. Each rack has one hardpoint. Other missions include: direct air support, antitank, reconnaissance, observation, and light utility.

## Russian Light Helicopter Mi-2/HOPLITE

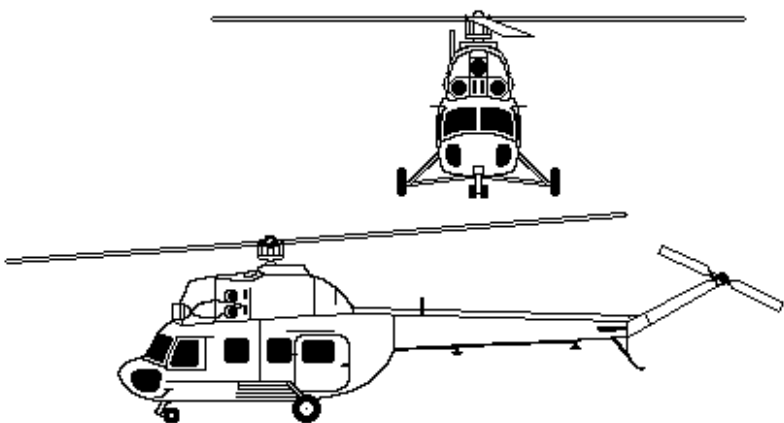
		<p><b>Weapon &amp; Ammunition Types</b></p> <p>1x 23-mm automatic cannon</p> <p>1x 7.62-mm or 12.7-mm MG</p> <p><b>Other Loading Options:</b></p> <p>AT-3c/SAGGER ATGM</p> <p>57-mm Rocket pods (16 each)</p> <p>Twin or single fixed 7.62-mm or 12.7-mm MG</p> <p>External fuel tanks (liters)</p> <p>SA-7b/GRAIL missile</p>	<p><b>Combat Load</b></p> <p>4</p> <p>2</p> <p>238</p> <p>4</p>
<p><b>SYSTEM</b></p> <p><b>Alternative Designations:</b> INA</p> <p><b>Date of Introduction:</b> 1965</p> <p><b>Proliferation:</b> Widespread</p> <p><b>Description:</b></p> <p>Crew: 1 (pilot)</p> <p>Blades:</p> <p>    Main rotor: 3</p> <p>    Tail rotor: 2</p> <p>Engines: 2x 400-shp PZL GTD-350 (series III and IV) turboshaft</p> <p>Weight (kg):</p> <p>    Maximum Gross: 3,700</p> <p>    Normal Takeoff: 3,550</p> <p>    Empty: 2,372</p> <p>Speed (km/h):</p> <p>    Maximum (level): 220</p> <p>    Cruise: 194</p> <p>Ceiling (m):</p> <p>    Service: 4,000</p> <p>    Hover (out of ground effect): 1,000</p> <p>    Hover (in ground effect): 2,000</p> <p>Vertical Climb Rate (m/s): 4.5</p> <p>Fuel (liters):</p> <p>    Internal: 600</p> <p>    Internal Aux Tank: N/A</p> <p>    External Fuel Tank: 238 ea.</p> <p>Range (km):</p> <p>    Maximum Load: 580</p> <p>    Normal Load: 340</p> <p>    With Aux Fuel: 790</p>	<p>Dimensions (m):</p> <p>    Length (rotors turning): 17.4</p> <p>    Length (fuselage): 11.9</p> <p>    Width: 3.2</p> <p>    Height: 3.7</p> <p>    Main Rotor Diameter: 14.6</p> <p>    Tail Rotor Diameter: 2.7</p> <p>Standard Payload:</p> <p>    Transports 6-8 troops or 700 kg internal cargo or 800 kg external load on 4x external hardpoints.</p> <p><b>Survivability/Countermeasures:</b></p> <p>    Main and tail rotor blades electrically deiced.</p> <p><b>ARMAMENT</b></p> <p><b>23-mm Automatic Cannon, NS-23KM:</b></p> <p>    Range: (practical) 2,500 m</p> <p>    Elevation/Traverse: None (rigidly-mounted)</p> <p>    Ammo type: HEFI, HEI, APT, APE, CC</p> <p>    Rate of Fire (rpm): (practical) 550</p> <p><b>7.62-mm or Pintle-mounted Machinegun:</b></p> <p>    (may be mounted in left-side cabin door)</p> <p>    Range: (practical) 1,000 m</p> <p>    Ammo type: HEFI, HEI, APT, APE, CC</p> <p>    Rate of Fire (rpm): (practical) 250</p> <p style="text-align: center;"><b>OR</b></p> <p><b>12.7-mm or Pintle-mounted Machinegun:</b></p> <p>    (may be mounted in left-side cabin door)</p> <p>    Range: (practical) 1,500 m</p> <p>    Ammo type: API, API-T, IT, HEI</p> <p>    Rate of Fire (rpm): (practical) 100</p>	<p><b>AVIONICS/SENSOR/OPTICS</b></p> <p>The cannon is pilot sighted, and fire is adjusted by controlling the attitude of the aircraft.</p> <p><b>Night/Weather Capabilities:</b></p> <p>The Mi-2 is primarily a daylight only aircraft.</p> <p><b>VARIANTS</b></p> <p><b>Mi-2R:</b> Ambulance version that carries 4x litter patients.</p> <p><b>Mi-2T:</b> Transport version that carries 8 personnel.</p> <p><b>Mi-2URN:</b> Armed reconnaissance variant, employs 57-mm unguided rockets, and mounts a gunsight in the cockpit for aiming all weapons.</p> <p><b>Mi-2URP:</b> The antitank variant. Carries 4x AT-3 Sagger wire-guided missiles on external weapons racks, and 4x additional missiles in the cargo compartment.</p> <p><b>Mi-2US:</b> The gunship variant, employs an airframe modification that mounted a 23-mm NS-23KM cannon to the portside fuselage. Also employs 2x 7.62-mm gun pods on external racks, and 2x 7.62-mm pintle-mounted machineguns in the cabin.</p> <p><b>PZL Swidnik:</b> A Polish-produced variant under license from Russia. Same performance, characteristics, and missions.</p>	

### NOTES

Available munitions are shown above; not all will be employed at the same time, mission dictates weapons configuration. External stores are mounted on weapons racks on each side of the fuselage. Each rack has two hardpoints for a total of four stations. Additional missions include; direct air support, antitank, armed reconnaissance, transport, medevac, airborne command post, smoke generating, minelaying, and training. The cabin door is hinged rather than sliding, which may limit operations. There is no armor protection for the cockpit or cabin. Ammo storage is in the aircraft cabin, so combat load varies by mission. Some Mi-2USs currently employ fuselage-mounted weapon racks rather than the 23-mm fuselage-mounted cannon which is removed. Some variants however, still employ the cannon.

## French Light Helicopter SA-341/GAZELLE

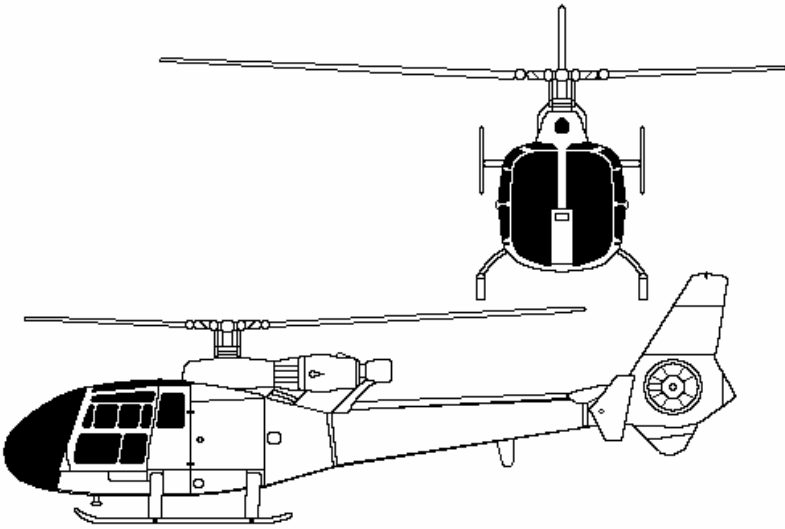
		<b>Weapon &amp; Armament Types</b> 7.62-mm MG or 20-mm GIAT M.621 cannon or 2x 7.62-mm AA-52 FN MG pods <b>Other Loading Options</b> 2.75-in rocket pods (7 ea.) 68-mm SNEB rocket pods (12 ea.) 57-mm rockets (18 ea.) HOT ATGM AT-3 SAGGER ATGM AS-11 ASM, or AS-12 ASM SA-7 GRAIL AAM MISTRAL AAM	<b>Combat Load</b>  100 1,000  2 2 2 4-6 4 4 or 2 2 2
		<b>SYSTEM</b> <b>Alternative Designations:</b> SA-342 <b>Date of Introduction:</b> 1973 <b>Proliferation:</b> At least 23 countries  <b>Description:</b> Variants in “( )” Crew: 1 or 2 (pilots) Blades: Main rotor: 3 Tail rotor: 13 (fenestron enclosed in tail) Engines: 1x 590-shp Turbomeca Astazou IIIB turboshaft Weight (kg): Maximum Gross: 1,800 (SA 341), 1,900 (SA 342K), 2,000 (SA 342L/M) Normal Takeoff: 1,800 Empty: 998 Speed (km/h): Maximum (level): 310 Cruise: 270 Ceiling (m): Service: 4,100 (SA 341), 5,000 (SA 342) Hover (out of ground effect): 2,000 (SA 341), 2,370 (SA 342) Hover (in ground effect): 2,850 (SA 341), 3,040 (SA 342) Vertical Climb Rate (m/s): 12.2 Fuel (liters): Internal: 445 Internal Aux Tank: 90 Additional Internal Aux Tank: 200 Range (km): Normal Load: 670 (SA 341), 735 (SA 342)	Dimensions (m): Length (rotors turning): 11.9 Length (fuselage): 9.5 Width: 2.0 Height: 3.1 Main Rotor Diameter: 10.5 Tail Rotor Diameter: 0.7 Cargo Compartment Dimensions (m): Floor Length: 2.2 Width: 1.3 Height: 1.2 Standard Payload (kg): Internal load: 750 External on sling only: 700 Transports 3 troops or 1 litter, or cargo.  <b>Survivability/Countermeasures:</b> IR signature suppressor on engine exhaust.  <b>ARMAMENT</b>  <b>Most Probable Armament:</b> <b>SA 341F:</b> A GIAT M.621 20-mm cannon is installed on starboard side of some aircraft. Rate of fire is selectable at 300 or 740 rpm. <b>SA 341H:</b> Can carry 4x AT-3 ATGMs, and 2x SA-7, or 128-mm or 57-mm rockets, and 7.62-mm machinegun in cabin. <b>SA 342K:</b> Armed antitank version with 4-6x HOT ATGMs. <b>SA 342L:</b> Either rocket pods or machineguns. <b>SA 342M:</b> Armed with 4-6x HOT antitank missiles, and possibly fitted with Mistral air to air missiles.

### NOTES

Available munitions are shown above; not all will be employed at the same time, mission dictates weapons configuration. External stores are mounted on weapons “outriggers” or racks on each side of the fuselage. Each rack has one hardpoint. Other missions include: attack, antitank, antihelicopter, reconnaissance, utility, transport, and training. The bench seat in the cabin area can be folded down to leave a completely open cargo area. Cargo floor has tiedown rings throughout.

# United States Attack Helicopter AH-1F/COBRA

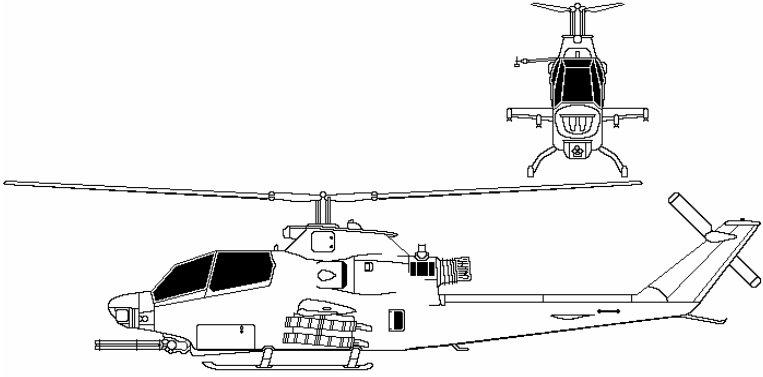
	<table border="1"> <thead> <tr> <th>Weapon &amp; Ammunition Types</th> <th>Combat Load</th> </tr> </thead> <tbody> <tr> <td>20-mm 3x barrel Gatling gun</td> <td>750</td> </tr> <tr> <td colspan="2"><b>Other Loading Options</b></td> </tr> <tr> <td>TOW missile pods (4 each)</td> <td>0-2</td> </tr> <tr> <td>2.75-in Hydra 70 rocket pods (19 each)</td> <td>2-4</td> </tr> <tr> <td>7.62-mm 6x barrel rotary MG pods</td> <td>0-2</td> </tr> </tbody> </table>	Weapon & Ammunition Types	Combat Load	20-mm 3x barrel Gatling gun	750	<b>Other Loading Options</b>		TOW missile pods (4 each)	0-2	2.75-in Hydra 70 rocket pods (19 each)	2-4	7.62-mm 6x barrel rotary MG pods	0-2
Weapon & Ammunition Types	Combat Load												
20-mm 3x barrel Gatling gun	750												
<b>Other Loading Options</b>													
TOW missile pods (4 each)	0-2												
2.75-in Hydra 70 rocket pods (19 each)	2-4												
7.62-mm 6x barrel rotary MG pods	0-2												
<p><b>SYSTEM</b></p> <p><b>Alternative Designations:</b> Hueycobra, Bell 209</p> <p><b>Date of Introduction:</b> 1986 (AH-1S)</p> <p><b>Proliferation:</b> At least 11 countries</p> <p><b>Description:</b>  Crew: 2 (pilots in tandem seats)  Blades:  Main rotor: 2  Tail rotor: 2  Engines: 1x 1,800-shp AlliedSignal Engines T-53-L-703 turboshaft  Weight (kg):  Maximum Gross: 4,535  Normal Takeoff: 4,524  Empty: 2,993  Speed (km/h):  Maximum (level): 315  Cruise: 227  Max "G" Force: INA  Ceiling (m):  Service: 3,720  Hover (out of ground effect): INA  Hover (in ground effect): 3,720  Vertical Climb Rate (m/s): 8.5  Internal Fuel (liters): 991  Range (km):  Normal Load: 610  With Aux Fuel: N/A  Dimensions (m):  Length (rotors turning): 16.3  Length (fuselage): 13.6  Width (including wing): 3.2  Height: 4.1  Main Rotor Diameter: 13.4  Tail Rotor Diameter: 2.6  Cargo Compartment Dimensions: negligible  Standard Payload (kg): 1,544</p>	<p><b>Survivability/Countermeasures:</b>  Infrared signature suppressors mounted on engine exhaust.  Radar warning receivers, IFF, Infrared jammer, chaff and flares.  Armored cockpit.</p> <p><b>ARMAMENT</b>  The chin-mounted turret accepts Gatling-type guns ranging from 7.62-mm to 30-mm. Some aircraft have been modified to accept Stinger missiles (air-to-air Stinger or ATAS).</p> <p><b>20-mm 3x barrel Gatling gun, M197:</b>  Range: (practical) 1,500 m  Elevation: 21° up to 50° down  Traverse: 220°  Ammo Type: AP, HE  Rate of Fire: burst 16±4, continuous 730±50</p> <p><b>Most Probable Armament:</b>  <b>AH-1G:</b> Either 2x 7.62-mm miniguns with 4,000 rounds or 2x 40-mm grenade launchers with 300 rounds (one each is possible) in chin turret. Also on underwing hardpoints, 2.75-in. FFAR, minigun pods, or 20-mm automatic cannons.  <b>AH-1S:</b> M197, 3x barrel 20-mm Gatling gun in chin turret. Also on underwing hardpoints, 8x BMG71 TOW antitank missiles, and 2x 2.75-in FFAR rocket pods.</p> <p><b>AVIONICS/SENSOR/OPTICS</b>  The TOW missile targeting system uses a telescopic sight unit (traverse 110°, elevation – 60°/+30°), a laser augmented tracking capability, thermal sights and a FLIR to allow for acquisition, launch, and tracking of all types of TOW missiles in all weather conditions.</p>	<p>The Cobra also uses a digital ballistic computer, a HUD, Doppler nav, and a low speed air data sensor on the starboard side for firing, and has in-flight boresighting. Available Israeli-made upgrades include an integrated FLIR with laser rangefinder, GPS, automatic boresighting, and the ability to fire both TOW II and Hellfire missiles.</p> <p><b>Night/Weather Capabilities:</b>  The AH-1 is fully capable of performing its attack mission in all weather conditions.</p> <p><b>VARIANTS</b>  Most older Cobra variants still in operation have been upgraded to the AH-1F standard. Also produced in Romania and Japan under license from Bell Textron in the U.S.</p> <p><b>AH-1G:</b> Initial production model in 1966</p> <p><b>AH-1S:</b> Upgraded 1960s produced aircraft in late 1980s to the standard TOW carrying version.</p> <p><b>AH-1P:</b> A set of AH-1S aircraft fitted with composite rotors, flat plate glass cockpits, and NVG capabilities.</p> <p><b>AH-1E:</b> A set of AH-1S aircraft upgraded with the Enhanced Cobra Armament System incorporating the universal turret, 20-mm gun, automatic compensation for off-axis gun firing, and weapon management system.</p> <p><b>AH-1F:</b> Current standard Cobra. Also referred to as the "Modernized Cobra". Incorporated all past upgrades.</p> <p><b>AH-1J/-1T/-1W:</b> See separate AH-1W entry.</p>											

**NOTES**

Available munitions are shown above; not all may be employed at one time. Mission dictates weapon configuration. External stores are mounted on underwing external stores points. Each wing has two hardpoints for a total of four stations. A representative mix when targeting armor formations would be eight TOW missiles, two 2.75-in rocket pods, and 750x 20-mm rounds. The gun must be centered before firing underwing stores. Additional missions include direct air support, antitank, armed escort, and air to air combat. Armored cockpit can withstand small arms fire, and composite blades and tailboom are able to withstand damage from 23-mm cannon hits and small arms fire. The composite blades and tailboom are able to withstand damage from 23-mm cannon hits.

## United States Attack Helicopter AH-1W/SUPERCOBRA

		<b>Weapon &amp; Ammunition Types</b>	<b>Combat Load</b>
		<b>20-mm 3x barrel Gatling gun</b>	<b>750</b>
		<b>Other Loading Options</b>	
		Hellfire missile pods (4 each)	0-2
		TOW missile pods (4 each)	0-2
		2.75-in Hydra 70 rocket pods (19 each)	2-4
		Sidewinder or Sidearm missiles	2
		External fuel tanks (liters)	<b>291/378</b>
<b>SYSTEM</b>  <b>Alternative Designations:</b> Seacobra, Supercobra, Bell 209 <b>Date of Introduction:</b> 1986 <b>Proliferation:</b> At least 3 countries <b>Description:</b> Crew: 2 (pilots in tandem seats) Blades: Main rotor: 2 Tail rotor: 2 Engines: 2x 1,775-shp General Electric T-700-GE-401 turboshaft Weight (kg): Maximum Gross: 6,700 Normal Takeoff: 6,700 Empty: 4,670 Speed (km/h): Maximum (level): 350 Cruise: 270 Max "G" Force: +2.5 to -0.5 g Ceiling (m): Service: 5,703 Hover (out of ground effect): 915 Hover (in ground effect): 4,270 Vertical Climb Rate (m/s): 4.0 Internal Fuel (liters): 1,150 Range (km): Normal Load: 590 With Aux Fuel: N/A Dimensions (m): Length (rotors turning): 17.7 Length (fuselage): 14.7 Width (including wing): 3.3 Height: 4.2 Main Rotor Diameter: 14.7 Tail Rotor Diameter: 3.0 Standard Payload (kg): 1,740	<b>Survivability/Countermeasures:</b> Infrared signature suppressors mounted on engine exhaust. Radar and laser warning receivers, IFF, Infrared jammer, missile warning system, chaff and flares, and rotor brake. Armored cockpit.  <b>ARMAMENT</b>  <b>20-mm 3x barrel Gatling gun, M197:</b> Range: (practical) 1,500 m Elevation: 21° up to 50° down Traverse: 220° Ammo Type: AP, HE Rate of Fire: Burst 16±4, continuous 730±50  <b>Most Probable Armament:</b> <b>AH-1W:</b> M197, 3x barrel 20-mm Gatling gun in chin turret. Also on underwing hardpoints, 8x TOW or Hellfire antitank missiles (or four of each), and 2x 2.75-in FFAR rocket pods. AIM-9 Sidewinder or AIM-123 Sidearm missiles provide air-to-air capability.	<b>Night/Weather Capabilities:</b> The AH-1 is fully capable of performing its attack and armed escort missions in all weather conditions from land- or sea-based launching platforms.  <b>VARIANTS</b>  Most older AH-1J and AH-1T Seacobra variants still in operation have been upgraded to the AH-1W standard.  <b>AH-1J:</b> Initial twin engine AH-1 variant fielded in the early 1970s.  <b>AH-1T:</b> Upgraded engines and powertrain system for improved performance. This minimally expanded rotor system and overall dimensions of the AH-1J.  <b>AH-1RO:</b> Construction of a variant of the aircraft may occur in the near future in Romania. Talks are ongoing between IAR industries and Bell Textron. It may be produced under the name "Dracula".  <b>AH-1Z/-1(4B)W:</b> Four-bladed variant called the "King Cobra" or "Viper" that contains an integrated digital cockpit, and has better flight performance.  <b>AH-1P/-1E/-1F:</b> See separate AH-1F entry.	

### NOTES

Available munitions shown above; not all may be employed at one time. Mission dictates weapon configuration. External stores are mounted on underwing external stores points. Each wing has two hardpoints for a total of four stations. A representative mix when targeting armor formations is eight TOW or Hellfire missiles (sometimes four of each missile is loaded), two 2.75-in rocket pods, and 750x 20-mm rounds. The gun must be centered before firing underwing stores. Additional missions include direct air support, antitank, armed escort, and air to air. Armored cockpit can withstand small arms fire, composite blades, tailboom, and fuel tanks withstand 23-mm cannon hits. This aircraft costs approximately \$10.7 million which is considered inexpensive when compared to other modern attack helicopters, but it's performance is similar. Therefore many nations consider this aircraft as a possible candidate for fielding in attack helicopter squadrons.

# Russian Attack Helicopter Ka-50/HOKUM

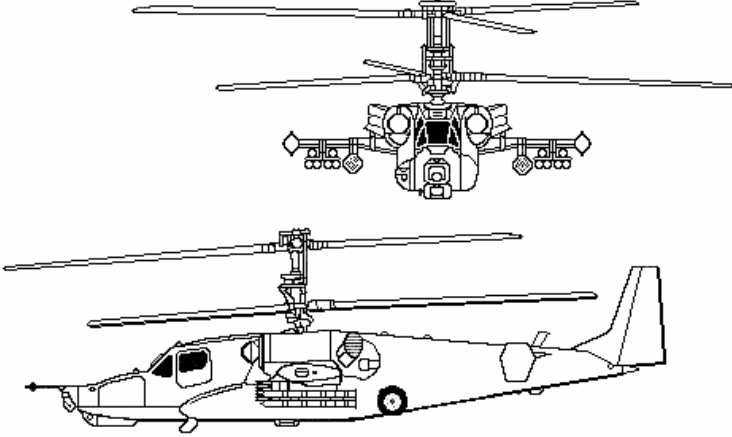
	<table border="1"> <thead> <tr> <th>Weapon &amp; Ammunition Types</th> <th>Combat Load</th> </tr> </thead> <tbody> <tr> <td>1x 2A42 30-mm cannon</td> <td></td> </tr> <tr> <td>HE-Frag</td> <td>250</td> </tr> <tr> <td>AP</td> <td>250</td> </tr> <tr> <td><b>Total</b></td> <td><b>500</b></td> </tr> <tr> <td colspan="2"><b>Other Loading Options</b></td> </tr> <tr> <td>AT-16 VIKhR ATGM (6 each)</td> <td>2</td> </tr> <tr> <td>80-mm rockets (20 each)</td> <td>2</td> </tr> <tr> <td>Twin 23-mm gun pods</td> <td>940</td> </tr> <tr> <td>500-kg bombs</td> <td>4</td> </tr> <tr> <td>AA-11/ARCHER AAM</td> <td>2</td> </tr> <tr> <td>External fuel tanks (liters)</td> <td>500</td> </tr> </tbody> </table>	Weapon & Ammunition Types	Combat Load	1x 2A42 30-mm cannon		HE-Frag	250	AP	250	<b>Total</b>	<b>500</b>	<b>Other Loading Options</b>		AT-16 VIKhR ATGM (6 each)	2	80-mm rockets (20 each)	2	Twin 23-mm gun pods	940	500-kg bombs	4	AA-11/ARCHER AAM	2	External fuel tanks (liters)	500	
	Weapon & Ammunition Types	Combat Load																								
1x 2A42 30-mm cannon																										
HE-Frag	250																									
AP	250																									
<b>Total</b>	<b>500</b>																									
<b>Other Loading Options</b>																										
AT-16 VIKhR ATGM (6 each)	2																									
80-mm rockets (20 each)	2																									
Twin 23-mm gun pods	940																									
500-kg bombs	4																									
AA-11/ARCHER AAM	2																									
External fuel tanks (liters)	500																									
<p><b>SYSTEM</b></p> <p><b>Alternative Designations:</b> Black Shark, Werewolf</p> <p><b>Date of Introduction:</b> N/A</p> <p><b>Proliferation:</b> Preproduction. An initial fielding plan is for 2 per year for 14 years.</p> <p><b>Description:</b>  Crew: 1 (pilots, 2 in Ka-52)  Blades:  Main rotor: 6 (2 heads, 3 blades each)  Tail rotor: None  Engines: 2x 2,200-shp Klimov TV3-117VK turboshaft  Weight (kg):  Maximum Gross: 10,800  Normal Takeoff: 9,800  Empty: 7,692  Speed (km/h):  Maximum (level): 340 (est.)  Cruise: 270  Sideward: 100+, Rearward: 100+  Turn Rate: unlimited  Max "G" Force: +3 to +3.5 g  Ceiling (m):  Service: 5,500  Hover (out of ground effect): 4,000  Hover (in ground effect): 5,500  Vertical Climb Rate (m/s): 10  Fuel (liters):  Internal: INA  External Fuel Tank: 500 ea. (max 4x)  Range (km):  Maximum Load: INA  Normal Load: 460  With Aux Fuel: INA  Dimensions (m):  Length (rotors turning): 16  Length (fuselage): 15.0  Width (including wing): 7.34  Height (gear extended): 4.93  Height (gear retracted): 4  Main Rotor Diameter: 14.5</p>	<p>Cargo Compartment Dimensions: Negligible  Standard Payload:  External weapons load: 2,500 kg on 4 under-wing stores points.</p> <p><b>Survivability/Countermeasures:</b>  Main rotors and engines electrically deiced.  Infrared signature suppressors can be mounted on engine exhausts.  Radar warning receivers, IFF, chaff and flares.  Armored cockpit and self-sealing fuel tanks.  Pilot ejection system.  (see NOTES)</p> <p><b>ARMAMENT</b>  <b>30-mm Automatic Cannon, 2A42:</b>  Range: effective 3,000 m  Elevation: -45° to +10°  Traverse: ±15°  Ammo type and rate of fire is selectable by pilot (HE or AP, 350 or 600)</p> <p><b>Most Probable Armament:</b> (shown above)  <b>HOKUM A/N:</b> Fuselage-mounted 30-mm cannon on right side, 80-mm rockets, AT-16 VIKhR ATGMs.</p> <p><b>HOKUM B:</b> Same as above.</p> <p><b>ATGM, AT-16/VIKhr:</b>  Guidance: Laser Beam Rider SACLOS  Range: 10,000 m  Warhead: HEAT  Penetration: 900 mm  Effective against ground &amp; air targets at converging speeds to 800 km/h.  ATGM racks can depress to 12°.</p>	<p><b>AVIONICS/SENSOR/OPTICS</b></p> <p>The HOKUM uses a low-light level TV or thermal sighting, a laser range-finder (10 km), FLIR, air data sensor, and digital datalink which interface with a fire control computer, an autopilot, a helmet sighting system and HUD for target location, acquisition, designation, and firing.</p> <p><b>Night/Weather Capabilities:</b>  This aircraft's avionics package ensuring a full day/night, all weather capability. If it is to be employed at night in an attack role, it must be fitted with a night targeting pod. This pod includes a FLIR, a millimeter wave radar, and an electro-optical sight takes up one of the underwing pylons. The Ka-50N, and Ka-52 are capable of performing attack missions in day/night, and all-weather conditions.  The French companies Thomson-CSF, and Sextant Avionique offer nav/attack systems, which can be fitted to export variants.</p> <p><b>VARIANTS</b></p> <p><b>Ka-50A/HOKUM A:</b> Standard direct air support variant.</p> <p><b>Ka-50N/HOKUM N:</b> Night attack variant fitted with a nose-mounted FLIR. The cockpit is fitted with an additional TV display, and is NVG compatible.</p> <p><b>Ka-52/HOKUM B:</b> The "Alligator" is a side-by-side, two-seat cockpit variant of the Ka-50. The gross weight of the aircraft is greater, so the performance is marginally degraded. But airframe characteristics, dimensions, and armaments are relatively similar. It includes a mast-mounted millimeter wave radar covering the front quadrant only. It is used as an attack aircraft, and as a trainer for the Ka-50.</p>																								

## Russian Attack Helicopter Ka-50/HOKUM continued

---

### NOTES

**This aircraft is not fielded. Only a handful of prototypes exist, and it has not yet been approved for full-scale production.**

The fully armored pilot's cabin can withstand 23-mm gunfire, and the cockpit glass 12.7-mm MG gunfire. The Zvezda K-37-800 pilot ejection system functions at any altitude. Available munitions are shown above; not all may be employed at one time. Mission dictates weapons configuration. External stores are mounted on underwing external hardpoints. Each wing has two hardpoints for a total of four stations. A typical mix for targeting armor formations is 12x AT-16 ATGMs, 500x 30-mm cannon rounds, and 2x 20-round pods of 80-mm folding fin unguided rockets. It was designed for remote operations, and not to need ground maintenance facilities for 2 weeks. The 30-mm cannon is the same as on the BMP-2. The firing computer will turn the aircraft to keep the gun on target. A coaxial counter-rotating rotor system negates the need for a tail rotor and its drive system. Because of this, this aircraft is unaffected by wind strength and direction, has an unlimited hovering turn rate, and gives a smaller profile and acoustic signature, while allowing a 10-15% greater power margin. The airframe is 35% composite materials with a structural central 1m<sup>2</sup> keel beam of kevlar/nomex that protects critical systems and ammunition. The HOKUM is fully aerobatic. It can perform loops, roll, and "the funnel", where the aircraft will maintain a concentrated point of fire while flying circles of varying altitude, elevation, and airspeed around the target.

# Russian Attack Helicopter Mi-24/HIND

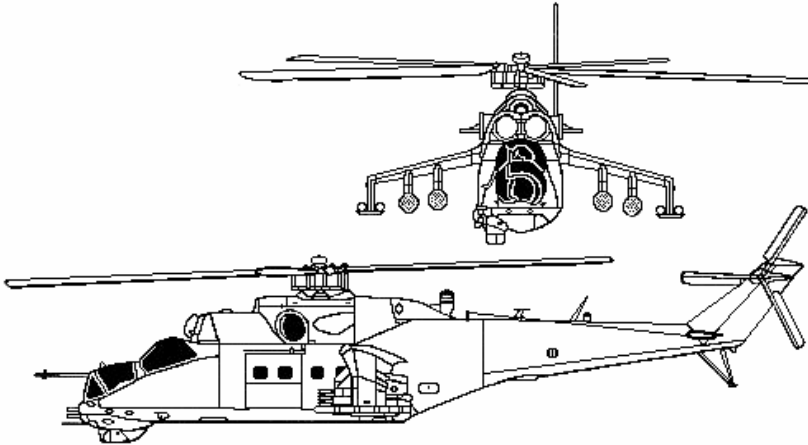
	<p><b>Weapon &amp; Ammunition Types</b></p> <p>1x twin 30-mm gun or 12.7-mm 4 barrel turret gun</p> <p><b>Other Loading Options</b></p> <p>AT-2C or AT-6C ATGMs</p> <p>80-mm S-8 rocket pods (20 ea.)</p> <p>57-mm S-5 rocket pods (32 ea.)</p> <p>GSh-23L twin 23-mm MG pods</p> <p>250-kg bombs</p> <p>500-kg bombs</p> <p>External fuel tanks (liters)</p>	<p><b>Combat Load</b></p> <p><b>750</b></p> <p><b>1,470</b></p> <p><b>2-12</b></p> <p><b>2-4</b></p> <p><b>2-4</b></p> <p><b>940</b></p> <p><b>4</b></p> <p><b>2</b></p> <p><b>500</b></p>
	<p><b>SYSTEM</b></p> <p><b>Alternative Designations:</b> INA</p> <p><b>Date of Introduction:</b> 1976 (HIND D)</p> <p><b>Proliferation:</b> At least 34 countries</p> <p><b>Description:</b></p> <p>Crew: 2 (pilots in tandem cockpits)</p> <p>Blades:</p> <p>    Main rotor: 5</p> <p>    Tail rotor: 3</p> <p>Engines: 2x 2,200-shp Klimov TV3-117VMA turboshaft</p> <p>Weight (kg):</p> <p>    Maximum Gross: 11,500</p> <p>    Normal Takeoff: 11,100</p> <p>    Empty: 8,500</p> <p>Speed (km/h):</p> <p>    Maximum (level): 335</p> <p>    Cruise: 295</p> <p>Max "G" Force: 1.75 g</p> <p>Ceiling (m):</p> <p>    Service: 4,500</p> <p>    Hover (out of ground effect): 1,500</p> <p>    Hover (in ground effect): 2,200</p> <p>Vertical Climb Rate (m/s): 15</p> <p>Fuel (liters):</p> <p>    Internal: 1,840</p> <p>    Internal Aux Tank (in cabin): 1,227</p> <p>    External Fuel Tank: 500 ea.</p> <p>Range (km):</p> <p>    Normal Load: 450</p> <p>    With Aux Fuel: 950</p> <p>Dimensions (m):</p> <p>    Length (rotors turning): 21.6</p> <p>    Length (fuselage): 17.5</p> <p>    Width (including wing): 6.5</p> <p>    Height (gear extended): 6.5</p> <p>    Main Rotor Diameter: 17.3</p> <p>    Tail Rotor Diameter: 3.9</p> <p>Cargo Compartment Dimensions (m):</p> <p>    Floor Length: 2.5</p> <p>    Width: 1.5</p> <p>    Height: 1.2</p>	<p>Standard Payload:</p> <p>    Internal load: 8 combat troops or 4 litters</p> <p>    External weapons load: 1,500 kg</p> <p>    External load (no weapons): 2,500 kg</p> <p><b>Survivability/Countermeasures:</b></p> <p>Main and tail rotors electrically deiced.</p> <p>Infrared signature suppressors can be mounted on engine exhausts.</p> <p>Radar warning receivers, IFF, Infrared jammer, rotor brake, chaff and flares.</p> <p>Armored cockpit.</p> <p><b>ARMAMENT</b></p> <p>Loaded combat troops can fire personal weapons through cabin windows.</p> <p><b>12.7-mm 4x Barrel Machinegun, YaKB-12.7:</b></p> <p>Range (m): (practical) 1,500</p> <p>Elevation/Traverse: 20° up to 60° down/ 120°</p> <p>Ammo Type: HEFI, APT, Duplex, DuplexT</p> <p>Rate of Fire (rpm): up to 4,500 (pilot selectable)</p> <p style="text-align: center;"><b>OR</b></p> <p><b>30-mm Twin Barrel Cannon, GSh-30K:</b></p> <p>Range (m): (practical) 4,000</p> <p>Elevation/Traverse: None (rigidly mounted)</p> <p>Ammo Type: HEFI, HEI, APT, APE, CC</p> <p>Rate of Fire (rpm): 300, or 2,000 to 2,600</p> <p><b>Most Probable Armament:</b> (HIND F pictured)</p> <p><b>HIND D:</b> Turret-mounted 4-barrel 12.7-mm Gatling type machinegun, 57-mm rockets, AT-2C/SWATTER ATGMs.</p> <p><b>HIND E:</b> Turret-mounted 4-barrel 12.7-mm Gatling type machinegun or twin barrel 23-mm turret gun, 57-mm rockets, AT-6C/SPIRAL ATGMs.</p> <p><b>HIND F:</b> Fixed 30-mm twin gun on the right fuselage side, 57-mm rockets, AT-6C/SPIRAL ATGMs.</p>



## **Russian Attack Helicopter Mi-24/HIND continued**

---

### **NOTES**

Available munitions are shown above; not all may be employed at one time. Mission dictates weapon configuration. External stores are mounted on underwing external stores points. Each wing has three hardpoints for a total of six stations. A representative mix when targeting armor formations would be eight AT-6 ATGMs, 750x 30-mm rounds, and two 57-mm rocket pods. Additional missions include direct air support, antitank, armed escort, and air to air combat. The aircraft can store an additional ammunition basic load in the cargo compartment in lieu of carrying troops. Armored cockpits and titanium rotor head able to withstand 20-mm cannon hits. Every aircraft has an overpressurization system for operation in a NBC environment.

The HIND's wings provide 22% to 28% of its lift in forward flight. In a steep banking turn at slower airspeeds, the low wing can lose lift while it is maintained on the upper wing, resulting in an excessive roll. This is countered by increasing forward airspeed to increase lift on the lower wing. Because of this characteristic, and the aircraft's size and weight, it is not easily maneuverable. Therefore they usually attack in pairs or multiple pairs, and from various directions.

# Russian Attack Helicopter Mi-28/HAVOC

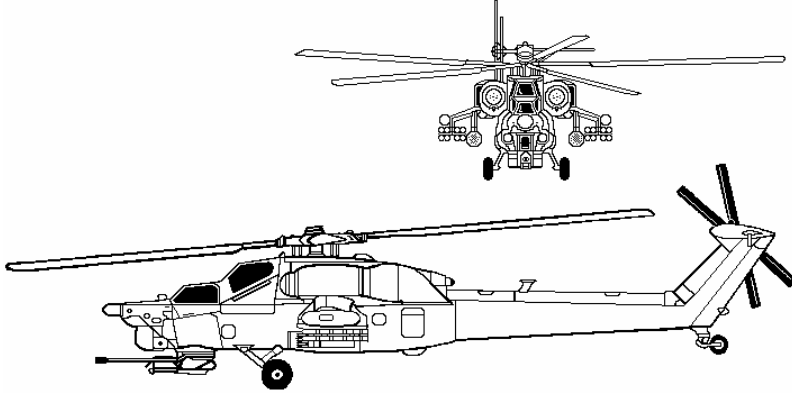
	<p><b>Most Common Armament:</b></p> <p>1x 2A42 30-mm cannon</p> <p>4x AT-6/SPIRAL or 4x AT-9/ATAKA ATGMs</p> <p>4x 80-mm rocket pod or 4x 57-mm rocket pod</p> <p><b>Other Loading Options:</b></p> <p>Twin 23-mm gun pods</p> <p>500-kg bombs</p> <p>External fuel tanks</p> <p>2x AA-16/GIMLET or 2x AA-18/ GROUSE AAM</p>	<p><b>Combat Load:</b></p> <p>300</p> <p>4 ea</p> <p>20 ea 16 ea</p> <p>940</p> <p>4</p> <p>2 ea</p>
	<p><b>SYSTEM</b></p> <p><b>Alternative Designations:</b> N/A</p> <p><b>Date of Introduction:</b> N/A</p> <p><b>Proliferation:</b> Preproduction. No fielding plan due to funding constraints. Only a few prototypes of each model have been constructed.</p> <p><b>Description:</b> Crew: 2 pilots in tandem cockpits</p> <p><b>Blades:</b> Main rotor: 5 Tail rotor: 4 (in "X" configuration)</p> <p><b>Engines:</b> 2x 2,200-shp Klimov TV3-117VMA turboshaft</p> <p><b>Weight (kg):</b> Max Gross: 11,500 Normal Takeoff: 10,400 Empty: 7,000</p> <p><b>Speed (km/h):</b> Max (level): 300 Cruise: 260 Sideward: 100, Rearward: 100 Turn rate: 60°/second Max "G" Force: -.5 to +3.7 g</p> <p><b>Ceiling (m):</b> Service: 6,000 Hover (out of ground effect): 3,600 Hover (in ground effect): INA</p> <p><b>Vertical Climb Rate (m/s):</b> INA</p> <p><b>Fuel (liters)</b> Internal: 1,900 Internal Aux Tank: N/A External Fuel Tank: INA</p> <p><b>Range (km)</b> Max Load: INA Normal Load: 475 With Aux Fuel: 1,100</p>	<p><b>Dimensions (m)</b> Length (rotors turning): 21.2 Length (fuselage): 16.8 Width (including wing): 4.9 Height: 4.7 Main Rotor Diameter: 17.2 Tail Rotor Diameter: 3.8</p> <p><b>Cargo Compartment Dimensions:</b> Negligible <b>Standard Payload:</b> 3,640 kg on 4 underwing stores points.</p> <p><b>Survivability/Countermeasures:</b> Main rotors and engines electrically deiced. Infrared signature suppressors can be mounted on engine exhausts. Radar warning receivers, pressurized cockpit, IFF, chaff, decoys and flares. Armored cockpit and self-sealing fuel tanks. Pilot ejection system (see NOTES).</p> <p><b>ARMAMENT</b> <b>30-mm Automatic Cannon, 2A42:</b> Range: Effective 3,000 m Elevation: -40° to +13°, Traverse: ±110° Ammo Type: HE, or AP Rate of Fire: 300 or 800</p> <p><b>Most Probable Armament:</b> <b>HAVOC A/N:</b> Chin-mounted 30-mm gun, 80-mm rockets, 16x ATGMs.</p> <p><b>ATGM, AT-6/SHTURM:</b> Guidance: SACLOS RF Range: 5,000-7,000 m (variant dependant) Warhead: Tandem HEAT Penetration: 700-950 mm (variant dependant)</p> <p><b>ATGM, AT-9/ATAKA:</b> Guidance: SACLOS RF Range: 6,000 m Warhead: Tandem HEAT Penetration: 1,000 mm</p>

## **Russian Attack Helicopter Mi-28/HAVOC continued**

---

### **NOTES**

**This aircraft is not fielded. Only a handful of prototypes exist, and it has not yet been approved for full-scale production.**

Although this aircraft is routinely compared to the U.S. AH-64 Apache, it is much larger and less maneuverable than its U.S. counterpart. The cockpit glass is bulletproof to 12.7-mm rounds, and resistant to fragmentation from 20-mm shells. The armored cockpit frame is made of titanium, steel, and ceramic. It can also withstand hits of 20-mm shells at a minimum. Rotor blade-tip pitot tubes give speed and drift information for targeting at low airspeed. The HAVOC has a high altitude ejection system that jettisons wings and cockpit doors while the crew jumps to safety with parachutes. It has a "technical compartment" which accommodates two persons. This is used to evacuate a crew from a downed aircraft. Available munitions are shown above; not all may be employed at one time. Mission dictates weapon configuration. External stores are mounted on underwing external hardpoints. Each wing has two hardpoints for a total of four stations. A typical mix for targeting armor formations is 16x ATGMs, 300x 30-mm cannon rounds, and 2x 20-round pods of 80-mm rockets. The 30-mm cannon is the same as on the BMP-2. A helmet sighting system turns the cannon in the direction the pilot is looking. However, the cannon is usually fired in the stowed position only.

## European Utility Helicopter AS-532/COUGAR

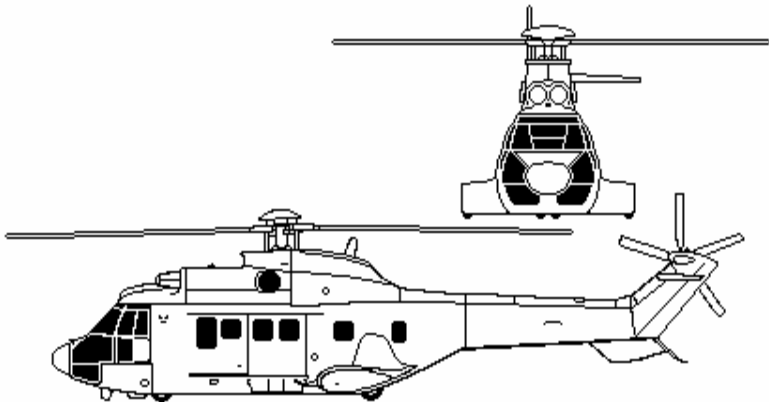
	<p><b>Weapon &amp; Ammunition Types</b></p> <p>7.65-mm MG</p> <p><b>Other Loading Options</b></p> <p>20-mm twin gun pods</p> <p>68-mm rocket pods (22 each)</p> <p>2.75-in rocket pods (19 each)</p> <p>External fuel tanks (liters)</p>	<p><b>Combat Load</b></p> <p>2</p> <p>2</p> <p>2</p> <p>2</p> <p><b>600</b></p>
	<p><b>SYSTEM</b></p> <p><b>Alternative Designations:</b> AS 332 Super Puma, SA 330 Puma</p> <p><b>Date of Introduction:</b> 1981</p> <p><b>Proliferation:</b> At least 38 countries</p> <p><b>Description:</b> Variants in “( )”</p> <p>Crew: 2 (pilots)</p> <p>Blades:</p> <p>    Main rotor: 4</p> <p>    Tail rotor: 5, 4 (U2/A2)</p> <p>Engines: 2x 1,877-shp Turbomeca Makila 1A1 turboshaft</p> <p>Weight (kg):</p> <p>    Maximum Gross: 9,000 (Mk I), 9,750 (Mk II)</p> <p>    Normal Takeoff: 8,600 (Mk I), 9,300 (Mk II)</p> <p>    Empty: 4,330 (UC/AC), 4,460 (UL/AL), 4,760 (U2/A2)</p> <p>Speed (km/h):</p> <p>    Maximum (level): 275 (Mk I), 325 (Mk II)</p> <p>    Cruise: 270</p> <p>Ceiling (m):</p> <p>    Service: 4,100</p> <p>    Hover (out of ground effect): 1,650 (Mk I), 1,900 (Mk II)</p> <p>    Hover (in ground effect): 2,800 (Mk I), 2,540 (Mk II)</p> <p>Vertical Climb Rate (m/s): 7</p> <p>Fuel (liters):</p> <p>    Internal: 1,497 (UC/AC), 2,000 (UL/AL), 2,020 (U2/A2)</p> <p>    Internal Aux Tank: 475 ea. (4x Mk I, 5x Mk II)</p> <p>Range (km):</p> <p>    Normal Load: 620 (UC/AC), 840 (UL/AL), 800 (U2/A2)</p> <p>    With Aux Fuel: 1,017 (UC/AC), 1,245 (UL/AL), 1,176 (U2/A2)</p> <p>Dimensions (m):</p> <p>    Length (rotors turning): 18.7-19.5 (U2/A2)</p>	<p>Dimensions continued (m):</p> <p>    Length (fuselage): 15.5 (UC/AC), 16.3 (UL/AL), 16.8 (U2/A2)</p> <p>    Width: 3.6-3.8 (U2/A2)</p> <p>    Height: 4.6</p> <p>    Main Rotor Diameter: 15.6-16.2 (U2/A2)</p> <p>    Tail Rotor Diameter: 3.1-3.2 (U2/A2)</p> <p>Cargo Compartment Dimensions (m):</p> <p>    Floor Length: 6.5 (AC/UC), 6.8 (UL/AL), 7.9 (U2/A2)</p> <p>    Width: 1.8</p> <p>    Height: 1.5</p> <p>Standard Payload (kg):</p> <p>    Internal load: 3,000</p> <p>    External on sling only: 4,500</p> <p>    Transports 20-29 troops or 6-12 litters (variant dependant), or cargo.</p> <p><b>Survivability/Countermeasures:</b></p> <p>Main and tail rotor blades electrically deiced. A radar warning receiver is standard, while a laser warning receiver, missile launch detector, missile approach detector, infrared jammer, decoy launcher, and flare/chaff dispensers are optionally available.</p> <p><b>ARMAMENT</b></p> <p>The Mk I variants may employ 2x 7.65-mm machine guns on pintle-mounts in the cabin doors when employed in a transport role.</p> <p><b>Most Probable Armament</b></p> <p>The armed versions have side-mounted 20-mm machineguns and/or axial pods fitted with 68-mm rocket launchers.</p> <p><b>AVIONICS/SENSOR/OPTICS</b></p> <p><b>Night/Weather Capabilities:</b></p> <p>The aircraft is NVG compatible, and through its instruments, avionics, full autopilot, and nav computer, is capable of operation in day, night, and instrument meteorological conditions.</p>

### NOTES

This helicopter is produced by the Eurocopter company. It was formed as a joint venture between Aerospatiale of France, and Daimler-Benz Aerospace of Germany. Additional missions include: VIP transport, electronic warfare, and anti-submarine warfare.

## Russian Utility Helicopter Mi-8/HIP

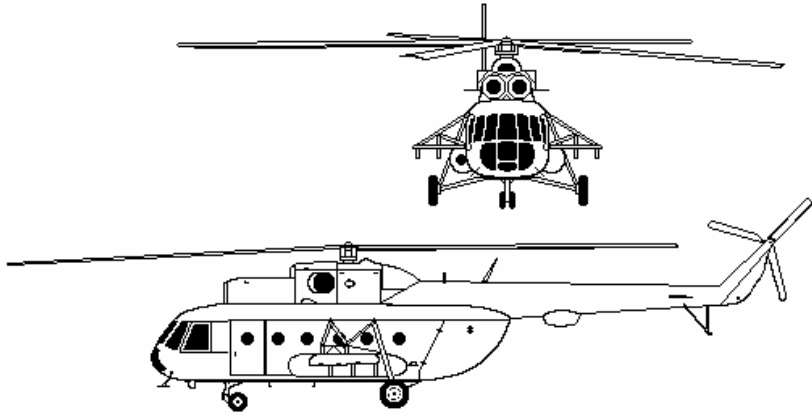
		<b>Weapon &amp; Ammunition Types</b> 2x 7.62-mm or 1x 12.7-mm MG	<b>Combat Load</b>
		<b>Other Loading Options</b> AT-2C or AT-3 ATGMs 57-mm rocket pods (16 each) 80-mm rocket pods (20 each) 250-kg bombs 500-kg bombs 12.7-mm MG pod Twin 23-mm gun pods Additional fuel tanks (liters)	4-6 4-6 2 4 2 2 2 <b>1,830</b>
<b>SYSTEM</b>  <b>Alternative Designations:</b> INA <b>Date of Introduction:</b> 1967 <b>Proliferation:</b> At least 54 countries  <b>Description:</b> Crew: 3 (2x pilots, 1x flight engineer) Blades: Main rotor: 5 Tail rotor: 3 Engines: 2x 1,700-shp Isotov TV2-117A turboshaft Weight (kg): Maximum Gross: 12,000 Normal Takeoff: 11,100 Empty: 6,990 Speed (km/h): Maximum (level): 250 Cruise: 225 Ceiling (m): Service: 4,500 Hover (out of ground effect): 800 Hover (in ground effect): 1,900 Vertical Climb Rate (m/s): 9 Fuel (liters): Internal: 445 Internal Aux Tank: 915 ea. External Fuel Tank: 745 in port tank, 680 in starboard tank Range (km): Maximum Load: INA Normal Load: 460 With Aux Fuel: 950	Dimensions (m): Length (rotors turning): 25.2 Length (fuselage): 18.2 Width: 2.5 Height: 5.6 Main Rotor Diameter: 21.3 Tail Rotor Diameter: 3.9 Cargo Compartment Dimensions (m): Floor Length: 5.3 Width: 2.3 Height: 1.8 Standard Payload: HIP C: 24 troops, or 3,000 kg internal or external loads on 4x hardpoints. HIP E: 24 troops, or 4,000 kg internal or 3,000 kg external on 6x hardpoints. HIP J/K: antennas on aft section of fuselage.  <b>Survivability/Countermeasures:</b> Main and tail rotor blades electrically deiced. Infrared jammer, chaff and flares.  <b>ARMAMENT</b>  Loaded combat troops can fire personal weapons through windows from inside cabin. The HIP E mounts a flexible 12.7-mm machinegun in the nose.  <b>AVIONICS/SENSOR/OPTICS</b>  <b>Night/Weather Capabilities:</b> The Mi-8 is equipped with instruments and avionics allowing operation in day, night, and instrument meteorological conditions.	<b>VARIANTS</b>  <b>Mi-8T:</b> The HIP C is a medium assault/transport version. The probable armament is 57-mm rockets, bombs, or AT-2C/ SWATTER ATGMs.  <b>Mi-8VPK:</b> The HIP D is an airborne communications platform with rectangular communication canisters mounted on weapons racks.  <b>Mi-8TVK:</b> The HIP E is used as a gunship or direct air support platform. Airframe modifications add 2x external hardpoints for a total of 6, and mount a flexible 12.7-mm machinegun in the nose. The probable armament is 57-mm rockets, bombs, or AT-2/SWATTER ATGMs.  <b>Mi-8MT/MTV/MTB/-171-17:</b> The HIP H is an upgraded medium assault/transport version. See separate Mi-17 entry.  <b>Mi-8SMV:</b> The HIP J is an airborne jamming platform characterized by small boxes on the left side of the fuselage.  <b>Mi-8PPA:</b> The HIP K is an airborne jamming platform characterized by 6x "X"-shaped antennas on the aft fuselage.  <b>Mi-9:</b> The HIP G is an airborne command post characterized by antennas, and Doppler radar on tailboom.	

### NOTES

Available munitions are shown above; not all may be employed at one time, mission dictates weapon configuration. External stores are mounted on weapons racks on each side of the fuselage. The HIP C has four external hardpoints; the HIP E, HIP H, have six; other variants have none. Interior seats are removable for cargo carrying. The rear clamshell doors open, an internal winch facilitates loading of heavy freight. Floor has tiedown rings throughout. The aircraft carries a rescue hoist capable to 150 kg, and a cargo sling system capable to 3,000 kg. The Mi-8 is capable of single-engine flight in the event of loss of power by one engine (depending on aircraft mission weight) because of an engine load sharing system. If one engine fails, the other engine's output is automatically increased to allow continued flight. See also Mi-17.

## Russian Utility Helicopter Mi-17/HIP

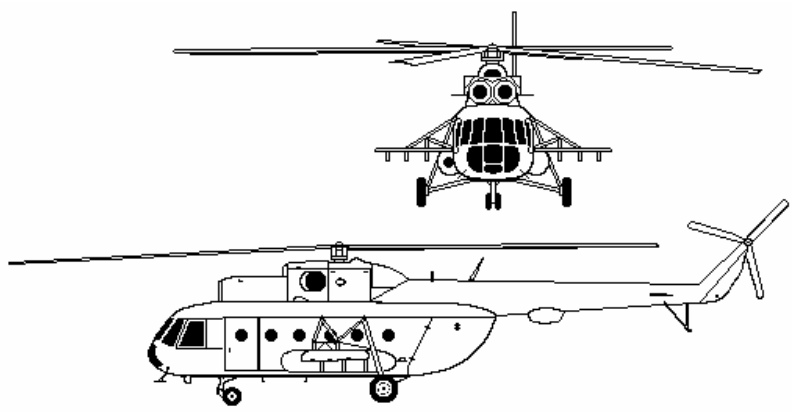
		<p><b>Weapon &amp; Ammunition Types</b></p> <p>2x 7.62-mm or 1x 12.7-mm MG</p> <p><b>Other Loading Options</b></p> <p>AT-2C or AT-3 ATGMs</p> <p>57-mm rocket pods (16 each)</p> <p>80-mm rocket pods (20 each)</p> <p>250-kg bombs</p> <p>500-kg bombs</p> <p>12.7-mm MG pod</p> <p>Twin 23-mm gun pods</p> <p>Additional fuel tanks (liters)</p>	<p><b>Combat Load</b></p> <p>4-6</p> <p>4-6</p> <p>2</p> <p>4</p> <p>2</p> <p>2</p> <p><b>1,830</b></p>
<p><b>SYSTEM</b></p> <p><b>Alternative Designations:</b> Mi-8MT HIP H</p> <p><b>Date of Introduction:</b> 1981 (as Mi-17)</p> <p><b>Proliferation:</b> At least 22 countries</p> <p><b>Description:</b></p> <p>Crew: 3 (2x pilots, 1x flight engineer)</p> <p>Blades:</p> <p>    Main rotor: 5</p> <p>    Tail rotor: 3</p> <p>Engines: 2x 1,950-shp Isotov TV3-117MT turboshaft</p> <p>Weight (kg):</p> <p>    Maximum Gross: 13,000</p> <p>    Normal Takeoff: 11,100</p> <p>    Empty: 7,100-7,370 (variant dependant)</p> <p>Speed (km/h):</p> <p>    Maximum (level): 250</p> <p>    Cruise: 240</p> <p>Ceiling (m):</p> <p>    Service: 5,000-5,700 (variant dependant)</p> <p>    Hover (out of ground effect): 1,760</p> <p>    Hover (in ground effect): 1,900-3,980 (variant dependant)</p> <p>Vertical Climb Rate (m/s): 9</p> <p>Fuel (liters):</p> <p>    Internal: 445</p> <p>    Internal Aux Tank: 915 ea.</p> <p>    External Fuel Tank:</p> <p>        Port Tank: 745</p> <p>        Starboard Tank: 680</p> <p>Range (km):</p> <p>    Normal Load: 495</p> <p>    With Aux Fuel: 1,065</p>	<p>Dimensions (m):</p> <p>    Length (rotors turning): 25.4</p> <p>    Length (fuselage): 18.4</p> <p>    Width: 2.5</p> <p>    Height: 5.7</p> <p>    Main Rotor Diameter: 21.3</p> <p>    Tail Rotor Diameter: 3.9</p> <p>Cargo Compartment Dimensions (m):</p> <p>    Floor Length: 5.3</p> <p>    Width: 2.3</p> <p>    Height: 1.8</p> <p>Standard Payload (kg):</p> <p>    Internal load: 4,000</p> <p>    External on sling only: 3,000</p> <p>    Transports 24 troops and cargo, or armaments on 6x external hardpoints.</p> <p><b>Survivability/Countermeasures:</b></p> <p>Main and tail rotor blades electrically deiced.</p> <p>Infrared jammer, chaff and flares.</p> <p><b>ARMAMENT</b></p> <p>Loaded combat troops can fire personal weapons through cabin windows from inside cabin.</p> <p><b>Most Probable Armament:</b></p> <p><b>HIP H:</b> Fitted with 2x 7.62-mm machineguns or possibly 2x 23-mm GSh-23 gun packs in cabin, 57-mm rockets, and AT3/SAGGER ATGMs.</p>	<p><b>AVIONICS/SENSOR/OPTICS</b></p> <p><b>Night/Weather Capabilities:</b></p> <p>The Mi-17 is equipped with instruments, avionics, Doppler radar, and a fully functioning autopilot for operation in day, night, and instrument meteorological conditions.</p> <p><b>VARIANTS</b></p> <p><b>Mi-17:</b> A mid-life upgrade of the widely proliferated Mi-8 HIP H medium assault/transport helicopter. Initially, only the export version was known as the Mi-17. The only visible differences between this variant and the older Mi-8s is that the tail rotor is on the portside rather than the starboard side, and crew armor plating.</p> <p><b>Mi-17P:</b> A descendent of the HIP K airborne jamming platform characterized by large rectangular antennas along the aft fuselage.</p> <p><b>Mi-171/-17M/-17V:</b> Also known as <b>Mi-8MTV</b>, and a descendent of the HIP H. The engines are upgraded to 2x 2,070-shp Klimov TV3-117VMAs to allow greater rates of climb and hover ceilings, yet performance characteristics remain virtually unchanged from the baseline Mi-17.</p> <p><b>Mi-8:</b> See separate entry.</p>	

### NOTES

Available munitions are shown above; not all may be employed at one time, mission dictates weapon configuration. External stores are mounted on weapons racks on each side of the fuselage. The Mi-17 has six external hardpoints. Additional missions include; attack, direct air support, electronic warfare, airborne early warning, medevac, search and rescue, and minelaying. Interior seats are removable for cargo carrying. The rear clamshell doors open, an internal winch facilitates loading of heavy freight. Floor has tie down rings throughout. The aircraft carries a rescue hoist capable to 150 kg. The Mi-17 is capable of single-engine flight in the event of loss of power by one engine (depending on aircraft mission weight) because of an engine load sharing system. If one engine fails, the other engine's output is automatically increased to allow continued flight. See also Mi-8.

## United Kingdom Multi-role Helicopter LYNX

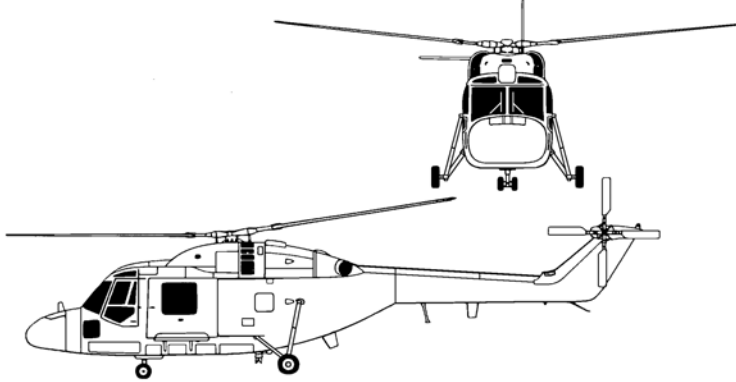
		<b>Weapon &amp; Ammunition Types</b>	<b>Combat Load</b>
		<b>Other Loading Options</b> 20-mm MG 2x 7.62-mm AA-52 FN MG pods 12.7-mm machinegun pod 20-mm GIAT Minigun pods 2x Antitank missile pods (4 each) 2x AAM pod 2x 68-mm or 2.75-in rocket pods (18 or 19 each)	2 2 2 2 8 2 36 or 38
<b>SYSTEM</b>  <b>Alternative Designations:</b> Battlefield Lynx, Super Lynx, Light Battlefield Helicopter, AH-1 <b>Date of Introduction:</b> 1977 <b>Proliferation:</b> At least 11 countries  <b>Description:</b> Variants in “( )” Crew: 2 (pilots) Blades: Main rotor: 4 Tail rotor: 4 Engines: 2x 900-shp Rolls Royce Gem 42-1 turboshaft, 2x 1,260 LHTEC CTS800-4N turboshaft (Mk 9) Weight (kg): Max Gross: 4,535, 5,126 (Mk 9) Normal Takeoff: 2,658, 3,496 (Mk 9) Empty: 2,578 Speed (km/h): Max (level): 289 Cruise: 259, 285 (Mk 9) Sideward: 130, Rearward: INA Max “G” Force: +2.3 to -0.5 Ceiling (m): Service: INA Hover (out of ground effect): 3,230, 5,126 Hover (in ground effect): 3,660 Vertical Climb Rate (m/s): 7 Fuel (liters): Internal: 985 Aux fuel: 696 Range (km): Normal Load: 630 With Aux Fuel: 1,342 Dimensions (m): Length (rotors turning): 15.2 Length (fuselage): 13.2 Width: 3.8, 3.0 (Mk 9) Height: 3.7 Main Rotor Diameter: 12.8 Tail Rotor Diameter: 2.2, 2.4 (Mk 9)	Cargo Compartment Dimensions (m): Floor Length: 2.1 Width: 1.8 Height: 1.4 Standard Payload (kg): Internal load: 907 External on sling only: 1,360, 2,000 (Mk 9) Transports 9 troops, 6 litters or cargo.  <b>Survivability/Countermeasures:</b> Engine exhaust suppressors. An infrared jammer, and flare/chaff dispensers are available. Rotor brake and self-sealing fuel tanks.  <b>ARMAMENT</b>  The Lynx employed by ground forces can be equipped with two 20-mm cannons mounted externally to permit 7.62-mm machineguns to be fired from the cabin. Two fuselage pylons allow for external stores.  <b>Most Probable Armament</b> The armed versions have side-mounted 20-mm machineguns and 8x HOT/Hellfire/TOW ATGMs. An additional load of 8 missiles can be carried in the cabin.  Army variants equipped for TOW missiles have a roof-mounted sight (over the left-hand pilot’s seat) with IR and thermal capabilities for firing. Optional equipment allows for target magnification, LLLTV, cameras, and IR searchlight.	<b>AVIONICS/SENSOR/OPTICS</b>  <b>Night/Weather Capabilities:</b> The aircraft is NVG compatible, and through its instruments, avionics, autopilot, and doppler navigation system, is capable of operation in day, night, and instrument meteorological conditions.  <b>VARIANTS</b>  Developed under a partnership between predominantly Westland of the United Kingdom, and Aerospatiale of France. Listed below are the primary, most proliferated variants used by ground forces. Many others exist in small numbers for ground and naval forces.  <b>Lynx AH. Mk 1:</b> The basic army general purpose and utility version. This aircraft has skid-type landing gear. Most have been converted to <b>Mk 7</b> format.  <b>Lynx AH. Mk 7:</b> Also known as <b>AH 1</b> . Upgraded British army version, some with improved main rotor blades. Reverse-direction tail rotor to reduce noise signatures and improve performance. This aircraft has skid-type landing gear.  <b>Lynx AH. Mk 9:</b> Also known as <b>Super Lynx</b> or <b>Light Battlefield Helicopter</b> . Implemented tricycle-type landing gear, improved rotor blades, and upgraded engines to increase performance. Mostly used in tactical transport role, with no ATGM launch capability.  <b>Battlefield Lynx:</b> Export version of Lynx AH. Mk 9 that can be armed with ATGMs.	

### NOTES

This aircraft was designed to be both a transport and an attack aircraft. Additional missions include: VIP transport, search and rescue, mine-laying, and anti-submarine warfare. Squadrons are aligned along aircraft models. Available munitions are shown above; not all may be employed at one time. Mission dictates weapon configuration. External stores are mounted on two points. Each fuselage side has one pylon allowing for a single gun pod or missile rack. The Lynx is capable of single-engine flight in the event of loss of power by one engine (depending on aircraft mission weight) because of an engine load sharing system. If an engine fails, the other’s output is increased to allow continued flight.

## Russian Transport Helicopter Mi-6/HOOK

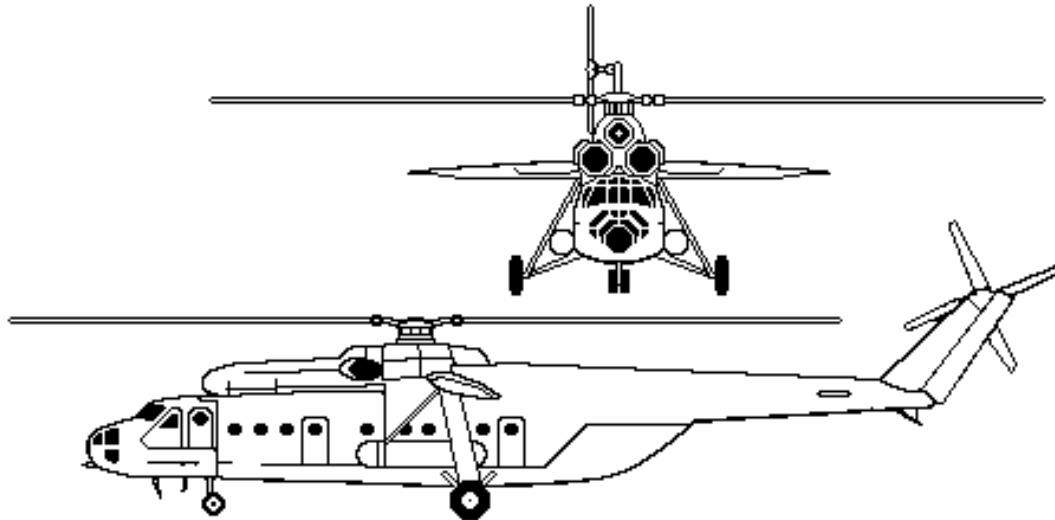

<p><b>SYSTEM</b></p> <p><b>Alternative Designations:</b> INA  <b>Date of Introduction:</b> 1961  <b>Proliferation:</b> At least 15 countries</p> <p><b>Description:</b>  Crew: 5 (2x pilots, 1x navigator, 1x flight engineer, 1x radio operator)  Blades:  Main rotor: 5  Tail rotor: 4  Engines: 2x 5,500-shp Soloviev D-25V (TV-2BM) turboshaft  Weight (kg):  Max Gross: 42,500-46,800  Normal Takeoff: 40,500  Empty: 27,240  Speed (km/h):  Max (level): 300  Cruise: 250  Ceiling (m):  Service: 4,500  Fuel (liters):  Internal: 6,315  Internal Aux Tank: INA  External Fuel Tank: 3,490</p>	<p>Range (km):  Max Load: 620  With Aux Fuel: 1,000 km  Dimensions (m):  Length (rotors turning): 41.7  Length (fuselage): 33.2  Width (including wing): 15.3  Height: 9.9  Main Rotor Diameter: 35.0  Tail Rotor Diameter: 6.3  Cargo Compartment Dimensions (m):  Floor Length: 12  Width: 2.65  Height: Variable from 2.0 to 2.5  Standard Payload:  Internal: 12,000 kg with rolling takeoff  External: 8,000 kg at hover  Transports over 65 troops, or 41 litters, or 1x BRDM-2 scout car, or 1x BMD, or 1x GAZ truck, or 1x 7,500 liter POL truck or 12,000 liters in soft bladders.</p> <p><b>Survivability/Countermeasures:</b>  Main rotor blades electrically deiced.  Tail rotor blades have internal anti-icing fluid.</p> <p><b>ARMAMENT</b></p> <p>Some aircraft used for tactical missions have a 12.7 mm machinegun in the nose.</p>	<p><b>AVIONICS/SENSOR/OPTICS</b></p> <p><b>Night/Weather Capabilities:</b>  The avionics and navigational package, and a fully functioning autopilot allow for day/night all-weather operation.</p> <p><b>VARIANTS</b></p> <p><b>Mi-6A/-6T/HOOK A:</b> Basic civil and military transport version.</p> <p><b>Mi-6VKP/HOOK B:</b> Airborne command post variant.</p> <p><b>Mi-6VUS/HOOK C:</b> Developed airborne command post. Also known as <b>Mi-22</b>.</p> <p><b>Mi-6AYaSh/HOOK D:</b> Airborne command post with possible side-looking airborne radar fairing.</p> <p><b>Mi-6S:</b> Medevac variant.</p> <p><b>Mi-6TZ:</b> Tanker variant.</p>
---	---	---

### NOTES

Removable stub wings, when installed, are fixed at a 15° incidence relative to the longitudinal axis. They provide 20% of the total lift in forward flight. Aircraft production ended in 1981. Aircraft has hydraulically actuated rear clamshell doors and ramp, provisions for internal cargo tie-down rings, an 800 kg capacity internal winch system in cargo compartment, floor capacity is 2,000 kg/m<sup>2</sup>, and a central hatch in the cabin floor for sling loads.



## Russian Transport Helicopter Mi-26/HALO

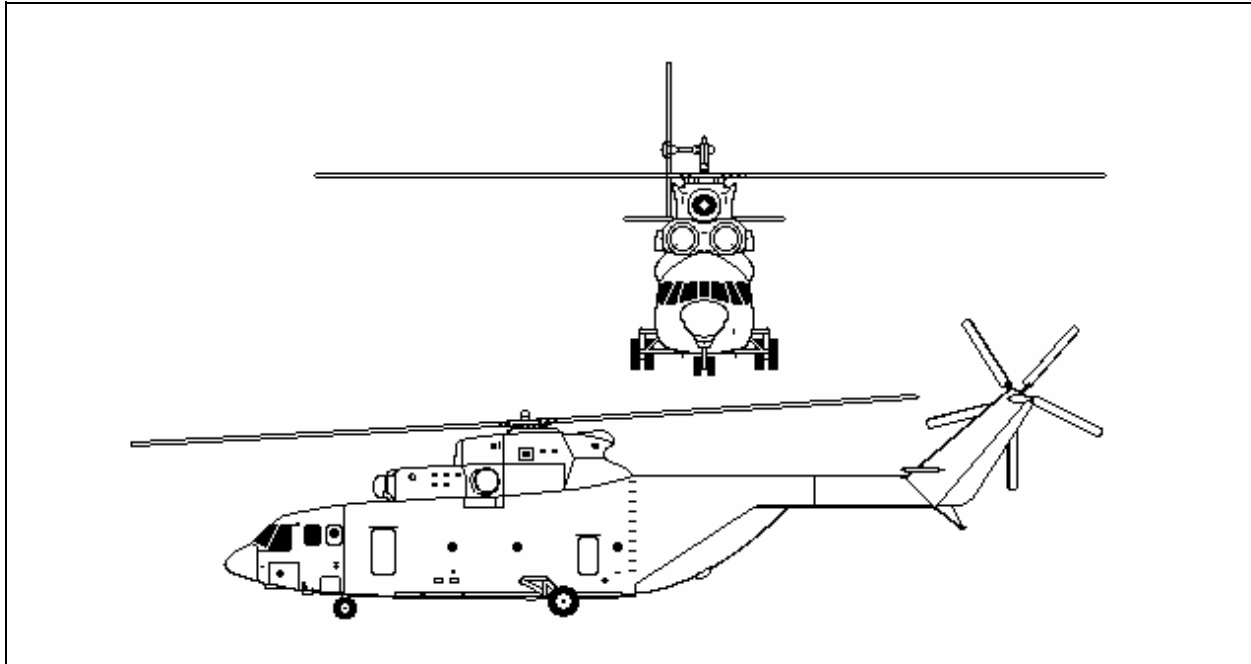

<p><b>SYSTEM</b></p> <p><b>Alternative Designations:</b> INA  <b>Date of Introduction:</b> 1983  <b>Proliferation:</b> At least 5 countries</p> <p><b>Description:</b>  Crew: 5 (2x pilots, 1x navigator, 1x flight engineer, 1x loadmaster)  Blades:  Main rotor: 8  Tail rotor: 5  Engines: 2x 11,400-shp Lotarev D-136 turboshaft  Weight (kg):  Maximum Gross: 56,000  Normal Takeoff: 49,500  Empty: 28,240  Speed (km/h):  Maximum (level): 295  Cruise: 255  Ceiling (m):  Service: 4,500  Hover (out of ground effect): 1,800  Hover (in ground effect): 4,500  Vertical Climb Rate: INA</p>	<p>Fuel (liters):  Internal: 11,900  Range (km):  Maximum Load: 800  Normal Load: INA  With Aux Fuel: 1200 km  Dimensions (m):  Length (rotors turning): 40  Length (fuselage): 33.5  Width: 8.2  Height: 8.1  Main Rotor Diameter: 32  Tail Rotor Diameter: 7.6  Cargo Compartment Dimensions (m):  Floor Length: 12  Width: 3.3  Height: variable from 2.9 to 3.2  Standard Payload:  Internal or external load: 20,000 kg  Transports over 80 troops, 60 litters, or 2x BRDM-2 scout cars, or 2x BMDs, or 1x BMP or, 1x BTR-60/70/80 or, 1x MT-LB.</p> <p><b>Survivability/Countermeasures:</b>  Main and tail rotor blades electrically deiced.  Infrared signature suppressors on engines.  Infrared jammers and decoys; flares.  Self-sealing fuel tanks.</p>	<p><b>ARMAMENT</b></p> <p>None</p> <p><b>AVIONICS/SENSOR/OPTICS</b></p> <p><b>Night/Weather Capabilities:</b>  The avionics and navigational package, a Doppler weather radar, and a fully functioning autopilot allow for day/night all-weather operation.</p> <p><b>VARIANTS</b></p> <p><b>Mi-26MS:</b> Medical evacuation version.  <b>Mi-26T:</b> Freight transport.  <b>Mi-26TZ:</b> Fuel tanker with an additional 14,040 liters of fuel in 4x internal tanks and 1,040 liters of lubricants, pumped through 4x 60-meter long refueling nozzles for refueling aircraft, and 10x 20-meter long hoses for refueling ground vehicles. Fuel transfer rate is 300 liters/minute for aviation fuel, and 75-150 liters/minute for diesel fuel. The refueling system can easily be removed to allow the aircraft to perform transport missions.</p>
--	---	---

### NOTES

The HALO A has no armament. The load and lift capabilities of the aircraft are comparable to the U.S. C-130 Hercules transport aircraft. The length of the landing gear struts can be hydraulically adjusted to facilitate loading through the rear doors. The tailskid is retractable to allow unrestricted approach to the rear clamshell doors and loading ramp. The cargo compartment has two electric winches (each with 2,500 kg capacity) on overhead rails can move loads along the length of the cabin. The cabin floor has rollers and tie-down rings throughout. The HALO has a closed-circuit television system to observe positioning over a sling load, and load operations. The Mi-26 is capable of single-engine flight in the event of loss of power by one engine (depending on aircraft mission weight) because of an engine load sharing system. If one engine fails, the other engine's output is automatically increased to allow continued flight.

## Chapter 10 Fixed-Wing Aircraft

This chapter provides the basic characteristics of selected fixed-wing aircraft readily available to the OPFOR. Both FM 100-60, *Armor- and Mechanized-Based Opposing Force: Organization Guide*, and FM 100-63, *Infantry-Based Opposing Force: Organization Guide*, use descriptors to indicate aircraft capabilities. In each manual, a substitution matrix enables the trainer to structure OPFOR air support requirements as required by capability rather than specific type.

**Fixed-Wing Aircraft**, generally covers the systems that will affect the planning and actions of the tactical-level ground maneuver force, and aircraft commonly employed by the OPFOR when in close proximity to enemy ground forces. Therefore, fighters and long-range bombers are not addressed unless they are routinely employed in training scenarios. This chapter classifies aircraft as strike, ground-attack, multi-role, and transport aircraft. Multi-role aircraft are able to support missions across each of the categories. This chapter encompasses many aircraft which may have a dual civil/military application. It does not include, however, aircraft designed and used primarily for civil aviation.

This sampling of systems was selected because of wide proliferation across numerous countries or because of already extensive use in training scenarios. Additional data sheets addressing other widely proliferated aircraft will be sent with further supplements to this guide.

Because of the increasingly large numbers of variants of each aircraft, only the most common variants produced in significant numbers were addressed. If older versions of airplanes have been upgraded in significant quantities to the standards of newer variants, the older versions were not addressed.

The munitions available to each aircraft are mentioned, but not all may be employed at the same time. The weapon systems inherent to the airframe are listed under armament. The most probable weapon loading options are also given, but assigned mission dictates actual weapon configuration. Therefore, any combination of the available munitions may be encountered.

Questions and comments on data listed in this chapter should be addressed to:

**CPT (P) Blake Burslie**  
DSN: 552-7922, Commercial (913) 684-7922  
e-mail address: [burslieb@leavenworth.army.mil](mailto:burslieb@leavenworth.army.mil)

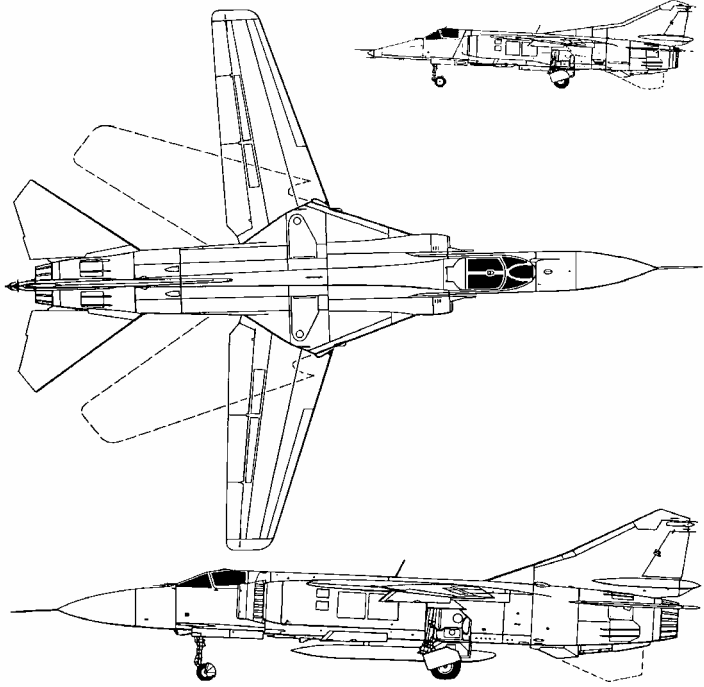

# Russian Strike Aircraft MiG-23/FLOGGER

		<b>Weapon &amp; Ammunition Types</b>	<b>Combat Load</b>
		23-mm Gsh-23L twin gun or 23-mm 6x barrel Gsh-6-23 gun	<b>200</b>  <b>260</b>
		<b>Other Loading Options</b>	
		240-mm S-24 rockets (1 each) or 80-mm S-8 rocket pods (20 ea) or 57-mm S-5 rocket pods (32 ea)	<b>4</b>
		AS-7/KERRY ASM or AS-10/KAREN ASM or AS-12/KEGLER ASM or AS-14/KEDGE ASM	<b>4</b>
		2x AA-7 APEX or AA-8/APHID AAM launchers	<b>2</b>
		Gun Pods	
		External fuel tanks (liters)	<b>800</b>
		50-kg, 100-kg, 250-kg, or 500-kg unguided and guided bombs	
<b>SYSTEM</b>  <b>Alternative Designations:</b> MiG-27, Bahadur, or Valiant (Indian variant) <b>Date of Introduction:</b> 1972 <b>Proliferation:</b> At least 23 countries  <b>Description:</b> Variants in ( ) Crew: 1 (pilot) Appearance: Wings: High-mount, variable, tapered Engines: One in fuselage Fuselage: Long and tubular, with box-like intakes and large, swept belly-fin Tail: Swept-back, tapered with angular tip, swept, tapered flats mounted on fuselage Engines: 1x 28,660-shp Soyuz/Kachaturov R-35-300 (MiG-23)/ or 1x 25,335-shp R-29B-300 (MiG-27) turbojet with afterburner Weight (kg): Max Gross: 17,800 (MiG-23)/ 20,700 (MiG-27) Normal Takeoff: 14,840 (MiG-23)/ 18,900 (MiG-27) Empty: 10,200 (MiG-23)/11,908 (MiG-27) Speed (km/h): Max (at altitude): Mach 2.35 (MiG-23)/ Mach 1.7 (MiG-27) Max (sea level): Mach 1.2 Takeoff/Landing Speed: 315/270 Max "G" Force (g): +8.5 g (MiG-23)/ +7.0 (MiG-27) Ceiling (m): Service (clean): 18,600 With External Stores: INA	Vertical Climb Rate (m/s): 240 Fuel (liters): Internal: 4,250 (MiG-23)/ 5,400 (MiG-27) External: Up to 5x 800 liter tanks Range (km): Max Load: 1,500 With Aux Fuel: 2,500 Combat Radius: 1,150 Takeoff Run/Landing Roll (m): Prepared Surface: 500/750 (MiG-23)/ 950/1,300 (MiG-27) Dimensions (m): Length: 16.8 (MiG-23)/ 17.1 (MiG-27) Wingspan: 14.0 extended, 7.8 swept Height: 4.8 (MiG-23)/ 5.0 (MiG-27) Standard Payload (kg): External: 3,000 (MiG-23)/ 4,000 (MiG-27) Hardpoints: 5 (MiG-23)/7 (MiG-27)  <b>Survivability/Countermeasures:</b> Pressurized cockpit with zero/130 ejection seat, infrared and radar jammer, radar warning receiver, decoy, chaff and flares. Armored cockpit on MiG-27  <b>ARMAMENT</b> The MiG-23 has a twin gun, and the MiG-27 has a 6x barrel Gatling gun.  <b>23-mm twin gun, Gsh-23L:</b> Range (m): (practical) 2,500 Elevation/Traverse: None (rigidly mounted) Ammo Type: HEFI Rate of Fire (rpm): 9,000	<b>23-mm 6x barrel gun, Gsh-6-23:</b> Range (m): (practical) 2,500 Elevation/Traverse: None (rigidly mounted) Ammo Type: HEFI Rate of Fire (rpm): 9,000  <b>AVIONICS/SENSOR/OPTICS</b> The MiG-23 has an acquisition and tracking radar, IR sensor, and Doppler nav system. The MiG-23B and MiG-27 series have a flattened nose section which houses a laser rangefinder/designator, TV sighting system, and a target tracker instead of the radar to attack ground targets.  <b>Night/Weather Capabilities:</b> The MiG-23 is capable of attacking air targets day or night. The MiG-27 is capable of attacking ground targets in day, night, and poor weather conditions.  <b>VARIANTS</b>  <b>MiG-23M/-23MF/-23MS/FLOGGER B:</b> Standard interceptor, and first production variant. Export version is <b>FLOGGER E</b> .  <b>MiG-23U/-23UM/-23UB/FLOGGER C:</b> A tandem seat combat and trainer variant.  <b>MiG-23B/-23BN/-23BN/-23BK/FLOGGER F/and FLOGGER H:</b> Export fighter/bomber variant with Gsh-23 twin barrel gun, and tapered nose. Evolved into MiG-27.	

## Russian Strike Aircraft MiG-23/FLOGGER continued

---

<p><b>MiG-23ML/-23P/-23MLD/FLOGGER G and FLOGGER K:</b> Primary production variant. Similar to FLOGGER B.</p> <p><b>MiG-27K/FLOGGER D:</b> Ground-attack variant with internal 6x barrel 23-mm gun. Appearance differs by tapered nose.</p> <p><b>MiG-27D/FLOGGER J:</b> Appearance differs by a long downward-sloping, pointed nose. Can be fitted with a three-camera recon pod.</p> <p><b>MiG-27M/-27L:</b> Export versions built by Hindustan Aeronautics in India.</p>		
---	--	--

### NOTES

Inset line-drawing shows nose and intake differences of the MiG-27. This difference allows for a laser rangefinder/target designator. The sweep wing is capable of three angles: 16, 45, and 72 degrees. The ventral fin on the bottom rear of the fuselage folds for takeoff and landing. Up to five external fuel tanks can be carried on the MiG-23, and four on the MiG-27, but the MiG-27 can also be fitted for aerial refueling. Available munitions are shown above; not all may be employed at one time. Mission dictates weapons configuration. External stores are mounted on underwing and underbody hardpoints. Each wing has one point, two points are under the intakes along the fuselage, and the center fuselage attachment point gives five total stations. The MiG-27 then adds two more bomb racks under the wings for a total of seven stations.

## Russian Strike Aircraft Su-24D/FENCER

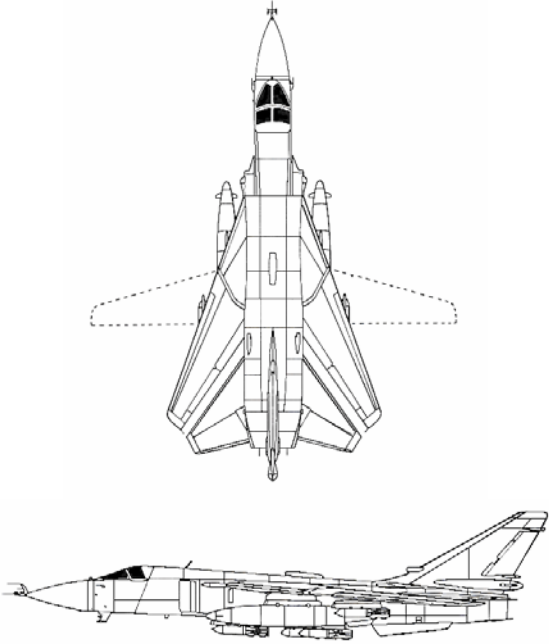
	<p><b>Weapon &amp; Ammunition Types</b></p> <p><b>23-mm 6x barrel Gsh-6-23 gun</b></p> <p><b>Other Loading Options</b></p> <p>TN1000 or TN11200 nuclear weapons</p> <p>100-kg FAB-100 bombs</p> <p>TV or laser-guided bombs</p> <p>AS-7/KERRY ASM or AS-10/KAREN ASM or AS-11/KILTER ASM or AS-12/KEGLER ASM or AS-13/KINGBOLT ASM or AS-14/KEDGE ASM or AS-17/KRYPTON ASM</p> <p>Gun pods</p> <p>AA-8/APHID AAM</p> <p>External fuel tanks (liters)</p>	<p><b>Combat Load</b></p> <p><b>250</b></p> <p><b>38</b></p> <p><b>4</b></p> <p><b>3</b></p> <p><b>2</b></p> <p><b>2,000 or 3,000</b></p>
	<p><b>SYSTEM</b></p> <p><b>Alternative Designations:</b> None</p> <p><b>Date of Introduction:</b> 1975</p> <p><b>Proliferation:</b> At least 11 countries</p> <p><b>Description:</b> Crew: 2 (pilot, weapon systems operator) Appearance: Wings: High-mount, variable, tapered back Engines: Both along body, under wings Engines: 2x 17,200-shp Lyulka AL-21F-3A turbojet (24,700-shp with afterburner) Weight (kg): Maximum Gross: 39,700 Normal Takeoff: 35,910 Empty: 22,320 Speed (km/h): Maximum (at altitude): 2,320 Maximum (sea level): 1,530 Maximum Attack Speed: 1,200 Cruise: INA Takeoff/Landing Speed: INA Max "G" Force (g): +6.5 g Ceiling (m): Service (clean): 17,500 With External Stores: INA Vertical Climb Rate (m/s): 150</p>	<p>Fuel (liters): Internal: 11,760 External: 8,000 Range (km): Maximum Load: 940 With Aux Fuel: 1,230 Combat Radius: 950 Takeoff Run/Landing Roll (m): Prepared Surface: 1,100-1,200/950 Dimensions (m): Length: 24.6 Wingspan: 17.6 extended, 10.4 swept Height (gear extended): 6.2 Standard Payload (kg): External: 8,000 Hardpoints: 9 underwing</p> <p><b>Survivability/Countermeasures:</b> Pressurized cockpit with zero/zero ejection seats, infrared and radar jammer, radar and missile warning receivers, chaff and flares.</p> <p><b>ARMAMENT</b> <b>23-mm 6x barrel gun, Gsh-6-23:</b> Range (m): (practical) 2,500 Elevation/Traverse: None (rigidly mounted) Ammo Type: HEFI Rate of Fire (rpm): 9,000</p>

### NOTES

This aircraft was the first developed specifically as a bomber for the ground-attack role. It has a variable swept-wing, that can be set at 16, 45, or 69 degrees. Some aircraft are capable of aerial refueling, and all can carry up to three external fuel tanks for extended range. There is no internal weapons bay. Available munitions are shown above; not all may be employed at one time. Mission dictates weapons configuration. External stores are mounted on underwing hardpoints. Each wing has four points, and the center fuselage attachment point gives nine total stations.

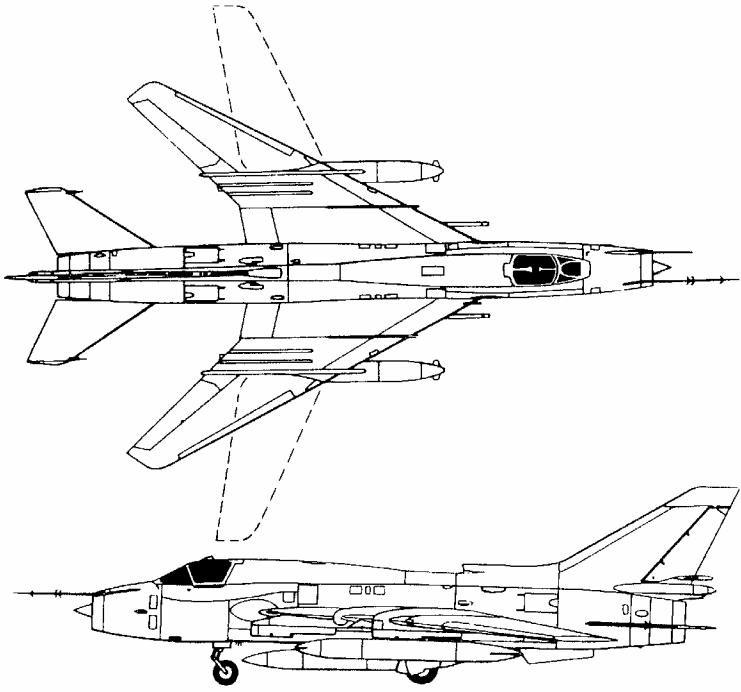

# Russian Ground-Attack Aircraft Su-17/FITTER

	<p><b>Weapon &amp; Ammunition Types</b></p> <p>2x 30-mm NR-30 guns</p> <p><b>Other Loading Options</b></p> <p>325-mm S-25 rockets (1 each) or 80-mm S-8 rocket pods (20 each) or 57-mm S-5 rocket pods (32 each)</p> <p>AS-7/KERRY ASM or AS-9/KYLE ASM or AS-10/KAREN ASM or AS-12/KEGLER ASM or AS-14/KEDGE ASM</p> <p>AA-2 ATOLL AAM or AA-8/APHID AAM or AA-11/ARCHER AAM launchers</p> <p>23-mm SPPU-22 Gun Pods</p> <p>External fuel tanks (liters)</p> <p>100-kg, 250-kg, and 500-kg un-guided and guided bombs</p>	<p><b>Combat Load</b></p> <p><b>160</b></p> <p><b>800</b></p>
<p><b>SYSTEM</b></p> <p><b>Alternative Designations:</b> Su-20, Su-22, Strizh or Martlet</p> <p><b>Date of Introduction:</b> 1970</p> <p><b>Proliferation:</b> At least 19 countries</p> <p><b>Description:</b> Variants in ( )</p> <p>Crew: 1 (pilot)</p> <p><b>Appearance:</b></p> <p>Wings: Low-mount, variable, swept and tapered with blunt tips</p> <p>Engines: One in fuselage, intake in nose</p> <p>Fuselage: Tubular with blunt nose</p> <p>Tail: Swept-back and tapered, flats mounted on fuselage and swept-back</p> <p>Engines: 1x 28,660-shp Lyulka AL-21F-3 (Su-17/20)/ or 1x 25,335-shp Tumansky R-29BS-300 (Su-22) turbojet with afterburner</p> <p>Weight (kg):</p> <p>Max Gross: 17,700 (M2)/19,500 (M4)</p> <p>Normal Takeoff: 14,000 (M2) /16,400 (M4)</p> <p>Empty: 10,000</p> <p>Speed (km/h):</p> <p>Max (at altitude): Mach 2.1</p> <p>Max (sea level): Mach 1.1</p> <p>Takeoff/Landing Speed: 265</p> <p>Max "G" Force (g): +7.0</p> <p>Ceiling (m):</p> <p>Service (clean): 18,000/15,200 (M4)</p> <p>With External Stores: INA</p> <p>Vertical Climb Rate (m/s): 230</p>	<p>Fuel (liters):</p> <p>Internal: 4,550</p> <p>External: Up to 4x 800 liter tanks</p> <p>Range (km):</p> <p>Max Load: 1,500</p> <p>With Aux Fuel: INA</p> <p>Combat Radius: 330 to 685</p> <p>Takeoff Run/Landing Roll (m):</p> <p>Prepared Surface: 900/950</p> <p>Dimensions (m):</p> <p>Length: 18.8</p> <p>Wingspan: 13.8 extended, 10.6 swept</p> <p>Height: 4.8</p> <p>Standard Payload (kg):</p> <p>External: 4,000/4,250 (M4)</p> <p>Hardpoints: 8</p> <p><b>Survivability/Countermeasures:</b></p> <p>Radar warning receiver, decoys, chaff and flares.</p> <p>Armored cockpit on M3 and M4</p> <p><b>ARMAMENT</b></p> <p>The Su-17 has a 30-mm machinegun with 80 rounds, mounted in each wing.</p> <p><b>30-mm machinegun, NR-30:</b></p> <p>Range (m): (practical) 2,500</p> <p>Elevation/Traverse: None (rigidly mounted)</p> <p>Ammo Type: HEFI, APT, CC</p> <p>Rate of Fire (rpm): 850</p>	<p><b>AVIONICS/SENSOR/OPTICS</b></p> <p>The early variants of the Su-17 feature relatively simple avionics and targeting packages.</p> <p>Newer variants, and upgraded aircraft can have better avionics, flight controls, targeting and fire control systems, attack computers, liquid-crystal displays, HUD, pulse-Doppler radar, laser designators, GPS, and self-defense packages with FLIR or TV packages provided by several western firms, and are modified to fire western armaments.</p> <p><b>Night/Weather Capabilities:</b></p> <p>The earlier models of the Su-17 are primarily daytime aircraft only.</p> <p>Some newer versions have upgraded night and weather capabilities based on upgraded avionics and sensor packages, and are day, night, and all weather capable.</p> <p><b>VARIANTS</b></p> <p>This aircraft was derived from the <b>Su-7 FITTER A</b> by incorporating variable wings. Many variants are in use, however, the M3 and M4 are the most proliferated versions. Domestic aircraft use the nomenclature <b>Su-17</b>, export versions use <b>Su-20</b> and <b>Su-22</b>.</p> <p><b>Su-17/-17MK/-20/FITTER C:</b> First production version. Export called <b>Su-20</b>.</p> <p><b>Su-17M/-17M2/-17M2D FITTER D:</b> External Doppler-nav and internal laser rangefinder. Reconnaissance version called <b>Su-17R</b>.</p>



Russian Ground-Attack Aircraft Su-17/FITTER continued

<p><b>Su-17UM/-22U/FITTER E:</b> Two-seat trainer with components of Su-17M.</p> <p><b>Su-17/FITTER G:</b> Combat-ready two-seat trainer variant of FITTER H. Export version is <b>Su-22</b>, with Tumansky engine.</p> <p><b>Su-17/-17M3/FITTER H:</b> Increased pilot visibility by drooping the aircraft nose, and incorporated an internal Doppler-nav and laser rangefinder. Reconnaissance version called <b>Su-17M3R</b>.</p> <p><b>Su-17M4/-22M4/FITTER K:</b> Fighter-bomber. Essentially same as above, but with an additional air intake. Employs digital navigation and attack avionics.</p> <p><b>Su-22/FITTER F:</b> Export version of FITTER D with Tumansky engine.</p> <p><b>Su-22/-22M3/FITTER J:</b> Similar to FITTER H, but with increased internal fuel capacity.</p>		
---	--	--

**NOTES**

The mid-wing pivot point of the sweep wings allows for positions of either 28, 45 or 62 degrees. Up to four external fuel tanks can be carried on wing pylons and under the fuselage. When under-fuselage tanks are carried, only the two inboard wing pylons may be used for ordnance. Available munitions are shown above; not all may be employed at one time. Mission dictates weapons configuration. External stores are mounted on underwing and underbody hardpoints. Each wing has two points, and the fuselage has four attachment points for a total of eight stations. Gun pods can be mounted to fire rearward.

## Georgian/Russian Ground-Attack Aircraft Su-25/FROGFOOT

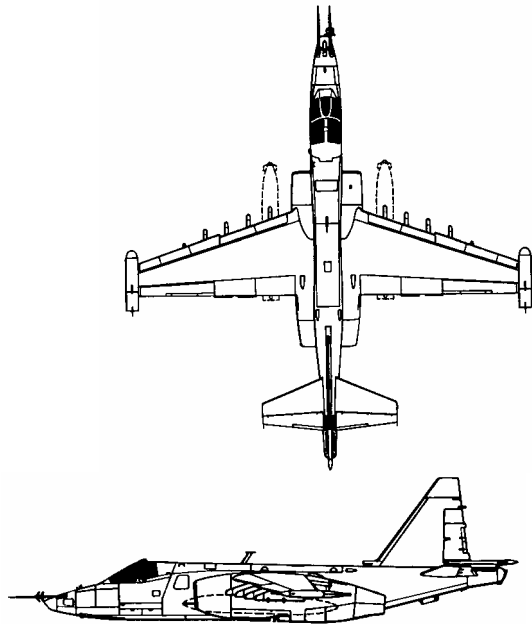
		<p><b>Weapon &amp; Ammunition Types</b></p> <p>30-mm twin barrel Gsh-30-2 gun</p> <p><b>Other Loading Options</b></p> <p>AT-16 VIKhR ATGM (8 each)</p> <p>23- or 30-mm GSH gun pods</p> <p>57-mm S-5 rocket pod (32 ea) or 80-mm S-8 rocket pod (20 ea)</p> <p>AS-7/KERRY ASM or AS-10/KAREN ASM or AS-14/KEDGE ASM or AS-11/KILTER ASM or AS-17/KRYPTON ASM</p> <p>AA-8/APHID or AA-10/ALAMO</p> <p>50-kg to 500-kg bombs</p> <p>External fuel tanks (liters)</p>	<p><b>Combat Load</b></p> <p><b>250</b></p> <p><b>16</b></p> <p><b>260 ea</b></p> <p><b>8</b> <b>8</b></p> <p><b>8</b></p> <p><b>2</b></p> <p><b>4,000 kg</b></p> <p><b>800/1,150</b></p>
<p><b>SYSTEM</b></p> <p><b>Alternative Designations:</b> Gratch, Rook <b>Date of Introduction:</b> 1980 <b>Proliferation:</b> At least 15 countries</p> <p><b>Description:</b> Crew: 1 (pilot) Appearance: Wings: High-mount, tapered back Engines: Both along body, under wings Engines: 2x 4,000-shp Ryzhov (Soyuz/Tumansky) R195 Turbojet Weight (kg): Maximum Gross: 17,600 Normal Takeoff: 14,500 Empty: 9,525 Speed (km/h): Maximum (at altitude): 880 Maximum (sea level): 950 Maximum Attack Speed: 690 Cruise: 700 Takeoff/Landing Speed: 220 Max "G" Force (g): +6.5 g Ceiling (m): Service (clean): 7,000 With External Stores: 5,000 Vertical Climb Rate (m/s): 72 Fuel (liters): Internal: 3,660 External: 3,762</p>	<p>Range (km): Maximum Load: 500 With Aux Fuel (2 tanks): 640 Combat Radius: 556 Takeoff Run/LandingRoll (m): Prepared Surface: 550/600 Unprepared Surface: 650/750 Max Load: 1,200 Dimensions (m): Length: 15.5 Wingspan: 14.5 Height (gear extended): 4.8 Standard Payload (kg): External: 4,400 or 6,400 (Su-25T) Hardpoints: 10 underwing, w/500 kg ea</p> <p><b>Survivability/Countermeasures:</b> Armored cockpit and engines, zero/100 km/hr ejection seat, self-sealing fuel tanks, and strengthened flight control linkages. IFF, infrared jammer, radar warning receiver, chaff and flares.</p> <p><b>ARMAMENT</b> <b>30-mm 2x barrel gun, Gsh-30-2:</b> Range (m): (practical) 4,000 Elevation/Traverse: None (rigid mount) Ammo Type: AP, HE, CC Rate of Fire: Burst 50</p>	<p><b>AVIONICS/SENSOR/OPTICS</b> The targeting system incorporates a LLLTV, integrated navigation and aiming system, active bomb sight, and laser rangefinder/designator. The aircraft uses an INS, GPS, and Doppler navigation.</p> <p><b>Night/Weather Capabilities:</b> The Su-25 is fully capable of performing its direct air support mission in day, night, and poor weather conditions.</p> <p><b>VARIANTS</b> Early Su-25s had 2x Soyuz/ Gavrillov R95SH engines. Most now upgraded.</p> <p><b>Su-25A/-25K:</b> Initial variant, and export.</p> <p><b>Su-25B/-25UB/-25UBK/-UBP:</b> A two-seat combat aircraft, naval version, and trainer.</p> <p><b>Su-25T/-25TM/-25TK:</b> Developed from the Su-25UB. Height changed to 5.2 m to hold avionics and extra fuel. All with R195 engine for increased range, ceiling, and load. Other characteristics generally similar. Upgraded targeting, acquisition, and countermeasures.</p> <p><b>Su-39:</b> Export variant of Su-25T.</p>	

### NOTES

Available munitions are shown above; not all may be employed at one time. Mission dictates weapons configuration. External stores are mounted on underwing hardpoints. Each wing has five points for a total of ten stations. A representative mix when targeting armor formations would be 16x AT-16 ATGMs, two rocket pods, two 23-mm gun pods, 250x 30-mm rounds, and two AA-8s. The titanium cockpit is invulnerable to 20-mm cannon fire, and 30-mm fire from oblique angles. The aircraft can carry a self-contained maintenance kit in 4 underwing pods. Also the engines can operate on any type of fuel likely to be found in the forward-operating areas, including diesel and gasoline. This allows the crew to operate from unprepared airfields for extended periods of time.

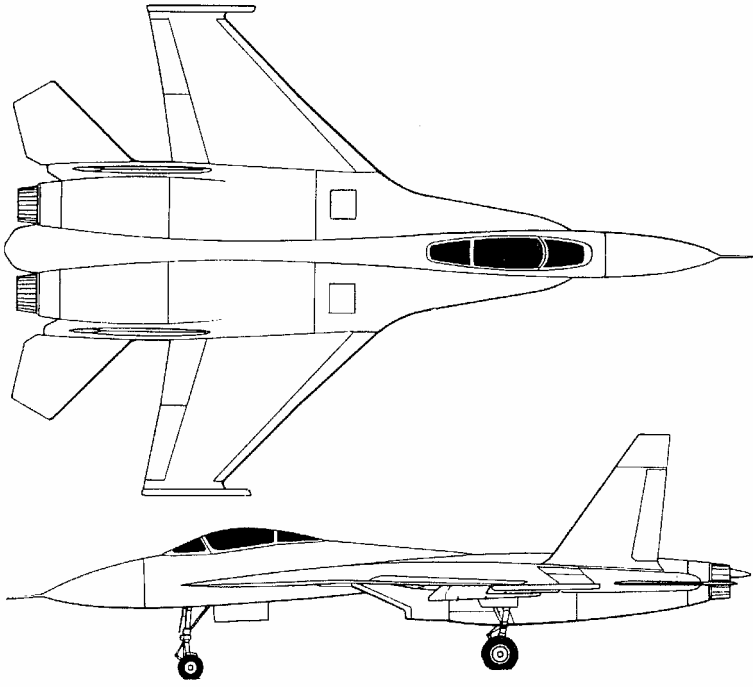

# Russian Multi-role Aircraft Su-27/FLANKER

	<p><b>Weapon &amp; Ammunition Types</b></p> <p>30-mm Gsh-30-1 cannon</p> <p><b>Other Loading Options</b></p> <p>420-mm S-25 rockets (1 each) or 122-mm S-13 rocket pods (5 each) or 80-mm S-8 rocket pods (20 each)</p> <p>AS-10/KAREN ASM or AS-7/KERRY ASM or AS-12/KEGLER ASM or AS-14/KEDGE ASM AS-17/KRYPTON ASM or AS-18/KAZOO ASM</p> <p>AA-10/ALAMO AAM or AA-8/APHID AAM or AA-9/AMOS AAM or AA-11/ARCHER AAM or AA-12 ADDER AAMs</p> <p>Gun Pods</p> <p>250-kg, or 500-kg unguided and guided bombs</p>	<p><b>Combat Load</b></p> <p><b>150</b></p> <p><b>4</b></p> <p><b>4</b></p> <p><b>4</b></p> <p><b>8</b></p> <p><b>6</b></p> <p><b>2</b></p> <p><b>10</b></p> <p><b>4,000 kg</b></p>
	<p><b>SYSTEM</b></p> <p><b>Alternative Designations:</b> Su-35, J-11 <b>Date of Introduction:</b> 1986 <b>Proliferation:</b> At least 5 countries</p> <p><b>Description:</b> Variants in ( ) Crew: 1 (pilot) Appearance: Wings: Mid-mount, swept, square tips Engines: Two in fuselage, with square underwing intakes Fuselage: Pointed nose, rectangular from intakes to tail Tail: Twin tapered, swept fins, with mid-mount, tapered, swept flats Engines: 2x 27,557-shp Lyulka AL-31F turbojet with afterburner Weight (kg): Max Gross: 28,300/33,000 (SM) Normal Takeoff: 23,000/23,700 (SM) Empty: 17,690 Speed (km/h): Max (at altitude): Mach 2.35 Max (sea level): Mach 1.1 Takeoff/Landing Speed: 250/231 Max "G" Force (g): Control limited to +9.0 g Ceiling (m): Service (clean): 18,000 With External Stores: INA Vertical Climb Rate (m/s): 305 Fuel (liters): Internal: 6,600/11,775 (SM) External: no provision Range (km): Max Load: 3,790 With Aux Fuel: 4,390 (SM) Combat Radius: 1,500</p> <p>Takeoff Run/Landing Roll (m): Prepared Surface: 500 to 650/600 to 720 (variant dependent)/ 1,200/1,200 (Su-35) Dimensions (m): Length: 21.9 Wingspan: 14.7 Height: 5.5 Standard Payload (kg): External: 6,000 Hardpoints: 10</p> <p><b>Survivability/Countermeasures:</b> Zero/zero ejection seat, infrared and radar jammer, radar and missile warning receivers, chaff and flares.</p> <p><b>ARMAMENT</b> The Su-27 has a 30-mm gun mounted in the right wing, and the primary missile for air defense missions is the AA-10 ALAMO.</p> <p><b>30-mm gun, Gsh-30-1:</b> Range (m): (practical) 4,000 Elevation/Traverse: None (rigidly mounted) Ammo Type: HEFI, APT, CC Rate of Fire (rpm): 1,500</p> <p><b>AVIONICS/SENSOR/OPTICS</b> The Su-27 employs a pulse-Doppler look-down/ shoot-down radar with a search range of 240 km and a track range of 185 km. It has multi-targeting capability, but cannot guide two missiles to separate targets It also has an IR sensor, and laser designator, HUD, helmet-mounted target-designating sight, and computerized fire control system.</p> <p><b>Night/Weather Capabilities:</b> The Su-27 is capable of attacking air targets under day, night, or all-weather conditions. It has a beyond visual range look-down/ shoot-down capability.</p> <p><b>VARIANTS</b></p> <p><b>Su-27/-27SK/-27P/FLANKER B:</b> Basic production version and export variant.</p> <p><b>Su-27B/-27UB/-30/FLANKER C:</b> Two-seat model used as command aircraft, combat trainer and interceptor. Also called <b>Su-30</b>.</p> <p><b>Su-27K/FLANKER D:</b> Naval variant, readily noticeable by canards forward of the wings.</p> <p><b>Su-27IB/-34/FLANKER E:</b> Naval variant, with side-by-side cockpit, folding wing and tail. Also called <b>Su-34</b>.</p> <p><b>Su-27SM/-27SMK:</b> Multi-role version. Has 12 hardpoints, greater internal fuel and payload capacity, and air refuel capability.</p> <p><b>Su-27M/-35/FLANKER:</b> Revised with more powerful 28,218-shp Lyulka AL-31SM engines with thrust-vectoring nozzles allowing a higher gross weight and greater range. Also fitted with better radar and targeting systems to allow multiple engagements. Dimensions increased slightly, readily noticeable by canards forward of the wings. Also called <b>Su-35</b>.</p> <p><b>J-11:</b> Single-seat Chinese built variant based on FLANKER B. <b>JJ-11:</b> Two-seat Chinese built variant based on FLANKER C.</p>	

## **Russian Multi-role Aircraft Su-27/FLANKER continued** \_\_\_\_\_

### **NOTES**

The Su-27 is primarily an all-weather interceptor/fighter aircraft used for air defense. It is also capable of performing ground attack missions. It is highly maneuverable because of a fly-by-wire control system which automatically restricts aircraft angles of attack and maximum G-loads during flight. External fuel tanks can be carried on some variants, and some are fitted for aerial refueling, but these are generally naval versions rather than air defense or strike versions. Available munitions are shown above; not all may be employed at one time. Mission dictates weapons configuration. External stores are mounted on underwing and underbody hardpoints. Each wing has two points, and an additional rail on the wingtip. Two points are under the intakes along the fuselage, and two are centrally located underneath the fuselage near the centerline and between the intakes for a total of ten stations.

## Russian Transport Aircraft An-2/COLT

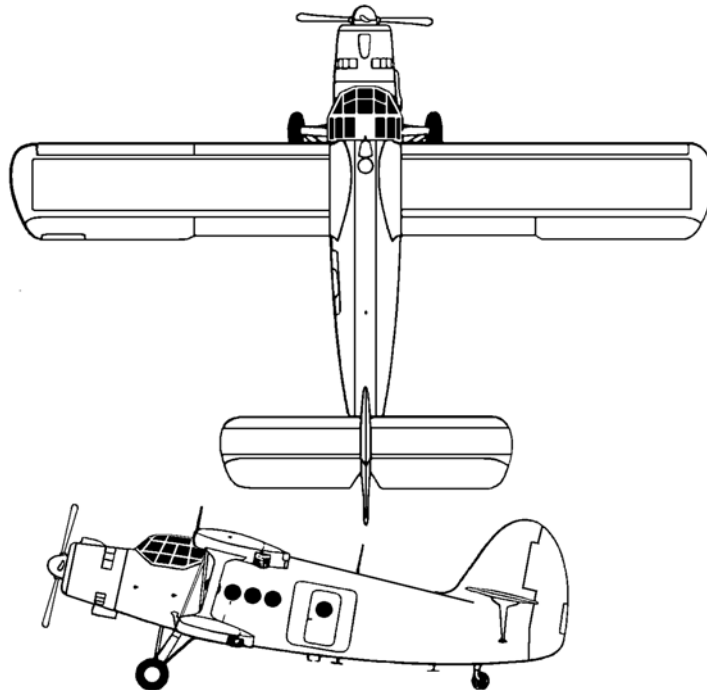

<p><b>SYSTEM</b></p> <p><b>Alternative Designations:</b> INA  <b>Date of Introduction:</b> 1948  <b>Proliferation:</b> At least 32 countries</p> <p><b>Description:</b>  Crew: 2 (pilots)  Appearance:  Wings: Biplane and rectangular-shaped with curved tips, one high-mount and one low mount (shorter), braced by struts  Engines: One mounted in nose  Fuselage: Short, thick, with blunt nose  Tail: Tapered with round tip, rectangular, low-mounted flats  Engines: 1x 1,000-shp Shevetsov Ash-62 or PZL Kalisz Ash-621R 9-cylinder radial piston driving a four-bladed, variable-pitch propeller.  Weight (kg):  Max Gross: 5,500  Normal Takeoff: INA  Empty: 3,450  Speed (km/h):  Max: 258  Min: 90  Cruise: 185  Takeoff/Landing Speed: 85  Max "G" Force (g): -1.0 to +3.7  Ceiling (m):  Service (clean): 4,400  Vertical Climb Rate (m/s): 3.0</p>	<p>Fuel (liters):  Internal: 1,200  External: None  Range (km):  Max Load: 900  Takeoff Run/Landing Roll (m):  Prepared Surface: 150/170  Unprepared Surface: 200/185  Max Load: INA  Dimensions (m):  Length: 12.7  Wingspan: 18.2  Height: 4.0  Cabin Dimensions (m):  Floor Length: 4.1  Width: 1.6  Height: 1.8  Standard Payload (kg):  Internal: 1,500  Transports 12 troops or paratroops, or 6 liters.</p> <p><b>Survivability/Countermeasures:</b>  None</p> <p><b>ARMAMENT</b>  Some early prototypes experimented with single 12.7-mm or 23-mm machineguns, and unguided aerial rockets. None produced.</p>	<p><b>AVIONICS/SENSOR/OPTICS</b>  Flight avionics only.</p> <p><b>Night/Weather Capabilities:</b>  The An-2 is capable of flight under day and instrument meteorological conditions.</p> <p><b>VARIANTS</b></p> <p>This aircraft was originally built in Russia. Now it is produced in China and Poland.</p> <p><b>An-2D/-2TD:</b> Specially modified for parachute training and special operations.</p> <p><b>An-2P/-2T/-2TP:</b> Passenger and general transport variants.</p> <p><b>An-2V/-2M/-4:</b> Seaplane variant with floats in place of main landing gear.</p> <p><b>An-3:</b> This variant employs an upgraded 1,450-shp Glushenkov TVD-20 turboprop engine, and a larger three-bladed propeller. This allows for an increased takeoff weight of 5,800 kg.</p> <p><b>Y-5/C-5:</b> Chinese-built version, and Chinese export nomenclature.</p>
--	--	--

### NOTES

The wings and elevators are fabric-covered, while the fuselage is metal. This aircraft can operate from unimproved airfields, and is noted for short takeoff and landing capabilities, and ruggedness. Its low acoustic signature and slower speeds allow for stealthy operation. Cabin contains tip-up seats which can be easily folded to allow space for cargo. Skis or pontoons can be employed on the main landing gear struts.

## Russian Transport Aircraft IL-18/COOT

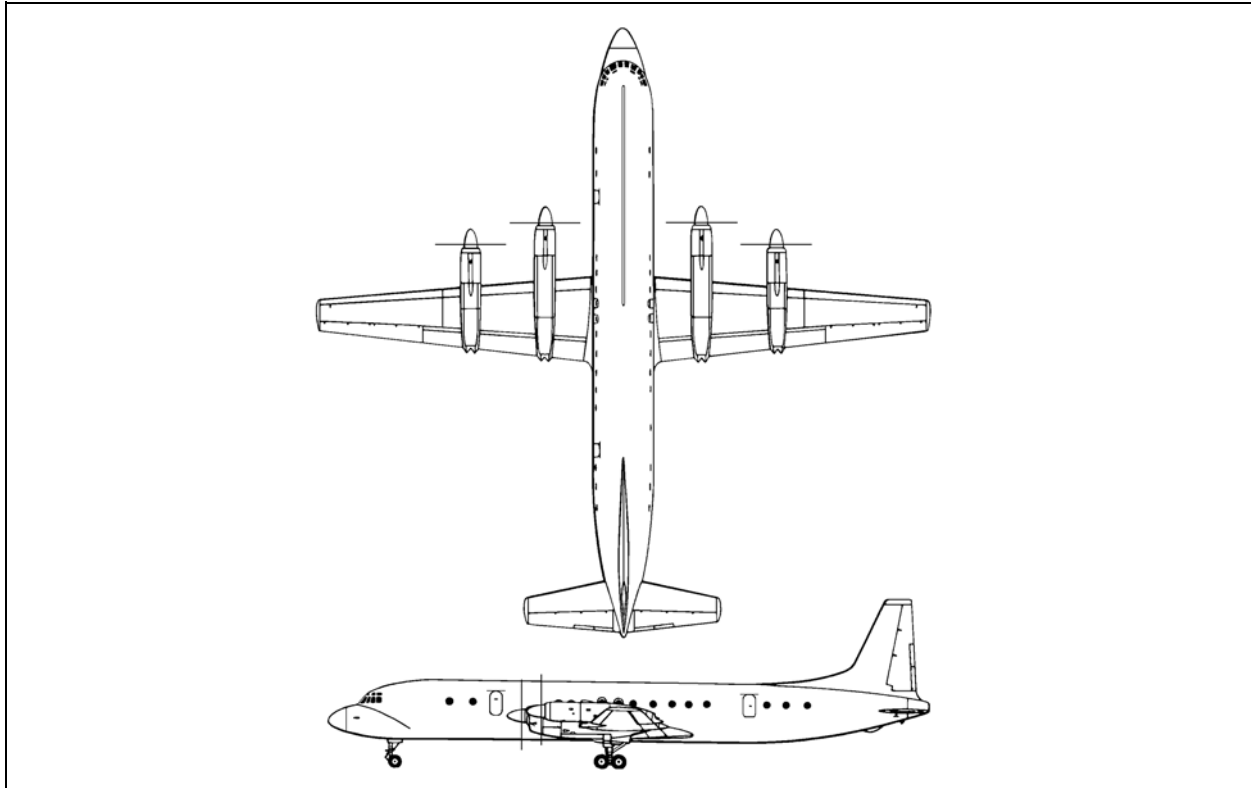

### SYSTEM

**Alternative Designations:** Il-20, Il-22

**Date of Introduction:** 1959

**Proliferation:** At least 5 countries

#### Description:

Crew: 5 (2x pilots, 1x navigator, 1x radio operator, 1x flight engineer)

#### Appearance:

Wings: Low-mounted and tapered with blunt tips

Engines: Four mounted on wings and extending forward

Fuselage: Round, cigar-shaped, tapered at rear with rounded nose

Tail: Tapered with square tip, fuselage-mounted, tapered flats

Engines: 4x 4,250-shp Ivchenko AI-20M turboprop driving 4x four-bladed, reversible-pitch propellers.

#### Weight (kg):

Max Gross: 64,000 (D)/61,200 (E)

Empty: 35,000 (D)/34,610 (E)

#### Speed (km/h):

Max: 675

Min: INA

Cruise: 625

Takeoff/Landing Speed: INA

Max "G" Force (g): INA

#### Ceiling (m):

Service (clean): 10,000

Operating Altitude: 8,000-10,000

Vertical Climb Rate (m/s): INA

#### Fuel (liters):

Internal: 30,000 (D)/23,700 (E)

External: None

#### Range (km):

Max Load: 4,000 (D)/3,200 (E)

Normal Load: 6,500 (D)/5,200 (E)

#### Takeoff Run/Landing Roll (m):

Prepared Surface: 1,300 (D)/850

Unprepared Surface: INA

#### Dimensions (m):

Length: 35.9

Wingspan: 37.4

Height: 10.2

#### Cabin Dimensions (m):

Floor Length: 24.0

Width: 3.2

Height: 2.0

#### Standard Payload (kg):

Internal: 13,500

Transports 122 troops or 20 ELINT operators.

#### Survivability/Countermeasures:

None

#### ARMAMENT

None

#### AVIONICS/SENSOR/OPTICS

Flight avionics only.

#### Night/Weather Capabilities:

The aircraft is capable of flight under day, and instrument meteorological conditions.

### VARIANTS

This aircraft was originally designed as a civilian transport aircraft, but has been adapted for military uses.

**Il-18D:** Has a center fuel tank for longer flight duration and extended range.

**Il-18E:** Variant without center fuel tank.

**Il-20/COOT A:** Unarmed strategic electronic intelligence/ reconnaissance and surveillance aircraft. The airframe is essentially the same as the Il-18D, but a cylinder containing a possible side-looking airborne radar is mounted under the fuselage forward of the wing. Smaller containers on the forward sides of the fuselage house possible cameras and sensors. Many small antennas are located under the fuselage.

**Il-22/COOT B:** An airborne command post variant of the Il-18D airframe.

## Chapter 11 Command and Communications Systems

Command systems in the WEG will initially be limited to command vehicles, such as the listed BMP-1KSh.

This chapter provides basic characteristics of selected tactical communications systems either in use or readily available to the OPFOR. This selection of radios is not intended to be complete; rather, it is representative of the types and capabilities that are currently fielded or available. Radio tables are divided into two sections, single channel and frequency hopping systems. Later updates of this chapter will include information on additional categories of communications systems.

Radio data was provided by Mr. Eric L. Berry, e-mail: [berrye@leavenworth.army.mil](mailto:berrye@leavenworth.army.mil). Questions and comments on data listed in this chapter should be addressed to:

**MAJ Jon Cleaves**

DSN: 552-7975 Commercial (913) 684-7975  
e-mail address: [cleaves@leavenworth.army.mil](mailto:cleaves@leavenworth.army.mil)



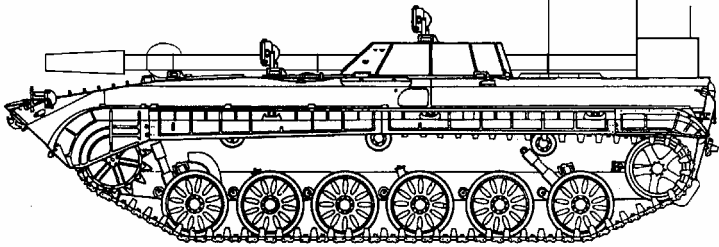

## Russian Command and Staff Vehicle BMP-1KSh

	<p><b>Weapons &amp; Ammunition Types</b></p> <p>Stowed 7.62-mm MG</p>	<p><b>Typical Combat Load</b></p> <p>2,000</p>
<p><b>SYSTEM</b>  <b>Alternative Designations:</b> BMP M1978  <b>Date of Introduction:</b> 1976  <b>Proliferation:</b> At least 3 countries  <b>Description:</b>  Crew: 3  Troop Capacity: N/A  Combat Weight (mt): 13.0  Chassis Length Overall (m): 6.74  Height Overall (m): 2.07  Width Overall (m): 2.94  Ground Pressure (kg/cm<sup>2</sup>): 0.57</p> <p><b>Automotive Performance:</b>  Engine Type: 300-hp Diesel  Cruising Range (km): 550  Speed (km/h):      Max Road: 65      Max Off-Road: 40-45      Average Cross-Country: INA      Max Swim: 7  Fording Depth (m): Amphibious</p> <p><b>Radio:</b> R-130 HF, R-107, R-111 VHF, R-123/173 VHF</p> <p><b>Protection:</b>  Armor, Turret Front (mm): 19-23  Applique Armor (mm): N/A  Explosive Reactive Armor (mm): Available  Active Protective System: N/A  Mineclearing Equipment: N/A  Self-Entrenching Blade: N/A  NBC Protection System: Collective  Smoke Equipment: VEES</p>	<p><b>ARMAMENT</b>  <b>Main Armament:</b>  Caliber, Type, Name: 7.62-mm (7.62x 54R) MG, PKM , stowed  Rate of Fire (rd/min): 250 practical / 650 cyclic, 2-10 round bursts  Loader Type: Belt-feed (100-rd belts)  Ready/Stowed Rounds: INA  Elevation (°): INA  Fire on Move: No</p> <p><b>ATGM Launcher:</b> N/A</p> <p><b>Firing Ports:</b> None</p> <p><b>SIGHTS</b>  Type: INA  Sighting range (m): 1,500  Magnification: INA  <b>Night Sights Available:</b> Yes</p> <p><b>VARIANTS</b>  <b>BMP-1KShM:</b> Variant has upgraded radios.  <b>MP-31/1V31 and 9S743</b> use different radio configurations.</p> <p><b>MAIN ARMAMENT AMMUNITION</b>  <b>Caliber, Type, Name:</b>  7.62-mm API, API-T      Maximum Aimed Range (m): 1,500      Max Effective Range (m):          Day: 1,000/400-500 on the move          Night: INA      Tactical AA Range: INA      Armor Penetration (mm): 8 (RHA) at 500 m</p> <p><b>Other Ammunition Types:</b> Light Ball/Ball-T, Heavy Ball</p>	

### NOTES

For stationary long-range transmissions, HAWK EYE 10-meter folding antenna is removed from carrying case on right side of vehicle and inserted into antenna base, which extends forward from the turret. The trunnions and motor from the base vehicle (BMP-1) gun are used to operate the antenna base. The antenna can then be elevated mechanically to a vertical position.

Other Electronics: R-102 automatic calling device, 1T-219M secure speech device, TNA-1inertial navigation, 1G11N gyrocompass. On the hull rear is a generator to operate the radios.

Options are spall liners, air conditioning, and a more powerful engine. A French SNPE explosive reactive armor (ERA) kit and others are available for use. Additional armor application may jeopardize amphibious capability.



Tactical Single Channel Radios

Radio	Country of Origin	Description	Frequency Range (MHz)	Channel Spacing (KHz)	Number of Channels	Range (km)	Power Output
PRC-105/A	Iran	Man-portable VHF radio	36-76	25	1,600		0.6/2.5/5 W
PRC-110	Iran	Man-portable HF radio with 10 pre-set channels	1.6-29.999	100	284,000		5/20 W
PRC-1077	USA	Man-portable VHF radio. PRC 1077/GRC-160 (low power) and PRC 1077/VRC-46 (high power) vehicular models.	30-88	25	2,320		Man-portable: 100m/2/5 W Vehicular: 100m/2/5/50 W
PRC/ VRC-4600	Turkey	Modular family of VHF/FM radios Embedded encryption	30-76	25 or 50	920 or 1,840	40 w/30W variant	2.5 W manpack PRC-4620 2.5/10/30 W vehicular VRC-4622 2.5 W tank set VRC-4621 (w/companion 12.5/10/30 W VRC-4623)
R-107	FSU	Provides tactical, manportable FM HF/VHF voice communications	20-52	25	1,281	6 w/1.5-m whip, 15 w/2.7-m rod or 40-m wire, 25 w/raised long wire	1 W
R-123M	FSU	Vehicle-mounted tactical FM HF/VHF communications	20-51.5	25	1,261	20 w/4-m whip ( moving) 50 w/10-m telescoping mast	20 W
R-130	FSU	Vehicle-mounted AM HF voice and CW communications	1.5-10.99 transmit 1.0-10.99 receive	10	950	50 w/4-m whip, 75 w/10-m whip or sloping wire, 350 w/symmetrical dipole	10-40 W
R-148	FSU	Lightweight FM VHF manportable transceiver.	37.0-51.95	50	300	5 w/1.5-m whip	1.1-2.1 W
R-171M	FSU	Vehicle-mounted FM VHF communications. Capable of 16 kbits/s data transmission.	30.0-75.999	INA		35-80 claimed	100 W
R-173	FSU	Tactical FM VHF communications	30-76	1		20 w/3-m whip	30 W

**Tactical Single Channel Radios (continued)**

Radio	Country of Origin	Description	Frequency Range (MHz)	Channel Spacing (KHz)	Number of Channels	Range (km)	Power Output
RU-3	FRY	Man-portable VHF radio. Digital data up to 2.4 kbit/s, digital voice up to 16 kbit/s. 40 preset channels.	30-79.975	25	2,000	7	0.3/3 W
SFH-41	Sweden	Chameleon tactical hand-held single-channel and FH radio. Receives single-or FH signals and automatically selects FH reply. 12.5,25, or 50 hps.	148-174	25 or 30	INA	INA	2/5 W
TRC350	France	Man-portable HF/SSB radio. Encryption capability. Vehicular-model TRC331, 20 W.	1.5-30	100	285,000	INA	2 W reduced power 10 W average in data mode 15 W morse, 20 W SSB voice
Type 889	China	Tactical FM VHF voice comms. Capable of 16 kbits/s data transmission in wideband mode and connected to a digital terminal set.	20.0-49.975	25 or 50	1,200 or 600	30 w/2.85-m (probable) whip, narrow band, and high-power mode	3 or 20 W
VRC-90	China	Vehicular VHF/FM radio. 16 kbit/s data capability.	30-87.975	25	2,320		0.2/3.5/50 W
XV3088	Germany	Man-portable VHF pouch radio. 9 pre-set channels. Maybe vehicular-mounted. 2.4 kbit/s data transmission.	30-87.975	25	2,320	500 meter remote.	0.2/5 W 25/50 W with power amp.

### Tactical Frequency Hopping Radios

Radio	Country of Origin	Spread Spectrum Radio Description	Frequency Range (MHz)	Channel Spacing (KHz)	Number of Channels	Power Output
ACV46	South Africa	Vehicular VHF FH. 99 preset channels, embedded encryption. Remote operation by wire up to 2 km	30-87.975	25	INA	INA
ACM48	South Africa	Man-portable VHF radio. Embedded encryption, data.	30-87.975	12.5 or 25	INA	0.4/4 W
ART 2000	Iran	Man-portable or vehicular VHF FH radio with 100+ hps. May be remoted up to 3 km.	30-88	25	2,320	0.1/3 W
JAGUAR-U	United Kingdom	Tactical UHF FH radio, with man-portable, airborne, and mobile/ground station capabilities. Embedded encryption in FH mode.	225-400	25	7,000	Man-portable: 10mW/4W. Airborne: 10mW/4W/15W. Mobile: 10mW/4W/50W.
JAGUAR-V	United Kingdom	Man-portable or vehicle-mounted VHF frequency hopping combat net radio, 100 hps. Compatible w/ conventional 25/50 KHz channel-spaced radios. Operates in nine 6.4 MHz sub-bands or full-band 58 MHz. May be remote -operated by wire to 4 km. Embedded encryption	30-88	25	2,320	Man-portable: 10 mW and 5 W. Vehicle-mounted: 20 and 50 watts
Leprechaun	USA	Hand-held FH VHF radio. Embedded encryption.	30-88	INA	INA	5 W
LVP 235	India	VHF radio available in FH or fixed-frequency models. Projected 100-150 hps over full band. Embedded encryption.	30-88	INA	INA	5 W
PANTHER 2000-V	United Kingdom	VHF FH radio with man-portable, vehicular, and airborne versions. 8 pre-programmable channels. May be remoted up to 4 km. Narrow band: 9 hop bands of 6.4 MHz with 256 channels. Wideband: 58 MHz band with 2320 channels. 100 hps. Embedded encryption.	30-108	25	3,120	Man-portable 20W Vehicular 20W/50W Airborne 20W
PRC-73B	Yugoslavia	Man-portable VHF FH radio with 100-200 hps over 5 MHz band.	30-90	INA	2,400	5 W
PRC-117A	USA	Man-portable VHF FM FH radio. Uses KY-57 VINSON encryption	30-89.975	25	2,400	0.1/1/10 W
PRC-119	USA	Man-portable VHF FM FH radio. 8 programmable single-channel and 6 frequency-hopping pre-set channels. Integrated voice and data secure communications.	30-88	INA	2,320	4.5 W

Tactical Frequency Hopping Radios (continued)

Radio	Country of Origin	Spread Spectrum Radio Description	Frequency Range (MHz)	Channel Spacing (KHz)	Number of Channels	Power Output
PRC-130	USA	Man-portable HF FH radio with 10 hps. Embedded encryption.	2.0-30	INA	280,000	5/20/100 W
PRC-710	Israel	Hand-held FH VHF radio, embedded encryption.	30-88	25	2,320	5 W adjustable
PRC 1080	USA	Hand-held FH VHF radio. Embedded encryption, 9 preset channels.	30-87.975	25	2,320	Selectable 100 mW-2W
PRC/VRC-9600	Turkey	Man-portable or vehicular-mounted VHF FH with 100-200 hps. Capable of burst-data transmission. Embedded encryption.	30-88	25	3,120	5 W man-portable 5/50 W vehicular
RAVEN 2V	United Kingdom	Man-portable, hand-held, vehicular, or base station VHF FH radio. Capable of burst-data transmission, data-rate adapter. Voice/data encryption, remote operation. Expected hop rate approx 150 hps.	30-88	25	2,320	Vehicular 50 W
RU-5	Yugoslavia	Man-portable VHF/FM FH radio. Embedded encryption. Up to 16 kbit/s data transmission. Full-band hop set at approx. 100 hps. 10 pre-set channels.	30-87.975	25	2,320	0.5/5 W
SCIMITAR-H	United Kingdom	Vehicular-mounted HF FH radio. Burst-data transmission capability. Wire-remote up to 3 km. Embedded encryption.	1.6-30	100	284,000	20 W man-portable, 100/400 W vehicular-mounted.
SCIMITAR-V	United Kingdom	Man-portable or vehicular VHF FH radio with 150-250 hps over 58 MHz band. Embedded encryption.	30-88	25	2,320	0.1/5/50 W
SEM 173-193 CNR System	Germany	Modular series of VHF CNR radios, with the SEM 173 transceiver as the common unit. Remote operation up to 4 km. Embedded encryption. SEM 173 man-portable; SEM 173 V vehicular SEM 183 vehicular; SEM 193 vehicular SEM 183/193 dual station; SEM 193/193 dual station	30-108	12.5 or 25	3,120 or 6,240	SEM 173, 183 0.05/0.5, 5 W. SEM 193, 183/193 0.05/0.5/5/50 W.
StarCom	Sweden	Man-portable and vehicular FH VHF radio. Embedded encryption, remote operation by wire up to 6 km.	30-87.975	25	2,320	Man-portable 5 W Vehicular 5/50 W

## **Chapter 12**

### **Unmanned Aerial Vehicles**

This chapter provides the basic characteristics of selected unmanned aerial vehicles (UAVs) either in use or readily available to the OPFOR. Therefore, the UAVs discussed in this chapter are those likely to be encountered by U.S. forces in varying levels of conflict. The selection of UAVs is not intended to be all-inclusive, rather a representative sampling of various military capabilities.

UAVs come in various types, sizes, and levels of complexity, each having their own niche over the battlefield. For example, fixed-wing, propeller-driven platforms excel in endurance and range; jet-propelled UAV's trade endurance for speed; and rotary-wing UAVs can carry relatively large payloads.

UAVs are also referred to as drones or remotely piloted vehicles (RPVs) depending on their flight control. An on-board computer with the flight plan programmed into it prior to the mission controls drones. RPVs use a data link to a ground control station where the pilot/operator controls the flight manually. Many modern UAVs are capable of operating in either manner.

Questions and comments on data listed in this chapter should be addressed to:

**Mr. Walter L. Williams**

DSN: 552-7923 Commercial (913) 684-7923

e-mail address: [williamw@leavenworth.army.mil](mailto:williamw@leavenworth.army.mil)





## French Unmanned Aerial Vehicle Fox AT1

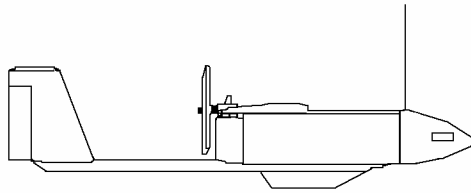

<p><b>SYSTEM</b>  <b>Alternative Designations:</b> ASPIC AT  <b>Date of Introduction:</b> 1988  <b>Proliferation:</b> France, United Nations, and civilian customers</p> <p><b>Description:</b>  Engines: 1 x Limbach 22 hp L 275 E two-cylinder, two-stroke, air-cooled  Propulsion: 2-blade push propeller  Weight (kg):      Takeoff: 90      Fuel and Payload (combined): 30  Speed (km/h):      Maximum (level): 216      Cruise: 145  Ceiling (m):      Maximum: 3,000      Minimum: 30  Fuel (liters): INA  Endurance (hr): 1.5  Range (km):      RPV Mode: 50      Relay/Programmed Mode: 100  Dimensions (m):      Wing Span: 3.6      Length (fuselage): 2.75      Height: 0.25</p>	<p>Launch Method: Hydraulic or sandow ramp.  Recovery Method: Parachute  Landing Method: skid  Maximum Flights Per Aircraft: INA</p> <p><b>Survivability/Countermeasures:</b> INA</p> <p><b>SENSOR/OPTICS</b>  <b>Payload Type:</b> CCD color video or infrared cameras, thermal analyzers, high definition line scanners, NBC and meteorological sensors.  Television field of view: INA  IR Linescan:      Length: INA      Resolution: INA</p> <p><b>VARIANTS:</b>  Fox AT2 UAV  Fox TX Electronic Warfare UAV  Fox TS1 Target Drone  Fox TS3 Target Drone  Mini-Fox Target Drone</p>
---	--

### NOTES

The Fox AT1 UAV is one of a family of low-cost UAVs designed by the French firm CAC SYSTEMES. Each UAV system is composed of a transportation and launching system, a ground control station (GCS) mounted on a 4x4 truck frame, and four UAVs. The Fox AT1 is launched from a mobile launching catapult (transportation and launching system) that is mounted on a trailer with transportation compartments for 4 UAVs. Normally two of the four UAVs are equipped with CCD cameras for daytime missions and the remaining two are FLIR equipped for nighttime missions. Upon mission completion the UAV can be reserviced and available for another mission in less than 30 minutes. The Fox AT1 is capable of carrying 15 kilograms of various payloads. Additionally, two underwing pods allow for four loads to be carried and dropped. Normally the GCS consist of a crew of three personnel: pilot, observer, and a technician. However, two people can deploy the UAV system and have it available for operation in less than 20 minutes. The guidance and control consists of an UHF data link with four proportional and eight numeric channels, of which four control the autopilot. Telemetry is through a 12-channel data link.

**French Unmanned Aerial Vehicle Fox AT2**

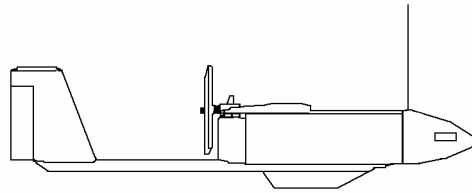

<p><b>SYSTEM</b>  <b>Alternative Designations:</b> None  <b>Date of Introduction:</b> 1988  <b>Proliferation:</b> France, United Nations, and civilian customers</p> <p><b>Description:</b>  Engines: 1 x Limbach 22 hp L 275 E two-cylinder, two-stroke, air-cooled  Propulsion: 2-blade push propeller  Weight (kg):      Takeoff: 135      Fuel and Payload (combined): 60  Speed (km/h):      Maximum (level): 216      Cruise: 145  Ceiling (m):      Maximum: 3,000      Minimum: 30  Fuel (liters): INA  Endurance (hr): 5  Range (km):      RPV Mode: 50, 100, 150 (200 as an option)      Relay/Programmed Mode: 350</p>	<p>Dimensions (m):      Wing Span: 4.0      Length (fuselage): 2.75      Height: 0.25  Launch Method: Hydraulic or sandow ramp.  Recovery Method: Parachute  Landing Method: Airbag  Maximum Flights Per Aircraft: INA</p> <p><b>Survivability/Countermeasures:</b> INA</p> <p><b>SENSOR/OPTICS</b>  <b>Payload Type:</b> Panoramic CCD color Camera, Low Light Television (with zoom), IR linescan CAMELIA camera, SAR camera, FLIR, multi-sensor gimball platform (IR and visible), etc.  Television field of view: INA  IR Linescan:      Length: INA      Resolution: INA</p> <p><b>VARIANTS:</b> None</p>
---	--

**NOTES**

The Fox AT2 UAV is one of a family of low-cost UAVs designed by the French firm CAC SYSTEMES. Each UAV system is composed of a transportation and launching system, a ground control station (GCS) mounted on a 4x4 truck frame, and four UAVs. The Fox AT2 (like the Fox AT1) is launched from a mobile launching catapult (transportation and launching system) that is mounted on a trailer with transportation compartments for 4 UAVs. Normally two of the four UAVs are equipped with CCD cameras for daytime missions and the remaining two are FLIR equipped for nighttime missions. Upon mission completion the UAV can be reserviced and available for another mission in less than 30 minutes. The Fox AT2 is capable of carrying 30 kilograms of various payloads. Additionally, two underwing pods allow for two loads to be carried and dropped. Normally the GCS consist of a crew of three personnel: pilot, observer, and a technician. However, two people can deploy the UAV system and have it available for operation in less than 20 minutes. The guidance and control consists of an UHF data link with four proportional and eight numeric channels, of which four control the autopilot. Telemetry is through a 12-channel data link.

## Chinese Unmanned Aerial Vehicle D-4

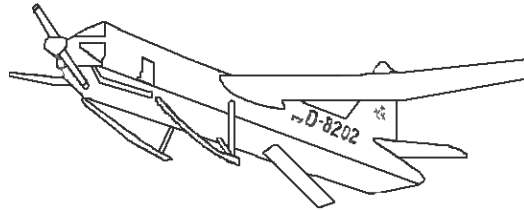

D-4 UAV with reusable solid rocket booster prior to jettison after take off

### SYSTEM

**Alternative Designations:** ASN-104/105

**Date of Introduction:** 1985

**Proliferation:** At least 1 country

### Description:

**Engines:** 1x -30 hp HS-510 four-cylinder, two-stroke gasoline air-cooled piston

**Propulsion:** 2-blade wooden push propeller

**Weight (kg):**

Takeoff: 140

Fuel and Payload (combined): INA

**Speed (km/h):**

Maximum (level): 205

Cruise: 150

**Ceiling (m):**

Maximum: 3,200

Minimum: 100

**Fuel (liters):** INA

**Endurance (hr):** 2

**Range (km):**

RPV Mode: 60

Relay/Programmed Mode: 100 (est.)

**Dimensions (m):**

Wing Span: 4.3

Length (fuselage): 3.3

Height: 0.9 (excluding skids)

**Launch Method:** Solid rocket booster on a zero length launcher.

**Recovery Method:** Parachute (nonsteerable)

**Landing Method:** 2 spring loaded skids

**Maximum Flights Per Aircraft:** INA

**Survivability/Countermeasures:** INA

### SENSOR/OPTICS

**Payload Type:** Panoramic Camera, Low Light Television (with zoom) and IR linescan

Television field of view: INA

**IR Linescan:**

Length: INA

Resolution: INA

**VARIANTS:** None

### NOTES

The D-4 UAV is launched from a zero-length launcher using a solid rocket booster that is jettisoned after take-off.

## Russian Unmanned Aerial Vehicle Shmel-1

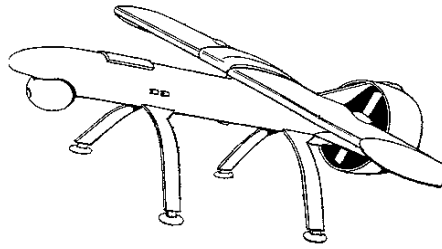

<p><b>SYSTEM</b>  <b>Alternative Designations:</b> Bumblebee  <b>Date of Introduction:</b> 1991  <b>Proliferation:</b> At least 2 countries</p> <p><b>Description:</b>  Engines: 1x 32-hp Samara/Trud (Kuznetsov ) P-032 two-cylinder, two-stroke gasoline  Propulsion: 3-blade shrouded pusher propeller  Weight (kg):  Takeoff: 130  Fuel and Payload (combined): 70  Speed (km/h):  Maximum (level): 180  Cruise: 140  Ceiling (m):  Maximum: 3,000  Minimum: 50  Fuel (liters): INA  Endurance (hr): 2  Range (km):  RPV Mode: 60  Relay/Programmed Mode: 120 (est.)  Dimensions (m):  Wing Span: 3.25  Length (fuselage): 2.78  Height: 1.10</p>	<p>Launch Method: Rocket-assisted catapult  Recovery Method: Parachute (nonsteerable)  Landing Method: 4 spring loaded landing legs  Maximum Flights Per Aircraft: 10 to 20</p> <p><b>Survivability/Countermeasures:</b>  The engine and propeller are enclosed in a shrouded ring that serves the purpose of reducing noise as well as reducing the surface reflection and heat signature.</p> <p><b>SENSOR/OPTICS</b>  <b>Payload Type:</b> Television and IR linescan  Television Field of View: 3° to 30° (zoom)  IR Linescan:  Length: 3 to 4 times aircraft altitude  Resolution: 3 milliradians</p> <p><b>VARIANTS:</b> None</p>	<p><b>LAUNCH VEHICLE</b>  <b>Designation:</b> BTR-D  <b>Alternative Designations:</b> BMD M1979  <b>Description:</b>  Crew: 2  Combat Weight (mt): 6.7  Chassis Length Overall (m): 5.88  Height w/o Launch unit (m): 1.67  Width Overall (m): 2.63</p> <p><b>Automotive Performance:</b>  Engine Type: 240-hp Diesel  Cruising Range (km): 500  Speed (km/h):  Max Road: 61 (est.)  Max Off-Road: 35 (est.)  Average Cross-Country: INA  Max Swim: 10 (est.)  Fording Depth (m): Amphibious</p> <p><b>Radio:</b> R-123</p> <p><b>Protection:</b>  Armor, Turret Front (mm): "Antibullet" (7.62-mm)  NBC Protection System: Yes  Smoke Equipment: None</p>
---	---	--

### NOTES

The Shmel-1 is part of a complex called the STERKH, which is probably an acronym of unknown expansion. The STERKH complex consists of a launcher, a support/maintenance vehicle, and at least one (probably as many as three) aircraft. The Yakolev Design Bureau designed the STERKH.

The transporter-launcher-controller (TLC) has positions for two UAV operators and is capable of controlling two Shmel-1's simultaneously. Automatic pre-launch monitoring, launch, flight control, and displaying of the received data is conducted from the TLC. The display in the TLC indicates aircraft position overlaid onto the television image. Given the system's digital downlink, the IR image could also be recorded on magnetic tape or displayed on a video monitor. However, the data is almost certainly recorded on electronic medium for playback. The description of the system may indicate a problem involving the inability of the operator to translate aircraft coordinates to those of the targets being located. A laser rangefinder or designator could easily accomplish this, but such a capability is not indicated for the Shmel-1. The current system requires coordinate conversion from map association or photographic interpretation with a laser capability to be added later.

The area coverage of the sensor payload is excellent. Analysis indicates that the camera, at an altitude of 1500 meters and a field of view of 30°, can image an area of approximately 500,000 m<sup>2</sup> or a circle with a radius of 400 meters. The IR linescan at the same altitude would see a strip approximately 5,100 meters long and 4.5 meters wide. Ground resolution would decrease significantly at the ends of the scan. At a nominal speed of 120 km/h and flying the maximum altitude, the aircraft could observe a maximum of 192 km<sup>2</sup>/h with the television system or 1,200 km<sup>2</sup>/h with the IR linescan.

## Russian Unmanned Aerial Vehicle TU-143 Reys

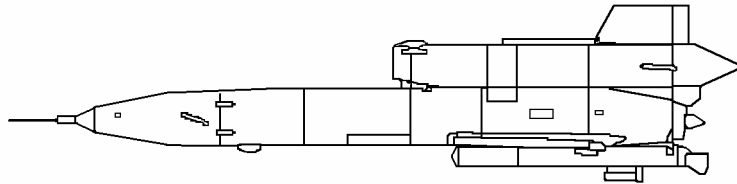

### SYSTEM

**Alternative Designations:** DR-3

**Date of Introduction:** 1973

**Proliferation:** At least 7 countries

### Description:

Engines: 1x – TRD TR3-117 turbojet

Propulsion: Jet

Weight (kg):

Takeoff: 1,600

Fuel and Payload (combined): 1,540

Speed (km/h):

Maximum (level): 940

Cruise: 850

Ceiling (m):

Maximum: 5,000

Minimum: 50

Fuel (liters): 190

Endurance (minutes): 25

Range (km):

RPV Mode: N/A

Relay/Programmed Mode: 360

Dimensions (m):

Wing Span: 2.24

Length (fuselage): 8.06

Height: 1.54 (excluding skids)

Launch Method: Solid rocket booster on a mobile transporter-erector-launcher (TEL)

Recovery Method: Parachute (nonsteerable)

Landing Method: 3 retractable skids (tricycle gear)

Maximum Flights Per Aircraft: 10

**Survivability/Countermeasures:** INA

### SENSOR/OPTICS

**Payload Type:** Panoramic Camera, Low Light Television and radiation detection equipment

Television field of view: INA

IR Linescan:

Length: INA

Resolution: INA

**VARIANTS:** None

### NOTES

The DR-3 normally operates at a reconnaissance depth of 150 km and is preprogrammed prior to each mission. It is launched from a mobile TEL using a solid rocket booster (that is jettisoned after take-off) in tandem with the turbojet engine. The DR-3 uses its onboard navigation and guidance control to cruise at preset altitudes (four total) between 50 to 2,000 meters. Prior to landing, a drogue chute is deployed to slow the speed of the DR-3 prior to deployment of the main recovery parachute. A braking rocket engine (located in the fuselage) is activated at an altitude of approximately 1.8 meters to soften the landing on the "tricycle landing gear". The DR-3 reconnaissance payload normally consists of two versions (besides the radiation detection version). The first version consists of an AP-402M aerial camera with Zima-M IR-reconnaissance equipment. The second payload consists of an AP-402M aerial camera with an Aist-M TV system. The camera film is removed and processed in a data processing station upon completion of the mission. However, data from both the TV and radiation detection equipment is downlinked in real-time to the ground control station.



## Israeli Unmanned Aerial Vehicle Hermes 450S



<p><b>SYSTEM</b>  <b>Alternative Designations:</b> INA  <b>Date of Introduction:</b> INA  <b>Proliferation:</b> At least 1 country, selected for testing by another  <b>Description:</b>  Engines: 52 hp gasoline UEL  AR-80-1010 rotary engine  Propulsion: 2-blade pusher propeller  Weight (kg):  Takeoff: 450  Payload (combined): 150  Speed (km/h):  Maximum (level): 175  Cruise: 130  Ceiling (m):  Maximum: 7,000  Minimum: INA  Fuel (liters): INA  Endurance (hr): 20  Range (km):  RPV Mode: 200  Relay/Programmed Mode: INA  Dimensions (m):  Wing Span: 10.5  Length (fuselage): 6.1  Height: 2.36, body diameter 1.7  Launch Method: Wheeled take-off  Recovery Method: Conventional landing  Landing Method: 3-wheeled, w/arrest cable  Maximum Flights Per Aircraft: INA</p>	<p><b>Survivability/Countermeasures:</b>  Light composite structure, low radar signature  <b>SENSOR/OPTICS</b>  <b>Payload Type:</b> Four stabilized sensor pods  Sensor Pod: MOSP, high end  Television day/night, autotracker, auto-scan  Sensor Pod: FSP-1 mid-high end  FLIR with 3-FOV telescope  Sensor Pod: POP, low-mid-range  CCD Television day and/or night  Sensor Pod: ESP-600C, low end  Television, color, day only  Other options: MTI radar and SAR</p>	<p><b>VARIANTS:</b> None  <b>FLIGHT CONTROL</b>  <b>Control System:</b>  Ground Control Station (GCS) vehicle  <b>Flight control Method:</b>  Pre-programmed or in-flight re-program</p>
---	--	--

### NOTES

An available option is DGPS automatic take-off and landing. Recommend that this option is played in simulations.





## Chapter 13 Theater Missiles

The trend among military forces for acquisition of theater missiles has expanded with the growth of regional rivalries and the strategy of using long-range strike capability to gain regional leverage. Theater missiles can be categorized among two types—theater ballistic missiles (TBMs) and cruise missiles. They are launched from ground launchers, aircraft, or naval vessels. These systems are designed for deep strike missions—beyond those of close battle assets. Because of the high cost and limited numbers of these systems compared to artillery, they will be used against high-priority targets at critical phases of a conflict, or against political targets. Selected OPFOR forces with limited numbers of missiles may hold them in a separate missile unit at echelons above the supported ground force commander. Those missiles may be used for purposes other than execution of military strike missions. Where missiles are subordinate to the ground force commander, they will be used as another strike asset to support his plan.

The OPFOR cruise missiles can be launched from ground launchers or naval platforms. Air-launched cruise missiles (ALCMs) are treated as munitions in aircraft chapters. Foreign ground and sea-launched cruise missiles are generally employed in an anti-ship role. However, applications may be developed for use against ground targets. Such systems can be addressed in future WEG updates.

The TBMs employ a high-atmosphere or exo-atmospheric ballistic trajectory to reach the target. That trajectory is easier to track than a cruise missile flight profile; however, the TBM can deliver a high-lethality payload a long distance quickly, and for most of its trajectory, it cannot be intercepted by even state-of-the-art anti-ballistic missiles (ABMs). These missiles are launched from ground launchers or naval platforms. Ground launchers include—

- Fixed ground launchers (usually associated with hardened underground sites).
- Mobile launch complexes with dozens of vehicles and significant set-up time.
- Trailer launchers.
- Highly mobile transporter-erector-launchers (TELs).

Launchers vary from older systems with simple modifications, to specialized vehicles designed for operation in all types of terrain. Newer launchers may incorporate improved mobility to reduce vulnerability to location by terrain analysis and intelligence preparation of the battlefield.

The missile system is selected for a mission based on its ability to reach the target within targeting timelines, and its ability to deliver effective lethality on the target. Improved heavy multiple-rocket launcher systems with course correction and increased-lethality warheads have replaced TBMs as preferred strike systems against selected deep targets. For instance, a Russian 9A52 MRL can deliver twelve 300-mm rockets 70-90 km with precision and minimal preparation time. However, a modern TBM can deliver twice the payload a farther distance with better precision against critical heavy targets.

Keys for timely delivery include target location, fire mission calculation and transmission, launcher and missile responsiveness, reload time, and move times. Therefore, modern missile system support equipment can include computerized fire control and location/navigation systems (such as global positioning systems), as well as dependable and secure communications.

The most critical component of a theater ballistic missile system, which differentiates system capabilities and limitations, is the missile. Missiles are generally classified according to their range—

- Short-range ballistic missile (SRBM), 0-1,000 km.
- Medium-range ballistic missile (MRBM), 1,001-3,000 km.
- Intermediate-range ballistic missile (IRBM), 3,001-5,500 km.

Various approaches are used to improve range, such as lengthening missiles for increased fuel and longer burn time, improving motors (in the propulsion section), using more efficient solid fuel motors, and employing smaller and lighter warheads. Below is an example of a modern missile (the Russian Tochka-U SRBM) and its major components.

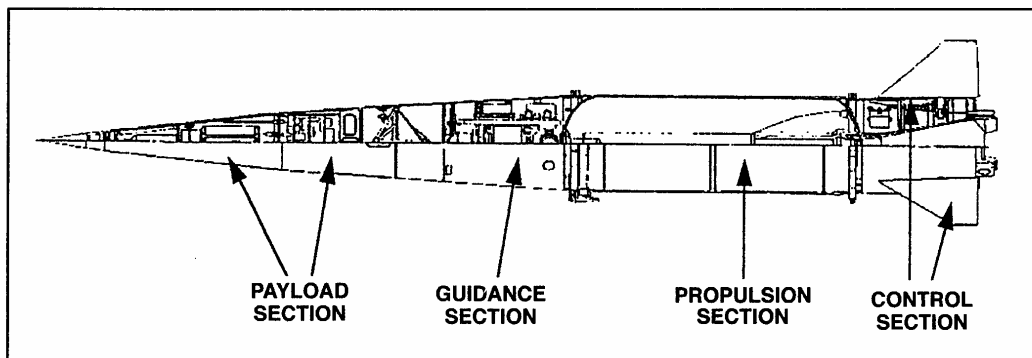

The warhead (within the payload section) is the munition, the lethality mechanism which is selected for that strike mission and around which the system is designed. Many countries acquired ballistic missiles specifically to deliver weapons of mass destruction (WMD) against civilian targets such as urban centers. For such a mission, a less accurate system with a large payload capacity is sufficient for the mission. A substantial proportion of SRBM and some MRBM designs are copies or variants of the former-Soviet SCUD-B/SS-1c. Although these systems lack accuracy and responsiveness of some the newer systems, they can deliver large lethal payloads against fixed targets or targets whose limited mobility permits them to be stationary long enough for the TBMs' operational timelines.

A number of newer TBM designs with improved range, accuracy and operational considerations have been fielded. Modern warhead developments include separating warheads, multiple warheads, maneuvering reentry vehicles (RVs), varied lethal and electronic warhead fills, warhead buses (varied submunitions), precision navigating and homing warheads, and warheads with

countermeasures (penaids). Separating and maneuvering warheads, penaids, and other technical measures will further challenge the capability of theater missile defense assets to prevent strikes against priority targets.

Operational timelines include launcher emplacement and survey times, mission transmission time, missile preparation time (which includes aiming), launch sequence, displacement time, move to a hide/transloading point, then move to the next launch point. Target location, command and control, and fire mission transmission times are separate. Often the launcher will be emplaced with some launch preparation steps completed and ready for a mission. These steps may sacrifice accuracy for reduced exposure time. More modern launchers will have a minimal preparation time between emplacement and execution of a fire mission.

After a launch, the launchers will displace as quickly as possible (often <5 minutes) to reduce the possibility of detection and tracking, and to avoid strikes from specially-assigned counter-missile assets and units. To assure survivability of these expensive long-range weapons, the forces will employ tactical countermeasures and, where possible, use rapid emplacement and autonomous operations to reduce losses. Some forces employ technical countermeasures to add increased survivability of the launcher and increased probability of missile/warhead success. Countermeasures include improved coatings and camouflage patterns and nets, underground hides/facilities, decoys, and secure communications. These measures are intended to degrade the enemy's detection, targeting, impact or effectiveness kill, and lethality effects.

State-of-the-art TBMs can cost more than a million dollars each. If the systems are not accurate enough, or if the enemy has ABM capabilities, those TBMs may not have a high assurance of success, and may not be a factor in the OPFOR plan. The OPFOR may limit its missile requirement to systems used to gain regional political leverage by targeting civilian targets. Thus, budgetary, political, and military considerations affect TBM decisions. Given the budget limitations and systems costs which have impacted most military forces in the last decade, the OPFOR will likely have a mix of older and newer systems and selected upgrades. Systems featured in this chapter are the more common systems, or represent the spectrum of missile systems which can threaten US Army forces or interests within an operational environment.

Questions and comments on data in this specific update should be addressed to Tom Redman, DSN: 552-7925, e-mail: redmant@leavenworth.army.mil. Otherwise, TBM analyst is:

**Dr. Don Madill**

DSN: 552-7926 Commercial (913) 684-7926

e-mail address: madilld@leavenworth.army.mil



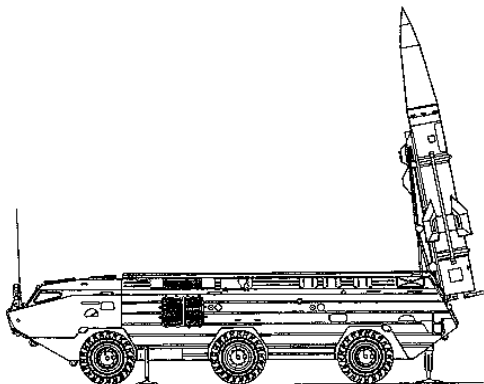

Tochka-U/SS-21

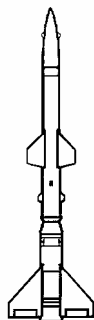

B610 / CSS-8



M-11/ CSS-7

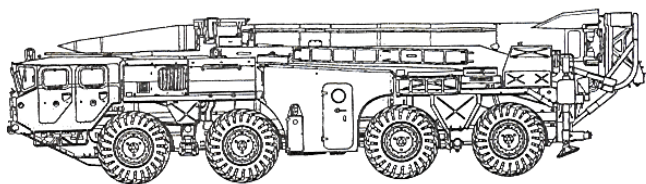

SCUD-B / SS-1c

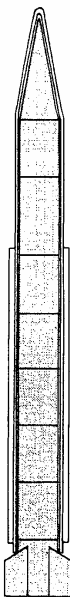

Nodong-1



DF-3 / CSS-2

**Foreign Theater Ballistic Missiles**

<b>System Type</b>	SRBM	SRBM	SRBM	SRBM	SRBM	SRBM	SRBM	MRBM	IRBM	<b>Technologies &amp; Trends</b>
<b>Name/ NATO Name Designator</b>	Tochka-U SCARAB SS-21 Mod 2	B610 / M-7  CSS-8	SCUD-B SS-1c	SCUD-B SS-1c Mod 2	M-11/ DF-11  CSS-7	SCUD-C SS-1d	M-9/DF-15  CSS-6	Nodong-1	DF-3  CSS-2	More SCUD variants
<b>Producing Country</b>	Russia	China	Russia North Korea	Russia	China	Russia North Korea	China	North Korea	China	Technology Transfer
<b>Proliferation (countries)</b>	At least 6	At least 2	At least 20	At least 1	At least 2	At least 5	At least 1	At least 1	At least 2	Increased proliferation
<b>Type Launcher</b>	TEL	TEL	Fixed, TEL	Fixed, TEL	TEL	Fixed, TEL	TEL	TEL	Fixed, Mobile complex	Mobile/decoy launchers
<b>Propulsion</b>	Single-stage Solid	Single-stage (est) Solid	Single-stage Liquid	Single-stage Liquid	Single-stage Solid	Single stage Liquid	Single-stage Solid	Single-stage Liquid	Single-stage Liquid	Non-ballistic trajectory
<b>Range Min- Max (km)</b>	20-120	50-150	50-300	300	50-300	500	200-600	170-1,300	1,500-3,000+	Increased range
<b>Guidance</b>	Inertial	Inertial	Inertial	Inertial IR homing	Inertial	Inertial	Inertial	Inertial	Inertial	Multi-sensor Homing
<b>Accuracy (m)</b>	50	150	1,000	50	300	<800	600	4,000	2,000-2,500	Improved Guidance
<b>Payload (kg)</b>	480	190	1,000	600	800	700	500-600	770	1,500-2,150	Separating multiple RVs
<b>Warheads</b>	HE, Chem, Nuc, ARM, EMP, Submunitions	HE, Chem	HE, Chem, Nuc	Separating HE, Nuc	Separating HE, Nuc poss Chem	HE, Chem	Separating. HE, Nuc poss Chem Poss Fuel- Air Submuni- tions	HE, Chem poss Nuc	HE, Nuc, or 3 separating reentry vehicles (RVs)	Cluster, Volumetric, Submunitions BW warheads, ARM, EMP
<b>Comments</b>	TEL is amphibious	Modified SA-2 SAM  Tracked TEL	Technology widely used	Requires compatible IR imagery	Possible export or technology export to other countries		SCUD-B variant  Russia limited production	SCUD-B variant  ND-2 IRBM variant  Poss export	Variants with varied warheads and ranges  Towed launcher  Lengthy prep time	Autonomous operation  Penaid/ Counter- measures  Reduced prep/ displace times

13-6



## Chapter 14 Equipment Upgrades

Armed forces worldwide employ a mix of legacy systems and selected modern systems. In the current era characterized by constrained military budgets, the single most significant modernization trend impacting armed forces worldwide is upgrades to legacy systems. Other factors impacting this trend are:

- A need for armed forces to reduce force size, yet maintain overall force readiness for flexibility and adaptiveness
- Soaring costs for modern technologies, and major combat systems
- Personnel shortages and training challenges
- Availability of a wide variety of upgrade packages and programs for older as well as newer systems
- New subsystem component technologies (lasers, GPS, imaging sensors, microcircuits, and propellants) which permit application to platforms, weapons, fire control systems, integrated C2, and munitions old and new, and
- An explosion of consortia and local upgrade industries which have expanded worldwide and into countries only recently introduced to capitalism.

The upgrade trend is particularly notable concerning aerial and ground vehicles, weapons, sensors, and support equipment. From prototype, to low-rate initial production (LRIP), to adoption for serial production, minor and major improvements may be incorporated. Few major combat systems retain the original model configuration five or more years after the first run. Often improvements in competing systems will force previously unplanned modifications. Upgrades enable military forces to employ technological niches to tailor their force against a specific enemy, or integrate niche upgrades in a comprehensive and well-planned modernization program. Because of the competitive export market and varying requirements from country to country, a vehicle may be in production simultaneously in many different configurations, as well as a dozen or more support vehicle variants fulfilling other roles. In light of this trend, OPFOR equipment selected for portrayal in simulations and training should not be limited to the original production model of a system, rather a version of the system that reflects the armed force's strategic and modernization plans and, as well as likely constraints that would apply.

The adaptive OPFOR will introduce new combat systems and employ upgrades on existing systems to attain a force structure which supports its plans and doctrine. Because the legacy force mix and equipment were historically selected earlier in accordance with plans and options, upgrades vs costly new acquisitions will always be an attractive option. A key consideration is the planned fielding date. For this document, OPFOR time frame is current to near-term. Thus,

only upgrades currently available (or marketed, with production capability and fielding expected in the near term), are considered. Also, system costs and training and fielding constraints should be considered.

The following tables describe selected upgrades available for system modernization. The lists are not intended to be comprehensive. Rather, they are intended to highlight major trends in their respective areas. For instance, for armored combat vehicles, the focus is on upgrades in mobility, survivability, and lethality.

The category of survivability upgrades includes countermeasures (CM). The CM upgrades can apply not only to systems targeted initially in specific branches (tanks, IFV, and air defense guns), but, in time, to other systems subject to similar threats based on availability of the applications. An example of this is the proliferation of smoke grenade launchers to artillery and air defense vehicles.

Implementation of all upgrade options for any system is generally not likely. Because of the complexity of major combat systems and need for equipment subsystem integration and maintenance, most force developers will chose a mix of selected upgrades to older systems, as well as limited purchases of new and modern systems. Please note that systems featured in this document may be the original production system or a variant of that system. On data sheets, the **VARIANTS** section describes other systems available for portrayal in training and simulations. Also, equipment upgrade options (such as night sights) and different munitions may be listed, which allow a user to consider superior or inferior variants. Within the document chapters, multiple systems are listed to provide other substitution options. Of course there are thousands of systems and upgrade options worldwide which could be considered by an adaptive OPFOR.

An OPFOR trainer has the option to portray systems or upgrade packages not included in the OPFOR Worldwide Equipment Guide, to reflect an adaptive thinking OPFOR. In future WEG updates, we will expand on the upgrade tables with names descriptions of upgrade options and specific systems applications which have been noted. Our functional area analysts are available to assist OPFOR users in selecting reasonable upgrade options for system configuration in specific force portrayals. Questions and comments on tables and data in this chapter should be addressed to the POC for each chapter impacted by the below tables.

**Tom Redman**

DSN: 552-7925 Commercial (913) 684-7925  
e-mail address: redmant@leavenworth.army.mil

**OPFOR ANTITANK WEAPON UPGRADES**

GRENADE LAUNCHER	TOWED AT GUN	GROUND ATGM LAUNCHER
Take-apart launchers/disposable launch tubes	Auxiliary propulsion unit for local movement	Manportable/ground launch and shoulder launch
Tripod, bipod, pintel mount for vehicles/ground	Take-apart capability for lighter guns	Take-apart launcher and sub-systems
Ballistic computer/laser rangefinder sights	Improved gun and recoil system	Pintel mount for variety of vehicles/platforms
Image intensifier/thermal night sights	Ballistic computer/laser rangefinder sights	1st or 2nd generation thermal night sights
Larger, more lethal disposable grenade launchers supplement grenadier launches at critical times.	MMW radar target tracker FCS	Extended range missile
Improved reusable sights for disposable launchers	Image intensifier/thermal night sights	Soft-launch for use from bunkers and buildings
Counter-charge for firing inside buildings	Automated battle management system with graphic flat panel display	Launcher countermeasures (CM), such as reduced noise, smoke, flash
Reduced noise, smoke, and flash signature	Indirect fire rounds/FCS for fire support role	SACLOS Guidance CCM, e.g., pulsed codes
Tandem shaped-charge (HEAT) warhead	Increased DF range, new tank/AT gun rounds	Increased ATGM velocity/reduced flight time
Thermobaric Frag-HE warhead	Improved more lethal APFSDS-T round	New guidance modes: Semi-active laser-homing Fiber-optic guided missile (FOG-M) guidance Fire and forget imaging infrared seeker
Dual-purpose (HE/AT) longer range rounds	Tandem HEAT round	Larger warhead/tandem warhead HEAT ATGM
HE longer range rounds	Improve Frag-HE round and DPICM submunition	Sensor-fuzed EFP/HEAT top-attack
Multi-purpose (HE/AT/anti-bunker) rounds	Canister/flechette round	Thermobaric HE warhead, for new applications <b>Changeable warheads</b>
Guided (SAL-H) grenades	New type lethalties (DPICM submunition, etc.)	<b>UPGRADE PRIORITY</b> Take-apart launcher, with pintel mount Improved 1st gen thermal night sights SACLOS CCM Reduced signature Improved ATGMs (tandem HEAT, etc.)
Improved AT and dual-purpose rifle grenades permit riflemen to supplement grenade launchers.	Gun-launched ATGM (100 mm+)	
<b>UPGRADE PRIORITY</b> Computer/LRF FCS II night sights Tandem AT grenades, HE/DP grenades, thermobaric grenades	<b>UPGRADE PRIORITY</b> APU and take-apart for lighter guns Improved gun and recoil system Improved sights, 1st gen thermal night sights Automated battle management system Improved ammunition, inc ATGM.	

### OPFOR LIGHT ARMORED VEHICLE UPGRADES

COMBAT SUPPORT VEHICLE	APC/IFV	ATGM LAUNCHER VEHICLE
<p>Used for a variety of roles, e.g., light infantry (less than squad), and support vehicles. Most are light, 4x4 wheeled, van or jeep-type; but auxiliary wheel, 6x6, tracked versions exist. Included are motorcycles and 4x4 fast-attack vehicles (similar to recreational dune buggies).</p> <p>Central tire inflation system and/or run-flat tires</p> <p>GPS hand-held or bracket mount</p> <p>Ford capability, swim capability desired</p> <p>Add-on light armor, mine protection desired</p> <p>CM, such as multi-spectral smoke grenades</p> <p>Laser warning receiver desired</p> <p>7.62-14.5-mm machine gun or 20-40-mm automatic grenade launcher main weapon</p> <p>Remote or overhead weapon station (RWS/OWS)</p> <p>Individual weapons, RPG, MANPADS, or ATGM launcher for secondary weapons</p> <p>Daysight and II or thermal night sight</p> <p>Add encrypted voice and digital data capability.</p> <p>Graphic display battle management system</p> <p><b>UPGRADE PRIORITY</b> Light armor and smoke grenade launchers Remote MG or auto grenade launcher Day/night (thermal sights), RPG GPS, secure comms</p>	<p>Must be able to carry a squad</p> <p>Higher horsepower diesel engine</p> <p>GPS and inertial land navigation, graphic display battle management system, IFF</p> <p>Swim or deep ford (due to armor increases)</p> <p>Add-on armor, ERA, and improved mine protection. Fire and blast suppression</p> <p>CM, e.g., multi-spectral smoke grenades, LWR</p> <p>Firing ports (or forego due to armor increases, use periscopes or side and rear view cameras)</p> <p><u>IFV</u>: 20-100 mm gun, 2-plane stabilization, and 2-man turret.</p> <p>Upgraded FCS: Cdr's independent viewer, 2-plane stabilized TV sights, 1 - 2 gen FLIR.</p> <p>Improved secondary MG or grenade launcher with improved sights (integrated, high-angle, night). Additional remote MGs/AGLs for high-angle fires security.</p> <p>Improved KE, HEAT, Frag-HE rounds, ATGMs</p> <p><u>APC</u>: Includes truck/light vehicle conversions</p> <p>Remote weapon station or 1-man turret with high-angle-of fires 7.62-23 mm MG, grenade launcher (some with 20-30-mm auto-cannon and ATGM launcher)</p> <p><b>UPGRADE PRIORITY</b> Add-on armor, ERA, LWR, new grenades Add auto grenade launcher, upgrade ATGM, and KE round to APFSDS. FCS, stabilized sights, Imp 1st gen FLIR</p>	<p>Use <u>APC/IFV</u> wheeled/tracked chassis or <u>tank</u> chassis, with mobility and protection upgrades</p> <p>CM, e.g., multi-spectral smoke grenades, LWR</p> <p>1-2 man turret, or turretless design <u>alternative design</u>: 1-5 pedestal/turret or mast-elevated ATGM launchers</p> <p>Autoloader or manual loader under armor</p> <p>FCS with commander's independent viewer, 2-plane stabilized sights, TV, and target tracking. Use 1st or 2nd gen FLIR</p> <p>Side and rear-view cameras</p> <p>Graphic display battle management system</p> <p>Multiple ATGM launch and targeting capability</p> <p>Improved ATGMs, as noted in above table, or RF, laser-beam rider, SAL-H/IIR ATGMs</p> <p>7.62-12.7-mm MG secondary arms</p> <p><u>Most common ATGM vehicles</u> are combat support vehicles with pintel-mount ATGM launcher, see above table for ground launcher.</p> <p>Recent development: motorcycle with sidecar and pintel-mount ATGM launcher</p> <p><b>UPGRADE PRIORITY</b> Autoloader/multiple ATGM launcher (APC/IFV/tank version), single manual for others Stabilized sights and 1st gen thermal sights Improved ATGMs</p>

RECONNAISSANCE VEHICLE	LIGHT TANK/ASSAULT GUN/SP AT GUN	MAIN BATTLE TANK
<p><u>Light recon vehicle:</u> Combat support vehicle with light armor and TV, thermal sights, Add encrypted voice and digital data capability</p> <p><u>Combat recon vehicle:</u> See IFV upgrades, e.g.: 20-100 mm gun with 2-plane stabilization, and 2-man turret. Improved secondary MG or automatic grenade launcher and sights.</p> <p>CM, e.g., multi-spectral smoke grenades, LWR</p> <p>Upgraded FCS: Cdr's independent viewer, 2-plane stabilized TV camera sights, 1 - 2 gen FLIR</p> <p>Elevated battlefield surveillance radar/TV/FLIR sensor suite with TV, encrypted voice, and digital data transmission capability</p> <p>GPS and inertial land navigation, and graphic display battle management system, IFF</p> <p>Improved KE, HEAT, HE rounds, and ATGMs</p> <p>Manportable SAM (MANPADS)</p> <p><u>Sensor vehicle:</u> APC/IFV or combat support vehicle and mast-mounted sensor pod: radar, thermal and TV Encrypted voice SATCOM/digital data systems</p> <p><b>UPGRADE PRIORITY</b> Add higher HP diesel engine Add-on armor, ERA, LWR, new grenades Imp 1st gen FLIR, gunner and commander, Add auto grenade launcher, upgrade ATGM, and KE round to APFSDS. Elevated sensor suite and transmission capability.</p>	<p>Distinction among heavy recon, infantry fire support, assault gun, light tank has blurred</p> <p>APC/IFV chassis with increased armor and higher horsepower diesel engine.</p> <p>GPS and inertial land navigation, graphic display battle management system, IFF</p> <p>Swim or deep ford capability</p> <p>Add-on armor, ERA, improved mine protection, fire and blast suppression.</p> <p>CM, e.g., multi-spectral smoke grenades, LWR Side and rear-view cameras for security</p> <p>76-125 mm tank gun with 2-plane stabilization,</p> <p>Improved MG or auto grenade launcher, sights</p> <p>FCS with commander's independent viewer, 2-plane stabilized sights, TV, and target tracking. Use of 1st or 2nd generation FLIR. Side and rear-view cameras</p> <p>Improved KE, electronic fuzed Frag-HE, and tandem HEAT rounds</p> <p>Gun-launched ATGMs (100+ mm)</p> <p><b>UPGRADE PRIORITY</b> Add higher HP diesel engine Add-on armor, ERA, LWR, new grenades Imp 1st gen FLIR, gunner and commander, Larger stabilized gun, gun-launch ATGM, and KE round to APFSDS.</p>	<p>Higher horsepower diesel engine</p> <p>Add-on reserve fuel tanks</p> <p>GPS and inertial land navigation, graphic display battle management system, IFF</p> <p>Deep ford snorkel capability</p> <p>Add-on armor and ERA, improved mine and turret protection, fire and blast suppression.</p> <p>CM suite, including multi-spectral smoke grenade mix, LWR, VEES capability</p> <p>Tank gun with 2-plane stabilization</p> <p>Improved remote-firing MG, high-angle AD sights</p> <p>FCS with commander's independent viewer, 2-plane stabilized sights, TV, and target tracking. Use of 1st or 2nd generation FLIR. Side/rear-view security cameras</p> <p>Improved KE, electronic fuzed Frag-HE, and tandem HEAT rounds</p> <p>Gun-launched antitank guided missiles (100+ mm)</p> <p><b>UPGRADE PRIORITY</b> Add higher HP diesel engine Land navigation and deep ford snorkel Add-on armor, ERA, CM suite Imp stabilization and FCS, 1st gen FLIR, Remote MG, Imp ammo (sabot, Frag-HE, and HEAT) Gun-launch ATGM.</p>

ARTILLERY RSTA/C2 SUPPORT	TOWED AND SELF-PROPELLED CANNON	MULTIPLE ROCKET LAUNCHER
<p>Automated secure digital joint C2 network with SATCOM, linking artillery, air, EW, and reconnaissance units</p> <p>Integrated artillery recon vehicle with sensor mast</p> <p>Automated battle management equipment use for towed and SP guns, mortars and MRLs</p> <p>Navigation system with GPS/inertial update, linked to automated net</p> <p>Reconnaissance strike and fire complexes</p> <p>Forward air controllers linked to artillery units</p> <p>Artillery links to selected special purpose forces</p> <p>Phased array counter-battery radars, networked to automated artillery net, with increased range, lower probability of error, windows-based man-machine interface</p> <p>Acoustic vehicle detection and location</p> <p>Target-acquisition UAVs, networked to artillery net</p> <p>Artillery surveillance vehicles with ground surveillance radars, sensor suite and networked</p> <p>Observation teams with goniometers, thermal sights, digital comms, and laser target designators</p> <p><u>UPGRADE PRIORITY</u>            Integrated artillery recon vehicle, sensor mast            Reconnaissance strike and fire complexes            Target-acquisition UAVs, networked            Observation teams, radars, acoustic sensors</p>	<p>Conventional munitions, e.g., controlled fragmentation, multi-option fuzes, special munitions, and propellant s (modular propellants)</p> <p>Artillery delivered high precision munitions (ADHPM) e.g., SAL-H, sensor-fuzed, course corrected, and terminally homing projectiles</p> <p><u>Self-Propelled:</u> Automated fire control with barrel cooling and thermal warning systems</p> <p>Auxiliary power unit</p> <p>Mobility and weight improvements</p> <p>Muzzle velocity analyzer</p> <p>CM, such as smoke grenade launcher and LWR</p> <p>Upgrade to 52-caliber cannon for longer range</p> <p><u>Towed:</u> Addition of auxiliary propulsion unit</p> <p>On board technical fire control computer</p> <p>Reduced weight and emplace/displace times</p> <p>Muzzle velocity analyzer permanently connected to on-board technical fire control computer</p> <p>Upgrade to 52-caliber cannon for longer range</p> <p><u>UPGRADE PRIORITY</u>            Mobility and weight improvements            On-board navigation and fire direction systems            Use of modular propellant            Procurement of ADHPM            Overall range and accuracy improvements</p>	<p>Mobility and weight improvements, truck-based launchers which conceal the MRL signature</p> <p>Rapid emplace-displace and response capabilities</p> <p>CM, such as smoke grenade launcher and LWR</p> <p>On-board computer-based fire direction and land navigation systems, which permit autonomous launcher, platoon ,and battery operations</p> <p>Tube-launched UAVs linked to the launchers and to the fire control network for real-time acquisition</p> <p>Extended-range rockets</p> <p>Improved lethality/range conventional munitions</p> <p>Computer-based fire control system for electronically-fuzed rockets</p> <p>Artillery delivered high precision munitions (ADHPM), such as sensor fuzed.</p> <p>Course-corrected rockets</p> <p>Special munitions, such as FASCAM and chemical warhead rockets</p> <p>Mine clearer and fuel-air explosive rocket MRLs</p> <p><u>UPGRADE PRIORITY</u>            Autonomous/ semi-autonomous launcher            Countermeasures            Improved munitions, e.g., extended range, DPICM and thermobaric            ADHPM, e.g., sensor-fuzed munitions and course corrected rounds or rockets</p>

AIR DEFENSE GUN/GUN-MISSILE SYSTEM	MANPORTABLE AIR DEFENSE SYSTEM	SURFACE-TO-AIR MISSILE
<p><u>Light AD vehicle:</u> Combat support vehicle with light armor and TV, thermal sights, Add encrypted voice and digital data capability, and overhead launcher turret</p> <p><u>Armored AD vehicle:</u> See IFV upgrades, e.g.: improved armor, and suspension, 2-man turret</p> <p>CM, e.g., multi-spectral smoke grenades, LWR</p> <p>Upgraded FCS: Cdr's independent viewer, 2-plane stabilized TV gunner sights, FLIR, multi-mode targeting (TV/radar, day/night modes). Improved target acq radar, longer range, low probability of intercept. Reduced radar mean-time to detect and system response time</p> <p>Links to AD network, encrypted voice, digital data transmission capability, computer display GPS and inertial land navigation, IFF</p> <p>Improved multiple MGs/autocannons to 40 mm or cannons to 100 mm, with stabilized guns with fire on the move capability</p> <p>Improved rounds, e.g., electronic-fuzed HE, APFSDS-T, and frangible rounds</p> <p>MANPADS or multi-stage AD missiles with ACLOS radar dual and multi-band seekers</p> <p>Kinetic-energy missiles with sabots, for use in AD role, and against ground vehicle targets</p> <p><b><u>UPGRADE PRIORITY</u></b> Improved day/night optics and radar Automated secure links to AD network Improved multiple stabilized guns, rounds Improved missiles and guidance</p>	<p>Vehicle, ground platform, helicopter mounts</p> <p>Thrust-vectoring capability</p> <p>All-aspect engagement capability</p> <p>Strap-on imaging infrared or thermal sights</p> <p>Early warning datalinks and alert display boards for mount on launcher</p> <p>Upgraded IFF capabilities</p> <p>Missiles in disposable launch tubes</p> <p>Improved missiles and seeker heads with better counter-countermeasure resistance</p> <p>Uncooled seeker heads, wider FOV</p> <p>Increased range</p> <p>Improved warheads and blast/frag effects, base fuzing of propellant for increased blast</p> <p>Improvements in aerodynamics, fuels, and materials, for increases in speed, reduced smoke signature, maneuverability, and accuracy</p> <p>Integrate with anti-helicopter mines</p> <p><b><u>UPGRADE PRIORITY</u></b> Improved sights and warning display boards Strap-on II/FLIR Improved seekers, warheads, propulsion Uncooled seeker heads, wider FOV Flare rejection capability</p>	<p>Improved vehicle or platform launcher for rapid emplacement/displacement</p> <p>CM, e.g., multi-spectral smoke, LWR</p> <p>Upgraded FCS: 2-plane stabilized TV gunner sights, 1 - 2 gen FLIR, multiple target engagement capability, All-weather fire control, multi-mode targeting, with TV and radar, day and night.</p> <p>Improved EW and target acq radars, longer range, low probability of intercept, and signal processing in radars</p> <p>Reduced radar mean-time to detect, and system response time</p> <p>Links to AD network, encrypted voice, digital data transmission capability, computer display</p> <p>GPS and inertial land navigation, and graphic display battle management system, IFF</p> <p>Missiles with SACLOS, ACLOS radar, IR or multi-band terminal seekers, more lethal warheads, longer range, maneuverability with improved counter-countermeasure resistance</p> <p>Vertical missile launch</p> <p><b><u>UPGRADE PRIORITY</u></b> Improved FCS with day/night optics and radars, and multi-target capability and modes Automated secure links, digital AD network Improved missiles and guidance CM protection from jamming and ARMs</p>

**OPFOR AERODYNAMIC SYSTEM UPGRADES**

<b>ROTARY-WING AIRCRAFT</b>	<b>UNMANNED AERIAL VEHICLE (UAV)</b>	<b>THEATER BALLISTIC MISSILE (TBM)</b>
<p>Older airframes and utility helicopters can be upgraded sensors and weapons</p> <p>Western upgraded avionics, fire control computers, sights, and technology readily available to retrofit into existing older airframes</p> <p>Many new aircraft being built with cost controls to make entice new markets in developing nations.</p> <p>Emerging belief in upgrade of existing platforms rather than developing new airframes, primarily due to financial constraints</p> <p>Development of quieter, more efficient main and tail rotor blades and engines to increase aircraft performance</p> <p>Digital data-linking with ground systems and air defense networks</p> <p>Increased use of millimeter wave, FLIR, and NVG technologies to allow greater night/ weather weapons delivery and mission completion</p> <p>Service life extension programs</p> <p>Improved weapons and munitions, including ATGMs, air-to-service missiles, and precision bombs</p> <p><b><u>UPGRADE PRIORITY</u></b> MMW, FLIR, and NVG technologies Upgraded avionics Service life extension programs</p>	<p>Extend operational radius and endurance</p> <p>Reduce sensor-shooter timeline</p> <p>Enhanced third-generation image intensifiers and second-generation thermal imagers may be available to limited countries.</p> <p>Multiple sensors will be employed on the same platform for enhanced target detection under all-weather conditions and may be linked to weapon delivery platforms.</p> <p>Integrated laser target designators for smart munitions in priority target areas</p> <p>Multiple sensors for chemical and biological agents will be employed on this platform and may be linked to comms platforms.</p> <p>Precision attack variants, such as anti-radiation UAVs for radar attack</p> <p><b><u>UPGRADE PRIORITY</u></b> Extend operational radius and endurance Obtain improved EO capability Reduce sensor-shooter timeline Laser target designator integration</p>	<p>Improved launcher (swim capability, multiple missile capability, reduced signature)</p> <p>Reduced preparation time, emplace and displace times, shoot and scoot operation</p> <p>Automated secure digital C2 network, linking with artillery, air, EW, and reconnaissance units</p> <p>Navigation system with GPS/inertial update, linked to automated net</p> <p>Autonomous operations or increased interval</p> <p>Launcher countermeasures: decoys, missile non-ballistic launch trajectory</p> <p>Missile countermeasures (e.g., non-ballistic trajectory, penetration aids, separating warhead, multiple maneuvering re-entry vehicles)</p> <p>Extended range missiles</p> <p>Improved smokeless propellant</p> <p>Multi-sensor or other improved homing with increased accuracy (&lt;50 m CEP)</p> <p>Advanced munitions (cluster munitions, FAE/thermobaric munitions, biological, electro-magnetic pulse, anti-radiation missiles), larger payloads</p> <p><b><u>UPGRADE PRIORITY</u></b> Improved smokeless propellant Separating warhead and larger payloads Survivability countermeasures.</p>



## *Countermeasures*

Countermeasures (CM) are survivability measures which a force can employ to preserve the readiness of assets and personnel by degrading the enemy's RSTA and weapons effectiveness. These measures often fit within the US Army term CCD (camouflage, concealment and deception) or within the OPFOR term C3D (camouflage, cover, concealment and deception). However, assets used in deception operations are addressed as a subset of Information Warfare (IW), and are directed at the operational-strategic level. Decoys used by tactical units within branch operations are designed to aid survivability, and are considered to be countermeasures. Countermeasures can take the form of tactical CM (or reactive measures), or they can be technical CM. Because of the equipment focus of this document, it will not address tactical measures. Countermeasures for use on aircraft will be discussed at a future time.

Modern forces will upgrade systems with selected countermeasures. Many CM noted are intended to protect combat vehicles from antiarmor sensors and weapons. Although the below CM can be used to counter precision weapons, many were developed for use against conventional weapons. Several factors must be considered when selecting countermeasures.

- Some countermeasures can affect a variety of sensors and weapons capabilities. Others are more technology-specific, and may not be fielded until that technology is identified as a threat. They can be grouped by threat to be countered, such as artillery CM or ATGM CM. Driven by threatening weapons technologies, military forces may initiate a short-response program to fabricate or purchase countermeasures for rapid fielding. The R&D process has led to the development of counter-countermeasures, intended to negate the effects of CM. However, at some level, these are also CM. To avoid confusion on labeling, these will also be called countermeasures.
- Although a variety of countermeasures are now marketed, high costs for some CM may restrict availability within limited budgets. Thus OPFOR users should consult the POC as noted below for assistance in selecting CMs for a specific system.
- Countermeasure development may be restricted due to resource, technology, and fabrication limitations, which vary by country and time frame. Budget limitations may limit fielding of feasible and valuable countermeasures, or will compel the selection of less capable countermeasures.
- When countermeasures are added to a vehicle or within close proximity, they must be mutually compatible and compatible with other subsystems. Thus issues such as electromagnetic interference and self-blinding with smokes must be considered.

Questions and comments on countermeasures for specific BOSs should be addressed to the respective chapter POC. Questions concerning data in this chapter should be addressed to:

**Tom Redman**

DSN: 552-7925 Commercial (913) 684-7925  
e-mail address: redmant@leavenworth.army.mil



## LETHALITY COMPONENT VERSUS COUNTERMEASURE RESPONSES

Intent of this table is to assist in selection of CM and understanding the categorization for use in upgrade schemes. Many of the more widely-fielded countermeasures are designed to degrade a variety of sensors and munitions, for minimal upgrade cost. Thus, countermeasure types may be repeated under several functions. Because new technologies are emerging rapidly, and systems are finding applications which can place them in several CM types, the placement of CMs can be somewhat arbitrary. Use against artillery vs ATGMs vs ground vehicle weapons will vary.

Capability to Be Degraded	Type of Countermeasure
Detection and location	Camouflage: nets, paints, fasteners for added natural materials Cover: entrenching blades, hole-blast device, underground facilities Concealment: screens, skirts, thermal engine covers, scrim, other signature reduction Deformers, engine exhaust diversion, other signature alteration measures Aerosols: smoke and flares, water spray systems Decoys, clutter, and acoustic countermeasures Counter-location measures: GPS jammers, laser and radar warning systems
C2/sensor-shooter links	See Information Warfare (IW) Chapter
Platform or weapon	Counterfire: directional warning systems, laser radars, for rapid response Directed energy weapons (DEW), such as high-energy lasers System prioritization for hard-kill, e.g., anti-helicopter mines (See Ch 7)
Weapon sensors and fire control	CCD as noted above. Directed energy weapons, such as low-energy lasers (LEL) Electro-optical countermeasures (EOCMs)
Submunition dispensing/activation	Global positioning system (GPS) jammer Fuze (laser/IR/RF), RF barrage jammers, acoustic jammers
Precision munition and submunition sensors	CCD as noted above. False-target generator (visual, IR, RF/acoustic) Electromagnetic mine countermeasure system, to pre-detonate or confuse Fuze jammers (laser/IR/RF), RF barrage jammers, acoustic jammers
Munition/submunition in-flight, and its effects	Sensors to detect munitions: MMW radars, RF/IR/UV passive sensors Air watch and air defense/NBC warning net, to trigger alarm signal Active protection systems, for munition/submunition hard kill Cover, additional armor to reduce warhead effects
Other system effects	Miscellaneous CM (See below)

### COUNTERMEASURES AGAINST SENSORS

Type Countermeasure	Countermeasure	Example	Application
Camouflage	Camouflage nets Camouflage paints, IR/radar/and laser-absorptive materials/paints Fasteners, belts for attaching natural materials	Russian MKS and MKT Salisbury screen rubber epoxy Chinese "grass mat" set	Variety of vehicles Variety systems Uniforms and vehicles
Cover	Natural and manmade cover, civilian buildings Entrenching blade to dig in vehicles Hole-blast devices for troop positions, spider holes Underground facilities, bunkers, firing positions	Tree cover, garages, underpasses T-80U tank, BMP-3 IFV, 2S3 arty  Hardened artillery sites, bunkers	TELS, vehicles, troops IFVs, tanks, SP arty Infantry, SOF Iraqi and NK sites
Concealment	Screens, overhead cover for infantry (conceal IR/visible signature) Canvas vehicle cover, to conceal weapons Thermal covers, vehicle screens Scrim, side skirts and skirting around turret	Colebrand netting Cover on Chinese Type 90 MRL Kintex thermal blanket over engine French "Ecrim" track cover scrim	Infantry, weapon, sensor Truck-based weapons For combat vehicles Combat vehicles
Deformers/ signature modification	"Wummels" (erectible umbrellas to change/conceal shape/edges) Exhaust deformers (redirect exhaust under/behind vehicle) Engine and running gear signature modification (change sound) IR/radar deformers (in combination with RAM and RAP, etc)	Barracuda RAPCAM/TOPCAM Russian exhaust deflectors Track pads, road wheel/exhaust change Cateyes, Luneberg lens	Vehicles, sites, weapons Combat vehicles Tracked, other vehicles Tracked, other vehicles
Aerosols	Visual suppression measures, smokes, WP rounds Multi-spectral smokes for IR and or MMW bands, Flares, chaff, WP, to create false targets, disrupt FLIR Toxic smokes (irritants to disrupt infantry and weapons crews) Water spray systems (to reduce thermal contrast)	Smoke generators, fog oil, S-4, RPO-D ZD-6 Smoke grenades (visual/IR) WP rounds, Galix 6 flare system, Adamsite and CN in smoke mix Add-on kits for vehicles	Blinding, screening Vehicle protection Combat vehicles, arty Smoke generators Recon, C <sup>2</sup> , AD, arty
Decoys	Clutter (civilian/military vehicles, structures, burning equipment) Low to high-fidelity (multi-spectral) decoys Radar/IR decoy supplements (to add to visual/fabricated decoys) Acoustic countermeasures (to deceive reconnaissance, sensors)	Log site, truck park, tank farm, derricks Barracuda decoys, Corner reflectors, KFP-1-180 IR heater Acoustic tape/speaker systems	Artillery, combat vehicles  Vehicle/site decoys Vehicles, sites
Counter-location measures	Degrade GPS by jamming to reduce precision location capability Jam radars/IR sensors Laser, IR, and radar warning systems (to trigger move/CM)	Aviaconversia GPS jammer SPN-2 truck-borne jammer set Slovenian LIRD laser warner	Infantry and others tactical/operational area Combat vehicles

**COUNTERMEASURES AGAINST WEAPONS AND WEAPON SENSORS**

<b>Type Countermeasure</b>	<b>Countermeasure</b>	<b>Example</b>	<b>Application</b>
Added protection (supplements to armor in reaction to specific capability)	Armor supplements (ERA, screens, bar or box armor, sand bags) Armor skirts over road wheels Mine rollers, plows and flails Vehicle belly armor, raised or redesigned belly design, skirt Vertical smoke grenade launchers (to counter PGM top attack)		
EOCM	Use EOCCMs such as IR jammer/IR searchlights to redirect ATGM	KBCM infrared CM system	Combat vehicles
False-target Generators	Acoustic jammers and directed acoustic countermeasure Laser false-target generator (against semi-active laser homing) Electromagnetic mine countermeasure system, counters fuzes	In development, can be improvised In development	To distract acoustic seekers Combat vehicles
Jammers	Altimeter jammer (counters submunition dispersion altimeter) Fuze jammers (to spoof RF proximity fuzes on munitions) Incoherent infrared jamming (to jam IR fuzes on munitions)	SPR-1 armored ECM vehicle	High priority sites, CPs etc.
Active countermeasures	Active protection systems, for munition hard kill. Directed energy weapons Directed MGs	Arena hard-kill system ZM-87 low energy laser weapon	Tanks, recon vehicle, IFVs AT, AD systems
Counterfire/Threat response warners	Directional warning system (locate laser/radar, to direct weapons) Employ sensors (RF/IR/UV - to detect munitions) Acoustic directional systems (to detect munitions) Laser radars (laser scanner to locate optics and direct weapons) Directed energy weapons (against optics) Anti-helicopter mines (against aircraft) Employ air watch/security, AD, NBC, nets to trigger alarm signal Dazzle grenades (temporarily blind personnel)	Star-burst grenades	Infantry
Miscellaneous CM	Optical filters to degrade effect of battlefield lasers. Pulse code/thermal CCM beacons on SACLOS ATGMs (to counter EOCCM)		

