



**Calhoun: The NPS Institutional Archive**  
**DSpace Repository**

---

Theses and Dissertations

1. Thesis and Dissertation Collection, all items

---

1991-09

# A comparison of the UHF Follow-on and MILSTAR satellite communication systems

Perkins, Clifton E.

Monterey, California. Naval Postgraduate School

---

<http://hdl.handle.net/10945/30975>

*Downloaded from NPS Archive: Calhoun*



Calhoun is a project of the Dudley Knox Library at NPS, furthering the precepts and goals of open government and government transparency. All information contained herein has been approved for release by the NPS Public Affairs Officer.

**Dudley Knox Library / Naval Postgraduate School**  
**411 Dyer Road / 1 University Circle**  
**Monterey, California USA 93943**

<http://www.nps.edu/library>

ADA245806



# NAVAL POSTGRADUATE SCHOOL Monterey, California



## THESIS

A COMPARISON OF THE UHF FOLLOW-ON  
AND MILSTAR SATELLITE  
COMMUNICATION SYSTEMS

by

Clifton E. Perkins, Jr.

September, 1991

Thesis Advisor:

Dan C. Boger

Approved for public release; distribution is unlimited.

REPRODUCED BY  
U.S. DEPARTMENT OF COMMERCE  
NATIONAL TECHNICAL  
INFORMATION SERVICE  
SPRINGFIELD, VA 22161

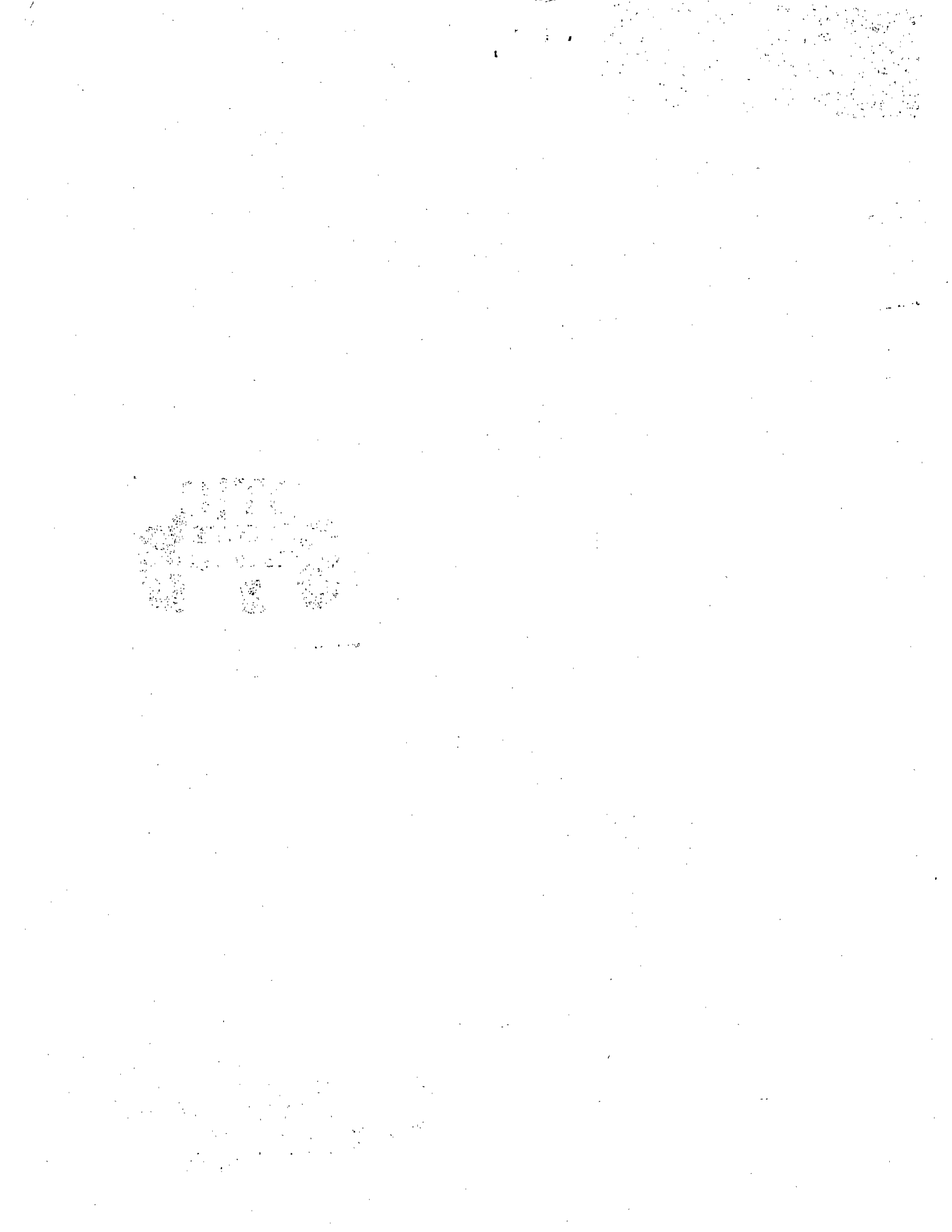

REPORT DOCUMENTATION PAGE				Form Approved OMB No. 0704-0188			
1a. REPORT SECURITY CLASSIFICATION <b>Unclassified</b>			1b. RESTRICTIVE MARKINGS				
2a. SECURITY CLASSIFICATION AUTHORITY			3. DISTRIBUTION/AVAILABILITY OF REPORT <b>Approved for public release; distribution is unlimited.</b>				
2b. DECLASSIFICATION/DOWNGRADING SCHEDULE							
4. PERFORMING ORGANIZATION REPORT NUMBER(S)			5. MONITORING ORGANIZATION REPORT NUMBER(S)				
6a. NAME OF PERFORMING ORGANIZATION <b>Naval Postgraduate School</b>		6b. OFFICE SYMBOL <b>39</b>	7a. NAME OF MONITORING ORGANIZATION <b>Naval Postgraduate School</b>				
6c. ADDRESS (City, State, and ZIP Code) <b>Monterey, CA 93943-5000</b>			7b. ADDRESS (City, State, and ZIP Code) <b>Monterey, CA 93943-5000</b>				
8a. NAME OF FUNDING/SPONSORING ORGANIZATION		8b. OFFICE SYMBOL	9. PROCUREMENT INSTRUMENT IDENTIFICATION NUMBER				
8c. ADDRESS (City, State, ZIP Code)			10. SOURCE OF FUNDING NUMBERS				
			PROGRAM ELEMENT NO.	PROJECT NO.	TASK NO.	WORK UNIT ACCESSION NO.	
11. TITLE (Include Security Classification) <b>A COMPARISON OF THE UHF FOLLOW-ON AND MILSTAR SATELLITE COMMUNICATION SYSTEMS</b>							
12. PERSONAL AUTHOR(S) <b>Perkins, Clifton E., Jr.</b>							
13a. TYPE OF REPORT <b>Master's Thesis</b>		13b. TIME COVERED FROM _____ TO _____		14. DATE OF REPORT (Yr., Mo., Day) <b>September 1991</b>		15. PAGE COUNT <b>72</b>	
16. SUPPLEMENTARY NOTATION <b>The views expressed in this thesis are those of the author and do not reflect the official policy or position of the Department of Defense or the U.S. Government.</b>							
17. COSATI CODES			18. SUBJECT TERMS (Continue on reverse if necessary and identify by block number)				
FIELD	GROUP	SUB-GROUP	MILSTAR, UHF Follow-on, EHF, SHF, Geosynchronous, Molniya, GPS				
19. ABSTRACT (Continue on reverse if necessary and identify by block number) <b>The author compares the UHF Follow-on and MILSTAR satellite communication systems. The Comparison uses an analytical hierarchy process. Although the two systems have been tasked with different missions, a comparison of cost, capability, and orbit is conducted. UFO provides many of the same capabilities as MILSTAR, but on a smaller scale. Since UFO is also a new space system acquisition, it is used to compare dollars spent to field a viable communication system. A review of frequency bands, losses, and problems is conducted to establish the similarity of the systems. The available classical orbits are investigated to further establish the relationship. Cost data is provided to establish the major difference in the systems. While MILSTAR does possess more total capability than UFO, it is 10 times more costly. Additionally, UFO is a satellite that will evolve with new technology while MILSTAR is built to full capability immediately. In the author's opinion, the incremental performance of MILSTAR does not justify its incremental cost.</b>							
20. DISTRIBUTION/AVAILABILITY OF ABSTRACT <input checked="" type="checkbox"/> UNCLASSIFIED/UNLIMITED <input type="checkbox"/> SAME AS RPT. <input type="checkbox"/> DTIC USERS				21. ABSTRACT SECURITY CLASSIFICATION <b>Unclassified</b>			
22a. NAME OF RESPONSIBLE INDIVIDUAL <b>Dan C. Boger</b>			22b. TELEPHONE (Area Code) <b>(408) 646-2607</b>		22c. OFFICE SYMBOL <b>AS/Bo</b>		

Approved for public release; distribution is unlimited.

A COMPARISON OF THE UHF FOLLOW-ON  
AND MILSTAR SATELLITE COMMUNICATION SYSTEMS

by

Clifton E. Perkins, Jr.  
Lieutenant Commander, United States Navy,  
B.S., United States Naval Academy, 1979

Submitted in partial fulfillment  
of the requirements for the degree of

MASTER OF SCIENCE IN SYSTEMS TECHNOLOGY  
(SPACE SYSTEMS OPERATIONS)

from the

NAVAL POSTGRADUATE SCHOOL  
September 1991

Author: \_\_\_\_\_

Clifton E. Perkins, Jr.

Approved by: \_\_\_\_\_

Dan C. Boger, Thesis Advisor

Carl R. Jones, Second Reader

Rudolph Panholzer, Chairman,  
Space Systems Academic Group

**ABSTRACT**

The author compares the UHF Follow-on and MILSTAR satellite communication systems. The comparison uses an analytical hierarchy process. Although the two systems have been tasked with different missions, a comparison of cost, capability, and orbit is conducted. UFO provides many of the same capabilities as MILSTAR, but on a smaller scale. Since UFO is also a new space system acquisition, it is used to compare dollars spent to field a viable communication system. A review of frequency bands, losses, and problems is conducted to establish the similarity of the systems. The available classical orbits are investigated to further establish the relationship. Cost data is provided to establish the major difference in the systems. While MILSTAR does possess more total capability than UFO, it is 10 times more costly. Additionally, UFO is a satellite that will evolve with new technology while MILSTAR is built to full capability immediately. In the author's opinion, the incremental performance of MILSTAR does not justify its incremental cost.



<b>Accession For</b>	
NTIS GRA&I	<input checked="" type="checkbox"/>
DTIC TAB	<input type="checkbox"/>
Unannounced	<input type="checkbox"/>
Justification	
By _____	
Distribution/	
Availability Codes	
Dist	Avail and/or Special
A-1	

TABLE OF CONTENTS

	<u>Page</u>
I. INTRODUCTION .....	1
A. GENERAL .....	1
B. BACKGROUND .....	1
C. METHODOLOGY .....	2
D. SCOPE AND LIMITATIONS .....	2
E. ORGANIZATION OF THESIS .....	3
II. UFO.....	4
A. BACKGROUND .....	4
B. SYSTEM REQUIREMENTS.....	6
C. SATELLITE .....	7
D. SPACECRAFT BUS MODULE .....	9
E. PAYLOAD MODULE AND CONFIGURATION.....	11
F. GROUND CONTROL/TERMINALS .....	13
III. MILSTAR .....	15
A. BACKGROUND .....	15
B. SYSTEM REQUIREMENTS.....	17
C. SATELLITE .....	18
D. SPACECRAFT BUS MODULE .....	20
E. PAYLOAD MODULE AND CONFIGURATION.....	20
F. GROUND CONTROL/TERMINALS .....	21

IV.	FREQUENCY .....	23
A.	BACKGROUND.....	23
B.	EHF .....	25
1.	Rainfall Loss .....	26
2.	Jamming .....	28
3.	Spread Spectrum .....	32
C.	UHF AND SHF .....	35
V.	ORBITS .....	38
A.	BACKGROUND .....	38
B.	GEOSYNCHRONOUS .....	40
C.	TWENTY-FOUR HOUR MOLNIYA .....	41
D.	TWELVE-HOUR MOLNIYA .....	44
E.	GLOBAL POSITIONING SYSTEM (GPS).....	46
F.	LOW EARTH ORBITS .....	48
G.	DOPPLER/ANGULAR VELOCITY AND ACCELERATION....	49
H.	ORBITAL ANALYSIS CONCLUSIONS.....	50
VI.	SATELLITE SYSTEM COMPARISON.....	52
A.	BACKGROUND .....	52
B.	SCENARIO DRIVEN COMPARISONS.....	54
1.	Persian Gulf (Hypothetical Scenario 1)..	55
2.	The North Pole (Hypothetical Scenario 2).....	57
3.	Mediterranean/European Theatre (Hypothetical Scenario 3).....	58



VII. CONCLUSIONS/FOLLOW-ON STUDY.....60  
    A. CONCLUSIONS.....60  
    B. FOLLOW-ON RESEARCH .....61  
  
LIST OF REFERENCES .....63  
  
INITIAL DISTRIBUTION LIST .....65

## I. INTRODUCTION

### A. GENERAL

In this thesis the author sets out to compare two current satellite communications programs: Military Strategic and Tactical Relay Satellite Communications System (MILSTAR) and the Ultra-High Frequency Follow-on Satellite System (UFO). Although the missions are officially different, it is this author's opinion that there is enough similar capability to warrant a comparison and to ask the question, "Can the military afford to continue funding MILSTAR?"

### B. BACKGROUND

In the 1979 to 1981 timeframe, military and strategic planners recognized that existing satellite strategic communications systems were aging and in need of replacement. With the Soviet threat still in full bloom, a generation of satellites needed to be developed that could withstand a nuclear threat and be jam proof. The UHF spectrum was inundated with commercial as well as military users, and it was susceptible to jamming.

A large acquisition of a space system was beginning. This was the MILSTAR system. Research and development was to encompass new technology in communications, computing, travelling wave tube amplification, and more. However, as

time passed, the budget dollars mounted and the MILSTAR program slowed.

A second acquisition of a space system began in the mid '80's with the Navy's desire to replace an aging Fleet Satellite Communications System (FLTSAT) and Leased Satellite Communications System (LEASAT) with the UFO system. Since MILSTAR had five years of research and development completed, the UFO program office could use some of the same requirements and not pay the same price for the technology. UFO and MILSTAR are the focus of this thesis.

#### **C. METHODOLOGY**

This thesis examines these two satellite systems based on cost, capability, and orbit. The MILSTAR program is still considered sensitive, and exact figures were unavailable at an unclassified level. It is not the author's intent nor desire to look at a classified comparison of the two programs, as data available on the unclassified level proved sufficient for a reasonable contrast. The primary focus is on system similarity.

#### **D. SCOPE AND LIMITATIONS**

As stated previously, this is an unclassified thesis. It therefore contains some numbers which upon close inspection, may not be close to the same number shown in classified documents. If a number was used, the author tried to find it in two source documents to avoid any outliers.

## E. ORGANIZATION OF THESIS

Following this chapter, Chapters II and III describe the background, system requirements, satellite, spacecraft bus, payload, and ground control of MILSTAR and UFO. Chapter IV discusses the frequency used, including Extremely High Frequency (EHF), Ultra-High Frequency (UHF), and Super High Frequency (SHF). Additionally, some detrimental problems are discussed such as jamming, rain attenuation, and noise. Chapter V looks at the possible orbits available for the satellites. Finally, Chapter VI compares the two systems and concludes the thesis.

## II. UFO

### A. BACKGROUND

With the 21st century less than ten years away, UHF satellite systems continue to be the United States Navy's workhorse in global tactical communications. Long standing programs, FLTSAT and Leased SATCOM satellite (LEASAT), still provide outstanding network availability, however, advancing age in these systems has forced the Government to procure replacement satellites. An industry-wide, competitive request for proposal in 1987 resulted in a 1988 fixed price contract award to the Space and Communications Group of Hughes Aircraft Company. The contract, which was named the UFO Satellite Program, calls for the design, manufacturing, integration, and testing of up to ten replacement satellites [Ref 1].

A bold step in contracting procedures, the UFO program was unique for several reasons. Most significantly, the spacecraft contractor was tasked with procurement of launch vehicles, launch integration services, and the actual launch operations for the entire series of satellites. This new policy was in contrast to previous satellite programs where each phase was handled by a different contractor [Ref 1]. A DoD Inspector General (IG) study conducted between June and October of 1988 raised questions regarding UFO's projected costs and recommended holding funding until satisfactory

answers were provided to IG [Ref 1]. Had the Navy not responded to IG's requests, IG recommended stopping the program. A halt in funding would have made the projected launch dates of late July 1992 through 1995 slip to an even later schedule.

The actions identified by the IG were advisory in nature; however, if taken, the recommendations would have stopped full rate production. IG complained that the Navy did not provide an adequate:

- assessment of its satellite quantity requirements;
- justification for its nuclear hardening needs;
- manpower estimate, baseline description, and independent cost estimate;
- assessment of systems effectiveness and suitability supported by subsystem component testing; and
- Acquisition Strategy Report [Ref 1].

With those discrepancies outstanding, the IG concluded that full rate production for UFO should not be approved for 1989. Both the Navy and Operational Test and Evaluation at DoD responded quickly to the IG report. The Navy justified its position on satellite numbers, nuclear hardening, documentation, lack of responsiveness, and completion of operational test and evaluation with careful analysis and an interesting thank you to the IG:

The Navy believes that all significant draft Report conclusions and recommendations have already been accommodated by decisions and directions resultant from the 22 July Defense Acquisition Board (DAB) meeting. We suggested that the DoD IG update this report prior to the next scheduled UHF-FO DAB in August 1989.

The Navy appreciates the DoD IG team's assistance in ensuring that the UHF-FO program is a model of effective space system acquisition. We would be pleased to provide additional information as necessary. [Ref 1].

Operational Test and Evaluation made no editorial comments, but supported the Navy. The program was approved and Hughes is developing UFO [Ref 1].

#### B. SYSTEM REQUIREMENTS

Using performance requirements from the successfully proven FLTSAT and LEASAT programs, UFO requirements remain similar. Table II-1 below summarizes payload performance requirements [Ref. 2].

TABLE II-1  
UFO PAYLOAD PERFORMANCE REQUIREMENTS

Channel Type	No. Provided	Bandwidth, kHz	EIRP, dBW	G/T, dB/K	1 dB BW, kHz	60 dB BW, kHz	Dynamic Range, dB	Phase Linearity, deg	Amp Ripple, dB p-p	Inband C/IM, dB
Fleet broadcast	1	25	28	-16	+12	+37.5	47	+6	0.4	>20
Enhanced relay	2	25	28	-16	+12	+37.5	47	+6	0.4	>20
Normal relay	15	25	26	-16	+12	+37.5	47	+6	0.4	>20
Narrowband relay	21	5	20	-16	+4	+7.5	47	+15	0.4	>20

A significant upgrade in total channel capacity exists in that a single UFO satellite is equivalent to more than the sum of a FLTSAT plus a LEASAT. Additional requirements include full hardening for natural and full nuclear environments for a 14-year mission (10-year mean) and autonomous operation of all bus and payload functions, with the exception of station keeping maneuvers, for 30 days without Telemetry, Tracking and Command (TT&C) contact. By contrast, FLTSAT was designed for a 5-year life and 14-day autonomous operation [Ref 2].

UFO is designed to be compatible with either shuttle or expendable launch vehicle services to eliminate launch delay from redesign or potential grounding of either type of launch vehicle such as was experienced after the Challenger disaster.

The communications payload is significantly expanded, providing 39 UHF channels with 21 narrowband (5 KHz) relay channels, 17 wideband (25 KHz) channels and one high power 25 KHz fleet broadcast channel crossbanded from an SHF antijam uplink to a clear mode UHF downlink. UFO provides a significantly larger number of narrowband unprocessed channels than either of its predecessors. The uplink supports a dual channel, anti-jam command, and broadcast capability simultaneously. UFO can provide from one to three multiplexed antijam broadcast uplinks that can be crossbanded to three preselected UHF wideband downlink channels and can operate in the normal single channel fleet broadcast mode [Ref 2].

From the fourth through the tenth satellite in the series, a MILSTAR compatible EHF payload upgrade will be installed. The UFO EHF package will include fixed earth-coverage antennas and a steerable 5° spot beam antenna. The EHF package will provide a spread-spectrum processed, jam-resistant COM/TT&C capability to supplement the MILSTAR user capability [Ref 2].

### **C. SATELLITE**

Figure II-1 is the actual on-orbit configuration of the Hughes UFO satellite. The satellite is capable of supporting



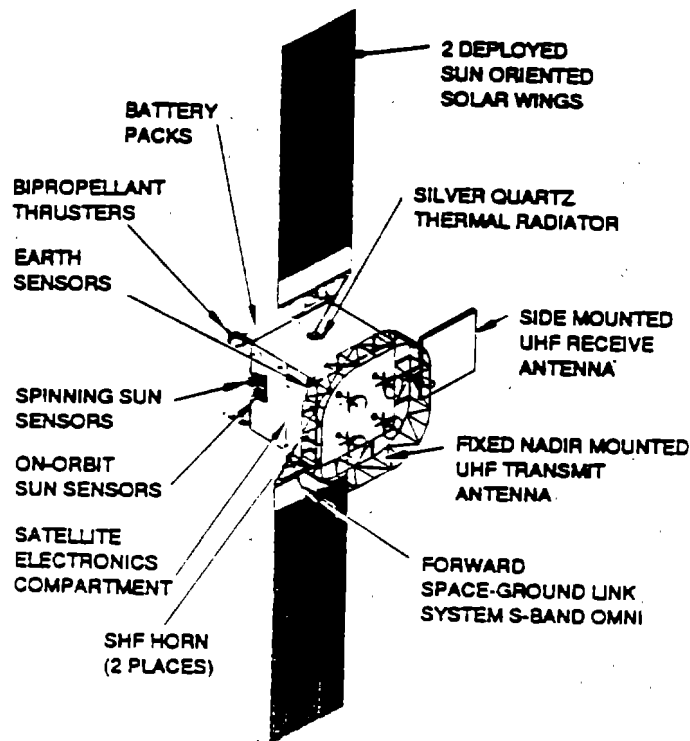

Figure II-1  
 UHF Follow-On Satellite On-Orbit Configuration

500 to 1500 pounds of payload in geosynchronous orbit and supplying between 1500 to 6000 watts of dc power during sunlight or eclipse [Ref 2].

The first four satellites are the basic UHF/SHF configuration weighing approximately 850 pounds and requiring 1600 watts of power. Atlas Centaur I will launch these vehicles to orbit. The satellites containing the EHF upgrade will have an additional 450 pounds and 350 watts required. The upgrade will be launched to orbit by the Atlas II [Ref 2].

Satellite orientation is normal to the equatorial orbit plane, with solar panels pointing north-south and the UHF

transmit antenna array facing the earth. The receive antenna is located on a boom extending from the west face of the vehicle. Two earth coverage horn antennas are mounted on the east rim of the transmit antenna to provide transmit and receive coverage for the SHF (7 to 8 GHz) anti-jam TT&C communication. Telemetry service and backup command and ranging communications for transfer orbit or emergency operations are provided by dual S-band omni-directional antennas. The TT&C antennas are placed such that they provide hemispherical coverage and will be controllable from the satellite operations center in Colorado Springs [Ref 2].

#### **D. SPACECRAFT BUS MODULE**

Another design innovation in the UFO project is its modular design. By using a modular system, parallel integration and testing of payload and spacecraft bus modules are possible. Time and money are both saved by using this unique design technique. Figure II-2 is an exploded view of the UFO satellite and details the spacecraft structure and the major components. The propulsion module supports four propulsion system tanks. The subsystem uses bi-propellant propulsion/ attitude control thrusters for orbit injection and on-orbit attitude and stationkeeping control. A central 100 pound thruster serves as a liquid apogee engine for perigee raising to achieve final orbit circularization. More small thrusters are included in the package to account for trim and

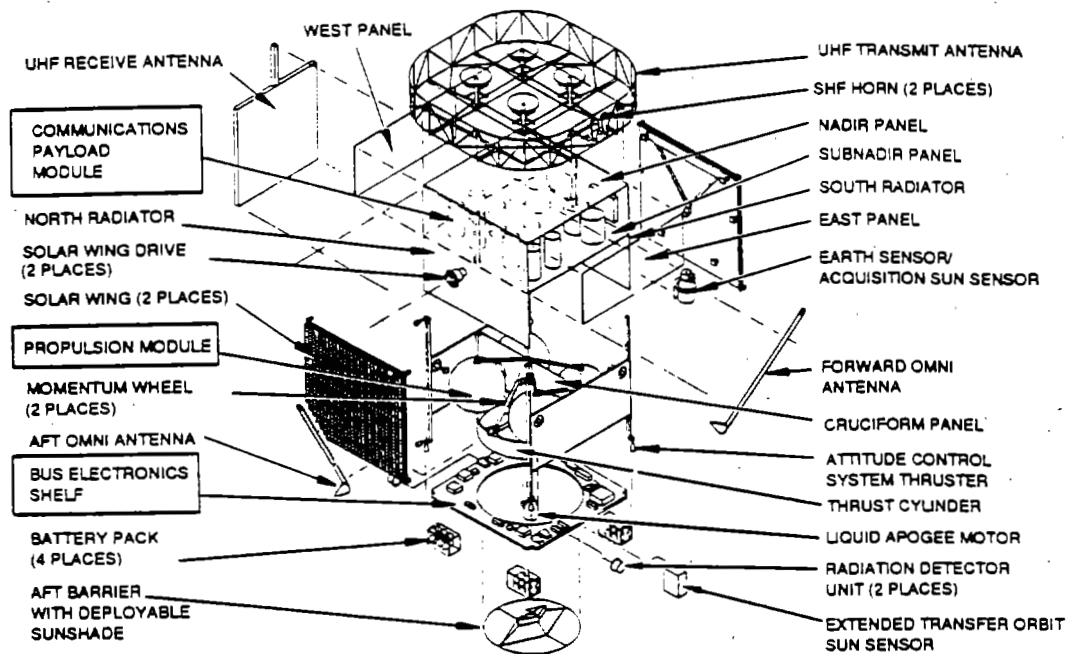

Figure II-2  
Exploded View of UHF Follow-On Satellite

on-station control. Additionally, redundant momentum wheels are also included [Ref 2].

The bus shelf provides support for four multi-cell battery packs at each corner of the module. Bus electronics units are also mounted on the equipment shelf. Power control electronics include battery charge and discharge units. Attitude controls are redundant three-axis rate-gyro packages which act in tandem with a redundant centralized satellite control processor (SCP) and an attitude control sensor group to control satellite attitude. The SCP also controls solar panels, monitors payload configuration, and conducts fault sensing to achieve autonomous operation for up to 30 days.

A pair of radiation detector units are located on the east and west faces of the bus module to provide four-pi steradian coverage and nuclear event detection signals to the SCP and spacecraft command decoder units (CDU). If a nuclear event occurred, the spacecraft would initiate procedures to circumvent, and then in post attack autonomously reconfigure, spacecraft and payload components [Ref 2].

#### **E. PAYLOAD MODULE AND CONFIGURATION**

Figure II-3 depicts the communications payload module. A three panel design, the module actually splits the communications payload into compartments. By splitting into separate compartments, the high power amplifiers which run hot are separated from the payload components which run cool resulting in a more steady state temperature schedule for each component. Figure II-4 describes in a simple line diagram the UFO communication payload. The payload consists of the UHF communications plus S-band and SHF TT&C transponder equipment, which provide communication links for secure TT&C of bus and payload functions during initial orbital insertion and on-station operations [Ref 2]. The multichannel design is to add more capability to the fleet user and provide secure back-ups to UHF communication.

Two problems had to be overcome for the communication payload to be effective. The first problem, intermodulation (IM) products, has been a problem in high powered UHF satellites -- FLTSAT, LEASAT and UFO. The design team needed

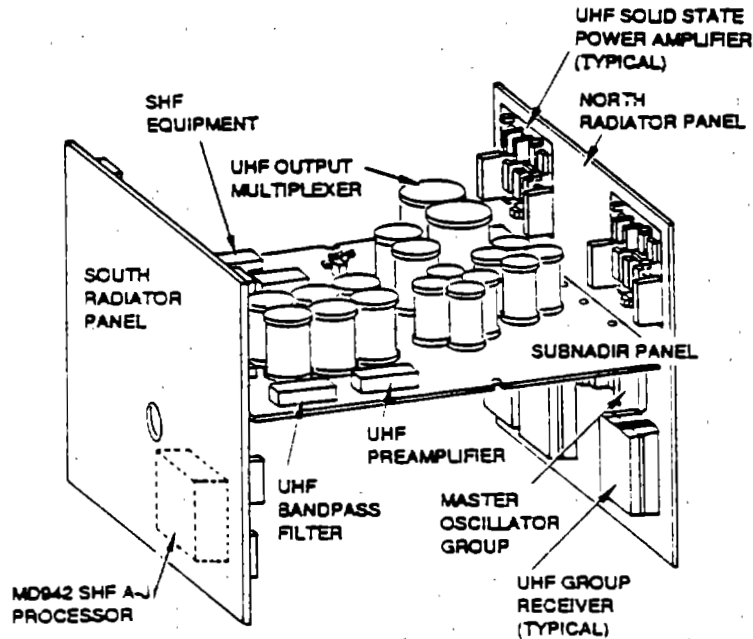

Figure II-3  
Communications Payload Module

to develop an antenna which minimized spacecraft illumination by UHF radiated power. Hughes chose an array of short back-fire elements which would achieve a smaller IM interference rate [Ref 2].

The second problem was the requirement to meet stringent out of band interference limits in the frequency bands adjoining the assigned downlink frequencies. These limits impose challenging requirements on downlink transmitter linearity that require operating the power amplifier at a point where the drive is backed off significantly relative to saturation to reduce out of band IMs.

The SHF payload, as well as the S-band TT&C communications group, are not new technology. The former was designed by Hughes and proven on LEASAT while the latter was provided by

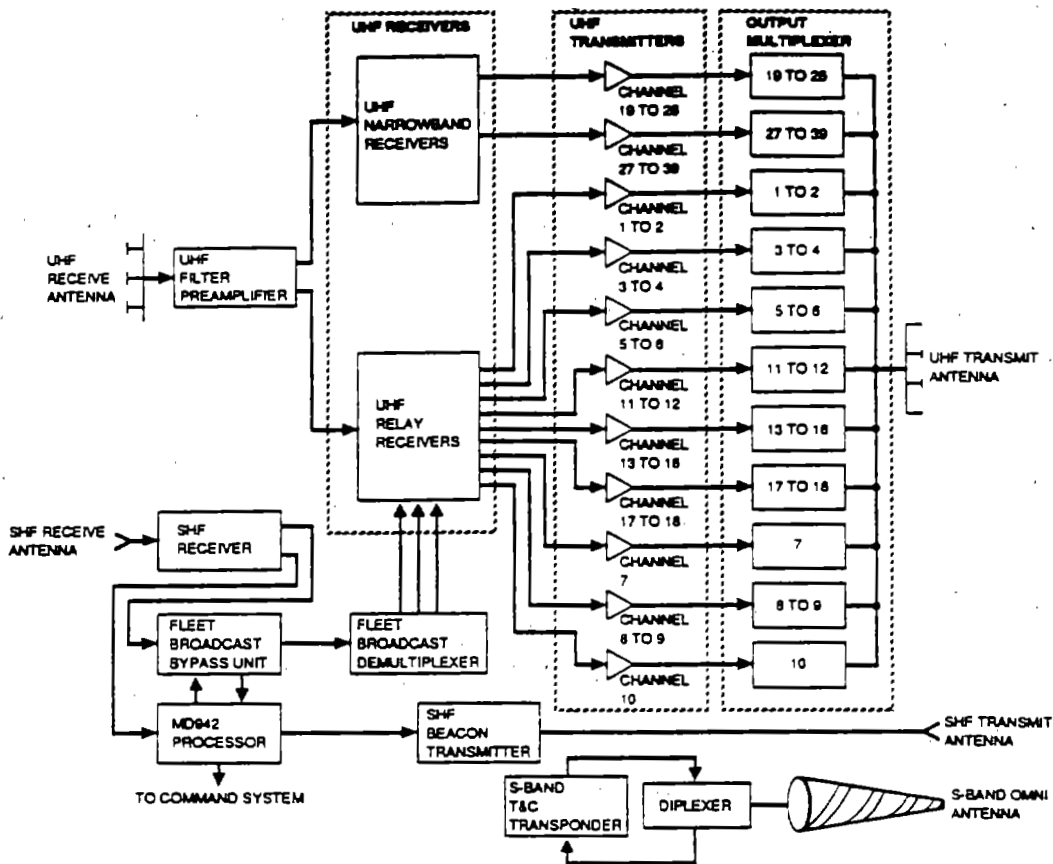

Figure II-4  
Simplified Payload

Motorola and is virtually identical to transponders provided for FLTSAT, GPS, DSCSIII and MILSTAR [Ref 2].

UFO's fleet communication frequency plan will be discussed in Chapter IV.

**F. GROUND CONTROL/TERMINALS**

The United States government, and most notably the Navy, has a significant investment in UHF satellite communication equipment. Military/Department of Defense dependence on these assets is a consideration when looking at replacement. For

example, more than 6500 highly reliable AN/WSC-3 UHF terminals have been deployed [Ref 2].

With the current group of UHF FLTSATCOM satellites reaching the end of their useful life, replacement with upgraded secure satellites is critical. The follow-on program for UHF SATCOM will need to employ cost effective approaches providing additional channels that also can reduce susceptibility to interference and low-level jamming. Current technology provides for making UHF SATCOM channels unavailable to unauthorized users with minimal cost impact and simple modifications to the current earth terminals. With the Navy's large investment in shipboard UHF systems, the upgrade must expand on existing capability [Ref 2].

### III. MILSTAR

#### A. BACKGROUND

MILSTAR is jointly sponsored by the Air Force, Army, and Navy. The system is designed to meet the minimum essential wartime communication needs of the President and Commanders-in-Chief (CINCS) to command and control our strategic and tactical forces through all levels of conflict.

MILSTAR's origin arose out of the debates between 1979 and 1981 over which satellite communication system should replace the in-place Air Force Satellite Communication (SATCOM) system. Several options proposed by the Air Force were defeated in budget battles until finally in 1981 the Reagan Administration cleared the way for an across-the-board military upgrade. The Assistant Secretary of Defense (Command, Control, Communications, and Intelligence (C<sup>3</sup>I)) stated the President had given strategic C<sup>3</sup>I top priority in modernization [Ref 3].

The strategic modernization plan, as it was called, consisted of five elements:

- 1) Improvements in communications and control systems,
- 2) Modernization of strategic bombers,
- 3) Deployment of new submarine launched missiles,
- 4) Phased introduction of new land-based MX missiles, and
- 5) Improvements to strategic defenses. [Ref 3].

With a mandate from DoD to build a new communication system, the Air Force assumed the lead in MILSTAR development. New



systems historically take years to proceed through the first milestones in the procurement process. MILSTAR proceeded slowly from 1982 to 1988 with design proposals, engineering developments, research, and contract awards. In 1982, \$48 million was allocated to Advanced Space Communication and Air Force Satellite Communication System. Lockheed Missiles and Space Company was awarded \$1.05 billion for full scale engineering development [Ref 4].

MILSTAR has continually slipped behind the original schedule and as a result has suffered cost overruns. The overruns essentially doubled previous delivery estimates. In May 1988 the Air Force released a revised cost estimate of \$1 billion for each satellite/booster combination. [Ref 4].

MILSTAR began as a special-access or black program with many of its capabilities still shrouded in secrecy. What is not a secret is the fact that MILSTAR is a first real attempt at global communications in the Extremely High Frequency (EHF) range. The Military Satellite Communications (MILSATCOM) system currently being operated is in the super-high frequency (SHF) and ultra-high frequency (UHF) ranges. MILSTAR is designed to be compatible with the older systems.

As in any design, trade-offs have been made. As big, expensive, versatile and survivable as MILSTAR truly is, it will be unable to handle high data rates and a plethora of users. The bottom line is that the Air Force is spending billions of dollars for a system intended to supplement, not

replace existing communications systems/satellites. MILSTAR's role or value is in its ability to still be flying long after the Navy's Fleet Satellite Communication System (FLTSATCOM) or the Defense Satellite Communication System (DSCS) is overburdened, jammed or destroyed.

#### **B. SYSTEM REQUIREMENTS**

A 1983 estimate of the MILSTAR channel capacity is for 50 EHF channels and 4 UHF channels to maintain compatibility with existing systems. It will provide low data rate teletype at either 75 or 2400 bits per second [Ref 5]. The shift to the EHF band is partly due to the fact that the UHF and SHF bands are inundated with military and commercial users. The large number of users in UHF and SHF has left very few operating or bandwidth windows available for the dedicated user [Ref 5].

MILSTAR is designed for a 10 year average mission life. The satellite's primary downlink will operate at 20 GHz while the primary uplink will be at 44 GHz. A 1 GHz bandwidth is used to achieve spread spectrum which makes MILSTAR almost unjammable. Crosslinks will operate at 60 GHz which will make the earth essentially opaque. Crosslink communications (satellite-to-satellite) are therefore secure from any earth snooping. Satellites in the path, however, could potentially collect the signal; yet without decryption or knowledge of transmission, the intercept would potentially sound like noise and be discarded.

Additional requirements include anti-jamming, survivability, adaptive antenna technology which includes uplink nulling and steerable downlinks. (The actual frequencies and spread spectrum techniques will be discussed in Chapter IV). More features include crosslinks between satellites, communications security, error corrections, encoding and encryption. MILSTAR is also projected to be hardened against threats such as high-powered lasers and electromagnetic pulse (EMP) which is to say it will have a nuclear survivability capability [Ref 5 and 6].

MILSTAR will also possess the capability to communicate in the UHF spectrum to maintain interoperability with existing SATCOM systems and ground stations. The UHF portion will not be the low data rate that MILSTAR's EHF side will have.

### **C. SATELLITE**

Although a picture of the proposed MILSTAR satellite is unavailable at the unclassified level, some of the satellite's estimated specifications are provided. The Fleet EHF package (FEP) currently flown on FLTSAT 7 and 8 weighs approximately 245 pounds with 305 watts of payload power. FEP was designed to test the feasibility of EHF communications in the space environment. Since FEP represents only a small portion of the MILSTAR package, estimates of total dc power in sunlight or eclipse produced on MILSTAR range from 1000 to 6000 watts and a satellite weight of between 5000 and 8000 pounds [Ref 2 and 5].

Contributing to MILSTAR's already high costs are the paucity of launch vehicles in the United States inventory. Since the Challenger disaster a shortfall in rocket boosters and lengthy delays in placing space systems in orbit have occurred. MILSTAR's first seven satellites are currently scheduled to be boosted to orbit using the Titan IV with a Centaur upper stage. [Ref 6].

The original plan was to launch MILSTAR aboard Shuttle with Boeing Inertial Upper Stages (IUS) to take the satellites to geosynchronous orbit. The early estimates put the weight of MILSTAR at 5000 pounds which is the throw weight limit of the IUS. With the Centaur upper stage developed by General Dynamics, 8000 pounds could be boosted to orbit which led the Air Force to opt for the more capable launch vehicle.

Extensive studies by Communications Systems Engineering and Integration Center looked carefully at Molniya, Geosynchronous, Low Earth and Global Positioning Systems orbits [Ref 7]. Defense Electronics published an article in the February 1989 issue describing the proposed MILSTAR orbit plan. With seven satellites in orbit at all times a combination of highly elliptical polar orbits for three satellites coupled with four in geosynchronous would provide continuous global coverage. Additional robustness would be achieved by having a minimum of two on-orbit spares with ready-to-fly spares positioned for quick replacement. The on-orbit spares would be "parked" in

high orbits [Ref 4]. A detailed analysis of the various orbits will be discussed in Chapter V.

#### **D. SPACECRAFT BUS MODULE**

A considerable amount of new technology is being developed for use in MILSTAR, however, attitude control and station keeping is state of the art. Hughes Aircraft has developed the controls for both UFO and MILSTAR and with minor differences one could almost say they were the same [Ref 8].

The cornerstone to the spacecraft bus is the fault tolerant computer which should be capable of controlling the satellite autonomously for lengthy periods. The latest in computer technology will employ a myriad of techniques to control advanced adaptive antennas, nulling antennas, radiation detector units, conduct fault sensing and isolation, and monitor the payload configuration [Ref 9]. In addition to the capabilities previously mentioned, the computer also controls the self defenses which include chaff and ECM features. The redundant design of the system serves to reinforce the main goal of MILSTAR -- survivability [Ref 9].

#### **E. PAYLOAD MODULE AND CONFIGURATION**

The data for this section is unavailable in unclassified documents.

## F. GROUND CONTROL/TERMINALS

As MILSTAR gets closer to orbit the Air Force, Army, and Navy will need to be totally completed with testing the ground terminals. The most ambitious plan for linking MILSTAR with the ground resides in the Air Force. Plans for MILSTAR terminals include: B-1B, B-52, EC-135, RC-135, E-4B, and E-6A aircraft, as well as fixed ground sites. The major Air Force site will be the MILSTAR ground control station in Colorado Springs, Colorado.

The Army spent \$105.8 million in 1986 on a firm fixed price contract with Magnavox Electronic Systems Co. to produce fifteen Single-Channel Objective Tactical Terminals (SCOTT). The SCOTT equipment has been delivered and used operationally during Desert Storm [Ref 4]. Results and performance figures have not been released on an unclassified level. A production contract award to Magnavox is a pretty good indicator that SCOTT functioned as expected. Prior to the operational testing of SCOTT equipment the program was in trouble in Congress. In the fiscal 1989 Defense Authorization Bill SCOTT production funds were slashed from \$55 million to zero [Ref 4]. The resultant ripple through the procurement system potentially added \$6 million to \$10 million in cost to the program. The loss of a year's worth of work, the inability to procure raw materials, the value of 1989 dollars versus 1990 dollars all contributed to raising the price of the final deliverable.

The Navy has moved forward with a series of tests and operationally verified some of MILSTAR's hardware and software applique packages. Naval Satellite Operation Center, Pt. Mugu, California has taken the lead in testing MILSTAR equipment during operational testing of the Fleet EHF package flown on FLTSAT-7 and FLTSAT-8. Navy terminals completed more than 250 operational tests for compatibility and interoperability in 1988 and continued the testing throughout Desert Shield/Storm. In the Desert Shield environment the system proved more than satisfactory. The only test uncompleted by the Navy is the satellite to satellite cross-link [Ref 4].

MILSTAR has many strengths and yet it has been delayed each year by refinement, more engineering, money problems, and finally the fact that it is not quite ready. The research and development budget for MILSTAR is expected to rise to more than \$700 million per year in the early 90's. Concurrently MILSTAR's procurement budget is expected to exceed \$460 million annually [Ref 4]. The constellation will ultimately cost in excess of \$10 billion on orbit. The design is now "frozen", however, more contractors can become involved by continuing to develop the ground equipment that will replace what is rapidly becoming obsolete [Ref 4].

## IV. FREQUENCY

### A. BACKGROUND

The military historically has been the group that has desired the most diverse communications capability since the invention of the radio telephone. The use of all available frequencies from extremely low frequencies to the extremely high frequencies puts a special demand on the manufacturer to maintain military communications on the leading edge of technology.

Radio frequency from 3 to 30 MHz by convention is called high-frequency radio (HF). HF was the mainstay of military communications until satellite communications were developed [Ref 10]. In HF communications a groundwave and skywave component characterized the waveform. A peculiar phenomenon in HF communications is its ability to 'skip' or refract on the ionosphere thereby producing extremely long ranges with a small amount (1-2W) of radiated power [Ref 10]. HF communications remain a primary backup for all major communications in the Navy today with monthly tests conducted by all ships.

Since HF communications refract off the ionosphere a need developed for a more secure means of communicating. Whenever an HF transmitter is operated, people that possess direction finding equipment are able to pinpoint the source of the



transmission. The evolution in communications required a more secure method of operation. Line of sight communications were developed to provide more security and a higher data rate.

Above 30 MHz three main frequency areas were developed: Ultra-High Frequency (UHF), Super High Frequency (SHF) and finally Extremely High Frequency (EHF). In this analysis the lower end will be referred to as centimeter wave technology, to include microwave, while the upper end will be referred to as millimeter wave technology. Additionally, frequencies above 60 GHz will not be discussed since MILSTAR operates between 20 and 44 GHz.

As a result of the unreliability of communications which used the ionosphere for propagation, the UHF MILSATCOM came into being. The Navy portion of the FLTSATCOM system evolved into nine hard-limited, 25 KHz bandwidth, frequency-translated UHF communications channels and one channel that has an SHF anti-jamming uplink for the important jam-protected communications information that is broadcast to the Fleet on a narrow-band UHF downlink [Ref 2]. The system has been cost effective and reliable; however, outside of the fleet broadcast service, the nine translation channels are very sensitive to interference. Disruptions in communications happen frequently as a result of overlap, open or hot microphones and generally inadvertent errors [Ref. 10]. Suffice it to say it takes very little effort to jam or interfere with any of the translation channels. Some

estimates indicate that lost service each year due to UHF SATCOM interference represents a loss of millions of dollars to the Navy [Ref 1].

## B. EHF

Reference Data for Radio Engineers states that the 3-30 GHz frequency range is centimetric waves and the 30-300 GHz frequency range is in the millimetric range [Ref 10]. The Telecommunication Transmission Handbook refers to the 13 GHz to 100 GHz spectrum as millimeter wave [Ref 10]. For continuity and since MILSTAR operates between 20 and 44 GHz, the author will consider MILSTAR's operating frequency to be millimeter wave.

When designing a transmitter, whether on earth or for satellite use, a main concern for the engineer is propagation. Millimeter wave transmission through the atmosphere is more adversely affected by certain propagation properties than its centimeter counterpart. These properties are the absorption and scattering of a wave as it is transmitted through the atmosphere. The result of this phenomenon is one reason millimeter wave has not been extensively used in satellite communications, until recently [Ref 10].

One of the reasons for the renewed interest in millimeter wave technology is the increasing congestion in the centimeter wave bands. A second reason is the need for much greater bandwidth to accommodate digital transmission or spread spectrum waveforms. Finally, research and development

primarily driven by the military has placed millimeter wave technology in roughly the same position as centimeter wave technology in the late 50's, when that region of the spectrum was opened for wide usage [Ref 10].

#### 1. Rainfall Loss

The ideal for the transmission system engineer would be to create a formula which would be valid anywhere on earth and would provide path loss in decibels. In free space such a formula is available: Attenuation (dB) =  $3.244 + 20 \log f + 20 \log D$  where D = hop or path length (Km) and f = operating frequency (MHz) [Ref 10]. With millimeter wave transmission one must add in five extra variables to account for water vapor, mist and fog, oxygen (O<sub>2</sub>), sum of the absorption losses due to other gases, and losses due to rainfall [Ref 10].

The principal factor causing excess attenuation is due to the losses brought on by rainfall. Looking at the downlink frequency of 20 GHz for MILSTAR (1.5 cm), excess attenuation caused by water vapor accumulates at only .1 dB/Km and for a 10 Km path only 1.0 dB must be added to an already large free space loss [Ref 10]. Rain, however, is another matter. Common practice has been to express path loss due to rain as a function of the precipitation rate. The generally accepted equation for rain attenuation is:  $A = aR^b$  where A = the attenuation in dB, R = the rain rate, and a and b = functions of the frequency and the propagation path lengths

[Ref 11]. Two methods for determining rain rate have been employed in computations for MILSTAR's frequency ranges.

The first approach, the Rice and Holmberg method, employs a derived equation which takes into account total average annual rainfall and the ratio of the thunderstorm annual rain to the total annual rain. The method requires data for the average annual rainfall and the thunderstorm ratio for the location. A second equation is then employed to determine a set of curves which then yield loss due to rainfall [Ref. 11].

The second approach, developed by R.K. Crane, provides eight different rain rate regions to describe the weather in any part of the world. The basic function of the Crane method is to give an estimate over a large area, and so it may ultimately be inaccurate in any local area. [Ref 11].

Irrespective of which method is used, the results must be recognized as an average estimate. Considerable operational variations from this estimate could force use of alternative methods; however, short-term variations are to be expected [Ref 11].

With these factors in mind, eight locations were selected that favor a synchronous orbit telemetry tracking and control subsystem where high antenna elevation angles are desired. The locations selected are: Norfolk, Virginia; Virgin Islands; Ascension Island; Naples, Italy; Diego Garcia; Guam; Hawaii; and Stockton, California. Computer runs were

conducted for these locations for elevations angles of 20°, 30°, 40°, 50°, 60°, 70°, and 90°. Both previously discussed methods for calculation of rain loss were used. Tables IV-1 and IV-2 are examples of both methods [Ref 11].

With the data from this study and others using similar assumptions, rain loss was determined to be a consideration rather than a limitation in building an EHF communication satellite. The curves indicate that a clear weather margin is required to offset statistical rain absorption effects to achieve 99% circuit availabilities. The general conclusion is that for the 44 GHz uplink, a clear weather margin of 16 dB is necessary for 99% availability at a 20° elevation angle to allow for rain absorption effects [Ref 11]. The impact of the rain attenuation study on both UFO and MILSTAR is that power requirements will be much higher to achieve the necessary margin [Ref. 11]. When compared to SHF, the EHF Telemetry Tracking & Control (TT&C) package has a severe weather penalty. The largest Navy EHF terminal, the AN/USC-38(V) shore terminal, does not provide adequate gain and/or Effective Isotropic Radiated Power (EIRP) to provide reliable TT&C without extensive modifications [Ref 11].

## **2. Jamming**

The free use of the electromagnetic spectrum has become a top priority in military communications. Since the development of various jamming techniques from spot jamming to the broader barrage-type jamming, communication engineers and

TABLE IV-I  
RAIN ATTENUATION STATISTICS USING RICE-HOLMBERG METHOD

EARTH STATION LOCATED AT STOCKTON CA  
EARTH STATION LATITUDE= 38 DEGREES ELEVATION= 40 DEGREES  
UPLINK FREQUENCY= 44.5 GHZ; DOWNLINK FREQUENCY= 20.5 GHZ  
TOTAL YEARLY RAINFALL= 360 mm THUNDERSTORM RATIO= .15  
CLIMATE REGION IS A,B,C OR D.

RAIN ATT (dB)	TIME ATTENUATION EXCEEDED		DOWNLINK	
	YEARLY PERCENT	HOURS/ YEAR	YEARLY PERCENT	HOURS/ YEAR
3.0	1.03791	90.98279	0.24316	21.31524
4.0	0.84045	73.67427	0.16463	14.43121
5.0	0.69691	61.09122	0.11219	9.83438
6.0	0.59198	51.89275	0.07722	6.76900
7.0	0.51368	45.02915	0.05404	4.73715
8.0	0.45342	39.74650	0.03873	3.39520
9.0	0.40532	35.53065	0.02862	2.50912
10.0	0.36553	32.04276	0.02192	1.92187
11.0	0.33156	29.06468	0.01745	1.52930
12.0	0.30182	26.45794	0.01441	1.26304
13.0	0.27532	24.13492	0.01230	1.07850
14.0	0.25142	22.03971	0.01080	0.94684
15.0	0.22970	20.13579	0.00969	0.84950
16.0	0.20988	18.39827	0.00884	0.77455
17.0	0.19175	16.80920	0.00815	0.71441
18.0	0.17516	15.35475	0.00758	0.66422
19.0	0.15998	14.02360	0.00708	0.62090
20.0	0.14609	12.80595	0.00664	0.58248
21.0	0.13339	11.69301	0.00625	0.54770
22.0	0.12180	10.67675	0.00588	0.51575
23.0	0.11122	9.74969	0.00555	0.48610
24.0	0.10158	8.90485	0.00523	0.45838
25.0	0.09281	8.13566	0.00493	0.43236
26.0	0.08483	7.43601	0.00465	0.40786
27.0	0.07757	6.80018	0.00439	0.38476
28.0	0.07099	6.22280	0.00414	0.36293
29.0	0.06501	5.69890	0.00391	0.34232
30.0	0.05959	5.22386	0.00368	0.32283
31.0	0.05468	4.79340	0.00347	0.30441
32.0	0.05023	4.40355	0.00327	0.28700
33.0	0.04621	4.05066	0.00309	0.27054
34.0	0.04257	3.73137	0.00291	0.25499
35.0	0.03927	3.44260	0.00274	0.24029
36.0	0.03629	3.18148	0.00258	0.22641
37.0	0.03360	2.94544	0.00243	0.21330
38.0	0.03117	2.73211	0.00229	0.20092
39.0	0.02897	2.53930	0.00216	0.18924
40.0	0.02698	2.36505	0.00203	0.17820
41.0	0.02518	2.20755	0.00191	0.16779
42.0	0.02356	2.06516	0.00180	0.15797
43.0	0.02209	1.93640	0.00170	0.14870
44.0	0.02076	1.81992	0.00160	0.13996
45.0	0.01956	1.71448	0.00150	0.13171
46.0	0.01847	1.61900	0.00141	0.12394
47.0	0.01748	1.53245	0.00133	0.11661
48.0	0.01659	1.45395	0.00125	0.10970

TABLE IV-2  
RAIN ATTENUATION STATISTICS USING CRANE'S 8 AREA METHOD

EARTH STATION LOCATED AT STOCKTON, CA  
 EARTH STATION LATITUDE = 38 DEGREES, ELEVATION = 40 DEGREES  
 UPLINK FREQUENCY = 44.5 GHZ; DOWNLINK FREQUENCY = 20.5 GHZ  
 RAIN RATE CLIMATE REGION IS C

YEARLY PERCENT	TIME ATTENUATION EXCEEDED		DOWNLINK ATT. dB
	HOURS YEAR	UPLINK ATT. dB	
2.00000	175.32000	4.2	0.8
1.00000	87.66001	7.1	1.4
0.50000	43.83000	9.9	2.0
0.20000	17.53200	15.5	3.3
0.10000	8.76600	21.8	4.7
0.03000	4.38300	31.1	7.0
0.02000	1.75320	47.0	11.0
0.01000	0.87660	68.0	16.5
0.00500	0.43830	93.6	23.4
0.00200	0.17532	132.4	34.2
0.00100	0.08766	163.9	43.2

Electronic Warfare specialists have looked to development of jam resistant equipment.

Uplink jamming protection is most critical for SATCOM operations to preserve satellite control. Downlink jammers are at a disadvantage since they must be in the local area of each user, even though they have a significant range advantage when they are in the area. EHF uplinks protected with large anti-jamming (AJ) margins can be cross-connected on board the satellite to unprotected UHF downlink channels to provide connectivity to the large number of existing UHF terminals [Ref 12].

Part of the attraction of EHF frequencies for communications is that the propagation medium itself appears to offer an AJ capability particularly for ground based

jammers [Ref 12]. An analysis conducted at Georgia Tech Research Institute reveals that EHF is capable of withstanding jamming in both stand-off and close-in cases. In the stand-off scenario the jammer is postulated to be 20 Km from the communications transmitter. Figures IV-1 (A-H) represent plots for the communications receiver at various ranges between transmitter and jammer [Ref 12]. Two weather conditions, clear air and rain, are used for evaluation. In the clear air case, Figure IV-1 (E), one frequency 52.5 GHz optimizes the Signal to Jamming plus Noise ( $S/(J+N)$ ) ratio. The optimization is a result of sufficient atmospheric absorption to significantly reduce the jamming signal to the point where the natural noise term, N, dominates the jamming term, J, over short link ranges. For frequencies under the optimum, jamming power becomes significant over short ranges [Ref 12].

For the close-in jammer, the jammer is located at 5 Km from the transmitter. In the clear air case, Figure IV-1 (G), there are two different regions of optimization. In the case of rain, Figure IV-1 (H), frequencies which exhibit higher specific attenuations are suboptimum at all ranges [Ref 12].

By using spread spectrum, MILSTAR will be able to select an operating frequency that will exploit the communication system range advantage by using excess attenuation to "mask" the jammer, while maintaining a shorter path for the



communication signal. In the close-in scenario, the optimum frequency will be the one that leads to a high specific excess attenuation when there is a communications range advantage [Ref 12].

### 3. Spread-Spectrum

Direct Sequence Spread Spectrum (DSSS) is the subject of at least five separate studies presented at the MILCOM 90 Conference. It is the unique waveform being developed for MILSTAR that significantly enhances the low probability of intercept in the communications bands. A straightforward procedure has been developed for masking spread-spectrum signals by intentionally adding non-stationary noise of relatively low power [Ref 13].

DSSS waveforms are usually considered to be similar to noise processes due to their creation through the use of psuedo-noise generators. In MILSTAR's case 1 GHz of bandwidth is used to spread the signal out and make it virtually undetectable from the noise [Ref 13].

Spread spectrum signals are known to be detectable using non-linear processing such as chip rate line and carrier harmonic detectors. MILSTAR's waveform becomes undetectable because the goal of a featureless waveform is achieved. With no features, rate line and carrier detection is impossible to any order of non-linearity with or without memory [Ref 13].

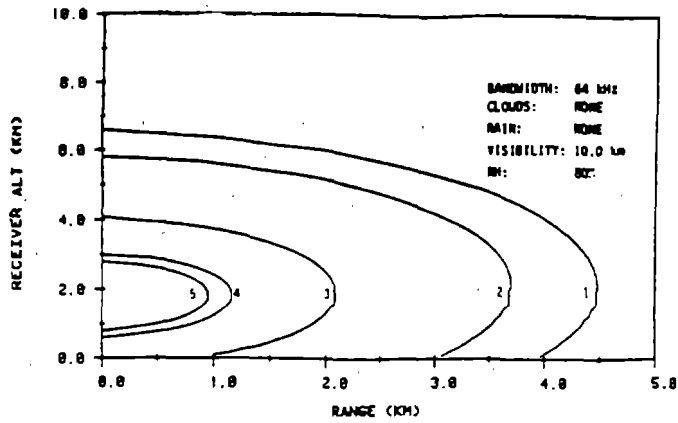

Figure A. Effective Communications range for receiver altitudes 0-10 km at various frequencies in clear air.

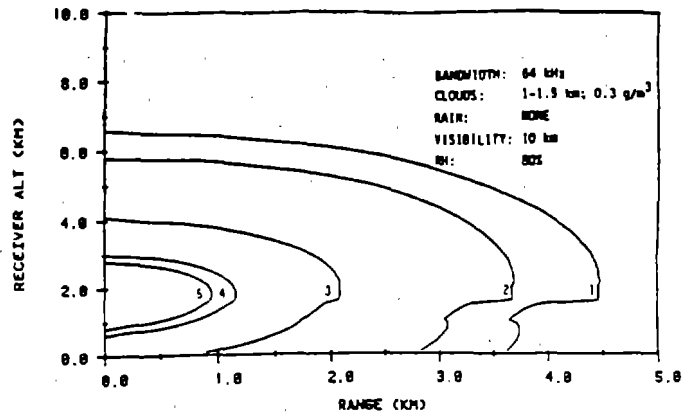

Figure B. Effective communications range for receiver altitudes 0-10 km at various frequencies in clouds.

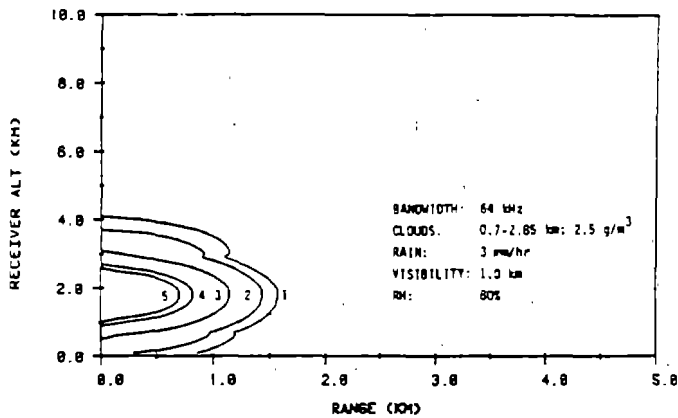

Figure C. Effective communications range for receiver altitudes 0-10 km at various frequencies in rain.

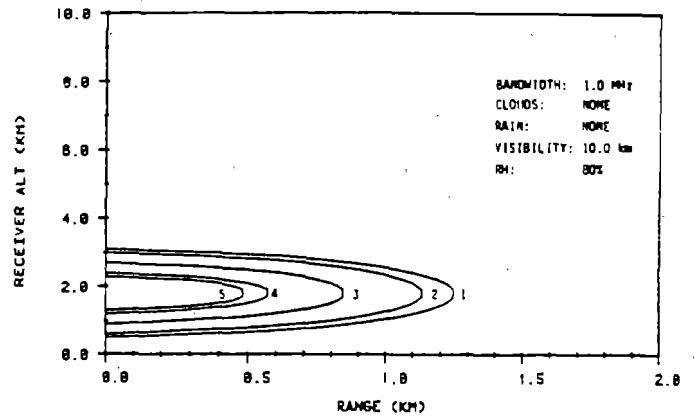

Figure D. Effective communications range for receiver altitudes 0-10 km at various frequencies in clear air.

Figure IV-1 (A-D)  
Effective Communications Range for Receiver Altitudes

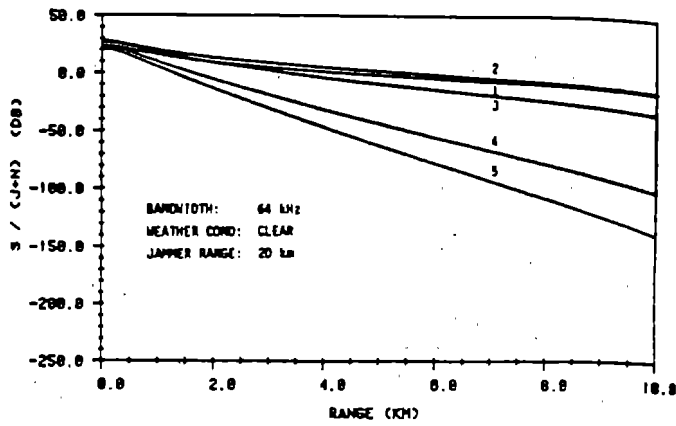

Figure E. Signal-to-(jamming + noise) vs. communications range for coherent FSK/standoff jammer in clear air.

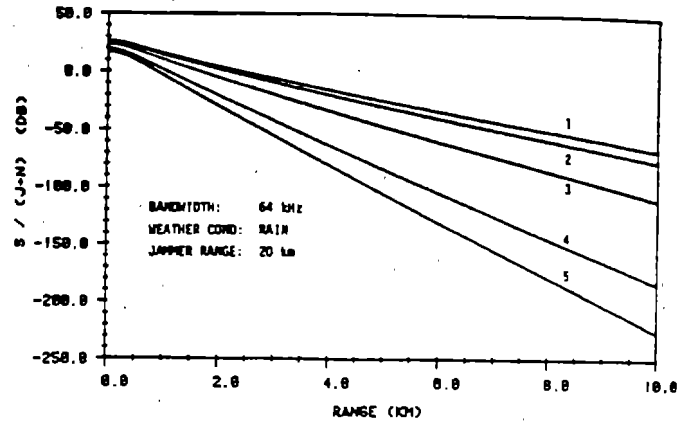

Figure F. Signal-to-(jamming + noise) vs. communications range for coherent FSK/standoff jammer in rain.

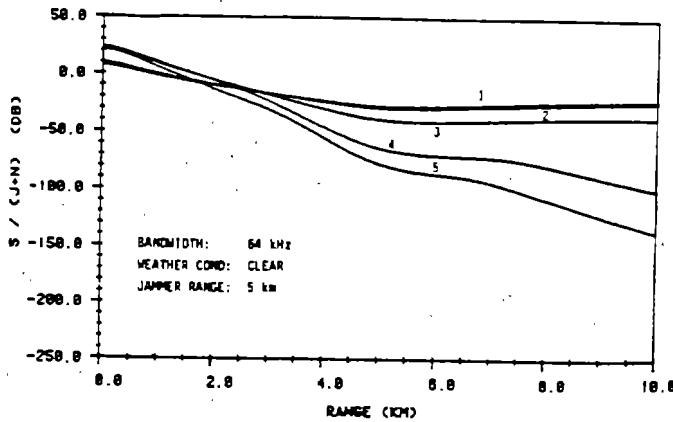

Figure G. Signal-to-(jamming + noise) vs. communications range for coherent FSK/close-in jammer in clear air.

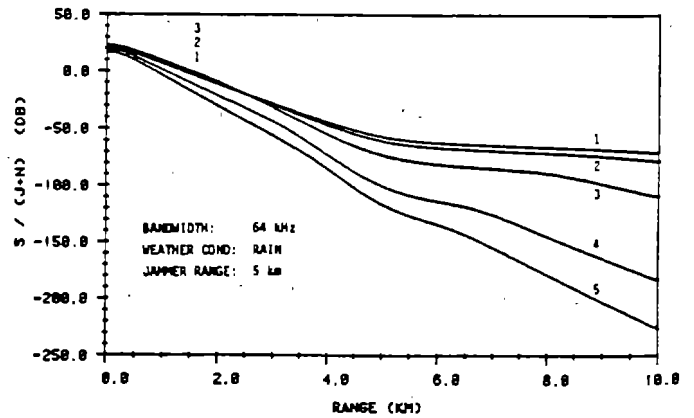

Figure H. Signal-to-(jamming + noise) vs. communications range for coherent FSK/close-in jammer in rain.

Figure IV-1 (E-H)  
Signal-to-(Jamming + Noise) vs. Communications Range

### C. UHF AND SHF

Military UHF (225 to 400 MHz) and SHF (7 to 8 GHz) communications are the primary frequencies used for DoD today. With jam resistance and spread spectrum being the major advantage to EHF, UHF requires a significant technology boost to remain a viable communication alternative [Ref 2].

UHF signals have a history of being very jammable, if not by a determined adversary then by the systems themselves. Open microphones have disrupted Battle Group communications for hours with numerous lost manhours isolating the faulty equipment. UFO attempts to tackle some satellite hardware problems between transmit and receive antennas. Projected locations for receive and transmit antennas provide a high degree of isolation to allow maximum efficiency in each satellite [Ref 2].

Since the UHF spectrum is extremely crowded, the potential for interference exists due to the close proximity of users in the frequency ranges to be used. Figure IV-2 graphically depicts the close proximity to Soviet communications that UFO will be operating. The uplink and downlink frequencies have been chosen to minimize mutual interference and gain the most use of assigned bandwidth. The new plan actually upgrades and diversifies the existing channel assignments for FLTSAT and LEASAT [Ref 2].

The receivers are designed to process four groups of individual uplink channels having uniform bandwidth and

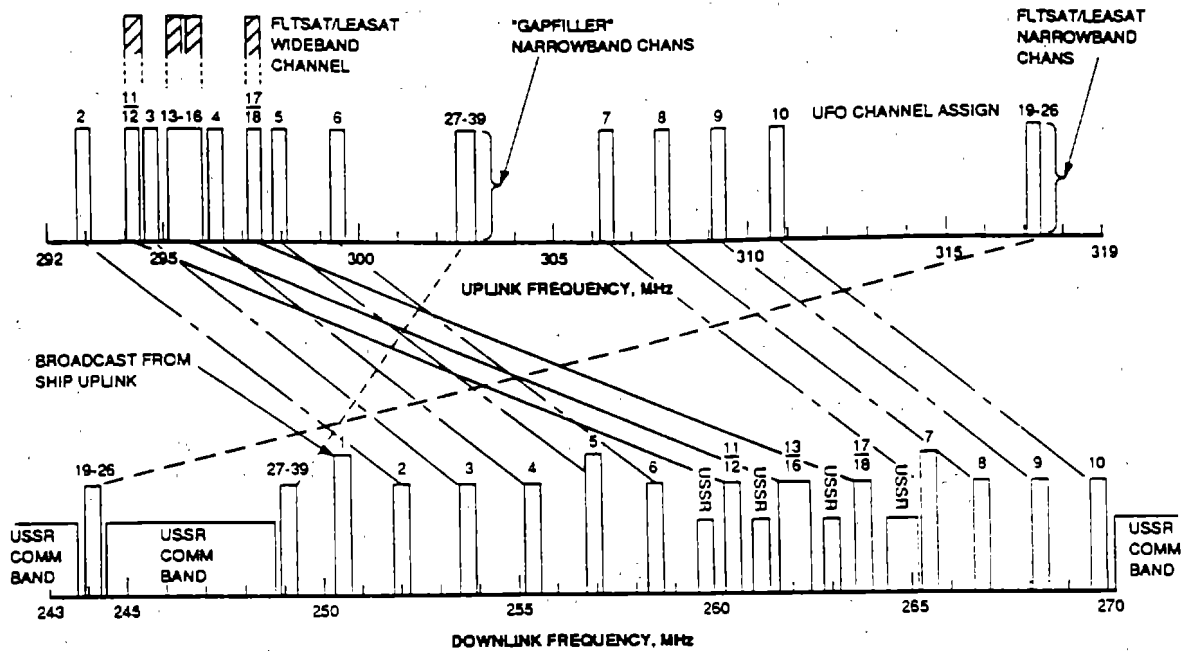

Figure IV-2  
UHF Communications Frequency Plan

uplink/downlink offset frequency assignments. The receiver input contains a preselect filter and downconverter assembly, which drives a bank of eight to 13 intermediate frequency amplifier/limiter strips. The limiter output signals are combined in groups and upconverted to the assigned UHF downlink frequency. Timing is controlled by a frequency synthesizer in each receiver which selects one of four preset frequency plans by ground command. The four plans allow pairs of UFO satellites to operate at each of the four assigned longitude slots without mutual interference [Ref 2].

Jamming and noise or interference are two areas that have continually plagued UHF communications. A potential source for interference in the UFO satellite is the close proximity of the UFO uplink and downlink frequencies to USSR

requirements. The stringent limitation of the out of band noise and interference which can be radiated by UFO's payload made it possible to develop the frequency plan as indicated in Figure IV-2.

Another potential source for noise is in the thermal spectrum. A technology feature of UFO is to use the active temperature control in the receiver to minimize the variation in gain with temperature of each channel. A secondary source, ground command, can control gain which will be used to compensate for variations during the satellite's lifetime [Ref 11].

Advances in component technology also add extra advantage to the satellite. Specifically, solid state power amplifiers, low power amplifiers, medium power amplifiers, high power amplifiers, and channelization filters have been upgraded with one major goal which is to reduce interference. [Ref 11].

One final source for noise is the Continuous Wave (CW) variety. CW can be caused by a variety of sources and therefore control of CW interference is more difficult [Ref 11].

## V. ORBITS

### A. BACKGROUND

Choosing the proper orbit to maximize coverage and minimize gaps has been the subject of extensive studies for both UFO and MILSTAR. Five orbits have been chosen to evaluate the orbital dynamics on the EHF packages as well as UHF coverage areas. These orbits range from a low earth orbit to inclined geosynchronous. Additionally, two highly eccentric Molniya orbits and the half-synchronous Global Position System (GPS) orbit are considered [Ref 7]. Table V-1 contains the parameters for these orbits.

TABLE V-1  
PARAMETERS OF CANDIDATE EHF ORBITS

Orbit.	Inclination	Apogee Height NM	Perigee Height NM	Semi Major Axis NM	Eccen- tricity	Repeating Ground Track
GEOSYNCHRONOUS	0°-60°	19323	19323	22767	0	Yes
24 HR MOLNIYA	63.435°	38260	378	22767	.8321	Yes
12 HR MOLNIYA	63.435°	21416	378	14352	.7335	Yes
GPS	55°	10898	10898	14352	0	Yes
LOW EARTH ORBITS	0°-90°	80-1000	80-1000	3525-4445	Variable	No

The most stringent orbital requirements occur for the proposed EHF packages. The reason for these requirements is in the proposed 24-hour global coverage, communication cross-

link capability, polar positioning, and anti-jam/low probability of intercept in the MILSTAR program. UFO does not approximate the ambitiousness of this coverage, however, the data for geosynchronous and low earth orbit applies equally well. Groundtrack and coverage will be discussed for each of the five orbits with some additional characteristics included in tabular form.

A satellite's groundtrack is the locus of intersections over one period of the spacecraft position vector with the Earth's surface. Simply stated, it is the path on the globe for which the satellite is directly overhead. Besides detailing information on the orbit with respect to earth, the groundtrack aids in visualizing the coverage patterns of a particular orbital configuration [Ref 7].

Coverage plots presented in this thesis were generated using a computer program which projects a satellite through a twenty-four hour period. Statistics are kept which allow calculation for the amount of time a satellite is visible at each discrete latitude-longitude point. The visibility time per day is pictured for each satellite in the form of a contour plot. Each dark line represents a particular coverage time in hours/day. The resolution for the plots are five degrees in latitude and longitude [Ref 7].

For purposes of this thesis, coverage is constrained by the requirement that a spacecraft be at least  $20^{\circ}$  above the local horizon to ensure visibility. Although the indicated



coverage regions are for a particular right ascension of the ascending node (the point on the equator where the orbit crosses the equatorial plane in a northerly direction), the same contour patterns apply to any node.

## **B. GEOSYNCHRONOUS**

A geosynchronous orbit is one whose period is matched to the Earth's rotation. An altitude of 19,323 nautical miles (NM) is required for a circular orbit to maintain a match with the Earth's rotation. A non-inclined geosynchronous orbit remains fixed over a point on the equator and is termed geostationary. Continuous coverage of the hemisphere of interest is available with this orbit. The amount of coverage is dependant on elevation angle constraints [Ref 7].

An inclined geosynchronous orbit produces a figure-eight groundtrack (Figure V-1). The amount of movement is limited to a relatively small range of longitudes about the node and latitude excursions equal to the inclination. The ground-track of an inclined geosynchronous satellite repeats daily. Coverage of higher latitudes is achieved, however, continuous visibility is substantially reduced or eliminated depending on elevation angle requirements. Figure V-2 is a representation of an inclined geosynchronous orbit.

Figure V-3 is an inclined geosynchronous orbit with a  $20^\circ$  elevation angle constraint. Note that near continuous coverage is achieved at the equator and greater than eight-hour coverage exists near the poles in  $120^\circ$  of longitude. The

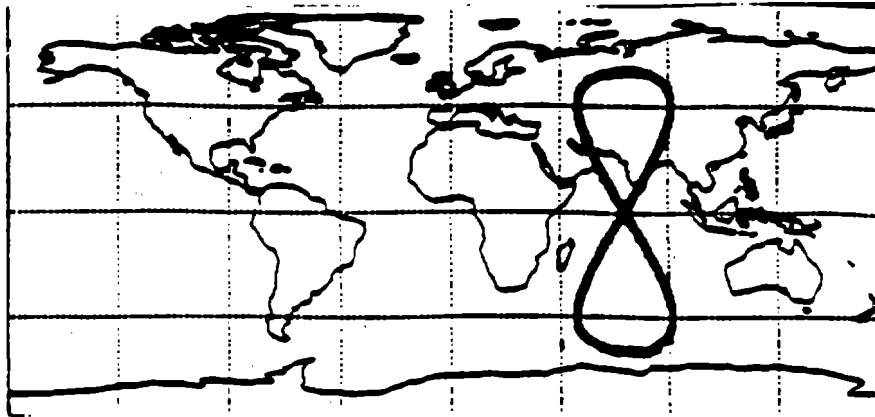

Figure V-1  
Inclined Geosynchronous Groundtrack

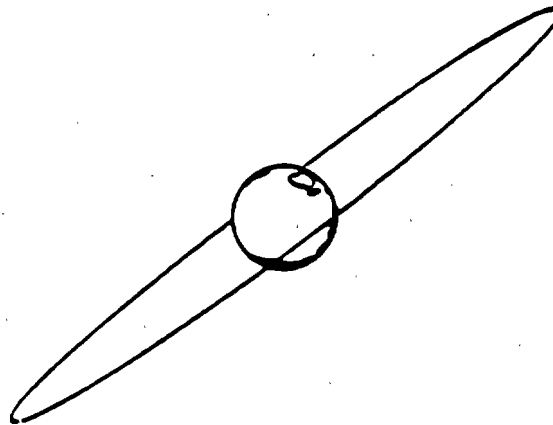

Figure V-2  
Inclined Geosynchronous Orbit

orbital elements for inclined geosynchronous orbit are tabulated in Table V-2.

#### C. TWENTY-FOUR HOUR MOLNIYA

Orbital perturbations occur in satellites due to the Earth's oblateness. They produce an apsidal rotation which in

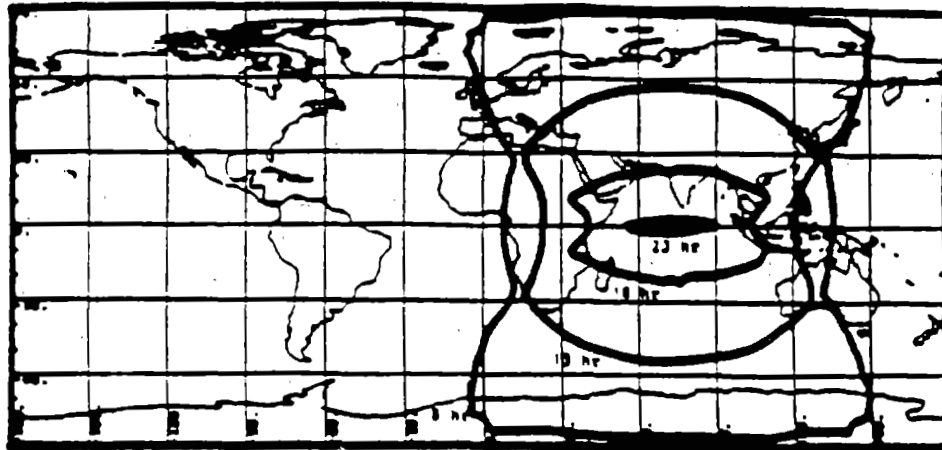

Figure V-3  
Inclined Geosynchronous Visibility

TABLE V-2  
INCLINED GEOSYNCHRONOUS ORBITAL ELEMENTS

semimajor axis	22767 NM
eccentricity	0.0
inclination	60.0 degrees
argument of perigee	N/A

effect rotates the line connecting perigee and apogee about the angular momentum vector. The apsidal rotation especially affects highly eccentric orbits in which the spacecraft is designed to loiter at apogee literally appearing to hover over a fixed point on Earth. The inertial movement of the apsis prohibits this, without extensive stationkeeping [Ref 7].

There is, however, a critical inclination at which the earth's perturbative forces combine such that they actually cancel rotation of the apsis. The class of orbits which

reside at this inclination are known as Molniya orbits. The value of the critical inclination is  $63.435^\circ$  [Ref 7].

The twenty-four hour Molniya orbit delivers a closed groundtrack. Figure V-3 depicts a typical groundtrack for this orbit. As can be seen by the figure, this orbit is not limited to a small range of longitudes. Instead, the Molniya

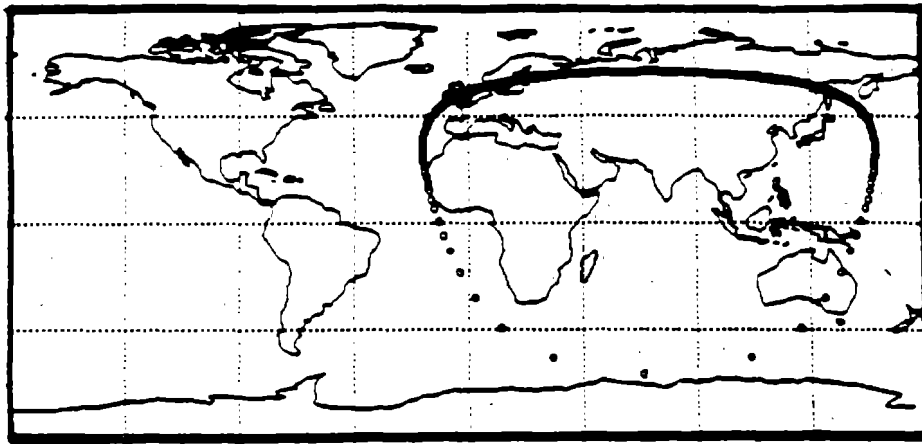

Figure V-3  
24-Hour Molniya Groundtrack

track covers half the globe. This particular plot represents a satellite with apogee positioned over the northwest Soviet Union. With each dot representing six minute intervals in satellite position, one can easily see the loiter phenomenon in the Northern Hemisphere and the non-existent coverage in the Southern Hemisphere. At apogee this satellite is extremely high (38,000 NM) while at perigee it is very low (380 NM) and moving very quickly.

Figure V-4 depicts the  $20^\circ$  elevation angle constraint and the plot, though busy, depicts the high coverage attainable in northern latitudes. Twenty hours per day or better coverage

is available at latitudes above  $65^{\circ}$ , with greater than six hours per day coverage available for the entire northeast quadrant. An additional bonus with this satellite is its ability to simultaneously cover both East and West hemispheres due to the 38,000 NM apogee. Table V-3 depicts the twenty-four hour Molniya orbital elements.

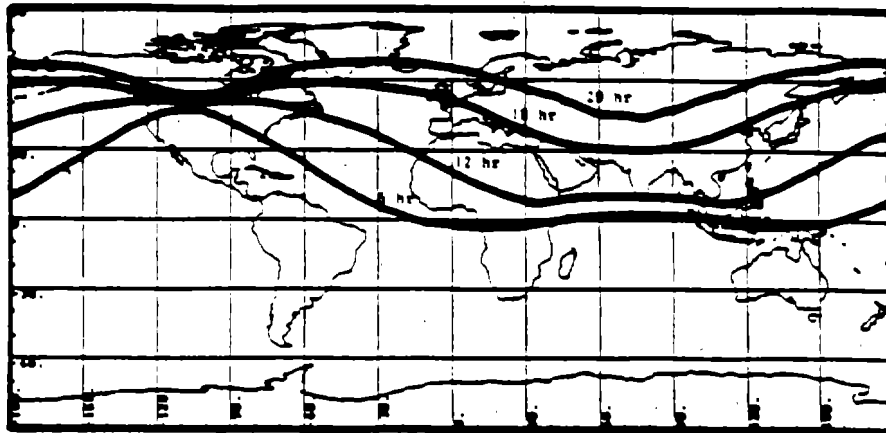

Figure V-4  
24-Hour Molniya Coverage Visibility

TABLE V-3  
24-HOUR MOLNIYA ORBITAL ELEMENTS

semimajor axis	22767 NM
eccentricity	0.8321
inclination	63.435 degrees
argument of perigee	270.0 degrees

#### D. TWELVE HOUR MOLNIYA

Figure V-5 portrays the twelve hour Molniya orbit. The unique feature of the twelve hour orbit is that the ground-track repeats itself identically daily. The effect achieved, based on this representation, is that two equal loiter periods

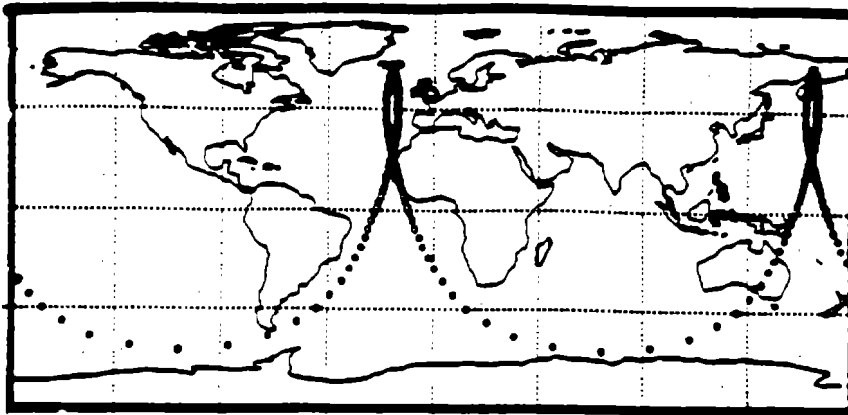

Figure V-5  
12-Hour Molniya Groundtrack

occur, one over Iceland and the other over Kamchatka. Figure V-6 is a graphic comparison of the twelve and twenty four hour Molniya orbit. Note that the twelve-hour orbit has a considerably lower apogee which produces the orbital period as a multiple of the Earth's rotation rate [Ref 7].

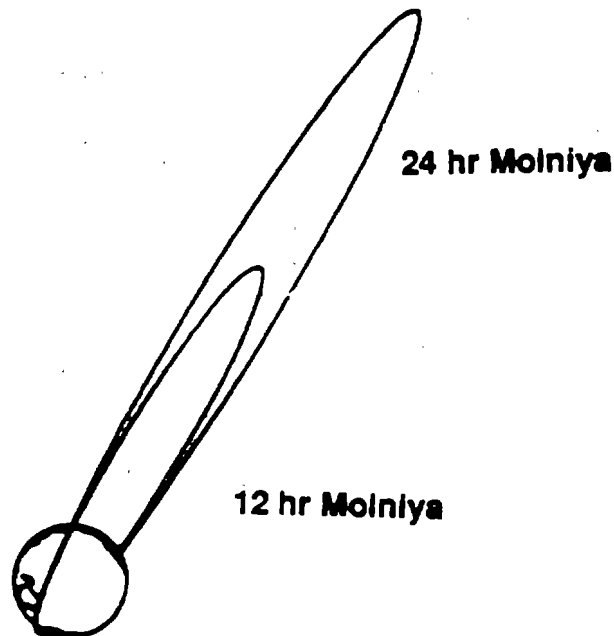

Figure V-6  
12-Hour/24-Hour Molniya Orbit

Figure V-7 constrains the elevation angle to  $20^\circ$ . The lower contour line of this figure represents six hours per day

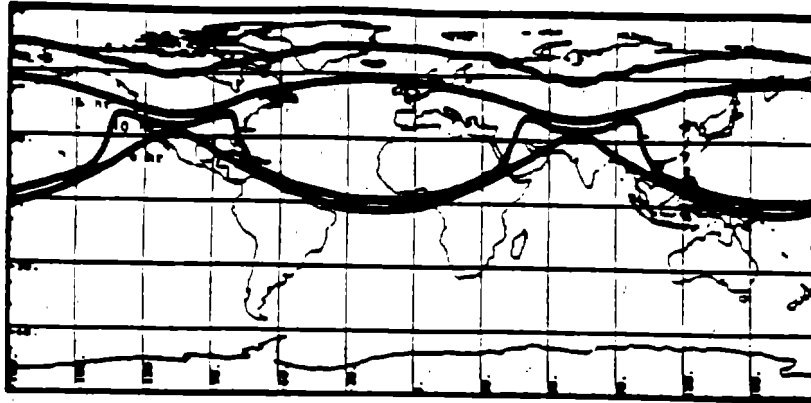

Figure V-7  
12-Hour Molniya Coverage Visibility

visibility and the upper contour indicates eighteen hours per day. The best coverage at higher latitudes occurs at the longitude of perigee, not apogee. The reason for this perplexing phenomenon results from the fact that, at these positions, the satellite is visible around both apogees in the day. In the mid-latitudes, the greatest coverage is found at the longitudes of apogee, making most of the northern oceans visible at least ten hours per day. Table V-4 represents the twelve hour Molniya orbital elements [Ref 7].

TABLE V-4  
12-HOUR MOLNIYA ORBITAL ELEMENTS

semimajor axis	14352 NM
eccentricity	0.7335
inclination	63.435 degrees
argument of perigee	270.0 degrees

#### E. GLOBAL POSITIONING SYSTEM (GPS)

Although Figure V-8 appears to be a single sinusoidal orbit, it is in fact two complete orbits. GPS uses a half-synchronous orbit which repeats daily. The circular nature

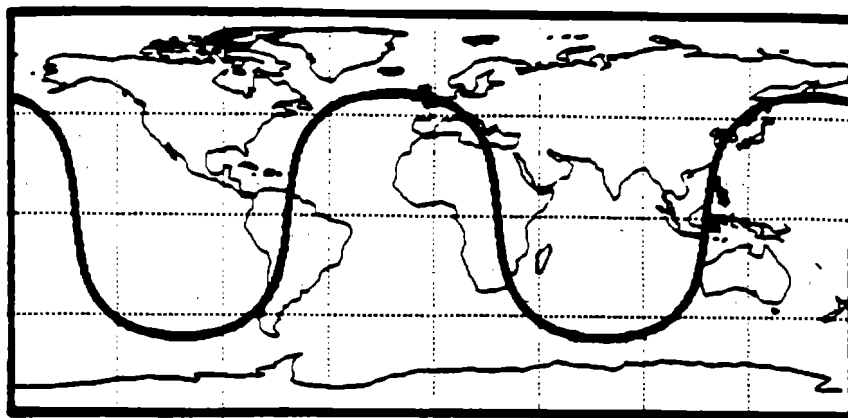

Figure V-8  
GPS Groundtrack

(Figure V-9) of the orbit produces no loitering at any point in the orbit, satellite velocity remains constant over the period [Ref 7].

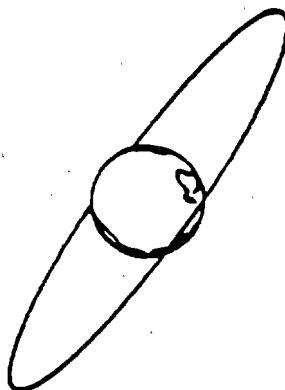

Figure V-9  
GPS Circular Orbit

Using the  $20^\circ$  elevation constraint for Figure V-10 it appears that the GPS orbit is potentially useless for achieving global coverage. A single satellite covers only a small area at the equator, but the concept of GPS has been to fly as a constellation which achieves nearly global coverage [Ref 7]. Table V-5 provides the GPS orbital elements.



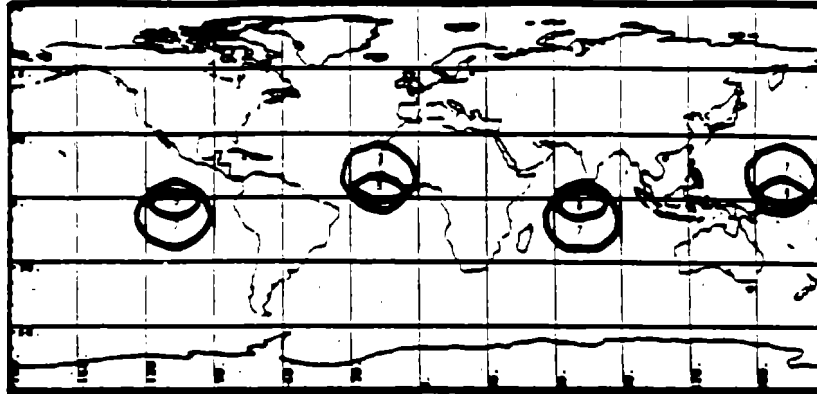

Figure V-10  
GPS Coverage Visibility

TABLE V-5  
GPS ORBITAL ELEMENTS

semimajor axis	14352 NM
eccentricity	0.0
inclination	55.0 degrees
argument of perigee	N/A

#### F. LOW EARTH ORBITS

A graphic depiction of a low earth orbit will not be provided due partly to a lack of information and partly because an orbital ground trace may not be enlightening. The following sums up the main points of the low earth orbit:

- Variety of orbits
  - Altitudes between 90 and 1000 NM
  - Various inclinations and eccentricities
- Large number of satellites required for large area coverage
- Possibly useful for small area coverage [Ref 7].

Notice that with so many inclinations and eccentricities available groundtracks for a single case would misrepresent rather than support meaningful data. Suffice it to say, low

earth orbit is not the orbit of choice for the MILSTAR or UFO constellation.

#### G. DOPPLER/ANGULAR VELOCITY AND ACCELERATION

Doppler and angular velocity and acceleration are important because they indicate whether communication connectivity is possible with the satellite at a given point. Doppler velocity was computed by taking the dot product of the vector difference in velocity between the satellite and the ground station, with the vector connecting the two points. It thus represents the velocity component along the line of sight. The greatest magnitude of Doppler velocity occurs, in general, at a ground station along the groundtrack, at the limb of visibility when the satellite is at perigee and thus, is moving fastest. The Doppler acceleration is computed numerically [Ref 7]. The data in Table V-6 are results from a computer program which calculates the maximum angular rate and acceleration of a satellite with respect to an Earth based observer. These results are in the direction of the maximum instantaneous values, and not in a fixed coordinate system such as polar or azimuth-elevation. For Molniya orbits, the angular and Doppler rates and accelerations are only evaluated when the satellite is more than  $90^\circ$  in true anomaly from perigee. Below this, the satellite is moving very rapidly and is not considered useful for communications purposes [Ref 7]. This table characterizes all of the orbits discussed using a

10° and 20° terminal elevation angle to determine which orbits will be useful [Ref 7].

#### H. ORBITAL ANALYSIS CONCLUSIONS

Table V-7 provides a table format for the conclusions of this analysis. One important note is that the low earth orbit is not compatible with MILSTAR terminals. An assumption made

TABLE V-6  
ORBITAL CHARACTERISTICS SUMMARY

ORBIT	Terminal Elevation Angle (Deg)	Maximum Doppler (ppm)	Maximum Doppler Rate (ppm/sec)	Maximum Angular Rate (mdeg/sec)	Maximum Angular Acceleration (mdeg/sec/sec)
Geosync 60 Deg Inclination	10	1.53	1.53E-04	4.91	2.20E-04
	20	1.48	1.53E-04	4.90	2.17E-04
24 Hr Molniya	10	14.71	1.68E-03	9.51	4.02E-03
	20	14.64	1.65E-03	9.51	4.02E-03
12 Hr Molniya	10	19.25	6.41E-03	36.58	3.64E-02
	20	19.08	6.41E-03	36.61	3.64E-02
GPS (Half-Sync)	10	2.51	4.60E-04	9.05	3.83E-04
	20	2.38	4.60E-04	9.05	3.83E-04
Leo 0 Degree Inclination	10	20.61	1.96E-01	537.43	2.93
	20	19.67	1.96E-01	537.43	2.95
Leo 90 Degree Inclination	10	22.16	2.27E-01	578.69	3.42
	20	21.03	2.27E-01	578.69	3.42

by the engineers conducting the orbital analysis was that the best estimate for the orbital characteristics which a MILSTAR terminal can support must be equivalent to a half synchronous orbit. Since the LEO orbit has a high angular rate and acceleration, it therefore cannot work. Geosynchronous orbits are probably overall the best choice as they provide adequate coverage either from the equator or the higher latitudes. The GPS coverage is good but it is in a twelve hour orbit and in

view less than eight hours a day for the majority of terminal locations. Time in view must then be divided in two because of the orbital period leaving two four hour blocks of continuous availability per day before losing contact. The twenty-four hour Molniya does very well if one restricts oneself to the portion of the orbit above the equatorial plane. Below the plane, Doppler and angular velocity are too high to have communication connectivity. The twelve hour Molniya orbit also doesn't work well because it has a useful communication window of only about seven hours per day.

TABLE V-7  
ORBITAL ANALYSIS CONCLUSIONS

ORBIT	Compatibility with Milstar Terminals	Coverage for Single Satellite	Overall Feasibility
Geosync 60 Deg Inclination	Compatible	Adequate for many purposes	Feasible for area coverage or worldwide coverage with multiple satellites
Molniya 24 Hr	Compatible for Northern latitudes	Adequate for Northern Hemisphere coverage, greater than 6 hours/day	Feasible for area (Northern Hemisphere) coverage with multiple satellites
Molniya 12 Hr	Compatible for Northern latitudes	Adequate for Northern Hemisphere coverage, greater than 6 hours/day	Feasible for area (Northern Hemisphere) coverage with multiple satellites
GPS (Half-Sync)	Compatible	Less than 8 hours/day in two periods	Feasible only with a large constellation of satellites
Leo	Not Compatible	Limited	Not Feasible currently

## VI. SATELLITE SYSTEM COMPARISON

### A. BACKGROUND

One way to look at two systems is to use an Analytic Hierarchy Process (AHP). The process is a relatively new technique developed over the last ten years. It is a process not rooted in utility theory and has therefore remained outside the mainstream of decision analysis research. Since comparing two satellite communications systems that are different in mission, yet similar in capability may be considered odd, it was felt that the practical nature of the AHP would be satisfactory for solving or at least considering the elusive nature of this comparison problem [Ref 14].

The process itself involves four steps:

- Step 1 - Setting up the decision hierarchy by breaking down the decision problem into a hierarchy of interrelated decision elements,
- Step 2 - Collecting input data by pairwise comparisons of decision elements,
- Step 3 - Using the "eigenvalue" method to estimate the relative weights of decision elements,
- Step 4 - Aggregating the relative weights of decision elements to arrive at a set of ratings for the decision alternatives (or outcomes) [Ref 14].

Setting up the process is perhaps the hardest part of the decision apparatus, however, Figure VI-1 presents a standard form for the decision scheme.

In setting up the decision hierarchy, the number of levels depends on the complexity of the problem. The whole system is

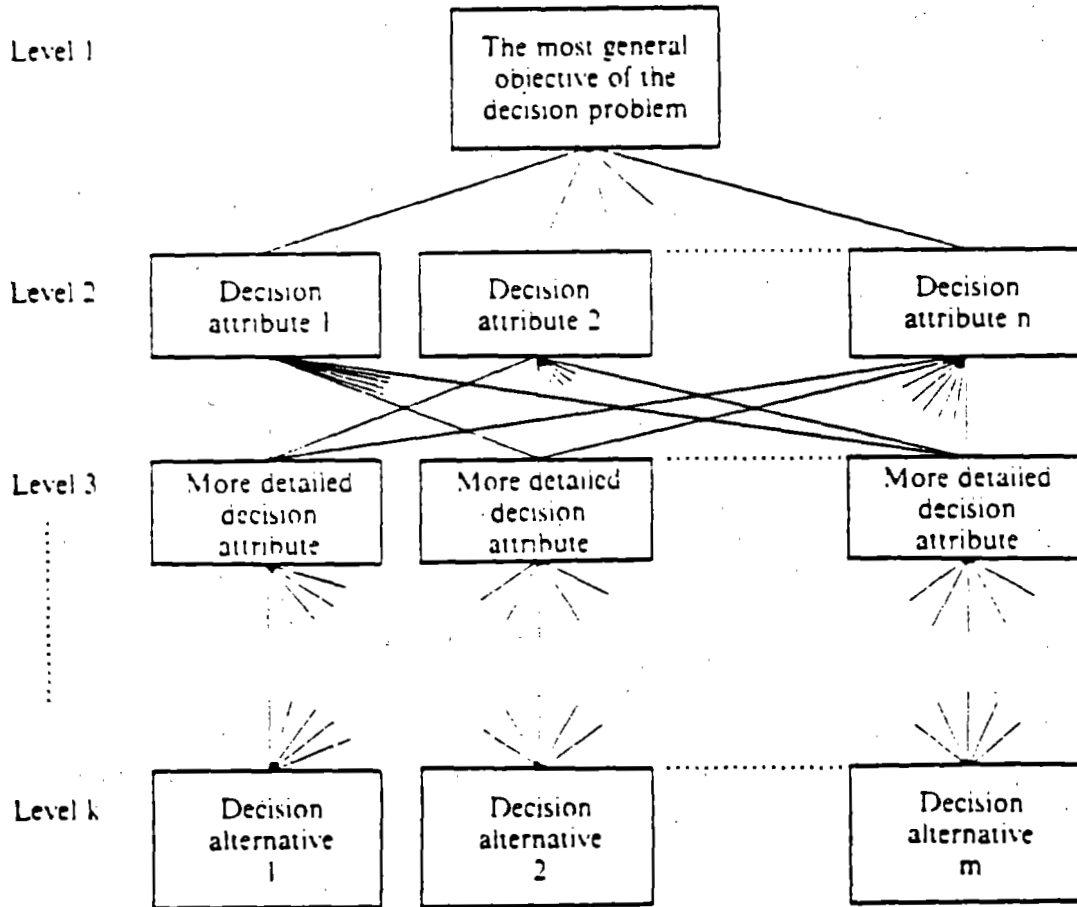

Figure VI-1  
The Standard Form of Decision Schema in the Analytic Hierarchy Process

dependant on pairwise comparisons within each level and to overload a level would probably be detrimental to a good solution. A self-imposed limitation of nine elements is the standard rule of thumb when setting up the model [Ref 14].

At Step 2 the pairwise comparisons are conducted by setting up a simple matrix. For example, in the Indianapolis 500, technical capacity may be twice as important as

behavioral capacity in winning the race. The input matrix would look like this:

	Technical Capacity	Behavioral Capacity
Technical Capacity	1	2
Behavioral Capacity	1/2	1

Value 2 in Row 1 indicates that technical capacity is twice as important as behavioral capacity in achieving the higher objective of the next level -- winning at Indy.

Step 3 uses the pairwise comparisons of Step 3 that assigns relative weights to each level. It is in Step 3 that the "eigenvalue" method is used to develop a scheme for the relative weighting. Other methods are available but none is as widely applied or well known [Ref 14].

Step 4 uses the previously determined relative weights to produce a vector of composite weights which serve as rating of decision alternatives (or selection choices) in achieving the most general objective of the problem [Ref 14]. It is the objective of the author to apply this theory to the satellite systems reviewed, couple them with potential scenarios, and determine which system is better suited for military communications in the future.

#### **B. SCENARIO DRIVEN COMPARISONS**

As United States military commitments continue to have a global trend, potential areas of hostility and rapid response will be considered. Three areas of concern: The Persian Gulf, the North Pole or Polar Ice Cap, and the Mediterranean/

European Theater are chosen arbitrarily as potential hot spots for future conflict.

In each scenario only communications in the global sense will be considered. Logistics, on-station time, actual units deployed, etcetera will not be considered. Table VI-1 represents the hierarchy to be considered in comparing the satellite systems, including the weighting assigned by the author. Additionally, a report card or key is provided to rate the scores in each scenario. Similarly, three areas considered important by the author are highlighted in the Table and assigned weights accordingly.

**1. Persian Gulf (Hypothetical Scenario 1)**

**Problem:** A need for fast, reliable, global communications exists in order to interconnect National Command Authorities (NCA) with the Battlefield Commander to maintain initiative, surprise, and the offensive. The environment is extremely harsh on ground equipment and the threat is primarily conventional with little or no electronic countermeasures (ECM) or jamming.

**Solution:** The use of communication satellites in this area of the world is critical to the success of the operation. Table VI-2 rates MILSTAR against UFO in this scenario with the results tabulated.

Both systems function well, except that in MILSTAR's case the NCA is the one receiving superb communication using MILSTAR while the battlefield would rely on DSCS, UFO, or



FLTSAT. MILSTAR would be able to cross-link which would be advantageous in peak periods but the advantage still goes to UFO because MILSTAR's mission is too narrowly defined.

TABLE VI-1  
HIERARCHY CONSIDERATIONS AND WEIGHTING

CHARACTERISTICS	WEIGHTING
cost per satellite	100
frequency band	50
primary	
additional	
channel capacity	50
cross-link	25
nuclear survivable	25
anti-jam/low probability of intercept	75
10 year mission life	50
autonomous operation for minimum 30 days	50
satellite hardware	25
ground station compatible	100

Note: The two systems received ratings ranging from unacceptable to excellent in various categories. Scores are derived by multiplying the weighting of each criterion by its rating where:

Excellent = 1.0 - Outstanding in all areas.  
Very Good = 0.75 - Meets all essential criteria and offers significant advantages.

Good = 0.625 - Meets essential criteria and includes some special features.

Satisfactory = 0.5 - Meets essential criteria.

Poor = 0.25 - Falls short in essential areas.

Unacceptable or N/A = 0.0 - Fails to meet minimum standards or lacks this feature.

Scores are summed, divided by 100, and rounded down to one decimal place to yield the final score out of a maximum possible score of 10. All weights are subject to personal choice.

TABLE VI-2  
PERSIAN GULF SCENARIO

CHARACTERISTICS	WEIGHTING	MILSTAR	UFO
cost per satellite	100	Poor	Excellent
frequency band	50		
primary		Very Good	Very Good
additional		Very Good	Very Good
channel capacity	50	Excellent	Excellent
cross-link	25	Very Good	N/A
nuclear survivable	25	Very Good	Good
anti-jam/low probability of intercept	25	Excellent	Very Good
10 year mission life	50	Good	Good
autonomous operation for minimum 30 days	50	Good	Good
satellite hardware	25	Very Good	Very Good
ground station compatible	100	Good	Very Good
Score		3.19	3.78

**2. The North Pole (Hypothetical Scenario 2).**

Problem: The Soviet threat under the polar ice cap has escalated into more than can be tolerated by the United States. The United States Submarine forces are tasked with going under the ice in hunter-killer groups to flush out the Soviet menace. Communications must function in an ECM intensive environment and the high probability that the Soviets will use anti-satellite (ASAT) weapons.

Solution: The burden of communications rapidly falls to MILSTAR in this scenario as it is designed to be up and communicating long after FLTSAT, LEASAT, DSCS, and even UFO have been neutralized. Its anti-jamming, nuclear survivable, ASAT defeating plethora of capability truly makes it a tremendous space asset for this scenario. Table VI-3 displays the results for the hierarchial breakdown.

TABLE VI-3  
NORTH POLE SCENARIO

CHARACTERISTICS	WEIGHTING	MILSTAR	UFO
cost per satellite	25	Poor	Excellent
frequency band	50		
primary		Very Good	Very Good
additional		Very Good	Very Good
channel capacity	75	Excellent	Excellent
cross-link	75	Very Good	N/A
nuclear survivable	100	Very Good	Good
anti-jam/low probability of intercept	100	Excellent	Very Good
10 year mission life	50	Good	Good
autonomous operation for minimum 30 days	50	Good	Good
satellite hardware	25	Very Good	Very Good
ground station compatible	100	Good	Very Good
Score		4.94	4.31

3. Mediterranean/European Theater (Hypothetical Scenario 3).

Problem: Tensions in the Eastern block have risen dramatically. Economic pressures on the Soviet Union to allow independence to some of its states has resulted in a power vacuum in Eastern Europe. Global terrorism continues to plague the United States and a military presence to add stability is required. With internal pressure in the Soviet Union, ECM is possible, anti-satellite weapons are considered to be a low probability.

Solution: Both MILSTAR and UFO are going to perform well in this scenario. MILSTAR will provide outstanding support to NCA while UFO will be able to provide the theater as well as National Commander outstanding coverage. Table VI-4 displays the results of this scenario with the author still choosing UFO as the most desirable satellite.

TABLE VI-4  
MEDITERRANEAN/EUROPEAN SCENARIO

CHARACTERISTICS	WEIGHTING	MILSTAR	UFO
cost per satellite	100	Poor	Excellent
frequency band	75		
primary		Very Good	Very Good
additional		Very Good	Very Good
channel capacity	75	Excellent	Excellent
cross-link	25	Very Good	N/A
nuclear survivable	25	Very Good	Good
anti-jam/low probability of intercept	75	Excellent	Very Good
10 year mission life	50	Good	Good
autonomous operation for minimum 30 days	50	Good	Good
satellite hardware	25	Very Good	Very Good
ground station compatible	100	Good	Very Good
Score		4.13	4.59

The scenarios chosen were picked as potential candidates to display the differences between global threats. The weighting system used can be adjusted by the individual based on experience, threat analysis, or criteria supplied yet not weighed here. The next chapter concludes the analysis of the comparison of the two satellite communication systems.

## VII. CONCLUSIONS/FOLLOW-ON STUDY

### A. CONCLUSIONS

Initially, the author sought to compare two satellite communication systems. Both are communications satellites and both represent the future. It is the author's conclusion that the technological advances gained from the MILSTAR program should not be lost. It is also this author's conclusion that MILSTAR should not be orbited. It costs too much and it will be used primarily by the National Command Authorities in times of crises. With usage only at that level, it is this author's opinion that very little is gained for the money spent.

If money were an unlimited resource the question of funding MILSTAR would be moot. Of course we would fund the program. It is state of the art. It does for EHF in the 90's what research did for UHF in the 50's; it makes it viable. Money, however, is a big concern in any acquisition in the 90's. With an unclear global threat, countries in a power-vacuum, and Congress looking to cut rather than increase the defense budget, the Air Force does none of the services a favor by driving ahead with this program.

It is the opinion of this author that, should the services desire to maintain funding to keep ourselves at the cutting edge of technology, we will have to learn to field systems which can be developed at reasonable cost; with the foresight

that allows for significant future upgrades; and the rational minds to recognize when to stop funding things that become money sponges.

#### **B. FOLLOW-ON RESEARCH**

This author did not develop any software supported models to compare the two satellite systems. A potential area for further research would be to develop the hierarchial model using a software such as Expert Choice with DoD developed scenarios. Additionally, a classified thesis would be able to more deeply explore the generation of the unique MILSTAR waveform versus the waveform used by UFO.

The research conducted on MILSTAR could be applied to more integrated satellite programs such as the theater/user dedicated communications satellite system concept [Ref 15] or a program that more appropriately evolves as new technology is developed, such as the DSCS program. More research must be conducted in developing cheaper ways to deliver hardware to space. The cost per pound to put U.S. satellites in space is too high today and prices are not likely to recede.

Finally, a complete look at the acquisition process needs to be conducted to develop a set of guidelines for cutting off new requirements and building systems that have room to grow. It is this author's opinion that new technology is tremendous and provides the edge in battle, however, if adding requirements keeps the technology from the field 10 to 12 years, the military will always be saying next year we will

have the edge. Next year may not come so it is time to get smart and field the systems that can evolve with the technology.

## LIST OF REFERENCES

1. Defense Logistics Studies Information Exchange Study Abstract, Department of Defense, *Report on the Review of the Follow-on Ultra-High Frequency Satellites Program as a Part of the Audit of the Effectiveness of the Defense Acquisition Board Process*, DoD Inspector General, Assistant IG for Auditing, December 1988.
2. Shultheis, LCDR Charles; Skene, Robert, *The UHF Follow-on Satellite Program*, Abstract, July 23, 1990.
3. United States General Accounting Office, *Report to Congressional Requesters, Case Study of the MILSTAR Satellite Communications System*, July 31, 1986.
4. Defense Electronics, *Milstar Soars Beyond Budget and Schedule Goals*, by James W. Rawles, February 1989.
5. Defense Electronics, *Milstar to Close Dangerous C<sup>3</sup>I Gap*, by James B. Schultz, March 1983.
6. Defense Electronics, *Military Satellites: The Next Generation*, by James B. Rawles, May 1988.
7. Defense Communications Agency, *Assessment of EHF Package Designs, Final Report*, by Science Applications International Corporation (SAIC) Communication Systems Engineering & Integration Center and Hughes Aircraft Company Space and Communications Group, August 18, 1989.
8. Telephone interviews between Randy Glein, Hughes Aircraft and the author, March, June, and August 1991.
9. SIGNAL, *Extremely High Frequency Satellites Offer Flexibility*, by Dr. Kostas Liopiros and Dr. Edward Lam, July 1990.
10. Freeman, Roger L., Telecommunication Transmission Handbook 2nd Ed., John Wiley & Sons, 1981.
11. The Naval Center for Space Technology, *A Comparative Study of SHF and EHF Satellite Communications, Volume I*, by Martin Marietta Corporation Information and Communications Systems, September 28, 1987.



12. Georgia Tech Research Institute, *Performance of EHF Communications Systems in the Presence of Jamming*, by Robert W. Rice and Eric N. Barnhart, 1984.
13. Sonnenschein, A. and Fishman, P.M., *An Approach to Minimization of the Detectability of Spread-Spectrum Signals*, 1990.
14. INTERFACES, *The Analytic Hierarchy Process -- A Survey of the Method and its Applications*, by Fatemeh Zahedi, August 1986, pp. 96-108.
15. SPARTA, Inc., *Theater/User-Dedicated Communications Satellite System Concept*, by Roger R. Bennett, 1990.