



Calhoun: The NPS Institutional Archive
DSpace Repository

Theses and Dissertations

1. Thesis and Dissertation Collection, all items

2001-03

A business process review of the Satellite
Access Request, Gateway Access Request,
and Request for Services processes at United
States Transportation Command

Bramble, Michael L.

<http://hdl.handle.net/10945/10820>

Downloaded from NPS Archive: Calhoun



Calhoun is a project of the Dudley Knox Library at NPS, furthering the precepts and goals of open government and government transparency. All information contained herein has been approved for release by the NPS Public Affairs Officer.

Dudley Knox Library / Naval Postgraduate School
411 Dyer Road / 1 University Circle
Monterey, California USA 93943

<http://www.nps.edu/library>

**NAVAL POSTGRADUATE SCHOOL
Monterey, California**



THESIS

**A BUSINESS PROCESS REVIEW OF THE SATELLITE
ACCESS REQUEST, GATEWAY ACCESS REQUEST, AND
REQUEST FOR SERVICES PROCESSES AT UNITED
STATES TRANSPORTATION COMMAND**

by

Michael L. Bramble

March 2001

Thesis Advisor:
Associate Advisor:

Mark E. Nissen
Erik Jansen

Approved for public release; distribution is unlimited.

20010508 037

REPORT DOCUMENTATION PAGE

Form Approved
OMB No. 0704-0188

Public reporting burden for this collection of information is estimated to average 1 hour per response, including the time for reviewing instruction, searching existing data sources, gathering and maintaining the data needed, and completing and reviewing the collection of information. Send comments regarding this burden estimate or any other aspect of this collection of information, including suggestions for reducing this burden, to Washington headquarters Services, Directorate for Information Operations and Reports, 1215 Jefferson Davis Highway, Suite 1204, Arlington, VA 22202-4302, and to the Office of Management and Budget, Paperwork Reduction Project (0704-0188) Washington DC 20503.

1. AGENCY USE ONLY (Leave blank)

2. REPORT DATE
March 2001

3. REPORT TYPE AND DATES COVERED
Master's Thesis

4. TITLE AND SUBTITLE : A Business Process Review of the Satellite Access Request, Gateway Access Request, and Request for Services processes at United States Transportation Command

5. FUNDING NUMBERS

6. AUTHOR(S)
Bramble, Michael L.

7. PERFORMING ORGANIZATION NAME(S) AND ADDRESS(ES)
Naval Postgraduate School
Monterey, CA 93943-5000

8. PERFORMING ORGANIZATION REPORT NUMBER

9. SPONSORING / MONITORING AGENCY NAME(S) AND ADDRESS(ES)
N/A

10. SPONSORING / MONITORING AGENCY REPORT NUMBER

11. SUPPLEMENTARY NOTES

The views expressed in this thesis are those of the author and do not reflect the official policy or position of the Department of Defense or the U.S. Government.

12a. DISTRIBUTION / AVAILABILITY STATEMENT

Approved for public release; distribution is unlimited.

12b. DISTRIBUTION CODE

13. ABSTRACT (maximum 200 words) The current emphasis on the implementation of e-business and automated solutions in the quest for increased efficiency accentuates the importance of Business Process Reengineering. The existing method for processing Satellite Access Requests (SAR), Gateway Access Requests (GAR) and Requests for Services (RFS) at USTRANSCOM is an ideal candidate for review and innovation. The premise of this thesis is that Business Process Reengineering, using information technology and other enablers of change, may produce quantum performance gains in these processes, particularly in terms of cycle time. Three redesign alternatives to the current process are developed using the Nissen methodology in conjunction with computer modeling and simulation tools. All three processes have tremendous potential to demonstrate dramatic reductions in cycle time, resulting in more efficient, streamlined satellite communications access request procedures at USTRANSCOM. The redesigns are based on delegation of authority, reducing the length of the process, and the introduction of an automated, web-based solution to streamline workflow and increase productivity. The research concludes that the SAR, GAR, and RFS processes can be dramatically improved through the application of an automated, information technology solution.

14. SUBJECT TERMS Business Process Reengineering, Military Satellite Communications Access

15. NUMBER OF PAGES
84

16. PRICE CODE

17. SECURITY CLASSIFICATION OF REPORT
Unclassified

18. SECURITY CLASSIFICATION OF THIS PAGE
Unclassified

19. SECURITY CLASSIFICATION OF ABSTRACT
Unclassified

20. LIMITATION OF ABSTRACT
UL

THIS PAGE INTENTIONALLY LEFT BLANK

Approved for public release; distribution is unlimited

**A BUSINESS PROCESS REVIEW OF THE SATELLITE ACCESS REQUEST,
GATEWAY ACCESS REQUEST, AND REQUEST FOR SERVICES PROCESSES
AT UNITED STATES TRANSPORTATION COMMAND**

Michael L. Bramble
Major, United States Marine Corps
B.S., United States Naval Academy, 1988

Submitted in partial fulfillment of the
requirements for the degree of

MASTER OF SCIENCE IN INFORMATION SYSTEMS TECHNOLOGY

from the

**NAVAL POSTGRADUATE SCHOOL
March 2001**

Author:



Michael L. Bramble

Approved by:



Mark E. Nissen, Thesis Advisor

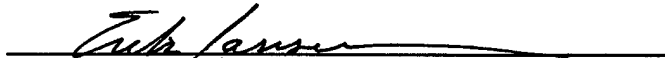

Erik Jansen, Associate Advisor



Dan C. Boger, Chairman
Information Systems Academic Group

THIS PAGE INTENTIONALLY LEFT BLANK

ABSTRACT

The current emphasis on the implementation of e-business and automated solutions in the quest for increased efficiency accentuates the importance of Business Process Reengineering. The existing method for processing Satellite Access Requests (SAR), Gateway Access Requests (GAR) and Requests for Services (RFS) at USTRANSCOM is an ideal candidate for review and innovation. The premise of this thesis is that Business Process Reengineering, using information technology and other enablers of change, may produce quantum performance gains in these processes, particularly in terms of cycle time. Three redesign alternatives to the current process are developed using the Nissen methodology in conjunction with computer modeling and simulation tools. All three processes have tremendous potential to demonstrate dramatic reductions in cycle time, resulting in more efficient, streamlined satellite communications access request procedures at USTRANSCOM. The redesigns are based on delegation of authority, reducing the length of the process, and the introduction of an automated, web-based solution to streamline workflow and increase productivity. The research concludes that the SAR, GAR, and RFS processes can be dramatically improved through the application of an automated, information technology solution.

THIS PAGE INTENTIONALLY LEFT BLANK

TABLE OF CONTENTS

I. INTRODUCTION	1
A. BACKGROUND	1
B. OBJECTIVES	2
C. RESEARCH QUESTIONS.....	3
D. SCOPE OF THESIS	3
E. RESEARCH METHODOLOGY	4
F. CHAPTER OUTLINE.....	4
II. BACKGROUND.....	7
A. UNITED STATES TRANSPORTATION COMMAND	7
1. The SAR/GAR Process.....	8
2. The RFS Process	9
B. BUSINESS PROCESS REENGINEERING	10
1. Business Process Reengineering Overview	10
2. Business Process Reengineering Methodologies.....	12
a. The Davenport Methodology	13
b. The Hammer and Champy Methodology	13
c. The Nissen Methodology	14
d. The GAO Methodology	15
3. Methodology Used in the Redesign of the SAR/GAR/RFS Processes	16
III. MODELING TOOLS AND THE CURRENT PROCESS.....	19
A. MODELING TOOLS	19
1. EXTEND.....	19
a. EXTEND Overview	19
b. EXTEND Input Variables.....	23
2. KOPeR.....	26
a. KOPeR Overview.....	26
b. KOPeR Input Variables	27
B. THE SAR/GAR/RFS PROCESSES	28
1. Baseline Process Description.....	29
2. EXTEND Simulation of the Baseline Process.....	32
a. EXTEND Simulation Inputs	32
b. Analysis of the EXTEND Simulation of the Baseline Process	34
3. KOPeR Diagnosis of the Baseline Process.....	36
a. KOPeR Simulation Inputs.....	36
b. Analysis of KOPeR Simulation of Baseline Process.....	37
IV. PROCESS REDESIGNS	41
A. REDESIGNS.....	41
1. Redesign Alternative I.....	42
2. Redesign Alternative II.....	44
3. Redesign Alternative III.....	47
B. TESTING ALTERNATIVES	49

1. EXTEND Simulation Results	49
2. KOPeR Simulation Results	52
C. MIGRATION PLAN.....	53
1. Introduction.....	54
2. Implementing Change.....	55
3. Migration Recommendations.....	56
D. SUMMARY	56
V. SUMMARY, CONCLUSIONS AND FUTURE RESEARCH.....	59
A. SUMMARY	59
B. CONCLUSIONS.....	59
C. RECOMMENDATIONS	61
D. TOPICS FOR FURTHER RESEARCH.....	61
LIST OF REFERENCES.....	65
INITIAL DISTRIBUTION LIST.....	67

LIST OF FIGURES

3-1. EXTEND Model Example.....	21
3-2. Generator Dialog Box.....	22
3-3. KOPeR Process Diagram.....	28
3-4. SAR/GAR/RFS Baseline Process Diagram.....	32
3-5. KOPeR Process Decomposition	36
4-1. Redesign I Process Diagram.....	43
4-2. Redesign Alternative II Process Diagram	45
4-3. Redesign II Process Diagram	48

THIS PAGE INTENTIONALLY LEFT BLANK

LIST OF TABLES

3-1. Extend Input Variables	24
3-2. Example Process Measures. From Ref. (Nissen, 1998)	27
3-3. Subordinate Command Processing Times	29
3-4. Component Command Processing Times	30
3-5. USTRANSCOM Processing Times	31
3-6. EXTEND Simulation Inputs	33
3-7. Summary Statistics For EXTEND Baseline Run	35
3-8. KOPeR Diagnosis of the Baseline Process	37
4-1. Automation Effects on Process Delay	47
4-2. EXTEND Simulation Output Comparison	50
4-3. Mean Cycle Time Comparison.....	51
4-4. KOPeR Measurement Comparison	52

THIS PAGE INTENTIONALLY LEFT BLANK

ACKNOWLEDEGEMENT

The Author would like to acknowledge USTRANSCOM for providing funding to cover the travel necessary to conduct research in support of this thesis. The timely and responsive assistance of Mr. Jim Ables and Major Tom Heckroth, from the J6-PC at USTRANSCOM, proved invaluable.

I would also like to thank Dr. Mark Nissen and Dr. Erik Jansen for taking this project on. Their advice and direction at critical junctures during the research and writing process facilitated the successful completion of this project.

THIS PAGE INTENTIONALLY LEFT BLANK

I. INTRODUCTION

Chapter 1 discusses the purpose and content of this thesis. It also provides a brief overview of the background and objectives, research questions and the methodologies used.

A. BACKGROUND

Currently, there are a number of processes in place at United States Transportation Command (USTRANSCOM) that are utilized to request different types of communications services. These services range from commercial voice and data terrestrial systems to satellite communications services. The process requests include the Satellite Access Request (SAR), Gateway Access Request (GAR) and the Request For Service (RFS). The process in each case is different, requiring different administrative forms and lower level approval authority. However, each request is similar, requiring some redundant information. At the same time, each request requires specific information and may have varying routing requirements. The end result is a system that is confusing to the user, ambiguous and time consuming. The common denominator in each case is the final approval authority, within the Command, Control, Communications and Computer Systems Directorate (J6), prior to forwarding the request to service providers, principally the Defense Information Systems Agency (DISA) and the Defense Information Technology Contracting Organization (DITCO) or appropriate controlling authority.

The premise of this thesis is that Business Process Reengineering, using information technology and other enablers of change, can produce quantum performance gains in the key enterprise processes.

Innovation and improvement, as indicated by Davenport in *Process Innovation* (1993), are fundamentally different. Improvement involves keeping the majority of the current processes intact, while making minor adjustments in order to achieve incremental gains in desired areas. Improvement might result in cost reductions or in the improvement of overall time to complete a process. Innovation, on the other hand, is a complete and radical redesign of a process, seeking dramatic performance gains. Innovation can result in a completely new process that often produces across the board gains in efficiency, cost, processing time and in reduced redundancy. However, in some cases, a particular process is not necessarily a candidate for innovation. The process may have certain requirements that are a factor of the environment of which they are a part, and may simply require improvement.

B. OBJECTIVES

The principal area of research in this thesis deals with business process innovation, particularly as it pertains to the implementation of information technology in order to increase efficiency, improve process flow and decrease redundancy. The objective of this thesis is to apply lessons learned from the review of current literature regarding business process innovation and reengineering to the communications service request processes at USTRANSCOM, resulting in a more streamlined and efficient process.

C. RESEARCH QUESTIONS

The research conducted through the course of this thesis is intended to answer the following question: How can the communications service request process at USTRANSCOM be innovated through information technology and other enablers of change? In order to best answer the primary question, the following subset of questions is addressed.

- What are the key elements of the satellite communications request processes?
- What pathologies or shortcomings exist in these processes?
- What is process innovation, and how can it be applied to this process?
- How should the organization migrate from its current processes?
- How can the results of this study be generalized to other processes and organizations?

D. SCOPE OF THESIS

The scope of this thesis is the communications services request process at USTRANSCOM. While these requests are initiated within USTRANSCOM, and oftentimes result in action outside of the command, the focus is limited to internal processes and workflow. The processes include requests for all types of communications services. As such, the research entails the conduct of a business process review, design of one or more models using KOPeR and EXTEND, and analysis of those models to serve as a basis for recommendations for innovation or improvement.

E. RESEARCH METHODOLOGY

Davenport's five-step process is the centerpiece of the methodology used in the development of this thesis. These steps include: (1) Identifying Processes for Innovation; (2) Identifying Change Levers; (3) Developing Change Levers; (4) Understanding Existing Processes; and (5) Designing and Prototyping New Processes. Modeling tools, KOPeR and Extend, are used to more accurately depict and analyze processes. KOPeR is used in the conduct of static processes analysis, while Extend is used in the conduct of dynamic process analysis. The literature review is also an integral portion of the research methodology.

In order to effect process improvement in the communications service ordering process at USTRANSCOM, developing an understanding of the current process is the first step. In order to develop this understanding, a combination of direct observation and personal interviews are conducted. Through these interviews and direct observation, the key attributes of the current processes can be determined and then effectively incorporated in a model. Once the model has been developed, with the ordering value chain accurately depicted, the model can be used to study potential innovation of the process. The results can serve as a basis for a recommended new process format.

F. CHAPTER OUTLINE

This thesis is organized as follows. Chapter II provides an organizational overview of the USTRANSCOM and a discussion of process innovation. Chapter III introduces the two modeling tools, KOPeR and EXTEND. These tools are used to depict the current process and develop an understanding of it as a baseline fore redesign.

Chapter IV is dedicated to the generation of redesign alternatives, and the subsequent analysis of proposed redesigns based on performance metrics. Chapter V serves to summarize the results of research and study, make specific recommendations for process improvement and areas for further study.

THIS PAGE INTENTIONALLY LEFT BLANK

II. BACKGROUND

A. UNITED STATES TRANSPORTATION COMMAND

The United States Transportation Command (USTRANSCOM) is one of nine unified commands within the Department of Defense. It was created in 1987 and is headquartered at Scott Air Force Base in Illinois. The primary mission of USTRANSCOM is to serve as the single manager of America's global defense transportation system. As such, USTRANSCOM is responsible for the coordination of the people and transportation assets required to equip and maintain US forces around the globe. In order to accomplish this mission, USTRANSCOM is composed of three component commands: the Air Mobility Command (AMC), the Military Sealift Command (MSC), and the Military Traffic Management Command.

AMC is an Air Force command equipped with a variety of transport and refueling aircraft responsible for moving people and equipment around the globe in support of DoD and national interests. MSC, as USTRANSCOM's maritime component, is a Navy command tasked with the coordination of both government and commercial shipping to support DoD worldwide commitments. MTMC is an Army command responsible for the land-based movement of DoD personnel and equipment via rail and military and commercial trucking. These three component commands serve to facilitate the movement of personnel, equipment and supplies around the globe in a timely and efficient manner.

Coordination of these activities is a daunting task and requires a sophisticated, robust and flexible command and control network. To this end, USTRANSCOM relies

heavily on both commercial and military satellite communication systems. Due to the limited availability of satellite resources, gateway access to terrestrial networks is also required. These services are requested using the Satellite Access Request, the Gateway Access Request, and the Request For Services.

1. The SAR/GAR Process

The Satellite Access Request and the Gateway Access request go hand in hand and follow the same submission scheme. The SAR is primarily used to access two specific, but different, types of satellite communications services. The Defense Satellite Communications System (DSCS) satellites serve communication requirements in the Super High Frequency (SHF) band; they are controlled by the Defense Information Systems Agency. The US Navy controls communication in the Ultra High Frequency (UHF) frequency band. The GAR is utilized when there is a need for a link to the terrestrial Defense Integrated Switched Network from the satellite network. (CJSCI 6250.1) Accordingly, SARs and GARs must be routed to the appropriate controlling organization for approval and access information. In the case of the GARs, DISA is the controlling authority. It is important to note that demand for bandwidth in satellite communications channels is at a premium, as it is both costly and limited in quantity. Therefore, access must be carefully scrutinized and controlled in order to assure efficient allocation of the available bandwidth in accordance with priorities and availability.

Both SARs and GARs are initiated at the user level within the component commands of USTRANSCOM (MTMC, MSC and AMC). Requests are then forwarded for review and approval to the component command headquarters. After review and

approval at the component command level, requests are forwarded to USTRANSCOM for review. If approved by USTRANSCOM, the request is assigned an Integrated Communications Data Base Number and a priority. It is then forwarded to the appropriate controlling authority, depending on the specific type of request. CJCSI 6250.1 mandates that requests be submitted by the 15th of the month prior to month of the intended need.

2. The RFS Process

The Request for Services is designed for use when commercial communications services are required. While this particular type of request actually pertains to any type of commercial communications, this thesis only considers the satellite communications related requests. In the cases where there is a need that cannot be met with existing military satellite resources, commercial systems are available for employment. An example of this type of service is commercial C and Ku-band satellite services. These services augment current DoD wide and broadband capabilities, which are extremely limited and are increasingly in high demand.

DISA is designated as the procuring agency of commercial satellite communications, and is the recipient of RFSs. Like the SAR and GAR, the RFS is planned for at the user level within the component commands and subsequently forwarded to component command headquarters for review and approval. If approved, the request is forwarded to USTRANSCOM for further review. If approved at USTRANSCOM, the request is forwarded to DISA with an assigned ICDB number and priority. Approval and review at the various levels are crucial in the RFS process due to

the cost associated with commercial satellite communications systems. RFSs are submitted 30 days prior to the date of intended need for service.

B. BUSINESS PROCESS REENGINEERING

1. Business Process Reengineering Overview

Business Process Reengineering is a name, coined by Michael Hammer in his book, *Reengineering the Corporation* (Hammer, 1996), to describe a phenomenon that began to appear in the late 1980's and grew in the early 90's. They observed that some corporations were taking a fresh look at the way they were doing business and then making drastic changes in the name of increased productivity, quality and reduced costs. Review of the popular literature yields unanimity of understanding as to what constitutes BPR. While differing in the methodologies of execution, the prominent scholars in the field agree that BPR must be "radical", invoking a completely new look and subsequent reform of business processes.

Hammer and Champy (Hammer and Champy, 1993) provide the following definition, "the fundamental rethinking and redesign of business processes to achieve dramatic improvements in critical, contemporary measures of performance, such as cost, quality, service and speed." They focus on four key words in the definition: **fundamental, radical, dramatic and processes**. *Fundamental* refers to the most basic question that can be asked about a particular process, *Why?* Why do we do this, or why do we do it this way? Diagnosing this elementary question allows an organization to get to the heart of a process and develop and understanding of its most basic and essential

properties. *Radical* refers to the dramatic nature in which a process must be modified to achieve the desired results. The entire process must be broken down and created again from scratch. Merely tweaking the finer points of a process will only provide incremental results. *Dramatic* refers to the order of magnitude of change. BPR results in improvements that are measured in orders of magnitude, not 10% improvement, but rather 1000% or ten times better performance in any given area. Finally, *processes* refers to a collection of tasks that, through a synergy derived from their collective contribution, provide some value to a customer.

In *Process Innovation*, Thomas Davenport also focuses on the need for radical change in order to achieve true innovation. He states that “only process innovation is intended to achieve radical business improvement”. Davenport also articulates the difference between process improvement and innovation, with process improvement yielding incremental gains over time as opposed to the radical nature of the gains associated with innovation. (Davenport, 1993) It is important to distinguish here that all processes are not candidates for innovation, but may be better suited for improvements and incremental change. To assume that every process that is in place is fundamentally flawed and in need of rework would be a critical error.

The United States General Accounting Office (GAO) addresses the concept of the application of BPR to government agencies and processes in their *Business Process Reengineering Assessment Guide* of 1997. In their analysis, the GAO indicates the relevance of BPR to government specific processes. They state, “Business process reengineering is one approach for redesigning the way work is done to better support the organizations mission and reduce costs.” (GAO, 1997) The belief that BPR does not

have application beyond the private sector would be erroneous. The DoD is an organization that provides services to customers, whether they are the American people in terms of national security as the service, or military units or individual service members relying on another DoD element for support. In particular, as it pertains to this thesis, customers include end users within the Major Commands (AMC, MSC, or MTMC) that request access to satellite communications resources, terrestrial network access, or commercial telecommunications services. The GAO, reflecting the concepts articulated by experts such as Hammer and Davenport, also focuses on processes, and like the experts, defines business processes as “the steps and procedures that govern how resources are used to create products and services that meet the needs of particular customers or markets,” and further that processes are a “structured ordering of steps across time and space...can be decomposed into specific activities, measured, modeled, and improved.” (GAO, 1997) The key concept is that, and as discussed in the following section, a process must be broken down into individual steps in order to appropriately diagnose pathologies and recognize candidates for redesign.

2. Business Process Reengineering Methodologies

There are a variety of different recipes in the experts' cookbooks for Business Process Reengineering. This section provides a brief discussion and analysis of four different methodologies. In particular, Davenport's five step process, as articulated in *Process Innovation*; that of Hammer and Champy, as detailed in *Reengineering the Corporation*; that of Nissen, as set forth in his article in *MIS Quarterly* in 1998; and the framework established by the GAO in the *Business Process Reengineering Guide*.

a. *The Davenport Methodology*

Davenport advocates a five-step process in the conduct of business process reengineering, as depicted in Figure 1. His prescribed methodology involves (1) Identifying Processes for Innovation; (2) Identifying Change Levers; (3) Developing Process Visions; (4) Understanding Existing Processes; and (5) Designing and Prototyping the New Processes. (Davenport, 1993) This is a very methodical and thorough process that steps an organization through the intricacies of getting to know its own processes, what needs to be accomplished in order to facilitate change, mapping out a framework for the implementation of new processes, as well as the design of the new processes. Central to this methodology is the understanding of the current processes and the determination of their associated pathologies, and even more importantly if there is even a need for change.

b. *The Hammer and Champy Methodology*

Hammer and Champy, like Davenport, focus on looking for reengineering opportunities. They specifically describe the practice of identifying the key processes within an organization, looking for problems with processes, and developing a keen understanding of each process before embarking on a course for change. However, their first prescribed order of business is identifying who will conduct the reengineering process. While they expressly dictate the separation of people and the organizational structure from processes, they realize that choosing the person(s) who is(are) to pursue and author a reengineering of a process is critical to the ultimate success of a reengineering project. Additionally, they place a great deal of emphasis on the

implementation of change within an organization prior to undertaking a reengineering project. Focusing on selling the change to the people within the organization who must accept and implement any results of a project is paramount in their methodology. (Hammer and Champy, 1993) Common sense dictates that people are necessary to implement a new idea or planned change. If grass roots support does not exist for a given initiative, it is doomed to failure.

c. The Nissen Methodology

In his article “Redesigning Reengineering Through Measurement-Driven Inference”, Nissen synthesizes the works of Davenport, Hammer and Champy, and others into a nine-step process that is spiral in nature. These steps are (1) Identify the process; (2) Model process; (3) Measure configuration; (4) Diagnose pathologies; (5) Match transformations; (6) Generate redesigns; (7) Test Alternatives; (8) Select Preferred Choice and (9) Implement redesign. This methodology, as Nissen notes, is designed with the intent of automating configuration measurement, pathology diagnosis, and transformation matching. (Nissen, 1998) In his fusion of redesign methodologies, Nissen incorporates the significant elements of Davenport’s, as well as Hammer and Champy’s methodologies. He specifically focuses on the identification of key processes, as well as coming to an understanding of the processes to be reengineered through modeling. However, he provides a greater degree of granularity to the process during the latter stages of the redesign. He specifically articulates the need to develop a number of alternative solutions, testing the alternatives, as well as the selection and subsequent

implementation. While the other authors mentioned previously talk to these steps, they are not laid out specifically as definitive steps.

d. The GAO Methodology

The Government Accounting Office's *Business Process Reengineering Assessment Guide* outlines a series of questions that must be answered in the course of a reengineering effort. The authors of this document also distilled the work of the leading experts in the field of process reengineering, and subsequently derived a framework that is applicable to government agencies. This document prescribes the following nine questions, grouped into three general areas:

- Has the agency reassessed its mission and strategic goals?
- Has the agency identified performance problems and set improvement goals?
- Should the agency engage in reengineering?
- Is the reengineering project appropriately managed?
- Has the project team analyzed the target process and developed feasible alternatives?
- Has the project team completed a sound business case for implementing the new process?
- Is the agency following a comprehensive implementation plan?
- Are agency executives addressing change management issues?
- Is the new process achieving the desired results?

The first three questions are grouped together in an area dealing with the agency evaluation of whether or not to pursue reengineering. The next group of three concerns the development of an understanding of the current process, and the final group of three deals with the implementation and assessment of the new process. (GAO, 1997) While this document appears to be written from an auditor's standpoint, it does pose relevant questions that must be asked before, during and after a reengineering project is undertaken. They, too, focus heavily on the need for change management and on the importance of management support in the success of a reengineering project.

3. Methodology Used in the Redesign of the SAR/GAR/RFS Processes

The literature and practices developed by the various experts cited in the previous discussion of BPR are well suited for application in this thesis. While the methodologies are semantically different in some cases, and emphasis is placed in different areas by the various authors, all tend to converge on the most salient points of BPR. All agree that candidate processes must be identified and thoroughly understood prior to any attempt at reengineering. They also concur that some form of prototyping and evaluation of alternatives must occur following the identification of a process in need of reengineering. Finally, there is agreement that there must be an implementation plan in place to facilitate the success of any redesigned process. Nissen's nine-step process offers a synthesis of the more important aspects of the different methodologies and is particularly suited for application in this thesis.

This thesis uses Extend and KoPER, the automated inference tool developed by Nissen and detailed in MIS Quarterly, to model the SAR, GAR and RFS processes.

Therefore, the steps in the Nissen methodology that are specifically tailored for the application of automated tools: measure configuration, diagnose pathologies and match transformations (Nissen, 1998), render his model even more relevant to the development of this thesis.

THIS PAGE INTENTIONALLY LEFT BLANK

III. MODELING TOOLS AND THE CURRENT PROCESS

A. MODELING TOOLS

Both EXTEND and KOPeR are used to model the SAR, GAR and RFS processes at USTRANSCOM. As is explained further in this chapter, EXTEND is used to measure specific performance variables in a quantitative fashion, and KOPeR is used to diagnose pathologies and evaluate potential for improvement in the processes. The rationale behind the use of two distinct tools is that they are complementary in nature and serve to provide a more accurate depiction of the current process, as well as the relative performance gains associated with process redesigns discussed in Chapter IV.

1. EXTEND

a) Extend Overview

EXTEND is a modeling and simulation tool that makes use of various blocks, connections and routing mechanisms to represent processes, measure performance parameters and serve as a basis for redesigns of a process. It takes advantage of easy to recognize and configure Graphical User Interface (GUI) icons with predefined properties that are adaptable to represent steps and links in a process. The purpose behind the development of EXTEND, according to Bob Diamond, its chief architect, is to provide a generalized simulation application for people who do not have access to high powered computer systems, or the technical background to write complicated programs to simulate complex processes. (Diamond, 1997) EXTEND is

utilized because it is simple in nature and flexible, allowing for visibility of the process in action, as well as near instantaneous feedback following modifications.

For the purpose of modeling the SAR/GAR and RFS processes, each group of blocks represents a link in the process flow and is designed to simulate the time required to prepare, evaluate and forward a request. Various queues and routing mechanisms are in place to simulate the delay associated with the flow of the requests between elements of the component commands, between the component commands and USTRANSCOM, and further between USTRANSCOM and the providers of the requested services.

Figure 3-1 is a representative segment of the EXTEND model of the baseline process. It is illustrative of the different types of blocks, routing and delay mechanisms used in EXTEND to simulate a process. The segment in Figure 3-1 depicts the combination SAR/GAR message generation at the subordinate command. Each block is linked by a connector that represents the flow of the process. The blocks are identified in the figure by a corresponding number and are explained in turn below.

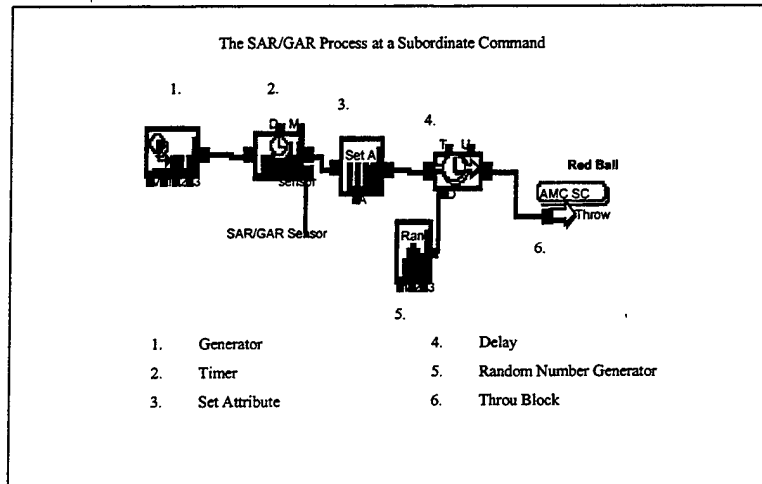

Figure 3-1. EXTEND Model Example

The “Generator” block, identified as number (1) in Figure 3-1, serves to generate objects at a designated interval. Each block has a dialog box that allows for customization of its performance parameters. Figure 3-2 depicts the SAR/GAR Generator dialog box, from Figure 3-1. EXTEND allows the user to regulate the generation of objects by specifying the mean, distribution, time units and maximum number of items generated for the object controlled by the block. In the case depicted in Figure 3-2, the Erlang distribution is selected and the mean interarrival time is set at 11 days. This corresponds to two messages every working month, given that a working month comprises twenty-two working days. The maximum number of objects generated per simulation is set at four.

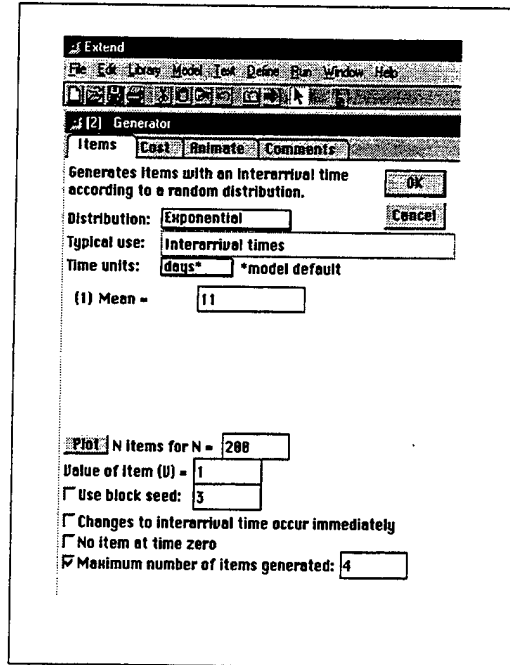

Figure 3-2. Generator Dialog Box

The “Timer” block, identified as number (2) in Figure 3-1, measures the elapsed time between generation of an object and when it completes the process. The Timer depicted measures the cycle time associated with the combination SAR/GAR messages from generation to process completion.

The “Set Attribute” block, identified as number (3) in Figure 3-1, allows the model designer to attach specific attributes to an object that pass through the block. A “Get Attribute” block reads these attributes as the objects pass through the model, facilitating routing, tracking and measurement of the objects.

The “Delay” block, in conjunction with the “Random Number” generator block, identified as numbers (4) and (5) in Figure 3-1, holds an object for a specified period of time. By attaching a “Random Number” generator to the “Delay” block, a range of possible delays is selected. The “Random Number” block has a dialog box

similar to that depicted in Figure 3-2, allowing for specification of a particular distribution about a given mean corresponding to the delay desired.

The "Throw" block, identified as number (6) in Figure 3-1, is an example of an EXTEND routing mechanism. Each "Throw" block has a corresponding "Catch" block, allowing for objects from numerous sources to be routed to a named collection point. Figure 3-1 illustrates the passing of a combination SAR/GAR message from a subordinate command communications section, using a "Throw" block, to the AMC communications section via the "AMC SC" catch block.

b) EXTEND Input Variables

In this thesis, the key parameter to be tracked in the measurement of process efficiency is cycle time. Accordingly, the time required to prepare and submit a request at the subordinate command level, for submission to the Component Command, is incorporated in the EXTEND model as **Subordinate Command Processing**. The time required for the development of the initial SAR/GAR/ RFS at the Component Command is included as **Component Command Processing**. **TRANSCOM Processing** reflects the delay associated with time spent reviewing the request by the TRANSCOM J-6 prior to forwarding to the appropriate controlling authority or service provider. Each of the processing time variables is associated with a "Delay" block as described above and illustrated in Figure 3-1. The frequency, considered on a monthly basis, of the requests from each of the component commands are designated **Frequency of Requests**, and are implemented in the model using the "Generator" blocks depicted in Figure 3-1 and further in Figure 3-2. EXTEND also facilitates the generation of a variety of different

types of messages from a given source in the form of an attribute. Thus, **Request Type** is set as an attribute, using the "Set Attribute" block, for each message at the time of generation, representing whether the request is a SAR (UHF or DSCS), combination SAR/GAR or a RFS. The Request Type also indicates the final destination of each message for routing of each message upon approval at USTRANSCOM. The variables described above are encapsulated in Table 3-1.

Variable	Distribution	Source
Subordinate Command Processing		
DSCS (SHF) SAR	Erlang	Expert Estimate
UHF SAR	Erlang	Expert Estimate
SAR/GAR	Erlang	Expert Estimate
RFS	Erlang	Expert Estimate
Component Command Processing Time		
DSCS (SHF) SAR	Erlang	Expert Estimate
UHF SAR	Erlang	Expert Estimate
SAR/GAR	Erlang	Expert Estimate
RFS	Erlang	Expert Estimate
TRANSCOM Processing Time		
DSCS (SHF) SAR	Erlang	Expert Estimate
UHF SAR	Erlang	Expert Estimate
SAR/GAR	Erlang	Expert Estimate
RFS	Erlang	Expert Estimate
Frequency of Requests		
DSCS (SHF) SAR	Exponential	Expert Estimate
UHF SAR	Exponential	Expert Estimate
SAR/GAR	Exponential	Expert Estimate
RFS	Exponential	Expert Estimate

Table 3-1. Extend Input Variables

The data used as a basis for the generation of the input variables is derived from interviews with, and observations of, the individuals responsible for the execution of the process at USTRANSCOM from the J-6 Operations Section (J-6, OC), and at the

AMC Communications Section (SC). Specific data have not been collected from the other component commands, MTMC and MSC regarding specific processing times. However, the processing times and methods at AMC are assumed to be reflective of those at the other component and subordinate commands.

Each variable is assigned a distribution and source. The distribution represents statistical basis of the particular variable, and the source is indicative of the classification of the basis of the information. As indicated in the EXTEND Users Manual, the Erlang distribution is most appropriate for use when the intent is to “combine several similar steps into one representative step.” (Diamond, 1997) As each individual step of the SAR/GAR/RFS processes comprises several incremental and similar subordinate tasks, that exceed the granularity desired in the conduct of this thesis, the Erlang distribution is used to represent the distribution about the mean for the various cycle times. Diamond also indicates that the exponential distribution is suited for situations when measuring time between occurrences of independent events. Therefore, the frequency of the different requests is exponentially distributed, as each submission is independent of the previous submission, as well as of the next. Further, the frequency is considered on a monthly basis and the time between occurrences is stated in numbers of days, based on the number of requests received during a typical month.

2. KOPeR

a. KOPeR Overview

Business Process Redesign is traditionally conducted, in large part, without the aid of automated tools, particularly in the area pathology diagnosis and the development of alternatives for redesign. The Knowledge-Based Organizational Process Redesign (KOPeR) tool is a proof of concept, knowledge based utility that serves to buttress several of the key steps in BPR. More specifically, it is designed to automate “process measurement, pathology diagnosis, and transformation matching.” (Nissen, 1998) Nissen further states that KOPeR relies heavily on taxonomies of process breakdowns and repairs, as well as “production rules for matching classes of breakdowns with general repair strategies.” The main components of KOPeR are: a process model, which is generated external to the KOPeR utility; an Inference Engine, for diagnosing process breakdowns and inferring potential solutions to the diagnosed breakdown; Utilities, for diagnostic measurement and matching; and the Rules/Taxonomies module, which is the knowledge base used by the inference engine in the diagnosis of processes.

Where EXTEND serves as the primary tool for measuring performance in terms of cycle time, KOPeR serves as the basis for recommended modifications to the process. In the diagnosis of the pathologies associated with the baseline process and the subsequent recommendation of solutions those pathologies, KOPeR provides direction and rationale to the redesign effort based on known solutions to common pitfalls associated with process flow. Thus, it is apparent that the two tools work well in tandem to increase the success of the redesign effort.

b. Input Variables

The variables required by KOPeR to perform analysis of a process are derived from a process model and manually entered prior to execution of the diagnosis phase. According to Nissen, it is important to develop a “relatively small, fundamental set” of process measures that serve as the basis for the redesign inference. While not all-inclusive or mandatory, Table 3-2 represents a number of variables that are considered appropriate for inclusion in the KOPeR analysis.

Measure	Graph Based Definition
Process Length	Number of nodes in longest path
Process Breadth	Number of distinct paths
Process Depth	Number of process levels
Process Size	Number of nodes in process model
Process Feedback	Number of cycles in graph
Parallelism	Process Size divided by Length
IT Support	Number of IT-support attributes
IT Communication	Number of IT-communication attributes
IT Automation	Number of IT-automation attributes
Organizational Roles	Number of unique agent role attributes
Process Handoffs	Number of interrole edges
Organizations	Number of unique agent org. attributes
Value Chains	Number of unique activity Value Chain attributes

Table 3-2. Example Process Measures From Ref. (Nissen, 1998)

For the purposes of analyzing the SAR/GAR/RFS processes at USTRANSCOM, Process Length, Process Size, Process Feedback, Parallelism, IT Support, IT Communication, and Process Handoffs are considered. Table 3-2 adequately defines each of the variables considered in the conduct of this thesis. However, it is important to note that a node represents an activity in the process where a specific task is

performed. Figure 3-3 illustrates the concept of nodes in a process. Each circle represents a node, labeled "A", "B", "C" and "D". In turn, each node represents a point in a process where a task is performed. Accordingly, with respect to the SAR/GAR/RFS process, each level in the chain of command represents a node. Handoffs represent each instance of a transfer of a request from one level of the chain of command to another or from node to node; they are represented by the emboldened, right-facing arrows in Figure 3-3. IT-Communication refers to the method used to transfer the request (e-mail, Autodin, etc.). This information is derived substantially from the description of the baseline process described in the following section.

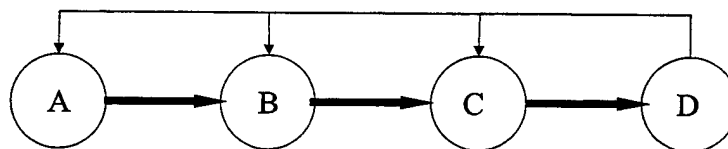

Figure 3-3. KOPeR Process Diagram

B. THE SAR/GAR/RFS PROCESSES

This section describes the SAR/GAR/RFS processes in place at USTRANSCOM. It is important to note that these processes are not unique to USTRANSCOM and, indeed, the SAR/GAR/RFS is common all components of the U.S. Armed Forces. The focus of this thesis is not the physical requests, but the process of completing, approving and routing the requests through the chain of command at USTRANSCOM and its component commands.

1. Baseline Process Description

The SAR/GAR/RFS process is initiated at subordinate commands within the component commands (AMC, MTMC, MSC). In many cases, the request is generated during mission planning at the component command level; however, the situation that most reflects the more general process flow occurs when requests are generated at units subordinate to the component command.

The subordinate commands initiate the process by generating a detailed e-mail and forwarding the request to the component command. This e-mail is not an actual SAR/GAR/RFS, but a seed document that contains required information detailing basic parameters for inclusion in the actual request at the component command level. The e-mail originates from the communications section (SC) of the subordinate command. The inputs are products of the planning and requirements identification portion of the mission planning process and are extracted from a variety of sources including hand-written notes, e-mails and various publications, orders and directives. The time required for completion of these tasks, as it relates to information collection and composition of the request and depending on complexity, is detailed in Table 3-3.

Request Type	Preparation Time
DSCS (SHF) SAR	6-10 Hours
UHF SAR	2-4 Hours
SAR/GAR	25-40 Hours
RFS	5-20 Hours

Table 3-3. Subordinate Command Processing Times

Upon receipt at the component command SC, the information is reviewed and reorganized for inclusion in the actual SAR/GAR/RFS format. The component command maintains an electronic template for the preparation of each type of request. Although a template exists, there is still a substantial amount of effort involved with the preparation of the various requests. Each request must be verified in terms of accuracy, completeness, and validity. All required information must be present, and a legitimate requirement for the request must exist. Questions that arise from the verification process are addressed to the subordinate command via telephone conversations and e-mail. The average preparation times at the component command level for the different types of requests are detailed in Table 3-4. The completed SAR/GAR/RFS is forwarded to USTRANSCOM in message format via Autodin or the Defense Messaging System (DMS).

Request Type	Preparation Time
DSCS (SHF) SAR	1-3 hours
UHF SAR	1-3 hours
SAR/GAR	2-4 hours
RFS	4-6 hours

Table 3-4. Component Command Processing Times

Upon receipt of the request at USTRANSCOM, another review and validation process begins.¹ Requests are again screened for accuracy, validity and compliance with the appropriate format, as the controlling authority of each type of service (DSCS, SHF, Terrestrial Gateways) requires a different format for the SAR/GAR, and the prescribed format for commercial satellite requests (RFS) is extremely complex and detailed. Requests are also screened for a valid Integrated Communications Data Base (ICDB) number prior to approval. USTRANSCOM processing times of each type of request are detailed in Table 3-5.

Request Type	Preparation Time
DSSC (SHF) SAR	1-3 hours
UHF SAR	1-3 hours
SAR/GAR	2-4 hours
RFS	4-6 hours

Table 3-5. USTRANSCOM Processing Times

Figure 3-4 depicts the flow of the requests from subordinate commands, through the component command and USTRANSCOM and ultimately to the controlling authority of the particular service requested. Each block represents an element of the chain of command, arrows connecting the sides of the block and pointing to the right represent

¹ **Note:** In many cases, routine and regular requests generated at the component command level receive blanket approval at USTRANSCOM and are not reviewed for approval, but rather for informational purposes only. This is not the case considered in the context of this thesis. This situation occurs as a matter of convenience in light of the amount of effort required to process each request and the personnel available.

process flow between the different command elements, and the return arrows connecting the tops of the blocks represent feedback between the elements regarding any need for clarification about a request.

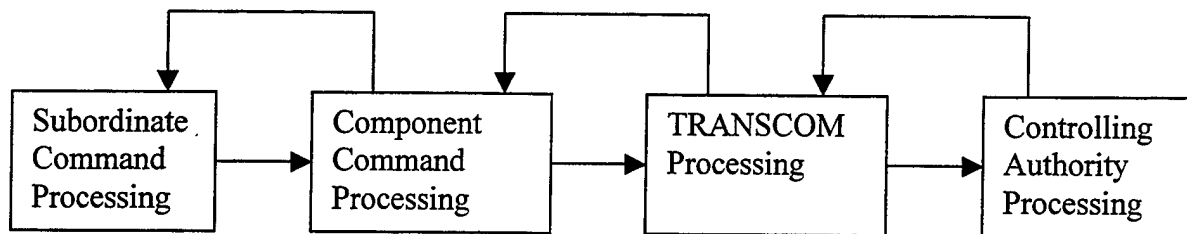

Figure 3-4. SAR/GAR/RFS Baseline Process Diagram

2. **EXTEND Simulation of the Baseline Process**

a. *EXTEND Simulation Inputs*

Data derived from Tables 3-3, 3-4 and 3-5 are incorporated with the variables and distributions outlined in Table 3-1 in order to serve as a basis for the EXTEND model of the baseline process. The resulting data are detailed in Table 3-6. The values are reflective of average processing times and follow the Erlang distribution for process times and the Exponential distribution for frequency of requests.

Variable	Value	Distribution	Source
Subordinate Command Processing	Hours		
DSCS (SHF) SAR	3	Erlang	Expert Estimate
UHF SAR	8	Erlang	Expert Estimate
SAR/GAR	32.5	Erlang	Expert Estimate
RFS	12.5	Erlang	Expert Estimate
Component Command Processing Time			
DSCS (SHF) SAR	2	Erlang	Expert Estimate
UHF SAR	2	Erlang	Expert Estimate
SAR/GAR	3	Erlang	Expert Estimate
RFS	5	Erlang	Expert Estimate
TRANSCOM Processing Time			Expert Estimate
DSCS (SHF) SAR	2	Erlang	Expert Estimate
UHF SAR	2	Erlang	Expert Estimate
SAR/GAR	3	Erlang	Expert Estimate
RFS	5	Erlang	Expert Estimate
Frequency of AMC Requests			
DSCS (SHF) SAR	2	Exponential	Expert Estimate
UHF SAR	6	Exponential	Expert Estimate
SAR/GAR	2	Exponential	Expert Estimate
RFS	1	Exponential	Expert Estimate

Table 3-6. EXTEND Simulation Inputs

Underlying assumptions are made concerning the process in order effectively simulate workflow within the bounds of the environment at USTRANSCOM, as well as the component and subordinate commands. These assumptions are principally related to timing issues and are directed at ensuring the model accurately reflects cycle time. They include:

- 8 hour work days
- 5 day work weeks
- 22 working days per month
- One day delay in processing time between command levels

A one-day delay is incorporated between nodes in the process in order to simulate a lag in request processing associated with the transmission of a request to the next higher approval authority. It is representative of the time from when a request is transmitted between commands, until receipt is acknowledged and processing begins at the next level.

One disadvantage or shortcoming of the EXTEND simulation must be taken into consideration and supported with an assumption. There is no reasonable method for predicting or modeling breakdowns in the process. It is assumed that once a request is received and enters processing, that processing is continuous. Any delays, or pauses in the process flow are incorporated in the processing times outlined in Table 3-6. Therefore, this model does not address the situation where an individual begins processing a request and sets it aside to perform another task.

b. Analysis of the EXTEND Simulation of the Baseline Process

Table 3-7 illustrates the data derived from the EXTEND simulation of the baseline process. The data encapsulates twelve separate runs of the simulation, with each run encompassing 22 days, or 1 working month based on the assumptions outlined above. With each separate run reflecting one month, the total number of runs approximates a typical year.

	Request Type			
	<i>UHF SAR</i>	<i>DSCS SAR</i>	<i>SAR/GAR</i>	<i>RFS</i>
Total Delay (Days)	308.708	56.273	185.456	87.366
Mean Delay	4.229	3.517	5.620	4.598
Standard Deviation	0.400	0.164	0.248	0.217
Total Observations	73	16	33	19
Mean Obsv/Month	6.083	1.333	2.750	1.583
Standard Deviation	0.793	0.310	0.250	0.149

Table 3-7. Summary Statistics For EXTEND Baseline Run

Table 3-7 is representative of the input data derived from Table 3-6. There were a total of 16 DSCS SAR, 73 UHF SAR, 33 SAR/GAR, and 19 RFS observations through the entire simulation. Mean processing times for the DSCS SAR were 3.517 days, or 77.374 hours; 4.229 days, or 93.038 hours for the UHF SAR; 5.620 days, or 123.64 hours for the SAR/GARs; and 4.598 days, or 101.156 hours for the RFSs. The results outlined in the table are in line with the expected values based on the input data in Table 3-6. The expert estimate values fall within one standard deviation of the mean delay times and frequencies derived from the EXTEND simulations of the baseline process. It is important to note that these times are reflective of total cycle time, or the amount of time that elapses from the initiation of a request, until it is approved at USTRANSCOM and forwarded to the appropriate controlling authority in message format.

3. KOPeR Diagnosis of the Baseline Process

a. KOPeR Simulation Inputs

The KOPeR decomposition of the process is depicted in Figure 3-5. The number of feedback loops, indicated by "FB" in the diagram, is three. There are three hand-offs between nodes, indicated by HO. The Information Technology Support (IT-S) for each node is marked as yes (Y), as each node makes use of word processors and other electronic tools in the composition of the requests. The Information Technology Communication (IT-C) attribute is also marked as yes for each node, in recognition of the fact that the requests are transmitted between nodes using e-mail, Autodin or DMS. The Information Technology Automation (IT-A) attribute is marked as no (N) for each node, as there are no automated features integrated in the baseline process.

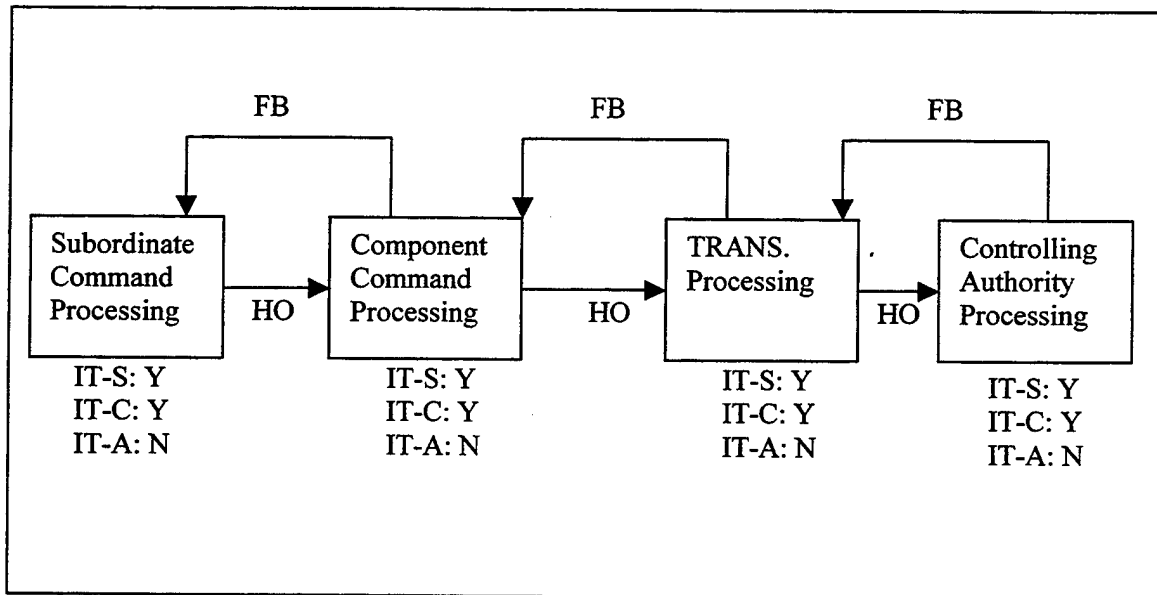

Figure 3-5. KOPeR Process Decomposition

b. Analysis of KOPeR Simulation of Baseline Process

The results of the KOPeR diagnosis of the Baseline Process are illustrated in Table 3-8. Each measure, value and pathology are determined based on the inputs developed from Figure 3-5 and detailed in the previous section. Each of the measures and their corresponding values and pathologies are discussed below.

Measure	Value	Pathology
Parallelism	1.0	Sequential Process
Handoffs	.75	Process Friction
Feedback	.75	Checking and Complexity
IT Support	1.0	OK
IT Communication	1.0	OK
IT Automation	0.0	Inadequate Automation

Table 3-8. KOPeR Diagnosis of the Baseline Process

Parallelism refers to concurrent activity in a process. The value of 1.0 corresponding to parallelism in the SAR/GAR/RFS process is indicative of a completely sequential process. The KOPeR recommended solution to the problems that arise from sequential processes is to “delinearize process activities to increase parallelism”. Delinearization is noted to reduce cycle time and promote efficiency. (Nissen, KOPeR Web Page) However, the sequential nature of the SAR/GAR/RFS process is typical of military organizations and arises from the requirement of higher elements of the chain of command to control allocation of limited resources. In the case of military satellite communications, where bandwidth is a precious commodity apportioned to CINCs and allocated to component commands, commanders must maintain control of the resources at their disposal. The tool that enables them to exercise this control is the approval process, which is, by nature, sequential and hierarchical. Also, the steps in the process

are “sequentially dependent”. Higher elements in the chain of command cannot act until a request is either initiated or approved at the next lower level in the process chain.

The next measure, Handoffs, refers to the number of times that a request is passed between nodes. The .75 value indicated in Table 3-8 is reflective of the number of handoffs divided by the total number of nodes. Handoffs are seen as a source of friction in a process. The KOPeR recommended solutions to friction resulting from excessive handoffs revolve around the reduction in the length of the process by empowering individuals and allocating responsibility for the performance of more than one task to individuals, possibly a case manager, or to groups of people as in Integrated Process Teams. (Nissen, KOPeR web page) Case managers or IPTs are responsible for a process from start to finish, thus eliminating the need for handoffs and injecting unity of effort and coordination into the process.

The third measure is Feedback. The .75 value reflects the number of feedback paths divided by the number of nodes in the process. KOPeR sites complexity and checking as the side effects of excessive feedback. As Hammer and Champy note, “the purpose of reengineering is not to get the rework done more efficiently, but to eliminate it entirely by doing away with the mistakes that and confusion that necessitate it.” (Hammer and Champy, 1993) The continual need for oversight and review associated with feedback, as well as the resultant rework, dramatically affects the efficiency of a process. The third and fourth measures are IT-Support and Communication. The SAR/GAR/RFS process scores favorably according to KOPeR standards. The integration of word processors and electronic communication tools, such as e-mail and DMS, increase efficiency in the process by facilitating communication and

enhancing ease coordination. However, the IT-Automation receives the lowest possible score in the KOPeR evaluation. This measure is an ideal candidate for dramatic process improvement, particularly in the area of cycle time. Allowing for the automation of certain steps of a process and eliminating the need for human activity through the addition of computer-based tools can improve performance by precluding human behavior. (Nissen, KOPeR web page)

THIS PAGE INTENTIONALLY LEFT BLANK

IV. PROCESS REDESIGNS

The previous three chapters of this thesis address the first five steps of the Nissen methodology outlined in Chapter II: (1) identify the process; (2) model process; (3) measure configurations; (4) diagnose pathologies; and (5) match transformations. This chapter addresses the final steps: (6) generate redesigns; and (7) test alternatives. However, the final two steps also involve iterations of steps 1-5 for each redesign alternative, thus the spiral nature of the Nissen methodology. In doing so, the pathologies diagnosed during the KOPeR evaluation and the performance data derived from the EXTEND simulation of the baseline process serve as seed material for redesigns discussed in this chapter.

A. REDESIGNS

Prior to commencing the redesign effort, the pathologies derived during the KOPeR analysis and the associated Transformation Enablers must be identified. Transformation Enablers are the tools that serve to mitigate the effects of the pathologies diagnosed during the KOPeR analysis of the baseline process. The two candidates with the most potential for producing dramatic reductions in cycle time are IT-automation and delinearization of the process. There is significant room for automation of the SAR/GAR/RFS process, as no automated tools are currently in place. As noted earlier, the SAR/GAR/RFS process is sequentially dependent and does not allow for delinearization. However, there is an opportunity to empower lower levels of the chain

of command by delegating authority to approve requests, resulting in a shortening of the process and reducing cycle time.

1. Redesign Alternative I

This redesign is the most simplistic of the redesign alternatives and results in relatively minor changes to the KOPeR and EXTEND representations of the baseline process. The premise of this alternative is that routine and recurring requests are allowed to pass directly from the component command to the appropriate controlling authority or service provider. In the interest of maintaining situation awareness, copies of the requests are sent to USTRANSCOM but require no action or approval. The exception to this rule occurs in those cases where the request is not routine in nature and arises out of a unique mission requirement. The purpose of this redesign is to alleviate the KOPeR identified pathologies of excessive handoffs and the corresponding friction. Although USTRANSCOM is not physically removed from the process in this redesign, its reduced role leads to a minimization of effect on cycle time.

Non-recurring and non-routine requests are accounted for with two assumptions. First, it is assumed that 90% of all requests are recurring and routine. This assumption is based on data provided by USTRANSCOM describing typical monthly message flow, and closely approximates established monthly patterns. The EXTEND model allows for the incorporation of conditional routing, facilitating routing 10% of the requests generated through the delays associated with USTRANSCOM processing. The remaining 90% are routed directly to the appropriate controlling authority. The second assumption concerns the KOPeR input variables, which are manipulated to account for

this situation. It is assumed, for the purposes of the KOPeR diagnosis, that the 10% processing that occurs at USTRANSCOM is negligible. This allows for the reduction in number of nodes from 4 to 3, and a reduction in the number of feedback loops from 3 to 2, simulating the reduced role of USTRANSCOM in the process. Appropriately, this reduction in nodes and feedback loops most closely represents the general case, rather than the conditional case.

Figure 4-1 depicts the Redesign Alternative I process flow. Node "A" represents the subordinate command, node "B" represents the component command, node "C" represents USTRANSCOM, and node "D" represents the satellite access controlling authority. The emboldened lines represent the process flow from the subordinate command, to the component command and directly to the satellite access provider. The dashed line represents the transmission of the informational copy of the request to USTRANSCOM.

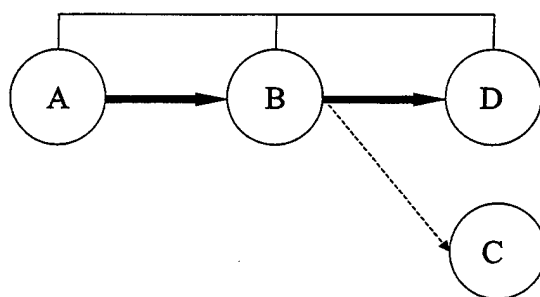

Figure 4-1. Redesign I Process Diagram

2. Redesign Alternative II

The second redesign alternative is intended to improve the automation associated with the completion of forms corresponding to the SAR, GAR, and RFS, and is patterned after the DISA Direct solution to commercial terrestrial communications services.

DISA-Direct is a web-based application that serves to automate the processes associated with requesting contracted, commercial, terrestrial communications services at posts, bases and stations throughout the world. (DISA Telecommunications Seminar CD-ROM, 2000) It is highly customizable and adaptable to specific organizations and their unique, internal approval authorities. Each organization that participates in the DISA-Direct solution establishes a multi-tiered approval chain, allowing for retention of control and oversight at the upper levels of the organization, while allowing users at the lower levels to generate and customize requests. Upon the initiation of a request, routing through the approval chain is initiated with automatic e-mail notification provided to the next member in the approval chain. Each successive approving authority is notified in turn, until final approval is granted and the request is forwarded to DITCO for processing and service.

The DISA-Direct model addresses many of the pathologies diagnosed in Chapter II with KOPeR. Specifically, it reduces time delays associated with handoffs by alerting the members of the approval chain automatically by e-mail. It reduces friction by implementing an easy to follow and navigate web-based forms, reducing the number of errors associated with data input and the corresponding need for checking and corrective feedback. Additionally, DISA-Direct allows organizations to automatically track and collect data relating to their use of the services contracted through DISA- Direct.

Alternative II incorporates the positive aspects of the DISA-Direct solution by implementing a web-based interface and database maintained and administered at USTRANSCOM. Figure 4-2 is representative of the redesign alternative process flow described below (node "A" represents the subordinate command, node "B" the component command and node "C", USTRANSCOM). While this alternative does not reduce the number of hand-offs comprised by the SAR/GAR/RFS processes, it does serve to increase automation. A significant portion of the delays associated with the baseline process arise from the variability in the formats associated with the different requests, particularly with regard to the UHF SARs (UHF SARs formats vary according to the geographic location world where services are requested and the regions controlling CINC). The delay is reduced by providing an interface that links to the appropriate formatted request based on the selection of a particular geographic area and type of service. Similar to the DISA-Direct solution, approving authorities are designated with automatic routing and notification in order to enhance automation and reduce friction. Data regarding each transaction is collected and maintained in a database and referenced during validation of the Integrated Communications Database, as well as when forecasting future requirements for inclusion in the Emerging Requirements Database.

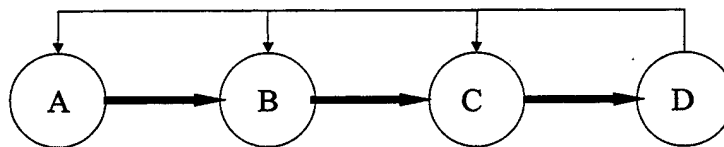

Figure 4-2. Redesign Alternative II Process Diagram

While it is difficult to accurately predict the impact of automation on a process, increased IT-automation has been demonstrated to have “positive performance effects in terms of cost and cycle time”, typically in terms of an order of magnitude. (Nissen, 1998) The KOPeR reflection of this redesign is an adjustment of the IT-automation measurement from 0 to 3, reflecting the incorporation of the automated features of this alternative. An assumption is critical to the EXTEND simulation of this redesign. The process flow remains the same; however, the delays corresponding to the processing times at each node in the approval chain are reduced in each case.

In order to adequately assess the impact of automation on the delay associated with each type of request, further decomposition of the process is necessary. Accordingly, the processing at each node is broken down into the following components: Requirement Determination, Data Collection, and Data Entry. Requirement determination comprises the identification of a need for satellite communication arising from the mission planning process and analysis of organic capabilities that might otherwise satisfy the requirement. Data collection encompasses gathering mission parameters and technical requirements as well as information concerning applicable orders and directives. Data Entry pertains to the physical completion of the selected request. The three phases and their corresponding weighted averages are detailed in Table 4-1. The first row is representative of the baseline process. The second row is indicative of the increased efficiency associated with the impact of instituting an information technology, automated solution. The Requirement Determination phase is not affected by enhancements made in this alternative and retains its original weight (0.50). The Data Collection phase (0.25 weighting) is impacted to the extent that

redundancy exists between requests and that data elements are accessible in the form of drop down menus incorporated in the Form Completion phase. This type of redundant and repetitive information is estimated to comprise 50% of the data required for entry during the Form Completion phase according to individuals familiar with request processing within USTRANSCOM. Therefore, half of the Data Collection phase weighting receives full benefit of automation (.125*.1). The resulting weight is thus (.125*1 + .125*.1= .126). The Form Completion phase benefits fully from the application of IT and automation tools, and its full weight (0.25) is adjusted by an order of magnitude (0.25 * .1). The resultant total represents the overall effect of automation on the processing at each node. Accordingly, processing delay is reduced by 34.9% at each processing level (subordinate command, component command, USTRANSCOM) in order to accurately assess the impact of the application of automation and information technology for this alternative.

	Requirement Determination	Data Collection	Form Completion	Total Process Delay
Baseline Weights	0.50	0.25	0.25	1.00
Weights w/ Automation	0.50	0.126	0.025	0.651

Table 4-1. Automation Effects on Process Delay

3. Redesign Alternative III

This redesign alternative is a combination of the previously discussed alternatives. The process is accorded the benefit of the automation described in Alternative II, as well as the reduction in friction and complexity associated with the decrease in nodes and handoffs described in Alternative I. The web-based interface is coupled with the

empowerment of the component commands to shorten the length of the process and achieve additional performance gains. Figure 4-3 represents the process flow associated with this redesign alternative (note that the process flow is the same between alternatives I & II).

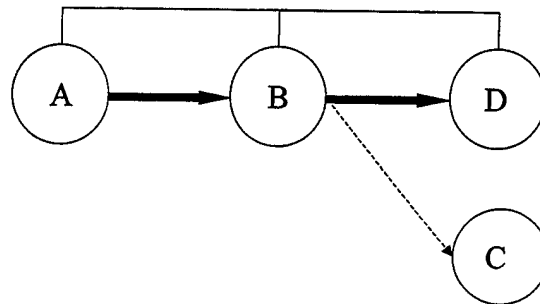

Figure 4-3. Redesign II Process Diagram

The KOPeR input variables reflect the increased automation, from 1 to 3, in addition to the reduction in the number of nodes, from 4 to 3, and the reduction in feedback loops, from 3 to 2. The EXTEND model incorporates the 20% reduction in processing times at each level in the approval chain (subordinate, component, and USTRANSCOM), as well as the conditional routing of 90% of the requests directly to the appropriate controlling authority, with the remaining 10% routing through the USTRANSCOM processing delay mechanism.

B. TESTING ALTERNATIVES

1. EXTEND Simulation Results

Table 4-1 encapsulates the measurements resulting from the EXTEND simulation of each revision in addition to those of the baseline process. As with the baseline process, the simulations of the revisions were each run twelve times in order to replicate the number of observations comprised by a typical year. The data from each individual run is collected and compiled in a Microsoft Excel spreadsheet for comparative analysis. The first column of the table identifies the type of request and the variables measured during the simulations. The "Total Delay" reflects the cumulative cycle time of all observations of a particular request over twelve simulations. The "Mean Delay" reflects the average delay per request, "Total Observations" reflects the number of instances of a particular request, and Mean Observations per Month, measures the monthly frequency of each request. Standard deviations are included as an indicator of the variance and range of the different measures.

Request Type	Baseline	Revision I	Revision II	Revision III
DSCS SAR				
Total Delay (Days)	133.912	39.520	72.882	41.619
Mean Delay	3.524	1.976	2.209	1.343
Standard Deviation	0.854	0.509	.393	.290
Total Observations	38	20	33	31
Mean Obsv/Month	3.167	1.667	2.750	2.583
Standard Deviation	1.467	1.073	.754	1.621
UHF SAR				
Total Delay (Days)	308.708	145.050	114.841	80.451
Mean Delay	4.229	1.837	1.823	1.117
Standard Deviation	0.400	0.359	0.318	.232
Total Observations	73	79	63	72
Mean Obsv/Month	6.083	6.583	5.25	6.00
Standard Deviation	0.793	2.275	1.960	2.314
SAR/GAR				
Total Delay (Days)	185.456	103.067	123.233	75.298
Mean Delay	5.620	4.685	3.995	2.596
Standard Deviation	0.248	1.27	1.191	.727
Total Observations	33	22	31	29
Mean Obsv/Month	2.750	1.833	2.583	2.417
Standard Deviation	0.250	0.835	.996	.900
RFS				
Total Delay (Days)	87.366	61.700	57.694	36.054
Mean Delay	4.598	2.927	2.885	1.898
Standard Deviation	0.217	0.810	.586	.470
Total Observations	19	21	20	19
Mean Obsv/Month	1.583	1.750	1.667	1.583
Standard Deviation	0.149	0.452	.492	.515

Table 4-2. EXTEND Simulation Output Comparison

The most significant data element in Table 4.1 is the mean delay associated with each of the different types of request and is the basis chosen for comparison of the different alternatives. While Total Delay is instructive in that it provides an indicator as to tremendous amount of time and resources dedicated to processing these requests, it is not an indicator of efficiency. Likewise, although Total Observations and Mean

Observations illustrate the volume of process activity, they do not vary appreciably enough between alternatives to serve as a basis for comparison.

Table 4-3 is the basis for the comparisons of the improvements associated with the three redesign alternatives. The table's columns contain the relative performance data associated with each of the alternatives (R I, II and III), and the Baseline (BL). Dividing the Mean Delay of the redesign alternative by the corresponding measurement for the baseline for particular request, by the corresponding revision measurement, yields the relative performance measure contained in columns 2-4 of the table. For example, the Mean Delay (from Table 4-2) for the DSCS baseline simulation is 3.524 days, and the corresponding R1 (Revision 1) Mean Delay is 1.976 days. Dividing 1.976 by 3.524 yields .56, corresponding to a 44% improvement in cycle time over the baseline performance.

	BL V R1	BL V R2	BL V R3
DSCS	43.9	37.3	61.9
UHF	56.6	56.9	73.6
SAR/GAR	16.6	28.9	53.8
RFS	36.3	37.3	58.7

Table 4-3. Mean Cycle Time Comparison

There is an important distinction to be drawn from this analysis. Changes to process flow were just as critical to decreased cycle time and increased efficiency, as was the implementation of a technology based solution. The results show that by empowering subordinate commands to approve requests of a routine nature offers substantial performance gains. The largest gain in cycle time, corresponding to the UHF

SAR, is even more significant in that the UHF requests occur with more than twice the frequency of the other types of requests.

Another critical observation pertains to the effect of combining R1 and R2 (i.e., R3). While both revisions result in significant performance gains, the synergistic nature of incorporation of both revisions nearly doubles the individual cycle time improvements. The lesson derived from this result is that efforts directed at process improvement must be multi-faceted, relying on two or more transformation enablers to achieve the radical gains sought after through Business Process Reengineering efforts.

2. KOPeR Simulation Results

Table 4-3 encapsulates the comparison data associated with the KOPeR evaluation of the baseline process and the alternative redesigns. Each measure is discussed in turn. The 1.00 value accorded to the baseline process and each of the alternatives pertaining to parallelism is unavoidable with the processes in question. The approval process in a hierarchical organization, like the Department of Defense, mandates a sequentially dependent process. Additionally, for one node or approval authority to act, a lower node in the approval chain must first initiate a request.

	BL	R I	R II	R III
Parallelism	1.00	1.00	1.00	1.00
Handoffs Fraction	0.75	0.67	0.75	0.67
Feedback Fraction	0.75	0.67	0.75	0.67
IT Support Fraction	1.00	1.00	1.00	1.00
IT Comm. Fraction	1.00	1.00	1.00	1.00
IT Auto Fraction	0.00	0.00	0.75	0.75

Table 4-4. KOPeR Measurement Comparison

The Handoffs and Feedback fraction can be limited by bypassing levels in the approval chain, as evidenced in Alternatives I & III. Allowing component commands to interface directly with the service providers and appropriate controlling authorities, which removes a layer of the chain of command, efficiency is improved and the need for feedback between levels is reduced. However, it is important to note that the chain of command, in this case USTRANSCOM, must be informed as resources are allocated in order to maintain situation awareness.

IT-Support and IT-Communication remain constant throughout all four simulations. The 1.0 score is reflective of a process that adequately utilizes electronic communication tools, e-mail for example, and information technology support tools, such as word processors. However, neither the Baseline nor Alternative I score well with regard to automation. Alternatives II and III effectively employ the use of automation tools, in this case a web-based tool that automates portions of the request process, resulting in an increase from 0.00 to 0.75 for both alternatives. If the automated solution were to include the service providers as well, the measure would increase to 1.0 for the alternatives employing some form of automation.

C. Migration Plan

Instituting a new process and supplanting the old processes in hopes of achieving performance gains requires substantial effort, incorporation of a detailed plan, and organizational leadership. A base of support among the end users is essential and requires user input during the development process. Any implementation must be coordinated with and reflect the needs of the individuals who will be responsible for the

maintenance and upkeep of the process, and enjoy the support of leaders within the affected organization. The three redesign alternatives developed in this chapter all provide viable alternatives that are shown to reduce cycle time and promote efficiency. This section provides the framework for the implementation of a redesign of the SAR/GAR/RFS process at USTRANSCOM.

1. Introduction

Successful migration and implementation plans provide a detailed analysis of the current situation, the desired end state and the method prescribed to achieve that state. (Cassidy, 1998) The analysis of the current situation includes a detailed examination of the internal environment and resources available, as well as a study of the external environment, covering capabilities and technologies available from outside sources. A microscope is placed over the current process in order to develop an understanding of the current process, while available technology is investigated and evaluated for suitability and application to the current process. Once redesigns are developed and tested, and the desired alternative is identified, the implementation plan dictates schedule, pace and scope of the process.

The understanding of the SAR/GAR/RFS processes at USTRANSCOM developed in Chapters 1-3 is an accurate depiction of the current situation and internal environment at USTRANSCOM. A precise understanding of the technologies and capabilities in place is developed and provides a clear picture of the current environment at USTRANSCOM, specifically as it relates to satellite access request procedures. The alternatives generated in this chapter result from an understanding of the current process

and the technologies available in the external environment, while establishing a target for the desired end state.

2. Implementing Change

Change must be implemented from the top down and must enjoy the full support of the organizational leadership, as well as of the individuals tasked with operating in the new environment. Support for change is enhanced by addressing five key areas: 1) the overall magnitude of the change; 2) uncertainty associated with the outcome of change; 3) the breadth of the change; 4) attitudinal and behavioral resistance to change; and 5) the duration of the change process. (Davenport, 1993) Change also must be supported by change agents, key personnel who “are effective at influencing opinions and attitudes so as to persuade fellow employees to release the familiar and embrace the uncertain”, within the organization. (Hammer, 1996)

The SAR, GAR and RFS processes at USTRANSCOM fall well below the “radar screens” of the senior leadership of the command; however, they do cut across several organizations and are critical to the sustainment of satellite communications. While these processes do cut across boundaries, involving several organizations around the world, they are carried out by a small cadre of individuals. Garnering support for change and enlisting the support of these individuals is central to the successful implementation of any of the proposed redesigns. They are the change agents for this process. They are the ones who must be impressed with answers to the five areas of concern delineated by Davenport. They are the individuals who understand the inadequacies of the current system and fully understand the benefits associated with the three alternatives,

particularly if they are the beneficiaries of a process that slashes the time required to perform a task by nearly 200%.

3. Migration Recommendations

While the SAR, GAR, and RFS procedures lie well below the "radar screen" of the upper echelons of the USTRANSCOM command element, they do represent a large demand on the amount of time and effort of a selected few individuals tasked with their preparation, submission and approval. The amount of time that they have vested in the process, balanced with competing demands of their primary assignments, make them the principal stakeholders.

Primary actors from all levels of the process, including the subordinate and component commands, in addition to the individuals from USTRANSCOM, are all ideal candidates to serve on an Integrated Process Team, chartered with implementing change in the RFS process. These individuals have the expertise and knowledge to successfully evaluate alternatives, measure the benefits associated with each, and institute a plan that is effective, timely and beneficial. However, the leadership within TRANSCOM, particularly within the Command, Control, Communications and Computer Systems Directorate (J6), must embrace the need and rationale for change, supporting and empowering the IPT to affect a satisfactory solution.

D. SUMMARY

Literature suggests that the purpose of BPR is to affect dramatic change, realizing performance objectives that reflect improvements measured in orders of magnitude. The

three redesign alternatives presented in this chapter do provide substantial gains with respect to cycle time of the SAR, GAR, and RFS processes in place at USTRANSCOM. The range of increased efficiency, in terms of cycle time, of the different alternatives ranges from 1.2 to 3.8 times faster than the measured efficiency of the baseline process. The first alternative takes advantage of reorganization of the workflow process and empowerment of lower-level approval authorities in order increase efficiency, reducing cycle time by a factor 1.8 for the DSCS SARs, 2.3 for the UHF SARs, 1.2 for the combination SAR and GAR, and 1.6 for the RFSs.

The second alternative leverages web-based technologies to achieve high levels of efficiency, resulting from enhanced automation of key elements of the process. This alternative improved cycle time by a factor of 1.6 for the DSCS SAR, 2.3 for the UHF SAR, 1.4 for the combination SAR/GAR, and 1.6 for the RFS. The third alternative achieved a synergistic effect by combining elements of the first two redesigns, nearly doubling the previous cycle time improvements. Results of the third redesign yielded improvements in the DSCS SAR cycle time by a factor of 2.6, 3.8 for the UHF SAR, 2,2 for the combination SAR/GAR, and 2.4 for the RFS.

However, there are tradeoffs associated with each of the alternatives. Alternative I reduces the situational awareness at USTRASCOM with regard to the satellite access requirements of the command and its' components. This limits the accuracy associated with understanding current requirements and the ability to forecast future requirements, both critical tasks dictated by CJSCI 6250.1. Alternative II requires either a capital commitment to develop an automated solution, or it requires an in house design and implementation effort. In either case, Alternative II and III both require a substantial

commitment of time and resources. Alternative III mitigates some of the negatives associated with Alternative I by capturing relevant data and retaining it in a database. This information could serve to enhance situational awareness and control with the addition of a data mining utility.

V. SUMMARY, CONCLUSIONS AND FUTURE RESEARCH

A. SUMMARY

This thesis examines how redesigning the Satellite Access Request, Gateway Access Request, and Request for Services processes at USTRANSCOM can improve cycle time, freeing key personnel to effectively balance competing priorities. Chapter I provides the information supporting the need for a study, as well as the research questions to be answered through the course of the study. Chapter II details the background information surrounding the SAR/GAR/RFS process and provides a basic description of the current process. Chapter II also introduces Business Process Reengineering and the methodologies used to develop this thesis. Chapter III introduces KOPeR and EXTEND, modeling tools used to simulate the baseline process. It also provides a detailed description of the baseline process, as well as the results of the KOPeR diagnosis and the EXTEND simulation of the baseline process. Chapter IV presents three redesign alternatives for further analysis and comparison with the baseline process. In this final chapter, conclusions, recommendations and topics for further research are presented below.

B. CONCLUSIONS

The SAR, GAR and RFS processes at USTRANSCOM can benefit from the application of solutions based on the application of information technology. The KOPeR analysis of the process indicates that there are pathologies associated with insufficient automation and the absence of parallelism. The current process makes efficient use of

IT-communication and IT-support tools, but it is encumbered by the manual nature of data collection and entry. The hierarchical nature of the approval process in a military organization results in excessive feedback, checking and delays.

The redesign alternatives discussed in Chapter IV offer solutions to these pathologies. By increasing the automation attributes of the processes, cycle time is reduced dramatically, in some cases by a factor of three. However, the sequential nature of the process is difficult to circumvent. Management of limited resources requires centralization of control higher levels in the organization. This situation exists not to maintain control during routine operations, but in the case of contingency operations. Alternative I addresses this concern by allowing a conditional direct link between the component commands and the service provider. Alternative II applies automation as a transformation enabler, establishing a web based database application with automated routing, data entry and message composition attributes. Alternative III represents a synergy of the previous two redesigns, applying the conditional direct link as well as web-based interface.

The interesting result of the redesign analysis is that merely throwing information technology at a problem is not sufficient to effect dramatic change. The entire business process must be examined for existing pathologies, with transformation enablers identified subsequently to determine what measures can be emplaced to achieve desired results. This is apparent when examining the improvements in cycle time of the three redesign alternatives. Both Alternatives I and II achieve similar, if not statistically equivalent results. It is not until they are combined that the resultant synergy produces even more radical improvements.

C. RECOMMENDATIONS

The conclusions suggest the J6 at USTRANSCOM use the results of this thesis and its redesign alternatives as a basis for a reengineering effort in the SAR, GAR, and RFS processes within USTRANSCOM. These processes are tedious, cumbersome and time intensive. A solution based on the findings of this thesis would promote efficiency and allow for more effective management of limited, valuable resources. Another recommendation is for the request formats themselves to be examined for duplicity and commonality, as this would benefit all users of satellite communications, as common request format would most likely serve to improve cycle time, even without the application of an automated, technology based solutions.

D. TOPICS FOR FURTHER RESEARCH

The scope of this thesis has been narrowly focused on the SAR/GAR/RFS processes within USTRANSCOM, examining the macro processes involved with the request procedures. Further research into the micro processes associated with the satellite access request procedures would identify further pathologies and associated solutions. Increased granularity would provide additional detail and provide greater validation to the assumptions made through the course of this thesis.

The SAR, GAR, and RFS processes are not unique to USTRANSCOM as they have DoD wide application. In addition to the study of the request formats for commonality and duplicity mentioned in the previous section, another opportunity for research lies in a comparative study of processes that exist within disparate commands.

A universal automated request system, incorporating the satellite access providers in addition to the users, is the next logical step beyond a USTRANSCOM specific system.

LIST OF REFERENCES

- Ables, Jimmy, Theater Information Manager, E-mail message, 30 January 2001.
- Ables, Jimmy, Theater Information Manager, E-mail message, 13 February 2001.
- Ables, Jimmy, Theater Information Manager, E-mail message, 16 February 2001.
- Chairman of the Joint Chiefs of Staff Instruction 6250.01: *Satellite Communications*, October 1998.
- Davenport, T. H., *Process Innovation: Reengineering Work through Information Technology*, Harvard Business School Press, 1993.
- Defense Information Systems Agency, *DISA Telecommunications Seminar: DISA Direct Computer Based Training*, CD-ROM, 2000.
- General Accounting Office, *Business Process Reengineering Assessment Guide*, Government Printing Office, 1997.
- Hammer, M., *Beyond Reengineering: How the Process-Centered Organization is Changing our Work and our Lives*, Harper Collins, 1996.
- Hammer, M. and Champy, J., *Reengineering the Corporation: A Manifesto for Business Innovation*, Harper Collins, 1993.
- Imagine That Inc., *Extend: Simulation Software for the Next Millennium, Extend Users Manual, Version 4, for Macintosh and Windows*, 1997.
- Nissen, M. E., KOPeR Web Page, [<http://131.120.43.3:8080/koper.htm>]. 2001.
- Nissen, M. E., "Redesigning Reengineering Through Measurement-Driven Inference", *Management Information Systems Quarterly*, 1998.
- Norton, E. C., *Innovating Outpatient Prescription Dispensing in Navy Military Treatment Facilities to Improve Cost Performance*, Naval Postgraduate School, September 2000.
- Telephone Interview between Mr. Jim Ables, USTRANSCOM, TC J6 PC, January 21, 2001.
- Telephone Interview between Mr. Jim Ables, USTRANSCOM, TC J6 PC, February 18, 2001.
- United States Transportation Command Home Page, [<http://public.transcom.mil/>]. 2001.

THIS PAGE INTENTIONALLY LEFT BLANK

INITIAL DISTRIBUTION LIST

1. USTRANSCOM, J6-PC.....1
508 Scott Dr.
Scott Air Force Base, IL 62225
2. Defense technical Information Center.....2
8725 John J. Kingman Rd., Ste 0944
Ft. Belvoir, VA 22060-6218
2. Dudley Knox Library.....2
Naval Postgraduate School
411 Dyer Rd.
Monterey, CA 93943-5101
4. Director, Training and Education.....1
MCCDC, Code C46
1019 Eliot Rd.
Quantico, VA 22134-5027
5. Director, Marine Corps Research Center.....2
MCCDC, Code C40RC
2040 Broadway St.
Quantico, VA 22134-5107
6. Director, Studies and Analysis Division.....1
MCCDC, Code C45
300 Russell Rd.
Quantico, VA 22134-5130
7. Dr. Mark Nissen, Code SM/ME.....1
Department of Systems Management
Naval Postgraduate School
Monterey, CA 93943-5103
8. Dr. Erik Jansen, Code CC/EK.....1
C3 Academic Group
Naval Postgraduate School
Monterey, CA 93943-5103
9. Major Michael L. Bramble.....2
5315 Montfort Ln.
Crestwood, KY 40014