





THE J. PAUL GETTY MUSEUM LIBRARY



Digitized by the Internet Archive
in 2017 with funding from
Getty Research Institute

<https://archive.org/details/papersreadatroya1874roya>

ROSA

PAPERS

READ AT THE

Royal Institute of British Architects.

SESSION 1874-75.

USUI CIVIUM, DECORI URBIUM.

LONDON:

PUBLISHED AT THE ROOMS OF THE INSTITUTE, 9, CONDUIT STREET, HANOVER SQUARE, W.

1875.

[ENTERED AT STATIONERS' HALL.]

The right of Reproduction and Translation is reserved by the Council.

DRYDEN PRESS: J. DAVY & SONS, 137, LONG ACRE, LONDON.

THE J. PAUL GETTY CENTER
LIBRARY

TABLE OF CONTENTS.

TITLE.	AUTHOR.	DATE.	PAGE.
Opening Address	By Sir G. Gilbert Scott, R.A., President.	Nov. 2nd, 1874	1 — 14
The Orwell Park Observatory	By J. Macvicar Anderson, Fellow.	Nov. 16th, ,,	15 — 29
History and Development of Gothic Vaulting.	By G. Herbert-West, M.A., Associate.	Nov. 30th, ,,	31 — 52
On "The Hope of English Architecture."	By William H. White, Fellow.	Dec. 14th, ,,	53 — 77
Architects and Master Workmen	By John J. Stevenson, Esq.	Jan. 4th, 1875	79 — 108
On the Restoration of the Lodge at Sheffield Manor.	By C. Hadfield, Fellow.	Jan. 18th, ,,	109 — 118
"On Public Abattoirs"	By A. Darbyshire, Fellow.	Feb. 1st, ,,	119 — 134
On the Temple of Diana at Ephesus	By J. T. Wood, Fellow.	Feb. 15th, ,,	135 — 147
On "Certain New or Recently Revived Processes in Decorative Art."	By G. T. Robinson, Con- tributing Visitor.	Mar. 1st, ,,	149 — 164
On Iron as a Constructive Material	By C. H. Driver, Fellow.	Apl. 5th, ,,	165 — 183
The Church of St. Francis, Assisi	By J. Beavington Atkinson, Esq.	Apl. 19th, ,,	185 — 198
On New Materials and recent Inventions connected with Building.	By T. Roger Smith, Fellow.	May 24th, ,,	199 — 216

TITLE.	AUTHOR.	DATE.	PAGE.
Presentation of the Royal Gold Medal	June 7th, 1875	217 — 219
Memoir of the late Mr. Joseph James .	By C. Forster Hayward, Fellow.	June 7th, „	220 — 221
Discussion on T. Roger Smith's Paper— “ New Materials and recent Inventions connected with Building.”	June 7th, „	221 — 230

Royal Institute of British Architects.

SESSION 1874-5.

At the Opening Meeting of the Session, held on Monday, the 2nd of November, 1874,
SIR G. GILBERT SCOTT, R.A., delivered the following

PRESIDENT'S ADDRESS.

GENTLEMEN,—Though it is nearly two years since you did me the honour of electing me as your President, this is the first occasion on which I have had the pleasure of appearing personally before you at the opening of a Session, and of delivering to you in person the customary Opening Address.

I was deprived of that pleasure last year through having felt it my duty, at the advice of my friends, to indulge in half a year's rest from professional work ;—the first absence from business of that duration which I had enjoyed since I commenced practice. My inaugural address was read in my absence by our friend Mr. Eastlake. The writing of it had greatly interested and stirred me up while at a distance, and if it failed to produce a similar effect on the minds of those who heard or read it, I can only say that I regret but cannot help it.

My long absence, on that occasion, was divided equally between the enjoyment of the works of nature and of art—between God's architecture in the mountains and man's architecture in the cities of France and Italy. This recollection suggests to me that, on our reunion after our autumnal recess, we may, many of us, have to congratulate each other on our return from a well-earned vacation, during which our bodily system has been invigorated and re-strung after the labours of the year, and our artistic system refreshed and supplied with new material—the one by the aid of the country, the mountain or the ocean ; and the other by drinking deeply and afresh at that exhaustless fountain of art, whether ancient or otherwise, which happily yet remains to us in nearly every country of Europe, and in many beyond its confines.

It is a trite observation, but one which the too often repeated neglect of its precepts may excuse, that we, architects, especially need both these forms of relaxation and re-invigourment. Our customary labours are peculiarly exacting upon body and mind ; both of which have, therefore, a special necessity for change,—and, careful and frequent as may have been our studies from the great examples of our art, their impressions and our memory of them grows dull, and our very sketches lose their early value, unless we introduce, ever and anon, new matter by the study of ever fresh examples, and by the repeated study of those with which we were once familiar.

To the young and ardent student, the study of the ancient examples of his glorious art is the subject of romantic anticipations, of delightful realities, and of hallowed and cherished memories ; while, as we grow older, it is not only essential to take every opportunity of relighting the lamp of our youthful enthusiasm by revisiting the objects which delighted us in earlier life, and of ever adding to its flame by seeking out fresh objects for our studies,—but it is consoling to feel conscious that, while other sentiments may possibly become less vigorous, this all absorbing source of delight never fails to kindle in our hearts the same enthusiasm as ever ; and that even old age does not lessen the almost childlike earnestness with which we re-visit and again sketch from the objects of our youthful admiration.

Let us, then, encourage these feelings, and never for a moment imagine that advancing years have any right to damp them ! These considerations lead on to what is always the most melancholy part of

our annual addresses;—the memory of those who, though keeping up, perhaps to the last these lively feelings for their art, have been, during the past year, taken from amongst us.

The losses by death which this Institute has to deplore are as follows:—

M. BALTARD, Architect, of Paris, Honorary and Corresponding Member, of whose life no doubt our Foreign Secretary will furnish some particulars.

Mr. ELKINGTON GILL, Architect, of Bath, Fellow: a most respectable and excellent Member of our Institute.

Mr. WILLIAM PERKINS, Architect, of Worcester: an old pupil of Thomas Rickman, of honoured memory.

Mr. Perkins was the official architect to Worcester Cathedral, and carried out the recent restoration there. I was associated with him in respect of internal fittings and decorations, and can bear witness to his knowledge of our ancient architecture, to his practical skill, and to his honourable and thoroughly trustworthy character, both professionally and personally.

Lastly, I have again to advert to the loss, not only to our Institute, but to our art and to the world,—sustained by the decease,—all too antedate,—of our highly gifted and most valued friend and Fellow, Mr. OWEN JONES.

Enough has perhaps already been said at different meetings to show what were our feelings towards Mr. Owen Jones, and how deeply we have felt, and must ever continue to feel, his loss. I do not myself feel able worthily to add to this; inasmuch as nothing short of a memoir by one whose privilege it has been to enjoy his intimate personal acquaintance can so add to what has been already said, as to do any justice to the gravity of the subject. Sir Digby Wyatt is obviously the man to do this. He was away at the time of his friend's decease; but I trust he will, ere long, favour the Institute with such a personal sketch of the life and of his own reminiscences of his and our common friend, as may adequately represent, on the face of our Transactions, both the eminent qualities of our distinguished member and our appreciation at once of his merits and of our loss.

Among the special donations we have received during the past season, besides many books, drawings, and other objects, I may mention that by Mr. John Gibson, Vice-President, of £25. to the Library Fund; and that by Mr. J. L. Wolfe, of a beautiful marble bust of the late Sir Charles Barry, executed by J. H. Foley, R.A.

Our offers of Medals, Prizes, &c. during the season have generally been well responded to and have called forth many very excellent drawings, papers, &c. The only exception has been The Soane Medallion, to which the responses were deemed to be so inferior in merit, that the medallion was not awarded. The following is a list of the Gentlemen who have won medals, prizes, studentships, and honourable mention:—

The Ashpitel Prize was won by Mr. Hugh H. Stannus, the Candidate who had gained the highest number of marks in the Architectural Examination of 1873.

Of Ten Candidates who submitted Drawings and Testimonials in competition for the Pugin Travelling Studentship of 1874, the Council elected Mr. Richard C. Page, of 15, Clarendon Street, Warwick Square, subject to the conditions prescribed in the Pugin Deed of Trust.

The Council considered the Drawings submitted by Mr. Edwin J. Munt, of 10, John Street, Adelphi, W.C., so excellent of their kind, that they determined to award that gentleman a *Medal of Merit*.

The Council also distinguished by *Honourable Mention* the Drawings of two other Candidates for the Studentship, viz.:—Mr. W. Wood Bethell, of 19, Craven Street, Strand, and Mr. William Wilson, Jun., of 14, Hanover Terrace, Regent's Park.

MEDALS AND PRIZES.

The Institute Silver Medal, with £5. 5s., was awarded to G. Dale Oliver, of 150, Stanhope Street, Regent's Park, author of the Drawings illustrating St. Mary's Church, Warmington. In the same competition a Medal of Merit was awarded to Walter Talbot Brown, of 20, Wood Street, Northampton, author of the Drawings illustrating St. Mary's Abbey, Buildwas, Salop. The Drawings submitted in the same competition, by W. T. Whyte, of 45, Doughty Street, W.C., and illustrating Bayham Abbey, Kent, were Honourably Mentioned.

The Institute Medal was awarded to A. T. Taylor, 16, Oakley Road, Church Road, Islington, N., author of the Essay on 'The Architecture of London in the Sixteenth Century.'

A Medal of Merit was awarded to T. H. Eagles, Associate, of Cooper's Hill, Staines, author of the excellent Essay on 'Vaulting,' which was afterwards printed in our Sessional Papers.

The Student's Prize in Books was awarded to H. R. Perry, 9, Seymour Street, Green Park, Bath, author of the Design for an Oak Ceiling.

I may here mention that the bequest of of £1000 by our lamented Fellow and Past-President, Sir William Tite, has been thoroughly considered, as to the precise mode of carrying out the instructions of the testator, by a special Committee; two members of which were especially selected from among those personally acquainted with his wishes. This committee was efficiently aided by our Honorary Solicitor, and it is trusted that the result will prove satisfactory.

A bequest has recently been made by the will of the late Mr. Thomas Grissell, of Norbury Park, of £250., the interest of which is to be devoted to a Medal Prize. I have a melancholy pleasure in recording my sentiments of friendship and respect for the memory of Mr. Grissell. It was many many years ago that I placed myself for a short time under him, for the purpose of studying the more practical departments of my profession, and I can never remember him but with feelings of respectful regard.

ELY CHAPEL.

Early in the present year the attention of the Council was called, by a letter from Mr. Christian, to the proposed sale by auction of Ely Chapel in Holborn; that gentleman urging that some steps should be taken towards preserving that interesting example of mediæval architecture.

I may here mention,—for the information of the few, either among the hearers or readers of my address, who may need it,—that the chapel of St. Etheldreda, in Holborn, is the solitary remnant of the once splendid London Palace of the Bishops of Ely. It appears to have been erected by Bishop de Luda (or Louth), who held the See from 1290 to 1298, and is consequently about coeval with the exquisite monument to that Bishop in Ely Cathedral,—a work clearly by the same hand with the tombs of Edmund, Earl of Lancaster, and Aveline, his wife, at Westminster, and of Archbishop Peckham at Canterbury; four works of art which may challenge Christendom for any to surpass them; and this chapel bears so much resemblance to them in some of its details as to suggest a like authorship. It may be said to be a worthy cotemporary of the Sanctuary and earlier eastern chapels at St. Albans; of the Abbey Churches at Newstead, Tintern, and of Sweet Heart, and of many other of the noblest productions of the most refined and completed variety of mediæval architecture. It has been immortalized by Shakespeare in Richard III. and by Pugin in his Contrasts; and thus stands high, both as a historical monument and as a work of art.

These claims, however, were unavailing to save it from the inexorable hammer: not used, we may hope, to "break down the carved work thereof," but still, at all risks, to knock it down to the highest

bidder. The Council lost not a moment in taking up the cause of the threatened monument. A deputation called both on the law officers who had ordered the sale, and on the auctioneers who were commissioned to carry it out. Our accomplished Secretary pleaded its cause in the *Times*. I wrote myself to the two men whom I deemed from their antecedents most likely to open their hearts and their purses in such an extremity—but received no efficient offers of help; when, as a response to Mr. Eastlake's appeal, Baron Albert Grant came forward with offers of immediate aid, but under certain conditions which would have entailed a financial responsibility on the Institute. The responsibility was subsequently undertaken by the Welsh Congregation who had long used the chapel for Divine Service, and who, backed by Mr. Grant's offer, endeavoured to secure the building. Unfortunately they were outbidden at the sale. In due time, however, it transpired that the purchase had been made for Roman Catholic uses, so that we may hope that the precious relic may be preserved and its mutilations restored.

THE METROPOLITAN BUILDINGS BILL.

Among public events of the past Session with which the Institute has been brought into official connection, may be mentioned, the attempt made by the Metropolitan Board of Works to supersede the present Building Act by a New Bill, which was introduced in the House of Commons by Sir James Hogg, M.P.

It will be remembered that our Council in their Annual Report for 1874, drew attention to the fact that the draft of this bill was only submitted for their opinion at the eleventh hour, when there was but little or no time left for its examination. A committee was, however, appointed to consider the subject, and they prepared a report, which was subsequently adopted by the Council and forwarded to the Board of Works. In that report objection was made to the general principle of the New Bill, which appeared to confer upon the Metropolitan Board of Works too full and too arbitrary powers, and to reduce the position and individual authority of the District Surveyors. It was also remarked that this Institute, to which for nearly twenty years the duty of examining candidates for that office had been entrusted, was practically ignored in the bill; and this naturally led to the inference that the examination itself, which had been carefully and gratuitously conducted for so long a period, might lapse altogether, at least under its present system. Several other objections, chiefly of a technical nature, were raised to the bill in our report, which, having been duly circulated among our members, was brought forward for discussion at a Special General Meeting, held here on the 11th May last. Meanwhile, a petition against the bill had been drafted by the Council, and presented in the House of Commons by Mr. Beresford Hope, our late President, who, I may here say parenthetically, is always ready to render us services of this kind, and give this Institute the full benefit of his position and influence in Parliament. It was also intended that a deputation from the Institute should wait on the First Commissioner of Works for the purpose of explaining the objects of the petition. Unfortunately Lord Henry Lennox's engagements prevented him from receiving the deputation before the New Bill came on for discussion in Parliament, but he subsequently made an appointment with Mr. Eastlake, who had an interview with him on the subject. The bill was eventually referred to a Select Committee of the House of Commons; and, when the matter was discussed at our Special General Meeting, a series of resolutions were passed, the purport of which you will probably all recollect. Copies of these resolutions were forwarded to the several members of the Parliamentary Committee, and counsel was retained to represent this Institute and support our petition against the bill while the Committee sat. In taking this step, the Institute really acted in conjunction with the District Surveyor's Association, who themselves had drawn up a careful report on the subject, but who, not having lodged a petition against the Bill, would have had no *locus standi* except as members of the Institute.

The bill received opposition, as might have been expected, from more than one quarter; and, after hearing arguments and evidence on both sides of the question, the Parliamentary Committee suggested certain amendments which, if they had been adopted by the Metropolitan Board, would have met some, at least, of the objections raised to the bill, and might have helped its progress in the House. But the promoters of the bill, though prepared to concede certain points,—as, for instance, the re-insertion of a clause authorizing this Institute to examine candidates for the office of District Surveyor,—were not prepared to withdraw or remodel those clauses which represented what may be called the principle of their scheme; and, finding this to be the case, the Parliamentary Committee decided that it was inexpedient to proceed with the bill, and made an official report to that effect.

THE FINANCES AND EFFICIENCY OF THE INSTITUTE.

I will now notice a matter concerning deeply the interests of our Institute, on which considerable divergence of opinion has existed, but which I entertain very sanguine hopes may lead to arrangements tending greatly to our future prosperity and practical usefulness. Though the Finances of the Institute evince a satisfactory progression, the increase in our expenditure has advanced at a more rapid rate, and was found last year to have so nearly overtaken our income, as to excite some alarm. The Finance Committee, after taking these circumstances into their consideration, came to the somewhat bold resolution :

“ That, in the opinion of this Committee, it would be advisable to raise the Entrance Fees and Subscriptions of Members of the Royal Institute of British Architects.”

This suggestion was laid by the Council before the Special General Meeting on March 9th, when, after much discussion, it was resolved :—

“ That further consideration of this subject be adjourned until the Annual General Meeting to be held on the 4th of May.”

At that Meeting the subject was again discussed very much in detail, and the following resolution was passed :—

“ That a Special Committee be appointed to consider and report to a Special General Meeting as to the financial condition of the Institute, and the best mode of increasing its efficiency,”

and further,

“ That the Special Committee consist of twelve Members of the Institute, of whom four shall be Associates, and that it be left to the President and Vice-Presidents to nominate the Committee and report the names in due course.”

On June 15th it was duly announced that the names selected were those of —

MR. T. CHATFIELD CLARKE,	} Fellows.	MR. T. ROGER SMITH,	} Fellows.
MR. F. P. COCKERELL, Hon. Sec.		MR. A. WATERHOUSE,	
PROFESSOR T. L. DONALDSON,		MR. T. WORTHINGTON,	
PROFESSOR T. HAYTER LEWIS,		MR. T. H. WYATT,	

and

MR. E. B. FERREY, Associate.	MR. E. J. TARVER, Associate.
MR. R. PHENÉ SPIERS, do.	MR. T. H. WATSON, do.

To these gentlemen then, this very important duty is deputed, and we must all heartily wish them every possible success in their consideration of it.

It has been, I think, clearly shown by our Secretary and others, that the alarm felt by the Finance Committee was rather prospective than bearing directly upon present exigencies, and that the unfavour-

able figures were the result of some exceptional calls upon our funds, which need not be repeated ; but, on the other hand, it is the farthest from being desirable or satisfactory that a great Society like our own,—the standing representative of the professors of a great and universal art,—should ever be in danger,—under circumstances however exceptional,—of scraping the bottom of its purse, or finding itself unable to meet expenses which the exigencies of the profession it represents may point out, from time to time, as being beneficial. Such a position, I urge, is beneath our just dignity, and would at times render nugatory our efforts for the great objects for which our Institute was founded.

Not to mention, however, these extraneous calls upon our finances,—have we not every year demands upon us which our great position seems to render imperative, but which the limits of our resources compel us to under-rate ?

Is our *Library*, for example, on a scale commensurate with the dignity and the just demands of our profession ? Have we the means to procure measured drawings of the ancient monuments, even of our own land, which every winter is reducing to impalpable dust, or the hand of spoliation sweeping away ? Have we funds to enable us to procure fac-simile drawings of ancient decorations, which the very air we breathe is every moment destroying ? Our Rooms ought to be the Public Record Office of all which relates to the ancient and perishable relics of our own and of the collateral arts.

Again :—Have we sufficient means of sending students about to study their art, in our own or in foreign countries ? Happily we *are* able to do a little ; but are we content with that little ?

And yet again :—Have we the means at our disposal to aid and promote schools of study under our own eye ? or, on the contrary, are not the few poor pittanees doled out most unwillingly for such objects reckoned as among those *exceptional* expenses which we promise ourselves and bargain with others never again to repeat ?

I rejoice to think that a portion of the new Committee consists of *Associates* ;—of men young enough to remember the defects and needs of their own pupilage, and to sympathise with those who are still but students. I rejoice, too, to think that some of these belong to that younger Society, which is doing much towards avoiding and meeting these defects and these needs.

It has been suggested that this house, and the galleries it contains, should be made the means of exhibiting, from year to year, specimens and objects of cotemporary art, tending to excite ambition and emulation ; and were such exhibitions conducted with a fearless and rigorous censorship, it would be most useful. The fear is lest it might descend to the rank of an advertising office. Far more, however, do we want a constant exhibition of the works of those artists and workmen of good old times, which would excite no jealousy, and respecting whose claims upon our study there would be little difference of opinion.

I trust that this new Committee will not report till they are able to show us how to attain these objects, and all others we need ;—if without raising fees and subscriptions—*well* ;—but *anyhow* to attain them. I will only add on this subject that the number of our members, though large, is small as compared with the extent of the profession ; and that the increase of our members brings with it also the increase both of our *usefulness* and of our *resources*.

THE COMPLETION OF ST. PAUL'S.

One circumstance which has somewhat disturbed the public mind in relation to our art and to one of its noblest monuments, it may be hardly safe to allude to while so much excitement exists. Yet it is so exceptionally important that to pass it by in silence might be attributed to cowardice or carelessness. I allude to the project for decorating the interior of St. Paul's.

The Council of the Institute, as long ago as 1870, passed a resolution cordially approving of

this project, and offering the co-operation and sympathy of the Institute, though even in the absence of any such voluntary expression of feeling, it needed no assurance that a Society like ours would feel the deepest interest in the success of such a work. The outline of the intended treatment of this noble interior, which was laid before the public at that time (1870) as the ground work on which the Committee sought subscriptions, was as follows :—

After alluding to the great care which would be required in the selection of artists and designs, and the necessity of a considerable amount of experiment before any final decision could be arrived at in so many difficult questions of art, they proceed to say :—

“ The leading principle affirmed by all who have been consulted is this—To make Sir Christopher Wren’s intentions for the completion and decoration of the Cathedral the main text, as it were, and to study to carry out as implicitly as possible whatever he may have expressed in drawing, model, or writing; and, where these materials for guidance fail, that harmony is to be sought for to the fullest practicable extent with what he has proposed or done.”

“ Sir Christopher Wren’s views are consistent with the most magnificent ideal. We know that mosaic painting; rich marbles, and sumptuous gilding entered largely into the calculation of what he thought was due to his design.”

Proceeding to mention Sir Christopher Wren’s intended marble ciborium or altar piece, and his magnificent choir screen, which, with its architecture, metal work, and sculpture, would be a very gem of art ; they continue :—

“ The better to illustrate the idea of the magnificence which has been imagined, let the entrance be supposed at the west end, about to become the easiest access to the Cathedral. On passing through bronze doors richly charged with devices, the first most striking effect would be produced by the brilliant roof covered with mosaic patterns, and rich with gold. The cupola immediately overhead, 40 feet in diameter, and the panels of the exquisite side chapels, would be pictorially treated in the same material. The walls relieved with marble slabs and marble inlay ; the pavement also and the windows, enriched with colour, must be so treated as to preserve a due regard for breadth of effect and the necessity in St. Paul’s for a large amount of unobstructed sunlight. All panels to be filled with coloured marbles or sculpture, and no niche to be without its statue. The nave and transepts must, however, be in some respects subordinate to the choir.”

“ In the great Dome, which has been happily called the very ‘ essence of the building,’ the *grisaille* pictures of Sir James Thornhill cannot fail, ultimately, to give place to Sir C. Wren’s cherished wish for mosaic pictures. And, in addition to these, the drum and the eight spandrels (the latter already commenced in mosaic) will afford grand scope for the highest efforts of art and magnificence.”

“ The roof of the choir should be a splendid and impressive work in mosaic, elaborate while massive and dignified in general effect, surpassing the richness of the rest of the church. The windows in the apse will here also be more fully coloured ; and the marbles, whether used structurally as replacing the stonework of the principal pilasters, or in panels and inlaid patterns on the walls and pavement, would all be arranged so as to impart a fuller idea of sumptuousness. This must be especially the case with the ciborium and the choir screen already referred to.”

They then quote from Sir Christopher himself the following remarks :—

“ Painting and sculpture,” said the judicious Sieur de Cambray (Roland Freart) “ are the politest and noblest of ancient arts, true, ingenuous, and claiming the resemblance of life, the emulation of all beauties, the fairest of records of all appearances, whether celestial or sublunary, whether angelical, divine, or human. And what art can be more hopeful or more pleasing to a philosophical traveller, an architect, and every ingenious mechanician ? *All must be lame without it.*”

I have quoted these passages because, in the state of excited confusion into which the whole subject has recently fallen, it may be well to have a fair conspectus before us of the actual programme thus early laid before the public, as the foundation for the appeal to their co-operation. Such, then, was the proclaimed intention; nor is it possible to conceive a promise of more gorgeous sumptuousness than it offers; so that we must not now complain of excess of splendour, though the treatment and design are fully open to our criticism.

At about this stage of the proceedings, the executive committee appear to have requested Mr. Burges,—not as an architect, but rather as a man learned in Christian iconography, to lay a scheme before them for the arrangement of subjects for the mosaic work, sculpture, &c., which he did in a very detailed form, displaying great mastery of the subject, though I would suggest one falling off from the spirit, though not the letter, of the programme, in the omission of figure subjects from the small domes in the bays of the nave and choir. At that time Mr. Penrose was the sole architect to the committee—as well as being officially the surveyor of the fabric—and it was, I suppose, nearly two years later that for some reason, right or wrong, the committee determined to nominate an architect to the work distinct from the surveyor of the fabric. I had been myself a member of the executive committee, though I had not usually acted; but I attended at that time expressly to oppose this change, which I thought unfair towards Mr. Penrose; but on its being carried, I advocated and voted for the nomination of Mr. Burges, thinking that his knowledge of iconography and of ecclesiastical art would, when united with Mr. Penrose's learning in the classic and renaissance styles, ensure a good result.

Mr. Burges's instructions were (roughly speaking) to follow Sir Christopher Wren's intentions, wherever they could be ascertained or inferred; but, where they failed, the directions were, not so much (as expressed in the programme) that "harmony was to be sought for to the fullest practicable extent with what he had proposed or done," (though this was suggested) as that reference should be made to the works of the best Italian artists of the 16th century. The reason, I presume, why the continuator of a work of the 18th century was referred back to artists of the 16th, was the impression that the revived classic of the earlier period had become more or less corrupted in the time of Wren, and that the lamp should be rekindled from its earlier flame. I know not whether this was ever made clear to Mr. Burges, nor do I know much,—excepting from the printed statements,—of the mutual arrangements and relations which have subsequently existed between that gentleman and those with whom he had to act; but it would appear from those statements that, where the most implicit freedom of communication and the greatest possible mutual confidence were essential,—the very reverse of these has on both sides existed. No wonder, then, at the utter chaos and confusion which has arisen!

I do not go into these particulars with a view to take either side on a question on which the public mind has been lashed almost into frenzy. Where one party is disposed to approve and the other utterly to condemn the whole of what is laid before them, woe to the ill-starred wight who ventures to suggest intermediate or moderate views. The exceptional character, however, of the subject is such as to outweigh all such risks, and my object in going into the matter is to urge the importance and the justice of an *absolutely dispassionate* investigation of all the questions at issue, each calmly and on its own merits. I do not think that this can possibly be done by those who have allowed themselves to become infuriated, and have committed themselves to desperate extremes, but I feel convinced that, if entered upon in a calm manner and a spirit of justice and good feeling, by persons at once qualified and uncompromised, the difficulties would one by one vanish, and that the highly talented architect and his eminent colleagues of his own and the sister arts would produce a result which might defy hostile criticism, and be acknowledged to be a system of treatment worthy of the great architect of whose work they are continuators. Mr. Burges is accused of speaking contumeliously of Sir Christopher

Wren, and of not having paid due regard to his intentions; but who does not sometimes in an unguarded moment give vent to thoughtless expressions afterwards regretted, and who is the judge of Sir Christopher's intentions? Indeed, if Mr. Burges were disposed to carry the same accusations into the camp of his critics, he could readily obtain practical commentaries on both of these questions from the writings of our talented and valued friend, Mr. Fergusson, who may be shewn to have repeatedly said about as hard things of Wren in good earnest, as Mr. Burges, unhappily, seems to have said (let us hope) in jest; nay, that he has not long since proposed in a printed letter to the Dean, almost entirely to reconstruct Wren's choir, converting it bodily into a new and vast dome of which he gives a design. This, however, he defends against all charges of irreverence for the great architect's intentions, such as he feels it right to press against Mr. Burges, by pointing it out to be composed of *Wrennic elements*, and by expressing his earnest conviction that, had Sir Christopher foreseen the change, it would have gladdened his death-bed, and it is almost suggested that, were it possible, he would *even now*, signify his approval of the proposal.

Mr. Ferguson has more recently condemned *in toto*, the use of mosaic so early and so publicly announced by the programme, and repudiated the Italian architects to whose works Mr. Burges had been so emphatically referred; so that, so far as he could look to that gentleman as a guide, poor Mr. Burges must find himself reduced to a state of supreme puzzlement, which seems to demand some new and unpledged agency to clear it away. Anyhow, unless some such step be taken, this noble project of completing St. Paul's, which has for years excited such lively interest, seems doomed to inevitable shipwreck; for depend upon it, the Dean and Chapter will never incur the responsibility of making it over to amateurs. My personal wish would be to see the two architects working hand in hand; each supplying that in which his special strength lies, and both together guiding into unity the efforts of a band of the noblest artists whom our age can produce.

But, whatever may be the course pursued, I would urge that the work be one of *completion* and of *decoration*, and in no degree, however small, a work of architectural *alteration*. The public have long since accepted the one, but they justly reject the other; for, to use with a slight modification, the words of an excellent modern writer (though they cut in one special instance, I am sorry to say, against myself):

"Patchwork improvements in the modern style,
Bestow'd upon some venerable pile,
Do but deface it—structures to revise
That *Wren* has built—*another Wren* must rise."

THE ROYAL GOLD MEDAL.

I now come to a circumstance which has caused some feeling of vexation, though it has happily culminated in what would, but for a melancholy circumstance, have been the most agreeable item in the agenda of this evening. I refer to the award of the Royal Gold Medal for the year 1874.

Had the Council from the first determined to recommend as the recipient of the medal for this year an English architect, there would scarcely have been room for a doubt as to the architect whom they would have selected; but they, after careful consideration, thought that on this occasion the consideration should be limited to Englishmen distinguished for their literary productions in connection with architecture,—and it was most natural that, under these conditions, the choice should fall on Mr. Ruskin. That gentleman being abroad, we failed to obtain an immediate reply from him to the intimation of our choice; and time pressing, the recommendation of the Council, after being ratified by the general meeting of the Institute, was communicated to Her Majesty, and received her gracious approval.

To our great disappointment, we afterwards received from Mr. Ruskin a letter in which he declined to accept the proposed honour; a refusal which subsequent correspondence failed in inducing him to retract. As the season was then far advanced, I suggested through General Sir Thomas Biddulph that the award might perhaps remain in abeyance for this year; but on receiving Her Majesty's command to submit to her another name, the Council rescinded their former resolution, (*viz.* that an author rather than an architect should be recommended), and unanimously chose Mr. Street;—a choice since confirmed by a general meeting of the Institute and graciously approved by the Queen.

In judging of the conduct of Mr. Ruskin in declining the proposed honour, a wide range of circumstance and sentiment demands our consideration. In my own personal communication to him on the subject, besides the apparent disregard which his refusal seemed to involve for the honour graciously offered by the Sovereign, I argued that he and our Institute were labourers in the same cause whether we define that cause as the advancement and perfecting of architectural art or the conservation of its ancient monuments and productions; that, in so far as we may have failed, we were sharers in that failure, and *vice versâ*; and that for him to refuse the sympathy of us—a corporation established for those ends, as expressed towards himself—a corporation sole labouring in the same direction—was, to say the least, vexatious and inconsistent.

His ostensible reasons were based on the general havoc he found, whether in the form of "restoration" or of direct spoliation, made or making in all countries with ancient monuments; and I argued that we had for years had a standing committee for their defence in this country, and were really doing actively and practically what he advocated for their preservation; so that to visit these misdoings on us would be the reverse of being just.

It may be reasonable, however, to modify our judgment by taking another view of the case. In doing this we may remember that Mr. Ruskin has ever raised a protesting voice against the artistic or non-artistic vices of the age. Had we at once co-operated with him and been successful in stemming the course of these vices, it would on his view be consistent for us now to be giving and receiving compliments and congratulations; but as he says we took no notice, twenty years back, when he lifted up his voice like a trumpet, and he adds that now we desire to show sympathy we cannot point to a very practical result as a ground for our congratulations, but, on the contrary, are compelled to admit that the ancient monuments of every country in Europe, and our own no less than others, show at all points the marks of the desolating hand of pseudo-restoration or of open rapine.

The instances which Mr. Ruskin selects as representative of this deplorable class of facts are as follows:—

1st. The neglected and sordid condition of the tomb of Cardinal Brancaccio at Naples, which he views as the most important example in Europe of the architectural sculpture of the fifteenth century.

2nd. The conversion of the church of San Miniato, at Florence, the most beautiful example of the twelfth century architecture in that city, into a common cemetery.

3rd. The destructive restorations carried on in the exquisite chapel Santa Maria della Spina, at Pisa.

4th. The recklessness with which the ruins of Furness Abbey have been approached by the railway engineers.

These four facts he considers only too illustrative of the general agency of the public, and of the builders employed by them, on the existing architecture of Europe; consisting in the injurious neglect of the most precious works, in the destruction under the name of restoration of the most celebrated works for the sake of emolument, and in the sacrifice of any and all to temporary convenience.

For the existence of this state of things he considers that we—the members actual and honorary of the Institute of British Architects—are assuredly answerable, at least in England; and under these

circumstances, he says, he cannot but feel that it is no time for us to play at adjudging medals to each other, and that he must for his own part very solemnly decline concurrence in such complimentary formalities, whether as regards others or himself. "For we have none of us," it seems to him, "any right remaining either to bestow or to receive honours, and least of all those which proceed from the grace and involve the dignity of the British Throne." He concludes with an assurance of his personal respect for the members of the Institute, and of profound regret at finding himself compelled to decline their intended kindness and courtesy.

Now, all this may be viewed from two very different points. We may, on the one hand, very fairly protest against the injustice of being made in any degree responsible for acts in which we have had no hand, over which we had no control, and against which we should protest as loudly as Mr. Ruskin; but, on the other hand, we, being the incorporated representatives of architectural practice, may, in a certain sense, be held to represent its *vices* as well as its *virtues*, and in the eyes of a self-constituted censor, and one who from his first appearance before the public has devoted himself wholly to protest and warning, we can hardly wonder that, if he holds us thus responsible, he should not think it a time for us to be playing at compliments with our censor.

Read for a moment his expressions of righteous indignation uttered nearly a quarter of a century back, and imagine what must be his feelings wherever he directs his steps. If he travels in France, he finds restoration so rampant that nothing which shows much of the hand of time is considered worthy of continued existence, but must be re-worked or renewed, cleverly, artistically, and learnedly perhaps, but nevertheless it is *new work* taking the place of the *old work*, or the old work re-tooled till scarce a vestige of the surface on which the old men wrought so lovingly is allowed to remain. If he goes into Italy, much the same meets his eye. In his own Venice the Fondaco dei Turchi, the most venerable secular Byzantine work, is rebuilt. At Rome, he would observe, an area of some half a square mile excavated and carted away, which contained—discovered only to be in great measure destroyed—the ancient wall of Servius Tullius, twelve feet thick, of solid masonry, and against it a second Pompeii of antique Roman houses, hardly explored, but merely disinterred and carted away as rubbish. At Assisi he would find the works of Cimabue and Giotto in the hands of the restorer, though, as I trust, with better promise. In Belgium he would find ancient buildings chipped over and made to look like new; or, as is the case with the wonderful church of the Dominicans, at Ghent, deliberately destroyed. And, is the case much better in our own country? Has not the hand of false and destructive restoration swept like a plague over the length and breadth of our land, and are not those churches which have been treated with veneration and care a mere gleanings among those which have been dealt with in careless ignorance of any value to be attached to them? To Mr. Ruskin's eye the best of our restorations are mere vandalisms, for he protests against them root and branch; and to him all the difficulties and disappointments met with in carrying them out would be only so many reasons for reproaching us for having undertaken them at all. Anyhow, he would find in England far more than one half of our ancient churches to have been so dealt with by ignorant and sacrilegious hands that one is ready to curse the day when the then youthful Cambridge Camden Society, all too sanguine and ardent, adopted for their motto the ominous words so sadly realized, "*Donec Templum refeceris.*" But restoration has not laboured alone in the work of Vandalism; deliberate destruction has been rife amongst us. Has not one great cathedral body deliberately pulled down its ancient hospitable hall of the 14th century, and another its stupendous tythe barn of the 13th? Near another cathedral, where the episcopal palace is formed out of a vast Norman hall, (the sole remaining instance of a hall of that age supported by original timber pillars and arcades), I have only just now seen some of these timber arches lying as old material in a builder's yard, having been turned out, I fear under the eye of a Fellow of this Institute, for the purpose, to use Mr. Ruskin's own words, of "temporary convenience."

Knowing, then, who it is that we have sought to honour, we need not, on consideration, wonder that he does not permit his ascetic voice to be softened by our proffered compliment, but that he rather exclaims like a fellow-ascetic of olden time: "Is it a time to receive money and to receive garments, and olive yards and vineyards?"—"It is no time for us to play at adjudging medals to each other."

Fully, however, as we may allow that we have in these days more cause for humiliation than for mutual gratulation, we cannot go so far as to admit that this deprives us of the right and privilege of giving honour where we know that honour is due. Great as are Mr. Ruskin's merits, they are in the main those of *words* rather than of *deeds*; we would fain have paid a tribute of acknowledgment to the utterer of those burning words, whether we may in all points agree with them or not; but our approaches having been repelled, we, in reconsidering our position, determined to transfer the honour to one who has shown himself great in actual and substantial works of the highest merit; and we feel that in doing so we honour also another powerful and instructive writer on Architecture; and, while rescinding our resolution that "the consideration of the person to be recommended for the Gold Medal of 1874 be limited to Englishmen distinguished for their literary productions in connection with architecture," and determining to recommend an English architect, we scarcely depart from the spirit of the resolution we rescind, for we are only adding to the qualifications which it prescribed, the more substantial merits of a great practical architect. Mr. Ruskin says we have not any right remaining either to bestow or receive honours; but he perhaps reserves to himself the pontifical power of dispensation; and as he has somewhere pronounced of Mr. Street's greatest work in prospect, that it will be a source of perpetual delight to future generations, we may fairly presume that he has thereby exempted Mr. Street from the disability referred to. Anyhow, we will not only venture on acting instrumentally in the bestowing of this honour, but may go the length of congratulating ourselves on having been led by force of circumstances to a better choice than we had at first made.

I may say for myself that I had gone to the Council meeting with the intention of proposing Mr. Street, when the course of discussion led us to choose a man whom we might have guessed, had we sufficiently thought of it, would be likely to bring some theory to militate against our intentions, and who has really not done so much to merit this honour as Mr. Street; for, after all, an anathematizer of what is bad claims lesser honours than he who practically carries out what is good.

Mr. Street, I feel, needs no laudation from me; but I cannot forbear to say a little in that direction. It was my privilege to know him in very early life, when he had just completed the years of his pupilage. He was already a most devoted and advanced student of mediæval architecture; so much so, that I have within the present year mistaken for old mediæval work, details which I now believe were produced by him during his pupilage. From that time (the date I refrain from giving as it may betray my own antiquity) I knew Mr. Street, in the most practical manner possible, till he commenced practice, and had every means of watching the rapid development of his artistic power, his intense devotion to his art, and his almost super-human capability of hard work, and that in its most artistic form; added to his enormous study of ancient examples of the style to which he especially devoted himself. Since then his labours need no record; they have been ever before the public. He sprung suddenly into fame, and has been ever advancing more and more rapidly in the estimation of all who can appreciate genius and skill, till he has attained a point of eminence beyond which an architect need scarcely aspire.

I will not attempt to enumerate even a small selection of Mr. Street's works. They are sown broadcast over this and other countries, and it is our own fault if we are not personally acquainted with their excellencies. I will rather dwell on the *moral* side of Mr. Street's artistic character; his *steady pertinacity* in following on the great movement to which he from the first attached himself. I will not say that he has been wholly unmoved by the passing fluctuations of taste which ever and anon float over us; that would be to convert steadfastness into dull immobility; but he has adhered with absolute

loyalty to the great revival, and that in its best form,—the revival of the earlier, the most vigorous, and more perfect types of mediæval art. For it is my opinion that no revival can be defended which is not based on the *best*, the *most pure*, and the *most vigorous* types of the style to be revived. Not only, then, has Mr. Street closed his ears to the siren's song which would lure him away from his great purpose by the quaint mysteries of the period when Gothic had been lost and Classic *not* regained, or by the blandishments of Queen Anne of blessed memory, but he has resisted in a great degree even that eclectiveness which would treat all the true varieties of mediæval art as having an equal or even a joint claim to revival. I envy and revere this unbending steadfastness, and earnestly wish that it may prevail.

I alluded in my last year's address to Mr. Street's great and mighty work, the Law Courts, and expressed a hope that the threatened cutting down in costs would be reconsidered and relinquished. I know not how this matter may stand, but I repeat my earnest hope that in a work of so much magnificence and of so national a character, no petty economies will be allowed place, but that it may be carried out in all its integrity and nobleness. I have not that knowledge of the design which would warrant my offering any remarks upon it. I have alluded to Mr. Ruskin's expression of feeling, and will avoid thrusting my head into (what shall I say?) *the busy hive of critics*, though, as the industrious swarm seems just now to have settled under a neighbouring cupola, there, perhaps at once to distil their sweet condiments, and to whet their spicula for another contest, I am probably shrinking from a danger which has ceased to exist. I will content myself with wishing all success to Mr. Street's great work.

But, as I have said before, Mr. Street's claims do not rest wholly on his structural works. He is an author of no mean eminence, and his volumes on "The Brick and Marble Architecture of Italy," and on the "Gothic Architecture of Spain," will always stand forth as practical evidences of this fact, not to mention the more fugitive productions of his pen. These works are not only of the utmost value from the talent of their author, but are more especially so as proceeding from one who has probably extended his studies and his wonderful powers of sketching to the mediæval buildings of a greater number of countries and places than any other living man.

Since I wrote the above, an affliction of the heaviest form has fallen upon him whom we were rejoicing to honour. He has suddenly been bereft of the companion of his life, the sharer of his wonderful success, and the efficient and sympathising coadjutor in many of the labours, collateral, to say the least, to those which have rendered his career so brilliant. We have already, in our corporate capacity, expressed to him our deep condolence, and every member of this Institute will render him, silently or expressed, his own special tribute of heartfelt sympathy. We are necessarily, through this most sad event, deprived of the pleasure which would have arisen from a personal presentation of the Medal; and Mr. Street has deputed *his* valued friend and *ours*, Mr. Pearson, to receive it in his name. *Par nobile fratrum!* Mr. Street is appropriately represented by a brother architect, whose works are well worthy to stand side by side with his own; and I hope to see the day when Mr. Pearson may receive this token of honour otherwise than as a deputy. I beg you, my dear Mr. Pearson, to receive this medal—the gift of the Queen—in the name of our common friend, Mr. Street, and to assure him of our admiration of his genius, and the share we one and all feel in his sorrow.

Mr. Pearson, A.R.A., having received the medal for Mr. Street, briefly acknowledged his appreciation of the honour and Sir Gilbert's complimentary remarks.

Professor DONALDSON said—After an involuntary absence of some years, I have the greatest pleasure at being present on an occasion when the chair is occupied by our distinguished President, Sir Gilbert Scott. I am sure we all sympathised with him in the illness, which necessitated his absence at the opening of the last session of the Institute, as we all now rejoice at seeing

him looking so well and recovered from his recent indisposition. We regard Sir Gilbert as a great example of a great architect—an example to imitate and look up to, I hope, for many years. Allusion has been made by our president to the pulling to pieces of our cathedrals and other public buildings, but I believe it is the unanimous feeling of the profession and of the public, that in no hands can our cathedrals be safer than in his. With great pleasure and happiness I have to propose that the best thanks of the Institute be proffered to Sir Gilbert Scott for the eloquent address with which he has favoured us. (Loud applause). The President has alluded to the study of ancient buildings, as having been a great source of pleasure to him in his earlier days. No doubt we all feel, that, in our early years in going abroad and studying the works of past periods, we have been stimulated to devote ourselves more intensely to the perfecting of our knowledge of the art, and striving to imitate the great men who have gone before. For my own part, I can say, that the five years which I spent in France, Italy, Greece, and Asia Minor, I now look back upon with delight, as being the period of the poetry of my existence. No doubt you have all felt this in visiting those countries, and in studying the monuments which they contain; and they could hardly have failed to stimulate you to greater exertions in the study and practice of your art. The President has borne feeling testimony to the merits of one whom we all admired—I may say loved—that is Mr. Owen Jones; (hear, hear). A better man never lived—a man of exquisite taste and perseverance and energy; who devoted not only time and powers, but also a modest though considerable fortune, to the perfecting of the great work of the Alhambra, which he brought to so successful an issue. His memory is dear to us all, and we must all look forward with eager anticipation to Sir Digby Wyatt's promised memoir of him. It is a touching circumstance that, instead of seeing Sir Digby amongst us this evening, we find that he is abroad for the restoration of his health, but our hope is, that he may return looking as well and as radiant as we are happy in seeing our President looking this evening. (Applause). It will be a great pleasure to us to receive that memoir from Sir Digby Wyatt, inasmuch as his cultivated mind and noble disposition, his fine appreciation of art, and his felicity of expression, render whatever comes either from his pencil or his pen, of great value and interest to us all. Many topics have been touched upon by our President with feeling and judgment. I will not trespass upon your time with any remarks upon Gothic art, nor will I follow him far into St. Paul's. I will merely say, I do not think Sir Christopher Wren has once used the word "gold" in connection with the decoration of St. Paul's. We all wish, I am sure, that this magnificent building should not only excel others in internal decoration, but that its embellishment should be carried out in the spirit and sobriety of Sir Christopher Wren's designs. It is not in mere gorgeousness of decoration alone, that a work, so noble as that which the great architect has left to us, can be satisfactorily completed. I have great pleasure in now proposing a cordial vote of thanks to our President, for his very able and eloquent address.

Mr. THOMAS HENRY WYATT: I beg very cordially to second the proposition. I will not detain you by expressing my admiration of the address we have heard. I would say one word with regard to my brother. I know what grief it has occasioned him that he has not been able to prepare his promised memoir of the late Mr. Owen Jones. Owing to the state of his health, my brother has been compelled to go abroad, but your regret with regard to the paper will be lessened when I tell you that my brother will take the earliest opportunity possible to fulfil his promise. (Cheers).

Professor DONALDSON then put the motion, which was adopted by acclamation, and the Meeting then adjourned.

Royal Institute of British Architects.

At the Ordinary General Meeting of the Institute, held on Monday, the 16th of November, 1874,
JOHN GIBSON, Vice-President, in the Chair, the following Paper was read:—

THE ORWELL PARK OBSERVATORY,

By J. MACVICAR ANDERSON, Fellow.

It is not my intention to occupy your time by offering any apologies for my presence here this evening. I am fully sensible of my own shortcomings, and of what may appear presumption in venturing to address men, many of whom are, no doubt, of greater age, and possess more extensive experience than myself. I am still more sensible of the great disadvantage under which I labour, following so close upon the eloquent Address of our distinguished President. Let it suffice to assure you that I should not have appeared here unasked, but acting on the principle, that it is the duty of each one of us to do something for the benefit of the body corporate (a duty which I fear each member of the Institute does not realize to the extent that might be wished), I thought, that in response to the invitation of our Secretary, I might venture to impart to you a brief narrative of some professional experience acquired in the arrangement and execution of a building which was entrusted to my care, and to which I do not direct your attention on account of its magnitude or importance, so much as because it possessed, in many respects, features of a distinctive and exceptional character.

To design an Observatory cannot fail to be, I should think, under any circumstances, a work of considerable interest, calling for the exercise of great care and no small amount of ingenuity; but when, as was the case at Orwell Park, the Observatory had to be connected with an existing edifice, so connected as to admit of facility of access, and to combine with the somewhat complicated domestic arrangements of a country mansion, and yet so isolated, as to secure complete privacy and perfect quiet to the astronomical observer, the difficulties, I apprehend, are intensified to no small extent. As the Observatory, of which I am now about to give some account, formed only a portion of other works which I was called upon to design at the same time in connection with the house at Orwell Park, I think it may not be altogether without interest, and at all events is essential to the proper understanding of the subject, that I should in the first instance trouble you with a very brief sketch of the whole scheme, so as to convey some idea of what the house was before the operations in question were commenced, and what the nature of the requirements were that I had to fulfil. Without this it would be quite impossible for you to arrive at anything like a correct judgment as to the result.

The original house consisted of a square block, to which had, at various times, been added the several adjuncts you see on the large plan, such as the picture gallery, billiard room, and conservatory to the west, and an entirely new wing to the east, embracing the whole of the domestic offices, and beyond that again, the stable offices, brew-house, and laundry offices, &c. In connection with these additions the main block of the mansion had, so far as the south front is concerned, been refaced, and made to assume the architectural garb it now possesses. These operations had, at different periods, been carried out by the late Mr. Burn. Such was the subject for treatment. The requirements of the proprietor were, one or two suites of first class bedrooms, in which the house was deemed to be deficient,

forming state apartments, a Turkish bath, and, though last not least, an Observatory, with other minor and subsidiary wants not necessary to specify. The main building, comprising the principal apartments, was complete in itself, and answered every purpose required of it. The east wing, comprising the domestic offices, was excellently arranged in point of comfort and convenience, and of a substantial character. It was clear, therefore, that neither one nor the other could be materially altered without disturbing arrangements which were good, and incurring a large and unnecessary outlay. Accordingly I resolved to adopt an arrangement which possessed the merit of retaining the whole of the existing buildings intact, with some unimportant exceptions—while it extended to more than double its then length the principal architectural front of the building, and obviated the inconvenience of the servants' offices overlooking the private grounds. This was done by building up the whole of the windows of the offices which looked to the south, and (by the sacrifice of one or two servants' bedrooms only, which were obtained elsewhere) lighting and thoroughly ventilating from the roof the offices which had previously looked to the south, an operation which proved perfectly successful and satisfactory. This simple expedient solved all difficulty, for the whole space to the south of the east wing was thus made available for the erection of an entirely new wing, comprising the additional accommodation that was required, shutting out from view the ugly and unfinished appearance of the old east wing, and completing the architectural façade of the building to the south. This new wing consisted of a handsome suite of apartments on each floor, so arranged that the rooms might be used together or separately, as occasion required, accessible on both floors by means of a corridor 170 feet in length; in connection with which was provided a new principal staircase, a feature of which the house was much in want. At the extreme easterly end of this new wing I placed the Observatory, thereby providing a handsome and convenient access from either floor, by means of the corridors already mentioned, and at the same time securing that complete isolation that the peculiar circumstances of the case called for. The rooms on the principal floor were arranged so that they might be used as a complete suite of family apartments, the proprietor's business room being at the east end of the suite, in close proximity to which—but properly shut off—were the Turkish bath chambers, and in immediate communication with which was the observatory above, by means of the private staircase.

Having thus taken a cursory survey of the general arrangement, I will now proceed to describe in detail the portion of the work which more immediately concerns us at present.

To say that an Observatory is a place from which to study and take observations of the Heavenly bodies, is to repeat a definition familiar to every schoolboy—but accepting that definition as correct, it follows that the structure is one which is formed for the reception, permanently, of astronomical instruments of the utmost delicacy, and of great intrinsic value—the mathematical accuracy and consequent utility of which would be destroyed by the smallest defect in the constructive properties of the edifice which contains them—and I think, therefore, that I am not exaggerating the importance of the subject when I say that there is, perhaps, no building which calls for more anxious thought, and more careful attention to every detail, on the part of the architect to whose care it is confided. On the other hand, there is perhaps no subject, the peculiar properties of which lend themselves so little to the production of a good architectural effect—so much so that it has been doubted, by Gwilt, whether it is possible to combine such features with beauty of design. And when it is considered, for instance, that the dome of an Observatory intended for an equatorial instrument, such as the one at Orwell Park, must be made to revolve, must have a moveable shutter, and must be finished without any lantern or spiral termination, it must be conceded that the doubt which I have alluded to did not arise without sufficient reason. I shall probably illustrate most clearly the difficulties attending the design and erection of such a building, whether viewed from a constructional or architectural point of view, by referring in point of order to what appear

to me questions of primary importance, and by explaining how such questions were treated in the case of the Orwell Park Observatory.

The first point of primary importance that demands attention in the construction of such a building, the site. In the case of Orwell Park, this did not admit of much choice, inasmuch as the observatory was required to form part of the mansion. Fortunately, the position of the house, standing as it does on the high banks of the river Orwell, was well adapted to the required purpose. As a rule, however, for general guidance, I believe the best position for an observatory is considered to be the summit of a low hill or rising ground, so as to command the horizon without entailing the expense, and involving the difficulties, which attend the construction of a lofty edifice. At Orwell Park the Observatory, although standing on high ground, had necessarily to be of considerable height, in order to surmount the adjacent buildings and the lofty trees in the vicinity. It was stipulated by Mr. Airy, the engineer who designed the scientific and mechanical portions of the work, that the floor of the equatorial room should be 6 feet below the top of the highest chimney in the mansion adjoining, a stipulation which involved a height of 53 feet from the ground level, and of 72 feet to the top of the dome, the total height from the bed of the foundations to the top of the dome being 86 feet. In selecting the site of an Observatory, it is important that the situation should be dry and free from moisture, and it is to be further noted that when it is in the vicinity of a river, the Observatory should be placed at such an elevation as to be above the reach of fogs, for such may prevail when the sky above is clear and well adapted for astronomical observations. I gather from an article recently published in "Engineering" by Mr. Airy, that he "has frequently seen a dense fog extending as high as 100 feet above the Thames, at Greenwich, while at the Royal Observatory, 150 feet above the river, the air was perfectly clear, and the stars brilliant."

The next point of primary importance that calls for special consideration, is the nature of the Foundation. It is not so much on account of the actual weight of the superstructure (although in the case in point that was very considerable) as on account of the absolute necessity of securing a basis perfectly immovable, beyond all fear of settlement, and above all, free from any chance of vibration. The nature of the foundation at Orwell Park was a hard loamy sand, which was so firm that for the buildings generally I did not deem it necessary to resort to any artificial foundation, but bedded the footings at once upon the sand. In the case of the Observatory, however, where the excavations had to be carried to a considerably greater depth, there were occasional soft places, with water. The soil in such places was removed, and the holes filled in with concrete, and in addition to this, the whole Observatory building was placed upon one solid bed of concrete, 4 feet in thickness, and extending 30 inches beyond the lower course of the footings. The only possible objection that might be urged against this plan is, that the concrete being one mass, upon which both the outer walls and the central pier of the Observatory stand, might act as a conductor of tremour or vibration from the outer shell to the kernel which it enclosed. The chances of this, however, were considered remote in the case in point, and the result has, I believe, perfectly justified the conclusions then arrived at. One can easily imagine, however, that were the central pier made to stand upon a foundation separate from that of the building which encloses it, and consisting say of piles driven deep into the surface of the earth, there would be less risk of the pier being affected, even to the remotest extent, by vibration—and in theory, therefore, it may I suppose be conceded, that such a foundation would be the most perfect—but from a practical point of view, the distinction does not appear to my mind to be one of material consequence.

Next in importance, and second only to the foundation upon which it stands, comes the Pier or pillar which constitutes the heart of the structure, being the support of the instrument in the Observatory above. The difficulty in obtaining a secure support for the instrument, perfectly free from vibration,

must of course increase proportionately with the height to which it is carried—and it might possibly be better in some cases where the height is exceptionally great, or where it might facilitate the planning of the lower portions of the building, to introduce more than one support, thereby leaving a clear space beneath uninterrupted by any central shaft. In the case of Orwell Park, Mr. Airy stipulated that the instrument should be supported upon one central pier or pillar, circular on plan, and carried up from the foundation to the height of 60 feet in one solid and unbroken mass of brickwork. At the base, and for the height of 12 feet, this pier was 10 feet in diameter; from this point to the height of 32 feet it was 8 feet in diameter; and for the remaining 16 feet it was 6 feet in diameter. It is perhaps superfluous to state that the brickwork of this pier was of the very best description; but it is worth noting that it was built in mortar, not cement, by Mr. Airy's special desire, the former material being less subject to expansion; and the precaution was taken of carrying up the work slowly, so as to allow the brickwork to set thoroughly throughout the entire mass of the column. At the level of 7 feet from the top of the pier, a 12 inch hard York stone, from the Idlestone quarry, was inserted, 6 feet diameter, and again on the top of the pier a similar stone was bedded, which latter formed the upper surface of the column at the exact level of 3 feet 10 inches below the floor of the equatorial room, and to this stone was afterwards fixed the iron easting which formed the support of the instrument.

The one point of supreme importance, which required to be specially attended to in connection with this pier was, that it should have absolutely no contact whatever with any portion of the surrounding building, from the foundation upwards, just as much so indeed as if it had stood by itself, an isolated pillar. To effect this object I encased the pier with a circular wall of 14 inch brickwork the whole height from the foundation upwards to the floor of the Observatory, leaving a clear space of 6 inches throughout between the outer surface of the pier and the inner surface of the enclosing wall, and thus it became utterly impossible that the pier could be, even to the smallest extent, affected by its proximity to the surrounding buildings. The diameter of this circular wall, as it might be called, was made to diminish upwards, following the diminishing diameter of the pier which it encased, so as not to lose space in the surrounding building, which might prove valuable for other purposes. The internal diameter of the dome of the Observatory was fixed by Mr. Airy at 20 feet in the clear, and the circular walls which supported it and formed the equatorial room, were consequently required to enclose a space 19 feet 6 inches diameter. It is obvious that had these walls been carried up from the foundations, the space between them and the 14 inch wall enclosing the pier would, especially towards the bottom, have been so limited as to have been practically useless. On the lower floors, therefore, I constructed the building of a much larger diameter, and of octagonal form, measuring 32 feet from out to out. By this means I obtained a space all round the central pier, 7 feet 6 inches in the clear between the external walls and the 14 inch enclosing wall already alluded to.

This space in the principal floor appeared to me well adapted for what was one of the requirements of the Proprietor, a Turkish bath. I therefore formed an adjunct to the Observatory building on this floor, and placed therein the "sudarium" and "tepidarium," being the two hot chambers, and reserved the whole of the space surrounding the central pier of the observatory for the "frigidarium" or cooling chamber. These chambers were heated by a special furnace, placed in the basement immediately beneath, capable of raising the temperature in the innermost or hot chamber to 200 degrees, and a proportionate amount of warmth was also introduced to the other chambers, the whole being so arranged that the temperature in each chamber could be regulated as might be desired. The cooling chamber, which occupied the space around the central pier of the Observatory, was of octagonal form, and was proposed to be finished in a style of Oriental luxuriance, with shafts of polished marble, a dado and wall linings of coloured marbles, and a veined marble floor, the groining, which was executed in plaster, being intended for

ORWELL PARK OBSERVATORY.

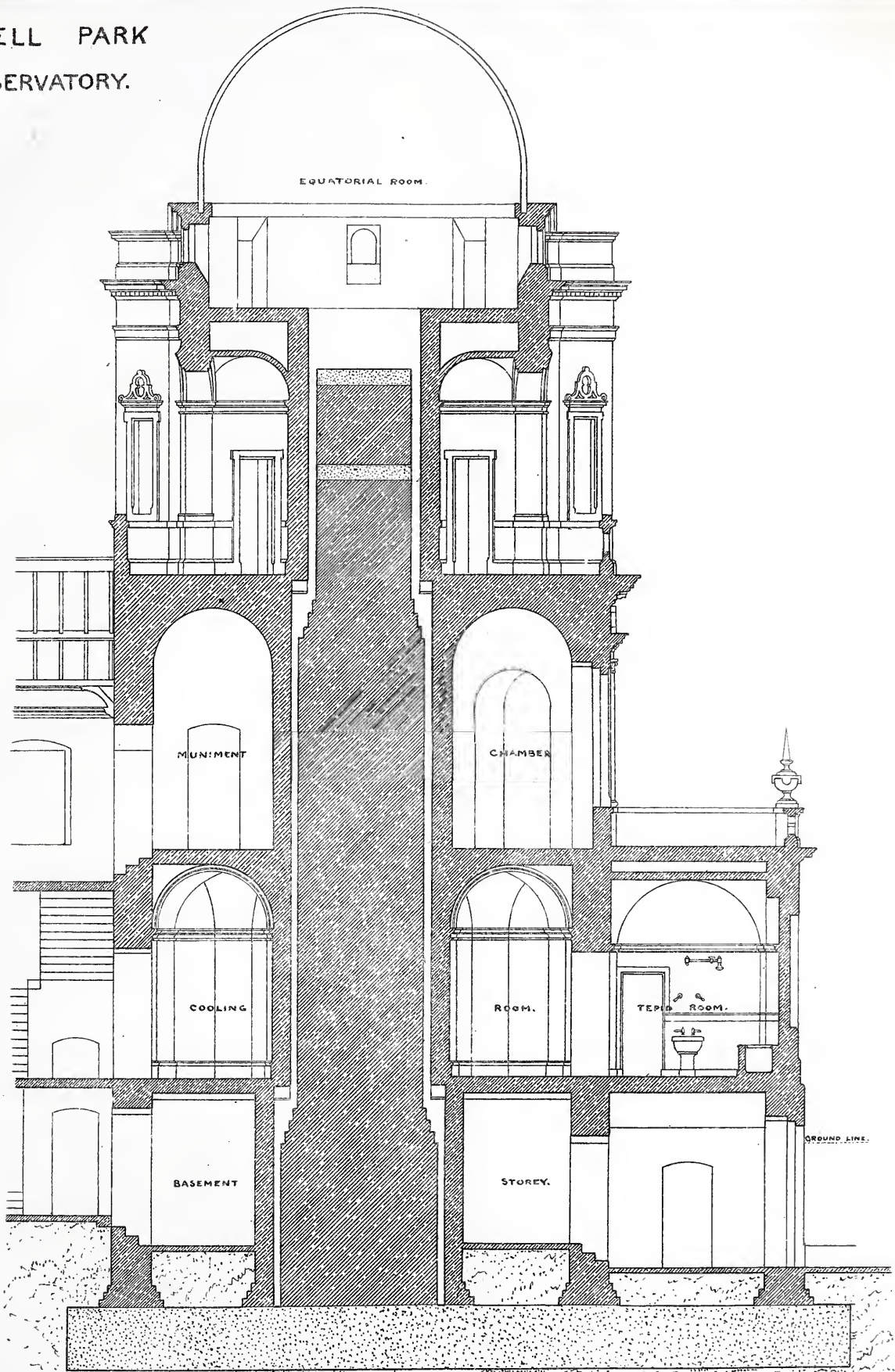

SECTION.

SCALE OF 10 5 0 10 20 FEET.

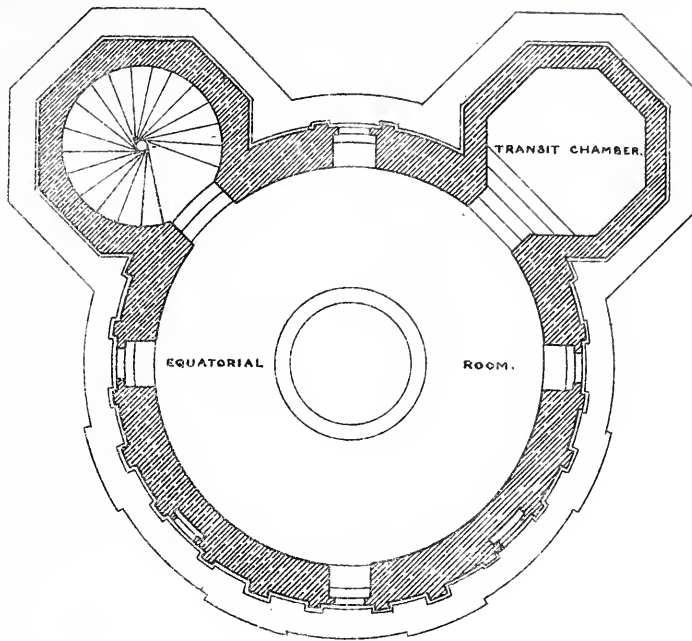

PLAN OF THE UPPER FLOOR.

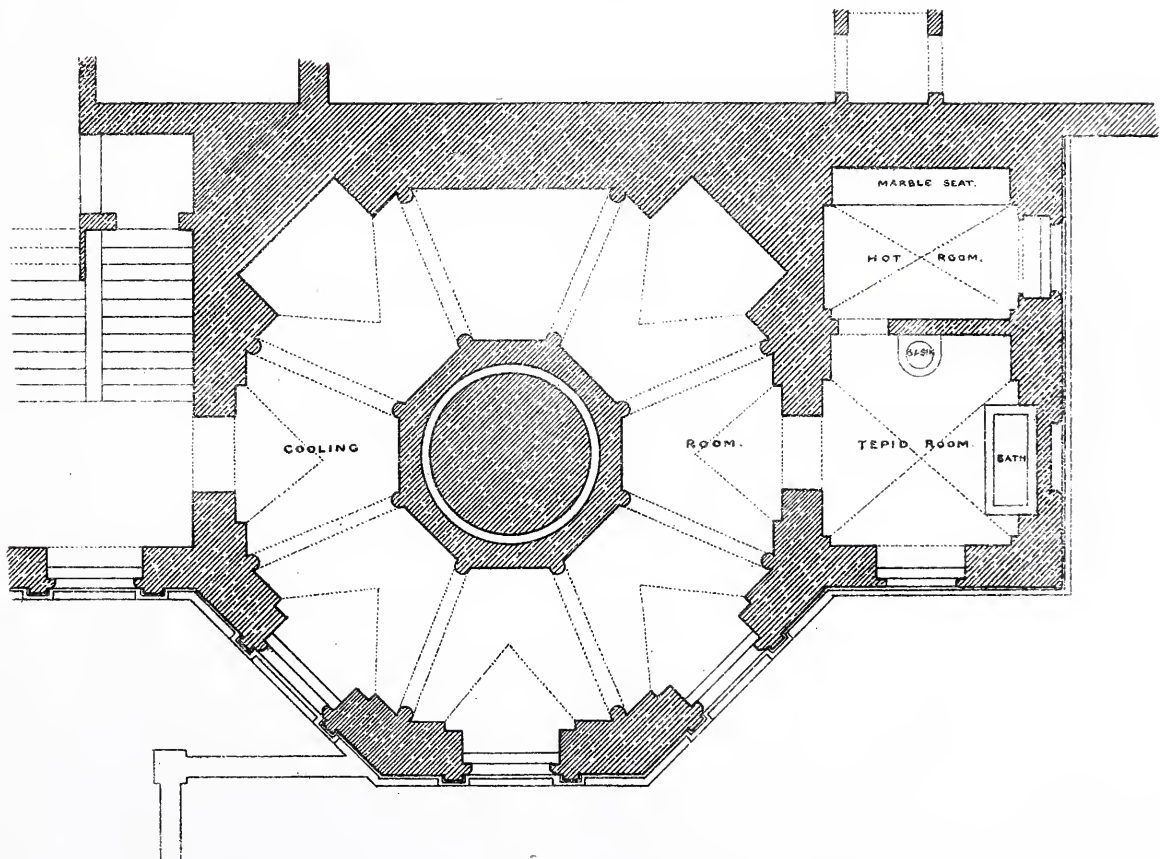

PLAN OF THE GROUND FLOOR.

(TURKISH BATH.)

SCALE 0 10 20 30 FEET.

coloured and painted decoration. The large recesses were prepared for luxurious couches, and the chamber was thus intended to form a sumptuous and agreeable lounge for general purposes, as well as for the more immediate requirements of the Turkish bath. The space on the first floor, immediately above, was occupied as a muniment room, arched over, as well as the chamber beneath, with brickwork in cement. On the floor above this muniment room, the circular external walls of the Observatory proper commence. These, however, were not in any way supported on the brick arches just referred to, but upon a series of sixteen wrought iron girders, resting at one end on the external walls of the octagon below, and at the other on the 14 inch wall enclosing the central pier, overlapping the latter inwards, so as to form the support to the diminished diameter of the 14 inch enclosing wall above, and receiving about midway between the bearings the circular wall of the Observatory. At this level, the space was occupied by a Belvidere, accessible by means of the spiral stone stair leading to the equatorial room above, and from which might be obtained good views of the park and surrounding scenery. For this purpose the walls of the Observatory were on this floor pierced with a series of arches, and the junction architecturally between this circular building and the larger octagonal one below, was formed with large scrolls or trusses of moulded and carved masonry, one being placed over each angle of the octagon. The Observatory itself, or, as it is otherwise called, the equatorial room, was reached by means of the spiral stair already referred to, at the top of which was a doorway, 6 feet high by 2 feet 6 inches wide, the height of the door being thus restricted in consequence of Mr. Airy's stipulation that the extreme top of the observatory wall should be exactly 6 feet 5 inches above the level of the floor. The Observatory as has been already stated, was circular on plan, 19 feet 6 inches diameter in clear of the walls, which were $22\frac{1}{2}$ inches in thickness. It was lighted by means of small circular headed windows in the walls forming lucarnes externally, the apex of which did not rise above the stipulated height of 6 feet 5 inches from the floor. Corresponding with the doorway from the circular stair, was another and similar doorway leading to the Transit chamber, a small room prepared for the reception of the transit instrument, a necessary accompaniment to the equatorial instrument which Mr. Airy adopted for the Observatory. In the floor of this chamber a hard York stone, 5 feet by 3 feet, was fixed, forming the foundation for the transit instrument. It was stipulated that this chamber should be upon a certain axis, which condition I was so far fortunate in securing by placing it on the north east side of the Observatory, corresponding to the spiral stair on the north west side, in which position they were less prominent than they could have been elsewhere. These projections or turrets for the stair and the transit chamber, it was difficult to make architecturally effective, in consequence, first, of their destroying the circular outline of the Observatory, and secondly, of the necessity of keeping them beneath the top of the general line of masonry, and finishing them with flat roofs. They were in short excrescences, to which I did not hope so much to impart beauty, as to redeem them from positive ugliness.

It is not my intention to enter at all in detail upon the construction of the Dome, or of the mechanical contrivances for working it, nor yet to allude even to the astronomical instruments, because these will be much more ably and clearly described by the engineer who designed them, Mr. W. Airy, C.E., son of the Astronomer Royal, who has placed me, and I think I may venture to say all of us, under an obligation, by his kindness in coming here to enlighten us to-night. I must, however, be permitted to render this descriptive sketch complete, by referring briefly to one or two particulars. The chief constructive feature of an equatorial room is the Dome, which must be made to revolve, and it is of course of the greatest consequence that it should do so easily, and without the application of much effort. There are different methods of effecting this object, to which Mr. Airy will no doubt direct your attention, and I shall therefore content myself with stating that in the case of Orwell Park, the Dome, which weighed about three tons, revolved upon a series of wheels contained in boxes formed in the masonry for the purpose, the

motive action being by means of a grooved wheel and endless rope, which acting on a circular rack on the top of the wall, caused the dome to revolve with great ease. The wheel boxes just referred to were, I think, twelve in number, and were formed in the top course of the masonry, and constructed with a stone in front of each, bolted and made removeable at pleasure, in case of the boxes becoming choked, or the wheels requiring repair, in course of time. The Dome was constructed of iron ribs 4 inches deep, covered on the outside with deal boarding to receive the copper sheathing which formed the external covering, and lined on the inside with polished mahogany boards, with joints radiating towards the apex. The walls were similarly lined on the inside with polished mahogany boarding. The Dome was provided with a shutter, which was so contrived as to open easily and yet be perfectly weather-tight when closed, and which extended from the base to the apex, forming a complete slit when open on one side of the dome. The casting which formed the support of the equatorial instrument, was securely bolted to the top stone of the central pier which has already been described in detail, and as it was of considerable weight, it was necessary to specify that the contractor's scaffolding should be of sufficient strength to hoist a weight of several tons. The equatorial room was provided with the means of being heated by warm air flues from the boiler of the Turkish bath below.

Were it not for Mr. Airy's kindness in consenting to explain the mechanical and scientific parts of the Observatory, I should as a matter of course, and however inadequately, have attempted to place before you a more particular description of this interesting portion of the work. As it is, I do not think I need detain you with any further observations of my own. I do however wish, if you will allow me, to record my sense of the extreme courtesy displayed by Mr. Airy, who at all times met me most heartily in maintaining what I conceived to be points of architectural propriety, and in making his work, so far as possible, conform to them. Much has been said and written on the great advantage of architects and engineers working together. Here at all events is a case where Mr. Airy and myself worked together harmoniously and heartily, to the great and manifest advantage of our mutual employer.

I should perhaps mention that I am not responsible for the style of architecture adopted at Orwell Park. All I did was to carry out what I found in existence in the main part of the house, so as to form one harmonious façade. This in my judgment, is the true and proper spirit in which to carry out an addition to an existing edifice. Even if the original architecture is not so good as it might be, as not unfrequently happens, it is better I think to perpetuate it, than to make it apparent by adopting a different style or period for the extension, that the original edifice had been patched or added to. At all events, I conscientiously carried out this principle at Orwell Park, and treated the Observatory with truth in making the architecture conform, and give expression, to the peculiar and exceptional requirements of the building. The whole of the works which I have thus briefly attempted to describe, including the Dome and its working gear, were executed in a thoroughly satisfactory manner by Messrs. George Smith & Co., the well-known firm of London contractors, and the warming arrangements by Messrs. Haden & Son, of Trowbridge.

In conclusion, I will only venture to hope that by reading this paper before you, I have demonstrated that it is not impossible to erect an Observatory in connection with a country house, forming an integral part of it, and combining facility of access with complete isolation, and at the same time to treat it in such a manner that it need not necessarily prove an architectural eyesore. It may indeed be thought by some that an Observatory is a somewhat unnecessary, as it is no doubt a very unusual adjunct to a country house. But why, let me ask, should it be either? Is there any reason why a country gentleman, the inheritor, it may be, of vast domains and unbounded wealth, who has surrounded himself with the noblest and most elevating productions of human genius, should not occasionally devote himself to the grand, the wondrous study of the works of God in Nature and Creation?

Apart altogether from its scientific importance, is there any study better calculated to sink into utter insignificance all that we esteem to be great and valued? The power acquired by wealth, title, position, the most cherished possessions, and most costly treasures, do they not drop from our affections like crumbling clay, in the contemplation of the great Universe, whose limits are boundless space, in comparison with which man, and all he possesses, is but as a drop in the great ocean?

Mr. WILFRED AIRY, Visitor, C.E., said—In the few remarks which I shall offer upon Mr. Anderson's paper, I will confine myself to what may be termed the constructive necessities of a private observatory. The uses of a private observatory are in general the careful and continuous observations of certain definite objects and phænomena, and the instruments best adapted to these observations are a powerful equatorial instrument and a small transit instrument. The latter is for the most part an adjunct to the equatorial, and is used for obtaining the true sidereal time. The space required for the equatorial instrument depends upon the length of the telescope, and that will depend upon the diameter of the object glass. In the case of the Orwell Park Equatorial, the diameter of the object glass is ten inches, and this requires a telescope of about thirteen feet focal length, which with its fog cap, could scarcely be manipulated in a dome of less than twenty feet diameter. The transit instrument need not be large, but it should be placed near the equatorial instrument; and in the case of the Orwell Park Observatory the transit instrument was placed in a small turret, corresponding to the staircase turret on the opposite side of the observatory. With regard to the height of the observatory, it is necessary that the telescope should be placed high enough to look over trees and adjacent buildings right down to the horizon. This is important, more especially for the observation of planets and comets when near the sun, which is often a favourite subject of observation with amateur astronomers. There is considerable inconvenience in this condition, when the observatory is attached to a lofty mansion; and in the case of the Orwell Park Observatory it was necessary to place the instrument at a height of sixty feet above the foundations, in order to overlook the trees and adjacent buildings.

For the proper support of an equatorial instrument it is necessary to carry up a column or columns from the foundations, without contact of any kind with the walls or floors of the building. This is necessary on account of the tremor which would be caused by persons moving about the rooms attached to the observatory, which would be communicated to the instrument and give great trouble to the observer. In the case of the Orwell Park Observatory the instrument is carried upon a single column, upwards of fifty feet in height. The column is ten feet in diameter at the bottom, and tapers gradually to six feet diameter at the top. For the foundation of such a column, unless it was upon the natural rock, piling would seem preferable, because that kind of foundation would probably more completely preserve the column from tremors transmitted through the foundations; but in the case of the Orwell Park Observatory, the reason for not piling the foundation was, that the operation might have shaken down some of the adjacent buildings. It is evident that a column such as that described, greatly tends to impair the usefulness of the rooms below the observatory, and necessitates very skilful arrangements on the part of the architect. An equatorial instrument requires a revolving dome, fitted with a shutter opening from beyond the crown of the dome to the horizon. The usual way of carrying such domes, is either upon cannon balls running in a groove or upon a live ring of wheels. In the case of the Orwell Park Observatory, the dome is carried upon wheels revolving in fixed wall boxes, and the reason for this arrangement needs a little explanation.

It is of great importance that the centre of motion of the telescope should be kept as low as possible, in order to avoid, as much as possible, the necessity of climbing about the telescope while observing; but

it is also necessary to provide sufficient head way for the doors into the dome, and it will be seen, that by placing the wall-boxes on either side of the doors, it is possible for the edge of the dome to pass very close to the top of the doors, and thus to keep the centre of motion of the telescope very low. This question of headway for the doors into observatories invariably presents a difficulty. In some private observatories the only entrance is by a trap door in the floor, reached by a ladder, and in others by means of a flight of stairs extending some distance into the floor of the observatory. Both of these methods are very inconvenient. With regard to the construction of the dome, it is advisable that the shell of the dome should be double, in order to prevent the observatory from getting too hot in the sun; and in the best domes, the skeleton of the dome should be made of iron, in order that it may keep its shape and run truly on its wheels. Those constructed of wood are apt to warp and twist and run very heavy. The construction of the Orwell Park Dome may be seen by the diagrams. The ribs are of wrought iron, and they spring from a cast iron curb which runs on the wheels. Between the ribs are horizontal rings of wood which project a little beyond the iron work, and to these rings of wood are serewed the outer and inner linings. The inner lining is of polished mahogany, and the outer lining, which carries the copper sheathing, is of deal. The movement of the dome is effected by means of an endless rope on a grooved wheel. On the same axle as the wheel, is a pinion which gears into a circular rack fixed on the top of the wall, and thus the dome is easily turned by the power of one man. With regard to the wheel boxes, it is very important that means should be provided for getting at the wheels, in case one of them should get out of order, without having to move the whole dome. This is effected by means of a moveable slab of stone, which is bolted against the inner side of each wall-box, and can be removed at pleasure to examine the wall-box.

With regard to the shutter of the dome, it is necessary that it should open beyond the zenith, and therefore it is impossible to relieve the appearance of the observatory by fixing an ornament on the top of the dome. The shutter is carried on two tangent bars, one at the top and the other at the bottom of the dome, and draws away to one side in order to open the slit. It is now necessary to refer briefly to the different kinds of mounting which may be adopted for equatorial instruments, because, according as one system or another is adopted, it is necessary to carry the instrument either upon one central column or two side columns, and the arrangement that may be adopted affects greatly the disposition of the rooms below. There are in common use two systems of mounting for equatorials—the English system and the German system. According to the English system the polar axis is carried on two piers or columns—one on the north side of the observatory and the other on the south side of the observatory, and the telescope is slung midway between them. The advantage of this method of mounting is, that the floor of the observatory is kept comparatively clear and it is easy to get at the telescope in most positions; also the great length of the polar axis facilitates the accurate adjustment of the instrument. The disadvantages are, first, that the north standard of the instrument sometimes obstructs the view of an object in the north (as was at one time the case with the last large comet); secondly, the weight of the telescope and polar axis is considerable; and thirdly, the polar axis, by reason of its great length and the weight upon it, will in general shew a little deflection, which is a bad defect. In the German method of mounting, the telescope is carried by a vertical standard which is fixed upon a single central column. The advantages of this arrangement are, the lightness and ease of motion which the construction admits of. The disadvantages are that the polar axis is in general short, and does not admit of very accurate adjustment; the hour circle is small, and there is the further disadvantage, that in following circum-polar stars the telescope is frequently brought up by the vertical standard of the instrument.

In the case of the Orwell Park Observatory, the arrangement adopted is as follows: The

DOME OF THE OBSERVATORY AT ORWELL PARK.

Fig. 1

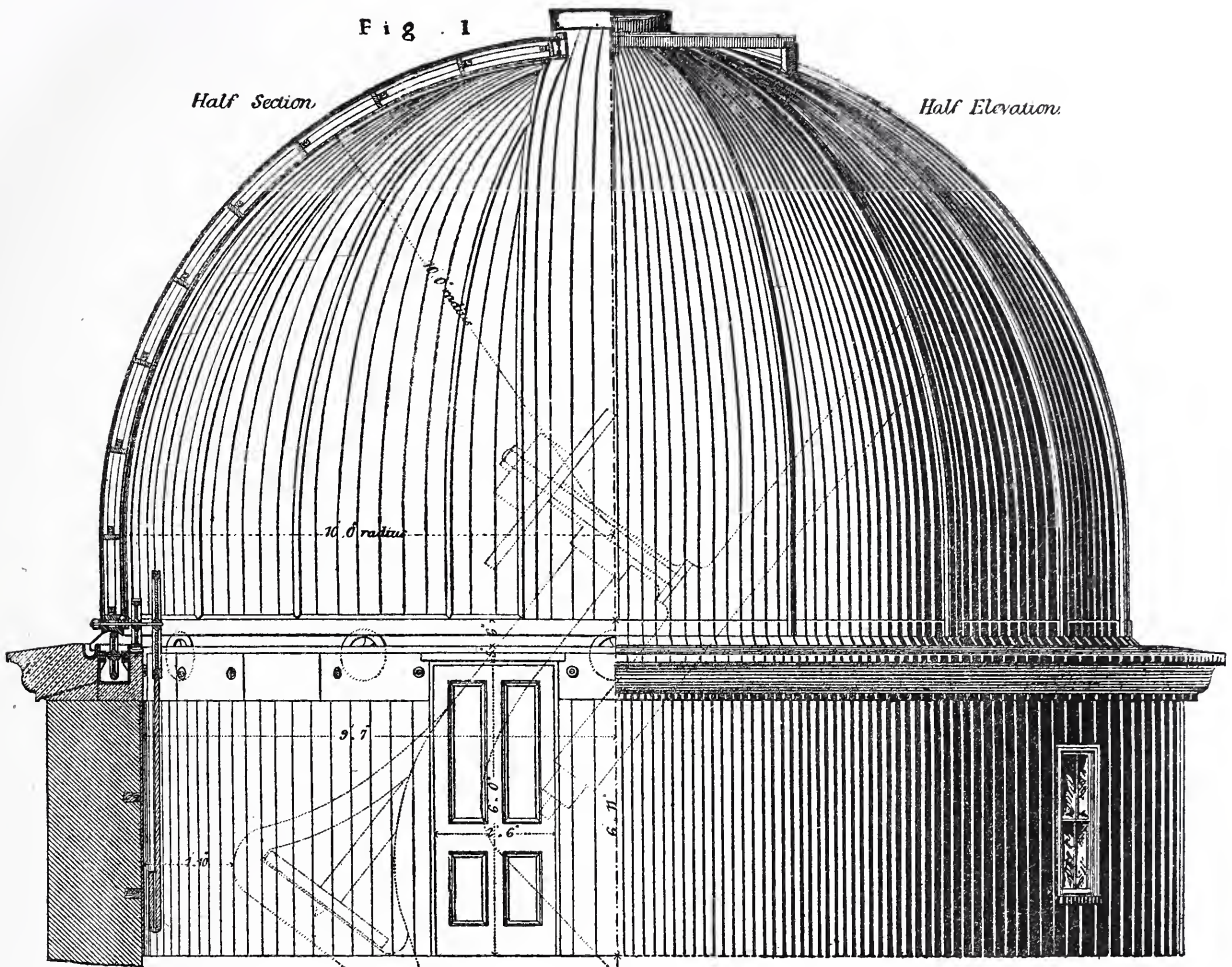

Fig. 2.
Sectional Plan of Shutter.

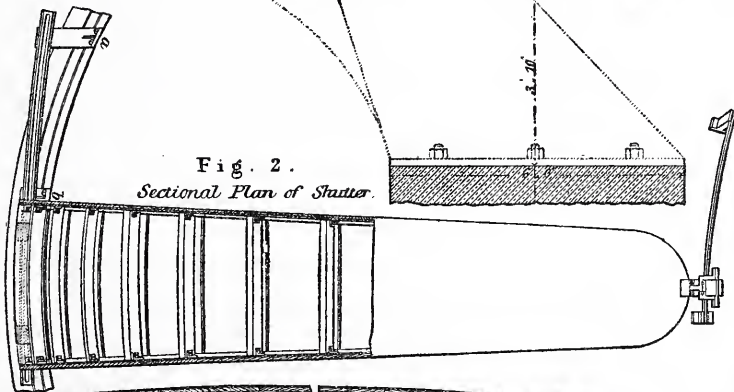

Fig. 3
Cross Section of Shutter.

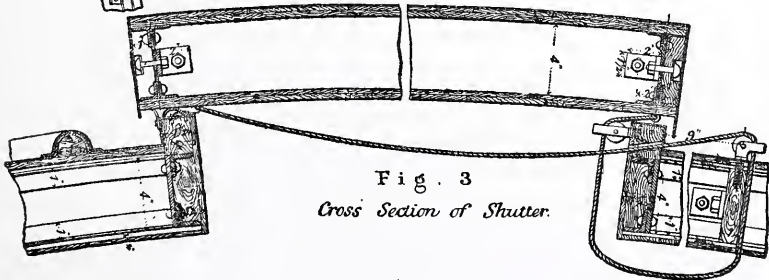
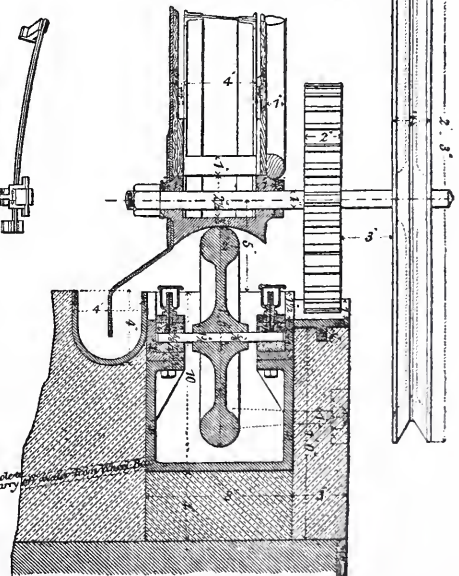

Fig. 4.
Section thro' Wheel Box &
Showing V Wheel and Pinions.



telescope is carried on a powerful bent casting, and the polar axis is produced to the floor of the observatory. This arrangement allows considerable length of polar axis, and consequently the means of accurate adjustment: it also admits of a large hour circle being used, and finally, by using the bent form of casting, the telescope can follow any circum-polar star whatever throughout its course without interruption. This arrangement has met with much approval from the practical astronomers to whom it has been submitted. With regard to warming the observatory, it is the customary practice to set the observatory open for an hour or so before observing, and during observations, it is essential that the temperature of the air outside and inside the observatory should be as nearly as possible the same; but at the same time it is always advisable to have the means of warming the observatory when not in use, in order to preserve the instruments and books from rust and damp. In the case of the Orwell Park Observatory, Mr. Anderson very successfully arranged a plan for warming the observatory by means of hot hair from the Turkish Baths below, which was admitted into the observatory through gratings in the floor.

With regard to lighting the observatory and instruments, wherever gas can be obtained, it is advisable to introduce it. It cannot conveniently be applied to all parts of the instruments, but wherever it can be applied it is a very great convenience. There is gas to be had at Orwell Park, and it is used wherever possible in the observatory. I venture to make a few additional remarks concerning the shutter of the dome. I have always considered the shutter at Orwell Park as a great success, for it is moved with great ease, opens the slit from the zenith to the horizon, and is quite watertight. There is almost always more or less difficulty with regard to these shutters in observatories: some are very heavy and cumbrous, others are slow in action, and others are continually getting out of order. I do not take credit to myself for inventing the shutter, inasmuch as through the courtesy of Mr. Talmage, I have had the opportunity of examining the shutter at Mr. Barclay's Observatory at Leyton, and after due consideration I adopted it precisely as I found it. I beg leave to express my sense of the honour which the Council have conferred upon me, in asking me to attend on the present occasion, and to acknowledge heartily the kind terms in which my name has been mentioned by Mr. Anderson in his paper.

Mr. C. G. TALMAGE, Visitor, said—Through the kindness of your Secretary I have been invited to attend this meeting, and to offer such remarks as might occur to me with reference to this dome. Astronomers, I am sure, will be happy to acknowledge any saving of labour which architects may be kind enough to introduce. A night's work in an observatory sounds a light thing, but I have heard it said it is equivalent to a good day's digging in a garden. The manner of moving the dome I would say, I think is not the best. I think the lever with plates round the dome is best, for the reason that, although you require at the commencement a greater exertion of force to move the dome, yet that exertion will move the dome more quickly than the same exertion would do distributed over the pulley and the rope. The dome of the observatory, of which I have charge, is 18 feet diameter, and is very easily moved. With two or three turns I can make the dome perform a complete revolution. I think that is rather preferable. I have not used the rope very much, but I have used it at Mr. De La Rue's, where the pulley was hooked on to vertical pieces round the wall under the dome. The shutter I think is very complete, and its arrangements are designed by Messrs. Ashby and Horner, who built it. There is, however, a liability to the rusting of the tangential bars, from the rain getting in, and where frost sets in after heavy rain, may get frozen where the dome is open, and it is sometimes an awkward thing to shut the dome, because the bars have become fixed in the ice. The danger then occurs that you may, by pulling suddenly, give the shutter such an impetus that it may move and fall over; and I have had the shutter slip on to the outside bed of the dome. It strikes me that if the

bottom were perforated with holes, the water would be able to escape, and that would obviate what I have mentioned. Using erude oil as a lubricator, I have found not advantageous, as it freezes and gets harder than ordinary grease or train oil. The arrangement of Mr. Airy, with regard to the wheels is, I consider, very admirable. The dome to which I refer moves upon a live ring; the wheels get clogged, and then it is necessary to take down the boarding and revolve the dome round several times, before we can get the wheels to come under the operator's hand. Mr. Airy's arrangement, with regard to the instruments, is one of considerable beauty and utility, for it will often happen, and it is by no means an extraordinary occurrence, that when you are observing circum-polar stars, you may not think for the moment on which side your telescope is, and it will soon jamb, and you have to go right away round to get it into position again. I think the arrangements of Mr. Airy are, for all purposes, most admirable.

Mr. PENROSE, Fellow (responding to the Chairman's invitation), said—I have very few observations to offer on the subject of this interesting building, the combined work of the architect and the engineer. I have not seen it myself, besides which, my experience is not amongst the great observatories of the country, as is that of Mr. Talmage. Regarding it at a distance, one sees a number of interesting contrivances. It is, however, obvious, that for extremely accurate purposes, no instruments should be set on so lofty a tower as this, but whilst the extreme refinements of measurement are, for the most part left to the public observatories, where the instruments for obtaining accurate measurements are set much nearer to the ground: there are many points of physical astronomy in which extreme accuracy is not required, and for these, there can be no doubt, this building and its arrangements are very admirably adapted. Great care has evidently been taken in the construction of this pillar, so as to reduce the possibility of external disturbances, and the inaccuracies thence resulting, as far as the equatorial is concerned, to the smallest possible degree. We did not, however, hear how the foundation of the transit instrument is made. As far as I gathered that does not share in the contrivances which have been described, but since the adjustments of the transit instrument can always be easily tested and corrected, if necessary, from week to week, the disadvantages arising from a less perfect foundation could not be serious.

I cannot but admire the extreme felicity of the arrangements for the improvement of the German mounting which have been introduced by Mr. Airy, taking the wind, as one might say, out of the German sails; for as Mr. Talmage says, great inconvenience is apt to arise, from the sudden bringing-up of the telescope, by which some interesting observations may be lost. I am not sufficiently versed in the practice of a revolving dome to offer an opinion on the point, but I think the arrangement of the fixed wheels in boxes must be preferable to that of common balls in a groove, as they are very liable to jamb. One could have perhaps wished theoretically that the great centre column had an independent foundation, but we have heard from Mr. Anderson that that has not produced any difficulty, and we may take it that the foundation is quite sufficient. I am very much interested by the contrivances by which Mr. Anderson has utilised the spaces beneath the dome. Of course, one would have thought in theory the heat of the tepidarium of the Turkish bath would have been prejudicial to the instruments, as causing a liability to expand, but the perfect and continuous groove or airspace placed between the domestic apartments and the pillar, with, no doubt, other contrivances for ventilation, will, I have no doubt, have been successful, as respects the instruments. It must, however, I imagine, be still a matter of some difficulty to get a sufficiently uniform temperature inside the dome, for the exquisite nicety of extremely accurate astronomical definition, and with reference to this point I would ask Mr. Airy what is the width of the opening of the shutter in this dome.—[Mr. AIRY.—It is 3 feet 6 inches at the bottom and 2 feet 6 inches at the top].—

Mr. PENROSE.—I would say a word on the subject of vibration, as I have a scrap of information upon it. It happened that whilst living about half a mile from the South Western Railway I had often been sensible of the vibration arising from the railway at that distance; and when the question of the threatened railway near the Greenwich Observatory was before the Astronomer Royal, I communicated to him what I had remarked. He thereupon sent Mr. Stone to make experiments, because it was an exact case in point. Mr. Stone brought down a collimator and a trough of mercury, and made experiments at the time when heavy luggage were passing at the distance of half a mile. He found there was a very sensible vibration, although Mr. Stone stated it was less than he expected to find, but it was enough to interfere seriously with the firm astronomical observations. I have myself been sensible of the vibration, so much as that it sometimes caused objects on a table to vibrate, but that was only now and then; but when it did occur it produced a vibration which, I should imagine, would seriously interfere with the working of an observatory.

Mr. T. MORRIS, Associate.—Considering how stupendous an edifice is under the immediate charge of Mr. Penrose, he may probably have an opportunity of observing such effects as have been alluded to by a previous speaker. I am not aware that a record has been anywhere kept of meteorological effect, in relation to the interiors of our large buildings, and I have in fact inquired for such information in vain. After the statement just made, however, that buildings are really found to be sensibly influenced by changes of temperature, due to the hours and the seasons, it seems possible that the masses of atmosphere they confine may have also come under examination. Such notices are undoubtedly rare, if any exist at all, but should Mr. Penrose be able to turn his attention to the subject some interesting results may be confidently expected.

Mr. J. MACVICAR ANDERSON.—I do not know that there is any point, with regard to the architectural purposes of the building, which requires any reply. The only point which calls for remark is that which Mr. Penrose alluded to, as to the foundation of the transit instrument. Not being an astronomer myself, I worked in conjunction with Mr. Airy, who is more of an astronomer, and on those matters I should prefer him to give you his own opinions and views.

Mr. AIRY.—With regard to the foundation of the transit instrument, it is not a perfect foundation: but seeing that it could not, with any convenience, be combined with the foundation of the equatorial; (and it seemed out of the question to carry up such a large mass of masonry as would be required for the separate foundation of the transit instrument), I was content with the sufficiently solid foundation afforded by some powerful wrought-iron girders which were used in the construction of the building, and these carried the transit room and instrument. I have already mentioned the transit instrument as being, in the present instance, not of the first importance, but mainly to be used as an adjunct to the equatorial. There is no fear of its getting seriously out of order: it may get a very little movement in consequence of the expansion and contraction of the iron girders, but iron, when entirely enclosed in masonry, does not contract or expand in the same degree as iron exposed to the atmosphere. I was, therefore, content with a foundation of that kind, although I should not think of adopting such a foundation for a transit instrument used solely for transit observations of the highest accuracy. With reference to the vibration caused by railway trains, I shall be happy to obtain for the Institute a copy of the Records of Observations which have been made by the Astronomer Royal for the purposes of the Greenwich Observatory (see Appendix, p. 27), if they should be considered of any value. Of course the effect of vibration is very different with different kinds of ground. The Observatory at Greenwich is placed upon a hard gravel, practically as hard as rock, and, doubtless, the effect of vibration would be greater than if the ground had been softer. The observations were taken near the Blackheath tunnel, and at other places. The method of observation was to have two telescopes mounted

on tripod stands: one of the telescopes was directed towards a bowl of mercury placed upon the ground, and its wires were observed by reflection with the other telescope. With this arrangement the slightest vibration would be distinctly perceptible. The tremor caused by trains was very serious near the tunnel, but at the distance of about a furlong the vibration was practically *nil*. With regard to the South Eastern Railway, which had been a constant source of terror to the Greenwich Observatory, it has been driven so far away from the Observatory that there is no fear of any evil effects resulting from the vibration. The railway is nearly a quarter of a mile away from the Observatory, and is carried in a covered way, or tunnel. A good many questions arose with the South Eastern Company at the time. They offered to do all they could to diminish the vibration, provided they were allowed to carry the railway through the Greenwich Park. They offered to surround the railway with a considerable thickness of peat earth, and to lay the rails upon india rubber packings for a certain distance: in fact, to do all in their power, but it was considered that the most effectual safeguard was to drive the railway to a distance at which it could not possibly do harm. With regard to the astronomical clock in connection with the Orwell Park Observatory, it is a thoroughly good clock, made by Dent, and it has been placed against the wall of the transit room in the line of the two piers of the instrument, so as to be equally well read from either side of the instrument.

The CHAIRMAN.—It is now my pleasing duty to propose a vote of thanks to Mr. Anderson and Mr. Airy, for the kind manner in which they have severally described a building which, together with its various arrangements, appears to answer all the purposes required in a very admirable manner. I think great ingenuity has been shown in the construction of the building, and I think a special vote of thanks is due to Mr. Airy for his kindness in explaining the working of the instruments, and of the dome itself. I am sure we are all exceedingly obliged to him for his kindness in that particular, and also for his promised contribution to our Society.

The vote of thanks having been passed by acclamation,

Mr. ANDERSON said,—I beg to return my best acknowledgements for your kindness in passing this vote of thanks. I feel, as I have already said, under great obligations to Mr. Airy, whose portion of the work is most interesting. I feel, with regard to myself, that my acknowledgements are due for the patience with which you have listened to the somewhat dry details which I have had the honour to lay before you.

The Meeting then adjourned.

APPENDIX TO MR. AIRY'S REMARKS ON MR. ANDERSON'S PAPER.

Extracts from the Further Report of the Astronomer Royal as to the probable effects of the London, Chatham and Dover Railway on the Royal Observatory in Greenwich Park (9th April, 1863).

IN planning experiments for observation of the effect of existing railways, I have found great difficulty in fixing on any whose circumstances exactly resemble those of the proposed line through Greenwich Park. In similarity of soil, and of shallow covering, I have been fairly successful, but I cannot find a railway in a shallow tunnel on the side of a hill so steep as that on which the Royal Observatory stands. It is my belief that this circumstance is unimportant, and that the place of communication of tremors has respect to the external surface of the ground. I think it proper, however, expressly to notice this departure in my experiments from the circumstances of the Royal Observatory.

The places which I selected for experiment are the following :—

(A). The shallow entrance of the tunnel of the North Kent Railway, near to Morden College, Blackheath. The distance of the place of observation from the centre of the railway was 665 feet.

(B). The Metropolitan Railway, at the upper end of Portland Place. The place of observation was in Regent's Park, its distance from the centre of the railway was 864 feet.

In station (A), the soil is precisely similar to that of Greenwich Park; the thickness of the tunnel-covering increases from a small quantity at the mouth to about 10 feet. In station (B), the sides of the tunnel, and a thin covering of the bottom, are of soil similar to that of Greenwich Park, the sub-soil being hard clay.

The apparatus used in the experiments was as follows :—A telescope furnished with wires in its field of view, is directed downwards to a trough of quicksilver, which is protected from the wind by a glass shade. The rays of light from the wires pass through the object-glass, fall upon the quicksilver, are reflected upwards, and are there viewed by another telescope at which the observer is stationed. When the surface of the quicksilver is undisturbed, the wires of the first telescope are seen well with the second telescope; but a tremor of the quicksilver, entirely undiscoverable in any other way, causes them to become indistinct and disappear. The aperture of the telescope employed is $3\frac{3}{4}$ inches, and the magnifying power of the observing telescope is 120.

On the morning of the 2nd April, observations were made on the North Kent Railway. Their results may be epitomized as follows :—

OBSERVERS, G. B. AIRY and E. J. STONE.

	Probable duration of obscuration of wires.	Limit in excess of the duration of any indistinctness.	
		m.	s.
1st Experiment	37	2	20
2nd „	37	1	51
3rd „	53	1	30
4th „	34	0	46
MEAN	40	1	37

Supposing the speed of the train to be twenty miles per hour, the distances from the train to the disturbed quicksilver are nearly the following :—

At total disappearance of the wires 900 feet or less.
 At the smallest perceptible disturbance less than 1560 feet.

The latter number is undoubtedly much too large, as it includes the effect of every accidental disturbance. The fourth experiment alone would give 970 feet.

On the morning of 4th April observations were made on the Metropolitan Railway.

OBSERVERS, G. B. AIRY and W. ELLIS.

	Probable duration of obscuration of wires.	Limit in excess of the duration of any indistinctness.	
		<i>m.</i>	<i>s.</i>
1st Experiment	30	1	43
2nd " 	17	2	10
3rd " 	29	1	45
4th " 	45	1	46
5th " 	33	1	35
6th " 	20	1	22
7th " 	28	1	0
8th " 	33	2	5
9th " 	38	1	38
MEAN	30	1	40

From which, as before, the distances are—

At total disappearance of the wires..... 970 feet or less.
 At the smallest perceptible disturbance less than 1700 feet.

The latter number is of little value, as there were many small causes of disturbance.

In regard to the effect of the earth-covering, on which experiments were made by me several years ago, but at a smaller distance from the tunnel, the general impression now left on my mind is, that the saving or protecting power of the earth-covering bears a smaller proportion to the residual disturbance when the distance of the quicksilver from the tunnel is considerable than when it is small.

It will be remarked that the test of tremor which has been used in these experiments, namely, the disturbance of an image, as seen by reflection on the surface of quicksilver by the aid of a powerful telescope, is one which will present itself several times every day in the course of the ordinary observations at the Royal Observatory.

All things having been carefully considered, I have the honour to report the following as my opinion. First, in regard to the engineering of the railway—

- I. It is indispensable that the railway pass through the Park in a covered tunnel.
- II. It is indispensable that its minimum distance from the transit circle of the Royal Observatory exceed 1000 feet.

It has been suggested for consideration whether there might be advantage in requiring the tunnel to be formed as a complete barrel of brickwork, and in requiring continuous bearing of the rails. It is very difficult to institute discriminating experiments on these points. I have conversed with some engineers, but I am unable to obtain from them any valid information. And, finally, I express as my opinion, that the barrel form of the tunnel is unimportant, but that there may be a small advantage in continuous bearing; and I would therefore record as a recommendation, that the rails be laid in continuous bearing.

I now advert to the point which relates to the speed of the trains. The difficulty of making varied experiments upon an active railway is so great that I have not attempted to ascertain the difference of tremor produced by trains running at high speed, and by the same trains running at low speed. But it is perfectly notorious that the trains at high speed produce far the greater tremor. I therefore deem it indispensable, for the security of the Royal Observatory, that the speed of trains passing through the Park be limited by the Railway Act to a definite rate—I propose twelve miles per hour.

Royal Institute of British Architects.

At the Ordinary General Meeting of the Institute, held on Monday, the 30th of November, 1874,
H. CURREY, Vice-President, in the Chair, the following Paper was read:—

ON THE HISTORY AND DEVELOPEMENT OF GOTHIC VAULTING.

By G. HERBERT WEST, M.A., Associate.

(To introduce the Discussion on a Paper read at the Closing Meeting of last Session by
Mr. T. H. EAGLES, M.A.)

WHEN the Council did me the honour, a little more than a week ago, of asking me to attend this meeting, I hesitated very much, for I felt I could not hope to add anything of importance to Mr. Eagle's most interesting paper. There seemed, however, room for dwelling rather more fully on one or two points. If in trying to do so, I only say what is known to all those here, forgive me and believe that I should not have ventured to come forward of myself. I agree with Mr. Morris in wishing that I knew more of Roman vault construction, for the very little that I have seen at Nismes and Arles has filled me with extreme admiration. It is true that the buildings in those two towns are strongly imbued with Greek spirit, and are far superior in the thought and artistic feeling shewn to many buildings of Italy. M. Viollet le Duc goes into Central Syria to find the origin of the Romanesque buildings of the South of France; but at Nismes and Arles every point on which he lays stress is found almost in as great perfection as at Chagga. These buildings are the more important, since it was certainly from them that the architects of the Cleric or Cluny school drew their inspiration while the Northern Laie or Ile de France school owed not a little to the builders of Cluny and Veselay.

The Romans used two sorts of vaults—the barrel vault, and its derivative, the groined or intersecting vault. About the latter of these two I will say nothing at present, but I should like to say a little about the former. When the Romans built a barrel vault of masonry, a thing which they comparatively seldom did, they did not make the courses break joint as we should do, but composed it of a series of juxtaposed arches, made up of very large stones of uniform size. A centre was placed at each joint, and no continuous centering was necessary, while one templet would serve for all the voussoirs. There are many examples of this, both at Nismes, Arles, and the Pont du Gard, and the same system was made use of so late as the end of the Twelfth Century, in the wonderful bridge over the Rhone at Avignon. Still further economy was obtained in the so-called Baths of Diana at Nismes, by separating these juxtaposed arches by about their own width, and using them as centering, to carry a concentric covering of thin slabs, as described by Mr. Eagles.

A still further step is taken in the outer ground floor gallery of the Amphitheatre at Nismes, where there is a transverse arch carried on corbels against each pier of the arcading. These arches then carried a continuous centering, on which a rubble barrel vault was laid. Surely it is more natural to consider this as the origin of the waggon vaults on transverse arches, which cover so many of the Romanesque churches of the South of France, than to go to Central Syria to look for it. At Arles the corresponding gallery is not vaulted but covered with immense slabs of stone, 18 ft. by 3 ft. by 1 ft. 3 in. thick, carried on the cornice of the interior order and perfectly free from the walls. But in both cases the

first floor gallery offers a most ingenious arrangement. The arcading seen in the exterior elevation is really composed of the open ends of radiating barrel vaults, perpendicular to the exterior wall, and resting on either side on a great lintel, spanning the gallery, and carried on corbels flush with the outer edge of each pier. Between the two lintels, and behind each pier, is a barrel vault, turned in the opposite direction, and resting on the outer and inner walls. This system struck me as being admirably adapted to get over the difficulties caused by the curve of the gallery, for by bringing the ends of the lintels nearer together on the inner wall, the opposite sides of the larger waggon vaults are kept nearly parallel. I was, however, so pressed for time at Arles that I was not able to make quite sure of this having been done by taking any measurements.

When the Romanesque builders began to vault the naves of their larger churches they naturally made use of the barrel vault, for they found a difficulty in covering an oblong span with an intersecting vault, and it was not always possible to cut up the nave into square compartments. Besides, and here I think is the real reason, all these early vaults were meant to support the tiles without any wooden roof, and a barrel vault was therefore indispensable. This was usually constructed by means of a permanent centering of transverse arches, just like that at Nismes, while the aisles were covered by a series of waggon vaults perpendicular to the nave, and concentric with the pier arches carried on transverse arches, which replace the lintels of the upper gallery at Nismes. These perpendicular barrel vaults thus formed a continuous buttress against the central vault. This system, which exists at Limoges and is common in Poitou, had several inconveniences. The only windows possible were in the aisle walls, the upper part of the vault was in darkness, and there was no triforium gallery. It is curious though that they never hit upon the system adopted in the Twelfth Century, in certain wooden roofed churches of Champagne, of placing a separate roof over each aisle vault, and so getting windows over the piers of the nave.

This system gave rise to a series of churches of extreme interest, all more or less resembling the Basilica of Maxentius at Rome. The earliest of these are Notre Dame des Doms at Avignon and St. Trophime at Arles. From them arose a set of churches which, I think, we English should do well to study more closely. It does not seem right that the Church of England, one of the richest and most intelligent religious bodies in the world, should have let herself be beaten by the Non-conformists, in the matter of making buildings adapted to her services. I suppose that there are few who would not own that the three-aisled cruciform church is about as ill adapted to our purposes, especially in great towns, as any form that could be devised. I can, however, imagine none more fitted for our requirements, than such buildings as the two churches in the town of Carcassonne, the Taur Church, and that of the Cordeliers at Toulouse, and, lastly, and especially, the Cathedral of Alby. In all these there is a wide nave without aisles, vaulted generally (these buildings being late) by a Gothic vault, and lighted by rose windows under the wall arch. The buttresses are brought inside the church, and the space between them is converted into chapels, roofed either, as at the Cordeliers and originally at Avignon and Arles, by a series of barrel vaults perpendicular to the nave, or, much less reasonably, by a Gothic vault. At Alby these chapels are in two stories, the lower one of which has no windows at all, while the upper set are connected by openings in the buttresses, and lighted by narrow lancet windows.

The arrangement is very much what would exist at St. James', Piccadilly, if the lower set of windows were stopped up, and I can imagine none more suitable to a large town, and to brick and iron construction. Alby indeed, and the church of the Cordeliers at Toulouse are built of brick. Suppose three slender iron columns, carrying the transverse and diagonal arches of the main vault, standing 12 or 14 feet out from the wall, and stiffened by two iron girders resting on the wall, one

carrying the gallery floor and the other forming lintel to carry the smaller barrel vaults, which might be made to form the wall arches of the main vault. The outer walls might then be a mere enclosure; and to my thinking, such a church as this would be far more truly Gothic than the careful copies which are springing up all over the country. Then, and not till then, may we hope to see at last, that "Hope of Architecture"—the style of the Nineteenth Century.

Churches of this kind are, as a rule, of much later date than those we have been considering. In the majority of cases it was probably the height of the pier arches which frightened these early builders, for even so late as 1220, we find in the Cathedral of Rouen, the pier arch composed of two stories. In Auvergne this difficulty was got over by the introduction of a triforium gallery, covered by a continuous half-barrel vault, while the aisles as a rule have groined vaults. The nave of Notre Dame du Port at Clermont has columns in one place ready to carry a transverse arch under the barrel vault, which was, however, never placed. At Issoire there are transverse arches to every other pier, so that the vaulting compartments are nearly square. When, as at St. Sernin at Toulouse, the triforium windows are made very large, a good deal more light is got into the upper part of the vault, but still not more than is just sufficient in that Southern climate.

I just said that at Issoire, the transverse arches exist only on every other pier, leaving the vaulting bays, both of the nave and aisles, square, two of the latter going to one of the former. The Northern architects adopted this arrangement, and covering the nave, as well as the aisles, with a groined vault, succeeded in getting windows under the wall arch, but were then prevented from laying their roof covering directly on the upper surface of the vault, owing to its being no longer continuous. This is the typical form of church throughout the Rhine provinces, and finds its grandest expressions in the Cathedrals of Spire, Worms and Mayence.

During the Eleventh Century a great step was made by some of the Burgundian builders, to which they were led, partly by a desire to vault an oblong space, partly by a wish to avoid the trouble of setting out and constructing the elliptical centering necessary for the groins of a Roman vault. They made the diagonal arches semi-circular, as well as the wall and transverse arches, and thus found themselves able to cover any space, but with a vault domical in section. At Vezelay, built about 1150, we find this system in perfection. Every pier supports a transverse arch, and the oblong space between is groined. These semi-circular transverse arches however, not being properly buttressed, dropped a little, opening at the extrados at the haunches, and at the intrados at the key.

These builders, noticing this, concluded that the triangle, A. B. C., between the two points of pressure, A. C., was useless, they therefore omitted it, taking two centres, a little on each side of the median line, and put a joint, instead of a keystone to avoid the double fracture. That this was the origin of the pointed arch is shewn, says M. Viollet le Duc, by the fact that in the Ile of France, where,

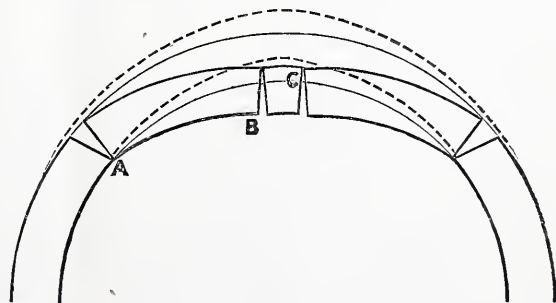

owing to the smallness of the materials, the transverse arches are of slight thickness, the pointing is scarcely visible in the earliest pointed arches, while in Burgundy, where thick arches of large stones are used, it is much more marked, as in the narthex of the church at Vezelay, where all the transverse arches are pointed, and some of the groined vaults have little purely decorative ribs on the angles. The Northern builders of the Twelfth Century seized upon the idea of these ribs, and making of them a permanent centering to carry the vaulting cells, produced the true Gothic vault which we

first see at St. Denis, in 1140. For some time they adhered to the system of including two bays of the nave in one vaulting bay, though the difficulty of covering an oblong space had been conquered at Vezelay. There still remained, however, many difficulties to be conquered, especially in aisle surrounding the apse, and to see how they were got over we must turn back a little.

I do not know that any example remains of a circular aisle being vaulted, as at Nismes, by radiating barrel vaults concentric with the pier arches, but it seems very probable that such churches must once have existed, for we find this very arrangement at Mantes, in the triforium, which is vaulted by a series of radiating barrel vaults perpendicular to the wall of the choir, and carried, not upon transverse arches, but upon rows of columns supporting lintels. The ingenious double lintel of Nismes and Arles is, however, wanting, so that the barrel vaults are larger on the outside than on the inside, and in some the crown slopes, while in others the crown is level, and the resulting curve cannot be developed. Usually the circular aisle is covered by an intersecting vault, formed by the penetration of the pier arches into a continuous barrel vault bent round the choir. At Notre Dame du Port there are no real

Fig. 2.

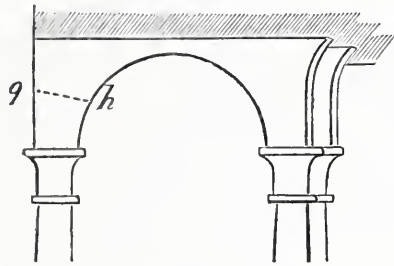

pier arches, but the vault itself forms the pier arch (fig. 2), the crown being kept level by placing the springing on a sloping line, $q h$ fig. 2. There are no transverse arches, but at the entrance to the choir aisle there is a single column on the inside and two on the outside wall, and it is possible that the original intention was to make a transverse arch larger on the outside than on the inside, so as to get the vaulting bay more nearly square. It is, however, impossible to say what the real plan was, for with these early builders everything went smoothly till they got to the vaults, and then they were put to their wits'

end to finish their buildings, which are consequently full of hesitations and alterations, sometimes shewn inside the building, as at Notre Dame du Port, sometimes shewn outside, as in the alterations to the buttresses at St. Sernin, Toulouse. In a much later church than Notre Dame du Port, the idea which seems to have crossed the mind of the Auvergnat builder is carried out with even more skill than by the Roman constructor of the Amphitheatre of Arles. In the church of Chalons sur Marne, and originally at St. Remy of Rheims, each pier of the sanctuary carries three transverse arches over the aisle, one, as usual, radiating from the centre of the apse, and one on each side of it, parallel to the axis of each bay. The vaulting compartments are thus reduced to a square, all the irregularity being thrown into the triangles between the transverse arches. At Notre Dame, Paris, where there are five aisles, the number of columns is doubled in each row proceeding outwards, and the aisle vaults are cut up into triangles, by a series of transverse arches, there being no true ribs. The builders of Langres rightly felt that the pier arch ought to be brought out of the vault since it has to carry the wall above, and they overcame the difficulty of the radiation by making the capitals trapezoidal, and so getting the sides of the arch parallel. The effect, was, however, anything but satisfactory, and they soon went back to the square abacus. Now, when as at Langres, there are both pier arches and transverse arches, the groins no longer fall, as they ought to do, in the re-entering angle, but on the haunches of the arch. All sorts of methods were tried in order to get over the difficulty, for instance, at Poissy, the pier arch is doubled on the side of the aisle, the capitals are made oblong, and the transverse arch is eorbelled out a little from them, so as to leave space for the groin to come down on to the capital in the angle. At Langres, the ribs of the aisle vaults are straight on plan, and consequently intersect close to the pier arch, thus giving a sloping vault. Not till later did they dare to make them broken upon plan, and place the crown upon the centre line of the aisle.

Now let us turn for a moment to England. At Christchurch, in Hampshire, is a small crypt covered with a barrel vault, supported by very broad transverse arches, about 5 feet wide, on which were laid planks, which were covered with a layer of fine cement, something like the layer of tiles used by the Romans; and the rough rubble vault was then turned over it. A window and one or two niches penetrate into the waggon vault. A small space is left between the vault and the transverse arches where the planks rested. It is curious that they were not quite strong enough, and sagged a little. At the end of this crypt is a small apse, possibly an addition, which presents, however, all the characteristics of Flambard's work, and cannot, I think, be later than the beginning of the Twelfth Century. This apse is vaulted by two large ribs of semi-circular section, carried by two short columns and butting against the crown of the last transverse arch. The vaulting cells are excessively arched, and give an elliptical section against the wall. Rough as it is, the whole principle of the Gothic vault is there, and I cannot agree with Mr. Eagles that vaulting was imported complete, as it stood, from the Continent.

M. Viollet le Duc speaks as follows (Const. p. 101). "About the middle of the Thirteenth Century, the English had arrived at very scientific and perfect combinations of vaulting arches. The Normans soon became clever constructors, and in their round arched buildings made remarkable efforts which shew great independence of spirit and an exceptional perfection of execution. Already, at the beginning of the Twelfth Century, they were making vaults with projecting ribs, while in France scarcely any vaults were made, except Roman ones, without ribs." They knew also the use that can be made of springers, and they divided their capitals, if not their piers, into as many members as there were arches to be carried.

I referred just now to the difficulty which the builders of Notre Dame du Port and of Langres had experienced in finding room for all the arches of their vaults on the capital, and shewed how at Langres they had been forced to corbel out a little the transverse arch. This same difficulty had attacked the builders of Peterborough, and had been resolved by them in a much bolder fashion, by corbelling out for every arch, instead of for only one. The builders of the South of France, in spite of their constructive skill, were held back on the path of progress by their adherence to the cherished decorative features of Roman architecture. Thus, at Langres, the columns have the general proportions of the Corinthian order, and their capitals might almost pass muster by the side of late Roman ones. The Anglo-Normans, on the contrary, were completely unfettered; indeed, their barbarous cushion capital, composed of a flat stone laid on the top of a pier, with its corners knocked off on the slant, almost suggested some such arrangement as that which we find at Peterborough. From this arrangement it is but a step to that adopted at Notre Dame de Paris, where the aisle-vaults are carried against the exterior wall by three engaged columns, the centre one carrying the transverse arch, and the two side ones, which are turned at right angles to the diagonal, carrying the ribs. The isolated piers between the double aisles are alternately monostyle and composed of a circular column surrounded by twelve detached colonnettes. This system, however logical, of keeping each arch separate and giving it its own column, soon made the points of support very unwieldy, far too much so to please men, one of whose great objects was to keep their buildings as open as possible. They therefore, found themselves forced to make their ribs interpenetrate, and thereby gained two other advantages as well, a still further concentration of the thrust, and a diminution of it, by making the beds horizontal till the ribs separated, so forming a *tas de charge*. This penetration of the ribs soon led to other modifications, to trace which I must again go back a little.

The early French vaults were always domical, partly because the builders had not learnt thoroughly to trust their system, and were afraid of too flat a curve for their vaulting cells, but also, and chiefly,

because the use of the semi-circular arch forced them to make them so. For if the ribs are semi-circular, especially in a hexpartite vault, the transverse and wall arches must be either enormously stilted or very pointed to bring their keys to a level with the intersection of the ribs, or else the diagonal ribs must be segmental as at Peterborough, the effect of which is very unpleasing. Now, the pointed arch was not considered a pleasing form at first, and was only resorted to as a constructive expedient. But these domical vaults were soon found to be very wasteful, by forcing the walls to be raised sufficiently high to allow the tie beam to pass above them. And as this blank wall needed some arcading or other ornament, at Sens, the consequent useless expense was very great. Now, as these men used their reason, and never let a liking for a particular form prevail against it, they soon made up their minds to accept the pointed arch. But, with pointed wall arches, they could no longer indulge in round-headed windows; and so, by degrees, the pointed traceried window arose out of this constructive necessity in the vaulting. Even this did not get over all the difficulties, for when, as often happened, the spans of the arches springing from one pier were very different, it was not possible to keep their keys level, even when using the pointed arch, without putting their springings at different heights. In that case, the capitals of the colonnettes carrying the different arches were no longer level. This is well seen in the porch of Notre Dame at Dijon, and in the later part of St. Nazaire at Carcassonne, the Cathedral of Auxerre, and many other early 14th century churches.

We have seen how a colonnette was given to every member carried by a pier, the section of which thus became approximately that of the arches carried by it. We have seen too how it had become necessary to make the different mouldings interpenetrate. This penetration, unless cleverly managed, tended to interfere with the principle of the pier giving the block plan of the vaults, and sometimes made the placing of capitals at different levels very difficult to manage, for while some members would naturally find their place on the caps, others would run down by the side of them, or lose themselves too soon in the other mouldings. Besides, the nearer the pier approached in section to the section of the arch, the less reasonable did it become to have capitals at all, they became a mere ornament, marking the point of transition from the vertical to the curve, and not really supporting anything. These terrible rationalists, therefore, do one of two things—either, from the difficulty of managing all the various springings, they give up the principle of continuity altogether, and make the pier cylindrical with a slight band at the lowest springing, and with the various ribs growing out of the cylinder above at different levels, as at St. Nazaire, Narbonne, and, without any band at all, at St. Etienne du Mont, Paris; or, making the pier-arch the full width of the pier, they let the mouldings run down to the ground without any break, as is done at St. Ouen of Rouen, St. Severin, Paris, and nearly all 15th century churches.

We have now seen how every slightest modification of the arches of a vault led to alterations through the whole building: it still remains to notice the methods employed for filling in the cells, and though it is quite true that they may be left to take care of themselves so far as the stability of the vault is concerned, yet in the hands of these straightforward 13th century men, a very slight modification of the original plan caused even greater alterations than any of those whose origin we have just been tracing.

The French vaults are filled in on the following system:—half the wall-arch and half the rib are each divided into an equal number of divisions, but the span of the rib being much greater than that of the wall-arch, the divisions on it are of necessity larger. Each row of stones then forms an arch resting on the wall-arch and on the rib, but with its stones larger at one end than at the other, and a straight joint joins the keys of the wall-arch and rib. Care has to be taken to keep each joint in a straight line, for owing to the arched form of each course, and its consequent greater

development in the middle, unless this is done, the last few rows of stone will be of an awkward balloon-like shape. A moveable board cut to the curvature of the cell is all the centering required, but unless the workman has his wits about him, he is very likely not to spread these differences of development and width equally over all the cell, but to let them all run into one or two of the courses, which thus become wedge-shaped and of all sorts of irregular forms. This is well seen in the two or three bays of the cloister at Westminster, opposite the entrance to the Chapter House, where the filling-in is very badly laid. May I venture to hope, that when the cloisters come to be restored, as I fear they soon must be, that this most instructive clumsiness will not be made good, for on it hangs the whole history of the development of our English vaults. This system left too much to the workman, and during the Hundred Years War, when there was no connection between the great parent freemason societies of the Continent and of England, it was doubtless difficult to get men sufficiently intelligent to be left thus to themselves, for freemasonry never seems to have attained the proportions in England which it did in France. Some simpler method was necessary, and this was found by dividing up the arches, not into an equal number of unequal parts, but into an unequal number of equal parts. Consequently, in whatever way the stones were placed, whether at right angles to the rib, or at right angles to the line bisecting the angle formed by the rib and the wall arch, or at right angles to the line bisecting the opposite angle—and vaults exist in the cloisters of Westminster arranged in all these ways, as well as in the French fashion—in any case, the stones no longer form a straight joint joining the crowns of the arches, but dovetail on the ridge. To avoid the somewhat unsightly effect of this, it was natural to put in a ridge rib, on which the ends of the stones rested. This had already been done by the French architects, as at Amiens, but there, the ridge-rib so far from supporting the panels, is upheld by them, and is introduced as a mere ornament. It is, indeed, rendered to some extent a decorative necessity, by the fact of intermediate ribs, or tiercerons, having been introduced. For even in the French vaults, where every course of the cell forms an arch, their general surface became very flat when the ridge of the vault was kept level, and tiercerons are therefore introduced where the space covered is large, as it is at the crossing at Amiens. In the English vaults, this weakness of the vaulting cell was far more felt after the change in the arrangement of the filling-in. A tierceron became absolutely necessary to support this flat surface, and then it was natural to use it as another rib, and rest the fillings in of the cells upon it. Then other tiercerons being added, and the same operation being repeated, our English vaults give a convex conical section a little above the springing, instead of the concave one of the French vaults.

We have already seen how the French architects, even when using the pointed arch, had found it impossible to keep both the crowns and the springings of their vaulting arches at the same level. This same difficulty was felt by the English, but in an aggravated form. They were determined to keep the crowns level, because if they did not, they got a very awkward sort of triangular form attached to the wall by its apex, as the section of the spandril solid, as we see in some early English and decorated vaults at Ely, Exeter, Lincoln, Westminster, and elsewhere. They could not well put the springings at different levels, partly for this same reason, and partly because, owing to the multiplicity of their ribs, they would have found it even more difficult than the French had to keep them separate. They were therefore driven by sheer necessity to adopt the second or Peterborough plan of keeping all the keys and springings level, and using a segmental arch. Their artistic feeling however, and certain constructive advantages, induced them soon to convert this into a three or four centered arch; and here again precisely the same thing occurs which we have seen take place at the beginning of pointed architecture. The flattened arch is used only in the ribs, and transverse arches, while the

wall arches are kept pointed, in order to preserve what had now become the consecrated form for windows, as is seen at Christ Church, Hampshire. But they soon found that by using the same curve for all the springings, they could obtain a true cone or trumpet shape, and by altering the upper curve could keep all the ridges level. But when the vaults thus became generated by the revolution of a curve round a vertical, the wall arch of necessity took the same shape as the others, and the windows had to be made four centered. I do not enter into the detail of the construction of these vaults, as Professor Willis and Mr. Eagles have already done so. We should notice, however, that the ribs at last became so numerous that they and the panels are cut out of a single piece of stone, so that the late English Gothic builders had got back in construction to the point from which they started, the Roman intersecting vault, built of masonry. It is curious that the last expression of French vaulting also carries one back to a Roman form. Some of the subterranean vaults of the Amphitheatre at Arles are formed by arches carrying walls built up to a level with the crown, on which are placed slabs of stone, forming a flat ceiling. Now at La Ferté Bernard exactly the same system is adopted; the ribs no longer support the cells, but on them are placed open arcadings carrying a flat ceiling of large slabs of stone. The windows are still pointed, but the next step would have been to make them square-headed, for the pointed arch, which at first was a constructive necessity, has here become a purely decorative feature. A curious example of the way in which an unavoidable expedient ends by being considered a pleasing form is given us by the Priory at Christ Church. There the vaults are later than the walls, which are Norman. The masonry of these latter is extremely irregular, so much so that in one or two cases where a wall arch had to be applied to the Norman masonry, it was found that the wall was not perpendicular, so that the arch detached itself from it and stood out. Instead of carrying the arch up straight and letting a sort of little barrel vault unite it to the wall, the early English builder has preferred to keep it always against the slanting wall, and whenever he found the mouldings leaving it has mitred them back. After having done this a few times, he began to think the effect was rather good, and so he makes breaks in his diagonal ribs without any cause, and puts little heads and bits of carving on the projecting angles so obtained. In one or two places he even mitres his rib up for the pleasure of bringing it down again. It is true that these vaults are all on a very small scale, or the thing would not have been possible.

One word with regard to the reproach commonly brought against Gothic vaults, not being the true covering of the building. I mentioned that in the south of France all the earlier vaults carry the tiles directly, and it was only in the north that the impossibility of making this covering watertight, and the adoption of the intersecting vault, forced the builder to cover it with a wooden roof. The southern architects never really liked this, as we see at Clermont Ferrand, where a northern architect built a cathedral in the 14th century. While the building was in progress he covered his south aisle roughly with large slabs of the splendid lava of the neighbourhood, and made all his working drawings upon them. That this was not intended to be the permanent covering is shown by the presence of corbels to carry the wall plate, and by the fact that the triforium is not pierced. This same architect, when he came to build the cathedrals of Limoges and Narbonne, covered the aisle roofs with slabs from the beginning, and glazed his triforium, as did also the builder, or rather finisher of the church at Louviers. Even in this country we find some attempts in the same direction, as for instance, at Minchinhampton, where very acutely pointed transverse arches carry a high pitched roof of weathered slabs. I am not sure whether some flat stone roof may not have been originally intended over the aisles at Westminster.

I fear I have been very tedious, but I have been anxious to bring out this point—that Gothic architecture was the result of the closest possible reasoning. The men of the Middle ages were anxious to build like the Romans; but with an analytical spirit worthy of the Greeks, they felt

that it was not building like the Romans merely to copy the outward form of their buildings; that if in Roman vaults a skeleton was needed to carry the outward form, it was right that this skeleton should be shown, and that every member should tell its own tale, that form and structure ought to march hand in hand; that if when conditions change one has to give way, it must be the former, and not the latter. By following out the principle, instead of copying the form of the Roman vault, regardless of the result to which they were tending, they ended by creating the most complete system of architecture which the world has seen, and one whose beauty no one will deny. For the last three hundred years we have been copying the outside form of every style in turn, and we may go on for ever copying and commenting upon Roman and Greek, and Gothic and Queen Anne, without producing a true architecture. True architecture is that which is true to its programme, and true to its means; which exactly, scrupulously and economically fulfils the conditions imposed by a want, and employs its materials without waste, according to their qualities and their properties. That which is now considered the all-important question, the form, is but a secondary condition, certain to be satisfactorily fulfilled by adherence to the ruling principle.

I cannot but think that if Ictinus and Agrippa, and Robert de Coucy, could come back upon earth, they would each claim as Greek or Roman or Gothic, not the Walhalla or St. George's Hall, not St. Peter's at Rome, nor the Colonnade of the Louvre, nor any of our faultless modern Gothic buildings, however beautiful all these may be, but in spite of all their faults and possible lack of beauty, such buildings as the Crystal Palace and the Albert Hall, the roof of St. Pancras station, and the dome of the Vienna Exhibition, Menier's Chocolate Manufactory at Noisy, and the Parish Church of Rambouillet. The architecture of a people ought to be the expression of its daily life and wants, homogeneous in all its parts. Gothic was so, as we have seen. Can as much be said of ours?

The Secretary then read,—

A COMMUNICATION FROM MR. E. SHARPE, M.A., Fellow.

C. L. EASTLAKE, Esq.

Hurst Bank, Bolton-le-Moors,

My dear Sir,

Nov. 28th, 1874.

I feel much honoured by the invitation of the Council to attend the meeting of the Institute on Monday next, in order to take part in the Discussion on Mr. Eagles' Paper on Vaulting, but I am sorry to say that my engagements here preclude the possibility of my doing so. I shall, however, be glad to offer a few remarks, which I should have made had I been present, and which the meeting may, perhaps, be disposed to accept as my contribution towards the Discussion: They are made, I shall explain, without the advantage of Mr. Eagles' Paper, which I have not with me here.

There can be no doubt that the introduction of Vaulting into the Churches of the Middle Ages affected very materially their design; but this was not so much the case in those times, and in those countries, where the simplest and earlier form of cylindrical or barrel-vaulting was practised, as in those in which the cross vault, formed by the intersection of two barrel vaults, at right angles to each other, became prevalent. For this earlier and simpler longitudinal barrel vault pressed equally and uniformly on the wall which carried it, which was therefore pretty nearly of uniform thickness throughout; whereas the cross or quadripartite vault brought the whole of the weight of the vault, and the consequent thrust outwards, down on certain points only of the longitudinal clerestory or aisle wall, and had to be met at these points with an equivalent resisting force.

There is, however, one device of the builders of these longitudinal barrel vaults of the 11th century

which is worthy of notice, before we go on to consider what was the effect produced by the introduction of the quadripartite vault in the designs of this period.

Throughout the whole of the South of France these barrel vaults, whether circular or pointed, were generally erected on *apteral*, or aisle-less churches, the side walls of which were made sufficiently strong to offer, with the addition of shallow buttresses at certain intervals, a sufficient resistance to the lateral pressure of the vault. But in the case of the larger conventual and cathedral churches, where side-aisles and a blindstory or triforium occurs, it was not uncommon, in order to afford additional support to the clerestory wall, on which the main vault rested, to throw the half of a semi-cylindrical barrel vault across, from the top of the aisle wall, over the triforium, to the base of the clerestory wall (see illustration).

It is obvious that we have in this device the idea and suggestion, if not the actual realization, in a continuous form, of the flying buttress, which became, in a detached form, the chief support, at certain intervals, of the quadripartite vault of a later period.

The noblest example that we have of this continuous longitudinal semi-circular barrel-vault, supported by the continuous demi-semi-circular vault—if I may be allowed the expression to convey its quadrant-like form—over the triforium, is in the grand five-aisled Church of St. Saturnin at Toulouse, commenced about 1060, and consecrated by Pope Urban the Second in 1090.

When, however, the quadripartite vault became common, new forces were created, the treatment of which demanded the chief attention of the designer, and were the first to be considered. The vault became, in fact, not only the fire-proof covering of the whole building, but the chief principle of the whole design; and my belief is that, from this moment, the architects of those periods thought and designed downwards instead of upwards, and that, the capacity of the building being fixed, they began their design by first laying out their main vault and their clerestory walls; that they next designed the arches which were to carry these walls, and the mouldings with which the latter were to be clothed; and that they then lastly decided on the bulk and the form of the piers that were to carry these arches, instead of beginning, as probably most architects do at the present day, by arranging the ground plan first, and the covering of the building last.

I am confirmed in this impression that the plan of the upper walls of these early buildings was that which was first thought of, and designed, by the remarkable fact, that if the plan of by far the greater part of our cathedral and conventual churches, as presented by a horizontal section of the clerestory walls be laid down on paper, it will be found that it presents almost invariably the true form of the Latin Cross; whereas the ground-story plan of these buildings presents, with its side aisles, porches, and eastern chapels, a much more complicated figure. Of the simple longitudinal barrel vault the only example I know of in this country is that of the chapel in the White Tower in the Tower of London, built A.D. 1081.

Quadripartite vaulting on a large scale was not introduced into England until long after it had become prevalent on the continent, but the whole of the side-aisles of our Norman churches were usually vaulted in this manner, and one of the chief results of thus bringing down the burden of many different forces in a convergent mass on the top of a Mediæval pier is better exemplified in the pier of a Norman cathedral in England, than in any building in Continental Europe with which I am acquainted; a fact which is also testified to by M. Viollet le Duc, who states, in his *Dictionnaire Raisonné*, that the earliest example of what became a ruling principle in the design of a Gothic church—that, namely, of providing a corresponding support for each member of the combined arches that fall upon it—is to be seen in the piers of Peterborough Cathedral, a drawing of which, on a large scale, is given in my "Ornamentation of the Transitional Period," part I.

TRANSVERSE SECTION OF THE
NAVE OF A BARREL-VAULTED CHURCH OF THE SOUTH OF FRANCE,

*In which the semi-cylindrical Vault of the Nave is supported
by the half of a semi-cylindrical Vault, springing over the Trisforium
from the side aisle wall; being the primitive idea of the Flying Buttress.*

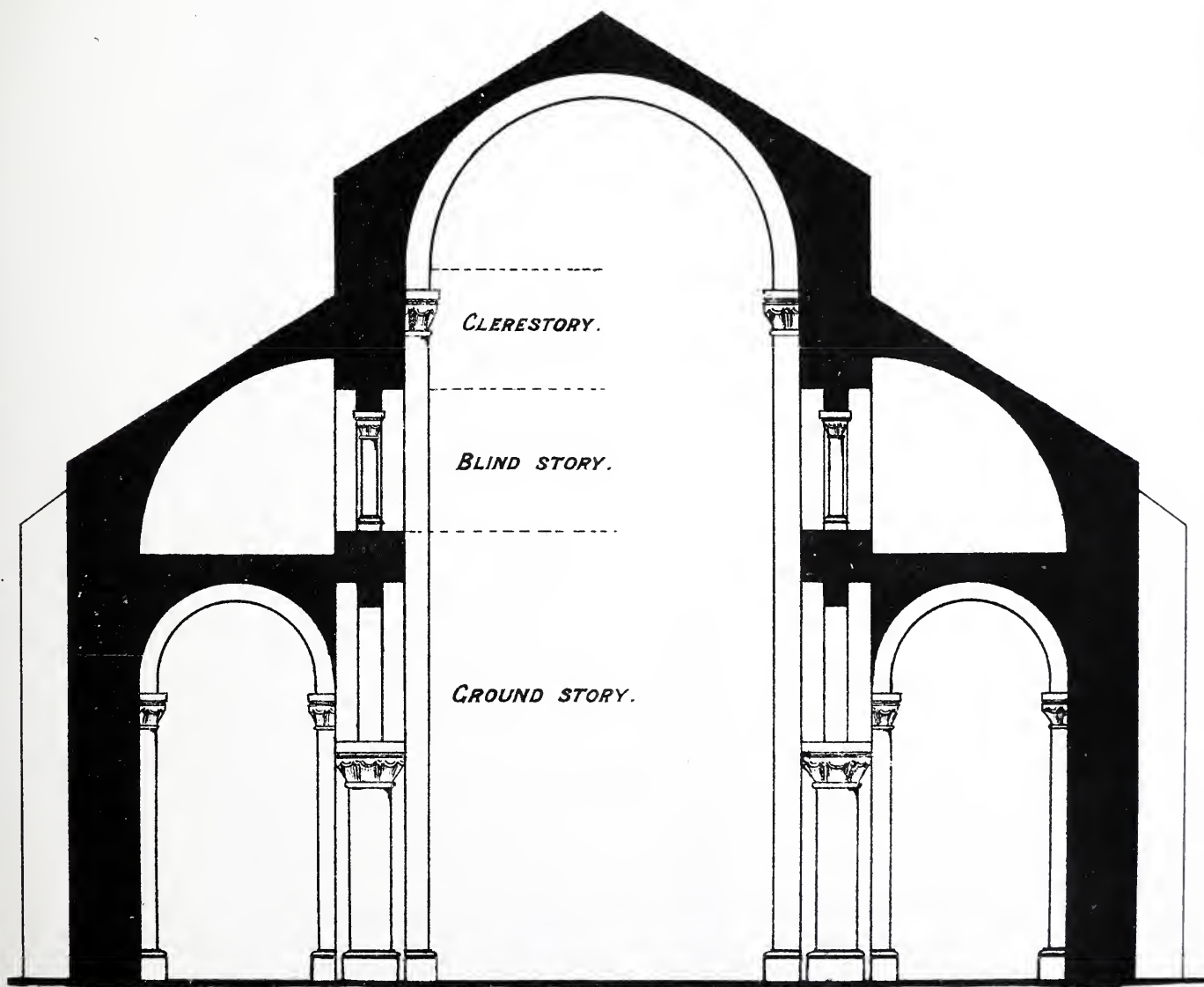

DIAGRAM IN ILLUSTRATION OF MR SHARPE'S LETTER.

My remarks on the facilities offered by the Pointed Arch in the construction of vaulting, and the causes of its early appearance there, as well as in other arches of construction, have been so frequently published as not to require repetition here. But I cannot conclude these observations without venturing to suggest, where the means are adequate, the more frequent adoption in modern designs of this most beautiful and durable mode of ceiling a church, as a more fitting employment of these superabundant resources, than the gandy decoration of its walls and fittings which is becoming so prevalent. As an encouragement to those who may agree with me in this matter, I would suggest that a means exists now of lightening the weight of such vaults, and consequently their cost, with which our Mediæval predecessors were not acquainted, by the use of hollow fire-clay bricks, which may, I believe, be made so light as to render it unnecessary to employ flying buttresses, and for which an inexpensive centering might, I think, be easily devised. Bricks of this nature, whether as groin-ribs, or in the coursed work of the vaulting cells, may also be made, at little or no additional cost, to contribute to the architectural effect of the vaulting.

Nov. 28th, 1874.

EDMUND SHARPE.

The Chairman having invited discussion,—

SIR EDMUND BECKETT, Q.C., Visitor.—Although I am glad to accept the invitation to this discussion, I have but little to contribute to it. It seems to be thought that there is some analogy between Gothic vaults and domes. But though the word domical may be used for want of a better to express the middle part of a vault, which rises in every direction, there is this essential contrast between domes and vaults: a dome springs from a continuous base, and narrows as it rises, while a vault rises from four props, and widens upwards. [Mr. HALL:—Barrel vaults rise from a continuous base]. Yes, but continuous barrel vaults are not vaults at all in the sense we are now considering: such a vault is nothing but an enormously wide arch; and, moreover, I showed in my paper on Domes, in February, 1871, (S. P. No. 6 1870-71), that they differ essentially from arches, because the weight of each "lune" of a dome diminishes to nothing at the top, and therefore they require different principles of calculation for stability. A barrel vault cannot properly stand at all on walls pierced with wide windows, because the piece of wall over the window has no strength to resist the thrust, except by virtue of great thickness and the strength of mortar, which ought never to be relied on. The mechanical problem to be solved in Gothic vaulting is to carry a roof on narrow props at considerable intervals, these props being capable of resisting a great thrust outwards by virtue of the buttresses either flying, as in most cathedrals, or solid as in King's Chapel. There are several ways of looking at this problem. The common way is to consider the ribs as carried across from the northern to the southern buttresses, and to assume that they would stand by themselves as arches, either round or pointed, and then the panelling or filling to be added as so much dead weight. But that is a mistake. Such ribs would not stand alone, or would only stand if their depth happens to be sufficient for independent arches, according to the calculations in the Paper on Domes. The round arches would have a tendency to burst at the haunches, and the pointed ones also tend to fall in somewhere between the middle and the top, according to number of degrees of a quadrant that they embrace. The panelling and filling in upon the haunches performs the very important function of preventing the ribs from so falling in, *i. e.* falling towards each other, and *pro tanto* converts the vault into a dome. And it does not matter whether the filling in is of thin flat stones, or rubble plastered inside, as usual, in the oldest Gothic vaults, or pots, or even, concrete provided it will stick together; for in any of these forms it is stiff enough for that purpose. And the panelling frequently performs another duty too; without it

you could not have a horizontal middle rib along the axis of the vault, which, though not essential, is both common and ornamental; for it could not hold itself up without being arched between every pair of adjacent bosses or convergences of vaulting ribs, which would look ugly. The panelling makes a continuous arch quite strong enough to prevent the intermediate stones of that long horizontal rib from dropping. In fact, the panelling, if carefully constructed, would be stronger without ribs than ribs without panelling; though, as a matter of construction and architecture, it is better to treat the ribs as primary and the panelling as secondary. There is another way of looking at the problem

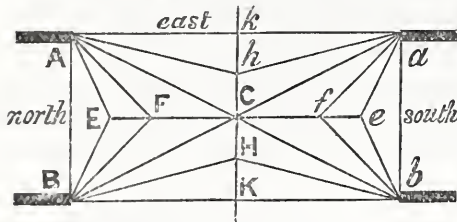

meehanically, which I think worth notice. Let AB be horizontal sections of two northern buttresses, and ab southern ones, which I represent only by thick lines to indicate the direction in which they act as buttresses, though all east and west pressures are balanced by the equal pressures of adjacent bays. Now the bit of wall over window, from A

to B , will bear no outward thrust; but if you break it into two pieces and incline them inwards in the direction AE , BE , and arch them, they will stand if E is resisted, and if the arches are made stiff enough by panelling or filling in. Similarly another pair of arches or ribs, AF , BF , will stand on the same conditions, and any number of them that you like. And all these obviously will be resisted and balanced by the opposite pairs, ae , be , &c., from the southern side, and a stiff rib from E to e , which may either be horizontal or arched. Then again we build a pair of ribs, BH , bH , leaning eastward, and balanced by similar ones, Ah , ah , and another horizontal rib, $KHCkh$, which receives all the east and west thrusts. The narrow triangular pieces, AEB , BHb , and the two other corresponding ones, only require panelling to fill them up, and there may or may not be ribs thrown straight across from A to a and B to b , as you please. If Mr. Sharpe had been at Cambridge when the new piece of the University Library behind the Senate House was building, under the late Mr. Cockerell, as I was, he would have seen pots, like flower pots with a top as well as a bottom, used in the barrel vault over it, as they were long ago in the dome of St. Vitale at Ravenna. That vault exhibits a singular and probably unique peculiarity in its ribs; for it has diagonal ribs below the barrel, which are of course plastered. They are divided to imitate stones, and (if I remember right) coloured slightly also to make the imitation better. But the strange thing is that the divisions are all horizontal or parallel to the axis of the vault, instead of being at right angles to the ribs, as real stone joints must have been. The consequence is that they present the pleasing appearance of all trying to slide past each other, and of the whole thing wanting to fall to pieces. I ventured to ask Mr. Cockerell himself, thirty-six years ago, the reason for that peculiar imitation of an impossible construction, but he did not vouchsafe me any answer. The external aspect of that building gave the finishing blow to Renaissance architecture in Cambridge, which at that time was strongly advocated by Dean Peacock, a leading man there, who afterwards became one of the most distinguished restorers of Gothic at Ely. That brings one naturally to its splendid neighbour, King's College Chapel, the fan vaulting of which Mr. Eagles, I see, calls "debased, and exhibiting false construction, because the ribs "are not veritable independant arches," &c. I am no admirer of the Perpendicular style myself, and consider it manifestly Gothic on the wane; but if all its ornamental panelling were shaved off, or filled up flush, nobody will deny that it would be a great deal worse. If any one thinks the ornamental ribs of fan tracery not ornamental, I cannot help it; but he may as well remember that they are quite as real as the shallow Decorated arcading round the nave of York Minster, and many other churches, though I am far from thinking perpendicular panelling equal to decorated arcading. It is singularly inappropriate to call fan vaulting a false construction. Shave off all the ornament if you like, and the

construction is as genuine and real as that of a dome or a wall, and a very elegant form of construction too. And what is more, it happens to be the only genuine original characteristic of any advance in Perpendicular architecture; for the straight-barred windows are manifestly a degradation and decline from the preceding style. I agree however in condemning the heavy pendants half way up the vaulting of Henry VII's chapel, as an essentially false construction, and hanging of dead weights of stone constructively useless and unmeaning in a way that looks and actually is unsafe, for the tenacity of long pieces of stone lengthwise can never be relied on. The pendants at the top of King's Chapel are quite different, having no long hanging length, but in fact being merely large bosses. Nor do I know anything like a reasonable objection to the beautiful fan vaults of that and the Peterboro' Lady Chapel, and others of that kind. If such things perished it would be a grievous and irreparable loss to architecture. Few inquiries are more unprofitable than speculations on the origin of pointed arches. But I must say that I agree with Professor Willis, who has had far more architectural experience and insight than Dr. Whewell, that they had no such recondite origin as this of vaulting, even though M. Viollet-le-Duc is quoted to-night as supporting that theory. The first pair of intersecting round arches that were ever made produced a pointed one to look at; and it is absurd to suppose that the early Gothic builders had not sense to perceive the superiority and beauty of pointed arches for nearly every purpose where variations of their width occurred naturally or were wanted. Nor do I agree in attributing so much as some persons do of the general construction of old churches to the necessities of vaulting, though of course those necessities had to be considered down to the very foundations; but only in the strength of the buttresses and pillars. A heavy timber roof with large principals between the clear-story windows involves the same general construction. And if anybody thinks that the division of our churches into a nave and aisles, which Mr. West finds fault with, was due originally to vaulting, there is one very decisive answer to it, that it began before anybody had ventured to vault over a nave. It has the much simpler origin that a clear-story and aisles are the best, lightest and cheapest way of roofing over and lighting a long room of the width of large churches. I remember saying to Mr. Henry Cole, when the Exhibition building of 1862 was making, "So you have to come to a clear-story and aisles after all." It is diverging somewhat from the present subject, but as Mr. West spoke of the general arrangement of our churches, especially cross ones, as being wrong and unsuitable to our worship, I may also; especially as I have had to consider that very point not unfrequently, having myself designed half a dozen churches or more, of very different sizes, besides having a good deal to do with others which I did not design. I have already disposed of the nave and aisle question, and I need not say that it is useless in the present day to talk of galleries, inasmuch as people will not have them, and are even pulling them down whenever they can manage it, and so the necessity for high aisles, or a huge ugly roof spreading over a width of 50 or 60 feet, is gone. There remains then only the question of transepts to consider. I agree at once that sham transepts, by which I mean a piece of aisle turned sideways and faced with gables, are both ugly and ridiculous, though very common in new churches, but very uncommon in old ones. Practically a cross church means or ought to mean one with a tower in the middle, and in the middle (allow me to remark) of four equal and not unequal roofs; the latter being a modern abomination hardly to be found (if at all) in any considerable old church of the same date throughout. Undoubtedly the two western tower piers are a difficulty; for if the pulpit and reading desk are against the eastern piers, the west ones obstruct the view and the sound—as they are generally made. But so long ago as Norman times they knew how to get over that, as you may see in Winchester Cathedral, Malvern Abbey Church, and sundry others, by keeping the north and south faces of the western piers flat, and without projecting shafts, so as to leave the opening between them nearly as wide as between the nave pillars. Later, in Rievaulx Abbey and

elsewhere, the shafts and the corresponding orders of the western tower arch are carried by large corbels at some considerable height above the floor, so as again to leave the utmost width where it is wanted. I adopted rather the Norman plan of the two in the church which I designed for Mr. Bass at Burton, of which a plan and view appeared in the *Builder* of Aug. 29; and the consequence is that the pulpit and reading desk near the two eastern piers of the tower command practically the whole congregation in the nave, besides all the transept space without any interruption; while at Doncaster and most other cross churches it is impossible to put the pulpit there on account of the obstruction of the western tower piers, and so a great part of transepts are deserted. Moreover I say boldly that in architecture, as in other things, we sometimes gladly sacrifice a little convenience to obtain greater pleasure from what we think beautiful, though good architecture ought to require such sacrifices as little as possible. Returning to the immediate subject, I have only one more remark to make. Most of us have read a Quarterly Review article which tells us that the Hope of Architecture lies in leaving as much as possible to the workman, and that independent designing by persons called architects is the despair of architecture. I see this subject is to be discussed at your next meeting, and therefore I will only say upon it now that I should like to know how a great vaulted church was to be designed, except by one designer, who had to think of every stage of it up to the top when he began the very foundations. Does that writer believe that this was the result of the deliberations of a set of workmen co-operating to "cut and fix the stones in some instinctively harmonious way, in perfect and spontaneous concert with a general design"? Men with theories of art can persuade themselves of anything requisite to support them, and it is a capital plan to assert boldly that whatever you admire was done in the way you think it ought to have been done, and leave other people to disprove it if they can. But I prefer leaving such theories for their authors to prove them, if they can, not by fine language and pretended analogies, but by any thing worthy to be called evidence. All this however, and much more, we shall doubtless hear at the next meeting from some of you, who are more interested in defending your profession than I am.

Mr. R. H. CARPENTER, Associate, said—I have been asked to say a few words on the subject of fan vaulting, more especially with regard to Sherborne Abbey, but as I have not had time to work out this subject properly, and prepare plans to do it justice, I have asked to be allowed more time to put my remarks in the form of a paper to be read on a future occasion. I am glad to hear Sir Edmund Beckett speak in praise of "poor Perpendicular." Mr. Eagles speaks of the vaulting in King's College Chapel as typical of fan vaulting, but I think there ought to be more than one type drawn for fan vaulting. The type of fan vaulting of King's College Chapel and Henry the Seventh's Chapel is perfectly distinct from the vaulting at Sherborne and in the Gloucester cloisters. In the latter there are pure curves up to the apex of the cellular vault. At Sherborne the ribs of the choir vault rise to the ridge in a curve through the horizontal line of the fan vault, which is level with the apex of the cellular arch or wall rib. The ribs are of a flatter curve above this point, but in the nave they rise in one pure curve to the ridge; this is very different from the vaulting in King's College Chapel. At Gloucester the ribs of the fan rise in a pure curve to the level of the apex of the wall rib, leaving between the semi-circular horizontal fan ribs a flat space, therefore the vault has the effect of a flat ceiling on corbels circular in plan. At Peterborough in the eastern chapels of the choir the semi-circle of the fan is a very small one, and the upper semi-circular lines intersect one another: that is another distinct type of fan vaulting. At Windsor the vault is really not a fan vault at all. I do not myself see how fan vaulting "exhibits false construction," because the panelled filling will *not* stand entirely by itself. As regards the ribs, in the case of Sherborne, they rise to the ridge, and if that is

“false construction,” any pointed vaulting ribs are of false construction too. Then, again, fan vaulting has been condemned as a costly way of “doing what may as well be done in a simpler manner;” but I think in the latter work there is much more economy of material and much more science, and it is *not* done in a more expensive way. In a recent paper by Mr. G. Gilbert Scott, Jun., on “Village Churches,” the author refers to the later styles as involving the employment of less materials and labour, and thus being more adapted to present requirements than the early styles, with their thick walls and more massive and therefore expensive form of construction. In the case of Sherborne there is a fan vault which stands without flying buttresses; but in the 13th century work, to support an arched vault of the same span, there are necessarily great flying or other forms of buttresses. The semi-circular plan of the later fan vault seems to have been approached to in the early vaults of Westminster Abbey; for one sees the courses of the dark chalk or freestone filling in dip down from the apex of the wall rib towards the diagonals, and up again towards the transverse ribs. The effect of this when seen from below, is to keep back the diagonal rib, and to make the rectangular solid of the vault appear octagonal, and in some cases almost semi-circular, as the plan of the ribs and solid would be in a fan vault. Perhaps it was felt that the extreme projection from the vaulting shaft centre of the diagonal rib beyond the others was an objection, and so it was kept back in appearance by adopting the apparently half octagonal or semi-circular plan. It seems to me an interesting question, whether or not that idea had the effect of introducing the semi-circular plan of vaulting solid for fan vaults, and I should be glad to hear opinions upon it.

Mr. H. W. BREWER, Visitor. —I would remark with regard to the use of ribs in Gothic vaulting, that I have come across two examples, which I consider worthy of special mention. One is in the large side chapel of the church of the ruined Abbey at Lehon, in Brittany. The other is in the chapter house of the Abbey of Netley, in which all the ribs have absolutely fallen out, and yet the vaulting still exists whole and entire. This I think shows that in the 13th century, ribs were very frequently used simply as ornamental features; that in point of fact they did not support the roof, and did not act as centres. It might not be uninteresting if I said a word on one or two singular examples of vaulting, which I have met with in Germany and Holland. One in the church of Our Lady at Roermonde, in Lunenburg in the extreme south-west of Holland. This is a very beautiful church of the 13th century, the nave of which is covered by three bays of quadripartite vaulting. The vaulting is slightly domical, and the ribs start at a curve, which if continued would bring them to a pointed arch, but when they arrive within some 4 feet of what would be the centre, they drop down again—forming a pendant. This is somewhat remarkable in a building of this date (between 1212 and 1226.) The peculiarity, however, does not end here. When I was in the church I noticed these pendants were terminated by a very delicately carved pendant boss, representing a flower of the crocus tribe inverted. I made the acquaintance of Mr. Cuypers, the talented architect entrusted with the restoration, and he assured me that these bosses were of wood. The stone pendants were perforated, and this wooden boss formed the end of a kind of continuation of the king-post of the roof above the vaulting, which was brought right through the stone pendant. Another singular treatment of the ribs of vaulting is to be found in the Church of Boppard, on the Rhine, where the ribs instead of radiating from the springers, as is usually the case, radiate from the bosses, and as the vaulting is rather domical, each bay of vaulting has the appearance of the underside of an umbrella. The whole thing is peculiar, and seems to prove more than anything that the ribs are really in point of fact an ornamental feature, and in many cases certainly are not constructive features. Another remarkable example of vaulting is in the Church of St. Wolfgang, at Rothenburg. Here the ribs which support the vaulting do not form the same arch as the vaulting itself, but form a much sharper arch, and the consequence

is that at the crown of the vaulting the rib is only some 3 or 4 inches in thickness, whereas where it dies into the wall it is 3 or 4 feet thick.

Another example is presented on a small scale in the rood screen of the Cathedral of Munster, and I have seen the same under a large baldachin in the Thyne Church at Prague. There the vaulting ribs are absolutely isolated; in fact the ribs rise up and support nothing until they come to the crown, and there they support a flat stone ceiling; yet there are not only diagonal ribs, but intermediate ribs. In this case the spandril is open and filled in with delicate traceries. I have seen several other examples of this kind of vaulting in Germany, and I believe there is one in England, which if I mistake not is to be found in the rood screen of Southwell Minster Church in Nottingham. I think these examples go to prove that the ribs are by no means a constructural necessity but were really an ornamental feature used simply for the purposes of accentuation or richness of the angle of the vaulting.

Mr. EDWARD HALL, Visitor.—I believe I have seen in the ruins of Kirkstall Abbey groining wherein the ribs remain, whilst in the majority of cases the filling in has fallen away—showing that there the ribs were structural; so that I do not think it can be ever admitted that, as Sir Edmund Beckett argued, the ribs are not essential to the stability of groining. [Sir E. BECKETT.—What I say is, you can build pointed arches without panelling between.] I would ask whether in many cases the whole strength was not derived from the ribs, while the filling-in was of the lightest character? There is something calling for notice in Sir Edmund Beckett's remarks with regard to the plan of an ordinary church. The pulpit and reading desk are the leading features to which we might suppose the attention of worshippers should be directed. But according to popular ritual there is a more important feature in the plan, viz.: the altar, to be regarded. Nevertheless, if not in the case of the plan with nave-piers and aisles, at all events in the cruciform plan, the altar could not be seen from the ends of the transepts; therefore where transepts are a feature, the plan must be essentially a bad one.

Mr. R. P. SPIERS, Associate.—There are one or two points which I wish to notice, and one or two questions I should like to ask. Mr. West, in the course of his remarks, mentioned the existence of stone or tile roofs of the South of France, where they preferred, when possible, to have real stone roofing. There is a curious example of a stone roof in the church at Montataire, in Picardy. The roof is very much inclined and the pitch is extremely high. It is formed of slabs of stone, supported at intervals by stone arches. The distance apart of the stone arches is some 10 feet, which would have been too great a bearing for the stones except that the inclination of the roof causes them to rest one on the other. With regard to the use of hollow bricks in vaulting, there are many instances in which they have been employed. In the church of St. Vitale, at Ravenna, hollow bricks or pots are used, as also in St. Sophia, Constantinople, and there is an instance in which they have been lately employed in the Abbey and domes at Caen. The vault in this abbey which was thought to be of stone, was really in wood, and painted, till about six or seven years ago. It was found necessary after the first construction of the vault, in consequence of the low position of the buttresses, (the walls having given way) to take down the stone vault and put in its place a wooden one, and this is the one shown in "Pugin's Normandy;" and a few years ago when the abbey was being restored by M. Russrick Robert, it was replaced by a vault constructed with hollow bricks. The point I would refer to in Mr. Eagles' paper is this: first, when speaking of the careful arrangement required to make the various ribs mitre into each other properly, he remarks: (p. 196) "With ribs of varying curvatures, we are liable to find some particular one disengaging itself from the spandrel solid before its neighbours, which introduces a certain amount of awkwardness."

He then gives an instance of a case at St. Mary Minster, Thanet, in which there is difficulty,

and after explaining how the difficulty was got over, continues: (p. 197) "The solution of the difficulty was found in making each rib a compound instead of a simple curve."

I think this is the first time I have heard that theory brought forward, and it is one of which one would like to have some additional proof. I had hoped that Sir Gilbert Scott would have been here, because he could have informed us whether he has found that feature in any of our cathedrals, particularly at Worcester. The difficulty which arises is this—supposing one has a simple form of vault with diagonal and tranverse ribs only (Mr. Eagles' illustration is too complicated) if the axis of these ribs meet on the wall surface and the ribs all rise to the same height, it will be found that the diagonal rib will detach itself sooner from the *tas-de-charge* than the tranverse, and that the web will start unequally from the two ribs. To obviate this difficulty Mr. Eagles points out, that having ascertained the height on the back of the tranverse rib at which it would be disengaged, the diagonal rib was set back to accord with it, and the lower portion of the rib was struck from a different centre, so that the rib might come down on the cap in its usual position. Mr. Eagles cites Worcester and Beverley as instances of this arrangement, which I do not remember having heard referred to before. There are two ways in which I have noticed the awkwardness remedied, (though I may remark that M. Viollet-le-Duc looks upon this irregularity of detachment as an advantage, as it enables you to start your web on a line instead of on a point); the first which is common is England, and which was adopted in this Church of St. Mary Minster Thanet, was to set back the diagonal rib on the columns at the springing, and this I believe is the universal method adopted. The second method which is adopted in France is effected by shifting the axis of the diagonal rib away from the axis of the tranverse rib, until in fact or nearly so, the axis of the diagonal rib meets the outer line of the tranverse rib on the wall surface. Both of these two latter systems were frequently adopted, and it would be interesting to know if the one pointed out by Mr. Eagles was an alternative method.

There are many points connected with the subject of vaulting, which Mr. Eagles' mathematical knowledge enables him to investigate further, and I would suggest it would be very valuable to have some information relative to the means employed in the Middle ages for carrying across the nave and choir aisles, and chapels beyond, the thrust of the immense mass of material, whose vertical weight was carried on the slightest possible supports. Last year in the church at Senlis, I was trying to make out the mouldings of the base of the columns in the choir, and found a feature which I could not understand. It turned out to be the bedding of lead on which these columns had been set, and which was nearly 2 inches thick. These columns were only 18 inches diameter, and it struck me that the weight they carried must be stupendous. Professor Brune of the Ecole des Beaux Arts, who was with me at the time, made a calculation, taking in account the height of the walls and the vault, and he found there must be a weight of some hundreds of tons on this column, which would amount to something like 5 tons to the square inch.

The shaft was of very hard stone, bedded on 2 inches of lead, and if I recollect rightly it was calculated that there must have been nearly 1,000 tons upon that column, which being only 18 inches diameter, did not impede the view in any way. The way in which they obtained the line of resistance of thrust, and the exact amount of the same, so as to allow the vertical weight only to descend—and that with just certainty of calculation—is a study which might well be taken up on a future occasion, and Mr. Eagles' mathematical knowledge would enable him to pursue the subject further.

THE CHAIRMAN,—I may mention to the meeting, that the President has written a letter expressing his regret that in consequence of a severe cold, he is not able to leave his house.

Professor KERR,—I will ask leave to make a very few remarks. The real question of interest seems to me to be this: Whether in this system of vaulting, we have a mode of construction capable of being revived with advantage in the present day, and likely to be carried to equal or greater perfection than that which was formerly displayed. I think we are all agreed that mediæval vaulting was more creditable to the ingenuity and scientific skill of the designers of that day, than almost anything else. But listen to what Professor Willis says: “I have said nothing respecting mechanical principles, and have confined myself to form and arrangement. But it appears to me, from examination of the works of the Middle age architects, that the latter considerations had an infinitely greater influence upon their structures than the relations of pressure, then very little understood, and about which they made manifest and sometimes fatal errors.”

If, then, we at the present day are to revive the mediæval system of vaulting to any advantage—and it is useless to attempt it unless it is done to good purpose, I think it is thus clear that we have not that solid basis of scientific perfection upon which to build up our efforts, which some might suppose. I imagine Professor Willis is still one of the very highest authorities on that particular subject, and the language of his which I have read is very decided. He was not a man to attribute want of success to mediæval builders, if he could avoid it. Now the system of mediæval vaulting arose, as it seems to me, wholly out of the use of the pointed arch; and the use of pointed arches in the Middle ages, I have always thought, came out of no mere imitation of anything else at all. It did not come out of any accidental interlacing of arches, for instance, any more than from the interlacing of the branches of trees, which an ingenious gentleman once thought to be the origin of the whole scheme of Gothic architecture. Every one ought to know that the structure of an arch has nothing to do primarily with mere circularity of form; but that the form is in fact the product of the arch principle under certain conditions, and no more. The primitive arch was clearly the two inclined struts of stone which are found in the interior of one of the pyramids. The next step towards what we now call a semi-circular arch, consisted in the same two struts of stone with a third horizontal strut, or key-stone between them. We can see, I think, clearly enough, that the pointed arch in its actual origin must have been, and must have been perceived to be by the builders of the 12th and 13th centuries, simply a stronger form than the semi-circular arch of previous periods. It was palpably more to the purpose, and the more pointed it was the more easily it was made use of. Thus they were enabled gradually to build up, upon the use of stones as struts, the whole system of arcuation, which has been carried almost to excess in the works of the middle ages, and upon which I think the whole merit of mediæval architecture is based, in spite of what Professor Willis says about other than structural considerations having undue control. At any rate, science in the present day we must admit does not tend towards any development of vaulting. The engineers have abandoned the use of the arch wherever they could. It is in fact an obsolete system of building if we judge by the advanced work of the times. We have other modes of construction and other materials at command, far in advance of the arch and far in advance of stone, for the purposes of erecting a roof; and my own opinion therefore is, that whatever operates to revive the use of vaulting in these days must be confined to that which is the principal field of the revival of Gothic architecture—the peculiar ecclesiastical reproductions which in their way we all admire so much. As a scientific problem the revival of vaulting is in my opinion of no real value. I consider there is nothing to be got out of it as a scientific mode of construction; but if gentlemen who are building churches, and especially such as our eminent visitor Sir Edmund Beckett—who is independent of those trammels which are so irksome to many of us—are inclined to introduce vaulting, and to endeavour to carry it out to the full as it was

practised in the middle ages, we can have no possible sort of objection to it—but quite the contrary—as a delightful exercise in archæological design.

Mr. EAGLES, Associate.—I should like to say a few words as to the claim the vault has to be considered the ruling feature in Gothic architecture; because such claim was disputed both after the reading of the paper and since in the professional press. The question is not one of merely idle interest, but is, I think, essential to understanding the principles on which the mediæval architects worked; systematic proceeding on which principles seems to me to constitute the great difference between genuine Gothic and much of the Gothic of the present day. Copying forms has surely now had a sufficient trial to convince every one that good architecture cannot be produced by it alone, but by finding out the method of proceeding of any men who have produced good work, we may I think hope to gain hints and perhaps a system which may even enable us to rival the most successful buildings of former times.

I take it that the grand distinction between styles of architecture is the mode in which voids are covered in; and as yet there have been discovered only two ways in which this can be done—by the lintel or by the arch. The northern architects of the Middle ages of course covered in their voids with the arch, *i. e.* they made use of a principle introducing oblique thrusts, coupled with relatively small vertical loads. Consistent construction required that equilibrium should be secured by resisting each action in an appropriate manner, and the early history of Gothic architecture is the history of the various steps made to the securing such a result, and to its full and frank acknowledgment in the building. A vertical load on a pier or column tends to steady and stiffen it, and since the oblique thrust of the arch was not permitted to act in overturning the piers, which were intended only for such vertical load, a sufficient area to resist the actual crushing force of such load was all that is necessary. This is, I think, the explanation of the marvellously small shafts, for they can hardly be called columns, found especially in the apses of many French cathedrals, and to which Mr. Spiers has alluded. Again the oblique thrusts of the vault were the immediate cause of the buttress, both flying and buttress proper, or counterfort, and so important a characteristic of the style are they that it has even been called the “buttressed style.” But in addition to their effect in elevation, these masses of masonry, the position and size of which is by no means arbitrary, but depends absolutely on the design of the vault they support, must have exercised a most important influence on the arrangement of the ground plan. Further, the concentration of the supporting masses at definite and isolated points gradually led to the walls being changed from weight carriers into mere screens, which might be omitted altogether, and through which large openings, *i. e.* windows, could easily be made. These openings again could not be left mere yawning chasms, and therefore I say we have here directly dependent on the vault, a strong incentive to the development of tracery. Its growth was necessarily gradual, but unless there had been some vivifying principle in the mode of construction, the mere fact of the juxtaposition of two lancets might have remained to all eternity without fructifying into the traceried windows of 8 or 10 lights, the glories of the geometrical and curvilinear periods.

To the clustered pier I referred when the paper was read, and therefore I will say nothing about it now, but the special characteristics of Gothic mouldings seem to me entirely due to attempts to emphasise the principle of construction, and the forms adopted are admirably calculated (in the words of Petit), “to mark the directions of several thrusts and supports, distinguish angles, and other important lines, and to give an apparent strength to the sustaining masses and lightness to those sustained.” One word on double aisles. These, as giving intermediate points of support to the flying buttresses, are very effective in enabling the thrust of a wide vault to be resisted with a minimum

expenditure of materials, and here again I think we have an instance of the influence of vaulting on the ground plan, and indeed, if we wish to see how the mode of covering adopted must modify the plan, we need only consider the churches of S. Sophia, of S. Mark, and of S. Front, Perigueux.

My friend Mr. Spiers has said that it is possible to make ribs formed of arcs struck from one centre disengage properly if we settle on one rib first, and then simply make those adjacent to it pass through a certain point on its extrados—this is no doubt true, but the difficulty is to secure this in conjunction with other conditions, such as the place of the foot of the rib on the abacus, and its level at ridge. Taking the diagonal and transverse rib of the westernmost bay of vault of S. Mary, Minster, Thanet (illustrated in essay), I have here (referring to diagram) attempted to secure simultaneous disengagement by accommodating the diagonal rib to the existing transverse rib, and vice versâ; in both cases assuming the ridge to be level—in the first case the nosing of diagonal rib is thrown back on the abacus within the wall surface; in the second, the transverse rib is thrown considerably forward, and would require much greater projection to be given to the abacus, while by using a compound curve the radii of the two segments differing very slightly from each other, all difficulty is avoided, and I undertake to say it would be extremely difficult to detect in execution that the rib was not a simple arc.

The filling in of vaults, to which Mr. West has referred, is a subject, which offers some puzzles. I would remark in passing that the instance alluded to by Mr. Brewer of the filling in of a vault remaining in position, although its ribs had fallen out, must be I think altogether exceptional, and that it would be most unsafe to conclude from it that the ribs are merely ornamental. It was probably due, as was subsequently suggested, to the good quality of the mortar in which the filling in and backing had been laid, the whole having become in the course of years a perfectly concrete mass.

At first indeed the filling in is mere rubble, sometimes laid dry, packed together almost anyhow, without any attempt at regularity in the courses, and frequently plastered on soffit, but even in later vaults the direction of the courses seems to have been to a great extent a matter of choice or chance. Professor Willis notices it “as remarkable that the courses of the vaults are not laid level, but are in most cases made to incline downwards upon the diagonal rib.” Viollet-le-Duc says that two distinct methods were employed by French and English architects. The French, he says, divided each of the two half arches bounding any cell of the vault into the same number of equal parts, and made each course of the filling in run from one of such points on the one arch to the corresponding point on the other, so that each course varied in breadth from end to end. This required somewhat complicated stone cutting, but it had the advantage of making an ordinary bed of the filling in coincide with the ridge, whilst the English method, which consisted in setting off the *same* distance along both arches, and making the courses run between corresponding points, left a triangle in the upper part of the vault, which had to be closed by courses abutting against the ridge lines of each cell. This would certainly make the courses incline downwards upon the diagonal, but it cannot I think be accepted as the actual method used, because as pointed out by Willis, the downward inclination is greater than that which would arise from this cause, which my own observation enables me generally to confirm. I have seen somewhere a theory broached to the effect that the courses start perpendicularly from the diagonal rib, but this again, though very likely true in a few isolated cases, does not admit of general application, and in fact there seems to have been no definite rule, but a good deal of chance. *A priori* perhaps one might think that each course should be perpendicular to an imaginary rib lying midway between the two bounding ribs of the triangle whose filling in we are considering, *i. e.* to a vertical plane bisecting the angle between the vertical planes in which these ribs lie, since this arrangement distributes the weight of the filling in approximately equally between the ribs; and possibly this or something like it was intended, but not always accurately carried out. There is frequently

a sudden change in the direction of the joints at some little distance above the "tas de charge"—we find courses inclined at a very decided angle to those below, and this is perhaps due to the difficulty of working at starting when the spaces between the ribs are very narrow, the rectification being made as soon as there was a workable width.

May I be excused if I say a few words on some criticism which the method I adopted for investigating the stability of any proposed arched structure has received. Two articles on the Thrust of Arches and Vaults have recently appeared in the *Building News*, the writer of which refers to my essay, but states that I "confined my attention entirely to the case of the surcharged arch, and did not attempt to solve the problem of finding the thrust of a vaulting rib which has no surcharge"; in fact, he adds, "the method he employs is quite unsuited to such a case, and is both laborious and uncertain in its application even to the loaded arch, as it requires great accuracy in forming the diagrams, and considerable care in the calculations, a slight error in either of which may vitiate the results."

He could scarcely have read the Paper, or he would have seen the last paragraph refers distinctly to a vaulting rib, carrying only its share of the shell or web of the vault, and I beg to assure him the method is strictly applicable to an unloaded arch, or to one loaded with a surcharge of any form, and requires indeed only very slight modification to deal even with the case of a lop-sided load. Accuracy in a drawing is I suppose always looked for, and it is not likely that careless drawing, any more than slovenly analysis, will give an accurate or satisfactory result; but I unhesitatingly assert that the chance of error in any graphic process is very much less than in any investigation carried on by means of symbols, inasmuch as the whole is distinctly visible in the former case, and a proof of its correctness is given by the lines of the polygon closing on certain definite points. The calculations required moreover are merely a few of the simplest possible operations in duo-decimals of less difficulty than scores of those necessary for arriving at the "bill of quantities" for any work. Much has been said lately about the education of architects, and it seems to be admitted on all hands that the standard of scientific and mathematical knowledge among architects is far too low, in fact that the present system of education is wrong, or at least quite inadequate. This is of course too large a question to enter on here, but I would say that great hope of improvement in this respect for the future lies in the application of graphic methods, which in some cases, *e. g.* a complicated roof in which the bars are at all angles to each other, and in which consequently the complication of trigonometrical formulæ is something enormous, are the only ones of practical application. I am very glad to see by the syllabus of the Architectural Association that some attention is to be given there this session to graphic methods. At any rate no more striking example of the need of improved training can be furnished than is given in the papers to which I have alluded; the author of which, after premising that a certain joint opens at the intrados, proceeds to take moments about the point where such joint cuts the intrados, *i. e.* supposes that rotation takes place about such point, that consequently the surfaces there are in contact, and that therefore the joint does not open at the intrados at all.

We have lately seen the astounding statement made by an architect of high reputation that "Stonehenge is more scientifically constructed than York Minster." As it happens that York Minster is covered in with a pseudo-groined vault made of wood, there may perhaps be some truth in the assertion; but there is no doubt that it was not meant to bear reference to this sham, which would probably be held to be venial, but is intended to maintain that the lintel is a more scientific piece of construction than the arch. A wooden lintel would undoubtedly be more so than if we were to saw up the same piece into voussoirs and arrange them in an arch, but how stands it with stone?

Scientific employment of material requires it to be so used that the stress upon it shall act in the direction of its greatest resisting power, otherwise there is waste of material and false science. Since

all stone resists compression in a far greater degree than it resists either tension or cross strain, it should be exposed to compression only, and in a properly designed arched construction this can be absolutely secured.

Sir E. BECKETT.—Mr. Eagles has made a remark which ought not to remain unnoticed, viz. that vaulting gave rise to windows of eight or ten lights, filled with tracery in the head. One fact is decisive on that point, viz. that all such windows occur in the large gabled fronts which are entirely independent of vaulting, and just the same in a vaulted and an unvaulted church. They manifestly came from wheel windows, which existed very early, set over a number of lancets.

Mr. T. MORRIS.—Before you tender our thanks, Sir, to the authors of this brilliant discussion—it has certainly been a most interesting one—I would express a hope that when Sir Edmund Beckett again meets the member of the Institute who asked him, “What is there to be said about vaulting? we know all about it;” he will tell him that the subject proved almost exhaustless, and that there really was a great deal to be said about vaulting. It is the business of this Institute to elicit the best opinions on this and other subjects relating to architecture. Our functions would be of little value if we too readily gave things up as sufficiently known and understood. I hope nothing that has been said will discourage the continued discussion of the subject, so as to embrace fan vaulting, and I trust, we shall be favoured with Mr. Carpenter’s communication, because he would be able to show in some examples a wonderful display of constructive skill, combined with a large amount of decorative details.

A vote of thanks was unanimously passed to Mr. Eagles, the author of the paper, as well as to Sir Edmund Beckett and the other gentlemen who took part in the discussion, and the Meeting then adjourned.

Royal Institute of British Architects.

At the Ordinary General Meeting, held on Monday, the 14th of December, 1874, Sir GILBERT SCOTT, R.A., President, in the Chair, the following Paper was read:—

ON "THE HOPE OF ENGLISH ARCHITECTURE,"

By WILLIAM H. WHITE, Fellow.

"In the reign of Edgar, the Isle of Ramsay, in Huntingdonshire, belonged to a nobleman named Aylwine, 'who was attracted to Oswald, Bishop of Worcester, by the sanctity of his deportment,' and during a long and holy conversation with the Bishop, it came out that Aylwine having been long ill, was cured by St. Benedict, and received a mission to erect a monastery in the island. Oswald having in his diocese 'twelve brethren in one village who had cast behind their backs the lusts of the flesh, and were only warmed with divine love,' and who would willingly undertake the charge, proposed, like the famous man of business that he was, at once to go with Aylwine and inspect the place. And then explaining to his companion that 'while erecting there a temporary mansion, we shall also be erecting, if our faith fail not, a mansion eternal in the heavens,—Let us, (said he) commence at once lest the devil should take occasion of any delay to breathe a colder spirit upon us. Let me, therefore, send hither a certain man faithful and approved in such works, under whose management a little refectory and dormitory may be prepared.' Ædnothus was sent, who laid out the ground, enlarged the chapel, and added other buildings according to Oswald's plan. Ædnothus had the care of all the out-door works. He, during the winter, provided the masons' tools of wood and iron, and in the spring he set out the plan of the foundations and dug out the ground. He was in fact the chief of the workmen, and he made a fine building of it. The central tower of the church however began to crack, and Ædnothus had to report the failure to Aylwine, who agreed to find the money for the restoration. The labourers approached the tower by the roof, and going stoutly to work razed it to the very ground, dug out the treacherous earth, made the foundation sure, and again 'rejoiced to see the daily progress of the work.' What a contrast all this is to our present condition and practice! The nobleman 'attracted to the bishop by the sanctity of his deportment;' the memory of the vow after recovery; the 'twelve brethren in one village who had cast behind their backs the lusts of the flesh;' the fear of the 'cold breath of the devil;' a bishop who could make a plan, and the 'man faithful in works;' the cleverness and alacrity of the labourers, and their 'rejoicing in the progress of their work,' are such a beatific vision that our retrospective view confirms the holy Oswald's prescient declaration, 'Verily, this is another Eden, preordained for men destined for the highest heaven;' a remark that has not reached our ears respecting the scene of any recent architectural effort.

"Such was the system of artistic practice that for six centuries served to make England the finest scene of architectural display that the world ever saw. The workmen 'worked after their manner;' they were totally without extraneous artistic tutelage. The masons were, of course, largely employed on ecclesiastical buildings; not under the patronage of the clergy, however, but on the contrary, rather patronizing them."—*The Quarterly Review*, Oct. 1874, p. 364.

AN old and venerable *Review*, long eminent for the respectability of its conduct and its contributors' opinions, has lately carried on a war of epigram and assertion against the whole profession of architects not only of this country but of all civilised countries. Shielded by the ægis of a learned editor, and by that of a publisher whose name is almost historical, a writer of no mean powers of description and invective has passed so sweeping a condemnation of the art-system of Europe, and hurled so much personal abuse at individuals as to weaken a case still further impaired by exaggerated advocacy. Nevertheless, I have the conviction that he has been influenced by a conscientious desire for the reform and advancement

of the building art, and that regard for the public good has prompted him to write; although in these days of rapid composition it is not the fashion to admit that opponents may be disinterested, statesmen patriotic, or philosophers sincere. An article, entitled *THE HOPE OF ENGLISH ARCHITECTURE*, appeared in the *Quarterly Review* of October last; another article on *THE COMPLETION OF ST. PAUL'S* was published in October, 1872; and a third, which was called *THE STATE OF ENGLISH ARCHITECTURE*, and which obtained no small notoriety, occupied the first place in the number for April, 1872. These three articles are so intimately allied, both in mode and matter, that it is impossible to reply to one without touching upon the substance of the others; but if I have preferred to adopt for the title of this refutation "*THE HOPE OF ENGLISH ARCHITECTURE*," it is because that article has an advantage over the two others which preceded it, for it is written with the ease of a gentleman and the felicity of a scholar; and if at the conclusion of my Paper it should be proved that I have "rushed in" where wiser men would have hesitated to tread, upon my own shoulders must rest the responsibility of its preparation.

The *Quarterly Reviewer* reminds the public that now-a-days, "*instead of a class of noble working men we have the architectural profession—a number of soft-handed 'gentlemen.'*"* The majority of architects may justifiably own the soft impeachment. But in any calculation of the value of things past and things present some allowance is always made for the altered state of human feeling. Although there may not be much difference, as far as the manners of the Senate and the Bar go, between the Rome of Cicero and the England of Lord Palmerston, the age in which we live is more heedful of life and suffering, both of man and beast—more effeminate, in fact—than any known one which has preceded it. Those men who, in the first century, first promulgated a system of morality more perfect than the world had hitherto enjoyed were of low origin; and some of them belonged to that very class which the Reviewer has properly extolled; yet it is questionable whether the cause of truth and virtue would be advanced if the present rulers of churches—teachers of the gospel—were to affect the semblance of an impossible humility. But there is a practical illustration of the great changes which, during even the last two hundred years, have contributed to the softening of humanity. Lord Macaulay tells how in the time of Charles II the clergy were regarded "as a plebeian class"—mere menial servants: and a chaplain, though permitted to partake of "the corned beef and carrots" with his master's family, was expected to leave the table when "the tarts and cheese-cakes made their appearance."† Swift wrote, in the time of George II, that "in a great household the chaplain was the resource of a lady's maid whose character had been blown upon, and who was therefore forced to give up hopes of catching the steward." It is impossible to doubt that the general morality of the kingdom is better to-day than in the time of the Stuarts and the earlier Georges, yet parsons are become too "*soft-handed*" to mate with waiting maids; and their flocks are too wise not to perceive the strength that is imparted to doctrine taught in the phrase and manner of a gentleman. The present state of the Navy affords a similar illustration. Whatever opinions may be entertained of it by Englishmen, foreigners still regard it with very much the same respect as their ancestors did. Yet those who have visited Her Majesty's ships know that to command them it is necessary to be a gentleman as well as an officer. But in days when British ships sometimes succumbed to the Dutch and the French, the British Naval Officers were "a strange and half savage race. All their knowledge," says Macaulay, "was professional; and their professional knowledge was practical rather than scientific. . . . Their deportment was unorth. There was roughness in their very good nature; and their talk, when it was not made up of nautical phrases, was too commonly made up of oaths and curses."

* *State of English Architecture*, page 305.

† *Hist. of England*, Chap. III, *State of England in 1685*.

In the article, entitled *THE STATE OF ENGLISH ARCHITECTURE*, occur the following passages:—

"The old builder had not heard anything about the profession of art. He was a simple workman and would make the plan, arrange the elevations, and be in fact the foreman of the work.

"When all our workmen are again restored to intelligence and thought, and are relieved from the bondage that professionalism inflicts upon them, we may reasonably expect that they will again be filled with the 'Spirit of God' to devise curious works.

"The workman, instead of being, like Issachar, 'a strong ass crouching down between two burdens,' would be relieved of the double incubus of architects and law, and begin to have his own again."

In the article on *THE COMPLETION OF ST. PAUL'S*, is the following passage:—

"Workmen should not merely do the work, but should make the entire design. An intelligent workman is far more to be trusted than any of our sketchers and schemers."

In the article on *THE HOPE OF ENGLISH ARCHITECTURE*, the ruling idea is developed in the following passages:—

"The inspired workman *feels* the necessary and for ever varying rules of art.

"The habitual notion of the middle and superior classes that the workmen are inferior in . . . the higher qualities of lively genius and imaginative mind is very English. In fact these men are frequently above their betters in power of mental application and endurance.

"The Public should aspire to cultivate the social and artistic friendship of the master-workman.

"But we may hear that the upraising of the workman is a revolutionary project, and that its tendency would be to shatter the foundations of society. . . . These true *gentlemen* would soon become the efficient balance weight of all society.

"The emancipated workman, gloriously impelled, must always be, and is, the only real hope of English architecture."

Very similar opinions to these have been expressed, during the last eighty years, by the orators and rhetoricians of a neighbouring country. Having personally mixed with French workmen, almost constantly for ten years, I have heard a great deal of this sort of language, and have believed in it; but happily I have since participated in the anarchy and confusion to which it inevitably tends. Some years ago, an ardent and high-minded English reformer advanced a proposition which, analysed, would have virtually led to dividing the lands of the rich among the poor. Something of the same nature is now proposed for the building fraternity. Because the brains of an ordinary workman are only ordinarily developed, and those of an architect are enlarged by education, social refinement and travel; because living British architects have successfully contested the palm with native talent in European cities; because they have successfully erected buildings side by side with native ones in Germany, Italy, and France; because, at the present hour, a professional man of moderate attainments can always earn, either with pen or pencil, a moderate subsistence; and because, in matters of art, the public are inconsistent and illiterate—therefore, architects must be abolished, and "*noble working men*" be installed in their places, under the direct patronage of those who are naïvely invited to worship the pewter image which an irresponsible Reviewer would set up! It is well to avoid any approach to flippancy in the examination of this important subject. The utterances of a writer, whose sponsor is the editor of the *Quarterly Review*, are regarded by the public in a serious light:—"By the god of Friendship," cries he, appropriating the language of Socrates, "I must beg you, Callicles, not to jest, or imagine that I am jesting with you, for you will observe that we are arguing about the way of human life, and what can be more serious than this to a man who has any sense at all?"* Nevertheless, it is logically certain, that an argument which is humorous in itself must afford humour, even in a serious attempt to refute it.

Had there not been a substratum of truth in the strictures upon modern professional practice

* Completion of St. Paul's, p. 386.

published by the *Quarterly Review*, no reply would have been necessary, because the public, even if deceived for a time, soon undeceives itself. It is well-known to professional men, that isolated sentences from the writings of M. Viollet-le-Duc and others can be quoted to support the Reviewer in parts of his argument and some of his assertions. Years ago, M. Viollet-le-Duc said that as he belonged to no school so he was certain to have all schools against him. Of late he has written with excusable bitterness. Among his opponents is the mass of artistic mediocrity who held sinecures at the close of the Second Empire; and he has always had to endure the organised hostility of the Central Art School of France. But, as he himself has admitted, his repeated attacks against the unpractical nature of French education, and the small scientific knowledge displayed by ordinary French architects, do not equally apply to this country, because it is the custom of English architects to show, drawn to a large scale, all the various constructive details, and the mode of combining them; and to draw, to their real size, all mouldings and similar important details; and this before beginning the mechanical execution of a building. In France, the details of roofs, girders, windows, staircases, and doors, are often left to be done by the contractors' assistants; and, among our neighbours, it is only recently that the small but compact Gothic school have introduced a more workmanlike habit. With them, as it is with the English, a building is built upon paper by the "master-of-the-work" before it is entrusted to the master-workmen. There is fundamentally small difference between the conscientious architect of to-day and his brethren of the best period of mediæval art. Then, as now, the "master-of-the-work" contributed "knowledge, but not manual labour;"* then, as now, he knew much of men and countries; then, as now, he was called to foreign lands and from foreign lands, to construct not one but many buildings. And this I hope to show principally from the learned researches of M. Viollet-le-Duc, than whom, in my poor judgment, there does not flourish a better exponent of the history and philosophy of either ancient or mediæval architecture.

But first it is necessary to clear the ground of the thick underwood of error and exaggeration which, though frequently cropped, is constantly shooting up again. A great fuss is always being made about "national" art; and the chronic evaporation of weak patriotism over what is popularly called "Early French Gothic," is a periodical nuisance that sets aside both history and common sense.† From the 10th to the 12th centuries, the centre of the art of Western Europe was the Abbey of Cluny; and in the 11th, 12th, and 13th centuries, art radiated from France into Germany, Spain, and England. Until the 14th century, the common architecture of France and England developed similarly and together. After the 14th century, the architecture of one country developed independently of the other; and then art in England became national—because at that period only commences the history of the English nation. When King John was driven from Normandy, "the Norman nobles," in the language of Macaulay, "shut up by the sea with the people whom they had hitherto oppressed and despised, gradually came to regard England as their country, and the English as their countrymen. . . . In the 14th century, the amalgamation of the two races was all but complete; . . . and there was scarcely anything in common between the England to which John had been chased by Philip Augustus, and the England from which the armies of Edward III. went forth to conquer France."‡ It is an exaggeration to say, as the Reviewer says, that the "*system of artistic practice* (which he advocates) *served for six centuries to make England the finest scene of architectural display that the world*

* Plato.

† Mr. Cavendish Bentinck, M.P., in his Letter to the Dean of St. Paul's (page 4), objects to Mr. Burges, because that architect "has preferred in architecture the heavy cumbrous forms of Early French Gothic." Harrison and Sons, St. Martin's Lane.

‡ Hist. of England, chap. III.

ever saw."* Any one who has climbed the walls of Carcassonne and Avignon; the mountains of Auvergne and the steeps of Languedoc; who has penetrated the cities of Brittany; seen Norman churches, halls, and abbeys; the monuments of religious, civil, and military splendour which crowd the old province of Île-de-France, must admit that, though a few English cities may have rivalled in beauty a few French ones, the Paris of Philip Augustus was as superior to the London of King John as the Paris of Louis XIV. surpassed the London of Queen Anne.

In the year 909, William, Duke of Aquitaine founded the Abbey of Cluny. A bull of John XI., dated March 932, confirmed the charter of William and freed the Abbey from all dependence upon any king, bishop, or count whatsoever, and the relations even of William himself. Gauzon, the first architect of Cluny, was a *Clunite* and formerly Abbot of Baume.† The great church was completed by a Fleming, named Hezelon, who, before entering at Cluny, taught at Liege. The kings of Spain and England furnished the funds necessary for the completion of this large building.‡

In 1009, "Hugues, of Farfa (in Italy), sent one of his disciples, named John, to examine the place, and describe the uses and usages of Cluny. His work in MS. is in the Vatican Library, No. 6808 §; and it contains information which is nowhere else to be found at the present day." From the Abbey of Cluny, issued for more than a century, nearly all the men who succeeded in evolving order out of the chaos which had hitherto reigned, and who founded similar establishments throughout a great part of Western Europe, from Spain to Poland. "The greatest prince was not educated in the palace of kings with more care than was the meanest of children at Cluny,"|| where professors, architects, and doctors were educated together with clerks, ambassadors, bishops, sovereigns, and popes.

Since the 8th century, the large abbeys and even the priories had established round their cloisters and on their domains workshops of carriers, carpenters, joiners, smiths, goldsmiths, sculptors, and painters. Those workshops, although they were composed indiscriminately of clerks and laymen, were amenable to discipline; and the work was methodical. But about 1119 the Counts of Nevers claimed certain rights over the town dependent upon the abbey of Vezelay, and a very pretty quarrel ensued between them and the abbots. The inhabitants sided for a consideration with one Count William of Nevers; and no sooner free than they established themselves into a *commune*, which they fortified.¶ The insurrection spread; and the beginning of the 12th century is remarkable as the period when the working classes left the seclusion of the cloisters, and formed themselves into lay corporations or guilds, in imitation of those originally organized by the religious establishments; though in changing their centre they merely changed their direction, and instead of working inside the cloister they worked outside of it. Then probably other trades besides that of the masons took the prefix of free. Once out of monastic leading strings, architecture, like all the other arts, became an "etat"—that is, a trade, business, or profession; and that the extraordinary impulsion given to it at the close

* Hope of English Architecture, page 365.

† *Cluny au XI. Siècle par l'Abbé Cucherat*, 1851. *Lyon et Paris*.

‡ Cluny is in the Department of Saône-et-Loire, 200 miles S.S.E. of Paris. In the early part of the 10th century, 2000 religious houses adopted the discipline of Cluny, which alone of those in which the rule was observed retained the rank of an abbey; the others were all simple priories. The church of the monastery was above 600 feet in length. The monastery was three times plundered: before the last pillage the library contained 1800 manuscripts. All the monasteries of this order in England were governed by foreigners, had more French than English monks in them, and were not only subject to the foreign houses of Cluny, La Charité-sur-Loire, and St. Martin-des-Champs at Paris, but could be visited by them only.

§ *Ann. Bénéd. t. IV. p. 207*. See the article "*Architecture*," page 125, of M. Viollet-le-Duc's Dictionary, in which quotations are given from the Abbé Cucherat's work on Cluny,

|| *Udalrici Antiq. consuet. Clun. Mon., lib. II. c. VIII.—Bernardi Cons. cænob. Clun., p. I. c. XXVII.*

¶ *Lettres sur l'Histoire de France, p. 412. Aug. Thierry. Paris, 1842.*

of the 12th and the beginning of the 13th centuries was the work of a few men is proved from the similarity of form and details which exists in the principal buildings erected at that time in France, Western Germany, England, and Northern Spain. It is remarkable that many of the buildings erected during the course of the 13th century evince as much neglect in their execution as learning in their system of construction.* Buildings were hastily begun, the works hastily stopped, and as hastily recommenced. Much, and that quickly, was required for little money; and the wise deliberation and superintendence of the central authority seems to have been often wanting.

It is a popular superstition that because mediæval churches and cathedrals are composed of parts known to have been built at different periods that therefore they took several centuries to build. The fact is that people in those days never "restored"; † they pulled down, added, and rebuilt; and the manner in which they did these things may still be seen at Laon Cathedral. Everything movable and immovable of the Sainte Chapelle, at Paris, was completed in less than eight years. Notre Dame was begun and entirely finished within sixty years.‡ The idea of dedicating a new cathedral at Reims to "Our Lady" was started in 1211, and the first stone was laid on the 6th of May, or the 24th of July, 1212. Divine service was celebrated in the building on the 8th of September, 1232, although it was not completed until 1241. An honorary canon of Reims has published an exhaustive history and description§ of this building, and although I admit that a great deal of sentimental romance concerning the origin of mediæval architecture has been written by cathedral canons, still men like the Abbé Cerf must be listened to with attention. He says—"Reims Cathedral is the cast in stone of a single idea (*d'une seule idée*). It is made in some sort in the image of the Trinity. In its height, its width, its length, the edifice is divided into three parts: three floors, three naves, the principle of which is divided into three almost equal portions—the nave proper, the choir, and the sanctuary." To this technically true description M. Viollet-le-Duc adds—"At Reims more than anywhere else the work of the master was respected; and if anyone wished to form an idea of what must have been a cathedral conceived by an architect at the beginning of the 13th century, let him go to Reims." Is it possible to suppose that the harmony which reigns throughout the majority of mediæval buildings, not only in France but throughout Western Europe, the scientific exactness which marks their construction, the order in which their members strengthen and counteract each other, were produced by gangs of workmen, superintended not by one foreman, but by a gang of foremen, each working independently of the other, according to his fancy or his will, and with no other guiding influence or central authority than that same "spirit of God," or "inspiration," which each shared more or less with his fellow mortals? Surely there is nothing better to compare to such a hypothetical state of things than the proceedings of a certain army in a late famous war, where regiments were marshalled under the banners, not of the State, but of political parties; and impulsive soldiers, asserting their individual rights, acknowledged no authority until the inevitable hour when officers and men with one accord surrendered to a disciplined and scientific conqueror.

That there is sometimes abuse in the relations between the brains and the limbs of the building body—that a more direct communication than is possible at present between the architect and the working man would be advantageous to both, few professional men will deny. But a remedy for this acknowledged defect will not be obtained by blowing out the brains. Even presuming that many of our mediæval

* Viollet-le-Duc.

† See some excellent remarks upon "Restoration" in the History of the Gothic Revival, ch. VI. C. L. Eastlake. Longmans, London, 1872.

‡ Viollet-le-Duc.

§ *Histoire et Description de Notre Dame de Reims. Ch. Cerf. Dubois Reims, 1861.*

brethren worked with the chisel as well as the pencil, it by no means follows that if modern architects learnt to use the chisel, their work would be equally as good as that of their predecessors. As well argue that because Phidias and Ictinus were slaves (for which there is only the Reviewer's assertion), therefore no future building can equal the Parthenon until slavery be re-introduced. Because Hindoo artists built domes which all Christendom has failed to surpass, or even understand, therefore modern artists must learn to squat upon their haunches and eat curry-bhaut with chopsticks. There is no doubt, to take a particular case, that viaducts and bridges would be more beautiful and better built than they are at present, if there existed co-operative societies whose special work was confined to bridge-building, such as those which flourished in France in the 12th century. The well known ruined bridge at Avignon, begun in 1178, and finished in 1188, was the work of the *Frères Hospitaliers Pontifes*, which was a religious order, established in 1164, at Maupas, in the diocese of Cavaillon. The duties of the order consisted in building bridges, establishing ferries, and rendering assistance to travellers on the banks of rivers. Like the other brotherhoods, it was disciplined: and there were consequently both practical and scientific members of it, forming a concentration of technical talent devoted to a particular object, and the construction of a particular form of building. It may be urged that the modern representative of such an order is a government department of works. But if there is similarity between them, there is also this difference—that whereas, originally, several communities devoted themselves each to a speciality—now one government department embraces several specialities; and the discipline, which was a reality in the middle ages, has no other signification in the present one than an apparent devotion to what is called "red tape."

The *Quarterly Review* has informed the world that in old churches and cathedrals the design was obviously done by the workman; in fact that there is no record of design at all.* This is a strange error. Under the word "Drawing," in the Dictionary of the Architectural Publication Society, is a list of the earlier designs and drawings scattered about Europe. On the 19th of November, 1860, Mr. Burges read a Paper† upon the subject to the members of this Institute. In it he said, "that nothing whatever is known of the architectural drawings of the Greeks and Romans. The *lapides Capitolini*, containing a plan of Rome, are simply inscribed in marble, and formed anciently part of the pavement of the Temple of Romulus and Remus; and the light and beautiful architecture painted on the walls of Pompeii was never resolved into materials. Our series of drawings then opens with the Monastery of St. Gall, now preserved in the library of that establishment. The plan, which is drawn in thin red lines upon a large sheet of parchment—with inscriptions all over it, showing the uses of the different parts of the building—was sent (as one of the said inscriptions informs us) for the use of the Abbot Gospertus,‡ by some anonymous friend, who is supposed to have been Eginhard, the son-in-law of Charlemagne; and who held the office of prefect of the royal buildings. The plan presents us with a very complete monastery, with its great church and accompanying buildings. The red line not only seems to mark the external and party walls, but also to indicate the furniture, such as benches, tables, stoves, &c., requisite to each building. Certain figured admeasurements enable us to form some idea of the sizes of the various parts. A view of the church and monastery of Canterbury contained in the illuminated Psalter of Eadwin is preserved at Trinity College, Cambridge. It is curious as showing the complete development of the practice of drawing elevations upon plans as at St. Gall. In all probability such documents would not be very common; and, when the work was done, the erasing knife would be brought into use, and the parchment, which was very valuable in those days, would receive a new employment. That this was the case we know from the discovery, made by MM. Varin and Didron in 1838, of a

* State of English Architecture, page 305.

† Transactions—Roy. Inst. Brit. Archts., 1860-61.

‡ This Abbot began to rebuild the church and monastery in 829.

design for the west end of a cathedral, besides several details, which they found under the writing of a manuscript containing a list of the deceased members of the cathedral chapter of Reims." The last entry was dated 1270. The drawings, says Mr. Burges, had been first washed out, then scraped over, the lines obliterated with a knife, and finally the parchment was cut into leaves.

Most archæologists have examined the celebrated sketches of Wilars de Honecort, an architect of the 13th century, the facsimile* of whose sketch-book was published in Paris under the superintendence of MM. Lassus and Quicherat; and a translation of it, edited by Professor Willis, was published in London in the year 1859. Mr. Burges remarks a peculiarity of Wilars which was, "that when he copied any executed work, he copied it not as he saw it, but with variations of his own, and as he would execute it himself." In his remarkable sketch-book Wilars de Honecort wrote under a particular drawing, "This shews the elevations of the chapels of the church of Reims—like them will be those of Cambrai, if they be built." Now the sanctuary of Cambrai, the construction of which was directed by Wilars de Honecort, was destroyed at the great revolution; but in 1824 the architect of the city, M. Aimé Boileux, was enabled to make a complete plan of the foundations, and this plan coincides exactly with that given in the MS. of Wilars de Honecort. Against another sketch is written, "This is one of the windows of Reims. When I drew this I was under orders to go to the land of Hungary." Wilars de Honecort was the contemporary of Peter de Corbie, another master of the 13th century, who directed the construction of several churches in Picardy. They composed together a church upon an original plan, which is described by Wilars in the sketch-book as "a church with a double circumscribing aisle, which Wilars de Honecort and Peter de Corbie contrived together." During the middle ages, in parts of Western Europe, a building called *de l'œuvre* was attached to large religious edifices, which was used by the architect and the master-workmen; but the title of architect was not given to an artist engaged in the direction of building works until the 16th century. He was called the *maître-de-l'œuvre* † or master-of-the-work—a much more positive appellation than that of architect, which means only arch-workman; for by *œuvre* was meant everything movable and immovable in a building, from the foundations to the tapestry and furniture. The *œuvre* of Nôtre Dame, at Strasbourg, has preserved the mediæval custom; and there may still be seen a part of the designs upon parchment, which served for the execution of the portal, tower, spire, north porch, throne and organ case. Among the drawings are some which date from the last years of the 13th century; some are only designs which have not been executed; others are details prepared to be worked out full size upon the ground or against a wall, exactly as is now done by the master-workmen in France. There are plans of different floors of the tower and spire which date from the 14th century; and M. Viollet-le-Duc adds that these are drawn with a knowledge of line, a precision and judgment of projection, which give a high idea of the science of him who drew them.

There is a curious document extant of the 14th century which affords precise information concerning an architect's functions; and in which there is mention of two Frenchmen being employed to direct the construction of Gerona Cathedral in the north of Spain; this is a translation: ‡—

"The Cathedral Chapter of Gerona in 1312 decided to replace the old Romanesque

* In the Institute Library, where, it may not be inopportune to add, almost every important work upon Architecture published in Europe is carefully stored; and it is, perhaps, not generally known that any amateur with a note from a member can make use of it.

† Article "*Architecte*." M. Viollet-le-Duc's Dictionary, page 113. In the French portion of Hamilton and Legros' Dictionary, the churchwarden's pew is called "*œuvre*;" a parish vestry-board is also called "*œuvre*," but the more modern designation of the latter is "*fabrique*." In the *Glossarium Latinitatis*, Ducange, 1733—*Fabrica* is described as the revenue set apart for the repair of a church; and *Opus* as the income of a church from various sources.

‡ Extracted from the register entitled:—*Curia del vicariato de Gerona, liber notularum, ab anno 1320 ad 1322, folio 48.* (Archives, Gerona Cathedral).

church by a new one, larger and worthier. The works were not immediately begun, and two administrators of the work, Raymond de Viloric and Arnould de Montredon, were appointed. In 1316 the works were in full activity, and the name of an architect, Master Henri de Narbonne, is inscribed upon the capitular register. He died, and his place was taken by one of his countrymen, named Jacques de Favariis, who engaged to come to Gerona from Narbonne *six times a year*, and the Chapter guaranteed him a salary of 250 sueldos a quarter."

This positive evidence of the existence in the 14th century of "a class of men who were not workmen, but really and only superintendents of buildings, has been referred to by Mr. Street in his valuable book on Gothic Architecture in Spain.* The *Quarterly Reviewer* has quoted both Mr. Street's words and part of the extract from the Gerona register, but, as may be readily imagined, he attaches little importance to either. Mr. Street also refers to one Matheus, master-of-the-work at Santiago Cathedral from 1168 to 1188, who by a warrant issued by King Ferdinand II. in 1168 was granted an annual pension for the rest of his life; and this, as Mr. Street remarks, proves "somewhat as to the degree of importance" he attained in being thus recognised by the king. The title of "Fabricator" in Spanish inscriptions is sometimes, though rarely, given to the architect, who is usually described as "magister operis." At Reims there is an inscription referring to the cathedral, and also to a neighbouring church, which runs: "Ci git Robert de Coucy, maistre de Notre Dame et de Saint Nicaise qui trespassa l'an 1311." In the Baptistery at Pisa, in Italy, there is an inscription, "Diotisalvi magister hujus operis." But in England, according to Mr. Wyatt Papworth,† the term master-of-the-work appears to have been seldom employed; and when used, it referred rather to the officer called in Spain and the South of France, "operarius," than to the architect. And here I would say a word about the title, "operarius." In the extract from the register of Gerona, which I have just quoted, the two administrators of the work are called "operarii"; and twenty years afterwards, in 1340, the Chapter of Gerona appointed two of their own body—one an archdeacon and the other a canon—to be the "operarii" of the works. In the celebrated museum of Toulouse there are preserved several stones bearing inscriptions—one recording the name of the Canon Arnaud Rufus, who bore the title of "operarius" of the Chapter, and who died in 1251; and another of Bernard de Succo, priest, canon, and "operarius" of the Chapter of St. Sernin, who died in 1261. Now the *Quarterly Reviewer* complains that Mr. Street gets confused with his nomenclature; so I think it may fairly be inquired of the former as to the meaning he attaches to the Latin word "operarius."‡ Literally it means a workman, a slave bred to hard work. Are we to suppose then that in the 13th and 14th centuries archdeacons contributed manual labour as well as clerky administration to the work? Yet upon the

* Gothic Architecture in Spain, Ch. XXI. G. E. Street, R.A. Murray, 1865.

† See a Paper on "The Superintendents of English buildings in the Middle Ages," by Mr. W. Papworth. Institute Transactions, 1859-60.

‡ Museum of Toulouse, No. 681. A white marble bas-relief containing six figures and the following inscription:—Anno Domini M CCLXXXII, XVI kalendas augusti illustrissimo Philippo rege Francorum reverendissimo et valentissimo Bertrando episcopo tolosano obiit magister Aymericus canonicus, cancellarius et operarius ecclesie Tolosane cujus anima requiescat in pace. Amen.

No. 714. An inscription:—Kalendas marcii obiit Arnaldus Rufus canonicus et operarius ecclesie sancti Saturnini anima ejus requiescat in pace. Amen. Anno Domini M CC L I.

No. 715. An inscription:—Anno Domini nostri Iesu Christi MCCLXI, VII idus novembris obiit dominus Bernardus de Succo sacerdos canonicus et operarius sancti Saturnini Tolosæ cujus anima sine fine requiescat in pace. Amen.

No. 1034. A copper seal representing heads of Virgin and Child, St. Peter standing with a key in his hand, and before him a monk on his knees, hands clasped, and head surmounted with a star of eight rays; with the following inscription:—✠ S ROBTI OPERARI ET MOACHI EXCIEN (Sigillum Roberti operarii et monachi Exciensis).

signification of terms, upon mere words, which probably had a different meaning in the middle ages, the Reviewer has built up an entire theory, and supported it with pages of assertion. If the records of mediæval artists disclose principally the names of master-workmen, it simply proves that such men existed; if those of the architects have not been preserved, neither have those of the poets to whom the 13th century owes the *Nibelungen Lied*, the *Histoire de Charlemagne et Roland*, and a host of French and German romances composed at the beginning of that century. Six hundred years hence Indian archæologists, exploring the ruins of the English city of Bombay, will possibly find the names of engineer colonels cut upon odd stones; and, comparing them with similar entries in ancient documents, they may ascribe to them the authorship of more than one building—the original designs for which were made by Sir Gilbert Scott, Mr. Roger Smith, and other qualified members of the Institute of British Architects.

M. Viollet-le-Duc says, that the documents which throw any light upon the exact duties of an architect are not anterior to the 14th century; and at that time he was "un homme de l'art que l'on indemnise de son travail personnel." People who wished to build provided materials and hired workmen. Neither estimate or valuation of the work, nor the administration of the funds, appears to have concerned the architect. But at the end of the 14th century the architect had lost the elevated position he held during the previous two hundred years. In the 15th century each corporate body worked in its own way, apart from any general direction. The decline of Gothic art had begun; although the hands of the artists had not lost their cunning, the intellect which had formerly directed them was gone. When the Chapter of Reims* repaired the cathedral after the disastrous fire which destroyed the upper portions of it in the reign of Louis XI., a *procès-verbal* (dated 1492) was drawn up, in the presence of notaries, of the repairs necessary to be done; and in this agreement were made with four master-carpenters, five master-masons, two master-slaters, one smith, two master-founders, two joiners, and two master-organists, all living at Reims. The advice of the different trades was taken separately, and the central authority appears to have been vested in certain canons, one of whom is called master-administrator; and others are designated as having charge of the repairs. No architect is mentioned; and M. Viollet-le-Duc says of what was then done: "The monstrous results of that disorder are to be seen at the present day. The beautiful harmony of that admirable church was destroyed, and its existence endangered." Thus when Philibert Delorme appeared upon the scene it was perfectly natural that he should express his contempt for the confusion, want of harmony, and defects of proportion which characterized the Gothic buildings of his early days.

Thus, it has been seen, that before the end of the 12th century the masters-of-the-work were, so to speak, ecclesiastics; and those who dotted Western Europe with buildings issued from Cluny and the houses dependent upon it; and that the fame of Cluny spread to the very heart of Italy. After the 12th century the masters-of-the-work were laymen; and some were sent from France to Hungary and Spain. "I have been in many lands," wrote Wilars de Honecort, "as this book shews." In another case positive evidence has been produced of an administrative council, and an architect from Narbonne in France employed at Gerona in Spain, not to follow the daily execution of the work, or to overlook the workmen, but only to direct the design, details, &c. How then did all these men make themselves understood in the different countries in which they worked? It is difficult for an architect to explain his ideas to a subordinate, even in his native tongue; it is still more difficult in a foreign one. Was there really a common language, and was it Latin? Not improbably the masters-of-the-work wrote and conversed in Latin, but to the ordinary workmen of France and England, Spain and Hungary, there is only one language which they could have used, and that is the universal language of the pencil and the brush.

If the *Quarterly Reviewer* is sometimes right in his premisses he is generally wrong in their application.

* *Histoire de Notre Dame de Reims, Ch. Ceryf. t. 1, p. 405, Dubois, Reims, 1861.*

It is incontestable, as he says, that "*for three centuries there had been a gradual moderate improvement in the architecture of Greek temples; but under the influence of Phidias this at once rose to perfection;*"* but this result was attained from the fact that there had been three centuries of experience—of success and disaster—not because Phidias used the chisel, and Ictinus or Callicrates left no record of their drawings. It is incontestable that "*owing to the great supply of illustrated works, the means of knowledge far surpass the power of analysis in either the professional or the public mind*"; but who has made the books that are worth anything to architects? Is it not the architects themselves? It is incontestable that the cathedral of Cologne is inferior to those of Rouen, Reims, or Paris; but the finding of an ancient vellum drawing of it does not account for its demerits. It simply proves that while some of the noblest mediæval buildings were still new, it was the custom to make drawings of them, and, by implication, for them. The art of drawing is older than the art of writing. Man conversed by signs until he learnt to express himself in words. The tombs of Egypt are covered with hieroglyphics, which are drawn, not written. The forms portrayed in Greek ornament prove that the architect then used the brush much in the same way as his modern representative uses the pencil. Painting upon glass is mentioned by historians from the first century of our era. Manuscripts were illuminated in the days of Charlemagne. Because there is no original plan or diagram extant of the Parthenon, therefore that building was made with hands and not heads! Surely such a supposition would be marvellous in its absurdity had not the Psalmist, while singing the praises of the great Architect of the Universe, lamented—"The fool has said in his heart, There is no God."

As I had the privilege to tell the members of the Institute on a recent occasion, and no contradiction has yet been offered to my statement, the building disasters in Bengal proceed from the absence of any central authority responsible for the design of a building, and the difficulty of procuring lucid and scientific drawings. In my journey across a part of India, I noticed not an absence of architectural features, but an unskilful combination of materials, unscientific planning, and a misapplication of the principles of construction. Building disasters are not frequent in Madras and Bombay, because the principal works in those Presidencies are carefully studied by architects, some of whom are Fellows of the Institute. No comparison is possible between the City of Bombay, with its continuous line of splendid buildings, and Calcutta, which still boasts of the tottering "palaces of Chowringhee."

The Reviewer is eloquent upon "*the propensity to scrape and daub,*" which, within the last thirty years, has "*spread like a disease among the clergy.*" He says that, instead of appealing to architects, "*they should have sought the village mason, carpenter, and smith.*"† As if there were any village in England thirty years ago that did not contain traces of the combined efforts of clergyman, mason, carpenter, and smith! It may nevertheless be useful at the present time to speculate upon the direct patronage of workmen by the committee now sitting for the completion of St. Paul's. Imagine a sub-committee of "operarii" to be formed of two docile members and two irreconcilables for the purpose of imparting to the foreman at the New Wellington Monument the probable intentions of Sir Christopher Wren. Imagine the probable state of that workman's mind when he learnt, that if Sir Christopher Wren, who died in the eighteenth century, had ever visited Italy he would have adopted the style of the best Italian artists of the sixteenth. The success of direct patronage in such a case is doubtful, because in the presence of divided "operarii," the province of an architect is that of a mediator. He must possess tact as well as education; he must be patient, "ne'er answer till a member cools;" silent, and submit to mis-representation in pamphlet and review. It may be questioned whether, under similar circumstances a master-workman would acquit himself better than Mr. Burges. And I take leave to correct a false impression of this architect, which the public may have formed from reading the *Quarterly Review* and other minor publications. Mr. Burges is not a "*sketching draughtsman*"—not clever, in a professional

* Hope of English Architecture, page 359.

† State of English Architecture, page 312.

point of view, with his "*pencil and bow-pen*."* His innumerable drawings, made during long tours in different and remote parts of Europe, are not pictorial effects; but rough diagrams, drawn with pencil stumps to scale with a foot-rule, on the tops of ladders and in dark corners of vaulting and roof. They resemble rather the sketches of a mediæval architect than those of a pupil of a school of art. True, like Wilars de Honcourt, he has a vile habit of drawing the human figure, and this must be left to the generous forbearance of reviewers.

That the profession is of "*the nature of an imposture*," and that English architecture is "*an artistic inferno and a national disgrace*," † is at least amenable to argument. Some of those guilds or corporations which, in France, were founded at the close of the 12th century still exist in the City of London. There is still a Company of Barbers, one of Spectacle-Makers, another of Tallow-chandlers, but the names of few living operatives are inscribed upon their books. The masons are still "free and accepted," yet few working masons could gain admission into a modern lodge. But the guild of British Architects, though of modern origin, follows the custom of an earlier age. The founder of the Institute was a practising architect, and he is honoured by the older and kindred Societies of Europe. The President is a genuine master-of-the-work; one of the Secretaries is the hereditary possessor of a name associated with those of the men who have most contributed to the popular appreciation of Greek architecture; the other is an author of standard books upon art. The Fellows, with a few exceptions, are practising architects; and the cause of the comparative poverty of this corporation is due to the fact that none but honourable men and bonâ-fide members of the profession are permitted to swell its ranks. Nevertheless it cannot be concealed that the public, having had its attention directed towards some of the abuses of architectural practice, have sometimes visited upon the mass the errors of a few. The robust manners of Mr. Ayrton, and the muscular opposition to professional intervention which distinguished Her Majesty's Office of Public Works during his career were caught up by individuals, who have been ably represented by a *Quarterly Reviewer*. But since the 14th century there never has been a time when the English people more surely promised to imbibe the spirit of art than at present. The fact is palpable in the satirical attacks, made by amateur critics from Prime Ministers downwards, upon the whole army of artists; in the affectation of archæological excursions; in collections of bric-à-brac; and in the polite small-talk of drawing rooms. Art, new to England, is now passing through the ordeal to which English science was subjected more than 200 years ago. The Royal Society was founded in 1660, and then, to quote Macaulay again, "it was almost necessary to the character of a fine gentleman to have something to say about air pumps and telescopes . . . and even ladies broke into cries of delight at finding that a magnet really attracted a needle, and that a microscope really made a fly look as large as a sparrow." The truth is Art is suffering from a superabundance of vigour. Dame Architecture is "in a plethora absolutely dying from too much health:" and this in spite of more than one *faux pas*. But the mistakes of the present must surely instil caution into the artists of the next generation. If, however, the principles of construction are not now uniformly respected, it is because they are not understood by the people; if the philosophy of architecture is only studied by a minority of the profession it is because it is ignored by the upper classes. Yet the ruling principle of every useful art was preached twenty-four centuries ago. "What," said Aristippus, "can a dung-basket be beautiful?" "Of course it can," said Soerates, "and a golden shield can be very ugly if the one be well fitted to its proper use and the other not." ‡ In the universal acceptance of the inseparable nature of beauty and utility has ever been, and must ever be, the true hope of all architecture.

* Completion of St. Paul's, page 369.

† State of English Architecture, page 295.

‡ Xenophon, by Sir A. Grant, page 113. Blackwood and Sons, 1871.

The PRESIDENT having invited remarks upon the subject—

Mr. WILLIAM WHITE, F.S.A. Fellow, said,—I would ask to be allowed to propose a vote of thanks to the author of this paper. I am sure I have listened to it with great interest, as all in the room must have done. He has touched upon a subject which has been the one great interest of my life—the study of ancient architecture; the true development of which he has correctly indicated. How it was possible for a reviewer in a publication of such note as the *Quarterly Review* to make such a series of blunders, it seems difficult to conceive. The only question which arose in my mind, when Mr. White was speaking of the little regard that was paid to what had been said on the other side of the question, was, whether too much regard had not been paid to what the *Quarterly* has said; for it is impossible to suppose, on the one hand, that a band of crude workmen could have the remotest amount of scientific knowledge requisite for the laying down of the general plan and idea of those buildings which decorated the Middle ages, and that such buildings could be designed without the greatest intelligence and the greatest scientific research; or, on the other hand,—which is a chief point I think of Mr. White's paper,—that such uniformity could prevail without the undeviating traditions emanating from one central authority, although developed into a great number of directions, in the various localities and countries where this development took place. I beg to propose a vote of thanks to Mr. White for his paper, and I am sure the meeting will be glad to record their appreciation of it.

Mr. E. P'ANSON, Fellow.—Like the last speaker, I have been greatly interested in the paper we have heard. My attention has only lately been drawn to one of the articles in the *Quarterly* which have been referred to. The former articles I am not acquainted with. In reading the last article, it occurred to me that there were some fallacies in it; for example, as I understand the article, the writer's views are that there is no novelty in the architecture of the present day, and he contrasts that want of novelty with the originality of Mediæval and Classic Art. But, I for one, think this is a fallacy. For my own part I think there is great novelty in the present day. When we look back centuries ago to the works of the Greeks, and of the Middle ages, we do not think perhaps of the generations of thought which have passed by between the time when one great development of art took place, and when it was followed by another. I believe that there never was absolute originality in architecture. All architecture has been developed from something which has gone before; the greatest works of art are simply the elaboration of the thoughts of preceding generations, and there is no less originality in the present day than in times past. I believe the Victorian epoch will leave its stamp, and will be as distinct a school and deemed hereafter as full of thought and genius as many schools which have gone before. Whether succeeding generations will say it rivals the wonderful simplicity and beauty of the Greek, or the constructive ability of the best time of Gothic architecture I do not know; but I do say we are as original, as truthful, and as productive of important and interesting works as any of our predecessors. Then again, I think the reviewer has been unfortunate in some of his illustrations in the latter part of his review. He speaks of uneducated artists—master workmen—erecting important works. Amongst others he speaks of a mason erecting a magnificent dome in a church in the neighbourhood of Malta—what church it may be I do not know—but he also alludes, as I understand it, to those produced by the Industrial Dwellings Association, as meritorious works of art. If these are the types he suggests for our admiration, I regret I am myself so badly educated that I do not understand the artistic value of the work to which he points. He mentions also the successful results of co-operative industry in some recent works near the Wandsworth Road. I verily believe the master workman who achieved creditable results, but certainly no high art, was employed, not on account of his artistic ability, but simply because he was a competent foreman, working at workman's

wages, and his employers were fortunate in obtaining so successful a result. For all that, I agree with Mr. White that there is some truth and a great deal of interest in the review under consideration. I cannot help thinking that we architects do not give, and in the nature of our practice cannot give, all that personal time and attention to our works which it would be so gratifying to us to give, if we could. But it must be remembered that the state of society is very different now from what it was in the days of our forefathers. Architects are honourably striving to keep pace with the great leaders of thought and the leading men in other professions, and in their efforts to do so it is difficult to give that individual attention to every detail which it is probable was given under different circumstances. The author of the paper alluded to an instance in which an architect was employed and adequately paid to devote his entire time and sole attention to one building. This is not however the custom of the present day. It is impossible for an architect in the present day, who has to direct the erection of many buildings at the same time, generally carried out with great rapidity, to devote his whole time and attention to one building alone, as the Mediæval architects appear to have done. This involves the whole question of an architect's remuneration, which should then be something different from the 5 per cent.. He might no doubt in some cases with advantage devote his whole attention to the study of one building at a time, but that in the present state of society is almost impracticable.

Mr. R. PHENÉ SPIERS, Associate.—As allusion has been made to the buildings erected by working men, I would beg to refer to the remarks which appear on that subject at page 380 of the review under consideration, where it is stated—"We may now quote the latest instances of true building master workmanship. The Porteuillis Club, 93, Regent Street, Westminster, is a working man's club in the strictest sense of the word. *The ground upon which it stands has been purchased, the materials of which it is built have been paid for, and the labour has been found by the working men themselves, many of them working until twelve o'clock at night. Not only so; they have been their own architects. The whole of the plans and elevations have been beautifully drawn by one of the members, and thus the little front is much more satisfactory and respectable than the Charing Cross Hotel or the Royal Academy façade.*" I went with Mr. White to see this wonderful Porteuillis Club, and I have ventured to make a rough drawing of it on the board, which I will now turn round in order that you may see it. I regret it was impossible for me to attempt to draw it so artistically as the working man would have done, but it will give you some idea of the value of the reviewer's criticism.* It is about 25 feet across, built in stock bricks, covered over with cement. I have drawn the moulding of the coping, the only moulding which could have been drawn by the working man referred to, because all the ornamental parts are cast in cement or terra-cotta, and have been purchased at a fixed price: they are all stock-in-trade in fact. The corner stones here are what is called "vermiculated," and are all fastened on the surface of the building, so that when you come to the side, you see the stones finish on the surface and terminate with a cement edge, and then comes the stock brickwork. The vases or urns at the sides are of a form certainly not found in Greek work, and there seems to have been a difference of opinion as to whether they should be Gothic or Classic; the frames of the panels being filled in with quatrefoils. The capitals of the pilasters to windows stop short 3 inches or so behind the wall surface, so that they look ridiculous at the side; and the consoles or brackets which carry the cornice of the doorway are too small for the position they occupy. The arms of the Porteuillis Hall were modelled by an ordinary artist, and were purchased by the working man, but were certainly not as the reviewer says, "beautifully drawn by one of the members." The only other point worth noticing is the jointing of the

* Mr. Spiers here exhibited a drawing of the building referred to.

arches of the basement windows, which are in cement; but there would seem to have been a dispute as to whether the joint should be in the centre of the arch or not. Lines have been drawn in the centre or axis of the arch, filled up again, and a keystone admitted. This one example, the Portcullis Club, goes far enough to show the value of the critical opinions of the *Quarterly Reviewer*, against whom I am speaking, and not against the working man. I can only say this, that either the writer of the article never saw the building he referred to, or (on the principle that if you throw mud at a person some of it is sure to stick), so when this Portcullis Club was brought into its unworthy prominence, the reviewer trusted that out of the hundreds who read his article, only the units probably would take the trouble to go and see the building, and so there might to the others seem to be some reasonable basis for his argument. In either case I can scarcely imagine that any one in his senses would dare to hold up for admiration so degraded an example of even a working man's attempt to design.

Mr. HENRY CURZON, Associate.—I am sorry to see that drawing on the board, and I hope it will be soon wiped off. There is no need for us to be critical about this work of some working men. The able paper we have heard to-night was directed against a reviewer, not against the working man. It is a notable fact to me that the lecturer could do nothing better to refute the reviewers than to quote some remarks by Mr. Burges made in 1860. There is no doubt these reviews have been called forth in consequence of certain architectural works that are either in progress or in contemplation, and I believe the proposed decoration of St. Paul's is one. It is a notable fact to my mind, that the quotation read from Mr. Burges' paper in 1860 has been the most complete answer to the reviewer. I hope the diagram on the black board will not be published in our Transactions.

Mr. EDWARD HALL, Visitor,—It may be known to many present that I have taken some interest in the position and progress of that individual who is now referred to as "the working man," and I quite agree with the last speaker, that it would be unfortunate—or rather I agree with what I think he was about to say—that it would be exceedingly unfortunate if any prejudice were created against workmen, including, of course, those who are connected with buildings, or against those engaged upon particular works. I have endeavoured, in one instance, on the occasion of a meeting at the Architectural Museum, to urge that great advantage would accrue to architecture if there were more cordial relations maintained, than at present exist, between the architect and the workman. I myself do not care very much what becomes of the mere contractor. In the North of England, as is well known, the system of employing directly, several master-builders, or, as we may call them, master-workmen, under the architect's control, is prevalent; and it is, I think, possible to show that there would be advantage resulting for our art, and for the objects generally of professional practice, if a similar system were observed commonly in the metropolis. Whether we shall revert speedily to that system is not of much consequence to my present argument, which is simply this: that architects should take more interest in the elevation and education of the building artizan, and should be ready to appreciate the services that he can render. As some of you know, I have been lately attempting, in a very humble way, to convey to working-men such information as I possessed, with regard to the principles of design in several classes of buildings and works of civil engineering, and the practical exemplification in individual examples in those classes. I have conducted parties of working men over such buildings as St. Thomas's Hospital, and such great engineering works as have been lately in progress in this metropolis; and I can say I have never found any disposition on the part of my auditors to consider what I was doing in the way of teaching them officious, that is to say from the high position compared with theirs, which was necessarily, for the time, assumed. On the contrary, I have felt in all cases that there was the greatest possible appreciation of the position and value of an architect. I have endeavoured to show them that prior to their having

work to do, somebody's head and hand must have been at work, designing and contriving. That argument I endeavoured to give expression to at the commencement of the visits conducted by me; it has been referred to in the Reports of the Working Men's Club and Institute Union, and if you will pardon me, I will read you shortly the views that I held, and that I am still putting forth. Previous to a visit to a building or engineering work, a placard is issued by the Union announcing the visit. At the head of this appears a statement that the Council of the Union, "in the year 1869, had the advantage of Mr. Hall's assistance towards carrying into effect an idea of his, which was connected with the technical instruction of workmen, in matters pertaining to their craft, not less than with the furnishing agreeable and profitable relaxation on Saturday afternoons," "and that Mr. Hall considered that if, in addition to the visits under the auspices of the Union, to places interesting historically, or by their relations with the art of the past, or with certain branches of science and industry, visits could be made to buildings and engineering works in process of construction—the nature of the problem in each case, along with the particular aims of the architect or engineer, being explained—benefit might accrue, not merely to men whose vocations would, in numerous cases, be connected with building construction, but in several ways to classes of persons not directly addressed." Then follows a perhaps necessary reference to my having had as "an architect, and a writer on architecture, decorative art, engineering and public improvement," occasion to make myself "acquainted with many of the works referred to;" and it is added, in words of my own, quoted by the Council in their seventh annual report (1868-9), that I "hoped in bringing these features to the knowledge of members of the clubs, and whilst contributing something to the workman's instruction, to induce an appreciation of DESIGN and directing skill as elements in the production of those works of the architect and the engineer, and thus to promote a cordiality in the relations between the supervising authorities and the executants, where art or science were combined with handiwork—a fusion of aims and a harmony of interests—that would be attended by growth in the workmen, of a love of, and a pride in the excellence of, his work, and would potently conduce both to the improved construction and the higher art character of buildings." Now what I have to argue is this: that "the hope of English architecture is in an intimate alliance between the architect and the workman." [A MEMBER,—“No, no.”] A gentleman says “no.” If he will take the trouble to think out the question as carefully as some others have done, he will unavoidably come to conclusions something like what I have endeavoured to sketch out, and what I hope and believe will contribute to the solution of what is really a very important question in the present day.

PROFESSOR KERR, Fellow.—I hope our attention will not be distracted from the important question which is really before us, by sentimental reflections with regard to the workman. The working man of the present day is, in my opinion, being a great deal too much petted outside these walls, without our taking up the matter here. Much good may it do him in the end. Do not let us contribute to raise him to a false position, from which sooner or later he must inevitably fall. The question before us, interests ourselves as architects, apart altogether from our relations to the workman; and it rests upon a different basis from anything which the mere accidental mention of the workman by a hysterical Reviewer may involve. I am of opinion—I believe, in common with most persons here—that it is a mistake to attach too much importance to the opinions of this gentleman, whoever he may be. I had hoped he might have been present this evening; in which case, I am sure we should have listened to his explanations with the greatest attention, and with that excessive courtesy which is always displayed here towards amateurs. The question of greatest interest to us, is the state—I was going to say, of unpopularity, but it is scarcely that—of alleged discredit in which architects stand before the public. The alleged condition of architecture as a fine art in England is, that it is in the lowest possible

condition ; that nothing is done which any human being with a head on his shoulders can deserve credit for ; and that future ages will look upon the works of the present day with the most supreme and universal contempt. This may be so or not : I believe not. Assuming, however, as our critics do, that this is the case, they then attack the professional architects. They display no sympathy for the architects of England, because of their being surrounded, as it is said, by unfavourable circumstances and conditions. They express no desire to assist them with their own superior knowledge to an escape from the degradation in which they are placed. They simply attack the profession tooth and nail ; and English invective is scarcely able to express the force and vigour of the sentiments which they are prepared to utter, if language did not fail them. The controversy has, at last, reached this position—that remedies are being suggested ; and the last remedy—the latest fashion—is this notion of the inspired working man ! There is, no doubt, something like a substratum of truth underlying the idea, that if the working man were really so inspired—if he were possessed, by some supernatural accident or incident, of all that information, all that skill, all that imagination, which are supposed to be indispensable in a great architect, then something might possibly come out of it for the benefit of architecture. But we must look at the world as we find it ; and we, who are architects, ought to bear strictly in mind, that our function is quite separate from that of the working man, and that his function is quite separate from ours. Now, who is it that complains of architectural art and the profession of architecture ? Our assailants are of two classes. I am bound to mention one class for the sake of the completeness of my argument, though I think the number of these enemies is creditably few. It will always be the case in our art, as in all arts, that there will be a few unscrupulous self-asserters. We have few, but we have some. We will not denounce them here, or suggest who they may be. They have some of them elbowed their way into fame and distinction by condemning their brethren ; but this is their inevitable end :—they go on, encouraged by various circumstances, by whose means nature induces " vaulting ambition to o'erleap itself and fall on the other side ;" and you will not require me to mention the names of one or two belonging to the generation which has passed away, who, having trumpeted their way to a supreme position in the profession, have actually, at length, died of a broken heart, in consequence of inevitable failures, and of the difficulties and disgrace which consequently overwhelmed them. Therefore, I say, it is bad policy on the part of any man to be disloyal to his craft, and to attempt by mere self-assertion to elevate himself above his brethren, and to cast discredit on his profession at large, for the inadequate purpose of temporarily advancing himself individually. I am happy to be able to assert, however, there are but few of these amongst us—much fewer than in any other profession of distinction, that I know. But I now come to a still more objectionable class of enemies, our hysterical amateurs. These gentlemen represent that enormous waste of intellect, which unluckily is just now part and parcel of the waste of wealth of all kinds in England. We have any number of men who are positively at their wit's end for subjects on which to exercise their intellectual powers. They are more or less idle men by force of circumstances, rather than by inclination. They have nothing to which the necessity of earning a living causes them to become attached. They crave for distinction, and must by hook or by crook discover some subject in which to distinguish themselves. Some of these have fastened upon architecture. It must be a strong hallucination under which such a man fastened on a subject like architecture, without knowing even the elements of its practice ; but there are such gentlemen, and they have been received with favour in this room ; and, I venture to submit, that in most cases this is a mistake. I can understand a man of science coming into this room and displaying his erudition by conveying to us special information which happens to be superior to our own ; but, I cannot understand a gentleman who never held a pencil, coming here discussing principles of art ; and dogmatically criticising questions of recondite design, which any

member knows, all the time he is courteously applauding him, that he does not comprehend at all. The true aim of architecture is comparatively humble in the great majority of works. It is simply to lend grace to all descriptions of building. The question before us is—does the architectural profession in England in the present day—for it seems to be demonstrated now, that the architectural profession always has existed in one form or other from the most remote ages—does the architectural profession of England, as it exists at this day, fulfil this function fairly? I venture to say it does. For the ordinary beautification of buildings, it is pronounced sufficient; the public at large are satisfied. Go into the City of London; men of business admire the buildings erected there, and very properly refuse to listen to the fantastic criticism of inexperts upon their merits. Go to hundreds of village churches, unpretendingly and unambitiously designed, and you will find those who are really entitled to express an opinion, are universally satisfied that the end intended has been accomplished. It is only writers in reviews, and writers of books—without a purpose, I was going to say, but rather with a purpose they do not understand, who express, on behalf of the public, a dissatisfaction with architecture and architects, which you will find does not exist if you make inquiries into the facts. But when I come to that kind of design, which I call the ambitious, then I acknowledge we do not always succeed. I may perhaps say that, in England, this is peculiarly an age of *ad captandum* design. Now if we, as a profession, condescend to attract the public by such design as that, what else can we expect but that a race of critics of this kind should arise? For we appeal to them, and they come at our own call. There are one or two incidents in the architectural practice of the day which tend a little to the accentuation of this difficulty, when brought about in the way I have said. In the first place, there is that most pestilent practice of reckless competition. Competition drawings are a nuisance. They are unsatisfactory things in themselves, and I am quite sure the greatest masters of the art of competition view it with regret after all, and mourn over the necessity which has compelled them to engage in it. The drawings submitted in competition are all, more or less, expressly *ad captandum*, and are, in fact, an appeal to that very order of criticism which we are met to deplore. Another matter which I think is to be, in a certain sense, regretted, is the custom of publishing architectural designs, which at the present day so much prevails. No doubt these designs are interesting; and I do not say we can entirely dispense with their publication, or that they are not of use, but observe the style of draughtsmanship which it brings about. Anything more delusive than our popular drawings of Buildings of the present day one can scarcely imagine. The consequence is, the public are appealed to by this means as well as the other; and thus is brought about again that ignorant or misinformed criticism which we now see before us. The direct consequence of all this is the existence of a class of amateur writers who obviously cannot for a moment pretend to understand the *arcana* of such a recondite science as that of architectural design. This again brings about a reaction upon the architectural designers themselves. We have heard papers read and speeches delivered in this room (I am speaking from memory), in which homage has been paid to certain amateur architectural writers as the sources of inspiration from which the writers and speakers have drawn all their artistic ideas, and on the basis of whose vague and visionary notions these gentlemen have professedly founded a system of speculative art, far beyond anything that could have been accomplished by them as practical men. This is precisely the kind of reaction that is produced upon the profession by amateur writers. What are the consequences? Wild design, sentimental ecclesiology, passionate ritualism, the *odium Theologicum* itself, under conditions and circumstances which have nothing to do with art, and never had, and which, when developed as they have been to a great extreme, have tended to this result—to confuse and confound the art of architectural designing with any one of a thousand other things, rather than anything that is legitimately connected with it. I am not going to suggest a remedy in contrast with the remedy of the *Quarterly* reviewer—the theory of the working man; but the true

remedy is that which Mr. White appears to suggest at the close of his paper, where he speaks of the study of the "Philosophy" of art. Permit me to call it criticism. In my young days we were taught criticism; now-a-days such a thing is never heard of. The theory of art design is not in itself a positive science, but it enables us, with courage and satisfaction, to cultivate its study. What I say now is only what I have said before. Let the profession of architects cultivate art criticism, and all will be right. I hope before many years we shall see a return to common sense in various forms, and amongst others in this form; and then we shall at one step leave amateurs at an infinite distance behind. Their sentimentalism will fade and die away; and their specious arguments will fall harmless on the ear. At present we devote, compulsorily perhaps, a great deal of attention to what is said by amateurs; but, let us be masters of our own business, and then you will find they cannot possibly be followers of such an art as ours. A single word more: their mere happy design, without critical knowledge, can have no abiding influence. I will not say, no historical influence—no abiding present influence over the profession in practice, as one year succeeds another. But let us only understand the philosophy of our works, and there will be an end at once of the theory of the working man superseding the architect. This calls to my mind a rather peculiar illustration. Some members of the Institute may not be surprised to hear that I am a relative of the late Joseph Hume; in my early days I happened to be at one time with him a good deal, and this was one of his remarks: "I have been associated in various ways" said he, "with all classes of the community, and I have found the working classes by far the most intelligent, and infinitely the most honest." For my own part, I cannot now agree with him. He saw the working classes, I will not say from a distance but through a somewhat disordered medium. He was a man of infinite shrewdness, but with a slightly perverted bias in that particular direction. A great many people have adopted his views to their own amazement, and have even carried them a little further than he did. But what I have personally found is, that the working man of England is very well in his place, and very much otherwise out of his place. The proper duty of every working man, is to be content to remain a working man while he is so, but to escape from that condition, if he can, as soon as possible. Therefore, I view with extreme suspicion, anything that is founded upon the argument, that the working man, typically spoken of, is to remain for ever in the condition of a working man. The best advice, perhaps, that we can give him, is to try his best to escape from that condition. Sir, I have derived great pleasure from hearing Mr. White's paper, and have even greater pleasure in supporting the vote of thanks which he has so well entitled himself to receive at your hands.

Sir EDMUND BECKETT, Q.C., Visitor, on being called on, said,—At this late hour you can hardly expect much from the "hysterical and sentimental amateur," of whom Professor Kerr has such horror. I did once write a book on architecture, but I never heard it accused of being sentimental, whatever else it may have been; and if I write another it will be, if possible, still less so. For the longer I live the less I believe in the philosophy and theories of art which so many people write about, and professional men no less than amateurs, and the more I am inclined to stick to the experimental and practical view of building. The first half of Mr. White's Paper was rather too philosophical and theoretical, and analogical for my taste; for analogies never prove anything, beyond sometimes answering objections, for which purpose alone they were used by the greatest master of that art, Bishop Butler. But I have no doubt we all learnt a good deal from the latter and more historical part of the paper. I must confess also to some disappointment at hearing so little of your own views of the real Hope of Architecture. Mr. Spiers, however, has taken the most practical and convincing mode of knocking to pieces the article in the *Quarterly*, which formed the text of Mr. White's discourse. And I differ entirely from the gentleman who wants Mr. Spiers's drawing of the Portcullis Hall to be effaced and forgotten, as a reflection on the sacred working man, of whom it seems nothing but praise is to be

uttered now-a-days in public. On the contrary, I advise you to publish it; not as a reflection on the working men who are said to have made the design, but as being at once the measure of the theory, and the taste of this anonymous reviewer and exalter of the working man's tastes and capacity for designing. If he had published his article as a pamphlet with his name, nobody would have noticed it. And if he had himself exhibited this wonderful specimen of his own taste and theory, nobody would have read the article to the end, but it would have been at once thrown aside as the visionary nonsense of some "hysterical amateur;" although in fact it seems to be well known to be the work of a professional architect, who seems bent on showing mankind the uselessness of his own profession. And if you do publish this climax of 19th century design, take care to show the roof also, which is ever so many feet below the height which this sham stucco front leads one to expect; a remarkable specimen of the "truth and reality" which we hear so much about, as a primary condition of architecture. I cannot say I am disposed to differ much from the criticisms on many of our modern buildings in his former article in 1872, though probably some of you think differently about them. But criticising is a much safer process than the designing of either buildings or theories. His theories extend backwards as well as forwards. He admires, as most people do, the Baptistery at Pisa, and as I said a fortnight ago, it is a capital plan in arguing about art, to assert boldly that anything good must have been done in the way you think it ought to have been, and leave the other side to prove if they can that it was not, or to demolish this fallacy as they may. He says accordingly (p. 363) of that building, "the stones seem cut and fixed in some instinctively harmonious way, each by separate workmen, yet in perfect and spontaneous concert with a general design. This is the climax of Italian mediæval art," which obviously means that they worked with a general design or object, not that they followed a design or plan made for them by somebody else. I wonder how he knows anything of the kind. Saying that it "seems" to have been so is saying less than nothing without some evidence of the fact; for the fact may have been the other way, and then it would prove that this building, which he thinks so admirable, is an instance not for but against his theory. Now it happens that there is evidence that this building had an original designer; at least that is Mr. Fergusson's account of it; and that after his death that design was in some respects spoilt by others; which shows that its history is perfectly well known, and is just the contrary of what this reviewer assumes.

The fact is that the whole of his paper does not contain one bit of historical evidence that any building worth notice in the world, ever was designed by the workmen as a body. And there certainly never was a time when there was less Hope of Architecture being advanced by the instinctive co-operation of workmen to produce a harmonious and beautiful result, than now, when every working builder is the slave of a trades union, which teaches him in effect that it is his duty to do as little and as ill as he can manage to get paid for, and to answer, if the master builder complains of his doing stupid things, that "he is not paid for thinking," as I hear they do. Dismissing then that visionary theory, we may turn to the Reviewer's other alternation of designing by the master workman; for which I must say that there is a real historical foundation, notwithstanding a few instances to the contrary adduced by Mr. White. But both methods might very well co-exist. There is abundant evidence that the designers of many, and perhaps most of the old buildings, were what we should now call builders or contractors, rather than architects. But what then? There is no magic in a building being designed by one man rather than another, provided he is competent, and really master of the work, in a larger sense than that of the mere hirer of workmen. No builder of any large work has time to work at it with his own hands, and what better would it be if he did? There is an old and true saying that "the eye of the master is worth more than both his hands." It does of course make an infinite difference whether the designer and director of a work thoroughly understands it and looks after it,

or not. But so long as he does, it does not signify the least how he has learnt his business, whether by working or by looking on. And as to the taste which is necessary to design good architecture it signifies still less (if possible) whether the designer is a workman besides. People may write fine language about the philosophy of art and theories of architecture, and tell us that it is "the expression of a people's wants" and many other things, which sound well and mean anything or nothing; but the long and short of the matter is that architecture, or an architect, wants only two things expressible in two short words, taste and knowledge. Taste can neither be defined nor taught, and the only test of it is that things in good taste are admired in the long run and permanently, and that those who have seen them once desire to see them again. Moreover it is odd that taste does not follow education, but sometimes the reverse; for there seems no doubt that people far below us in civilization and knowledge, working by themselves entirely, display an instinctive taste which they actually lose on becoming more civilised. This is unfortunate, and I do not pretend to have a remedy for it, especially as the bad taste is not at all confined to workmen, but extends a long way above them, as those of you who go into architectural competitions know too well. But the other essential quality of an architect, practical and scientific knowledge of building and all that belongs to it, can be taught and ought to be possessed more completely now than ever, inasmuch as there were never such facilities for acquiring it. Now I am going to ask an unpleasant question and a bold one to put in this room. Have the public any security whatever that any man who calls himself an architect does understand his business practically even as much as the builders whom he professes to instruct, or that he will exercise any efficient superintendence, or that his certificate of completion to his satisfaction according to the contract, will be any guarantee for it being found in good condition ten or even two years hence? Many of you doubtless do fulfil these conditions, but the question is how is anybody to know whether any given architect, whose reputation is not yet established, does or will fulfil them? I am sorry to say I know that there are too many who do not. It is very little compensation to a man who finds his house full of faults or falling into decay in a few years, to be able to tell his friends what a bad architect he had; nor will that do the architect much harm, unless the case happens to acquire some unusual publicity—or perhaps even if it does. For the blame will then be laid by the architect on the builder, who may very possibly have been a rogue, or on the clerk of the works, who may have been ignorant or careless or bribed, and it is not everybody who will reflect that the architect appointed the clerk of the works, and has been paid for superintending the work himself besides, and that his certificate in effect and in law, declares that he has examined it all, and that it has been done properly,—so that he is himself liable for giving a false certificate if it has not.

Now one of the points in the *Review* is that superintendence by the designer is very far short of what it used to be in old times, when the designer was on the work continually, and seeing the effect of everything as it went on, besides seeing that the work was done properly. And I must say that that does not appear to me very easy to answer, beyond saying, what is true as a fact, that architects have too much to do to be able to superintend their work much, and that clerks of the works are substituted for them and paid by the employer, in addition to what is paid for the architect's superintendence. But though that is true enough as a fact, I was glad to hear Mr. P'Anson admit that it is not satisfactory. It is indeed no answer at all to the charge that this is one cause of the great quantity of bad building that we suffer from; and I must add, bad designing too; because I am sure no man can design details satisfactorily without trying them as the work goes on, in the only way in which they can be tried, viz.: by models. I never saw any details so tried without some improvement being suggested. The last time I was here a print of a lecture was received from one of your own body, Mr. Boulton, of Liverpool, and a sort of protest was made by several of you against some of the doctrines he pro-

pounded as to the relations of architects and builders. I see he expresses the opinion that there ought to be more of what we lawyers should call consultation between them, and that architects might often learn a good deal from builders. I should have thought that self-evident. To protest against it, as degrading to the man of theory to consult the man of practice, seems to me to invert the relation of theory and experience, and an attempt to put back the world 300 years to the time when *a priori* reasoning, which is in fact guessing, was thought a better guide than induction from experience. I have sometimes got better advice from builders than from architects, and I have known, though not on works of my own, the builder ordered by the architect to do what was decisively proved to be wrong by the results. I have seen and heard of houses where the floors are already destroyed by dry rot (as damp rot is absurdly called) because the architect would have them laid so that damp must be continually rising into them and without proper ventilation. I don't know how many times I have been asked to subscribe to rebuild towers which have fallen as soon as they were finished, and yet although the work had been certified by the architect as done to his satisfaction. Only the other day I accidentally turned up in a Doncaster newspaper of 25th April, 1862, the report of an event which I had by no means forgotten, though I was not aware that I had the record of it. I went to see a great house which was building under a London architect for a rich man, who wanted to have everything as good as possible and spared no expense, with a porch for carriages to drive under, in the Italian style, and therefore without arches. The lintels were of course too long to be single stones, and there were three in each long lintel apparently joined endwise. I said to the clerk of the works, "I suppose there are iron beams inside." He answered that there were not, but that the stones were dove-tailed. I replied, "Then there will be a nice smash some day;" and see that prediction of mine is recorded in the newspaper. The very day after the props were removed the whole thing came down without a moment's notice and killed the foreman. There was of course an inquest, and an intelligent jury and coroner returned a verdict of accidental death. I also learnt afterwards that the architect, I suppose by way of putting a good face on the matter and repudiating all idea of it being his own fault, actually called on the contractor to rebuild it. But luckily for him the employer of them both remembered that he had protested against it from the first, but the architect had insisted on it. I am quite ready to believe that this was an extreme case, and that few architects are so ignorant of the strength of materials and the elements of mechanics as that; but I have recorded in my book on clocks a dispute of my own, with a much more celebrated architect, who insisted that a certain great bell frame would be strong enough as he designed it, and then after the bells were hung had to spend some months, and I don't know how much money in altering it, as I had told him that he would have to do. If it were worth while I could easily rake up other stories about defective roofs and other things, all tending to prove that an acquaintance with mechanics and practical details of working are by no means to be taken for granted, because a man can draw captivating plans. Mr. White seems to think that the rejection of Mr. Burges's design for painting and veneering with marble the inside of St. Paul's, is a specimen of the mischief done to the Hope of Architecture by amateurs; though I did not hear any specific answer to Mr. Fergusson's criticism of it in the *Contemporary Review*, but only some defence of Mr. Burges personally, or artistically. But that kind of defence is entirely beside the mark; for the peculiarity of this case is that here was an architect, selected by no delusive competition, but expressly from his reputation, and notoriously in a great measure by the influence and vote of a former President of your own, and supported, I see, at the late meeting—which rejected his design finally—by the President now in the chair, and yet what was the result? Why, a design more unanimously condemned by public taste (if possible) than the Law Courts design of another architect no less eminent. If the committee had persisted after that in carrying out Mr. Burges's design, it would have been fatal to

their getting any more subscriptions. It is true that neither this nor any other test can demonstrate mathematically that those designs were bad. But it is the only test that is applicable to designs before they are executed; and these things are at any rate an absolute demonstration that the public have not that confidence in architects which Mr. Kerr thinks they have in the bottom of their hearts, notwithstanding the occasional outbreaks of dissatisfaction which he admits. How many modern works can he point to which will bear the test I gave just now, of those who have seen them once desiring to see them again, as they contemplate the buildings of the middle ages over and over again with continued admiration? He said, "Go into the city and see how much architects are doing." He might have said, "Go everywhere." For everywhere people must have building, and must employ architects, and 99 people out of 100 must take what architects will give them, and make the best of it. I should not say "Go into Westminster Hall and Lincoln's Inn, and see how much lawyers are employed; there are twice as many courts as there were 40 years ago, besides county courts all over," as a proof that the public are satisfied with either law or lawyers. However little amateurs may know of architecture, and whatever mischief we may do by writing about it, you must admit that we are more likely to know what people in general think of your works than you are, as it is not the custom to tell professional men that you are dissatisfied with them. You must not conclude that a new church is going to be permanently admired because the bishop at the consecration preaches a ready-made sermon about "this beautiful building worthy of the best times of architecture," and so forth, and because the speakers at the luncheon and the local newspapers echo those praises for a week.

Mr. White properly referred to Viollet-le-Duc's amusing description in his late book of how architects are generated in France; and he added that it is not the same here. But is it any better? What real measures do you take, collectively or individually, to secure that men calling themselves architects should know anything of architecture, beyond what they pick up in the offices where they sit for a time, copying drawings and specifications? Lawyers and doctors are not let loose upon mankind to ruin or to kill them without having satisfied competent examiners that they are competent, besides having gone through certain practical courses of education, doing under the direction of others what they will have to do for themselves. What evidence is there for the public that any man setting up as an architect has the smallest scientific knowledge, or even a decent practical knowledge of mechanics, or even of the common work of building, of the qualities of different materials, or in short of anything at all, beyond being able to make a sketch which will satisfy ignorant employers, and plans and elevations from which builders will contract—as they would from anything? An architect in the country told me lately that his clerk had left him. Knowing the clerk, I answered, "I should think that is no great loss." "Oh, but he tells me he has acquired a connection here, and is going to set up for himself!" I replied, "He acquired a connection! Why, where did he ever see a bit of building done, or do anything but copy your plans and specifications?" So a man becomes an architect in that way, and acquires a connection by going out to tea in a country town, and talking about the plans he has been making. Now here I do not doubt that you will agree with me, more than in some of my previous remarks, and will think as I do, that you ought to have some power of giving diplomas or some kind of certificate of qualification for practice as an architect.

At the same time I must warn you against expecting that you would get an Act of Parliament to prohibit any body from being employed to design buildings whom anybody else chooses to employ, though you may have power to distinguish those whom you have ascertained to be qualified. Here again you must not be misled by analogies. Ruination by bad advice, or killing instead of curing, are rather more serious matters than the difference between good and bad architecture. I remember the excitement once caused among you when some of you complained of the late Captain Fowke being employed,

as the gardener Paxton was before, to design the Great Exhibition Building, instead of an architect, and Mr. Cole puzzled you by asking "What is an architect?" And when we see such a really grand and successful building as the Albert Hall designed by no professional architect, but by that same Captain Fowke, and other buildings elsewhere, such as the best London houses which are designed by the great builders, and others designed by amateurs (though I admit some of them are very bad, but not worse than can be matched by architects), you may be quite sure that the idea of prohibition is visionary. But it does not follow that you should not give certificates of competency and distinguish successful men by prizes; which I venture to say, would be a far better application of them, than awarding medals to those whose reputation needs no such testimony, and is really rather lowered by it, because it looks as if they thought it did. The refusal of your medal was, I think, the wisest thing Mr. Ruskin has done for a long time. Medals have become only the fit object of ambition to advertising tradesmen, or to young men whose merits have to be tested and testified before they can be known by their works. I confess, however, that I see great difficulty in testing young men's practical qualification for being architects, for those most easily tested, such as drawing, are no tests at all of a capacity for designing, much less any proof of good taste. The designers of most of the grandest buildings in the world could not have made a picture of them which would have had a chance in an architectural competition; or of a prize in a drawing school; and some very nice artists are utterly bad architects. But knowledge of mechanical science, in which some architects are woefully deficient, can be tested easily; and you who are in the habit of taking pupils to educate for architects ought to be able to know how to test their proficiency, though I may not be able just now to suggest the best way of doing it. I do know, however, that the present mode of educating architect's clerks is very far from being what it should be, especially in practical matters, and I have been frequently surprised at the ignorance which architects rather profess than confess of a variety of practical things connected with the buildings they design. So far are they from accepting the maxim attributed to Viollet-le-Duc—that an architect ought to know everything (which of course means everything connected with building directly or indirectly), that many architects, like most workmen now-a-days, seem to be rather proud of saying, "O, I know nothing about that; you must employ such and such a tradesman;" what is worse they profess to provide for what has to be done afterwards by tradesmen, without the least real knowledge of what the provision ought to be. I have special reason to know that from my frequent consultations about clocks and bells, that I never met with an architect who knew anything about the provisions proper to be made for them in the towers which they build.

I entirely agree with Professor Kerr's condemnation of architectural competitions, and I wonder the leaders of your profession have not agreed by this time to have nothing more to do with them. They tend, perhaps more than any one thing, to degrade architecture by tempting you to work down to the level of the taste of town councillors and committee men, who you know are most certain to prefer the most showy and very likely the most vulgar and worst design to the best. You know that they are utterly incompetent to translate (as we may call it) from paper into stone, and utterly ignorant of proportions in any practical sense, and have no idea that what will look well in a large building may look contemptible in a small one; that drawings give them no means whatever of judging, first, because they never measure them; and secondly, because they would not realize this effect if they did. To put it simply, I will say that you all know very well that if I asked you for a non-competing design for a building to cost £10,000. or £100,000., you would give me a very different one from that which you would send in for a competition. [The PRESIDENT.—We are obliged.] Undoubtedly you are, if you compete at all. But there is another reason why I wonder you have not agreed to have no

more to do with competitions. All the great ones, for the last twenty years at least, though with a higher class of judges than town councillors, have ended in disappointment, and might as well now not have taken place. There was the famous Foreign-office competition, with what a government official of the day described to me as a "representative committee," who gave the first prize to a design which it was somehow speedily discovered could not be adopted. After months, if not of years' discussion, the First Commissioner of the day appointed the architect, whom he probably would have appointed without any competition, and distributed a number of other public buildings among others of the competitors for that. The Law Court competition ended in the same way, and it oddly happened by the turn of the parliamentary wheel, that the very same First Commissioner, after about fourteen years, had to perform the same operation again. Descending to much smaller things, I had two designs for a church sent to me to choose between, which had been selected out of fourteen by a country town committee. Whether the other twelve were really worse I cannot tell, because I did not see them. But the two were both so bad that I could only answer that I was sure one was a delusion, and could not be done honestly for the money; and having no reason to suspect that of the other, and knowing something of the architect, I thought they might employ him—provided he would adopt a perfectly different design, which I made myself; and so they did, and are well satisfied with the result. I had previously recommended a better architect, who would not compete, but they would have a competition, and that was the result. In fact, wherever you go, you may see the most hideous results of competition; and what is worse, that competition style is infectious, and contaminates even private buildings all round; private people having come to think that plain buildings, depending on good proportions and comfortable arrangements for their effect, are behind the taste of the age and the much talked of but yet undiscovered "style of the 19th century," which is too large a subject to enter upon now. I will only say that I see no more hope of architecture in the fussy and pretentious magnificence of new Belgravia and Curzon Street than in the monotonous repose of old Marylebone. And the sad descent from Doncaster church and Exeter College Chapel, through the successive phases of translation of Italian and French Gothic into modern English, down to the lower depth of the harsh crudities and oddities of the style called by its patrons "vigorous," seems to me to have turned the hope of architecture into something very like despair.

At the conclusion of Sir E. Beckett's remarks, the President, having remarked that the lateness of the hour would prevent his inviting other gentlemen to speak that evening, proposed that the discussion should be adjourned until the next Ordinary General Meeting on Monday the 4th of January, when Mr. J. J. Stevenson had promised to read a Paper on a kindred subject, viz. :—"Master Workmen and Architects."

Sir Gilbert's proposal having been received with acclamation, the Meeting adjourned.

Royal Institute of British Architects.

At the Ordinary General Meeting of the Institute, held on Monday, the 4th of January, 1875,
SIR G. SCOTT, R.A., President, in the Chair, the following Paper was read:—

ARCHITECTS AND MASTER WORKMEN,

By JOHN J. STEVENSON.

MR. FERGUSSON, in his able and interesting history of architecture, expresses the opinion that the system of architecture for the last three centuries has been false, and that the works produced have been mere copies and shams, void of interest, and valueless, as compared with the products of the true styles which, till the Reformation, had prevailed in every country.

“The great change which was introduced at the Reformation,” he says, “was this. A Technic art came to be cultivated on principles which belong only to one of the Phonetic class;” that is to say, architecture which is only the useful art of building elevated to a *fine* art, as “cooking may be refined into gastronomy, and tailoring into an important art without a name,” came to be treated as if it were like poetry, painting, or sculpture, one of the phonetic arts, “merely different modes in which men’s thoughts can be communicated to other men, or perpetuated for the use of posterity.” In the technic or useful arts, those, for instance, connected with food, clothing, or shelter, progress has been slow and gradual. Each worker is heir of an accumulated experience, and so “any mechanic can now make a better steam engine than Watt:” “as in India, at this hour, local masons, who can neither read, write nor draw, can design as beautiful buildings as ever graced that land.” But in the phonetic arts, poetry, painting, sculpture, “the individual stamps the value.” “We do not now find men writing better epics than Homer, or better dramas than Shakespeare. We do not see finer sculptures than those of Phidias, or more beautiful paintings than those of Raphael.” “No one dreams,” therefore, “of altering a poem or of improving a statue or picture, though they may be the production of inferior artists. But in the middle ages no one ever hesitated to rebuild the nave of a cathedral, or to add towers or chapels in the newest fashion to the oldest churches,” just as “no Comptroller of the Navy ever hesitated to cut one of Sir W. Symond’s ships in two, if by lengthening her he could improve her qualities.” “No one has cared to record the names of the mediæval cathedrals; probably nobody knew who the architects were. The art was a true art; it was more difficult to do wrong than to do right now. No genius, however great, could then enable an individual to get much ahead of his compeers, while the most ordinary ability enabled anyone to do as well as the rest.” But “the individual is now everything in architectural art, while the age is of as little importance as in a poem or a picture.”

And so “it would be considered sacrilege to meddle with or attempt to improve St. Paul’s Cathedral out of respect for Wren” (I only wish it were so considered,) “and Blenheim must remain the most uncomfortable of palaces, because it was so left by Vanbrugh.” “The new system subjects art to the caprices and vagaries of individuals.” “What a man learns in his lifetime dies with him;” “his successor has to begin at the beginning;” “their careers probably cross each other.” “An architect in

practice can never afford many hours to the artistic elaboration of his design," and hence "the remarkably small amount of thought that a modern building ever displays. The evil has been aggravated in modern times by architecture being handed over too exclusively to professional men who live by it, and generally succeed more from their businesslike habits than their artistic powers." In conclusion, Mr. Fergusson says that, "without a re-organization of the whole system, we must be content to allow copying to the fullest extent, and must be satisfied with shams, either classical or mediæval, until at least the public are better instructed, and demand or initiate a recurrence to the principles that guided the architects of those ages when true and real buildings were produced."

I do not think it is a straining of Mr. Fergusson's opinions to say that his view is that, under the present system in which architects direct the construction of buildings, by means of drawings, good architecture cannot be produced, and that we should return to the system of the "true styles" when there were no architects in the modern sense, but the employer communicated directly with the workman who executed the work; in other words, that architects should be dispensed with.

These opinions of Mr. Fergusson have been restated in three articles in the *Quarterly Review*, entitled "The State of English Architecture" (April, 1872); "The Completion of St. Paul's" (December, 1872); and the "Hope of English Architecture" (December, 1874.) In these articles the writer argues that in Greece, Rome, and Mediæval England (which last with more patriotism than accuracy, he says, was "for six centuries the finest scene of architectural display that the world ever saw"), as well as the Continent, architecture was produced, not by architects directing workmen by means of drawings, but by men who, while working with their own hands, had a charge of their fellows as foremen or master-workmen. He quotes numerous cases in proof of this from Mr. Street's book on Spanish Architecture, in a tone which seems to imply that he convicts Mr. Street of inconsistency in relating them and yet continuing to practise as an architect on the system now prevalent. His latest article concludes as follows:—"Such was the master workman of the past, whose free imaginative power has ever been the life of art; and in like manner the emancipated workman, gloriously 'impelled' must always be, and is, the only real hope of English architecture." He expresses his hostility to architects more unrestrainedly than Mr. Fergusson. "These eminent persons," he says, "have been the bane of art for the last three hundred years." Again, he calls them, "A spurious, we had almost said a quack profession;" and again, he says, "There will then be no need of the 'profession,' and architects will subside into their proper places as bookmakers, artists, business men, students of symbolism and archaeology, and, in fact, pupils and illustrators of those very workman whom they now profess to direct and to control."

The reiterated publication of such opinions on high authority is a challenge to architects to show reason for their existence, for Mr. Fergusson is without an equal, in his peculiar province, as a writer on the various architectural styles. If these opinions be well founded, let us as architects, by all means, perform with what dignity remains to us, the "happy dispatch;" and withdrawing from the practice of an art whose true progress we are arresting, give place to our worthier successors, the builder and the British workman. But before doing so, we may be permitted to examine the justice of our sentence.

The opinions above recited assert or imply not only that in the best times of the art architecture was produced without architects, but that this is the only right way of producing it. If they have any practical meaning, and are to influence the conduct of any one in the present day who is thinking of building, they amount to an advice to him not to go to an architect for his plans, but to work them out himself with some intelligent foreman or builder.

That we as architects should oppose this new teaching is to be expected, and I think is right; but there is a risk that our opposition may not make so much impression as we could wish on the public, for

they may think it the same in kind as that against Paul's preaching at Ephesus, which those who made silver shrines for the great goddess Diana united to stir up (though doubtless each had his grudge against another at losing jobs which the other had got) because their craft was in danger. I do not think there is much danger of the suppression of the architectural profession. It will certainly, at least, die hard. The public certainly cannot do without us if they want something better in art and building arrangements than the builders unaided have been giving them in those miles of houses growing up like mushrooms in all our towns.

We might admit as true all that Mr. Fergusson and the Reviewer say as to the difference of the modes in which architectural works were produced in former times and now; we might admit the reality of Mr. Fergusson's distinction of architectural styles into false and true, though not, perhaps, approving of his nomenclature; we might even admit a just dissatisfaction on the part of the public with the results of our late efforts in architecture (and we were told on good authority at our last meeting, that the public are not satisfied with us); and yet be under no constraint to acquiesce in the conclusion that architects should be abolished, and that it is to the working men we should turn our eyes for light and guidance.

Mr. Fergusson's condemnation of us is that since the Reformation architecture has been conducted on a false method; that whereas it is a "technic" art, it has been treated as if it were a "phonetic" art, like sculpture or poetry; and that instead of developing by a natural process of evolution, it has been under the control of individuals. I do not think the terms technic and phonetic are happy. To say "*technic* art" seems tautological. "Phonetic," implying sound or speech, does not properly describe painting or sculpture. This is, perhaps, of little importance, but the distinction itself has no existence in reality. The arts which Mr. Fergusson calls "phonetic" do not arise out of the gift of speech as Mr. Fergusson asserts, but are rather substitutes for speech. He seems to have classified the arts as technic and phonetic, putting aside the familiar distinction of the arts as useful and fine, in order to avoid classing architecture as a fine art with painting and poetry. But in truth the distinction among these arts does not lie in the subject matter of the art, but in the *manner* of treatment. Any useful art may become a fine art by having added to it the element of *fineness*—of beauty of colour or form, or of expression, that is, any element making it the vehicle of human feeling or emotion, such as tenderness, gladness, solemnity, or even, perhaps, mere refinement and perfection in work. "Every useful art," Mr. Fergusson says, "is capable of being refined into a *fine* art."

Architecture is not only a fine art, but it is included in Mr. Fergusson's list of the "phonetic" arts, being one of the noblest and most lasting modes by which men's thoughts can be communicated to other men, or perpetuated for the use of posterity. Now, one of the results of an art developing into a fine art is that, the art expressing the personal emotions and feelings of the artist, we come to have an interest in his personality. We resent the alteration and interference of others, as destroying the value of the work—the art becomes individual.

This, at least, is the case in our present state of society and civilization. But in certain states of society we find arts flourishing in what we may call a traditional manner. Their origin is lost in the past. They are handed down from father to son. They are understood by the whole community, and seem the expression of the national character. Their progress is slow and gradual, and we can measure it only by comparing the productions of the art at long intervals of time. This is what Mr. Fergusson means by a "true" style of architecture. But he is in error in saying that architecture in being so practised differs from poetry and other arts, for in these arts, as well as in architecture, in primitive states of society, we find the same state of things—we cannot recognize the individual inventors in poetry and sculpture. They are lost in the community, or in a school of poets or sculptors handing down a tradition.

In them as in architecture the age seems everything, the individual little or nothing. Mr. Fergusson ranks Homer with Shakespeare, as both equally historical personages. But few now hold that the poems of Homer are the work of any one man. They and other early Greek poems come to us as the collected traditions of the schools of professional singers and rhapsodists, who recited them at the public festivals. In the early history of every race literature and all the arts exhibit the same characteristic. The folks' lore and national tales, characteristic of the genius of each people, even when traceable to some far back source common to them with other races, the national proverbs are all authorless, so far as we know, and with as much truth as a style of architecture or ornament might be said to be the result of slow accretions of tradition. But no one would think of calling only such national poetry and literature true, and that by poets whose names we know false, or of lamenting that under our modern system literature had lost its ethnological value. All other arts were conducted on the same principles in these early stages of society.

The art of sculpture was practised in the same anonymous traditional manner; a useful art to begin with, to supply idols for worship, of the rudest and most practical kind, as we see from those lately found at Hissarlik (claimed as the site of Troy) the growing refinement of the Greek race, which tingled with art to the finger tips, in time made these statues of the gods the highest expression of art which the world has seen. Early Greek coins show a slowly developing tradition. The later coins of Syracuse are signed by their sculptors. In the art of music it is the same; each nation has its national airs, breathing the spirit and sentiment of the race handed down by tradition, and doubtless changing and growing as each musician passed them on. But since the time of Palestrina, composers, like architects, have asserted their individuality, and the history of music, like that of architecture, as Mr. Fergusson complains, has become an account of the lives of inventors.

And in other than the fine arts the same thing is seen. Any ship carpenter used to be able to build a ship about as well as any other, but now we hear of individual inventors; and though this takes from us the safety of slow progress, and renders us liable to a fiasco like the *Great Eastern*, no one thinks of urging that the designing of ships should be relegated again to the hands of working carpenters. In like manner the so-called phonetic art of painting has passed through a stage similar to that of the "true" styles of architecture—the state in which it was in Italy when Cimabue gave it life, in which it still exists, in the supply of pictures for Greek churches—a fine art in a sense, not without a sort of beauty, under its conditions—a tradition transmitted by common workmen, gradually advancing, or at least changing with the advancement or decline of the race.

Now let us consider the state of society in which the arts are traditional. It is a state of stagnation. There is a stock of ideas, very small, common to all the tribe; every man thinks exactly like his neighbour and as his fathers did before him. All wisdom comes from their ancestors, and the old men as nearest that source are the sole repositories of truth. New ideas are regarded as blasphemy, and if they spring up are crushed out by the common sense of the people. The thoughts and ways of other nations are regarded with hatred as things the earth should be purged of; or, if with tolerance, as strange and inconceivable. The customs are often circumscribed in the narrowest districts: each village has its own peculiar dress, each district its own type of building.

The length of the period during which a nation may remain in such a state is absolutely indefinite. Many savage tribes appear never to have changed since the stone age. The East is still much as it was in the time of Moses, and from its daily life supplies illustrations of Biblical customs. The breaking up of such a state of things is always an epoch in a nation's history, and fills it with the gladness of new birth. The change may come to only one part of their life, or the whole social arrangements may be broken up. It came to the Florentines, in the art of painting, when Cimabue painted for the

first time a Madonna with some touch of human feeling—when he made the art phonetic, as Mr. Fergusson would say; and however feeble the flicker of life may seem in the picture, as it hangs gaunt on the wall in Santa Maria Novella, to us who know what the life grew to of which it was the germ, it filled the people with such joy that they carried it with shouting and triumph through the streets; and to this day the suburb through which it passed is called the Borgo Leto.

In our own day a new birth has come to the Japanese, affecting not their art only but all their social state and customs. Their art, which to us was a new sensation, to them seems now crude and barbarous. They are delighted with the new idea of perspective and distance. They feel proud of marching in the ranks of European civilization, and glory in black trowsers and tail coats, as the outward and sensible sign of their new inward life. One who was present in Japan during the change told me that though the command of the Mikado, believed to be divine, was needed to start the nation on its new road, it would be powerless now to arrest it.

The same sort of thing is happening everywhere. There will soon be no good to be got out of travel, for every place is getting like another. The beautiful national costumes of Norway are disappearing. In this country all the old ways are dying out. The Great Exhibition of 1851, as has been not untruly said, destroyed the last remnants of art in England. The old traditional arts are perishing everywhere. New Turkey carpets are harsh and bad in colour. We only know what the colour of them once was when we see an old one in some country house where the furniture has been unchanged for a century. Every year, in India, carpets with the exquisite old colour have to be sought for farther up the country. I fear if Mr. Fergusson went back to India now, he might not find his village mason building the traditional tombs. In Persia the art has perished by the destruction of the old weavers in the famine, and the country has gone in for European ways. All over the East the art which has lived there since the days when the mother of Sisera looked for her son returning from battle with "a prey of divers colours of needlework," is perishing before our eyes. This age of steam and universal intercommunication is witnessing the destruction everywhere of arts which have their roots in the earliest traditions of the race. Their continued transmission depended on a stagnant social condition in the people, and when that is broken up they perish with it. It is sad, but it is inevitable; for the taste for individual freedom is like the tiger's taste for blood—when once a man has known it, he can never again be a mere transmitter of tradition.

And this is the age in which Mr. Fergusson tells us to return in architecture to those old ways which he says we gave up three centuries ago. He might as well tell the dead to rise. His book "A History of Architecture of all Countries from the Earliest Times to the Present Day," is of itself proof that we have emerged from the state which conceives its traditional ways the only possible ones—that we can appreciate new and foreign ideas which, if they seem better to us, we are sure to follow under the guidance of their originators, and not of common workmen who do not understand them. We see, therefore, that there is no ground, in fact, for Mr. Fergusson's division of arts into phonetic and technic, the first produced by individuals whose names we know, the latter anonymous, transmitted by tradition, and, therefore, he thinks, advancing by the slow improvements of ordinary and unknown men; that, on the contrary, anonymity and transmission by tradition has been at certain times a condition of all other arts as well as of architecture.

Equally erroneous is Mr. Fergusson's assertion, on which depends his division of the history of architecture into two markedly different periods, namely, that till the Reformation the so-called true system everywhere prevailed; and that since then, throughout Europe, the so-called false system has prevailed. It is no doubt true that most of the old styles of architecture, especially those which continue, as in India, to the present day, were practiced during long periods as traditional styles by

common workmen, and continued gradually progressing without any great originality, or such change as to be marked by the names of the architects. But I think it can be shown that this is not true as regards the rise of Gothic architecture. It arose in France in the building of the great cathedrals, in a period of remarkable social and mental activity; when the towns threw off the fetters of the feudal system, and gained their liberties and the right of having walls—an outcome of that Renaissance within the Middle Ages, which produced the free thought of Abelard, the love poetry of Provence, the new music of rhyme. The rise of the new architecture was rapid, the whole of the French cathedrals being built and left almost as we find them within a period of eighty years. It was not a slow improvement of traditional ideas by unknown workmen. On the contrary, we find in it one of Mr. Fergusson's characteristics of a "false" style; we know the names of the architects. These seem chiefly to have been laymen, judging from their names and the layman's dress in which some of them are represented on their tombs.

In the centre of a labyrinth marked in lines on the pavement of Amiens Cathedral were engraved the names of the "masters" who in succession in the beginning of the thirteenth century had directed the works—Robert de Luzarches, Thomas de Cormont, and his son Regnault. Peter of Montereau, in 1240, was commissioned by St. Louis to build the Sainte Chapelle at Paris. With his wife he was buried in the choir of the Lady Chapel of St. German des Pres, now destroyed, which he also designed. Libergier was the designer of the very perfect Church of St. Nicaise, at Rheims, as his tombstone, removed on the destruction of the church to the cathedral, tells. Peter de Corbie built several churches in Picardy, and probably—Viollet-le-Duc thinks—the chapels of the apse of Rheims. John de Chelles constructed, in 1257, the gables of the transept, and the first chapels of the choir of the Cathedral of Paris. In 1277, Erwin of Steinbach commenced the great doorway of the Cathedral of Strasburg.

The names of the masters who directed the work at Rheims, Noyon, Laon, and the façade of Paris, are lost; as, however much they might be honoured in their time, they well might be from the lapse of centuries and the destruction of records in France. But the instances given, collected by Viollet-le-Duc, show that Mr. Fergusson is in error in stating that no one seems to have cared to preserve the names of the designers of the mediæval cathedrals. There is sufficient evidence that the small respect in which the Reviewer holds architects and their drawings was not the feeling of the thirteenth century.

The Reviewer and Mr. Fergusson may, perhaps, answer that these men were not architects, but master-workmen. But the sketch-book of Villars de Honnecourt proves that he designed and directed work by means of drawings, while there is nothing to show that he worked with his own hands at the buildings; and the plan which he gives us of a church, designed by himself and his friend, Peter de Corbie, seems as much individual work as any produced under the "false" system.

These men, it is true, may have been engaged on only one cathedral at a time. But a cathedral, as then conceived, with its wealth of design, would furnish work for the lifetime of any man. It might, perhaps, be an improvement on our practice if we had a greater number of competent men among whom our great works might be distributed, so that to each the architect might give his whole time and thoughts. But this proves nothing against the existence of architects, or that they should be superseded by the workmen. It is rather the result of our system of building contracts which compels the planning of the building to its minutest details, usually in haste, before it is commenced, and makes after-revision and improvement difficult. And when we see the enormous number of buildings, sometimes designed by modern architects—as for example, the brothers Adam—in London, Dublin, Edinburgh, and all over the country,—all full of invention, elegant, finished, and correct according to their style, although we may dislike the style, we are bound to admit the fact that an architect designing a great number of buildings does not prevent his doing good and original work full of variety.

The instance of the Cathedral of Gerona, in Spain, where, in 1320, an agreement was made with a French architect, Jacques de Favariis, to superintend the works, and to visit them six times a year, seems very like our modern practice. And not only have we documentary evidence that the design of these buildings in each case was the production—or, at least, under the control—of an architect superintending every part of the work from the foundation to the furnishing, but the buildings themselves prove it in their structure, from their unity of design, and from the admirable adjustment of the various parts to one another—a result which, in a new art rapidly developing, and before its principles were settled, could not have been attained by a mere understanding among hosts of workmen; though it might perhaps be possible, in a fully developed art, with established principles and traditional modes of work; as, indeed, was the case later in Gothic art—the various trades, without an architect to direct them, working harmoniously enough together at the sort of buildings they were accustomed to, though this system might fail, as M. Viollet le Duc shows, in the restoration of Rheims Cathedral after the fire in the reign of Louis XI., when the building and its architecture were strange to them. I think, therefore, there is ground for believing, contrary to Mr. Fergusson's statement, that, at the rise of Gothic architecture, buildings were designed by architects having much the same functions as the architects of the present day. And more easily can it be shown that the second part of Mr. Fergusson's statement is erroneous, namely, that the so-called false system has prevailed throughout Europe since the Reformation to the present day; for the evidence to the contrary exists everywhere round us.

In the fifteenth century in Italy, in the sixteenth in England, architecture again took a new start. Gothic had solved its problems, had reached the limit of height in cathedrals, the limit of twisting stone in tracery windows, and of tracery decoration on the walls; while in England it had stiffened into perpendicular, and, for reasons logically good, the pointed arch was gradually flattened till it became a straight lintel. The art could go no farther than it had gone. In a stagnant state of society it would have lingered on, degraded like modern Chinese pottery, but to the creative age of the Renaissance it had lost its interest and was chucked away like a sucked orange.

It was impossible that an age which had found a new life in classic literature and sculpture could avoid, in the then state of Gothic, adopting classic architecture. But it was not mere copying, as Mr. Fergusson, by his nickname of "copying styles" seems to assert; the great palaces of Rome and Florence are original works, not copies of any old Roman remains. This age in France, Germany, and England was fortunate, not only in having great original architects, but in having the good sense to employ them instead of mere copyers and bunglers. Thus the new style became established as the style of Europe and of every country which adopted European civilization. It soon came to be worked on the system of what Mr. Fergusson calls a true style, not by original architects but by workmen following a tradition. It was mingled with such tradition of the old Gothic style as remained in each country, each of which produced its own type of the style characteristic of the genius of the people; and, notwithstanding the more common employment of architects during the last few years, it remains everywhere the traditional style to the present day. Every workman has been apprenticed to it and understands it; and in it builds, without drawings, according to Mr. Fergusson's "true system," those houses which the Reviewer truly says Englishmen who must live in them justly abuse. The style has, to borrow a term applied in ecclesiastical controversy to a true church, a *note* of a "true style," it is practised by workmen like an instinct, and its productions can be reasoned about with the same certainty as those of the instincts of the lower animals; and, like them, produces sometimes curious results by being followed out in unsuitable circumstances. I remember seeing once a row of houses in a street where the side wall of the last house overhung a wooded bank and commanded an extensive view. *Reason* would have dictated to put the windows in this wall, but the builder's instinct prompted him to make this house exactly like the others, and to make this wall blank like the other party walls with the chimneys in it.

It would seem then from the history of the progress of the Gothic and Renaissance styles, that the law of progress in architecture is this : Architects with the gift of originality, and whose names consequently have been remembered, design buildings different from those commonly built. The new fashion is imitated by the ordinary workman, and a traditional, or true style, if Mr. Fergusson prefers so to call it, is established, which continues developing by constant improvement, or at least changes, till a new "epoch-making" period of mental activity produces or rather gives a chance to original minds again to make a new start. The same thing happens in other arts. Our original painters now, as in old days, have each their school of followers. When railways were first started, original minds, like George Stephenson's, were needed to lay them out ; now any contractor, or even, perhaps, as the Reviewer suggests, common workman, can make them. Any fool now can go to America or make an egg stand on its end, though it needed a Columbus to do it for the first time.

The late Gothic revival is an instance of the same thing. Pugin and others started it, and his works, though among the earliest, are still among the best, from possessing the originality of genius. The style has now become traditional, with established forms and modes of work, if not for houses, at least for churches ; not indeed with workmen who, still imbued with the ways of the degraded classic tradition, though they make abortive attempts in it, have never understood it ; but with architects who, except when they unite with bad taste a belief that they are capable of originality, design fairly good Gothic churches.

And the same is also true of the new fashion so-called "Queen Anne ;" although those whom accident may have caused to be accounted its leaders may not be those who first started it. The London builder is adopting its features, with more chance of success than in Gothic, since it is the natural outcome of London materials and modes of work ; but it is to be feared that he, as well as the more ignorant architects, in attempting to get out of common-place will run into vulgarity, to avoid which, in this style, requires the constant restraint of good taste and refinement.

We see, then, that in architecture, as in other arts, in times of which we have any record, we can trace the rise of new inventions and know the names of their authors, while in times of which the records are lost, the names of the poets and sculptors have perished equally with those of the first inventors of new styles of architecture. The anonymity, therefore, of the "true" styles of architecture is an accident of our ignorance, and not inherent in the nature of the art, and forms no ground for distinction between it and other arts. Reasoning from what we know to have happened in times of which we have records, we may be certain that in times of which the records are lost, new improvements in architecture, great or small, were not made by common workmen or by the general sentiment of the community, but by individual inventors whom then, as now, the multitude copied and followed ; and if these old works of art express the feelings and genius of the race, it is because the race had adopted them and taken them as the expression of their own thoughts. National poetry is the creation of individual poets, national music of individual composers, and national architecture of individual architects, and those patterns and colours which we admire in Eastern carpets, the invention of some long dead and forgotten designer, who have each in their own arts impressed their thoughts on the nation, so that they have become the expression of the national sentiment. Everywhere, and in all time, progress has been determined by the individual. Tennyson's soft music has infected all the youth of our age. Before him was Campbell, "blowing trumpets and beating drums." For a time all aspirants to poetry were Byronic. When we go far back in time, we must believe the same infection of personal influence and mood existed.

Now, as in all time, individuals are, in a sense, the products of their age and country, however remarkable they may be, but there is no reason for thinking they were more so formerly than now.

And architecture is necessarily a product of its time, and influenced by national movements rather than by individuals, to a greater degree than an art, such as poetry, for several reasons. In the first place, it must, in domestic work, suit itself to our life and habits; and these do not readily change, even for the better, at the bidding of any single individual; while in its application to religious purposes it is dependent on the prevailing religious sentiment. Thus, we find that the romantic revival which in architecture was a sequence of the romantic spirit in literature and religion, and will last as long as these.

In the second place, originality has not the same chance of showing itself as in poetry. A poet produces his work notwithstanding that his audience is unfavourable, and if, as in the case of Wordsworth and Tennyson, it is received at first with opposition and ridicule, time, if the work is genuine, will give it currency and favour. But an architect's work must be approved before he is employed and has an opportunity of exercising his gifts; and in his case, as in the poet's, new ideas being strange, are received with opposition and dislike all the greater the better they are, and the higher above the heads of the people. It is sad to think of the chances of good buildings which have been lost to us from this cause. We wasted, for instance, our gift of Pugin. One sees in his little church at Ramsgate, where he had his own way—which seems almost to contain in itself the whole Gothic revival—what a wealth of architectural design he could have given us if we had had eyes to see and hearts to receive it.

A third reason why architecture cannot to such an extent as poetry or literature be dependent on individual originality is that a building cannot, like a poem, be the work of one man. No doubt, as all of us know, by full and careful drawings one man can direct a work down to its minutest details, and that, in the present state of workmen's training, this is the only way to get it right. But not the less is it true that in such a state of things the architecture of a country labours under enormous difficulties. The number of men who are capable of doing this when architecture has no settled rules, as at present, and when they have only their own innate taste and sense of right to guide them, is necessarily few; and as we see, they are the least likely to be employed. The public taste at present is ignorant and uninformed, and is especially debased by a vulgar sensationalism to which the boasted freedom of Gothic has too readily lent itself. It is otherwise when the laws of art are settled, when they are universally diffused and learned as traditions of the trade by apprenticeship, and practiced without difficulty by men who could never of themselves have invented them, when the work of architects, sculptors, carvers, painters, furnishers, fits together naturally without special effort. But if we ever again come to this, it will not be by the fortuitous efforts of common workmen, but by men who can conceive, see clearly, and work out new order and beauty in the art. On our having men who can do this, and in our giving them the opportunity of doing it in actual work, depends the hope of our architecture. But as in Pugin's case, there is more chance of our having the men than of their being employed.

I agree with Mr. Fergusson and the Reviewer, that the present unsettled state of architecture is a misfortune to the art. But the causes of this are deeper than architects can control; they cannot change the spirit of an age; they are but straws in the tide of opinion which, in more important subjects than architecture, is now in a state of flux and movement. But all the more on this account does it seem to me our duty to preserve, instead of destroying, such building traditions as remain among workmen, to give new vigour and interest to a style still living, though common-place and degraded, and to give beauty and refinement to forms which, left to uneducated builders for half a century, had become vulgarized, while the talent and refinement of the country was following the new cry after Gothic. This consideration, though not the cause of the late reaction to free classic architecture, which lies deeper, is, I think, a good justification for it.

When, then, the Reviewer says that the hope of English architecture lies in the working man

without the aid of architects working on the traditional system of the true styles, we answer, you have had that condition for fifty years, and the result is our dismal suburbs of London builders' houses. It was not so, we have seen, that architecture has progressed in the past, and, as Bishop Butler says, there is no reason to believe that it will be otherwise in the future.

There may be virtue in working with our hands. The digging and delving to which Mr. Ruskin has set Oxford students may be wholesome moral training. Mr. Gladstone may find benefit in felling trees. Monks, old and modern, have believed in the virtue of manual labour. It might be well for everybody if the old custom still prevailed of apprenticing every lad, however rich, to some hand-working trade. The discipline, however, has been recommended for its moral rather than its intellectual benefits, and in architecture especially it is brains, not hands, that are wanted for designing it, and when that talent exists in a workman it is a waste of it to keep him to manual labour. That architects, as well as poets, should be born among them is to be expected, and the instances which Mr. Fergusson and the Reviewer give of common workmen designing great buildings in modern times are merely examples of this, not of a return to his "true" system of architecture. The church at Moustá was a break in the current building tradition of Malta, a bad copy of the Pantheon (including the two modern towers which spoil it), cleverly carried out. That its designer, Anthony Gatt, got only fifteenpence a day is an accident similar to Milton's getting only ten pounds for "Paradise Lost." Both ought to have got much more, but the true reward of both, as of every true artist, is his delight in doing the work.

The Reviewer's instance of the Scott Monument at Edinburgh, designed by Kemp, originally a working carpenter, is still more unfortunate for his argument. Not without faults (for the worst of which, the spoiling of its line at the top by the introduction by the Committee, after his death, of a projecting gallery, Kemp is not responsible) it is a true work of genius, striking in design and perfectly truthful in construction. But it is not a production of a true style, but something altogether new to Edinburgh; and neither is it an instance, as the Moustá Church may be, of the designer working at it with his own hands, for it is one of our few buildings which are wholly of mason work. Now Kemp, its architect, was by trade a carpenter, or wright, as he would call it, who probably never cut a stone in his life, but whose own trade gave him the practice of making working drawings. He was, in fact, one of the sketching architects whom the Reviewer condemns. One of his friends, beside whom I worked in the office at Edinburgh where I was apprenticed, told me that Kemp used to disappear for long periods, during which he went abroad, and, working at his trade enough to support himself, employed himself in sketching the old buildings of Continental towns.

The talent for designing architecture, like that of making poetry, may be born in any rank. Bishops may have had it in old time, and with the principles and practice of the art commonly understood (which, if we get our opinions settled, we may hope to have again) may have found no difficulty in carrying out their ideas, though in the instance the Reviewer quotes, where the church tower fell down from having a bad foundation, it might have been better for the bishop if he had had a competent architect to consult. I see no reason why women should not have it. I have known some ladies excellent planners. One of our best artists in furniture and decorations is a lady. Lord Burlington, doubtless, was an architect, though Colin Campbell in his "Vitruvius Britannicus" inserts Burlington House as his own design. Builders may have it, and some large firms supply the want of it by keeping a young architect on the establishment; though their designs, even those of the best firms, often fail, not only through commonplaceness and poverty of invention, but in management of lighting and in planning. It is within my experience that a builder, asked to do some work requiring design, has come to an architect to advise him. I think he showed therein more wisdom than his employers, and that we would have better architecture if builders in their own work oftener did the same.

To say that workmen only can produce good architecture is absurd and contrary to fact, and I do not think they would thank us for pushing them into this position. I have had occasion to know something of them, and have found them mostly honest and sensible, with perhaps over- veneration for acquirements in others which they did not themselves possess, with interest and pride in their work and in the design they were helping to carry out, and conscious that, to produce better art than they were used to, they must work under guidance. I have heard a different account of them—that they take no interest in their work, that all they care for is to get as big a wage and to do as little work as possible for it. Doubtless, this is partly true, and the workman's trades union regulations seem framed to foster such feelings. But who first taught him to give as little and to get as much as he could; that his only value was his market value; that it was all a question of hard bargain, in which considerations of sentiment or honour were out of place? If in dealing with men political economy has dropt out humanity as a factor in the problem, it is not the teachers of its dreary gospel who should complain that the workmen have taken them at their word.

Working men would not appreciate being left to make designs themselves, or understand the veneration of the Reviewer for them. Hero worship has reason in it, but I can see none, nor would they, in the Reviewer's new religion of the worship of the working man.

We have no directions, either from Mr. Fergusson or the Reviewer, as to the practical steps which the public should take to introduce the "true" system of architecture. On one point I would desire information, namely, which of the numerous trades connected with house-building—bricklayer, plasterer, carpenter, plumber, bell-hanger, decorator, &c.—is to have the direction of the work. Old buildings had not this complication: the other trades were subordinate to the mason; but a mason now-a-days would find himself very helpless in adjusting the requirements of a modern house. Our London builders' houses, though each merely a repetition of what has been done a thousand times, do not show much hope for the system of leaving workmen to their own devices. It is, indeed, a curious theory that knowledge, education, and refinement should be hurtful to an art, to the proper practice of which, in the present day especially, they are essential. It seems to have arisen from the fallacy that because architecture, in a wholly different state of society from ours, and when good art was traditional, was practised successfully by men who could neither read nor write, the right way to advance it now is to leave it in the hands of ignorant men. The contrary is the truth; for if our architecture be in the deplorable state the Reviewer asserts, it needs to raise it, not ignorant men, but men who, to education, refinement, and special training for the work, unite the faculty of original design. As the hope of poetry lies in our getting good poets, the hope of music in good composers, so the hope of architecture lies in the country possessing good architects and in the public employing them.

The PRESIDENT,—I hope you will not forget that the discussion at the last meeting was adjourned, and the admirable Paper we have just heard may be taken as the re-opening of the subject. I shall be glad to hear any further remarks upon it.

Mr. C. F. HAYWARD,—At the commencement of the Paper read by Mr. White is given a long quotation from the article in the *Review* which I suppose was intended to be taken as a sort of text for his paper. I wish to furnish an illustration to that, if the Institute will accept it. It is a photographic copy of a picture we have all seen hanging on the walls of the Academy this year, under the title of "Capital and Labour." It forms an admirable illustration of the quotation taken from the *Review*. We may suppose that grand gentleman standing on the scaffold to be the nobleman Aylwine, and the man who is talking to him to be the foreman or master workman Ædnothus, explaining the necessity of finding a great deal more money, because the tower was cracking and threatening to fall; then, with some

allowance for costume, consider the figure who holds the plan in his hand to be the person Bishop Oswald, the man who *produced the plan* in this case, or in other words, the *architect*, and we have then a very good illustration of this particular paragraph of the Review, which contradicts itself if it is written to show that there was no need of an architect, or some master mind to produce *the plan*. Think for a moment how such a business as that could be described, even by the most enthusiastic of dreamers, as in the particular paragraph to which allusion has been made, "another Eden, pre-ordained for men destined for the highest heaven." If the Institute will give that photograph which I have brought with me a place in their portfolio, I shall be very gratified.

In saying a few words about the subject-matter of this discussion, and referring only to article No. 3, the "Hope of English Architecture," I may remark it seems almost a misnomer. I think the peculiar architectural turn of thought has been given very much from the fact (which I believe is now well known) that the article was written by a practising architect, one who has now retired; but it does not deal with architecture so much as with the general social arrangements of the day. First of all it begins with art amateurs, ascribing to them chiefly the "constantly declining state of English art;" at the end it deals in equally strong language, quoting Goethe, with the "Dilettants." In the middle it goes out of its way to assail the memory of Brunel, the designer of the 'Great Eastern,' because there was a difficulty in getting that noble vessel into the river. Then it goes on further to describe the various ways in which Bond Street tradesmen carry out their work, and it takes care also to give a slap at modern educators generally. It speaks of the Universities and the way in which studies are carried on there, and how much less satisfactory they are than previously. It actually abuses the working classes as "profoundly vulgar," and says the agricultural labourer is in every sense made only to "*follow the plough*," as if he ought to precede it? It goes on further to speak of the objectionable system of leases, leaseholds, and ground-rents; and in fact takes a general review of the present condition of the trades and system of working in society generally.

These views I admit are not entirely out of tone with what we all more or less feel and sometimes express. There is no doubt a great deal of the work of the present day, the credit of which is given to persons who do not deserve it, and a great proportion of the profits of trade and business generally is obtained by the use of the brains of other people, by capitalists and others. There are workmen in various great positions with regard to their art, whose names do not appear in connection with the productions of their skill: this is the case for instance in the trade of jewellery or designing in gold and silver work. We know, in the Renaissance period, the works of jewellers and silversmiths, and that they traded largely upon the celebrity of their own names. Of this Benvenuto Cellini was a particular example; but in the present day who cares to know the designer of every kind of plate or jewellery work? It was made a rule in a late Exhibition that the names of the actual workers should be attached to the work itself, a good step in the right direction, and so far we may safely agree with the writer of this article. But I think it rather accidental that architecture and architects are chiefly singled out, and I think we must feel that the hit is distributed all round against the general state of society. When the Reviewer comes to speak of the condition of the workmen of the present time he by no means states that they are fit for the purposes to which he would assign them. The hope of English architecture is said to be in the workmen, but how can everything be hoped for from men who the Reviewer says are "acute and clever to a folly about pay, but for all else their minds have been crushed out of them; and in the great and many sided building trade, ubiquitous and constant in movement, the whole class of working men is sunk into the lowest state of mental and imaginative feebleness." There is no question it seems how the

working-man must be improved, "he must first be recognised," and the only recognition proposed in this article is to bring him out of the position which he is in now, viz.: "an alien and outcast from 'society.'" Now what is 'society' that the working man should want to get into it and so to put himself in a position to be inspired and do great and noble works?

Referring to Mr. Spiers' sketch of the Porteuillis Club, I cannot help thinking the paragraph about that particular building must have been inserted through some friend of the Reviewer, or some side information; perhaps some out of the way newspaper slip: for I cannot believe the author, who is said to have executed some good and noble buildings, and some we can all admire, could ever have seen the building himself. On this ground I would take no further notice of it, though I, for one, am sorry that it has not been photographed and reproduced with the paper. I think nothing is worse for the welfare of any class of men, than to be petted and patted on the back with all their faults and failings slurred over, as the working men have lately been; and one gentleman has said he was sorry to see this faulty building of working men pointed out, because it was a workman's design. I appeal to our President, who has seen a greater number of working men of high artistic character, than most or indeed perhaps any of us:—I ask him whether an ordinary good workman is not generally ready to learn, and willing to see his faults, whenever they are fairly pointed out to him? I was delighted to hear the statement in the paper of Mr. Stevenson, that, working men have an inordinate desire to improve themselves by communicating with others who they think know better than themselves. I should be glad to hear from any one who can give us the practical information, whether any advantage to working men has come out of the Architectural Museum in Westminster.

With regard particularly to architecture as a profession, it seems to me one of its greatest hopes is, that, we its practisers are now thoroughly abused. Time was when the profession, as such, was hardly in existence, when it was dependent upon the support of special art patrons, and when it was necessary for an architect to be patronised by some lordly man if he wished to do anything. But now the architectural profession is established in every town in England, and become an every day necessity, and there is a love of art or pretension to it everywhere, and consequent demand upon its professors. Not being perfect, and not likely to be, bad is mixed with good work, but on account of both, a great deal of abuse, from parties of every class and on every side, is lavished on architecture and architects, and too frequently by the press. At the opening meeting of the session previous to this, the Duke of Westminster stated his belief that, the study of architecture, and art generally, should be encouraged in our public schools, and generally amongst his own class, as well as others of the public, and that I believe to be one of the greatest hopes of architecture, viz., that the public should be educated in the 'principles' of architecture, so that they may be able to appreciate the efforts of genius when they arise, and appreciate also the abilities which the profession have already displayed in the practice of their art.

Mr. T. BLASHILL, Associate.—I thought it might be interesting if I brought a rubbing from the brass of the tombstone of a master mason in the church of Caudebec on the Seine. It gives not only a drawing of him, with compasses in his hand, but also a plan of the church on which he was occupied for thirty years. That master mason is spoken of in French books as the *architect* of the church. The church was really commenced thirty years before he came to the work, having been begun in the year 1426, while he only became its master mason in 1454. I have been astonished that neither my friend Mr. White, nor the reader of the paper to-night, has at all noticed one great point made by the Reviewer in the article on the State of English Architecture. He instances Hiram as the workman who was employed by Solomon in the erection of the Temple, and he speaks of him throughout as if he were the architect of Solomon's Temple who made the designs, and was himself responsible for the work. Now

surely the Reviewer could never have read the history of the building of the Temple as given in holy writ, in which this point is very clear, viz.:—that Hiram himself was nothing more than a “cunning workman” who did everything according to the pattern given him. It is clear also that David not only bought the materials and left money for providing the labour, but he left also the drawings, and not only general but detail drawings (patterns) of the work; Solomon himself never pretending to do more than carry out the building strictly as directed by his father. Surely it is matter of importance that we should take some pains to know who were the designers or architects of ancient buildings, and who were merely the patrons and the workmen. A few weeks since we saw an article in a professional journal in which the poet Chaucer was spoken of as an architect, who was especially an honour to the profession. Now I have no hesitation in saying that there is no evidence in any writings to which we have access that Chaucer had anything to do with architecture beyond being, at a late period of his life, and for a few months only, clerk of the king’s works. During the last years of his life he was a receiver of custom duties, and was compelled to be at his post every day, and could not appoint others to do the work; but immediately he was appointed Clerk of the Works by royal favour he was allowed to appoint a deputy, which he did at once, and if he had not been on one occasion robbed of some of the king’s money, which may have been intended for the payment of wages, we should conclude that the whole of his duties were performed by his deputy. Yet this workman and this poet are held up to us as distinguished architects! If errors like these are passed over by those of our own profession, what can we expect from Quarterly Reviewers?

MR. G. AITCHISON, Fellow.—I have been asked to say something, but it is little I have to say. I have read two out of three of the articles in the *Quarterly Review*, in a cursory way. If I had known nothing of the subject, I should have said to any architectural friend, “Go to the ant, thou sluggard,” and learn to work; but having studied architecture and having the misfortune to be obliged to pick up a precarious livelihood by it, I should say that this article is almost a simple conversion of A:—A being the proposition that “every goose is a bird.” The simple conversion is “that every bird is a goose.” The Reviewer comes to the logical conclusion, that because some architects have been workmen, every workman must be an architect. I think as we all know something of architecture, it is useless to enlarge on this fallacy, but if any architect believes in the efficacy of the prescription, let him try being a pavier’s rammer man for three or six months, and see if he can design better, or become greater in construction or decoration after the trial. For my own part I shall not put it to the test. Is turning workmen into architects the hope of architecture? I am afraid the Reviewer has hit the wrong nail on the head. I at first thought I had found out in the Reviewer the gentleman who applied at the Dublin Post Office for a berth, and when asked his qualifications said “he was great at denunciation.” But in one way the Reviewer is right. He feels that there is something wrong about the profession, and so do we.

We have had a good deal said about the “working-man”—and that is a term which may be taken to include the whole of mankind, as there are very few who do not work in some way—but I suppose when we speak of the working-man, it applies to those who work with their hands. I have had many opportunities of examining the working-man pretty minutely. He is for the most part a good sort of fellow, who takes an interest in his work and does as well as he can. He is fond of a holiday when he can get it, and has the common English liking for beer. I don’t think there is much difference between the working-man and anybody else. Architecture in the present day is something like the French nobleman who left word that he died last night and did not wish it to be known. We have got an immense quantity of industry and a great deal of talent and energy, but they are turned in the wrong direction. Nineteenth century architecture is like Holywell Street, people go there for their

dresses for fancy balls. There are shops where you can get any kind of dress, from the time of Pharoah down to that of the last century; and some can supply the dress of some particular century very perfectly indeed; but no one seems to think it is necessary to get a dress for his own time. What Professor De Morgan used to say of his superior students may be said of architects:—they could tell what A, B and C thought, but when he asked the student what *he* thought, he replied he thought he should like to get the prize. I had occasion to say something on the subject of these articles to a patron of our profession. I said to him, as far as we could we did our best, but we had fallen on unfortunate times—all the desires of mankind ran in the way of physical science or its application, and all the highest intelligence went to them. And we ought not to be blamed for that; for if the Pope or Princee Bismarek found out a new nerve in the back bone of an oyster, it would be a feather in their cap, but if they had erected the finest building of the day, it would add nothing to their reputation.

Of the early times of architecture we know little, but in the mediæval times there was a great demand for architecture and for something new; there was a great intellectual ferment in society, and there were only one or two occupations in which a man could be safe. There was war, and there was architecture; a man might kill any number of people, or build any number of cathedrals without being roasted alive, but if he engaged in any other intellectual pursuit he would live in constant danger of being burnt; therefore it is not surprising that a good many people turned their attention to architecture. As the subject is the hope of English architecture, the question is in what does it lie? In my opinion the hope of architecture lies in the younger men devoting themselves to it with the spirit of martyrs, studying antiquity for its beauty and fitness as much as they can, but determining to do something of their own, original, fit for the age, beautiful, but to resolutely avoid copying or paraphrasing bygone works, and there are new materials—iron in particular—which as yet have been stamped with no particular style. If they cannot do anything new that is beautiful, let them avoid all such attempts, and confine themselves to building wisely, economically, and truly, and doubtless sooner or later some genius will arise, who will clothe the dry bones of structure with beauty, and perhaps a time may arrive when it will be as honorable to start a new style as to make a large fortune.

Mr. E. WOODTHORPE, Fellow,—I feel there is one thing essentially necessary for the hope of architecture, and that is that the trade unions which are so much patted on the back by modern political writers, should be regarded as so many schemes for the destruction of good workmen and the advance of wages. My own hope for architecture arises from our having a better understanding in the profession; and the more we call the attention of the public to the necessity of being paid a higher per centage, the more personal attention shall we be able to devote to our work. There has been too much of pandering to the appetite of the day by publishing encomium with regard to the working men. I have had a good deal to do with working men, having been professionally engaged in winding up the affairs of the Chartists. They paid me well and complimented me afterwards, for my professional services in the distribution of their acreage and the valuation of their buildings. I am not going into any high flown admiration of Sir Christopher Wren, or into all the mere assertions which appear in these talented articles. There is no positive or satisfactory proof of what is stated with regard to master masons or master carpenters. Architects have existed from the time of Vitruvius to the present hour; call them master masons or what you will, there must be a head, and guide, and designer. I defy any eight or ten workmen of the present day to design or execute a building like St. Paul's. I also defy them to be able to do more in that way than has already been done in Westminster, by producing the 'Portcullis Club' style of architecture. I think we must all go a great way with Mr. White's observations in regard to amateur architects and archæologists. Look at the number of the latter, who take upon themselves to describe this and that

building of such and such a date. At one meeting, the assembled archæologists were told, "What a treat it is for you, gentlemen, to understand that this portion of the building is of the date of the 12th century; that of the 14th; this of the 16th, and that of the 18th:" till at last the gentleman, whose buildings were being described, said "I beg to inform you that you are misleading these archæologists, inasmuch as these works were more or less the work of my own hands in the year 1866." I hope we shall learn a lesson from this debate, and that we shall unite our intelligence, and try to get a practical college for architects, or a school of art, into which young men may pass after they have served their paltry three or five years in an architect's office, and in order that they may assume a proper position before the public, so that we shall not be condemned daily as we are at the present time. I shall have great pleasure in proposing a vote of thanks to the author of the Paper which we have been discussing, and I have been much delighted during my attendance here on this and on the previous occasion, in listening to the able papers and the debate, inasmuch as, there has been more energy in both than is usual.

Mr. WILLIAM WHITE, F.S.A., Fellow,—I have a singular illustration, which probably has not come before the members, of what, I believe, to have been the manner in which works were carried out in the later middle ages. I believe the architect gave instructions to a certain number of foremen: that all, being instructed on the same system, knew what to do when they commenced, and if they had to set out a niche, or canopy, or base, of a certain height and width, they were able to do it without further assistance from the architect, merely from the traditions and education they had received through the state of architecture at that day. The example to which I refer is the church of St. Probus, in Cornwall. On the south side of the tower is a niche, and the jambs consist of some little attached buttresses on each side with a canopy over for a figure, which figure, if it was ever put in, is not there now. These buttresses are brought down in this manner:* the inner one of the jamb fits in to the outer one of the base. The dimensions were accurately set out, and it is evident that instruction was given by dimensions from centre to centre of buttress; the niche itself being given to one man, and the base, which is carved and foliated, to another. One of them got his dimension from the wrong buttress, so that the centre of the inner buttress of the niche came in a line with the centre of the outer buttress of this corbel, and they let it be fixed without the delay of re-working. I feel sure from the manner in which it is treated, this was the way in which it was done. It is very true that workmen of a certain class had some education in that day, as they no doubt always have had. There were different orders of men in the Middle ages, with a certain amount of knowledge and certain privileges, and they rose in the scale according to their ability. Some were capable of setting out work and others were not, and I have no doubt this is an illustration of that system of work. I have very great pleasure in seconding the vote of thanks to the authors of the Papers which have formed the subject of this discussion.

SIR GILBERT SCOTT, R.A., President:—Gentlemen,† In my capacity as Chairman I suppose I must add a few words; though, as one who has been specially singled out by the Reviewer in question for his bitterest vituperation, I had rather (as Mr. White advises), "be silent and submit to mis-representation (as I trust it is), in Pamphlet and Review." It is, indeed, a balm to my smarting wounds to see, as Mr. Spiers and Sir Edmund Beckett have shewn us, what it is that my censor likes; and I may add to this a specimen of what he dislikes: for, thinking that I was the author of it, he has recorded his dislike of the altar screen in Westminster Abbey, perhaps the most exquisite work of its kind of the fifteenth century—which in reality I have but recovered.

* Mr. White illustrated this portion of his remarks by a sketch on the board.

† These remarks have been since somewhat amplified by the President.

Having indulged in this soothing palliative (a weakness which I trust may be forgiven), I will proceed to deal with the subject from a wholly different point of view. When considering a phase of art of undoubted merit but of bygone time, it is, at least, highly interesting to enquire by what manner of men this art was generated and carried out; and, if it evinces a state of things very different from what prevails in our own day—and especially if that difference is to our own disadvantage—it is most desirable that the causes of it should be investigated, with a view, if possible, to the suggestion of a remedy.

Now in my first inaugural address, which I wrote while enjoying more than usual opportunities of quiet though a year or more ago, I called your special attention to one point of distinction of somewhat alarming importance; and, at the risk of being accused of imitating the Quarterly Reviewer in vituperativeness, I will beg you to permit me to read a passage from that address.

“The first question which suggests itself is:—do all, each in his chosen camp, and each according to his ability and opportunities—strive to the utmost to do their work well, and to fit themselves for doing it in a manner characteristic of a period of earnest onward striving?”

“Now, one of the most marked characteristics of the productions of the great periods of Architecture is this:—that, though the works of any one of them differ in artistic merit; some displaying the highest genius, others only comparatively unassuming correctness and propriety, yet no really bad architecture is ever to be found among them. From the most majestic and glorious building downward, to the least pretending, the same matured knowledge and the same careful, thoughtful working, is found ever to prevail. Who ever heard of a work of the Greeks at the great period of their art which they would presume to call *bad* architecture? Even in Byzantine art, though it laboured under great disadvantages, we have proofs in the ruined cities discovered in Syria, that buildings of the mere vernacular classes were as carefully studied as the mighty works by which their architecture is better known, while in works of the twelfth and thirteenth centuries in our own and neighbouring lands, as well as in Italy, the same masterly skill, and the same studious handling, is found in the simple village church as in the noblest cathedral—nay, one is often disposed to uncover oneself in humbled reverence before the work of some unheard of mason or carpenter in an obscure village of which we had never before so much as heard the name; nor did these old workmen, so unambitious of fame, ever produce work to the like of which the best or the most self-satisfied among ourselves, need be ashamed to attach his name.

“Now, is such the case among ourselves? It is worse than idle to attempt to blind our eyes by bland felicitations or to seek the bliss of a fool’s paradise;—let us rather look facts boldly in the face; and, if they prove unpalatable, let us make it our business to correct them. The true answer to the question is, that no contrast could be more marked than the difference in this respect, between the present state of things amongst ourselves, and that which prevailed at the great eras alluded to. Instead of all works (each in its own style) displaying the same instinctive sentiment, the same understanding of its style of art, the same careful, wise and thoughtful handling,—the very reverse of all this is actually the case. From each of our art-camps, productions are put forth of the highest, and of the most contemptible character, as well as of every intervening stage of merit and of demerit. Our age and country will hand down some works of which no age or country need be ashamed, and others at which any age or country, however degraded its art, ought to blush; while I fear a large number of the buildings which will represent our period, are of that negative kind which, being neither hot nor cold, but only lukewarm, will not tend to excite any but a sickly emotion.”

I have suggested three causes of this extraordinary circumstance of our day, but they all culminate in one, viz.: The custom of viewing of architecture by the multitude, and especially by parents, when choosing a calling for their sons, rather as a *profession* than an *art*, and selecting it where no natural zeal or aptitude exists in the youth to be brought up to it. To this source may be traced the absurd ignorance of architecture, good or bad, on the part of the public; the fact that a young man of connection *gets on* whether qualified or not, the absurdity of our competitions; and the tone of architectural criticism (the object of which is rarely to correct faults, but merely to write an inconvenient man down); for, when addressing a wholly ignorant public—indeed, a public all too anxious to make openings for incompetent protégés, it is as easy and as grateful a task to condemn the good as the bad.

Now, has the Quarterly Reviewer pointed out the causes of these evils? I would reply that in some respects he has, but that in others he has failed to do so. He has, I think, succeeded in shewing that, during the middle ages, there was not the same distinction between the designer and the worker as there is now; that an architect was "*the master of the work*," a name, by the way, not differing much in meaning from that by which we are at present designated, yet differing *de facto* in this: that the master was more constantly on his works; that his attention was less divided between different buildings, and, which is much more important, that he had been brought up and trained in more direct contact with actual work than we ourselves are. That this, however, was not universally the case, is proved by what we hear of great ecclesiastics—such as Bishop Gundulph of Rochester, Alan de Walsingham, Prior and at one time Bishop Elect of Ely, and William of Wykeham, Bishop of Winchester and Lord Chancellor—all acting as masters of the works. Our Reviewer attempts to shelve the evidence, so far as it applies to Wykeham, by abusing his work; and has, with strange infelicity, selected the west front of Winchester—which was not the work of Wykeham, but of his predecessor—for his most emphatic condemnation. The octagonal lantern of Ely, the special work of Walsingham, he leaves unnoticed.

The value of these exceptions to the usual practice is, however, wholly independent of the merits of the works of these priestly architects, and lies in the evidence it affords that our great 'masters of the works' were not viewed as belonging to an inferior order in society, but that the great men of the age were proud to share in their labours and to emulate their fame. The fact, I believe, is that the demarcations of social life were not by any means so rigid then as now. It is possible that the lowest stratum of all was not far removed from that slavery to which our Reviewer seems to consign the greatest artists of classic antiquity. It was not from among these, however, that the great masters of the building art arose: they belonged to an honoured middle class, just as is the case with most of the professional men in our own day.

They were the fellow-workers of Bishops; were commissioned by Bishops and Abbots, and by Nobles and Kings, to undertake the greatest works of the age, whether of architecture, of fortification or of engineering; and were sent for this purpose to the confines of Europe, and probably to the Holy Land. We hear of one sent from France to Hungary, of another to Spain, and another to England; of a German architect sent by the Emperor to the centre of Italy; and of architects from all countries (England included), being invited to a professional and practical conference at Florence. We find not only their own mortal remains, but those of their wives by their sides, honourably entombed (just as it might be in Westminster Abbey), in the glorious temples they had erected. We find them also travelling about to study and sketch from works of their own art, and drawing from every object which they thought calculated to improve their skill. In social position then, they seem in short to have been not unlike ourselves.

Perhaps the distinction I have mentioned, as to uniformity in skill, may have largely arisen from

the fact that the architects and masons were trained in the main alike, and that only those whose talents fitted them for the higher walks rose to the top. With ourselves, as with them, most of those who have talents and souls fitted for architecture are, or were, brought up to its practice; but with both a large number not so qualified are and were similarly trained. The difference between the two cases is probably this: that, whereas with them such as could not rise to the higher positions could be usefully and harmlessly employed as working masons,—those among ourselves who are unfitted for their art *must* nevertheless practice it; and as Sir E. Beckett said, they usually have no difficulty in “getting a connection,” thus inflicting upon the world the disgraceful architecture to which I have alluded, the very existence of which on a large scale dulls all sense of art in the perceptions of the public, and thus of itself originates and increases all the other evils which I have enumerated.

I fear we have no real remedy for this state of things. It is vain and futile to seek a remedy among workmen; for neither are those who have a soul for architectural art brought up in these days as workmen, nor is there anything among the circumstances of workmen to excite a love of art. The only exception lies among carvers and others whom we, in modern parlance, call *art-workmen*; and even these have not in any case been brought up to the art they practise, but have joined it through mere love and zeal, from other callings. The architects are, in fact, their instructors, and even from among that *crème de la crème* of workmen, I have never seen any but exceptional tendencies towards architecture itself. For the rest of our workmen, if the public desire their architecture, I would say,—Go buy their productions in the ready-made shops; or, go in any direction where new streets of the lower or middle class are growing up, for these are all designed by workmen architects, and, when our builders’ foremen put by a little money, which they invest in building houses, they have scope for the artistic genius which it will be edifying to refer to.

Another cause of the ill-condition of our art is the absence of what may be called a *traditional* or *vernacular* style. It is the strange lot of our age that we (alone of all generations of the human race) know our own artistic standpoint, and can look back upon all which has preceded us, tracing clearly all the changes in the art of the past; and yet have not a style of art which we can call our own! Mr. Stevenson has ably, yet most uncheerfully, pointed out the hopelessness of our position in this respect; and I fear that any attempt to remedy it will be as futile as it would be to attempt to recruit our architects from among workmen, to raise *them* to the level of architects, or to reduce ourselves to their social level. The changes are the results of the providential ordering of human affairs; we are in no degree responsible for them, nor would any attempts of ours bring back the old state of things unless in mere masquerade, as would be the revival of hair powder and spinning wheels as a means of recovering the art of *their* period.

It is, however, a curious fact that one evidence I have adduced of the similarity of the architects of the middle ages to ourselves, proves, from another point of view, the reverse. I have said that they travelled about sketching from works of their own art. I may go further and say that they sketched and studied the *very same* works that we do now. Thus we find Willars de Honnecourt sketching the chapels at Rheims, the great rose windows at Chartres and at Lausanne, and the towers at Laon, objects which we most of us possess in our own sketch books, or in some other form. Of the last-named work, Willars says, “I have been in many lands as you may see by this book; never in any place have I seen a tower equal to this at Laon,” and, after giving some particulars and advice to those who may desire to emulate its merits, he adds: “proceed carefully, and you will do as a wise and skilful man ought to do.”

It is, doubtless, a strong proof of the intrinsic merits of these works of art, that he, as ourselves, delighted in sketching and studying them. Yet it is a marvellous point of difference that, whereas we

study and sketch them as objects of six centuries old, he did so when they were absolutely new. If we so delight now in these glorious works, need we wonder that all the instincts of Europe were saturated with art-feeling, when such works were *vernacular, traditional and universal!* Yet all attempts at bringing back such a state of things seem hopeless; for, no sooner do we indulge a flattering hope, than we are apt to grow tired of our work, and run off after some passing taste, like a tailor to a new fashion book for the season; and this, perhaps, simply because what we were once zealous about has grown vernacular and is becoming vulgarized; and truly all styles *do* become vulgarized; and will continue to do so as long as we are inflicted with a swarm of architects to whom nature has granted no part nor lot in the matter, except the opportunity of doing mischief.

The three evils, then, which we should make it our object to abate (we cannot, I fear, eradicate them), are—first and above all others, to keep if possible from our profession all youths whom nature has endowed with no gifts for the practice of our art. I can only think of one way of doing this: viz. that we should enter into a mutual engagement to receive no pupils whose objects and qualifications have not been examined and tested by a disinterested and well qualified body of examiners, who shall report whether or not he has the right stuff in him;—secondly, that we shall make our pupils more practically conversant with practical works, by stationing them, when building, for a time under the clerk of the works; and that, so far as lies in our power, we shall do our best to make our workmen, especially those in the artistic departments, more conversant with architecture;—and, thirdly, that we shall each cultivate or aim at as great a steadiness and unity as may be possible in our own architectural aims. The world is wearied out with ever-fresh revivals! Revivals are in the abstract wrong, and only to be justified under circumstances of great necessity; otherwise their tendency is only to render “confusion worse confounded,” and to sicken the public of an art which does not know its own basis or position. Finally, I would only add that, living under a state of things whose greatest characteristic is *confusion*, it is incumbent upon each of us to strive to do his best, according to the light or talent which God has given him; to do all in his power to mitigate the evils he sees and deplures; and to remember that it is not on the accidental circumstances which surround his art, so much as on his own individual efforts to do his own duty and his own work *well*; and not so much on the *style* he happens to work in as on the true earnest art which he brings to bear upon that style, that his own artistic success and the future destinies of his art will depend.

The President then announced to Mr. White and Mr. Stevenson the thanks of the meeting for their several papers.

Mr. W. H. WHITE, Fellow,—Sir Gilbert and Gentlemen, in acknowledging the vote of thanks which you have been good enough to accord me, I beg leave to add a few words to the subject of my Paper. I replied to the Quarterly Reviewer on historical grounds only, for it is generally admitted that in his “Hope of English Architecture,” he is impracticable in his theory, and theoretically wrong in the argument with which he attempts to support it. But, had he confined himself to the substance of his first article, called “The State of English Architecture,” I should have hesitated to reply to his strictures, for there must have been a great deal of truth in that article, because in newspaper literature only the truth stings. And I am confirmed in this opinion by the knowledge that many architectural assistants—Associates of the Institute—who have done and are still doing good service to their masters, believe most of that article to be true. Now I, also, have been an assistant in both England and France, and lately in Calcutta; and I am convinced, that in many instances, the actual system of architectural practice does not conduce to artistic excellence; nor is it fair to the junior and subordinate members of the profession. Though I believe that the hope of architecture depends more upon the public and upon amateurs than ourselves, I still think that no small amount of good might be effected, if a certain number, say forty members of the Institute, would zealously combine to introduce a practical reform.

Suppose that ten of the younger Fellows, men like myself, for instance, and thirty of the elder Associates' men like Mr. Spiers or Mr. Watson, for instance, were to compose what may be called a Reform League; and that, having discussed the ways and means of action, we were to petition the President and Council to appoint a Board of Examiners for the special purpose of examining us *forty* in the theory and practice of the Building Art? Such a Board might consist of the President as Chairman, and six of the English recipients of the Queen's Medal, to be chosen by ballot of the Council. The names of the happy *forty* who, I am confident would successfully undergo the ordeal, might be posted upon the walls of this room, and advertised for six days in six of the public journals. A certificate might be granted to them, but no fresh letters or title would be necessary, because there would always be a sufficient tacit distinction between those who had submitted to an examination, and those who had not. After a certain number of Members had thus passed, the elder Fellows might be declared exempt from the test. When the public came to understand this movement, and the rest of the profession to see the utility of it, it might be possible to compel future applicants for admission to our ranks to pass an examination; and then the present titles of Fellow and Associate would acquire almost the force of a degree.

I hold in my hand a letter addressed to myself, from which I ask permission to read an extract; it is from Mr. Roger Smith, a Fellow of some years standing; he says:—"If you bring forward your proposal, that a certain number of Fellows and Associates should ask the Council to examine them, you are at liberty to add that I am perfectly willing to join in making such an application; and to present myself to undergo any examination, which it is fair to expect a man to pass, who parted from his school-books twenty-five years ago, but who professes to be a competent architect."

Let me add, that from this moment, I am prepared to devote myself seriously to the task of organising the movement I propose; and that I will write a form of petition for the approval of members willing to join in it. In conclusion, I have to say, that as a man is very properly judged by the books he reads, and the society he frequents, so I am happy that my Paper has been discussed in the company of that to which we have just listened; and I thank you, Sir, and others, for the encouraging manner with which you have received a feeble endeavour to promote the good of the profession.

Mr. R. PHÉNE SPIERS, Associate, briefly reminded the Meeting that a scheme amply sufficient to realize the suggestions made by Mr. White already existed. The Architectural Examination was established by the Institute twelve years ago, and under its rules, which had lately been modified, any member of the profession desiring to submit himself to such a test of ability as had been proposed could do so. The examination was held biennially, and the next would take place in May, 1875. The names of passed Candidates were always published. He confessed that he saw no advantage in devising a fresh scheme for the same object.

Mr. JOHN J. STEVENSON,—From the length of my Paper, I left a portion of it unread, but I regret this the less as Sir Gilbert Scott has stated with greater authority than I could have done, two of the points I should have mentioned. The difficulty of any scheme such as that proposed by Mr. White is that it cannot secure the one thing wanted, that architects should all be men who can design; and any mechanical hindrances to entering the profession might prevent such men from employing their faculties, and so far be an injustice to them, and a loss to the community. Incompetent practitioners are a greater evil in architecture than in the other arts or in literature, for bad paintings, and music, and stupid books go out of sight, and are forgotten, while bad buildings, being in imperishable materials, remain not only themselves an evil but destructive of the public taste; and therefore produce more bad buildings, just as bad society produces bad manners.

The following communications, having been announced by the Secretary, were ordered to be printed and appended to the discussion :—

“APPRECIATION OF ARCHITECTURE,”

By EDWIN NASH, Fellow.

The foolish notion that a workman is the fittest man for making the design of a building and for arranging the method of carrying it out, has, like many other statements made by simpletons, done some good, inasmuch as it has induced wise and skilful men to declare their views. The monstrosity of the idea is so ridiculous that it might have been treated with silent contempt, but as it has elicited amusement and instruction it will at least have served some purpose. I doubt whether the writer has ever designed and superintended the erection of any building, and if he has not, the worthless character of his opinion on practical matters is accountable, and the escapade may be pitied and forgiven.

In the Fine Arts, and perhaps in other arts, adverse criticism by some persons is equivalent to commendation, inasmuch as there are many whose inability to form a right opinion is well known, and whose judgment must therefore be taken as the reverse of correct. At the same time I think that in the present day our ideas regarding architectural art require some consolidation. Opinions of all kinds are received both by architects and by the public with some degree of favour, and be they right or be they wrong, no test seems to be applicable to them.

The faculty of *appreciation* of Architectural Art has not yet been fully arrived at. It is a faculty which must be cultivated, and it is far more difficult in architecture than it is in painting and sculpture, because as respects the direct imitation of the works of nature, the three arts of architecture, sculpture and painting, have very different powers. Architecture is the least imitative, sculpture is more so, but painting the most imitative of all; and the more imitative an art is, the more easy and the more general will be the appreciation of it, inasmuch as less cultivation of mind is needful for a recognition of the excellencies contained in fine transcripts of nature, than of the excellencies contained in works founded upon conventional forms.

Architecture being composed of forms, which though educed from nature, have been adapted to the necessities of building, it is evident that some degree of special education is needful for even a moderate appreciation of its beauties. We have constant evidence of the difficulties of *appreciation*, even amongst the practitioners of architecture, and largely also amongst amateurs, and thus, for instance, the subject of styles has met with very rough treatment, and even a new style has been proclaimed as the pressing want of the day, which is as much as saying that a new language is necessary to enable modern Europeans to produce noble works of literature.

‘Style’ seems to have been a great curse with many, yet every genuine variety of style demands admiration, inasmuch as no work possesses the quality of style until it has arrived at the condition of beauty. There may be better styles than others, and styles that are more suited for one purpose than for another, also styles of greater purity, and styles of greater exaltation than others. These then—all these—will be received by the genuine lover of art with feelings of appreciation, and here it must be admitted that the faculty of *appreciation* is not always as strong in the practical artist as in the amateur or the critic, and perhaps this arises from the wider range taken over the domain of art by the two latter than by the artist, who is sometimes absorbed in his own peculiar walk, and has neither the leisure nor the inclination to study with equal favour the numerous branches into which art is divided.

Appreciation is itself an art, and it is honest, discriminating, generous, full of love, full of faith,

seeking for excellencies rather than for defects. Many instances of the want of it have however occurred, such as when a really good building has been put into the hands of an architect to alter, he has disregarded the excellences of the older building and has engrafted upon it his own mode and method with an apparent carelessness about the style and beauty of the original.

But to our point more strictly—the skilled workman is a most valuable auxiliary to art—yet it is self-evident that he whose range of vision is confined to a particular portion only of that workmanship which makes up the total of a building, cannot in any way be fit to conduct the large complication of workmanship combined in a fine architectural edifice. The whole subject opens the enquiry as to whether the architect of the present day, as *an artist*—is not too much mixed up with mere business transactions, and whether these do not impair his knowledge and skill in Fine Art—but, be that as it may, there can be no doubt that the practising architect is far more likely to appreciate—that is to say to understand good art, than any workman whatever. An architect is a workman of a peculiar sort—no men work harder—but he should have less anxious responsibility—and be rewarded by a fuller appreciation of his skill.

EDWIN NASH.

THE ARCHITECT, THE WORKMAN, AND THE CRITIC.

By W. JACKSON, Esq., Hon. Sec. of the Leicester Society of Architects.

Those who have attended to the practice of our literary tribunals, says Macaulay in one of his essays, “are well aware, that by means of certain legal fictions, we are frequently enabled to take cognizance of cases lying beyond the sphere of our original jurisdiction.”

In a recent number of the *Quarterly Review*, *Mr. Fergusson* is plainly the “Richard Roe,” whose name is used for the sole purpose of bringing two persons into Court, the modern Architect, and the modern Workman; and, if the Reviewer has made out his case, the public will have to record a verdict that the former is one of the most useless and the latter one of the most deserving characters in the world. At a first glance, indeed, there is a little inter-changeable confusion of terms; and it, seems unimportant, even on the Reviewer’s own shewing, whether we call a man ‘architect,’ ‘master workman,’ or ‘workman,’ so long as the fact remains that we have some one whose office it is to “prepare for and direct the work;” but, it soon becomes evident that our Reviewer has a more practical aim; that his object is to set up one class and pull down another; that he is, in fact, one of those “practising English critics,” whom Matthew Arnold has stereotyped and immortalized for us:—

“For what is at present the bane of criticism in this country? It is that practical considerations cling to and stifle it; it subserves interests not its own; our organs of criticism are organs of men and parties having practical ends to serve, and with them those practical ends are the first thing, and the play of mind the second; so much play of mind as is compatible with the prosecution of those practical ends is all that is wanted. An organ like the *Revue des Deux Mondes*—having for its main function to understand and utter the best that is known and thought in the world—we have not, but we have the *Quarterly Review* existing as an organ of a party, and for as much play of mind as may suit its being that, &c.*

But let us see what are the accusations, and what the arguments upon which our reviewing Critic

* Essays on Criticism.

expects us to pass judgment. "All history," he asserts "tells us that in every scene, or kind, or "period of art, whenever it was true, original, or great, the workman was the master," p. 357. Let us be modest, at the outset over this vast field; it is all history, and every scene, without limitation of kind or period, which is appealed to. It is enough to take away the breath; until we come to regard it steadily, and find that it is:—not the mountain, but the Critic, in labour; and that out of it, a little residuum of truth may be discovered and stated thus:—In every period of art, whenever it was original, or great, there existed true and disinterested critics, who endeavoured to learn and propagate the best that was known and thought, and there existed true and generous patrons, who, having so learned, encouraged and rewarded the artists. Such was the Athens of Pericles, the Rome of Augustus, the England of Chaucer, and of Shakespeare; but such is not, we fear, the England of the *Quarterly Review*. Our critic proceeds;—"Let us again hear Plato." "The master workman does not work "himself, but is ruler of the workmen. He contributes knowledge but not manual labour, and may "therefore be justly said to share in theoretical science. But he ought not when he has formed a "judgment to regard his functions as at an end, like the calculator; he must assign to the individual "workmen their appropriate task until they have completed the work." And the Critic's argument thereupon:—"He was the ruler of the workmen, and so must always have been upon the works; and "he assigned to the individual workman their appropriate task, and to do this, he must himself have "been a workman."

We venture to add that in "all history" such conclusions were never before drawn from such premises, by any intelligent man.

Again *the Critic*:—"And four master workmen were engaged on the foundations of the Temple of "the Olympian Jove at Athens."

The answer:—Yes and the work was stopped, and afterwards Coputius was appointed the architect, and he with great judgment and science determined the dimensions of the cell, the dipteral disposition of the columns, and disposed the epistilium according to the rules of symmetry—Vitruvius, B. 7.

The Critic:—"It is abundantly evident that Greek art of all kinds was entirely and exclusively "the product and expression of the workmen. The design of the Parthenon, exquisite as it is, would "have been but a small affair for any draughtsman, and all the special merits of the work are quite "beyond the draughtsman's sphere."

The answer:—To use Mr. Fergusson's words:—"all this is pomp and semblance, vanity and lies;" nay more, the very reverse is true, as, we venture to assert, the people who know most about it, will be most ready to admit.

The Critic:—"Architecture, we have been told, is a fine art, and that Vitruvius has said it. "Vitruvius has in fact said nothing of the kind; but in the first line of his treatise he declares that "architecture is a science arising out of many other sciences." "Architecture in practice thus trans- "muted, science takes the place of art, and instead of masters, we shall now find only scholars."

The answer:—Vitruvius wrote about the time of Vespasian, and was an able, practical, and professed disciple of the Greeks; and he wrote therefore with the best means of knowing many things which make our critic's position simply untenable, for instance:—"It appears that there were formerly "some great architects of our own nation, as well as of the Greeks, and several even in our own "memory." And again:—"That "some who take not the evident meaning of authors, but invidiously "glory in perverting it, ought to be punished" (Book 7.) Let us here pause, for the sake of a few of our Critic's lines, with which we can agree:—

"Until we get entirely rid of the fine words that have imposed upon the public, we shall not "have sound knowledge and intelligent ideas. *Fine art* for instance is a term of fashion, and the *fine*

“gentlemen who got themselves dubbed ‘dilettanti,’ ‘connoisseurs,’ and ‘men of taste,’ used this ‘superior’ epithet to scare the uninitiated, and exclude the ‘vulgar.’”

Yes, that is good, and true, and if we could but do so;—get entirely rid, not only of the fine words, but of the fine critics, “that have imposed upon the public,” there would indeed be some hope for sound knowledge and intelligent ideas, and some hope also for English architecture.

The Critic, upon Gothic work:—“Benedict the Abbot of Wearmouth, A.D. 676, crossed the ocean “to Gaul, and brought back with him *Stone Masons* (sic) to make a church.” p. 363.

The answer:—The italics are intended, we suppose, to lead to a logical conclusion that the stone masons designed the church; and we are not, in the face of those italics, to suppose that the Abbot himself either designed the work, or brought back a design along with the stone masons.

The Critic:—“The same method continues—in the reign of Edgar, a nobleman named Alwyne “consulted Oswald Bishop of Worcester as to erecting a monastery. Oswald, having in his diocese “twelve brethren in one village who had cast behind them the lusts of the flesh, and were only warmed “with divine love, and who would willingly undertake the charge, went with Alwyne to inspect the “place,” &c., “what a contrast all this to our present condition and practice.”

The answer:—Yes, truly, a great contrast, and therefore utterly unfair as an argument applicable to our “present condition and practice.”

But there is the Scott Monument at Edinburgh; that, at least, is applicable. The architect, as our Critic informs us, “George Kemp, a village carpenter, who was therefore much objected to by his “superiors, who desired that some ‘professional’ of eminence should be employed, and not a common “man of great ability, whose work and powers were much above their mental range.” O, excellent Critic! we thank you for that word; their *mental range*, then, must have been small indeed. The Scott Monument is very creditable as and for the work of a village carpenter, but, we venture to add, that no competent judge would say much more about it; except, perhaps, that it now comes to “point a moral, and adorn a tale;” a tale, to wit, of the Quarterly Critic’s mental range, and a moral, that is upon the “Hope of English Architecture.”

But we now come, as the Quarterly Review truly says, to a very interesting episode in Ecclesiastical and Architectural history; the burning and rebuilding of Canterbury Cathedral in the year of grace 1174, and the Reviewer quotes a long account of the same (he does not tell us from what authority,) and then proceeds; “William of Sens thus continued the old Athenian method, and “assigned to the individual workmen their appropriate task” (we should prefer to write, individual workman *his* appropriate task):—but, he continues, “William of Sens was no compiling copyist; “he was a man of thoughtful, independent mind. We hear nothing of his drawings, but only of his “moulds for shaping the stones.”

Wonderful simplicity!—moulds for shaping the stones can be made without drawings?—climax of absurdity to draw painfully the difference between early and late Gothic and Classic, Greek and Roman mouldings—there is no such thing; our Reviewer has said it, and his readers “must accept it as conclusive evidence.”

But let us turn to Professor Willis’s excellent history for further information on this point. “The most remarkable mediæval writer of Architectural History is undoubtedly *Gervaise*. Himself a “monk at the time of Becket’s death, and an eye witness of the fire in 1174, and of the rebuilding “of the Church, he has left us a most valuable and minute account.” p. xiv. And then we read, after the account of the fire, and of William of Sens, “and he residing many days with the monks, “and carefully surveying the burnt walls within and without, did yet for some time conceal what he “found necessary to be done” * * “But he went on preparing all things that were needful for the

“work either of himself, or by the agency of others” * * “He delivered molds for shaping the stones to the sculptors who were assembled, and dilligently prepared other things of the same kind.” p. 36. But this is not all:—In the summer of 1178 we are told that William of Sens fell to the ground from a height of fifty feet, and was “sorely bruised and rendered helpless, but no other person, against the *Master* only was this vengeance of God, or spite of the devil directed,” and we read after, “the *Master*, thus hurt, gave charge of the work to a certain monk,” &c.

Now, I must confess, that to me this reads very much like what any careful architect of the present day would do, and not at all like what any workman, according to the Reviewer’s definition, either could or would do. There is something touching in this 700 years’ old account of the diligent “*Master*” carefully surveying the work, preparing all things and delivering molds for shaping the stones; and of his fall to the ground and being sorely bruised and rendered helpless. All honour to his memory, and to all who like him, labour honestly in whatever field or sphere of activity. It is not the lot of every man to live in one of those creative epochs of the world, or to leave behind him a landmark for future ages; but we may all help, according to our lights, to further the cause of truth, whether we be called architect, master workman, workman, or critic.

W. JACKSON.

The Discussion having been thus brought to a close the Meeting adjourned.

The Secretary has since received the following

REMARKS ON MR. STEVENSON’S PAPER,

By SIR EDMUND BECKETT, Q.C.

DEAR SIR,

At the late hour when the President invited me to speak on Mr. Stevenson’s Paper I thought it much better that he should have time to review the discussion than that I should be heard again. At the same time the paper and the speeches of the evening did suggest to me some reflections which I take the liberty of sending you, because several members present were pleased to say afterwards that they wished I had spoken, and also because two other papers are going to be added, to complete this very interesting disussion.

On the main subject of Mr. Stevenson’s Paper I can only say that I should be amused to hear him and Mr. Fergusson fight it out between them. But as a practical matter I do not care the least whether architecture ever was, or is now, or ought to be, a “*technic*” or a “*phonetic art*,” or to be called by other epithets which ingenious men may invent. I am sure, because I see, that architecture has not been advanced or improved one bit by all the eloquence and philosophy of that kind which has been poured out upon it in the last twenty or thirty years: rather I believe it has been worsened by it, or that the advance, such as it has been, has been turned into a wrong direction:—if you like, chiefly by amateurs, as they have been the most profuse in that kind of literature, though they by no means stand alone. I was glad to hear that the President had come to the same conclusions as myself about the position of the designers of buildings in old times; and that he was no more able than I am to say in what the Hope of Architecture does consist, though it is easy to see many things in which it does not; and specially in the abolition of your profession, which is as necessary to mankind as mine. I was also glad to hear so many candid admissions that the present state of architecture is by no means satisfactory. I was, however, surprised to hear several of you intimate, half jocosely, but apparently half seriously too, that one cause of that condition is that architects are not allowed a higher commission; and therefore (I conclude they meant) it is necessary to undertake more than they can properly attend to. First I remark that that is a stereotyped and inevitable complaint against the

most eminent men in all professions, and must be left to adjust itself by the public choosing in every case whether they will have the undivided attention of men who have little to do, or as much as they can get from those whose attention many people choose to share among them. But if any architect expects the public to believe that he would take less work if he were paid more for it, he expects the public to be a good deal "greener" than they are. I know of nothing, or rather, I know that there is nothing to prevent architects from naming beforehand any charge they please for any given work, although it is true that if they say nothing a jury would be directed to assume the 5 per cent., which architects in trials have sworn over and over again to be the customary charge for designing and superintendence. I need hardly remind you that the percentage system has been abolished in the new arrangements with all architects employed by the Government, and that they are to receive a fixed sum to be agreed on beforehand; and that the same system has been followed in some other cases. I only wonder that architects did not long ago perceive that the percentage mode of payment gives a constant support to the most constant complaint of the public against them, that their estimates are nearly always exceeded—not so much by miscalculation or mistake in the estimate itself, as by the omission of things which the architect must foresee will be wanted, though his employer for want of experience does not. It is true that that complaint is very frequently unjust, and that estimates will always be liable to be exceeded under any system, because nobody can foresee all that will occur to him as desirable improvements in the progress of any but the simplest building. But people in general do not know that, and they naturally set down every suggestion of the architect for an improvement to a wish to increase his own bill, so long as it depends on the cost of the building, and every omission to a desire to make the employer believe that he was going to spend much less than the architect well knew would be necessary. I have indeed known that motive distinctly confessed afterwards, as a piece of cleverness of which the confessor was rather proud than ashamed. It would take more time than it is worth to illustrate some of the many absurd and unjust results of the percentage system, sometimes on one side and sometimes on the other. The excuse made for it, that it is "fair upon the whole," is only like the idea of some people that what they call "substantial justice," is a kind of balance of injustice, and that if A gets too much from B in one case, B is compensated by A getting too little from C in another case. I am quite sure that it has had a very prejudicial effect upon architecture, and that the sooner everybody else follows the system of payment adopted by the Government the better. An architect must be better able to judge for himself than any arbitrary general rule can judge for him, what amount of trouble any given work will require, and to estimate the value of his own time according to his position and other circumstances.

The next point on which I have to remark is the frequent assertion here that the bad taste of the public, and of amateur critics and writers, is the cause of the great quantity of bad architecture which is admitted to exist. Undoubtedly it is, of some. But for one design which is affected by the public, or the employer, or by amateurs, architects have simply their own way and do just as they like in ten, and probably in many more. You need not be influenced by amateurs unless you like; and I confess I cannot see how the contempt with which some of you speak and write of them, is to be reconciled with these repeated declarations that you are influenced by them to such an extent that they are responsible for what you produce; except in the very rare cases when you get hold of an employer who knows how to make a contract, and to reserve the right of paying his money for what he likes and not for what he dislikes, which some architects evidently make it a matter of principle to resist whenever they can, and always try to have contracts which enable them to do so. That also is now prevented in the Government agreements, and in all that I have had any hand in, both public and private, for a long time.

I did not understand what practical view Mr. Stevenson meant to take of the question of originality or "individuality" in architecture, of which he said a good deal historically. If he meant that there is more of it now than there was in old times, I agree with him; but if he meant to claim that as a merit of modern architecture, and as a good answer to the critics who are always "crying after the moon" of a new and original style, I disagree with him. The proper answer to them is that which (as far as I know) I alone gave in my book on church building twenty years ago, when that cry began; that a new and original style (with the old materials) is impossible, for the simple reason that all the available geometrical forms of every building and every part of a building have been long ago exhausted: at any rate no man has a right to call on us to believe the contrary until he proves it by producing new ones. The other answer, which has been often given, and repeated by somebody in this discussion, is also perfectly correct, that no new style ever was invented, but that all of them grew by spontaneous development and insensible degrees out of the existing style of the time. Further I am convinced that the striving after originality and individuality in these days is the cause of the worst architecture we have, except that British workman's style which is the Quarterly Reviewer's climax, and which consists in buying or copying odd bits of other peoples' patterns and sticking them together. That again,—I mean the pretence of originality,—is just the style which competitions have done so much to foster. I do not believe that a drawing of any old parish church, school, hall, or any other building, would have the smallest chance of a prize from an ordinary—or perhaps *extraordinary* competition committee, if they did not know where it came from.

I believe that everybody, however eminent as an author, who has written a word in support of that theory of a new style being either wanted or possible, has added his one or more stones, as it may be, to the mountain of nonsense on which most architecture has been built of late, since the justly condemned mere copying of fifty years ago went out. The *via media* is always the least popular of any way: otherwise it would seem strange that so few people should see that there is a middle way between that slavish copying and putting together of bits of old architecture, and the miserable pretences of originality and invention by designing something which is only new because it is too ugly for anybody to have ventured on it before. Boys used to be flogged at Eton if they copied their Latin verses, but praised for making them after the fashion, and in the spirit of the old poets; which perhaps one boy in a thousand could really do. Verses by Lord Wellesley and Bishop Lonsdale have been pronounced worthy of the Augustan age, and frequently reprinted; and perhaps some later ones; though it is as true of Latin poetry as of architecture, that as a whole it must be far behind the best originals. The President has rightly declared that the idea of a "vernacular architecture" ever again existing is absurd and not worth talking about: that is, an architecture of everybody, and peculiar to the age, as the language of any people is for the time, and as the architecture of each period of the middle ages and the earlier ones was, and as it seems there still is in India, where the indigenous or vernacular style has not yet been driven out by others. The present confusion or universality of styles, which we must take as a *datum* or a fact beyond contending against, may be a cause of the decline and almost disappearance of any public architectural criticism, which Professor Kerr lamented the other night. I join in his regrets; only I cannot forget that while there was any periodical or regular criticism of architecture, it had sunk pretty nearly to the level of the literary criticism of the theological newspapers, which is merely the prejudiced rubbish of partizanship. In fact architectural criticism had become almost all ecclesiastical; and even now architects know that the best way of creeping into practice is to play up to ecclesiastical prejudices, and get some well sounding epithet attached to them or to their style of building. Every now and then public opinion does break out into real and genuine criticism of very outrageous attempts, such as I noticed before. But it would undoubtedly be a benefit to architecture

and architects if their works were generally reviewed by persons as competent as I suppose some of the regular critics of pictures are, who are employed by the best newspapers. I am afraid the late *Quarterly Review* attempt at discriminative criticism, especially after the President's amusing exposure of its success at Westminster, does not afford much more hope of architectural criticism than it does of Architecture.

What then, if any, is the conclusion of the whole matter? I mean, if we were starting a young architect on his career, what should we advise him? If his object is to make money as soon as possible, no doubt there are ways better known to architects than I can pretend to teach. But if his object is to make good buildings, and gradually to make a lasting name and reputation, though perhaps very slowly, I should think the humblest and most prosaic course would be the best. I should say, dismiss all grand ideas of new styles and the "poetry of art," and the philosophy of architecture, and all that kind of thing; and whatever you do, don't call yourself an "artist." An artist is a man or woman who executes, whether he more or less designs besides; and ranges from Phidias and Apelles down to a singer, a dancer, a cook or hair-dresser: all excellent things in their way; but no good ever comes of confusing well understood terms. You are artists in respect of your drawings, but not in respect of the buildings made from them; and experience has long enough shown that there is no connexion between the power of drawing nice architectural pictures, and the power of producing fine buildings. All the fine talking in the world cannot and need not make anything better of an architect than a designer of buildings, as every man of common sense knows that he is. If he chooses to paint or carve besides, he would therein be a painter or a carver, but an architect not a bit the more or less, just as a lawyer may also be a painter or a mechanic.

I should next say, when you have a building to design, make up your mind, unless it is made up for you, in what known style it is to be; bearing in mind always that it is hardly possible for any man to design with spirit in styles so opposite in their principles as Classical and Gothic; and accordingly no architect of any fame willingly does so, and it is a pity when they do it unwillingly. Then, simply set to work to design whatever you think will in the long run look the best, not the most original, or the most fashionable, or the most of anything, except the best. If your employers will not have it, do the best you can either to convince or to satisfy them by such alterations as will also best satisfy yourself; but if you begin to ride the high horse, and tell them in effect that they are fools, they may not be too foolish to reply that they are spending their money to please themselves and not you. In the long run you will have pretty much your own way, and quite as much as most people have in this world. You may be inclined to answer, "Why, do you suppose we do design anything that we don't think will look as well as possible?" Yes, I do. I should be sorry to think that any man worthy to be called an architect himself admires many of the designs he makes now. They are made to look striking, original, fashionable, to please the party that he cultivates, to contribute something to the ever talked of Victorian style; because he knows something very grand is expected, that his employer is rich and ostentatious, that he has such a sum to spend as he never had before and perhaps never will again; because he wants to try some particular effect, as doctors want to try new medicines or operations; because he knows that no decently quiet design will have any chance in a competition; because he believes in the doctrine first preached by a celebrated amateur who has sown the seed of many delusions, though fortunately a good deal of his seed takes no root, that architecture is distinguished from mere building by ornamentation, and that there cannot be too much of it if it is good, as of course he thinks his own will be; because he is afraid of criticism; and I dare say for sundry other reasons. A man may be influenced by all or any of these motives without being distinctly conscious of it; and by not one of them, we may be certain, were the old builders

influenced. Of course, I do not pretend that the very best motives and the entire absence of the worst can make up for the want of either natural taste and genius or practical knowledge, which I said before are the only requisites for good designing. But the misfortune is that the possessors will not give them fair play, but allow the taste and judgment which they can apply well enough in writing about old buildings to be overridden or distorted by such considerations as these when they begin to design new ones. Nothing is more surprising to me in modern architecture than the contrast between some men's *works* in the literary and the architectural sense. I know by experience that any man who has the boldness to design on the simple principle that I have been suggesting must be prepared for all sorts of ignorant criticism in the early stages of his work; and yet I adhere to what I said twenty years ago, that a building which is going to look well looks well in every stage, to those who have eyes to see and minds to understand: faults are never cured without eradication, though unfortunately it is never too late to introduce them and to spoil a building by its very top. But architects should look far more ahead than they do, and they will see in time that every really good thing is more and more appreciated, and every bad thing less, and will learn the value of its being said of them, as it is said preeminently of one, "Well, so and so, may make mistakes in proportions and other things sometimes, but he never designs anything vulgar;" which I end by saying does not mean "common," but makes a false pretence of being superior to what is common, whether in architecture or in habits and manners.

Yours truly,

EDMUND BECKETT.

33, QUEEN ANNE STREET, W.

5th January, 1875.

THE LODGE AT SHEFFIELD MANOR

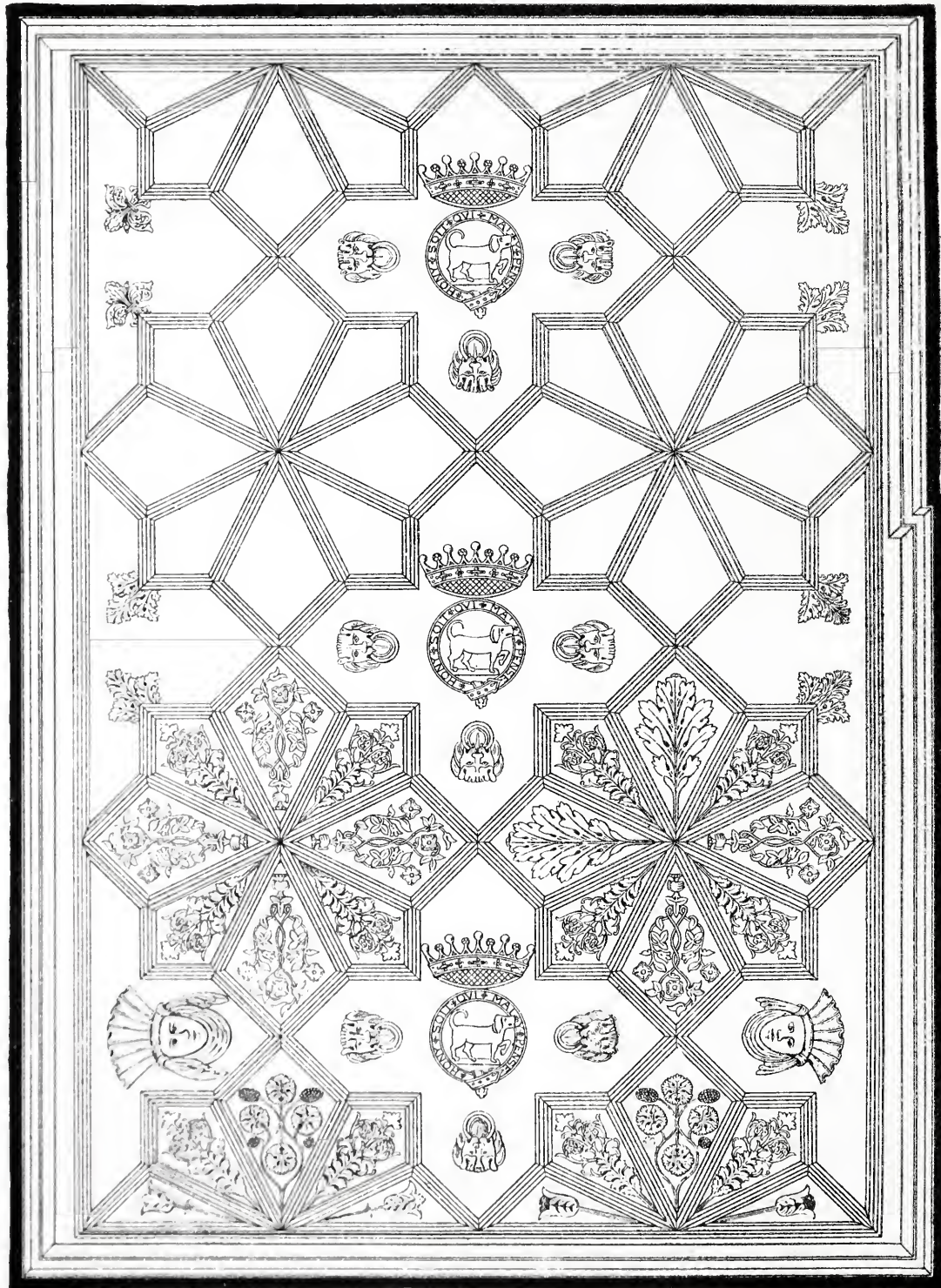

THE CEILING TO ROOM ON SECOND FLOOR MARKED B

Royal Institute of British Architects.

At the Ordinary General Meeting, held on Monday, the 18th of January, 1875, B. FERREY, Fellow, in the Chair, the following Paper was read:—

ON "THE RESTORATION OF THE LODGE AT SHEFFIELD MANOR,"

By CHARLES HADFIELD, Fellow.

THE subject of this paper which I have the pleasure of reading here to night, in answer to the invitation of our Secretary, would not under ordinary circumstances, have been deemed of sufficient importance in itself, to claim the attention of the members of this Institute, and find a place in the printed transactions. It is not, however, the study of any artistic merits or peculiarities possessed by the little structure which I am about to describe, that seem to me to commend it to your careful attention, so much as the further investigation of an already well developed idea thrown out some years ago by the Rev. Jno. Stacey, M.A., the accomplished President of the Sheffield Architectural and Archæological Association, which proves that in it, we still possess the occasional abode of the ill fated Mary Stuart, whose weary sojourn in Sheffield, from the close of the year 1570, to September, 1584, under the surveillance of George Talbot, the Sixth Earl of Shrewsbury, is matter of history. For the benefit of those who may wish hereafter to investigate the matter further, I will mention at starting, that Hunter's History of Hallamshire, and the collection known as the Talbot Papers in the Library of the College of Arms, and notably a folio volume labelled G, give many interesting details of the Scottish Queen's captivity in Sheffield; and I will add that any trouble the preparation of this paper may have cost me, will be amply repaid if the discussion to which it gives rise be the means of aiding our local antiquaries to complete the task they have already so well in hand. I am glad to be able here to mention the following sources, from which additional information may probably be gathered, and for this I am indebted to the kindness of my friend Mr. S. W. Kershaw, the Librarian at Lambeth Palace:—

SHEFFIELD CASTLE.

(See 3rd Report Historical MSS. Commission, 1872).

A.—*In possession of* MARQUIS OF BATH, LONGLEATE, WILTS.—Two volumes of original papers and letters from *Sheffield Castle*, by and to George, Earl of Shrewsbury, and his successor, Gilbert, 1574—1608.

The originals from Sheffield Castle, are upwards of 6,000, bound in 15 vols., and are in the College of Arms, London.

B.—*In possession of* MATTHEW WILSON, ESQ., ESHTON HALL, YORKS.—Two volumes, (20, 21,) transcripts of letters from the Talbot papers, formerly at Sheffield Castle, relating to matters of state, foreign and domestic news, &c., &c.,—found in Castle of Sheffield, 1676.

Vol. 33.—Transcripts of letters to the Talbots, Earls of Shrewsbury, found at *Sheffield Castle*.

C.—*In possession of* ARCHBISHOP OF CANTERBURY, LAMBETH LIBRARY.—"*The Shrewsbury Papers*," transcripts of domestic and foreign affairs, from Henry VIII—James I.

Before proceeding to describe the building and its restoration, I feel I ought to give you an outline of the history of Sheffield Manor, its connection with the Shrewsbury family, its present condition, and the efforts made at the instance of its noble owner, the Duke of Norfolk, to rescue from oblivion one of the few historic relics remaining in Sheffield, which link her closely to the past, amidst the constant change and hurry of this busy nineteenth century.

Sheffield Manor was from the period of its erection, early in the reign of Henry VIII., by George Talbot the fourth Earl, until the death of Earl Gilbert in 1616, the favourite residence of the powerful Shrewsbury family, whose chief, the Lord of Hallamshire, owned the castle at Sheffield, rebuilt by Thos. de Furnival in the reign of Henry III., at the confluence of the rivers Sheaf and Don. This building was dismantled after the civil war, and finally razed to the ground, and little seems to be known regarding it, beyond the tradition handed down to us in the names of the streets, &c., which now occupy the site as "Castle Hill," "Castle Folds," &c. The position of the Manor must have been singularly well chosen, for standing on a lofty wooded eminence in the centre of the park, about two miles distant from the town, it commanded views of the adjacent country of surpassing loveliness. Harrison who surveyed it in 1637, says "The seite of Sheffield Lodge standing on a hill in the midst of the park, being fairly built with stone and timber, with an inward court and an outward court, two gardens, and three yeards, containeth 4 acres, 1 rood, 15 perches;" and that it was a place of some pretence, is clear from Mr. Hunter's description. He tells us that the principal entrance to the court on the west side through two lofty towers, about 60 feet apart, led to what is known as the Great Gallery, and he speaks of the last of these towers falling to the ground during the great storm of March, 1793.

Sir William Dugdale visited Sheffield Manor, and has left a record of certain armorial bearings noted by him in the great gallery, and these, as my friend Mr. J. D. Leader (whom I am glad to see amongst us to-night) pointed out, in a Paper read at Sheffield to the members of the British Archæological Association, give a tolerably clear indication of the date of its erection. I make the following extract from his paper: "Among other shields of no special significance, were three well worthy of attention. One displayed the six great quarterings of Talbot impaling Hastings; another gave Talbot, as before, impaling Walden; and a third displayed France and England impaling Spain. The Earl of Shrewsbury's first wife was Ann, daughter of William Lord Hastings, and his second, Elizabeth, daughter of Sir Richard Walden of Erith, in Kent. The gallery was built, therefore, after the second marriage, which took place about 1521 or 1522. The royal arms of England impaling those of Spain, would not have been displayed by a courtier after Henry VIIIth's conscience had become uneasy about his marriage with Catharine of Aragon, an event that was made public in the year 1527. Between 1522 and 1527, therefore, the hall was built, and we cannot be far wrong in assigning to it the date of 1525." Of this portion of the building a fragment remains, occupied as two cottagers dwellings. The east elevation is timber framed, and has traces of well designed mouldings, a ribbed ceiling is visible in the living room of one cottage, and there is no doubt that a proper survey, and a small amount of judicious reparation, will bring to light other features of interest, and give the old structure a chance of withstanding, for years to come, the further action of time.

The inventory of my Lord of Shrewsbury's household stuff at Sheffield Manor (see vol. G. of the Talbot papers), taken in 1582, shews that the furniture and appointments were not merely handsome, but even luxurious, and leaves no doubt as to the extent and importance of the mansion. Cavendish, the gentleman usher of Cardinal Wolsey, who passed several days with his master at Sheffield Manor, journeying to Leicester, gives a curious yet graphic account of the visit, during the course of which the great Cardinal was seized with the mortal sickness which terminated his earthly career four days afterwards at Leicester. From his description we gather, that there was "a faire gallery, where was in the further ende thereof a goodlie tower, with lodgings where my Lorde was lodged. There was also in the mideste of the same gallery, a travers of sarcenette drawne, so yt the one ende thereof was preserved for my Lorde, and the other for the Earle." Further on he tells us, "And once everie daye my Lorde of Shrewsburey woulde repaire unto him, and comon with him sittinge upon a benche in a great windowe in the gallerye." Leaving this range of buildings, which fronts west, are found to the south the remains of what appear to have been a number of small apartments, and

THE LODGE AT SHEFFIELD MANOR

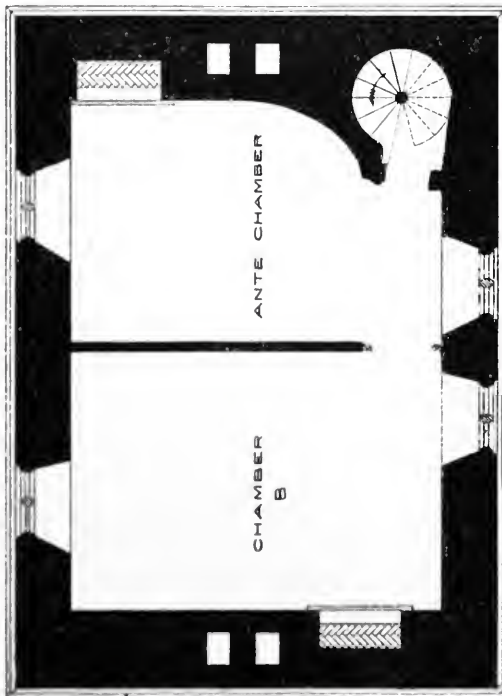

PLAN OF SECOND FLOOR

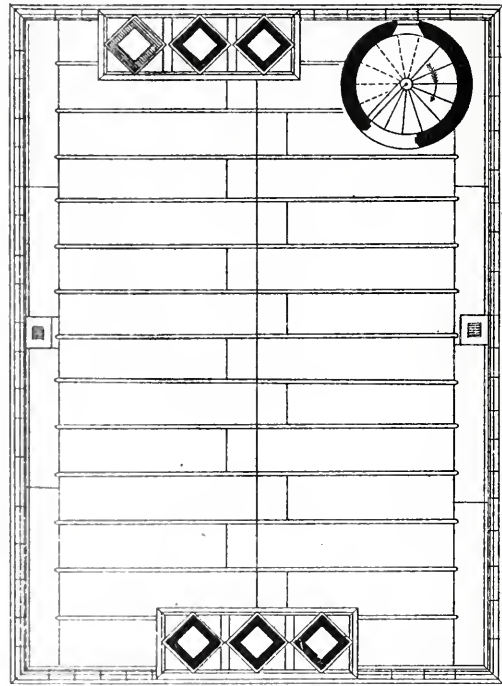

PLAN OF LEAD FLAT

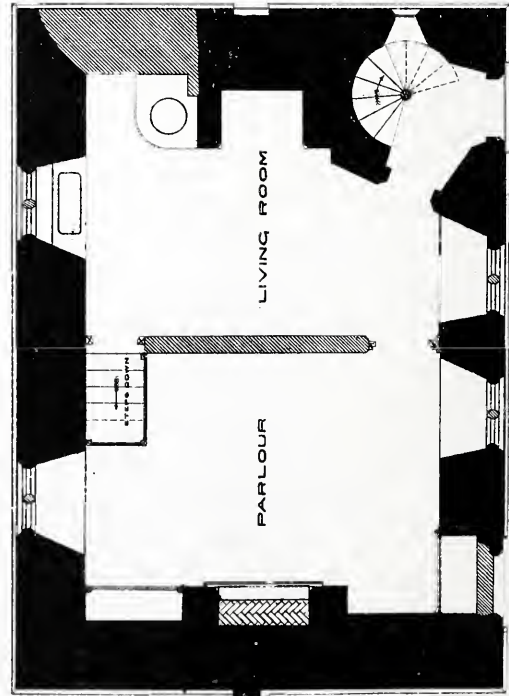

PLAN OF GROUND FLOOR

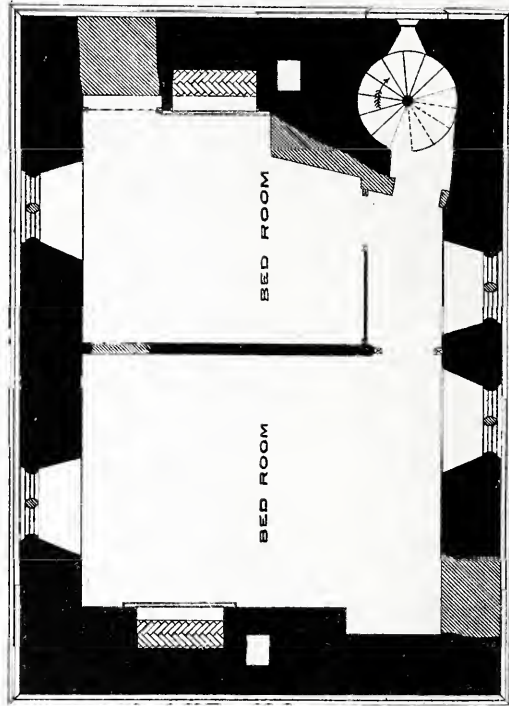

PLAN OF FIRST FLOOR



from the east end of this front the buildings returned for a short distance to the north. In the enclosure between the tower chamber on the north, the long gallery on the west, and the range of buildings on the south, lay the garden, a portion of the original wall, which formed its eastern boundary, still standing unaltered. Away to the east were probably stables and offices, amongst which are fragments of timber-framed erections, and traces of a gateway. On the west or entrance front, separated by what may have been a garden or pleasure ground, stands the little building with which I propose to-night to occupy your more immediate attention. Hunter, in his description of Sheffield Manor, speaks of it as the porter's lodge, but this view, I contend, the important character of the finishing of the two chief apartments, which I shall describe presently, and its distance from the entrance, and the ascertained position of the road from the manor to the town, put clearly out of the question. It was evident on the removal of the farm buildings erected about a century ago, and abutting on the north and south fronts, that it had been originally, a detached building, excepting alone, traces in the centre of each front, from the plinth to the level of the 1st floor string, of what was probably a boundary wall, and a chamfered doorway jamb, (see plan), still remains engaged to the plinth course on the south front. The general character of the details of the design, is about forty years later in date than the work at the manor, and it is therefore, probable, that the structure was erected early in Elizabeth's reign. The manor itself, was inhabitable, and occasionally inhabited, from 1616 to 1706, and from that date to the present time has been steadily crumbling away. A colliery shaft was about thirty-five years ago sunk hard by the "fayre tower chamber where my Lorde was lodged." Squalid and ricketty cottages, like parasites, have fastened themselves about the tottering walls; indeed anything more dangerous than these dwellings, or better calculated to rouse the ire of our sanatory reformers, cannot well be conceived; and it is satisfactory to learn they are only on sufferance, until arrangements for their removal can be effected, and the ruins enclosed and protected, as far as practicable, from further destruction.

The subject of my Paper owes its preservation, to the fact, of its use, as the farm house, for a century or more; and I think the drawings exhibited will explain to you its general appearance, a few months prior to the visit of the British Archæological Association in August 1873, when, in compliance with the instructions of the present Lord of Hallamshire, a survey of the building was made, with a view to its reparation; his Grace having previously made a careful inspection, accompanied by my father, and devoted some time to a thorough examination of the structure. Restoration is, under any circumstances, a work of difficulty when one has to subject the landmarks of old times to our modern, and but too often sadly contracted modes of architectural treatment; but the ease in question, interwoven as it is, with the history of the unfortunate Queen of Scots, and forming a well defined stand point, from which to view a very interesting period of her sad story; connected, moreover, as it was, with the great house of the Lords of Hallamshire, presented an opportunity, of which it is trusted good use has been made, to transmit to posterity the incidents of the ill-fated Queen's imprisonment.

Before proceeding to describe the building, I would draw attention to the general plan of the whole site, which is before you, upon which the relative position of the main structure is shewn; and I have also marked thereon the plan of a staircase turret, and doorway of a brick building, brought to view during some recent excavations, with the plinth course of the west front of the Manor itself.

The Lodge, as will be understood from the drawings, consisted of a ground, chamber, and upper floor, with a circular stone staircase surmounted by a brick turret, by which staircase alone access was obtained to the various parts of the interior, and the lead flat or terrace—about this more hereafter. The ground floor had originally, and as now restored, two rooms separated by a braced oak partition or studding, plastered, on which the main floor girders rested. The floors above, owing to the decay of the timber ends, and the weakening of the lower part of the partition by the opening of a modern doorway and the originally defective construction, had sunk, and it therefore became necessary on the

ground floor to replace the studding by a brick wall marked on the plan, which now takes the whole weight of the upper floors and roof. The inner room once had a separate external entrance, traces of which were found when removing one of the modern window frames, and it was considered advisable in the absence of evidence as to the design of this doorway, to wall up the opening, leaving the fragments of the jamb stones *in situ*, as now shown on the elevation, a lintel being put across to carry the walling. In each room is a capacious stone fire place, and two windows with stone mullions and transoms. The internal doors are of oak, hung to chamfered oak posts; those which give access from the staircase to the various chambers being specially strong, as the original iron crooks which remain in the jambs bear testimony. The ground and first floor apartments are now used as a dwelling for the care-taker, the upper floor remaining unoccupied, as it has been for many years past.

The first or chamber floor, consisting of inner and outer chambers, is divided as below, the floor being of gypsum or plaster, and the inner room having a ribbed plaster ceiling of simple but effective geometric pattern, of which a drawing is exhibited; the fire places are of stone as below, with herring-bone brick backs, and stone fender hearths, and they were found unaltered on the removal of the modern grates and chimney pieces, which had, luckily, only masked them. Still ascending the stair, we come to what was undoubtedly the principal apartment in the lodge. This room, with its heraldic mantel piece, its admirably designed ceiling, and general *ensemble*, has always been popularly known as "Queen Mary's room." There is an ante-chamber attached, and the floors are also of plaster, as is the case at Haddon Hall and other local mansions of the period. It may, in passing, be well to note here, that in both these upper rooms hooks are remaining close under the plaster cornice mold, from which doubtless, the tapestry was suspended. Evident care had been taken with the design and execution of this beautiful ceiling, for such it undoubtedly is. The rib moldings are well designed, sharp and delicate as becomes the material plaster in which the work is executed; the panels contain delicately modelled enrichment of early Elizabethan character, and the Talbot badge encircled by the garter, surmounted with the coronet, is prominently displayed in the leading panels.

The repairing of this work was an operation of some difficulty, for it was found on examination that the ends of many of the ceiling joists, as indeed was the case with the bearing timbers throughout the building, had become decayed; and further, that the oak plastering laths were much decayed above; portions of the ceiling itself had also been damaged by the leakage from the roof, and the delicate ornament was nearly obliterated by repeated coatings of limewhite. It was necessary, in the first place, to splice the ends of the joists, and thus give them a good bearing on the walls; but before attempting to do this, the whole ceiling was carefully propped from the underside. The work of splicing was then carried out in safety, the decayed laths removed and replaced, by blue slate secured to the oak ceiling joists, and run solid with plaster, and the lead flat relaid. The whitewash was removed by repeated softenings with warm water and the application of a hair brush, the enriched panels, some of which had become loosened, were securely fastened, and the whole then carefully flatted in oil color to prevent future damage. Immediately below the cornice molding is a frieze composed of conventional ornament of exceedingly graceful character, eight inches deep, with a neck molding at the foot, which, no doubt, formed a border to the tapestried hangings of the room. So far as could be ascertained from a careful inspection, there were no traces of color or gilding, which, as is well known, was freely used on such ceilings at that period.

I have now to describe the principal object in this interesting apartment, viz., the heraldic chimney piece, which, in the opinion of the Rev. John Stacey, "seems to give considerable support to the hypothesis that the building which contains it, and the room especially to which this fire place belongs, was designed as a place of safe keeping for the Queen of Scots on such occasions as

THE LODGE AT SHEFFIELD MANOR

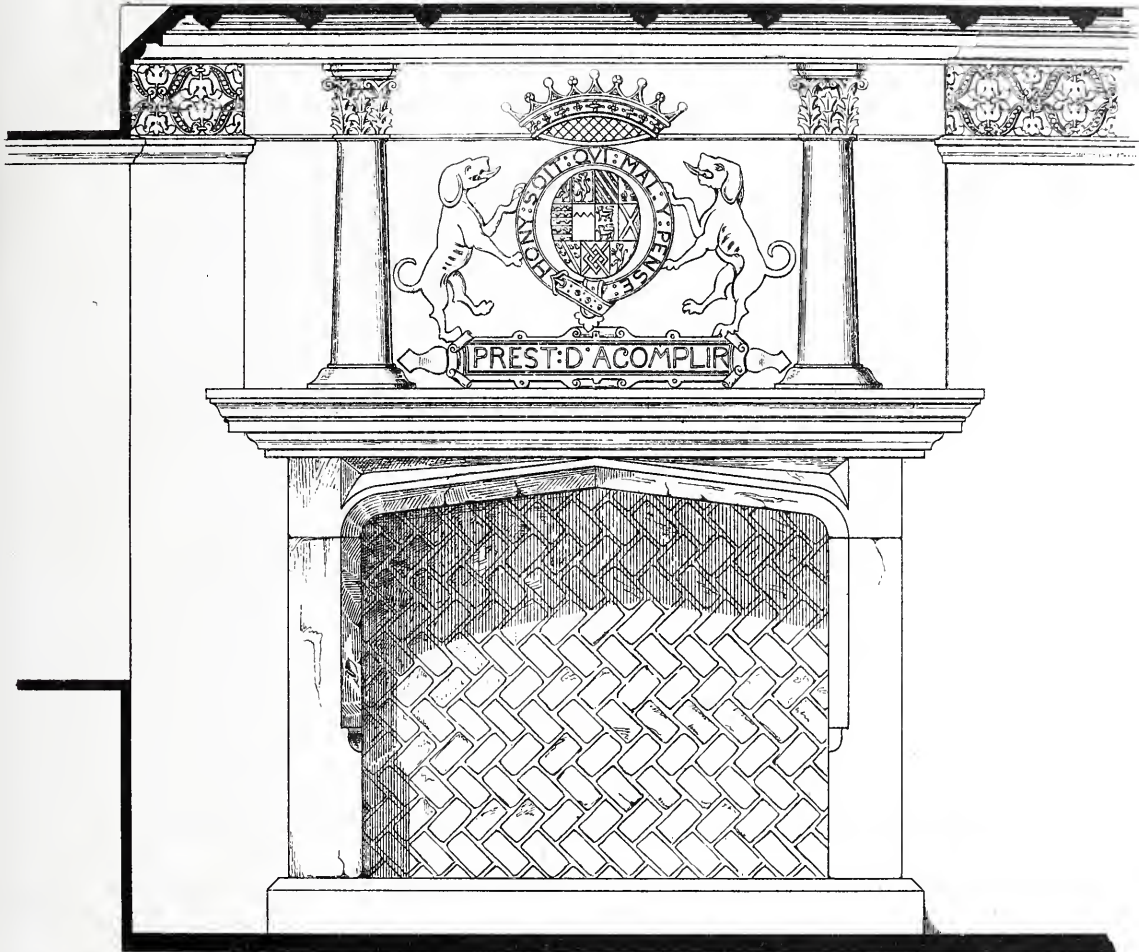

ELEVATION OF FIRE PLACE IN ROOM ON SECOND FLOOR MARKED B

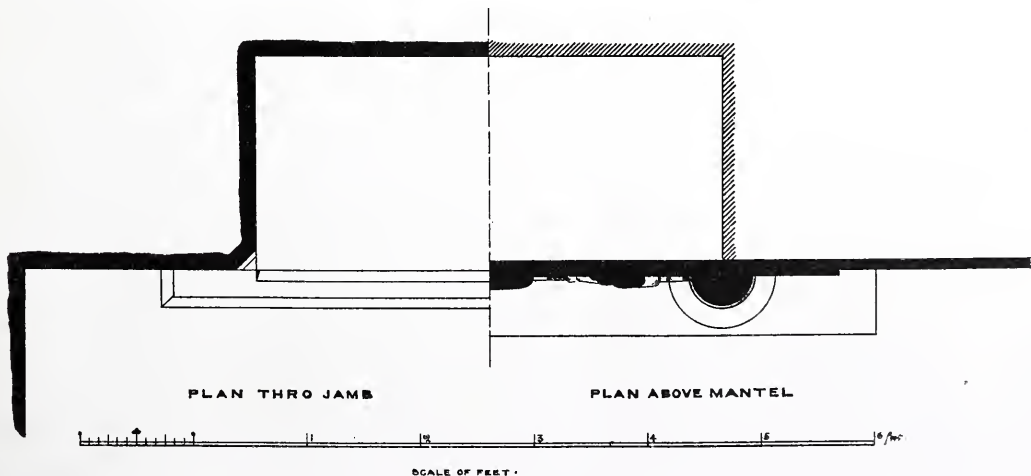

she was permitted to retire thither from her durance in the castle of Sheffield." It will be seen from the detailed drawing exhibited, that the structure consists of two parts, the stone jambs and head, of Tudor form, enclosing the fire place proper, similar to that shown in the outer room on the section. An architectural framework surmounting the whole is constructed in stucco, which has acquired the hardness of marble, on an oak cradling, secured to the wall, obviously fixed for a purpose, and in a somewhat rough and ready fashion; indeed, owing to the decayed state of the cradling, the whole had become partially detached from the wall, for some time past, and was in a condition which threatened its early destruction. The fire place opening had been walled up, as also had been that in the outer room, and plastered over, and on clearing out the rubbish several fragments of majolica tiles of good design were discovered; they are on the table to-night. The whole design bears a striking resemblance to the like structures one observes at Haddon, Hardwick, and other mansions of the same date. Upon a stucco cornice, which forms as it were the shelf of the fire place, rest a pair of engaged columns, with rude Corinthian caps, the centre being occupied by a shield, charged with the quarterings of George, the sixth Earl of Shrewsbury, encircled by the garter with the Talbot supporters, and coronet; below on a ribbon or scroll is the motto "Prest d'acomplir." It was not possible to decypher the whole of the quarterings, notably that of Butler, Earl of Ormond, until after the removal of the thick coating of limewhite, but the following is the correct reading of the achievement, as rendered by Mr. S. J. Tucker, Rouge Croix, during the visit to Sheffield, of the British Archæological Society:—quarterly of 11, 4, 4, and 3,—composed as follows,—1. Montgomery (De Belesme), *azure*, a lion rampant within a bordure *or*. 2. Talbot (Rhys ap Griffith), *gules*, a lion rampant within a bordure inverted *or*. 3. Talbot bendy of 10, *argent* and *gules*. 4. Comyn, *gules* three garbs *or*. 5. Valence, barry of 10, *argent* and *azure*, an orle of ten martlets *gules*. 6. Butler (of Ormond), *or*, a chief indented *azure*. 7. Strange of Blackmerc, *argent*, two lions passant in pale *gules*. 8. Neville, *gules*, on a saltire *argent* a martlet of the field. 9. Furnival, *argent*, a bend between six martlets *gules*. 10. Verdon, *or*, a fret *gules*. 11. Lovctot, *argent*, a lion rampant *gules*. This achievement is identical with the garter plate of the sixth Earl, still preserved at the College of Arms, and I am informed it is a curious fact, that the Ormond quartering, though blazoned on the garter plate, was seldom adopted by this Earl, and never by his father, grandfather, or his son the seventh Earl Gilbert.

I submit that we have here reasonable evidence that the building was completed, if not erected, by the custodian of the Queen of Scots, George, sixth Earl of Shrewsbury, the trusty counsellor, and faithful servant of Elizabeth, who was herself, through her mother Ann Boleyn, also descended from James the fourth Earl of Ormond, whose daughter had been married to John, second Earl of Shrewsbury. I give the

PEDIGREE SHOWING THE COMMON DESCENT OF QUEEN ELIZABETH AND GEORGE,
6TH EARL OF SHREWSBURY, FROM JAMES BUTLER EARL OF ORMOND.

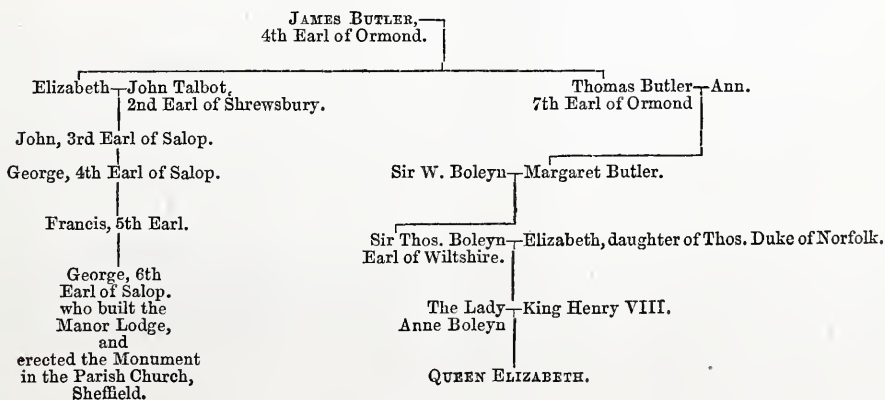

In the Shrewsbury chapel of the parish church of Sheffield is an imposing monument of Elizabethan character, erected by Earl George during his life time, and on it, a highly panegyric inscription known to have been written by Fox the martyrologist, which after setting forth the Earl's titles and descent, as also his early military services, dwells especially upon his unshaken fidelity to the crown, as chiefly shewn in the matter of the Queen of Scots who had been long in his custody, and whose execution had taken place under his superintendance. It is well to note the allusion to this fact, for it fixes the date of the work with great exactness, for as is well known, Mary Stuart was executed on the 8th February, 1587, and Fox the writer of the epitaph died before the close of that year, while the death of Earl George did not take place until the end of 1590. I give out of Hunter's Hallamshire an extract from this epitaph which will probably be interesting; the original draft in Fox's handwriting is, I am informed, preserved at the Harleian Library. "Deinde regnante Elizabethâ Anglorum gemmâ, cum Scotorum Regina Maria prælio domi superata, in Angliam compulsâ esset, atque apud Scotici limitis præfectum primum diverteret, donec in utriusque regni perniciem, magna moliri est comperta, huic illustri Comiti tutius custodienda traditur, anno MDLXVIII. Quem penes honorifice ac splendide satis usque annum MDLXXXIII, per tria amplius lustra, hospitata, non sine magnâ ipsius hospitis impensâ, curâque anxîâ vix exprimendâ. Qui, divinâ providentiâ gubernante, in causa tam arduâ, ejus magnitudo gravissima utilitas publica fuit, tam laudate ac feliciter se gessit, cum virum fidelem non minus quam providum atque prudentem, ipsa Invidia judicare debet. Quamque semper ab omni suspicione fuerat alienus, illud declarat, quod licet a malevolis propter suspectam cum captivâ reginâ familiaritatem sæpius male audiret, cum tamen ejusdem reginæ causa ex senatûs regni consultu a proceribus in arce Fodringshaiensi cognoscenda esset, inter magnates qui reatus sui in testimonium ac vindictam admittendi erant, hunc nobilissimum Comitem serâ Regina Elizabetha unum esse voluit; illum que post judicium latum, ejusdem sententiæ transactorem constituit; dato ad hoc diplomato regio, magno sigillo Angliæ communito." . . .

The Ormond quartering is, curiously enough, conspicuously displayed on this monument, being repeated on a series of small shields, which form a border round the inscription with military trophies interspersed. Six of these shields shew Talbot (Rhys ap Griffith) and Ormond, while the alternate six bear the arms of Talbot, with a blank impalement, and at each corner is a shield bearing the arms of old Talbot alone. The Rev. Jno. Stacey, from whose paper on the Shrewsbury monuments I have gathered these particulars, thinks this prominence is easily to be explained by Shrewsbury's desire, at a time of unusual danger, and anxiety, (for the Spanish Armada was then threatening the coasts of England) to proclaim his unshaken loyalty and fidelity to his Queen, to whom he was further bound by the ties of blood relationship.* Is it too much to assume, that the coat of arms over the fireplace, in what we have reason to believe was the apartment occupied by the captive Queen, was placed there, as a stern reminder to her, that she was in the custody of one, who would on no account fail in the duty entrusted to him by Elizabeth?

Mr. Froude relates an anecdote which bears upon the delicate and often disagreeable nature of the task entrusted to the Earl of Shrewsbury by Elizabeth.—At the close of the year 1584 a family quarrel seems to have been going on at the Manor; the ladies, and notably his countess, having taken up the cause of the young Countess of Lennox (afterwards mother of the Lady Arabella Stuart) against the Earl, who thereby got into trouble and was sent for to court; this matter, it will be seen, led to the final

* The following observations of Camden seem well to accord with the spirit in which the Earl may be supposed to have erected this monument. "In those ticklish times he made shift to assert his honour and make good his trust for fifteen years together, against all the machinations and slanders of the court-party, and the ill conduct of his second wife, to such a degree, that he left behind him the double character of a wise and faithful statesman and a worthy and brave commander."—*Camden's Eliz*, p. 147, edit. 1625.

THE LODGE AT SHEFFIELD MANOR

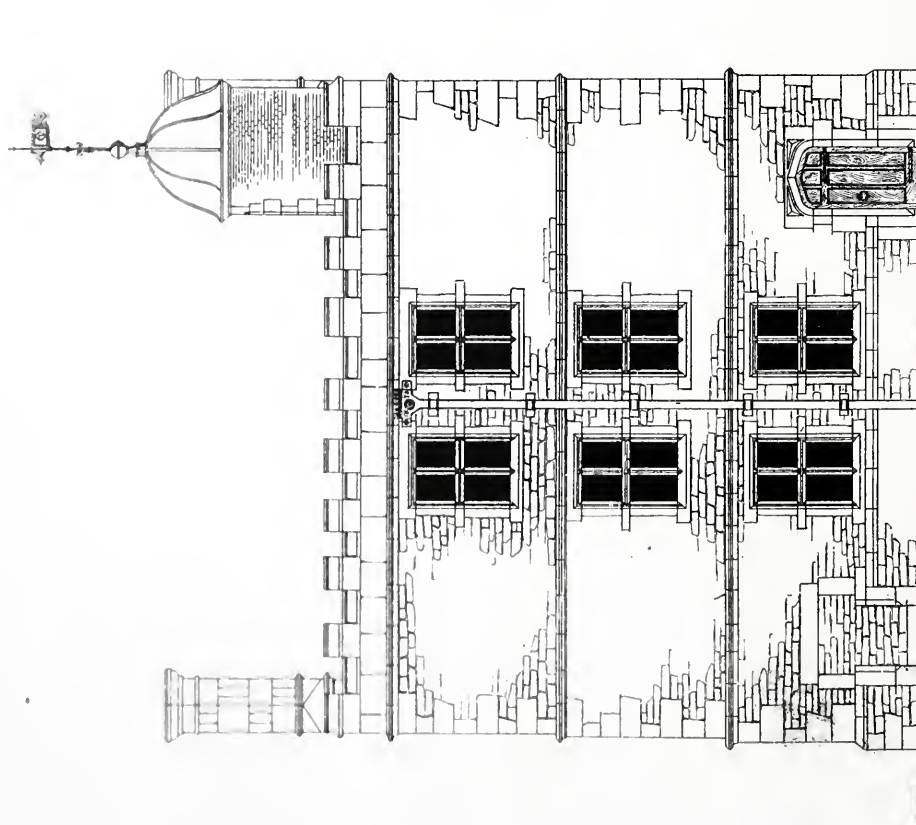

ELEVATION TOWARDS THE MANOR

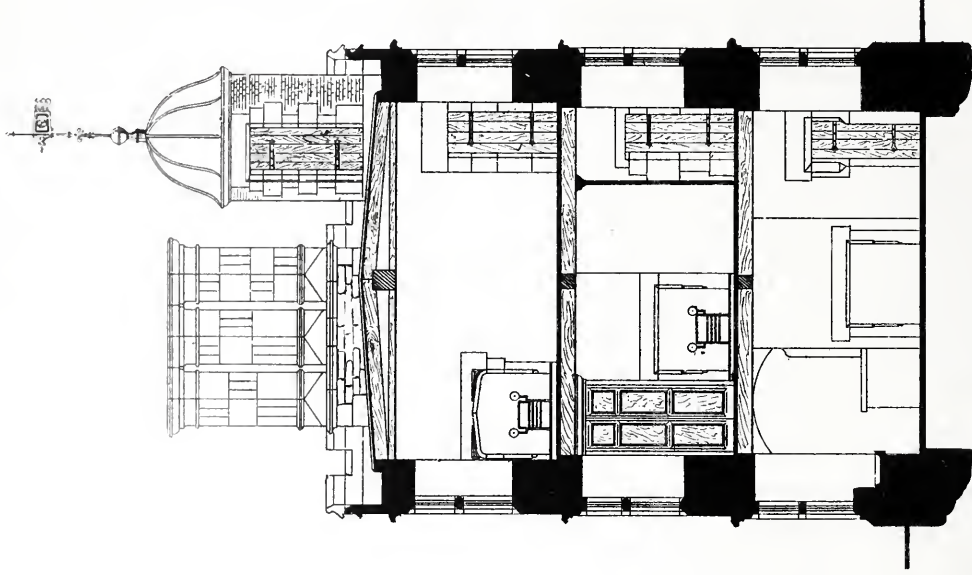

CROSS SECTION

SCALE OF FEET. 0 10 20 30 feet.

removal of the Queen of Scots from Sheffield,—“Elizabeth,” says Mr. Froude, “received him (Shrewsbury) with some *badinage*, asking him how he had left his queen. He said he had no queen but her Majesty; if her Majesty distrusted him he begged her to relieve him of his charge. She said she had spoken to him in jest, there was not one of her subjects whom she esteemed more highly; but in consideration of what had passed, she told him that some change had been made necessary. She gave him a command in Lancashire which would separate him at once from his countess and his prisoner.” Shrewsbury kissed her hands, and in language, which I fear will grate on ears polite, from its manifest want of courtesy and gallantry, “thanked her majesty for delivering him from two devils.” It is quite clear from Shrewsbury’s numerous letters, preserved amongst the Talbot papers, that during Mary’s sojourn at Sheffield, Elizabeth’s fears and suspicions in her regard were ever active, and on the receipt of intelligence from France of the so-called Massacre of St. Bartholomew, an intended removal from the Castle to the Manor was postponed. Some months afterwards when the alarm had passed away, she appears to have been taken to the Manor, and this change was the cause of a remarkable conversation between a certain Dr. Wilson and the Earl’s second son, then at court. In the course of a letter written to his Father at Sheffield, recounting the matter, is the following curious paragraph:—“Then I told him “what great hede and care you had to hir safe keeping; especially beyng there that good numbers of men, “continually armed, watched hir day and nyght, and both under hir windowes, over her chamber,” (sic) “and of every side hir, so that unless she could transform himself to a flee or a mouse, it was impossible” (sic) “that she could scape,” &c.

Does not the little building we are now considering appear perfectly consistent with such a condition of things? Perhaps some of you may reply, this is mere sentiment; to such then, I say, by all means investigate the point further, and if in showing that some of my premises are badly founded, new light be thrown on any of the numerous details which the Sheffield Society are seeking to unravel, I shall be well contented to find myself in the wrong. The quarry glazing of the windows in the two upper chambers has heraldic bearings, &c.; in the ante chamber are the arms of Talbot and Nevill, Furnival and Lovetot. In the inner room the window towards the Manor has the Fitzalan and Howard badges, and in the border of the glazing below the legend, “This lodge was restored by Henry Howard, Duke of Norfolk, 1873.” In the opposite window are the badges of Mary Stuart and the legend “Tradition hath it that Mary Stuart, Queen of Scots, was imprisoned here.”

We have now completed the survey of this apartment, and returning to the turret stair we ascend by it to the terraced flat which forms the roof of the lodge. From this elevated position a magnificent panorama of the surrounding country, for many miles may be seen on a clear day, and here, perhaps, the captive Queen, as is recorded of her when at Sheffield castle, was wont to take the air. The lead forming this flat is the original covering, and in order to preserve it as far as possible intact, it has been taken up and relaid, sheet by sheet upon new lead after the repairs to the roofing timbers. The winding stair is enclosed by a circular turret, built with thin red bricks, and surmounted by a lead covered dome. On the removal of the rough casting which covered the exterior, a small window or loop hole, which commanded the road from the Manor to the town, was brought to view. I have only now to describe the exterior of the building, which had been greatly disfigured by modern alterations. The upper portion of the parapet and one of the chimneys had disappeared, the stone mullions of most of the windows had given place to wooden sash frames, while those at the back had been walled up; new doors and openings had been introduced, to the serious detriment of the structure, and the original external entrance had been walled up and concealed by the plastering, which covered the whole exterior face of the walls. The drawings exhibited have been prepared after the completion of the repairs, and are an accurate representation of the building as it now stands, and will, I apprehend, explain to you

what has been done, without further comment. I have only to add that the exterior is of a somewhat coarse rubble masonry, and the details generally are later in style than the remains of the Manor, the whole work bearing evident marks of hasty construction. I feel that having already trespassed too long on your forbearance it is quite time to bring my paper to its close, and I will only say in conclusion, that the restoration has been throughout effected in the most conservative manner, and that in accordance with the expressed wish of the noble owner, all old work has been reverently and carefully preserved, and new materials have been introduced only where absolutely necessary.

THE CHAIRMAN.—Gentlemen, Mr. Hadfield has given us an interesting Paper. It is not only archæological and architectural, but historical: into the latter part, it is not our province to enter: but we shall be happy to hear any remarks from members present. A few points occur to me, but I would rather learn from those gentlemen what they have to say, and listen to the observations they may have to make; and I am quite sure Mr. Hadfield himself will be pleased to hear all who can throw any light upon the general subject.

MR. TUCKER, Rouge Croix.—I am a little taken by surprise at one of Mr. Stacey's suggestions about this quartering of the arms alluded to, and I should have been glad to have availed myself of the opportunity of looking into the subject before speaking upon it. Of two evils, I think however, you would prefer that I should choose the less of addressing to you what few observations occur to me, rather than adopt the course which Sir Edmund Beckett has done this evening, and inflict upon your next meeting a "*verbosa et grandis epistola*." I have seen the arms in question, and I identified them as those of George, sixth Earl of Shrewsbury, who was custodian of Mary Queen of Scots; but I am somewhat astonished at the suggestion that this quartering was assumed by him. All the others enumerated by Mr. Hadfield, and which I take it he obtained from the list I made of them, were undoubtedly the right bearings of the Earl; and, as a shield of arms should at all times (and at that day generally did) represent a man's actual descent and representation, I think it would be a most unusual thing, even for such a quasi advantage as to show his fourth cousinship to Queen Elizabeth through common descent from the Ormond-Butlers, that he should have placed in the centre of his shield the arms of that family. I have not investigated the subject, but I should be prepared to find that the Earl of Shrewsbury was entitled by another descent to quarter the shield of the Ormond-Butlers, and I have no doubt we should discover that it was introduced by some previous marriage; but that *he impaled* Butler is simply impossible. There must have been some mistake, for that would have implied a marriage with the Butlers of that day, which never took place. It is an interesting point, and I should have been glad had I known it would have been raised, to have investigated it, and thrown what light I could upon it. As it is I can only promise that I will look into it, and see if I can show why the quartering was introduced.

MR. T. MORRIS, Fellow.—There is one point connected with the architectural part of the subject, which may be worth noticing. Mr. Hadfield spoke of this building as having been termed a gatekeeper's lodge, but I think the author quoted went rather away from the probability of the case. It strikes me that the proper term would perhaps be the "gatehouse," because then it would be analogous with such buildings as the large gatehouses attached to all important mansions of that time. I suppose it was an old Dutch fashion introduced into this country by Henry VII. and his followers. We have an instance in Lincoln's Inn gateway, and another at Lambeth Palace, erected by Archbishop Morton. There is the well known example also of St. James's Palace, erected by Henry VIII. There must have been some much more important officer who inhabited that part, or it was used for some special occasional purpose, which, perhaps, we are not so well acquainted with now, but something very distinct

THE LODGE AT SHEFFIELD MANOR

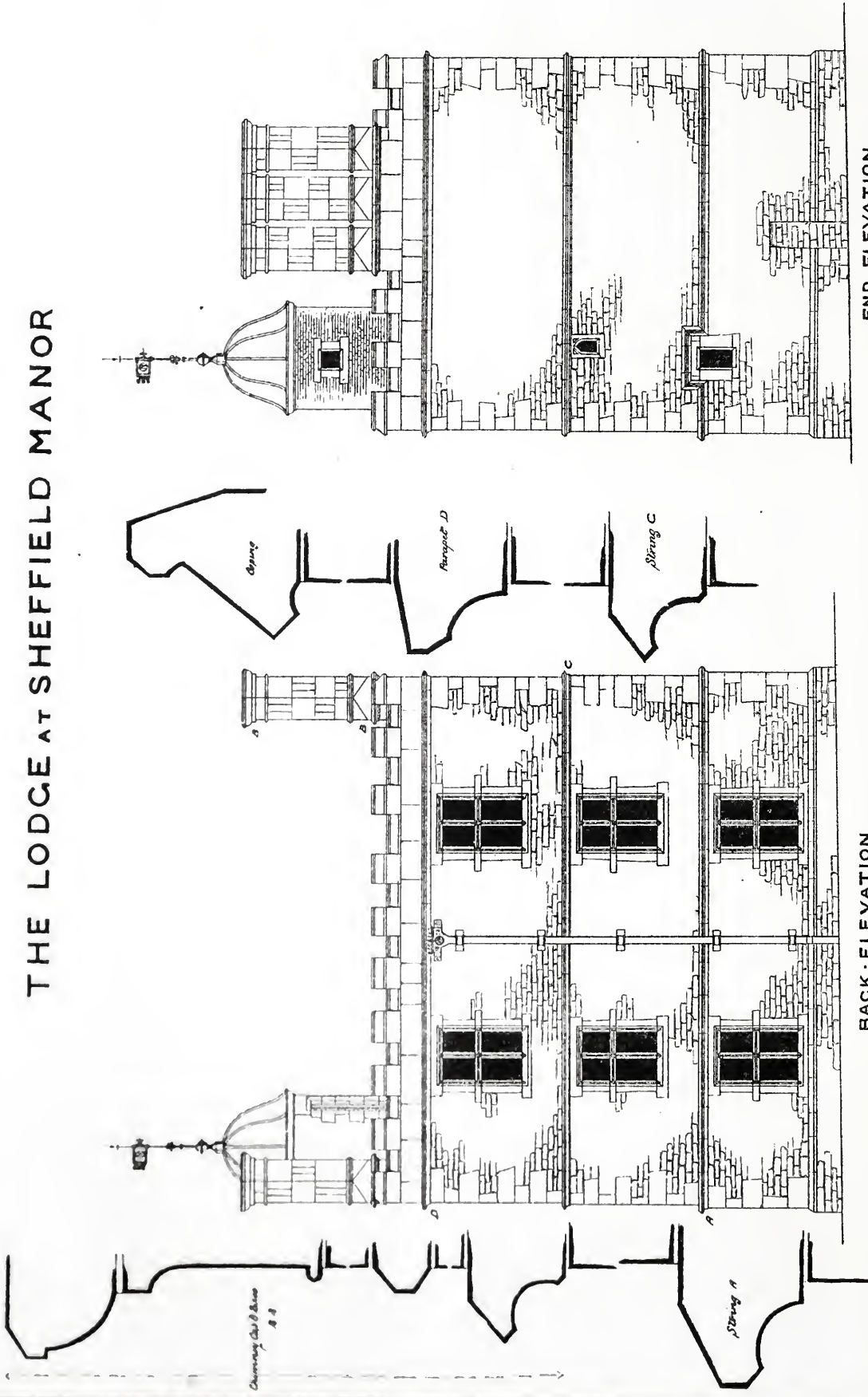

from anything like a subordinate gatekeeper's duties. The form of the structure seems to fall in with that class of erections, and by some such assumption may possibly be brought into proper relation with the rest of the buildings as they once existed.

THE CHAIRMAN.—I was surprised at the fact, when looking at Mr. Hadfield's drawings, that this building should be called a "lodge," and I at once dismiss that idea; but with reference to its having been a gatehouse, I am not aware of any such structure which did not possess an archway. It is generally constructed with an entrance into some external quadrangle. I speak subject to correction, but I do not know a gate-house proper without an archway. That this building was a lodge, in the sense in which we understand it, I cannot believe. It might have been the residence of some high officer, because it was of a capacity which admitted of the accommodation of a large establishment.

MR. TUCKER, Rouge Croix.—I may mention that there was a tradition that Queen Mary attempted to escape from the castle, and it is assumed that the Earl of Shrewsbury wished to place her in better security; and we have amongst the "Talbot Papers," in the Herald's College, a letter in which the Earl speaks of sending to London the plans of a lodge he was building. I think there can be no doubt that it refers to this building, which he intended for the better securing the person of the Queen. That letter is in existence, and I think goes far to confirm the fact. I may also mention that in the list of the contents of the house, which is also in the Herald's College, there are some things which evidently referred to furniture *out* of the house, and would not be included in any appropriate to a gatehouse.

Mr. J. D. LEADER, of Sheffield, responding to the call of the Chairman, said—Taking advantage of your kind invitation I have great pleasure in saying how much gratification I have had in listening to Mr. Hadfield's paper. I will content myself with reminding the meeting that supposing the theory to be right which Mr. Hadfield supports, and which I endorse, that this little lodge was built as a place of safe custody for Mary Queen of Scots, it is now the only building in existence in which that unfortunate lady was confined. All the other houses in which she resided have perished. Bolton Castle is in ruin: Tutbury Castle and Wingfield Manor are also ruins: Chatsworth has been replaced by the splendid mansion that now bears its name: Chartley and Worksop Manor were destroyed by fire: and Fotheringay Castle was destroyed by order of James the First. Therefore, supposing this to have been really a place of confinement of Queen Mary, it is the only one which had escaped destruction. [The Chairman—There is Skipton Castle I think.] I believe she was never at Skipton; Bolton is not far from Skipton. There is a good deal of interest attached to this building if it is conclusively proved that it was used for the purpose we suppose; and Mr. Tucker's elucidation of the coat of arms went a long way towards proving it was built, or at least adorned, by George, the Sixth Earl of Shrewsbury, the keeper of the Queen of Scots. The remains of the manor before us are at present in a disgraceful state; but that long gallery, where the black line is shown on the west front, is still in such a state that it is capable of being restored to a respectable appearance; and one would very much indeed like to see the cottages removed that have obtruded against it, and the old gallery where Wolsey was confined brought into a cleanly if not a habitable condition. Amongst some papers I was turning over in the British Museum a short time ago I came across an interesting account of the demolition of Sheffield Manor in the year 1708, in which was this item—"April ye 25 to 8 men taking timber down Cardinall Woollsey's tower 7s. 1d."

THE CHAIRMAN.—I think Mr. Tucker's remarks satisfy me that the building was not a gateway. I think therefore we may dismiss that idea, and consider it was a structure erected for a special purpose.

MR. HADFIELD.—I quoted Hunter as naming this building "The Porter's Lodge:" whereas I consider it is a building of too much importance to have been designed for that purpose. Hunter

mentions the fact of the Earl of Shrewsbury sending to Lord Burleigh the plans of a lodge he was building in Sheffield Park, but whether this was the lodge or not I am unable to say. It is not however likely the Earl would have sent the plans to Lord Burleigh unless it were a building of some special interest and importance.

Mr. J. T. WOOD, Fellow, expressed the gratification which the Paper had afforded him, and proposed a vote of thanks to the author.

MR. DAVID BRANDON, Fellow.—The subject is so interesting, archæologically and historically, that it could hardly fail to give us great pleasure as architects to hear Mr. Hadfield's Paper. I am delighted with a Paper of this description, because it introduces to us a new source of interest. It is interesting to hear occasionally of matters connected with, but still distinct from, strictly professional topics. It is that kind of information which we desire for the edification and pleasure of our meetings. This is an Essay in connection with the history of very stirring times in this country, and as this example has been set, I hope it will be followed by other members occasionally selecting themes somewhat distinct from architectural subjects, but still embodying matters which we may derive advantage and satisfaction from discussing. I have great pleasure in seconding a vote of thanks to Mr. Hadfield for the Paper he has been so kind as to read.

The vote having been carried by acclamation.

MR. HADFIELD said,—I beg to thank the meeting very sincerely for the reception accorded to my Paper. I felt it was almost requisite to apologise for bringing so comparatively unimportant a structure under the notice of this Institute; but it appears to me that when these works fall into one's hands in the course of the routine of our professional career, it is due from the architect engaged upon them to bring them under the notice of his professional brethren; more particularly, as in the case under consideration, when there seemed to exist so much doubt and so much to learn as to the real purpose for which the building had been originally destined. With respect to Sheffield Castle itself, the Archæological Society of that town have entirely failed hitherto to discover any drawings or general plans of the structure. It seems to have been entirely blotted out, and little is to be learned from the records to which, at present, there is access. Nothing remains, so far as has yet been discovered, to give any idea of its original appearance; and I need not say our friends at Sheffield will be under great obligation to any member of this Institute who can give them information on this point. With regard to the Manor Lodge, it is satisfactory to know that the work of repair was taken in hand in time, for had it been delayed a few years longer this interesting building must inevitably have followed in the general ruin. I feel my best thanks are due to Mr. Wood and Mr. Brandon for the kind manner in which they have noticed my Paper, and to yourselves for the attention you have given to it.

The meeting then adjourned.

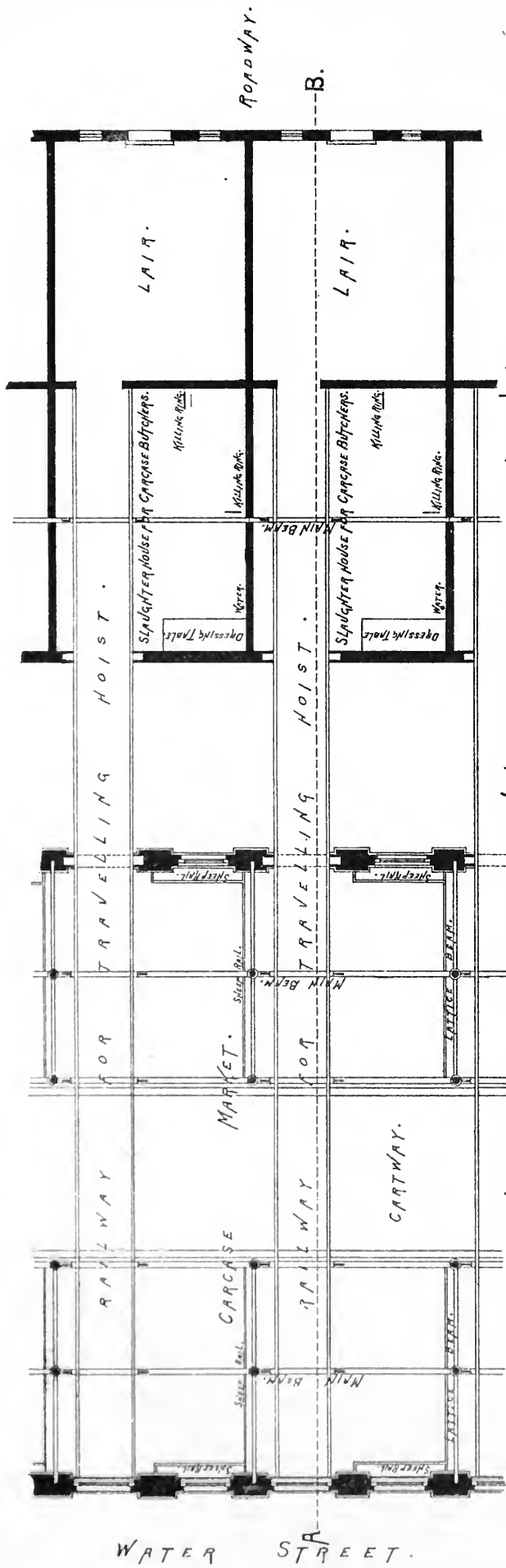

PLAN SHOWING CONNECTION OF CARCASE MARKET WITH CARCASE-BUTCHERS' SLAUGHTER HOUSES.

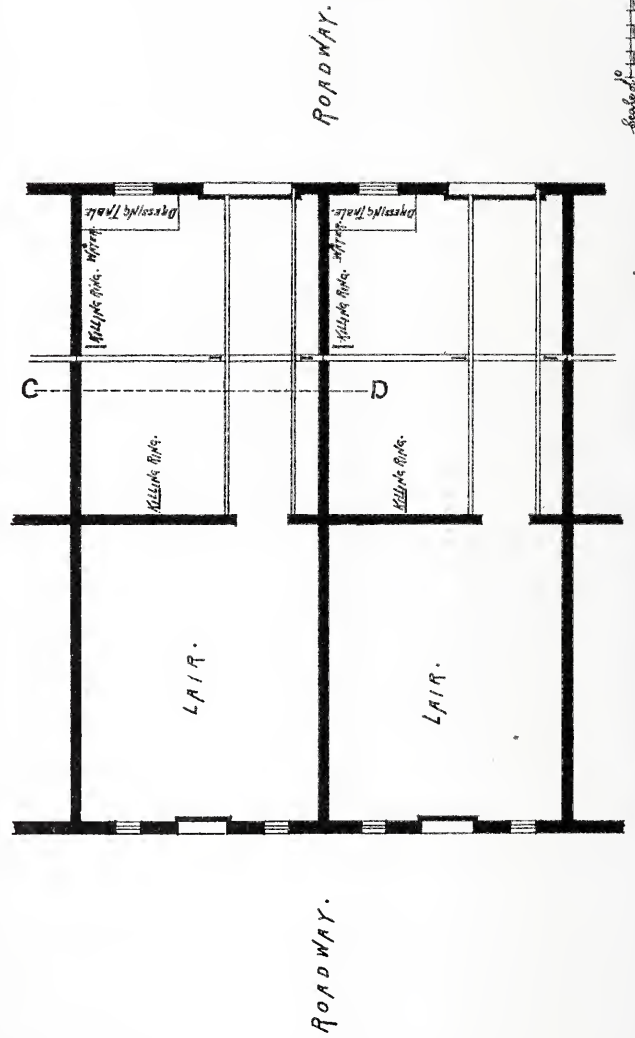

PLAN OF RETAIL BUTCHERS' SLAUGHTER HOUSES.

· ABATTOIR ·
 · AND ·
 · CARCASE MARKET ·
 · ERECTED FOR THE ·
 · CORPORATION OF MANCHESTER ·

Scale of 10 Feet

Royal Institute of British Architects.

At the Ordinary General Meeting of the Institute, held on Monday, the 1st of February, 1875,
H. CURREY, Vice-President, in the Chair, the following Paper was read:—

“ON PUBLIC ABATTOIRS,”

With special reference to one recently erected at Manchester,

By A. DARBYSHIRE, Fellow.

IT is with some little misgiving that I venture to appear here this evening with a Paper treating on a somewhat dry and unpalatable subject; a subject eminently practical in its bearing, and absolutely devoid of anything like fine art. When it was represented to me by some professional friends that I ought to lay before this Institute my experiences in abattoir building, I felt that there were two objections in the way: firstly, I feared the matter was perhaps of a dry and unpleasant nature; and secondly, I experienced a feeling of dislike to making one of my own works the subject of a Paper to be read before an audience in this room. On the other hand, it appeared desirable, when the question of public abattoirs was being discussed in this country, that the results of our efforts in Manchester should have publicity, in the hope that our experience and investigation might possibly be of use in the future; and in this hope I take refuge; and this is the only excuse I can offer for occupying your attention for a short time this evening.

Some few years ago, the Corporation of Manchester turned its attention to the disreputable state of many slaughter houses in the city, which, from their filthy condition, were an intolerable nuisance; and owing to many of them occupying sites in the very heart of the town, and in densely populated neighbourhoods, a demoralizing influence was brought to bear, especially on the rising generation; in some localities it became almost a pastime for young children of both sexes to frequent slaughter houses, and witness the death struggles of the butchers' victims. This familiarity with scenes of blood and slaughter was justly considered as having an immoral influence, and afforded ample justification for a comprehensive measure of reform. It was also considered that the drainage of the city was vitiated by the existing system of slaughtering, and that therefore, from a sanitary point of view, it was absolutely necessary some action should be taken to provide a remedy for the existing state of things.

In dealing with a measure of reform, the Markets Committee of the Corporation found it necessary to proceed with extreme caution. The “Fleshers” of Manchester were, and are a strong and numerous body of tradesmen, cemented together, so to speak, by an “Association,” through which they were naturally prepared to combat, and possibly defeat, any effort which they might consider an infringement of independent rights. After careful consideration, the Committee (very wisely, as the result has proved) discarded the idea of seeking compulsory powers from Parliament to enable them to carry out their object; whilst many slaughtering establishments were highly objectionable from a sanitary and moral point of view, there also existed many which were a credit to their owners, and against which no reasonable objection could be raised. The Committee therefore resolved to take the butchers into their confidence, and to enlist assistance from the trade in the great work to be undertaken at the expense of

the Corporation; for whilst the Council already possessed powers through its Nuisance and Health Committees to compel the closing of objectionable slaughter houses, it was logically argued that if a public abattoir could be satisfactorily established, replete with every convenience, the butchers themselves would see the desirability of migrating thereto, and so avoid the trouble, expense, and sometimes litigation, which the compulsory closing of slaughter houses frequently entailed.

For my own part I have every reason to be thankful that the course I have mentioned was adopted by the Committee in charge of this work, inasmuch as I have been enabled to place myself in direct communication with the men for whom we had to cater; and in the place of antagonism and resistance, I have experienced courtesy, and received valuable advice and assistance, the absence of which would have rendered my share of the work extremely troublesome, and created a task of almost insurmountable difficulty. I regret to learn that in the town of Liverpool, the compulsory course has been adopted, and defeated at considerable expense and loss.

When the Markets Committee of the Manchester Corporation first entered upon the consideration of the practical working out of a public abattoir, it appeared desirable that the Old Meat Market, or "Shambles," being inadequate to the wants of the wholesale meat trade, should be dispensed with, and incorporated with the abattoir, and so secure the slaughtering and sale of meat in one establishment; and also that the Wholesale Meat or Carcase Market should be attached to, and work in immediate connexion with, the slaughter houses to be occupied by the wholesale butchers. This idea being definitely fixed upon, the problem for solution became possessed of some interest and originality to the architect; for whilst the abattoir question had occupied the attention of Municipal Authorities in some parts of the country, attention had been directed to slaughtering accommodation only, and not to the sale of meat in connexion therewith. On first turning my attention to the solution of this question, I visited the abattoir in Edinburgh, erected under the care of Mr. David Cousins, the city architect. My attention was directed to this establishment as probably the best of its kind then existing in this country, and through the kindness and courtesy of its architect, I was enabled to obtain many useful hints and suggestions as to the arrangement of the slaughter houses and lairs for cattle, but could obtain no help from it as to the working out of the important problem under consideration for the Manchester abattoir: namely, the association of a carcase market with slaughter houses.

From what I observed at Glasgow, Edinburgh, and Bradford, and also in the latter town from a careful perusal of Mr. Mawson's sketch book, containing the results of his investigation into several Continental abattoirs (kindly placed at my disposal), I concluded that the best and most efficient plan for a slaughter house was that which placed the slaughter house and lair for cattle under one roof, one in front of the other, with a communication between the two, the lair being entered by the cattle intended for slaughter at the back, and the meat, when dressed and ready for human food, passing out at the front for the purposes of commerce, either wholesale or retail. It then occurred to me, that any number of these slaughter houses and lairs might be associated in parallel blocks, the lairs facing each other, with a roadway between, and the slaughter houses also face to face, divided by a cartway. The peculiar shape of the site, resembling the letter L in form, enabled me to carry out this parallel block system, and to place the Carcase Market the whole length of the longer arm, with the wholesale slaughter houses of the carcase butchers immediately behind, with a roadway between.

The site occupied by the Manchester abattoir is situated some little distance from the centre of the city, separated from the Borough of Salford by the River Irwell; it contains 12,840 square yards, and is bounded on its north-easterly side by the River Medlock, and on the north-westerly side by Water Street. The frontage to Water Street is 533 feet; along this frontage is placed the Carcase Market, extending to a length of 418 feet, the remainder being occupied by the Entrance Gateway and Lodges.

• ABATTOIR •
 AND
 • CARCASE MARKET •
ERECTED FOR THE
 • CORPORATION OF MANCHESTER •

• BLOCK PLAN •

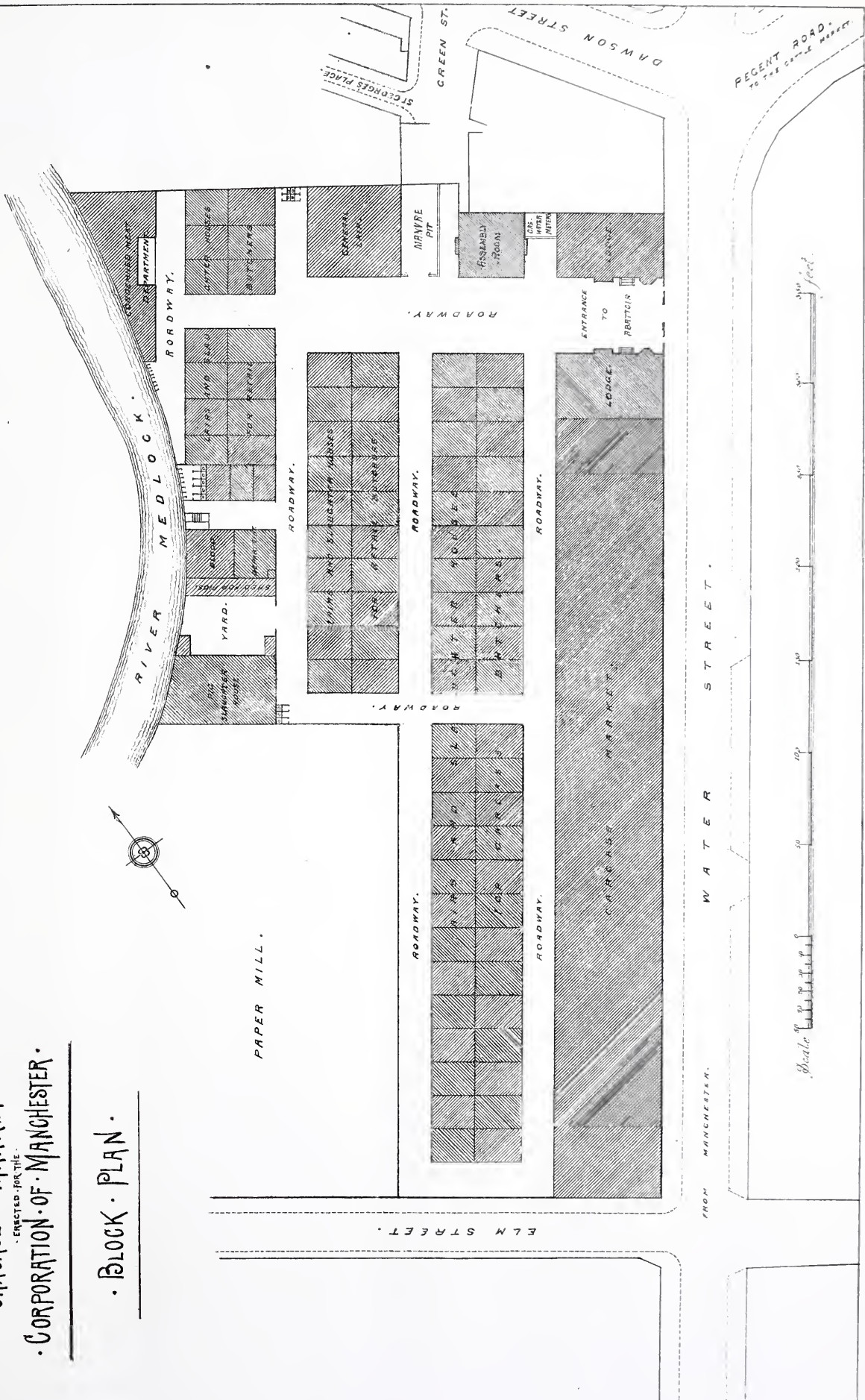

Photo lithogr. for the RIBA by C.F. Kell London

Behind the wholesale slaughter houses in rear of the Market, are placed those occupied by the retail butchers; behind these, again, are the blocks of buildings devoted to the pig slaughtering, blood store, and condemned meat, dead and alive. The rest of the site is occupied with a large general lair for cattle, manure pit, and a common room for drovers and butchers' employés.

The Carcase Market, as before remarked, occupies the frontage to Water Street, and is 417 feet 11 inches in length by 55 feet 6 inches wide, is spanned by an iron trussed roof as indicated on the sections, having sheet iron louvres the entire length of the building; the market is lighted exclusively from the roof. As part of my scheme was to facilitate the operation of the carcase butchers as much as possible, and to reduce the labour of moving carcasses to a minimum, four gateways are provided in the street front, communicating with a cartway in the centre of the building; by this arrangement the purchaser of carcasses can drive his cart to the particular bay or stall in the market occupied by the carcase butcher from whom he buys, and by a mechanical arrangement, which I shall hereafter describe, the carcasses can be placed in the cart without any lifting or carrying into the street, which was a necessity in the old markets. This roadway is wide enough for two carts to pass, and a very large trade is conducted without any confusion or trouble. In towns where a large export trade is carried on, this roadway might be occupied by a line of railway metals communicating with the main line, provided the site of the market was convenient; by this means the carcasses, after being packed in the usual way, might be deposited in trucks, and with very little trouble despatched direct from the scene of slaughter to their destination. The back wall of the market is pierced with large doorways, directly opposite to the doorways in the wholesale slaughter houses, a necessity of the mechanical arrangement carried out, and the accommodation provided for a carcase butcher consists of a lair, slaughter house, and a bay in the market equal in width to his slaughter house.

The Wholesale Slaughter Houses are 21 in number, and are 24 feet by 17 feet 6 inches inside measure, the lairs attached being 22 feet by 17 feet 6 inches. These houses and lairs are open to the roofs which are simple in construction, as shown on the accompanying sections. The slaughter houses are well lighted from the roofs, top lights being superior to side lights for purposes of slaughtering. The lighting of slaughter houses requires careful attention, as the operations of killing, skinning, and dressing, must be performed by a steady hand: the portions of the animal not used for human food, such as the hide, and guts, might easily be spoiled by an operator not having a good light upon his work, and the commercial value of these interesting fragments of the beast would be affected thereby.

The Retail Slaughter Houses are 19 in number, and similar to the others with the exception of the doorways, which are much wider in their openings, to enable the butcher's cart to be backed partially into the slaughter house so as to facilitate the removal of the meat to the private sale room or shop, where it is cut up and distributed to customers.

The Condemned Meat Department consists of a lair, slaughter house, meat store, and boiling house. All animals pronounced unsound, diseased, or unfit for human food, by the Corporation inspector, are removed to this establishment, slaughtered, and the meat boiled down to a consistency of fat or grease which is applied to various useful purposes. Any meat also which should happen to pass through the usual operations of dressing and afterwards be condemned shares the same fate.

The Blood Department is an interesting section of this abattoir, and consists of a storing room, drawing off room, and drying room.

The Pig Slaughtering Department is adjacent to the above, and contains a large pig slaughter house, open yard, and piggeries.

The Entrance Lodges contain residences for the porter and Corporation inspector, and also rooms for the convenience of the Markets Committee. These lodges are arranged on either side of the entrance gates, through which all cattle enter the establishment.

In addition to the above accommodation, the site contains a *Large General Lair for Cattle*, manure pit for the temporary storage of the manure from the live animals, and a common room for drovers and others having business in the establishment; on several points of the site are provided suitable conveniences, and also stable and gig house for the inspector.

Having now given an idea of the general character of the various buildings forming this abattoir, I shall endeavour to explain in detail the uses to which they are applied in respect to the slaughtering of cattle, and the dressing and sale of meat. I shall do so as clearly and in as concise a manner as possible: I shall commence with the poor beast at the entrance gateway, and follow it to its death, then accompany its carcase through the various processes, until its final removal from the establishment in the shape of human food.

When the cattle enter the grounds they are driven into the streets or roadways between the lairs before alluded to; the bullocks or "beasts" as they are technically termed, are secured to strong wrought iron rings built into the walls of the lairs at right angles therewith, and the sheep are allowed to remain loose, or if the butcher desires it he may provide his own sheep pens. The door of communication between the lair and the slaughter house is placed near to one of the side walls, so as to secure the largest amount of wall space; in the latter place, in the floor, and almost close to the wall dividing the lair and slaughter house, is fixed the *killing ring*. When the animal enters the house from the lair it simply turns the corner of the doorway and is instantly at the scene of slaughter. At this point we must pause to note the killing ring. On turning my attention to this matter of killing I became naturally anxious to facilitate and to quicken the operation. I had occasionally noted that the death struggles of the animal had been prolonged, sometimes by an unsteady or unskilful slaughterer, and in some instances owing to the clumsy method of tying-up preparatory to the death blow. I concluded after careful investigation that the frontal bone, or forehead of the beast, should be secured at right angles to the striker, and also at a certain elevation from the ground to suit the peculiar character of the pole-axe, or instrument of death. After submitting my views on this matter to those practically interested, it was determined to adopt a killing ring of the form and section shown on the drawing, this is a round iron bar bent to the form, with a circular ring forged to the underside of the horizontal portion, the rope or chain round the animal is then passed through the ring, and secured to an upright iron hook in the floor, which brings the head down tight to the horizontal bar, thus the skull is presented to the full force of the pole-axe. The animal having fallen on its side the knife is inserted at a certain point, and the blood carefully drained off into a vessel, and taken away to the blood store house, where for the present we leave it. Without taking up time with more unpleasant details connected with slaughtering, I proceed to the dressing of the carcase, and the mechanical appliances associated with this part of my subject. Next in importance to the general arrangement of an abattoir comes the question of the scientific application of mechanical aids to the various processes associated with slaughtering, and, with your permission, I will describe briefly the problem I proposed to the engineer, and then explain the method adopted in its solution.

I had not given this question of abattoir machinery much consideration before it became evident that the success of the whole establishment depended in a great measure on its proper and efficient application. In the first place, it was necessary to take into account the low order of intelligence possessed by the men who would have to use the machinery, (this remark applies only to the slaughterers and not to the master butchers;) from what I had seen of these men I concluded that the machinery must be of the simplest form, so as to involve no brain exercise or any mental effort whatever. In the second place, it seemed desirable to reduce manual labour to the minimum; and lastly, it appeared to me to be a *sine qua non* that meat intended for human food should receive as little handling as

possible after being dressed, and on no account should it be transferred from the pendant position to the dirty and greasy backs and shoulders of the slaughterers.

These being the main points constituting the desiderata of the question, it fell to the lot of Mr. John Meiklejohn, of Dalkeith, to devise a plan by which their realization might be achieved.

Following up the dressing of the carcase, the first thing to be done after the bleeding operation before alluded to, is to raise the carcase from the floor, so that the hide can be easily removed and other little matters attended to, such as decapitation; and at this point the machinery comes in to the assistance of the butcher; this machinery is simply a small hoist travelling overhead, moveable at the will and pleasure of the operator in the slaughter house. The construction of the railroad is also simple; a girder is fixed transversely in the slaughter house, with brackets cast to the bottom flange; these brackets support the rails upon which the hoist runs, and are deep enough to admit of the hoist running under the supporting beam. By this method all uprights or columns are avoided in the slaughter house, thus leaving the whole floor area available. In the wholesale department these rail beams are carried from the slaughter house across the roadway, and traverse the carcase market transversely, thus enabling the butcher to run the carcasses from the extreme end of his slaughter house to the street side of the market.

As this little travelling hoist is the medium by which the whole work is achieved from the death of the beast to the moment when the carcase leaves the market as an article of commerce, it will be well to adhere nearly to the description given by its inventor in the "blue book."

This hoist is mounted on grooved wheels, and is moved on the rails by a shaft or handle depending to the level of the hand, or is propelled by means of traction on the fore wheels which are made to revolve by a grooved pulley fixed to the axle and driven from the hand by an endless chain. The rest of the machinery fitted to the framework consists of grooved driving pulley wheels and pinions giving a double power, chain barrel, chains and pulleys. The larger pulley is driven from the hand by a rope, which pulley runs loose upon the spindle, transmitting its power by a small pinion fixed to a larger pulley and to wheel fixed to its spindle. The power is conveyed back to original spindle by a different wheel and pinion; on this spindle the chain barrel is fixed; the barrel is rigged with two chains, the end of one hanging down at one side of the hoist, and the end of the other chain at the other side of the hoist; while one chain is ascending the other is descending, so that while the end of one chain is at the top the end of the other will be at the bottom; one of the chains serves for hanging and taking carcasses off the hooks or loops on one rail, and the other chain for hanging and taking carcasses off the loops on the other rail. The two chains, besides being required for working right and left, save time in reversing, as there will always be one chain available and ready to hoist or lower a carcase as the case may be.

The carcase being ready for lifting from the floor of slaughter house, there is inserted in each hough, along with the cross tree or way, a double horned hook, and the chain being attached to the hook in the centre of the cross tree, the whole can be partially raised by the hoist and checked at any point by a ratchet; and as the carcase is gradually raised up, can be skinned and disembowelled. The rail beams above are furnished with jointed swivel hooks or loops. These hooks or loops are attached to rail beams at distances apart corresponding to the length of the "tree," and when the carcase is raised up, the double hooks inserted in houghs along with the "tree" come immediately under two of the loops on the beams, and each double hook is hooked by one of these loops. When the hoist is lowered away, the whole carcase is transferred to the loops and to the double horned hooks, and the cross tree or way comes out of the houghs and frees the hoist, which is then available for raising another carcase. This is left hanging to the rail beam held by a hook in each hough; here it is

dressed and finished, and as soon as finished it is divided down the back, leaving a half hanging on each swivel-hook or loop, where it is ready for the market. To carry the half carcase into the market, it has to be transferred to the hoist, which is done by linking the chain of the hoist into the unoccupied horn of the double horn hook. When the hoisting takes place, the carcase is drawn up, followed by the jointed loop on which it has been hanging, and as soon as the chain has come to the perpendicular, the jointed loop falls out, leaving the weight of the carcase hanging to the hoist, with a ratchet holding it. The carcase is then ready to be moved along the rails to the market, which is done by means of the handle before described, or by the traction on the two fore wheels, which are made to revolve by a grooved pulley fixed to the axle and driven from the hand by an endless chain, all as before described. Upon arrival in the market, the butcher stops his hoist and the carcase opposite the hook or loop on which he wishes it hung; he is furnished with a rod with a hook at its end with which he lifts up the jointed hook or loop hanging from underside of rail beam as shown; the hook or loop when lifted up comes to a nearly horizontal position, and far enough out to catch the unoccupied horn of the double horned hook on which the half carcase is hanging; when the hoist is lowered away the hook or loop grips, and as the lowering is continued the weight is transferred to the jointed loop which comes to the perpendicular, and the chain of hoist drops out, leaving the half carcase hanging to the beam. The picking off for the purpose of loading in the cart of the purchaser is just the reverse of the hanging process, and to the same movement as that described in taking the carcase off the jointed swivel-loop in the abattoir.

The machinery just described applies also to the retail abattoirs, the only difference being that the carcasses are loaded at the door of slaughter house and taken away for sale at the private shop or shamble of the butcher.

The sheep and pig carcasses are hung in the market at a lower level than those of the beasts. A projecting corbel is cast on to the face of the columns, supporting the overhead hoistway; this corbel supports a small rail supplied with hooks sliding horizontally on its bottom flange. The demand for hanging space for these carcasses since the opening of the market has been so great that additional rails have been provided, held by suspending rods.

If I have succeeded in explaining and describing clearly the operation of Mr. Meiklejohn's machinery, it will be seen that both the apparatus and the *modus operandi* are of the simplest nature, and, as the result has proved, highly successful, and worked with perfect ease and the utmost celerity. All I desired as to this part of my abattoir scheme has been realized. To sum up the advantages gained by the machinery and appliances above described:—a considerable amount of manual labour is saved; after the dead carcase once gets on the hoist, it never leaves the hanging apparatus overhead till the moment it drops into the cart which removes it from the establishment; also from whatever part of the market a carcase is purchased, this machinery enables the seller to detach it from the others and deposit it in the cart of the buyer without in any way disturbing the other carcasses hanging on the beam; and lastly, the handling of meat is reduced to a minimum, a fact which I think of great importance; and in all future abattoirs, constructed on scientific principles, I would recommend this as a desideratum always to be sought after and secured. From experience during the last two years, I am inclined to believe that it would be a matter of considerable difficulty to devise an apparatus superior to the above in its working qualities, which entirely supersedes such plans as the central crane and semi-circular hanging beam, in operation at Edinburgh, and the ingenious but impracticable hydraulic lifting power in use at the Bradford abattoir.

Having detained you quite long enough, I will draw this Paper to an end as quickly as possible.

It will naturally occur to any one interested in this subject that the drainage of so large an

ABATTOIR
 AND
 CARCASS MARKET
 ERECTED FOR THE
 CORPORATION OF MANCHESTER

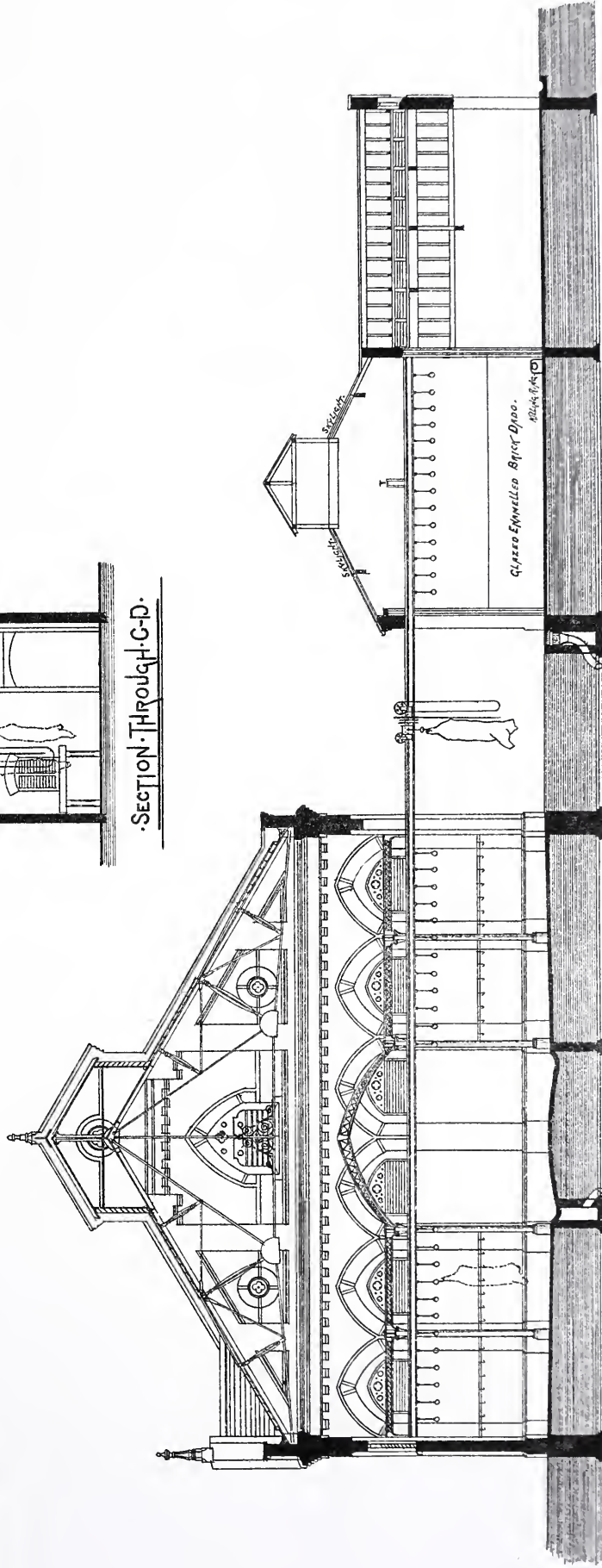
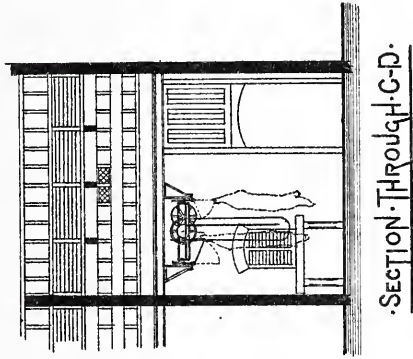

establishment as the Manchester abattoir is a matter of considerable importance. I will briefly describe the plan I adopted, and which I believe to be sound in principle.

In an establishment of this kind there is an unavoidable accumulation of filth ; and the main point to be observed in carrying out a system of drainage, is to prevent the admission of solid matter into the drains, which would have a tendency to choke them up, and cause endless trouble. I therefore determined that in this abattoir there should not be any openings into the drains, either in the slaughter houses or cattle lairs ; the floors are laid with an inclination from the walls, and a general fall towards the doorways into streets. During the process of slaughtering, all liquid matter finds its way out ; and when the floors are cleaned by means of hose pipes attached to a water-cock in connection with the city water supply, the cleaners sweep all out at the doors. In the roadways close to the outside walls, stone channels are laid the whole length of the elevations of the various blocks of buildings ; these channels are provided at certain intervals with a special form of eye or grid ; the grids are hinged to fall back against the walls, and on being opened reveal a cast iron box or chamber, with a flange all round the top edge, which rests on a rebate cast on the outer shell ; this box is moveable, and is perforated through the bottom and sides ; under the moveable box is another chamber opening direct into the trap, which is cast to the outer shell of framework. Nothing of any consequence in the shape of solid matter can get into the trap, but the liquid portion passes away freely.

The scavengers of the Corporation attend to the moveable boxes at regular seasons, and the contents are carried away to the manure depôt, under the control of the Health Department of the Corporation. The streets in the abattoir are drained and paved in the usual way, the surface and roof water going direct into the drains coming from various parts of the establishment. The grids, boxes and traps were cast by Messrs. Bunnett & Co. to special pattern, and in connection with the plan of drainage, have answered their purposes thoroughly, and I should be inclined to recommend the system of drainage adopted in this abattoir, to those who may have similar works to carry out.

The liquid manure is disposed of by the drains, and the solid manure from the live animals is deposited in a temporary pit, which is emptied at certain intervals by the servants of the Corporation.

The blood, as before stated, is carefully preserved, collected during the process of killing, and taken to a large store, where it is manipulated by a company on the premises, but not under corporation control. After passing through a process in the stoving room, the blood is placed in shallow tin vessels furnished with a tap at one corner. After a time the drawing-off commences whereby the albumen is extracted ; the matter drawn off is an important and valuable ingredient in producing the famous aniline dyes. After the drawing-off is completed, the residue is a peculiar pink coloured matter of the consistency of jelly, which can be divided by a knife. By a process recently discovered this jelly is converted into a valuable manure.

When the carcase is being dressed, a certain portion of the interior is cut away and sold by the butchers as unfit for human food until it has passed through a manufacturing process ; this matter is termed the offal, and consists principally of the stomachs and intestines. The stomachs after a process of manipulation become an article of trade known as tripe. At the Edinburgh abattoir the tripe is dressed on the premises, but the Market's Committee of the Manchester Corporation deemed it advisable that the whole of the offal should be removed from the site to the private establishments of the tripe dressers. The intestines, large and small, are taken to the gut-emptying room and then sent away, the large gut or intestine going principally to Germany to form cases for a well known kind of sausage. The stomachs and intestines of pigs are all used for human food.

There are a few constructive features in the Manchester abattoir perhaps worthy of a passing notice. The buildings are of red bricks, with Yorkshire stone used where absolutely necessary. The internal

walls of the slaughter houses are lined to a height of 5 feet with white glazed enamelled bricks; blood stains or any discolouration on these bricks are easily removed by washing, no filth can accumulate on the surface, and a neat and clean appearance is the result. The Carcase market also has a dado of the same bricks, with a band of cream coloured bricks as the top course.

The floor of the market is somewhat peculiar in its construction, and had to be specially prepared to withstand heavy weights from carts and "hurries" passing over. The entire floor area was first laid with good common bricks on edge, set on a firm bottom, and each brick having a space round it about half-an-inch in width; boiled bitumen or asphalt was poured over all until the interstices were filled up, and several coats of the same material were laid on the surface, the finishing coat was mixed with Spanish sand, and carefully manipulated, until the bitumen was completely covered. The roadway in the centre of market was formed in the usual convex section, the water channels at each side being formed by a slight sinking of the groundwork of bricks. By this method a jointless floor was secured, which can be cleaned with the greatest ease, and hitherto it has resisted all wear and tear, and remains as sound as when it was first laid. A variation of the method above described was used at the Bradford Abattoir, and, I believe, has since been patented by the inventor Mr. Atkins, of Liverpool.

Considerable difficulty was experienced in selecting a flooring for the slaughter houses, owing to the chemical action they would be subjected to during the process of slaughtering, and after a lengthy investigation into various kinds of asphalt and concrete, it was determined to adopt Yorkshire flags. It would be very desirable that some material should be used for the floors of abattoirs, which would dispense with joints; the joints are liable to wear and become filled up with the dirt arising from slaughtering, and much trouble is entailed in efforts to keep the floors clean.

The ventilation in this abattoir is regulated throughout with wood louvres; and by a simple device of attaching the nosing of each louver blade to a continuous flat iron bar, the whole window can be regulated at pleasure. The establishment is supplied by the Corporation with water and gas under the usual municipal regulations; each slaughter house being supplied with a stop cock, to which a hose can be attached for the purpose of thoroughly cleaning the apartment.

The total cost of the Manchester abattoir, exclusive of street paving and retaining boundary wall next the River Medlock, has been a little over £ 30,000. This sum includes gas and water mains, gas fittings, street lamps, and also various fittings for the butchers, in addition to the mechanical appliances.

Having touched upon the main features of interest in the Manchester abattoir, it now only remains to be stated, that the establishment has been in full working order for the last two years; and it is a source of satisfaction and pleasure to be enabled to state that it has fully answered the expectations of those interested. The slaughter houses are let at a moderate rental to the butchers, and a few yet remain empty. The Market has proved a great boon to the trade, and so large a number of carcasses are brought for sale, in addition to those produced on the premises, that it is feared the building will shortly want extending. Prior to the erection of this abattoir, the carcase trade was confined to a few hands; since the new Market was opened, the number of carcase butchers has been considerably increased, and an extensive and profitable trade has been developed.

I am informed by Mr. John Page, the Superintendent of the Manchester Markets, that during the month ending December 24th, 1874, there were 1,555, beasts, and 7,611 sheep and calves slaughtered at this abattoir; being 288 beasts, 1,507 sheep, and 44 calves in excess of those slaughtered during the same month in the previous year. These figures, I think, are satisfactory, as indicating an increasing appreciation of the usefulness of the abattoir I had the honour of carrying out for the Corporation of Manchester.

The CHAIRMAN.—Before we proceed to the discussion of this interesting paper, I may mention that two or three gentlemen have been specially invited, whose opinions on this subject will be very valuable. I am happy to say we have present this evening, Dr. Sedgwick Saunders, Officer of Health to the City of London; Dr. Hardwicke, the Coroner for Middlesex; Mr. Thomas Rudkin, Chairman of the City Markets' Committee; Mr. Colam, Secretary to the Royal Society for the Prevention of Cruelty to Animals; and lastly, Mr. Meiklejon, the inventor of the ingenious machinery for conveying the carcasses from the slaughter-houses into the market. I am sure we shall be happy to hear from those gentlemen any observations that occur to them.

Dr. SEDGWICK SAUNDERS (responding to the Chairman's invitation) said:—I feel honoured in being called upon to offer some remarks on this subject, but they will necessarily be from a sanitary point of view. There are one or two points which struck me as being worthy of a little more reflection. I do not know whether I correctly understood the author of the paper to say, that the walls of the slaughter-houses were of porous brick. [Mr. Darbyshire.—They are of glazed brick to the height of 5 feet.] I am glad to find that I am mistaken to some extent, but I am not sure whether glazed bricks to a height of 5 feet only is sufficient to prevent the absorption of the gases given off in the slaughtering process, especially in hot weather; and, I believe, it would be much safer to cover the whole of the walls with some kind of non-porous material. There is a point also with regard to condemned meat which is worthy of consideration, namely, as to the uses made of the meat after it has been digested in the chamber as described, and reduced to fibre, fat and bone. It is important to know, that in this meat fibre there is a valuable manure, which represents a commercial value of £1 per ton for every unit of ammonia. In some of this fibre which I analysed for the Markets Committee of the Corporation of London, I found 100 parts yielded 75·5 of organic matter, of which 9·6 consisted of ammonia; and, I therefore estimated the fibre alone at a commercial value of £10. per ton. In reducing this to a chemical problem, it shews this substance ought not to be thrown away, as it is in many instances, as mere refuse matter. The bone dust will also suggest itself to all as a valuable product, the phosphate of lime representing an active fertilising agent, the worth of which may be easily arrived at. There yet remains the fat which finds a ready sale for various special purposes. I regard it as a great merit in Mr. Darbyshire's scheme, that the condemned meat is destroyed *on the spot* where it is seized. At Deptford Foreign Cattle Market, we possess an admirably contrived apparatus for the destruction of condemned meat in closed cylinders heated by steam, which would repay the trouble of inspection. At one time there was a doubt whether the condemned meat was not tampered with *in transitu*, but this has been obviated by the free use of carbolic acid spread over the meat before it leaves the market, which renders it worthless for purposes of human food, because the odour of the carbolic acid is inerradicable, and prevents all possibility of being so used without certain detection. I consider it therefore most important that these appliances should exist on the site of the market, and that the meat should be destroyed for all edible purposes where it is seized and condemned. I think it also a valuable suggestion that no drain should exist inside the slaughter-house, because in the best constructed drains and gullies in many well-regulated slaughter-houses in London, the fact of their being so placed is a constant source of nuisance and trouble, it being impossible to prevent accumulations of blood and filth in them from day to day, which might be obviated by having all the gullies and drains outside. Another practical point is, that the hydrants or water service should be constant and placed at the highest part of the floor level of the slaughter-house, in order to get rid of the effete matter in the most effectual and speedy manner. I did not understand the writer of the paper to say that the lairs in this case are separated from the slaughter-houses. It is not only desirable that this should be so, but the separation should be from the floor to the roof, for in the hot part of the year,

the heat given off by the cattle, and the emanations from their perspiration, &c. must have a prejudicial effect upon the dead meat in the slaughter-houses, and, therefore, it is essential that all these lairs, in which the animals are waiting to be killed, should be effectually shut off from the slaughter-houses to which they are to be subsequently taken. It is impossible to over-estimate the value of this precaution, if the information is correct which was conveyed to me by a very intelligent meat salesman at the Metropolitan Meat Market, Smithfield, viz., that during the summer months when the temperature is very high, a rise of a single degree in the Fahrenheit's scale will make the difference of sound or putrid meat, and that nothing conduces to this effect more certainly than any admixture of moisture with the heat. Quite recently by the new bye-laws of the City Commissioners of Sewers, it was made a *sine qua non* that every slaughter-house should have the lairs separated from the slaughter-house by a strong partition extending from the floor to the roof. I feel honoured in having been called upon to speak on this subject, and I regret that I have not been able to say anything more useful.

DR. HARDWICKE, Visitor, said—I feel much honoured by having been asked to attend here, although I do not know that I can say anything which may be worthy of your attention. As to construction the paper is so admirable in all the details that it leaves nothing wanting in that respect. But there are some points which might be mentioned before a body of gentlemen like yourselves, which, I think are of great importance. We in London (except in the City) have not yet arrived at the decision of abolishing private slaughter houses, and if you can put pressure in this direction upon the Board of Works, and other public corporate bodies, you will do very great service to the community. In London the iniquitous practice of private slaughter houses is still retained to a great extent, and is sometimes so barbarous to contemplate, that I am astonished the public authorities in rich districts do not endeavour to get them suppressed. There are many points in which you may consider them more than nuisances, inasmuch as from want of inspection diseased cattle and cows from dairy sheds on the point of death can be taken off to these private slaughter houses, and there killed, in spite of the best system of inspection that can be organized. It is nonsense to say they are under proper inspection. I might go there in the day time, at any time, and might find no particular fault; but in the night, or early in the morning, there can be no doubt an enormous number of inferior and diseased cattle are killed in these private slaughter houses, which would not pass muster on the inspection of a public abattoir. I want to impress upon you that for this reason alone private slaughter houses ought to be tolerated no longer. With regard to the Act passed last year, it was smuggled through Parliament, and has given the Board of Works power to continue these nuisances. This subject did not receive last year in Parliament the attention it ought to have done. The interests of the butchers were paramount in the committee. Not only should there be public abattoirs north and south of the Metropolis, but there should be the means in these abattoirs of dealing with the blood and offal, the fat, the hides and hoofs, and horns of the animals. There should be places for the salting down of the hides in hot weather, the reception of the tallow and fat, and a melting place should be provided, properly constructed. In properly constructed abattoirs it involves a *depôt* for the treatment of the manure and blood. Another point which struck me was with respect to the cattle lairs; they need not be necessarily situated close to the slaughter houses. I think there might be lairs near to but apart from them, where provender and water for the cattle should be at hand. It is to the advantage of the butchers in buying cattle to be able to keep them three or four days for market purposes, or to kill as required. With regard to the construction of public abattoirs, all I have seen have been more or less imperfect, and do not meet the requirements of the case as they ought. I am therefore glad that your Institute has brought this subject forward, and set such excellent plans before the members. I am not sure whether corporations, or public boards, or private associations would best do this work; I am not one who thinks public bodies would in all cases do it best; but these places must necessarily

be under public inspection, I would make it a *sine quâ non*, that they should be under parliamentary regulations. At all events private slaughter houses are nuisances no longer to be tolerated in business parts of towns.

Mr. THOMAS RUDKIN (late Chairman of the Markets Committee) Visitor, said,—I think we may congratulate ourselves on having listened to a very able paper, and I must say for myself, the slaughter house and apparatus shown, seem to me to work admirably. There is only one point about it which struck me, and that is a matter of detail, viz.—whether there is as much economy of space as one might desire. Possibly by other arrangements you might get more space in the slaughter house and market than is shown on this plan; in some other respects there seems to be a great deal more space than is necessary. With reference to the question of compulsory powers being given to local authorities, I have always been an advocate for compulsory powers in this and other sanitary matters. Having been connected with the meat trade all my life, and knowing the inside working as well as that which comes before the public, I have no hesitation in saying that if compulsory powers were given to do away with the private slaughtering establishments in different districts of the metropolis, and if public abattoirs were substituted for them, the effect upon the trade itself would be immensely beneficial, whilst it would improve the trade as far as the public is concerned. Instead of increasing the price of meat to the public, as has been suggested, it would materially reduce it. The cost of driving cattle through the streets, if done away with, would positively pay the rents of the slaughter houses, whilst the proper and economical treatment of the offal would prevent a great waste in what might be used as good and wholesome food. The loss of weight of meat under the existing system, is something fearful to contemplate; it has been proved that an animal slaughtered in Edinburgh, near where it was fed, and another taken from the same herd and sent to London as carefully as possible by railway and slaughtered in London, will lose at least three stones in weight as compared with the other, and three stones of meat represent a sovereign. That is the loss to the community on every animal sent to London to be slaughtered. Therefore I have been an advocate for the slaughter of cattle in the country, and for the last ten years that course of things has set in to such an extent, that the quantity of dead meat sent into the market over that which is slaughtered in London, is steadily progressing. In the year 1868, when the Metropolitan Meat Market was first opened, we had about 130,000 tons of dead meat per annum; last year we had 160,000 tons; and though of course there is a large increase in the supply as the demand increases, still it is apparent, from the number of live animals sent to the market falling off, that there is more meat slaughtered in the country. On this question of slaughter houses there is one point which must impress the minds of all who have to design slaughter houses in any part of the country, that is the absolute necessity of having lairs separate from the slaughter house, as suggested by Dr. Saunders. In the next place the slaughtering department should be separate from that where the carcase is left to cool. I do not know whether I rightly gathered that this is the case in the instance which has been described to-night; if not, it should be. There is another point which is omitted in this plan, but which exists in Edinburgh and in Paris, and works admirably; that is a triperery. The offal of animals, on the continent, seems to be more used for food than it is in this country, and placed before the public in a more cleanly manner. In Paris you never see anything dirty in a butcher's shop. In London, unfortunately, you often find the reverse of that. With regard to the tripereries in Paris—take the simple article of sheep's trotters; it seems a small item. In London sheep's trotters are chiefly boiled down for glue, but in Paris they are taken to the triperery, thoroughly washed, then placed in a tank of boiling water, to scald off the hair; they are then carried away in a wheelbarrow with a false bottom into an adjacent building where from fifty to a hundred women and children are at

work scraping the hair off the feet with a blunted knife; they are then brought back again to the tank, cleansed again, and finally they are put into another tank and thoroughly boiled, and the oil alone produced from boiling the feet more than twice pays the expense of the manipulation. They are then bleached in a running stream of water and sold in the different shops in Paris at about 1½ francs per dozen. In London these are for the most part carried away with the skins; but a more beautiful food cannot be placed before any person—very gelatinous and edible, and they are just as good as calves' feet. A tripery, therefore, should be insisted upon for the manufacture of the offal on the spot. There should also be blood stores, and, what there does not seem to be here, a place for salting hides; in fact, from the beginning to the end the arrangements should be upon the most complete scale. The lairs should be comfortable and warm. I should like to see lairs in which the cattle can be as comfortable as the horses in a nobleman's stables. There is no reason why they should not be; but the cattle are often ill-used and kept without water, and they are slaughtered in such a state that it does not astonish me that so much meat comes before the public which one can hardly get one's teeth into; it is hard and has lost its nutriment to a great extent. There is one question about the flooring of the slaughter-house. I think it will be found impossible to get anything to do so well as the stone flags. There is one thing which is also absolutely necessary in the art of slaughtering that has to be provided for, and no other material so far as we see at present that will admit of a pick-hole being made so well—that is a hole in the floor to put in a stick with an iron point, which is inserted in the fore leg of the animal to keep it on its back while the legs are flayed. It is necessary that should be done, and there is no material that I know of which stands that so well as stone flags. There is one point also as to the expense of this abattoir at Manchester. I do not know whether I rightly gathered that £30,000. was the cost of the slaughter-houses and market, or whether it was for the slaughter-houses alone.

Mr. DARBYSHIRE :—The slaughter-houses and market.

Mr. RUDKIN :—I quite agree with Dr. Saunders that there should be complete separation of the slaughter house from the place in which the live animals are placed; and the most essential point of all is that the dead carcase of the animal should not be allowed to remain in the slaughtering department. The plan of lifting the meat, and never permitting it to be handled, is a very wise one; a similar plan was successfully tried by myself at Deptford. We established some new slaughter houses in connection with the Foreign Cattle Market, where we have something similar to this apparatus at work; but the difficulty we experienced was in getting the men to lift the carcasses a sufficient height to enable them to be loaded into the wagons. That arose from the fact that the men who slaughtered the animals were not those who cut the carcasses down, and put them in the vans, and they showed no disposition to save their fellow workmen's labour in the matter of loading the meat. That was the only objection raised to it, and we could not get them to work it except in cases where the butchers superintended the slaughtering of their own animals, and insisted upon the men pulling the carcasses up so that they could be conveniently loaded. I must say that in the course of my investigation of this question of slaughter houses, in company with my friend Mr. Horace Jones, I went to Liverpool, where there was a slaughtering establishment occupied by a person of the name of Stride, I believe, who slaughtered very largely for the shipping trade, and he had a very ingenious traveller apparatus at work, by means of which the carcasses were carried from the slaughter-house and placed along the front of his shop, and inside the shop as well, so that he never kept any carcasses in the slaughter-house while the slaughtering was going on. We have been trying to carry that plan out at the Copenhagen Cattle Market. With reference to the provision of slaughter-houses for London, I may say that we have decided upon erecting twenty at Copenhagen Fields. That will test the question whether private butchers will send their animals there to be slaughtered, or whether they will prefer to continue to resort to the private ones. I have no

hesitation in saying when these slaughter-houses are constructed the trade will largely avail themselves of the accommodation. There is a great desire to prevent the driving of cattle through the streets of London, which is not only detrimental to the animals, but the saving of the fees to the drovers will more than cover the cost of the slaughtering at the Copenhagen market. On the point of inspection I would say, the inspection of private slaughter-houses is a mere farce, and I know from my own experience that in those houses a large quantity of bad meat is slaughtered and sold to the public and consumed as human food.

Mr. JOHN COLAM, (Visitor) said,—As well as the gentlemen who have preceded me, I, as Secretary to the Royal Society for the Prevention of Cruelty to Animals, feel honoured by the invitation to be present here this evening. I may say that all previous speakers have confined their remarks to the interest of man with reference to the slaughtering of animals. I am far from saying that is not an important matter, but considering that animals are endowed with capabilities of pain, I regard it as an important matter to consider on their behalf how the animals themselves should be treated in the slaughter-house. I would say, first, as far as my experience goes, that it is impossible to prevent cruelty to animals in the private slaughter-houses of London. Take the number of slaughter-houses that exist. There are nearly 1500 in London. It is impossible, either for sanitary purposes or for the prevention of cruelty, that inspectors should go to all these slaughter-houses. We may say slaughter-houses are in most cases private property : and though we are not refused entrance to the Copenhagen Fields Abattoirs, it is impossible for officers in the police to obtain admission into the many hundreds of private slaughter-houses that exist in London ; and so as far as cruelty is concerned there could be no inspection even if the number were reduced : but as soon as you erect commodious abattoirs, like those at Manchester, it is manifest that cruelty will be reduced to a minimum : first by the circumstance that the place is public, the public eye acting as a deterrent in such cases ; and secondly, with regard to the efficiency of the men employed, for the most efficient men will be engaged in houses where the largest number of animals are slaughtered : and the efficiency of the men is an important element in the abatement of cruelty. Then again as to the treatment of the animals by lads. One of the causes of much cruelty in private slaughter-houses is that boys get hardened by finding they can do things with impunity. In public slaughter-houses that will not be tolerated. Then again there will be a better means devised for the destruction of animals. We have by no means reached perfection in the modes of killing. I am not here to condemn the English mode of killing, for I think the poleaxe in the hands of an efficient workman is the most simple instrument and the least productive of pain. I contend the animals never really feel the effect of the blow. The poleaxe, which is a punch, cuts through the skull and enters the brain : a cane is introduced into the hole, which breaks the spinal chord and instantly destroys all sensibility of pain. Other modes might however be made use of, and physiologists are at present advancing views on the subject, more consonant with the ideas of humane persons, and at the same time provide a solution of a difficult religious question affecting the Jews, whose butchers have a method of killing oxen which I cannot but regard as a cruel process. Their animals are thrown to the ground and their throats are cut, and the average time of dying is five or six minutes, which I have timed myself, whilst the Christian system of killing is almost without any cruelty at all. I think therefore that the erection of public abattoirs would cause a great reduction of cruelty. Other consequent changes would tend in the same direction : as for instance, wide entrances for the animals leading into each large building, through which they could pass without difficulty. Mr. Rudkin, who probably knows more about the London slaughter-houses than I do, will I am sure agree with me when I say the great bulk of them are unprovided with proper appointments, considering the purposes to which they are devoted. The passages are for the most part so narrow that the animals are made to go forward by the cruel process

of screwing their tails, and to my own knowledge in some parts of London the animals have to be taken down a flight of steps to be slaughtered. Then there are other matters, such as the lairs. Except in one or two instances, which could be named, there is very inadequate provision with regard to lairs. In Aldgate the lairs are generally a part of the slaughter-house cut off with beams and stanchions. I often think the animals do know something of what is going on whilst they are compelled to witness the slaughtering of their fellows. In Paris nothing of that kind occurs. Then again there is another advantage gained by these abattoirs. This is in respect of the cruelty which often takes place in driving the animals through the traffic-crowded streets of London. That would be reduced ten-fold by the erection of abattoirs in various parts of London: and the great thing would be to get as many slaughtered as possible at the cattle market, so that they have only to travel from the lairs to be slaughtered as required; and this would be a great advantage, especially in the hot season of the year, when by sending a telegraph message a butcher can have his bullocks killed according to his business requirements. I repeat that if these abattoirs were distributed over various parts of London, the cruelty of animals travelling through the streets would be very much reduced. The animals, after being taken from peaceful fields, are brought to London by train; they reach the market in a frightened and inflamed state, and they sometimes get water and sometimes none, unless they are fortunate enough to be taken at once to the commodious lairs provided in Copenhagen Fields. The drovers have a difficult task to perform in getting the animals through the streets, and it often involves a great deal of cruelty. In conclusion I would add that I have seen slaughtering done in butcher's shops, and in parts of the country I could take you to places where, at the present time, the slaughtering takes place in the shops of the High-street of the town before crowds of boys and girls who seem to gloat over the sensation of such scenes.

Mr. HORACE JONES, Fellow, said.—At this late hour there is one duty which devolves upon us, and it is my good fortune to perform it. It is to propose a vote of thanks for the very excellent essay which our friend Mr. Darbyshire has read to us. He has had the good fortune to have been engaged in carrying out a work connected with one of the most important subjects of the day, and we have heard the united testimony of the gentlemen who have spoken as to the benefits and advantages which abattoirs are calculated to confer. I hope our friend will go on and show his skill in Liverpool with even better results than at Manchester and elsewhere. I must say a trip made to Paris for the purpose might not be lost, which city I visited a short time ago, and found one large abattoir in lieu of five which had been formerly established there, to the great advantage of the community of Paris. There are some points in the paper which have been alluded to by abler hands, but there is one matter which I would call your attention to, and that is the question of lighting. Some people hold the opinion that a diffused light is never desirable, but that whether for killing animals, painting pictures, or examining diamonds, a light without shifting rays and from one direction is best. I am sure all present will join in tendering our best thanks to Mr. Darbyshire for his paper.

Mr. JENNINGS, Fellow,—I have great pleasure in seconding the proposal, and in doing so I would observe that I concur to a great extent in the opinions expressed on this subject, and I regard it as a most important matter that abattoirs should be provided—especially as far as London is concerned. There is, I know, a strong prejudice amongst the butchers, that it would make meat more expensive, and that they would not be able to get rid of the offal so advantageously, and as I can speak from my own knowledge with regard to our parish having actually opposed the compulsory powers which it has been contemplated to apply for, I trust the first step taken will not be to endeavour to obtain compulsory powers, and that those powers may be retained, after it has been found that the system works well. I believe that abattoirs on the right system will work well;

but the feeling at present is that they are more required for cattle than for sheep. We are much obliged to Mr. Darbyshire for the Paper, and also to the other gentlemen who have kindly given us their views on the subject.

Professor KERR, Fellow,—With regard to the lighting, I understand that some of these compartments are lighted from the roof. Is not that objectionable, and would it not be better always to light from the north side of the building? Another thing is, if you want light very effectually diffused, a good plan is to use obscured glass flush with the outside of the wall, the obscured side being placed outside, the effect of that being remarkable with regard to the diffusion of light.

Mr. HENRY DAWSON, Fellow—I think as our friend Mr. Horace Jones has proposed a vote of thanks to the author of the paper, it is due from us also to express our sense of the kindness of such gentlemen as Dr. Saunders, Dr. Hardwicke and Mr. Rudkin in coming here and giving us the benefit of their practical knowledge and advice on this subject. We all know in the clerical profession it is often stated that they want more of the advice and co-operation of the laity; and I am sure, we as architects, equally admit the advantages to be gained by more frequent intercourse with those whom we may call laymen, and that our success in carrying out any particular work often depends upon our availing ourselves of the special knowledge and experience of such laymen as those gentlemen who have favoured us with their remarks this evening. We are therefore very much obliged to those gentlemen, and I have much pleasure in proposing a vote of thanks to them for the useful information they have afforded us.

Mr. C. FOWLER, Fellow.—I would take the opportunity of suggesting that the author of the paper should oblige us by giving a little further explanation of the drawings which would be interesting to many present. We are told that the building has a roof of a certain form, and Mr. Darbyshire has alluded to iron bearers, but at present I am not aware whether the roof is an iron one or what it really is.

Mr. E. ROBERTS, Fellow.—I was not fortunate enough to be present early enough to hear the paper read, but I gather from the discussion that one of the points was in reference to the kind of paving, and I would add my testimony to much of what Mr. Rudkin has said. He has, however, stated that he considers flagstone to be the best material for the flooring of slaughter houses, and I gather that Mr. Darbyshire recommends asphalt. [Mr. DARBYSHIRE—Flags.] I would say in my experience that flags prove to be porous, are not a good material for the purpose, and I will give you my reason for saying so. Some years ago I was called upon to advise with regard to some property contiguous to the slaughter houses at Copenhagen Fields. The gardens of the houses so contiguous were some few feet lower than the level of the flag paving of the slaughter houses. I visited the slaughter houses, and could not detect any defects in the paving, but the part on the outside was apparent that the blood and sullage oozed through the garden-beds, and run down the outside of the walls into the adjacent soil, and thus occasioned a serious nuisance to the inhabitants. I therefore came to the inevitable conclusion that flag pavement would not prevent the percolation of the blood. An action was intended against the Corporation of London, but after a few weeks I heard no more of it. My friend Mr. Pownall and myself were perfectly prepared to prove the fact of the permeation of the blood through the walls into the gardens. There is one other matter:—If Mr. Rudkin is right in his views with regard to the subsequent treatment of the offal, &c. it would only seem reasonable and proper that every trade connected with the subsequent manipulation of those matters should be placed in the vicinity of the slaughter houses. It shows that we do many odd things. I recollect at the time cesspools were done away with it was followed by the sending of the sewage into the river, and ever since then great efforts have been made to get it out again. So we put the slaughter houses in situations where there are no trades or manu-

factures connected with them; and whether we go to Bermondsey or Copenhagen Fields, or anywhere else, it is quite certain that all slaughter houses should be out of the precincts of cities. They are a nuisance always to a certain extent, and the sooner we come to the conclusion that they should be ten or even twenty miles out of London the better. I beg to thank Mr. Darbyshire and the gentlemen who have carried on the discussion.

The vote of thanks to Mr. Darbyshire and the visitors who had taken part in the discussion was unanimously adopted.

Mr. DARBYSHIRE, having complied with Mr. Fowler's request, by pointing out on the drawings the principal features of the plan, said: In reply to Dr. Saunders, perhaps I omitted to mention that the butchers lay great stress on the fact of having their beasts and sheep brought close to the place of slaughter. If they have a larger stock than there is accommodation for in the separate lairs, they are placed in this large general lair. The bullocks are ranged along the wall, and the sheep are placed in pens, and there is a solid brick wall from floor to ceiling which effectually separates the slaughter-house from the lairs. There is no means of the two atmospheres mixing together when the slide door is closed. The moment one bullock is killed the door is opened to admit another, and the door is closed again immediately afterwards, inasmuch as I objected to even a possibility of the animals themselves having any notion of what was going on. With regard to the pick holes in the floor, we do not require them by this arrangement. As soon as the animal falls the tree is placed in the hocks, and the mechanical apparatus comes into play. The animal is raised and the butcher proceeds with his work, and the carcase is raised imperceptibly during the flaying and dressing. For my own part, however, I should like to do away with the flags, and have a jointless floor in the slaughter house such as we have in the market, and which has stood remarkably well. With regard to the offal, that question was discussed a good deal in Manchester, and it was decided that with the exception of the blood all offal should be removed from the establishment. There are in Manchester several tripe dressing establishments under the control of the sanitary authorities of the city, and it was thought better that, after undergoing a certain extent of cleansing, this portion of the offal should be taken away by those who purchase it. A tripery was a part of my scheme. They have a tripery in the Edinburgh abattoir, but it was such an offensive thing on the establishment, that the Corporation of Manchester decided the tripery should be removed from our abattoir. In this case what was intended for the tripery has been added to the portion appropriated to the treatment of the blood, and we have no tripery at all. The market roof is covered with slate and glass—a row of slate and then a row of glass, and then slates again. In conclusion, I beg to thank you for the kind way in which you passed the vote of thanks to me. It has given me great pleasure to do what I have done, and I feel greatly obliged to the scientific gentlemen who have graced the meeting with their presence, and whose remarks I have listened to with great pleasure and interest.

The Meeting then adjourned.

Royal Institute of British Architects.

At the Ordinary General Meeting of the Institute, held on Monday, the 15th of February, 1875,
SIR G. G. SCOTT, R.A., President, in the Chair, the following Paper was read:—

ON THE TEMPLE OF DIANA AT EPHEBUS,

By J. T. WOOD, Fellow.

AS I was informed by the Secretary that a number of gentlemen interested in Grecian architecture had been invited to come here this evening, and I therefore anticipated a most lively and instructive discussion, I have prepared as short a paper as would allow me to point out and describe the main features of the Temple of Diana, the remains of which have now been entirely laid bare by the excavations carried on at Ephesus, under the auspices of the Trustees of the British Museum.

I will first of all point out the site of the temple, and I shall then confine myself to a description of the result of the excavations, as far as the Temple of Diana is concerned, which I trust, imperfect as it is, will still be found sufficient as a groundwork for discussion. On the last day of the year 1869 the pavement of the Temple of Diana was found nearly twenty feet below the present surface of the ground; this pavement proved to be that of the last temple but two, which was commenced about the year 500 B.C., and was built by Chersiphron* and Metagenes his son, on foundations laid by Theodorus of Samos. This pavement was formed of two thicknesses or layers, the lower one 15 in. thick, of limestone from the quarries on Mount Coressus, and roughly tooled: the upper one of white marble 9 in. thick, rubbed and polished; the upper layer consisted of irregular blocks, chiefly wedge-shaped, as if they had been previously used in conjunction with columns, and the joints made to radiate from their centres. In conjunction with the first patch of pavement found, there was the lowest course of the southern anta of the west front of the same temple (the last but two), and this, with some additional masonry, had served for the foundation of the same anta for the last two temples, which I afterwards discovered had been raised one above the other. On enlarging the excavation where the pavement was found, some drums of columns were laid bare. They had fallen from one of the outer columns of the peristyle, and had remained as they had fallen upon the remains of foundation piers and the connecting walling; this column I therefore traced to its base, under the foundations of which I found the square plinth stone of the base of the last temple but two. The drums of columns were from the last temple, and being from the middle of the column measured only 5 ft. 7½ in. in diameter. Near this spot I found remains of two capitals, so much mutilated that only one of them was forwarded to England, and this and two other capitals, afterwards found, are in the British Museum. In sinking a number of trial holes to ascertain the direction of the temple I found most fortunately the base of one of the outer columns of the peristyle on the south side in position, with the lowest drum of the shaft superimposed; this is re-erected in the Elgin Gallery. The bases of the two

* Or "Ctesiphon," according to Vitruvius and Pliny.

columns now found, being about 150 feet apart, I had a considerable area to explore, which was without doubt a portion of the site of the temple. This done, large patches of the pavement were found undisturbed, excepting by earthquakes, which had made it somewhat like a sheet of crumpled paper, and upon it rested many drums of the columns, fragments of the enrichments, and some Greek pottery. A considerable portion of the massive masonry, which supported the steps, was also laid bare; here also were eventually found two stones from the tympanum which give the angle of the pediment as 17° , rather a steep pitch for the roof of a Greek temple.

As the excavations proceeded, the portions of the temple which enabled me to make the plan now before you were discovered, a small portion of the cella wall on the south side, and a considerable length of the west wall of the cella remained undisturbed to the height of three courses, and the distinct impression of both the flank walls and of one of the cross walls to the height of four courses above the plinth, was found upon the rubble masonry of some foundation piers of a building, which must have been commenced some centuries after the destruction of the temple, and which had been thrown in against the cella walls before they were entirely removed. These piers were eighteen in number, nine on each side, and their existence and position enabled me to ascertain the probable whereabouts of the cross walls at the east end of the cella; there followed in due time the discovery of the base of one of the inner columns of the peristyle, and a very considerable length of the masonry which supported the steps of the platform on the north side, with the walling between it and the foundation piers of the outer columns of the peristyle. The position of this walling, and the distance between the column on the south side and that on the north side, enabled me to determine the intercolumniations between the columns on the flanks, which intervened between the antæ at each extremity of the temple. The base of the column on the south side had been thrust out of its original position at the time the column fell, but I was assisted in ascertaining its exact original position by that of one of the plinth stones of the base, which had evidently remained undisturbed, and the measurement was checked by a long dimension obtained between the buttress walls; the error, therefore, if any, must be infinitesimal. The dimension thus obtained is 17 ft. $1\frac{3}{13}$ in. The walling of the cella, which was 6 ft. 4 in. in thickness, had been thickened out to 13 ft. for the foundations of the two succeeding temples. The lower part of the southern anta at the west end remained in position, as I have before said, and this, with the walls of the pronaos, had been also thickened out; the thickening of the anta remaining to the height of several courses. The actual relative positions, then, of the columns of the peristyle and the antæ were exactly ascertained, and in the disposition of the columns of the west and east fronts, it only remained to decide the position of the two central columns. There was, unfortunately, so little remaining of the foundations of these columns, that their actual position could not be positively decided, and I was obliged to place them so that the entrance door, with its architrave and finishings might stand between them; also that there might be a gradual and harmonious diminution of the intercolumniations from the centre to the extremities of the front. It must have been the immense block which formed the architrave between the central columns of the temple, which gave the architect so much trouble, and which the goddess Diana is said to have assisted him in placing, the bearing being a little more than twenty feet.

The position of the southern anta at the west end, and of the foundation piers of the western columns of the peristyle, determine the position of the columns at the two extremities, and the intercolumniations are there increased from 17 ft. $1\frac{1}{2}$ in. to 19 ft. 4; this was done to allow for the projection of the sculpture on the *columnæ calatæ*, as well as to correspond (as it does exactly) with a wider intercolumniation in front. The foundations of the altar were found as shown in plan, and this had evidently been its position for the last three temples. It was extremely difficult to explore the

cella, as it was full of immense blocks of marble; there was no cross wall found, excepting the west wall of the cella. The impression, however, of one of the cross walls at the east end upon the foundation piers proves the position of that wall; the cella is nearly 70 feet wide. I have supposed the works of Praxiteles, Scopas and others, which are described by Pliny as adorning the altar, to have been placed in a recess behind the altar.

In course of time a long length (more than 100 feet) of the lowest step of the platform on which the temple was raised was found in position on the north side. A short length was also found at the east end. This discovery was very important, as it enabled me to complete my plan, and to ascertain the length and breadth of the platform, the number of steps required to mount to the peristyle, and various other matters of detail in respect to the temple, and the platform on which it was raised, which had been wanting up to that time.

The temple proved to be octastyle and diastyle as described by Vitruvius. I have supposed it to have been hypæthral, not only from its immense size, but because I found a Corinthian capital elliptical in form, which I suppose might have come from the upper tier of columns of the interior.

What the hypæthron of the Greeks really was has not yet been determined, and I am sorry to say I found nothing on the site of the temple which can advance our knowledge of it. I have supposed the expression to imply that it means literally, open to the sky, and that a considerable portion of the cella had no roof whatever; the statue might have been defended from the weather by a canopy, or something like a baldachino.

I found many fragments of the torus of the lowest drums of the columns, which were inscribed with dedicatory inscriptions. The lower diameter of the columns was 6 ft. 0½ in., the upper diameter 4 ft. 10½ in., they were built in frusta or drums varying in height from 2 ft. 6 in. to 4 ft. 6 in. I have taken the statement of Vitruvius as my guide for the proportion of the columns, and have made them 8½ diameters in height, from the top of the base on which they were raised; this will make them 55 ft. 8¾ in. in height, *including* the base, which dimensions approximate nearly enough to Pliny's statement, that they were sixty Roman feet in height—a Roman foot being, as you know, a little less than an English foot. The outer columns of the peristyle had twenty-four flutings, the inner columns had twenty-eight flutings. Vitruvius describes the inner columns of the peristylia of temples as having thirty flutings. The flutings were elliptical, the fillets dividing them being only a full inch wide. The outline of the base is particularly beautiful, excelling in refinement all the bases of Ionic columns I have ever seen, and it gains much by being raised above the pavement upon a square plinth nearly 18 in. high. The capitals of the columns are remarkable for their boldness and simplicity of design, the eggs composing one of its chief features are nearly a foot in depth; the volutes are of corresponding beauty; the abacus was adorned with the egg and tongue a little more than 5 in. deep. Fragments of the architrave were found, but in all cases the mouldings of the upper part had been chopped away. Several large fragments of the frieze were found, two of which had a portion of the bed-mould of the cornice, and one of the larger fragments gives us the total depth of the frieze itself, which is 5 ft. 6 in. One large fragment of the cymatium was found, it was enriched with a beautiful example of the conventional Greek honey-suckle. Some lions' heads from the last three temples were found; the best specimen, which probably belonged to the last temple, is nearly 2 ft. across the forehead. Fragments of the flat marble tiles were found, also the circular cover tiles—the latter measure 7 in. in width, and two fragments of an antifixa, which was nearly 18 in. wide and about 2 ft. in height.

The walling of the cella of the most ancient of the three temples was composed of large blocks of fine white saccharine marble, which were slightly bevelled at the joints, to prevent fracture of the

arrises ; the fronts of the blocks were frosted. Bearing in mind Pliny's description of the manner in which the foundations were laid, I sank some holes against the walls of the cella with the aid of a pump, and found at a depth of 5 ft. 9 in. below the pavement, a layer 4 in. thick of a composition resembling glazier's putty in appearance and consistency. Under this there was a layer of charcoal 2 in. thick, below which there was another layer of the putty-like composition 4 in. thick. There is, therefore, no doubt about the charcoal having been used as described by Pliny; and the composition as it appeared to be, might have been the fleeces of wool, as chemists have assured me. I may say, I very much doubt this myself. The water came in upon us so quickly, that we found it impossible to obtain a clean cut of the three layers as they were found, but specimens of the composition and charcoal were obtained and sent to the Museum, and I hope the former will one day be analysed.

I have now to complete the description of the *last* Temple of Diana, as far as I have been able to restore it, from the data obtained by the excavations on its site. I found that the last temple had been raised upon a platform of fourteen steps, the height of the peristyle was 9 ft. 5½ in. from the pavement, found in position beyond the lowest step. This pavement was Roman, and was of white marble 3 in. thick, laid on *korassan* or red cement 3 in. thick, which was placed upon a compact foundation of rubble masonry 21 inches thick. The rise of each step of the platform was a little more than 8 in., much less therefore than ordinary temple steps, which I suppose would average 11 in.—the treads were 19 in. The width of the platform measured on the lowest step was 239 ft. 4½ in., the length 418 ft. 1½ in.; measured on the upper step, the width was 198 ft. 2½ in., the length 376 ft. 11½ in. The former dimension was that of the "universum templum" given by Pliny as 220 ft. by 425 ft. (Roman), and which led to so much misconception as to the size of the temple, making a reasonable restoration impossible. Mr. Watkiss Lloyd, however, conceived the idea, before the discovery was fully made, that Pliny's "universum templum" implied the platform upon which it was raised, and not the temple itself. Great credit is therefore due to this gentleman for his suggestion, and I take the present opportunity of mentioning it publicly.

The dimensions of the temple itself, measured on the plinth line, were: length 342 ft. 6½ in., width 163 ft. 9½ in. There were eight columns in front and twenty on the flanks. The columns of the peristyle were according to my plan, as Pliny described them, 100 in number. Twenty-seven of these, he tells us, were the gifts of Kings. Thirty-six of these were *cœlatæ* or sculptured, and probably the whole of the twenty-seven given by kings were *columnæ cœlatæ*. On the only torus of a sculptured column found, there was no inscription, as on that of the other columns, which were, I suppose, given by communities or individuals whose zeal was further stimulated by vanity, in the same manner in which that human weakness has been indulged and utilized in modern times at Glasgow. In the windows of the beautiful crypt of the cathedral there, is to be seen a great variety of stained glass, and what strikes the visitor at first sight, is the conspicuousness and obtrusiveness of the armorial bearings and names of people who have been allowed to indulge their vanity, and bring their names and their dignities, such as they are, before the public, on the condition that they paid the expense of glazing the window, their personalities taking up, in some cases, as much as one-third of the whole window. In this manner the sexton, who showed me over the cathedral, told me the windows were all glazed in about three years. The same spirit might have assisted materially in the rebuilding of the temple from time to time, to which their dedicatory inscriptions in a great measure testify. The dedications of the *columnæ cœlatæ* were probably inscribed on a band above the sculpture, which, I have supposed, was discontinued at the height of 6 feet above the base, or one subject in height. This however scarcely accords with the Roman medal of Gordianus published, in Professor Donaldson's "Architectura

Numismatica," and bearing a representation of the temple, which shows a band above the base at about one-third the height of the shaft. This would allow for three tiers of sculptured frusta, and that will be one of the points for the discussion which I trust will take place this evening.

Portions of four or five of the sculptured drums are now in the Museum, the most entire of which represents an assemblage of the gods and goddesses, in which Hermes and Thanatos are conspicuous figures. The figures are here planted as closely as they can be placed, and there must have been as many as ten in the whole circumference of the column. Another drum found shows the figures equally numerous, but one half-drum of another column has only two figures in the semi-circumference, the projection of these two figures being as much as 13 inches, while that of the other drums is bas-relief, the projection in no place exceeding 5 inches. Another example shows a number of figures which are alternately standing and seated, the stools or chairs of the latter having an architectural character and thus serving to preserve to a great extent the form of the column.

Another drum represents male figures in Persian costume in very low relief; the variety of treatment exhibited in these few examples, which constitute all that was found of the sculptured columns, is very striking, and is worthy of special study. I found traces of colour (blue and red) on many of the fragments found, and one example where gold had been used: this consisted of two astragals, with a doubled strip of thin lead between them, enclosing a strip of gold, which had, I suppose, been turned down and formed a fillet between the astragals. In taking down the foundation piers, which had been built within the walls of the cella, I discovered the pavement of the temple which had been burnt by Herostratus, the night Alexander the Great was born: this was merely 4 feet above the pavement of the last temple but two. I also found the distinct remains of the last three temples, and rescued about 200 fragments of sculpture and architectural enrichment; about a hundred of these fragments had formed part of an archaic frieze from the most ancient of the three temples.

I shall add, that I found the heavy blocks of marble which were grooved for the wheels on which the large entrance doors of the west end of the cella had moved, these showed that the doors themselves had been about 15 feet wide. Part of the architrave of the doors of the last temple was also found: this was 3 feet in width. It was inscribed with the names of Marcus Aurelius, his wife Faustina, and daughter Fadilla. In the pavement of the pronaos between the antæ at the west end, I found mortice holes cut. I presume therefore, that the pronaos had been fenced off from the peristyle by an iron grill with central gates. The marble of which the last temple was built, was inferior in quality to that used in the last temple but two. The neighbouring mountains abound in marble of several kinds, and a very fine saccharine marble is found in a quarry at Cosbonnar, which is more than five miles from Ephesus, the marble for the more ancient temple might have come from this quarry, and that for the last temple, which is inferior, and is full of grey streaks, might have come from the immediate vicinity of the temple, but not from Mounts Coressus or Prion.

It remains for me only to add, that Deinocrates, the Macedonian architect, who lived in the time of Alexander the Great, was the architect of the last temple. Many architects must have been employed from time to time during the period of upwards of two centuries occupied in building the last three temples. The names Demetrius, a priest of Diana, and Pæonius, an Ephesian, are associated with the most ancient of these, and an inscription recording a votive offering to Diana, which I found near the temple, is from Frontinus, an architect of the temple; this might have been the same Frontinus who lived in the time of Cæsar Augustus, and who was the author of a Treatise on Aqueducts. The whole site of the temple was explored for 30 feet beyond the lowest step of the platform on all sides excepting on the east side, where a length of about 60 feet remained, which was explored only 6 feet from the lowest step. The ground at the west end, however, was explored to a greater distance than

30 feet beyond the steps. The exploration of the site of the temple occupied thirty-six months, and extended over a period of nearly five years. An average force of about 200 men was employed; the average depth of the excavation is 22 feet, its area being about 500 feet by 300 feet. The excavations were abandoned by order of the Trustees of the British Museum in March, 1874.

Mr. HYDE CLARKE, Visitor, (responding to the President's invitation to open the discussion) said—Mr. President, I can scarcely respond to your appeal, because Mr. Wood has stated that his remarks apply chiefly to the Temple of Diana rather than to the City of Ephesus itself generally. I am myself rather more conversant with the city and the general subject of Ephesus than with the special matter to which Mr. Wood has addressed himself on this occasion. I however think we may all congratulate ourselves that our friend Mr. Wood has been the means of effecting this remarkable discovery, and I say so with the less hesitation, because, though I have had some controversy with him on some points, I have never denied the exactness of the discovery, its importance and the high credit which is due to Mr. Wood for it. I have had the opportunity of seeing him labouring there in almost every part of the city, and I know he has felt the most earnest zeal to furnish the members of this Institute and the profession at large with every detail which could be got from the relics of such a great school of architecture. It is no fault of Mr. Wood's that the remains we have, with reference to the whole, are relatively insufficient to give an adequate idea of that enormous and beautiful structure. It has rather tended to whet our appetites than to satisfy them. I say this the more, because whatever was the influence which the old Greeks exercised on Asia Minor, Asia Minor must have exercised a still greater influence in reflex. If we consider the numerous and great growth of architecture, sculpture, and painting at Ephesus, Samos, Miletus and so many cities, we must be convinced that they exercised a deep influence upon that age. I cannot help being struck with the contrast between those higher paintings on the walls of the Temples of Jupiter Olympius, and those which Mr. Wood has portrayed to us. The one is what we understand as Grecian, the other, as in the case of those drums and the statue of Diana, is Asiatic in its traditions. There was a yielding to Asiatic influences, which in the last moments of the temple preserved that archaic figure of the goddess, while in the statue of Jupiter Olympius the taste of the Greeks bestowed every attribute of beauty and magnificence. The more information we get, the better we shall appreciate the distinction which undoubtedly existed between the two schools, and the influence which one exercised upon the other. The Asiatic influence, I consider, is far more worthy of study than that which is generally attributed to the Egyptian, and later discoveries may make us doubt whether we are justified in claiming for the Egyptian that inspiration which we are apt to attribute as one of the points of distinction. The discoveries of Dr. Schliemann were in conformity with the general tending of archæological research, and shows how ancient were the schools of Asia, and how great and vital was the influence which it exercised. Whatever we owe to the genius of those whom we understand as Greeks, we owe still more to those great schools which pre-existed in Asia, and which will be better understood the more the remains of Babylon and Assyria are made known. The great object is to get more materials on these subjects. I miss this evening one of our old friends—the veteran of classic explorers—Professor Donaldson.* I regret he is not present to tell us how he studied this subject half a century ago on this very ground. We must, however, while we are examining the records and testimonies before us, bear in mind that they have not only been achieved by the great labour of our friend, but at the risk of his health, and even of his life. During the years I was in Asia Minor I had the pain of witnessing the loss, through death, of many distinguished artists sent out from Europe. Mr. Wood himself has had to resort to a curious piece of arithmetic, when he said

* Professor Donaldson was unfortunately prevented by illness from attending the meeting.

he had been employed on this work for thirty-six months, and that thirty-six months made five years; but when we take out of these five years the periods devoted to fever and others which would ever trench upon a considerable part of the thirty-six months, and consider likewise that he worked beneath the surface down to the ancient water bed, and has had to contend not only with miasma and fever, but with many obstacles and privations, it is fortunate he has discovered as much, and so much of a remarkable character, as he has done in his labours. We are apt, indeed, to be unjust to explorers. We may think that nothing is to be done but to excavate on an ancient site in order to discover many remarkable statues, or of some great work of architectural art, when all has been destroyed ages ago. On the contrary, Mr. Wood had to labour under circumstances of great discouragement, which he has by no means stated. The results before us are those of two explorations. He had to seek during several years for what was commonly supposed to be the site of the temple. He devoted his labours and spent large sums of money without arriving at any satisfactory result. He began again with admirable patience and great energy, and he has now brought before us that which, as I have said, causes us almost as much disappointment as pleasure:—surprise at the remarkable objects we have obtained, disappointment at the many more irrecoverably lost to us. How gratified we should have been if he had been enabled to find fifty of these sculptured drums instead of two or three. How much they would have added to our knowledge of the subject, because, as Mr. Wood has pointed out, these columns were contributed by various kings and several cities, constituting, perhaps, distinct specimens of several artists. I regret, instead of being able to contribute anything on this subject, I have only been able to do an act of justice to our friend Mr. Wood in paying a personal tribute to his labours; and I can only trust he will lay before the Institute, on another occasion, some of the results of his other architectural studies and measurements, because when he was not able to work on the temple he never threw away his time, but every moment he was on the spot was spent in measurements, in researches, and in practical work.

Mr. PENROSE, Fellow.—I, too, regret that it is not in my power to contribute to the information on this subject, and I apprehend that but few questions can be raised from the mere listening to the paper; besides which I have never been at Ephesus, nor have I made the subject of Ionic architecture my study in any peculiar degree. There are, however, one or two questions of general interest. I should be glad if Mr. Wood will inform us in what state he left the excavation, and whether it is likely to be filled up again, or only loosely covered with earth, to protect it from the Turks and other spoilers. With regard to the architecture itself, the one remarkable thing respecting this temple is the broad platform outside the columns. I know of no instance of that in any temple, and if I understood aright Mr. Wood spoke of that platform as being a Roman construction.

Mr. WOOD.—I spoke of the *pavement* at the foot of the steps as *Roman*.

Mr. PENROSE.—It is then unique, as far as I know, in Greek architecture. In all other examples I believe the columns stand immediately upon the steps, with only just space enough between the columns and the stylobate to carry them properly. Another question I would ask is, whether there are any remains of the plinth, on which the base of the columns are placed, in Mr. Wood's drawing.

Mr. WOOD.—As regards the site of the temple, I may state I bought the ground, consisting of eight acres, which included the site of the temple and a considerable portion of the ground round it, and it is at present in the hands of a gauger whom I employed throughout the whole work, who having taken a fancy to Ephesus, built himself a house, and lives on the spot. He has the advantage of cultivating the ground for his own benefit, under strict injunction not to touch the site of the temple, and also to prevent any acts of spoliation upon the remains. The ground, therefore, belongs to us, and I must say I ardently look forward to going on with the work again by some means or

other. I am quite ready to go out again with sufficient funds—not less than £3000.—and renew the work. I feel convinced that there are many drums of columns lying beyond the site already explored, inasmuch as they must have cleared the pavement at the foot of the steps, for the conveyance of the stones to other buildings in which they were employed. I have not attempted to give a history of the explorations. It has taken four lectures at the Royal Institution to give a rough sketch of eleven years work—for the whole work has spread over that period of time. The large pit which I have dug out, and which I have described, is 500 feet long by 300 feet wide, and 22 feet deep. Beyond that, I have no doubt, many drums of columns lie buried. I found the remains of kilns a little distance from the lower step of the platform, in which probably most of the sculpture and architectural enrichments of the temple were burnt; and I found a number of marble chippings apparently ready to be put into the kilns. That gives us a very melancholy notion of what became of all the sculpture, so that we might be disappointed if we enlarged the excavation in the hope of finding any sculptural remains. It was against my advice that the excavation was discontinued. The last year was particularly favourable for the work, because the water was lower than I have ever known it to be. We might have sunk below the lowest pavement and have found much more. My own notion was to extend the excavation thirty feet at least round the present one, and there I think something must be found. I only await the necessary funds and the commission to go out again and complete the exploration. With respect to the Roman pavement, I have described the pavement at the foot of the steps but not that of the platform itself. With regard to the plinth of the columns, I thought at first it was a step, but it was too high for that as it measured 1 ft. $4\frac{2}{3}$ in. in height *in situ*; and then I was doubtful, till I found the inner columns of the peristyle, whether the inner columns of the peristyle had a similar plinth, or whether they were raised upon a step, as is the case in many Greek temples; but I found a portion of the plinth remaining—just enough to prove it was a plinth and not a step—a square plinth.

Mr. PENROSE.—Might not that have been part of the ornamental paving? Were there no complete plinths?

Mr. WOOD.—No: there were no complete plinths, but part of the plinths of the outer and inner columns, ranging, as they did, on the same level, is sufficient proof that they both had square plinths.

Mr. PENROSE.—It is a magnificent subject, and I am sure we are much indebted to Mr. Wood, for what he has brought before us, and still more for his self-devotion and energy in prosecuting this great work; but I am not prepared to be his examiner on this occasion.

Mr. F. W. BURTON, Director of the National Gallery, said—I am unprepared to offer any special remarks upon this subject, nor will I presume to pass any eulogium upon Mr. Wood, who has done so great service to art in general by his discoveries, at the risk of his health, I am afraid, and at the cost of some of the best years of his life. From my own particular point of view, the most interesting thing is the light which Mr. Wood's discoveries have thrown upon Greek art. The results of his labours may not be very large in compass, but their value is not to be estimated by their mere number or state of completeness. The two or three drums, or fragments of drums he has brought home, appear to me to be of great importance. Their being found *in situ* imparts greater interest to them, and the being able to fix their date within a few years, is a matter of the first consequence. I apprehend they belong to the so-called Second Attic School. We know, in fact, that they proceeded from artists of that school, and therefore we may form some idea of the mode in which, in the days of Scopas and Bryaxis, the Greeks treated decorative art in connexion with architecture, and we have a great lesson in the broad and noble style in which these fragments are handled, without over attention to details. It is difficult at this time of day to form an estimate of the effect of these bases or portions of the columns, sculptured as they

were ; but I can conceive, that in that beautiful climate, with the light playing from all sides, directly and by reflection, upon these decorations, the effect must have been glorious ; and the influence of this maze of lovely forms, as the spectator passed through them, must have been something magical, more especially upon the mind of the Pagan worshipper. I am sure we cannot sufficiently thank Mr. Wood for what he has done, and I, for my own part, feel extremely grateful to him.

SIR CHARLES HARTLEY, C.E., Visitor.—I have not been on the ground, but at the time I visited Smyrna I heard of Mr. Wood's useful labours at Ephesus. The work is very interesting in every respect. There is only one question I would ask, and that is, about how many cubic yards may have been executed, and what was the width of the excavation.

Mr. WOOD.—I think, as near as I can remember, there were between 130,000 and 140,000 cubic yards. Some of the students present will perhaps check me. The length is, as I have stated, about 500 yards, the width 300 yards, and 22 feet deep. A few figures will bring out the result.

Professor KERR, Fellow.—If I had anything to say on the subject it would be to ask Mr. Wood to be kind enough to give us some description of that singular statue, which is depicted on one of his drawings. It has something very peculiar about it, and at present I should imagine it is rather of traditional than historical character. The legend is no doubt acknowledged that there was a stone figure, in probably the earliest of the temples, which fell from heaven. We know that this referred to that primitive worship of meteoric stones, which I have always contended was the origin of sculpture—the first efforts of that art being the adaptation and imitation of such stones for idols, they being identified with the form of the human figure for the sake of being worshipped as representatives of divinity. I want to know, therefore, whether there is any supposition to be entertained that this statue is in some degree an actual record of such an object of worship? If so, it would be an interesting matter to enlarge upon. With regard to the peculiar style of art in this temple, amongst architects there cannot be two opinions. It is obviously in several respects not quite up to the mark of the best Greek work ; but as regards any specific Asiatic influence, I cannot conceive this to have been of much importance. I think I can understand the principle upon which the lower drum of the columns had been sculptured ; but I see nothing Asiatic about the sculpture, and I am inclined to hold, although there may be no doubt of many of these columns having been votive offerings of kings and independent cities, that they ought not on that account to be taken as necessarily affording illustrations of various schools of art. I think whilst strangers may have contributed the money by which the columns were produced, the better theory is that the whole design was of one school of taste, and I had hoped it might have been shown to be the work of one architect. I cannot refrain from bearing my testimony to the services which Mr. Wood has rendered to the world of art and archæology. I cannot join in speaking of them as in any way inconsiderable in their results. I think the mere discovery of the temple is itself a great result. True, if we count the number of stones placed in the British Museum it may not be large ; but if we look at the years of labour that this gentleman has bestowed upon the task, and think of his personal exertions in the solution of his important problem, and of the perfect success with which he has solved it, it becomes unnecessary to go into details, and we must all agree that the enterprise is one for which Mr. Wood deserves enormous credit. At the same time I hope the funds will be forthcoming with which he may still continue his interesting explorations. It ought not to be left to some other country or to another generation to complete what has been so well begun in this case. We have more money in England than we know what to do with ; and it would not require any very perceptible portion of our superabundant wealth to effect a complete development of many other works than this under such explorers as Mr. Wood, with the certainty that highly honourable results would be accomplished before the world.

Mr. WOOD.—The first question of Professor Kerr's I have to answer is in respect of that representation of Diana, which is simply put there as a copy from a print, and is similar to the statue in the Museum at Naples. With regard to the original worship of Diana, I attribute it to a tree-stump, and it is supposed that the tree-stump by degrees was carved into the form of the human figure, and hence into a goddess. We know from the Bible that the statue which was placed in the last temple was supposed to have fallen from Jupiter, and therefore I suppose it must have been a large aereolite, afterwards carved by the sculptors of the day. I have myself noticed that the lava of Mount Vesuvius assumes on the sides of the mountain the shapes of human forms. So much was I impressed with that, that a fellow traveller and myself agreed that it had the appearance in some places of a large battle field—the human form was so wonderfully represented (not that I would confound aereolites with lava). With regard to the style of sculpture on the drums, it is very various. There are some male figures in Persian costume in a very low relief, and all the drums I have found varied very much in character; for instance, the half of one drum has only two figures on it in its semi-circumference, whereas others have five or six figures. [Professor Kerr:—was the drum of such a style of work as to be identifiable with Assyrian or Persian work, and were either identifiable with the Greek, or were they not all as near as possible of the same style?] Mr. WOOD.—The Persian figures I think have a distinct character. I have not gone so much into the question of sculpture this evening, but I have mentioned that I have recovered some 100 fragments of an archaic frieze which belonged to the last temple but two. [The President suggested that Mr. Wood might give them some information with respect to the previous temples.] Mr. WOOD.—The pavement I have shewn on this section, large patches of which I found remaining, belonged to the last temple but two. [The President.—What would be about the date of that?] Mr. WOOD.—The foundations were laid 500 years before Christ, and it was built by Ctesiphon and his son Metagenes. [The President.—Have you anything to prove what its character was?] Mr. WOOD.—As regards that particular temple, I did not find any fragments of the columns, as they were sold. They were probably monolithic. I found no fragments of these columns, but some of the architecture remained. There is in the British Museum a collection of fragments of architectural enrichments. I have not yet arranged them, and it will require a space equal to that of this room to do so. The temple which was burnt by Erostratus was built 400 years B.C., and was the last temple but one. Then came the last temple, of which I found a small portion of the pavement of the peristyle. Of the columns of the last temple only have I found remains.

Mr. ARTHUR CATES, Fellow.—I have listened with great interest to the account which Mr. Wood has given us of his explorations extended over so long a period, and much regret that, although last year not far distant from the scenes of his discoveries, I was not able to visit them. Interested as we all are in what Mr. Wood has so well done, we must bear in mind that he tells us there is still much more to do, and we should effect a great service for the history of architecture if we could this evening take some efficient steps towards facilitating the accomplishment of that work. Mr. Wood has told us that funds are now wanting to complete by further excavations the discoveries he has already made. So far as these explorations have as yet been carried, the funds have, I believe, been provided by the trustees of the British Museum under the authority of the Government; in 1872, these funds had been exhausted and the explorations brought to a close, but strong representations having been made to the Government, Mr. Wood was enabled to resume his explorations with the results he has this evening described to us. It is quite possible, that if the importance of the further discoveries which Mr. Wood is so confident he could make, were duly represented to the Government, the funds which are necessary to complete the investigation would be forthcoming. The German Parliament last year voted a large sum approaching £10,000. towards the exploration of the Plain of

Olympia, that Government having made arrangements with the Greek Government for commencing excavations on that site, which are expected to produce considerable results in remains of sculpture, &c. At Ephesus the work is almost complete; Mr. Wood has acquired the freehold of the site, and the small sum which he now asks for, would enable him to complete an exploration of the highest archæological and architectural importance. The English Government should bear in mind the great results which the energy of the Archæological Society at Athens has attained. With limited funds, they have laid open the Sacred Way, lined on each side with tombs of the greatest interest, and are now engaged in clearing the Dipylon Gate, and have around it discovered remains of ancient houses, streets and walls, which gave to those excavations an appearance like Pompeii—a very unveiling of the ancient city. The exertions of private individuals should not be overlooked—as at Athens, M. Barnouf, the director of the French Academy, had recently made important discoveries at the Acropolis, and is now endeavouring to raise by subscription funds to clear away the debris accumulated round the Propylea, and to seek to solve the curious questions involved in the ascent to the Acropolis. The Government might also be reminded that some ten years ago a great opportunity was allowed to slip, when Mr. Frank Calvert suggested to the trustees of the British Museum the advisability of making excavations in the Troad, at Hissarlik, where, a few years later, a private individual at his own cost made remarkable discoveries, which are of the greatest archæological interest, even if the evidence on which Dr. Schliemann claims them to be relics of Troy may not be convincing to all. Dr. Schliemann has there at his own cost, and in the face of great difficulties, carried out vast excavations to a depth exceeding 60 feet, and attained results of remarkable value—results which, had the guardians of the public purse relied on the representations of Mr. Calvert, would have been the property of this country, and the *imbroglio* with the Turkish Government, which has so much detracted from the immediate value of Dr. Schliemann's extraordinary discoveries, would have been avoided. With this example of the German Government to guide them, and the neglect of Mr. Calvert's suggestions as a warning, the Government can hardly refuse now to supply sufficient funds to enable Mr. Wood to put the crowning stone to the discoveries he has so well commenced, and I trust that this Institute and the other learned Societies of London will not allow this opportunity to pass, but will be most earnest in their representations to the Government on the subject.

THE PRESIDENT,—There is a standing committee of the Institute for the Conservation of Ancient Monuments, but I apprehend so great a monument as this would be hardly within their province. We might, however, pass a resolution requesting them to consider the desirability of memorialising the Government on this subject.

Mr. CATES said he should be happy to propose it, and it was supported by Mr. Penrose.

A Resolution to that effect having been proposed from the Chair, and carried by acclamation, the Discussion was resumed.

Mr. WOOD.—I may add, that in addition to the Temple of Diana, I found on the south side of it another temple, which must have been built not long after the temple itself. I have just found it, and have explored it as far as the funds would allow, and I have discovered the remains of four columns, 20 feet apart, and it must have been a very considerable building.

Mr. H. DAWSON, Fellow, remarked that it was highly desirable that the valuable fragments of these temples collected by Mr. Wood, and deposited in the British Museum, should be properly arranged by that gentleman, while the circumstances attaching to them were fresh in his memory. Seeing that a comparatively small space was required for the purpose, he thought it was a pity they should be allowed to remain in their present confused state.

Professor KERR having suggested that Mr. Wood should favour the meeting with a few remarks

with respect to other buildings at Ephesus, and also the means by which he discovered the site of the temple—

Mr. WOOD said, that having searched on the west side of the city in vain, he moved further towards the city itself. By the time he arrived at the foot of the mountain he was tired of spending his own money, and applied for a grant from the Museum. It occurred to him that he might by exploring some of the public buildings, find something which would give him a clue to the position of the temple. He therefore applied for funds to explore the great theatre, and funds were granted on condition that he explored the Odeon. He began there, and found some sculpture and inscriptions which well repaid the outlay. Further funds were supplied, little by little, and he then proceeded to explore the great theatre. In that he found a most interesting inscription—one of the longest ever found in Asia Minor—containing a description of the gold and silver images voted to the Temple of Diana by C. Vibius Salutarius, a Roman. These gold and silver images were carried in procession on certain days of assembly to the theatre from the temple, through the Magnesian Gate, and were met by the young men of the city, who assisted in carrying them to the theatre. After the assembly they were carried back again to the temple through the Coressian Gate. The information given on that inscription not only encouraged the notion he had formed of endeavouring to find the temple by discovering some of the gates of the city, and following the most worn roads leading from those gates, but it also enabled him to change, he thought correctly, the names of the mountains which had hitherto been erroneously named. That which he called *Mount Prion* was on all the charts hitherto published, called Mount Coressus. He imagined the term Prion was derived from its serrated form, which the name implied. The Coressian Gate must have been at the foot of Mount *Coressus*. Having determined, if possible, to find the two gates, he worked in the direction in which they were likely to be found, and found the Magnesian Gate near the Gymnasium on the east side of the city, and the Coressian Gate on the north side of the city—both gates were found at about the same time; and he forthwith began to open up the roads from those gates, in doing which the roads bifurcated—one leading to Magnesia, and the other round the mountain towards Ayasalonk. He followed the roads from the two gates simultaneously, and he found that they converged somewhere in that direction. He then abandoned that road, and spent all his means upon the road which led from the Magnesian Gate, and there at last, he found what he had been looking for—viz: a road leading outwards from the foot of the mountains—a road 10 feet wider than the other, being 45 feet as compared with 35 feet. The barley crop had grown high at the time. He therefore passed over the barley without disturbing it, and hit upon a point which he had looked at very suspiciously two or three years before, and where he set some men to dig. They subsequently came to him and said it was of no use to dig, as the hole had fallen in. He remembered the circumstance and had dug a deep hole there. He examined the ground carefully and saw that there was a modern boundary, which often covers an ancient one. He sank another hole and there an angle of the wall was found into which an inscription was built which gave the information that this particular wall was the identical wall which they knew Cæsar Augustus had built to restrict the sacred precincts which approached too near the city. He traced this wall eastward and northward for a considerable distance, and then abandoned it in favour of exploring the ground defined as being within the sacred precincts. He now came upon a long line of buildings and conceived the idea that the temple was beyond it. He sunk a hole, and more than three years ago he found the pavement of the temple. It was a Greek pavement composed of two layers, the upper one being of fine white marble, but built in irregular blocks. This proved to be the platform of the last temple but two—the temple built about 500 years before Christ, which was shown in the diagram.

Mr. PENROSE having proposed a vote of thanks in very complimentary terms to Mr. Wood—

Professor KERR said,—I beg to second it with great sincerity. The Institute of British Architects must be proud of possessing a member of Mr. Wood's high position in the scientific world. I think the modesty with which he has described his discoveries, and the vigour of character which underlies every word he has said, must show us that England possesses men of the right stuff for promoting discoveries of this kind, and we can only hope that means will be afforded for carrying these interesting researches still further.

The PRESIDENT.—I am quite sure it needs no words from me to induce you to confirm most heartily that vote of thanks. I do not think I have anything to add to what has been said so ably and in so interesting a manner by the gentlemen who have spoken; but I cannot sit down without saying something, however little it may be. I think we are in danger of underrating the extreme importance of these discoveries. We have all heard from childhood that the whole site of Ephesus has been searched over and over again, without finding the slightest trace of the great Temple of Diana; and we suddenly found out from the newspaper notices that it had at length been discovered, and in a very remarkable way. The gentleman who has made this great discovery has come before us and has described the result of his explorations, but was going to omit any mention of the wonderful way in which the discovery has been effected. He did not discover the lost temple by accident, but he traced it outstep by step, and by thorough investigation and inductive reasoning he found it. That is the most creditable way in which a discovery can be made. If a man in passing over that site happened to find a stone belonging to this temple, and through this clue found the site of the building, one would give him credit for it, though there would not be much ingenuity about it; but here, without the slightest trace being afforded, by the mere exercise of reason, followed by a laborious and costly process, this great discovery was made; and even if it had done nothing for the history of architecture, no discovery of the present day would be more interesting. As regards the means by which it was effected, the modesty of Mr. Wood would have passed it over, if we had not asked of him the favour of an account of it: but that account far exceeds in interest what I expected. Mr. Wood has shown us how, by the guidance of an inscribed stone, which he had exhumed on the opposite side of the city, the roads from two distant gates were step by step traced out, till they converged upon the temple enclosure, far away from the city, and by excavations within the enclosure, he then discovered the temple itself. With regard to the statement that the results have been small, I do not myself agree with that idea. That we should have discovered the actual site at all would have been a very great thing. But we have discovered, through Mr. Wood's able agency, portions of the most remarkable columns which are to be found in the whole range of classic antiquity—columns 6 ft. diameter, the shafts of which are enriched with magnificent sculpture, and differing, so far as I am aware, from anything else ever found in antiquarian research. The actual sculpture on these columns is, perhaps, not so fine as the finest Athenian art, although it may be said to approach it in excellence. Taken for all in all, it is unquestionably the greatest antiquarian discovery of the present day. The question which is raised by all this is, whether this work of exploration is to be left only partially executed. Are we to allow the Government to suspend operations whilst we have the most confident assurance that architectural remains and sculpture are lying hidden all around? Should we not press the Government thoroughly to follow out this work, under at least the advice of Mr. Wood, even if he were not able to be upon the spot himself? I am sure you will express most heartily your concurrence in the vote of thanks to Mr. Wood, and having done that, I shall have the greatest possible pleasure in conveying it to that gentleman.

The motion having been carried by acclamation, Mr. Wood expressed his thanks for the manner in which his paper had been received, and the Meeting then adjourned.

Royal Institute of British Architects.

At the Ordinary General Meeting, held on Monday, the 1st of March, 1875, Sir GILBERT SCOTT, R.A., President, in the Chair, the following Paper was read:—

ON "CERTAIN NEW OR RECENTLY REVIVED PROCESSES IN DECORATIVE ART."

By G. T. ROBINSON, Contributing Visitor.

PROFESSIONAL practice in the present day shows so many and such manifest tendencies to revert to that wholesome habit of the past, by which the architect was not only expected to be the structural edifier but also the decorator of the building he reared, that some remarks upon certain new or recently revived processes in decorative art may neither be useless nor unwelcome to the members of the Royal Institute of British Architects.

I need not here point out how, in olden days, the architect presided over the colonies of assistant artists that congregated round those important buildings, of which the bare bones are but too frequently all that remain to us now; or how that under his directions the smiths forged or founded; how the painter painted, or the sculptor carved; or how he guided the errant ideas which so many cunning craftsmen brought to his aid in Mediæval times. All this has been made the theme of so much writing, and the subject of so many recent controversies, that my words would be but the echo of a well known strain did I enter thereon. It will however be to the purport for one moment to consider how very much this general supervision must have enlarged the range of technical knowledge possessed by the Mediæval architect, and how this encyclopedic wide-mindedness must have fostered and purified those decorative arts which he directed.

In the Renaissance period of art-history this same intimate union between structural and decorative art existed; indeed to such an extent was it carried, that it is difficult to classify the artists of those days, and the fame of their more portable works in painting or sculpture—works which come under the notice of the many, has often eclipsed those which have brought to the artist his reputation as an architect; and whilst a style of ornamentation hands down his name in a generic term, his style of architecture is popularly almost unknown. Indeed at all the best epochs of architectural history this conjunction of the building with the decorative power is to be remarked, and its greatest artists are those who have excelled in both. Probably they became the greater in each branch of their art from studying the other; the study of the minor accessories refining the detail of the major building, whilst the architectural severity and precision inculcated by that gave vigour and force to their decorative detail.

We are, perhaps, too prone to take long telescopic glances into the distant past to remark those features of art-history which come within our more immediate view, and I would therefore recall for a moment the memories of those almost forgotten and rather ungratefully treated architects of the last century—Sir William Chambers and the brothers Adam. It is impossible to examine their works without being struck with the very great attention they paid to the minor embellishments and accessories of their buildings, and the nice distribution of their ceilings and wall spaces for decorative appliances.

Scarcely a technic process of their day existed with which they were not acquainted, and for most of these they designed some special application. Ready made decoration did not please them, they were not satisfied with the baskets-full of fragments which remained after others had feasted, but they sought from the materials at their disposal to set forth something new and good. Even the simple implements of every-day life received their care, and had impressed upon them by their artist-hands the stamp of elegance and refinement. Nor were they alone then: in many of the old houses of the last century we come upon the evidence of much loving thought for decorative detail, and much cunning knowledge of decorative process, which show that their architects were not unmindful of the fact that it was possible to be great in little things, even when the status of the art and the architect was declining. At the commencement of the present century that status was indeed a low one, and the profession, the which I trust you will of your courtesy still let me speak of as "ours," had sunk to such a depth of degradation that a vigorous struggle was needed to keep it from being entirely extinguished. Architects had need to fight for their place in the world, and in this fray the fringes of their robe were cast aside, and the minor elegancies of their art were lost sight of in the stern necessity for preserving the useful. All traces of that fray are not yet removed, though thanks, mainly to this Institute, there is now no doubt in the public mind as to the status of an English architect:—albeit that the *arbiter elegantium* of English taste did not so long ago enquire what manner of man he might be, and obsolete minded writers in reviews do yet revile him. Now-a-days the title of an English architect is recognized as one that a gentleman may be proud to bear, and the bearing of which stamps him as a gentleman. With this rehabilitation of the title it behoves then the architect to return to those pleasant paths his predecessors trod. Good pioneers have of late prepared his way, breaking indeed some axes in their labour to clear his path, and foremost amongst these was Augustus Welby Pugin, whose name must be revered by all who love our craft, and mostly so by those who love those accessories, the technic processes of which he so thoroughly mastered, and in his own art language expounded so well. Quite recently too has passed away from us one who for many years of his life strove hard and successfully to make the title of an English architect a world-wide synonym for a master of design in all its branches, and the name of Owen Jones will, I am sure, cause a proud yet painful feeling to thrill amongst you as I recall it. Nor can I overlook the fact that for the most important decorative effort which has perhaps ever been made in England, an English architect, one of your own body, was called in to advise a curiously constructed committee of clerics and *dilettanti*. The result, it is true, has not been so happy as we hoped for, though perhaps we do not yet see the result, but only an incomplete process; still the very fact that an architect was selected as the most fitted for the post of æsthetic director, is one on which we may congratulate ourselves and our day.

In thus drawing attention to the past history of and the present need for the study of decorative design and a knowledge of decorative processes by architects, I must not withhold the fact that dangers bylay the pleasant path. The fascinations—which environ it are apt to withdraw its followers from the sterner and severer duties of their profession, especially when beyond being the deviser and director, the architect would be the detailer too, and I present myself before you as an example to avoid. I have fallen a victim to the blandishment of that Circe whose ways are so winning—I have suffered the metamorphose she effects upon her too ardent wooers, and she has changed me from a Fellow of the Royal Institute of British Architects into that anomalous and strangely anamorphic animal—a Contributing Visitor.

My reason for addressing you to-night, and my apology for so doing, arises from the fact that when engaged in the more general practice of our profession I found great difficulty in learning and following the many ways in which "the ever-whirling wheel of change" spun off the threads of popular thought

and popular esteem into the region of decorative art, and the labour that was entailed in seeking to gather up those threads for useful purposes was long and toilsome. I do not say that popular opinion is always a safe guide, but they who would do good for others and to themselves must pay heed to its direction, and he who joins the throng which makes that opinion popular is more likely to turn it into a wise and healthy channel than he who stands aloof and cynically regards it. Especially so is this the case in decorative art, wherein—

"Nothing is thought rare
Which is not new and followed: yet we know
That what was worn some twenty years ago
Comes into grace again."

And the difficulty of finding out some new way of doing something old, or some old way by which something new might be produced, turned me into such devious ways, which led to nothing, that I am desirous of rendering to similar searchers the service of a finger post, by pointing out some of the more recent directions in which decorative art is striving to progress and the processes by which she makes her ways.

Of entirely new processes there is but little to record, but in many of the revivals of old ones, new elements enter. Long ago, a very wise man who knew a good deal about decorative art, and who sought far and wide for its professors, and their processes, declared that there was "nothing new under the sun"; but nevertheless, we have discovered some things since he recorded that, even to him, ancient maxim. In spite of this we find an eloquent living writer, mournfully proclaiming that—"The Renaissance, the spring-tide of modern life, with its genial freshness, is far behind us. The Creative period is past, the Accumulative has set in; Genius can now do nothing, the day is to dull Industry," but he is not a member of this Institute—not even a contributing visitor, or I am sure he would have acknowledged that there is something more than dull industry left us in the world, and that accumulative periods are essentially periods of new growth. In Nature this is always so, and the disintegrations of older formations by their very debris create fresh ones. That same process is a general one in all art, and markedly so in that of decoration.

This new growth from old soil is very apparent in the first illustration I shall bring before your notice, namely, painted cloth:—When men first hung their wigwams with hides, or the early products of their rude looms, to secure comfort and privacy, their next thought seems to have been to decorate these sheltering accessories, and painted cloths made their appearance long before art and mechanical skill had so far allied themselves as to produce woven tapestries. It would be tedious to search far back into the early use of these decorative accessories, and I shall content myself with noticing the record of them in our own country during the sixteenth and seventeenth centuries. Such notices abound in old wills and inventories, such items as "an hangyng of steyned werk in the Hall,"* or "steyned clothes hangyng about the parlour,"† are of very frequent occurrence, and might be multiplied *ad libitum*. In the accounts of the Corpus Christi Guild at Coventry occurs a charge in the 1 Hen. VIII. for painting part of the Hall, "and for the clothe and the peynting of the hyngyng that honges at the hydeys" and in St. Mary's Hall, in that very interesting city, was put up in the early part of the reign of Q. Elizabeth, a painted cloth extending from the cornice to the top of the panelled dado, covered with armorial ensigns and mottoed scrolls, and Dr. Bullyne in his quaint "Dialogue bothe pleasaunte and pietifull," published in 1564, in describing what he would consider a model house of his day, introduces

* Bury Wills, dated 1522.

† Household Inventories, dated 1463, Ret. Rev. 3rd series, vol. I. p. 101.

us into "a comlie parlour with faire clothe with pleasaunte borders aboute the same with many wise sayings peynted on them." Those wise sayings and mottoed scrolls played a great part in such hangings, and it was the pastime and witty exercise of many of our gentry, not only to compose, but actually to paint them and their illustrative subjects; and Rastell tells us that "Mayster Thomas More, in hys youth, devysed in hys fathers house in London, a goodly hangyng of fyne paynted clothe with nyne pageaunts and verses over every of those pageaunts." Sir Thomas More's interest in Holbein may have been fostered by his early essays in the painter's art, and it would be well if leisured men, in these our days, would take some practical and individual part in the decoration of their homes. They would then the better appreciate the work of others, and the more value its result. Some, it is true, are doing so, and an increase of their number is much to be desired and hoped for.

Painted cloths, however, do not always seem to have been devised by men of the like wit or learning to Sir Thomas More, and some of the old dramatists are severe on the weakness of their poesies,

"Who fears a sentence or an old man's saw,
Shall by a painted cloth be kept in awe."

says Shakespeare in his Rape of Lucrece, and the unknown author of "The Match at Midnight," makes Bloodhound say that he will have a poesy, "which shall savour of a saw," obtaining the derisive answer that "'twill smell of the painted cloth," the which in its new state was by no means savoury.

So bad both in morals and wit, in an age more free in speech than ours, did many of these proverbs become, that they somewhat deserved the finding of another old dramatist, when he exclaims, "that painted cloth is worthy to be hanged up for lying." As the wealth of the country became greater, and the introduction of the products of the loom from foreign countries became more common, these painted cloths passed into desuetude, and so early as 17 Elizabeth the painters of London prayed the Commons to restrict the importation of foreign manufactures by "merchaunts strangers," as thereby their craft was in danger, and that "payntyng on cloth is decayed," and henceforth stencil work on the plaster, or afterwards paper hangings, took their place in the commoner apartments. The painted cloths, to which I have referred, were principally painted in oil, but distempered cloths were in use for commoner purposes; and that doughty knight, Sir John Falstaff, was of the opinion that "a pretty slight drollery, or the German hunting in waterwork, is worth a thousand of those bed hangings and their fly blown tapestries." But "waterwork," except upon the stage, and "steyned cloth" have passed away until now, when the change of Time is bringing these latter back again. The very process, indeed, seems to have been lost for at least two centuries, and any one who has tried to paint direct upon a linen cloth has found what a mess he succeeds in making, but recently a M. Guichard, after many experiments, has found out a medium which is at once supple and clear, and for which it is claimed that it resists the effect of sun, water and air. By it the linen cloth is either printed, stencilled or painted, with any device and in any colouring, and cloths are now woven so wide as ten feet, and of course of any length which could ever be required, without a seam. I have just had some made thirty-eight feet long, and am perfectly satisfied with the process as a wall covering. It is easily attached to the walls, can be taken down and replaced without destruction or difficulty, and may be sponged or shaken without danger, and this in London is no slight advantage. Moreover, as a groundwork for hand painting, it offers an excellent opportunity of producing an effective and by no means costly means of decoration. In one of the specimens you will see a figure painted upon a printed ground, which will serve to illustrate this application in manner at least if not in art, and borders can be obtained so as to margin the cloth or divide it into panels in any fashion deemed desirable. The fabric of most of these specimens

is made of unbleached linen, and when it is desired that the fabric should form the groundwork, or partake of a decorative function in the pattern, this is decidedly the best material, and can be obtained in many degrees of texture or pattern of weaving, but when the whole surface is covered with painting a thick cotton rep is available at a much lower price, and such a specimen I place before you in the frame containing the figure of a signal man freely rendered from one of Durer's woodcuts.

In this you will perceive that the groundwork or fabric performs little or no part in the decorative design. This painting is of an entirely different character to the other, being executed in a glutinous material, and carefully flocked over afterwards, thus producing perfect flatness in colour, with some subtle qualities of light, which no mere pigment can obtain. There is no reason why parts of a decorative scheme might not be carried out in this way, and many pleasant effects thereby produced. Of course the question of cost is one which depends entirely on the amount of art employed, but the blocked or stencilled patterns cost from six shillings per yard upwards, and the hand painted work, according to the fineness of the finish and the value of the artistic labour bestowed upon it.

It seems to me that the revival is an useful one, offering a relief to our flat and hard wall papers, and providing us with the means of giving an individuality to our rooms at no ruinous cost, whilst at the same time it classes the wall decoration with the moveable furniture of the tenant, an important consideration in these nomadic days.

Tapestry, that is the woven picture wrought upon the loom, is really an imitation of these painted cloths, copied with the most jealous care from coloured cartoons: but he who would preach against the use of all imitations and condemn tapestry on this account would not be very much regarded, nor would he be very right. On the next subject I bring before you I am prepared to find a divergence of opinion as to this very question of imitation, the most casuistic and subtle of all questions with which a decorative architect has to deal; the utmost latitude being accepted in some cases, whilst the sternest puritanism is enforced in others.

Staining woods of a different colour to that which nature has given them has never seemed to me a greater sin against truth than dying wools, though to many this gnat is irritating in the throat. Yet in the best days of the Renaissance, stained woods, either homogeneously tinted, or shaded or party coloured, entered largely into the decorative furniture and joinery designed by some of the greatest and most graceful artists of that great and graceful period. Fra Giovanni da Verona in the sixteenth century, as we are told by Vasari, gave artificial colours to his woods "by means of waters, coloured infusions and penetrating oils" and Fra Damiano da Bergamo, the most celebrated of the *Tarsiatori* of that fertile period, changed the colours of his woods by chemical fluids and oils, and produced varied shades by charring or singeing his materials. Bernardino Luini, the celebrated pupil of Leonardo da Vinci, did not scruple to paint in direct imitation of Tarsia work those exquisitely ornamented presses in the sacristy of the church of Sta. Maria delle Grazie at Milan, so well known by Professor Gruner's illustrations. If then we are to sin it is pleasant to sin in good company, and the process I am about to notice is one which I am sure would have been greatly made use of by the designers of the *tarsia* work of the Renaissance. This process to which I would draw your attention is one bearing the excessively unarchitecturally word-built title of *Xylotechnographica*. Difficult as is its name the process is in principle exceedingly simple, and I quote from the specification of the patent filed by Mr. A. F. Brophy, its inventor: "In order to stain wood in various colours, according to any suitable design, leaving, if desired, parts of the wood unstained, so as to obtain an imitation of inlay, I proceed," says he, "as follows. I first apply a varnish or solution which will fill the pores of the wood, and exclude the staining liquid from such parts of the surface as are to remain unstained.

Then when the varnish or solution is dry I apply over the whole surface the lightest stain I intend to use; this stain being dry I again apply the varnish, or stopping, coating with it such parts of the surface as I desire to retain of a colour corresponding to the lightest stain, and so I proceed until the desired effect is obtained, the last stain applied being usually black or a very dark stain. The surface having been cleaned off may, if desired, be varnished or polished all over, or it may remain as it is left by the last staining process."

It is, in fact, an analogous procedure to that known to etchers "as stopping out and biting in," the various coloured stains taking the place of the acid. Much care is, however, required in treating the various woods and in adjusting the stain and varnish to their absorbent or non-absorbent qualities, and like many other things excessively simple in description, it requires a great deal of technical practice to ensure a good result. If the grain of the wood is very open, as in oak, it requires a preparatory treatment of plaster of Paris and spirits of wine; if tolerably close, such as sycamore, or spongy as in pine, it requires a different treatment, and this treatment can hardly be formulated; but the several examples, which I now exhibit, will at once shew how that beautiful *chatoyant* lustre, obtained from the grain of the wood, is in no case destroyed, excepting where positive black is used. As a decorative treatment for all joinery it is particularly available, and where the vexed question of imitating inlay of real woods obtrudes itself, the designs may be so carried out as to be absolutely a painting in transparent colours on the wood in such a manner as to be beyond all imitation by *tarsia*. Indeed almost anything which may be painted can be produced in these stains, with the great addition of the brilliant lustre of the grain of the wood, and the further durability obtained by a penetrating rather than an overlaying colour being used. To ceilings, doors, dados in our private houses, to partitions, and fittings of our banks and commercial offices, this process is, I conceive, exceedingly applicable, and to our larger and less moveable pieces of furniture it is not misapplied, though I confess to a lurking dislike to it in those lesser articles, to which true inlay, by reason of their smaller surface, seems more aesthetically appropriate.

An analogous process has lately been applied to marble in Belgium, by which that material is rendered susceptible of polychromatic decoration. Nature, it is true, has been very liberal in her bounteous display of colour in marble, yet the cost of cutting it and inlaying it has induced many attempts to produce the effect of inlay by an easier process. In Siena and in many of the churches of Sicily I have seen various attempts made to lessen the labour of inlay by means of stains, and I exhibit here some attempts to revive or recreate this process. The precise means by which this is done is not published, but it appears to me that the dark stains are obtained by the use of nitrate of silver, and the other tones by means of chromates of potash and sulphate of copper. To this process the same objections may be raised as those noted in treating of the stained wood work, yet for wall treatments, in our dull and moist climate, it is suggestive of many applications. Few materials are less used amongst us than marble, and yet, in the whole range of nature's bounties, there is, perhaps, none more beautiful or more permanent in colour for internal use. The great drawback has been the cost of working it, and any process which will give us a variety of effect on a plain surface is a great boon. Our dark London halls and well-hole staircases demand some reflective surfaces; our murky atmosphere requires something which may be washed without injury, and in this process we have the undeveloped germs of a great accessory. By it the cheaper monotonous marbles, such as "Sicilian," and the self-coloured limestones found in our own country and in France, may be made the ground-work for a decoration at once permanent and pleasing, and not unduly costly. It has been applied to pavements, and I have laid down a specimen of it as a test. Of course it produces the effect of the *pavimenta sectilia* at a very much smaller cost, but the question yet to be proved is whether the stain does penetrate sufficiently into the body of the marble as to wear well enough for pavements; for wall decoration there is no doubt of

its durability, and the possibility of now obtaining real mosaic pavements of marble, at a comparatively moderate cost, provides us with a better addition to our decorative repertory.

Of late years, throughout Italy, France and Belgium, there has been a great revival of the very ancient art of mosaic, and as a wall decoration in vitreous pastes it has been much used in our own country, but I think I may claim for myself the first introduction of the marble "opus incertum," into this country as an available article of commerce. Many attempts, of course, have been made at all times, but the great difficulty was to obtain a really compact floor of marble tesserae at a small cost. Those floors in which the tesserae are firstly laid on slabs, and then fitted together like tiles, are open to many objections. The joints are always visible, very often the tile or section becomes loose, and a repetitive design is almost enforced upon the work by the very nature of its manufacture. In the true mosaic a bed of mortar and finely pulverized brick is spread and rolled level to form a basis, and on this the tesserae are imposed and rammed down hard into the body of the cement, thus forming the whole into one solid concrete slab. When this has become sufficiently set, the surface is rubbed down to one even face, by means of a heavy gritstone rubber, and then the work may be oiled, or friction polished, to any degree of lustre desired. You have thus a homogeneous floor, solid and silent, and affording a pleasant foothold; its design can be accommodated to any space or style, and as there is no mechanical necessity to reproduce the same design, each pavement becomes an individual work. Its durability is incontestable. The old Roman pavements we yet find in England have withstood all the hard usage of Anglo-Saxon barbarism and the neglect of centuries, and this modern revival of it has, in Paris, been subjected to the severest tests during the last few years, and borne them well. It is there adopted for the flooring of the passages of the new Opera, and is common in shops—and I may refer to the entrance hall of the Criterion, as one of the first specimens laid under my superintendance in England, as an illustration of how it bears both traffic and exposure, for the external vestibule, exposed to all weathers, is paved with it too.

As to its cost:—it may be considered as being about twice that of tiles—a good plain floor and margin being laid at about twenty shillings per square yard, and from this price it is easy to ascend; but a floor fairly executed with ornamental borders and centres can be obtained for thirty-five or forty shillings per yard—of course depending on the proportion of the surface of the plain ground-work bears to the ornamental details, and also upon the intricacy of these.

Ceramic processes present almost endless applications to internal decoration, these are much more largely pressed into service on the continent than they are here, and those among you who visited the Industrial Exhibition at Paris last year cannot fail to have been struck with the beauty of the *faiences* of MM. Deck, Parvillée, and other French potters. I regret that the difficulty and risk attendant upon removing and replacing such works prevents my exhibiting to you other than small specimens, but I would direct you to a small portion of a frieze, executed in what may be termed ceramic *champlevé* of translucent enamel by M. Deck, and a plaque in opaque enamel by M. Parvillée. In the former an impression is made in the body of the tile, into which a translucent enamel is fused: the dividing ridge of the body forming the boundary line of the pattern. Extreme richness and great variety of tone and colour is thus produced in an indestructible material, and as the patterns are hand wrought, illimitable variety of design is obtainable. The process of M. Parvillée is the reverse of this. In his work the pattern is modelled in low relief, and then painted over with opaque enamel colours, and I need only point out the plaque which illustrates his process to shew you how very servicable it is. Dados, borders, architraves, friezes, and other architectural features are executed in both these processes, offering decorative resources of very great artistic value. In the more usual process of painting on tiles there is but little new. In the old metallic lustres which give such glorious life to the Hispano-Moresco ware, and the

old Faience of Italy, are being revived in Italy, but as yet they have hardly made their way as decorative aids from an architectural point of view, but I venture to draw your attention to some specimens of the little-known tile works of Southern Italy, in which archaic design and antient process of fabrication have been most conservatively continued. All these are now procurable in England, at prices considerably below those of our own manufacture, and present suggestive application to the apparently coming future of our domestic architecture, in which, according to Dutch tradition, ceramics will no doubt play an important part.

I have ventured thus to place before you some thought-matter—the subject is, however, almost inexhaustible, and I have confined myself to that portion of it I could illustrate by portable specimens, but in conclusion, I would beg to say that a very great variety of these, and many other decorative processes, such as, sgraffito work and printing on tinfoil, already brought before your notice in former papers, and many illustrations of continental terra-cottas, glazed stones, metal work, &c., will be found in a Museum of Decorative Art which the Messrs. Trollope are establishing, under my direction, in Halkin Street West, Belgrave Square, where any member of this Institute will always be welcome, and where, by appointment, I shall be happy to meet him, and afford him every further information in my power, in the hope that I shall thus aid the research and enquiry into decorative process, foster the cultivation of decorative art, and ensure that refinement it must receive when it places itself under the hands of the Architect.

The PRESIDENT having invited Discussion on Mr. Robinson's Paper,

MR. G. AITCHISON, Fellow, said—I don't know how I can adequately thank Mr. Robinson for his extremely interesting paper. The only regret I have is, that he has selected so large a subject that it is impossible for any person perfectly unacquainted with what is going to be said to follow it, or make any remarks which might be interesting to the meeting. I have been engaged a little myself in decoration, and I am sure I hail with satisfaction many of the means by which the more costly decorations can be reproduced, particularly those stainings on wood. I dare say the greater number of members have occasionally used inlaid work or marqueterie; but it is extremely costly. A dado with inlaid panels will come to nearly £1 per foot super, so that one but 3 feet high in a large room costs so much that to persons, unless they are millionaires, it becomes a serious question whether they can decorate even one room in a house in this way. If this method of staining could be adopted (though Mr. Robinson has not told us the cost)—I presume the cost would be much less, and although we have something not equal in some respects to inlay, yet the staining has many advantages. It can be laid on in tints and a variety of colours got, which it is difficult, if not impossible, to get in inlay and marqueterie work. In inlaying you can only get such colours as wood will stain. I once designed a looking-glass frame to match a blue and white room. The frame was white with blue inlay, but, after all our pains, the frame looked grey and yellow, and did not match at all. I fancy a better match might have been by blue paint on a white wood.

If patterns can be stained on marble in various colours, it will be extremely valuable if we can afford to use marble at all; but I am afraid the expense of marble is so great that it precludes its use except for small or costly places. In either case of staining all we want to avoid is the imitation of a costlier process. I may, if I can, ornament my door or wall as I please, only I must not make a pretence that the one is inlay and the other *pietra dura*. The marble mosaic pavement which Mr. Robinson has introduced is one of the most valuable things we can have; for though at present it is incapable of producing very fine work, on account of the largeness of the tesserae, still the cost is so much less than tile mosaic, that it is with the greatest satisfaction one hails the opportunity of making designs in it. Tile mosaic with small tesserae will cost 1*l.* or 30*s.* per foot; while marble mosaic

may be done for from 50s. to 60s. per yard super, though the pattern cannot be so fine. I have no doubt when this is more known it will be very largely used; for one of the objections to tile pavement is that when the glaze comes off the thing is spoilt; whereas marble, being of a uniform colour all through even when much worn is not spoilt, and it is, I believe, very hard and durable. Of course, if this staining of marble can be done so as to stand traffic over it, much more elaborate patterns might be used at less cost, but until we have an opportunity of testing it, it is impossible to say whether it is suited for the purpose. As far as the tile-work goes, though it is greatly used in England, there are still many opportunities of using it to a greater extent. One objection to tiles in a house is that if they are placed where they will be naturally touched by the hand, they are generally cold, damp, and unpleasant. In places of large traffic, and where delicate feelings have not to be consulted, tiles are more largely used, though not generally of a decorated sort. In the staircases of houses, it appears to me, this mode of wall-lining might be used, but I think it should be above the dado, rather than for the dado itself. Some of the magnificent specimens brought here are beyond anything I have seen produced in this country, and they struck me as being the finest things of their kind I have seen. We have splendid examples, both in form and colour, in the tiles which comes from Rhodes, from Egypt, and from different parts of *Persia*, but I don't know anything more splendid for harmony of colour than the large tile frieze of M. Deck, before us. The opaque enamels of M. Parvillée are not, I think, so effective as the translucent ones. I saw in Paris, last year, one of M. Parvillée's copies of a panel of Turkish tiles in which, by some accident in the kiln, the colours had been producing that artistic effect that hitherto we have been unable to give. The regularity of the pattern, the sharpness, accuracy and uniformity with which the colours are laid on, give to English imitations of Eastern tiles a dry and mechanical look, while in the panel of Monsieur Parvillée the colours having run, harmonised the thing, and had given it more the appearance of the work of *Persia* or Rhodes than anything I have seen. I have made inquiries about this in England, and Messrs. Doulton (the most artistic of fictile manufacturers) are hoping to be able to get their colours to run and so produce those effects we so much admire in the Persian and Rhodian tiles. When we want to imitate Eastern tiles we must draw them roughly and get the colours to run, but for our own work we should not trust for our effects to slovenly drawing and careless or imperfect execution, but so design our work that our effects are produced by the most perfect skill of design, drawing, and execution. A diaper, for instance, will often produce the effect of colour irregularly laid. As to the painted cloths, I have no doubt, in large rooms and at a considerable distance above the eye, they would be extremely effective. In many cases I do not know anything which gives so rich an appearance to a room as tapestry, the objection to it in London being that it presents a dreadful harbour for dust.

MR. J. D. CRACE, Contributing Visitor.—I have listened to the paper with pleasure, but I have not much to remark upon it. The various processes Mr. Robinson has brought to your notice are, each in its way, likely to be useful to the members of the profession. With respect to the specimens of painted cloth, I think they will be found useful in many instances, especially in country houses. Probably in town houses the objections to tapestry, mentioned by Mr. Aitchison, would be applicable to this kind of wall decoration—viz., the harbouring of dust and the liability to destruction by the soot of London, but they do afford an extremely telling and harmonious decoration for the walls of a dining-room especially, and at the same time make an admirable back-ground for portraits. I think these cloths have only been before the public for a year or eighteen months, and on two or three occasions I have seen them used with great satisfaction. With regard to the stained woods, the particular process now brought forward is to a certain extent novel; but of course stained woods, and woods stained to a variety of tints, have been in use by different methods, more or less complete, for many

centuries. I think it is a question how far it is possible to carry artistic attempts in stained wood to any very great amount of refinement. My own feeling is that if one has the money to spend which would be necessary to produce a panel of the elaborate character of that on the table, one had better expend it upon the execution of a simpler design in actual marqueterie. That is my own feeling; I have no strict theory on the matter, such as we used to think the right thing ten years ago; but when the stained method is carried out on an elaborate design it is, I think, more meretricious than when employed as a simple adornment of a surface in order to get rid of crudity. I have used with satisfaction the staining of woods to different colours for woodwork and not attempting to rival marqueterie, but I should be inclined to limit these imitations to very simple treatment. When they encourage comparison with more elaborate work one's mind rather expects a more perfect process. I have no acquaintance with the stained marble process mentioned. I do not know what its durability may be; but an additional objection to the use of marble inlay for floors in London is the extent to which it absorbs the dirt. It is a great objection to marble pavement in London that all the colours soon become indistinguishable. It is only vitrified surfaces that will resist the all-pervading dirt of London. The beautiful specimens of pottery which Mr. Robinson has brought before us are very interesting. M. Deck has produced in Paris many specimens of pottery in various branches which afford very valuable lessons to our English potters; and, although pottery is a branch of art-manufactures of which this country has reason to be proud, yet M. Deck has more than run the English potters close. Besides this process by which rich, translucent colours are introduced, he has discovered an oriental blue which our potters look at with an envious eye. The only other question is, as to the use of marble. Generally the cost of using marble for decoration is a great difficulty with people of ordinarily large fortune. I think we can hardly hope to use marble to any great extent whilst its price is so high. In fact, we must look to pottery and other means at our disposal to supplement such resources of nature. I have great pleasure in proposing a vote of thanks to Mr. Robinson for his paper.

Mr. WILLIAM WHITE, Fellow.—I should like to second the proposition of a vote of thanks, and to add my acknowledgments to Mr. Robinson for bringing these valuable processes before us. I think, in spite of what Mr. Crace has said, this process of staining in wood may be of great use, but we have not yet heard anything as to the cost of it, and it may be accompanied by a great danger: that is, a process of that sort which is produced for little money may lead to an undue overlaying of ornamentation, and may thus lead to decadence in these branches of decorative art which these processes aim at improving and supplying. As to the printed hangings, I think Mr. Robinson said the cost was about 6s. per yard. [Mr. Robinson, per lineal yard.] That would seem rather costly for the kind of work if it comes to that. There is one process which came before me the other day: though it has been in use six or eight years it had not come before me till then, and I should like to know whether others have had experience of it. That is a process called wood tapestry. It seems to me a marvellous invention. The material is not much thicker than paper, and is mounted on canvas; the canvas being mounted on deal or plaster, and having all the effect of wood, it is impossible to tell it from solid board. Even in a flat surface each board may be of a different colour, and these formed into a panel with mouldings round, has all the effect of wood panelling at about one-third or one-fourth the cost, being produced at 1s. 6d. or 1s. 9d. per foot super, whilst in the solid wood it would cost 6s. or 7s. per foot. I have not satisfied myself as to the legitimacy of its use, but I saw some of it on a staircase in Berners-street, which had been up five or six years, and it had worn extremely well. It was unvarnished and had the appearance of a simple plain inlaid piece of woodwork.

Mr. R. P. SPIERS, Fellow.—It may be interesting to the meeting to know that this subject, as

far as Ceramic ware is concerned, will be followed up at the Architectural Association, on Friday the 17th instant, by a paper by Mr. Sparkes, the head master of the Lambeth School of Art, who will bring forward a series of examples to show how applicable this description of ware is to architectural purposes. A paper was read last year by Mr. Sparkes before the Society of Arts, which contained a great deal of information, showing the applicability of pottery for chimney-pieces and other internal decorations, which I think should be more looked into by the profession. I think it is generally considered that for external work highly-glazed materials are objectionable as they retain their high glaze while the rest of the building tones down very much and thus they get out of character. There is one other manufacturer, who started a short time ago, whose works are probably known to a good many here. He produces tiles somewhat similar to this panel of Deck's, which is exhibited by Mr. Robinson. I understand that, in this, the surface is scooped out by hand, and the colours are run in entire, whereas the old Spanish way of making tiles was with wooden or other moulds; and Mr. Garrard (who was at one time an architect) when travelling in Spain was so enamoured with the colouring of those tiles that he tried to make some himself. He succeeded very satisfactorily in producing colours in some cases equal to the old Spanish tiles. At the same time he experienced that difficulty which Mr. Aitchison spoke of (and which is noticeable in that plaque of Parvillee's). They are too mechanically correct, and he finds it very difficult to get his workmen to let their colours overflow their borders and run one into the other. It is quite certain that the tiles which we so much admire in old works present a much more harmonious and refined description of work than those produced in the present day. I should be glad to hear something about the ornamental leathers which are exhibited at the end of the room, as they appear to be of some interest.

Mr. AITCHISON.—Perhaps I may be allowed to make a few further remarks. Mr. Crace said that for external decoration marble was useless, vitrified substances alone being of use in the atmosphere of London. In some respects that is true. The surface of all the true marbles is rapidly destroyed by the atmosphere, whilst in Venice and in the clear atmosphere of Italy nothing is more charming than the effect of these crumbling coloured marbles. In London, however, directly the polish has gone all is covered with soot, and all the marbles you let in are with these stone surroundings of one uniform dirty black. The porphyries and the harder sorts of granite are, I believe, unaffected by the London atmosphere. But I am far from being able to speak in favour of some vitrified materials; for instance, the ordinary white tiles used for light, take what precautions you may, before they have been up a year in every exposed situation half of them are destroyed, and have to be replaced by new ones. I have applied to the tile makers and used every means I could to prevent this unfortunate result, but, at present, without success; wherever the tiles are exposed to wet and cold during winter, some disintegrate, others crack, some flake off, and in some few cases they fall down altogether. I have not had an opportunity of testing them, but Mr. Doulton tells me his tiles are perfectly free from those faults, and no atmospheric effect will produce cracking, flaking, or disintegration. If that is so, they will be a valuable adjunct to the architect. Mr. Spiers remarked that vitrified substances, when used with other materials for the external decoration of buildings in a short time become out of tone with the rest, the softer materials becoming black. That is true, but why in a climate like ours should we not get a good vitrified material with which we could cover the whole external surface. The Venetians covered the whole of their buildings with fine plaques of marble. I do not see why we should not have some means of external artistic decoration in the shape of tiles or glazed terra cotta. It is impossible to compare the effect of the climate of Italy with our own. We know in the towers of churches there are pieces of pottery taken by the Pisans from Minorca embedded in the walls which appear to be as good as ever. The quantity of sulphuric acid in the atmosphere of London is most destructive, but

it may not destroy tiles. Mr. Doulton says most emphatically that it will not destroy his tiles. I understand that the metallic iridescent painting of Hispano-Moorish pottery and of the earlier works of the Italian potters, particularly the glorious ruby-colour of Maestro Giorgio, is being imitated by Mr. De Morgan, at Cheyne-walk, Chelsea, and that he has to some extent succeeded. The metallic glaze or lustre, mentioned to-night, was very common twenty or thirty years ago in this country, and was to be met with on the jugs and teapots used in cottages and public-houses, and many other descriptions of pottery ware were covered over with an iridescent glaze nearly identical with the Hispano-Moorish.

MR. C. L. EASTLAKE, Secretary,—As the specimens of embossed leather exhibited this evening have been referred to, I may mention that they do not belong to Mr. Robinson, but to Mr. T. Morris, who will no doubt be able to give us some information on the subject. For my own part, I am unwilling to add to the long list of questions which Mr. Robinson will have to answer, but I should like to know if the samples of printed tapestry hung on the walls are complete in themselves as patterns, or are only portions of a larger design. Because it seems to me, that it will make all the difference in this mode of decoration whether the quasi-tapestry is designed so as to form a subject extending over the whole of a large panel, or whether it will consist in the mere repetition of a pattern in narrow widths like a wall paper. In the latter case of course the appearance of real tapestry could not long be maintained, though I must confess that in point of colour and even by daylight the resemblance is very strong in these specimens.

The imitation of tapestry, as Mr. Robinson has explained, is in itself no modern art, though the printing machine may now do what was once the work of hand and brush. I remember that when I was at Orvieto some years ago, I saw a large piece of painted tapestry hanging in one of the rooms of my hotel, which I believe had once been a palace. The style of the design was late, but good of its kind and well drawn. It completely deceived me at first, and it was only on close examination when I found the colour could be scratched off, that I ascertained the real character of the work. Now I understand Mr. Robinson to say that in these specimens the colour not only does not rub off, but that the surface can be washed from time to time. If that is the case this printed tapestry certainly possesses a decided advantage in these respects over the hand painted work I have mentioned, and the objection to its harbouring dust is at once removed. With regard to the examples of stained wood, in imitation of marqueterie, which Mr. Robinson has shown us, I should be glad to know, without entering on artistic considerations, what is the cost of the process as compared with actual inlay. I can scarcely suppose it cheaper than the so-called Dutch marqueterie of which such large quantities are annually imported into this country in the shape of wardrobes, escritaires, cabinets, chairs and tables. The execution of this furniture has always been a mystery to me. Where can labour be so cheap as to allow the whole surface of a large bureau to be richly covered with inlay and sold for twelve guineas? That is the price I gave for one at a sale not long ago. It is true that the design of this Dutch marqueterie is coarse, but the work is sound, the colours are often well associated, and the effect, taken as a whole, very decorative. I am told that much of the inlay is modern but applied to old furniture, and that it is executed by women and children. Even on this supposition it is wonderfully cheap, and in that respect is I think likely to be a formidable rival to any painted imitations of inlay. With regard to pottery, as the English revival of artistic stoneware has been mentioned, I should like to ask Mr. Robinson if he can explain why it is so much dearer than foreign reproductions of the same art. The prices of the English ware are to my mind absurdly high, while style of ornamentation and in quality of colour it is far behind the Belgian pottery and modern "Gres de Flandres" of which some excellent specimens have lately found their way to this country. The extravagance of English prices extends to all artistic

examples of ceramic art. Our reproductions of arabesque majolica for instance are rare and enormously dear. Compare them with the clever imitations of *faïence* and Rouen ware executed at Gien in France where the designs are partly printed in outline and then cunningly touched up by hand and painted with excellent effect. There is a *depôt* for this Gien ware now in London, and if the English manufacturers do not take care it will beat them out of the field. Having offered these few remarks I will merely add that I have listened to Mr. Robinson's paper with great pleasure, and that I am not surprised it has elicited such interest.

MR. T. MORRIS, Associate.—With regard to these specimens of leather, I will just say, in two or three words, that knowing them to be in the hands of Messrs. Battam and Craske, of Oxford-street (though uncertain whether they were originals or squeezes from other works), I thought they would suit the subject of Mr. Robinson's paper, and I caused them to be sent here. I have been hoping that either in the lecture or discussion some reference would occur to what I believe to have been the very general application of leather for decorative purposes in the fourteenth or fifteenth century. In my own mind I have associated the scroll-work of the Elizabethan style with the application of leather ornaments upon grounds or horsings of wood. The whole system of Elizabethan decoration seems to take the form of a yielding flexible material like leather so applied. These specimens show the capabilities of the substance, and are indeed very excellent examples. I believe a similar use at one time prevailed in this country and on the Continent, especially in France, and that such decorations were effected by embossing, perforating, curling, japanning and gilding to the most fanciful and elaborate pitch of embellishment. It is a noticeable thing, too, that at this very time some of the most splendid paper-hangings prepared by the French are imitations of the stamped leather works of previous centuries. They are got up in a style of superb decoration, and show that the leather tradition has never died out in France.

MR. CRACE said the leather on the wall was of the same character as that produced in Paris thirty or forty years ago.

MR. JENNINGS.—I did not intend to make any observations because I do not like to speak on a subject unless I am perfectly acquainted with it, but I would say that the observations of Mr. Aitchison and my experience do not altogether agree. I think when tiles are perfectly good they will stand, but very frequently they are not, and in that case when the damp gets behind them their glaze cracks off. In cases where I have used them twenty years ago I have not had a single failure. I have been told that there are three distinct degrees of goodness. I have always used the best, but considering the great liability there is to failure, I have recently used the vitreous surface brick itself, but that has not been employed a sufficient length of time for me to speak with any certainty respecting it. My own belief is that it will stand perfectly; and we know from the experience of the black vitrefied bricks found in the interior of a kiln that some vitreous bricks will stand every sort of weather. The producing them, and whether it is worth doing so is, a mere question of expense. It is an open question whether it is less expensive to renew a thing than to have it perfect in the first instance. With respect to these painted cloths do I understand rightly that the body colour is put on first and the figure painted on it afterwards, because if the whole thing is painted by hand it must have been a disadvantage to put the figure on the body colour afterwards. [MR. ROBINSON, The body colour is printed first.] Then I do not see why we should adapt anything which is a mere imitation of what is ancient. I think it is preferable to adopt a course more in accordance with the brightness we wish to secure for modern rooms rather than what appears to give a dark effect. If the pattern is printed on the surface of the cloth it is a question whether it is so durable as if it were woven. We know that these

patterns can be woven, and they would be much more substantial than if printed, and with a large quantity I do not think the difference of price would be too great, as compared with 6s. per yard, to prevent its being adopted. Speaking generally with regard to both cloth and leather decorations, it may be remarked that they have the effect of improving the acoustic qualities of a room.

THE PRESIDENT having put the motion of a vote of thanks to Mr. Robinson, and the same having been unanimously adopted, said: I have scarcely anything to add to what has been said excepting to express my great pleasure in seeing a number of new modes of decoration and a number of old ones revived brought before us. I think it is only those who have had the opportunity of looking at these closely who can safely venture an opinion upon them. I therefore beg to be excused from doing so without such advantage. I may mention that marble inlay, heightened in its effect by coloured staining, is a revived method of decoration. I have seen it, I think, in old buildings in Italy, and also in some English buildings. It was used for internal window-cills, hearth slabs, and, I think, for chimney-pieces in the parts of Ham House, which were erected in Lauderdale's time. It is very delicate work, and retains its colours and design perfectly. The system shown by Mr. Robinson might, perhaps, be applied to that kind of marble inlay which is seen in the pavements of the cathedrals of Sienna and Lucca, while the coloured draperies, &c., are inlaid in marbles, and the lines incised and filled with dark cement, substituting for the latter the stain now exhibited, though this would hardly do for pavements. The same may possibly be applied to inlaid wood-work. If, however, you wish to inlay figure subjects in wood there is a great lack of brightness about the effect. It looks well when one is close to it, but at the distance even of a width of a room it merges into a quiet and indistinct effect. The introduction of stains and lines in the way shown by Mr. Robinson might, very possibly, just do for that sort of work what it requires without depriving it of the truthfulness of being really inlaid wood. With regard to the cloth hangings, if they could be woven anything like the price at which these painted hangings have been produced one would of course much prefer it. With a painted material of this kind it may be a question whether it might not give off unwholesome or unpleasant emanations (as is sometimes the case with paper hangings). The subject, however, is well worthy of consideration, and may lead to the introduction of a mode of decoration highly advantageous. In all these systems of decoration, however, there may be a danger, as Mr. White suggests, of over-ornamentation, or, as Mr. Crace says, of lowering the moral value of ornamentation, by producing what ought to be rare and high-class work by a cheap method, or (to borrow an expression from an enemy) "making all things common and unclean." I think those who have the command of their inventions by the means of patents should be careful not to allow their systems to be used for low and unworthy purposes; otherwise the whole thing is vulgarised and degraded. One would expect where a pattern has to be repeated over and over again that there would be no temptation to cheapen the small amount of art devoted to it, but we usually find the reverse to be the case, and that the more frequent the repetition the meaner is the design. Perhaps this a happy Nemesis which follows cheap systems, and severs them broadly from those of a nobler stamp. I think indeed we have no reason to find fault if a good thing is proportionably expensive. I have very great pleasure in tendering the thanks of the meeting to Mr. Robinson for his paper.

MR. ROBINSON.—I have not only to thank you very much for the kindness with which my paper has been received, but also to express my obligations to those gentlemen who have taken the trouble to comment upon that which I have laid before them. There have been many questions asked in the discussion, and there have been remarks made upon the quality of the designs. I am not myself responsible for any of the designs you see. My object has been simply to illustrate processes, not

designs; and I wish most thoroughly that every architect using anything of this kind, should make his own design, and insist upon its execution. When we get a greater amount of individuality in decorative work, we shall then be getting good work, and manufacturers will not repeat a thing a thousand times when they find that architects do not care to have it more than once. Touching the relative price of stained woods and inlays, we can scarcely make the comparisons. Taking the instance of these panels, I should judge that the cost of staining them as they are, would not be greater than one-half more than that of plain painting. The object of this process is not to repeat the same patterns. They are not necessarily stencilled, but are drawn on, and transferred from, paper cartoons, and so carried out. I should suppose the cost of one of these panels would be about 4s. 6d. complete, whilst those of simpler patterns would be about 2s., dependent on the number of stains and their intricacy. The panels I produce are not exhibited for designs, but to show the effects which can be produced by colours on various woods, and it will be perceived that in some of them there is an utter absence of any imitation of inlay. As to the danger of over-ornamentation by cheap processes, anybody who cares for decorative art would guard against that. As I have already said, I wish to put art under the ægis of the architect. A question has been raised upon the re-introduction of the metallic lustres on pottery. Alluding to those lustres referred to, as being in use at the beginning of the present century, and up to twenty or thirty years ago. They were lustres which I believe did not last very long. It was a sort of manganese glaze, and were metallic, but not iridescent in their reflection, but the old bright ruby iridescent lustre is now being reproduced on small articles of pottery in Italy, near to its original birthplace. The wood tapestry referred to by Mr. White, has been in use for a great number of years; indeed ever since the Americans found out it was extremely 'cute to cut wood as thin as possible. It was sent over here some fourteen or fifteen years ago, and I used it myself some years ago in a bank at Huddersfield, and it has stood very well. It produces a very good effect in the decoration of old country houses, where the walls are bad, and it is a good mode of doing the work rapidly and at a cheap rate. Not being a new process I did not refer to it. I am not able to answer the question with regard to the price of the Doulton pottery, but I regret we cannot get these ceramics produced here at the price of foreign ware. The tiles exhibited on the mantel-piece cost about twelve or fifteen francs per hundred in Italy, whilst those with more work in them are there sold at prices varying from forty to fifty francs per hundred. If we attempt to get such made in England, we are checked by the cost of producing them, but by going to the smaller tile-works abroad, they may be obtained at reasonable prices. With regard to these painted cloths, unfortunately, all those executed by a printing process of this kind are repetitive in design. That particular pattern of tree is not one to be greatly admired, so far as detail is concerned, but is, nevertheless, effective in the mass, but there is ample room for the display of genius on this kind of material, and it is a form of wall-decoration which was very general in the middle ages. With regard to its harbouring dust, I think there is not much in that, because they are washable. I do not mean that they should be sent to a laundress, but they can be cleansed by sponging, or the dust can be shaken off as with all other household hangings and curtains; and there is this advantage about them, that a person using this kind of decoration can take it away with him if he removes to another house, instead of having to lament leaving behind him a large expense for decoration which cannot be removed. With regard to the stamped leather decorations, some very beautiful things in that way are, and have been ever since the 16th century, produced in France and Holland, and in this country, some successful attempts have been made to get the relief and brilliancy of colour of the old Venetian leather, yet though it is true that there is "nothing like leather," unfortunately there is hardly anything more expensive than leather for wall decoration,

for good skins, averaging about five and a-half superficial feet, cost from 25s. to 30s., which is too costly to be frequently indulged in. The cost of the stained marble-work depends, of course, on the amount of decoration imposed upon it, but a good simple pattern can be produced on ordinary Sicilian marble at 3s. 6d. per foot super, and marble-work need not be such an unattainable luxury if care is taken in the selection of the material and its adoption. In conclusion, I again beg to thank you for the reception which you have given to an erring and wandering brother, and also for the way in which you have received my paper.

The Discussion having been thus brought to a close, the vote of thanks to Mr. ROBINSON was carried by acclamation, and the meeting adjourned.

Royal Institute of British Architects.

At the Ordinary General Meeting of the Institute, held on Monday, the 5th of April, 1875,
H. CURREY, Vice-President, in the Chair, the following Paper was read:—

ON IRON AS A CONSTRUCTIVE MATERIAL.

By C. H. DRIVER, Fellow.

IT is only of late years that iron, as compared with other metals, has been used as a constructive material, but it was known and employed for various other purposes from the very earliest times; and though it is now the metal of all others the most frequently used by the architect or engineer, and is the best adapted of any to their requirements, it is as I say but comparatively recently that its great value for building and constructive purposes has been fully appreciated, and to a certain extent, utilized; and it is with the hope of showing that it may be employed in a still better manner than at present, I venture to take up your time this evening.

The earlier employment of gold, silver, copper and tin by the ancients, was due probably to the readiness with which these metals could be obtained, either in a native state or from their ores, and the ease with which they could be worked as compared with iron, which was both hard to obtain and difficult to work, requiring great heat and labour to extract it from its ore. The vast store of iron ore which Britain possesses, was quickly discovered and made serviceable by the Romans, who however worked it very imperfectly. The following epochs in the history of iron serve to mark the progress made in its manufacture, and are intimately connected with its constructive use, viz.—the employment of the artificial blast as a means of intensifying heat, and thus more readily reducing iron ore: the use of coke in smelting, about the year 1750, which was first successfully accomplished by Mr. Abraham Darby, of Colebrookdale, and at about which time cast iron began to be employed to supersede timber in various details of construction: the introduction of the steam engine by James Watt, in the year 1770: puddling and rolling by Mr. Cort of Gosport, in the year 1783-4: the employment of the hot blast by Mr. Neilson, in the year 1824: the invention of the steam hammer by Mr. Nasmyth, in the year 1833: and lastly, Mr. Bessemer's process of converting iron into steel, published in the year 1856.

Cast iron was but little known or used in England till about the middle of the sixteenth century, but in the seventeenth century the art of casting had greatly advanced. It is likely however that cast iron was known and utilized on the Continent earlier than with us; Mr. H. W. Brewer gives us in the *Builder* of July 16th, 1870, a drawing of a cast iron stove from Coburg, which he states to be of the fifteenth century, and "that it is remarkable not only for its design, but for the material in which it is executed, there being not the least doubt that it is cast iron, and probably the earliest example of the use of that metal." As early however as the sixteenth century, there was a proposition to erect on some Italian works then in progress, a bridge in cast iron, but though the

idea was not carried out, it is worthy of note as showing that its capabilities were even thus early attracting attention; and though between that time and the year 1777 the idea was frequently revived, it was not until then that the first bridge was actually built in iron, this bridge was constructed in cast iron over the river Severn, near the village of Brossley, Colebrookdale, Shropshire. From that time the use of cast iron for bridge building rapidly extended, culminating in Southwark Bridge, built by Mr. Rennie between the years 1814 and 1819; since then cast iron has given place to wrought for all bridges of large span.

Though the use of iron by architects in building structures has enormously advanced, the credit of discovering and applying the great advantages that iron unquestionably possesses over almost every other material to constructive purposes, is due, I think, to the engineers and not to the architects. Architects as a body have neglected and slighted this universally useful metal, either rejecting it altogether, or employing it as it were under protest, and as if they were ashamed of it. They use it in fact as a drudge, and not as I venture to think they should, as a valuable friend, equal indeed to most other building materials and superior to some; valuable both for constructive and decorative purposes, and I apply these terms in the same sense as we employ them when speaking of wood, stone, or any other material we use in building. And while it is remarkable that we should have thus neglected it, the way in which engineers seized it is no less remarkable, for they with wonderful acuteness brought their science and practical knowledge to bear upon it, producing results that ought to be an example to us; for as a rule engineers, with regard to brick or stone, pay us the compliment of copying as well as they can our architectural forms and practice; but with respect to iron the reverse is the case, as they, finding that architects had done, I will not say could do, little or nothing with it, struck out a path for themselves, and it cannot be denied, have achieved in it a great success. I think however it is unfortunate to some extent that they did so, for it is in a great measure the cause of the want of appreciation iron obtains from architects, not because architects are jealous of the success of the engineers, but rather because of the disgust they feel at the inartistic result of their labors. Can this be remedied, and can iron be placed in its proper position with regard to architecture? I venture to hope it may, by taking advantage of the practical skill and knowledge which engineers have already obtained, and upon the foundation laid by them, advancing step by step, till we succeed in finding uses for iron both in construction and decoration, which, while perfectly adapted to the material, will yet combine and harmonize with those we have heretofore had in use.

Let us consider for a moment some of the principal attributes of iron, and then see how architects generally take advantage of them. As regards wrought iron—first, it is very strong, bearing a working tensile strain of from five to six tons, and a compressive strain of from four to five tons per inch of section, and as regards strength it is as twenty-seven to five as compared with oak, and as twenty-seven to four as compared with fir, and yet if it is employed as a beam or girder, it is generally so swaddled up with cradling and lath and plaster, that as much room is taken up by it as if it had been a beam of oak or fir. Then again it is very light as compared with its strength, but by the same process as last mentioned, its weight is brought up to that of a wood beam; It is very ductile, easily cut and hammered to any variety of shape, and yet almost the only form ever given to a wrought iron girder when used in building, is that of the ordinary rolled or plate girder.

Again, iron, though very durable, is not an imperishable material, and this appears to be practically forgotten, for though, unlike wood and perhaps stone, it is free from internal deterioration, yet it is liable to serious destruction by rust and oxydation of its outer surfaces, a most important point

considering the fact that but little excess of material is usually provided than is absolutely necessary for the required work, and therefore it would be but reasonable to suppose that when used arrangements should be made by which all parts of a girder or column could be readily inspected; but in the system in vogue the reverse is the case, for the girder is so covered and hidden up that no inspection is possible, nor can any means be taken to paint or otherwise preserve it from the inevitable destruction that must result from rust. It is almost the same as regards cast-iron:—a material admirably adapted for columns, from its fitness to bear great compressive strains, and by its very nature capable of assuming almost any form that architects may design, from a plain column to the most elaborate effort of ornamental art the mind can conceive, yet as ordinarily employed the cast-iron column is either a plain round shaft with a square cap and base plate with gusset pieces to strengthen their connection with the shaft, or as a story post like a girder standing up on end. This column or story post is often covered with lath and plaster and appears in the glorified shape of a Doric, Ionic, or Corinthian column with cap, &c., to match, or as is the case in most shops it is left in its native bareness behind a plate-glass front, and has to be wrapped up in glazed calico or baize by Mr. Showemoff, the shop window dresser, who wishes that ugly column were out of the way.

I repeat that we are glad enough to make use of the strength, lightness, and adaptability of iron, but we are ashamed to acknowledge that we have employed it, and therefore cover and hide it up; and I think this arises in a great measure from the idea (a mistaken one, however) that iron does not accord with other materials and is unsuited for architectural forms, and therefore if we use it, as at the present time we are almost compelled to do, we should do our best to hide it up as far as possible; and it is argued that it is necessary to lath, plaster, and case it up to satisfy the eye, as from its strength so little is required that no effect can be obtained in using it, and therefore it is better to cover it up with other materials to avoid the thinness and poverty of appearance that is produced when employed alone, in the same way that the flesh covering the bones produces a beautiful form and at the same time hides a ghastly skeleton. This, in fact, is the opinion of a gentleman (and it is probably shared by many) who in his remarks in the discussion which ensued with respect to Mr. Scott Russell's paper upon the Vienna dome said, "The properties of iron being admirable for frames and skeletons the architect should employ this material so as to obtain its power but conceal its presence, a principal adopted in the works of nature, and especially displayed in our own bodies. Therefore I think we may be content to take iron for the skeleton frame, and case it up with stone and other material that may seem to conduce to the object in view."

This argument, however, appears to beg the whole question, for the flesh is not put on to hide the skeleton merely, as the lath and plaster is put on to hide the iron. The skin and flesh and muscle perform most important and necessary functions, so important indeed, that the body cannot live without them; but this is not the case as regards the lath and plaster casing to iron, strip it off and the building stands as well as ever, further, flesh and muscle add *strength* to the bones and assist them in their work; not so with the cradling and lath and plaster or any other casing to iron, they do no good to the real girder or column, but are on the contrary detrimental, as instead of being an assistance to it, in the way the flesh is to the bones, they only weaken by adding uselessly to the load to be carried or the work to be done, besides, as has been before mentioned, preventing that inspection which is so necessary for its preservation.

But to return to the question of effect, does the hiding up of iron by other material meet the object intended, viz., better effect? (and setting aside for a moment the principle of honesty of construction) is not the result obtained most unsatisfactory? For owing to the introduction of iron much larger spaces are bridged over without requiring columns and arches than heretofore, and hence there is

produced a bareness and an apparent weakness anything but satisfactory to the eyes. As an example I will take that most familiar one of all, the shop front; there, as a rule, we have a structure of three, four, or more stories high, with elaborate and massive architectural features, columns, cornices, pediments, &c., &c., piled up with lavish richness, all carried apparently by a stone lintol of twenty thirty, or forty feet span, and of an absurdly little depth in proportion to what in appearance it has to carry over a huge field of plate-glass; while, as we all know, the real work of supporting the fine front is done by the wrought or cast-iron girder, which is hidden behind the stone fascia aided by cast-iron columns or story posts, as the case may be. The effect is not pleasing or satisfactory, for it is untruthful, and I contend that if the money spent upon the sham lintol which forms the casing to the girder were spent upon the girder and column by making them pleasing in design and form the effect, the result would not only be much better but positively good, for though we should still have the wide span and the plate-glass under as before, yet we should *see* how the building above was really carried, and as we *know* that iron is strong and capable of doing its work, the eye as well as the mind would be satisfied.

With regard to this point, viz. the satisfaction of the eye, it is possible that the eye may require some amount of education before it becomes accustomed to the use of iron and its employment in connection with other material. For we are so accustomed to see beams, columns, and brackets of certain proportions that we are at first sight shocked at the idea of detached columns of twenty-five or thirty diameters carrying great loads, or slender beams carrying a heavy building; and it is difficult to adjust their proportions with the styles of architecture we have in use. But I have hopes that architects will, if they give the matter their earnest attention, with the sincere desire to succeed, produce designs for iron which though not perhaps exactly in accordance with any existing particular style, shall yet harmonise, even perhaps by contrast, with them. Iron sometimes meets with other, but very different treatment from the hands of architects, and I hardly know which is the worst, for instead of being hidden, it is brought prominently forward, but in such a form as to suggest a different material, as stone or wood. This is especially the case with cast-iron, which in addition to other disguises occasionally assumes the appearance of wrought iron. I may instance balustrades, vases, parapets, tracery, &c. A prominent example of its misuse in this way is seen in the parapet and spandrils of Westminster Bridge, though happily, however, these were not the work of an architect.

There is, I think, another reason why architects as a rule ignore iron as a constructive material, and that is perhaps the most general one, viz., that few of them comparatively know anything about it, never studying or looking upon it other than as the aforesaid useful drudge, and this more especially so with respect to wrought iron. As to cast-iron they may perhaps use it for columns, railings, finials, or rain-water gutters and spoutings, but these they take ready designed from an ironfounders catalogue, probably thinking that it is not worth their while to take the trouble to design such things for themselves. Or if they want a wrought iron girder they are perhaps able to work one out from the simple formula given in the various handbooks; or, as is more likely, they leave it to the builder's foreman. But if the quantity required is large and the work important, they employ an engineer to work out the calculations, and as the engineer (with every respect to him) cares nothing about art, but a great deal as to whether his girders are strong and economical, it is very probable that the result is ugly. This being the case, the architect naturally enough covers up ordinary plate girders and columns with a material he does know something about, and therefore can design in; whereas if the architect did but know and understand as much about iron he would calculate for himself and study to so design his girders or columns, or whatever else he may require, that the result should be artistic and suitable to the structure for which it was intended.



Nº 1

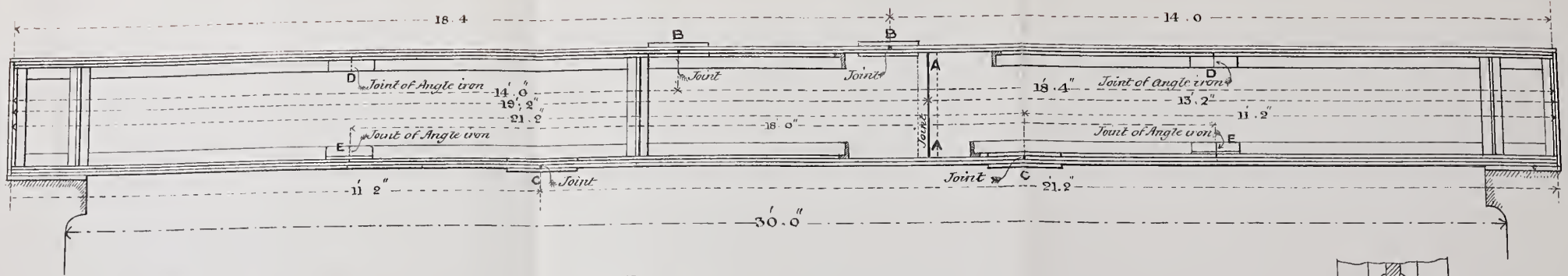

Nº 2.

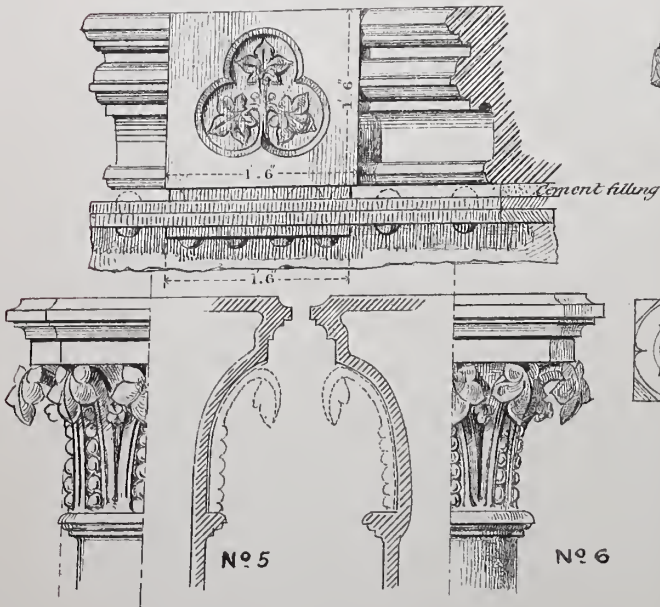

Nº 3

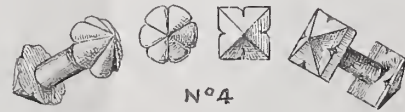

Nº 4



Nº 7.

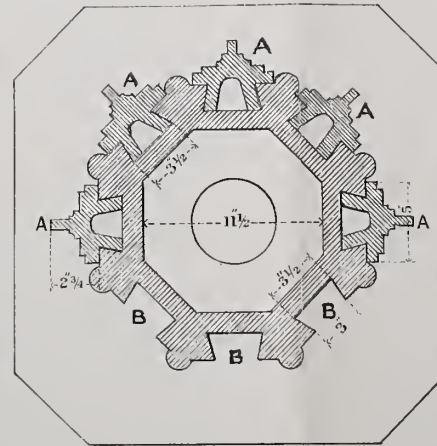

Nº 8

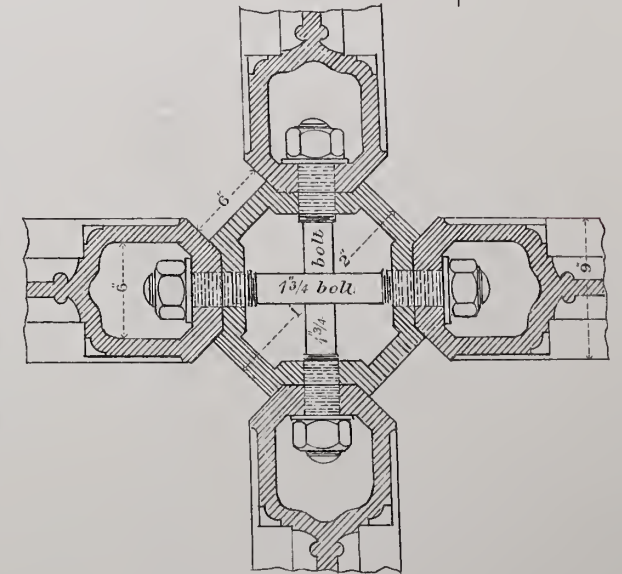

Nº 9.

DIAGRAMS TO ILLUSTRATE MR C. H. DRIVER'S PAPER ON "IRON AS A CONSTRUCTIVE MATERIAL."

Surely, architects, if they will, can so design their girders in wrought or cast iron that they shall be pleasing and effective. Let us but take the trouble to draw them out and calculate them for ourselves, we shall soon find it is easy enough to arrange flanges, webs, cover plates, angle and tee irons so symmetrically as to be pleasing, and still preserve the necessary scientific proportions and the relation of the several parts to each other in a practical manner. Plates and angle and tee irons are now rolled in such lengths, that very large spaces may be spanned by girders without any cover or junction plates being required. As for instance, plates can be obtained from twenty to twenty-five feet long by two to three feet wide; angle and tee irons up to thirty or thirty-five feet or even forty feet. Many varied forms and even mouldings could and would be rolled, if manufacturers found there was a demand for them, and that it would pay to make the necessary rolls.

But suppose that cover plates are required, and I specially speak of them, as they are what generally disfigure a plate girder or, indeed, any girder, they can be arranged so as to divide the girder up into panels to agree with the fenestration or some other feature of the work. For example, suppose a girder has to be designed for a shop of say thirty feet opening, the doorway six feet wide, being in the centre, it may be done thus (see sketch No. 1)—the vertical web would be in two parts, jointed at A with a cover plate at back and vertical tee irons in front forming the joint—the joint of the top and bottom flange plate being at B and C with cover plates to same, and the joint of the angle irons at D and E with cover plates to them also: the longest plate or angle iron would not then exceed twenty-two feet, an ordinary length. By this arrangement, which is very commonplace and simple, the girder is divided into three panels, which may be varied in length as required. The cover plates projecting as they do, above and below the top and bottom flanges, can be made features, if it is desired, to show the construction completely—by stopping the moulding above, thus (see sketch No. 2), or the intervening spaces caused by the plates standing above the flange can be filled in with packing,* the rivets of the cover plate being in any case countersunk, to the cover plate on the bottom flange a pendant of wrought or cast iron may be attached. When, however, columns are introduced, the arrangement of plates becomes a very simple matter, as all the joints can be arranged so as to come over one column or other, the girder being as it were divided into separate portions, but yet when complete having all the advantages of being continuous.

In the example I have just given, I have taken the most simple arrangement that can be made, but I think it is easy to see that the principle can be worked out to any extent. We are not confined to plate girders, as there are all the varieties of form that the lattice and Warren's girders place at our disposal. I have here three sketches showing how the different girders may be treated, and I must ask you to consider them merely as suggestions and not as designs or examples to be followed.

As regards rivetting, I do not see why something better cannot be done in this way than the ordinary round headed rivet universally employed, the rivet head may and can be made thus (see sketch No. 3), or in any other form—the part to be heated and hammered up to form the rivet complete being at the back of the girder and the ornamental head to the front. If, however, the girder is seen on both sides the rivets should be of course made to correspond, which can be done by the use of steel cups or swages in the process of rivetting up. A great deal can be effected by different forms of washers, thus (see sketch No. 4).

I do not think it is necessary to go further into this matter, or into the question as to how columns and girders can be made ornamental as well as constructional in cast iron, as I have no doubt, if you

* Portland cement in the proportion of one of cement to one and a half or two of sharp sand, makes a very good filling between iron and brick or stone.

give the matter your attention, most of you can do that better for yourselves than I can tell you, but I wish to point out some little matters which tend to give a finish to construction in cast iron and which are sometimes overlooked. For instance—the foliage to the cap of a column is often applied in such a way, as to spoil an otherwise good design, by starting from the neck in a line beyond the face of the shaft, thus (see sketch No. 5), especially when the foliage is loose and put on separately, the reason being that the bell of the capital is in a line with the shaft and the leafage put on, of course, projects beyond. The bell of the cap should be set back, thus (see sketch No. 6), which will allow the enrichment to be put in its proper position.

Again, you may often see ornament in cast iron spoilt by the clumsy way it is put together, commonly by ordinary square or hexagonal headed bolts and nuts. Now, as a rule, if proper attention is paid in designing the work, cast iron construction can generally be put together without requiring any bolts at all; or, at least without showing them; but if it is necessary that they should show, they can readily be made ornamental. For instance, the ordinary square and hexagonal headed bolts and nuts can, by a few nicks with a chisel or file, be made like stars or flowers, and yet retain all their use and strength, thus (see sketch No. 7). To give you an example how cast iron construction can be put together, so as either to avoid bolts altogether or to hide them if used, I will take as an illustration of the first the junction of eight brackets on to a column. This can be done by the use of a dovetail joint, thus (see sketch No. 8), the brackets sliding into their places from the top; if great accuracy of fit is required, the parts A A of the brackets and B B of the shaft should be planed or machined. (As a general rule, it is better that all joints in cast iron should be faced and the bolt holes drilled, so as to insure greater accuracy in fitting together). And as an example as to how bolts, if used, may be hidden, I have here an instance of the mode of connecting four or more girders together over a column, the lines of which are at right angles to each other. It is done thus (see sketch No. 9): pockets are formed at the end of each girder at the point of junction with the column and are fitted to the column, which is moulded to match, the surfaces of junction being machined as before, the bolts for connecting the girders have a thread at each end, and, as you see, can be readily inserted; the nuts are screwed up by means of what is called a ratchett spanner, and are easily made tight. By this construction the tension of the girder is made continuous by means of the bolts, no strain except the compressive strain due to the dead weight alone being put on the columns.

It will probably be said that ironwork designed in the manner I have attempted to describe will be a great deal more costly than if made in the ordinary regulation way, and this, of course, I must admit, but the item of cost ought not to be an argument against the employment of well-designed and ornamental ironwork, any more than it is against the use of moulded and carved stone or wood in place of plain masonry or joiner's work. The principle is the same, whether it be applied to wood, stone, brick or iron, and if it is right to bestow labor in ornament (which means to a certain extent—money) on the one, it is equally right to do so on the other; and I see no reason why iron has not as good a claim to artistic attention as any other material.

I cannot leave this part of my subject without again referring to the discussion on Mr. Scott Russell's paper, and I think Mr. C. Fowler goes very much to the point when in speaking of the Vienna Dome, he says "The design is in many respects charming, but I confess in one essential respect it is disappointing. No one looking at the drawing of the exterior, as finished, would have the slightest idea how it was put together. No one could conceive that the nicely designed Italian work was entirely constructed on wrought iron boxes, and it does seem a pity that so cleverly designed a building structurally should not have been treated architecturally and decoratively in some manner consistent with its structure instead of that being entirely hidden. No doubt it is a misfortune of engineering

“works that the engineer has not time to devote himself to the decorative as well as the structural part of his work, and he has to apply to some one to assist him in that. The architect in many cases has comparatively little knowledge of, or has not time to investigate the principle of the construction, and merely looks at the form put before him and makes his design accordingly. He is not able in many cases to work out the decorative form from the structural one. We can only look forward to the time when we may hope the designer of such structures may be able to understand both the principles of construction and the decorative treatment, sufficiently to indicate in a general manner what that treatment of his structure should be, so that though he may not be able to work out all the details, he may superintend those under him sufficiently to give more consistent decorative treatment to his own structure.”

Reverting for a moment to the point that the constructive employment of iron is of comparatively late date, one significant fact is worthy of remark, viz.—that the artists of the middle ages had brick and stone and other materials, but no iron, at least not in quantities they could make structural use of, and they made such good use of the materials they had that we are fain to copy them. Is it not therefore fair to suppose that if they had had iron at their command as we have, they would have produced works in that material as admirable as are their works in others? I am justified in assuming this from the wonderfully beautiful works they achieved in the ornamental wrought iron work they did make. I cannot help therefore feeling that to a certain extent the poor results we have accomplished with all the facilities we have at our command does not indicate much progress of true art in these modern times.

You may perhaps have noticed that I have nearly always spoken of girders in wrought, and columns in cast iron. I have preferred to do this for the sake of brevity, as they are the principal items for which iron is used in building and therefore serve as types, but my remarks upon them are intended to refer equally to any other structural form to which iron might be applied.

There is yet another matter closely connected with iron as a constructive material which requires attention, and that is the relative positions in which wrought and cast iron should be placed, viz. whether in internal or external work, and this more especially applies to ornament. Now it is a certain and well known fact that wrought iron is much more susceptible to the influence of weather as regards oxydation than cast, and though therefore there can be no question as to the superior art and beauty of wrought iron, yet it is a matter worthy of some consideration if it be not more advisable for the sake of durability to employ cast iron for ornamental work externally and confine our use of wrought iron to purposes of internal decoration. I am perfectly aware that in advocating the use of cast iron ornament at all I am touching upon dangerous ground, as I know that among many of the highest authority there is a strong feeling against it, but be that as it may the fact remains the same, that cast iron is better adapted for external work than wrought, and I am inclined to think that the feeling which undoubtedly does exist against it is due to the way in which it is misused, and that if the design is *properly adapted to the material* one of the principal objections to its application is removed. I know it is said that cast iron ornament is inartistic, showing no feeling, utterly wanting in individuality, and vulgar in the extreme, so that cast iron ornament has almost become a bye-word; but surely it is unfairly treated, for might not the same be said of work in bronze? A work in cast iron requires to have a model prepared and a mould made, so also does a work in bronze. The iron has to be melted and run into the mould, and it is the same with bronze, if the model is badly designed and badly executed in either case the resultant cast will be bad also.

There can be feeling, individuality and refined art in the design, and art workmanship in the model for cast iron as well as for bronze. The fact that iron is cheap and bronze expensive does not detract from

the one or add to the other. The great and general mistake made, is the endeavour to make cast iron ornamentation an imitation of wrought work, but if the idea is steadily kept in view that we are working with a material that requires to be run in a mould and not worked with the hammer, I think we shall succeed in producing cast iron ornament which if not equally a thing of beauty with wrought iron, shall still be worthy of admiration.

But whether we use cast or wrought iron in ornamental work it would be better for the sake of durability if more attention were paid to the form we give to it in external work, and in designing it the two great points to be observed are, I think, the facility with which all parts are able to be reached by the painter's brush and the avoidance of cup-like arrangements, of leafage and flower-work, which retain dust and moisture and tend towards rust and decay, and this last especially applies to wrought iron work as the leafage is generally thin and crinkled, and therefore peculiarly liable to be affected and injured by rust. In cast ironwork such parts are usually filled up solid.

With respect to iron as a constructive material, the different qualities of the metal used present a very important and serious point for consideration, much more so than at first sight appears; for, as in the case of cast iron, there is not only a great difference of strength in the different brands, but also in the same iron, from the manner in which it is manufactured, and it is almost impossible to judge by the outward appearance of a casting whether the iron used is good or bad, for even when fractured it requires great skill and experience to do so. I do not, however, purpose to go into this matter this evening.

Though hardly touching upon this point, I wish to draw the attention of the members of the Institute to a very able paper upon "Iron Construction," read by Mr. Richard Moreland, Jun., at the Architectural Association on January 9th, 1874, for therein is contained a large amount of practical information, particularly useful to architects who may have occasion to use either wrought or cast iron.

For works in cast iron it is very necessary to pay particular attention to the patterns required. All patterns should be made in the best manner: no expense should be spared on them, and they should be inspected by the architect or his assistant before being cast from. As to the patterns for ornamental work, it is better that the drawings for them should in all cases be done to the full size and completely show what is intended, so as to insure the design being correctly rendered. And in fact it is better, if possible, to have these patterns prepared under the immediate superintendance of the architect himself. Allow me also to say a few words upon the drawings that are necessary for a work in iron. It must be borne in mind, that in designing for ironwork, everything must be shown clearly and distinctly by the drawings themselves: little or nothing should be left to be described by the specification, beyond the quality, &c., of the material; therefore, in addition to the general drawings showing the work complete, there must be provided detail drawings of every part, showing each bolt, nut, bolt-hole, rivet, flange, gusset or chipping piece required,—for workmen in iron are accustomed to work to drawings for everything and to drawings alone, and in this respect they differ materially from the joiner, who, if he were to see a door specified to be a 7 ft. by 3 ft. two inch four-panel bead butt and square door, would at once know what to do; but if that door, for argument's sake, had to be made in iron it would be necessary to show in detail the whole construction of it, tennon and mortice, rebate and panel, and not only is it necessary to show everything on the drawing, but every dimension must be put on in figures: nothing should be left to scale. As an illustration of the sort of drawings required, I refer to those on the walls, which were prepared by me for Mr. Woods, the Engineer, for the Santiago Market. I may, perhaps, be allowed to mention that not a single alteration was necessary in them, the work having been executed exactly as shewn.

Hitherto I have only spoken of matters which concern iron as a building material, but I propose, with your permission, before closing my paper, to add a few remarks upon constructive ornamentation of ironwork, or as it would perhaps be better to describe it the ornamental construction of ironwork, for though in my previous remarks I have several times referred to ornamental work in iron it has been irrespective of its being constructive or otherwise. I can, however, only give a passing glance at it, for the subject is one which in itself would extend to almost any length.

We most of us know what ornamental construction consists of in wood or stone, as opposed to constructing for ornament, but it is I confess difficult to apply the principles which guide us in the last named materials to iron; for though it is true we can, as I have said, so arrange our Tee and angle irons, webs and plates, &c., &c., that they shall be symmetrical, that is not all that is required, for true ornament does not consist in symmetry alone, though symmetry is a very important element in it. We are placed in this difficulty, that almost any ornament we employ on constructive ironwork has to be itself constructed, thus flying in the face of that golden rule which tells us to "ornament our construction and not to construct for ornament." When working with wood and stone and some other building materials we can build in blocks or masses of material and cut and carve them as it seemeth to us best, and it can hardly be said that we are able to do this in the same sense in iron; but though we cannot carve it we can stamp, emboss, engrave, and even mould it if we will, for machinery is now so powerful that mouldings, splays, chamfers, &c., can be executed in this material with nearly the same facility as in wood. There is some ground for consolation too in the fact that whatever difficulties we may have to encounter with respect to having to construct ornament in iron, the same difficulty has to be met with respect to all other metals, and I am inclined to take advantage of "there being no rule without an exception," and make that exception in favour of iron and all other metals. Though we may have in some measure to construct our ornament, I think we should be careful to so manage it that the ornament we *do* employ shall not be wholly useless, and that if it does not add much to the strength of the structure it shall not at least be detrimental. All added ornament in ironwork should I think be of the very lightest description, and if not actually constructive it should at least grow naturally from, and appear to be part of the real constructive portion of the work.

Time, however, will not permit to go further into this point, in itself a sufficient subject for a paper, which at some future time I may ask to be allowed to read.

Allow me, in conclusion, to thank you for your attention, and at the same time to request your kind indulgence for much that I have said. Many of you, as I know, have already by your works anticipated my ideas with respect to constructive and architectural ironwork; and to you, therefore, my remarks, I fear, have been tedious. But still, I hope, you will endorse my views, as I have been encouraged to maintain them by the knowledge that, of those who stand the highest in our profession, there are some who have not thought it beneath them to design in iron, and who have done so with successful results. Among them I will venture to mention the name of one, our honored President, Sir George Gilbert Scott.

Mr. ALEXANDER PAYNE, Associate.—I beg to express the gratification which Mr. Driver's Paper has afforded me, and to propose a vote of thanks to him. I will take this opportunity of calling the attention of the members to some models I have placed on the table illustrating a form of construction in which ironwork is employed in a manner which sins, I fear, against nearly every rule which Mr. Driver has laid down. Having required last year a fireproof floor of considerable extent and intended to support a great weight on columns dividing it into compartments about 15 feet square, I sent plans of the building to different iron manufacturers and asked their advice with regard to the best

disposition of the girders. They recommended main girders from column to column, and two cross girders to each compartment, with concrete arches between, and it was mentioned as an essential point that the proper description of girder to be used was that which was manufactured by themselves. I found however that in every case the cost was so considerable that it became a question whether the floor could be carried out at all. I therefore turned my attention to and ultimately patented a form of construction of floors—still employing iron—but without girders at all, by which the total cost is much decreased. [See illustrations.] I treated each compartment as a vault, and instead of putting the weight upon continuous girders I brought it to different points. The ties here shown hold the columns together, which last are carried up above the springing of the vault, as shown, the ties attached to the upper part being out of sight and bedded in the mass of the concrete. Another plan is to mould the underside of the vault after the manner of flat fan vaulting, tying in both the fans and the space between them with a series of concentric wrought iron rings, so disposed that no spreading can take place without bursting the rings and overcoming the enormous tensile strength of wrought iron.*

MR. F. A. SKIDMORE, Visitor.—I have great pleasure in seconding the vote of thanks to Mr. Driver. There has been, in all ages, an intimate connection between metallic art and architecture; and therefore there is a fitness in the present discussion. Historians describe the temples of Assyria as having vast quantities of gold applied to them. The Tabernacle and the Court had their pillars of wood, with sockets of silver, of a hundred weight each; the walls of wood, with the pillars and capitals being covered with overlaying plates of gold. The quantity of gold used for these, the altar, &c., amounted to twenty-nine talents, or about twenty-nine cwt., while 100 talents, or five tons of silver, were also used in addition. David provided 100,000 talents of gold for the Temple. Solomon overlaid pillars, capitals, walls, doors, and ceilings with over 600 cwt. of gold. The floor of the house within and without was covered with gold; the doors of carved wood, the ceilings and porch similarly, even overlaid with plates of gold. Homer, describing the Palace of Alcinoüs, speaks of the walls of brass, the doors incased with golden plates, the pillars and lintels of silver. Pausanius says that in his day there was erected a temple of brass in Lacedæmonia, and the Romans had a Forum with a brazen roof. The Byzantine Cathedral of St. Sophia had its doors of silver, and ciborium and synthronus of silver-gilt; and the inventories of the Middle Ages furnish one continuous record of the vast quantities of gold and silver used not only for vessels but to enrich the construction of churches. The works of art composed of these rich materials have passed away, destroyed by avarice and necessity. When the study of architecture was revived, there only remained compositions of stone and kindred materials to refer to, and to imitate; and a prejudice in consequence arose against the use of metal, as not being in harmony with the visible remains of ancient constructive art. A wider knowledge, gathered by lapse of time, has modified this view, but the principal metals available in the present day, viz., iron and brass, are still generally treated as a cheap expedient, the former being sometimes concealed by plaster. There are certain legitimate treatments of cast-iron which are involved in its production, the fair recognition of which, in capitals, columns, &c., would open out new and varied forms not hitherto developed, because arising from different necessities than those of stone and wood-work. The photograph I hold, exhibited by Mr. Driver, will explain my meaning. Here spandrils rest on a square capital, the size and details of which are designed from stone. It would have been a truer and happier treatment to have carried down brackets under the spandrils into the columns instead of using a copy of a stone capital, fitted in size to support arches, but too large to receive the smaller spandrils of iron. Such treatments would develop new forms of beauty. As an instance I would call atten-

* An illustration of this was given on the black board, together with a comparison between its cost and strength and that of the ordinary girder method which are shown at Figs. 3 and 4 in the Appendix to the Paper, with a description.

tion to the manner of modelling the columns at the Great Western Station at Paddington. Here the model is made with special regard to the requirements of iron casting, and a new form of capital is produced. This theory once admitted, capitals after such a type might be developed in countless variations, all beautiful. The experience of many years of the immense congregations in the large churches of Coventry, the number assembled under the dome of St. Paul's, and the events passing under our eyes in connection with the religious requirements of the age, have impressed me with the importance of not confining our efforts to producing small churches as at present, and of endeavouring to meet the needs of populations exceeding the capacities of the parochial system. It appears to me that in the erection of buildings of such large capacities iron may be eminently available, since its constructive possibilities as regards height, width, length, &c., are comparatively unlimited.*

Mr. C. FOWLER, Fellow (replying to the Chairman's invitation) said.—I rather hesitate to say anything on this subject, although Mr. Driver has alluded to some remarks which I made on a former occasion. With reference to cast-iron it occurs to me that one reason why its employment is apt to be so unsatisfactory is that the designers, as it appears to me, very commonly think of the material as iron, and therefore the examples of wrought-iron work naturally occur to them; but I think the way to treat cast-iron is—not as a wrought—but as a cast material, and generally speaking it should be designed as panels put in frames, either of wrought-iron, if that is most convenient, or of cast-iron. Such things as cast-iron railings, as ordinarily designed, are clearly wrong. They are designed as upright and horizontal bars, and as a rule we know they are cast in panels, therefore the thing is false; whereas if the railings were formed by standards, cast or wrought, with horizontal bars, and the spaces so formed filled in with panels of suitable design, then you would get a satisfactory construction, designed in accordance with the material. Then again with regard to beams, there is the difficulty of combining science with artistic form. This was brought to my mind on looking over some works of my father's in one of his markets erected about forty years ago, when the use of cast-iron was not known as it is now scientifically. He, I think, in some cases made a fair and proper use of cast-iron, not perhaps using it in the most scientific way with reference to economy, but using it in a manner to produce an architectural effect and at the same time serve a practical purpose—say a gutter which served the purpose of a girder. The form used may not be the most scientific for a girder of cast-iron necessary to support the given weight, but a little extra material may enable you to put it into a form in accordance with your architectural design. The great difficulty of cast-iron is to divest one's mind of the idea of its being iron at all. With reference to wrought-iron it appears to me the difficulty is that it is more expensive, the labour is costly, and the forms which are most economical are not those which we should desire to show. If you attempt to ornament a mere plain structure your beams look too heavy, and if you attempt to make the beam itself of an artistic form it becomes very expensive. If, however, cost is no object, then no doubt satisfactory results may be obtained, but not without labour disproportionately great to the designer as compared with other materials. I have seen both these attempts made, and the former is nearly always unsatisfactory. It is generally done by attaching ornament in cast-iron, or in some other material, which invariably has the effect of rendering the structure heavy without making it ornamental. Allusion has been made to the iron-work at Paddington Station, designed by Sir Digby Wyatt for Mr. Brunel. In that case I know Sir Digby designed

* The tendencies to decay externally would be obviated by panels of marbles, mosaics, or terra-cottas; the structure of iron admitting the insertion of blocks less thick and costly than stone edifices. A richer treatment on the same same principles, at a proper distance in the interior, and the intervening space filled with concrete, would meet the requirements of heat and cold.

with reference to the material employed, and an attempt was made to ornament the wrought-iron ribs, which, as far as it goes, is good. As you are aware, the web of a wrought-iron girder is generally in excess of the necessary strength, so that much of it may be cut away without impairing its strength. If to perforate the girder with a simple pattern, the girder always showing dark the perforations show light through and make a pleasing variety. The columns which Mr. Skidmore alluded to are pleasing in form, and there is no attempt made to imitate wood or stone forms. There is one thing Mr. Driver did not allude to in his Paper. Amongst the drawings on the wall there is one representing ornamented bolt-heads; these may be made ornamental with very little trouble, particularly if they were more commonly used. They are made with stamps, and it would be very little extra expense to make the stamps slightly ornamental, but the great difficulty of getting over the effect of common rivets is one which I have never seen satisfactorily solved.

MR. EWING MATTHESON, Visitor.—As a manufacturer of ironwork, I should like to say a few words with reference to the paper. I do not presume, in an assembly such as this, to discuss questions of taste in architecture, although, as a manufacturer, having all sorts of designs to carry out, I cannot help forming some opinion of what architects think of iron as a material. As a rule architects appear to me to use cast-iron in an apologetic sort of manner; for instance, though they are constrained to employ it for columns sometimes, they use it nowhere else where they can avoid it. This is I think to be deplored, because if architects had more information as to some of the qualities of iron, they might in some cases do better. There is a too common belief that east-iron has little or no elasticity. That is a mistake, as good east-iron may be used in light forms, even where it is subject to percussion. Mr. Driver has spoken of the notable iron bridge at Colebrookdale, the earliest example of the kind, and also of Southwark Bridge, in which he seems to consider that the application of east-iron culminated wrought-iron in new forms, having, as a better material, superseded east-iron since that time. I maintain, however, that east-iron is as suitable for arched bridges as it ever was, and as a general rule more suitable than wrought-iron; and I venture to say that Southwark Bridge, old as it is, will survive many of the modern wrought-iron bridges. With respect, for instance, to the wrought-iron arched bridge at Blackfriars, those engineers who are best informed, are of opinion that a great mistake was made in not constructing it of east-iron, which is so admirably adapted for a compression arch. But it is not only in substantial forms like that, but also in lighter forms, such as the rafters or compression members of arched roofs, that east-iron is suitable. I put up a few years ago the roof, of 120 feet span, at the Blackfriars Station of the London, Chatham and Dover Railway. The principals of that roof are entirely of wrought-iron, and in that respect are unlike the roof of which it was a copy; namely, that of the Amsterdam Station of the Dutch-Rhenish Railway, where the rafters or upper members consisted of east-iron tubes. It was, and is exposed to gales of wind, and under severe strains has proved that east-iron is not too brittle for such service. There is no doubt there are many forms in which east-iron might be used with advantage where it is now ignored.

Mr. Driver spoke of the effect of rust on iron. The danger to which iron structures are exposed from rust is not sufficiently appreciated. In London, buildings are erected upon exposed sites, and are, I presume, supposed to last for 100 years, whereas I feel persuaded that many of them will not live that time. In the City they are building large plate glass fronts, carried upon box girders, which are covered in so that the interior surfaces of the iron are inaccessible to the painter's brush. The joints of the girder are not air-tight, and the London atmosphere penetrates to the interior. In four or five years the rust will scale off at a rapid rate, and in twenty or thirty years they will probably have to be built over again, and all the stone-work above will be wasted. Where

there is a brick wall on the girder, the wall may, by its own cohesion, acquire the properties of an arch, which will stand even if the girder be taken away. But where the wall is cut away by many windows it will have no such stability. Where it is necessary to use box girders, I would suggest that they should be filled with concrete, which makes them air-tight, and so protect the iron from oxidation. I have seen iron from Westminster Abbey as good as ever, which had been built in lime, and entirely kept from the air for 600 years. Mr. Driver spoke of wrought-iron ornaments not being suitable for out-door work. I can mention one or two cases in London which illustrate this. Mr. Skidmore has no doubt designed some very beautiful iron work in the building of the new India and Foreign Offices, but I am afraid in twenty years time there will not be much of that iron-work left to be enjoyed by anybody. Three years after it was put up I examined it, and I found iron of $\frac{1}{8}$ in. thickness was scaling off rapidly, owing to the impossibility of getting at the interior work with the paint brush. An eminent member of the Institute (the late Sir W. Tite), architect of the Royal Exchange, designed gates, which were made entirely of cast-iron by Messrs. Grissell, a firm now no longer in existence. They are massive and, I should say, very suitable, and those gates will probably last as long as the stone-work itself, and will long outlive Mr. Skidmore's more recent work at the West end. I am afraid much of the dislike there is to cast-iron results from the bad way in which the work is executed. That I think is partly owing to the architect not being brought directly into contact with the iron manufacturer. The architect is for the most part at the mercy of the builder, who decides where the iron shall come from, and that system, as we know, involves getting iron from the cheapest and most incompetent manufacturers. All over the kingdom bad iron-work may be seen, and hence there is a natural prejudice in the minds of architects against its use.

Mr. SKIDMORE explained, with regard to the iron gates of the Foreign Office, that they were allowed to go unpainted for a long time. He would not enter into a controversy on the comparative merits of wrought and cast-iron. They all knew how cast-iron ornaments were liable to be broken off by the smallest jar, and that was worse than the scaling off of the wrought iron.

Mr. C. L. EASTLAKE, Secretary.—As Mr. Matheson has mentioned the subject of rust, and his opinion on the question is likely to be valuable, on account of his practical experience in the manufacture of iron, I should like to ask him if he can explain how it is that modern iron-work, when at all exposed to the weather, suffers so much more severely and so much more rapidly from oxydation than similar work executed in the Middle Ages, and even down to the last century. Some years ago I passed several months at Nuremberg, which, as every one knows, is rich in elaborate and beautiful specimens of wrought iron-work—some of them at least 300 years old, but as sharp and well preserved as if they were fresh from the hammer and pliers of the workman. Now we may be sure, that modern iron-work similarly exposed, in this country at least, would not last a tenth part of that time, but would become rapidly corroded by rust. I am told that this deterioration is due to the use of coal as fuel in the manufacture of iron, instead of wood or charcoal. Perhaps Mr. Matheson will kindly tell us whether this is the case, or whether the effect I have mentioned may be attributed to other causes.

Mr. MATHESON.—There can be no doubt the use of coal produces a different quality of metal to that which is produced by charcoal. Modern iron-work made with coal fuel will, however, last longer in exposed situations in Paris than in London, because damp atmosphere and the fumes of coal gas in London destroy the iron. The oxydation of wrought-iron is entirely different to that of cast-iron. When cast-iron is made there is a skin on it which may be preserved for ever if it is properly painted. Upon wrought-iron, directly it leaves the furnace and comes in contact with the atmosphere, while it is passing through the rollers, a peroxide of iron is formed in the shape of a black scale.

Some architects specify that the iron shall be immediately painted or treated with oil, so as to protect the iron from the commencement. But the black scale cannot be preserved by any number of coats of paint, and it will generally peel off as the time for the second painting arrives. In the case of a bridge for instance, after two or three years this skin will scale off the wrought-iron, and then the permanent surface of the iron is reached, and attention should be given to it then to preserve the iron permanently rather than when it is new. In Holland, a method of pickling the iron obtains, which is analagous to that used in this country for cleaning the iron before galvanizing it. The iron is dipped in dilute acid, which bites off the scales. Then, if the iron be painted, it may be protected permanently from rust, as is done with cast-iron. Cast and wrought-iron require entirely different treatment.

Mr. SKIDMORE remarked, that in order to avoid that scaling, his plan was always to pickle the wrought-iron, and that removed the scale entirely. In all small ornamental iron-work that ought to be made a condition to be done, and not left to be scaled with the hammer.

Mr. G. AITCHISON, Fellow,—I beg to thank Mr. Driver personally for his paper. The subject is so large that it is impossible to enter fully into the various points touched upon. The mere constructive qualities of cast and wrought iron are quite enough to occupy several evenings, and when we regard the artistic treatment of it as well, the time at our disposal is so small that it almost induces me to say nothing. I may, however, make one or two remarks as to the use of iron as a plain constructive material, without regard to its appearance. The advantages of cast iron are in many respects great. Its power of resisting compression compared with other materials is very great; and when we use it for columns and stanchions nothing I know of can be used so advantageously, apart from its liability to destruction by fire. As far as girders are concerned there is a risk, where there is considerable impact. In very cold weather I have known iron girders amply sufficient for the weight or impact they had to sustain, break in half and jeopardise the whole building. In a warehouse built by my father, I have known cases in which some of the girders cracked right across during severe frost, though they were tested before fixing, and had been in use for 20 years. Cast iron is convenient for certain shapes of girders,—particularly in gutters, because where you have a wide bottom you can use the material to advantage. Wrought iron has many advantages over cast for certain purposes, particularly in the case of girders, because wrought iron is not so brittle. It has, however, the notorious disadvantages for outside work of which we have heard. Its principal advantage is the extreme thinness with which the parts which have to carry small weight may be made. In a plate girder the web perhaps may not be more than $\frac{1}{8}$ th of an inch; in that case a small amount of scaling from rust will make this in a dangerous condition. I could enlarge considerably on points connected with this subject, but if you will allow me a few minutes, I will advert to the artistic capabilities of iron. As far as cast iron is concerned, the capacity of the material is open to almost any treatment which the skill of the architect can give it. We live in unfortunate times when architecture is perhaps hardly in existence. We can imitate or paraphrase any style that has ever been with a degree of skill that might deceive the architects of a former age themselves, could they come to life; but when we come to treat a new material—or an old material in a new form, we give up the attempt as perfectly hopeless. It is true that certain forms may be found that may be said to be original; but most of them are so extremely hideous, that they are hardly to be called architecture at all. In dealing with cast-iron we have to a certain extent our hands tied; but if there were among us any real, natural-born architects, nothing would give them such delight as endeavouring to overcome these difficulties, and investing these forms with some pleasing shape; but hitherto that has hardly been attempted. I cannot help thinking, if we ever are to have any architecture, we must endeavour to look less at *absolute* ornament, than at general gracefulness of

form. Whenever we have to treat cast-iron ornamentally, that has to carry weight, it becomes rather a dangerous experiment. A man hesitates to introduce ornament when he is not quite sure that his girder will then carry the weight. Consequently, nearly all ornament is put on afterwards. Ornamental cast-iron open work girders of any considerable span are, I must say, rather dangerous experiments. The least flaw in one of these may bring your whole building to ruin. With regard to wrought iron we have the difficulty of its expanse. There is no doubt, it may be hammered or cut into any shape, but the difficulty generally is on account of the expense to get it done in the plainest and simplest way. We have no difficulty in making a building of iron, but even if the external part is cast iron, we know of nothing that will prevent it being shortly covered with rust, except constant painting; and even inside, if it is painted, it condenses damp so rapidly, as to rust all parts about it, and iron columns have to be covered with plaster or mastic. It is, therefore, difficult, to know how to use this form of construction, for monumental purposes.

Mr. JOHN DIXON, Visitor, said,—I think this Paper is worthy of the attention of any Society of Architects; but looking at the architects of this country, I think it will be acknowledged that sufficient attention has not been paid to the advantages which iron presents—not only for ornamental forms, but also for useful and economical construction. I was struck with the remark of a gentleman when he said, that iron work ought to be carved out and made to represent something else. I think the first principle of architecture is, that materials of construction should be precisely what they are represented to be, and that iron should be used as such, and should be used in a way which its qualities qualify it to be used; and I think that if the architects of England gave more attention to the facilities of the materials they have to deal with, they would be able to produce more elegant forms than those which are now presented; and instead of clothing the cast-iron girders which they give us in shop fronts and buildings, we ought to have something more ornamental, and at the same time more useful. Iron is adapted for permanent construction, and I cannot help thinking that if the great architects of ancient times had the facilities for the use of cast-iron which we have, they would have shown us by their skill the great adaptability which that material possesses to be utilized, not only to advantage, but with a great amount of ornament and economy. I think on this point, architects ought to devote more attention to the consideration of the merits which iron possesses as a constructive material. I am quite sure, if instead of looking back to the examples which we have of the works of great architects of by-gone times, who only had stone and wrought iron before them—if instead of looking to them, architects relied more upon their own resources, and turned their attention more to the utilisation of those materials which those architects had not, they would be able to produce quite as beautiful designs in stone and wrought iron. And I think if the old architects had had cast iron as readily to their hand as it is in the present day, they could have utilized it with as great advantage as they did the materials which they then possessed. Some architects—especially the worthy gentleman who occupies the chair—have shown us in many cases what may be done with materials at hand; but I say, generally speaking, it does not appear to me that what Mr. Driver has brought before the meeting to-night is well worthy the attention of architects. I do not think the use of cast-iron at the present day is worthy of the Institute of Architects or of the profession, and I consider it far from having reached that point to which a little attention and devotion to the subject ought to bring it.

Mr. A. PAYNE.—Perhaps I may be allowed to state with reference to the fan vaulting and the alleged additional cost of carrying the walls higher to obtain the necessary height, that I do not make the spring of the groined vault lower than the ordinary arch, and the cost of such a floor as that shown in the model would be only about one-half that of the other mode of construction.

Mr. CHATFIELD CLARKE, Fellow.—A "*tu quoque*" is always easy, but I must say engineers have

had many opportunities of employing iron not only usefully but ornamentally, and in truth I am unable to say they have taken advantage of these opportunities. [Mr. DIXON.—Engineers do not profess to be architects.] Look at the hideous monstrosities which have been put up in various parts of London. I would ask any man connected with architecture or art to go across London Bridge and see the immense girders shutting out the view of the beautiful church close by, and say what he thinks. With regard to the general question there are some points which have not been dealt with. It must be felt that the difficulty of the use of iron is not only the expense, and expansion, and contraction, but there is the question of repose. Take the Crystal Palace for example, and the spider-work constructions put up in various parts of the country—what repose have they? what beauty? what rest? If you look at the question of design that point is not got over, and I do not see, from the nature of the material, how it can be got over, although that day may arrive. No doubt there is considerable difficulty in casting ornamental iron work. We generally feel we come out of it with non-success. We have to contend with the careless way in which columns are supplied by the manufacturers, and the experience of most architects, I believe, is the trouble they have with the contractor to get these things corrected. No doubt most architects reserve to themselves the power of appointing their own iron-founder in a large work, but it is nevertheless the fact that defective castings often give great trouble and frequently do not please the eye afterwards. I would say although we may be deeply humbled as a profession, although we may have no pretence to art-power, and are totally unable to design, yet at the same time we cannot allow the engineering profession to sit in judgment upon us, because with the large opportunities they have at command they have done very little indeed to ornament this great Metropolis.

Mr. WALTER MACFARLANE, (Visitor) said,—Though not a member of this Institute, I would wish to be allowed to say a word or two. We are under great obligations to Mr. Driver, for the great intelligence displayed in his paper. Mr. Eastlake put a very pertinent question when he asked what was the reason for the difference in the quality of iron of the present age and that of the past? To my mind the answer to that question has not yet been fully brought out. The difference is this: since the hot blast was introduced a lot of rubbish is left in the body of the iron, there being now produced out of the same raw materials a greater amount of iron, or rather semi-iron; consequently the iron of the present day is deteriorated in quality, as compared to the cold blast iron of forty years ago. With regard to cast-iron there are one or two points I would call attention to. If you speak of it architecturally and artistically, you must not think of introducing it as a cheap substitute. If fine castings are wanted, the patterns must go through processes which make the production of such castings expensive, if only a small number are required; it is when a large number of articles are repeated that you introduce cast-iron under its best auspices. I would guard architects against going too freely into designs of their own, unless under special circumstances, or where a considerable number of one pattern is wanted. The expense of getting up proper patterns for a single job seldom answers the purpose. Consequently as a rule, an architect had much better employ the funds at his command in some other way, and apply to a manufacturer whose special walk the class of casting may be in, than go into new patterns when only one or two are required. There is one point connected with this subject, which has not been noticed in the discussion—that is the capacity of cast-iron in the architect's hands, enabling him to lay out his building in a way best suited for its purpose. For instance, in a four-story mansion we have generally the servant's apartments in the basement; then the public rooms on the street floor; and the drawing room and W. C. on the floor above; and last the bed rooms, all greatly different as to size and division from each other. The ordinary architect's practice is to rigidly insist that the inside brick walls rise from basement to attic on each other, irrespective of the necessities of the case.

I have myself been interested in a mansion comprising 20,000 square feet of flooring, where my architect introduced columns and girders out of sight to an unusual extent in lieu of brick walls. My object was to bring out of a very irregular piece of ground, the walls of every room in the establishment at comparatively right angles, the one wall not necessarily resting upon the top of the other. I allowed it to be as much as 3 ft. even from the line of the other,—of course taking care to support it thoroughly. The consequence is every room, hall, corridor and passage in that house is not only at right angles but of suitable breadth. As for instance, a passage may come out on the plan 4 ft. 6, and you wish it to be 5 ft. 6; if you confine yourself to the brick system of construction you cannot have that; but if you go into iron girders and columns, you may have a passage any size you like. Iron as a constructive material, and as an adjunct to other materials, is one of the most valuable in nature, in the hands of the architect. In an artistic point of view, cast-iron has features of its own, and it is only by long working with it, and the highest intelligence being brought to bear upon it, that its true features and value can be realized. I agree with the gentleman who spoke last. I do not hold out the construction of the Crystal Palace, as a thing to be repeated. There is a mechanical character about it unworthy of the architectural intelligence of the present day, and were our architects to give more attention to cast and wrought iron, there would be such buildings created as we have never yet seen. Iron when judiciously introduced with stone and brick, is capable of economizing space, and of giving that grace and beauty which the present age have a right to look for. This would contrast with the terra cotta and crockery work of South Kensington. I ask, why is the architectural profession so quiet on these matters; why allow, without protest, the money of the country to be spent upon such worthless efforts? I will only add, there is no public body more capable of expressing itself on that point, than the one I have now the honour of addressing.

Professor KERR, Fellow.—It is agreeable for us architects to hear occasionally in our own rooms the frank opinions of such gentlemen as have spoken on this subject. I would say, for my own part, that I have heard a great deal to-night which is both instructive and picturesquely entertaining. Mr. Driver is a member of the Institute and of course an architect, but he has said a great deal that is to me entirely novel. I look, however, chiefly at the drawings which he exhibits. They are highly meritorious; but I hope he does not suggest that architects in general are incapable of doing what he has done. Mr. Driver has had an opportunity of actually designing a building in iron, but he must know many members of the profession who could have done precisely the same thing, and who would have done it in all probability precisely in the same way. It is altogether a mistake to suppose that the architectural profession for the last twenty years has been idle in this matter, and I venture to say if a commission for work of this kind were carried by an engineer to any one of fifty architects in London he would get the work perfectly well and easily done. At the same time I venture to agree with one of the previous speakers in saying that these are by no means iron forms which Mr. Driver makes use of. The prevailing dialect of mediæval design is freely and cleverly employed, but the work cannot be said to be done on metallic principles. Then when Mr. Driver asserts that in the introduction of wrought or rather rolled iron work in girders, and cast-iron work in columns, it is our rule to encase the iron in lath and plaster, I say this is not so. Many persons may do so, but that does not make the profession at large liable for what is so done. I hope Mr. Driver will satisfy himself before long that such a remark is undeserved. There is no lack of architects who have executed good iron work. Many of us here present, I doubt not, have done iron work of which we are not ashamed. I say I have myself done iron work nearly twenty years ago that I am not ashamed to look at now, in which, although no effect of this particular kind is produced, yet the principles laid down by Mr. Driver are honestly carried out; and in still more recent times the same has been done repeatedly.

The accusation is brought against architects broadly that they do not use iron because they do not like it. That again is an error. It is not English architects who do not like iron, but the English climate that does not agree with it; and we know well that if we attempted to introduce iron in anything like this elaborate style of Mr. Driver's in our English climate the experiment would be surrounded with difficulties. Mr. Driver, therefore, must give us credit for doing as much in the way of iron work as the climate of England, and of London particularly, will allow us to do. With regard to the question asked as to the difference in the quality of the iron of former times and that of the present, it has been, as I think, correctly remarked that since the introduction of the hot blast the amount of iron extracted from the ore is increased at the expense of the retention of a certain amount of earthy matter in the metal, which, so to speak, can never be got entirely out of it; besides that modern rolling and ancient hammering are very different processes in their effect. If so there are sufficient reasons why the iron of the present day should not be equal to that of former times.

The vote of thanks having been unanimously passed,

Mr. DRIVER said.—I have to thank you very much for the kind way in which my Paper has been received, and I will reply to one or two of the remarks that have been made, and will begin with Professor Kerr. I think he has a little misunderstood the object for which I have exhibited these drawings. I do not exhibit them as specimens of what iron work should be, I merely show them as examples of the sort of drawings required for the manufacturer of iron work, whilst the photographs show that the work was carried out in accordance with the drawings. I did not presume to suggest that other architects could not design equally well and better than myself in cast-iron. In the concluding portion of my remarks I stated that many of you, I knew, have already by your works anticipated my ideas with respect to constructive and architectural iron work, and to you, therefore, my remarks I fear have been tedious; but on the other hand a good many have not studied it, and my remarks were addressed to them. I shall bear in mind the remarks that have been made and I hope in future days to produce iron work which shall be perfectly satisfactory even to Professor Kerr. With Mr. Skidmore's remarks upon the columns at Paddington Station I entirely concur. I have noticed the columns and caps and iron work generally, and I think they are good examples of what wrought and cast-iron work should be. With regard to the other remarks I think the one has almost answered the other, therefore I will detain you no longer.

The Discussion having thus been brought to a close, the Meeting adjourned.



FIG. 1.

Showing iron columns and ties bedded in the concrete

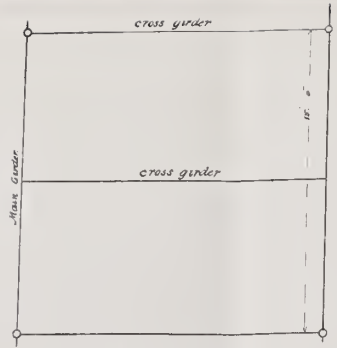
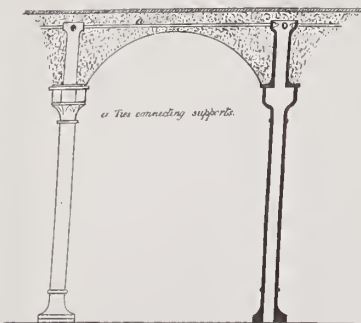

Plan of compartment.
FIG. 3.

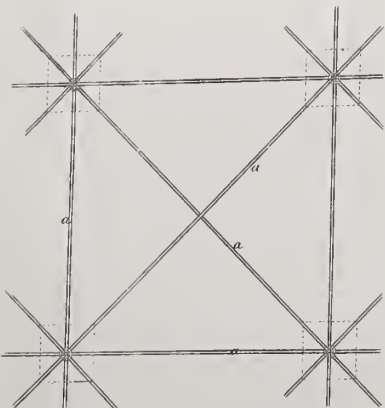

FIG. 2.
Plan.

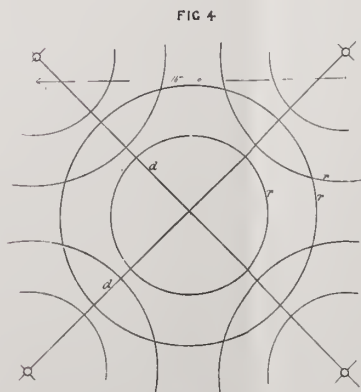

FIG. 4.

Plan
a. a. 2" Diagonal ties.
r. r. r. concentric ring ties.

SECTION and PLAN of solid corbel for supporting
ornel windows projections etc. showing ring-ties

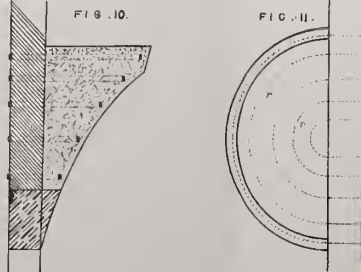

FIG. 10.

FIG. 11.

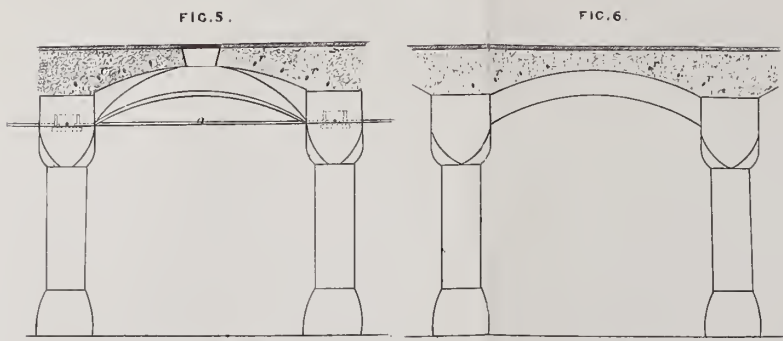

FIG. 5.

FIG. 6.

Section on A B
Groined Vaulting

Section A B
Domical Vaulting

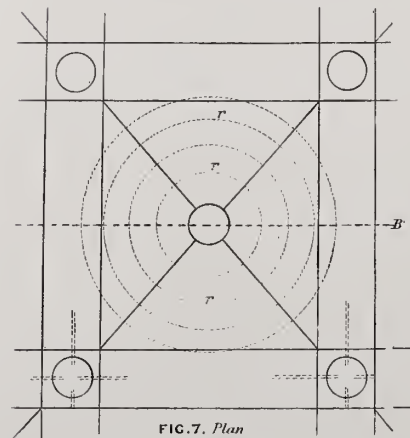

FIG. 7. Plan

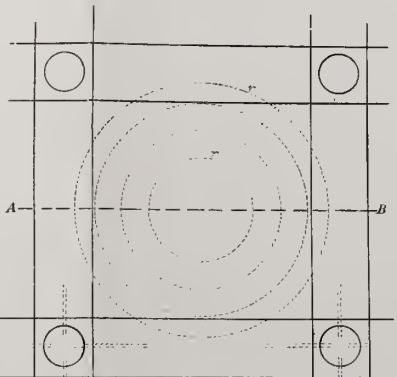

FIG. 8. Plan

Showing ring ties

Figs 6, 7, 8, 9 show various forms
of vaulted compartments with
ring ties and stone columns.

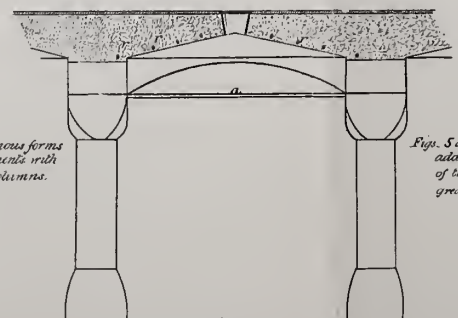

FIG. 9.

Soffit formed with straight lines

Figs 5 and 9 show methods of
adding ties a. a. the springing
of the vault, where very
great strength is required.

DOMICAL CONSTRUCTION WITH RING TIES

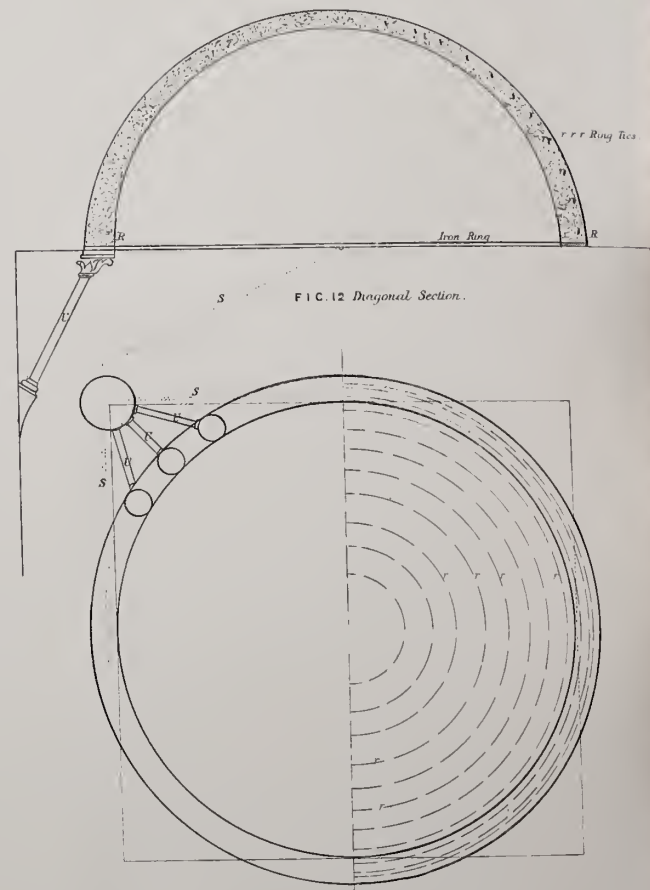

FIG. 12 Diagonal Section.

FIG. 13. Plan.

Showing method of supporting
Base of Dome over corners of Square
S.S.S. Suspension ties to resist thrusts at corners.

PATENT CONCRETE FLOORS &c
WITH IRON TIES
AND WITHOUT GIRDERS.

Alex^r Payne, Inv^t

APPENDIX

To the Paper on "Iron as a Constructive Material," read 5th of April, 1875.

Mr. ALEXANDER PAYNE, Associate, drew the attention of the members to a new patented method of employing iron as a constructive material, in the form of ties, to neutralise the thrusts in concrete vaulting, flooring, &c., of which models were exhibited on the table.

Hitherto in the construction of concrete floors and flat concrete roofs, it had been the practice to divide out the space to be covered in by girders of cast or wrought iron, placing them at such distances apart as would be convenient for forming continuous supports of arches which would be turned between them. By the new method it was proposed to abandon the girders, and dispose the concrete in flat vaults, resisting the thrusts by wrought iron ties in different directions bedded in the concrete :

1. By connecting the supports or columns together, in which case the ties are concealed by carrying the columns above the springing of the vaults, and then connecting them through the mass of the concrete, as in figs. 1 and 2.
2. In domical or fan vaulting, by embedding in the domes or fans a series of concentric rings, in such a manner that the floor or vault can only give way by bursting these rings, and overcoming the enormous tensile strength of wrought iron. By this means the quantity of iron employed would be so greatly reduced that a floor of equal strength would only be about half the cost of one with girders in the ordinary method.

For example, supposing it is required to form a concrete floor, divided into compartments 15 ft. square to carry a weight of $3\frac{1}{2}$ cwts. per sup. foot or 37 tons to each compartment, including the floor itself. The ordinary method would be to provide main girders over the supports in one direction and cross girders in the other, with say two cross girders to each compartment, and to turn brick or concrete arches from one cross girder to another, fig. 3. Employing girders of the usual strength this would involve about 24 cwt. of iron to each compartment.

In the method described by Mr. Payne, without girders, the underside of the floor would be moulded into any kind of vaulting, say flat fan vaulting with two concentric ring ties of 1 in. section bedded in each fan, and in the centre space interlocking the four fans, and cross ties between the supports, each of 2 in. section, fig. 4.

Computing the resistance of the ties at about 20 tons per square inch, it will be seen that the sum of the tensile strength in each compartment in the ties alone amounts to 160 tons, and the amount of iron employed would weigh about 6 cwts., or a quarter what was required in the former case. Thus making all allowances for extra cost of centering and labour this floor would not be found to cost more than one half of the former one. The same principle of ring ties can be easily adapted to the compartments of other vaulting besides fan vaulting, the under surfaces being moulded to almost any shape to suit the designer, as shown on the accompanying illustrations, figs. 5 to 9, or it can be used for solid corbels for supporting oriel windows, projections, &c., the ring ties being carried at the back of the wall, as shown on figs. 10 and 11. It is also extremely adaptable for domes, as shown on fig. 12 and 13, where the pendentive is formed of three struts or columns, and the thrust at the bottom resisted by ties carried through the thickness of the rectangular supporting walls as shown.

Royal Institute of British Architects.

At the Ordinary General Meeting, held on Monday, the 19th of April, 1875, Sir GILBERT SCOTT, R.A., President, in the Chair, the following Paper was read:—

THE CHURCH OF ST. FRANCIS, ASSISI,

By J. BEAVINGTON ATKINSON.

THE history and a full description of the Lower and Upper Churches at Assisi would far exceed the limits of a short paper. I, therefore, will in fewest words indicate dates, structures and styles, by way of reminder merely, in order that more space may remain for some account of the present state of the building and the nature of the restorations therein, as witnessed by me during last autumn.

In addressing a professional audience I crave indulgence as approaching the subject somewhat from the side of an amateur.

You all know that the double or triple Church of St. Francis holds a commanding position. The city of Assisi, in common with the neighbouring towns of Spoleto, Spello, Trevi, Cortona, and Perugia, is planted after the habit of the ancient Etruscans, on a spur of the Apennines; and the geographical and geological, not to say the military conditions, have naturally influenced architectural construction. Thus the site chosen for the united churches and monastery falls so abruptly and rises so considerably as to give to the arched basement on the one side the magnitude and elevation of a fortress, while on the other the level of the floor of the Upper Church is the same as that of the grass-grown piazza. The difficulties of the ground, as often happens, are made to enhance the picturesque effect. In no other country in the world do the forms of outward nature lend themselves so kindly to the exigencies of structural and decorative art.

The Lower Church was commenced in 1228, and finished in 1234; the Upper Church did not reach completion till 1253. The architect was a German called by the Italians Lapo, with whom seems to have been associated an Italian monk of the order of St. Francis, Fra Filippo da Campello. Limits of time forbid details, but the following points may be briefly noted:—First, the extent and the early date of the Gothic movement which swept over and occupied the plains, vallies, and hills of the Apennines. In my recent tour I have again been struck with the abundant and luxuriant growth of the pointed arch and its cognate ornament, not as an exotic coming from afar, but apparently as much at home and acclimatized as the acanthus—not employed for ecclesiastical purposes only, but entering into the structure of humble dwellings in the narrowest streets—not established at great centres and chief capitals exclusively, such as Florence, Siena, and Orvieto, but finding a footing in the outlying towns of Spello, Citta di Castelio Borgo San Sepolchro, Assisi, and Urbino. In this complex Italian development the churches of St. Francis and the sister church of Sta. Chiara at Assisi stand as early and simple examples. It has been truly said that Assisi was as a light set on a hill for art no less than for religion. Gothic architecture, with kindred pictorial decoration, become from this centre diffused over the hills and the vallies of Central Italy:

A further point arises from some peculiar characteristics in construction. The Lower Church is cavernous and crypt-like; the columns in the nave are of single massive shafts, as in the Norman style of England, or the transition from the Romanesque to the Gothic in France. The arches and vaulting between these stunted columns are round, with possibly a slight aspiration here and there, according to the spaces spanned, to a point. These columns, which now stand at the entrances to the side chapels of later date, are continued to the Upper Church, where they serve as external buttresses—anomalous and undecorative. The Upper Church soars into the sky in contrast, and yet not in discord with the Lower. It is as a lantern rising out of a crypt; it is full of light, and speaks, as it were, of the resurrection after the sepulture. The semi-detached columns at the transepts divide into clusters; the vaulting, of the elementary form for a rectangular space, with diagonal ribs, is fairly lofty, compared with the width of the floor. Here in the Upper Church the forms exchange strength for elegance; the colours, enlivened by a flood of light, are joyous. Judging from internal evidence, there would seem to be a development in style more than correspondent to the difference of twenty years in the date. I do not know of any record of change in the design during the progress of the work, and the two structures are not without unity: the apse especially is in accord in the two churches. Moreover, it would seem in an architectural structure reasonable to take into account what in nature is a principle of vital growth from root or base to flower or roof; at all events, in the present instance it was a manifest necessity that the under church, which had to bear the weight, should be strong, and equally needful that the upper should be light. Thus it would appear to me probable that any apparent diversity in style is but one of the many proofs of the power of adaptation to circumstances in Gothic architecture. I will just add that the vestibule and most of the side chapels to the Lower Church were appended during the last quarter of the fifteenth century, yet some must be earlier, because they still preserve on their walls pictures of the fourteenth century. The dates of the structures are of all the more consequence, because they thus sometimes serve to indicate the age of the decorations. It is evident that a fresco could not have been painted before the wall was built.

One more matter may be worthy of mention before I pass to the recent restorations. It has already been stated that an Italian architect shared the work with a German—a fact which may the better account for certain accommodations of the Northern Gothic to Southern and Italian treatments. This is seen in the surrender of mouldings, surface panellings, and details, for the sake of large, unbroken spaces, reserved expressly for frescoes. Here, in fact, in Assisi, as in the Arena Chapel at Padua, the pictures become principals, and the architectural members and the sculpture subordinates. Mouldings are merged into divisional lines between pictures; indeed, the painter uniformly seizes on the diagonal ribs in the vault, and treats them as picture-frames. It is not here necessary to discuss the advantages and the penalties of divers modes of decoration. All that need be said is that Assisi is rather an ultra example of how light and shade, form and proportion—in other words, how architecture and sculpture—may be made the servants of painting. The principle involved could scarcely be wholly wrong when the results reached were so nearly right.

I now beg to direct your attention to those recent and radical changes which have provoked a storm of criticism. The purpose of the works undertaken may be said in the general to be to reinstate, as far as practicable, the Lower and the Upper Churches to something approaching their original integrity. The narrative which follows is made from notes taken by myself on the spot, and still more from verbal statements, letters, and a manuscript report to the Italian Government by Signor Cavalcaselle, to whom has fortunately been entrusted these perilous operations. Beginning with the exterior, the first object has been to place the building in safety. Thus, the roof was made sound, the buttresses were strengthened, crevices in the stonework stopped, so as to prevent the rain from penetrating through

the walls to the back of the frescoes. Provision also had to be made for the escape of water, and lightening conductors were put up, to the need of which I can testify from having witnessed from within the building one of the severest of storms which visit the Apennines.

I will now speak of the alterations in the Lower Church. The clearances have been effected with so strong and swift a hand that priests and people were alike taken by surprise. Thus during a single night a staff of twenty or more men made a clean sweep of wood-altars, rococo carpentry, and gim-crack ornaments, much to the consternation of the monks who came in the morning as usual to say mass. By this bold stroke of business light was let in at darkened windows, frescoes by the dozen were made to look out once more from walls long masked, and the stone-altars before which the immediate followers of St. Francis had worshipped, being disencumbered from impertinent excrescences, again stood out in their original moderation and simplicity of proportion. The following details I take in an abridged form from Signor Cavaleaselle's official report to the Italian Government:—

1st. The iron enclosure round the High Altar in the Lower Church has been for historic reasons removed to its original position at the High Altar of the Upper Church. 2nd. An iron railing, or low screen, has been placed between the nave and the presbytery of the Lower Church; marks in the structure indicate the prior position of a similar erection. 3rd. The singing gallery and organ have been taken away from the apse and east end, thereby are revealed frescoes before hid, and also the wooden choir of 1471; likewise thereby much required light is admitted to the frescoes in the vault, especially to the four famous compositions of Giotto over the High Altar at the transept. 4th. The huge marble altar on the west wall of the north transept has been cleared away. Thus can now be seen the immense crucifixion by Pietro Lorenzetti, which covers the greater part of the wall. 5th. From the opposite transept has been removed the altar of gilded wood, which covered half of Cimabue's noble fresco of the Madonna, Child, and Angels. 6th. From the Chapel of the Orsini has been taken a marble altar; thereby is discovered the sepulchre of Cardinal Gaetano Orsini, together with a fresco. A new altar is now put like to the ancient one. The chapel is better lighted, and the painted windows are no longer shut out from view. 7th. Likewise from the opposite chapel, that of Cardinal Napoleon Orsini, was carried away an altar of gilded wood, thus revealing a tomb also a fresco of the Madonna and Child. 8th. In the chapel of St. Antonio Abate were discovered two sepulchral monuments of Blaise, Duke of Spoleto and his son. The vast barocco marble altar has been taken down, and a small one of ancient form substituted. When such restorations became imperative, the types adopted were those of the old stone altars—little else than rectangular tables. 9th. In like manner all the remaining altars of gilded wood were removed. They disguised and disfigured the original stone altars, mostly still lying hid within. Lastly. The painted windows now once more serve the purpose of windows. They light up the darkness visible of this grand, though gloomy, interior.

I will next tell of the changes in the Upper Church. They have been analogous to those in the Lower, though, in the absence of side chapels and side altars, they could not be identical. The following are the chief points for observation. Again the notes made on the spot find most important additions from Signor Cavaleaselle.

Careful consideration has been given to the original level of the floor of the nave, and the conclusion come to is that there was a rise of three steps between the nave and the presbytery, that subsequently the nave and the door on the west were placed on a higher level. During my visit last autumn men were employed with pickaxe about the foundations of the entrance, but nothing was discovered. The inference is that the columns and bases of the doorway were raised at the time when the nave was elevated. This elevation of the floor necessarily threw additional weight on the Lower Church, but the massive columns are sufficient to sustain the further burden. Of the strength of the vaulting

it is not so easy to speak, as the surface is disguised pictorially. This rise in the nave presented a difficult problem to the restorers, but Signor Cavalcaselle came to the conclusion that, under present conditions, it would not be wise to lower the nave to its original level. Such a change would necessitate the lowering of the base of the western door, and of the grass-grown piazza in its front—processes very difficult, if not impossible. It was deemed that a descent into the Upper Church by steps from the piazza would be a sacrifice of dignity. Thus a wise caution has induced a discreet compromise. The ascending slope from the nave to the transepts, made when the three steps were removed, is now converted into one step. Thus it has not been attempted to take back the church precisely to its state in the thirteenth century, as conceived by Lapo, and we are told that we may reasonably rest content to see the structure placed in the intermediate condition of the fifteenth century. At all events, we can now realize the interior as it was before the changes of the sixteenth century and the frightful intrusions of later and recent times.

The most important alterations in the Upper Church have been in the transepts, apse, and the High Altar. From the west walls of the transepts have been removed two painted wooden altars of corrupt design. The result is the uncovering of two frescoes of the Crucifixion. The early simple stone altars were found set away from the walls, and names scratched, and an inscription behind one of them bearing the dates of 1469, 1559, 1677, and 1680, show that in these years the walls were free from the huge painted incumbrances now happily removed.

The radical reformation has been the withdrawal from the apse and transepts of the intarsia coro of the sixteenth century, executed by the well-known worker in wood, San Severino, of Florence. This uncompromising measure provoked more opposition than any other of the recent changes. This coro, no doubt, was an intrusion, but yet it formed an imposing piece of church furniture, and its removal, though revealing frescoes—not, however, of a high order—leaves the east end of the church bald and desolate. Signor Cavalcaselle defends the proceeding. He says truly that the structure was ill-suited to the position, that the style is cinque cento, and that, with the exception of the figures in tarsia, the execution is rude. I may add what I conceive to be a paramount reason for the removal—the restitutions, either accomplished or contemplated, would not otherwise have been practicable.

The Papal Throne in the centre of the apse was examined. The original simple structure had evidently been tampered with. The level had been raised from two steps to five above the floor, and a semi-classic canopy, supported by columns on false bases, had been added. This canopy is removed. The lower part of the wall of the apse on either side of the Papal Chair was found without intonaco—a fact which led to the inference that the space had been occupied, as in many other churches, with a range of seats. Furthermore, in the transepts, below the line of the frescoes, were discovered painted tapestries up to the dado. It is one of the interesting coincidences arising out of the recent investigations that in the Lower Church are marble and mosaic wall coverings corresponding in dimensions to the undecorated spaces in the apse. This marble-work, of the generic character of *Opus Alexandrinum*, also fits in with the proportions of a supposed original coro. It is proposed to re-clothe the denuded wall space in the apse according to this conjectured precedent.

One important advantage accruing from the removal of the encroachment of the large wooden stall-work has been the needful space gained for the restoration of the High Altar to its original position immediately under the transept. The altar had been thrust down into the nave to make way for the increased dimensions of the choir. In its present position it stands immediately above the High Altar in the Lower Church, which in turn is directly over the tomb of St. Francis in the Crypt Church. Before we quit the High Altar in the Upper Church, I would again refer to the transfer of the enclosure of iron-work from the High Altar of the Lower Church. Signor Cavalcaselle considers that it was

made for the upper altar, and had been wrongly removed to the lower in the sixteenth century. This iron enclosure underwent many alterations, and bears the signs of at least two dates—the earlier is of the first half of the fifteenth century; some additions are of the second half of the sixteenth, the period of the stall-work removed from the upper apse. It may seem an anomaly that the wood-work should be removed while the iron-work is restored. But the excuse is, as before said, that circumstances suggest, if, indeed, they do not impose, a compromise.

Next, let us consider the question of an ancient marble coro. Signor Cavalcaselle, in his manuscript report before quoted, writes:—"Observations made on the spot demonstrate that originally the coro was composed of a marble enclosure, which separated the nave from the transept, extended along the walls of the apse on either side of the Papal Chair, and enclosed in the centre the High Altar with the Tabernacle." Foundations have been found which lead to this conjecture. Signor Cavalcaselle argues that as the original plan of the church was German Gothic, with the form of the Latin cross, this coro could not have been contemplated in the first design—that it came as an after-thought in course of the construction, consequent on the decree of Gregory IX. in the first half of the thirteenth century, which made the church of St. Francis a Papal Basilica. Accordingly the Papal Throne was placed in the centre of the apse, and the coro raised bearing two ambones. The arrangement as thus explained must have been a little anomalous. It would seem to have differed from, though it is analogous to, the typical form of the choir enclosure in the church of San Clemente, Rome. This arrangement existed nearly three centuries from the time of the completion of the church, in 1253, to the first transformations in the early part of the fifteenth century. The subsequent history may be briefly stated as follows:—The first transformation in the fifteenth century consisted in the breaking up and scattering about of the marble coro, and in the substitution of a smaller choir, probably of wood, and occupying only the apse; also in the removal of the original altar, and the substitution of a larger one with iron enclosure. At the same time, the Papal Throne underwent the changes before described. This state of things lasted about a century and a half—that is from the early part of the fifteenth century down to the end of the sixteenth, when the second transformation occurred, consisting in the breaking up of the choir of wood in the apse, the substitution of the *intarsia* stalls of San Severino, the consequent removal, in order to gain space for this large mass of wood-work, of the High Altar from beneath the cross of the transepts to the first bay of the nave; and finally the transposition, as we have seen, of the iron enclosure from the Upper to the Lower Church. This second transformation gave to the internal arrangements the aspect preserved down to our day. The third and last transformation is, of course, manifest in the restitutions now in progress.

The evidence of the existence of the marble coro, as just described, is as follows: first, foundations found beneath the pavement; second, the existence of sundry marble slabs decorated with mosaics inserted in the pavement, found attached but not belonging to the pulpit in the nave of the Lower Church and to the wall of the Pontani Chapel: (these marbles, as before said, correspond in size with the unclothed wall spaces on either side of the Papal throne); third, the small pulpit of stone now attached to the shafts of the clustered column at the angle between the nave and the north transept. The column has been chiselled away to admit of this addition, and the little staircase leading from the sacristy below is also subsequent to the original structure, apparently the date is of the 15th century, the time it will be remembered of the breaking up of the marble coro. This pulpit then, very lovely in its proportions, is supposed to be one of the two ambones of the choir. The conjecture it would seem to me ingenious without being quite conclusive. Fourth, the existence in the Church of Sta. Chiara, in Assisi, of a similar choir of the almost synchronous date of 1257, the design of Fra Filippo Campello, who also, as we have seen, worked in the Church of St. Francis. Fifth, a fresco by Giotto in the nave

of the Upper Church, depicting the Saint instituting the representation of the Nativity. The scene is laid in the interior of a church, wherein appears a coro of marble with a pulpit or ambo and stairs corresponding to the supposed arrangement in this Upper Church. In the picture the part in which the second ambo would come happens to be cut off from the composition. Another fresco in the nave introduces a like marble coro. I may here add that in these two wall pictures are seen painted wooden crosses raised on a beam stretching across the nave in front of the high altar. Accordingly in the recent restorations a similar cross has been erected by way of experiment, the data being ancient brackets still remaining in the wall with the tradition that in this position was placed the wooden cross painted by Giunta Pisano. I am bound to say that this somewhat bulky cross strikes me as incongruous, partly perhaps because its synchronous coro no longer remains to keep it in countenance.

The whole of this difficult problem Signor Cavalcaselle sums up as follows:—Such being the results of the observations made, the natural wish would have been to reduce the work to the integrity of its primitive form, and with this end to dispense with the iron enclosure, to make in the altar and papal throne radical restorations, to set up again the marble coro, in short entirely to rearrange the transept and apse. But to do this he says would be absolutely impossible, and therefore it has been thought better to take the middle course—an accommodation to existing circumstances which I have attempted to explain if not to justify.

Having spoken thus far of the structure, it is time now to turn to the painted decorations. I premise by stating that I use the word fresco merely as a generic term, strictly speaking there are no frescoes, the process is secco. And just as in the architecture we encounter a conglomerate of divers styles and masonrics, so in these wall paintings there is a medley of masters and a succession of pictorial strata. We all know of the practice of clearing away prior frescoes for later, thus in the Sistine Chapel a field was found for the genius of Michael Angelo; a like destruction and renovation from century to century may be traced on the walls of the Lower and Upper Church. First came Giunta of Pisa, who was still under Byzantine bondage, next followed his pupil, Cimabue, then a clearance was made for a third generation under Giotto, afterwards followed Giottino and other pupils; these painters represent the Florentine school in the two churches. But the desire to secure the best talent of the day naturally led to the employment of the leading masters in the rival school of Siena; accordingly we find on the walls frescoes by Simone Martini, commonly called Simone Memmi, and of Ambrogio, or Pietro Lorenzetti. Many of these compositions have suffered grievously from decay and from restorations, and some having been entirely swept away are replaced by later works in the worst taste. At a rough estimate the two churches contain from four to five centuries of frescoes, and it will be easily understood how difficult it becomes after this lapse of time to distinguish with certainty the authorship of individual works, especially as the greater number are, as I have said, either wrecks or restorations. Giunta merges into Cimabue, and he in turn is easily confounded with his immediate followers. Like perplexities beset Giotto and the masters of Siena. Unfortunately contemporary documents are wanting, the monks were not chroniclers, and Vasari as usual falls into errors which long obtained unquestioned currency in the art literature of Europe. Latterly, as we all know, a more critical spirit has prevailed, unfortunately the ambition of each successive student has been to introduce a new nomenclature, often little more than guesswork. Assisi has been in this way so specially favoured that the pictures in general are ascribed to two or more authors. I have been entrusted with the proof sheets of the forthcoming Italian edition of the well-known work by Crowe and Cavalcaselle, and I made as far as I was able notes on the spot; these are my data.

The wall pictures in the Lower and the Upper Church, owing in part to persistent destruction of old work and the interpolation of new, admit of no consecutive chronology. Thus two hundred years

divide adjacent chapels. It is evident, however, that as soon as the mason had laid aside his trowel the painter came with his brush, and therefore the Lower Church being first built, it may be reasonably supposed that there the frescoes are of the earliest date. This is true of those which remain on the nave, the probable date being the first half of the thirteenth century, the style accords with that period. The authorship of these works will probably, in the absence of documentary records, ever remain in dispute. Mere internal evidence can scarcely decide between the tribe of Byzantine painters on the one hand and Giunta and Cimabue on the other, the fact in my opinion being that Byzantine art has been unfairly decried and the reformation wrought by Cimabue too greatly magnified. Signor Cavalcaselle argues against the probability of Greek artists having been employed. This may perhaps be strictly true, but Italian artists working in the manner of Byzantines would produce almost identical results. In fact in the face of these designs it once more becomes evident that the generic manner goes for more than the individual master. A comparison may be made between these frescoes and the mural paintings in the mother Church of Pisa, planted in the plain half way between the city and the sea. In the presence of these compositions in Assisi I cannot but feel how much has been lost in the total overthrow of the Byzantine manner. The figures stand firmly as columns and the draperies are cast into broad symmetric folds not very remote from classic originals. In colour and in decorative service the school is acknowledged to be supreme. Such is the pictorial point of departure at Assisi.

Cimabue follows; nowhere can this grand and even creative master be so well studied as within these twin churches; what pertains precisely to him, and how much may be divided between his master Giunta and his immediate followers, will never with certainty be determined. Thus much, however, seems certain, that Cimabue painted in the transepts of the Lower Church, also in the transepts on the vault and side walls of the Upper Church. Of great nobility and beauty is the Madonna with child and angels, still preserved amid general clearances in the south transept of the Lower Church. From extant remains I am inclined to think that about two-thirds of the Lower and the Upper Church were covered with frescoes by Cimabue and his immediate forerunners and followers. Possibly, indeed, the whole was thus decorated, for it is hard to believe that in those days of religious enthusiasm the great sanctuary should have remained unfinished for even half a century. And it seems to me strange that the Fraternity being in possession of such noble works could not let well alone.

And yet the next epoch, that of Giotto, is probably separated from the former by more than half a century; indeed Giotto was not born till forty-two years after the Under Church was finished. In England such has been the speedy decay of frescoes that the periods at Assisi in comparison are not short but long. Possibly it was found that the style and especially the scale of Cimabue did not accord with the treatment of his pupil Giotto; and if we may judge from the allotment of walls made for the new decorations the desire for unity was a controlling consideration. Thus in the Lower Church to Giotto and his scholars were assigned the vault over the high altar, the greater part of the south transept and two adjacent chapels, and in the Upper the best parts of the nave. These pictorial creations are almost too well known to need description, even did space permit. They are copious in idea, symmetric in the distribution of the figures, and compared with Byzantine art light and animated in tone and colour. If they have a fault it is one perhaps inseparable from the system; they are, I think, open to the objection of being too much of the nature of easel pictures just hung to the wall, but this exigent criticism would strike at most mural decoration, save that of the ceiling of the Sistine. Among all the works of Giotto none show more creative genius or technical power than the "three vows" of St. Francis on the vault of the Lower Church.

The Sienese school had a shorter career at Assisi than that of Florence. It was limited to the

fourteenth century, and the space it occupies does not extend beyond the north transept, small portions of the south, and the chapel of San Martino, all in the Lower Church. The paintings in the chapel are for drawing, character, and perspicuity of narrative among the most mature works of Simone Memmi, now called Simone Martini. The series on the vault of the north transept after much debate are now assigned by Signor Cavalcaselle to Pietro Lorenzetti. The Sieneſe ſeem to have been required to conform to the already existing Florentine ſyſtem of decoration, accordingly, I am ſorry to ſay, they ſurrendered one of the moſt diſtinctive characteristics of the ſchool—that of a gold ground. In Aſſiſi, as in the Arena Chapel, the ſcale of colour conforms to the more naturaliſtic and leſs decorative background of blue.

The ſubjects choſen for illuſtration are like the architecture and the pictorial ſtyles, a conglomerati- on: they do not fall into conſecutive thought. But ſpeaking generally they divide themſelves between Biblical hiſtory and the life of the titular Saint. Strange to ſay the one Church has little or no relation to the other: ſome themes are found equally in each; thus in both Churches occur in the two tranſepts two crucifixions: that St. Francis receiving the Stigmata ſhould be repeated is ſcarcely remarkable. The following ſeem the points moſt worthy of note:—Foremoſt, freedom of thought: even as early as Giunta and Cimabue painters begin to work out ideas old and new according to the promptings of their individual minds; this is ſeen in bold and imaginative conceptions concerning the Apocalyſe. A minor matter is the frequent introduction of the ſix-winged Seraph, alſo may be obſerved in the Stigmata the apparition of a crucifix ſimilarly winged. And very exceptional novelty attaches to Giotto’s allegories of Poverty, Chaſtity, and Obedience. The painter here reaches the mental calibre of a creative poet.

In the reſtorations the greateſt difficulty has been to know what to do with this amazing maſs of freſcoes. They preſent different ſtages of decay, amounting in many places to abſolute deſtruction; ſome have crumbled wholly from the walls, others are ſo far obliterated that the ſubjects can hardly be deciphered at all, while ſcarcely a ſingle compoſition remains without the loſs of a head, a hand, or an entire figure. Under theſe perplexed conditions it was hard to know what courſe to adopt. Several alternatives preſented themſelves. Some perſons doubtleſs would be found to urge that the pictures were too precious to be touched at all, but to this *laissez faire* policy the answer, which applies equally to Aſſiſi and other cities throughout Europe, is, that if decayed works are not dealt with ſome- how they muſt periſh irremediably; in fact in Aſſiſi the only cauſe for regret is that reparation was not effected a century or more ago: then might have been preſerved what is now loſt beyond recovery. But there are other experts who would inſiſt on a thorough ſyſtem of reſtoration, that is of partial or entire repairing—this uſed to be the univerſal panacea in Italy, but the remedy proved worſe than the diſeaſe, reſuſcitation more painful than decay or death. Some of the freſcoes in the Upper Church have been thus killed by kindneſs. To enumerate a tenth or a hundredth part of the pictures thus ruined in Italy would occupy time to drearineſs. But ſtill worſe, there have never been wanting at Aſſiſi counſellors to recommend the ſubſtitution of decayed freſcoes by ſpan new pictures. The Lower Church proves with what fatal facility compoſitions priceleſs in value were from time to time made to give place to works which, though the loweſt of the low, the monks accepted as improvements. I cannot but think that theſe various plans have been wiſely ſet aſide in favour of a meaſure which, ſtopping ſhort of reſtoration or renovation, ſeeks ſimply to preſerve what- ever ſtill remains.

The plan and proceſs adopted I will briefly explain. I mounted the ſcaffolding in the Upper Church and there found workmen with chiſels, hammers, trowels, and mortar ſteadily operating on the freſcoes of Cimabue, under the immediate ſuperviſion of Signor Cavalcaselle and Profeſſor Botti.

Where a large piece of wall had fallen into rottenness and been denuded of its picture, it was simply cut out and replaced by sound cement. Again where only a part of the intonaco was in decay a chisel removed the crumbling mortar, and a trowel replaced the void by a firm material which bound the surroundings together as by a wedge or a plug. The process it may be observed is honest, the new mortar is so coloured as to speak distinctively for itself. Next and chiefly, those parts have been operated upon, fortunately very considerable, which though in decay and threatened with destruction are still capable of preservation. I may observe that the malady which afflicts these frescoes is one common to the whole genus of wall paintings. The surface or pellicle of the picture rises into blisters, the mortar becomes disintegrated and ready to fall down on the floor as dust, thus the entire work must speedily die if left to its disease. For the purpose of fixing these flying particles and fleeting paints some glutinous fluid is infused, and then surface pressure applied, gently but firmly, brings the picture once more soundly together. Furthermore the frescoes are refreshed, the dust of ages is cleared off, by means of simple water and a soft brush, then finally some fixing medium is washed over the surface, which when sucked into the pores renders permanent the perishing particles. I naturally conjectured that this fluid medium was identical or at least analogous with the silicate known in Germany and England as *wasser-glas*, but I am assured that the process is both a novelty and a secret. Somewhat the same medium, whatever it may be, will be applied to the external stonework not only for the purpose, as in our Houses of Parliament, of arresting further decay, but also of precluding the percolation of the rain and moisture which have proved, as might have been readily conjectured, destructive to the frescoes. The result of these operations, though not all that might be desired, is on the whole satisfactory. Without the addition of colour or the use of a paint brush the frescoes are wonderfully "refreshed," and they are moreover, as I have said, placed in permanence.

In conclusion, all that I have attempted is to give a slight sketch of a monument in which is inscribed a history. Much has been lost and now all that remains possible is to spell out past times line by line. To complete the picture more details must be filled in and even then all is not finished, for each year brings new materials, fresh clearances make additions to the revelations; further restorations provoke continuous criticism. In process of time it is proposed to restore the whole Convent, including the Hall of the Musicians, and it has been suggested that then the vast structure might, as a Lyceum, be devoted by the Government to educational uses. Perhaps it is not too much to say that the works undertaken can have no end; structures of this magnitude, especially when old, must ever be under process of restoration as a means to preservation. At Assisi an architect and a caretaker of the pictures should always be on the spot. Aptly have the Churches and Monastery of St. Francis in their present dilapidated state been compared to a chronic invalid who needs to be constantly in the hands of a medical man.

The PRESIDENT having invited discussion,

Mr. HOLIDAY, Visitor, said—Mr. Atkinson has treated the subject in a manner which has anticipated almost all one might have to say upon it. I spent some weeks in Assisi, during which time I made a copy of a very splendid painting, which does not appear among the illustrations placed on the walls. It represents St. Francis healing a wounded man; two angels are standing by the bed-side, while on the left a doctor appears to be telling two ladies that there is no hope for their friend, thus emphasising the miraculous nature of the cure. The story is told in an admirably dramatic manner. Much discussion has taken place whether these paintings in the upper church are by Giotto. I do not think it is of much moment, for though doubtless

no one painter could have achieved so great an amount of work with his own hands, yet if the designs are not by Giotto, I know of no other painter of that period who could have produced conceptions so dramatic and powerful throughout. At the same time these works are not to be compared to the four paintings, over the high altar in the Lower Church, by the same master. Those compositions are beyond anything I have ever seen in Italy. They are full of angels, and convey the impression of inspiration, such as one would suppose to have been imparted had the painter been carried up to the Seventh Heaven, and seen the actual living angels, and drawn them from nature. The conception of these super-human beings is so marvellous, that I know of nothing like it in art. With regard to the materials used in these pictures, it could not have been fresco in most of the paintings. I should like to know whether Mr. Atkinson observed any instances of the surface colour flaking off, for there is evidence of work under the surface which resembles fresco painted in the fresh plaster and united with the original grain in a way which would not be the case if the painting was done on the dry surface. I should be glad to hear whether Mr. Atkinson has observed this. [Mr. ATKINSON replied in the negative]. There are many paintings in the Lower Church, of which the head by Simone Memmi, copied by Mr. Lonsdale, may be regarded as an excellent type; the majority of which showed no signs of the surface flaking off, and which might possibly be frescoes. With regard to these copies of the pictures contributed by the Arundel Society, it may be remarked that much of their effect is destroyed by the violent blue back-ground on which they are drawn. In this respect they do not resemble the original pictures, where the blue is luminous and apparently painted on a green ground, and the effect of the colour is injured by the change. The picture exhibited of St. Francis upholding the Church, the Ancient Vatican, during an earthquake, is worthy of remark. I was struck with the sublimity of the conception. Although the saint places his hand and shoulder underneath the tottering frieze of the edifice and so supports it, yet there is no sense of preternatural muscular effort exhibited, the action of support appears merely symbolical, the power being that of faith on the part of the saint. The account of this beautiful edifice which we have been favoured with to-night, shows that it has undergone most extraordinary changes, and I hope the result of these restorations will be of a satisfactory character, and worthy of the object to which they have been directed.

Dr. BARLOW, Visitor.—All who have visited and examined the Churches of St. Francis at Assisi, and their marvellous contents, must feel much indebted to Mr. Atkinson for his paper. It is now more than thirty years since I was there, drawing and sketching and measuring, and Mr. Atkinson has brought back to my memory, by the graphic account he has given, the pictorial treasures of early art which are there enshrined, as vividly as if I had them now before me. The Upper and Lower Churches of St. Francis at Assisi occupy the first place in the history of Italian painting. We have there the works of a continuous series of Italian painters, from Giunta Pisano, Cimabue and Giotto, down to several of his followers. Simon de Senis, or di Martino (better known as Simon Memmi), Pietro Cavallino, and others. It is satisfactory to know that the Florentine Academy has approved of the way in which the restorations have been conducted, and that my old friend Signor Cavalcaselle, who has given much attention to early art, if he has not superintended them, has examined them from time to time and reported of them very favourably to the Government.

Mr. J. D. CRACE, Contributing Visitor.—I would add my testimony as to the interest of this paper, and, as I think no one has as yet done so, I beg to move a vote of thanks to Mr. Atkinson. There are many interesting points he has raised for consideration. I think, perhaps, in the first place, very few of us were prepared to learn the extent to which these restorations have been carried. They would suggest to one's mind something akin to destruction; and were they not connected with the honoured name of Signor Cavalcaselle, one would be almost in despair on hearing of the extensive system of

clearance, which is being applied to this monument of art. There are some points of detail mentioned by Mr. Atkinson, on which I would make one or two remarks, more especially with regard to the details of these paintings in these churches, as to which I may say, parenthetically, my impression is that they are not "buon fresco" at all; but for the most part paintings in "secco." Although the outline may have been traced on the wet plaster, I believe the actual colour is in secco. I do not think true fresco painting was largely practised, if at all, in Giotto's time. One point of interest which the architectural details of these pictures present is the proof they afford in the history of architecture, that the classic influence was never dead in Italy, even during the fullest life of gothic architecture in that country. Gothic architecture in Italy was rather an exotic, and never had any deep root there; and the details of the building depicted in these pictures are more or less Byzantine in feeling, though they possess mainly a Gothic character. There is another point which Mr. Atkinson has not touched upon, and that is the extraordinary beauty and value of the distribution of colour in the building. Apart from the merits of the paintings themselves, the way in which the masses of colour are handled in the Upper Church is perhaps one of the most valuable, if not the most valuable early example we have of the decorative treatment of pictorial art, and one which is invaluable at the present time, when there is a strong tendency to introduce subject pictures in churches. The colour of the blue black ground of the pictures referred to by Mr. Holiday I believe, is not accurately given in the drawings hanging in this room, and we may presume that the back-ground was selected in accordance with the general scheme of the decoration of the building itself—not because it was the most convenient back-ground for each picture, but that each picture's back-ground should add to the effect of the building itself. Even inferior drawings will afford the student of coloured decoration invaluable assistance. With regard to the blue black ground adverted to by Mr. Holiday, and which he surmises to have been painted over green, I think he will find that the blue changes its colour, and in this case it has greatly changed in tone, probably owing to the influence of damp from the exterior of the building,—those portions nearest the exterior having been the first so to change colour. This has been the case with a great number of these pictures; and the same result of damp may be seen elsewhere.

Mr. ASTON WEBB, Associate, (late Pugin Travelling Student) responding to the President's invitation, said, being only a young student he could not attempt to follow the Paper through all its details; but he was glad to hear that the restoration of the pictures in the Church of Assisi was such as in Mr. Atkinson's opinion would be likely to improve rather than damage them. He would like to know whether in the removal of the altars—particularly in the Lower Church, any further frescoes had been discovered, which he thought would probably be the case.

Mr. C. L. EASTLAKE, Secretary.—I take this opportunity of informing the Meeting that we are indebted to the courtesy of Mr. F. W. Maynard, Secretary to the Arundel Society, for the loan of the interesting series of drawings, illustrating mural paintings in the Church of St. Francis, Assisi, which are exhibited here this evening. I have also to acknowledge the kindness with which Mr. G. Aitchison, Mr. H. Holiday, Mr. H. W. Lonsdale and Mr. Aston Webb have contributed pictorial studies, which will also be noticed on the walls, and which relate in various ways to the subject of Mr. Atkinson's Paper.

THE PRESIDENT.—A vote of thanks to Mr. Atkinson having been proposed and seconded, before I put it to the meeting, I would ask whether there is any other gentleman who will favour us with his thoughts on the subject. I may mention that Mr. Beresford Hope has sent a note expressing his regret that his parliamentary duties prevent him from being present. In closing the discussion I will say a few words, although the lateness of the hour precludes me from saying much, if I had much to say. With regard to the architecture of this church I think it bears a wonderfully exact testimony to history. Mr. Atkinson has told us of circumstances which, from my own obser-

vation, I have noticed more minutely in detail than he has stated. He has told us that this church was built by a German architect associated with an Italian architect. That it was built by a German, as distinguished from a French architect, I think is quite clear. We know clearly the distinction at that date between French and German architecture. Just about that date the Germans had ceased to develop their own genuine form of architecture, and had suddenly fallen into the French style, and attempted, with some success, to imitate it; but, like most imitators, they did not reproduce exactly the same thing, but gave it a tone and character of their own. Take for instance the Church of St. Elizabeth at Marburg, that of St. Mary at Treves, and that of Naumburg in Saxony. If you compare these German works with contemporary French buildings, they are found to be imitations of them; but there is a distinct feeling in the German works, by which you know at once that they are German and not French—they are, in fact, a sort of second-hand French, but with a great deal of original matter of their own, apart from and different to those imitated. The Gothic architecture at Assisi is not French, but it is of that peculiar character which you find produced at second-hand in Germany, and was imported at third hand into Italy. But it is not pure, it is mixed up with Italian detail—not united as the work of one man who knew both styles, but here a bit of German and there a bit of Italian. Even in one arch you may see an Italian order and another pure German, as if each architect did a little bit alternately. That magnificent doorway of the Lower Church at the north-west entrance is, for the most part, purely German in detail, but has one order formed of an Italian modillion cornice bent, as it were, round it. The great rose window at the west end is German work, united with half-classic detail, as for example, a guilloche inlaid with mosaic externally, showing the wonderful way in which Italian architects worked with their German colleagues. All through this church you see the same thing going on in consequence of the two architects working together. When we come to the decoration of the church it is out of my place to say much about it, but one great feature of it has been entirely left out by Mr. Atkinson, no doubt for want of time. That is the purely decorative work apart from the high-class paintings. This is a subject which I recommend every young architect who has the opportunity to study from that church. My own personal knowledge of the church is as nothing compared with that of some who have spoken; but I would especially mention the vaults of the nave of the Upper Church, which were decorated, as it is said, by Cimabue. Two of these are decorated with a richer class of painting than the others. In the western bay each half cell of the quadripartite vaulting contains a seated figure of very remarkable treatment, one of each pair of figures being a Doctor of the Church instructing a friar of one of the four great orders. One is seated in the half of each division, and in the opposite half to him is seated a monk. The borders to the ribs of that part are most superb, consisting of the most exquisite foliated arabesque interspersed with figures. The foliage, it is true, is not exactly suited for imitation in English Gothic buildings, because it is founded on classic *reminiscences*, but the painting is most admirable. The way in which the colours are toned and intermixed, and changed and varied, is a perfect study for decorators, beyond anything I have ever seen. Every piece of colour of any size is varied in itself. A little patch of red, for instance, contains half a dozen tones of red, and the other colours are toned in like manner, in the most charming way that can be conceived. I regard this as a most important work for study, with this qualification:—that the English student on his return home must divest himself of the actual details. He must study the tone and feeling of that art rather than its actual details. I need not say what an endless assortment of diaper patterns the whole church contains, both on walls and mouldings, as the framework of pictures, and in the decorations of buildings, furniture, and costumes in the pictures themselves. A great deal of the decoration of both of the Upper and Lower Church, is of a sort which, though pervading the works of the school of Giotto, may be said to be of

dubious merit, being designed in imitation of mosaic. No doubt, however imitative, mosaic does give strength and firmness to the parts which you cannot get in any other way.* I do not think Mr. Atkinson alluded to the ceiling, which I have mentioned, of the western bay of the Upper Church, and I would ask him whether he thinks that was painted by Cimabue. My reason for asking, is because there is a picture of a similar character in the Church of Santa Maria, in Ponto Fuori, near Ravenna, with precisely the same distribution. In that case we find four doctors facing four Evangelists, sitting on extremely quaint chairs with desks before them, with various little properties on the floor about them, all of which would make a study, particularly for our friend Mr. Crace. They are very splendid specimens of the furniture of the period. The picture is, as I have said, of similar character to that which I have referred to in the Church of Assisi, and it is somewhat curious that one is attributed to Cimabue and the other to a pupil of Giotto's (Pietro di Rimini). It does seem curious that they should skip over two generations of painters, and yet that the same very peculiar arrangement should have been adopted in each case.† Another part I remember is the beautiful chapel (I think alluded to by Mr. Atkinson) on the western side of the south transept of the lower church, which I think was decorated by Buffalmaco. It seemed to me that the architectural parts of that decoration were (with the exception of the ceiling I have referred to) the very best in the church—better even than Giotto's. I have spoken merely from my recollections of this church, and I thought I might mention these two or three things as being worthy of attention, and I have now to beg you to thank Mr. Atkinson in the heartiest way you can, and I would ask to join with your thanks to him your thanks also to those gentlemen who have favoured us with the exhibition of so many and beautiful paintings and sketches in illustration of the paper.

A vote of thanks having been unanimously accorded,

Mr. ATKINSON said,—I have already occupied so much of your time, that I will only in the briefest terms thank you for the reception you have given to my Paper. With regard to the President's observations about Cimabue's works, I feel that the best authorities are so doubtful on the subject, that it is impossible to decide whether these pictures are by him or not. In the Upper Church the pictures in the various compartments of the nave, no doubt belong to the Cimabue period; and I think if any of the vault paintings are by Cimabue, those four figures may be considered to have been painted by him; but there are authorities who say Cimabue is not on the vault at all. I am sorry I cannot give a better answer, but Cimabue is a most difficult man to understand. He comes in for Byzantine art, and his followers were like himself. I do not think I can pronounce an opinion upon the subject; it is too uncertain a question.

* *The following is extracted from the Notes in my Sketch Book, made at the time of my visit to Assisi.*—"The universal use of painted mosaic is open to question. It is a sort of sham, or at least a *borrowed* enrichment, yet no other scheme seems to give such brilliancy of effect. The foliage is mostly founded on the study or tradition of the antique, but is excessively beautiful; I do not know whether most to admire Cimabue's foliated borders in the Upper Church, or Buffalmaco's in the Chapel, referred to (that on W. side of S. Transept). The latter may be best in foliage, pure and simple, but the former surpasses in the brightness of the white flowers, the introduction of varied colours in the ground, the use of animals—real and mythic, and in the supporting nude figures at the feet (of the borders of vaulting ribs). The colouring *in tone* is exquisite. How much it owes to time I cannot tell; but I see proofs of great effort to tone colours into harmony; varying the same colour in numerous degrees; introducing many forms of grey; black toned into grey,—white subdued in different directions, some towards *buff*, some towards *pink*, some towards grey, and some towards blue. This makes me think that much, or indeed *most* of the softness of the tone is genuine."

† I think the bay of the upper church which forms the *crossing* is somewhat similarly treated; but (unless my memory fails me), it is in that case (in each cell), an Evangelist seated contemplating a representation of a magnificent city.

THE PRESIDENT.—Can you form an opinion as to the paintings in the Church of Sta. Chiara attributed to Giotto?

Mr. ATKINSON.—I have examined them. My opinion of the art history of that period is at present in such incertitude between master and pupils that it is almost impossible to decide. I think the frescoes referred to are quite worthy of the master. With regard to the architectural decorations, I wish my knowledge had extended sufficiently to have spoken of them; but careful drawings are among the illustrations kindly furnished to my paper. I fancy they are of the same description as the decorations of the Arena Chapel, being of the same generic style.

THE PRESIDENT.—They are carried out more beautifully at Assisi.

Mr. ATKINSON.—The ornamentation in the Arena Chapel belongs to the same style; and the Arundel Society possess some rather accurate drawings which they had the intention of publishing at one time; such designs would have been a valuable contribution to decorative art. In reply to the gentleman who spoke of restoration and destruction, I wish distinctly to state, that strictly speaking there has been no work of destruction in this church. There has been a sweeping away of the things I have described, but you cannot call that destruction. Those things were put up in the most corrupt period. They were excrescences, and they put the church into a condition that I have never known any person able to tolerate, excepting artists who go to make picturesque drawings with costume figures in front; I have heard strong opinions from artists on that point. I come now to answer the question of the gentleman who asked whether any new frescoes had been discovered from the clearing away of those late intrusions. I have no object at all to disguise matters. I merely wish to state what I know, and I should say there has been considerable disappointment as to the frescoes discovered. For the most part they are not of a high character. They are much dilapidated and in part invisible. Some early work of merit had long ago been swept away, and in places you come upon later frescoes of an inferior order almost obliterated; I fancy the restorers were taken a little by surprise; there has been some disappointment as to the frescoes revealed. Notwithstanding, in the transept of the Upper Church there is a fine architectural arcading, within the arches of which on the lower walls are boldly imaginative compositions from the Apocalypse. Still I repeat there must have been some disappointment, but it comes to this: when a work of this magnitude is taken in hand it is difficult to know exactly where to stop, or what may be discovered as they go on. But on the whole I think the principles have been good, and the results somewhat satisfactory, though of course there are matters for regret.

As regards the remarks made on the system of colour, they are valuable and agree with what I have stated. No doubt blue is used as the key-note of the decorations, bringing all together; and just as in the system of Siena they use gold, which brings all things into harmony, so here in Assisi they use blue with gold stars, a method which also produces unity. Thus the pictures with the decorated mouldings, as far as I am able to judge, make this church one of the finest examples of decorative art which has been found in any time.

The discussion having then terminated, the meeting adjourned.

Royal Institute of British Architects.

At the Ordinary General Meeting of the Institute, held on Monday, the 24th of May, 1875,
Sir GILBERT SCOTT, R.A., President, in the Chair, the following Paper was read:—

ON NEW MATERIALS AND RECENT INVENTIONS CONNECTED WITH BUILDING,

By T. ROGER SMITH, Fellow.

THE subject which I have the honour of introducing to your notice to-night is that of New Materials and Recent Inventions connected with Building. Such a subject is necessarily full of details, and when once we have plunged into these it is not likely we shall be able to quit them for generalities. I therefore ask you to permit me to lay before you such general considerations as seem to belong to it now, at the outset, rather than to reserve them till the close of the paper.

The first remark that will occur to most observant men is that the building art, as conducted in England at the present day, presents fewer novelties than almost any others of the leading technic processes. Steam, electricity, and the progress of mechanical inventions and chemical research have revolutionized most of the great divisions of human industry. Sometimes it is a new method of manufacture which has supplanted an old one—the material remaining unchanged. Sometimes the old material has given way to a new one; and not unfrequently both material and method are alike revolutionized by discoveries made through that restless and eager spirit of enquiry and invention which is perhaps the chief glory of the present century.

For examples of new methods of employing old materials, we may turn to the principal fabrics used in clothing. Wool, flax, cotton, and silk, are what they always were, but spinning, weaving, dyeing and ornamenting, which once were handicrafts, are now mechanical processes carried on by steam machinery in vast factories. Printing is another example of the same change; paper, ink and type are still employed, but the contrast between the hand press, which within the recollection of many of us was the only method in use, and one of Mr. Hoe's magnificent steam machines, is enormous.

Of new materials which have supplanted or supplemented old ones a very long list could be made out. One or two will suffice for the purposes of an illustration. Various grasses and other substances have now come into use either along with linen rags or as a substitute for them in the manufacture of paper. Stearine and various similar products have almost displaced wax, spermaceti, and even tallow as material for candles. Mineral oil has largely displaced fish oil. We are using stamped and printed paper for window curtains, and printed cloth for embroideries, german silver instead of plate, and papier mâché in place of wood; and in a hundred other instances the craftsman has a constantly increasing series of new substances placed within his reach by the scientific discoverer.

The most remarkable cases of all are, of course, those where material and method are both alike new, having either been called into being to supply some new want, or else presenting themselves with such capacities for being useful or pleasant inherent in them, that a want has sprung up, after the

power of supplying it was acquired. All the applications of photography, of the electric telegraph, of the spectroscope, and of our amazingly enlarged chemical knowledge, seem to belong to this head. Till we knew we could have them, our wildest dreams never led us to desire such things as photographs of our friends, or telegrams from them when at the antipodes; and such contrivances as the sewing machine, such materials as gutta percha, or such inventions as the locomotive, have brought into existence a whole range of new requirements, which the world had never dreamed of till the power of supplying them was called into existence.

Building, compared with such matters as locomotion, the manufacture of clothing, or the transmission of intelligence, is an art which has changed wonderfully little, so little indeed that I am sometimes tempted to believe that there still remain open to some inventive genius among ourselves, the possibility of effecting something like the revolution which Arkwright commenced for textile fabrics, when he applied steam-power to spinning. It is of course natural to say that it cannot be done; but the same thing might have been said before-hand of all the great steps which handicrafts have taken, and we might, I believe, do worse than entertain very seriously indeed the possibility of adapting machinery, mechanical processes, and novel combinations of material to building, on such a scale and in such a way as to cheapen the cost of simple plain structures to a great extent. This subject would land us at once in a region of speculations which might prove of practical advantage, and which to me I confess are tempting in the extreme, but I have not any intention of inviting you to pursue them to-night. If, however, a wholesale transformation, such for example as would be effected were we prepared to abandon brick-work for concrete and slates for felt, is not within our reach, there are available for use no small number of inventions, in which the progress of contrivances and discovery has told upon the resources at the builder's disposal; and it is some of these which we are to consider to-night.

Granted then that there exist a certain number of novelties, my second preliminary observations must be directed to the position which the architect ought to take with regard to them. This is a question which has two sides. It may be said that the architect as the skilled, cultivated, and trained director of the work, is bound to know what is going on, to make himself familiar with the latest improvements, and to give his clients the benefit of his knowledge; in short he is to be abreast of the building art in his own day, and is to show that he is surely making himself acquainted with each capital invention as it comes out, and ready to embrace every opportunity of using it. This is a position which has much to be said in its favour, and if men expect their doctors to know the latest medicines, and their lawyer to be acquainted with the most recent legislation, they may be excused if they ask that their architect shall be equally well posted. If, however, you ask your medical man whether if some new remedy of which you have heard, is not said to suit your symptoms, he will probably reply: "Yes, but I doubt whether it would suit your constitution; the reports of its action are by no means uniform or complete, and if you take it you will be trying an experiment." Your solicitor when you ask him to take proceedings under some new act, will if he be prudent and honest reply: "True, the language of the act seems to fit the case, but it has not yet been tested before the Courts, and your case will be the one to fix the interpretation upon the language if you proceed under this act; better be cautious."

In both instances the professional man if he had no duties to his client, would be delighted at the opportunity of contributing to the fabric of professional experience an item possibly of much importance; the expense or distress of the process being borne by the vile body—or purse—of his client. But if he is true to that maxim of professional conduct—which I take to be a sound one, so long as it does not carry a man beyond the limits of honour and good faith, "do the best you can for your client," the

experiment is left for some one else to try, while better known and safer methods, supposing such to exist, are adopted, even if they be less brilliant. This I hold illustrates an architect's true position in regard to new inventions. He ought to make himself familiar with them all; he ought to neglect no advantage offered by them; but he has no business to try experiments at a client's expense. If this be true there are only three conditions under which an architect is at liberty to adopt a novelty. First, if it has been in some way put beyond doubt that the novelty will succeed. Second, if it is certain that received methods will not succeed, and the novelty offer a better chance. Third, if the client knowing that there is the possibility of failure decides that the novelty shall be tried.

It may be said that these conditions very much limit the adoption of new inventions,—and no doubt they do so; but I hold that our first duty as architects is to secure that our buildings shall answer their purpose, and that trying experiments in them is not justifiable except under conditions which either render failure impossible, or at least shift the entire responsibility on to other shoulders.

It now only remains to guard you and the readers of this paper against any misconception as to its nature and scope. I do not claim to have hunted up and named all the inventions worth notice brought forward during the past few years. Still less do I claim to have selected the best. I shall not attempt to do more than to point out the directions in which invention has been chiefly exercised, and to give under each head a few specimens, selected not as the best but as the most convenient illustrations. The subject thus looked at seems to divide itself into (1) new materials, (2) new methods, (3) new structures, and (4) new appliances. New materials may include revived ones, and applications of known materials to new purposes. New methods refer to new modes of working, chiefly to the substitution of machinery for manual labour. The term "new structures," hardly, perhaps, needs explanation; but must of course be understood as applying to structures of hitherto unknown sorts, and which from their novel nature are essentially new inventions, or new introductions. New contrivances will embrace those appliances which form portions of our buildings, and also will include some few new combinations of building materials for special purposes.

NEW OR REVIVED MATERIALS.—Of these the most important by far are iron and glass. The modern application of both to building has been well known to us now for a quarter of a century; in fact, ever since the Exhibition building of 1851 shewed how rapidly and cheaply vast structures of iron and glass (the iron-work being chiefly cast) could be erected, and how great a charm they possessed. The applications of these materials have been numerous and varied. The leading principle upon which the Exhibition building depended, and to which it owed both its architectural quality and its constructional success, was the continued repetition of a small number of well considered forms. Every pane of glass was of one size, and so upwards. Every column was of the same length, and every girder was of the same span. This principle was adhered to in the design of the Sydenham Crystal Palace, but it has been in some other instances overlooked. An iron and glass building is no doubt not a very durable one, nor very weather-tight, and the expense of its maintenance will be considerable; but nothing is in first cost so cheap, and for the purposes of large gatherings of people, nothing so appropriate.

Treated in a different way, iron ribs, carrying some light filling-in, which may be glass or wood, have enabled us, when we enclose enormous spaces in a more permanent manner, to roof them over. The great railway sheds, and such buildings as the Agricultural Hall, the British Museum reading room and the Albert Hall are examples of buildings having iron roofs of prodigious span. These are buildings such as, from time to time, come within the ordinary scope of an architect's practice. It is very desirable for us to obtain a familiarity with the principles upon which these roofs are constructed, as although it may be very wise to obtain for them the assistance of an engineer, whose whole time is spent in working out the details of iron work, the architect will find that he is at a great advantage

if he can design their general forms himself. All these applications of iron as a building material seem, however, to shrink into insignificance before Mr. Scott Russell's Vienna cone; but this has been so recently described here by the inventor himself that I need not do more than refer to it.

Other applications of iron to construction are so familiar that I shall hardly be justified in referring to many of them among new inventions. I may, however, allude to Phillips's girders, as a contrivance which is still tolerably new. These are built up, as you are aware, by bolting two rolled iron joists together, and sometimes four such joists are combined with plates, in addition to their own flanges, into one large beam. It is not easy to see the scientific ground upon which this combination (which places a very large amount of material comparatively near the neutral axis of the beam) can be advocated, but there is obviously a good deal of simplicity and handiness in the combination, and it is said to have good practical qualities. Messrs. Moreland and Son, who are well known as skilled in the application of iron to building purposes, have contrived a description of fire proof construction, in which they imbed a kind of slight bow string truss in the concrete, which they fill in in an arched form between large girders. This construction is so far different from ordinary fire-proofing as to deserve to be mentioned. It was employed at the St. Pancras Hotel, and appeared to me, when I saw it being fixed there, to offer considerable advantages.

The next material which I propose to notice is one which has but recently been introduced, and may fairly, on that account, lay claim to the title of a perfectly new invention. I refer to selenitic mortar, the invention of General Scott. This mixture I shall, I believe, correctly describe if I say that it consists of the ordinary ingredients of mortar, namely, lime and sand (though the sand is in larger proportions than usual), with the addition of a small quantity of gypsum (sulphate of lime), very intimately mixed with the lime. This mortar requires to be mixed in a pug-mill very thoroughly, and when carefully prepared, will be found to have acquired, to some extent, the properties of a cement, for it sets rapidly, and when set it is extremely hard and tenacious. It is to the admixture of the gypsum that the rapid setting is due, but perhaps some of the general excellence of the material may be owing to its having been better mixed than usual. The Albert Hall was the first large building in which this material was employed; and while that Hall was in course of erection I had repeated opportunities of noticing its admirable behaviour. The London School Board have latterly adopted it throughout their new buildings, and probably their architects may have met with varying results, considering the various builders who have worked for them; but there can, I think, be no doubt that, on a building of any magnitude and under proper supervision, selenitic mortar will be found to be a trustworthy auxiliary to the architect. Of the use of the same material for plastering I cannot speak so fully. The adaptation of concrete to building walls, floors and roofs, as well as to foundations, may fairly claim a moment's notice. Tall and Drake are two names best known in connection with it. As far as I am aware the use of lime concrete, which involves walls, &c., of considerable thickness, has not been much pushed. Portland cement concrete, a stronger material, capable of being used in thin walls, and having the property of hardening very rapidly, is more commonly employed. The different patents have for their object, when walls are to be built, the construction of troughs by the help of frames and moveable boards or shutters. These troughs are the exact size of the wall, and the concrete is filled into them. When the material has set the trough is taken to pieces, refixed at a higher level, and the process is repeated. The whole of the advantages and disadvantages were exhaustively treated by Mr. Wonnacott in a brief and very condensed paper, read before the Conference of architects in 1871. I am not disposed to believe that much economy results from building in concrete, except where the work is very plain and straightforward, and when little is spent on subsequent finish, but there can be no doubt that a wonderfully strong and tenacious material is obtained;

and probably where the foundation is unquestionable, the materials good, and the supervision during the progress of the work thorough, a stronger building is erected—and one more proof against attacks of weather than if brick were employed—and at a not greater expense.

Allied to concrete is artificial stone, and this, with the various panaceas for arresting the decay of building stones, has of late retreated to some extent from the public view. It is happily very difficult indeed to make bad stone into good, and consequently most of the solutions and washes which have that for their object have proved unsuccessful. Not that many of them have not a sound scientific basis, but the difference is very great between treating a specimen of stone in the course of a well arranged laboratory experiment, and treating similar stone, built into a wall, perhaps saturated with wet, and exposed to all vicissitudes of weather, in the rough way in which, on a scaffold, even careful workmen will apply, what they call chemical stuff; and we cannot wonder that solutions, which are theoretically excellent, have often in practice failed to protect masonry. On this head the members of this Institute may probably be able to furnish useful information. The artificial stone of Mr. Ransome is, I think, the only material called artificial stone which has held its ground; and I believe that under his more recent patents an excellent and durable substance has been produced, but in many cases, not at such a price as has enabled it to displace natural stone for plain work. Where elaborate work, such as would admit of being produced in a mould, has been required, this material has, I am informed, proved both economical and satisfactory.

Another material which (while it is incorrect to call it a substitute for stone) can often be adopted as an alternative material, is that very old form of brick, known as *terra cotta*, the use of which has revived to such an extent as to stimulate the manufacture. Although *terra cotta* is not a new material in one sense, it is so in another, for it is only very recently that it has become possible to obtain it in such quantities, and of such varied quality, that it could be readily adopted by the English architect. He who would employ *terra cotta* must submit to a certain amount of limitation; he cannot deal with it as freely as he can with masonry. He must design his ornament long beforehand; he must, if possible, arrange for a large amount of repetition; he must so design his work that, if slightly warped in burning, the effect shall not be entirely spoilt; he must prepare for delay and trouble, and he, or some one for him, must draw out all profiles, &c., to a sufficient scale to allow for their shrinkage. But subject to these and other minor conditions *terra cotta* is an admirable material. When used in large quantities it is cheap, it is very durable, it can be obtained of beautiful colour and texture, it is the most appropriate material to employ along with brick, and it admits of the introduction of great richness, and of the indefinite multiplication of a few pieces of artistically modelled work. It is to be hoped that the Natural History Museum, where Mr. Waterhouse is employing it on an extensive scale, will give a great stimulus to its use. In the various buildings of the department at South Kensington and in the Albert Hall, *terra cotta* has been extensively employed; and Mr. Charles Barry's Dulwich College and Mr. Christian's Insurance Office in Bridge Street, may be pointed to as other good examples of its use. Bricks themselves and tiles have not furnished of late years many really new inventions. The damp courses, air bricks, L-shaped facing bricks, and roofing tiles of the ingenious Mr. John Taylor are, I have no doubt, known to all present. I do not recollect any other varieties of brick requiring mention here till we come to Pether's ornamental bricks, a variety available for use in surface decoration. These bricks have a pattern impressed on them, and being made of fine clay and well executed, have been often introduced lately into decorative work, and might with great advantage be more generally employed, as architects could readily design ornament appropriate to them.

The various sorts of flooring and encaustic tiles are no longer new, indeed they present one of the best possible examples of a new building material becoming generally so adopted as in a few years to

grow perfectly familiar. A tile of German manufacture was, however, introduced into this country a short time ago which has not yet become very generally known, it is in large slabs and rather delicate tones of colour seem preferred, though very elaborate decorations have been executed in it.

A comparatively new mode of employing tiles for the lining of rooms has been introduced by Messrs. Simpson, who have decorated the interior of many parts of Messrs. Spiers and Pond's Criterion in this manner. The tiles are placed together in their unglazed state, and a picture is painted upon them in colours suitable for firing. They are then taken asunder and put into the furnace and there subjected to great heat and glazed. If this is successfully accomplished, the tiles can now be fixed against the wall of the room and present an absolutely indestructible decoration, which can be washed as often as it is needed, though from its high glaze it is not easily apt to catch dirt.

Mosaic—the most ancient of all the arts of decoration—has a claim to be named among the revived processes if not admissable as a new one. I shall only mention Salviati's most praiseworthy revival of glass mosaic, which has placed in the hands of our architects a method of executing surface decoration which, ancient though it be, is, I think, really new to Great Britain in its application to vaults such as the Wolsey Chapel, at Windsor, or the vault of the Albert Memorial.

Other descriptions of mosaic, however, especially tile mosaics, if less sumptuous, are less out of reach, on the score of cost, and deserve our notice as affording a means of executing original decorative work at a distance from the eye as well as near. The ornamental frieze round the galleries of the Albert Hall, executed in tesserae of about an inch square, is a good example. Here only two or three tints of colour were employed, and the mosaics were rapidly made, after the full size cartoon had once been completed, by placing the tesserae on a tracing of a portion of the cartoon till a space of a certain size has been covered (about six superficial feet, I think) and then upon the back of the tesserae Portland cement was applied, till a stout slab was formed, which admitted of being handled readily and could be hoisted up and fixed in place.

Another description of work approaching mosaic has been lately introduced to London, and is obtainable of Mr. Burke, of Regent Street—I allude to marble mosaic. This work is executed to a large extent out of smallish irregularly shaped fragments of the material, of two or three tints, so laid as to produce the general appearance of a mottled ground which gives relief to a few portions of brighter colours executed in more valuable marbles. When well done this sort of mosaic is very effective, it can be obtained at a very moderate price, and it may be expected to prove extremely durable.

NEW METHODS.—We will now proceed to consider for a few moments the second head, not because the list of materials is exhausted, far from it; but because enough has been said to carry out my promise that I would name a few as specimens of the whole, in the hope that in the discussion your own sources of information will enable you to enlarge my list.

New methods need not detain us long. The building trade has not been revolutionized by the introduction of machinery as other trades have been, and it is really only in one or two of its branches that anything approaching to innovation awaits us. A remarkable attempt to introduce machinery into the production of high art work was made when the machines by which the woodwork of the Houses of Parliament was roughed out were designed. These, I believe, are now in the possession of Messrs. Cox and Son, and are still worked by them; but from various circumstances they do not seem to have become generally known or copied.

Machinery for dressing stone has been again and again attempted, and has been employed with considerable success. The contractor for St. Thomas's Hospital had a series of machines at work, partly employed in sawing up the stone and partly in dressing it; and one or two stone-dressing yards exist, or did lately exist, where plain descriptions of work are performed by mechanical means. The

Conference of Architects were invited in May of last year—and in very small numbers accepted the invitation—to visit some stone dressing works. There stone steps, with their moulded nosings and strings, cills, and other such pieces of masonry as are required in numbers, were being worked. The action of such machines is, generally speaking, that they bring a series of chisels, or tools answering to chisels, forcibly down upon the stone so as to imitate the action of a mason at many points at the same time. Usually the chisels are carried on the periphery of a wheel, though different arrangements are adapted by different inventors. Probably sawing can be done better by machinery than by hand, as well as cheaper. The plain dressing of surfaces, and even the moulding of them, is within the reach of machinery, but it is doubtful if it will be so well executed as a good mason would do it, especially if the stone operated upon were of uneven or unequal texture, and the more elaborate the work or the fewer the repetitions, the less advantage, generally speaking, can be expected from the machine. This is obvious, because to execute any piece of work the machine must be *set*, often a long and troublesome process; and if it soon requires to be set again, either because all the pieces of the pattern or profile it is working to are completed, or because a new pattern or profile has to be combined with what has been done, the saving in time and labour disappears fast.

Joiner's work admits of the application of machinery to a larger extent than mason's work, chiefly if not solely because it includes so much more repetition. In a first-class joiner's shop you now find a very interesting and complete series of machines: working circular and cross-cut and ribbon saws, mortising and tenoning machines, moulding machines, what are called "general joiners," and other such inventions render it possible to diminish the labour on joinery very largely. It is hardly necessary to describe these inventions at length; they may be seen at work in the establishments of our large builders, and no one who has watched their operation can doubt their efficiency in all ordinary work. Here, perhaps, I may most appropriately introduce a reference to the contrivances for testing materials, which supply us with information as to their strength and behaviour under different kinds of strain. The earlier machines were all of them open to serious objections. The nature of the means employed for applying force and registering it was such that the strokes of the hydraulic press gave a series of shocks to the specimen, and that the actual force under which fracture took place could only be approximately noted. Where these defects were absent, as in the testing machine described in Mr. Anderson's admirable book, the powers of the machine were so small and the dimensions of the specimen which it will take in so limited, that the results cannot be termed trustworthy guides. We have now, however, in Mr. Kirkaldy's large and accurate machine a testing engine of a power practically unlimited, and accurate to the extent of marking single pounds of pressure, while it will admit specimens as large as forty feet in length. Here then we have a means of investigating the strength of building materials such as has not been previously at our disposal, and we have only ourselves to thank if our knowledge is not extended thereby.

NEW STRUCTURES for our third head. New structures are not so often met with as that the enumeration of them should fill much space; and were we to attempt more than an enumeration, a single novelty would claim the whole time at our disposal. A railway station, a Crystal Palace, a modern hospital on the pavilion plan, a cottage hospital, a monster hotel, an aquarium, a winter garden, a model prison, a workhouse, a block of model dwellings, a Board school—each of these embodies very modern ideas, each of them requires to be studied with some care before it can be safe for an architect to venture upon it, and each is in fact a new structure. And further, every such modern building as a market, a town hall, an exchange, or a court of law, built to serve the same purposes as ancient structures, must in the present day be much more perfect and much more elaborate than was formerly necessary, and is in effect an almost new contrivance.

A year or two back we were threatened with an importation of Swedish or Norwegian buildings, which, so far as their employment in this country is concerned, would be new buildings. I refer to timber dwelling houses. The publicity given to Mr. Vicary's importation of a timber house, which he erected in Devonshire, turned attention to the possibility of building very roomy structures of wood at a low cost. I have no means of knowing how far this house has been copied, but it does not seem to have led to many such experiments, or some of them would have been pretty sure to become generally known. It is not easy to see why this build of house should not be followed in sheltered situations in this country. No doubt careful examination would shew that it has drawbacks, but for use as a country resort, a shooting lodge or a hunting box, a timber house properly constructed ought to be fairly comfortable and cheap.

This leads us to another attempt at importation, this time from our own colonies, and due to the ingenuity of Mr. John Taylor, whom I have already had occasion to name as a building inventor. I allude to the bungalows which that gentleman has erected near Westgate, and at Birchington in the Isle of Thanet. I have had the opportunity of seeing these houses and of examining one of them in course of construction. They are very simple in shape, mostly, but not always, one storey high, spanned by a simple low-pitched roof, portions of which are prolonged in the true Anglo-Indian style to form a verandah. These buildings seem thoroughly well adapted to the purpose for which they are erected—that of summer sea-side dwelling houses; they can be worked and kept clean with a very small amount of labour, as many contrivances to diminish servants' work have been introduced, and they are evidently cheap to build, though tasteful both outside and in. For the purpose of these buildings Mr. Taylor has invented what may perhaps be called a water-proof wall, and though the description of this wall more properly belongs to the next and last section, you will, I dare say, pardon my introducing it here. The external walls of these buildings, as I saw them in process of erection at Birchington, are less than twelve inches thick, and consist of two half-brick walls, separated by a cavity of a little under three inches. These walls are tied together by galvanized iron ties, made to take a good hold on both skins of brick-work, and bent into a loop, hanging downwards in the cavity. The series of these loops support a course of slates, laid not quite vertical, but sloping back slightly. The next course of ties is built in at such a level that it fixes the top of this first course of slate in place, and provides a starting for the next course. Thus, in the heart of the wall there is a continuous surface of slates, slightly overlapping at joints and at beds, and so placed that whatever moisture blows through the outer skin is not able to penetrate, but will trickle down the slates to the bottom of the cavity in the hollow wall. This expedient enables a brick wall to be plastered almost immediately after it has been built, and I was assured prevents moisture penetrating even when the blustering winds of the very exposed situation where these bungalows stand, blows the moisture of a stormy day violently against the building. This invention has been patented by the inventor, who is willing to grant licences to those who desire to use it.

Other new buildings are now to be found about watering places where a public room, more or less resembling the *établissement* of a French sea-side town, is often now seen, and where also an aquarium or winter garden, and a pier with a pavilion at its head is almost *de rigueur*. As, however, the Committee on Sessional Papers will, without doubt, see fit to obtain a descriptive account of some, if not all these structures, they need not detain us at the present moment; and the same remark applies to that strikingly new construction which the Safe Deposit Company have engaged our Fellow, Mr. Whicheord, to erect opposite the Mansion House.

NEW CONTRIVANCES AND APPLIANCES.—The fourth and concluding part of our subject must necessarily be very miscellaneous in its nature, but as far as possible the inventions named shall be

mentioned in the order in which they would occur in a specification. Any attempt to make an approximately complete list of such inventions would be sure to fail, might do serious injustice to those who were left out, and would only weary you. I have therefore designedly refrained from carrying this part of the subject far, and shall not attempt to do more than select a very few of the inventions and contrivances which circumstances have brought under my notice. Unfortunately want of time has prevented me from securing, as I had once hoped to do, the exhibition of a large number of specimens, (though in one or two cases inventors have sent them voluntarily), and obtaining the attendance of such of the inventors themselves as might have been willing to be present. This, however much I regret it on some accounts, is not a circumstance without its advantages. It is a very great injustice to an inventor who may happen not to be practised in speaking before an audience, if the merits of his contrivance are judged of by such an explanation as he can give on the spur of the moment, and under circumstances which he finds embarrassing. It would also not be quite so easy after inviting a series of inventors to send us their contrivances to hold exactly that tone of caution about them which it appears to be the duty of an architect to take. An architect's first inquiry with regard to a new invention should be How will it go wrong? His second, When it has gone wrong, what are the worst consequences possible? And his last, Is failure preventible? It is generally easy to see the advantages which may be hoped for from any new invention; the inventor himself rarely underrates them—and though cases have arisen in which an inventor has overlooked certain applications of his invention which have subsequently proved to be valuable, these occur seldom. We may take it that ordinarily we soon find out what we gain by any new contrivance. It remains to be seen what we lose or what we risk; and without considerable pains and caution the adopter of new contrivances may sometimes find himself seriously inconvenienced.

Supposing the questions I have suggested have been answered more or less satisfactorily,—the nature of any possible failure and the extent of the damage has been ascertained, and the means of prevention have been considered, it still remains to inquire what the difficulties in the way of repair will be. It is not a fatal objection to the use of iron shutters that they are known to stick, if the manufacturer's works are a hundred yards off, but if the distance be a hundred miles the inconvenience might be intolerable. Again, a cast-iron plate exposed to fire, and which can be unscrewed, and replaced by another plate when it has cracked or burnt through, occasions but small inconvenience. Let the same thing be built into a mass of brick-work, and perhaps covered with costly decorations, and its decay may cost hundreds of pounds and an untold amount of vexation.

I make these observations with no wish to disparage the great ingenuity of inventors or to underrate the benefits we have derived from their discoveries, but because the position of the architect with regard to these novelties is peculiarly responsible and demands great caution on his part. The ordinary inconveniences of buildings, such as for example smoky chimnies, are difficult enough to cope with, but still they are known to be usual, and if they occur are sometimes accepted as not more than might have been expected. A new nuisance of an unaccustomed and unanticipated sort is a grievance which those who occupy a building have no reason to expect or put up with, and the architect should be very cautious in recommending anything which may possibly give rise to it.

To begin now at the beginning of a building, we come first to contrivances relating to *excavator's* work. These are more employed by the engineer than ourselves, therefore it will suffice if we mention such machines as that of Mr. Brunton, which will excavate in chalk and in harder stones. The mechanical drills which will drill granite, and the hollow iron piles of Mr. Hughes, which are now commonly used for foundations of bridges, and can be sunk by pneumatic action, by a method of hermetically sealing them, pumping out the air and then letting it return with a rush are all but exclusively used in engineering works.

The new applications of concrete have been already noticed. The use of L-shaped facing bricks in connection with concrete walling should, however, be mentioned.

New varieties of paving have been lately introduced. The main points to guard against in employing them are the danger of the material wearing out, the disturbing effect of the weather on its surface, and the defects caused by the failure of the foundation.

Liverpool builders boast of a cement floor of local manufacture—a Mr. Jones is, I believe, the maker—which surpasses all such floors as used in the South. It was, I understand, employed in the Exchange, and has been extensively made use of in docks and warehouses. The composition of it is a secret. I have myself seen an admirable floor made of cement with which pounded granite was mixed. The various descriptions of mineral asphalte afford the means of laying good floors; but all of them are apt to be slippery in wet weather, and some grow soft in very hot weather, and if the foundations subside they crack. They are therefore best for use under shelter from the weather, and should rest upon a good bottom. A very large amount of tar pavement has been employed lately for play-grounds. It does not readily crack, but subsides if the foundation yield; it is rather liable to fail under a very hot sun, and is not so durable as mineral asphalte.

The various methods of fire-proof construction of which I may name that known as Fox and Barratt's, which Mr. Barratt carries out; that known as Dennett's Arch; that of Messrs. Moreland, already alluded to; and that patented by Mr. Hornblower, come under the head of contrivances. As methods of obtaining a solid floor which might be expected to withstand a fire in an ordinary dwelling-house, where household furniture and a certain amount of carpentry and joinery are the chief combustibles, they are no doubt satisfactory; but no method which trusts to iron girders that can be reached or even approached by heat is safe for a moment against such a fire as would occur in a warehouse. Dennett's arch, if not resting upon girders, ought to be a capital safeguard, but it is not easy to make a satisfactory ceiling out of it. Barratt's plan, which has been well known for years, is in many respects admirable. It consists, as you no doubt know, of rolled iron joists about two feet apart, with strips of wood laid across their lower flanges, and on to these concrete is filled in; the wooden floor is carried by very shallow joists embedded in the concrete, and the invention admits of a ceiling being used such as will protect the flanges of the joists. It puts a considerable weight on the walls, and before using it I had at one time been led to apprehend the possibility of so large a mass of concrete making the floors damp and occasioning decay, but after careful inquiry I have not been able to find any case of this having occurred.

Mr. Moreland's invention admits a ceiling, but it seems to occupy a greater degree of height than Mr. Barratt's, as some rise is given to the concrete arch which goes from girder to girder.

The Bricklayer offers but few novelties, and one or two of these have been already discussed under new materials. His trade, however, has to do with our smoky chimnies and the cures for them, and here the chimney terminal of the late Mr. Billing ought to be named. It consists of a low conical top to the flue, not a foot high, screened on each side by a terra-cotta baffle rising considerably above the mouth of the pot. The theory is that in whichever direction the wind strikes the chimney it shall impinge on a sloping surface that will throw it to a certain extent upward, and so rather draw the contents of the flue out than drive them back. The baffle is, I believe, intended to prevent the smoke from one flue being driven into the mouth of another not in use. This invention I have found very serviceable in cases of smoky chimnies, and as it is by no means unsightly it may often be used where a tall pot would not be admitted. Of other varieties of panacea the common terra-cotta pot with a louvered side is useful. So is what is known as Kite's wind-guard, a square or polygonal pot with a slit in each face and a metal plate fixed opposite the slit, but at a short distance so that air may blow

between. Perhaps a tall plain zinc tube is the best remedy in many cases, at least this is what I have known Mr. Boyd prescribe with success.

Another contrivance which belongs to the bricklayer's trade may be here noticed, Parr and Strong's patent combination. This consists in employing, as a material with which to construct walls, a series of short hexagonal terra-cotta tubes, closed at one end by a plug suitable to the purpose, and at the other by a filling in of granite or other hard stone in small pieces and flushed with cement. The advantages claimed are lightness, a good form for compactness, an exceedingly hard weather face, and the warmth and dryness of a hollow wall. Of course there will be difficulties where anything that is not perfectly plain walling (and a good deal of it) is contemplated, and the appearance of the wall, which is strikingly marked like a honey comb, will not suit all architectural purposes. The bond cannot I fancy be quite so good as that of common brickwork or masonry; but the invention is no doubt an ingenious one, and a wall so built bids fair to be very dry.

The Mason need not detain us, as artificial stone, the induration of stone, and the working of stone by machinery have been already dealt with. The various imitations of marble, however, have not yet been named. Of these enamelled slate has held its ground, but is no longer a novelty. Some newer varieties such as Marezzo marble appear to imitate the markings of the finer sorts of marble fairly well, as may be seen in the entrance hall of the Society of Arts. But it is difficult for an invention of that sort to hold its ground against the cheaper and easily worked marbles of Belgium, which are so largely employed for our chimney pieces, &c.

I am not aware of any new contrivance to name to you under the head of Carpenter. Under that of Slater, I should like to name the French method of fixing slates by means of wire clips, which hold the bottom of the slates; and a method invented by Mr. Jennings for doing much the same thing by the aid of lead clips. Mr. Jennings (who lives in a house roofed in this manner) claims to be able to dispense with a considerable proportion of slates; how the French method would affect the quantity required I cannot say. Of course the expense of laying would be greater, but I am inclined to believe that the difficulty of repair is less, as each slate is held in something the same manner which we are now driven to adopt when a broken slate is replaced. The main advantage is supposed to be that the slates are firmer. The common method fixes the slate at the top, and steadies it by the weight of other slates near the top but leaves the lower edge unsteadied, so that a high wind may get under and lift up the slate, and dropping it suddenly let it crack. The methods which secure the slate at the bottom offer some obstacle to this, as they hold it at the point where on other systems it is free—while they also put weight upon its upper edge.

The Joiner's trade covers one or two miscellaneous inventions. The recent run of school-building work has given prominence to Stone's sliding partition, which I had an opportunity of naming to you some time ago. Two or three large sliding shutters form this partition and felt is relied upon to render them sound proof. I cannot express myself as thoroughly satisfied that they prevent the transmission of sound as much as they ought; in other respects they seem satisfactory. Williams's sliding partition consists of a series of shutters pivoted at top and bottom and with the pivots running on grooves at top and bottom, so that the shutters may be formed into a pilaster-like mass at the side of the room. One specimen which I have had an opportunity of seeing in use in a school, appeared to me to answer its purpose well, and to prevent a good deal of sound from passing. The general construction is less simple than Stone's. The evils of all these partitions are the possibility that accidents may happen to children's fingers, the possibility that the partition may become jammed or out of level and stick, and the imperfect degree of separation which they furnish.

The dual desk, the patent of Mr. Moss, is an instance of a new invention which has had a remarkable effect in determining the dimensions and arrangement of an immense number of buildings. I

had an opportunity of describing it to you at length, when I read my paper on schools, and need not therefore say more here than that it is a bench and desk for two pupils in a school, intended to be so placed that there may be access to each end of it. The desk has a flap which can at pleasure be turned up for reading or singing, or turned down for writing and cyphering—and the dimensions and proportions are mainly dependant upon the use of this flap. The objections urged against it are the possibility of injury to the children and of damage to the contrivance, and the very heavy expense. The advantages claimed for it are however considered to counter-balance them.

Windows have led to one or two contrivances, for enabling parting beads to be taken out or dispensed with, so that sashes may be cleaned. Mr. Bullivant's name is connected with a contrivance of this sort. A contrivance for opening and closing sashes of very large size, and which has been a great deal pushed by the proprietor, is Meakin's sash fastener—it consists of an arrangements of cords and pullies, which at the same time unfasten the sash and open it. I am not aware that any recent addition has been made to the number of water-bars and such like contrivances for keeping out the weather from sash windows or casements; but the increased use of plate glass has led to the adoption of some capital inventions in the shape of sash fasteners, which cannot be opened from without by a knife. One which I have employed effects this purpose by the use of a second spring, which clips the projection on the lower sash when the fastening is closed, and has to be drawn back before it will move at all; in another rather simpler one the same object is effected by altering the shape of the arm of the fastener. In connection with joinery I may refer to the ornamentation of wood by the process called xylography (specimens of which are on the walls), and to the various parquet floors which are now obtainable, and the fine class joinery imported into this country from the continent, chiefly I believe from Austria, and the common joinery imported from Sweden, as matters, which if they cannot be called new contrivances, are at least new elements in the the builder's art.

A contrivance advertised by Cranston & Luck as their patent building for horticulture deserves to be named. The novelty consists of forming the roof of a conservatory with curved ribs, and arranging the rows of sashes, so that they shall form tangents to the rib—consequently between the foot of one sash and the head of the next, there is a small space available for ventilation. Nothing short of the testimony of a gardener would be quite satisfactory as to this method of ventilation being sufficiently perfect for it to supersede the one in common use, but it has the appearance of being simple and well judged, and deserves examination.

A different part of the joiner's business is affected by Hawksley's patent treads for staircases, which we must all have noticed in use on the Metropolitan Railway. These are in fact iron frames in which small blocks of wood are so secured, that they present to the foot a roughened surface, the end way of the grain. They appear to be durable and to admit of easy renewal of the wood.

The only plasterer's novelty which I shall name is an invention which is not very new but which I regret not to see followed up. I allude to the admirable contrivance suggested by Mr. Owen Jones, and carried out for him by Mons. Desachy, for executing the elaborate moulded and enriched ceiling of St. James's Hall, and which was described in this room by its author. The whole of that ceiling is executed in a material composed of plaster toughened by strips of canvas and under a quarter of an inch in thickness. The ceiling was formed in slabs in moulds, and of course being so thin could be handled and fixed in its place with the greatest facility. You can see by the present condition of the Hall, that this work has proved durable, and if some of you should be induced to employ it for similar works, you will, I believe, find it very satisfactory. This, it may be observed, is only one out of many proofs of constructive as well as artistic genius which Owen Jones displayed; a genius that entitles him to more of our respect than he has I think ever received.

The Plumber's trade suggests many sanitary contrivances, as they are called, which I think we

must omit to-night. They indeed would form, if taken with drainage, warming, and ventilation,—which I also propose to omit, an ample subject for an evening by themselves. This course will restrict our subject a little, but leaves us amply sufficient for the present purpose; and though it precludes my touching upon the new ventilator of Mr. Tobin, it does not shut it out from our discussion if you are so pleased. Among the materials at the plumber's disposal, there is one called "lead-encased block tin pipe," which has been for some time in use in Paris, where however it is looked upon as lead pipe lined with tin, which deserves attention. It will, if it answers the expectations of those who put it forward, serve all the purposes of lead pipe, without that risk of lead poisoning which at times attends the use of the ordinary leaden pipe. It is made in various sizes, and appears to be as easily bent, dressed, jointed, &c. as the common article. Some years ago glazed iron water pipes were manufactured in Birmingham, which were admirable for use where iron pipe was wanted and the quality of the water was suspected of acting upon it, but they do not seem now to be procurable. I have myself once employed them; and found that some difficulty was experienced, owing to the very hard nature of the enamel, in making joints and in cutting lengths of pipe: but this was the only draw-back. A very large number of new contrivances exist in the brass-work of stop-cocks, draw-off cocks, service-boxes, waste preventers, and other such appliances employed by the plumber;—some of them called into existence by the New Water Company's regulations, but I am not going to trouble you with an analysis of them. Messrs. Heale and Gowan have sent me one or two ingenious stop-cocks which lie on the table.

The Glazier enjoys the results of improved manufacture to a remarkable degree, but most of the materials at his command are too well known to be termed novelties. It may, however, be worth while to direct attention to the sand-blast, as placing a new and easily managed method of engraving on glass within reach. The nature of this contrivance is well known; it consists in a jet of air blown violently through a tube and caused to carry with it particles of fine sand. When a piece of glass is held over the tube the action of the sand on its surface is astonishingly rapid, and in a surprisingly short time the glass is roughened—in fact reduced to the condition of ground glass. Yet a piece of lace is sufficient, if stretched over the surface of the glass, to protect it from the action of the sand, at every spot which it covers; so that the most intricate ornament might, if cut out in paper and pasted out on the glass, be engraved in a few minutes.

Another invention which has to do with glass has been lately placed at our disposal in the shape of "pavement lights,"—frames of iron with a series of dome-shaped or prism-shaped blocks of glass intended to be let into pavement. These distribute the light to a greater extent than a piece of rough plate, but of course they are liable to be obscured by dirt—and they require that a strong light should fall on them. Another invention connected with glass, although by no means a new one, ought not to be passed over, as it is one which has slipped out of notice. I allude to Reece's patent glass, an embossed and coloured glass very well adapted for use in screens, and in domestic work generally—as may be seen in some panels of it on the ground floor of this building. When last I heard of it, the invention had, if I am not mistaken, become the property of Mr. Moore (whose window ventilator might have been named as a novelty some time ago), but its sale does not seem to have been pressed. Messrs. Powell, it may be remarked in passing, have manufactured somewhat similar embossed glass of very brilliant effect. They have also made excellent opaque glass for mosaics; as well as coloured glass for the use of the glass painter.

The Gas-fitter's novelties are few. The sun-burners and the star-light (this last due again to Owen Jones) are become familiar, and the ventilating gas-burner is scarcely now a novelty. In this contrivance the gas is burned within a glass globe suspended by a tube from the ceiling, and the products of combustion are carried off ordinarily between the ceiling and the floor. It must be recollected that air raised to a very high temperature will be given off by such a contrivance as this,

and provision must be made accordingly, otherwise the coolness of air in the room is compensated for by other disadvantages. Gas-works for making gas for home use are hardly contrivances within our limit.

The novelties in the Bell-hanger's trade are pneumatic bells and electric. These are exactly the novelties which an architect hesitates to recommend, the convenience is undoubted, but the disadvantage if any bell goes out of order may be that no artizan within easy-reach knows how to repair the damage. In the case of electric bells this is intensified by the fact that a failure, when it occurs, affects not only one bell but the entire system. Perhaps the means may have been found now for placing electric bells beyond the danger of this sort of accident, but there can be no doubt they used to be subject to it. There are, however, many temptations to their use, they are elegant, easily fixed, take up very little space, and act very efficiently, thanks to the index that accompanies them.

The pneumatic bells, which Mr. Zimdar desires to introduce to London and has very extensively employed, seem to be free from many of the objections which the electric bells lie open. His apparatus is extremely simple. The push in the room compresses the air in a little india-rubber bladder, and the compression is carried along a composition tube, like gaspipe, any distance to the bell which acts like the electric bell, ringing with the same continuous note. In these systems one bell only is used, and the room is pointed out by a label in an indicator being displayed. I do not see how it is easy for all these bells to become silent at once, which is the amiable weakness of the electric bells, and though the tubes are by no means so easy to deal with as the wires of an electric bell system, still they are more manageable than the wires and cranks of the present plan.

The last group of inventions which I shall notice refers to the Smith's art. The most important of these, such as cooking apparatus and improved stove grates, are excluded when we shut out heating. Next in order perhaps come iron shutters, the manufacture of which Clark, Bunnett, Francis, and Snoxell have introduced. One variety consists in a sheet of well tempered steel, which coils up on itself like a roll of paper, the others consist of distinct bars like those of a Venetian blind. The advantages consist in the small space occupied, the great security obtained, and the ease with which the shutters are opened and shut. The disadvantages lie in the fact that they are apt to stick, and require some one who knows them to set them going again; and that even the best of them are noisy, circumstances which render them unfit for use in remote places, and unsuitable for dwelling-houses where they would be daily opened and shut. It is remarkable that the sliding iron shop shutter in common use in Paris seems quite unknown in this country.

Lifts are among familiar engineering contrivances, and were well described here some time ago by our Fellow Mr. Whichecord, we may therefore pass from them to a much humbler fitting—iron wine-bins. These are now manufactured by several firms. They seem to possess some economy of space with additional security for the wine, as each bottle has its own place. They will, however, rust and perish sooner than shelves of slate or York stone, and as wine is sometimes stored for many a long year and required not to be moved, it seems unsuitable to employ for storage these fittings, however useful they may be for a cellar of wine for daily use.

An application of iron-work to a new and original purpose has been repeatedly brought into notice by the various descriptions we have seen of the experiment of stretching iron wires across the vaults or roofs of churches and large halls to improve the transmission of sound. I confess that I am at a loss to understand how they are likely to have this effect. They have been fixed in Cork Cathedral, and were said to have been of service there, but the statement has never been authenticated; and they are said to have been recently tried without success at the Agricultural Hall. Probably some members present may be able to give us some definite accounts of what has been done in this matter.

A general review of the subject of invention in building matters such as has now been attempted, is necessarily partial and incomplete. If you will kindly pardon its defects and will supplement its

imperfections from that large store of information which forms the common property of a body of practising architects such as this, I shall be grateful; and if I shall have succeeded in throwing any description of light upon any of the building materials or contrivances of which members of this Institute may desire to make use, I shall have fully accomplished the aim of the present Paper.

Mr. JOHN HEBB, Associate, said—I beg to call attention to some specimens of decoration upon wood, exhibited upon the walls, the production of Mr. Thomas Whitburn, of Portsmouth Road, Guildford. In doing so, I think it right to offer a few words of explanation, as I do not think it desirable that new inventions should be brought indiscriminately before an institution of this kind, unless there are some circumstances to justify their introduction. In this case the proprietor of the invention, who is an artist of considerable ability, is the actual producer, the specimens before you having been designed and executed by himself. To this may be added the circumstance that he lives in the country where there are but few opportunities occur of bringing his invention before the public, and that he has not hitherto made use of this process of decoration for commercial purposes. These conditions seem to me apart, from any merit in the invention itself, to justify Mr. Whitburn's designs being brought under the notice of the Institute. The process employed, which is called *xylography*, differs from a process of a somewhat similar name, described in a paper lately read in this room by Mr. Robinson, inasmuch as the design is actually impressed instead of being merely stencilled upon the surface of the wood. The patterns are first cut upon wood blocks from which electrotype casts is taken. These casts are "set up" in the same manner as ordinary type, and are printed upon a printing press with a specially prepared ink, which has been patented by Mr. Whitburn. The process, I am informed, is chiefly applicable to soft woods, but it may also be applied to veneers or hard woods; in the latter case, however, much of the beauty of the invention is lost, as the design cannot be produced in relief as is done in the case of soft woods. With regard to cost, this will necessarily vary with the quality required.

Professor KERR, Fellow.—I rise to propose a vote of thanks to Mr. Roger Smith for his paper. I have before to night thought this subject is one on which the Institute of Architects ought to have an annual paper read. The public complain so much of our alleged supineness and backwardness in the knowledge of those innovations which affect our business, that it would be, at the least, extremely good policy if we adopted an idea of that kind; and I am further quite sure that the difficulty would be—not to supply materials for an annual discussion, but to confine the supply of materials within such limits as would admit of the subject being disposed of in one or two nights.

The paper of Mr. Roger Smith is eminently suggestive. Like all he does, it is unambitious and moderate in character, but it displays a large amount of knowledge, a considerable degree of research, and a great deal of pains in discovering precisely where to stop, in describing what he has brought before us. At the same time there are several subjects which, in the course of the reading of the paper, appeared to me to be deserving of discussion; indeed, speaking generally, I observed that, although he began by telling us that building has been making no advance as compared with the remarkable progress of various other scientific operations, yet in the course of his disquisition he could not help showing us that building is really taking very great strides; and certainly, any one who looks back twenty or thirty years must testify that its progress, both in detail and in principle, has been very considerable in various ways.

One interesting subject referred to by the lecturer, was that of iron and glass building. The time was within the recollection of most of us, when the application of this peculiar principle of construction was little else than a speculative idea; it is now an accomplished fact, and it has indeed become a speciality, which has branched out into various distinct departments, and is at this moment threatening,

rather than promising, to become still more ambitious in its endeavours after novelty. Now I venture to say, we cannot consider the Crystal Palaces, which have been built in various parts of the country, to be a great building success. They have been no doubt illustrative of the high intellectual enterprise of the age, but in my own opinion, the more the system of iron and glass is amplified, the more it will be seen that no really permanent scientific work can be produced by that means; and, though some excellent effects may be accomplished for the moment, yet architecture at large is not so greatly advanced constructively, as we might expect by that innovation. There is another question in connection with this which Mr. Roger Smith did not happen to mention, and which it is desirable for those who are of a speculative turn of mind, in constructive matters, to take it into consideration just now; that is, whether the new manufacture of steel can be rendered subservient to the purposes of building. For my own part, I am obliged to say I am not able to make any suggestion in answer to the question. We all know that this steel has been largely experimented upon for engineering purposes, but hitherto the architectural world seems to have left it altogether alone.

The Vienna dome—or cone as it should rather be called—which Mr. Scott Russell so well described to us not long ago, is to my mind, one of the most remarkable building innovations of modern times. The marvellous simplicity of the principle, when fully investigated, is most striking. It is quite unnecessary that I should remark upon it just now in any detail, but I must repeat what I have said before, that our students of constructive science, and their seniors too, would do well to reason out the principles involved in that work, some of which perhaps its designers themselves did not pursue to the full extent, in the conception of their remarkable structure.

A single word may be useful with regard to the Phillips girder. I consider this to be an invention which possesses great merits of simplicity, and which scarcely deserves to be passed over without a reconsideration. The remark which Mr. Roger Smith happened to make, viz.: that it is characterised by an accumulation of useless metal at the neutral axis—that accumulation of metal, at any rate, enables us to dispense with the featherings which is necessary in built-up girders; and, unless you consider the various modes in which the “Phillips” girders are put together; and bear in mind, moreover, that the mere act of rivetting a plate iron girder together reduces the strength of the metal as against compression, to the extent of from 25 to 75 per cent., and produces besides a peculiar mode of failure—that which is described by the terms buckling and crumpling up—it is worth while to consider, whether the avoidance of rivetting to so great an extent, and the saving of the featherings, do not become a question worthy of still further study and experiment. The selinitic mortar which Mr. Roger Smith spoke of with so much approval, is a rather peculiar thing. One Mr. Westmacott read a paper to this Institute some years ago, upon an invention of his which has, as I think, not unfairly claimed to be almost identical with this. He had observed in old limestone walls that the mortar adhered to the limestone surface with remarkable tenacity, and became indurated to an exceptional degree of hardness; and his theory was, that the mortar which, after setting, commonly became indurated by the process of absorbing carbonic acid from the atmosphere, is able in this case to abstract the carbonic acid much more rapidly and effectually from the stone—a proposition, by the bye, which chemists absolutely deny; and therefore, he said, if you introduce into your mortar a certain proportion of carbonate of lime in whatever form—say as ground chalk—you supply your mortar with that carbonic acid which it requires to become indurated in this way. General Scott, instead of ground chalk, uses gypsum, which serves, I am inclined to think, the same purpose; and therefore it is, that it has been said, General Scott's invention is really an alternative to that of Westmacott. With regard to the use of concrete, which Mr. Roger Smith has treated of so well, I think there is more in the question than most of us suppose. I am myself accustomed to say that concrete makes the only theoretically perfect wall we have. Brick walls and stone walls may exhibit various degrees of success, but a

concrete wall seems to me in principle absolutely perfect, as it is incapable of irregular settlement, and of other failure in half a dozen ways. The chief difficulties with regard to its use seem, at present, to be two—first, how to manipulate concrete with sufficient facility, and secondly, how to make it weather-tight, for I believe a concrete wall at this moment requires to be covered with a cement facing, to keep the wet out, which is of course a very serious consideration. On the interesting subject of artificial stone, I would only say it is quite true we have not yet succeeded in bringing any kind of artificial stone into our buildings which can compete with natural stone for plain work. But I believe the reason why Ransome's artificial stone has not been made to compete in this way with natural stone, is simple because the proprietors have kept up the price as high as they could. The actual manufacture, I believe, is comparatively cheap; and I think the comparative failure of the invention is in a large degree due to the circumstance of its not being brought down to a low price, for plain work. One fact is worth observing—though the use of Ransome's stone for ornamental work in this country has never been common, yet in the United States of America it is being used to a great amount; and I would almost say, that if Mr. Ransome, instead of bringing out his invention chiefly in England, and devoting himself to its development here, had pushed it chiefly in America and the Colonies, from the first, there would have been large fortunes made out of it before now. Terra cotta is a subject which Mr. Roger Smith has dealt with very properly, but of course not exhaustively. Terra cotta has been explained to be capable of being used in two distinct forms, and it is an important question, whether the one form is not exceedingly good, and the other almost exceedingly bad. The form which is good, in my view of the case, is that which has been carried out at South Kensington, whereby the artistic design is accommodated to the essential conditions of the material. That is to say, you are dealing with a material which is naturally in a rough state, and if you use it artistically, so as to accept the rough material in its own way, then I think you have a perfect æsthetic result. But if, as the other process dictates, you trim the terra cotta just before it goes into the oven, and even trim it also when it comes out of the oven, then I cannot but think the result is not true art—you are using terra cotta in mere imitation of stone. But is there not a third process—one indeed which I have never heard discussed? I am inclined to object to the principle of the infinite reproduction of identical detail in such a material. Why cannot terra cotta, instead of being moulded so as to be a constant repetition of the same features, like a plaster frieze, be manipulated with the tool, every block by itself, in such a way as to produce a continual variety? I cannot help thinking something might be done with terra cotta upon that idea, so as to make it more serviceable to architects and to architecture than anything which has yet been done in the material. There are several other questions of interest which have occurred to me, but the lateness of the hour compels me now to stop.

Mr. J. EDMESTON, Fellow.—I rise to second the vote of thanks to Mr. Roger Smith for his paper. I will mention one or two things on which I should like to have a little more information. One is the selenitic mortar: I have tried it myself once or twice, but without success. The first invention of General Scott was to pass the fumes of sulphur through lime, which was then ground and made a first-class hydraulic cement. The impregnation of the lime was, however, somewhat uncertain, in which case the cement of course was bad, and afterwards General Scott adopted the selenitic process, and I believe the invention is his. With regard to concrete walling I have not found it necessary to use any patent. Talls's Company made a great fuss for a time, but is now extinct. They tried many ingenious applications of concrete—amongst other things to staircases and floors, and they built houses at their works five or six storeys high. What I have found is, if you get good shingle near at hand, it is cheaper than brickwork, and it is an excellent mode of construction. I believe it to be the driest kind of wall you can have: in the case of buildings erected by me on the

seashore exposed to driving rains, and also on the banks of the Thames, I have covered the walls with rough cast or cement; but if I recollect aright, some of the buildings at Talls's Works in the Borough, are not cemented at all, and my idea of concrete walls is, that they are not only strong but perfectly dry, and that it is a description of wall which you can use when you can use nothing else so cheaply and efficiently. With regard to mineral asphalté paving, I have paid some attention to that, There is no pure mineral asphalté used except the Val de Travers and the Seyssel; all others are mixed more or less with pitch and grit, and formed into a composition which is afterwards laid in a liquid state. A recent application of asphalté has been that for roofs, to obtain a fire-proof roof, and in several large buildings in the city it has been used successfully, as well as in the country—at Warwick Castle among others. With regard to paving, there are two or three modes in which it is used which are but little known. In our own streets you see the paving done by compressing the pure powder of the rock, but in Paris on the Pont de l'Europe, the paving has been done by compressing the asphalté first of all in the form of a tile about 6 inches square. The theory is, that the pressure makes the tiles adhere together at their sides, and being laid upon a good foundation, this paving, some of which was cut up in my presence, appears to stand the traffic very well. In Glasgow, some bricks with bevelled edges to give foothold, formed under great hydraulic pressure, have been used; but whether the bricks will keep their form, or roll up, or flatten with the pressure of the vehicles, remains to be seen. The remarks I have made have reference to pure mineral asphalté only. The Seyssel asphalté has some of these qualities, but all others are simply mixtures.

Mr. F. P. COCKERELL, Hon. Sec.—I think Mr. Edmeston is mistaken in supposing concrete work to be necessarily perfectly dry. In my experience, before the rough cast is put on the water runs through it like a sieve. I assume the concrete to be, what in my opinion it should be, viz., not a solid mass, but more or less honey-combed. That is the proper construction of concrete. If a hard and non-absorbent material is used, it is useless to fill up the interstices altogether; it would be a mere waste of cement to do so. With average ballast if you go upon the other principle, you would require to use at least one to three of cement. Water will, of course, run through concrete such as I have described and think the best, but it will not draw through by capillary attraction as is the case with other materials. Any skin, be it cement, plaster, or common rough cast, which closes the interstices, keeps the wall as dry as can be. I may further remark, that the use of concrete produces an inconvenience which nobody would suspect without experience of it, viz., that unless the flues are lined with pipes or panelled with very exceptional care, the smoke will percolate through the walls and issue in distant parts of the house wherever any part of the walls is not plastered.

Mr. G. MITCHISON, Fellow.—I have had little experience in concrete walls for houses, but Professor Lewis stated in this room, that a concrete wall over 60 feet in length cracked; the cracking, he said, was probably caused by changes of temperature; and he instanced a case in France, where a church was built of concrete; a telegram was sent to Paris, stating that the church was giving way, cracks into which you could get your arm having appeared. The Government engineer went to see it. When he got there he saw there were cracks, but they were hardly visible. Professor Lewis also stated, that the military engineers were of opinion that concrete ought not to be used for walls over 60 feet in length. I have myself seen some curious cracks in concrete walls, I built a wharf wall of concrete 124 feet long, which has stood well, but as the face is boarded, I cannot say if it has cracked. I have found that concrete is not impervious to water unless it is of immense thickness, or the surface is rounded over. If it is made with a certain proportion of cement and carefully manipulated, it may form a valuable building material, but as yet we have hardly had sufficient time to judge.

At this point, and in consequence of the late hour, the Discussion on Mr. Smith's Paper was adjourned until the next Meeting.

Royal Institute of British Architects.

At the Ordinary General Meeting of the Institute, held on Monday, the 7th of June, 1875,
Sir GILBERT SCOTT, R.A., President, in the Chair.

PRESENTATION OF THE ROYAL MEDAL.

The preliminary business of the evening having been concluded,

The PRESIDENT rose and said :—We have now arrived at that agreeable part of the programme—the presentation of the Royal Gold Medal. I must apologise before I go further for having hardly voice enough to make myself heard. I will begin by saying, what you all know, that in the recommendation of the recipient of the Royal medal for this year we come to the conclusion that it was fairly the turn of those who had laid our art and profession under obligations to them by their literary contributions and published works, and taking that view we were perfectly unanimous in selecting for our recommendation to the Queen the name of Mr. Edmund Sharpe. I need hardly add that Her Majesty graciously, and I have no doubt very gladly, confirmed that recommendation.

Just as in centuries immediately preceding the last, when Englishmen, though most thoroughly alive to the value of Roman antiquities, were ignorant of or tacitly ignored those of the Greek; so it may be said of the century which preceded the present one, that though they valued the antiquities both of Greece and Rome they seemed perfectly ignorant of the value which attached to those of the Mediæval architecture, of our own, and neighbouring countries. It is true that Mr. John Carter did begin the work of the thorough illustration of these antiquities by measured details during the last decade of the last century, but practically speaking the illustration of those antiquities by actual working drawings such as would hand down their architecture in a precise form to future ages belongs to our own century, and really hardly began till the end of its first quarter. I speak of illustration not by pictures, for that was carried out splendidly by Britton, but I mean illustrations by actual measured details. I believe I am quite safe in saying that nearly the first person to do this was the eldest Pugin. After his time the subject was followed up by many others; but among all those who have contributed to the illustration of our own English antiquities in this way—by actual measured detail—I think no one equals in the importance of his works those of our valued friend Mr. Sharpe. (Applause.) Mr. Sharpe's "Architectural Parallels" has, as it were, resuscitated from the dead innumerable magnificent details of our ruined abbeys; those abbeys may be considered at once the pride and disgrace of our country, at once the delight and the same of every intelligent traveller; for beautiful as the details are, and picturesque as may be the ruins, the neglect which they have received in our time, and the fact of their being allowed to go to ruin, and not only go to ruin but to continue without proper representation, is undubitably one of the greatest disgraces as far as the art and art-feeling of England is concerned. This Mr. Sharpe has done more than any other man to redeem. He has, moreover, added to that great publication of his a number of other works, publications of a scientific and literary

kind, which illustrate and explain the antiquities, the details of which he has so beautifully portrayed. He has even gone further than that: in his more recent works, particularly in the paper which he read before this Institute in 1871, and the more recent work in which he has followed out more completely the history of Cistercian Architecture, he has done much to add to the interest of those abbeys by bringing before us the history, customs, habits, and rules of that special order to which we owe so many of these glorious buildings. Mr. Sharpe has added to the obligations which we are under to him by another mode of illustration—by his peripatetic lectures at archæological gatherings in different parts of the country. I have not myself been present at many of these, but I last year had the privilege of hearing him lecture at Fountains Abbey, and I must say anything more graphic, more interesting, more calculated to excite and keep up the interest not only of members of the profession but of all who study the art history of our country I have never had the pleasure of listening to. I will add another source of obligation which art and the profession are under to Mr. Sharpe, not less in importance I venture to think than those I have already enumerated—and that is the most generous mode in which for the last few years he has devoted a portion of each summer to the conducting of large classes of architectural students through different neighbourhoods, particularly in France, where interesting architectural remains abound, and guiding and directing their studies on the spot under his own superintendence. I have heard that last year Mr. Sharpe had a class of no fewer than fifty students, whom he conducted through an important district of France, and I also learn that he is going to do the same this year, through an equally important district—that of Angoulême—where he has a large list of churches searched out by himself, many of which were not generally known to the profession, and perhaps of a more obscure character than those generally visited; but he is going again to conduct one of these large classes, and for several weeks together he will carry on this system of generous intellectual and artistic guidance of their studies, which strikes me as being the most important step ever taken in awakening and keeping up the interest of the students of our art. The President then formally presented the Royal medal to Mr. Sharpe.

Mr. EDMUND SHARPE, Fellow, who was greeted with loud and protracted applause, said,—Sir Gilbert Scott and Gentlemen, I believe that in order duly to appreciate the honour which the medal that has just been presented to me confers upon him who receives it, it is necessary that the recipient should either be an architect in professional practice, or one who has been so at some earlier period of his life. For to such an one this testimonial, which although the gift of the Queen, is the award of the representative body of the whole of his professional brethren, comes with a fuller significance, and a higher value, than it possibly can to any one else. For my own part, I can assure you that on this account I look upon it as the highest possible honour that I could ever wish for, or hope to attain. In my own case its value is enhanced by a consideration the force of which you will readily understand. The works, the publication of which has procured for me this honour, are not works of general interest; they appeal to no popular sentiment. In fact, they were intended chiefly, if not solely, for the use and instruction of architects. They are, in fact, what the publishing trade calls “class books.” Their circulation consequently is very limited; much more so, perhaps, than those who have not tried the experiment might be disposed to believe. The publication of such works is in fact, it must be confessed, a somewhat expensive luxury; and the sole reward that those who indulge in this pursuit can expect is the satisfaction which is derived from the belief that their publication is of use and value to those for whom they are intended. To receive, then, so satisfactory a confirmation of this belief at that which is conveyed by this testimonial, is, I need scarcely repeat, the highest possible reward that I can receive for any past efforts of mine in this direction; and in very sincerely thanking the Council of the Institute for the choice they have made this year of the recipient of the medal which Her Majesty

is graciously pleased annually to bestow, and in thanking you, gentlemen, for your confirmation of that choice, and our worthy and distinguished President for the flattering terms with which he has accompanied the presentation of the medal, I can assure you that, greatly as I appreciate this honour, I shall look upon it quite as much as an encouragement to renewed efforts as the reward of those which you have been pleased to approve. [Mr. Sharpe resumed his seat amid renewed cheers.]

The PRESIDENT,—I will add one or two words if you will excuse my doing so—to this effect: that many ruined buildings are falling into decay winter by winter, until in a few years those noble edifices which delight our eye so much will probably become wholly unintelligible. It is such works as Mr. Sharpe's which prevent them from being lost to future generations. In my own comparatively short course of researches, I know that many which I sketched in former years have become so far obliterated by decay as to be now scarcely intelligible. Mr. Ruskin has said this has taken place in France much more than in our own destructive times. I think we are under obligation to all who contribute towards the preservation or record of these interesting relics of ancient architecture by such publications as those of Mr. Sharpe, and I could wish that what we have been talking about this evening might induce members of the profession, to inaugurate a society which, by degrees, might chronicle one by one, the finest and best, as well as the more obscure, of the remains which are mouldering from the effects of time.

Mr. EWAN CHRISTIAN, Fellow,—I can most fully confirm the observations our President has just made. Thirty-seven years ago by Mr. Sharpe's advice I visited Furness Abbey, and have never ceased to feel grateful to him for one of the most delightful days of hard work I ever spent. Twenty-five years after I again visited the spot, and was much distressed to see the change that had taken place during that interval. The making of the railway so close to the buildings, and the conversion of the Abbey precincts into hotel gardens, though much to be lamented, may have been inevitable, but the decay and dilapidation by which the architectural remains have so greatly suffered, might, I think, by timely and judicious care, to a great extent have been prevented. It is to be earnestly hoped that those to whom the Abbey remains now belong will use their best endeavours to protect from further decay and damage one of the most beautiful examples remaining of the architecture of the period in which it was erected.

Mr. SHARPE,—If I may be allowed to add one word more it would be to say that on this occasion we ought not to omit to pay our tribute to a name to which we owe, perhaps, more than to any other. I refer to him who distinguished himself by the classification of styles which no man knew so well, and our professional knowledge is due in a great measure to the classification which he established so long ago. Among our present members is the son of that great man whom I would refer to by the name we students of Gothic architecture well remember—as “dear old Rickman.” I had the pleasure of his acquaintance when a young man, and of staying some time in his house; and knowing much of the manner in which he amassed that extraordinary amount of knowledge which he possessed, and which was wonderful in his day, I have the greatest respect and veneration for his name, and I hope you will excuse me for having reminded you how much we owe to him.

The President then proceeded to present the prizes awarded in accordance with the resolution of the special meeting on the 15th of March.*

Mr. C. F. HAYWARD, Fellow, then read the following biographical sketch:—

* For the list of successful candidates and the subjects for which the Institute prizes were offered, see the notice paper for the current Session.

THE LATE MR. JOSEPH JAMES.

ON the 9th May last died, in his 47th year, Mr. Joseph James (for some years a Fellow of this Institute), having been a practising architect about 25 years or more, and the author of some very successful works chiefly in the school of the Gothic Revival. In the following brief biographical sketch, I desire to recount to this Institute the labours of a brother architect and one well known and esteemed by many here present.

Mr. Joseph James, the son of the Rev. Thomas James, and nephew of the Rev. Angel James (a Dissenting Minister of Birmingham, I believe) was born on the 29th May, 1828. He was a man of singularly quiet and unassuming demeanour, and one in whose private character kindness and consideration for others was always a distinguishing trait. Though endowed with much talent and remarkable for his professional knowledge and skill, he was not of a disposition to push himself rudely forward or even make the most of what power he possessed. At the same time he did not at all decline the hard work of his day, nor refuse to join in the race of competition, but, on the contrary, he frequently entered the lists and not seldom came off victorious. Only within the last few years he won in private competition the Taunton Dissenters Grammar School (a view of which is hanging on the walls), and his last work was the Bermondsey School Board Schools, also won in limited competition, which, however, he was hardly able to see completed, for he fell a victim to over work and the anxieties partly incidental to all professional careers. About two years ago his eyesight began to fail, and then his brain was affected, and all work was necessarily stopped. This with the anxieties of a young family chiefly dependent upon his own exertions, preyed upon his mind occasionally and increased upon his maladies. At last all hopes of further work, with its anxieties and fears, were suddenly brought to a close by his death, while a widow, and young children are left to lament his loss.

Mr. James was articled to Mr. Eppy of Lincoln's Inn Fields, and attended (as so many of us have done) the lectures of Professor Donaldson at the University College, where he was a diligent pupil. He studied also at the Academy in the usual way. There being no Architectural Examination in his day, he commenced practice about the year 1848, having, I believe, previously been engaged some little time in the office of our late Vice-President, Mr. Horace Jones.

The following are some of the many works designed and carried out by Mr. Joseph James :—

Chapel at Sligo, Ireland.	Chapel at Dalston.
„ Halifax, Yorkshire.	Church at Smethwick.
„ Norwich.	College at Birmingham.
„ Hemel Hempstead.	„ Taunton.
„ Llandudno.	Schools at Hemel Hempstead.
„ Brighton.	„ Tottenham.
„ Hornsey.	„ Bermondsey (for London Sch. Board)
„ Bexley Heath.	Offices for Gasworks, Kingsland Road.
„ Richmond.	Houses, two at Birmingham.
„ Arundel Square, London.	Various alterations and additions to Chapels,
„ Cambridge Heath, London.	Schools, and Houses, not mentioned in this
„ Rugby.	List.
„ Barnsley.	

As examples of the Gothic Revival, Mr. James's works deserve to be mentioned, especially his church at Barnsley, of which an illustration will be found in our Library, having been presented to

this Institute by Mr. James in 1854. The boldness of the design of the tower deserves commendation—for twenty years ago such appendages were not so common as now to dissenting places of worship—nor are they often now so well designed. The smaller chapels, too, were often very specially adapted in various minor details to the circumstances of the case, and as far as I can judge from the little I have seen of them they are worthy of Mr. James's reputation and skill. Many of his designs will be found by reference to the *Builder*, and in other professional journals.

CHAS. FORSTER HAYWARD.

June 7, 1875.

NEW MATERIALS AND RECENT INVENTIONS CONNECTED WITH BUILDING.

The adjourned discussion on Mr. Roger Smith's Paper on "New Materials and Recent Inventions connected with Building," read at the Ordinary General Meeting, on Monday, the 24th May, was then resumed by

Mr. G. AITCHISON, Fellow, who said,—It is impossible to go through the whole of the re-discoveries, inventions, and new methods of application of materials which Mr. Roger Smith has treated of, as they embrace everything, from a sash-fastening to the Crystal Palace. I think the best thing I can do is to say there are one or two new inventions which I did not hear mentioned, and which I think are well worth attention. One is a mosaic pavement of glass, used for the transmission of light in some of the new courts of South Kensington Museum. This is not only very beautiful, but very useful as well; the other is the so-called new invention of toughened glass, which appears not unnaturally to have slumbered since the early part of the Christian Era, as the inventor was rewarded by having his head cut off. As far as the numerous inventions which Mr. Roger Smith has mentioned are concerned, I will not attempt to discuss them, but I entirely echo what he has said, viz., that it would be a most desirable thing if some architect arose who should discover a means of making fine and permanent buildings in a way which would cost little money, and be readily done. I agree with him that though there have been a great many splendid discoveries in other directions, architects have not yet "struck oil."

MR. EDWIN NASH, Fellow.—I imagined that when Mr. Aitchison rose he would have continued his remarks upon concrete walling, he having stated at the last meeting that concrete walls of great length are apt to split perpendicularly; but as he has made no further observations on concrete, I may remark that for many years past I have observed the same thing which he has stated, for if you look at the old concrete walls built by the Romans in England, you find that one and all have perpendicular fissures at almost regular intervals. I remember being struck with that circumstance at Richborough Castle, which is built of flint rubble; as also at Pevensey, and other castles. In fact, it is seen that rubble walls of all kinds shrink in this manner, and probably continue to shrink for a very long time, and I believe that no wall of rubble concrete, not even our flinty walls of modern times, can be found without perpendicular fissures, if they be of much length. This, however, is not of much consequence with regard to the use of concrete in house building, because the length of the walls is moderate, but the fact remains, that concrete walls, whether built with common gravel or flints, do shrink materially.

They shrink downwards, of course, but that is of slight moment compared with perpendicular fissures, which might be of consequence sometimes, and it is these fissures which enable these gigantic walls to topple over in the way they do when they get weak at their ground line. The conglomerate itself is so hard that it would last another thousand years, but the fissures, notwithstanding the customary bond of tiles, allow the walls to become ruined. With regard to the selenitic mortar, there can be no danger in using it. I have some doubt as to the benefit of using it as mortar, but as a plastering material we know its value. It is a material which has a drying nature and will soon harden. In allusion to the necessity of architects being cautious in what they use, I will refer to a case: A person once called upon me with a specimen of indurated stone, which was the stone commonly found about Tunbridge Wells, and I think the patentee of this indurated stone was a Mr. Mackintosh. When I saw it, I said the stone was inflammable. "No, nothing of the kind, was the reply." I repeated my conviction that it was inflammable, and I asked if I might put the specimen into the fire. Permission being given, it was seen that in about five minutes it flared up like an oil lamp. The fact was, it was indurated with turpentine, which might have been good for keeping out weather, but I doubt whether it would be desirable to build the walls of a house with a material which would be the most inflammable portion of the building. The invention did not last long, but it illustrates the caution which an architect has to exercise in choosing a new material.

Mr. HORACE JONES, Fellow.—With regard to the question of concrete, I will relate a little circumstance which was told me to-day, and which though probably not novel to many present, was novel to me. It is with regard to the construction of foundations and using concrete for them. The place was a marsh, and an excavation was made for a large gasometer. Instead of excavating to a great depth, with piling, strutting, and shoring of surrounding earth, the mode adopted was that of forming cylinders of concrete about 6 feet in diameter and 6 feet in height. The end driven is sharpened off to a point. They proceeded on the principle of the ordinary caisson sinking for bridges or other water works; these being put down, they excavated by machinery, the cylinder working up the soft soil, and as this was loosened from it it sank down gradually and another 6 feet was put on, using 6 feet lengths of concrete instead of iron caissons, at about one-tenth the price and equally effective. A large gasholder 200 feet in diameter has been built upon this foundation, excavated without any trouble whatever.

Mr. GILBERT REDGRAVE, Visitor.—The subject of selenitic mortar having been mentioned, I should like to say a few words upon it. At the last meeting it was maintained that this mortar had not been invented by General Scott, and Professor Kerr stated that he thought the invention was more properly due to a Mr. Westmacott. As I have encountered this statement on several occasions, I have tried to ascertain upon what erroneous impression it could have been founded. I find that in an able paper read by Professor Kerr, in 1863, on artificial stone, the invention of Mr. Westmacott was brought before the notice of the Institute, and a specimen of the material was shown. The artificial stone was said to be composed of lime and sand, with a small proportion of ground marble or carbonate of lime. The theory was that the carbonic acid gave greater rapidity of setting, and that the material indurated in less time than other similar compositions. It was based, in fact, upon the well-known action of carbonic acid in the gradual conversion of hydrate of lime into carbonate of lime in common mortar. I find that some three years ago it was stated in the "Building News" that the invention of selenitic mortar was due—not to General Scott, but to Mr. Westmacott. It was however at that time clearly shown by General Scott, that his invention differed entirely from that of Mr. Westmacott, inasmuch as his (General Scott's) patent depended upon the presence of small quantities of sulphate of lime, an ingredient which is not made use of at all in the mixture of Mr. Westmacott. If the inven-

tion was subsequently modified, and if Professor Kerr has any other reasons for his statement, I think it is due to General Scott that he should explain them.

PROFESSOR KERR.—One word on this matter. The gentleman misunderstood me. I did not take upon myself the responsibility of saying that General Scott was not the inventor of the selenitic mortar; but I pointed out on the assertion of others who had paid more attention to the matter, that the idea prevailed that General Scott's invention was almost identical in substance and in science, with that which was introduced by Mr. Westmacott. At the same time I should be sorry to deprive General Scott of the merit of that and many other inventions.

Mr. J. EDMESTON, Fellow,—I would say a word or two in addition to what I stated at the last meeting. In the course of the discussion a question arose as to the right way to make a concrete wall; and it was said the wall should be made of pebbly material, without sand. It was also said that these walls were damp, and it was further said that if you use sand with pebbles, you must use a larger quantity of cement. Where I have had work of this kind done, I have carefully prescribed that sand in proper proportion should be mixed with the concrete. There is a difference of practice in this respect I know. Our Hon. Secretary, Mr. Cockerell, said the smoke came through the flues and walls in an instance he knew of. That I apprehend would be the case where the concrete was made with pebbles,—the interstices not being filled up with cement and sand. As my object was to get a good practical opinion on this matter, I wrote to Mr. Broughton, late manager of Tall's Company, who in reply stated he considered a concrete wall built with two parts of sand, four of ballast, and one part of cement, if carefully done,—the cement being of best heavy quality—would make a substantial and dry wall, without being stuccoed outside. It is clear it depends a great deal upon the excellence of the cement and the care with which a proper quantity of clean sand is mixed, so dense that under ordinary circumstances the walls would not be damp. With regard to the selenitic mortar as I have already said, I have tried to use it, but without success. The manager of the company has kindly placed some information at my disposal, and I have also received a communication from a clerk of works employed upon concrete work,—the concrete being made chiefly of selenitic lime. The way it is used in that case is to mix 1 part of Portland cement with 3 parts of the lime, which gives it a quicker setting. It is stated that in 14 inch work it sets sufficiently in three days for the wall to be raised another stage, and the work becomes very hard in six weeks, though not even then where I made an examination, quite throughout the mass. I have no doubt concrete made thus will answer very well. The most severe test must be to use it in building the walls of a house.

Mr. F. P. COCKERELL, Hon. Sec.—I have had some little discussion on various occasions about the mode of making concrete. My own opinion has been that the principle in making concrete is that the substance of which the concrete is made should be hard and non-absorbent, and that only a sufficient quantity of pure cement should be used to form a joint between each stone or knob, and its neighbour; but to fill up the interstices, I think, adds nothing to the strength, whilst it uses more cement. If you use sand, you have not only to cover each individual stone with cement, but also every particle of sand; thus the cohesive power of a given quantity of cement is attenuated and frittered away. True every stone of concrete in which sand is used is completely bedded, and it may be held that it is the less likely to move; but if you consider the infinite number of sub-divisions of the thrust (in compression) and the number of points of contact between the stones, it is not necessary that every stone should be bedded solid. If the wall is not solid, if there is a partial dis-connection between the stones—there can be no capillary attraction. I did not say that concrete makes a damp wall: but that water would run through, because there are holes in it; but that by shielding those holes by an outside coating, however slight, the evil is obviated, because there is no capillary attraction, and therefore such damp as the outside coating

might absorb, would go no further. The absence of capillary attraction enables one to dispense with a damp course; but where solid concrete is used it cannot be dispensed with.

Mr. EDMESTON.—The only way you can use this lime is to make it in a liquid state before you put in the sand; otherwise the sulphuric acid is not mixed with the lime sufficiently to turn it into cement.

Mr. J. HEBB, Associate.—I may refer to the case of a church built of concrete, at Vésinet, near Paris, and the architect in reporting upon it distinctly stated, that he found concrete was extremely permeable to damp. The walls were at least 2 feet thick, and the frescoes painted on the interior surface of the wall were destroyed. In this case the concrete was not built in the usual way in troughs by layers, thrown in from time to time, but in blocks—the concrete being first worked in a pug mill, and then cast in moulds. I remember distinctly the architect, M. Boileau, reported it was a serious objection to the use of concrete—that it was so excessively permeable to damp, the slightest moisture on the outer surface finding its way into the inner surface. With regard to sand in concrete; I had some experience in building in concrete, with a man who was very practical in that matter, and who fought the battle of concrete with the Metropolitan Board of Works, and he was of opinion that any sand beyond the smallest admixture was decidedly deleterious to concrete. His view was—and I think it a reasonable one—that it was necessary that the substance which forms the body of the concrete should be brought as nearly as possible in contact with the cementing material, and that only a very small quantity of sand was required to fill in the interstices.

Mr. AITCHISON suggested that the various points raised with regard to the composition of concrete, could be easily settled by experiments upon cubes of different sizes, and in other practical modes.

Mr. T. MORRIS, Fellow.—Upon the subject of concrete buildings, it may be well to refer to the Chapel at Potter's-bar, an early example, and to the Imperial Insurance Office in Pall Mall, which is a lofty and remarkable building, as among the instances from which proper data as to this material can be obtained. Much as we are indebted to Mr. Roger Smith for his admirable paper, I cannot help thinking the subject unmanageably large, for it seems impossible to embrace in one discussion all its numerous details. Architects are not perhaps obliged to follow the cycle of innovation with extreme eagerness, but they are undoubtedly under the most imperative necessity of understanding thoroughly the novelties they do adopt, and for which they in fact become responsible. Therefore, with a view to practical benefit, I should think it better to take a more circumscribed field at a time, and work it completely and exhaustively. Coming to iron beams, a further word or two may be allowable in reference to the Phillips girder. I regard it as a simple and ingenious mode of building up an iron beam on the same mathematical principles that apply to timber and other materials. The iron manufacturers are in the habit of sending out sheets of sections of rolled joists as obtained from the mills, and suitable for various purposes and spans. They give the weight per foot of the joist itself and its working capacities for different bearings. If loaded uniformly between the ends, it will carry so much—or if loaded in the middle, so much. You have thus a sort of unit to work by, and if you put these units together horizontally as the joists of a floor, every unit is equal and takes a proportionate share of the work. When disposed side by side four units do but count as four, but if you unite them vertically thus \ddagger , you obtain the power of $4 \times 4 = 16$, the square of the number. The Phillips joist has a scientifically proportioned section with flat backs to the flanges, and the girder is built up in this way: The webs are selected according to the purpose in hand, and the flanges are riveted firmly together, so that you build them up, knowing what you are about, as clearly as if calculating timber girders with the help of Tredgold's Tables.

Going on to a decorative material associated with the name of Owen Jones—the thin fibrous plastering, some of which was done with a mere lining of canvas, and received the name of

cannabic, I am disposed to think that although light, strong, and suitable for many purposes, this class of material has very much given way to the cheaper method of forming reliefs in which a relatively large quantity of flock on paper is employed. This manufacture is usually very ably and effectively treated, and is most easy of application. Then as to glass, we hear of a recent invention for tempering glass. In ancient times an architect invented a means of making glass malleable; he was a Roman architect, and according to Dr. Lardner, was beheaded in order that his secret might be effectually suppressed. At the same time, if a method were discovered of making glass more tenacious without impairing its brilliancy, a great step would be gained. Fractures of plate glass in shops are very numerous and remarkable. The mischief would seem to be done with a very small external force. From a minute orifice on the face a large conchoidal fragment is often thrown inwards unattended with any radial crack or other injury to the plate. That was the nature, I believe, of the fracture which so much alarmed the Princess of Wales near Windsor the other day, and which alone (to say nothing of its general claims) would render the subject worthy of attention.

Mr. J. D. MATHEWS—I have used Portland cement concrete 9 and 12 inches thick with sand as well as ballast backing to a wall, but instead of keeping it dry the water ran through the cement like a riddle.

THE PRESIDENT.—With sand and mortar to fill up the interstices?

Mr. MATHEWS.—Yes; the proportions were, I should think, about 4 of ballast, 1 of sand, and 1 of cement, placed *in situ* as concrete is ordinarily thrown in.

Mr. LEWIS SOLOMON, Associate.—I was engaged on one occasion, on works, where concrete known as Phillip's patent was used, and the water run through it from floor to floor. The thickness of the concrete was about 8 inches. Subsequently a description of asphalte, which was said to be fire-proof, was brought under my notice, but I put a piece of it into the fire, and it burnt like coal. Mention has been made of Cliff's vitrified bricks, which are often specified, but they will not fit with ordinary bricks, being rather too large. Of Halkin's copper wire, which the inventor thinks very good, it may be mentioned that it breaks very easily indeed when it is used for window sashes. If you throw up the window sash suddenly the wire snaps like so much tinsel. With reference to the French revolving shutters, I would say I do not regard them as being of the simple construction mentioned by Mr. Roger Smith, whilst I believe the price is 20 per cent. higher than those made in this country. The great point of difference is that the latter requires only one groove, whereas the others require four or five grooves.

Mr. A. PAYNE, Associate,—Great diversity of opinion has been expressed relative to the merits of concrete as a building material. Some have asserted that water runs through it like a riddle, whilst others maintain it to be a water-tight method of construction. I can quote instances to show that water does not run through concrete, and also that the fissures spoken of are not a necessary consequence of its employment. The Manchester Water Works has an enormous reservoir supported by an embankment half a mile long, and between 70 and 80 feet high. The engineer abandoned the use of puddles and trusted entirely to a lining of concrete inside the immense embankment. The wall of concrete is about 70 feet high, and has an enormous pressure of water upon it. If the water penetrated through it, it would fail in the purpose required. Besides this, reservoir channels have been formed to take the water to Manchester. These are 25 feet wide, and between 9 and 10 feet deep, and they are formed with concrete about 8 inches thick puddled into its place. That is the only thing to keep out the water. With regard to the fissure spoken of as occurring in concrete work, opposed to that we have the enormous breakwaters constructed in the formation of harbours of refuge. In many cases they are made entirely of concrete, sometimes thrown into place and sometimes used in the form of large blocks, and an engineer would not dream of using a material which was liable to perpendicular

fissures—not to say at every 50 or 60 feet, but at even 500 feet apart. To make such breakwaters with the force of the waves upon them would be simply useless, and it is quite certain that engineers do make concrete which is impervious to water.

Mr. E. NASH,—What is the age of the concrete in the cases you have mentioned?

Mr. PAYNE,—In the case of the Manchester reservoir it is not more than four or five years old.

Mr. NASH,—You perceive that those works have not the test of age, and I have said that concrete and rubble walls shrink during a long period, even naming so much as a 100 years; but the particulars Mr. Payne has given apply to wet concrete only, which is a wholly different thing to a wall built up in air, and to which my observations alone apply.

Mr. PAYNE,—One of the greatest authorities on the subject of concrete is Mr. Grant, who superintended the construction of the Thames Embankment. I recollect hearing him state that if concrete is properly made there is no danger of shrinkage.

Mr. E. C. ROBINS, Fellow, mentioned that in an extensive concrete work in the Isle of Wight fissures occurred at intervals of about 60 feet, but they had been repaired. It had not been built more than about 20 years, but the work stood for some years before the fissures occurred, and this may be regarded as an instance of machine work which has yielded in the way described.

Mr. MACVICAR ANDERSON, Fellow.—All that has been said to-night appears to me to amount to this: that there is concrete and concrete. I think there can be no doubt that it is possible to make concrete water-proof. I remember going to see a house which was being built of concrete by Mr. Tall, which for all I know may now be as high as the Tower of Babel, for it was some four or five stories high at the time I saw it, and Mr. Tall had furnished, and with his family was then inhabiting the basement, although the roof was not yet on, for each floor formed in itself a perfectly dry and water-proof covering. The walls were about 9 inches thick. [Mr. COCKERELL. Cemented?] I believe not. With regard to the use of concrete generally. I confess that having had a somewhat unfortunate experience, I am not altogether a believer. Think of the great risk the architect runs in its use, for granting that if properly proportioned and conscientiously mixed, the material is good, everything it is manifest depends upon such proportions and mixing; whereas in the case of bricks or stone you have another and distinct element, the principle of "bond," to depend upon. A wall of those materials will not fall over even if it is not built in a first-rate manner, but a concrete wall, if the materials are not in proper proportion and honestly mixed, is very liable to fail. I may mention the case of a concrete wall built in Hampshire, under my direction some two or three years ago, by a first-rate London contractor. The wall was about 300 feet in length, and from 10 to 20 feet high, 4 feet thick at bottom, diminishing to a little over 2 feet at the top, with a considerable batter, and was formed for the purpose of supporting a large terrace. Latterly it has exhibited cracks on the face and signs of decay, and on removing the cement facing the other day, I was horrified to find the whole wall in many places was crumbling to pieces. The only way in which I can account for the failure is this: that the ballast used does not appear to have been, as was intended, thoroughly washed, and there was therefore a certain amount of loam left in it, which proved fatal to the lime. I mention this—not as an argument against the efficiency of concrete, for we know that if properly mixed it is most efficient, but as an illustration of the risk the architect incurs in using it, and for my own part, I say decidedly, commend me to a good brick wall—old fashioned though it be.

THE PRESIDENT.—In the case you speak of, was the concrete made with Portland cement?

Mr. ANDERSON.—No; it was made of blue lias lime, which was thought to be as good a material for the purpose by the engineer who was consulted.

Mr. C. L. EASTLAKE, Secretary, stated that Mr. Roger Smith, owing to a pressing engagement, was obliged to go to the Isle of Wight, and therefore would not reply upon the discussion.

THE PRESIDENT remarked that the discussion hitherto had principally been upon the subject of concrete, whilst multifarious inventions had been brought before their attention in the paper. He asked Professor Kerr whether he had any additional remarks to offer.

PROFESSOR KERR said,—There are certainly one or two points I might refer to; indeed, the subject is so large that we might go on discussing it during several meetings. But I would again express the hope that the Council may be able to take some notice of the suggestion, that we should have something like an annual report upon the progress of inventions, and the improvement of materials, in order to enable us in the face of the public as well as before the profession, to manifest our interest in the matter, and to consider it intelligently and attentively. The discussion on concrete seems to me to have displayed a good deal of science—almost more than might be at first supposed. I will only say that in whatever way you make concrete, it is to be regarded as a species of artificial stone; and as it is not formed under the pressure which the operations of nature have given to the natural material, it follows that concrete, which is not in fact compacted under any pressure at all, but is left to its own consolidation, must, do what you will, be not only porous, but more porous than stone. It becomes a question, whether it is desirable to make concrete as Mr. Cockerell quite scientifically suggests, with intentional interstices, or whether it is better to make it as compact as possible by introducing smaller gravel and sand. In the one case, if you put in cement or lime and no sand, you make an artificial lime-stone, and we may say the concrete is then as absorbent of moisture as lime-stone is; whereas, if you make it with small gravel and sand, with the least efficient quantity of lime, you have a sand-stone, and this, as we know, is quite as absorbent as lime-stone. However, if, as Mr. Aitchison suggests, we were to make some experiments with concrete composed in various ways, we might certainly have a practical means of determining the absorbent or non-absorbent qualities of each form of composition.

There are many other important points in Mr. Roger Smith's Paper which are worthy of our consideration. One is the introduction of machinery for carving, and this not merely in wood but in stone. If machinery were brought to bear upon stone carving, no doubt we could produce a large amount of work, for what it is worth, at a comparatively small cost; but I venture to say the work of an invention of this sort is simply a superfluous quantity of spurious art. I think, therefore, that as architects we must look with suspicion upon anything like the application of machinery to the production of such ornamental work. Indeed there are several ways in which we can remember that machinery, as it was called, was applied to the carving of wood, and all those systems one after the other have fallen into disuetude—none of them having made their mark. Supposing, however, that machinery is made applicable only to the dressing of stone surfaces, then, if you have an indefinite quantity of ashlar to dress, it might be a ready and inexpensive way of doing it; but still, if you have stone even moulded by machinery, the mouldings must necessarily be limited to what the machine will produce, and then, as I think, good-bye to true art. You will produce merely a mechanical counterfeit, with no real art about it.

Turning to another question, I still think Mr. Roger Smith was wrong in stating that building has not made such great progress as many other matters of science. For instance he has forgotten one thing which ought not to be left out of sight, namely: that scientific architectural design has certainly advanced greatly,—I mean design with regard to the contrivances of dwelling-houses and public buildings. I think we must be disposed to admit that this has advanced considerably within the last twenty-five years. Take hospital construction for example; although no doubt doctors differ upon it, yet it cannot be denied that architects have done a great deal. This question of hospital construction, however, has

been very much before the public recently ; but there are many other problems of the same kind in house construction of which I cannot undertake to give a catalogue off-hand, in which architects within the last twenty years have most signally displayed progress of invention, and if Mr. Roger Smith were present, I should like to ask him whether he had taken that fairly into account and had ignored it, or whether he had merely overlooked it. Again, upon such questions as that of smoky chimneys, we are continually being baited by the public, but I think architects, from what I know personally, have done their share ; and if heating, and ventilation, and plumber's work, the contrivance of chimneys, and so on, do not seem to progress in the same manner as some other departments of building art, the reason is that these are in practice petty vexatious things, which it is not clear that architects ought to be responsible for at all. They are subjects which appeal to the lower instincts of science, and lie within the proper province of mere trade ingenuity, dealing in nostrums ; and I cannot see why architects ought to be charged as they have been, with neglect of their duty, for not having devoted to these small matters, that attention which they cannot spare from their more proper task. Yet I venture even to say that under the patronage of architects, if not by their direct instrumentality, houses are much better warmed and ventilated than they used to be, and chimneys do not smoke so much. There is another important consideration to be taken into account in all these questions,—that is, the very rapid growth of English fastidiousness. That which was regarded as a great comfort a few years ago, is regarded as a positive discomfort now. What was considered as a model of inventive genius within our own recollection in sanitary and other such matters, is now pronounced by people at the west end, who write to *The Times*, to be only an evidence of English stupidity, as if, for instance, any other nation ventilated its houses better than we do ! But the truth is our climate is so disadvantageous, and people are so fastidious, that architects who have other matters to attend to, cannot devote their attention to these small things even to satisfy people who write in *The Times*. But what I contend is that we have done our fair share after all in these matters within the last twenty years. Timber houses have been spoken of. A gentleman went to Norway and saw some timber houses there, which he greatly admired, and forthwith he set himself to import one on the same model for the South of England, and to describe it in *The Times* in glowing colours. What was generally thought seems to have been that whilst there was nothing really new about the thing, there was a great deal that was Norwegian and could not be made English. As for timber building in itself we have always known it. Whether it is now to be proposed to re-introduce it as preferable to stone and brick is another question ; but certainly it cannot be done in houses of magnitude and importance. But there is one way in which I think timber building might be introduced with advantage ; that is, in country cottages. It must be admitted that great improvement is needed in cottage design ; and, if timber were employed, my own opinion is you would build cottages for poor men's families in the country for a very small sum of money. I should say for £30. or £40. you could build a labourer's cottage, which would accommodate his family comfortably ; and the rent required to pay interest upon that outlay with a small piece of land attached, would be quite within the means of those persons who occupy such dwellings. This, however, does not at all touch the question of dwellings for the poor in towns. I have only one other remark to make with regard to smoky chimneys. You all know, I hope, the simple plan adopted by one of the best smoke doctors in London. It is no more than to do away with the gathering of the flue. He puts in an iron soffit plate with an aperture in the middle for the flue, and then fills up solid at each side, and the thing is done.

Mr. ANDERSON said he had put that plan into his specifications for the last three years, and found it answer.

Mr. EDWARD HALL, Visitor.—With regard to the influence of new inventions, I think it is

important that we should consider whether they have been actually advantageous in point of art. Certainly the present product of them in architectural details affords great opportunity for the setting-up what, without being good architecture, passes with the public as such; and although I so far agree with Professor Kerr as to say there has been great improvement in architecture where under the hands of architects, yet it seems to me that the improvement is only of the nature of an arithmetical progression; whereas the bad use of architectural details now is of the nature of a geometrical progression. These new inventions unfortunately enable the speculative builder to make use of various forms which he finds ready manufactured; and unfortunately also there is a tendency on the part of men in our profession to use these things. I do really think it is doubtful whether any of the ready-made articles—substitutes for carved stone, manufactured roof decorations, ornamental metal-work, and the like—are on the whole advantageous to our art, and to the general architectural character of buildings. You cannot go about the suburbs of London without seeing that nine-tenths of the constructors of the buildings are making use of architectural details to an extent that would not have been thought of fifty years ago; yet these buildings, abounding in features introduced as ornaments, are those which, prominent in contemporary architecture, are most deficient in art. I think it would have been desirable if some attention had been given in the discussion to that part of the paper which referred to the Crystal Palace style of architecture. As regards this sort of architecture, called *ferro-vitreous* by Mr. Fergusson, the experience has been such as should be most instructive to the public. Looking back to the Exhibition building of 1851, coming down to the Crystal Palace at Sydenham, and pursuing the history to the present time, some very curious evidences will present themselves. With regard to the building of 1851, that was produced in answer to precisely-stated demands, whereof one was for a fire-proof building: it was, however, the most deficient in “fire-proof” characteristics of any building ever constructed. Far from being a building of iron and glass it was one in which the chief material was wood: therefore it afforded no response to one of the problems set forth, more than it did to some others. The chief structural arrangements of the building of 1851 were reproduced in the Crystal Palace at Sydenham. That structure has been found to have been singularly deficient in certain requisites of materials and stability, which are required accompaniments of good architecture. The report of the committee appointed to inquire into the state of the building at Sydenham is particularly instructive. It is to be regretted that those who lavished extravagant praise on Sir Joseph Paxton—a very eminent man no doubt—cannot now all see the absurdities into which they fell, and the tendencies of such encomiums. The floor of the building was laid upon wooden supports, which have had to be replaced by brick piers, and one would like to know why an individual who proposed or permitted such construction should be ranked, as Sir Joseph Paxton was, amongst the first architects not only of his day but of all time? There are numerous suggestions that might be made after hearing the paper and discussion. One is, that there could be better arrangements available by architects for testing the duration of the life of invented materials and contrivances. I imagine that at the Crystal Palace and the Alexandra Palace there would be some corner in the grounds that could be appropriated as a depository where materials intended for external use, and marked with the date of the deposit, could be placed so as to be tested for durability during any number of years, under influences of the weather. If this were done under the auspices of a joint committee of the Institute of Architects and the Institution of Civil Engineers, we should in a few years arrive at some most valuable practical results, such as we are now in want of.

The PRESIDENT.—I will not at this late hour of the evening add any observations of my own to this interesting discussion. It has been very practical though somewhat desultory. What Professor Kerr suggested, viz., that we should annually take up this subject in some form, is what I should very

much like to see carried out. At present we have not gone over half the ground taken by the paper, although the best part of two evenings has been occupied. I have been reminded in the course of the discussion of a little tale with reference to the great Pugin and Sir Joseph Paxton in connection with the first Exhibition building. Sir Joseph was intimate with Pugin, and on introducing that new style of architecture which was adopted for the building of 1851, a conversation took place between the two which was terminated by Pugin patting Sir Joseph's back and saying, "You may build the green-houses; I will build the cathedrals."

The discussion having thus been brought to a close, the vote of thanks to Mr. T. Roger Smith for his paper was unaimously passed by the Meeting, and the proceedings terminated.

GETTY CENTER LIBRARY



3 3125 00614 6183

