

HEADQUARTERS  
1st Reconnaissance Battalion (Rein) (Rear)  
1st Marine Division (Rein) FMF  
APO San Francisco, California 96602

UNCLASSIFIED

COMMAND CHRONOLOGY (CHU LAI)

01000H to 312400H March 1967

INDEX

- PART I Organizational Data
- PART II Narrative Summary
- PART III Sequential Listing of Significant Events
- PART IV Supporting Documents
  - (a) Operations Orders and Patrol Reports (Chu Lai)
  - (b) SITPREPS; 01 March 67 through 31 March 67 (Chu Lai)
  - (c) Statistical Data Chart (Chu Lai)
  - (d) References

is p. 4 →

1ST RECON BN - CHU LAI - CMD CHRON

Enclosure (1)

UNCLASSIFIED

MAR 1967

PART IORGANIZATIONAL DATA

UNCLASSIFIED

1. Designation

1st Reconnaissance Battalion (Rein) (Rear)

Executive Officer

Major G. R. JOHNSTON

16 March 1967

Subordinate UnitsH&S Company  
Company "A"  
Company "D"Capt. L. K. NELSON  
Capt. E. J. CONNELLY  
1stLt. R. S. ROBERTS, Jr.Attached Units

1st Force Reconnaissance Company (-) Major M. D. CERRETA

2. Location

01 March 67 through 31 March 67 at Chu Lai, RVN

3. a.STAFF OFFICERS1st Reconnaissance Battalion (Rein) (Rear) Chu Lai

Adjutant/S-1	SSgt. R. J. MORIN
S-2 Officer	GySgt. J. L. WILLIAMS
S-3 Officer	Capt. R. A. CARNES
Assistant S-3 Officer	2dLt. G. MURRAY
S-4 Officer	2dLt. D. T. STEVENS
Supply Officer	2dLt. D. LITTLEJOHN
Motor Transport Officer	2dLt. D. T. STEVENS
Communications Officer	Capt. L. K. NELSON

09 March 1967

PART IINARRATIVE SUMMARY

The 1st Reconnaissance Battalion (Rein) (Rear) in general support of Task Force X-Ray maintained its elements deployed outside the periphery of the Chu Lai TAOR. In addition, one reconnaissance platoon with liaison/radio relay team was in direct support of Operation DE SOTO through the reporting period.

Enclosure (1)

-2-

UNCLASSIFIED

PART IIISEQUENTIAL LISTING OF SIGNIFICANT EVENTS

1. 20 March 67- an eight day Reconnaissance Indoctrination Program was completed for 30 newly joined enlisted personnel.
2. 30 March 67- Transition of the XM-16E1 rifle for the M-14 rifle began in the operational platoons and will be completed on 1 April 1967.

PART IVChronology of Subordinate Command and Supporting Documents

- Filed* ✓ a. Operations Orders and Patrol Reports (Chu Lai)
- Dep* ✓ b. SITREPS; 01 March 67 through 31 March 67 (Chu Lai)
- Filed w/c/chron/c.* c. Statistical Data Chart (Chu Lai)

Enclosure (1)

-3-

UNCLASSIFIED

STATISTICAL CHART (Chu Lai)010001H to 012400H March 1967

Number of Patrols	51
Artillery Fire Missions	93
Naval Gunfire Missions	0
Air Strikes	26
Arc Light	0
VC/VCS Sighted	998
VC KIA	195
VC Captured	0
Weapons Captured	18

Patrol days performed (CHU LAI)

Patrol days possible for March	310
Patrol Days Performed	199
Patrolling Percentile	5.9

USMC Casualties (Chu Lai)

KIA	2
WIA	33

Enclosure (1)

-4-

REFERENCES



UNIT DIARY

	TO
H&S Company	125 - 105
"A" Company	118 - 85
"D" Company	97 - 85

A-1

Appendix A  
to Enclosure (1)



## A:

- #1: Bn Frag Order 52-67 dtd 3 Mar 67
- #2: Bn Frag Order 53-67 dtd 11 Mar 67
- #3: Bn Frag Order 54-67 dtd 17 Mar 67
- #4: Bn Frag Order 55-67 dtd 24 Mar 67
- #5: 4/1 Patrol Report dtd 1 Mar 67
- #6: 2/1 Co A Patrol Report dtd 1 Mar 67
- #7: 3/D Patrol Report dtd 2 Mar 67
- #8: 2/1 Patrol Report dtd 3 Mar 67
- #9: 6/1 Patrol Report dtd 4 Mar 67
- #10: 2/D Patrol Report dtd 4 Mar 67
- #11: 4/A Patrol Report dtd 4 Mar 67
- #12: Beacon Light "A" Patrol Report dtd 4 Mar 67
- #13: 3/A Patrol Report dtd 5 Mar 67
- #14: 1/A Patrol Report dtd 7 Mar 67
- #15: 4/1 Patrol Report dtd 8 Mar 67
- #16: 2/A Patrol Report dtd 8 Mar 67
- #17: 2/D Patrol Report dtd 10 Mar 67
- #18: 1/D Patrol Report dtd 11 Mar 67
- #19: 4/A Patrol Report dtd 11 Mar 67
- #20: 6/1 Patrol Report dtd 11 Mar 67
- #21: 3/D Patrol Report dtd 12 Mar 67
- #22: 2/1 Patrol Report dtd 13 Mar 67
- #23: 1st Sqd, 1/1 Patrol Report dtd 14 Mar 67
- #24: 3/A Patrol Report dtd 14 Mar 67
- #25: 4/1 Patrol Report dtd 14 Mar 67
- #26: 2/D Patrol Report dtd 15 Mar 67
- #27: 1st Sqd, 4/1 Patrol Report dtd 16 Mar 67
- #28: 4th/A Patrol Report dtd 16 Mar 67
- #29: 1/A Patrol Report dtd 16 Mar 67
- #30: 1/D Patrol Report dtd 17 Mar 67
- #31: 6/1 Patrol Report dtd 18 Mar 67
- #32: 3/A Patrol Report dtd 18 Mar 67
- #33: 2/D Patrol Report dtd 20 Mar 67
- #34: 2/1 Patrol Report dtd 20 Mar 67
- #35: 4/A Patrol Report dtd 20 Mar 67
- #36: 4/1 Patrol Report dtd 21 Mar 67
- #37: 1/A Patrol Report dtd 22 Mar 67
- #38: 3/D Patrol Report dtd 22 Mar 67
- #39: 2/A Patrol Report dtd 23 Mar 67
- #40: 6/1 Patrol Report dtd 23 Mar 67
- #41: 1/D Patrol Report dtd 24 Mar 67
- #42: 2/A Patrol Report dtd 24 Mar 67
- #43: 3/A Patrol Report dtd 25 Mar 67
- #44: 3/D Patrol Report dtd 26 Mar 67
- #45: 4/1 Patrol Report dtd 27 Mar 67
- #46: 2/1 Patrol Report dtd 27 Mar 67
- #47: 1/A Patrol Report dtd 27 Mar 67

- #48: 4/A Patrol Report dtd 28 Mar 67
- #49: 3/A Patrol Report dtd 29 Mar 67
- #50: 2/D Patrol Report dtd 30 Mar 67
- #51: 2/A Patrol Report dtd 20 Mar 67
- #52: 1/D Patrol Report dtd 30 Mar 67
- #53: 6/1 Patrol Report dtd 31 Mar 67

Copy No \_\_\_\_\_ of 15 Copies  
1st Reconnaissance Battalion  
 CHU LAI, RVN  
 031200H March 1967

1st Recon Bn Frag Order 52-67 to BnOpOrder 321-66

Ref: (a) Maps: VIETNAM, 1:50,000 AMS L701 Sheets 6657 I-IV, 6757 II, III  
 6656 I-IV, 6756 I-IV, 6755 I, IV  
 (b) BnOpOrder 321-66  
 (c) DivO P3800.LF (intelligence SOP)

**Tash Organization:**

1st Reconnaissance Battalion (-) (Rein)	LtCol D. N. MCKEON
Company "A"	Capt E. J. CONNELLY
Company "D"	1stLt R. S. ROBERTS
Detachment 1st Force Recon Company	Major M. D. CERRETA

**1. SITUATION**

**a. Enemy Forces.**

- (1) See Current ISUMS
- (2) AS briefed by Battalion S-2

**b. Attachments and Detachments: None**

**2. MISSION** 1st Reconnaissance Battalion conducts ground reconnaissance/observation in assigned areas of QUANG TIN and QUANG NGAI Provinces, RVN. See Annex A (Operation Overlay).

**3. EXECUTION**

**a. Concept of Operation** 1st Reconnaissance Battalion conducts ground reconnaissance within assigned sectors of QUANG TIN and QUANG NGAI Provinces, RVN. See Annex A (Operation Overlay) for assigned sector of reconnaissance. Additionally, other means of reconnaissance will be employed as available. Emphasis throughout the reconnaissance effort will be placed on:

- (1) Routes of egress and entry.
- (2) Lines of communications.
- (3) LZs suitable for exploitation forces.



(4) Verifying the Order of Battle.

(5) Location of major installations and facilities to include rest areas, command posts, communication facilities, hospitals, training areas and POW camps.

b. Company "A"

(1) Commencing 071000H - TBA March 1967 provide a platoon (DATELINE) to conduct observation vicinity BT 358045 and maintain surveillance of the surrounding area. Primary direction to the North and Northeast. Emphasis throughout the reconnaissance effort will be placed on those areas indicated in the Concept of Operations. Annex A (Operation Overlay) establishes your No Fire Zone.

(2) Commencing 110900H - TBA March 1967 provide a platoon (DONOHUE) to conduct observation from vicinity BS 635588 and maintain surveillance of the surrounding area. Emphasis throughout the reconnaissance effort will be placed on those areas indicated in the Concept of Operations. Annex A (Operation Overlay) establishes your No Fire Zone.

(3) Commencing 141430H - 161430H March 1967 provide a platoon (CLUBCAR) to conduct observation from vicinity BS 413849 and maintain surveillance of the surrounding area. The primary direction of observation is to the north of your assigned area. Emphasis throughout the reconnaissance effort will be placed on those areas indicated in the Concept of Operations. Annex A (Operation Overlay) establishes your No Fire Zone.

c. Company "D"

(1) Commencing 051500H - 190800 March 1967 provide a platoon (ANTI FREEZE) OPCON to 3/7 (Operation DE SOTO) for a period of about 15 days. Emphasis throughout the reconnaissance effort will be placed on those areas indicated in the Concept of Operations. Annex A (Operation Overlay) establishes your No Fire Zone.

(2) Commencing 061000H - TBA March 1967 provide a platoon (ANTI-FREEZE) to conduct observation from vicinity BS 447714 and maintain surveillance of the surrounding area. The primary direction of observation is to the North and Northeast of your assigned area. Emphasis throughout the reconnaissance effort will be placed on those areas indicated in the Concept of Operations. Annex A (Operation Overlay) establishes your No Fire Zone.

(3) Commencing 090900H - 120900H March 1967 provide a platoon (DUCK-BILL) to conduct observation at Montagnard outpost and maintain surveillance of the surrounding area. Emphasis throughout the reconnaissance effort will be placed on those areas indicated in the Concept of Operations. Annex A (Operation Overlay) establishes your No Fire Zone.

UNCLASSIFIED

(4) Commencing 110900H - 131000H March 1967 provide a platoon (BENINGTON) to conduct an OP in the vicinity of Hill 141 BT 664047 in support of infantry operations in that area and maintain surveillance of the surrounding area. Emphasis throughout the reconnaissance effort will be placed on those areas indicated in the Concept of Operations. Annex A (Operation Overlay) establishes your No Fire Zone.

d. Detachment 1st Force Recon Company

(1) Commencing 070800H - 091500H March 1967 provide a platoon (BEIPOST) to conduct observation from vicinity BT 432010 and maintain surveillance of the surrounding area. Emphasis throughout the reconnaissance effort will be placed on those areas indicated in the Concept of Operations. Annex A (Operation Overlay) establishes your No Fire Zone.

(2) Commencing 091100H - TPA March 1967 provide a platoon (APRIL-DATE) to conduct ground reconnaissance/observation vicinity BT 255062 and maintain surveillance of the surrounding area. Emphasis throughout the reconnaissance effort will be placed on those areas indicated in the Concept of Operations. Annex A (Operation Overlay) establishes your No Fire Zone.

(3) Commencing 101100H - 121000H March 1967 provide a platoon (HOIKONG) to conduct an OP vicinity of Hill 410 BS 452930 in support of 2/7 infantry operations in your area and maintain surveillance of the surrounding area. Emphasis throughout the reconnaissance effort will be placed on those areas indicated in the Concept of Operations. Annex A (Operation Overlay) establishes your No Fire Zone.

(4) Commencing 051000H - 071100H March 1967 provide a platoon (HOIKONG) to conduct observation from vicinity BT 098245 in support of 3/5 infantry operations in that area and maintain surveillance of the surrounding area. Emphasis throughout the reconnaissance effort will be placed on those areas indicated in the Concept of Operations. Annex A (Operation Overlay) establishes your No Fire Zone.

e. Coordination Instructions.

- (1) Report all sightings immediately to BEACON LIGHT.
- (2) SITREP every hour (unless otherwise directed), and monitor net continuously. With each SITREP submit POSITION REPORT, if "NO CHANGE", so state.
- (3) Code Names. See Radio Brevity Code.
- (4) All patrol leaders will insure that the following items are accomplished prior to departure.

UNCLASSIFIED

- [REDACTED]
- (a) Receive the intelligence brief from S-2.
- (b) Submit roster of personnel participating in operation to S-1.
- (c) Read Rules of Engagement IAW reference (c).
- (d) Submit preplanned concentrations and TPO-10's to S-3 if required.
- (e) Plan and coordinate one phase insert with each insertion.
- (f) Record of all MIKE designators.
- (g) Spot report guide.

(5) Supply caches will not be destroyed without approval of S-3. Samples (one quart) of rice will be kept and brought in with the patrol for further evaluation. Record DPG, location and circumstances of capture.

- (6) Be prepared to call and adjust artillery fire on targets of opportunity.
- (7) Be prepared to exploit with air.
- (8) Bury all trash, return all batteries.
- (9) LZ will be marked with yellow smoke.
- (10) When reporting utilize SALUTE format.
- (11) Emphasis on EEI's.
- (12) Report to S-2 upon extraction for debriefing.

(13) <u>PATROL</u>	<u>INSERTION</u>	<u>EXTRACTION</u>	<u>THRUST POINT</u>
DATELINE	071000H	TBA	A-3406 B-380
DONOHUE	110900H	TBA	A-6259 B-675
CLUB CAR	101330H	121300H	A-4087 B-448
ANTI FREEZE	051500H	190800H	A- N/A B- N/
BENNINGTON	061000H	TBA	A-4373 B-477
DUCKBILL	090900H	120900H	A-6259 B-675

BENNINGTON	110900H	131000H	A-6605 B-6704
HONG KONG	051100H	071100H	A-0926 B-112
BEDPOST	070800H	091500H	A-3902 B-44
APRIL DATE	091100H	TBA	A-2312 B-28
HONG KONG	101100H	121100H	A-4396 B-47

NO FIRE ZONES

3403, 3407, 3807, 3803

6255, 6260, 6755, 6760

4084, 4088, 4484, 4488

N/A , N/A , N/A , N/A

4369, 4374, 4769, 4774

6255, 6260, 6755, 6760

6604, 6605, 6704, 6705

0924, 0926, 1124, 1126

3903, 3999, 4403, 4499

2308, 2313, 2898, 2813

4392, 4397, 4792, 4797

(14) Caution all troops to be alert for AP mines, and booby traps. When found give type of mine/booby trap, method of emplacement, siting, method of detonation, whether destroyed or disarmed. Lives of unqualified personnel will not be endangered to determine any of the above information.

4. ADMINISTRATION AND LOGISTICS

a. See 1st Recon Bn AdminO 324-66

b. Special Equipment

- (1) One signal mirror per team.
- (2) One flashlight per team.
- (3) One day/night flare per team.

- (4) Minimum of 10 CS grenades per platoon and one gas mask per man.
- (5) Air panels.
- (6) Two Strobe Light indicators per team.
- (7) BC Scope as required.
- (8) Star Light Scope as required.
- (9) Two 50 ft lines per platoon.

5. COMMAND COMMUNICATIONS-ELECTRONICS.

- a. See reference (b).
- b. Command Post. Command post positions are as set forth in reference (b).
- c. The following communications support provided by Communications Section H&S Company.

(1) Establish and maintain communications on the following:

- (a) Bn TAC
  - 39.5
  - 44.3
  - 50.6
  - 51.1
  - 51.7
- (b)
  - 35.5
  - ~~39.1~~
  - 37.0
  - 34.4
  - 34.2
  - 35.8

- (2) Provide artillery liaison personnel as required.
- (3) Maintain radio-relay stations as presently established.
- d. Authentication and shackles in accordance with reference (b).
- e. Reporting Schedule. Deployed elements will report at least every 1 hour. All situation reports will be accompanied by a position report. Thrust line method will be used whenever possible.
- f. AO support for radio-relay provided on request.

g. Resupply of comm-elec items provided on request. 24 hour lead time is desired.

BY COMMAND OF LIEUTENANT COLONEL McKEON

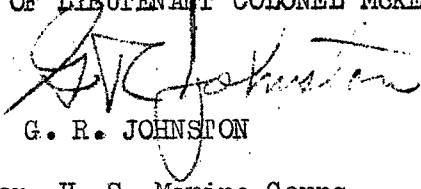
  
G. R. JOHNSON

Major, U. S. Marine Corps

Executive Officer

ANNEXES:

A-- Operation Overlay

DISTRIBUTION: Annex X (Distribution), to 1st Recon Bn OpOrder 321-66

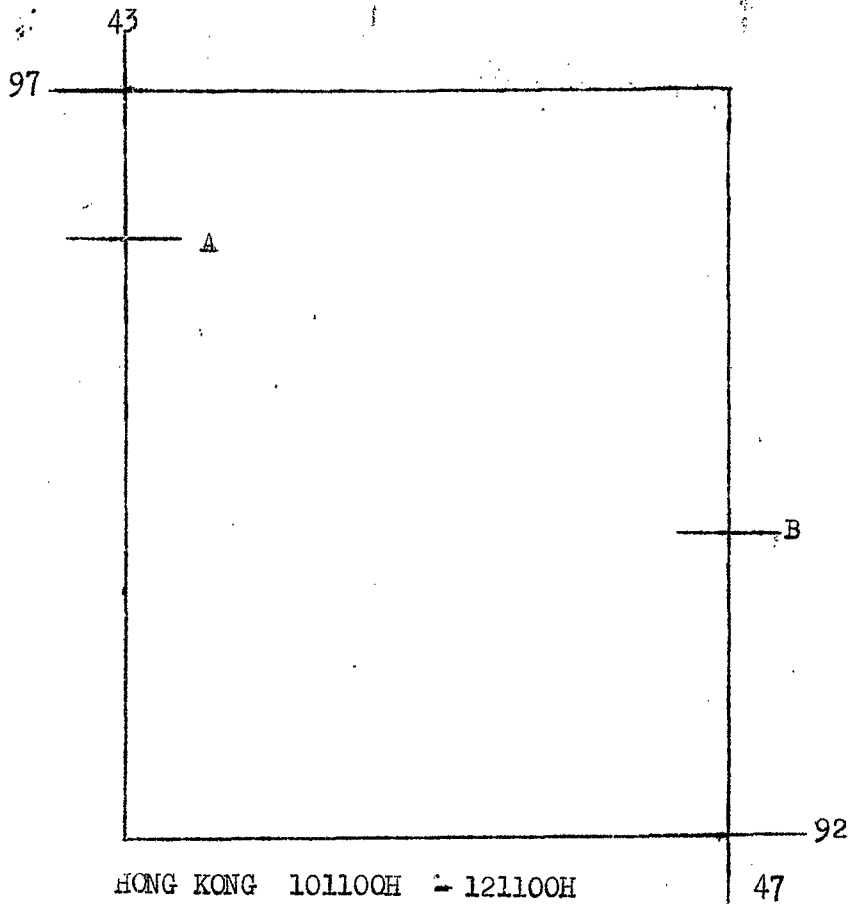

ANNEX A TO FRAG ORDER 52-67  
 1st Recon Bn OpO 321-66

1st Reconnaissance Battalion  
 CHU LAI, RVN

Maps: VIETNAM, 1:50,000, AMS L701  
 Sheets 6657 I-IV, 6757 II, III  
 6656 I-IV, 6756 I-IV, 6755 I, IV

031200H March 1967

BY COMMAND OF LIEUTENANT COLONEL MCKEON

*R. A. Carnes*  
 R. A. CARNES

Capt, U. S. Marine Corps

Operation Officer

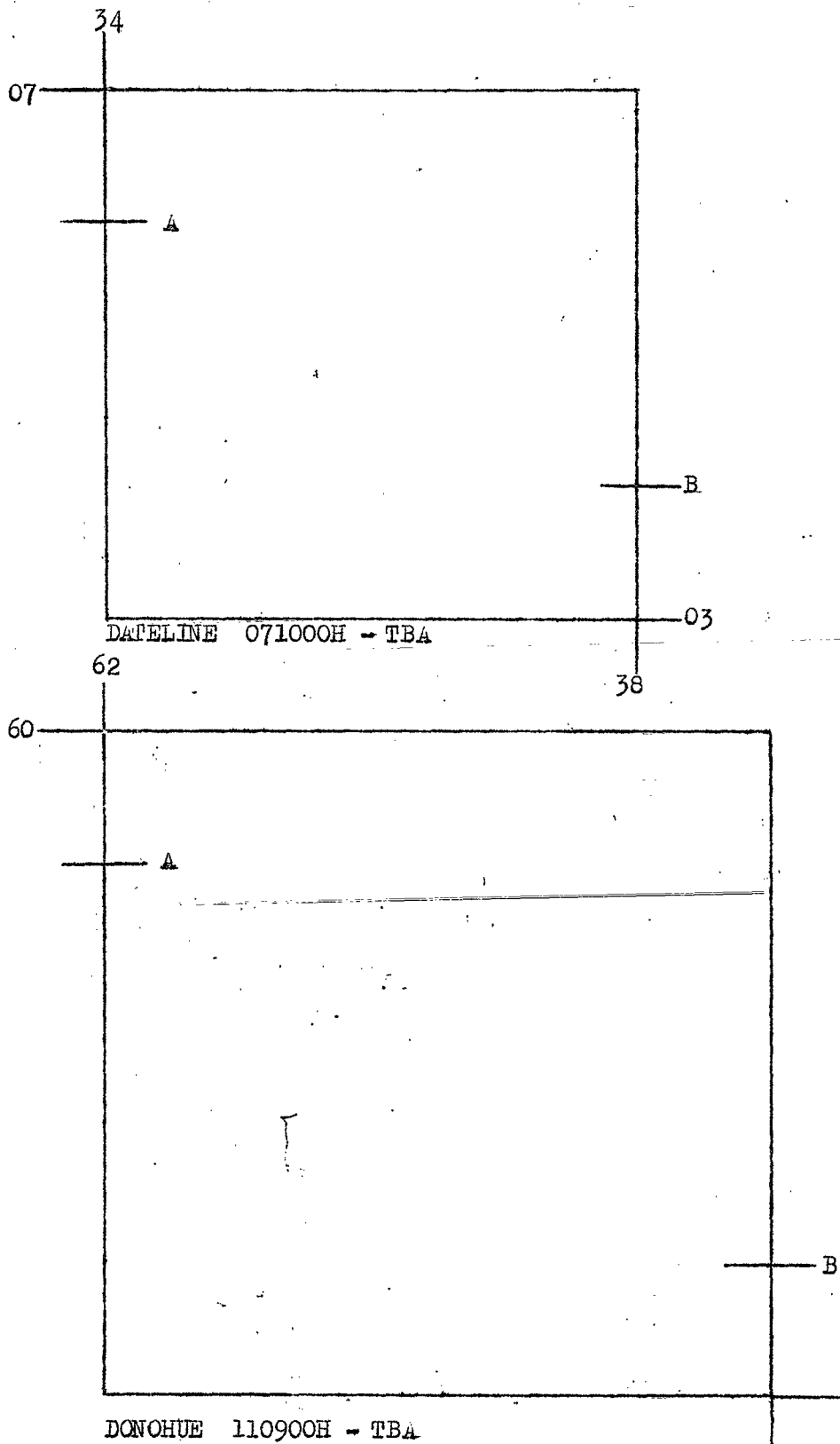



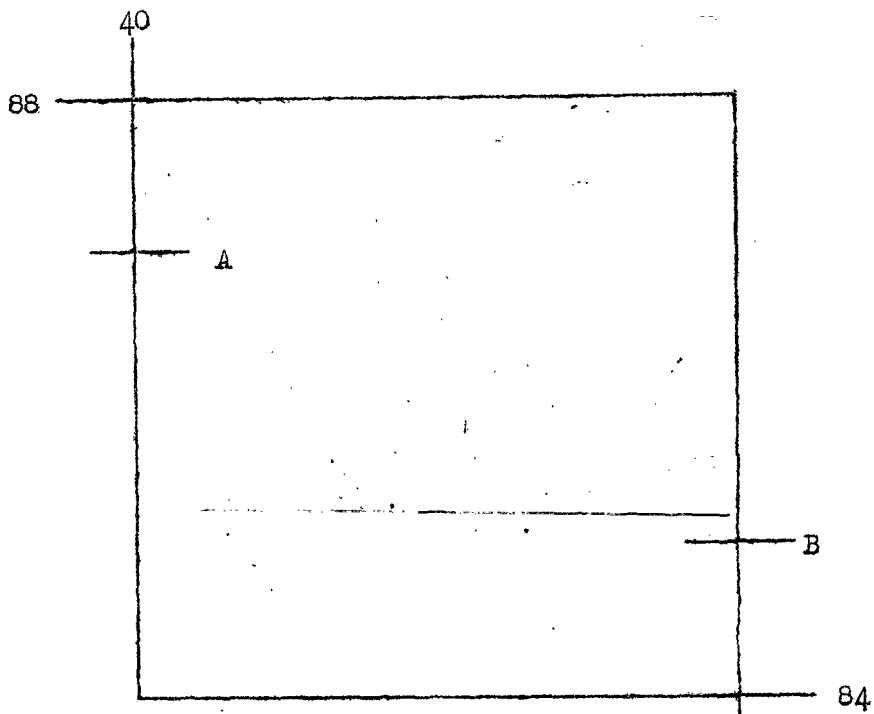

CLUB CAR 101330H - 121300H

ANTI FREEZE'S NO FIRE  
ZONE IS N/A.  
051500H - 190800H

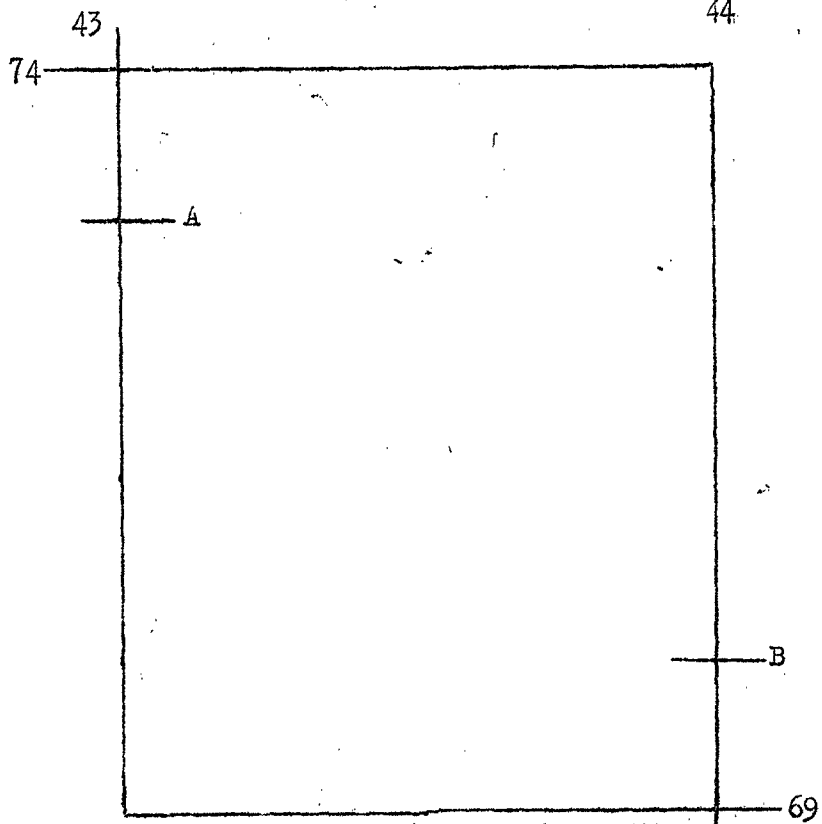

BENNINGTON 06100CE - TBA.

47

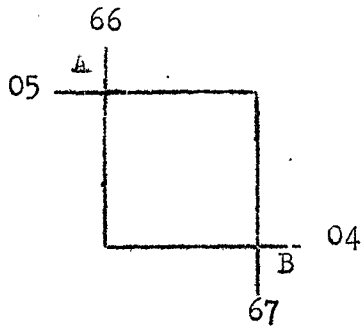
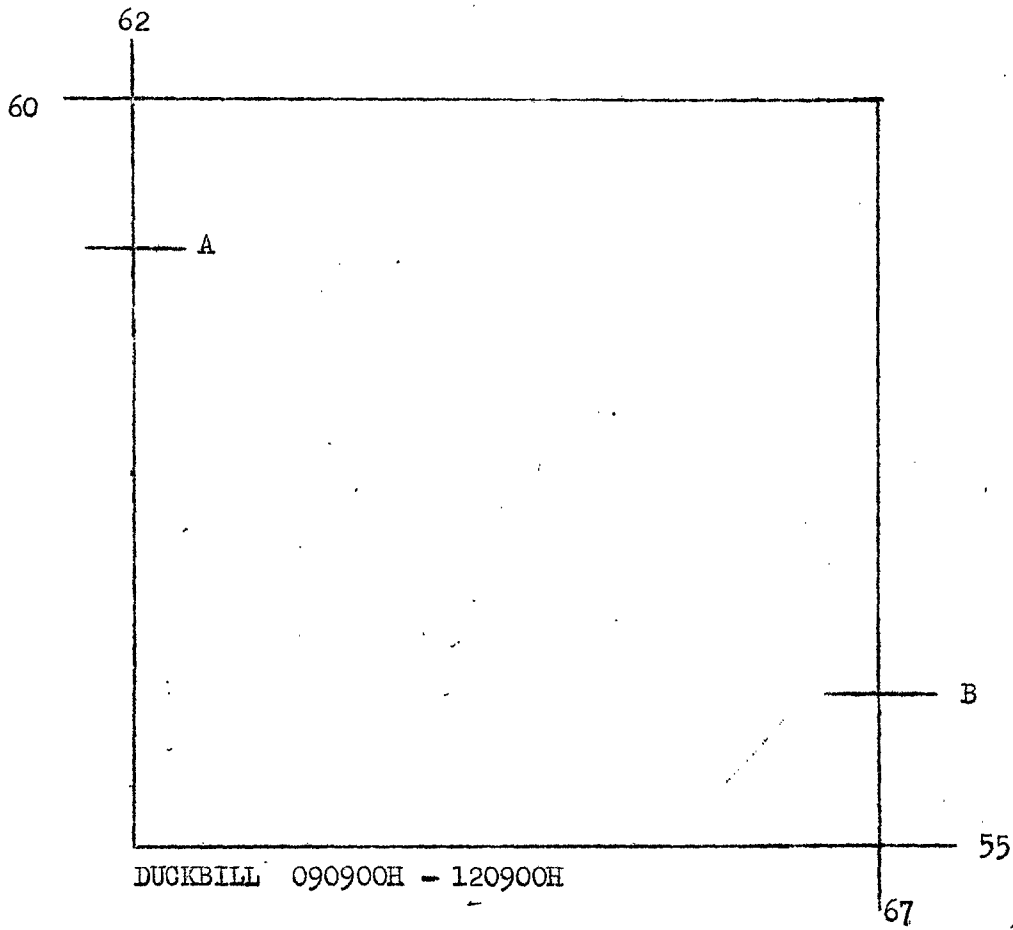

BENNINGTON 110900H - 131000H

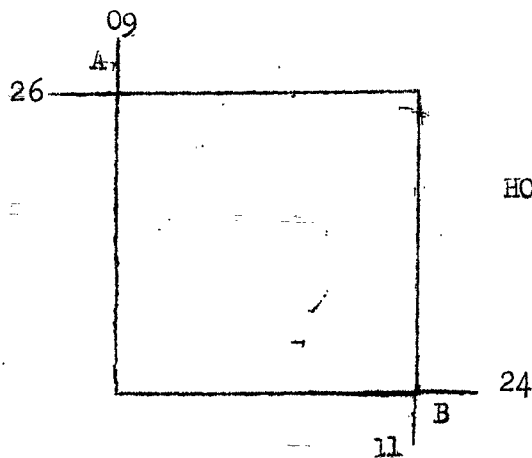

HONG KONG 051000H  
071100H

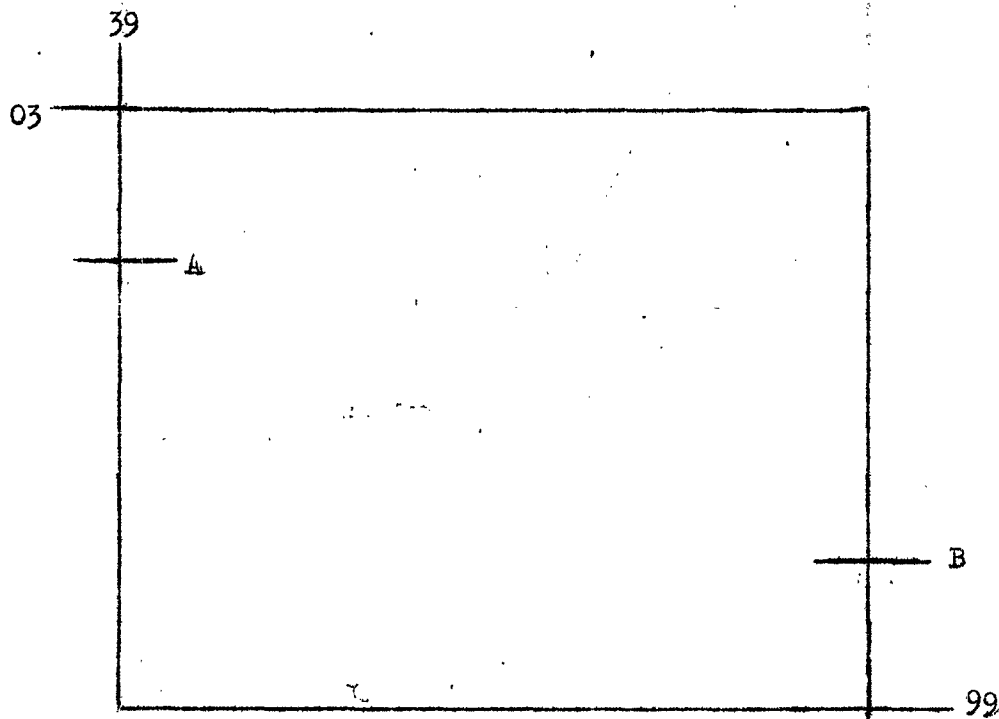

BEDPOST 070800H - 091500H

44

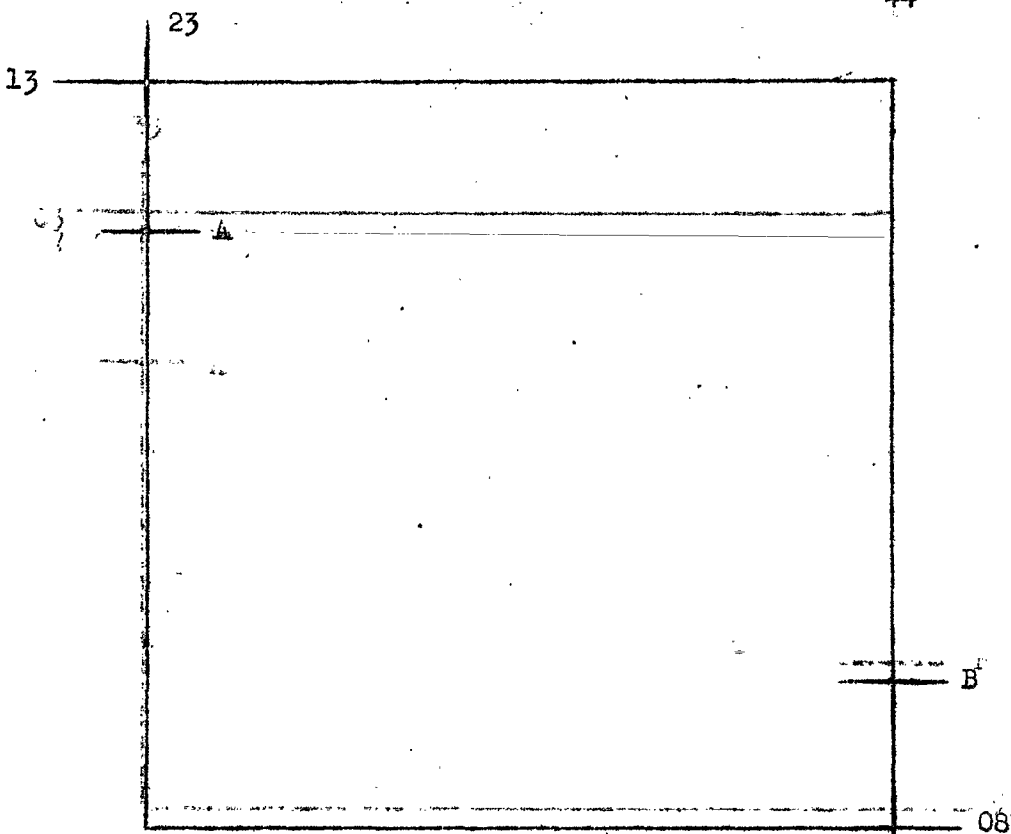

BEDPOST 091100H - TBA

28

Copy No \_\_\_\_\_ of 15 Copies  
 1st Reconnaissance Battalion  
 CHU LAI, RVN  
 111200H March 1967

1st Recon Bn Frag Order 53-67 to BnOpOrder 321-66

Ref: (a) Maps: VIETNAM, 1:50,000, AMS L701 Sheets 6657 I-IV, 6757 II, III  
 6656 I-IV, 6756 I-IV, 6755 I, IV

- (b) BnOpOrder 321-66  
 (c) DivO P3800.1F (Intelligence SOP)

Task Organization

1st Reconnaissance Battalion (-) (Rein)	LtCol D. N. McKEON
Company "A"	Capt E. J. CONNELLY
Company "D"	1stLt R. S. ROBERTS
Detachment 1st Force Recon Company	Major M. D. CERRETA

1. SITUATION

a. Enemy Forces

- (1) See current ISUMS
- (2) As briefed by Battalion S-2

b. None

2. MISSION 1st Reconnaissance Battalion conducts ground reconnaissance/observation in assigned areas of QUANG TIN and QUANG NGAI Provinces, RVN. See Annex A (Operation Overlay).

3. EXECUTION

a. Concept of Operations. 1st Reconnaissance Battalion conducts ground reconnaissance within assigned sectors of QUANG TIN and QUANG NGAI Provinces, RVN. See Annex A (Operation Overlay) for assigned sectors of reconnaissance. Additionally, other means of reconnaissance will be employed as available. Emphasis throughout the reconnaissance effort will be placed on:

- (1) Routes of egress and entry.
- (2) Lines of Communications.
- (3) LZ's suitable for exploitation forces.

UNCLASSIFIED

(4) Verfyng the Order of Battle.

(5) Location of major installations and facilities to include rest areas, command posts, communication facilities, hospitals, training areas and POW camps.

b. Company "A"

(1) Commencing 121000H - 211000H March 1967 provide a platoon (CRANKCASE) to conduct reconnaissance in support of Operation DE SOTO for a period of about 10 days. Emphasis throughout the reconnaissance effort will be placed on those areas indicated in the Concept of Operations. Annex A (Operation Overlay) establishes your No Fire Zone.

(2) Commencing 141430H - 161430H March 1967 provide a platoon (DAI LINE) to conduct observation from vicinity BT 286043 and maintain surveillance of the surrounding area. The primary direction of observation is to the North and Northeast of your assigned area. Emphasis throughout the reconnaissance effort will be placed on those areas indicated in the Concept of Operations. Annex A (Operation Overlay) establishes your No Fire Zone.

(3) Commencing 160700H - 250900H March 1967 provide a platoon (BASKETBALL) to conduct reconnaissance in support of Operation DE SOTO for a period of about 10 days. Emphasis throughout the reconnaissance effort will be placed on those areas indicated in the Concept of Operations. Annex A (Operation Overlay) establishes your No Fire Zone.

c. Company "D"

(1) Commencing 120800H - 150900H March 1967 provide a platoon (BELLINGTON) to conduct observation from vicinity BT 388034 and maintain surveillance of the surrounding PHUOC KHACK Valley. Emphasis throughout the reconnaissance effort will be placed on those areas indicated in the Concept of Operations. Annex A (Operation Overlay) establishes your No Fire Zone.

(2) Commencing 140800H - 161400H March 1967 provide a platoon (DUB BILL) to conduct ground reconnaissance/observation from vicinity BS 333963, and maintain surveillance of the surrounding area. Emphasis throughout the reconnaissance effort will be placed on those areas indicated in the Concept of Operations. Annex A (Operation Overlay) establishes your No Fire Zone.

(3) Commencing 161300H - 201300H March 1967 provide a platoon (WINTER FREEZE) to conduct observation from vicinity BS 635588 and maintain surveillance of the area surrounding the Montagnard Outpost. Emphasis throughout the reconnaissance effort will be placed on those areas indicated in the Concept of Operations. Annex A (Operation Overlay) establishes your No Fire Zone.

UNCLASSIFIED

d. Detachment 1st Force Recon Company

(1) Commencing 120900H - 141300H March 1967 provide a platoon (CONSULATE) to conduct ground reconnaissance/observation vicinity BT 245060 and maintain surveillance of the BONG MIEU and CO BAY area. Emphasis throughout reconnaissance effort will be placed on those areas indicated in the Concept of Operations. Annex A (Operation Overlay) establishes your No Fire Zone.

(2) Commencing 130800H - TBA March 1967 provide a platoon (DIAGNOSIS) to conduct ground reconnaissance/observation from vicinity BS 390944 and maintain surveillance of the surrounding area. Emphasis throughout the reconnaissance effort will be placed on those areas indicated in the Concept of Operations. Annex A (Operation Overlay) establishes your No Fire Zone.

(3) Commencing 150800H - TBA March 1967 provide a platoon (BEDPOST) to conduct ground reconnaissance/observation vicinity BT 245084 and maintain surveillance of the surrounding area. Emphasis throughout the reconnaissance effort will be placed on those areas indicated in the Concept of Operations. Annex A (Operation Overlay) establishes your No Fire Zone.

(4) Commencing 161100H 181500H March 1967 provide a platoon (APRIL DATE) to conduct observation on trails in grid square BT 3103 and maintain surveillance of the surrounding area. Emphasis throughout the reconnaissance effort will be placed on those areas indicated in the Concept of Operations. Annex A (Operation Overlay) establishes your No Fire Zone.

e. Coordination Instructions

(1) Report all sightings immediately to BEACON LIGHT.

(2) SITREP every hour (unless otherwise directed), and monitor net continuously. With each SITREP submit a POSITION REPORT, if "NO CHANGE", so state.

(3) All patrol leaders will insure that the following actions are accomplished prior to departure:

(a) Receive the intelligence brief from S-2.

(b) Submit rosters of personnel participating in operation to S-1 and S-3.

(c) Read Rules of Engagement LAW reference (c).

(d) Submit preplanned concentrations and TPQ-10's to S-3 if required.

(e) Plan and coordinate one phase insert with each insertion.

(f) Record of all MIKE designators.

(g) Spot report guide.

(5) Supply caches will not be destroyed without the approval of S-3, samples (one quart) of rice will be kept and brought in with the patrol for further evaluation. Record DTG, location and circumstances of capture.

(6) Be prepared to call and adjust artillery fire on targets of opportunity.

(7) Be prepared to exploit with air.

(8) Bury all trash. return all batteries.

(9) LZ will be marked with yellow smoke.

(10) When reporting utilize SALUTE format.

(11) Emphasis on EET's.

(12) Report to S-2 upon extraction for debriefing.

(13). <u>PATROL</u>	<u>INSERTION</u>	<u>EXTRACTION</u>	<u>THRUST POINT</u>
CRANKCASE	121000H	211000H	A-N/A B-N/A
DATELINE	141430H	TBA	A-2706 B-310
BASKETBALL	160700H	250900H	A-N/A B-N/A
BENNINGTON	120800H	150900H	A-3604 B-400
DUCKBILL	140800H	161400H	A-3102 B-350
ANTI FREEZE	161300H	Ø 1300H	A-6259 B-675
CONSULATE	120900H	141300H	A-2307 B-280
DIAGNOSIS	130800H	TBA	A-2595 B-409
BEDPOST	150800H	TBA	A-2209 B-26C
APRILDATE	161100H	181500H	A-2804 B-32C

NO FIRE ZONES

N/A , N/A , N/A , N/A

2703, 2708, 3103, 3108

N/A , N/A , N/A , N/A

3606, 3601, 4006, 4001

3103, 3196, 3503, 3596

6255, 6260, 6755, 6760

2303, 2307, 2803, 2807

3593, 3596, 4093, 4096

2206, 2210, 2606, 2610

2801, 2805, 3201, 3205

(14) Caution all troops to be alert for AP mines and booby traps. When found give type of mine/booby trap, method of emplacement, siting, method of detonation, whether destroyed or disarmed. Lives of unqualified personnel will not be endangered to determine any of the above information.

4. ADMINISTRATION AND LOGISTICS

a. See 1st Recon Bn AdminO 324-66

b. Special Equipment.

- (1) One signal mirror per team.
- (2) One flashlight per team.
- (3) One day/night flare per team.
- (4) Minimum of 10 CS grenades per platoon and one gas mask per man.
- (5) Air panels.
- (6) Two Strobe Light indicators per platoon.
- (7) BC Scope as required.
- (8) Star Light Scope as required.
- (9) Two 50 ft lines per platoon.



5. COMMAND COMMUNICATIONS-ELECTRONICS

- a. See reference (b).
- b. Command Post. Command Post position are as set forth in reference (b).
- c. The following communications support provided by Communications Section H&S Company.
- (1) Establish and maintain communications on the following:
 

(a) Bn TAC	39.5
	50.6
	51.1
	51.7
(b) Artillery	35.5
	39.1
	37.0
	34.4
	34.2
	35.8
  - (2) Provide artillery liaison personnel as required.
  - (3) Maintain radio-relay stations as presently established.
- d. Authentication and shackles in accordance with reference (b).
- e. Reporting Schedule. Deployed elements will report at least every hour. All situation reports will be accompanied by a position report. Thrust line method will be utilized whenever possible.
- f. AO support for radio-relay provided on request.
- g. Resupply of comm-elec items provided on request. 24 hour lead time is desired.

BY COMMAND OF LIEUTENANT COLONEL McKEON

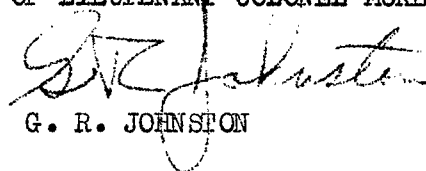

G. R. JOHNSTON

Major, U. S. Marine Corps

Executive Officer

ANNEXES:

A - Operation Overlay

DISTRIBUTION: Annex X (Distribution) to 1st Recon Bn OpOrder 321-66

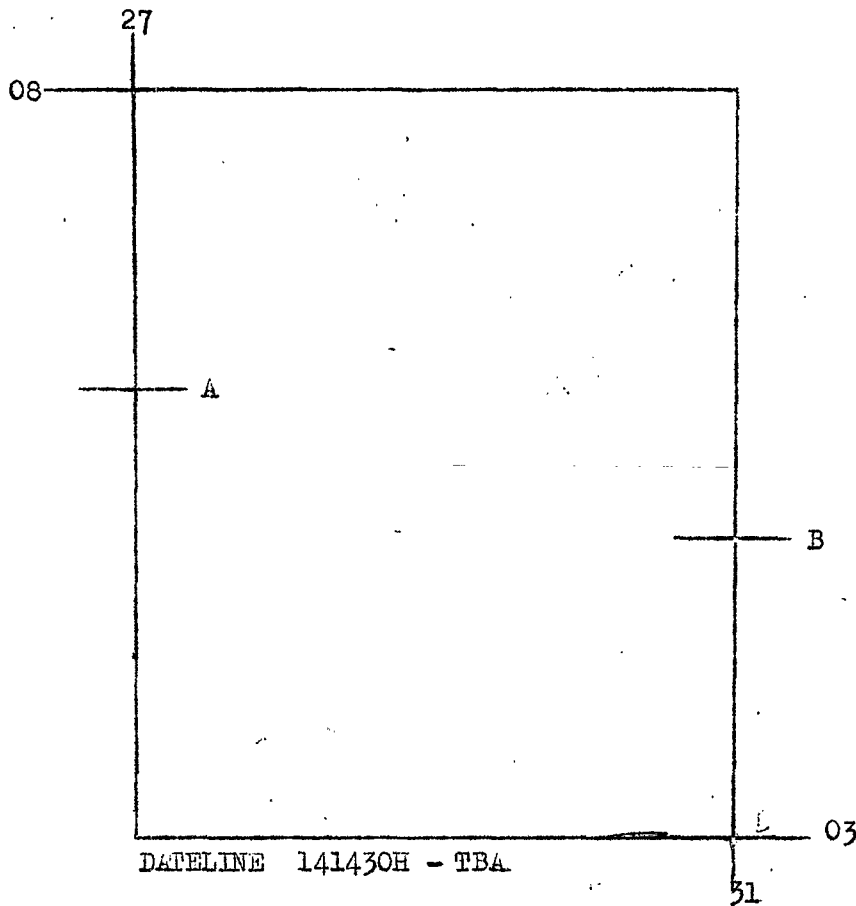

GRANKCASE'S NO FIRE ZONE  
IS N/A  
121000H - 211000H

BASKETBALL'S NO FIRE ZONE  
IS N/A  
160700H - 250900H

ANNEX A TO FRAG ORDER 53-67  
1st Recon Bn OpO 321-66

1st Reconnaissance Battalion  
CHU LAI, RVN

Maps: VIETNAM, 1:50,000, AMS L701  
Sheets 6657 I-IV, 6757 II, III  
6656 I-IV, 6756 I-IV, 6755 I, IV

111200H March 1967

BY COMMAND OF LIEUTENANT COLONEL McKEON

*R. A. Carnes*  
R. A. CARNES

Capt, U. S. Marine Corps

Operation Officer

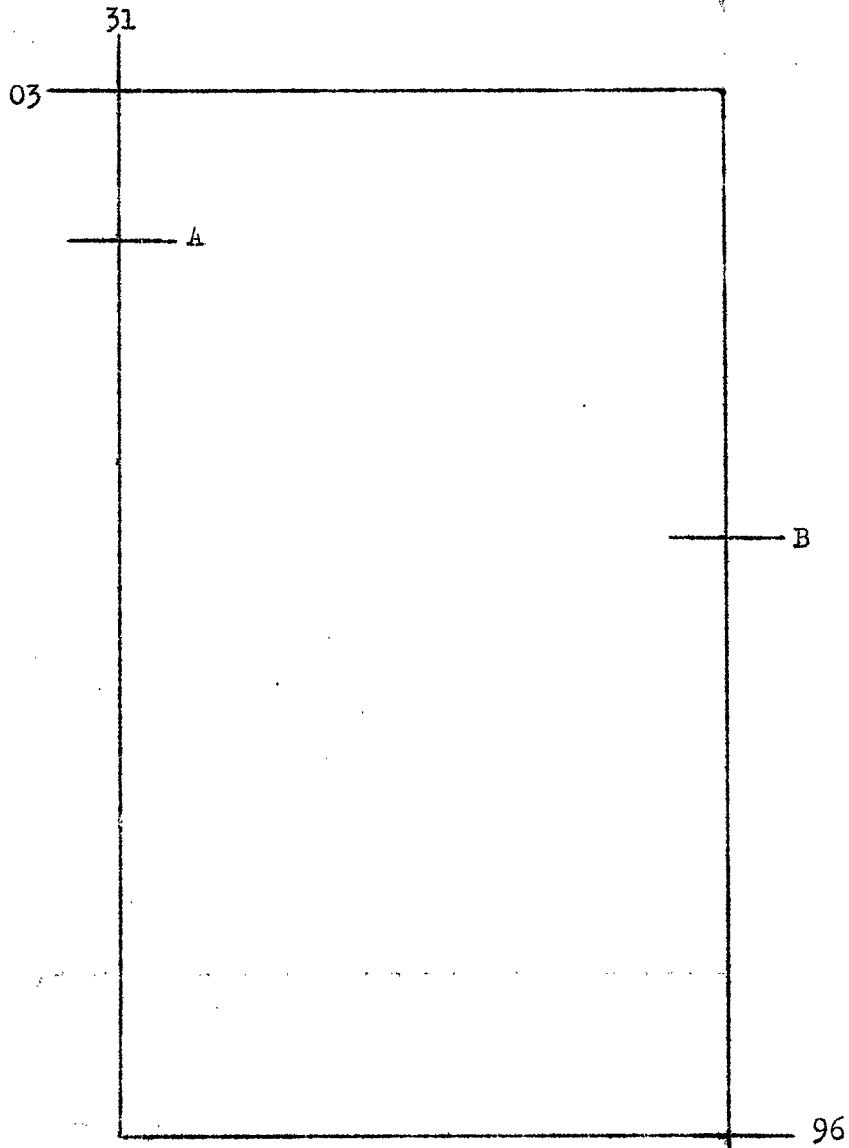

DUCKBILL 140800H - 161400H

35

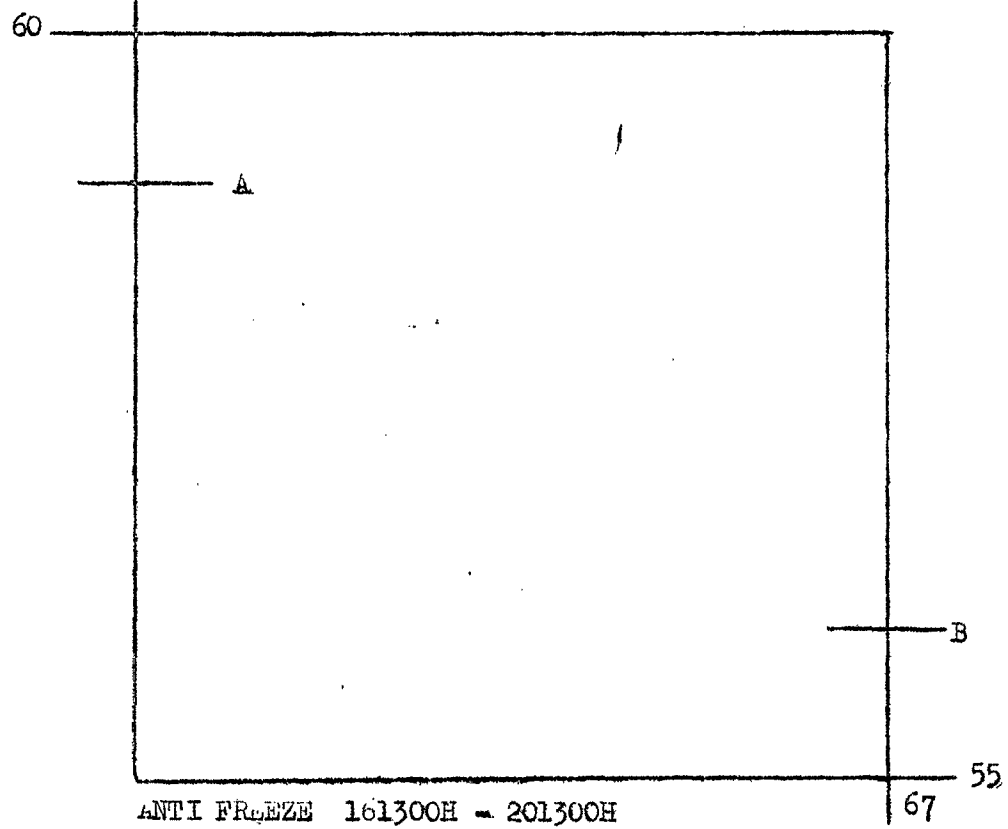
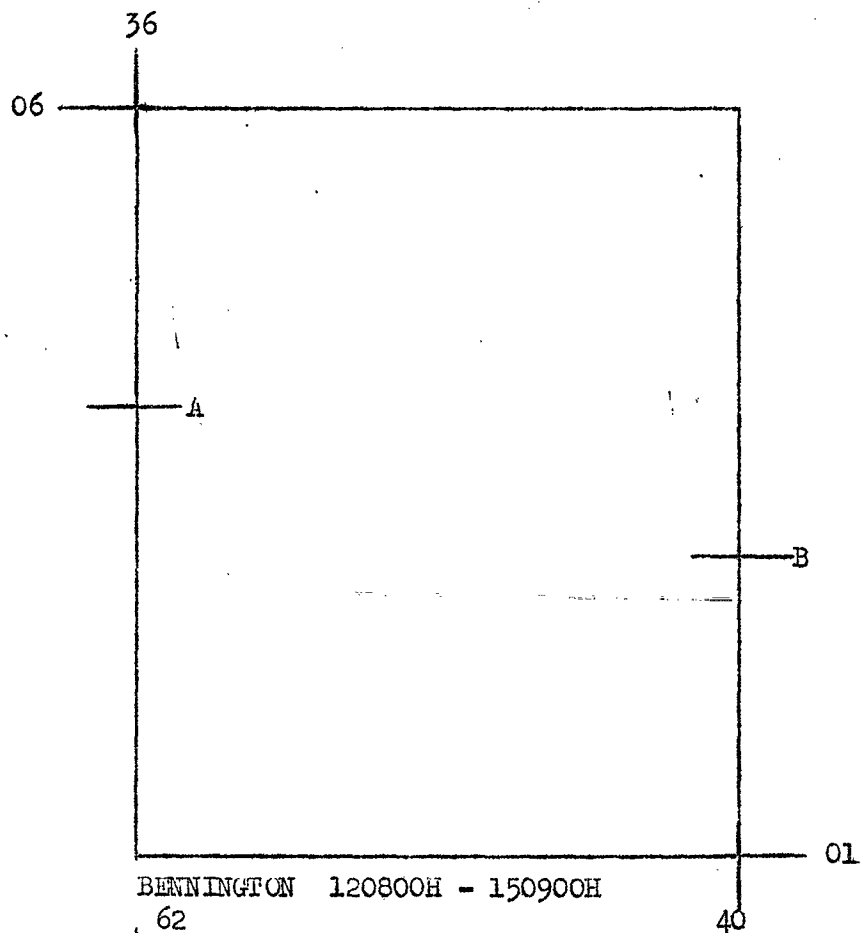

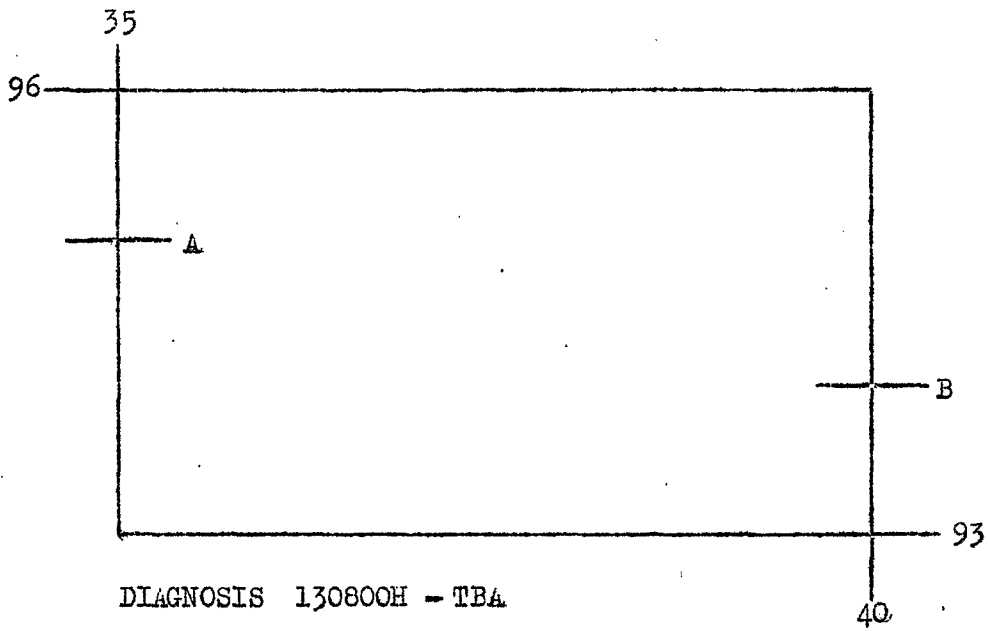
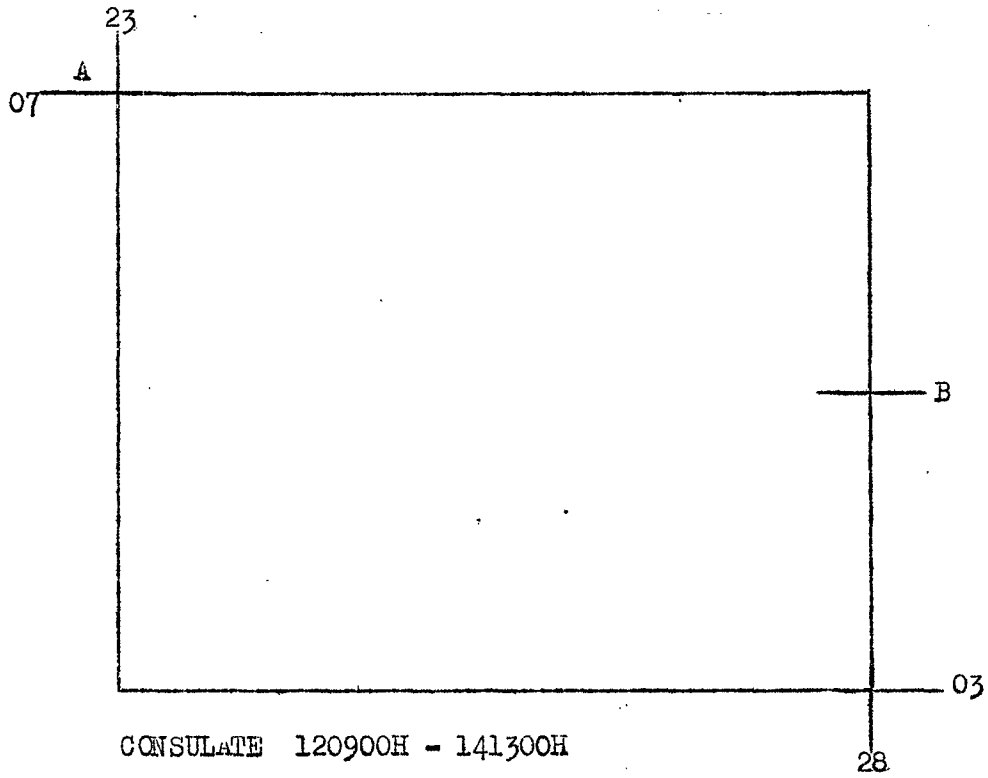

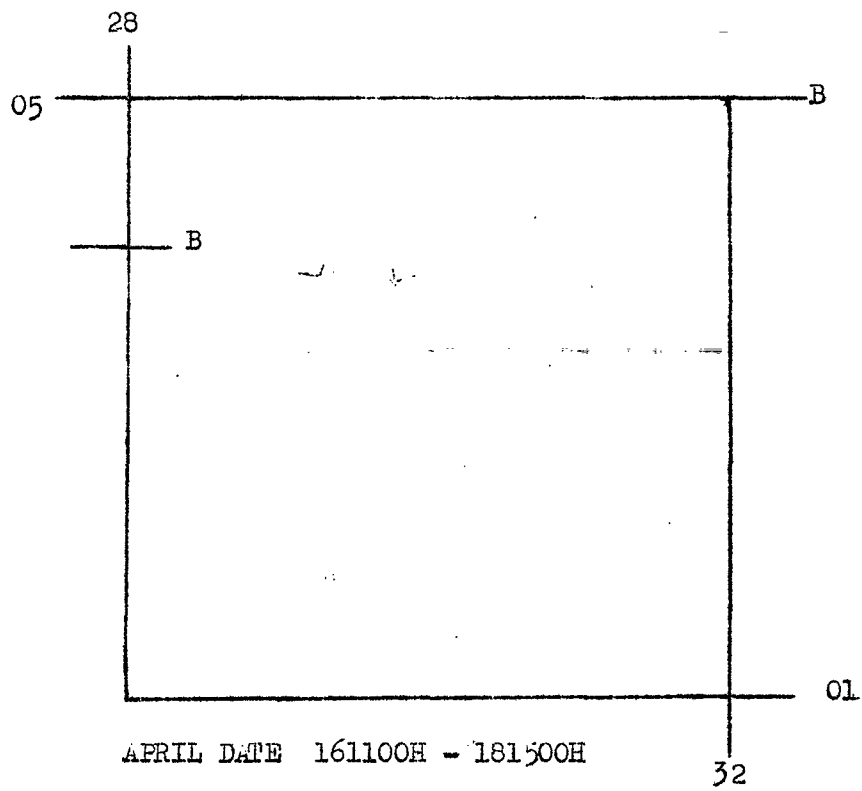
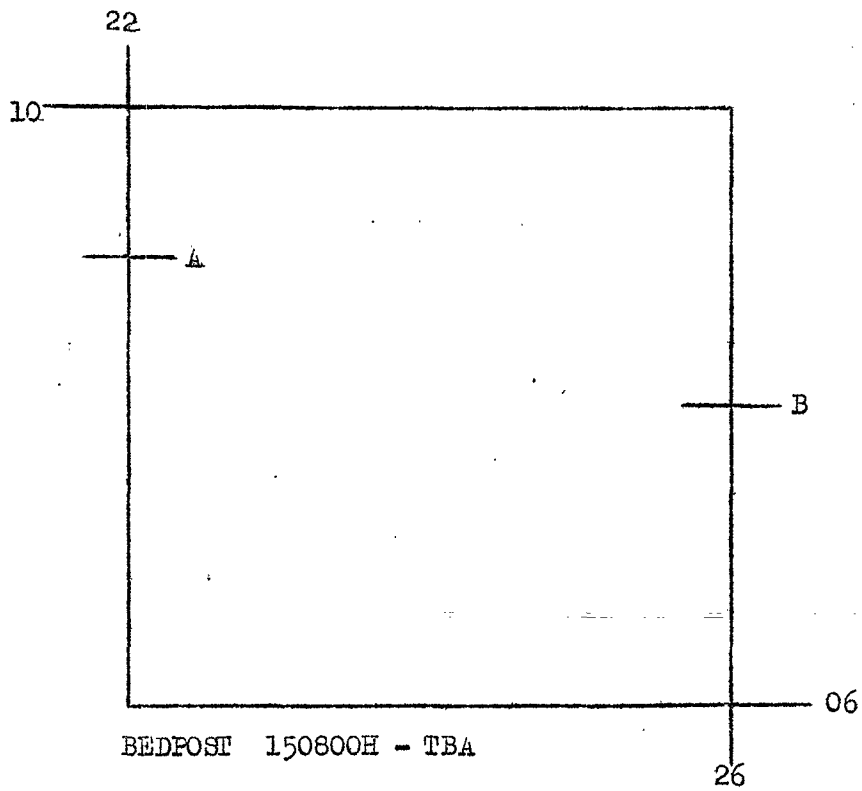

Copy No \_\_\_\_\_ of 15 Copies  
 1st Reconnaissance Battalion  
 CHU LAI, RVN  
 171200H March 1967

1st Recon Bn Frag Order 54-67 to BnOpOrder 321-66

Ref: (a) Maps: VIETNAM, 1:50,000, AMS L701 Sheets 6657 I-IV, 6757 II, III  
 6656 I-IV, 6756 I-IV, 6755 I, IV

- (b) BnOpOrder 321-66  
 (c) DivO P3800.1F (Intelligence SOP)

Task Organization

1st Reconnaissance Battalion (-) (Rein)	LtCol D. N. McKEON
Company "A"	Capt E. J. CONNELLY
Company "D"	1stLt R. S. ROBERTS
Detachment 1st Force Recon Company	Major M. D. CERRETA

1. SITUATION

a. Enemy Forces

- (1) See current ISUMS
- (2) As briefed by Battalion S-2

b. None

2. MISSION 1st Reconnaissance Battalion conducts ground reconnaissance/observation in assigned areas of QUANG TIN and QUANG NGAI Provinces, RVN. See Annex A (Operation Overlay).

3. EXECUTION

a. Concept of Operations. 1st Reconnaissance Battalion conducts ground reconnaissance within assigned sectors of QUANG TIN and QUANG NGAI Provinces, RVN. See Annex A (Operation Overlay) for assigned sector of reconnaissance. Additionally, other means of reconnaissance will be employed as available. Emphasis throughout the reconnaissance effort will be placed on:

- (1) Routes of egress and entry.
- (2) Lines of communications.
- (3) LZ's suitable for exploitation forces.



UNCLASSIFIED

(4) Verifying the Order of Battle.

(5) Location of major installations and facilities to include rest areas, command posts, communication facilities, hospitals, training areas and POW camps.

b. Company "A"

(1) Commencing 180900H - 211530H March 1967 provide a platoon (DOE OHUE) to conduct observation from hill 707 vicinity BS 445925 and maintain surveillance of the surrounding area. Emphasis throughout the reconnaissance effort will be placed on those areas indicated in the Concept of Operations. Annex A (Operation Overlay) establishes your No Fire Zone.

(2) Commencing 190700H - 290900H March 1967 provide a platoon (DAI LINE) to conduct reconnaissance in support of Operation DE SUTO for a period of about 10 days. The primary direction of observation is to the North and East of your assigned area. Emphasis throughout the reconnaissance effort will be placed on those areas indicated in the Concept of Operation. Annex A (Operation Overlay) establishes your No Fire Zone.

(3) Commencing 190900H - 220900H March 1967 provide a platoon (CRANKCASE) to conduct observation from vicinity BS 445929 and maintain surveillance of the surrounding area. Emphasis throughout the reconnaissance effort will be placed on those areas indicated in the Concept of Operations. Annex A (Operation Overlay) establishes your No Fire Zone.

(4) Commencing 221000H - 251300H March 1967 provide a platoon (BAS KETBALL) to conduct observation from vicinity BS 418998 and maintain surveillance of the surrounding area. Emphasis throughout the reconnaissance effort will be placed on those areas indicated in the Concept of Operations. Annex A (Operation Overlay) establishes your No Fire Zone.

c. Company "D"

(1) Commencing 181000H - 211600H March 1967 provide a platoon (BEN INGTON) to conduct ground reconnaissance/observation from vicinity BS 325935 and maintain surveillance of the surrounding area. Emphasis throughout the reconnaissance effort will be placed on those areas indicated in the Concept of Operations. Annex A (Operation Overlay) establishes your No Fire Zone.

(2) Commencing 210900H - TBA March 1967 provide a platoon (DUCK-BILL) to conduct ground reconnaissance/observation from vicinity BT 341012 and maintain surveillance of the surrounding area. Emphasis throughout the reconnaissance effort will be placed on those areas indicated in the Concept of Operations. Annex A (Operation Overlay) establishes your No Fire Zone.

UNCLASSIFIED

(3) Commencing 220900H - TBA March 1967, provide a platoon (BENN-INGTON) to conduct ground reconnaissance/observation from vicinity BS 454817 and maintain surveillance of the surrounding area. Emphasis throughout the reconnaissance effort will be placed on those areas indicated in the Concept of Operations. Annex A (Operation Overlay) establishes your No Fire Zone.

d. Detachment 1st Force Recon Company

(1) Commencing 181100H - 201500H March 1967 provide a platoon (COSULATE) to conduct ground reconnaissance/observation from vicinity BT 262048 and maintain surveillance of the surrounding area. Emphasis throughout the reconnaissance effort will be placed on those areas indicated in the Concept of Operations. Annex A (Operation Overlay) establishes your No Fire Zone.

(2) Commencing 210800H - TBA March 1967 provide a platoon (BEDFORD) to conduct ground reconnaissance/observation from vicinity BT 263107 and maintain surveillance of the surrounding area. Emphasis throughout the reconnaissance effort will be placed on those areas indicated in the Concept of Operations. Annex A (Operation Overlay) establishes your No Fire Zone.

(3) Commencing 221300H - 271300H March 1967 provide a platoon (HOKONG) to conduct observation from vicinity BS 635588 at Montagnard Outpost and maintain surveillance of the surrounding area. Emphasis throughout the reconnaissance effort will be placed on those areas indicated in the Concept of Operations. Annex A (Operation Overlay) establishes your No Fire Zone.

e. Coordination Instructions

(1) Report all sightings immediately to BEACON LIGHT.

(2) SITREP every hour (unless otherwise directed), and monitor net continuously. With each SITREP submit a POSITION REPORT, if "NO CHANGE" so state.

(3) All patrol leaders will insure that the following actions are accomplished prior to departure:

(a) Receive the intelligence brief from S-2.

(b) Submit roster of personnel participating in operation to S-1 and S-3.

(c) Read Rules of Engagement IAW reference (c).

(d) Submit preplanned concentrations and TPO's to S-3 if required.

(e) Plan and coordinate one phase insert with each insertion.

(f) Record of all MIKE designators.

(g) Spot report guide.

(5) Supply caches will not be destroyed without the approval of S-3, samples (one quart) of rice will be kept and brought in with patrol for further evaluation. Record all DTG, location and circumstances of capture.

(6) Be prepared to call and adjust artillery fire on targets of opportunity.

(7) Be prepared to exploit with air.

(8) Bury all trash, return all batteries.

(9) LZ will be marked with yellow smoke.

(10) When reporting utilize SALUTE format.

(11) Emphasis on EEI's.

(12) Report to S-2 upon extraction for debriefing.

(13)	<u>PATROL</u>	<u>INSERTION</u>	<u>EXTRACTION</u>	<u>THRUST POINTS</u>
	DONOHUE	180900H	211530H	A-4395 B-4693
	DATELINE	170700H	290900H	A- N/A B- N/A
	CRANKCASE	190900H	220900H	A-4395 B-4693
	BASKETBALL	221000H	251300H	A-4395 B-4693
	BENNINGTON	181000H	211600H	A-3195 B-3694
	DUCKBILL	210900H	TBA	A-3104 B-3500
	BENNINGTON	220900H	TBA	A-4583 B-5080
	CONSULATE	181100H	201500H	A-2404 B-2703
	BEDPOST	210800H	TBA	A-2509 B-2911
	HONG KONG	221300H	271300H	A-6259 B-6756

NO FIRE ZONES

3998, 3902, 4302, 4398

N/A , N/A , N/A , N/A

4396, 4392, 4692, 436960, 460939

4302, 4398, 3998, 3902

3195, 3192, 3695, 3692

3199, 3105, 3599, 3505

4579, 4584, 5079, 5084

2408, 2403, 2708, 2703

2508, 2512, 2912, 2908

6255, 6260, 6755, 6760

(14). Caution all troops to be alert for AP mines and booby traps. When found give type of mine/booby trap, method of emplacement, siting, method of detonation, whether destroyed or disarmed. Lives of unqualified personnel will not be endangered to determine any of the above information.

#### 4. ADMINISTRATION AND LOGISTICS

a. See 1st Recon Bn AdminO 324-66

##### b. Special Equipment.

- (1) One signal mirror per team.
- (2) One flashlight per team.
- (3) One day/night flare per team.
- (4) Minimum of 10 CS grenades per platoon and one gas mask per man.
- (5) Air panels.
- (6) Two Strobe Light indicators per platoon.
- (7) BC Scope as required.
- (8) Star Light Scope as required.
- (9) Two 50 ft lines per platoon.

## 5. COMMAND COMMUNICATIONS-ELECTRONICS

- a. See reference (b).
- b. Command Post. Command post position are as set forth in reference (b).
- c. The following communications support provided by Communications Section H&S Company.

## (1) Establish and maintain communications on the following:

(a) Bn TAC	39.5
	50.6
	51.1
	51.7

(b) Artillery	35.5
	39.1
	37.0
	34.4
	34.2
	35.8

(2) Provide artillery liaison personnel as required.

(3) Maintain radio-relay stations as presently established.

- d.. Authentication and shackles in accordance with reference (b).
- e. Reporting Schedule. Deployed elements will report at least every hour. All situation reports will be accompanied by a position report. Thrust line method will be used whenever possible.
- f. AO support for radio-relay provided on request.

g. Resupply of comm-elec items provided on request. 24 hour lead time is desired.

BY COMMAND OF LIEUTENANT COLONEL McKEON

  
G. R. JOHNSTON

Major, U. S. Marine Corps

Executive Officer

ANNEXES:

A - Operation Overlay

DISTRIBUTION: Annex X (Distribution) to 1st Recon Bn OpOrder 321-66

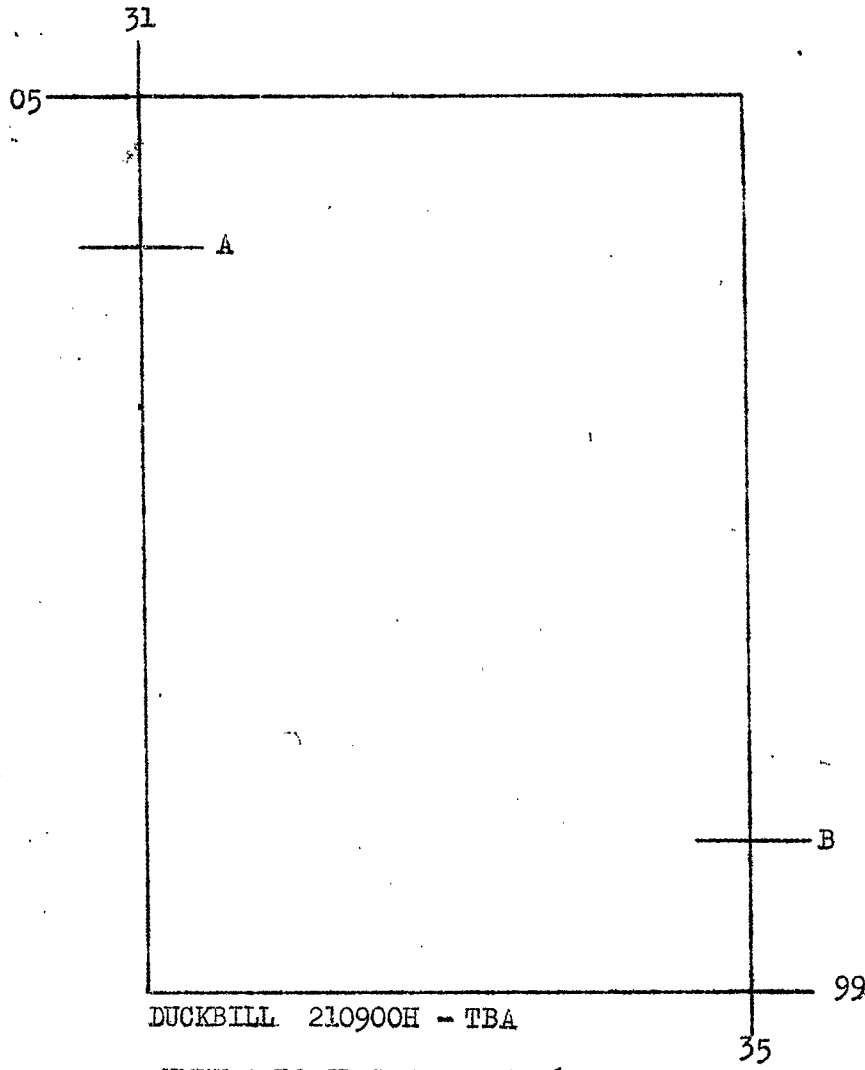

DUCKBILL 210900H - TBA

ANNEX A TO FRAG ORDER 54-67  
1st Recon Bn OpO 321-66

1st Reconnaissance Battalion  
CHU LAI, RVN  
Maps: VIETNAM, 1:50,000, AMS, L701  
Sheets 6657 I-IV, 6757 II, III  
6656 I-IV, 6756 I-IV, 6755 I, IV

171200H March 1967

BY COMMAND OF LIEUTENANT COLONEL McKEON

*R. A. Carnes*  
R. A. CARNES

Capt, U. S. Marine Corps

Operation Officer

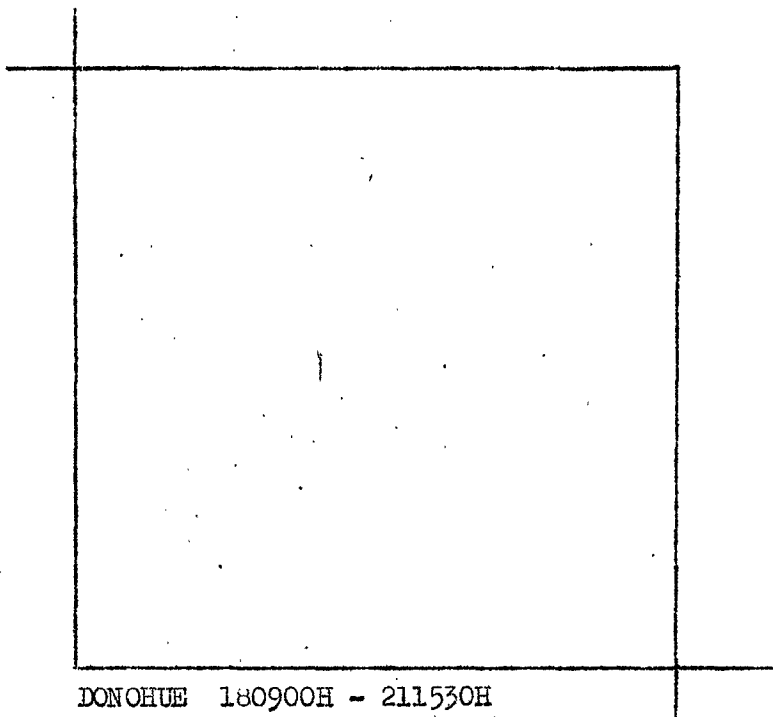

DONOHUE 180900H - 211530H

DAPELINE'S NO FIRE ZONE IS N/A 190700H - 290900H

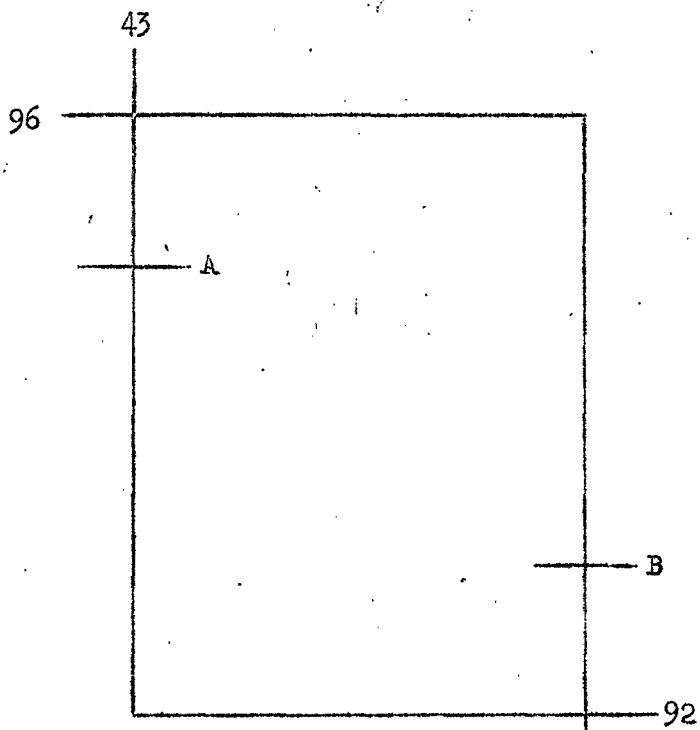

CRANKCASE 190900H - 220900H

46



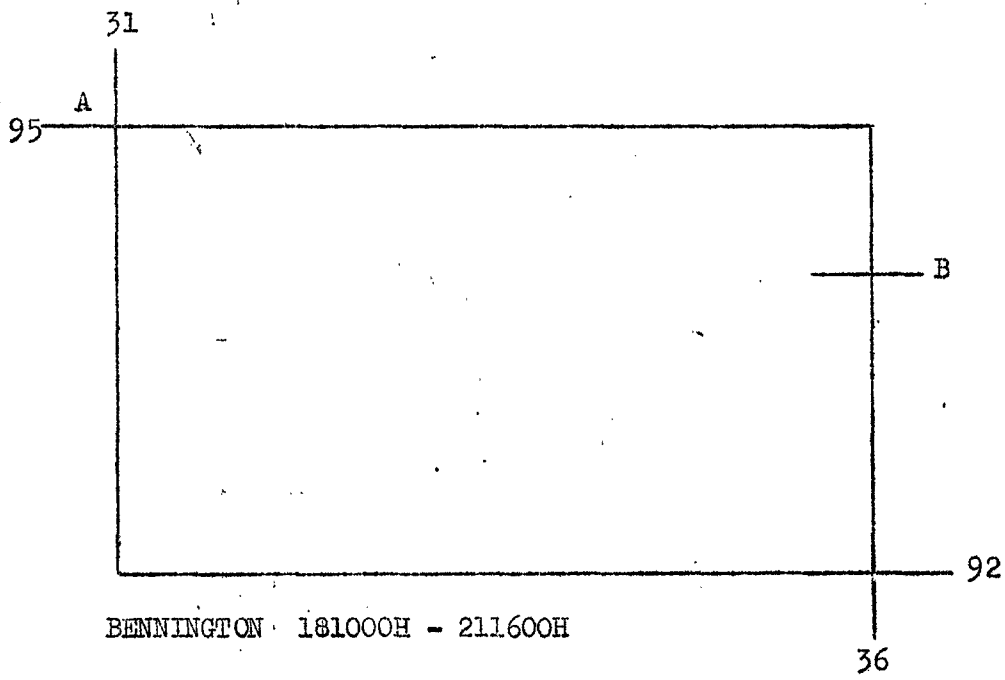
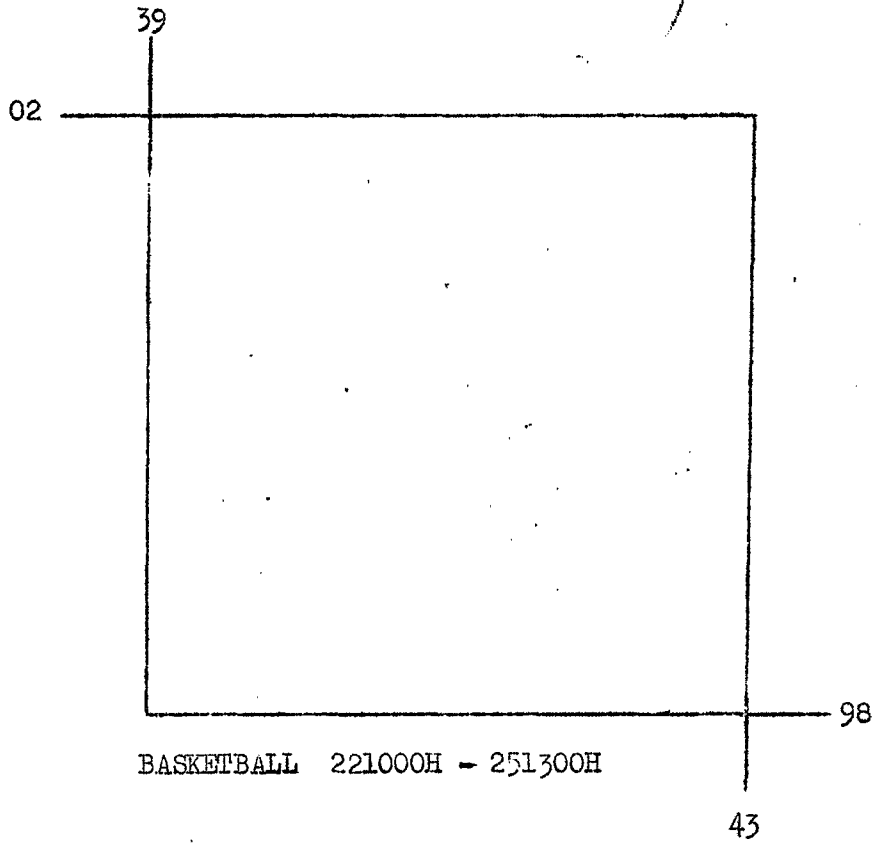

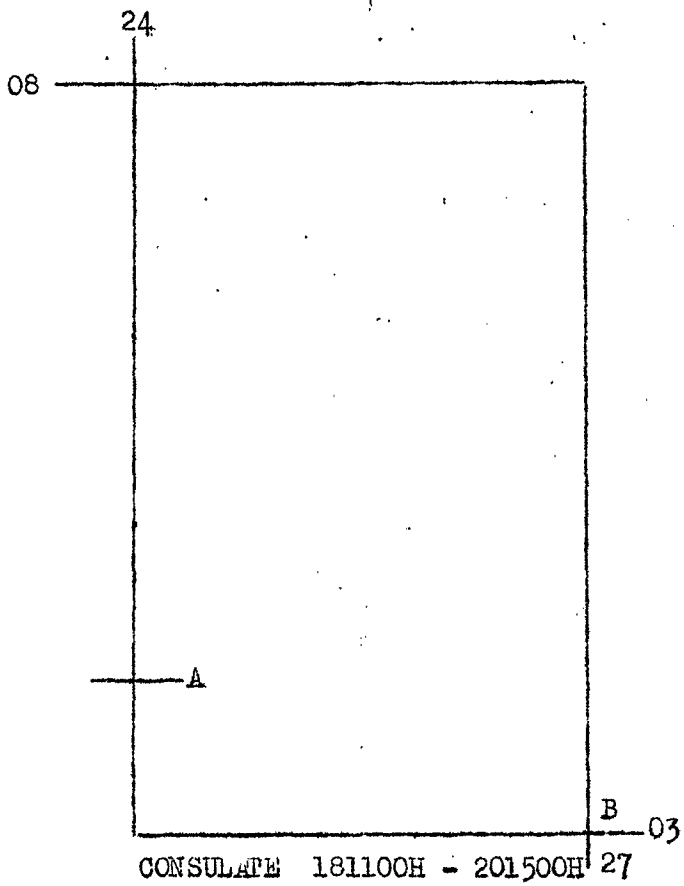
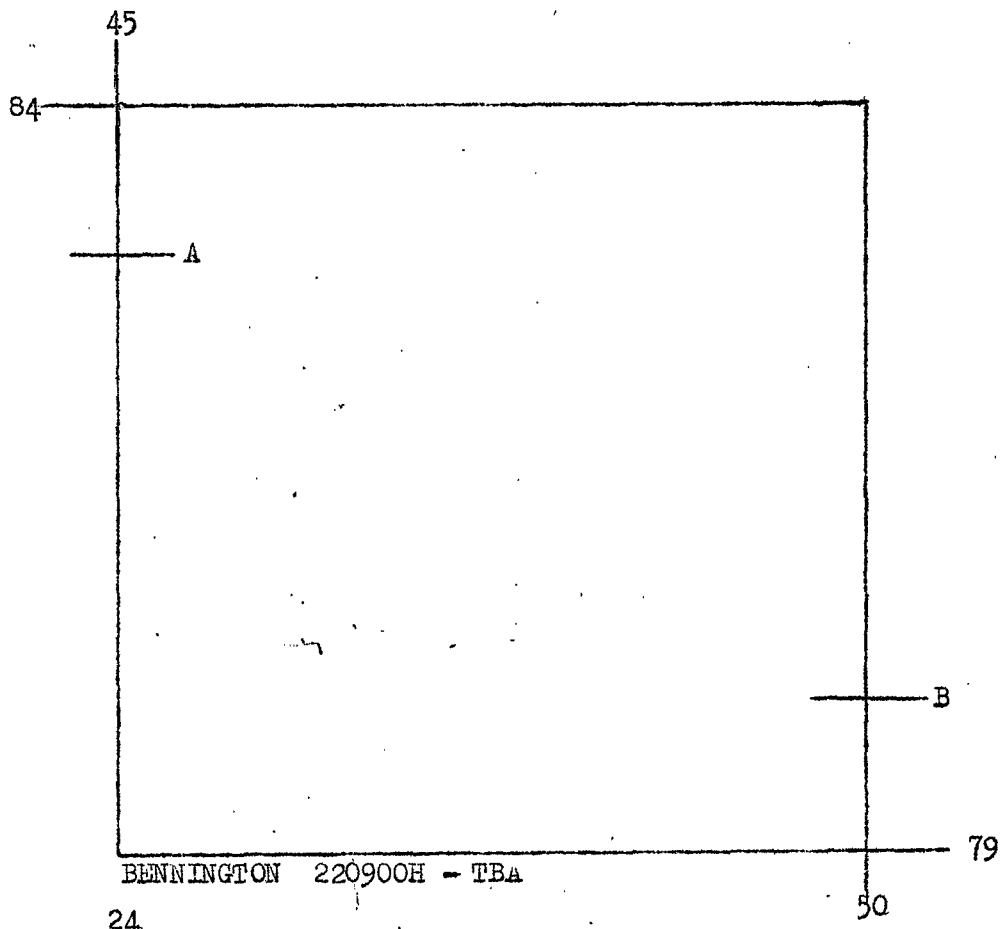

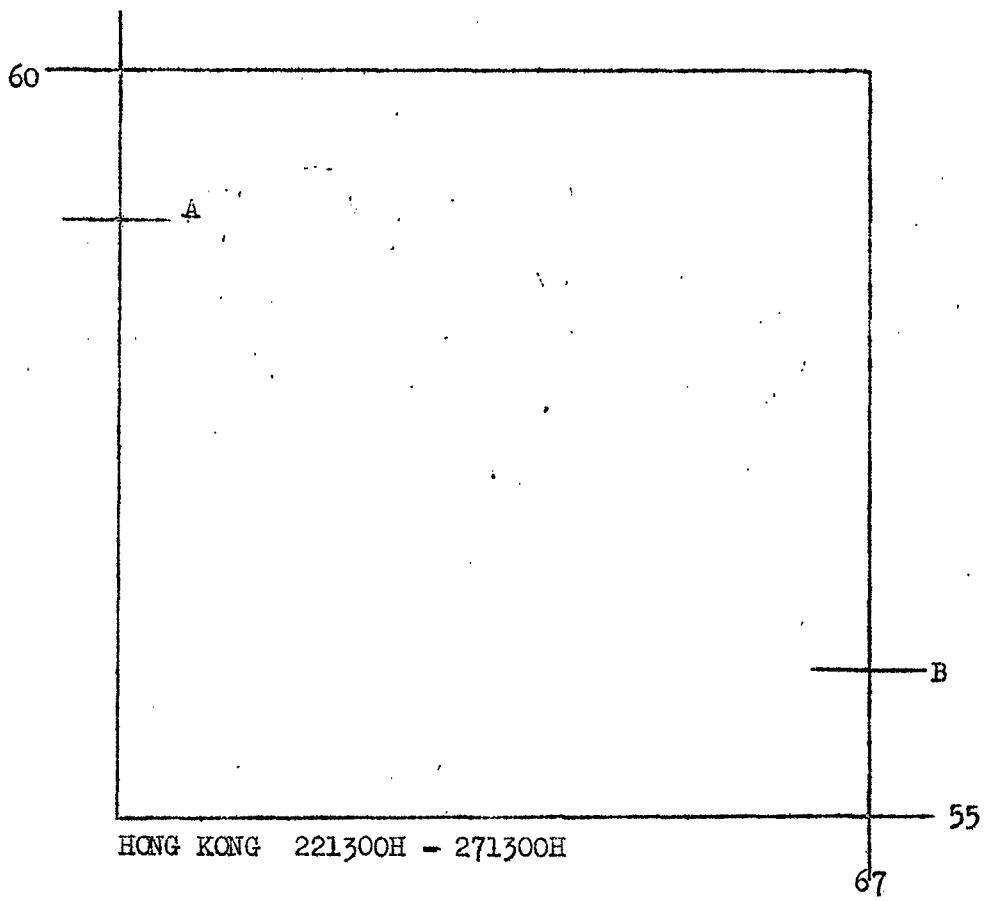
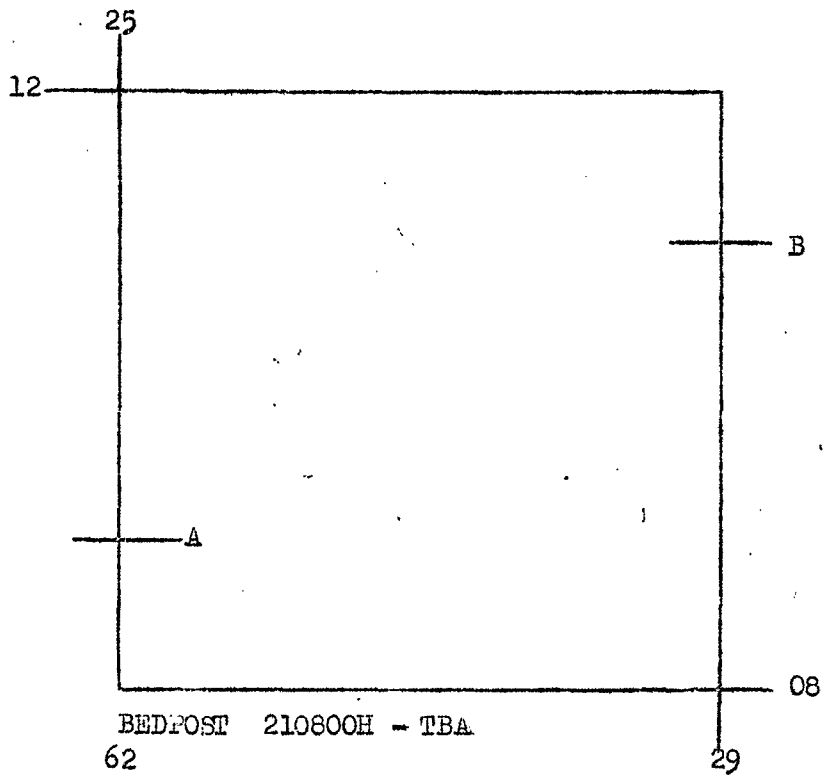

SECRET

Copy No. \_\_\_\_\_ of 15 Copies  
 1st Reconnaissance Battalion  
 CHU LAI, RVN  
 241200H March 1967

1st Recon Bn Frag Order 55-67 to BnOpOrder 321-66

Ref: (a) Maps: VIETNAM, 1:50,000 AMS L701 Sheets 6657 I-IV, 6757 II, III  
 6656 I-IV, 6756 I-IV, 6755 I, IV  
 (b) BnOpOrder 321-66  
 (c) DivO P3800.LF (Intelligence SOP)

Tash Organization:

1st Reconnaissance Battalion (-) (Rein)	LtCol D. N. McKEON
Company "A"	Capt E. J. CONNELLY
Company "D"	1stLt R. S. ROBERTS
Detachment 1st Force Recon Company	Major M. D. CERRETA

1. SITUATION

a. Enemy Forces.

- (1) See Current ISUMS
- (2) As briefed by Battalion S-2

b. Attachments and Detachments: None

2. MISSION 1st Reconnaissance Battalion conducts ground reconnaissance/observation in assigned areas of QUANG NGAI and QUANG TIN Provinces, RVN. See Annex A (Operation Overlay).

3. EXECUTION

a. Concept of Operation 1st Reconnaissance Battalion conducts ground reconnaissance within assigned sectors of QUANG TIN and QUANG NGAI Provinces, RVN. See Annex A (Operation Overlay) for assigned sector of reconnaissance. Additionally, other means of reconnaissance will be employed as available. Emphasis throughout the reconnaissance effort will be placed on:

- (1) Routes of egress and entry.
- (2) Lines of communications.
- (3) LZs suitable for exploitation forces.

A-4

SECRET

(4) Verifying the Order of Battle.

(5) Location of major installations and facilities to include rest areas, command posts, communication facilities, hospitals, training areas and POW camps.

b. Company "A"

(1) Commencing 250900H - TBA 1967 provide a platoon (DONOHUE) to conduct observation vicinity BS 441912 and maintain surveillance of the surrounding area. Emphasis throughout the reconnaissance effort will be placed on those areas indicated in the Concept of Operations. Annex A (Operation Overlay) establishes your No Fire Zone.

(2) Commencing 241000H - 241500H March 1967 provide a platoon (CRANKCASE) to conduct ground search in vicinity BS 433943. Annex A (Operation Overlay) establishes your No Fire Zone.

(3) Commencing 251300 - TBA March 1967 provides a platoon (DATELINE) to conduct observation from vicinity BS 418998 and maintain surveillance of the surrounding area. Emphasis throughout the reconnaissance effort will be placed on those areas indicated in the Concept of Operations. Annex A (Operation Overlay) establishes your No Fire Zone.

(4) Commencing 271300H - TBA March 1967 provide a platoon (CRANKCASE) to conduct ground reconnaissance/observation vicinity BT 238067. and maintain surveillance of the surrounding area. Emphasis throughout the reconnaissance effort will be placed on those areas indicated in the Concept of Operations. Annex A (Operation Overlay) established your No Fire Zone.

(5) Commencing 281300H - TBA March 1967 provide a platoon (AFRILDATE) to establish an observation post vicinity of Hill 707 and maintain surveillance of surrounding area. Emphasis throughout the reconnaissance effort will be placed on those areas indicated in the Concept of Operations. Annex A (Operation Overlay) establishes your No Fire Zone.

(6) Commencing 281400H - TBA March 1967 provides a platoon (BASKETBALL) to conduct ground reconnaissance/observation vicinity BS 288983, and maintain surveillance of the surrounding area. Emphasis throughout the reconnaissance effort will be placed on those areas indicated in the Concept of Operations. Annex A (Operation Overlay) establishes your No Fire Zone.

c. Company "D"

(1) Commencing 271400H - TBA March 1967 provide a platoon (DUCKBILL) to conduct ground reconnaissance/observation vicinity BS 452816, and maintain surveillance of the surrounding area. Emphasis throughout the reconnaissance effort will be placed on those areas indicated in the Concept of Operations. Annex A (Operation Overlay) establishes your No Fire Zone.

SECRET

(2) Commencing 241400H - 271400H March 1967 provide a platoon (ANTI FREEZE) to conduct observation from vicinity BS 398770 and maintain surveillance of the surrounding area. The primary direction of observation is the southeast of your assigned area. Emphasis throughout the reconnaissance effort will be placed on those areas indicated in the Concept of Operations. Annex A establishes your No Fire Zone.

d. Detachment 1st Force Recon Company

(1) Commencing 271500H - TBA March 1967 provide a platoon (BEDPOST) to conduct observation from vicinity BS 635588 and maintain surveillance of the surrounding area. Emphasis throughout the reconnaissance effort will be placed on those areas indicated in the Concept of Operations. Annex A (Operation Overlay) establishes your No Fire Zone.

(2) Commencing 241300H - 271300H March 1967 provide a platoon (CONSULATE) to conduct observation from vicinity BS 304077 and maintain surveillance of the surrounding area. The primary direction of observation is to the north and northwest. Emphasis throughout the reconnaissance effort will be placed on those areas indicated in the Concept of Operations. Annex A (Operation Overlay) establishes your No Fire Zone.

e. Coordination Instructions.

(1) Report all sightings immediately to BEACON LIGHT.

(2) SITREP every hour (unless otherwise directed), and monitor net continuously. With each SITREP submit POSITION REPORT, if "NO CHANGE", so state.

(3) Code Names. See Radio Brevity Code.

(4) All patrol leaders will insure that the following items are accomplished prior to departure.

(a) Receive the intelligence brief from S-2.

(b) Submit roster of personnel participating in operation to S-1.

(c) Read Rules of Engagement LAW reference (c).

(d) Submit proplanned concentrations and TPQ-10's to S-3.

(e) Plan and coordinate one phase insert with each insertion

(f) Record of all MIKE designators.

(g) Spot report guide.

SECRET

(5) Supply caches will not be destroyed without approval of S-3. Samples (one quart) of rice will be kept and brought in with the patrol for further evaluation. Record DTG, location and circumstances of capture.

(6) Be prepared to call and adjust artillery fire on targets of opportunity.

(7) Be prepared to exploit with air.

(8) Bury all trash, return all batteries.

(9) LZ's will be marked with yellow smoke.

(10) When reporting utilize SALUTE format.

(11) Emphasis on EEI's.

(12) Report to S-2 upon extraction for debriefing.

(13) PATROL                      INSERTION                      EXTRACTION                      THRUST POINTS

DONOHUE                      250900H                      TBA                      A-4391 B-4789

CRANKCASE                      241000H                      241500H                      A-4395 B-4693

DATELINE                      251300H                      TBA                      A-3901 B-4399

CRANKCASE                      271300H                      TBA                      A-2107 B-2704

APRIL DATE                      281300H                      TBA                      A-3901 B-4399

BASKETBALL                      281400H                      TBA                      A-2801 B-3399

DUCKBILL                      271400H                      TBA                      A-3979 B-4577

ANTI FREEZE                      241400H                      271400H                      A-4483 B-5081

BEDPOST                      271500H                      TBA                      A-6259 B-6756

CONSULATE                      241300H                      271300H                      A-2808 B-3306

NO FIRE ZONES

4388, 4392, 4788, 4792

4396, 4392, 4692, 436960, 460939

3998, 3902, 4302, 4398

4

241500H

211300H

271300H

SECRET

2103, 2108, 2703, 2708

3998, 3902, 4302, 4398

2898, 2802, 3302, 3398

3980, 3976, 4580, 4576

4480, 4484, 5080, 5084

6255, 6260, 6755, 6760

2809, 3109, 310077, 330077, 3305, 2805

(14) Caution all troops to be alert for AP mines and booby traps. When found give type of mine/booby trap, method of emplacement, siting, method of detonation, whether destroyed or disarmed. Lives of unqualified personnel will not be endangered to determine any of the above information.

#### 4. ADMINISTRATION AND LOGISTICS

a. See 1st Recon Bn AdminO 324-66

##### b. Special Equipment

- (1) One signal mirror per team.
- (2) One flashlight per team.
- (3) One day/night flare per team.
- (4) Minimum of 10 CS grenades per platoon and one gas mask per man.
- (5) Air panels.
- (6) Two strobe Light indicators per team.
- (7) BC Scope as required.
- (8) Star Light Scope as required.
- (9) Two 50 ft lines per platoon.

#### 5. COMMAND COMMUNICATIONS-ELECTRONICS.

a. See reference (b).

b. Command Post. Command Post positions are as set forth in reference (



SECRET

c. The following communication support provided by Communications Section H&S Company.

(1) Establish and maintain communications on the following:

(a) Bn TAC	39.5
	44.3
	50.6
	51.1
	51.7

(b) Artillery	35.5
	39.1
	37.0
	34.4
	34.2
	35.8

(2) Provide artillery liaison personnel as required.

(3) Maintain radio-relay stations as presently established.

d. authentication and shackles in accordance with reference (b).

e. Reporting Schedule. Deployed elements will report at least every hour. All situation reports will be accompanied by a position report. Thrust line method will be used whenever possible.

f. AO support for radio-relay provided on request.

g. Resupply of comm-elec items provided on request. 24 hour lead time is desired.

BY COMMAND OF LIEUTENANT COLONEL MCKEON

*G. R. Johnston*  
G. R. JOHNSTON

Major, U. S. Marine Corps

Executive Officer

ANNEXES:

A-- Operation Overlay

DISTRIBUTION: annex X (Distribution) to 1st Recon Bn OpOrder 321-66

ANNEX A TO FRAG ORDER 55-67  
1st Recon Bn OpO 321-66

1st Reconnaissance Battalion  
CHU LAI, RVN

Maps: VIETNAM, 1:50,000, AMS L701  
Sheets 6657 I-IV, 6757 II, III  
6656 I-IV, 6756 I-IV, 6755 I, IV

241200H March 1967

BY COMMAND OF LIEUTENANT COLONEL McKEON



R. A. CARNES

Capt, U. S. Marine Corps

Operation Officer

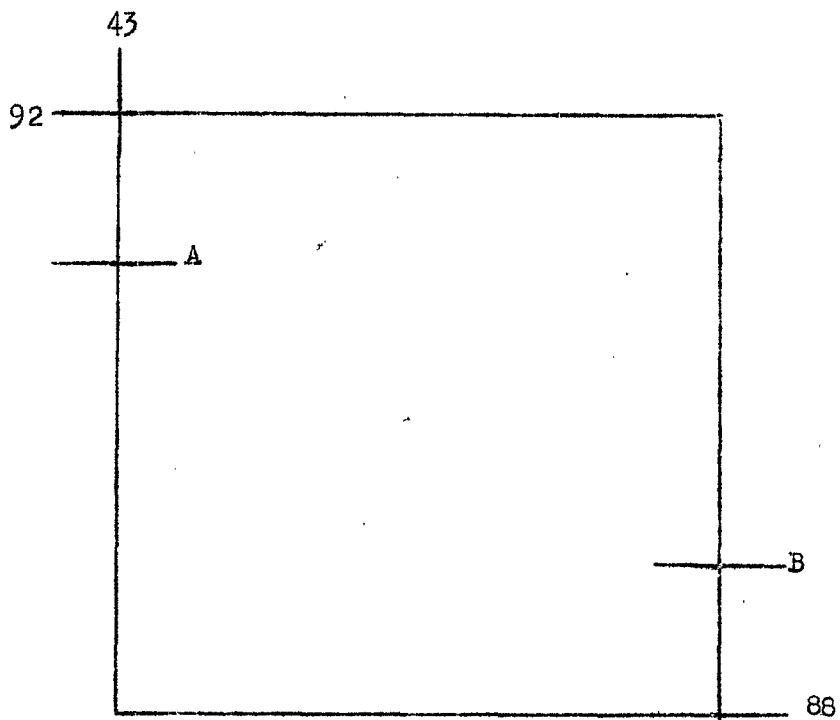

DONOHUE 250900H - TBA

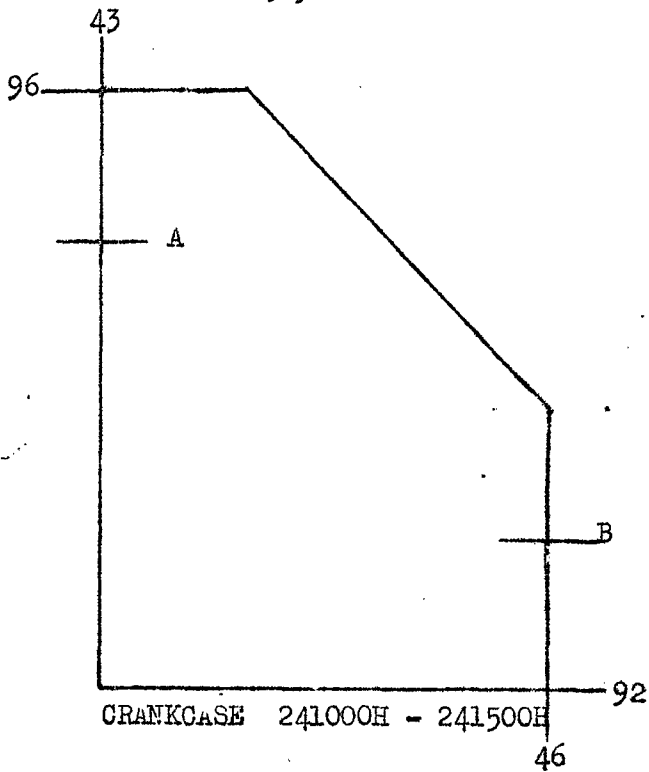

CRANKCASE 241000H - 241500H

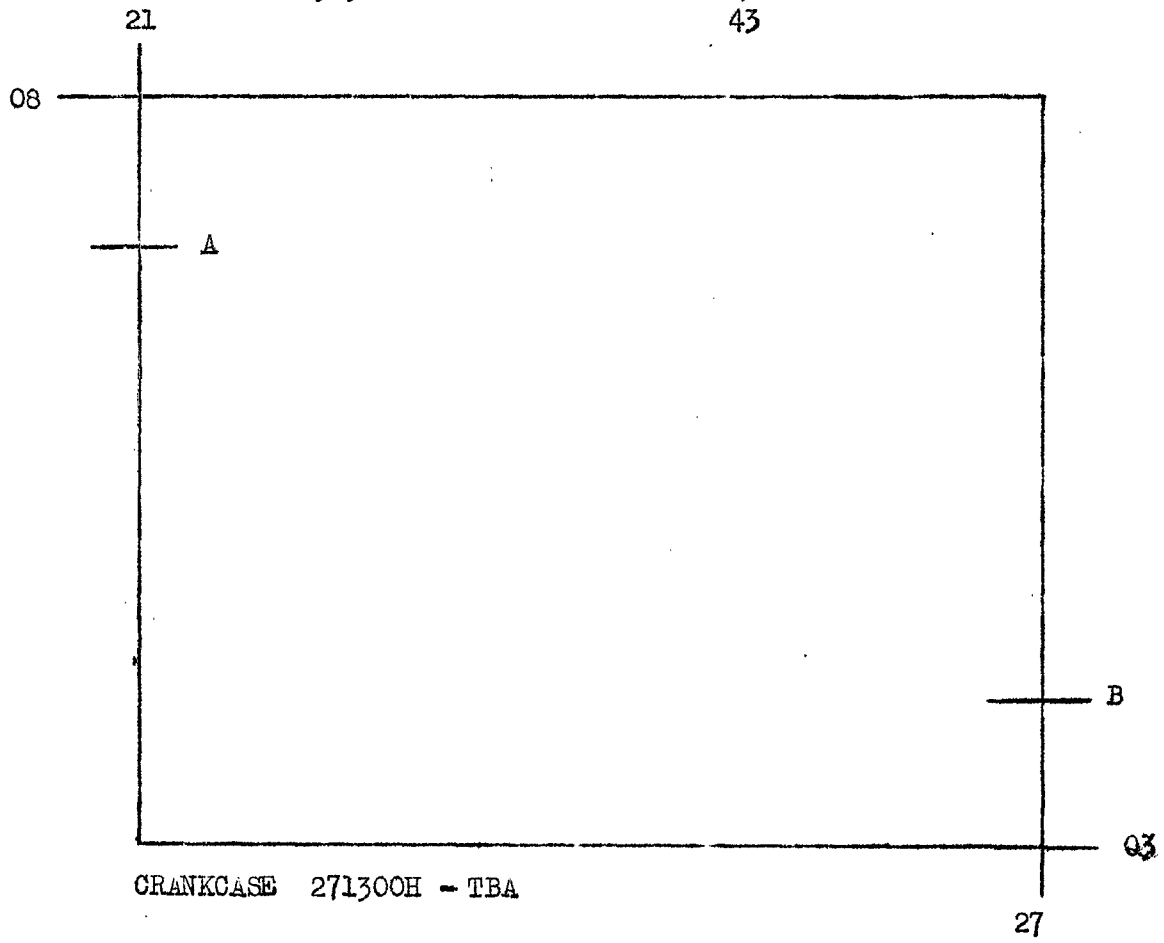
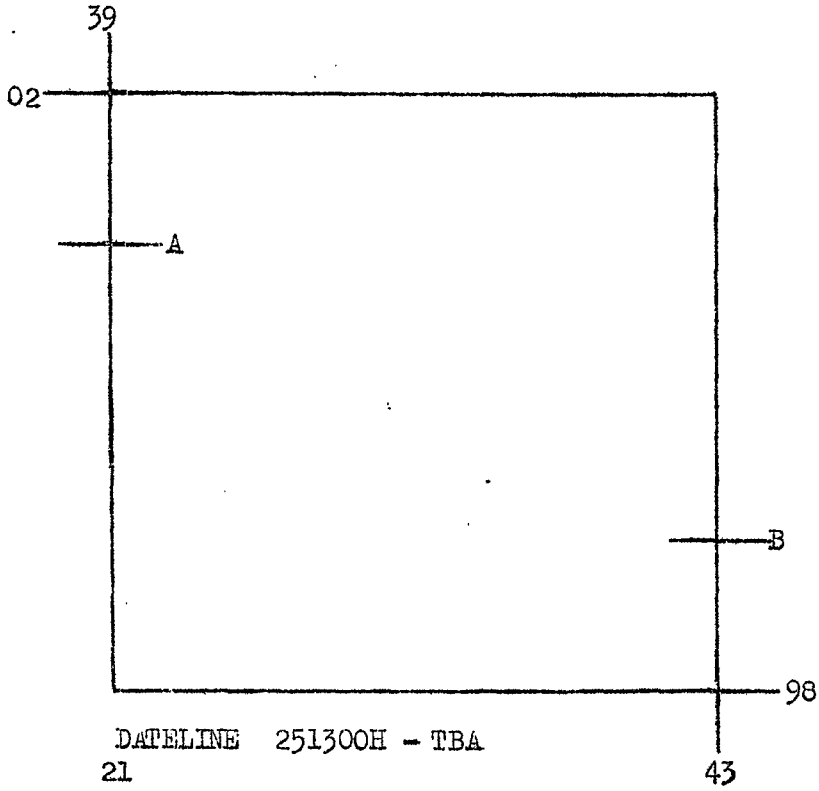

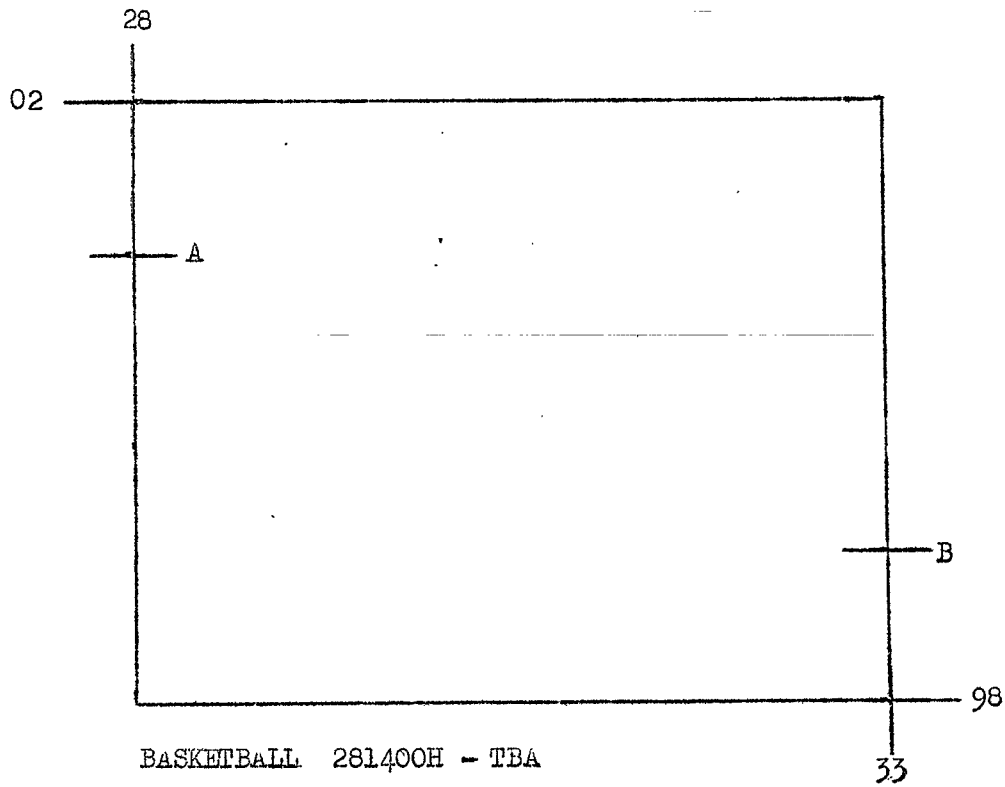
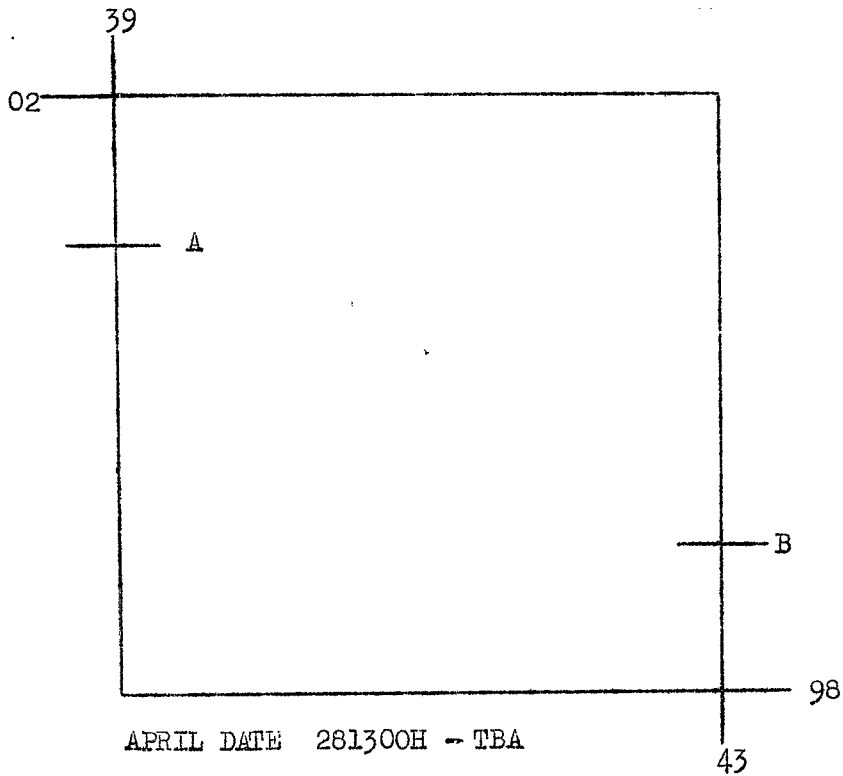

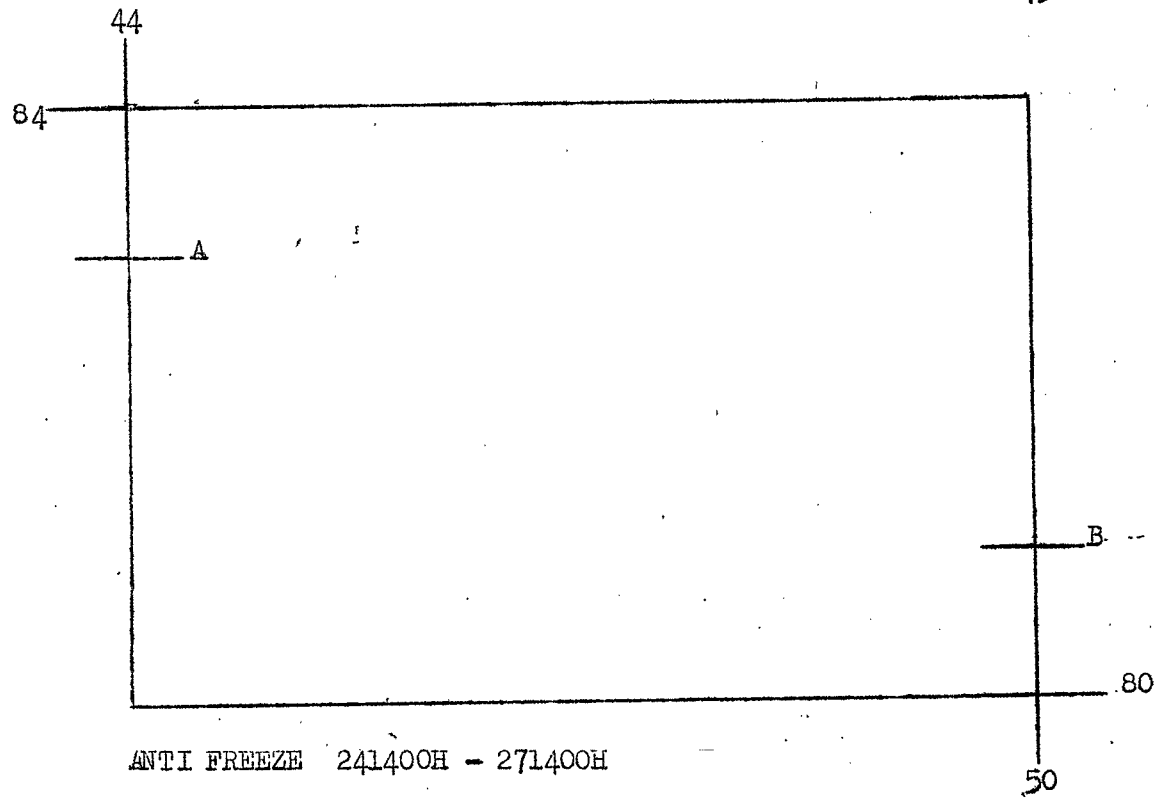
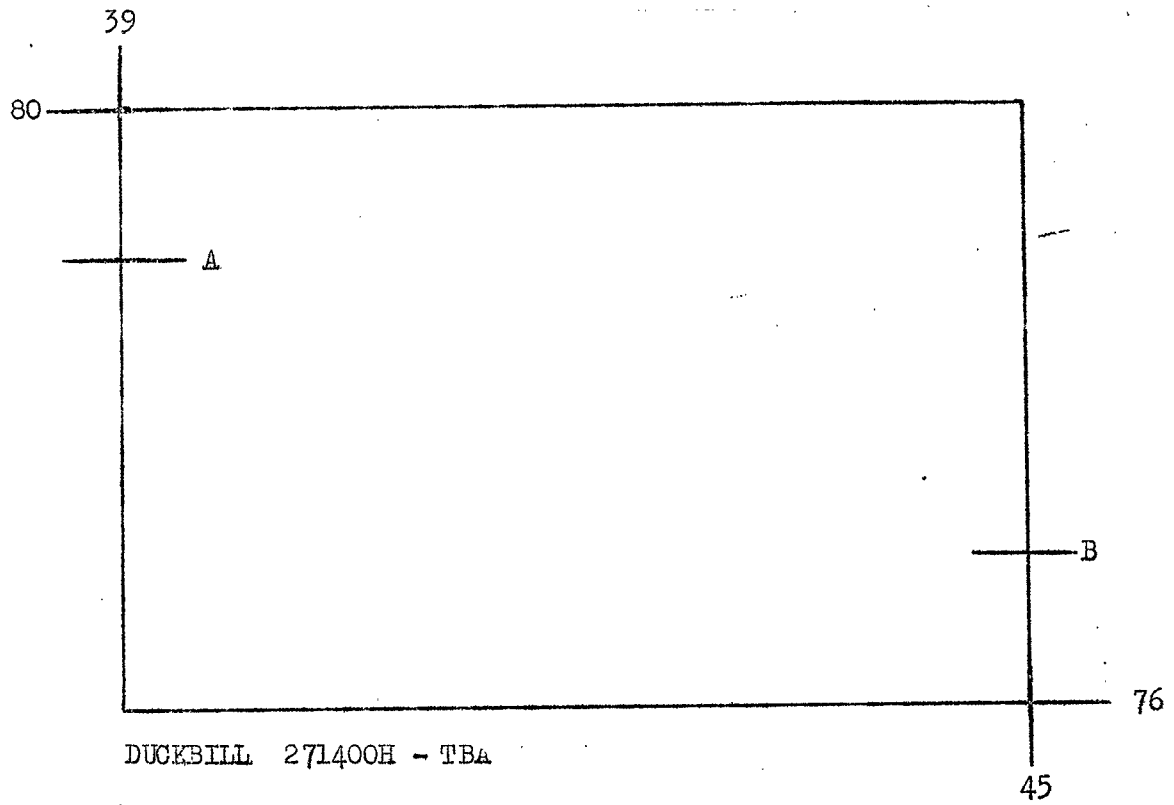

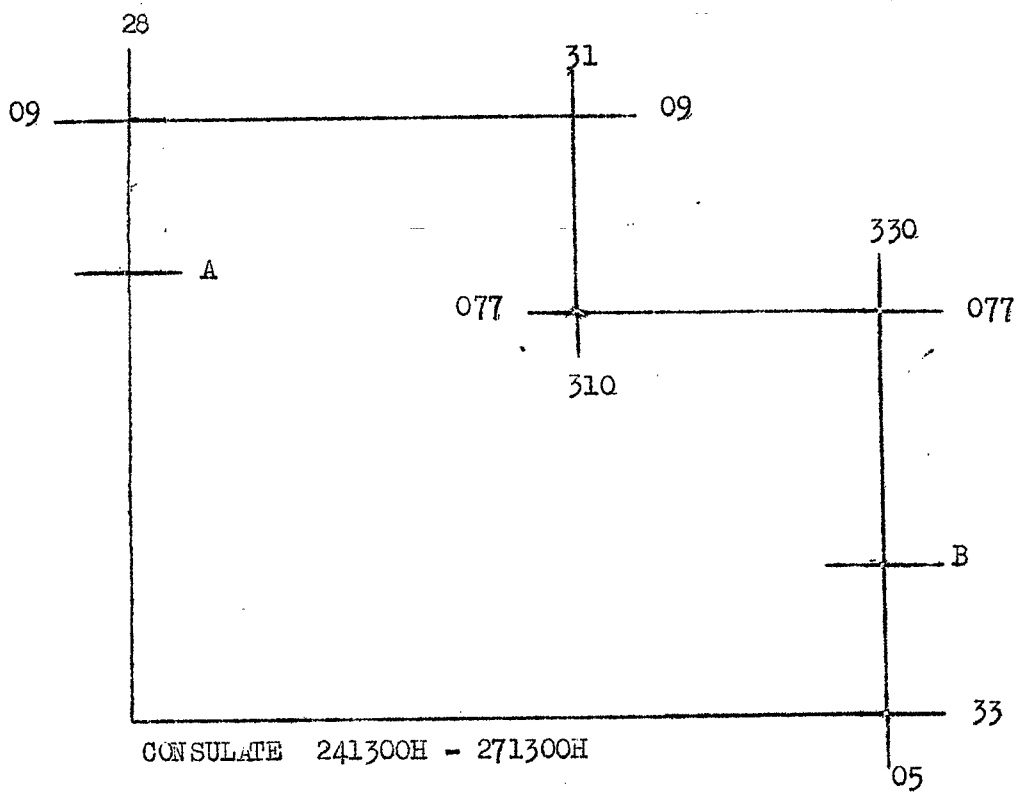
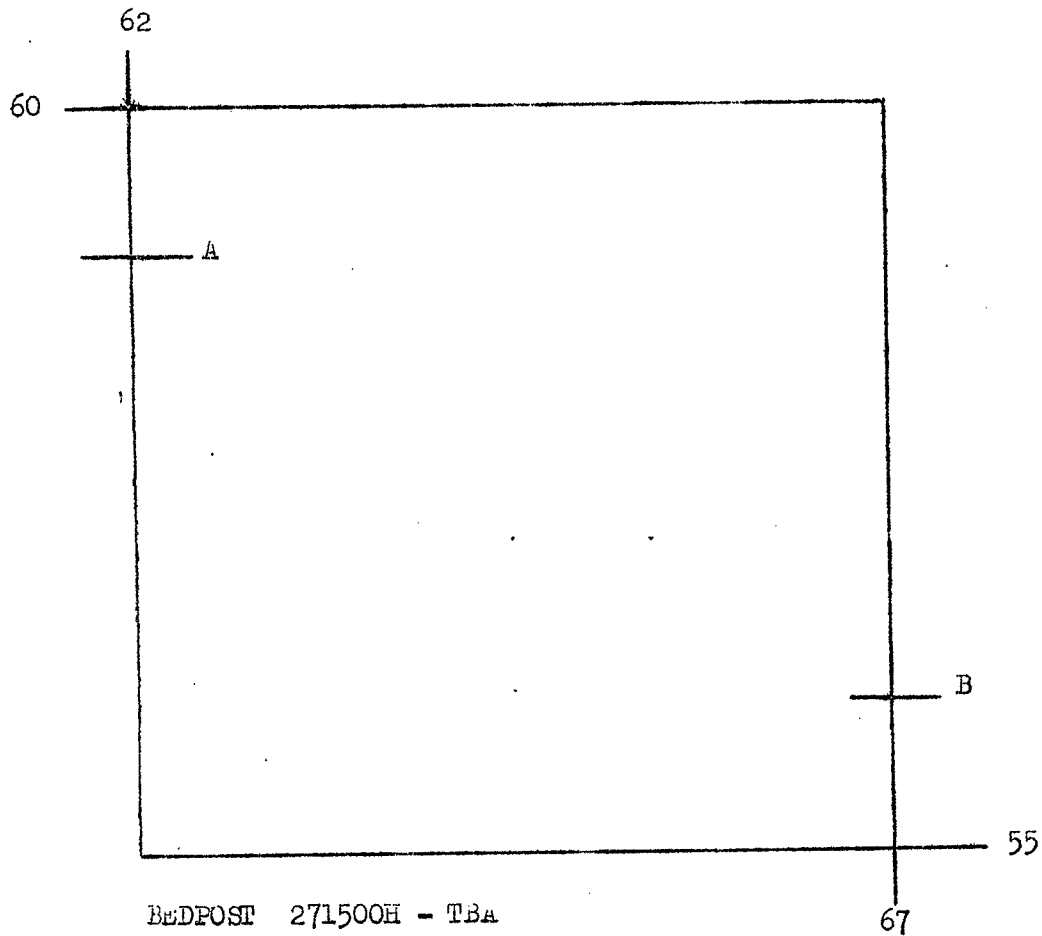

5.3

1st Reconnaissance Battalion  
 CHU LAI, RVN  
 011330H March 1967

Bn Frag Order 51-67  
 Team: 4th Plt, 1st For Recon Co  
 Debriefing: GySgt WILLIAMS  
 Maps: AMS Series L 7014  
 Sheet 6738 I

PATROL REPORT

1. Size and Composition: 10 Enlisted, 1 USN , 3 NGF team
2. Mission: Establish OPs at BS 7045, and BS 6941. Support of Operation DE SOTO.
3. Time of Departure: 260715H February 1967
4. Time of Return: 011115H March 1967
5. Route: None
6. Synopsis: This patrol covered a period of 76 hours with 6 sightings of 47 VC/VCS. 1 arty fire mission called and 1 air strike. Patrol made contact with 15 VC resulting in 3 VC KIA (conf) and 3 VC KIA (prob). 2 Rifles captured.
7. Observations:

Insert #1.

260900H insert LZ BS 701453 good LXH46 zone on ridgeline. Trails shown on map are well used. OP site BS 704450.

260935H	BS 710456	6 VCS moving east, black PJs, heavy loads.
271015H	BS 726454	15 VCS moving north. Black PJs. Moving fast. Observation poor due to heavy mist.
271230H	BS 699427	9 VCS in a group, 1 all white, 8 blk. PJs. Requested AO. AO reported fighting holes along road where VCS were observed.
271315H	BS 709449	5 VC observing patrol. Blk PJs. Rifles. Called fire mission, good coverage.
280845H	BS 700454	3 VC moving northwest. Black PJs. 2 rifles, 3 packs.
281025H	BS 700454	9 VC moving toward patrol, black PJs. Packs and rifles. Patrol opened fire, pinned VC down and called TAGA for air strike. 3 VC KIA (conf), 3 VC KIA (prob). Air strafed area at 281215H patrol made search of area, found 2 bodies, numerous blood trails. 2 rifles and personal effects of 2 dead VC.

A-#5



281245H BS 702453 Patrol was extracted from OP site.

Insert #2.

281400H insert LZ BS 705422 poor LXH46 zone. OP site top of hill BS 698417. Normal civilian activity in valley. Extract LZ BS 701411, good 2XH46 zone. Patrol extracted at 010845H.

8. Other Information: Fortified position vic BS 708447, fighting holes and barbed wire. Thick canopy base of hill BS 718458.
9. Results of Encounters with the Enemy: 3 VC KIA (conf), 3 VC KIA (prob).
10. Condition of Patrol: 2 WIA (minor)
11. Conclusion and Recommendations: None

*Arthur T. Torizzo*  
 A. T. TORIZZO  
 Gysgt USMC  
 Patrol Leader

12. Comments by Debriefers: None

PATROL ROSTER

1. BENNETT, H. K. CPL 2052409	8. TORIZZO, A. T. GYSGT 1248749
2. CAMPBELL, G. W. SGT 2892428	9. TOY, D. W. PFC 2209515
3. HERNANDEZ, A. PFC 2169614	10. SMITH, L. G. HM3 6953224
4. HUFF, J. E. CPL 2152547	11. ZINKHON, R. A. PFC 2304318
5. NOLL, J. R. PFC 2222220	12. MCGREARY PFC 2157670 NGF
6. OWENS, W. J. LCPL 2130769	13. SPAMLER PFC 2243459 NGF
7. SIMMONS, R. G. PFC 2239883	14. ROCKENSTYRE PFC 2153971 NGF

S-3

1st Reconnaissance Battalion  
 CHU LAI, RVN.  
 011400H March 1967

Bn Frag Order 50-67  
 Team: 2d Sqd 1st Plt Co A  
 Debriefers: GySgt WILLIAMS  
 Maps: AMS Series L 7014  
 Sheet 6738 I

PATROL ROSTER

1. Size and Composition: 9 Enlisted, 1 USN
2. Mission: Establish an OP at the Montaguard outpost NUI DANH KHUONG vic BS 6358.
3. Time of Departure: 260800H February 1967
4. Time of Return: 011115H March 1967
5. Route: None
6. Synopsis: This patrol covered a period of 75 hours with 3 sightings of 29 VC. 2 arty fire missions and 2 air strikes were called resulting in 11 VC KIA (conf).
7. Observations:

<u>TIME</u>	<u>COORDINATES</u>	<u>OBSERVATIONS</u>
261100H	BS 675567	10 VC moving northeast. Black PJs, 3 rifles. Called fire mission, good coverage. Contact TACA, conducted air strike, 5 VC KIA (conf), 5 structures destroyed, one secondary explosion
261105H	BS 655575	15 VC firing at aircraft. Black PJs automatic and semi-automatic weapons. Called TACA for air strike, 11 VC KIA (conf), 3 structures destroyed.
272030H	BS 645597	Undetermined number of VC probing outpost. Returned fire, VC broke contact.
281330H	BS 642572	4 VC moving north on trail, black PJs, packs and rifles. Called fire mission, good coverage.

8. Other Information: Patrol corpsman held MED-CAP for outpost inhabitants.
9. Results of Encounters with the Enemy: 16 VC KIA (conf).
10. Condition of Patrol: good

1st Reconnaissance Battalion  
 CHU LAI, RVN  
 011400H March 1967  
 2d Sqd 1st Plt Co A Continued

11. Conclusions and Recommendations: None

*C. W. Hockaday*  
 C. W. HOCKADAY  
 Sgt USMC  
 Patrol Leader

12. Comments by Debriefers: None

PATROL ROSTER

1.	HOCKADAY, CARLTON W.	Sgt	2071016
2.	LAWTON, THOMAS R.	LCpl	2151619
3.	DAY, TIMOTHY J.	Pfc	2295197
4.	ANDERSON, GEORGE E.	Pfc	2290226
5.	MAHOVLIC, JOSEPH T.	LCpl	2203091
6.	MOSKAL, ANTHONY F. JR.	LCpl	2178959
7.	KUBS, CHRISTOPHER S.	Pfc	2294924
8.	DAVIS, DONALD R.	Pfc	2197171
9.	BARTON, LANCE B.	Pfc	2312733
10.	SHACKLEY	HN3	6949462

S-3

1st Reconnaissance Battalion  
 CHU LAI, RVN  
 021830H, March 1967

Bn Frag Order 51-67  
 Team: 3d Plt, Co D  
 Debriefed: Gysgt WILLIAMS  
 Maps: AMS Series L 7014  
 Sheet 6738 I

PATROL REPORT

1. Size and Composition:
2. Mission: Establish an OP vic BT 7237. Support Operation DE SOTO.
3. Time of Departure: 260830H February 1967
4. Time of Return: 011830H March 1967
5. Route: See attached overlay
6. Synopsis: This patrol covered a period of 82 hours with 10 sightings of 84 VC/VCS. 4 arty fire missions were called resulting in 7 VC KIA (prob). 1 air strike was called.
7. Observations:

<u>TIME</u>	<u>COORDINATES</u>	<u>OBSERVATIONS</u>
261150H	BS 748383	20 VC moving northeast. Black PJs, packs and rifles. No fire mission due to save-a-plane.
261250H	BS 7437	20 VCS moving northeast. Black PJs.
261255H	BS 748386	4 VC moving east. Black PJs. 2 rifles, 4 packs.
270730H	BS 725385	7 VC moving north. 2 white, 5 black PJs. 3 rifles.
271120H	BS 734382	4 VC moving north. Black PJs, rifles. Called fire mission, excellent coverage.
271405H	BS 727386	7 VC moving north. Black PJs, packs and rifles. Called fire mission, excellent coverage.
271535H	BS 744405	10 VC in paddy, black PJs, rifles. No fire mission due to save-a-plane.
280900H	BS 731396	3 VC moving southeast. Black PJs, packs and rifles. Called fire mission, excellent coverage. 3 VC KIA (prob).

A-#7

010800H BS 732371 4 VC moving north. Camouflage utilities, rifles. Called fire mission, excellent coverage. 4 VC KIA (prob).

011145H BS 724374 5 VC probed patrol position with a/w and s/a fire. Patrol returned fire, called for air strike. VC broke contact. Patrol was extracted, at 011830H.

8. Other Information: Insert LZ BS 728374 good LXH46 zone. There are fighting holes near the LZ. OP site BS 727377, good observation. OP site vic BS 725375 good observation of valley. This hill has sparse vegetation with little cover. Extract LZ BS 725375 cut by patrol good LXH46 zone.

9. Results of Encounters with the Enemy: 7 KIA (prob).

10. Condition of Patrol: good

11. Conclusions and Recommendations: None

*M. B. Johnson*  
M. B. JOHNSON  
2dLt USMC  
Patrol Leader

12. Comments by Debriefers: None.

PATROL ROSTER

1. JOHNSON, MARTIN B.	2dLt	099647
2. HOWARD, WILLIAM C. III	LCpl	2213450
3. HAWLEY, JOHN H.	Pfc	2183653
4. BOYKINS, JOHNNY H. JR.	Cpl	2174884
5. McAWARD, JAMES B.	Cpl	2030271
6. FOSTER, BILLY L.	Pfc	2248941
7. MOON, RICHARD A.	Pfc	2238647
8. McCLELLAN, LARRY N.	Pfc	2302290
9. MORRIS, IRVIN	Pfc	2278080
10. MARTIN, LAWRENCE P.	Pfc	2320061

Continued-

1st Reconnaissance Battalion  
 CHU LAI, RVN  
 021830H March 1967  
 3d Flt, Co D

-Continued

11.	HINES, JOHN L. III	Cpl	2044741
12.	DUNCAN, RAYMOND A. JR.	Pfc	2237647
13.	CUELLAR, BENITO	LCpl	2210820
14.	HOWARD, FLOYD JR.	Pfc	2223449
15.	KNEREM JAMES J.	Pfc	2316661
16.	HUBANKS, EDWARD W.	Pvt	2242249
17.	CULLINAN, DANIEL J. JR.	Pfc	2281077
18.	RHODES, JOHN O.	LCpl	2199835
19.	BROERMAN, B. B.	Pfc	2199153
20.	PETERS, A. J.	HN	7887017
21.	MCDOWELL	Lt.	

OVERLAY

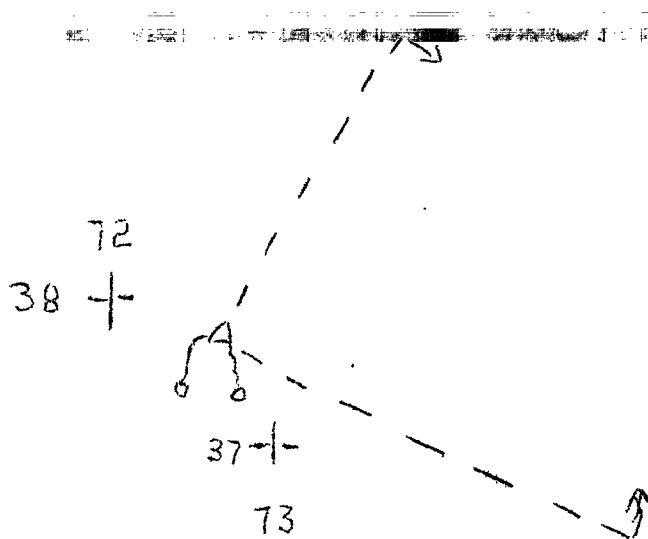

S. 3

1st Reconnaissance Battalion  
 CHU LAI, RVN  
 031615H March 1967

Bn. Frag Order 51-67  
 Team: 2nd Plt, 1st Force Recon Co  
 Debriefers: Gysgt J. L. WILLIAMS  
 Maps: AMS Series L7014  
 Sheet 6738 I

PATROL REPORT

1. Size and Composition: 11 Enlisted, 1 USN
2. Mission: Establish an OP vic BS 7535 and vic BS 7934. Support Operation DE SOTO.
3. Time of Departure: 251600H February 1967
4. Time of Return: 031530H March 1967
5. Route: See attached overlay
6. Synopsis: This patrol covered a period of 6 days with 7 sightings of 44 VC. 7 arty fire missions were called and 3 air strikes conducted resulting in 7 VC KIA (Conf) and 9 VC KIA (Prob).
7. Observations: (Enemy and Terrain)

<u>TIME</u>	<u>COORDINATES</u>	<u>OBSERVATIONS</u>
Patrol # 1		
Insert 251820H vicinity BS 761355 very poor LZ. OP site BS 757358.		
251830H	BS 758353	3 VCS hiding in brush
260900H	BS 763366	Heard A/W firing at AO in area.
261145H	BS 759365	12 VC firing at aircraft. Blk PJ's, khakis. Packs and rifles. Friendly troops in area.
OP site	BS 754359	
271400H	BS 757368	5 VC moving along trench line. Blk PJ's. 2 packs. Requested AO. Called fire mission, good coverage.
271430H	BS 757368	4 VC entered house. 1 khaki, 3 blk PJ's. 3 packs, 2 rifles. Called fire mission, excellent coverage. 2 VC KIA (Prob).
OP site	BS 752361	

281030H BS 752368 3 VC moving along ditch. Camouflaged utilities, 1 rifle. Called fire mission, excellent coverage. 2 VC KIA (Conf).

Patrol was extracted at 281730H vicinity BS 757357 poor LXH46 zone.

Patrol # 2

Insert 010835H vicinity BS 791343 large bare hill good LZ. OP site BS 793344. OP site March 2 vicinity BS 792344.

021140H BS 782348 2 VC moving South. 1 blk PJ's, 1 khaki. 2 rifles, 2 packs. Called fire mission, good coverage.

OP site BS 791345

030930H BS 782353 15 VC near possible caves. Blk PJ's, 3 rifles, cartridge belts, baskets of rice. 3 fire missions called, 3 air strikes. 5 VC KIA (Conf), 7 VC KIA (Prob) by air. Arty was called on cave openings at BS 782353 and BS 783353.

Patrol was extracted at 031500H vicinity BS 791343 good LZ.

8. Other Information: House vicinity BS 758369 used by VC. Caves vicinity BS 782353 and BS 783353.

9. Results of Encounters with the Enemy: 2 VC KIA (Conf), 2 VC KIA (Prob) with arty. 5 VC KIA (Conf), 7 VC KIA (Prob) by air.

10. Condition of Patrol: Good

11. Recommendations and Conclusions: Hill at BS 7943 may be booby trapped.



G. A. IKONEN  
SSgt USMC  
Patrol Leader

12. Comments by Debriefers: Prep hill vic BS 7943 before insert.



1st Reconnaissance Battalion

SSgt G. A. EKONEN

Maps: AMS Series L7014

Sheet 6738 I

PATROL ROSTER

1.	ARNOLD, JERRY L.	Cpl	2047215
2.	FULTON, JAMES T.	LCpl	2158847
3.	GILPIN, RICHARD D.	PFC	2227368
4.	HECK, ROBERT L.	LCpl	2169613
5.	HOWZE, LONNIE R.	Cpl	2175217
6.	HUFFMAN, ANTHONY P.	LCpl	2160635
7.	EKONEN, GEORGE A.	SSgt	1837523
8.	KLEVEN, GREGORY J.	PVT	2278448
9.	MOOS, RICHARD R.	LCpl	2192362
10.	CRUZ, DONALD S.	PFC	2249686
11.	HERGENBLADER, EDDIE A.	LCpl	2212739
12.	MESSER, HERVIE E.	HN	B 106457

37 — | —  
75

EX  
IN

— | — 36  
78

IN-EX

34 — | —  
78

— | — 33  
81

S-3

1st Reconnaissance Battalion  
 CHU LAI, RVN  
 040930H March 1967

Bn Frag Order 51-67  
 Team: 6th Plt, 1st Force Recon Co  
 Debriefing: Gysgt J. L. WILLIAMS  
 Maps: AMS Series L7014  
 Sheet 6739 III

PATROL REPORT

1. Size and Composition: 8 Enlisted, 1 USN
2. Mission: Establish an OP vicinity BS 4384.
3. Time of Departure: 280910H February 1967
4. Time of Return: 040830H March 1967
5. Route: See attached overlay
6. Synopsis: This patrol covered a period of 95 hours with 3 sightings of 41 VC. 2 arty fire missions were called resulting in 10 VC KIA (Prob).
7. Observations: (Enemy and Terrain)

<u>TIME</u>	<u>COORDINATES</u>	<u>OBSERVATIONS</u>
281645H	BS 446885	10 VC moving East. Blk PJ's. 5 packs, 5 rifles. Called fire mission, excellent coverage. 10 VC KIA (Prob).
011330H	BS 443864	30 VC moving West. Blk PJ's. 15 packs, 15 rifle. Called fire mission, good coverage.
021025H	BS 426869	1 VC moving South. Blk PJ's. 1 pack.

8. Other Information: Insert LZ BS 434847 good LXH46 zone. OP site BS 435854 good observation. VC harbor site 2 months old vic BS 433854. Much civilian traffic on road. Extract LZ vic BS 434848 good LXH46 zone.
9. Results of Encounters with the Enemy: 10 VC KIA (Prob).
10. Condition of patrol: Good
11. Conclusions and Recommendations: There are not many good OP sites in this area.

*Harvey S. Mc Clain*  
 H. L. MC CLAIN  
 Sgt USMC  
 Patrol Leader

12. Comments by Debriefers: None

PATROL ROSTER

1.	MC CLAIN, HARVEY L.	Sgt	1975132
2.	BEASON, CHARLES E.	LCpl	2105886
3.	HAGER, JAMES W.	Cpl	2108203
4.	STOWE, LUTHER T.	PFC	2296163
5.	TAYLOR, TRAVIS B.	PFC	2307321
6.	WALLS, RALPH E.	PFC	2263538
7.	WILLIAMS, RONALD A.	PFC	2236072
8.	WILLINGHAM, THOMAS A.	PFC	2212213
9.	LAPORTE, MICHEAL L.	HM2	6845414

1st Reconnaissance Battalion.

Sgt. H. L. MC CLAIN.

Maps: AMS Series L7014

Sheet 6739 III

+ 87  
42

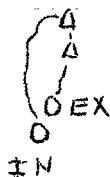

46  
+ 83

S-3

1st Reconnaissance Battalion  
 CHU LAI, RVN  
 041015H March 1967

Bn. Frag Order 51-67  
 Team: 2nd Plt, Co "D"  
 Debriefers: Gysgt J. L. WILLIAMS  
 Maps: AMS Series L7014  
 Sheet 6739 IV

PATROL REPORT

1. Size and Composition: 18 Enlisted, 1 USN
  2. Mission: Conduct ground reconnaissance/observation vicinity BT 3404.
  3. Time of Departure: 281000H February 1967
  4. Time of Return: 040945H March 1967
  5. Route: See attached overlay
  6. Synopsis: This patrol covered a period of 95 hours with no sightings. There was moderate civilian traffic in the valley.
  7. Observations: None
  8. Other Information: Insert LZ vic BT 318047 fair LXH46 zone in creek bed. Area has thick vegetation, 20-40 ft canopy on South side of hill. Observed light during night of 3 March vic BT 314067. Extract LZ BT 304076 poor LXH46 zone, soft ground.
  9. Results of Encounters with the Enemy: None
  10. Condition of Patrol: Good
  11. Conclusions and Recommendations: Take climbing ropes and/or pole climbers.
- G. E. Brosch*  
 G. E. BROSCH  
 SSgt USMC  
 Patrol Leader
12. Comments by Debriefers: None

1st Reconnaissance Battalion  
SSgt G. E. BROSCHE  
Maps: AMS Series L7014  
Sheet 6739 IV

10 +  
33

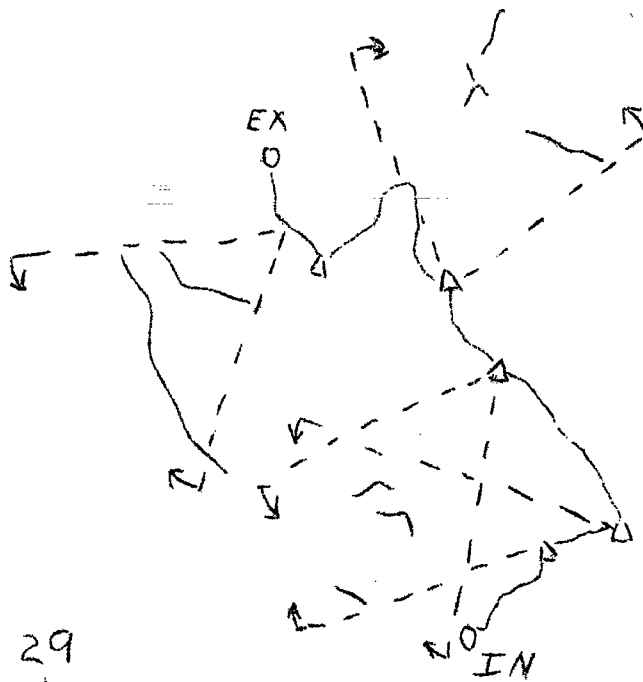

29  
+ 04



5.3

1st Reconnaissance Battalion  
 CHU LAI, RVN  
 041930H March 1967

Bn Frag Order 51--67  
 Team: 4th Plt, Co "A"  
 Debriefed: GySgt J. L. WILLIAMS  
 Maps: AMS Series L7014  
 Sheet 6738 I, 6838 II

PATROL REPORT

1. Size and Composition: 2 Officers, 19 Enlisted, 1 USN
2. Mission: In support of Operation DE SOTO establish OP vicinity BS 6941 and BS 8526.
3. Time of Departure: 010800H March 1967
4. Time of Return: 041630H March 1967
5. Route: See attached overlay
6. Synopsis: This patrol covered a period of 80 hours with 7 sightings of 22 VC. 6 arty fire missions were called resulting in 11 VC KIA (Prob).
7. Observations: (Enemy and Terrain)

TIMECOORDINATESOBSERVATIONS

## Patrol #1

Insert at 010900H vicinity BS 704415 good LXH46 zone on hill 186. OP site BS 698416 excellent observation.

011625H	BS 690423	4 VC moving Northeast. Green utilities, metal helmets, 4 packs, 3 rifles. Called fire mission, excellent coverage. 2 VC KIA (Prob).
011700H	BS 695424	1 VC moving East. Grey PJ's. Pack and rifle. Called fire mission, excellent coverage. 1 VC KIA (Prob).
020845H	BS 699428	2 VC moving West. Blk PJ's. 1 pack, 1 rifle. Called fire mission, excellent coverage. 2 VC KIA (Prob).

Patrol was extracted at 021310H. Helo received 8 rounds of S/A fire on extract. TACA ran air strike.



## Patrol #2

Insert at 031430H vicinity BS 855265, good LZ's along top of hill. OP sites on hill 322 vic BS 855265, BS 857267 and BS 851267.

031520H	BS 853268	2 VC moving South towards patrol position. Blk PJ's. 2 rifles.
041030H	BS 868264	5 VC moving South. Blk PJ's. 1 pack, 2 rifles. Called fire mission, excellent coverage. 4 VC KIA (Prob).
041120H	BS 877861	2 VC moving West. Blk PJ'S. 2 rifles. Called fire mission, excellent coverage. 2 VC KIA (Prob).
041305H	BS 878268	6 VC crossing river. Blk shorts, blk tops. 1 rifle, 3 packs. Called fire mission, excellent coverage.

Patrol was extracted at 041600H.

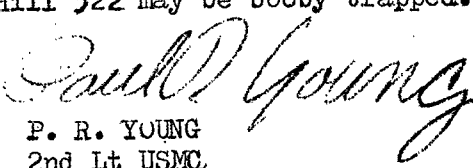
8. Other Information: Hill 322 has 4 foot high scrub growth.
  9. Results of Encounters with the Enemy: 11 VC KIA (Prob).
  10. Condition of Patrol: Good
  11. Conclusions and Recommendations: Hill 322 may be booby trapped.
-   
 P. R. YOUNG  
 2nd Lt USMC  
 Patrol Leader
12. Comments by Debriefers: None

1st Reconnaissance Battalion  
 2nd Lt P. R. YOUNG  
 Maps: AMS Series L7014  
 Sheet 6738 I, 6838 II

PATROL ROSTER

1. YOUNG, PAUL R.	2nd Lt	094373	12. ALBREITON, RONNIE M.	FFC	
2. BELOW, JACK W.	SSgt	1889549			2276839
3. BAROS, MARTIN	Sgt	1475350	13. WITMER, JOHN F.	Cpl	2174276
4. MCNAUGHTON, WILLIAM R.	FFC	2279381	14. HENDERSON, FRANK R.	FFC	2283176
5. BROWN, STEPHEN H.	LCpl	2211015	15. LAWSON, MELVIN L.	FFC	2290853
6. WITMER, FRED M.	LCpl	2265313	16. COPPERMAN, KENNETH E.	LCpl	
7. SPARKS, PRESTON H. JR	FFC	2265996			2269364
8. MOORE, LARRY R.	FFC	2333725	17. SULLIVAN, DANIEL J.	FFC	2290011
9. BINGHAM, ROBERT L.	LCpl	2184486	18. SMITH, ROBERT C. JR	PVT	2214782
10. JAMES, ROBERT L.	FFC	2226104	19. CRONK, JAY W. JR	FFC	2333035
11. MCCULLOUGH, DAVID W.	FFC	2307828	20. NIMMO	FFC	2230619
			21. SHANNON	HN2	9999537
			22. MC DOWELL	Lt	

+ 43  
 68

71  
 + 40

1st Reconnaissance Battalion  
 CHU LAI, RVN.  
 042000H March 1967

OPERATION DE SOTO/DECKHOUSE VI  
 Team: Beacon Light "A"  
 Debriefers: GySgt J. L. Williams MS  
 Maps: AMS Series L7014  
 Sheets 6738 I, 6838 IV, 6838 III, 6738 II

53

PATROL REPORT

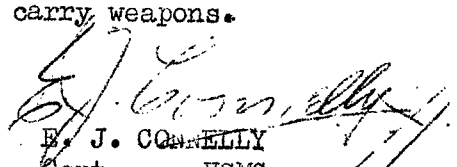
1. Size and Composition: 2 Officers, 5 Enlisted
  2. Mission: Reconnaissance by rubber boat of shore line from BS 852403 to BS 345394.
  3. Time of Departure: 030730H March 1967
  4. Time of Return: 041700H March 1967
  5. Route: None
  6. Synopsis: This patrol covered a period of 33½ hours with no sightings.
  7. Observations: None
  8. Other Information: Insert LZ BS 345394 good 3XH46 zone, firm beach paddy. Launched rubber boat and proceed along shore line to BS 852403. Small island vic BS 847398 not on map. No sign of life on island, found small Buddhist shrine. Found cave vic BS 848399 not used for at least a week. Patrol was extracted at 040700H and reinserted at 040900H vicinity BS 853397. There was high surf and many rocks. It was not feasible to launch boats. There was evidence of 50 graves in the beach area.
  9. Results of Encounters with the Enemy: None
  10. Condition of Patrol: Good
  11. Conclusions and Recommendations: Recommend M-79 be carried as armament for rubber boats. Recommend all hands carry weapons.
-   
 E. J. CONNELLY  
 Capt USMC  
 Patrol Leader
12. Comments by Debriefers: None

DECLASSIFIED

1st Reconnaissance Battalion  
CHU LAI, RVN  
04200QH March 1967

PATROL ROSTER

1. CONNELLY, E. J.	Capt	078786
2. FONDERLIN, T. L.	Cpl	2103493
3. HAYES, D. P.	Cpl	2099200
4. HURLEY, J. M.	LCpl	2170234
5. JOHNSON, P. B.	LCpl	2135560
6. MARTINEZ, J. C.	Cpl	2158715
7. TORRES, L. E.	Lt	093488

DECLASSIFIED

5-3

1st Reconnaissance Battalion  
 CHU LAI, RVN  
 051800H March 1967

Bn Frag Order 51-67  
 Team: 3rd Plt, Co "A"  
 Debriefers: Gysgt J. L. WILLIAMS  
 Maps: AMS Series L7014  
 Sheet 6738 I

PATROL REPORT

1. Size and Composition: 9 Enlisted, 1 USN
2. Mission: Establish an OP at Montagnard outpost vicinity BS 6358. The primary direction of observations is to the South and Southeast.
3. Time of Departure: 011000H March 1967
4. Time of Return: 051800H March 1967
5. Routes: None
6. Synopsis: This patrol covered a period of 102 hours with 2 sightings of 7 VC. Patrol corpsman held MED-CAP for outpost inhabitants. 2 arty fire missions were called.
7. Observations: (Enemy and Terrain).

<u>TIME</u>	<u>COORDINATES</u>	<u>OBSERVATIONS</u>
021125H	BS 670590	5 VC moving East. Blk PJ's. 5 rifles. Called fire mission, good coverage.
031200H	BS 659578	2 VC moving East. Blk PJ's. 2 rifles. Called fire mission, good coverage.

8. Other Information: Outpost was probed by S/A and A/W fire by an estimated 10 VC at 040130H.
9. Results of Encounters with the Enemy: None
10. Condition of Patrol: Good
11. Conclusions and Recommendations: Take disinfectant for heads.

*L. H. Watkins Jr.*  
 L. H. WATKINS, JR  
 SSGT USMC  
 Patrol Leader

12. Comments by Debriefers: Good place to use sniper team or sniper rifle.

A-#13

1st Reconnaissance Battalion.  
 CHU LAI, RVN.  
 051800H March 1967

PATROL ROSTER

1.	WATKINS, LEE H. JR	SSgt	1881368
2.	KELLER, DAVID B.	LCpl	2168520
3.	STORY, JAMES D.	LCpl	2147566
4.	CARR, MARC A.	LCpl	2170983
5.	WARREN, RICHARD J.	EFC	2271695
6.	GIORDANO, LOUIS	EFC	2253271
7.	BASCO, DAMON K,	EFC	2303787
8.	MORGAN, RICHARD	LCpl	2175337
9.	RUEHL, DAVID	Cpl	2133947
10.	HOTELDOR	HN	9985050

S-3

1st Reconnaissance Battalion  
 CHU LAI, RVN  
 071430H March 1967

Bn Frag Order 51-67  
 Team: 1st Plt, Co "A"  
 Debriefers: GySgt J. L. WILLIAMS  
 Maps: AMS Series L7014  
 Sheet 6738 I, 6738 II

PATROL REPORT

1. Size and Composition: 16 Enlisted, 1 USN, 1 PIO.
2. Mission: In support of Operation DE SOTO establish OP sites as directed - BS 7739, BS 7237, BS 8032.
3. Time of Departure: 021215H March 1967.
4. Time of Return: 071400H March 1967.
5. Route: None
6. Synopsis: This patrol covered a period of 5 days with 5 sightings of 32 VC. 1 arty fire mission was called, 2 air strikes called resulting in 5 VC KIA (Conf). 5 VC KIA (Prob).
7. Observations: (Enemy and Terrain)

<u>TIME</u>	<u>COORDINATES</u>	<u>OBSERVATIONS</u>
Patrol # 1		
		Insert 031400H vic BS 773395 good LXH46 zone. Patrol received sporadic sniper fire on insert.
031545H	BS 769388	15 VC moving East. Blk PJ's, green utilities, khakis. Received 2 rounds of S/A fire from same location. Called AO to check area.
031600H	BS 773388	2 VC sniping at patrol, blk PJ's. 2 rifles. Called fire mission, excellent coverage. 1 VC KIA (Conf).
031620H	BS 775387	8 VC moved into ville. Blk PJ's. Packs and rifles. Requested AO. AO received S/A fire from ville. TACA strafed and called air strike resulting in 4 VC KIA (Conf) and 5 VC KIA (Prob). 18 structures destroyed, 2 secondary explosions.

Patrol was extracted at 031830H vic BS 773394 good LXH46 zone. Helo received S/A fire on extract from high ground vic BS 774396.

Patrol # 2

Patrol was inserted at 041530H vic BS 725376 good LXH46 zone. OP site vic BS 723373.

041600H BS 737371 5 VC on trail with mixed blk and green PJ's. Packs and rifles.

041620H BS 724373 2 VC approaching patrol position. Blk PJ's. 2 rifles. Patrol took them under fire, VC returned fire and broke contact. TACA in area straffed and received fire from vic BS 725375. Called air strike. 2 USMC WIA (minor).

Patrol was extracted at 041730H vic BS 723374 good LXH46 zone.

Patrol conducted ground reconnaissance/observation from NUI DANG to BS 8138 with negative results. Patrol was extracted at 051430H.

8. Other Information: None
9. Results of Encounters with the Enemy: 5 VC KIA (Conf), 5 VC KIA (Prob).
10. Condition of Patrol: Poor -- 2 USMC WIA (minor).
11. Conclusions and Recommendations: None

*J. P. Rudman*  
 J. P. RUDMAN  
 GySgt USMC  
 Patrol Leader

12. Comments by Debriefers: None

PATROL ROSTER

1. RUDMAN, JAMES P. GySgt 1366141	14. DAY, TIMOTHY J. EFC 2295197
2. HOCKADAY, CARLTON W. Sgt 2071016	15. BARTON, LANCE B. EFC 2312733
3. SMOGER, STEPHEN S. EFC 2078703	16. BOWEN, F. D. 2006598
4. TAYLOR, ALAN D. LCpl 2109643	17. BISHOP HN
5. ULSTAD, DENNIS D. EFC 2120343	
6. WINKLER, JERRY W. S. EFC 2260722	
7. LEDFORD, DANIEL F. LCpl 2054293	
8. ADAIR, ALVIN D. EFC 2214648	
9. CLOW, JOHN R. EFC 2100282	
10. MC CARTHY, FRANCIS T. EFC 1869365	
11. DAVIS, DONALD R. EFC 2197171	
12. MAHOVLIC, JOSEPH T. LCpl 2203091	
13. KUBS, CHRISTOPHER S. EFC 2294924	



S-3

1st Reconnaissance Battalion  
 CHU LAI, RVN  
 081030H March 1967

Btl Frag Order 51-67  
 Team: 4th Plt, 1st Force Recon Co  
 Debriefers: GySgt J. L. WILLIAMS  
 Maps: AMS Series L7014  
 Sheet 6739 IV

PATROL REPORT

1. Size and Composition: 12 Enlisted.
2. Mission: Establish an OP on hill 440 vicinity BS 4396. The primary direction of observation is to the South and Southwest.
3. Time of Departure: 040800H March 1967.
4. Time of Return: 081000H March 1967.
5. Route: See attached overlay
6. Synopsis: This patrol covered a period of 98 hours with no sightings due to bad weather.
7. Observations: None
8. Other Information: Insert LZ BS 438967 good 3XH46 zone along finger. OP sites were BS 436965 and BS 439966. Patrol observed two bright lights turned on for a few seconds at 041940H and 050120H at coordinates BS 438952. OP site at BS 436965 is a good defensive position and has good observation on MIN trail through valley. Well used trail on north side of valley running through brush vic BS 434957.
9. Results of Encounters with the Enemy: None
10. Condition of Patrol: Good
11. Conclusions and Recommendations: Conduct ground reconnaissance of valley.
12. Comments by Debriefers: None

*Arthur T. Torizzo*  
 A. T. TORIZZO  
 GySgt USMC  
 Patrol Leader

1st Reconnaissance Battalion  
 GySgt A. T. TORIZZO  
 Maps: AMS Series L7014  
 Sheet 6739 IV

PATROL ROSTER

1. BENNETT, HARRY K.	Cpl	2052409
2. CAMPBELL, CHARLES W.	Sgt	1892428
3. GRACE, HARRY W.	LCpl	2147176
4. HERNANDEZ, ALEXANDER	PFC	2169614
5. HUFF, JAMES E.	Cpl	2152547
6. OWENS, WILLIAM J.	LCpl	2130769
7. SIMONS, RICHARD G.	PFC	2239883
8. TOY, DENNIS W.	PFC	2209515
9. SCHIFFBAUER, JAMES E.	PFC	2280627
10. ZINKHON, RODGER A.	PFC	2304318
11. NANCE, NORMAN D.	LCpl	2156833

43  
 + 98

EX  
 200 IN  
 GW

+ 96  
 46

5.3

1st Reconnaissance Battalion  
 CHU LAI, RVN  
 081100H March 1967

Bn Frag Order 51-67  
 Team: 2d Plt, Co A  
 Debriefers: GySgt WILLIAMS  
 Maps: AMS Swries L 7014  
 Sheet 6739 I

PATROL REPORT

1. Size and Composition: 1 Officer, 13 Enlisted, 1 USN
  2. Mission: Establish an OP vicinity BT 2706. Primary direction of observation to the north and northeast. Observe the SONG BA KY valley.
  3. Time of Departure: 040920H March 1967
  4. Time of Return: 081010H March 1967
  5. Route: See attached overlay.
  6. Synopsis: This patrol covered a period of 97 hours with negative sightings due to weather.
  7. Observations: None
  8. Other Information: Insert LZ vic BT 276062 good LXH46 zone. Extract LZ vic BT 277067 poor LXH46 zone cut by patrol.
  9. Results of Encounters with the Enemy: None
  10. Condition of Patrol: good
  11. Conclusion and Recommendations: None
-   
 R. S. WILLIAMS  
 1stLt USMC  
 Patrol Leader
12. Comments by Debriefers: None

1st Reconnaissance Battalion  
CHU LAI, RVN  
081100H March 1967  
2d Plt, Co A

PATROL ROSTER

- |                                  |                                    |
|----------------------------------|------------------------------------|
| 1. WILLIAMS, R. S. 1stLt 0920199 | 9. BITTECUFFER, C. A. LCpl 2178348 |
| 2. GRIFFIN, H. D. Cpl 2148065    | 10. EATON, E. L. II Pvt 2129393    |
| 3. OESTMAN, D. E. LCpl 2261021   | 11. SHORE, R. M. Pfc 2246028       |
| 4. DAVIS, J. H. JR. Pfc 2307979  | 12. KEEFER, J. H. Pfc 2205263      |
| 5. URBANIAK, K. H. Pfc 2260319   | 13. BRUCH, S. W. Pfc 2313624       |
| 6. BACKER, D. L. Pfc 2274817     | 14. STOWE, M. D. Cpl 2140868       |
| 7. BAILEY, W. H. Pfc 2283860     | 15. GOERS, L. L. HN 7950906        |
| 8. BARRON, N. J. Pfc 2305676     |                                    |

OVERLAY

+ 07  
26



32  
02+

S-3

1st Reconnaissance Battalion  
 CHU LAI, RVN  
 101400H March 1967

Bn Frag Order 52-67  
 Team: 2d Plt, Co D  
 Debriefers: GySgt WILLIAMS  
 Maps: AMS Series L 7014  
 Sheet 6739 III

PATROL ROSTER

1. Size and Composition: 17 Enlisted, 1 USN.
2. Mission: Establish an OP vicinity BS 4471. Primary direction of observation to north and northeast.
3. Time of Departure: 081205H March 1967.
4. Time of Return: 082130H March 1967.
5. Route: None.
6. Synopsis: This patrol covered a period of 8½ hours with 3 sightings of 11 VC. 2 arty fire missions were called. Patrol made contact with an estimated 20 VC. Air strike was called. Patrol was extracted. 1 VC KIA (conf) on contact. AA position observed vic BS 454756.
7. Observations:

<u>TIME</u>	<u>COORDINATES</u>	<u>OBSERVATIONS</u>
081415H	BS 425725	4 VC moving north. 3 black PJs. 1 brown. 1 Thompson SMG. 2 packs.
081430H	BS 423725	2 VC moving north. Black PJs, camouflaged covers, 1 rifle, 2 packs. Called fire mission. Good Coverage.
081530H	BS 454726	5 VC moving north. 4 grey, 1 black shirt with grey shorts, 1 metal helmet. 2 rifles, 4 packs. Called fire mission. Good Coverage.
081900H	BS 448717	Patrol received s/a and a/w fire from an estimated 20 VC within 100 meters of harbour site. Patrol returned M-79 fire and moved to BS 447716 to cut LZ. HUE straffed area and ran fixed wing strike. Patrol was extracted at 2100H.

1st Reconnaissance Battalion

CHU LAI, RVN

2d Plt, Co D 101400H March 1967

8. Other Information: Insert LZ vic BS 448721, good LXH46 zone. OP site vic BS 448717, good observation to north and east. Helos received s/a fire on insert from vic BS 447724. Extract LZ vic BS 447716, cut by patrol. Helos received s/a fire on extract. Evidence of VC in OP site vic BS 448717, found 2 empty VN cigarette packs and C-RATS had been dug up. Note on one cigarette pack forwarded to IIT.

9. Results of Encounters with the Enemy: 1 VC WIA (conf).

10. Condition of Patrol: good.

11. Conclusions and Recommendations: None

*G. E. Brosch*

G. E. BROSCH  
SSgt USMC  
Patrol Leader

12. Comments by Debriefers: None

PATROL ROSTER

1. BROSCH, G. E. SSGT 1428088	11. KEISTER, R. P. LCPL 2180551
2. HOLCOMB, L. N. CPL 2106551	12. ROOS, D. R. EFC 2294766
3. RATLIFF, F. W. CPL 2154394	13. SPARROW, J. S. JR. EFC 2300387
4. SPACEK, J. A. JR. EFC 2258013	14. ETHERIDGE, J. C. LCPL 2138435
5. GRAY, R. L. EFC 2269923	15. OLIVER, S. R. EFC 2140019
6. POTTS, R. W. EFC 2280378	16. HANSARD, A. L. EFC 2275700
7. SCANLON, T. S. JR. LCPL 2174222	17. KERWIN, A. S. LCPL 2141619
8. ROE, C. E. JR. EFC 2235243	18. REEDER, J. E. EFC 2219076
9. HARRIS, C. E. EFC 2307780	19. CARSON, M. HN 9191388
10. SMITH, S. R. EFC 2204989	

S-3

1st Reconnaissance Battalion  
 CHU LAI, RVN  
 111330H March 1967

Bn Frag Order 51-67  
 Team: 1st Plt, Co D  
 Debriefed: GySgt WILLIAMS  
 Maps: AMS Series L 7014  
 Sheet 6738 I

PATROL REPORT

1. Size and Composition: 8 Enlisted, 1 USN.
2. Mission: Establish an OP at Montagnard outpost vicinity BS 6358.
3. Time of Departure: 051530H March 1967.
4. Time of Return: 111130H March 1967.
5. Route: See attached overlay.
6. Synopsis: This patrol covered a period of 6 days with 4 sightings of 47 VC. 10 fire missions were called. Patrol corpsman held MED-CAP. 1 VC KIA (Conf).
7. Observations: (Enemy and Terrain)

<u>TIME</u>	<u>COORDINATE</u>	<u>OBSERVATIONS</u>
090930H	BS 643571	5 VC moving Southwest. Blk PJ's. 5 rifles, 2 pole baskets.
071015H	BS 635570	11 VC moving Southwest. Blk PJ's. 7 rifles, 4 packs, 2 pole baskets. Fired at with .50 cal MG. 1 VC KIA (Conf).
071215H	BS 655575	8 VC burning hut. 7 blk PJ's, 1 grey uniform, 5 rifles. Called fire mission, good coverage.
071750H	BS 620553	23 VC entering ville. Blk PJ's. 9 rifles. Called fire mission, good coverage of the area.

8. Other Information: Patrol corpsman held MED-CAP for outpost inhabitants. ARVN commander reported to patrol that there was a VC company at the following locations: BS 621585, BS 624577, BS 635576 and BS 643578. The patrol called 4 fire missions on these coordinates at 051955H. At 101840H ARVN commander reported VC at BS 650571, BS 650574, BS 684587, and BS 687579. Patrol called fire for effect on these coordinates.

9. Results of Encounters with the Enemy: 1 VC KIA (Conf).

10. Condition of Patrol: 1 MED-EVAC with possible malaria.

11. Conclusions and Recommendations: Take plenty of candles and flashlights.

*D. J. Landry*  
 D. J. LANDRY  
 Cpl USMC  
 Patrol Leader

12. Comments by Debriefers: None

PATROL ROSTER

1.	LANDRY, DANIEL J.	Cpl	2098154
2.	CHARLES, JAMES M.	LCpl	2145332
3.	HARRIS, DAVID S.	EFC	2225445
4.	LENGRIN, DARREL L.	EFC	2260156
5.	PAULNER, LARRY F.	EFC	2328333
6.	HOLMES, MICHAEL R.	LCpl	2121489
7.	DECESARE, DANNY T.	EFC	2309640
8.	PATTON, MICHAEL W.	Cpl	2100352
9.	IROLA, JAMES M.	HM3	6927427



1st Reconnaissance Battalion  
D. J. LANDRY Cpl  
Maps: AMS Series L7014  
Sheet 6738 I

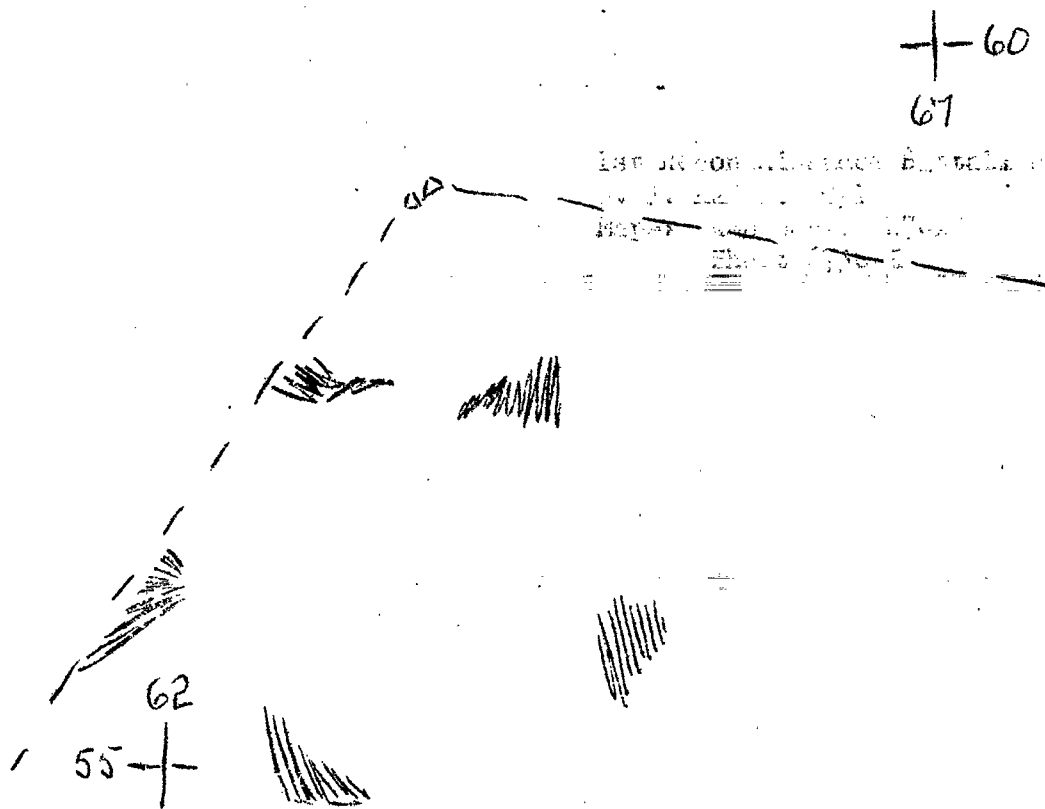

8-3

1st Reconnaissance Battalion  
 CHU LAI, RVN  
 111800H March 1967

Bn Frag Order 52-67  
 Team: 4th Plt, Co "A"  
 Debriefed: GySgt J. L. WILLIAMS  
 Maps: AMS Series L7014  
 Sheet 6739 IV

PATROL REPORT

1. Size and Composition: 14 Enlisted, 1 USN.
  2. Mission: Establish an OP vicinity BT 3504. The primary direction of observation is to the North and Northeast.
  3. Time of Departure: 081100H March 1967.
  4. Time of Return: 111600H March 1967.
  5. Route: See attached overlay.
  6. Synopsis: This patrol covered a period of 78 hours with no sightings. 2 USMC WIA by friendly booby trap. The weather limited visibility.
  7. Observations: None
  8. Other Information: Insert IZ vic BT 362041 good LXH46 zone. OP site BT 360044, good observation to East and Southeast into valley. Extract IZ vic BT 363056 good LXH46 zone.
  9. Results of Encounters with the Enemy: None
  10. Condition of Patrol: 2 USMC WIA.
  11. Conclusions and Recommendations: None
-   
 J. W. BELOW  
 SSgt USMC  
 Patrol Leader
12. Comments by Debriefed: None

1st Reconnaissance Battalion  
 SSgt J. W. BELOW  
 Maps: AMS Series L7014  
 Sheet 6739 IV

PATROL ROSTER

1. BELOW, JACK W.	SSgt	1889519	12. CRONK, JAY W. JR.	FFC	
2. BAROS, MARTIN	Sgt	1475350			2333035
3. WITMER, JOHN F.	Cpl	2174276	13. MCNAUGHTON, WILLIAM R.	FFC	
4. COTTERMAN, KENNETH E.	LCpl	2269364			2279381
5. WIMER, FRED M.	LCpl	2265313	14. SMITH, ROBERT C. JR.	FVT	
6. MCCULLOUGH, DAVID W.	FFC	2307828			2214782
7. ALBRITTON, RONNIE M.	FFC	2276839	15. NIMMO	FFC	2230619
8. SPARKS, PRESTON H. JR.	FFC	2265996	16. SHANNON	HN	9999537
9. MOORE, LARRY R.	FFC	2333725			
10. JAMES, ROBERT L.	FFC	2226104			
11. HENDERSON, FRANK R.	FFC	2283176			

+07  
 40



34  
 +02

5-3

1st Reconnaissance Battalion  
 CHU LAI, RVN  
 111830H March 1967

Bn Frag Order 52-67  
 Team: 6th Plt, 1st For Recon Co  
 Debriefers: GySgt WILLIAMS  
 Maps: AMS Series L 7014  
 Sheet 6739 IV

PATROL REPORT

1. Size and composition: 9 Enlisted, 1 USN.
2. Mission: To establish an OP vic BT 4301 and observe the DONG CO valley.
3. Time of Departure: 080800H March 1967.
4. Time of Return: 111630H March 1967.
5. Route: See attached overlay.
6. Synopsis: This patrol covered a period of 79½ hours with 1 sighting of 25 VC Suspects. There was heavy traffic in the valley.
7. Observations:

<u>TIME</u>	<u>COORD.</u>	<u>Observations</u>
081515H	427024	25 VC Suspects bathing in river, black PJs. Had just cut 20 foot long poles. Left area going North on trail.

8. Other information: Insert LZ located vic BT 432008, good 8XH46 zone. 1st OP loc BT 430015, good observation of east end of valley. 2nd OP loc BT 421014, excellent observation. 3rd OP loc BT 431017, fair observation with thick secondary growth. 4th OP loc BT 413012, fair observation. At coord BT 432012, patrol found enemy harbour site approximately 2 weeks old harbouring an estimated 40-50 VC. At coord BT 430023 patrol observed 2 well used trails leading up Hill 127. At coord BT 421014, found 2 caves with connecting tunnel. At coord BT 426018, there is a dam in the stream. At coord BT 405015, saw 4 sticks, 10 foot - 15 foot high, possible anti-helo stakes. Extract LZ coord BT 425013, good zone. There are no houses in the valley but a lot of traffic, mostly men.

9. Results of Encounters with the Enemy: None
10. Condition of Patrol: 1 USN NBC MED-EVAC.

11. Conclusions and Recommendations: Conduct ground recon of valley, possible VC harbour/storage area in woodline on Hill 127 vicinity BT 422023.

*Henry S. McClain*  
H. L. McCLAIN  
Sgt USMC  
Patrol Leader

12. Additional Comments by Debriefers: None

OVERLAY

+ 03  
39

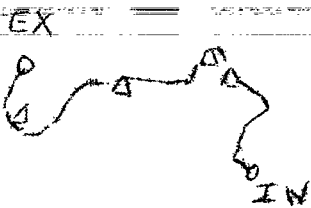

+ 00  
44

1st Reconnaissance Battalion  
 CHU LAI, RVN  
 111830H March 1967  
 6th Plt, 1st For Recon Co

PATROL ROSTER

1. McCLAIN, HARVEY L.	SGT	1975132
2. HAGER, JAMES W.	CPL	2108203
3. HOLCH, JOHN W. JR.	LCPL	2127047
4. PHILLIPS, JOSEPH W.	PFC	2229881
5. STOWE, LUTHER T.	PFC	2296163
6. TAYLOR, TRAVIS B.	PFC	2307321
7. WALLS, RALPH E.	PFC	2263538
8. WILLIAMS, RONALD A.	PFC	2236072
9. WILLIAMS, JAMES W. JR.	PFC	2213202
10. WILLINGHAM, THOMAS A.	PFC	2212213
11. LaPORTE, MICHAEL L.	HM2	6845414

S-3

1st Reconnaissance Battalion  
 CHU LAI, RVN  
 121400H March 1967

Bn Frag Order 52-67  
 Team: 3rd Plt, Co "D"  
 Debriefed: GySgt J. L. WILLIAMS  
 Maps: AMS Series L7014  
 Sheet 6738 I, 6738 II

PATROL REPORT

1. Size and Composition: 1 Officer, 20 Enlisted, 1 USN.
2. Mission: OPCON to 7th Marines for Operation DE SOTO. Establish OP's in the following locations: BS 8032, BS 7936 and BS 7238.
3. Time of Departure: 051515H March 1967
4. Time of Return: 121230H March 1967.
5. Route: See attached overlay.
6. Synopsis: This patrol covered a period of 7 days with 3 patrols. There were 5 sightings of 26 VC/VCS. 1 fire mission was called and 3 air strikes. Patrol made contact with the enemy 3 times.
7. Observations: (Enemy and Terrain)

<u>TIME</u>	<u>COORDINATES</u>	<u>OBSERVATIONS</u>
Insert # 1		
Patrol left DUC PHO with infantry company at 060730H. Left infantry company at 061230H vic BS 803314. OP site vic BS 800322.		
061545H	BS 803316	15 VC crossing trail to rear of patrol. Patrol set up ambush, VC moved North around hill.
061645H	BS 804324	3 VC observing patrol's position. Blk PJ's. 2 rifles, 1 SMG. Called fire mission, good coverage.
061730H	Patrol was extracted from vic BS 805315, LZ cut by patrol, poor LZ 46 zone.	

Insert # 2

Patrol left DUC PHO at 091230H and walked to vic BS 7936.

091615H BS 795365 1 VCS observing patrol, blk PJ's.

091910H BS 793354 Patrol received 1 grenade and 5 rounds of S/A fire. Patrol returned fire. 1 USMC KIA, 3 USMC WIA.

092130H BS 793354 Patrol received S/A fire and two grenades. Patrol returned fire. VC broke contact.

100300H BS 793354 Reaction platoon arrived. . . . .

100900H MED-EVAC for wounded.

101045H Patrol returned to DUC PHO.

Insert # 3

111140H insert LZ BS 728377 fair LXH46 zone. Bunker near LZ. 3 to 5 feet deep, 5 feet long, 6 inches thick, roof covered with dirt.

111150H BS 728377 5 VC running Northeast from LZ. HUIE straffed area.

111315H BS 728380 OP site fair observation to East and Northeast. Observed cave vic BS 734396. 4 foot opening.

111000H BS 728380 Patrol received S/A and A/W fire and 2 grenades. Patrol returned fire. VC broke contact. Observed 2 VC in dark green uniforms. Patrol was extracted at 1700H vic BS 728380 good LXH46 zone.

8. Other Information: Vegetation not as shown on map.
9. Results of Encounters with the Enemy: None
10. Condition of Patrol: 1 USMC KIA, 3 USMC WIA, 1 USMC NBC.
11. Conclusions and Recommendations: There is a great need for overflights.

*R. S. Johnson*  
 R. S. JOHNSON  
 2dLt USMC  
 Patrol Leader

12. Comments by Debriefer: None



1st Reconnaissance Battalion  
2dLt R. S. JOHNSON  
Maps: AMS Series L7014  
Sheet 6738 I, 6738 II

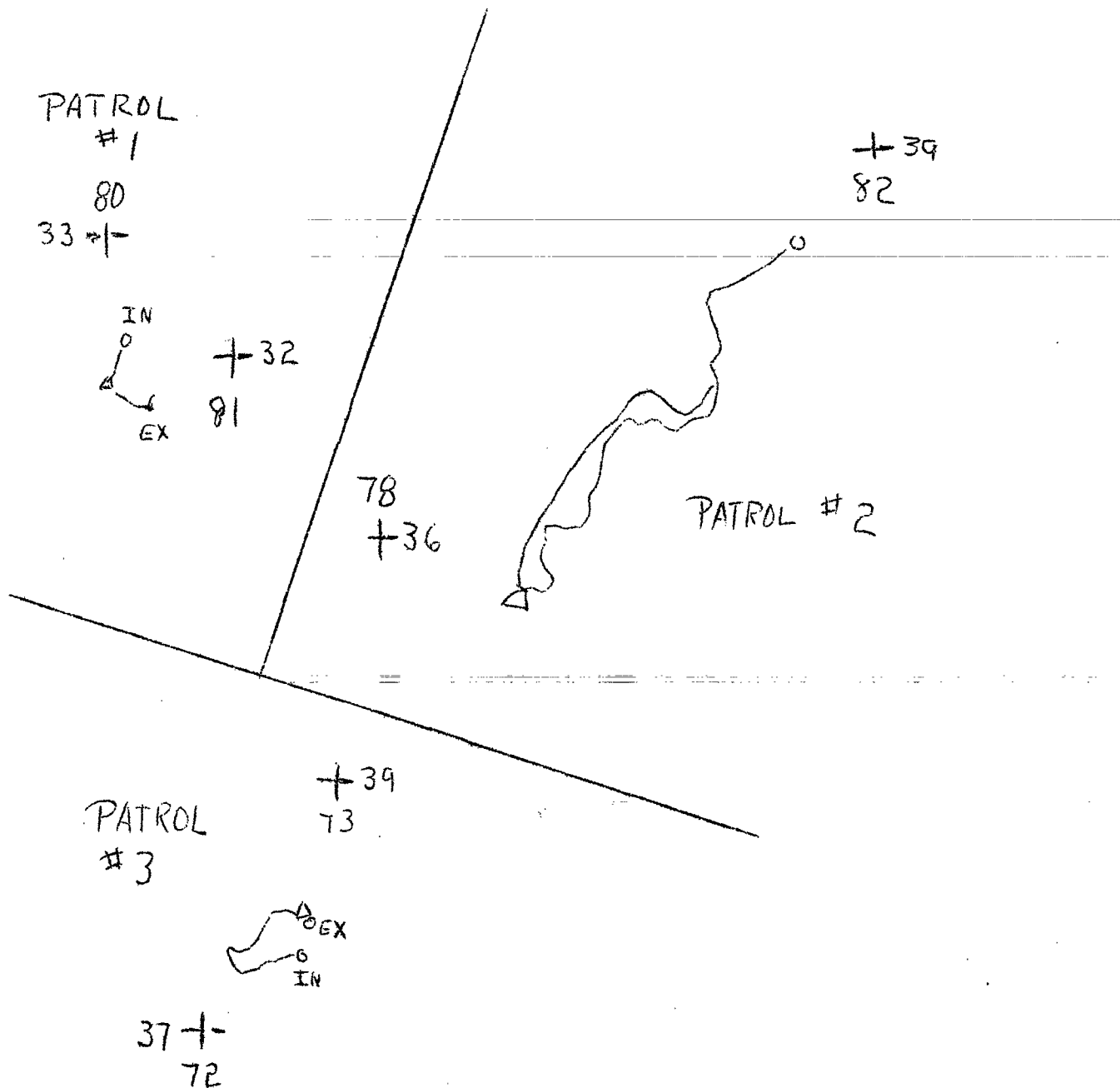

1st Reconnaissance Battalion  
 CHU LAI, RVN  
 121400H March 1967

PATROL ROSTER

1.	JOHNSON, RICHARD S. JR.	2dLt	094438
2.	VANDETTA, NICHOLAS D.	Cpl	2136850
3.	JONES, JAMES F.	LCpl	2117471
4.	CHERAMIE, WAYNE P.	LCpl	2144138
5.	DUNCAN, RAYMOND A. JR.	EFC	2237647
6.	HUBANKS, EDWARD W.	PVT	2242249
7.	RHODES, JOHN O.	LCpl	2199835
8.	CULLINAN, DANIEL J. JR.	EFC	2281077
9.	BROBERMAN, BARRY B.	EFC	2199153
10.	HOWARD, FLOYD JR.	EFC	2223449
11.	CUELLAR, BENITO	LCpl	2210820
12.	HINES, JOHN L. III	Cpl	2044741
13.	FOSTER, BILLY L.	EFC	2248941
14.	KNEREM, JAMES J.	EFC	2316681
15.	JACKSON, EDWARD G. JR.	EFC	2266542
16.	MOON, RICHARD A.	EFC	2238647
17.	MARTIN, LAWRENCE	EFC	2320061
18.	MORRIS, IRVIN	EFC	2278080
19.	MC CLELLAN, LARRY N.	EFC	2302290
20.	HAWLEY, JOHN H.	EFC	2183653
21.	ESTERS, A. J.	HN	7887017

S-3

1st Reconnaissance Battalion  
 CHU LAI, RVN  
 131800H March 1967.

Bn Frag Order 52-67  
 Team: 2nd Plt, 1st Force Recon Co  
 Debriefers: Cpl E. L. DRAKE  
 Maps: AMS Series L7014  
 Sheet 6639 I

PATROL REPORT

1. Size and Composition: 7 Enlisted.
2. Mission: Conduct ground reconnaissance/observation vicinity BT 2506.
3. Time of Departure: 111030H March 1967.
4. Time of Return: 131500H March 1967.
5. Route: See attached overlay.
6. Synopsis: This patrol covered a period of 52½ hours with no sightings.
7. Observations: None
8. Other Information: Insert and extract LZ vic BT 236101, poor LXH46 zone. OP's located vic BT 234099 - 237098, poor observation. At 122200H patrol heard 25 rounds covering an area from BT 262094 to BT 226093 coming from along trail. There was no sequence to shots.
9. Results of Encounters with the Enemy: None
10. Condition of Patrol: Good
11. Conclusions and Recommendations: Carry plenty of insect repellent for leeches.
12. Comments by Debriefers: None

  
 G. A. IKONEN  
 SSgt USMC  
 Patrol Leader

1st Reconnaissance Battalion  
 SSgt G. A. IKONEN  
 Maps: AMS Series L7014  
 Sheet 6639 I

PATROL ROSTER

1. FULTON, JAMES T.	Cpl	2158847
2. HECK, ROBERT L.	LCpl	2169613
3. HERGENRADER, EDDIE A.	LCpl	2212739
4. HUFFMAN, ANTHONY P.	LCpl	2160635
5. IKONEN, GEORGE A.	SSgt	1837523
6. MOOS, RICHARD R.	LCpl	2192362
7. LONG, P. E.	SSgt	2005909

23  
 12 +

INSERT  
 EXTRACT  

+

S-3

1st Reconnaissance Battalion  
 CHU LAI, RVN  
 141500H March 1967

Bn Frag Order 52-67

Team: 1st Sqd, 1st Plt, 1st For Recon Co

Debriefing: Cpl E. L. DRAKE

Maps: AMS Series L 7014  
 Sheet 6739 IV

PATROL REPORT

1. Size and Composition: 1 Officer, 6 Enlisted
2. Mission: Establish an OP on Hill 410 vic BS 4593 and support infantry operations in the area.
3. Time of Departure: 110900H March 1967
4. Time of Return: 141430H March 1967
5. Route: See attached overlay
6. Synopsis: This patrol covered a period of 77½ hrs with 3 sightings of 21 VC/VCS.
7. Observations:

<u>TIME</u>	<u>COORDINATES</u>	<u>OBSERVATIONS</u>
111615H	474943	12 VCS moving NE on dike, blk PJs, bundles on poles.
120915H	474935	5 VCS moving NE along dike, blk PJs and bundles.
121220H	475943	4 VCS moving NE on trail away from infantry, blk PJs, bundles.

8. Other Information: Insert and Extract LZ loc vic BS 452931, good 2XH46 zone with 1 foot water, scattered scrub brush. 1st OP loc vic BS 448927, good observation to north, northeast and east, 20-30 foot canopy. 2d OP site loc vic BS 447928, good observation. No canopy, large boulders used for OP.

9. Results of Encounters with the Enemy: None
10. Condition of Patrol: good
11. Conclusions and Recommendations: None

*H. E. McDonald*  
 H. E. McDONALD  
 1stLt USMC  
 Patrol Leader

12. Comments by Debriefing: None

1st Reconnaissance Battalion

CHU LAI, RVN

1st Sqd, 1st Plt, 1st For Recon Co

141500H March 1967

PATROL ROSTER

1. McDONALD, H. E.	1stLt	082026
2. CRUZ, D. S.	Pfc	2249686
3. GILPIN, R. D.	LCpl	2227368
4. HOWZE, L. R.	Cpl	2175217
5. MOOS, R. R.	Cpl	
6. NEEL, L. D.	Cpl	2147474
7. WILLIAMS, C. D.	Cpl	2147185

OVERLAY

413  
46 +

*ADK*

+ 413  
47

S-3

1st Reconnaissance Battalion  
 CHU LAI, RVN  
 141830H March 1967

Bn Frag Order 52-67  
 Team: 3rd Plt, Co "A"  
 Debriefers: Cpl E. L. DRAKE  
 Maps: AMS Series L7014  
 Sheet 6739 III

PATROL REPORT

1. Size and Composition: 2 Officers, 18 Enlisted, 1 USN.
2. Mission: Establish an OP vicinity BS 4184. Observe North into the TRA BONG Valley.
3. Time of Departure: 110930H March 1967.
4. Time of Return: 131530H March 1967.
5. Route: See attached overlay
6. Synopsis: This patrol covered a period of 54 hours with 1 sighting of 1 VC. Light civilian activity in the valley.
7. Observations: (Enemy and Terrain),

<u>TIME</u>	<u>COORDINATES</u>	<u>OBSERVATIONS</u>
121245H	BS 42587L	1 VC moving East on trail, blk PJ's. Rifle.

8. Other Information: Insert LZ located vic BS 413837, good 8XH46 zone with 8 foot elephant grass. OP sites located vicinity BS 415838 and BS 417839, good observation to the North. Extract LZ vicinity BS 417838, good LXH46 zone with 8 foot elephant grass. OP good defensive pos. with grass going to top of hill.

9. Results of Encounters with the Enemy: None
10. Condition of Patrol: Good
11. Conclusions and Recommendations: None

*Paul R. Young*  
 P. R. YOUNG  
 2nd Lt USMC  
 Patrol Leader

12. Comments by Debriefers: None

A-#24

1st Reconnaissance Battalion  
 2nd Lt P. R. YOUNG  
 Maps: AMS Series L7014  
 Sheet 6739 III

PATROL ROSTER

1. YOUNG, PAUL R.	2ndLt	094373.
2. WATKINS, LEE H. JR	SSgt.	1881368
3. MC CARPHY, CHARLES T.	LCpl.	2150564
4. KELLER, DAVID B.	LCpl.	2168520
5. BAND, EMMET C.	LCpl.	2216081
6. LUCAS, ROBERT D.	PFC.	2329712
7. BEGIN, ROBERT A.	PFC.	2239395
8. HYNE, MICHAEL G.	PFC.	2247315
9. COLE, DAVID A.	PFC.	2332435
10. GIORDANO, LOUIS	PFC.	2253271
11. STORY, JAMES D.	LCpl.	2147566
12. PEACOCK, JAMES R.	LCpl.	2213219
13. BASCO, DARWIN K.	PFC.	2303787
14. WARREN, RICHARD J.	PFC.	2271695
15. CARR, MARC A.	LCpl.	2170983
16. KLAUS, JOHN P.	LCpl.	2250188
17. HOLTHAOS	HN.	9985050
18. CAHILL	1stLt	090805

86 + 41

was opt out  
 insert

+ 83  
 44



5-3

1st Reconnaissance Battalion  
 CHU LAI, RVN  
 141830H March 1967

Bn Frag Order 52-67  
 Team: 4th Plt, 1st Force Recon Co  
 Debriefed: GySgt J. L. WILLIAMS  
 Maps: AMS Series L7014  
 Sheet 6639 I

PATROL REPORT

1. Size and Composition: 1 Officer, 4 Enlisted.
2. Mission: Conduct ground reconnaissance/observation of BONG MIEW (42), and CO BAY MINE vicinity BT 2406.
3. Time of Departure: 120900H March 1967.
4. Time of Return: 141700H March 1967.
5. Routes: See attached overlay.
6. Synopsis: This patrol covered a period of 56 hours with no sightings. There is a dam at BT 255045, possible water supply for VC. Many well used trails in the area.
7. Observations: None
8. Other Information: Insert LZ vic BT 239066 good LXH46 zone, 2 foot of mud, unused paddy, OP site BT 238062 good observation of valley. There is no ford or road vic BT 239053, as shown on maps. The trails are well used and movement is difficult off of trails due to thick vegetation. Patrol heard rifle fire from vic BT 239066 and BT 253070. Saw foot prints in the sand at BT 253043. Extract LZ vic BT 255044, very poor LZ can be used in emergency only.
9. Results of Encounters with the Enemy: None
10. Condition of Patrol: Good
11. Conclusions and Recommendations: Travel light, very few OP sites.
12. Comments by Debriefed: None

*L. E. Torres*

L. E. TORRES  
 2d Lt USMC  
 Patrol Leader

A-#25

1st Reconnaissance Battalion  
2dLt L. E. TORRES  
Maps: AMS Series L7014  
Sheet 6639 I

PATROL ROSTER

1. TORRES, LEONARD E.	2dLt	093488
2. BENNETT, HARRY K.	Cpl	2052409
3. ORTIZ, HARRY	Cpl	2030196
4. OWENS, CHARLES N. JR	EFC	2172789
5. SCHMIDT, RAYMOND M..	LCpl	2188946

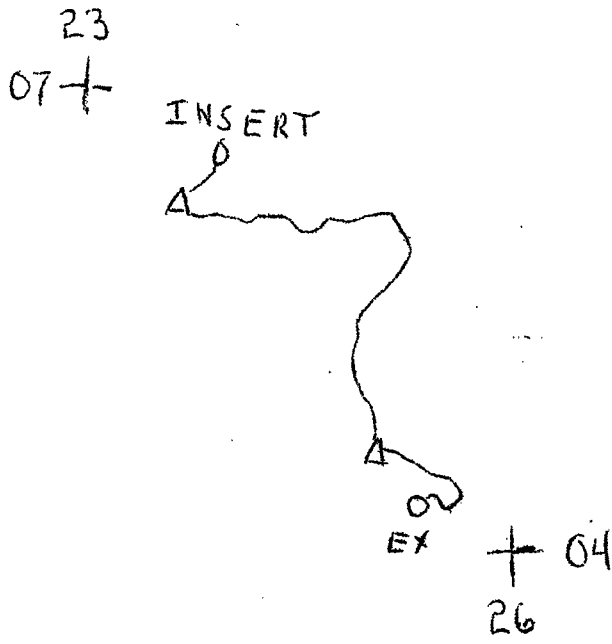

S-3

1st Reconnaissance Battalion  
 CHU LAI, RVN  
 151500H Mar 67

Bn Frag Order 53-67  
 Team: 2dPlt, Co "D"  
 Debriefers: GySgt J. L. WILLIAMS  
 Maps: AMS Series L 7014  
 Sheet 6739 IV

PATROL REPORT

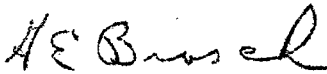
1. Size and Composition: 17 enl, 1 USN
  2. Mission: Establish an OP on Hill 410 vicinity BT 3803. Observe into the PHOUC KHACH Valley.
  3. Time of Departure: 120815H Mar 67
  4. Time of Return: 151410H Mar 67
  5. Route: None
  6. Synopsis: This patrol covered a period of 78 hours with no sightings. There was limited civilian activity in the valley. No evidence of VC on Hill 410.
  7. Observation: None
  8. Other Information: Insert and extract LZ vic BT 388036 good LXH46 zone.
  9. Results of Encounters with the Enemy: None
  10. Condition of Patrol: Good
  11. Conclusions and Recommendations: Conduct ground recon of PHOUC KHACH VALLEY.
-   
 G. E. BROSCH  
 SSgt USMC  
 Patrol Leader
12. Comments by Debriefers: None

A-#26

1st Reconnaissance Battalion  
 CHU LAI, RVN  
 151500H

PATROL ROSTER

BROSCH, George E	SSgt	
KERWIN, Alan S	LCpl	2141619
REEDER, Joseph E.	Pfc	2219016
KEISTER, Roger F	LCpl	2180331
ETHERIDGE, Jimmy O	LCpl	2138435
OLIVER, Steven R.	Pfc	2140019
MOOS, Donald R.	Pfc	2294766
HANSARD, Author L.	Pfc	2275700
SPARROW, Joseph S. JR.	Pfc	2300387
HOLCOMB, Larry N.	Cpl	2106331
SCANTON, Thomas	LCpl	2174245
HARRIS, David S.	Pfc	2223443
POTTS, Ronnie W.	Pfc	2280378
CANNON, Everet E.	GySgt	1188363
CARSON, M.	HN	9191388

3-3

1st Reconnaissance Battalion  
CHU LAI, RVN  
 161330H March 1967

Bn Frag Order 53-67  
 Team: 1st Sqd, 4th Plt, 1st For Recon Co  
 Debriefers: GySgt J. L. WILLIAMS  
 Maps: AMS Series L 7014  
 Sheet 6739 IV

PATROL REPORT

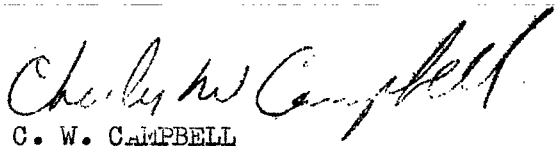
1. Size and Composition: 5 Enlisted.
  2. Mission: Conduct ground reconnaissance/observation vicinity BS 3994.
  3. Time of Departure: 131440H March 1967.
  4. Time of Return: 161200H March 1967.
  5. See Attached Overlay.
  6. Synopsis: This patrol covered a period of 70 hours with no sightings. Patrol heard 1 round small arms fire and found 1 trail that had been used recently.
  7. Observations: None.
  8. Other Information: Insert LZ vicinity BS 394938, very poor zone on ridge line. OP vicinity BS 390934, 35 foot canopy with thick undergrowth. Very poor observation of the area. OP vicinity BS 385936, heard 1 round small arms fire 500 meters from OP site. Crossed trail BS 384936, had been recently used. There are no LZs in the area. Extract LZ vicinity BS 384937, very poor zone.
  9. Results of Encounters with the Enemy: None.
  10. Condition of Patrol: good.
  11. Conclusions and Recommendations: None.
-   
 C. W. CAMPBELL  
 Sgt USMC  
 Patrol Leader
12. Additional Comments by Debriefers: None.

1st Reconnaissance Battalion  
CHU LAI, RVN  
161330H March 1967  
1st Sqd, 4th Plt, 1st For Recon Co

PATROL ROSTER

1. CAMPBELL, C. W.	SGT	1892428
2. GRACE, H.	LCPL	2147176
3. McCONNELL, J. R.	LCPL	2247922
4. TOY, D. W.	PFC	2209515
5. SCHIFFBAUER, J. E.	PFC	2280627

OVERLAY

+ 97  
37

EX O IN

42  
92 +

S.3

1st Reconnaissance Battalion  
 CHU LAI, RVN  
 161400H Mar 67

Bn Frag 53-67  
 Team: 4th Plt, Co "A"  
 Debriefed: Cpl E. L. DRAKE  
 Maps: AMS Series L 7014  
 Sheet 6639 I

PATROL REPORT

1. Size and Composition: 13 Enlisted
  2. Mission: Conduct ground recon/observation vicinity BT 2804 with primary direction of observation to North-Northeast.
  3. Time of Departure: 141440H Mar 67
  4. Time of Return: 161155H Mar 67
  5. Route: See attached overlay
  6. Synopsis: This patrol covered a period of  $46\frac{1}{2}$  hours with no sightings. There was no evidence of VC in the area.
  7. Observations: None
  8. Other Information: Insert and extract LZ located vic. BT 283043, good 5YH46 zone with approximately 5' elephant grass and 1' water. OP located vic BT 283060, poor observation, could not get above trees. At coord. BT 288047 patrol moved across well used trail running East to West, approx. 5' wide with all brush and rocks removed.
  9. Results of Encounters with the Enemy: None
  10. Condition of Patrol: Good
  11. Conclusions and Recommendations: Future patrols stay on either Hill 377 or 257 for best observation.
-   
 J. W. BELOW  
 SSgt USMC  
 Patrol Leader
12. Additional Comments by Debriefed: None

1st Reconnaissance Battalion  
 CHU LAI, RVN  
 15 OCT 67

PATROL ROSTER

BELOW, Jack W.	SSgt	1889549
WITMER, John F.	Cpl	2174276
COTTERMAN, Kenneth E.	LCpl	2269364
WIMER, Fred M.	LCpl	2265313
BROWN, Stephen H.	LCpl	2211015
MCORE, Larry R.	Pfc	2333725
McCULLOUGH, David W	Pfc	2307828
LAWSON, Melvin L	Pfc	2290853
HENDERSON, Frank R.	Pfc	2283176
CROMK, Jay W. JR	Pfc	2333035
JAMES, Robert L.	Pfc	2226104
McNAUGHTON, William R.	Pfc	2279381
NIMMO	Pfc	2230619

09  
 27



03  
 30



5-3

1st Reconnaissance Battalion  
 CHU LAI, RVN  
 161500H March 1967.

Bn Frag Order 52-67  
 Team: 1st Plt, Co "A"  
 Debriefers: Gysgt J. L. WILLIAMS  
 Maps: AMS Series L7014  
 Sheet 6738 I

PATROL REPORT

1. Size and Composition: 13 Enlisted, 1 USN.
2. Mission: Establish an OP at the Montagnard outpost vicinity BS 6358. The primary direction of observation is to the South and Southeast.
3. Time of Departure: 111030H March 1967
4. Time of Return: 161400H March 1967
5. Route: None
6. Synopsis: This patrol covered a period of 5 days with 28 sightings of 239 VC/VCS. 19 arty fire missions were called and 5 air strikes. 24 VC KIA (Conf) and 36 VC KIA (Prob). Patrol corpsman held MED-CAP for outpost inhabitants.
7. Observations: (Enemy and Terrain)

<u>TIME</u>	<u>COORDINATES</u>	<u>OBSERVATIONS</u>
111415H	BS 653574	5 VC standing in open, moved South after first round. 3 blk PJ's, 1 green, 1 khaki. 1 rifle, 1 cartridge belt. Called fire mission, excellent coverage. 1 VC KIA (Conf).
121045H	BS 659576	7 VC moved into woodline. Blk PJ's, khakis, greens. 3 rifles, 1 pack and bundles. Called fire mission, excellent coverage.
121115H	BS 618533	14 VCS moving west on trail in column. Blk PJ's. Unable to observe equipment.
121140H	BS 627607	8 VC moving Northeast. 4 khakis, 4 blk PJ's. 3 rifles, 1 BAR, 1 pack. Called fire mission, excellent coverage. 4 VC KIA (Conf).
121415H	BS 642573	2 VC moving Southeast. Blk PJ's, packs, rifles. Taken under fire with .50 cal MG. 1 VC KIA (Conf)
121500H	BS 617526	10 VCS moving Southwest. Blk PJ's, unable to observe equipment. Came from VC ville vic BS 618534.

A-#29

121550H	BS 625554	11 VC moving Northeast. Blk PJ's, packs and rifles Called fire mission, excellent coverage.
121815H	BS 658573	9 VC moving Northeast. 3 khaki, 6 blk PJ's. Rifles, packs and bundles. Called fire mission, excellent coverage. 4 VC KIA (Prob).
121830H	BS 665578	AO reported bunker complex. Patrol called arty fire mission, excellent coverage.
130900H	BS 678576	2 VC moving East. Blk PJ's. 1 rifle, 2 bundles. Called fire mission, good coverage.
131030H	BS 618534	9 VCS moving West in column. Blk PJ's, mixed khakis. Unable to observe equipment.
131040H	BS 623619	20 VCS standing in a group. Mixed blk PJ's, green khaki. Appear to be holding meeting. Dispersed at 1100H.
131115H	BS 660577	6 VC entering village. Blk PJ's. 1 rifle, 6 packs. Called fire mission, excellent coverage. 4 VC KIA (Prob). 2 structures destroyed.
131230H	BS 623532	13 VCS moved from ville vic BS 618534 gathered for meeting. Khaki and blk PJ's. Packs and bundles.
131300H	BS 660579	5 VC gathering. Blk PJ's. Rifles. Called fire mission, good coverage.
131345H	BS 668580	50 VC gathering. Mixed blk PJ's, green and khaki. Rifles and packs. VC popped yellow smoke in open field and VC assembled in area of smoke. Called fire mission, good coverage, requested air. AO received A/W fire from vic BS 685578. Called air strike. 4 VC KIA (Conf), 10 VC KIA (Prob).
131620H	BS 658585	2 VC entered house. Blk PJ's. 1 mortar tube. Called fire mission, good coverage.
131630H	BS 655575	10 VC moving East into ville. Blk PJ's. Packs and rifles. Air on station. Called air strike. 6 VC KIA (Conf), 1 VC WIA (Conf).
131720H	BS 635570	6 VC moving Southwest. Green utilities. VC carrying a tube 8 inches in diameter and five feet long tied on a pole. 1 .30 cal MG. Had another fire mission in progress, target moved out of sight.
141200H	BS 686576	12 VCS moving East. Blk PJ's. Unable to observe equipment. Relayed information to ARVN.

141315H	BS 665581	5 VC moved into treeline. Blk PJ's. 2 rifles. 1 cartridge belt, 1 pack, 2 water cans. Called fire mission, good coverage.
141420H	BS 628563	7 VC moving Northeast. Blk PJ's, rifles. Called fire mission, excellent coverage, 7 VC KIA (Prob).
151105H	BS 675584	3 VCS crossed river and entered house. Blk PJ's. Unable to observe equipment.
151145H	BS 675576	4 VCS moving East. Blk PJ's. 2 packs.
151340H	BS 665581	2 VC crossing river. Blk PJ's. 1 rifle. Called fire mission, excellent coverage. 1 VC KIA (Prob)
151410H	BS 665577	Aircraft received heavy A/W and MG fire from these coordinates. Requested AO.
151430H	BS 654575	6 VC rebuilding bunker. Blk PJ's. 2 rifles. Called fire mission, excellent coverage. 2 VC KIA (Conf), 3 VC KIA (Prob).
151445H	BS 665577	AO arrived and called air strike on coordinates where aircraft received fire from. AO and fixed wing received fire from BS 660585, called air strike. Observed 3 VC move from house BS 660585 with a MG. 5 VC KIA (Conf), 8 structures destroyed 2 secondary explosions.
151730H	BS 6355	Leaflet aircraft received heavy volume of MG fire
152300H	BS 675584	VC using a signal lamp. Called fire mission, good coverage. Lamp out.
160945H	BS 686595	14 VC in 4 boats moving South on river. Blk PJ's. Rifles, equipment in boat. Called fire mission, excellent coverage. 1 VC KIA (Conf), 4 VC KIA (Prob), 2 boats destroyed.
161000H	BS 652576	4 sampans on beach, called fire mission, 2 boats destroyed, 2 boats damaged.
161200H	BS 660586	5 VC moved into treeline. Blk PJ's. Rifles. Called fire mission, excellent coverage, 3 VC KIA (Prob).

8. Other Information: None.

9. Results of Encounters with the Enemy: 24 VC KIA (Conf), 36 VC KIA (Prob).

10. Condition of Patrol: Good
11. Conclusions and Recommendations: None

*J. P. Rudman*  
 J. P. RUDMAN  
 GySgt USMC  
 Patrol Leader

12. Comments by Debriefers: None

PATROL ROSTER

1. SUMNER, JOHN W.	LFC	2235044
2. RUDMAN, JAMES P.	GySgt	1366141
3. DAVIS, DONALD R.	LFC	2197171
4. WALLACE, TERENCE K.	LFC	2207322
5. MAHOVLIC, JOSEPH T.	LCpl	2203091
6. KUBS, CHRISTOPHER S.	EEC	2294924
7. DAY, TIMOTHY J.	LFC	2295197
8. BARTON, LANCE B.	LFC	2312733
9. SMOGER, STEPHEN S.	LFC	2078703
10. CLOW, JOHN R.	LFC	2100282
11. ULSTAD, DENNIS E.	LFC	2120343
12. ANDERSON, GEORGE E.	LFC	2290226
13. HOCKADAY, CARLTON W.	Sgt	2071016
14. SHACKLEY	HN	6949462

1st Reconnaissance Battalion  
 CHU LAI, RVN  
 171600H March 1967

Bn Frag Order 53-67  
 Team: 1st Plt, Co "D"  
 Debriefers: 2d Lt R. R. BENOIT  
 Maps: AMS Series L7014  
 Sheet 6739 IV

PATROL REPORT

1. Size and Composition: 1 Officer, 11 Enlisted, 1 USN.
2. Mission: Conduct ground reconnaissance/observation posts vicinity BS 3396.
3. Time of Departure: 140830H March 1967
4. Time of Return: 171425H March 1967
5. Route: See attached overlay
6. Synopsis: This patrol covered a period of 78 hours. The team was engaged on two separate occasions with a total of 8 VC resulting in 4 VC KIA (Conf). 4 weapons were recovered - MAS-36's. 3 USMC WIA minor. 2 air strikes were called.
7. Observations: (Enemy and Terrain)

<u>TIME</u>	<u>COORDINATES</u>	<u>OBSERVATIONS</u>
161450H	BS 336985	5 VC made contact with the patrol. Blk PJ's, 2 rifles - MAS-36's. Patrol received several rounds of S/A fire. Patrol returned fire resulting in 1 VC KIA (Conf). Recovered 1 MAS-36. Air strike called, good area coverage.
171210H	BS 345988	3 VC fired 4 rounds of S/A fire into position. Patrol returned fire resulting in 3 VC KIA (Conf), 3 MAS-36 rifles were recovered. Heard movement in the area, called air strikes.

8. Other Information: Insert LZ BS 326980 poor. Extract LZ BS 343986 good 2XH46 zone. There are many trails not appearing on the map. Many VC signs and symbols that appear to be fairly old. Trail were mostly running East and West. There are several streams in this area with clear, fast running water BS 345998.
9. Results of Encounters with the Enemy: 4 VC KIA (Conf). 4 VC rifles MAS-36's were recovered, 1 cartridge belt.
10. Condition of Patrol: 3 USMC WIA minor.

11. Conclusions and Recommendations: Grid BS 3499 has good OP's, water is available. Bring salt tablets, M-49 scope. HULE's and AO provided excellent support and assistance.

*G. Mc Dowell*  
 G. Mc DOWELL  
 1st Lt USMC  
 Patrol Leader

12. Comments by Debriefers: None

PATROL ROSTER

1. KEENE, WILLIAM E.	HN	B500066
2. ROGERS, PHILLIP D.	PFC	2260648
3. PORTER, JOHNNY L.	PFC	2257495
4. PATTON, MICHAEL W.	Cpl	2100352
5. LINIGREN, DARREL L.	PFC	2260156
6. HILL, JERRY S.	PFC	2221067
7. HART, PATRICK W.	Cpl	2114321
8. HARRIS, DAVID S.	PFC	2223443
9. FONDERLIN, TIMOTHY L.	Cpl	2103493
10. DOHERTY, WILLIAM A.	LCpl	2169608
11. DECESARE, DANNY T.	PFC	2309640
12. CHARLES, JAMES M.	LCpl	2145332
13. MC DOWELL, GARY W.	1st Lt	091529

1st Reconnaissance Battalion  
1stLt G. W. MC DOWELL  
Maps: AMS Series L7014  
Sheet 6739 IV

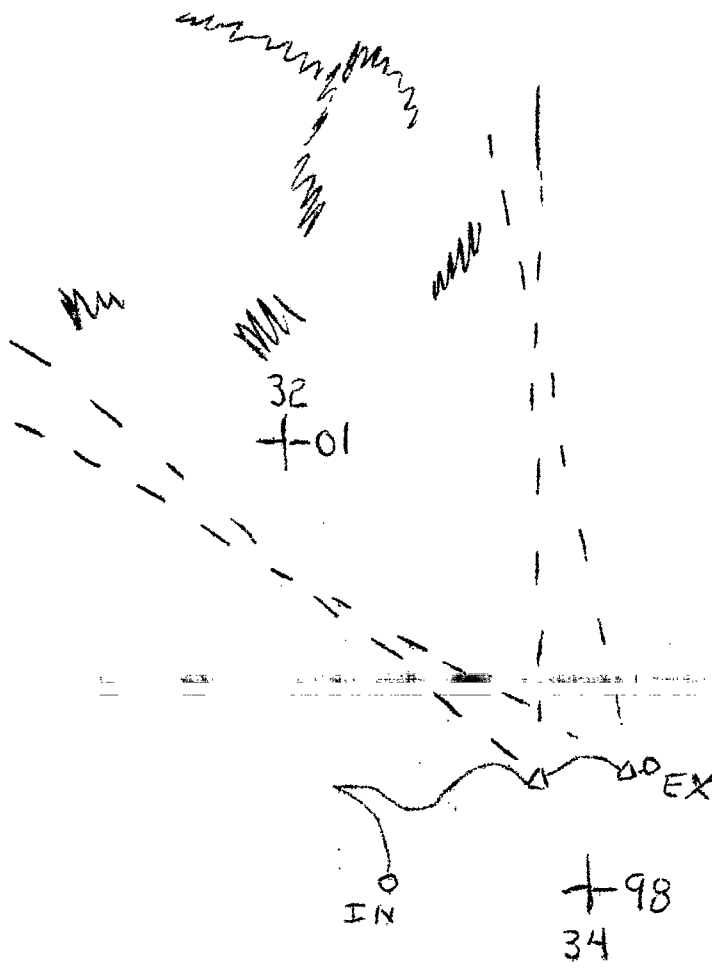

5-3  
1st Reconnaissance Battalion  
 CHU LAI, RVN  
 181500H March 1967

Bn Frag Order 53-67  
 Team: 6th Plt, 1st For Recon Co  
 Debriefing: GySgt WILLIAMS  
 Maps: AMS Series: L 7014  
 Sheet 6639 I

PATROL REPORT

1. Size and Composition: 7 Enlisted.
2. Mission: Conduct ground reconnaissance/observation of Hill 396 vicinity BT 2408.
3. Time of Departure: 150800H March 1967.
4. Time of Return: 181400H March 1967.
5. Route: See Attached Overlay.
6. Synopsis: This patrol covered a period of 78 hours with 5 sightings of 37 VC/VCS. Patrol made contact with 7 VC resulting in 2 VC KIA (prob). 1 air strike was called. Possible storage area vicinity BT 2508.

7. Observations:

<u>TIME</u>	<u>COORD</u>	<u>OBSERVATIONS</u>
151310H	BT 239073	8 VC Suspects moving west. Black PJs. Heavy packs.
161355H	BT 251080	7 VC Suspects moving north. Black PJs. Rice baskets.
171258H	BT 251080	6 VC Suspects moving north. Black PJs. Rice baskets.
171405H	BT 251080	9 VC Suspects moving north. Black PJs. Rice baskets.
181030H	BT 256083	7 VC fired on patrol with small arms and automatic weapons. Patrol returned fire resulting in 2 VC KIA (prob). Air strike was called and patrol was extracted.

8. Other Information: Insert LZ vicinity BT 247089, good 1xH46 zone, old rice paddy. 3 fighting holes, 2 weeks old vicinity BT 247086. OP site BT 248087, good observation to south and southeast. OP site vicinity BT 243083, thick undergrowth, fair observation to the south. OP site BT 241081, good observation to south. OP site BT 242082, good observation of trail thru LZ vic BT 254084. Extract LZ vicinity BT 254084, poor zone. Possible good LZ vicinity BT 247089.



6th Plt, 1st For Recon Co  
181500H March 1967 Continued

- 9. Results of Encounters with the Enemy: 2 VC KIA (prob).
- 10. Condition of Patrol: Good.
- 11. Conclusions and Recommendations: None.

*J. Arnold*  
J. ARNOLD  
Sgt USMC  
Patrol Leader

- 12. Additional Comments by Debriefer: None

---

OVERLAY

+11  
23

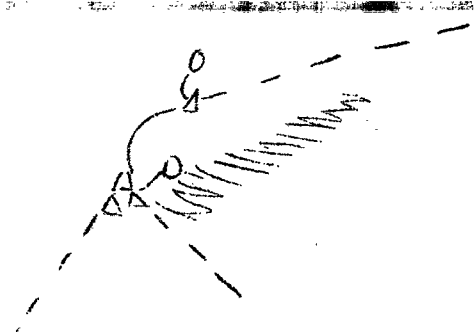

+07  
27

1st Reconnaissance Battalion  
CHU LAI, RVN  
6th Plt, 1st For Recon Co  
181500H March 1967 Continued

PATROL ROSTER

1. ARNOLD, JERRY	Sgt	2043215
2. WAIND, MARK R.	LCpl	2180160
3. DARBY, ARDY	LCpl	1862863
4. WILLIAMS, JAMES W. JR.	Pfc	2213202
5. PHILLIPS, JOSEPH W.	Pfc	2229881
6. HOLCH, JOHN W. JR.	LCpl	2127047

S-3

1st Reconnaissance Battalion  
 CHU LAI, RVN  
 181930H March 1967

Bn Frag Order 53-64  
 Team: 3d Plt, Co A  
 Debriefing: GySgt WILLIAMS  
 Maps: AMS Series L 7014  
 Sheet 6738 I

PATROL REPORT

1. Size and Composition = 2 USMC Officers, 13 USMC Enlisted, 1 USN.
2. Mission = OPCON to 3/7 for Operation DE SOPO. Establish an OP site at the following locations: BS 7535; BS 7530; BS 7634.
3. Time of Departure = 160930H March 1967.
4. Time of Return = 181830H March 1967.
5. Route = See Attached Overlay.
6. Synopsis = This patrol covered a period of 57 hours with 3 insertions. 5 sightings of 39 VC. 3 arty fire missions were called and 2 air strikes. Patrol made contact with the enemy 3 times resulting in 5 VC KIA (conf) & 5 VC KIA (prob). 3 USMC WIA and 3 USMC NBC.
7. Insertion # 1.

161100H Insertion LZ vicinity BS 758354, good zone, grass 4 foot high, 6xH46s. OP site BS 754358, good observation of valley to north and south and trail BS 750366.

161420H	BS 747365	7 VC moving north. Black PJs. 3 rifles. 4 packs. Called fire mission, excellent coverage.
161450H	BS 747363	4 VC observing patrol position. Black PJs. 1 rifle.
161630H	BS 758345	Patrol received small arms fire from estimated 3 VC. Called 2 fire missions and returned small arms fire. Patrol moved to BS 757346. Broke contact with VC.
162130H	BS 762347	Extraction LZ good lxH46 zone.

1st Reconnaissance Battalion

CHU LAI, RVN

3d Plt, Co A 181930H March 1967

Continued

## Insertion # 2.

170900H Insertion LZ vicinity BS 749306, grass, good lxH46 zone.  
OP site BS 752308, heavy vegetation.

171415H	BS 753308	Contact with 15 VC, 1 SMG, 1 BAR and rifles. 4 VC KIA (conf) 3 VC KIA (prob). Patrol broke contact moved to BS 755309. Air arrived, ran air strike BS 752308 to BS 750307. Found 50 man VC harbour site vicinity BS 757308.
---------	-----------	---

171730H	BS 756305	Extraction LZ large cultivated rice paddy.
---------	-----------	--

## Insertion # 3.

181200H Insertion LZ BS 767345, good lxH46 grass zone. Patrol moved to BS 766346, 2 NBC MED-EVAC. Moved to BS 764346, 1 NBC. Set up defensive position. Observed 10 VC on hill vicinity BS 764345 at 181430H. Patrol opened fire, received small arms and grenades. 2 VC KIA (prob) 1 VC KIA (conf). HULE straffed area and conducted air strike. Patrol was extracted at 181445H. 3 USMC WIA.

8. Other Information = None.

9. Results of Encounters with the Enemy = 5 VC KIA (confirmed).  
5 VC KIA (probable).

10. Condition of Patrol = 3 USMC WIA, 3 NBC.

11. Conclusions and Recommendations = None.

*P. R. Young*  
P. R. YOUNG  
2dLt USMC  
Patrol Leader

12. Additional Comments by Debriefers = None.

1st Reconnaissance Battalion  
3d Plt, Co A 131930H March 1967  
Continued

OVERLAY

1<sup>st</sup> PATROL

+ 36  
75  
IN  
O EY

+ 35  
77

2<sup>nd</sup> PATROL

+ 32  
77

IN A  
304  
75

+ 31  
77

3<sup>rd</sup> PATROL

EX  
IN

+ 34  
77

1st Reconnaissance Battalion  
 CHU LAI, RVN  
 3d Plt, Co A 181930H March 1967  
 Continued

PATROL ROSTER

1. YOUNG, PAUL R.	2dLt	094373
2. WATKINS, LEE H. JR.	SSgt	1881368
3. MCCARTHY, CHARLES T.	LCpl	2150564
4. KELLER, DAVID B.	LCpl	2168520
5. BAND, EMMET C.	LCpl	2216081
6. KLAUS, JOHN P.	LCpl	2250188
7. LUCAS, ROBERT D.	Pfc	2329712
8. COLE, DAVID A.	Pfc	2332435
9. BEGIN, ROBERT A.	Pfc	2239395
10. CARR, MARC A.	LCpl	2170983
11. PEACOCK, JAMES R.	LCpl	2213219
12. WARREN, RICHARD J.	Pfc	2271695
13. GIORDANO, LOUIS	Pfc	2253271
14. BASCO, DARWIN K.	Pfc	2303787
15. HOLTHAOS	HN	9985050
16. KICKLIGHTER, R. C.	Lt	092116

53

1st Reconnaissance Battalion  
 CHU LAI, RVN  
 200930H March 1967.

Bn Frag Order 54-67  
 Team: 2nd Plt, Co "D"  
 Debriefers: GySgt J. L. WILLIAMS  
 Maps: AMS Series L7014  
 Sheet 6739 IV

PATROL REPORT

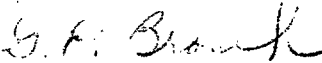
1. Size and Composition: 15 Enlisted, 1 USN
  2. Mission: Conduct ground reconnaissance/observation vicinity BS 3293 and BS 3393.
  3. Time of Departure: 181620H March 1967
  4. Time of Return: 191800H March 1967
  5. Route: See attached overlay
  6. Synopsis: This patrol covered a period of 25½ hours with no observations. There was no sign of life in the area. Buildings shown on the map do not exist.
  7. Observations: None
  8. Other Information: Insert and Extract LZ vic BS 331928 good 2XH46 zone. Patrol had very poor communications in the area due to steep hills on both sides. Area is rolling terrain with numerous streams. Scrub brush and kuni grass in the low ground and primary jungle with 10-30 foot canopy in the high ground. There was no evidence of VC in the area and no sign of life.
  9. Results of Encounters with the Enemy: None
  10. Condition of Patrol: Good
  11. Conclusions and Recommendations: None
-   
 G. E. BROSCH  
 SSgt USMC  
 Patrol Leader
12. Comments by Debriefers: None

1st Reconnaissance Battalion  
 SSgt G. E. BROSH  
 Maps: AMS Series L7014  
 Sheet 6739 IV

PATROL ROSTER

- |                                  |                                    |
|----------------------------------|------------------------------------|
| 1. BROSCH, G. E. SSgt 1428088    | 9. SPARROW, J. S. JR. PFC 2300387  |
| 2. HOLCOMB, L. N. Cpl 2106551    | 10. SMITH, S. R. PFC 2204989       |
| 3. SCANLON, T. S. LCpl 2174222   | 11. OLIVER, S. R. PFC 2140019      |
| 4. POTTS, R. W. PFC 2280378      | 12. ROOS, D. R. PFC 2294766        |
| 5. SPACEK, J. A. JR. PFC 2258013 | 13. HASKELL, H. N. LCpl 2220919    |
| 6. HANSARD, A. L. PFC 2275700    | 14. BOYKINS, J. H. JR. Cpl 2174684 |
| 7. KEISTER, R. P. LCpl 2180551   | 15. KERWIN, A. S. LCpl 2141619     |
| 8. ETHERIDGE, J. C. LCpl 2138435 | 16. CARSON, M. HN 9191388          |

OVERLAY

+95  
 31

36  
 +94

LZ



1st Reconnaissance Battalion  
 CHU LAI, RVN  
 201800H March 1967

Bn Frag Order 53-67  
 Team: 2d Plt, 1st For Recon Co  
 Debriefers: 2d Lt BENOIT  
 Maps: AMS Series L 7014  
 Sheet 6639 I

PATROL REPORT

1. Size and Composition: 8 USMC Enlisted.
2. Mission: To conduct a ground reconnaissance/observation main trail vicinity BT 3103.
3. Time of Departure: 161255H March 1967.
4. Time of Return: 201555H March 1967.
5. Route: See Attached Overlay.
6. Synopsis: This patrol covered a period of 99 hours with negative sightings.
7. Observations: Negative.
8. Other Information: A. 191305H, patrol heard 4 rounds fired 10-15 seconds apart. Firing came from the southwest vicinity 295017. At 200230H, patrol heard several rounds fired in the valley vicinity of 319028. Rounds were fired 10 minutes apart.  
 B. Trails vicinity of 288050 appear to be heavily used. Trails run east to west. Trail along ridge line 290045. Trail runs east to west.  
 C. Terrain: There are numerous overgrown and uncultivated rice paddies in the area. On the ridge line, the canopy is up to 15 feet high with sparse vegetation and heavy secondary growth.  
 D. Insertion LZ 282043, good LXH46 zone. Extraction LZ 299025, good LXH46 zone.
9. Results of Encounters with the Enemy: None.
10. Condition of the Patrol: good.
11. Conclusion and Recommendations: Machetes would be useful.
12. Additional Comments by the Debriefers: None.

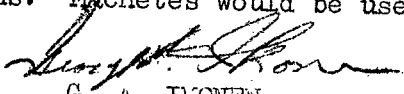
  
 G. A. IKONEN  
 SSgt USMC  
 Patrol Leader

1st Reconnaissance Battalion

CHU LAI, RVN

2d Plt, 1st For Recon Co

201800H March 1967

PATROL ROSTER

1. IKONEN, GEORGE A.	SSgt	1837523
2. FULTON, JAMES T.	Cpl	2158847
3. GILPIN, RICHARD D.	LCpl	2227368
4. MARACIE, PHILIP C.	LCpl	2173524
5. NEEL, LARRY D.	Cpl	2147474
6. WILKINS, CHARLES D.	Cpl	2147185
7. LONG, P. E.	Sgt	2005909
8. WINTERS, L. N.	Sgt	1904975

OVERLAY

+06  
26

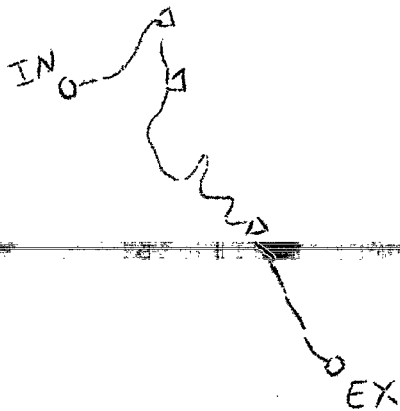

30  
+01



9. Results of Encounters with the Enemy: 2 enemy KIA confirmed.  
 1 enemy KIA probable.  
 3 enemy WIA confirmed.  
 4 USMC WIA.
10. Conclusion and Recommendations: Arc Light strike and TPQ-10.
11. Condition of Patrol: 9 USMC WIAs. 2 serious.

*J. W. Below*  
 J. W. BELOW  
 SSgt USMC  
 Patrol Leader

12. Comments by Debriefers: None.

PATROL ROSTER

1.	BELOW, JACK W.	SSgt	1889549
2.	WITMER, JOHN F.	Cpl	2174276
3.	BROWN, STEPHEN H.	LCpl	2211015
4.	BINGHAM, ROBERT L.	LCpl	2184486
5.	COTTERMAN, KENNETH E.	LCpl	2269364
6.	LAWSON, MELVIN L.	Pfc	2290853
7.	JAMES, ROBERT L.	Pfc	2226104
8.	CRONK, JAY W. JR.	Pfc	2333035
9.	HENDERSON, FRANK R.	Pfc	2283176
10.	MOORE, LARRY R.	Pfc	2333725
11.	McCULLOUGH, DAVID W.	Pfc	2307828
12.	BRANT, WILLIAM L.	LCpl	2198648
13.	SHANNON	HN	9999530
14.	SPARKS, PRESTON H. JR.	Pfc	2265996
15.	McNAUGHTON, WILLIAM R.	Pfc	2279381

5-3  
 1st Reconnaissance Battalion  
 CHU LAI, RVN  
 211330H March 1967

Bn Frag Order 54-67  
 Team: 4th Plt, 1st Force Recon Co  
 Debriefers: GySgt J. L. WILLIAMS  
 Maps: AMS Series L7014  
 Sheet 6739 I

PATROL REPORT

1. Size and Composition: 6 Enlisted
  2. Mission: Conduct ground reconnaissance/observation vicinity BT 2504.
  3. Time of Departure: 181640H March 1967
  4. Time of Return: 211145H March 1967
  5. Route: See attached overlay
  6. Synopsis: This patrol covered a period of 67 hours with one sighting of 5 VCS. The VCS included 3 children who walked into LZ and stood around and then left. There was no sign of habitation in the area.
  7. Observations: None
  8. Other Information: Insert LZ BT 262049 good 2XH46 zone, old paddy. Vicinity BT 262048 thick undergrowth. Trail vicinity BT 260052 possible main trail, not recently used. Extract LZ BT 260060 good 1XH46 zone.
  9. Results of Encounters with the Enemy: None
  10. Condition of Patrol: Good
  11. Conclusions and Recommendations: None
- Charles W. Campbell*
- C. W. CAMPBELL  
 Sgt USMC  
 Patrol Leader
12. Comments by Debriefers: None

1st Reconnaissance Battalion

Sgt C. W. CAMPBELL

Maps: AMS Series L7014

Sheet 6739 I

PATROL ROSTER

1.	CAMPBELL, C. W.	Sgt	1892428
2.	ORTIZ, H.	Cpl	2030196
3.	GRACE, H.	LCpl	2147176
4.	SCHMIDT, R. M.	LCpl	2188946
5.	NOLL, J. R.	PFC	2222220
6.	ZINKLON, R. A.	PFC	2304318

+08  
25

EX  
○  
|  
○  
|  
○  
IN

29  
+05

5-3

1st Reconnaissance Battalion  
 CHU LAI, RVN  
 221500H March 1967

Bn Frag Order 54-67  
 Team: 1st Plt, Alpha Co  
 Debriefers: 2dLt BENOIT  
 Maps: AMS Series L 7014  
 Sheet 6739 IV

PATROL REPORT

1. Size and Composition: 15 USMC Enlisted.
2. Mission: Set up Observation Post coordinates BS 418998.
3. Time of Departure: 181430H March 1967.
4. Time of Return: 221400H March 1967.
5. Overlay: None.
6. Observations: None
7. Synopsis: This patrol covered a period of 4 days with negative sightings.
8. Other Information: Insert LZ 418998, extract LZ 418998. Air strike was conducted prior to insertion.
9. Results of Encounters with the Enemy: None.
10. Condition of Patrol: Good.
11. Conclusion and Recommendations: Bring extra water, gas and DDT with sprayer.
12. Additional Comments by Debriefers: None.

*J. P. Rudman*  
 J. P. RUDMAN  
 GySgt USMC  
 Patrol Leader

1st Reconnaissance Battalion  
 CHU LAI, RVN  
 1st Flt, Alpha Co  
 221500H March 1967 Continued.

PATROL ROSTER

1. DAVIS, DONALD R.	Pfc	2197171
2. HOCKADAY, CARLTON W.	Sgt	2071016
3. SUMNER, JOHN, W.	Pfc	2235044
4. MAHOVLIC, JOSEPH T.	LCpl	2203091
5. ULSTAD, DENNIS E.	Pfc	2120343
6. CLOW, JOHN R.	Pfc	2100282
7. DAY, TIMOTHY J.	Pfc	2295197
8. BARTON, LANCE B.	Pfc	2312733
9. ANDERSON, GEORGE E.	Pfc	2290226
10. KUBS, CHRISTOPHER S.	Pfc	2294924
11. MOSKAL, ANTHONY F. JR.	LCpl	2178959
12. WALLACE, TERENCE K.	Pfc	2207322
13. SMOGER, STEPHEN S.	Pfc	2078703
14. RUDMAN, JAMES P.	GySgt	1366141
15. BENHAM, CAFARIS	LCpl	2232043



5-3

1st Reconnaissance Battalion  
 CHU LAI, RVN  
 221800H March 1967

B<sub>n</sub> Frag Order 53-67  
 Team: 3rd Plt, Co "D"  
 Debriefers: 2dLt R. R. BENOIT  
 Maps: AMS Series L7014  
 Sheet 6738 I

PATROL REPORT

1. Size and Composition: 1 Officer, 11 Enlisted, 1 USN.
2. Mission: Set up an observation post in vicinity of BS 6358.
3. Time of Departure: 161320H March 1967
4. Time of Return: 221630H March 1967
5. Route: None
6. Synopsis: This patrol covered a period of 6 days and 3 hours with 20 sightings of 104 VC. 17 fire missions were called resulting in 25 VC KIA (Prob).
7. Observations: (Enemy and Terrain)

<u>TIME</u>	<u>COORDINATES</u>	<u>OBSERVATIONS</u>
171125H	BS 624545	15 VC heading NW into woodline, blk PJ's. Packs and 57 mm or 3.5 launcher with shells.
171345H	BS 670581	4 VC pulled boat on beach and went into treeline, blk PJ's. 2 rifles. Called FM, good coverage.
171530H	BS 668581	4 VC moving on trail and into treeline, blk PJ's. Packs and rifles. Called FM, good coverage. 1 building destroyed and 1 VC KIA (Prob).
171930H	BS 657574	8 VC digging trenches and fortifications, blk PJ's. Shovels and picks.
181155H	BS 628564	1 Sampah with 2 VC unloading bundles onto river bank; 1 rifle visible. Called FM, good coverage.
181730H	BS 638573	3 VC moving SW through cane field, blk PJ's. 2 rifles. Called FM, excellent coverage. 2 VC KIA (Prob).
181915H	BS 608546	14 VC loading bundles into 6 sampans, blk PJ's. 2 rifles visible.

191125H BS 657591 3 VC moving S through rice paddies, blk PJ's. 2 rifles. Called FM, good coverage. 2 VC KIA (Prob). Only one was observed leaving area.

191520H BS 650586 3 VC moving SW, blk PJ's. 2 rifles. FM called, excellent coverage. Fired .50 cal MG. 2 VC KIA (Prob).

192145H BS 674585 1 light moving SW on river. Called FM, excellent coverage.

200845H BS 661585 3 VC swimming river and entering treeline, blk PJ's. 1 rifle visible. Called FM and fired .50 cal MG. Good coverage, 1 VC KIA (Prob).

201130H BS 667576 6 VC moving E on trail, blk PJ's. 4 rifles, 2 packs and 1 large bundle. Called FM, excellent coverage.

201415H BS 612550 9 VC unloading sampan on E bank. Large bundles and crates, blk PJ's. 3 packs and 3 rifles and 3 helmets visible. Called FM, good coverage.

201445H BS 668376 3 VC moving E on trail, blk PJ's. 2 rifles and 1 pack. Called FM, excellent coverage. 1 VC KIA (Prob).

201445H BS 612550 3 VC unloading sampans. Blk PJ's. 1 pack and 1 rifle visible. Called FM, excellent coverage. 3 sampans destroyed, 3 VC KIA (Prob).

201635H BS 644572 1 VC moving E on trail, blk PJ's. 1 rifle. Fired .50 cal. Good area coverage.

201735H BS 625545 15 VC observing area damaged by TR-10, blk PJ's. Packs and rifles. Called FM, excellent area coverage. 6 VC KIA (Prob).

201920H BS 612550 3 VC unloading sampan, blk PJ's. 1 pack and 1 rifle visible. Called FM, excellent coverage. 3 sampans destroyed and 3 VC KIA (Prob).

211525H BS 656574 3 VC moving between huts, blk PJ's. 2 rifles. Called FM, excellent coverage, 2 huts destroyed and 2 VC KIA (Prob).

211535H BS 652562 2 VC moving SW in treeline, blk PJ's. 1 rifle and 2 packs. Good area coverage. 2 VC KIA (Prob).

8. Other Information: 171215H AO reported automatic weapon position at BS 626543, a trench line at BS 624543 to BS 627544. At coordinates BS 656574 large gathering of farmers with rice baskets for 2 days. This position appears to be a rice collecting point. There is a tunnel entrance along the river at BS 645572. Canoes travel to this area and unload bundles periodically. Patrol corpsman held MED-CAP.
9. Results of Encounters with the Enemy: None
10. Condition of Patrol: Good
11. Conclusions and Recommendations: Bring necessary equipment to build sand bag bunkers. Bring 60 mm illumination ammo for night observation of the river.
- R. S. Johnson*  
R. S. JOHNSON  
2dLt USMC  
Patrol Leader
12. Comments by Debriefers: None

PATROL ROSTER

1. JOHNSON, RICHARD S.	2ndLt	094438
2. VENDETTA, NICHOLAS D.	Cpl	2136850
3. BARBOUR, JACK S.	Cpl	2101173
4. JONES, JAMES F.	LCpl	2117571
5. RHODES, JOHN O.	LCpl	2199835
6. BACIMAN, ALVIN D. JR.	PFC	2123801
7. HAWLEY, JOHN H.	PFC	2183653
8. CULLINAN, DANIEL J. JR.	PFC	2281077
9. MOON, RICHARD A.	PFC	2238647
10. KNEREM, JAMES J.	PFC	2376687
11. MCCLELLAN, LARRY N.	LCpl	2302290
12. CANNON, EVERT E.	GySgt	1170501
13. PETERS, A. J.	HN	7887017

5.3

1st Reconnaissance Battalion  
 CHU LAI, RVN  
 231530H March 1967

Bn Frag Order 54-67  
 Team: 2d Plt "A" Co  
 Debriefed: Cpl E. L. DRAKE  
 Maps: AMS, Series L 7014  
 Sheet 6739 IV

## PATROL REPORT

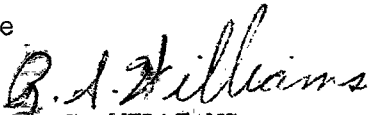
1. Size and Composition: 2 Off, 13 Enl.
  2. Mission: Establish an OP on Hill 410 located vicinity BS 4492.
  3. Time of Departure: 201545H March 67
  4. Time of Return: 231430H March 67
  5. Route: See attached overlay.
  6. Synopsis: This patrol covered a period of 70½ hours with no sightings.
  7. Observations: None
  8. Other Information: Insert LZ located vic. BS 435933 good LXH46 zone. Extract LZ located vic. BS 433944 good 4XH46 zone. 1st OP located vic BS 436935, fair observation with very thick vegetation. 2d OP located vic BS 434939, fair observation with thick vegetation. At coord. BS 433941 patrol found a weapons cache consisting of 8 shotguns and 8 rifles. The weapons appeared to be laying on 2 doors with a poncho over the top. Also there were 2 ammo cans, 1 with Vietnamese maps, 1 60mm mortar rd, and 2 81 or 82mm mortar rds. At same coord, there was a classroom with 1 bench 5' long and 1' off the deck and 1 stool.
  9. Results of Encounters with the Enemy: None
  10. Condition of Patrol: Good
  11. Conclusions and Recommendations: None
-   
 R. S. WILLIAMS  
 1stLt USMC  
 Patrol Leader
12. Comments by Debriefed: None

1st Reconnaissance Battalion  
CHU LAI, RVN  
231530H March 1967

PATROL ROSTER

- |                                 |                                 |
|---------------------------------|---------------------------------|
| 1. WILLIAMS, R. S. 1stLt 092019 | 11. VERHEYN, D. A. Sgt 2117334  |
| 2. WEAVER, J. M. 1stLt 092263   | 12. EATON, E. L. II PVT 2129393 |
| 3. MILLS, E. H. SSgt 1894711    | 13. HALL, L. R. Cpl 2124429     |
| 4. CLARY, J. C. III PFC 2246542 | 14. VARNADOE, T. C. Cpl 2110845 |
| 5. SHORE, R. M. PFC 2246028     | 15. GRIFFIN, H. D. Cpl 2148065  |
| 6. DICKSON, W. K. PFC 2213974   |                                 |
| 7. WAITE, B. W. LCpl 2138157    |                                 |
| 8. STONE, M. D. Cpl 2140868     |                                 |
| 9. BRUCH, S. W. PFC 2313624     |                                 |
| 10. OESTMAN, D. E. LCpl 2261921 |                                 |

OVERLAY

42  
96 + -

FOUND  
COPIES -  
EXTRACT  
A OF  
A OF  
INSERT

46  
+ 93

1st Reconnaissance Battalion  
 CHU LAI, RVN  
 231600H March 1967

Bn Frag Order 54-67  
 Team: 6th Plt, 1st Force Recon Co  
 Debriefers: 2dLt R. R. BENOIT  
 Maps: AMS Series L7014  
 Sheet 6639 I

PATROL REPORT

1. Size and Composition: 8 Enlisted
2. Mission: Conduct ground reconnaissance/observation vicinity of NUI MOP  
BT 2610.
3. Time of Departure: 210930H March 1967
4. Time of Return: 231530H March 1967
5. Routes: See attached overlay
6. Synopsis: This patrol covered a period of 49 hours with no sightings. AO spotted a total of 31 VC. Patrol was probed by fire. One arty fire mission was called with excellent area coverage. AO confirmed 2 VC KIA.
7. Observations: (Enemy and Terrain)

<u>TIME</u>	<u>COORDINATES</u>	<u>OBSERVATIONS</u>
231225H	BT 267105	4 VC probing patrol's position by fire. Called FM, excellent coverage. AO came in to adjust fire.
231340H	BT 264105	10 VC moving towards patrol's position. 10 rifles. AO adjusted fire, good coverage. AO confirmed 2 VC KIA with rockets.
231500H	BT 268110	18 VC firing at AO and patrol. Rifles and MG. Observed by AO.
231500H	BT 265112	3 VC firing at AO and patrol. Rifles. Observed by AO.

8. Other Information: First Insert LZ BT 249014 good LXH46 zone, second insert BT 258107, good LOAH46. Extraction LZ BT 263103 good 4AH46 zone. The area is honeycombed with well used trails and harbor sites. Tunnel and caves, approximately 3 to 4 months old, were found at BT 268107. The terrain is generally steep with sparse vegetation. Patrol reports that during the entire time that the patrol was out there was a great deal of firing throughout the valley. Weapons are believed to be of the .30 cal and .50 cal type.

9. Results of Encounters with the enemy: Patrol received several rounds of S/A fire from 300 meters North of their position. They returned 400 rounds of 7.62 mm and 4 M-26 grenades. Arty was called and adjusted by AO. AO observed a total of 31 VC moving towards patrol's position. Arty provided excellent coverage.
10. Condition of Patrol: Good, 1 USMC MED-EVAC at 221800H due to heat exhaustion.
11. Conclusions and Recommendations: Bring an ample supply of repellent.

*Henry S. McClain*

H. L. MC LAIN  
Sgt USMC  
Patrol Leader

12. Comments by Debriefers: None

PATROL ROSTER

1.	McCLAIN, HERVEY H.	SGT	1975132
2.	BRASON, CHARLES E.	LCPL	2105886
3.	HOLCH, HENRY W. JR.	LCPL	2127047
4.	PHILLIPS, ROBERT W.	PFC	2229881
5.	WILLIAMS, PAUL V. JR.	PFC	2213202
6.	WILLINGHAM, THOMAS A.	PFC	2212213
7.	DARBY, R. U.	LCPL	2662363
8.	LAEDTKE, D. A.	PFC	2201045

1st Reconnaissance Battalion

CHU LAI, RVN  
6th Plt, 1st Force  
231600H March 1967  
Continued

OVERLAY

13  
25



30  
10 - |



53  
1st Reconnaissance Battalion  
CHU LAI, RVN  
241615H March 1967

Bn Frag Order 54-67  
Team: 1st Plt, Co "D"  
Debriefers: 2ndLt R. R. BENOIT  
Maps: AMS Series L7014  
Sheet 6739 IV

PATROL REPORT

1. Size and Composition: 1 Officer, 13 Enlisted
  2. Mission: Conduct ground reconnaissance/observation vic BT 3401.
  3. Time of Departure: 211030H March 1967
  4. Time of Return: 241515H March 1967
  5. Route: See attached overlay
  6. Synopsis: This patrol covered a period of 77 hours with no sightings. The patrol was probed on the evening of the 21st with negative contact.
  7. Observations: None
  8. Other Information: Insert LZ BT 344013 good LXH46 zone, extract LZ BT 337033 good LXH46 zone. There is a well used trail running Southwest to Northeast through grid squares BT 3302 and BT 3402. Sounds resembling that of a vehicle were heard in the vicinity of BT 3102. Voices and the smell of charcoal in the vicinity of hill 330. Terrain is steep with a 20' to 30' canopy. Considerable secondary growth.
  9. Results of Encounters with the Enemy: None
  10. Condition of Patrol: Good
  11. Conclusions and Recommendations: None
-   
 G. W. MC DOWELL  
 1st Lt USMC  
 Patrol Leader
12. Comments by Debriefers: None

1st Reconnaissance Battalion  
1st Lt G. W. MS DOWELL  
Maps: AMS Series L7014  
Sheet 6739 IV

PATROL ROSTER

1. MC DOWELL, GARY W.	1st Lt	091524
2. FONDERLIN, TIMOTHY L.	Cpl	2103493
3. HOWARD, WILLIAM C.	LCpl	2213430
4. HILL, JERRY S.	PFC	2221067
5. LINIGREN, DARREL L.	PFC	2260156
6. HARRIS, DAVID S.	PFC	2224334
7. PORTER, JOHNNY L.	PFC	2257495
8. ROGERS, PHILLIP D.	PFC	2260648
9. DOHERTY, WILLIAM A.	LCpl	2169608
10. DECESARE, DANNY T.	PFC	2309640
11. CARPENTER, RICHARD A.	Cpl	2106999
12. SMITH, CHARLES A.	PFC	2203086
13. STOW, RICK M.	PFC	2322884

OVERLAY

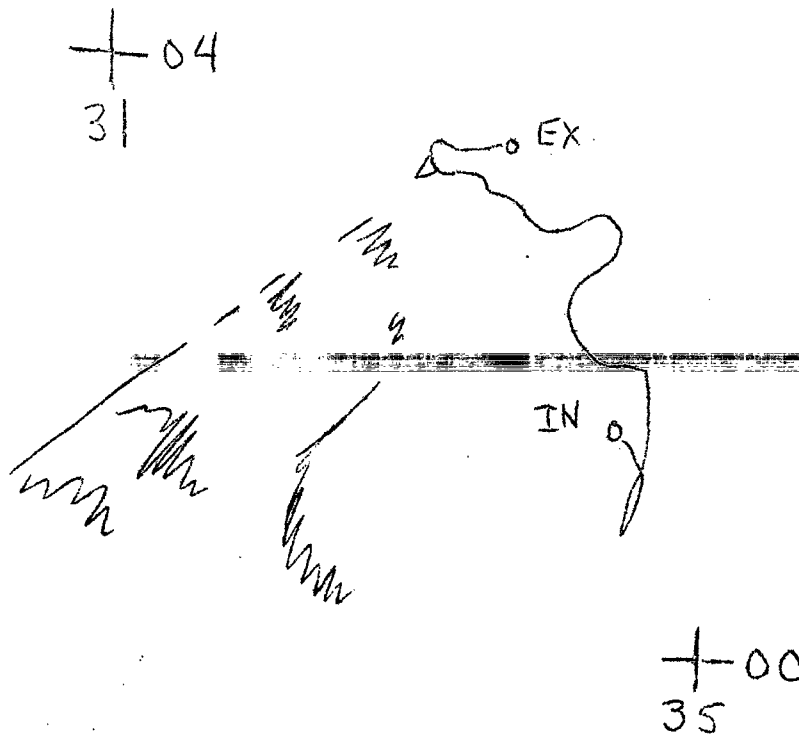

503  
 1st Reconnaissance Battalion  
 CHU LAI, RVN  
 241830H March 1967

Bn Frag Order 55-67  
 Team: 2nd Plt, Co "A"  
 Debriefed: Gysgt J. L. WILLIAMS  
 Maps: AMS Series L7014  
 Sheet 6739 IV

PATROL REPORT

1. Size and Composition: 2 Officers, 13 Enlisted, 1 dog and handler, 1 photographer, 5 man engineer team.
  2. Mission: Search area where arms cache was found vicinity BS 4394.
  3. Time of Departure: 241030H March 1967
  4. Time of Return: 241700H March 1967.
  5. Route: See attached overlay
  6. Synopsis: This patrol covered a period of 6½ hours with no sightings. Area of weapons cache was searched. Engineers blew mortar rounds found in area. Area had not been used in 4 - 7 months.
  7. Observations: None
  8. Other Information: Insert LZ BS 433944 fair 3XH46 zone, wet paddy. Near LZ found old hut with cooking pots and military water cans. One tunnel, search found empty. Searched area of previously found weapons cache vic BS 433941. 2 platforms built up off the ground. Found two WP 81mm Mortar rounds, 3 Illum 60mm Mortar rounds, 1 WP 60mm Mortar round, 2 HE 60mm Mortar rounds, 1 WP rifle grenade, 3 lbs of TNT, all blown in place by engineers. Found 9 BAR magazines and 1 phone hand set. There were some old fighting holes in the area. Extract LZ BS 433933 poor LXH46 zone, deep mud.
  9. Results of Encounters with the Enemy: None
  10. Condition of Patrol: Good
  11. Conclusions and Recommendations: None
- J. M. Weaver*  
 J. M. WEAVER  
 1stLt USMC  
 Patrol Leader
12. Comments by Debriefed: None

1st Reconnaissance Battalion  
 CHU LAI, RVN  
 241830H March 1967

PATROL ROSTER

1.	WILLIAMS, ROBERT S.	1stLt	092019
2.	WEAVER, JAMES M.	1stLt	092263
3.	MILLS, EDWIN H.	SSgt	1894711
4.	CLARY, JOHN C. III	PFC	2246542
5.	SHORE, ROBERT M.	PFC	2246042
6.	DICKSON, WILLIAM K.	PFC	2213974
7.	WAITE, BRUCE W.	LCpl	2138157
8.	SPOWE, MICHAEL D.	Cpl	2140868
9.	BRUSH, STEPHEN W.	PFC	2313624
10.	OBSTMAN, DAVID E.	LCpl	2261921
11.	VINEYAN, DAVID A.	Sgt	2117334
12.	EATON, PEREPT L. II	PVT	2129393
13.	HALL, MONNIE R.	Cpl	2124429
14.	VARNADON, EDOY C.	Cpl	2110845
15.	GRIFFIN, HAROLD D.	Cpl	2148065
16.	BACKER, DAVID L.	PFC	2274817
17.	DAVIS, JAMES H. JR.	PFC	2307979
18.	BARRON, NATHAN J.	PFC	2305676
19.	ALDANA, OSCAR	PFC	2291340
20.	SPECKELS, F. P.		790
21.	CRUZ, DANIEL A. (DOG HANDLER)	Cpl	2062916
22.	ALFONSO, FRANCIS N. (ENGINEER)	Sgt	2011646
23.	COCKRELL, RONALD E. (ENGINEER)	Cpl	2102459
24.	HARRINGTON, PAUL W. (ENGINEER)	Cpl	2148590
25.	JOYNER, KENNETH B. (ENGINEER)	LCpl	2149032
26.	LOWERY, MICHAEL (ENGINEER)	LCpl	2222087

OVERLAY

96 +  
46

EX 9 IN  
94 +  
43

58  
1st Reconnaissance Battalion  
CHU LAI, RVN  
251530H March 1967

Bn Frag Order 54-67  
Team: 3rd Plt, Co "A"  
Debriefers: GySgt J. L. WILLIAMS  
Maps: AMS Series L7014  
Sheet 6739 IV

PATROL REPORT

1. Size and Composition: 1 Officer, 16 Enlisted, 1 USN
2. Mission: Establish an OP on Hill 707 vicinity BS 4199. Observe the TU CHANH Valley.
3. Time of Departure: 221400H March 1967
4. Time of Return: 251400H March 1967
5. Route: None
6. Synopsis: This patrol covered a period of 72 hours with 1 sighting of 2 VC. 1 arty fire mission was called. At 241000H a smoke signal was observed vicinity BS 393984.
7. Observations: (Enemy and Terrain)

<u>TIME</u>	<u>COORDINATES</u>	<u>OBSERVATIONS</u>
240845H	BT 372012	2 VC moving South. Blk PJ's. 1 pack and 1 rifle. Called fire mission, excellent coverage.
241000H	BS 393984	Observed puffs of smoke for approximately 10 min.

8. Other Information: None
9. Results of Encounters with the Enemy: None
10. Condition of Patrol: Good
11. Conclusions and Recommendations: Take a can of DDT with hand sprayer.

*P. R. Young*  
P. R. YOUNG  
2ndLt USMC  
Patrol Leader

12. Comments by Debriefers: None

1st Reconnaissance Battalion  
 CHU LAI, RVN  
 251530H March 1967

PATROL ROSTER

1. YOUNG, PAUL R.	2ndLt	094373
2. WATKINS, LEE H. JR.	SSgt	1881368
3. BAND, EMMET C.	LCpl	2216081
4. MC CARTHY, CHARLES T.	LCpl	2150364
5. KELLER, DAVID B.	LCpl	2168520
6. HYNE, MICHAEL G.	PFC	2247315
7. LUCAS, ROBERT D.	PFC	2329712
8. COLE, DAVID A.	PFC	2332433
9. MARTIN, TERRY M.	PFC	2316311
10. CARR, MARC A.	LCpl	21 70983
11. MORGAN, RICHARD	LCpl	2173337
12. GIORDANO, LOUIS	PFC	2233271
13. WARREN, RICHARD J.	PFC	2271695
14. BASCO, DARWIN K.	PFC	2303787
15. CARVER, ROBERT L.	PFC	2260650
16. HAUCH, EDWARD H.	PFC	2248486
17. GODBY, JIM D.	PFC	2034544
18. HOLTHAUS	HN3	9985050

53

1st Reconnaissance Battalion  
 CHU LAI, RVN  
 261400H March 1967

Bn Frag Order 55-67  
 Team: 3rd Plt, Co "D"  
 Debriefed: GySgt J. L. WILLIAMS  
 Maps: AMS Series L7014  
 Sheet 6739 III

PATROL REPORT

1. Size and Composition: 1 Officer, 18 Enlisted, 1 USN.
2. Mission: Establish an OP vicinity BS 3977. The primary direction of observation is to the Southeast.
3. Time of Departure: 241530H March 1967
4. Time of Return: 261300H March 1967
5. Route: See attached overlay
6. Synopsis: This patrol covered a period of 45½ hours with 1 sighting of 2 VC sniping at patrol. 1 USMC KIA.
7. Observations: (Enemy and Terrain)

<u>TIME</u>	<u>COORDINATES</u>	<u>OBSERVATIONS</u>
251620H	BS 395787	Heard mortar fire, possible 60mm Mortar.
251650H	BS 3975	Heard S/A fire.
260930H	BS 405745	Heard A/W fire.
271150H	BS 398770	2 VC sniping at patrol. Patrol returned fire. 1 USMC KIA. TACA arrived, called air strike. Patrol was extracted.

8. Other Information: Insert LZ BS 395771, good LXH46 zone. Harbor site BS 394769. Poor communications in the area. Helo received fire on extract.
9. Results of Encounters with the Enemy: None
10. Condition of Patrol: 1 USMC KIA.
11. Conclusions and Recommendations: Go in vicinity BS 388774 bald LXH46 zone.

*E. E. Cannon*  
 E. E. CANNON  
 GySgt USMC  
 Patrol Leader

12. Comments by Debriefed: None

A-44

1st Reconnaissance Battalion  
CHU LAI, RVN  
 261400H March 1967

PATROL ROSTER

1. JOHNSON, R. S. JR.	2ndLt	094438
2. CANNON, E. E.	GySgt	1168363
3. McCLELLAN, L. N.	LCPL	2302290
4. MOON, R. A.	EFC	2238847
5. HAWLEY, J. H.	EFC	2183653
6. KNEREM, J. J.	PFC	2316681
7. LITTLE, T. L.	EFC	2315805
8. FISH, K. L.	EFC	2235812
9. RHODES, J. O.	LCPL	2199835
10. HUBANKS, E. W.	PVT	2242249
11. DUNCAN, R. A. JR.	EFC	2237647
12. HOWARD, F. JR.	EFC	2223449
13. SMITH, J. W.	EFC	2251952
14. RIZZO, J. J.	EFC	2279838
15. HINES, J. L. III	CPL	2044741
16. TINKER, A. L.	LCPL	2175396
17. BACIMAN, A. D. JR.	EFC	2123801
18. TUCKER, R. L.	SGT	2046092
19. JONES, J. F.	LCPL	2117871
20. PETERS, A. J.	HN	7887017



1st Reconnaissance Battalion  
CHU LAI, RVN  
261400H March 1967

OVERLAY

+ 40  
30

IN  
INDEX

43  
75 +

S-3

1st Reconnaissance Battalion  
 CHU LAI, RVN  
 271600H March 1967

Bn Frag Order 55-67  
 Team: 4th Plt, 1st For Recon Co  
 Debriefing: GySgt J. L. WILLIAMS  
 Maps: AMS Series L 7014  
 Sheet 6639 I

PATROL REPORT

1. Size and Composition: 6 Enlisted.
2. Mission: Establish an OP vicinity BT 3007. Primary direction of observation the northwest.
3. Time of Departure: 241410H March 1967.
4. Time of Return: 271400H March 1967.
5. Route: See Attached Overlay.
6. Synopsis: This patrol covered a period of 72 hours with no sightings.
7. Observations:
 

241600H BT 304076 10 fighting holes possible 2 days old.
8. Other Information: Insert LZ vic BT 304078, good 4xH46 zone, wet. OP site BT 305072, alimb tree, good observation of valley. OP site BT 306072, good observation. Extract LZ BT 302077, good 1xH46 zone, muddy.
9. Results of Encounters with the Enemy: None.
10. Condition of Patrol: good.
11. Recommendations : Take pole climbers.

*George K. Lawton*  
 C. LAWTON  
 Sgt USMC  
 Patrol Leader

12. Comments by Debriefing: None.

1st Reconnaissance Battalion

CHU LAI, RVN  
4th Plt, 1st For Recon Co  
271600H March 1967

PATROL ROSTER

1. LAWTON, C.	Sgt	1938835
2. OWENS, W. J.	Cpl	2130769
3. HUFF, J. E.	Cpl	2152547
4. FOY, D. W.	Pfc	2209515
5. SCHIFFHOVER	Pfc	2280627
6. McCONNEL	LCpl	2247922

OVERLAY

+08  
29

EXD IN  
20

+06  
32

5-3

1st Reconnaissance Battalion  
 CHU LAI, RVN  
 271800H March 1967

Bn Frag Order 54-67  
 Team: 2d Plt, 1st For Recon Co  
 Debriefers: GySgt WILLIAMS  
 Maps: AMS Series L 7014  
 Sheet 6738 I

PATROL REPORT

1. Size and Composition: 9 Enlisted.
2. Mission: Establish an OP at the Montagnard Outpost vicinity BS 6358. Primary direction of observation the South and East.
3. Time of Departure: 221550H March 1967.
4. Time of Return: 271525H March 1967.
5. Route: None.
6. Synopsis: This patrol covered a period of 5 days with 2 sightings of 10 VC. 1 arty fire mission was called. 5 VC KIA (prob), 1 USMC NBC.
7. Observations:

<u>TIME</u>	<u>COORD</u>	<u>OBSERVATIONS</u>
251430H	BS 635594	7 VC moving north. Black PJs. Rifle and cartridge belts. Patrol opened fire. 2 VC KIA (prob).
261145H	BS 662559	3 VC moving northeast. Black PJs. Rifles, packs, called fire mission, excellent coverage <del>3 VC KIA (prob).</del>

8. Other Information: Hill near outpost was set on fire twice, but fire burned out.
9. Results of Encounters with the Enemy: 5 VC KIA (prob).
10. Condition of Patrol: 1 NBC.
11. Recommendations: None.

*Paul C. Long*  
 P. E. LONG  
 Sgt USMC  
 Patrol Leader

12. Comments by Debriefers: None.

1st Reconnaissance Battalion  
CHU LAI, RVN  
2d Plt, 1st For Recon Co  
271800H March 1967

PATROL ROSTER

1. FULTON, J. T.	CPL	2158847
2. GILPIN, R. D.	LCPL	2227368
3. HECK, R. L.	LCPL	2169613
4. HERGENRDER, E. A.	LCPL	2212739
5. HUFFMAN, A. P.	LCPL	2160635
6. MARACLE, P. C.	LCPL	2173524
7. WILKINS, C. D.	CPL	2147185
8. NEEL, LARRY D.	CPL	2147474
9. LONG, F. E.	SGT	2005909
10. ROBERTS, J. G.	GYSGT	1029778

53

1st Reconnaissance Battalion  
 CHU LAI, RVN  
 271930H March 1967

Bn Frag Order 55-67  
 Team: 1st Plt, Co "A"  
 Debriefed: GySgt J. L. WILLIAMS  
 Maps: AMS Series L7014  
 Sheet 6739 IV

PATROL REPORT

1. Size and Composition: 15 Enlisted, 1 USN
2. Mission: Conduct ground reconnaissance/observation vicinity BS 4391.
3. Time of Departure: 251300H March 1967
4. Time of Return: 271800H March 1967
5. Route: See attached overlay
6. Synopsis: This patrol covered a period of 53 hours with 3 sightings of 10 VC. Patrol was probed 3 times. Contact resulted in 1 VC KIA (Prob). 3 USMC WIA.
7. Observations: (Enemy and Terrain)

<u>TIME</u>	<u>COORDINATES</u>	<u>OBSERVATIONS</u>
251830H	BS 435915	Patrol harbor site. Heard estimated 8 VC 100 meters from patrol. Heard drums.
261845H	BS 439909	2 VC probed patrol harbor site, blk PJ's. Rifles. VC threw hand grenade. Patrol took VC under fire, 1 VC KIA (Prob).
270430H	BS 439909	4 VC probed patrol's harbor site. Patrol threw CS, VC dispersed.
271430H	BS 438904	Received S/A fire and 2 grenades from an estimated 3 VC, 3 USMC WIA. Patrol observed 2 VC vic BS 440903 watching patrol. Patrol moved to BS 438901 and was extracted by hoist. Helo's received S/A fire on extraction.

8. Other Information: Insert LZ BS 428923 good 2XH46 zone, 6 foot high grass. Moved to BS 434916, no OP site, canopy 15-20 feet high. OP site BS 432912 climbed tree, poor visibility. Crossed trail vic BS 440908 well used with fresh trail markers. Extract LZ BS 438901, patrol extracted by hoist.

9. Results of Encounters with the Enemy: 1 VC KIA (Prob).

10. Condition of Patrol: 3 USMC WIA minor

11. Conclusions and Recommendations: There are no OP sites in the area. Take pole climbers.

*J. P. Rudman*

J. P. RUDMAN  
GySgt USMC  
Patrol Leader

12. Comments by Debriefers: None

PATROL ROSTER

- |                                 |                                   |
|---------------------------------|-----------------------------------|
| 1. RUDMAN, J. P. 1366141 GySgt  | 9. MOSKAL, A. F. JR. 2178959 LCpl |
| 2. DAVIS, D. R. 2197171 EFC     | 10. DAY, T. J. 2293197 EFC        |
| 3. SIMNER, J. W. 2235044 EFC    | 11. KUBS, C. S. 2294924 EFC       |
| 4. MAHQVLIC, J. T. 2203091 LCpl | 12. MC CARTHY, F. T. 1869363 EFC  |
| 5. ULSTAD, D. E. 2120343 PFC    | 13. WALLACE, T. K. 2207322 EFC    |
| 6. CUNNINGHAM, J. 2170687 PFC   | 14. BARTON, L. B. 2312733 EFC     |
| 7. ANDERSON, G. E. 2290226 EFC  | 15. DIXON 2045818 LCpl            |
| 8. CLOW, J. R. 2100282 EFC      | 16. ARIOLA HN 6927427             |

OVERLAY

42  
93 +

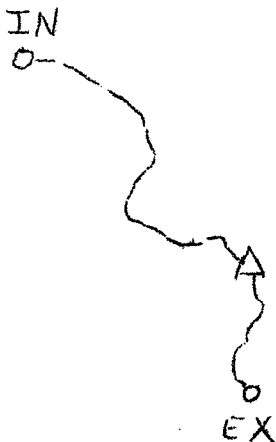

+ 90  
46

S-3

1st Reconnaissance Battalion  
 CHU LAI, RVN  
 281500H March 1967

Bn Frag Order: 55-67  
 Team: 4th Plt, Co "A"  
 Debriefers: Sgt FONG  
 Maps: AMS Series L 7014  
 Sheet 6739 IV

PATROL REPORT

1. Size and Composition: 13 Enlisted, 1 USN
  2. Mission: To conduct reconnaissance surveillance on OP at Hill 707 BS 418998.
  3. Time of Departure: 251315H March 1967.
  4. Time Of Return: 281400H March 1967
  5. Route: None.
  6. Synopsis: This patrol covered a period of 73½ hours with no sightings.
  7. Observations: None.
  8. Other Information: Normal civilian activity in valley. This patrol worked on improving bunkers. Trees have been cleared so that observation of valley is better.
  9. Results of Encounters with the Enemy: None.
  10. Condition of Patrol: Excellent.
  11. Recommendations: Take: M-49 scope and DDT for insects on the hill.
-   
 J. F. WIPMER  
 Cpl USMC  
 Patrol Leader
12. Comments by Debriefers: None.



1st Reconnaissance Battalion  
 CHU LAI, RVN  
 4th Plt, Co "A" 281500H March 1967

PATROL ROSTER

1.	WITMER, J. F.	CEL	2174276
2.	BROWN, S. H.	LCPL	2211015
3.	BRANDT, W. L.	LCPL	2198648
4.	COTTERMAN, K. E.	LCPL	2269364
5.	BINGHAM, R. L.	LCPL	2184486
6.	WINNER, F. N.	LCPL	2265313
7.	LAWSON, M. L.	EFC	2290853
8.	MARTIN, J. A. JR.	EFC	2323332
9.	HENDERSON, F. R.	EFC	2283176
10.	JAMES, R. L.	EFC	2226104
11.	SPARKS, R. L.	EFC	2265996
12.	EMMERHART, R. A.	EFC	2295104
13.	NIMMO	EFC	2230619
14.	SHANNON	HN	9999530

S.3

1st Reconnaissance Battalion  
 CHU LAI, RVN  
 291600H March 1967

Bn Frag Order 55-67  
 Team: 3rd Plt, Co "A"  
 Debriefers: GySgt J. L. WILLIAMS  
 Maps: AMS Series L7014  
 Sheet 6639 I

PATROL REPORT

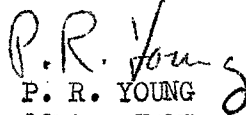
1. Size and Composition: 1 Officer, 6 Enlisted
  2. Mission: Conduct ground reconnaissance/observation vicinity BS 2998.
  3. Time of Departure: 281400H March 1967
  4. Time of Return: 291500H March 1967
  5. Route: See attached overlay
  6. Synopsis: This patrol covered a period of 25 hours with no sightings. There was poor communication in the area. Extremely heavy vegetation with 30 foot canopy.
  7. Observations: None
  8. Other Information: Insert LZ BS 296981 good LXH46 zone, 5 foot high grass. Crossed trail vic BS 296986 used 3 days to 1 week ago. Possibly 30 man VC harbor site near stream BS 296981. Extract LZ BS 298984, good LXH46 zone.
  9. Results of Encounters with the Enemy: None
  10. Condition of Patrol: Good
  11. Conclusions and Recommendations: Insert higher on hill, possibly on ridge line.
-   
 P. R. YOUNG  
 2dLt USMC  
 Patrol Leader
12. Comments by Debriefers: None

1st Reconnaissance Battalion  
 2dLt P. R. YOUNG  
 Maps: AMS Series L7014  
 Sheet 6639 I

PATROL ROSTER

1. YOUNG, PAUL R.	2dLt	094373
2. KELLER, DAVID B.	LCpl	2 68520
3. CARVER, ROBERT L.	PFC	2260650
4. COLE, DAVID A.	PFC	2332435
5. MARTIN, TERRY M.	PFC	2316511
6. GODBY, JIM D.	PFC	2034544
7. MEDCALY, L. W.	GySgt	1486847

OVERLAY

+ 01  
 29

EX  
 IN

+ 99  
 32

S.3

1st Reconnaissance Battalion  
 CHU LAI, RVN  
 301000H March 1967

Bn Frag Order 54-67  
 Team: 2nd Plt, Co "D"  
 Debriefed: GySgt J. L. WILLIAMS  
 Maps: AMS Series L7014  
 Sheet 6738 I

PATROL REPORT

1. Size and Composition: 1 Officer, 20 Enlisted, 1 USN
2. Mission: OPCON to 3/7 for OPERATION DE SOTO. Establish OP site vic BS 7739, BS 7934 and BS 7041.
3. Time of Departure: 221600H March 1967
4. Time of Return: 291830H March 1967
5. Route: None
6. Synopsis: This patrol covered a period of 7 days. Patrol was inserted 3 times. There were 14 sightings of 66 VC. 2 air strikes and 11 arty fire missions were called resulting in 1 VC KIA (Conf) and 7 VC KIA (Prob).
7. Observations: (Enemy and Terrain)

<u>TIME</u>	<u>COORDINATES</u>	<u>OBSERVATIONS</u>
-------------	--------------------	---------------------

Insert # 1

231000H March 1967, insert LZ vic BS 772393, good 2XH46 zone. LZ is booby trapped. Patrol found 5 booby traps and disarmed them, OP site BS 772394, bald hill, good observation.

231445H	BS 761395	Called fire mission on bunker, good coverage.
240805H	BS 732405	3 VC moving Southwest. 2 brown, 1 white PJ's. 3 packs, 1 rifle. Called fire mission, fair coverage.
240910H	BS 753400	2 VC carrying 1 dead. Moving Northwest on trail. 1 blk PJ's, 1 white PJ's. 1 rifle.
240945H	BS 798413	Called fire mission on AA gun emplacement, good coverage.
241435H	BS 765392	2 VC near fortified position. Called TACA, conducted fixed wing strike, good coverage.
241500H	BS 765392	7 VC moving East. Khaki trousers, dark shirts. 7 rifles. Called TACA, conducted fixed wing strike, good coverage.

241800H	BS 763393	3 VC moving North. 1 blk PJ's, 1 green PJ's. 1 shorts. 1 rifle. Called fire mission, good coverage.
250825H	BS 783395	7 VC entered ville. Blk PJ's. 1 pack, 3 rifles. Called fire mission, good coverage.
250910H	BS 756392	2 VC moving West. Blk PJ's. 1 rifle. Called fire mission, good coverage.
251240H	BS 758385	4 VC entered house. Blk PJ's. 3 rifles. Called fire mission, excellent coverage. 4 VC KIA (Prob).

Patrol returned to LZ BS 772393 and was extracted at 251710H March.

Insert # 2

261030H March insert LZ vic BS 790339, good LXH46 zone. OP site bald hill BS 790340, good observation.

261115H	BS 777331	1 VC moving South. Blk PJ's. 1 pack. Called fire mission, good coverage.
271220H	BS 791316	7 VC moving North. Helmets, camouflaged utilities. Packs, rifles, cartridge belts. Called fire mission, good coverage.
271230H	BS 791316	5 VC moving North. Helmets, camouflaged utilities. 5 packs, 5 rifles, 5 cartridge belts. Called fire mission, good coverage.
271845H	BS 787326	17 VC moving South. Mixed uniforms with heavy camouflage. Packs, 10 rifles. Called fire mission, 1 VC KIA (Conf), 3 VC KIA (Prob).
281130H	BS 785364	4 VC moving East along lake. 1 blk PJ's, 3 camouflaged with helmets. 3 rifles. Called fire mission, good coverage.

Patrol returned to LZ BS 790339 and was extracted at 281800H March.

Insert # 3

290840H March insert LZ BS 706420 good LXH46 zone. LZ is a VC fortified position with double apron barbed wire, 2 bunkers, fighting holes and a trench line are all abandoned. OP site vic BS 701417, poor observation, thick undergrowth.

291215H	BS 698427	2 VC moving South. Green utilities. 2 packs.
---------	-----------	--

Patrol returned to LZ BS 706420 and was extracted at 291715H March.

8. Other Information: None
9. Results of Encounters with the Enemy: 1 VC KIA (Conf) and 7 VC KIA (Prob).
10. Condition of Patrol: Good
11. Conclusions and Recommendations: Helmets and flak jackets for bald hill OP sites. Go heavy on ammo, claymores and water.

*R. C. Kicklighter*  
 R. C. KICKLIGHTER  
 2dLt USMC  
 Patrol Leader

12. Comments by Debriefers: None

PATROL ROSTER

1. KICKLIGHTER, RODNEY C.	2dLt	092116
2. BROSCHE, GEORGE E.	SSgt	1428086
3. CIOCHINO, SAMUEL	Sgt	1925335
4. BOWEN, FRED D.	Sgt	2006598
5. HOLCOMB, LARRY N.	Cpl	2106551
6. SCANLON, THOMAS J. JR	LCpl	2174222
7. KEISLER, RODGER P.	LCpl	2180551
8. HASKELL, HERBERS N.	LCpl	2220919
9. WITHERIDGE, JIMMY C.	LCpl	2158435
10. HATLER, JAMES H.	LCpl	2158654
11. POTTS, RONNIE W.	PFC	2280378
12. ROE, CARL E. JR.	PFC	2235243
13. SPACEK, JOSEPH A. JR	PFC	2258013
14. KRILL, JAMES F.	PFC	2279663
15. SMITH, SHAWN R.	PFC	2204989
16. ROOS, DONALD R.	PFC	2294766
17. SPARROW, JOSEPH S. JR.	PFC	2300387
18. OLIVER, STEVEN R.	PFC	2140019
19. HANSARD, ARTHUR L.	PFC	2275700
20. KERWIN, ALAN S.	LCpl	2141619
21. BOYKINS, JOHNNY H. JR.	Cpl	2174684
22. CARSON, M.	HN	9191388

1st Reconnaissance Battalion  
 CHU LAI, RVN  
 301600H March 1967

Bn Frag Order 55-67  
 Team: 2d Plt, Co "A"  
 Debriefers: GySgt J. L. WILLIAMS  
 Maps: AMS Series L 7014  
 Sheet 6639I

PATROL REPORT

1. Size and Composition: 1 Officer, 6 Enlisted, 1 USN
  2. Mission: Conduct ground reconnaissance/observation vicinity BT 2306.
  3. Time Of Departure: 271300H March 67
  4. Time Of Return: 301500H March 67
  5. Route: See attached overlay
  6. Synopsis: This patrol covered a period of 74 hours with no sightings.
  7. Observations: None
  8. Other Information: Insert LZ via BT 240065, good LXH46 zone, crossed recently used trail via BT 237067, OP site was very poor, vegetation and terrain were poor resulting in poor communications. Bridge via BT 238054 no longer exists and road is grown over. Extract LZ via BT 240056 poor LXH46 zone.
  9. Results of Encounters with the Enemy: None
  10. Condition Of Patrol: Good
  11. Conclusions and Recommendations: Check out comm gear before insert.
- J. M. Weaver*  
 J. M. WEAVER  
 1stLt USMC  
 Patrol Leader
12. Comments by Debriefers: Bridge and road have been reported before.

1st Reconnaissance Battalion  
CHU LAI, R  
301600H March 67

PATROL ROSTER

WEAVER, James M	1stLt	092263
VERHEYA, David A.	Sgt	2117334
STOWE, Michael D.	Cpl	2140868
SHORE, Robert M.	Pfc	2246028
EATON, Everett L II	Pvt	2129393
CLARY, John C III	Pfc	2246542
ALDANA, Oscar	Pfc	2291340
GOERS	HM3	2630335

RECENTLY  
USED  
TRAIL



+ 07  
26

22  
+ 04



S 3

1st Reconnaissance Battalion  
 CHU LAI, RVN  
 301645H March 1967

Bn Frag Order 55-67  
 Team: 1st Plt, Co "D"  
 Debriefers: GySgt J. L. WILLIAMS  
 Maps: AMS Series L7014  
 Sheet 6739 III

PATROL REPORT

1. Size and Composition: 1 Officer, 16 Enlisted, 1 USN.
2. Mission: Conduct ground reconnaissance/observation vicinity BS 4581.
3. Time of Departure: 271400H March 1967
4. Time of Return: 301615H March 1967
5. Route: See attached overlay.
6. Synopsis: This patrol covered a period of 74 hours with 1 sighting of 5 VC. 1 arty fire mission was called resulting in 5 VC KIA (Prob).
7. Observations: (Enemy and Terrain)

<u>TIME</u>	<u>COORDINATES</u>	<u>OBSERVATIONS</u>
291240H	BS 445799	5 VC moving West, blk PJ's. 5 packs. Called fire mission, excellent coverage, 5 VC KIA (Prob).

8. Other Information: Insert LZ BS 442822, good LXH46 zone. OP site BS 453816, good observation of valley to South and Southeast. 6 foot high grass in the area. There was civilian traffic on trail vic BS 445799. Extract LZ vic BS 442823, good 2XH46 zone.

9. Results of Encounters with the Enemy: 5 VC KIA (Prob).
10. Condition of Patrol: Good
11. Conclusions and Recommendations: Take BC or M-49 scope.

*G. W. Mc Dowell*

G. W. MC DOWELL  
 1stLt USMC  
 Patrol Leader

12. Comments by Debriefers: None

1st Reconnaissance Battalion

1stLt G. W. MC DOWELL

Maps: MS Series L7014

Sheet 6739 III

PATROL ROSTER

- |                                   |                                   |
|-----------------------------------|-----------------------------------|
| 1. MC DOWELL, G. W. 1stLt 091524  | 10. HILL, J. S. PFC 2221067       |
| 2. BRATSCHL, M. R. Sgt 1981993    | 11. ROGERS, P. D. PFC 2260648     |
| 3. HOWARD, W. C. III ICpl 2213430 | 12. PORTER, JOHNNY L. PFC 2257495 |
| 4. PATTON, M. W. Cpl 2100352      | 13. STOW, R. M. PFC 2322884       |
| 5. COSTA, DANIEL Cpl 2148501      | 14. DECESARE, D. T. PFC 2309640   |
| 6. CARPENTIER, R. A. Cpl 2106999  | 15. FAULKNER, L. F. PFC 2328333   |
| 7. RIDGEWAY, H. W. PFC 2221376    | 16. HEADS, C. G. PFC 2312927      |
| 8. HARRIS, D. S. PFC 2224334      | 17. SMITH, C. A. PFC 2203086      |
| 9. LINIGREN, D. L. PFC 2260156    |                                   |

OVERLAY

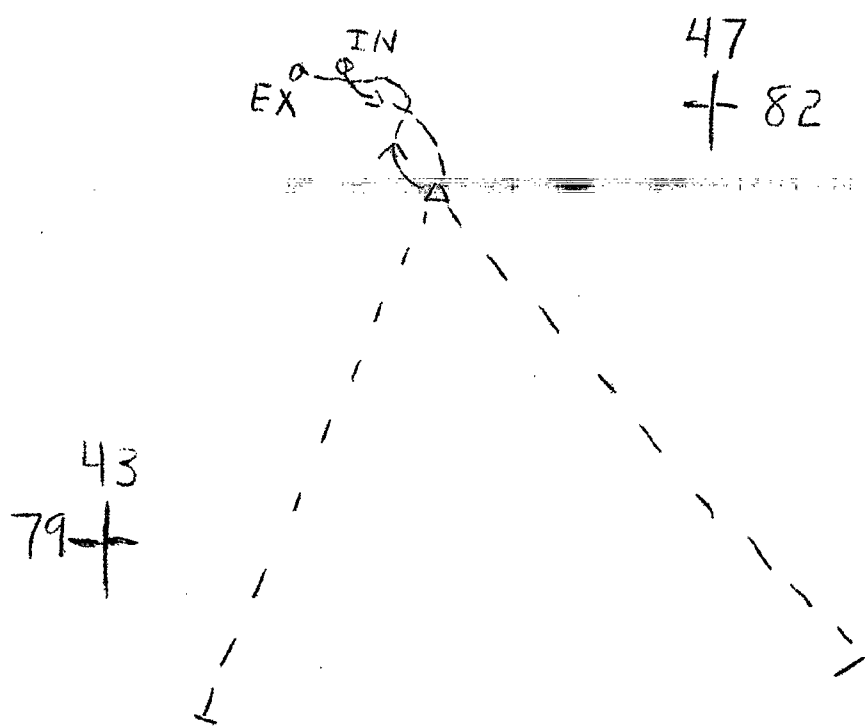

S. 8  
1st Reconnaissance Battalion  
 CHU LAI, RVN  
 311830H March 1967

Bn Frag Order 55-67  
 Team: 6th Plt, 1st For Recon Co  
 Debriefers: GySgt WILLIAMS  
 Maps: AMS Series L 7014  
 Sheet 6738 I

PATROL REPORT

1. Size and Composition: 8 ENLISTED.
  2. Mission: Establish an OP at NUI DANH KUONG montagnard outpost vic BS 6358.
  3. Time of Departure: 271505H March 1967.
  4. Time of Return: 311630H March 1967.
  5. Route: None.
  6. Synopsis: This patrol covered a period of 4 days with 1 sighting of estimated 3 VC. 1 arty fire mission was called.
  7. Observations:
 

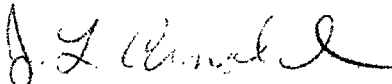
302035H	BS 641568	Estimated 3 VC sniping at patrol. Called fire mission, excellent coverage, sniper fire suppressed.
---------	-----------	--
  8. Other Information: None.
  9. Results of Encounters with the Enemy: None.
  10. Condition of Patrol: good.
  11. Recommendations: Take lime for heads. Check patrol members shot cards.
-   
 J. L. ARNOLD  
 Sgt USMC  
 Patrol Leader
12. Comments by Debriefers: None.

1st Reconnaissance Battalion

CHU LAI, RVN

6th Plt, 1st For Recon Co

311830H March 1967

PATROL ROSTER

1. ARNOLD, J. L.	SGT	2047215
2. BEASON, C. E.	LCPL	2105886
3. HAGER, J. W.	CPL	2108203
4. SAVORY, C. W.	LCPL	2123692
5. WILLIAMS, R. A.	PFC	2236072
6. WAIND, M. R.	LCPL	2180167
7. LADETKE, D. A.		2201064
8. DARBY, R. U.		1862863

CC

HEADQUARTERS  
1st Recon a/c-amp Battalion  
 RPO San Francisco, California 96602

J/HC/rps  
 1 March 1967

From: Commanding Officer  
 To: Commanding General, 1st Marine Division(Rein), FFW

SITREP # 336 010001H to 012400H

1. OPERATIONS NARRATIVE

a. General

(1) Bn Cmd Gpy 1st Recon Bn (-) sent to coordinate Recon Operations via BS 818384. Operation DE SOFO/DECKHOUSE & VI.

(2) 1 Squad, 1st Plt, Co "A" was extracted at 010800H after 72 hours of conducting grd recon/obser via BS 635588. 3 sightings were made with a total of 29 VC reported. 2 FM were called resulting in 3 VC KIA (Conf). 1 fixed wing strike was called resulting in 10 VC KIA (Conf).

(3) 3rd Plt, Co "A" was inserted at 010800H to conduct rd recon/obser via BS 635588. Arty support available fm the fol btrys: "A" Btry 175 Guns loc via BS 6384. Neg sightings du pd.

(4) 4th Plt, Co "A" was inserted at 010800H to conduct grd recon/obser via BS 698418. Arty support available fm the fol btrys: Arnies "D" 105 HOW loc via BS 7647.

(a) 011415H 7 VC milling around via BS 703427, blk PJ's, 2 packs and 1 rifle. FM called. Results unknown.

(b) 011420H 2 VC moving East along road via BS 702427, 1 grey utilities and 1 green shirt with blk bottoms. 2 packs and 1 rifle. Moved out of sight.

(5) 2nd Plt, Co "D" sent to conduct grd recon/obser via BS 327051. Arty same. Neg sightings du pd.

(6) 3rd Plt, Co "D" sent to conduct grd recon/obser via BS 725375. Arty same.

(a) 010800H 4 VC moving along trail via BS 732371, camouflaged utilities and rifles. FM called. 4 VC KIA (Prob).

(b) 011145H 5 VC probed position from Southwest via BS 724374 with 30-40 rounds auto carbine fire. Patrol returned 6 M-26 grenades. VC broke contact. Fixed wing conducted air strike. Results unknown.

1ST RECON BN - SITREPS  
 CHU KAI

MAR 1967

(7) 2nd Plt, 1st Force was reinserted at 010900H to conduct grd recon/obser via BS 790340. Arty support available fm the fol btrys: "H" Btry 105 HOW loc via BS 8158.

(a) 011045H 2 groups of 15 VCS (30 VCS) moving west over ridge via BS 815339, 24 blk PJ's and 6 white PJ's. Equipment unobserved.

(b) 011055H 37 VCS moving West along ridge via BS 813334, blk PJ's and unobserved equipment.

(c) 011045H to 011055H 95 VCS moving South to Southwest between BS 824348 and BS 808328, blk PJ's and white PJ's. Carrying hoes. AO called. AO confirmed them as woodcutters.

(d) 011250H 9 VC moving South on hill top via BS 794360, blk PJ's and 1 pack. FM called. Results unknown.

(8) 4th Plt, 1st Force was extracted at 010800H after 72 hours of conducting grd recon/obser via BS 6848. 5 sightings were made with a total of 38 VC reported. 1 FM was called. Results unknown.

(9) 6th Plt, 1st Force cont to conduct grd recon/obser via BS 433853. Arty same. Neg sightings du pd.

b. Contacts: 4. (a); 6. (a), (b); 7. (d).

c. Command Post Locations: No Change

d. Scout/ Sniper Teams: None

2. Casualties: None

3. Operation Summary: Attached

4. Operations Plans Summary: Attached

a. Intentions

(1) Extract 3rd Plt, Co "D" at 020800H via BS 724372.

(2) Insert 3rd Plt, Co "D" at 020800H via BS 7333.

(3) Extract 4th Plt, Co "A" at 021200H via BS 6840.

(4) Insert 4th Plt, Co "A" at 021200H via BS 8128.

5. Contact Action Report: Attached

G. R. JOHNSTON  
By direction

CC

HEADQUARTERS  
1st Reconnaissance Battalion  
 FPO San Francisco, California 96602

3/HU/rps  
 2 March 1967

From: Commanding Officer  
 To: Commanding General, 1st Marine Division(Rein), FMF

SITREP # 337 02000LH to 022400H

1. OPERATIONS NARRATIVE

a. General

(1) Bn Cmd Grp 1st Recon Bn (-) cont to coordinate Recon Operations via BS 818384. Operation DE SOTO/DECKHOUSE VI.

(2) 1st Plt, Co "A" was inserted at 021200H to conduct grd recon/obser via BS 818385. Arty support available fm the fol btrys: "H" Btry 105 HOW lee via BS 8138. Neg sightings du pd.

(3) 3rd Plt, Co "A" cont to conduct grd recon/obser via BS 635588. Arty same.

(a) 021125H 3 VC moving East on trail via BS 670590, blk PJ's and coolie hats. Rifles. FM called. Results unknown.

(4) 4th Plt, Co "A" cont to conduct grd recon/obser via BS 698418. Patrol was extracted at 021300H to via BS 818385.

(a) 020725H unknown number of VC firing at AO via BS 685423, automatic weapons, possible BM. Civilians in area.

(b) 020845H 2 VC moving West via BS 699428, blk PJ's, 1 pack, 1 rifle. FM called. 2 VC KIA (Prob).

(5) 2nd Plt, Co "D" cont to conduct grd recon/obser via BS 327051. Arty same. Neg sightings du pd.

(6) 3rd Plt, Co "D" was extracted at 011830H back to NUI DANG after conducting grd recon/obser via BS 723375. Patrol returned to CHU LAI at 021800H.

(7) 2nd Plt, 1st Force cont to conduct grd recon/obser via BS 790340. Arty same.

(a) 021140H 2 VC moving South along trail via BS 782348, 1 blk PJ's and 1 khaki. 2 rifles, packs and 1 camouflaged jungle cap. FM now in progress.

(8) 6th Plt, 1st Force cont to conduct grd recon/obser via BS 433853. Arty same. Neg sightings du pd.

- b. Contacts: 3. (a); 4. (b); 7. (a).
  - c. Command Post Locations: No Change
  - d. Scout/ Sniper Teams: None
- 2. Casualties: None
  - 3. Operations Summary: Attached
  - 4. Operations Plans Summary: Attached
    - a. Intentions
      - (1) Insert 8 man diving team at 030730H via NUI DANG.
      - (2) Extract 2nd Flt, 1st Force at 031700H via BS 790340.
  - 5. Contact Action Report: Attached

G. R. JOHNSTON  
by direction



CC

HEADQUARTERS  
1st Reconnaissance Battalion  
 FPO San Francisco, California 96602

J/ML/rps  
 3 March 1967

From: Commanding Officer  
 To: Commanding General, 1st Marine Division (Rein), FMF

SITREP #338 030001H to 032400H

1. OPERATIONS NARRATIVE

a. General

(1) Bn Cnd Grp 1st Recon Bn (-) sent to coordinate Recon Operations via BS 818384. Operation INS SOTO/BRUKHOUSE VI.

(2) 1st Plt, Co "A" was reinserted at 031420H to conduct grd recon/obser via BS 772393. Arty support available fm the fol btrys: "I" Btry 155 HOW loc via BS 8631. Neg sightings du pd.

(3) 3rd Plt, Co "A" sent to conduct grd recon/obser via BS 630588. Arty same.

(a) 031200H 2 VC moving East on trail via BS 659578, blk PJ's, 2 rifles. Called FM. Results unknown.

(4) 4th Plt, Co "A" was reinserted at 031400H to conduct grd recon/obser via BS 55266. Arty support available fm the fol btrys: "I" Btry 155 HOW loc via BS 8631. Neg sightings du pd.

(5) 2nd Plt, Co "B" sent to conduct grd recon/obser via BS 327051. Arty same. Neg sightings du pd.

(6) 2nd Plt, 1st Force was extracted at 031430H after 140 $\frac{1}{2}$  hours of conducting grd recon/obser via BS 755358 and BS 790340. 9 sightings were made with a total of 58 VC reported. 4 FM were called resulting in 5 VC KIA (Prob). 2 fixed wing strikes were called resulting in 3 VC KIA (Conf), 8 VC KIA (Prob).

(a) 030630H 7 VCS cooking chow via BS 782353, blk PJ's and green belts. Equipment unknown.

(b) 030930H 8 VC moving Northeast via BS 782353, blk PJ's, 3 cartridge belts, 2 rifles. Blackcoat directed air strike. 1 VC KIA (Conf), 5 VC KIA (Prob).

(c) 031140H 7 VC picking up rice via BS 782353, blk PJ's, rifle. Air strike called. 2 VC KIA (Conf), 3 VC KIA (Prob). 2 tunnel entrances at BS 782353.

(7) 6th Plt, 1st Force sent to conduct grd recon/obs r via BS 433853.  
Arty same.

(a) 03:330H 27 VC moving west on trail via BS 428661, blk PJ's,  
packs and bundles. FH called. FH ceased when AO arrived. AO said they were  
VC Suspects.

b. Contacts: 3. (a); 6. (b), (c); 7. (a).

c. Gen and Post Locations: No Change

d. Scout/Sniper Teams: None

2. Casualties: None

3. Operation Summary: Attached

4. Operations Plans Summary: Attached

a. Intentions

(1) Extract 1st Plt, Co "A" at 041600H via BS 732355.

(2) Insert 2nd Plt, Co "A" at 040900H via BT 285050.

(3) Extract 2nd Plt, Co "D" at 040900H via BT 342045.

(4) Insert 4th Plt, 1st Force at 040800H via BS 43/968.

(5) Extract 6th Plt, 1st Force at 040800H via BS 433853.

5. Contact Action Report: Attached

R. A. CANNON  
By direction

cc

**HEADQUARTERS**  
**1st Reconnaissance Battalion**  
**APO San Francisco, California 96602**

3/HC/rpc  
 4 March 1967

From: Commanding Officer  
 To: Commanding General, 1st Marine Division (Rein), FMF

SITREP #339 040001H to 042400H

**1. OPERATIONS NARRATIVE**

**a. General**

(1) Bn Cmd Grp 1st Recon Bn (-) sent to coordinate Recon Operations via BS 818384. Operation DE SOLO/DECKHOUSE VI.

(2) 6 man diving team was extracted back to Quail at 041600H from BS 818385.

(3) 1st Plt, Co "A" was extracted at 031830H back to NUI DANG after conducting grd recon/obser via BS 772393.

(a) LATE ENTRY: 031545H 5 sightings of 25 VC moving East via BS 7638, blk PJ's, green utilities, and khakis. 1 FM and 3 air strikes were called. 4 VC KIA (Conf) and 3 VC KIA (Prob).

(4) 1st Plt, Co "A" was reinserted at 041500H to conduct grd recon/obser via BS 726376. Arty support available fm the fol btrys: "H" Btry 105 HOW loc via BS 8138. 1st Plt, Co "A" was extracted at 041700H back to NUI DANG after conducting grd recon/obser via BS 726376. Neg sightings du pd.

(5) 2nd Plt, Co "A" was inserted at 040900H to conduct grd recon/obser via BF 285050. Arty support available fm the fol btrys: "L" Btry 155 HOW loc via BF 3914. Neg sightings du pd.

(6) 3rd Plt, Co "A" sent to conduct grd recon/obser via BS 635588. Arty same. Neg sightings du pd.

(7) 4th Plt, Co "A" was extracted at 041600H after 26 hours of conducting grd recon/obser via BS 855266. 6 sightings were made with a total of 21 VC reported. 5 FM were called resulting in 10 VC KIA (Prob).

(a) LATE ENTRY: 031520H 2 VC walking South on trail towards our position via BS 855266, blk PJ's and 2 rifles. No FM due to air craft in area.

(b) 041120H 2 VC going West down trail via BS 878266, blk PJ's and 2 rifles. FM called. 2 VC KIA (Prob).

(c) 041305H 6 VC crossing river via BS 878266, blk PJ's and light hats. 1 rifle and 3 packs. FM called. Results unknown.

(8) 2nd Plt, Co "D" was extracted at 040930H after 96 hours of conducting grd recon/obser via BS 305074. Neg sightings du pd.

(9) 4th Plt, 1st Force was inserted at 040800H to conduct grd recon/obser via BS 437968. Arty support available fm the fol btryes: "M" Btry 133 HOW loc via BS 5395. Neg sightings du pd.

(10) 6th Plt, 1st Force was extracted at 040830H after 95½ hours of conducting grd recon/obser via BS 433853. 1 sighting was made with a tot l of 10 VC reported. 1 FM was called resulting in 10 VC KIA (Conf). Neg sightings du pd.

b. Contacts: 3. (a); 6. (b), (c).

c. Com and Post Locations: No Change

d. Scout/ Sniper Teams: None

2. Casualties: None

3. Operation Summary: Attached

4. Operations Plans Summary: Attached

a. Intentions

(1) Insert 1st Plt, Co "D" at 050900H via BS 635588.

(2) Extract 3rd Plt, Co "A" at 050900H via BS 635588.

(3) Insert 3rd Plt, Co "D" at 051500H via BS 818385.

5. Contact Action Report: Attached

R. A. CARNES  
By direction

CC

HEADQUARTERS  
 1st Reconnaissance Battalion  
 FPO San Francisco, California 96602

3/HG/rpe  
 3 March 1967

From: Commanding Officer  
 To: Commanding General, 1st Marine Division(Rein), FWF

SITREP #340 050001H to 052400H

1. OPERATIONS NARRATIVE

a. General

(1) Bn Cmd Gp 1st Recon Bn (-) sent to coordinate Recon Operations via Bo 818384. Operation DM SOTO/DECKHOUSE VI. Conducted Foot Patrol

(2) 1st Plt, Co "A" ~~walked out~~ at 050700H to ~~conduct grd recon/obser~~ via BS 8032 where an OP was established. Arty support available in the fol brigs: "H" Btry 105 HOW loc via BS 8138. 1st Plt, Co "A" was extracted at 051430H after 7½ hours of conducting grd recon/obser via BS 8032. Neg sightings du pd.

(3) 2nd Plt, Co "A" sent to conduct grd recon/obser via BT 283065. Arty same. Neg sightings du pd.

(4) 3rd Plt, Co "A" was extracted at 051530H after 10¾ hours of conducting grd recon/obser via BS 635588. 2 sightings were made with a total of 7 VC reported. 2 FM were called. Results unknown. Neg sightings du pd.

(5) 1st Plt, Co "D" was inserted at 051530H to conduct grd recon/obser via BS 635588. Arty support available in the fol brigs: "A" Btry 175 Guns loc via BS 6384. Neg sightings du pd.

(6) 4th Plt, 1st Force cont to conduct grd recon/obser via BS 437968. Arty same. Neg sightings du pd.

b. Contacts: None

c. Command Post Locations: 360048

d. Scout/Sniper Teams: None

2. Casualties: None

3. Operation Summary: Attached

4. Operations Plans Summary: Attached

a. Intentions

- (1) Insert 2nd Plt, 1st Force at 061000H via RF 098246.
- (2) Insert 2nd Plt, Co "D" at 061000H via RF 133245.
- (3) Extract 1st Plt, Co "A" at 061200H via RF 818385.

3. Contact Action Report: N/A

R. A. GARNES  
By direction

CC

HEADQUARTERS  
1st Reconnaissance Battalion  
 P.O. San Francisco, California, 94602

3/HC/gah  
 6 March 1967

From: Commanding Officer  
 To: Commanding General, 1st Marine Division(Rein), FAW

SIGNAL # 341 060001H to 062400H

1. OPERATIONS NARRATIVE

a. General

(1) Bn Cmd Grp 1st Recon Bn (-) cont to coordinate Recon Operations via BS 818384 Operation DE SORO/DECKH-USE VI.

(2) 2nd Plt, Co "A" cont to conduct grd recon/obsr via BT 283065. Arty same. Neg sightings du pd.

(3) 1st Plt, Co "D" cont to conduct grd recon/obsr via BS 635586. Arty same.

(a) LATE ENTRY: 05195H unknown number of VC moving on our position from via BS 621585, BS 624577, BS 635576 and BS 643578. Equipment unknown. FM called. Results unknown due to heavy fog.

(b) 060930H 3 VC moving SW via BS 643571, blk PJs, 5 rifles. FM called. Results unknown.

(4) 4th Plt, 1st Force cont to conduct grd recon/obsr via BS 437968. Arty same. Neg sightings du pd.

b. Contacts: 3. (b).

c. Command Post Location: No Change

d. Scout/ Sniper Teams: None

2. Casualties: None

3. Operation Summary: Attached

4. Operations Plans Summary: Attached

a. Intentions

(1) Extract 2nd Plt, Co "D" at 071600H via BT 283050.

(2) Insert 6th Plt, 1st Force at 070945H via BT 432010.

(3) Extract 4th Plt, 1st Force at 071400H via BS 437968.

- (4) Insert 4th Plt, Co "A" at 070900H via BF 358045.
- (5) Insert 2nd Plt, 1st Force at 071045H via BF 044273.
- (6) Extract 1st Plt Co "D" at 071500H via BS 635588.
- (7) Insert 2nd Plt, Co "D" at 071300H via BS 447714.
- (8) Extract 1st Plt, Co "A" at 071200H via BS 818385.
- (9) Insert 3rd Plt, Co "D" at unk time DUC PRO area.

5. Contact Action Report: Attached

R. A. CARRIS  
By direction



CL

HEADQUARTERS  
 1st Reconnaissance Battalion  
 FPO San Francisco, California 96602

3/NG/rps  
 7 March 1967

From: Commanding Officer  
 To: Commanding General, 1st Marine Division (Main), FMM

SITREP #342 070001H to 072400H

1. OPERATIONS NARRATIVE

a. General

(1) Bn Cmd Grp 1st Recon Bn (-) sent to coordinate Recon Operations via BS 615384. Operation DE SOFO/DECKHOUSE VI.

(2) 2nd Plt, Co "A" sent to conduct grd recon/obser via BT 283065. Arty same. Neg sightings du pd.

(3) 1st Plt, Co "D" sent to conduct grd recon/obser via BS 655588. Arty same.

(a) 071015H 11 VC moving Southwest on trail via BS 655570, blk PJ's and white coolie hats. 7 rifles, 4 packs and 2 with baskets. Neg FH due to fog. Used .50 cal. 1 VC KIA (Conf).

(b) 071215H 8 VC burning hut via BS 655575, 7 blk PJ's, 1 grey PJ's. 3 rifles. FH called, good coverage. Results unknown.

(4) 3rd Plt, Co "D" at 070730H conducted foot patrol to via BS 612332 where an OP was established. Arty support available in the fol btys: "E" Btry 105 HO; loc via BS 6138. Neg sightings du pd.

(5) 4th Plt, 1st Force sent to conduct grd recon/obser via BS 437968. Arty same. Neg sightings du pd.

b. Contacts: 3. (a), (b).

c. Command Post Locations: No Change

d. Scout/Sniper Teams: None

2. Casualties: None

3. Operation Summary: Attached

4. Operations Plans Summary: Attached

(a) Intentions

- (1) Extract 2nd Plt, Co "A" at 081600H via BF 285050.
- (2) Insert 6th Plt, 1st Force at 080945H via BF 432010.
- (3) Extract 4th Plt, 1st Force at 081400H via BS 437968.
- (4) Insert 4th Plt, Co "A" at 080900H via BF 358045.
- (5) Insert 2nd Plt, Co "D" at 081300H via BS 447714.
- (6) Extract 1st Plt, Co "D" at 081500H via BS 635588.
- ~~(7) Extract 2nd Plt, Co "A" at 081100H via BF 084873.~~
- ~~(8) Insert 2nd Plt, 1st Force at 081600H via BF 599250.~~

5. Contact Action Report: Attached

R. A. GARNES  
By direction

HEADQUARTERS  
1st Reconnaissance Battalion  
APO San Francisco, California, 96602

3/HG/gah  
8 March 1967

From: Commanding Officer  
To: Commanding General, 1st Marine Division (Rein), FMF

SITREP # 342 060001H to 082400H

1. OPERATIONS NARRATIVE

a. General

- (1) Bn Cmd Gp 1st Recon Bn (-) sent to coordinated Recon Operations via 818384 Operation DE SOTO/DECKHOUSE VI.
- (2) 2nd Plt, Co "A" was extracted at 081100H after 98 hrs of conducting grd recon/obser via BT 283065. Neg sightings du pd.
- (3) 4th Plt, Co "A" was inserted at 081000H to conduct grd recon/obser via BT 358045. Arty support available in the fol btrys: A/11 155 HOW loc via BT 4410.
- (4) 1st Plt, Co "D" sent to conduct grd recon/obser via BS 635588. Arty same.
  - (a) LATE ENTRY: 071750H 18 VC walking into hut via BS 620553, blk PJs and 9 rifles. FM called. Results unknown.
  - (b) 080143H Unknown number of VC tried to breach mines. Booby trap activated. Exchange w/a fire. Results unknown.
- (5) 2nd Plt, Co "D" was inserted at 081130H to conduct grd recon/obser via BS 447714. Arty support available in the fol btrys: "A" btry 175 GUNS loc via BS 6384.
  - (a) 081415H 4 VC moving N via BS 425725, blk PJs, khaki, 1 sub MG, 2 packs. No FM called, target disappeared.
  - (b) 081430H 2 VC moving N via BS 425725, blk PJs, 1 rifle, 2 packs. FM called. Results unknown.
  - (c) 081530H 5 VC moving N via BS 454726, 4 gray khaki, 1 blk shirt, gray shorts. 1 French styled helmet, 2 rifles, 4 packs. FM called. Good affect, results unknown.
- (6) 3rd Plt, Co "D" was extracted at 071830H after conducting grd recon/obser via BS 812332. LATE ENTRY.
  - (a) LATE ENTRY: 071610H 15 VC following patrol since insertion. BS 803316. Patrol has ambush set up.
  - (b) LATE ENTRY: 071700H 3 VC watching our position via BS 804324, blk PJs, 2 rifles and 1 MG. Hides called. Results unknown. FM called. Results unknown.

(7) 3rd Plt, Co "D" was inserted at 081030H to conduct grd recon/obser via BS 735355. Arty support available fm the fol btrys: "H" btry 105 HOW loc via BS 8138. Mission aborted due to heavy grd fire.

(8) 4th Plt, 1st Force was extracted at 081000H after 98 hrs of conducting grd recon/obser via BS 437968. Neg sightings du pd.

(9) 6th Plt, 1st Force was inserted at 080800H to conduct grd recon/obser via BT 432010. Arty support available fm the fol btrys: "F" btry 105 HOW loc via BT 4408. Neg sightings du pd.

b. Contacts: 4. (b). 5. (b), (c).

c. Command Post Locations: No Change

d. Scout/Sniper Teams: None

2. Casualties: None

3. Operation Summary: Attached

4. Operation Plans Summary: Attached

a. Intentions

(1) Insert 1 sqd 1st Plt Co "D" at 091000H via BS 635588.

(2) Extract 1 sqd 1st Plt Co "D" at 091000H via BS 635588.

(3) Insert 3rd Plt, Co "D" at 091400H via BS 781319.

(4) Insert 1 sqd, 2nd Plt, 1st Force at 091100H via BT #506.

(5) Insert 1 sqd, 2nd Plt, 1st Force at 091100H via BT 2310.

5. Contact Action Report: Attached

M. A. CARRIS  
By direction

CC

**HEAD-QUARTERS**  
**1st Reconnaissance Battalion**  
**WFO San Francisco, California, 96602**

3/HE/gah  
 9 March 1967

From: Commanding Officer  
 To: Commanding General, 1st Marine Division(Rein), FMF

SITREP # 343 090001H to 092400H

1. OPERATIONS NARRATIVE

a. General

- (1) Bn Gnd Grp 1st Recon Bn (-) sent to coordinate Recon Operations via BS 818384 Operation DE SOTO/DECKHOUSE VI.
- (2) 4th Plt, Co "A" sent to conduct grd recon/obser via BT 362041. Arty same. Neg sightings du pd.
- (3) 1st Plt, Co "D" sent to conduct grd recon/obser via BS 635588. Arty same. Neg sightings du pd.
- (4) LATE ENTRY: 2nd Plt, Co "D" was extracted at 082145H after 9 3/4 hrs of conducting grd recon/obser via BS 447714. 4 sightings were made with a total of 31 VC reported. 2 FM were called, results unknown. 1 fixed wing strike was called resulting in 5 VC KIA (prob).
- (a) LATE ENTRY: 081700H - 082130H 20 VC probed position via BS 448718, grey uniforms, carbines and M-1 rifles. Patrol returned fire and called air. Fixed wing conducted air strikes. 5 VC KIA (prob).
- (5) 3rd Plt, Co "D" at 091200H conducted foot patrol to BS 781319, where an OP was established. Arty support available fm the fol btrys: "H" btry 105 HOW loc via BS 8138. Neg sightings du pd.
- (6) 6th Plt, 1st Force cont to conduct grd recon/obser via BT 430016. Arty same. Neg sightings du pd.

b. Contacts: 4. (a).

c. Command Post Locations: No change

d. Scout/Sniper Teams: None

2. Casualties: None

3. Operation Summary: Attached

4. Operations Plans Summary: Attached

a. Intentions

- (1) Insert 3rd Plt, Co "A" at 101200H via BT 355094.
- (2) Insert 1 sqd, 2nd Plt, 1st Force at 101100H via BT 2506.
- (3) Insert 1 sqd, 2nd Plt, 1st Force at 101100H via BT 2510.
- (4) Insert 2nd Plt, Co "D" at 101000H via BS 413849.
- (5) Extract 3rd Plt, Co "D" at 101700H via BS 781343.

5. Contact Action Report: Attached

E. A. GARNES  
By direction

cc

HEADQUARTERS  
 1st Reconnaissance Battalion  
 PPO San Francisco, California, 96602

5/NO/gah  
 10 March 1967

From: Commanding Officer  
 To: Commanding General, 1st Marine Division(Rein), FPF

SITREP # 34# 100001H to 102400H

1. OPERATIONS NARRATIVE

a. General

- (1) Bn Cnd Grp 1st Recon Bn (-) sent to coordinate Recon Operations via # 818384 Operation DE SOTO/DECKHOUSE VI.
- (2) 4th Plt, Co "A" sent to conduct grd recon/obser via BT 362041. Arty same.
  - (a) 100900H while preparing to leave harbour site and continuing grd recon, 1 friendly booby trap was activated resulting in 2 USMC WIA (MED EVAC).
- (3) 1st Plt, Co "D" sent to conduct grd recon/obser via BS 635588. Arty same. Neg sightings du pd.
- (4) LATE ENTRY: 3rd Plt, Co "D" sent to conduct foot patrol via BS 7936. Foot patrol terminated 101045H.
  - (a) LATE ENTRY: 091910H estimated 1 VC fired 5 rds a/a and threw 1 grenade into harbour site, via BS 995360. Uniform unknown. 3 USMC WIA.
  - (b) LATE ENTRY: 092100H Patrol received unknown number a/a fire from north and southeast, via BS 7936.
  - (c) 100227H Cumulative losses, 2 USMC WIA, 1 USMC KIA.
- (5) 6th Plt, 1st Force sent to conduct grd recon/obser via BT 430016. Arty same. Neg sightings du pd.

b. Contacts: 4.(a), (b).

c. Command Post Locations: No Change

d. Snout/ Sniper Teams: None

2. Casualties: 2 USMC WIA, 1 USMC KIA

3. Operation Summary: Attached

4. Operations Plans Summary: Attached

## a. Intentions

- (1) Insert 2nd Plt, 1st Force at 111100 via BS 4496.
- (2) Insert 3rd Plt, Co "A" at 111130H via BS 413849.
- (3) Insert 1st Plt, Co "A" at 111300H via BS 635588.
- (4) Extract 1st Plt, Co "D" at 111300H via BS 635588.
- (5) Extract 4th Plt, Co "A" at 111400H via BT 358045.
- (6) Extract 6th Plt, 1st Force at 111500H via BT 432010.
- (7) Insert 2nd Plt, 1st Force at 111200H via BT 2310.

5. Contact Action Report: Attached

R. A. GARNES  
By Direction



HEADQUARTERS  
1st Reconnaissance Battalion  
APO San Francisco, California, 96602

S/HG/gah  
11 March 1967

From: Commanding Officer  
To: Commanding General, 1st Marine Division (Rein), FFW

SITREP # 345 11000H to 112400H

1. OPERATIONS NARRATIVE

a. General

(1) Bn Cnd Grp 1st Recon Bn (-) cont to coordinate Recon Operations via BS 818384 Operation DE SOTO/DECKHOUSE VI.

(2) 1st Plt, Co "A" was inserted at 111100H to conduct grd recon/obser via BS 635588. Arty support available fm the fol btrys: "A" btry 175 GUNS loc via BS 6384. Have sniper capabilities. Neg sightings

(a) 111445H 5 VC standing in open via BS 655574, blk PJs, 1 khaki and 1 in green utilities. 1 rifle and 1 cartridge belt. FM called, excellent coverage. 1 VC KIA (conf).

(3) 3rd Plt, Co "A" was inserted at 110930H to conduct grd recon/obser via BS 415849. Arty support available fm the fol btrys: "M" btry 155 HOW loc via BS 5395. Neg sightings du pd.

(4) 4th Plt, Co "A" was extracted at 111600H after 78 hrs of conducting grd recon/obser via BT 362041. Neg sightings du pd.

(5) 1st Plt, Co "D" was extracted at 111100H after 139½ hrs of conducting grd recon/obser via BS 635588. 5 sightings were made with a total of 42 VC reported. 4 FM were called resulting in 1 VC KIA (conf).

(6) 3rd Plt, Co "D" was inserted at 111145H to conduct grd recon/obser via BS 730381. Arty support available fm the fol btrys: "H" btry 105 HOW loc via BS 8138.

(7) 3rd Plt, Co "D" was extracted at 111615H after 4½ hrs of conducting grd recon/obser via BS 730381.

(a) 111545H Patrol received 2 grenades from unknown number of VC. Patrol returned 20 rds s/a and through 2 US grenades. Patrol was extracted at 111615H.

THREW

(8) 1 sqd, 2nd Plt, 1st Force was inserted at 110300H to conduct grd recon/obser via BS 446927. Arty support available fm the fol btrys: "K" btry 155 HOW loc via BS 5395.

(a) 111615H 12 VCS moving E along dike into village via BS 474943, blk PJs. Carrying bundles.

(9) 1 sqd, 2nd Plt, 1st Force was inserted at 111030H to conduct grd recon/obsr via HF 235100. Arty support available fm the fol btrys: 3rd 155 GUNS loc via HF 4308. Neg sightings du pd.

(10) 6th Plt, 1st Force was extracted at 111630H after 60 hrs of conducting grd recon/obsr via HF 432010. Neg sightings du pd.

b. Contacts: 2. (a); 7. (a); 8. (a).

c. Command Post Locations: No Change

d. Scout/Sniper Teams: None

2. Casualties: None

3. Operation Summary: Attached

4. Operation Plans Summary: Attached

a. Intentions

(1) Insert 2nd Plt, Co "D" at 120800H via HF 389035.

(2) Insert 4th Plt, 1st Force at 120900H via HF 245060.

5. Contact Action Report: Attached

R. A. CANNES  
By Direction

HEADQUARTERS  
1st Reconnaissance Battalion  
APO San Francisco, California, 96602

3/20/gah  
12 March 1967

From: Commanding Officer  
To: Commanding General, 1st Marine Division(Rein), F&F

SITREP # 346 120001H to 122400H

1. OPERATIONS NARRATIVE

a. General

- (1) Bn Cmd Grp 1st Recon Bn (-) sent to coordinate Recon Operations via BS 618384 Operation DE SOTO/DECKHOUSE VI.
- (2) 1st Plt, Co "A" sent to conduct grd recon/obser via BS 635588. Arty same.
  - (a) 121045H 7 VC moving into brushline via BS 659576, blk PJs, khaki, greens, 3 rifles, 1 pack. FM called. Excellent coverage. Results unknown.
  - (b) 121115H 14 VCS moving W via BS 618533, blk PJs, no equip observed.
  - (c) 121140H 8 VC moving NE along trail via BS 627607, 4 blk PJs and 4 khakis. 3 rifles, 1 auto weapon and 1 pack. FM called, excellent coverage. 4 VC KIA (conf).
  - (d) 121415H 2 VC walking SE on trail via BS 642573, blk PJs and occlus hats. Packs and rifles. Fired .50 cal. 1 VC KIA (conf).
- (3) 2nd Plt, Co "A" was inserted at 121030H to conduct grd recon/obser via BS 731355. Arty support available in the fol btrys: "H" btry 105 HOW loc via BS 6136.
- (4) 3rd Plt, Co "A" sent to conduct grd recon/obser via BS 415849. Arty same.
  - (a) 121215H 1 VC moving E on trail via BS 425871, blk PJs and 1 rifle.
- (4) 2nd Plt, Co "D" was inserted at 120800H to conduct grd recon/obser via BT 309035. Arty support available in the fol btrys: "F" btry 105 HOW loc via BS 4408. Neg sightings du pd.
- (6) 1 squad, 2nd Plt, 1st Force sent to conduct grd recon/obser via BS 446927. Arty same. Neg sightings du pd.
- (7) 1 squad, 2nd Plt, 1st Force sent to conduct grd recon/obser via BT 235100. Arty same. Neg sightings du pd.
- (8) 1 squad, 4th Plt, 1st Force was inserted at 120830H to conduct grd recon/obser via BT 245060. Arty support available in the fol btrys: 4/11 155 GENS loc via

BT 4410. Neg sightings du pd.

- b. Contacts: 2. (a), (c), (d).
  - c. Command Post Locations: BT 560048.
  - d. Secret/ Sniper Teams: None
- 2. Casualties: None
  - 3. Operation Summary: Attached
  - 4. Operations Plans Summary: Attached
    - a. Intentions
      - (1) Extract 3rd Plt, Co "A" at 131400H via BS 415849.
      - (2) Extract 1 sqd, 2nd Plt, 1st Force at 131300H via BT 235100.
      - (3) Extract 1 sqd, 2nd Plt, 1st Force at 131430H via BS 446927.
      - (4) Insert 1 sqd, 4th Plt, 1st Force at 130800H via BS 390944.
      - (5) Extract 2nd Plt, Co "A" at 131700H via IL 737355.
  - 5. Contact Action Report: Attached

R. A. GARNES  
By direction

cc

HEADQUARTERS  
 1st Reconnaissance Battalion  
 PFC San Francisco, California, 94602

3/BC/gah  
 13 March 1967

From: Commanding Officer  
 To: Commanding General, 1st Marine Division(Rein), FMF

SITREP # 347 130001H to 132400H

1. OPERATIONS NARRATIVE

a. General

(1) Bn Cmd Grp 1st Recon Bn (-) sent to coordinate Recon Operations via BS 618384 Operation DE SOTO/DECKHOUSE VI.

(2) 1st Plt, Co "A" sent to conduct grd recon/obser via BS 635588. Arty same.

(a) LATE ENTRY: 121550H 11 VC moving NE on trail via BS 625554, blk PJs, rifles and packs. FM called. Results unknown.

(b) LATE ENTRY: 121815H 9 VC moving NE on trail via BS 658573, 3 khakis, and 6 in blk PJs. Rifles, packs and bundles. FM called. 4 VC KIA (prob).

(c) 130900H 2 VC moving E on trail via BS 678576, blk PJs, 1 rifle and 2 bundles. FM called. Results unknown.

(d) 131030H 9 VCS moving W on trail in ebluan via BS 618534, mixed khakis and Blk PJs.

(e) 131030H 20 VCS assembled via BS 623619, mixed blk PJs, khakis and greens.

(f) 131115H 6 VC moving into house via BS 660577, blk PJs, 1 rifle and packs. FM called 2 WJ structures destroyed, 1 partially destroyed. 4 VC KIA (prob).

(g) 131230H 13 VCS loc via BS 623532, blk PJs, khaki, bundles and packs. No wps observed.

(h) 131300H 3 VC in group via BS 660579, blk PJs, rifles. FM called. Results unknown.

(i) 131500H 10 VCS moving out of ville via BS 617526, blk PJs. Unable to observe equip.

(3) 2nd Plt, Co "A" was extracted at 131500H after 20 1/2 hrs of conducting grd recon/obser via BS 713555. 2 sightings were made with a total of 3 VC reported. 1 FM was called. Results unknown. 1 VC KIA (prob) due to s/a fire.

(a) 130820H 1 VC moving SW via BS 790355, blk PJs and 1 pack. FM called. Results unknown.

(b) 131350H Patrol received 4 rds of sniper fire fm patrols rear. Estimated 2 VC in blk PJs with white scarfs at via BS 713350. Patrol returned 4 rds s/a fire. 1 VC KIA (Prob). Patrol extracted at 131500H.

(4) 3rd Plt, Co "A" was extracted at 141630H after 79 hrs of conducting grd recon/obser via BS 415849. 1 Sighting was made with a total of 1 VC reported.

(5) 2nd Plt, Co "D" sent to conduct grd recon/obser via BF 389035. Arty same.

(a) 131300H 4 VCS moving SW via BF 357069, blk PJs. Too distant to observe equip.

(b) 131520H 3 VCS milling around huts via BF 375055, 1 blk PJ, 1 green khaki and 1 brown khaki.

(6) 1 sqd, 2nd Plt, 1st Force sent to conduct grd recon/obser via BS 446927. Arty same. Neg sightings du pd.

(7) 1 sqd, 2nd Plt, 1st Force was extracted at 131530H after 53 hrs of conducting grd recon/obser via BF 235100. Neg sightings du pd.

(8) 1 sqd, 4th Plt, 1st Force sent to conduct grd recon/obser via BF 245060. Arty same. Neg sightings du pd.

(9) 1 sqd, 4th Plt, 1st Force was inserted at 131430H to conduct grd recon/obser via BF 390944. Arty support available fm the fol btrys: 4/11 155 GUNS loc via BF 4410.

b. Contacts: 2. (a), (b), (c), (f), (h); 3. (a).

c. Command Post Locations: No Change

d. Scout/Sniper Teams: None

2. Casualties: None

3. Operation Summary: Attached

4. Operations Plans Summary: Attached

a. Intentions

(1) Insert 4th Plt, Co "A" at 141430H via BF 261043.

(2) Insert 1st Plt, Co "D" at 140800H via BS 342999.

- (3) Extract 1 sqd, 4th Flt, 1st Force at 141300H via BF 243060.
- (4) Extract 1 sqd, 2nd Flt, 1st Force at 140830H via BS 446927.
- (5) Insert 2nd Flt, Co "A" at 140730H via BS 727376.

5. Contact action Report: Attached

R. A. CANNON  
By direction

CC

HEADQUARTERS  
1st Reconnaissance Battalion  
PTO San Francisco, California, 96602

E/NO/gk  
14 March 1967

From: Commanding Officer  
To: Commanding General, 1st Marine Division(Rein), PIF

SITREP # 348 140001H to 142400H

1. OPERATIONS NARRATIVE

a. General

- (1) Bn Cmd Grp 1st Recon Bn (-) sent to coordinate Recon Operations via BS 815384 Operation DE SOFO/DECKHOUSE VI.
- (2) 1st Plt, Co "A" sent to conduct grd recon/obser via BS 635588. Arty same.
- (a) LATE ENTRY: 131345H 50 VC assembling via BS 668580, mixed blk PJs and khakis. Rifles and Packs. FM called. Results unknown. Air strike called. 4 VC KIA (conf); 10 VC KIA (prob).
- (b) LATE ENTRY: 131630H 10 VC moving E into ville via BS 635575, blk PJs. Packs, rifles and bundles. Air strike called. 6 VC KIA (conf).
- (c) LATE ENTRY: 131630H 2 VC moving into house via BS 658585, blk PJs and carrying mortar tube. FM called. Results unknown.
- (d) LATE ENTRY: 131720H 6 VC moving SW on trail via BS 635570, green utilities. Carrying 1 MB. Also carrying tube 5 to 6 feet long and 8 inches in diameter. Air called. Air was on another mission. Target moved out of sight.
- (e) 141200H 12 VC Suspects moving E on trail via BS 686576, blk PJs. Equipment unobserved.
- (f) 141315H 5 VC moved into brush line via BS 665581, blk PJs. 2 rifles, 1 cartridge belt, 1 pack and water cans. FM called. Results unknown.
- (3) 2nd Plt, Co "A" was inserted at 140800H to conduct grd recon/obser via BS 727376. Arty support available in the fol btrys: "E" btry 105 RCW loc via BS 8138.
- (a) 141045H 4 VC moving S via BS 753368, blk PJs, rifles. FM called. Results unknown.
- (b) 141055H 4 VC moving into hedgerow via BS 752375, blk PJs, 1 pack, 4 rifles. FM called. Excellent coverage. Results unknown.
- (c) 141150H 3 VC moving N via BS 745388, fleg hats and camouflaged caps. 2 packs and 3 rifles. FM called. Results unknown.



(d) 141215H 1 VC moving out of area that last three were in vic BS 750386, flop hat and camouflaged caps. 1 pack and 1 rifle. FM called. Results unknown.

(e) 141230H 4 VC moving into brush vic BS 744379, blk FJs and 3 rifles. FM called. Results unknown.

(4) 4th Plt, Co "A" was inserted at 141430H to conduct grd recon/obser vic BT 281043. Arty support available fm the fol btrys: "L" btry 155 HOW loc vic BT 3914.

(5) 1st Plt, Co "D" was inserted at 140800H to conduct grd recon/obser vic BS 326980. Arty support available fm the fol btrys: "K" btry 155 HOW loc vic BT 4410.

(6) 2nd Plt, Co "D" sent to conduct grd recon/obser vic BT 389035. Arty same. Neg sightings du pd.

(7) 1 sqd, 2nd Plt, 1st Force was extracted at 141400H after 77 hrs of conducting grd recon/obser vic BS 446927. 2 sightings were made with a total of 16 VC/VCS reported. Neg sightings du pd.

(8) 1 sqd, 4th Plt, 1st Force was extracted at 141700H after 56½ hrs of conducting grd recon/obser vic BT 245060. Neg sightings du pd.

(9) 1 sqd, 4th Plt, 1st Force sent to conduct grd recon/obser vic BT 390944. Arty same. Neg sightings du pd.

b. Contacts: 2. (f); 3. (a), (b), (c), (d), (e).

c. Command Post Locations: No Change

d. Scout/ Sniper Teams: None

2. Casualties: None

3. Operation Summary: Attached

4. Operation Plans Summary: Attached

a. Intentions

(1) Extract 2nd Plt, Co "D" at 151400H vic BT 389035.

(2) Insert 6th Plt, 1st Force at 150800H vic BT 245084.

5. Contact Action Report: Attached

R. A. GARNES  
By direction

cc

HEADQUARTERS  
 1st Reconnaissance Battalion  
 PFO San Francisco, California 96602

3/20/67  
 15 March 1967

From: Commanding Officer  
 To: Commanding General, 1st Marine Division (Rein), FMB

SITREP #390 150001H to 152400H

L. OPERATIONS NARRATIVE

a. General

- (1) Bn Cmd Gp 1st Recon Bn (-) sent to coordinate Recon Operations via BS 816384. Operation DE SUFO/DECKHOUSE VI.
- (2) 1st Plt, Co "A" sent to conduct grd recon/obser via BS 635580. Arty same.
- (a) 151105H 3 VCS walking South across river via BS 675584, blk PJ's and carrying bundles.
- (b) 151145H 4 VCS moving East via BS 675576, blk PJ's. 2 packs. No weapons visible.
- (c) 151340H 2 VC in tree line via BS 665581, blk PJ's. 1 rifle. FM called. 1 VC KIA (Conf).
- (d) 151430H 6 VC rebuilding bunker via BS 654575, blk PJ's and scolic hats. 2 rifles. FM called, excellent coverage. 2 VC KIA (Conf), 3 VC KIA (Prob).
- (3) 2nd Plt, Co "A" sent to conduct grd recon/obser via BS 727376. Arty same.
- (a) LATE ENTRY: 141640H 3 VC moving into brush via BS 744379, blk PJ's. 2 rifles. FM called. Results unknown.
- (b) 151040H 3 VC moving North via BS 742381, blk PJ's, shorts and flop hats. 3 packs and 3 rifles. FM called, excellent coverage. Results unknown.
- (c) 151135H 3 VC, one wounded, in brush via BS 741381, grey and blk PJ's. 1 rifle and 1 pack. FM called, excellent coverage. Results unknown.
- (d) 151255H 3 VC searching area via BS 743382, blk PJ's, camouflaged capes. 1 pack and 1 rifle. FM called. Results unknown.
- (4) 4th Plt, Co "A" sent to conduct grd recon/obser via BF 261043. Arty same. Neg sightings du pd.
- (5) 1st Plt, Co "D" sent to conduct grd recon/obser via BS 322985. Arty same. Neg sightings du pd.

**HEADQUARTERS**  
**1st Reconnaissance Battalion**  
**RPO San Francisco, California, 96602**

J/HO/gh  
 24 March 1967

From: Commanding Officer  
 To: Commanding General, 1st Marine Division (Rein), FVM

SIRREP # 358 240000H to 242400H

**1. OPERATIONS NARRATIVE**

**a. General**

- (1) An Cnd Grp 1st Recon Bn (-) sent to coordinate Recon Operations via BS 416384. Operation BE SOTO.
- (2) 2nd Plt, Co "A" was inserted at 241030H to conduct grd recon/obsr vic BS 433943. Arty support available in the fol btys: "H" btry 155 HOW loc vic BS 5395. 2nd Plt, Co "A" was extracted at 241630H after 6 hrs of conducting grd recon/obsr vic BS 433939. Neg sightings du pd.
- (3) 3rd Plt, Co "A" sent to conduct grd recon/obsr vic BS 416976. Arty same.
  - (a) 240845H 2 VC walking S vic BT 372012, blk PJs, 1 pack. FH called, results unknown.
- (4) 1st Plt, Co "D" was extracted at 241530H after 7½ hrs of conducting grd recon/obsr vic BT 333032. Neg sightings du pd.
- (5) 2nd Plt, Co "D" sent to conduct grd recon/obsr vic BS 773394. Arty same.
  - (a) 240805H 3 VC moving SW vic BS 732405, 2 brown khaki, 1 white PJs, 3 packs, 1 rifle. FH called. Results unknown.
  - (b) 240815H 6 VCS moving SW vic BS 714385, 2 brown khaki, blk PJs. No equip observed.
  - (c) 240910H 2 VC carrying 1 body vic BS 753400, 1 blk PJ, 1 white PJ, 1 rifle. No FH called, target moved from sight.
  - (d) 240930H 1 anti-aircraft gun in woods vic BS 796413. FH called. Good coverage.
  - (e) 241145H 30 refugees moving W to E on trail vic BS 791384, mixed civilian clothes. Carrying household effects.
  - (f) 241315H 37 refugees moving E to W on trail vic BS 764385, mixed civilian clothes. Carrying household effects.
  - (g) 241500H 7 VC moving E vic BS 763392, light coloured trousers, dark shirts, 7 rifles. Called Fixed Wing. Results unknown.

(6) 2nd Plt, Co "D" was extracted at 151400H after 78 hours of conducting grd recon/obser via BF 389835. 2 sightings were made with a total of 7 VCS. Neg sightings du pd.

(7) 1 Squad, 4th Plt, 1st Force sent to conduct grd recon/obser via BF 390944. Arty same. Neg sightings du pd.

(8) 6th Plt, 1st Force was inserted at 150800H to conduct grd recon/obser via BF 245084. Arty support available in the fol btrys: "L" Btry 155 HOW loc via BF 3914.

(a) 151400H 8 VCS moving West via BS 239073, blk PJ's. 2 packs. Will continue to observe.

b. Contacts: 2. (c), (d); 3. (a), (b), (e), (d).

c. Command Post Locations: No Change

d. Scout/Sniper Teams: None

2. Casualties: None

3. Operation Summary: Attached

4. Operations Plans Summary: Attached

a. Intentions

(1) Insert 3rd Plt, Co "D" at 161300H via BS 635588.

(2) Extract 1st Plt, Co "A" at 161300H via BS 635588.

(3) Insert 3rd Plt, Co "A" at 160700H via BS 754358.

(4) Insert 1 Squad, 2nd Plt, 1st Force at 1:1100H via BF 282043.

(5) Extract 4th Plt, Co "A" at 161100H via BF 282043.

(6) Extract 1 Squad, 4th Plt, 1st Force at 161100H via BS 386936.

(7) Extract 2nd Plt, Co "A" at 160000H via BS 755375.

5. Contact Action Reports: Attached

R. A. GAMES  
By direction

HEADQUARTERS  
1st Reconnaissance Battalion  
 PPO San Francisco, California, 96602

3/HC/gh  
 16 March 1967

From: Commanding Officer  
 To: Commanding General, 1st Marine Division (Rein), PFM

SITREP # 351 160001H to 162400H

1. OPERATIONS NARRATIVE

a. General

(1) Bn Cmd grp 1st Recon Bn (-) sent to coordinate Recon Operations via BS 818384 Operation DE SOTO/DECKHOUSE VI.

(2) 1st Plt, Co "A" was extracted at 161400H after 123 hrs of conducting grd recon/obser via BS 635588. 26 sightings were made with a total of 240 VC/VCS reported. 17 FM were called resulting in 9 VC KIA (conf), 19 VC KIA (prob). 2 fixed wing strikes were called resulting in 10 VC KIA (conf), 10 VC KIA (prob).

(a) 160945H 14 VC in 4 boats moving supplies S along river via BS 686595, blk PJs and rifles. Boats heavily loaded with equipment. FM called, excellent coverage. Two boats destroyed, 1 VC KIA (conf) and 4 VC KIA (prob).

(b) 161000H 4 VC supply boats beached on sand via BS 652576. FM called, excellent coverage. 2 boats destroyed, 2 sinking fast.

(c) 161200H 5 VC in tree line via BS 660586, blk PJs, rifles. FM called. 3 VC KIA (prob).

(3) 2nd Plt, Co "A" was extracted at 161515H after 55 hrs of conducting grd recon/obser via BS 727376. 10 sightings were made with a total of 31 VC reported. 10 FM were called, results unknown.

(a) LATE ENTRY: 151620H 3 VC moving NE via BS 752386, 1 blk PJ and 2 grey clothes. 1 rifle. FM called. Results unknown.

(4) 3rd Plt, Co "A" was inserted at 161215H to conduct grd recon/obser via BS 754358. Arty support available fm the fol btrys: "I" btry 105 how loc via BS 8138.

(a) 161420H 7 VC moving N via BS 747365, blk PJs, 3 rifles, 4 packs. FM called. Results unknown.

(b) 161450H 4 VC in bushes observing our position via BS 747363, blk PJs and 1 rifle. No FM due to priority mission.

(5) 4th Plt, Co "A" was extracted at 161330H after 47 hrs of conducting grd recon/obser via BS 281043. Neg sightings du pd.

(6) 1st Plt, Co "D" sent to conduct grd recon/obser via BS 322985.

(a) 161450H 5 VC 25 meters SE of our position via BS 336985, blk PJs and 1 rifle. 1 VC KIA (conf) by a/a fire from patrol. 1 captured weapon.

(7) 3rd Plt, Co "D" was inserted at 161300H to conduct grd recon/obsr via BS 635588. Arty support available fm the fol btry: "A" btry 175 GMS loc via BS 6384.

(8) 1 sqd, 2nd Plt, 1st Force was inserted at 161200H to conduct grd recon/obsr via BT 282043. Arty support available fm the fol btry: "L" btry 155 R&W loc via BT 3914.

(9) 1 sqd, 4th Plt, 1st Force was extracted at 161200H after 69½ hrs of conducting grd recon/obsr via BT 390944. Neg sightings du pd.

(10) 6th Plt, 1st Force cont to conduct grd recon/obsr via BT 245084.

(a) 161355H 7 VCS moving N via BS 251080, blk PJs. No equip visible.

b. Contacts: 2. (a), (B), (c); 3. (a); 4. (a); 6. (a)

c. Command Post Locations: No Change

d. Scout/Sniper Teams:

<u>UNITS</u>	<u>OP</u>	<u>NO TEAMS</u>	<u>NO TEAMS EMPLOYED</u>	<u>RESULTS</u>
3rd Plt, Co "D"	BS 635588	1	1	None

2. Casualties: None

3. Operation Summary: Attached

4. Operations Plans Summary: Attached

a. Intentions

(1) Extract 1st Plt, Co "D" at 171400H via BS 332982.

5. Contact Action Report: Attached

R. A. CANNES  
By direction

CC

**HEADQUARTERS**  
**1st Reconnaissance Battalion**  
**PO San Francisco, California 96602**

S/EC/rpe  
 17 March 1967

From: Commanding Officer  
 To: Commanding General, 1st Marine Division(Rein), FMB

SITREP # 352 170001H to 172400H

1. OPERATIONS NARRATIVE

a. General

(1) Bn Cnd Grp 1st Recon Bn (-) cont to coordinate Recon Operations via BS 818384. Operation DE SOLO/DECKHOUSE VI.

(2) LATE ENTRY: 3rd Plt, Co "A" was extracted at 162200H after 10 hours of conducting grd recon/obser via BS 754358. 4 sightings were made with a total of 16 VC reported. 2 FM were called. Results unknown.

(a) LATE ENTRY: 161745H Patrol received 3 rounds of sniper fire from 2 VC via BS 748346, 2 rifles. FM called. Sniper fire ceased.

(b) LATE ENTRY: 161830H 3 VC moved into tree line via BS 768347, equipment unknown. Patrol was extracted at 162200H.

(3) 3rd Plt, Co "A" was inserted at 171100H to conduct grd recon/obser via BS 766309. Arty support available fm the fol btrys: "I" Btry 155 HOW loc via BS 8631.

(4) 3rd Plt, Co "A" was extracted at 171730H after 6½ hours of conducting grd recon/obser via BS 766309. 1 sighting was made with a total of 15 VC reported.

(a) 171430H 15 VC probed position via BS 753308. Patrol engaged with S/A fire. 5 VC KIA (Conf).

(5) 1st Plt, Co "D" was extracted at 171430H after 78½ hours of conducting grd recon/obser via BS 322385. 2 sightings were made with a total of 8 VC reported. Engaged with S/A fire. 4 VC KIA (Conf). 4 captured weapons. 4 MAS-36, 7.5mm French. Serial numbers: 23690, 68439, 94811, 31963.

(a) 171210H Patrol ran on to 3 VC via BS 344984, blk PJ's and 3 rifles. Patrol engaged VC with S/A. 3 VC KIA (Conf). 3 rifles and cartridge belt. 3 MAS-36, 7.5MM French. 3 USMC KIA.

(6) 3rd Plt, Co "D" cont to conduct grd recon/obser via BS 635588.

(a) 171050H 15 VC heading Northwest into woodline via BS 624545, blk PJ's. Packs and 57mm or 3.5 and shells. No FM called. Target moved out of sight.

(b) 171330H 4 VC pulled boat on beach then went into treeline via BS 670561, blk PJ's and 2 rifles. FM called, excellent coverage. Results unknown.

(c) 171515H 4 VC moving along trail into treeline via BS 668581, blk PJ's and occlus hats. Packs. FM called, good coverage. 1 VC KIA (Prob).

(7) 1 Squad, 2nd Plt, 1st Force sent to conduct grd recon/obsr via BF 262043. Arty same. Neg sightings du pd.

(8) 6th Plt, 1st Force sent to conduct grd recon/obsr via BF 245084. Arty same.

(a) 171258H 6 VCS moving on trail South to North via BS 251080, blk PJ's and carrying baskets.

(b) 171405H 9 VCS moving along trail South to North via BF 251080, blk PJ's, carrying large baskets.

b. Contacts: 2. (a); 4. (a); 5. (a); 6. (b), (c).

c. Command Post Locations: No Change

d. Scout/Sniper Teams: None

2. Casualties: 3 USMC WIA

3. Operation Summary: Attached

4. Operations Plans Summary: Attached

a. Intentions

(1) Insert 1 Squad, 1st Plt, Co "A" at 180900H via BS 445925.

(2) Insert 4th Plt, 1st Force at 181100H via BF 262045.

(3) Extract 6th Plt, 1st Force at 181130H via BF 245084.

(4) Insert 1 Squad, 1st Plt, Co "A" at 180900H via BS 418996.

(5) Insert 2nd Plt, Co "D" at 181000H via BS 325935.

5. Contact Action Report: Attached

R. A. GARNES  
By direction



CC

HEADQUARTERS  
1st Marine Division  
770 San Francisco, California 96602

3/20/67  
25 March 1967

FROM: Commanding Officer  
TO: Commanding General, 1st Marine Division (Main), FM

SERIAL # 353 18000H to 182400H

1. OPERATIONS NARRATIVE

a. General

- (1) BA Cad Coy 1st Recon Bn (-) sent to coordinate Recon Operations via BS 818384. Operation DE SOFO/SECKH-JUNE VI.
- (2) 1 Squad, 1st Plt, Co "A" was inserted at 181400H to conduct grd recon/obsr via BS 418998. Arty support available in the fol btys: "H" Btry 155 HOW loc via BS 5395. Neg sightings du pd.
- (3) 3rd Plt, Co "A" was inserted at 181145H to conduct grd recon/obsr via BS 799331. Arty support available in the fol btys: "I" Btry 155 HOW loc via BS 8631.
- (4) 3rd Plt, Co "A" was extracted at 181500H after 3 hours of conducting grd recon/obsr via BS 799331. 1 sighting was made with a total of 18 VC reported. 2 VC KIA (Prob) due to S/A fire.
  - (a) 1-1405H Patrol received 30-75 rounds of S/A fire from via BS 762348, blk PJ's, rifles and grenades. VC broke contact and patrol was extracted at 181500H. 4 UNSC WIA. 2 VC KIA (Prob).
- (5) 2nd Plt, Co "D" was inserted at 181600H to conduct grd recon/obsr via BS 325935. Arty support available in the fol btys: "X" Btry 155 HOW loc via BE4410. Neg sightings du pd.
- (6) 3rd Plt, Co "D" sent to conduct grd recon/obsr via BS 635586. Arty same.
  - (a) LATE ENTRY: 171700H 8 VC digging trenches and buildin. fortifications via BS 657574, blk PJ's. Shovels and picks. No weapons visible.
  - (b) 181130H 2 VC, 1 sampun loc via BS 628564, blk PJ's. 1 rifle. FM called. Results unknown.
- (7) 2nd Plt, 1st Force sent to conduct grd recon/obsr via BE 282043. Arty same. Neg sightings du pd.
- (8) 4th Plt, 1st Force was inserted at 181630H to conduct grd recon/obsr via BE 262048. Arty support available in the fol btys: "L" Btry 155 HOW loc via BE 3914. Neg sightings du pd.

(9) 6th Plt, 1st Force was extracted at 181300H after 7 1/2 hours of conducting grd recon/obsr via HF 245084. 1 sighting was made with a total of 9 VC reported. 2 VC KIA (Prob) due to E/A fire. 1 fixed wing strike was called. Results unknown.

(a) 181200H Patrol received 30 rounds E/A fire from an estimated 3 VC via HF 256083, blk PJ's. Rifles. Air strike called, excellent coverage. Patrol was extracted at 181300H. 2 VC KIA (Prob).

b. Contacts: 4. (a); 6. (b); 9. (a)

c. Command Post Locations: No Change

d. Scout/Skinner Teams: None

2. Casualties: 4 MIA

3. Operation Summary: Attached

4. Operations Plans Summary: Attached

a. Intentions

(1) Insert 2nd Plt, Co "A" at 190900H via HF 445929.

(2) Extract 2nd Plt, 1st Force at 1,1400H via HF 386936.

5. Contact Action Report: Attached

R. A. GARNES  
By direction

CC

HEADQUARTERS  
1st Reconnaissance Battalion  
FPO San Francisco, California 96602

3/HC/rpo  
19 March 1967

From: Commanding Officer  
To: Commanding General, 1st Marine Division (Rein), FVF

SITREP # 354 19000H to 192400H

1. OPERATIONS NARRATIVE

a. General

- (1) Bn Cnd Coy 1st Recon Bn (-) cont to coordinate Recon Operations via BS 818384. Operation IE 3070/DECKHOUSE VI.
- (2) 1st Plt, Co "A" cont to conduct grd recon/obsr via BS 416998. Arty sumo. Neg sightings du pd.
- (3) 2nd Plt, Co "B" was extracted at 191800H after 26 hours of conducting grd recon/obsr via BS 325935. Neg sightings du pd.
- (4) 3rd Plt, Co "C" cont to conduct grd recon/obsr via BS 635588. Arty sumo.
- (a) LATE ENTRY: 3 VC moving Southwest via BS 638573, blk PJ's. 2 rifles. FH called, excellent coverage. 2 VC KIA (Prob).
- (b) LATE ENTRY: 14 VC plus bundles in 6 sampans moving North to South bank of river then unloading via BS 606546, blk PJ's. 2 rifles. Fog moved in before arty could be called.
- (c) 191040H 3 VC moving South via BS 657591, blk PJ's. 2 rifles. FH called. 2 VC KIA (Prob).
- (d) 191445H 3 VC in ditch observing our position via BS 690586, blk PJ's. 2 rifles. FH called and fired .50 cal. 2 VC KIA (Prob).
- (5) 2nd Plt, 1st Force cont to conduct grd recon/obsr via BT 282043. Arty sumo. Neg sightings du pd.
- (6) 4th Plt, 1st Force cont to conduct grd recon/obsr via BT 262048. Arty sumo. Neg sightings du pd.

b. Contacts: 4. (a), (c), (d).

c. Command Post Location: BT 560047

d. Scout/ Sniper Teams: None

2. Observations: None

<u>UNITS</u>	<u>OP</u>	<u>NO TRANS</u>	<u>NO TRANS EMPLOYED</u>	<u>RESULTS</u>
3rd Plt, Co "D"	BS 635588	1	1	None

2. Casualties: None

3. Operation Summary: Attached

4. Operations Plans Summary: Attached

a. Intentions

- (1) Insert 4th Plt, Co "A" at 201000H via BS 779319.
- (2) Extract 4th P Co, 1st Force at 201400H via BT 262048.
- (3) Insert 2nd Plt, Co "A" at 200900H via BS 445929.
- (4) Extract 2nd Plt, 1st Force at 200930H via BS 386936.

Gen Contact Action Report: Attached

R. A. GAMER  
By direction

cc

HEADQUARTERS  
1st Reconnaissance Battalion  
 FPO San Francisco, California 96602

3/20/67  
 20 March 1967

From: Commanding Officer  
 To: Commanding General, 1st Marine Division (Rein), FMF

SITREP # 355 200001H to 202400H

1. OPERATIONS NARRATIVE

a. General

(1) Bn Comd Gp 1st Recon Bn (-) cont to coordinate recon operations via BS 818384. Operation BS 2070/DECKHOUSE VI.

(2) 1st Plt, Co "A" cont to conduct grd recon/obs r via BS 416998. Arty same.

(a) 201220H 3 VC moving Northwest on trail via BF 435022, blk PJ's and 2 coolie hats. Weapons unobserved.

(3) 2nd Plt, Co "A" was inserted at 201600H to conduct grd recon/obs r via BS 445929. Arty support available in the fol btry: "H" Btry 155 HOW loc via BS 5394. Neg sightings dr pd.

(4) 4th Plt, Co "A" was inserted at 201150H to conduct grd recon/obs r via BS 738366. Arty support available in the fol btry: "H" Btry 105 HOW loc via BS 8138.

(5) 4th Plt, Co "A" was extracted at 201200H after negative hours of conducting grd recon/obs r via BS 738366. 1 sighting was made with a total of 20 VC reported. 1 PH was called. Results unknown. 3 VC KIA (Conf) due to S/A fire.

(a) 201150H Patrol received S/A and automatic fire from an estimated 15-20 VC via BS 738366, green uniforms, steel helmets and camouflaged covers. Patrol returned S/A and automatic fire before extraction at 201200H. 3 VC KIA (Conf). 7 USMC WIA.

(6) 3rd Plt, Co "D" cont to conduct grd recon/obs r via BS 635588. Arty same.

(a) 200820H 3 VC swimming river and entering tree line on North bank via BS 661585, blk PJ's and 1 rifle. PH called, excellent coverage. 1 VC KIA (Prob).

(b) 201105H 6 VC moving East via BS 667576, blk PJ's. 4 rifles, 2 packs, 1 large bundle. PH called, good coverage. Results unknown.

(c) 201150H 9 VC dragging flat sampans Northeast in river via BS 612550, blk PJ's. Helmets and 3 rifles. PH called. Results unknown.

(d) 201345H 3 VC moving East on trail via BS 668576, blk PJ's and white coolie hats. 2 rifles and 1 pack. FM called, excellent coverage. 1 VC KIA (Prob).

(e) 201350H 3 VC unloading sampans on East bank of river via BS 612550, blk PJ's. 1 pack and rifle. FM called, excellent coverage. 3 VC KIA (Prob).

(7) 2nd Plt, 1st Force was extracted at 201615H after 99 $\frac{1}{2}$  hours of conducting grd recon/obser via BT 262043. Neg sightings au pt.

b. Contacts: 5. (a); 6. (a), (b), (c), (d), (e).

c. Command Post Locations: No Change

d. Scout/ Sniper Teams:

<u>UNITS</u>	<u>OF</u>	<u>NO TEAMS</u>	<u>NO TEAMS EMPLOYED</u>	<u>RESULTS</u>
3rd Plt, Co "D"	BS 635586	1	1	None

2. Casualties: 7 USMC KIA

3. Operat on Summary: Attached

4. Operations Plans Summary: Attached

a. Intentions

(1) Extract 4th Plt, 1st Force at 210830H via BT 262048.

(2) Insert 1st Plt, Co "D" at 210900H via BT 344015.

(3) Insert 6th Plt, 1st Force at 210800H via BT 263107.

5. Contact Action Reports: Attached

R. A. GARNES  
By direction

CC

HEADQUARTERS  
1st Reconnaissance Battalion  
 FPO San Francisco, California 96602

3/NO/rps  
 21 March 1967

From: Commanding Officer  
 To: Commanding General, 1st Marine Division (Rein), FPM

SITREP # 356 210001H to 212400H

1. OPERATIONAL NARRATIVE

a. General

- (1) Bn Cmd Grp 1st Recon Bn (-) sent to coordinate Recon Operations via BS 618384. Operation DE SOFO/DECKHOUSE VI.
- (2) 1st Plt, Co "A" sent to conduct grd recon/obscur via BS 416998. Arty same. Neg sightings du pd.
- (3) 2nd Plt, Co "A" sent to conduct grd recon/obscur via BS 445929. Arty same. Neg sightings du pd.
- (4) 1st Plt, Co "D" was inserted at 211000H to conduct grd recon/obscur via BT 344015. Arty support available in the fol btrys: 4/11 155 HOW loc via BT 4410. Neg sightings du pd.
- (5) 3rd Plt, Co "D" sent to conduct grd recon/obscur via BS 635588. Arty same.
  - (a) 211345H 3 VC going between 2 huts via BS 656574, blk PJ's. 2 rifles. FM called, good coverage. 2 VC KIA (Prob).
  - (b) 211515H 2 VC moving Southwest through tree line via BS 652562, blk PJ's. 1 rifle and 2 packs. FM called, good coverage. 2 VC KIA (Prob).
- (6) 4th Plt, 1st Force was extracted at 211030H after 66 hours of conducting grd recon/obscur via BT 262048. Neg sightings du pd.
- (7) 6th Plt, 1st Force was inserted at 211000H to conduct grd recon/obscur via BT 263107. Arty support available in the fol btrys: "L" Btry 155 HOW loc via BT 3914. Neg sightings du pd.

b. Contacts: 5. (a), (b).

c. Command Post Locations: No Change

d. Scout/Sniper Teams:

<u>UNIT</u>	<u>OP</u>	<u>NO TEAMS</u>	<u>NO TEAMS EMPLOYED</u>	<u>RESULTS</u>
3rd Plt, Co "D"	BS 635588	1	1	None

2. Casualties: None

3. Operational Summary: Attached

4. Operations Plans Summary: Attached

a. Intentions

- (1) Insert 3rd Plt, Co "A" at 221000H via BS 418996.
- (2) Extract 1st Plt, Co "A" at 221000H via BS 418998.
- (3) Insert 2nd Plt, 1st Force at 221300H via BS 635588.
- (4) Extract 3rd Plt, Co "D" at 221300H via BS 635588.

5. Contact Action Report: Attached

R. A. GARNES  
By direction



CC

HEADQUARTERS  
1st Reconnaissance Battalion  
APO San Francisco, California, 96602

1/HS/gh  
22 March 1967

From: Commanding Officer  
To: Commanding General, 1st Marine Division (Rein), FMF

BIUREP # 357 220001H to 222400H

1. OPERATIONS NARRATIVE

a. General

- (1) Bn Cmd Grp 1st Recon Bn (-) sent to coordinate Recon Operations via BS 818384. Operation DE SOTO.
- (2) 1st Plt, Co "A" was extracted at 221400H after 95½ hrs of conducting grd recon/obser via BS 416998. Neg sightings du pd.
- (3) 2nd Plt, Co "A" sent to conduct grd recon/obser via BS 445929. Neg sightings du pd.
- (4) 3rd Plt, Co "A" was inserted at 221300H to conduct grd recon/obser via BS 418998. Arty support available fm the fol btrys: "E" btry 155 HOW loc via BS 5395.
- (5) 1st Plt, Co "D" sent to conduct grd recon/obser via BF 344015. Neg sightings du pd.
- (6) 3rd Plt, Co "D" was extracted at 221600H after 146½ hrs of conducting grd recon/obser via BS 635588. 18 sightings were made with a total of 101 VC reported. 15 FM were called resulting in 22 VC KIA (prob).
- (7) 2nd Plt, 1st Force was inserted at 221600H to conduct grd recon/obser via BS 635588. Arty support available fm the fol btrys: "A" btry 175 GUNS loc via BS 6384.
- (8) 6th Plt, 1st Force sent to conduct grd recon/obser via BF 263107. Neg sightings du pd.

b. Contacts: None

c. Command Post Locations: No Change

d. Scout/Sniper Teams: None

2. Casualties: None

3. Operation Summary: Attached

4. Operations Plans Summary: Attached

a. Intentions

(1) Extract 2nd Plt, Co "A" at 231400H via BS 445929.

5. Contact Action Report: N/A

R. A. GARNES  
By direction

CC

HEADQUARTERS  
1st Reconnaissance Battalion  
 FPO San Francisco, California 96602

J/HG/rpc  
 23 March 1967

From: Commanding Officer  
 To: Commanding General, 1st Marine Division(Rein), FMF

SIEREP # 357 230001H to 232400H

1. OPERATIONS NARRATIVE

a. General

(1) Bn Cnd Grp 1st Recon Bn (-) sent to coordinate Recon Operations via BS 818384. Operation DE SOTO.

(2) 2nd Plt, Co "A" was extracted at 231430H after 7½ hours of conducting grd recon/obser via BS 445929. Neg sightings du pd.

(a) 231400H Patrol found 8 rifles (French and Chi Com), 8 shotguns (American) and 1 flare pistol (American) wrapped in canvas and half way buried at BS 433944. 2 rifle serial numbers were 49097 and 1907-15. The rest of the weapons had their bolts rusted shut. Impossible to identify serial numbers.

(3) 3rd Plt, Co "A" cont to conduct grd recon/obser via BS 418998. Arty same. Neg sightings du pd.

(4) 1st Plt, Co "D" sent to conduct grd recon/obser via BF 344015. Arty same. Neg sightings du pd.

(5) 2nd Plt, Co "D" was inserted at 231000H to conduct grd recon/obser via BS 773394. Arty support available fm the fol btrys: "I" Btry 105 HOW loc via BS 8138. Neg sightings du pd.

(6) 2nd Plt, 1st Force cont to conduct grd recon/obser via BS 635588. Arty same.

(a) 230730H 35 VCS moving North and South on trail via BS 632567 to BS 656576, blk PJ's and white oolie hats. Equipment unobserved.

(b) 231215H 5 VCS wading river via BS 652575, blk PJ's. No equipment visible.

(7) 6th Plt, 1st Force was extracted at 231500H after 5½ hours of conducting grd recon/obser via BF 263107. 2 sightings were made with a total of 21 VC reported. 1 FM was called. Results unknown.

(a) 231230H Patrol received S/A fire from estimated 21 VC via BF 268110 and BF 265112, blk PJ's and oolie hats. Patrol returned S/A fire and 4 grenades. Patrol was extracted at 231500H.

- b. Contacts: 7. (a).
  - c. Command Post Locations: No Change
  - d. Scout/Sniper Teams: None
- 2. Casualties: None
  - 3. Operation Summary: Attached
  - 4. Operations Plans Summary: Attached
    - a. Intentions
      - (1) Extract 1st Plt, Co "D" at 241345H via BT 344015.
      - (2) Insert 3rd Plt, Co "D" at 241400H via BS 398770.
      - (3) Insert 4th Plt, 1st Force at 241300H via BT 304077.
  - 5. Contact Action Report: Attached

H. A. GARNES  
By direction

(6) 3rd Plt, Co "D" was inserted at 241600H to conduct grd recon/obser via BS 358770. Arty support available fm the fol btrys: "A" btry 175 GUNS loc via BS 6384. Neg sightings du pd.

(7) 2nd Plt, 1st Force sent to conduct grd recon/obser via BS 635588. Arty same.

(a) 241145H 11 VCS moving E and W on trail via BS 641574, blk FJs and white coolie hats. Equip unobserved.

(8) 4th Plt, 1st Force was inserted at 241300H to conduct grd recon/obser via BS 304077. Arty support available fm the fol btrys: 4/11 155 HOW loc via BS 4410.

b. Contacts: 3. (a); 5. (a), (g).

c. Command Post Locations: No Change

d. Scout/ Sniper Teams: None

2. Casualties: None

3. Operation Summary: Attached

4. Operations Plans Summary: Attached

a. Intentions

(1) Insert 1st Plt, Co "A" at 251230H via BS 441912.

(2) Extract 3rd Plt, Co "A" at 251330H via BS 418998.

(3) Insert 4th Plt, Co "A" at 251300H via BS 418998.

5. Contact Action Reports: Attached

B. A. CARNES  
By direction

HEADQUARTERS  
 1st Reconnaissance Battalion  
 P.O. San Francisco, California, 96602

3/10/67  
 25 March 1967

From: Commanding Officer  
 To: Commanding General, 1st Marine Division (Rein), FMF

SIERP # 359 250001H to 252400H

1. OPERATIONS NARRATIVE

a. General

- (1) Bn Cmd Grp 1st Recon Bn (-) sent to coordinate Recon Operations via BS 018384. Operation DE SOTO.
- (2) 1st Plt, Co "A" was inserted at 251300H to conduct grd recon/obser via BS 441912. Arty support available in the fol btry: "H" btry 155 HOW loc via BS 5395.
- (3) LATE SNTRY: 2nd Plt, Co "A" found the following gear at BS 433940 and destroyed. 3 lbs TNT; 2 (US) WP 81 mm rds; 3 (US) illum 60 mm rds; 2 (UK) HE 60 mm rds; 1 (US) WP 60 mm rd; 1 (US) WP rifle grenade. The following gear was brought back by patrol. 9 BAR magazines; 1 handset (type unknown.)
- (4) 3rd Plt, Co "A" was extracted at 251330H after 72½ hours of conducting grd recon/obser via BS 418998. 1 sighting was made with a total of 2 VC reported. 1 FM was called, results unknown. Neg sightings du pd.
- (5) 4th Plt, Co "A" was inserted at 251330H to conduct grd recon/obser via BS 418998. Arty support available in the fol btry: "H" btry 155 HOW loc via BS 5395.
- (6) 2nd Plt, Co "D" was extracted at 251700H after 55 hours of conducting grd recon/obser via BS 773394. 8 sightings were made with a total of 30 VC reported. 5 FM were called. Results unknown. 1 fixed wing strike was called. Results unknown.
- (a) LATE SNTRY: 241830H 3 VC sniping into our position from via BS 779393, 3 rifles. FM called. Results unknown.
- (b) 250700H 65 refugees moving W via BS 775385, mixed civilian attire, household articles. By passed village.
- (c) 250825H 7 VC entering village via BS 783395, blk PJs, 1 pack, 3 rifles. FM called. Good coverage. Results unknown.
- (d) 250910H 2 VC moving W via BS 756392, blk PJs, 1 blue shirt, 1 rifle. FM called. Good coverage. Results unknown.
- (e) 251240H 4 VC moved into house via BS 758385, blk PJs and 1 bush hat. 3 rifles. FM called. Results unknown.
- (7) 3rd Plt, Co "D" sent to conduct grd recon/obser via BS 398770. Arty sanc. Neg sightings du pd.

(8) 2nd Plt, 1st Force cont to conduct grd recon/obser via BS 635588. Arty same.

(4) 251430H 7 VC moving off hill from E to H via BS 635594, blk PJs and white coolie hats. Rifles and cartridge belts. Montagnard outpost opened fire before arty could be called. 2 VC KIA (prob).

(9) 4th Plt, 1st Force cont to conduct grd recon/obser via BS 305073. Arty same. Neg sightings du pd.

b. Contacts: 6. (a), (c), (d), (e); 8. (a).

c. Command Post Locations: No Change.

d. Scout/ Sniper Teams: None.

2. Casualties: None.

3. Operation Summary: Attached

4. Operations Plans Summary: Attached

a. Intentions

(1) Insert 2nd Plt, Co "D" at 260900H via BS 792355.

5. Contact Action Report: Attached.

R. A. CARRIS  
By direction

cc

HEADQUARTERS  
1st Reconnaissance Battalion  
APO San Francisco, California, 96602

3/15/67  
26 March 1967

From: Commanding Officer  
To: Commanding General, 1st Marine Division (Rein), MAF

DIRMARP / 360 260101L to 262400H

1. OPERATIONAL SUMMARY

a. General

- (1) Bn Cmd Gp 1st Recon Bn (-) cont to coordinate Recon Operations via BS 818384. Operation BS 8070.
- (2) 1st Plt, Co "A" cont to conduct grd recon/obser via BS 441912. Arty same. Neg sightings du pd.
- (3) 4th Plt, Co "A" cont to conduct grd recon/obser via BS 418998. Arty same. Neg sightings du pd.
- (4) 2nd Plt, Co "B" was inserted at 261000H to conduct grd recon/obser via BS 792355. Arty support available fm the fol btry: "I" btry 103 HOW loc via BS 8138.
- (a) 261115H 1 VC moving S via BS 777331, blk PJs, 1 pack. FH called. Results unknown.
- (5) 3rd Plt, Co "D" was extracted at 261300H after 43 hours of conducting grd recon/obser via BS 398770.
- (a) 261130H Patrol received 8 rds of sniper fire from unknown number of VC at via BS 400768. Patrol returned 20 rds of a/a fire to break contact. Rules provided suppressive fire. Patrol extracted at 261300H. 1 USMC KIA.
- (6) 2nd Plt, 1st Force cont to conduct grd recon/obser via BS 635288. Arty same.
- (a) 261145H 3 VC moving NE on trail via BS 662559, blk PJs and white boogie hats. Rifles, packs and cartridge belts. FH called, excellent coverage. 3 VC KIA (prob).
- (7) 4th Plt, 1st Force cont to conduct grd recon/obser via BS 305073. Arty same. Neg sightings du pd.



- b. Contacts: 4. (a); 5. (a); 6. (a).
  - c. Command Post Locations: BS 560047
  - d. Scout/ Sniper Teams: None
- 2. Casualties: 1 USMC KIA
  - 3. Operation Summary: Attached
  - 4. Operations Plans Summary: Attached
    - a. Intentions
      - (1) Insert 2nd Plt, Co "A" at 271300H via SE 238067.
      - (2) Insert 1st Plt, Co "D" at 271400H via BS 452816.
      - (3) Insert 6th Plt, 1st Force at 271500H via BS 635588.
      - (4) Extract 2nd Plt, 1st Force at 271500H via BS 635588.
      - (5) Extract 4th Plt, 1st Force at 271330H via SE 303072.
  - 5. Contact Action Report: Attached

E. A. CARNES  
By direction

CC

HEADQUARTERS  
1st Reconnaissance Battalion  
 FPO San Francisco, California, 96602

3/HC/gh  
 27 March 1967

From: Commanding Officer  
 To: Commanding General, 1st Marine Division, (Rein), FIF

SITREP # 361 270001H to 272400H

1. OPERATIONS NARRATIVE

a. General

(1) Bn Cnd Grp 1st Recon Bn (-) cont to coordinate Recon Operations via BS 818384. Operation DE SOTO.

(2) 1st Plt, Co "A" was extracted at 271800H after 53 hours of conducting grd recon/obser via BS 441912.

(a) LATE ENTRY: 261845H 2 VC moving toward this position via BS 438908, blk PJs and bush hats. Rifles and grenades. Patrol received 1 grenade this position. Patrol returned s/a fire. Results unknown.

(b) 270430H 4 VC moving S toward our position via BS 438908, uniform or equipment unknown. 6 CS grenades were used. VC moved north.

(c) 271800H Patrol was extracted due to contact with VC. Details to follow.

(3) 2nd Plt, Co "A" was inserted at 271300H to conduct grd recon/obser via BF 238067. Arty support available fm the fol btrys: "L" btry 155 HOW loc via BF 3914. Neg sightings du pd.

(4) 4th Plt, Co "A" cont. to conduct grd recon/obser via BS 418998. Arty same. Neg sightings du pd.

(5) 1st Plt, Co "D" was inserted at 271400H to conduct grd recon/obser via BS 452816. Arty support available fm the fol btrys: "M" btry 155 HOW loc via BS 5395. Neg sightings du pd.

(6) 2nd Plt, Co "B" cont to conduct grd recon/obser via BS 792355. Arty same.

(a) 271220H 7 VC moving S via BS 791316, camouflaged utilities, helmets, rifles, packs, cartridge belts. FM called. Good coverage. Results unknown.

(b) 271230H 5 VC moving N via BS 791316, camouflage utilities, helmets, packs, rifles, cartridge belts. FM called. Good coverage. Results unknown.

(7) 2nd Flt, 1st Force was extracted at 271500H after 119 hours of conducting grd recon/obser via BS 635588. 5 sightings were made with a total of 61 VC/VCS reported. 1 FM was called resulting in 3 VC KIA (prob). 2 VC KIA (prob) due to a/a fire.

(a) 271430H accidental shot in hand and shoulder due to cartridge discharge with bolt half closed. 1 USMC WIA.

(8) 4th Flt, 1st Force was extracted at 271400H after 71 hours of conducting grd recon/obser via BS 305073. Neg sightings du pd.

(9) 6th Flt, 1st Force was inserted at 271445H to conduct grd recon/obser via BS 635588. Arty support available fm the fol btrys: "A" btry 175 GUNS loc via BS 6384. Neg sightings du pd.

b. Contacts: 2. (a), (b); 6. (a), (b).

c. Command Post Locations: No change.

d. Scout/Sniper Teams: None.

2. Casualties: 1 USMC WIA

3. Operation Summary: Attached

4. Operations Plans Summary: Attached

a. Intentions

(1) Insert 1 sqd, 3rd Flt, Co "A" at 281400H via BS 288983.

(2) Insert 1 sqd, 2nd Flt, Co "D" at 281300H via BS 418998.

(3) Extract 4th Flt, Co "A" at 281330H via BS 418998.

5. Contact Action Report: Attached.

E. A. GARNES  
By direction

CC

HEADQUARTERS  
1st Reconnaissance Battalion  
APO San Francisco, California, 96602

2/MS/gb  
28 March 1967

From: Commanding Officer  
To: Commanding General, 1st Marine Division, (ReIn), 77F

SITREP # 362 280001H to 282400H

1. OPERATIONS NARRATIVE

a. General

- (1) Bn Cnd Gp 1st Recon Bn (-) sent to coordinate Recon Operations via 418364. Operation DE SOFO.
- (2) LATE ENTRY for Donohue. 2 sightings were made with a total of 6 VC reported. S/A fire from patrol resulted in 1 VC KIA (prob). 1 fixed wing strike was called. Results unknown. HUFs provided suppressive fire.
  - (a) LATE ENTRY: 271430H Patrol received 2 grenades and sniper fire from estimated 3 VC via BS 438908. Patrol returned a/a with 1 VC KIA (prob). HUFs and fixed wing provided suppressive fire. Results unknown. Patrol extracted at 271800H.
- (3) 1 squad, 2nd Plt, Co "A" sent to conduct grd recon/obser via BT 238067. Arty same. Neg sightings du pd.
- (4) 1 squad, 2nd Plt, Co "A" was inserted at 281330H to conduct grd recon/obser via BS 418990. Arty support available in the fol btrys: "H" btry 155 HOW loc via 7 5395. Neg sightings du pd.
- (5) 3rd Plt, Co "A" was inserted at 281400H to conduct grd recon/obser via BS 280935. Arty support available in the fol btrys: "X" btry 155 GWS loc via BT 4410. Neg sightings du pd.
- (6) 4th Plt, Co "A" was extracted at 281330H after 72 hours of conducting grd recon/obser via BS 418998. Neg sightings du pd.
- (7) 1st Plt, Co "D" sent to conduct grd recon/obser via BS 447619. Arty same. Neg sightings du pd.
- (8) 2nd Plt, Co "D" sent to conduct grd recon/obser via BS 792355. Arty same.
  - (a) LATE ENTRY: 271845H 17 VC moving S and E via BS 787526, mixed with heavy camouflage. Packs and 10 rifles. FM called, excellent coverage. 3 VC KIA (prob).
  - (b) 281130H 4 VC moving E along Laks via BS 785364, blk FJs and white coolie hats. 3 rifles. FM called, good coverage. Results unknown.
- 2nd Plt, Co "D" was extracted at 281800H after 56 hrs of conducting grd recon/obser via BS 792355. 3 sightings were made with a total of 34 VC reported. 5 FM were called resulting in 3 VC KIA (prob).

(9) 6th Plt, 1st Force cont to conduct 2nd recon/obsrv via BE 635586. Arty same. Neg sightings du pd.

b. Contacts: 2. (a); 8. (a), (b).

c. Command Post Locations: No Change.

d. Scout/Sniper Teams: None.

2. Casualties: None.

3. Operation Summary: Attached.

4. Operations Plans Summary: Attached.

a. Intentions

(1) Insert 1 sqd 3rd Plt, Co "A" at 291230H via BS 435965.

(2) Insert 2nd Plt, Co "D" at 290800H via BS 699417.

(3) Extract 1 sqd, 2nd Plt, Co "A" at 291300H via BT 238063.

(4) Extract 2nd Plt, Co "D" at 291700H via BE 699417.

5. Contact Action Report: Attached.

R. A. GARNES  
By direction

HEADQUARTERS  
1st Reconnaissance Battalion  
P.O. San Francisco, California, 96602

M/UC/gh  
19 March 1967

From: Commanding Officer  
To: Commanding General, 1st Marine Division, (Rein), FV

SITREP # 363 290001H to 292400H

1. OPERATIONS NARRATIVE

a. General

- (1) Bn Comd Grp 1st Recon Bn (-) cont to coordinate Recon Operations via BS 618384. Operation DE JOTO.
- (2) 1 squad, 2nd Plt, Co "A" sent to conduct grd recon/obsrv via BS 238667. Arty same. Neg sightings du pd.
- (3) 1 squad, 2nd Plt, Co "A" sent to conduct grd recon/obsrv via BS 418998. Arty same.
  - (a) 291407H 9 VCS running west on trail via BS 420011, blk PJs, equipment unknown.
- (4) 1 squad, 3rd Plt, Co "A" was extracted at 291430H after 24 1/2 hours of conducting grd recon/obsrv via BS 288983. Neg sightings du pd.
- (5) 1 squad, 3rd Plt, Co "A" was inserted at 291530H to conduct grd recon/obsrv via BS 435965. Arty support available in the fol btys: "H" bty 155 HOW loc via BS 5395. Neg sightings du pd.
- (6) 1st Plt, Co "B" sent to conduct grd recon/obsrv via BS 447819. Arty same.
  - (a) 291240H 3 VC walking west on trail via BS 445797, blk PJs and white coolie hats. 3 packs. FM called. Excellent coverage. 3 VC KIA (prob).
- (7) 2nd Plt, Co "D" was inserted at 290900H to conduct grd recon/obsrv via BS 699417. Arty support available in the fol btys: "J" bty 105 HOW loc via BS 7647. 2nd Plt, Co "D" was extracted at 291700H after 8 hours of conducting grd recon/obsrv via BS 699417. 1 sighting was made with a total of 2 VC reported.
  - (a) 291215H 2 VC moving south on trail via BS 698427, green utilities and 2 packs. Target moved out of sight before FM could be called.
- (8) 6th Plt, 1st Force cont to conduct grd recon/obsrv via BS 635588. Arty same. Neg sightings du pd.

b. Contacts: 6. (a).

c. Command Post Locations: No Change.

d. Scout/ Sniper Teams: None.

2. Casualties None

3. Operation Summary: Attached.

4. Operations Plans Summary: Attached.

a. Intentions

- (1) Insert 3rd Plt, Co "D" at 300900Z via BS 759347.
- (2) Extract 1st Plt, Co "D" at 301330Z via BS 451816.
- (3) Insert 4th Plt, 1st Force at 301230Z via RF 315047.
- (4) Extract 1 sqd, 2nd Plt, Co "A" at 301300Z via RF 258063.

5. Contact Action Report: Attached.

E. A. GARNES  
By direction

CC

HEADQUARTERS  
1st Reconnaissance Battalion  
 FPO San Francisco, California 96602

3/MG/rpc  
 30 March 1967

From: Commanding Officer  
 To: Commanding General, 1st Marine Division(Rein), FMF

SITREP # 364 300001H to 302400H

1. OPERATIONS NARRATIVE

a. General

- (1) Bn Cmd Grp 1st Recon Bn (-) cont to coordinate Recon Operations via BS 818384. Operation DE SOTO.
- (2) 1 Squad, 2nd Plt, Co "A" was extracted at 301430H after 73½ hours of conducting grd recon/obser via BF 238061. Neg sightings du pd.
- (3) 1 Squad, 2nd Plt, Co "A" cont to conduct grd recon/obser via BS 418998.
  - (a) 301200H 20 VCS traveling Northeast at vic BF 416022, blk PJ's and coolie hats. Equipment unknown.
- (4) 1 Squad, 3rd Plt, Co "A" cont to conduct grd recon/obser via BS 435963. Arty same. Neg sightings du pd.
- (5) 1st Plt, Co "D" was extracted at 301600H after 74 hours of conducting grd recon/obser via BS 447819. 1 sighting was made with a total of 5 VC reported. 1 FM was called resulting in 5 VC KIA (Prob). Neg sightings du pd.
- (6) 3rd Plt, Co "D" was inserted at 300915H to conduct grd recon/obser via BS 759347. Arty support available fm the fel btrys: "H" Btry 105 HOW lec via BS 8138.
  - (a) 301445H 2 VC sniping at our position via BS 758348, uniform unknown with 2 rifles.
  - (b) 301525H 3 VC observing us via BS 769342, 1 green utilities and 2 blk PJ's. 1 rifle, 1 MG and 1 possible mortar.
- (7) 4th Plt, 1st Force was inserted at 301400H to conduct grd recon/obser via BF 315047. Arty support available fm the fel btrys: "L" Btry 155 HOW lec via BF 3914. Neg sightings du pd.
- (8) 6th Plt, 1st Force cont to conduct grd recon/obser via BS 635588. Arty same. Neg sightings du pd.

b. Contacts: 6. (a)

c. Command Post Locations: No Change



- d. Scout/Sniper Teams: None
2. Casualties: None
3. Operation Summary: Attached
4. Operations Plans Summary: Attached
- a. Intentions
- (1) Insert 2nd Plt, 1st Force at 311400H via BF 263005.
  - (2) Insert 4th Plt, Co "A" at 311300H via BS 442992.
  - (3) Insert 1 Squad, 1st Plt, Co "A" at 311500H via BS 635588.
  - (4) Extract 6th Plt, 1st Force at 311500H via BS 635588.
5. Contact Action Report: Attached

R. A. CARRIS  
By direction

CC

## HEADQUARTERS

1st Reconnaissance Battalion  
 FPO San Francisco, California, 96002

3/EC/gn  
 31 March 1967

From: Commanding Officer  
 To: Commanding General, 1st Marine Division (Rein), FMF

SUBJECT: 365 315000H to 312400H

## 1. OPERATIONAL NARRATIVE

## a. General

- (1) An Cmd Gp 1st Recon Bn (-) sent to coordinate Recon Operations via BS 818564. Operation BS 540.
- (2) 1st Plt, Co "A" was inserted at 311600H to conduct grd recon/obsr via BS 635588. Arty support available in the fol btrys: "A" btry 175 GWS loc via BS 6384. Neg sightings du pd.
- (3) 1 squad, 2nd Plt, Co "A" sent to conduct grd recon/obsr via BS 418928. Arty same. Neg sightings du pd.
- (4) 1 squad, 3rd Plt, Co "A" sent to conduct grd recon/obsr via BS 455963. Arty same. Neg sightings du pd.
- (5) 4th Plt, Co "A" was inserted at 311300H to conduct grd recon/obsr via BS 442922. Arty support available in the fol btrys: "A" btry 155 How loc via BS 5395. Neg sightings du pd.
- (6) ~~LATE ENTRY:~~ 3rd Plt, Co "D" was extracted at 301730H after 8 1/2 hours of conducting grd recon/obsr via BS 759347. 2 sightings were made with a total of 5 VC reported. No FM called. Infantry sweeping area.
- (7) 3rd Plt, Co "D" was inserted at 311100H to conduct grd recon/obsr via BS 771394. Arty support available in the fol btrys: "D" btry 105 How loc via BS 8138.
  - (a) 311305H 3 VC shooting at aircraft via BS 764397, blk PJs, 7 rifles, 1 auto wpn. VC moved into tunnel same coord. Notified BLACKOUT of position.
  - (b) 311403H 23 VCS moving west then east on trail via BS 763385, blk PJs and carrying large baskets and bundles. KLOWDINE checking it out.
  - (c) 311405H 1 long tube sitting in village at via BS 776406. no called, excellent coverage. Tube no longer visible.
- (8) 2nd Plt, 1st Force was inserted at 311430H to conduct grd recon/obsr via BS 263005. Arty support available in the fol btrys: 3rd 155 GWS loc via BS 4410. Neg sightings du pd.
- (9) 4th Plt, 1st Force sent to conduct grd recon/obsr via BS 342034. Arty support available in the fol btrys: 3rd 155 GWS loc via BS 4410. Neg sightings du pd.

(10) 6th Plt, 1st Bn was extracted at 311600H after 97 hours of conducting and rescue/evacuation via BS 635988. 1 sighting was made with a total of 10 VC reported. 1 FM was called. Results unknown.

(c) LAMB BATT: 302032H Receiving sniper fire from opposite side of river bank via BS 641568. Rifles and unknown uniforms. FM called, excellent coverage. Snipers ceased firing.

b. Contact: 7. (c); 10. (a).

d. Command Post Location: No Change.

e. Scout/Signal Team: None.

2. Casualties: None.

3. Operation Summary: Attached.

4. Operations Plans Summary: Attached.

a. Intentions

(1) Insert 1 sqd, 2nd Plt, Co "A" at 011300H via BS 418998.

(2) Extract 1 sqd, 2nd Plt, Co "A" at 011300H via BS 418998.

(3) Extract 3rd Plt, Co "A" at 011300H via BS 437965.

b. Contact Action Report: Attached.

R. A. GARNES  
By direction