

Draft



Environmental Impact Statement for the Gold Rock Mine Project Volume 1

White Pine County, Nevada
BLM/NV/EL/ES/15-05+1793

Lead Agency:

U.S. Department of Interior
Bureau of Land Management
Ely District
Egan Field Office



Cooperating Agencies:



Nevada Department of Wildlife



Duckwater Shoshone Tribe



White Pine County



Eureka County



February 2015

Mission Statement

It is the mission of the Bureau of Land Management (BLM), an agency of the Department of the Interior, to manage BLM-administered lands and resources in a manner that best serves the needs of the American people. Management is based upon the principles of multiple use and sustained yield while taking into account the long-term needs of future generations for renewable and nonrenewable resources.

BLM/NV/EL/ES/15-05+1793

#903537351

1D88068254

HD
243
.N3
G653
2015
v.1
c.2



United States Department of the Interior



BUREAU OF LAND MANAGEMENT

Egan Field Office

HC33 Box 33500 (702 N. Industrial Way)

Ely, Nevada 89301-9408

http://www.blm.gov/nv/st/en/fo/ely_field_office.html

In Reply Refer To:

3809 (NVL0100)

NVN-91957

February, 2015

Dear Interested Party:

You are receiving this letter because you have expressed interest in the following proposal or you have expressed interest in past Federal actions pertaining to public lands managed by the Bureau of Land Management (BLM) Ely District.

The BLM Ely District, Egan Field Office is soliciting written comments regarding the Draft Environmental Impact Statement for the Gold Rock Mine Project (Draft EIS), prepared by the BLM Egan Field Office. In compliance with the National Environmental Policy Act, this Draft EIS analyzes the Proposed Action (as described in the Plan of Operations submitted by Midway Gold U.S., Inc. for the Gold Rock Mine Project), six action alternatives, and the No Action alternative.

The proposed project would be located east of the Pancake Mountain Range, in White Pine County, Nevada, approximately 50 miles west of Ely and 30 miles southeast of Eureka. The proposed project would be located in the same geographic area as the reclaimed and closed Easy Junior Mine. The proposed project would include an open pit; a heap leach pad and associated ponds, process facility, and refinery; a mill; a carbon-in-leach (CIL) plant; waste rock dumps; a tailings storage facility; water supply wells; haul roads; ancillary facilities; and a 69 kV transmission line that would be extended from the Pan Mine approximately six miles across the valley to tie into the west side of the Gold Rock Project electrical system. A county road that currently passes through the project area would be re-located onto existing and new BLM and county roads. Construction and operation of the mine would result in approximately 3,946 acres of disturbance that includes the previously authorized exploration disturbance of 267 acres. Upon completion of mining, 3,456 acres would be reclaimed. Approximately 250 to 300 people would be employed during facility construction, and approximately 150 to 250 people would be employed during operations.

The Draft EIS will be available for a 45-day public comment period. Written comments should be addressed to the BLM Ely District Office, HC 33 Box 33500, Ely, NV 89301, Attn: Dan Netcher. Comments should be postmarked or otherwise delivered to the Ely District Office by Monday, March 30, 2015, to ensure full consideration. Comments may also be faxed to Netcher at (775) 289-1910 or submitted electronically on the BLM's ePlanning website:

<http://on.doi.gov/1zAxyW9>. Please make your comments as specific as possible.

The BLM has scheduled three public meetings for the Gold Rock Project Draft EIS in Nevada, from 5 p.m. to 7 p.m. Dates and locations are:

- Tuesday, March 10, 2015, Great Basin Community College, Ely Center, 2115 Bobcat Drive, Ely
- Wednesday, March 11, 2015, Eureka County Courthouse, 10 South Main Street, Eureka
- Thursday, March 12, 2015, Best Western Plus Reno Airport Plaza, 1981 Terminal Way, Reno.

Additional information is available online at <http://on.doi.gov/1DDx6by>. The Draft EIS is also available on the NEPA register at <http://on.doi.gov/1zAxyW9>. Project materials may also be viewed at the BLM Ely District Office, 702 N. Industrial Way, Ely, NV, from 7:30 a.m. to 4:30 p.m., Pacific Standard Time, Monday through Friday, except holidays.

Before including your address, phone number, email address, or other personal identifying information in your comment, you should be aware that your entire comment—including your personal identifying information—would be part of the public record for the project, and may be made publicly available at any time. While you may ask the BLM in your comment to withhold your personal identifying information from public review, we cannot guarantee that we would be able to do so.

If you would like any additional information, please contact Dan Netcher, Project Manager, at (775) 289-1872 or dnetcher@blm.gov.

Sincerely,

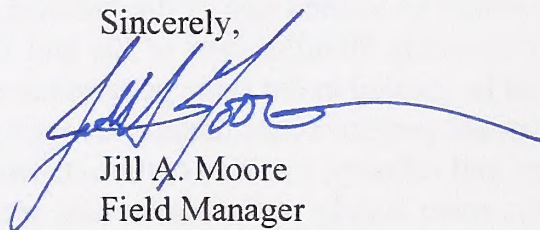

Jill A. Moore
Field Manager
Egan Field Office

Enclosures

Draft Environmental Impact Statement for the Gold Rock Mine Project

(X) Draft

() Final

Lead Agency: U.S. Department of the Interior
Bureau of Land Management
Egan Field Office

Cooperating Agencies: Duckwater Shoshone Tribe
Eureka County Board of Commissioners
Nevada Department of Wildlife
White Pine County Board of Commissioners

Counties Directly Affected: Eureka and White Pine, Nevada

Date EIS Filed with EPA: February 13, 2015

Comments on the EIS can be directed to: Dan Netcher, Project Manager
Bureau of Land Management, Egan Field Office
HC 33 Box 33500
Ely, NV 89301-9408
Fax (775) 289-1910
web site: <http://on.doi.gov/1zAxyW9>

Comments must be received by: March 30, 2015

ABSTRACT

In compliance with the National Environmental Policy Act, this Draft Environmental Impact Statement (EIS) evaluates the environmental effects of the construction, operation, and maintenance of a gold mine known as the Gold Rock Mine Project in White Pine County, Nevada, on lands managed by the Ely District Office of the U.S. Bureau of Land Management (BLM). The proposed project would be located in the Upper Railroad Valley, approximately 50 miles west of Ely, 30 miles southeast of Eureka, and 15 miles south of U.S. Route 50. The proposed project is an open-pit gold mine that would include an open pit; a heap leach pad and associated ponds, process facility, and refinery; a mill; a carbon-in-leach plant; waste rock dumps; a tailings storage facility; ancillary facilities; a 69 kilovolt (kV) transmission line to serve the project which would be supplied by Mount Wheeler Power on a new BLM Right-of-Way. In addition, a county road that currently passes through the Gold Rock Mine Project area would be relocated onto existing and new BLM and county roads. Construction and operation of the mine would result in approximately 3,946 acres of disturbance that includes the previously authorized exploration disturbance of 267 acres. Upon completion of 10 years of mining activities, the majority of the operation would be reclaimed, extending the project life to 48 years.

Eight alternatives were carried through the analysis and include the No Action Alternative; Proposed Action Alternative; Northern Power Line Route Alternative; Southern Power Line Route Alternative; Northwest Main Access Route Alternative, Northern Power Line Route; Northwest Main Access Route Alternative, Southern Power Line Route; Modified County Road Re-Route Alternative, and Western Tailings Storage Facility Alternative.

The BLM is responsible for administering mineral rights access on certain federal lands as authorized by the General Mining Law of 1872. The BLM Egan Field Office has the responsibility and authority to manage the surface and subsurface resources on public lands located within the Egan Resource Area. The BLM must review the Plan of Operations to ensure use of public land in the Egan Resource Area is in conformance with BLM's Surface Management Regulations (43 Code of Federal Regulations 3809) and other applicable statutes, including the Federal Land Policy Management Act of 1976 (as amended).

Authorized Officer Responsible for the Environmental Impact Statement:

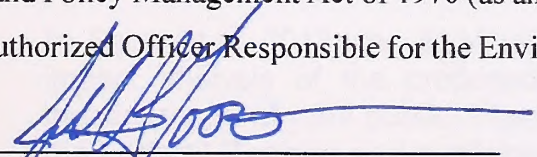

Jill A. Moore
Field Manager, Egan Field Office



Date

This page intentionally left blank.

EXECUTIVE SUMMARY

The Ely District, Egan Field Office (EFO) of the Bureau of Land Management (BLM) is evaluating an application for a proposed gold mine. Midway Gold U.S. Inc. (Midway) submitted a Plan of Operation and Reclamation Permit Application (Plan) to construct and operate the Gold Rock Mine Project (project). The project is located in White Pine County, Nevada on the east side of the Pancake Range. The mine would be approximately 50 miles west of Ely, 30 miles southeast of Eureka, and 15 miles south of US Highway 50.

The Plan area would encompass 18,745 acres, and about 8,757 acres within the Plan boundary would be fenced to preclude access by the public, wild horses, and livestock. Mining activities would occur within this fenced area (mine area) in all or portions of Township 15 North, Range 56 East, sections 3 through 10, 15 through 22, and 27 through 29. Exploration activities would occur anywhere within the Plan area.

ES.1 PURPOSE AND NEED

The BLM's Purpose for the Proposed Action is to authorize a legitimate use of public lands, which would allow Midway to construct and operate a gold mine and associated facilities in the Proposed Action area. If authorized, the BLM would allow Midway to develop this mine in a manner to prevent unnecessary and undue degradation of public lands, to provide for reasonable reclamation, and to comply with applicable federal, state, and local laws and regulations.

The BLM's Need for the Proposed Action is to respond to Midway's Plan of Operations in compliance with the surface management regulations (43 CFR 3809), NEPA, and other statutes. To fulfill this Need, the BLM will respond to Midway's Plan and issue decisions related to the method of development of the Plan, including alternative mining approaches and decisions to authorize the Proposed Action.

Midway's essential objective for the Proposed Action, which is the subject of the BLM's Purpose and Need, is to profitably extract precious metals from mining claims in the project area. Midway intends to operate and reclaim the proposed facilities in a manner that is environmentally responsible and in compliance with federal mining laws, the Federal Land Policy Management Act of 1976 (FLPMA), Nevada Mine Reclamation Law, and other applicable laws and regulations.

ES.2 DECISION TO BE MADE

The BLM will decide whether to approve the Plan with no modifications, to approve the Plan with additional terms and conditions to prevent unnecessary or undue degradation of public lands, or not to approve the Plan if additional terms and conditions would not prevent unnecessary or undue degradation of public lands.

ES.3 PUBLIC INVOLVEMENT

In September 2013, the BLM informed the public of its intent to conduct an environmental impact analysis of the proposed project and provided the dates, times, and locations of meetings open to the public. The BLM published a Notice of Intent (NOI) to prepare an EIS in the Federal Register and published a public notice in the High Desert Advocate, Reno Gazette

Journal, Ely Daily Times, and Eureka Sentinel. It also mailed a “Dear Interested Party” letter to 401 interested parties on the EIS mailing list. BLM also published the NOI and “Dear Interested Party” letter to the Nevada Clearinghouse and distributed them to public posting locations in Ely and Eureka. Finally, a news release was distributed to local media, Nevada’s Congressional delegation, appropriate State senate and assembly persons, Eureka and White Pine County elected officials, BLM Nevada State Leadership Team, and BLM Nevada public affairs specialists.

The BLM held three public scoping meetings to discuss the NEPA process, introduce the Proposed Action, and receive comments from the public. The meetings were held in Ely (September 24), Eureka (September 25), and Reno (September 26). Representatives of the BLM, Midway, and the third-party contractor (ARCADIS U.S., Inc.) provided information and project handouts, answered questions, and encouraged submittal of comments.

The U.S. federal government shutdown from October 1–16, 2013 complicated the scoping process. The BLM’s e-mail account that was set up to receive scoping comments during the initial scoping period (September 5 through October 7, 2013) was deleted during the shutdown. Therefore, the BLM issued a NOI for the Gold Rock Mine Project EIS in the Federal Register on March 28, 2014 to invite members of the public to submit comments, and request that anyone who submitted comments by email during the initial 30-day scoping period resubmit their comments. BLM also published another round of public notices, mailed another “Dear Interested Party” letter, and distributed another news release similar to the original efforts in September 2013. No changes were made to the Proposed Action and no additional scoping meetings were held.

The BLM met with the Confederated Tribe of the Goshute on April 4, 2014; with the Duckwater Shoshone Tribe on April 28, 2014; and with the Ely Shoshone Tribe on August 12, 2014. During each meeting, the BLM provided an overview of the NEPA process and described the status of the Gold Rock Mine Project EIS.

All comments received during public scoping were recorded. Most of the concerns raised focused on potential impacts on socioeconomic issues, water resources, wild horses, soils and reclamation, vegetation, wildlife, and air quality. Additional comments noted concerns about hazardous materials and solid waste; Native American traditional and religious values; cumulative effects; land use authorization and access including transportation, traffic, public health, and safety; visual resources; range resources; cultural resources; recreation; forest products and fuels; and environmental justice.

ES.4 ALTERNATIVES

On December 19, 2013, BLM held an agency scoping and alternatives development meeting. During this meeting, the BLM, cooperating agencies, and Midway discussed the Proposed Action, issues, and concerns to be addressed in the NEPA analysis for the project. The meeting ended before the group could discuss alternatives. Consequently, the BLM and ARCADIS held a conference call on January 6, 2014 to discuss alternatives. On April 29, 2014 the BLM distributed a description of alternatives to the cooperating agencies, held several conference calls, received and addressed comments, and agreed on a preliminary list of alternatives to be carried forward in the process and analyzed in detail.

Eight alternatives were analyzed in detail. They include the Proposed Action and No Action Alternative. The other six alternatives involve variations in the location of roads and facilities.

ES.4.1 Proposed Action

The Proposed Action would include the construction, operation, reclamation, and closure of the Gold Rock Mine. The Plan area would encompass 18,745 acres, and major components of the mining operation would be located within a fenced 8,757-acre mine area. The Gold Rock Mine would include an open pit, two waste rock disposal areas, a heap leach pad, processing ponds and plant, a mill with a carbon-in-leach circuit, a tailings storage facility, water supply wells and delivery/storage system, haul and access roads, growth medium stockpiles, and ancillary support facilities. Transformers and distribution lines within the Plan area would carry power to the processing plant, mill, and other facilities. Approximately 3,468 acres of surface disturbance would occur within the mine area.

Midway proposes to perform exploration activities on a total of 467 acres in the Plan area, including the 267 acres previously authorized under the amended 2011 Plan and approximately 200 additional acres within the Plan area boundary. Of the 467 acres of exploration disturbance, approximately 75 acres would be re-disturbed during construction of proposed facilities and reclaimed in accordance with the facility that covers it. To avoid double counting, 75 acres would be subtracted from the total, resulting in 392 acres of exploration disturbance, which when added to the 3,468 acres of disturbance within the mine area, would result in 3,860 acres of disturbance within the Plan area under the Proposed Action.

Midway would obtain water for construction and operations from the existing Easy Junior well. If necessary, Midway would install a second water supply well within 0.5 mile of the existing Easy Junior well. If drilling indicates that a well would provide water, then Midway would apply for a water well permit within the Railroad Valley Northern Part. The well pad, two-track road, and associated power line would disturb approximately 6 acres.

The Easy Junior Road extends south from US 50 through the Newark Valley, passing on the western side of Easy Ridge to connect with County Road 62, which leads southeast to Green Springs Road. To promote public safety and mine security, Midway would relocate the segment of Easy Junior Road that passes through the mine area west onto existing BLM and county roads and a short segment of new road. The proposed re-route would be approximately 12 miles long, including approximately 2 miles of new road construction and approximately 10 miles of existing BLM or BLM/county road. Construction of the new road segment would involve approximately 7 acres of disturbance. In the future, if White Pine County decides to widen the road, those activities would result in approximately 22 additional acres of disturbance.

To provide electrical power to the mine, Mount Wheeler Power would extend a 69 kV transmission line from the Pan Mine across the valley to tie into the west side of the Gold Rock Project electric system. Mount Wheeler Power would also establish a two-track maintenance road. Approximately 51 acres of surface disturbance would occur.

ES.4.2 Northern Power Line Route Alternative

To address concerns about sage-grouse from the Proposed Action due to the power line, the BLM considered the Northern Power Line Route Alternative. Under this alternative, Midway would implement the Proposed Action, with one modification—a different route would be used for the power line. Instead of using the Proposed Action power line route, Midway would tie in to a right angle on the Pan Mine Southwest Power Line Route, follow a segment of the Proposed Action power line route, then continue to the Gold Rock Plan area. Mount Wheeler Power would establish a new two-track road along the entire length. This alternative would be approximately 3.6 miles long, would include only two turning points, and would span relatively flat ground.

ES.4.3 Southern Power Line Route Alternative

To address concerns about sage-grouse from the Proposed Action due to the power line, the BLM considered the Southern Power Line Route Alternative. Under this alternative, Midway would implement the Proposed Action with one modification—a different route would be used for the power line. Instead of using the Proposed Action power line route, Midway would tie in to a right angle on the Pan Mine Southwest Power Line Alternative and extend south and east, roughly paralleling existing BLM 4106/County Road 1180 and BLM 4006, then entering the Plan area. This alternative would be approximately 4.0 miles long. Mount Wheeler Power would use the existing roads to access the power line; however, if existing roads do not provide sufficient access to the power line, Mount Wheeler Power would establish segments of new two-track road where appropriate.

ES.4.4 Northwest Main Access Route Alternative, Northern Power Line Route

Under this alternative, Midway would implement the Proposed Action with one modification—a different main access route would be used. Instead of using Green Springs Road as the main access route for commercial truck traffic and employees traveling from US 50, mine-bound commercial truck and employee traffic from US 50 would be directed to follow the Pan Mine access road to reach the existing Easy Junior Road and the main entrance to the Gold Rock Mine. If this alternative were selected, the Northern Power Line Route Alternative maintenance road would be widened and incorporated into the access route. This alternative main access route from US 50 to the Gold Rock Mine parking lot would be approximately 17.4 miles long, compared to the 18.4-mile-long existing main access route. The road would have a minimum of a 32-foot running surface, a central crown, and ditches for controlling surface water runoff, for a total road width of approximately 66 feet in accordance with appropriate standards.

Segments of the existing Pan Mine access road and Easy Junior Road, both of which already support commercial truck traffic, would make up part of the alternative main access route. These segments would not require upgrading. Segments of existing or approved two-track roads, including the Pan Mine Southwest Power Line Route maintenance road and BLM 4006, would be widened and upgraded. Proposed segments, including the connector road from the Pan access road to the Southwest Power Line maintenance road and the Northern Power Line Route maintenance road, would be constructed to support commercial truck traffic.

ES.4.5 Northwest Main Access Route Alternative, Southern Power Line Route

Under this alternative, Midway would implement the Proposed Action with one modification—a different main access route would be used. Instead of using Green Springs Road, mine-bound commercial truck and employee traffic from US 50 would be directed to follow the Pan Mine access road to reach the existing Easy Junior Road and the main entrance to the Gold Rock Mine. If this alternative were selected, the Southern Power Line Route Alternative maintenance road, which may include segments of existing roads, would be widened and incorporated into the access route. This alternative main access route from US 50 to the Gold Rock Mine parking lot would be approximately 18.3 miles long, compared to the 18.4-mile-long existing main access route. The road would have a minimum of a 32-foot running surface, a central crown, and ditches for controlling surface water runoff, for a total road width of approximately 66 feet in accordance with appropriate standards.

Segments of existing roads that already support commercial truck traffic would make up part of the alternative access route. Segments of existing or approved two-track roads, including segments of the Pan Mine Southwest Power Line Route maintenance road and BLM 4006, would be widened and upgraded. Proposed segments, including the connector road from the Pan access road to the Southwest Power Line maintenance road and the Southern Power Line Route maintenance road, would be constructed to support commercial truck traffic.

ES.4.6 Modified County Road Re-Route Alternative

To minimize potential impacts due to surface disturbance in sage-grouse habitat during construction of a new road segment along the proposed county road re-route, and to maintain a through-route to Green Springs Road in compliance with U.S. Revised Statute 2477, the BLM considered the Modified County Road Re-Route Alternative. Under this alternative, Easy Junior Road would be re-routed around the mine area on existing roads instead of constructing a new road segment to connect BLM 4006 and BLM 4059. The length of the modification is approximately 5 miles. In combination with the existing BLM road segments on the proposed county road re-route, this alternative would be 13 miles long, which is approximately 1 mile longer than the Proposed Action county road re-route.

ES.4.7 Western Tailings Storage Facility Alternative

Under this alternative, Midway would implement the Proposed Action with several modifications. To minimize effects to mule deer crucial winter range, Midway would construct the tailings storage facility and associated stormwater controls west of the heap leach pad and South Waste Rock Dump, instead of south of the pit and ore stockpile. This alternative location would require moving several facilities within the mine area, including mine roads, reclamation soil storage areas, secondary roads, sediment basins, stock piles, explosives storage facilities, storm water controls, the water pipeline, and monitoring wells. These changes would result in a more compact footprint with shorter roads and power and water corridors between these facilities. The water pipeline for the project would be slightly longer than that under the Proposed Action to extend it to the new mill location near the center of the mine site. To minimize effects to mule deer crucial winter range further, Midway would shift the eastern boundary of the mine area and associated fence line west. Midway also would avoid performing surface disturbing exploration activities in mule deer crucial winter range from November 1 to March 31.

The alternative tailings storage facility would be contained by a narrow dam between the small ridges, or "hogbacks," to the west, and supplemented by two smaller embankments to the south. It would cover about 403 acres, which is about 134 acres larger than the 269-acre Proposed Action tailings storage facility. However, the amount of borrow area needed for this alternative would be about 53 acres, which is 102 acres fewer than 155 acres of borrow area under the Proposed Action. Midway anticipates that most of the borrow material for the tailings storage facility embankments could be obtained from within the footprint of the alternative tailings storage facility location. About 20 acres of borrow area disturbance outside of the alternative tailings storage facility location may be needed. Assuming that most of the borrow material for the dams can be obtained from within the tailings storage facility footprint itself, disturbance within the mine area under this alternative would involve approximately 3,350 acres, which is about 118 fewer acres than mine area disturbance under the Proposed Action.

By moving the tailings storage facility west, it would no longer be a limiting physical feature for moving the perimeter fence west out of mule deer habitat, and the eastern fence line would be

moved west to within a technically safe and secure distance of proposed mine facilities. This alternative fence line would surround 7,049 acres. In comparison, the Proposed Action fence line would surround 8,757 acres, or an additional 1,708 acres.

ES.4.8 No Action Alternative

Under the No Action Alternative, activities associated with the Proposed Action would not occur. Mineral resources in these areas of expansion would remain undeveloped. The construction and operation of the open pit, waste rock disposal areas, heap leach facilities, mill, tailings storage facility, and support facilities would not occur as currently proposed in the Plan. The county road would not be re-routed. The authorized exploration operations for the project would continue however. NEPA requires analysis of the No Action Alternative.

ES.5 AFFECTED ENVIRONMENT

The Plan area is located at approximately 6,430 feet above mean sea level in the Basin and Range Physiographic Province—a region characterized by narrow, north-south trending mountain ranges separated by broad, flat, arid valleys. Terrain west of the area is bounded by the Pancake Range and terrain east of the Plan area is bounded by the White Pine Mountains. The area experiences cold winters, warm summers, and average annual precipitation of less than 12 inches.

The tectonic history in the project area has produced a series of thrust faults, reverse faults, and associated folds that generally strike about north 15 degrees east. Mineralization is localized in the slightly overturned, fault-bounded Easy Junior anticline. The Basin and Range Province is an active seismic region—the probability of a Magnitude 5.0 or greater earthquake occurring within 62 miles of the project area over the 15-year operational life of the project is estimated at more than 50 percent.

Water resources are limited in the Plan area. Although no streams within the Plan area are classified as perennial, three segments of streams nearby but outside the Plan area have been classified as perennial. They include a tributary to Bull Creek that is partially channelized as an irrigation canal, a segment in the upper portion of Green Springs Wash where it originates from Green Springs, and a segment in the lower reach of Bull Creek. No active springs are located within the Plan area. Two aquifers of note exist in the region—an extensive but discontinuous basin fill alluvial aquifer and a deeper, regional carbonate rock aquifer that underlies east-central Nevada and western Utah known as the Basin and Range Carbonate Aquifer System.

Soils in the Plan area are coarse-grained overall. Although the potential for wind erosion is generally low, the potential for water erosion is more moderate. Overall suitability of these soils as a source of reclamation material ranges from poor to fair.

Shrublands and woodlands dominate the Plan area's vegetation. Great Basin Xeric Mixed Sagebrush Shrubland occupies most of the area, occurring on dry flats, plains, alluvial fans, rolling hills, rocky hillslopes, saddles, and ridges. Great Basin Pinyon-Juniper Woodland inhabits most of the remaining area. Although native vegetation dominates the area, limited amounts of human-altered vegetation types and populations of noxious and invasive weeds also are present.

Wildlife species present in the area are typical of the arid/semiarid environment. Altogether, 39 species of birds, 18 species of mammals, and six species of reptiles were observed, detected

by sign (tracks, burrows, scat, feathers, bones, or vocalizations), or recorded by bat detectors, in the Plan area. No aquatic habitat exists in the area; consequently, no amphibians or fish were identified. Wild horses also occur in the area.

Several species present in the area are of particular interest to governmental agencies and the public. They include the mule deer, elk, pronghorn antelope, greater sage-grouse, golden eagle, and pygmy rabbit. Although, the Railroad Valley springfish, which is listed as threatened under the Endangered Species Act, does not occur in the Plan area, concern exists about potential adverse indirect effects on the springs in Railroad Valley that the fish inhabits.

Although humans have inhabited the region for thousands of years, settlement of the region and transition from the prehistoric to historic periods occurred in the mid-1800s. Historic use of the area is generally associated with mining, ranching, and transportation (railroads and roads). Ongoing land uses include livestock grazing, recreation, and mineral extraction. The primary counties in the area (White Pine and Eureka) are rural and sparsely populated—their populations fluctuate with the level of mining activity in the area. The largest population centers are the communities of Ely and Eureka. In addition, the community of Duckwater is the economic center for the Duckwater Shoshone Reservation, which is just south of the Plan area.

ES.6 ENVIRONMENTAL CONSEQUENCES

The table below provides a comparative summary of the potential impacts of implementing each alternative for the project.

This page intentionally left blank.

Table ES-1 Summary of Environmental Effects

Potential Impact	Indicator	Proposed Action	Northern Power Line Route Alternative	Southern Power Line Route Alternative	Northwest Main Access Route Alternative, Northern Power Line Route	Northwest Main Access Route Alternative, Southern Power Line Route	Modified County Road Re-Route Alternative	Western Tailings Storage Facility Alternative	No Action Alternative
Water Resources (Surface Water)									
Construction and operation activities would result in reduced infiltration, increased runoff, and could result in alteration of drainage paths, channel morphology, and retention of stormwater could affect peak flow and low flow of seasonal and/or perennial water sources	Precipitation events, surface water flows, stormwater controls	The project would not result in increased runoff or changes in peak flow because water resources in the Plan area are ephemeral to intermittent. Stormwater controls such as drainage diversion ditches, sediment control basins, straw bales, and other Applicant-Committed EPMs would be implemented to divert stormwater and snow melt around disturbance areas and control the transportation of sediment. Runoff that is contained in on-site sediment control basins would not discharge downstream in the existing drainage channels, so the flow of surface water out of the project area would be less compared to baseline conditions.							There would be no project-related impacts to water resources beyond those associated with the exploration activities that have been approved already.
Increased erosion and sedimentation	Water chemistry, precipitation events, surface water flows, stormwater controls	Stormwater controls such as drainage diversion ditches, sediment control basins, straw bales, and other Applicant-Committed EPMs would be implemented to divert stormwater and snow melt around disturbance areas and control the transportation of sediment. Runoff that is contained in on-site sediment control basins would not discharge downstream in the existing drainage channels.							There would be no project-related impacts to water resources beyond those associated with the exploration activities that have been approved already.
Contamination from chemical spills or leaks		The potential for hazardous materials or other wastes to spill and subsequently affect surface water quality would be minimized through installation of secondary containment features and implementation of the SPCC Plan and the Spill Contingency and Emergency Response Plan.							There would be no project-related impacts to water resources beyond those associated with the exploration activities that have been approved already.
Water Resources (Groundwater)									
Changes in groundwater level in aquifer, perched groundwater zones, or discharge from springs, seeps, or wetlands and impacts to plants, animals, and rangeland water sources	Groundwater pumping rates, flow rates, and volumes	The quantity of water at Green Springs would not be impacted because Green Springs is fed by groundwater sourced in the mountains to the east of the Plan area and this spring is not in direct hydraulic communication with groundwater in the basin fill aquifer. Impacts to water at Big or Little Warm Springs are not anticipated because these springs and the Plan area are separated by more than 12 miles. Potentiometric drawdown at Little Warm Springs would be limited to 0.1 feet (i.e., approximately 1 inch of drawdown) after pumping the Easy Junior Well at a rate of 1,200 gallons per minute continuously for 10 years and then at a rate of 600 gallons per minute for 3 years.							There would be no project-related impacts to water resources beyond those associated with the exploration activities that have been approved already.
Changes in groundwater quality	Water chemistry, water drawdown rates, and water infiltration rates	Mining activities would not encounter groundwater; therefore, no impacts are expected. The quality of water at Green Springs would likely not be affected because Green Springs is fed by groundwater sourced in the mountains to the east of the Plan area and this spring is probably not in direct hydraulic communication with groundwater in the basin fill aquifer. Impacts to the quality of water at Big or Little Warm Springs are not anticipated because these springs and the Plan area are separated by more than 12 miles.							There would be no project-related impacts to water resources beyond those associated with the exploration activities that have been approved already.
Contamination from chemical spills or leaks		The potential for hazardous materials or other wastes to spill and subsequently affect water quality would be minimized through installation of secondary containment features and implementation of the SPCC Plan and the Spill Contingency and Emergency Response Plan.							There would be no project-related impacts to water resources beyond those associated with the exploration activities that have been approved already.
Impacts to water rights in region	Groundwater pumping rates, volumes, perennial yield, appropriation, and consumption	NDWR has appropriated 26,402 afy of water rights in the Railroad Valley/Northern Part, which is about 35 percent of the perennial yield. 2,000 afy of the NDWR water rights would be appropriated for the proposed project.							There would be no project-related impacts to water resources beyond those associated with the exploration activities that have been approved already.

Table ES-1 Summary of Environmental Effects

Potential Impact	Indicator	Proposed Action	Northern Power Line Route Alternative	Southern Power Line Route Alternative	Northwest Main Access Route Alternative, Northern Power Line Route	Northwest Main Access Route Alternative, Southern Power Line Route	Modified County Road Re-Route Alternative	Western Tailings Storage Facility Alternative	No Action Alternative
Geology and Minerals									
Loss of geologic resources	Quantity of ore and waste material to be excavated	The quantity of ore excavated over the life of the mine would vary somewhat with market conditions, but the heap leach pad would be designed for a capacity of approximately 77 million tons.							There would be no project-related mineral extraction beyond that associated with the exploration activities that were approved previously.
	Number and types of mining claims, geothermal nominations, and oil and gas leases in the affected area	Surface access to existing oil and gas leases would be affected, as would access to the leased minerals unless directional drill methods are employed from outside the mine facilities. No geothermal nominations have been established within the							There would be no project-related minerals beyond that associated with the exploration activities that were approved previously.
	Areas of surface disturbance	Approximately 3,946 acres	Approximately 3,913 acres	Approximately 3,912 acres	Approximately 4,010 acres	Approximately 4,018 acres	Approximately 3,945 acres	Approximately 3,828 acres	No project-related disturbance would occur.
	Facilities to be constructed in areas of potential geotechnical instability	No facilities would be constructed in areas of potential geotechnical instability. With the exception of the existing Easy Junior pit, no areas of potential geotechnical instability are known to be present within the analysis areas.							No project-related facilities would be constructed.
Paleontological Resources									
Loss of paleontological resources	Acres of surface disturbance in areas with PFYC classes of 3, 4, or 5.	Approximate acreage that would be within geologic units with a PFYC Class 3 designation, which has a moderate potential to contain scientifically significant fossils: 1,062	Approximate acreage that would be within geologic units with a PFYC Class 3 designation, which has a moderate potential to contain scientifically significant fossils: 1,051	Approximate acreage that would be within geologic units with a PFYC Class 3 designation, which has a moderate potential to contain scientifically significant fossils: 1,051	Approximate acreage that would be within geologic units with a PFYC Class 3 designation, which has a moderate potential to contain scientifically significant fossils: 1,108	Approximate acreage that would be within geologic units with a PFYC Class 3 designation, which has a moderate potential to contain scientifically significant fossils: 1,110	Approximate acreage that would be within geologic units with a PFYC Class 3 designation, which has a moderate potential to contain scientifically significant fossils: 1,062	Approximate acreage that would be within geologic units with a PFYC Class 3 designation, which has a potential to contain scientifically significant fossils: 826	No direct or indirect effects to fossil resources or their geologic content would occur.
Soils and Reclamation									
Reduced infiltration	Acres of soils disturbed; soil characteristics, including erosion hazard ratings and reclamation potentials; soil loss	Approximate acreage of new soil disturbance would occur: 3,946	Approximate acreage of new soil disturbance would occur: 3,913	Approximate acreage of new soil disturbance would occur: 3,912	Approximate acreage of new soil disturbance would occur: 4,010	Approximate acreage of new soil disturbance would occur: 4,018	Approximate acreage of new soil disturbance would occur: 3,945	Approximate acreage of new soil disturbance would occur: 3,828	No new project-related soil disturbance would occur.
Increased wind and water erosion		Soils that would be disturbed generally have severe erosion hazards once the existing vegetative cover is removed because of a combination of slope and erodibility. They also are generally poorly suited for reclamation purposes.							No new project-related soil disturbance would occur.
Increased sedimentation		Stormwater controls such as drainage diversion ditches, sediment control basins, straw bales, and other Applicant-Committed EPMs would be implemented to control the transportation of sediment.							No new project-related soil disturbance would occur and no stormwater controls would be constructed.
Prime and Unique Farmland									
Reduced productivity	Acres of soils disturbed	3 acres of soils designated as Prime Farmland could be disturbed Assuming that reclamation is successful, little or no loss of Prime Farmland productivity is anticipated.	1 acre of soils designated as Prime Farmland could be disturbed. Assuming that reclamation is successful, little or no loss of Prime Farmland productivity is anticipated.	1 acre of soils designated as Prime Farmland could be disturbed. Assuming that reclamation is successful, little or no loss of Prime Farmland productivity is anticipated.	15 acres of soils designated as Prime Farmland could be disturbed. Assuming that reclamation is successful, little or no loss of Prime Farmland productivity is anticipated.	15 acres of soils designated as Prime Farmland could be disturbed. Assuming that reclamation is successful, little or no loss of Prime Farmland productivity is anticipated.	Similar to Proposed Action	Similar to Proposed Action	The areal extent of soils designated as Prime Farmland that could be disturbed during permitted exploration activities is not known. Assuming that reclamation is successful, little or no loss of Prime Farmland productivity is anticipated.

Table ES-1 Summary of Environmental Effects

Potential Impact	Indicator	Proposed Action	Northern Power Line Route Alternative	Southern Power Line Route Alternative	Northwest Main Access Route Alternative, Northern Power Line Route	Northwest Main Access Route Alternative, Southern Power Line Route	Modified County Road Re-Route Alternative	Western Tailings Storage Facility Alternative	No Action Alternative	
Air Quality										
Changes in air quality	Concentrations of fugitive dust and criteria pollutants, greenhouse gases, and HAPs.	The mining activity would result in an increase in air emissions throughout the life of the project. Most of the emissions would be from fugitive emissions from vehicular travel.							No impacts other than those previously authorized.	
Changes to regional climate	Changes to storm magnitude or frequency	Although climate may change in the Plan area over the long term, the effects of these changes are not fully understood or certain. Changes in storm magnitude or frequency induced by climate change could affect various resources over the long term. Higher levels of precipitation could increase soil erosion and alter vegetative species composition over the long term. Conversely, lower levels of precipitation could increase stress on vegetation resulting in changes in communities and the wildlife occupying them. Because ground water use is below annual yield, potential reductions in precipitation resulting from climate change would not affect ground water use.							No impacts other than those previously authorized.	
Reduction in air quality and impact on human health through inhalation or ingestion of contaminated dust or water	Existing concentrations of constituents in air, estimated concentrations of constituents in air, air quality standards	The air emissions analysis indicated that impacts for all criteria pollutants would be below all applicable air quality standards. The standards were developed with an adequate margin of safety to protect public health. Consequently, no practical adverse effects to public health are expected because the emissions would be below the air quality standards.							No impacts other than those previously authorized.	
Vegetation and Invasive, Non-Native Plant Species, and Special Status Plant Species										
Reduced productivity	Acres and types of vegetation disturbed and vegetative productivity	Approximate acreage of native vegetation would be removed from production: 3,946	Approximate acreage of native vegetation would be removed from production: 3,913	Approximate acreage of native vegetation would be removed from production: 3,912	Approximate acreage of native vegetation would be removed from production: 4,010	Approximate acreage of native vegetation would be removed from production: 4,018	Approximate acreage of native vegetation would be removed from production: 3,945	Approximate acreage of native vegetation would be removed from production: 3,828	No change in existing vegetation disturbance would occur. No project-related impacts to vegetation productivity beyond those associated with the exploration activities that are already approved would occur.	
		491 acres would be removed from production permanently.							453 acres would be removed from production permanently.	No impacts other than those previously authorized.
		Approximate acreage of vegetation that would be disturbed: 3,946	Approximate acreage of vegetation that would be disturbed: 3,913	Approximate acreage of vegetation that would be disturbed: 3,912	Approximate acreage of vegetation that would be disturbed: 4,010	Approximate acreage of vegetation that would be disturbed: 4,018	Approximate acreage of vegetation that would be disturbed: 3,945	Approximate acreage of vegetation that would be disturbed: 3,828	No impacts other than those previously authorized.	
		491 acres would be disturbed permanently.							453 acres would be removed from production permanently.	No impacts other than those previously authorized.
Removal of vegetation		57 percent of the long-term disturbance would be in Great Basin Xeric Mixed Sagebrush Shrubland and 21 percent in Great Basin Pinyon-Juniper Woodland.							54 percent of the long-term disturbance would be in Great Basin Xeric Mixed Sagebrush Shrubland and 18 percent in Great Basin Pinyon-Juniper Woodland.	No change in existing vegetation disturbance would occur. No project-related impacts to vegetation beyond those associated with the exploration activities that are already approved would occur.
Increased potential for establishment of noxious and non-native, invasive weeds	Existing populations of noxious or non-native, invasive weeds in the Plan area and the region	Acreage of native vegetation removed that would increase the potential for the introduction and spread of weeds: 3,946	Acreage of native vegetation removed that would increase the potential for the introduction and spread of weeds: 3,913	Acreage of native vegetation removed that would increase the potential for the introduction and spread of weeds: 3,912	Acreage of native vegetation removed that would increase the potential for the introduction and spread of weeds: 4,010	Acreage of native vegetation removed that would increase the potential for the introduction and spread of weeds: 4,018	Acreage of native vegetation removed that would increase the potential for the introduction and spread of weeds: 3,945	Acreage of native vegetation removed that would increase the potential for the introduction and spread of weeds: 3,828	There would be no change in existing disturbance. Therefore, no change in the introduction and spread of weeds would occur beyond that associated with the exploration activities that are already approved	

Table ES-1 Summary of Environmental Effects

Potential Impact	Indicator	Proposed Action	Northern Power Line Route Alternative	Southern Power Line Route Alternative	Northwest Main Access Route Alternative, Northern Power Line Route	Northwest Main Access Route Alternative, Southern Power Line Route	Modified County Road Re-Route Alternative	Western Tailings Storage Facility Alternative	No Action Alternative	
Loss of habitat or loss of individual special status plants	Acres of potential habitat	Direct and indirect impacts to special status plant species would occur in special status plant species habitats.							No project-related impacts to vegetation beyond those associated with the exploration activities that are already approved would occur.	
Wildlife and Fisheries and Special Status Animal Species										
Adverse impacts to big game including mortality as a result of increased vehicular traffic near migration route to mule deer crucial winter range or antelope habitat including potential birthing sites, loss of habitat due to surface disturbance, fencing	acres of habitats available	Approximate acreage of range that would no longer be available to mule deer: 2,350	Approximate acreage of range that would no longer be available to mule deer: 2,329	Approximate acreage of range that would no longer be available to mule deer: 2,328	Approximate acreage of range that would no longer be available to mule deer: 2,382	range that would no longer be available to mule deer: 2,391	Approximate acreage of range that would no longer be available to mule deer: 2,349	Approximate acreage of range that would no longer be available to mule deer: 1,764	No additional effects to mule deer ranges would occur.	
		2,266 acres of mule deer crucial winter range							1,522 acres of mule deer crucial winter range (744 fewer than Proposed Action)	No additional effects to mule deer ranges would occur.
		84 acres of mule deer year-round range	63 acres of mule deer year-round range	62 acres of mule deer year-round range	116 acres of mule deer year-round range	125 acres of mule deer year-round range	83 acres of mule deer year-round range	475 acres of mule deer year-round range	No additional effects to mule deer ranges would occur.	
		Approximate acreage of pronghorn antelope year-round range that would be removed for the duration of the project: 3,536	Approximate acreage of pronghorn antelope year-round range that would be removed for the duration of the project: 3,520	Approximate acreage of pronghorn antelope year-round range that would be removed for the duration of the project: 3,519	Approximate acreage of pronghorn antelope year-round range that would be removed for the duration of the project: 3,593	Approximate acreage of pronghorn antelope year-round range that would be removed for the duration of the project: 3,602	Approximate acreage of pronghorn antelope year-round range that would be removed for the duration of the project: 3,535	Approximate acreage of pronghorn antelope year-round range that would be removed for the duration of the project: 3,397	No additional effects to pronghorn antelope year-round range would occur.	
	Number of vehicle/big game collisions	The number of vehicle/big game collisions could increase.	The number of vehicle/big game collisions could increase.	The number of vehicle/big game collisions could still increase.	The number of vehicle/big game collisions could increase, but at a rate less than under other alternatives because the access route is farther from the mule deer migration corridor.	The number of vehicle/big game collisions could increase, but at a rate less than under other alternatives because the access route is farther from the mule deer migration corridor.	The number of vehicle/big game collisions could increase.	The number of vehicle/big game collisions could increase.	No change in the number of vehicle/deer or antelope collisions would occur beyond that associated with the exploration activities that are already approved	
Adverse impacts to greater sage-grouse populations through direct impacts to habitat; noise and vibration; mortality through power line strike; predation or avoidance of habitat use near power lines	Area of habitats disturbed, number of leks disturbed, and area of greater sage-grouse habitat within line-of-sight view (1,968 feet [600 meters]) of power lines (applying Braun's (1998) findings on avoidance of habitat)	Approximate acreage of PPH directly disturbed: 19	Approximate acreage of PPH directly disturbed: 8	Approximate acreage of PPH directly disturbed: 8	Approximate acreage of PPH directly disturbed: 31	Approximate acreage of PPH directly disturbed: 31	Approximate acreage of PPH directly disturbed: 19	Approximate acreage of PPH directly disturbed: 19	No additional habitats or leks for greater sage-grouse would be affected.	
		Approximate acreage of PGH directly disturbed: 3,077	Approximate acreage of PGH directly disturbed: 3,071	Approximate acreage of PGH directly disturbed: 3,071	Approximate acreage of PGH directly disturbed: 3,098	Approximate acreage of PGH directly disturbed: 3,101	Approximate acreage of PGH directly disturbed: 3,075	Approximate acreage of PGH directly disturbed: 2,957		
		9 leks could be affected (6 active, 2 inactive, and 1 unknown).								
		Power lines outside the Plan area could impact: 1,374 acres of PPH and 1,341 acres of PGH.	Power lines outside the Plan area could impact: 238 acres of PPH and 429 acres of PGH.	Power lines outside the Plan area could impact: 238 acres of PPH and 260 acres of PGH.	Power lines outside the Plan area could impact: 238 acres of PPH and 429 acres of PGH.	Power lines outside the Plan area could impact: 238 acres of PPH and 260 acres of PGH.	Power lines outside the Plan area could impact: 1,374 acres of PPH and 1,341 acres of PGH.	Power lines outside the Plan area could impact: 1,374 acres of PPH and 1,341 acres of PGH.		
Impacts to migratory birds or raptors through reduction of available nesting habitat	Acres of habitat available within the analysis area	Approximate acreage of potentially suitable breeding, roosting, and foraging habitats would be lost over the long term: 3,184	Approximate acreage of potentially suitable breeding, roosting, and foraging habitats would be lost over the long term: 3,151	Approximate acreage of potentially suitable breeding, roosting, and foraging habitats would be lost over the long term: 3,150	Approximate acreage of potentially suitable breeding, roosting, and foraging habitats would be lost over the long term: 3,233	Approximate acreage of potentially suitable breeding, roosting, and foraging habitats would be lost over the long term: 3,242	Approximate acreage of potentially suitable breeding, roosting, and foraging habitats would be lost over the long term: 3,184	Approximate acreage of potentially suitable breeding, roosting, and foraging habitats would be lost over the long term: 3,057	No additional habitats for migratory birds would be affected.	
Exposure to toxic solutions and materials	Risk of releases; rates of plant uptake and concentration in tissues; toxicity of solutions, petroleum products, and metals to wildlife	Although an increased potential for wildlife to ingest toxic solutions would exist, proper handling of toxic materials would minimize this potential.							No increased potential for ingestion of toxic solutions would occur.	
Loss of water source or habitat as result of	Groundwater pumping rates.	Use of water would not cause groundwater drawdowns that would affect Little Warm Spring or any other surface water resources.							No potential for groundwater drawdown to	

Table ES-1 Summary of Environmental Effects

Potential Impact	Indicator	Proposed Action	Northern Power Line Route Alternative	Southern Power Line Route Alternative	Northwest Main Access Route Alternative, Northern Power Line Route	Northwest Main Access Route Alternative, Southern Power Line Route	Modified County Road Re-Route Alternative	Western Tailings Storage Facility Alternative	No Action Alternative
reduced flow in springs or reduction in vegetative productivity of food sources	flow rates, volumes, and surface expression of groundwater								affect surface water resources.
Range Resources									
Reduced forage within allotment or grazing use area due to surface disturbance or restriction by fencing	Number of acres available within allotment or grazing use area	Approximate acreage that would be disturbed within area grazing allotments: 9,289	Approximate acreage that would be disturbed within area grazing allotments: 9,256	Approximate acreage that would be disturbed within area grazing allotments: 9,255	Approximate 8,884 acreage that would be disturbed within area grazing allotments: 9,225	Approximate 8,884 acreage that would be disturbed within area grazing allotments: 9,215	Approximate acreage that would be disturbed within area grazing allotments: 9,288	Approximate acreage that would be disturbed within area grazing allotments: 7,581	No impacts other than those previously authorized.
		This disturbance would reduce the number AUMs available by 232.	This disturbance would reduce the number AUMs available by 231.	This disturbance would reduce the number AUMs available by 231.	This disturbance would reduce the number AUMs available by 231.	This disturbance would reduce the number AUMs available by 230.	This disturbance would reduce the number AUMs available by 232.	This disturbance would reduce the number AUMs available by 178.	
The loss of AUMs that would be permanent: Approximately 12								The loss of AUMs that would be permanent: Approximately 10.	
Reduced productivity of food sources from groundwater pumping	Reduction in forage	Use of water would not cause groundwater drawdowns that would affect surface water resources.							No potential for groundwater drawdown to affect surface water resources
Forest Products and Fuels									
Loss of forest product, including pinyons used to harvest pine nuts	Forested area available, estimate of forest products, acres of pinyon habitat	Approximate acreage of pinyon-juniper woodland that would be inaccessible during operations: 2,650	Approximate acreage of pinyon-juniper woodland that would be inaccessible during operations: 2,633	Approximate acreage of pinyon-juniper woodland that would be inaccessible during operations: 2,630	Approximate acreage of pinyon-juniper woodland that would be inaccessible during operations: 2,651	Approximate acreage of pinyon-juniper woodland that would be inaccessible during operations: 2,643	Approximate acreage of pinyon-juniper woodland that would be inaccessible during operations: 2,650	Approximate acreage of pinyon-juniper woodland that would be inaccessible during operations: 1,471	No impacts other than those previously authorized.
		Acres removed temporarily: 746	Acres removed temporarily: 729	Acres removed temporarily: 726	Acres removed temporarily: 747	Acres removed temporarily: 739	Acres removed temporarily: 746	Acres removed temporarily: 599	
Loss of 115 acres would be permanent.								Loss of 109 acres would be permanent.	No impacts other than those previously authorized.
Wild Horses									
Mortality through collision as result of increased traffic	Number of vehicle/wild horse collisions, acres of habitat available	Increased risk of vehicle/wild horse collisions for the life of the mine.							No increased risk of vehicle/wild horse collisions for the life of the mine beyond those associated with the exploration activities that are already approved.
Groundwater pumping could affect amount or quality of water present in local water sources used by wild horses, and release or spill of toxic solutions or materials could affect wild horses	Groundwater elevations, location, number, origin of water sources available and use by wild horses, risk of releases	No effects to access to water sources for wild horses.							No effects to access to water sources for wild horses.
Loss or fragmentation of habitat or changes in migration routes through noise from mining operations, surface disturbance, or fencing	Acres of habitat available within herd management area or wild horse territory	Short-term loss of access to approximately 8,757 acre during construction & operation						Short-term loss of access to approximately 7,049 acres during construction & operation	No impacts other than those previously authorized.
Long-term loss of 491 acres of habitat							Long-term loss of approximately 453 acres of habitat		

Table ES-1 Summary of Environmental Effects

Potential Impact	Indicator	Proposed Action	Northern Power Line Route Alternative	Southern Power Line Route Alternative	Northwest Main Access Route Alternative, Northern Power Line Route	Northwest Main Access Route Alternative, Southern Power Line Route	Modified County Road Re-Route Alternative	Western Tailings Storage Facility Alternative	No Action Alternative
		Approximate acreage that would be disturbed within HMA: 9,289	Approximate acreage that would be disturbed within HMA: 9,256	Approximate acreage that would be disturbed within HMA: 9,255	Approximate 8,884 acreage that would be disturbed within HMA: 9,225	Approximate 8,884 acreage that would be disturbed within HMA: 9,215	Approximate acreage that would be disturbed within HMA: 9,288	Approximate acreage that would be disturbed within HMA: 7,581	No impacts other than those previously authorized.
		Loss of 491 acres of habitat permanently after fencing is removed.							
Cultural Resources									
Disturbance of historic properties (cultural resource sites listed on or eligible for the National Register of Historic Places)	Presence of identified historic properties (cultural resource sites listed on or eligible for the National Register of Historic Places) in the Plan area that could be disturbed	Known historic properties could be adversely affected. Sites would be avoided where feasible; if unavoidable, Midway would comply with the Programmatic Agreement. Data recovery is the likely mitigation measure.						9 known historic properties could be adversely affected – 5 that are considered eligible for listing on the NRHP and 4 that have not been evaluated. Data recovery is the likely mitigation measure.	None of the known historic properties in the amended 2011 Plan area would be affected.
Native American Religious and Traditional Values									
Direct or indirect effects to greater sage-grouse	Presence of identified sites with Native American Religious and Traditional Values in the Plan area that could be disturbed	See "Wildlife and Fisheries and Special Status Animal Species"							No impacts other than those previously authorized
		See "Wildlife and Fisheries and Special Status Animal Species"							No impacts other than those previously authorized
		See "Wildlife and Fisheries and Special Status Animal Species"							No impacts other than those previously authorized
Direct effects to antelope traps		Two traditional antelope traps that are recommended eligible as prehistoric resources could be adversely affected. Consultation with the Tribes would determine the treatment of these traps.							None of the known traditional antelope traps in the Plan area would be affected by this alternative.
Direct effects to pinyon and indirect effects to pine nut gathering		See "Forest Products and Fuels"							
Extraction of minerals from ancestral lands of Western Shoshone		Midway's valid minerals claims permit mining of the deposit with approval of the Plan.							No mining activities would occur, as described under the amended 2011 Plan.
Land Use Authorization and Access									
Increased risk to public health and safety, primarily from increased traffic or risk of exposure to hazardous materials in the event of a release or spill during transport	Number of vehicles or number of annual average daily trips (AADT), proposed number and frequency of vehicles transporting hazardous materials to the mine	<p>AADT would increase during the construction.</p> <p>Increased vehicular traffic would be noticeable on some county or BLM roads.</p> <p>Disruptions to local traffic circulation would be short term.</p> <p>Effects to public transportation would be temporary in duration and primarily limited to the immediate areas near the Plan area.</p> <p>Impacts during operations, maintenance and reclamation would be similar to those for construction.</p>						No change in existing land use authorizations would occur, and the mine project would not be constructed. No project-related impacts to land use or access beyond those associated with the exploration activities that are already approved would occur.	

Table ES-1 Summary of Environmental Effects

Potential Impact	Indicator	Proposed Action	Northern Power Line Route Alternative	Southern Power Line Route Alternative	Northwest Main Access Route Alternative, Northern Power Line Route	Northwest Main Access Route Alternative, Southern Power Line Route	Modified County Road Re-Route Alternative	Western Tailings Storage Facility Alternative	No Action Alternative
Recreation									
Reduction of access to public lands	Potential restricted access to recreational use areas	8,757 acres of BLM-administered recreational resources would be unavailable for OHV use or hunting over the life of the project. 491 acres would be permanently removed.						7,049 acres of BLM-administered recreational resources would be unavailable for OHV use or hunting over the life of the project. 453 acres would be permanently removed.	No additional impacts to OHV use would occur beyond that already approved.
Visual Resources									
Potential loss of scenic views, construction of new roads, structures, infrastructure and installation of lighting would affect the existing viewshed in the vicinity of the proposed mine. Siting of structures and infrastructure without consolidating or co-locating facilities and/or without using building materials, colors and site placement compatible with the natural environment could increase visibility of facility and affect visual resources in the area. Without using "Dark Sky" lighting practices could impact visibility of the nighttime sky in the vicinity of the proposed project.	Changes in view from key observation points, visual simulations	The project components and facilities would appear as visible alterations to the existing landscape within portions of the Plan area for the life of the project. Visual effects would be localized and the facilities would not be visible in the foreground from US 50 or SR 379 or the Duckwater Shoshone Reservation or other well-traveled, publically accessible viewing areas. At night, motorists travelling on U.S. Highway 50, SR 379 and Green Springs Road would not be able to observe lights used for the project, given the distance from the site and the terrain. Passing motorists near the Plan area may see the project lights in the background area for several minutes.							No project-related impacts to visual resources would occur. Some additional impacts to visual resources could occur from ongoing exploration activities that are already approved.
Socioeconomic Resources									
New employment	Employment, public revenue base, housing, and the demand for community services and schools.	About 300 employed at peak of construction and 150-250 employed during operations.							No new employment would occur under this alternative.
Increase in public revenue		Construction of the mine would have a positive, short-term fiscal effect on the entities within the analysis area through an increase in sales tax receipts. The operation and maintenance of the mine would have a long-term, positive fiscal effect through an increase in property tax revenues and net proceeds taxes.							No additional public revenue would be generated beyond that already permitted.
Increase in demand for housing		Demand for housing would increase, most likely in Ely or Eureka.							No increase in demand for housing would occur.
Increase in commercial development		Potential for commercial development would increase to support mine and employee demands.							No potential for commercial development.
Increase in demand for community services, schools, and infrastructure		Demand for community services, schools, and infrastructure would increase.							No increase in demand for community services, schools, or infrastructure would occur.
Impact on economic viability of the area from loss of scenic views	Visitor use data, changes in view from key observation points, and visual simulations	Potential for loss of economic viability due to construction and operation of the mine is not anticipated.							No negative or positive effects from mine construction and operation.

Table ES-1 Summary of Environmental Effects

Potential Impact	Indicator	Proposed Action	Northern Power Line Route Alternative	Southern Power Line Route Alternative	Northwest Main Access Route Alternative, Northern Power Line Route	Northwest Main Access Route Alternative, Southern Power Line Route	Modified County Road Re-Route Alternative	Western Tailings Storage Facility Alternative	No Action Alternative	
Environmental Justice										
Disproportionate effect to minority or low-income population	Identification of minority or low-income populations affected disproportionately	No disproportionately adverse effects would occur to an identified minority or low-income population. No minority or low-income population would have an increased risk or rate of exposure to an adverse environmental hazard. No health or safety hazards would disproportionately affect children.							No change in impacts beyond that associated with the exploration activities that are already approved.	
Hazardous Materials and Wastes										
Exposure to hazardous materials in the event of a release or spill on roads located in Eureka County—primarily SR 278 and US 50.	Hazardous materials inventory, Spill Prevention Control and Countermeasure Plan, and other mitigation and controls to prevent or remediate releases or spills.	Impacts would be short term with compliance with SCERP, regulations, and Applicant-Committed EPMs and timely spill response procedures.							No additional impacts over current conditions.	

Table of Contents

CHAPTER 1 INTRODUCTION	1-1
1.1 Overview	1-1
1.2 Project History	1-2
1.3 Agency Purpose and Need	1-8
1.4 Decision to be Made	1-8
1.5 Midway's Objectives.....	1-8
1.6 Proposed Action – Overview	1-9
1.7 Existing Analysis Documents Used for this Statement	1-9
1.8 Relationship to Agency and Other Policies and Plans.....	1-10
1.9 Authorizing Actions	1-12
1.10 Public Involvement.....	1-13
1.10.1 Scoping.....	1-13
1.10.2 Issues Raised during Public Scoping	1-15
CHAPTER 2 PROPOSED ACTION AND ALTERNATIVES	2-1
2.1 Introduction.....	2-1
2.2 Existing Operations	2-1
2.3 Proposed Action.....	2-2
2.3.1 Water Supply, Delivery, and Storage	2-9
2.3.2 Roads	2-9
2.3.3 Power Line.....	2-13
2.3.4 Open Pit.....	2-13
2.3.5 Waste Rock Disposal Areas	2-18
2.3.6 Heap Leach Facilities	2-23
2.3.7 Processing Ponds and Carbon-In-Columns Processing Plant.....	2-28
2.3.8 Mill and Carbon-In-Leach Circuit.....	2-30
2.3.9 Tailings Storage Facility.....	2-33
2.3.10 Stormwater Management	2-40
2.3.11 Exploration.....	2-43
2.3.12 Ancillary Facilities	2-43
2.3.13 Transportation.....	2-50
2.3.14 Emergency Planning and Response	2-50
2.3.15 Employment.....	2-53
2.3.16 Reclamation Plan.....	2-53
2.3.17 Applicant-Committed Environmental Protection Measures	2-68
2.4 Alternatives.....	2-75
2.4.1 Power Line Route Alternatives	2-75
2.4.2 Route Alternatives	2-79
2.4.3 Western Tailings Storage Facility Alternative	2-81
2.4.4 No Action Alternative	2-82
2.4.5 Summary of Alternatives	2-82
2.5 Alternatives Considered But Eliminated From Detailed Analysis	2-85
2.5.1 Midway Design Options Eliminated From Detailed Analysis.....	2-85

2.5.2	Agency-Developed Alternatives Eliminated From Detailed Analysis	2-86
2.6	Comparative Analysis of Alternatives	2-89
CHAPTER 3	AFFECTED ENVIRONMENT	3-1
3.1	Introduction.....	3-1
3.2	Water Resources	3-1
3.3	Geology and Minerals	3-20
3.4	Paleontological Resources.....	3-30
3.5	Soils.....	3-36
3.6	Prime and Unique Farmlands	3-41
3.7	Air Resources.....	3-42
3.8	Vegetation, Including Noxious and Non-Native Invasive Weeds and Special Status Plants	3-51
3.9	Wildlife Resources, Including Migratory Birds and Special Status Wildlife.....	3-62
3.10	Range Resources	3-89
3.11	Forest Products and Fuels	3-97
3.12	Wild Horses	3-103
3.13	Cultural Resources.....	3-107
3.14	Native American Religious and Traditional Values	3-111
3.15	Land Use Authorization and Access	3-112
3.16	Visual Resources	3-122
3.17	Recreation	3-130
3.18	Socioeconomics	3-132
3.19	Environmental Justice	3-159
3.20	Hazardous Materials and Wastes	3-161
CHAPTER 4	ENVIRONMENTAL CONSEQUENCES	4-1
4.1	Impact Assessment.....	4-1
4.1.1	Impacts/Effects	4-1
4.1.2	Direct Effects	4-1
4.1.3	Indirect Effects	4-1
4.1.4	Significance	4-1
4.1.5	Indicators	4-2
4.1.6	Environmental Effect Categories.....	4-2
4.1.7	Additional Monitoring and Mitigation.....	4-2
4.2	Water Resources	4-2
4.2.1	Analysis Areas	4-2
4.2.2	Indicators	4-3
4.2.3	Proposed Action	4-3
4.2.4	Northern Power Line Route Alternative	4-10
4.2.5	Southern Power Line Route Alternative	4-10
4.2.6	Northwest Main Access Route Alternative, Northern Power Line Route	4-10
4.2.7	Northwest Main Access Route Alternative, Southern Power Line Route.....	4-10
4.2.8	Modified County Road Re-Route Alternative	4-10
4.2.9	Western Tailings Storage Facility Alternative.....	4-10
4.2.10	No Action Alternative	4-11
4.2.11	Additional Monitoring and Mitigation.....	4-11

4.3	Geology and Minerals	4-11
4.3.1	Analysis Areas	4-11
4.3.2	Indicators	4-12
4.3.3	Proposed Action	4-12
4.3.4	Northern Power Line Route Alternative	4-14
4.3.5	Southern Power Line Route Alternative	4-14
4.3.6	Northwest Main Access Route Alternative, Northern Power Line Route	4-15
4.3.7	Northwest Main Access Route Alternative, Southern Power Line Route	4-15
4.3.8	Modified County Road Re-Route Alternative	4-16
4.3.9	Western Tailings Storage Facility Alternative	4-17
4.3.10	No Action Alternative	4-17
4.3.11	Additional Monitoring and Mitigation	4-17
4.4	Paleontological Resources	4-17
4.4.1	Analysis Areas	4-17
4.4.2	Indicators	4-17
4.4.3	Proposed Action	4-18
4.4.4	Northern Power Line Route Alternative	4-19
4.4.5	Southern Power Line Route Alternative	4-19
4.4.6	Northwest Main Access Route Alternative, Northern Power Line Route	4-19
4.4.7	Northwest Main Access Route Alternative, Southern Power Line Route	4-19
4.4.8	Modified County Road Re-Route Alternative	4-19
4.4.9	Western Tailings Storage Facility Alternative	4-20
4.4.10	No Action Alternative	4-20
4.4.11	Additional Monitoring and Mitigation	4-20
4.5	Soils	4-20
4.5.1	Analysis Areas	4-20
4.5.2	Indicators	4-22
4.5.3	Proposed Action	4-22
4.5.4	Northern Power Line Route Alternative	4-24
4.5.5	Southern Power Line Route Alternative	4-24
4.5.6	Northwest Main Access Route Alternative, Northern Power Line Route	4-25
4.5.7	Northwest Main Access Route Alternative, Southern Power Line Route	4-25
4.5.8	Modified County Road Re-Route Alternative	4-26
4.5.9	Western Tailings Storage Facility Alternative	4-27
4.5.10	No Action Alternative	4-27
4.5.11	Additional Monitoring and Mitigation	4-27
4.6	Prime and Unique Farmlands	4-28
4.6.1	Analysis Areas	4-28
4.6.2	Indicators	4-28
4.6.3	Proposed Action	4-28
4.6.4	Northern Power Line Route Alternative	4-29
4.6.5	Southern Power Line Route Alternative	4-29
4.6.6	Northwest Main Access Route Alternative, Northern Power Line Route	4-29
4.6.7	Northwest Main Access Route Alternative, Southern Power Line Route	4-30

4.6.8	Modified County Road Re-Route Alternative	4-30
4.6.9	Western Tailings Storage Facility Alternative	4-30
4.6.10	No Action Alternative	4-30
4.6.11	Additional Monitoring and Mitigation.....	4-30
4.7	Air Resources.....	4-30
4.7.1	Analysis Areas	4-31
4.7.2	Indicators	4-31
4.7.3	Proposed Action	4-31
4.7.4	Northern Power Line Route Alternative	4-36
4.7.5	Southern Power Line Route Alternative	4-36
4.7.6	Northwest Main Access Route Alternative, Northern Power Line Route	4-36
4.7.7	Northwest Main Access Route Alternative, Southern Power Line Route.....	4-36
4.7.8	Modified County Road Re-Route Alternative	4-37
4.7.9	Western Tailings Storage Facility Alternative	4-37
4.7.10	No Action Alternative	4-37
4.7.11	Additional Monitoring and Mitigation.....	4-37
4.8	Vegetation, Including Noxious and Non-Native, Invasive Weeds and Special Status Plants	4-38
4.8.1	Analysis Areas	4-38
4.8.2	Indicators	4-38
4.8.3	Proposed Action	4-38
4.8.4	Northern Power Line Route Alternative	4-45
4.8.5	Southern Power Line Alternative	4-46
4.8.6	Northwest Main Access Route Alternative, Northern Power Line Route	4-46
4.8.7	Northwest Main Access Route Alternative, Southern Power Line Route.....	4-51
4.8.8	Modified County Road Re-Route Alternative	4-52
4.8.9	Western Tailings Storage Facility Alternative	4-53
4.8.10	No Action Alternative	4-54
4.8.11	Additional Monitoring and Mitigation.....	4-54
4.9	Wildlife Resources, Including Migratory Birds and Special Status Wildlife.....	4-54
4.9.1	Analysis Areas	4-54
4.9.2	Indicators	4-57
4.9.3	Proposed Action	4-58
4.9.4	Northern Power Line Route Alternative	4-82
4.9.5	Southern Power Line Route Alternative	4-87
4.9.6	Northwest Main Access Route Alternative, Northern Power Line Route	4-90
4.9.7	Northwest Main Access Route Alternative, Southern Power Line Route.....	4-97
4.9.8	Modified County Road Re-Route Alternative	4-102
4.9.9	Western Tailings Facility Alternative.....	4-105
4.9.10	No Action Alternative	4-110
4.9.11	Additional Monitoring and Mitigation.....	4-111
4.10	Range Resources	4-113
4.10.1	Analysis Areas	4-113
4.10.2	Indicators	4-114
4.10.3	Proposed Action	4-114

4.10.4	Northern Power Line Route Alternative	4-116
4.10.5	Southern Power Line Alternative	4-119
4.10.6	Northwest Main Access Route Alternative, Northern Power Line Route	4-119
4.10.7	Northwest Main Access Route Alternative, Southern Power Line Route	4-119
4.10.8	Modified County Road Re-Route Alternative	4-119
4.10.9	Western Tailings Storage Facility Alternative	4-119
4.10.10	No Action Alternative	4-120
4.10.11	Additional Monitoring and Mitigation.....	4-120
4.11	Forest Products and Fuels	4-120
4.11.1	Analysis Areas	4-120
4.11.2	Indicators	4-120
4.11.3	Proposed Action	4-120
4.11.4	Northern Power Line Route Alternative	4-124
4.11.5	Southern Power Line Alternative	4-124
4.11.6	Northwest Main Access Route Alternative, Northern Power Line Route	4-124
4.11.7	Northwest Main Access Route Alternative, Southern Power Line Route	4-124
4.11.8	Modified County Road Re-Route Alternative	4-124
4.11.9	Western Tailings Storage Facility Alternative	4-125
4.11.10	No Action Alternative	4-125
4.11.11	Additional Monitoring and Mitigation.....	4-125
4.12	Wild Horses	4-125
4.12.1	Analysis Areas	4-125
4.12.2	Indicators	4-126
4.12.3	Proposed Action	4-126
4.12.4	Northern Power Line Route Alternative	4-127
4.12.5	Southern Power Line Route Alternative	4-127
4.12.6	Northwest Main Access Route Alternative, Northern Power Line Route	4-127
4.12.7	Northwest Main Access Route Alternative, Southern Power Line Route	4-127
4.12.8	Modified County Road Re-Route Alternative	4-128
4.12.9	Western Tailings Storage Facility Alternative	4-128
4.12.10	No Action Alternative	4-128
4.12.11	Additional Monitoring and Mitigation.....	4-128
4.13	Cultural Resources	4-128
4.13.1	Analysis Areas	4-129
4.13.2	Indicators	4-131
4.13.3	Proposed Action	4-132
4.13.4	Northern Power Line Route Alternative	4-132
4.13.5	Southern Power Line Route Alternative	4-132
4.13.6	Northwest Main Access Route Alternative, Northern Power Line Route	4-132
4.13.7	Northwest Main Access Route Alternative, Southern Power Line Route	4-132
4.13.8	Modified County Road Re-Route Alternative	4-133
4.13.9	Western Tailings Storage Facility Alternative	4-133
4.13.10	No Action Alternative	4-133
4.13.11	Additional Monitoring and Mitigation.....	4-133

4.14	Native American Religious and Traditional Values	4-133
4.14.1	Analysis Areas	4-134
4.14.2	Indicators	4-134
4.14.3	Proposed Action	4-134
4.14.4	Northern Power Line Route Alternative	4-134
4.14.5	Southern Power Line Route Alternative	4-135
4.14.6	Northwest Main Access Route Alternative, Northern Power Line Route	4-135
4.14.7	Northwest Main Access Route Alternative, Southern Power Line Route	4-135
4.14.8	Modified County Road Re-Route Alternative	4-135
4.14.9	Western Tailings Storage Facility Alternative	4-135
4.14.10	No Action Alternative	4-135
4.14.11	Additional Monitoring and Mitigation.....	4-135
4.15	Land Use Authorization and Access	4-136
4.15.1	Analysis Areas	4-136
4.15.2	Indicators	4-136
4.15.3	Proposed Action	4-136
4.15.4	Northern Power Line Route Alternative	4-139
4.15.5	Southern Power Line Route Alternative	4-139
4.15.6	Northwest Main Access Route Alternative, Northern Power Line Route	4-139
4.15.7	Northwest Main Access Route Alternative, Southern Power Line Route	4-140
4.15.8	Modified County Road Re-Route Alternative	4-140
4.15.9	Western Tailings Storage Facility Alternative	4-140
4.15.10	No Action Alternative	4-141
4.15.11	Additional Monitoring and Mitigation.....	4-141
4.16	Visual Resources	4-141
4.16.1	Analysis Areas	4-142
4.16.2	Indicators	4-142
4.16.3	Proposed Action	4-142
4.16.4	Northern Power Line Route Alternative	4-147
4.16.5	Southern Power Line Route Alternative	4-148
4.16.6	Northwest Main Access Route Alternative, Northern Power Line Route	4-148
4.16.7	Northwest Main Access Route Alternative, Southern Power Line Route	4-148
4.16.8	Modified County Road Re-Route Alternative	4-149
4.16.9	Western Tailings Storage Facility Alternative	4-149
4.16.10	No Action Alternative	4-150
4.16.11	Additional Monitoring and Mitigation.....	4-150
4.17	Recreation	4-150
4.17.1	Analysis Areas	4-150
4.17.2	Indicators	4-150
4.17.3	Proposed Action	4-150
4.17.4	Northern Power Line Route Alternative	4-153
4.17.5	Southern Power Line Route Alternative	4-153
4.17.6	Northwest Main Access Route Alternative, Northern Power Line Route	4-153
4.17.7	Northwest Main Access Route Alternative, Southern Power Line Route	4-154

4.17.8	Modified County Road Re-Route Alternative	4-154
4.17.9	Western Tailings Storage Facility Alternative	4-154
4.17.10	No Action Alternative	4-155
4.17.11	Additional Monitoring and Mitigation.....	4-155
4.18	Socioeconomic Resources.....	4-155
4.18.1	Analysis Areas	4-155
4.18.2	Indicators	4-156
4.18.3	Proposed Action	4-157
4.18.4	Alternatives	4-169
4.18.5	Additional Monitoring and Mitigation.....	4-169
4.19	Environmental Justice	4-169
4.19.1	Analysis Areas	4-170
4.19.2	Indicators	4-170
4.19.3	Proposed Action	4-171
4.19.4	Action Alternatives to the Proposed Action	4-173
4.19.5	No Action Alternative	4-173
4.19.6	Additional Monitoring and Mitigation.....	4-173
4.20	Hazardous Materials and Wastes	4-173
4.20.1	Analysis Areas	4-174
4.20.2	Indicators	4-175
4.20.3	Proposed Action	4-175
4.20.4	Northern Power Line Route Alternative	4-180
4.20.5	Southern Power Line Route Alternative	4-181
4.20.6	Northwest Main Access Route Alternative, Northern Power Line Route	4-181
4.20.7	Northwest Main Access Route Alternative, Southern Power Line Route	4-181
4.20.8	Modified County Road Re-Route Alternative	4-181
4.20.9	Western Tailings Storage Facility Alternative	4-182
4.20.10	No Action Alternative	4-182
4.20.11	Additional Monitoring and Mitigation.....	4-182
4.21	Unavoidable Adverse Impacts	4-182
4.21.1	Water Resources	4-182
4.21.2	Geology and Minerals.....	4-182
4.21.3	Paleontological Resources	4-182
4.21.4	Soils	4-183
4.21.5	Prime and Unique Farmlands.....	4-183
4.21.6	Air Resources	4-184
4.21.7	Vegetation Including Noxious and Non-Native, Invasive Weeds and Special Status Plants.....	4-184
4.21.8	Wildlife Resources, Including Migratory Birds and Special Status Wildlife	4-184
4.21.9	Range Resources	4-185
4.21.10	Forest Products and Fuels	4-185
4.21.11	Wild Horses	4-185
4.21.12	Cultural Resources	4-185
4.21.13	Native American Religious and Traditional Values	4-186
4.21.14	Land Use Authorization and Access.....	4-186

4.21.15	Visual Resources.....	4-186
4.21.16	Recreation	4-186
4.21.17	Socioeconomic Resources	4-186
4.21.18	Environmental Justice.....	4-187
4.21.19	Hazardous Materials and Wastes.....	4-187
4.22	Irreversible and Irretrievable Commitments of Resources.....	4-187
4.22.1	Water Resources.....	4-187
4.22.2	Geology and Minerals.....	4-187
4.22.3	Paleontological Resources	4-187
4.22.4	Soils	4-187
4.22.5	Prime and Unique Farmlands.....	4-188
4.22.6	Air Resources	4-188
4.22.7	Vegetation Including Noxious and Non-Native, Invasive Weeds and Special Status Plants.....	4-188
4.22.8	Wildlife Resources, Including Migratory Birds and Special Status Wildlife	4-188
4.22.9	Range Resources	4-188
4.22.10	Forest Products and Fuels	4-189
4.22.11	Wild Horses	4-189
4.22.12	Cultural Resources	4-189
4.22.13	Native American Religious and Traditional Values	4-189
4.22.14	Land Use Authorization and Access.....	4-189
4.22.15	Visual Resources.....	4-190
4.22.16	Recreation	4-190
4.22.17	Socioeconomic Resources	4-190
4.22.18	Environmental Justice.....	4-190
4.22.19	Hazardous Materials and Wastes.....	4-190
4.23	Relationship of Short-Term Uses and Long-Term Productivity	4-190
4.23.1	Water Resources	4-190
4.23.2	Geology and Minerals.....	4-190
4.23.3	Paleontological Resources	4-191
4.23.4	Soils	4-191
4.23.5	Prime and Unique Farmlands.....	4-191
4.23.6	Air Resources	4-191
4.23.7	Vegetation Resources Including Noxious and Non-Native, Invasive Weeds and Special Status Plants.....	4-191
4.23.8	Wildlife Resources, Including Migratory Birds and Special Status Wildlife	4-192
4.23.9	Range Resources	4-192
4.23.10	Forest Products and Fuels	4-192
4.23.11	Wild Horses	4-193
4.23.12	Cultural Resources	4-193
4.23.13	Native American Religious and Traditional Values	4-193
4.23.14	Land Use Authorization and Access.....	4-193
4.23.15	Visual Resources.....	4-193
4.23.16	Recreation	4-194
4.23.17	Socioeconomic Resources	4-194

4.23.18	Environmental Justice.....	4-194
4.23.19	Hazardous Materials and Wastes.....	4-194
CHAPTER 5 CUMULATIVE EFFECTS.....		5-1
5.1	Introduction.....	5-1
5.1.1	Time Frame for Analysis.....	5-5
5.1.2	Past, Present, Reasonably Foreseeable Future Actions, Disturbances and Projects	5-8
5.2	Past Actions	5-8
5.2.1	Mineral Development and Exploration Past Actions	5-8
5.2.2	Oil and Gas Development Past Actions	5-16
5.2.3	Utilities, Infrastructure and Public Purpose Past Actions	5-16
5.2.4	Roads Past Actions	5-19
5.2.5	Recreation Past Actions	5-23
5.2.6	Wild land Fires, Restoration, and Seeding Past Actions.....	5-24
5.3	Present Actions.....	5-24
5.3.1	Mineral Development and Exploration Present Actions	5-24
5.3.2	Utilities, Infrastructure and Public Purpose Present Actions	5-29
5.3.3	Oil, Gas, and Geothermal Development Present Actions	5-29
5.3.4	Recreation Present Actions	5-29
5.3.5	Wild land Fires.....	5-29
5.3.6	Urban Development Present Actions	5-29
5.4	Reasonably Foreseeable Future Actions.....	5-30
5.4.1	Mineral Development and Exploration.....	5-30
5.4.2	Oil, Gas, and Geothermal Development.....	5-32
5.4.3	Utilities Infrastructure and Public Purpose.....	5-33
5.4.4	Roads	5-34
5.4.5	Other Reasonably Foreseeable Actions.....	5-34
5.5	Water Resources	5-34
5.5.1	CESA Boundary.....	5-34
5.5.2	Introduction	5-35
5.5.3	Past and Present Disturbances	5-35
5.5.4	Reasonably Foreseeable Future Disturbances	5-38
5.5.5	Cumulative Disturbances.....	5-39
5.5.6	Cumulative Effects.....	5-39
5.6	Geology and Minerals	5-40
5.6.1	CESA Boundary.....	5-40
5.6.2	Introduction	5-40
5.6.3	Past and Present Activities	5-41
5.6.4	Reasonably Foreseeable Future Activities.....	5-41
5.6.5	Cumulative Disturbances.....	5-41
5.6.6	Cumulative Effects.....	5-45
5.7	Soils.....	5-45
5.7.1	CESA Boundary.....	5-45
5.7.2	Introduction	5-45
5.7.3	Past and Present Activities.....	5-45

5.7.4	Reasonably Foreseeable Future Activities	5-46
5.7.5	Cumulative Disturbances	5-46
5.7.6	Cumulative Effects	5-46
5.8	Prime and Unique Farmland	5-47
5.8.1	CESA Boundary	5-47
5.8.2	Introduction	5-47
5.8.3	Past and Present Disturbances	5-47
5.8.4	Reasonably Foreseeable Future Disturbances	5-47
5.8.5	Cumulative Disturbances	5-48
5.8.6	Cumulative Effects	5-48
5.9	Air Resources	5-48
5.9.1	CESA Boundary	5-48
5.9.2	Introduction	5-48
5.9.3	Past and Present Actions	5-49
5.9.4	Reasonably Foreseeable Future Actions	5-49
5.9.5	Cumulative Disturbances	5-50
5.9.6	Cumulative Effects	5-50
5.10	Vegetation, Including Noxious and Non-Native, Invasive Weeds and Special Status Plants ..	5-50
5.10.1	CESA Boundary	5-50
5.10.2	Introduction	5-50
5.10.3	Past and Present Disturbances	5-51
5.10.4	Reasonably Foreseeable Future Disturbances	5-52
5.10.5	Cumulative Disturbances	5-52
5.10.6	Cumulative Effects	5-52
5.11	Wildlife Resources, Including Special Status Wildlife and Migratory Birds	5-53
5.11.1	CESA Boundary	5-53
5.11.2	Introduction	5-54
5.11.3	Past and Present Disturbances	5-58
5.11.4	Reasonably Foreseeable Future Disturbances	5-61
5.11.5	Cumulative Disturbances	5-62
5.11.6	Cumulative Effects	5-65
5.12	Range Resources	5-67
5.12.1	CESA Boundary	5-67
5.12.2	Introduction	5-67
5.12.3	Past and Present Disturbances	5-67
5.12.4	Reasonably Foreseeable Future Disturbances	5-71
5.12.5	Cumulative Disturbances	5-71
5.12.6	Cumulative Effects	5-72
5.13	Forest Products and Fuels	5-72
5.13.1	CESA Boundary	5-72
5.13.2	Introduction	5-72
5.13.3	Past and Present Disturbances	5-72
5.13.4	Reasonably Foreseeable Future Disturbances	5-73
5.13.5	Cumulative Disturbances	5-74

5.13.6	Cumulative Effects	5-74
5.14	Wild Horses	5-75
5.14.1	CESA Boundary	5-75
5.14.2	Introduction	5-75
5.14.3	Past and Present Disturbances	5-76
5.14.4	Reasonably Foreseeable Future Disturbances	5-76
5.14.5	Cumulative Disturbances	5-76
5.14.6	Cumulative Effects	5-77
5.15	Cultural Resources	5-78
5.15.1	CESA Boundary	5-78
5.15.2	Introduction	5-78
5.15.3	Past and Present Actions	5-78
5.15.4	Reasonably Foreseeable Future Actions	5-79
5.15.5	Cumulative Disturbance	5-79
5.15.6	Cumulative Effects	5-80
5.16	Land Use Authorization and Access	5-80
5.16.1	CESA Boundary	5-80
5.16.2	Introduction	5-80
5.16.3	Past and Present Disturbances	5-80
5.16.4	Reasonably Foreseeable Future Disturbances	5-81
5.16.5	Cumulative Disturbances	5-81
5.16.6	Cumulative Effects	5-81
5.17	Visual Resources	5-82
5.17.1	CESA Boundary	5-82
5.17.2	Introduction	5-82
5.17.3	Past and Present Disturbances	5-83
5.17.4	Reasonably Foreseeable Future Disturbances	5-83
5.17.5	Cumulative Disturbances	5-83
5.17.6	Cumulative Effects	5-83
5.18	Recreation	5-84
5.18.1	CESA Boundary	5-84
5.18.2	Introduction	5-84
5.18.3	Past and Present Disturbances	5-84
5.18.4	Reasonably Foreseeable Future Disturbances	5-85
5.18.5	Cumulative Disturbances	5-85
5.18.6	Cumulative Effects	5-86
5.19	Socioeconomics	5-86
5.19.1	CESA Boundary	5-86
5.19.2	Introduction	5-87
5.19.3	Past and Present Activities	5-87
5.19.4	Reasonably Foreseeable Future Activities	5-87
5.19.5	Cumulative Effects	5-87
5.20	Hazardous and Solid Waste	5-88
5.20.1	CESA Boundary	5-88

5.20.2	Introduction	5-89
5.20.3	Past and Present Actions	5-92
5.20.4	Reasonably Foreseeable Future Actions	5-92
5.20.5	Cumulative Disturbances.....	5-92
5.20.6	Cumulative Effects.....	5-93
CHAPTER 6 CONSULTATION AND COORDINATION		6-1
6.1	Cooperating Agencies and Consultation.....	6-1
6.2	Scoping Process	6-2
6.2.1	Notice of Intent.....	6-2
6.2.2	Legal Notices and Press Releases.....	6-3
6.2.3	Project Website.....	6-3
6.2.4	Scoping Letter.....	6-4
6.2.5	Scoping Meetings	6-4
6.2.6	Scoping Response.....	6-4
6.3	DEIS Mailing List.....	6-5
6.4	DEIS Notification and Distribution.....	6-5
6.5	Next Steps in the Planning Process.....	6-5
6.6	List of Preparers and Reviewers.....	6-5
CHAPTER 7 REFERENCES, ACRONYMS AND ABBREVIATIONS, GLOSSARY		7-1
7.1	References	7-1
7.2	Acronyms and Abbreviations	7-39
7.3	Glossary	7-45
INDEX		I-1

Tables

Table 1.9-1	Required Permits	1-12
Table 2.3-1	Summary of Authorized and Proposed Disturbance.....	2-7
Table 2.3-2	Estimated Conceptual Timeline for the Gold Rock Mine Project.....	2-8
Table 2.3-3	Proposed Mobile Mine Equipment.....	2-17
Table 2.3-4	Fuels, Reagents, Volumes and Shipments.....	2-45
Table 2.3-5	Soil Salvage Volumes	2-56
Table 2.3-6	Reclamation Seed Mixture.....	2-59
Table 2.3-7	Applicant-Committed Environmental Protection Measures By Resource for Proposed Action.....	2-69
Table 2.6-1	Summary of Environmental Effects.....	2-91
Table 3.2-1	Water Balance for Railroad Valley/Northern Part (afy).....	3-6
Table 3.3-1	Mapped Quaternary or Younger Faults in the Region.....	3-22
Table 3.3-2	Regional Earthquake Probabilities.....	3-29
Table 3.3-3	Summary of Recent Earthquakes in Nevada.....	3-29
Table 3.5-1	Soil Erosion and Restoration Limitations for Mapped Soils in the Analysis Areas	3-39
Table 3.7-1	Meteorological Conditions Near the Project Area at Eureka, Nevada (Station 262708).....	3-45

Table 3.7-2	Nevada and National Ambient Air Quality Standards	3-47
Table 3.8-2	Special Status Plant Species Targeted During the 2011-2013 Gold Rock Botanical Surveys68TP1	3-61
Table 3.9-1	NDOT Big Game Collision Data: December 1, 2008 to December 1, 2013	3-65
Table 3.9-2	NDOW Lek Survey Data for the Butte/Buck/White Pine PMU	3-77
Table 3.9-3	Activity Status for Leks Identified by NDOW as Occurring In the Project Area	3-78
Table 3.9-4	BLM Sensitive and State of Nevada Protected Species with the Potential to Occur in the Plan Area	3-83
Table 3.10-1	Allotment Information and Grazing Use	3-93
Table 3.11-1	Community Productivity for Mapped Vegetation Community Types in the Project Area	3-99
Table 3.13-1	Tally of Cultural Resource Components in the Plan Area and within 1 Mile of the Plan AreaP1	3-110
Table 3.13-2	Summary Counts of Potential Historic Properties	3-111
Table 3.15-1	Annual Average Daily Traffic	3-115
Table 3.15-2	Active Mining Claims	3-120
Table 3.16-1	Key Observation Points	3-124
Table 3.18-2	Project Region Population, 1970-2010	3-135
Table 3.18-3	Projected Resident Population: White Pine and Eureka Counties, 2010 – 2030	3-136
Table 3.18-4	Housing Inventory	3-136
Table 3.18-5	Recent White Pine and Eureka County Assessor Housing Counts	3-137
Table 3.18-6	Temporary Housing Resources in Ely and Eureka	3-138
Table 3.18-7	White Pine and Eureka County School District Enrollment	3-140
Table 3.18-8	Total Employment in White Pine County and Eureka County – 1990, 2001 and 2011	3-146
Table 3.18-9	County Employment, by Broad Industrial Grouping (Place of Work Basis): 2012	3-148
Table 3.18-10	Geographic Distribution of Private Sector Establishments and Employees in White Pine and Eureka Counties, 2011	3-149
Table 3.18-11	Major Employers in White Pine and Eureka Counties, First Quarter 2014	3-149
Table 3.18-12	Regional Labor Force, Unemployment and Unemployment Rates, 2008 to 2013	3-150
Table 3.18-13	White Pine and Eureka County Personal Income by Place of Residence: 2011	3-151
Table 3.18-14	White Pine County General Fund Revenues (In Dollars): Fiscal Years 2011-12 to 2014-15	3-152
Table 3.18-15	Eureka County General Fund Revenues (In Dollars): Fiscal Years 2010-11 to 2013-14	3-153
Table 3.18-16	Countywide Ad Valorem Tax Rates in White Pine County and Eureka County, Fiscal Year 2013-2014	3-153
Table 3.18-17	White Pine and Eureka County Assessed Values, Fiscal Years 2002/2003 through 2013/2014P1	3-154
Table 3.18-18	Sales and Use Tax Rates: White Pine and Eureka Counties	3-155
Table 3.18-19	Taxable Sales – Eureka and White Pine Counties, Fiscal Years 2007-2008 to 2012-2013	3-156
Table 3.18-20	Taxable Retail Sales, Total and By Major Industry – Eureka and White Pine Counties, Fiscal Year 2012-2013	3-156
Table 3.18-21	Federal Payments In Lieu of Taxes: Acreages and Annual Payment, Fiscal Year 2012-2013	3-156
Table 3.18-22	White Pine County Expenditures, Fiscal Years 2011-2012 to 2014-2015	3-157

Table 3.18-23	Eureka County Budgeted Expenditures Fiscal Years 2010-2011 to 2013-2014.....	3-157
Table 3.18-24	Eureka and White Pine Counties, Full Time Equivalent Positions, Fiscal Years 2012 and 2013	3-158
Table 3.18-25	White Pine County Fiscal Summary: Fiscal Years 2010-11 to 2013-14	3-158
Table 3.18-26	Eureka County Fiscal Summary: Fiscal Years 2010-11 to 2013-14.....	3-159
Table 3.18-27	City of Ely Fiscal Summary: Fiscal Years 2010/2011 to 2013/2014.....	3-159
Table 3.19-1	Racial and Ethnic Minority Populations.....	3-160
Table 3.19-2	2012 Estimated Poverty Rates for White Pine County and Eureka County	3-161
Table 3.19-3	2012 School Age Incident of Poverty Data	3-161
Table 4.3-1	Pit Design Parameters and Dimensions	4-12
Table 4.3-2	WRDA Design Parameters and Dimensions	4-13
Table 4.8-1	Disturbance by Vegetation Community Type Under the Proposed Action	4-39
Table 4.8-2	Additional Daily Trips Under the Proposed Action	4-40
Table 4.8-3	Disturbance by Vegetation Community Type Under the Northern Power Line Route Alternative.....	4-45
Table 4.8-4	Disturbance by Vegetation Community Type Under the Southern Power Line Route Alternative.....	4-46
Table 4.8-5	Disturbance by Vegetation Community Type Under the Northwest Main Access Route Alternatives.....	4-49
Table 4.8-6	Additional Daily Trips Under the Northwest Main Access Route Alternatives (Northern or Southern Power Line Route)	4-50
Table 4.8-7	Disturbance by Vegetation Community Type Under the Modified County Road Re-route Alternative	4-52
Table 4.8-8	Disturbance by Vegetation Community Type Under the Western Tailings Storage Facility Alternative	4-53
Table 4.9-1	Mule Deer Range Surface Disturbance under the Proposed Action	4-61
Table 4.9-2	Pronghorn Antelope Range Surface Disturbance under the Proposed Action.....	4-62
Table 4.9-3	Greater Sage-Grouse Lek Proximity to Nearest Noise-Producing Activity Associated with Proposed Action.....	4-67
Table 4.9-4	Greater Sage-Grouse Lek Proximity to Nearest Onsite Noise-Producing Activity Associated with Proposed Action.....	4-70
Table 4.9-5	Greater Sage-Grouse Habitat Impacts Associated with Proposed Action and Alternatives1	4-71
Table 4.9-6	Special Status Migratory Bird Species Disturbance under the Proposed Action	4-76
Table 4.10-1	Impacts To Grazing Allotments under the Proposed Action	4-117
Table 4.11-1	Disturbance to Great Basin Pinyon-Juniper Woodlands Under the Proposed Action and Alternatives1	4-121
Table 4.11-2	Proposed Action Fuel Availability and Loading.....	4-122
Table 4.11-3	Disturbances to Fuel Availability and Loading Under the Proposed Action and Alternatives	4-123
Table 4.18-1	Communities In the Analysis Area: Population and Travel Distance to Proposed Mine Site	4-155
Table 4.18-2	Annual Economic Impacts of Lost Animal Unit Months	4-160
Table 4.20-1	Hazardous Material National Accident Rate per Mile	4-177
Table 4.20-2	Hazardous Material Probability of Transportation Release	4-179
Table 5.1-1	Cumulative Effects Study Area by Resource	5-2

Table 5.2-1	Surface Disturbance in Acres of Past, Present, and Reasonably Foreseeable Future Actions for the Gold Rock Mine Project Cumulative Effects Study Area.....	5-11
Table 5.2-2	Other Utility Lines Past Actions (Direct Disturbance)	5-17
Table 5.2-3	Roads Past Actions.....	5-19
Table 5.2-4	Recreation, Wilderness Study Areas, and Wilderness and Areas Parks Past Actions	5-24
Table 6.6-1	List of Preparers and Technical Specialists.....	6-5
Table 6.6-2	Third Party Contractor – ARCADIS U.S., Inc.....	6-6

Figures

Figure 1.1-1	Project Location	1-3
Figure 1.1-2	Land Ownership and Access	1-4
Figure 1.2-1	Existing and Reclaimed Facilities	1-5
Figure 2.2-1	Authorized Exploration Disturbance	2-3
Figure 2.3-1	Proposed Action Facilities	2-4
Figure 2.3-2	Typical Haul Road Cross-Section.....	2-11
Figure 2.3-3	69 kV Transmission Line Structures.....	2-15
Figure 2.3-4	Typical Cross-Section of the Pit	2-16
Figure 2.3-5	Typical Cross Section of Waste Rock Disposal Areas.....	2-19
Figure 2.3-6	Cross-sectional View of Geochemical Sample Locations	2-21
Figure 2.3-7	Typical Cross-Section of Heap Leach Pad.....	2-25
Figure 2.3-8	Typical Design of Heap Leach Liner.....	2-26
Figure 2.3-9	Heap Leach Flowsheet.....	2-31
Figure 2.3-10	Mill Flowsheet.....	2-32
Figure 2.3-11	Conceptual Tailings Storage Facility Layout	2-35
Figure 2.3-12	Typical Cross Section of Tailings Storage Facility	2-37
Figure 2.3-13	Typical Cross-Section of a Stormwater Diversion	2-41
Figure 2.3-14	Site-Wide Reclamation Plan and Post-Mining Topography	2-57
Figure 2.3-15	Roads and Surface Facilities Not Subject To Reclamation.....	2-65
Figure 2.4-1	Power Line Route Alternatives	2-77
Figure 2.4-2	Access Route Alternatives.....	2-83
Figure 2.4-3	Western Tailings Storage Facility Alternative.....	2-84
Figure 3.2-1	Water Resources.....	3-3
Figure 3.2-2	Topographic Map of the Plan Area.....	3-4
Figure 3.2-3	Regional Hydrogeology	3-7
Figure 3.2-4	Hydrogeologic Cross Section Near the Plan Area	3-11
Figure 3.2-5	Generalized Geologic Cross Section at the Existing Easy Junior Pit.....	3-12
Figure 3.2-6	Water Rights Points of Diversion.....	3-17
Figure 3.3-1	Local Geology.....	3-23
Figure 3.3-2	Stratigraphic Column	3-24
Figure 3.3-3	Gold Rock Mine Project Cross Section Geology.....	3-25
Figure 3.3-4	Quaternary Faults.....	3-27
Figure 3.4-1	Geologic Units with Unknown Paleontological Sensitivity	3-33

Figure 3.5-1	Plan Area Soils	3-37
Figure 3.6-1	Prime Farmlands	3-43
Figure 3.8-1	Vegetation Communities	3-53
Figure 3.9-1	NDOW Hunt Units.....	3-63
Figure 3.9-2	Mule Deer Seasonal Ranges.....	3-64
Figure 3.9-3	Pronghorn antelope Seasonal Ranges.....	3-67
Figure 3.9-4	Elk Seasonal Ranges	3-68
Figure 3.9-5	Raptor Nests.....	3-71
Figure 3.9-6	Greater Sage-grouse Population Management Units and Preliminary Habitat Categories	3-75
Figure 3.9-7	Pygmy Rabbits.....	3-81
Figure 3.10-1	Grazing Allotments	3-91
Figure 3.11-1	Forest Products and Fuels	3-101
Figure 3.12-1	Herd Management Areas and Wild Horse Territory	3-105
Figure 3.15-1	Land Ownership, Special Designations, and Authorizations.....	3-117
Figure 3.15-2	Road System and Hazardous Material and Waste Transportation Routes.....	3-118
Figure 3.16-1	Visual Resource Management (VRM) Classifications and Potential Key Observation Points (KOPs)	3-125
Figure 3.18-1	Census Population: White Pine and Eureka Counties 1900 – 2010.....	3-135
Figure 3.18-2	Employment 1990-2011	3-147
Figure 3.18-3	Annual Average Unemployment Rates 2006-2013.....	3-150
Figure 4.8-1	Routes Leading to the Plan Area.....	4-42
Figure 4.9-1	Wildlife Impact Analysis, Proposed Action	4-59
Figure 4.9-2	Wildlife Impact Analysis, Power Line Route Alternatives	4-84
Figure 4.9-3	Wildlife Impact Analysis, Access Route Alternatives.....	4-93
Figure 4.9-4	Wildlife Impact Analysis, Western Tailings Storage Facility Alternative.....	4-106
Figure 5.1-1	Comprehensive CESA Boundary and Disturbance Map.....	5-6
Figure 5.1-2	Water Resources, Soils and Reclamation, Prime and Unique Farmland, Air Resources, Vegetation and Invasive, Non-Native Plant Species, Forest Products and Fuels, Wild Horses, Cultural CESAs.....	5-36
Figure 5.1-3	Geology and Minerals, Land Use Authorization and Access, Visual Resources and Socioeconomic CESAs.....	5-43
Figure 5.1-4	Wildlife and Recreation CESAs	5-56
Figure 5.1-5	Range Resources and Wildfire Activity	5-69
Figure 5.1-6	Hazardous Materials and Waste CESA.....	5-90

Appendices

- Appendix 1A Programmatic Agreement Between the Bureau of Land Management, Egan Field Office and the Nevada State Historic Preservation Officer Regarding the Midway Gold US Inc. Gold Rock Project
- Appendix 2A BLM Ely District Recommended Bird Nest Buffer Sizes
- Appendix 3A Nevada Division of Water Resources Water Rights Database Records
- Appendix 3B List of Scientific Names for Plant Species Described in the Draft Environmental Impact Statement for the Gold Rock Mine Project
- Appendix 3C List of Scientific Names for Wildlife Species Described in the Draft Environmental Impact Statement for the Gold Rock Mine Project
- Appendix 3D Visual Contrast Rating Worksheets

This page intentionally left blank.

CHAPTER 1

INTRODUCTION

1.1 OVERVIEW

Midway Gold U.S. Inc. (Midway) submitted the *Gold Rock Project Plan of Operations and Reclamation Permit Application* (Plan) to the Bureau of Land Management (BLM) Ely District Egan Field Office (EFO) in March 2013 in compliance with Code of Federal Regulations (CFR) 43 CFR Subpart 3809. The Gold Rock Mine Project (the project) is located in White Pine County, Nevada on the east side of the Pancake Range approximately 50 miles west of Ely, 30 miles southeast of Eureka, and 15 miles south of U.S. Highway 50 (US 50) (Figure 1.1-1). The proposed project is located within all or portions of the following sections of the Public Land Survey System (PLSS), Mount Diablo Baseline and Meridian (MDBM):

- Township 15 North, Range 55 East, sections 1, 13, and 24
- Township 15 North, Range 56 East, sections 2 through 10, 15 through 22, and 27 through 35;
- Township 16 North, Range 55 East, sections 2, 11, 14, 23, 26, 35, and 36;
- Township 16 North, Range 56 East, sections 22, 23, 25, 26, 27, 28, 29, and 31 through 35; and
- Township 17 North, Range 55 East, sections 22, 27, 34, and 35.

The Plan area would encompass 18,745 acres. Approximately 8,757 acres within the Plan area would be fenced to preclude access by the public, wild horses, and livestock. Mining activities would occur within this fenced area (mine area) in all or portions of Township 15 North, Range 56 East, sections 3 through 10, 15 through 22, and 27 through 29 (Figure 1.1-2). Exploration activities would occur anywhere within the Plan area.

This *Draft Environmental Impact Statement of the Gold Rock Mine Project* (DEIS) was prepared in compliance with the National Environmental Policy Act of 1969 (NEPA); the Council on Environmental Quality (CEQ) regulations for implementing NEPA (40 CFR 1500 – 1508); and in accordance with the BLM NEPA Handbook H-1790-1 (BLM 2008a), applicable instruction memoranda, and other applicable laws and regulations. All baseline data reports and other information used in preparation of this DEIS are included in the Project Record and are available for review at the BLM EFO.

Chapter 1 explains the Purpose of and Need for the Proposed Action, lists the issues evaluated in the DEIS, and provides other introductory information. Chapter 2 describes the Proposed Action and alternatives including the No Action Alternative and other Action Alternatives. Chapter 3 describes the affected environment, and Chapter 4 documents the environmental consequences of the Proposed Action and each alternative, including measures that would mitigate adverse effects. Cumulative effects are described in Chapter 5. Chapter 6 provides the consultation and coordination information used for the preparation of this document. Chapter 7 provides the references, glossary, and index. This DEIS discloses the environmental consequences of implementing the Proposed Action and alternatives.

1.2 PROJECT HISTORY

Mining has taken place in the general region since the 1860s. Earth Resources Co. first staked the project area in 1979. Since then, several exploration and/or mining companies have explored the Gold Rock property. These companies include Houston International Minerals, Santa Fe Mining, Tenneco, Echo Bay Exploration, and Alta Gold Co. (Alta Gold).

Within the Plan area, Alta Gold and Echo Bay worked together through the Alta Bay joint venture and initiated operation of the Easy Junior Mine in 1989. Mining began in February 1989 and continued until November 1990, when gold prices dropped. The Easy Junior Mine was maintained in care and maintenance status in 1991 and 1992, during which time Alta Gold acquired Echo Bay Mine's interest in the property (Midway 2013a). The Proposed Action would involve expanding the Easy Junior pit and incorporating several other Easy Junior facilities. Figure 1.2-1 shows the site layout of the Easy Junior Mine in 2004 during reclamation and closure activities described below.

Alta Gold resumed mining the property in 1993 and completed its mining in 1994. The pit was mined to an elevation of 6,190 feet amsl, and had a footprint of approximately 33 acres. Alta Gold had received approval for a total disturbance of 298 acres of facilities; however, only portions of some of the facilities were constructed. In addition to the pit, Alta Bay or Alta Gold constructed an 18-acre crusher area, a 23-acre heap leach pad with other disturbance totaling 30 surveyed acres, a 67-acre waste rock dump, a barren solution pond, a settling pond, an overflow (storm) pond, a pregnant solution sump, and carbon adsorption columns at a 22-acre process/shop area. Facilities also included a 15-acre borrow area, a 21-acre water pipeline corridor, and about 42 acres of haul, drill, and site roads. In summary, the total area of disturbance covered approximately 248 acres, and the remaining 50 permitted acres had not been disturbed (Alta Gold 1996, Alta Gold 1999b).

Concurrent with mining activities, the waste rock dump slopes were pushed to 3 horizontal feet for each vertical foot (3h:1v) (Alta Gold 1996). Other reclamation activities were performed in 1994 and 1995, including establishment of an isolation berm for the pit, and revegetating a portion of the 67-acre waste rock dump area by applying cover soil and reseeding (CDM Federal Programs and CDM Constructors Inc. 2003).

Leaching continued through October 1996, and residual leaching and rinsing continued until June 1997. From April to September 1998, Alta Gold land-applied residual rinse-down solution to an area immediately south of the heap. During this period, Alta Gold also disconnected the process ponds from the heap and commissioned a drainfield to infiltrate long-term residual leach pad effluent (CDM Federal Programs and CDM Constructors Inc. 2003). In April 1999 following completion of active mining, Alta Gold Company filed for bankruptcy. In 1999 and early 2000, Alta Gold requested approval for surety release for reclamation of approximately 109 acres of disturbance, removal of the shop, carbon plant, and crushing plant, along with the 50 permitted acres that hadn't been disturbed (Alta Gold 1999b, 2000a).

In June 2001, the Nevada Interagency Abandoned Mine Lands Environmental Task Force proposed to the U.S. Army Corps of Engineers (USACE) Western Region Restoration of Abandoned Mine Sites a list of abandoned mine land projects scattered across the State of Nevada that required extra funding for additional assessment prior to beginning reclamation.

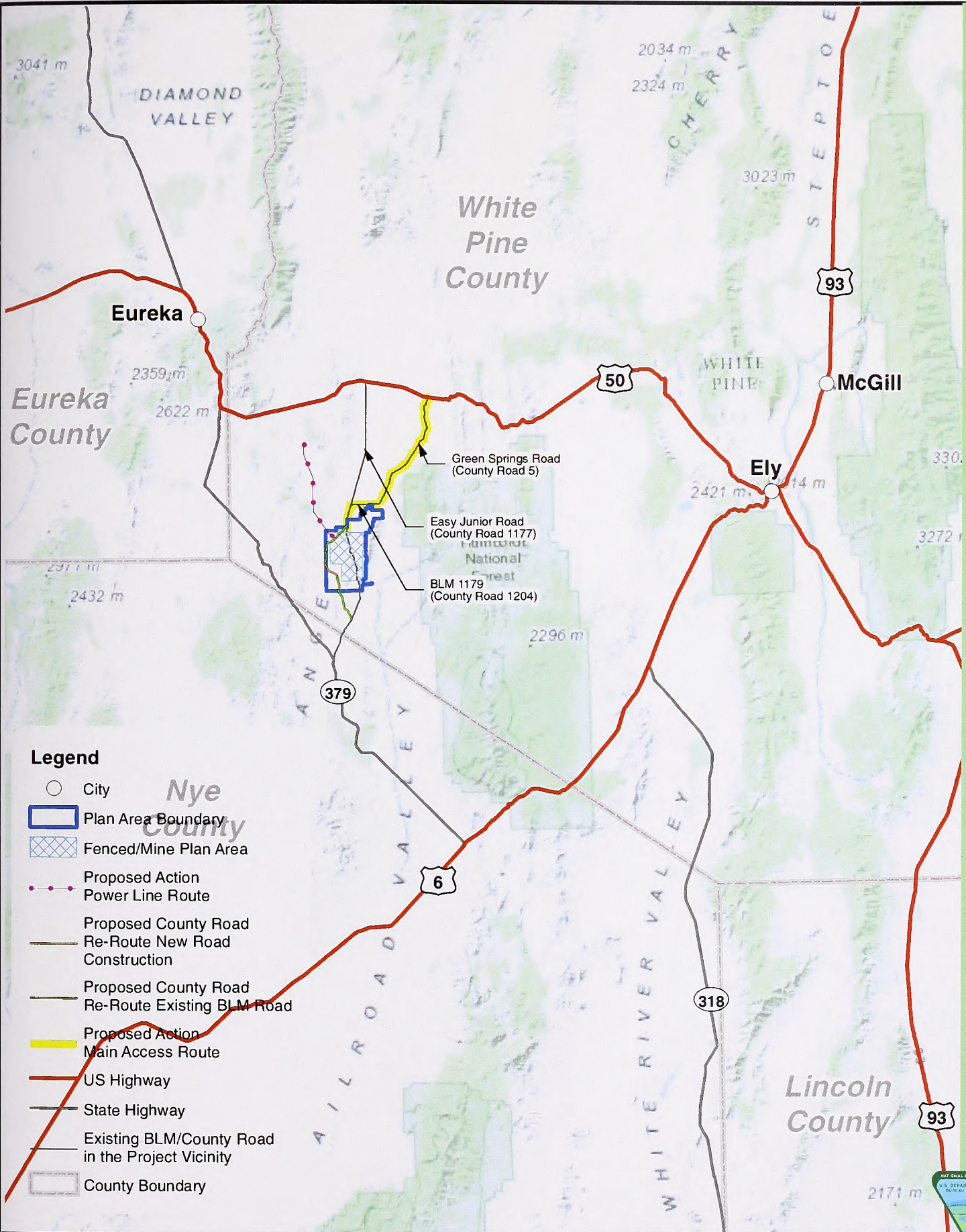

Legend

- City
- Plan Area Boundary
- Fenced/Mine Plan Area
- Proposed Action Power Line Route
- Proposed County Road Re-Route New Road Construction
- Proposed County Road Re-Route Existing BLM Road
- Proposed Action Main Access Route
- US Highway
- State Highway
- Existing BLM/County Road in the Project Vicinity
- County Boundary

**FIGURE 1.1-1
PROJECT LOCATION**

**MIDWAY GOLD US INC.
GOLD ROCK MINE PROJECT**

MAPPED DATE: 10/16/2014

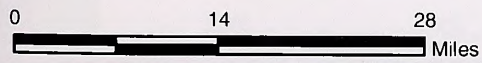

**U.S. BUREAU OF LAND MANAGEMENT
ELY DISTRICT
EGAN FIELD OFFICE**

NO WARRANTY IS MADE BY THE BUREAU OF LAND MANAGEMENT AS TO THE ACCURACY, RELIABILITY, OR COMPLETENESS OF THESE DATA FOR INDIVIDUAL USE OR AGGREGATE USE WITH OTHER DATA.

Basemap Source: ESRI Topographic Map Service

PATH: Z:\GIS\PROJECTS\ENW\00001817_GOLDROCK\GIS\ARCMAP_MXD\2014_DRAFT_LEIS\FIGURE_1_1\PROJECT_LOCATION_V3.MXD | LAST SAVED BY: JOHEN | LAST SAVED ON: 10/16/2014 2:44:27 PM

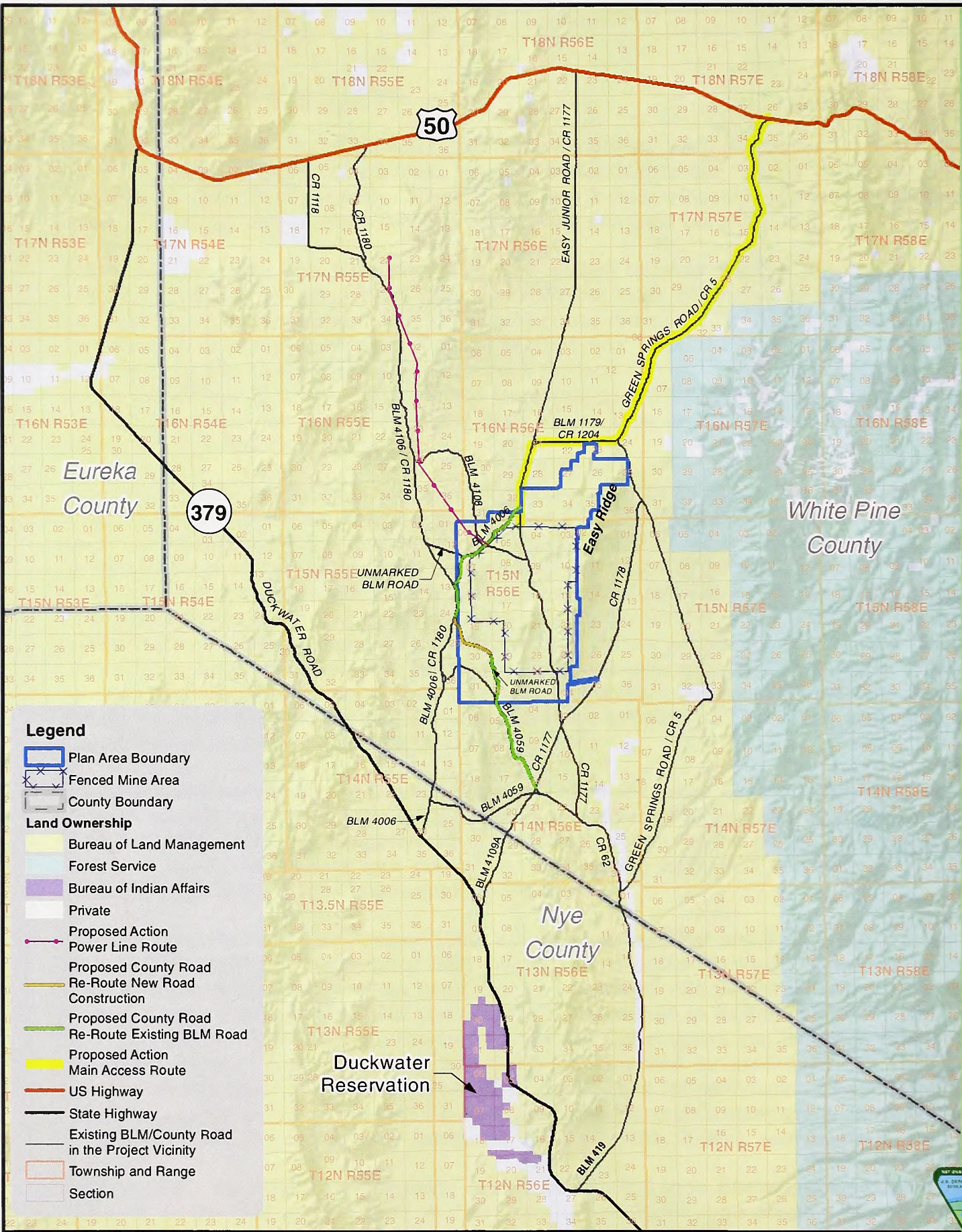

- Legend**
- Plan Area Boundary
 - Fenced Mine Area
 - County Boundary
 - Land Ownership**
 - Bureau of Land Management
 - Forest Service
 - Bureau of Indian Affairs
 - Private
 - Proposed Action Power Line Route
 - Proposed County Road
 - Re-Route New Road Construction
 - Proposed County Road Re-Route Existing BLM Road
 - Proposed Action Main Access Route
 - US Highway
 - State Highway
 - Existing BLM/County Road in the Project Vicinity
 - Township and Range
 - Section

FIGURE 1.1-2
LAND OWNERSHIP AND ACCESS
 MIDWAY GOLD US INC.
 GOLD ROCK MINE PROJECT

MAPPED DATE: 10/16/2014

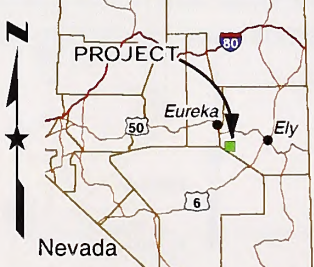
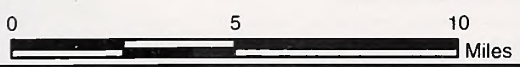

U.S. BUREAU OF LAND MANAGEMENT
 ELY DISTRICT
 EGAN FIELD OFFICE

NO WARRANTY IS MADE BY THE BUREAU OF LAND MANAGEMENT AS TO THE ACCURACY, RELIABILITY, OR COMPLETENESS OF THESE DATA FOR INDIVIDUAL USE OR AGGREGATE USE WITH OTHER DATA.

Basemap Source: ESRI World Shade Relief Map Service



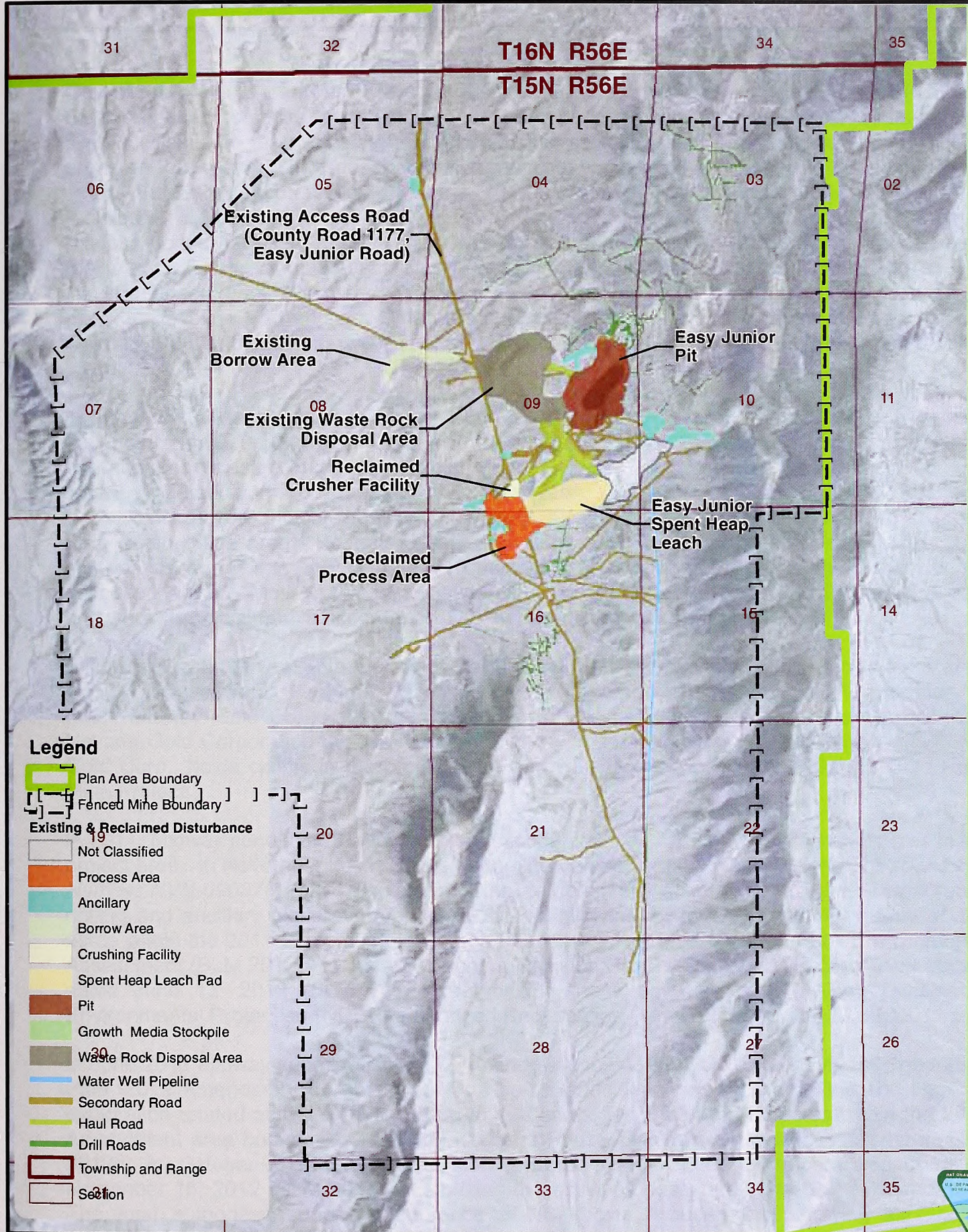

Legend

- Plan Area Boundary
- Fenced Mine Boundary
- Existing & Reclaimed Disturbance**
- Not Classified
- Process Area
- Ancillary
- Borrow Area
- Crushing Facility
- Spent Heap Leach Pad
- Pit
- Growth Media Stockpile
- Waste Rock Disposal Area
- Water Well Pipeline
- Secondary Road
- Haul Road
- Drill Roads
- Township and Range
- Section

FIGURE 1.2-1
EXISTING AND RECLAIMED FACILITIES
MIDWAY GOLD US INC.
GOLD ROCK MINE PROJECT

MAPPED DATE: 9/17/2014

0 3,500 7,000 Feet

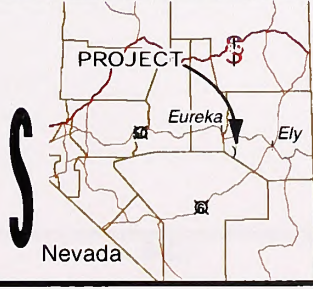

U.S. BUREAU OF LAND MANAGEMENT
 ELY DISTRICT
 EGAN FIELD OFFICE

NO WARRANTY IS MADE BY THE BUREAU OF LAND MANAGEMENT AS TO THE ACCURACY, RELIABILITY, OR COMPLETENESS OF THESE DATA FOR INDIVIDUAL USE OR AGGREGATE USE WITH OTHER DATA.

Basemap Source: ESRI World Imagery Map Service

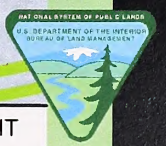

This page intentionally left blank.

One of the projects identified in this proposal included the Easy Junior Mine. The USACE and BLM proposed to close and reclaim the spent heap, ponds, and draindown management system, dismantle the remaining structures, remove debris, and, if funding permitted, reclaim areas on the waste rock disposal area that were not successfully reclaimed in the past. Based on the BLM's review of available records, 104 acres of existing disturbance had already been reclaimed (BLM 2004a). The USACE reclaimed approximately 71 acres, including the heap, process ponds, facilities, ancillary disturbance, and portions of the previously regraded waste rock dump. Final reclamation activities were initiated and completed in 2004 (BLM 2004a). The *Nevada Abandoned Mine Lands Report for 2005* (NDOM 2006) reported reclamation of the Easy Junior Mine as complete. The existing Easy Junior pit with a footprint of 33 acres (Alta Gold 1999), along with the water well and associated building and security fence were left in place.

In summary, surface disturbance has occurred within the Plan area (Figure 1.2-1). Available documents indicate that Alta Gold disturbed approximately 248 acres during construction, operation, and closure of the Easy Junior Mine. However, aerial mapping (Midway 2013a) and recent vegetation mapping within the Plan area (EcoSynthesis and Wildlife Resource Consultants 2013a) indicate that approximately 395 acres of surface disturbance exist in the Easy Junior Mine area. Portions of this area currently support reclamation vegetation. This disturbance represents approximately 10 percent of the proposed total disturbance under the Proposed Action. Most of this disturbance would be re-disturbed under the Proposed Action, and would be reclaimed in accordance with the facility that covers it.

Following bankruptcy of Alta Gold, several entities held claims in the Easy Junior Mine area, including Castleworth Ventures, which eventually became Pan-Nevada Gold Corporation. In 2007, Midway Gold Corporation gained control of the project through its acquisition of Pan-Nevada Gold Corporation (Midway 2013a). Midway, also a wholly owned subsidiary of Midway Gold Corp., holds claims in the project area and would construct and operate the Gold Rock Mine Project.

In 2011, Midway conducted Notice of Intent (Notice)-level exploration activities on 5 acres in the project area. In November 2011, Midway submitted an exploration plan of operations (*Case File Number NVN-090376*) (2011 Exploration Plan) to obtain authorization for additional exploration drilling and ancillary exploration-related activities involving up to 137 acres, for a total of 142 acres within the 2011 Exploration Plan area boundary. The BLM issued a Final Environmental Assessment (BLM 2012b) in June 2012 and a Decision Record/Finding of No Significant Impact dated June 12, 2012 (BLM 2012c) authorizing these activities. The Nevada Division of Environmental Protection (NDEP) authorized Reclamation Permit 0326 on July 22, 2012.

In June 2012 Midway submitted its 2012 Amendment to the 2011 Gold Rock Project Exploration Plan (2012 Amendment) to obtain authorization for additional exploration drilling and ancillary exploration-related activities involving up to 125 acres, for a total of 267 acres within the 2012 Amendment area boundary. The BLM issued a Preliminary Environmental Assessment (BLM 2012h) in October 2012 and a Decision Record/Finding of No Significant Impact dated November 15, 2012 (BLM 2012i) authorizing the activities described in the 2012 Amendment. The total authorized surface disturbance of 267 acres includes the following exploration operations:

- Using overland travel
- Constructing drill roads

- Constructing drill pads and sumps
- Conducting geologic mapping
- Performing surface hand sampling of rocks, soils, and/or vegetation
- Excavating trenches for activities such as geotechnical testing, geochemical analyses, bulk samples, or metallurgical analyses
- Drilling auger boreholes
- Monitoring groundwater wells
- Using a mobile microwave tower for communications (to be installed as part of the 2011 Exploration Plan)
- Using one laydown area for temporary storage of drilling materials, equipment, and support facilities (to be installed as part of the 2011 Exploration Plan)

In October 2013, Midway amended the 2012 Amendment boundary to include the existing well, to allow for installation of an observation well as part of a drawdown test for use in this environmental analysis, and to provide data for locating a second well if one becomes necessary (Williams 2014f).

1.3 AGENCY PURPOSE AND NEED

The BLM's Purpose for the Proposed Action is to authorize a legitimate use of public lands, which would allow Midway to construct and operate a gold mine and associated facilities in the Proposed Action area. If authorized, the BLM would allow Midway to develop this mine in a manner to prevent unnecessary and undue degradation of public lands, to provide for reasonable reclamation, and to comply with applicable federal, state, and local laws and regulations.

The BLM's Need for the Proposed Action is to respond to Midway's Plan of Operations in compliance with the surface management regulations (43 CFR 3809), NEPA, and other statutes. To fulfill this Need, the BLM will respond to Midway's Plan and issue decisions related to the method of development of the Plan, including alternative mining approaches and decisions to authorize the Proposed Action.

1.4 DECISION TO BE MADE

The BLM will decide whether to approve the Plan with no modifications, to approve the Plan with additional terms and conditions to prevent unnecessary or undue degradation of public lands, or not to approve the Plan if additional terms and conditions would not prevent unnecessary or undue degradation of public lands.

1.5 MIDWAY'S OBJECTIVES

Midway's essential objective for the Proposed Action, which is the subject of the BLM's Purpose and Need, is to profitably extract precious metals from mining claims in the project area. Midway intends to operate and reclaim the proposed facilities in a manner that is environmentally responsible and in compliance with federal mining laws, the Federal Land Policy Management Act of 1976 (FLPMA), Nevada Mine Reclamation Law, and other applicable laws and regulations.

1.6 PROPOSED ACTION – OVERVIEW

Midway proposes to develop an open pit gold mine in White Pine County, Nevada. The proposed Gold Rock Mine would be located approximately 50 miles west of Ely and 30 miles southeast of Eureka (Proposed Action). The mine would occupy the same general geographic area as the reclaimed and closed Easy Junior Mine and would be accessed using the existing main access route from US 50: County Route 5 (CR 5) (Green Springs Road) south to BLM Road 1179/CR 1204 west to CR 1177 (Easy Junior Road) south to the mine area (Figure 1.1-2).

The project would include open pit mining, on-site ore crushing and processing using a central heap leach facility and/or a mill with a carbon-in-leach (CIL) circuit, and tailings storage facility (TSF), along with water supply wells and a delivery and storage system, exploration, and ancillary support facilities associated with mining operations (Midway 2013a). In addition to the 267 acres of previously authorized exploration disturbance (BLM 2012i), Midway proposes approximately 200 additional acres of exploration disturbance within the Plan area boundary, for a total of 467 acres of exploration disturbance. Midway would obtain power for the mine by constructing a power line and associated maintenance road that would tie into the approved power line to the Pan Mine. To promote public safety and mine security, Midway would work with the BLM and White Pine County to re-route a segment of CR 1177 (Easy Junior Road), which passes through the mine area. This re-route would include a construction of a short segment of new road. In total, the Proposed Action would disturb approximately 3,946 acres of surface disturbance.

The projected mining period is 10 years, with associated construction, closure, reclamation, and post-closure monitoring periods extending the project life to approximately 48 years. Upon completion of mining, the operation would be closed and reclaimed per Nevada mining regulations and the proposed Reclamation and Closure Plans. The Proposed Action is described in further detail in Chapter 2 of the EIS.

1.7 EXISTING ANALYSIS DOCUMENTS USED FOR THIS STATEMENT

Numerous NEPA environmental analysis documents have been completed in the proposed project region.

This EIS incorporates by reference the following existing environmental analyses:

- Bureau of Land Management (BLM). 2007a. *Ely Proposed Resource Management Plan and Final Environmental Impact Statement* (Proposed RMP/FEIS). U.S. Department of the Interior, Bureau of Land Management. November 2007;
- Bureau of Land Management (BLM). 2008b. *Ely District Record of Decision and Approved Resource Management Plan*. U.S. Department of the Interior, Bureau of Land Management. August 2008;
- Bureau of Land Management (BLM). 2012a. *Midway Gold Rock Project Final Environmental Assessment*. U.S. Department of the Interior, Bureau of Land Management. June 2012;
- Bureau of Land Management (BLM). 2012b. *Finding of No Significant Impact (FONSI) Midway Gold Rock Project*. DOI-BLM-NVL010-2012-0010-EA. Department of the Interior, Bureau of Land Management. June 2012;

- Bureau of Land Management (BLM). 2012c. *Environmental Assessment for the Midway Gold Rock Project; Exploration Amendment*. U.S. Department of the Interior, Bureau of Land Management. October 2012.
- Bureau of Land Management (BLM). 2012d. *Finding of No Significant Impact (FONSI) Midway Gold Rock Project. DOI-BLM-NVL010-2012-0044-EA* U.S. Department of the Interior, Bureau of Land Management. November 2012;
- Bureau of Land Management (BLM). 2013a. *Final Environmental Impact Statement for the Pan Mine Project*. U.S. Department of the Interior, Bureau of Land Management. November 2013;
- Bureau of Land Management (BLM). 2013b. *Pan Mine Project Record of Decision Plan of Operations Approval, and Approval of Issuance of Right-Of-Way Grant*. U.S. Department of the Interior, Bureau of Land Management. December 2013

These documents are included in the Project Record, and are available for review at the BLM EFO.

1.8 RELATIONSHIP TO AGENCY AND OTHER POLICIES AND PLANS

The BLM is responsible for administering mineral rights access on certain Federal lands as authorized by the General Mining Law of 1872. Under the law, qualified prospectors are entitled to reasonable access to mineral deposits on public domain lands that have not been withdrawn from mineral entry.

The BLM Egan Field Manager has the responsibility and authority to manage the surface and subsurface resources on public lands located within the Ely District's Egan Field Office, in western White Pine and northeastern Nye counties. Midway's use of public land in the Egan Field Office requires conformance with BLM's Surface Management Regulations (43 CFR 3809), and other applicable statutes, including the Mining and Mineral Policy Act of 1970 (as amended) and FLPMA. The BLM must review Midway's plan for mining and development to ensure the following:

- Adequate provisions are included to prevent unnecessary or undue degradation of Federal lands and to protect the non-mineral resources of the Federal lands.
- Measures are included to provide for reclamation of disturbed areas.
- Compliance with applicable local, state and federal laws is achieved.

In accordance with Section 202 of FLPMA, the Proposed Action and alternatives are in conformance with the approved Ely Proposed Resource Management Plan and Final Environmental Impact Statement (BLM 2007e) and the Ely District Record of Decision and Approved Resource Management Plan (BLM 2008b). The Proposed Action and alternatives have also been analyzed within the scope of other relevant plans, statutes, regulations, executive orders, and manuals including those listed below and found to be in compliance:

- Management Guidelines for Sage-Grouse and Sagebrush Ecosystems in Nevada – BLM (BLM 2004a);

- Greater Sage-Grouse Interim Management Policies and Procedures (IM No. 2012-043) (BLM 2011a);
- BLM National Greater Sage-Grouse Land Use Planning Strategy (IM No. 2012-044) (BLM 2011b);
- Mule Deer Herd Prescription for Management Area 10 (Nevada Department Of Wildlife [NDOW] 2007);
- Mule Deer Management Plan (NDOW 2006),
- Wildlife Action Plan (NDOW 2012b)
- Policy For the Management of Pronghorn Antelope (Nevada Board of Wildlife Commissioners 2003)
- State Protocol Agreement between the BLM, State of Nevada, and the Nevada State Historic Preservation Office (SHPO) (BLM and SHPO 2012);
- Northeastern Great Basin Resource Advisory Council (RAC) Standards and Guidelines For Rangeland Health, Off Highway Vehicles, and Vegetation (BLM 2007a,b,c);
- 1973 Endangered Species Act (USFWS 1973);
- Migratory Bird Treaty Act (1918 as amended) and Executive Order (USFWS 1918);
- BLM Manual 8400 – Visual Resources Management (BLM 1984);
- BLM Cyanide Management Plan (BLM 1991);
- State Implementation Plan (Nevada Division of Environmental Protection Bureau of Air Quality Planning);
- White Pine County 2011 Comprehensive Economic Development Strategy (White Pine County 2011a);
- White Pine County Land Use Plan (White Pine County Community and Economic Development Office 2009);
- The Proposed Action and alternatives are consistent the White Pine County Public Lands Policy Plan (WPCPLUAC 2007), which specifically states “Recognize that the development of Nevada’s mineral resources is desirable and necessary to the nation, the State, and White Pine County. Retain existing mining areas and promote the expansion of mining operations and areas.”; and
- The Proposed Action and alternatives are consistent with the Eureka County Master Plan, 1973 with expansion of the Master Plan and the Natural Resources and Land Use Element of the Plan in 1998, 2005, and 2010. Both the Eureka County Code and the Eureka County Master Plan mandate "the involvement of Eureka County in the management of federal lands and in the development of criteria that are meaningful in any decision making process, as contemplated by 43 C.F.R. Section 1610.3-1(a), Section 1610.3-1(b), Section 1620.3-2(a); 36 C.F.R. Ch II, Section 219.7(a), Section 219.7(c), and Section 219.7(d)." Chapter 40 in Title 9 of the Eureka County Code calls for County participation, through the Board of County Commissioners and its Natural Resources Manager, "in all actions that are being taken or are being proposed to be taken regarding federal lands located within Eureka County" (Eureka County 2010).

Midway has initiated the National Historic Preservation Act (NHPA) Section 106 Archaeological process. Archaeologists have received Field Authorizations, performed block surveys,

developed historic property treatment plans (HPTPs), and worked with BLM and SHPO to find consensus on mitigation measures. In addition, the BLM consulted with the Nevada SHPO and the two agencies have signed the Programmatic Agreement Between The Bureau of Land Management Egan Field Office and the Nevada State Historic Preservation Officer Regarding the Midway Gold US Inc. Gold Rock Project (BLM 2014a) (Appendix 1A).

1.9 AUTHORIZING ACTIONS

In accordance with BLM’s surface management regulations at 43 CFR 3809, the BLM will be the decision-making authority regarding leasing of locatable minerals on public lands and verifying an operation’s compliance with the terms and conditions of 43 CFR Part 3809.

The BLM has determined that submittal of the Plan triggers the environmental analysis process under NEPA. The BLM also determined that the proposed mining project constitutes a major Federal action, and determined that an EIS was required to assess the potential environmental, social, and economic effects of the proposed project and associated facilities. This EIS was prepared in conformance with NEPA. The BLM EFO evaluated consistency of the proposed mining activities with existing BLM Resource Management Plans, along with relevant plans from other agencies. In compliance with NEPA, a Proposed Action, No Action Alternative, and a reasonable range of Action Alternatives was developed.

The BLM serves as the lead agency in preparing this EIS, and has invited other agencies or entities to participate as cooperating agencies in preparing the EIS. CEQ regulations emphasize agency cooperation early in the NEPA process and state that any other Federal agency, which has jurisdiction by law, shall be a cooperating agency (40 CFR 1501.6). The following agencies have agreed to serve as Cooperating Agencies on the EIS and each has signed a Memorandum of Understanding (MOU) with the BLM:

- The Duckwater Shoshone Tribe;
- Eureka County Board of Commissioners;
- Nevada Department of Wildlife (NDOW); and
- White Pine County Commission.

NDOW is the State agency directly responsible for managing fish and wildlife resources in Nevada.

The BLM is responsible for the analysis of the Proposed Action, document preparation, and public review and comment. Implementing the Proposed Action or the alternatives would require authorizing actions from other Federal, State, and local agencies with jurisdiction over certain aspects of the proposed project. Table 1.9-1 lists the required major permits or approvals and the responsible agencies. Midway is responsible for applying for, and acquiring, these permits.

Table 1.9-1 Required Permits

Authorizing Action / Permit	Agency
43 CFR 3809 Plan of Operations Authorization	Bureau of Land Management (BLM)
Right-of-Way Permit, Mount Wheeler Power	BLM
Right-of-Way Permit (N-52041) amendment, White Pine County	BLM

Table 1.9-1 Required Permits

Authorizing Action / Permit	Agency
Air Quality Operating Permit	NDEP Bureau of Air Pollution Control (BAPC)
Reclamation Permit	NDEP Bureau of Mining Regulation and Reclamation (BMRR)
Water Pollution Control Permit	NDEP Bureau of Mining Regulation and Reclamation (BMRR)
Solid Waste Class III Wavered Landfill Authorization	NDEP Bureau of Waste Management (BWM)
General Permit for Storm Water Discharges Associated with Industrial Activity from Metals Mining	NDEP Bureau of Water Pollution Control (BWPC)
General Permit to Operate Septic Systems	NDEP Bureau of Water Pollution Control (BWPC)
Encroachment Permit	Nevada Department of Transportation
Industrial Artificial Pond Permit	Nevada Department of Wildlife (NDOW)
Hazardous Materials Storage Permit	Nevada State Fire Marshal
Explosives Permit	U.S. Department of the Treasury, Bureau of Alcohol, Tobacco, Firearms and Explosives (BATFE)
Jurisdictional Delineation Report Concurrence	U.S. Army Corps of Engineers (USACE)
RCRA (EPA) Hazardous Waste Identification Number	U.S. Environmental Protection Agency (EPA) issued by NDEP
Dam Safety Permit to Construct Impoundments	Nevada Division of Water Resources (NDWR)
Permit to Appropriate Water	Nevada Division of Water Resources (NDWR)
County Special Use Permit	White Pine County
Road Maintenance Agreement	White Pine County
Road Abandonment and Relocation Authorization	White Pine County

1.10 PUBLIC INVOLVEMENT

Public involvement is an important aspect of the NEPA process. As part of this process, the BLM invited the participation of the public, both formally at scoping meetings and through comments and informally through personal contacts.

1.10.1 Scoping

Under NEPA, scoping is an early phase of the process where ideas, information, and concerns are sought from concerned parties. The goal of scoping is to define the range of issues and topics that should be addressed in the environmental analysis. Specifically, we used the scoping process to:

- Identify people and organizations interested in the proposed action.
- Identify the key issues to be analyzed in the EIS.
- Identify and eliminate from detailed review those issues that will not be significant or that are beyond the scope of this EIS.
- Identify any related environmental assessments (EAs) or EISs.
- Identify gaps in data and informational needs.
- Identify other environmental review and consultation requirements that need to be integrated with the EIS.

The BLM published a Notice of Intent (NOI) to prepare an EIS for the Gold Rock Mine Project in the Federal Register on September 5, 2013 (Vol. 78, No. 172, pages 54674-54675). In this notice, the BLM informed the public of its intent to conduct an environmental analysis of gold ore mining at the Gold Rock property, announced a 30-day scoping period (September 5 to October 7, 2013), and solicited comments on the proposed project. The BLM also announced the dates, times, and locations of three public scoping meetings that the BLM would host to solicit and receive comments on the proposed project. The BLM published a public notice in the High Desert Advocate on September 6 and 18, 2013; in the Reno Gazette Journal on September 18, 2013; and in the Ely Daily Times and Eureka Sentinel on September 19, 2013.

The BLM EFO generated a mailing list for this EIS from existing information on persons with known and potential interest in the proposed mining project and from previous NEPA action mailing lists. The BLM prepared and mailed a “Dear Interested Party” letter to 401 interested parties on the EIS mailing list on Friday, September 6, 2013. In this letter, the BLM provided information on the project, announced the scoping meetings, and solicited comments to help identify specific issues and concerns that should be considered in the EIS. It also requested that written comments be submitted by October 7, 2013 to ensure full consideration.

The BLM published the NOI and “Dear Interested Party” letter to the Nevada Clearinghouse and distributed them to public posting locations in Ely and Eureka. A news release was distributed to local media, Nevada’s Congressional delegation, appropriate State senate and assembly persons, Eureka and White Pine County elected officials, BLM Nevada State Leadership Team, and BLM Nevada public affairs specialists.

The BLM held three public scoping meetings to discuss the NEPA process, introduce the Proposed Action, and receive comments from the public. The meetings were held in Ely, Eureka, and Reno, Nevada on September 24, 25, and 26, 2013, respectively, from 4:00 pm to 7:00 pm. The meetings were held in an informal, open house style. Representatives of the BLM, Midway, and the third-party contractor were in attendance to provide information and project handouts, answer questions, and encourage submittal of comments. Public attendees at the meetings were invited to sign a register, view informational display boards, speak with project representatives, and provide scoping comments. Six people attended the public meeting in Ely, 13 people attended the public meeting in Eureka, and one person attended the public meeting in Reno.

From October 1 through October 16, 2013, the U.S. federal government shut down. On October 18, 2013, the BLM issued a press release in the local newspapers and posted a notice on the BLM ePlanning web page stating that the comment period was re-opened and extended by 1 week, from October 18 to October 25, 2013.

The BLM’s e-mail account that was set up to receive scoping comments on the Gold Rock Mine Project Environmental Impact Statement (EIS) during the initial scoping period (September 5 through October 7, 2013) was deleted during the federal government shutdown. Therefore, the BLM issued a second notice for the Gold Rock Mine Project EIS in the Federal Register (Vol. 79, No. 60, pages 17565-17566) on March 28, 2014 to invite members of the public to submit comments, and request that anyone who submitted comments by email during the initial 30-day scoping period resubmit their comments. No changes were made to the Proposed Action. No additional scoping meetings were held during this 30-day extension of the public input period, as the original meetings were not affected by the technical difficulties with the email account.

The BLM prepared and mailed a “Dear Interested Party” letter to 401 interested parties on the EIS mailing list on Friday, March 28, 2014. In this letter, the BLM provided information on the proposed Gold Rock Mine Project and solicited comments to help identify specific issues and concerns that should be considered in the EIS. The BLM also requested that written comments be submitted by April 28, 2014 to ensure full consideration. The BLM published a public notice in the High Desert Advocate and the Reno Gazette Journal on Thursday, April 3, 2014 and in the Ely Daily Times and Eureka Sentinel on Friday, April 4, 2014.

The BLM published the NOI and “Dear Interested Party” letter to the Nevada Clearinghouse and distributed them to public posting locations in Ely and Eureka. A news release was distributed to local media, Nevada’s Congressional delegation, appropriate State senate and assembly persons, Eureka and White Pine County elected officials, BLM Nevada State Leadership Team, and BLM Nevada public affairs specialists.

The BLM reviewed and analyzed the comments it received during the scoping process. Public response to the notices and meetings included a total of 60 letters, comment forms, faxes, and e-mails.

On December 19, 2013, BLM held an agency scoping and alternatives development meeting at BLM’s District Office in Ely, Nevada. During the meeting, the BLM, cooperating agencies and Midway discussed the Proposed Action, issues, and concerns to be addressed in the NEPA analysis for the project. The BLM decided to close the office due to deteriorating weather conditions before the group could discuss alternatives. On January 6, 2014, the BLM and ARCADIS held a conference call to discuss alternatives. On April 29, 2014 the BLM distributed a description of alternatives to the cooperating agencies, held several conference calls, received and addressed comments, and agreed on a preliminary list of alternatives to be carried forward in the process and analyzed in detail.

The BLM met with the Confederated Tribes of the Goshute Reservation on April 4, 2014; with the Duckwater Shoshone Tribe on April 28, 2014; and with the Ely Shoshone Tribe on August 12, 2014. During each meeting, the BLM provided an overview of the NEPA process and described the status of the Gold Rock Mine Project EIS.

The BLM attended regularly scheduled the White Pine County Board of County Commissioners’ public meeting at the White Pine County Commission Chambers in Ely, Nevada on April 23, 2014. During this public meeting, the BLM provided an overview of the NEPA process and described the status of the Gold Rock Mine Project EIS. The BLM also plans to present similar information during a regularly scheduled Eureka County Commissioners’ public meeting at the Eureka County Courthouse in Eureka, Nevada.

Following completion of the public scoping activities, a detailed scoping document was prepared (ARCADIS 2014). This document summarized issues identified during scoping and included copies of all scoping comments received prior to the date of that report. This document is included in the Project Record and is available for review at the BLM EFO.

1.10.2 Issues Raised during Public Scoping

All comments received during public scoping were recorded. Most of the concerns raised included potential impacts on socioeconomic issues, water resources, wild horses, soils and reclamation, vegetation, wildlife, and air quality. Additional comments noted hazardous materials and solid waste; Native American traditional and religious values; cumulative effects;

land use authorization and access including transportation, traffic, public health, and safety; visual resources; range resources; cultural resources; recreation; forest products and fuels; and environmental justice. Potential issues identified during scoping are summarized below. These and other issues for analysis are described further under each resource in Chapters 3, 4, and 5.

Water Quality and Quantity

Commenters expressed that the proposed project could affect the quantity of surface water if present in or near the Plan area. Physical disturbance in the Plan area would contribute to reduced infiltration of precipitation and increased runoff of precipitation, if not controlled appropriately. In addition, the construction of facilities would increase the portion of the Plan area covered by impervious surfaces, such as roofs or concrete slabs, which would reduce infiltration of precipitation and contribute to increased runoff. The proposed project could affect the drainage paths and channel morphology of natural drainages in the vicinity of the Plan area. Retention of stormwater could affect peak flow and low flow of any existing water sources.

The proposed project could adversely affect the quality of surface water runoff in the Plan area through the release of stormwater, toxic solutions, or toxic materials if a spill or leak occurred and was not addressed. Physical disturbance in the Plan area would contribute to increased erosion by water from disturbed areas, and increased deposition of eroded soils, if not controlled appropriately. The project would use various toxic solutions for processing ore, including a dilute cyanide solution, sodium hydroxide, and hydrochloric acid, that could discharge to surface water if released to the environment and not appropriately controlled. Project equipment would use petroleum, oil, and lubricants that could be released to the environment if spilled. Rock mined by the project may contain metals that could be released to the environment. Finally, mining would involve placement of potentially acid-generating (PAG) rock in waste rock disposal areas (WRDAs) that could release acidic water to surface drainages if not neutralized appropriately.

The proposed project could affect the quantity of groundwater if present in or near the Plan area because groundwater would be the source of water for the project. Approximately 1,200 gallons per minute on average would be pumped from water wells over the life of the mine. This water would supply the fire suppression water system, the potable water circuit, and process circuits that require freshwater. Commenters expressed concern that although depth to groundwater in the Plan area is more than 1,000 feet, groundwater could discharge as springs, seeps, or wetlands downgradient from the Plan area. In addition, some perched water may be encountered during mining. If the mine were to require dewatering and resources were located below the mine, then dewatering could affect groundwater levels in the area, indirectly impacting vegetative productivity and wildlife and livestock water sources.

The proposed project could adversely affect the quality of groundwater if present in the Plan area through the release of toxic solutions and materials if a spill or leak occurred and was not appropriately controlled. As noted for surface water, the project would use various toxic solutions for processing ore. If released to the environment, these solutions could infiltrate to groundwater resources, if present. Project equipment would use petroleum, oil, and lubricants that could be released to the environment if spilled. Rock mined by the project may contain metals that could be released to the environment. Finally, mining would involve placement of PAG rock in WRDAs that could release acidic water if not neutralized appropriately.

The proposed project could affect water rights in the region through groundwater pumping.

Soils and Reclamation

The proposed project would affect soils in the Plan area. Physical disturbance would contribute to reduced infiltration of precipitation, increased erosion (by water and wind) from disturbed areas, and increased deposition of eroded soils in undisturbed areas and in surface water runoff.

Air Quality

The proposed project would generate emissions during exploration, construction, and operation that if not controlled could adversely affect the quality of air and visibility in the local and regional airshed. These emissions would include fugitive dust and other criteria pollutants, greenhouse gases (carbon emissions), and hazardous air pollutants (HAPs) including mercury. Sources of fugitive dust would include areas of exposed soil, roads, the pit, stockpiles, crushing facilities, and the WRDAs. Internal combustion engines on equipment would emit criteria pollutants and greenhouse gases. The operation of vehicles, mobile equipment, and crushing and processing facilities could emit HAPs that could be deposited on soils, vegetation, or water and could result in wildlife, wild horse, livestock, or human exposure.

The proposed project would generate emissions that, in combination with other sources' emissions, could affect the regional climate.

Commenters raised that the proposed project could reduce air quality and impact human health through inhalation or ingestion of contaminated dust or water.

Vegetation, Including Invasive, Non-native Species

The proposed project would affect vegetation in the Plan area. Construction of project facilities would disturb vegetation directly, which would reduce overall plant productivity in the Plan area. Disturbance could increase the potential for establishment of noxious and non-native, invasive weeds. Project activities in the Plan area also could affect vegetation indirectly, such as dust generated by vehicles coating plants' leaves along the roads. Successful post-mining reclamation could limit the long-term loss of vegetation and productivity. In addition, pumping of groundwater could affect plant productivity.

The proposed project could result in the establishment or expansion of noxious or non-native, invasive weed populations.

Wildlife and Fisheries Resources, Including Special Status Species and Migratory Birds

The proposed project could affect populations of mule deer and pronghorn antelope directly and indirectly. The increase in vehicular traffic as workers and delivery vehicles travel to and from the mine could result in an increase in vehicular collisions with mule deer crossing US 50 to reach crucial winter range east of the Plan area or with pronghorn antelope crossing to reach habitats near the Plan area. In addition, loss of habitats (including potential antelope birthing sites) because of surface disturbance and fencing in and around the Plan area could affect populations of mule deer and pronghorn antelope.

The proposed project could adversely affect greater sage-grouse populations present near the Plan area. Green Springs Road, which would serve as the main access route to the mine for employees and delivery trucks, crosses various greater sage-grouse habitats. The project traffic on Green Springs Road could generate noise and vibration that could adversely affect the

greater sage-grouse populations that occupy habitats along Green Springs Road, including a lek that is within 0.5 mile of Green Springs Road. In addition, power lines and their support structures may affect greater sage-grouse populations directly (power line strikes) and indirectly (raptor perches and avoidance of habitat use).

The proposed project could impact other migratory birds or raptors through reduction of available nesting habitat.

The proposed project could expose populations of wildlife to toxic solutions and materials that could adversely affect individual animals. The project would use various solutions for processing ore that could be toxic to wildlife if released and not appropriately controlled. Project equipment would use petroleum, oil, and lubricants that could be released to the environment through spills. Rock mined through the project may contain metals that could be released to the environment and affect wildlife. Precipitation may mobilize metals from project facilities to locations where animals could be exposed.

The proposed project would involve groundwater pumping that could adversely affect wildlife in the Plan area by reducing flow in water sources or habitat, such as springs or seeps, or by reducing vegetative productivity of wildlife food sources if the groundwater systems are connected.

Range Resources

The proposed project could adversely affect grazing of livestock in the Plan area. A loss of acreage within grazing allotments because of surface disturbance and fencing in and around the Plan area would reduce the forage available for livestock, which in turn could require a reduction in the number of animals allowed to graze in affected allotments. In addition, pumping of groundwater could affect vegetative productivity of grazing animal food sources if the groundwater systems connect to surface resources.

Forest Products and Fuels

The proposed project could affect forest products, including trees harvested for firewood or Christmas trees, or pinyons used for pine nut harvesting, if forest products are present in the proposed project area.

Wild Horses

The proposed project could impact wild horses through an increase in vehicle traffic in the vicinity of the Plan area. The risk of vehicular collision could increase with an increase in traffic in the area.

Groundwater pumping associated with the proposed project could draw down the water table and affect the amount or quality of water present in local water sources used by wild horses if the groundwater systems connect to surface resources. The proposed project could expose populations of wild horses to toxic solutions and materials that could adversely affect individual animals. The project would use various solutions for processing ore that could be toxic to wild horses. Project equipment would use petroleum, oil, and lubricants that could be released to the environment through spills. Rock mined through the project may contain metals that could be released to the environment and affect wild horses. Precipitation may mobilize metals from project facilities to locations where animals could be exposed.

Noise from mining operations, surface disturbance, or fencing could cause habitat loss or fragmentation, or affect migration routes in the vicinity of the Plan area or herd management area.

Cultural Resources

The proposed project could adversely affect historic properties (cultural resource sites listed on or eligible for the National Register of Historic Places) in and near the Plan area if they exist.

Native American Religious and Traditional Values

The proposed project could adversely affect sites with Native American Religious and Traditional Values in and near the Plan area if they exist in the area. The proposed project could have potential direct or indirect effects to greater sage-grouse lek sites, which the Tribes consider sacred land. The proposed project could have potential direct or indirect effects to greater sage-grouse, which Tribes in the region and throughout the west use in ceremonies. The proposed project could have potential effects to antelope traps in the area. Proposed mining activities could impact geologic and mineral resources on ancestral lands of the Western Shoshone.

Land Use Authorization and Access

Public health and safety could be affected, primarily by increased traffic or exposure to hazardous materials if a release or spill during transport occurred. In Eureka County the main transportation routes would be SR 278 and US 50.

Visual Resources

The proposed project could impact scenic views. Construction of new roads, structures, infrastructure and installation of outdoor lighting would affect the existing viewshed near the proposed mine. Siting of structures and infrastructure without consolidating or co-locating facilities and/or without using building materials, colors, and site placement compatible with the natural environment could increase visibility of facility and affect visual resources in the area. Outdoor lighting installed without using “Dark Sky” lighting best management practices could impact visibility of the nighttime sky in the vicinity of the proposed project.

Socioeconomic Resources

The proposed project would affect the socioeconomic environment of the State of Nevada, White Pine County, Eureka County, the Town of Eureka, and the City of Ely beneficially and adversely, depending on perspective. Directly, the proposed project would generate new employment and increase the public revenue base (taxes). Indirectly, the project would increase demand for housing, commercial development, community services, and schools; and would offset effects of the Ruby Hill Mine’s closure; and increase demand for additional development of infrastructure, such as the power line that would be constructed for the project.

The project could affect economic resources as a result of loss of scenic views if it can be seen from any publicly frequented viewpoint.

Environmental Justice

The proposed project could affect minority or low-income populations disproportionately. The Plan area is in rural White Pine County, Nevada. The Duckwater Shoshone Reservation is located approximately 12 miles south of the Plan area. In addition, Eureka, Nevada is

approximately 30 miles northwest of the Plan area and Ely, Nevada is approximately 50 miles east of the Plan area. While not within the Plan area, these communities include populations that qualify as minority populations.

Hazardous Materials and Wastes

The proposed project could result in exposure to hazardous materials in the event of a release or spill during transport or operations. In Eureka County on the main transportation routes would be SR 278 or US 50.

Cumulative Effects

The proposed project could result in cumulative effects, which will be analyzed for each environmental resource described in the EIS.

CHAPTER 2

PROPOSED ACTION AND ALTERNATIVES

2.1 INTRODUCTION

This chapter describes and compares the Proposed Action, five Action Alternatives, and the No Action Alternative, in accordance with 40 CFR 1502.14. Each component is described in sufficient detail to facilitate understanding of each alternative. Tables present information on existing and proposed surface disturbance, and show the current exploration activities and proposed mine plan.

Section 2.3 presents a summary of the Proposed Action. This summary is based on the Plan and its appendices, including the baseline geochemistry and waste rock handling report, stormwater management plan, petroleum-contaminated soils management plan, groundwater monitoring plan and spill contingency and emergency response plan (Midway 2013a).

The BLM, cooperating agencies, and the third-party contractor developed alternatives to the Proposed Action, referred to as action alternatives, to address issues identified during the public and agency scoping process. These action alternatives are intended to reduce or minimize potential effects associated with the Proposed Action. The BLM carried five action alternatives forward for detailed analysis in this EIS, as summarized in Sections 2.4.1 through 2.4.4.

The BLM also considered the No Action Alternative. The No Action Alternative provides a benchmark enabling decision makers to compare the environmental effects of the Proposed Action and action alternatives. The No Action Alternative is summarized in Section 2.4.5.

A summary of additional alternatives that were initially considered but eliminated from further study is provided in Section 2.5. Section 2.5.1 summarizes design options that Midway had determined to be infeasible during development of the Plan but that the BLM considered as possible alternatives to the Proposed Action. During the alternatives development process, the BLM determined that these design options were not reasonable alternatives to the Proposed Action. Section 2.5.2 summarizes other alternatives to the Proposed Action that the BLM, cooperating agencies, and the third-party contractor had developed and later determined not to be reasonable alternatives.

2.2 EXISTING OPERATIONS

Midway is conducting exploration activities permitted under the *2011 Gold Rock Project Exploration Plan of Operations (Case File Number NVN-090376)* (2011 Plan) (Midway 2011) authorized by the Decision Record/Finding of No Significant Impact dated June 12, 2012 (BLM 2012c) as amended November 15, 2012 (BLM 2012i); and Reclamation Permit 0326 authorized on July 22, 2012 by the NDEP.

The exploration plan area (BLM 2012h) includes approximately 267 acres of authorized surface disturbance (Figure 2.2-1). To date, Midway has disturbed approximately 4 of the 267 authorized acres during exploration activities (Snell 2014a). The authorized exploration operations for the project are ongoing and include the following:

- using overland travel
- constructing drill roads

- constructing drill pads and sumps
- using ground water pumped from Water Well #1, the existing well used for the previous Easy Junior Mine operation, for exploration drilling (Williams 2014a)
- conducting geologic mapping
- performing surface hand sampling of rocks, growth media and/or vegetation
- excavating trenches for activities such as geotechnical testing, geochemical analyses, bulk samples, or metallurgical analyses
- drilling auger boreholes
- constructing groundwater monitoring wells and monitoring these wells
- installing a meteorological tower
- installing a mobile microwave tower for communications
- constructing one laydown area for temporary storage of drilling materials, equipment, and support facilities.

2.3 PROPOSED ACTION

The Proposed Action would include the construction, operation, reclamation, and closure of the Gold Rock Mine. Figure 2.3-1 shows the project area and proposed disturbance areas for the Proposed Action. Table 2.3-1 lists existing, reclaimed, and authorized disturbance in the project area, as well as the proposed disturbance acreage for each component of the Proposed Action.

The Plan area would encompass 18,745 acres, and major components of the mining operation would be located within a fenced 8,757-acre mine area (Figure 2.3-1). The Gold Rock Mine would include an open pit, two WRDAs, a heap leach pad, processing ponds and plant, a mill with a CIL circuit, a TSF, water supply wells and delivery/storage system, haul and access roads, growth medium stockpiles, and ancillary support facilities. The surface area between mine components is referred to as “inter-facility disturbance” and is assumed to be potentially subject to disturbance during operation of the mine. Transformers and distribution lines within the Plan area would carry power to the processing plant, mill, and other facilities. Approximately 3,468 acres of surface disturbance would occur within the mine area. The mine facilities are described in subsequent sections.

Midway proposes to perform exploration activities on a total of 467 acres in the Plan area, including the 267 acres previously authorized under the amended 2011 Plan (BLM 2012i) and approximately 200 additional acres within the Plan area boundary. Of the 467 acres of exploration disturbance, approximately 75 acres would be re-disturbed during construction of proposed facilities and reclaimed in accordance with the facility that covers it. To avoid double counting, 75 acres would be subtracted from the total, resulting in 392 acres of exploration disturbance, which when added to the 3,468 acres of disturbance within the mine area, would result in 3,860 acres of disturbance within the Plan area under the Proposed Action.

Midway would obtain water for construction and operations from the existing Easy Junior well. Midway has applied for a permit to appropriate water, and is awaiting approval. Additional information on water rights is presented in Section 3.2. If necessary, Midway would install a second water supply well within 0.5 mile of the existing Easy Junior well. If drilling indicates that

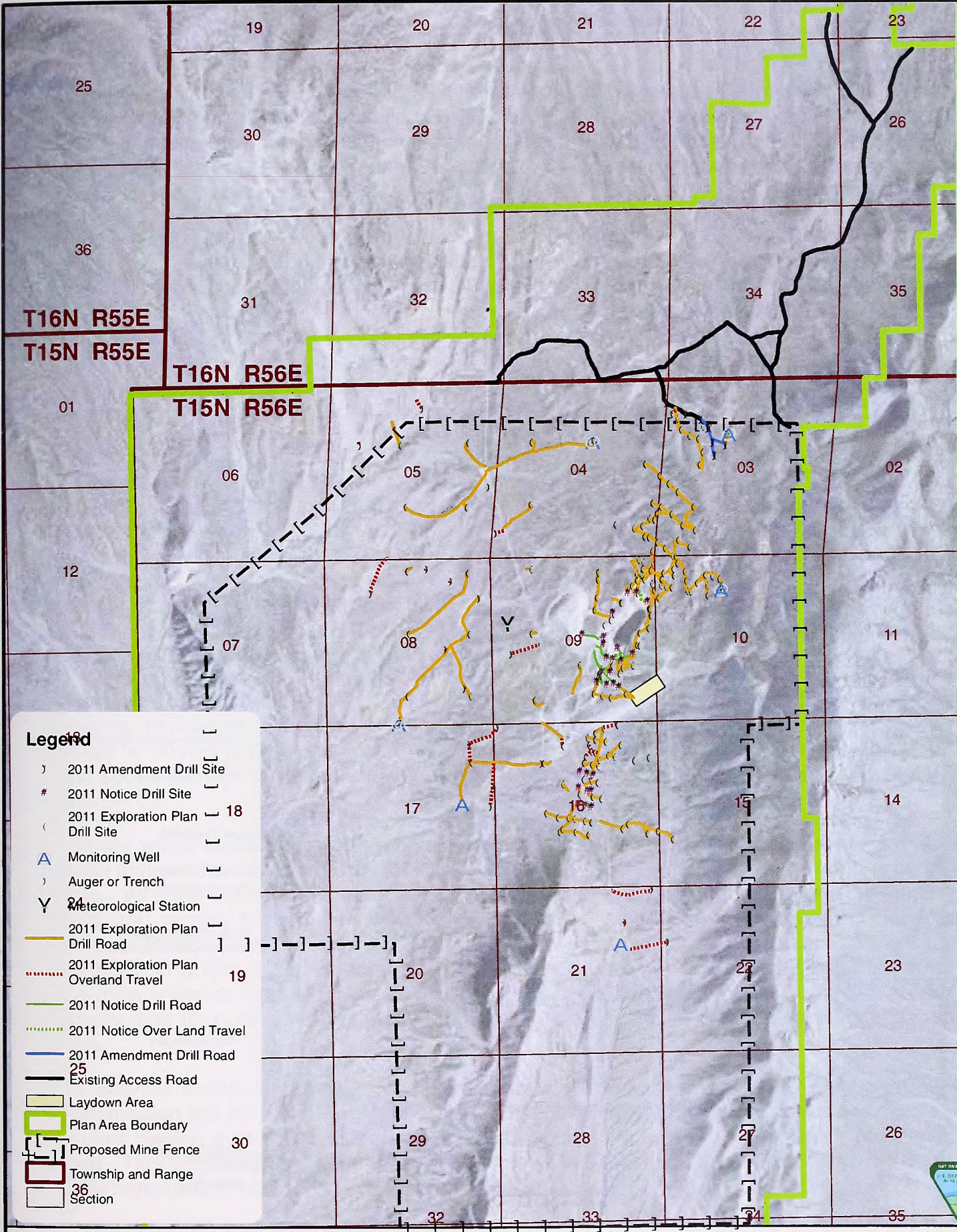

- Legend**
- ⌋ 2011 Amendment Drill Site
 - # 2011 Notice Drill Site
 - ⌋ 2011 Exploration Plan Drill Site
 - A Monitoring Well
 - Y Auger or Trench
 - Y Meteorological Station
 - 2011 Exploration Plan Drill Road
 - ⋯ 2011 Exploration Plan Overland Travel
 - 2011 Notice Drill Road
 - ⋯ 2011 Notice Over Land Travel
 - 2011 Amendment Drill Road
 - Existing Access Road
 - Laydown Area
 - Plan Area Boundary
 - ⌋ Proposed Mine Fence
 - Township and Range
 - Section

FIGURE 2.2-1
AUTHORIZED EXPLORATION DISTURBANCE
MIDWAY GOLD US INC.
GOLD ROCK MINE PROJECT

MAPPED DATE: 9/17/2014

0 4,500 9,000 Feet

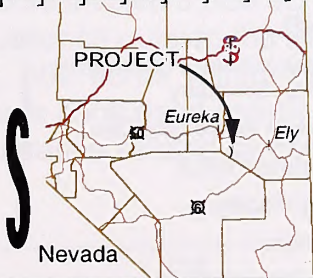

U.S. BUREAU OF LAND MANAGEMENT
 ELY DISTRICT
 EGAN FIELD OFFICE

NO WARRANTY IS MADE BY THE BUREAU OF LAND MANAGEMENT AS TO THE ACCURACY, RELIABILITY, OR COMPLETENESS OF THESE DATA FOR INDIVIDUAL USE OR AGGREGATE USE WITH OTHER DATA.

Basemap Source: ESRI World Imagery Map Service

PATH: C:\USERS\JCHEN\DOCUMENTS\PROJECTS\TRAC\001817_GOLDROCK\GIS\ARCMAP_MXD\2014_DRAFT_EIS\FIGURE_2.2-1 AUTHORIZED EXPLORATION DISTURBANCE.MXD | LAST SAVED BY: JCHEN | LAST SAVED ON: 9/17/2014 12:33:16 AM

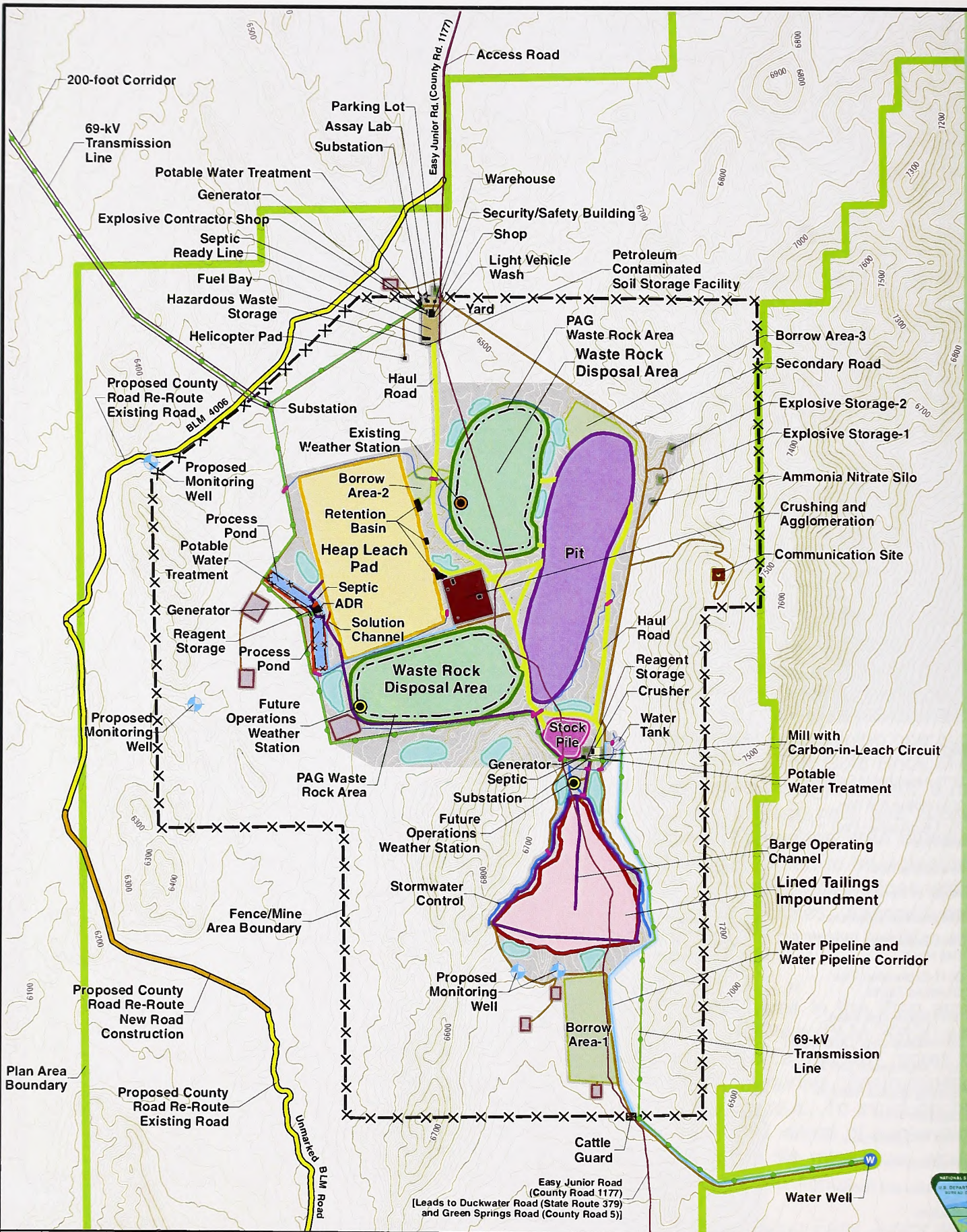

FIGURE 2.3-1
PROPOSED ACTION FACILITIES
MIDWAY GOLD US INC.
GOLD ROCK MINE PROJECT

MAPPED DATE: 9/3/2014
 0 0.5 1 Miles

- LEGEND**
- Potentially Acid Generating (PAG) Boundary
 - Growth Media Stockpile
 - Sediment Basin
 - Inter-Facility
 - Culvert



U.S. BUREAU OF LAND MANAGEMENT
 ELY DISTRICT
 EGAN FIELD OFFICE

NO WARRANTY IS MADE BY THE BUREAU OF LAND MANAGEMENT AS TO THE ACCURACY, RELIABILITY, OR COMPLETENESS OF THESE DATA FOR INDIVIDUAL USE OR AGGREGATE USE WITH OTHER DATA.

Basemap Contour Interval: 20 feet.



PATH: C:\USERS\JCHEN\DOCUMENTS\PROJECTS\CITRIX\GOLDROCK\GOLDROCK\GOLDROCK\GOLDROCK\MXD\2014_DRAFT_EIS\FIGURE_2_3-1_PROPOSED_ACTION_FACILITIES.MXD | LAST SAVED BY: JCHEN | LAST SAVED ON: 9/3/2014 10:14:42 AM

a well would provide water, then Midway would apply for a water well permit within the Railroad Valley Northern Part. Midway would construct a well pad, establish a two-track road, and install an associated power line with structures and pole spacing appropriate for the voltage of the line. These activities are described further in Section 2.3.1 and would result in approximately 6 acres of surface disturbance.

The existing main access route to the site would be used during construction, operation, and closure of the proposed mine. This existing main access route extends south from US 50 on Green Springs Road (CR 5), then west on BLM Road 1179 (BLM 1179)/CR 1204, then south on Easy Junior Road (CR 1177) to the proposed mine area. Site access would be restricted to employees and authorized visitors. Midway would restrict public access to existing roads that cross active mining areas in the Plan area boundary in accordance with MSHA requirements. Public access would be controlled through the security gatehouse; a fence would be installed on the perimeter of the mine area with locked gates or other physical control methods.

To promote public safety and mine security, Midway proposes to re-route a segment of Easy Junior Road. Easy Junior Road currently leads south from US 50 through the Newark Valley, passing on the western side of Easy Ridge to connect with CR 62, which leads southeast to Green Springs Road (Figure 1.1-2). Under the Proposed Action, the segment of Easy Junior Road that passes through the mine area would be relocated to the west onto existing BLM and county roads and a short segment of new BLM road (Figure 2.3-1). In the future, White Pine County may decide to upgrade this re-route. In total, up to approximately 29 acres of surface disturbance could occur. The BLM would issue a FLPMA Title V Right-of-Way amendment and develop a Travel Management Plan for this re-route.

Signs would be posted on Easy Junior Road noting that the segment of Easy Junior Road passing through the mine area is a dead end road and is for mine access only. These signs would be posted north of the Plan area at the intersection of Easy Junior Road and BLM 4006, and south of the Plan area at the intersection of Easy Junior Road and BLM 4059, BLM 4109A, and CR 62.

Midway would install gates at the northern and southern ends of the segment of Easy Junior Road that passes through the mine area. The northern gate would serve as the mine entrance gate. All mine-bound traffic from the north and south would be directed to enter through this gate, and security staff would regulate entry and exit. The southern gate would be closed and locked. Midway environmental staff would use this gate periodically. Southbound mine traffic from US 50 would continue south from the intersection of Easy Junior Road and BLM 4006 to the mine entrance gate. Northbound mine traffic from Duckwater Road would use the proposed county road re-route to reach the northern portion of Easy Junior Road and the mine entrance gate.

To provide electrical power to the mine, Mount Wheeler Power would extend a 69 kV transmission line from the Pan Mine across the valley to tie into the west side of the Gold Rock Project electric system. Mount Wheeler Power would also establish a two-track maintenance road. This proposed power line is described further in Section 2.3.3. Approximately 51 acres of disturbance would occur.

In summary, the Proposed Action would involve 3,860 acres of disturbance within the Plan area and up to 86 acres of additional disturbance outside the Plan area, for a total of 3,946 acres. As described further in Section 2.3.16, 462 acres within the Plan area would not be subject to reclamation requirements. This area is comprised mainly of the 367-acre pit. Outside the Plan area an additional 29 acres of disturbance related to construction (7 acres) and widening (22

acres) of the proposed county road re-route would not be subject to reclamation requirements. In total, approximately 491 acres of surface disturbance would not be subject to reclamation. Approximately 3,456 acres of disturbance in the project area would be reclaimed.

Table 2.3-2 lists the phases of the proposed project schedule. Permitting of the project is expected to take approximately 2 years. The remaining phases would include construction, mining, concurrent heap leaching and milling, and reclamation. These phases would overlap in time. The project would operate in conformance with all MSHA safety regulations (30 CFR Parts 1-199).

After obtaining all required permits and authorizations, Midway would construct the mine facilities. Construction activities are expected to take 6 to 9 months and would include pre-stripping in required areas, pit development, construction of the North and South WRDAs, heap leach pad construction including re-use of former reclaimed Easy Junior heap material; mill, CIL circuit, and TSF construction; and construction of ancillary facilities.

Mining of gold ore from the pit is expected to begin at or about the end of year 1 and is intended to last approximately 10 years. Heap leaching is expected to begin about the end of year 1 when mining starts, and is intended to continue beyond the end of mining until recovery drops below economic levels. Milling and tailings deposition are expected to start at the same time as heap leaching, about the end of year 1. Depending on the price of gold, milling and tailings deposition may continue for a year or longer beyond the end of mining.

Heap drain down, followed by heap and process pond closure and reclamation, is expected to require approximately 3 years, beginning in about year 12. Closure and reclamation of the TSF would also take about 3 years, beginning in about year 12. The closure and reclamation of supporting facilities and post-closure monitoring, with the exception of the associated downgradient monitoring wells, is expected to require approximately 10 years, beginning in about year 12. Midway would construct the ET cell in year 13, and monitor the associated downgradient monitoring wells for 30 years. Midway would close the ET cell in year 43, and would perform 5 years of post-closure monitoring, bringing the entire project life to 48 years (Table 2.3-2). Concurrent reclamation during active mining has been planned to begin as soon as practicable on areas where no further disturbance would occur, minimizing the need for post-mining reclamation.

In summary, the projected mining production period is 10 years. Associated construction, closure, reclamation, and post-closure monitoring periods would extend the Project life for an estimated 38 years, to approximately 48 years.

Table 2.3-1 Summary of Authorized and Proposed Disturbance

Component	Proposed Action Disturbance (acres)	Area Not Reclaimed (acres)	Total Area To Be Reclaimed (acres)
Within Plan Area			
Open Pit	367	367	
WRDAs			
South	280		280
North	266		266
Other			
Roads ¹	180		180
Heap Leach Facility	430		430
Process Facilities	74		74
Tailings Storage Facility	269		269
Process Ponds	25	13	12
Yards	15		15
Exploration ^{2,3}	392		392
Ancillary Facilities ⁴	420	82	338
Water Pipeline Corridors ⁵	84		84
Inter-facility Disturbance ⁶	1,026		1,026
Transmission Line	32		32
<i>Subtotal, Within Plan area</i>	<i>3,860</i>	<i>462</i>	<i>3,399</i>
Outside Plan Area			
Proposed Action Power Line Route ⁷	51		51
Second water supply well and related infrastructure ⁸	6		6
Proposed County Road Re-Route, new road construction ⁹	7	7	
Proposed County Road Re-Route, existing road widening if, in the future, White Pine County decides to upgrade route ⁹	22	22	
<i>Subtotal, Outside Plan area</i>	<i>86</i>	<i>29</i>	<i>57</i>
Total	3,946	491	3,456

Notes:

Rounding of acreage results in total acreage discrepancies.

1 Includes the access, haul, and secondary roads.

2 Includes 267 acres of exploration authorized by the Finding of No Significant Impact (FONSI), Midway Gold Rock Project, DOI-BLM-NVLO10-2012-0044-EA (BLM 2012i).

3 75 acres of authorized exploration roads would be occupied by proposed facilities; this disturbance would be reclaimed in accordance with the facility that covers it.

4 Ancillary facilities include the following: crusher facilities; power supply; stormwater controls; reagent, fuel, and explosives storage; buildings including administration, laboratory, security, warehouse, core shed, potable water supply and septic systems; maintenance shop; ready line; light vehicle wash; communications facilities; helicopter pad; plant growth media stockpiles; class III-waivered landfill; area to store petroleum contaminated soils; monitoring wells; borrow areas; fencing; and yards.

5 Includes the fresh water pipeline corridor, the pipeline from the heap to the TSF, and the TSF pipeline corridor to the mill.

6 Inter-facility disturbance is the disturbance that may occur in areas between components during construction, operations, and closure.

7 Includes 50-foot-radius area of disturbance per pole along the length of the route, with 300-foot pole spacing, plus 12-foot-wide two-track road times the length of the route. To be conservative, the maintenance road was assumed to be located outside of the disturbance area for the poles.

8 Includes 150-foot by 150-foot pad area, plus 0.5-mile long two-track road, approximately 12 feet wide, plus power line with 50-foot-radius area of disturbance and 100-foot pole spacing to account for lower voltage and/or double-pole structures

9 Total disturbance width assumed to be 30 feet – Includes 12-foot-wide existing road width; 30-foot-wide upgraded width.

Source: Midway 2013a, Midway 2014, Ratke 2014.

Table 2.3-2 Estimated Conceptual Timeline for the Gold Rock Mine Project

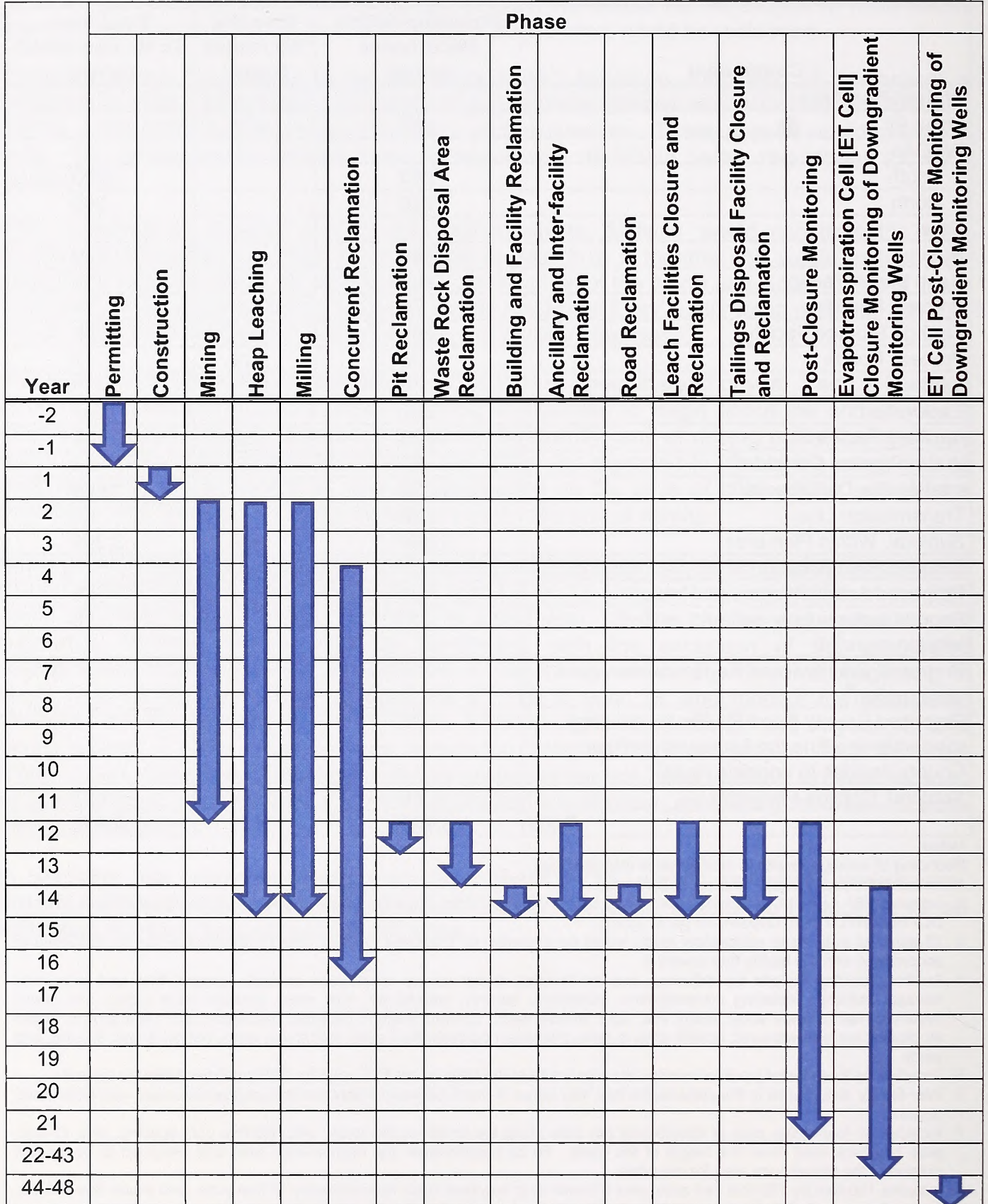

2.3.1 Water Supply, Delivery, and Storage

Operation of the mine would require about 1,200 gallons per minute (gpm) of groundwater on average during the 10-year life of mine. Approximately 600 gpm would be required on average during the three years following mining until leaching is complete (Williams 2014a). The groundwater would be provided from Water Well #1, also known as the “Easy Junior well” (shown on Figure 2.3-1), and from a second well drilled in the vicinity of the existing well. If these well locations could not provide sufficient production, additional wells would be located within the mine area or to the south of the mine area near the existing well. Midway holds an existing right to appropriate 0.38 cfs, but not to exceed 20.89 million gallons. Midway has applied for two permits to appropriate this groundwater. Water rights are described further in Section 3.2.

The existing well site includes a building surrounded by a security fence. A second water well would be drilled within 0.5 mile of the existing Easy Junior well. Midway would establish a 12-foot-wide two-track road from the Easy Junior well to the new well location, disturbing up to approximately 0.7 acre of land. Well drilling activities would disturb an area about 150 feet by 150 feet, or about 0.5 acre of land. Pumping equipment associated with the new well would be installed in the existing well pump building. A new power line would be extended from the existing well along the new two-track road to the new well (Williams 2014b). The associated power line was assumed to be a distribution line (69 kV or lower voltage appropriate for load demands). Pole spacing was conservatively estimated at 100 feet, and would be determined by ground conditions and design requirements. The area of disturbance during pole installation was assumed to be a 50-foot radius circle per pole. Construction of this line would disturb approximately 4.8 acres. In summary, installation of the well and associated activities would result in approximately 6 acres of disturbance.

Fresh water would be stored in a fresh/fire suppression water tank located near the mill as shown on Figure 2.3-1. Water from the fresh/fire suppression water tank would be distributed to the fire suppression water system, the potable water circuit, and process circuits that require fresh water. Fresh water would be distributed from the fresh/fire suppression water tank by gravity or pumped to the fire water suppression system and to the process circuits.

Potable water would be supplied from a separate tank and treated in accordance with NDEP Bureau of Safe Drinking Water regulations. The potable water delivery system would be designed, constructed, and operated as required by a certified operator.

2.3.2 Roads

Existing Roads

Several BLM and White Pine county roads (CR) provide access to the project area. In the early 1990s, segments of Green Springs Road (CR 5), BLM road 1179 (BLM 1179)/CR 1204, and a segment of Easy Junior Road (CR 1177) were widened and improved to provide access to the Easy Junior Mine area. Several years ago, White Pine County upgraded these roads. Under the Proposed Action, the main access route would follow this same route from US 50 and would not require further upgrading. The segment of Easy Junior Road south of the Easy Junior Mine was not upgraded and remains as a two-track road.

BLM FLMPA Title V Right-of-Way grant stipulations and road use agreements with White Pine and Nye Counties would allow Midway to perform road maintenance and snow removal for year-round access to the project area on roads leading to the Plan area. All road maintenance

would be done in accordance with the BLM Title V Right-of-Way grant stipulations and road use agreements and could include grading and watering. Where appropriate and necessary, road base or gravel would be placed on the road to reduce rutting; this has been the road maintenance practice conducted by White Pine County. Road base or gravel would be obtained from BLM-approved sources along a route (Williams 2014e). No road modifications would occur (BLM 2012c).

Proposed County Road Re-Route

To allow for greater public safety and mine security, the Proposed Action includes a proposed re-route of a segment of Easy Junior Road that currently passes through the mine area (Figure 2.3-1). Approximately 2 miles of Easy Junior Road would be closed to through-traffic. Midway would work with the BLM and White Pine County Commission to relocate this segment of Easy Junior Road through a FLPMA Title V Right-of-Way amendment.

North of the Plan area, Easy Junior Road would be re-routed to the west onto BLM 4006, to BLM 4006/CR 1180, to a new BLM road segment, to an existing unmarked BLM road, to BLM 4059, to reconnect with the existing Easy Junior Road route south of the mine area (Figure 1.1-2 and Figure 2.3-1). This re-route would maintain access to CR 62 and Green Springs Road southeast of the Plan area.

The proposed county road re-route would be approximately 12 miles long, and would include approximately 10 miles of existing BLM or BLM/county road and 2 miles of new road construction. A 0.3-mile stretch of this new road segment would be located outside of the Plan area. The new road segment would be constructed to meet appropriate standards. A BLM "resource road" or "local road" typically consists of a 14-foot crowned running surface, a 4-foot shoulder on each side, and ditches on each side to fit terrain and direct flow of surface water runoff.

Based on the typical 30-foot width of a BLM resource road, construction of the new BLM road segment would result in about 7 acres of surface disturbance. This segment would remain as a post-mining feature and would not be reclaimed. White Pine County would continue to classify this section of road as a Non- Standard County Road.

The existing BLM and county roads along the proposed county road re-route are roughly 12-foot-wide two-track roads. Minimal traffic is known to use these roads at present, and minimal increase in traffic would be anticipated under the Proposed Action. Existing roads along the proposed county road re-route would not be upgraded under the Proposed Action or alternatives. However, in the future White Pine County may decide to upgrade this re-route to White Pine County road standards, disturbing an additional 22 acres.

Proposed Roads Within the Plan Area

Under the Proposed Action, Midway would disturb approximately 180 acres for haul roads and secondary roads to connect facilities as shown on Figure 2.3-1. Haul road running surfaces would vary from 50 to 120 feet wide depending upon location and use (Williams 2014c), and would be designed to accommodate haul trucks and conveyors. Haul roads would be bermed in accordance with MSHA regulations. Figure 2.3-2 shows a typical haul road cross section. Secondary roads would be approximately 30 feet wide. The actual road disturbance width may be wider, depending on topography. Midway would use best management practices (BMPs) where necessary to control erosion, and would control fugitive dust emissions from roads using water or chemical dust suppressant application (such as magnesium chloride or lignin sulfonate) where appropriate. Reclamation activities associated with roads are described in Section 2.3.16.

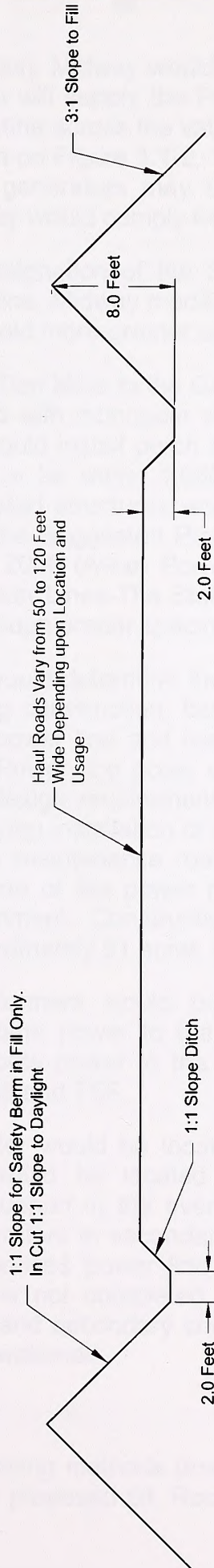

FIGURE 2.3-2
TYPICAL HAUL ROAD CROSS-SECTION
 MIDWAY GOLD US INC.
 GOLD ROCK MINE PROJECT

ADAPTED FROM FIGURE 15 IN MIDWAY 2013a.
 ADAPTED ON: AUG. 27, 2013

U.S. BUREAU OF LAND MANAGEMENT
 ELY DISTRICT
 EGAN FIELD OFFICE

NO WARRANTY IS MADE BY THE BUREAU OF LAND MANAGEMENT AS TO THE ACCURACY, RELIABILITY, OR COMPLETENESS OF THESE DATA FOR INDIVIDUAL USE OR AGGREGATE USE WITH OTHER DATA.

This page intentionally left blank.

2.3.3 Power Line

Under the Proposed Action, Midway would obtain its power from the Mount Wheeler Power 69 kV transmission line that will supply the Pan Mine. The Proposed Action power line would be extended from the Pan Mine across the valley to tie into the western side of the Gold Rock Mine electric system as shown on Figure 1.1-2. The power line alignment would be approximately 11 miles long. Temporary generators may be needed during construction or initial operations (Williams 2013a). Midway would comply with applicable permit requirements.

Following the BLM's designation of the Southwest Power Line Alternative as the preferred alternative for the Pan Mine, Midway modified the Proposed Action power line alignment slightly at the northern end to avoid more greater sage-grouse habitat (Midway 2013a).

The power line from the Pan Mine to the Gold Rock Mine would consist of three conductors and one static line supported with monopole structures (Figure 2.3-3) approximately 43 to 48 feet high. Mount Wheeler would install perch deterrents approved by the BLM in areas where the power line would cross or be within 1,968 feet (600 meters) of greater sage-grouse habitat. Power lines and associated structures would be constructed to conform to the practices and standards described in the Suggested Practices for Raptor Avian Protection on Power Lines—The State of the Art in 2006 (Avian Power Line Interaction Committee 2006) and Reducing Avian Collisions with Power Lines-The State of the Art in 2012 (APLIC 2012). These standards prevent electrocution through proper spacing between overhead transmission line features.

Mount Wheeler Power would determine the exact locations of the power poles and associated maintenance road during construction, based on field conditions and technical requirements. After final siting of the power line and maintenance road in the field, a 60-foot-wide corridor would be established. Power line poles would be installed approximately 300 feet apart, as ground conditions and design requirements would allow. Surface disturbance would include clearing of vegetation during installation of the poles, and clearing of vegetation associated with the two-track power line maintenance road along the length of the route). Blasting may be required during installation of the power poles or maintenance road, depending on geologic conditions along the alignment. Construction of this power line and an associated maintenance road would disturb approximately 51 acres (Table 2.3-1, Figure 1.1-2).

Three step-down transformers would be located in the Plan area (Figure 2.3-1). One transformer would distribute power to the process plant and support buildings. The second transformer would distribute power to the crushing facilities, and the third transformer would distribute power to the mill and TSF.

One emergency generator would be located at the heap facility process plant, and another emergency generator would be located at the mill to maintain solution circulation and emergency operations support in the event of temporary power loss. Fuel storage would be located next to the generators in secondary containment with 110 percent containment of the largest tank. If the proposed power line connecting the Gold Rock Mine to the Pan Mine Southwest Power Line is not completed in time for project startup, temporary generators, associated fuel storage and secondary containment facilities may be used at these locations until the power line is operational.

2.3.4 Open Pit

Conventional open pit mining methods (truck and shovel/loader) would be used to extract ore and waste rock from the proposed pit. Rock would be drilled and blasted for excavation using

ammonium nitrate and fuel oil (ANFO) or other appropriate blasting agents as determined by rock characteristics. All explosives would be stored and used in accordance with MSHA and Bureau of Alcohol, Tobacco, and Firearms and Explosives (BATFE) regulations and any other applicable federal, state, or local statutes and regulations. Blasting material would be kept in secure structures known as magazines. One blast per day is anticipated, and the total amount of explosives used would vary depending on the size of the working face of the pit.

Midway would begin mining in the existing open pit formerly known as the Easy Junior pit. Mining would start on the north end of the pit and continue during and after relocation of the previously reclaimed Easy Junior spent heap, which is described further in Section 2.3.6.

The rock to be mined contains either non-economic concentrations of metal or economic concentrations of metal. Zones of rock that contain economic metal concentrations either contain heap-grade ore or mill-grade ore. During preparation of the Plan, Midway used test results from rock core drilled for the Easy Junior mine and from rock core drilled during Midway's exploration activities to develop a model of the geologic formations in the vicinity of the pit. Midway used this modeling information to develop a mine plan. During operations, Midway would use information collected from blast hole sample testing to update the mine plan and direct equipment operators at the pit to dig ore from certain areas to obtain either mill-grade ore or heap-grade ore.

Mining equipment operators in the pit would segregate waste rock, mill-grade ore, and heap-grade ore and handle each material separately. Truck drivers would transport run-of-mine waste rock to the WRDAs. For ore destined for the heap leach pad, equipment operators would place the ore directly onto the heap as run-of-mine, or would haul the ore to a primary crusher located on the east side of the heap, where they would stockpile the ore adjacent to the crusher. Loader or other equipment operators would feed ore from the stockpile into the crusher. Stationary conveyors would transport heap-grade ore from the primary crusher to the secondary screen, secondary crusher, tertiary screen, and tertiary crusher, an agglomeration belt conveyor, then either trucks or conveyors would transport the ore on to the heap. This process is described in more detail in Section 2.3.6. Midway has designed haul roads to support the use of both haul trucks and conveyors. The decision to use trucks or conveyors would be based on economics, practicality, and the ability to maintain the necessary operational flexibility.

For ore destined for the mill, truck drivers would haul the ore to the mill crushers. Equipment operators either would feed the ore directly to the primary jaw crusher or place the ore in a stockpile, then use a front-end loader or other equipment to feed the ore to the crusher. The ore would undergo three stages of crushing prior to further processing in the mill.

Ore production is planned at a nominal rate of 10,000 to 17,000 tons per day (tpd), equivalent to 6.2 million metric tons (MMT) per year, with a peak rate of 25,000 tpd (9.1 MMT per year) (Williams 2014c). Mining is scheduled for 10 years on a 7-day-per-week schedule, with two 12-hour shifts per day. Peak ore and waste rock production is scheduled at 68,000 tpd. The average life-of-mine stripping ratio is projected to be about 2.5:1 waste rock to ore. This rate can, however, vary with economics. Table 2.3-3 lists the mining equipment that may be used during peak mining years.

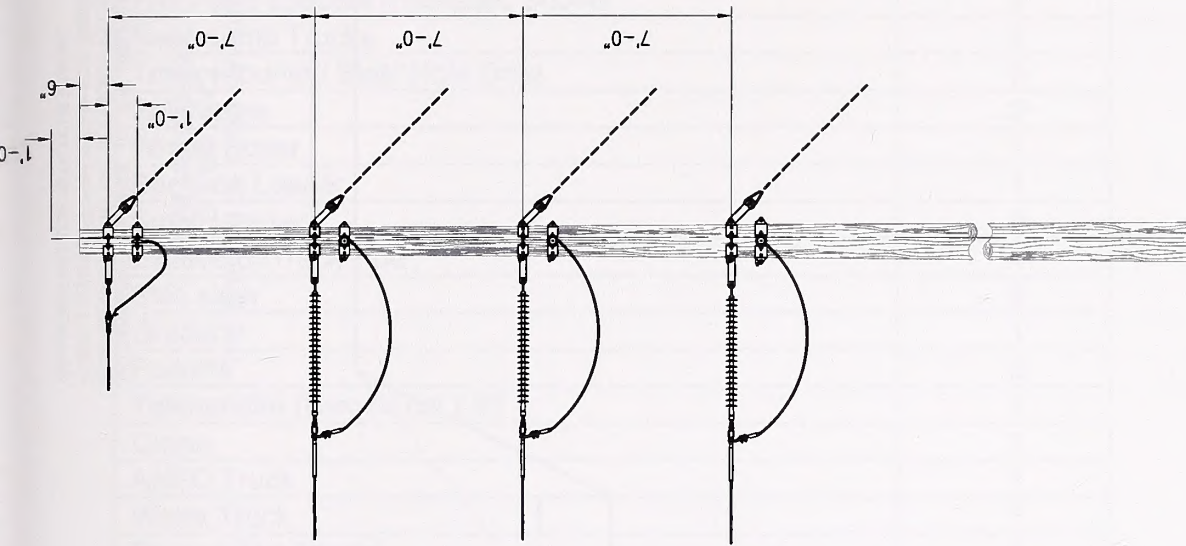

Single Circuit Dead Structure

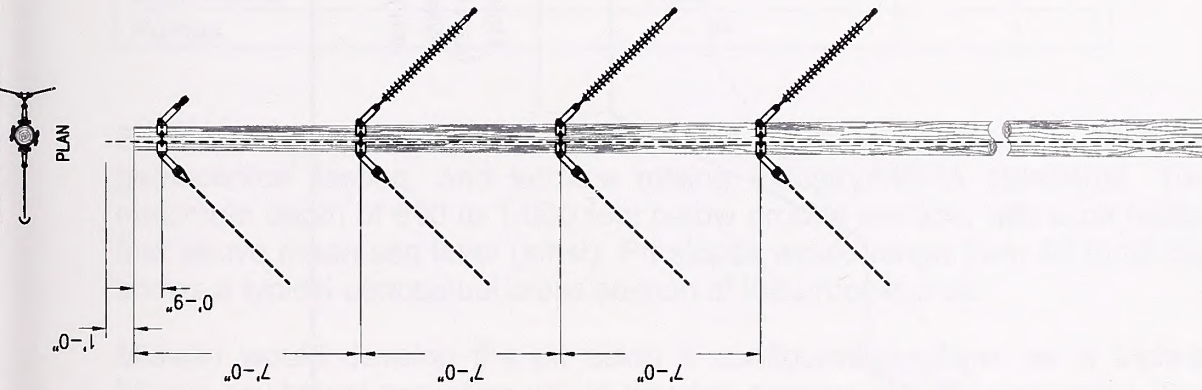

Single Circuit Running Angle Structure

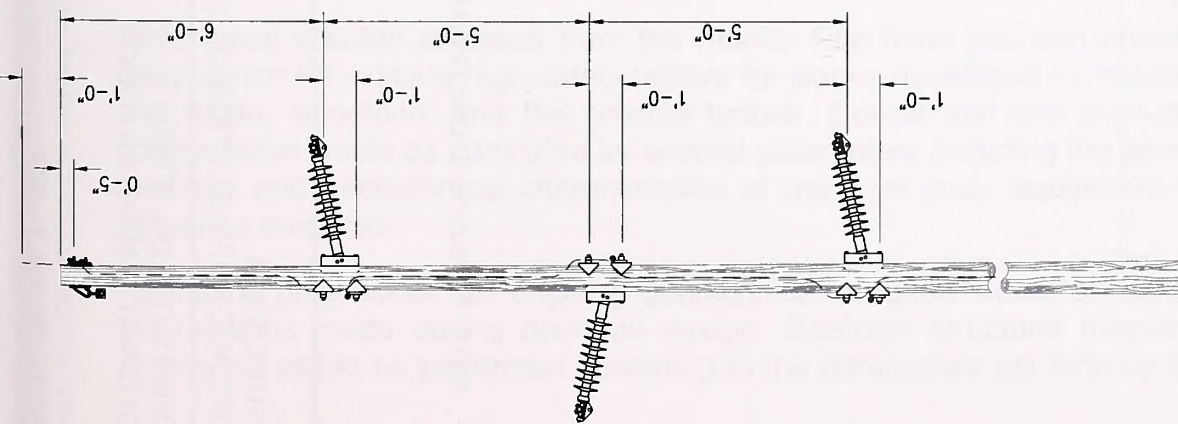

Single Circuit Tangent Structure

U.S. BUREAU OF LAND MANAGEMENT
ELY DISTRICT
EGAN FIELD OFFICE

NO WARRANTY IS MADE BY THE BUREAU OF LAND MANAGEMENT AS TO THE ACCURACY, RELIABILITY, OR COMPLETENESS OF THESE DATA FOR INDIVIDUAL USE OR AGGREGATE USE WITH OTHER DATA.

FIGURE 2.3-3
69 KV TRANSMISSION LINE STRUCTURES
MIDWAY GOLD US INC.
GOLD ROCK MINE PROJECT

ADAPTED FROM FIGURE ? IN MIDWAY 2013a.
ADAPTED ON: AUG. 27, 2013

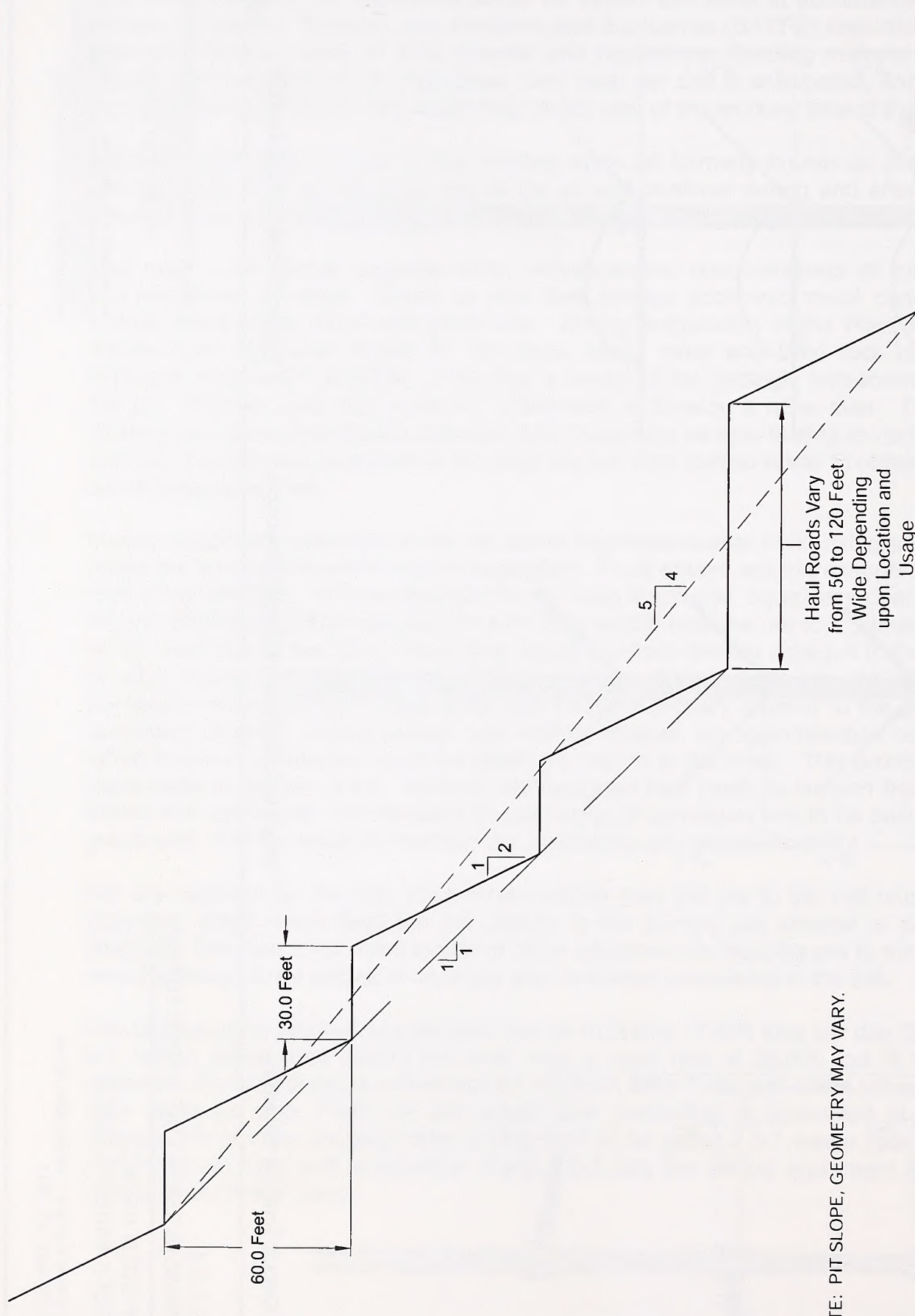

NOTE: PIT SLOPE, GEOMETRY MAY VARY.

FIGURE 2.3-4
 TYPICAL CROSS-SECTION OF THE PIT
 MIDWAY GOLD US INC.
 GOLD ROCK MINE PROJECT

ADAPTED FROM FIGURE 6 IN MIDWAY 2013a.
ADAPTED ON: AUG. 27, 2013

U.S. BUREAU OF LAND MANAGEMENT
ELY DISTRICT
EGAN FIELD OFFICE

NO WARRANTY IS MADE BY THE BUREAU OF LAND MANAGEMENT AS TO THE ACCURACY, RELIABILITY, OR COMPLETENESS OF THESE DATA FOR INDIVIDUAL USE OR AGGREGATE USE WITH OTHER DATA.

Table 2.3-3 Proposed Mobile Mine Equipment

Description	Units
Front-end Loaders /Hydraulic Shovel	2
Rear-dump Trucks	6
Track-mounted Blast Hole Drills	3
Bulldozers	2
Wheel Dozer	1
Backhoe Loader	1
Small Loader	1
Excavator/Track Hoe	1
Skid steer	2
Graders	1
Forklifts	5
Telehandler (Large Fork Lift)	1
Crane	1
ANFO Truck	1
Water Truck	1
Service/Tire Trucks	1
Flatbed Truck	1
Utility Truck (RO)	1
Pickup Trucks	16
Sand Truck/Snow Plow	1
Light Plants	6
Pumps	1

Engineers designed the open pit mining plan using previous pit mining data, results of geotechnical testing, and surface mining industry/MSHA standards. The pit would have a maximum depth of 800 to 1,000 feet below ground surface, with a pit bottom elevation of 5,740 feet above mean sea level (amsl). Pit slopes would range from 40 to 55 degrees. Figure 2.3-4 shows a typical conceptual cross section of the proposed pit.

Midway would develop the pit using a configuration known as a triple-bench configuration. Mining equipment operators would develop a series of three production benches, then establish a catch bench. Each of the three benches in the triple-bench formation would be up to 30 feet high and would result in an overall height of 60 vertical feet between catch benches. Catch bench widths are expected to average 30 feet. The operators would continue to develop the pit by repeating this process. Bench heights may vary depending upon mining requirements or rock geotechnical properties. Pit slope inter-ramp angles are expected to average 40 to 55 degrees, but overall slope angles would be less due to inclusion of haul roads.

Rock mass stability analyses from the nearby Pan Mine pits and observation in the existing Easy Junior Pit indicate high safety factors for slopes developed in massive limestone, siltstone and shale, limestone, and the breccia bodies. Operational and post-closure open pit slope configuration would be controlled by several parameters including the geometry of the ore body, geologic and geotechnical characteristics of the host rock, equipment constraints, and safe operating practices.

As mining progresses, an ongoing geotechnical program would be conducted to confirm the assumptions made during open pit design. Geologic structural mapping and open pit wall monitoring would be performed according to the parameters set forth by the design engineer to

optimize the open pit design and to help ensure pit stability during operations. Monitoring generally would include periodic surveying of pit wall surfaces to identify movement or deflection relative to benchmarks set outside the geotechnical influence of the pit. Final pit contours are designed to incorporate changes in slope that occur over long periods of time. These changes may occasionally present unstable conditions. At closure, Midway would construct post-mining safety barricades on the open pit ramps to prevent entrance.

2.3.5 Waste Rock Disposal Areas

Under the Proposed Action, Midway anticipates that mining would generate approximately 169.6 million tons of waste rock. Midway would place the waste rock in one of two WRDAs: the North WRDA (83.4 million tons) and the South WRDA (86.2 million tons). Both WRDAs would be located along the western perimeter of the pit. The North WRDA would be located in the same place as the existing Easy Junior WRDA and would eventually surround the Easy Junior WRDA.

Prior to placing waste rock, Midway would clear vegetation from the existing Easy Junior WRDA and remainder of the WRDA footprints. Midway would then salvage up to 2 feet of growth media from the Easy Junior WRDA and the remainder of the WRDA footprints. The salvaged plant growth media would be placed in stockpiles. Removing plant growth media may expose weathered geologic materials. On sloped terrain, where safe and practicable, Midway may push some of these weathered materials downhill to construct toe berms to prevent rocks from scattering on the hillside below the toes of the WRDAs.

Haul truck operators would place the waste rock then dozer operators would construct the WRDAs in 50-foot benches, which would be pushed down to a 3-foot horizontal distance to one-foot vertical distance (3H:1V) slope during reclamation. The maximum height of each WRDA would be 380 feet, with a crest elevation of 6,790 feet amsl. Midway would implement its waste rock management plan, which is appended to the Plan. Both WRDAs would be covered with a 12-inch vegetated soil cover to minimize the long-term potential for metals leaching. The final configurations of both WRDAs have been designed to improve surface runoff. The final surface would also prevent ponding of water, promote long-term stability, and limit erosion and channel scour over time. Figure 2.3-5 shows cross sections of the proposed WRDAs over the mine life.

Midway would construct diversion ditches to direct stormwater runoff around the WRDAs and into natural drainages downstream, as described further in Section 2.3.10. Groundwater quality would be monitored through monitoring wells as described in Section 2.3.12 and in the ground water monitoring plan (Interralogic 2012) appended to the Plan. Sample results would be used to verify whether any suspected seepage of water and leaching of materials is taking place through the WRDAs.

Geochemical testing was performed on representative samples of rock that would be excavated from the pit to characterize materials that would ultimately be placed on the WRDAs, exposed in pit walls, used as backfill or construction material, or otherwise exposed to the environment. The analytical results provide a definition of the rock types that are PAG or non-acid generating (NAG). Cross sections of sample locations in the pit are shown on Figure 2.3-6. The results are presented in the Midway Gold US Inc. Draft Baseline Geochemistry and Waste Rock Handling Report, Gold Rock Project, Nevada (Interralogic 2013a) appended to the Plan, and are summarized in Section 3.2.

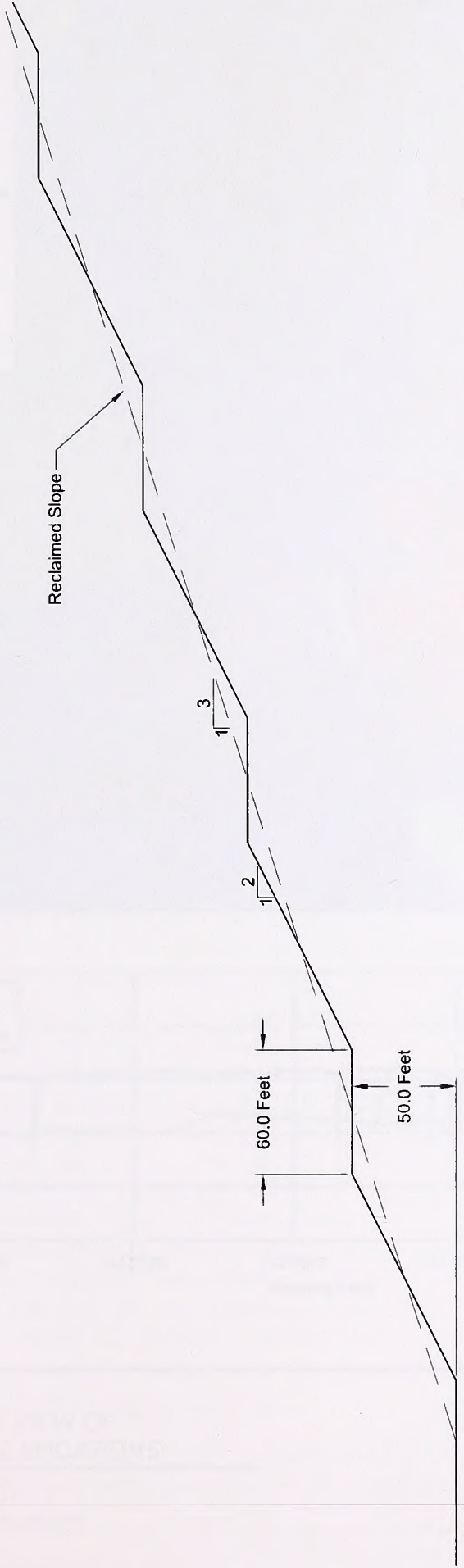

TYPICAL SECTION OF THE NORTH AND SOUTH WASTE ROCK DISPOSAL AREAS

FIGURE 2.3-5
TYPICAL CROSS-SECTION OF WASTE ROCK DISPOSAL AREAS

MIDWAY GOLD US INC.
GOLD ROCK MINE PROJECT

ADAPTED FROM FIGURE 7 IN MIDWAY 2013a.
ADAPTED ON: NOV. 19, 2013

U.S. BUREAU OF LAND MANAGEMENT
ELY DISTRICT
EGAN FIELD OFFICE

NO WARRANTY IS MADE BY THE BUREAU OF LAND MANAGEMENT AS TO THE ACCURACY, RELIABILITY, OR COMPLETENESS OF THESE DATA FOR INDIVIDUAL USE OR AGGREGATE USE WITH OTHER DATA.

This page intentionally left blank.

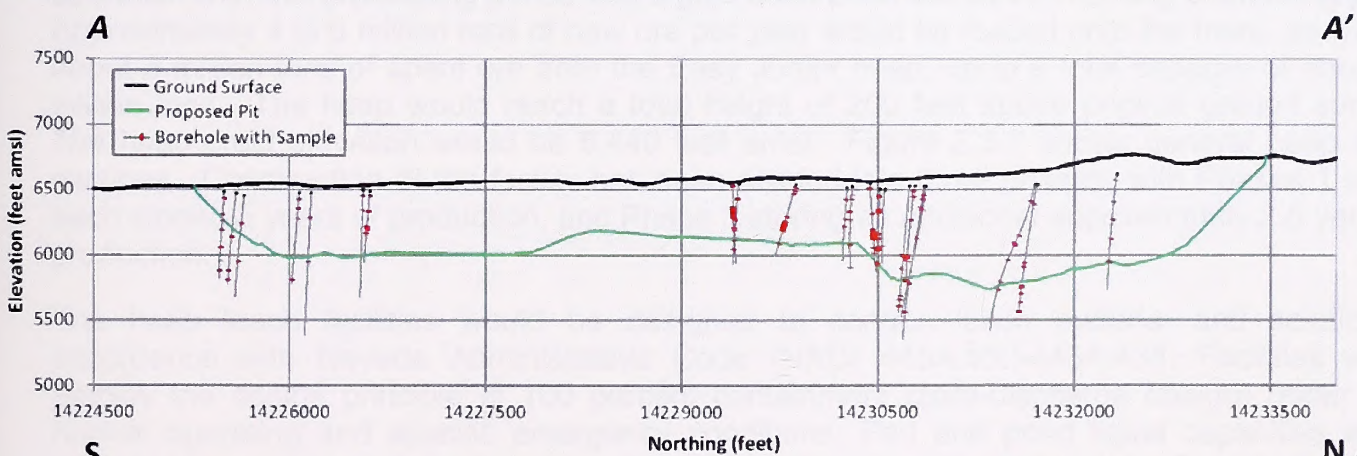
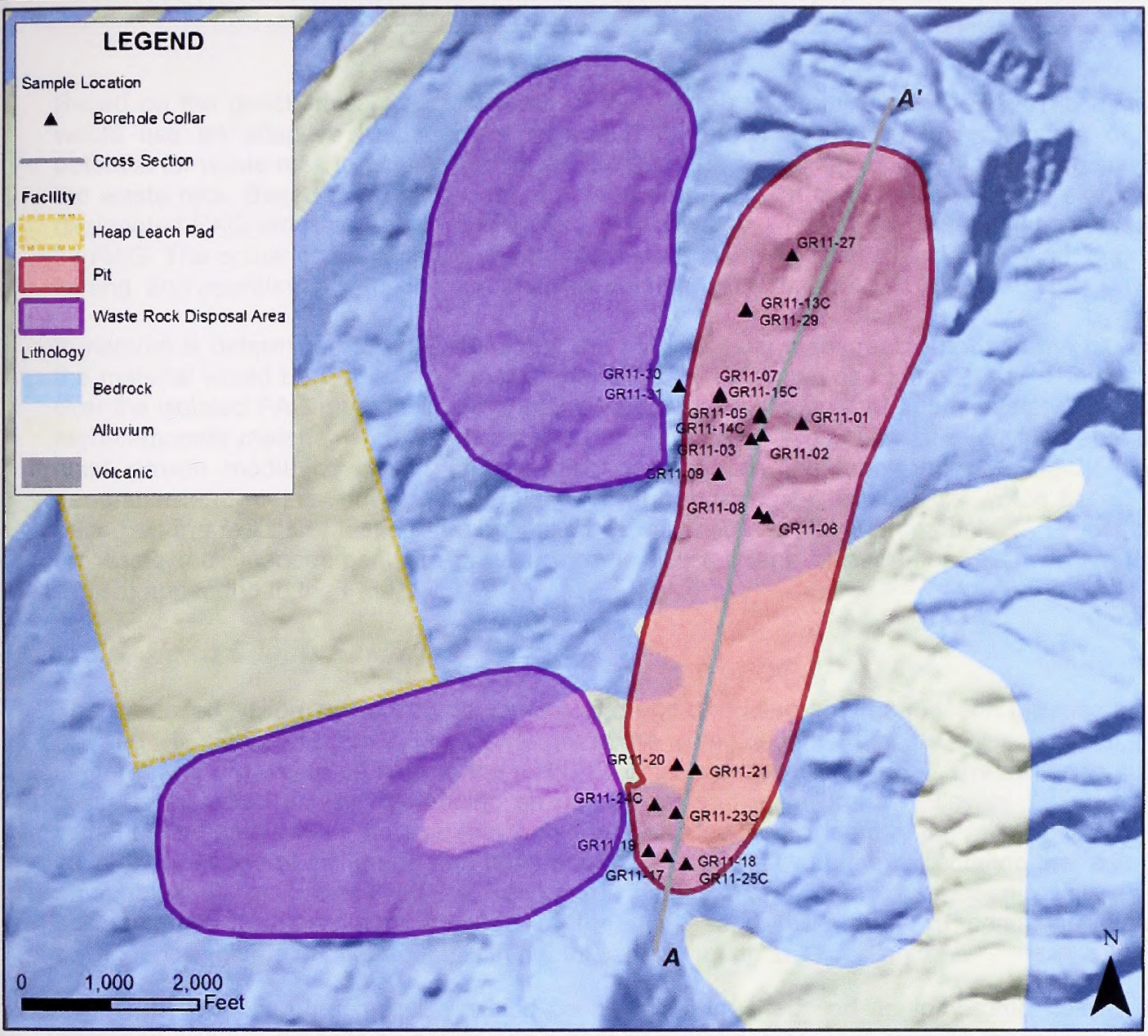

***Proposed Pit shell is preliminary

FIGURE 2.3-6
PIT CROSS-SECTIONAL VIEW OF
GEOCHEMICAL SAMPLE LOCATIONS

U.S. BUREAU OF LAND MANAGEMENT
ELY DISTRICT
EGAN FIELD OFFICE

MIDWAY GOLD US INC.
GOLD ROCK MINE PROJECT

NO WARRANTY IS MADE BY THE BUREAU OF
LAND MANAGEMENT AS TO THE ACCURACY,
RELIABILITY, OR COMPLETENESS OF THESE
DATA FOR INDIVIDUAL USE OR AGGREGATE
USE WITH OTHER DATA.

ADAPTED FROM FIGURE 3 IN INTERRALOGIC, 2013.
ADAPTED ON: NOV. 19, 2013



This page intentionally left blank.

Based on the geochemical characteristics of the waste rock from the Gold Rock Pit, Midway would use an adaptive management approach to further refine the understanding of the potential for waste rock to actually generate acid and metals leaching through ongoing testing of the waste rock. Based on existing data, a portion of the PAG material would require storage in designated PAG areas as shown on Figure 2.3-1; however, most of the material is expected to be NAG. The actual percentage would be determined during additional block modeling, ongoing testing, and operational sampling and analysis during mining (Interralogic 2013a).

If material is determined to be PAG, and if the material is in manageable pods in the pit, then the material would be isolated in either of the WRDAs, as shown on Figure 2.3-1. The final lift over the isolated PAG material in either of the WRDAs would consist of approximately 10 feet of high-carbonate material using waste rock set aside during mining, with an overlying vegetated plant growth media cover (12 inches thick) to minimize the long-term potential for acid generation and metals leaching. The plant growth media cover thicknesses would be refined based on the results of testing and optimized by infiltration and erosion modeling. Procedures for waste rock management are provided in the Waste Rock Management Plan (Interralogic 2013a) appended to the Plan.

2.3.6 Heap Leach Facilities

The Proposed Action would include constructing and operating both heap leach facilities and a mill and CIL circuit (Section 2.3.8). Lower grade ore would be sent to the heap leach circuit, and higher-grade ore would be sent to the mill/CIL circuit and associated TSF. The mill/heap cutoff grade is expected to vary depending on economics and metallurgical recovery, which would influence the amounts of material that would be heap leached or sent to the mill/CIL circuit. As such, the tonnage of mill-grade and heap-grade ore may shift with the expectation that a larger amount would be reclassified as heap-grade material. The heap has been designed to accommodate the maximum tonnage of the heap- and mill-grade ore combined plus a contingency volume of 25 percent, with a total capacity of up to 77 million tons.

The proposed heap leach facility would be a typical crushed and agglomerated heap leach operation with two processing ponds and a gold adsorption/desorption refining processing plant. Approximately 4 to 6 million tons of new ore per year would be loaded onto the heap, as well as about 3 million tons of spent ore from the Easy Junior heap, up to a total capacity of about 77 million tons. The heap would reach a total height of 200 feet above original ground surface. The heap crest elevation would be 6,440 feet amsl. Figure 2.3-7 shows general heap cross sections. Construction of the facility has been divided into three phases, with Phases 1 and 2 each storing 5 years of production, and Phase 3 storing an additional approximately 2.5 years of production.

The heap leach facilities would be designed to contain leach material and solution in accordance with Nevada Administrative Code (NAC) 445A.432-445A.438. Facilities would employ the design principle of 100 percent containment (zero-discharge design) under both normal operating and specific emergency conditions. Pad and pond liquid capacities would contain all process solution and accumulated precipitation within the system. Outside the heap, stormwater runoff would be diverted around the heap and returned to natural drainages downstream, as described in Section 2.3.10. Groundwater monitoring wells would be located and monitored as described in Section 2.3.12.

Stability analyses for the heap would be performed during detailed design and included in the Nevada water pollution control permit (WPCP) application. Seismic analysis and engineering

principles would determine the actual catch benches, lift height, maximum heap height, and overall foundation and heap leach facility slopes in compliance with NAC 445A.432-445A.438 and best engineering judgment.

During construction, equipment operators would clear vegetation from the heap leach pad and pond footprints. The operators would salvage coarse woody debris and plant growth medium and would place the materials in separate stockpiles (Snell 2014b). Current designs for the pad include compacting the sub-base, removing protruding rocks or debris for burial beneath the WRDAs, then establishing a compacted, low-permeability soil layer (LPSL) equivalent to a 12-inch layer with maximum permeability of 1×10^{-6} centimeters per second (cm/sec). Protruding rocks or debris would be removed from this LPSL.

Workers would then install an 80-mil high-density polyethylene (HDPE) geomembrane primary liner. Dozer operators would then spread a uniform, permeable overliner consisting of crushed rock to protect the primary liner from puncture. As the overliner is being spread, workers would install slotted pipes within the overliner to promote rapid conveyance of fluids from the leach material to the internal and perimeter berms and reduce the hydraulic head of the heap to less than 3 feet during normal operations. Standard quality assurance and control consistent with NAC 445A.439 would be conducted to identify, prevent, and/or repair liner punctures or welding defects along the liner seams during construction. Figure 2.3-8 presents a typical liner design.

The previously reclaimed Easy Junior heap covers an area of about 33 acres and contains about 3 million tons of leached ore. During construction, Midway would salvage and stockpile about 2 feet of growth media from the spent heap for future use. Midway would relocate the spent heap material to allow development of the pit.

Spent ore would initially be excavated from the Easy Junior heap using a combination of loaders, trucks, and conveyors. The spent ore would be crushed and screened if necessary. The screened-out oversized material would be placed as overliner on the primary liner of the proposed Gold Rock heap leach pad. The undersized material passing through the screen would subsequently be placed on the proposed heap leach pad and re-leached. The clay underliner from the Easy Junior spent heap would be salvaged and used as an underliner for a portion of the proposed Gold Rock heap leach pad. Midway would begin excavating the Easy Junior heap during the construction phases after a sufficient quantity of liner and the fluid management system would be in place to allow the spent ore to be placed in a contained system. The liner from the Easy Junior spent heap would be cut and buried in the WRDA.

The heap leaching process involves applying process solution to the top of the heap, collecting the solution as it reaches the bottom of the heap, and processing the solution to extract the gold. As the solution flows through the pores within the heap, the solution dissolves gold particles from the ore. Figure 2.3-9 shows a diagram of the heap leaching operations. To optimize distribution of process solution within the heap and contact with the surface of the ore, Midway would use primary, secondary, and tertiary crushers to break up heap-grade ore removed from the pit to a nominal 1.5-inch to 0.5-inch size, depending on ore type. Screening at secondary and tertiary crushing stations would control the crush size. The secondary and tertiary crushers, located just east of the heap facilities, would discharge the ore onto conveyors that would move the ore toward the heap.

The secondary and tertiary screens would separate smaller pieces of ore from the rest of the ore before it entered the secondary or tertiary crusher. Conveyors would then transfer these



U.S. BUREAU OF LAND MANAGEMENT
ELY DISTRICT
EGAN FIELD OFFICE

NO WARRANTY IS MADE BY THE BUREAU OF LAND MANAGEMENT AS TO THE ACCURACY, RELIABILITY, OR COMPLETENESS OF THESE DATA FOR INDIVIDUAL USE OR AGGREGATE USE WITH OTHER DATA.

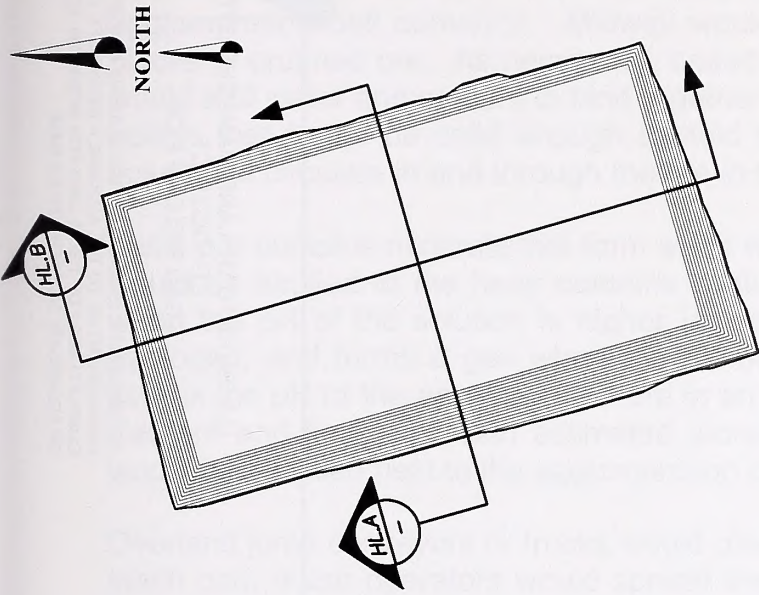

PLAN VIEW

Scale: 0 2000'

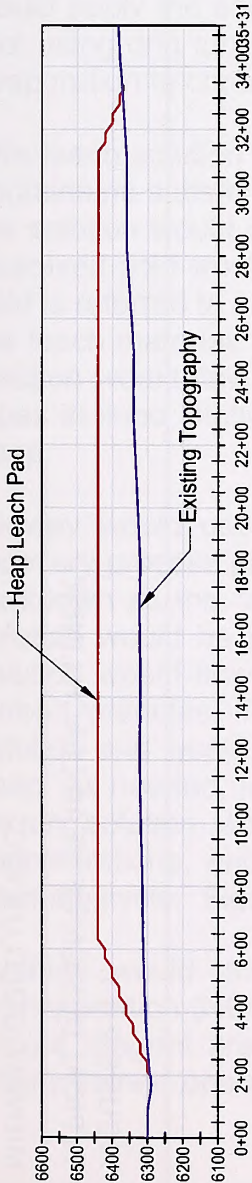

PROFILE VIEW OF HL.A

Horizontal Scale: 0 600'

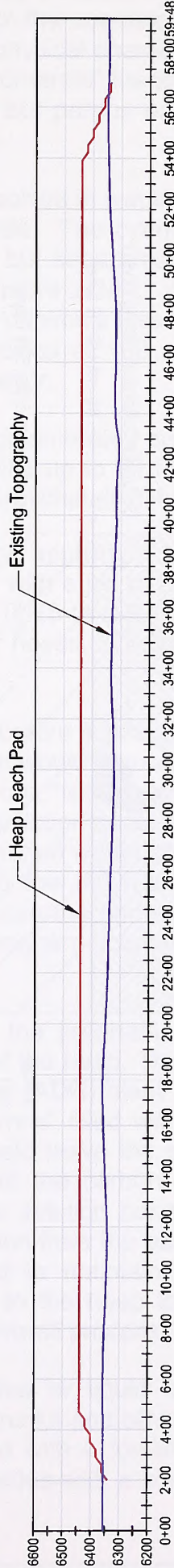

PROFILE VIEW OF HL.B

Horizontal Scale: 0 600'

FIGURE 2.3-7
TYPICAL CROSS-SECTION OF HEAP LEACH PAD
MIDWAY GOLD US INC.
GOLD ROCK MINE PROJECT

ADAPTED FROM FIGURE 12 IN MIDWAY 2013a.
ADAPTED ON: NOV. 19, 2013



U.S. BUREAU OF LAND MANAGEMENT
ELY DISTRICT
EGAN FIELD OFFICE

NO WARRANTY IS MADE BY THE BUREAU OF LAND MANAGEMENT AS TO THE ACCURACY, RELIABILITY, OR COMPLETENESS OF THESE DATA FOR INDIVIDUAL USE OR AGGREGATE USE WITH OTHER DATA.

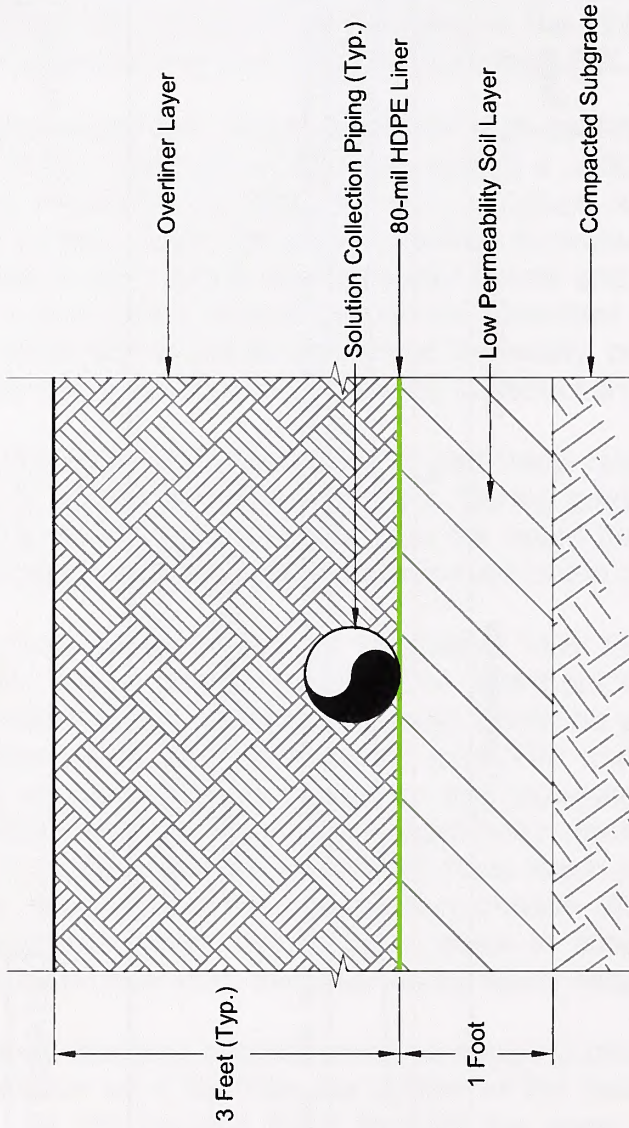

HEAP LEACH PAD BASE LINER DETAIL

NOT TO SCALE

FIGURE 2.3-8
TYPICAL DESIGN OF HEAP LEACH LINER

MIDWAY GOLD US INC.
GOLD ROCK MINE PROJECT

ADAPTED FROM FIGURE 13 IN MIDWAY 2013a.
ADAPTED ON: NOV. 19, 2013

smaller pieces of ore from the secondary and tertiary screens to a conveyor known as the agglomeration belt conveyor. Midway would monitor the consistency and pH of the smaller pieces of crushed ore. As necessary, based on the physical characteristics of the ore, Midway would add water and cement to bind together or “agglomerate” the smaller pieces of ore to form pellets that would be solid enough to hold together but porous enough to allow the process solution to circulate in and through the ore in the heap.

Metal ore contains minerals that form acids when dissolved in water. The process solution that would be applied to the heap contains sodium cyanide. The cyanide stays bound to sodium when the pH of the solution is higher (more basic), but separates from the sodium, binds to hydrogen, and forms a gas when the pH becomes more acidic. Midway would add lime to control the pH of the agglomerated ore in an effort to minimize loss of cyanide during leaching. Cement and lime silos with estimated storage capacities of 100 and 250 tons, respectively, would be installed next to the agglomeration belt conveyor.

Overland jump conveyors or trucks would place the agglomerated ore on the heap. At the heap leach pad, dozer operators would spread the ore in lifts up to 20 feet high, with setbacks that would result in an overall reclaimed slope angle of approximately 3H:1V.

Midway would leach gold from the ore on the heap by applying a dilute (0.004 to 0.005 gram sodium cyanide [NaCN] per gallon) solution of NaCN with a pH of approximately 10.5. Midway would apply the solution at a rate of approximately 0.0025 to 0.005 maximum gpm per square foot using drip tube emitters similar to garden soaker hoses. Sprays may be used at times for evaporation to control process fluid inventory volumes.

This leach solution is referred to as “barren solution” before it is applied to the heap because it contains no substantial amount of gold. As the solution would percolate down through the heap, the solution would dissolve the gold contained in the ore, “leaching” the gold from the ore. The dissolved gold would enter the leach solution. Leach solution containing substantial amounts of gold is referred to as “pregnant solution.” The leach solution would continue to percolate through the leach material, dissolving gold along the way, and flow down to the base of the heap. The solution would flow into the slotted pipes installed above the primary liner, then flow into solid pipes in lined ditches, and discharge into the lined pregnant solution pond located west of the heap.

Midway would use pumps to move the solution in the pregnant solution pond to the gold recovery process plant (process plant) located west of the heap. This process plant would also be known as the “adsorption, desorption, and refining (ADR) plant”. At the process plant, the solution would be pumped into metal tanks or “columns” filled with activated carbon. As the solution would flow through the carbon, the gold would leave the solution and collect on the carbon granules. The process solution flowing out of the carbon columns would be barren solution and would drain through pipes to the barren solution pond, also located west of the heap. As needed, Midway would remove barren solution from the barren solution pond, mix the barren solution with additional cyanide as required to maintain leaching-strength cyanide concentrations, and pump the barren solution back to the heap to continue the closed-loop leaching cycle. Figure 2.3-9 shows a diagram of the overall process.

Cyanide would arrive at the site as solid briquettes or liquid in Nevada Department of Transportation (NDOT)-approved tote bins or tanker trucks and off-loaded from the truck in the secure reagent area. Tote bins would be transported with a forklift to the reagent mix area, where trained operators would mix the cyanide briquettes with a solution of water and sodium

hydroxide. The mixing area would have hydrogen cyanide gas monitors in accordance with MSHA standards.

Makeup (fresh) water would be added to the barren pond as required to maintain a stable water balance in the leach system and replenish water lost to evaporation or trapped as immobile moisture in the heap.

2.3.7 Processing Ponds and Carbon-In-Columns Processing Plant

Midway proposes to construct a barren pond and a pregnant pond during Phase 1. Midway would expand each of those ponds prior to Phase 2 in order to limit the amount of construction required prior to Phase 1 and to reduce the size of the pond area and the amount of HDPE liner that would remain exposed during Phase 1 (Midway 2013a).

Final designs for the process solution ponds would be developed and submitted to NDEP for approval prior to construction. Process water ponds would be constructed in two phases. Phase 1 process ponds would be adequately sized for Phase 1 heap leach pad operations. Phase 2 process water pond expansions would be required to accommodate precipitation and potential storm accumulations resulting from development of Phase 2 (and Phase 3) heap leach pad operations, and must be constructed concurrent with HLP Phase 2 expansion.

The ponds constructed for Phase 1 would be 14 feet deep, and the ponds constructed for Phase 2 would be 15.5 feet deep. In both the Phase 1 and Phase 2 ponds, interior slopes would be 3H:1V, and exterior slopes would be 2H:1V or flatter. Process pond crests would be 60 feet wide to provide access for vehicle access and piping. The Phase 1 ponds would be connected to the Phase 2 ponds by internal spillways. At a minimum, process ponds are required by NAC 445A.433.1.(d) to be sized and operated to fully contain process fluids as well as projected accumulations from a 25-year, 24-hour storm event.

The proposed pond designs are more conservative than the NAC requirements, as the process ponds are sized to contain the following components:

- dead storage for pump operation (bottom 4 feet of the pond)
- operating process fluid storage
- drain down process fluid storage
- storage of projected accumulations from a 100-year, 24-hour storm event
- freeboard (top 2 feet of the pond).

In addition, Midway would provide and maintain a backup generator to supply power to the process pond pumps in the event of a line power outage. The pregnant process pond would be connected to the barren process pond by an internal spillway to provide, in combination, containment of runoff and direct precipitation from the 100-year, 24-hour storm event. The barren pond would also have an external spillway to protect the integrity of the pond embankments in the event of a storm larger than the 100-year, 24-hour event. Midway would install 8-foot high chain link fencing around the process ponds to protect wildlife, livestock, and wild horses and would cover the surface of the process ponds with bird balls or other best available technology to prevent birds from accessing the ponds as required by the NDOW Industrial Artificial Pond Permit.

For each pond, the liner system would consist of a LPSL, an HDPE layer, and a leak collection and recovery system (LCRS) in the sump area. Within the sump area under each pond, Midway would amend and compact the soil to create a 2-foot-thick low-permeability soil layer with a maximum permeability of 10⁻⁷ cm/sec. Midway would then install the LPSL secondary liner by placing a layer of soil a minimum of 12 inches thick with a maximum permeability of 1x10⁻⁶ cm/sec. Midway would then install the LCRS by placing geotextile in the sump area, filling the sump area with gravel, and then wrapping the geotextile around the gravel. Midway would install a riser pipe that would be perforated within the gravel and solid from the gravel layer to the surface. Midway would then overlay the LCRS with an 80-mil HDPE primary liner.

Pregnant solution would be treated in a conventional ADR plant and would be subject to the following unit processes:

- carbon-in-columns (CICs)
- acid wash
- carbon elution
- electrowinning
- carbon regeneration
- carbon handling and sizing
- reagent mixing and storage
- refinery.

Pregnant solution would be pumped from the pregnant solution pond to the CIC circuit at the process plant. The pregnant solution would be pumped through the carbon columns to adsorb or “load” gold onto the granular, activated carbon in the columns. The loaded carbon would then be removed from the carbon columns in batches and transferred via piping to a carbon wash vessel. Mineral scale and other impurities would be washed from the carbon with a dilute hydrochloric acid solution. The washed carbon would be transferred to a carbon stripping vessel, where alkaline cyanide solution would re-dissolve (strip) the adsorbed gold from the carbon. Stripped carbon would be sent to a thermal regeneration kiln, where it would be re-activated for reuse in the carbon columns. The re-activated carbon would be transferred to a quench tank and fines would be screened out before returning to the process circuit. Undersize carbon fines separated from the carbon granules would be collected and shipped off site for recycling and gold recovery.

The gold-rich strip solution produced in the carbon stripping step would be pumped to the electrowinning cells, where gold would be electroplated onto cathodes, producing a gold sludge material. This gold-bearing material would be collected from the electrowinning cells and heated in closed retorts to drive off any contained mercury. The barren strip solution reporting from the electrowinning cells would be recycled to the strip circuit.

Each retort would consist of a sealed heating chamber where the mercury would be vaporized. The mercury vapor would be swept in the airflow from the heating chamber to a connected condenser, where the mercury vapor would be cooled and liquid mercury would be produced. The airflow from the condenser would be routed through a carbon adsorption air pollution control device to remove any trace mercury vapor before discharging the airflow to the atmosphere. Mercury vapor controls that meet the Nevada Maximum Achievable Control

Technology in accordance with NAC 445B.3611-445B.3689 would be installed on all thermal devices. The mercury produced in the retort equipment would be collected in flasks and shipped off-site to a secure facility for recycling and gold recovery.

The retorted gold-bearing material would then be placed into a doré furnace, where the gold-bearing material would be melted and separated from impurities collected in molten slag. The molten metal would be poured into gold doré bars. The doré would be shipped off-site for further refining. The slag would be crushed and reprocessed on-site to remove residual gold content. Figure 2.3-9 shows a diagram of the typical gold recovery process.

Containment within the process building would include tanks, pipes, and vessels; and sealed concrete floor slabs, floor sumps, and walls to contain any spilled process solutions or materials. Secondary containment would accommodate 110 percent of the largest tank located within each building. The sealed concrete floor slabs would drain through a double-walled pipe to a process pond. Any reagents stored outside buildings would be in containment areas that would discharge to the ponds. The surrounding area outside of the buildings would be graded such that spills outside of the building would flow to the process ponds.

The heap leach facility would be surrounded by berms to prevent run-on from entering the process facilities. In addition, culverts and diversion ditches may be placed in and around the process facilities as necessary for further stormwater control. Stormwater runoff collected within the heap leach pad area would be channeled to the process ponds, as further described in Section 2.3.10.

Final design of the proposed process components would be in accordance with the WPCP requirements. Final designs would be submitted to the BLM and the NDEP prior to construction. As-built drawings would also be submitted within 30 days after construction.

2.3.8 Mill and Carbon-In-Leach Circuit

Under the Proposed Action, Midway would construct and operate a ball mill and CIL circuit to process higher-grade ore. By constructing and operating both a Heap Leach Pad and a CIL plant, Midway would attain maximum economic use of the gold resource (Midway 2013a). At the pit, mine equipment operators would feed mill-grade ore first through a jaw crusher at a nominal rate of 5,000 tpd and then through a vibratory feeder. Oversized material would be screened out and sent to secondary and tertiary crushers. Undersized material passing through the screens would report to the crushed ore bin. Dust collection devices and water sprays would be used to control fugitive dust at transfer points.

A conveyor would transport crushed ore and lime (added to neutralize acid-forming minerals) to a ball mill. Water would be added during primary grinding. The ball mill would discharge slurry into a sump, where the material would be pumped to cyclones for classification. The cyclone underflow of coarser material would return to the ball mill for further size reduction. The cyclone overflow of finer material would go to a thickener. The thickener underflow of fine material would report to a series of CIL tanks, and the clarified water would return to the process circuit. Figure 2.3-10 shows a diagram of the milling operation.

In the CIL circuit, chemicals in solution would leach gold from the finely crushed ore. The gold would then load onto the activated carbon. Loaded carbon would be sent from the CIL tanks to a pressure strip vessel, where chemicals in solution would desorb the gold from the carbon back

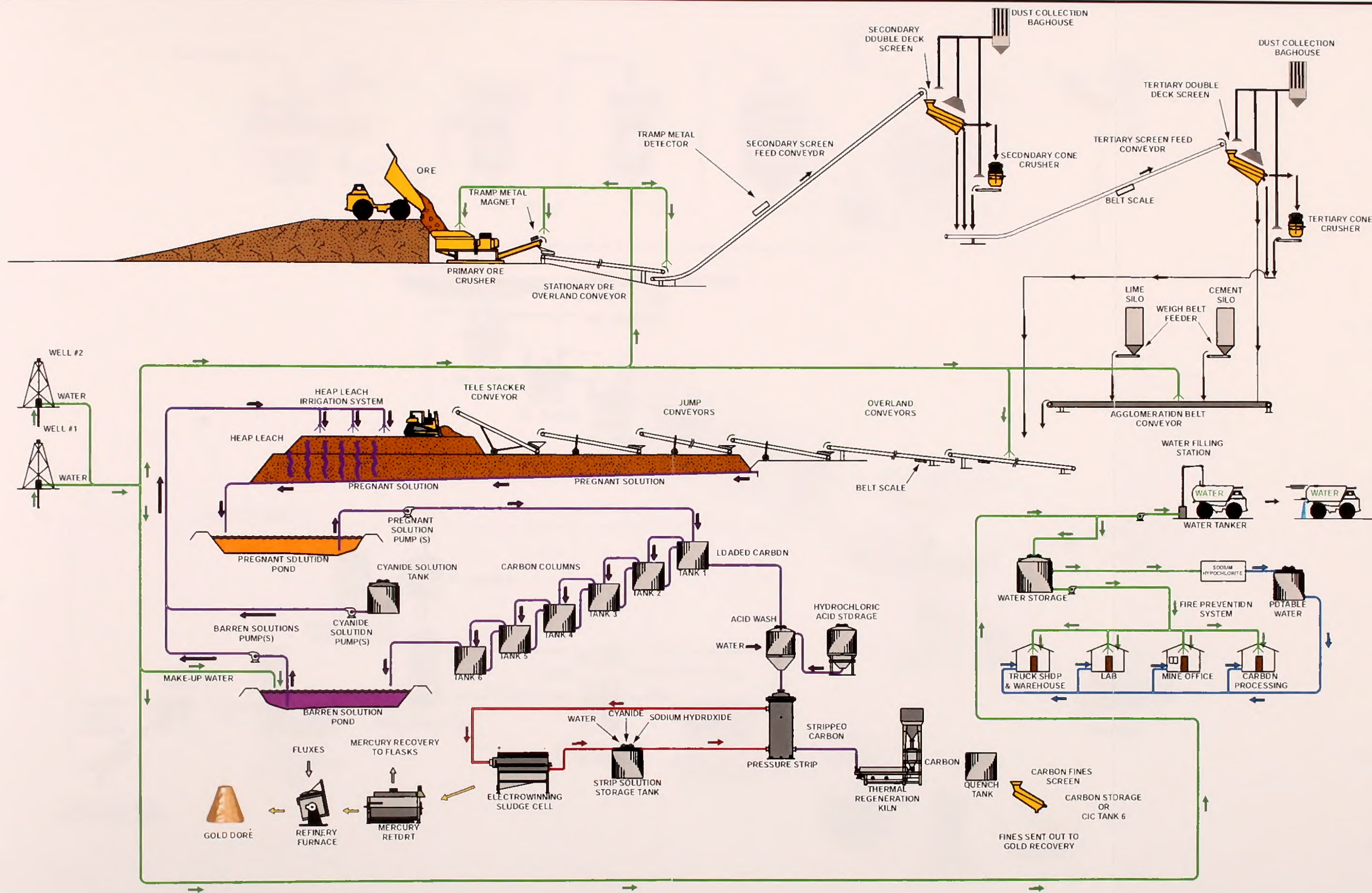

FIGURE 2.3-9 HEAP LEACH FLOWSHEET
 MIDWAY GOLD US INC.
 GOLD ROCK MINE PROJECT
 ADAPTED FROM FIGURE 11 IN MIDWAY 2013a.
 ADAPTED ON: NOV. 19, 2013

U.S. BUREAU OF LAND MANAGEMENT
 ELY DISTRICT
 EGAN FIELD OFFICE
 NO WARRANTY IS MADE BY THE BUREAU OF
 LAND MANAGEMENT AS TO THE ACCURACY,
 RELIABILITY, OR COMPLETENESS OF THESE
 DATA FOR INDIVIDUAL USE OR AGGREGATE
 USE WITH OTHER DATA.



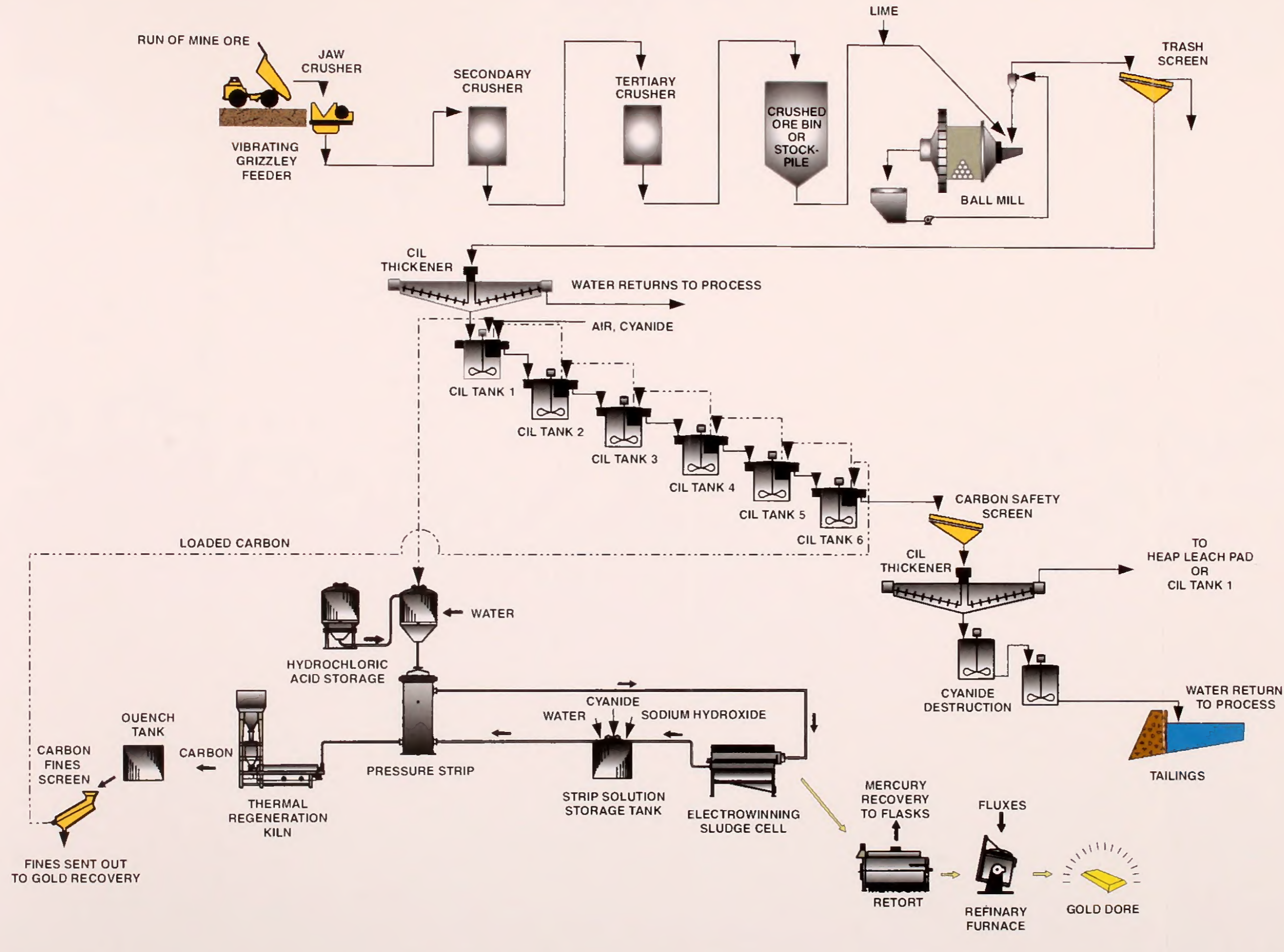

FIGURE 2.3-10 MILL FLOWSHEET
 MIDWAY GOLD US INC.
 GOLD ROCK MINE PROJECT
 ADAPTED FROM FIGURE 9 IN MIDWAY 2013a.
 ADAPTED ON: 10/17/2014

U.S. BUREAU OF LAND MANAGEMENT
 ELY DISTRICT
 EGAN FIELD OFFICE
 NO WARRANTY IS MADE BY THE BUREAU OF
 LAND MANAGEMENT AS TO THE ACCURACY,
 RELIABILITY, OR COMPLETENESS OF THESE
 DATA FOR INDIVIDUAL USE OR AGGREGATE
 USE WITH OTHER DATA.



into solution. The stripped carbon would be regenerated in a kiln and recycled back to the CIL circuit. The gold-bearing solution would be sent to an electrowinning cell, where an electric current would cause the gold and other metals to be deposited. This deposited material would be removed and sent to a mercury retort, where the material would be heated and the mercury volatilized and recovered into flasks. Mercury vapor controls that meet the Nevada Maximum Achievable Control Technology (MACT) in accordance with NAC 445B.3611 - .3689 would be installed on all thermal devices. The remaining retorted material would then be mixed with fluxes in a refining furnace to produce gold doré.

After flowing through the CIL circuit, final tails would be washed in a second thickener to recover gold. Tailings would be thickened from about 30 percent solids by weight to about 40 percent solids by weight. By thickening the tailings to this optimal consistency, Midway would conserve water and achieve a steeper beaching angle for the TSF beach, minimizing the size of the supernatant pond. If the tailings were much thicker, Midway would not be able to pump the tailings to the TSF (Midway 2013a).

The thickened tailings would then undergo a cyanide destruction process, in compliance with the NDOW Industrial Artificial Pond Permit. The thickened tails would be mixed with a strong oxidizing compound known as Caro's acid to reduce the concentration of cyanide in residual tailings to below 50 parts per million (ppm) of free cyanide. Caro's acid would be formed by mixing aqueous solutions of concentrated sulfuric acid and concentrated hydrogen peroxide. The mixture would be metered into the slurry to react with free cyanide and form a stable cyanate. The treated tails would then be pumped to the TSF for impoundment.

Overflow water from the thickener would be pumped back to the mill as part of the make-up water supply. The mill, CIL circuit, and thickener circuit would be located within secondary concrete containment covered with a sealant to prevent releases to the environment. Indoor containment would be sized to hold 110 percent of the largest tank. Outdoor containment would have a similar design but would also be able to hold the 100-year, 24-hour storm event.

2.3.9 Tailings Storage Facility

Equipment operators would construct a TSF (Figure 2.3-11) using "downstream" dam construction methods where the crest of the tailings starter embankment and subsequent embankment raises would move progressively downstream with changes in embankment height. With this downstream construction method, embankment raise construction would be founded on the ground surface and not tailings; the embankment would not be affected by potential liquefaction of the tailings stored within the impoundment; and tailings impoundment liner elements could be extended with each downstream raise.

Equipment operators would borrow soil either from within the upstream TSF basin or from an oxide waste rock borrow source located within the South WRDA to construct the tailings 'starter' embankment and subsequent phased embankment raises. The starter embankment and subsequent raises would be constructed at a 3H:1V slope. Crest elevation of the final embankment of the TSF would be 6,580 feet amsl (Figure 2.3-12).

During construction of the TSF, the deposition area would be lined with either a geosynthetic HDPE 60-mil liner, or a 12-inch thick layer of alluvial soils, amended with bentonite, if necessary, and compacted to provide a permeability of not greater than 1×10^{-6} cm/sec. Both options would meet minimum design criteria for tailings storage in NAC 445A.437.1.(a).

Workers would construct a drainage layer and piping system on top of the liner to minimize the build-up of hydraulic head within the facility and allow the tailings to drain and consolidate. The above-liner drainage system would incorporate slotted pipe installed in a sand berm following a herringbone pattern to provide a preferential flow path for entrained moisture in the tailings. This solution would be pumped from internal low-point sumps to minimize the head on the TSF liner during its operational life and accelerate head elimination during closure.

The drain pipes would convey the collected tailings drainage water by gravity to two underdrain collection intake pipes (one in each of the natural drainages within the facility). From the underdrain collection intake pipes, the drain water would be pumped out of the system by a submersible pump. A seepage collection pond is not currently included in the design, as the drainage would be collected within the TSF; however, if the design changes based on additional site-specific information, a double-lined pond would be constructed at the ultimate downstream toe of the facility.

Up to about 5,000 tpd of tailings would be pumped to the TSF through an HDPE pipeline inside of an HDPE-lined ditch. Alternatively, "pipe-in-pipe" secondary containment may be used. Both the lined ditch and the pipe-in-pipe would be designed to drain by gravity either into the TSF, or into lined spill-containment temporary storage ponds. The lined ditch and water pipe would connect or be "tied in" to the TSF liner to prevent releases to the environment.

Tailings slurry would be pumped into the TSF. Heavier solids would settle to the base of the TSF and form a tailings beach with an assumed slope ranging between 0.5 percent and 1 percent. The remaining solution, known as supernatant water, would rise to the surface and form a supernatant pond. For the first 1 to 2 years, Midway would discharge tailings primarily from the TSF embankment. Deposition points would be established to "push" tailings solids and entrained water away from the embankment. During this period, Midway would establish deposition cycles that optimize the creation and maintenance of a well-drained beachhead with a positive gradient to the north and away from the embankment.

Midway would recover the solution from the supernatant pond using a barge-mounted submersible pump system. The barge would be located within a lined barge operating channel as shown on Figure 2.3-11. The channel and barge operations would move progressively northward with time until the pond would be located in the northern extremes of the impoundment. By establishing a barge operating channel, the additional depth of water needed to provide clearance for the barge would be focused in one area, minimizing the area required for the supernatant pond, as well as decreasing evaporation losses and increasing tailings consolidation (Midway 2013a).

Solution that may collect at the base of the tailings would flow into the above-liner drainage collection pipe system. Any collected liquid would be pumped to the supernatant pond. By installing a sump and pump-back system, no pipes would penetrate the TSF liner, and all of the solution would stay within the TSF basin (Midway 2013a). Water recovered from the supernatant pond and the above-liner drainage system would be pumped back to the mill for reuse in the process system.

Midway would install four-strand barbed wire fencing around the TSF to discourage wildlife, livestock, and wild horses from accessing the area.



ELY DISTRICT OFFICE

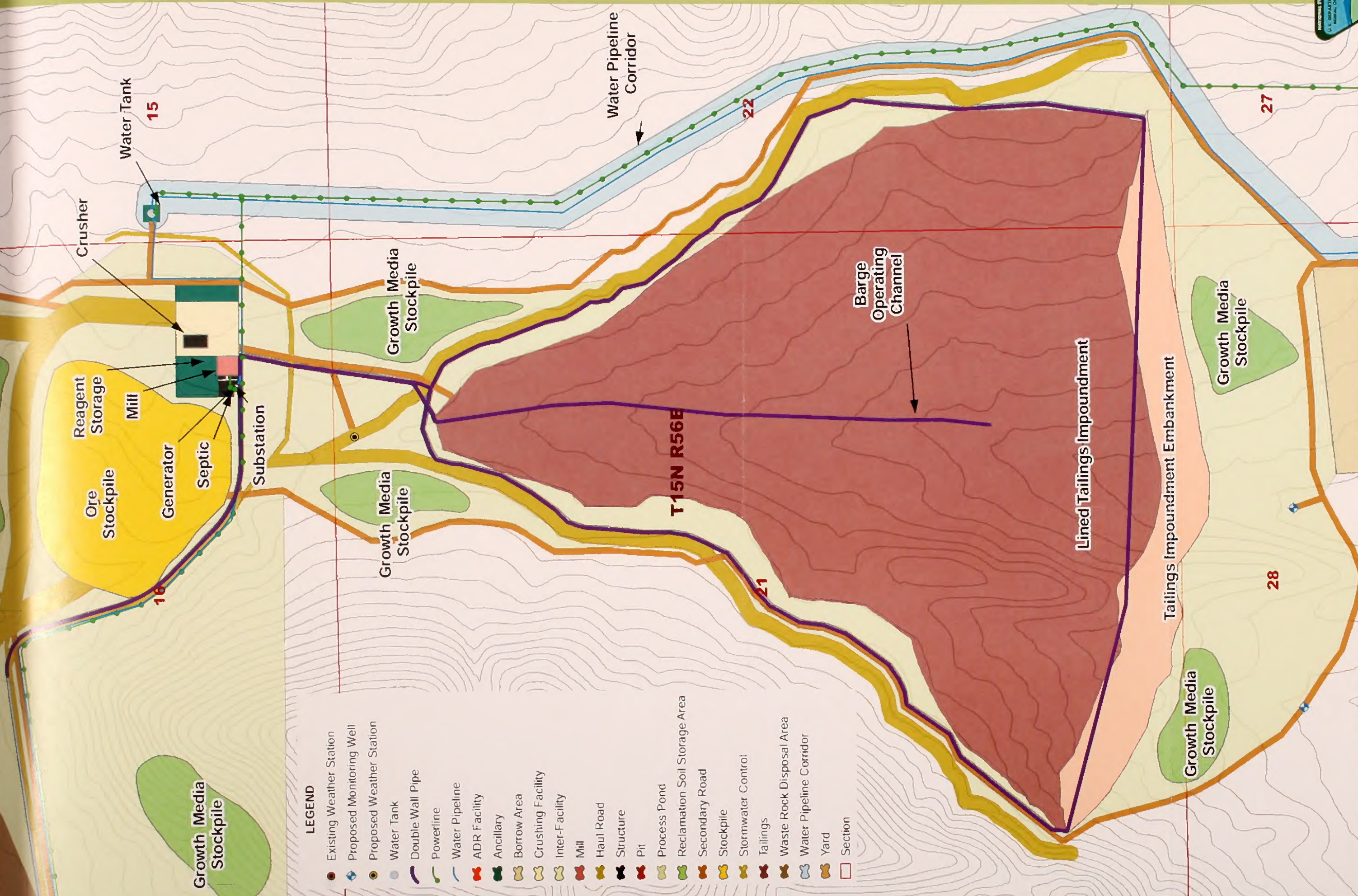

- LEGEND**
- Existing Weather Station
 - ◆ Proposed Monitoring Well
 - Proposed Weather Station
 - Water Tank
 - ▬ Double Wall Pipe
 - ▬ Powerline
 - ▬ Water Pipeline
 - ▬ ADR Facility
 - ▬ Ancillary
 - ▬ Borrow Area
 - ▬ Crushing Facility
 - ▬ Inter-Facility
 - ▬ Mill
 - ▬ Haul Road
 - ▬ Structure
 - ▬ Pit
 - ▬ Process Pond
 - ▬ Reclamation Soil Storage Area
 - ▬ Secondary Road
 - ▬ Stockpile
 - ▬ Stormwater Control
 - ▬ Tailings
 - ▬ Waste Rock Disposal Area
 - ▬ Water Pipeline Corridor
 - ▬ Yard
 - ▬ Section



U.S. BUREAU OF LAND MANAGEMENT
ELY DISTRICT
EGAN FIELD OFFICE

NO WARRANTY IS MADE BY THE BUREAU OF LAND MANAGEMENT AS TO THE ACCURACY, RELIABILITY, OR COMPLETENESS OF THESE DATA FOR INDIVIDUAL USE OR AGGREGATE USE WITH OTHER DATA. ORIGINAL DATA WERE COMPILED FROM VARIOUS SOURCES. THIS INFORMATION MAY NOT MEET NATIONAL MAP ACCURACY STANDARDS. THIS PRODUCT WAS DEVELOPED THROUGH DIGITAL MEANS AND MAY BE UPDATED WITHOUT NOTIFICATION.

FIGURE 2.3-11
CONCEPTUAL TAILINGS
STORAGE FACILITY LAYOUT
MIDWAY GOLD US INC.
GOLD ROCK MINE PROJECT

ADAPTED FROM FIGURE 10 IN MIDWAY 2013a.
ADAPTED ON: NOV. 19, 2013

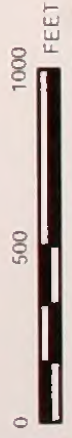

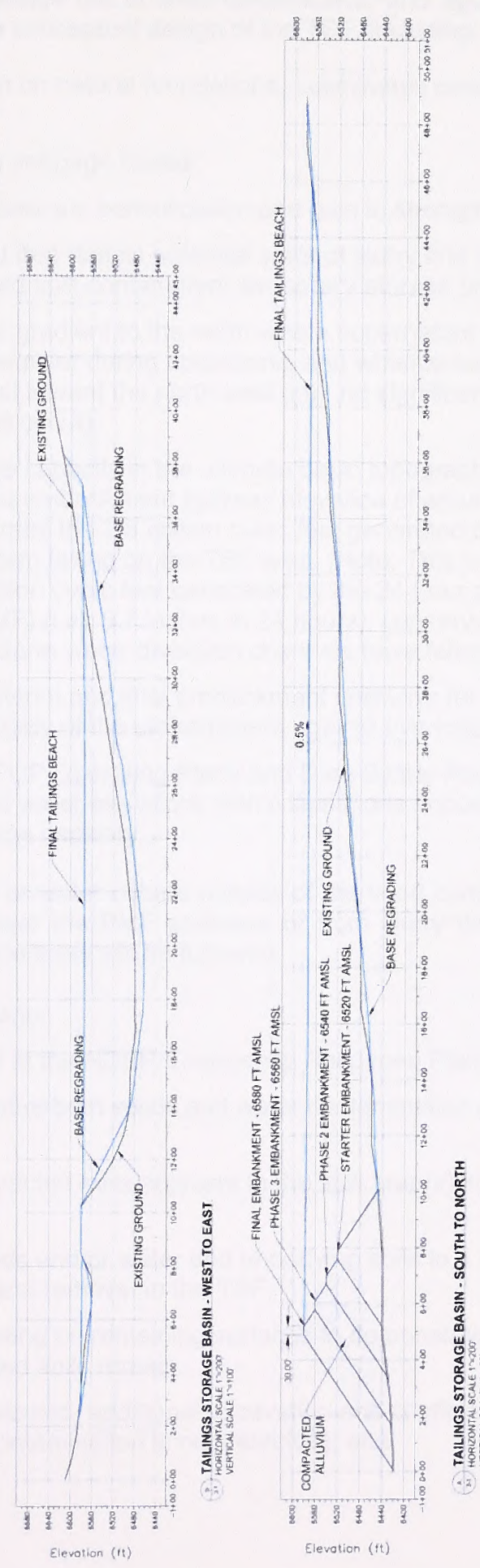
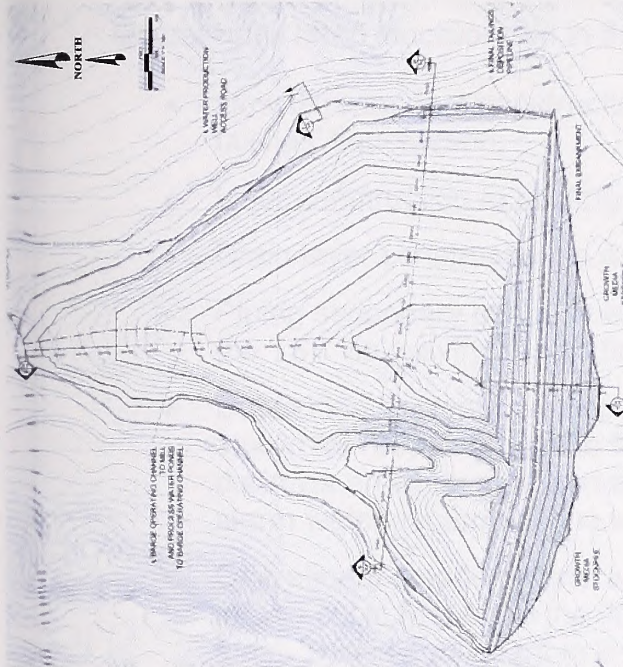

FIGURE 2.3-12
TYPICAL CROSS SECTION OF TAILINGS STORAGE FACILITY
MIDWAY GOLD US, INC.
GOLD ROCK MINE PROJECT

ADAPTED FROM FIGURE 3-1 CONCEPTUAL LAYOUT, TAILINGS STORAGE FACILITY AND FIGURE 3-3 CONCEPTUAL SECTIONS, TAILINGS STORAGE FACILITY, SRK 2013.
 ADAPTED MAY 27, 2014.

U.S. BUREAU OF LAND MANAGEMENT
 ELY DISTRICT
 EGAN FIELD OFFICE

NO WARRANTY IS MADE BY THE BUREAU OF LAND MANAGEMENT AS TO THE ACCURACY, RELIABILITY, OR COMPLETENESS OF THESE DATA FOR INDIVIDUAL USE OR AGGREGATE USE WITH OTHER DATA.

This page intentionally left blank.

Risk reduction measures against spillage out of lined containment, and against embankment failure, have been incorporated in the conceptual design of the TSF, including:

- Downstream dam construction on natural foundations – eliminates consequences of tailings' liquefaction;
- Liner construction to minimize seepage losses;
- Drain layer construction to accelerate consolidation and gain in strength of tailings;
- Piping secondary containment that directs potential spills of slurry and water either into the TSF via gravity, or into lined spill-containment temporary-storage ponds;
- Deposition to create a positive gradient to the north where supernatant water will be stored for recycling back to the plant during operations, and whence water will ultimately drain via an excavated channel toward the north-east (i.e., no significant post-closure storm water accumulations will occur);
- Operational creation of storage capacity in the ultimate basin topography of about 18 million cubic feet up to the final embankment spillway elevation of around 6,977 feet amsl. This is equivalent to 6 times the 2.8 million cubic feet generated during a single 100-year, 24-hour duration storm falling on the TSF area. [Note: This is also equivalent to more than half of the 30 million cubic feet generated by the 24-hour duration Probable Maximum Flood (PMF) (i.e., 9.7 inches in 24 hours), conservatively assuming that both east and west TSF storm water diversion channels have failed;
- Phased provision of starter, interim and final embankment spillways for PMF peak flow conditions to maintain the integrity of the embankment against overtopping failure; and
- Commitment under NDEP WPCP Operating Plans and Dam Safety Regulations to maintain the supernatant pond water elevations within limitations imposed by mass stability and storm water storage capacity.

If reportable spillage of tailing solids or water occurs outside of the lined confines of the tailing impoundment (from either spillage over the PMF spillways or from slurry deposition or water recycling pipelines), the following procedures will be followed:

- Eliminating the source of spillage;
- Reporting the spill as required in the NDEP Emergency Response Plan;
- Ascertaining the surface extent of both solids and water contamination resulting from the spill;
- Sampling and testing of unimpacted soils adjacent to the spill area(s) for MWMP and ABA chemistry;
- Excavating spilled tailings solids and/or water and underlying soils to a depth consistent with seepage front migration and removal to the TSF;
- Performing of confirmation testing on remaining surfaces to demonstrate that no residual tailings-solids or water-impacted soils remain.
- If residual contamination is detected, additional excavation and confirmatory testing will be performed (until residual contamination is not detected); and

- The impacted areas will be graded, covered with growth media as required, amended as required, and seeded with the BLM-recommended seed mixture.

2.3.10 Stormwater Management

In accordance with the Stormwater Management Plan included as an appendix to the Plan, Midway would construct diversion ditches to direct stormwater runoff around the flanks of the pit and into natural drainages. Stormwater collection trenches would direct stormwater from disturbed areas to sediment basins to minimize transport of sediment. The diversions would be designed to handle flows generated for up to and including 25-year, 24-hour storm conditions. Figure 2.3-13 shows a typical cross section of a stormwater diversion. Sediment basins would be designed to contain the 10-year, 24-hour event and approximately 1 year of accumulated sediments, while maintaining a minimum freeboard of 1 foot. Sediment basin spillways would be designed to safely pass flows from the 25-year, 24-hour storm event.

Midway also would construct diversion ditches to direct stormwater runoff around the WRDAs and into natural drainages downstream. Culverts would be installed where roads cross natural drainages. The diversions would be designed to handle flows generated for up to and including 25-year, 24-hour storm conditions. Sediment basins would be located in drainages downgradient of the WRDAs. Sediment basins would be sized for the annual estimated sediment yield from the WRDAs.

The WRDAs would be visually inspected a minimum of once per year immediately after the spring melt/runoff period, and additionally within one to two weeks after storm events equal to or greater than the 25-year, 24-hours event. Any seeps would be identified, coordinates noted, and described in terms of flow rate estimate, and color or unusual character. If the flow rate is sufficient, a water sample would be collected and sent for Profile I analysis. If Nevada reference values are exceeded, a plan would be developed to minimize potential seepage and consequent impacts to groundwater, including but not limited to the following possible actions:

- Elimination of ponding on the dump surface to promote runoff and minimize infiltration and seepage;
- Creating new and/or deepening existing upstream surface water diversion ditches to better intercept shallow groundwater flux and reduce seepage;
- Concurrent reclamation of the source area to maximize in-situ (i.e., on dump) surface losses via runoff and/or vegetation transpiration;
- Collection and pumping of seepage water into the mill circuit for make-up water use during operations; and
- Longer term closure management via evaporation from an evaporation or evapotranspiration cell.

Stormwater run-off would be diverted around the heap leaching facilities, mill, and the west and east sides of the TSF, and returned to natural drainages. The diversions would be designed to handle the 100-year, 24-hour storm event. In addition, culverts and diversion ditches may be placed in and around the process facilities as necessary for further stormwater control.

Stormwater runoff from the heap would be channeled to the process ponds. Stormwater collected in the ponds would be handled in accordance with the WPCP, which would allow for

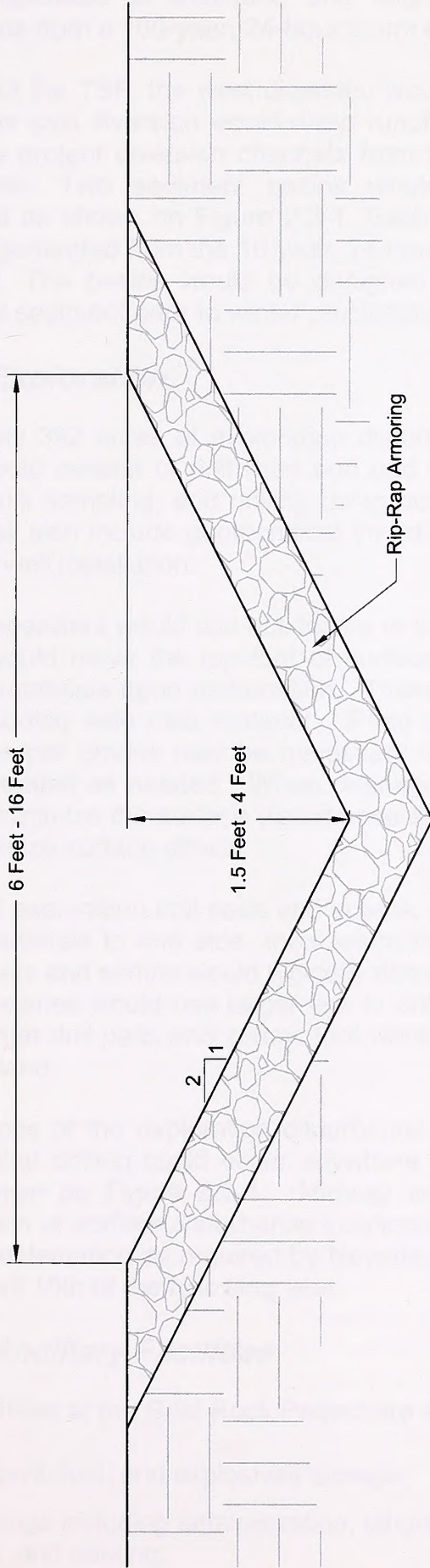

STORMWATER DIVERSION TYPICAL SECTION

NOT TO SCALE

**FIGURE 2.3-13
TYPICAL CROSS-SECTION OF
A STORMWATER DIVERSION**

**MIDWAY GOLD US INC.
GOLD ROCK MINE PROJECT**

ADAPTED FROM FIGURE 8 IN MIDWAY 2013a.
ADAPTED ON: NOV. 19, 2013

U.S. BUREAU OF LAND MANAGEMENT
ELY DISTRICT
EGAN FIELD OFFICE

NO WARRANTY IS MADE BY THE BUREAU OF LAND
MANAGEMENT AS TO THE ACCURACY, RELIABILITY, OR
COMPLETENESS OF THESE DATA FOR INDIVIDUAL USE
OR AGGREGATE USE WITH OTHER DATA.

This page intentionally left blank.

using collected stormwater in the process circuit. At a minimum, the solution ponds would be sized and operated to withstand and fully contain process fluids as well as projected accumulations from a 100-year, 24-hour storm event.

Upgradient of the TSF, the west diversion would divert stormwater runoff from the knoll to the west, and the east diversion would divert runoff from the main north-south oriented ridgeline to the east. To protect diversion channels from erosion, rock armor (riprap) would be sized for each channel. Two sediment basins would be constructed downgradient of the TSF embankment as shown on Figure 2.3-1. Each basin would be sized to contain the volume of stormwater generated from the 10-year, 24-hour storm event in addition to an estimated volume of sediment. The basins would be designed with access for maintenance and removal of accumulated sediment prior to winter precipitation.

2.3.11 Exploration

Approximately 392 acres of exploration disturbance would occur under the Proposed Action. Activities would consist of drill road and pad construction, overland travel, surface sampling, trenching, bulk sampling, and drilling using both reverse circulation and core rigs. Exploration activities may also include geotechnical investigations, geophysical surveys, water exploration, and monitor well installation.

Equipment operators would use bulldozers or tracked excavators to construct exploration roads. Operators would move the top foot of surface growth media and plant materials aside, then replace the materials upon reclamation. These roads would be bladed to an average width of 20 feet, including side cast material. Road grades generally would be 10 percent or less; however, steeper grades may be necessary for short pitches. Stormwater control measures would be installed as needed. When drainages must be crossed by a road, BMPs would be followed to minimize the surface disturbance and erosion potential. Temporary culverts may be used to minimize surface effects.

To construct exploration drill pads and sumps, operators would bulldoze or blade growth media and plant materials to one side, then return the material during reclamation. Construction of these drill pads and sumps would typically disturb 4,000 square feet (less than 0.1 acre) of land. Drillers sometimes would use larger rigs to drill deeper holes, and equipment operators would construct larger drill pads and sumps that would disturb up to 5,000 square feet (just more than 0.1 acre) of land.

Exact locations of the exploration disturbance have not been determined. However, Midway anticipates that drilling could occur anywhere within the Plan area including the fenced mine area as shown on Figure 2.3-1. Midway would provide the BLM and NDEP with annual documentation of surface disturbance locations for the exploration activities and any completed concurrent reclamation as required by Nevada Revised Statute (NRS) 519A and NAC 519A on or before April 15th of the following year.

2.3.12 Ancillary Facilities

Ancillary facilities at the Gold Rock Project are shown on Figure 2.3-1 and will include:

- Reagent, fuel, and explosives storage;
- Buildings including administration, laboratory, safety and security, warehouse, core shed, and parking;

- Potable water and septic systems;
- Maintenance shop;
- Ready line;
- Light vehicle wash;
- Communication facilities;
- Helicopter pad;
- Plant growth media stockpiles;
- Waste management including a Class III-waivered landfill;
- Area to store petroleum contaminated soils prior to off-site disposal;
- Monitoring wells;
- Borrow areas;
- Fencing; and
- Yards and inter-facility disturbance.

Reagent, Fuel, and Explosives Storage

Most reagents tanks would be located outside of the process facilities in secondary containment. The secondary containment would hold 110 percent of the largest volume tank and, if out of doors, additional capacity to hold the 100-year, 24-hour storm event. The floor of the reagent areas would be sealed to prevent spills from entering cracks or permeating the concrete and being released to the environment. The sealed concrete floor slab would drain through a double-walled pipe to a process pond. Table 2.3-5 presents the reagents that would be used, the volumes that would be stored on-site, and the number of shipments anticipated per month. These estimates may vary depending on the metallurgical conditions encountered during operations. Midway may elect to substitute reagents with similar chemical compositions for those listed if higher efficiencies can be realized.

Drivers off-loading fuel would be certified and trained in appropriate handling. Appropriate equipment would be located within the containment to facilitate collection of any spilled fuels. A sump would be located at one end of the containment so that spilled fuels could be pumped from the containment using a portable pump.

Other smaller quantities of hydrocarbons and regulated materials would be located at the truck shop, warehouse, and process area. These would be kept indoors in proper storage and secondary containment systems. Table 2.3-5 shows the fuels and reagents that would be used, approximate quantities, average usage rates, and the numbers of monthly shipments.

Explosives and blasting agents would be purchased, transported, stored, and used in accordance with the BATFE; Department of Homeland Security provisions; MSHA regulations; and other applicable federal, state, or local legal requirements. The primary blasting agent used would be a mixture of ANFO. Ammonium nitrate prill would be stored in a silo in a secure area. Explosives, blasting agents, boosters, and blasting caps would be stored within a secured magazine.

Table 2.3-5 Fuels, Reagents, Volumes and Shipments

Reagent	Storage	Amount/ Delivery	Anticipated Trucks/Month	Approximate consumption/day
Sodium cyanide	13,500 gallons	5,000 gal	5.0	740 gal
Sodium hydroxide	10,000	5,000 gal	0.8	127 lbs
Sulfuric acid	100	20	18	11.8 tons
Hydrogen peroxide	40	20	7	4.3 tons
Lime	100-ton silo	30 tons	17.0	17 tons
Cement	250-ton silo	30 tons	43.0	43 tons
Off-road Diesel Fuel	2 x 30,000-gallon tanks	6,000 gallons	29.0	5,800 gallons
Highway Diesel Fuel	2,000-gallon tank	1,800 gallons	0.4	25 gallons
Gasoline	5,000-gallon tank	4,500 gallons	0.8	125 gallons
Automatic Transmission Fluid	1,000-gallon tank	500 gallons	0.9	15 gallons
Engine Oil	1,500-gallon tank	1,000 gallons	0.7	29 gallons
Hydraulic Fluid	1,000-gallon tank	500 gallons	0.5	8 gallons
Gear Oil (50W)	2,000-gallon	1,000 gallons	0.7	24 gallons
Gear Oil (90W)	100 gallons	50 gallons	0.25	12 gallons
Gear Oil (80W90)	100 gallons	50 gallons	0.2	6 gallons
High Pressure Oil (HP-350)	100 gallons	50 gallons	0.2	25 gallons
SAE 60 Oil	2,000 gal	1,000 gal	0.5	533 gallons
SAE 40 Oil	100 gal	50 gal	0.25	12 gallons
Cat FD01 Lube	100 gal	50 gal	0.04	2 gallons
Drill Oil (ISO VG 100-150)	2,000 gal	500 gal	0.4	197 gallons
Antifreeze	1,000-gallon tank	500 gallons	0.2	5 gallons
Used Oil	3,000-gallon tank	2,500 gallons	0.9	76 gallons
Used Antifreeze	500-gallon tank	500 gallons	0.4	5 gallons
Ammonium Nitrate	50-ton silo	30 tons	10.0	10 tons
Ammonium Nitrate Emulsion	45-ton silo	30 tons	12.0	12 tons
Propane	80,000 gallons	5,000 gallons	10.2	1,535 gallons (cold weather)
Antiscalent	500 gallons	250 gallons	0.5	63 lbs
Hypochlorite	1,000 gal	500 gal	2.4	40 gal
Lead (Litharge)	800 lbs	800 lbs	0.4	1 lbs
Carbon	5 tons	2 tons	2.6	175 lbs
Hydrochloric Acid	10,000 gallons	6,000 gallons	1.3	265 gallons
Borax Flux	2.5 tons	1.5 tons	0.6	14 lbs
Sodium Carbonate	1 ton	1 ton	0.5	34 lbs
Fluorospar	0.5 ton	0.5 ton	0.6	3 lbs
Nitre (Potassium Nitrate)	1 ton	0.5 ton	0.4	4 lbs
Silica Sand	1 ton	1,200 lbs	0.6	5 lbs
Methanol	500-gallon tank	250 gallons	0.5	5 gallons

Source: Midway 2013a

Buildings

The truck shop would include maintenance bays to support mobile equipment maintenance. In addition, the building would have offices, a lunch room, locker rooms with showers, and crew meeting rooms. Lubricants and antifreeze would be managed and stored in the area as required by MSHA and other state and federal regulations. Oil totes of different sizes for certain types of

oils would be used throughout the shop area. Individual tote capacity would be less than 500 gallons and would have built-in secondary containment, or would be stored within secondary containment for larger tanks. Small quantities of solvents, paints, and other materials would be stored at the truck shop and managed according to state and federal regulations.

An enclosed truck wash facility would be located adjacent to the truck shop. Hoses would be used to clean mobile equipment. Wash water would be directed to a settling basin where water and solids would be separated. Water would be treated with an oil-water separator and re-circulated. Solids collected from the settling basin would be tested and handled as petroleum contaminated soil if necessary. The hazardous waste storage area would be located next to the truck shop as described under the waste management section.

A warehouse would be located near the truck shop and would be used for the storage of supplies and small equipment. The laboratory would be located near the warehouse as shown on Figure 2.3-1. The laboratory would include separate areas for sample preparation, wet analysis, a metallurgical laboratory, a balance room, and offices. The laboratory would operate 7 days per week and would be capable of processing mine and process samples.

Reagents used in the analytical and metallurgical test procedures would be stored at the laboratory and generally include small quantities of nitric acid, sulfuric acid, hydrochloric acid, hydrofluoric acid, dilute sodium cyanide, and sodium hydroxide. Fire assay reagents would generally include litharge, borax, carbon, silica, and sodium carbonate. Small quantities of other reagents may be used periodically. Lab sinks would be designated either as an "acid" sink or a "base" sink. These sinks would drain to tanks within containment. The tank contents would be neutralized regularly. The neutralized waste would be disposed in accordance with applicable regulatory requirements.

The administrative building would be located near the access road as shown on Figure 2.3-1. These offices would house the reception area, offices for administrative staff, and meeting rooms.

The safety/security building would be located along the access road as shown on Figure 2.3-1. A gatehouse manned by security guards would be located next to the safety/security building, and a parking area for personal vehicles would be located outside of the mine area fence. The safety/security building would include a first aid clinic and a meeting/training room.

Emergency response vehicles would be stationed at the safety/security building to respond to accidents and incidents. These vehicles would be staffed by mine employees certified to provide emergency fire and medical services for mining operations in the State of Nevada. A helicopter pad for emergency use would be located next to the access road between the guard shack and the administrative building.

The insides of buildings, and the currently active parts of the pit areas, the WRDAs, and the heap and process area would use artificial lighting at night as necessary to comply with MSHA illumination requirements and to allow Midway to conduct operations safely and efficiently.

Potable Water and Septic Systems

Water from supply wells would be pumped to the fresh water storage tank as shown on Figure 2.3-1. Water would gravity feed to storage tanks at several locations in the mine area. At each of these areas, water from the storage tank would be used for several purposes. This water would feed into a small potable water treatment system which would then serve the nearby

structures. The potable water delivery systems would be designed, constructed, and operated as required by a certified operator, and potable water would be treated in accordance with Nevada NDEP Bureau of Safe Drinking Water regulations (Williams 2013a). Water from the storage tank also would be used during exploration drilling activities, or could be used as firewater.

Septic systems and leach fields would be installed near the administrative building, mill, heap leach process plant, and warehouse. Biosolids would be pumped as necessary by a licensed septic waste hauler and transported to a licensed repository.

Fire Water Supply

Fire protection equipment and a fire protection plan would be established for the proposed Plan area in accordance with State Fire Marshal standards. A fire suppression water system would be installed to provide service to the buildings as required by National Fire Protection Association and applicable building codes. Fire protection water would feed from the fresh water storage tank located near the mill as shown on Figure 2.3-1. Fire hydrants would be placed at regular intervals around the buildings. The buildings would have sprinkler systems and hand-held fire extinguishers available in accordance with MSHA regulations and industry standards. Employees would be trained in the use of hand-held fire extinguishers and alarm systems.

Light vehicles would be fitted with spark arrestors and would carry a small water supply or a fire extinguisher in order to control sparks that may be generated by exhaust.

Emergency response vehicles and a trained mine rescue team would respond to fire and medical emergencies at the site. Mine rescue and fire response teams may be available to assist with off-site response if requested by agency personnel or others. However, Midway understands that local and regional agencies would maintain responsibility for response to incidents outside of the Plan area. A separate radio frequency would be established for emergency use, and emergency response and communication protocols would be established.

Waste Management

Midway would obtain a Hazardous Waste Identification Number from the U.S. Environmental Protection Agency (EPA). Hazardous waste management is subject to specific requirements that are dependent on the amount of hazardous waste produced at a facility in a calendar month. The mine is expected to be in the "large quantity generator" category, generating greater than 220 pounds or 100 kg of hazardous waste per month, as defined by the EPA. Used lubricants and solvents would be characterized according to the RCRA requirements and would be stored appropriately. Used solvents and fire assay crucibles are the only identified potential hazardous wastes at this time. Midway would institute a waste management plan that would identify the wastes generated at the site and their appropriate means of disposal. Employees who deal with these wastes would be trained in their proper handling, storage, and emergency procedures relevant to their responsibilities. The firm selected to transport and dispose of these materials would be certified by the NDOT and NDEP, as required. Midway anticipates that transport would occur monthly.

Small quantities of hazardous waste would be stored according to state, federal, and local laws and regulations on a covered and sealed concrete pad with secondary containment berms near the truck shop until removal and disposal at an authorized facility. Used oil and coolant would also be stored at the truck shop in secondary containment. The materials would be either recycled or disposed in accordance with state, federal, and local regulations. Used coolant and

oil would not be mixed. Used containers would be disposed or recycled according to federal, state, and local regulations.

Industrial, non-hazardous solid waste would be generated during construction and operations. Solid waste generated by the mine and process departments would be collected in dumpsters near the point of generation. Industrial solid waste would be disposed in an on-site Class III industrial landfill that complies with NAC 444.731 through 444.747, or shipped offsite to a licensed landfill. The landfill would be constructed as a trench within an active lift of the North WRDA. The landfill would be covered weekly in accordance with the solid waste management plan, and its location surveyed and documented. As the landfill nears capacity, another landfill would be located and permitted in accordance with NDEP – Bureau of Waste Management requirements. The filled landfill would be closed and monitored in compliance with NDEP – Bureau of Waste Management requirements.

A training program would be implemented to inform employees of their responsibilities in proper waste disposal procedures. Proper waste disposal practices would include:

- Hazardous materials, liquid wastes, and petroleum products would be stored, disposed, and transported according to requirements.
- Used antifreeze would be collected and stored in a “Used Antifreeze” tank located at the truck shop. Used antifreeze would be sent to a licensed recycling facility by a licensed trucking company.
- Used oil would be collected and stored in a “Used Oil” tank located at the truck shop. Used oil would be tested to determine its status prior to shipping to a recycling facility or other appropriate destination.
- Used aerosol cans would be emptied in satellite accumulation can-puncturing devices located in the truck shop and process building, core shed, and other areas where aerosol cans are used extensively. The can-puncturing devices would be equipped with closed-top drums to collect the contents of the punctured cans. The contents collected in the drum would be shipped off-site for disposal in accordance with the RCRA. Empty, punctured cans would be disposed in the landfill or recycled as light scrap steel.
- Used haul truck tires would be placed in specific locations within the WRDAs and buried. Only one layer of tires would be placed in each bench. The locations would be surveyed. Alternatively, haul truck tires may be recycled if a suitable recycling facility is available.
- Used fluorescent light bulbs would be collected and sent off-site to a recycling facility.
- Used oil filters would be drained prior to being crushed and recycled.
- Shop wipes would be collected in metal receptacles near the point of use and then disposed in accordance with state and federal regulations.
- Used containers that held reagents or petroleum products would be drained, rinsed, and recycled.

Ready Line

Haul trucks and other mobile mine equipment would be temporarily staged when not in use at the ready line located near the mine maintenance building as shown on Figure 2.3-1. The equipment would be parked here during shift changes and when required for light maintenance. The area would be lit for safety and security.

Light Vehicle Wash

A light vehicle wash would be located next to the safety/security building for washing vehicles entering or leaving the site. The light vehicle wash would be fitted with a water wash system to accommodate weed management protocol. Oil would be collected from wash water and included with the used oil transported off-site by a licensed oil transporter.

Communications Facilities

Communication facilities would include a microwave tower and on-site repeaters as needed. These systems would be powered by either propane, line power, solar, or wind. These facilities would support an on-site radio system, communications with outside systems, internet, and cell phones for the safety of employees, contractors, and regulators.

Petroleum-Contaminated Soil Storage Area

Petroleum contaminated soils resulting from spills or leaks of hydrocarbons would be removed from the spill site and placed in roll-off bins as described in the petroleum-contaminated soils management plan (SRK 2013) appended to the Plan. Midway would sample the material in accordance with federal, state, and local regulations, and contractor requirements to characterize the material prior to shipping off-site. The material would be transported off-site to a licensed facility authorized to accept petroleum-contaminated soils. The hazardous waste storage area would be located next to the truck shop as described under the waste management section.

Monitoring Wells

A groundwater monitoring program for baseline water monitoring would be conducted to monitor changes in water levels and groundwater quality associated with mining activities should this occur. The groundwater monitoring plan is appended to the Plan. Midway would install two alluvial monitoring wells along the drainages west and south of the mine. Well MW-1 would be located west and downgradient of the WRDAs and heap. Well MW-2 would be located south and downgradient of the TSF. Figure 2.3-1 shows the locations of the proposed alluvial monitoring wells. Adjustments to this plan may be required depending on groundwater conditions encountered in these wells. The alluvial monitoring wells would be maintained and sampled for ongoing quarterly compliance monitoring during operations.

Borrow Areas

Borrow sources would be required for construction materials including heap leach pad underliner, prepared subgrade materials, drainage materials, pipe bedding materials, road surfacing materials, closure materials, and riprap. Construction-related borrow areas would be located as shown on Figure 2.3-1. Depth of potential borrows are expected to be between 5 and 15 feet. Borrow areas may be reused over the mine life. Borrow areas would generally be designed as free draining.

Plant Growth Medium and Woody Debris Stockpiles

Growth media including woody debris would be salvaged and either directly placed on areas being actively reclaimed (an activity known as "live handling") or would be placed in stockpiles. Midway proposes to establish 15 stockpiles as shown on Figure 2.3-1. These stockpiles would be in place for varying lengths of time and would be seeded with an interim seed mixture and protected from run-on and runoff until final placement. Management of plant growth media stockpiles is described in Section 2.3.16.

Fencing

Midway would construct BLM- and NDOW-approved barbed wire fencing to prevent livestock and wild horses from entering the mine area (Figure 2.3-1). This fence would be constructed to NDOW standards for wildlife-friendly fencing, and would consist of a three-strand fence with the bottom barbless strand 18 inches off the ground and the top two barbed strands 28 inches and 40 inches off the ground. In areas where a higher level of security is needed, 8-foot high chain-link fences would be erected. Eight-foot chain-link fences would also be constructed around the lined process ponds. Four-strand barbed wire fence would be installed around the TSF to prevent wildlife, livestock, and wild horses from accessing the area (Williams 2014d). Gates and/or cattle guards would be installed along roadways within the proposed mine area as necessary.

Yards and Inter-Facility Disturbance

Yards are defined as relatively flat areas that may be used for equipment storage, access, supplies, and buffer areas between facilities. Undisturbed “islands” of vegetation may remain between the facilities. Midway does not anticipate disturbing these areas; however, to allow for unanticipated drilling, road construction or establishment of buffer areas around facilities and for permitting purposes, Midway has designated land within the mine area not otherwise designated as a facility on Figure 2.3-1 as inter-facility disturbance.

2.3.13 Transportation

Employees would commute to the mine from Ely or Eureka via US 50, or from the community of Duckwater via Duckwater Road. Busses or vans may be used to shuttle employees from Ely and/or Eureka to the mine site. Under the Proposed Action, all workers, contractors, vendors, and visitors from the north would be directed to use the main access route from US 50 south on Green Springs Road to BLM 1179/CR 1204 west to Easy Junior Road south to the mine area (Figure 1.1-2); however, public roads that provide access to public and private lands and would remain open throughout the life of the mine. A worker, contractor, vendor, or visitor may choose to approach by other roads that lead to the Plan area. With the exception of the new road segment along the proposed county road re-route, these roads are not slated for improvement and travelers would use at their own risk. All workers, contractors, vendors and visitors from the south would be directed to use the proposed county road re-route (Figure 1.1-2). Parking for private vehicles would be provided near the administration building.

Bulk chemicals and supplies would typically be transported to the site by trucks via US 50 and the main access route from either the east (Ely) or west (Eureka) and the major connecting highways including Interstate 80 (I-80), US 93, and SR 278. Table 2.3-5 describes the number of expected shipments for reagents to the site. Currently, no restrictions on delivery times exist, and no restrictions are proposed.

2.3.14 Emergency Planning and Response

Midway has developed a Spill Contingency/Emergency Response Plan (SCERP) to establish responsibilities and guidelines for actions to be taken by mine personnel in the event of a spill at the mine, mill, or heap leaching facilities. The SCERP identifies potential sources of spills, establishes measures of prevention, and defines control, cleanup, and reporting procedures, including instructions for what to do in the event of a hazardous material spill, petroleum release, or natural disaster.

Midway would involve stakeholders in the emergency planning process, and would distribute the SCERP to the following agencies:

- Local Emergency Planning Committee (LEPC) for White Pine County - Potential Responding Agency;
- BLM - Potential Responding Agency;
- NDEP - State Enforcement Agency;
- White Pine County Sheriff's Department - Emergency Services Coordinator;
- Eureka Fire Department - Potential Responding Agency;
- Nevada Division of Forestry - Potential Responding Agency; and
- Nevada Highway Patrol - Potential Responding Agency.

As final information concerning permit requirements, construction, and operations for the Gold Rock Mine facility is developed, the SCERP would be revised prior to project commissioning. Midway would seek input from emergency responders that would be involved in on-site emergency response actions to confirm that the responder could perform its designated role. The SCERP would be reviewed and updated regularly during operations to ensure that it remains applicable to the hazards associated with the operation. Modifications or changes could be made at any time if conditions pertaining to this SCERP change at the site. Modifications would be issued to all SCERP holders and recorded. Throughout operation, Midway would continue to seek input from outside responders when reviewing the SCERP to confirm that the outside responders can fulfill their designated roles.

During operations, if a release were to occur, Midway would comply with its approved SCERP by assessing the release and if the release were determined to be a reportable quantity, Midway would report the incident by telephone not later than 5 p.m. of the next regular work day from the time of the incident to:

- NDEP's 24-hour emergency notification number at 1.888.331.6337 (in-state) or 1.775.687.9485 (out of state)
- LEPC – to be determined
- Nevada Division of Emergency Management at 775-687-4240 during normal working hours or at 775-687-5300 after hours
- National Response Center (NRC) at 1.800.424.8802
- BLM-Egan Field Office at 775.289.1800
- Transportation incidents would be reported to 911.

Midway also would develop a Fluid Management and Monitoring Plan (FMMP) as part of its WPCP application. The FMMP would describe the containment systems and procedures for monitoring and controlling process solutions at the heap leach pad, process ponds, process plant, mill, CIL, and TSF during normal operating conditions, and during unusual natural or operational events. The FMMP would be updated as part of the NDEP permitting process for any new process components associated with the Proposed Action, and periodically to incorporate improvements identified during operation.

Public Safety

Prior to and during operations, Midway would implement public safety measures at the facility including:

- Installing and maintaining chain link fencing around potentially hazardous areas such as the process buildings and ponds, and barbed wire fencing around the TSF (Williams 2014d);
- Constructing and maintaining berms along haul roads;
- Posting and enforcing speed limit (25 miles per hour) on access routes and on roads throughout the project area;
- Posting and maintaining warning signs in areas where flammable materials and hazardous materials are stored and in areas where conditions warrant posting of signs;
- Maintaining artificial lighting in compliance with MSHA illumination requirements;
- Restricting public access locally during active mining; and
- Maintaining training programs for all employees as required by MSHA.

Closure of the pit would include construction of berms, where constructible, outside of the anticipated pit wall ravel perimeter to limit public access. In-pit haul roads would be blocked with rock or soil berms unless the BLM identifies a post-mining use for such roads and except as required temporarily to access monitoring points (after which a road would be reclaimed).

Measures To Be Taken During Extended Periods of Non-Operation

Midway does not anticipate planned temporary closures of the mine and/or the heap leach and processing facilities. In the event that continuous, full-scale production would be interrupted due to economic considerations or unforeseen circumstances, the following measures would be implemented to maintain site safety and stability:

- *Security:* On-site security would be maintained by personnel at the site or by remote monitoring. Sufficient staff would remain to operate the fluid management systems.
- *Supplies:* Supplies such as explosives, reagents, fuels, and lubricants would be removed from the site.
- *Contractor Equipment:* Contractor equipment may be removed.
- *Fluid Management:* Process ponds and other fluid management systems would be inspected and operated to prevent overtopping in accordance with permit requirements.
- *Power Lines:* Power lines would be inspected regularly and maintained as necessary.
- *Roads:* The main access road would receive maintenance, as necessary.
- *Mine Open Pit:* Berms or fences would be placed to help restrict access to bench face areas.
- *Erosion Control Measures:* Erosion control measures and BMPs would be regularly inspected and maintained.
- *Buildings:* Building, equipment, and support facilities would be protected from public access and maintained as necessary.

Per NAC 519A.320(2), Midway would notify NDEP and the BLM in writing within 90 days after any project suspension (except any temporary suspension resulting from weather conditions) that is anticipated to last longer than 120 days. Midway would identify the nature and reason for the suspension, the duration of the suspension, and the events expected to result in either resumption of mining or the abandonment of the project.

No actions would be taken that will preclude or inhibit resumption of operations. Midway personnel would staff the site as necessary and perform monitoring, security, maintenance of the fluid management system, and necessary maintenance during extended periods of non-operations.

2.3.15 Employment

The average number of people employed during construction would be approximately 250, with a peak of about 300. During the operations phase, this number would be approximately 150 to 250. Midway anticipates that most employees would reside in Ely with some employees living in Eureka and other areas.

Based on information received from the Nevada Rural Housing Authority, housing may also be available in Eureka in the County's new development. A socioeconomic study was prepared to evaluate housing availability and other socioeconomic effects associated with the workforce required for this Project and is summarized in Chapter 3.

Given the uncertainty and volatility of the factors that affect housing demand in the analysis area, including potential closure, resumption of mining and expansion or contraction of existing mines and/or initiation of new mines, it is difficult to forecast housing availability in affected communities at the start of Proposed Action-related construction or operations. Subsequent to the issuance of the ROD and approval of a right-of-way grant, and prior to the initiation of construction, Midway would undertake an assessment of regional labor force conditions and the availability of sales and rental housing, RV and mobile home spaces, and readily developable lots in Ely, Eureka and nearby unincorporated areas of White Pine and Eureka counties. Midway would also review the residency patterns of its Pan Mine employees before and after hiring to benefit from the recent experience of a similar mine in a nearby location. If housing shortages exist at that time, Midway would consult with White Pine and Eureka counties and the City of Ely to discuss strategies to accommodate its workforce housing needs.

2.3.16 Reclamation Plan

Reclamation activities described in this section would be implemented for the facilities or disturbance associated with the Proposed Action. Reclamation of disturbed areas resulting from activities associated with the Proposed Action would be completed in accordance with BLM and NDEP regulations. The BLM Surface Management Regulations (43 CFR 3809) establish procedures and standards to prevent operations authorized by the mining laws from causing unnecessary or undue degradation of public lands. The 43 CFR 3809 regulations also provide for the maximum possible coordination with appropriate state agencies. The State of Nevada requires a proponent to develop a reclamation plan for any new exploration or mining project or expansion of existing operations (NRS and NAC Chapters 519A). The Plan and reclamation plan addresses mining and reclamation activities associated with the Proposed Action.

The goals of the reclamation plan are to:

- Minimize surface disturbance and environmental effect to the extent practicable.
- Return project-related disturbances to productive post-mining land uses that emphasize livestock grazing, wild horse use, and wildlife use with dispersed recreation and mineral exploration use.
- Comply with applicable state and federal environmental rules and regulations.
- Limit visual effects.
- Limit and/or eliminate long-term maintenance following reclamation to the extent practical.

These goals would be achieved by meeting the primary objectives listed below:

- Establish stable surface topographic and hydrologic conditions during mining and after reclamation that are compatible with the surrounding landscape by designing stable fill and cut slopes, controlling erosion, and managing surface water and earthen materials to minimize water quality effects.
- Establish a stable, diverse, and self-sustaining plant community through removing (either direct replacement or stockpiling) and redistributing suitable plant growth media on disturbed areas and by the seeding and planting of native and adapted plant species.
- Reclaim facilities that are no longer needed for operations as soon as practicable during the production period ("concurrent reclamation").
- Integrate mining plans with soil, water, and waste management and reclamation plans.
- Separate process water and contact water from non-contact (un-impacted) water.
 - Incorporate operational stormwater management facilities into the design of closure stormwater management systems.

Midway has proposed a reclamation plan to reclaim the land to productive post-mining land uses. Such measures would include:

- Live handling of plant growth medium (removal and direct placement of plant growth medium on surfaces that have been prepared for reclamation without stockpiling);
- Construction of WRDAs using geomorphic design principles;
- Salvage and redistribution of woody debris for final reclamation;
- Contouring the top of the spent heap to create more natural forms and lines; and
- A revegetation plan that includes sowing seed and planting shrub seedlings according to landscape position and aspect.

The reported acreage of surface disturbance and reclamation is based on the two-dimensional footprint of each planned facility. Soil redistribution, seeding quantities, and mass balance calculations for the major project facilities (i.e., WRDAs, heap, and TSF) are based on estimates of the three-dimensional surface areas. Overlap of surface disturbance is associated with some planned facilities and is according to the disposition of the land at the time of reclamation.

Schedule

The closure and reclamation of supporting facilities and post-closure monitoring, with the exception of the ET cell and associated downgradient monitoring wells, would require approximately 10 years. The ET cell would be constructed in year 13, and associated downgradient monitoring wells would continue to be monitored for 30 years. The ET cell would then be closed, and post-closure monitoring would be performed for 5 years, bringing the entire project life to 48 years.

Concurrent with mining and processing activities, Midway would begin reclamation in areas where no further disturbance would occur as soon as practical and safe. Concurrent reclamation would involve contouring, applying growth media, and revegetating the permanently inactive areas. In addition, to limit the amount of surface disturbance at any one time, Midway would perform interim reclamation on areas disturbed during construction, mining, or waste rock placement that would be disturbed again at a later date. Growth media would not be applied to these areas. The surface of the area would be roughened and revegetated. Fertilizer and surface mulch or erosion control fabric would be applied only if necessary. To control noxious weed species proliferation, herbicide would be applied as necessary to areas that are reclaimed on an interim basis.

Post-Mining Land Use

Major land uses currently occurring in the plan boundary area include mineral exploration and development, wild horse habitat, livestock grazing, wildlife habitat, and dispersed recreation. The reclamation plan for the Project is designed to reestablish the current land uses by employing advanced reclamation techniques that include:

- Reclamation concurrent with mining activities when practical and safe;
- Plant growth media salvage and redistribution of plant growth media;
- Establishment of native species where possible; and
- Engineered drainage channels.

Midway would work with the agencies and local governments to evaluate alternative land uses that could provide other long-term socioeconomic benefits from the mine infrastructure. The proposed reclamation activities and post-mining land uses are designed to be in conformance with the approved Ely RMP Record of Decision (BLM 2008b) and White Pine County zoning ordinances.

Post-Mining Topography

The post-mining topography would blend with surrounding natural topography as shown on Figure 2.3-14. Disturbed areas would be recontoured to the approximate natural slope with slopes at 3H:1V or to the original topography, whichever is less. The design would mitigate aesthetic impacts, provide stability, promote runoff, and reduce infiltration. Straight-line features would be interrupted where practical. Growth media would be placed on the TSF surface, TSF embankment, WRDAs, and the heap to limit erosion, and the areas would be seeded. The open pit would remain an open pit. Safety berms or barricades would be constructed around the perimeter of the pit.

Plant Growth Media Management

Surface disturbance (Table 2.3-1) would occur in stages (Table 2.3-2). To limit the total area of surface disturbance at any one time during the life of the mine, soil salvage would be delayed as long as practicable. Plant growth media that are practicably salvageable would be removed prior to facility construction. The salvageable depths of suitable plant growth media within the proposed disturbance areas are estimated based on the Natural Resources Conservation Service soil data for the area. The associated soil volume is provided in Table 2.3-6.

Table 2.3-6 Soil Salvage Volumes

Component	Proposed Disturbance (acres)	Cubic Yards of Growth Media
Open Pit	367	461,000
WRDAs	546	699,000
Roads	180	257,000
Heap Leach Facility	430	620,000
Process Facilities	74	107,000
Tailings Storage Facility	269	428,000
Process Ponds	25	4,000
Yards ¹	99	166,000
Exploration	200	0
Ancillary Facilities	420	626,000
Inter-facility Disturbance	1,026	0
Transmission Line	32	0
Total		3,368,000

Notes:

1 Includes 84 acres of pipeline disturbances.

Prior to growth media salvage, pinyon and juniper trees within the planned area of surface disturbance would be harvested, added to the growth media stockpiles, or chipped and added to the plant growth media stockpiles. The remaining woody debris would be directly placed on areas that are being seeded or would be windrowed into long narrow stockpiles at the toe of the disturbed areas for redistribution during reclamation. Unless used directly for concurrent reclamation, salvaged growth media would be excavated, loaded, and hauled to one of the designated plant growth media storage locations shown on Figure 2.3-1. Plant growth media handling operations would be conducted using dozers, front-end loaders, haul trucks, and other equipment.

Stormwater diversions would be constructed upgradient of each stockpile and berms would be constructed around their perimeters to retain transported sediments from the stockpiles. Plant growth media stockpiles would be reclaimed on an interim basis as soon as practicable to minimize erosion and non-native or noxious weed infestations.

A minimum of 6 inches of plant growth media would be redistributed on disturbed areas with the exception of the Gold Rock Pit. The plant growth media would be distributed down the slopes using dozers.

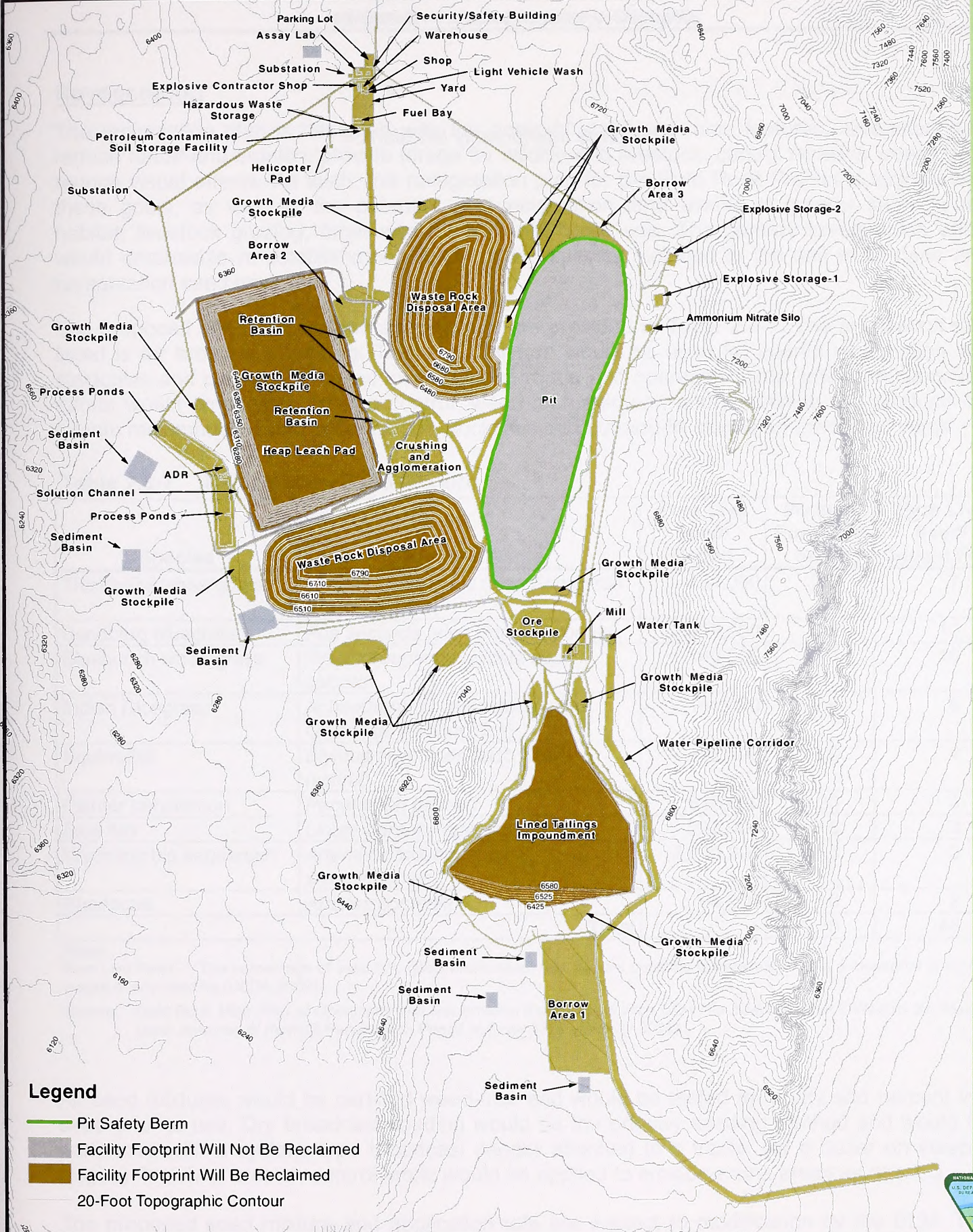

- Legend**
- Pit Safety Berm
 - Facility Footprint Will Not Be Reclaimed
 - Facility Footprint Will Be Reclaimed
 - - - 20-Foot Topographic Contour

FIGURE 2.3-14
SITE-WIDE RECLAMATION PLAN
AND POST-MINING TOPOGRAPHY
MIDWAY GOLD US INC.
GOLD ROCK MINE PROJECT

MAPPED DATE: 9/17/2014

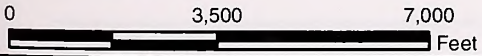

U.S. BUREAU OF LAND MANAGEMENT
 ELY DISTRICT
 EGAN FIELD OFFICE

NO WARRANTY IS MADE BY THE BUREAU OF LAND MANAGEMENT AS TO THE ACCURACY, RELIABILITY, OR COMPLETENESS OF THESE DATA FOR INDIVIDUAL USE OR AGGREGATE USE WITH OTHER DATA.



PATH: C:\USERS\JCHEN\DOCUMENTS\PROJECTS\CITRIX\GOLDROCK\GOLDROCK\MXD\2014_DRAFT_EIS\Figure_2_3-14_POST-RECLAMATION_TOPOGRAPHY.MXD | LAST SAVED ON: 9/17/2014 12:55:22 AM

This page intentionally left blank.

Revegetation

The reclamation plan is designed with the goals of stabilizing mine features, revegetating to reduce runoff and erosion, provide forage for wildlife and livestock, control invasive weeds, and reduce visual effects. As such, the revegetation plan for the Gold Rock Project is aligned with these goals, as well as the potential post-reclamation land use(s) of greater sage-grouse habitat, livestock grazing, other wildlife, and wild horse use. The primary revegetation effort would emphasize re-establishment of the native species included in the soil seed bank and revegetation seed mixtures.

The proposed seed mixture and seeding rate are provided in Table 2.3-7. The application rate listed is for broadcast seeding. This seed mixture would be used for interim reclamation soil stockpiles and cut-and-fill slopes located along roads and operation yards. Interim reclamation efforts would emphasize erosion control, weed management, and sustaining soil productivity. Interim reclamation would occur on soil stockpiles and cut-and-fill slopes on roads and yards.

Table 2.3-7 Reclamation Seed Mixture

Species	Scientific Name	Pure Live Seed/ Pound	Pounds Pure Live Seed	Pure Live Seed/ Square Foot
Thickspike wheatgrass	<i>Elymus lanceolatus</i> (also <i>Agropyron dasystachyum</i>)	154,000	2.0	7
Sandberg bluegrass	<i>Poa secunda</i> (also <i>Poa Sandbergii</i>)	925,000	0.5	10
Bluebunch wheatgrass	<i>Pseudoroegneria spicata</i> spp. <i>spicata</i>	140,000	3.0	10
Indian Ricegrass	<i>Achnatharum hymenoides</i> (also <i>Oryzopsis hymenoides</i>)	141,000	2.0	6
Squirreltail	<i>Elymus elymoides</i> (also <i>Sitanion hystrix</i>)	192,000	1.0	4
Palmer penstemon	<i>Penstemon palmeri</i>	610,000	0.25	3
Blue flax	<i>Linum perenne</i> spp. <i>Appar</i>	293,000	0.5	3
Wyoming big sagebrush	<i>Artemisia tridentata</i> ssp. <i>wyomingensis</i>	2,500,000	0.5	3
Shadscale	<i>Atriplex confertifolia</i>	64,900	2.0	2
Total		-	11.75	48

Notes:
Pure Live Seed - , The percentage of seed (i.e. good viable seed) that has the potential to germinate within a measured one pound weight of any seed lot (USDA 2009).

Source: Gold Rock Mine Plan of Operations and Reclamation Permit Application BLM File Serial Number NVN-(To Be Assigned Upon Issuance of Permit) Reclamation Permit Number 0326. (Midway 2013a).

All seed mixtures would be certified weed-free and would be tested for purity and percent live seed prior to use. Dry broadcast seeding would be the primary seeding method and would be performed with a cyclone-type broadcast seeder attached to a tractor (or a dozer on steeper slopes). Mulch or erosion-control fabric would be applied to erosion-prone areas as needed.

The proposed seed mixture and application rate are subject to modification by the BLM. The actual seed mixture, application rates, and locations would be determined prior to seeding based on the results of interim and concurrent reclamation, availability, or BLM recommendations. Reclamation would be determined to be successful and complete upon demonstrating compliance with NDEP (1998b) guidelines and upon approval by BLM and NDEP.

Surface Water and Sediment Control

Surface water would be diverted around mine features where practicable through primary stormwater diversions, culverts, and secondary perimeter berms and/or ditches. Silt fences, sediment traps, and/or other BMPs would be used to prevent migration of sediment from disturbed areas until reclaimed slopes and exposed surfaces have demonstrated erosional stability. Stormwater runoff from the reclaimed WRDAs, the heap leach facilities, and other slopes may occur following heavy precipitation events; however, regraded slope angle, revegetation (including plant growth medium placement), and BMPs would be used to limit erosion and reduce sediment in runoff from reclaimed areas.

Measures to Minimize Loading of Sediment to Surface Waters

In general, the greatest risk of sedimentation to surface water is expected to occur during growth media salvage operations, diversion channel construction, growth media stockpiling operations, construction of surface facilities, and immediately following implementation of reclamation. Best management practices for temporary erosion and sedimentation control of disturbed areas would be used. Active areas of the WRDAs are expected to have minimal runoff and erosion potential, as the waste rock will be both coarse-grained and porous.

Following attainment of reclamation standards, sediment basins would be cleared of accumulated sediments and left in place to promote the post-mining land uses. The run-on diversions above the facilities would be left in place and continue to divert flow from up to the 100-year, 24-hour storm event around the heap and process ponds.

The mill, heap process plant, crushers, and administration/laboratory building areas, as well as the conveyor and road corridors, would be graded to blend into the surrounding topography and to generally reestablish existing drainage patterns.

Open Pit

Access logistics and safety concerns related to the pit slopes prohibit the reclamation practices of plant growth media placement and revegetation. The open pit would remain as an open pit, and the pit ramps would be barricaded to prevent entrance.

Midway would construct berms along the pit perimeter where access exists to preclude public access and deter livestock. Pit berms would not be constructed in locations where no public access is possible, the personal safety of equipment operators would be compromised by constructing the berm, or where a high wall is absent. Pit benches would ravel over time, which should effectively break up linear features and create naturally appearing scree and talus slopes. These talus slopes would allow wildlife access and egress. Cracks and crevices would remain. Backfilling or reclamation of the Gold Rock pit is not proposed because of the potential to bury a valuable resource should gold prices rise, and due to the lack of economic feasibility. Exemption would be sought under NAC 519A.250.

Waste Rock Disposal Areas

The WRDA slopes would be designed, constructed, and reclaimed to an average slope of 3H:1V. Once regraded, surfaces of the WRDAs would be covered to mimic surrounding regional landscape vegetative patterns. Growth media would be placed to a minimum depth of 6 inches and seeded with the seed mixture listed in Table 2.3-7, or as determined at the time of reclamation through consultation with the BLM.

Heap Leach Pad

The heap leach facilities would be decommissioned in accordance with NDEP regulations and guidelines for closure. A Tentative Plan for Permanent Closure, as required by NAC 445A.398, would be included within the WPCP application. A Final Plan for Permanent Closure, to include the proposed expansion components, would be prepared and submitted to the NDEP and the BLM 2 years prior to the anticipated final termination of the heap leach facility operation, as per NAC 445A.447.

Chemical stabilization of the heap leach facilities is required to obtain permanent closure. NAC 445A.379 defines “stabilized” as “the condition which results when contaminants in a material are bound or contained so as to prevent them from degrading waters of the state under the environmental conditions that may be reasonably expected to exist at a site.” Midway anticipates that the spent heap would be allowed to drain with no fresh water rinsing. Final details of heap neutralization and closure would be developed at least 2 years prior to Project closure pursuant to the requirements of NAC 445A.446 and NAC 445A.447.

The heap would be constructed in lifts 20 feet high (design benches 30 feet wide), depending upon operational considerations. The heap would be constructed in lifts set on a 3H:1V balance line so that the overall reclaimed slope angle would be approximately 3H:1V. Each bench would be regraded to the final slope configuration of approximately 3H:1V. This design would mitigate aesthetic effects, provide stability, promote runoff, and reduce infiltration.

When no longer required for evaporation of fluids, the surface solution distribution piping would be removed. The side-slopes of the heap would be graded, so that the final toe is within the interior crest of the perimeter berm. A store-and-release or ET cover would be installed on the regraded heap surface to limit infiltration of precipitation into the spent ore. The soil cover on the spent heap would allow retention of water in the cover material during snow melt and precipitation to establish grass and herbaceous vegetation. By retaining the water in the soil cover for plant uptake and ET, the amount of water infiltrating is reduced, thus minimizing the drain down solution and steady-state seepage that would need to be managed during closure and post-closure. The recontoured heap would be covered with 2.5 feet of growth media (i.e., cover soil).

Midway conducted vadose zone modeling to determine the optimal soil cover thickness that would minimize water infiltration through the cover. Samples of potential cover soil types within the mine disturbance and borrow areas were collected during a geotechnical investigation. These samples were analyzed and the grain size analyses were used to describe a representative cover soil type. Based on the representative cover soil type, the vadose zone modeling indicates that a cover thickness between 2.5 feet and 3.0 feet would limit infiltration through the cover to 1 percent of annual precipitation (Interralogic 2013b).

Revegetation of the heaps would be carried out following growth media placement. The working slopes and the ability to operate equipment safely would determine the method of seeding. Stormwater diversion structures would be constructed upgradient of the heap to prevent effects from stormwater run-on. These structures would be maintained to minimize erosion over the long term.

Midway has developed the following conceptual plan for process fluid stabilization:

- After cessation of leaching, process solution would be recirculated from the process ponds to the heap or to the TSF until drain down is less than active evaporation capacity.

- Process solution would be actively evaporated on the heap or the TSF until drain down flows can be managed through passive evaporation in the process ponds.
- The heap would be regraded.
- Growth media would be placed on the heap, with the aim of limiting long-term flow from the heap to a *de minimus* quantity.
- The pregnant process pond would be converted to an ET cell to store and release heap drain down through ET until *de minimus* flow is achieved, at which time the ET cell would be closed.

Modeling of flows from the closed heap leach was conducted to determine the short-term flow rates requiring initial evaporation in the ET Cell (i.e., before closure cover placement), as well as a post-closure infiltration model to determine flow rates requiring evaporation in the ET Cell. The Heap Leach Draindown Estimator Model for heap leach closure draindown flows immediately following leaching operations is provided in the Standardized Reclamation Cost Estimator Version 1, which is appended to the Plan. The model results show that following cessation of operational leaching the drain down flow rate reduces from 7,559 gpm to around 14 gpm within 12 months and further reduces to a consistent flow rate of around 9.6 gpm within a few months thereafter. This is the initial minimum design flow rate for the ET Cell, theoretically requiring 5 acres of post-closure evaporation area to manage (refer NDEP Guidelines for Closure; and HLDE Model guidelines). A single process water pond (area of about 6.5 acres) is therefore sufficient to manage the effluent flow prior to cover construction.

Operational monitoring data for draindown flows and chemistry would be used to confirm modeled flows and submitted as part of the Final Plan for Permanent Closure at least 2 years prior to the closure of the heap leach facility.

Solution Ponds

After cessation of leaching, drain down from the spent heap would be recirculated between the heap and process ponds or drained to the TSF for evaporation until drain down can be managed through passive evaporation in the ET cell. When the volume of drain down is manageable through passive treatment, the process pond solids would be analyzed through the Meteoric Water Mobility Procedure test. Depending on the test results, the solids would be stabilized in place, removed to the heap, or taken off-site.

The process pond that would not be used as an ET cell would have the synthetic liner folded into the bottom of the pond and buried in place. Midway would backfill that pond and grade the surface to prevent impoundment of water and to blend with the surrounding topography. Midway would apply plant growth media and revegetate the pond. The working slopes and the ability to operate equipment safely would determine the method of seeding.

Tailings Storage Facility

The TSF would be decommissioned in accordance with NDEP regulations and guidelines for closure. A Tentative Plan for Permanent Closure, as required by NAC 445A.398, would be included within the WPCP application for the proposed TSF. A Final Plan for Permanent Closure, to include the proposed expansion components and final details of TSF neutralization and closure, would be prepared and submitted to the NDEP and the BLM at least 2 years prior to the anticipated final termination of the TSF operation, as per NAC 445A.446 and NAC 445A.447. The TSF would undergo a drain down period at the end of milling operations, during

which time the dry beach areas would consolidate, and the supernatant fluids and tailings slimes in the supernatant pond depressions would dry.

The TSF fluid management approach is based on preventing discharge and seepage. Solution held within the tailings, referred to as “entrained solution inventory,” is anticipated to drain from the tailings for about 10 years. Entrained solution inventory would be removed from the TSF by evaporation. Midway would incorporate both active evaporation, pumping solution through spray nozzles or similar devices to create small droplets with high surface area to volume ratio, and passive evaporation, allowing ambient solar radiation to evaporate solution from open ponds.

Following removal of entrained solution inventory, Midway would install a soil store-and-release cover over the TSF to limit infiltration. The core approach to long-term closure would include installation of an “access” platform constructed out of waste rock to provide the ability to rapidly complete cover construction. The access platform construction would result in rock penetration to an estimated 1 to 2 feet into the tailings, forming a “mixed” layer consisting of impermeable rock with tailings-filled interstices. Given that the tailings interstices form about 30 percent of the volume of the rock mass, the effective area for seepage through the mixed layer would be reduced (compared to a tailings-only layer), thus reducing the permeability of the total area by an amount proportional to the total rock surface area. Establishing the mixed layer is expected to result in a 1×10^{-7} cm/sec hydraulic conductivity layer, or one order of magnitude lower than the expected tailings permeability of 1×10^{-6} cm/sec. Waste rock and stockpiled growth media would be placed for total minimum thickness of 3 feet on the TSF beach surfaces to conform to beach angles at the time of placement.

Growth media used for the impoundment cover would come from stockpiled growth media excavated from the facility footprint during construction. Growth media material balances indicate that the recovered volumes would be adequate to provide the proposed cover amounts. Should a shortfall be experienced, alluvium would be excavated below grade within the footprint of the growth media stockpile areas. Growth media/cover stockpile locations for the closure activities are shown on Figure 2.3-1.

Because the downstream TSF embankment would ultimately be constructed at a 3H:1V slope, no additional regrading would be necessary. A 6-inch layer of growth media would be placed over the embankment surface. This growth media for the embankment cover would come from stockpiled growth media excavated from the facility footprint areas during construction. Growth media stockpile locations for the TSF reclamation activities are shown on Figure 2.3-1. After growth media placement, the embankments would be revegetated.

Roads

The existing main access route from US 50 to the Plan area (Figure 1.1-2) includes county roads and would not be reclaimed; maintenance would revert back to White Pine County.

Following construction of mine-related roads, cut-and-fill slopes would be reclaimed on an interim basis as previously described. Mine-related roads without a defined post-mining use would be reclaimed when they are no longer needed. Inside the mine area perimeter fence secondary and haul roads would be reclaimed as reclamation of the facilities is completed. Portions of mine access roads would remain during the post-closure monitoring and maintenance period to provide access to monitoring points. Once closure is complete, these roads would be reclaimed unless the BLM requests that the road remains. Culverts would remain at drainage crossings and would be modified if necessary.

The roads that would be removed would be ripped to reduce compaction. Roads with significant cut or fill would be graded to blend into the surrounding topography and to generally reestablish the existing drainage patterns. Dozers would grade slopes flatter than 2.5H:1V, and excavators would grade slopes steeper than 2.5H:1V. Where necessary, road surfaces would be deep ripped, and a 6-inch thick cover of stockpiled growth media would be applied to reworked surfaces. Growth media would be removed from the windrowed or regular growth media stockpiles and redistributed on the deep ripped and regraded roads. Erosion and sediment control BMPs would be installed and maintained where necessary on roads following seeding activities. Reclaimed roads that could experience continued unauthorized use after reclamation would be blocked with earth or rock berms to discourage vehicle access.

Haul roads within the pit would not be reclaimed unless the BLM identifies a post-mining use for the in-pit haul roads and except as required temporarily to access monitoring points (after which it would be reclaimed). Furthermore, Midway would seek exemption pursuant to NAC 519A.250. To provide for public safety, these roads would be blocked with rock or soil berms.

Roads and Surface Facilities Not Subject to Reclamation

As determined by BLM, roads on public lands that are suitable for public access or that continue to provide public access consistent with pre-mining conditions would not be reclaimed at closure. Midway would continue to use the existing main access route to the mine area fence line to access the Plan area for monitoring and other purposes. In-pit roads would not be reclaimed.

Midway has planned for the removal of the fences associated with mining activities at the end of reclamation and closure of each component, including the mine area perimeter fence. Surface facilities that would remain as post-reclamation features within the mine area include the pit (with a total disturbance footprint of 367 acres) and one process solution pond to be used as the ET cell (with a total disturbance footprint of approximately 13 acres). In addition, stormwater controls including sediment basins and run-on diversion structures (with a total disturbance footprint of approximately 82 acres) would be left in place to evaporate seepage from the TSF and heap; promote the post-mining land uses of livestock grazing and wildlife use; and to protect the TSF, spent heap, and WRDAs from extreme storm events. One 2.8-acre sediment basin located outside Plan area captures runoff from the entrance facilities and is included in this total. Figure 2.3-15 shows the areas not subject to reclamation.

In summary, under the Proposed Action, approximately 491 acres of disturbance would not be subject to reclamation, and approximately 3,456 acres of temporary disturbance would occur within the Plan area.

Removal of Buildings and Support Facilities

Buildings and support facilities would be reclaimed during the closure period. Buildings and support structures necessary for the reclamation of the mill, heap processing facilities, and TSF water reclaim system would remain until these facilities are closed and reclaimed. The main procedures for facility and building decommissioning, site demolition, and equipment and material salvage are briefly summarized below:

- Mine facilities, conveyors, crushers, offices, shops, and other infrastructure would be demolished (disassembled), removed (salvaged), or hauled to solid or hazardous waste landfills, as appropriate.

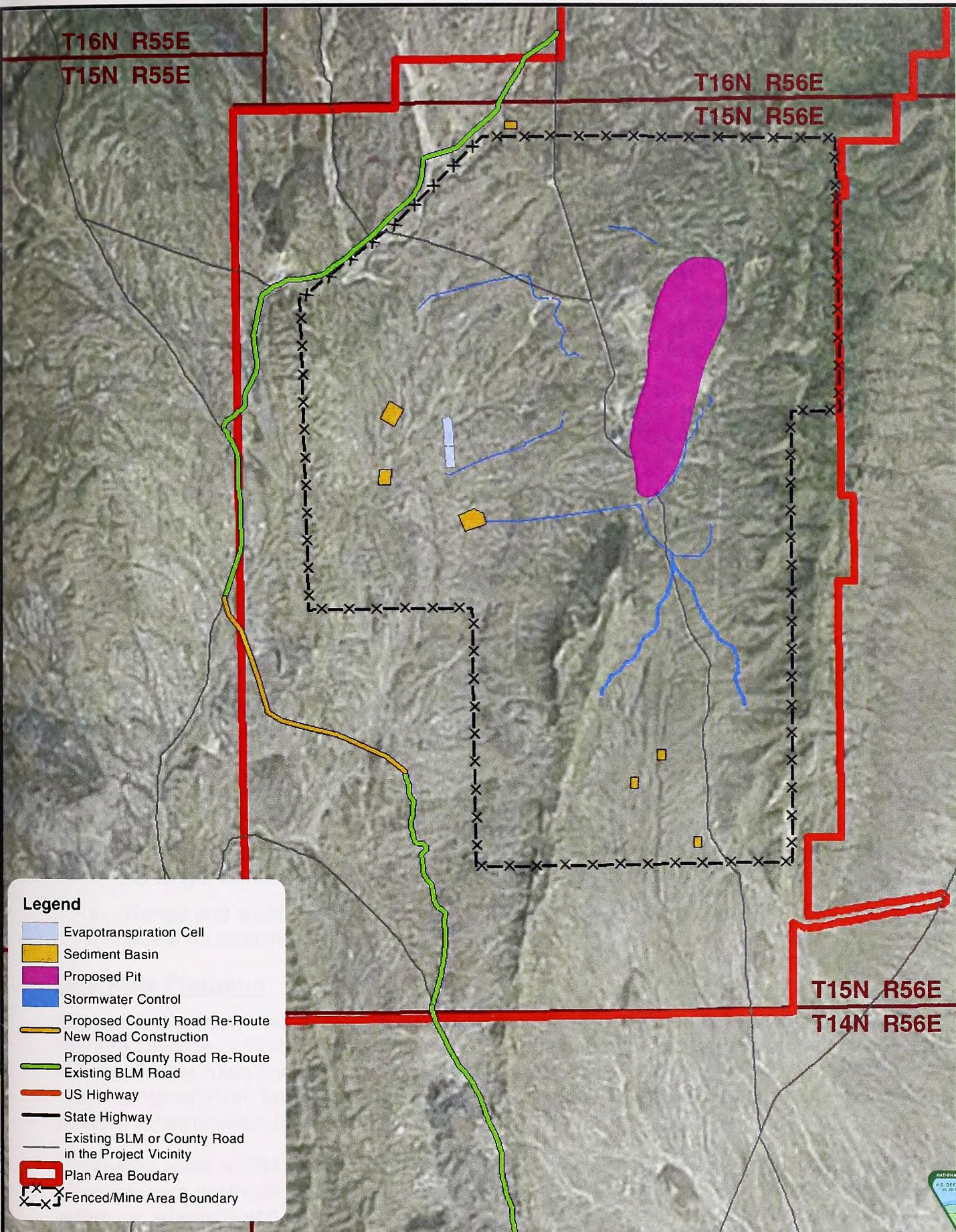

Legend

- Evapotranspiration Cell
- Sediment Basin
- Proposed Pit
- Stormwater Control
- Proposed County Road Re-Route
- New Road Construction
- Proposed County Road Re-Route
- Existing BLM Road
- US Highway
- State Highway
- Existing BLM or County Road in the Project Vicinity
- Plan Area Boundary
- Fenced/Mine Area Boundary

FIGURE 2.3-15
ROADS AND SURFACE FACILITIES
NOT SUBJECT TO RECLAMATION

MIDWAY GOLD US INC.
GOLD ROCK MINE PROJECT

MAPPED DATE: 9/17/2014

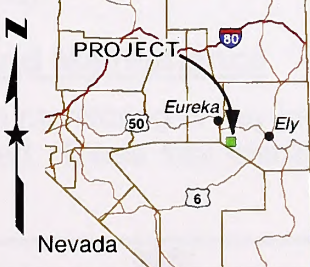
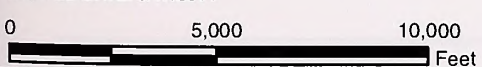

U.S. BUREAU OF LAND MANAGEMENT
ELY DISTRICT
EGAN FIELD OFFICE

NO WARRANTY IS MADE BY THE BUREAU OF LAND MANAGEMENT AS TO THE ACCURACY, RELIABILITY, OR COMPLETENESS OF THESE DATA FOR INDIVIDUAL USE OR AGGREGATE USE WITH OTHER DATA.

Basemap Source: ESRI World Imagery Map Service

PATH: C:\USERS\JCHEN\DOCUMENTS\PROJECTS\GOLDROCK\GOLDROCK\MXD\2014_DRAFT_EIS\FIGURE 2.3-15_ROADS_N_SURFACEFACILITIES_NOT_SUBJECT_TO_RECLAMATION.LMXD | LAST SAVED ON: 9/17/2014 12:54:32 AM

This page intentionally left blank.

- Equipment and materials in contact with cyanide solution and process ponds would be decommissioned by rinsing and sending the rinsate to the TSF for evaporation.
- Equipment, tanks, and ponds in contact with acid, hydrocarbon, petroleum-based solutions, and other process chemicals would be properly rinsed.
- Following decontamination, demolition, and salvage of facilities, growth media and fill materials would be visually inspected for spills and sampled as necessary to determine the type and extent of petroleum and solvent contamination. If present, and based on the type and extent of petroleum and solvent contamination, remedial plans would be developed. Material that cannot be treated *in situ* would be excavated to the extent of growth media contamination and disposed in an off-site solid or hazardous waste landfill as appropriate.
- Concrete foundations; culverts; pipelines; and other non-reactive, non-combustive, non-corrosive, and non-hazardous demolition waste would be left intact or broken up and either:
 - If left intact, covered with 4 feet of native fill and at least 0.5 foot of suitable growth media;
 - If broken up: placed in the landfill; and/or covered in place with 3 feet of suitable growth media or backfilled against cut banks and highwalls throughout the disturbed area.
- Reagents and explosives would be removed for use as product at other operations or appropriately disposed.
- Surface pipelines would be removed and salvaged, buried in place, or disposed. Pipelines located more than 3 feet below the ground surface would have their openings plugged with concrete or other suitable materials and left in place.
- Materials removed from the site would be recycled, reused, or disposed of in a manner consistent with local, state, and federal regulations.
- Power lines associated with the plant, mine, and wells would be removed once power is no longer needed during closure and reclamation activities.
- Range and wildlife fences, including the perimeter fence, not required after operations would be removed.

Drill Hole Plugging

Mineral exploration and development drill holes, monitoring, and production wells subject to Nevada Division of Water Resources (NDWR) regulations would be abandoned in accordance with applicable rules and regulations (NAC Chapter 534). Boreholes would be sealed to prevent cross-contamination between aquifers, and the required shallow seal would be placed to prevent contamination by surface access.

Monitoring wells would be abandoned and reclaimed as required by NAC Chapter 534. Well abandonment methods would differ based on well hydrologic conditions (e.g., dry, standing water, or artesian) and completion methods (e.g., type of casing – polyvinyl chloride [PVC] or steel, perforated interval, unperforated).

Post-Reclamation Monitoring and Maintenance

During operations, annual qualitative monitoring of key indicators of site stability of concurrently reclaimed areas would be conducted. These key stability indicators may include vegetation,

surface erosion, sedimentation, and slope stability parameters. If specified performance guidelines are not satisfied, then appropriate maintenance activities would be implemented. Following completion of concurrent reclamation activities, and until a final bond release is attained, maintenance activities would occur as necessary to satisfy performance guidelines. Maintenance activities may include one or more of the following:

- Sediment would be removed from sediment ponds, stormwater drainage channels, and diversions as necessary to maintain their design capacity.
- The function of temporary erosion control BMPs such as silt fences and straw bales would be maintained. These BMPs would be removed when no longer essential for erosion control.
- Surface water would be diverted away from reclaimed areas where erosion jeopardizes attainment of reclamation standards.
- Rills, gullies, other erosion features, or slope failures that have exposed mine waste would be stabilized.
- Noxious weeds would be controlled.
- Reclaimed areas would be reseeded or re-treated in areas where determined through monitoring and agency consultation that reclamation has not yet met reclamation standards.

Quantitative reclamation monitoring to measure compliance with the revegetation success criteria would begin during the first growing season after final reclamation has been completed and would continue for a minimum of 3 years or until the reclamation success criteria are achieved. The release criteria would be applied to the data collected in the third year following reclamation. Data from previous years would be used to determine the management needs. Revegetation success would be determined based on *Attachment B—Nevada Guidelines for Successful Revegetation for the Nevada Division of Environmental Protection, the Bureau of Land Management, and the U.S.D.A. Forest Service* (NDEP 1998b).

Midway would submit an annual report on or before April 15 of each year to the BLM and NDEP for the preceding calendar year. The annual report would contain descriptions of the reclamation activities completed during the previous year. The annual report would also include a summary of areas reclaimed and a discussion of the general vegetation performance, surface erosion status, slope stability status, and corrective actions completed and/or proposed.

2.3.17 Applicant-Committed Environmental Protection Measures

Midway (the Applicant) has committed to implementing environmental protection measures (Applicant-Committed EPMs) under the Proposed Action as a way of minimizing or avoiding environmental effects. Table 2.3-8 presents these Applicant-Committed EPMs. Most of the Applicant-Committed EPMs presented in Table 2.3-8 are included in the Plan as regulated by the corresponding regulations outlined in 43 CFR 3809.401 and 43 CFR 3809.420 Performance Standards Applicable to Plans of Operation.

Table 2.3-8 Applicant-Committed Environmental Protection Measures By Resource for Proposed Action

Resource	Potential Effects	Actions to Minimize or Avoid Effects
Water Resources	<ul style="list-style-type: none"> • Surface water quality, quantity • Groundwater quality, quantity 	<ul style="list-style-type: none"> • Construct roads to BLM road standards. • Close surface drill holes per Nevada Revised Statute 534. • Install erosion control berms, silt fence, straw bales, detention basins, or other features as necessary in areas prone to erosion. • Construct and maintain runoff diversions and sediment control basins. • Perform concurrent reclamation to the extent reasonable. • Construct and operate all process systems as no-discharge facilities. • Manage any PAG waste rock to minimize generation of acid rock drainage. • Monitor WRDAs for surface seeps and take mitigative actions as necessary. • Install wells to monitor water quality. • Implement risk reduction measures in the construction, operation, reclamation, and closure of the TSF as summarized in Section 2.3.9 and in compliance with NDEP and NDWR permitting requirements.
Geology and Minerals	<ul style="list-style-type: none"> • Removal of mineral resources 	<ul style="list-style-type: none"> • Pits with remaining resources would not be backfilled. • Address safety issues related to pits with barriers, berms, and signage. • Implement risk reduction measures in the construction, operation, reclamation, and closure of the TSF as summarized in Section 2.3.9 and in compliance with NDEP and NDWR permitting requirements.
Paleontology	<ul style="list-style-type: none"> • Loss of paleontological resources of scientific interest 	<ul style="list-style-type: none"> • If paleontological resources of potential scientific interest are encountered (including all vertebrate fossils and deposits of petrified wood), leave them intact and immediately bring them to the attention of the BLM Authorized Officer. • Implement risk reduction measures in the construction, operation, reclamation, and closure of the TSF as summarized in Section 2.3.9 and in compliance with NDEP and NDWR permitting requirements.
Soils	<ul style="list-style-type: none"> • Soil erosion (wind and water) 	<ul style="list-style-type: none"> • When preparing the site for disturbance, include appropriate BMPs as determined appropriate for site-specific conditions. • Use existing roads as much as possible. • Store plant growth media in stable stockpiles. • Upon completion or temporary suspension of mining operations, re-contour disturbed areas to the approximate natural slope with slopes at 3H:1V or to the original topography, whichever is less. • If stockpiles would remain over a growing season, seed with interim seed mix. • Implement risk reduction measures in the construction, operation, reclamation, and closure of the TSF as summarized in Section 2.3.9 and in compliance with NDEP and NDWR permitting requirements.
Vegetation	<ul style="list-style-type: none"> • Loss of native vegetation 	<ul style="list-style-type: none"> • Where seeding is required, use appropriate seed mixture and seeding techniques approved by the BLM. • Reclaim with interim and final seed mixes. • Generally, conduct reclamation with native species that are representative of the indigenous species present in the adjacent habitat. Possible exceptions would include use of non-native species for a temporary cover crop to out-compete weeds. In all cases, ensure that seed mixes are approved by the BLM prior to

Table 2.3-8 Applicant-Committed Environmental Protection Measures By Resource for Proposed Action

Resource	Potential Effects	Actions to Minimize or Avoid Effects
		<p>planting.</p> <ul style="list-style-type: none"> • Reclaim disturbed areas in accordance with the approved reclamation plan. Disturbance would be re-contoured to blend with the natural topography, erosion stabilized, and an acceptable vegetative cover established in accordance with Nevada Guidelines for Successful Revegetation prepared by the Nevada Division of Environmental Protection, the BLM, and the U.S. Department of Agriculture Forest Service. • Curl-leaf mountain mahogany (<i>Cercocarpus ledifolius Nutt.</i>) shrubs, and single-leaf pinyon pine (<i>Pinus monophylla</i>) and juniper (<i>Juniperus osteosperma</i>) trees would be removed only as necessary in proposed disturbance areas. • Implement risk reduction measures in the construction, operation, reclamation, and closure of the TSF as summarized in Section 2.3.9 and in compliance with NDEP and NDWR permitting requirements.
<p>Non-Native Invasive Species</p>	<ul style="list-style-type: none"> • Increasing weed infestation from existing local sources 	<ul style="list-style-type: none"> • Continue to work with the BLM, the Tri-County Weed District, and the Newark Valley/Long Valley Cooperative Weed Management Area to prevent the spread of invasive, non-native species in the area affected by the Proposed Action. • Prior to project approval, a site-specific weed survey would be performed and a weed risk assessment would be completed. • Conduct monitoring for a period no shorter than the life of the permit or until bond release, and monitoring reports would be provided to the BLM. • If the spread of noxious weeds is noted, determine appropriate weed control procedures in consultation with BLM personnel. • Should chemical methods be approved, submit a Pesticide Use Proposal to the BLM 60 days prior to the planned application date. • During clearing and grubbing in areas where a high prevalence of weedy species is present, do not salvage plant growth media. Instead bury this growth media in a WRDA. • Provide information and training regarding noxious weed management and identification to all personnel who would be affiliated with the implementation and maintenance phases of the project. • Clean vehicles and equipment with power or high-pressure equipment after leaving a weed-infested area of the mine. • All interim and final seed mixes, hay, straw, hay/straw, or other organic products used for reclamation or stabilization activities, feed, or bedding would be certified free of plant species listed on the Nevada Noxious Weed List or specifically identified by the BLM. • Keep removal and disturbance of vegetation to a minimum through construction site management. • Reclamation would be accomplished with native species whenever feasible, and when possible would be concurrent with mining activities. These would be representative of the indigenous species present in the adjacent habitat. In all cases, seed mixes would be approved by the BLM prior to application. • No noxious weeds would be allowed on the site at the time of reclamation release. Any noxious weeds that become established

Table 2.3-8 Applicant-Committed Environmental Protection Measures By Resource for Proposed Action

Resource	Potential Effects	Actions to Minimize or Avoid Effects
Wildlife	<ul style="list-style-type: none"> • Disturbance to wildlife habitat • Disturbance to big game habitat • 	<p>would be controlled.</p> <ul style="list-style-type: none"> • Construct 8-foot chain-link fencing around the process ponds and place bird balls or other best available technology in the process ponds to discourage access by birds, in accordance with its Industrial Artificial Pond Permit from NDOW. • Reclaim disturbed areas as soon as activities are complete. • Use dust abatement techniques on unpaved, unvegetated surfaces to minimize airborne dust. • Post and enforce speed limits (e.g., 25 miles per hour) to minimize the potential for collisions with wildlife. • Remove and properly dispose of all trash, garbage, debris, and foreign matter. • Construct BLM- and NDOW-approved wildlife friendly barbed wire fencing along the perimeter of the mine area. • Consider seasonal distribution of large wildlife species when determining methods used to accomplish weed and insect control objectives. • Implement risk reduction measures in the construction, operation, reclamation, and closure of the TSF as summarized in Section 2.3.9 and in compliance with NDEP and NDWR permitting requirements • Use anti-glare light fixtures with fugitive light control designs to limit the extent to which artificial lighting is visible from adjacent wildlife habitats.
Migratory Birds	<ul style="list-style-type: none"> • Migratory bird nesting interruption • Disturbance to active raptor nests 	<ul style="list-style-type: none"> • A qualified biologist would conduct nesting surveys for migratory birds if disturbance needed to occur between March 15 and July 31. If nests were found, the "BLM Ely District Recommended Bird Nest Buffer Sizes" document (BLM 2012g) (Appendix 2A) would be followed to determine the appropriate buffer size for avoidance of activity and/or mitigation, as appropriate. • Ground disturbing activities must occur within 7 days of the nest survey. Nest surveys would be conducted prior to and during all mine-related ground disturbing activities throughout the nesting season so that no more than 7 days elapse between surveys. • Do not conduct noxious and invasive weed control within 0.5 mile of nesting and brood rearing areas for migratory birds during the nesting and brood rearing season, between March 15 and July 31. • Inventory areas containing suitable nesting habitat for active raptor nests prior to the initiation of any project work. • Where appropriate, restrict permitted activities from May 1 through July 15 within 0.5 mile of raptor nest sites unless the nest site has been determined to be inactive for at least the previous five years. Where a 0.5-mile raptor nest buffer is not feasible, Midway would coordinate with the USFWS, NDOW, and BLM on a case-by-case basis to develop appropriate protective measures for breeding raptors and/or obtain an Eagle Take Permit under the Bald and Golden Eagle Protection Act, as appropriate. (Note: Per the Ely District Resource Management Plan (BLM 2008b), protect active raptor nests in undisturbed areas within 0.25 mile of areas proposed for vegetation conversion using species-specific protection measures provided by the BLM, NDOW, and USFWS.)

Table 2.3-8 Applicant-Committed Environmental Protection Measures By Resource for Proposed Action

Resource	Potential Effects	Actions to Minimize or Avoid Effects
		<ul style="list-style-type: none"> • Where the power line passes through or within 1,968 feet (600 meters) of PGH or PPH, use APLIC avian deterring design measures, which could include appropriate spacing between conductors and grounded hardware; use of insulating or cover up materials for perch management; installation of bird flight diverters on the top grounding wire; and/or anti-perch protection on the top of every pole, which would be created by using the ground/static wire that goes up the pole, bending it to the center of the top of the pole and then upwards another ten to 12 inches, in accordance with Suggested Practices for Avian Protection on Power Lines – The State of the Art in 2006 (APLIC 2006) and Reducing Avian Collisions with Power Lines – The State of the Art in 2012 (APLIC 2012).
Special Status Animal Species	<ul style="list-style-type: none"> • Herbicide application in areas of special status species • Non-native invasive species control in special status species areas • Greater sage-grouse breeding (strutting and nesting) interruptions (March 1 to May 15) • Disturbance in greater sage-grouse lek areas • Ferruginous hawk nesting interruptions • Golden eagle disturbance • Pygmy rabbits and pygmy rabbit habitat disturbance • Special status bat species disturbance 	<ul style="list-style-type: none"> • When managing weeds in areas of special status species, carefully consider the effects of the treatment on such species. Wherever possible, use mechanical methods to manage weeds. Apply herbicides only as a last resort and hand-spray herbicides over other methods of application. Use BMPs to reduce herbicide drift during application. • Do not conduct noxious and invasive weed control within 0.5 mile of nesting and brood rearing areas for special status species during the nesting and brood rearing season. • Avoid line-of-sight views between power line poles and greater sage-grouse leks whenever feasible. • Within 1,968 feet (600 meters) of PPH and PGH, implement line strike diverters and perch deterrents on all power line alternatives. • Control litter to minimize the supplemental feeding of ravens. • Obtain raven depredation permit from USFWS or operate under NDOW permit to address raven nesting on facility structures. • Mark fences within PGH according to NRCS guidelines to increase their visibility to greater sage-grouse. • When reclaiming impacted areas, include restoration objectives to meet greater sage-grouse habitat needs. • Habituate raptors to noise by utilizing pre-disturbance signals such as sounding sirens prior to blasting (Romin and Muck, 1999).² • Where appropriate, restrict permitted activities from May 1 through July 15 within 0.5 mile of raptor nest sites unless the nest site has been determined to be inactive for at least the previous five years. Where a 0.5-mile raptor nest buffer is not feasible, Midway would coordinate with the USFWS, NDOW, and BLM on a case-by-case basis to develop appropriate protective measures for breeding raptors and/or obtain an Eagle Take Permit under the Bald and Golden Eagle Protection Act, as appropriate. • Identify pygmy rabbit habitat (either occupied or not) and avoid, including a 200-foot buffer. • Use a bush hog or similar equipment to mow vegetation 72 hours before conducting surface disturbing exploration activities in north-northwest portion of Study Area where signs of pygmy rabbit were detected during baseline studies. • Conduct bat surveys where appropriate.

Table 2.3-8 Applicant-Committed Environmental Protection Measures By Resource for Proposed Action

Resource	Potential Effects	Actions to Minimize or Avoid Effects
		<ul style="list-style-type: none"> Do not disturb bats while they are hibernating. Avoid disturbance within 0.5 mile of underground mine openings unless the mines are surveyed and deemed not important for bats.
Wetlands	<ul style="list-style-type: none"> Disruption of wetlands 	<ul style="list-style-type: none"> Avoid disturbance in wetlands. Implement risk reduction measures in the construction, operation, reclamation, and closure of the TSF as summarized in Section 2.3.9 and in compliance with NDEP and NDWR permitting requirements.
Range Resources	<ul style="list-style-type: none"> Livestock Loss of forage 	<ul style="list-style-type: none"> Fence active mine areas to exclude livestock. Reclaim disturbed areas to restore forage resources.
Wild Horses	<ul style="list-style-type: none"> Wild horses Loss of forage 	<ul style="list-style-type: none"> Install road signs and speed limits for safety and protection of wild horses. Fence active mine areas to exclude horses. Reclaim disturbed areas to restore forage resources.
Land Use, Authorization, and Access	<ul style="list-style-type: none"> Post-mining configuration of access roads Public safety 	<ul style="list-style-type: none"> Maintain security fencing and signage during operations to control access to active mine operations. Provide permanent barriers and berms to control public access to pit highwalls. Establish post-mining access in conjunction with BLM travel management plan. Use traffic control measures during operations. Implement risk reduction measures in the construction, operation, reclamation, and closure of the TSF as summarized in Section 2.3.9 and in compliance with NDEP and NDWR permitting requirements.
Recreation	<ul style="list-style-type: none"> Potential restriction of recreation use 	<ul style="list-style-type: none"> Reclaim as soon as activities are complete to restore recreation access.
Air Quality	<ul style="list-style-type: none"> Fugitive dust from roads and loading/dumping Exhaust emissions Reduction of airborne fugitive dust Fugitive dust during mining activities 	<ul style="list-style-type: none"> Use dust abatement techniques on unpaved, unvegetated surfaces to minimize airborne dust. Maintain equipment to ensure proper function. Post and enforce speed limits (e.g., 25 miles per hour). Comply with NDEP air permits.
Visual Resources	<ul style="list-style-type: none"> Light pollution Viewshed 	<ul style="list-style-type: none"> Use anti-glare light fixtures with fugitive light control designs to limit light pollution. Reclaim disturbed areas as soon as activities are complete. Place light fixtures at the lowest practical height and direct at the ground and/or work areas to avoid being cast skyward or over long distances. Berms required for haul roads would minimize visibility of vehicle lights emanating from haul roads and the pit areas that may be directed toward public roads during travel. In the pit and WRDAs, the lights and equipment would be naturally shielded by the pit walls and distance. In the Plan Area, the lights would be naturally shielded by distance from US 50, which is about 15 miles north of the proposed project.

Table 2.3-8 Applicant-Committed Environmental Protection Measures By Resource for Proposed Action

Resource	Potential Effects	Actions to Minimize or Avoid Effects
		<ul style="list-style-type: none"> • Incorporate shields and/or louvers on light fixtures where possible and use full cut-off type. • Paint or stain buildings to produce flat-toned, non-reflective surfaces. • Use dimmers, timers, and motion sensors where appropriate. • Minimize fugitive dust by reducing the light reflectance from the dust particles in order to reduce "sky glow."
Cultural Resources	<ul style="list-style-type: none"> • Cultural resources 	<ul style="list-style-type: none"> • Prior to surface disturbing activities, permitted archeologists would conduct inventories for un-surveyed sites or those not evaluated within the past 10 years. • BLM would determine level of inventory needed (Class I, II, or III, reconnaissance or none). • Avoid all historic properties and cultural resources if possible. • If avoidance is not possible, develop treatment plan for the historic properties affected by the proposed disturbance. • If un-identified resources are discovered, ensure that all activities associated with the undertaking (within 100 meters of a discovery) are halted and the discovery is appropriately protected until the BLM authorized officer issues a Notice to Proceed. • Submit all cultural reports to the BLM. • Inform all persons associated with the project that knowingly disturbing cultural resources (historic or archaeological) or collecting artifacts is illegal.
Socioeconomics	<ul style="list-style-type: none"> • Housing shortages • Emergency services demand • Increased traffic 	<ul style="list-style-type: none"> • Subsequent to the issuance of the ROD and approval of a right-of-way grant, and prior to the initiation of construction, Midway would undertake an assessment of regional labor force conditions and the availability of sales and rental housing, RV and mobile home spaces, and readily developable lots in Ely, Eureka and nearby unincorporated areas of White Pine and Eureka counties. • Midway would also review the residency patterns of its Pan Mine employees before and after hiring to benefit from the recent experience of a similar mine in a nearby location. If housing shortages exist at that time, Midway would consult with White Pine and Eureka counties and the City of Ely to discuss strategies to accommodate its workforce housing needs.
Hazardous and Solid Waste/Hazardous Materials	<ul style="list-style-type: none"> • Accidental spills of hydrocarbons that could contaminate water, soil, and vegetation • Storage of hazardous materials • Handling of hazardous and solid wastes • Transportation of hazardous materials • Potential of public 	<ul style="list-style-type: none"> • Take measures to isolate, control, and properly dispose of toxic and hazardous materials. • Remove and properly dispose of all trash, garbage, debris, and foreign matter. • Maintain the disposal site and leave it in a clean and safe condition. • Do not allow burning at the site without prior approval. • Do not drain oil or lubricants onto the ground surface. • Immediately clean up any spills smaller than 25 gallons; clean up spills larger than 25 gallons as soon as possible and report the incident to the BLM and NDEP. • Containerize petroleum products such as gasoline, diesel fuel, and lubricants in approved containers. • Properly store hazardous materials in separate containers to prevent mixing, drainage, or accidents.

Table 2.3-8 Applicant-Committed Environmental Protection Measures By Resource for Proposed Action

Resource	Potential Effects	Actions to Minimize or Avoid Effects
	mine site accidents	<ul style="list-style-type: none"> • Clean up spills in accordance with NDEP guidelines. • Restrict public access locally during active mining.

Notes:

- 1 USFWS Threatened, Endangered, Candidate, and Proposed Species; State Protected Species; BLM Sensitive Species
- 2 Romin and Muck recommend "beginning land use, human activities, or construction prior to the breeding season will allow a pair of raptors to "choose" whether the nest site is still acceptable considering the disturbance. Warning sirens at regular intervals have also been used to alert raptor pairs to potentially startling noises such as blasting. This technique has generally been used where there is no acceptable alternative to the proposed action. While loss of the nest site may occur. The goal of this technique is to avoid loss of eggs or young and allow the adults an opportunity to select an alternate nesting site." If activities such as blasting were to begin during early spring and summer, birds potentially nesting in proximity to the project area would either become habituated to the disturbance or seek another location. Pre-disturbance signals such as sounding sirens prior to blasting may be effective in limiting negative raptor responses blasting. As sounding sirens prior to a blast is a standard safety practice at most mine sites, this technique would be implemented to reduce impacts.

PAG = Potentially Acid Generating

USFWS = United States Fish and Wildlife Service

2.4 ALTERNATIVES

The CEQ policy regulation (40 CFR 1500.2(e)) states that the NEPA process must "identify and assess the reasonable alternatives to proposed actions that will avoid or minimize adverse effects of these actions upon the quality of the human environment." The CEQ NEPA and agency planning regulation (40 CFR 1501.2(c)) states that agencies need to "study, develop, and describe appropriate alternatives to recommended courses of action in any proposal which involves unresolved resource conflicts concerning alternative uses of available resources... ."

The Alternatives proposed for detailed analysis in this EIS meet the following criteria of a "reasonable alternative":

- Generally meets the Purpose and Need and is needed to address one or more significant issues;
- Would be subject to the "rule of reason," with the alternative being in proportion to the significance of the environmental impacts related to the Proposed Action. Reasonable alternatives include those that are practical or feasible from the technical and economic standpoint and using common sense; and
- Would be environmentally reasonable, that is would not be obviously environmentally inferior to other action alternatives.

The BLM, the cooperating agencies, and the third-party EIS contractor developed alternatives based on the criteria for reasonable alternatives, through internal scoping discussions, and with input from public scoping comments. The BLM considered each alternative and either carried the alternative through detailed evaluation in the EIS or eliminated the alternative. The alternatives carried forward are described below. The alternatives considered but not carried forward for detailed analysis, along with any related reasons for elimination, are described in Section 2.5.

2.4.1 Power Line Route Alternatives

The Proposed Action for the Gold Rock Mine, including the proposed power line route and tie-in to the nearby Pan Mine substation, was developed before the BLM selected the preferred

alternative for the Pan Mine EIS. In November 2013, the BLM selected the Southwest Power Line Alternative as the preferred alternative for the Pan Mine Project, and in December 2013, the BLM issued the ROD on the Pan Mine EIS.

As a result of the BLM's decision to select the Southwest Power Line Alternative for the Pan Mine EIS, the starting point for the Gold Rock Mine Project power line could be moved farther south, and the length of the associated power line could be shortened. Effects to resources could be reduced or eliminated. Consequently, the BLM considered two above-ground power line route alternatives that would tie into the Pan Southwest Power Line Route, described in Sections 2.4.1.1 and 2.4.1.2.

Under either of the proposed above-ground power line route alternatives, Mount Wheeler Power would use the same 69 kV mono-pole design suggested for the Proposed Action power line. Electrical control equipment would be mounted on the power poles where the Gold Rock Mine power line ties into the Pan Mine Southwest Power Line. Up to four poles would be required at the intersection depending on the angle of the power line and the need for guide line poles. No substation would be required at this intersection. Mount Wheeler Power would construct a two-track maintenance road within the selected power line corridor. If the Proposed Action is approved and implemented, staff from either mine could use the maintenance road associated with the selected power line route to access the other mine to perform environmental monitoring.

Northern Power Line Route Alternative

To address concerns about greater sage-grouse from the Proposed Action due to the power line, the BLM considered the Northern Power Line Route Alternative. Under this alternative, Midway would implement the Proposed Action described in Section 2.3, with one modification: a different power line route would be used.

Instead of using the Proposed Action power line route, Midway would tie in to a right angle on the Pan Mine Southwest Power Line Route, follow a segment of the Proposed Action power line route, then continue to the Gold Rock Plan area (Figure 2.4-1). This alternative would be approximately 3.6 miles long.

The Northern Power Line Route Alternative incorporates a segment of the Proposed Action, and was identified by Mount Wheeler Power as the most suitable route for power line construction because the route includes only two turning points, spans relatively flat ground, and is shorter than the Southern Power Line Route Alternative described below.

Southern Power Line Route Alternative

To address concerns about to greater sage-grouse from the Proposed Action due to the power line, the BLM considered the Southern Power Line Route Alternative. Under this alternative, Midway would implement the Proposed Action described in Section 2.3, with one modification: a different power line route would be used.

Instead of using the Proposed Action power line route, Midway would use the Southern Power Line Route Alternative, which would tie in to a right angle on the Pan Mine Southwest Power Line Alternative and extend south and east, roughly paralleling existing BLM 4106/CR 1180 and BLM 4006, then entering the Plan area (Figure 2.4-1). This alternative would be approximately 4.0 miles long.

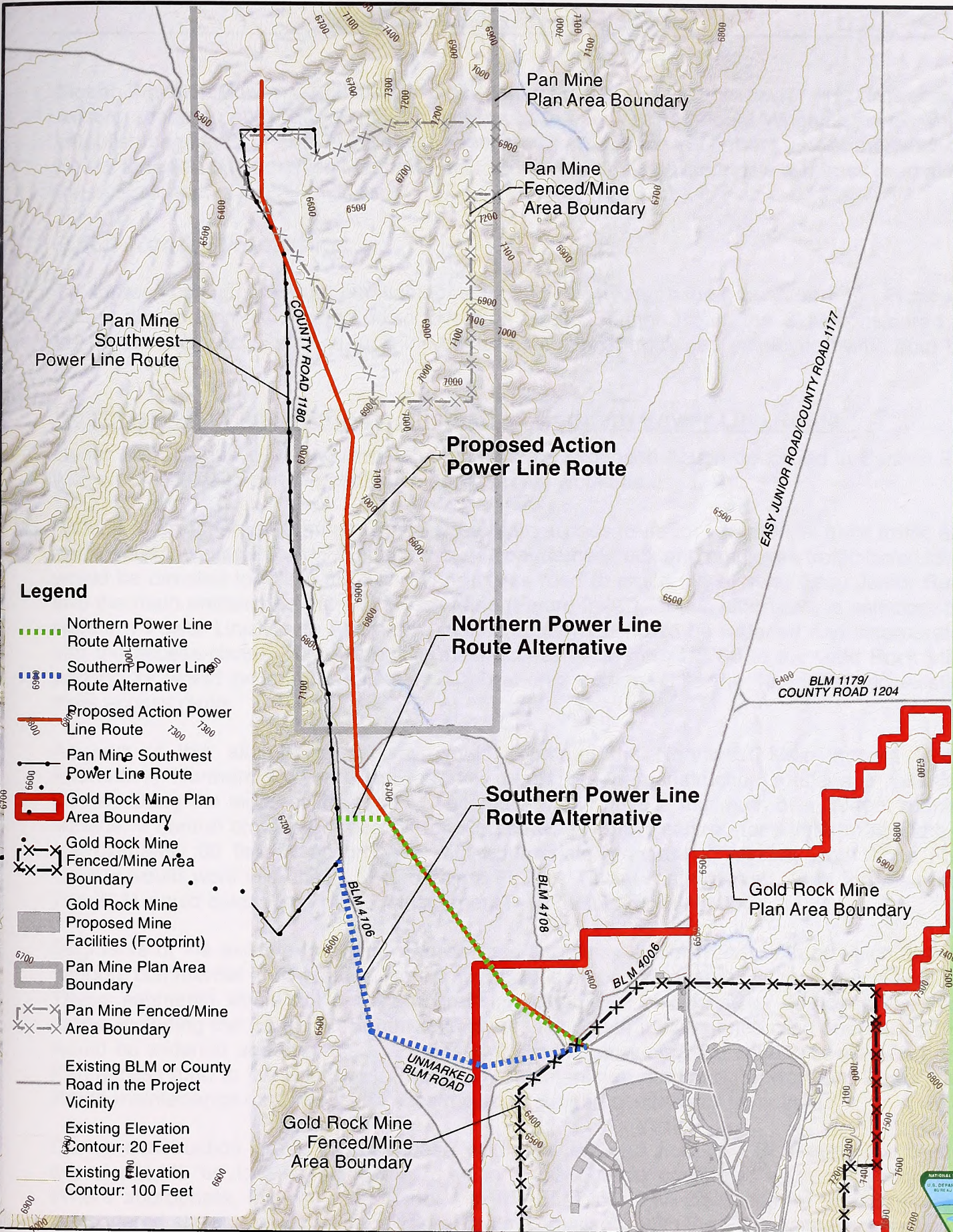

Legend

- Northern Power Line Route Alternative
- Southern Power Line Route Alternative
- Proposed Action Power Line Route
- Pan Mine Southwest Power Line Route
- Gold Rock Mine Plan Area Boundary
- Gold Rock Mine Fenced/Mine Area Boundary
- Gold Rock Mine Proposed Mine Facilities (Footprint)
- Pan Mine Plan Area Boundary
- Pan Mine Fenced/Mine Area Boundary
- Existing BLM or County Road in the Project Vicinity
- Existing Elevation Contour: 20 Feet
- Existing Elevation Contour: 100 Feet

FIGURE 2.4-1
POWER LINE ROUTE ALTERNATIVES
MIDWAY GOLD US INC.
GOLD ROCK MINE PROJECT

MAPPED DATE: 10/16/2014

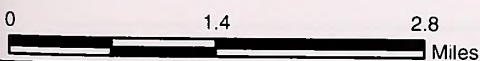

U.S. BUREAU OF LAND MANAGEMENT
 ELY DISTRICT
 EGAN FIELD OFFICE

NO WARRANTY IS MADE BY THE BUREAU OF LAND MANAGEMENT AS TO THE ACCURACY, RELIABILITY, OR COMPLETENESS OF THESE DATA FOR INDIVIDUAL USE OR AGGREGATE USE WITH OTHER DATA.

Basemap Source: ESRI World Shaded Relief Map Service

This page intentionally left blank.

Mount Wheeler Power would use the existing roads to access the power line; however, if existing roads do not provide sufficient access to the power line, Mount Wheeler Power would establish segments of new two-track road where appropriate. In contrast, under the Northern Power Line Route Alternative Mount Wheeler Power would establish a new two-track road along the entire length of the 3.6-mile route.

2.4.2 Route Alternatives

To address concerns about potential indirect effects to greater sage-grouse from the Proposed Action due to increased traffic noise levels on Green Springs Road, the BLM considered an alternative main access route for mine-bound commercial truck and employee traffic from US 50.

Northwest Main Access Route Alternative, Northern Power Line Route

Under this alternative, Midway would implement the Proposed Action described in Section 2.3, with one modification: a different main access route would be used.

Instead of using Green Springs Road as the main access route for commercial truck traffic and employees traveling from US 50, mine-bound commercial truck and employee traffic from US 50 would be directed to follow the Pan Mine access road to reach the existing Easy Junior Road and the main entrance to the Gold Rock Mine (Figure 2.4-2). If this alternative is selected, the Northern Power Line Route Alternative maintenance road would be widened and incorporated into the access route. This alternative main access route from US 50 to the Gold Rock Mine parking lot would be approximately 17.4 miles long, compared to the 18.4-mile-long existing main access route.

As part of this alternative, Midway would construct the Northwest Main Access Route Alternative, Northern Power Line Route by upgrading or constructing roads and installing ditches along the sides of the roads. The route would have a minimum of a 32-foot running surface, a central crown, and ditches for surface water runoff control, for a total road width of approximately 66 feet in accordance with appropriate standards. Midway and White Pine County would work with the BLM to obtain a FLPMA Title V Right-of-Way Grant for this route. The BLM would develop a Travel Management Plan for this Right-of-Way.

Segments of the existing Pan Mine access road and Easy Junior Road, both of which already support commercial truck traffic, would make up part of the alternative main access route. These segments would not require upgrading. Segments of existing or approved two-track roads, including the Pan Mine Southwest Power Line Route maintenance road and BLM 4006, would be widened and upgraded. Proposed segments, including the connector road from the Pan access road to the Southwest Power Line maintenance road and the Northern Power Line Route maintenance road, would be constructed to support commercial truck traffic.

During construction gravel or road base would be sourced from two BLM-approved 5-acre gravel pits, to be located along the route in areas outside of greater sage-grouse habitat. Where appropriate, Midway would work with the BLM to obtain clearance for threatened and endangered species and for cultural resources in compliance with the Programmatic Agreement (Appendix 1A) before performing surface disturbance activities. Midway would address surface water drainage along the route in compliance with NDEP's temporary stormwater permit (Williams 2014i). In contrast, the proposed main access route was upgraded several years ago, and no new surface disturbance would be required during road maintenance activities.

Under this alternative, road use would differ from that described under the Proposed Action. All workers, contractors, vendors and visitors would be directed to use the Northwest Main Access Route Alternative, Northern Power Line Route rather than the main access route; however, a worker, contractor, vendor or visitor may choose to approach by other roads that lead to the Plan area. With the exception of the new road segment along the proposed county road re-route, these roads are not slated for improvement and travelers would use the roads at their own risk.

Northwest Main Access Route Alternative, Southern Power Line Route

Under this alternative, Midway would implement the Proposed Action described in Section 2.3, with one modification: a different main access route would be used.

Similar to the Northwest Main Access Route Alternative, Northern Power Line Route, this alternative would involve using a different main access route for commercial truck traffic and employees traveling from US 50. Instead of using Green Springs Road, mine-bound commercial truck and employee traffic from US 50 would be directed to follow the Pan Mine access road to reach the existing Easy Junior Road and the main entrance to the Gold Rock Mine (Figure 2.4-2). If this alternative is selected, the Southern Power Line Route Alternative maintenance road, which may include segments of existing roads, would be widened and incorporated into the access route. This alternative main access route from US 50 to the Gold Rock Mine parking lot would be approximately 18.3 miles long, compared to the 18.4-mile-long existing main access route.

As part of this alternative, Midway would construct the Northwest Main Access Route Alternative, Southern Power Line Route by upgrading or constructing roads and installing ditches along the sides of the roads. The route would have a minimum of a 32-foot running surface, a central crown, and ditches for surface water runoff control, for a total road width of approximately 66 feet in accordance with appropriate standards. Midway and White Pine County would work with the BLM to obtain a FLPMA Title V Right-of-Way Grant for this route. The BLM would develop a Travel Management Plan for this Right-of-Way.

Segments of existing roads that already support commercial truck traffic would make up part of the alternative access route. Segments of existing or approved two-track roads, including segments of the Pan Mine Southwest Power Line Route maintenance road and BLM 4006, would be widened and upgraded. Proposed segments, including the connector road from the Pan access road to the Southwest Power Line maintenance road and the Southern Power Line Route maintenance road, would be constructed to support commercial truck traffic. In contrast, the proposed main access route was upgraded several years ago, and no new surface disturbance would be required during road maintenance activities.

During construction gravel or road base would be sourced from two BLM-approved 5-acre gravel pits, to be located along the route in areas outside of greater sage-grouse habitat. Where appropriate, Midway would work with the BLM to obtain clearance for threatened and endangered species and for cultural resources in compliance with the Programmatic Agreement (Appendix 1A) before performing surface disturbance activities. Midway would address surface water drainage along the route in compliance with NDEP's temporary stormwater permit (Williams 2014i).

Under this alternative, road use would differ from that described under the Proposed Action. All workers, contractors, vendors and visitors would be directed to use the Northwest Main Access

Route Alternative, Southern Power Line Route rather than the main access route; however, a worker, contractor, vendor or visitor may choose to approach by other roads that lead to the Plan area. With the exception of the new road segment along the proposed county road re-route, these roads are not slated for improvement and travelers would use the roads at their own risk.

Modified County Road Re-Route Alternative

To minimize potential impacts due to surface disturbance in greater sage-grouse habitat during construction of a new road segment along the proposed county road re-route, and to maintain a through-route to Green Springs Road, the BLM considered the Modified County Road Re-Route Alternative.

Under this alternative, Easy Junior Road would be re-routed around the mine area on existing roads instead of constructing a new road segment to connect BLM 4006 and BLM 4059 (Figure 2.4-2). The length of the modification is approximately 5 miles. In combination with the existing BLM road segments on the proposed county road re-route, this alternative would be 13 miles long, which is approximately 1 mile longer than the Proposed Action county road re-route. In the future, White Pine County may decide to widen this re-route to White Pine County Road Standards. Midway and White Pine County would work with the BLM to obtain a FLPMA Title V Right-of-Way Grant for this re-route alternative. As part of the Right-of-Way Grant, the BLM would develop a Travel Management Plan for this re-route.

2.4.3 Western Tailings Storage Facility Alternative

Under this alternative, Midway would implement the Proposed Action described in Section 2.3, with several modifications. To minimize effects to mule deer crucial winter range, Midway would construct the TSF and associated stormwater controls west of the heap leach pad and South WRDA, instead of south of the pit and ore stockpile. Figure 2.4-3 shows the proposed layout. This alternative TSF location would require moving several facilities within the mine area, including mine roads, reclamation soil storage areas, secondary roads, sediment basins, stock piles, explosives storage facilities, storm water controls, the water pipeline, and monitoring wells. These changes would result in a more compact footprint with shorter roads and power and water corridors between these facilities. The water pipeline for the project would be slightly longer than that under the Proposed Action to extend it to the new mill location near the center of the mine site. To further minimize effects to mule deer crucial winter range, Midway would shift the eastern boundary of the mine area and associated fence line west. As recommended in the Ely District Approved Resource Management Plan (BLM 2008), Midway would avoid performing surface disturbing exploration activities in mule deer crucial winter range from November 1 to March 31.

This alternative TSF would be contained by a narrow dam between the small ridges, or "hogbacks," to the west, and supplemented by two smaller embankments to the south. This TSF would cover about 403 acres, which is about 134 acres larger than the 269-acre Proposed Action TSF. However, the amount of borrow area needed for this alternative would be about 53 acres, which is 102 acres fewer than 155 acres of borrow area under the Proposed Action. Midway anticipates that most of the borrow material for the TSF embankments could be obtained from within the footprint of the alternative TSF location. About 20 acres of borrow area disturbance outside of the alternative TSF location may be needed. Assuming that most of the borrow material for the dams can be obtained from within the TSF footprint itself, disturbance within the mine area under this alternative would involve approximately 3,350 acres, which is about 118 fewer acres than mine area disturbance under the Proposed Action.

By moving the TSF west, the TSF would no longer be a limiting physical feature for moving the perimeter fence west out of mule deer habitat, and the eastern fence line would be moved west to within a technically safe and secure distance of proposed mine facilities. This alternative fence line would surround 7,049 acres. In comparison, the Proposed Action fence line would surround 8,757 acres, or an additional 1,708 acres.

2.4.4 No Action Alternative

Under the No Action Alternative, activities associated with the Proposed Action would not occur. Mineral resources in these areas of expansion would remain undeveloped. The construction and operation of the open pit, WRDAs, heap leach facilities, mill, TSF, and support facilities would not occur as currently proposed in the Plan. The county road would not be re-routed. However, the authorized exploration operations for the project as described in Section 2.2 would continue.

The No Action Alternative is required to be analyzed under NEPA.

2.4.5 Summary of Alternatives

In summary, seven alternatives to the Proposed Action were identified for detailed evaluation in this EIS: Two power line route alternatives (the Northern Power Line Route and the Southern Power Line Route), two main access route alternatives (the Northwest Main Access Route Alternative, Northern Power Line Route and the Northwest Main Access Route Alternative, Southern Power Line Route), one county road re-route alternative (the Modified County Road Re-route Alternative), one TSF location alternative (the Western Tailings Storage Facility Alternative), and the No Action Alternative.

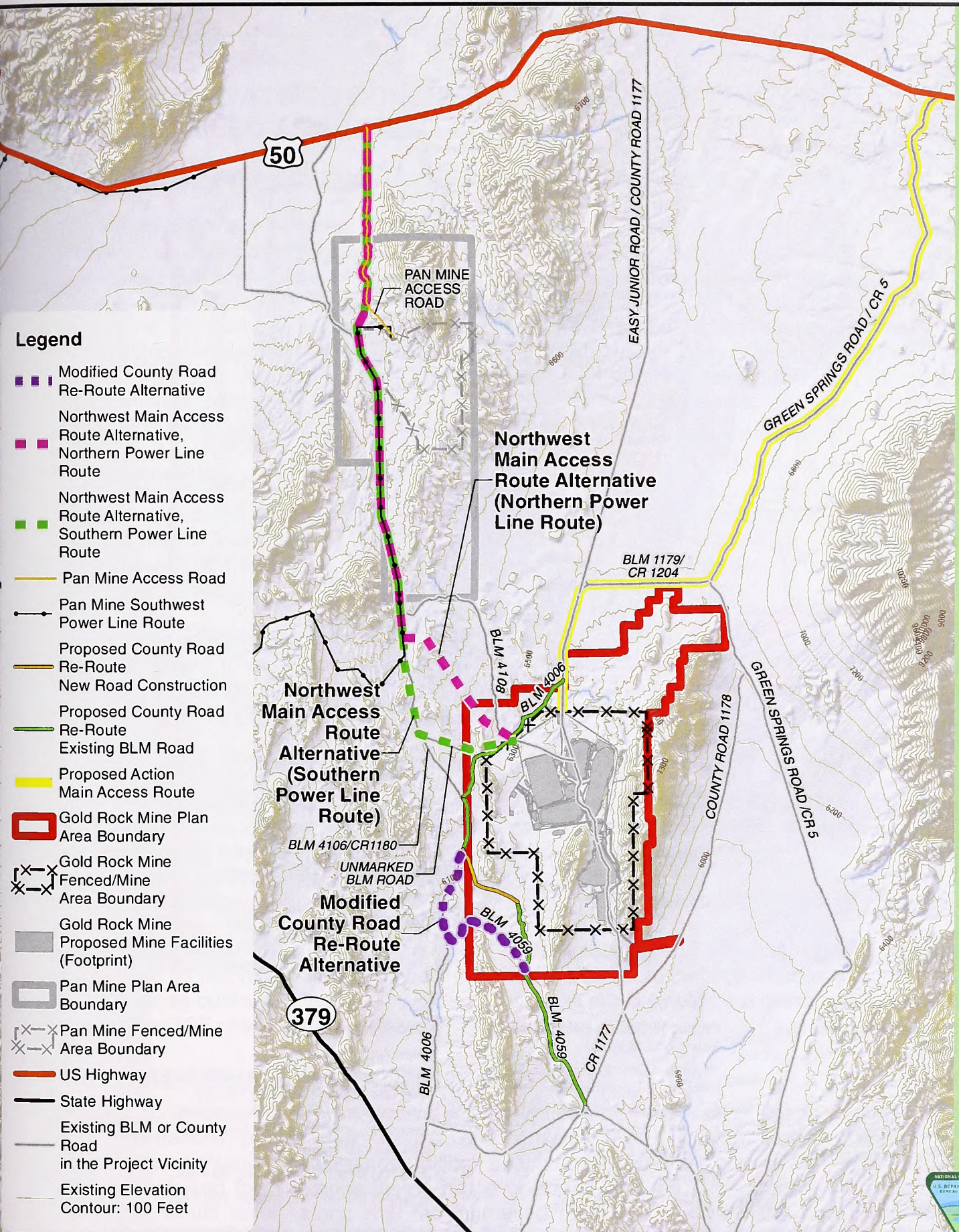

- Legend**
- Modified County Road Re-Route Alternative
 - Northwest Main Access Route Alternative, Northern Power Line Route
 - Northwest Main Access Route Alternative, Southern Power Line Route
 - Pan Mine Access Road
 - Pan Mine Southwest Power Line Route
 - Proposed County Road Re-Route
 - New Road Construction
 - Proposed County Road Re-Route
 - Existing BLM Road
 - Proposed Action Main Access Route
 - Gold Rock Mine Plan Area Boundary
 - Gold Rock Mine Fenced/Mine Area Boundary
 - Gold Rock Mine Proposed Mine Facilities (Footprint)
 - Pan Mine Plan Area Boundary
 - Pan Mine Fenced/Mine Area Boundary
 - US Highway
 - State Highway
 - Existing BLM or County Road in the Project Vicinity
 - Existing Elevation Contour: 100 Feet

FIGURE 2.4-2
ACCESS ROUTE ALTERNATIVES
MIDWAY GOLD US INC.
GOLD ROCK MINE PROJECT

MAPPED DATE: 10/16/2014

0 3.2 6.4
 Miles



U.S. BUREAU OF LAND MANAGEMENT
ELY DISTRICT
EGAN FIELD OFFICE

NO WARRANTY IS MADE BY THE BUREAU OF LAND MANAGEMENT AS TO THE ACCURACY, RELIABILITY, OR COMPLETENESS OF THESE DATA FOR INDIVIDUAL USE OR AGGREGATE USE WITH OTHER DATA.

Basemap Source: ESRI World Shaded Relief Map Service

PATH: Z:\GIS\PROJECTS\LEN\MCO001817_GOLDROCK\GIS\MARCMAP_MXD\12014_DRAFT_EIS\FIGURE_2_4-2_MAIN_ACCESS_ROUTE_ALTERNATIVES_L_V10162014.MXD | LAST SAVED BY: JCHEN | LAST SAVED ON: 10/16/2014 3:27:22 PM

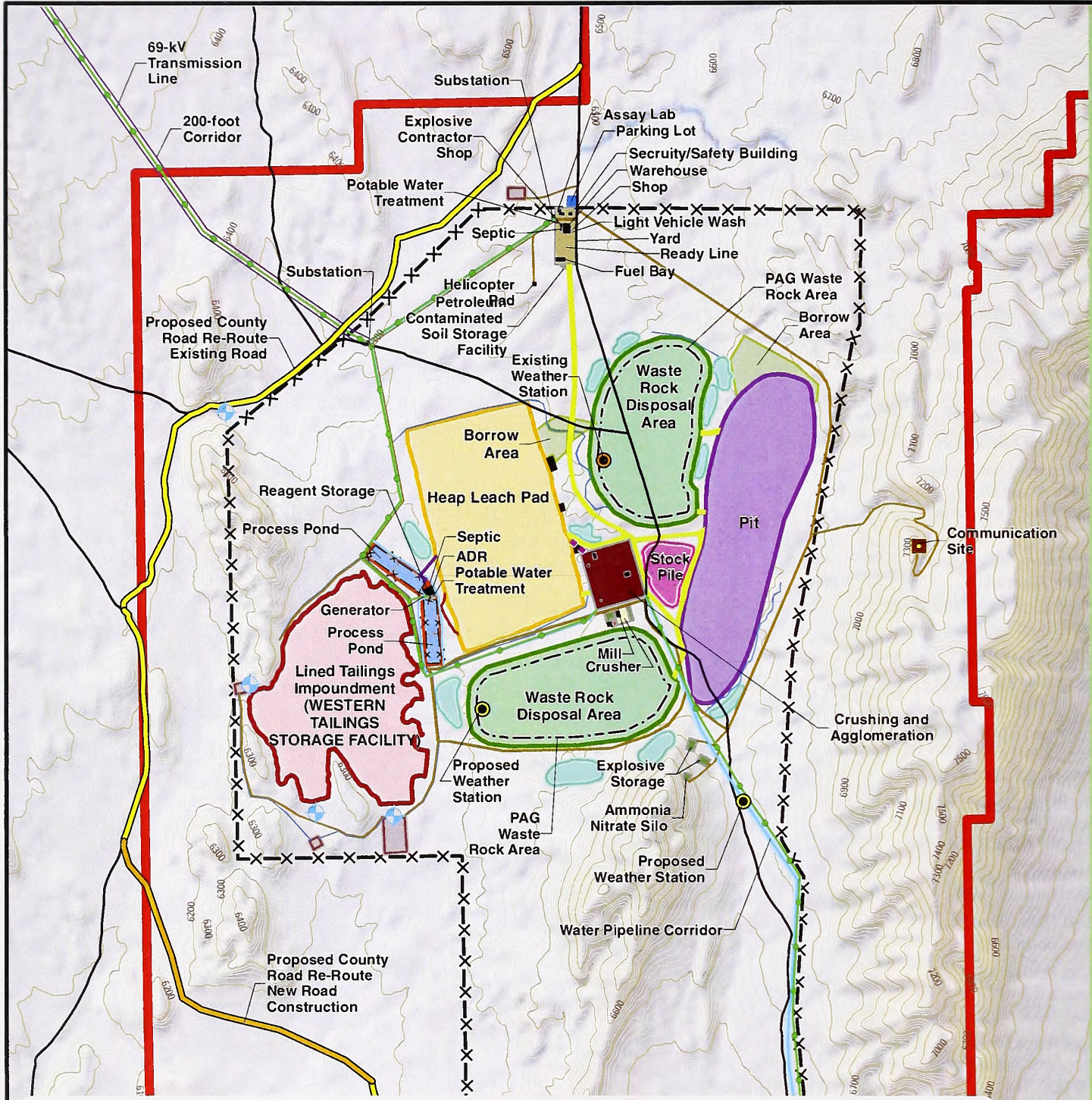
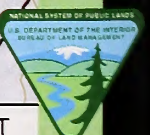

Legend

- Proposed Monitoring Well
- Structure
- Powerline
- Conveyor Belt
- Water Pipeline
- Water Pipeline Corridor
- Haul Road
- Secondary Road
- Proposed County Road Re-Route
- Existing BLM Road
- Proposed County Road Re-Route
- New Road Construction
- Existing BLM or County Road in the Project Vicinity
- Stormwater Control
- Process Pond Fence
- Growth Media Stockpile
- Sediment Basin
- Plan Area Boundary
- Mitigation Measure to Be Applied to Western Tailings Storage Facility
- Alternative: shift mine area eastern fence line west to impact less mule deer crucial winter range
- Existing Elevation Contour: 20 Feet
- Existing Elevation Contour: 100 Feet

FIGURE 2.4-3
WESTERN TAILINGS STORAGE FACILITY ALTERNATIVE
MIDWAY GOLD US INC.
GOLD ROCK MINE PROJECT
 MAPPED DATE: 9/18/2014

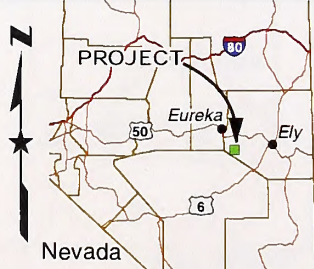
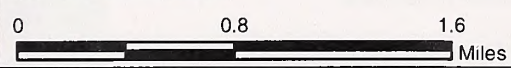

U.S. BUREAU OF LAND MANAGEMENT
 ELY DISTRICT
 EGAN FIELD OFFICE

NO WARRANTY IS MADE BY THE BUREAU OF LAND MANAGEMENT AS TO THE ACCURACY, RELIABILITY, OR COMPLETENESS OF THESE DATA FOR INDIVIDUAL USE OR AGGREGATE USE WITH OTHER DATA.

Basemap Source: ESRI World Shaded Relief Map Service

2.5 ALTERNATIVES CONSIDERED BUT ELIMINATED FROM DETAILED ANALYSIS

2.5.1 Midway Design Options Eliminated From Detailed Analysis

The Proposed Action is based on the Plan (Midway 2013a). During development of the Plan, Midway considered design options for several facilities and processes (Midway 2013a). Midway determined that some of the design options were not feasible for inclusion in the Plan.

During the alternatives development process for the EIS, the BLM considered those design options that Midway had excluded from the Plan as possible alternatives. Following further review, the BLM determined that the options would not be reasonable for technical or environmental reasons. Design options considered as alternatives, and the reasons for eliminating them from further analysis, are summarized below.

Waste Rock Disposal Area Site Selection

Midway considered several locations for the WRDAs, including siting the WRDAs just east of the pit. Midway found that the area east of the pit was too small for the volume required and too steep for efficient operation. The area is also classified as mule deer crucial winter range (Midway 2013a).

During alternative development for the EIS, the BLM considered this WRDA site and found that potential impact to mule deer crucial winter range could be greater than the potential impact under the Proposed Action. This site would not be environmentally reasonable, and was not carried forward for detailed analysis.

Tailings Storage Facility Site Selection

Midway analyzed and considered three locations (sites A, B, and C) for storing 20 million tons of dry solids (Midway 2013a). Midway selected the TSF location for inclusion in the Plan based on whether the site had the capability of holding the projected tailings volume. Midway found that sites A and B would not provide the required storage capacity. Only site C would provide the required storage capacity, and Midway selected this site for inclusion in the Plan.

During alternative development for the EIS, the BLM considered TSF sites A and B and found the sites to be technically infeasible because neither site would be large enough to contain all of the tailings as outlined in the Plan. Neither TSF site A nor B would be a reasonable alternative, and neither TSF site was carried forward for detailed analysis.

Supernatant Water Recovery Method Selection

Midway considered installing a decant system but rejected this option due to concerns about liner penetrations, potential for leakage, and consequent embankment stability. Midway also considered operating a barge on the tailings beach but rejected this alternative due to the depth of water required for clearance during barge operation and the large area of the supernatant pond that would result, along with the increased evaporation losses and decreased tailings consolidation. Midway chose to operate a barge in a barge operating channel because the barge operating channel provides additional draft for the barge, limiting the area required for the supernatant pond operation, decreasing evaporation losses, and increasing tailings consolidation.

During alternative development for the EIS, the BLM found that the decant system was not technically practical because of the risk of embankment instability. This option would not be a reasonable alternative and was not carried forward for detailed analysis. The BLM found that the option of operating a barge on the tailings beach could have a greater potential impact on water resources through evaporation losses and would be environmentally inferior to the Proposed Action. This method would not be a reasonable alternative and was not carried forward for detailed analysis.

2.5.2 Agency-Developed Alternatives Eliminated From Detailed Analysis

The BLM, cooperating agencies, and third-party contractor developed alternatives to several elements of the Proposed Action including the main access route, power line route, proposed county road re-route, and TSF location. Alternatives to these elements that were considered but not carried forward for detailed analysis are summarized below, along with reasons for not carrying the alternative forward.

Northeast Main Access Route Alternative

To address concerns about potential impacts to greater sage-grouse related to increased noise along the main access route during strutting season, the BLM considered use of an alternative main access route to reach the mine area. Under this alternative, mine-bound commercial truck and employee traffic from US 50 would be directed to use the Northeast Main Access Route Alternative. This new access route would include constructing a road from US 50 and extend southward along the western slope of the White Pine Mountains, then turn southwest, crossing through US Forest Service land and part of the Mount Hamilton Mine, and connect to Green Springs Road. The road would be approximately 13 miles long, and would be constructed according to appropriate standards to accommodate commercial truck traffic, with a central crown and ditches for surface water runoff control. The Northeast Main Access Route Alternative would pass through rough terrain, requiring a major road building effort with a large amount of cut and fill activities to establish and maintain a safe running surface width and grade for commercial truck traffic.

Although Midway could direct commercial and employee traffic associated with the Gold Rock Mine to this main access route alternative, Green Springs Road would remain open to vehicular traffic. Existing impacts to greater sage-grouse due to traffic noise on Green Springs Road would continue at existing levels.

The Northeast Main Access Route Alternative would be located within mule deer habitat and a known mule deer migration corridor.

Using this alternative access route from US 50 to the mine parking lot, the travel distance would be 21 miles long, compared to the existing main access route, which is almost 19 miles long. The cost to construct and maintain this alternative main access route would be significantly greater than the Proposed Action, which would involve use of an existing access route that would require no upgrading at this time. The environmental effects due to traffic (potential accidents, air emissions, fuel consumption, collisions with wildlife, and potential for accidental spills) would also be greater for this alternative compared to the existing main access route.

This alternative route would cut across the western slope of the White Pine Mountains, curving often to follow the topography. The route would pass through forested habitat that is a main migration route for mule deer. The winding roads would result in lower speeds, and the terrain

and risk of collision with wildlife would pose as increased driving hazards during mine employees' commutes, especially during mule deer migration and winter weather conditions. The length of this alternative as well as the terrain, which results in lower speeds, would increase employee travel to the mine site.

The Northeast Main Access Route Alternative would be technically feasible; however, construction, management, and maintenance of the access route would be economically infeasible. In addition, the Northeast Main Access Route Alternative would not be environmentally reasonable and was not carried forward for detailed analysis.

Central Power Line Route Alternative

To address concerns about potential impacts to greater sage-grouse, a Central Power Line Route Alternative was considered. This alternative would use a straight line route starting at a right angle on the Pan Mine's Southwest Power Line Route, running southeastward to the Gold Rock Plan area. This alternative would be approximately 3.4 miles long.

Although this alternative would be approximately 0.2 mile shorter than the northern power line route alternative, this alternative would pass through steeper terrain. Surface disturbance would include cut and fill activities to establish and maintain a safe running surface width and grade for vehicular traffic on the maintenance road. Maintenance of the road would also be required during all seasons in order to provide for continuous power service to the mine site.

This alternative would be technically feasible; however, the cost of construction, management, and maintenance of the power line would be economically infeasible. Construction of the road would also involve environmental impacts due to the increased disturbance required for a major road building effort. This alternative would not be environmentally reasonable. This alternative was not carried forward in the analysis.

Burial of Southern Power Line Route Alternative

To address concerns about potential impacts to greater sage-grouse from the Proposed Action power line, the BLM considered an alternative of burying the Southern Power Line Alternative. Overhead power lines may pose risks to greater sage-grouse due to raptor perching or collisions with the structures or conductors during evening flights (NGSGCT 2010). Burial of the power line could avoid some potential direct interference with greater sage-grouse. Instead of using the Proposed Action power line route, Midway would use the Southern Power Line Route Alternative described in Section 2.4.1.2; and instead of constructing an above-ground power line, Mount Wheeler Power would bury the power line within the power line corridor. The total length of this alternative would be approximately 4 miles long. This alternative would include burial of a 25 kV underground line as opposed to an overhead 69 kV line, due to the lack of local repair and maintenance support for an underground 69 kV line. Because of the high risk of maintenance problems due to accidental grounding in lightning storms, Mount Wheeler Power has indicated they would not be willing to bury just parts of a transmission line. A system to protect the line from ground electrical fluctuations is available; however, purchase and installation of the system is not economically feasible.

This alternative would require installation of junction boxes. These junction boxes would be approximately 8 feet wide by 6 feet deep by 4 to 6 feet high and spaced approximately 800 feet apart with security fences around each junction box for access. The junction boxes and fences could serve as raptor perches and impact greater sage-grouse. This alternative would not be environmentally reasonable.

This alternative would be technically feasible; however, burying of the power line, along with management and maintenance of the buried power line, would be economically infeasible. This alternative would not be environmentally reasonable. This alternative would not be a reasonable alternative and was not carried forward for detailed analysis.

Southern Power Line Route Alternative Construction and Maintenance by Helicopter Alternative

To address concerns about potential impacts to greater sage-grouse habitat, the BLM considered an alternative of using helicopters to construct and maintain a power line within the Southern Power Line Route Alternative. Under this alternative, Midway would use the Southern Power Line Route Alternative described in Section 2.4.1.2; and instead of conventionally constructing an above-ground power line, Mount Wheeler Power would construct the power line with helicopters.

Mount Wheeler Power does not use helicopters to construct power lines. The cost of construction, management, and maintenance of a power line by helicopter would be economically infeasible. Use of helicopters could be limited by weather conditions, yet maintenance of the power line would be required during all types of weather in order to provide for continuous power service to the mine site. Furthermore, helicopter noise could impact wildlife, including special status species. Noise associated with helicopter flyovers during maintenance activities could cause species to avoid portions of the analysis area and could affect productivity of nesting birds and increase physiological stress levels for a variety of species, particularly large mammals and birds.

The alternative of building and maintaining a power line by helicopter within the Southern Power Line Route Alternative would be technically feasible. However, because construction of the Southern Power Line Route Alternative with helicopters would be much more expensive and harder to maintain, construction and maintenance of the Southern Power Line Route Alternative by helicopter would be economically infeasible. Construction and maintenance activities could cause wildlife to avoid portions of the area and would be environmentally unreasonable. This alternative was not carried forward for detailed analysis.

Southern Drainage Bottom County Road Re-Route Alternative

To address concerns about potential impacts raised during scoping, including maintaining access and existing through-routes, the BLM considered an alternative of using the northern portion of the proposed county road re-route in combination with an existing 7.7-mile-long segment of BLM 4006/CR 1180 that would extend south through the Duckwater Creek valley to Duckwater Road. This alternative re-route would be approximately 14.5 miles long, compared to the 12-mile long proposed county road re-route.

The Southern Drainage Bottom County Road Re-Route Alternative would be technically feasible; however, implementation of the alternative would not be consistent with White Pine County's transportation planning goal of maintaining Easy Junior Road as a through-route to Green Springs Road. This alternative would result in additional disturbance due to road widening compared to the proposed county road re-route. Because White Pine County's need would not be met under the Southern Drainage Bottom County Road Re-Route Alternative, and because the alternative would have resulted in greater environmental impact, the Southern Drainage Bottom County Road Re-Route Alternative was not carried forward for detailed analysis.

Southern Side-Slope County Road Re-Route Alternative

To address concerns about potential impacts raised during scoping, including maintaining access and existing through-routes, the BLM considered an alternative of using the northern portion of the proposed county road re-route in combination with 8.7 miles of existing and new BLM/county road that would extend south through the Duckwater Creek valley to Duckwater Road. This alternative re-route would be approximately 16 miles long, compared to the 12-mile long proposed county road re-route.

The Southern Side-Slope County Road Re-Route Alternative would be technically feasible; however, implementation of the alternative would not be consistent with White Pine County's transportation planning goal of maintaining Easy Junior Road as a through-route to Green Springs Road. This alternative would result in additional disturbance due to road construction and widening compared to the proposed county road re-route. Because White Pine County's need would not be met under the Southern Side-Slope County Road Re-Route Alternative, and because the alternative would have resulted in greater environmental impact, the Southern Side-Slope County Road Re-Route Alternative was not carried forward for detailed analysis.

2.6 COMPARATIVE ANALYSIS OF ALTERNATIVES

Table 2.6-1 provides a summary and comparison of potential effects from the Proposed Action and alternatives. Detailed descriptions of potential effects for specific resources are presented in **Chapter 4**.

This page intentionally left blank.

Table 2.6-1 Summary of Environmental Effects

Potential Impact	Indicator	Proposed Action	Northern Power Line Route Alternative	Southern Power Line Route Alternative	Northwest Main Access Route Alternative, Northern Power Line Route	Northwest Main Access Route Alternative, Southern Power Line Route	Modified County Road Re-Route Alternative	Western Tailings Storage Facility Alternative	No Action Alternative
Water Resources (Surface Water)									
Construction and operation activities would result in reduced infiltration, increased runoff, and could result in alteration of drainage paths, channel morphology, and retention of stormwater could affect peak flow and low flow of seasonal and/or perennial water sources	Precipitation events, surface water flows, stormwater controls	The project would not result in increased runoff or changes in peak flow because water resources in the Plan area are ephemeral to intermittent. Stormwater controls such as drainage diversion ditches, sediment control basins, straw bales, and other Applicant-Committed EPMs would be implemented to divert stormwater and snow melt around disturbance areas and control the transportation of sediment. Runoff that is contained in on-site sediment control basins would not discharge downstream in the existing drainage channels, so the flow of surface water out of the project area would be less compared to baseline conditions.							There would be no project-related impacts to water resources beyond those associated with the exploration activities that have been approved already.
Increased erosion and sedimentation	Water chemistry, precipitation events, surface water flows, stormwater controls	Stormwater controls such as drainage diversion ditches, sediment control basins, straw bales, and other Applicant-Committed EPMs would be implemented to divert stormwater and snow melt around disturbance areas and control the transportation of sediment. Runoff that is contained in on-site sediment control basins would not discharge downstream in the existing drainage channels.							There would be no project-related impacts to water resources beyond those associated with the exploration activities that have been approved already.
Contamination from chemical spills or leaks		The potential for hazardous materials or other wastes to spill and subsequently affect surface water quality would be minimized through installation of secondary containment features and implementation of the SPCC Plan and the Spill Contingency and Emergency Response Plan.							There would be no project-related impacts to water resources beyond those associated with the exploration activities that have been approved already.
Water Resources (Groundwater)									
Changes in groundwater level in aquifer, perched groundwater zones, or discharge from springs, seeps, or wetlands and impacts to plants, animals, and rangeland water sources	Groundwater pumping rates, flow rates, and volumes	The quantity of water at Green Springs would not be impacted because Green Springs is fed by groundwater sourced in the mountains to the east of the Plan area and this spring is not in direct hydraulic communication with groundwater in the basin fill aquifer. Impacts to water at Big or Little Warm Springs are not anticipated because these springs and the Plan area are separated by more than 12 miles. Potentiometric drawdown at Little Warm Springs would be limited to 0.1 feet (i.e., approximately 1 inch of drawdown) after pumping the Easy Junior Well at a rate of 1,200 gallons per minute continuously for 10 years and then at a rate of 600 gallons per minute for 3 years.							There would be no project-related impacts to water resources beyond those associated with the exploration activities that have been approved already.
Changes in groundwater quality	Water chemistry, water draindown rates, and water infiltration rates	Mining activities would not encounter groundwater, therefore, no impacts are expected. The quality of water at Green Springs would likely not be affected because Green Springs is fed by groundwater sourced in the mountains to the east of the Plan area and this spring is probably not in direct hydraulic communication with groundwater in the basin fill aquifer. Impacts to the quality of water at Big or Little Warm Springs are not anticipated because these springs and the Plan area are separated by more than 12 miles.							There would be no project-related impacts to water resources beyond those associated with the exploration activities that have been approved already.
Contamination from chemical spills or leaks		The potential for hazardous materials or other wastes to spill and subsequently affect water quality would be minimized through installation of secondary containment features and implementation of the SPCC Plan and the Spill Contingency and Emergency Response Plan.							There would be no project-related impacts to water resources beyond those associated with the exploration activities that have been approved already.
Impacts to water rights in region	Groundwater pumping rates, volumes, perennial yield, appropriation, and consumption	NDWR has appropriated 26,402 afy of water rights in the Railroad Valley/Northern Part, which is about 35 percent of the perennial yield. 2,000 afy of the NDWR water rights would be appropriated for the proposed project.							There would be no project-related impacts to water resources beyond those associated with the exploration activities that have been approved already.

Table 2.6-1 Summary of Environmental Effects

Potential Impact	Indicator	Proposed Action	Northern Power Line Route Alternative	Southern Power Line Route Alternative	Northwest Main Access Route Alternative, Northern Power Line Route	Northwest Main Access Route Alternative, Southern Power Line Route	Modified County Road Re-Route Alternative	Western Tailings Storage Facility Alternative	No Action Alternative
Geology and Minerals									
Loss of geologic resources	Quantity of ore and waste material to be excavated	The quantity of ore excavated over the life of the mine would vary somewhat with market conditions, but the heap leach pad would be designed for a capacity of approximately 77 million tons.							There would be no project-related mineral extraction beyond that associated with the exploration activities that were approved previously.
	Number and types of mining claims, geothermal nominations, and oil and gas leases in the affected area	Surface access to existing oil and gas leases would be affected, as would access to the leased minerals unless directional drill methods are employed from outside the mine facilities. No geothermal nominations have been established within the analysis area.							There would be no project-related minerals beyond that associated with the exploration activities that were approved previously.
	Areas of surface disturbance	Approximately 3,946 acres	Approximately 3,913 acres	Approximately 3,912 acres	Approximately 4,010 acres	Approximately 4,018 acres	Approximately 3,945 acres	Approximately 3,828 acres	No project-related disturbance would occur.
	Facilities to be constructed in areas of potential geotechnical instability	No facilities would be constructed in areas of potential geotechnical instability. With the exception of the existing Easy Junior pit, no areas of potential geotechnical instability are known to be present within the analysis areas.							No project-related facilities would be constructed.
Paleontological Resources									
Loss of paleontological resources	Acres of surface disturbance in areas with PFYC classes of 3, 4, or 5.	Approximate acreage that would be within geologic units with a PFYC Class 3 designation, which has a moderate potential to contain scientifically significant fossils: 1,062	Approximate acreage that would be within geologic units with a PFYC Class 3 designation, which has a moderate potential to contain scientifically significant fossils: 1,051	Approximate acreage that would be within geologic units with a PFYC Class 3 designation, which has a moderate potential to contain scientifically significant fossils: 1,051	Approximate acreage that would be within geologic units with a PFYC Class 3 designation, which has a moderate potential to contain scientifically significant fossils: 1,108	Approximate acreage that would be within geologic units with a PFYC Class 3 designation, which has a moderate potential to contain scientifically significant fossils: 1,110	Approximate acreage that would be within geologic units with a PFYC Class 3 designation, which has a moderate potential to contain scientifically significant fossils: 1,062	Approximate acreage that would be within geologic units with a PFYC Class 3 designation, which has a potential to contain scientifically significant fossils: 826	No direct or indirect effects to fossil resources or their geologic content would occur.
Soils and Reclamation									
Reduced infiltration	Acres of soils disturbed; soil characteristics, including erosion hazard ratings and reclamation potentials; soil loss	Approximate acreage of new soil disturbance would occur: 3,946	Approximate acreage of new soil disturbance would occur: 3,913	Approximate acreage of new soil disturbance would occur: 3,912	Approximate acreage of new soil disturbance would occur: 4,010	Approximate acreage of new soil disturbance would occur: 4,018	Approximate acreage of new soil disturbance would occur: 3,945	Approximate acreage of new soil disturbance would occur: 3,828	No new project-related soil disturbance would occur.
Increased wind and water erosion	Soils that would be disturbed generally have severe erosion hazards once the existing vegetative cover is removed because of a combination of slope and erodibility. They also are generally poorly suited for reclamation purposes.	Stormwater controls such as drainage diversion ditches, sediment control basins, straw bales, and other Applicant-Committed EPMs would be implemented to control the transportation of sediment.							No new project-related soil disturbance would occur.
Increased sedimentation		Stormwater controls such as drainage diversion ditches, sediment control basins, straw bales, and other Applicant-Committed EPMs would be implemented to control the transportation of sediment.							No new project-related soil disturbance would occur and no stormwater controls would be constructed.
Prime and Unique Farmland									
Reduced productivity	Acres of soils disturbed	3 acres of soils designated as Prime Farmland could be disturbed. Assuming that reclamation is successful, little or no loss of Prime Farmland productivity is anticipated.	1 acre of soils designated as Prime Farmland could be disturbed. Assuming that reclamation is successful, little or no loss of Prime Farmland productivity is anticipated.	1 acre of soils designated as Prime Farmland could be disturbed. Assuming that reclamation is successful, little or no loss of Prime Farmland productivity is anticipated.	15 acres of soils designated as Prime Farmland could be disturbed. Assuming that reclamation is successful, little or no loss of Prime Farmland productivity is anticipated.	15 acres of soils designated as Prime Farmland could be disturbed. Assuming that reclamation is successful, little or no loss of Prime Farmland productivity is anticipated.	Similar to Proposed Action	Similar to Proposed Action	The areal extent of soils designated as Prime Farmland that could be disturbed during permitted exploration activities is not known. Assuming that reclamation is successful, little or no loss of Prime Farmland productivity is anticipated.

Table 2.6-1 Summary of Environmental Effects

Potential Impact	Indicator	Proposed Action	Northern Power Line Route Alternative	Southern Power Line Route Alternative	Northwest Main Access Route Alternative, Northern Power Line Route	Northwest Main Access Route Alternative, Southern Power Line Route	Modified County Road Re-Route Alternative	Western Tailings Storage Facility Alternative	No Action Alternative	
Air Quality										
Changes in air quality	Concentrations of fugitive dust and criteria pollutants, greenhouse gases, and HAPs.	The mining activity would result in an increase in air emissions throughout the life of the project. Most of the emissions would be from fugitive emissions from vehicular travel.							No impacts other than those previously authorized.	
Changes to regional climate	Changes to storm magnitude or frequency	Although climate may change in the Plan area over the long term, the effects of these changes are not fully understood or certain. Changes in storm magnitude or frequency induced by climate change could affect various resources over the long term. Higher levels of precipitation could increase soil erosion and alter vegetative species composition over the long term. Conversely, lower levels of precipitation could increase stress on vegetation resulting in changes in communities and the wildlife occupying them. Because ground water use is below annual yield, potential reductions in precipitation resulting from climate change would not affect ground water use.							No impacts other than those previously authorized.	
Reduction in air quality and impact on human health through inhalation or ingestion of contaminated dust or water	Existing concentrations of constituents in air, estimated concentrations of constituents in air, air quality standards	The air emissions analysis indicated that impacts for all criteria pollutants would be below all applicable air quality standards. The standards were developed with an adequate margin of safety to protect public health. Consequently, no practical adverse effects to public health are expected because the emissions would be below the air quality standards.							No impacts other than those previously authorized.	
Vegetation and Invasive, Non-Native Plant Species, and Special Status Plant Species										
Reduced productivity	Acres and types of vegetation disturbed and vegetative productivity	Approximate acreage of native vegetation would be removed from production: 3,946	Approximate acreage of native vegetation would be removed from production: 3,913	Approximate acreage of native vegetation would be removed from production: 3,912	Approximate acreage of native vegetation would be removed from production: 4,010	Approximate acreage of native vegetation would be removed from production: 4,018	Approximate acreage of native vegetation would be removed from production: 3,945	Approximate acreage of native vegetation would be removed from production: 3,828	No change in existing vegetation disturbance would occur. No project-related impacts to vegetation productivity beyond those associated with the exploration activities that are already approved would occur.	
		491 acres would be removed from production permanently.								453 acres would be removed from production permanently.
		Approximate acreage of vegetation that would be disturbed: 3,946	Approximate acreage of vegetation that would be disturbed: 3,913	Approximate acreage of vegetation that would be disturbed: 3,912	Approximate acreage of vegetation that would be disturbed: 4,010	Approximate acreage of vegetation that would be disturbed: 4,018	Approximate acreage of vegetation that would be disturbed: 3,945	Approximate acreage of vegetation that would be disturbed: 3,828	No impacts other than those previously authorized.	
		491 acres would be disturbed permanently.							453 acres would be removed from production permanently.	No impacts other than those previously authorized.
Removal of vegetation		57 percent of the long-term disturbance would be in Great Basin Xeric Mixed Sagebrush Shrubland and 21 percent in Great Basin Pinyon-Juniper Woodland.							54 percent of the long-term disturbance would be in Great Basin Xeric Mixed Sagebrush Shrubland and 18 percent in Great Basin Pinyon-Juniper Woodland.	No change in existing vegetation disturbance would occur. No project-related impacts to vegetation beyond those associated with the exploration activities that are already approved would occur.
Increased potential for establishment of noxious and non-native, invasive weeds	Existing populations of noxious or non-native, invasive weeds in the Plan area and the region	Acreage of native vegetation removed that would increase the potential for the introduction and spread of weeds: 3,946	Acreage of native vegetation removed that would increase the potential for the introduction and spread of weeds: 3,913	Acreage of native vegetation removed that would increase the potential for the introduction and spread of weeds: 3,912	Acreage of native vegetation removed that would increase the potential for the introduction and spread of weeds: 4,010	Acreage of native vegetation removed that would increase the potential for the introduction and spread of weeds: 4,018	Acreage of native vegetation removed that would increase the potential for the introduction and spread of weeds: 3,945	Acreage of native vegetation removed that would increase the potential for the introduction and spread of weeds: 3,828	There would be no change in existing disturbance. Therefore, no change in the introduction and spread of weeds would occur beyond that associated with the exploration activities that are already approved.	

Table 2.6-1 Summary of Environmental Effects

Potential Impact	Indicator	Proposed Action	Northern Power Line Route Alternative	Southern Power Line Route Alternative	Northwest Main Access Route Alternative, Northern Power Line Route	Northwest Main Access Route Alternative, Southern Power Line Route	Modified County Road Re-Route Alternative	Western Tailings Storage Facility Alternative	No Action Alternative	
Loss of habitat or loss of individual special status plants	Acres of potential habitat	Direct and indirect impacts to special status plant species would occur in special status plant species habitats.							No project-related impacts to vegetation beyond those associated with the exploration activities that are already approved would occur.	
Wildlife and Fisheries and Special Status Animal Species										
Adverse impacts to big game including mortality as a result of increased vehicular traffic near migration route to mule deer crucial winter range or antelope habitat including potential birthing sites, loss of habitat due to surface disturbance, fencing	acres of habitats available	Approximate acreage of range that would no longer be available to mule deer: 2,350	Approximate acreage of range that would no longer be available to mule deer: 2,329	Approximate acreage of range that would no longer be available to mule deer: 2,328	Approximate acreage of range that would no longer be available to mule deer: 2,382	range that would no longer be available to mule deer: 2,391	Approximate acreage of range that would no longer be available to mule deer: 2,349	Approximate acreage of range that would no longer be available to mule deer: 1,764	No additional effects to mule deer ranges would occur.	
		2,266 acres of mule deer crucial winter range							1,522 acres of mule deer crucial winter range (744 fewer than Proposed Action)	No additional effects to mule deer ranges would occur.
		84 acres of mule deer year-round range	63 acres of mule deer year-round range	62 acres of mule deer year-round range	116 acres of mule deer year-round range	125 acres of mule deer year-round range	83 acres of mule deer year-round range	475 acres of mule deer year-round range	No additional effects to mule deer ranges would occur.	
		Approximate acreage of pronghorn antelope year-round range that would be removed for the duration of the project: 3,536	Approximate acreage of pronghorn antelope year-round range that would be removed for the duration of the project: 3,520	Approximate acreage of pronghorn antelope year-round range that would be removed for the duration of the project: 3,519	Approximate acreage of pronghorn antelope year-round range that would be removed for the duration of the project: 3,593	Approximate acreage of pronghorn antelope year-round range that would be removed for the duration of the project: 3,602	Approximate acreage of pronghorn antelope year-round range that would be removed for the duration of the project: 3,535	Approximate acreage of pronghorn antelope year-round range that would be removed for the duration of the project: 3,397	No additional effects to pronghorn antelope year-round range would occur.	
	Number of vehicle/big game collisions	The number of vehicle/big game collisions could increase.	The number of vehicle/big game collisions could increase.	The number of vehicle/big game collisions could still increase.	The number of vehicle/big game collisions could increase, but at a rate less than under other alternatives because the access route is farther from the mule deer migration corridor.	The number of vehicle/big game collisions could increase, but at a rate less than under other alternatives because the access route is farther from the mule deer migration corridor.	The number of vehicle/big game collisions could increase.	The number of vehicle/big game collisions could increase.	No change in the number of vehicle/deer or antelope collisions would occur beyond that associated with the exploration activities that are already approved	
Adverse impacts to greater sage-grouse populations through direct impacts to habitat; noise and vibration; mortality through power line strike; predation or avoidance of habitat use near power lines	Area of habitats disturbed, number of leks disturbed, and area of greater sage-grouse habitat within line-of-sight view (1,968 feet [600 meters]) of power lines (applying Braun's (1998) findings on avoidance of habitat)	Approximate acreage of PPH directly disturbed: 19	Approximate acreage of PPH directly disturbed: 8	Approximate acreage of PPH directly disturbed: 8	Approximate acreage of PPH directly disturbed: 31	Approximate acreage of PPH directly disturbed: 31	Approximate acreage of PPH directly disturbed: 19	Approximate acreage of PPH directly disturbed: 19	No additional habitats or leks for greater sage-grouse would be affected.	
		Approximate acreage of PGH directly disturbed: 3,077	Approximate acreage of PGH directly disturbed: 3,071	Approximate acreage of PGH directly disturbed: 3,071	Approximate acreage of PGH directly disturbed: 3,098	Approximate acreage of PGH directly disturbed: 3,101	Approximate acreage of PGH directly disturbed: 3,075	Approximate acreage of PGH directly disturbed: 2,957		
		9 leks could be affected (6 active, 2 inactive, and 1 unknown).								
		Power lines outside the Plan area could impact: 1,374 acres of PPH and 1,341 acres of PGH.	Power lines outside the Plan area could impact: 238 acres of PPH and 429 acres of PGH.	Power lines outside the Plan area could impact: 238 acres of PPH and 260 acres of PGH.	Power lines outside the Plan area could impact: 238 acres of PPH and 429 acres of PGH.	Power lines outside the Plan area could impact: 238 acres of PPH and 260 acres of PGH.	Power lines outside the Plan area could impact: 1,374 acres of PPH and 1,341 acres of PGH	Power lines outside the Plan area could impact: 1,374 acres of PPH and 1,341 acres of PGH		
Impacts to migratory birds or raptors through reduction of available nesting habitat	Acres of habitat available within the analysis area	Approximate acreage of potentially suitable breeding, roosting, and foraging habitats would be lost over the long term: 3,184	Approximate acreage of potentially suitable breeding, roosting, and foraging habitats would be lost over the long term: 3,151	Approximate acreage of potentially suitable breeding, roosting, and foraging habitats would be lost over the long term: 3,150	Approximate acreage of potentially suitable breeding, roosting, and foraging habitats would be lost over the long term: 3,233	Approximate acreage of potentially suitable breeding, roosting, and foraging habitats would be lost over the long term: 3,242	Approximate acreage of potentially suitable breeding, roosting, and foraging habitats would be lost over the long term: 3,184	Approximate acreage of potentially suitable breeding, roosting, and foraging habitats would be lost over the long term: 3,057	No additional habitats for migratory birds would be affected.	
Exposure to toxic solutions and materials	Risk of releases, rates of plant uptake and concentration in tissues; toxicity of solutions, petroleum products, and metals to wildlife	Although an increased potential for wildlife to ingest toxic solutions would exist, proper handling of toxic materials would minimize this potential.							No increased potential for ingestion of toxic solutions would occur.	

Table 2.6-1 Summary of Environmental Effects

Potential Impact	Indicator	Proposed Action	Northern Power Line Route Alternative	Southern Power Line Route Alternative	Northwest Main Access Route Alternative, Northern Power Line Route	Northwest Main Access Route Alternative, Southern Power Line Route	Modified County Road Re-Route Alternative	Western Tailings Storage Facility Alternative	No Action Alternative
Loss of water source or habitat as result of reduced flow in springs or reduction in vegetative productivity of food sources	Groundwater pumping rates, flow rates, volumes, and surface expression of groundwater	Use of water would not cause groundwater drawdowns that would affect Little Warm Spring or any other surface water resources.							No potential for groundwater drawdown to affect surface water resources.
Range Resources									
Reduced forage within allotment or grazing use area due to surface disturbance or restriction by fencing	Number of acres available within allotment or grazing use area	Approximate acreage that would be disturbed within area grazing allotments: 9,289	Approximate acreage that would be disturbed within area grazing allotments: 9,256	Approximate acreage that would be disturbed within area grazing allotments: 9,255	Approximate 8,884 acreage that would be disturbed within area grazing allotments: 9,225	Approximate 8,884 acreage that would be disturbed within area grazing allotments: 9,215	Approximate acreage that would be disturbed within area grazing allotments: 9,288	Approximate acreage that would be disturbed within area grazing allotments: 7,581	No impacts other than those previously authorized.
		This disturbance would reduce the number AUMs available by 232.	This disturbance would reduce the number AUMs available by 231.	This disturbance would reduce the number AUMs available by 231.	This disturbance would reduce the number AUMs available by 231.	This disturbance would reduce the number AUMs available by 230.	This disturbance would reduce the number AUMs available by 232.	This disturbance would reduce the number AUMs available by 178.	
The loss of AUMs that would be permanent: Approximately 12								The loss of AUMs that would be permanent: Approximately 10.	
Reduced productivity of food sources from groundwater pumping	Reduction in forage	Use of water would not cause groundwater drawdowns that would affect surface water resources.							No potential for groundwater drawdown to affect surface water resources
Forest Products and Fuels									
Loss of forest product, including pinyons used to harvest pine nuts	Forested area available, estimate of forest products, acres of pinyon habitat	Approximate acreage of pinyon-juniper woodland that would be inaccessible during operations: 2,650	Approximate acreage of pinyon-juniper woodland that would be inaccessible during operations: 2,633	Approximate acreage of pinyon-juniper woodland that would be inaccessible during operations: 2,630	Approximate acreage of pinyon-juniper woodland that would be inaccessible during operations: 2,651	Approximate acreage of pinyon-juniper woodland that would be inaccessible during operations: 2,643	Approximate acreage of pinyon-juniper woodland that would be inaccessible during operations: 2,650	Approximate acreage of pinyon-juniper woodland that would be inaccessible during operations: 1,471	No impacts other than those previously authorized.
		Acres removed temporarily: 746	Acres removed temporarily: 729	Acres removed temporarily: 726	Acres removed temporarily: 747	Acres removed temporarily: 739	Acres removed temporarily: 746	Acres removed temporarily: 599	
Loss of 115 acres would be permanent.								Loss of 109 acres would be permanent.	No impacts other than those previously authorized.
Wild Horses									
Mortality through collision as result of increased traffic	Number of vehicle/wild horse collisions, acres of habitat available	Increased risk of vehicle/wild horse collisions for the life of the mine.							No increased risk of vehicle/wild horse collisions for the life of the mine beyond those associated with the exploration activities that are already approved.
Groundwater pumping could affect amount or quality of water present in local water sources used by wild horses, and release or spill of toxic solutions or materials could affect wild horses	Groundwater elevations, location, number, origin of water sources available and use by wild horses, risk of releases	No effects to access to water sources for wild horses.							No effects to access to water sources for wild horses.
Loss or fragmentation of habitat or changes in migration routes through noise from mining operations, surface disturbance,	Acres of habitat available within herd management area or wild	Short-term loss of access to approximately 8,757 acre during construction & operation						Short-term loss of access to approximately 7,049 acres during construction & operation	No impacts other than those previously authorized.
Long-term loss of 491 acres of habitat							Long-term loss of approximately 453		

Table 2.6-1 Summary of Environmental Effects

Potential Impact	Indicator	Proposed Action	Northern Power Line Route Alternative	Southern Power Line Route Alternative	Northwest Main Access Route Alternative, Northern Power Line Route	Northwest Main Access Route Alternative, Southern Power Line Route	Modified County Road Re-Route Alternative	Western Tailings Storage Facility Alternative	No Action Alternative	
or fencing	horse territory							acres of habitat		
		Approximate acreage that would be disturbed within HMA: 9,289	Approximate acreage that would be disturbed within HMA: 9,256	Approximate acreage that would be disturbed within HMA: 9,255	Approximate 8,884 acreage that would be disturbed within HMA: 9,225	Approximate 8,884 acreage that would be disturbed within HMA: 9,215	Approximate acreage that would be disturbed within HMA: 9,288	Approximate acreage that would be disturbed within HMA: 7,581	No impacts other than those previously authorized.	
		Loss of 491 acres of habitat permanently after fencing is removed.								
Cultural Resources										
Disturbance of historic properties (cultural resource sites listed on or eligible for the National Register of Historic Places)	Presence of identified historic properties (cultural resource sites listed on or eligible for the National Register of Historic Places) in the Plan area that could be disturbed	Known historic properties could be adversely affected. Sites would be avoided where feasible; if unavoidable, Midway would comply with the Programmatic Agreement. Data recovery is the likely mitigation measure.							9 known historic properties could be adversely affected – 5 that are considered eligible for listing on the NRHP and 4 that have not been evaluated. Data recovery is the likely mitigation measure.	None of the known historic properties in the amended 2011 Plan area would be affected.
Native American Religious and Traditional Values										
Direct or indirect effects to greater sage-grouse	Presence of identified sites with Native American Religious and Traditional Values in the Plan area that could be disturbed	See "Wildlife and Fisheries and Special Status Animal Species"							No impacts other than those previously authorized	
		See "Wildlife and Fisheries and Special Status Animal Species"							No impacts other than those previously authorized	
		See "Wildlife and Fisheries and Special Status Animal Species"							No impacts other than those previously authorized	
Direct effects to antelope traps		Two traditional antelope traps that are recommended eligible as prehistoric resources could be adversely affected. Consultation with the Tribes would determine the treatment of these traps.							None of the known traditional antelope traps in the Plan area would be affected by this alternative.	
Direct effects to pinyon and indirect effects to pine nut gathering		See "Forest Products and Fuels"								
Extraction of minerals from ancestral lands of Western Shoshone		Midway's valid minerals claims permit mining of the deposit with approval of the Plan.							No mining activities would occur, as described under the amended 2011 Plan.	
Land Use Authorization and Access										
Increased risk to public health and safety, primarily from increased traffic or risk of exposure to hazardous materials in the event of a release or spill during transport	Number of vehicles or number of annual average daily trips (AADT), proposed number and frequency of vehicles transporting hazardous materials to the mine	<p>AADT would increase during the construction.</p> <p>Increased vehicular traffic would be noticeable on some county or BLM roads.</p> <p>Disruptions to local traffic circulation would be short term.</p> <p>Effects to public transportation would be temporary in duration and primarily limited to the immediate areas near the Plan area.</p> <p>Impacts during operations, maintenance and reclamation would be similar to those for construction.</p>							No change in existing land use authorizations would occur, and the mine project would not be constructed. No project-related impacts to land use or access beyond those associated with the exploration activities that are already approved would occur.	

Table 2.6-1 Summary of Environmental Effects

Potential Impact	Indicator	Proposed Action	Northern Power Line Route Alternative	Southern Power Line Route Alternative	Northwest Main Access Route Alternative, Northern Power Line Route	Northwest Main Access Route Alternative, Southern Power Line Route	Modified County Road Re-Route Alternative	Western Tailings Storage Facility Alternative	No Action Alternative
Recreation									
Reduction of access to public lands	Potential restricted access to recreational use areas	8,757 acres of BLM-administered recreational resources would be unavailable for OHV use or hunting over the life of the project. 491 acres would be permanently removed.						7,049 acres of BLM-administered recreational resources would be unavailable for OHV use or hunting over the life of the project. 453 acres would be permanently removed.	No additional impacts to OHV use would occur beyond that already approved.
Visual Resources									
Potential loss of scenic views, construction of new roads, structures, infrastructure and installation of lighting would affect the existing viewshed in the vicinity of the proposed mine. Siting of structures and infrastructure without consolidating or co-locating facilities and/or without using building materials, colors and site placement compatible with the natural environment could increase visibility of facility and affect visual resources in the area. Without using "Dark Sky" lighting practices could impact visibility of the nighttime sky in the vicinity of the proposed project.	Changes in view from key observation points, visual simulations	The project components and facilities would appear as visible alterations to the existing landscape within portions of the Plan area for the life of the project. Visual effects would be localized and the facilities would not be visible in the foreground from US 50 or SR 379 or the Duckwater Shoshone Reservation or other well-traveled, publically accessible viewing areas. At night, motorists travelling on U.S. Highway 50, SR 379 and Green Springs Road would not be able to observe lights used for the project, given the distance from the site and the terrain. Passing motorists near the Plan area may see the project lights in the background area for several minutes.						No project-related impacts to visual resources would occur. Some additional impacts to visual resources could occur from ongoing exploration activities that are already approved.	
Socioeconomic Resources									
New employment	Employment, public revenue base, housing, and the demand for community services and schools.	About 300 employed at peak of construction and 150-250 employed during operations.						No new employment would occur under this alternative.	
Increase in public revenue		Construction of the mine would have a positive, short-term fiscal effect on the entities within the analysis area through an increase in sales tax receipts. The operation and maintenance of the mine would have a long-term, positive fiscal effect through an increase in property tax revenues and net proceeds taxes.						No additional public revenue would be generated beyond that already permitted.	
Increase in demand for housing		Demand for housing would increase, most likely in Ely or Eureka.						No increase in demand for housing would occur.	
Increase in commercial development		Potential for commercial development would increase to support mine and employee demands.						No potential for commercial development.	
Increase in demand for community services, schools, and infrastructure		Demand for community services, schools, and infrastructure would increase.						No increase in demand for community services, schools, or infrastructure would occur.	
Impact on economic viability of the area from loss of scenic views	Visitor use data, changes in view from key observation points, and visual simulations	Potential for loss of economic viability due to construction and operation of the mine is not anticipated.						No negative or positive effects from mine construction and operation.	

Table 2.6-1 Summary of Environmental Effects

Potential Impact	Indicator	Proposed Action	Northern Power Line Route Alternative	Southern Power Line Route Alternative	Northwest Main Access Route Alternative, Northern Power Line Route	Northwest Main Access Route Alternative, Southern Power Line Route	Modified County Road Re-Route Alternative	Western Tailings Storage Facility Alternative	No Action Alternative
Environmental Justice									
Disproportionate effect to minority or low-income population	Identification of minority or low-income populations affected disproportionately	No disproportionately adverse effects would occur to an identified minority or low-income population. No minority or low-income population would have an increased risk or rate of exposure to an adverse environmental hazard. No health or safety hazards would disproportionately affect children.							No change in impacts beyond that associated with the exploration activities that are already approved.
Hazardous Materials and Wastes									
Exposure to hazardous materials in the event of a release or spill on roads located in Eureka County—primarily SR 278 and US 50.	Hazardous materials inventory, Spill Prevention Control and Countermeasure Plan, and other mitigation and controls to prevent or remediate releases or spills.	Impacts would be short term with compliance with SCERP, regulations, and Applicant-Committed EPMs and timely spill response procedures.							No additional impacts over current conditions.

CHAPTER 3

AFFECTED ENVIRONMENT

3.1 INTRODUCTION

This chapter describes the existing conditions of the physical, biological, cultural, and socioeconomic resources that have the potential to be affected by activities related to the Proposed Action and Action Alternatives described in Chapter 2. These resources include those that occur within, are adjacent to, or are associated with the Plan area (i.e., Proposed Action and Action Alternative footprints, as well as those resources identified during the scoping process [Chapter 1]).

The environmental and socioeconomic baseline information summarized in this chapter was obtained from field and laboratory studies of the project region, published information sources, unpublished materials, and communication with relevant government agencies and private individuals with knowledge of the area. The affected environment for individual resources was delineated based on the area of potential direct and indirect environmental impacts for the proposed project. For some resources, such as geology, soils, and vegetation, the affected area was determined to be the physical location and immediate vicinity of the areas to be disturbed by the project. For other resources, such as water resources, air quality, and social and economic values, the affected environment comprised a larger area (e.g., watershed, airshed, local communities). This chapter is organized by environmental resources, and Sections 3.2 through 3.20 describe the existing conditions associated with these resources.

3.2 WATER RESOURCES

This section describes water resources that may be affected by project activities. Water resources include surface water features such as perennial, intermittent, and ephemeral streams; springs; wetland areas; floodplains; groundwater; water quantity; water quality; and water use and water rights.

The U.S. Geological Survey (USGS) has delineated watershed boundaries for surface waters throughout the United States. The Plan area is located within four surface water subwatersheds shown on Figure 3.2-1: Hoppe Spring, Upper Bull Creek, Middle Bull Creek, and Headwaters Duckwater Creek (USGS 2013).

The NDWR Office of the State Engineer has delineated administrative boundaries for groundwater regions and basins throughout the state of Nevada and assigned numbers to the basins. The Plan area is located within the Central Nevada Region (hydrographic region 10), primarily in basin 173B (Railroad Valley/Northern Part). A small portion of the Plan area extends north into basin 154 (Newark Valley). Figure 3.2-1 shows the location of the Plan area within to two basins. Both the Railroad Valley/Northern Part and the Newark Valley are terminal basins that drain to dry, barren, flat areas known as playas (NDWR 1971). The Railroad Valley/Northern Part is approximately 2,140 square miles in area (NDWR 2014a), and the Newark Valley is approximately 801 square miles in area (NDWR 2014b). The NDWR State Engineer has not designated either basin (NDWR 2010), so a person can drill a well in the basins prior to applying for a groundwater permit (Nevada Revised Statute Chapter 534.050).

The Proposed Action includes pumping of groundwater from the Railroad Valley/Northern Part. It also includes construction and operation of security facilities and use of existing transportation

routes in Newark Valley, just north of the surface hydrologic divide with the Railroad Valley/Northern Part basin (NDWR 2010) (Figure 3.2-1).

Existing Conditions

Precipitation

Most precipitation in the region falls as snow and rain in winter and early spring. The closest active weather recording station is the Western Regional Climate Center (WRCC) is in Eureka, approximately 22 miles northwest of the project area. Annual average total precipitation at the Eureka station is 11.83 inches, which includes an average of 58.9 inches of snowfall (WRCC 2013a). The Eureka station is at an elevation of 6,430 feet amsl (WRCC 2013c). According to the Conceptual Model of the Great Basin Carbonate and Alluvial Aquifer System (Heilweil and Brooks 2011), annual average total precipitation is 10 inches in the Railroad Valley Northern Part basin and 12 inches in the Newark Valley basin. Elevation ranges from about 6,200 feet amsl in the flats west of the Plan area to 7,678 feet amsl at the top of Easy Ridge east of the Plan area (Figure 3.2-2).

Surface Water

Surface water features in the region are shown on Figure 3.2-1. In the USGS National Hydrography Dataset (NHD), streams in the region are classified as intermittent, with the exception of three segments of streams classified as perennial. One stream classified as perennial is located approximately 1.2 miles east of and cross gradient from the Plan area. This segment is partially channelized as an irrigation canal and is tributary to Bull Creek. Another stream segment classified as perennial is located farther east of and cross gradient from the Plan area in the upper portion of Green Springs Wash, where it originates from Green Springs. The third stream segment classified as perennial is located approximately 3.2 miles south of and downgradient from the Plan area in the lower reach of Bull Creek. No streams within the Plan area are classified as perennial (USGS 2013).

Figure 3.2-1 shows three mapped, active springs in the region: Green Springs, Big Warm Springs, and Little Warm Springs. The three springs are located in the Railroad Valley/Northern Part. No active springs are located within the Plan area. Springs are described in the groundwater section.

The USFWS National Wetlands Inventory (NWI) mapping shows no wetlands in or near the Plan area (USFWS 2013). The closest NWI-mapped wetland is a freshwater emergent wetland located approximately 13 miles south of the Plan area, on and adjacent to the southern portion of the Duckwater Shoshone Reservation (Figure 3.2-1).

Field surveys were conducted in the Plan area from 2011 through 2013 to determine if any wetlands or other water bodies that could be disturbed under the Proposed Action would be jurisdictional waters of the U.S. (Ecosynthesis and Wildlife Resource Consultants 2012a,b, 2013). The surveys identified partially scoured channel beds in several of the largest intermittent tributaries; however, they determined that water flowed in these channels only for a few days following heavy precipitation and at no other time. Consequently, no jurisdictional waters of the U.S. were identified (Ecosynthesis and Wildlife Resource Consultants 2013).

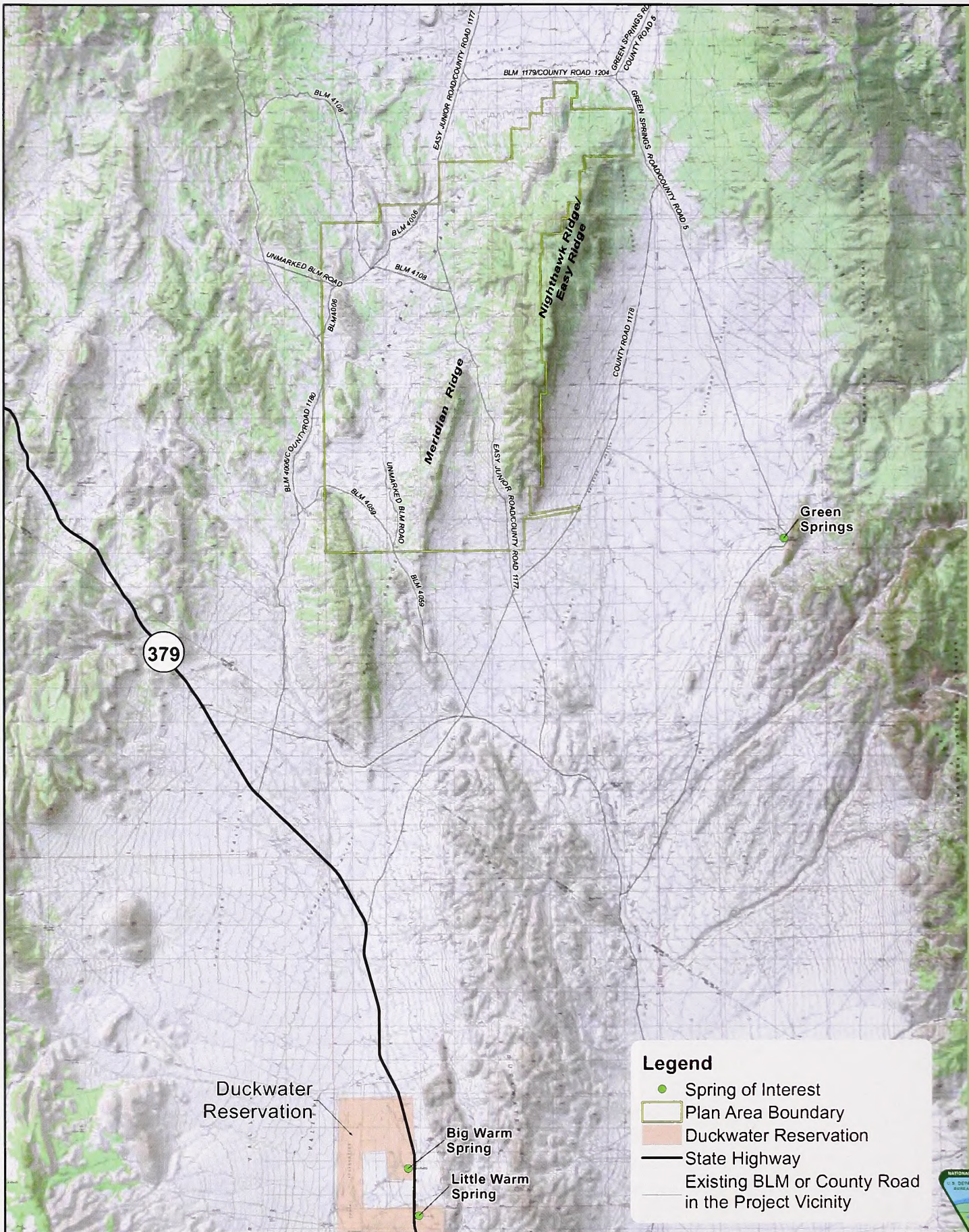

Legend

- Spring of Interest
- Plan Area Boundary
- Duckwater Reservation
- State Highway
- Existing BLM or County Road in the Project Vicinity

**FIGURE 3.2-2
TOPOGRAPHIC MAP OF THE PLAN AREA
MIDWAY GOLD US INC.
GOLD ROCK MINE PROJECT**

MAPPED DATE: 9/2/2014

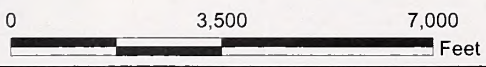

U.S. BUREAU OF LAND MANAGEMENT
ELY DISTRICT
EGAN FIELD OFFICE

NO WARRANTY IS MADE BY THE BUREAU OF LAND MANAGEMENT AS TO THE ACCURACY, RELIABILITY, OR COMPLETENESS OF THESE DATA FOR INDIVIDUAL USE OR AGGREGATE USE WITH OTHER DATA.

Basemap Source: ESRI USA Topo Maps Map Service



Floodplains

The Federal Emergency Management Agency (FEMA) implements the Flood Hazard Mapping Program and maintains and updates flood hazard data in partnership with states and communities. FEMA has not published Flood Insurance Rate Maps for the region. Within northern Nye County, FEMA has identified 100-year floodplains along Duckwater Creek (FEMA 2010). Review of aerial photography indicates that this floodplain likely extends northward into White Pine County. In the arid western United States, active floodplains in intermittent/ephemeral drainages, such as Duckwater Creek, receive overflow from bankfull channels during storm events and are often distinguished from surrounding areas by slope breaks and differences in vegetation species or abundance (Lichvar and McColley 2008).

Groundwater

The Plan area spans two hydrographic basins: Newark Valley and Railroad Valley/Northern Part (Figure 3.2-1). Only a small portion of the Plan area is located in the southern end of Newark Valley. No surface disturbance is proposed in that area. The rest of the Plan area is located in the northern end of the Railroad Valley/Northern Part.

Easy Ridge, also known as Nighthawk Ridge, divides this northern end of the Railroad Valley/Northern Part (Figure 3.2-2). The area west of Easy Ridge is hilly, while the area east of the ridge is gently sloping. These features suggest that the area to the east where the existing Easy Junior well is located has more uniform and thicker alluvial deposits than the area to the west where the proposed mine facilities would be located.

Two aquifers of note exist in the region: an extensive but discontinuous basin fill alluvial aquifer; and a deeper, regional carbonate rock aquifer that underlies east-central Nevada and western Utah and is known as the Basin and Range Carbonate Aquifer System or BARCAS. Available information indicates that the existing Easy Junior well in the Railroad Valley (Figure 3.2-1) pumps groundwater from the basin fill aquifer (USGS 2014a). In the Newark Valley, groundwater studies at the nearby Pan mine suggest that a perched shallow aquifer may be present below ephemeral stream drainages, but this shallow aquifer has not been encountered during exploration drilling within the Plan area (Interralogic 2012).

Figure 3.2-3 (Interralogic 2012) shows regional groundwater elevations in the BARCAS, which range from 5,800 feet west of the Plan area to greater than 7,300 feet of elevation AMSL to the east in the Mount Hamilton area of the White Pine Range.

Recharge to the aquifers is primarily from infiltration of rain and snowfall at higher elevations in the basins (Welch et al. 2007). Regional groundwater studies on the deeper BARCAS estimate that in the Newark Valley system both total recharge and total discharge range from 27,000 afy (Heilweil and Brooks 2011) to 60,500 afy (Nichols 2000). A study issued in 2000 suggests recharge from precipitation as high as 49,000 afy (Nichols 2000) and assumes up to 11,500 afy of inter-basin flow from Long Valley, Huntington Valley, and Little Smoky Valley into Newark Valley, with evapotranspiration as high as 60,500 afy (Nichols 2000).

A study issued in 2011 indicates 26,300 afy of recharge from precipitation and recharge from infiltration of unconsumed irrigation and public supply water from well withdrawals of about 1,300 afy, but does not estimate volumes of interbasin flow among basins. The 2011 study shows discharge of approximately 22,000 afy through evapotranspiration and about 3,600 afy through springs. Groundwater withdrawals in the Newark Valley total about 4,300 afy. The decrease in natural discharge and/or storage is approximately 3,000 afy (Heilweil and Brooks

2011). Several studies suggest that groundwater flows through the subsurface from the Newark Valley system into the Railroad Valley system.

In the Railroad Valley/Northern Part, regional studies estimate that the basin receives recharge of 57,000 afy (Heilweil and Brooks 2011) to 85,000 afy (Nichols 2000). The studies estimate that the basin discharges 81,000 afy (Heilweil and Brooks 2011) to 85,000 afy (Nichols 2000). The 2000 study suggests 61,000 afy of recharge from precipitation and 24,000 afy of interbasin flow into the Railroad Valley/Northern Part, with 85,000 afy of evapotranspiration.

The 2011 study indicates approximately 55,000 afy recharges in place, and approximately 2,200 afy of runoff infiltrates to recharge the Railroad Valley/Northern Part. Recharge from unconsumed irrigation and public supply water from well withdrawals is estimated at 300 afy. The basin discharges about 49,000 afy through evapotranspiration and roughly 31,000 afy through springs. Current (2000) groundwater withdrawals reported for the Railroad Valley/Northern Part total about 1,000 afy. The decrease in natural discharge and/or storage is approximately 700 afy. Combining these values, discharge from the basin exceeds recharge by about 24,000 afy which indicates there is a net-negative water balance in the Railroad Valley/Northern Part and suggests groundwater levels may decline over time. It is notable that the Heilweil and Brooks (2011) study indicates the margin of error on these estimates may be as high as 50 percent. This information is summarized in Table 3.2-1.

Table 3.2-1 Water Balance for Railroad Valley/Northern Part (afy)

Water Inputs		Water Outputs	
Recharge in Place	+55,000	Evapotranspiration	-49,000
Infiltration from Runoff	+2,200	Discharge to Springs	-31,000
Recharge from Unconsumed and Public Supply	+300	Groundwater Withdrawals	-1,000
--	--	Decrease in Natural Discharge/Storage	-700
Subtotal Inputs	+57,500	Subtotal Outputs	-81,700
Combined Water Balance		-24,200	

However, the 2011 study found that water levels have not declined more than 50 feet in either basin during the latter half of the 20th century (Heilweil and Brooks 2011). The 2011 study found differences in water table elevation and recharge volumes in the adjoining basins, and a high likelihood of hydraulic connections across basin boundaries. The 2011 study concluded that inter-basin flow from the Diamond Valley flow system, which is made up of Monitor Valley, Antelope Valley, Kobeh Valley, Stevens Basin, and Diamond Valley is likely. Flow from the Antelope Valley system could flow into the northern portion of the Little Smoky Valley, which is a part of the Newark Valley basin. Passage of flow through the Newark Valley basin and into the Railroad Valley/Northern Part is likely (Heilweil and Brooks 2011). In conclusion, the available information suggests that groundwater levels have been declining over time in the Railroad Valley/Northern Part of the basin due to groundwater withdrawals for irrigation and public supply. However, the extent of water level decline is uncertain due to uncertainties in the parameter estimation methods.

No active springs are located within the Plan area. Figure 3.2-1 shows the three mapped, active springs in the region. Green Springs is located approximately 3.8 miles east of the Plan area, on the eastern side of Railroad Valley at the toe of the slope of the White Pine Mountains. No data regarding spring flow or geology were identified for Green Springs. Based on best

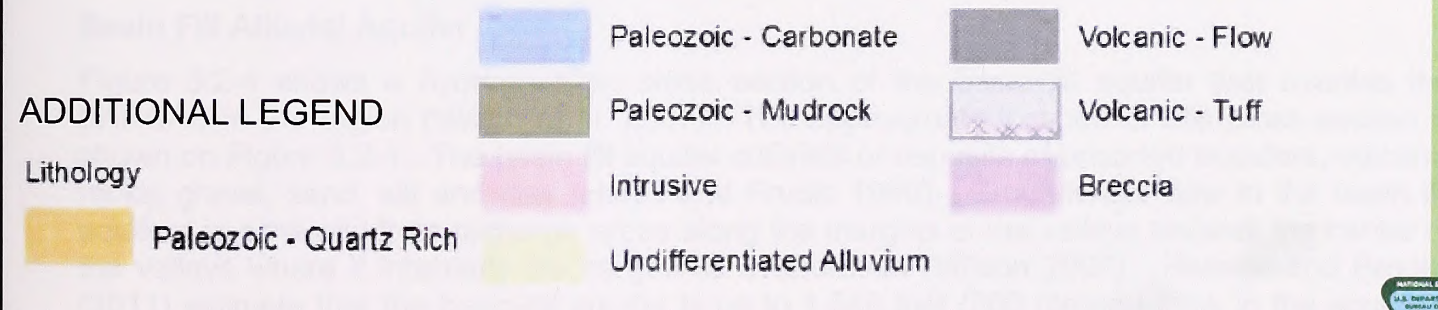
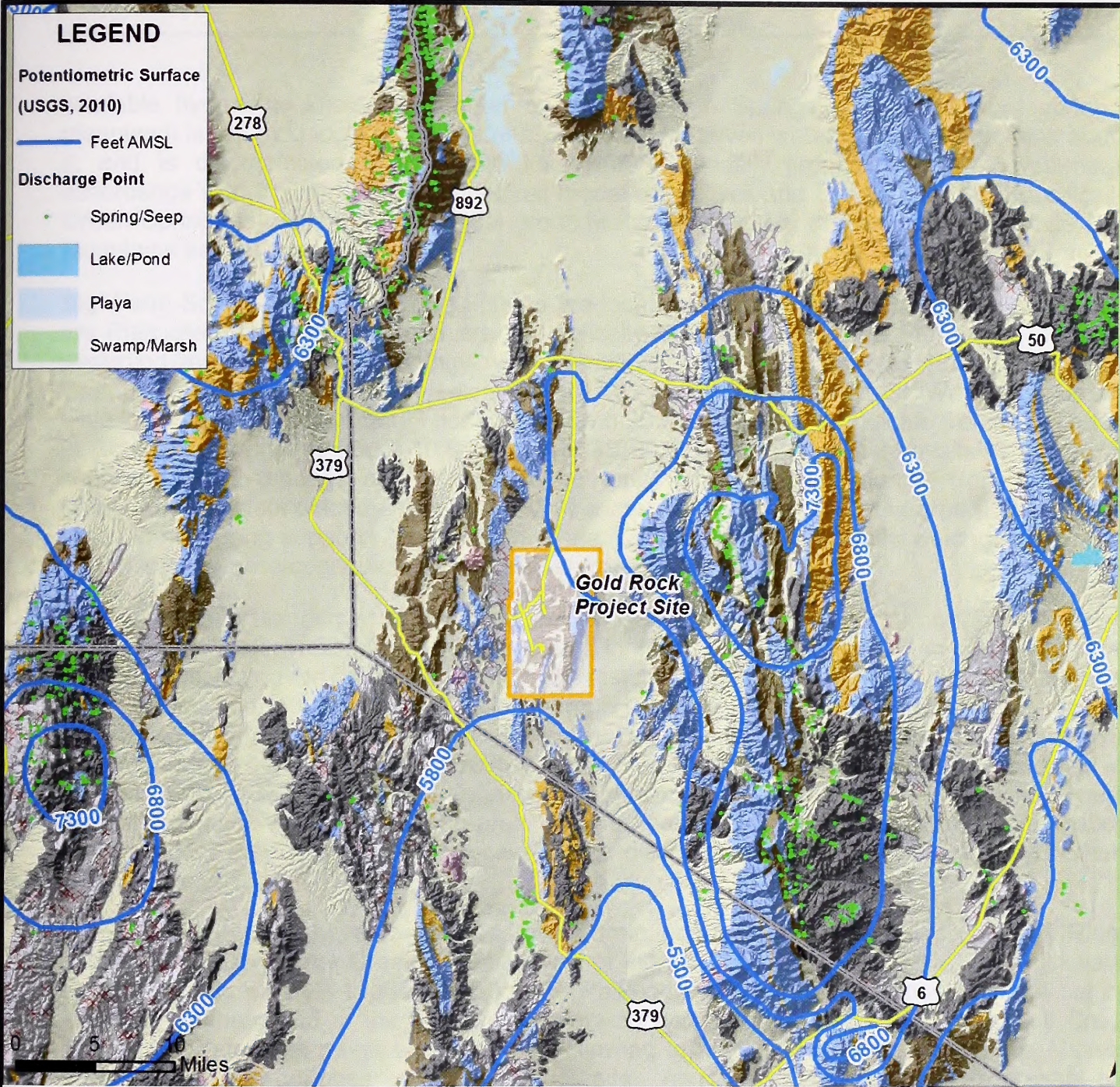

FIGURE 3.2-3
REGIONAL HYDROGEOLOGY

MIDWAY GOLD US INC.
GOLD ROCK MINE PROJECT

ADAPTED FROM FIGURE 8 IN INTERRALOGIC, INC. 2012.
ADAPTED ON: MAY 26, 2014

U.S. BUREAU OF LAND MANAGEMENT
ELY DISTRICT
EGAN FIELD OFFICE

NO WARRANTY IS MADE BY THE BUREAU OF
LAND MANAGEMENT AS TO THE ACCURACY,
RELIABILITY, OR COMPLETENESS OF THESE
DATA FOR INDIVIDUAL USE OR AGGREGATE
USE WITH OTHER DATA.



06/03/2014 SYRACUSE_DIV\GROUP-ENV\JM-DV DJHOWES
C0001817\0000\0000\CDR\01817\G07.CDR

This page intentionally left blank.

available hydrologic knowledge, water supplying Green Springs is a range front spring – meaning it is fed by a local groundwater flow system, receives water from the mountains above it, and is disconnected from intermediate and inter-basin groundwater flow systems in accordance with the hydrologic conceptual model of Heilweil and Brooks (2011). Specifically, Green Springs is sourced from a local groundwater flow system originating in the White Pine Mountains east of the spring.

Big Warm Springs and Little Warm Springs are located approximately 12 and 13 miles south of the Plan area, respectively, and are hydraulically downgradient of the Plan area. No data regarding the two springs' geology were identified. Data from 1982 to 1988 (Savard and Crompton 1993) indicate that approximately 13,500 afy discharged from Big Warm Springs and Little Warm Springs. USGS monitoring data from 2008 through 2013 indicate that average flow at Big Warm Springs is about 10,860 afy (USGS 2014d). Based on best available hydrologic knowledge, both springs are believed to be range front springs, sourced from an alluvial groundwater system discharging from the Duckwater Hills south of the Plan area (Figure 3.2-2). Little Warm Spring supports a population of the Railroad Valley springfish, which the U.S. Fish and Wildlife Service considers a threatened species (USFWS 2013).

Alluvial groundwater occurs at relatively shallow depths in Railroad Valley on the east side of Easy Ridge. Water wells have been completed in the Railroad Valley alluvium southeast of the Plan area, including the production well for the historical Easy Junior Mine. Total depth of these wells ranges from 100 to 465 feet bgs. Average depth to water observed in the wells ranges from 38 to 208 feet bgs (5,823 to 6,048 feet amsl). Depth to water in the Easy Junior well (Figure 3.2-1) is approximately 156 feet bgs based on water levels measured in the Easy Junior Well in 2009 (USGS 2014a). Alluvial groundwater is also present locally in the ephemeral alluvial drainages crossing the Plan area. At the nearby Pan mine observations from shallow wells suggest that groundwater is localized and discontinuous in the alluvial drainages there (Interrallogic 2013c).

Within the Plan area, several small east-west drainages originate on the slope of Easy Ridge and enter the Duckwater Creek drainage west of the Plan area (Figure 3.2-1). The Duckwater Creek drainage extends to the south toward Railroad Valley. Another minor drainage begins near the southern end of the proposed mine area and extends south toward the Bull Creek drainage. Water has never been observed flowing in any of these drainages since Midway began exploration activities at the Gold Rock site. Any alluvial aquifers that are present are anticipated to be localized and discontinuous, similar to conditions found at the Pan mine.

Basin Fill Alluvial Aquifer

Figure 3.2-4 shows a hydrogeologic cross section of the basin fill aquifer that overlies the BARCAS in the region (Welch et al. 2007). The approximate location of this cross section is shown on Figure 3.2-1. The basin fill aquifer consists of deposits of unsorted boulders, volcanic rocks, gravel, sand, silt and clay (Harrill and Prudic 1998). Groundwater flow in the basin fill aquifers is generally from recharge areas along the margins of the valleys towards the center of the valleys where it internally discharges as evaporation (Wilson 2007). Heilweil and Brooks (2011) estimate that the basin-fill aquifer is up to 1,640 feet (500 meters) thick in the southern portion of the Newark Valley and northern end of the Railroad Valley/Northern Part. Farther north in the Newark Valley and farther south in the Railroad Valley/Northern Part, the aquifer is estimated to be more than 16,400 feet (over 5,000 meters) thick.

The lateral extent of the basin fill aquifer and water level contours on Figure 3.2-3 are based on NWIS water level data from the Newark and Railroad Valley/Northern Part basins. In the

Newark Valley basin the water level in the basin-fill aquifer northwest of the Plan area was reported to be about 330 feet bgs in 2010 (USGS 2014c).

In the Railroad Valley/Northern Part, several miles west of the Plan area, a well installed in 255 feet of basalt has an initial water level of 190 feet bgs. Although this log indicates the groundwater to be in basalt and not in basin fill, it does provide some information on the occurrence of groundwater west of the Plan area (Bennett 1995). The Easy Junior well is located southeast of the mine area and southeast of Easy Ridge (Figure 3.2-1). Under the Proposed Action, water would be obtained from this well. Total depth is 465 feet (Christensen Drilling 1989). Depth to water in the well was about 156 feet bgs in 2009, with a water elevation of about 5,824 feet amsl. The Easy Junior well log does not indicate the lithology of the borehole, yet the NWIS record indicates that the well is located within the basin fill aquifer (USGS 2014a).

Recent records for a well installed east of Easy Ridge in the vicinity of Green Springs indicate that water levels in this area ranged from just over 39 feet to just over 42 feet bgs between 2009 and 2013 (NDWR 2014c). Slightly north of the Green Springs well, a well with an initial depth to water of about 208 feet bgs in 1971 was dry when measured in 2009 (USGS 2014b). More recently, Tetuan Resources completed a 2,960-foot deep oil well north of Green Springs in February 2014. Drillers encountered a water-bearing zone at 125 feet bgs, and a deeper zone from 500 to 684 feet bgs (Ehni 2014, Tetuan Resources 2014). Based on regional hydrogeology information (Heilweil and Brooks 2011), the basin fill aquifer in this area may be up to approximately 1,600 feet thick and, therefore, these water-bearing zones are probably within the basin fill aquifer. The depths of the water table, perched groundwater zones, or “first water” cannot be determined based on the drilling information from this well.

More than 700 exploration borings and coring holes have been installed near the proposed mine (Gustavson 2012). The deepest borings were installed to a depth of 1,500 feet bgs. Only one boring was reported to encounter water intermittently during drilling (Interralogic 2012). This information indicates that the basin fill aquifer is absent in the immediate vicinity of the proposed mine pit. This proposed pit is associated with folded and faulted sedimentary and altered sedimentary rock in close proximity to the north – south trending Easy Ridge. Figure 3.2-5 shows a generalized geologic cross section at the Easy Junior pit, and Figure 3.2-1 shows the approximate location of this cross section. Figure 3.2-2 shows the local topography. The geology of this ridge may pose a barrier to shallow groundwater flows between the eastern and western portions of the northern Railroad Valley.

South of the Plan area in the vicinity of Duckwater, available well logs indicate that the uppermost groundwater is present in basin fill alluvial sediments. However, rock was encountered while drilling the deeper wells, with total depths down to 250 feet (NDWR 2014d). The limited data suggest that both alluvial fill and bedrock comprise the geologic framework for the aquifer in this general area.

Deep Carbonate Bedrock Aquifer

The more extensive BARCAS underlies the region. Using the township, range, and section information provided for wells in the NDWR database and the NWIS, no logs or data for wells installed in this aquifer within a 10-mile radius of the Plan area were identified (NDWR 2014d,e, USGS 2014e). Borings installed for mineral exploration associated with the Proposed Action did not penetrate this aquifer (Interralogic 2012).

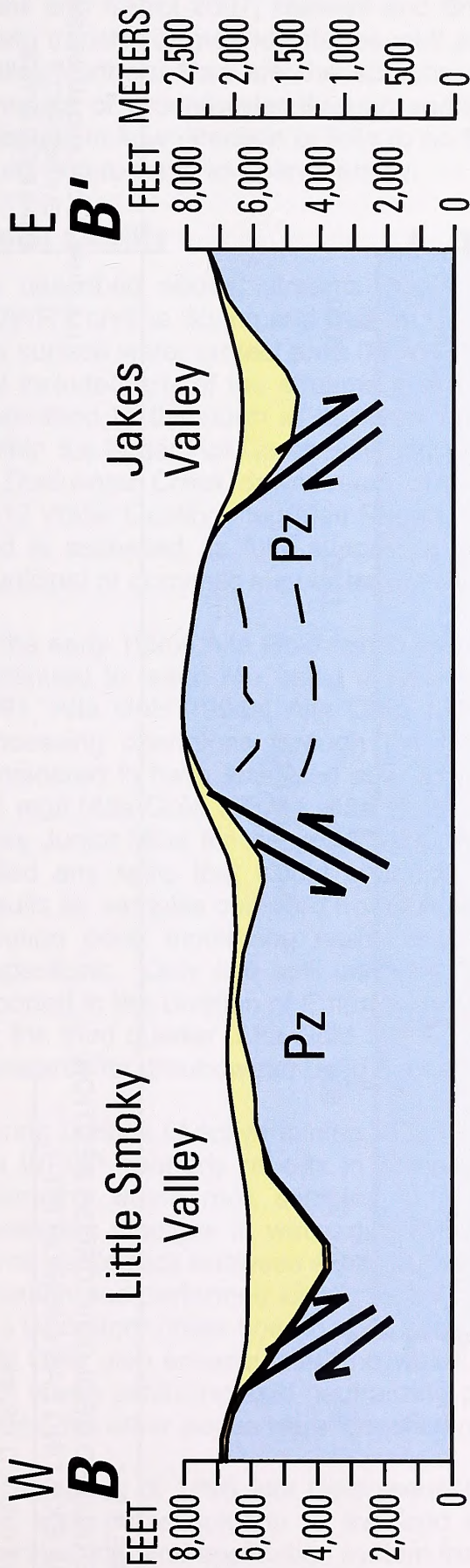
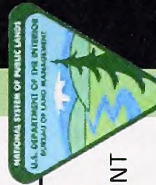

VERTICAL EXAGGERATION x 8

EXPLANATION

- Cenozoic basin fill**
Tso?, possible old, consolidated sediments
- Cenozoic volcanic rocks**
- pre-Cenozoic rocks**
Pz; Paleozoic, mostly carbonate rocks
PC; preCambrian, mostly non-carbonate rocks
- Fault**
- Contact**
- General bedding attitude**

FIGURE 3.2-4
HYDROGEOLOGIC CROSS SECTION
NEAR THE PLAN AREA

MIDWAY GOLD US INC.
GOLD ROCK MINE PROJECT

FORMATTED ON: AUG 22, 2014

U.S. BUREAU OF LAND MANAGEMENT
ELY DISTRICT
EGAN FIELD OFFICE

SOURCE:
CROSS SECTION A ON FIGURE 9 IN WELCH, BRIGHT
AND KNOCHENMUS 2007.

NO WARRANTY IS MADE BY THE BUREAU OF LAND
MANAGEMENT AS TO THE ACCURACY, RELIABILITY, OR
COMPLETENESS OF THESE DATA FOR INDIVIDUAL USE
OR AGGREGATE USE WITH OTHER DATA.

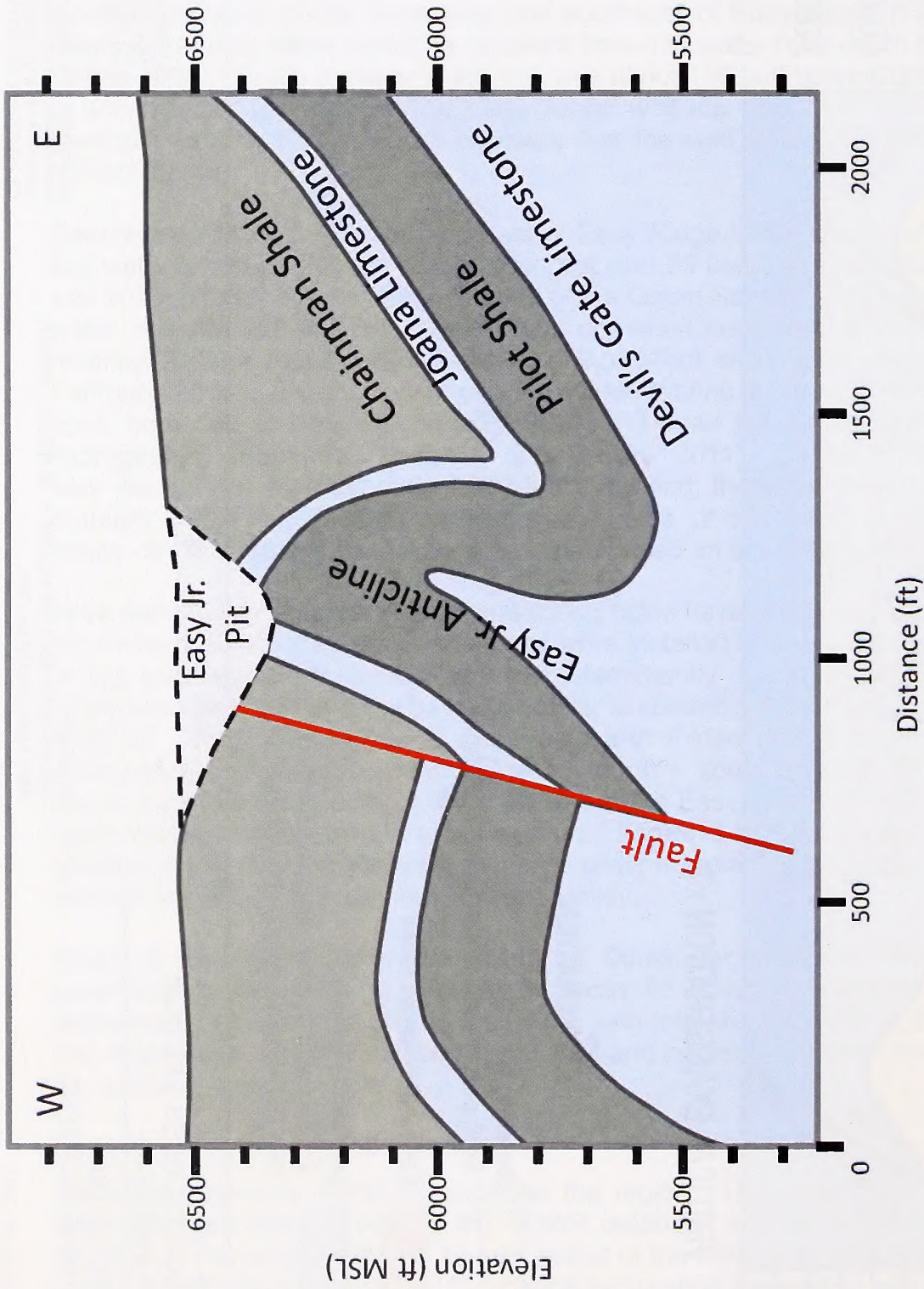

FIGURE 3.2-5
GENERALIZED GEOLOGIC CROSS SECTION
AT THE EXISTING EASY JUNIOR PIT
MIDWAY GOLD US INC.
GOLD ROCK MINE PROJECT

FORMATTED ON: MAY 26, 2014

U.S. BUREAU OF LAND MANAGEMENT
 ELY DISTRICT
 EGAN FIELD OFFICE

SOURCE:
 FIGURE 10 IN INTERRALOGIC, INC. 2012.

NO WARRANTY IS MADE BY THE BUREAU OF LAND
 MANAGEMENT AS TO THE ACCURACY, RELIABILITY, OR
 COMPLETENESS OF THESE DATA FOR INDIVIDUAL USE
 OR AGGREGATE USE WITH OTHER DATA.

Two recent USGS studies suggest that groundwater enters the Railroad Valley/Northern Part from the Newark basin in the north and from the Little Smoky Valley to the west (Lundmark, Pohll and Carrol 2007, Heilweil and Brooks 2011). These studies also suggest that this sub-basin transfer of groundwater as well as recharge from the highlands surrounding the Railroad Valley/Northern Part are the sources of water that allow the valley to discharge substantial amounts of groundwater through spring flow and evapotranspiration. Locally, there may be changes in flow direction or little to no flow because of geologic constraints such as structures, faults and rocks of low permeability.

Water Quality

As described above, streams within the Plan area only flow ephemeral (Figure 3.2-1). NDWR's on-line Spring and Stream Flow Data database contains no flow records for streams in the surface water project area (NDWR 2014f). Nevada's Bureau of Water Quality Planning has not included any of the streams in the project area or the larger Little Smoky-Newark Valleys watershed to the north in its water quality integrated reporting (NDEP 2013a,c; EPA 2014). Within the larger Hot Creek-Railroad Valley watershed, the NDEP includes a 3.5-mile segment of Duckwater Creek downstream of the Duckwater Indian Reservation. In the Draft Nevada 2012 Water Quality Integrated Report, this segment of Duckwater Creek is listed as intermittent and is assessed as fully supporting watering of livestock, irrigation, aquatic life, recreation, municipal or domestic supply, industrial supply, and propagation of wildlife (NDEP 2013c).

In the early 1990s Alta Gold mined and leached ore from the Easy Junior pit (Figure 1.2-1), and continued to leach ore using a weak cyanide solution periodically until late 1996 (Alta Gold 1991, Alta Gold 1994a, Alta Gold 1995, Alta Gold 1997a). Alta Gold continued rinsing and processing operations through the first half of 1997. On June 5, 1997, the rinsate was considered to have stabilized at a pH of about 8.1 and a WAD cyanide concentration of about 0.1 mg/l (Alta Gold 1997b). Alta Gold submitted quarterly and annual monitoring reports for the Easy Junior Mine for the years 1990 through 1999 in compliance with its WPCP. The reports noted any spills that would endanger public health or the environment, included analytical results for samples collected from the water supply well, the pregnant solution pond, and barren solution pond monitoring wells, and summaries or logs regarding leak detection system inspections. Only one spill involving 200 gallons of diesel fuel on September 27, 1993 was reported to the Division of Emergency Management and noted in the quarterly monitoring report for the third quarter (Alta Gold 1993). Results for the water supply well met the NDEP quality standards for groundwater used between 1990 and 2000.

During periods of active mining, Alta Gold included static test results for waste rock samples in the WPCP quarterly reports in compliance with permit requirements. Static testing involves saturating waste rock samples in a laboratory under a non-flowing conditions and then measuring changes in water quality over time. During the second half of 1993 and in 1994, some waste rock analyses exhibited acid generating potential. Alta Gold informed NDEP of the situation and performed kinetic testing. Kinetic testing involves saturating waste rock samples in a laboratory under flowing conditions and then measuring changes in water quality over time. Alta Gold also encapsulated the waste rock that was demonstrating acid generating potential with waste exhibiting acid neutralizing potential (Alta Gold 1994b), per NDEP approval (NDEP 1994). No other issues were identified regarding the WPCP.

In the spring of 1998 Alta Gold requested and received approval to construct two spray fields and apply rinse solution to the land surface (Alta Gold 1998a, NDEP 1998a). Alta Gold operated the land application system from March to September 1998. The two areas to receive

the spray application were located adjacent to and south of the heap leach pad, in an area that had been permitted for pad expansion. Alta Gold collected samples of the rinse water that drained from the heap into the barren solution pond before it was land applied, and reported results for pH, TDS, and weak acid dissociable cyanide in the WPCP quarterly reports. The pH of the rinse water slowly declined from 10.12 in March 1998 to a more neutral 8.71 by late August 1998. The level of TDS fluctuated over that time period, with a range of 2,240 to 4,140 mg/L. The concentration of WAD cyanide also gradually declined from 0.06 in May 1998 to 0.02 by August 1998 (Alta Gold 1998b, Alta Gold 1998c). Between March 24 and September 10, 1998, Alta Gold land applied 5.833 million gallons of rinse water. Following completion of application of the rinse water, Alta Gold applied 504,100 gallons of fresh water rinse to the application areas (Alta Gold 1998d).

After completion of land application, Alta Gold redirected residual draindown flow from the process pond to an infiltration leach field system in accordance with the submitted plan (Alta Gold 1998a, Alta Gold 1998c). Alta Gold collected samples of the leach pad effluent that entered this system and reported results in the WPCP quarterly reports for the fourth quarter of 1998 through the second quarter of 2000. The pH in these samples ranged from 7.68 to 8.61, compared to the earlier measurements of 10.12 to 8.71, indicating that pH continued to decline over time. Levels of TDS ranged from 3,208 to 3,988 mg/L. Concentrations of WAD cyanide steadily declined from 0.28 to 0.1 mg/L. Results for nitrates ranged from 174 to 228 mg/L and sulfates ranged from 1,010 to 1,317 mg/L. Results for metals including aluminum, antimony, arsenic, mercury, selenium and thallium were slightly above 2000 NDEP groundwater quality standards (Col-Tech EnviroLabs 1999, Alta Gold 2000b,c, Col-Tech EnviroLabs 2000). The rate of flow continually declined, from 2.5 gpm in March 1999 (Alta Gold 1999a) to 1.11 gpm in February 2000 (Alta Gold 2000c).

In June 2001 the Nevada Interagency Abandoned Mine Lands Environmental Task Force proposed adding a list of mines across Nevada, including the Easy Junior Mine, to the USACE Western Region RAMS. In 2002 a USACE contractor conducted the Easy Junior Mine Site field investigation and characterization. A sample of heap leach pad draindown effluent was collected and analyzed. The pH was still stable at 8.03, and WAD cyanide was still low (0.098 mg/l). Aluminum, antimony, arsenic, mercury, selenium, and thallium concentrations were still slightly above NDEP water quality standards, and total dissolved solids, nitrates and sulfate concentrations were still elevated, at levels typical of draindown effluent (Sierra Environmental Monitoring 2002).

In support of the USACE RAMS program, a site investigation was performed to characterize the Easy Junior site. As part of the investigation, the quality of the leach pad effluent was assessed. One sample of the leach pad effluent was collected and analyzed. Reported results exceeded federal drinking water standards or secondary maximum contaminant levels for nine constituents: aluminum, antimony, arsenic, mercury, nitrate, selenium, sulfate, thallium, and total dissolved solids (CDM 2003). These results were also typical of draindown effluent. The draindown effluent is disposed of in the infiltration system. Depth to groundwater in the vicinity of the Plan area is greater than 1,200 feet (BLM 2012h), and the draindown effluent is not anticipated to infiltrate to that depth.

During the site characterization, the physical condition of the heap effluent drainfield was evaluated. The heap effluent drainfield managed the low effluent flows (0.4 gallons per minute on November 22, 2002) from the heap. The distribution box had settled since installation in 1998, and the flow was being channeled to the southern infiltration trenches. The investigators concluded that leveling of the distribution box would correct this problem and provide equal

flows to the four infiltration trenches (CDM 2003). Improvements were made to the leach field distribution box between October 8 and 21, 2004. The repairs included leveling the distribution box and pouring a stable concrete pad for the distribution box (MWH 2005).

For the proposed Gold Rock mining operations, the potential for waste rock to generate acid rock drainage (ARD) metals leaching (ML) was evaluated by performing geochemical testing on 157 rock samples collected from boreholes completed within and adjacent to the proposed pit (Interralogic 2013a). Geochemical testing of the rock samples included whole rock analysis (WRA), acid-base accounting (ABA), meteoric water mobility profile (MWMP) testing, whole rock geochemistry and humidity cell testing (HCT), and carbon and sulfur speciation testing. The rock samples for geochemical testing were selected in proportion to the footages of waste rock encountered in the drill holes and by rock type, and were representative of five dominant rock types as follows:

- Argillized Chainman Shale
- Carbonized Chainman Shale
- Silicified Limestone
- Carbonized Limestone
- Silicified Solution Breccia

The following observations regarding ARD and ML potential were derived from statistics developed on the number of samples by rock type and location in the proposed pit:

- Low sulfur content (average sulfide sulfur less than 1.35 percent);
- 75 out of 124 (60 percent) waste rock samples were categorized as potentially acid generating (PAG); however, a significant portion of these are likely inert;
- The average neutralizing potential (NP) value is high due to the high percentage of limestone and calcareous shale present;
- Metals leaching potential is low for most samples based on results of the MWMP analyses. Over half of the waste rock consists of Carbonized Chainman Shale;
- Other waste rock lithologies (other than Carbon Chainman Shale) had sporadic exceedances of reference value in MWMP leachates by some metals including arsenic, selenium, and thallium;
- Metals exceedances were predominantly in the initial flush of the material and concentrations declined rapidly after the first flush;
- HCT results indicate neutral leachates for most waste rock types with low to moderate metals leaching rates including consistent leaching of arsenic concentrations at or above Nevada reference values;
- Only two HCT samples, silica-altered hydrothermal breccia and a low-NP carbonized shale, generated acid;
- Some of the waste rock designated as PAG may not actually be acid generating, based on results of the HCT testing. This material should be identified during mining as non-PAG;

- Some of the carbonized waste samples are highly variable with respect to NP and acid potential. Selective handling may be necessary for a subset of these materials and should be properly identified and handled during operations.
- Management of the waste rock would be achievable through standard practices.

Some PAG material would be generated during mining and would require storage in a designated PAG area; however, most of the material is expected to be non-PAG.

Water Use and Water Rights

NDWR regulates water rights in Nevada. The agency grants permits for use (appropriations) of water rights that allow specific flow rates and volumes of water from groundwater, springs, and streams to be used for specific beneficial uses. NDWR also maintains an on-line water rights database, and those records were reviewed for information relevant to the Proposed Action. Because no water withdrawals and minimal surface disturbance would occur in the Newark Valley basin under the Proposed Action, detailed water rights data on the Newark Valley basin are not presented in this section. For the Railroad Valley/Northern Part from T13N to its southern extent, the water rights database contains 237 water rights filings on springs, 111 on streams, 722 on groundwater, 3 on reservoirs, and 12 on other surface waters (NDWR 2014g) (Figure 3.2-6). Appendix 3A lists these water rights and includes information on their location, source, owner of record, and diversion rate, among other data.

NDWR also provides Hydrographic Area Summaries for individual basins. The summary for the Newark Valley (NDWR 2014b) provides the following information about current water appropriations in the Newark Valley:

- Perennial yield (the amount of water that can be withdrawn from a basin without reducing water storage) for groundwater is 18,000 acre-feet;
- The largest permitted beneficial use of groundwater is 25,143 afy for irrigation, with mining and milling the second most common use at 2,459 afy;
- Of the remaining appropriations in the valley, 247 afy are for stock water, 14 afy are for industrial use, 11 afy are for domestic use, 8 afy are for quasi-municipal use, and 2 afy are for wildlife; and
- Total appropriations are 27,884 afy
- Appropriations exceed perennial yield by 9,884 afy.

Appropriated water is not always used, particularly for water appropriated for irrigation. NDWR conducts crop inventories to determine the amount of irrigation water that is actually used. The 2012 inventory showed actual usage of water for irrigation at 9,319 acre-feet (NDWR 2012). Using this number in place of the 25,143 acre-feet appropriated for irrigation, but assuming all other appropriations (for other beneficial uses) are used, brings the actual water consumption in the Newark Valley to 12,060 acre-feet, which is well below perennial yield for the basin. Water rights for which the water is actually used are referred to as “wet rights” whereas water rights that do not get used are referred to as “paper rights”.

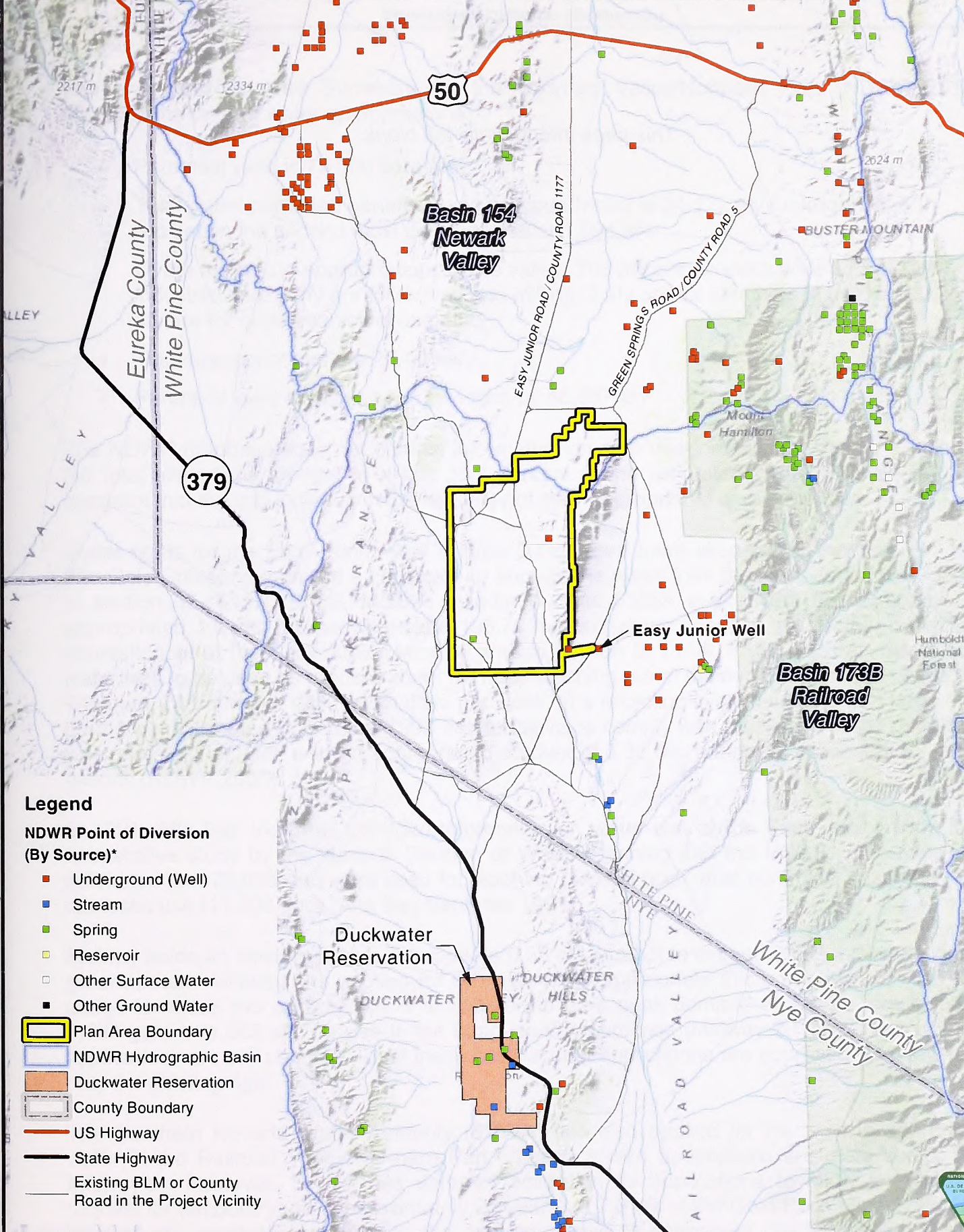

Legend

- NDWR Point of Diversion (By Source)***
- Underground (Well)
 - Stream
 - Spring
 - Reservoir
 - Other Surface Water
 - Other Ground Water
 - Plan Area Boundary
 - NDWR Hydrographic Basin
 - Duckwater Reservation
 - County Boundary
 - US Highway
 - State Highway
 - Existing BLM or County Road in the Project Vicinity

FIGURE 3.2-6
WATER RIGHTS POINTS OF DIVERSION
MIDWAY GOLD US INC.
GOLD ROCK MINE PROJECT

MAPPED DATE: 8/22/2014

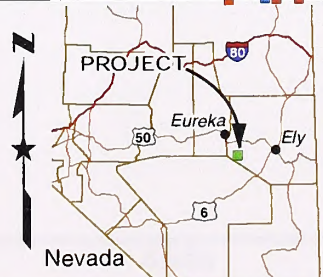
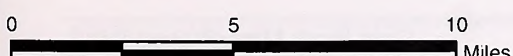

U.S. BUREAU OF LAND MANAGEMENT
 ELY DISTRICT
 EGAN FIELD OFFICE

NO WARRANTY IS MADE BY THE BUREAU OF LAND MANAGEMENT AS TO THE ACCURACY, RELIABILITY, OR COMPLETENESS OF THESE DATA FOR INDIVIDUAL USE OR AGGREGATE USE WITH OTHER DATA.

Basemap Source: ESRI World Topo Map Service
 Points of Diversion Data: provided by Nevada Department of Water Resources (NRWR) on 02/20/2014

This page intentionally left blank.

The Hydrographic Area Summary for the Railroad Valley/Northern Part (NDWR 2014a) indicates the current water appropriations:

- Perennial yield is 75,000 acre-feet;
- The largest permitted beneficial use of groundwater is 24,122 afy for irrigation, with recreation the second most common use at 1,994 afy;
- Of the remaining appropriations in the valley, 208 afy are for stock water, 72 afy for industrial use, 5 afy are for mining and milling, 2 afy are for commercial use, and 0.24 afy are for quasi-municipal use; and
- Total appropriations are 26,403 afy
- Perennial yield exceeds appropriations by 48,597 afy.

The NDWR database does not contain information on crop use for Railroad Valley. Given that the total allocations amount to a just 35.2 percent of the estimated yield of the aquifer, it is apparent that the groundwater in the basin is not over-appropriated or over-utilized.

Water rights for the Easy Junior well (Figure 3.2-6) have been allocated in the past. In 1990 Alta Gold Company received a certificate to appropriate water from the Easy Junior well located in section 35, T15N, R56E, MDBM. Under permits 53389 and 53390, the company was appropriated 1.0 cfs, but not to exceed 196.76 million gallons annually, for mining, milling and domestic use at the Easy Junior Mine located in section 9, T15N, R56E MDBM. Specifically, water was to be used as process water for heap leaching ore at the mine. Estimated usage was 448 gpm, 24 hours per day, seven days per week, in a recycling system with no discharge. The permit was cancelled in October 1993 due to failure to comply with provisions of the permit, but was re-issued in 1996, with an appropriated amount of 0.38 cfs, but not to exceed 20.89 million gallons (NDWR 2005).

In 1991, Alta Bay Ventures provided information on water use at the Easy Junior Mine for a cooperative study by the Nevada Division of Water Planning and the USGS. The mine staff estimated that 78,035 gpd were used for leaching (34,005 gpd), dust control (33,021 gpd), and domestic use (11,008 gpd) (Alta Bay Ventures 1991).

Midway holds an existing right to appropriate 0.38 cfs, but not to exceed 20.89 million gallons of groundwater. Midway has applied for two permits to appropriate this groundwater. The total usage for these two applications is anticipated to be a peak demand of 2.6 cfs, equivalent to 1,167 gpm or 1,882 afy, for use in the heap leaching process (Midway 2013b). Both of these applications are still pending. Until these two pending applications are approved, Midway holds only the existing right.

The Southern Nevada Water Authority (SNWA) has also applied for the right to appropriate water in the Railroad Valley/Northern Part. These SNWA applications are more senior than Midway's. However, SNWA has deferred action on its applications to allow for Midway's request for temporary use (approximately 25 years) of 2.6 cfs at the Gold Rock Mine Project, as long as any application to change the manner of use to permanent use is rejected (SNWA 2014).

3.3 GEOLOGY AND MINERALS

The Plan area is located in the Basin and Range Physiographic Province, a region characterized by narrow, north-south trending mountain ranges separated by broad, flat, arid valleys (Hose and Blake 1976). Figure 3.3-1 illustrates local geology as mapped by Midway geologists in 2013 (Payne et al. 2014). For areas not covered by Midway's mapping, state-level geologic mapping data is provided (USGS 2005). Descriptions of geologic units below follow the nomenclature of Hose and Blake (1976).

Existing Conditions

The following describes the physical characteristics of rock layers in the area, referred to as lithology or stratigraphy; the likelihood of earthquakes, or "seismicity," and the geotechnical setting. Mineral resources are described in section 3.15. The distribution and concentration of heavy metals and potential for generating acid in relation to water quality are described in Section 3.2.

Stratigraphy

A stratigraphic column of geologic units exposed within the Pancake Range is presented as Figure 3.3-2. Descriptions of units illustrated on Figure 3.3-2 found in the project area are provided below.

Devil's Gate Limestone

The Late Devonian Devil's Gate Limestone is the oldest geologic unit exposed in the northern Pancake Range. This unit is typically dark-gray to grayish-black, medium-bedded to massive limestone with zones of weakly (clay-rich) to sandy limestone. This unit is approximately 1,500 feet thick on the eastern face of Nighthawk Ridge, directly east of the mine area (GRE 2014), and is about 1,500 feet thick elsewhere in western White Pine County.

Pilot Shale

The Late Devonian to Early Mississippian Pilot Shale overlies the Devil's Gate Limestone. In the project area, this unit consists of tan, flaggy siltstone with zones of very thin, papery siltstone. Elsewhere in White Pine County, lower portions of this unit contain limestone and calcareous shale (Hose and Blake 1976), but these beds are not observed in the project area. The Pilot Shale measures approximately 230 feet in the project area (GRE 2014).

Joana Limestone

The Mississippian Joana Limestone overlies the Pilot Shale and is the main host of known mineralization and historic gold resources and reserves in the project area. The Joana Limestone consists of three zones: a lower fossil-rich and burrowed limestone; a middle clean, massive to thick-bedded limestone; and an upper limestone with moderate to abundant chert nodules and fossil hash. Fossils recognized within the Joana Limestone are further described in Section 3.4. The limestone is commonly silica altered throughout the project area, including areas outside zones of currently recognized mineralization. In the project area the thickness of the Joana Limestone measures approximately 125 feet thick (GRE 2014). In the White Pine Range, the Joana Limestone ranges from 150 to 250 feet thick (Hose and Blake 1976).

Chainman Shale

The Mississippian Chainman Shale consists of dark gray to black shale with thin interbedded fine-grained sandstone, which increases in abundance upwards. This unit measures 1,320 feet thick in the project area (GRE 2014). In the Pancake Range, this unit is approximately 1,100 feet thick (Hose and Blake 1976).

Diamond Peak Formation

The Mississippian Diamond Peak Formation consists of two zones. The upper zone contains thick-bedded chert pebble conglomerate with some sandstone. The lower zone contains thinly-bedded sandstone with interbedded conglomerate and shale. This unit has a maximum measured thickness of approximately 1,900 feet in the project area (GRE 2014). In the northern Pancake Range, the Diamond Peak Formation is estimated to be approximately 2,500 feet thick (Hose and Blake 1976).

Older Tertiary ash-flow tuffs

Various crystal-poor to crystal-rich ash-flow tuff deposits are exposed in the project area, primarily within the Pancake Range. In these mountains along the White Pine County-Nye County line, the deposits are several hundred feet thick. In areas, these deposits may be interbedded with other continental carbonate and clastic sedimentary rocks. Radiometric dating of these deposits generally indicates an Oligocene age (Hose and Blake 1976). These tuffs likely correspond to the Pinto Basin Tuff. In much of the project area, tuff deposits are generally less than 50 feet thick and occur sporadically (GRE 2014).

Younger Tertiary ash-flow tuffs

Some younger ash-flow tuffs are present in the northern portion of the CESA. These deposits are generally crystal-poor compared to older tuffs and are thinner, with an average thickness of about 50 feet (Hose and Blake 1976).

Younger Tertiary sedimentary and volcanic rocks

Sedimentary deposits of probable Miocene age are present in the western part of the project area along the eastern flank of the Pancake Range. The lithology of these rocks varies widely across the CESA, but generally consists of fissile calcareous siltstone, fine-grained calcareous sandstone, and conglomerate. Andesitic lava, alkaline olivine basalt, and other volcanic rocks are variably interbedded with sedimentary and volcanoclastic deposits within this unit. Exposures of this unit within the CESA are expected to be similar to the reported average range of 50 to 300 feet (Hose and Blake 1976).

Quaternary sedimentary rocks

Quaternary-age alluvium and colluvium are present in drainages and along hillsides in the region.

Structural Geology

Geology of the region reflects multiple phases of continental plate movement, or “tectonic activity”.

The tectonic history in the project area has produced a series of thrust faults, reverse faults, and associated folds that generally strike about north 15 degrees east (N15E) (GRE 2014). The subsurface geology of the project area as determined through an extensive exploratory boring

program and historical mining operations is illustrated by the cross-section presented on Figure 3.3-3.

Alteration and Mineralization

Alteration

Alteration at Gold Rock is typical of Carlin-type systems in Nevada. Alteration styles include silicification, argillization, decalcification and oxidation. Unlike at the Pan Project where carbon alteration is peripheral to mineralization, at Gold Rock, gold occurs within the carbon-altered, reduced zones and in the oxidized zones without carbon alteration. Gold is often associated with anomalous concentrations of arsenic, antimony, barium, iron, mercury, sulfur, and zinc at Gold Rock (GRE 2014).

Mineralization

Mineralization at Gold Rock is localized in the slightly overturned, fault-bounded Easy Junior anticline. The primary host is the Joana Limestone, but significant mineralization is also hosted in the overlying Chainman Shale. Scattered, minor mineralization also occurs in the underlying Pilot Shale formation (GRE 2014).

Using an estimate of the gold that could potentially be mined by open pit methods and a cutoff of 0.006 ounces per ton and an average gold price of \$1,500, the estimated measured, indicated, and inferred gold resources are 44,000, 401,000, and 227,000 troy ounces, respectively (GRE 2014). Internal waste at a 0.004 cutoff grade would be 119,000,000 tons.

Geologic Faults and Seismicity

The Basin and Range Province is an active seismic region. Multiple faults in the region exhibit evidence of Quaternary or more recent activity and have potential to cause ground shaking within the project region (Table 3.3-1 and Figure 3.3-4). The presence of unnamed down-to-the-west normal faults crossing the project area with interpreted movement in the past 1.6 million years was based on interpretations of aerial photography and has not been verified by field observations (Reedser 2000).

Table 3.3-1 Mapped Quaternary or Younger Faults in the Region

Fault Name	Age of Fault	Distance (miles) and Direction ¹
Unnamed fault zone	<1,600,000 years	Crosses project area
Eastern Little Smoky Valley Fault	<130,000 years	7.1 W
Unnamed faults in Northern Pancake Range	<1,600,000 years	9.2 NW
Newark Valley Fault Zone	<750,000 years	7.8 N
Railroad Valley Fault Zone	<1,600,000 years	6.5 E
Unnamed faults east of Mokomoke Mountain	<1,600,000 years	14.0 E
Unnamed faults east of Freeland and Lanspon Canyons	<1,600,000 years	11.0 SE
Bull Creek Fault	<1,600,000 years	10.0 S
Duckwater Fault	<130,000 years	2.1 W
Big Sand Springs Valley Fault	<1,600,000 years	16.3 SW
Unnamed faults near southern end of Moody Mountains	<1,600,000 years	18.0 SW
Unnamed faults east of Moody Mountains	<130,000 years	10.3 SW
Diamond Mountains Fault Zone	<130,000 years	16.6 NW

Notes:

¹ Approximate from center of Easy Junior Pit to closest portion of fault

Source: USGS and Nevada Bureau of Mines and Geology 2010

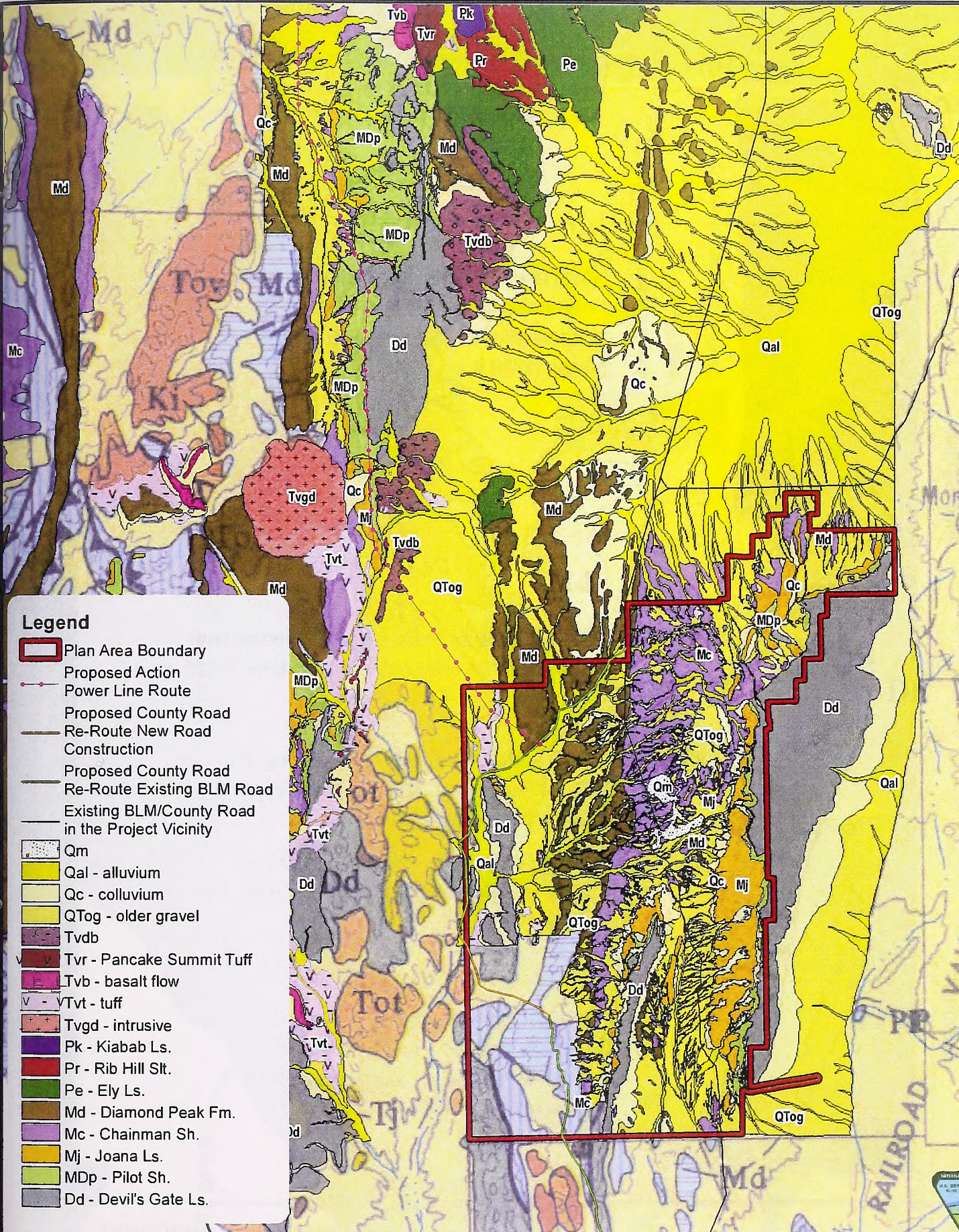

Legend

- Plan Area Boundary
- Proposed Action
- Power Line Route
- Proposed County Road
- Re-Route New Road Construction
- Proposed County Road
- Re-Route Existing BLM Road
- Existing BLM/County Road in the Project Vicinity

- Qm
- Qal - alluvium
- Qc - colluvium
- QTog - older gravel
- Tvdb
- Tvr - Pancake Summit Tuff
- Tvb - basalt flow
- VTvt - tuff
- Tvgd - intrusive
- PK - Kiabab Ls.
- Pr - Rib Hill St.
- Pe - Ely Ls.
- Md - Diamond Peak Fm.
- Mc - Chainman Sh.
- Mj - Joana Ls.
- MDp - Pilot Sh.
- Dd - Devil's Gate Ls.

FIGURE 3.3-1
LOCAL GEOLOGY
MIDWAY GOLD US INC.
GOLD ROCK MINE PROJECT

MAPPED DATE: 8/1/2014

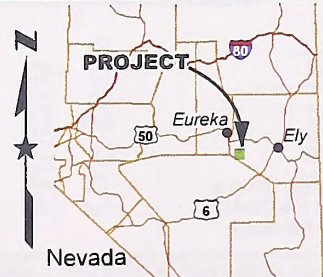
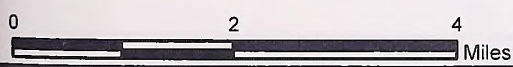

U.S. BUREAU OF LAND MANAGEMENT
 ELY DISTRICT
 EGAN FIELD OFFICE

NO WARRANTY IS MADE BY THE BUREAU OF LAND MANAGEMENT AS TO THE ACCURACY, RELIABILITY, OR COMPLETENESS OF THESE DATA FOR INDIVIDUAL USE OR AGGREGATE USE WITH OTHER DATA

Basemap Source: ESRI World Shade Relief Map Service
 Scanned Geology: Hose and Blake 1976
 Geology GIS Data: Midway 2014



PATH: Z:\GIS\PROJECTS\ENVC0001817_GOLDROCK\GIS\MAP_F_MXD\2014_DRAFT_EIS\FIGURE_3_3_LOCAL_GEOLOGY.MXD | LAST SAVED BY: JCHEN | LAST SAVED ON: 8/1/2014 12:49:32 PM

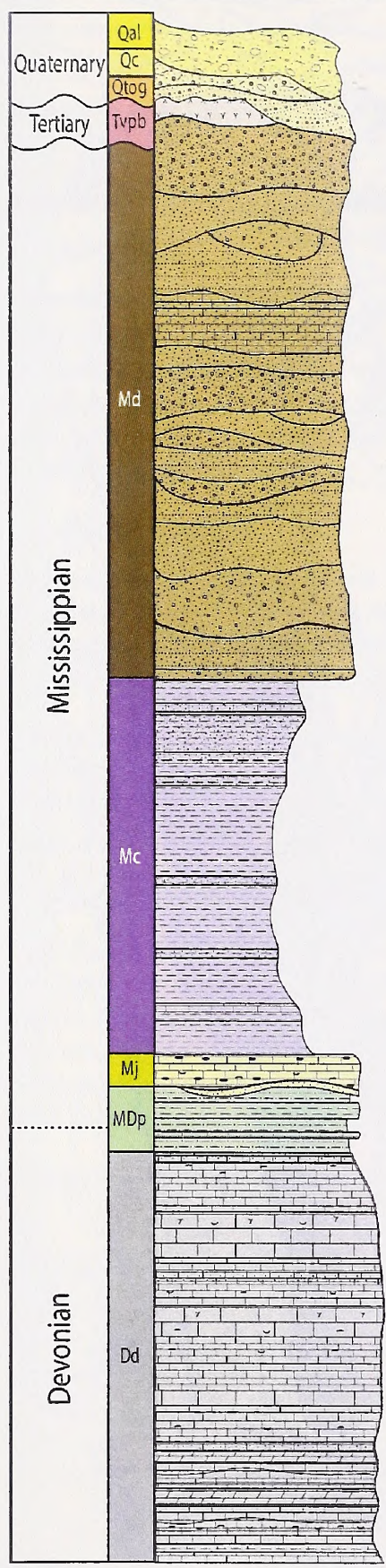

Gravels & Volcanics – Consists of Pinto Basin Tuff, older cemented gravels, colluvium, and alluvium. (Variable thickness)

(Md) Diamond Peak Formation – Interbedded lithic sandstone, paraconglomerate, orthoconglomerate, and shale. (1950 ft.)

(Mc) Chainman Shale – Fissile, carbonaceous shale with interbedded fine sandstone. (1320 ft.)

(Mj) Joana Limestone – Fossiliferous and bioturbated limestone. Abundant crinoids and chert nodules. (125 ft.)

(MDp) Pilot Shale – Flaggy, thin bedded siltstone. Carbonaceous and weathered tan.

(Dd) Devil's Gate Limestone – Medium to massive bedded, micritic limestone. Amphipora, rugose, and gastropods are common. (1500 ft. measured)



FIGURE 3.3-2
STRATIGRAPHIC COLUMN

MIDWAY GOLD US INC.
GOLD ROCK MINE PROJECT

SOURCE:
Figure 7-2 Simplified Stratigraphic Column, Gold Rock Project (Midway, 2014) in NI 43-101 TECHNICAL REPORT, UPDATED MINERAL RESOURCE ESTIMATE for the GOLD ROCK PROJECT, White Pine County, Nevada (Global Resource Engineering 2014).

U.S. BUREAU OF LAND MANAGEMENT
ELY DISTRICT
EGAN FIELD OFFICE

NO WARRANTY IS MADE BY THE BUREAU OF LAND MANAGEMENT AS TO THE ACCURACY, RELIABILITY, OR COMPLETENESS OF THESE DATA FOR INDIVIDUAL USE OR AGGREGATE USE WITH OTHER DATA.

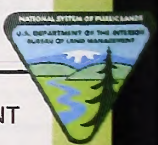

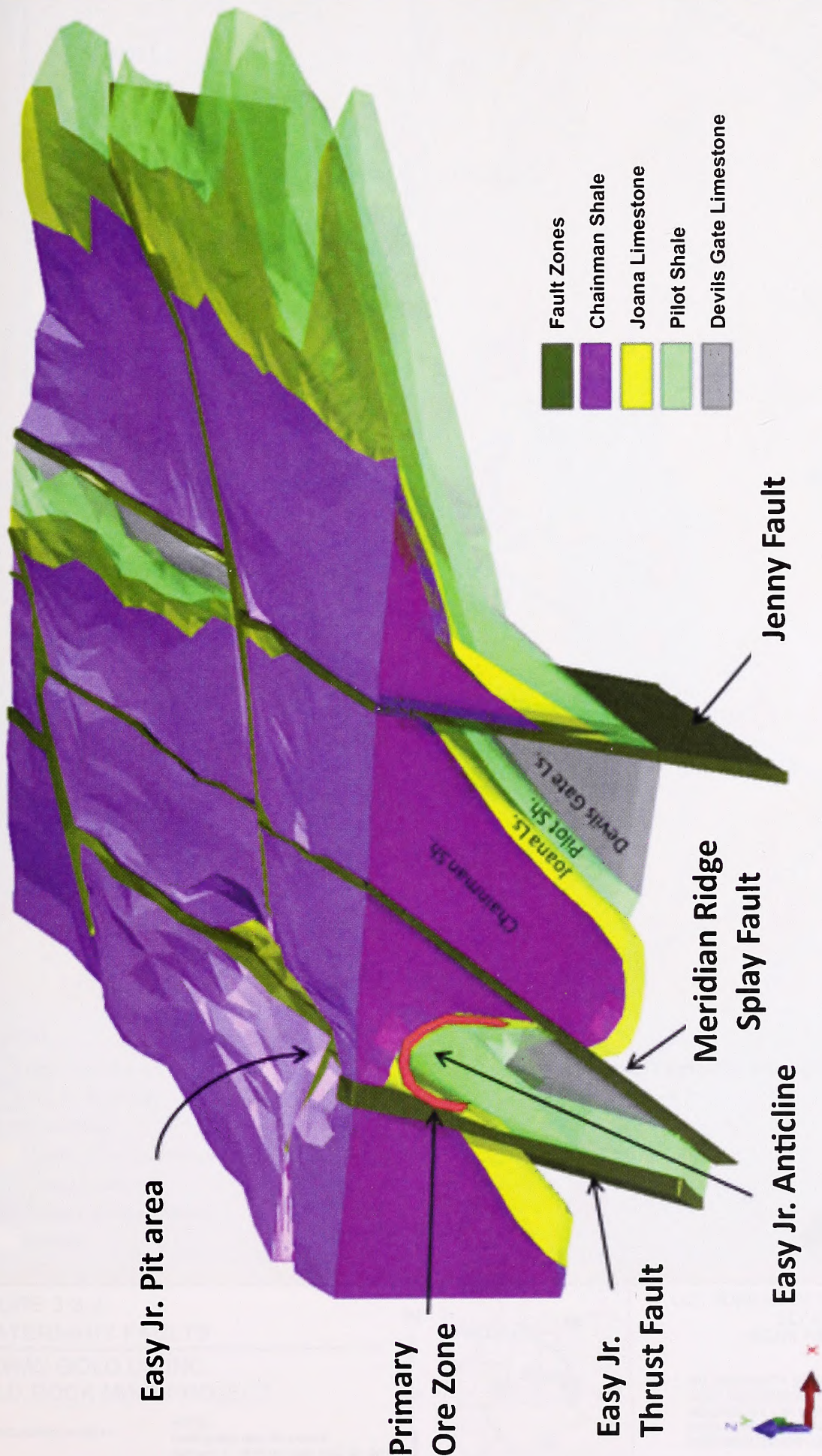

FIGURE 3.3-3
GOLD ROCK MINE
PROJECT CROSS SECTION GEOLOGY
MIDWAY GOLD US INC.
GOLD ROCK MINE PROJECT

SOURCE:
 Figure 14-2 3-D Lithology model, Looking North-North-West in NI 43-101 TECHNICAL REPORT, UPDATED MINERAL RESOURCE ESTIMATE for the GOLD ROCK PROJECT, White Pine County, Nevada (Global Resource Engineering, 2014).

U.S. BUREAU OF LAND MANAGEMENT
 ELY DISTRICT
 EGAN FIELD OFFICE

NO WARRANTY IS MADE BY THE BUREAU OF LAND MANAGEMENT AS TO THE ACCURACY, RELIABILITY, OR COMPLETENESS OF THESE DATA FOR INDIVIDUAL USE OR AGGREGATE USE WITH OTHER DATA.

This page intentionally left blank.



50 MILES

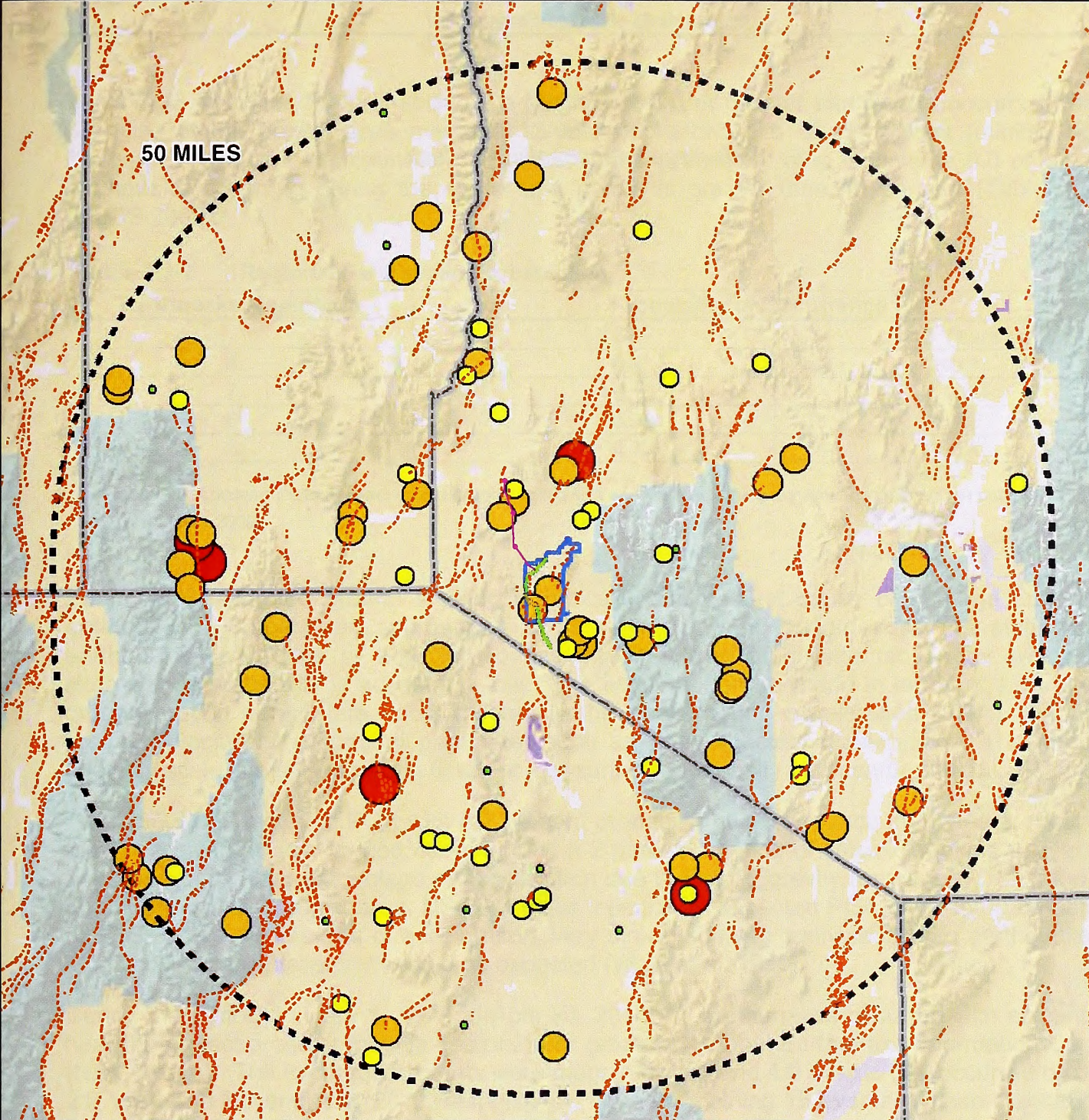

Legend

- Plan Area Boundary
- County Boundary

Land Ownership

- Bureau of Land Management
- Forest Service
- Bureau of Indian Affairs
- Private

- Proposed Action
- Power Line Route
- Proposed County Road
- Re-Route New Road Construction
- Proposed County Road
- Re-Route Existing BLM Road
- Quaternary Faults

Earthquake Epicenter Magnitude

- 1.52 - 2
- 2 - 3
- 3 - 4
- 4 - 4.2

FIGURE 3.3-4
QUATERNARY FAULTS
MIDWAY GOLD US INC.
GOLD ROCK MINE PROJECT

MAPPED DATE: 8/1/2014

NOTE:
 Earthquake data for period
 January 1, 1978 through April 30, 2014.

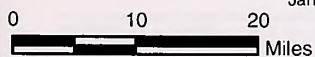

U.S. BUREAU OF LAND MANAGEMENT
 ELY DISTRICT
 EGAN FIELD OFFICE

NO WARRANTY IS MADE BY THE BUREAU OF LAND MANAGEMENT AS TO THE ACCURACY, RELIABILITY, OR COMPLETENESS OF THESE DATA FOR INDIVIDUAL USE OR AGGREGATE USE WITH OTHER DATA.

Basemap Source: ESRI World Shade Relief Map Service

PATH: Z:\GIS\PROJECTS\EN\W0001817_GOLDROCK\GIS\ARCMAP_MXD\2014_DRAFT_EIS\FIGURE_3-3-4_QUATERNARYFAULTS_MN.MXD | LAST SAVED BY: JCHEN | LAST SAVED ON: 8/1/2014 12:59:04 PM

This page intentionally left blank.

The USGS identifies the probability of a Magnitude 6.0 or greater earthquake occurring within 62 miles of the project area over the 13-year operational life of the project (mining, heap leaching, milling) as approximately 10 percent. The probability of a Magnitude 5.0 or greater earthquake occurring during the same time period is greater than 46 percent (Table 3.3-2) (USGS 2009).

Table 3.3-2 Regional Earthquake Probabilities

Earthquake Magnitude	Probability of Occurrence (%) ¹	
	1 Year	13 Years
8	< 0.1	<0.1
7	< 0.1	0.63
6	0.95	9.9
5	4.7	46.4

Notes:

1 Probability of occurrence for an earthquake to occur within a 62-mile radius of the Easy Junior pit in the given period.

Source: USGS 2009.

Earthquake-generated ground shaking is typically the greatest cause of damage during an earthquake. Probabilistic approaches to assessing seismic hazards use the statistics of earthquake occurrence in a region to estimate the level of ground motion for which the exceedance probability is acceptably low. The estimate can be made in terms of a variety of ground motion parameters, most commonly the peak ground acceleration (PGA), the peak ground velocity, or a spectral parameter such as peak spectral acceleration. The Mercalli Intensity scale is a seismic scale used for measuring the intensity of an earthquake.

The USGS has modeled PGA with a 2 percent probability of exceedance in 50 years, meaning that, in a given 50-year period, there is only a 2 percent chance of seismic shaking exceeding any given equivalent percentage of acceleration due to Earth's gravity (percent g) (Peterson, et al. 2008). For the project area, USGS models indicate an expected PGA of 18 to 30 percent g (USGS 2009). At this rate of acceleration, very strong shaking equivalent to an earthquake of Modified Mercalli Intensity VII could be expected (Wald et al. 1999).

During the period January 1, 1978 to April 30, 2014, 18 earthquakes occurred with epicenters near the project areas at magnitudes of 2.0 or greater (National Earthquake Information Center (NEIC) 2014). The two largest events were magnitude 4.1 and 4.0 events that occurred on July 21, 1992 and November 9, 2011, respectively. Of the remaining 16 events, 12 had magnitudes between 3.0 and 3.9 and four had magnitudes between 2.0 and 2.9. A Magnitude 3.7 earthquake occurred on August 11, 1999 with an epicenter in the project area and a focal depth of 5 miles.

As of November 15, 2013, the five most recent earthquakes to occur in Nevada with local magnitudes greater than 3.0 are summarized in Table 3.3-3. The epicenter of the August 29, 2013 Magnitude 3.8 event is located approximately 9 miles east of the project area (Figure 3.3-3).

Table 3.3-3 Summary of Recent Earthquakes in Nevada

Date	Location Description	Latitude (N)	Longitude (W)	Depth (miles)	Magnitude (M _L)
10-29-2013	12.9 miles NNE of Eureka Dunes	37.2651	117.5799	12.5	3.1
10-25-2103	23.0 miles ENE of Pinnacles Ridge	37.0573	116.0913	6.6	3.1
10-11-2013	35.0 miles SW of Ely	38.9051	115.3481	13.6	3.6

Table 3.3-3 Summary of Recent Earthquakes in Nevada

Date	Location Description	Latitude (N)	Longitude (W)	Depth (miles)	Magnitude (M _L)
09-16-2013	20.2 miles WNW of Alamo	37.5105	115.4841	5.5	3.7
08-29-2013	35.7 miles WSW of Ely	39.0807	115.5021	0.0	3.8

Notes:

M_L = Local magnitude as measured by University of Nevada – Reno – Nevada Seismological Laboratory (UNR-NSL)

Source: UNR-NSL 2013.

Stability and Liquefaction

Potential geotechnical issues relevant to the project area include in-pit slope stability, blast induced seismicity, tailing dam and heap leach pile stability, and liquefaction. Most of the project area consists of relatively flat topography where geotechnical instability is expected to be minimal. Areas where bedrock is exposed by excavations (e.g., mine pit, road cuts, etc.) are expected to be less stable. In particular, steeply dipping sections of exposed Chainman Shale and Pilot Shale or areas immediately underlain by steeply dipping beds of these units are expected to be unstable due to thin bedding and general incompetent nature.

Liquefaction is a loss of soil shear strength that can occur during a seismic event, as cyclic shear stresses cause excessive pore water pressure between soil grains. Loss of shear strength can cause damage to infrastructure such as roads, dams, and building foundations. This phenomenon is generally limited to unconsolidated, clean to silty sand lying below the groundwater table. The higher the PGA and longer the shaking caused by a seismic event occurs, the more likely liquefaction will take place. Although seismic activity is expected to occur in the region, the risk of seismically-induced liquefaction in the project area is low because no shallow (50 feet or less) groundwater is known to be present (Nevada Bureau of Mines and Geology 2013).

3.4 PALEONTOLOGICAL RESOURCES

Paleontological resources, or fossils, are the remains, imprints, or traces of once-living organisms preserved in rocks or sediments. Fossils commonly include bones, teeth, shells, wood, and leaf impressions, and sometimes include soft tissues, footprints, burrows, and microscopic remains. Fossils are considered nonrenewable and nonreplaceable resources because the organisms that they represent no longer exist and recreating the resources is impossible.

Occurrences of fossils are closely tied to the geologic units (formations, members, or beds) that contain them. The probability of finding fossils generally can be predicted from the geologic units present at or near the earth's surface. Geologic mapping can be used to assess the potential for occurrence of fossils.

Using the Potential Fossil Yield Classification (PFYC) system, geologic units are classified based on the relative abundance of vertebrate fossils and traces (skin impressions, footprints, burrows) or scientifically significant invertebrate or plant fossils and their sensitivity to adverse impacts. A higher PFYC number indicates a higher potential for finding scientifically significant paleontological resources. A fossil is considered to be scientifically significant if it is a rare or previously unknown species, is of high quality and well-preserved, preserves a previously unknown anatomical or other characteristic, provides new information about the history of life on earth, or has an identified educational or recreational value. On the other hand, a fossil may be

considered to lack scientific significance if it lacks geologic context or physical integrity, or is commonly found and not useful for research (BLM 2007d).

The PFYC system is applied to geologic units, preferably at the most detailed level of geologic mapping available. The system is not intended to be applied to specific paleontological localities (specific locations where a concentration of fossils are known to be present) or small areas within geologic units. Although significant localities may occasionally occur in a geologic unit, a few widely scattered important fossils or localities do not necessarily indicate a higher class; instead, the relative abundance of significant localities is intended to be the major factor in determining the class.

Passage of the Omnibus Public Lands Act and Paleontological Resources Preservation (OPLA-PRP) subtitle requires BLM to manage and preserve fossils on public lands using scientific principles and expertise. BLM is currently developing regulations to implement the OPLA-PRP. The PFYC system is currently used by many BLM field offices to provide baseline guidance for predicting, assessing, and mitigating impacts to fossils in accordance with OPLA-PRP.

Existing Conditions

No vertebrate or scientifically significant invertebrate or plant fossils such as petrified wood are known to exist in the project area, but geologic units that could contain them are present.

The BLM has not designated PFYC classifications in the project area; however, approximately 20 miles east of the project area Murphey and DeBusk (2011) recommended PFYC classification for geologic units in similar depositional environments approximately 20 miles east of the project area. The BLM EFO has concurred with these recommendations. These classifications were used to describe the geologic units exposed in the project region.

Geologic units in the project area are assigned one of two PFYC Classes as defined by BLM (2008):

- PFYC Class 2 = Low Potential. Sedimentary geologic units that are not likely to contain vertebrate fossils or scientifically significant nonvertebrate fossils.
- PFYC Class 3b = Unknown Potential. Sedimentary units of unknown fossil potential. Units exhibit geologic features and preservational conditions that suggest significant fossils could be present, but little information about the paleontological resources of the unit or area is known.

Geologic units in the project area that could contain fossils are described below (from oldest to youngest). Two geologic units with unknown potential to contain scientifically significant fossils (PFYC Class 3b) are present in the project area: Alluvium and colluvium; and Younger sedimentary and volcanic rocks. The project area includes approximately 3,752 acres of Alluvium and colluvium and approximately 70 acres of “Younger sedimentary and volcanic rocks.” The distribution of these two geologic units in the project area is shown on Figure 3.4-1.

Devil’s Gate Limestone (Middle to Upper Devonian)

This unit consists of limestone and dolomite representing shallow-water subtidal, intertidal, and supratidal deposits formed on a broad inner continental shelf (Murphey and DeBusk 2011). In other portions of White Pine County, rocks of equivalent stratigraphic position and similar lithologic character to the Devil’s Gate Limestone are mapped as Guilmette Formation. Much

of the Guilmette Formation, especially the upper part, contains blanket-like deposits of shells or sponges (biostromes), which mostly consist of stromatoporids such as *Stromatopora* or *Amphipora*, but also have abundant coral fossils in some zones (Hose and Blake 1976). Because these fossils consist of invertebrate remains that are widespread across eastern Nevada and the project area, they are not considered to be scientifically significant and a PFYC Class 2 designation is supported.

Pilot Shale (Upper Devonian)

This unit generally consists of tan, flaggy siltstone with zones of very thin, papery siltstone in the project area, but contains lower beds of limestone and calcareous shale elsewhere in White Pine County (Hose and Blake 1976; GRE 2014). Fossils have not been identified within the Pilot Shale (Humphrey 1960). Vertebrate fossils or scientifically significant invertebrate fossils are not likely to occur within the Pilot Shale and a PFYC Class 2 designation is supported.

Joana Limestone (Lower Mississippian)

This unit is somewhat older in the Pancake Range than in other portions of eastern Nevada. Limestone beds of this unit are predominantly composed of fragmented invertebrate fossils (echinoderms, bryozoans, foraminifera, and possibly algae) and calcareous mud (Hose and Blake 1976). Because these fossils are found in outcrops of the Joana Limestone throughout eastern Nevada, they are not likely to be considered scientifically significant. Some invertebrate fossils from the stratigraphically lowest portions of the unit in the project area may be of interest to researchers due to their comparatively older age, but are likely to be found elsewhere in the Pancake Range. Furthermore, due to the extensive mineralization of this unit in the project area, such fossils may be altered beyond recognition or completely replaced and a PFYC Class 2 designation is supported.

Chainman Shale (Mississippian)

This unit is correlative to rocks mapped as White Pine Formation. Invertebrate fossils including pelecypods, brachiopods, and cephalopods have been recovered from limestone and black shale units of the White Pine Formation near Mount Hamilton (Humphrey 1960). Similar invertebrate fossils are expected to be present within the Chainman Shale in the project area. However, because these fossils consist of invertebrate remains that are widespread across eastern Nevada and the project area, they are not considered to be scientifically significant and a PFYC Class 2 designation is supported for this unit.

Diamond Peak Formation (Mississippian)

This unit is dominated by zones of thick-bedded chert pebble conglomerate with some sandstone and thinly-bedded sandstone with interbedded conglomerate and shale in the project area and adjacent portions of the Pancake Range (Hose and Blake 1976, GRE 2014). Conglomerates are present at the top of the unit. Crinoids and brachiopods are known to occur in sandstone units of this formation and brachiopods, corals, and cephalopod fossils have been observed throughout the formation in the northern Pancake Range (Stewart 1962). Lithology and stratigraphy of the Diamond Peak Formation of the Pancake Range is different from other outcrops of the formation in White Pine and Eureka Counties and some fossils from this formation may be of interest to researchers due to their distinct depositional environment. Outcrops of the Diamond Peak Formation are prevalent in the Pancake Range; therefore, the invertebrate fossils are unlikely to be scientifically significant and a PFYC Class 2 designation is supported.

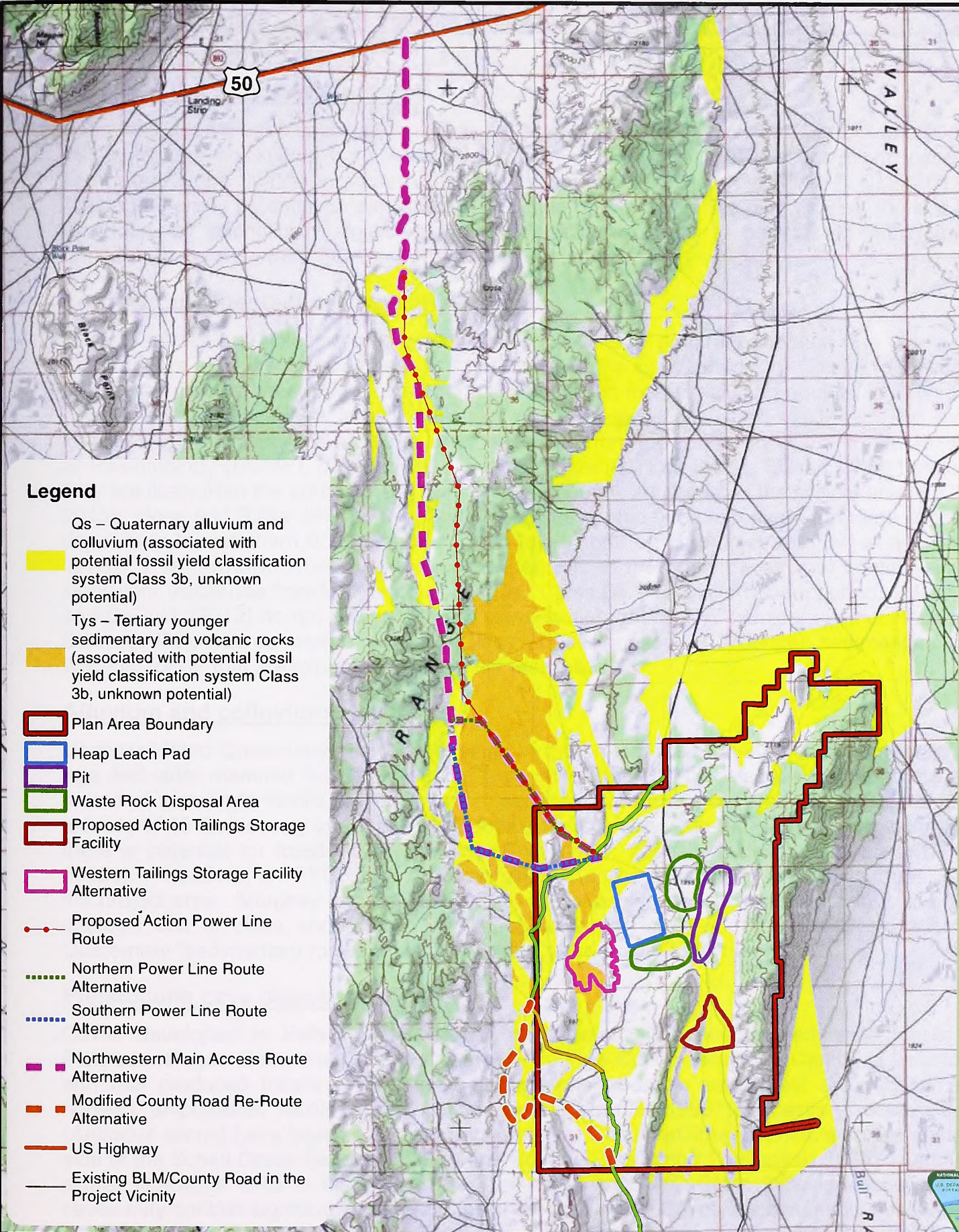

Legend















-  Qs – Quaternary alluvium and colluvium (associated with potential fossil yield classification system Class 3b, unknown potential)
-  Tys – Tertiary younger sedimentary and volcanic rocks (associated with potential fossil yield classification system Class 3b, unknown potential)
-  Plan Area Boundary
-  Heap Leach Pad
-  Pit
-  Waste Rock Disposal Area
-  Proposed Action Tailings Storage Facility
-  Western Tailings Storage Facility Alternative
-  Proposed Action Power Line Route
-  Northern Power Line Route Alternative
-  Southern Power Line Route Alternative
-  Northwestern Main Access Route Alternative
-  Modified County Road Re-Route Alternative
-  US Highway
-  Existing BLM/County Road in the Project Vicinity

FIGURE 3.4-1
GEOLOGIC UNITS WITH UNKNOWN PALEONTOLOGICAL SENSITIVITY
MIDWAY GOLD US INC.
GOLD ROCK MINE PROJECT
 MAPPED DATE: 9/2/2014



U.S. BUREAU OF LAND MANAGEMENT
 ELY DISTRICT
 EGAN FIELD OFFICE

NO WARRANTY IS MADE BY THE BUREAU OF LAND MANAGEMENT AS TO THE ACCURACY, RELIABILITY, OR COMPLETENESS OF THESE DATA FOR INDIVIDUAL USE OR AGGREGATE USE WITH OTHER DATA.

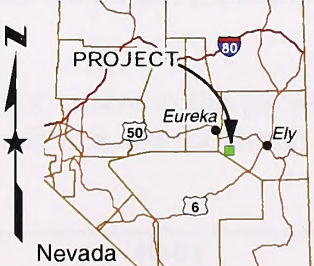
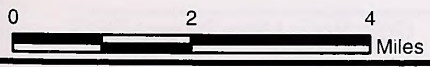
Basemap Source: ESRI USA Topo Maps Map Service

PATH: C:\USERS\JCHEN\DOCUMENTS\PROJECTS\CITRIX\CC0001817_GOLDROCK\GIS\ARCMAP_MXD\2014\MXD | LAST SAVED BY: JCHEN | LAST SAVED ON: 9/2/2014 3:07:54 PM

This page intentionally left blank.

Ash-flow tuff deposits (Tertiary)

Plant fossils have been collected from Tertiary ash-flow tuff deposits in northern Nevada (Coats 1987), but are not known from White Pine County. One locality of Miocene plant fossils is known from Lone Summit in western Nye County, southwest of the project area (UCMP 2013a). Although there is potential for similar plant fossils to be present in the project area, there is low likelihood for scientifically significant paleontological resources to be present within these deposits; therefore a PFYC Class 2 designation is supported.

Younger sedimentary and volcanic rocks

Mixed sedimentary, volcanic, and volcanoclastic deposits of probable Miocene age (34 to 5.3 million years ago) are present west and northwest of the Easy Junior pit. Similar deposits in White Pine County have produced numerous mammalian fossils including equids, lagomorphs, canids, and antilocapridae from a minimum of seven localities (UCMP 2013b). The exact locations of these localities have not been requested from the University of California Museum of Paleontology (UCMP), but published locality names (Willow Grove, Ellison Creek) indicate they are likely from the south-central portion of the county, southeast of the project area (UCMP 2013b; Hose and Blake 1976). Vertebrate fossils have also been recovered from late Miocene deposits in the southern Butte Range about 5 miles north of the project area (Hose and Blake 1976). It is unknown whether the Miocene deposits in the project area also contain similar significant vertebrate fossils; therefore, a PFYC Class 3b designation is supported. Murphey and DeBusk (2012) do not assign a PFYC classification to the “Tys” geologic unit of Hose and Blake (1976), but do assign a PFYC Class 3b designation to “Younger sedimentary and volcanic rocks” that are expected to be similar to this unit.

Alluvium and colluvium (Quaternary)

Unconsolidated Quaternary alluvial sediments in the project area have potential to contain Ice Age and older mammal fossils. However, a search of the UCMP database did not return any record of vertebrate fossils from Quaternary sediments in the project area. UCMP does have records of 45 Quaternary vertebrate fossil localities from elsewhere in Nevada, suggesting that there is potential for fossils to be present within similar deposits in the project area (UCMP 2013c). Therefore, a PFYC Class 3b designation is applied to Quaternary alluvial deposits in the project area. Murphey and DeBusk (2011) do not assign a PFYC classification to the “Qs” geologic unit of Hose and Blake (1976), but do assign a PFYC Class 3b designation to Quaternary “sedimentary rocks” that are expected to be similar to this unit.

Pleistocene cave deposits

Caves developed in Paleozoic limestones have potential to contain vertebrate fossils of Pleistocene age. Cathedral Cave in eastern White Pine County formed in Cambrian limestone and has produced fossils of mammals (lagomorphs, rodents, carnivores, artiodactyls, and horses), amphibians, reptiles, lizards, birds, and snails (Jass 2007). Fossils of a cave bear (*Arctodus simus*) have been recovered from a similar Cambrian limestone cave on the eastern side of the Schell Creek Range in White Pine County (Emslie and Czaplewski 1985). Although similar limestone units in the project area are assigned PFYC Class 2 designations, similar caves may contain significant vertebrate fossil assemblages. Caves are commonly observed in the Devils Gate Limestone of Newark Mountain (approximately 20 miles north-northwest of the area of analysis) (Nolan et al. 1956).

Alluvial cover and moderate vegetation cover in the project area reduce the amount of bedrock outcrop in the project area and minimize the potential for identifying fossils at the surface.

Scientifically significant vertebrate fossils may be present within Tertiary ash-fall deposits and Younger sedimentary (likely Miocene) rocks in the project area. However, limited research in the area has been done, and the potential for finding such fossils is unknown.

3.5 SOILS

Existing Conditions

The NRCS has mapped soils in the region. Figure 3.5-1 shows soils in the Plan area. Field investigations conducted in 2013 provide additional information of the distribution and characteristics of soils, including recommendations for reclamation (Ecosynthesis 2013). Most of the soils in the project area are undisturbed except where road construction and maintenance or past mineral exploration has created local disturbance. Approximately 395 acres of disturbance exist within the Plan area.

Soil Limitations

Interpretations of soil susceptibility to erosion, as well as other factors that could influence the short- and long-term function of soils in the project area, have been developed by cooperators in the National Cooperative Soil Survey and are maintained by the NRCS. Interpretation rules and criteria are stored in the National Soil Information System. These interpretations predict soil behavior to help in the development of reasonable and effective alternatives for the use and management of soil and other resources (NRCS 2014). Descriptions of interpretations presented below are based on information obtained from the NRCS Web Soil Survey (NRCS 2014). The NRCS Soil Survey of western White Pine County (NRCS 1998) provides the baseline data from which the interpretations were developed.

Table 3.5-1 summarizes the construction limitations of each soil map unit, including the potential for erosion (both from water and wind) and interpreted suitability for reclamation material. All soil map units in the project area are classified as well drained (NRCS 2014).

Erosion Potential

The NRCS determined erosion hazards for soils in its soil surveys. Table 3.5-1 provides a summary of these erosion hazards for soils in the project area (NRCS 2014). The water erosion hazard rating of a soil is determined by rating a soil as slight, moderate, or severe. In addition, soil erodibility factors (K_w) and (K_f) quantify soil detachment by runoff and raindrop impact. Factor K_w applies to the whole soil and factor while K_f applies only to the fine-earth (less than 2.0 mm) fraction. These erodibility factors are indices used to predict the long-term average soil loss from sheet and rill erosion under crop systems and conservation techniques. Because soil profiles will be variably disturbed, erosion factors presented in Table 3.5-1 represent a weighted average of all soil layers and represent the soil map unit as a whole, although components with greater or lesser potential for erosion may be present. The higher the K value, the more susceptible the soil is to sheet and rill erosion by water. As shown in Table 3.5-1, K_w is significantly lower than K_f for the majority of project area soils, indicating that the presence of rocks in native soil horizons contributes strongly to erosion resistance. Severe water erosion hazards are present within the majority (73 percent) of the project area. Slope and erodibility are the key factors contributing to erosion hazards in the project area.

The wind erosion hazard rating applies to the soil map unit as a whole. Due to the coarse grained texture of project area soils, wind erosion hazards are generally low to moderately low.

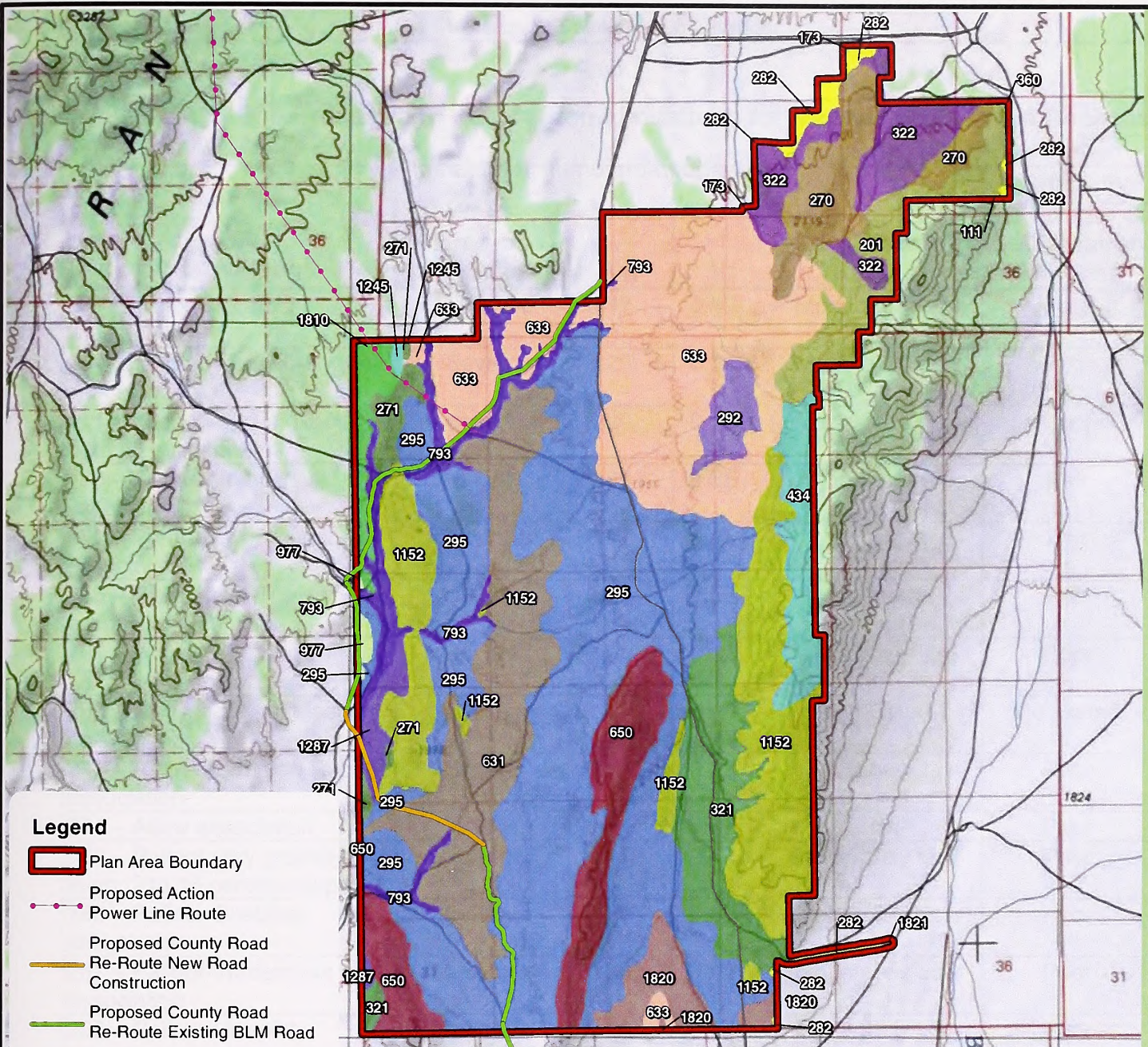

Legend

- Plan Area Boundary
- Proposed Action Power Line Route
- Proposed County Road
- Re-Route New Road Construction
- Proposed County Road Re-Route Existing BLM Road

NRCS Soil Map Unit Name

- | | |
|--|---|
| 111-Zimbob-Hyzen-Rock outcrop association | 282-Palinoir very gravelly loam, 2 to 15 percent slopes |
| 1152-Zimbob-Eaglepass association | 292-Palinoir-Urmafot-Urmafot, very shallow association |
| 1245-Biken-Tulase association | 295-Palinoir-Roden association |
| 1287-Palinoir-Izar-Biken association | 321-Palinoir association |
| 173-Tulase-Yody-Heist association | 322-Palinoir-Roden-Urmafot association |
| 1810-Ilton-Yody-Blimo association | 360-Bellmill association |
| 1820-Sodhouse association | 434-Pookaloo-Hyzen-Mijoysee association |
| 1821-Sodhouse-Palinoir association | 631-Roden-Haarvar association |
| 201-Mijoysee-Pookaloo-Tecomar association | 633-Roden-Izar association |
| 270-Atlow-Maderbak-Rubble land association | 650-Eaglepass-Kyler-Rock outcrop association |
| 271-Atlow association | 793-Bylo silt loam, 0 to 2 percent slopes |
| | 977-Zimbob-Pookaloo association |

NOTE:
Soil map units along the Proposed Action Power Line Route are not depicted due to map scale limitations. These include map units 104, 296, 351, 421, 633, 660, 800, and 1340.

Units 173, 270, 322, 360 are within the Plan area boundary but are not impacted or have impacts of less than 1 acre under the Proposed Action or any Alternatives.

Source - Soils Natural Resources Conservation Service, United States Department of Agriculture. Web Soil Survey.

**FIGURE 3.5-1
PLAN AREA SOILS**

**MIDWAY GOLD US INC.
GOLD ROCK MINE PROJECT**

MAPPED DATE: 8/1/2014

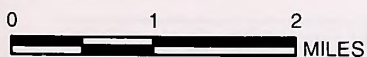

**U.S. BUREAU OF LAND MANAGEMENT
ELY DISTRICT
EGAN FIELD OFFICE**

NO WARRANTY IS MADE BY THE BUREAU OF LAND MANAGEMENT AS TO THE ACCURACY, RELIABILITY, OR COMPLETENESS OF THESE DATA FOR INDIVIDUAL USE OR AGGREGATE USE WITH OTHER DATA.

Basemap Source: ESRI USA Topo Maps Map Service



PATH: Z:\GIS\PROJECTS\ENVC0001817_GOLDROCK\GIS\ARCMAP_MXD\2014_DRAFT_EIS\FIGURE_3_5_1_PROPACTIONS\SOILS_MN.MXD | LAST SAVED BY: JCHEN | LAST SAVED ON: 8/1/2014 1:47:37 PM

This page intentionally left blank.

Table 3.5-1 Soil Erosion and Restoration Limitations for Mapped Soils in the Analysis Areas

Soil Map IDs – Names¹	Water Erosion Hazard	Kw	Kf	Wind Erosion Hazard²	Suitability As Source of Reclamation Material
53 – Palinoor-Urmafot association	Moderate	0.17	0.49	Moderately Low	Poor
104 Pookaloo-Zimbob-Hyzen association	Severe	0.20	0.64	Moderately Low	Poor
111 – Zimbob-Hyzen-Rock outcrop association	Severe	0.20	0.49	Moderately Low	Poor
173 – Tulase-Yody-Heist association	Slight	0.55	0.55	Moderate	Fair
181 – Pyrat-Cowgil-Broyles association	Moderate	0.17	0.43	Moderate	Fair
185 – Pyrat-Heist-Tulase association	Slight	0.55	0.55	Moderate	Fair
201 – Mijoysee-Pookaloo-Tecomar association	Severe	0.05	0.32	Low	Poor
232 – Linoyer-Heist-Tulase association	Not Rated	Not Rated	Not Rated	Not Rated	Not Rated
270 – Atlow-Maderbak-Rubble association	Severe	0.15	0.43	Low	Poor
271 – Atlow association	Severe	0.17	0.49	Low	Poor
282 – Palinoor very gravelly loam, 2 to 15 percent slopes	Moderate	0.17	0.49	Moderately Low	Poor
286 – Palinoor-Shabliss association	Moderate	0.20	0.49	Moderately Low	Poor
287 – Palinoor-Wintermute association	Moderate	0.20	0.49	Moderately Low	Poor
292 – Palinoor-Urmafot-Urmafot, very shallow association	Moderate	0.20	0.43	Moderately Low	Poor
295 – Palinoor Roden Association	Severe	0.15	0.32	Low	Poor
296 – Palinoor-Urmafot-Palinoor, steep association	Moderate	0.20	0.49	Moderately Low	Poor
321 – Palinoor association	Severe	0.20	0.49	Moderately Low	Poor
322 – Palinoor-Roden-Urmafot association	Moderate	0.24	0.49	Moderate	Poor
323 – Urmafot-Bobs-Palinoor association	Slight	0.20	0.43	Moderately Low	Poor
336 – Parisa gravelly loam, 2 to 8 percent slopes	Moderate	0.20	0.43	Moderately Low	Poor
351 – Heist-Tulase association	Slight	0.55	0.55	Moderate	Fair
360 – Belmill association	Moderate	0.17	0.32	Moderately Low	Fair
361 – Belmill-Cowgil-Selti association	Moderate	0.17	0.32	Moderately Low	Fair
421 – Wintermute gravelly sandy loam, 0 to 4 percent slopes	Slight	0.17	0.32	Moderate	Poor

Table 3.5-1 Soil Erosion and Restoration Limitations for Mapped Soils in the Analysis Areas

Soil Map IDs – Names ¹	Water Erosion Hazard	Kw	Kf	Wind Erosion Hazard ²	Suitability As Source of Reclamation Material
434 – Pookaloo-Hyzen association	Severe	0.20	0.43	Low	Poor
450 – Shabliss-Yody association	Moderate	0.32	0.55	Moderately Low	Poor
631 – Roden Haarvar association	Severe	0.15	0.32	Low	Poor
632 – Roden-Haarvar association, steep	Severe	0.15	0.32	Low	Poor
633 – Roden-Izar Association	Severe	0.15	0.32	Low	Poor
650 – Eaglepass-Kyler-Rock outcrop association	Severe	0.10	0.55	Low	Poor
660 – Stewval-Rock outcrop association	Moderate	0.10	0.37	Moderately Low	Poor
793 – Bylo silt loam, 0 to 2 percent slopes	Slight	0.49	0.49	Moderately Low	Fair
800 – Broland association	Moderate	0.17	0.43	Low	Poor
977 – Zimbob-Pookaloo association	Severe	0.20	0.49	Moderately Low	Poor
1152 – Zimbob-Eaglepass Association	Severe	0.20	0.49	Moderately Low	Poor
1245 – Biken-Tulase association	Moderate	0.10	0.28	Moderately Low	Poor
1287 – Palinor-Izar-Biken association	Moderate	0.20	0.49	Moderately Low	Poor
1340 – Pyrat-Tulase association	Slight	0.17	0.43	Moderate	Fair
1810 – Ilton-Yody-Blimo association	Severe	0.20	0.37	Moderate	Fair
1820 – Sodhouse association	Moderate	0.28	0.49	Moderately Low	Poor
1821 – Sodhouse-Palinor association	Moderate	0.28	0.49	Moderately Low	Poor
3233 – Stewval-Rock outcrop association	Severe	0.10	0.43	Moderately Low	Poor
3300 – Palinor very gravelly loam, 2 to 15 percent slopes	Moderate	0.17	0.49	Moderately Low	Poor
3400 – Parisa gravelly loam, 2 to 8 percent slopes	Moderate	0.20	0.43	Moderately Low	Poor
3700 – Leo-Delamar association	Moderate	0.15	0.28	Moderate	Poor
3941 – Peeko gravelly loam, 2 to 8 percent slopes	Moderate	0.24	0.49	Moderate	Poor

Reclamation Suitability

The greatest influences on a soil's use as reclamation material include erosion resistance and productive potential of the reclaimed soil. Measurable properties of these include (but are not limited to) the content of sodium, salts, and calcium carbonate; reaction; available water capacity; erodibility; texture; content of rock fragments; and content of organic matter. NRCS uses these properties to rate soils as potential sources of reclamation material based on the amount of suitable material, ease of excavation, and the expected performance of the material after it is in place. These ratings assume normal amounts of compaction, minor processing effects, and the use of standard construction practices.

Soil map units located in mountain areas and limestone hills in the project area (for example, map units 1152, 650, 434, 282, and 111) are shallow and generally unsuitable for reclamation (NRCS 1998). Other soil map units and components located in the project area are generally interpreted by NRCS to be poor potential sources of reclamation. Less than one percent of soils in the project area are interpreted to be fair sources of reclamation material. The "fair" designation is applied to soils in which vegetation can be established and maintained and the soil can be stabilized through modification of one or more limiting properties. These modifications may include placement of higher quality material at the surface or adding soil amendments.

In the project area the three most commonly encountered soil properties which limit soils' use as reclamation material are droughtiness, shallow depth to bedrock, and carbonate content. Droughty soils have low ability to store enough water to support vegetation. The use of shallow soils is limited by the available volume of soil and potential for rocky subsoils to be present. High carbonate content of soils in the project area is attributed to the widespread presence of limestone or other calcium-rich bedrock. Approximately 70 percent of soils in the project area have a calcium carbonate equivalent content (by weight percent) of 30 percent or higher. The deeper alluvial soils (greater than 200 cm to a restrictive layer) are generally rated as fair for use as reclamation material. As for other soils in the project area, the alluvial soils are typically droughty, and are also commonly limited by low organic matter content.

In addition to limiting the amount of moisture available to vegetation, the droughty nature of project area soils also influences water infiltration through cover materials. Infiltration modeling using a soil that represents measured site conditions indicates that infiltration of precipitation and snowmelt is rapid through the first foot of soils, and 30 to 50 percent of water infiltrates to a depth of one foot. However, within 2.5 to 3 feet of the surface, infiltration is reduced to less than 1 percent (Interralogic 2013b). Very little water is available for vegetation root systems at these depths. Similar characteristics would be expected of project area soils salvaged for reclamation.

3.6 PRIME AND UNIQUE FARMLANDS

Prime farmland is defined as land that has the best combination of physical and chemical characteristics for producing food, feed, forage, fiber, and oilseed crops and is available for these uses (USDA 2014b). Prime farmland soils have the quality, growing season, and moisture supply needed to economically produce sustained high yields of crops when treated and managed according to acceptable farming methods. The NRCS compiles lists of which soils in each survey area meet the quality criteria to be considered as Prime Farmland.

Unique Farmland is defined as land other than Prime Farmland that is used for the production of specific high-value food and fiber crops (7 CFR 657.5). These lands have the combination of soil quality, location, growing season, and moisture supply needed to economically produce sustained high quality and/or high yields of a specific crop when treated and managed according to acceptable farming methods. No Unique Farmland was identified in the project area.

Existing Conditions

Regionally, the NRCS has designated three soil map units, 173 (Tulas-Yody-Heist association), 232 (Linoyer-Heist-Tulase association), and 351 (Heist-Tulase association), as “Prime Farmland if Irrigated and Reclaimed of Excess Salts and Sodium” (NRCS 1998). Figure 3.6-1 shows the locations of these soil map units in the project area. Droughtiness, rock fragments, and salinity limit the productivity of these soils. Most of these contiguous alluvial soils are undisturbed, are currently undeveloped, and are used for livestock grazing, dispersed recreation, and mineral exploration activities. However, some of these soils are disturbed and used as existing road surfaces. Approximately 1,185 acres of these soils are located in the project area.

Within the Plan area, two small areas totaling approximately 3 acres occur in the northernmost portions of the Plan area. The remaining prime farmland soils in the project area are found north of the Plan area on and along Green Springs Road on the existing main access route, on and along existing Easy Junior Road, and on and along the Proposed Action power line corridor (Figure 3.6-1).

Other categories of prime and unique farmlands have been defined by NRCS; however, only Farmlands of Statewide Importance are present in the project area. Farmlands of Statewide Importance serve similar functions as prime farmlands but are designated on a state-by-state basis. Soil map units 181 (Pyrat-Cowgil-Broyles association), 336 (Parisa gravelly loam, 2 to 8 percent slopes), 361 (Belmill-Cowgil-Selti association), 421 (Wintermute gravelly sandy loam, 0 to 4 percent slopes), 793 (Bylo silt loam, 0 to 2 percent slopes), and 1340 (Pyrat-Tulase association) are designated as Farmland of Statewide Importance in the project area. All of the aforementioned soil map units are alluvial soils.

3.7 AIR RESOURCES

Existing Conditions

Local Climatology

The project area is located at approximately 6,430 feet amsl. Terrain west of the Plan area is bounded by the Pancake Range, which runs north and south. Terrain east of the Plan area is bounded by the White Pine Mountains, which also run north and south. Winds are affected by the terrain and predominately flow from south to north. Wind patterns atop the mountain ranges exhibit a stronger pattern of west-to-east flow. Wind speeds are generally more moderate in the daylight hours and lighter in the evening and night time hours (BLM 2013c).

An on-site meteorological tower was constructed in T15N, R56E, Section 9, near where the facilities would be located in the Plan area, at an elevation of 6,430 feet amsl. Data have been collected and processed for the last 1.5 years. In general, data show temperatures ranging from 46 degrees Fahrenheit (°F) to 73°F in the spring/summer period and from 21°F to 58°F in

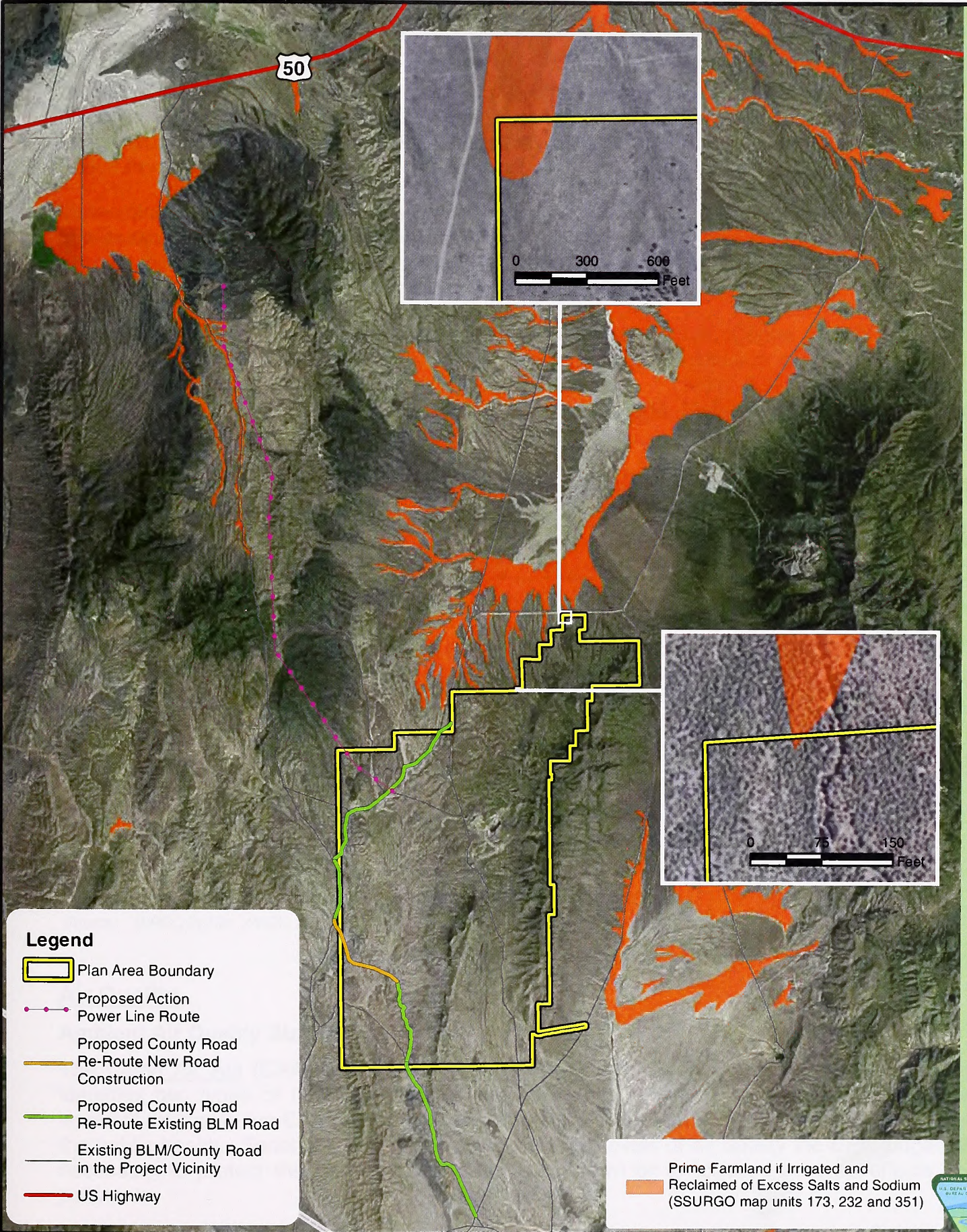

**FIGURE 3.6-1
PRIME FARMLANDS**

**MIDWAY GOLD US INC.
GOLD ROCK MINE PROJECT**

MAPPED DATE: 10/16/2014

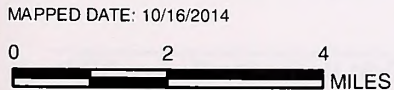

U.S. BUREAU OF LAND MANAGEMENT
ELY DISTRICT
EGAN FIELD OFFICE

NO WARRANTY IS MADE BY THE BUREAU OF LAND MANAGEMENT AS TO THE ACCURACY, RELIABILITY, OR COMPLETENESS OF THESE DATA FOR INDIVIDUAL USE OR AGGREGATE USE WITH OTHER DATA.

Basemap Source: ESRI World Imagery Map Service
Soil Data Source: Natural Resources Conservation Service, United States Department of Agriculture, Web Soil Survey.



PATH: Z:\GIS\PROJECTS\ENV\00001817_GOLDROCK\GIS\ARCMAP_MAPX\2014\2014_DRAFT_EIS\FIGURE_3_6-1_PRIMEFARMLANDS_MN.MXD | LAST SAVED BY: JCHEN | LAST SAVED ON: 10/16/2014 4:05:27 PM

This page intentionally left blank.

the fall/winter period. Temperature ranges for spring/summer and fall/winter periods recorded at the on-site Gold Rock meteorological tower over the last 1.5 year years are within the relative temperature ranges of the meteorological data reported for the Eureka station over the 129-year period from 1888 to 2013.

Meteorological data collected at the Pan Mine site (approximately 12 miles northwest) include a four-season environment with cold winters in the project area and show valley locations register warmer mean temperatures than found in the higher elevations and precipitation and snowfall occur more in the high elevations and less on the valley floor (BLM 2013c).

Historical climate summaries from the Western Regional Climate Center (WRCC) show an annual mean temperature of 46.7°F, total average annual precipitation of 11.83 inches, and an average annual total snowfall of 59.8 inches. Table 3.7-1 summarizes the WRCC meteorological data found at the Eureka Nevada Meteorological station located approximately 25 miles northwest of the project area.

Table 3.7-1 Meteorological Conditions Near the Project Area at Eureka, Nevada (Station 262708)

	Jan	Feb	Mar	Apr	May	Jun	Jul	Aug	Sep	Oct	Nov	Dec	Annual or Total
Average Max. Temperature (F)	38.3	41.2	48.3	57.0	66.0	77.2	86.4	84.3	74.9	63.3	48.8	39.7	60.4
Average Min. Temperature (F)	17.1	19.2	23.9	28.9	36.4	44.1	53.0	52.0	43.8	34.6	24.5	18.3	33.0
Mean Temperature (F)	27.7	30.2	36.1	43.0	51.2	60.7	69.7	68.2	59.4	48.9	36.7	29.0	46.7
Average Total Precipitation (in.)	1.07	1.05	1.34	1.34	1.41	0.83	0.68	0.78	0.78	0.89	0.78	0.89	11.83
Average Total Snow Fall (in.)	9.4	9.8	10.2	7.0	3.6	0.4	0.1	0.0	0.6	2.4	6.1	9.4	58.9
Average Snow Depth (in.)	3	2	1	0	0	0	0	0	0	0	1	2	1

Notes:

Period of Record: 4/ 1/1888 to 3/31/2013 (Mean Temp period of record 1888 to 2012)

Source: WRCC 2013b, WRCC 2013d

Air Quality

Ambient Air Quality Standards

The Clean Air Act (CAA) establishes National Ambient Air Quality Standards (NAAQS) and identifies two types of NAAQS—primary and secondary. Primary standards are defined as levels of air quality the EPA judges are necessary, with an adequate margin of safety, to protect the public health. Secondary standards are defined as levels of air quality the EPA judges are necessary to protect the public welfare from any known or anticipated adverse effects of a pollutant.

The CAA, last amended in 1990, establishes NAAQS for six principal pollutants, called "criteria" pollutants, which are considered harmful to public health and the environment. The criteria pollutants include carbon monoxide (CO), lead (Pb), nitrogen dioxide (NO₂), ozone (O₃), particulate matter 10 microns or less in diameter (PM₁₀), particulate matter 2.5 microns or less in diameter (PM_{2.5}), and sulfur dioxide (SO₂). Units of measure for the standards are parts per

million (ppm) by volume, parts per billion (ppb) by volume, and micrograms per cubic meter of air ($\mu\text{g}/\text{m}^3$) (EPA 2013a).

The standards of quality for ambient air in Nevada differ slightly from the EPA's NAAQS (NAC 2013) (Table 3.7-2). The Nevada Ambient Air Quality Standards also include a 1-hour O_3 standard for the Lake Tahoe Region (which does not apply to this project), a 1-hour CO standards for elevations greater than 5,000 feet, a 3-hours SO_2 standard, and a 1-hour hydrogen sulfide standard (Table 3.7-2). Nevada also has established an air quality standard for hydrogen sulfide and visibility. Table 3.7-2 lists the NAAQS and the Nevada minimum standards of quality for ambient air.

Attainment

The CAA established a classification system for attainment of the NAAQS. An area is classified as an Attainment area if the measured concentration of a pollutant in the area meets the national primary or secondary ambient air quality standard for the pollutant. An area is considered to be in Non-attainment if the concentration of a pollutant has exceeded the NAAQS (generally, if it has exceeded the NAAQS more than once annually). An unclassifiable area is any area that cannot be classified based on available information.

In 1979 the State of Nevada established 279 planning areas based on Hydrographic Area boundaries. Planning areas are classified as Attainment, Non-Attainment, or Unclassifiable for each criteria air pollutant. Planning area 179 is the planning area closest to the Plan area (NDEP 2013d).

The Nevada Division of Environmental Protection (NDEP) Bureau of Air Quality Planning (BAQP) is responsible for surveillance of air quality in all areas of the state other than in Clark and Washoe Counties. White Pine County, which includes the Plan area, is under the jurisdiction of NDEP-BAQP. Based on the period of the most recent Trend Report (2000-2010), White Pine County, and therefore the Plan area, is classified as in attainment or unclassified for all pollutants (NDEP 2013b) and therefore is considered in Attainment for all criteria pollutants. The only counties in Nevada designated Non-attainment areas are Clark and Washoe Counties, both for PM_{10} (EPA 2013a).

The EPA's Green Book Nonattainment Areas for Criteria Pollutants shows sulfur dioxide in White Pine County as a Maintenance Area Selection (Previously Non-Attainment Area) as of July 21, 2013 (EPA 2013b), but White Pine County is not currently designated a non-attainment area for any criteria pollutant (EPA 2013c).

Prevention of Significant Deterioration

The CAA established a program to protect or improve visibility, referred to as Prevention of Significant Deterioration (PSD). Federal PSD regulations apply to new major sources or major modifications at existing sources for pollutants where the area in which the source is located is in attainment with the NAAQS or is unclassifiable. One of the significant components of the PSD program is the requirement to evaluate increment consumption. Nevada uses the increment approach, and defines an increment as the allowable change in concentration above the baseline concentration (NDEP 2013b). Increment standards exist for three pollutants in Nevada: PM_{10} (24-hour and annual averages), NO_x (annual average only), and SO_2 (3-hour, 24-hour and annual averages) (NDEP 2013d).

Table 3.7-2 Nevada and National Ambient Air Quality Standards

Pollutant	Averaging Time	Nevada Standards ^A		National Standards ^B		
		Concentration ^C	Method ^D	Primary ^{C,E}	Secondary ^{C,F}	Method ^D
Ozone	8 hours	0.075 ppm	Chemiluminescence	0.075 ppm	Same as primary	Chemiluminescence
Ozone-Lake Tahoe Basin, #90	1 hour	0.10 ppm (195 µg/m ³)	Ultraviolet absorption	--	--	--
Carbon monoxide less than 5,000' above mean sea level	8 hours	9 ppm (10,500 µg/m ³)	Nondispersive infrared photometry	9 ppm (10 mg/m ³)	None	Nondispersive infrared photometry
		6 ppm (7,000 µg/m ³)				
Carbon monoxide at any elevation	1 hour	35 ppm (40,500 µg/m ³)		35 ppm (40 mg/m ³)		
Nitrogen dioxide	Annual arithmetic mean 1 hour	0.053 ppm (100 µg/m ³)	Gas phase chemiluminescence	0.053 ppm	Same as primary	Gas phase chemiluminescence
		--	--	100 ppb	None	
		0.030 ppm (80 µg/m ³)	Ultraviolet fluorescence	0.030 ppm	None	Spectrophotometry (Pararosaniline method)
		0.14 ppm (365 µg/m ³)		0.14 ppm		
Sulfur dioxide	Annual arithmetic mean 24 hours	0.5 ppm (1,300 µg/m ³)		None	0.5 ppm	
		--	--	75 ppb	None	
		50 µg/m ³	High volume PM ₁₀ sampling	None	None	--
Particulate matter as PM ₁₀	Annual arithmetic mean 24 hours	150 µg/m ³		150 µg/m ³	Same as primary	High or low volume PM ₁₀ sampling
		--	--	15.0 µg/m ³	Same as primary	Low volume PM _{2.5} sampling
Particulate matter as PM _{2.5}	Annual arithmetic mean 24 hours	--	--	35 µg/m ³	Same as primary	
Lead (Pb)	Rolling 3 mo. average	0.15 µg/m ³	High volume sampling, acid extraction and atomic absorption spectrometry	0.15 µg/m ³	Same as primary	High volume sampling, acid extraction and atomic absorption spectrometry

Table 3.7-2 Nevada and National Ambient Air Quality Standards

Pollutant	Averaging Time	Nevada Standards ^A		National Standards ^B		
		Concentration ^C	Method ^D	Primary ^{C,E}	Secondary ^{C,F}	Method ^D
Hydrogen sulfide	1 hour	0.08 ppm (112 µg/m ³) ^G	Ultraviolet fluorescence	--	--	--

Notes:

- A The Director shall use the Nevada standards in considering whether to issue a permit for a stationary source and shall ensure that the stationary source will not cause the Nevada standards to be exceeded in areas where the general public has access.
 - B The National standards are used in determinations of attainment or nonattainment. The form of a National standard is the criteria which must be satisfied for each respective concentration level of a standard for the purposes of attainment. The form for each National standard is set forth in 40 C.F.R. Part 50 and may be viewed at <http://www.epa.gov/air/criteria.html>.
 - C Where applicable and except as otherwise described in Note G, concentration is expressed first in units in which it was adopted. All measurements of air quality that are expressed as mass per unit volume, such as micrograms per cubic meter, must be corrected to a reference temperature of 25 degrees Centigrade and a reference pressure of 760 mm of Hg (1,013.2 millibars); "ppb" in this table refers to parts per billion by volume, or nanomoles of regulated air pollutant per mole of gas; "µg/m³" refers to micrograms per cubic meter.
 - D Reference method as described by the EPA. Any reference method specified in accordance with 40 C.F.R. Part 50 or any reference method or equivalent method designated in accordance with 40 C.F.R. Part 53 may be substituted.
 - E National primary standards are the levels of air quality necessary, with an adequate margin of safety, to protect the public health.
 - F National secondary standards are the levels of air quality necessary to protect the public welfare from any known or anticipated adverse effects of a regulated air pollutant.
 - G The official National annual standard for nitrogen dioxide is 0.053 ppm. The National annual standard is identified in this table in equivalent units of parts per billion for the purpose of simplifying its comparison with the National 1-hour standard which is also identified in parts per billion.
 - H The 1971 National sulfur dioxide standards remain in effect for an area until 1 year after the area is designated for the 2010 National sulfur dioxide standard, except that in an area designated nonattainment for the 1971 National sulfur dioxide standards, the 1971 standards remain in effect until an implementation plan to attain or maintain the 2010 National sulfur dioxide standards is approved.
 - I The ambient air quality standard for hydrogen sulfide does not include naturally occurring background concentrations.
1. The table contained in this section lists the minimum standards of quality for ambient air. (NAC 445B.22097 Standards of quality for ambient air. (NRS 445B.210))
 2. These standards of quality for ambient air are minimum goals, and it is the intent of the Commission in this section to protect the existing quality of Nevada's air to the extent that it is economically and technically feasible. [Environmental Common, Air Quality Reg. §§ 12.1-12.1.6, eff. 11-7-75; A and renumbered as § 12.1, 12-4-76; A 12-15-77; 8-28-79; §§ 12.2-12.4, eff. 11-7-75; § 12.5, eff. 12-4-76; A 8-28-79]—(NAC A 10-19-83; 9-5-84; 12-26-91; 10-30-95; R103-02, 12-17-2002; R198-03, 4-26-2004; R038-12, 9-14-2012; R042-13, 12-23-2013)

Source: NAC 2013

Federal PSD regulations established a land classification system for those areas of the country with air quality better than the NAAQS (Class I through III). Federal PDS regulations limit the maximum allowable increase in pollutants in Class I, Class II and Class III areas. In 1979, EPA promulgated a list of 156 mandatory Class I areas in which visibility was determined to be an important factor. In Nevada, EPA designated only one Class I area: the Jarbidge Wilderness Area, which is located in the northeast corner of the state and approximately 160 miles north of the Plan area. The Plan area is not in a Class I area. No Class III areas have been designated. Consequently, all regions not designated as Class I are designated as Class II areas, including the Plan area.

Regional Air Quality

Monitoring of criteria pollutants was discontinued in the region during the late 1990s when the EPA allowed monitoring to cease where pollutants were less than 60 percent of the NAAQS (BLM 2013c). The EPA's ambient air quality monitoring program is carried out by state and local agencies and consists of three major categories of monitoring stations, including State and Local Air Monitoring Stations (SLAMS). The Nevada Air Pollution Control Program (NAPCP) operates an ambient monitoring network of SLAMS in seven Nevada locations. The closest SLAMS site monitors continuous PM₁₀ and is located in the city of Elko approximately 120 miles north of the project area. Many of the PM₁₀ monitors in the NAPCP's network were taken offline because measurements remained well below the PM₁₀ NAAQS (NDEP 2013b). Generally, air quality in Elko County is excellent (BLM 2012a). Data for all NAAQS are not available. The maximum concentration data for PM₁₀ at the Elko monitoring station for the most recent year, 2010, was 25 µg/m³ for the 24 hour averaging period (NDEP 2013d).

Another monitoring site is located approximately 140 miles east of the project area at Great Basin National Park. Historic PM₁₀ monitoring indicates low particulate levels in rural areas similar to the project area. Monitoring data from the Lehman Caves in Great Basin National Park are used to simulate background concentrations for air quality permitting at NDEP-Bureau of Air Pollution Control. These values are 10.2 µg/m³ for the 24-hour averaging period and 9.0 µg/m³ for the annual averaging period. The Great Basin National Park estimated PM_{2.5} background concentrations from the monitored aerosol data from the monitoring station. Annual PM_{2.5} background concentration is a three-year weighted average equal to 2.4 µg/m³. The 24-hour PM_{2.5} background concentration is a three-year average of the 98th percentile and equal to 7 µg/m³ (BLM 2013c).

Visibility

Visibility in the project area is generally good. A monitoring site is located approximately 140 miles east of the project area at Great Basin National Park. Monitoring is conducted by Clean Air Status and Trends Network (CASTNET) and the Interagency Monitoring of Protected Visual Environments (IMPROVE). CASTNET is a national air quality-monitoring network that provides long-term monitoring of air quality in rural areas to determine trends in regional atmospheric nitrogen, sulfur, and ozone concentrations and deposition fluxes of sulfur and nitrogen pollutants in order to evaluate the effectiveness of national and regional air pollution control programs. The IMPROVE long-term monitoring program tracks changes in visibility and determines causal mechanisms for the visibility impairment in the National Parks and Wilderness Areas.

Great Basin National Park, which is in the middle of the intermountain West region and has been monitoring visibility since 1982, typically records some of the highest average visibility readings in the nation. The latest and most accurate data, from March 1993 through February 1994, indicate that the median annual non-weather-related standard visual range in the park is

approximately 150 km (93 miles). In addition, values rarely fell below 106 km (66 miles) and rarely exceeded 241 km (149 miles) (NPS 2013).

Monitoring data show that visibility at Great Basin National Park was affected principally by organic carbon, soot, sulfates, and coarse soil aerosols (NPS 2013). Visibility declines after periods of sustained northeasterly winds, when a brown-yellow haze appears in Snake Valley, obscuring the mountains east of the park. Presumably the pollution comes from the Salt Lake City area and the Intermountain Power Plant near Delta, Utah (NPS 2013). Ozone concentrations at Great Basin National Park are well within the current EPA health standard (0.120 ppm per hour), in contrast to ozone levels near many urban areas (NPS 2013). For the two-year period from March 1993 through February 1995, the median annual PM₁₀ concentration at Great Basin National Park was 6.5 µg/m³, and the median annual PM_{2.5} concentration was 2.9 µg/m³ (NPS 2013). Great Basin National Park typically records aerosol concentrations that are among the lowest in the nation (NPS 2013).

Pollutant Emission Sources

Existing sources of air pollution in and near the project area include mining, ranching, and recreation. The closest existing sources of air pollution are found approximately 30 miles northwest of the Plan area in Eureka, Nevada. The Pan Mine is being constructed approximately 10 miles northwest of the Plan area. The project area is located in a rural area where gaseous concentrations are expected to be low.

Climate Change

The EPA states that the earth's average temperature has risen by 1.4°F over the past century and is projected to rise another 2 to 11.5°F over the next hundred years. Small changes in the average temperature of the planet can translate to large and potentially dangerous shifts in climate and weather (EPA 2013d).

According to the Intergovernmental Panel on Climate Change (IPCC), "warming of the climate system is unequivocal, and since the 1950s, many of the observed changes are unprecedented over decades to millennia. The atmosphere and ocean have warmed, the amounts of snow and ice have diminished, sea level has risen, and the concentrations of greenhouse gases have increased. Each of the last three decades has been successively warmer at the Earth's surface than any preceding decade since 1850" (IPCC 2013). "In the Northern Hemisphere, 1983–2012 was likely the warmest 30-year period of the last 1,400 years (medium confidence)" (IPCC 2013).

"The atmospheric concentrations of carbon dioxide, methane, and nitrous oxide have increased to levels unprecedented in at least the last 800,000 years" (IPCC 2013). "Carbon dioxide concentrations have increased by 40 percent since pre-industrial times, primarily from fossil fuel emissions and secondarily from net land use change emissions. The ocean has absorbed about 30 percent of the emitted anthropogenic carbon dioxide, causing ocean acidification" (IPCC 2013).

"Human influence on the climate system is clear. This is evident from the increasing greenhouse gas concentrations in the atmosphere, positive radiative forcing, observed warming, and understanding of the climate system" (IPCC 2013).

"Continued emissions of greenhouse gases will cause further warming and changes in all components of the climate system. Limiting climate change will require substantial and sustained reductions of greenhouse gas emissions" (IPCC 2013).

Observed climate changes in the Great Basin over the past 100 years include the following:

- Region-wide warming of 0.6 to 1.1 degrees F. Minimum temperatures have increased more than maximum temperatures. The probability of very warm years has increased and the probability of very cold years has decreased.
- Annual precipitation has increased from six to 16 percent since the 1950s, but interannual variability in precipitation has also increased. The probability of extreme high precipitation events has increased, which has been reflected in increased streamflow, especially in winter and spring.
- April 1 snowpack volumes have declined.
- Spring snowmelt is 10-15 days earlier than in the mid-1900s, and there has been an increase in interannual variability in spring flow.
- Phenological studies indicate that in much of the west, the average bloom date is earlier for both purple lilac (two days per decade for the period of 1957-1994) and honeysuckle (3.8 days per decade for the period 1968 to 1994) (Chambers 2008).
- Since 1986 the length of the active wildfire season has increased by 78 days and the average duration of large fires has increased from 7.5 days to 37.1 days (HTNF 2011).
- Scientists have observed plant communities shifting their range north and to higher elevation to compensate for increasing temperatures; these migrations tend to isolate those communities that move to higher elevations (Loehman 2010; Finch 2012).

While in some cases climate change tends to mitigate ongoing impacts to vegetation and animals in the Great Basin (i.e., increased CO₂ in the atmosphere promotes vegetative growth), in most cases it exacerbates impacts from irrigation (i.e., less water available for other uses in the summer and increased evapotranspiration from higher temperatures), overgrazing (i.e., native grasses and forbs further stressed by higher temperatures and lower availability of water during the growing season), and invasive species (Chambers 2008).

3.8 VEGETATION, INCLUDING NOXIOUS AND NON-NATIVE INVASIVE WEEDS AND SPECIAL STATUS PLANTS

Existing Conditions

Vegetation Communities

In 2011, 2012, and 2013 vegetation specialists performed field studies including pedestrian transects to identify vegetation communities in a 13,405-acre study area (Study Area) (EcoSynthesis and WRC 2013). The Study Area covered approximately 72 percent of the 18,745-acre Plan area (Figure 3.8-1). Vegetation communities identified in the Study Area were merged with LANDFIRE (LANDFIRE 2013) Existing Vegetation Types (EVTs) (Figure 3.8-1). Both of these data sets distinguish vegetation community types using the Ecological Systems approach.

Based on the site field studies and LANDFIRE information, six Ecological Systems are present in the project area:

- Great Basin Pinyon-Juniper Woodland;
- Great Basin Xeric Mixed Sagebrush Shrubland;

- Intermountain Basins Big Sagebrush Shrubland;
- Intermountain Basins Mixed Salt Desert Scrub;
- Intermountain Basins Big Sagebrush Steppe; and
- Intermountain Basins Greasewood Flat.

Additionally, human-altered vegetation is present in the project area. Human-altered vegetation includes vegetation communities on reclaimed and unreclaimed areas of disturbance and a post-fire rabbitbrush community that are found within the Study Area. Developed roads and developed low-intensity areas are also found in the project area.

Ecological Systems are described below. Related plant associations, plant communities and/or complexes are described below in conjunction with their respective Ecological System and have been mapped in the Study Area where data were available. Ecological Systems and related plant associations, plant communities and/or complexes in relation to the project area are shown on Figure 3.8-1. Appendix 3B presents a list of scientific names for plant species noted in the EIS.

Great Basin Pinyon-Juniper Woodland

This Ecological System occurs on dry mountain ranges in and near the project area at elevations ranging from 1,600 to 2,600 meters amsl (5,248 to 8,528 feet). Woodlands are dominated by a mix of single-leaf pinyon and Utah juniper, ranging from pure to mixed stands of these species (NatureServe 2014a). Great Basin Pinyon-Juniper Woodland that has been mapped in the project area is shown on Figure 3.8-1. Several plant associations and communities occurring within this Ecological System occur in the project area and are described below.

Great Basin pinyon-juniper woodland/sparse herbaceous understory

This woodland association (mapped only within the Study Area) is characterized by a predominance of Utah juniper (in fact, more juniper than single-leaf pinyon, although the conventional community reference is to "pinyon-juniper"). Total tree canopy cover is approximately 30 to 35 percent (but could also range from 10 to 40 percent in other parts of the project area (NatureServe 2014b)). There is almost no woody or herbaceous understory (less than 1 percent overall understory cover) in most of this community, but where present includes sulphur-flower buckwheat and Simpson's buckwheat. The herbaceous species that are found also comprise less than one percent cover, and local dominance varies. In some areas, the most abundant species is Steptoe Valley beardtongue; in others, stemless mock goldenweed. Many other herbaceous species are locally common also, including Chamber's twinpod, thickstem wild cabbage, heartleaf twistflower, and desert green gentian. Data indicate that this community has rich diversity although the total mass of plant life in the area is overwhelmingly dominated by only a few species. Slopes may be gentle to moderate, always with a gravelly surface. At lower elevations within the Study Area (and likely in other parts of the project area), single-leaf pinyon is absent, and the only tree species is Utah juniper (EcoSynthesis and WRC 2013).

Great Basin pinyon-juniper woodland/black sagebrush sparse woodland

This association (mapped only within the Study Area but also likely extending to other parts of the analysis area) is an intermediate between pinyon-juniper/sparse understory and the most extensive of the shrubland communities, black sagebrush. Tree canopy is similar in structure

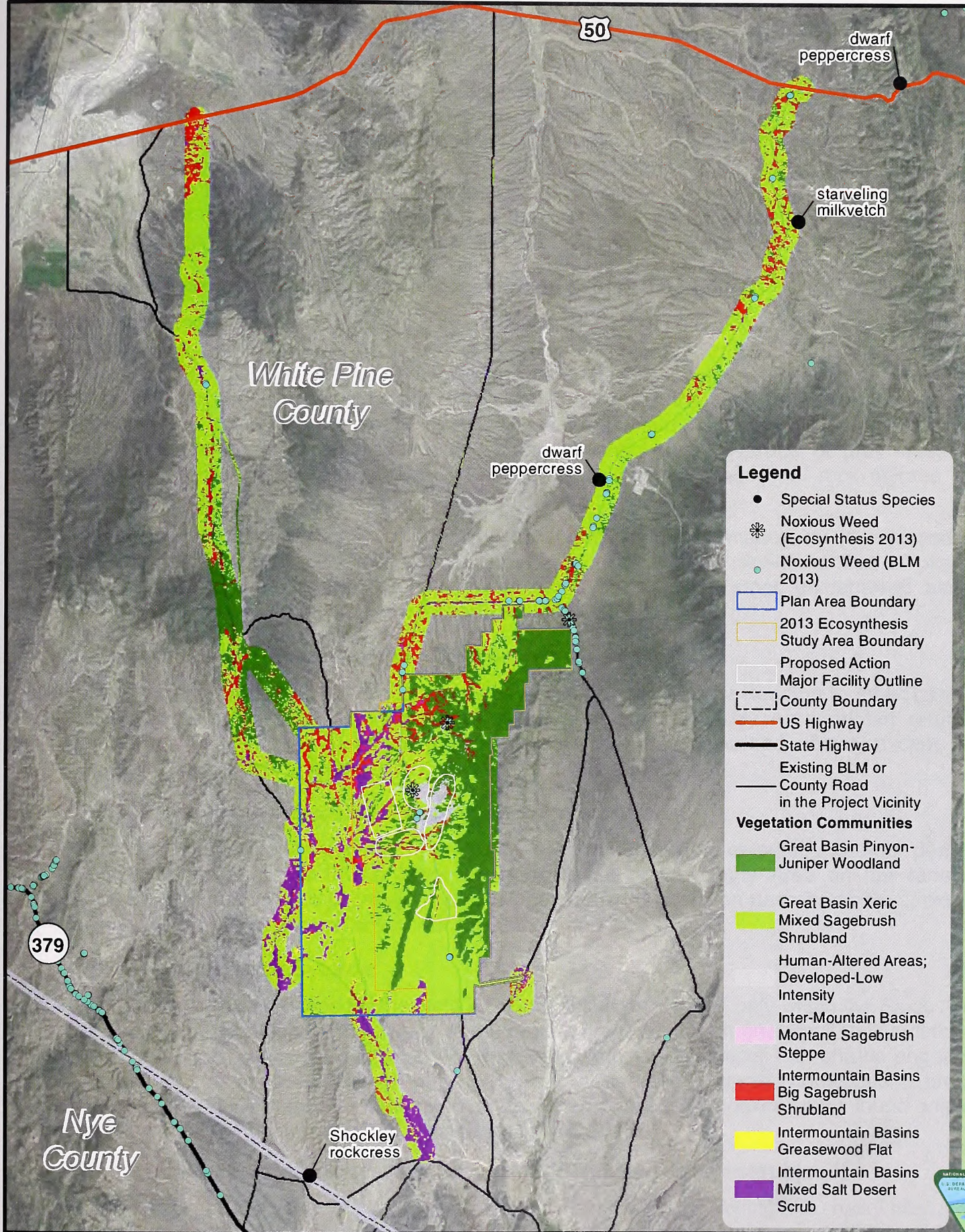

Legend

- Special Status Species
- ✱ Noxious Weed (Ecosynthesis 2013)
- Noxious Weed (BLM 2013)
- Plan Area Boundary
- 2013 Ecosynthesis Study Area Boundary
- Proposed Action
- Major Facility Outline
- County Boundary
- US Highway
- State Highway
- Existing BLM or County Road in the Project Vicinity

Vegetation Communities

- Great Basin Pinyon-Juniper Woodland
- Great Basin Xeric Mixed Sagebrush Shrubland
- Human-Altered Areas; Developed-Low Intensity
- Inter-Mountain Basins Montane Sagebrush Steppe
- Intermountain Basins Big Sagebrush Shrubland
- Intermountain Basins Greasewood Flat
- Intermountain Basins Mixed Salt Desert Scrub

FIGURE 3.8-1
VEGETATION COMMUNITIES
MIDWAY GOLD US INC.
GOLD ROCK MINE PROJECT

MAPPED DATE: 9/2/2014
 0 2.5 5 Miles



U.S. BUREAU OF LAND MANAGEMENT
 ELY DISTRICT
 EGAN FIELD OFFICE

NO WARRANTY IS MADE BY THE BUREAU OF LAND MANAGEMENT AS TO THE ACCURACY, RELIABILITY, OR COMPLETENESS OF THESE DATA FOR INDIVIDUAL USE OR AGGREGATE USE WITH OTHER DATA.

Basemap Source: ESRI World Imagery Service
 Vegetation Data Source: EcoSynthesis 2013 and LANDFIRE 2013.



PATH: C:\USERS\CHENDOCUMENTS\PROJECTS\CITRIX\0001817_GOLDROCK\GIS\ARCMAP_P_MXD\2014_DRAFT_LEIS\FIGURE_3_8-1_VEGETATION_RVUC09022014B.MXD | LAST SAVED ON: 9/2/2014 9:50:00 AM

This page intentionally left blank.

and cover to pinyon-juniper/sparse understory. Understory vegetation is similar to black sagebrush shrubland (described below) although total shrub cover is lower, presumably due to competition with the tree layer and possibly also as a result of soils differences. However, the shrub component of this community does differ consistently from that of black sagebrush shrubland in that species of Mormon-tea, especially Nevada jointfir, are characteristically present as a constant but low proportion of the shrub cover throughout this plant community type within the Study Area (EcoSynthesis and WRC 2013).

Pinyon-juniper/littleleaf mountain mahogany sparse woodland

This woodland association (mapped only within the Study Area but also likely extending to other parts of the project area) is described in NatureServe (NatureServe 2014c) as having Utah juniper as the sole tree species; however, in the Study Area, pinyon is present as well. This community occurs on the upper parts of the limestone ridges that form the eastern side of the Plan area and touch the southern boundary. Littleleaf mountain mahogany dominates the shrub layer. This community is also characterized by the substantial coverage of gray limestone bedrock that outcrops at the surface. These outcrops support masses of rock spiraea and claret-cup cactus.

On the lower elevation flanks of the limestone hills, mountain mahogany is replaced by Stansbury's cliffrose. The herbaceous layer of this association is similar to that of pinyon-juniper/sparse understory, however, it is dominated by stemless mock goldenweed almost everywhere in the association (EcoSynthesis and WRC 2013).

Utah juniper woodland/sparse herbaceous understory

This association (mapped only within the Study Area but also likely extending to other parts of the project area) occurs in the lower elevation areas of the Study Area on fan remnant landforms and is similar to pinyon-juniper/sparse understory described above, except that single-leaf pinyon pine is absent (EcoSynthesis and WRC 2013).

Utah juniper woodland/black sagebrush understory

This association (mapped only within the Study Area but also likely extending to other parts of the project area) occurs in the lower elevation areas of the Study Area on fan remnant landforms and is similar to pinyon-juniper/black sagebrush association described above, except that single-leaf pinyon pine is absent (EcoSynthesis and WRC 2013).

Utah juniper/Rock outcrop

This unusual vegetation type for the Gold Rock project area (mapped only within the Study Area but also likely extending to other parts of the project area) occurs on one small rock outcrop in the southern part of the Study Area. The vegetation consists of juniper with shrubs and forbs that are characteristically found only on rocky substrates: dwarf goldenbush, broom snakeweed, and Drummond's false pennyroyal. Elsewhere, broom snakeweed is found only on non-alluvial rocky substrates (EcoSynthesis and WRC 2013).

Great Basin Xeric Mixed Sagebrush Shrubland (Black sagebrush shrubland)

This Ecological System occurs on dry flats and plains, alluvial fans, rolling hills, rocky hillslopes, saddles and ridges of the Great Basin and at elevations ranging between 1,000 and 2,600 meters amsl (3,280 to 8,528 feet). Shrublands are dominated by black sagebrush at mid and low elevations, and other sagebrush species at higher elevations, most likely alkali sagebrush in the project area (NatureServe 2014d). Great Basin Xeric Mixed Sagebrush Shrubland that has been mapped in the project area is shown on Figure 3.8-1. Three associations were identified

within the Study Area and are described below. These associations also likely extend to other parts of the project area.

Black sagebrush shrubland

This is the shrubland association (mapped only within the Study Area but also likely extending to other parts of the project area) that covers the most area within the Study Area (over 34 percent including the two complexes). It is consistently dominated by black sagebrush with little or no other shrub cover. The herbaceous layer is split roughly evenly between squirreltail, Sandberg blue grass, and Indian ricegrass (EcoSynthesis and WRC 2013).

Some sagebrush plants in gently sloping, lower elevation black sagebrush communities appeared to be hybrids between black and Wyoming big sagebrush based upon their intermediate stature, color, and presence of a moderate density of leaf glands. Such hybrids are not yet recognized in the taxonomic literature but are common in the Study Area and elsewhere in east-central Nevada (EcoSynthesis and WRC 2013).

Black sagebrush-cheatgrass complex

This map designation (mapped only within the Study Area but also likely extending to other parts of the project area) was used for areas on high alluvial fans, just below the limestone ridge landform, where sagebrush and nearly pure cheatgrass occur as alternating patches (not the two species mixed together as an association) (EcoSynthesis and WRC 2013).

Black sagebrush-Utah juniper complex

This map unit (mapped only within the Study Area but also likely extending to other parts of the project area) was used to show areas that are primarily black sagebrush with scattered juniper individuals or groups too small to be individually mapped as juniper woodland (EcoSynthesis and WRC 2013).

Inter-Mountain Basins Big Sagebrush Shrubland

This Ecological System typically occurs in broad basins between mountain ranges, plains and foothills and at elevations ranging between 1,500 and 2,300 meters amsl (4,920 to 7,544 feet). Shrublands are dominated by basin big sagebrush and Wyoming big sagebrush and may be accompanied or co-dominated by other shrubs. The perennial herbaceous component of this Ecological System, typically including several graminoid species, can contribute up to 25 percent vegetation cover (NatureServe 2014e). Inter-Mountain Basins Big Sagebrush Shrubland that has been mapped in the project area is shown on Figure 3.8-1. One association was identified within the Study Area and is described below. This association also likely extends to other parts of the project area.

Big sagebrush-(spiny hopsage or rabbitbrush)/squirreltail-Sandberg bluegrass shrubland

This association is dominated by big sagebrush and occurs in the lower parts of the small valleys within the Study Area, perhaps associated with deeper soils where the slopes flatten out. Total (absolute) shrub cover of this community averages 32.7 percent, nearly all of which is sagebrush, with minor and variable components of spiny hopsage and rabbitbrush species (yellow rabbitbrush and, very rarely, rubber rabbitbrush) (EcoSynthesis and WRC 2013).

It is a shrubland community rather than shrub-steppe; only an average of 4 percent absolute cover is provided by grass (mostly Sandberg bluegrass and squirreltail, but also some Indian ricegrass). The total shrub cover is consistently relatively low for big sagebrush vegetation (less than 33 percent) (EcoSynthesis and WRC 2013).

Inter-Mountain Basins Mixed Salt Desert Scrub

This Ecological System of open-canopied shrublands typically occurs on saline basins, alluvial slopes and plains. Vegetation is typically dominated by one to several shrub species, such as shadscale and four-wing saltbush and may be accompanied or co-dominated by other shrubs. The perennial herbaceous component of this Ecological System, typically including several graminoid and forb species, is sparse to moderately dense (NatureServe 2014f). Inter-Mountain Basins Mixed Salt Desert Scrub that has been mapped in the project area is shown on Figure 3.8-1.

This ecological system occurs within a mosaic of several different plant communities distributed on various geomorphic landforms in the lower elevations found in the western portion of the Study Area. Low hills, probably constituting fan remnants or ballenas, are vegetated by black sagebrush, described above. Some drainage floodplains and narrow inset fans support stringers of big sagebrush.

In the Study Area, other low-lying landforms and gentle hillslopes support salt desert scrubs of four kinds, described below (EcoSynthesis and WRC 2013). These communities also likely extend to other parts of the project area.

Yellow (downy) rabbitbrush - shadscale shrubland

This community is co-dominated by the two species for which it is named, and has little or no sagebrush of any species as an important constituent of the canopy, though occasional plants of black sagebrush or bud sage may occur. Other shrub species present vary both within and among patches, and typically include horsebrush and rubber rabbitbrush, sometimes also winterfat. Four-wing saltbush may be present but is rarely abundant and is certainly not dominant. Shrub cover is typically less than 20 percent, with <1 to 5 percent herbaceous cover (EcoSynthesis and WRC 2013).

Yellow (downy) rabbitbrush – bud sage shrubland

This plant community is very similar to the rabbitbrush-shadscale shrubland described above, but with bud sage as co-dominant rather than shadscale; in other respects (total cover, other species present), it is similar. The one quantitative transect studied in this association was the only undisturbed vegetation area within the Study Area where significant cover of cheat grass was found (EcoSynthesis and WRC 2013).

Winterfat shrubland

This community occurs in long narrow low-elevation patches, presumably where fine textured soil materials have filled ancient floodplains. It is overwhelmingly dominated by the single (sub)shrub species, with minimal cover of native grass (typically rice grass). When disturbed, winterfat vegetation may be heavily invaded by cheat grass, tumble mustard, bur buttercup, halogeton and/or Russian thistle (EcoSynthesis and WRC 2013; Blackburn et. al. 1968).

Greasewood shrubland

The greasewood shrubland community consists almost exclusively of the single species, with hardly any other shrub or herbaceous cover. It occurs in very small patches on gentle hillslopes in the western part of the Study Area (EcoSynthesis and WRC 2013).

Inter-Mountain Basins Big Sagebrush Steppe

This shrub-steppe Ecological System is dominated by perennial grass species associations and forbs (less than 25 percent cover) with one to several sagebrush species (and/or antelope

bitterbrush) dominating or co-dominating the open to moderately dense (10 to 40 percent cover) shrub component. The typical patchy shrub distribution and grassland appearance of this Ecological System is likely maintained by a natural fire regime (NatureServe 2014g). Inter-Mountain Basins Big Sagebrush Steppe that has been mapped in the project area is shown on Figure 3.8-1.

Inter-Mountain Basins Greasewood Flat

This Ecological System typically occurs on stream terraces and flats near drainages or may also form rings around sparsely vegetated playas. It often occurs as a mosaic of multiple vegetation communities consisting of open to moderately dense shrublands dominated or codominated by greasewood and may be accompanied or co-dominated by other shrubs. The herbaceous component of this Ecological System is usually dominated by grass species including western wheatgrass, alkali sacaton and Kentucky bluegrass (NatureServe 2014h). Inter-Mountain Basins Greasewood Flat that has been mapped in the project area is shown on Figure 3.8-1.

Human-Altered Areas

Human-altered vegetation types found in the Study Area that do not presently correspond to any associations or higher-level categories of natural communities although they may ultimately succeed into native grasslands, steppe, or shrublands are described below. Reclamation area vegetation occurs on the reclaimed Easy Junior mine facilities (waste rock dump, heap leach pile, and reclaimed roads) and reflects the seed mix believed to have been applied: bluebunch wheatgrass, western wheatgrass, and a few plants of four-wing saltbush; sometimes also rubber rabbitbrush or four-wing saltbush are present. Great Basin wild-rye and needle-and-thread also may be found along the reclaimed roads. The reclamation areas are remarkably weed free, but the roads support various densities of invasive species (usually low, but a few dense patches of tumble mustard were found) (EcoSynthesis and WRC 2013).

In areas of surface disturbance within the Easy Junior operations area and along existing County and other dirt roads, patches of non-native plants were observed that were too small to be mapped. Instead point data were collected at these locations as shown on Figure 3.8-1. These communities generally consist of monocultures of one or another of the following species: clasping pepperweed, blue mustard, halogeton, or tumble mustard (EcoSynthesis and WRC 2013).

A patch of vegetation along the eastern toe of the southern end of Meridian Ridge (shown on Figure 3.8-1 as “Post-fire Rabbitbrush”) is believed to be a result of a lightning-strike fire that was probably extinguished by continuing rainfall. This community consists of a stand of downy rabbitbrush with cheatgrass and native grasses and areas of non-native forbs such as tumble mustard (EcoSynthesis and WRC 2013).

Additionally, areas of human-altered vegetation and/or disturbed areas in the project area include herbaceous vegetation or shrubland in low-intensity developed areas and along developed roads (Figure 3.8-1). These types of vegetation are often directly associated with human impacts and development.

Noxious and Non-Native, Invasive Weeds

Both noxious weed species and invasive weed species are found in the project area. As noted in the Risk Assessment for Noxious and Invasive Weeds, Midway Gold (Gold Rock) Exploration Project, 2012 Amendment EA (BLM 2012h), the BLM Ely District 2008 Weed Assessment documents two weed species, whitetop/hoary cress and Russian knapweed, in the Exploration

Plan area, and along roads and drainages leading to the Exploration Plan area. Based on additional weed data received from the BLM both of these species have been recorded throughout the project area and treatments for these two species have been carried out in the project area since 2002 (BLM 2014e).

Whitetop/hoary cress, was observed along Green Springs Road. This species is subject to some nomenclatural and taxonomic uncertainty among the names (*Cardaria draba*, *Cardaria chalepensis*, *Lepidium draba*, and *Lepidium draba* subspecies *chalepensis*). As best as can be determined, the plants found in and near the Study Area (Figure 3.8-1) belong to different taxa, but both should be treated as noxious (Category C) (EcoSynthesis and WRC 2013). Based on specimens observed in the field, the plant in the Study Area is *Lepidium appelianum* (formerly *Cardaria pubescens*), and the plant on Green Springs Road may be *Lepidium appelianum* or either *L. chalepense* (formerly *C. draba* var. *repens*) or *L. draba* (formerly *C. draba* var. *draba*), but more likely *Lepidium appelianum* (Juncosa 2014).

Russian knapweed a Nevada Category B noxious weed was also recorded in the project area during BLM 2013 weed surveys. This species was identified in two locations, one along Easy Junior Road and another location along BLM Road 4006/CR 1180 at the west edge of the project area (BLM 2014e).

Noxious and non-native, invasive weeds were identified during the 2011 to 2013 biological surveys. One individual plant of the noxious weed tamarisk was encountered during the biological surveys, immediately adjacent to the west side of Easy Junior Road, and was removed with prior BLM approval (EcoSynthesis and WRC 2013).

One invasive, but not noxious, species was identified in the Study Area: tumble mustard. This plant occurs sporadically in many areas of disturbed soils, but in especially large masses in several patches in disturbed big sagebrush shrub steppe near the northern Study Area boundary (EcoSynthesis and WRC 2013).

Other non-native species were also identified in the Study Area, including blue mustard, clasping pepperweed, elongated mustard, cheat grass, halogeton, herb sophia, and bur buttercup. No Russian knapweed was noted in the Study Area (EcoSynthesis and WRC 2013).

Special Status Plants

The Endangered Species Act (ESA) of 1973 was enacted to protect endangered and threatened species and to provide a means to conserve their ecosystem. Under the ESA, endangered species are defined as being in danger of extinction throughout all or a significant portion of their range. Threatened species are likely to become endangered in the foreseeable future.

Section 7 of the ESA directs federal departments and agencies to ensure that actions authorized, funded, or carried out by them are not likely to jeopardize the continued existence of any threatened or endangered species or result in the destruction or adverse modification of their critical habitat. The USFWS determines the status of threatened and endangered species under the provisions of the ESA. The USFWS also maintains a listing of species or subspecies (i.e., taxa) that may warrant listing as threatened or endangered, and for which the USFWS has sufficient biological information to support a rule to list as threatened or endangered. These species are referred to as candidate species. Proposed species are those species (taxa) for which the USFWS has published a proposal to list as threatened or endangered in the Federal Register. Based on consultation with the USFWS, no federally-listed plant species are known to occur in the project area.

In addition to federally-listed, candidate or proposed species, the BLM maintains a list of Nevada sensitive species. The BLM Manual 6840.06 E (BLM 2008c) states that native species may be listed as sensitive if the species:

- Could become endangered or extirpated from a state, or within a significant portion of its range in the foreseeable future;
- Is under review [for listing as threatened or endangered] by the USFWS;
- Is undergoing significant current or predicted downward trend in habitat capability that would reduce the species' existing distribution, and/or population or density such that Federally-listed, proposed, candidate, or State-listed status may become necessary;
- Typically consists of small and widely dispersed populations;
- Inhabits ecological refugia, or specialized or unique habitats; and
- Is state-listed, but may be better conserved through application of BLM sensitive species status.

The BLM affords these species the same level of protection as federal candidate species. The BLM's policy for sensitive species is to avoid authorizing actions that would contribute to the listing of a species as threatened or endangered. The BLM Ely District maintains a Special Status Species List, which it last updated in 2012 (Lichtler 2013). Currently 39 plant species are on the list.

The Nevada Natural Heritage Program (NNHP) develops and maintains a cost-effective, central information source and inventory of the locations, biology, and status of all threatened, endangered, rare, and at-risk plants and animals in Nevada (NNHP 2014a). The NNHP's species list for White Pine County includes 47 plant species (NNHP 2014b).

Information provided during consultation with the NNHP (NNHP 2013) indicated that five plant species have been recorded near the project area, none of which are considered at-risk:

- Needle Mountain milkvetch (not on NNHP White Pine County list)
- Starveling milkvetch (on NNHP White Pine County list, tracked on watch list only)
- Shockley rockcress (on NNHP White Pine County list, tracked on watch list only)
- Dwarf peppercress (on NNHP White Pine County list, tracked on watch list only)
- Rayless tansy aster (on the White Pine County list and is tracked on a watch list only).

The state of Nevada protects all succulents (yucca, cholla, Joshua tree, cactus, etc.) under Nevada Administrative Code (NAC) 527.010 – 527.560. Based on consultation with the BLM and NNHP, knowledge of the distribution of uncommon plant species in east-central Nevada, and recognition that state statute protects evergreen trees, yuccas, and cacti species, the baseline study contractor developed a list of target species for the field survey (Table 3.8-2).

According to NNHP watch list, no plant species listed as endangered, threatened, or protected by the State of Nevada were expected in the geographic region and habitats of the project area; however, all cacti including very common species are protected by NRS 527.060ff. Some taxa not accorded any federal status are considered to be vulnerable by NNHP.

Table 3.8-2 Special Status Plant Species Targeted During the 2011-2013 Gold Rock Botanical Surveys¹

Common Name	Federal Status ²
Eastwood milkweed, Eastwood's milkvetch	SC, S
low feverfew	S
gumweed aster	-
Welsh's cryptantha	-
Masonic rockcress, sagebrush rockcress	-
Shockley's rockcress	-
stalked whitlow-grass	-
sand (club-)cholla	S
Blaine pincushion	SC, S
Torrey's milkvetch	S
Needle Mountains milkvetch	S
starveling milkvetch	-
parish phacelia	SC, S
Jaeger's beardtongue	S

Notes:

1 Includes some species not on the 2012 Ely District list but which are known to the biological baseline contractor from herbarium specimens or from experience might be expected. Field surveys were floristic, so any special status species encountered would be recorded, even if not on this target list. The level of conservation concern for some plant species changed after the initiation of field work. For example, Welsh's cryptantha was dropped from the BLM sensitive list because it is regionally common, but it is retained on this target list for completeness. Welsh's cryptantha and other NNHP watch list species would not merit consideration under NEPA, unless their status changes during the course of project planning and approval.

2 Federal statuses: E, listed endangered; T, listed threatened; C, candidate for listing under ESA; SC, listed as species of concern by USFWS; S, BLM sensitive in state of Nevada

Source: *EcoSynthesis and WRC 2013, USDA 2014a.*

None of these species were observed or identified during the biological baseline surveys. Results of the baseline surveys, site characteristics, and the absence of indicator plant species indicate that suitable habitat for the rayless tansy aster is not present in the Study Area (EcoSynthesis and WRC 2012a; BLM 2012h; EcoSynthesis and WRC 2013). Intensive survey for sand cholla was carried out over 238 miles of transects within the Study Area, and no plants of that species were found.

Many individuals of four common cactus species protected by NAC 527 were observed:

- Beehive cactus (occasional, mostly on ridges);
- Claret-cup cactus (common on rock outcrops);
- Plains prickly-pear (most abundant species, found in all habitats); and
- Simpson's plains-cactus (common on gentle slopes in black sagebrush).

In summary, during 2011 to 2013 vegetation baseline surveys, 170 plant species were identified in the Study Area, none of which are federally listed or candidate species, BLM sensitive species, or other special-status plant species (EcoSynthesis and WRC 2013). Four species of state-protected cactus species were observed in the Study Area.

3.9 WILDLIFE RESOURCES, INCLUDING MIGRATORY BIRDS AND SPECIAL STATUS WILDLIFE

As described in Section 3.8, six vegetation communities exist in the project area. These communities cover a variety of terrain from alluvial flats to rocky cliffs. The different vegetation, elevation, and terrain types provide suitable habitats in the project area for a variety of wildlife species.

This section describes wildlife species that occur or have the potential to occur in the project area. These species include big game, non-game, game birds, migratory birds, bats, and reptiles. Wildlife species with a special status, as defined by government agencies, are also addressed in this section and include species listed as threatened, endangered, proposed, candidate, or sensitive. Appendix 3C presents a list of scientific names for wildlife species noted in the EIS.

Existing Conditions

Wildlife

The wildlife species in the project area are typical of the arid/semiarid environment in the central Great Basin. Within the Study Area, a total of 39 bird, 18 mammal, and six reptile species were directly observed, detected by sign (tracks, burrows, scat, feathers, bones, or vocalizations), recorded by bat detectors, or caught in Sherman traps (live rodent traps) in the Plan area during the baseline biological studies (EcoSynthesis and WRC 2012a,b, 2013). No amphibians were identified and no fish or aquatic habitat is present in the Study Area.

Big Game

Big game species in the project area consist primarily of pronghorn antelope and mule deer. Mapped elk distribution is present immediately to the east of the project area (NDOW 2014). Big game species use a variety of habitats throughout the year. Mule deer, pronghorn antelope, and elk are known to move between seasonal ranges but are typically found at higher elevations during summer (“summer range”) and lower elevations during winter (“winter range”).

The NDOW manages big game species by Hunt Unit and/or Hunt Unit group. The Hunt Units near the project area are shown on Figure 3.9-1. The project area lies within NDOW Hunt Unit 131, which encompasses portions of the Pancake Range, White Pine Range, Egan Range, Little Smoky Valley, Newark Valley, Railroad Valley, and Jakes Valley. The mule deer population associated with Hunt Unit 131 and the project area is managed as part of Hunt Units 131 through 134. The pronghorn antelope population associated with Hunt Unit 131 and the project area is managed as part of Hunt Units 131, 145, 163, and 164. The elk population associated with Hunt Unit 131 and the project area is managed as part of Hunt Units 108, 131, and 132.

The population status and trend for mule deer associated with Hunt Unit 131 show favorable range conditions and a small population increase for the fourth consecutive year (NDOW 2013). The project area is located within 27,279 acres of mapped year-round range, 27,087 acres of mapped winter range, 13,283 acres of mapped crucial winter range, and 614 acres of mapped crucial summer range for mule deer (NDOW 2014) (Figure 3.9-2). NDOW telemetry data verify previous NDOW observations that deer from the Ruby Mountain deer herd migrate south across

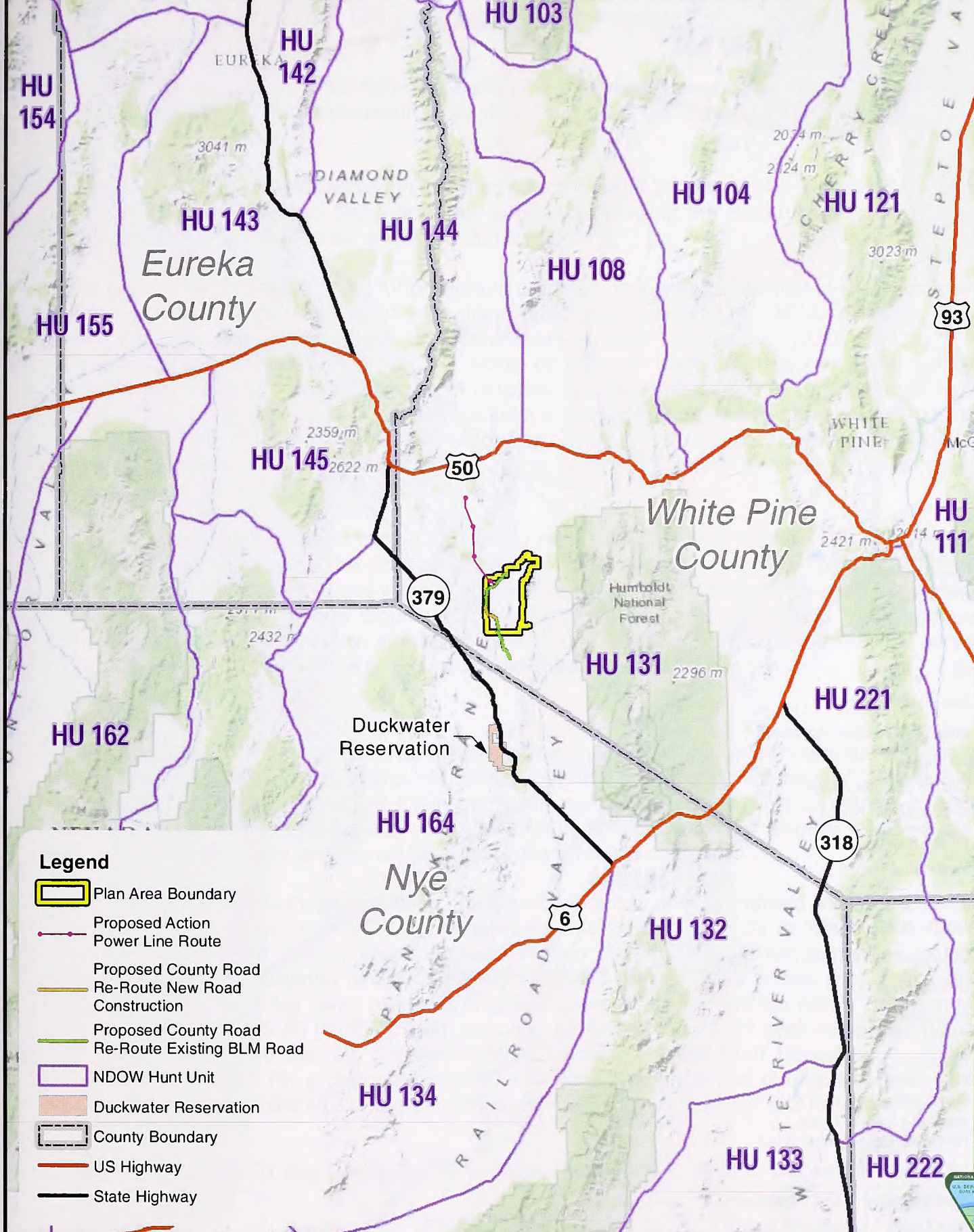

Legend

- Plan Area Boundary
- Proposed Action Power Line Route
- Proposed County Road
- Re-Route New Road Construction
- Proposed County Road Re-Route Existing BLM Road
- NDOW Hunt Unit
- Duckwater Reservation
- County Boundary
- US Highway
- State Highway

FIGURE 3.9-1
NDOW HUNT UNITS

MIDWAY GOLD US INC.
GOLD ROCK MINE PROJECT

MAPPED DATE: 8/2/2014

NOTE:
NDOW = Nevada Department
of Wildlife

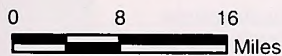

U.S. BUREAU OF LAND MANAGEMENT
ELY DISTRICT
EGAN FIELD OFFICE

NO WARRANTY IS MADE BY THE BUREAU OF
LAND MANAGEMENT AS TO THE ACCURACY,
RELIABILITY, OR COMPLETENESS OF THESE
DATA FOR INDIVIDUAL USE OR AGGREGATE
USE WITH OTHER DATA.

Basemap Source: ESRI World Topo Map Service

PATH: Z:\GIS\PROJECTS\ENVC0001817_GOLDROCK\GIS\ARCMAP_MXD\2014_DRAFT_EIS\FIGURE_3_9-1_NDOW_HUNT_UNITS_MN.MXD | LAST SAVED ON: 8/2/2014 1:14:57 AM

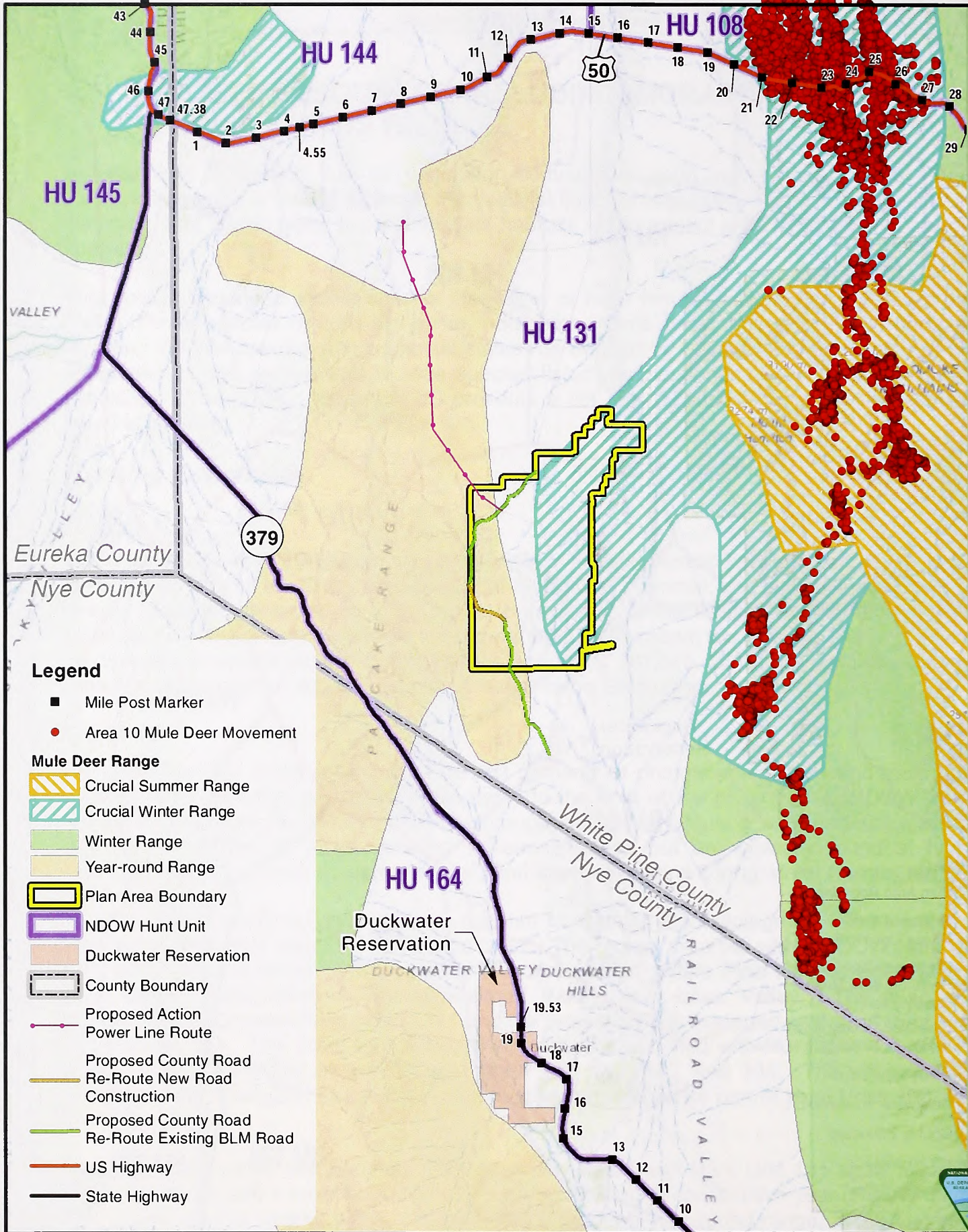
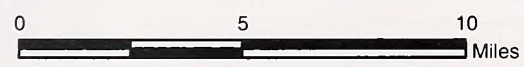

FIGURE 3.9-2
MULE DEER SEASONAL RANGES
MIDWAY GOLD US INC.
GOLD ROCK MINE PROJECT

MAPPED DATE: 10/16/2014



U.S. BUREAU OF LAND MANAGEMENT
 ELY DISTRICT
 EGAN FIELD OFFICE

NO WARRANTY IS MADE BY THE BUREAU OF LAND MANAGEMENT AS TO THE ACCURACY, RELIABILITY, OR COMPLETENESS OF THESE DATA FOR INDIVIDUAL USE OR AGGREGATE USE WITH OTHER DATA.

Basemap Source: ESRI World Topo Map Service
 Mule Deer Range Data Source: Nevada Department of Wildlife (NDOW).

US 50 in a corridor from Little Antelope Summit to the general area of the Green Springs turnoff (Figure 3.9-2). The Ruby Mountain mule deer herd uses the crucial winter range in and near the Plan area.

Mule deer were directly observed in the Study Area in April 2013 and their scat, tracks, antlers, and bones were observed throughout the wooded portions of the Study Area during baseline wildlife surveys (EcoSynthesis and WRC 2012a,b, 2013).

The population status and trend for pronghorn antelope associated with Hunt Unit 131 indicate a healthy population and a record high herd population estimate for 2012, although with a declining short-term trend based on below-average fawn recruitment (NDOW 2013). The project area is located within 131,242 acres of mapped year-round range, 5,518 acres of mapped winter range, and 238 acres of mapped crucial winter range for pronghorn antelope (NDOW 2014) (Figure 3.9-3). Pronghorn antelope scat was observed in desert scrub habitat in the westernmost portion of the Study Area during baseline wildlife surveys. Pronghorn antelope were also observed outside and to the west of the Study Area and to the south in Newark Valley (EcoSynthesis and WRC 2012a,b, 2013).

The 2013 population estimate for the elk herd in Hunt Units 131 and 132 was 450 elk, which is a 29 percent increase from the 350 elk estimated in 2012 (NDOW 2013). NDOW intends to adjust hunting quotas for these Hunt Units to achieve an elk population closer to 300 elk, as identified in the White Pine County Elk Management Plan (NDOW 2013). Elk scat was observed in the northeastern portion of the Study Area during baseline wildlife surveys (EcoSynthesis and WRC 2013). Figure 3.9-4 shows elk seasonal ranges.

Wildlife Collisions

Big game, particularly mule deer, pronghorn antelope, and elk, are of concern due to their use of the project area and vicinity and their ability to cause damage to vehicles and people during collisions. Big game's habits at dawn and dusk make them susceptible to vehicle collisions during periods of poor visibility and peak traffic for commuting workers. Smaller wildlife such as rabbits and coyotes are also at risk of mortality from vehicle collisions.

Vehicle-wildlife collisions may increase along roads in areas of concentrated wildlife populations and increased human activity. US 50 between mile posts 1 and 31 in White Pine County represents the most heavily impacted road section based on projected increases in traffic volume and the occurrence of big game winter range. Figure 3.9-2 shows mile post marker locations. Counts of big game road kills on US 50 were obtained from the NDOT between mile posts 1 and 31 of US 50 (NDOT 2014). According to these counts, 11 deer collisions (average of 1.8 per year) and five elk collisions (0.8 per year) occurred from December 1, 2008 to December 1, 2013. No pronghorn antelope collisions were reported during this time period. Table 3.9-1 summarizes NDOT big game collision data from December 1, 2008 to December 1, 2013.

Table 3.9-1 NDOT Big Game Collision Data: December 1, 2008 to December 1, 2013

County	Agency¹	Crash Date	Primary Street Name	Nearest Mile Post Marker	Species of Big Game
White Pine	NDOT	2/17/2009	US50	27	Deer
White Pine	NDOT	2/27/2009	US50	24	Deer
White Pine	NDOT	1/28/2010	US50	23	Deer
White Pine	NHP	2/3/2010	US50	23	Deer
White Pine	NDOT	2/4/2010	US50	24	Elk

Table 3.9-1 NDOT Big Game Collision Data: December 1, 2008 to December 1, 2013

County	Agency ¹	Crash Date	Primary Street Name	Nearest Mile Post Marker	Species of Big Game
White Pine	NHP	2/25/2010	US50	21	Deer
White Pine	NDOT	9/23/2010	US50	27	Elk
White Pine	NDOT	11/17/2010	US50	27	Elk
White Pine	NHP	12/16/2010	US50	25	Deer
White Pine	NDOT	1/27/2011	US50	25	Deer
White Pine	NDOT	1/27/2011	US50	25	Deer
White Pine	NDOT	1/31/2011	US50	23	Deer
White Pine	NDOT	11/14/2011	US50	30	Elk
White Pine	NDOT	7/18/2012	US50	26	Deer
White Pine	NHP	11/6/2012	US50	23	Elk
White Pine	NDOT	2/27/2013	US50	25	Deer

Notes:

1 NHP = Nevada Highway Patrol; NDOT = Nevada Department of Transportation

Source: NDOT 2014

It should be noted that while the NDOT (2014) data are the best available quantitative data on big game collisions in the vicinity of the Plan area. Not all big game road kills are reported to NDOT. In addition, many vehicle collisions that do not result in an obvious road kill go unreported. Therefore, the collisions reported in Table 3.9-1 likely only represent a small fraction of the total big game collisions on the roads near the Plan area.

Small Mammals

Based on Nevada Natural Heritage Program data, there are 50 species of small mammals (including rodents, rabbits, shrews, and bats) known to occur or with potential to occur in White Pine County (NNHP 2014c). Jackrabbits, ground squirrels, chipmunks, and packrats likely occur throughout the project area, based on the diversity of habitats. Small mammals incidentally observed in the Study Area during baseline wildlife surveys include the black-tailed jackrabbit, cliff chipmunk, desert cottontail, kangaroo rat, white-tailed antelope ground squirrel, woodrat, and deer mouse (EcoSynthesis and WRC 2012a,b, 2013). Pygmy rabbits may occur in the project area and vicinity and are described further in the Special Status Species section below. Five species of special status bat species were observed during baseline studies and are described further in the Special Status Species section below. Dark kangaroo mice, pale kangaroo mice, and a variety of BLM sensitive bat species may also occur in the project area and information on these species' habitats and occurrence is presented in the Special Status Species section in Table 3.9-4.

Predatory Mammals

Predatory mammal species known to occur or likely to occur in the project area include the mountain lion, bobcat, coyote, red fox, gray fox, kit fox, and badger. Coyote and kit fox scat were observed in the Study Area during baseline surveys (EcoSynthesis and WRC 2012a,b, 2013).

Reptiles

The project area provides suitable habitats for various species of reptiles found in the Great Basin. Reptiles observed in the Study Area during baseline surveys include the Great Basin gopher snake, Great Basin rattlesnake, desert horned lizard, greater short-horned lizard, side-blotched lizard, and western fence lizard (EcoSynthesis and WRC 2013).

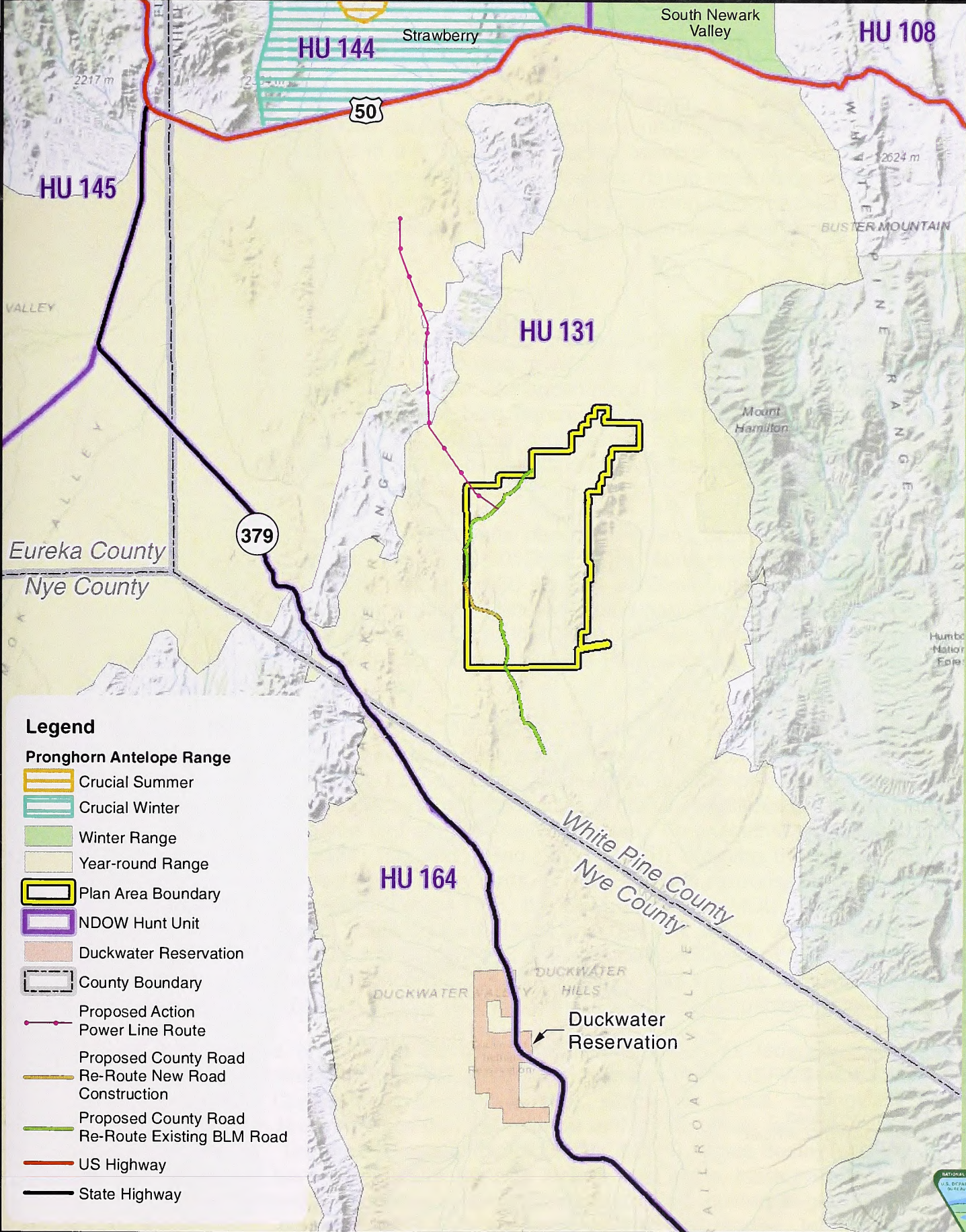

Legend

Pronghorn Antelope Range

- Crucial Summer
- Crucial Winter
- Winter Range
- Year-round Range
- Plan Area Boundary
- NDOW Hunt Unit
- Duckwater Reservation
- County Boundary
- Proposed Action Power Line Route
- Proposed County Road Re-Route New Road Construction
- Proposed County Road Re-Route Existing BLM Road
- US Highway
- State Highway

FIGURE 3.9-3
PRONGHORN ANTELOPE
SEASONAL RANGES
MIDWAY GOLD US INC.
GOLD ROCK MINE PROJECT
 MAPPED DATE: 8/2/2014

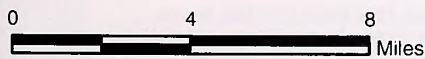

U.S. BUREAU OF LAND MANAGEMENT
 ELY DISTRICT
 EGAN FIELD OFFICE

NO WARRANTY IS MADE BY THE BUREAU OF LAND MANAGEMENT AS TO THE ACCURACY, RELIABILITY, OR COMPLETENESS OF THESE DATA FOR INDIVIDUAL USE OR AGGREGATE USE WITH OTHER DATA.

Basemap Source: ESRI World Topo Map Service
 Pronghorn Antelope Range Data Source: Nevada Department of Wildlife (NDOW)



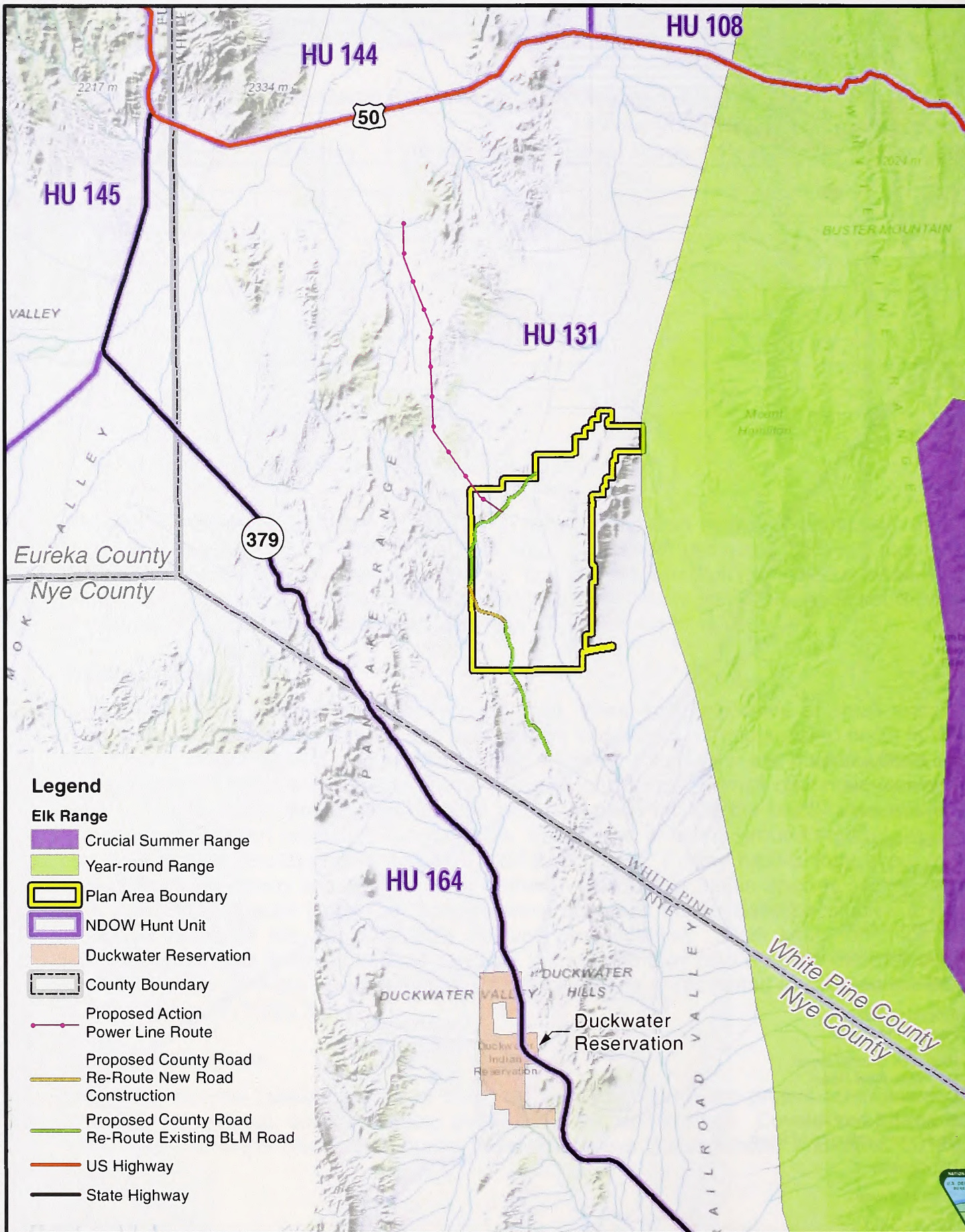

PATH: Z:\GIS\PROJECTS\ENVC0001817_GOLDROCK\GIS\ARCMAP_MXD\2014_DRAFT_EIS\Figure_3_9-4_ELK SEASONAL RANGES.MXD | LAST SAVED BY: JCHEN | LAST SAVED ON: 8/2/2014 11:29:21 AM

FIGURE 3.9-4
ELK SEASONAL RANGES

MIDWAY GOLD US INC.
GOLD ROCK MINE PROJECT

MAPPED DATE: 8/2/2014

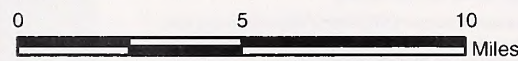

U.S. BUREAU OF LAND MANAGEMENT
ELY DISTRICT
EGAN FIELD OFFICE

NO WARRANTY IS MADE BY THE BUREAU OF LAND MANAGEMENT AS TO THE ACCURACY, RELIABILITY, OR COMPLETENESS OF THESE DATA FOR INDIVIDUAL USE OR AGGREGATE USE WITH OTHER DATA.

Basemap Source: ESRI World Topo Map Service
Elk Range Data Source: Nevada Department of Wildlife (NDOW).



Upland Game Birds

Chukar and greater sage-grouse are known to occur in and near the project area throughout the year. Chukar were observed in the Study Area during baseline surveys (EcoSynthesis and WRC 2012a,b, 2013). Greater sage-grouse were identified during consultation with the USFWS Nevada Fish and Wildlife Office, Reno, Nevada and are described in the Special Status Species section below. Mourning doves are also known to use the project area during migration and nest in low densities.

Migratory Birds

The project area provides suitable habitats for several migratory bird species, some of which are known to forage and nest nearby. According to NDOW, the following migratory bird species have been observed near the project area: American robin, blue-headed vireo, brown creeper, Cassin's finch, dusky flycatcher, great blue heron, green-tailed towhee, hairy woodpecker, hermit thrush, lesser goldfinch, red crossbill, violet-green swallow, warbling vireo, western tanager, white-breasted nuthatch, yellow-bellied sapsucker, yellow-rumped warbler, and yellow warbler (NDOW 2013, 2014).

Thirty-nine species of migratory birds were observed in the Study Area during baseline biological surveys (EcoSynthesis and WRC 2012a,b, 2013). Nine of these were raptor species, as described below. Most of the remaining 30 species were perching/song birds (passerines) that are commonly found in open shrubland and woodland habitats throughout Nevada. A full species list is provided in EcoSynthesis and WRC (2013). Migratory birds that have special status and suitable habitats within or adjacent to the Plan area are described further in the Special Status Species section below.

The Migratory Bird Treaty Act (MBTA [16 U.S.C. 703-712]) is a federal statute that makes it unlawful to take any migratory bird, part, nest, egg, or product thereof, with "take" defined as to pursue, hunt, shoot, wound, kill, trap, capture, or collect, or to attempt to pursue, hunt, shoot, wound, kill, trap, capture, or collect. Most bird species in the United States are legally protected under the MBTA, except game bird and non-native species. An executive order was issued in 2001 (Executive Order 13186) (66 Fed. Reg. 3853 [2001]) outlining the responsibilities of federal agencies with respect to migratory birds. The USFWS is responsible for enforcing the MBTA. Pursuant to Executive Order 13186, the BLM signed an MOU with the USFWS to promote the conservation of migratory birds (BLM and USFWS 2010). Among other actions, the MOU states that the BLM and the USFWS will work collaboratively to identify and address issues that affect species of concern, such as migratory bird species listed in the *Birds of Conservation Concern* (BCC) (USFWS 2008) and the USFWS Focal Species initiative.

BCC are bird species (in addition to those already designated as federally threatened or endangered) that represent the highest conservation priorities of the USFWS. USFWS (2008) lists BCCs by Bird Conservation Regions (BCRs), which are broad, ecologically distinct geographic regions in North America that have similar bird communities, habitats, and resource management issues. The project area is located within BCR 9 (Great Basin) (USFWS 2008). In BCR 9, BCCs that have the potential to occur include bald eagle, black rosy-finch, Brewer's sparrow, calliope hummingbird, eared grebe, ferruginous hawk, golden eagle, greater sage-grouse, green-tailed towhee, Lewis's woodpecker, loggerhead shrike, long-billed curlew, American peregrine falcon, pinyon jay, sage sparrow, sage thrasher, snowy plover, and Virginia's warbler.

Participants in the annual USGS North American Breeding Bird Survey (BBS) conduct surveys of birds during the peak of the nesting season (typically June) along fixed 24.5-mile-long routes

throughout North America. Each route includes 50 stops located at 0.5-mile intervals. A 3-minute point count is conducted at each stop, during which the observer records all birds heard or seen within 0.25 mile of the stop. These data are used to compile population trend analyses for more than 400 bird species. The nearest BBS route to the project area is the Illipah route, located along the western edge of Jakes Valley approximately 18 miles east of the project area. Between 1966 and 2011, the most abundant birds along this route included horned lark, Brewer's sparrow, sage sparrow, sage thrasher, and pinyon jay (Sauer et al. 2012).

According to NDOW, raptor species that have the potential to occur in the project area and vicinity include the American kestrel, bald eagle, barn owl, western burrowing owl, Cooper's hawk, ferruginous hawk, flammulated owl, golden eagle, great horned owl, long-eared owl, merlin, northern goshawk, northern harrier, northern saw-whet owl, osprey, peregrine falcon, prairie falcon, red-tailed hawk, rough-legged hawk, sharp-shinned hawk, short-eared owl, Swainson's hawk, turkey vulture, and western screech owl. Of these species, the ferruginous hawk, golden eagle, prairie falcon, and rough-legged hawk have been anecdotally observed in or near the project area (NDOW 2013, 2014). Figure 3.9-5 shows the PLSS sections in which NDOW has observed raptor nests near the project area. NDOW has not performed a comprehensive raptor survey of the project area.

Raptor species observed in the Study Area during baseline studies include the American kestrel, burrowing owl, Cooper's hawk, ferruginous hawk, golden eagle, northern harrier, prairie falcon, red-tailed hawk, and turkey vulture (EcoSynthesis and WRC 2012a,b, 2013). Suitable nesting habitats are available in the Study Area and immediate vicinity for all raptor species observed during baseline studies (EcoSynthesis and WRC 2012a). Raptor nests identified during 2013 baseline studies included four inactive and one active ferruginous hawk nests; three active, one inactive, and one unconfirmed golden eagle nests; and two active prairie falcon nests (EcoSynthesis and WRC 2012b, 2013). Figure 3.9-5 shows the PLSS sections where EcoSynthesis and WRC observed raptor nests near the Study Area during the 2013 baseline studies.

Special Status Species

The BLM defines special status species as those species that are federally listed or proposed and/or BLM sensitive species, which include both federal candidate and delisted species within 5 years of delisting (BLM 2008c).

Federally Listed, Proposed, and Candidate Species

The USFWS identified two species of concern that are known or expected to occur in or near the project area: the greater sage-grouse (candidate) and the Railroad Valley springfish (threatened). The USFWS recommended analysis for these species, because the species could potentially be affected by the project (USFWS 2013). These species are described below.

Greater Sage-Grouse

The greater sage-grouse is currently a candidate for listing under status review by the USFWS. Greater sage-grouse is also currently a BLM sensitive species and a State of Nevada-protected game bird managed in accordance with the *Greater Sage-Grouse Conservation Plan for Nevada and Eastern California* (Sage-Grouse Conservation Team 2004).

Between July 2002 and December 2003, the USFWS received several petitions requesting that the greater sage-grouse be listed as threatened or endangered range-wide. On April 21, 2004, the USFWS announced a 90-day petition finding in the Federal Register (69 FR 21484) that

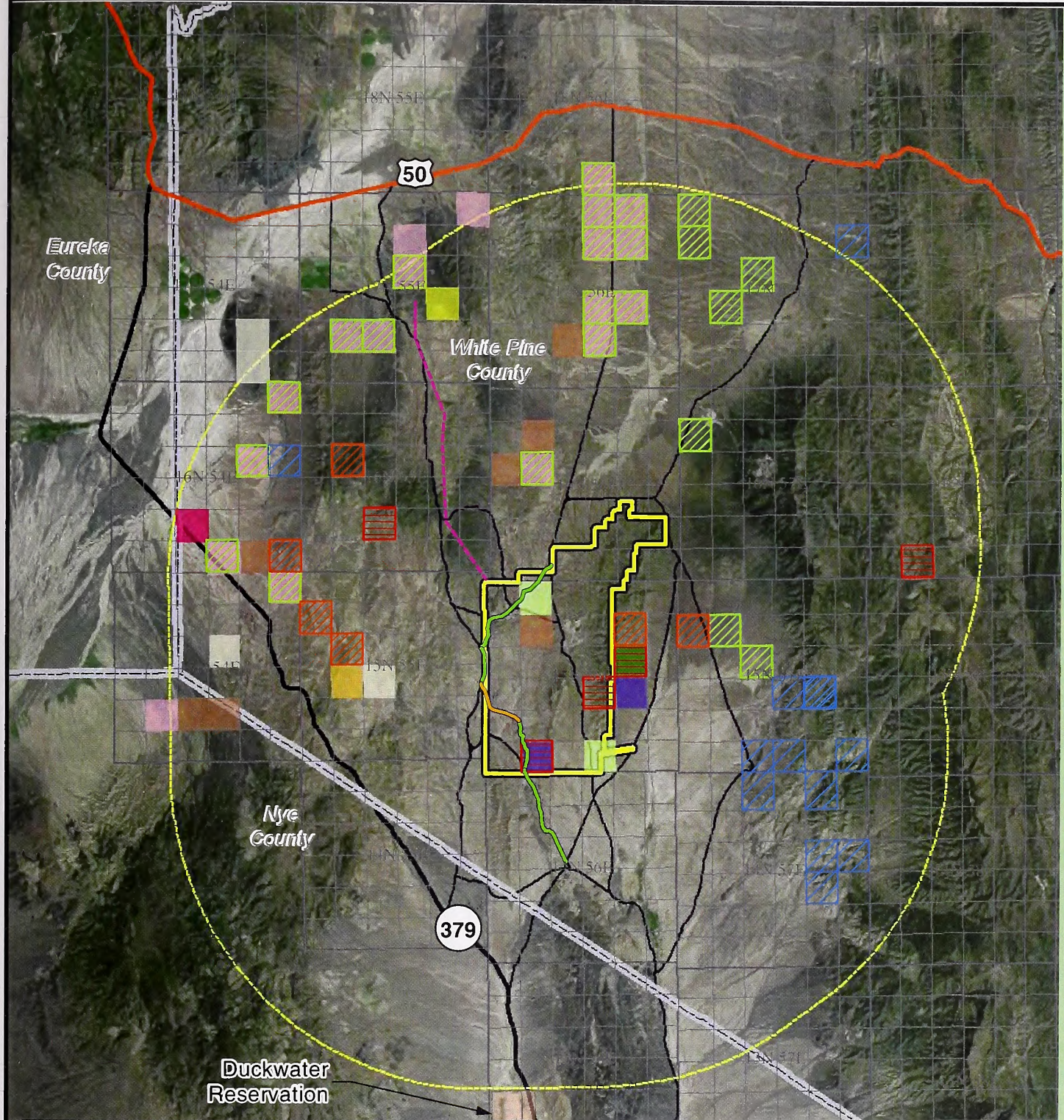

Legend

<p>Raptor Nest Locations (In Section) According to EcoSynthesis 2013</p> <ul style="list-style-type: none"> Active Golden Eagle Nest Active Ferruginous Hawk Nest Inactive Ferruginous Hawk Nest Active Prairie Falcon Nest 	<p>According to JBR 2011</p> <ul style="list-style-type: none"> Golden Eagle Nest, Status Unconfirmed <p>According to JBR 2012</p> <ul style="list-style-type: none"> Golden Eagle Nest, Status Unconfirmed Burrowing Owl Nest, Status Unconfirmed <p>According to JBR</p> <ul style="list-style-type: none"> Golden Eagle Nest, Status Unconfirmed Ferruginous Hawk Nest, Status Unconfirmed <p>According to NDOW 2012</p> <ul style="list-style-type: none"> Ferruginous Hawk Nest, Status Unconfirmed 	<p>According to NDOW *</p> <ul style="list-style-type: none"> Golden Eagle Nest Ferruginous Hawk Nest Prairie Falcon Nest Plan Area Boundary 10-Mile Radius of Plan Area Boundary Duckwater Reservation 	<ul style="list-style-type: none"> County Boundary PLSS Township PLSS Section US Highway State Highway Existing BLM or County Road in the Project Vicinity 	<ul style="list-style-type: none"> Proposed County Road Re-Route New Road Construction Proposed County Road Re-Route Existing BLM Road Proposed Action Power Line
--	---	--	---	--

* Nests came from letters dated 2012, 2013, and 2014

FIGURE 3.9-5
RAPTOR NESTS

MIDWAY GOLD US INC.
GOLD ROCK MINE PROJECT

MAPPED DATE: 10/16/2014

0 5 10
Miles



U.S. BUREAU OF LAND MANAGEMENT
ELY DISTRICT
EGAN FIELD OFFICE

NO WARRANTY IS MADE BY THE BUREAU OF LAND MANAGEMENT AS TO THE ACCURACY, RELIABILITY, OR COMPLETENESS OF THESE DATA FOR INDIVIDUAL USE OR AGGREGATE USE WITH OTHER DATA.

Basemap Source: ESRI World Imagery Service
NDOW = Nevada Department of Wildlife



PATH: Z:\GIS\PROJECTS\LEAVOC001817_GOLDROCK\GIS\MAP_3_9-5 RAPTOR NESTS RV10162014.MXD | LAST SAVED BY: JCHEN | LAST SAVED ON: 10/16/2014 4:37:49 PM

This page intentionally left blank.

these petitions, taken collectively, as well as information in their files, presented substantial information indicating that the petitioned actions may be warranted. On January 12, 2005, the USFWS announced that a 12-month review (70 FR 2244) of the best available scientific and commercial information found that listing the greater sage-grouse was not warranted. Western Watersheds Project filed a complaint on July 14, 2006, alleging that this finding was arbitrary and capricious under the Administrative Procedure Act (5 U.S.C. 701 et seq.). On December 4, 2007, the United States District Court, District of Idaho, ruled that the 12-month petition finding was in error and remanded the case to the USFWS for further consideration.

In February 2008 (73 FR 10218), the USFWS determined that it was appropriate to initiate a new status review to address information that became available after the 2005 petition finding. The 2005 finding had relied on information that was compiled in 2004; since that time, significant research and literature became available regarding threats, conservation measures, and population and habitat status of the greater sage-grouse. Further information was reviewed, and in March 2010, the USFWS published its decision on the petition to list the greater sage-grouse as "Warranted but Precluded" (75 FR 13910). In its "Warranted but Precluded" listing decision, the USFWS concluded that existing regulatory mechanisms, defined as "specific direction regarding greater sage-grouse habitat, conservation, or management" in the BLM's Land Use Plans, were inadequate to protect the species. The USFWS is scheduled to make a new listing decision in fiscal year 2015.

In response to the USFWS' inadequate regulatory mechanism findings and to avoid a potential listing, the BLM and the U.S. Forest Service (USFS) began a process to amend their land use management plans affecting greater sage-grouse habitat to incorporate greater sage-grouse conservation measures. Secretary of the Interior Salazar invited the states impacted by a potential greater sage-grouse listing to develop state-specific regulatory mechanisms to conserve the species and preclude the need for listing.

In July 2011 the BLM announced its *National Greater Sage-Grouse Planning Strategy* (BLM 2011b), which would review existing regulatory mechanisms and implement new or revised regulatory mechanisms through the land use planning process to conserve and restore the greater sage-grouse and its habitat. In August 2011, the BLM convened the Sage-Grouse National Technical Team (NTT), which brought together resource specialists and scientists from the BLM, State fish and wildlife agencies, the USFWS, NRCS, and USGS. The NTT met in Denver, Colorado in August and September 2011 and in Phoenix, Arizona in December 2011, and developed a series of science-based conservation measures to be considered and analyzed through the land use planning process. As a result of meeting and coordination, the NTT released *A Report on National Greater Sage-Grouse Conservation Measures* (NTT 2011). On December 27, 2011, the BLM released two Instructional Memoranda (IM 2012-043 and IM 2012-044) that provide direction to the BLM on how to consider the NTT conservation measures in the land use planning process and that provide interim management policies and procedures for the greater sage-grouse.

On March 30, 2012, Nevada Governor Sandoval issued Executive Order 2012-09, which established the Governor's Greater Sage-Grouse Advisory Committee with a directive to provide an updated strategy and recommended approach for greater sage-grouse conservation in Nevada. Prior to issuing its final report on July 31, 2012, the committee met for several months, taking significant evidence and expert testimony in public hearings with continuous participation and input from State and Federal agencies including the NDOW, the USFS, and the BLM.

On November 1, 2013, the BLM and the USFS released the *Nevada and Northeastern California Greater Sage-grouse Draft Land Use Plan Amendment and Environmental Impact*

Statement (greater sage-grouse DEIS [BLM and USFS 2013]), which describes alternatives for greater sage-grouse management and conservation measures that these agencies propose to incorporate into their land use plans. The agency preferred alternative in the greater sage-grouse DEIS incorporates management actions developed by adapting the NTT measures to the Nevada and Northeast California sub-region (BLM and USFS 2013). The BLM and USFS plan to finalize and approve the greater sage-grouse land use plan amendments by September 2014, with the ultimate goal of precluding the Federal listing of greater sage-grouse.

Populations of greater sage-grouse are allied closely with sagebrush (Connelly et al. 2000), meaning that they depend on big sagebrush and other sagebrush habitats for some part of their life cycle (Braun et al. 2005). They use sagebrush for breeding, roosting, cover, and food. According to Connelly et al. (2004), greater sage-grouse breeding habitats typically consist of sagebrush-dominated rangelands with extensive, relatively contiguous sagebrush stands, predominately on gentle terrain (less than 10 percent slope) and with relatively short distances to water (less than 2,000 meters [6,560 feet]). Leks (breeding display grounds) are situated in relatively open areas with less herbaceous and shrub cover than surrounding areas. Based on information from various studies across the range of the greater sage-grouse, leks may be located in dry stream channels, on the edges of stock ponds, on ridges, in grassy meadows, in burned areas, in gravel pits, on sheep bedding grounds, in plowed fields, and on roads. Leks are typically adjacent to or surrounded by dense sagebrush stands, which are used for escape and feeding cover (Connelly et al. 2004).

Nesting habitat includes sagebrush with horizontal and vertical structural diversity. The understory should be composed of native grasses and forbs, which provide food sources and among larger shrubs under which nests are placed (Connelly et al. 2004). Nesting habitat for greater sage-grouse in Nevada typically consists of big sagebrush communities with greater than 20 percent sagebrush canopy cover, greater than 30 percent total shrub cover, greater than 10 percent residual and live perennial grass cover, less than 5 percent annual grass cover, and less than 5 percent conifer encroachment (Sagebrush Ecosystem Technical Team 2014).

Brood-rearing habitats vary with age of the young greater sage-grouse. In Nevada, sagebrush stands with at least 10 percent canopy cover and at least 5 percent (in arid areas) to 15 percent (in mesic areas) perennial forb cover comprise the optimum early brood rearing habitat (Sagebrush Ecosystem Technical Team 2014). For late brood-rearing activities, which occur from about late June to early November, greater sage-grouse prefer moist habitats including riparian areas, wet meadows, lakebeds, and uplands including sagebrush and small burned areas within sagebrush (Stiver et al. 2010; Connelly et al. 2000).

During the winter, greater sage-grouse feed almost exclusively on sagebrush. In Nevada, they tend to frequent areas with a canopy cover of at least 10 percent sagebrush and an average sagebrush height of at least 25 cm (Sagebrush Ecosystem Technical Team 2014). They prefer areas with diverse topographic relief and sagebrush heights (BLM 2000a).

The project area is located within NDOW's Butte/Buck/White Pine Population Management Unit (PMU) for greater sage-grouse. Figure 3.9-6 shows the PMU boundaries near the project area, and Table 3.9-2 summarizes NDOW's lek survey data for this PMU since 2009. The Butte/Buck/White Pine PMU is relatively large compared to other PMUs in Nevada and, based on the data presented in Table 3.9-2, has a robust greater sage-grouse population that has been relatively stable for at least the past 4 years (NDOW 2012a).

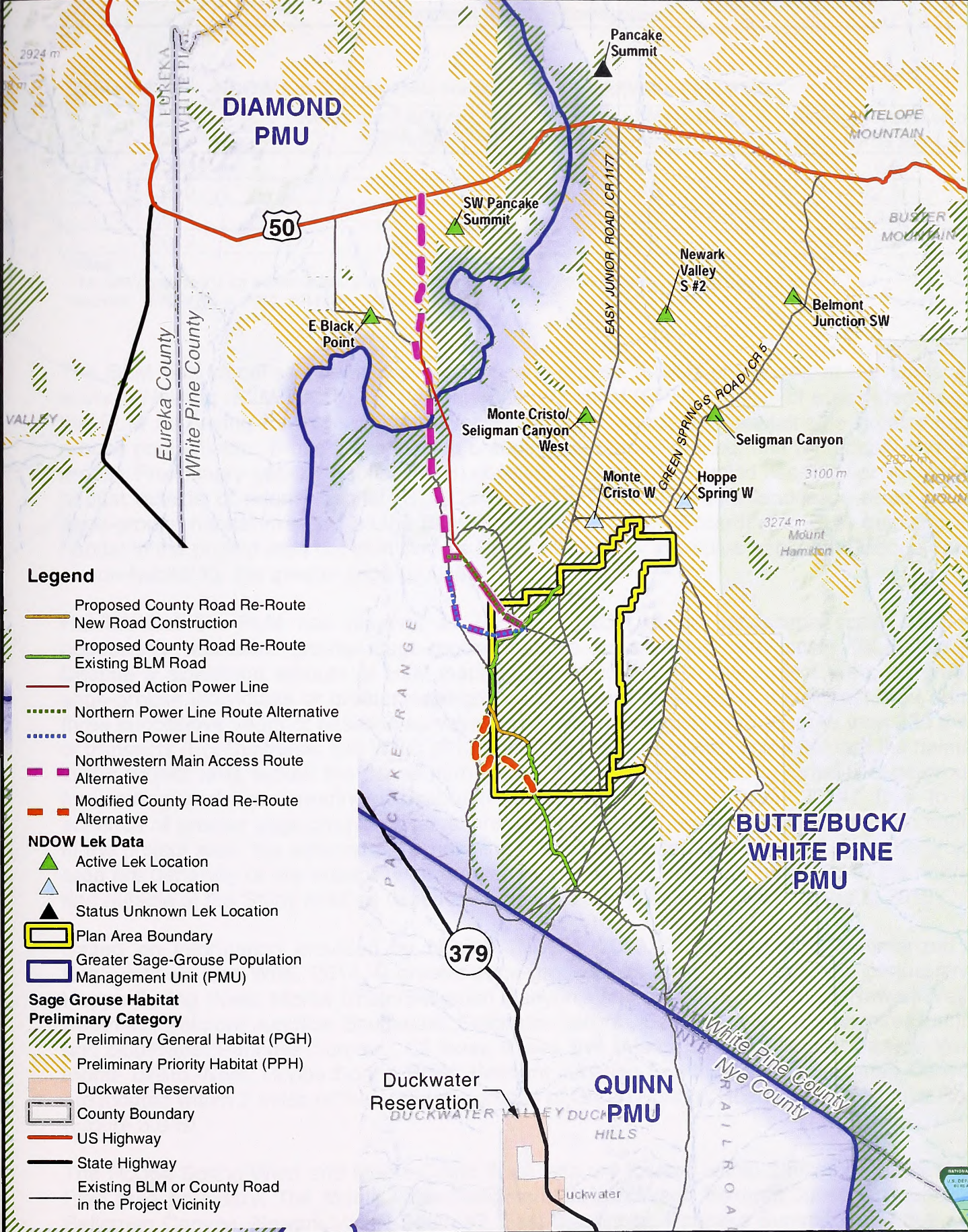

Legend

- Proposed County Road Re-Route
- New Road Construction
- Proposed County Road Re-Route
- Existing BLM Road
- Proposed Action Power Line
- Northern Power Line Route Alternative
- Southern Power Line Route Alternative
- Northwestern Main Access Route Alternative
- Modified County Road Re-Route Alternative
- Active Lek Location
- Inactive Lek Location
- Status Unknown Lek Location
- Plan Area Boundary
- Greater Sage-Grouse Population Management Unit (PMU)
- Sage Grouse Habitat Preliminary Category**
- Preliminary General Habitat (PGH)
- Preliminary Priority Habitat (PPH)
- Duckwater Reservation
- County Boundary
- US Highway
- State Highway
- Existing BLM or County Road in the Project Vicinity

FIGURE 3.9-6
GREATER SAGE-GROUSE POPULATION
MANAGEMENT UNITS AND
PRELIMINARY HABITAT CATEGORIES

MIDWAY GOLD US INC.
GOLD ROCK MINE PROJECT
 MAPPED DATE: 10/16/2014

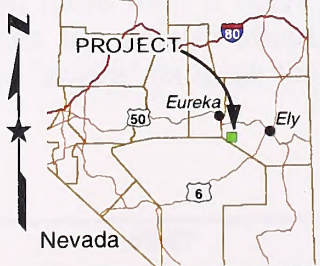
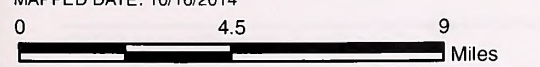

U.S. BUREAU OF LAND MANAGEMENT
 ELY DISTRICT
 EGAN FIELD OFFICE

NO WARRANTY IS MADE BY THE BUREAU OF LAND MANAGEMENT AS TO THE ACCURACY, RELIABILITY, OR COMPLETENESS OF THESE DATA FOR INDIVIDUAL USE OR AGGREGATE USE WITH OTHER DATA.

Basemap Source: ESRI World Topo Map Service
 NDOW = Nevada Department of Wildlife



PATH: Z:\GIS\PROJECTS\ENV\00001817_GOLDROCK\GIS\ARCMAP_MXD\2014_DRAFT_EIS\FIGURE_3_9-6_SAGEGROUSE_PMI_LAND_HABITAT_10162014.MXD | LAST SAVED BY: JOCHEN | LAST SAVED ON: 10/16/2014 4:46:00 PM

This page intentionally left blank.

Table 3.9-2 NDOW Lek Survey Data for the Butte/Buck/White Pine PMU

Year	Number of Active Leks Surveyed	Number of Male Birds Counted	Average Number of Male Birds per Lek
2009	43	698	16.2
2010	30	669	22.3
2011	33	655	19.8
2012	39	739	18.9

Notes:

The data presented is for all active leks surveyed in the Buck/Butte/White Pine PMU, not just trend leks.

Sources: NDOW 2009, 2010, 2011, and 2012a

The BLM has identified preliminary greater sage-grouse habitat categories at the landscape scale in Nevada (BLM 2011b). Preliminary priority habitat (PPH) consists of areas identified by the BLM as having the highest conservation value for maintaining sustainable greater sage-grouse populations. These areas include breeding, late brood-rearing, and winter concentration areas. Preliminary general habitat (PGH) consists of areas of occupied seasonal or year-round habitat outside of priority habitat (BLM 2011b). Figure 3.9-6 shows landscape-scale greater sage-grouse habitat mapped by the BLM in the project area. According to BLM mapping, the habitat in the project area not identified as PPH or PGH is of low value habitat/transitional range or non-habitat for the greater sage-grouse.

Habitat that the BLM has mapped as PPH and PGH at the landscape scale does not necessarily represent greater sage-grouse habitat on a project-level scale (BLM 2012e). Despite a significant amount of BLM-mapped PPH and PGH in the project area, no greater sage-grouse individuals or greater sage-grouse sign were observed in the project area during three successive years of baseline surveys during which biologists walked more than 230 miles of transects (EcoSynthesis and WRC 2012a,b, 2013). Biologists also observed that the habitats in the project area lacked the dense herbaceous understory preferred by greater sage-grouse for nesting and brood-rearing (Sagebrush Ecosystem Technical Team 2014). Due to the absence of greater sage-grouse observations and the lack of nesting and brood rearing habitat in the project area, the authors of the baseline studies concluded that the habitats in the project area are generally of low suitability for greater sage-grouse. Leks were observed to the north of and outside of the Study Area as described below (EcoSynthesis and WRC 2012a,b, 2013).

Based on information provided by NDOW (NDOW 2013, 2014) and also summarized by EcoSynthesis and WRC 2013, 9 greater sage-grouse leks are located near the project area: Hoppe Spring West, Monte Cristo/Seligman Canyon West, Monte Cristo West, Newark Valley South #2, Belmont Junction Southwest, Seligman Canyon, East Black Point, Pancake Summit, and Southwest Pancake Summit. Of these 9 leks, five (Monte Cristo/Seligman Canyon West, Monte Cristo West, Hoppe Spring West, Belmont Junction Southwest, and Seligman Canyon) are located within 2 miles of the northern portions of Green Springs Road and Easy Junior Road (Figure 3.9-6).

The Hoppe Spring West and Monte Cristo West leks are located within 2 miles of the northern Plan area boundary. The Monte Cristo/Seligman Canyon West, Belmont Junction Southwest, Seligman Canyon, Newark Valley South #2, East Blackpoint, Pancake Summit, and Southwest Pancake Summit leks are all located more than 2 miles north, northeast, or northwest of the Plan area. Table 3.9-3 summarizes the activity status of each lek based on NDOW data (NDOW 2013, 2014). NDOW defines "active" as a lek that had two or more males observed at least twice in the last 5 years.

During baseline studies in April 2011, April and May 2012, and March, April, and May 2013, male greater sage-grouse displaying activity was observed on several leks near the project area. These leks include Monte Cristo/Seligman Canyon West, Belmont Junction Southwest, and Seligman Canyon. The Hoppe Spring West and Monte Cristo West leks were also surveyed during baseline studies and no activity was observed at either of these leks (EcoSynthesis and WRC 2012a,b, 2013).

Table 3.9-3 Activity Status for Leks Identified by NDOW as Occurring In the Project Area

Lek Name	Last Survey	Approximate Location Relative to Plan Area	Approximate Distance to Nearest Road On Route To Mine	Status*
Monte Cristo West	2013	0.9 miles north	0 miles	Inactive
Hoppe Spring West	2013	1.2 miles north	0.3 miles	Inactive
Monte Cristo/Seligman Canyon West	2013	3.6 miles north	0.5 miles	Active
Seligman Canyon	2013	4.1 miles northeast	0 miles	Active
Newark Valley South #2	2013	6.6 miles north	1.5 miles	Active
Belmont Junction Southwest	2013	8.4 miles northeast	0.4 miles	Active
East Black Point	2013	9.9 miles northwest	1.6 miles	Active
Southwest Pancake Summit	2013	10.7 miles northwest	1.0 miles	Active
Pancake Summit	2002	14.2 miles north	1.8 miles	Unknown

Notes:

* NDOW defines "active" as a lek that had two or more males observed at least twice in the last 5 years.

Source: NDOW 2013, 2014; EcoSynthesis and WRC 2013.

The USGS is conducting an ongoing study of greater sage-grouse populations in the Pancake and White Pine Mountains, including capture and telemetry to assess movements of greater sage-grouse that attend leks in the Newark, Cathedral, Railroad, and Little Smokey Valleys (Coates et al. 2013; Andrie and Coates 2014). Thus far, this research has indicated that greater sage-grouse that attend the leks in the project area (including the East Black Point, Southwest Pancake Summit, Belmont Junction SW, and Newark Valley South #2 leks) generally stay in the vicinity of these leks during the spring, summer, fall and use habitats to the north and east of the Plan area. The telemetry data do not show greater sage-grouse using habitats within the Plan area (Coates et al. 2013; Andrie and Coates 2014).

Railroad Valley Springfish

In 1986, the Railroad Valley springfish was listed as threatened under the ESA. This small fish is isolated in six thermal springs in two areas of Railroad Valley, including Big Warm Spring and Little Warm Spring on the Duckwater Shoshone Reservation and in Big, Reynolds, Hay Corral, and North springs near Lockes Ranch. The fish historically occurred in Big Warm Spring and Duckwater Creek on the Duckwater Shoshone Reservation, but was extirpated from these sites. In 2007, Railroad Valley springfish were reintroduced to Big Warm Spring under a Safe Harbor Agreement between the USFWS and the Duckwater Shoshone Tribe (USFWS and Duckwater Shoshone Tribe 2007). Railroad Valley springfish remains common in Little Warm Spring. Introduced populations of this fish are also present in a spring in Hot Creek Canyon and in Chimney Spring near Lockes (USFWS 2012). There is no habitat or known occurrence of this species in the project area; however, several of the springs on which the species depends may be hydrologically connected to the groundwater underlying the project area.

Golden Eagle

The golden eagle is listed as sensitive by the BLM and is protected by the State of Nevada. Golden eagles are protected under the MBTA and the Bald and Golden Eagle Protection Act (BGEPA), which are enforced by the USFWS. The USFWS indicated a concern for the species and recommended analysis of project impacts to the affected individuals, their habitats, and regional populations. NDOW metadata suggest that as many as 11 historical golden eagle nests exist within 10 miles of the Plan area.

The golden eagle is a common permanent resident in the Great Basin. Most golden eagle nests in the Great Basin are located on ledges along canyon walls or on cliffs (Wildlife Action Plan Team 2013). Potentially suitable nesting habitat for the golden eagle is present on cliffs along the eastern boundary of the Plan area.

NDOW documented the occurrence of an active golden eagle nest immediately east of the Plan area in 1980 (NDOW 2013, 2014). NDOW checked this nest in 2011, and at that time the specialists considered the nest to be inactive (NDOW 2013, 2014). No eagle nests were observed in the location indicated by NDOW during baseline studies in 2012 and 2013.

NDOW records also indicate that a golden eagle nest was identified approximately two miles east of the Study Area and east of Meridian Ridge. NDOW last checked this nest in 2011, and considered it to be inactive. During baseline studies in 2012 and 2013, specialists surveyed this area from the ground and found no substrate (e.g., tree, rock outcrop) that could be used as a nest site by a golden eagle. Considering the availability of suitable nesting habitat in the surrounding area, this species is not likely to nest on the ground in this barren area. Based on discussions with NDOW, this record may be an error in the database related to digitizing of old records and/or conversion of Township, Range, and section (Fox 2014).

Five golden eagle nest territories were identified during baseline studies. Three were located within 0.5 mile of the Study Area boundary, including:

- A territory consisting of two nests located along Meridian Ridge. The Meridian Ridge territory was observed to be active in both 2012 and 2013.
- A territory located just east of the Study Area boundary and north of the Meridian Ridge territory, also consisting of two nests. This territory was observed to be active in 2012 but neither of the nests were occupied in 2013.
- A territory adjacent to the southern boundary of the Study Area consisting of two nests, one of which was active in 2013.

A fourth territory with one nest was observed approximately 4 miles west of the Study Area boundary during baseline surveys. This nest was presumed active in 2012 due to the presence of abundant whitewash, scat, pellets, and downy feathers, but no sign of activity was observed in 2013. A fifth territory with one nest was observed approximately 8 miles east of the Study Area boundary and was active in 2013 (EcoSynthesis and WRC 2012b, 2013). Locations and status of golden eagle nests identified during baseline studies are shown on Figure 3.9-5.

Baseline raptor nest surveys were conducted during fall 2012 and spring 2013 for the nearby Pan Mine EIS. During these surveys, two golden eagle nests were identified within the northern portion of the Pan Mine area and 39 were identified within a 10-mile buffer (BLM 2013c). Some of these nests overlap the Plan area and correspond with NDOW data as mapped on Figure 3.9-5.

BLM Sensitive and State of Nevada Protected Species

BLM sensitive species are defined as species that require special management consideration to avoid potential future listing under the ESA and that have been identified in accordance with procedures set forth in BLM Manual 6840 (BLM 2008c). The BLM also defines special status species as species that are federally listed or proposed, and BLM sensitive species, which include both federal candidate species and delisted species within 5 years of delisting (BLM 2008c). Nevada Administrative Code 503.030 through 503.050 identifies species listed as protected by the State of Nevada and further classifies those protected species listed as threatened and sensitive. Species identified as BLM sensitive and State of Nevada-protected with potential to occur in the Plan area, excluding greater sage-grouse and pygmy rabbit (which are described above and below), are listed in Table 3.9-4.

Pygmy Rabbit

Pygmy rabbits are a BLM sensitive species (BLM 2008c) that inhabit dense stands of sagebrush growing on deep, friable soil. They rely on sagebrush for food and cover. During the winter, big sagebrush may comprise up to 99 percent of the pygmy rabbit diet. Sagebrush canopy cover helps to conceal pygmy rabbits from predators. Pygmy rabbits also evade predators by digging their own burrows; they are one of only two species of rabbits in North America to do so (Larrucea and Brussard 2008).

Black sagebrush shrubland, which comprises the majority of sagebrush habitat in the project area, is not considered to be suitable for pygmy rabbits. Limited areas of big sagebrush habitat that are suitable for pygmy rabbits are present in the project area. These areas are primarily located in the north-northwestern portion of the Study Area (EcoSynthesis and WRC 2013).

Signs of pygmy rabbit were detected in the north-northwestern portion of the Study Area during baseline biological surveys. Biologists observed pygmy rabbit scat in six locations within the Study Area and in three locations outside the Study Area during baseline surveys (Ecosynthesis and WRC 2013).

In addition to the detections of pygmy rabbit scat described above, a pygmy rabbit and two burrows were directly observed just outside, approximately 82 feet (25 meters), and west of the north-northwest portion of the Study Area. BLM applies a 200-foot no-surface-occupancy buffer to pygmy rabbit burrows; therefore, the burrows found during baseline surveys would be subject to this mitigation measure. All detections of scat and direct pygmy rabbit and burrow observations are shown on Figure 3.9-7.

Special Status Bats

Acoustic surveys were conducted for bat species as part of the biological baseline studies in 2011 and 2012. Five special status bat species including the big brown bat, western small-footed myotis, long-eared myotis, little brown myotis, and Brazilian free-tailed bat, were identified in the Study Area during these surveys (EcoSynthesis and WRC 2013). Several special status bat species have suitable foraging and roosting habitat throughout the Plan area. These species and their habitat are described in Table 3.9-4. No mine shafts or caves that could serve as bat hibernacula have been identified within the analysis area (NBMG 2001; NDOM 2014).

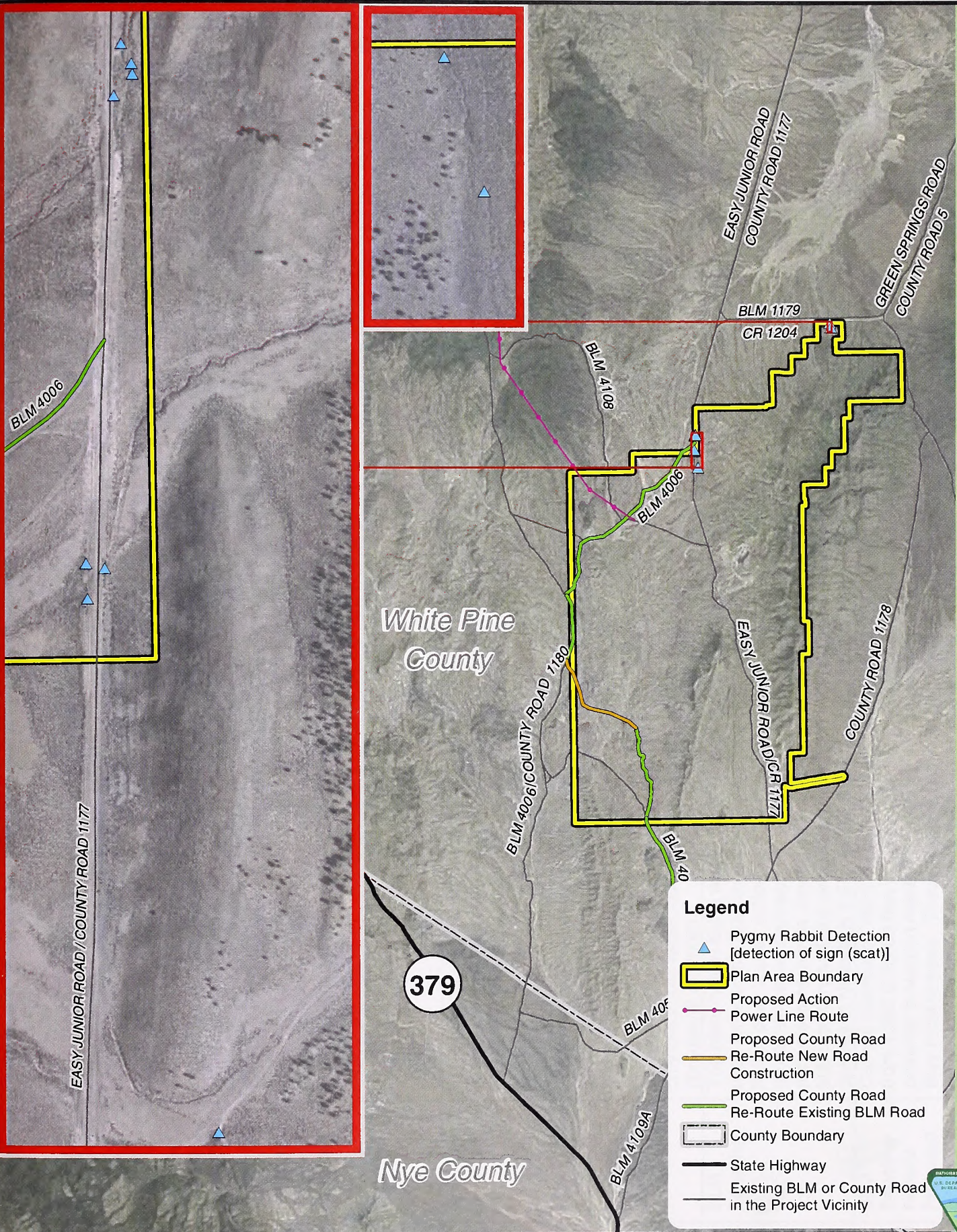

Legend

- Pygmy Rabbit Detection [detection of sign (scat)]
- Plan Area Boundary
- Proposed Action
- Power Line Route
- Proposed County Road
- Re-Route New Road Construction
- Proposed County Road
- Re-Route Existing BLM Road
- County Boundary
- State Highway
- Existing BLM or County Road in the Project Vicinity

FIGURE 3.9-7
PYGMY RABBITS
 MIDWAY GOLD US INC.
 GOLD ROCK MINE PROJECT
 MAPPED DATE: 12/1/2014

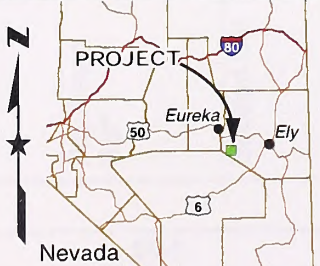
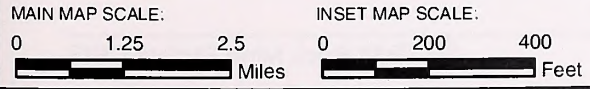

U.S. BUREAU OF LAND MANAGEMENT
 ELY DISTRICT
 EGAN FIELD OFFICE

NO WARRANTY IS MADE BY THE BUREAU OF LAND MANAGEMENT AS TO THE ACCURACY, RELIABILITY, OR COMPLETENESS OF THESE DATA FOR INDIVIDUAL USE OR AGGREGATE USE WITH OTHER DATA.

Basemap Source: ESRI World Imagery Map Service

This page intentionally left blank.

Table 3.9-4 BLM Sensitive and State of Nevada Protected Species with the Potential to Occur in the Plan Area

Common Name	Status	Description and Habitat	Potential to Occur in Plan Area
Pallid Bat	BLM Sensitive Nevada Protected	The pallid bat is found in a variety of habitats, ranging from low desert to coniferous forest. In Nevada, this species occurs between 1,380 and 8,150 feet in elevation in pinyon-juniper, blackbrush, creosote, sagebrush, and salt desert scrub habitats. Roost sites include rock outcrops, mines, caves, hollow trees, buildings, and bridges (Bradley et al. 2006).	Potential roosting habitat is available in rocky outcrops within and adjacent to the Plan area, and pinyon-juniper and shrubland foraging habitats are found throughout the Plan area.
Townsend's Big-eared Bat	BLM Sensitive Nevada Protected	Townsend's big-eared bats are found throughout Nevada between 690 and 11,500 feet in elevation. These bats use a variety of habitats including pinyon-juniper woodlands, white fir, blackbrush, sagebrush, salt desert scrub, agricultural fields, and sometimes urban areas. Townsend's big-eared bats roost in rock outcrops, mines, and caves (Bradley et al. 2006).	Mines and caves are limited in and near the Plan area (EcoSynthesis and WRC 2013; Nevada Bureau of Mines and Geology 2001); however, there are rock outcrops in and near the Plan area that could provide roosting habitat. Suitable pinyon-juniper and shrubland foraging habitats are present throughout the Plan area.
Big Brown Bat*	BLM Sensitive	In Nevada, the big brown bat is found between 980 and 9,850 feet in elevation. This species uses a variety of habitats including pinyon-juniper, blackbrush, creosote, sagebrush, agriculture, and urban areas. Big brown bats are well-adapted to human habitation. They roost in caves, trees, buildings, bridges, and mines (Bradley et al. 2006).	Trees, buildings, and bridges in and near the Plan area may provide potential roosting habitat. Suitable pinyon-juniper and shrubland foraging habitat is present throughout the Plan area.
Spotted Bat	BLM Sensitive Nevada Protected	The spotted bat is known from only 12 scattered localities throughout Nevada. Nevada records indicate that this species occurs between 1,770 and 6,990 feet in elevation in a variety of habitats ranging from desert scrub to high-elevation coniferous forest. Spotted bats have been found in pinyon-juniper, sagebrush, riparian, and urban habitats. They roost in crevices in cliff faces, but may occasionally roost in mines and caves (Bradley et al. 2006).	Potential roosting habitat is available in cliffs along the eastern boundary of the Plan area. Suitable pinyon-juniper and shrubland foraging habitat is present throughout the Plan area.
Silver-Haired Bat	BLM Sensitive	The silver-haired bat is widely distributed throughout Nevada, but primarily uses forested habitats including pinyon-juniper, subalpine fir, white fir, limber pine, aspen, cottonwood, and willow. During summer, this species roosts almost exclusively in trees; additional roost sites in the winter include rock crevices, mines, caves, and buildings. Silver-haired bats are migratory, but migratory patterns are poorly understood. The elevation range of this species in Nevada is 1,575 to 8,270 feet (Bradley et al. 2006).	The Plan area contains pinyon-juniper woodland that may provide suitable roosting and foraging habitat. Silver-haired bats may also pass through the Plan area during migration.
Western Red Bat	BLM Sensitive Nevada Protected	Current distribution records for the western red bat indicate that it occurs from 1,380 to 6,600 feet in elevation in Nevada. Western red bats are found primarily in wooded habitats, especially deciduous riparian areas, where they roost in trees. These bats are known to be migratory, but migration patterns are poorly understood (Bradley et al. 2006).	While there is no suitable deciduous woodland habitat in the Plan area that western red bats could use for roosting, there is potential for these bats to pass through the Plan area during migration.

Table 3.9-4 BLM Sensitive and State of Nevada Protected Species with the Potential to Occur in the Plan Area

Common Name	Status	Description and Habitat	Potential to Occur in Plan Area
Hoary Bat	BLM Sensitive	Hoary bat distribution is patchy throughout Nevada and the bats are primarily found in forested upland habitats. This is a tree-roosting species. Hoary bats are migratory, but migration patterns are poorly documented in Nevada. Distribution records indicate that this species occurs between 1,870 and 8,270 feet in Nevada (Bradley et al. 2006).	The Plan area contains pinyon-juniper woodland that may provide suitable roosting and foraging habitat. Hoary bats may also pass through the Plan area during migration.
California Myotis	BLM Sensitive	The California myotis is found throughout Nevada in a variety of habitats, ranging from low-elevation desert scrub to forests. Nevada distribution records range in elevation from 690 to 8,960 feet. Roost sites include rock crevices, mines, caves, buildings, hollow trees, and under tree bark (Bradley et al. 2006).	Potential roosting habitat is available in rocky outcrops within and adjacent to the Plan area. Suitable pinyon-juniper and shrubland foraging habitat is found throughout the Plan area.
Western Small-Footed Myotis*	BLM Sensitive	The western small-footed myotis is found throughout Nevada in a variety of habitats including desert scrub, grassland, sagebrush steppe, blackbrush, greasewood, pinyon-juniper woodlands, pine/fir forests, agricultural areas, and urban areas. It roosts in caves, mines, and trees. Western small-footed myotis have been documented at elevations ranging from 1,670 to 9,060 feet (Bradley et al. 2006).	Pinyon pine and juniper trees are available in the Plan area for roosting and suitable pinyon-juniper and shrubland foraging habitats are present throughout the Plan area.
Long-Eared Myotis*	BLM Sensitive	The long-eared myotis is distributed throughout Nevada at elevations ranging from 2,260 to 10,140 feet. The long-eared myotis is primarily associated with forests, but may be found in pinyon-juniper woodlands, sagebrush, and desert scrub habitats. Roost sites include tree hollows, spaces beneath tree bark, rock outcrops, and sometimes mines, caves, and buildings (Bradley et al. 2006).	Pinyon pine and juniper trees are available in the Plan area for roosting and suitable pinyon-juniper and shrubland foraging habitats are present throughout the Plan area.
Little Brown Myotis*	BLM Sensitive	The distribution and abundance of little brown myotis in Nevada is poorly understood. They are primarily found at higher elevations in association with coniferous forest. Roost sites include hollow trees, rock outcrops, buildings, mines, and caves (Bradley et al. 2006).	Potential roosting habitat is available in rocky outcrops, pinyon pine and juniper trees, and manmade structures within and adjacent to the Plan area. Suitable coniferous (pinyon-juniper) foraging habitat is present in the Plan area.
Fringed Myotis	BLM Sensitive Nevada Protected	In Nevada, the fringed myotis ranges in elevation from 1,380 to 7,090 feet and occurs in a variety of habitats including low desert scrub, high-elevation coniferous forests, creosote bush desert, pinyon-juniper woodlands, and white fir forests. This species roosts in mines, caves, trees, and buildings (Bradley et al. 2006).	Potential roosting habitat is available in pinyon pine and juniper trees and manmade structures within and adjacent to the Plan area. Suitable pinyon-juniper foraging habitat is present in the Plan area.

Table 3.9-4 BLM Sensitive and State of Nevada Protected Species with the Potential to Occur in the Plan Area

Common Name	Status	Description and Habitat	Potential to Occur in Plan Area
Long-Legged Myotis	BLM Sensitive	Nevada distribution records indicate that the long-legged myotis occurs between 3,050 and 11,220 feet in elevation and occupies pinyon-juniper, Joshua tree woodland, and montane coniferous forest habitats. This species also occasionally uses salt desert scrub, blackbrush, sagebrush, and mountain shrub habitats. Long-legged myotis primarily roost in hollow trees, although rock crevices, caves, mines, and buildings may also be used (Bradley et al. 2006).	Potential roosting habitat is available in pinyon pine and juniper trees as well as rocky outcrops within and adjacent to the Plan area. Suitable pinyon-juniper and shrubland foraging habitats are present in the Plan area.
Yuma Myotis	BLM Sensitive	The Yuma myotis is distributed between 1,470 and 7,680 feet in elevation in a wide variety of habitats, including sagebrush, salt desert scrub, agriculture, playas, and riparian habitats. Yuma myotis are well-adapted to human habitation and regularly roost in buildings in urban areas. Other roost sites include trees, mines, caves, bridges, and rock crevices (Bradley et al. 2006).	Potential roosting habitat is available in pinyon pine and juniper trees as well as rocky outcrops within and adjacent to the Plan area. Suitable shrubland foraging habitats are present in the Plan area.
Western Pipistrelle	BLM Sensitive	This small bat species is found throughout most of Nevada at elevations between 680 and 8,370 feet. Preferred habitat includes blackbrush, creosote, salt desert scrub, and sagebrush, with occasional use of Ponderosa pine and pinyon-juniper habitats. Western pipistrelles roost primarily in rock crevices, but also may be found in mines, caves, buildings, and vegetation (Bradley et al. 2006).	Potential roosting habitat is available in rocky outcrops within and adjacent to the Plan area. Suitable shrubland foraging habitats are present in the Plan area.
Brazilian Free-Tailed Bat*	BLM Sensitive Nevada Protected	Brazilian free-tailed bats use a wide variety of habitats ranging between 680 and 8,370 feet, from low deserts to high mountains. Brazilian free-tailed bats roost in cliff faces, mines, caves, buildings, bridges, and tree hollows, sometimes in large numbers (Bradley et al. 2006). The largest known colony in Nevada (Rose Guano Cave in White Pine County, approximately 65 miles east of the Plan area) has been estimated at 700,000 to 1.4 million individuals (Steel et al. 2011). These bats are known to be migratory (Bradley et al. 2006).	Trees, buildings, bridges, cliffs, and rocky outcrops in and near the Plan area may provide potential roosting habitat. Suitable pinyon-juniper and shrubland foraging habitat is present throughout the Plan area.
Dark Kangaroo Mouse	BLM Sensitive Nevada Protected	The dark kangaroo mouse burrows in gravelly sandy soil in valley bottoms and alluvial fans dominated by big sagebrush, rabbitbrush, and horsebrush. Its primary food source is seeds and insects. Dark kangaroo mice do not need to be near a water source, and instead obtain water from the food they consume (Wildlife Action Plan Team 2013).	Potential habitat is available in the sagebrush shrubland located throughout the Plan area; however, soil in the Plan area is generally unsuitable for this species. No kangaroo mice were captured during baseline trapping surveys (EcoSynthesis and WRC 2013). Additional surveys are planned for spring 2015.

Table 3.9-4 BLM Sensitive and State of Nevada Protected Species with the Potential to Occur in the Plan Area

Common Name	Status	Description and Habitat	Potential to Occur in Plan Area
Pale Kangaroo Mouse	BLM Sensitive Nevada Protected	The pale kangaroo mouse is restricted to fine, loose, sandy soil in saltbush and greasewood-dominated valley bottoms. It may also be found in sagebrush habitats near the higher end of its elevation range. It ranges between 3,900 and 6,000 feet in elevation (Wildlife Action Plan Team 2013).	Potentially suitable desert scrub habitat is available in the Plan area; however, soil in the Plan area are generally unsuitable for this species. No kangaroo mice were captured during baseline trapping surveys (EcoSynthesis and WRC 2013). Additional surveys are planned for spring 2015.
Pygmy Rabbit*	BLM Sensitive	The pygmy rabbit excavates burrows in deep, friable, loamy soil on plains and alluvial fans dominated by tall, densely clumped big sagebrush. Big sagebrush is the primary food source (Wildlife Action Plan Team 2013).	Potentially suitable big sagebrush habitat is available in the Plan area. Pygmy rabbit sign and individuals were observed along ephemeral drainages in the northernmost portion of the Study Area during baseline surveys (EcoSynthesis and WRC 2012b, 2013).
Bighorn Sheep	BLM Sensitive	Bighorn sheep inhabit a variety of vegetation communities depending on the season. They can be found anywhere from alpine mountains to desert grasslands; within these habitats, escape terrain (e.g., talus slopes, cliffs) is a key habitat feature. They primarily graze on grass, forbs, and shrubs. Bighorn sheep are not dependent on a freestanding water source and obtain their water from the food they consume (Wildlife Action Plan Team 2013).	Potential habitat is available in rocky cliff areas within and near the Plan area. However, the occurrence potential is low; according to NDOW, there is no known bighorn sheep distribution in the Plan area (NDOW 2013, 2014). A small area of mapped bighorn sheep distribution intersects the southeastern portion of the project area (NDOW 2014).
Northern Goshawk	BLM Sensitive Nevada Protected	In Nevada, the northern goshawk primarily nests in dense, mature stands of trees within aspen forests. Northern goshawks may forage in open sagebrush habitat adjacent to riparian aspen stands, where they prey on a variety of small mammals and birds (Wildlife Action Plan Team 2013).	There is no suitable nesting habitat for the northern goshawk within or near the Plan area. Use of the Plan area is expected to be limited to occasional foraging by transient or migrating individuals.
Western Burrowing Owl*	BLM Sensitive	The western burrowing owl inhabits areas of short vegetation with abundant small mammal burrows, including open grasslands, sagebrush, and sagebrush-steppe habitats. This species nests and roosts in burrows dug by small mammals such as ground squirrels, badgers, and foxes. In Nevada, western burrowing owls occur primarily in loose colonies in valley bottoms (Wildlife Action Plan Team 2013).	Potential open shrubland nesting and foraging habitat is available throughout the Plan area. One burrowing owl was observed in the western portion of the Study Area in April 2013 (EcoSynthesis and WRC 2013).

Table 3.9-4 BLM Sensitive and State of Nevada Protected Species with the Potential to Occur in the Plan Area

Common Name	Status	Description and Habitat	Potential to Occur in Plan Area
Ferruginous Hawk*	BLM Sensitive	In Nevada, ferruginous hawks most often occur in open sagebrush shrubland, saltbush-greasewood shrubland, and pinyon-juniper woodland habitats. Preferred nesting sites include live juniper trees, rock outcrops, and power line poles. Small mammals constitute this hawk's primary prey (Wildlife Action Plan Team 2013).	Potential nesting and foraging habitat is available in pinyon-juniper woodland and shrubland habitats throughout the Plan area. Ferruginous hawks are known to nest near the Plan area (NDOW 2013), and an active ferruginous hawk nest was observed within 1 mile of the eastern Study Area boundary during baseline studies (EcoSynthesis and WRC 2013).
Swainson's Hawk	BLM Sensitive	The Swainson's hawk uses open grasslands and shrublands and is well-adapted to agricultural areas. This raptor typically nests in scattered trees near open areas for foraging, usually in large, deciduous trees, often in riparian areas. The Swainson's hawk sometimes nests in junipers in the Great Basin (Great Basin Bird Observatory [GBBO] 2010).	Potential nesting and foraging habitat is available throughout the Plan area; however, preferred nesting habitats (deciduous trees in riparian areas) are absent.
Peregrine Falcon	BLM Sensitive Nevada Protected	The peregrine falcon occurs throughout Nevada in a variety of open habitats including open water, marshes, desert shrub, mountains, and open forest near suitable cliff nesting habitat. Nests are placed on ledges or in holes on cliff faces. Small- to medium-sized birds constitute the primary prey (Wildlife Action Plan Team 2013).	Potential cliff nesting habitat is present along the eastern boundary of the Plan area. Suitable open foraging habitat is present throughout the Plan area.
Pinyon Jay*	BLM Sensitive	Pinyon jays live in loose flocks primarily in pinyon-juniper woodlands, where they nest and forage. Foraging pinyon jays seem to prefer transitional areas where pinyon-juniper woodland is interspersed with sagebrush, whereas denser tree stands are used for nesting and roosting. Pinyon jays are usually found in areas with diverse woodland canopy closure and age structure, and are not typically found in large, contiguous tracts of mature, dense woodland (Wildlife Action Plan Team 2013).	Suitable pinyon-juniper woodland nesting and foraging habitat is available in the Plan area.
Bald Eagle	BLM Sensitive Nevada Protected	Only three to five nesting pairs of bald eagles are known to occur in Nevada; the majority of bald eagles that occur in the state are wintering birds. Nests are typically located in tall trees near permanent water sources (lakes, reservoirs, and major rivers). Wintering birds also typically forage near water sources; winter distribution is influenced by waterfowl concentrations or wetland sites with abundant dead fish (Wildlife Action Plan Team 2013).	There is no suitable nesting habitat for bald eagles in the Plan area or vicinity. Bald eagles may pass through the Plan area during migration or winter, but there is no suitable wetland foraging habitat.
Loggerhead Shrike*	BLM Sensitive Nevada Protected	Loggerhead shrikes are year-round residents of Nevada. They inhabit open country with scattered trees and shrubs, including desert scrub and open woodlands. Loggerhead shrikes nest in shrubs and small trees (Wildlife Action Plan Team 2013).	Potential woodland and shrubland nesting and foraging habitat is available throughout the Plan area.

Table 3.9-4 BLM Sensitive and State of Nevada Protected Species with the Potential to Occur in the Plan Area

Common Name	Status	Description and Habitat	Potential to Occur in Plan Area
Black Rosy Finch	BLM Sensitive	Black rosy finches are found among glaciers or beyond timberline. In the winter, they are found in open fields and cultivated lands. They are known to roost in mine shaft adits and feed primarily on seeds and insects (Wildlife Action Plan Team 2013).	There is no suitable nesting habitat in the Plan area. Potential winter habitat (open shrublands) is available throughout the Plan area.
Sage Thrasher*	BLM Sensitive Nevada Protected	The sage thrasher breeds and forages in tall sagebrush/ bunchgrass, juniper/sagebrush/bunchgrass, mountain mahogany/shrub, and aspen/sagebrush/bunchgrass communities in Nevada. Nests are placed in low shrubs. During winter, sage thrashers use arid and semi-arid scrub, brush, and thickets (Wildlife Action Plan Team 2013).	Suitable sagebrush nesting and foraging habitat is available throughout the Plan area. The sage thrasher was only recorded in the Study Area during April. It was noted in sagebrush-dominated habitats. Due to the lack of observations after April, it is unlikely this species breeds in the project area (Ecosynthesis and WRC 2013).
Brewer's Sparrow*	BLM Sensitive Nevada Protected	This species is found throughout Nevada in sagebrush communities. Brewer's sparrows nest in sagebrush communities with low shrubs and grasses and primarily feed on insects and seeds (Wildlife Action Plan Team 2013).	Suitable sagebrush nesting and foraging habitat is available throughout the Plan area. Within the Study Area, Brewer's sparrows were infrequently observed in sagebrush dominated habitat (Ecosynthesis and WRC 2013).

Notes:

* Documented during baseline studies (EcoSynthesis and WRC 2013).

3.10 RANGE RESOURCES

The BLM is responsible for the management of public rangelands within the area, which are divided into grazing allotments. The BLM issues and renews “term” grazing permits for portions or all of these allotments. The Northeastern Great Basin Resource Advisory Council (Northeastern Great Basin RAC) provides advice on the management of public lands and resources. In 1997 the Northeastern Great Basin RAC developed and approved Standards and Guidelines for Nevada’s Northeastern Great Basin Area (Standards). Each grazing permit is aimed at meeting the Standards.

One tool used to manage grazing is to specify the number of livestock allowed to graze on an area. The unit of measure used is an “animal unit month” (AUM), or the amount of forage needed to sustain one cow and her calf, one horse, or five sheep or goats for a month. The permittee is tasked with meeting the terms and conditions of each permit, including complying with the number of AUMs authorized. Grazing permits may also specify guidelines for feed, water and other management to ensure that the Standards are met.

Existing Conditions

Several allotments, grazing use areas, and grazing pastures are located in the project area (Figure 3.10-1):

- The Bull Corner/Poison Patch and Green Springs Valley grazing use areas in the Duckwater Allotment,
- The Monte Cristo Allotment,
- The West and East pastures of the South Pancake Allotment, and
- The 18 Mile House grazing use area and South Newark grazing pasture in the Newark Allotment

Available information on vegetation in the project area includes results from biological baseline studies performed between 2011 and 2013 within the Plan area. As described in Section 3.8, those studies indicated that vegetation in the Plan area is generally dominated by shrubland species (Figure 3.8-1). Black sagebrush, big sagebrush, hopsage, yellow rabbitbrush, rubber rabbitbrush, shadscale, and winterfat are the most common shrub species in the west and west-central portions of the Plan area. Pinyon-juniper woodlands occur at higher elevations in the eastern portion of the Plan area. Grasses and forbs occupy a small component of the understory and are generally comprised of Indian ricegrass, Sandberg bluegrass, squirreltail, needle grasses, and various annual grasses and forbs (Ecosynthesis and WRC 2013).

Range specialists gathered vegetation data for each of the allotments in 2009 as a part of the standards determination for each allotment. The Bull Corner/Poison Patch and Green Springs Valley grazing use areas in the Duckwater Allotment were found to be shrub dominated (primarily black sage, rabbitbrush and winterfat at Bull Corner/Poison Patch and winterfat in Green Springs). Neither Bull Corner/Poison Patch nor Green Springs Use Areas were meeting the standard vegetation guidelines for Salt Desert Shrublands and Sagebrush/Bunchgrass Rangelands. The Monte Cristo Allotment showed vegetation consistent with the expected plant community for the area (BLM 2009d). The primary plant communities on the South Pancake Allotment are winterfat with Indian ricegrass and black sagebrush with Indian ricegrass and

needle-and-thread. While the vegetation on the South Pancake allotment is consistent with the expected plant communities, on this allotment shrubs account for a greater composition than might be expected (BLM 2009a). Vegetation structure within the 18 Mile House grazing use area on the Newark Allotment are consistent with the expected plant community for the area, however again shrub composition is higher than would be expected (BLM 2009b).

Additional vegetation data for the 18 Mile House grazing use area collected in 2011 suggests that 43 percent of the area is covered by shrubs, including black sage, hopsage, four-wing saltbush, and winterfat. Grass cover was 13 percent and species included Sandberg bluegrass, Indian ricegrass, and squirreltail. Although more bluebunch wheatgrass was expected based on the NRCS rangeland ecological site description, Sandberg bluegrass was the dominant species. Some juniper also was present some sites had stability issues related to erosion (Lowrie 2013c).

Sources of water for livestock grazed on the allotments are limited. One active spring - Green Springs - occurs in the Green Springs Valley grazing use area of the Duckwater Allotment; however, the spring is located on private land and therefore not considered under BLM management. A number of dried springs are located throughout the Duckwater Allotment. The primary source of water for cattle, sheep, wild horses and wildlife are at water sources on private land, Forest Service land, or water haul sites (BLM 2009d). Water haul site locations have been agreed upon between the permittees and BLM within both the Bull Corner/Poison Patch and Green Springs grazing use areas. On the South Pancake Allotment one water tank is located on the western side of the valley near the border with the Newark Allotment and serves as a water source. Four water haul sites will be located throughout the allotment for use during authorized use periods (Swisher 2014, BLM 2009b). One spring located in the southern portion of the 18 Mile House grazing use area of the Newark Allotment serves as a water source (Swisher 2014b). One reservoir and five wells also serve as water sources within the 18 Mile House grazing use area (BLM 2009b). No springs or other natural surface waters occur within the Plan area.

Current grazing conditions for each of the allotments and grazing use areas located in or around the plan area are described in detail below. Table 3.10-1 provides a basic breakdown of the information about grazing use within the Plan area.

Information provided below is taken primarily from the Standards Determination Documents (SDD) prepared in 2009 by the BLM Egan Field Office in association with the renewal of grazing term agreements for the Duckwater, Monte Cristo, South Pancake and Newark grazing allotments. The purpose of the SDD documents is to evaluate and assess livestock grazing management achievement of the Standards and Guidelines for Nevada's Northeastern Great Basin Area. Standards are expressions of physical and biological conditions required for sustaining rangelands for multiple uses. Guidelines point to management actions related to livestock grazing for achieving the Standards. The SDD ranks each grazing unit according to three main categories 1) Upland Sites (Soils), 2) Riparian and Wetland Sites, and 3) Habitat. The only public riparian or wetland areas within the Plan area are located in the 18 Mile House grazing area of the Newark allotment, so this category was not evaluated within many of the SDD documents. For each of these categories the following rankings are assigned based on an assessment of the:

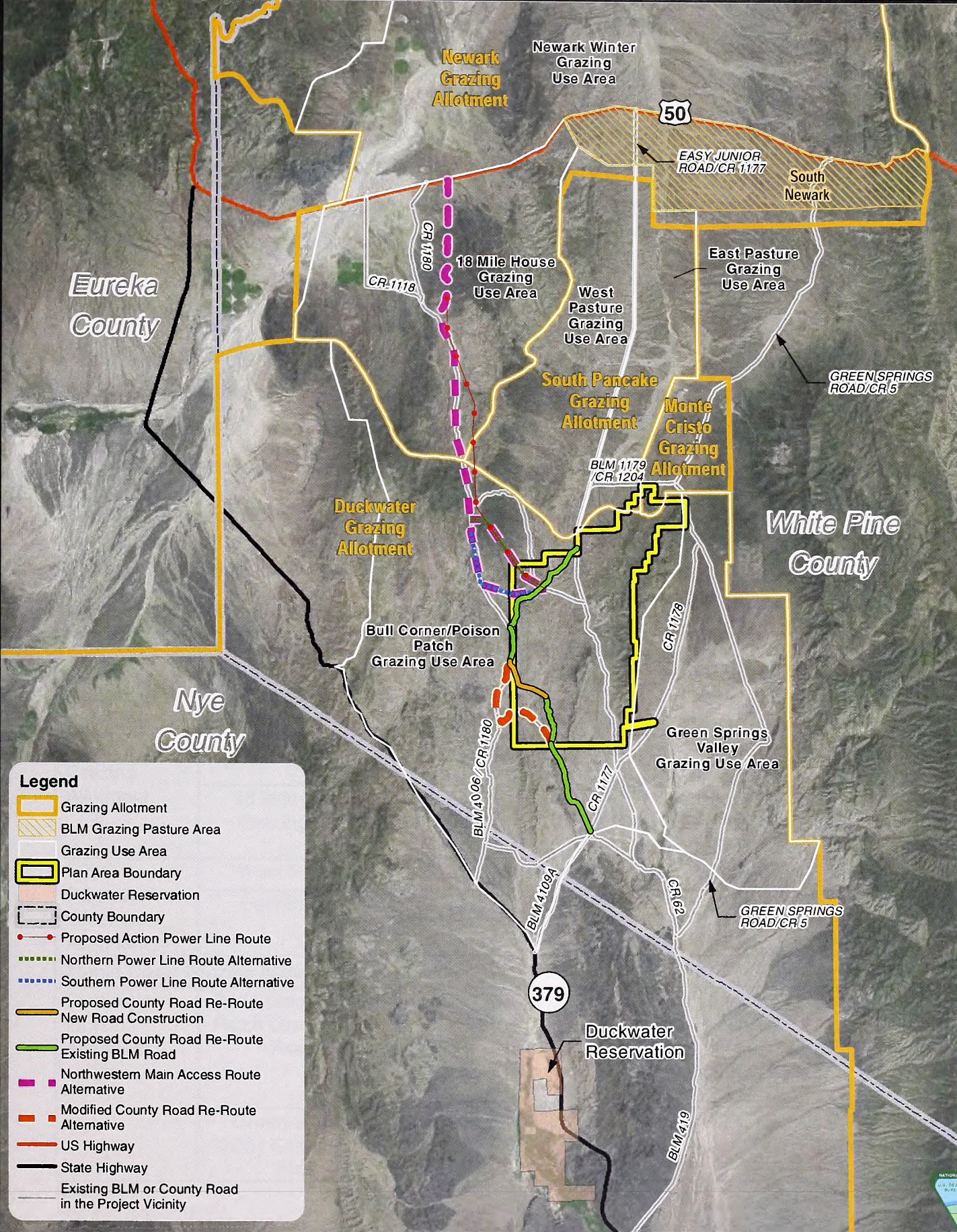
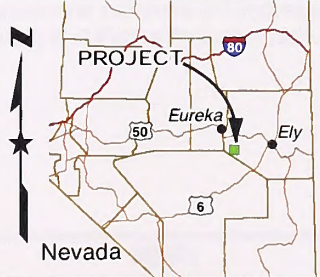
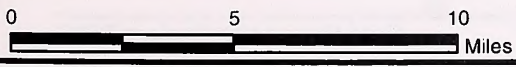

FIGURE 3.10-1
GRAZING ALLOTMENTS
MIDWAY GOLD US INC.
GOLD ROCK MINE PROJECT

MAPPED DATE: 9/18/2014



U.S. BUREAU OF LAND MANAGEMENT
 ELY DISTRICT
 EGAN FIELD OFFICE

NO WARRANTY IS MADE BY THE BUREAU OF LAND MANAGEMENT AS TO THE ACCURACY, RELIABILITY, OR COMPLETENESS OF THESE DATA FOR INDIVIDUAL USE OR AGGREGATE USE WITH OTHER DATA.

Basemap Source: ESRI World Imagery Map Service

PATH: C:\USERS\JCHEN\DOCUMENTS\PROJECTS\CITRIX\CO001817_GOLDROCK\GIS\MARMAP_MXD\2014_DRAFT_LEIS\FIGURE_3_10-1_GRAZINGALLOTMENTS_08182014.MXD | LAST SAVED BY: JCHEN | LAST SAVED ON: 9/18/2014 9:39:22 AM

This page intentionally left blank.

- Determination
 - Achieving the Standard
 - Not achieving the Standard, but making significant progress towards
 - Not achieving the Standard, not making significant progress towards
- Guidelines Conformance
 - In conformance with guidelines
 - Not in conformance with guidelines
- Livestock As A Causal Factor
 - Livestock are a contributing factor to not achieving the Standard
 - Livestock are not a contributing factor to not achieving the Standard
 - Failure to achieve the Standard is also related to other issues or conditions

The information outlined in these documents is then used to guide management practices within each allotment and grazing unit to and measure progress towards achieving the Standards and conforming to the Guidelines.

Table 3.10-1 Allotment Information and Grazing Use

Allotment Name	Grazing Unit/Pasture Name (As Applicable)	Total Acres	Active AUM (Total Allotment)	Permitted AUM (Pasture Specific)	Permitted Period
Newark Grazing Allotment	South Newark	15,901	9,709	420 Cattle/115 Cattle	Nov 1 – Apr 15
	18 Mile House Grazing Area	38,822		158 Cattle/102 Sheep/366 Sheep/578Cattle	Nov 1-Apr 15
South Pancake Grazing Allotment	West Pasture	22,825	1,155	715	Nov 1-Apr 15
	East Pasture	12,813		440	Nov 1-Apr 15
Monte Cristo Grazing Allotment		6,453	1,129	725	Jun 21-Sep 18
Duckwater Grazing Allotment	Bull Corner/Poison Patch Grazing Use Area*	73,901	20,098	Variable (approx. 531 Sheep/110 Cattle/approx. 1385 Cattle/approx. 633 Sheep/844 Sheep)	Typically 11/15 to 4/15
	Green Springs Valley Grazing Use Area	32,609		778 Cattle/90 Cattle	May 9-Jun 20/ Sep 19-Sep 30

Notes:

approx. = approximately

* Grazing permits for this grazing unit include AUMs not limited to Bull Corner/Poison Patch. AUMs shown are specific to Bull Corner/Poison Patch where possible with approximate numbers (~) representing permitted 30% of total AUMs for those permits issued for the entire Duckwater allotment including Bull Corner/Poison Patch.

Sources BLM 2014b.

Duckwater Allotment

The Duckwater Allotment covers approximately 807,662 acres of public land in both White Pine and Nye counties and is separated into 12 grazing use areas (BLM 2014b). In the northern portion of the allotment, the Bull Corner/Poison Patch grazing use area covers approximately 73,901 acres, and Green Springs Valley grazing use area covers approximately 35,609 acres. The eastern portion of the Duckwater allotment borders Forest Service lands, and the BLM manages approximately 21,941 acres within the Humboldt National Forest boundary in accordance with a 1980 MOU between the Forest Service and the BLM. The Duckwater Indian Reservation is entirely within the Duckwater Allotment. A large portion of the Duckwater Allotment is within the Pancake HMA. Portions of the allotment are within the Park Range Wilderness Study Area (WSA), the Blue Eagle WSA, and the Riordan's Well WSA. The eastern portion of the Duckwater Allotment borders the White Pine Wilderness Area and the Currant Mountain Wilderness Area. The Pancake Mountain Range is a major geographic feature in the allotment (BLM 2009d).

The Duckwater Allotment is managed for a total grazing preference of 45,448 AUMs. Of these, 20,098 AUMs are active and 25,390 AUMs are suspended. Period of use varies by permit and spans the year (BLM 2014b). As shown in Table 3.10-1 on the Bull Corner/Poison Patch grazing use area one cattle permits authorizes 110 AUMs from November 15 to January 31 and one sheep permit authorizes 844 AUMs from November 15 to April 15. In addition, three other permits authorize a total of 8,501 AUMs on the Duckwater Allotment with no specification as to grazing area (Swisher 2013). On the Green Springs Valley grazing use area a single cattle permit authorizes 778 AUMs from May 9 to June 20 and 90 AUMs from September 19 to 30 (Lowrie 2013a).

There are five permittees who use the Bull Corner/Poison Patch grazing use area of the Duckwater Allotment. Two sheep permits and one cattle permit have traditionally grazed lands surrounding the proposed Plan area. Two additional sheep permits are authorized to use in the areas surrounding the Plan area; however these permits holders have traditionally used other areas within the Bull Corner/Poison Patch Use Area. The BLM EFO processed grazing permit renewals for four of these five permits from 2009 to 2011, with permit terms expiring in 2020 and 2021. The fifth permit is currently up for renewal. The estimated AUMs for these five permits are shown in Table 3.10-1. For the purposes of analysis, these unspecified AUMs have been approximated for inclusion in Table 3.10-1 by estimating that 30 percent of the allotted AUMs may be distributed within the Bull Corner/Poison Patch grazing use area. The single permit for grazing in the Green Springs grazing unit was renewed in 2010 and is used mostly for transit between the Green Springs Ranch and allotments on Forest Service land.

During the grazing term permit renewal process in 2009, the BLM prepared an SDD in which it evaluated rangeland health in the Duckwater Allotment using the Northeastern Great Basin RAC Standards and Guidelines. The SDD did not evaluate or assess achievement of the Wild Horse and Burro Standards and Guidelines; however, the SDD included recommendations, based on findings, for future actions addressing wild horses in the Pancake Herd Management Area (BLM 2009d). A summary of the findings for the Bull Corner/Poison Patch and Green Springs Valley grazing use areas is as follows:

Bull Corner/Poison Patch Grazing Use Area

The 2009 SDD found that Bull Corner/Poison Patch Use Area was not achieving and not making significant progress towards the 1) Upland Sites (Soils) and 3) Habitat Standards. Winter grazing authorized by two sheep permits and a cattle permit were identified as not

contributing factors to the failure to achieve the land health standards; however spring/summer grazing authorized by a cattle permit was identified as a contributing factor. Other issues or conditions that contributed to the failure to achieve the land health standards included historical inappropriate livestock grazing practices, drought, and wild horse use. In terms of what is called the State and Transition Model, which is used statewide to classify the vegetative “state” of plant communities on public lands, portions of the salt desert shrub and sagebrush plant communities within the Bull Corner/Poison Patch Use Area have crossed a threshold to a shrub dominant or invasive species dominant state. These areas have a plant composition consisting of too many native shrubs and invasive species, and not enough herbaceous native grasses and forbs. These areas are classed as “shrub dominant” or “invasive Species” dominant areas (Lowrie 2013b).

According to a 2013 document provided by the BLM in the EAs prepared for the permit grazing term renewals, the identified cattle permit was modified and a grazing decision issued in 2010 with new terms and conditions of grazing use that are now making progress towards the land health standards. The other four permits also have grazing decisions in place that make progress towards or continue to achieve the land health standards (Lowrie 2013b).

Green Springs Valley Grazing Use Area

The 2009 SDD found that the Green Springs Use Area was not achieving the 1) Upland Sites (Soils) or 3) Habitat Standards, but that significant progress was being made towards standards achievement, and that cattle were not a contributing factor to the non-achievement of the Standards. Currently only one permit is issued for cattle grazing in this grazing unit. Non-achievement of the Standards was due to other issues or factors that included drought, wild horses, and historical inappropriate livestock management practices prior to 1995 (BLM 2009d). A grazing decision was issued in 2010 that renewed the permit with terms and conditions of grazing use that would continue to achieve or make progress towards achievement of the rangeland health standards for the Green Springs Use Area as well as the other use areas of this permit within the Duckwater Allotment (Lowrie 2013a).

Monte Cristo Allotment

The Monte Cristo Allotment covers approximately 6,138 acres of public land in White Pine County (BLM 2014b). The eastern portion of this allotment borders Forest Service lands. The Monte Cristo Allotment is within the Pancake HMA. No wilderness is designated within the allotment. The nearest wilderness is the White Pine Range Wilderness, which is approximately ten miles away. Due to its smaller size, the Monte Cristo Allotment is not divided into grazing use areas (BLM 2009d). The Monte Cristo Allotment is managed for a total grazing preference of 1,129 AUMs, as shown in Table 3.10-1. All of these AUMs are active. Currently, one permit authorizes 725 AUMs from June 21 to September 18 (BLM 2014b).

During the grazing term permit renewal process in 2009, the BLM prepared a SDD in which it evaluated rangeland health in the Monte Cristo Allotment. The SDD did not evaluate or assess achievement of the Wild Horse and Burro Standards and Guidelines; however, the SDD included recommendations, based on findings, for future actions addressing wild horses in the Pancake Herd Management Area (BLM 2009d).

The 2009 SDD for Monte Cristo found that the allotment was achieving the standard for 1) Upland Sites (Soils) and was not achieving the Standard, but making significant progress towards for 3) Habitat. Non-attainment of the Standards was not due to cattle grazing as cattle grazing did not occur on the allotment from 2003 to 2008. The non-attainment of the Habitat

Standard was due to other issues or factors that included drought, historic heavy ungulate grazing and lack of natural wildfire.

South Pancake Allotment

The South Pancake Allotment covers approximately 31,088 acres of public land in White Pine County. The South Pancake Allotment is within the Pancake HMA. No wilderness occurs within the South Pancake Allotment. The nearest wilderness areas are the White Pine Range Wilderness and Shellback Wilderness, which are approximately 15 miles away (BLM 2009a).

As shown in Table 3.10-1, the South Pancake Allotment is managed for a total grazing preference of 1,155 AUMs. All of these AUMs are active. Season of use is from November 1 to April 15 (BLM 2014b). During the term grazing permit renewal process in 2009, the BLM prepared an SDD in which it evaluated rangeland health in the South Pancake allotment. The SDD did not evaluate or assess achievement of the Wild Horse and Burro Standards or conformance to Guidelines (BLM 2009a).

The 2009 SDD for South Pancake found that the allotment was achieving the standard for 1) Upland Sites (Soils) and was not achieving the Standard, but making significant progress towards the standard for 3) Habitat. Non-attainment of the Habitat Standard was not determined to be due to livestock grazing. In fact sheep primarily forage on shrubs, which will not harm grasses and could allow for grass conditions to improve. The non-attainment of the Habitat Standard was likely due to wild horse and wildlife use, variable precipitation, and altered natural disturbance regimes that occur on the South Pancake Allotment.

Newark Allotment

The Newark Allotment covers approximately 218,105 acres of public land in White Pine County. The allotment is located in the Newark Valley. The northeastern portion of the Newark Allotment is within the Triple B HMA and the southern portion of the allotment is within the Pancake HMA. No wilderness occurs within the Newark Allotment. The nearest wilderness is the Shellback Wilderness, which is approximately 10 miles away (BLM 2009b).

The Newark Allotment is managed for a total grazing preference of 13,052 AUMs, as shown in Table 3.10-1. Of these, 9,709 are active AUMs and 3,343 are suspended nonuse AUMs. Season of use varies by permit and spans the year. In the South Newark pasture area, the BLM has authorized 535 AUMs. In the 18 Mile House grazing use area of the Newark Allotment, the BLM has authorized 1,204 active AUMs and no suspended use AUMs. Season of use for both pastures is November 1 to April 15 (BLM 2014b).

During the term grazing permit renewal process in 2009, the BLM prepared an SDD (BLM 2009b) in which it evaluated rangeland health in the Newark allotment. The SDD did not evaluate or assess achievement of the Wild Horse and Burro Standards or conformance to Guidelines (BLM 2009b).

The 2009 SDD for Newark allotment found that the allotment was achieving the standard for 1) Upland Sites (Soils), was not achieving the Standard, nor making significant progress towards the Standard for 2) Riparian and Wetland Sites, and was not achieving the Standard, but making significant progress towards the standard for 3) Habitat. Specific determinations were not available for the 18 Mile House or the South Newark grazing use areas. Livestock are a contributing factor in not achieving the Standard for Riparian and Wetland sites and failure to meet the standard is also related to other issues or conditions. During the development of the SDD six springs on the Newark Allotment were assessed for proper functioning condition.

These springs were considered to be representative of livestock use of riparian areas across the allotment. While most of these springs were found to be in proper functioning condition, some had been impacted by livestock grazing of bank vegetation and some bank trampling. Non-attainment of the Habitat Standard was not determined to be due to livestock grazing. The reasons for the loss of grasses and forbs in the Newark allotment are unknown at this time. In addition to livestock grazing, wild horse and wildlife use, variable precipitation, and altered natural disturbance regimes occur on the Newark Allotment.

3.11 FOREST PRODUCTS AND FUELS

Existing Conditions

Forest Products

Forest products harvested in the project area primarily consist of: fuel wood (dead wood and green wood), fence posts, and pine nut harvesting. In the project area single-leaf pinyon and Utah juniper provide the majority of the forest products. As described in section 3.8, these species are found in the Great Basin Pinyon-Juniper Woodland Ecological System and related plant associations. Most of the pinyon-juniper woodlands are located in the eastern portion of the project area (Figure 3.8-1). The NRCS compiles information on community productivity for the various pinyon-juniper community types. Community productivity information on mapped vegetation community types in the project areas is presented in Table 3.11-1.

Greenwood and Christmas Tree Cutting

Due to the lack of access roads to potential firewood cutting areas, and the relatively small diameter of the pine and juniper trees present in the project area, currently no active commercial tree cutting operations and no “personal tree cutting permits” exist in the Plan area. Two proposed commercial fuelwood harvest areas, one for 10.6 acres and one for 4.3 acres, are located along Green Springs Road and extend east towards the mountains (Figure 3.11-1). These permits are associated with the Mount Hamilton Mine ROW. These permits would be issued when the Mount Hamilton Mine proponent begins construction on the proposed access road, which is anticipated in summer 2014. The permits would cover removal of a total of 25 cords of wood, which is the estimated amount of wood that would be cleared during construction of the proposed road (Coombs 2014a,b).

Cutting of trees outside of any wilderness boundary is allowed for recreationists (campfires) and other authorized public land users (Mabey 2013). Only single-leaf pinyon pine and Utah juniper may be cut on BLM-administered lands in the Ely District. Christmas tree cutting can occur in the project area, and Christmas tree permits are available through the BLM EFO. No active permits and no permit applications exist, and access to areas that support the trees is limited (Mabey 2013).

Pine Nut Harvest

The public can collect up to 25 pounds of pinyon pine nuts each year with no cost and no permit required. A permit is required to collect more than 25 pounds annually. The majority of public lands administered by the BLM are open to the general public for pine nut collection. All pine nuts that are intended for resale require a permit/contract with the BLM. Approximately 1,220 acres of commercial pine nut collection acres are located in the project area, far to the northeast near the junction of US Highway 50 and Green Springs Road (Figure 3.11-1). This commercial pine nut area is active and was last used in 2011 (BLM 2014e).

Fuels

Throughout most of the region, the historical approach to fire management has been based on suppression, with limited use of prescribed fire or fuels management. This can lead to the development of a dense understory and limit the growth of a healthy herbaceous understory. Wildfire management within the Plan area falls under the Ely District Managed Natural and Prescribed Fire Plan. According to the current plan, there are no allowable burn acres in the project area (BLM 2000b). No wildfires have occurred or have been documented in the project area in the past 30 years. The project area does not fall within an allowable burn acre zone (BLM 2000b).

During the 2011 through 2013 vegetation field studies, an area of approximately 8.4 acres within the Study Area was documented as post-fire rabbitbrush, and the altered vegetation in the area was attributed to a lightning strike fire which was then extinguished by rainfall. It is expected that fires of this type are fairly common in the project area.

Table 3.11-1 Community Productivity for Mapped Vegetation Community Types in the Project Area

Community Type	Productivity Capacity	Fuelwood Production	Posts	Merchantable Timber	Christmas Trees	Pinyon Nuts
Pinyon-juniper/sparse understory woodland	Moderately low potential for tree production <1.3-2.7 cubic feet per acre per year	Relatively low fuelwood production, less than 3 cords per acre	Approximately 5 to 15 posts (7 feet in length) per acre in stands with medium canopy cover	Does not typically yield merchantable (dimension) timber	Approximately 5 trees per acre per year in medium canopy stands	150 pounds per acre in unfavorable years to 450 pounds per acre in favorable years
Pinyon-juniper/black sagebrush sparse woodland	Low to moderate potential for tree production with a growth rate, of 2.2 to 4.6 cubic feet per acre per year	Relatively low fuelwood production, from 3 to 6 cords	Approximately 15 to 30 posts (7 feet in length) per acre in stands with medium canopy cover	Does not typically yield merchantable (dimension) timber	Approximately 15 trees per acre per year in medium canopy stands and approximately 30 trees per acre per year in sapling stage stands	from 250 pounds per acre in unfavorable years to 500 pounds per acre in favorable years
Pinyon-juniper/little leaf mountain mahogany sparse woodland	Low quality for tree production with a growth rate of 3.3 to 5.2 cubic feet per acre per year	Relatively low fuelwood production, 4 to 7 cords (128 cubic feet) per acre	Approximately 15 posts (7 feet in length) per acre in stands with medium canopy cover	Does not typically yield merchantable (dimension) timber	Approximately 5 trees per acre per year in medium canopy stands and approximately 10 trees per acre per year in sapling stage stands	from 250 pounds per acre in unfavorable years to 500 pounds per acre in favorable years in stands with medium canopy cover classes

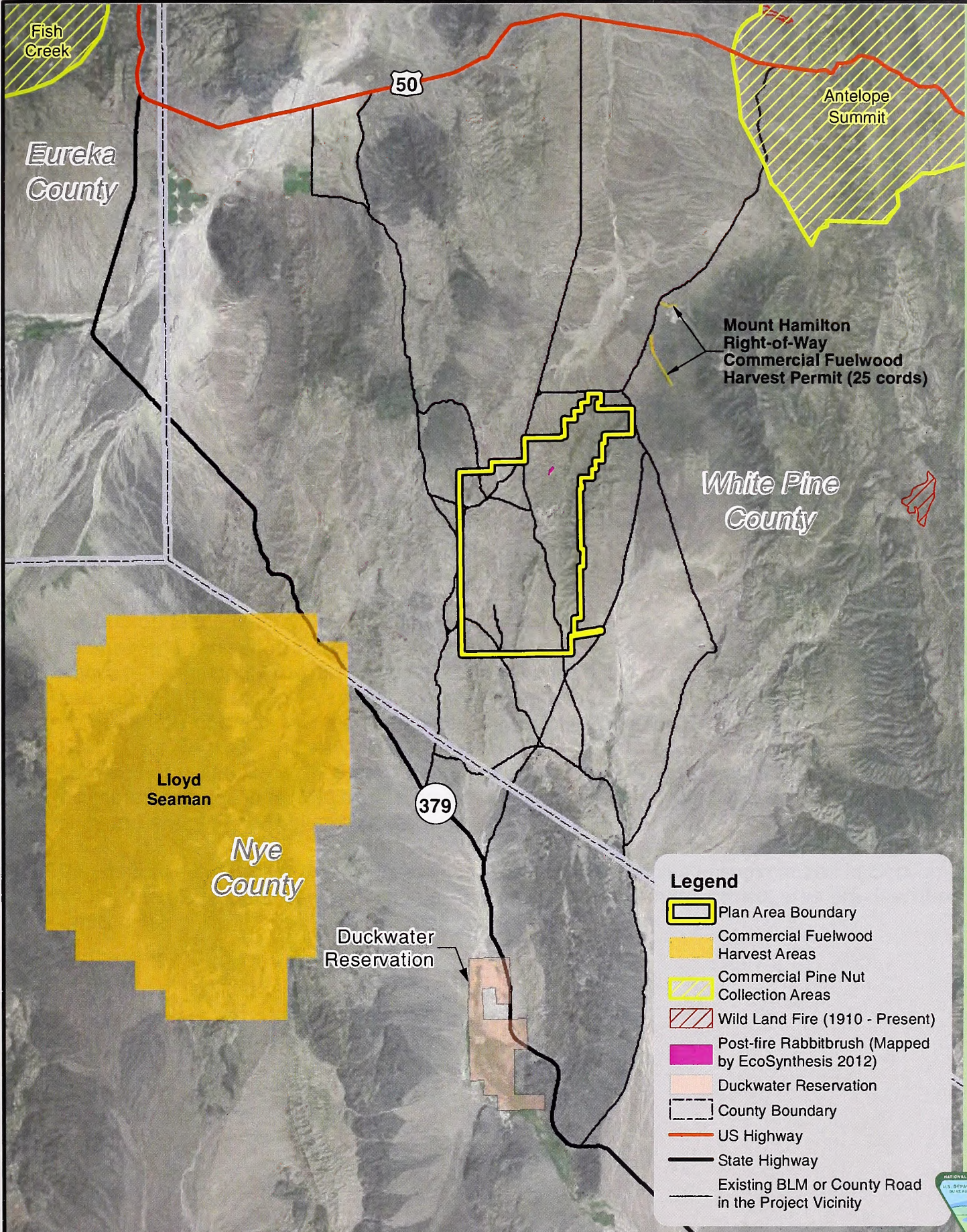

Legend

- Plan Area Boundary
- Commercial Fuelwood Harvest Areas
- Commercial Pine Nut Collection Areas
- Wild Land Fire (1910 - Present)
- Post-fire Rabbitbrush (Mapped by EcoSynthesis 2012)
- Duckwater Reservation
- County Boundary
- US Highway
- State Highway
- Existing BLM or County Road in the Project Vicinity

FIGURE 3.11-1
FOREST PRODUCTS AND FUELS
MIDWAY GOLD US INC.
GOLD ROCK MINE PROJECT

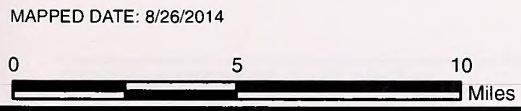

U.S. BUREAU OF LAND MANAGEMENT
 ELY DISTRICT
 EGAN FIELD OFFICE

NO WARRANTY IS MADE BY THE BUREAU OF LAND MANAGEMENT AS TO THE ACCURACY, RELIABILITY, OR COMPLETENESS OF THESE DATA FOR INDIVIDUAL USE OR AGGREGATE USE WITH OTHER DATA.

Basemap Source: ESRI World Imagery Map Service

PATH: C:\USERS\JCHEN\DOCUMENTS\PROJECTS\CITRINK\C0001817_GOLDROCK\GIS\ARCMAP_MXD\2014_DRAFT_EIS\FIGURE_3_11-1_FOREST_PRODUCTS_AND_FUELS.MXD | LAST SAVED BY: JCHEN | LAST SAVED ON: 8/26/2014 2:05:20 PM

This page intentionally left blank.

3.12 WILD HORSES

Existing Conditions

Wild horses, protected under the Wild Free-Roaming Horses and Burros Act of 1971 (Public Law 92-195), occur in the project area, which is located within the Pancake HMA. Figure 3.12-1 shows the Pancake HMA, which is located approximately 30 miles southwest of Ely, Nevada, and 10 miles southeast of Eureka, Nevada within White Pine and Nye counties. In implementing the Ely District Approved Resource Management Plan (BLM 2008b) the BLM combined two existing HMAs (Monte Cristo and Sand Springs East) into the Pancake HMA. The two HMAs were combined based on the historical interchange of wild horses between the two HMAs and an in-depth analysis of habitat suitability and monitoring data as set forth in the Ely District Approved Resource Management Plan (BLM 2008b).

The boundary of the Pancake HMA was established to ensure sufficient habitat for wild horses. The Pancake HMA is approximately 855,000 acres in size and occupies most of the project area. Wild horse populations in the Pancake HMA generally summer at higher elevations and move down to the valleys during the winter periods. Sufficient year-long range is available within the region, and wild horses are generally in good condition. However, competition exists among wild horses, livestock, and wildlife for forage and water resources.

An Appropriate Management Level was set that aimed to achieve a thriving natural ecological balance and rangeland health. An AML is the number of wild horses that can be sustained within a designated HMA that achieves and maintains a thriving natural ecological balance in keeping with the multiple-use management concept for the area. The Pancake AML range is between 240 and 493 wild horses. This AML was established at a level that would maintain healthy wild horses and rangelands over the long-term and was based on monitoring data collected over time as well as an in-depth analysis of habitat suitability (BLM 2008b). The HMA estimated population is 1,302 wild horses, which is approximately three times greater than the high end AML for the Pancake HMA.

Vegetation in the project area is described in Section 3.8, wildlife is summarized in Section 3.9, and grazing is summarized in Section 3.10. Water resources in the project area are described in Section 3.2.

This page intentionally left blank.

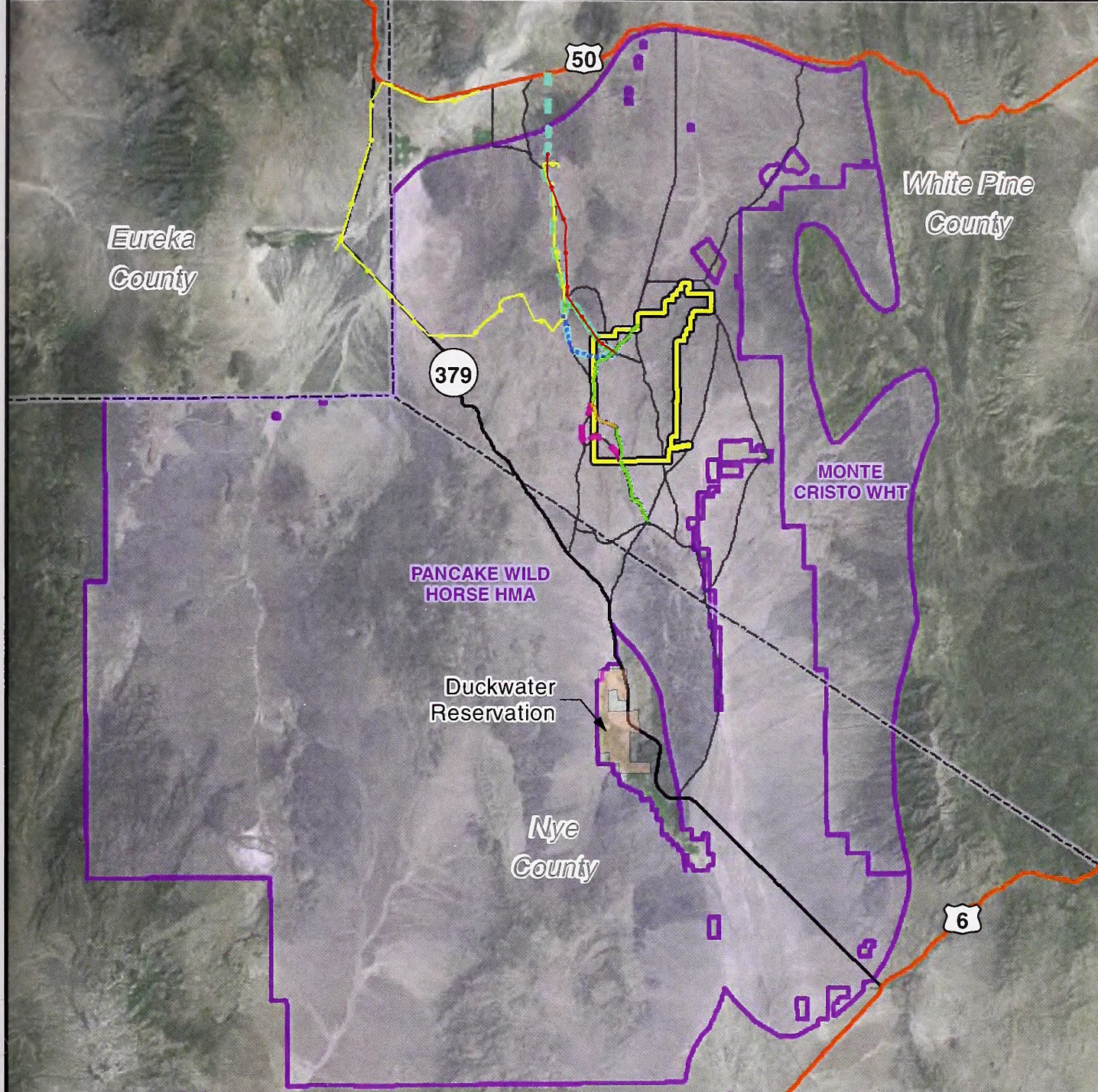

Legend

Plan Area Boundary	Northwest Main Access Route Alternative	State Highway
Herd Management Area (HMA) or Wild Horse Territory (WHT)	Modified County Road Re-Route Alternative	Existing BLM/County Road in the Project Vicinity
Duckwater Reservation	Proposed County Road Re-Route New Road Construction	
County Boundary	Proposed County Road Re-Route Existing BLM Road	
Proposed Action Power Line Route	Pan Mine Southwest Power Line Route	
Northern Power Line Route Alternative	US Highway	
Southern Power Line Route Alternative		

FIGURE 3.12-1 HERD MANAGEMENT AREAS AND WILD HORSE TERRITORY
MIDWAY GOLD US INC.
GOLD ROCK MINE PROJECT

MAPPED DATE: 10/16/2014

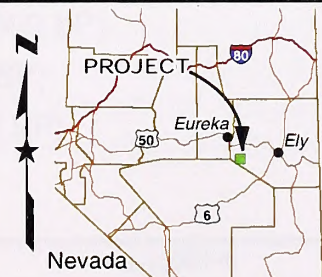
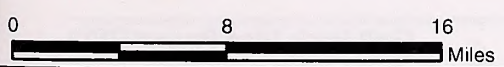

U.S. BUREAU OF LAND MANAGEMENT
 ELY DISTRICT
 EGAN FIELD OFFICE

NO WARRANTY IS MADE BY THE BUREAU OF LAND MANAGEMENT AS TO THE ACCURACY, RELIABILITY, OR COMPLETENESS OF THESE DATA FOR INDIVIDUAL USE OR AGGREGATE USE WITH OTHER DATA.

Basemap Source: ESRI World Imagery Map Service

PATH: Z:\GIS\PROJECTS\ENVC0001817_GOLDROCK\GIS\ARCMAP_MXD\2014_12-1_HMA_HTS_MN1.MXD | LAST SAVED BY: JCHEN | LAST SAVED ON: 10/16/2014 5:08:53 PM

This page intentionally left blank.

3.13 CULTURAL RESOURCES

Cultural resources are the material remains of past human activities and locations or landmarks associated with important historical or traditional events. They may include buildings, structures, landscape modifications, traditional locations or landmarks, cultural features, or portable artifacts (objects of human manufacture). Cultural sites (locations of past human activity) consisting of surface or buried features and artifacts without buildings or standing structures are referred to as archaeological sites. Cultural resources can be prehistoric, historic, or both, meaning that the remains may date from before or after the beginning of European settlement in the region. Cultural resources can include resources, landscape features, or traditional locations that are important to the heritage and identity of existing cultural groups, such as traditional cultural properties (TCPs). In most cases, TCPs are also Native American religious or traditional values.

Several laws and their implementing regulations require the protection or management of cultural resources, including the NHPA, Archaeological Resources Protection Act (ARPA), and NEPA. Section 106 of the NHPA requires that federal agencies consider the effects of federal undertakings to historic properties (cultural resources listed on or eligible for listing on the National Register of Historic Places [NRHP]) and allow the President's Advisory Council on Historic Preservation (ACHP) a reasonable opportunity to comment. The ARPA forbids damage to or removal of cultural resources or objects of patrimony located on Federal lands without a valid permit and specifies penalties for such actions. A finding of adverse effect to historic properties under Section 106 would be considered a significant impact under NEPA. Cultural resources are non-renewable resources and any significant impact would be permanent.

The BLM consulted with SHPO to complete a Programmatic Agreement for the Gold Rock Mine Project, establishing an Area of Potential Effect (APE) for cultural resources and outlining the methods of identification and treatment of cultural resources (BLM EFO and SHPO 2014a) (Appendix 1A). Both the BLM and SHPO have signed the Programmatic Agreement, and concurring parties including the Duckwater Shoshone Tribe have been invited to sign the document. Under the Programmatic Agreement, the BLM has assumed responsibility for completing Section 106 compliance for cultural resources within the APE.

Existing Conditions

Cultural Context

Prehistoric cultural resources encountered in the region generally range in age from the Early Archaic to Late Archaic periods. Early Archaic materials are less common and more widely scattered. This area of the Great Basin is characterized by high-altitude basins interspersed among mountain ranges. The region's prehistory is conventionally divided into a series of cultural periods based on changes in technology, settlement, economy, ideology, and social organization adapting to the physical environment and climatic changes. These periods or stages are:

- Pre-Archaic (11,500 to 7,500 BP [years before present])
- Early Archaic (7,500 to 4,600 BP)
- Middle Archaic (4,600 to 1,300 BP)
- Late Archaic (1,300 to 700 BP)
- Late Prehistoric (700 to 150 BP)

In some areas, Late Archaic and Late Prehistoric overlap or diagnostic markers for the Late Prehistoric are not found. The end of the prehistoric cultural periods is marked by European settlement of the region in the mid-1800s, or the Contact Period, and is a transition into the historic periods. The arrival of Europeans began with explorers, traders, and trappers as early as the late 1500s, but the Contact Period is represented by European settlement and the widespread appearance of European artifacts and materials. The period of overlapping use of the area by Europeans and unassimilated Native Americans is often referred to as the ethnohistoric period. Giambastiani (2013) describes the prehistoric cultural chronology for the region in greater detail.

Research themes for prehistory establish the types of information that may be found in prehistoric sites that would be considered important in prehistory and qualify the sites as eligible for the NRHP under Criterion D. Giambastiani (2013) identifies the important research themes for the Plan area as:

- Cultural chronology
- Settlement and subsistence patterns
- Toolstone procurement and lithic technology
- Communal antelope hunting
- Ethnohistoric cultural adaptations

Prehistoric or ethnohistoric sites that contain temporal diagnostics in association with other important cultural information, multiple discrete components, tool assemblages, floral or faunal remains, occupation or storage features, structural remains, or Euroamerican materials in verifiable association with Native American materials may be considered eligible for the NRHP.

Historic use of the general area ranges from the mid-1800s through the 1950s. Sites in the general area are predominantly associated with mineral exploration and mining. Several mining districts are present in the area, including the White Pine, Eureka, Newark, Pancake, and Gibellini districts. US 50 north of the area and US 6 south of the area follow earlier regional historic travel routes, including the Lincoln Highway, but most of the historic roads in and around the area connected to mines or mining towns. Key historic activities or themes include:

- Mining
- Ranching
- Transportation

As noted previously, the major historic theme for this area is mining. Mining in the general area began with discoveries of silver, lead, and copper in the White Pine Range in the 1860s. The White Pine Mining District was organized in 1865. Most of the early communities in the area emerged in association with mining; early mining camps in the area included Seligman, Hamilton, Treasure City, and Shermantown.

By the end of the decade, mining activity, particularly involving silver, had shifted to the Eureka Mining District. Silver production in the Eureka District was initially slow because of the refractory ores, but in 1869 a new smelting process that improved production was introduced. Most of the ore bodies were exhausted by 1885 and the district declined well before the Silver Panic of the early 1890s. Old workings can be found scattered through the mining districts in the general area and prospect activities extend beyond the district boundaries.

The local smelters used charcoal, and specialized workers known by the Italian name Carbonari worked charcoal kilns throughout the forests to meet this demand. Many of the Carbonari were of Italian, Swiss-Italian, or Chinese descent. Many Carbonari sites have been found in the region, however, only a few have been found in the project area.

Ranching began in the region as winter range for California cattle. As mining grew in the area, ranchers began to establish permanent ranches. Many unsuccessful prospectors and miners turned to ranching and farming.

Local express and stage systems centered on Hamilton. Express and stage routes included the Denver-Shepard Toll Road and the Hill Beachey Toll Road. Stagecoach systems were supported by mile houses, stage stations, and smaller way stations. The town never attracted a railroad. With completion of the railroad to Eureka and declines in mining, the routes to Hamilton declined.

Stagecoaches were displaced by automobiles and tractor-trailers in the twentieth century and a system of improved highways was developed. Early transcontinental highways, including the Lincoln Highway, were routes plotted along existing routes, many of them toll roads or improved stage roads. The routes of these early highways varied through the years. The Lincoln Highway Association also paved "seed miles" at selected points along the route, usually near large towns, to encourage local improvements.

Previous Cultural Resource Studies

Twenty-three cultural resource investigations have been conducted that included portions of the Plan area or were within 1 mile of the Plan area. These include the three recent baseline investigations by ASM Affiliates (ASM) that have covered the Plan area outside the historical disturbance of the Easy Junior Mine (Patsch et al. 2012, Giambastiani and Patsch 2013, and Patsch et al. 2013). With a few exceptions, these 23 investigations are more than 15 years old and do not meet current standards for survey and documentation. Many of the sites recorded in the Plan area before the ASM surveys, were recorded for the Easy Junior Mine. At least five of the previous investigations were for the Easy Junior Mine, which is within the Plan area. The following description is adapted from the three ASM baseline surveys listed above. Lists of previous investigations in the project area can be found in those reports.

Previously recorded cultural resources in the project area include prehistoric lithic scatters, a prehistoric habitation site, a rock shelter, prehistoric or early historic game traps, a historic Native American artifact scatter, historic habitation sites, charcoal-production platforms, historic artifact scatters, and historic road segments (Table 3.13-1). Temporally diagnostic artifacts (artifacts characteristic of a particular period or known to have had a discrete period of production) reflect the presence of prehistoric occupation or use of the project area from Early Archaic to Late Archaic periods and historic use of the area from the early 1900s through the 1950s.

This tabulation of documented cultural resources includes a 1-mile buffer area around the Plan area. Therefore, it includes some sites outside the Plan area that are not likely to be affected by the Proposed Action. However, the Plan area has been surveyed more completely than the smaller buffer area around it. Only 15 of the sites in the records search area are identified as outside the Plan area. Of the 39 sites recorded in the Plan area before the ASM surveys, only five were found and redocumented by the recent ASM surveys. Some may have been destroyed throughout the years and others consisted of only a few artifacts and were difficult to find. Including the previously recorded sites, 340 site locations are present in the project area.

These include 19 locations with both prehistoric and historic materials. If prehistoric and historic components are counted separately, there are 359 components. Sixty of these components (17 percent) are unevaluated or recommended eligible for the NRHP. If the potential existed for any of the components to be impacted by proposed project activities, they would be considered historic properties and appropriate treatment measures would be developed.

Table 3.13-1 Tally of Cultural Resource Components in the Plan Area and within 1 Mile of the Plan Area¹

Site Type	Eligible or Unevaluated	Not Eligible
Prehistoric		
Lithic Scatter	25	128
Camp; Locus; Complex Lithic Scatter	12	3
Game Trap	2	0
Rockshelter	2	0
Quarry	0	3
Subtotal	41	134
Historic		
Refuse Scatter	4	112
Charcoal Platform	6	46
Road Segment; Transportation	0	6
Habitation; Camp; Lean-to	8	6
Corral	1	2
Sheep Camp	0	1
Subtotal	19	173
Total	60	299

Notes:

Ten of the prehistoric lithic scatters, four of the historic refuse scatters, and the sheep camp were recorded outside the Plan area.

¹ Listed by site type and NRHP recommendation.

Fifty-four sites located in the Plan area have one or more components listed as unevaluated or recommended eligible for the NRHP. Seven of these sites were identified as consisting of 10 or fewer artifacts and were not found during subsequent survey (Patsch et al. 2012). Seventeen of these sites are previously recorded sites located within recent survey areas. Twelve of these previously recorded sites were not found during recent surveys. Updated descriptions and evaluations have been provided for five previously recorded sites, but the eligibility status has not been changed (three eligible and two unevaluated). In total, 27 sites are recommended eligible for the NRHP and 20 sites are unevaluated for eligibility. Two of the sites that are recommended as eligible have both prehistoric and historic materials, but are recommended eligible only for their historic components.

Table 3.13-2 summarizes the counts of potential historic properties by period and eligibility. If the 12 sites that could not be found during recent surveys are omitted, there are 35 potential historic properties, four of which include both prehistoric and historic eligible components. Potential effects to these historic properties by the Proposed Action or alternatives will be addressed in Chapter 4.

Table 3.13-2 Summary Counts of Potential Historic Properties

Period	Eligible	Unevaluated	Total
Prehistoric	13	15	28
Prehistoric and Historic	2	2	4
Historic	12	3	15
Total	27	20	47

3.14 NATIVE AMERICAN RELIGIOUS AND TRADITIONAL VALUES

Native American religious and traditional values or ethnographic resources include objects, sites, or areas of concern to Native American groups for either heritage or religious reasons. These resources may also be considered TCPs, a type of cultural resource that is also associated with the beliefs and cultural practices of a living community, is rooted in that community's history, and is important to the continuing cultural identity of the community. Several laws including NHPA, ARPA, American Indian Religious Freedom Act (AIRFA), and Native American Graves Protection and Repatriation Act (NAGPRA) require that federal agencies consult with Native Americans on actions that may affect their traditions or their uses of public lands.

Native American religious and traditional values are also protected from federal actions by the Religious Freedom Restoration Act, Executive Order 11593 Protection and Enhancement of the Cultural Environment, and Executive Order 13007 Indian Sacred Sites. Federal agencies must provide tribes a reasonable opportunity to identify their concerns about effects to their religious and traditional values, including historic properties. They must be allowed to articulate their views on the action's effects on those values, and to participate in the resolution of adverse effects.

In some areas, Native American tribes also retain additional treaty rights to uses of public lands. The Plan area is within the territory of the Ruby Valley Treaty of 1863 (Treaty). The Treaty (Kappler 1904), signed by 12 representatives of the Western Shoshone (spelled Shoshonee in the Treaty), is vague on several issues and implementation of the Treaty is disputed by Western Shoshone bands.

The Treaty required that the Western Shoshone:

- Cease all hostilities and depredations.
- Allow several routes of travel to be established across their lands, free and unobstructed, including the establishment of military posts and rest stations.
- Allow the continued and unhindered operation of telegraph and stage lines.
- Allow construction of a railway and its branches across their lands.
- Allow prospecting for and mining of gold, silver, and other valuable minerals on their lands.

The stipulation that mining of valuable minerals be allowed also specified that the Shoshone must allow the establishment of mines, construction of associated facilities including mills, and establishment of mining settlements and ranches. However, the Treaty specified neither that the Shoshone were to relinquish their lands nor what rights they were to retain to occupied or unoccupied lands.

Existing Conditions

The BLM has engaged in government-to-government consultation with Native American tribes and communities associated with the area to establish and maintain an awareness of religious and traditional values and to inform the tribes of actions that may affect these values. The following federally recognized Indian tribes have a cultural affiliation with the Plan area based on traditional use, ancestral ties, or oral histories associated with the area:

- Confederated Tribes of the Goshute Reservation, Nevada and Utah
- Duckwater Shoshone Tribe of the Duckwater Shoshone Reservation, Nevada
- Elko Band Council
- Ely Shoshone Tribe of Nevada
- Las Vegas Paiute Tribe of the Las Vegas Indian Colony
- Moapa Band of Paiutes of the Moapa River Indian Reservation, Nevada
- South Fork Band Council
- Te-Moak Tribe of the Western Shoshone Indians of Nevada
- Yomba Shoshone Tribe of the Yomba Reservation, Nevada

The Duckwater Shoshone Tribe, whose reservation is located approximately 14 miles south of the Plan area, is the Native American tribe located closest to the Plan area. The Duckwater Shoshone Tribe has traditional association with the Plan area. The Tribes in the region hunt greater sage-grouse roosters in the spring at lek sites, which the Tribes consider sacred land; there are dances and prayers associated with these areas. Tribes in the region and throughout the west use the greater sage-grouse legs to bless babies when they start to walk, to bring them the blessing of being fast runners. Also, when sage brush becomes covered with dirt and dust, the greater sage-grouse leave. Greater sage-grouse winter in tall sage brush areas, along with rabbits. The Duckwater Shoshone Tribe hunts rabbits at Bull Creek (Frank-Churchill 2013).

Regarding religious and traditional values, the Elders of the Duckwater Shoshone Tribe say that there may be antelope traps in the area. Burial grounds may be located in the area. The Tribe requested that if the Gold Rock Mine Project is approved, Tribal monitors would be invited to work with the archaeologists and Midway as Midway builds the project (Frank-Churchill 2013).

3.15 LAND USE AUTHORIZATION AND ACCESS

Existing Conditions

The Plan area, Proposed Action power line corridor, and BLM roads are located entirely on public lands within the jurisdiction of the BLM EFO. The BLM EFO administers these lands according to the Ely District Approved Resource Management Plan (BLM 2008b). White Pine County manages existing county roads. These roads are or would be authorized through right-of-way grants with the BLM.

Land Use Plans and Policies

BLM Ely Resource Management Plan

The Ely District Approved Resource Management Plan (BLM 2008b) provides guidance for management of public lands in the Ely District, along with the following goals and policies:

Livestock grazing: To promote the management and monitoring of livestock grazing to a level that is consistent with multiple use, sustained yield, rangeland health, and watershed function and health.

Wildlife: To provide habitat for wildlife (i.e., forage, water, cover, and space) and fisheries that is of sufficient quality and quantity to support productive and diverse wildlife and fish populations, in a manner consistent with the principles of multi-use management, and to sustain the ecological, economic, and social values necessary for all species.

Geology and mineral extraction: To promote the environmentally responsible production and exploration of leasable minerals (both solid and fluid), locatable minerals, and mineral materials to meet local, regional and national needs, while also protecting other resources and uses.

Recreation: To promote recreation opportunities on public land and undeveloped spaces while encouraging a minimum impact; and **Wild horses:** To maintain and manage healthy, self-sustaining wild horse herds inside HMAs within AMLs to ensure a thriving natural ecological balance while preserving a multiple-use relationship with other uses and resources.

In addition to special designations described below, the BLM uses a variety of land use plan decisions to manage these lands, including attaching conditions to permits, leases, and other authorizations. Federal regulations (Title 43 Code of Federal Regulations Subpart 8340) and BLM planning guidance require the Ely District Office to designate all BLM-administered land as either open, limited, or closed in regard to off-road vehicle (now termed off-highway vehicle) use. This process is completed by generating Travel Management Plans (BLM 2008b).

County Land Use Plans

White Pine County

The White Pine County Land Use Plan (White Pine County 2009) describes the land use patterns and designations of White Pine County. The federal government, principally the BLM, administers approximately 94 percent of all land within the county (Blankenship et al. 2013). Most land outside of established communities, including the Plan area, is designated in the county land use plan as Open Range. Land designated as Open Range is used mainly for ranching and agricultural use but also for mining, recreation, and wildlife habitat. Agricultural lands comprise the majority of private land in the county. The White Pine County Land Use Plan encourages the expansion of the mining sector and compatibility with environmental quality within the county.

In coordination with the Nevada State Land Use Planning Agency, the White Pine County Public Land Users Advisory Committee (WPCPLUAC) developed the 2007 White Pine County Public Lands Policy Plan (WPCPLUAC 2007). This plan was developed through a collaborative effort in order to establish and update the county's vision and policy voice concerning federal land management. The White Pine County Public Land Use Plan provides a coordinated land use planning effort among the county, BLM, and USFS. In general, the public land policies encourage environmentally responsible mineral exploration, opportunities for livestock grazing and other agricultural uses; encourage dispersed recreational opportunities; support the concept of Multiple Use Management as an overriding philosophy for management of public lands, and support a diversity of wildlife species and habitats.

Specific policies relating to development of mineral resources are included in the plan. Policies address items such as the need for careful development of mineral resources while recognizing

the need to conserve other environmental resources; support of state and federal policies that encourage both large and small-scale operations; the need for mineral operations to be consistent with best management practices for the protection of environmental quality; the need for mine site reclamation standards to be consistent with the best possible post-mine use for the specific area; and coordination with the county and the PLUAC regarding reclamation of mine sites.

Eureka County

The Eureka County Master Plan (Eureka County 2010) describes land use and planning for Eureka County. The Eureka County Master Plan supports the responsible exploration, development and reclamation of oil, gas, geothermal, locatable minerals, aggregate and other resources on federal land.

Land use within Eureka County is comprised mainly of mining and agriculture. Agricultural open space, comprised of designated grazing allotments, is the primary land use in the county. Approximately 2.4 million acres (90 percent of lands) are used for cattle and sheep grazing and pasture, as well as for crops such as hay or barley. Mining represents the next largest land use designation in the county. Approximately 79 percent of the land within Eureka County is managed by federal agencies (BLM and USFS). These publicly managed lands are primarily used for livestock grazing, mining, geothermal energy production, and outdoor recreation. Eureka County has not adopted a zoning ordinance, and the land use pattern has developed from economic activity such as mining and agriculture. The project area is not within Eureka County.

Land Use and Ownership

The primary land uses within and adjacent to the project area include livestock grazing, wildlife habitat, hunting, mineral exploration, and dispersed recreation. The federal government owns the land in the project area, and the BLM manages all lands in the project area. Figure 3.15-1 shows land ownership within and adjacent to the project area. The BLM has divided range lands in the region into grazing allotments to facilitate the management of the land for public livestock grazing (Section 3.10). Mining is an important land use in Nevada and there are numerous mining claims in the vicinity of the project area.

The closed Easy Junior Mine is located in the project area, approximately 248 acres were disturbed during operation of the Easy Junior Mine, and approximately 175 of those acres were reclaimed (Alta Gold 1999b, BLM 2004a). The 33-acre pit was not reclaimed (Alta Gold 1999b, BLM 2004a).

The Duckwater Shoshone Reservation is located about 12 miles south of the Plan area in northeastern Nye County (Figure 3.15-1). The community of Duckwater, located on the Duckwater Shoshone Reservation, is home to the Duckwater Shoshone Tribe. The 2013 population of the tribe is 140 (Blankenship et al. 2013). There are currently 390 enrolled members of the Duckwater Shoshone Tribe. The Reservation consists of approximately 3,850 acres of tribal land.

Access

The project area is approximately 30 miles southeast of Eureka, 50 miles west of Ely, and 15 miles south of US 50. Existing roads in the project area provide access to the Plan area (Figures 1.1-2 and 3.15-1) and a number of existing exploration roads occur in and near the project area (Figure 2.2-1).

Figure 3.15-2 shows the regional road system in the vicinity of the project area, which includes Interstate 80 (I-80), Interstate 15 (I-15), US 50, US 6, US 93, US Alternate Route 93 (US 93A), SR 278, SR 318, and SR 379 (Duckwater Road). I-80 is a major east-west highway located in the northern portion of Nevada and US 50 is a major east-west highway directly north of the Plan area. The Federal Highway Administration (FHWA) administers these regional highways and NDOT maintains them.

From Elko to the north, the Plan area can be accessed by traveling west on I-80 to Carlin, south on SR 278 to Eureka, east on US 50; or east on I-80 to Wells, south on US 93 to Ely, and west on US 50. In addition, I-80 east from Elko provides access from Wendover, Utah by traveling south on SR 93A to Ely and west on US 50. From northern Utah, the Plan area can be reached by traveling east on US 50 from Salt Lake City to Wendover, south on US 93A to Ely, and west on US 50. From Las Vegas, the Plan area can be reached by traveling on I-15 north to US 93, north on US 93 to US 6, northwest on US 6 to US 50, and west on US 50. Another route from Las Vegas includes I-15 north to US 93 to SR 318, north on SR 318 to US 6, south on US 6 to SR 379, and north on CR62 to Easy Junior Road. However, SR 379 is a dirt road and minimal traffic is anticipated to arrive by this route. The Plan area is typically accessed from US 50.

Table 3.15-1 Annual Average Daily Traffic

Station ID	County	Location	Number of Vehicles 2009	Number of Vehicles 2010	Number of Vehicles 2011	Number of Vehicles 2012
0330005	White Pine	U.S. Highway 50, 1.2 miles east of Fish Creek Rd to Duckwater	560	570	520	550
0330016	White Pine	U.S. Highway 50, west of Mill St in City limits of Ely, 50 miles east of Green Springs Road	3,400	3,500	3,400	3,300
0332150	White Pine	U.S. Highway 50, 1.0 miles west of road to Ruth (between SR-892 [Strawberry Rd] and Ruth Rd)	580	610	670	680
0330062	White Pine	U.S. Highway 6, 0.3 miles east of SR-318 to Preston & Lund (between SR-318 [Sunnyside Cutoff Rd] and Kimberly Rd) To Cross Street Ruth Rd.	1,600	1,800	2,000	1,800
0110036	Eureka	SR 278, Eureka-Carlin Road, 50 feet north of CR to Palisade South Junction (between Blackburn Rd and Street South in City Limits Carlin)	440	570	510	500
0110038	Eureka	U.S. Highway 50, 1.2 miles west of SR-278 (between Antelope Valley Rd and SR-278 (Eureka-Carlin Rd)	770	750	790	800
0110051	Eureka	U.S. Highway 50, 0.9 miles west of CR to Duckwater (Fish Creek Rd)	640	640	610	600
0230069	Nye	U.S. Highway 6, 0.6 miles west of SR-379 (between Lockes and SR-379)	230	240	230	200

Source: NDOT 2013a

County and BLM roads provide direct access to the Plan area, including the following:

- from US 50, south on Green Springs Road (CR 5), west on BLM 1179/CR 1204, and south on Easy Junior Road (CR 1177) to the Plan area;
- from US 50, south on Easy Junior Road to Plan area; and
- from SR 379, northeast on BLM 4109A to Easy Junior Road to the Plan area

Green Springs Road, BLM 1179/CR 1204, and a segment of Easy Junior Road from BLM 1179/CR 1204 were widened and improved during operation and reclamation of the Easy Junior Mine. The White Pine County Road Department recently re-graded these roads. Easy Junior Road from US 50 to BLM 1179/CR 1204 is an unpaved county road. South of the Plan area, Easy Junior Road is an unmaintained two-track road.

NDOT traffic count stations have not been installed on these roads. Existing traffic on these roads includes vehicles associated with Midway's ongoing exploration activities in the Plan area, as well as other users, including recreationists. Midway exploration activities may periodically result in up to 190 vehicles per day (BLM 2012h).

In 2011 Nevada had a total of 24,189 million annual miles driven and 246 motor vehicle-related fatalities, which translates into a fatality rate of 1.02 per 100 million vehicle miles driven (USDOT 2013). For the years 2011 and 2012, two fatal crashes occurred each year in White Pine County (NDOT 2013b).

Land Use Authorizations

Rights-of-Way

Two ROWs have been granted in the region: ROW N-2656 for a monitoring well, and ROW N-52041 for White Pine County Road ROW.

Special Designations

"Special Designations" fall into two categories: 1) Congressional Designations, and 2) Administrative Designations, such as those applied by the BLM through the land use planning process (BLM 2005a). This section describes specially designated resources located within 30 miles of the Plan area. All alternatives would be located within this 30-mile radius.

Congressional Designations

There are no national parks, national recreation areas, national wildlife refuges or ranges, lands with wilderness characteristics, Wilderness Areas, WSAs, or ACECs in the project area (Figure 3.15-1).

Five USFS Wilderness Areas are located within 30 miles of the project area (Figure 3.15-1). The closest Wilderness Area is the White Pine Range Wilderness Area located approximately 5 miles southeast of the Plan area in the Humboldt-Toiyabe National Forest Ely Ranger District. The remaining four Wilderness Areas located within 30 miles of the project area include Shellback, Bald Mountain, Currant Mountain, and Red Mountain. Portions of two BLM WSAs are located within 30 miles of the project area (Figure 3.15-1). Both the Antelope Range WSA and the Park Range WSA are located greater than 25 miles southwest of the Plan area.

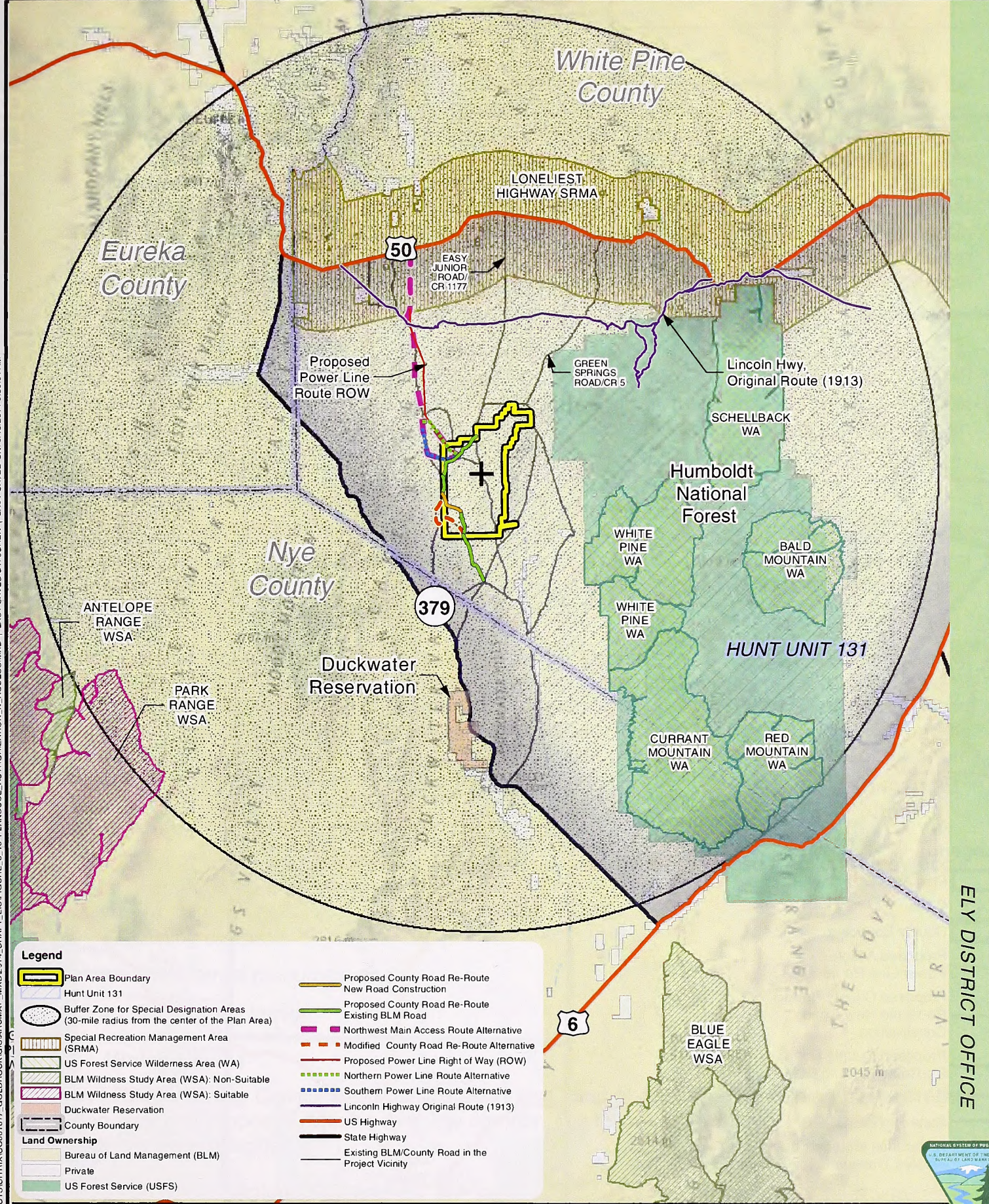

ELY DISTRICT OFFICE



FIGURE 3.15-1
LAND OWNERSHIP, SPECIAL DESIGNATIONS, AND AUTHORIZATIONS
MIDWAY GOLD US INC. GOLD ROCK MINE PROJECT
 MAPPED DATE: 9/18/2014



U.S. BUREAU OF LAND MANAGEMENT
 ELY DISTRICT
 EGAN FIELD OFFICE

NO WARRANTY IS MADE BY THE BUREAU OF LAND MANAGEMENT AS TO THE ACCURACY, RELIABILITY, OR COMPLETENESS OF THESE DATA FOR INDIVIDUAL USE OR AGGREGATE USE WITH OTHER DATA.

Basemap Source: National Geographic Map Service

PATH: C:\USERS\VOCHENDOCUMENTS\PROJECTS\ICITRIX\0001817_GOLDROCK\GIS\ARCMAP_MXD\2014_DRAFT_EIS\FIGURE_3_15-1_LANDUSE_AUTHORIZATION_N_ACCESS_MXD | LAST SAVED BY: JCHEN | LAST SAVED ON: 9/18/2014 9:59:04 AM

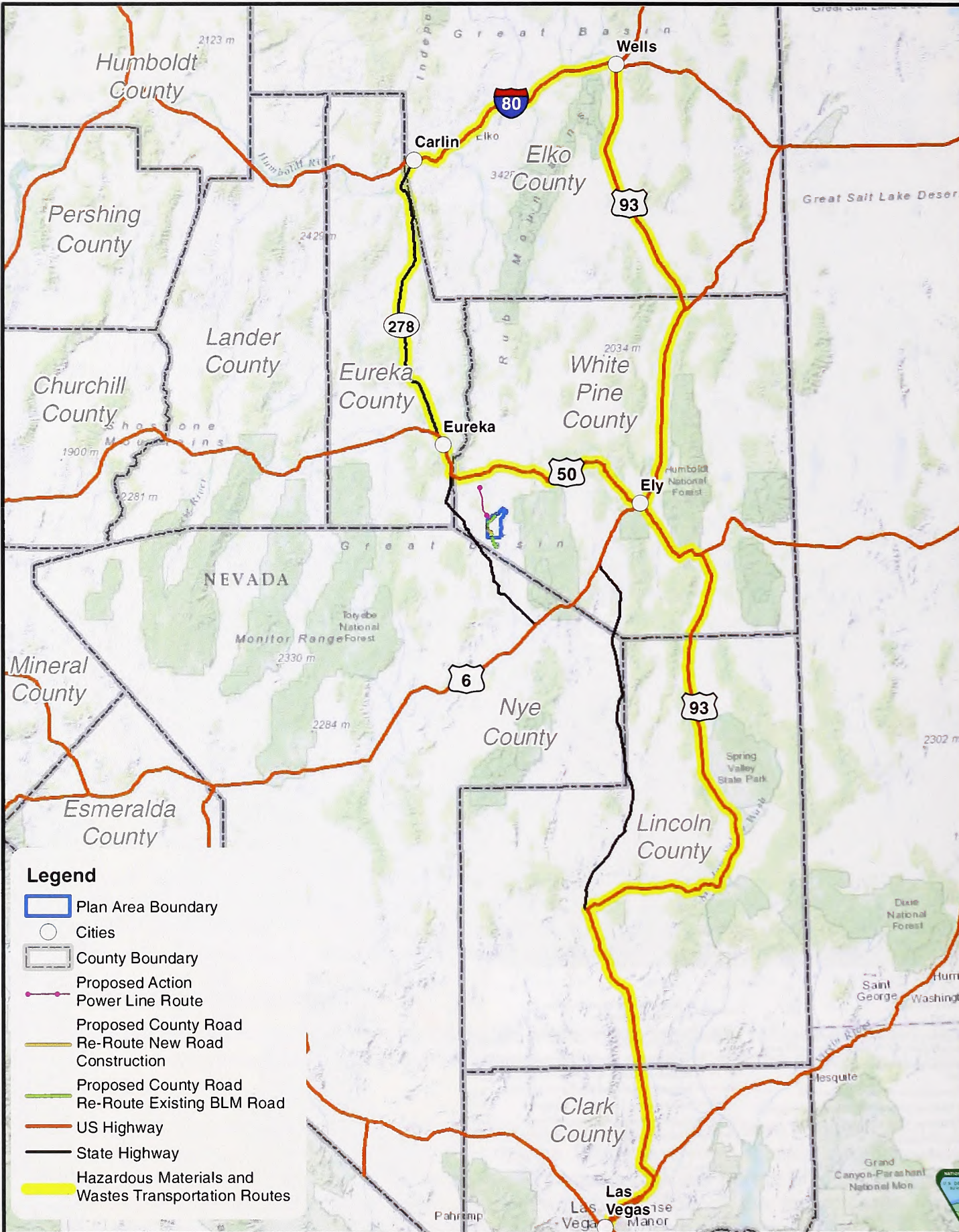
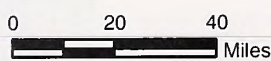

FIGURE 3.15-2 ROAD SYSTEM AND HAZARDOUS MATERIAL AND WASTE TRANSPORTATION ROUTES

MIDWAY GOLD US INC.
GOLD ROCK MINE PROJECT
MAPPED DATE: 8/10/2014



U.S. BUREAU OF LAND MANAGEMENT
ELY DISTRICT
EGAN FIELD OFFICE

NO WARRANTY IS MADE BY THE BUREAU OF LAND MANAGEMENT AS TO THE ACCURACY, RELIABILITY, OR COMPLETENESS OF THESE DATA FOR INDIVIDUAL USE OR AGGREGATE USE WITH OTHER DATA.

Basemap Source: ESRI World Topo Map Service

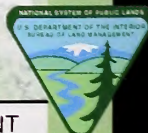

PATH: C:\USERS\JCHEN\DOCUMENTS\PROJECTS\CITRIX\GOLDROCK\GIS\ARCMAP_MXD\2014_DRAFT_EIS\FIGURE_3_15-2_HAZMAT_TRANSPORTATION_MN_MXD | LAST SAVED BY: JCHEN | LAST SAVED ON: 8/10/2014 2:44:00 AM

In 2006, the United States Congress acknowledged the region's national significance by designating the Great Basin National Heritage Area (GBNHA), the purpose of which includes the opportunity to conserve, interpret, and develop the archaeological, historical, cultural, natural, scenic, and recreational resources (Great Basin Heritage Area Partnership 2011). This designation does not provide any authority to regulate land uses, but promotes heritage tourism and visitation (Great Basin Heritage Area Partnership 2011). The GBNHA includes Millard County, Utah and White Pine County, Nevada, as well as the Duckwater Shoshone Reservation in Nye County, Nevada. The project area is located within the GBNHA. The Great Basin Heritage Area Partnership has not identified any heritage sites in the project area (Great Basin Heritage Area Partnership 2011).

The Great Basin Heritage Area Partnership identifies several ghost towns within 30 miles of the Plan area. Belmont Hill, Bonanza, Hamilton, Shermantown, and Eberhardt are located approximately 6 to 7 miles to the east of the project area, in the Humboldt-Toiyabe National Forest Ely Ranger District. The ghost town of Bull Creek, located approximately 4 miles south of the project area (Great Basin Heritage Area Partnership 2011).

Administrative Designations

ACECs are the principal BLM designation for public lands where special management is required to protect important natural, cultural, and scenic resources, or to identify natural hazards. The Honeymoon Hill/City of Rocks ACEC is the closest ACEC located approximately 20 miles southeast of the project area.

The Loneliest Highway SRMA, as described in the Ely District Approved Resource Management Plan (BLM 2008b), includes all BLM lands extending approximately four miles to either side of U.S. Highway 50. Accordingly, segments of Green Springs Road and Easy Junior Road adjacent to US 50 pass through parts of the Loneliest Highway SRMA (Figure 3.15-1). The Loneliest Highway SRMA is 675,123 acres in size, and provides access to some of the more popular destinations in the planning area (BLM 2007e).

Mineral and Energy Resource Authorizations and/or Leases Occurring in the Plan Area

The following lists the resources that could be impacted by the Proposed Action if they occur within or near the Plan area:

- Mining claims;
- Geothermal resources; and
- Oil and gas leases.

Mining Claims

An LR2000 Mining Claims Geographic Report was used to locate active mining claims in the Plan area and Proposed Action power line corridor. The following Township, Range, and Sections were searched:

T14N R56E Sections 5, 8, and 16

T15N R55E Section 1, 13, 24

T15N R56E Section 6

T16N R55E Sections 2, 11, 14, 23, 26, 35, 36

T17N R55E Sections 22, 27, 34, 35

T16N R56E Sections 22, 23, 25, 26, 27, 28, 29, 31, 32, 33, 34, 35

T15N R56E Sections 2, 3, 4, 5, 6, 7, 8, 9, 10, 15, 16, 17, 18, 19, 20, 21, 22, 27, 28, 29, 30, 31, 32, 33, 34, 35

Table 3.15-2 identifies the active mining claims that are located within the Plan area and Proposed Action power line corridor.

Table 3.15-2 Active Mining Claims

Lead File No.	Case Type	Claimant(s)	Location
NMC1087952	384101	Midway Gold Rock LLP	T14N R56E Sec 5 T15N R55E Sec 1, 13, 24 T15N R56E Sec 6, 7, 18, 19, 20, 29, 30, 31, 32, 33, 34, 35 T16N R56E Sec 31
NMC1057134	384101	Midway Gold Rock LLP	T15N R56E Sec 5, 6, 7, 8, 17, 18, 21, 28, 29, 32, 33 T16N R56E Sec 31, 32
NMC1057236	384101	Nevada Royalty Corp.	T16N R55E Sec 2 T17N R55E Sec 34 & 35
NMC815131	384101	Nevada Royalty Corp.	T16N R55E Sec 2
NMC980693	384101	Nevada Royalty Corp	T15N R56E Sec 3, 4, 9, 10, 15, 16 T16N R55E Sec 2 & 11 T16N R56E Sec 27 T17N R55E Sec 34 & 35
NMC1074083	384101	RR Exploration LLC	T15N R55E Sec 1 T16N R55E Sec 11, 14, 23, 26, 35, 36 T16N R56E Sec 22, 23, 25, 26, 27, 28, 29, 31, 32
NMC984556	384101	Midway Pan LLP & Midway Gold Rock LLP	T15N R56E Sec 15, 16, 21, 22, 33 T16N R55E Sec 11 & 14
NMC984635	384101	Nevada Royalty Corp	T15N R56E Sec 15, 16 T16N R55E Sec 14
NMC965337	384101	Midway Pan LLP & Renaissance Exploration Inc.	T16N R55E Sec 14 & 23
NMC973511	384101	Renaissance Exploration Inc. & Midway Pan LLP	T16N R55E Sec 14, 23 & 26
NMC977345	384101	Midway Pan LLP	T16N R55E Sec 14 & 23
NMC1028350	384101	Renaissance Exploration Inc.	T16N R55E Sec 23
NMC964608	384101	RR Exploration LLC	T16N R55E Sec 23 & 26
NMC964608	384101	Renaissance Exploration Inc.	T16N R55E Sec 26
NMC974410	384101	Renaissance Exploration Inc.	T16N R55E Sec 26, 35, 36
NMC958517	384101	Midway Pan LLP & Nevada Royalty Corp.	T17N R55E Sec 22 & 27
NMC980693	384101	Nevada Royalty Corp.	T17N R55E Sec 22
NMC1057292	384101	Midway Pan LLP	T17N R55E Sec 34
NMC815131	384101	Nevada Royalty Corp.	T17N R55E Sec 35
NMC977423	384101	Nevada Royalty Corp. ' Midway Gold Rock LLP Anchor Minerals Inc.	T15N R56E Sec 2, 3, 4, 8, 9, 10, 15, 16, 17, 22, 27 T16N R56E Sec 25, 26, 27, 28, 29, 32, 33, 34, 35
NMC325321	384101	Nevada Royalty Corp.	T15N R56E Sec 3, 4, 9, 10 T16N R56E Sec 34

Table 3.15-2 Active Mining Claims

Lead File No.	Case Type	Claimant(s)	Location
NMC1057255	384101	Nevada Royalty Corp.	T15N R56E Sec 4, 5, 8, 9 T16N R56E Sec 32, 33
NMC822700	384101	Peart Brian	T15N R56E Sec 9, 16
NMC863772	384101	Pankow Jerry	T15N R56E Sec 9
NMC849888	348101	Jordan Ronald W	T15N R56E Sec 10, 15, 16
NMC826346	348101	Jordan Ronald W	T15N R56E Sec 16
NMC947154	348101	Midway Gold Rock LLP	T15N R56E Sec 16, 17, 20, 21
NMC1068672	348101	Jordan Ronald W	T15N R56E Sec 17
NMC1068676	348101	Midway Gold Rock LLP	T15N R56E Sec 17, 18, 19, 20
NMC980977	348101	Midway Gold Rock LLP	T15N R56E Sec 20, 21, 28, 29, 32
NMC1057125	348101	Jordan Ronald W	T15N R56E Sec 21
NMC984539	348101	Anchor Minerals Inc. & Midway Gold Rock LLP	T15N R56E Sec 21, 22, 27, 28, 33
NMC929929	348101	Anchor Minerals Inc.	T15N R56E Sec 22, 27, 34
NMC950080	348101	Anchor Minerals Inc.	T15N R56E Sec 27, 28, 33, 34
NMC1076310	348101	Midway Gold US Inc.	T15N R56E Sec 35
NMC408429	348101	Nevada Royalty Corp.	T16N R56E Sec 22, 27, 34
NMC420337	348101	Nevada Royalty Corp.	T16N R56E Sec 22, 23, 27, 34
NMC968836	348101	Trend Resources LLC	T16N R56E Sec 23
NMC325321	348101	Nevada Royalty Corp.	T16N R56E Sec 26, 27, 35
NMC477661	348101	Nevada Royalty Corp.	T16N R56E Sec 34

Source BLM 2014c

Data compiled by the Nevada Bureau of Mines and Geology indicate that no producing oil or gas wells have been completed in the project area (Hess, et al. 2008). However, multiple previously drilled wells are present near the project area. None of these wells are known to be currently producing oil or gas (NDOM 2014). One well, drilled in 1961, is located within 0.3 mile of the project area in SWNESE corner of Section 31, T16N R56E. This well reported oil shows at depths of 2,272 to 2,486 feet and 6,419 to 6,433 feet but was plugged and abandoned (Hess et al. 2008).

A well was drilled in 2011 less than 0.5 mile west of the Proposed Action power line corridor in NENW corner of Section 11, T16N, R55E (Hess et al. 2011; NDOM 2011). A well was drilled in early 2014 approximately 2.6 miles east of the project area in SWNE corner of Section 30, T15N, R57E (Tetuan Resources 2014). Another well, drilled in 1950, is located approximately 3 miles east in Section 5, T15N R57E and is considered to be the first modern oil well drilled in Nevada (Garside et al. 1988).

Oil can be observed at the ground surface in at least two outcrops of Chainman Shale in White Pine County. In these locations, oil occurs within secondary porosity in Paleozoic carbonates. South of the project area in Railroad Valley of Nye County, oil and gas have been produced from Oligocene, Eocene, Pennsylvanian, and Devonian Paleozoic reservoirs (Garside et al. 1988). In general, potential for hydrocarbon production in the project area is considered to be low to medium (Meeuwig 2006); however, modern exploration and well completion techniques may enable future production of previously unrecognized or uneconomical hydrocarbon reservoirs.

BLM's LR2000 was used to identify authorized oil and gas leases in the project area. Multiple types of leases are present in the project area (e.g., lots, aliquots) or immediately

adjacent to the Plan area (BLM 2014c). Leases overlapping the project area have been issued in the following Townships, Range, and Sections:

T15N, R55E, Section 1;
 T15N, R56E, Sections 4, 5, 9, 10, 15, 16, 19, 30;
 T16N, R55E, Sections 2, 11, 14, 23;
 T16N, R56E, Section 31; and
 T17N, R55E, Section 27, 34, 35.

Geothermal Resources

All portions of the Great Basin, including the project area, have an elevated potential for hosting a geothermal system compared to most other areas of North America. Compared to the rest of Nevada, potential for geothermal energy development is below average in the project area. The probability of a geothermal system with potential to produce electrical energy being present in the project area is marginally favorable (Coolbaugh et al. 2005).

BLM's LR2000 was used to identify existing geothermal leases in the project area and any lands nominated for geothermal sale. The entirety of following Townships and Ranges (Mount Diablo Meridian) were searched:

T14N, R56E
 T15N, R55E
 T15N, R56E
 T16N, R55E
 T16N, R56E
 T17N, R55E and
 T18N, R55E.

Search results indicated that the above sections do not contain existing geothermal leases or lands nominated for geothermal sale (BLM 2014c).

3.16 VISUAL RESOURCES

Existing Conditions

The project area is located in the Pancake Range of White Pine County, approximately 15 miles south of US 50. The Pancake Range is a north-south running range consisting primarily of rolling hills and peaks ranging from 6,400 feet to 7,500 feet amsl (ViewPoint Consulting 2012). Clear skies and broad open vistas characterize this landscape. The project region includes rolling to angular hills and ridges with steep side slopes. Within the vicinity of the project area, the Pancake Range is overlain by volcanic rock that is a deep red-brown to black in color. Exposed gray, buff, and tan-colored soils also add contrasts and scenic quality to the area.

The dominant visual features in the project area include the White Pine Mountains, Easy and Meridian ridges, several unidentified ridges, Mount Hamilton, Mount Hamilton Mine, and the heap leach pad and access roads associated with the former Easy Junior Mine. The Easy

Junior spent heap has been partially revegetated, but is noticeable from the main access route as an angular structure that contrasts with the surrounding texture, color, and topography. Existing visual modifications to the landscape in and near the project area also include unimproved roads, evidence of past and current mineral exploration, the Mount Hamilton Mine to the east, and fences.

Vegetation typical of the Great Basin occurs throughout the area. The area is covered with patterns of sagebrush-grasses at lower elevations and pinyon-juniper and mixed shrubs at higher elevations. Vegetation colors include tawny gray, brown, dark green, gray-green, and green. Sagebrush is interspersed with other shrubs and grasses are gray-green in color. Additional vegetation consists of the darker green juniper present throughout the area.

The most commonly traveled route within the vicinity of the proposed project is the east-west corridor of US 50. In the vicinity of the project area, there are no rest stops, scenic overlooks, or other attractions that would create important viewing locations for passing travelers. The project area is not visible to people traveling either direction on US 50. There are no private residences, major roadways, developed recreation facilities, trails, scenic overlooks, or other destinations in and near the project area.

A casual observer is defined as someone who is looking at the proposed facilities but not examining them with careful attention. Casual observers include mineral exploration and mine-related personnel, residents of the community of Duckwater, hunters, and ranchers with grazing allotments.

Visual Resource Management Classes

According to the Ely District Approved Resource Management Plan (BLM 2008b), the project area occurs within areas that have been designated as VRM Class III and IV. Under the Ely District Approved Resource Management Plan, most of the BLM-administered public lands adjacent to US 50 in eastern White Pine County have been designated VRM Class III (BLM 2008b). Additionally, all BLM-administered public lands extending approximately four miles to either side of US 50 are part of the Loneliest Highway SRMA (BLM 2008b). Thus, the portion of the project area located within approximately five miles of US 50 has been designated as VRM Class III, and the portion within four miles of the highway is located within the Loneliest Highway SRMA. The remaining portion of the project area occurs largely within areas designated as VRM Class IV, but isolated areas assigned to VRM Class III also occur.

Per BLM Manual H-8410-1 Visual Resource Inventory (BLM 1986a), the objectives of VRM Class III and IV areas are:

- Class III: "...to partially retain the existing character of the landscape. The level of change to the characteristic landscape should be moderate. Management activities may attract attention but should not dominate the view of the casual observer. Changes should repeat the basic elements found in the predominant natural features of the characteristic landscape."
- Class IV: "...to provide for management activities that require major modification of the existing character of the landscape. The level of change to the characteristic landscape can be high. These management activities may dominate the view and be the major focus of viewer attention. However, every attempt should be made to minimize the impact of these activities through careful location, minimal disturbance, and repeating the basic elements of the landscape."

The VRM system includes effects of artificial lighting on night skies. Existing or potential sources of artificial nighttime light in the area include traffic along US 50, residences at the Duckwater Indian Reservation, and the communities of Eureka and Ely. Because there are so few sources of artificial light, the night skies in the project area and surrounding region are said to be some of the darkest skies in the continental United States.

Key Observation Points

A KOP is a specific place on a travel route or within an existing or potential use area where the view of a management activity or project would be most revealing for purposes of the contrast rating. KOPs are selected based on existing land use, frequency of visibility, duration of visibility, and anticipated activities of the observer. Typically, KOPs are selected along highways, well-used roadways and trails and near communities, and scenic overlooks, as these are areas where the greatest number of people is likely to occur, and often occur for the longest periods of time. Per BLM Manual H-8431: Visual Resource Contrast Rating (BLM 1986b), the criteria that should be considered when selecting KOPs are: angle of observation, number of viewers, length of time the project is in view, relative project size, season of use, and light conditions.

Once KOPs are selected, a description of the landscape visible from each KOP is prepared by describing the dominant land and water features, vegetation cover, and structures that comprise the landscape. These landscape components are described in terms of the basic design elements of form, line, color, and texture (BLM 1986b). The BLM Form 8400-4 (Visual Contrast Rating Worksheet) is used to record the various design elements that characterize the land and water features, vegetation cover, and structures that comprise each KOP landscape. The purpose of describing and characterizing the landscape is to establish the existing baseline conditions of the scenic values and aesthetic quality of an area. Typically, the existing conditions of the landscape are documented on BLM Form 8400-4 using photographs. The photographs and information recorded on BLM Form 8400-4 are then used to prepare the landscape description, often in conjunction with field observations made at the time the photographs were taken. The precise geographic locations of the KOPs are recorded using a Global Positioning System, and any relevant field notes are also recorded at that time.

In consultation with BLM resource specialist, a total of four KOPs were selected as representative of typical views of the current landscape in the vicinity of the project area: KOP 1, 2, 3 and 4. The four KOPs are described in Table 3.16-1 and shown on Figure 3.16-1.

Table 3.16-1 Key Observation Points

Map ID	Location*	Direction Camera Looking	Distance (miles)
KOP 1	CR 1177 (Easy Junior Road) at a high point near the Plan area boundary	South	3
KOP 2	BLM Road 4006 west of the intersection with CR 1177 (Easy Junior Road) and BLM 4006	Southwest	2
KOP 3	Parking area adjacent to Duckwater Hot Springs, inside the Duckwater Shoshone Reservation	North	15
KOP 4	SR 379 (Duckwater Road) & Bull Fork intersection in Nye County	Northeast	8

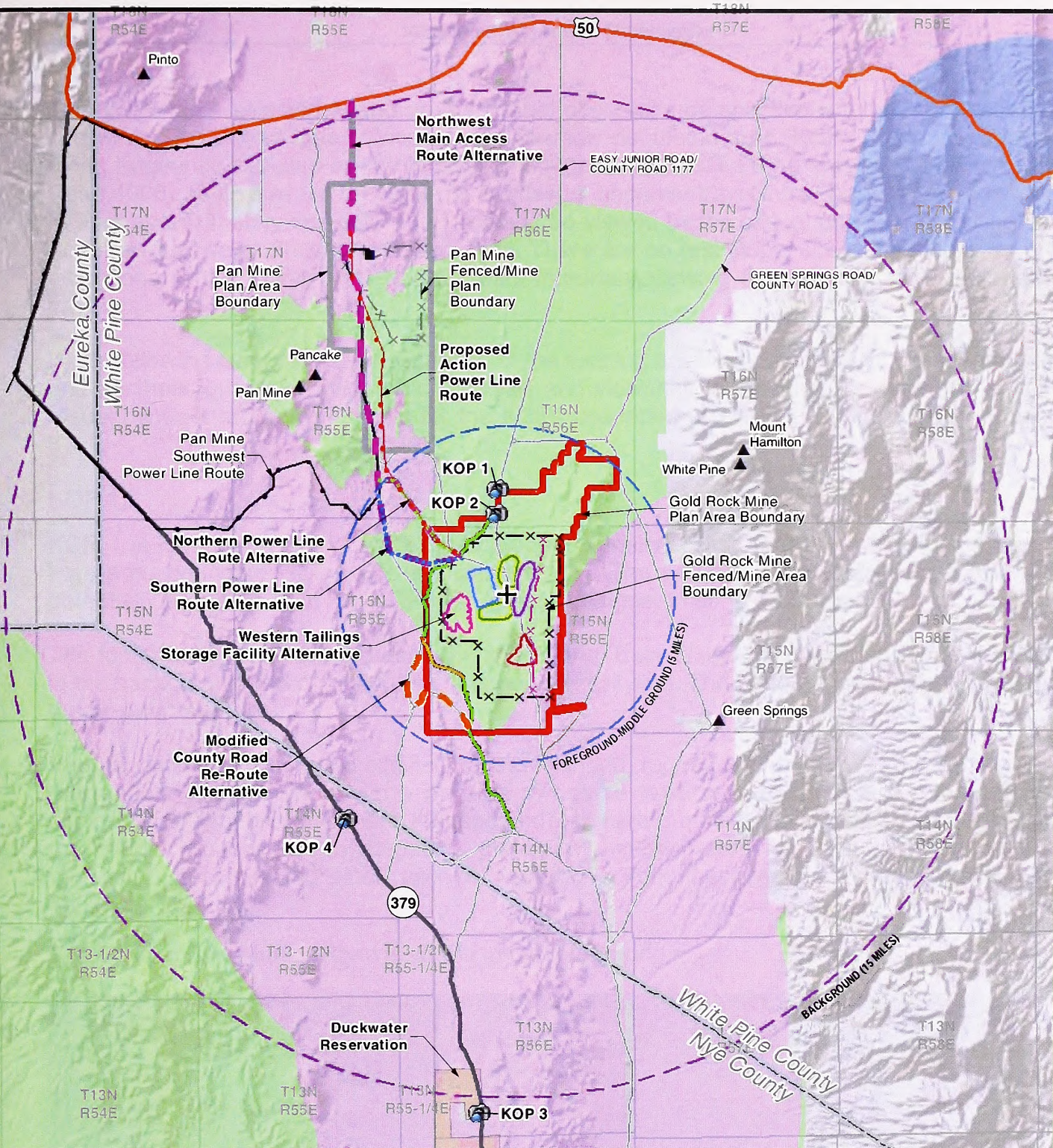

Legend

- Center Point
- KOP
- Existing Mine
- Mt. Wheeler Substation
- Proposed County Road
- Re-Route, New Road Construction
- Proposed County Road Re-Route, Existing BLM Road
- Location of East Fence Line under the Western Tailings Storage Facility Alternative
- Heap Leach Pad
- Pit
- Waste Rock Disposal Area
- Proposed Action Tailings Storage Facility
- VRM Classification
 - Class II
 - Class III
 - Class IV
- Foreground-Middle Ground (5 Miles)
- Background (15 Miles)
- County Boundary
- US Highway
- State Highway
- Existing BLM or County Road in the Project Vicinity

FIGURE 3.16-1
VISUAL RESOURCE MANAGEMENT (VRM)
CLASSIFICATIONS AND POTENTIAL KEY
OBSERVATION POINTS (KOPs)

MIDWAY GOLD US INC.
GOLD ROCK MINE PROJECT

MAPPED DATE: 1/11/2015

0 4.5 9
 Miles

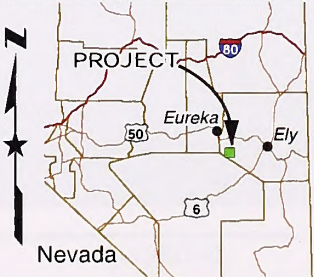

U.S. BUREAU OF LAND MANAGEMENT
ELY DISTRICT
EGAN FIELD OFFICE

NO WARRANTY IS MADE BY THE BUREAU OF LAND MANAGEMENT AS TO THE ACCURACY, RELIABILITY, OR COMPLETENESS OF THESE DATA FOR INDIVIDUAL USE OR AGGREGATE USE WITH OTHER DATA.

Basemap Source: ESRI World Shade Relief Map Service



PATH: Z:\GISPROJECTS\ENV\00001817_GOLDROCK\GIS\ARCMAP_MXD\2014_DRAFT_EIS\FIGURE_3_16-1_VISUAL_RESOURCE_MANAGEMENT_8X11_RV09032012.MXD | LAST SAVED BY: JCHEN | LAST SAVED ON: 1/11/2015 6:54:40 PM

This page intentionally left blank.

The KOPs were selected based on the casual observer's perspective when the project comes into view. The project area is located in a sparsely populated area. KOPs 1 and 2 are located along frequently travelled routes in the immediate vicinity of the Plan area (CR 1177 and BLM Road 4006). KOP 3 would be visible to the casual observer travelling at highway speeds on SR 379 for approximately one mile. KOP 4 would be viewed by the casual observer travelling north from the Duckwater Shoshone Reservation. There are no rest stops, scenic overlooks, or other attractions in the vicinity that would create important viewing locations for large numbers of travelers.

In the following paragraphs, a description of the existing baseline conditions of the scenic values and aesthetic quality of the area of analysis and viewshed is provided for each of the KOPs. Visual contrast rating worksheets for the KOPs described in the EIS are included in Appendix 3D.

KOP 1

KOP 1 is located on Easy Junior Road along the main access route at a high point near the Plan area boundary. This KOP is looking south. The portion of the project area that would potentially be visible from this KOP is in an area designated as VRM Class IV.

The topography in the foreground is gently sloping. Easy Ridge and Meridian Ridge are visible in the background and comprise the horizon at the skyline. The ridges appear dark gray against the brighter blue sky.

Vegetation in the foreground consists of low, rounded, rugged and irregular shrubs and grasses that appear mostly lumpy with a medium to coarse texture. Vegetation in the foreground is comprised of light brown grasses interspersed with bare ground. Moving from the foreground to the middle ground, the vegetation is generally a sage green, the form and texture of the vegetation becomes indistinct, and color patterns from the vegetation create subtle green horizontal lines.

The existing Easy Junior Road is visible in the foreground.

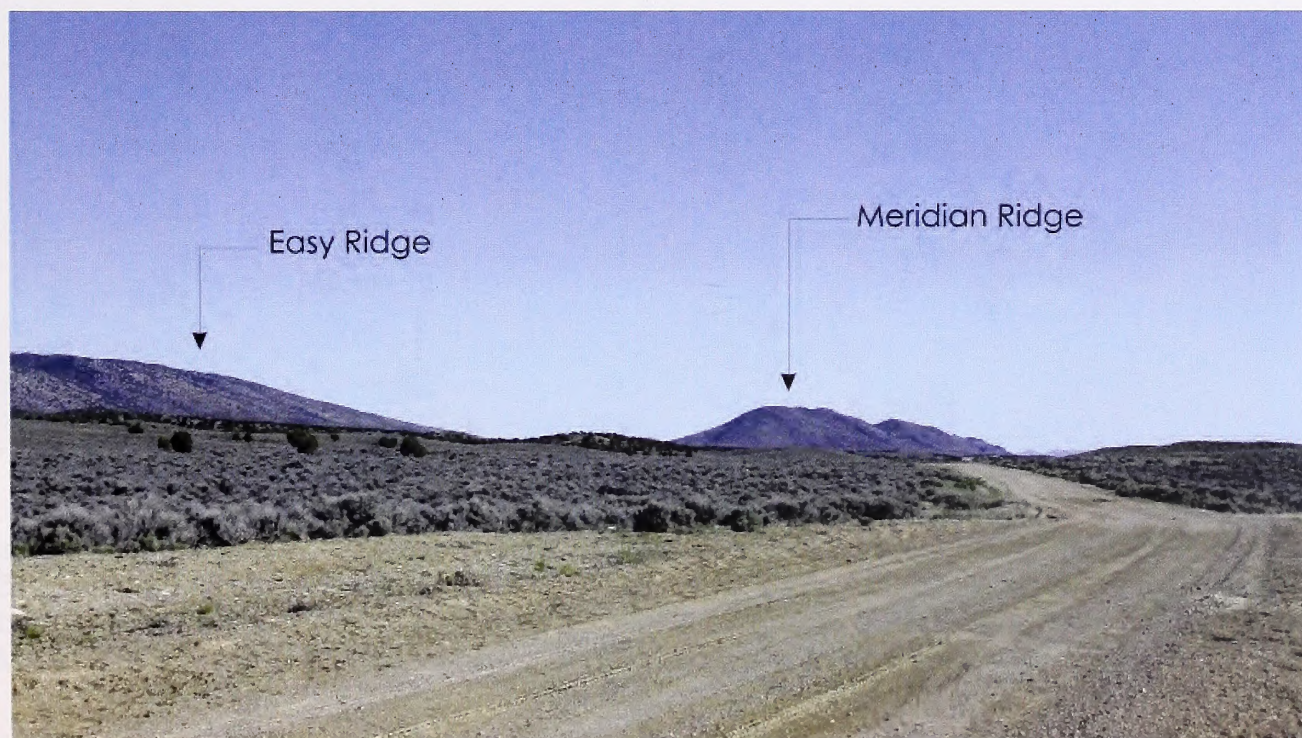

KOP 2

KOP 2 is located on BLM 4006 west of the intersection with Easy Junior Road and BLM 4006. This KOP is looking southwest towards the project area from BLM 4006 from the northern boundary of the Plan area. The portion of the project area that would potentially be visible from this KOP is in an area designated as VRM Class IV.

KOP 2 captures the view that casual observers travelling south on Easy Junior Road would have upon turning onto the proposed county road re-route of Easy Junior Road. The angle of view at this location is wide and the project area is in the foreground and middleground.

The topography in the foreground is flat to gently sloping. The existing unpaved BLM 4006 appears as a light brown linear feature in the foreground and middleground within an area designated as VRM Class IV. The Pancake Ridge appears as gray and blue rolling hills in the background and comprises the horizon at the skyline.

Vegetation in the foreground and middleground generally consists of short shrubs and grasses that appear in rounded and irregular forms with a medium to coarse texture. Vegetation in the foreground consists of low, sage green shrubs and brown grasses interspersed with bare ground.

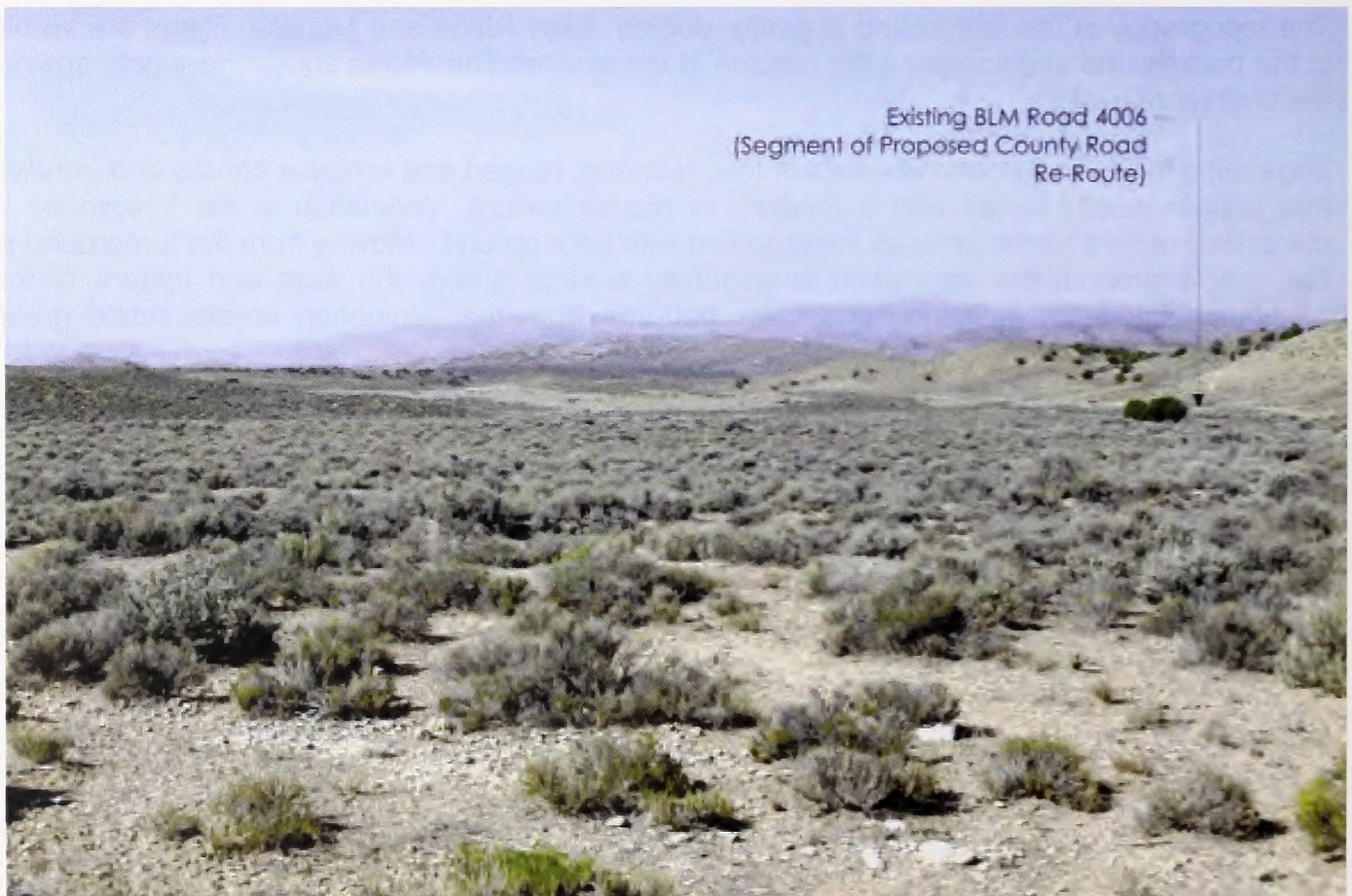
**KOP 3**

KOP 3 is looking north towards the project area from the driveway to the Duckwater Hot Springs (Big Warm Springs) within the Duckwater Shoshone Reservation. This KOP is approximately 15 miles south of the Plan area. KOP 3 is located within an area designated as VRM Class III, and the portion of the project area that would potentially be visible from this KOP are in VRM Class IV.

The topography in the foreground is relatively flat. Easy Ridge, Meridian Ridge and Mount Hamilton are visible as tan, brown and gray to blue rolling hills in the background and comprise the horizon at the skyline. Vegetation in the foreground is low to medium height green grasses and short shrubs. Rounded, rugged and irregular low sage green shrubs are visible in the middleground area.

The driveway to the Duckwater Hot Springs and a wooden post-and-rail fence are visible in the foreground, and SR 379 (Duckwater Road) is visible in the middle ground as a light tan linear features. The visual setting between the KOP and the project area is dominated by the existing unpaved road, wooden fence, white rocks visible in the foreground.

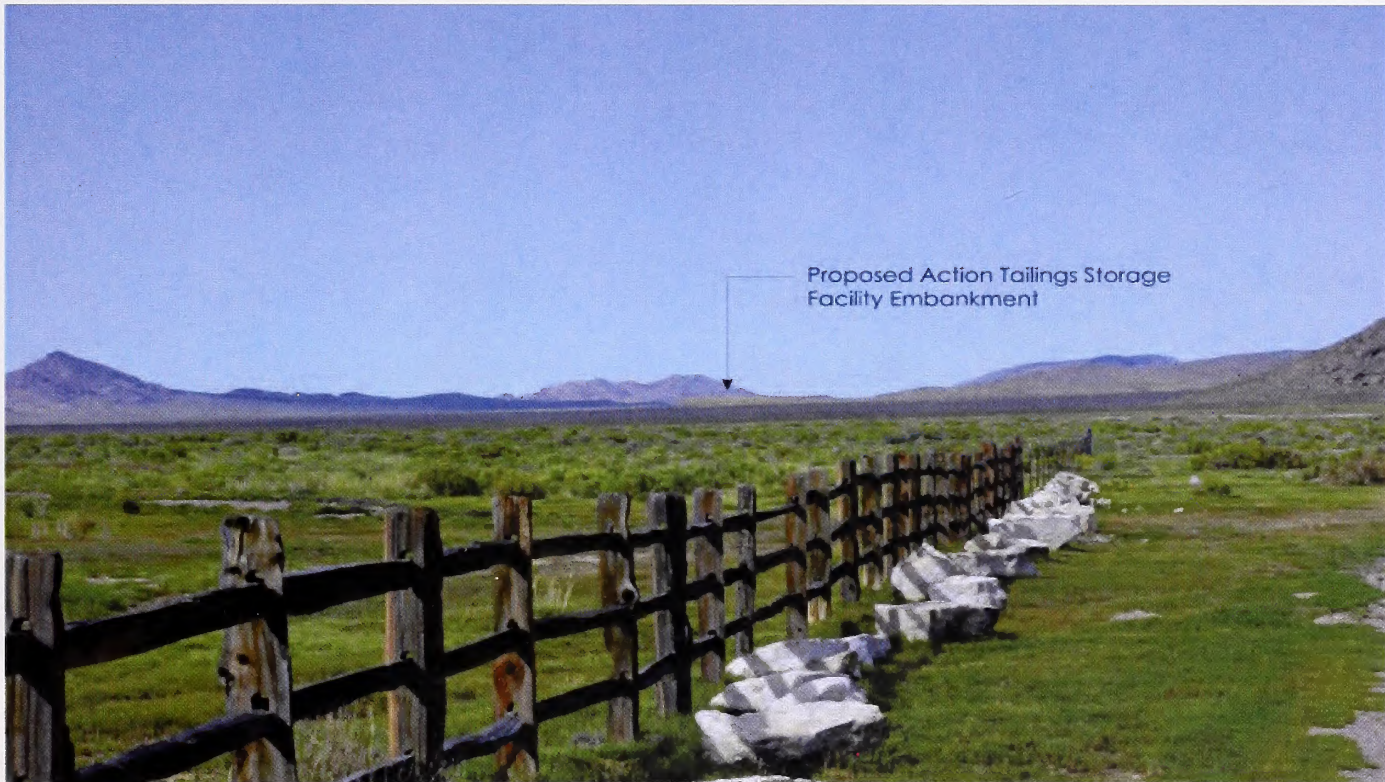

KOP 4

KOP4 is looking northeast from Duckwater Road near an area known as Bull Fork in Nye County, approximately 8 miles south/southwest (across the valley) from the project area. This KOP is located within an area designated as VRM Class III, and the portion of the project area that would potentially be visible from this KOP are in VRM Class IV.

KOP 4 also captures the wide angle of view that casual observers travelling on Duckwater Road would have of the project area and surrounding areas to the north and south. Topography in the foreground is flat and gently sloping. Gently rounded hills are seen in the middle ground at and the background consists of Mount Hamilton which creates a strong irregular horizontal, pyramidal line at the skyline. The rolling hills are a darker shade of brown, and the Mount Hamilton in the background appears as shades of blue against the brighter blue sky.

Vegetation in the foreground consists of low, homogeneous juniper shrubs, sagebrush, forbs, and grasses that appear mostly lumpy with a medium to coarse texture. Vegetation in the foreground is generally a dark-green color and brown and is interspersed with bare ground. Moving from the foreground to the middle ground, the form and texture of the vegetation becomes indistinct, and color patterns from the vegetation create subtle horizontal lines.

No existing structures are visible in the foreground, middleground or background areas. Landforms visible in the background include the closed Easy Junior Mine heap leach pile and waste rock disposal area, and the Mount Hamilton mine.

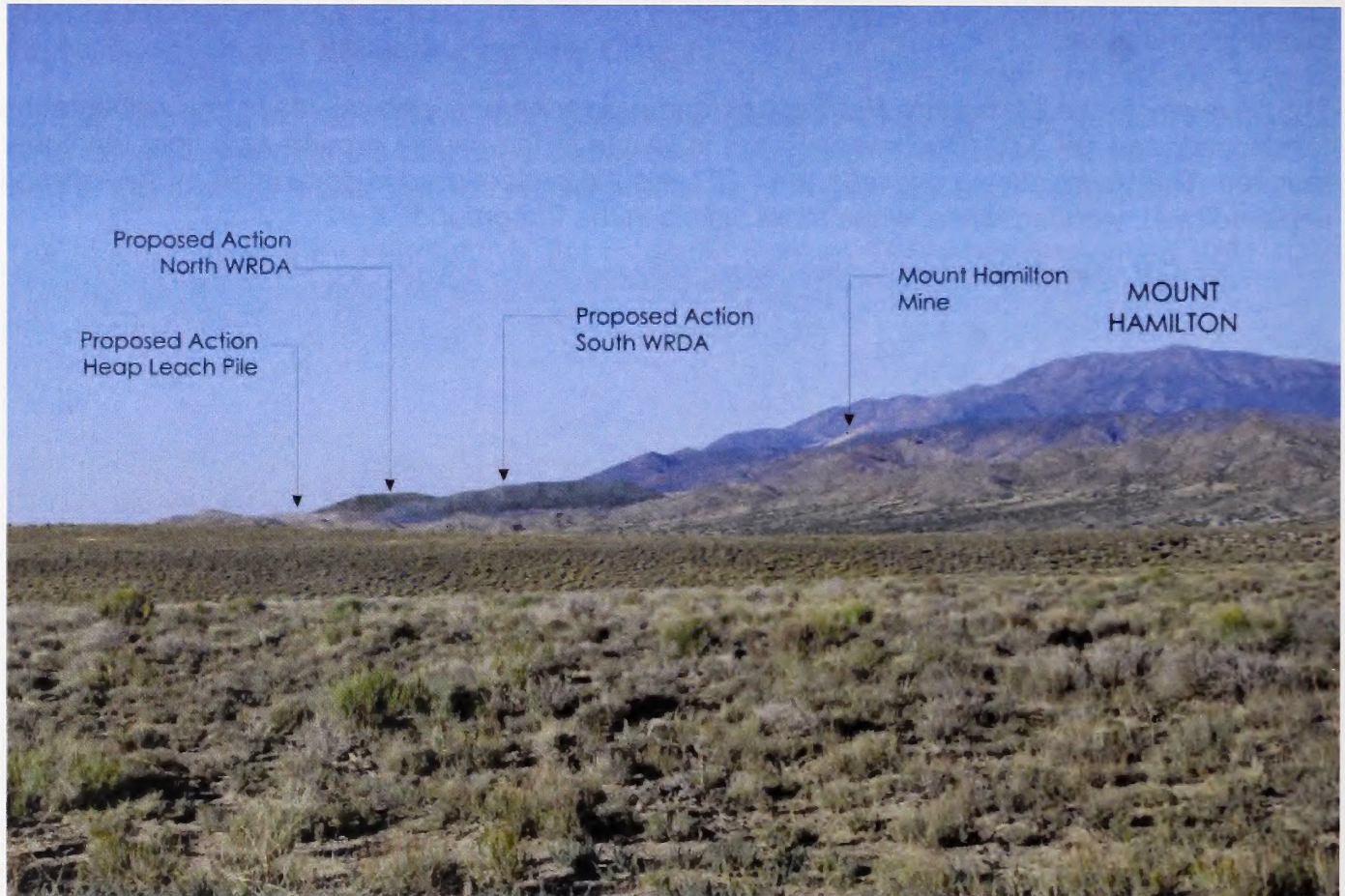

Dark Skies

Low light pollution conditions, or dark skies, is one of the most important properties for viewing stars, constellations, and other astronomical features, such as comets. There are no existing stationary light sources in the project area and very few existing stationary light sources in the project region. The project area is remote, rural and isolated from major cities and towns. Thus, the ambient light level in the project area is very low during the night and the sky is considered to be very dark. The very low ambient light level allows visibility of astronomical features. The night landscape generally appears as an otherwise dark and unlit, black or nearly black space with little to no distinguishable landscape features.

3.17 RECREATION

Existing Conditions

Existing conditions for recreation resources are described below. Existing conditions for all of the alternatives are similar. Existing conditions for the Northwest Main Access Route Alternative, Northern Power Line Route and the Northwest Main Access Route Alternative, Southern Power Line Route (Figure 2.4-2) also would include the existing Pan Mine access route and the maintenance road for the Pan Mine Southwest Power Line Route, which is likely to be constructed within the next year. A portion of the existing Pan Mine access road is located within the Loneliest Highway SRMA (Figure 3.15-1).

No designated Wilderness, WSAs or lands with wilderness characteristics are present in the Plan area. The nearest Wilderness is approximately 5 miles east of the Plan area (Figure 3.15-1).

The BLM Ely District manages surface use of lands in the project area. Recreation is managed through the designation of SRMAs and Extensive Recreation Management Areas (ERMAs) (BLM 2008b). An area is designated as a SRMA when:

- More intensive recreation management of that area is needed;
- The BLM Ely District Office has a commitment to provide specific recreation and experience opportunities within that area; and
- Recreation is a principal management objective of that area.

The Loneliest Highway SRMA is adjacent to U.S. Highway 50 and includes all BLM lands extending approximately four miles to either side of US 50 (BLM 2008b). The Loneliest Highway SRMA contains some of the most popular destinations in the region, including the Illipah Reservoir Recreation Area (BLM 2007e). Under the Ely District Approved Resource Management Plan (BLM 2008b), the management objectives of the Loneliest Highway SRMA are to:

- Provide recreational opportunities to the public that would otherwise not be available;
- Reduce conflict among users;
- Minimize damage to resources; and
- Reduce visitor health and safety issues.

Any area of BLM-administered public land that is not designated as an SRMA is managed as an ERMA. These areas include both developed recreation sites and primitive recreation sites with minimal facilities (BLM 2008b).

In the project area, the northern portions of the existing main access route (Green Springs Road) and Easy Junior Road are located within the Loneliest Highway SRMA (Figure 3.15-1). The Plan area and proposed second well, Proposed Action power line corridor, and portions of existing roads are located within an area managed as an ERMA.

There are no developed recreation facilities or sites in the project area; however, the majority of the project area is open for dispersed recreation use. Dispersed recreational uses in the project area include OHV use, hunting, fishing, camping, cross-country skiing, horseback riding, caving, rock climbing, hiking, sightseeing, outdoor photography, wildlife and bird watching, cultural tourism, and mountain biking (BLM 2008b; BLM 2012h; WPCPLUAC 2007).

The exact number of recreation visits that occur in the project area over a given period of time is unknown because of the dispersed nature of the uses that are provided in the area. However, recreational use of the public lands in the BLM Ely District has been consistently increasing (BLM 2008b).

Hunting is one of the most common recreational activities in the project area and surrounding region. The Nevada Department of Wildlife manages big game and hunting in the state, and has divided the state into 29 management areas (hunting areas) for antelope, deer, mountain lion, elk, bighorn sheep, mountain goat, and fur-bearing animals. Each hunting area has been

further divided into several hunt units by NDOW. The project area is located in NDOW Hunting Area 13, within a portion of NDOW Hunt Unit 131 (Figure 3.15-1). Hunt Unit 131 is open for elk, mule deer, and pronghorn antelope hunting.

There are approximately 1,800 miles of road in Hunt Unit 131. Access for hunters within Hunt Unit 131 is good, and includes many maintained roads as well as smaller jeep trails requiring four wheel drive vehicles (BLM 2012h). Access to the Plan area is currently open to the public.

In the project area a portion of the existing main access route passes through elk habitat. Elk hunting is generally most successful in the higher elevations of Hunt Unit 131 in the summer and fall, with elk moving to the lower elevations above Jakes and Railroad Valleys during winter. Portions of the project area are located in mule deer year-round range (Section 3.9). Mule deer are found mostly in the upper elevations of the White Pine Range but will migrate to lower areas in October. Most of the project area is located in pronghorn antelope habitat (BLM 2008b). Large pronghorn herds are generally found in Little Smoky Valley and Railroad Valley (BLM 2012h), although small herds and transient individuals may find forage and breed in the Plan area. A small area in the southeastern portion of the project area is located in bighorn sheep range (NDOW 2014).

There are approximately 5,100 acres of existing surface disturbance in Hunt Unit 131, including historical mining disturbance; the Robinson Mine, an active gold and copper mine located approximately 34 miles northeast of the Gold Rock project area (BLM 2012h); and ongoing exploration activities. In the project area the unreclaimed 33-acre Easy Junior Mine pit is unavailable for recreation, and areas of disturbance from on-going mineral exploration activities may be unavailable for recreation.

3.18 SOCIOECONOMICS

Existing Conditions

Economic Setting

White Pine County

White Pine County is located in the rugged high desert region of eastern Nevada. Ely is the county seat. The county's economic prosperity has traditionally been tied to mining of the region's deposits of silver, gold, and copper. Mining initially centered on silver and gold in the mid-1800s, while later investments developed around mining copper.

Development of the Nevada Northern Railroad in 1906 supported the expansion of copper mining by providing an effective means to transport copper ore from mines to smelters. From 1906 to the late 1970s, White Pine County's economy was dominated by the copper industry. For many years during this period, the value of White Pine County's mineral production was higher than that of all of the other counties in the state combined (White Pine County Water Advisory Committee [WPCWAC] 2006).

In 1933, after initial development by a series of owners, Kennecott Copper bought the copper resources in White Pine County and became the county's largest employer. The company developed and operated local housing, including the "company towns" of Ruth and McGill. Falling copper prices in the late 1970s, coupled with overseas copper production and stricter environmental regulations, led to closure of the copper mine in Ruth in 1978 and significant layoffs at the smelter in McGill. The smelter and the railroad closed in 1983.

Throughout the 1980s and 1990s, the county's economic prosperity continued to fluctuate with the boom and bust cycle of the mining industry, driven by fluctuations in metal prices. Ownership of the mines changed through time. With the decline of world copper prices in 1998, BHP announced that its operations in the county would be placed in "care and maintenance" status, and laid off 433 workers. Simultaneously, Alta Gold declared bankruptcy and closed two mines in the county. These events resulted in a significant rise in unemployment, decline in school enrollment, and decrease in taxable sales (WPCWAC 2006).

While mining was the backbone of the county's economy, a small agricultural industry developed to supply mining camps. The county has large amounts of open land and the primary agricultural activity has been and is grazing. The 160 farms in White Pine County generated \$20.651 million in value, for an average of \$129,069 per farm, an increase of 63 farms and more than \$5 million in value from 2007; Crops accounted for \$9.057 million, and livestock accounted for \$11.594 million in value (USDA 2012).

The shutdown of the Kennecott Copper operations in the 1970s and 1980s encouraged economic diversification efforts by county leadership. During the early 1980s, the county established an industrial park and eventually pursued construction of a maximum-security prison. The Ely State Prison was built in White Pine County in 1989 and now provides a stable source of jobs for county residents.

Although community leaders continue to explore options to diversify the county's economic base, mining will likely continue to play an important role in the local economy. Significant mineral resources have been documented in the county and could be developed further as demand for commodities and precious metals increases (WPCWAC 2006).

Eureka County

Eureka County is a sparsely populated, rural county in central Nevada. The unincorporated town of Eureka, located in the southern portion of the county, is the county seat and the county's largest community. The town of Eureka, and the Diamond Valley area located north of the town of Eureka, constitute the Eureka Census County Division (CCD).

Mining has been the economic base of Eureka County since its establishment in 1873, with the discovery of silver-lead mineralization near the site of the present town of Eureka. Improvements in the smelting process led to the county's first mining boom, and by 1878, Eureka was the state's second largest city with a population of more than 7,000. As ore bodies were exhausted, Eureka experienced its first mining bust and lost most of its population (Blankenship et al. 2013). Since the mid-1800s, other mining operations have opened and closed, reflecting the traditional boom and bust cycle inherent in the mining industry.

Development of mines in the county's early history brought sheep herders, cattlemen, and other settlers to Eureka, which led to the establishment of an agricultural industry. Through time, agriculture (principally hay and livestock production) has provided relatively stable employment and income opportunities in the county and continues to play an important role in the local economy (Eureka County 2010). The 101 farms in Eureka County generated \$36.02 million in value, for an average of \$356,636 per farm, an increase of 15 farms and more than \$11 million in value from 2007; Crops accounted for \$29.246 million, and livestock accounted for \$6.774 million in value (USDA 2012).

The legacy provided by the mining industry now forms the basis for an emerging tourism and recreational industry in Eureka. Surges in mining development provided government tax

revenue that has been used in part to develop historic attractions, upgrade public infrastructure, and restore historic buildings and streetscapes. These improvements, coupled with the area's scenic setting and recreational resources, are contributing to a growing tourism and recreation sector (Blankenship et al. 2013).

Despite some economic diversification, mining continues to play a significant role in Eureka County. Presently, the two largest employers in the county are mining operations. These operations provide the substantial tax revenues that Eureka County has used to develop and maintain a variety of public facilities (Blankenship 2009).

Community of Duckwater and Duckwater Shoshone Reservation

Duckwater is a rural community located in Nye County, Nevada near the southwestern corner of adjoining White Pine County. The community includes the Duckwater Shoshone Reservation, three privately owned ranches, and other privately owned lands (Sanchez 2012).

Duckwater is isolated from population centers in White Pine and Eureka counties by distance and poor roads. Employment opportunities within the Duckwater community are limited. The economic center of the area is concentrated on the Duckwater Shoshone Reservation where 68 percent of the community's residents live.

The Duckwater Shoshone Indian Tribe occupies the Duckwater Shoshone Reservation in northeastern Nye County, Nevada. The United States acquired these lands for the establishment of the Reservation. The Duckwater Shoshone Reservation now includes 3,815 acres of land. In 2010, 156 people lived on the Reservation.

Employment on the Duckwater Shoshone Reservation largely comprises Tribal programs, including the Duckwater Economic Development Corporation, a trucking business that is wholly owned by the Tribe. However, many residents of the Tribe are employed by businesses located off the Reservation, primarily at the Barrick Mine and the Foreland oil refinery in Ely (Sanchez 2012). The principal land use within the Duckwater Shoshone Reservation is agricultural. The Tribe has exclusive jurisdiction over its lands and is a federally recognized self-governance tribe.

Population

White Pine and Eureka counties are rural and sparsely populated. Population centers in both counties account for large percentages of the total population. In Eureka County, approximately two out of three people reside in the unincorporated community of Eureka and surrounding areas, including Diamond Valley. In White Pine County, approximately six out of 10 people live in Ely and the nearby communities of McGill and Ruth.

Historical and Current Population

Population in the project region has fluctuated through time, sometimes dramatically, in concert with the level of mining activity in the area (Figure 3.18-1 and Table 3.18-2). White Pine County's population grew dramatically between 1900 and 1940, increasing more than six-fold from 1,961 to 12,377. The county lost nearly 3,000 residents in the following decade as the mining industry contracted. Since that time, the county has seen several periods of expansion and contraction, with the population declining to 8,167 in 1980, but reaching more than 10,000 in both 1970 and 2010. Eureka County's population, which was more than 7,000 in 1880, reached a low of 767 residents in 1960 but climbed to 1,987 by 2010 (BCLLC/SDLLC 2013).

Figure 3.18-1 Census Population: White Pine and Eureka Counties 1900 – 2010

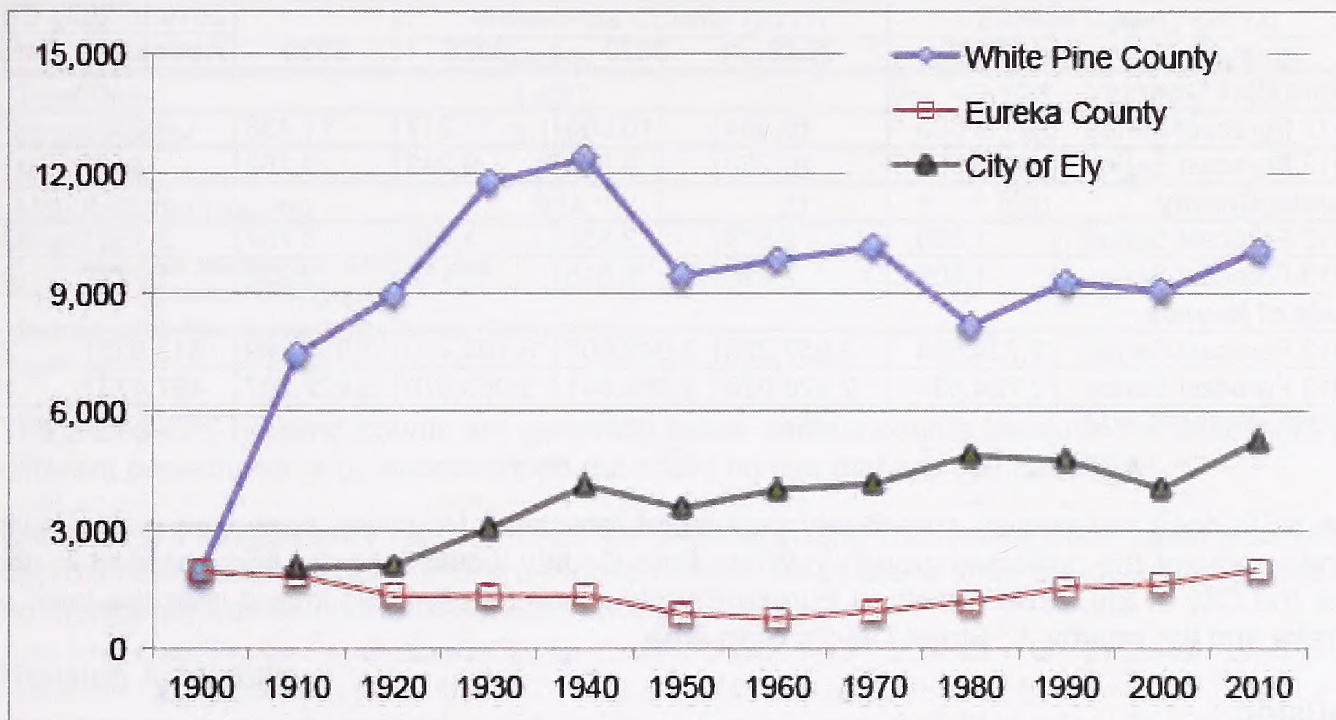

Sources: Blankenship et al. 2013.

Table 3.18-2 Project Region Population, 1970-2010

Community	Population by Year				
	1970	1980	1990	2000	2010
White Pine County	10,150	8,167	9,264	9,181	9,503
Ely	4,176	4,882	4,756	4,041	4,235
McGill	2,164	1,419	1,258	1,054	1,148
Ruth			552	506	440
Ely Reservation		78	59	133	202
Eureka County	948	1,198	1,547	1,651	1,609
Eureka CCD	547	798	1,107	1,103	1,351
Duckwater Shoshone Reservation		106	135	149	156

Sources: U.S. Census Bureau 1970, 1980, 1990, 2000, and 2010

Projected Population

The Nevada State Demographer (NSD) prepares annual population projections for the State of Nevada and its counties. These future population forecasts can vary considerably from year to year, as shown in Table 3.18-3. The October 2012 forecast projected White Pine County's population to grow by 1,933 inhabitants (or 20 percent) between 2010 and 2030, exceeding 11,400 by the end of the period. The recently released October 2013 forecast has a much different outlook, with a net loss of 341 residents by 2030, a net decline of 4 percent compared to 2010 (Hardcastle 2013). The difference between the two forecasts likely reflects uncertainty regarding active and proposed mining projects in the two counties.

Table 3.18-3 Projected Resident Population: White Pine and Eureka Counties, 2010 – 2030

	2010	2015	2020	2025	2030	2010 to 2030 Change	
						Absolute	Percent
White Pine County							
2012 Forecast Series	9,503	10,464	10,865	11,217	11,436	1,933	20
2013 Forecast Series	9,503	10,280	9,879	9,243	9,162	-341	-4
Eureka County							
2012 Forecast Series	1,609	2,379	2,856	3,446	3,767	2,158	134
2013 Forecast Series	1,609	2,020	2,015	2,130	2,336	727	45
State of Nevada							
2012 Forecast Series	2,724,634	2,857,223	3,043,607	3,199,430	3,338,269	613,635	23
2013 Forecast Series	2,724,634	2,828,028	2,959,641	3,083,970	3,222,107	497,473	18

Source: Hardcastle 2013

The NSD does not publish sub-county population forecasts. However, based on past growth trends, most of the projected growth in White Pine County would likely be concentrated in and near the City of Ely, while growth in Eureka County would be centered in and near the town of Eureka and the nearby 3rd Street/Devil's Gate area.

Housing

Conventional Housing

Conventional housing includes single and multifamily homes and mobile homes. Table 3.18-4 summarizes 2000 and 2010 housing conditions in Ely, McGill, Ruth, and Eureka as reported in the decennial census in each of those years. While only a small change was seen in the number of total units in both counties between 2000 and 2010, the number of vacant units dropped considerably. In White Pine County, the percentage of vacant units dropped from approximately 26 percent in 2000 to approximately 17 percent in 2010; in Eureka County, the drop in vacant units during this time period was even greater, from 35 to 22 percent of the total units.

The White Pine and Eureka County Assessors also provide housing counts for their respective counties. County assessors' housing counts for White Pine County (2011) and for Eureka County (2012) are shown in Table 3.18-5.

Table 3.18-4 Housing Inventory

Units	White Pine County			Eureka County		
	2000 Census	2010 Census	2000 to 2010 Change	2000 Census	2010 Census	2000 to 2010 Change
Total Units	4,439	4,498	59	1,025	1,076	51
Occupancy Status						
Occupied	3,282	3,707	425	666	836	170
Vacant	1,157	791	-366	359	240	-119
Occupied Units, by Type						
Owner Occupied	2,515	2,615	100	491	556	65
Renter Occupied	767	1,092	325	175	280	105

Sources: U.S. Census Bureau 2000 and 2010

Table 3.18-5 Recent White Pine and Eureka County Assessor Housing Counts

	White Pine County (2011)		Eureka County (2012)	
	Number	Percent	Number	Percent
Total Units	4,430	100	993	100
Single Family	3,152	71	268	27
Multifamily	364*	8	65**	7
Manufactured Housing	914	21	660	66

Notes:

* Includes both attached and detached units.

** Includes 12 senior housing units.

Sources: *White Pine County 2012a, Eureka County 2012a.*

The assessors' housing counts are generally below census counts because the assessors use different procedures (e.g., assessors do not count homes that are uninhabitable).

Currently, 74 single-family housing units are present on the Duckwater Shoshone Reservation; approximately one-third of these are mobile homes. All of these units are occupied. There are no multifamily homes on the Reservation (Knight 2013).

Housing Availability

Despite a large number of unoccupied units reported in the 2010 Census, there are limited housing units currently available for purchase or rent in either White Pine County or Eureka County. Many units reported as vacant are uninhabitable or are used as second homes or vacation homes. Other units are for sale or sold, but not yet occupied.

Few houses or apartments are available for rent in either Eureka or Ely. When available, monthly rental rates range from approximately \$650 to \$1,100 per month in both communities. In Eureka, the Nevada Rural Housing Authority recently constructed 50 rental units in the Eureka Canyon subdivision. Of those, 12 one-bedroom units and 1 two-bedroom unit were available in October 2013 (Green 2013).

During July 2013, approximately 75 homes were listed for sale in Ely with a median price of approximately \$135,000, and six homes were listed for sale in Eureka with a median price of approximately \$125,000. Residential building lots were available for sale in both communities.

There were no vacant housing units on the Duckwater Shoshone Reservation in September 2013 and only four vacant residential sites (Knight 2013).

The shortage of housing is a key issue for White Pine and Eureka counties (Nevada Rural Housing Authority 2005, Eureka County Board of Commissioners 2011, White Pine County 2012b). A recent study identified a shortage of 137 units in White Pine County alone (White Pine County 2012b).

Both White Pine County and Eureka County have recently implemented initiatives to encourage the development of affordable rental and owner-occupied housing. The White Pine County Economic Diversification Council has begun an initiative to address the County's housing needs. Recent steps in the initiative include researching United States Department of Agriculture (USDA) grant opportunities, assessing building departments' abilities to consider safety issues related to dilapidated structures, and possible incentives to lower or offset landfill costs if an older structure is removed and a new home is built in its place (Garza 2013, Ely Times 2013).

In the Eureka area, Eureka County recently subsidized the development of a subdivision. An ample supply of buildable lots currently exists in the Prospect Canyon and Eureka Canyon subdivisions, and in the nearby Devil's Gate General Improvement District. There are 66 vacant lots for sale in the Eureka Canyon subdivision, priced at \$20,000 per lot. Lots are served with water, wastewater, and electricity with streets, curbs, and gutters in place. The subdivision could be expanded to nearby areas given sufficient market demand (Damele 2011, 2013).

The availability of housing in the project area may also be affected by activities associated with planned and operating mines. Recent events, including a delay in construction of the Mount Hope Mine, the November 2013 high wall failure resulting in temporary shut-down at the Ruby Hill Mine, and possible restructuring of other area mines, may result in additional housing becoming available if former employees of these mines choose to relocate.

Temporary Housing

Temporary housing resources include motels, hotels, and recreational vehicle (RV) parks. Table 3.18-6 summarizes temporary housing resources in Ely and Eureka. There are no or limited temporary housing resources in McGill, Ruth, or Duckwater.

Temporary housing resources in Ely and Eureka routinely house construction and mining workers as well as tourists and recreationalists. Demand for temporary housing by tourists is typically high during the summer months.

Table 3.18-6 Temporary Housing Resources in Ely and Eureka

Housing Type	Ely	Eureka
Motel Rooms	663	88
RV Spaces	224	100

Sources Nevada Commission on Tourism 2013, Eureka County 2012a, White Pine County Tourism and Recreation Board 2013.

Recent mineral exploration and electric transmission line construction in the region has contributed to high occupancy rates in White Pine County. During peak summer travel periods and during the work week, hotels, motels, and RV parks in the project region routinely report full or near-full occupancy (Damele 2012, Blankenship et al. 2013). Temporary housing resources, particularly RV parks, are also used by some mine operations workers who commute weekly.

Education

School districts are delineated along county lines, resulting in two school districts in the project region: White Pine County School District (WPCSD) and Eureka County School District (ECSD).

White Pine County School District

Facilities

The WPCSD is headquartered in Ely. The WPCSD operates eight schools, an early childhood center, and an adult education program. The District's four elementary schools offering grades kindergarten (K) through 5 are located in Baker, Ely, Lund, and McGill. The White Pine Middle school (grades 6, 7, and 8) is in Ely and the District's three high schools are in Ely, Steptoe Valley, and Lund (grades 7 through 12). School-age children living in Ruth attend schools in Ely. The WPCSD's schools in Ely would most likely be affected by enrollments related to the proposed mine (Dolezal 2013).

A new private charter school, Learning Bridge, opened at the beginning of the 2013-2014 school year and offers a full-day kindergarten and single classrooms for first through sixth grades. The school plans to add seventh and eighth grade classes within 2 years. The current plan is that students graduating from the school would continue at the White Pine County High School (Dolezal 2013).

Enrollment

Fall enrollment in the WPCSD (grades K through 12) has varied somewhat during the past decade, from a low of 1,366 students in the 2003-2004 school year to a high of 1,477 students in 2005-2006, after which total enrollment trended downward until 2011-2012. A disproportionate share of the changes occurred in the McGill Elementary and Lund Junior/Senior High schools. More recently, increases in elementary students have more than offset declining secondary enrollment, raising total district enrollment to 1,408 students at the beginning of the 2012-2013 school year (Table 3.18-7). Secondary enrollment has trended downward since the 2005-2006 school year.

Preliminary counts for the 2013-2014 school year indicate a total enrollment of approximately 1,320 students in WPCSD schools. In part, the year-to-year decline compared to the 2012-2013 school year reflects the recent opening of the private Learning Bridge charter school in Ely, which drew an enrollment of approximately 120 students.

Capacity

The WPCSD has adequate capacity to accommodate a substantial increase in enrollment at its schools in Ely, particularly at the middle and high schools. An entire floor of the middle school and parts of the other two floors are unused. The White Pine High School and associated campus is in good repair and the existing physical capacity could accommodate approximately 180 additional students. Capacity is also available at the Norman Elementary School, in part a result of the recent opening of Learning Bridge in Ely.

Although physical capacity for enrollment is available, much of the WPCSD's educational infrastructure is in need of repair or replacement. Parts of the Norman Elementary School and White Pine Middle School facilities are more than 100 years old, and the physical facilities and plant have several critical deficiencies. In addition, the McGill Elementary School is dated and in need of major renovation or replacement.

Eureka County School District

Facilities

The ECSD is headquartered in Eureka. The ECSD operates three schools: Eureka Elementary School and Eureka Junior/Senior High School (located in Eureka) and Crescent Valley Elementary (located more than 100 miles north of Eureka outside of the project region).

Enrollment

Total fall enrollment in the ECSD has experienced a long-term decline from a peak of 378 students during the 1997-1998 school year to a low of 220 students at the start of the 2003-2004 school year. By fall of the 2012-2013 school year, total enrollment had increased to 251. In 2012-2013, more elementary than secondary students attended ECSD schools for the first time in 6 years. Preliminary counts for the 2013-2014 school year indicate a slight drop in total enrollment compared to the previous year (Table 3.18-7).

Capacity

Maximum capacity is typically a function of classroom number and size; optimum capacity considers the amount of space that the ECSD determines should be dedicated to specific instructional programs or administrative functions within a school building, as well as statutory limits on some elementary class sizes and specific needs of incoming students (e.g., English as a Second Language classes [Zunino 2007]).

Eureka Elementary School has an optimum capacity of 240; attendance during the 2012-2013 school year was 132 (Nevada Department of Education 2012). Class sizes are generally less than 20 students; kindergarten through third grades are required to have fewer than 15 students.

The junior/senior high school has an optimum capacity of 190. Attendance during the 2012-2013 school year was 119 students (Nevada Department of Education 2012).

Recent enrollment levels in the ECSD provide capacity to allow increases in future enrollment within current facilities without additional capital construction.

Duckwater Shoshone Reservation

The Duckwater Shoshone Tribe operates a kindergarten through eighth grade school on the Reservation. High school students from the Duckwater Shoshone Reservation attend school in Eureka by agreement between the ECSD, Nye County School District, Duckwater Shoshone Tribe, and U.S. Bureau of Indian Affairs (Zunino 2013 and Knight 2013).

Table 3.18-7 White Pine and Eureka County School District Enrollment

School Year	White Pine County School District			Eureka County School District		
	Kindergarten Through Grade 6	Grade 7 Through Grade 12	Total	Kindergarten Through Grade 6	Grade 7 Through Grade 12	Total
2002-2003	716	708	1,424	139	100	239
2003-2004	691	675	1,366	129	91	220
2004-2005	725	703	1,428	127	109	236
2005-2006	761	716	1,477	117	107	224
2006-2007	704	697	1,401	135	110	235
2007-2008	699	707	1,406	114	122	236
2008-2009	718	680	1,398	114	128	242
2009-2010	726	685	1,411	122	125	247
2010-2011	696	686	1,382	111	118	239
2011-2012	719	656	1,375	116	118	234
2012-2013	756	652	1,408	132	119	251

Source: Nevada Department of Education 2006 through 2013

Public Services

Given the rural, largely unpopulated nature of much of White Pine and Eureka counties, public services tend to be centralized in Ely and Eureka.

Law Enforcement

The White Pine County Sheriff's Office (WPCSO) provides law enforcement for the entire county including the City of Ely. The WPCSO has 15 patrol officers, two detectives, five full-time

and one part-time detention officers, five administrative personnel, and five dispatch staff. It also provides dispatch services for the WPCSO, emergency medical response, and fire suppression agencies throughout the county.

The WPCSO operates the county's detention facilities. The White Pine County detention facility in Ely can house 40 inmates, including eight female inmates. Recent occupancy has generally been between 20 and 30 inmates. Juvenile detainees are transported to Elko.

The Eureka County Sheriff's Office (ECSO) provides law enforcement for the entire county and provides dispatch services for all public safety functions for the county, including law enforcement and emergency medical and fire suppression activities. The ECSO staff of 17 includes the sheriff, undersheriff, patrol officers, dispatchers, administrative personnel, and jailers (Eureka County 2012b). The Eureka patrol division includes the southern half of Eureka County; the ECSO may respond to incidents in White Pine County.

Like the WPCSO, the ECSO operates the county's detention facilities. The detention facility in Eureka can accommodate 20 inmates, including four females. However, the facility does not have dedicated juvenile cells. Consequently, the ECSO transports juvenile offenders to juvenile detention facilities in Elko.

The Nevada Highway Patrol (NHP) provides law enforcement on federal and state highways. White Pine and Eureka counties are part of the NHP's Northern Command based in Elko (Nevada Department of Safety 2013). The NHP has a substation in Ely and officers stationed in Eureka.

The Duckwater Shoshone Tribe operates its own police department. Currently, it is staffed by two officers. Detainees are transported to Eureka County's facility for detention (Knight 2013).

Emergency Response

Fire Departments

The White Pine County Fire Protection District (WPCFPD) provides fire suppression services in all areas of the county, except for Ely. The WPCFPD typically has only two paid staff, including the Chief. The District maintains stations, volunteers, and equipment in Ely, McGill, Ruth, Lund, Baker, Cherry Creek, Lackawanna, and Cold Creek. The Ruth station is located closest to the proposed mine site and has approximately 14 volunteers and limited structure, vehicle extraction, and wildland firefighting equipment. The Ely station, located at the White Pine County Emergency Response Complex in Ely, houses the paid firefighters, approximately 15 volunteers, a command vehicle, wildland firefighting equipment, and tankers.

The WPCFPD does not have a hazardous materials response team. However, it does maintain some HAZMAT containment equipment. The WPCFPD coordinates with the NDEP, NHP, responsible companies, and hazardous materials vendors on accidents regarding hazardous materials (Derrick 2013; Peacock 2013).

The Ely Fire Department has five full-time firefighters supplemented by 31 volunteers. It maintains the only ladder truck in the county, in addition to a variety of other firefighting equipment (Peacock 2013).

Eureka County funds six local volunteer fire departments (VFDs). The Eureka and the Diamond Valley VFDs are the nearest fire departments to the proposed mine site. The other four VFDs serve other parts of the county and are not described further in this EIS.

The Eureka VFD is staffed by approximately 25 volunteers (Eureka County 2013a). It maintains eight vehicles, including two Type 1 structure engines; one 3,800-gallon water tender; one Type 6 brush fire truck; two Type 4 brush fire trucks; one rescue/extraction truck equipped with jaws-of-life, spreaders, and other equipment; and a pumper truck that is only used within the town. Although the Eureka VFD's primary service area is southern Eureka County, the department sometimes responds to incidents along US 50 in the western portion of White Pine County (BLM 2012f).

The Diamond Valley VFD has approximately 20 volunteers and four vehicles. Three of the volunteers are certified Emergency Management Technicians (EMTs). The Diamond Valley VFD maintains a structure/rescue unit, a 3,000-gallon tanker truck, an older military six-by-six wildland unit, and a 1-ton wildland unit (BLM 2012f).

The Nevada Division of Forestry (NDF) is responsible for fire protection on all non-Federal open lands in White Pine County. The NDF conservation camps in Ely provide crews for wildland fire suppression. Additional fire suppression resources are available in White Pine County through mutual aid agreements with the BLM Ely District Office, Humboldt-Toiyabe Ely Ranger District, and Great Basin National Park (BLM 2013c).

Nye County Fire Service's Currant Creek/Duckwater station provides fire protection to the Duckwater Shoshone Reservation; this station is staffed by a volunteer force.

Emergency Medical Response

The White Pine County Ambulance Service provides emergency medical response throughout White Pine County. Ambulances are stationed in Ely at the Emergency Response Complex and at McGill, Lund, and Baker. The Emergency Response Complex is located nearest to the proposed mine site. It has four full-time paid intermediate-level emergency medical technicians (EMTs) and seven volunteers, and maintains three ambulances, two of which are four-wheel-drive vehicles.

The Eureka County Emergency Medical Service is organized into two volunteer ambulance services: Eureka Volunteer Ambulance Service (EVAS) and Eureka County Emergency Medical Service (ECEMS). The EVAS serves the town of Eureka and Diamond Valley and portions of White Pine and Eureka counties. EVAS has two ambulances in Eureka and one in Diamond Valley. The ECEMS also has a non-transport squad vehicle and an off-road rescue vehicle. The ECEMS has two full-time EMTs, including an emergency medical services coordinator, in addition to volunteers.

Emergency services have limited capabilities to respond to mass casualty incidents in the project region. The Nevada State Health Division has staged a mass casualty trailer in Eureka, stocked with emergency medical supplies for treating nearly 1,000 patients. The EVAS is preparing an 18-litter mass casualty transport vehicle to be based at the Eureka airport as part of its overall emergency preparedness program. That unit would enhance EVAS's capability to respond to multivehicle crashes or major industrial accidents (Eureka County 2013b, Sullivan 2013).

Emergency medical transport for residents of the Duckwater Shoshone Reservation, when needed, is typically dispatched from the White Pine County Ambulance Service station in Lund (Knight 2013).

Water and Wastewater

White Pine County

The City of Ely provides water and wastewater services within its boundaries and to nearby unincorporated areas of White Pine County. Ely currently obtains its water supply from two wells with a combined pumping capacity of 7,000 gpm. Ely has five other production wells capable of contributing approximately 4,000 gpm to the system, but these are only used for backup. The Ely water system has a storage capacity of 7.5 million gallons. Ely has adequate water supply and storage capacity to accommodate existing population and foreseeable growth, although the distribution system may limit development in some areas of the city and surrounding unincorporated areas (Jenkins 2013, White Pine County 2012a).

The Ely wastewater treatment system is permitted by the NDEP to treat up to 1.5 million gallons per day (mgd) through a modified extended aeration plant process. However, the system configuration is only capable of treating 1 to 1.1 mgd. Current flows average approximately 0.7 mgd or approximately 65 percent of capacity (Jenkins 2013, White Pine County 2012a).

The McGill Ruth Consolidated Sewer and Water General Improvement District (McGill Ruth GID) provides water and wastewater service to the communities of McGill and Ruth. McGill's water is supplied from two wells, with a combined pumping capacity of 2,600 gpm. McGill has 1.5 million gallons of water storage capacity. McGill's water system has the capacity to accommodate approximately twice the current service population (Cummings 2013, White Pine County 2012a).

In McGill, wastewater is treated in a single partial mix/aerated pond that has been divided into two cells by a baffle, after which treated water is discharged through six rapid-infiltration basins. The NDEP permitted capacity of McGill's treatment system is 0.18 mgd. Operational flows currently range between 0.06 and 0.10 mgd. Consequently, McGill's wastewater treatment system could handle nearly twice the current service area population (Cummings 2013, White Pine County 2012a).

Ruth obtains water from the City of Ely, but the McGill Ruth GID is trying to identify and purchase a new water source. The distribution system was installed in the 1980s and the town has 0.75 million gallons of storage. There are no current plans to expand the existing Ruth water system beyond the current service area, except for potential expansion to serve the subdivided but unoccupied parcels located on the west side of town (Cummings 2013, White Pine County 2012a).

The NDEP permitted capacity of the Ruth wastewater treatment system is 0.06 mgd. Wastewater flow contributions reportedly range from 0.02 mgd in the summer months up to 0.05 mgd in the winter. The winter increase is attributed to water fixtures and faucets being set to drip to inhibit pipe freezing (Cummings 2013, White Pine County 2012a).

Eureka County

Eureka County maintains and operates two water systems in the southern part of the county: Eureka Town Water System and Devil's Gate General Improvement District (Devil's Gate GID) in Diamond Valley.

The Eureka Town Water System is supplied by two groundwater wells located approximately 3.5 miles north of town. In 2009, well production capacity was 1,296,000 gallons per day (gpd), average daily demand was 160,000 gpd, and maximum daily demand was 480,000 gpd. Eureka County recently rehabilitated and integrated a series of county-owned springs to the Eureka

Town Water System, which have enhanced the town's water supply and reduce transmission costs (Damele 2013). Water storage in town consists of a 0.35-million gallon tank on the southeast end of town and a 0.75-million gallon tank and a newly constructed 1.25-million gallon tank on the west side of town.

The installation of new water mains, water meters on all accounts, and new education programs to promote conservation have reduced consumption and expanded the potential service area capacity. Eureka County estimates that the potential customer base for the Eureka Town Water System could be approximately an additional 400 customers. Currently, there are slightly more than 300 customers on the system (Damele 2011 and 2013).

Wastewater treatment within the town of Eureka is provided by a multiple-cell, aerated, evaporative lagoon wastewater treatment facility managed by the county public works department. Although the wastewater treatment facility is permitted to discharge a maximum of 100,000 gpd, it operates at less than 75 percent of its permitted capacity. Eureka County has received permits to expand the facility to 200,000 gpd (Damele 2011 and 2013).

The Devil's Gate GID currently operates two wells, which are adequate for current demand and could accommodate some growth. There is concern that production from these two wells may be inadequate to accommodate complete build out of the GID service area. Options for additional supply include connecting to a well at the Eureka Airport and improving the quality of water in one of the GID's existing wells that is used for non-potable source water. Adequate water storage exists for current customers and an additional 250 residents. Full build out would require additional storage and rights to an additional 40 acre-feet of water. Wastewater treatment in Diamond Valley is accomplished through the use of individual septic systems (Damele 2011).

Duckwater Shoshone Reservation

The Duckwater Shoshone Reservation has adequate water supply and storage capacity for the existing community and for foreseeable growth (Knight 2013). The residential portion of the community is served by a wastewater collection and lagoon treatment system. The administrative buildings are served by a septic system (Knight 2013).

Solid Waste/Landfills

White Pine County

The City of Ely Municipal Utilities Board operates a regional landfill northwest of the City. The NDEP February 2013 Solid Waste Permitted Facility Summary (SWPFS) lists the landfill as having a total disposal capacity of 1,876,800 cubic yards with an estimated facility closure date of 2036. Local estimates are that the landfill has an additional 33 years of capacity at current fill rates (Bachmeier 2013).

Eureka County

Eureka County operates the Whiskey Flats landfill north of the community of Eureka, which serves the entire county. The 2013 SWPFS indicates that the facility had a total disposal capacity of 232,323 cubic yards and a remaining disposal capacity of 173,700 cubic yards, sufficient to serve needs through 2035. Eureka County has an application for expansion pending with the NDEP (Damele 2013, NDEP 2013e).

Duckwater Shoshone Reservation

Solid waste from the Duckwater Shoshone Reservation is transported to the Nye County-operated Tonopah landfill (Knight 2013). The Tonopah landfill has adequate capacity to accommodate current and foreseeable demand (Eastley 2011).

Health Care

White Pine County

The William Bee Ririe Hospital & Rural Health Clinic in Ely, operated by the White Pine County Hospital District, provides healthcare services for residents of White Pine County and surrounding rural areas. The 25-bed hospital is an accredited critical access hospital with a 24-hour emergency room and a wide range of medical diagnostic, treatment, and surgical services. The hospital and clinic have board-certified staff physicians and visiting specialists offering a wide range of medical specialties (William Bee Ririe Hospital 2013).

Eureka County

Healthcare in southern Eureka County is provided at the Eureka Medical Clinic, located in the town of Eureka and operated by the Nevada Health Centers, Inc. The clinic is currently operated by two nurse practitioners, one of whom is board certified. The clinic offers family medicine, women's health services, pediatrics, occupational health, urgent care, family planning, health screenings, well-child care and immunizations, sexually transmitted diseases/human immunodeficiency virus education, lab, x-ray, prescription dispensary, prenatal and newborn care, chronic illness management, and health education (Nevada Health Centers 2013). A Medicaid Eligibility Specialist visits the clinic monthly to assist the community with available programs. For acute care, Eureka County residents visit hospitals in nearby counties including Elko General Hospital, William Bee Ririe Hospital in Ely, and Reno-area hospitals (Eureka County 2012a).

Duckwater Shoshone Reservation

The Duckwater Shoshone Health Department operates the Indian Health Services-funded Duckwater Clinic, which is staffed by a full-time physician who also provides pharmacy services, and other medical and administrative employees (Knight 2013).

Social Services

The Nevada Department of Health and Human Services (NDHHS) maintains an office in Ely, which serves the project region. Services include Child and Family Services; Supplemental Nutrition Assistance Program (SNAP, also known as the food stamp program); Women, Infants, and Children's Nutrition Services; Health Protection Services including Aging and Disability Services; and Consumer Health Assistance (NDHHS 2013).

The Ely Mental Health Center, operated by the Nevada Division of Public and Behavioral Health (NDPBH), serves White Pine, Lincoln, and Eureka counties. Services for children, adolescents, and adults include: outpatient counseling; psychosocial rehabilitation; service coordination; consultation and education; crisis services; and group therapy (NDHHS NDPBH 2013).

Eureka County provides emergency assistance (emergency food, shelter, transportation to the NDHHS office in Ely) to those requesting it on an as-needed basis. The County Social Services Coordinator administers the assistance program that ranges from providing indigent healthcare to energy payment assistance. Residents seeking social assistance available through the

NDHHS apply for support online, through the mail, or through the office in Ely. The caseload from Eureka has traditionally been limited, with the largest demand being for SNAP benefits (Oram 2007).

Economics, Employment, and Personal Income, White Pine and Eureka Counties

Background and History

Mining has long been an economic mainstay in both White Pine and Eureka counties. Although agriculture is also important economically and culturally, it accounts for a smaller part of the economy than mining. Construction, tourism/travel support, and government employment also play important secondary roles.

The mining industry in the project region has experienced several expansion and contraction cycles in recent history. As a major driver of the economy in the project region, changes in mining activity are realized throughout the economy of the project region. The history of the Robinson Mine provides an example.

Closed since the late 1970s, construction activities to reopen the Robinson Mine began in 1994 and operations commenced in 1995. In 1999, the mine was closed because of low commodity prices. It reopened in 2004 and continues to operate today. Mapped against employment in White Pine and Eureka counties on Figure 3.18-2, the employment effects of one large mining project become evident.

Construction and opening of the Ely State Prison in 1990 brought a new and stable source of jobs to White Pine County. Those jobs, along with increases in Federal government employment, were the primary factors underlying the increase in importance of government employment in the region.

Employment

In 2011, the combined employment of White Pine and Eureka counties totaled 10,858 jobs. This represented a net gain of nearly 1,600 jobs in the two counties since 1990 and a compounded annual growth of 0.8 percent. Total employment gains were registered in both counties, with 58 percent of the net change occurring in Eureka County (Table 3.18-8).

Table 3.18-8 Total Employment in White Pine County and Eureka County – 1990, 2001 and 2011

	1990	2001	2011	1990 – 2011 Change
White Pine County	4,968	4,055	5,644	676
Eureka County	4,297	4,559	5,214	917

Source: U.S. Bureau of Economic Analysis (BEA) 2012a.

Structure of Employment

The structural composition of the local economies differs dramatically between the two counties. In White Pine County, the government and mining industries each account for approximately one of every four jobs, with farming and “all other private” (agricultural services and forestry, construction, manufacturing, wholesale and retail trade, transportation, utilities, and services) accounting for the remainder. Federal and State agencies including the BLM, USFS, and Nevada Department of Corrections and Department of Transportation account for many of the government jobs based in White Pine County.

Figure 3.18-2 Employment 1990-2011

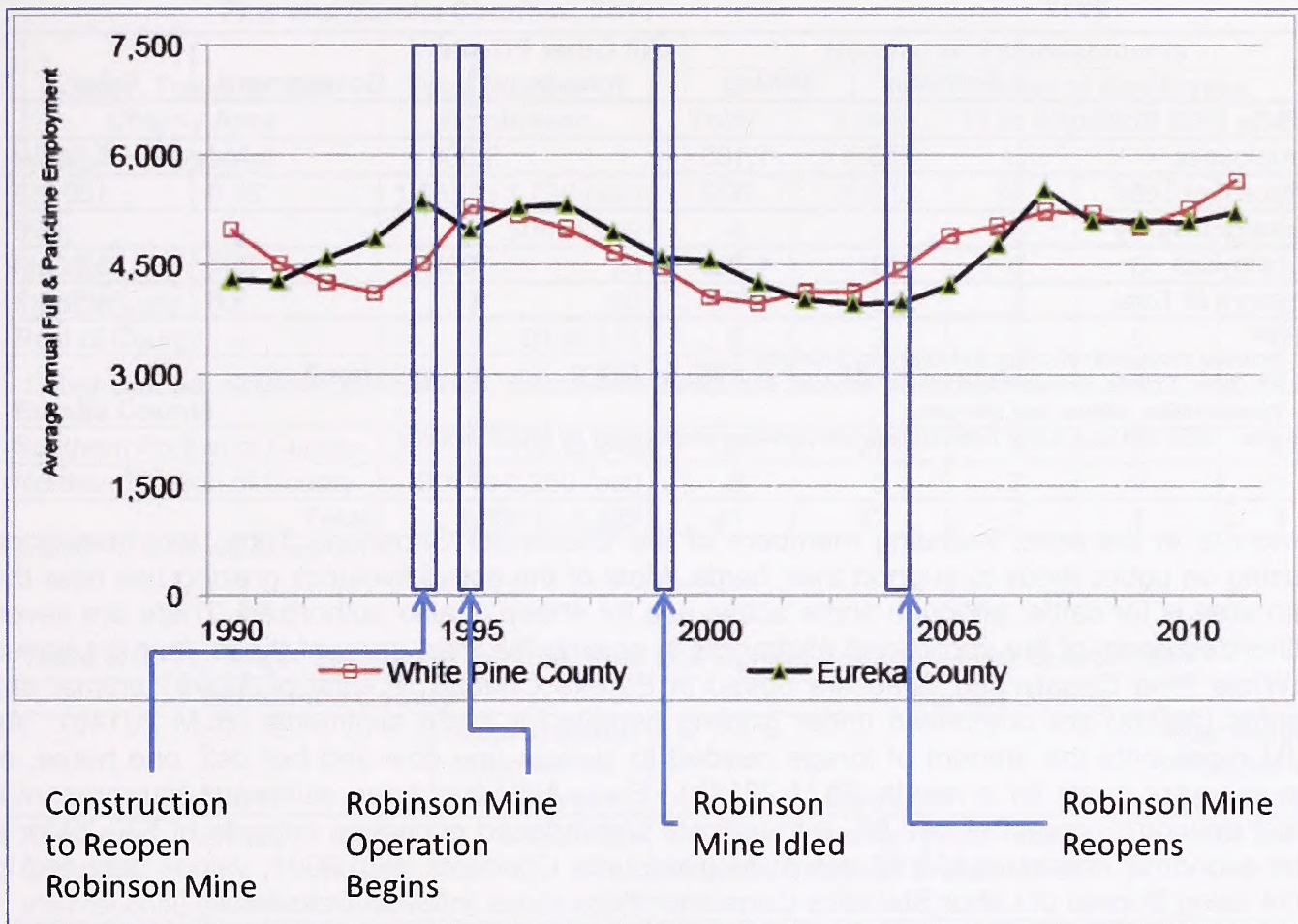

In Eureka County, mining accounts for nearly four of five jobs with farm, all other private, and government together accounting for approximately one of five jobs (Table 3.18-9). Although comparable employment data are not available for southern Eureka County alone, anecdotal information indicates that the distribution is more similar to that of White Pine County, except that farm employment likely accounts for one of five jobs. The Nevada Department of Transportation has a highway maintenance facility in the town of Eureka, but local government accounts for the majority of government employment in the county.

The project region has been shielded from the major economic dislocations realized in much of southern Nevada during the recession from 2007 to 2010. Industrial and residential construction slowed and some contraction occurred in the mining and retail trade industries, but net job growth has since resumed.

The regional agricultural industry, although relatively small in terms of the absolute number of jobs and personal income, helped buffer the local effects of the recession as farm income rose, providing direct and indirect support for local businesses. In Eureka County, 61 farms employed 225 individuals, with a total payroll of \$2.784 million; in White Pine County, 64 farms employed 268 people with a total payroll of \$3.071 million (USDA 2012). The production expenses for farms in Eureka County totaled approximately \$23 million and approximately \$21 million for farms in White Pine County.

Table 3.18-9 County Employment, by Broad Industrial Grouping (Place of Work Basis): 2012

	Farming ¹	Mining	All Other Private (non-farm) ²	Government	Total
White Pine County					
Employees	150	1,165	3,006	1,444	5,765
Percent of Total	2.6	20.2	52.1	25.0	100.0
Eureka County					
Employees	151	4,392	982	204	5,729
Percent of Total	2.6	76.7	17.1	3.6	100.0

Notes:

1 Includes production of crops and raising of livestock.

2 All Other Private includes agricultural services and forestry, construction, manufacturing, wholesale and retail trade, transportation, utilities, and services.

Source: BEA 2012a. CA25N Total full-time and part-time employment by NAICS industry

Ranchers in the area, including members of the Duckwater Shoshone Tribe, rely heavily on grazing on public lands to support their herds. Most of the active livestock grazing use near the Plan area is for cattle, although some active use for sheep is also authorized. There are seven authorized users of the public land allotments in or near the Plan area; of these, four are based in White Pine County and three are based in Eureka County. A total of 32,091 animal unit months (AUMs) are authorized under grazing permits for these allotments (BLM 2014b). An AUM represents the amount of forage needed to sustain one cow and her calf, one horse, or five sheep or goats for a month (BLM 2014h). Each AUM has been estimated to represent a direct economic impact of \$40.68, with indirect and induced economic impacts of \$33.20, for a total economic impact of \$73.88 per AUM (Resource Concepts, Inc. 2001; values adjusted to 2014 using Bureau of Labor Statistics Consumer Price Index Inflation Calculator).

The mining industry's contributions to local employment and economic activity extend beyond its direct effects, as the capital investment in new, upgraded, and replacement mining facilities supports commercial/industrial construction and the direct and indirect increases in employment and population foster new residential and public sector infrastructure development. Employment in the real estate, trade, and other consumer-oriented services also expanded during the period of growth in mining.

The geographic concentration of business establishments in the two counties in 2010 is evident in the information available on the number and size of firms presented in Table 3.18-10. The abundance of small businesses in the two counties is clear, because more than 70 percent of all establishments with employees have nine or fewer employees. Although fewer in number, the larger establishments account for larger shares of employment and wages and salaries paid.

The major employers in each county at the beginning of 2014 are shown in Table 3.18-11. The dominant role of mining firms in both counties (and particularly Eureka County) is evident.

Table 3.18-10 Geographic Distribution of Private Sector Establishments and Employees in White Pine and Eureka Counties, 2011

County, Town, or Sub-County Area	Total Number of Employees	Number of Establishments				
		Total	By Number of Employees			
			1 to 9	10 to 49	50 to 99	100+
White Pine County						
Ely	1,683 to 1,792 (est)	177	133	37	5	2
Ruth	500 to 999	4	3	0	0	1
McGill	23	10	10	0	0	0
Preston/Lund	52	7	5	2	0	0
Rest of County	91 to 174	6	3	3	0	0
Total	2,458	204	154	42	5	3
Eureka County						
Southern Portion of County	100 to 249	33	27	5	1	0
Northern Portion of County	900 to 2,250 (est)	8	5	2	0	1
Total	1,000 to 2,499	41	32	7	1	1

Source: U.S. Census Bureau 2013a

Table 3.18-11 Major Employers in White Pine and Eureka Counties, First Quarter 2014

White Pine County		Eureka County	
Employer	Approximate Number of Employees	Employer	Approximate Number of Employees
Robinson Nevada Mining Company [KGHM International] (Robinson Mine)	600 to 699	Newmont Mining (Gold Quarry, Phoenix, and Twin Creeks mines)	2,000 to 2,499
Barrick (Bald Mountain Mine)	400 to 499	Barrick (Goldstrike Mine)	1,500 to 1,999
Nevada Department of Corrections	300 to 399	Eureka County	100 to 199
White Pine County School District	200 to 299	Eureka County School District	70 to 79
William Bee Ririe Hospital	100 to 199	TS Power Plant	60 to 69
White Pine County	100 to 199	Barrick (Ruby Hill Mine)	20 to 29

Source Nevada Department of Employment, Training, and Rehabilitation 2014

Unemployment

Unemployment data for White Pine and Eureka counties are shown in Figure 3.18-3. While unemployment increased during the recession, the strength of the mining sector in the project region mitigated job losses, and unemployment rates remained below that of Nevada as a whole.

Figure 3.18-3 Annual Average Unemployment Rates 2006-2013

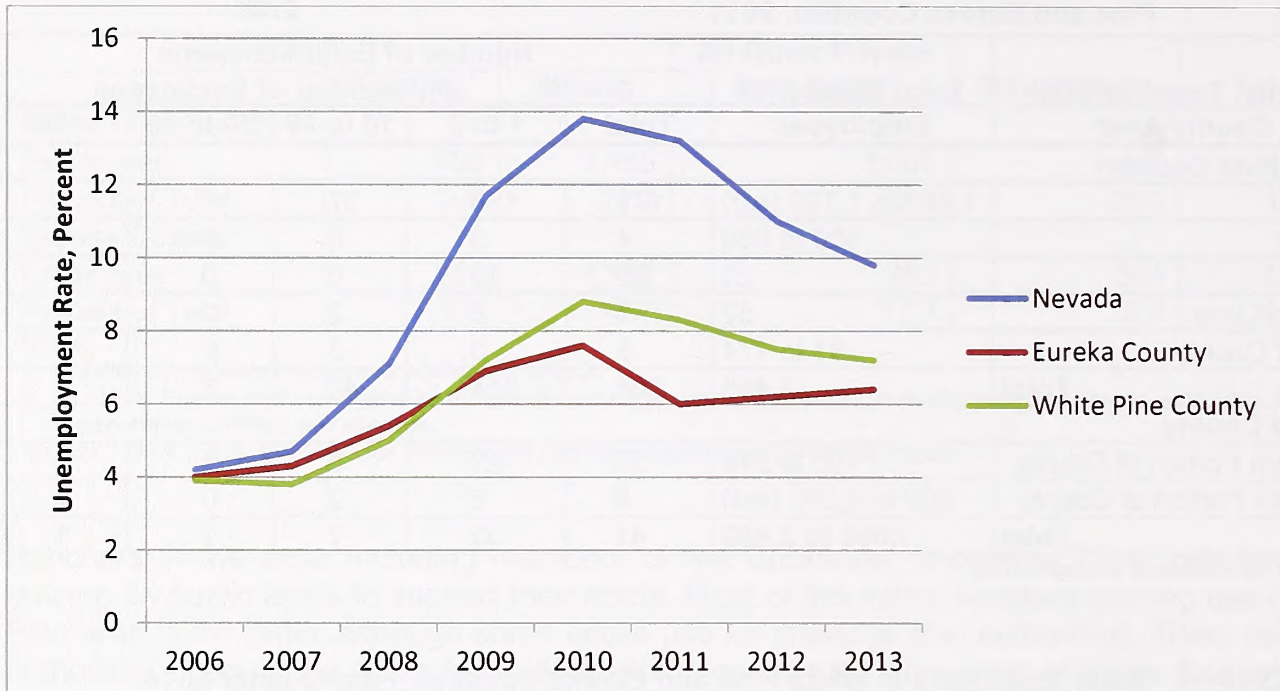

Source: U.S. Bureau of Labor Statistics 2013

Labor Market

The size of the labor force and the number of employed both increased in northeastern Nevada during the recessionary years (2007 to 2010), expanding by nearly 800 workers and job seekers in White Pine County and 300 workers and job seekers in Eureka County. Table 3.18-12 presents the labor force and numbers of unemployed workers in the project region. Information for the State of Nevada is provided for comparison.

Table 3.18-12 Regional Labor Force, Unemployment and Unemployment Rates, 2008 to 2013

	2008	2009	2010	2011	2012	2013 (June)
White Pine County						
Labor Force	4,741	5,021	5,257	5,826	5,837	5,532
Unemployed	236	362	466	481	416	414
Unemployment Rate (%)	5.0	7.2	8.9	8.3	7.1	7.5
Eureka County						
Labor Force	845	908	1,087	1,095	1,122	1,144
Unemployed	46	63	83	66	67	72
Unemployment Rate (%)	5.4	6.9	7.6	6.0	6.0	6.3
State of Nevada						
Unemployment Rate (%)	7.0	11.6	13.7	13.5	11.6	9.9

Source: U.S. Bureau of Labor Statistics 2013

Personal Income

A summary of earnings by place of work, the major adjustments to income, and resulting total personal income for White Pine and Eureka counties is presented in Table 3.18-13.

Table 3.18-13 White Pine and Eureka County Personal Income by Place of Residence: 2011

	White Pine County		Eureka County	
	\$ (,000)	%	\$ (,000)	%
Earnings by Place of Work	280,897	69.6	473,602	> 100 ²
Residency Adjustment ¹	34,622	8.6	-370,359	> -100
Social Security Deductions	-24,223	-6.0	-45,282	-60
Other Income to Residents	112,171	27.8	17,381	23
Total Personal Income of Local Residents	403,467	100.0	75,342	100

Notes:

1 A positive residency adjustment reflects a net inflow of earnings from residents of a county employed outside the county compared to earnings paid by local employers to workers who reside outside the county. A negative residency adjustment reflects the net outflow of earnings to non-resident workers employed in a county that exceed the earnings of local residents employed outside the county.

2 Because of the large net outflow, these values exceed the total personal income of local residents.

> = greater than

Source: BEA 2013.

Personal income data for White Pine County showed total earnings of nearly \$281 million for workers employed in 2011. The total, which amounted to 69.6 percent of the local income, included more than \$100 million in the mining sector, primarily in conjunction with KGHM's Robinson Mine (most of which accrues to residents of White Pine County) and Barrick's Bald Mountain Mine (where approximately 20 percent of the workforce lives in White Pine County) (BLM 2009c). Also in 2011, White Pine County residents earned more than \$47 million at establishments located outside the county. At the same time, nearly \$13 million in earnings was paid to non-residents employed in White Pine County. The net residency adjustment (inflow less outflow) was an inflow of nearly \$35 million, the equivalent of 12 percent of the total earnings by place of work (Table 3.18-13). Social Security deductions totaled more than \$24.2 million, equivalent to 6 percent of the total income. Other sources of income, including dividends, rents, interest, and certain personal and governmental transfers provided another \$112.2 million. The resulting total personal income for White Pine County in 2011 was \$403.5 million.

The situation is much different in Eureka County. Income is dominated by the location of the Barrick and Newmont mines in the northern part of the county. Most of the labor earnings paid by Eureka County employers flow out of the local economy, mostly to Elko and Lander counties where many of the employees of these mines live. The net outflow totaled \$370.4 million in 2011, which is the equivalent of nearly 80 percent of all earnings paid by employers located in the county. Deductions for Social Security, which are based on the place of work, exceeded \$45 million in 2011, while residents gained \$17.4 million in income from all other sources. The resulting total personal income for Eureka County in 2011 was \$75.3 million.

Per capita personal income in White Pine and Eureka counties has trailed that for the State of Nevada during the past decade. However, in 2011, per capita personal income in White Pine and Eureka counties (\$39,955 and \$38,071, respectively) surpassed the statewide average of \$36,964. The local increases were due to a combination of higher wages and salaries in mining and in construction that outpaced the increases elsewhere in the state (BEA 2012b). However, the 'true' per capita personal income in White Pine County is higher than these reported numbers, because the U.S. Bureau of Economic Analysis (BEA) includes the incarcerated population at the Ely State Prison in the derivation of per capital income. Given that the incarcerated population's income is negligible, this serves to depress the per capita personal income data for White Pine County.

Economics, Employment, and Finances, Duckwater Shoshone Reservation

Currently 46 workers are employed at the Duckwater Shoshone Tribal administrative, healthcare, and educational facilities in Duckwater. The Tribe also authorizes members to farm and graze cattle on specific plots of land and rents farm equipment and breeding bulls to authorized members. Authorized Tribal members graze cattle on adjacent BLM lands, but current grazing levels are substantially below levels from earlier periods. Some Reservation residents work for off-Reservation businesses. During September 2013, it was estimated that only two residents were unemployed.

Commercial businesses in Duckwater include a small convenience store and gasoline sales. A laundromat opened in fall 2013. The Duckwater Economic Development Corporation (DEDC) operates trucking and construction enterprises. In the past, the Tribe has operated greenhouses for growing native plants and provided reclamation services for replanting disturbed areas at area mines. The Tribe is planning to relocate the greenhouses to another part of the Reservation and resume greenhouse and reclamation activities (Knight 2013).

County Finances

Sources of Revenue

The general fund budgets of White Pine and Eureka counties rely heavily on ad valorem taxes (taxes based on the value of real estate or personal property, including sales taxes, property taxes, and taxes on the net proceeds from mining) and intergovernmental transfers. As shown in Table 3.18-14, the White Pine County general fund revenues increased in the past three budget years. Although lower intergovernmental revenues accounted for most of the decline seen in the 2012-2013 budget, local tax receipts are also expected to decline.

In Eureka County, general fund revenues registered a large increase between the 2009-2010 and 2010-2011 budget years (Table 3.18-15). The tentative budget for 2012-2013 is roughly half of the budget in 2010-2011. Changes in tax receipts account for most of the variation (the 2012-2013 tentative budget reflects a conservative estimate of anticipated ad valorem taxes from net proceeds of minerals).

Table 3.18-14 White Pine County General Fund Revenues (In Dollars): Fiscal Years 2011-12 to 2014-15

	2011-2012 (actual)	2012-2013 (actual)	2013-2014 (est. current)	2014-2015 (budgeted)
Taxes	\$12,281,646	\$11,752,269	\$9,747,470	\$9,763,295
Licenses and Permits	215,331	254,383	239,370	237,420
Intergovernmental	7,151,357	8,298,111	11,261,451	8,875,795
Charges for Services	1,014,589	1,047,283	988,050	881,000
Fines and Forfeits	431,800	388,648	401,200	396,200
Miscellaneous	1,164,416	1,420,856	1,520,704	5,606,399
Total Revenue	\$22,259,139	\$23,161,550	\$24,158,245	\$25,760,109

Source: White Pine County 2011 and 2012c.

Table 3.18-15 Eureka County General Fund Revenues (In Dollars): Fiscal Years 2010-11 to 2013-14

	2010-2011 (actual)	2011-2012 (actual)	2012-2013 (est. current)	2013-2014 (budgeted)
Taxes	\$19,364,310	\$17,853,501	\$16,862,735	\$5,450,649
Licenses and Permits	9,603	135,206	108,750	108,750
Intergovernmental	8,725,464	8,960,301	7,949,750	8,249,550
Charges for Services	2,124,753	2,012,515	1,284,470	1,298,470
Fines and Forfeits	94,306	106,948	86,810	86,810
Miscellaneous	737,312	862,399	367,345	406,635
Total Revenue	\$31,055,748	\$29,930,870	\$26,659,860	\$15,600,864

Source: Eureka County 2012b and 2013c.

Ad Valorem Taxes

For the fiscal year 2013-2014, property owners in White Pine County are assessed at the maximum permitted overlapping rate of \$3.66 per \$100 in assessed valuation, which is the maximum amount allowable by statute. The high countywide assessment rate is necessary because of the county's limited resources from other sources. Because the County's assessment is the maximum amount allowable by statute, the City of Ely is effectively prevented from levying a property tax.

Table 3.18-16 Countywide Ad Valorem Tax Rates in White Pine County and Eureka County, Fiscal Year 2013-2014

Taxing Entity	White Pine County	Eureka County
General County	1.951	0.8458
School District	0.999	0.7500
State of Nevada	0.1700 (Indigent healthcare)	0.1700 (Indigent healthcare)
Other Special Levies	0.540 (Hospital District)	0.0085 (TV District)
Total	3.660	1.7743

Note:

Rates are in dollars per \$100 of assessed valuation.

Source: Nevada Department of Taxation 2013a.

The overlapping countywide ad valorem tax rate of all entities in Eureka County is presently the lowest in the state and is 45 percent below the state-mandated maximum of \$3.66. Recognizing the volatility in revenues and timing lags associated with mining, assessment of taxes, and receipt of revenues, the Board of Eureka County Commissioners has a long-standing policy of maintaining relatively steady property tax rates, funding reserve accounts during periods of prosperity, and drawing down reserves to cushion the budgetary impacts of mine closures or declining net proceeds or assessments, or to fund capital improvement without resorting to long-term debt (Blankenship et al. 2013, BLM 2012h). An additional levy of \$0.2153 is imposed on property in the town of Eureka, yielding a total rate of \$1.9896 per \$100 of assessed valuation for properties in Eureka.

The ad valorem tax rates presented in Table 3.18-16 are levied on real property and on the net proceeds of minerals mined or processed. The net proceeds of mining tax is assessed by the State of Nevada. The net proceeds of mining tax is capped by statute at 5 percent. In effect, the state collects a 5-percent tax on net proceeds and royalties and returns to each county the

percentage of that 5 percent that is equal to the ad valorem tax rate of that county; therefore, White Pine County effectively levies a 3.66-percent tax on net proceeds and royalties and Eureka County levies a 1.7743-percent tax. The remainder of the 5 percent accrues to the State. The assessed valuations of real and other properties in each county are presented in Table 3.18-17.

Table 3.18-17 White Pine and Eureka County Assessed Values, Fiscal Years 2002/2003 through 2013/2014¹

Fiscal Year	White Pine County			Eureka County		
	Secured ²	Unsecured and Net Proceeds of Minerals ²	Total	Secured ²	Unsecured and Net Proceeds of Minerals ²	Total
2002/2003	\$110.1	\$8.9	\$119.0	\$400.4	\$91.4	\$491.8
2003/2004	112.9	21.8	134.7	308.2	228.3	536.5
2004/2005	104.7	17.4	122.1	340.2	261.4	601.6
2005/2006	111.1	70.6	181.7	273.4	322.6	596.0
2006/2007	137.5	287.9	425.4	333.8	488.9	822.7
2007/2008	152.4	268.8	421.2	381.9	653.0	1,034.9
2008/2009	165.4	221.6	387.0	473.1	1,034.4	1,507.5
2009/2010	197.1	208.7	405.8	583.7	832.6	1,416.3
2010/2011	208.0	618.4	826.4	546.2	2,627.2	3,173.4
2011/2012	215.4	256.2	471.6	531.7	1,356.2	1,887.9
2012/2013 ³	294.7	154.1	448.8	599.0	1,455.4	2,054.4
2013/2014 ³	337.7	96.6	434.3	630.4	1,329.5	1,959.9

Notes

1 Values are in millions of dollars.

2 Secured property generally refers to real property, mobile homes placed on foundations, and some improvements held by a title, whereby the taxes assessed create a lien on the property. Unsecured property generally refers to personal property, mobile homes not placed on foundations, and other property interest subject to property tax.

3 Estimated and projected.

Sources: Nevada Department of Taxation 2013b and 2013c.

The importance of the net proceeds of mineral valuation is evident, as is the variability in this valuation. The spike in assessed values realized in both counties in 2010-2011 was directly attributable to record prices for gold. Because ad valorem taxes levied on taxable assessed valuation are vital sources of local revenue, local revenue is sensitive to changes in the net proceeds of minerals.

The 2013 Nevada State Legislature adopted a joint resolution (SJR 15) calling for the removal of the net proceeds tax from the state constitution. The measure will be on the November 2014 ballot. If approved by Nevada voters, the measure would allow for potential changes in the way the mining industry is taxed. A companion bill, SB 400, triggered if the ballot measure is approved, provides a temporary tax structure to ensure that local governments continue to receive revenues equivalent to those they would have received under the current net proceeds formula, pending action by the Legislature to enact new taxing legislation. If approved by the voters, NRS 362.170 will read, in part: "There is hereby appropriated to each county the total of the amounts obtained by multiplying, for each extractive operation situated within the county, the net proceeds from that operation and any royalties paid by that operation, by the combined rate of tax ad valorem, excluding any rate levied by the State of Nevada, for property at the site of the operation..." Accordingly, counties will continue to receive the ad valorem tax rate value of the net proceeds of mining and royalties.

Intergovernmental Transfers

Intergovernmental revenues account for the vast majority of each county's non-ad valorem tax revenues (Table 3.18-15). Intergovernmental revenues from the state include the Basic County-City Relief Tax (BCCRT), Supplemental County-City Relief Tax (SCCRT), motor vehicle property taxes, and fuel taxes. The BCCRT and SCCRT are statewide sales and use taxes enacted to provide property tax relief. BCCRT is a state-mandated, county-imposed sales and use tax returned to the county of origin, while revenues derived from the SCCRT sales and use tax are pooled and distributed according to a specific formula. Local receipts from the Local School Support Tax (LSST) are distributed to the local school district as part of the education funding program. Use tax proceeds from out-of-state sales are pooled as part of the statewide funding program used to supplement district budgets where the LSST receipts are inadequate to meet the guaranteed funding levels.

Sales and use tax rates in Nevada are primarily established at the state level. Consequently, the ability of local governments to collect sales and use taxes is limited: No local option sales and use taxes are levied in Eureka County, but taxable sales in White Pine County are subject to a Local Options tax that supports school maintenance, road maintenance, and recreation and public safety improvements (Table 3.18-18).

Table 3.18-18 Sales and Use Tax Rates: White Pine and Eureka Counties

Description/Component	Rate (%)	Distribution
State Sales Tax	2.00	State general fund
BCCRT	0.50	Local receipts to county where sale is made. Out-of-state distributed to cities and counties based on formula.
SCCRT	1.75	Receipts distributed to qualifying local governments according to statutory formula.
LSST	2.60	Local receipts to local school district. Receipts from out of state go into state distributive schools fund.
Minimum Statewide Rate	6.85	Applies in Eureka County
Local Options: Extraordinary school maintenance, public transit and road maintenance, recreation and public safety improvements	0.875	Options levied in White Pine County
Total with Options	7.725	Applies in White Pine County

Source: Nevada Department of Taxation 2012

Sales and use taxes under Nevada's tax code are collected in all industries; the taxable sales in White Pine and Eureka counties in recent years are shown in Table 3.18-19, and the taxable retail sales by industry are shown in Table 3.18-20.

As shown in Table 3.18-20, sales by local utilities and out-of-state purchases by mining and other industrial companies account for substantial portions of the total taxable sales. Local wholesale trade is also heavily tied to the mining industry. Due to the ties to the mining industry and variations in year-to-year capital equipment purchases, local sales have tended to show relatively high year-to-year volatility; sales in White Pine County declined almost 37 percent from the 2011-2012 to 2012-2013 fiscal years, while sales increased less than 1 percent in Eureka County over the same timeframe.

Intergovernmental revenues also include various Federal payments and grants, including receipts of Federal payments in lieu of taxes (PILT). Administered by the U.S. Department of

Interior, the PILT program distributes payments to county governments to help offset foregone property taxes resulting from lands in Federal rather than private ownership. Annual payments are based on the number of acres of qualified federal lands in a county, the county population, the level of funding appropriated by Congress, and several other factors.

Table 3.18-19 Taxable Sales – Eureka and White Pine Counties, Fiscal Years 2007-2008 to 2012-2013

Fiscal Year	White Pine County		Eureka County	
	Annual Sales	Change from Previous Year	Annual Sales	Change from Previous Year
2007-2008	\$197,817,869	NA	\$328,505,567	NA
2008-2009	220,814,758	11.6%	285,941,250	-13.0%
2009-2010	174,705,288	-20.9%	266,356,436	-6.8%
2010-2011	314,234,656	79.9%	304,275,631	14.2%
2011-2012	469,737,233	49.5%	367,340,406	20.7%
2012-2013	296,597,716	-36.9%	370,492,295	0.9%

Source: Nevada Department of Taxation 2013d.

Table 3.18-20 Taxable Retail Sales, Total and By Major Industry – Eureka and White Pine Counties, Fiscal Year 2012-2013

Industry (Source of Sales/Receipts)	White Pine County		Eureka County	
	Taxable Sales	Percent of Total	Taxable Sales	Percent of Total
Agriculture	665,857	0	15,327	0
Mining	26,097,533	9	102,257,308	28
Utilities	22,484,926	8	357,927	0
Construction	21,471,312	7	16,156,905	4
Manufacturing	48,380,637	16	134,761,642	37
Wholesale	72,984,162	25	58,511,227	16
Retail	64,433,096	22	38,050,928	10
Transportation, Finance and Real Estate	17,831,790	6	8,061,797	2
Services	22,156,926	7	7,244,360	2
Other	37,973	0	1,789	0
Total	296,597,716	100	370,492,295	100

Source: Nevada Department of Taxation 2013d.

PILT payments help local governments fund services such as law enforcement, firefighting, search-and-rescue, and road maintenance and construction. The number of qualified Federal acres and PILT payments to White Pine and Eureka counties are summarized in Table 3.18-21.

Table 3.18-21 Federal Payments In Lieu of Taxes: Acreages and Annual Payment, Fiscal Year 2012-2013

	PILT Acres by Agency				PILT Payment
	BLM	USFS	Other	Total	
White Pine County	4,354,099	764,631	78,112	5,196,842	\$1,135,374
Eureka County	2,102,750	144,139	0	2,156,889	\$324,628

Notes:

“Other” includes the National Park Service and USFWS.

PILT payments are in addition to other sources of federal revenue such as the portion of public land grazing fees that are transferred to the state.

Source: U.S. Department of the Interior 2013.

Expenditures

Expenditures by both White Pine and Eureka counties have increased in recent years, with the rise in expenditures generally tracking the growth in revenues through time. The actual, estimated, and budgeted expenditures for both counties for recent years are presented in Tables 3.18-22 and 3.18-23.

Table 3.18-22 White Pine County Expenditures, Fiscal Years 2011-2012 to 2014-2015

	2011/2012 (actual)	2012/2013 (actual)	2013/2014 (est. current)	2014/2015 (projected)
General Government	4,136,469	4,283,749	8,650,071	4,208,967
Public Safety	4,604,749	4,810,899	5,002,361	4,507,415
Judicial	2,302,900	2,300,850	2,644,009	2,672,047
Highway and Streets	2,935,144	2,307,258	3,369,285	3,243,719
Health and Sanitation	111,063	238,346	128,583	131,897
Welfare	1,001,428	643,788	844,198	778,839
Culture and Recreation	1,325,027	2,488,871	10,285,583	3,602,114
Community Support	1,041,226	1,290,848	860,385	5,954,409
Intergovernmental	760,688	2,152,657	1,951,589	1,956,778
Total Expenditures	\$18,218,694	\$20,517,266	\$33,736,064	\$27,056,185

Source: White Pine County 2011 and 2012c.

Table 3.18-23 Eureka County Budgeted Expenditures Fiscal Years 2010-2011 to 2013-2014

	2010/2011 (actual)	2011/2012 (actual)	2012/2013 (est. current)	2013/2014 (projected)
General Government	\$5,225,105	\$9,768,334	\$12,502,308	\$7,057,095
Judicial	1,081,535	1,162,837	1,760,850	1,736,920
Public Safety	2,428,340	2,893,160	3,494,064	3,130,400
Public Works	4,789,686	7,251,554	7,381,000	7,145,000
Health, Sanitation and Welfare	1,386,523	1,741,541	1,710,849	1,705,000
Culture and Recreation	1,262,134	1,419,473	1,660,193	1,705,100
Community Support	813,633	2,053,522	1,270,450	1,335,525
Intergovernmental	6,230,572	8,866,469	3,879,000	2,874,000
Total Expenditures	\$23,217,528	\$35,156,890	\$33,658,714	\$26,689,040

Sources: Eureka County 2012c and 2013c.

Budgeted expenditures have increased through time across all major functions/ departments. The large increases are accounted for by non-recurring outlays for facility and road improvements. Incremental increases are accounted for by increases in staffing levels as shown in Table 3.18-24.

In White Pine County, a net increase of six full-time equivalents (FTEs) was included in the budget for fiscal year 2012-2013. Six FTEs were added to the county's public safety function and two FTEs were added in the judicial function with a net reduction of two FTEs in other functions. In Eureka County, staffing increases have been included for the Judicial and Health and Sanitation functions; employment in Culture and Recreation was trimmed by 1.5 FTEs, resulting in a net increase of 2.5 FTEs.

Table 3.18-24 Eureka and White Pine Counties, Full Time Equivalent Positions, Fiscal Years 2012 and 2013

Function/Department	White Pine County		Eureka County	
	Year Ending June 30, 2012	Year Ending June 30, 2013	Year Ending June 30, 2012	Year Ending June 30, 2013
General Government	27.0	27.0	21.0	20.0
Judicial	18.0	20.0	10.0	12.0
Public Safety	39.0	45.0	23.0	23.0
Public Works	25.0	25.0	25.0	25.0
Health and Sanitation	1.0	1.0	0.0	3.0
Culture and Recreation	6.0	5.5	9.5	8.0
Community Support	11.0	11.0	5.0	5.0
Other	1.5	0.0	0.0	0.0
Total Full Time Employees	130.5	136.5	94.5	97.0

Sources: Eureka County 2012c and White Pine County 2012c.

Financial Summary

Sometimes large changes in global commodity prices can lead to similarly large changes in the net proceeds of mining. These large changes can lead to large swings in state and local revenue. White Pine and Eureka counties have both established reserve funds to help deal with these swings. As shown in Tables 3.18-25 and 3.18-26, both counties have drawn or plan to draw from these funds to meet the differences between planned revenues and expenditures.

Table 3.18-25 White Pine County Fiscal Summary: Fiscal Years 2010-11 to 2013-14

	2010/2011 (actual)	2011/2012 (actual)	2012/2013 (estimated)	2013/2014 (budgeted)
Total Revenues	\$19,282,261	\$22,642,846	\$23,462,768	\$19,719,553
Total Expenditures	17,206,127	18,948,464	22,684,170	23,816,789
Net Current Revenue (Deficit)	2,076,134	3,694,382	778,598	(4,097,236)
Other Financing Sources	1,816,163	(807,060)	417,762	279,832
Net Transfer to/ Use of Reserve Fund Balance	+2,887,322	+3,896,895	-4,153,317	-7,209,892
Reserve Fund Balance (Ending)	32,106,796	36,868,772	32,715,455	25,505,563

Note:

The substantial deficit for fiscal year 2012-2013 was in part a reflection of the conservative approach taken by the Board of County Commissioners with respect to projecting net proceeds of minerals.

Source: White Pine County 2012c.

In recent years, Eureka County completed several major capital improvement projects. These projects included a new fire station in Eureka, water storage and transmission and wastewater collection and treatment projects in Eureka, and water system improvements in Devil's Gate GID. The County also made substantial investments in the Eureka Canyon Subdivision. Eureka County has a long-standing policy of refraining from the use of long-term debt for capital improvements. The policy of funding improvements using available resources reflects the substantial revenues generated by mining and the County's awareness of the uncertainties surrounding the industry and the associated potential implications for variability in tax revenues. Although current plans of the existing mines in the northern part of the county indicate sufficient reserves to sustain operations for some time, variability in the price of gold can affect production levels and net proceeds, in turn affecting the county's tax base.

Table 3.18-26 Eureka County Fiscal Summary: Fiscal Years 2010-11 to 2013-14

	2010/2011 (actual)	2011/2012 (actual)	2012/2013 (estimated)	2013/2014 (budgeted)
Total Revenues	\$31,055,748	\$29,930,870	\$26,659,860	\$15,600,864
Total Expenditures	23,217,528	35,156,890	34,058,714	27,089,040
Net Current Revenue (Deficit)	7,838,220	(5,226,020)	(7,398,854)	(11,488,176)
Other Financing Sources	1,760,773	0	1,001,000	1,000
Net Transfer to/ Use of Reserve Fund Balance	+9,598,993	-5,226,020	-6,397,854	-11,487,176
Reserve Fund Balance (Ending)	56,893,531	51,975,510	45,577,656	34,090,480

Source: Eureka County 2012b.

Financial Conditions, City of Ely

The City of Ely is the only incorporated community in the project region. The City of Ely is governed by a City Council. The city provides essential administrative functions, including city council, clerk and finance offices, a municipal court, law enforcement, public works, and municipal water, sanitation, and landfill enterprises.

Due to state statute limiting the maximum overlapping property taxes, the City is constrained from levying a property tax. As a result the City relies on intergovernmental revenues, primarily in the form of consolidated tax transfers from the state, revenues derived from licenses, permits and charges for services, and fines and forfeits for its revenues. Grants and transfers from White Pine County have also played an important role in the City's finances. A fiscal summary for recent years is provided in Table 3.18-27. The City currently maintains a reserve balance of approximately \$1.1 million.

Table 3.18-27 City of Ely Fiscal Summary: Fiscal Years 2010/2011 to 2013/2014

	2010/2011 (actual)	2011/2012 (actual)	2012/2013 (estimated current)	2013/2014 (budgeted)
Total Assessed Valuation	\$60,027,491	\$59,310,074	\$61,024,775	\$60,705,678
Total Revenues	\$3,540,718	\$3,558,670	\$2,691,959	\$2,771,467
Total Expenditures	\$3,290,649	\$3,467,528	\$2,484,699	\$3,332,312
Net Current Revenue (deficiency)	\$250,069	\$91,142	\$207,260	(\$560,845)
Reserve Fund Balance (ending)	\$981,780	\$1,231,852	\$1,322,994	\$1,530,354
City Employees (head count)	45	45	45	45

Notes:

* Constrained due to state statute and countywide levies.

Source: City of Ely 2011, 2012, 2013, 2014.

3.19 ENVIRONMENTAL JUSTICE

Executive Order (EO) 12898, "Federal Action to Address Environmental Justice in Minority Populations and Low-Income Populations" was published in the Federal Register (59 FR 7629) on February 11, 1994. EO 12898 requires Federal agencies to identify and address disproportionately high and adverse human health or environmental effects of their programs, policies, and activities on minority and low-income populations.

Existing Conditions

Racial and Ethnic Composition of the Population

As previously noted, the proposed Gold Rock Mine Project would be located in an unpopulated, remote area of southwestern White Pine County.

Table 3.19-1 presents information on the racial and ethnic composition of the population of the project region. This information is also provided for the United States and the State of Nevada for comparative purposes. As shown in the table, approximately 46 percent of Nevada's residents identified themselves as racial or ethnic minorities in 2010. The percentage of individuals identifying themselves as belonging to a racial or ethnic minority population was considerably lower in White Pine and Eureka counties than for the State of Nevada as a whole. Similarly, among the four non-Reservation communities or census-designated places (CDPs) in the project region (City of Ely, McGill CDP, Ruth CDP, and Eureka), the percentage of racial and ethnic minorities was substantially below the statewide average. The percentage of Native Americans (those identifying in whole or in part as American Indian or Native Alaskan) on the Duckwater and Ely Shoshone Reservations is substantially higher than the statewide average.

Low Income Population

The Census Bureau's Small Area Income and Poverty Estimates (SAIPE) program provides annual estimates of income and poverty statistics for all school districts, counties, and states. The estimated incidence of poverty in the counties in the project region is presented in Table 3.18-2; the estimated incidence of poverty among school age children is shown in Table 3.18-3. The incidence of poverty in both White Pine and Eureka counties and their respective school districts is lower than the Nevada statewide average. Median household incomes were also higher than the statewide average. Consequently, no concentrations of low-income populations have been identified in the project region.

Table 3.19-1 Racial and Ethnic Minority Populations

	Geographic Area Total Population	White and not Hispanic or Latino Population (Percent)	American Indian and Native Alaskan (Percent)	Total Racial and Ethnic Minority ¹ (Percent)
U.S.	308,745,538	63.7	0.7	36.3
Nevada	2,700,551	54.1	0.9	45.9
White Pine County	10,030	76.35	3.8	23.7
City of Ely	4,255	78.9	3.8	21.1
McGill CDP ²	1,148	85.8	1.7	14.2
Ruth CDP ²	440	84.3	2.5	15.7
Ely Reservation	202	14.9	72.3	85.1
Eureka County	1,987	83.6	1.5	16.4
Eureka	610	83.0	2.3	17.0
Duckwater Shoshone Reservation (Nye County)	156	19.9	69.2	80.1

Notes:

- 1 Racial minorities include all persons identifying themselves in the census as a non-white race, including "Black or African American," "American Indian and Alaska Native," "Asian," "Native Hawaiian and Other Pacific Islander," "Some other race alone," and "Two or more races." Ethnic minorities include persons who identify themselves as Hispanic or Latino. Persons of Hispanic or Latino origin can identify themselves as part of any race (including white) and as persons of Hispanic or Latino origins are an ethnic minority.
- 2 A CDP is a concentration of population identified by the U.S. Census Bureau for statistical purposes. CDPs are populated areas that lack separate municipal government, but otherwise physically resemble incorporated places.

Source: U.S. Census Bureau 2011

Table 3.19-2 2012 Estimated Poverty Rates for White Pine County and Eureka County

Geographic Area	Number of Persons with Incomes Below Poverty Level	Population Below Poverty Level (Percentage)	Median Household Income
Nevada	441,373	16.2	\$49,909
White Pine County	1,167	13.3	\$50,417
Eureka County	171	8.6	\$62,864

Source: U.S. Census Bureau 2013b.

Table 3.19-3 2012 School Age Incident of Poverty Data

District Name	School Age Population	Relevant Age 5 to 17 in Families in Poverty, Number of Individuals	Relevant Age 5 to 17 in Families in Poverty, Percentage of Student Population
All School Districts in Nevada	420,282	101,584	24.2
Eureka County School District	330	29	8.8
White Pine County School District	1,496	235	15.7

Source: U.S. Census Bureau 2013b

3.20 HAZARDOUS MATERIALS AND WASTES

Existing Conditions

The project region has been explored by several exploration or mining companies since 1979. Ongoing BLM-approved exploration activities in portions of the project area involve the use of hazardous materials and result in the generation of industrial, non-hazardous solid wastes, as well as hazardous wastes. Hazardous materials currently used for exploration activities in portions of the project area include diesel fuel, gasoline, and lubricating grease.

The historic Easy Junior Mine is located in the project area. The *Nevada Abandoned Mine Lands Report for 2005* (NDOM 2006) reported reclamation of the Easy Junior Mine as complete. Based on a review of available information and interviews with state and local agency personnel, one spill of 200 gallons of No. 2 diesel fuel was reported to the Nevada Division of Emergency Management on September 28, 1993 and approximately 50 tons of contaminated soil was removed from the site (Alta Gold Co. 1993). No releases have been reported for the former Easy Junior Mine (Gardner 2013, Flannery 2013, Anderson 2013). Similarly, no hazardous waste sites were identified in the vicinity of the former Easy Junior Mine (EPA 2013e).

Under the American Society for Testing and Materials (ASTM) *Standard Practice for Environmental Site Assessments: Designation E 1527-05* (ASTM 2005), recognized environmental conditions are defined as “the presence or likely presence of any hazardous substance or petroleum products on a property under conditions that indicate an existing release, a past release, or a material threat of a release of any hazardous substances or petroleum products into structures on the property or into the ground, ground water, or surface water of the property”. Midway has not conducted a formal Phase I environmental site assessment but has completed a thorough internal site assessment for hazardous materials and

health and safety risks. No recognized environmental conditions have been identified in the project area.

Hazardous substances are defined as:

- Any element, compound, mixture, solution, or substance designated as hazardous under section 102 of the Comprehensive Environmental Response, Compensation, and Liability Act (CERCLA).
- Any hazardous substance designated under section 311(b)(2)(a) of the Clean Water Act (CWA), or any toxic pollutant listed under section 307(a) of the CWA.
- Any hazardous waste having the characteristics identified or listed under section 3001 of the Resource Conservation and Recovery Act (RCRA).
- Any hazardous air pollutant listed under section 112 of the Clean Air Act, as amended.
- Any imminently hazardous chemical substance or mixture which the EPA Administrator has "taken action under" section 7 of the Toxic Substances Control Act (TSCA).

Hazardous waste is defined under RCRA as a solid waste (or combination of solid wastes) which, because of its quantity, concentration, or physical, chemical, or infectious characteristics, may cause or contribute to an increase in mortality or an increase in serious irreversible, or incapacitating illness; or pose a substantial present or potential hazard to human health or the environment when improperly treated, stored, transported, disposed of, or otherwise managed. Under RCRA, four characteristics are used to determine whether a substance is considered hazardous, including ignitability, corrosiveness, reactivity, and toxicity. Any solid waste that exhibits one or more of these characteristics is classified as a hazardous waste under RCRA and, in turn, as a hazardous substance under Superfund.

Existing federal, state, and local regulations govern the transport, storage and use of hazardous materials and the disposal of hazardous wastes. All containers of hazardous substances would be labeled and handled in accordance with Nevada Department of Transportation (NDOT) and Mine Safety and Health Administration (MSHA) regulations. The federal regulations pertaining to hazardous materials and wastes include, but are not limited to, the following:

- 40 CFR Parts 240-258, EPA's non-hazardous solid waste regulations;
- 40 CFR 261, RCRA;
- 40 CFR 700-799, Toxic Substances Control Act (TSCA);
- 49 CFR 106-7, 171-179, Hazardous Materials Transportation Act (HMTA);
- 40 CFR, 112, Oil Pollution Prevention
- 40 CFR 300, National Contingency Plan (NCP);
- 26 USC 4611-4682, 1980, as amended 1983 and 1986, CERCLA;
- EO 12088, 1978, Federal Compliance with Pollution Control Standards;
- EO 13423, Strengthening Federal Environmental, Energy and Transportation Management;
- Emergency Planning and Community Right-to-Know Act (EPCRA) Regulations; and
- Superfund Amendments and Reauthorization Act (SARA).

Federal and state roads have regulations pertaining to the transport of hazardous materials and wastes. Transporters must comply with applicable transportation and handling regulations and practices, including federal, state and county regulations governing the transportation of hazardous materials and wastes.

The Oil Pollution Prevention regulations (40 CFR 112) were developed to protect U.S. waters from oil pollution. These regulations require facilities with onsite storage of more than 1,320 gallons of oil (fuel and petroleum products) to have a Spill Prevention, Controls and Countermeasures Plan (SPCC Plan). SPCC Plans provide an inventory of onsite oil storage, secondary containment measures, employee training on proper work procedures, and defined measures regarding how the facility will prevent releases and control inadvertent spills.

The purchase, transport, storage and use of explosive agents is regulated by the Bureau of Alcohol, Tobacco, Firearms and Explosives (BATFE); Department of Homeland Security provisions; Mine Safety and Health Administration (MSHA) regulations and other applicable federal, state, and local legal requirements.

Bulk chemicals and supplies, including hazardous materials and wastes, are currently transported to and from the Plan area via the routes described in Section 3.15 and shown on (Figure 3.15-2). Currently, there are no restrictions on delivery times for materials required for exploration activities.

The potential transportation routes from which materials from the major hubs would be transported to the Plan area are listed below:

- From Eureka via US 50 (Lincoln Highway) east;
- From Ely via US 50 west; or
- From Elko via I-80 east or from Utah via I-80 west to US 93 and south on US 93 or US 93A to US 93, respectively, to Ely, west on US 50.

This page intentionally left blank.

Bureau of Land Management
Egan Field Office
702 North Industrial Way
Ely, Nevada 89301