





22500487737





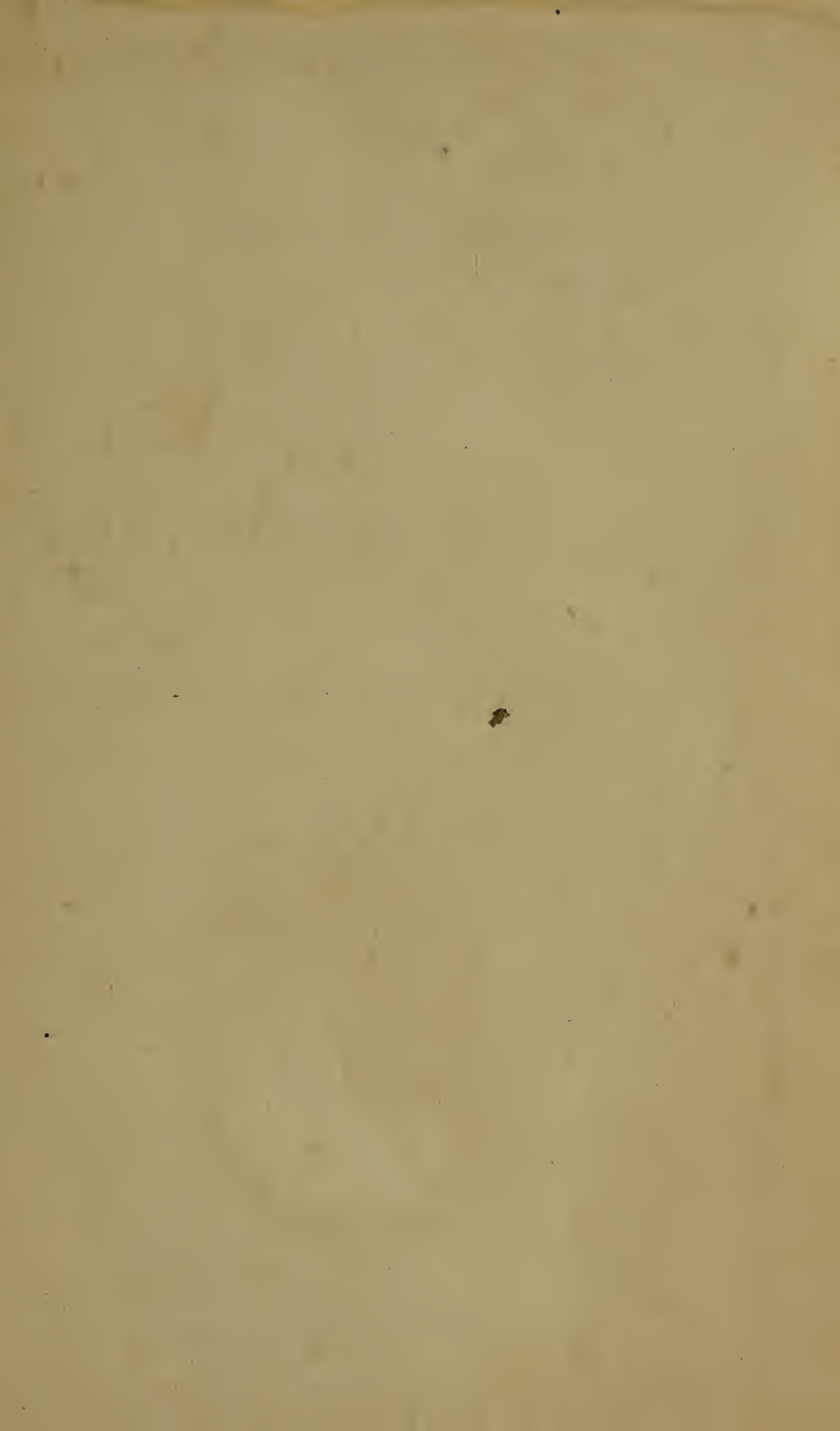

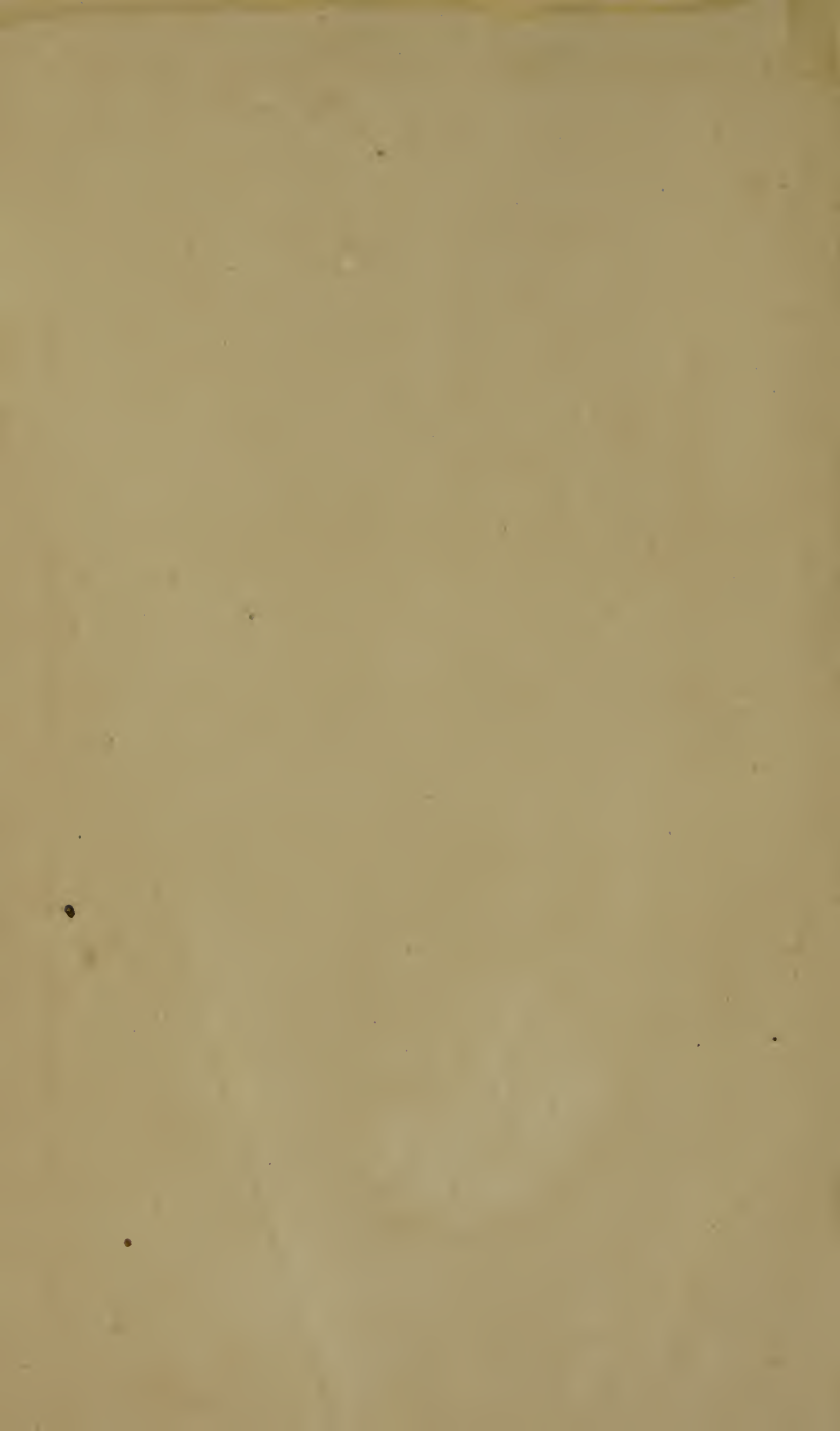

ANNUAL REPORT

OF THE

COMMISSIONER OF PATENTS

FOR

THE YEAR 1866.

—  
VOLUME III.  
—

WASHINGTON:  
GOVERNMENT PRINTING OFFICE.  
1867.

WELLCOME INSTITUTE LIBRARY	
Coll.	WeIMOmec
Coll.	
No.	



---

---

ILLUSTRATIONS.

---

---



51784—H. H. Abbe—*Call Bell*.

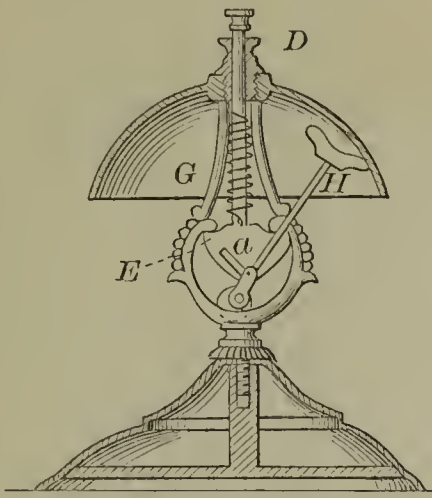

51785—J. Adams—*Preserve Jar*.

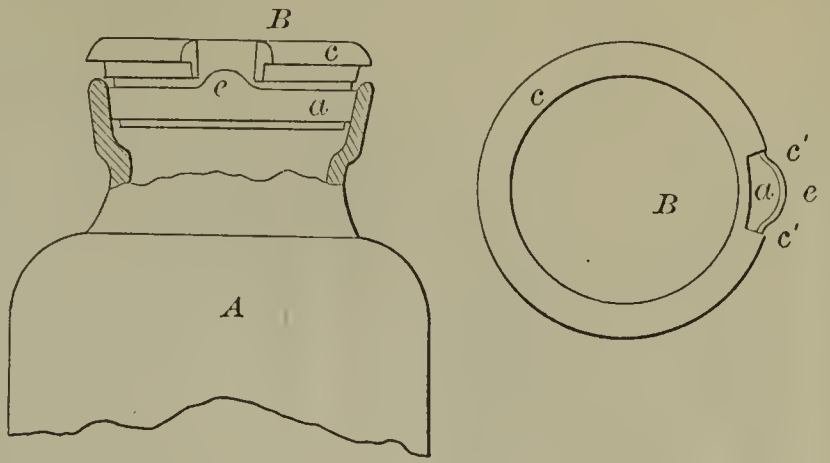

51787—H. N. Avery—*Latch Fastening*.

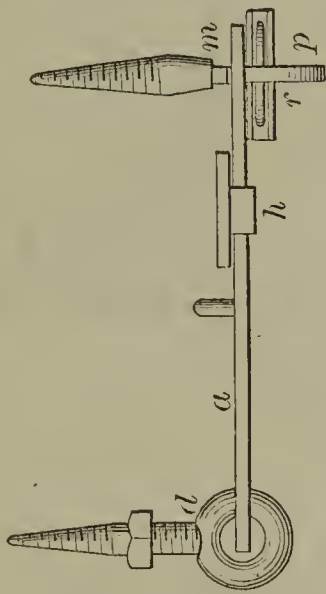

51788—J. Badger—*Steam Generator*.

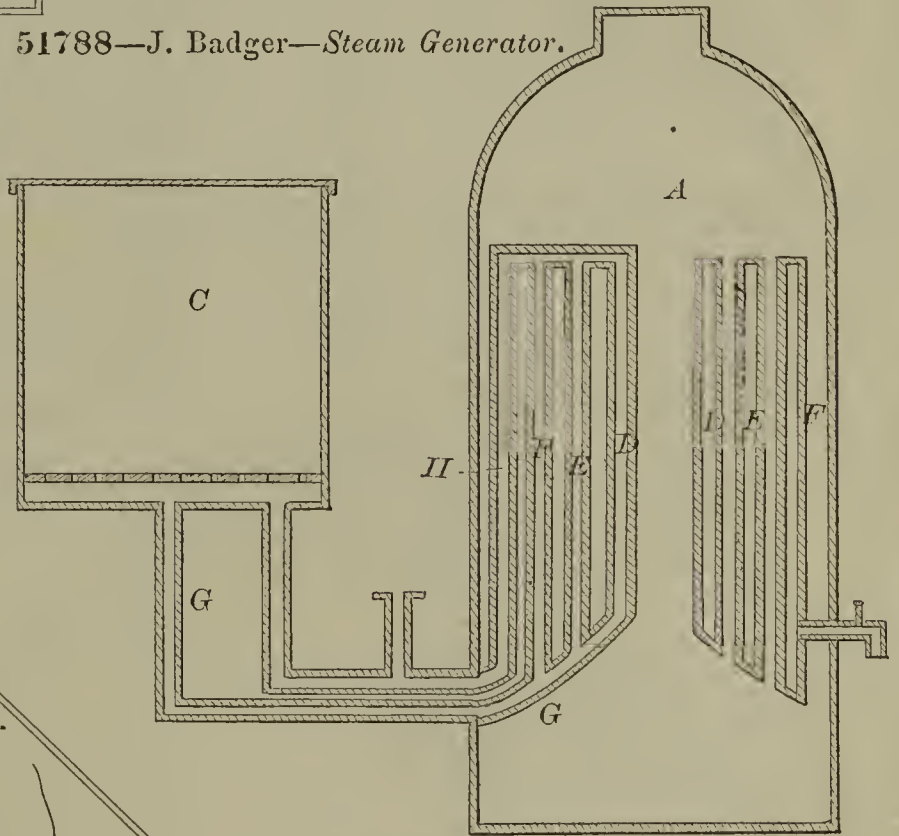

51786—J. Austin—*Horse Shoe*.

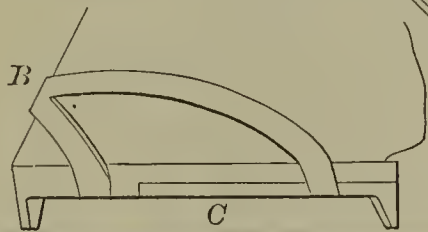

51789—E. Beeman—*Knife Sharpener and Polisher*.

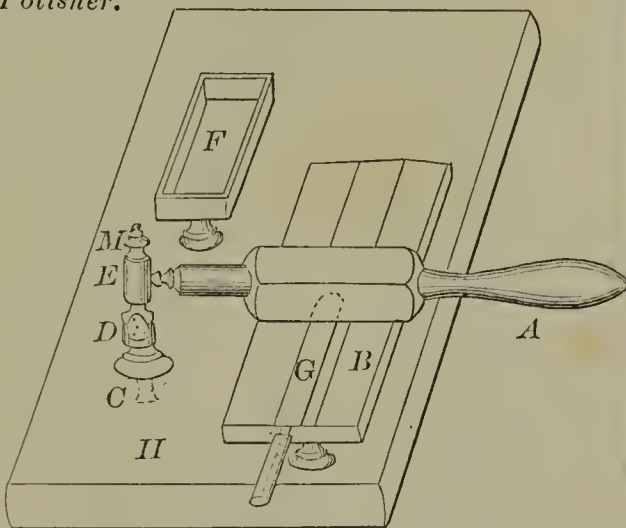

51791—S. Bennett—*Broom*.

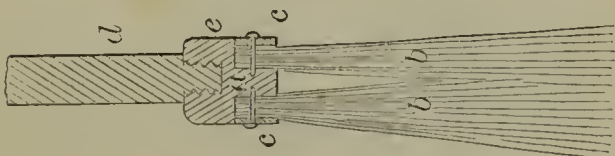

51790—C. Belden—*Gang Cultivator*.

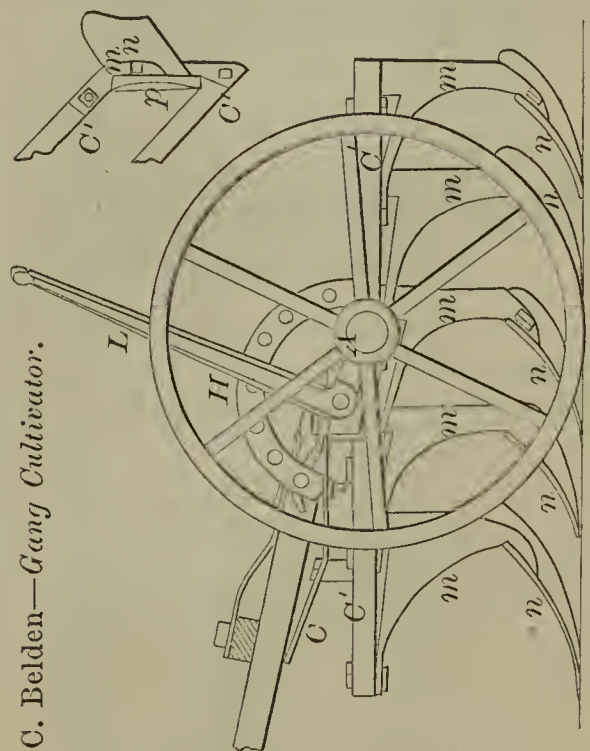

51792—J. I. Boone—Fruit Dryer.

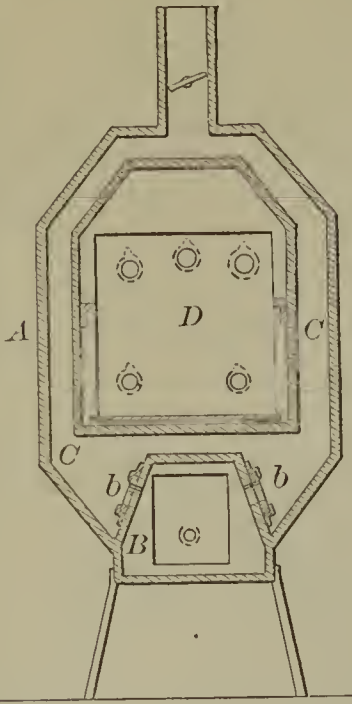

51794—D. C. Brown—Loom Harness.

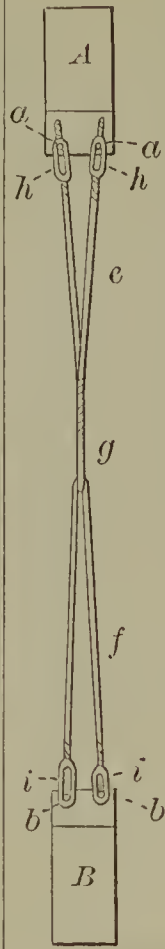

51795—J. H. Brown—Baby Walker and Cradle.

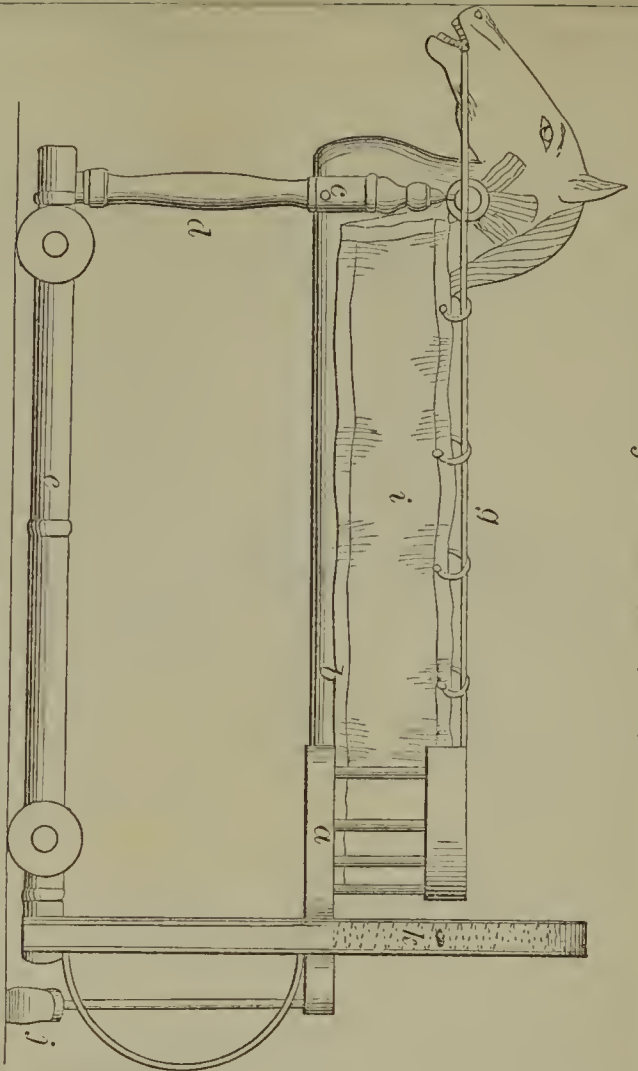

51793—L. W. Bowers—For Bending Wood.

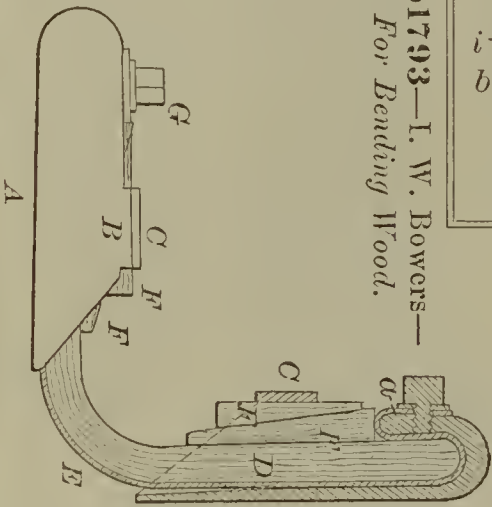

51797—X. X. Buckner—Steam Car Brake.

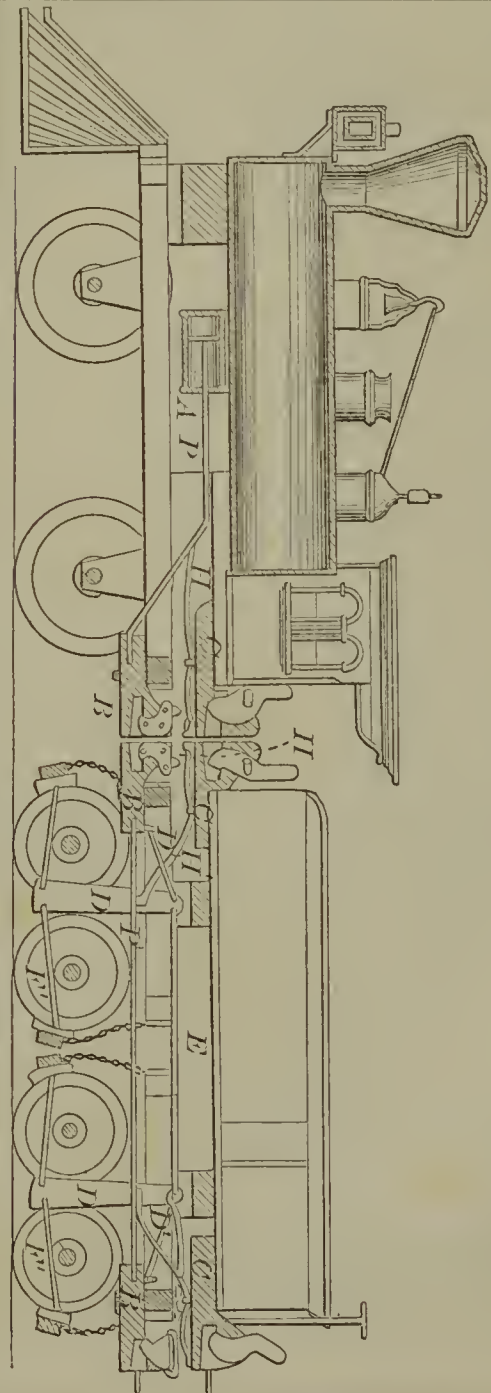

51796—Brown & Gregg—For Superheating.

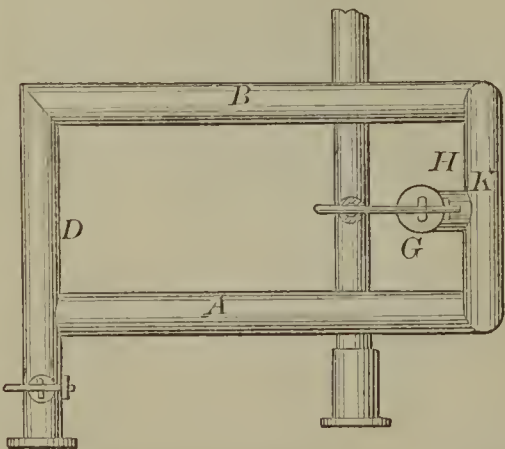
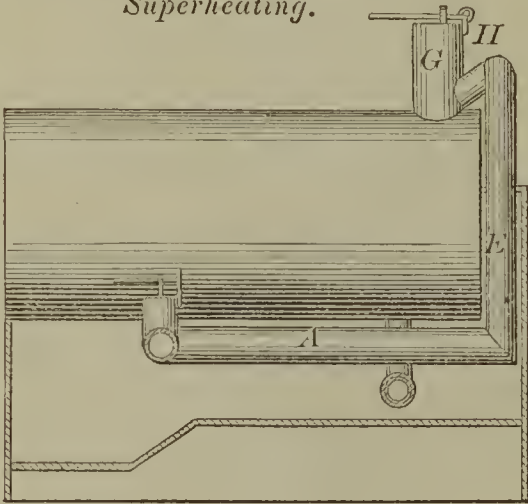

51798—W. Burns—*Lantern.*

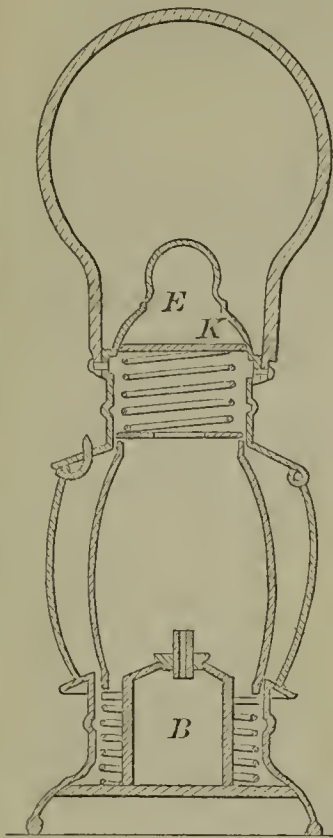

51799—P. L. Butler—*Window Sash and Frame.*

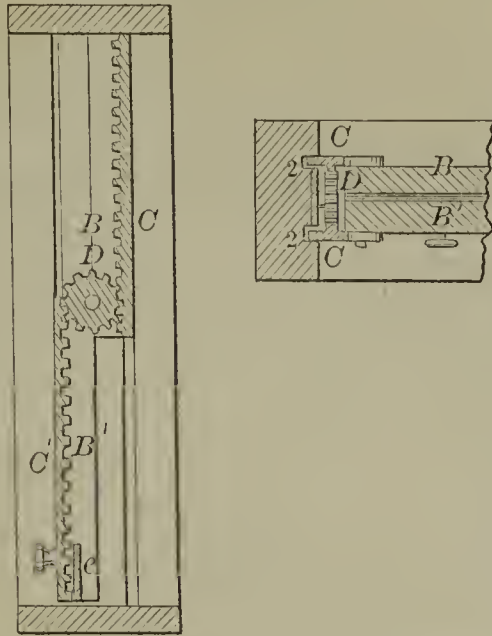

51800—E. Calderwood—*Detaching Breeching Straps from Shifts.*

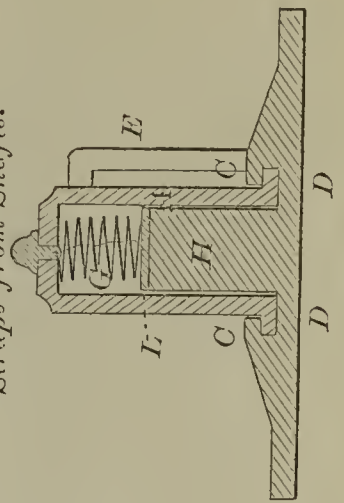

51802—B. Cerf—*Lounge Bedstead.*

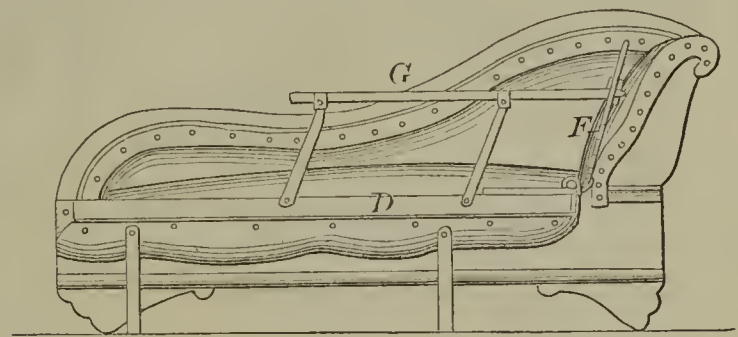

51801—S. B. Castle—*Operating Bored Wells.*

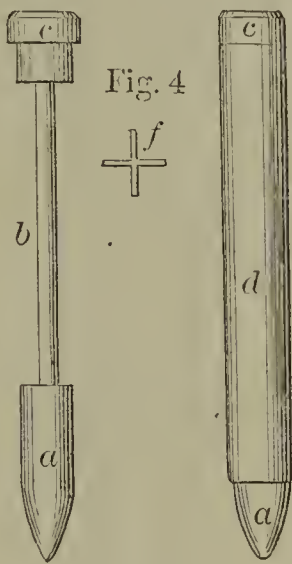

51806—L. J. Crans—*Well Boring Machine.*

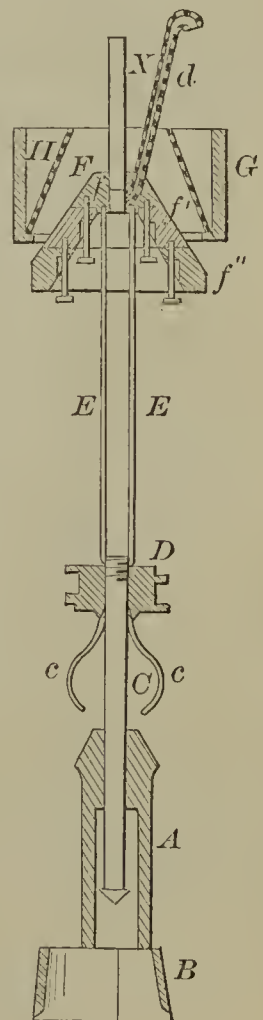

51804—C. C. Clapp—*Book Leaf Turner.*

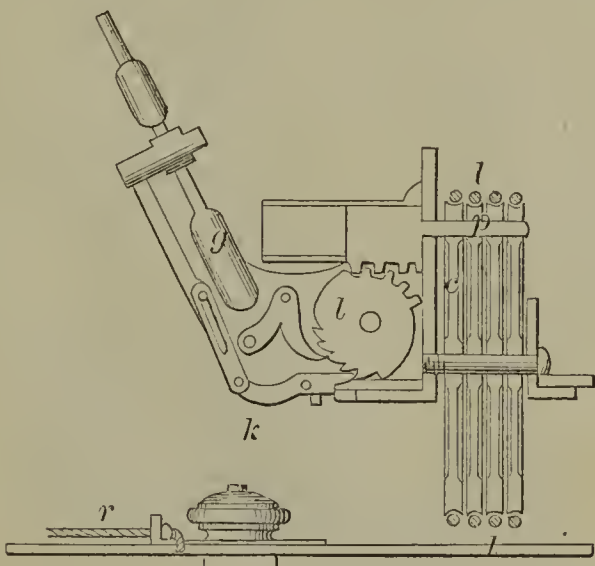

51803—E. Childs—*Window Shutter Bolt.*



51807—H. Culver—*Lifting Jack.*

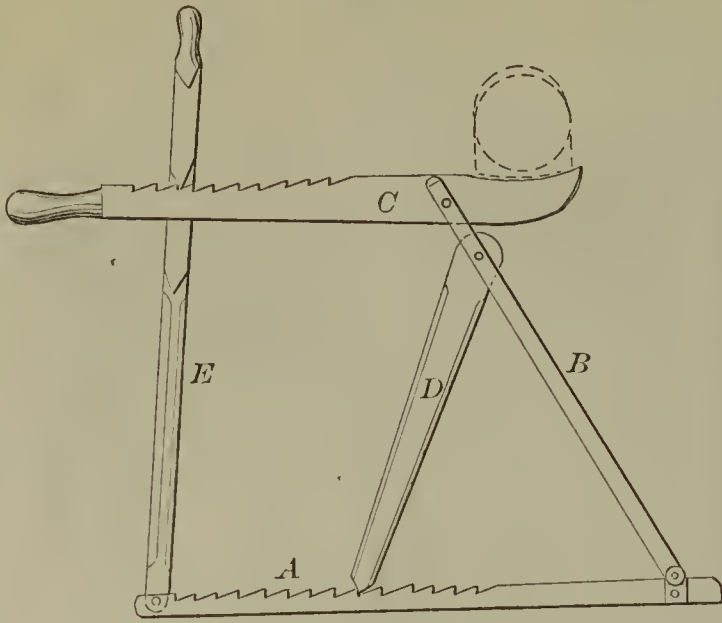

51808—A. J. Curtis—*Carriage Wheel.*

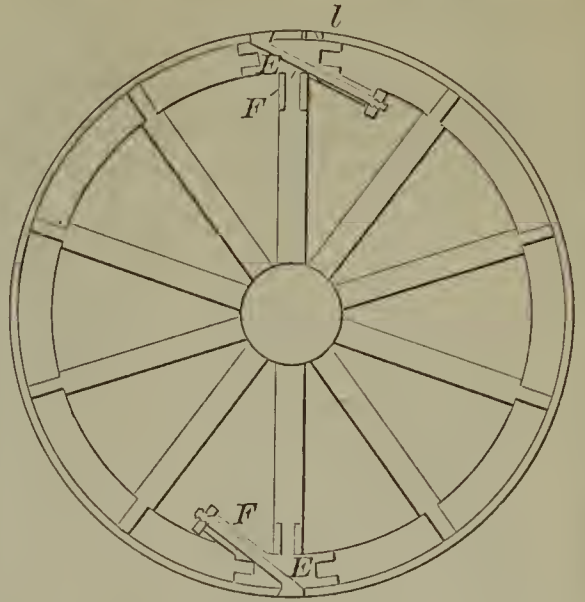

51809—M. L. Deering—*Annunciator.*

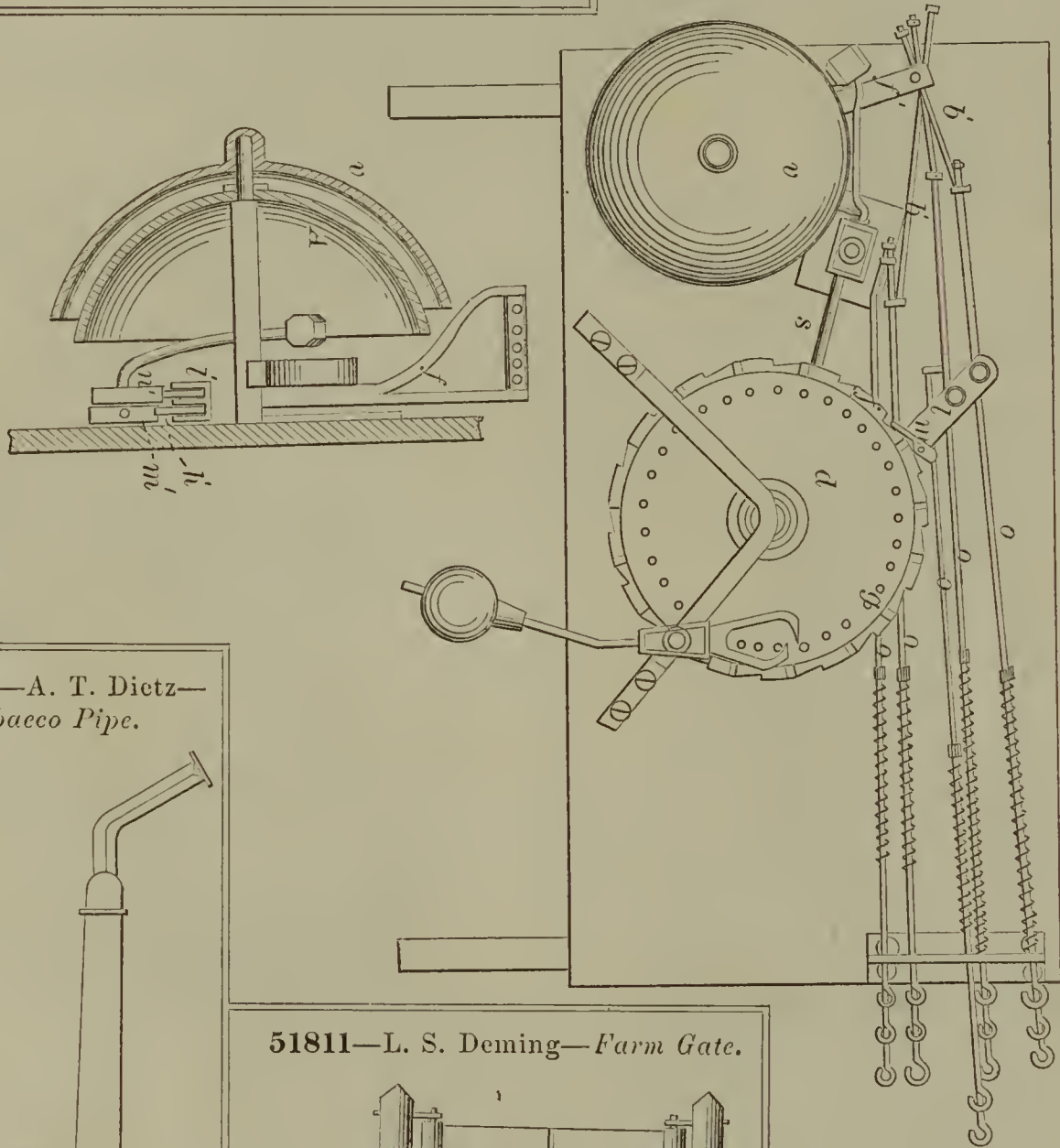

51812—A. T. Dietz—*Tobacco Pipe.*

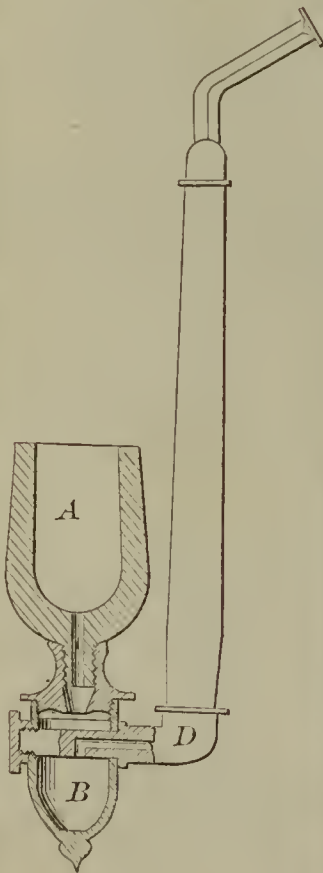

51811—L. S. Deming—*Farm Gate.*

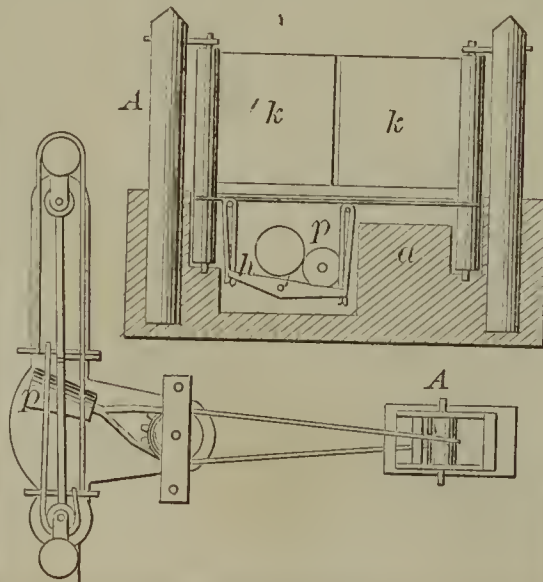

51814—L. Dow—*Drill for Rock Boring.*

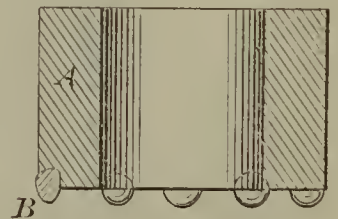

51815—J. B. Eads—*Converting Motion.*

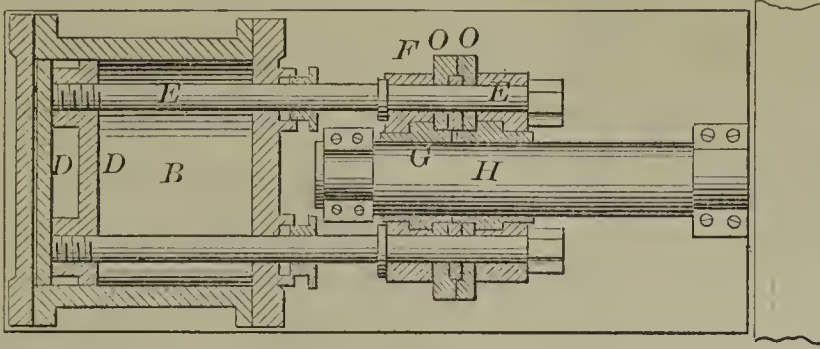

51816—J. Ekin—*Coal Stove.*

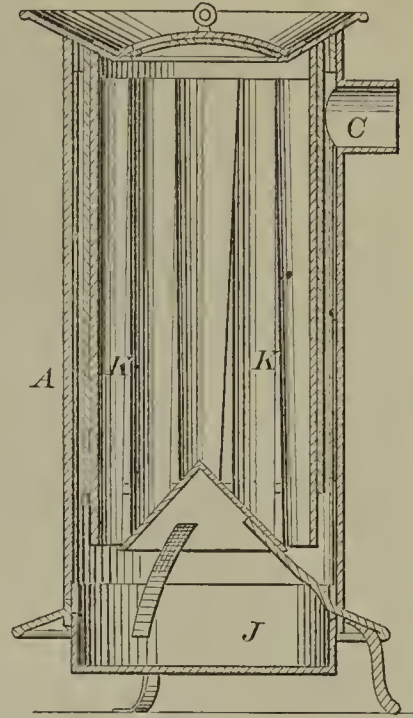

51817—R. Elliot—*Plow and Scraper.*

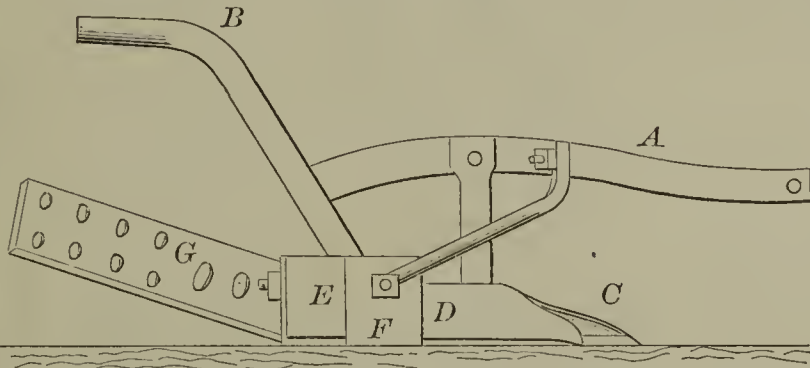

51818—J. Ells—*Drawing Railroad Spikes.*

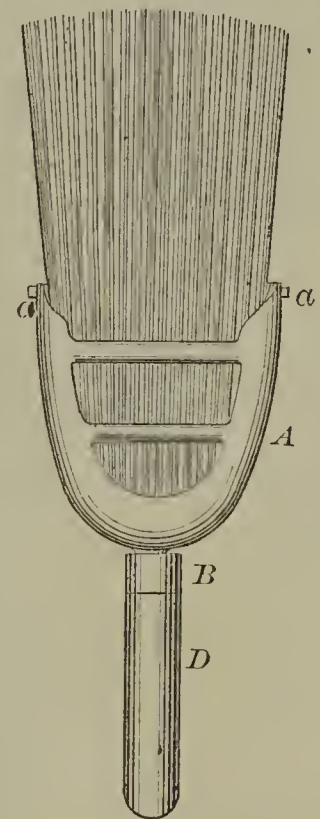
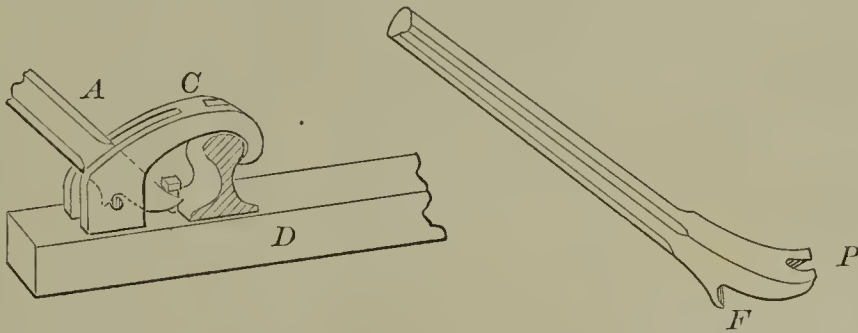

51819—J. U. Fiester—*Broom Head.*

51820—J. Firmenich—*Beer Faucet.*

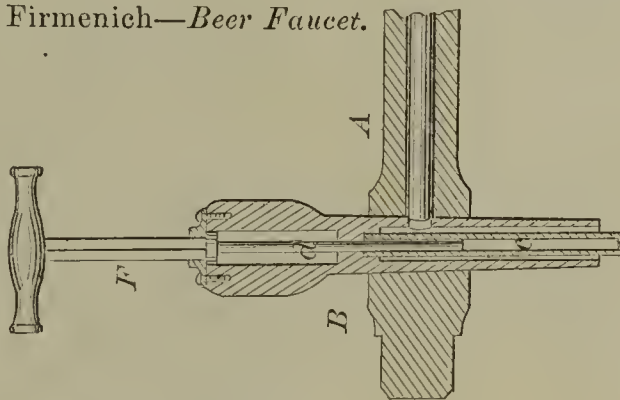

51822—W. M. Fuller—*For Extracting Gold from Quartz, &c.*

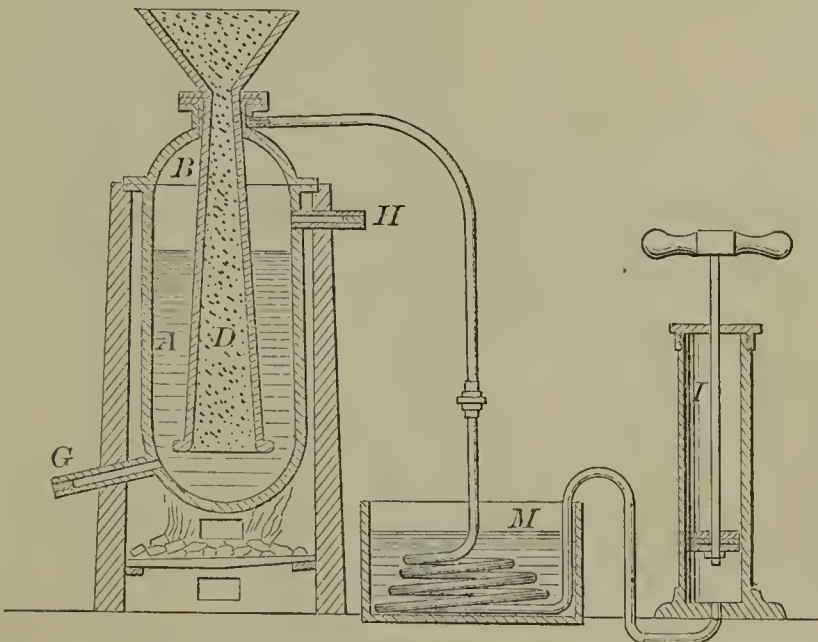

51821—A. W. Foster, Jr.—*Cut-off Valve Gear.*

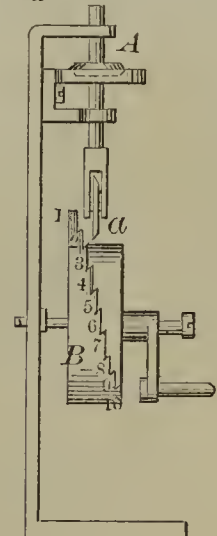

51823—J. M. W. Geist—System for Libraries.

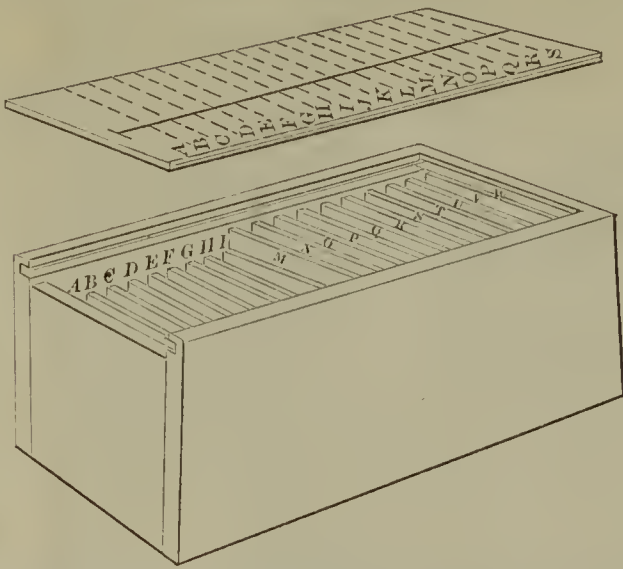

51825—C. L. Green—Hand Corn Planter.

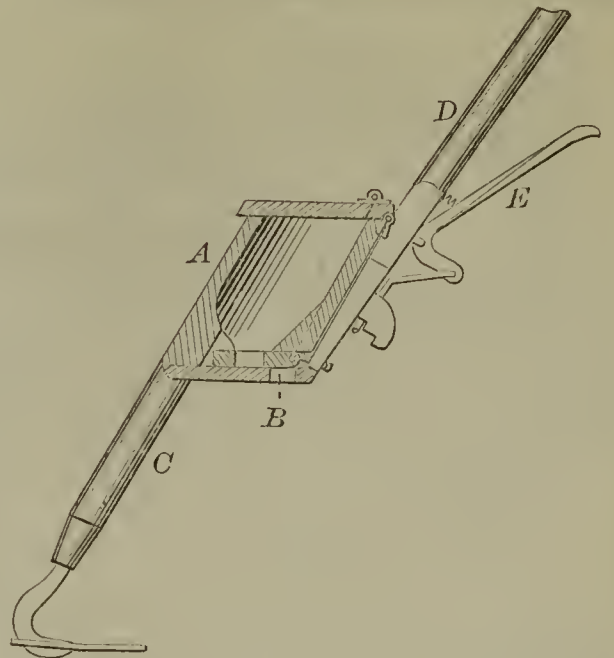

51824—Gibbs & Shaw—Farm Gate.

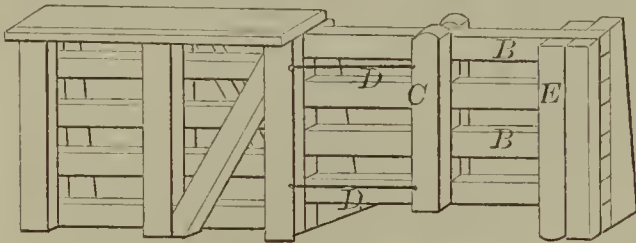

51827—J. W. Griffiths—Wood Bending.

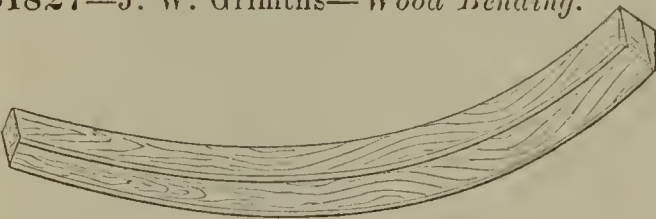

51828—F. M. Harris—Evaporator.

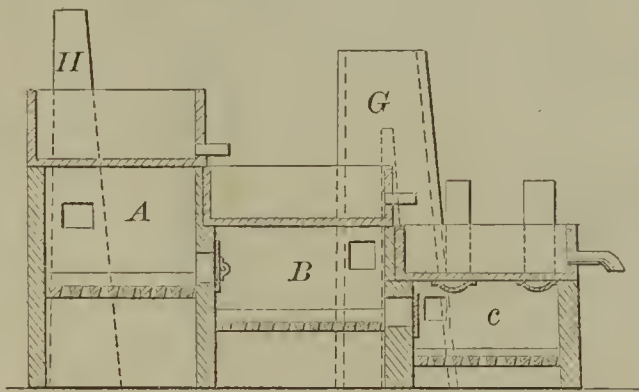

51829—C. L. Heywood—Railway Snow Plow.

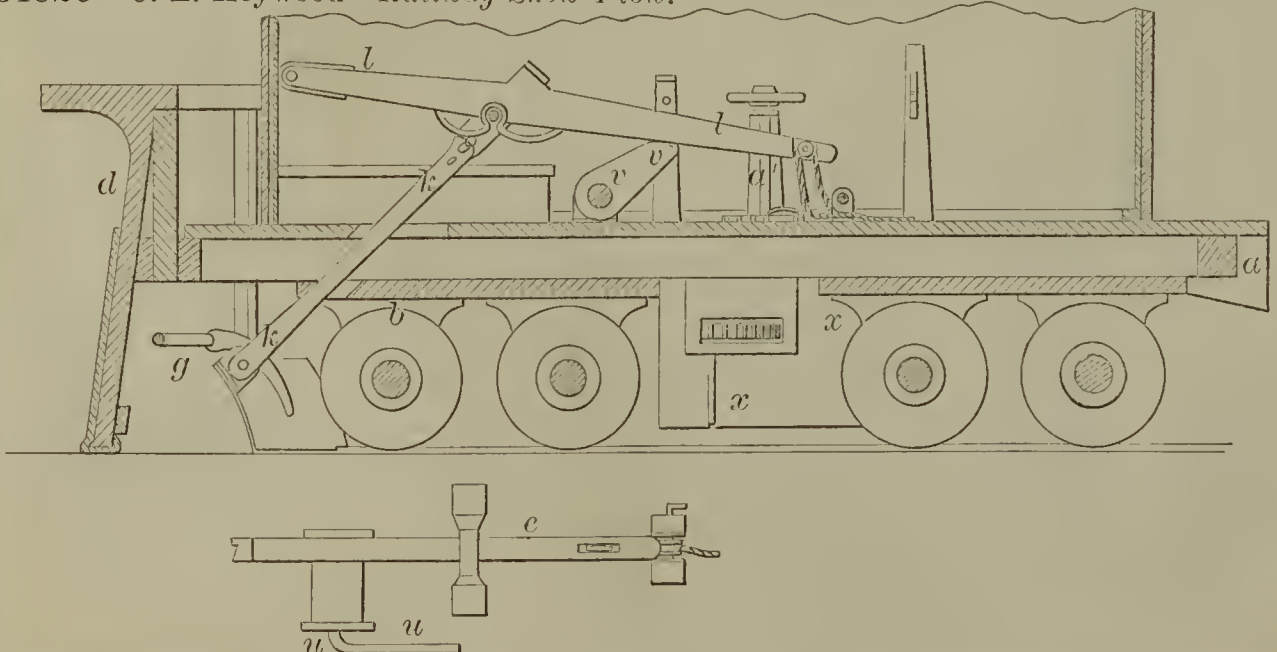

51826—J. W. Griffiths—Wood Bending Machine.

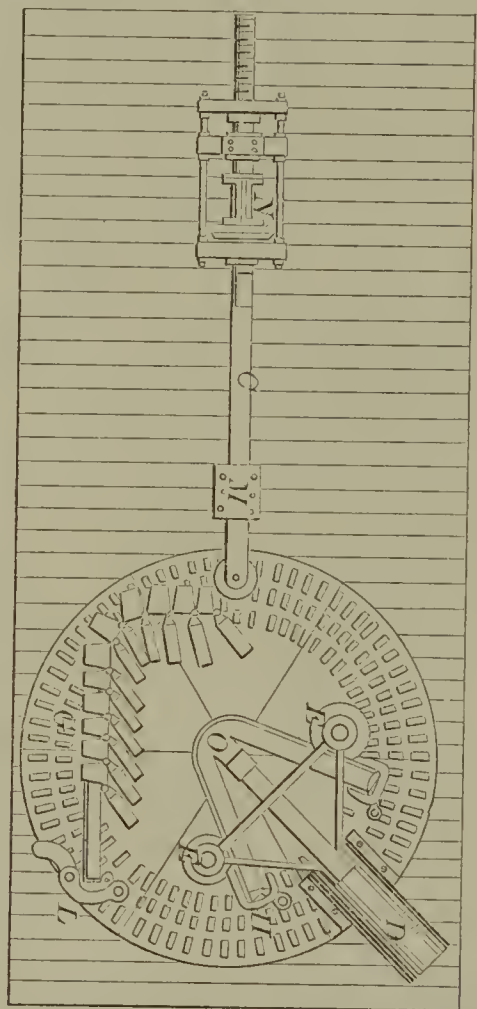



51831—C. Hood—  
Packing for Pumps.

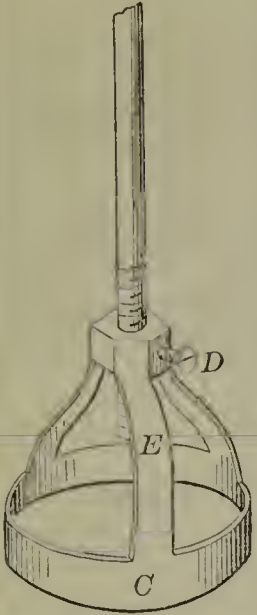

51835—F. Imhorst—Lamp Chimney Cleaner.

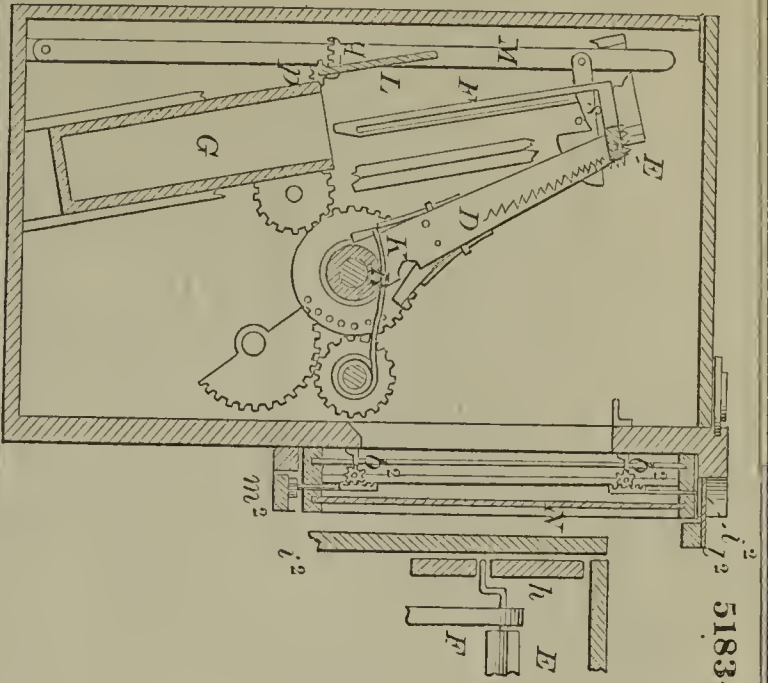
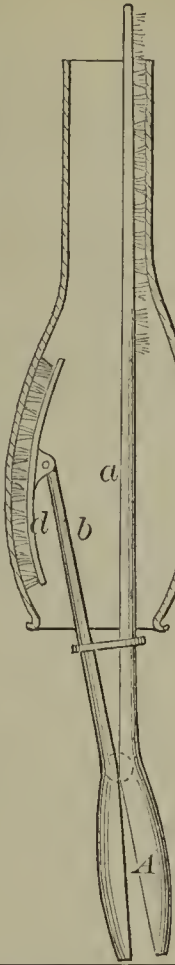

51834—W. & A. L. Hudson—Photographic  
Sensitizing Box.

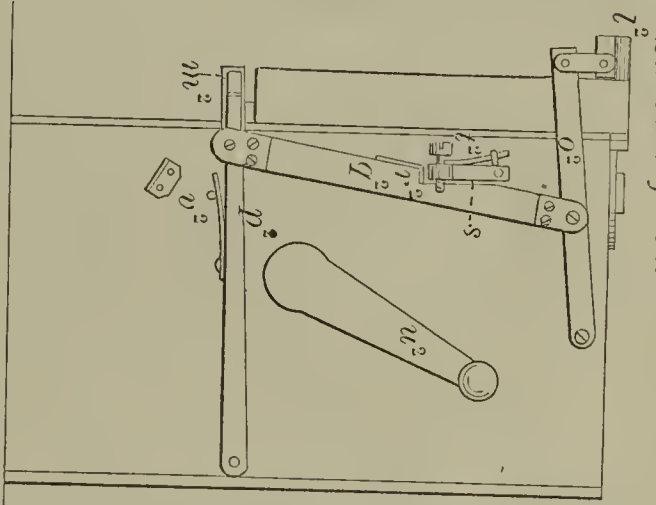

51836—B. F. Joslyn—Revolving Fire Arm.

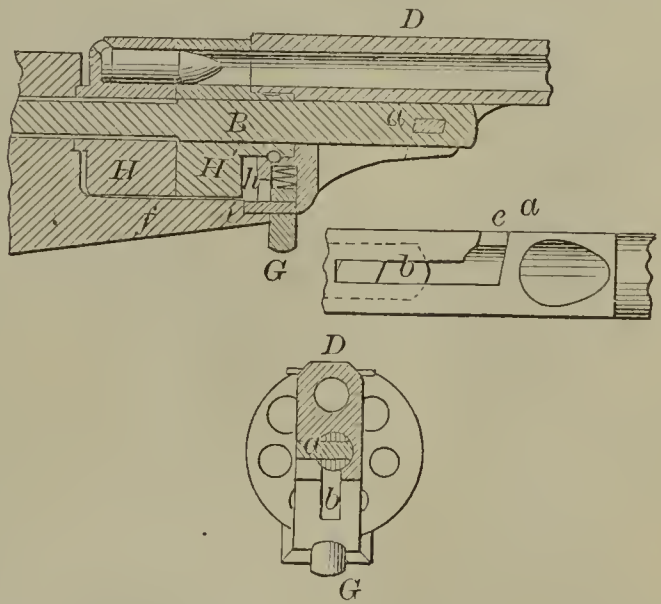

51838—J. C. Kellogg—Gate Fastening.

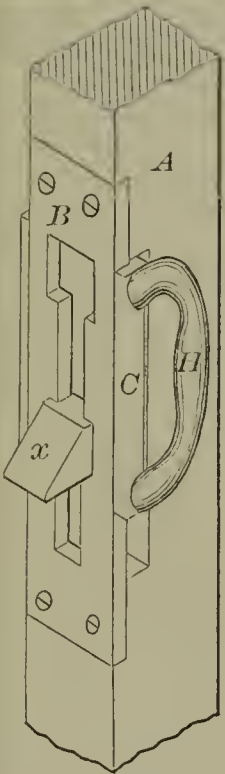

51837—B. F. Joslyn—Breech-Loading Fire Arm.

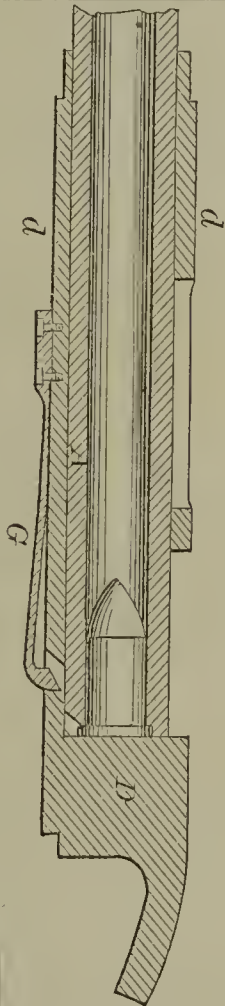

51839—F. L. King—Egg Beater.

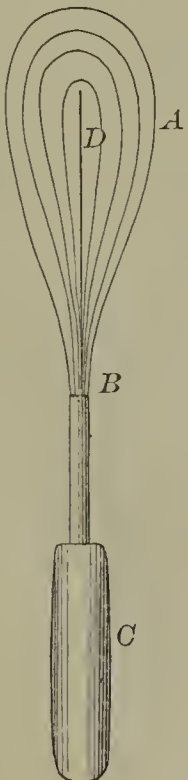

51840—D. Lampson—Washing Machine.

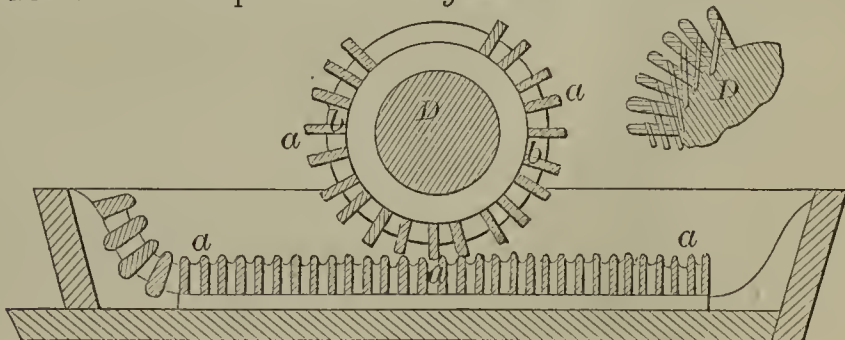

51841—C. B. Loveless—For Carburetting Air.

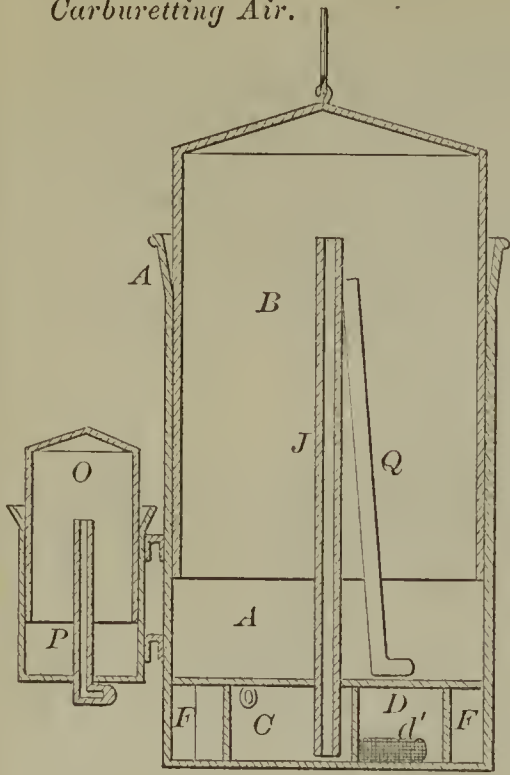

51842—T. Lowry—For Drawing Pipes from Wells.

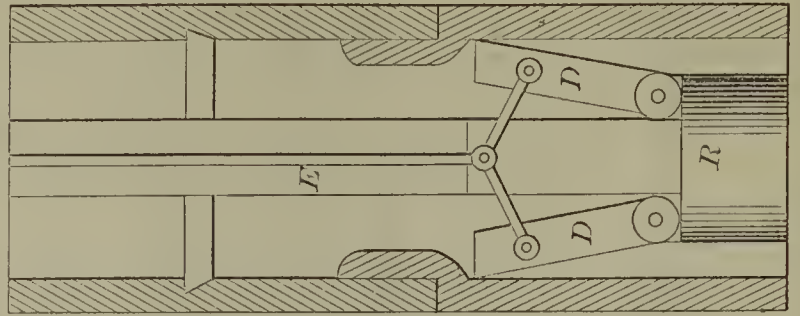

51845—J. Mac Mullen—Pencil Sharpener.

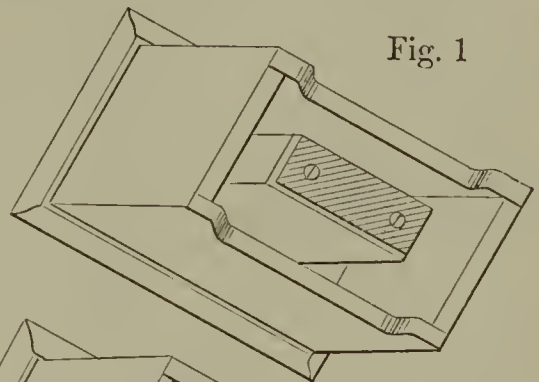
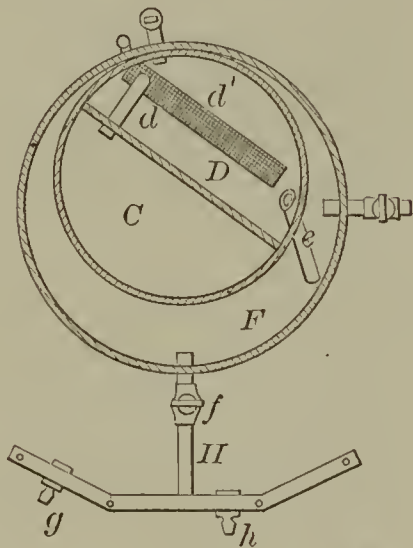

Fig. 1

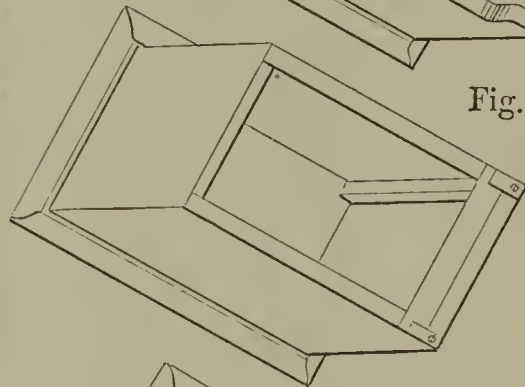

Fig. 2

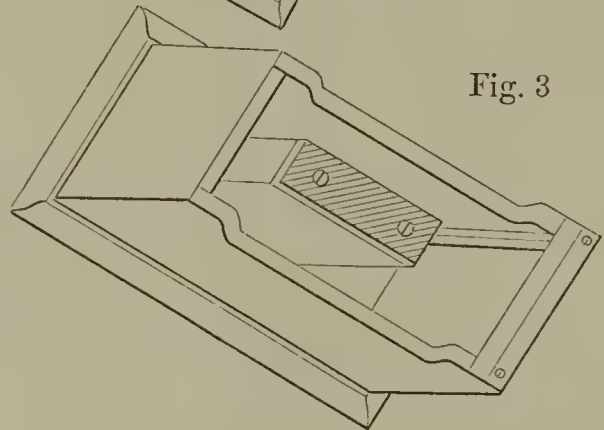
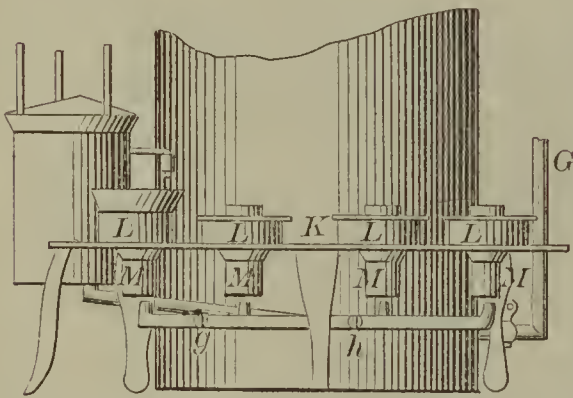
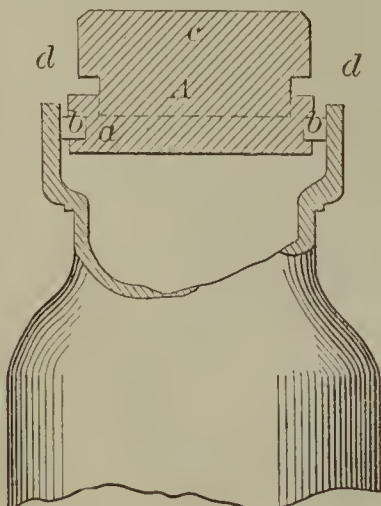

Fig. 3



51844—W. W. Lyman—Fruit Jar Stopper.



51850—Medbury & Wyatt—Railroad Plow.

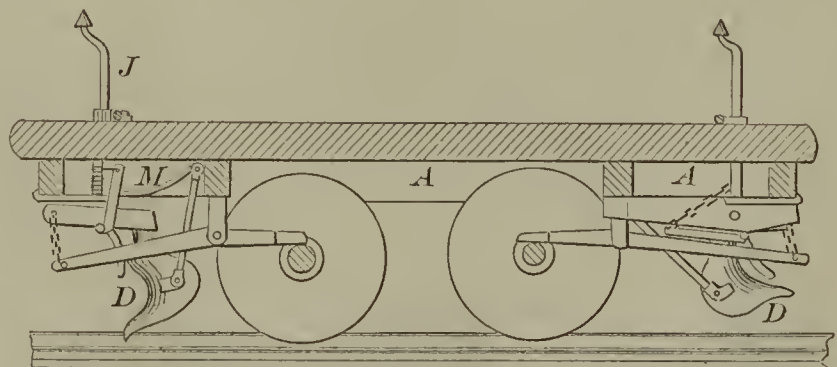

51851—W. Melville—Sawing Machine.

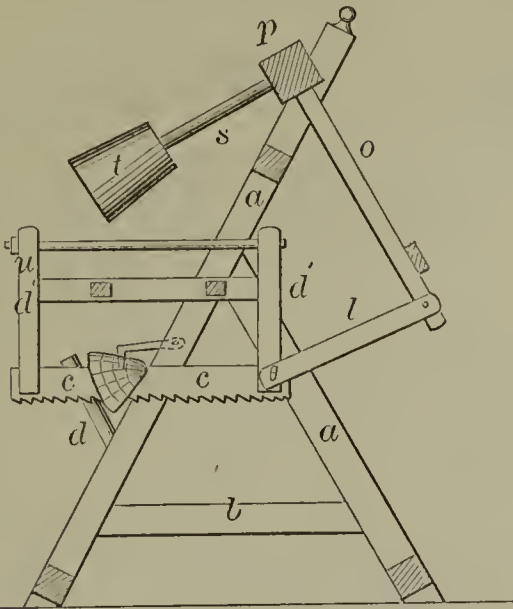

51852—G. W. Mitchell—Lamp.

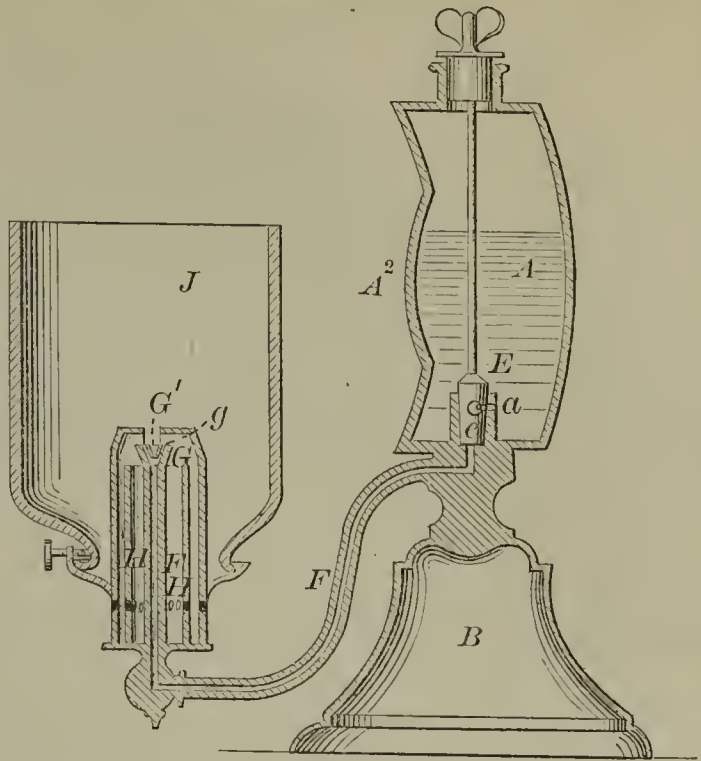

51856—H. H. Palmer—Bed Bottom.

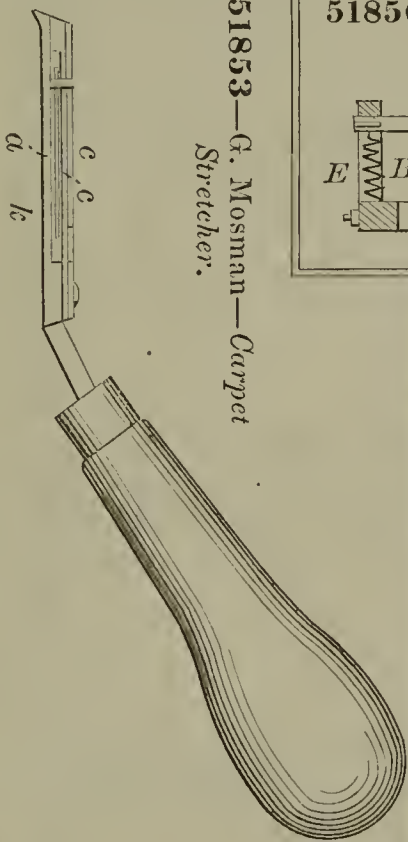

51853—G. Mosman—Carpet Stretcher.

51854—W. S. Nelson—Draining Pump.

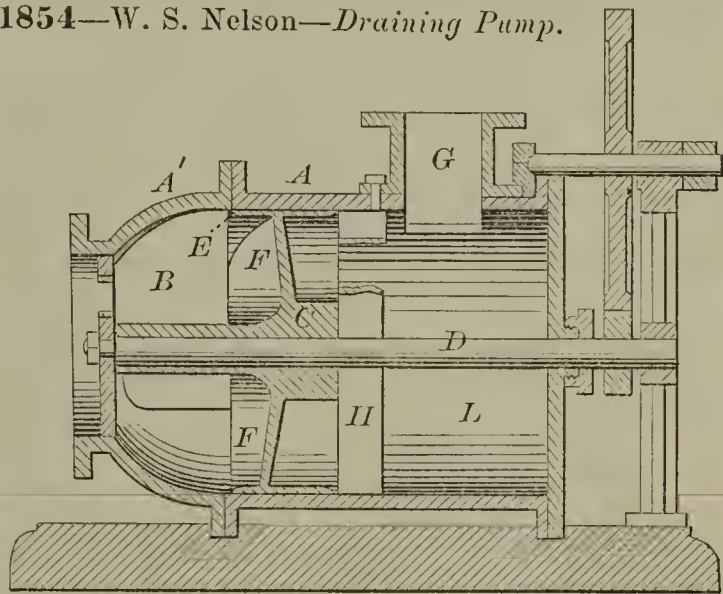

51855—F. R. Osgood—Extension Table.

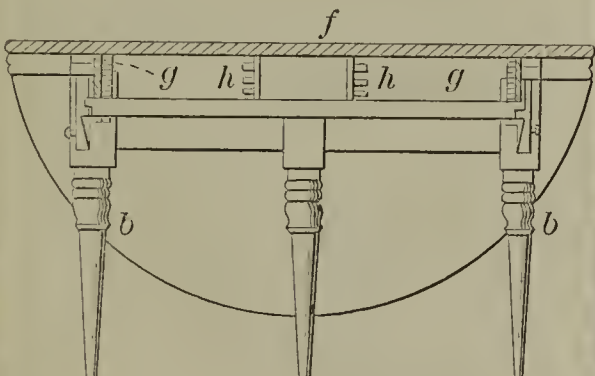

51858—G. G. Percival, M. D.—Hotel Annunciator.

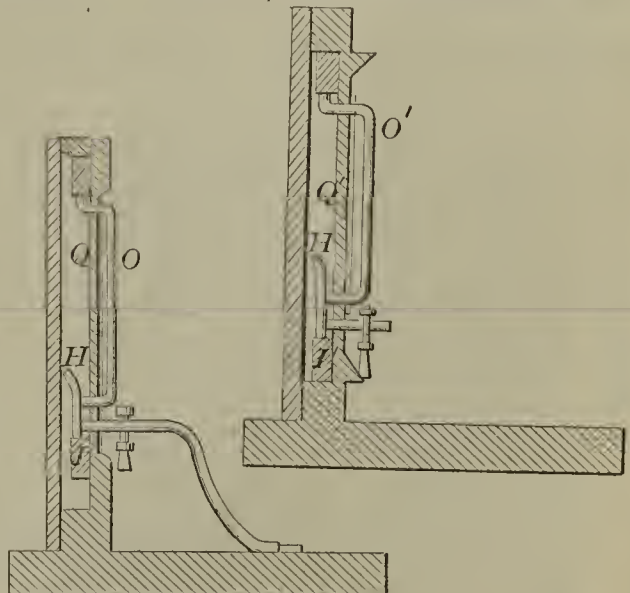

51859—W. M. Perkins—*Ditching Machine.*

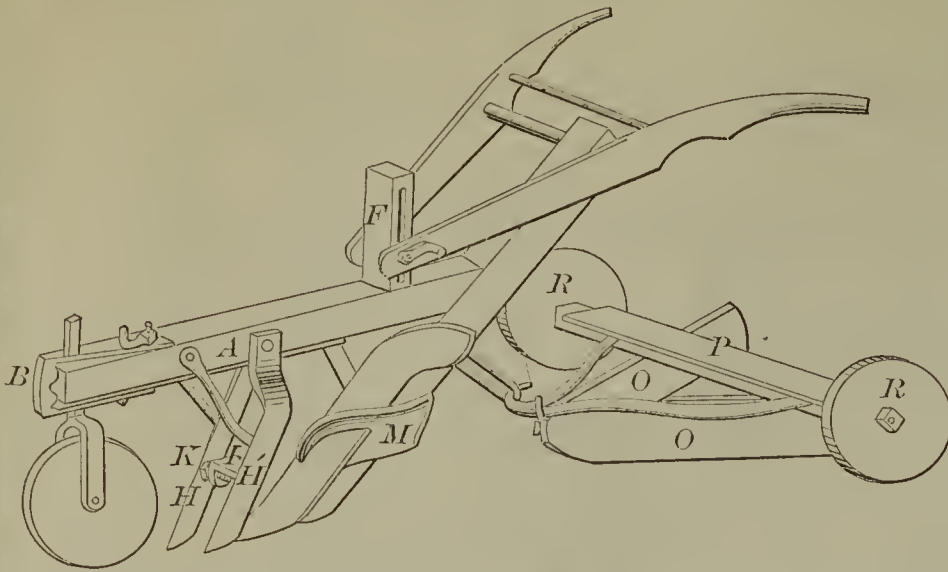

51862—J. F. Pond—*Clothes Wringer.*

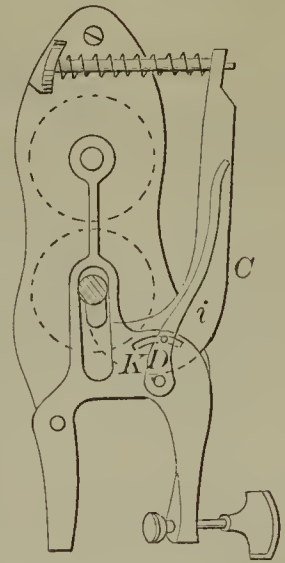

51860—T. Perrins—*Kite.*

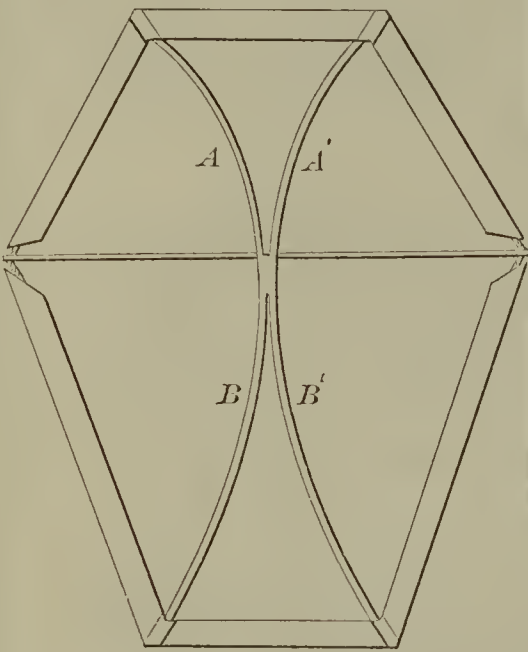

51864—J. H. R. Reffelt—*Alphabeticon.*

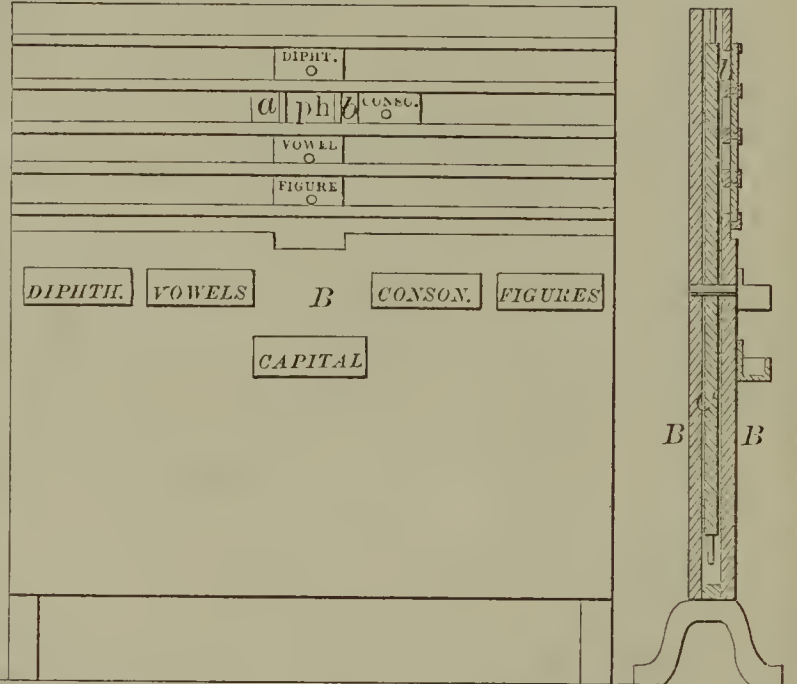

51861—J. C. Plummer—*Carriage Jack.*

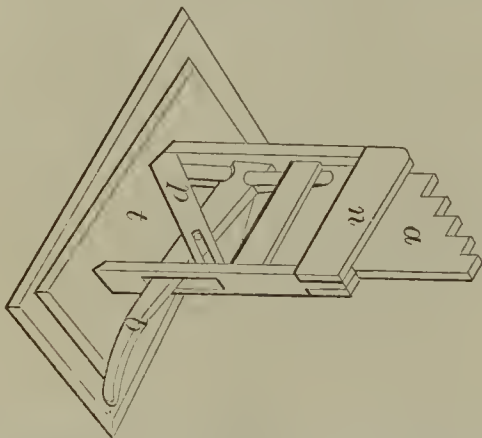

51863—Porter & Glines—*Table Stand.*

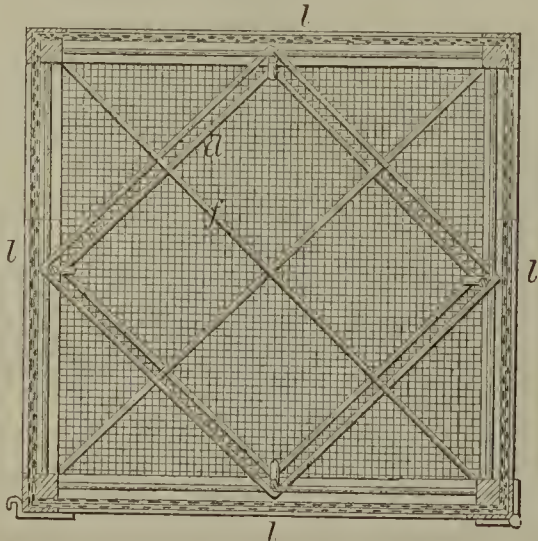

51865—J. C. Robie—*For Filling Moulds for Hard Rubber.*

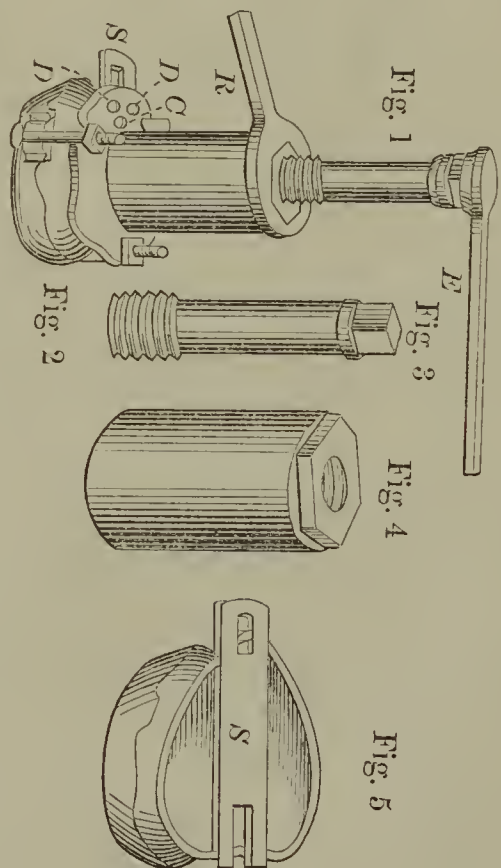

51866—W. W. Robinson—*Bed Bottom.*

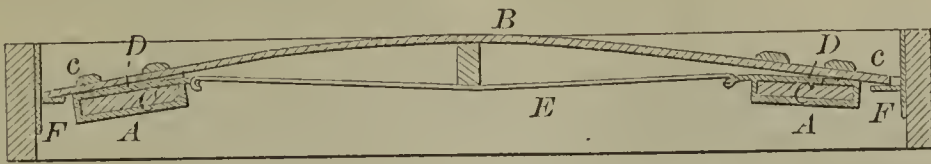

51869—H. Seevers—*Sheep Rack.*

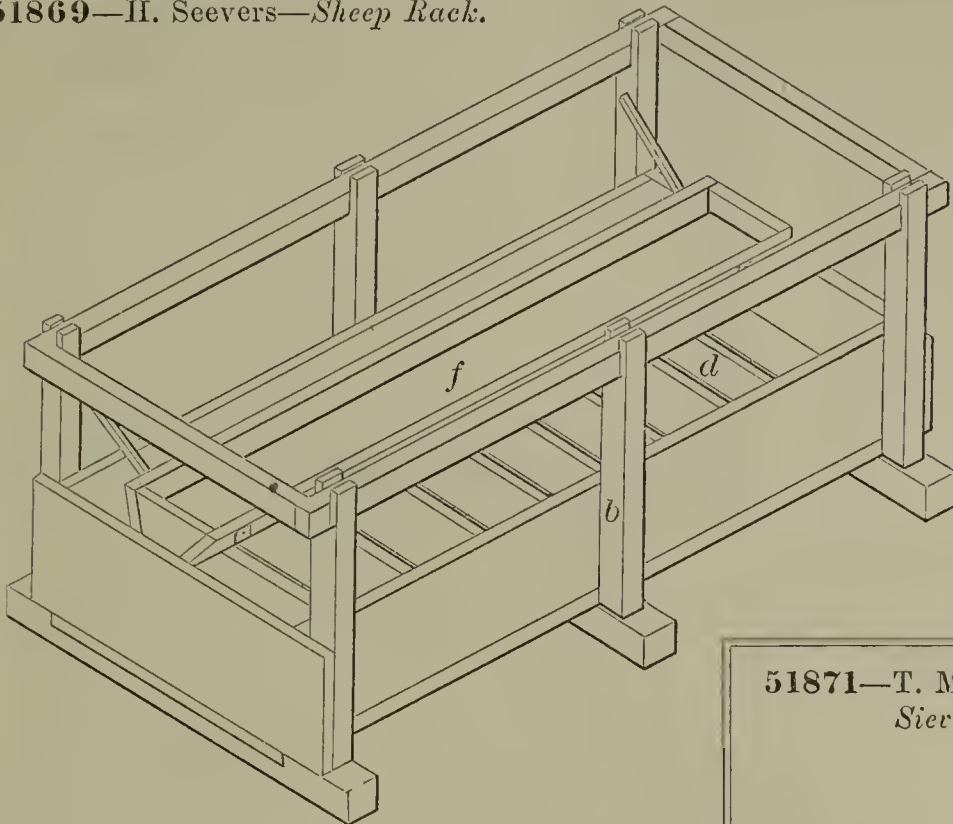

51870—T. Sharp—*For Tanning.*

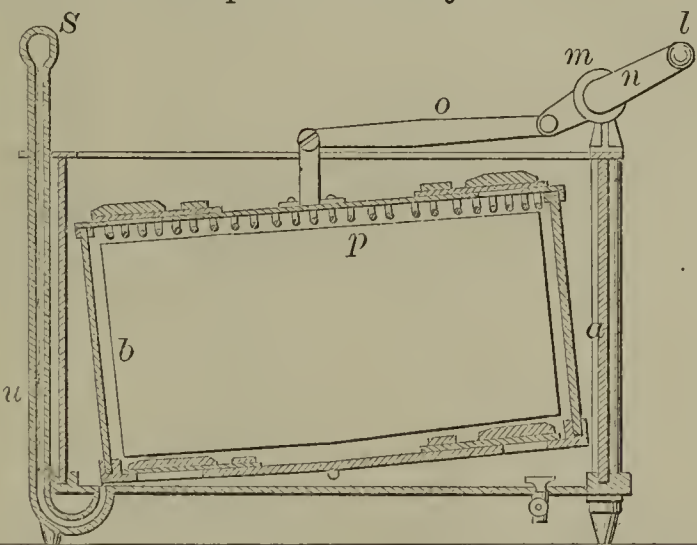

51872—E. Shopbell—*Upsetting Wagon Tire.*

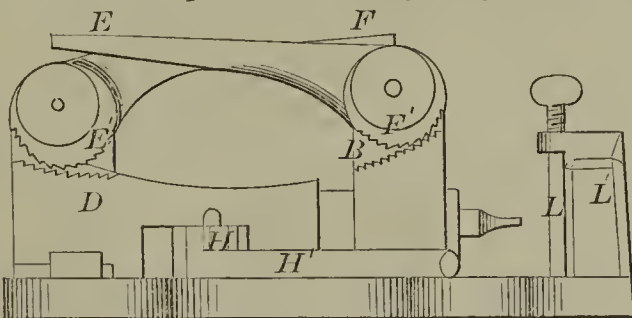

51874—A. W. Smith—*Bit Stock.*

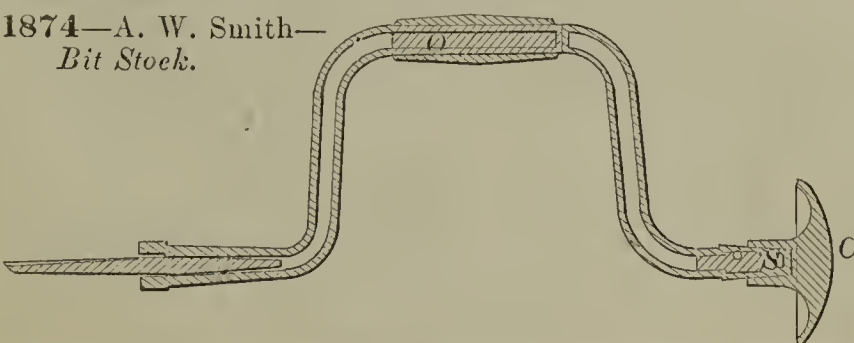

51873—Shurr & Palmer—*Churn.*

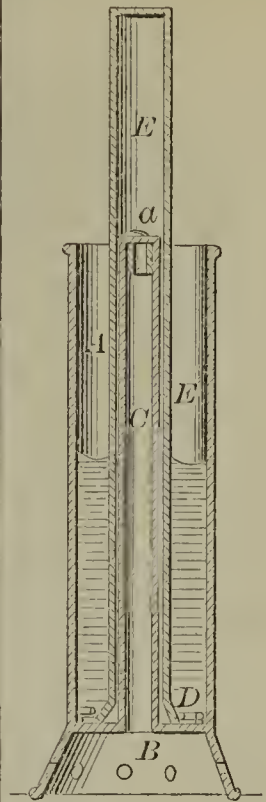

51871—T. M. Sheppard—*Sieve.*

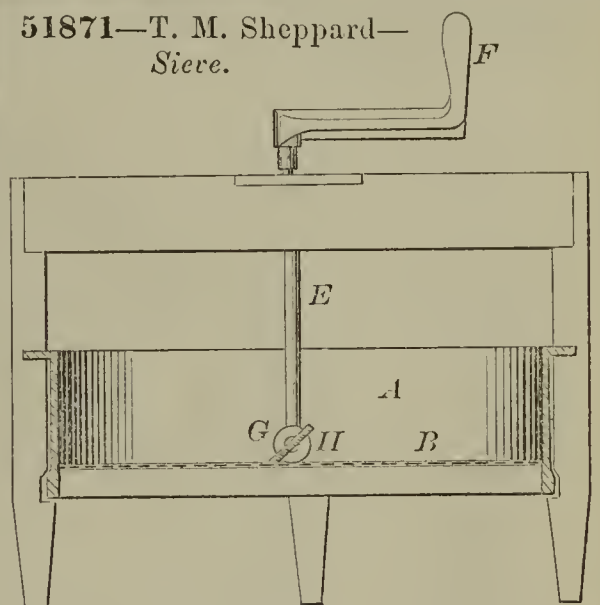

51875—H. C. Smith—*Gang Plow.*

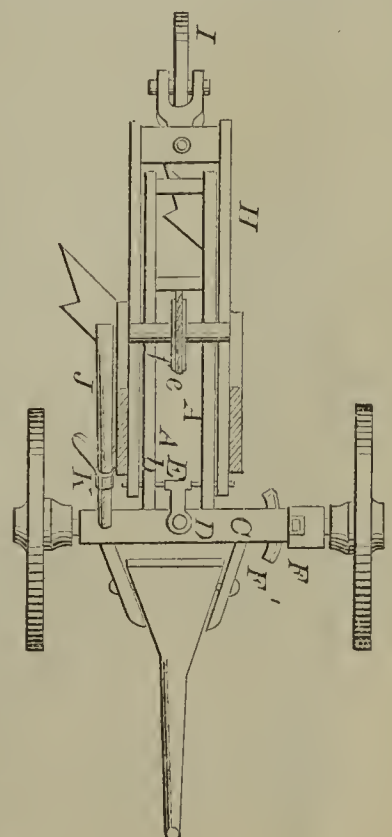

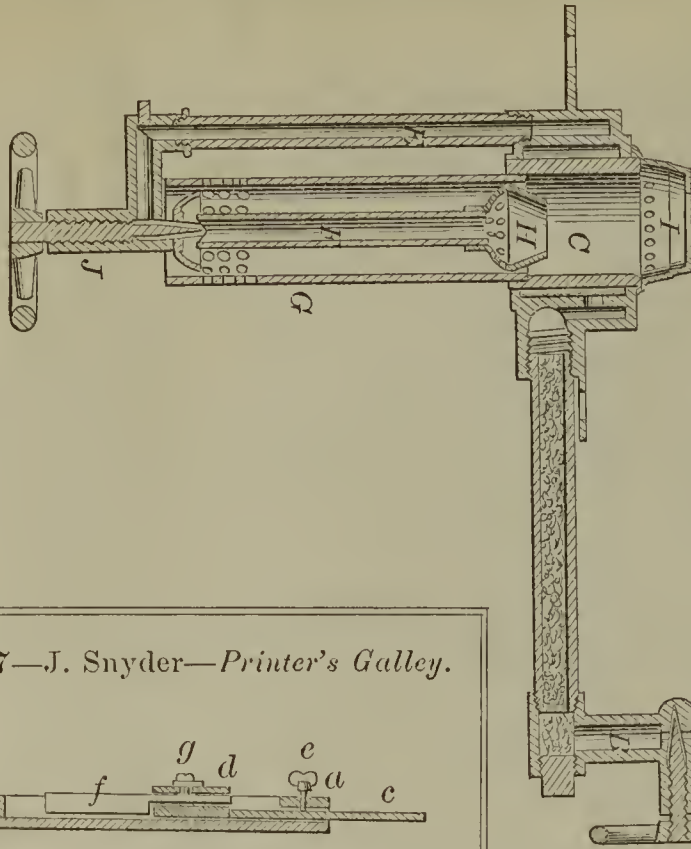

51876—W. H. Smith—Petroleum Burner.

51878—L. A. Sprague—Shoe Lacing.

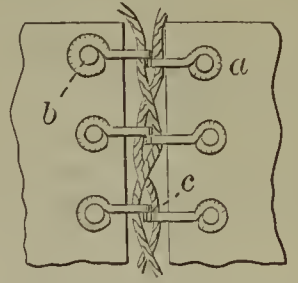

51877—J. Snyder—Printer's Galley.

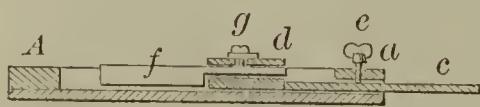

51879—N. Stafford—Test for Liquids.

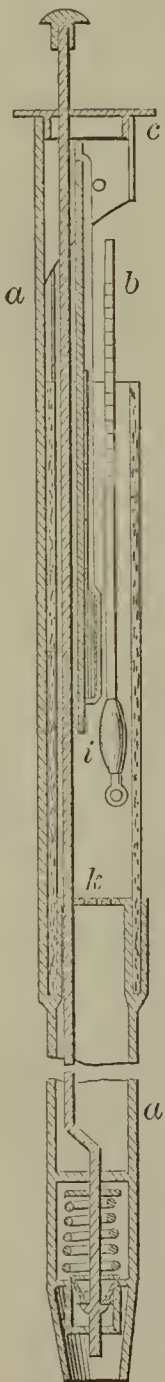

51881—H. Tilden—Flour Sifter.

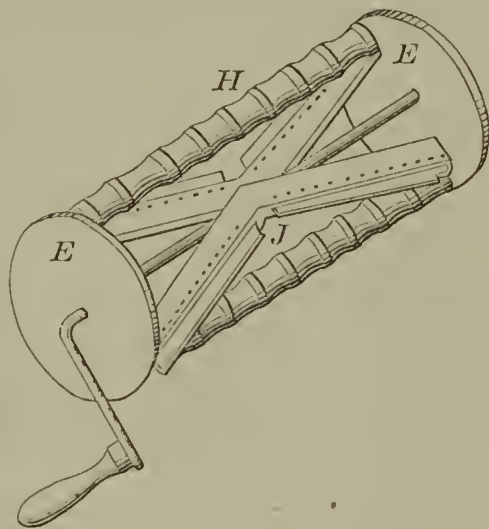

51880—R. T. Sutton—Grain Dryer.

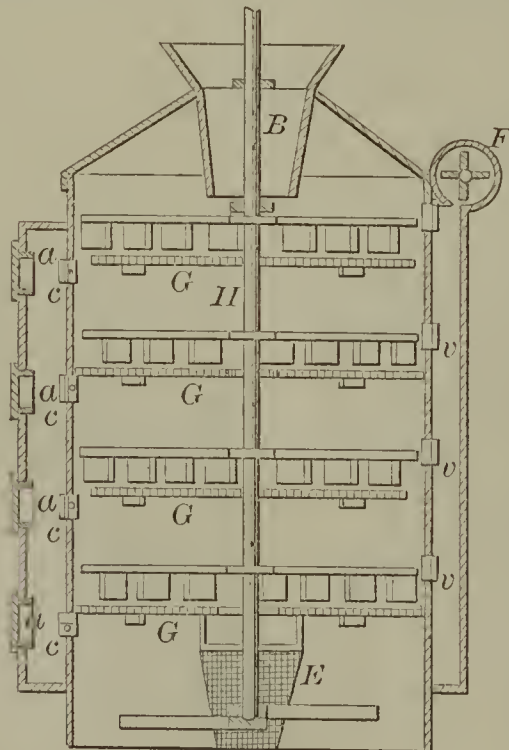

51882—A. M. Tomb—Bed Bottom.

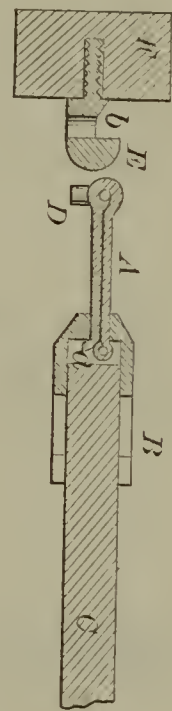

51883—M. Wells—Sheet Metal Ware Die.

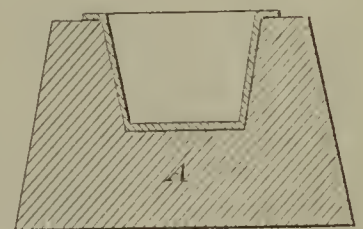

51884—M. D. Whipple—*Fulling and Finishing Felted Cloth.*

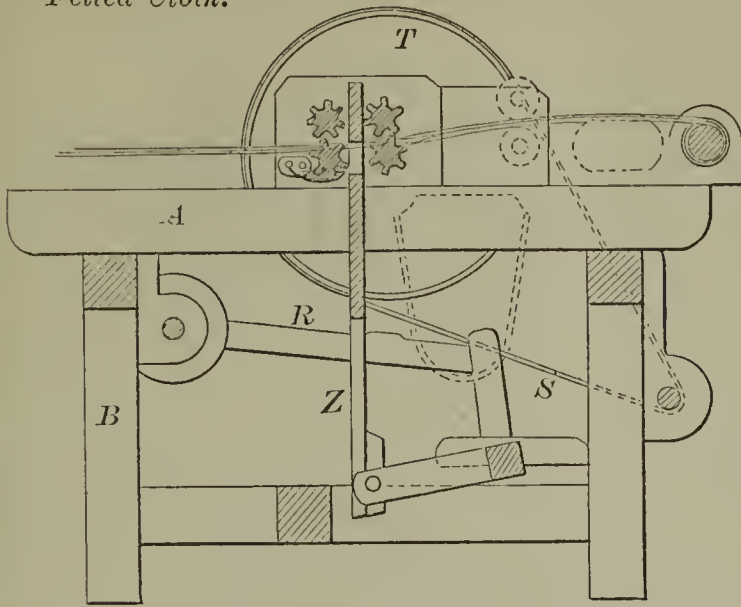

51886—G. B. Whiting—*Valve Gear.*

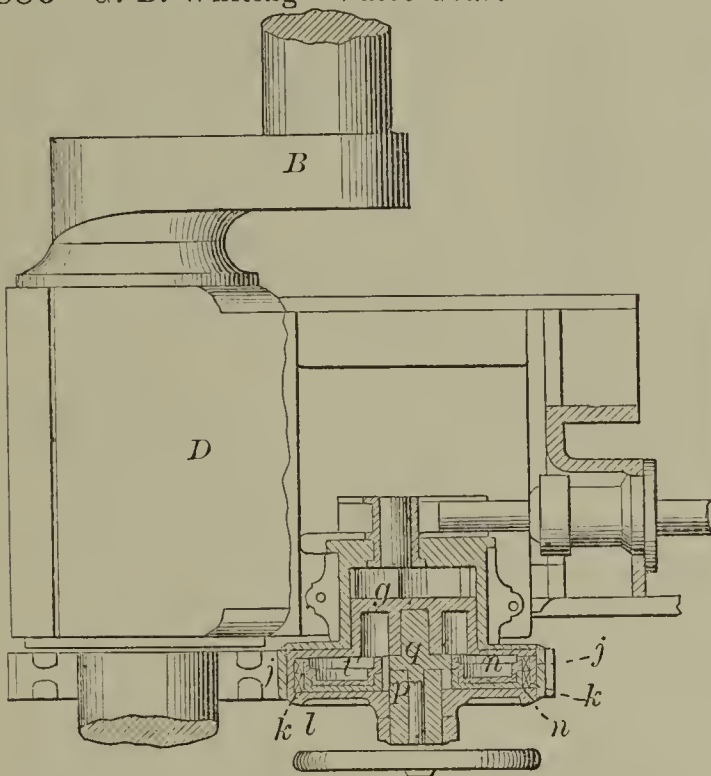

51891—T. A. Campbell—*For Oiling Wool, &c.*

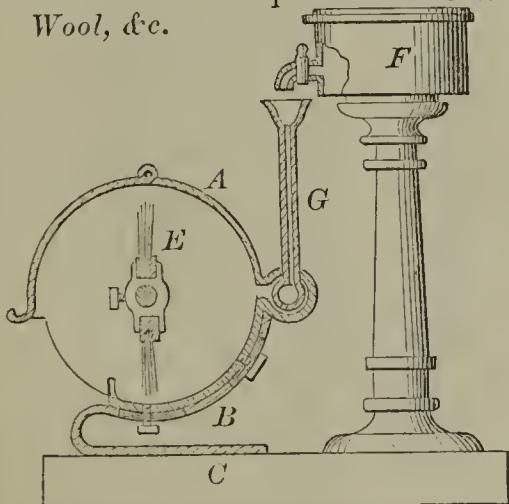

51887—B. Wilbur—*Bobbin for Spinning, &c.*

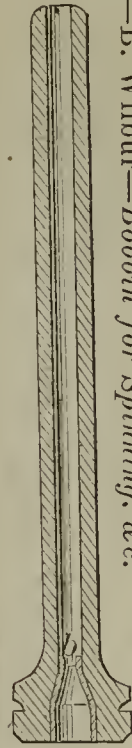

51888—D. F. Williams—*Clothes Wringer.*

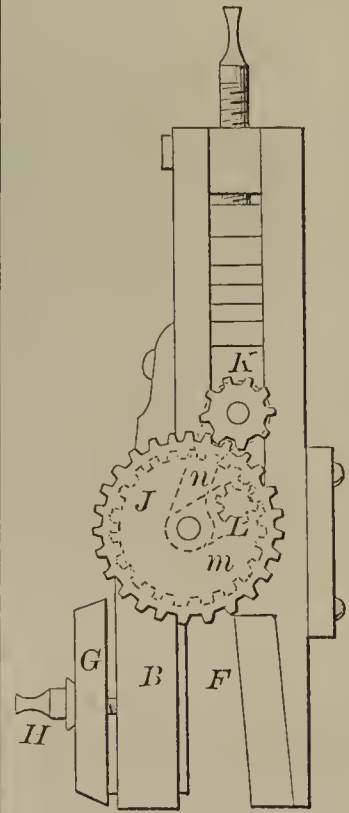

51890—E. E. Bean—*Sewing Machine.*

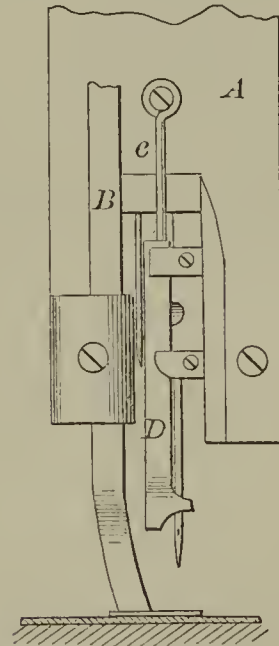

51885—G. B. Whiting—*Steam Engine.*

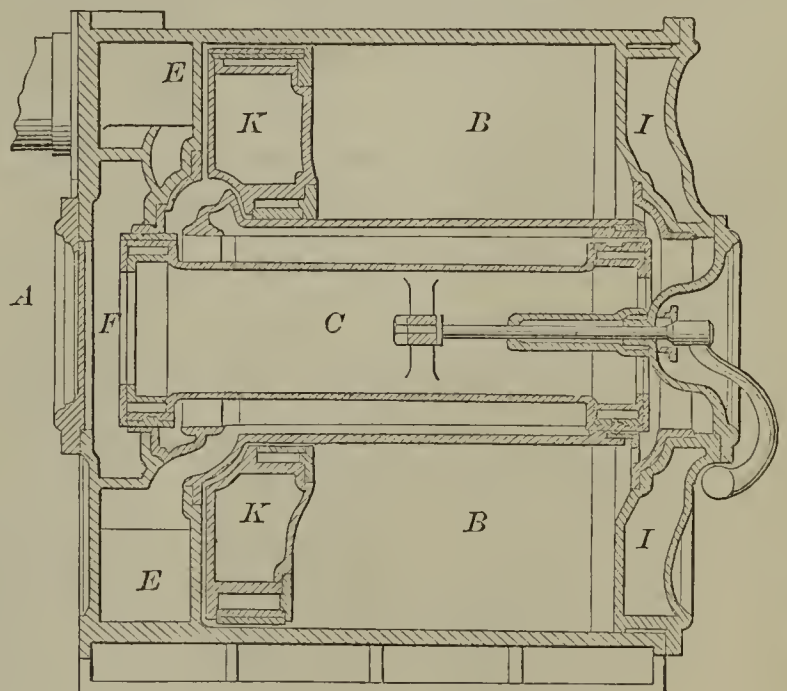

51892—J. E. Carver—Cotton Gin.

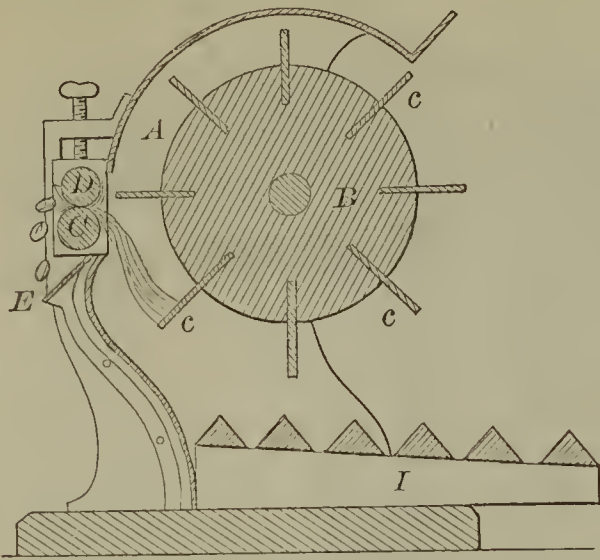

51895—H. Hall—Drawing Rollers for Spinning.

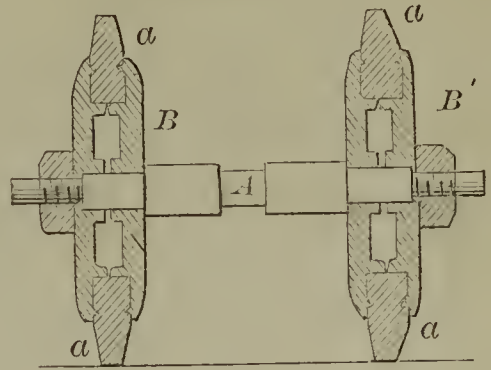

51897—L. Kirkup—Spike.

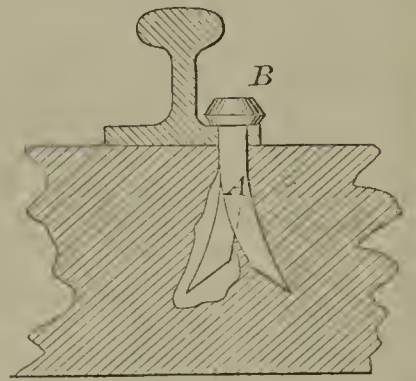

51898—J. Marchbank—Printing Oil Cloths.

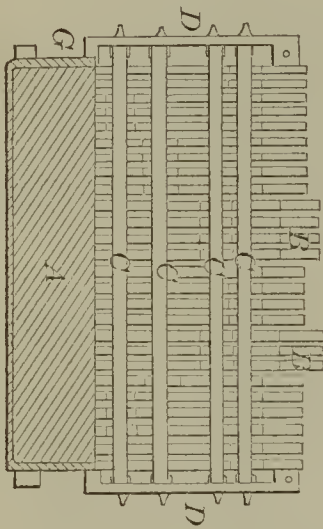

51893—D. E. Eaton—Garden Hoe.

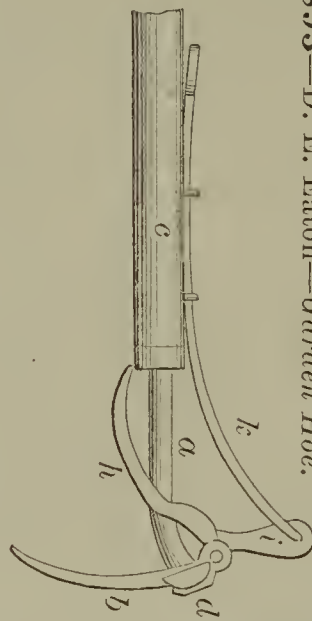

51899—W. S. McLean—Pruning Hook.

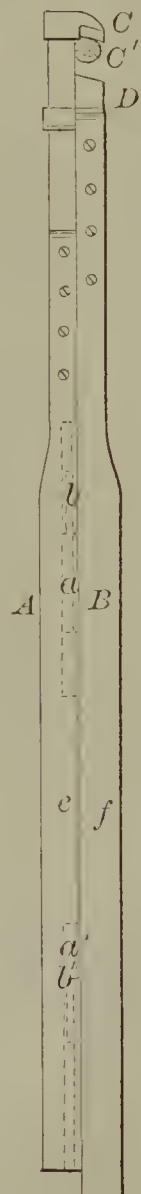

51896—C. J. Holman—Sawing Staves.

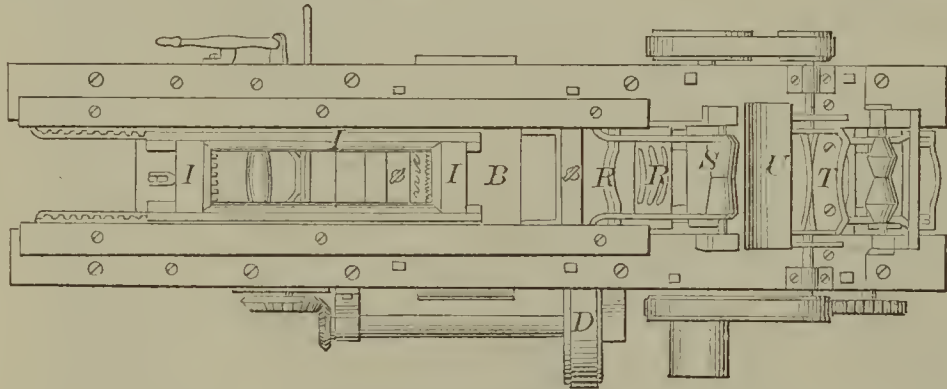

51900—W. Murkland—For Washing Wool, &c.

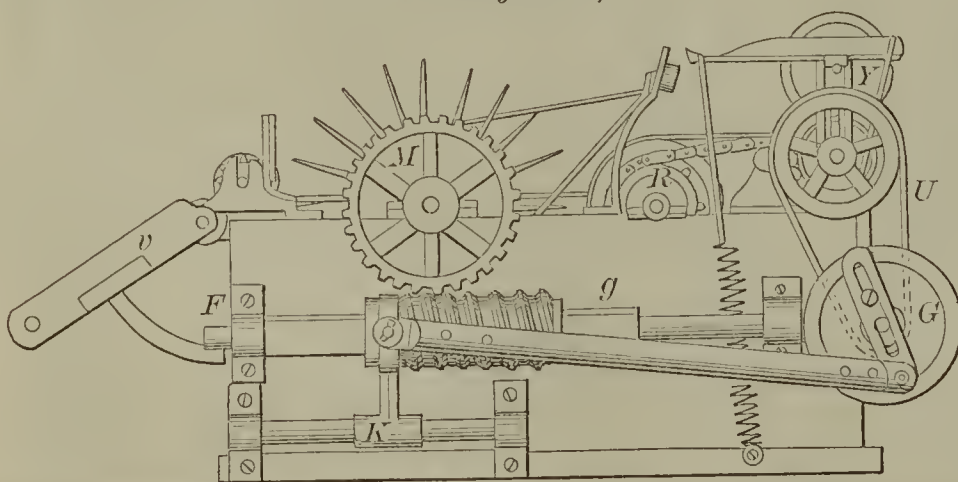



51901—D. T. Robinson—*Flour Sifter.*

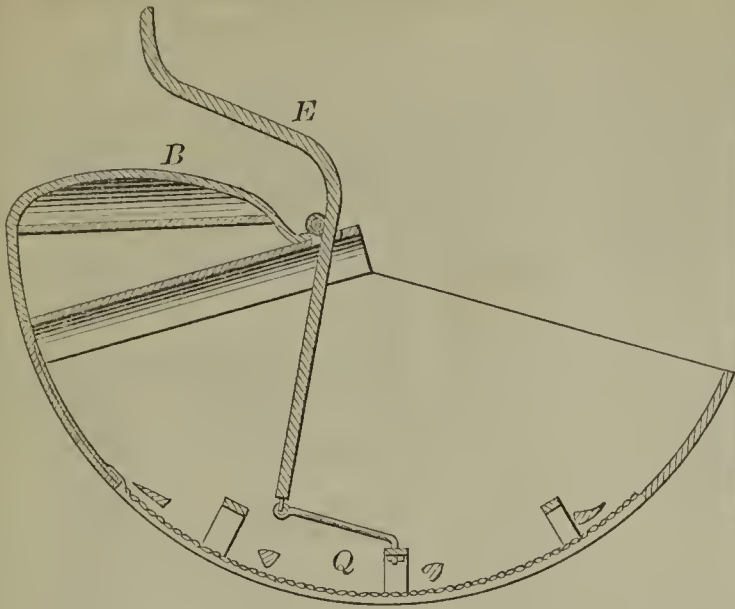

51902—P. Sweeney—*Rock Drill.*

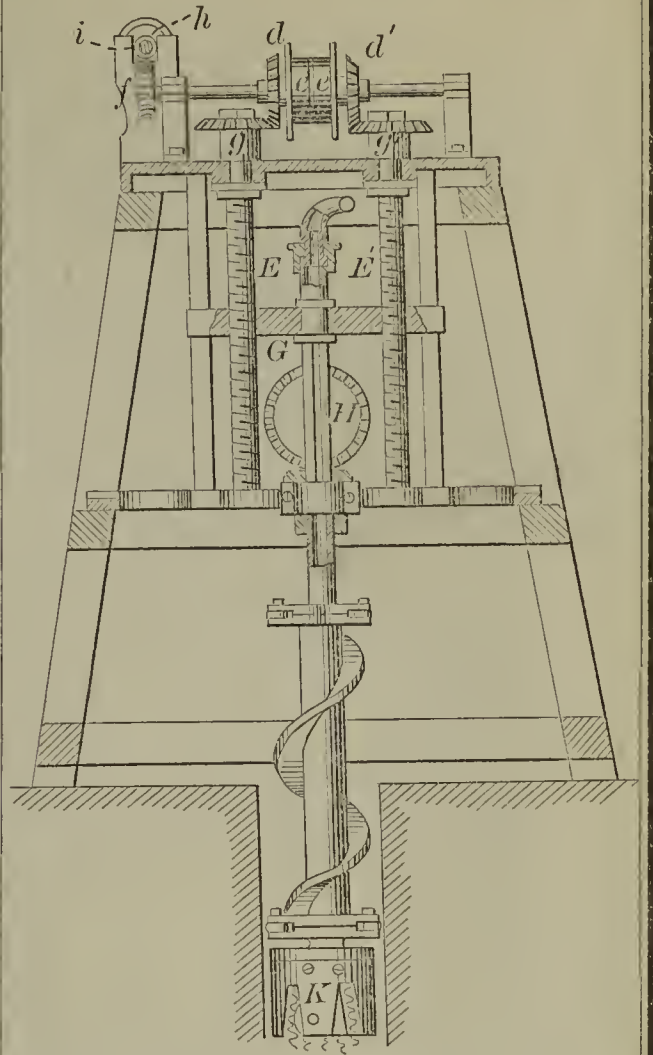

51903—C. Treusdale—*Moulder's Clamp.*

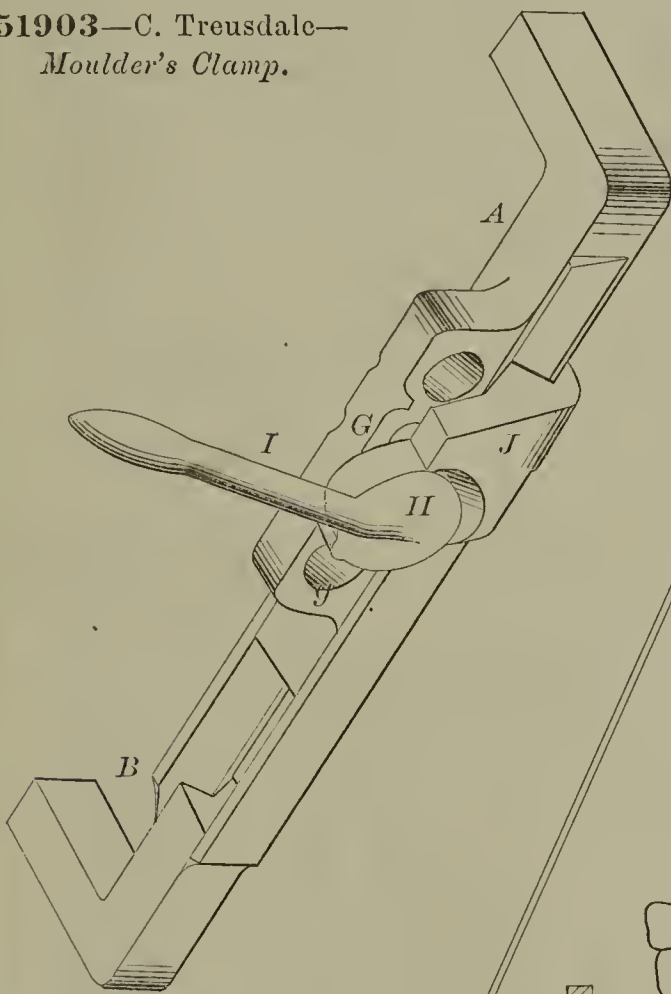

51905—P. L. Boulengi—*Electro-Ballistic Chronograph.*

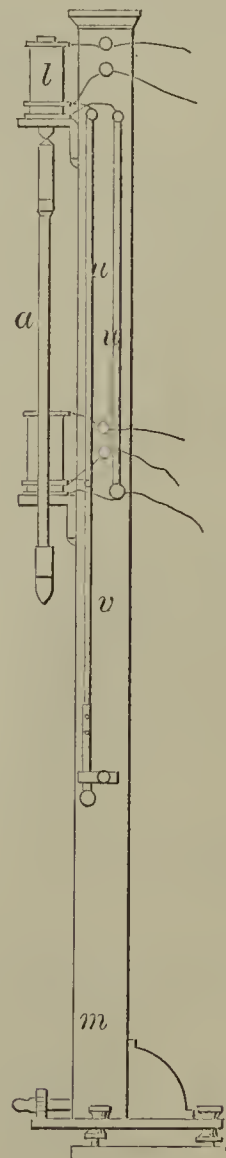

51906—H. Swan—*Stereoscopic Apparatus.*

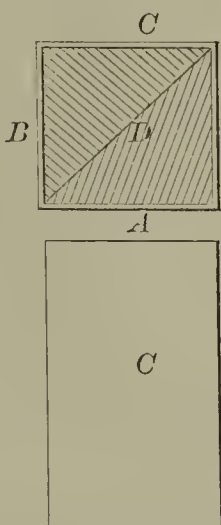

51904—Peet & Hyde—*Construction of Railways.*



51907—W. Weild—For Winding Thread.

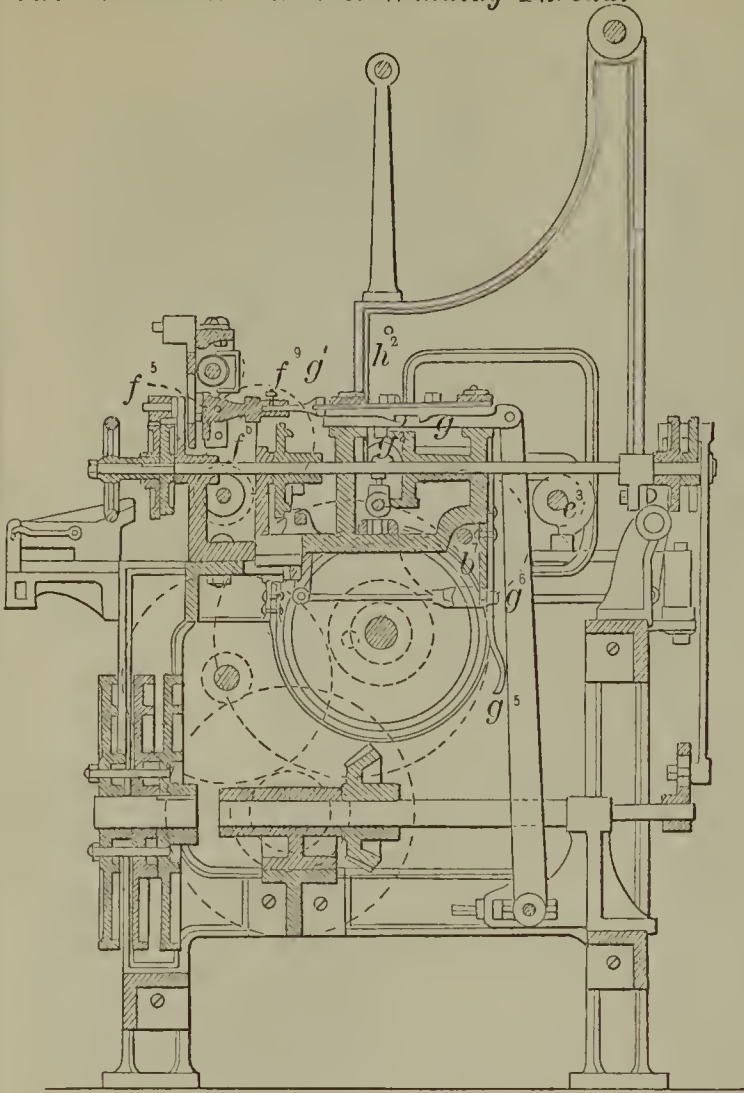

51908—J. B. Atwater—Steam Water Elevator.

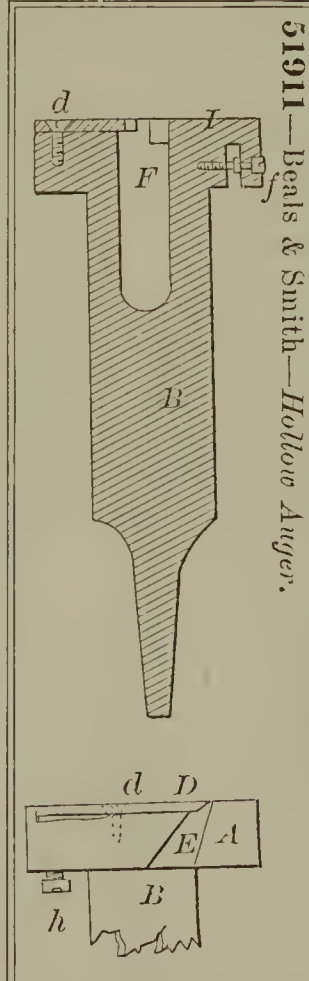
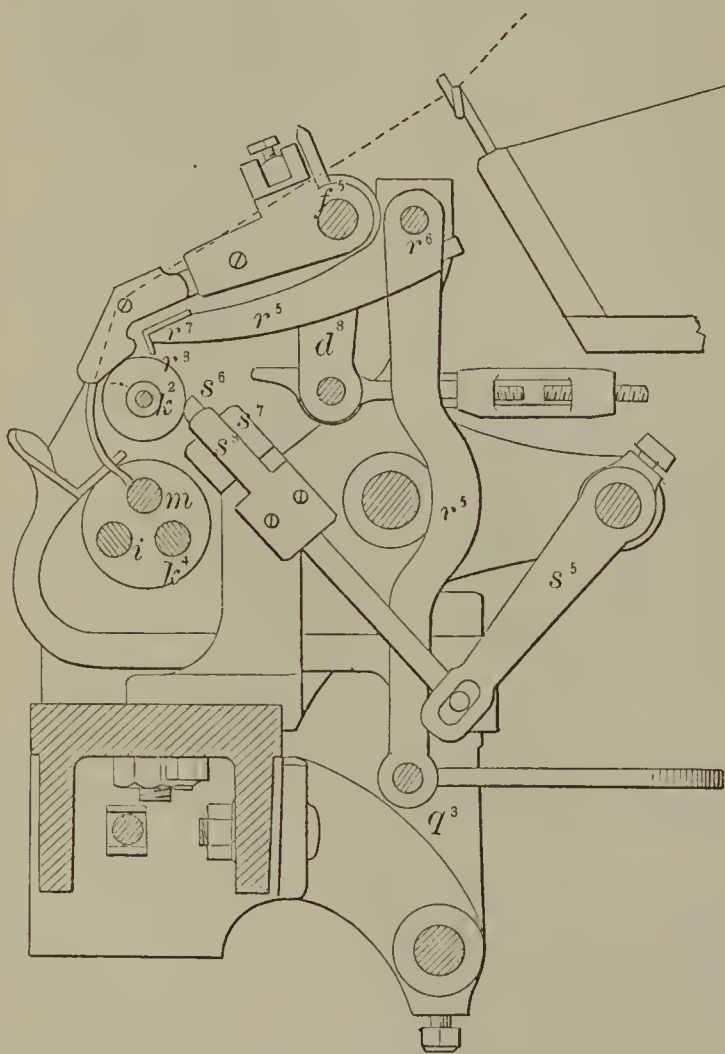
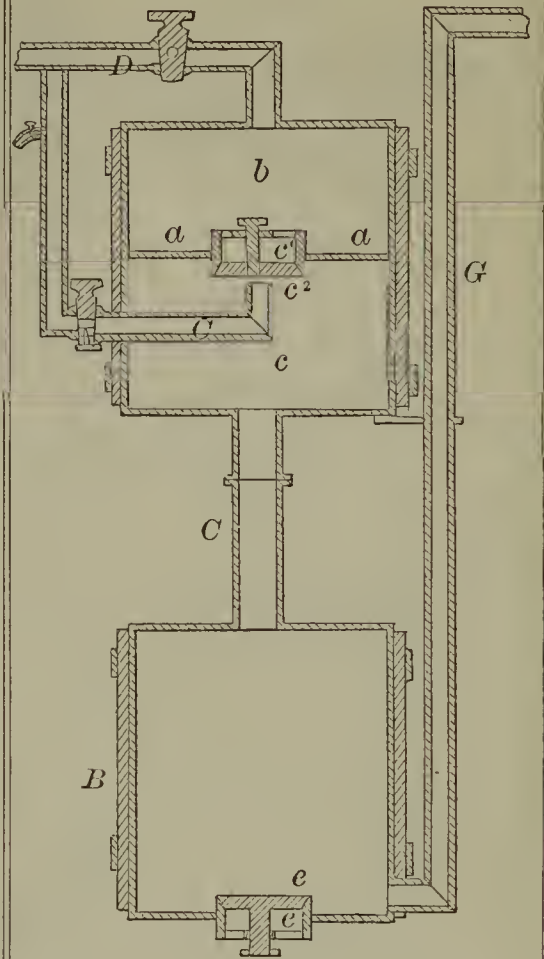

51911—Beals & Smith—Hollow Auger.

51912—B. F. Bee—Salinometer.

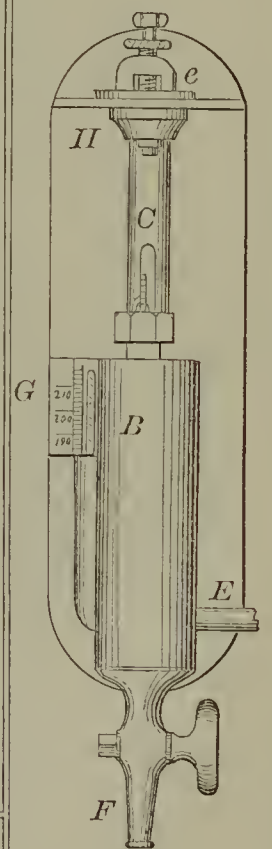

51910—E. Barbaroux—Pipe Coupling.

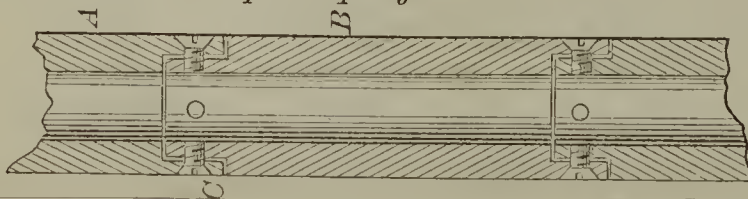

51915—J. Blackie—Rope Machine.

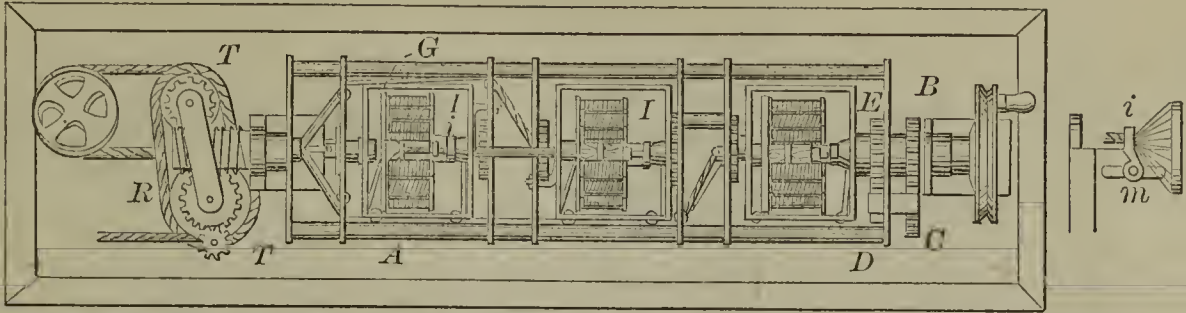

51916—J. H. Brown—Horse Shoe.

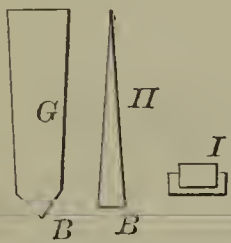
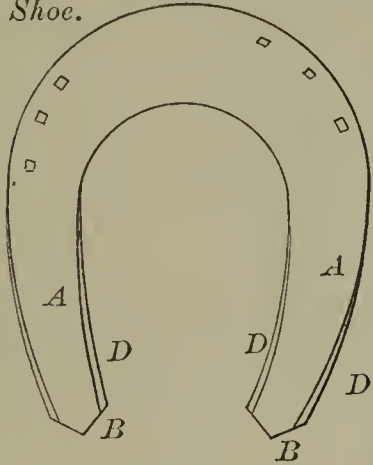

51922—J. Chilcott—Setting Open Boilers.

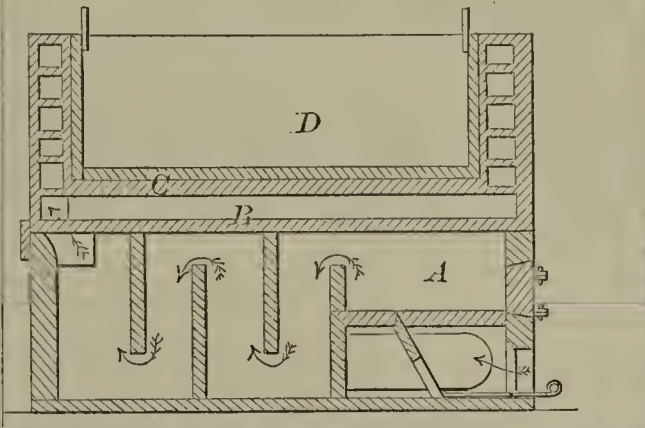

51921—J. Chilcott—Hot Air Furnace.

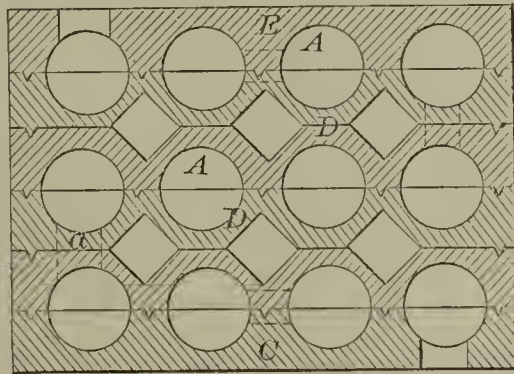

51918—E. Calderwood—Window Sash Fastener.

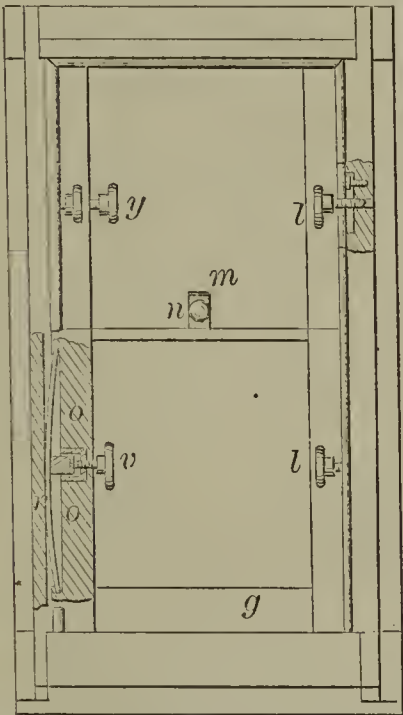
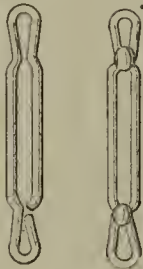
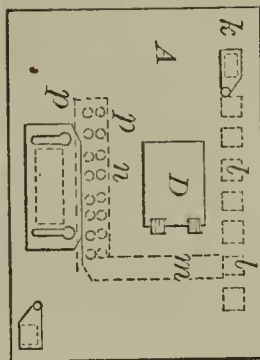

Fig. 1



51920—J. L. Cheney—Heddle Eye for Loom Harness.



51917—Burton & Hoyt—Plow.

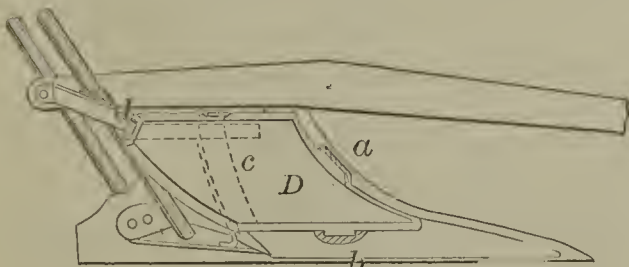

51919—J. C. & M. V. Campbell—Sinking Wells.

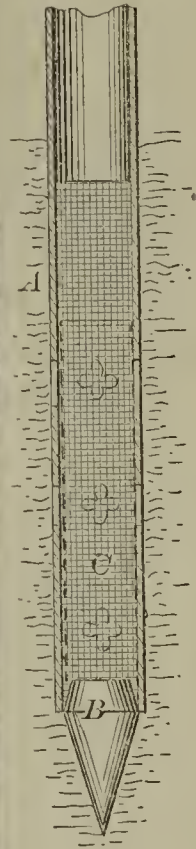

51923—J. Chilcott—Steam Boiler Furnace.

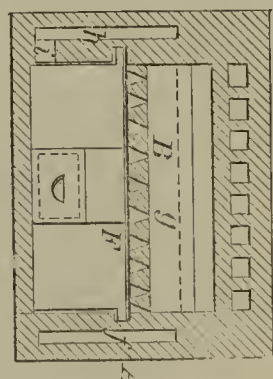
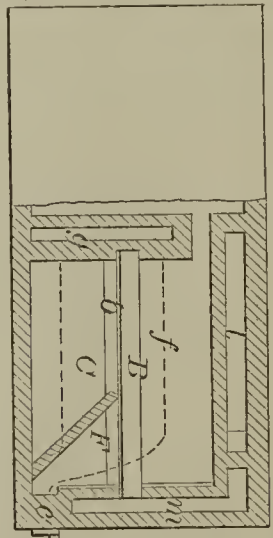

51924—E. Cole—*Shutter Fastening.*

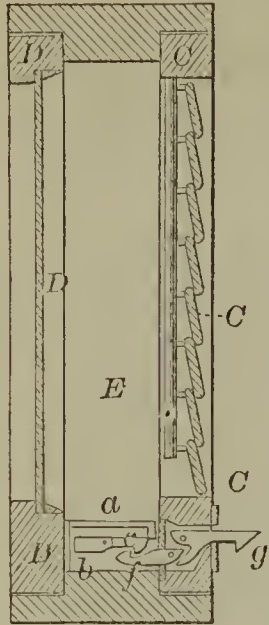

51927—A. S. Cox—*Railroad Station Indicator.*

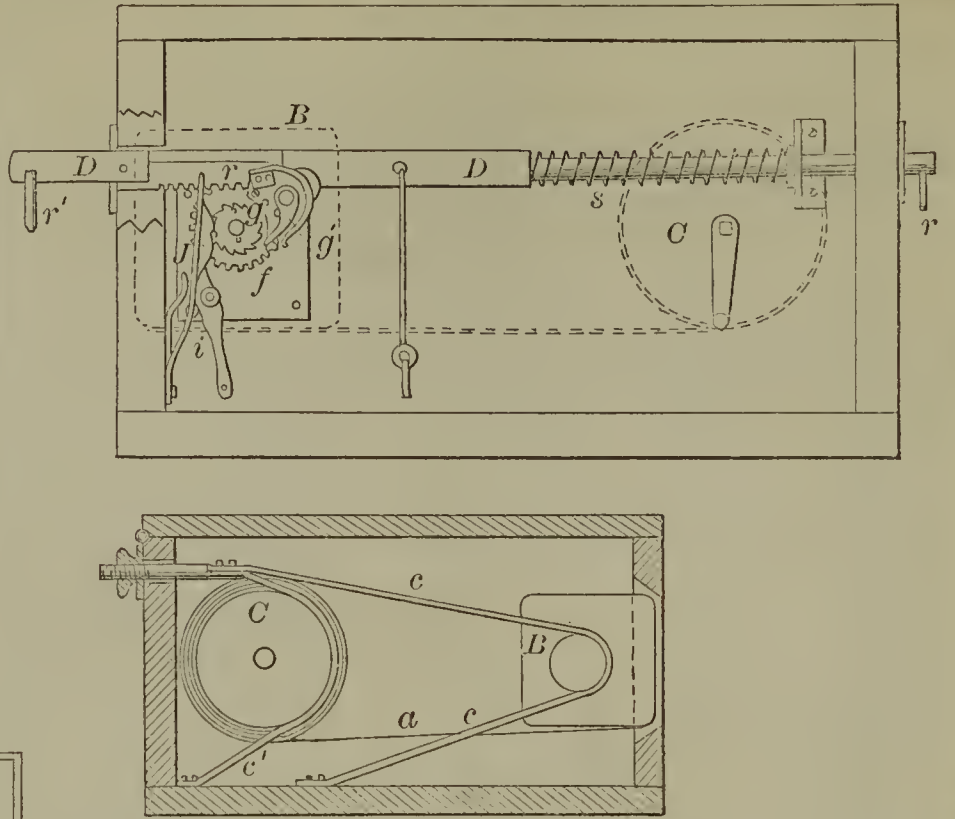

51928—G. Crompton—*Fancy Loom.*

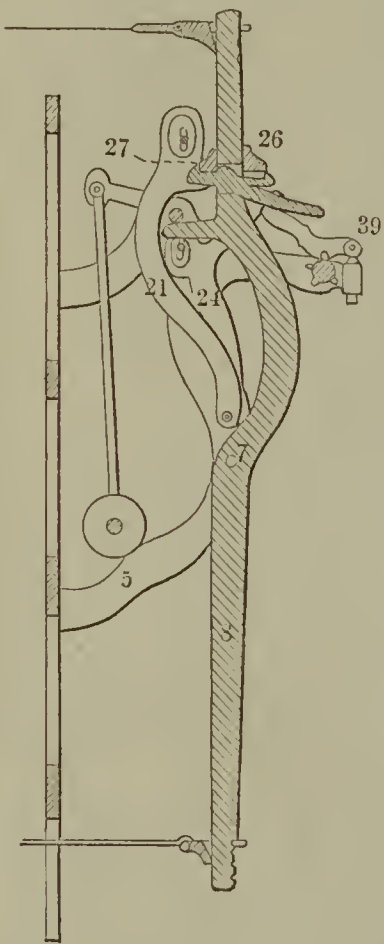

51925—A. G. Coles—*Well Drill.*

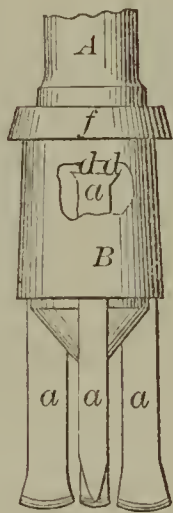

51926—A. B. Conde—*Strap Clasp.*

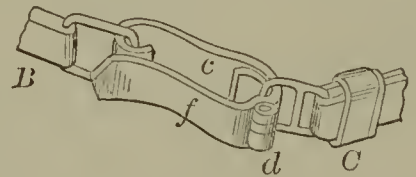

51930—Dam & Wigley—*Self-Acting Mule.*

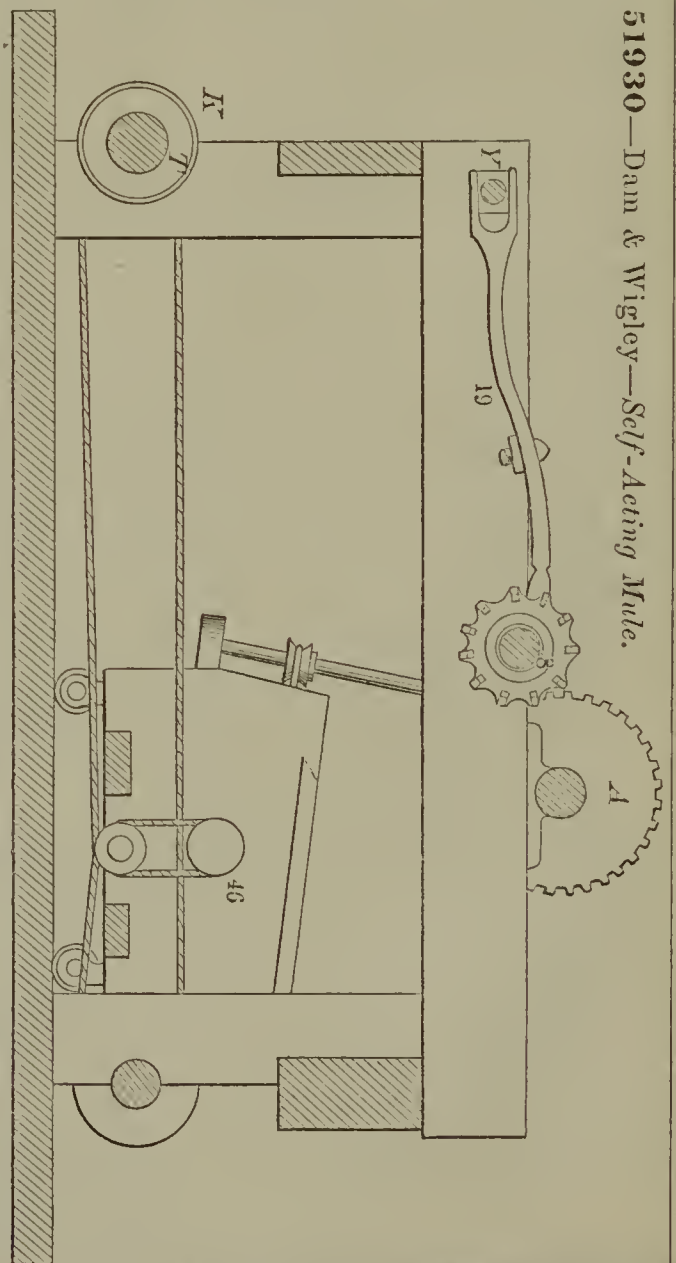

51931—S. Darling—*Inkstand.*

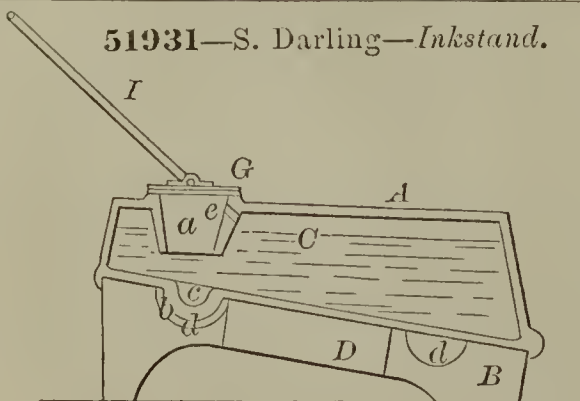

51932—C. Duckworth—Loom.

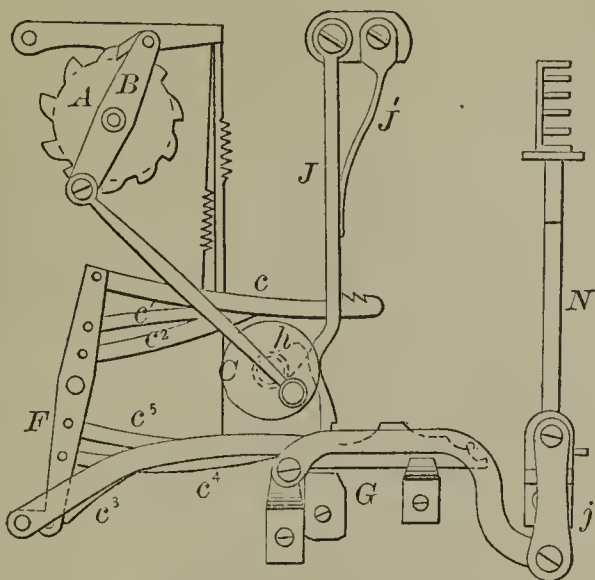

51933—J. H. Elward—Animal Trap.

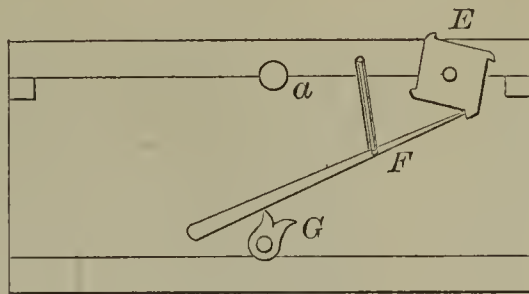

51934—A. B. Ely—Telegraph Insulator.

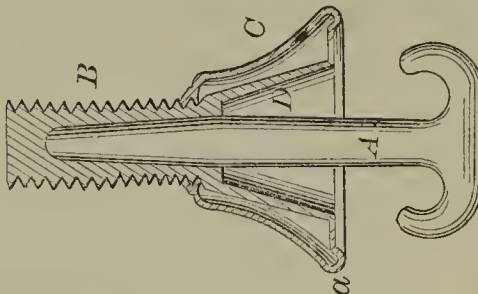

51936—W. & R. Foster—Rotary Pump.

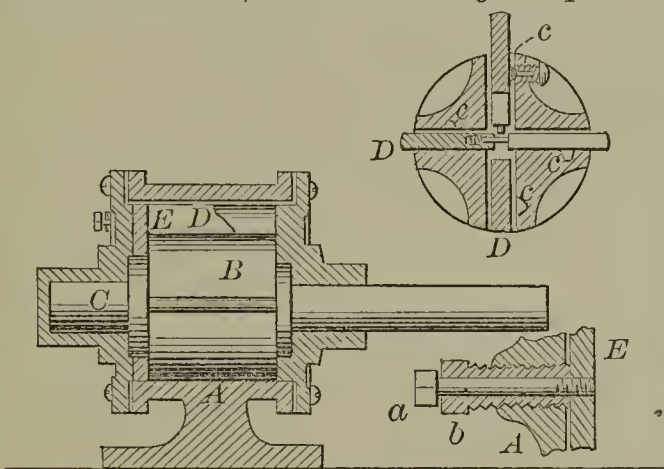

51940—A. L. Grinnell—Gate.

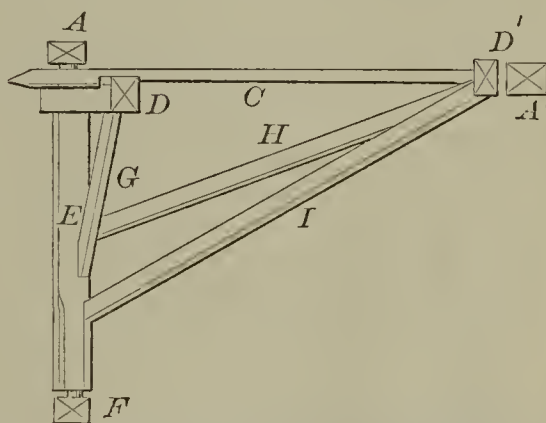

51938—Geer & Palmer—Wagon Box.

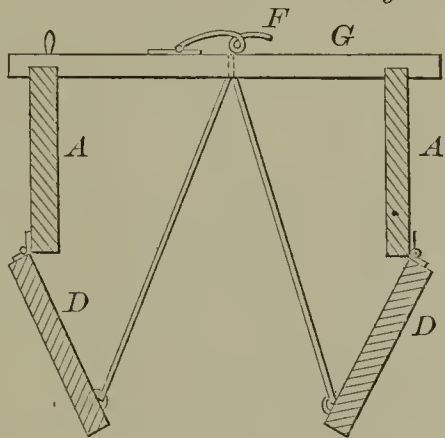

51939—S. Godfrey—Bolt for Flouring Mills.

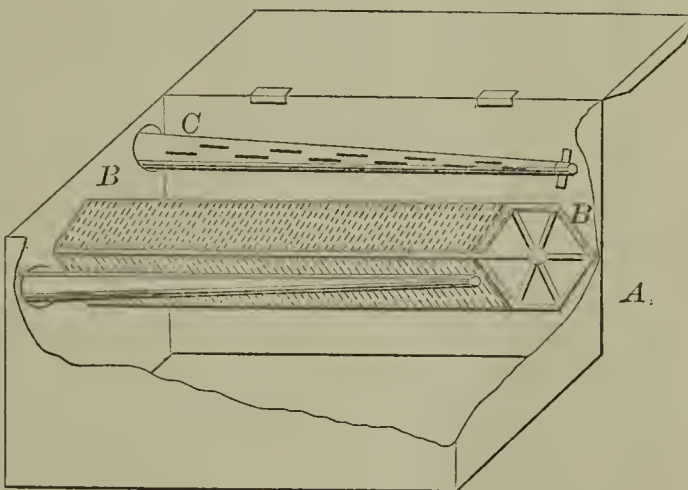

51937—S. T. Fowler—Fire Proof Safe.

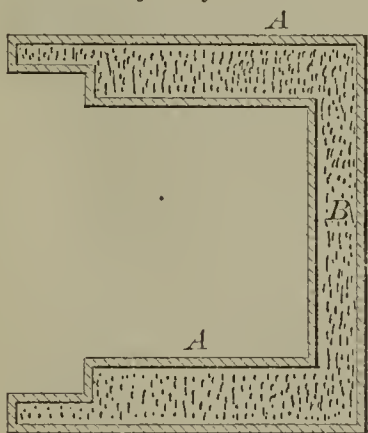

51941—J. T. Guthrie—Releasing Horses from Carriages.

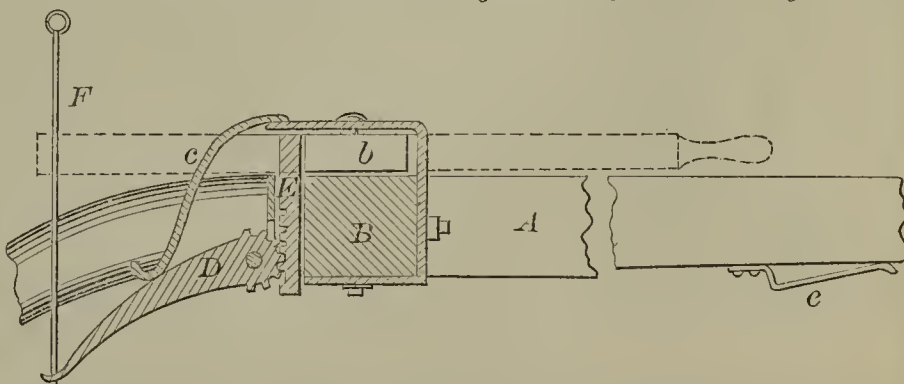

51942—J. P. Hawks—*Carrier's Knife.*

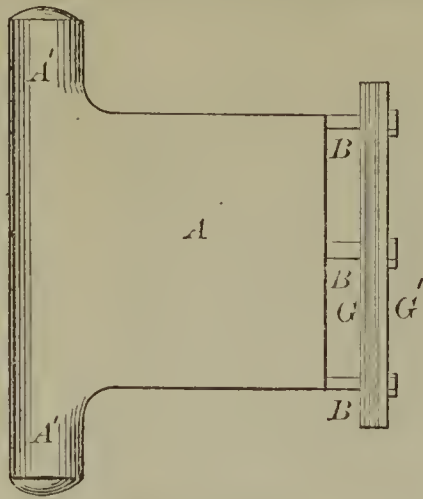

51943—H. Hayward—*Cutting Uppers for Boots.*

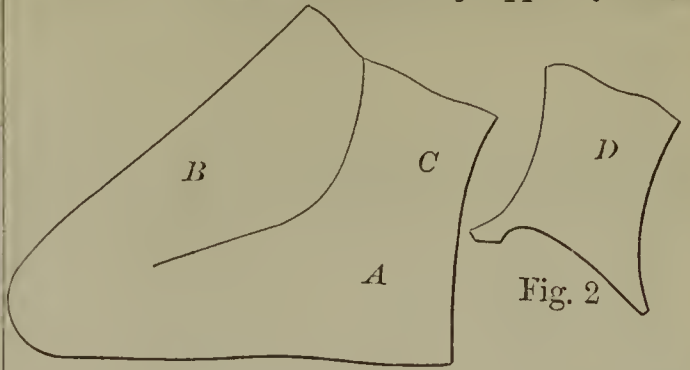

51944—

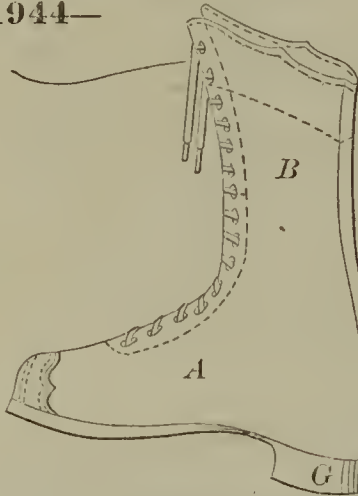

H. Hayward—*Babonard Boot.*

51946—Hutchinson & McAvoy—*For Carburetting Air.*

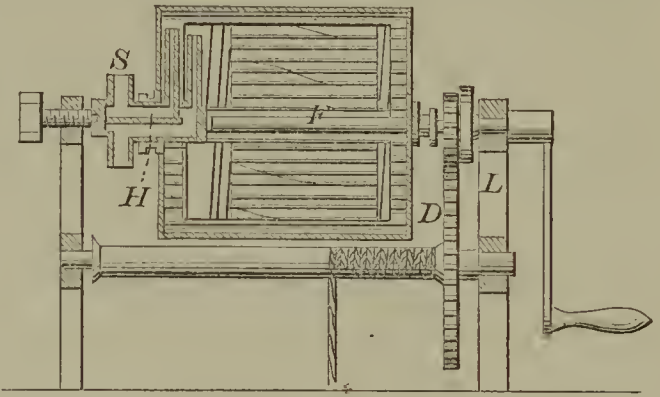

51947—Jewett & Bowen—*Hay Loader.*

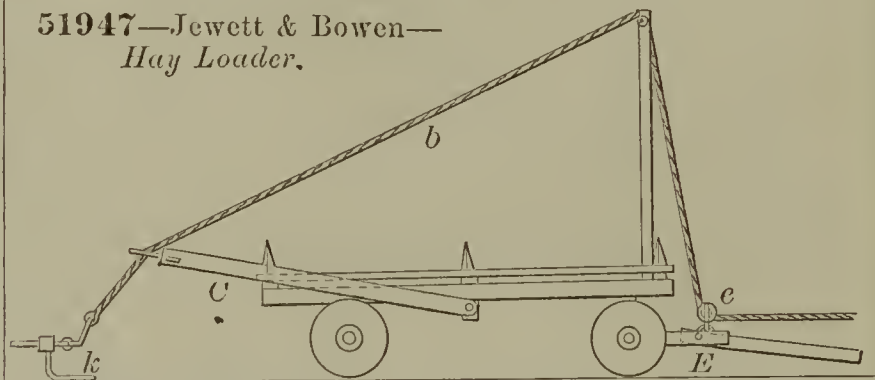

51945—S. E. Hewes—*Well Tube Packing.*

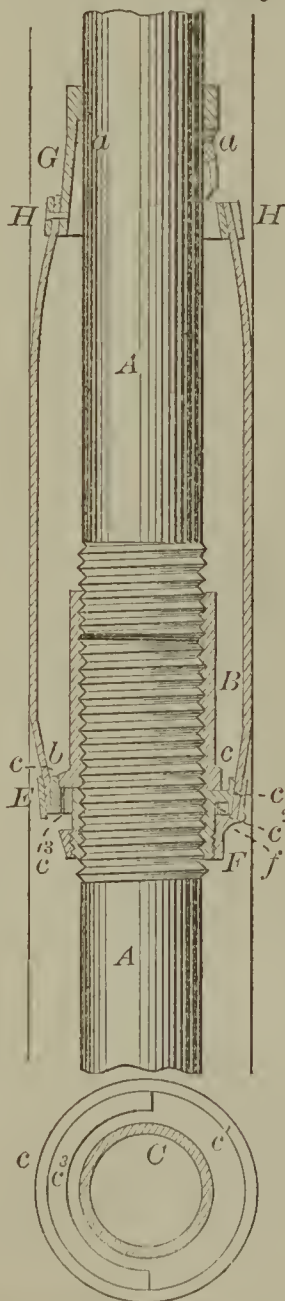

51948—J. Kidder—*Electrical Bath Tub.*

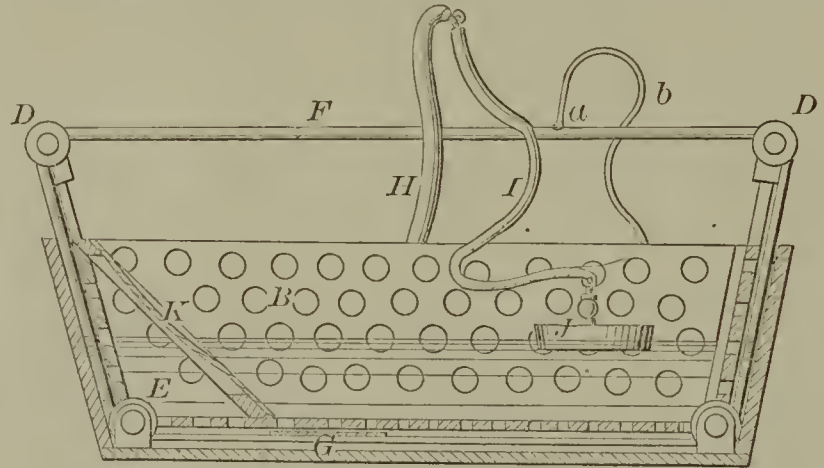

51949—W. Leas—*For Raising Dough.*

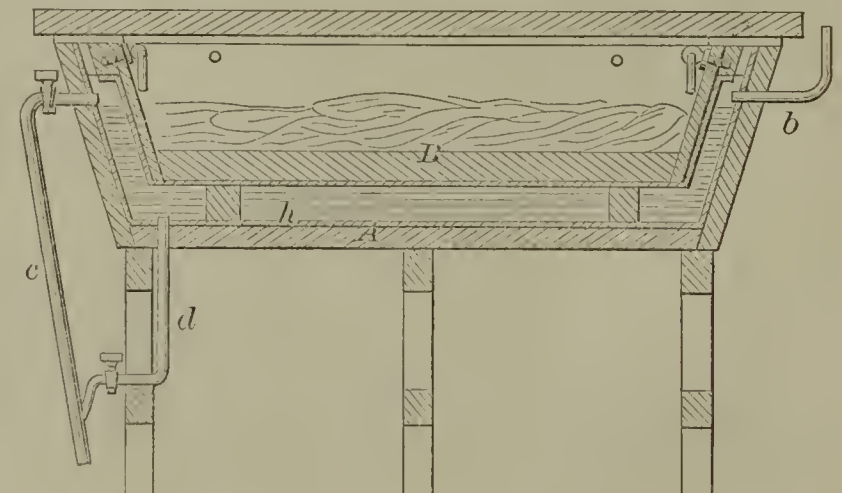

51950—D. Lippy—Horse Hay Fork.

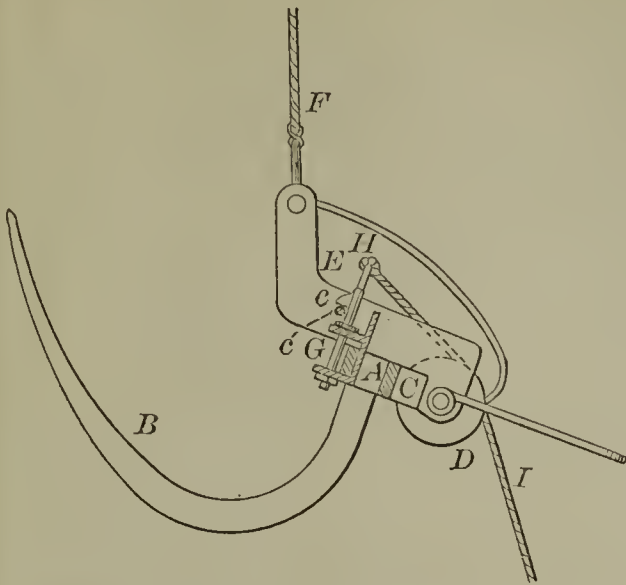

51956—J. Merlett—Pneumatic Spring for Cars.

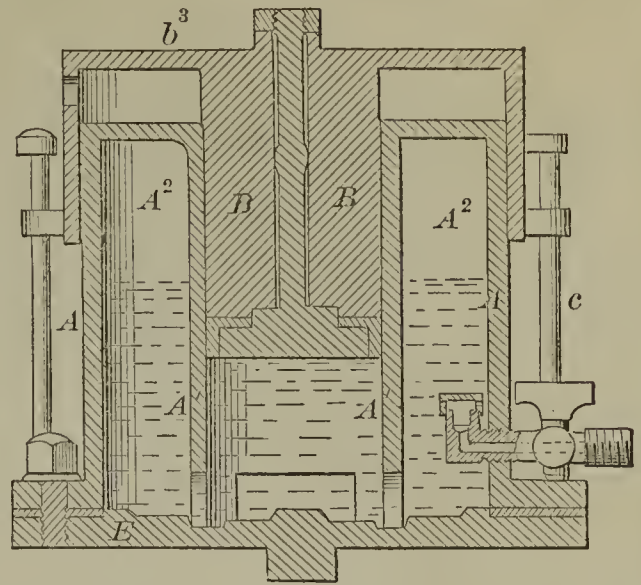

51952—A. W. Livingston—Railway Signal.

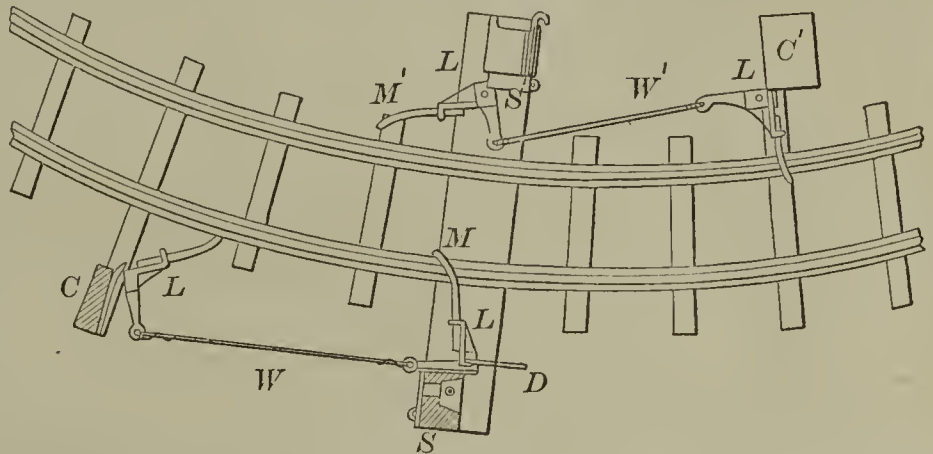

51955—J. T. Martin—Propeller.

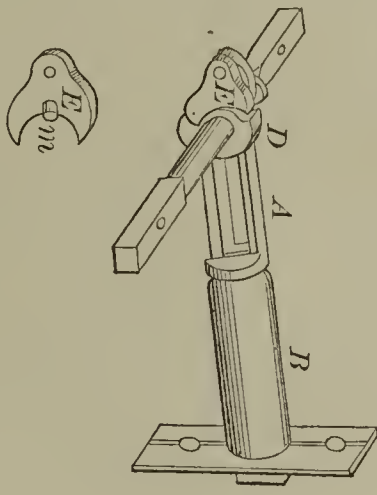
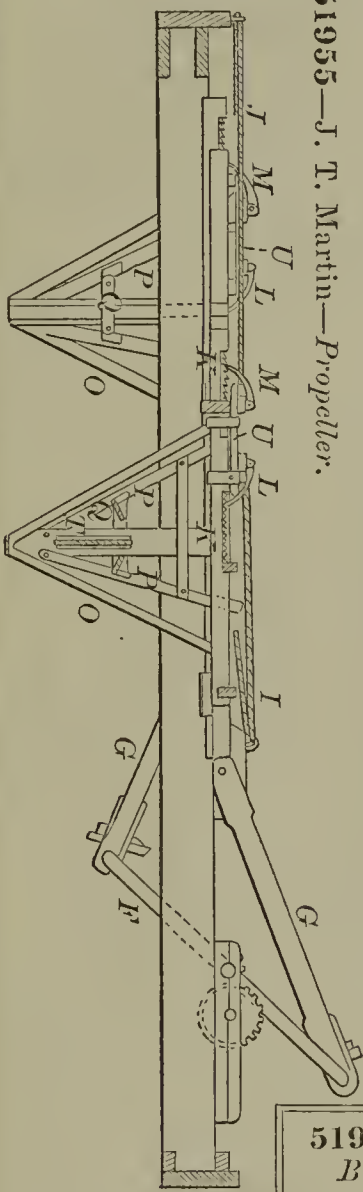

51954—E. Manley—Door Latch.

51953—J. Madden—Artificial Leg.

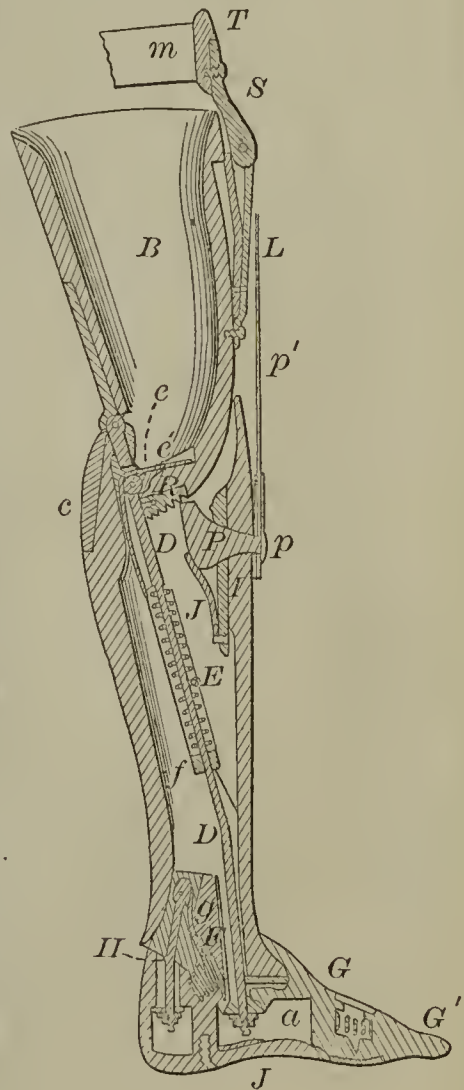

51957—J. A. Minor—Folding Lunch Box.

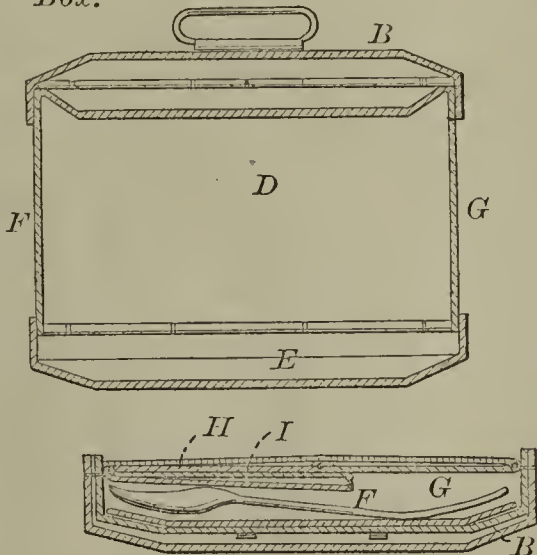

51951—H. B. Livermore—Fish Hook.

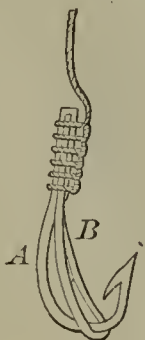

51958—H. Nash—Washing Machine.

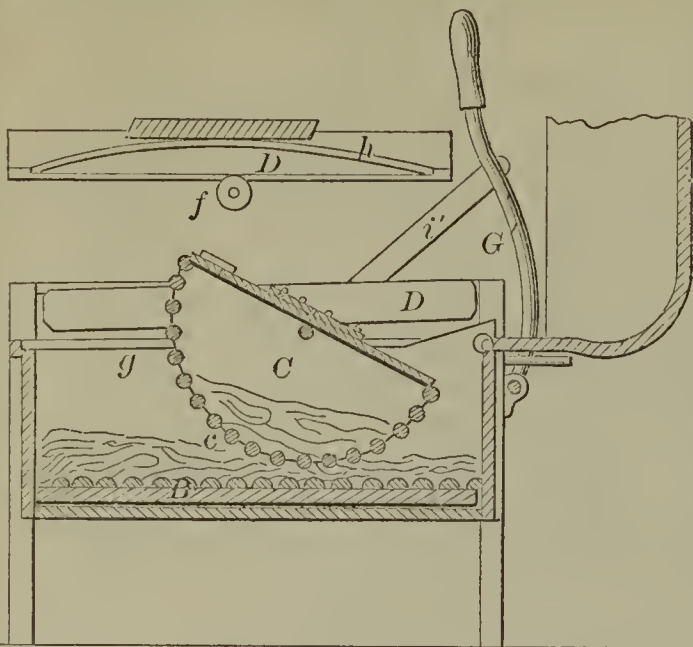

51962—S. R. Parkhurst—Cotton Gin.

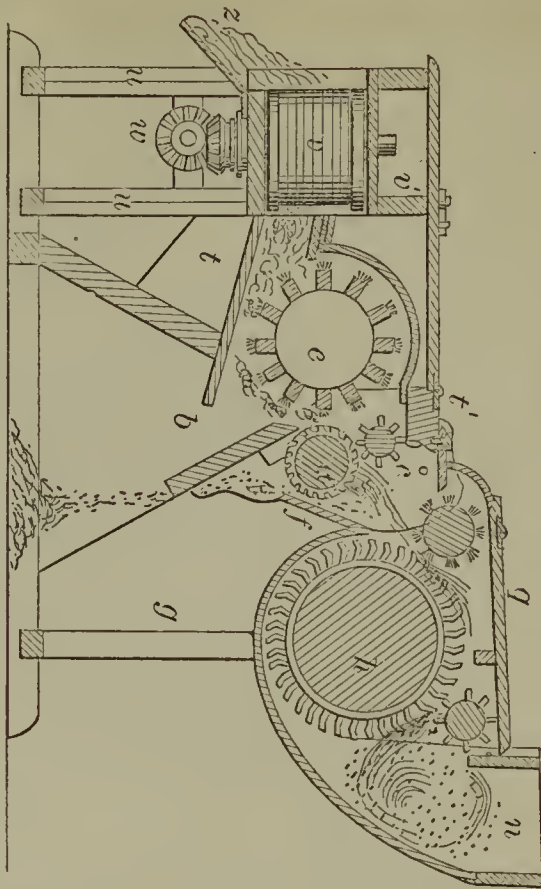

51963—S. J. Parmele—Lifting Jack.

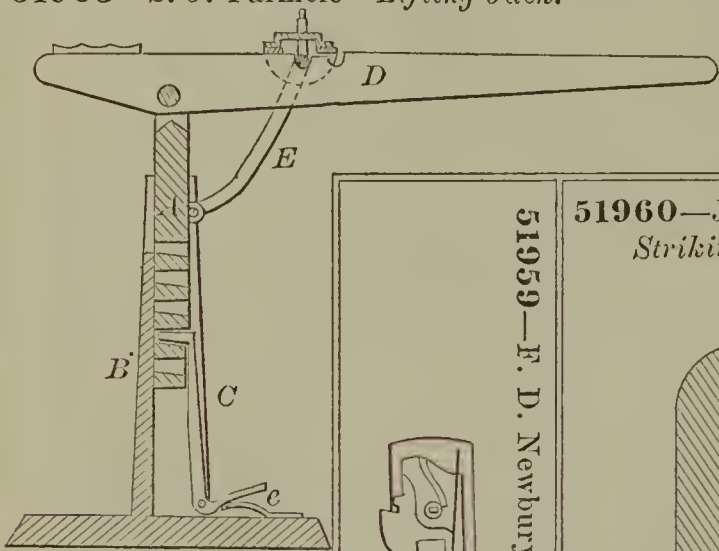

51960—J. North—Press for Striking up Metal.

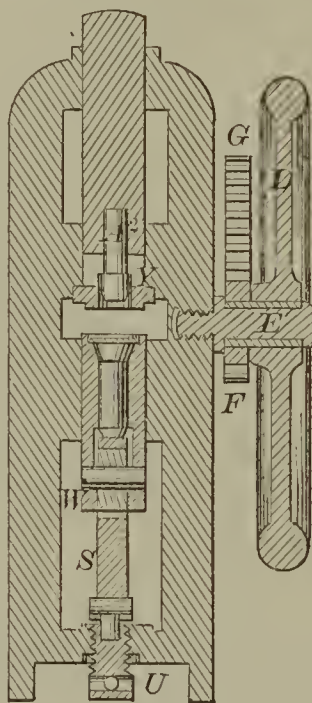

51959—F. D. Newbury—Breech-Loading Fire Arm.



51964—G. W. Parsons—Broom Head.

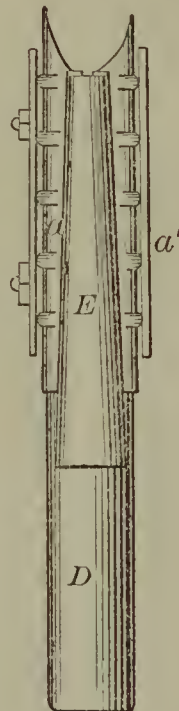

51961—T. C. Page—Wrench.

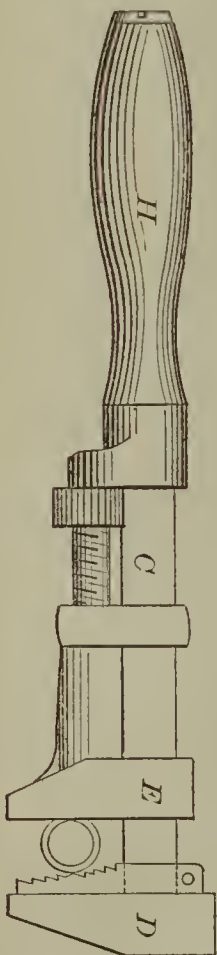

51965—F. S. Pease—Pump.

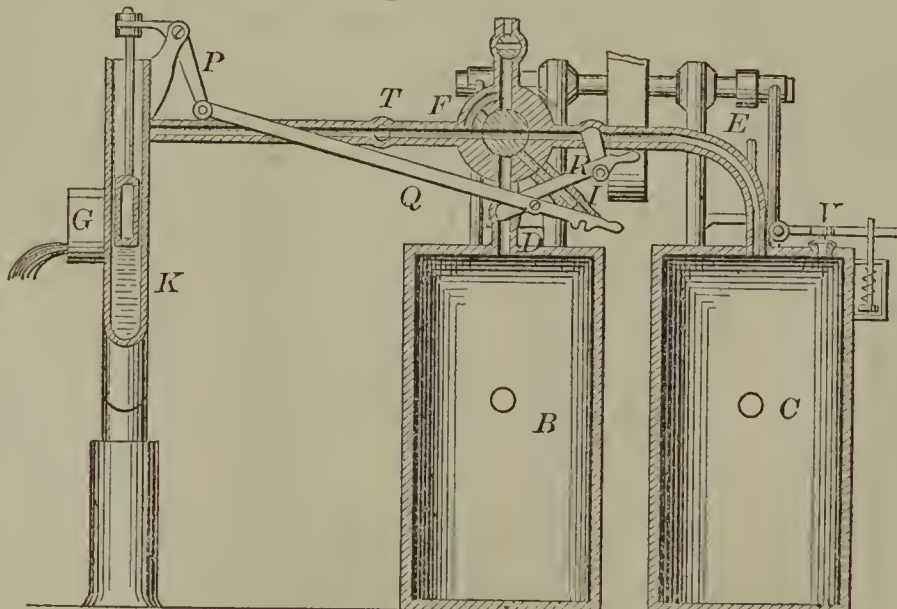



51966—G. Peugeot—Lantern.

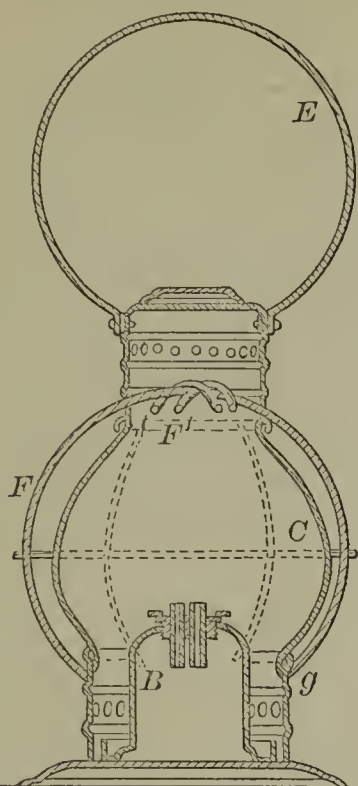

51967—Pfeghar & Schollhorn—Compass and Culipers.

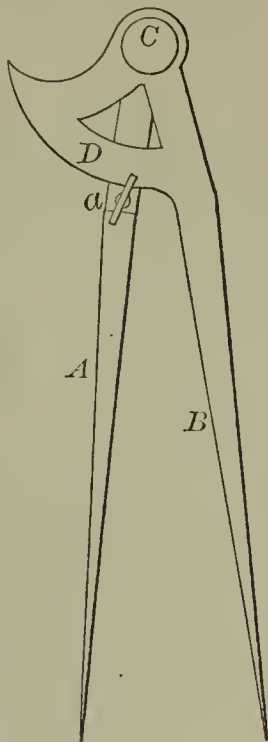

51968—J. C. Plumer—Boots and Shoes.

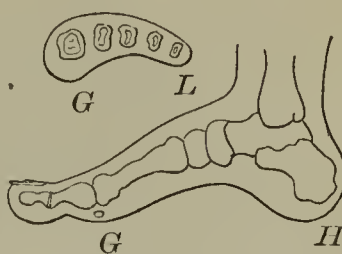

51970—S. Rogers—Belt Stretcher.

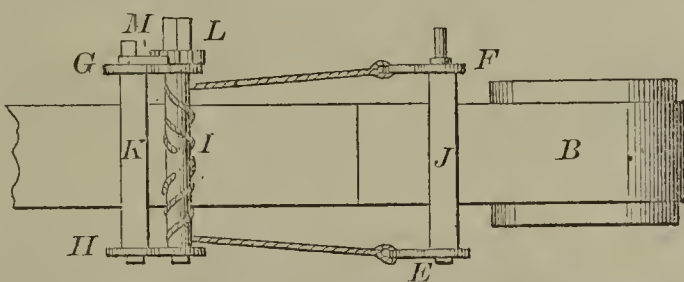
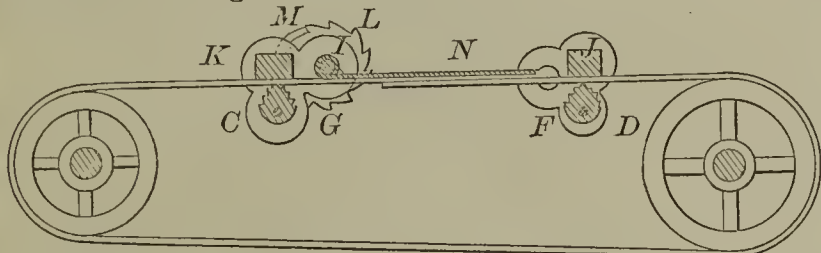

51972—N. Rowland—Calculating Machine.

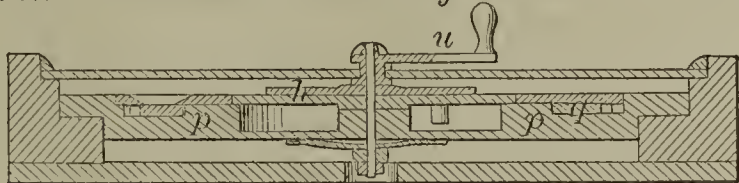

51973—Sargent & Covert—Lock.

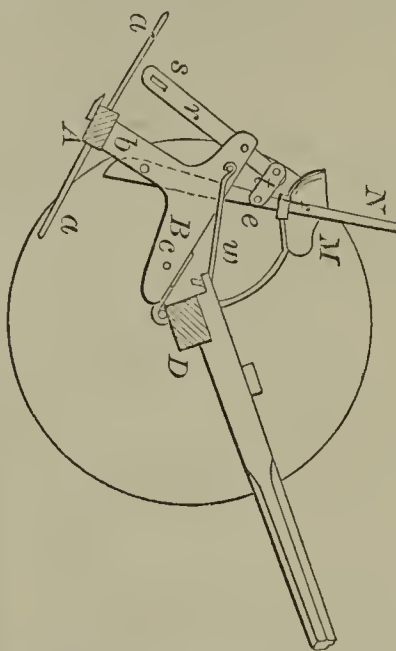
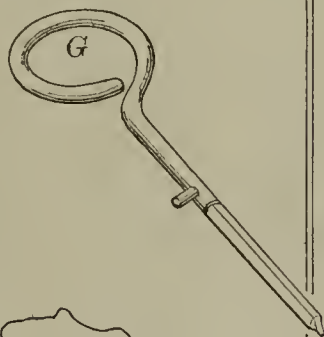
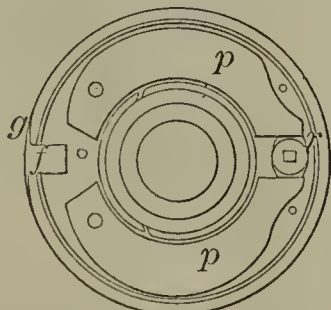
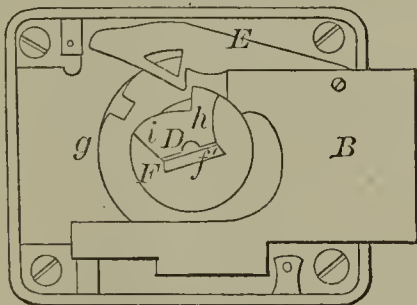

51969—S. B. Reed—Horse Rake.

51971—E. Rousseil—Life Preserver.

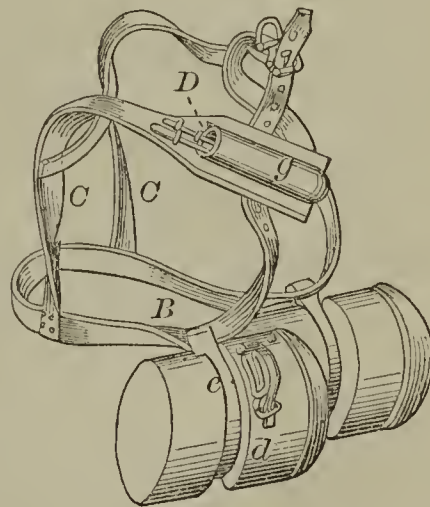

51974—J. Scott—Truss.

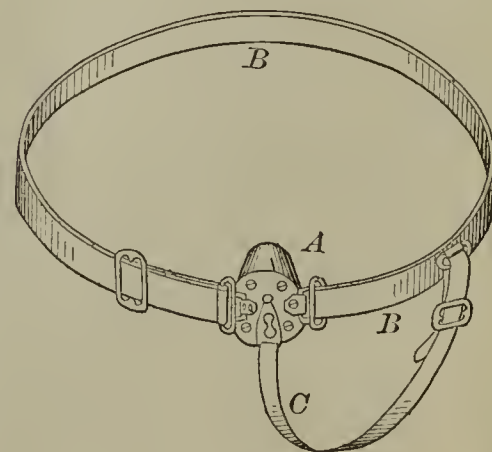

51975—M. R. Shalters—Harvester.

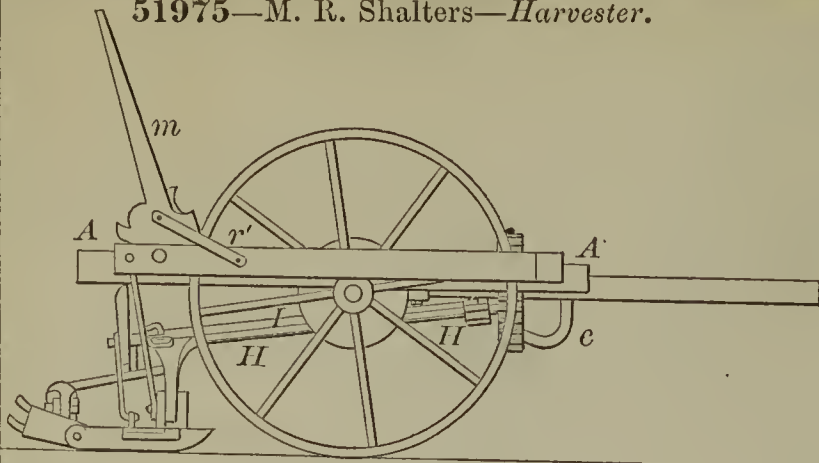

51979—U. Stewart—Forming Horse Shoes.

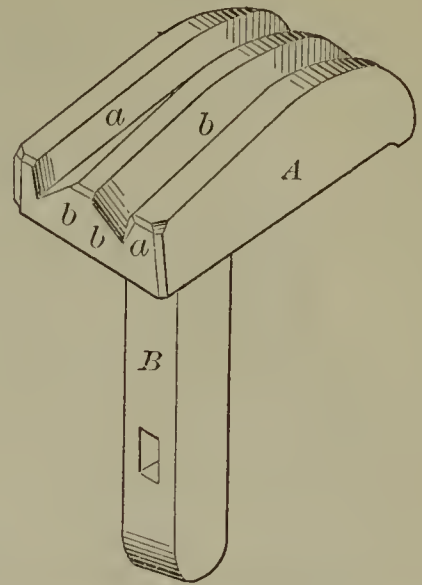

51978—H. E. Stager—Wood Bending Machine.

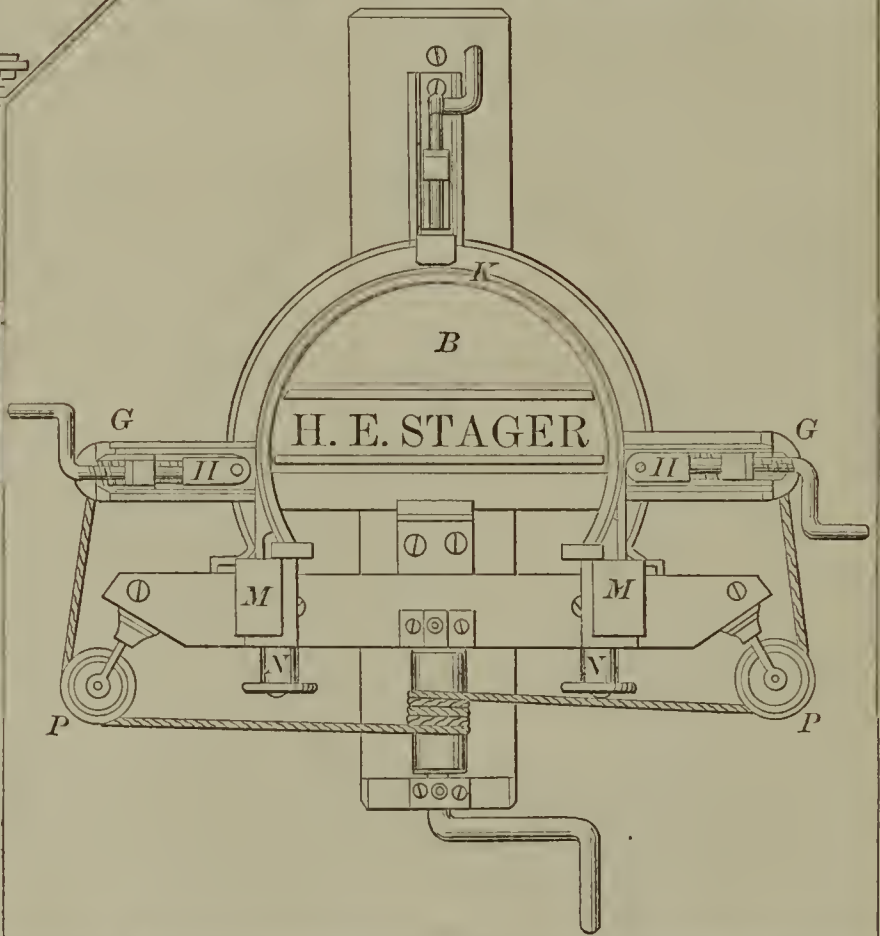

51976—H. E. Smith—Petroleum Cook Stove.

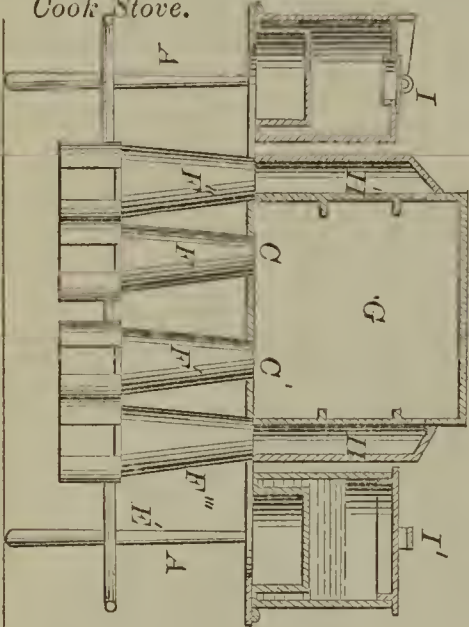

51981—J. E. Todd—Bed Bottom.

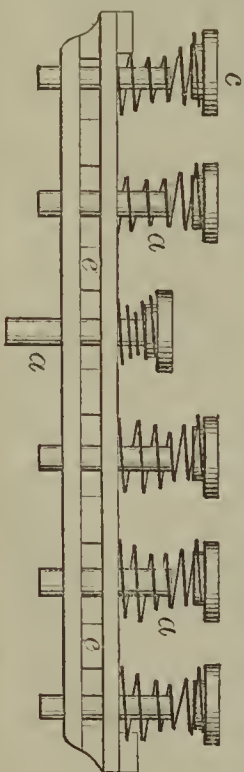

51980—W. W. St. John—Drill Head.

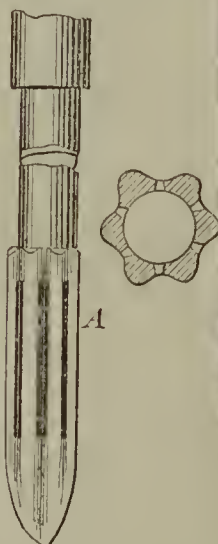

51977—Stafford & Crossman—Washing Machine.

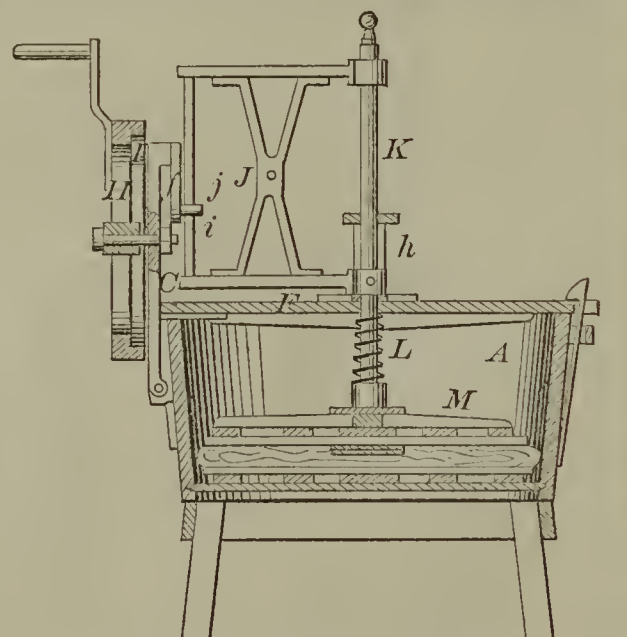

51982—R. Vose—Sash Fastener.

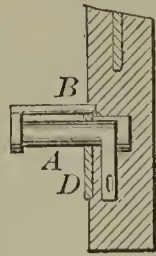
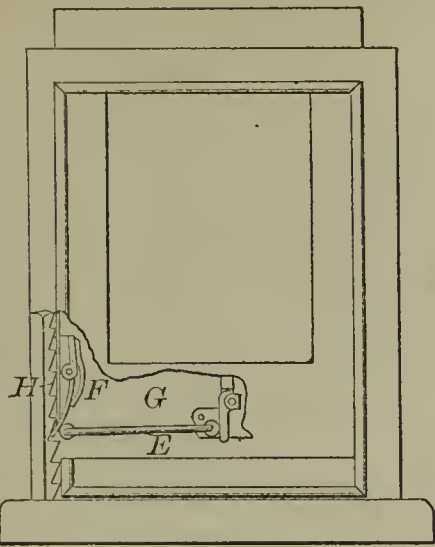

51985—E. Whitney—Revolving Fire Arm.

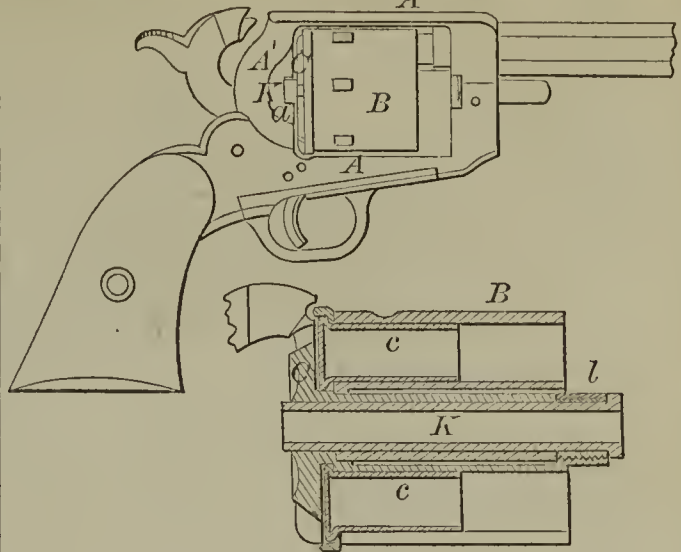

51983—G. W. Wareham—Sash Fastener.

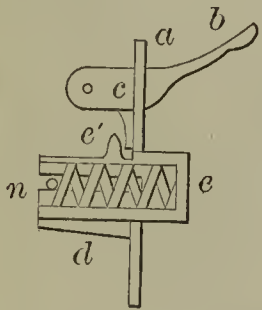

51984—O. G. Warren—Suction Drill.

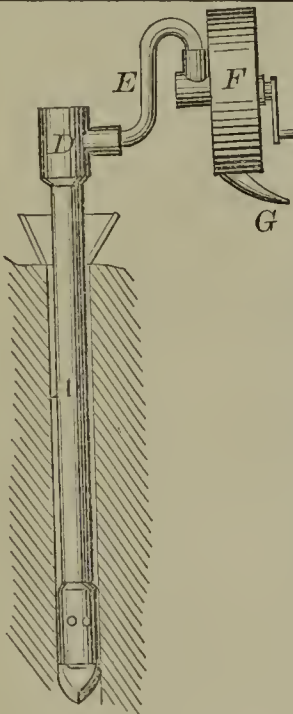

51989—Winter & Brewer—Boring Wells.



51986—J. A. Whitney—Horse Shoe Nail Machine.

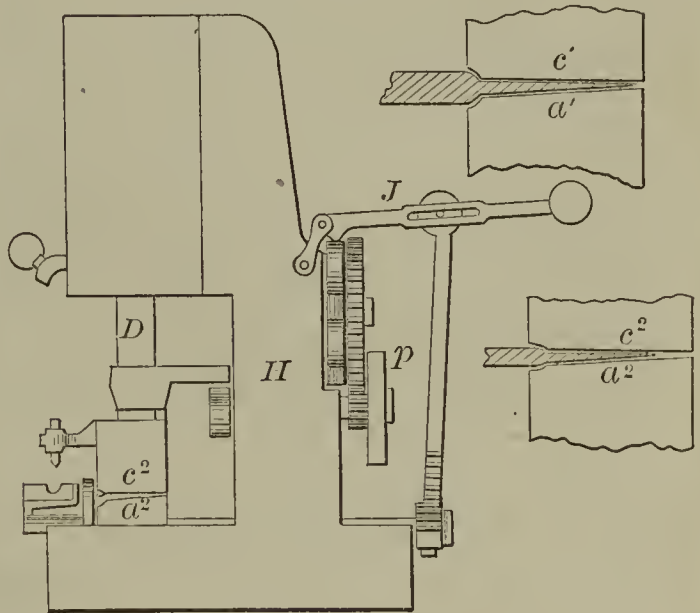

51988—Wilder, Wales & Nichols—Obtaining Silk from Spiders, &c.

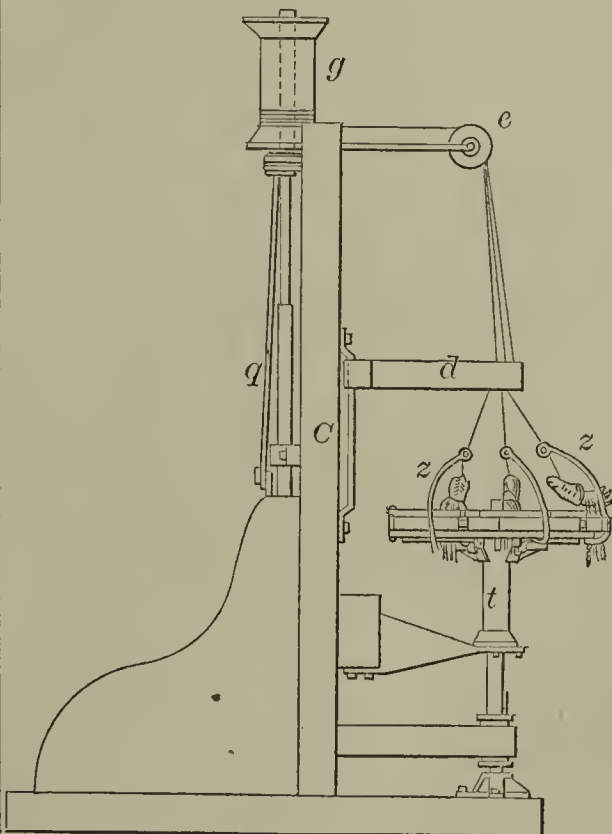

51990—Allen, Rouse & Melcher—Packing Pump Pistons.

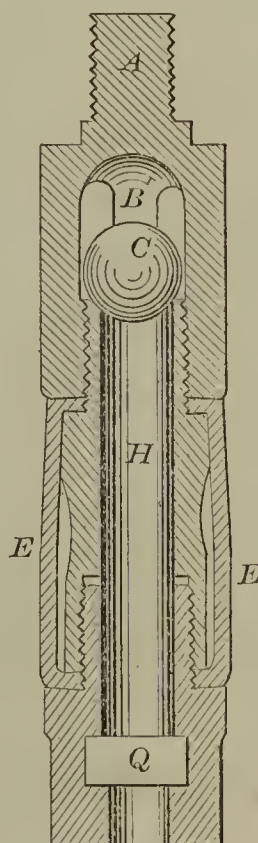

51987—J. M. Whitney—Portable Head Rest.

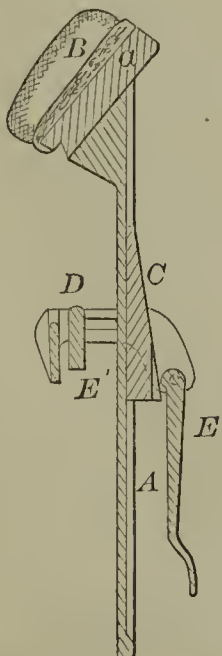

51991—H. Berdan—Breech-Loading Fire Arm.

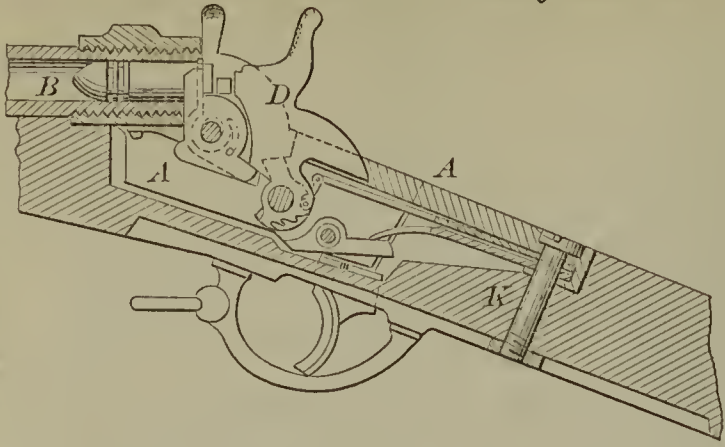

51995—J. B. Crowley—Moulder's Clamp.

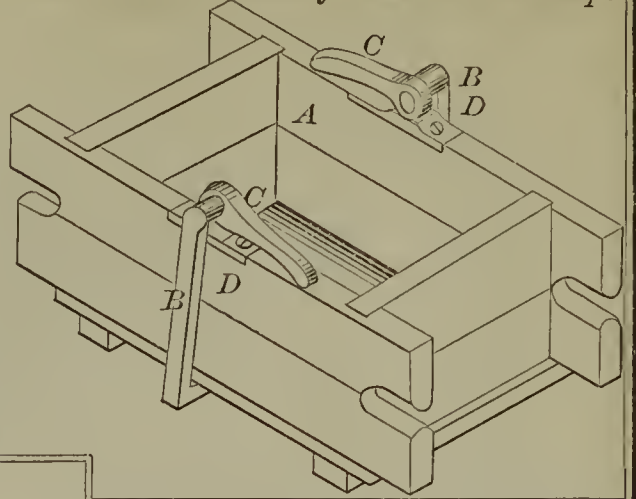

51994—R. Burditt—Reed Musical Instrument.

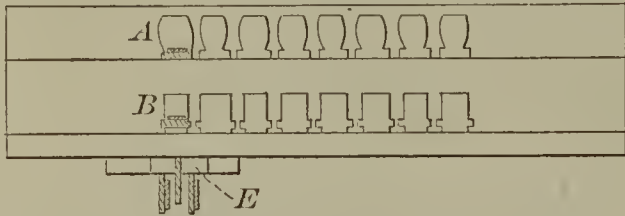

51993—T. L. Brown—Horse Shoe Jack.

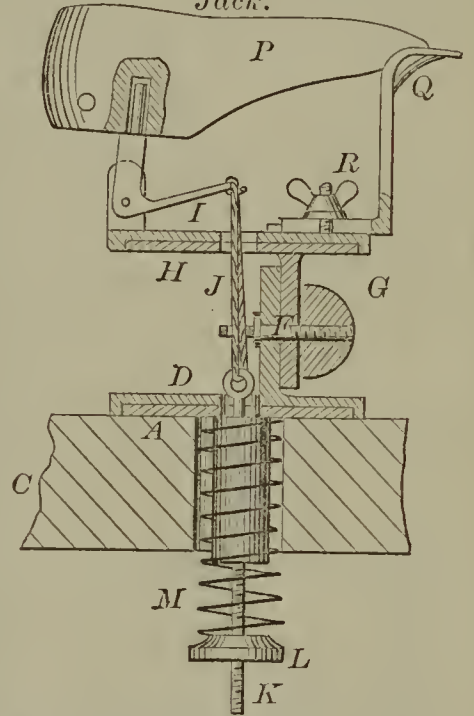

51996—W. Goodwin—Rotary Steam Engine.

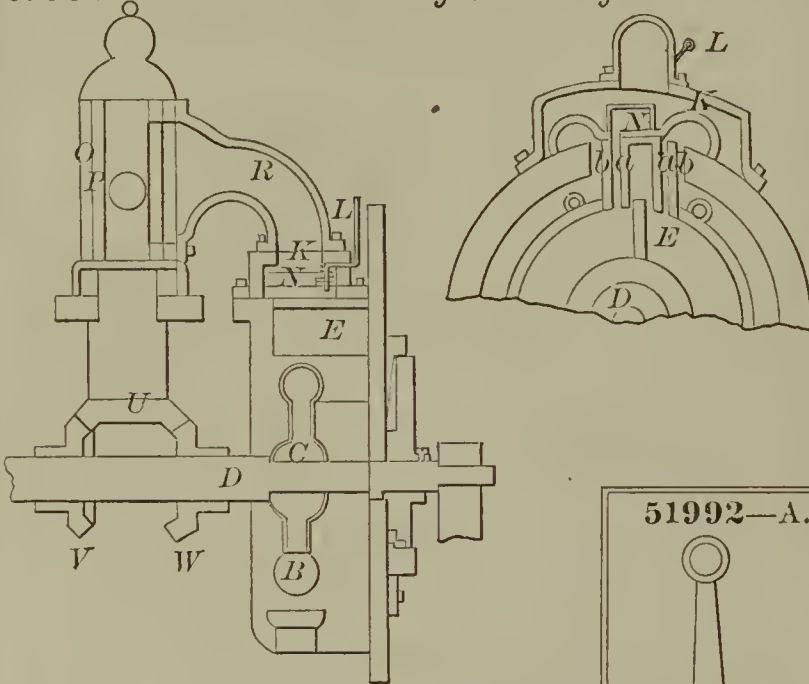

51992—A. E. & J. B. Blood—Flour Sifter.

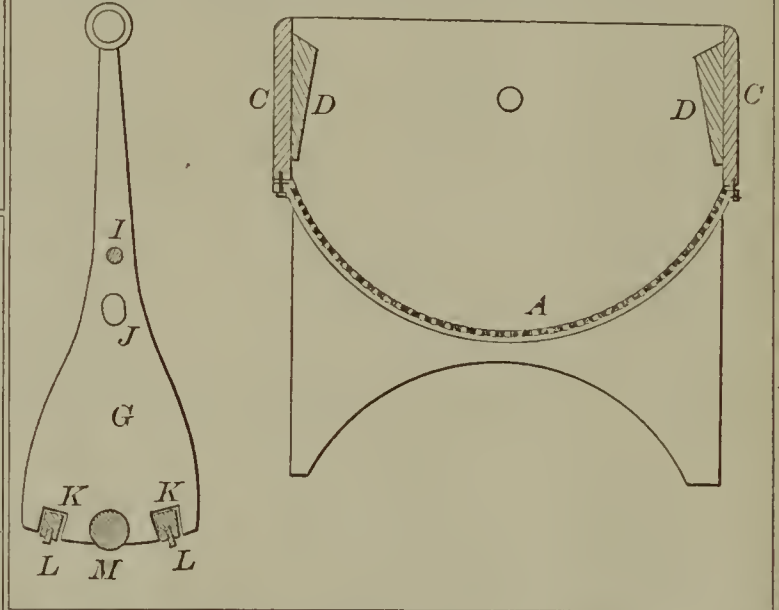

51999—G. M. Hopkins—For Turning Leaves of Music.

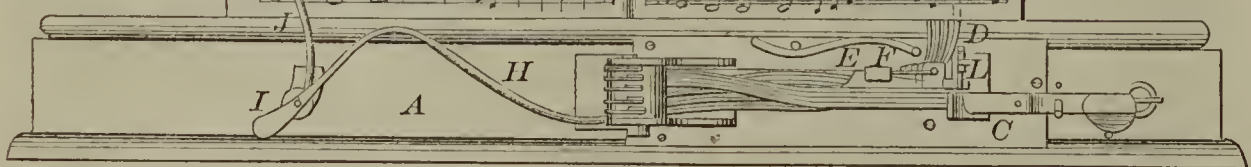
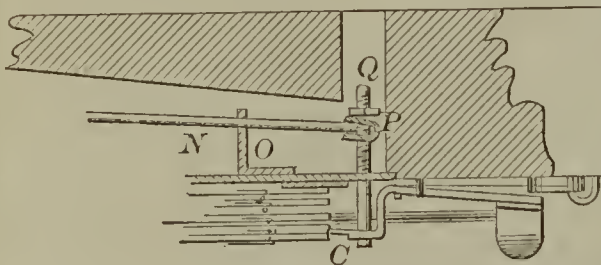

52000—A. Mackie—Cork Cutting Machine.

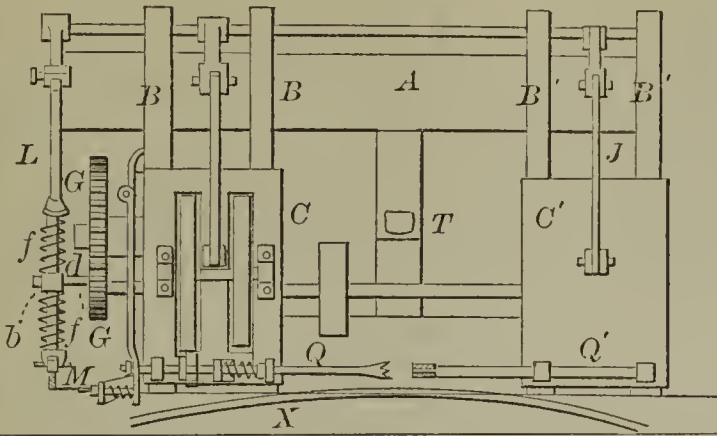

52002—J. H. Parker—Springs for Trusses.



52003—W. A. Shaw—For Separating Shot.

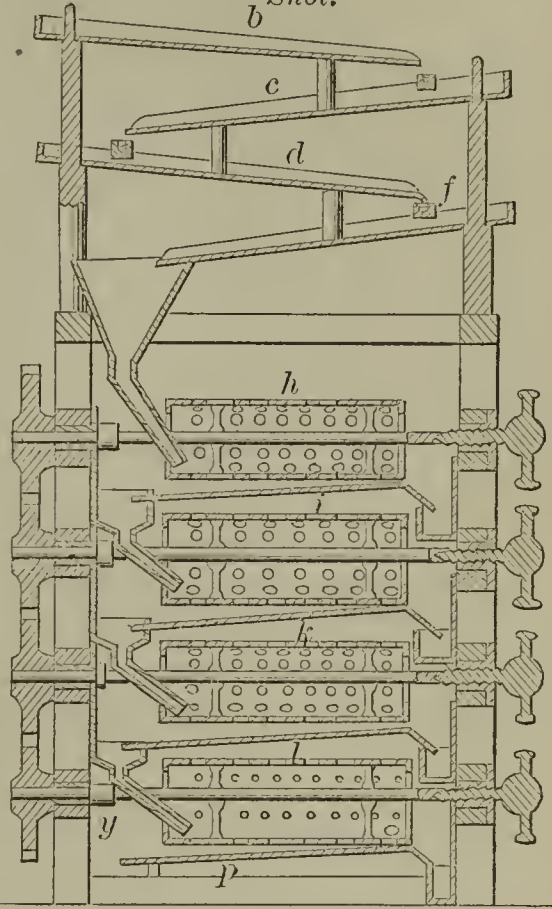

52001—Manderson & Favinger—For Removing Carries of Vessels.

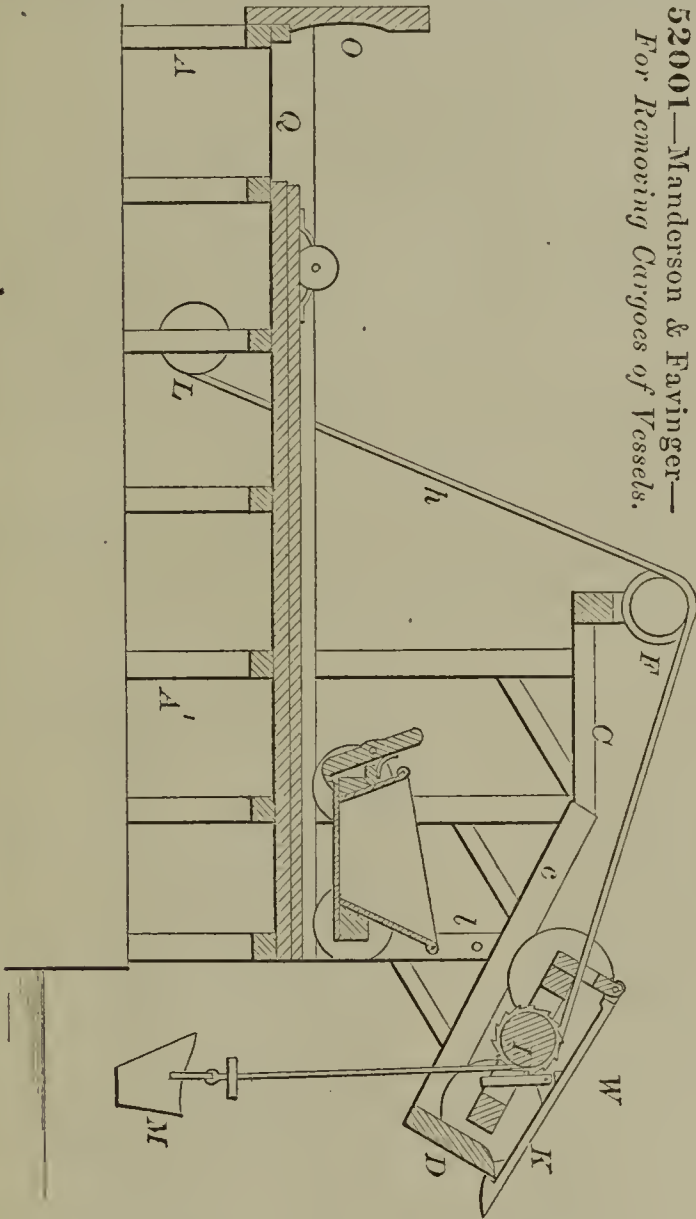

52004—J. Sherman—Shingle.

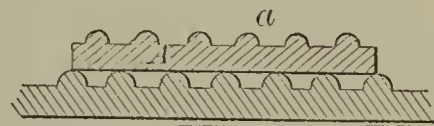

52005—J. W. Sutherland—Railroad Chair.

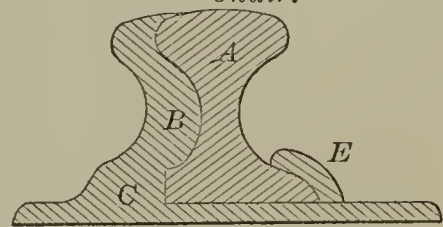

52006—J. J. Ducomet—Steam Gauge.

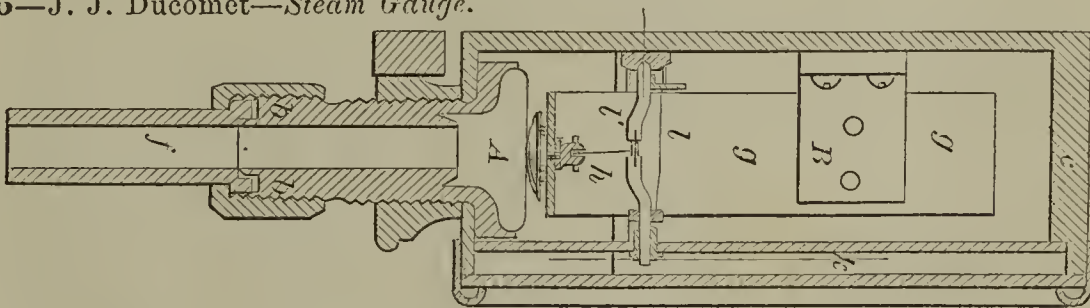

52007—Krans & Szigethy—Cigarette Machine.

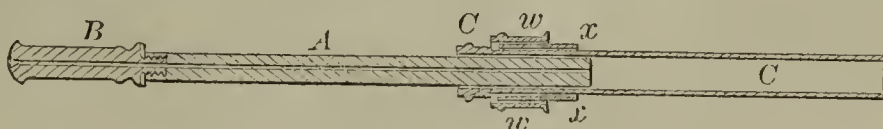

52011—J. B. Atwater—Cattle Pump.

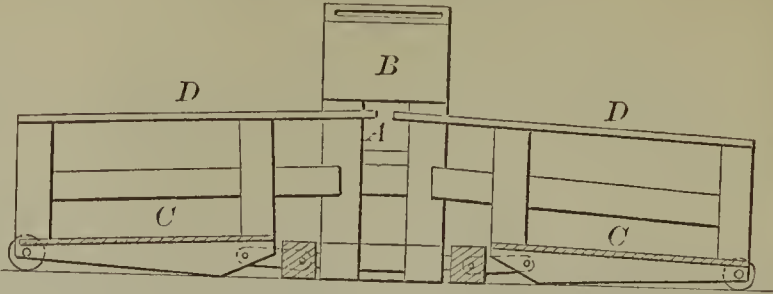

52009—H. J. Ruttan—For Ventilating Railroad Cars.

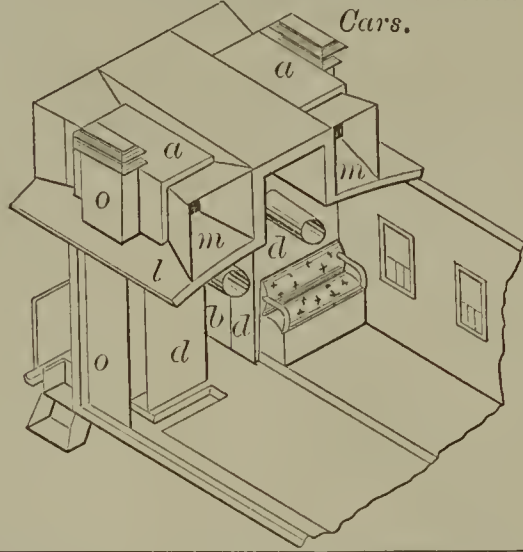

52010—J. Aldrich—Aqueduct Coupling.

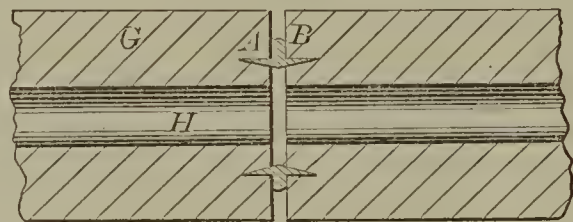

52012—W. Ballard—Dentistry.

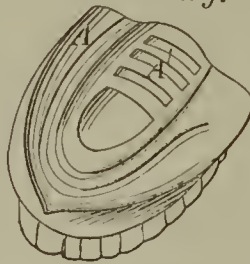

52014—E. M. Bartlett—Spectrum.

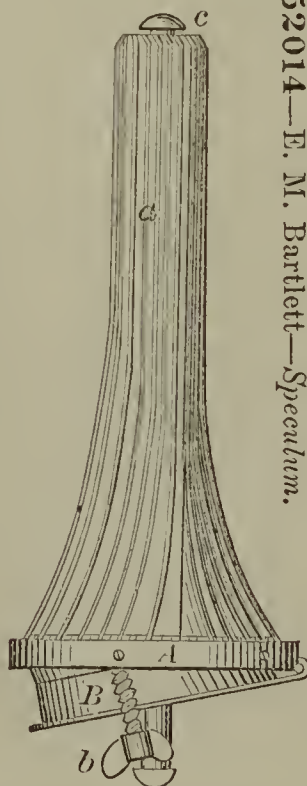

52013—E. H. Barney—Slate.

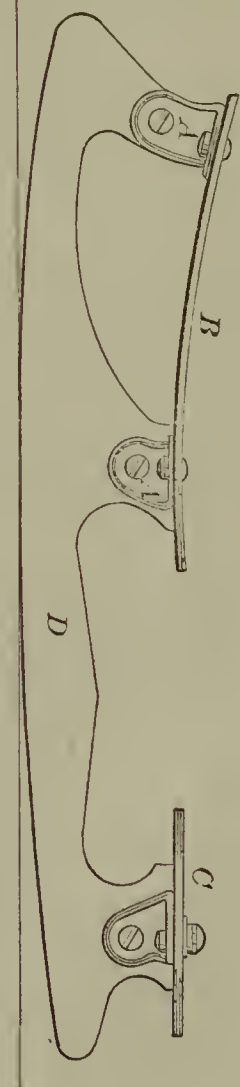

52015—F. J. Belknap—Shoe and Die for Amalgamating Machines.

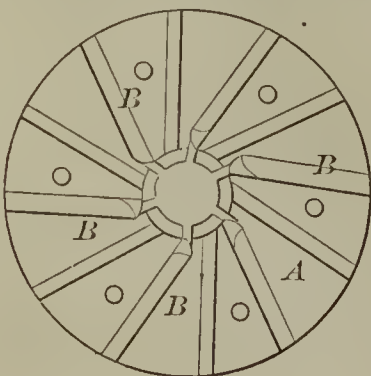

52008—E. Lord—Cleaning Cotton.

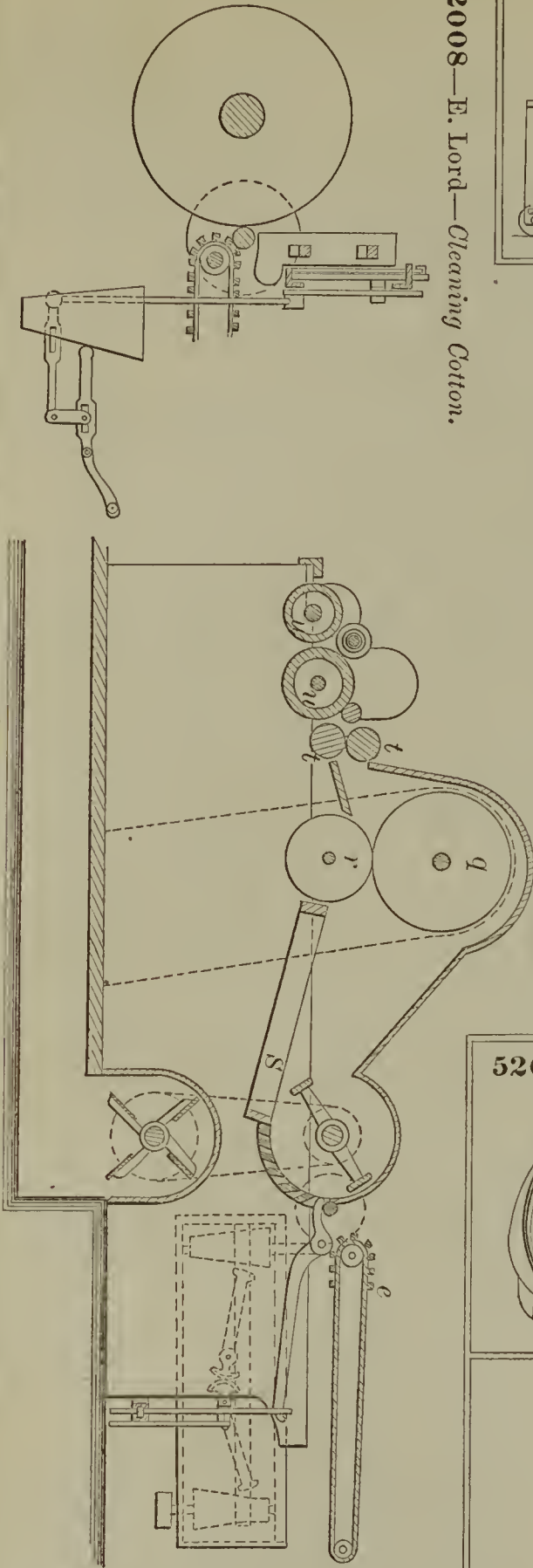

52016—H. M. Bidwell—*Bow Irons for Carriages.*

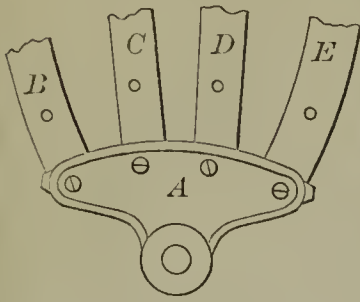

52017—M. E. Bishop—*Spike Extractor.*

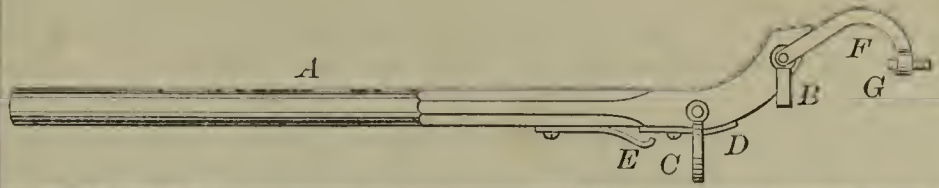

52021—N. Bowker—*Water Wheel.*

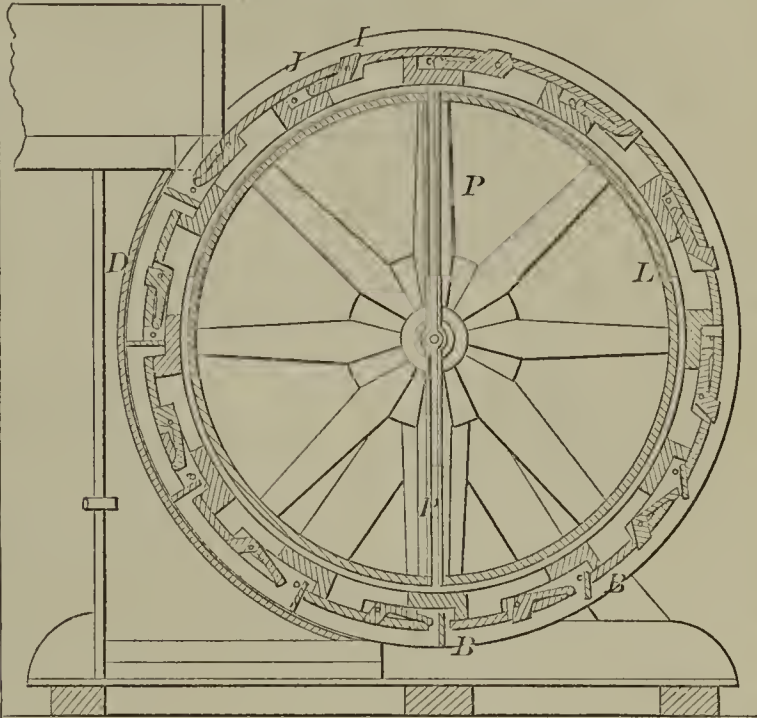

52020—F. Boeger—*Sofa Bedstead.*

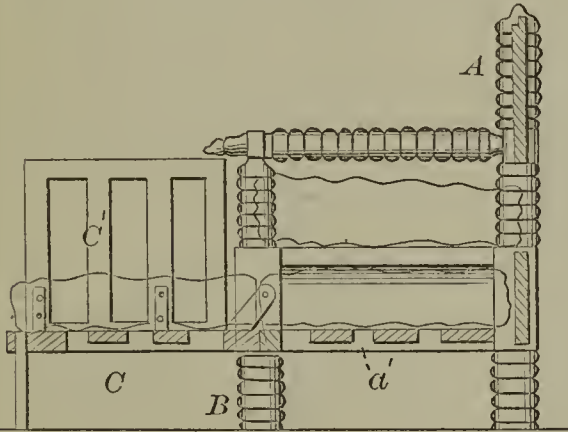

52019—J. A. Bloom—*Deep Well Pump.*

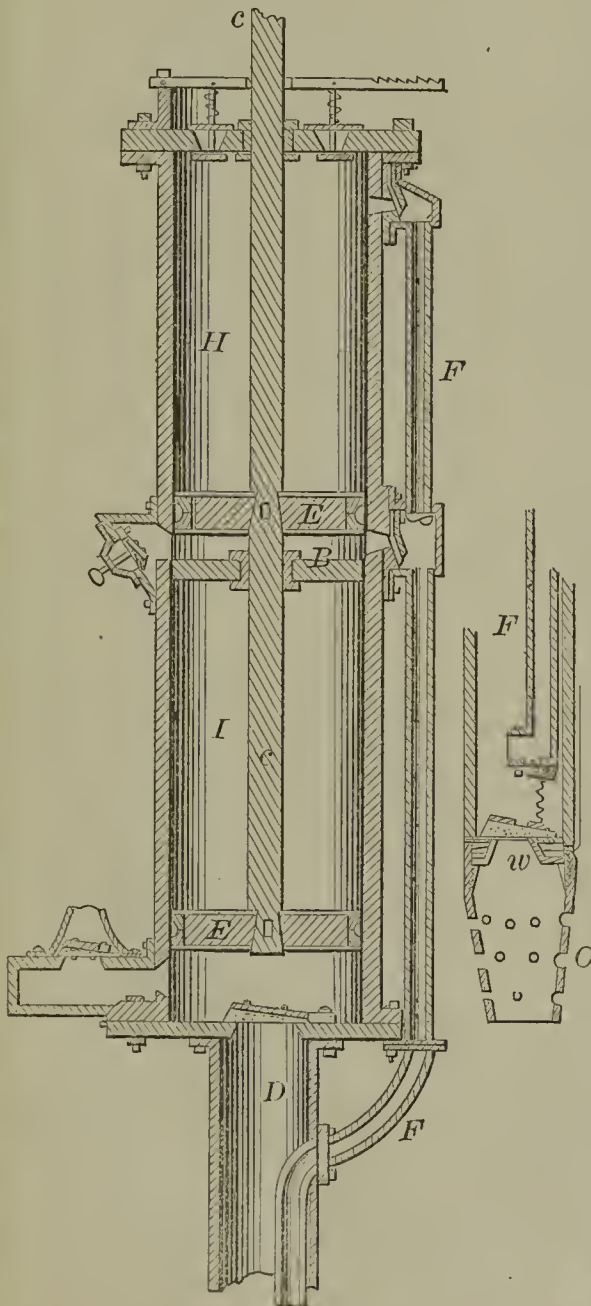

52022—A. L. Brink—*Sugar Evaporator.*

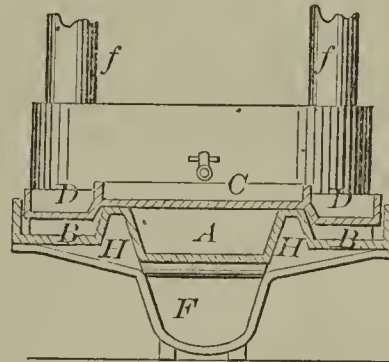

52023—J. Brakeley—*Petroleum Vessel.*

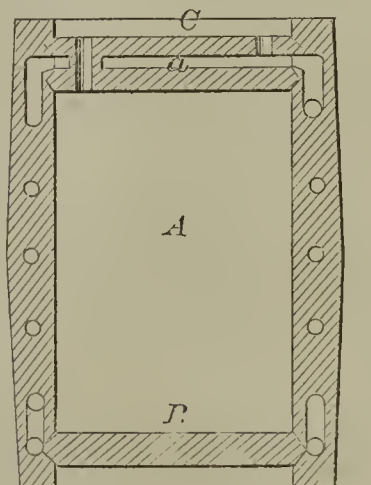

52018—C. D. Blinn—*Window Shade.*



52028—J. C. Carneross—  
*Railroad Snow Plow.*

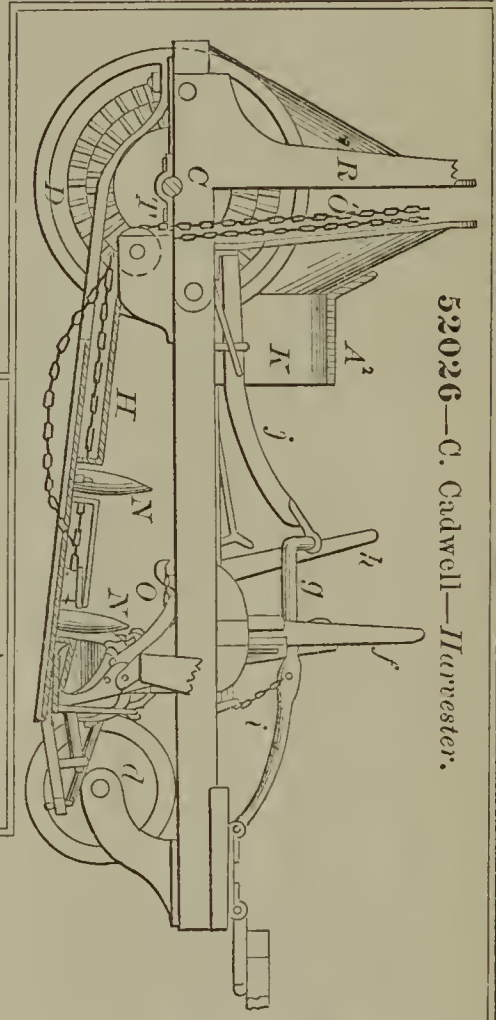
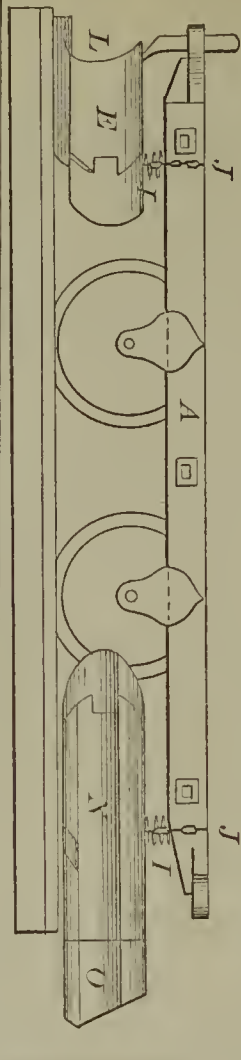
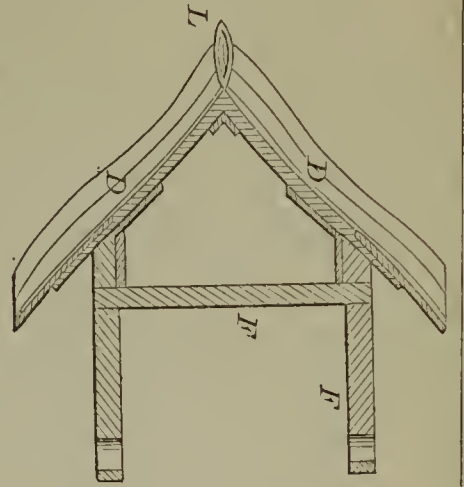

52026—C. Cadwell—*Harvester.*

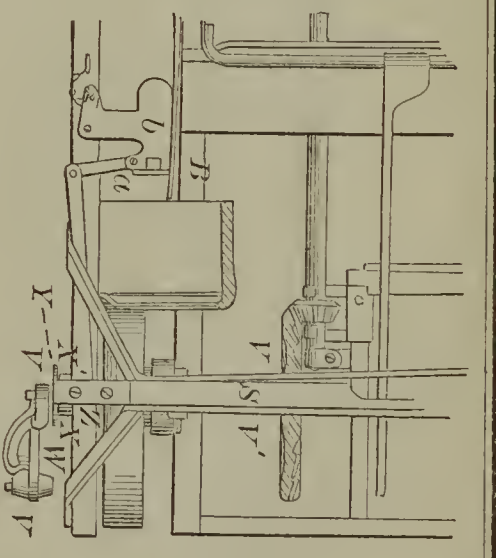

52024—F. Brown—*Oscillating Engine.*

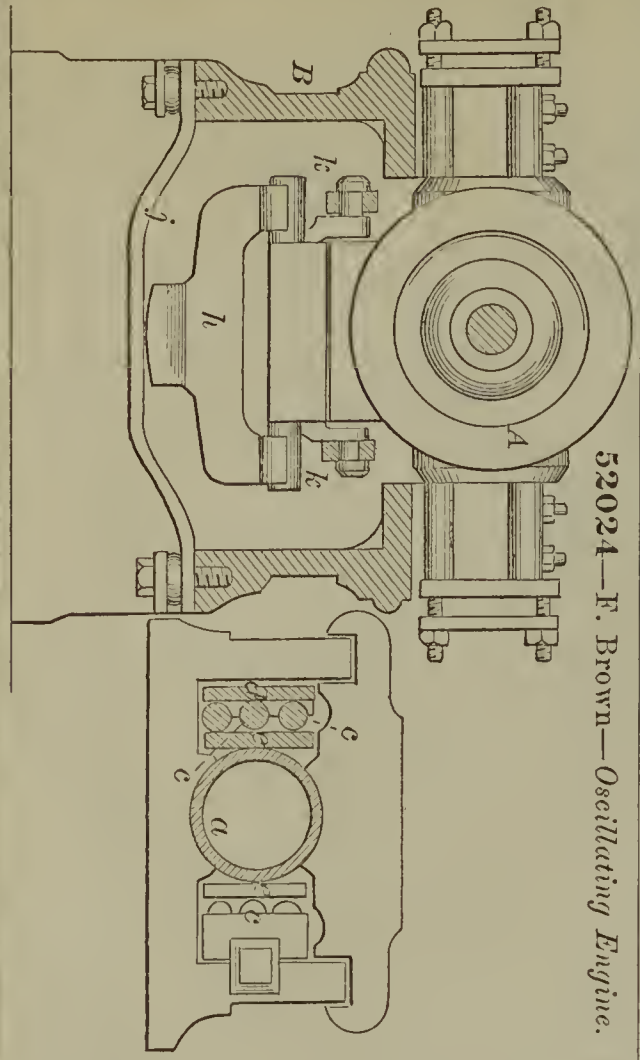

52027—C. Cadwell—*Harvester.*

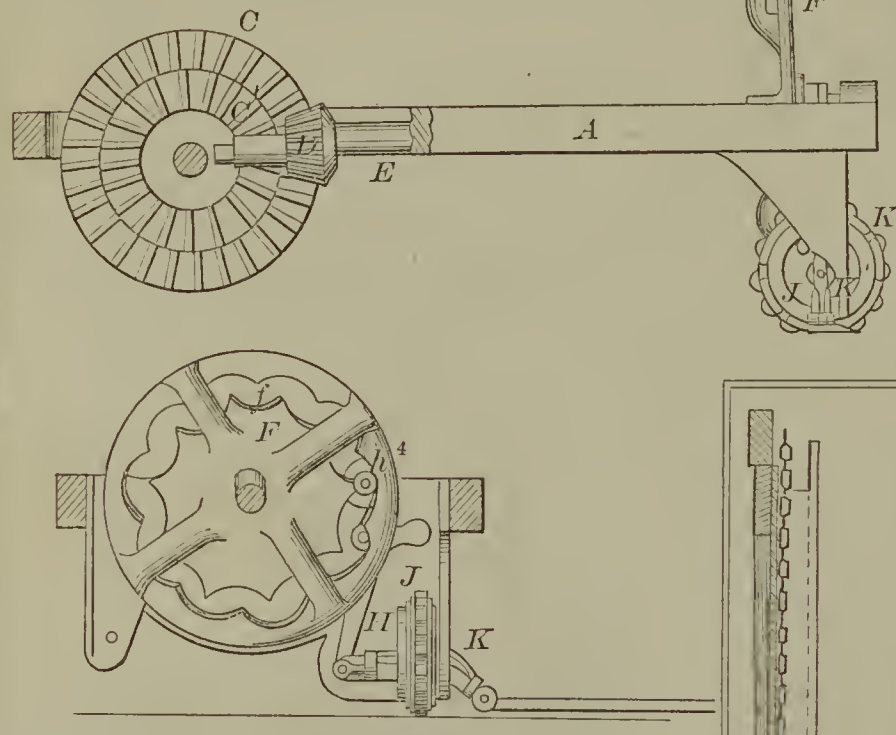

52029—J. Christy—*Axle Box.*

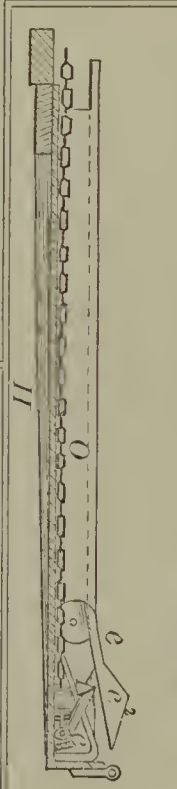
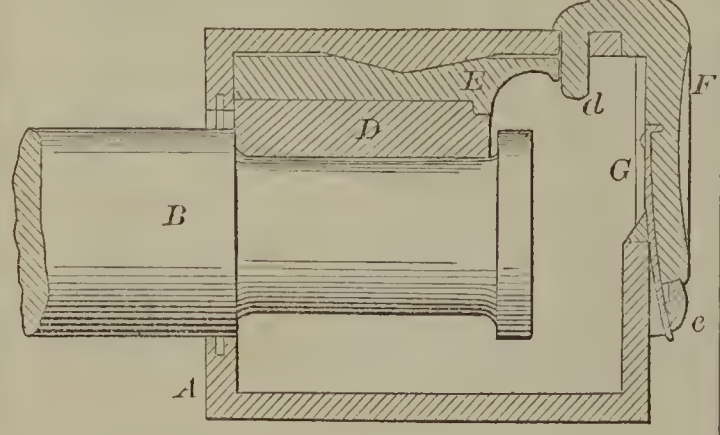



52030—N. B. Clabaugh—Washing Machine.

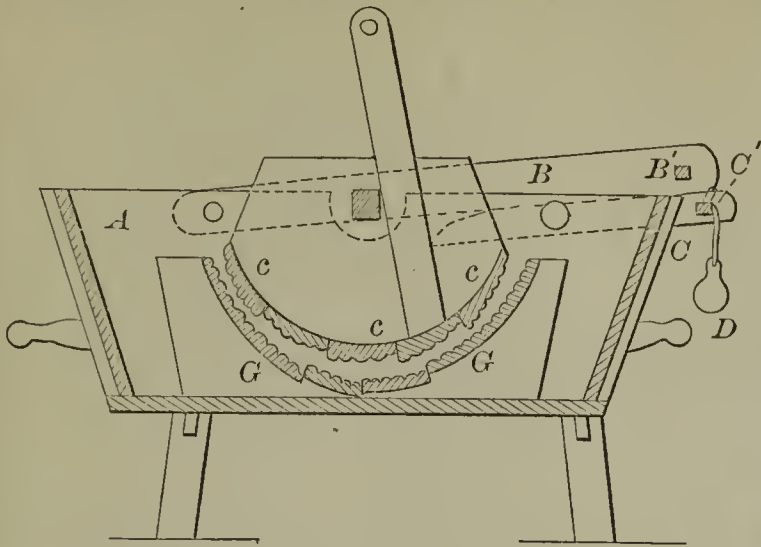

52031—I. Clark—Lamp.

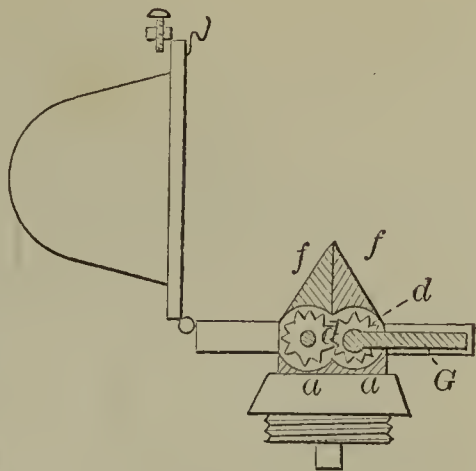

52033—J. D. Conner—Coal Stove.

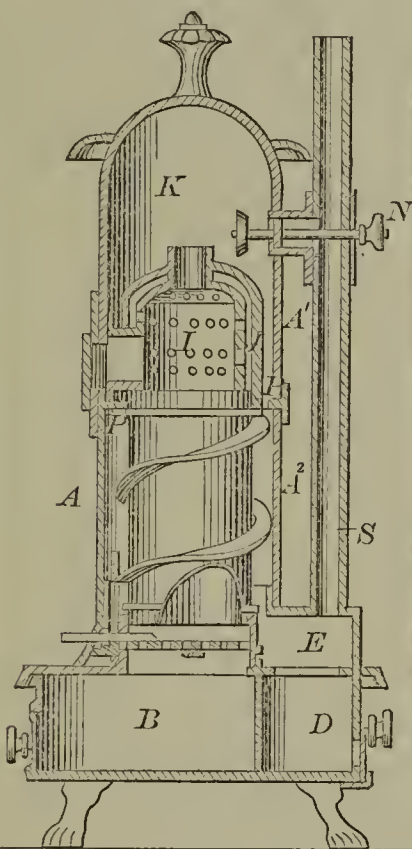

52034—E. N. Cummings—Fly Trap.

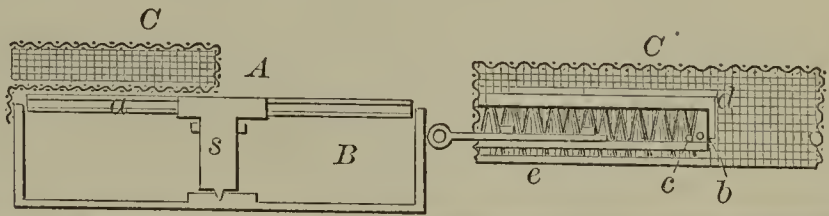

52037—C. L. Fleischmann—Cotton Gin.

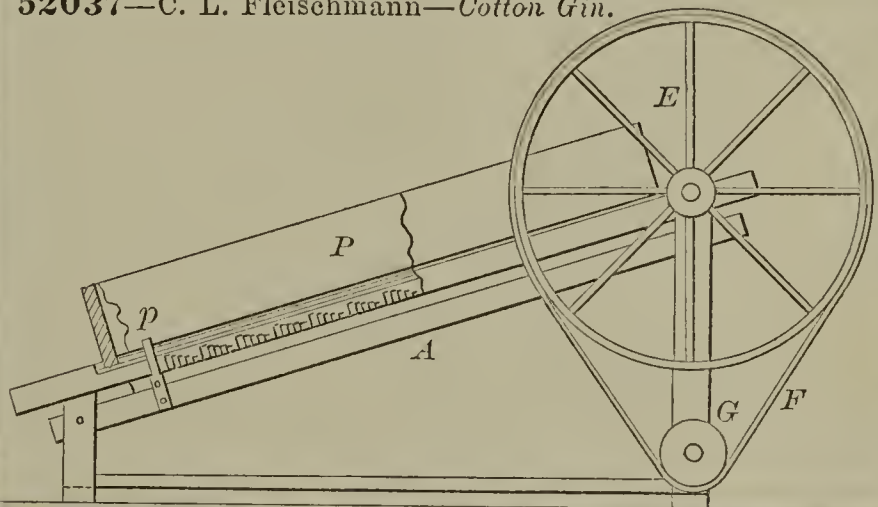

52035—H. Doolittle—Washing Machine.

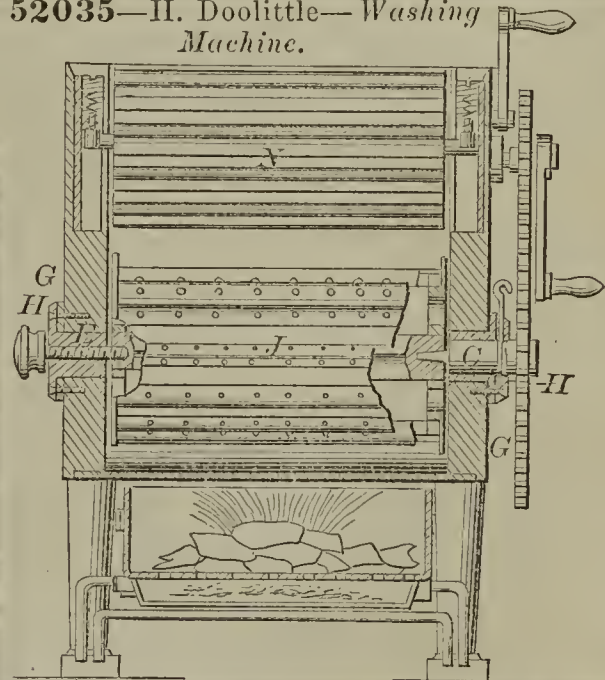

52036—A. Exton—For Making Scroll Biscuit.

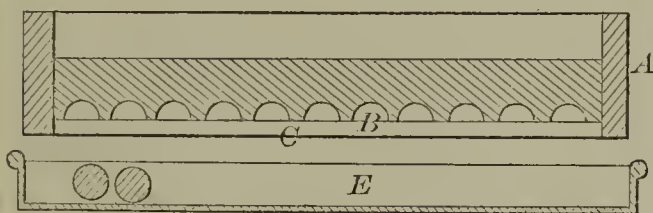

52038—H. N. Foster—Steam Trap.

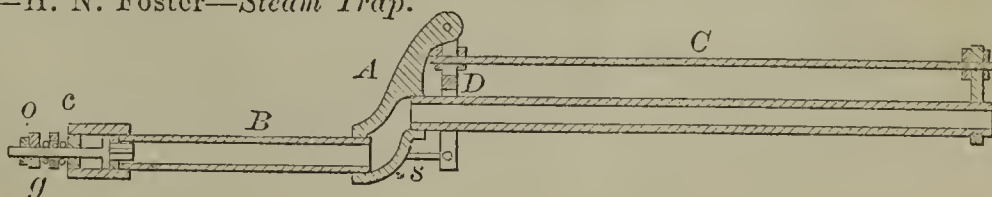

52039—J. A. Geer—Sewing Machine.

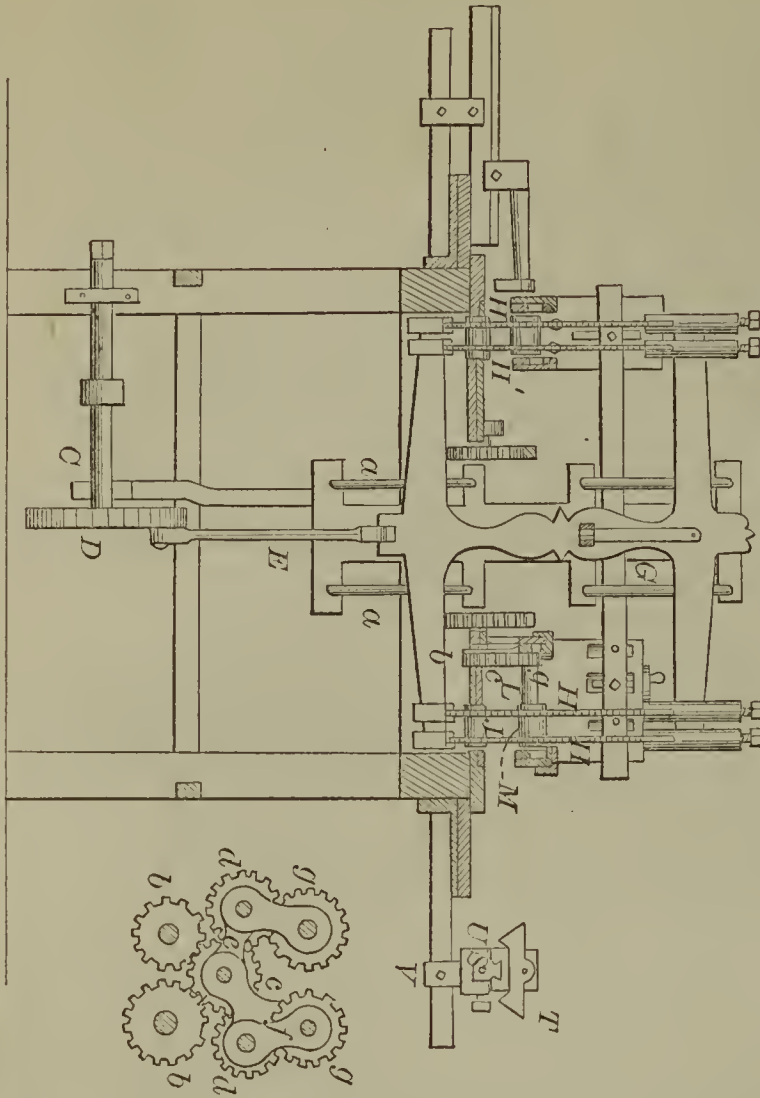

52041—M. Gootmann—Billiard Indicator.

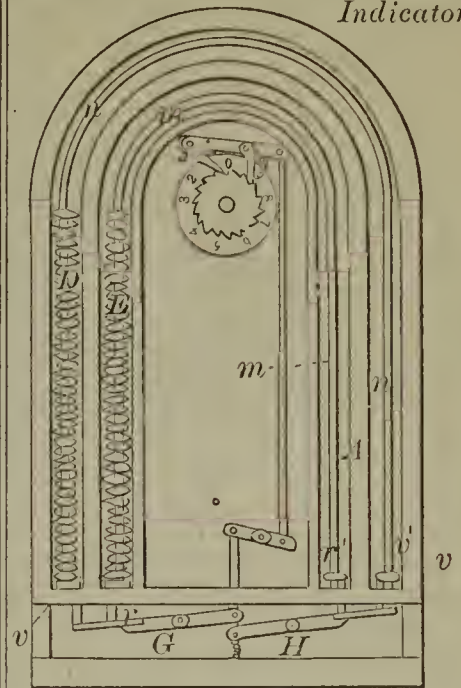

52045—G. W. Holmes—Windlass.

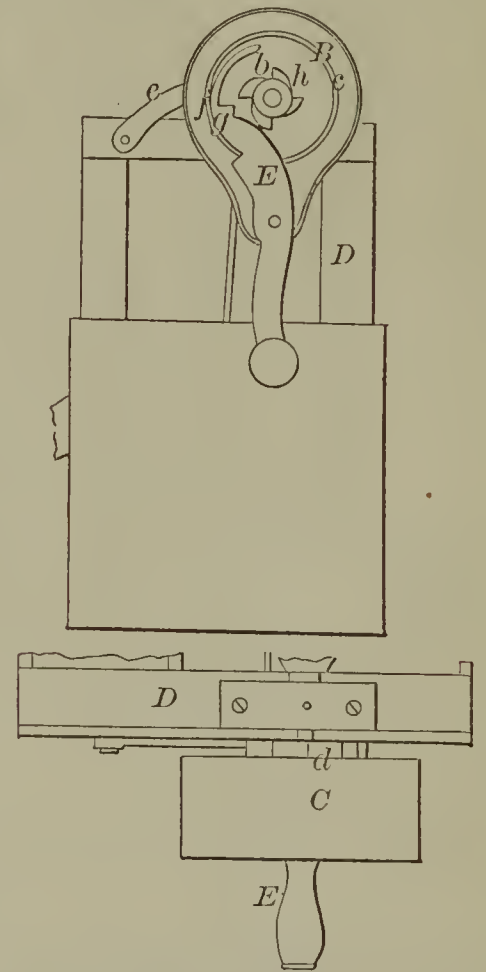

52043—E. Hamburger—Passenger Register.

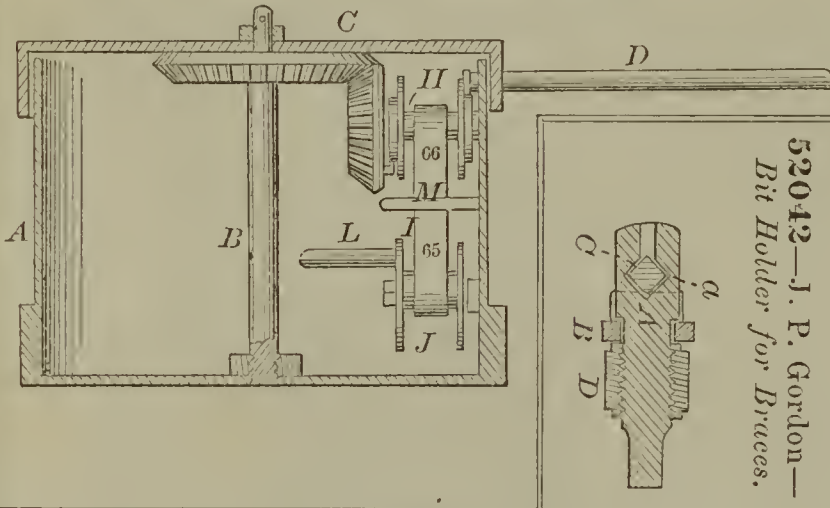

52042—J. P. Gordon—Bit Holder for Braces.

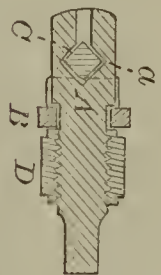

52044—F. Hoffman—For Polishing Wood.

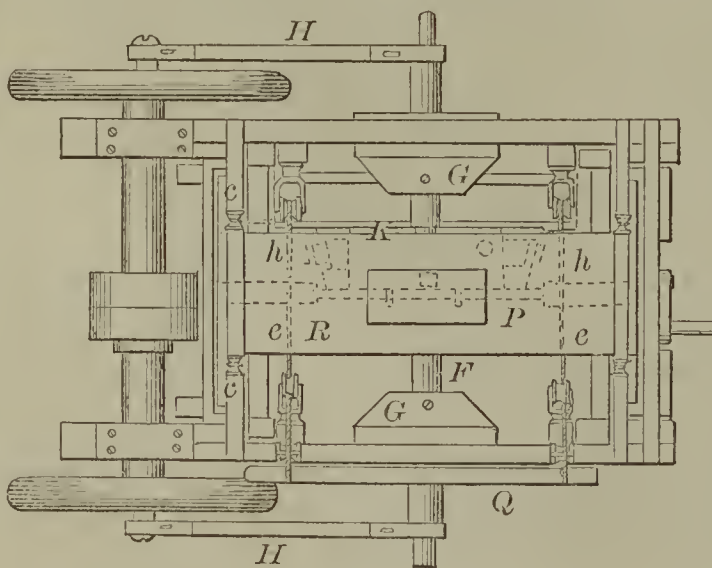

52047—E. E. Hopkins—Water Cooler.

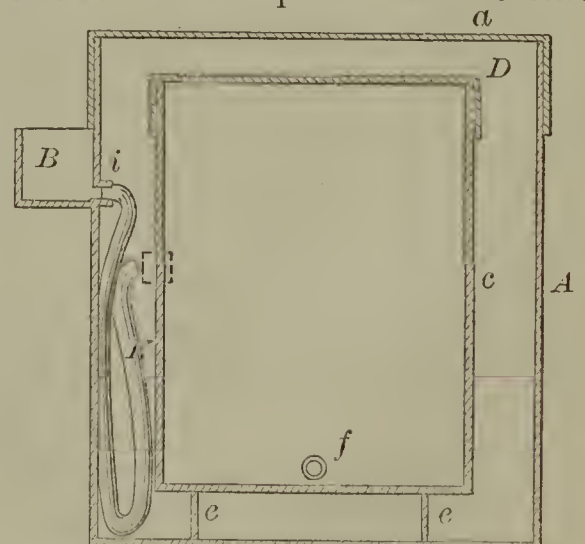

52048—L. B. Hubbell—*Threshing Machine.*

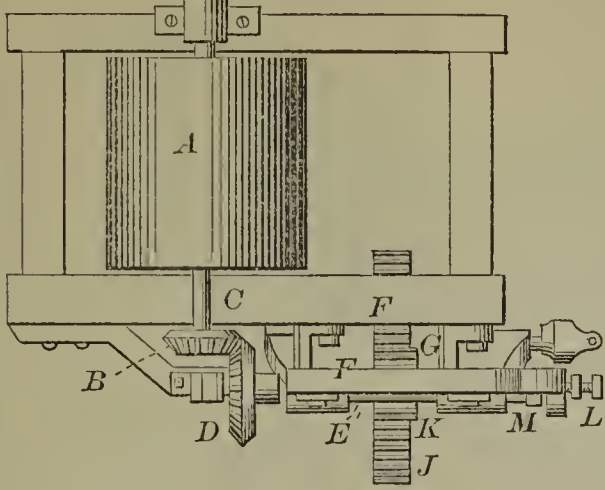

52052—H. P. Jones—*Washing Machine.*

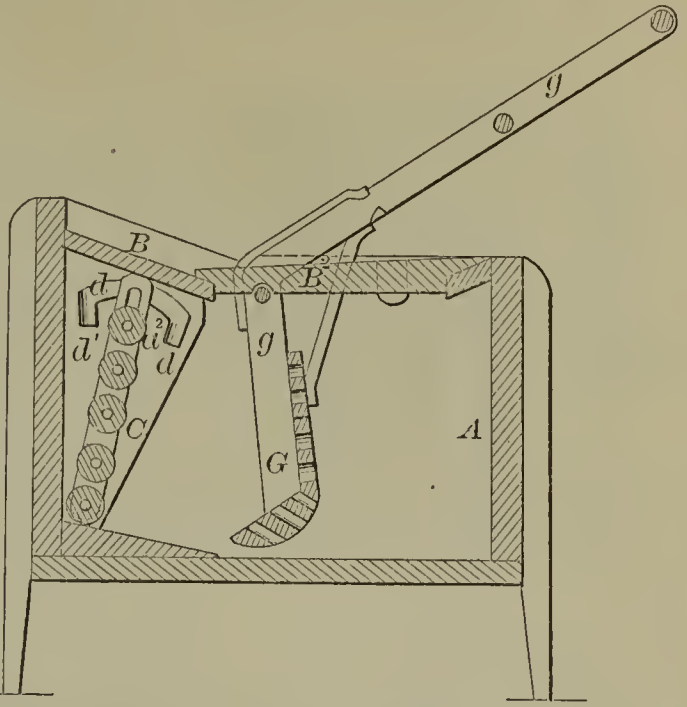

52050—F. A. & A. J. Illingworth—*Door Fastening.*

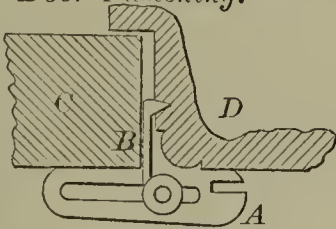

52049—G. L. Hutchinson—*Cultivator.*

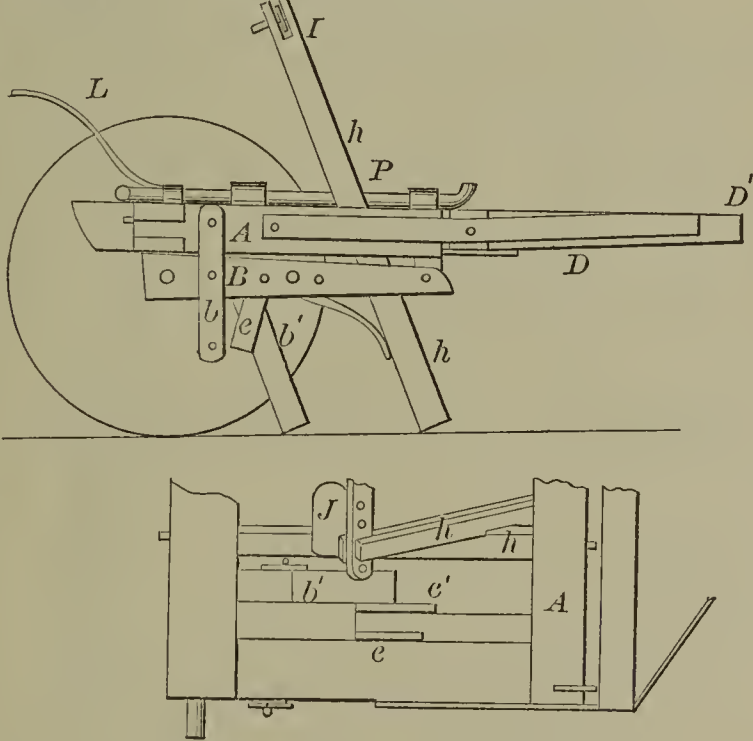

52053—B. F. Kessler—*Cultivator.*

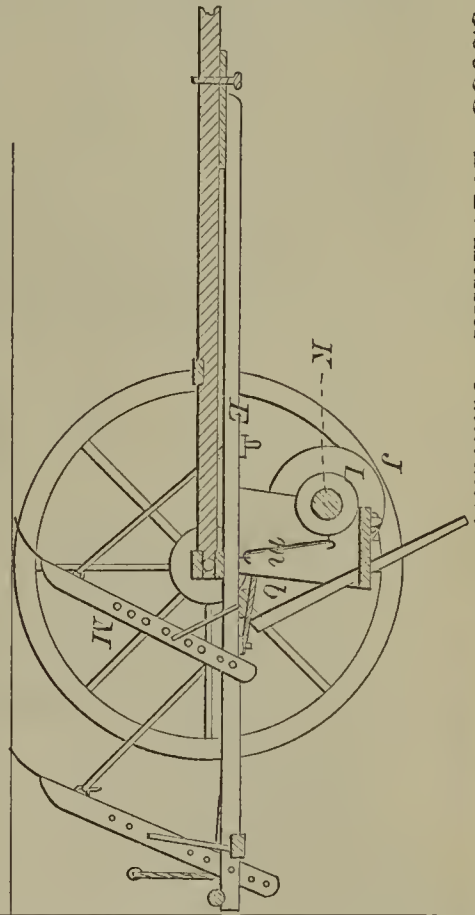

52051—A. Jackson—*Fence.*

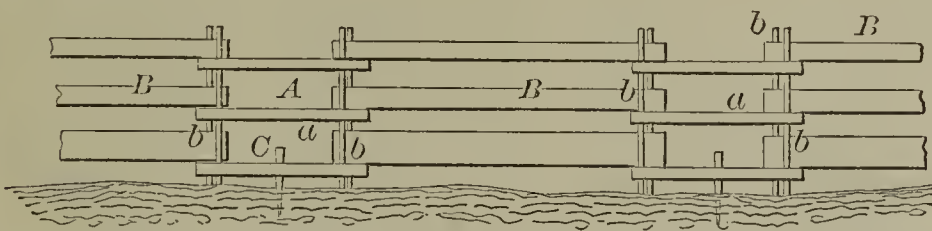

52055—G. Kump—*Lasting Pincers.*

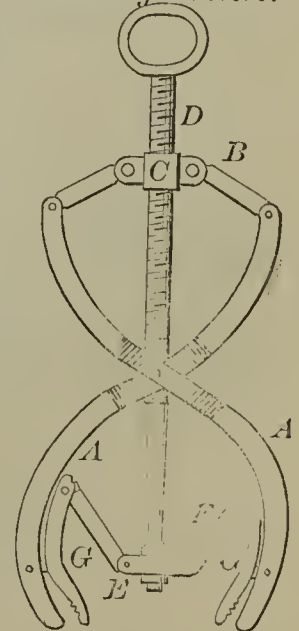

52054—Dr. J. Kidder—*Induction Coil.*

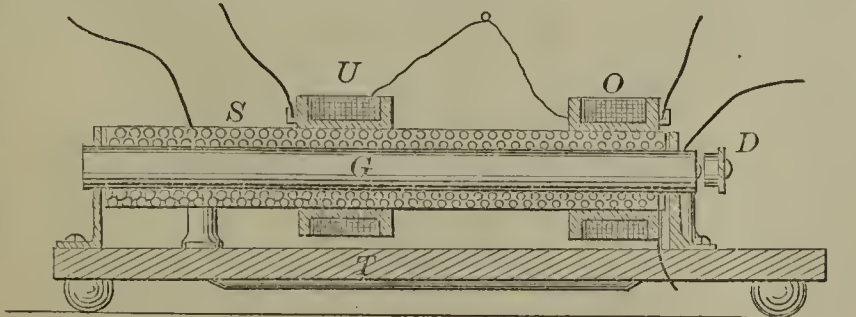

52058—C. T. Liebold—*Harness Bell.*

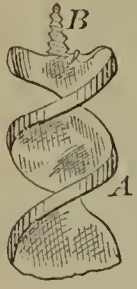
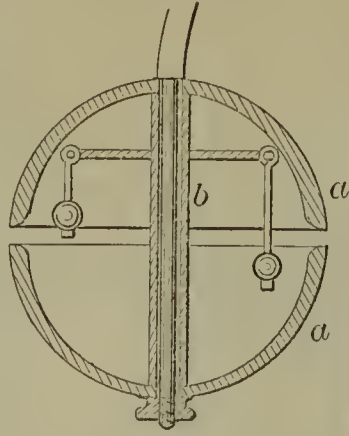

52056—E. G. Lanson—*Auger.*

52062—J. C. Loveland—*Dough Kneader.*

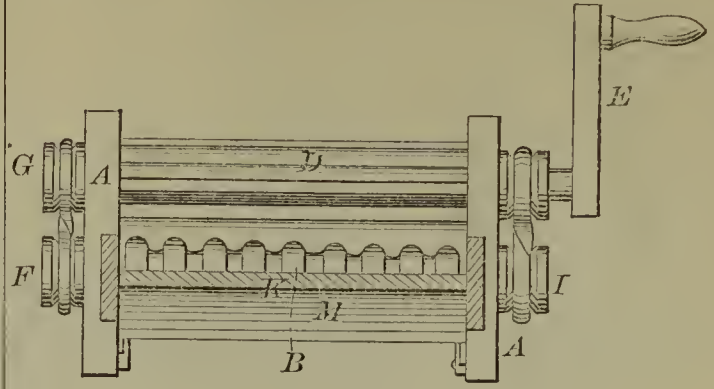

52057—L. Legran—*Artificial Leg.*

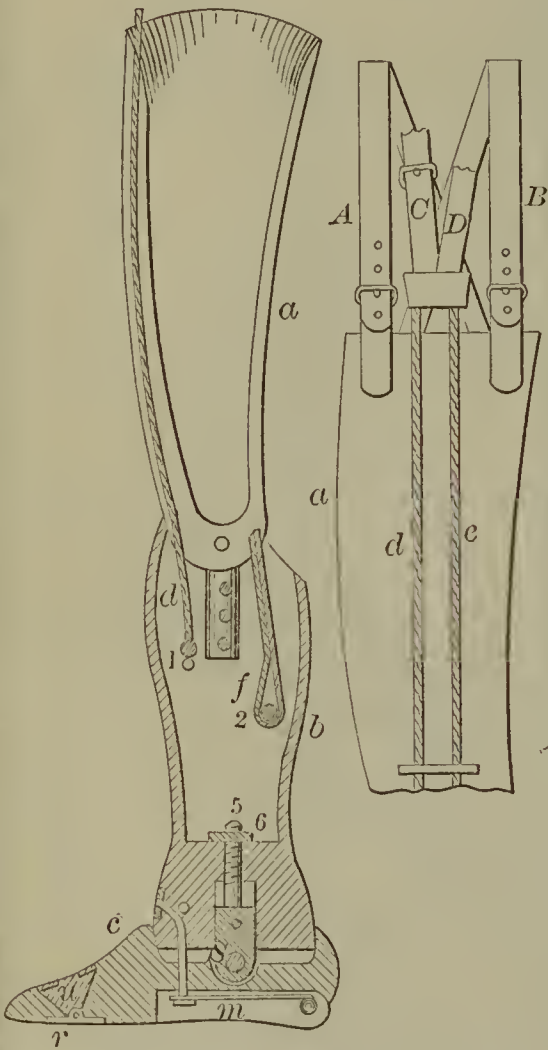

52059—J. F. Light—*Shipper Device.*

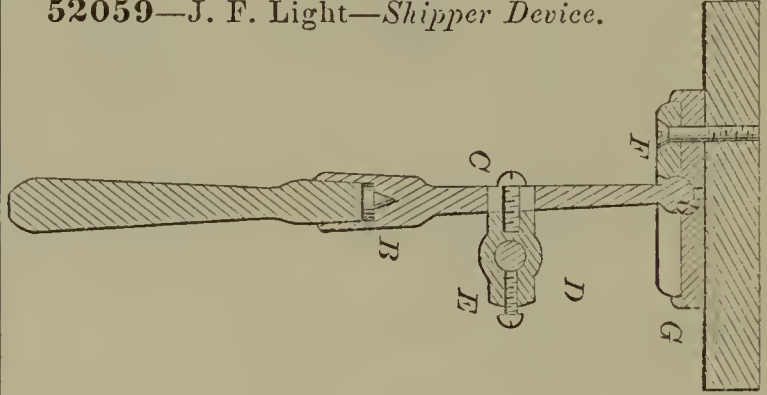

52060—R. W. Liscomb—*Horse Hay Fork.*

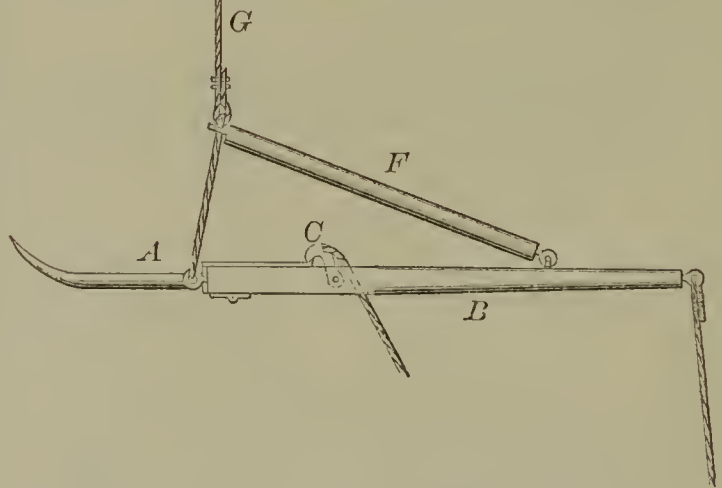

52061—J. L. Livingston—*Lime Kiln.*

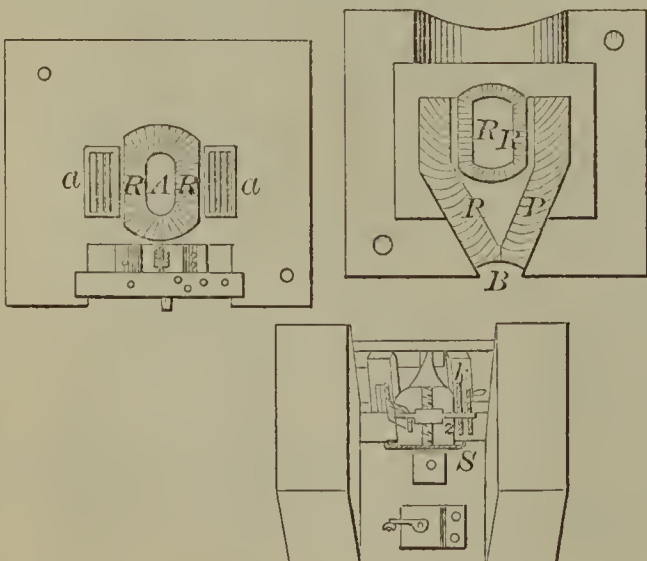

52063—G. F. Lynch—*Car Brake.*

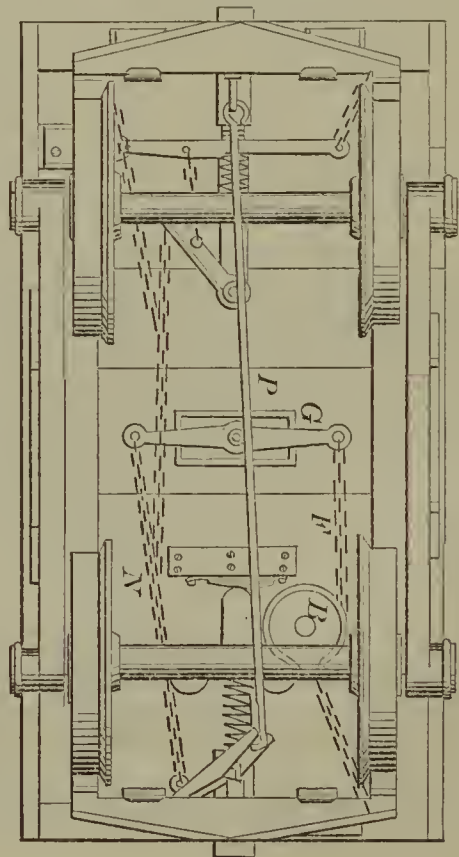

52064—J. K. Mizner—*Cavalry Accoutrements.*

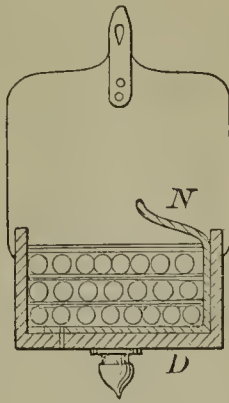
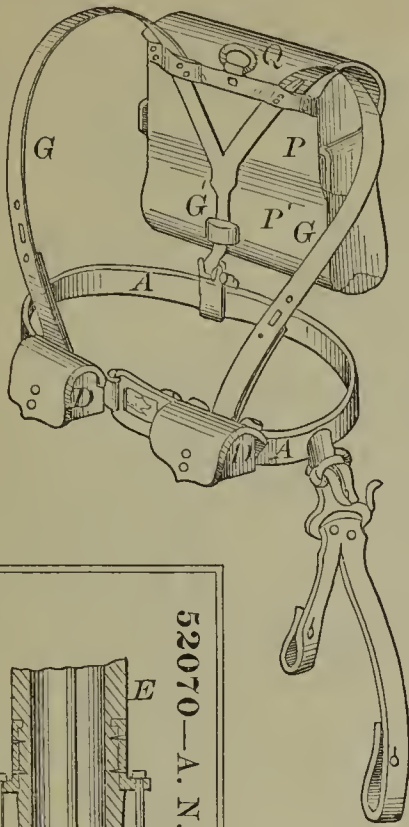

52066—J. O'Donald—*Churn.*

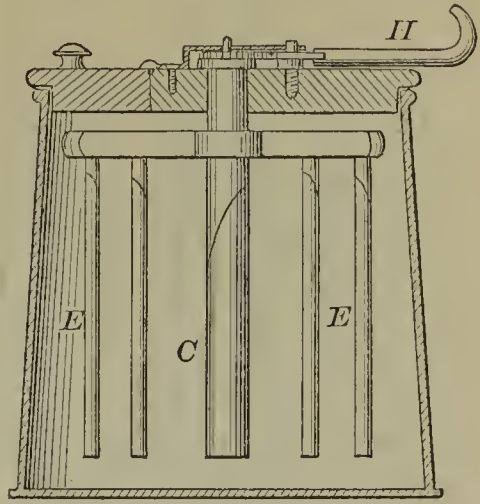

52070—A. N. Parkhurst—*Pump.*

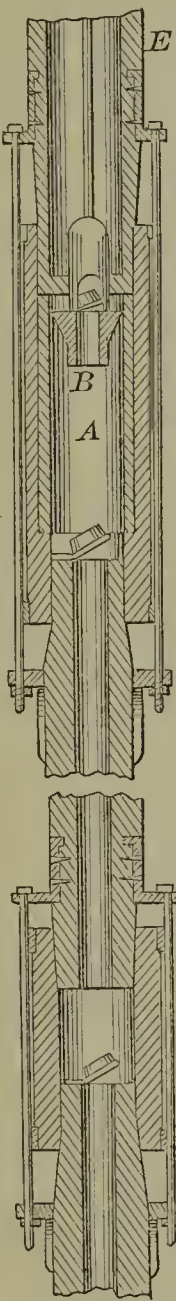

52065—J. Moulton—*Pipe Tongys.*



52067—W. Ogden—*Insect Trap.*

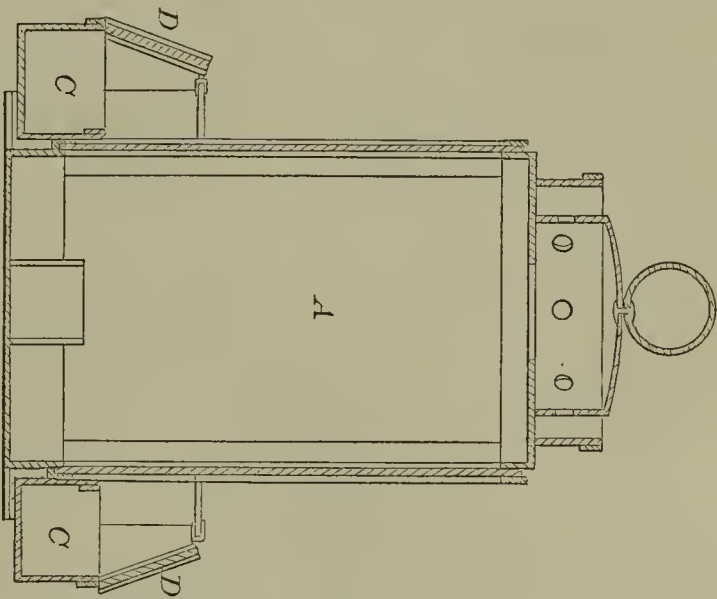

52069—A. J. Ohmer—*Soda Fountain.*

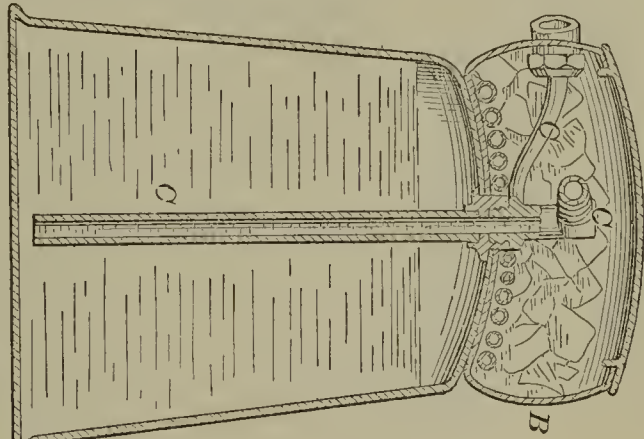

52071—E. C. Patterson—*Grain Separator.*

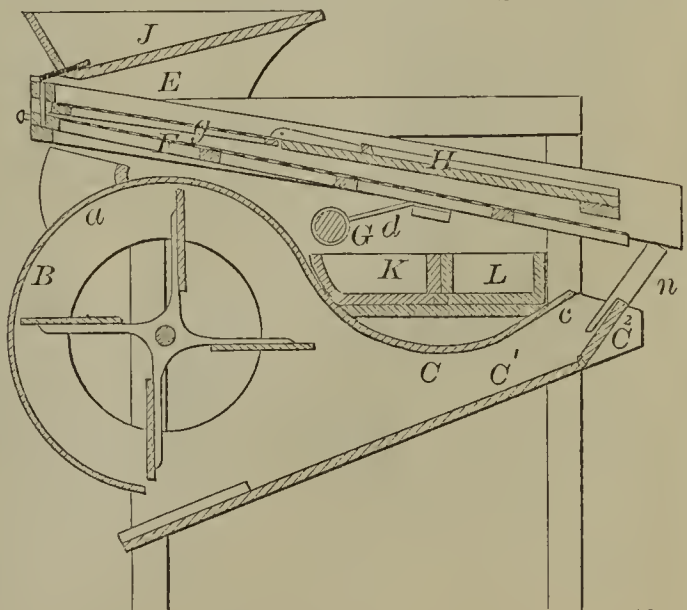

52068—G. A. Ohl—*Expanding Trap.*

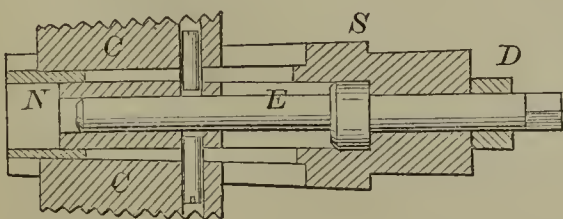

52073—J. Paulding—*For Setting Type.* II

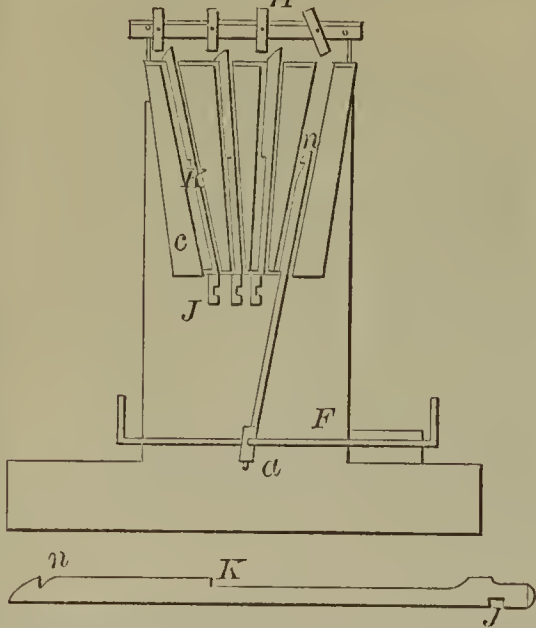

52074—I. L. Plumer—*Trunk.*

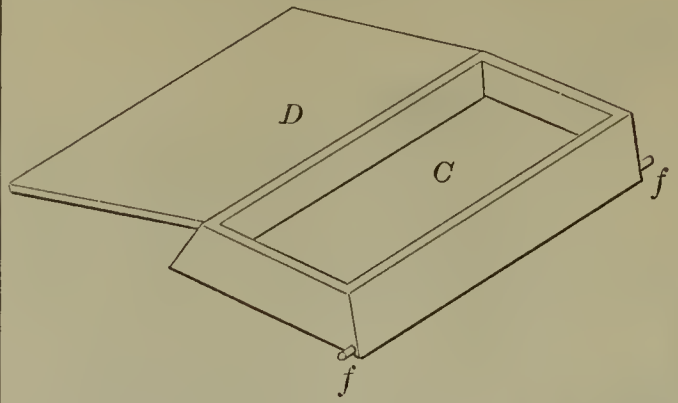

52076—F. Reichenbach—*Uterine Supporter.*

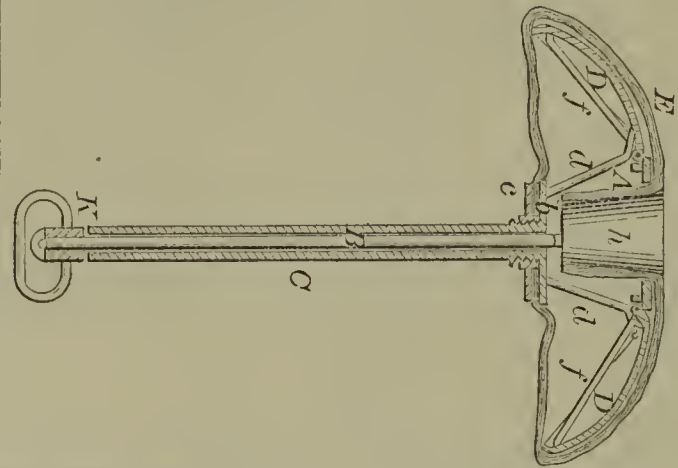

52075—J. Rankin—*Churn.*

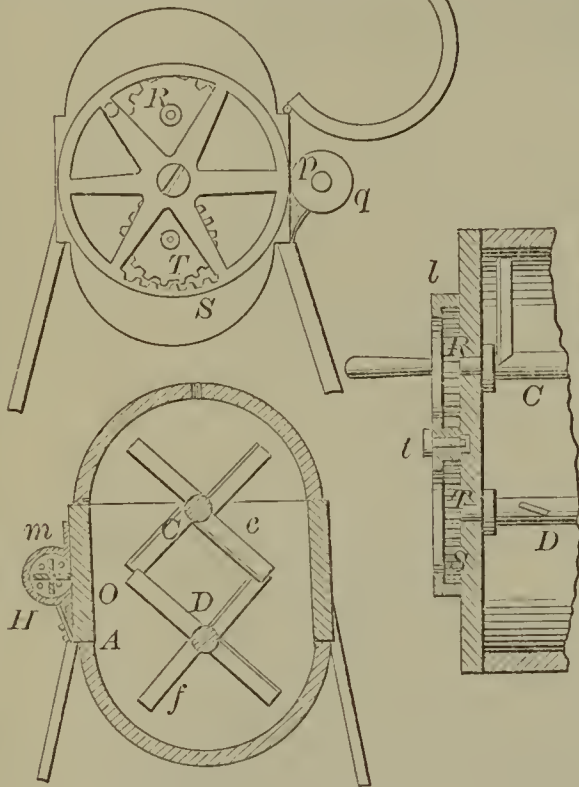

52077—Richardson & Morse—*Heel Calk.*

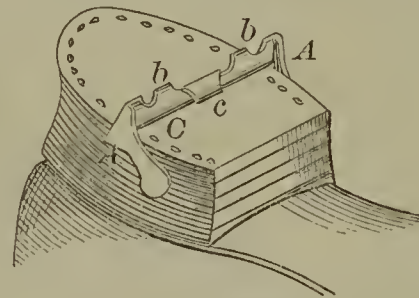

52079—S. Rogers—*Hoe.*

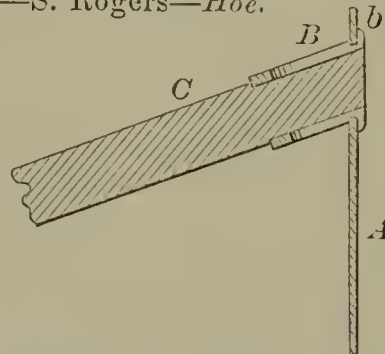

52078—T. C. Robinson—*Steam Engine.*

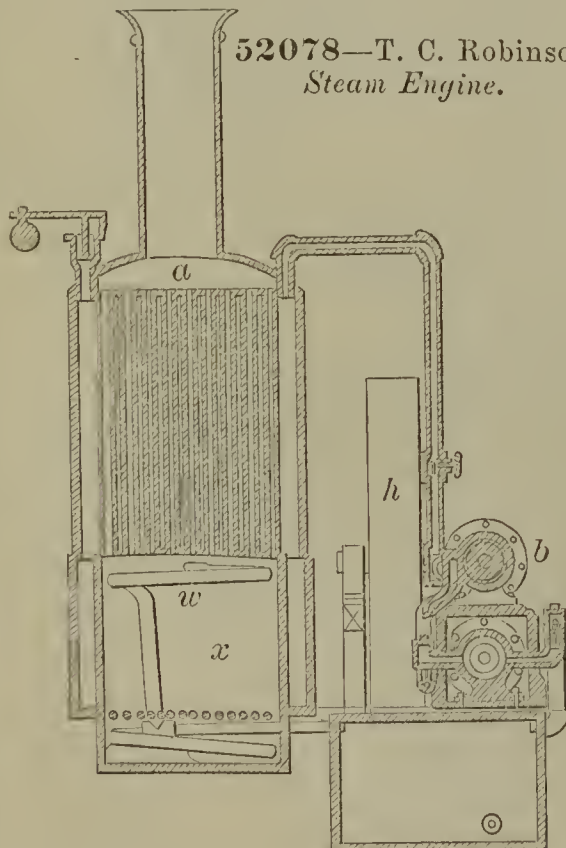

52080—C. Rowland—*Portable Fence.*

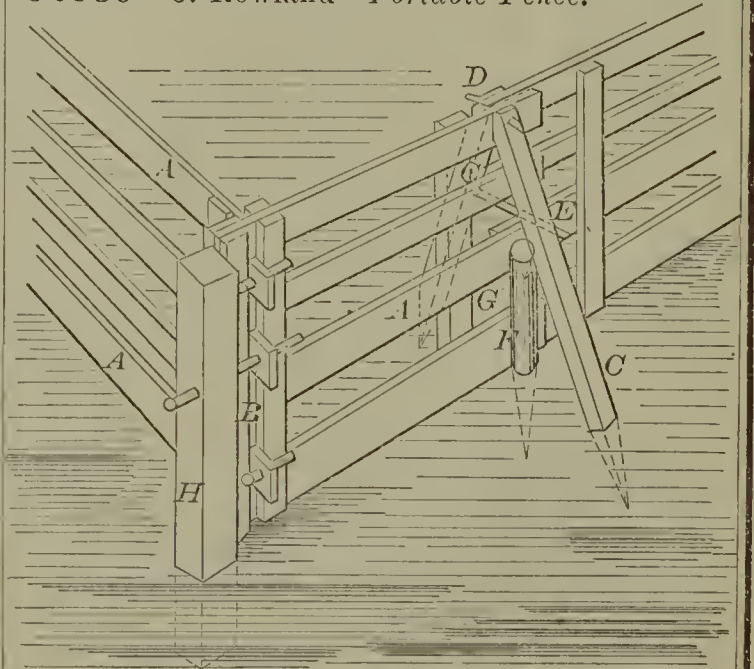

52081—Sargent & Rider—Horse Shoe Nail Machine.

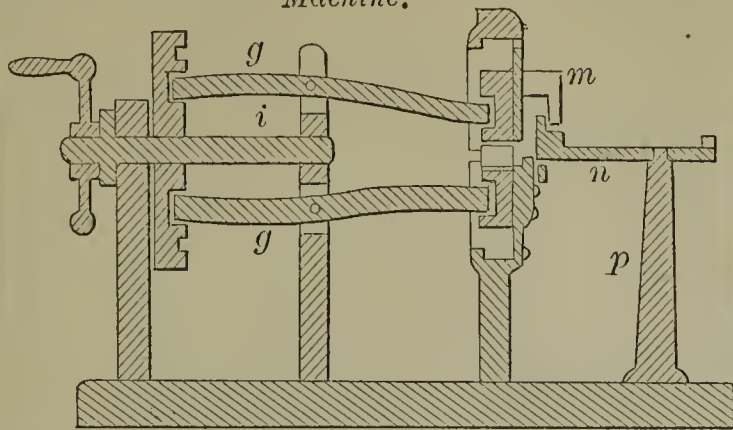

52086—Spaulding & Coffin—Copying Press.

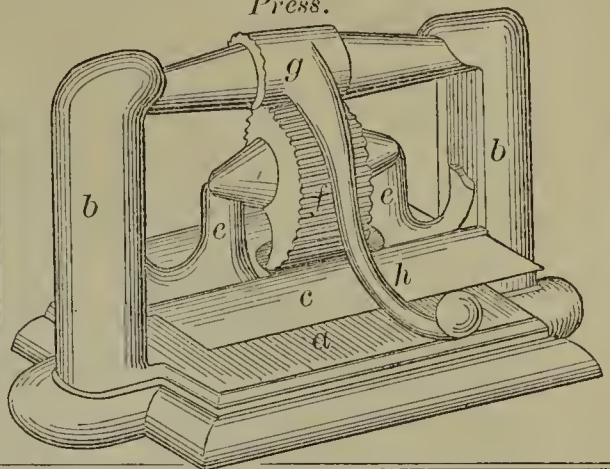

52084—J. N. Smith—Hay and Cotton Press.

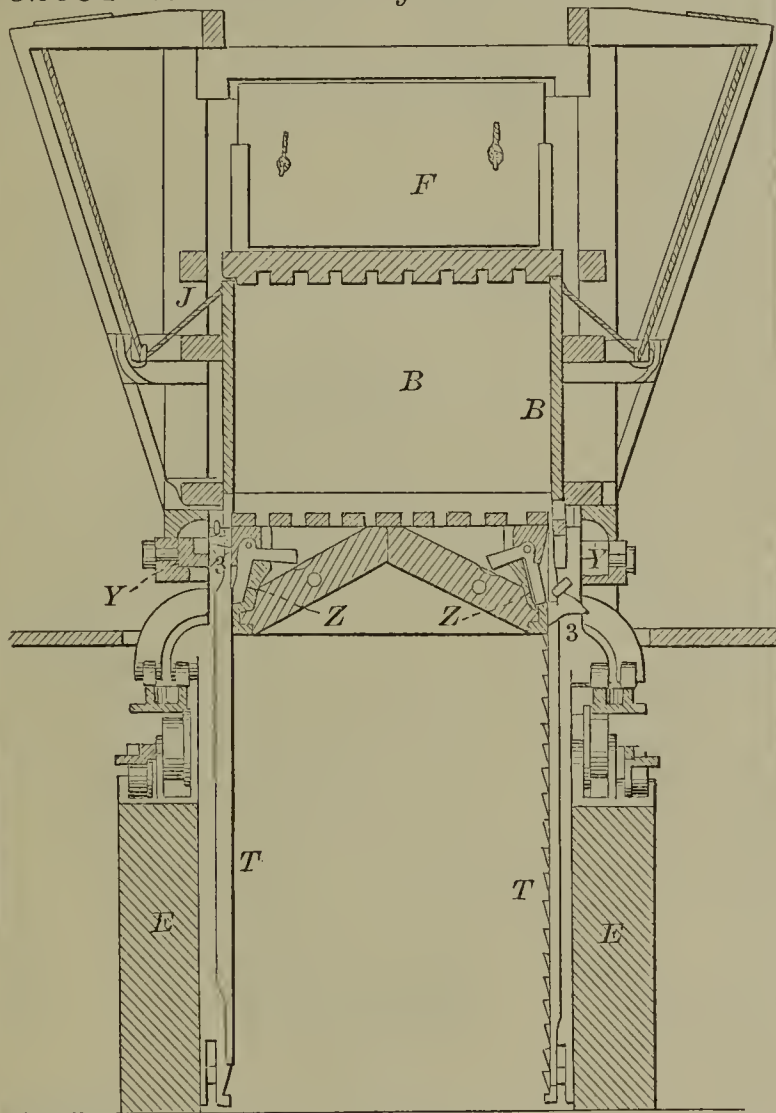

52087—J. F. Spence—For Carburetting Air.

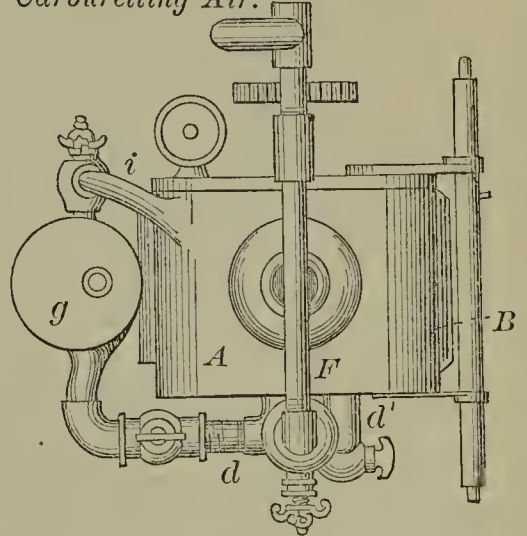

52085—S. Spelman—Washing Machine.

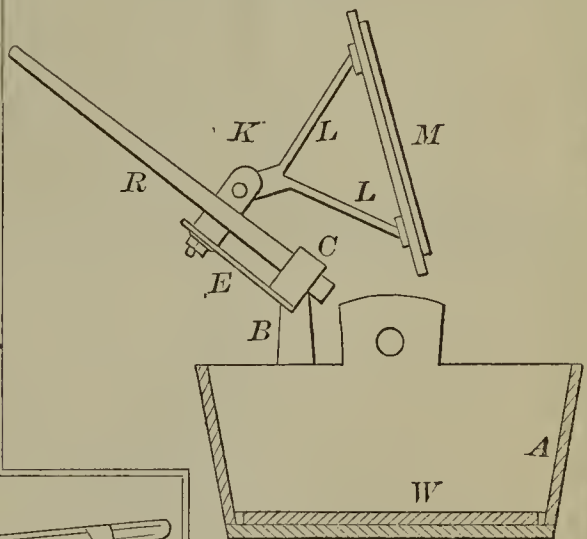

52083—G. Smith—Hand Cultivator.

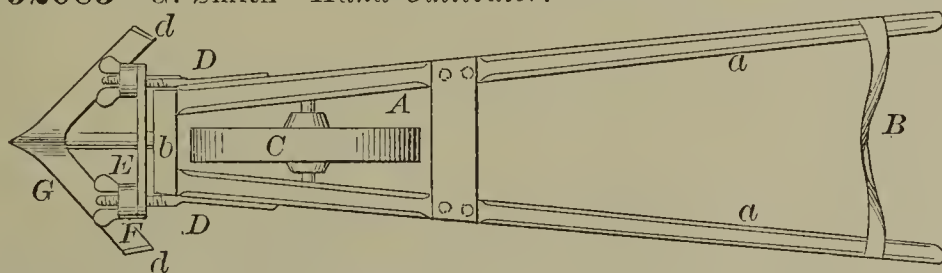

52088—S. E. Stowell—Breast Collar.

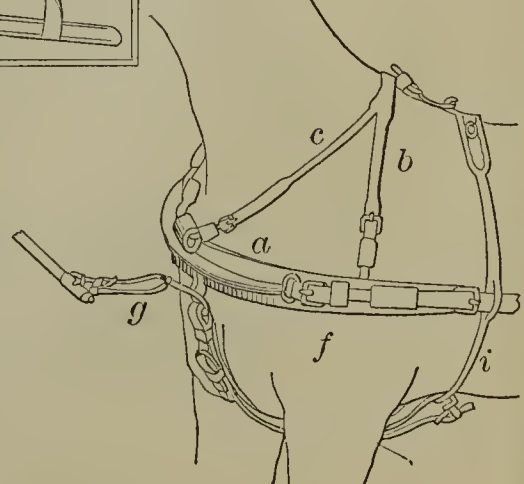

52082—W. H. Sears—Tide Wheel.

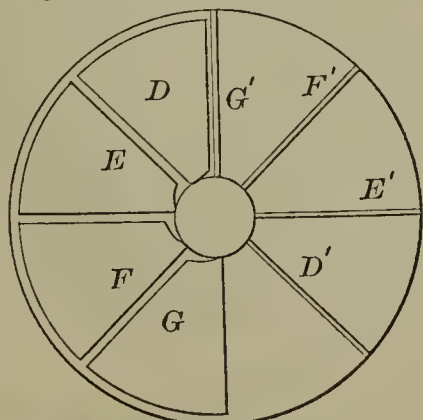

52093—Thomas & Mast—Cultivator.

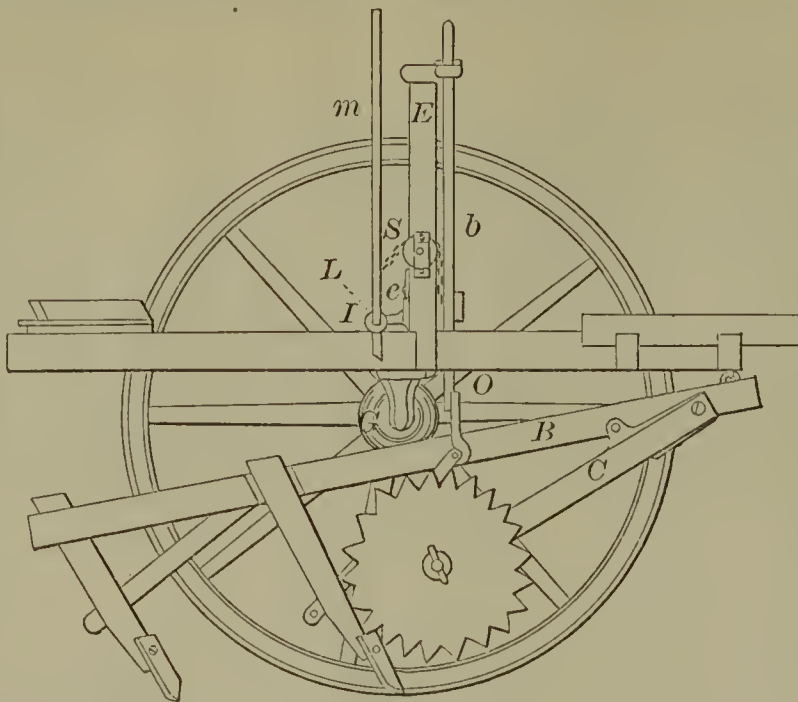

52089—A. W. Straub—Railroad Car Wheel.



52092—E. L. Tevis—Corn Shelter.

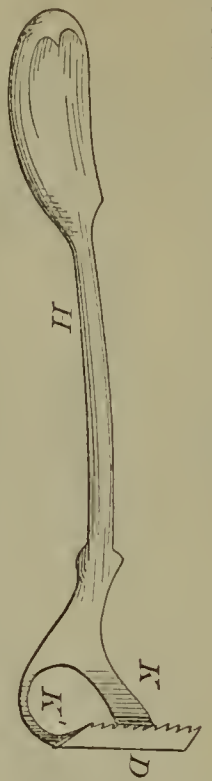

52090—Tait & Avis—For Desulphurizing Ores.

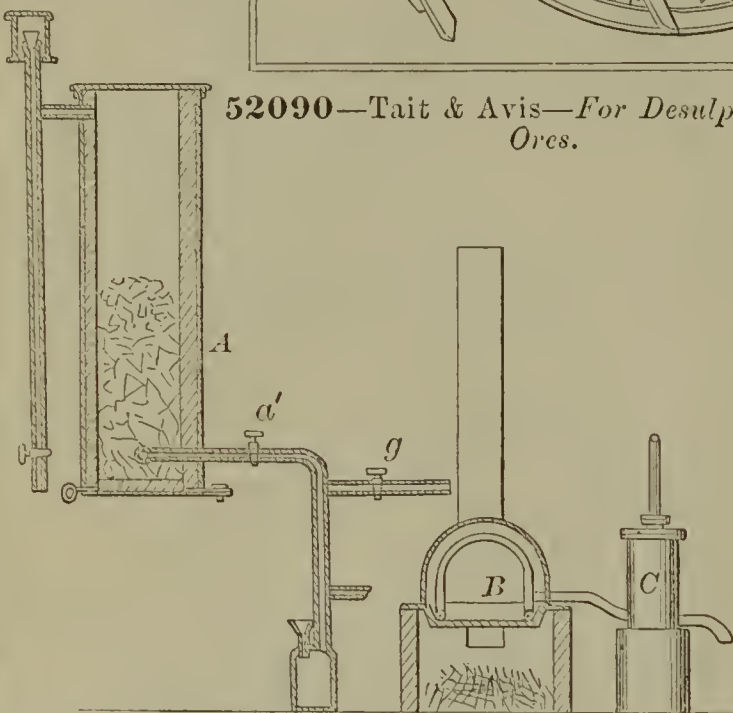

52094—Topliff & Tunnington—Manufacturing Woven Wire Articles.

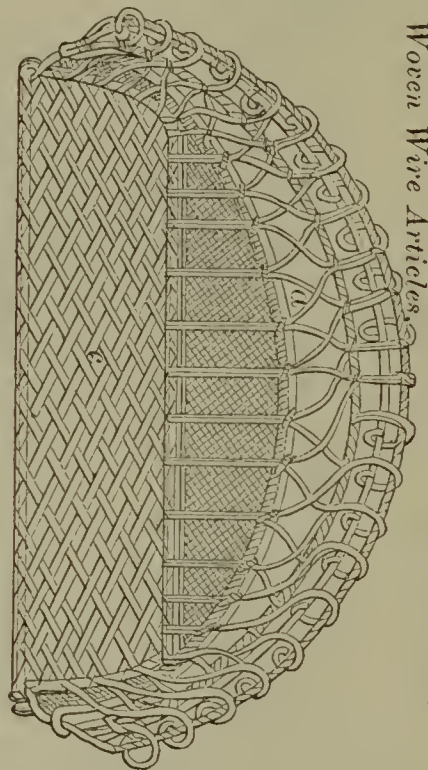

52096—A. F. Wagner—Lifting Jack.

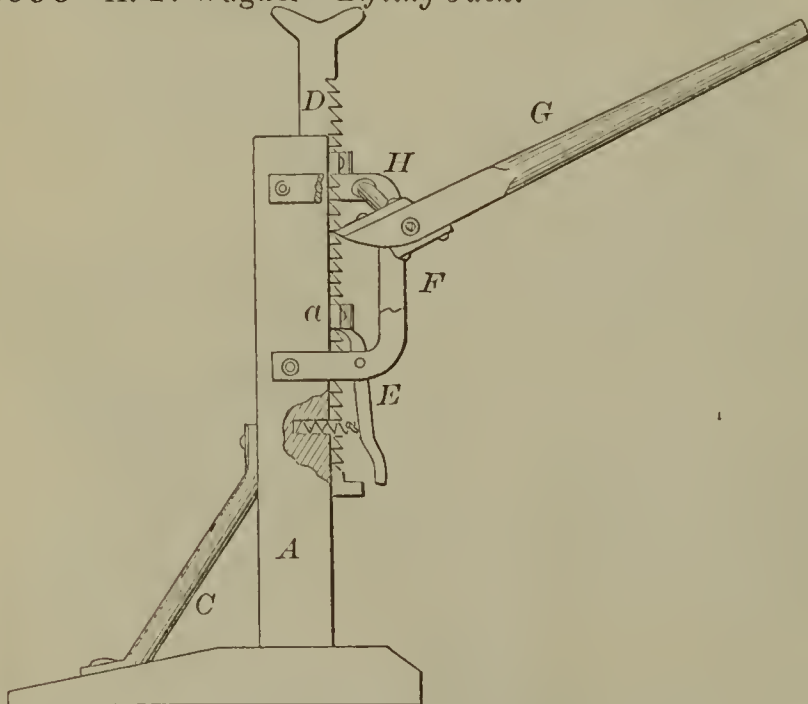

52095—A. K. Washburn—Pegging Jack.

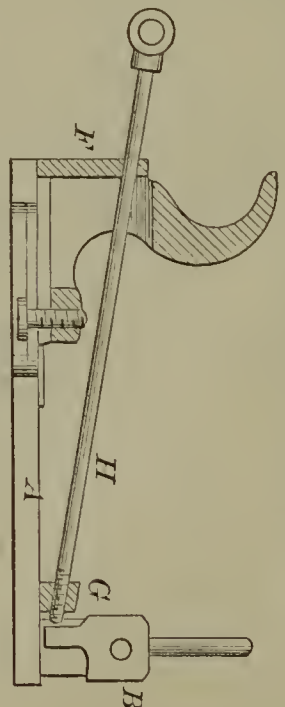

52097—H. Webster—Car Coupling.

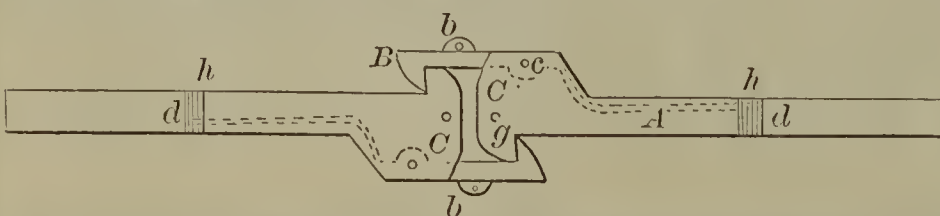



52098—A. Wells—Horse Rake.

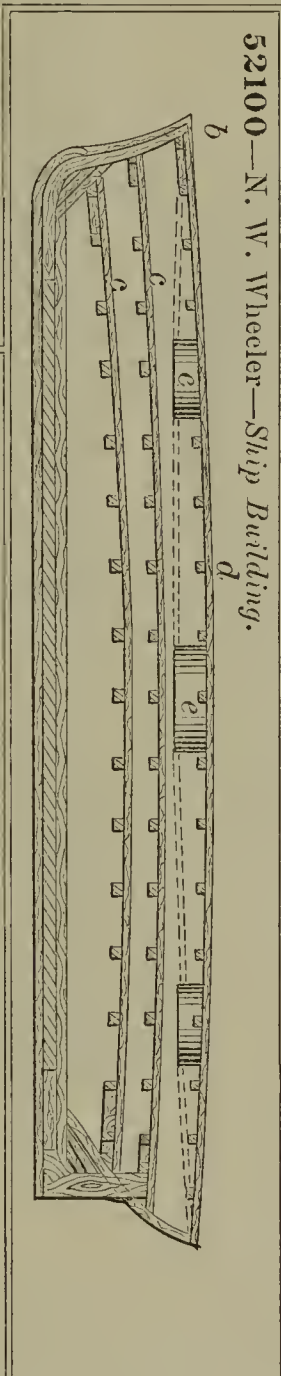
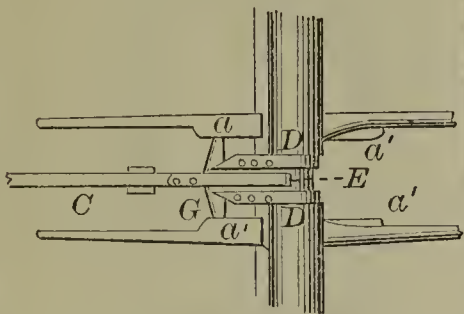
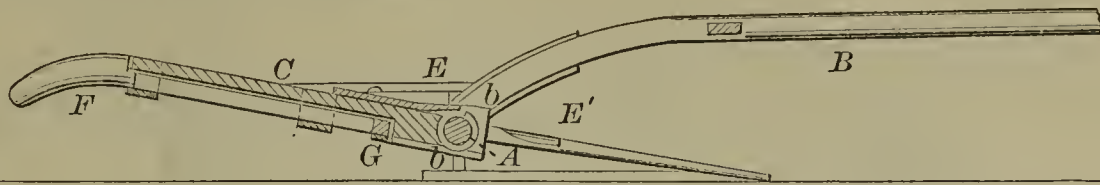

52100—N. W. Wheeler—Ship Building.

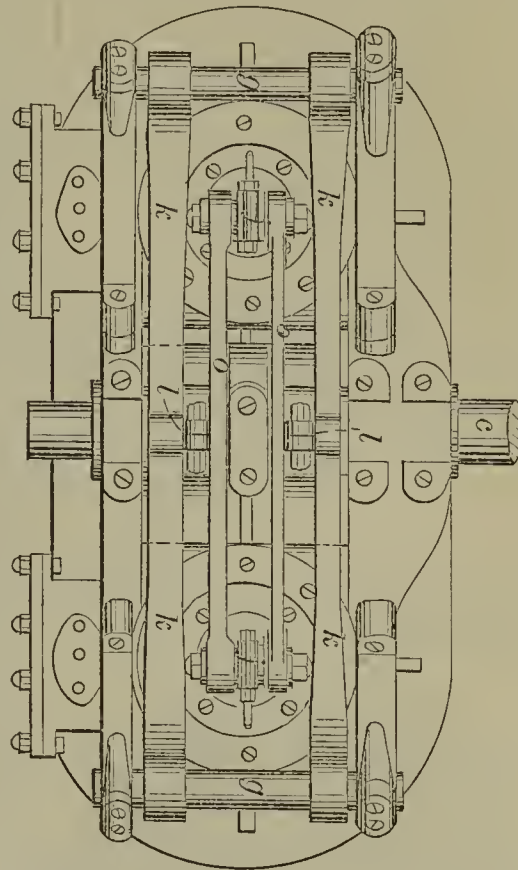

52101—N. W. Wheeler—Triangular Beam Engine.

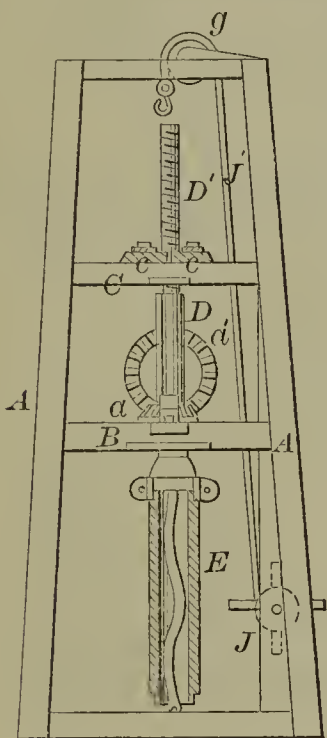

52102—G. L. Witsill—Well Boring.

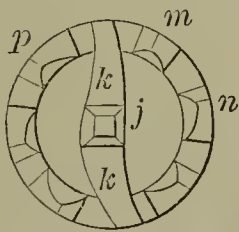

52103—G. Wolf—Churn.

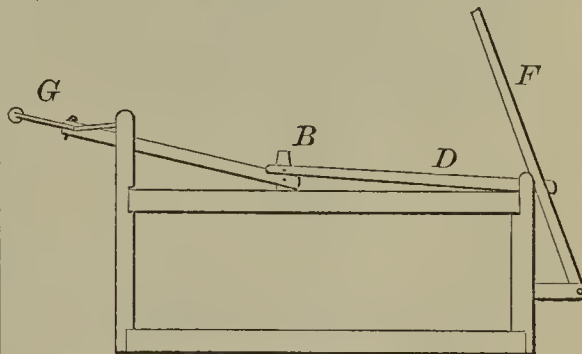

52099—W. Wharton, Jr.—Railroad Frog.

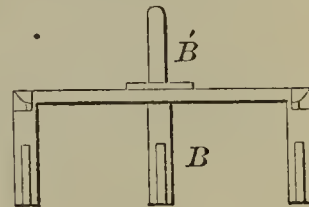
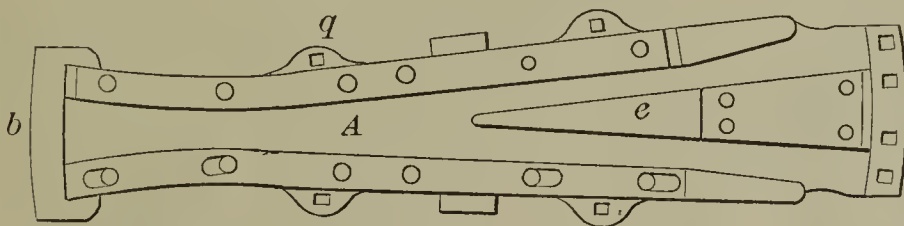

52104—T. Wolfe—Sulky Plow.

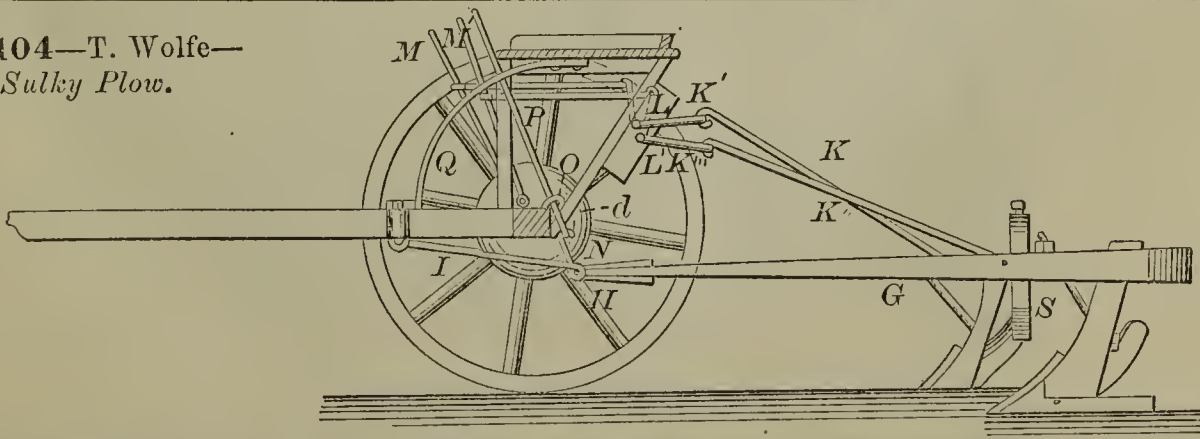

52105—S. W. Wood—*Cartridge Retraeter.*

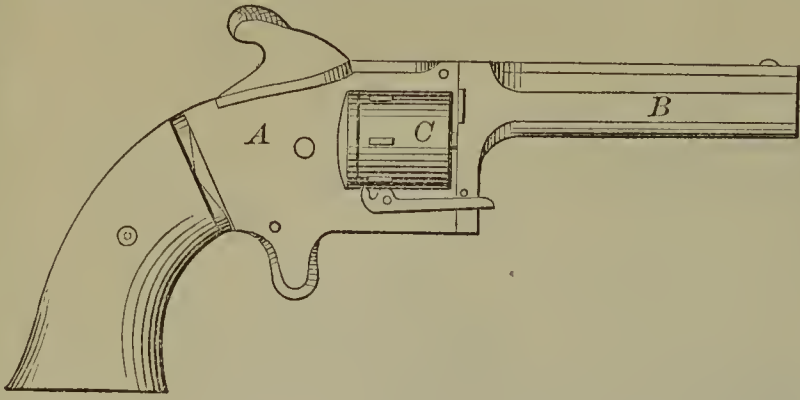

52107—A. B. Woodward—*Vulcanizing Flask.*

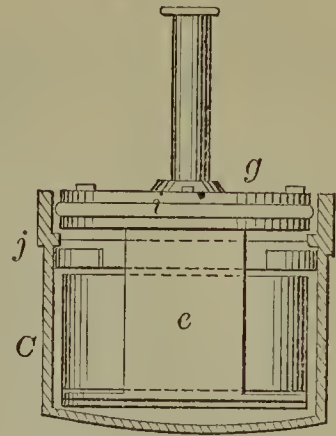

52106—N. W. Woodbury—*Wrench and Drill.*

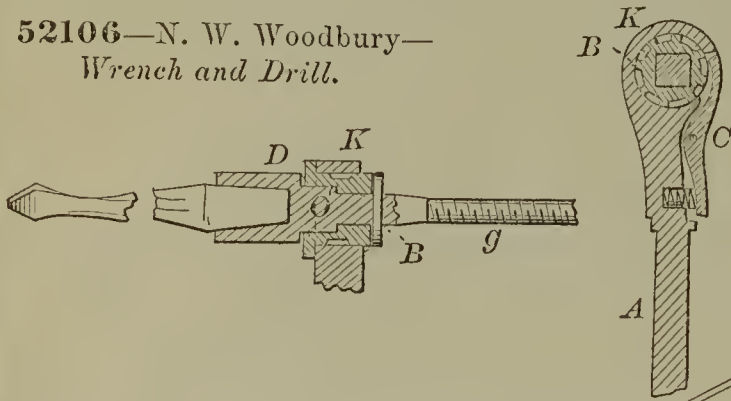

52108—J. Adams—*Washing Machine.*

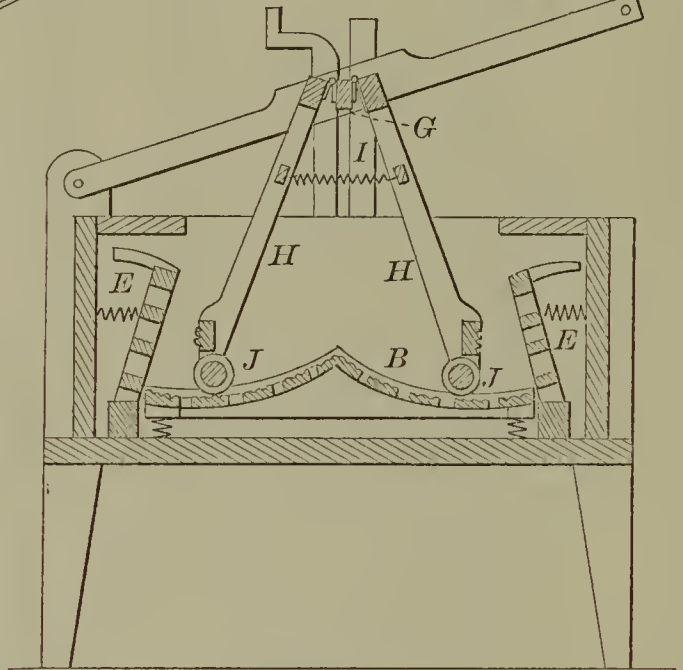

52109—G. Anton—*Fan.*

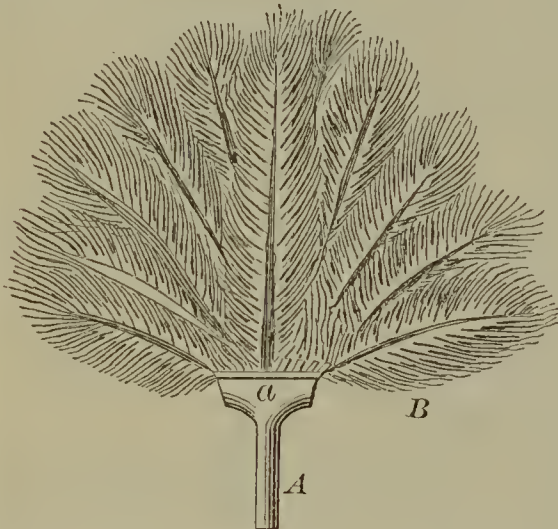

52111—J. B. Collen—*Steam Generator.*

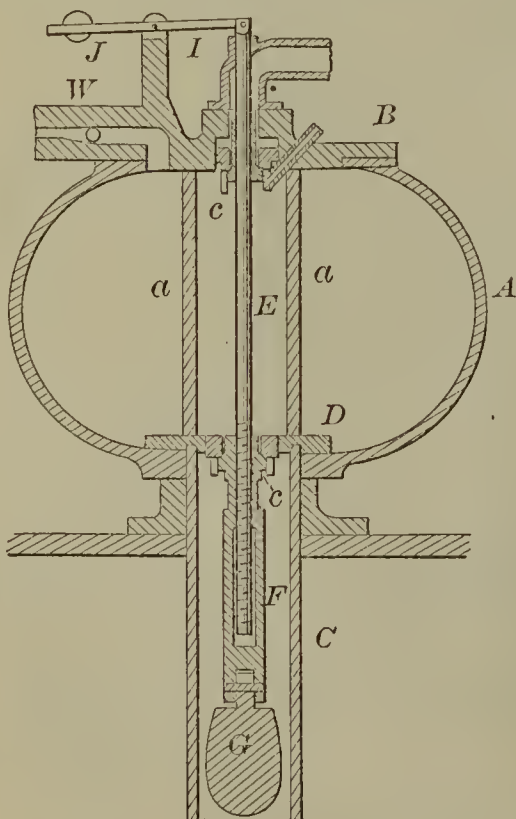

52110—J. C. Bailey—*Shoe.*

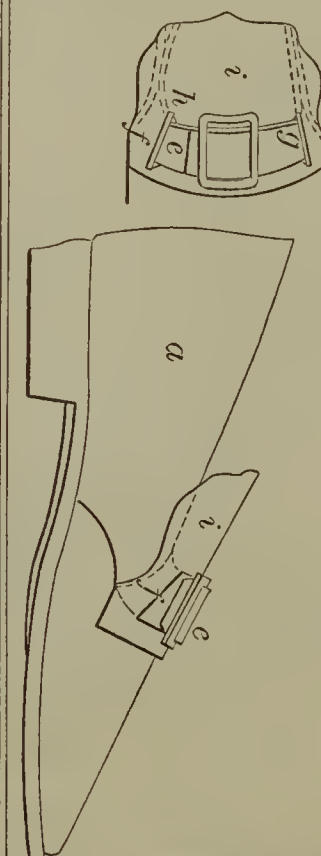

52112—S. P. Crafts—*Buckle.*



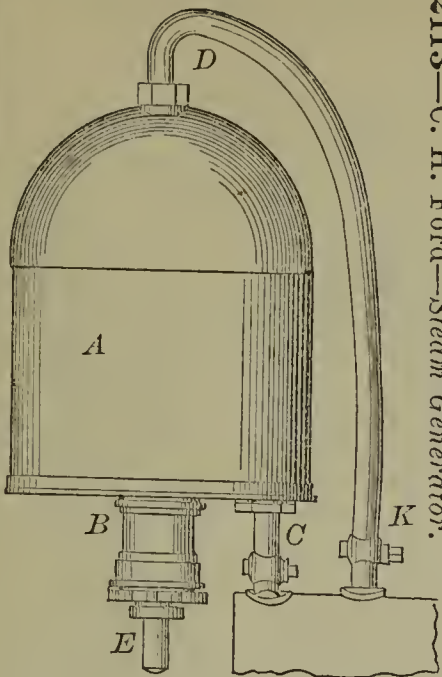

52113—C. H. Ford—Steam Generator.

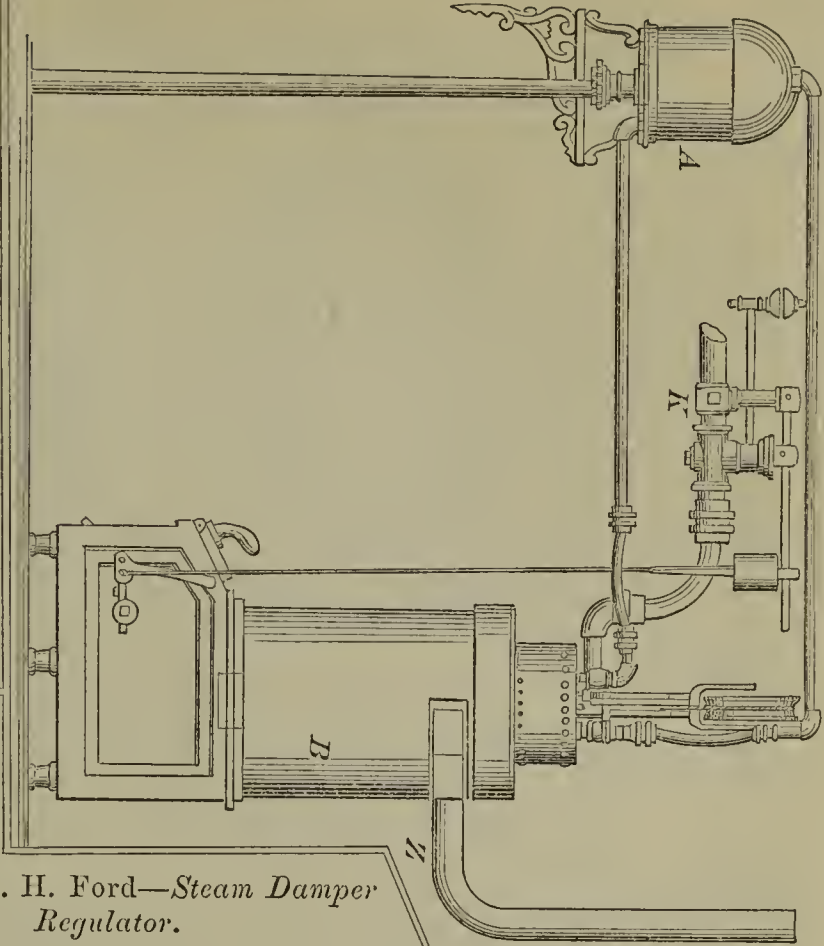

52115—C. H. Ford—Steam Generator.



52114—C. H. Ford—Steam Damper Regulator.

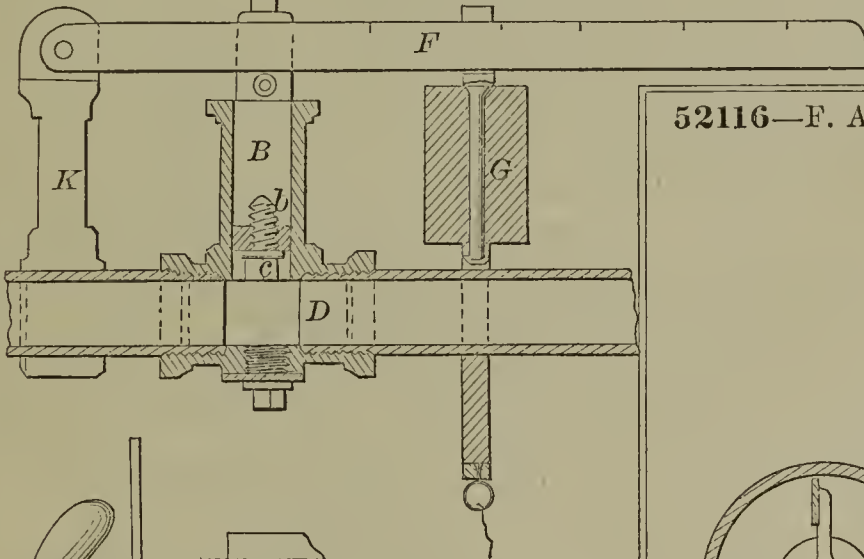

52116—F. A. E. G. de Massas—Cotton Seed Machine.

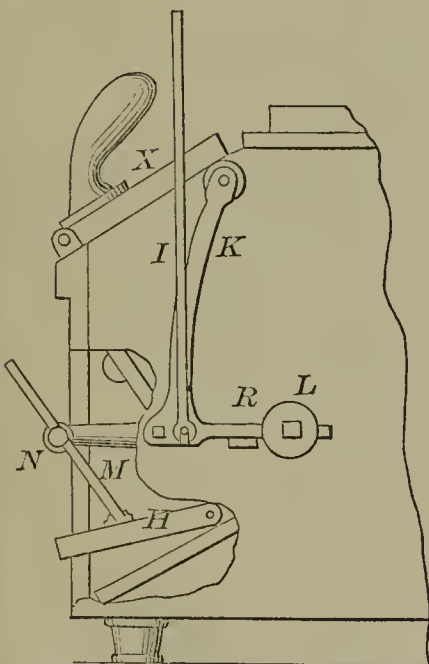
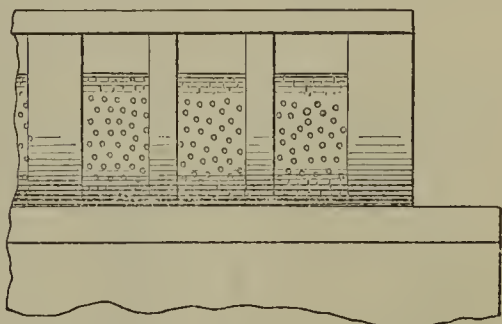
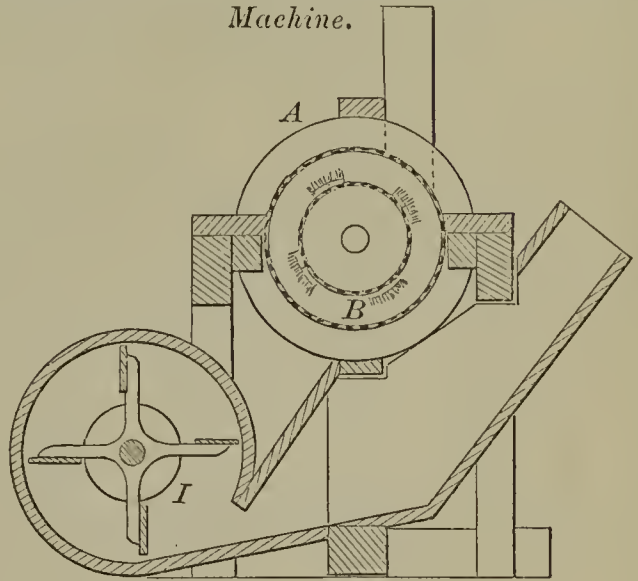

52117—R. F. Fairlie—Locomotive Engine.

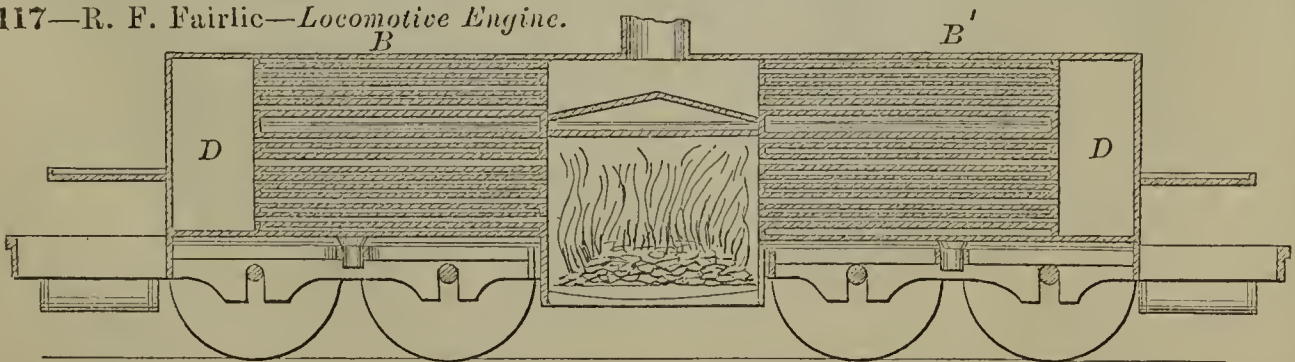

52118—J. Haworth—Brush.



52120—J. Absterdam—For Desulfurizing Ores.

52125—W. C. Baker—Curb Bit.

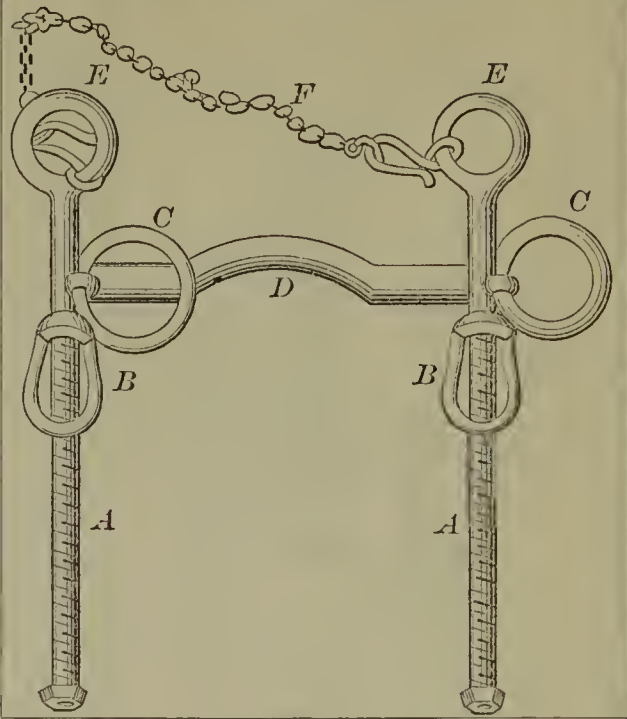

52122—D. G. Adelsberger—Horse Rake.

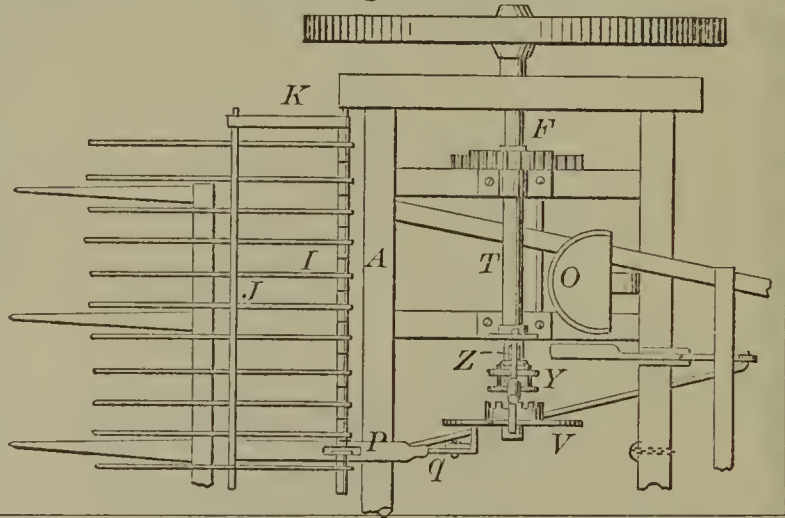

52119—F. P. Catlin—Sash Supporter.

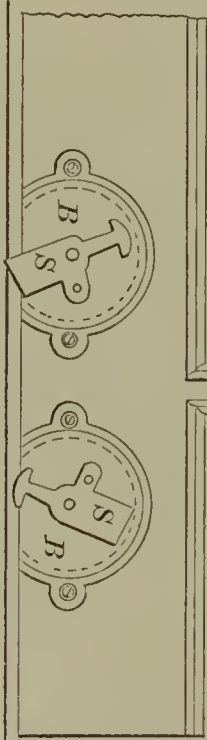

52126—W. N. Barnett—

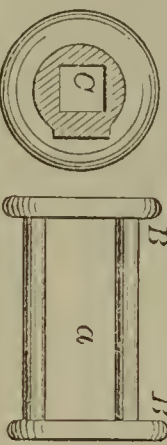

Carriage Top Prop Block.

52121—J. Absterdam—For Refining Iron and Steel.

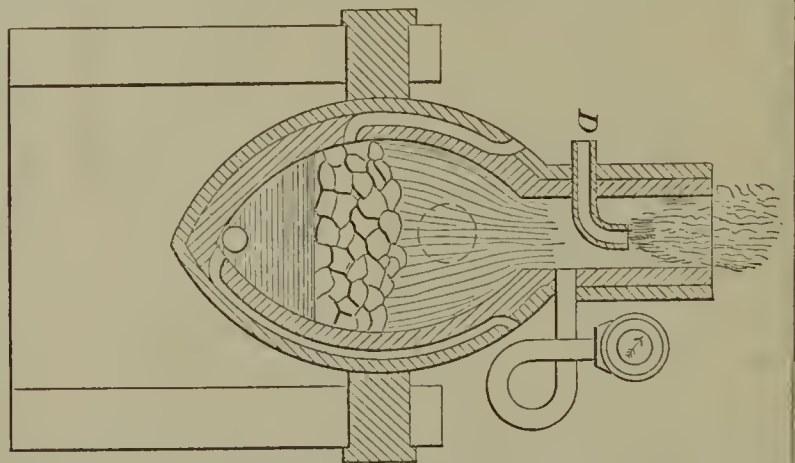

52123—L. W. Alden—Plow Clevis.

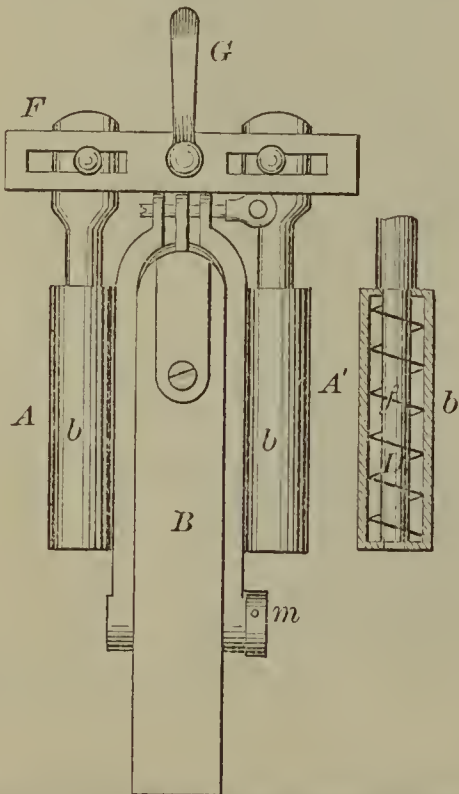

52127—G. Bevitt—Sugar Mill.

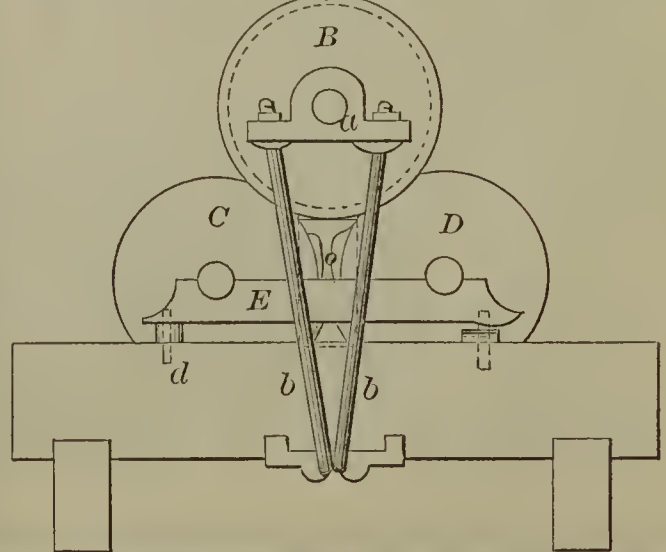

52128—G. Bevitt—Billiard Cue.

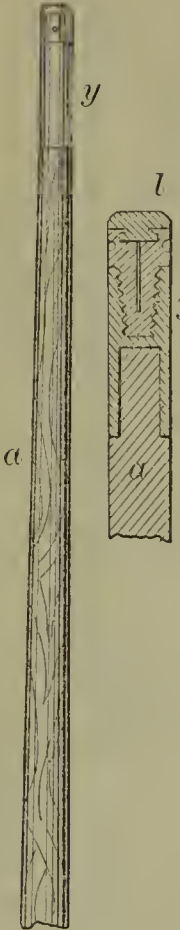

52129—C. B. Boyle—  
Photographic Lens.

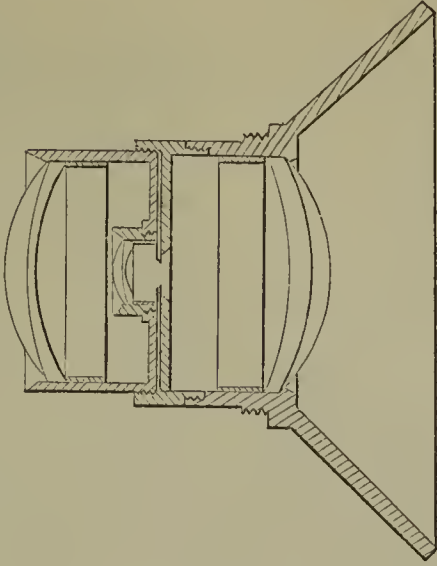

52130—R. H. Boynton—Spoke Machine.

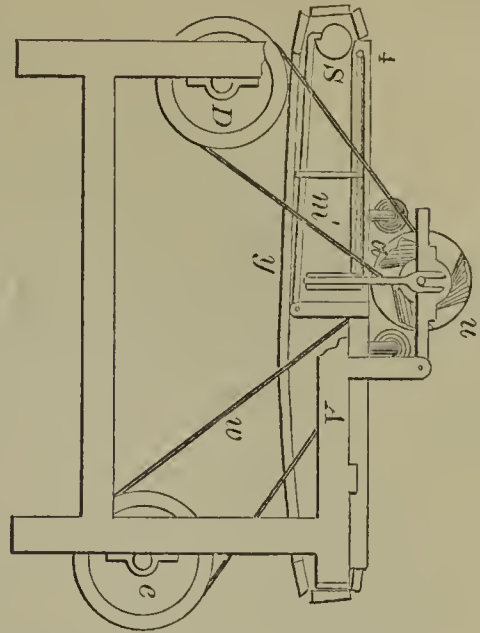

52131—R. M. Breckenridge—Hand Saw.

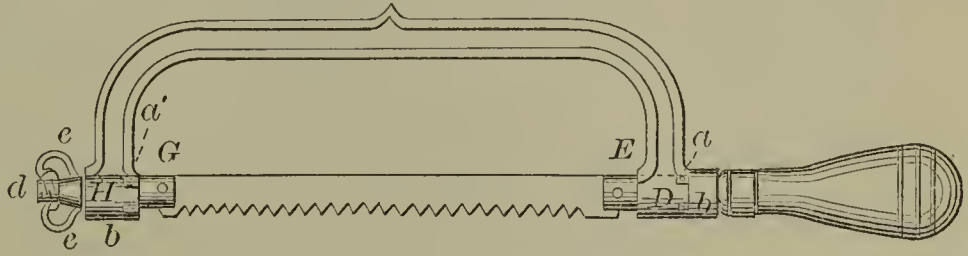

52133—A. C. Brush—Treating  
Fur.

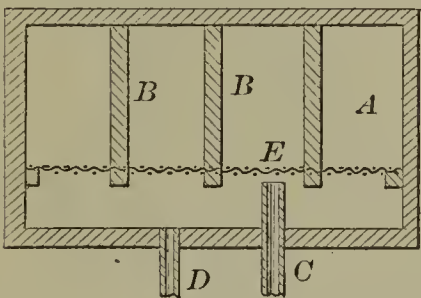

52135—H. Bundel—Seeding Machine.

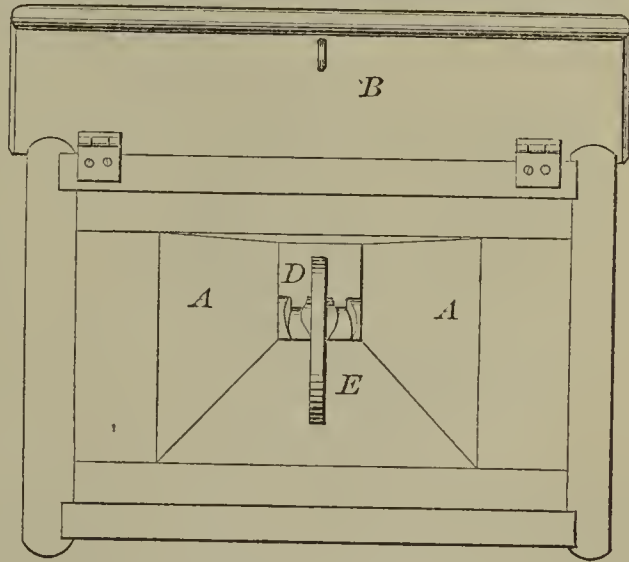

52134—E. & A. Buckman—  
Horse Hay Fork.

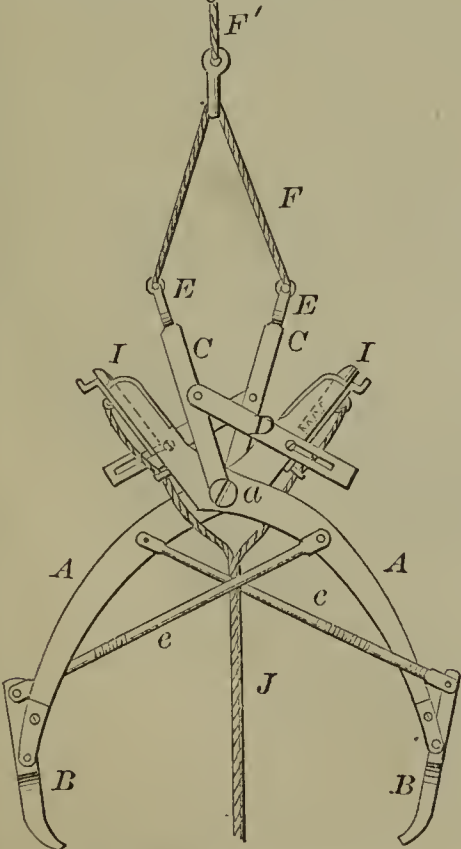

52136—M. P. Carpenter—Mop Wringer.

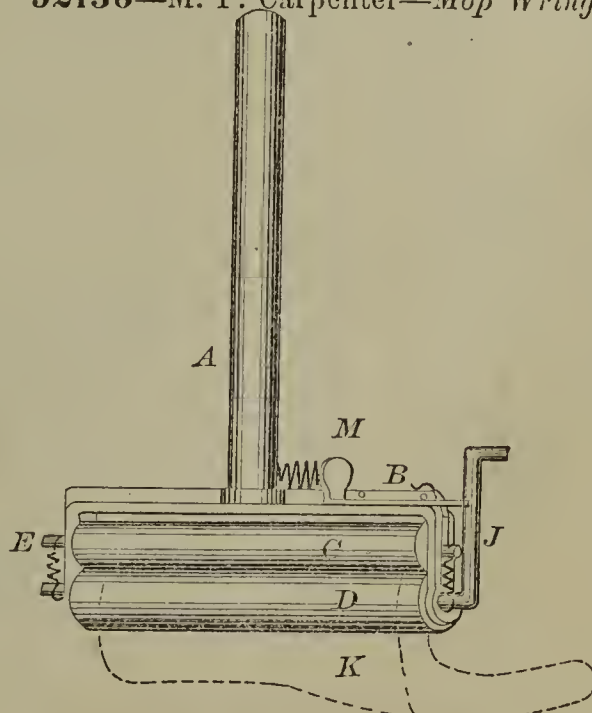

52137—W. I. Carroll—Cotton Tie.



52138—E. Chesterman—Shoe.

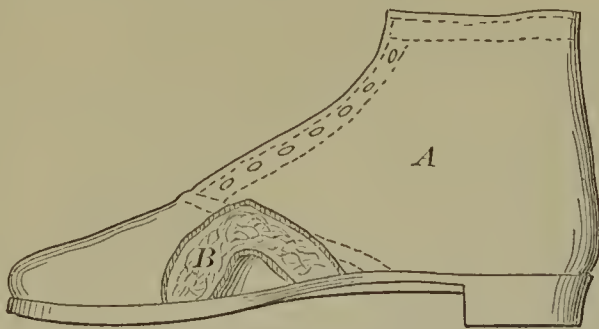

52143—E. Davidson—Anchor Tripper.

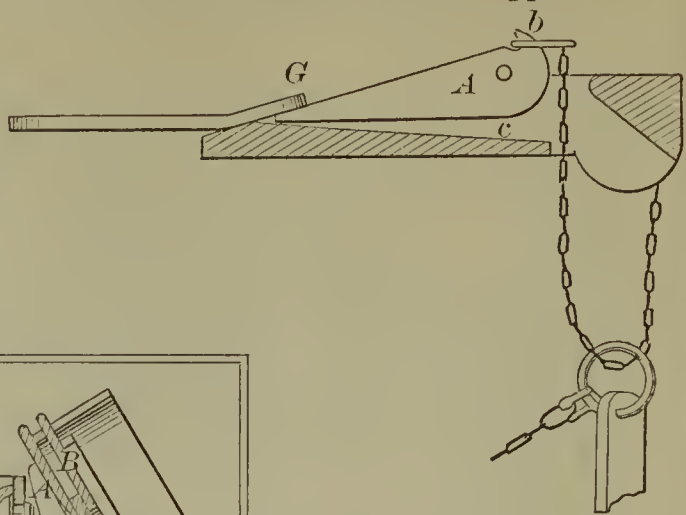

52140—W. B. Coates—Iron Holder.

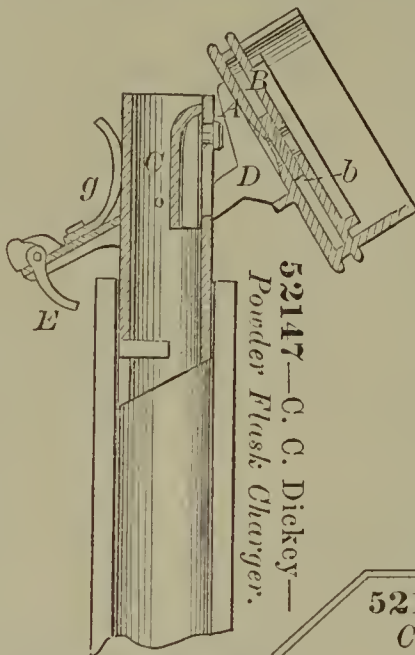
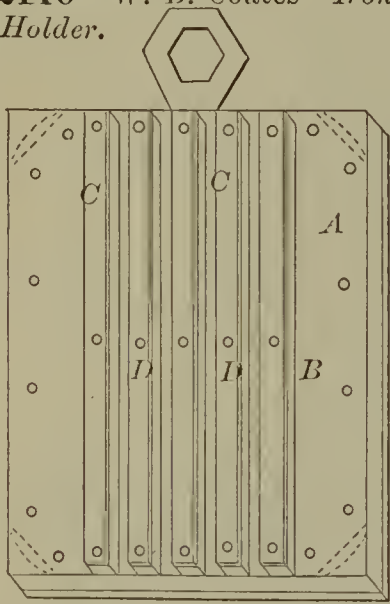

52147—C. C. Dickey—Powder Flask Charger.

52148—L. Dow—Drilling Tool.

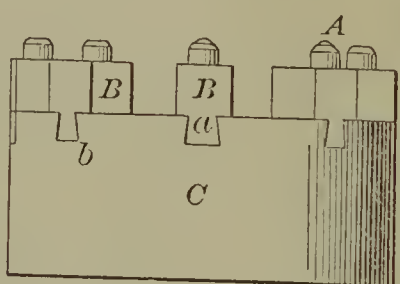

52141—J. A. Crandall—Sled for Children.

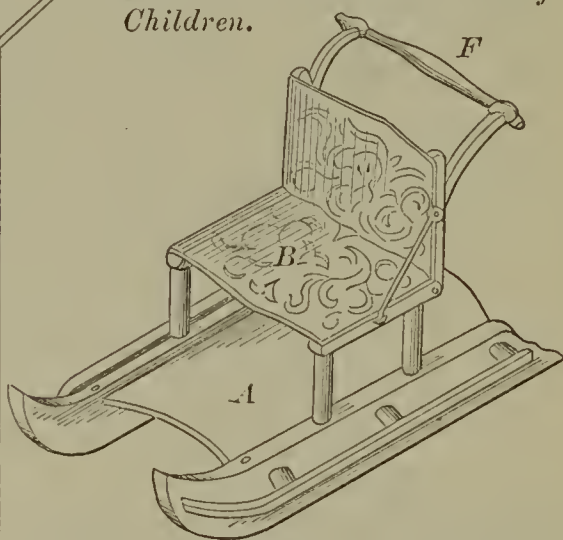

52139—Christ & Stehman—Safety Bridle.

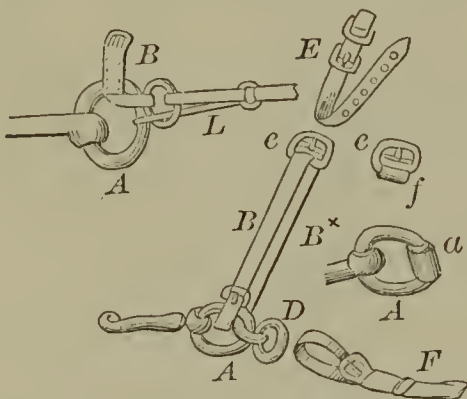

52146—A. Dick—Cradle.

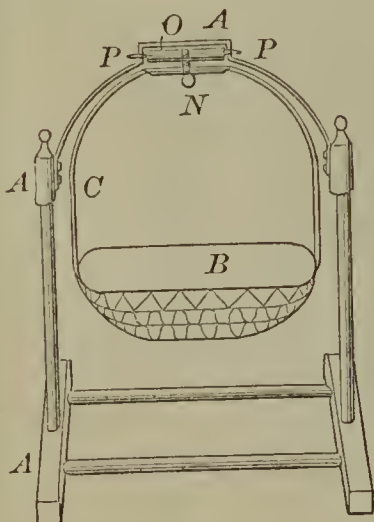

52150—J. Ericsson—Operating Gun Carriages.

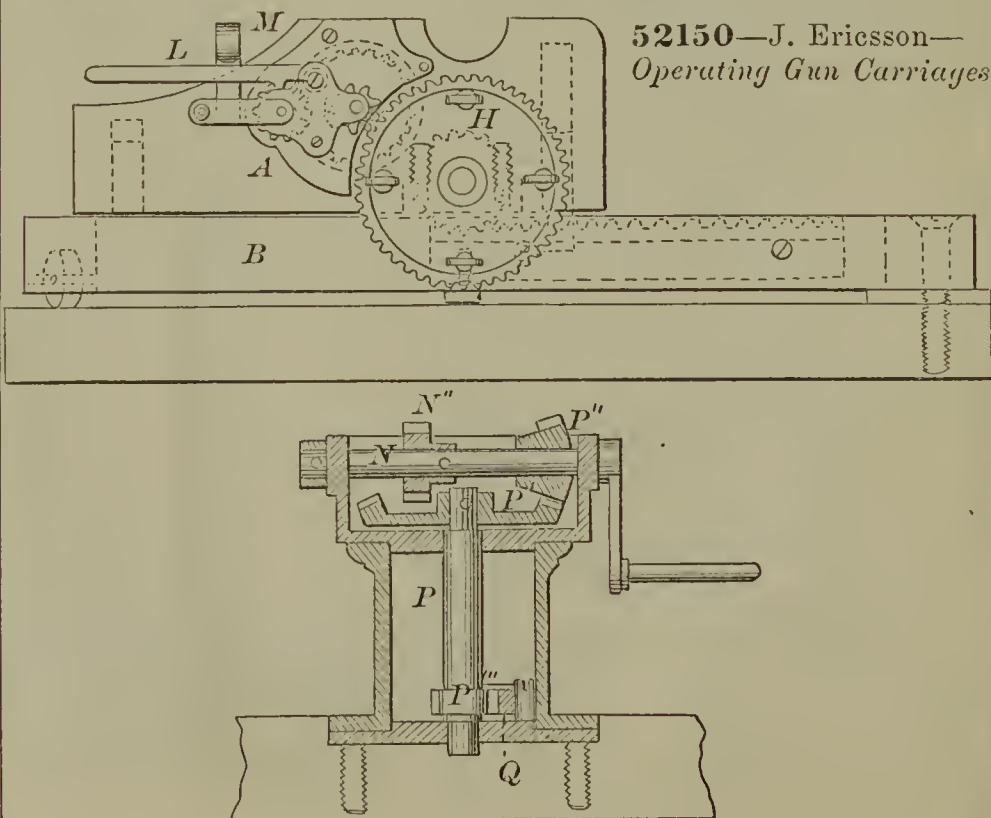

52151—L. S. Fales—For the Distillation of Tar, &c.

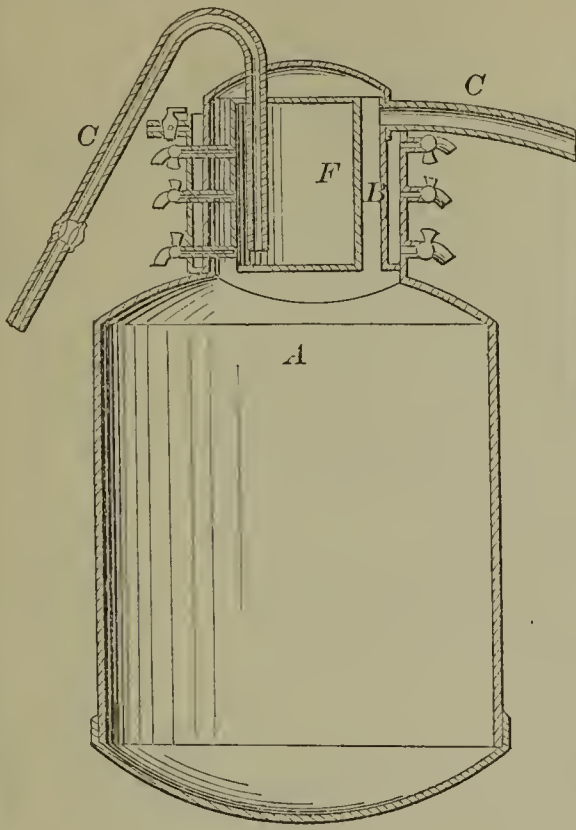

52152—C. H. Finson—Horse Rake.

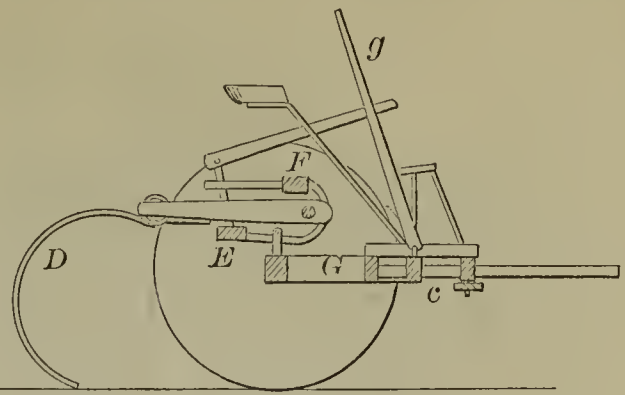

52153—J. B. Forsyth—Roller for Wringers.

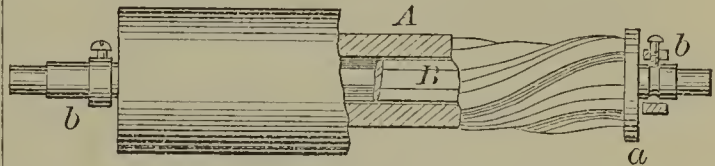

52156—E. R. Gard—Brick Machine.

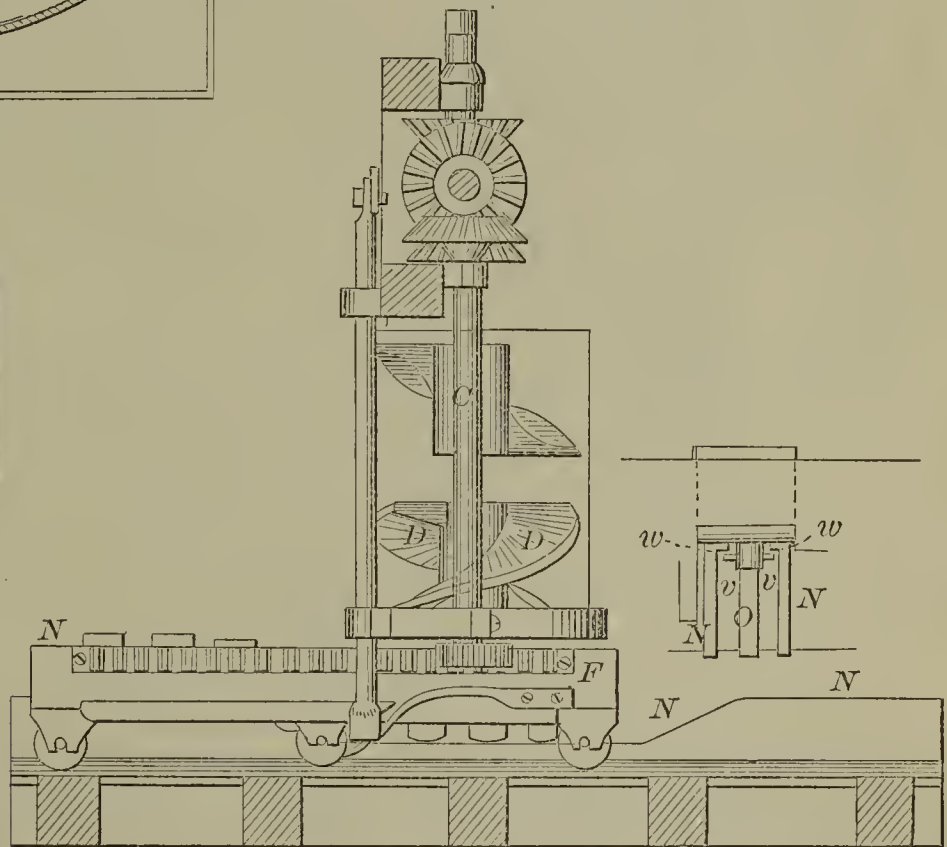

52155—E. P. Furlong—Wrench.

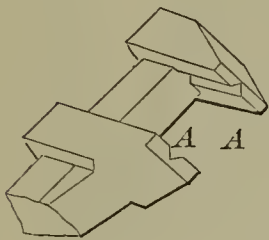

52154—R. E. Fryc—Buckle.

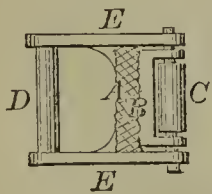

52157—E. M. Gardner—Ice Creeper.

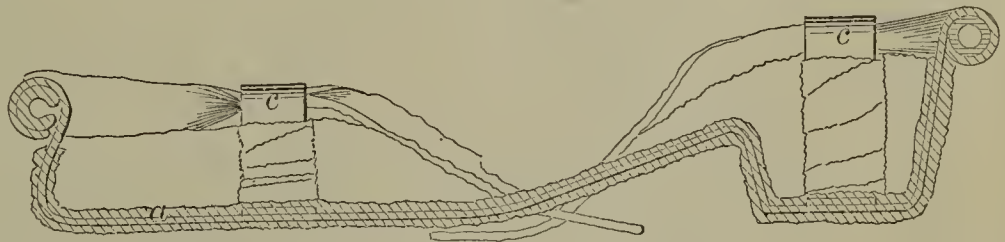

52158—J. L. Gill, Jr.—Railroad Car Truck.

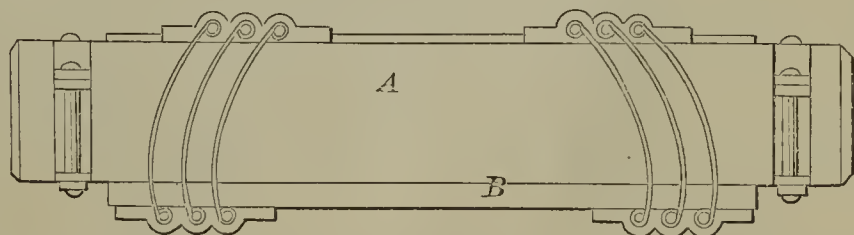

52159—J. S. Gilmore—Cultivator Plow.

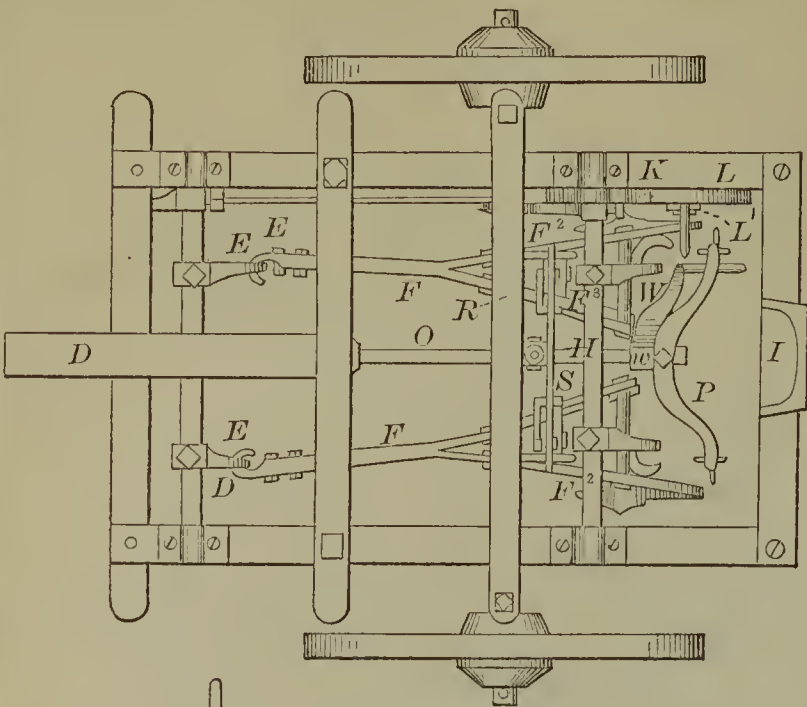

52161—Gordon & Frame—Loom.

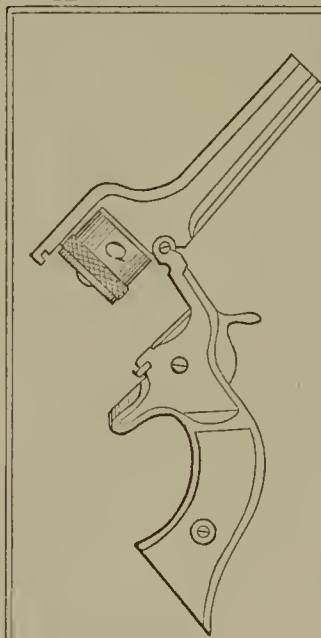
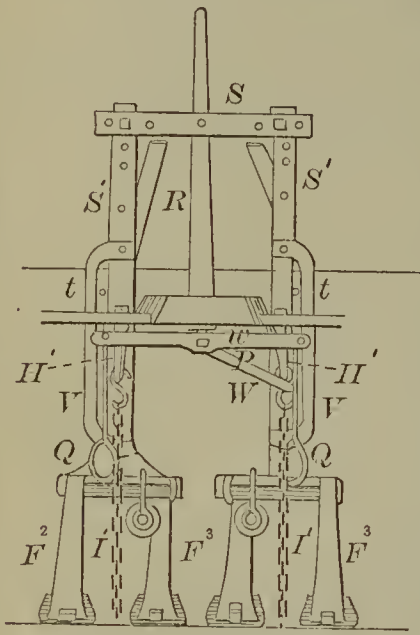
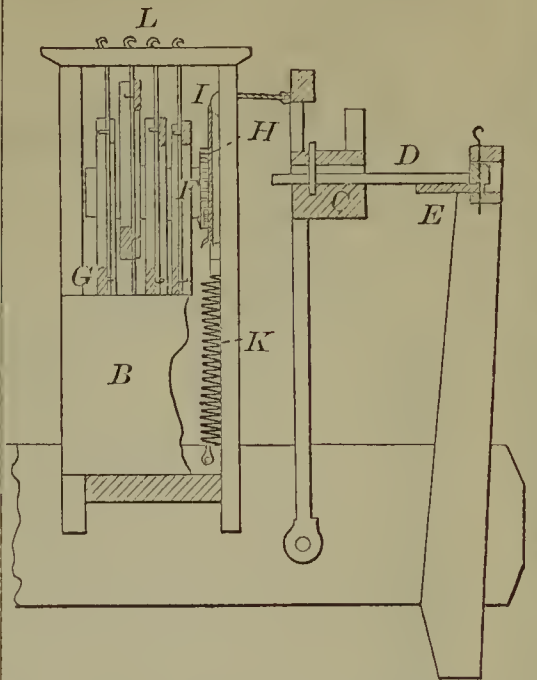

52165—H. Hammond—Cartridge Retractor.

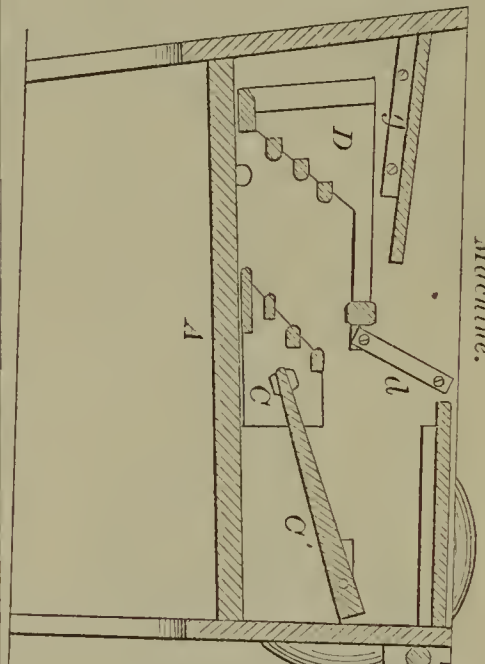

52160—J. S., E. J. & R. Godfrey—Washing Machine.

52163—S. S. Gray—Paper Collar.

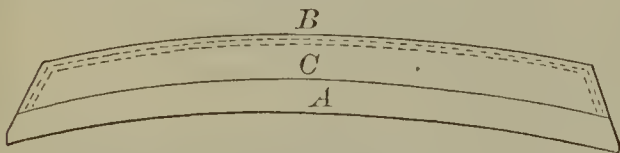

52162—L. Gray—Coupling for Shafting.

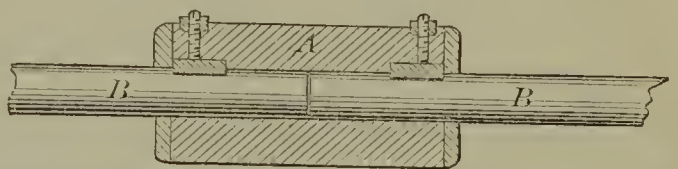

52164—J. Grieves—Drill for Wells.

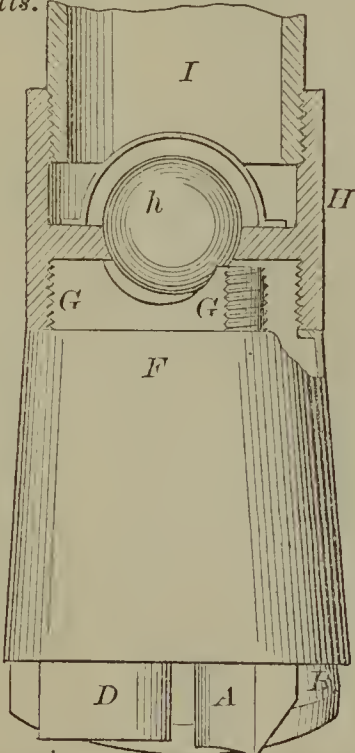

52166—J. I. Herrick—Washing Machine.

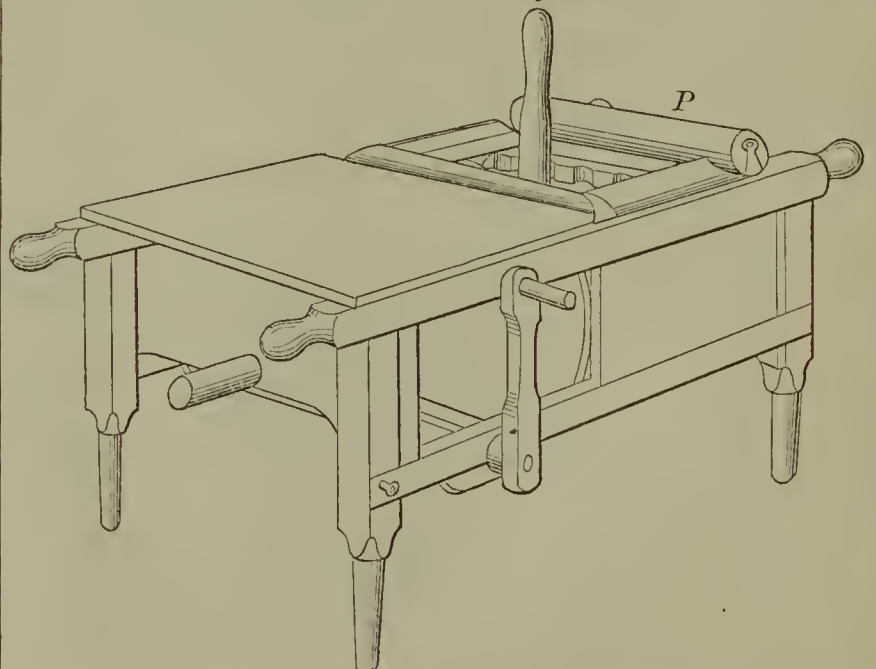



52167—L. B. Hoit—Reaping and Mowing Machine.

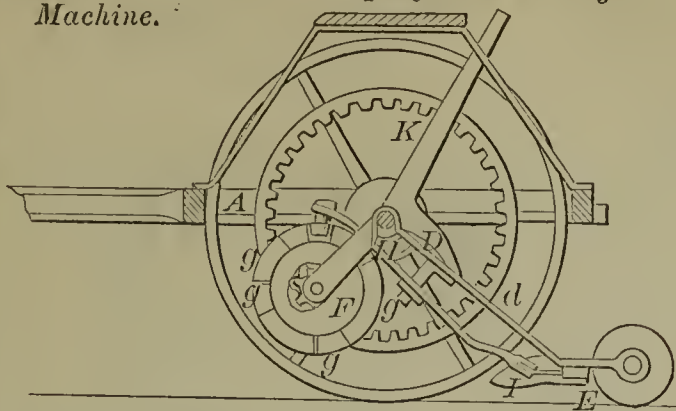

52168—C. C. Holman—Harvester.

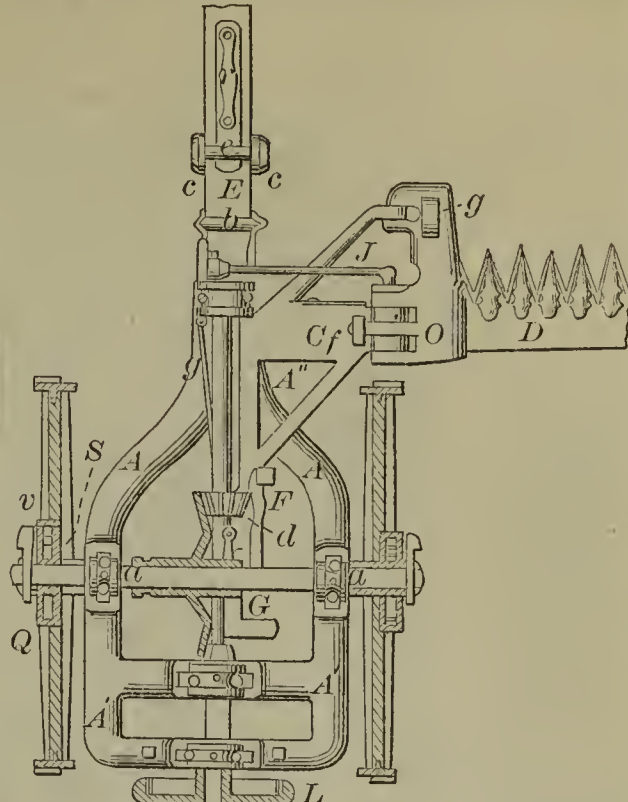

52173—Kleinschmidt & Schlater—Tool for Making Lighters.

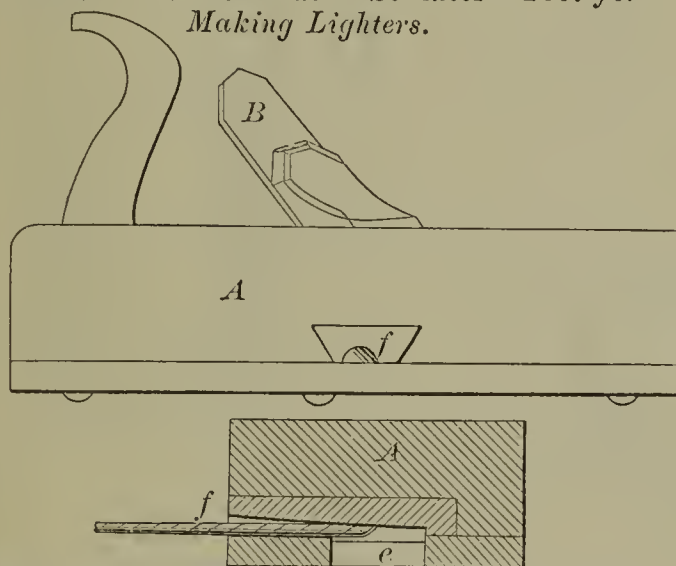

52169—H. Holt—Marking Wheel.

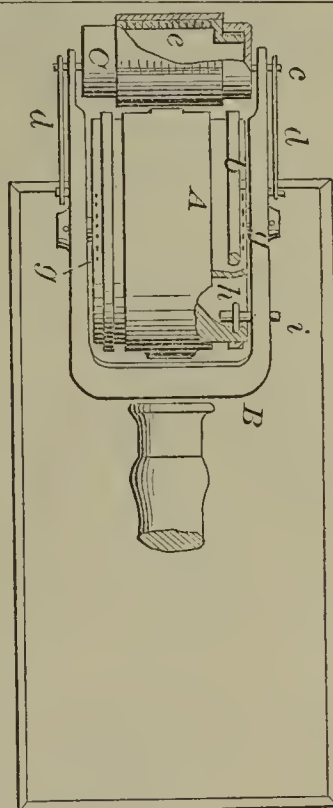

52171—D. H. Howell—Hand Corn Planter.

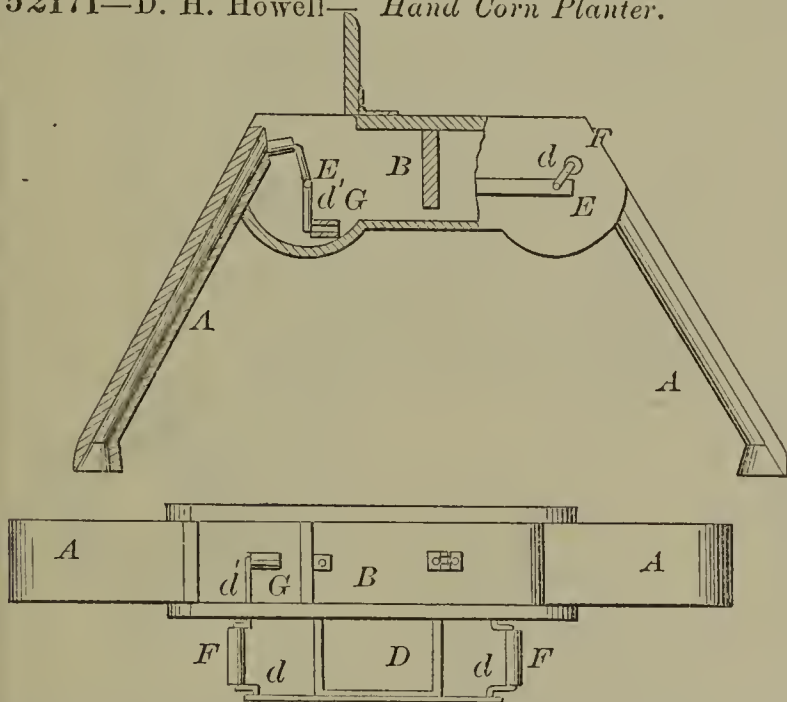

52172—S. Hudson—Fruit Ladder.

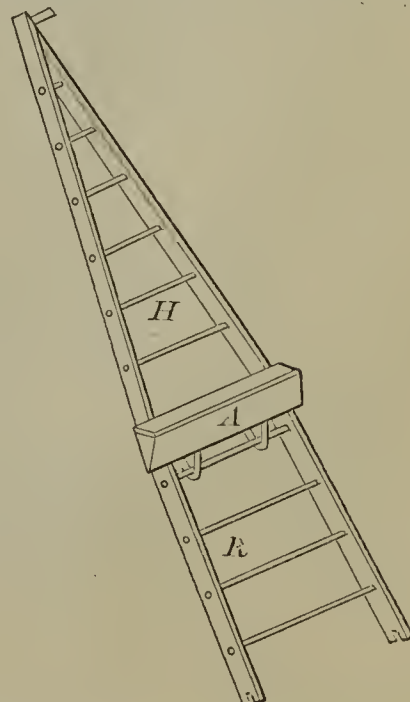

52170—J. Howarth—Coupling for Carriage Thills.

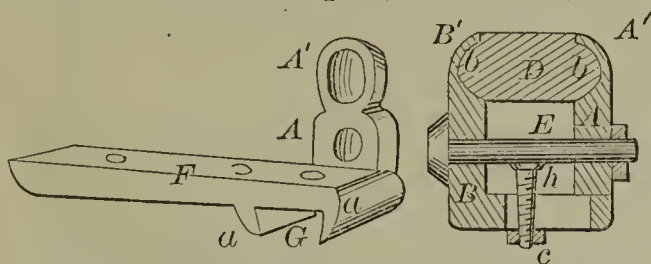

52174—Kimball & Parsons—Bit for Boring Holes.

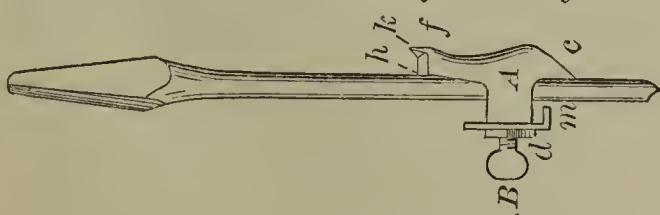

52180—  
Leeds & Hollowell—  
Post Hole Auger.

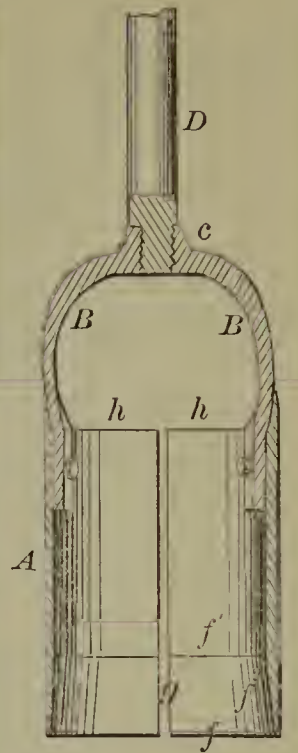

52175—I. Lancaster—Grain Binder.

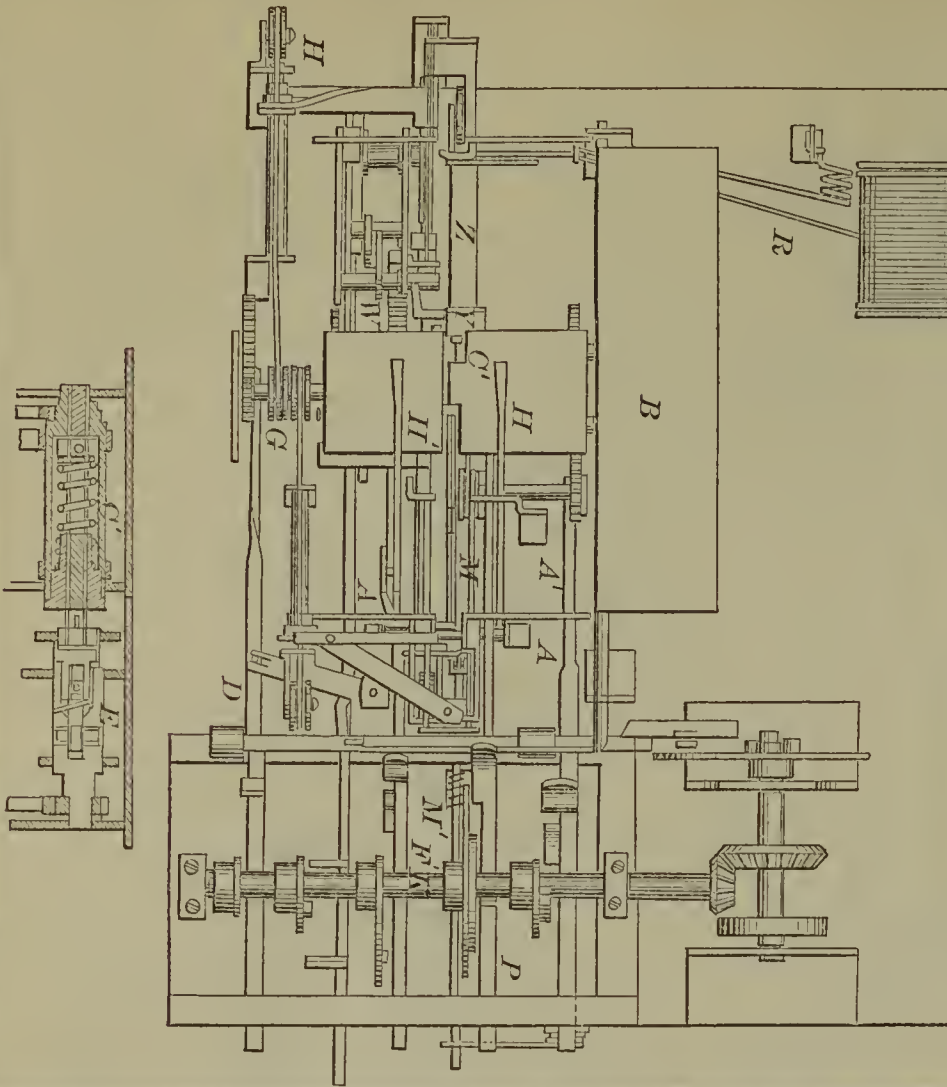

52179—R. Leavitt—Eyelet.

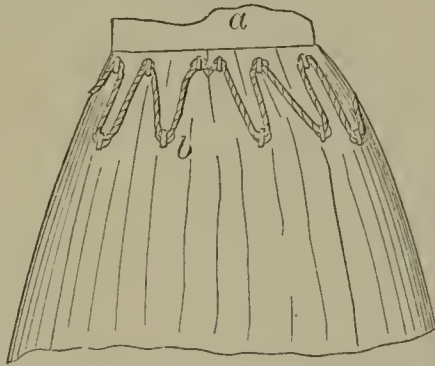

52177—P. Lear—Chimney Cap.

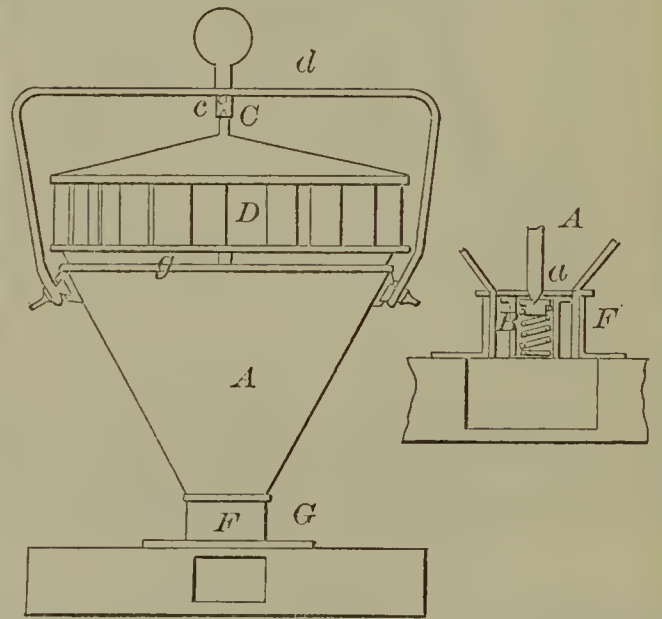

52181—G. F. Lynch—Railroad Car Box.

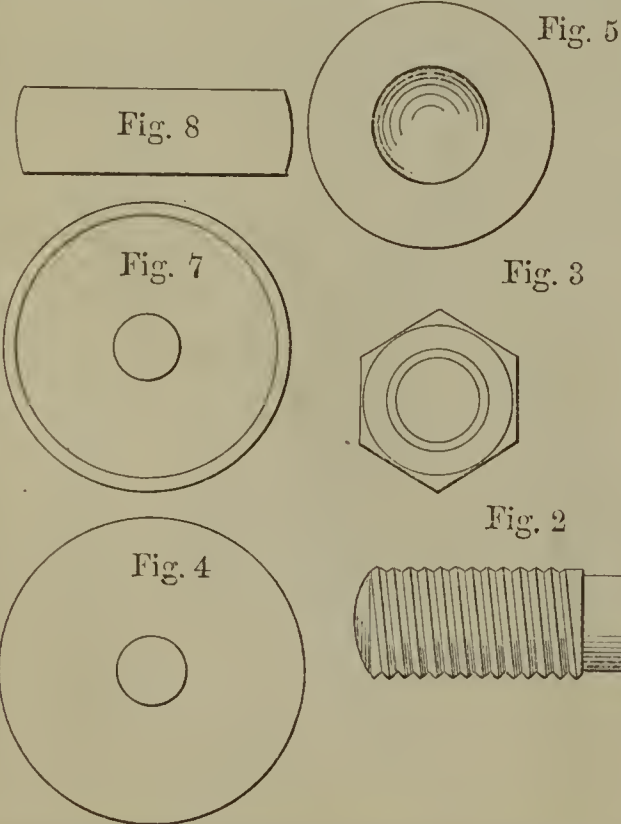

52178—W. Leas—Belt Coupling.

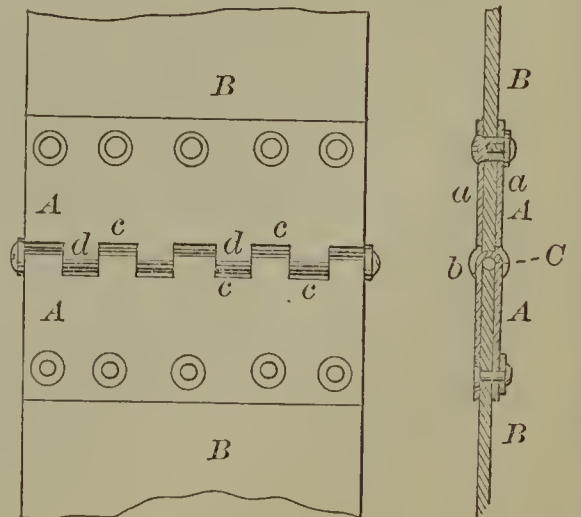

52182—J. McCammon—*Barrel Head.*

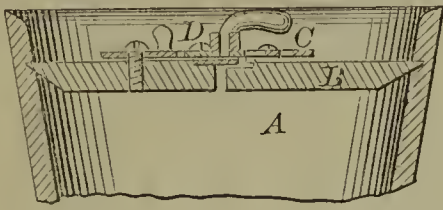

52184—S. G. Mills—*Cultivator.*

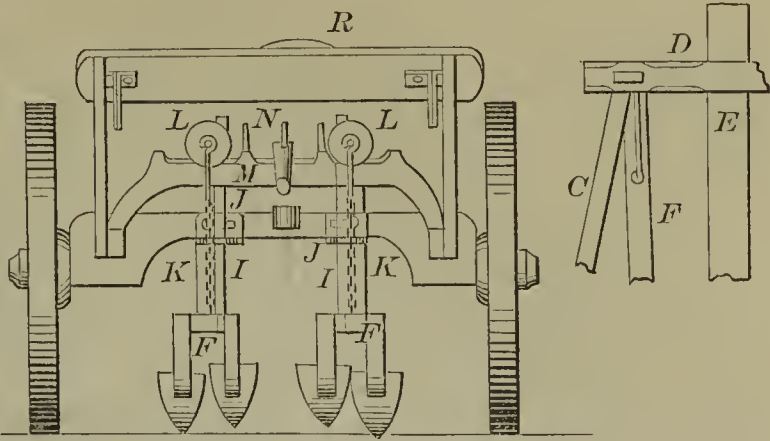

52183—M. McGonnigle—*Lock.*

52185—A. Mitchell—*Washing Machine.*

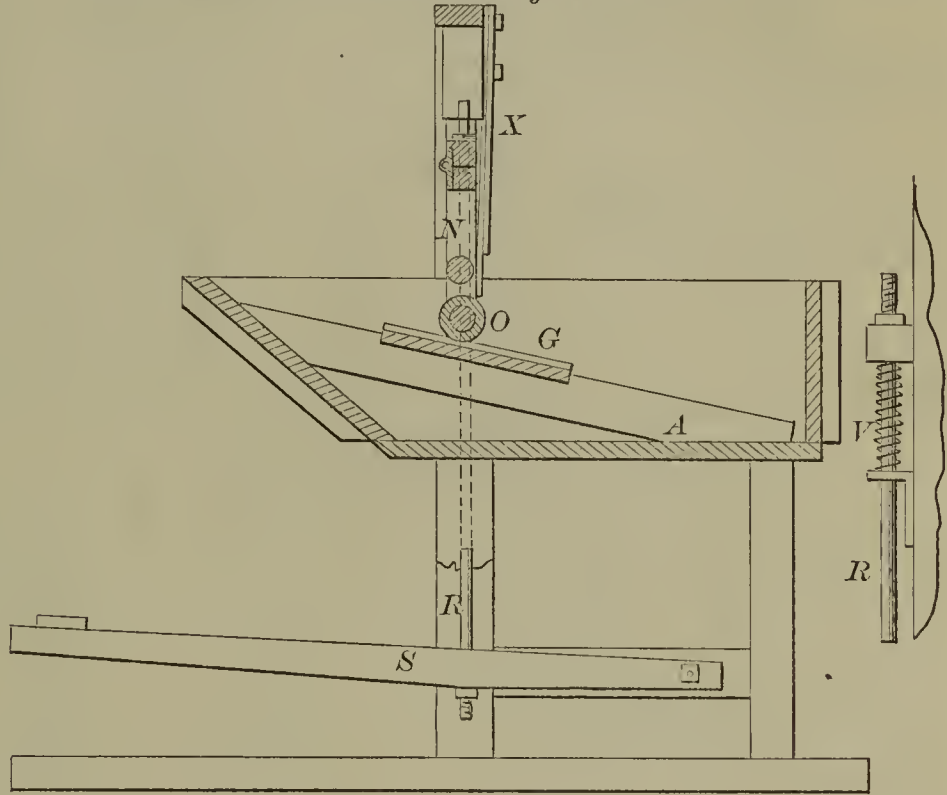

52187—W. Morley—*Thill-Holding Loop.*

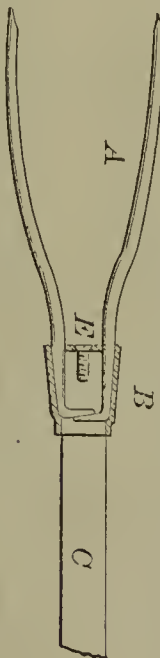

52186—J. A. Montgomery—*Hay Fork.*

52188—J. Mutt—*Feed Rollers to Circular Saws.*

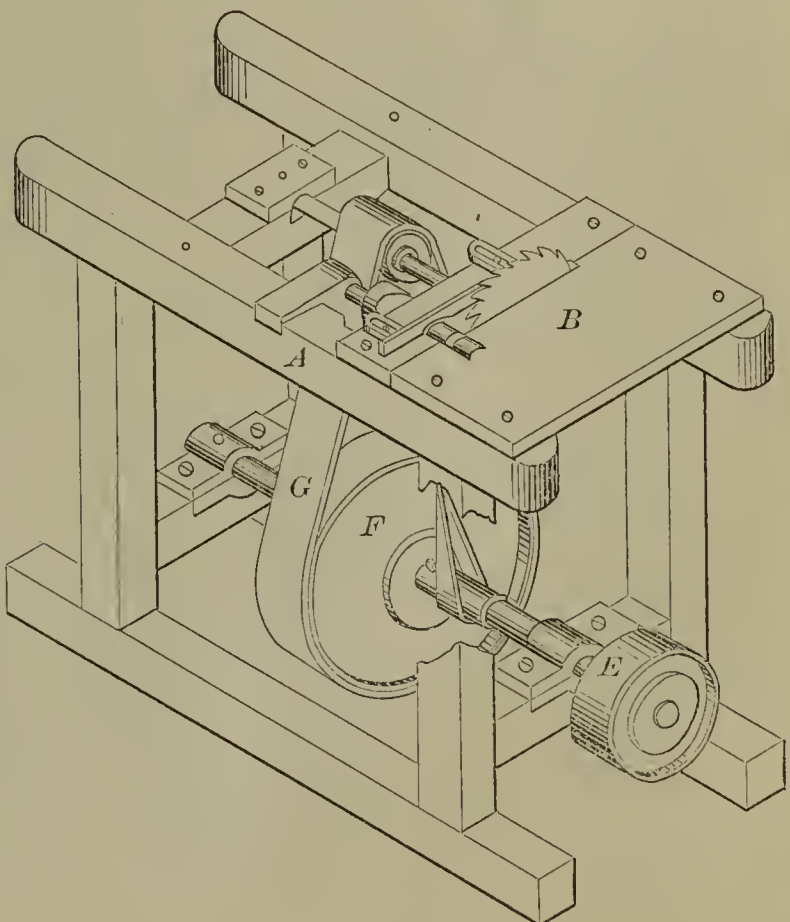

52189—G. S. Nevins—Grate Bars.

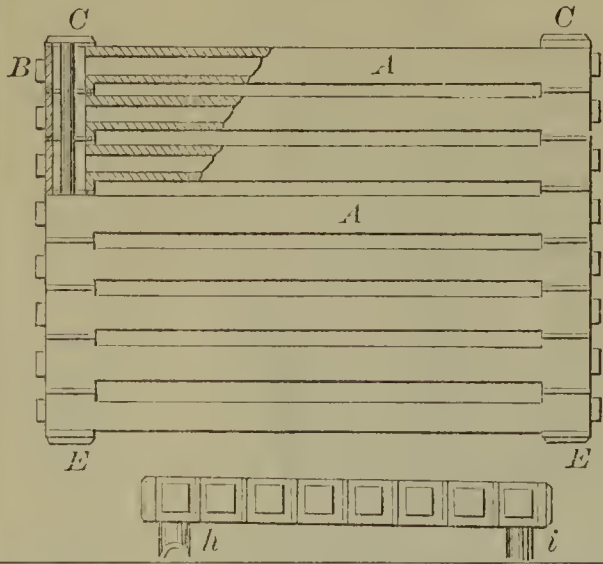

52191—B. G. Noble—For Desulphurizing Ore.

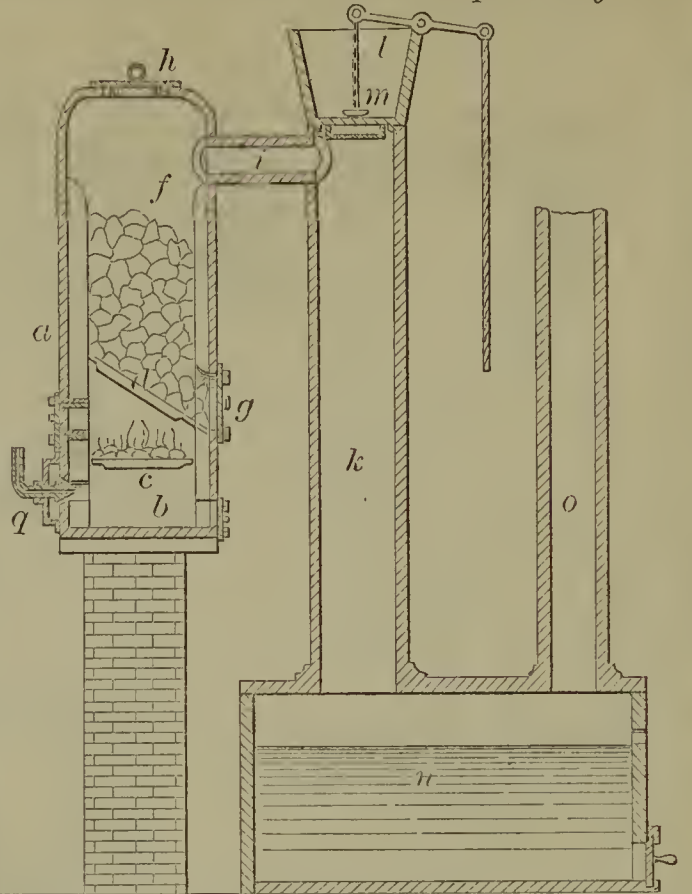

52193—O. Pearl—Spinning Frame.

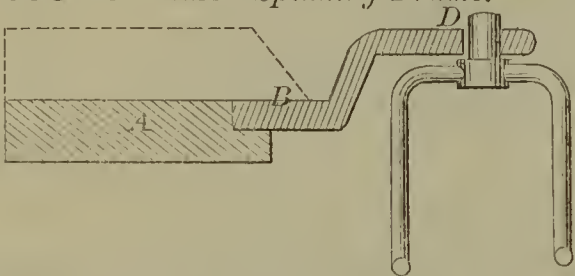

52190—Niles & Gillett—Loading Hay Wagons.

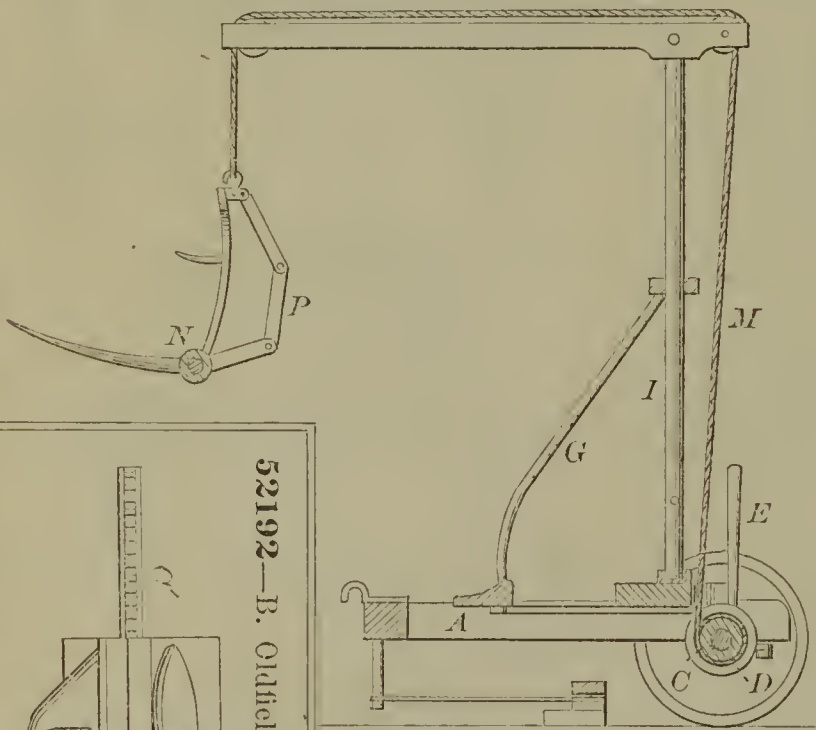

52195—T. W. Pierce—Reaping and Binding Machine.

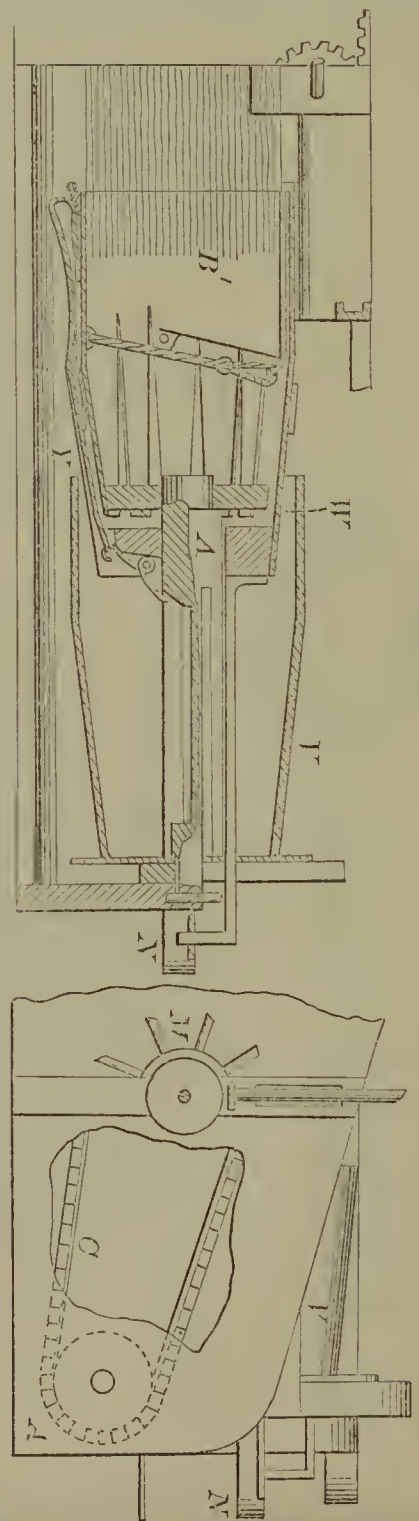

52192—B. Oldfield—Loom.

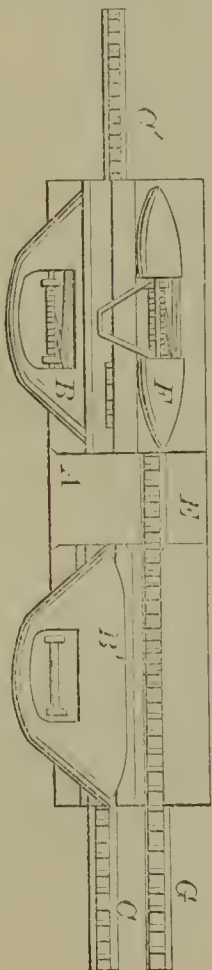

52194—M. Peck—Low Water Detector.

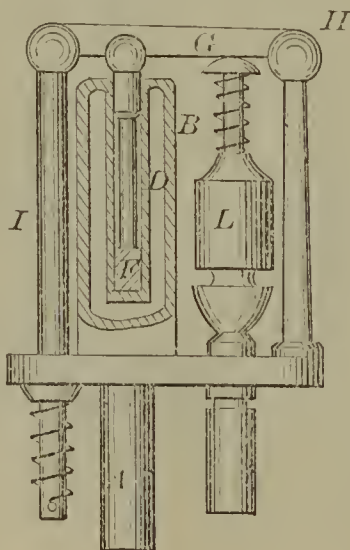

52196—V. Percheron—*Traveling Bag.*

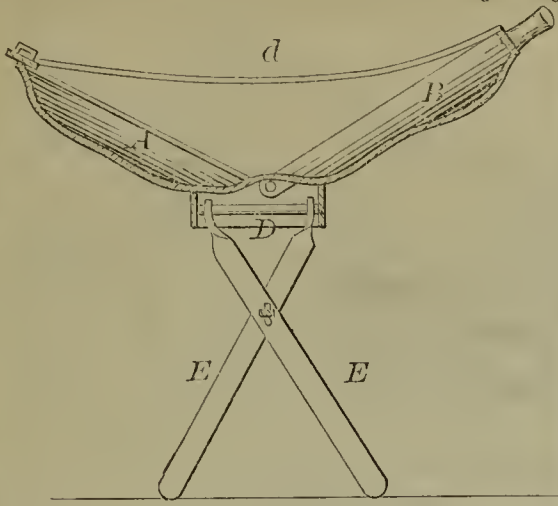

52198—D. L. Pettigrew—*Sheep Rack.*

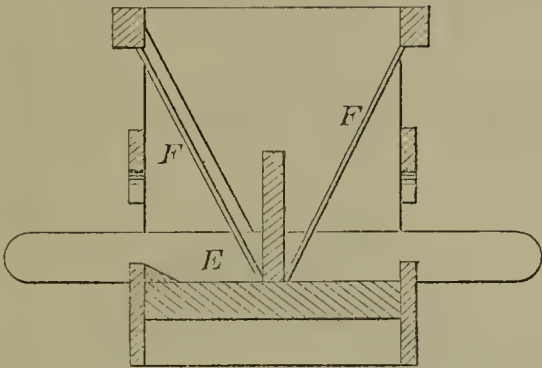

52199—T. J. Price—*Straw Cutter.*

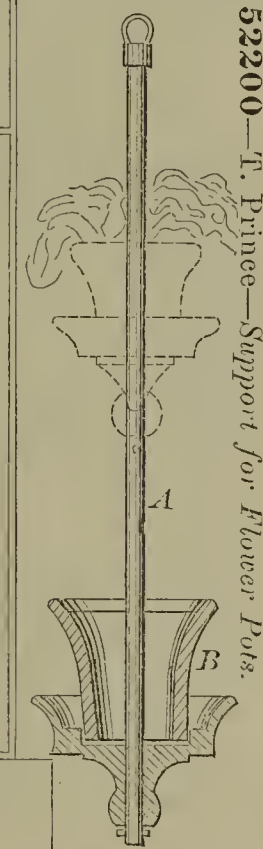
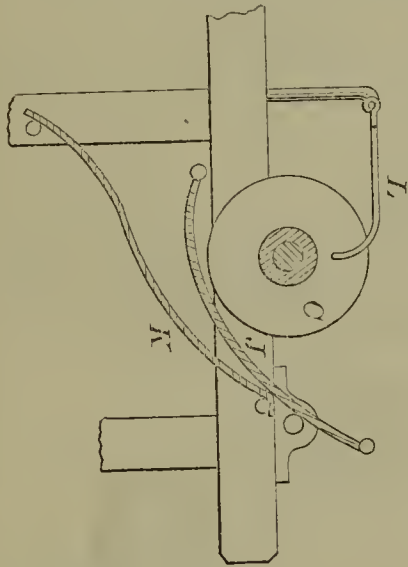

52200—T. Prince—*Support for Flower Pots.*

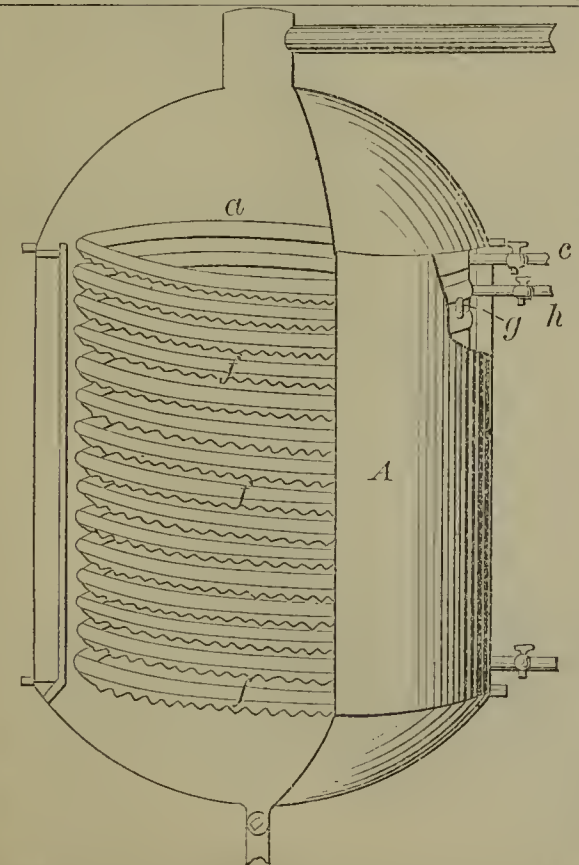

52197—G. R. Percy—*Vacuum Pan.*

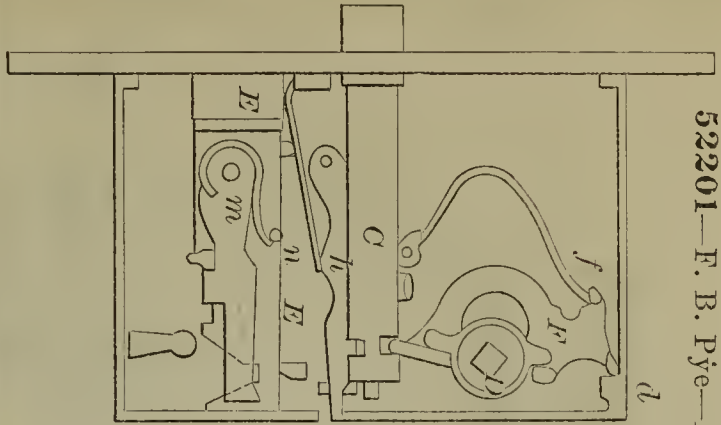

52201—F. B. Pye—*Knob Latch.*

Fig. 5

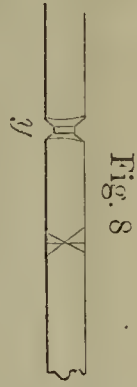
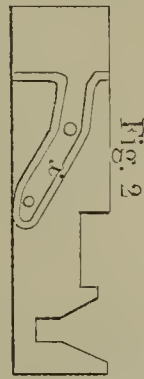

52202—A. L. Rand—*Wine Press.*

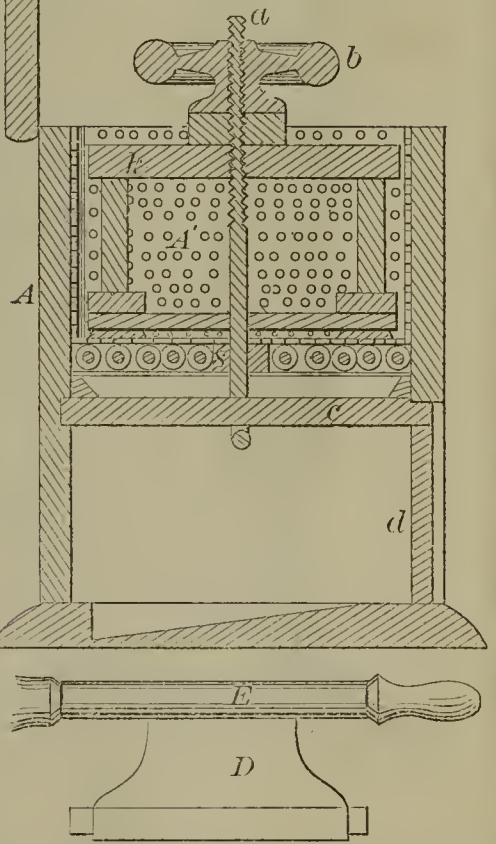

52203—J. Redlein—*Cider Mill.*

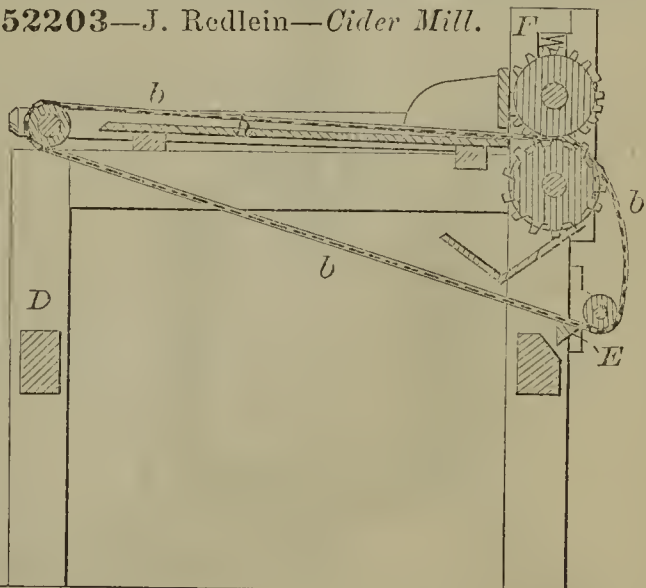

52204—Richardson & Hughes—  
Pump Filter.

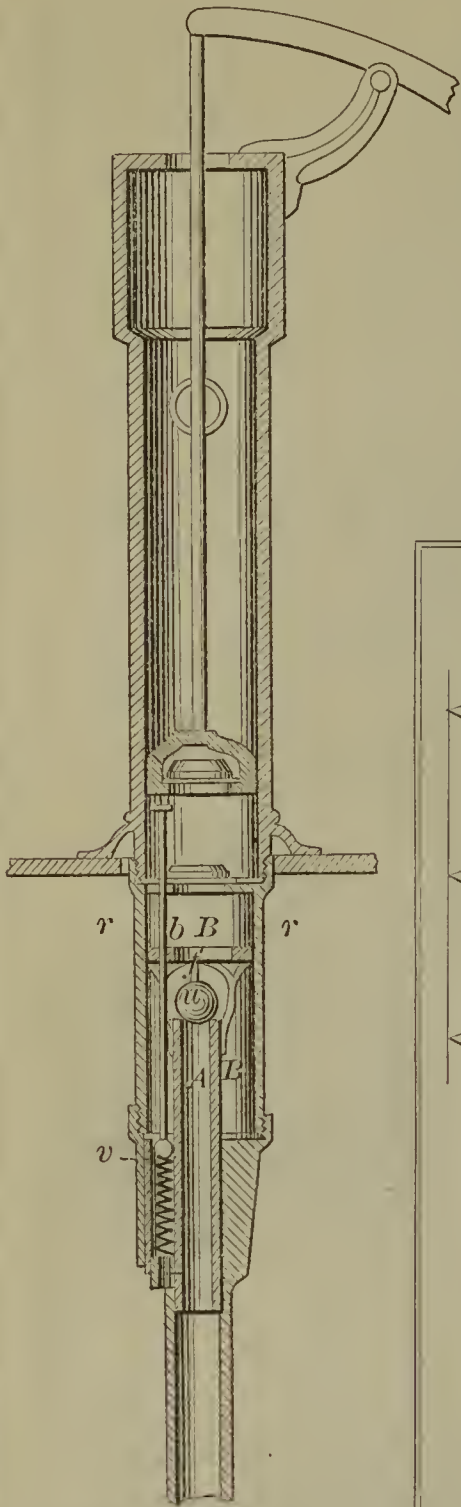

52207—T. L. Roberts—Mill for Grinding Sugar Cane.

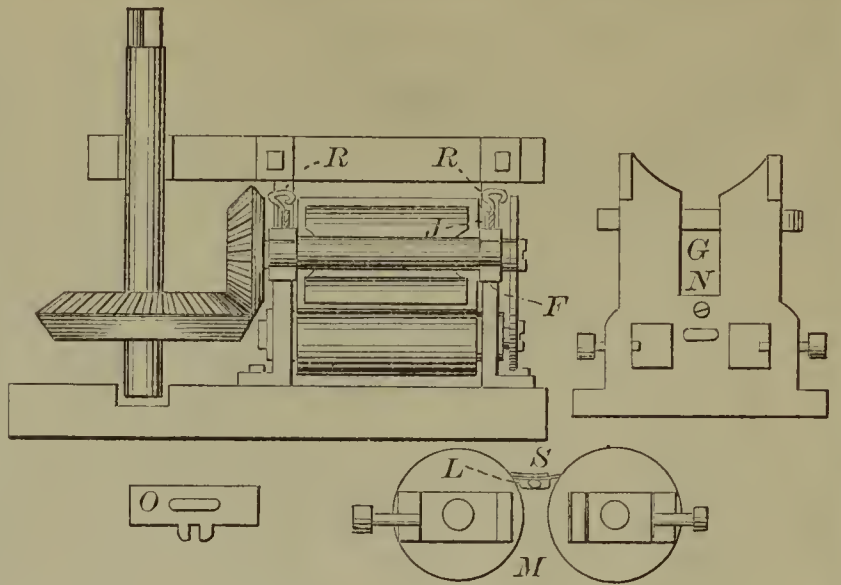

52205—D. T. Rickey—Grape Trellis.

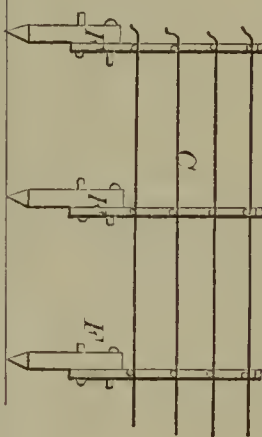

52206—A. K. Rider—Steam Blower.

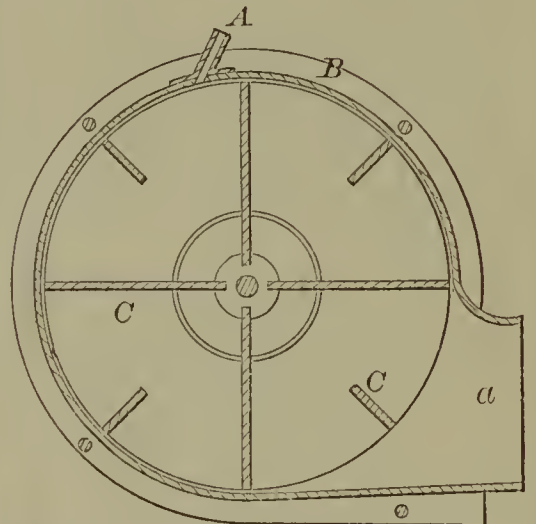

52209—O. Rotton—Obtaining Oil from Wells.

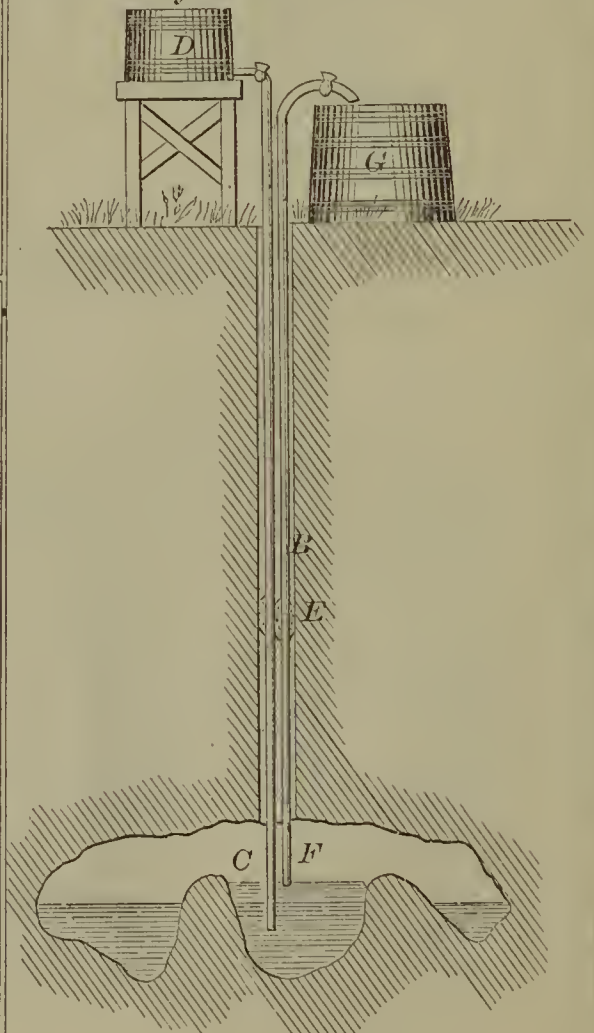

52208—J. Robertson—Wine Press.

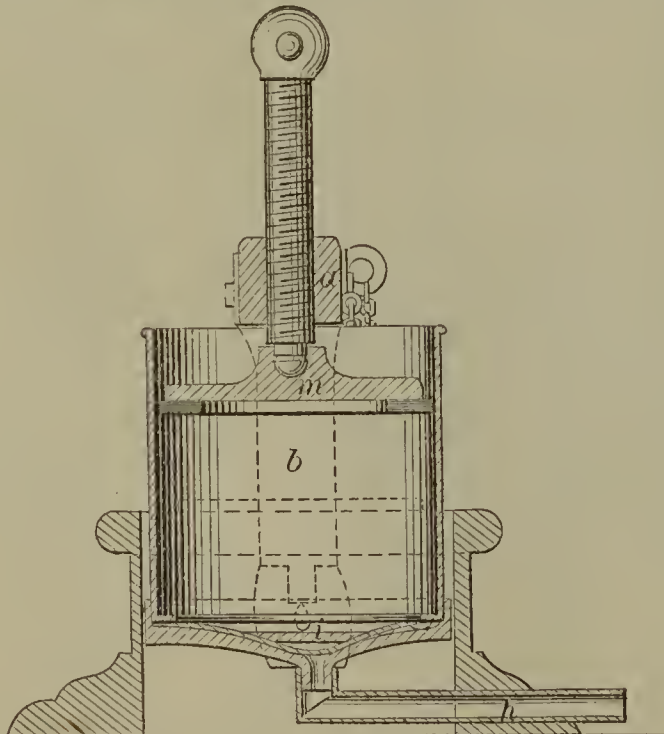

52210—J. Ryan—Hydraulic Jack.

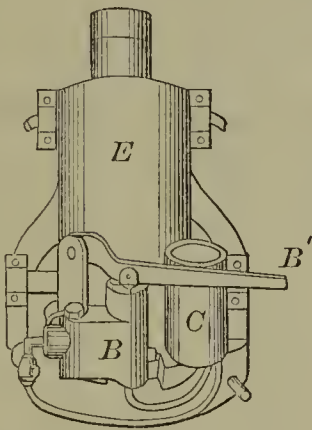
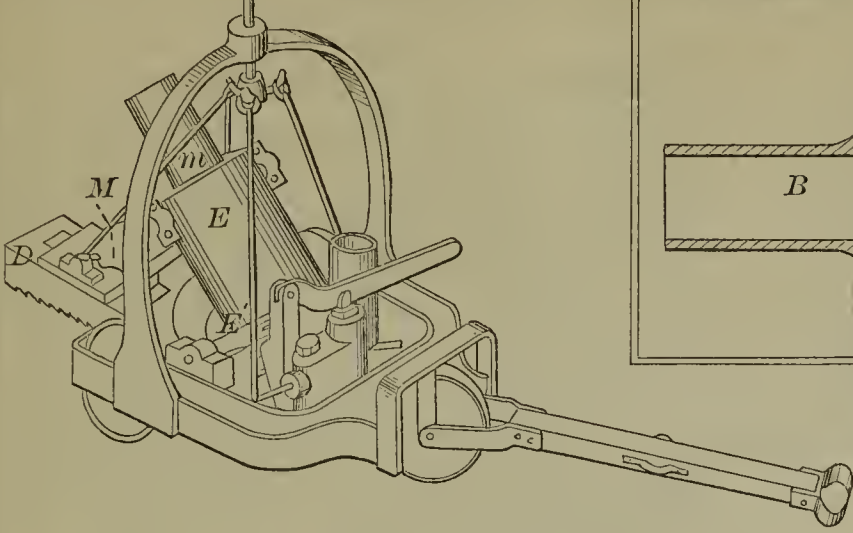

52214—G. Shone—Pipe Coupling.

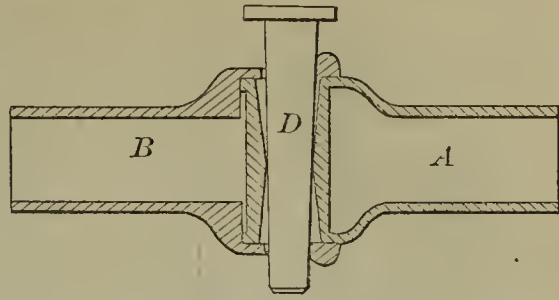

52211—C. C. Schmitt—Step Ladder.

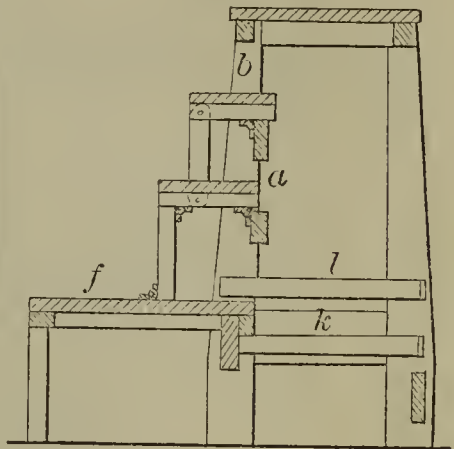

52213—T. N. Sherwood—Cultivator.

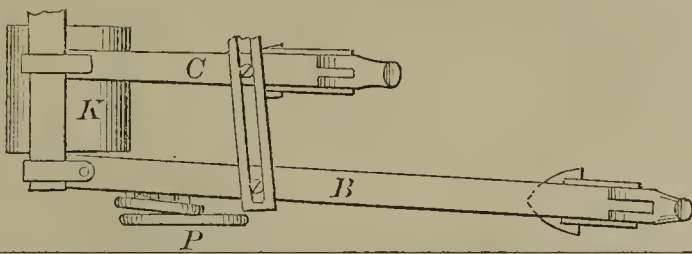
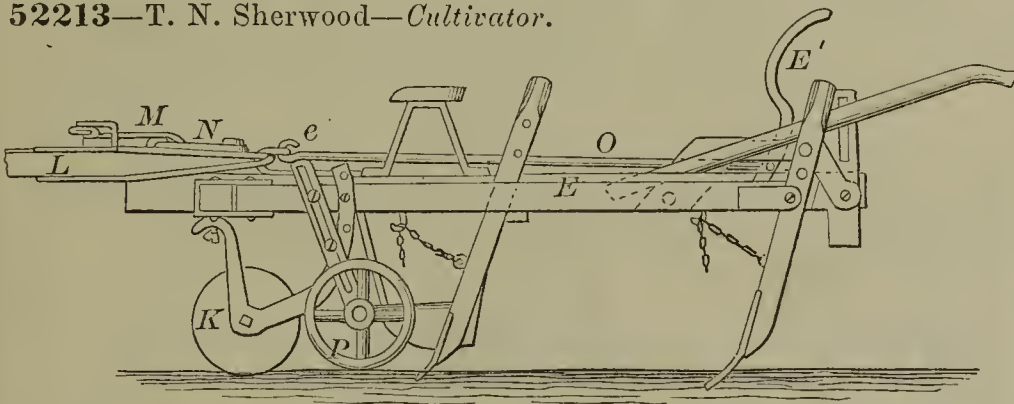

52212—Sennett & Essex—Skate.



52215—J. H. Silkman—Wood Splitting Machine.

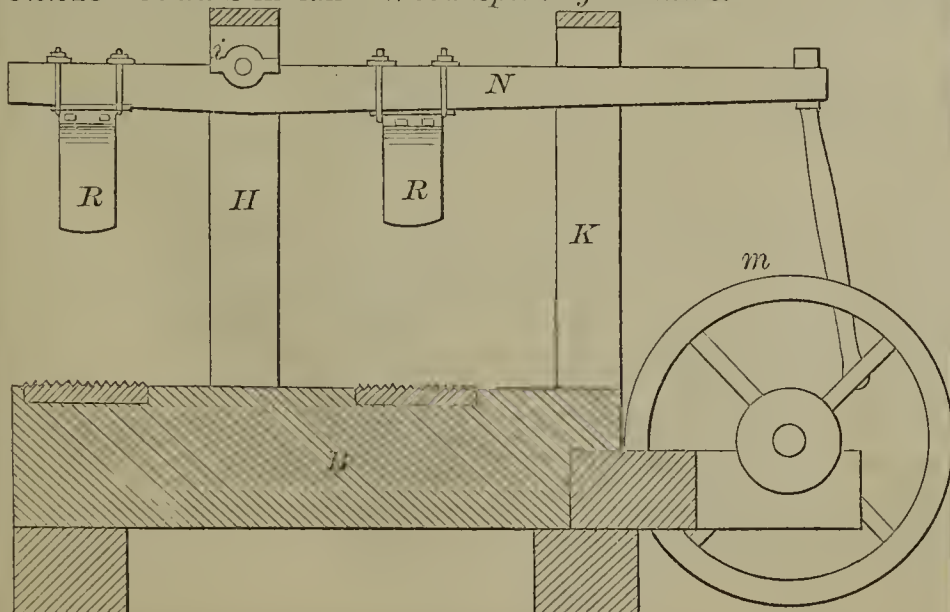

52216—J. H. Silkman—Axe for Wood Splitting Machines.

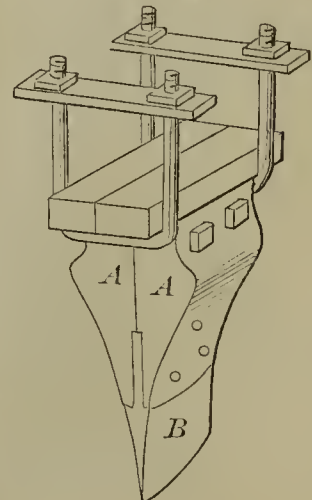

52219—H. B. Smith—Tenoning Machine.

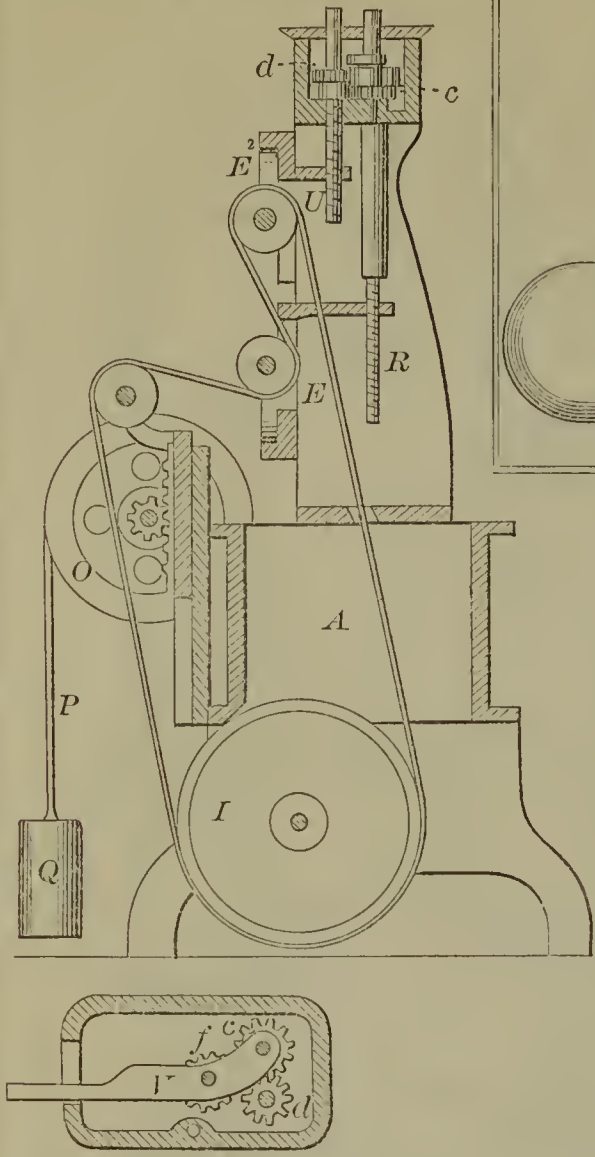

52217—J. B. Skinner—Cultivator.

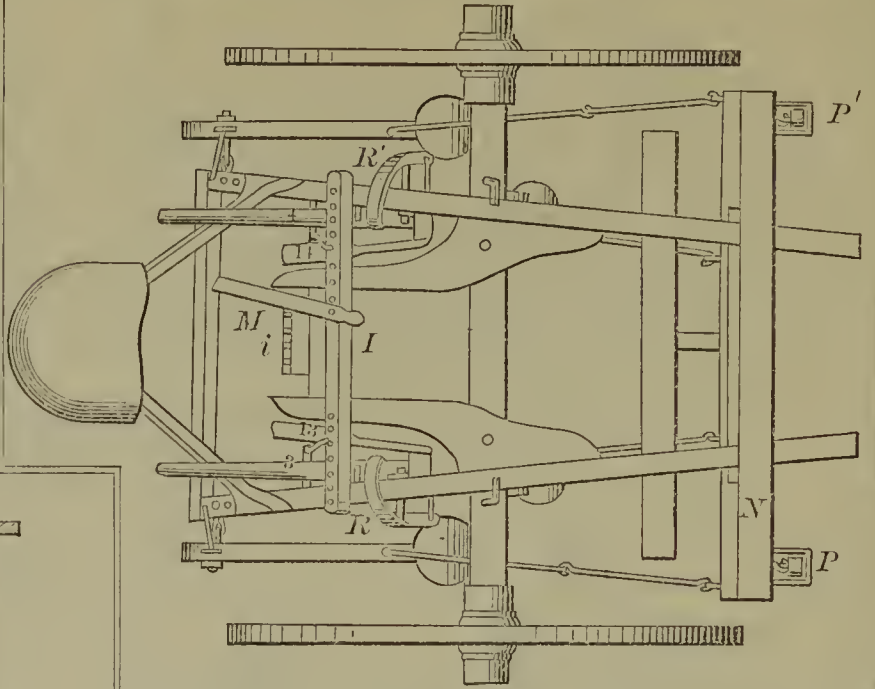

52218—E. Smith—Saw Set.

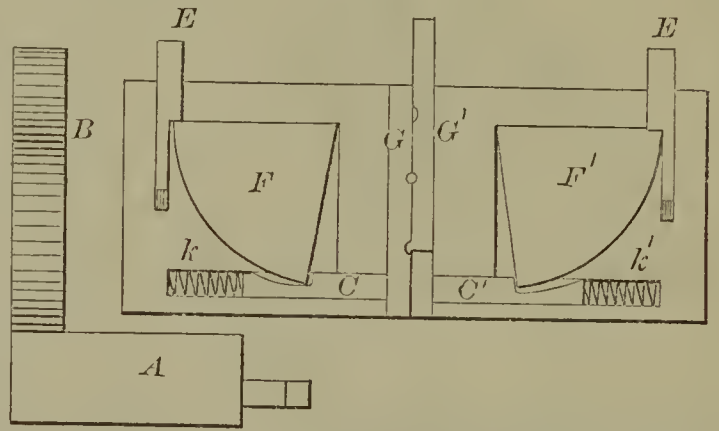

52221—R. Stewart—Cut-off Valve.

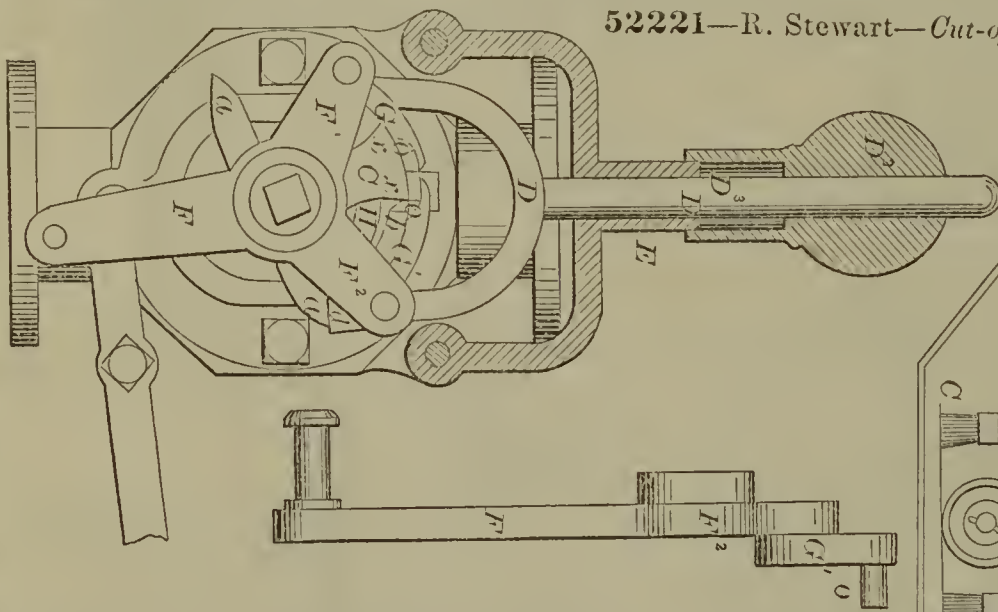

52220—W. S. Smyth—Scrubbing Machine.

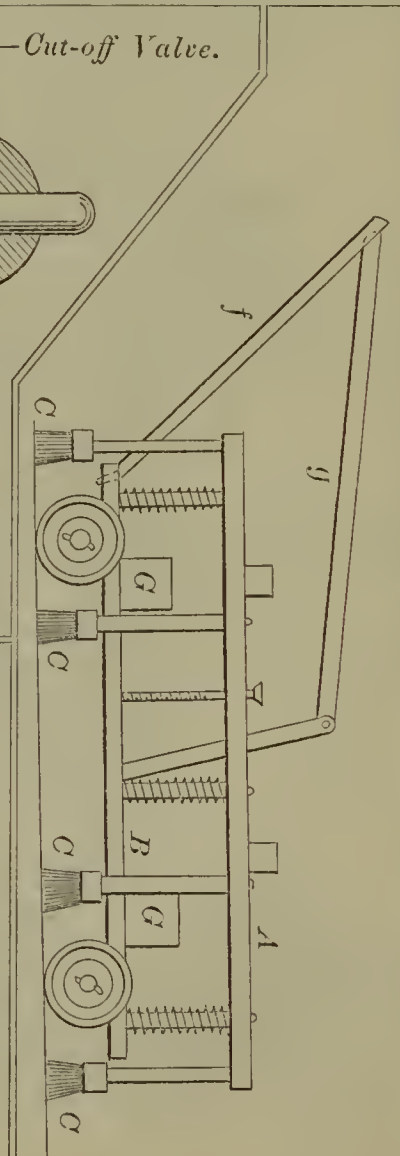

52222—L. Strickland—Cultivator Plow.

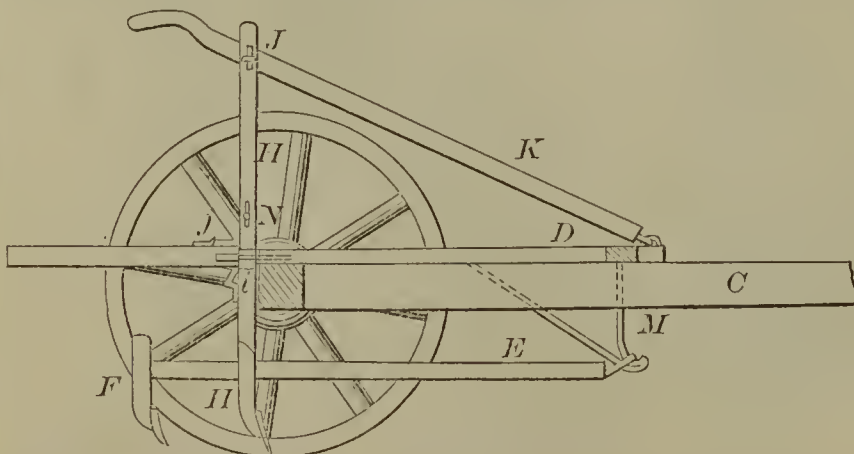



52223—M. A. Sunderland—*For Cutting Oil Cloth.*

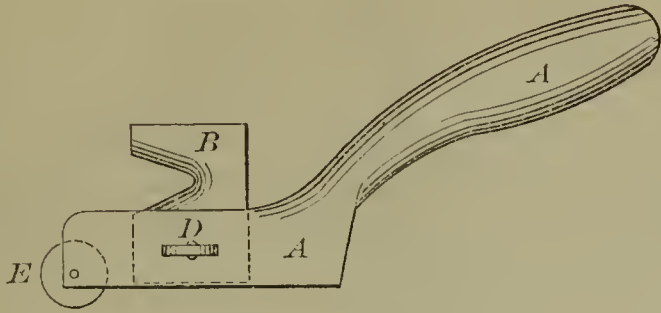

52227—A. Wadsworth—*Watch.*

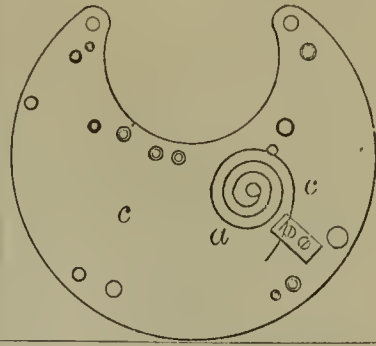

52224—F. Swatzel—*Water Wheel.*

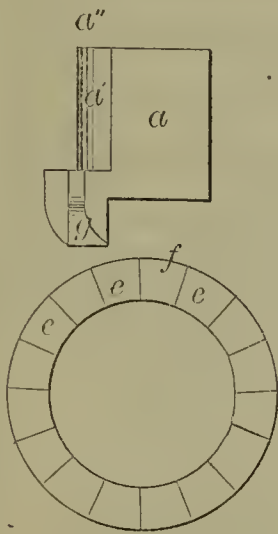

52225—J. Tedford—*Seed Drill.*

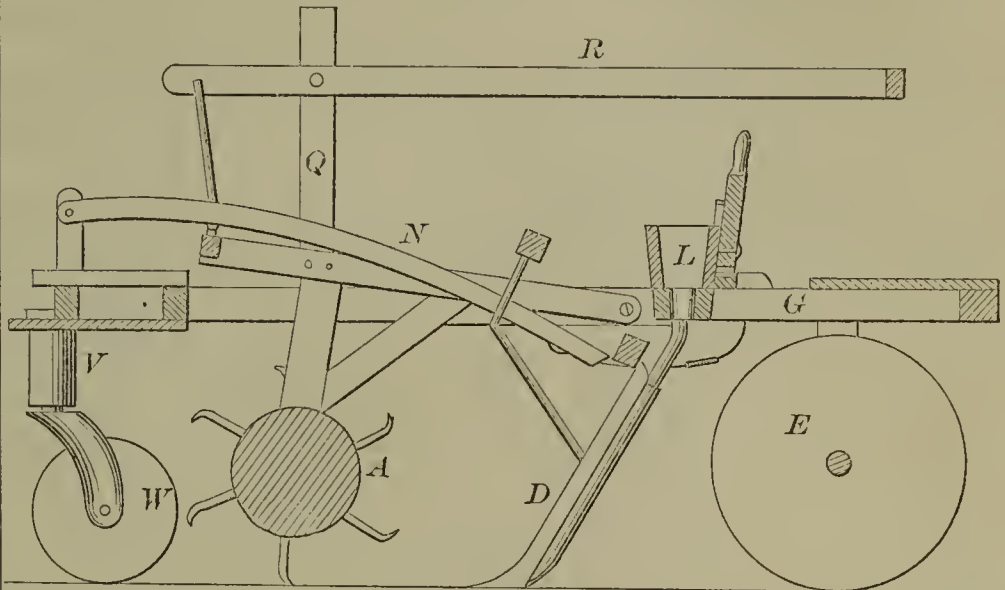

52226—C. F. Toll—*Lock.*

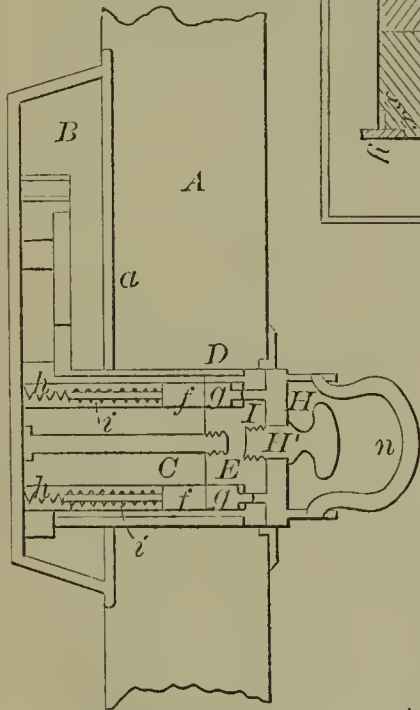

52228—S. Wales—*Window.*

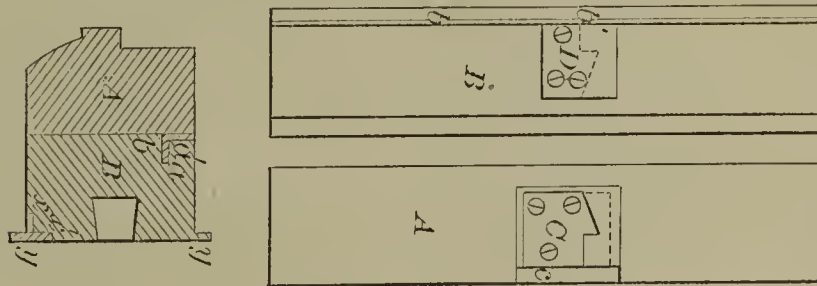

52229—R. Walker—*Carriage Seat.*

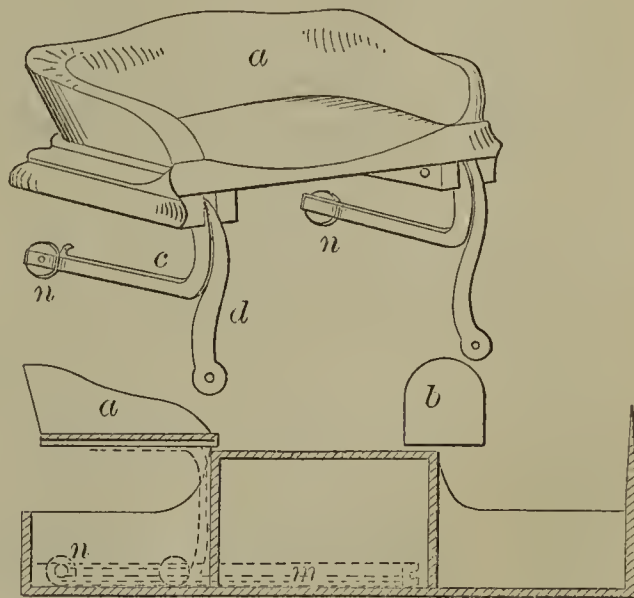

52230—S. Walker—*Self-Locking Tail Board.*

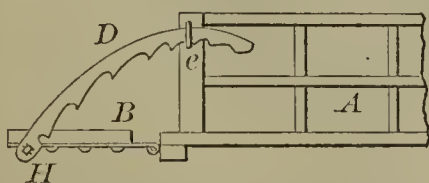

52231—B. F. Walton—*Lamp Wick.*



52232—J. Watt—Steam Hammer.

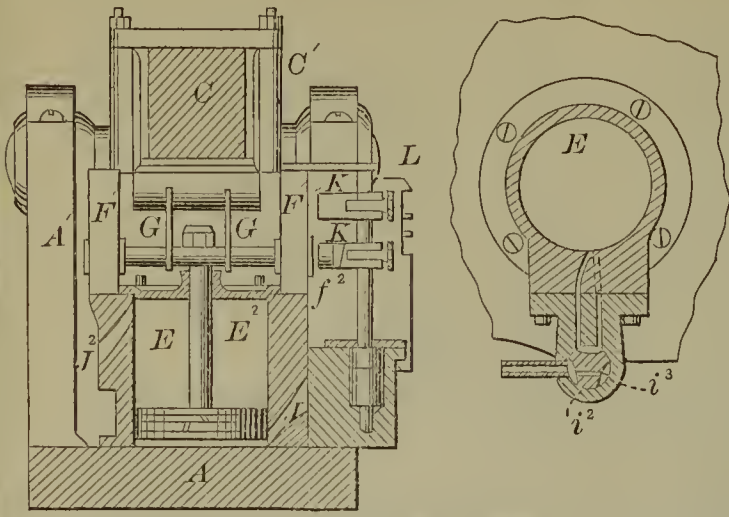

52235—J. G. Whitlock—Steam Oven.

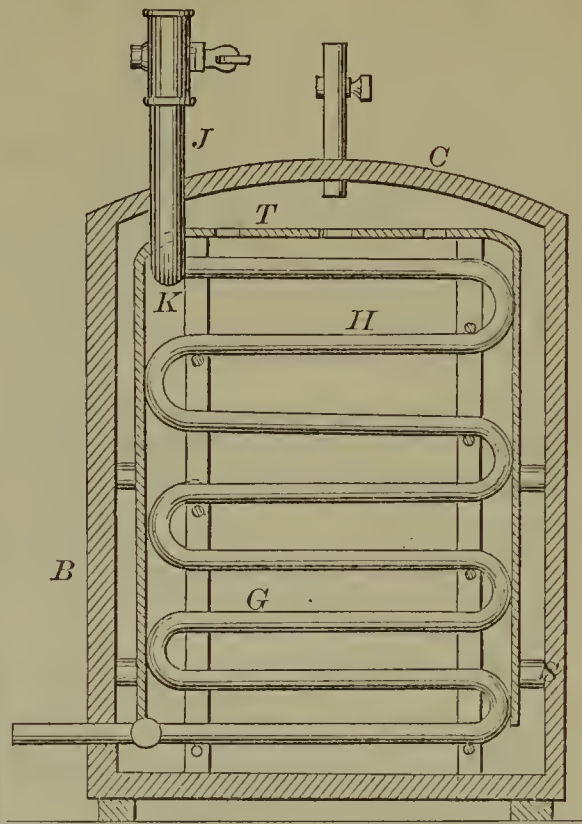

52234—J. Wentz—Stencil Plate.

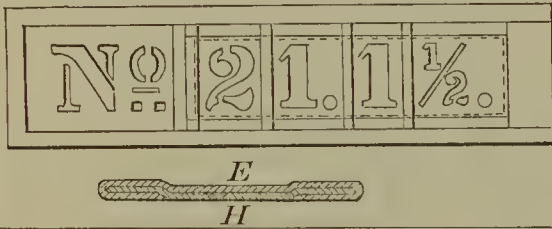

52236—C. Whittier—Furnace Grate.

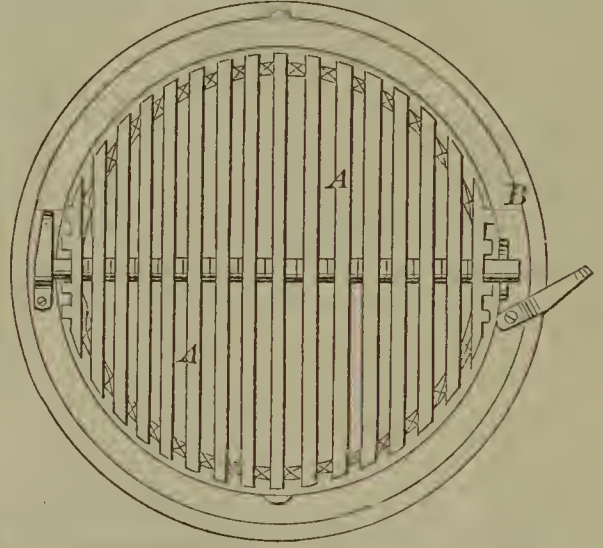

52238—J. P. Worrall—Branding Tool.

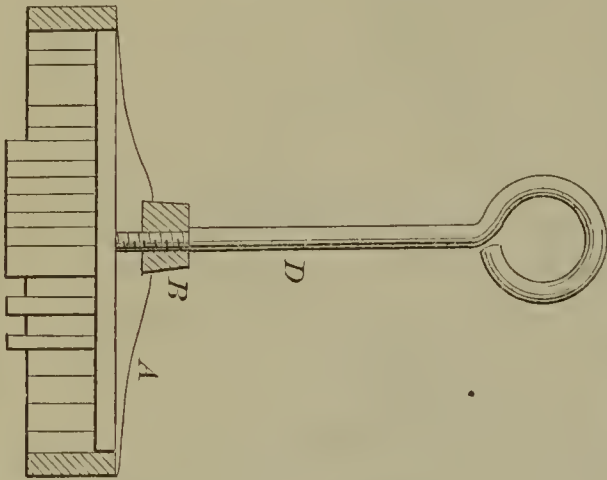

52233—M. D. Wells—Harrow.

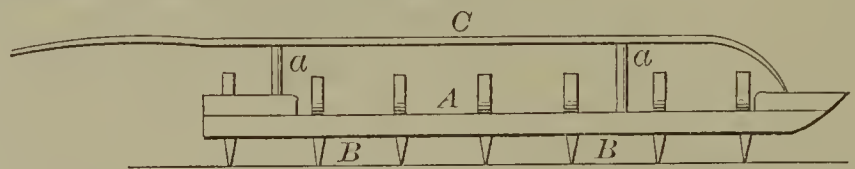

52239—N. Wright—Photographic Apparatus.

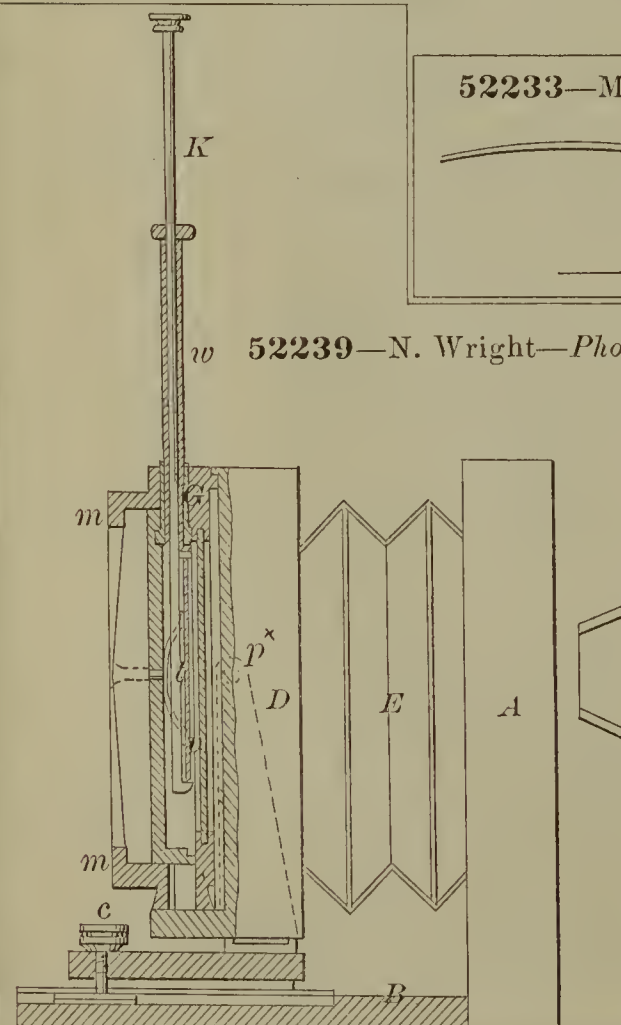

52237—H. B. Wolf—Sorghum Cane Stripper.

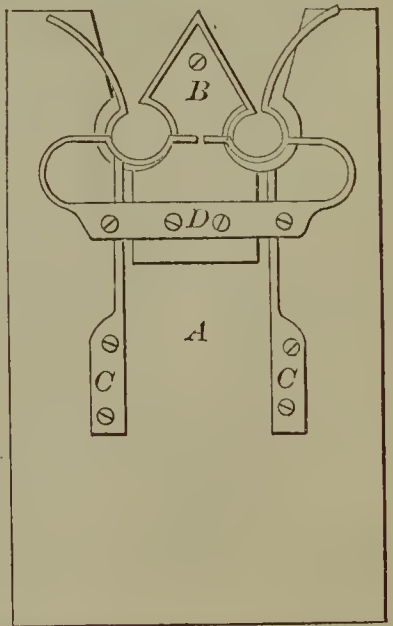

52240—S. W. Young—For Making Eyelet Blanks.

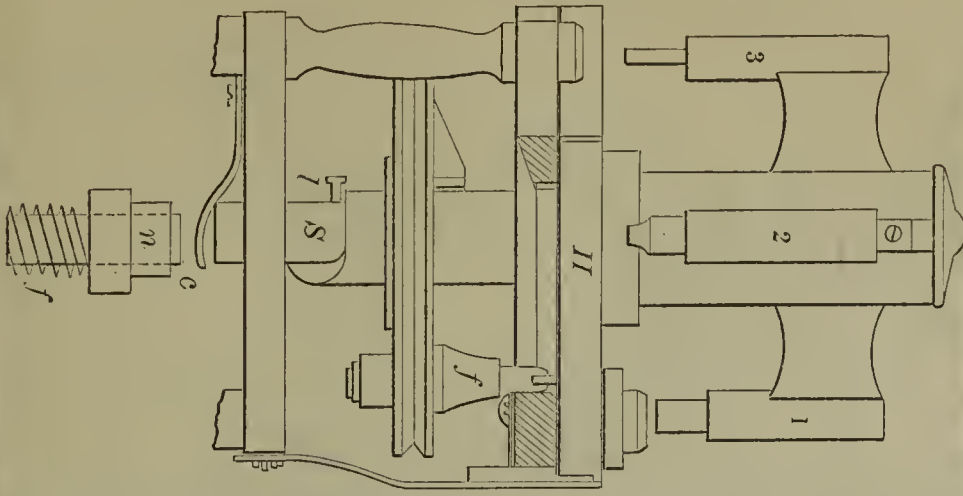

52243—C. H. Ford—Steam Generator.

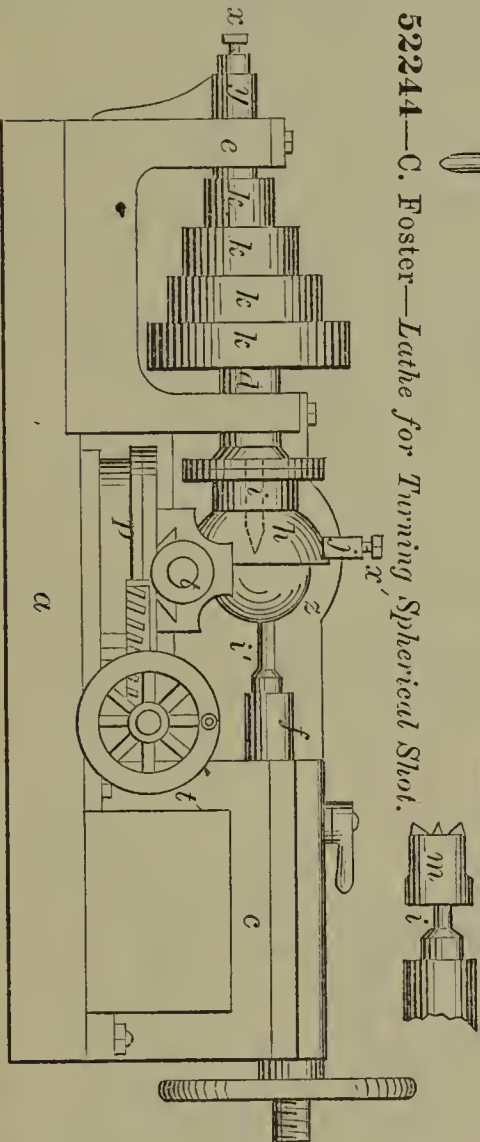
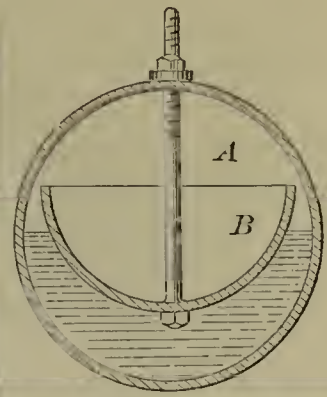

52244—C. Foster—Lathe for Turning Spherical Shot.

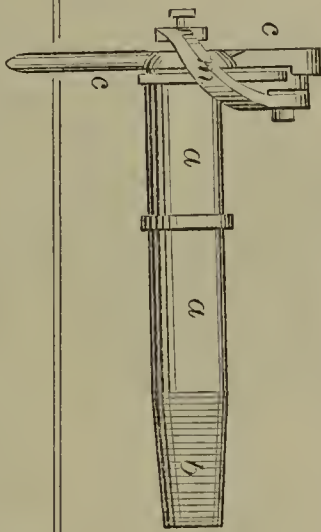

52241—H. D. Blake—Molasses Faucet.

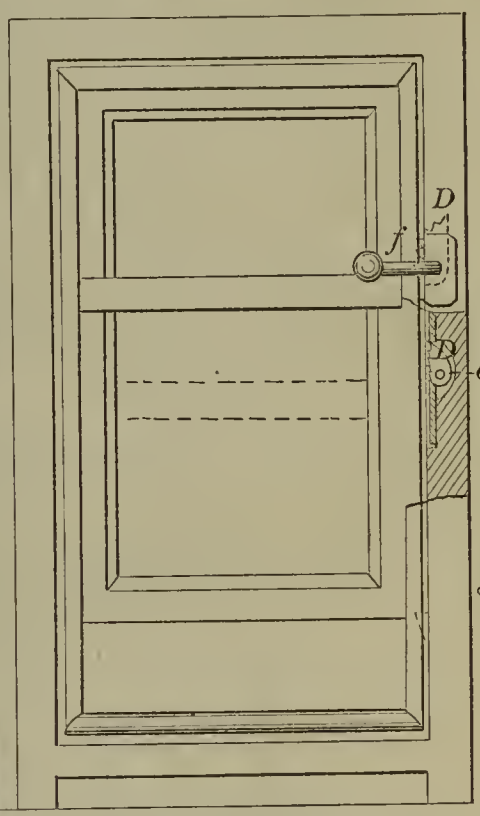

52242—I. B. Cottrell—Sash Fastening.

52245—J. Grant—Brick Machine.

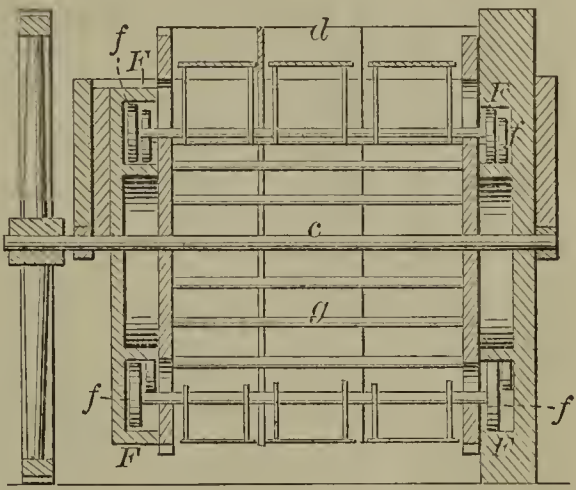

52246—A. J. Griffin—Hydro-Carbon Stove.

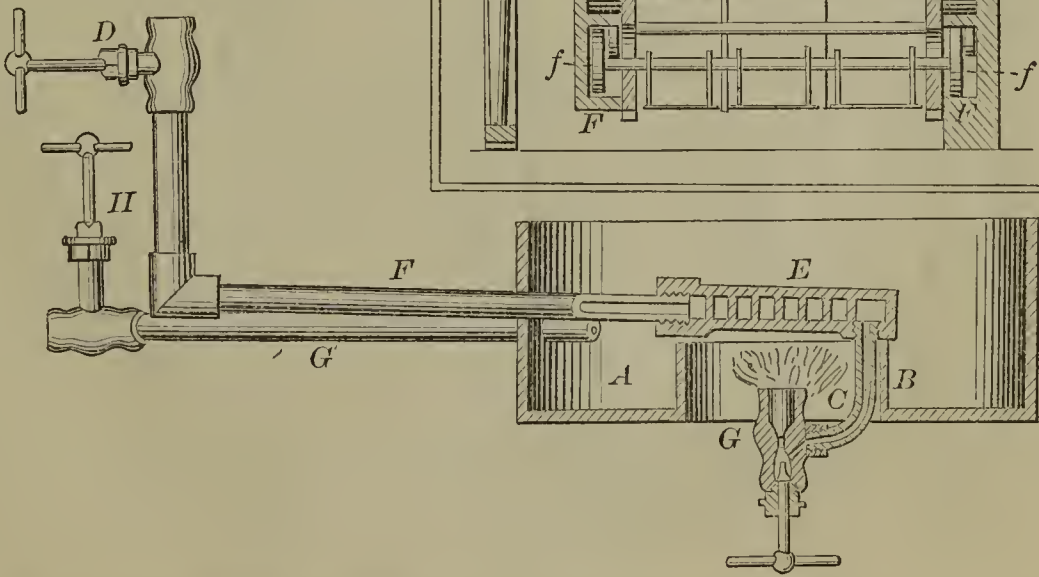

52247—F. H. Higgins—Screw Cutting Chuck.

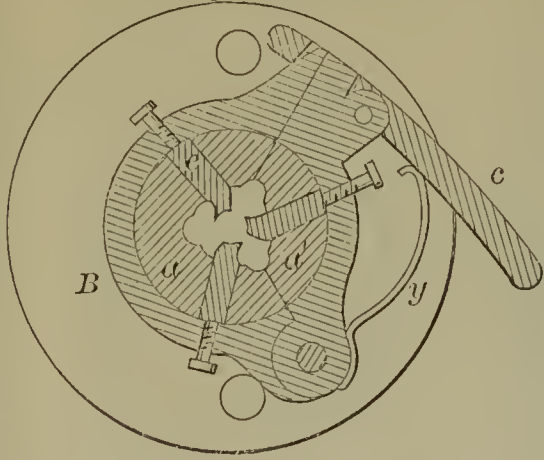

52248—H. S. Josselyn—Revolving Fire Arm.

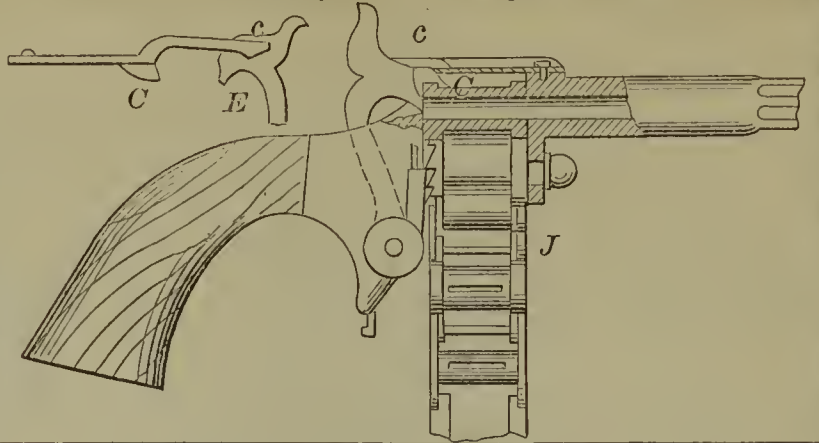

52251—J. Taggart—For Slivering Wood.

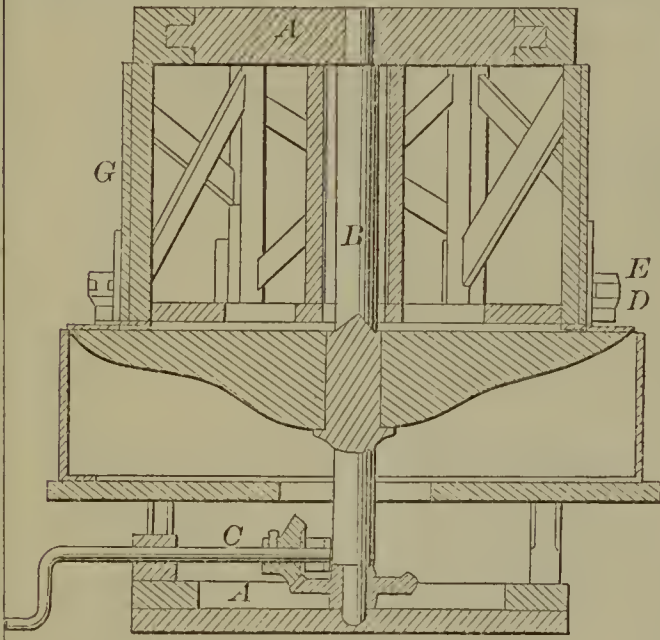

52252—Howard & Dangleish—For Making Aerated Bread.

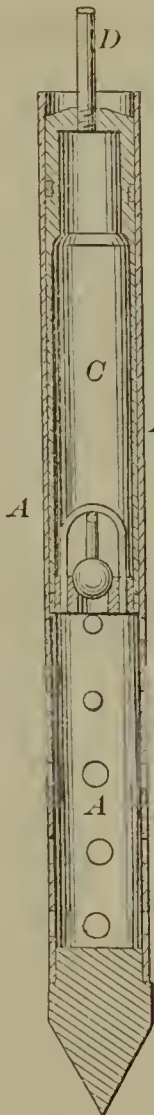
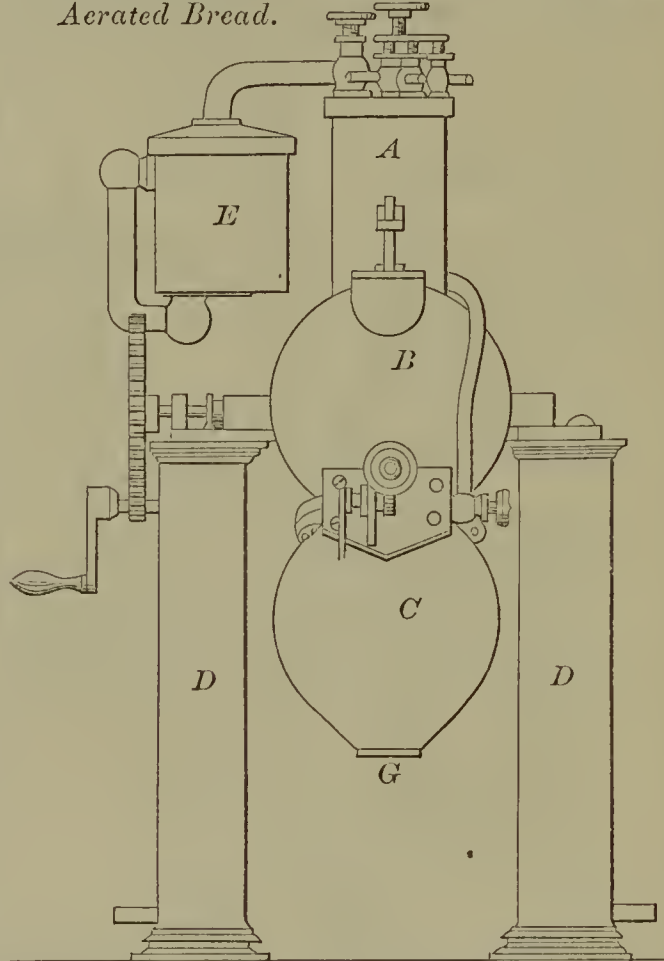

52249—M. V. Nobles—Mode of Sinking Tubular Wells.

52253—J. Miller—For Making Extracts.

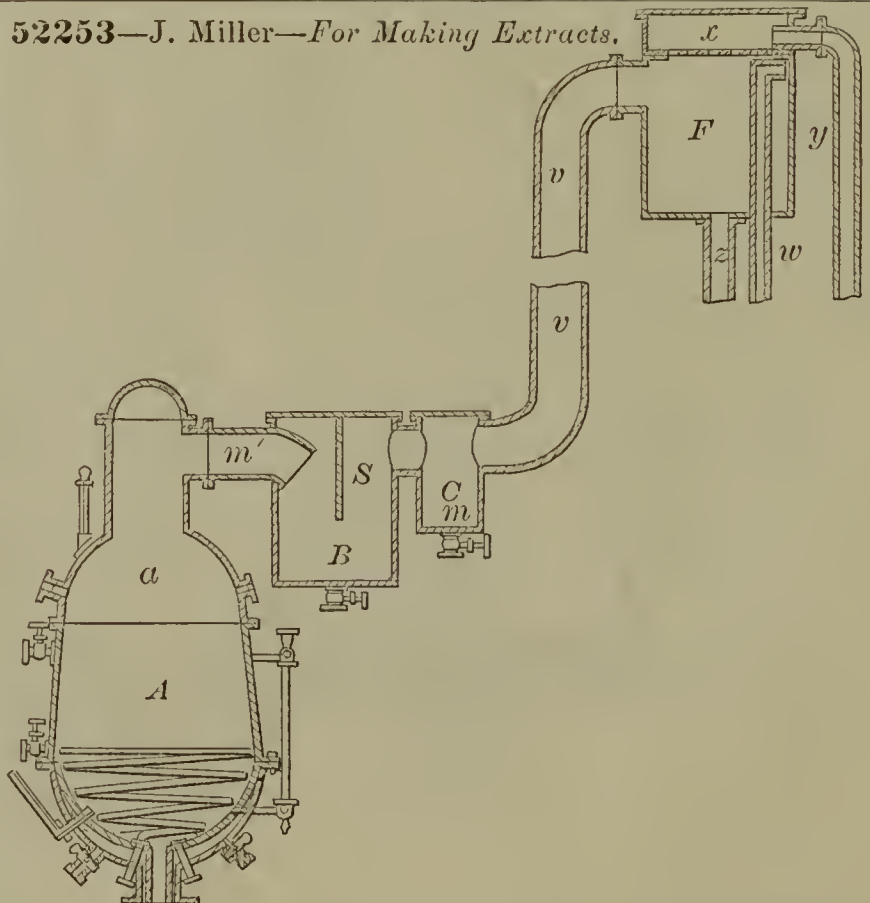

52254—Alden & Mackay—Setting and Distributing Types.

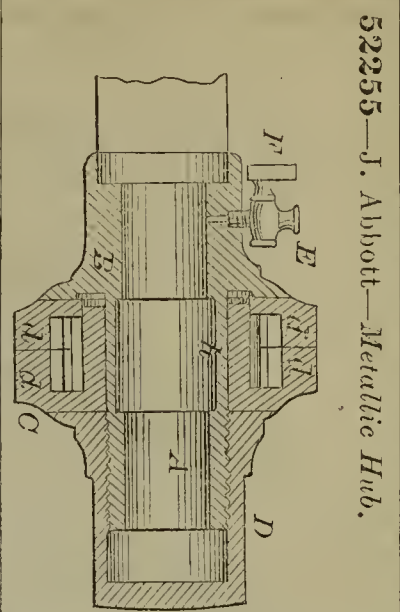
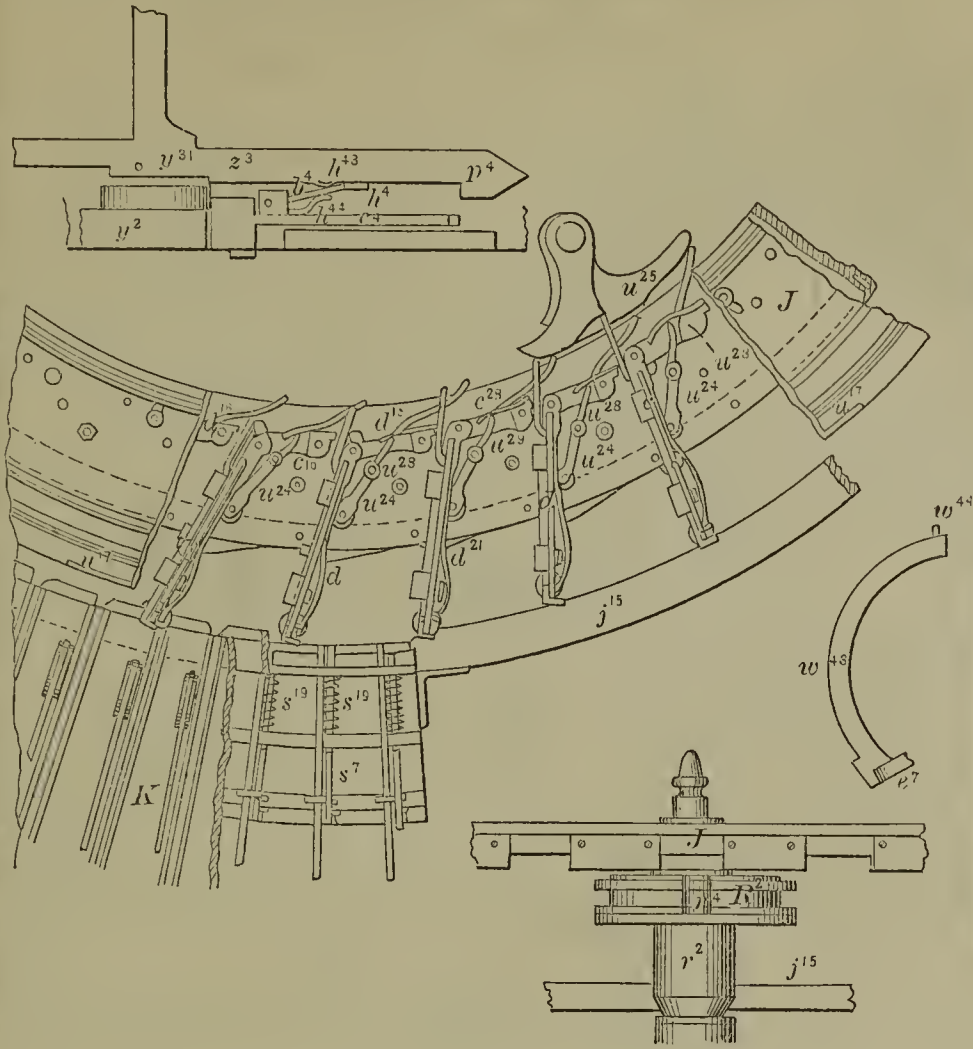

52255—J. Abbott—Metallic Hub.

52257—W. B. Bartram—Furniture Casters.

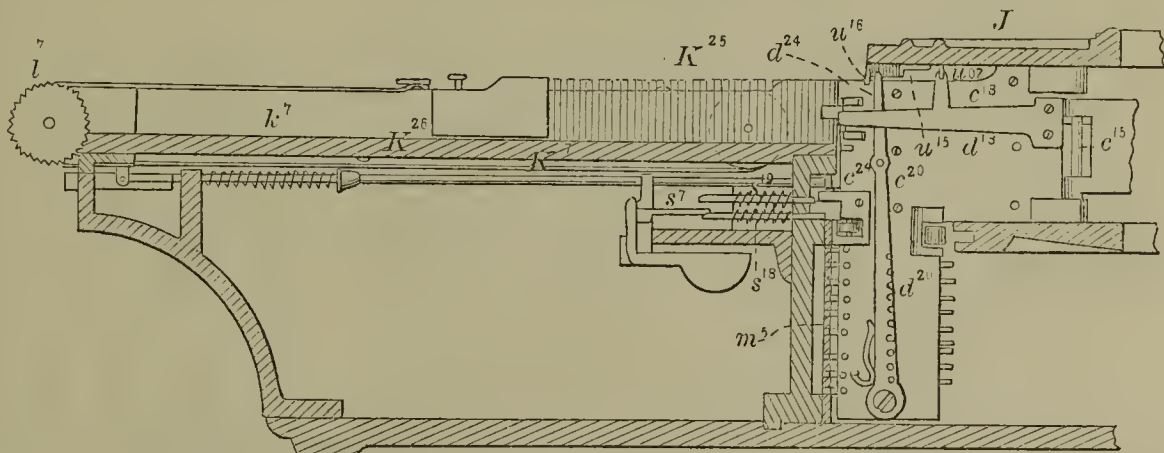
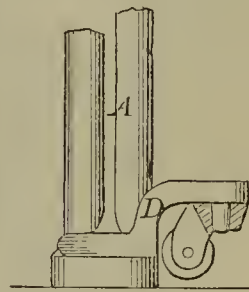

52259—M. Bell—Water Wheel.

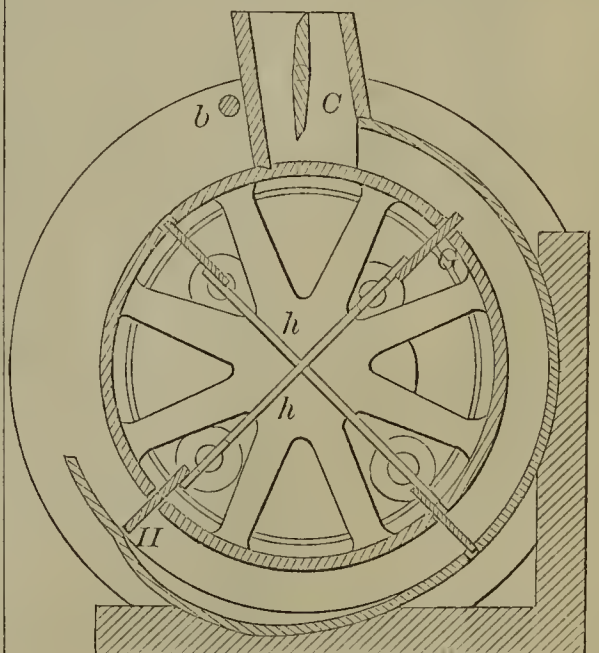

52258—F. Beals—Breech-Loading Fire Arm.

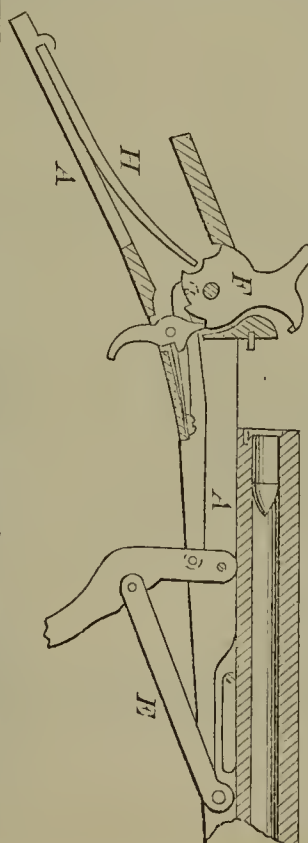

52256—J. M. Armour—Knitting Machine Needle.

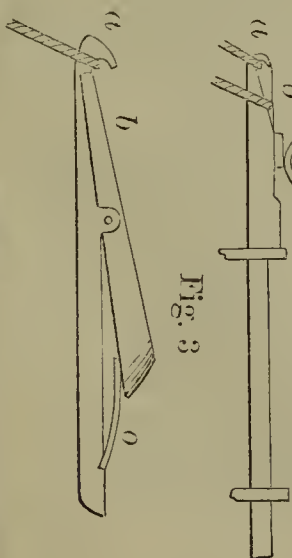

52260—G. & W. Bench—*Reach for Lumber Wagons.*

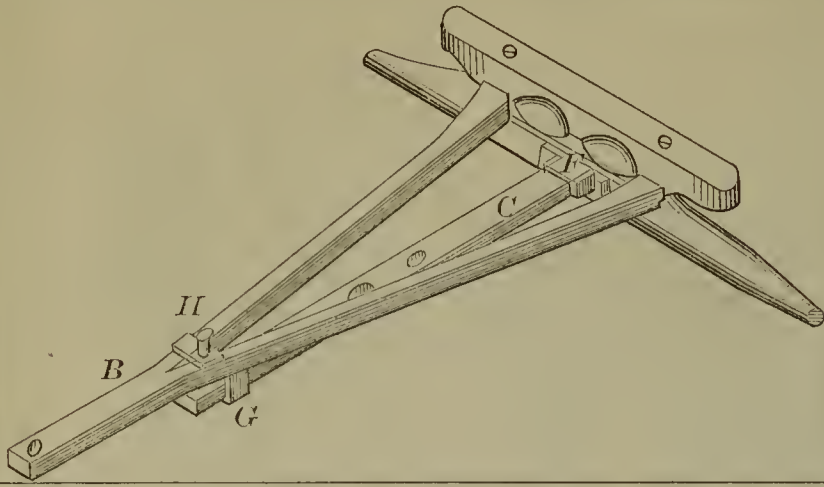

52261—H. R. Bodine—*For Making Pottery Ware.*

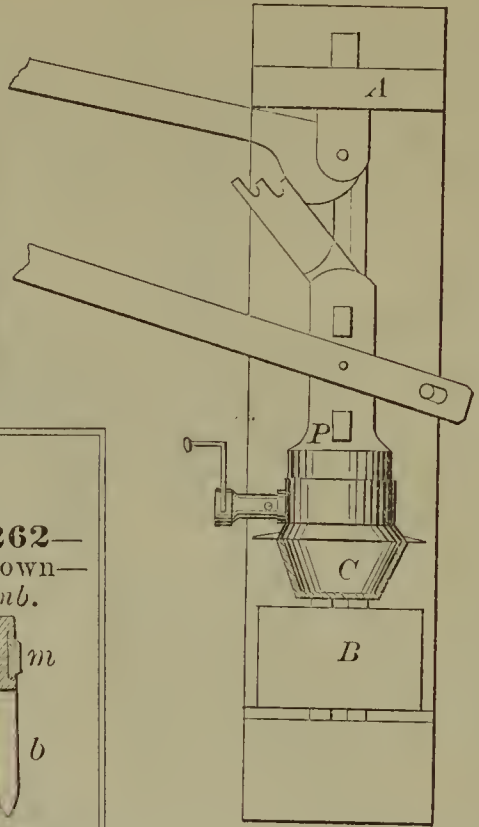

52264—W. H. Burkhart—*Harvesting Machine.*

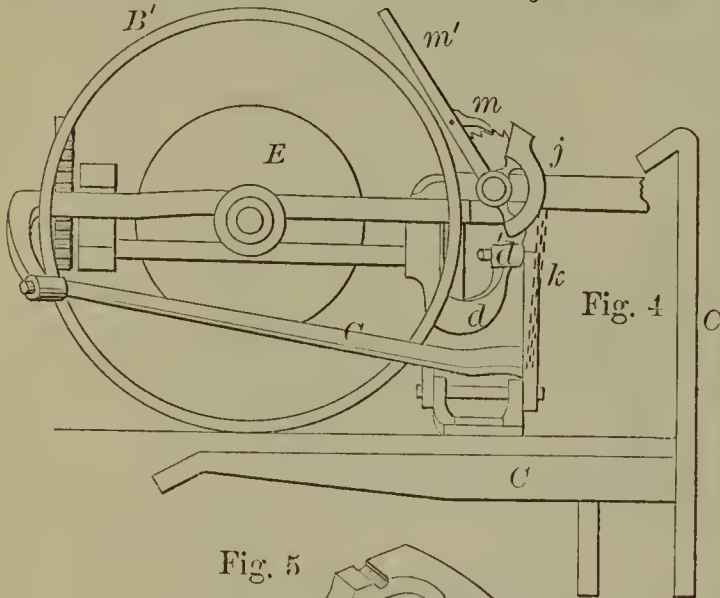

52262—E. Brown—*Comb.*



52266—G. G. Carver—*Flour Sifter and Measure.*

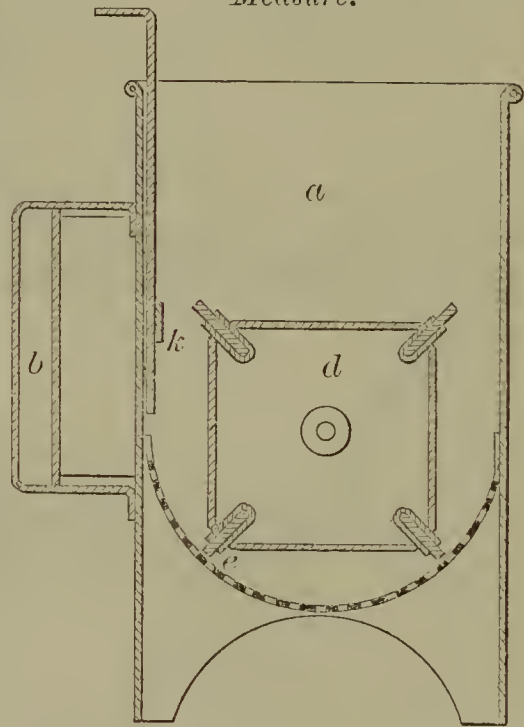
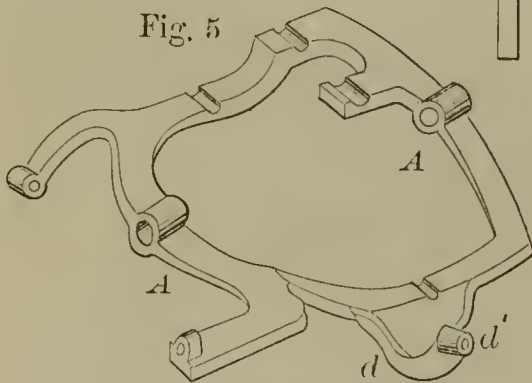
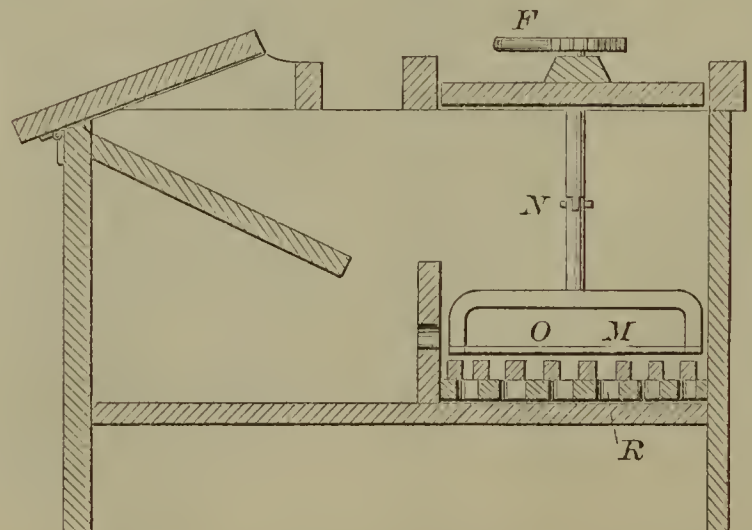

Fig. 5



52265—C. G. Campbell—*Washing Machine.*



52267—M. C. Chamberlin—*Earth Borer.*

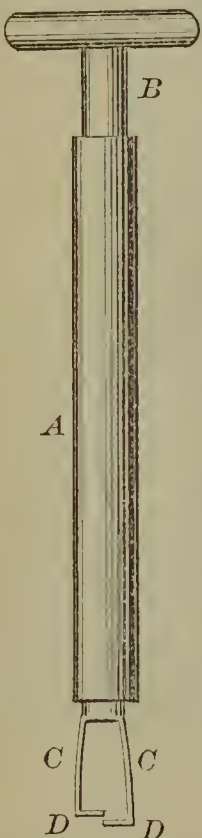

52263—H. Buck—*Broom Head.*

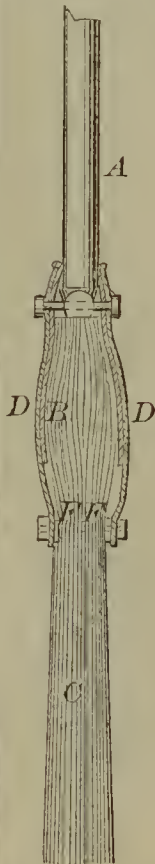

52268—N. Chapman—Churn.

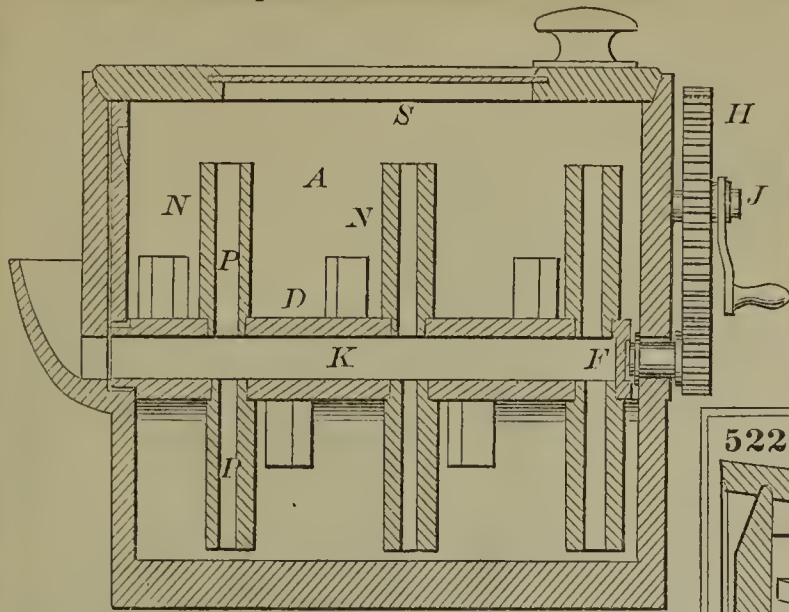

52269—R. S. Connelly—Bottle Stopper.

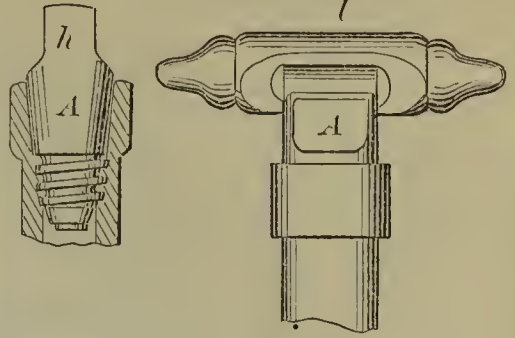

52270—J. E. Crane—Screen for Wool Dryer.

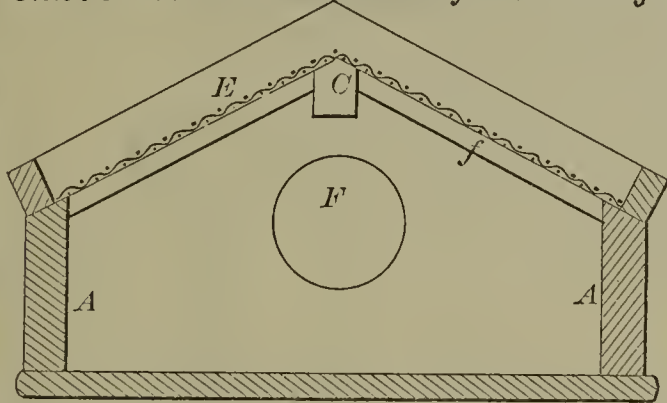

52272—J. Dodder—Churn.

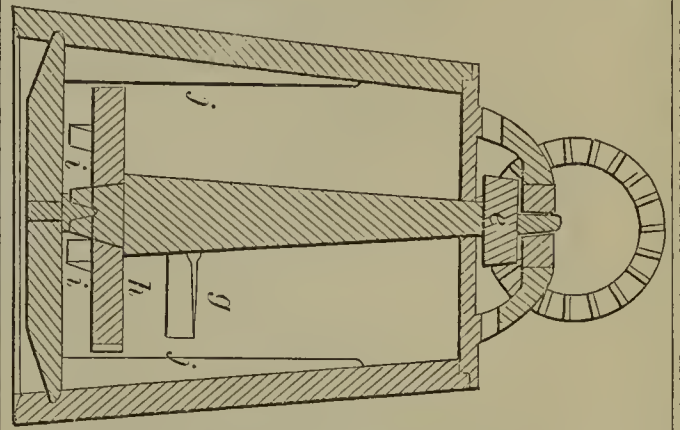

52273—W. M., E. P. & E. Doty—Washing Machine and Churn Power

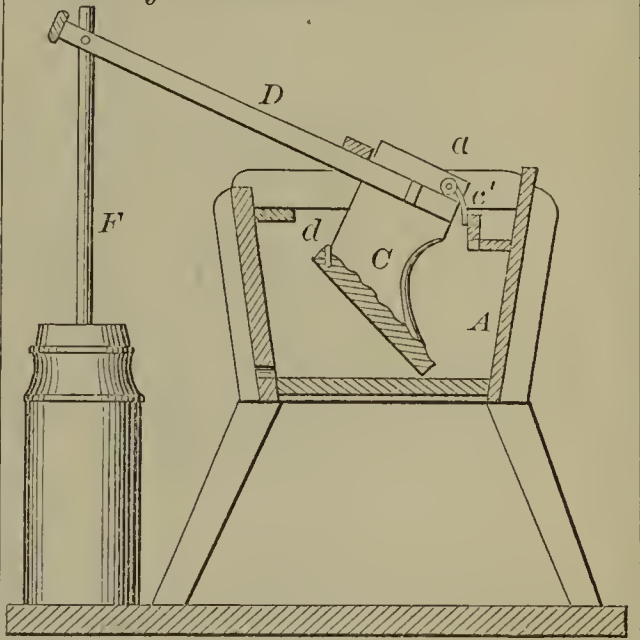

52271—J. Crowner—Stump Extractor.

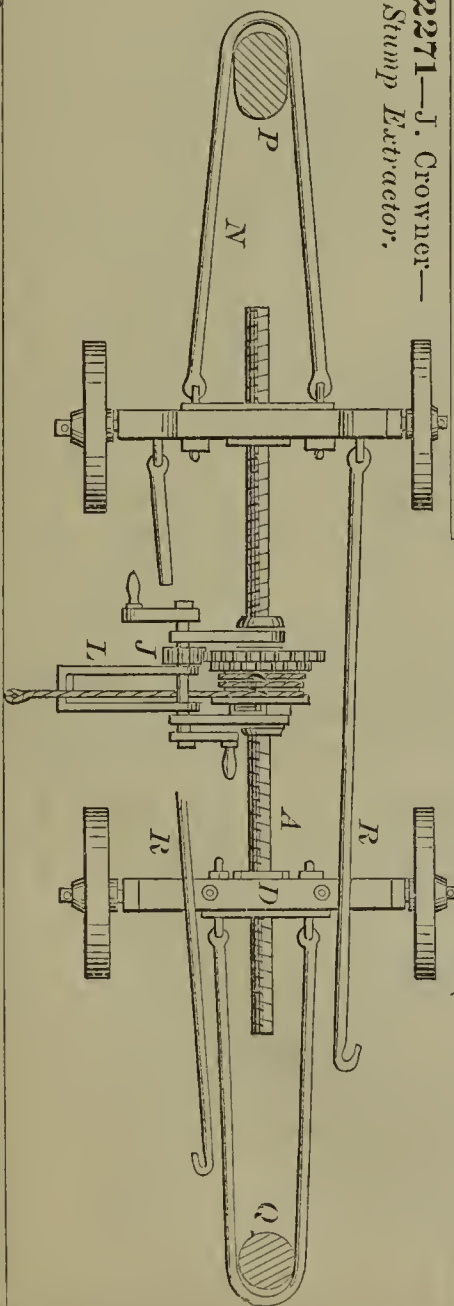

52274—A. D. Drew—Cutting Gaiter.

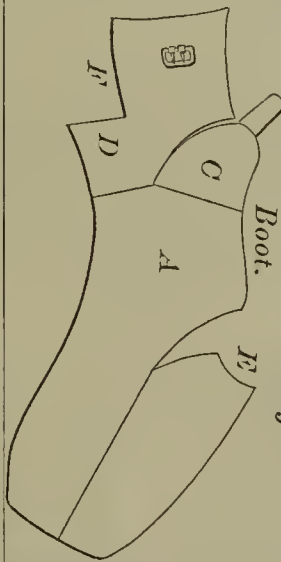

52275—S. R. Drummer—Beater Press.

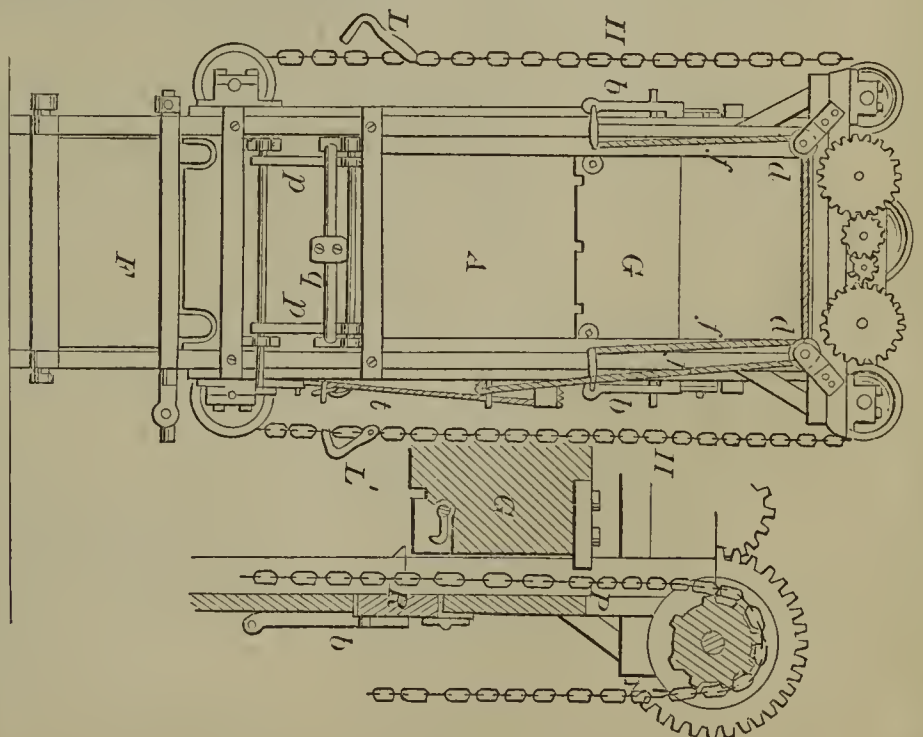

52276—E. F. Dunaway—Wiring Blind Slats.

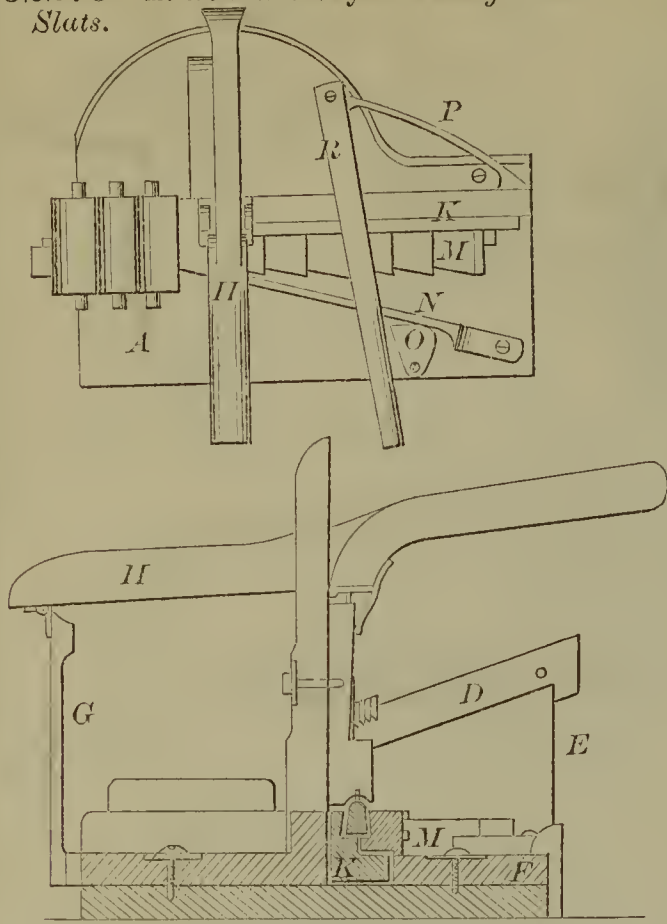

52278—A. Exton—Biscuit Machine.

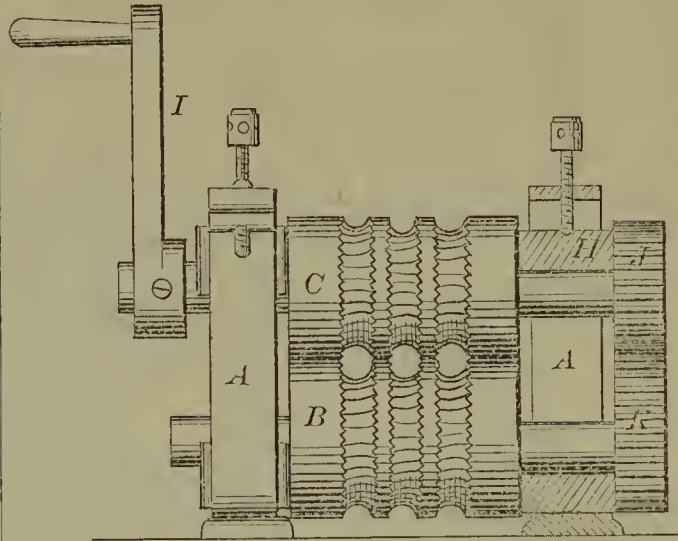

52281—M. C. Floyd—Corn Planter.

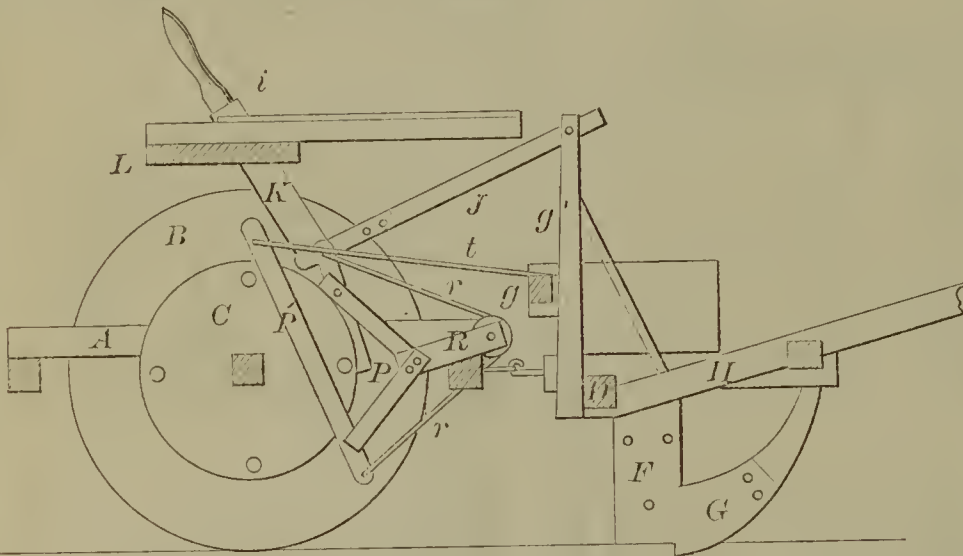

52279—J. Fasig—Hay and Pruning Knife.

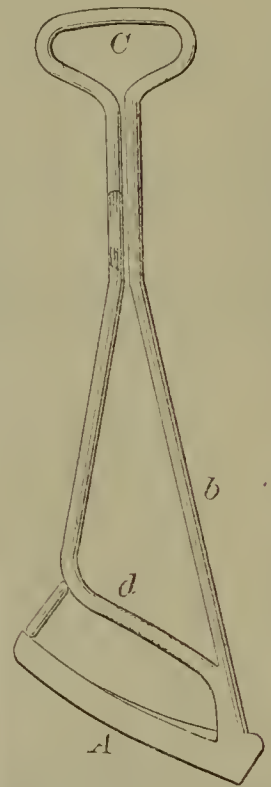

52280—W. N. Flagg—Shank Luster.

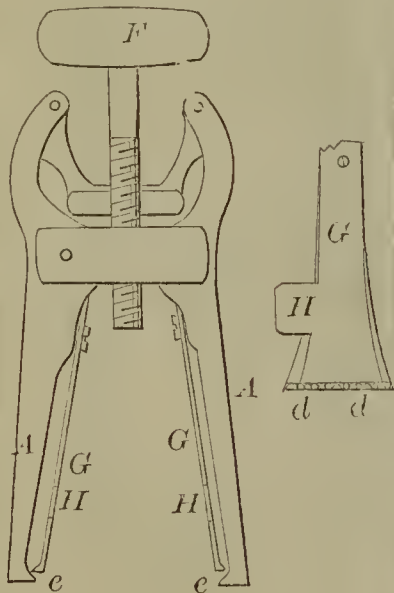

52277—S. B. Ellithorp—Refrigerator.

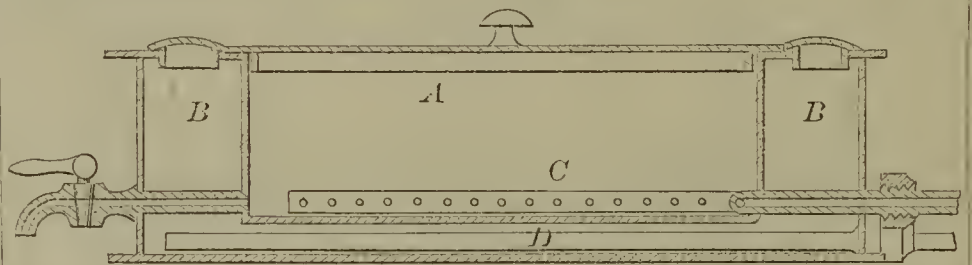

52282—N. Gabel—Corn Stalk Cutter and Stripper.

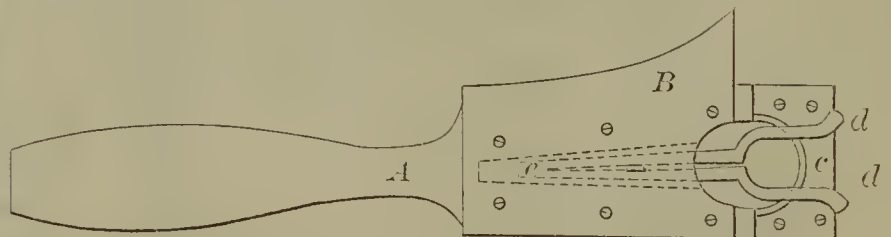



52283—H. P. Gengembre—For Extracting Oil, &c., from Minerals.

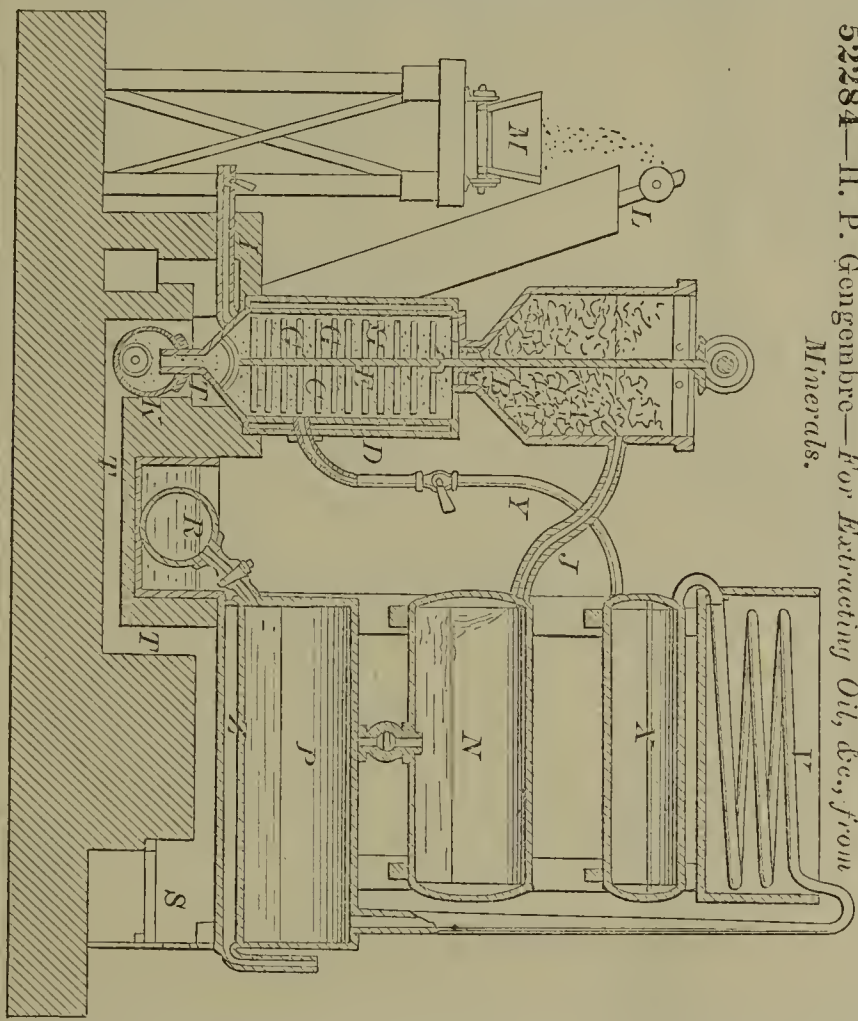
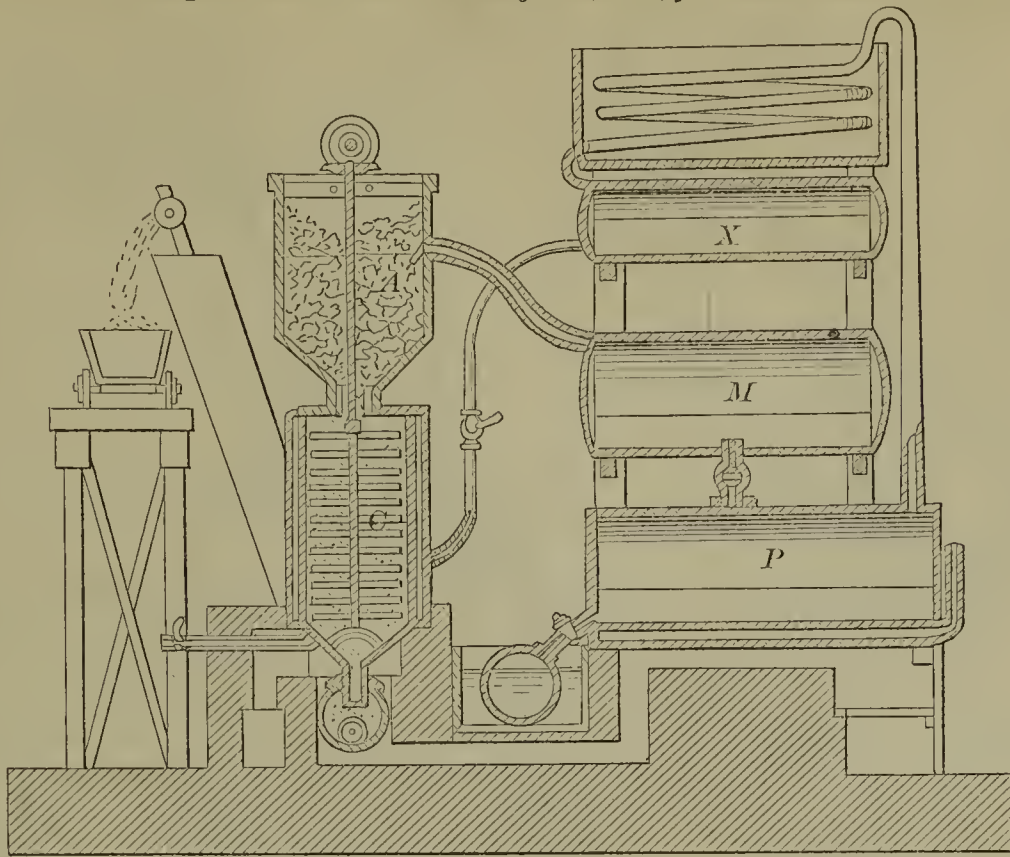

52284—H. P. Gengembre—For Extracting Oil, &c., from Minerals.

52285—W. H. Gilliam—Attaching Saws to Handles.

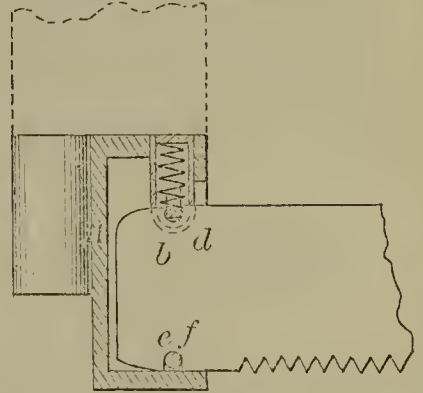

52286—V. D. Green—Balanced Slide Valve.

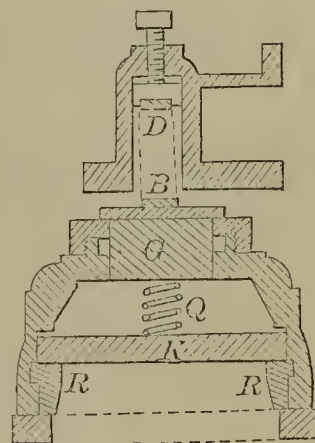

52287—J. H. Haven—Motive Power.

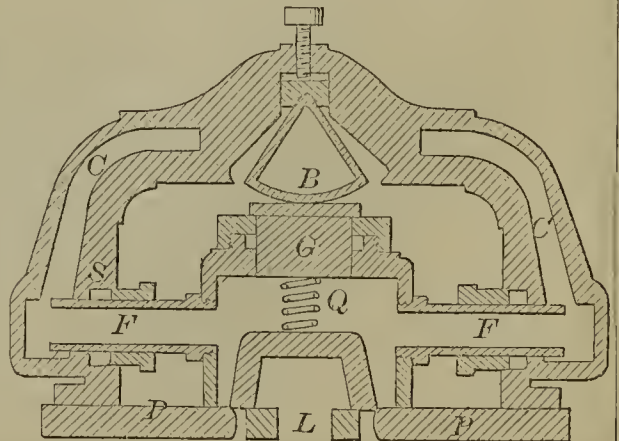
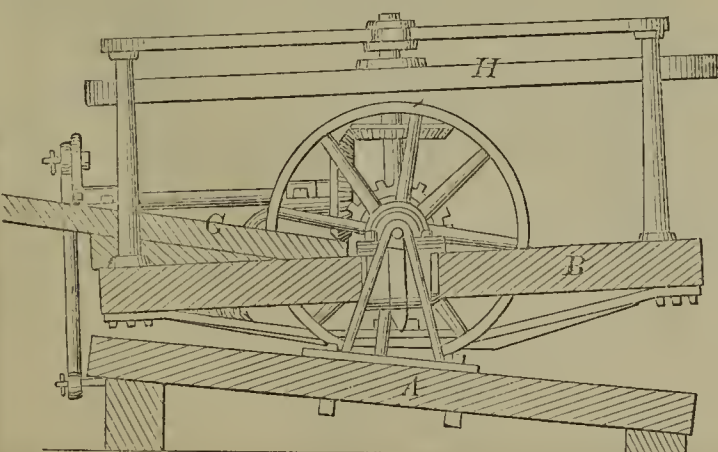

52288—Hills & Woodruff—*Bag Holder.*

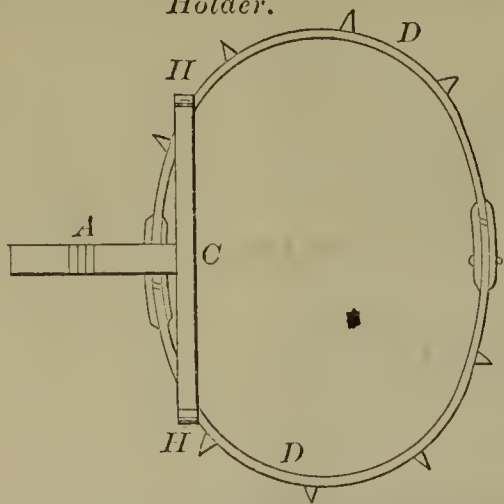

52292—H. Jung—*Rock Drill.*

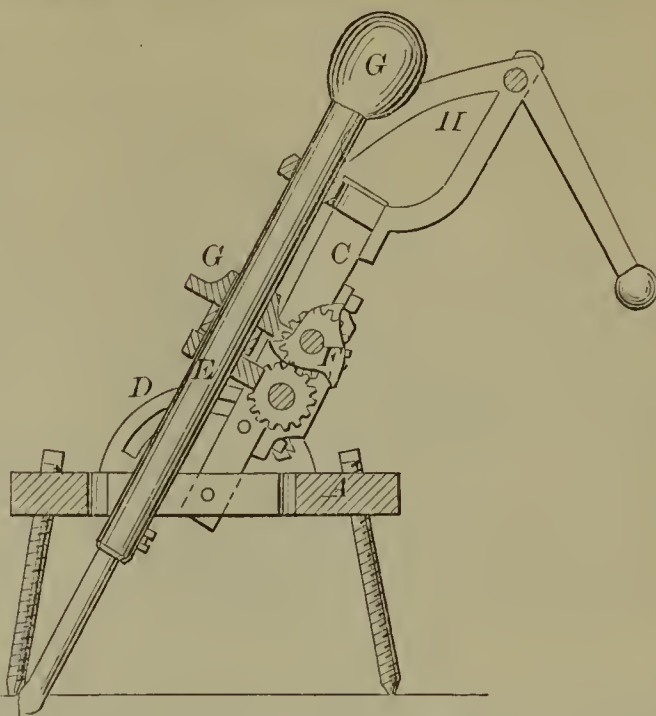

52289—J. E. Hooper—*Machine for Cleaning Cotton.*

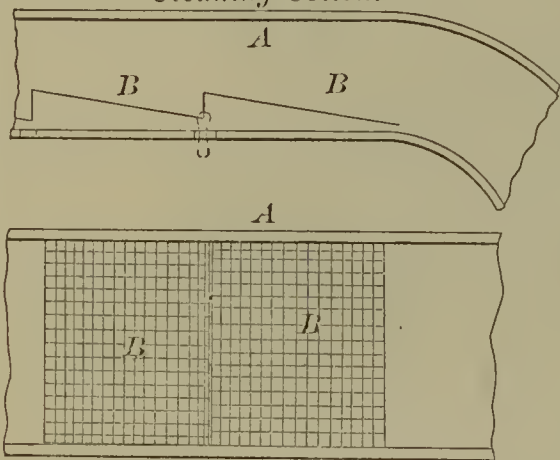

52293—A. H. Kennedy—*Sheep Shears.*

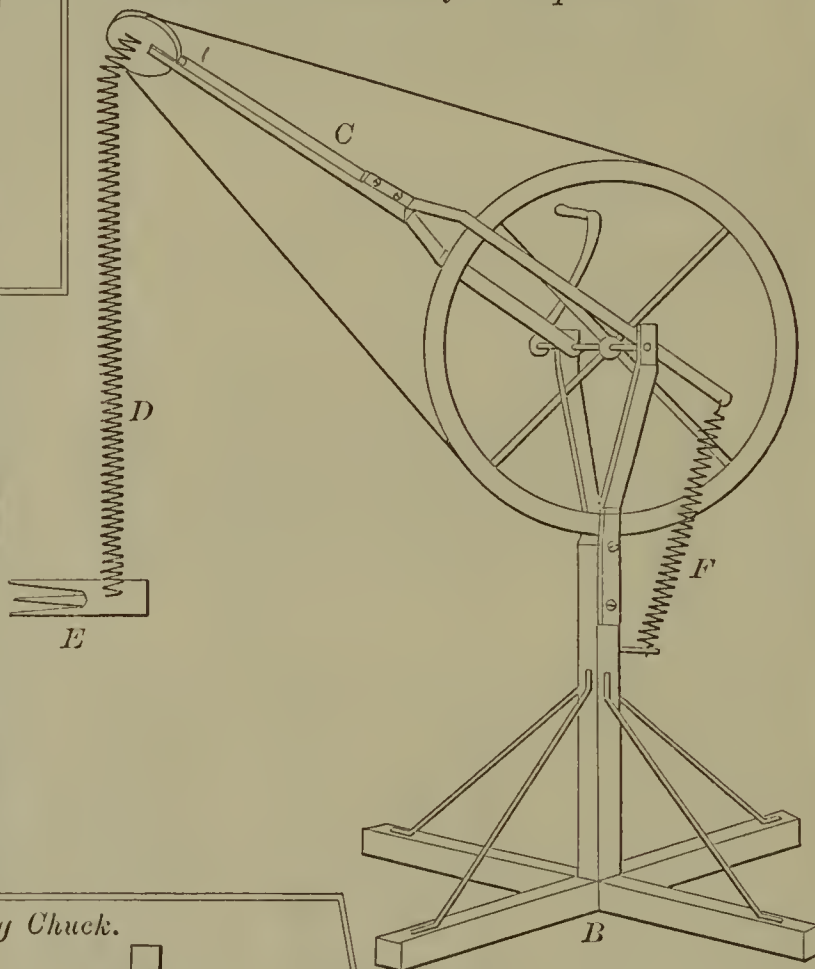

52290—E. I. Hoyt—*Artificial Teeth.*

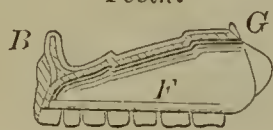

52291—C. S. Hurlbut—*Folding Lunch Box.*

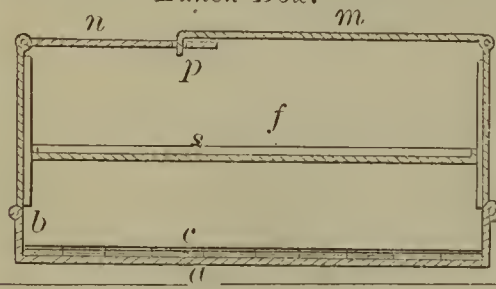

52294—T. Kennedy—*Screw Cutting Chuck.*

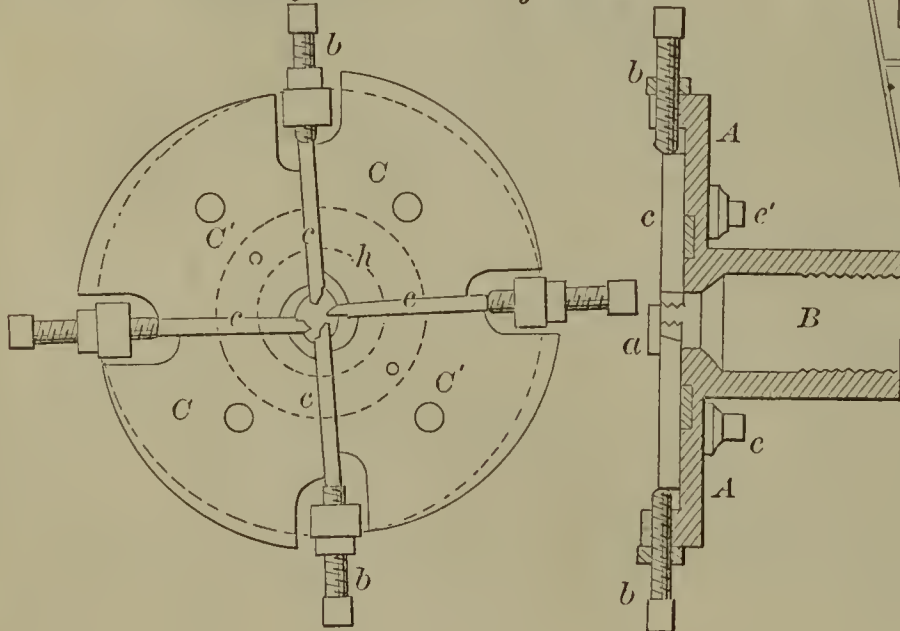

52295—W. S. & J. S. Lakin—*Fertilizer Sower.*

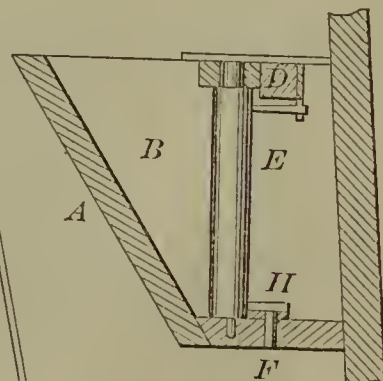

52296—Lamberson & Morton—  
*Curtain Fixture.*

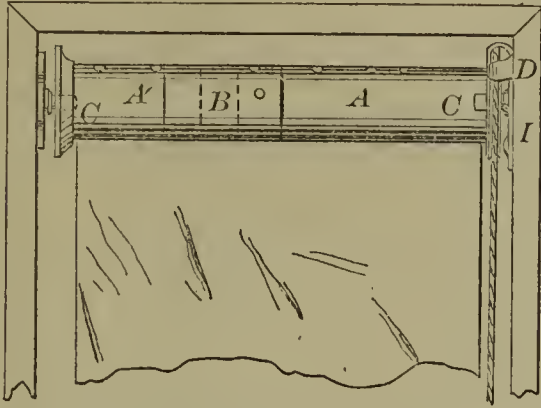

52298—A. P. & B. F. Lanterman—*Governor for  
Steam Engines.*

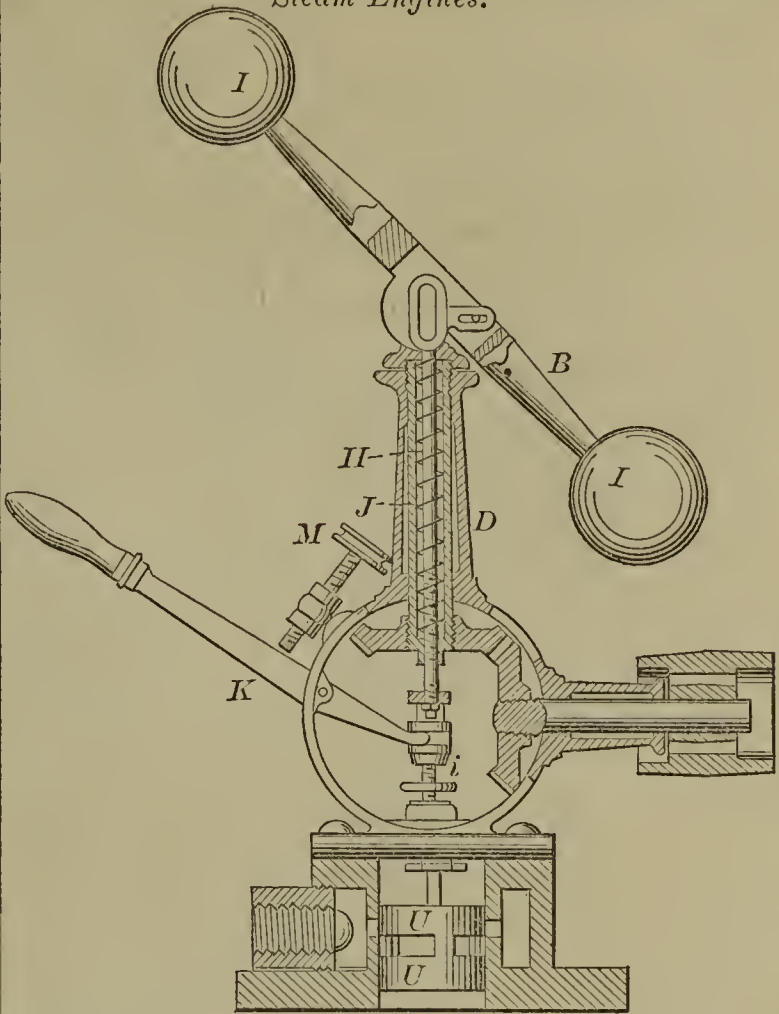

52299—Lesley & Craig—*Gas Stove.*

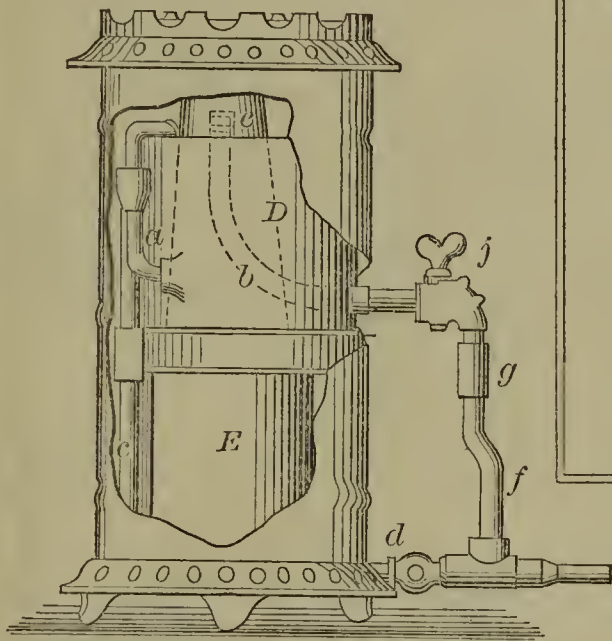

52302—R. Livingston—*Tobacco Pipe.*

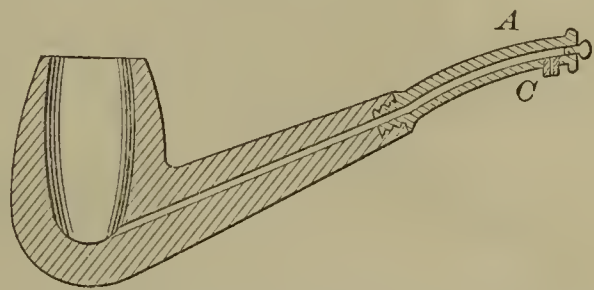

52300—Lesley & Craig—*Gas Stove.*

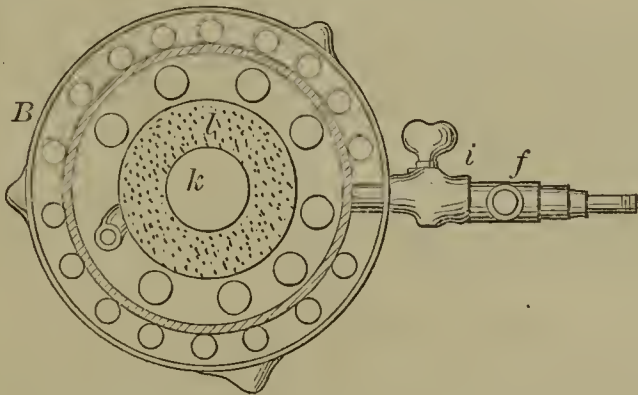

52297—Lautenschlager & Gott—  
*Tobacco Pipe.*

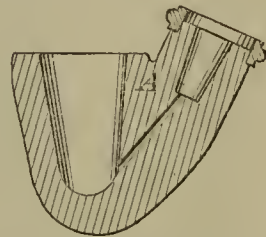

52303—W. D. Ludlow—*Cotton Picker.*

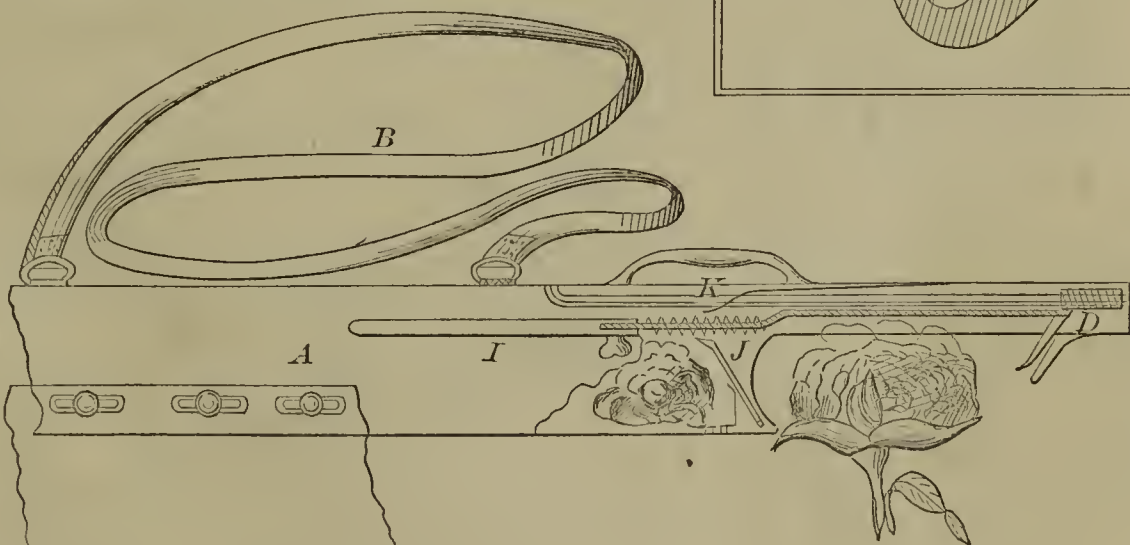

52304—W. G. Lumbar—Sawing Machine.

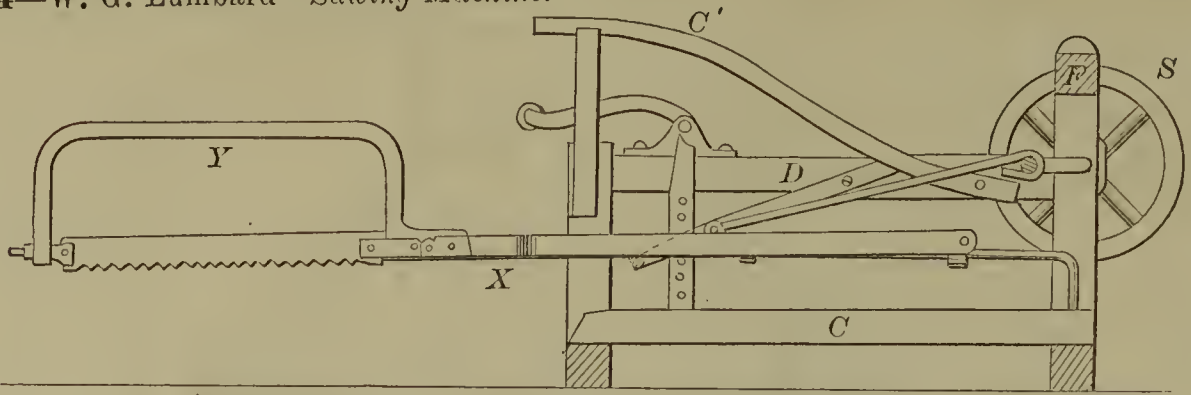

52308—G. Meader—Propeller.

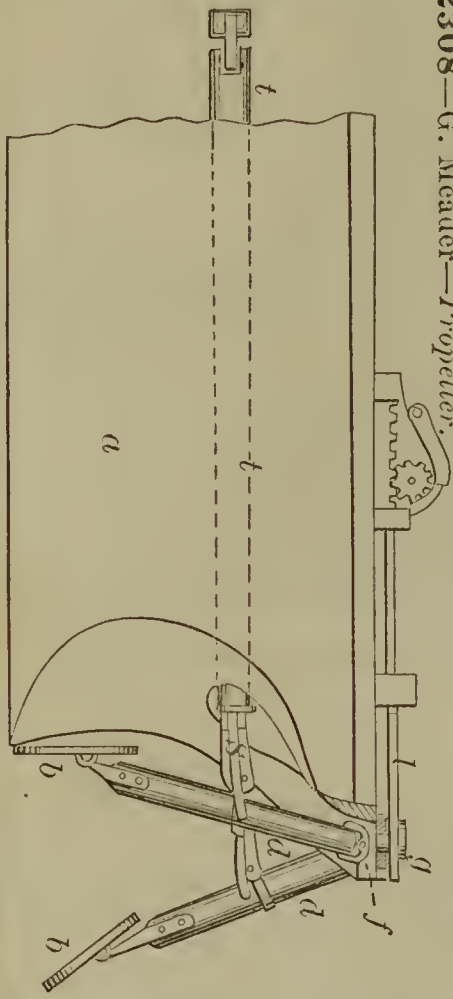

52306—

B. C. L. McDowell—Hand Loom.

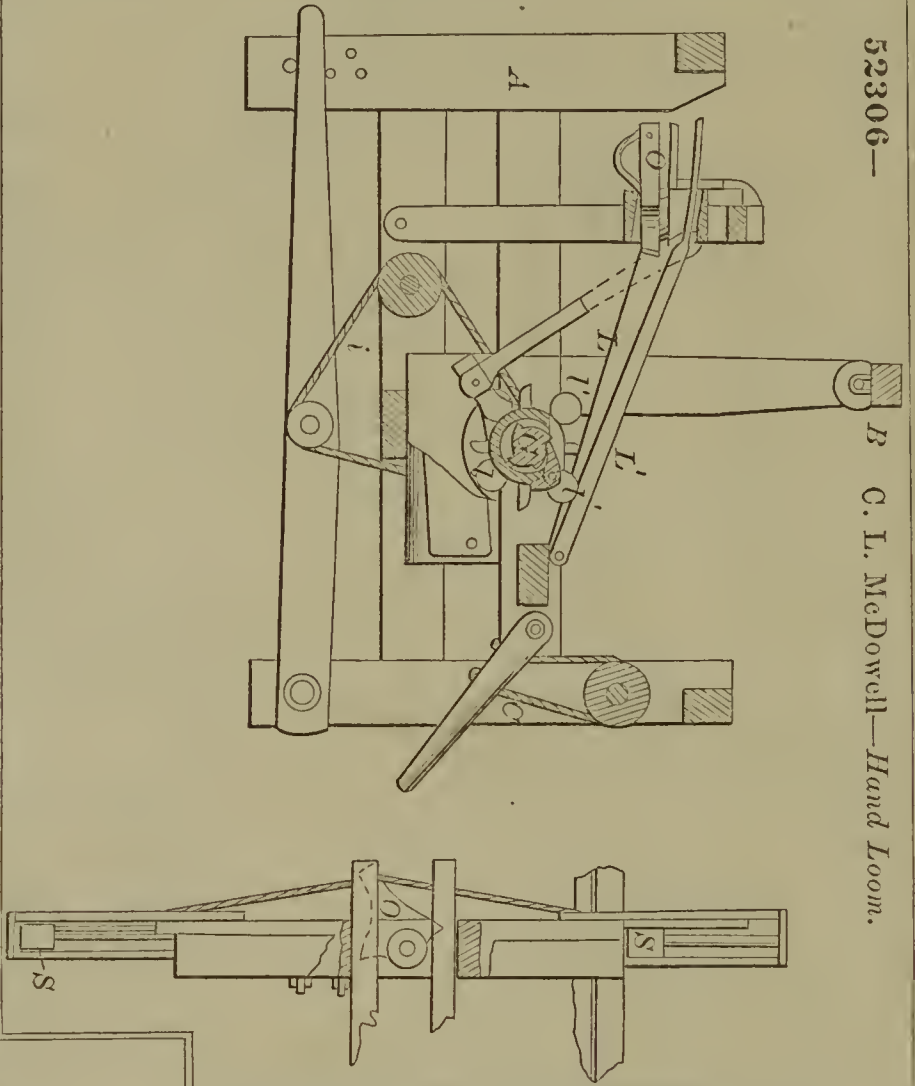

52305—T. McDonough—Hot Air Engine.

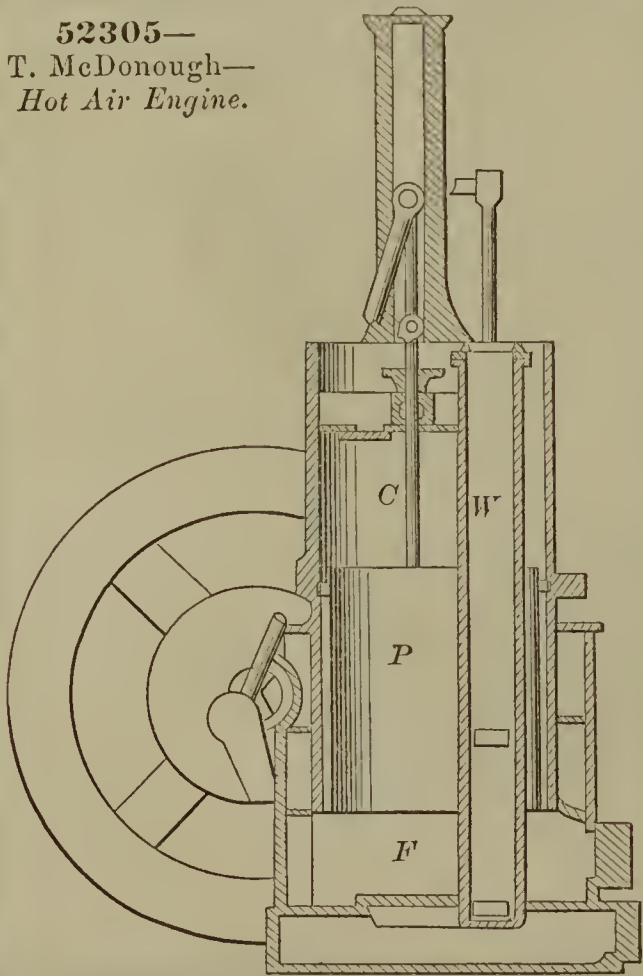

52307—M. Mead—Shaft Coupling.

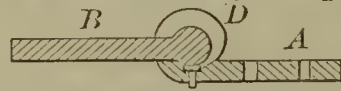

52309—W. Moses—Grain Mover.

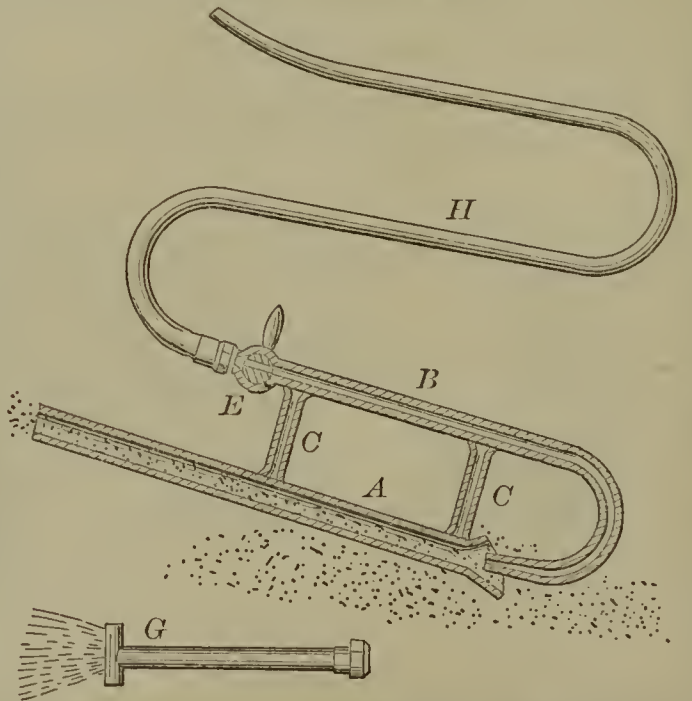

52310—D. Myers—Car Brake.

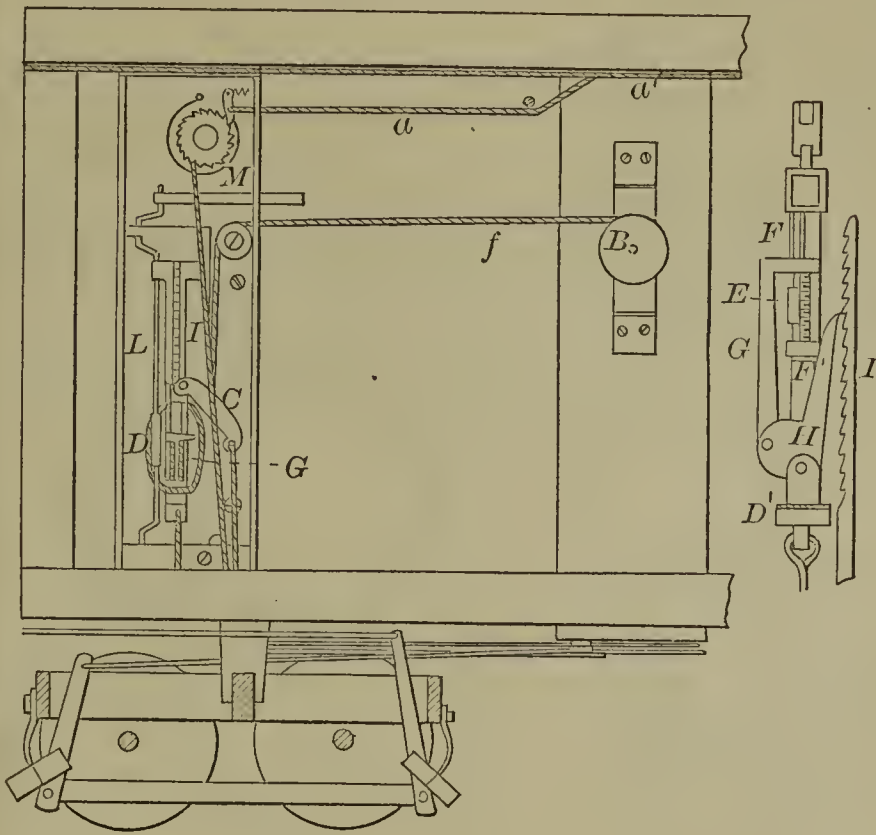

52311—D. Myers—Car Brake.

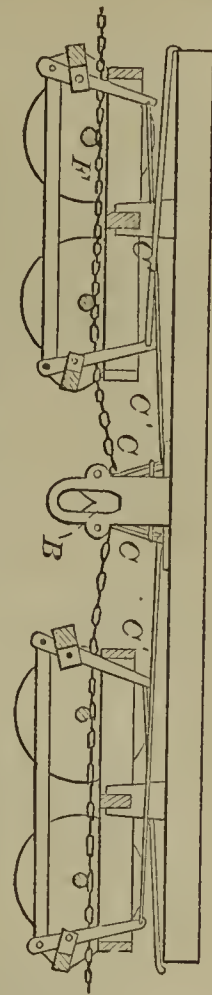

52312—D. Myers—Car Brake.

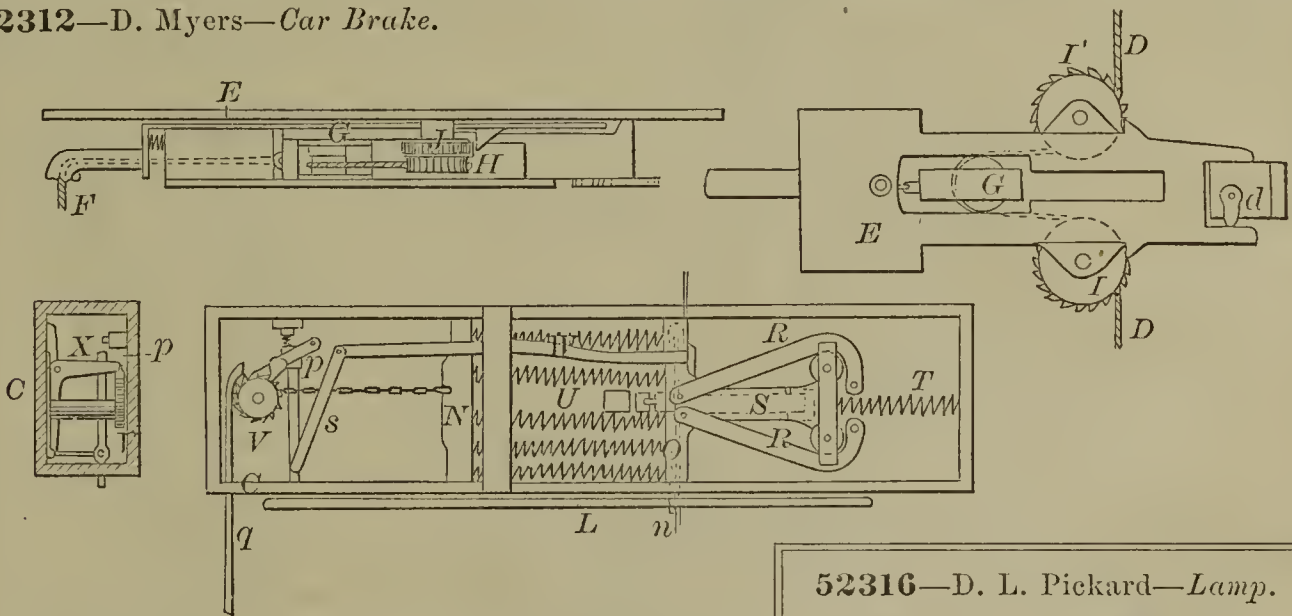

52316—D. L. Pickard—Lamp.

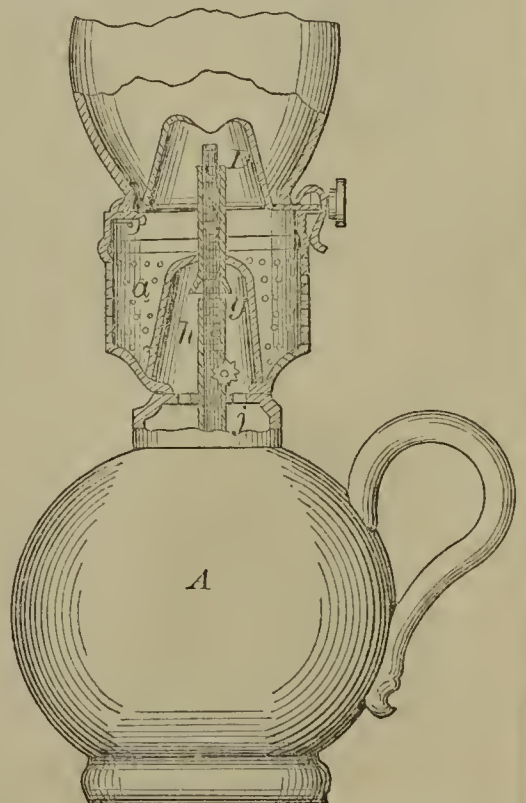

52313—M. Neal—Churn.

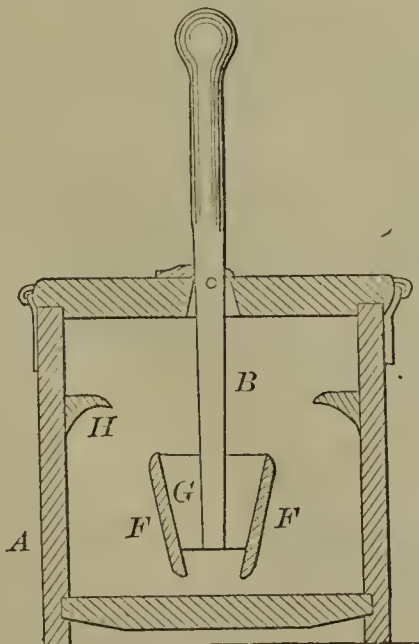

52314—I. P. Noyes—Explosive Shell.



52317—R. G. Pike—Mowing Machine.

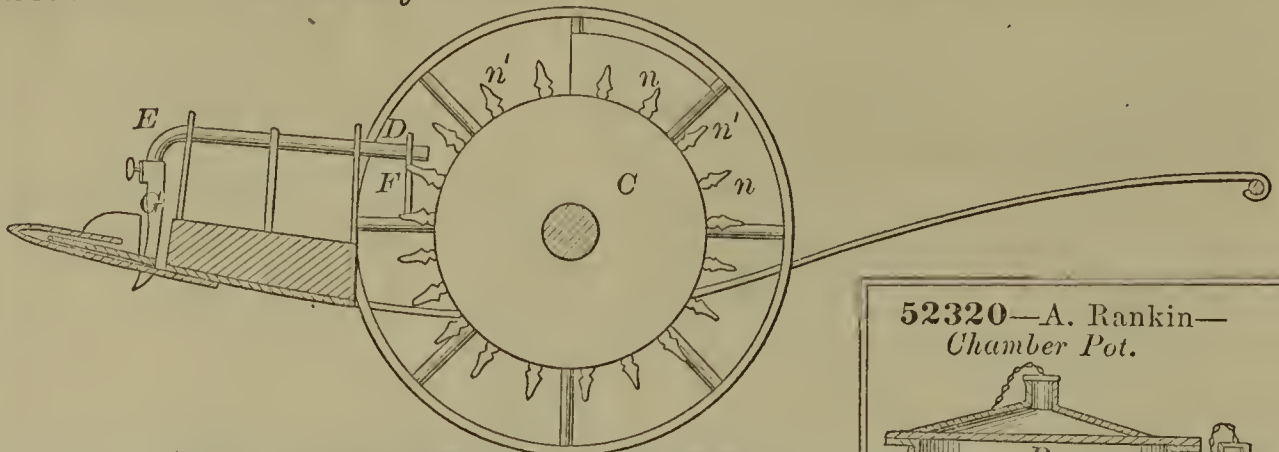

52320—A. Rankin—Chamber Pot.

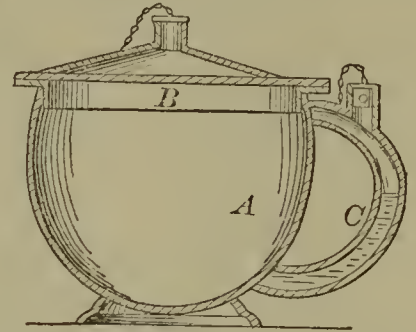

52318—J. Price—Cotton Seed Planter.

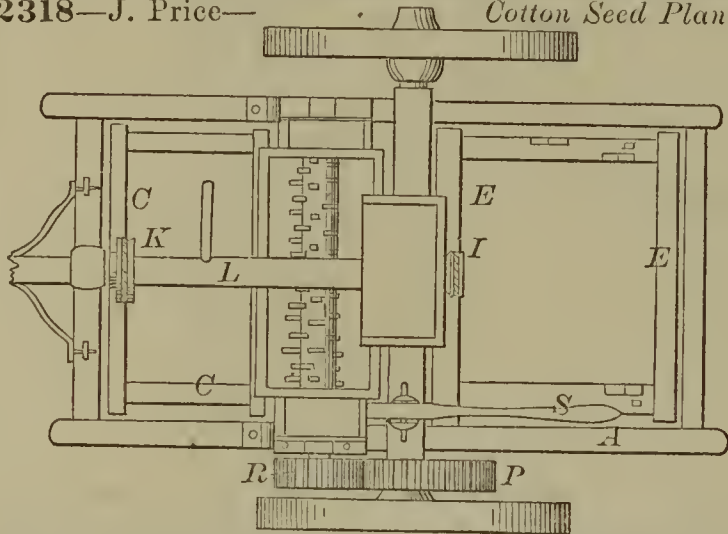

52322—H. Reynolds—Chimney Cap.

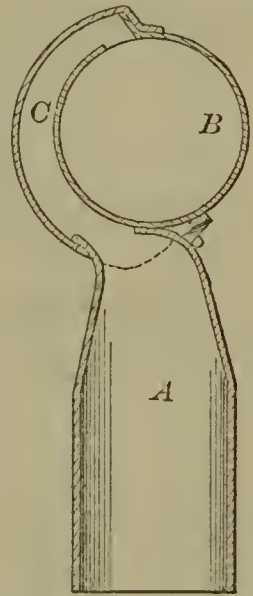

52319—G. Race—Broadcast Seeder.

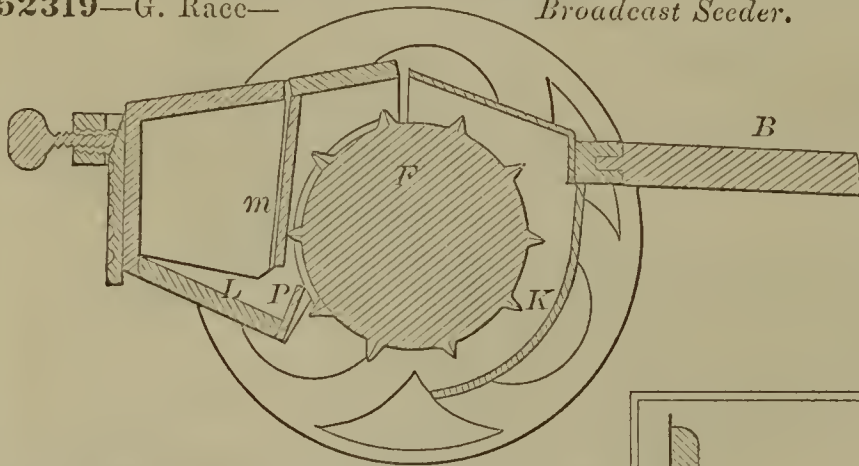

52323—I. S. Richardson—File Clasp for Documents.

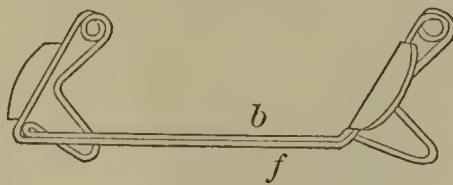

52324—J. Ryan—Hydraulic Jack.

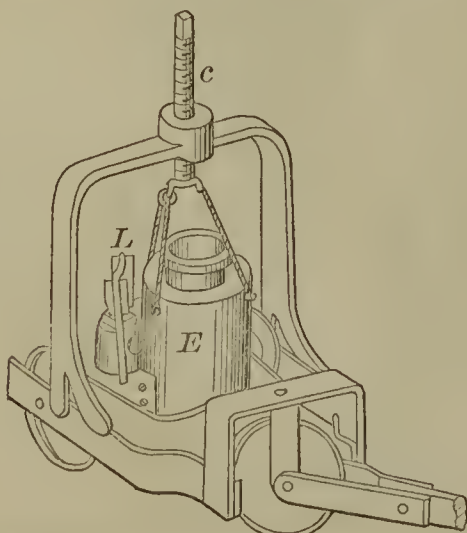

52321—J. B. Ruperts—Machine for Pulling Cotton Seeds.

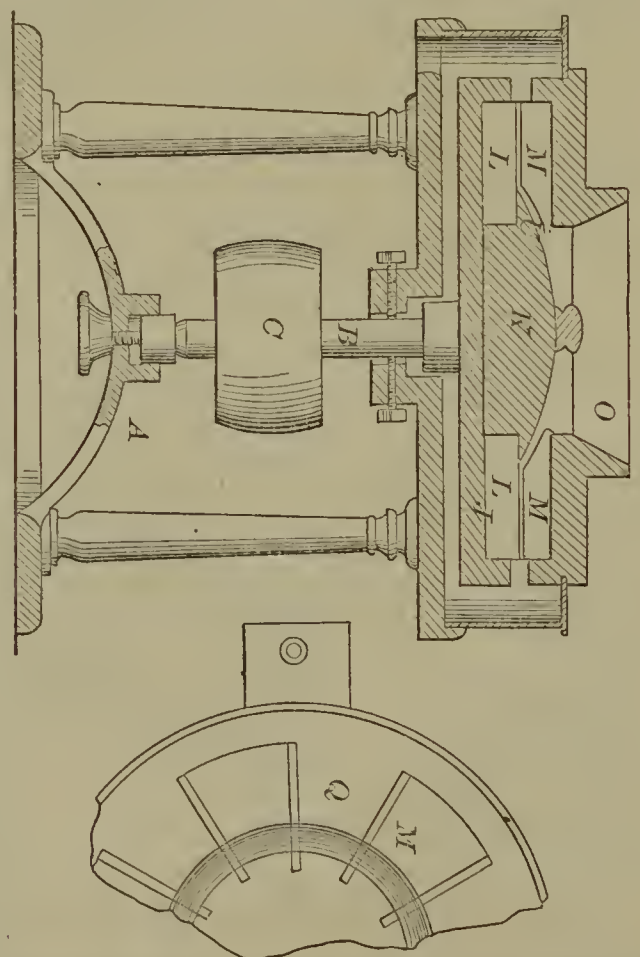

52325—G. A. Scherpf—For Parting Gold, Silver and Copper.

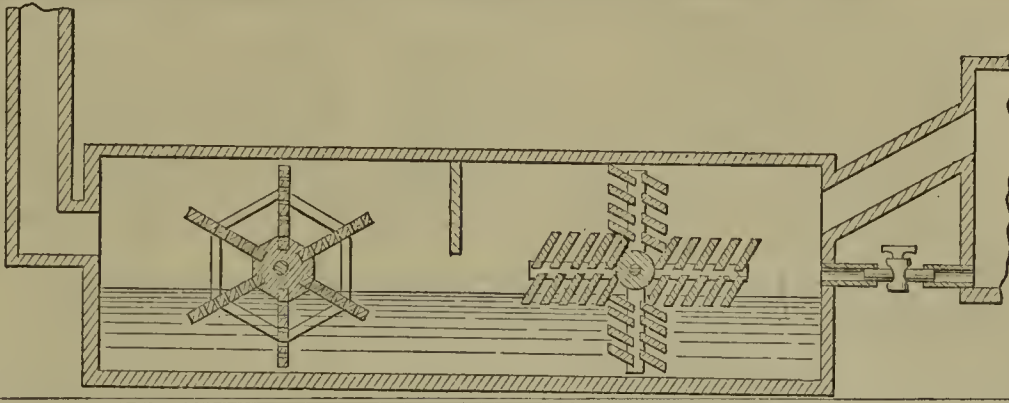

52327—J. F. Seiberling—Harvester.

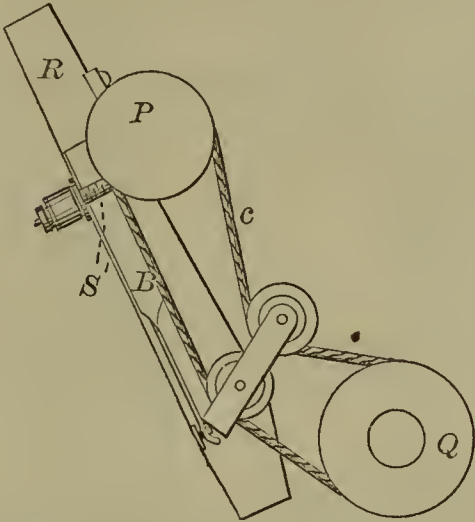

52228—G. Sewell—Attaching Car Wheels to Axles.

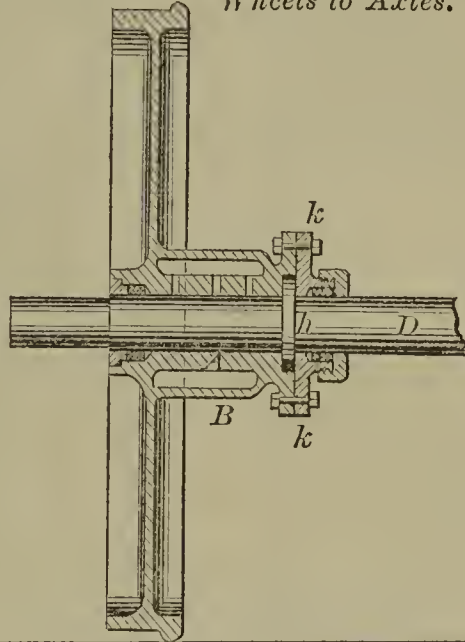

52329—A. S. Sherwood—Lightning Rod.



52330—J. E. Short—Broom Head.

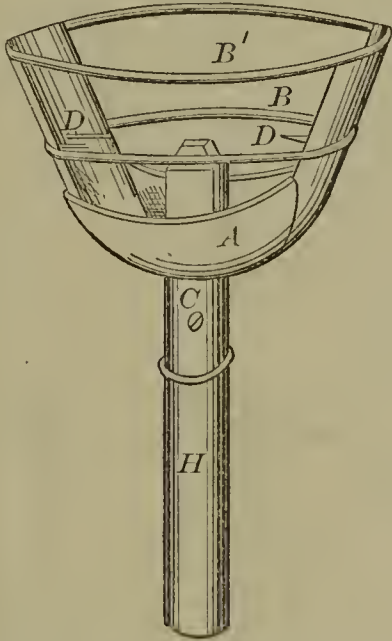

52226—S. R. Screven—Artificial Teeth.

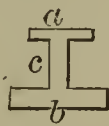

52331—H. N. M. Smith—Skate.

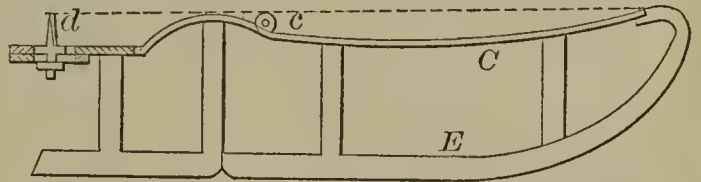

52334—H. Smith—Mechanical Movement.

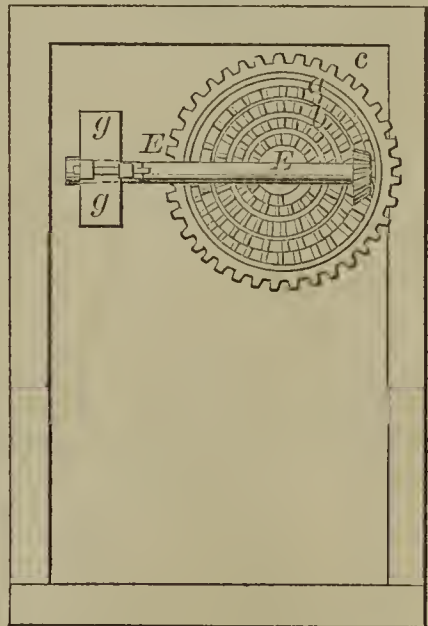

52332—H. Smith—Window Blind.

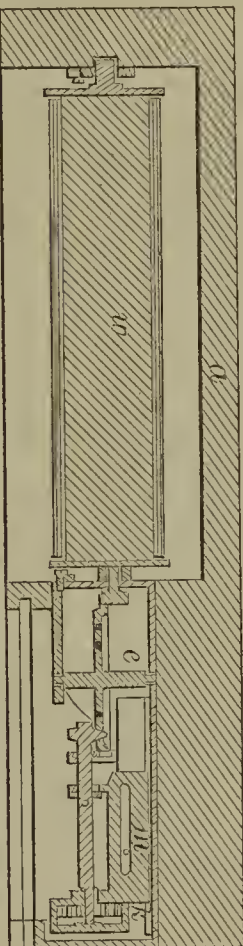

52333—H. Smith—Window Sash.

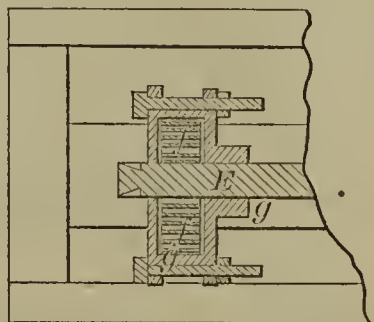
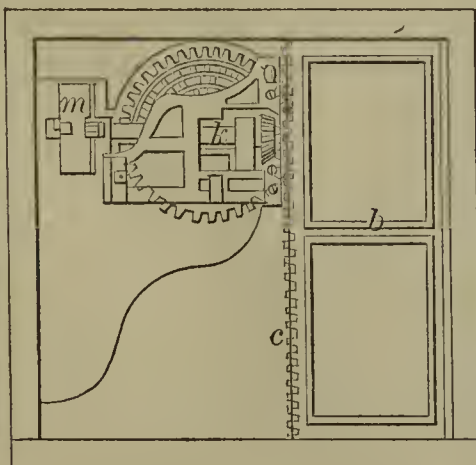

52335—N. C. Stiles—Clutch for Power Presses.

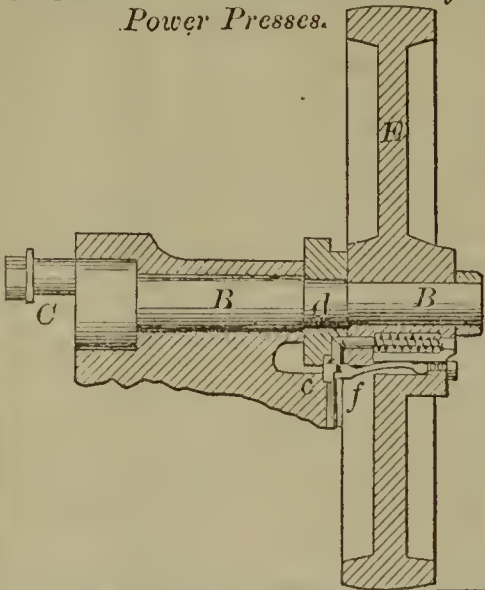

52338—Sweeney, Mathews & Hartley—Glass Mould.

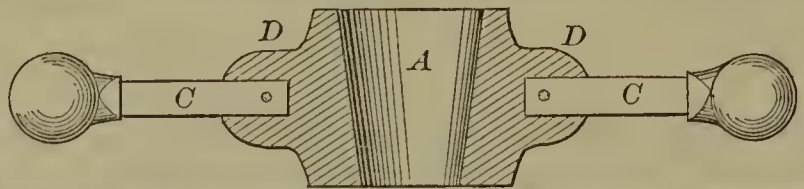

52343—E. J. Toof—Paper Holder.

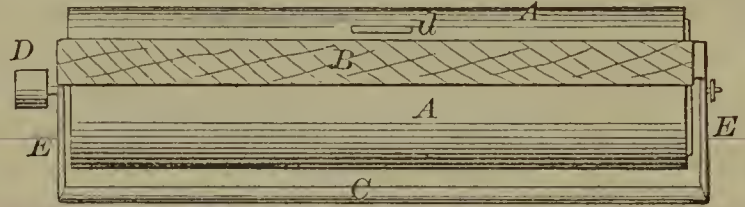

52336—N. C. Stow—Burnishing Machine.

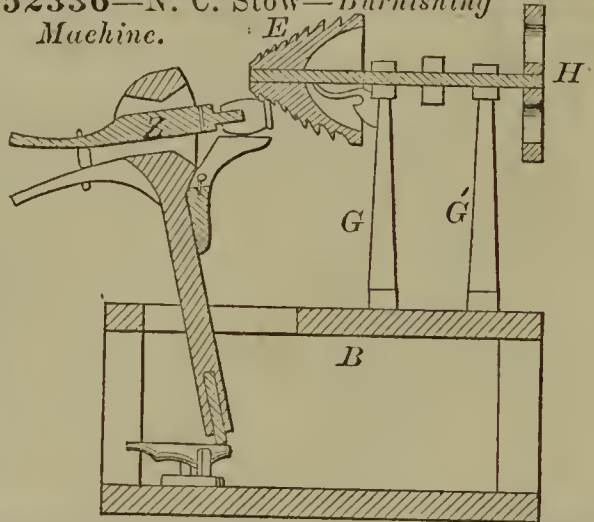

52339—S. Taylor—Knee Swell for Organs.

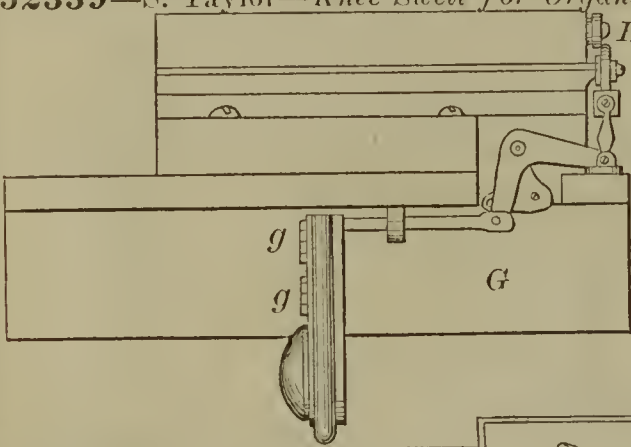

52341—J. Thrasher—Wagon Wheel.

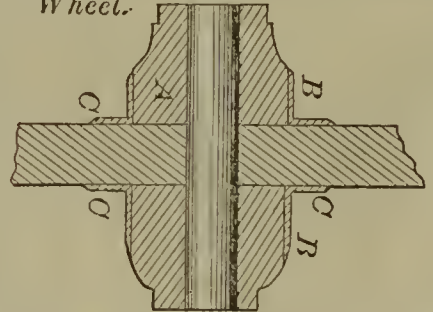

52340—T. J. Thorn—Churn.

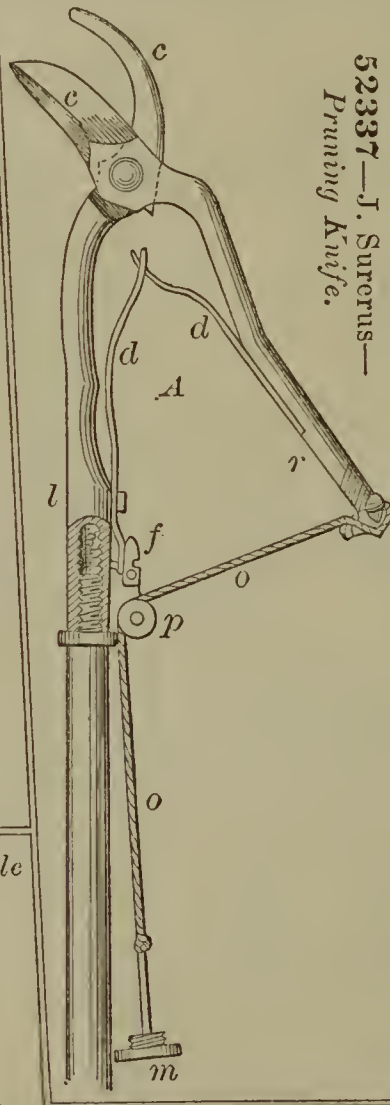
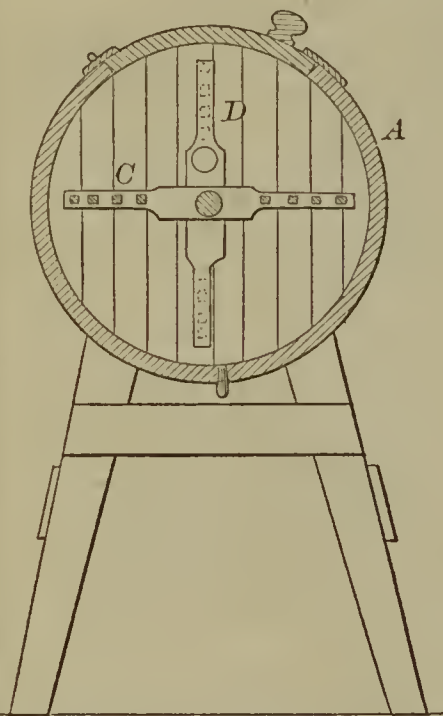

52337—J. Surernus—Pruning Knife.

52342—S. E. Tompkins—Saddle Tree.

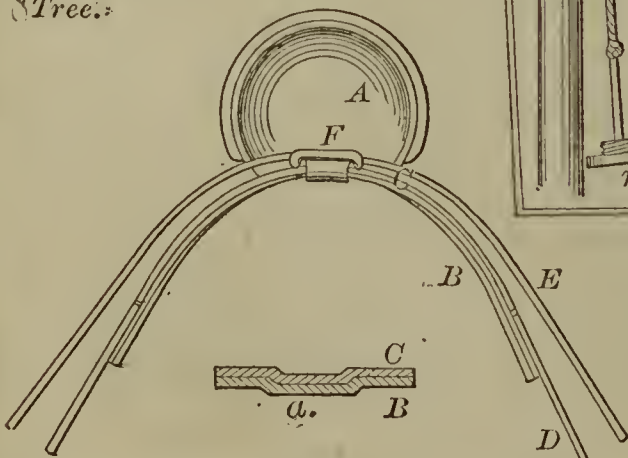

52344—A. W. Turner—Call Bell.

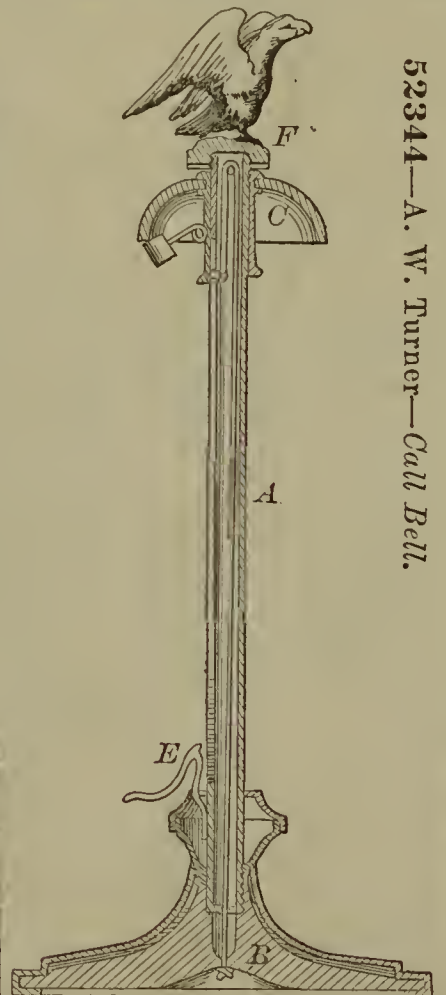



52346—S. Vance—Pump.

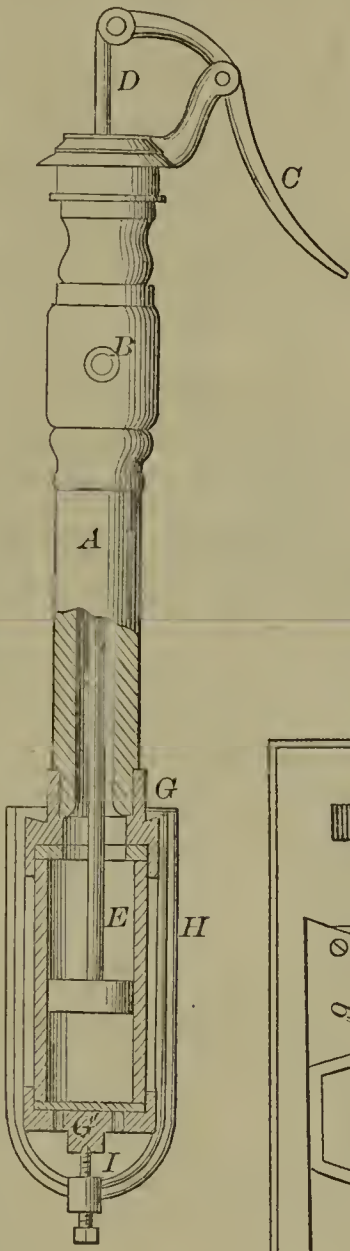

52347—C. P. Wagner—Quartz Mill.

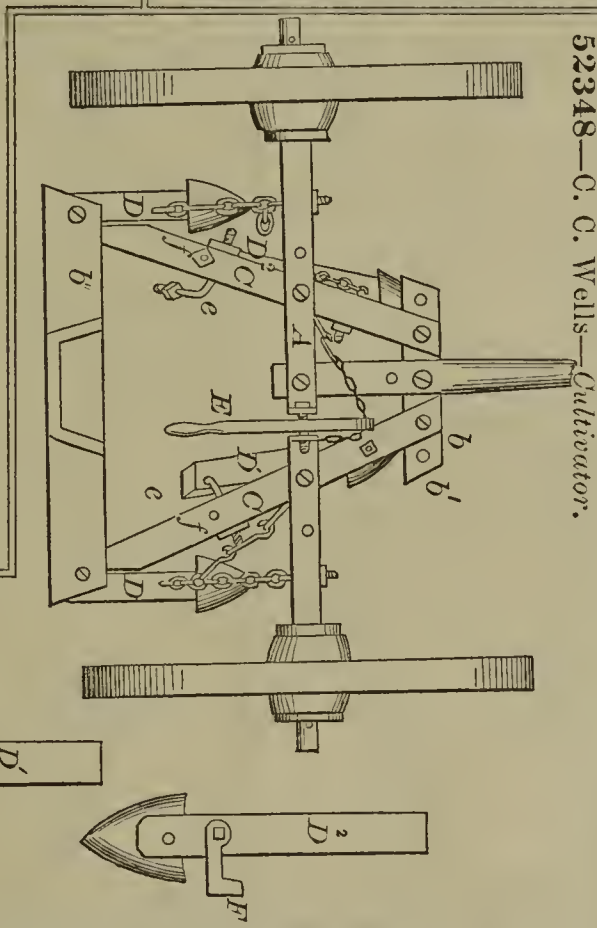
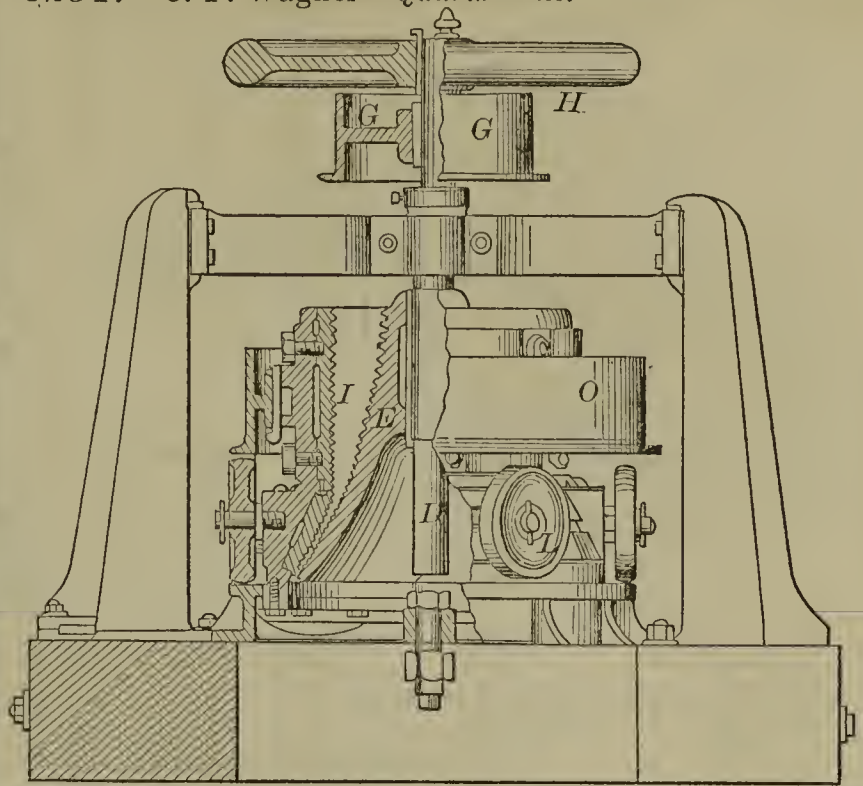

52348—C. C. Wells—Cultivator.

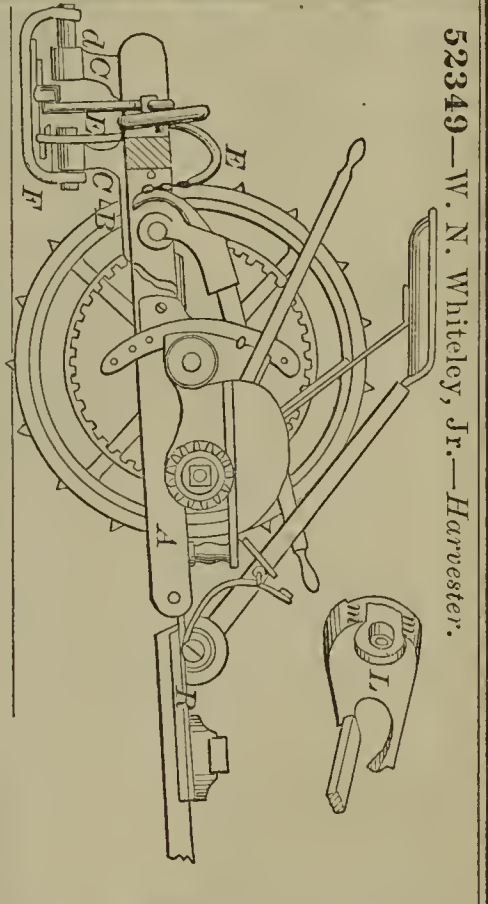

52349—W. N. Whiteley, Jr.—Harvester.

52351—W. N. Whiteley, Jr.—Harvester.

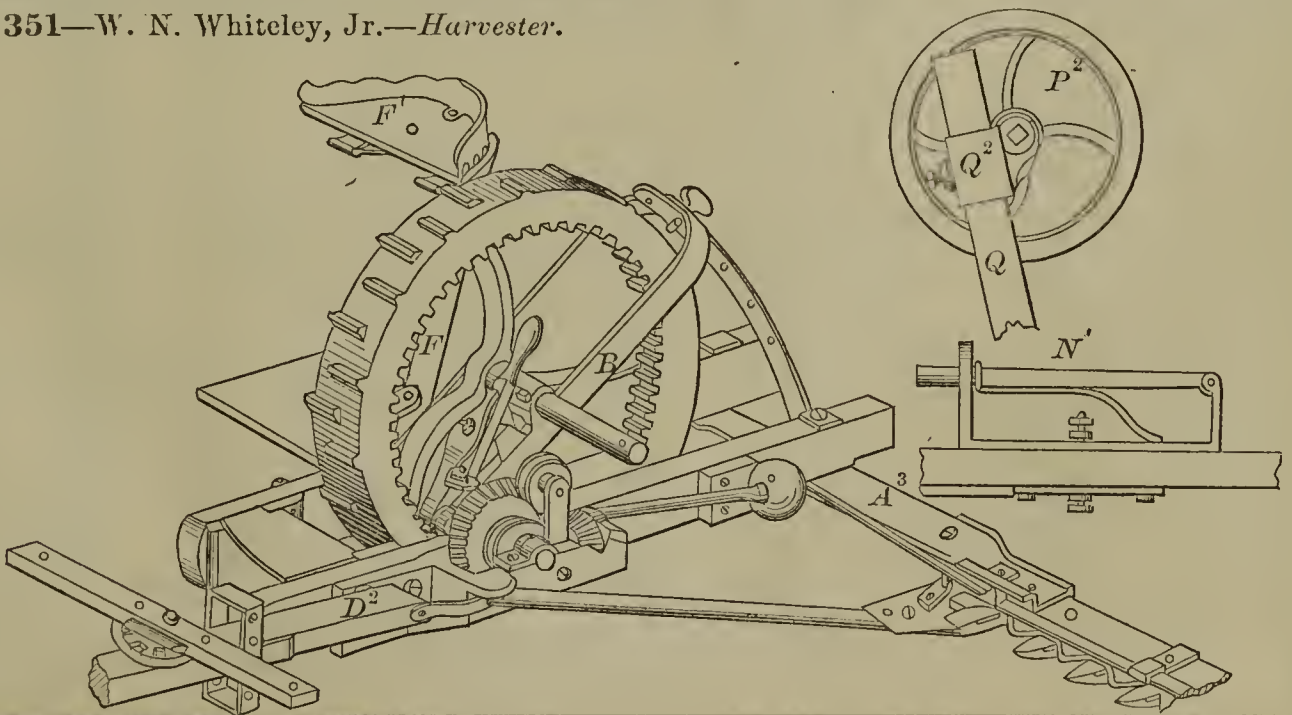

52350—W. N. Whiteley, Jr.—Harvester.

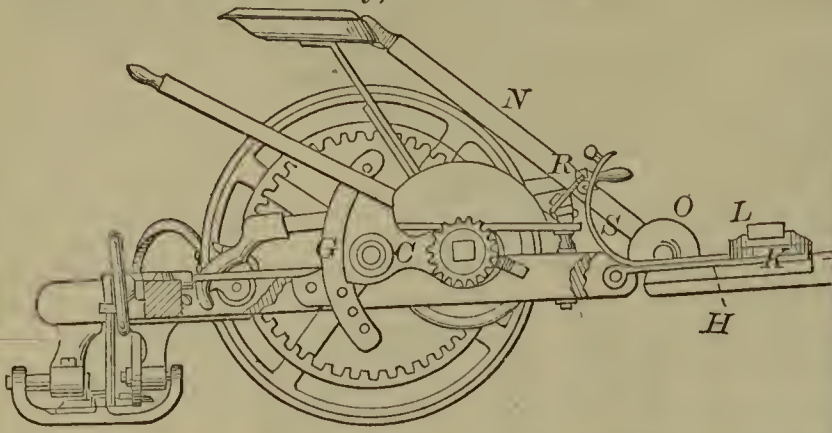

52352—W. L. Williams—Wood Splitting Machine.

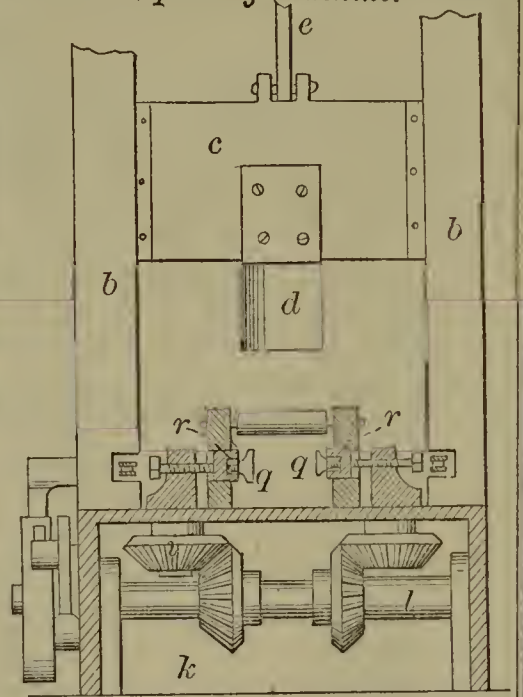

52354—F. Yeiser—Transmitting Motion.

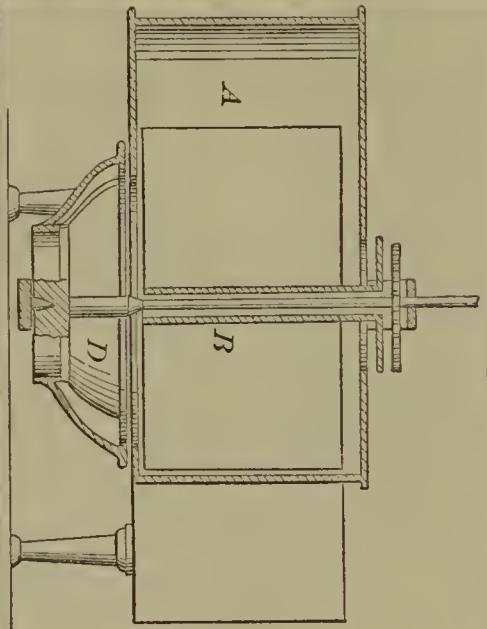
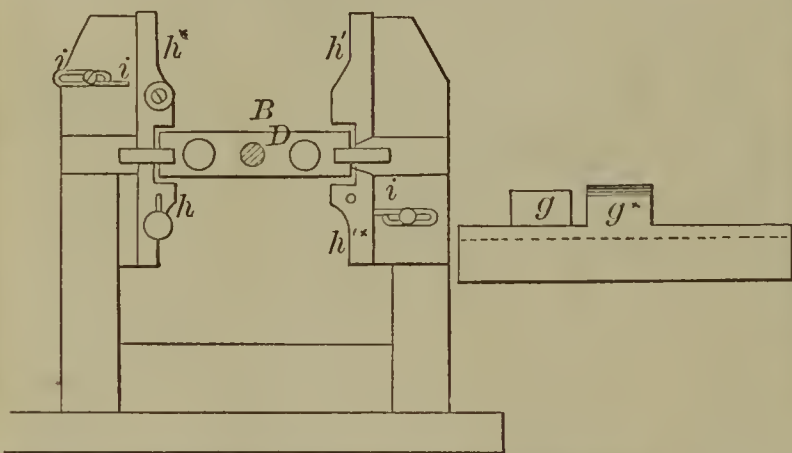
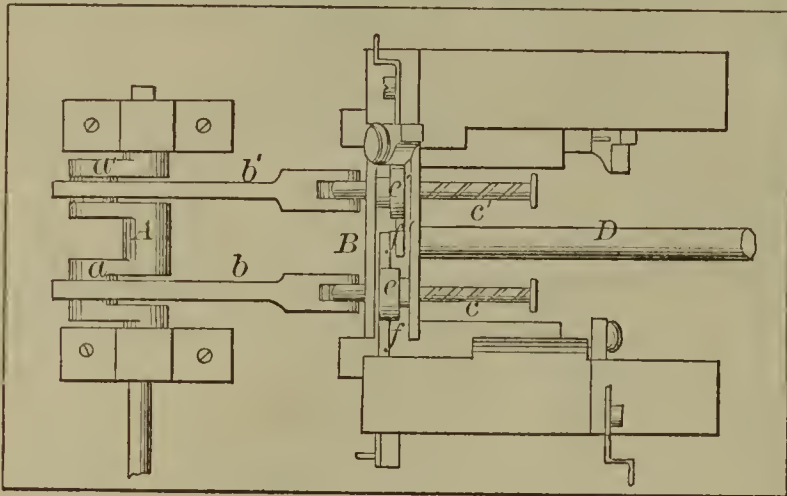

52353—L. D. Wynkoop—Water Wheel.

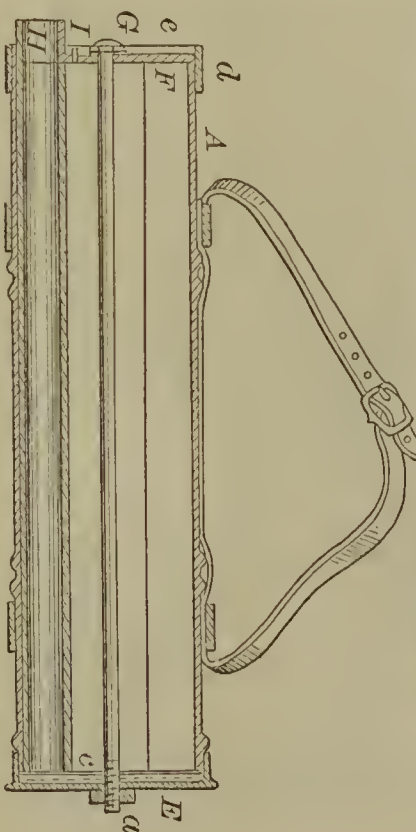
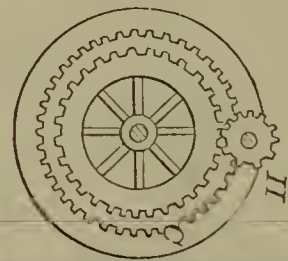

52357—Bryan & Bigelow—Cartridge Box.

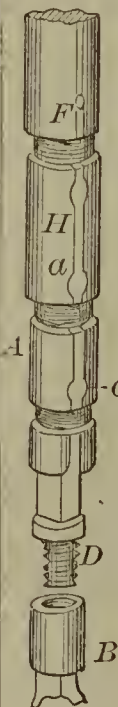

52355—R. N. Allen—Piston Rods for Deep Wells.

52356—Bray & Talpey—Pea Shelling Machine.

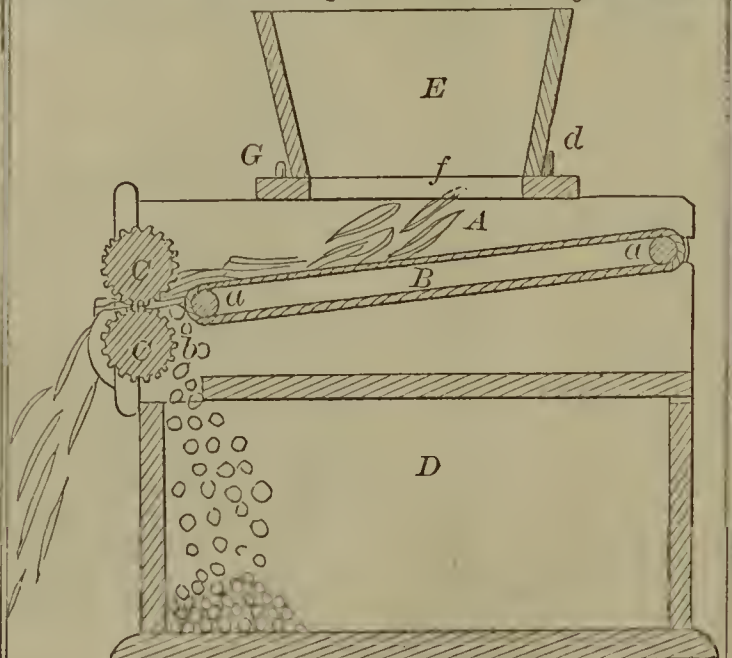

52358—W. R. Close—Water Wheel.

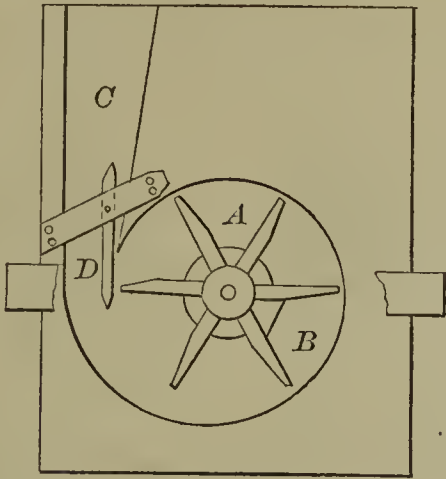

52361—R. Harper—Railroad Turnout.

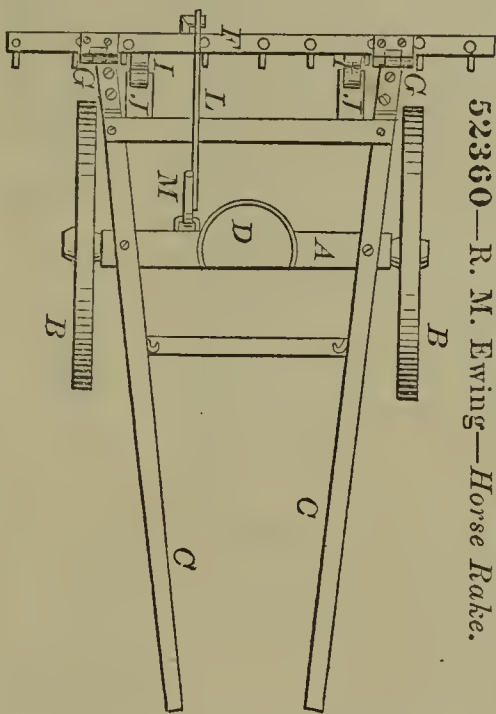
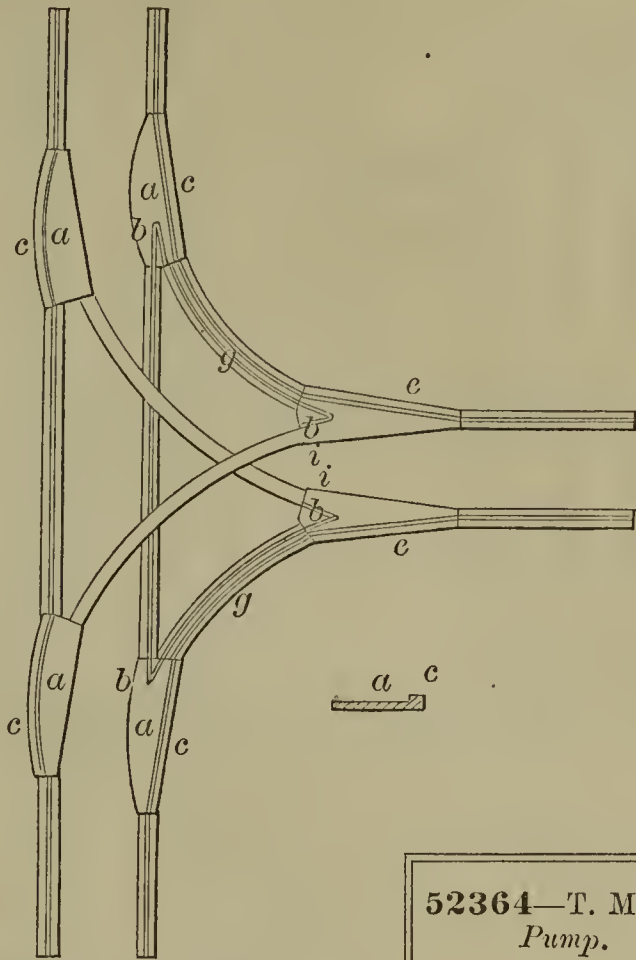

52360—R. M. Ewing—Horse Rake.

52364—T. Mayhew—Pump.

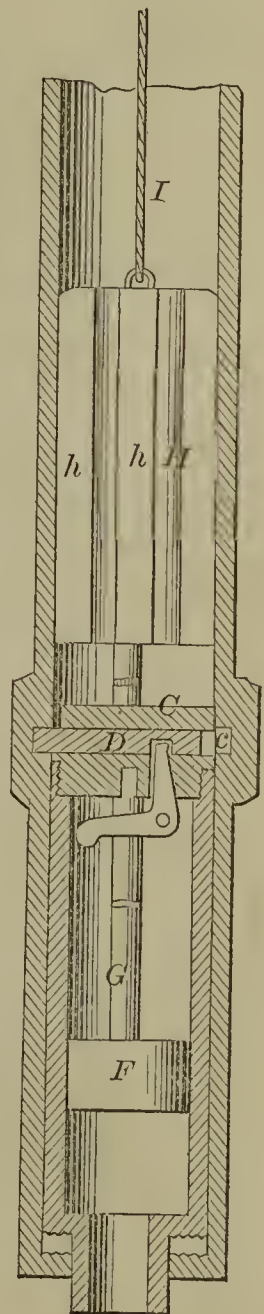

52363—H. Kellogg—Quartz Mill.

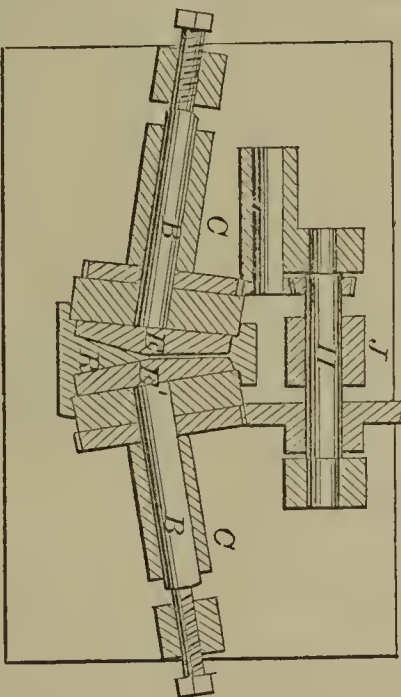

52362—C. F. Jauriet—Spark Arrester.

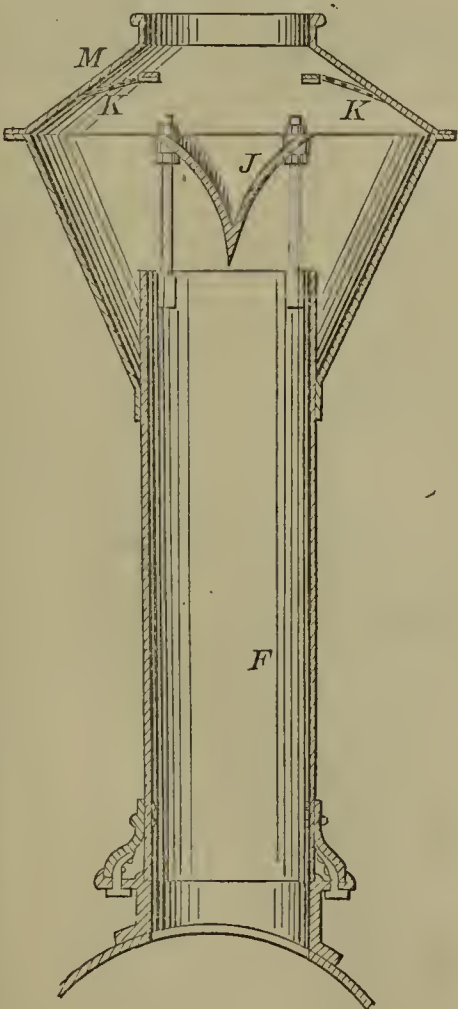

52365—W. H. Nichols—Door Bell.

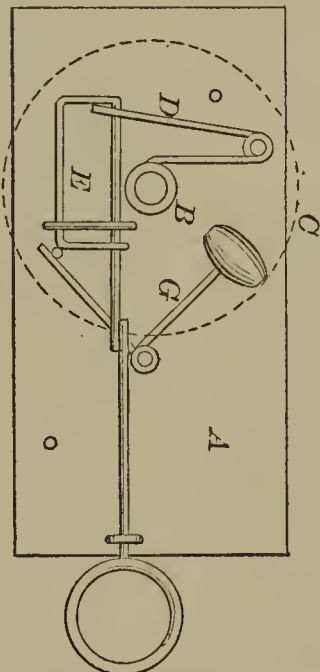

52372—H. Allman—Lock.

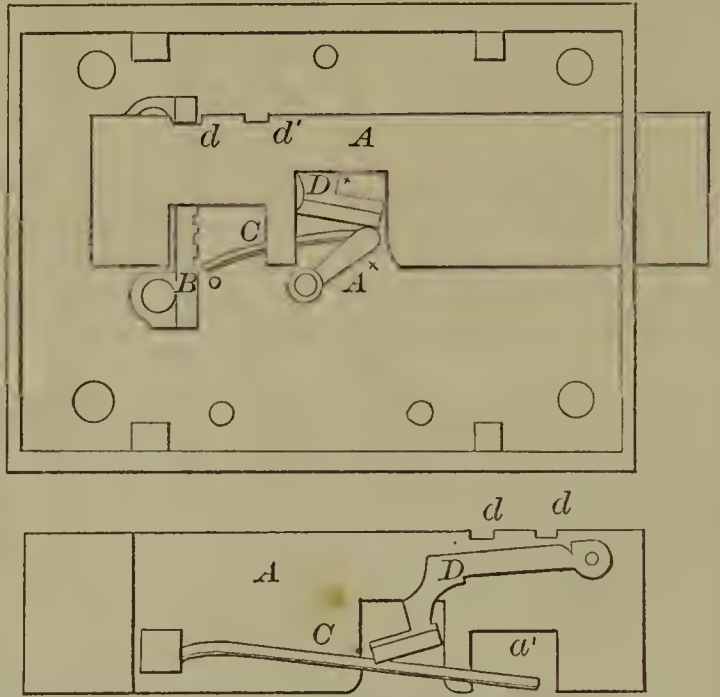

52371—G. K. Snow—Piper Collar Band.



52366—Northup & Paterson—Stove Pipe Drum.

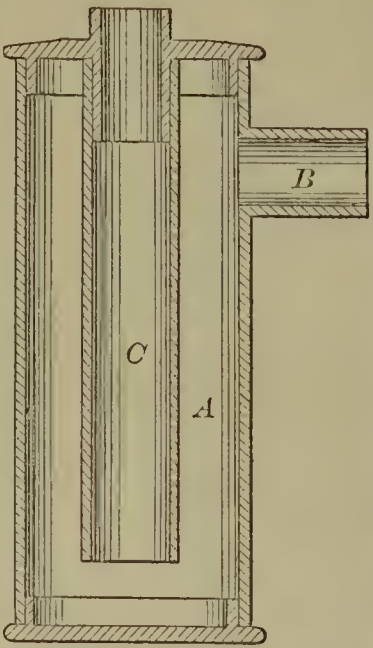

52374—A. H. Boyd—Sewing Machine.

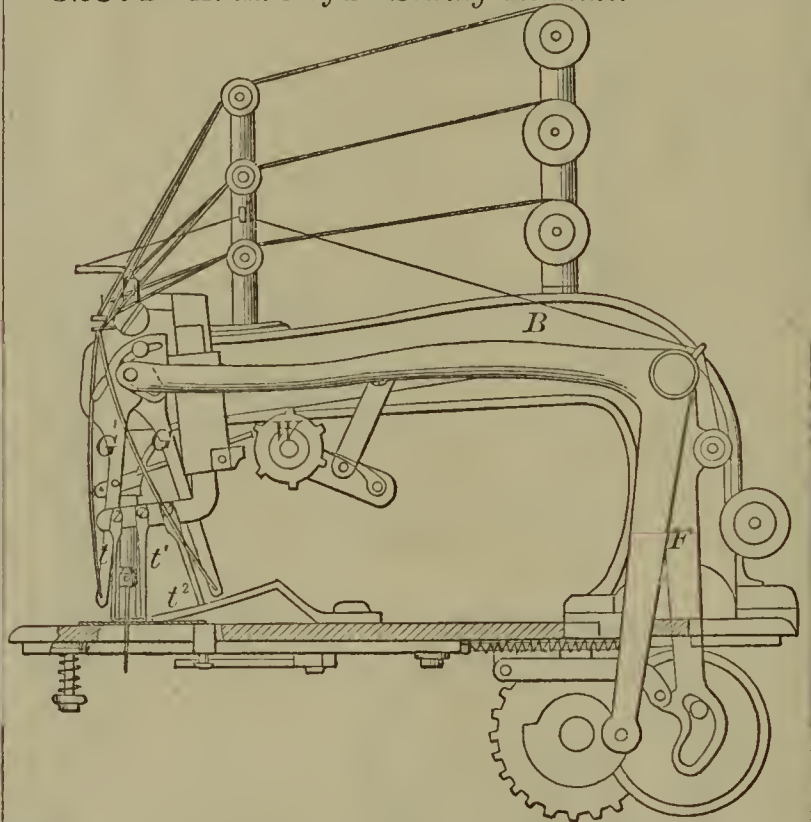

52367—E. & H. C. Phillips—Picker Staff Arrester.

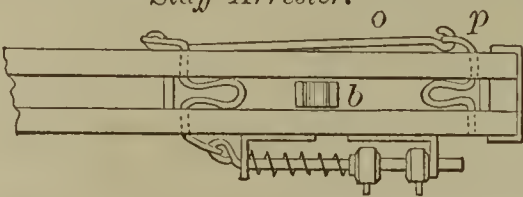

52369—E. F. Rogers—Lamp.

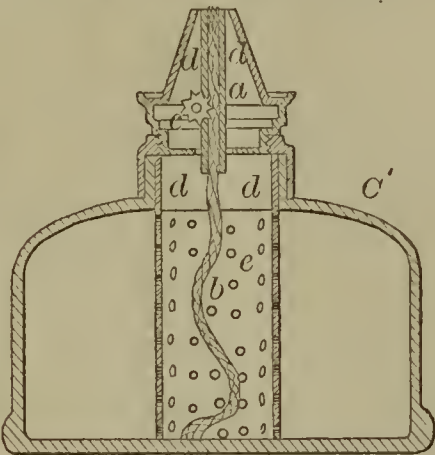

52370—J. W. Smith—Cartridge for Fire Arms.



52375—G. Moody—Fireplace.

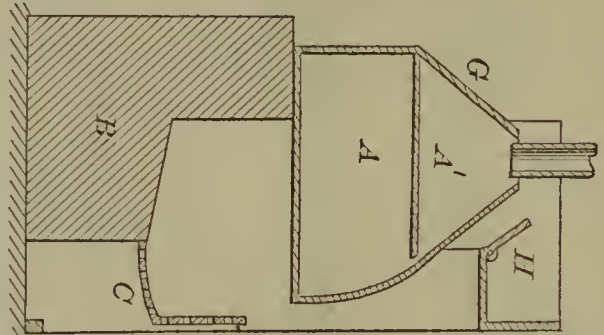

52376—E. Quinn—Automatic Boiler Feeder.

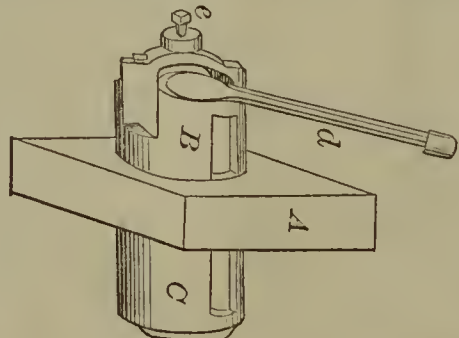

52368—T. K. Reed—Sewing Machine.

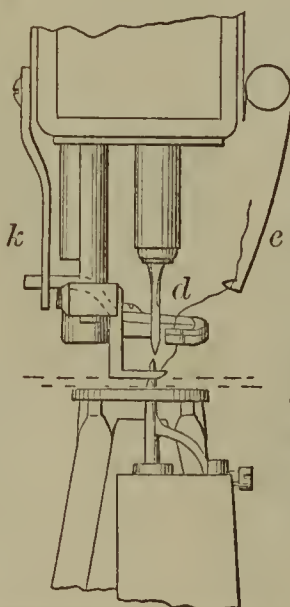

52373—G. Ireland—Bottle Handle.

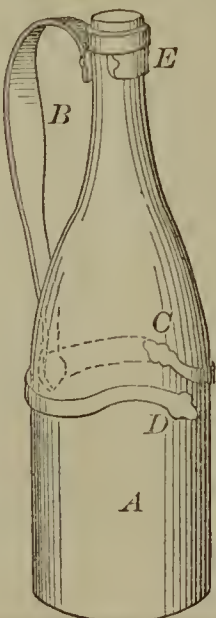

52377—W. A. Barnes—*Pump.*

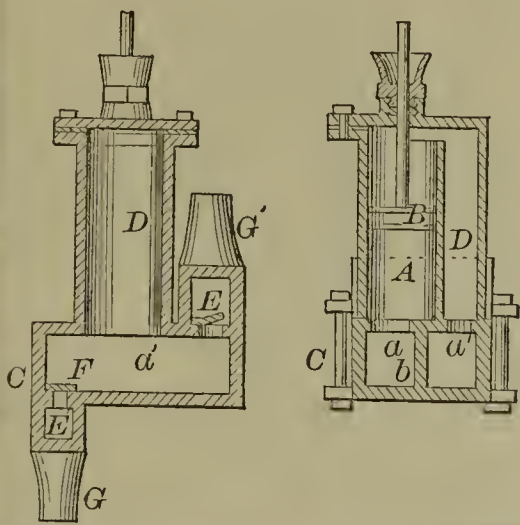

52381—D. B. Boynton—*Boot Blacking Ottoman.*

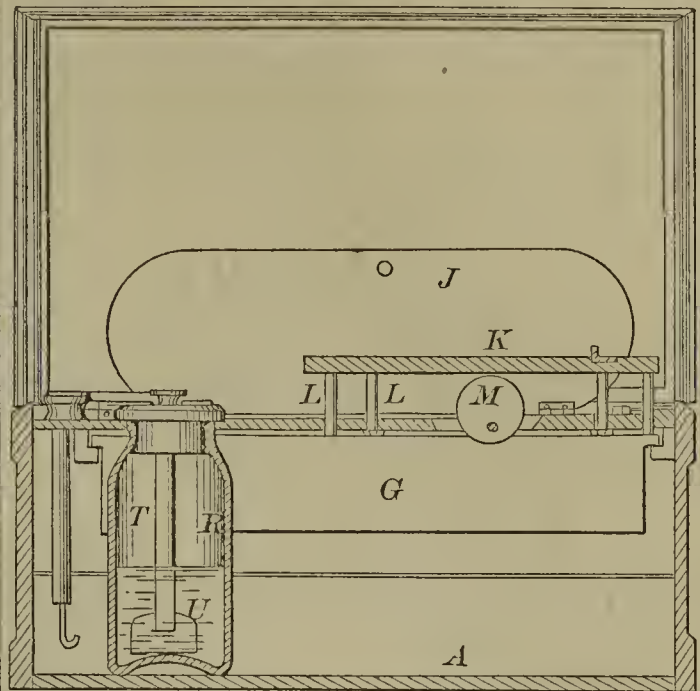

52378—J. I. Benham—*Cloth Measuring Machine.*

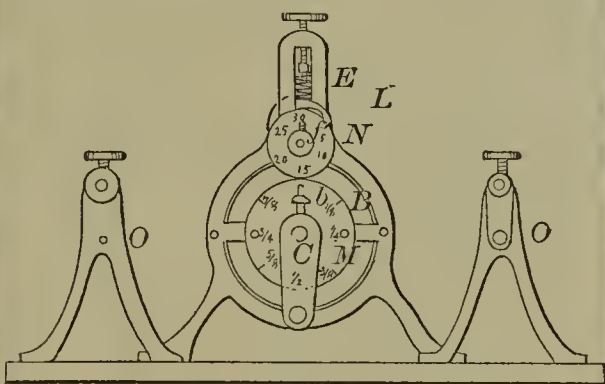

52382—E. Brown—*For Winding Cord.*

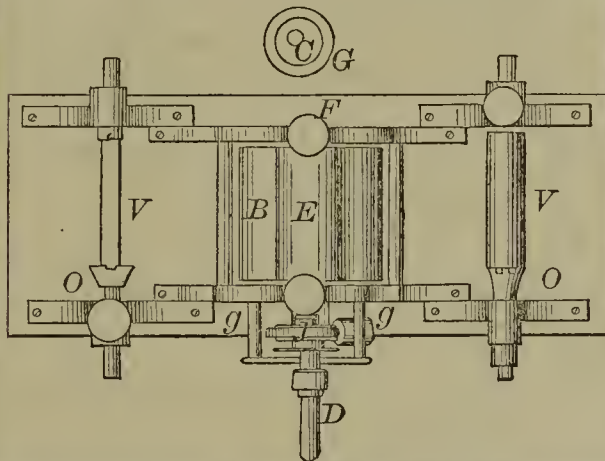
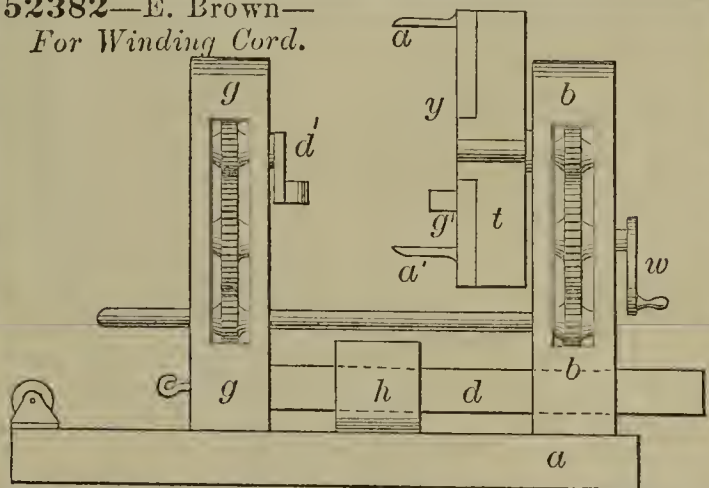

52380—C. Bourgeois—*Steam Gauge*

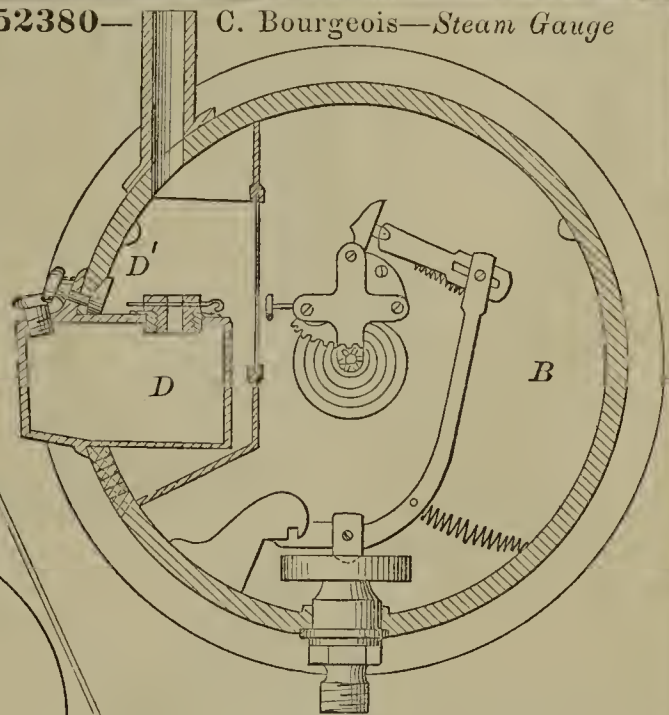

52383—Burnett & Vandevort—*Wind Wheel.*

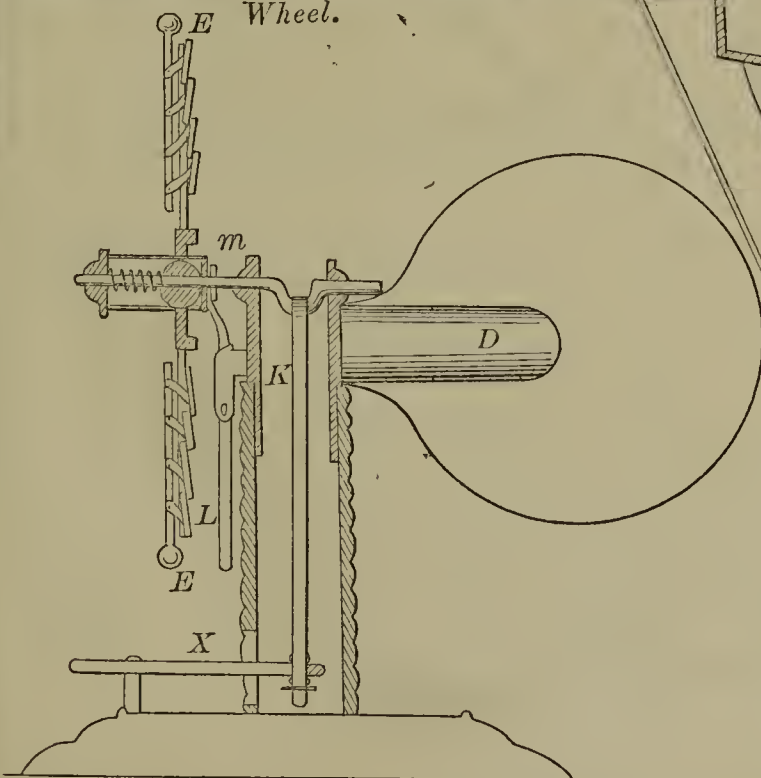

52379—E. Bennett—*Fruit Jar.*

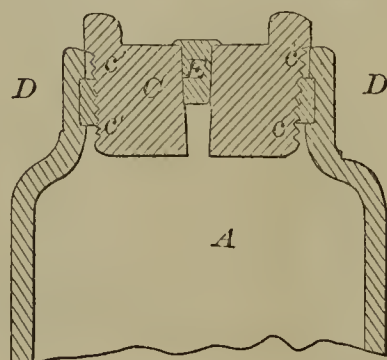

52384—T. Butterworth—*Corn Harvester.*

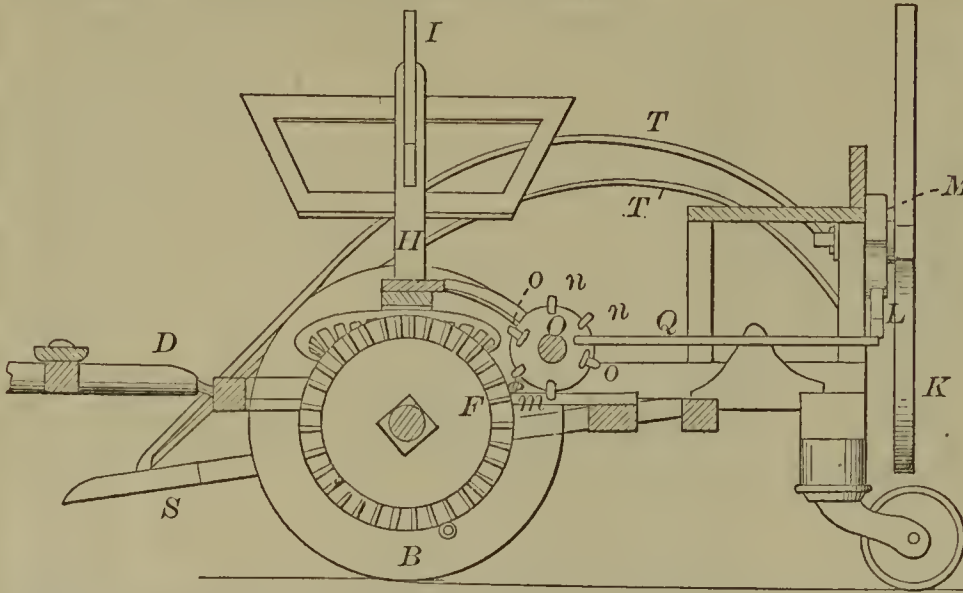

52388—C. B. Clark—*Sash Fastening.*

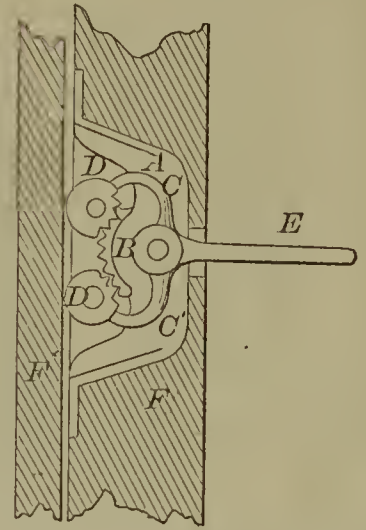

52385—Carr & Andrews—*Detaching Tow Lines.*

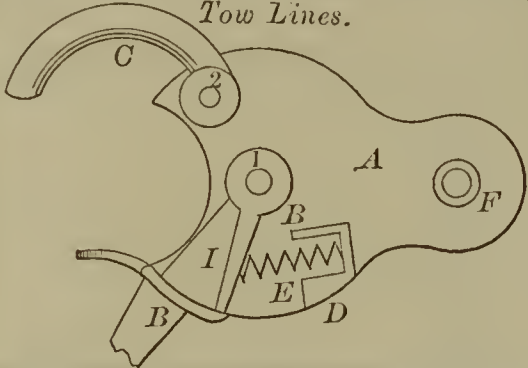

52390—A. J. Colby—*Skeleton Skirt.*

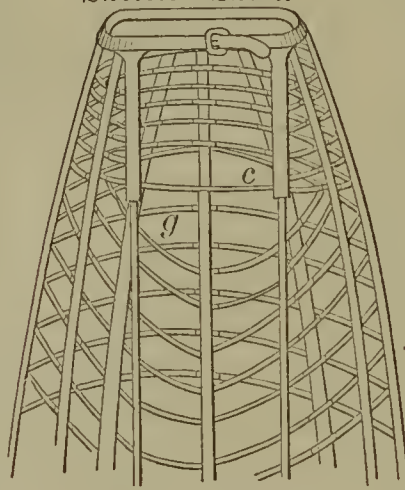

52393—L. I. Davis—*Bolt Heading Machine.*

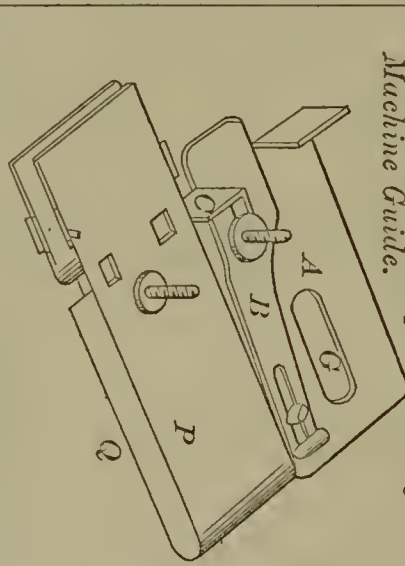
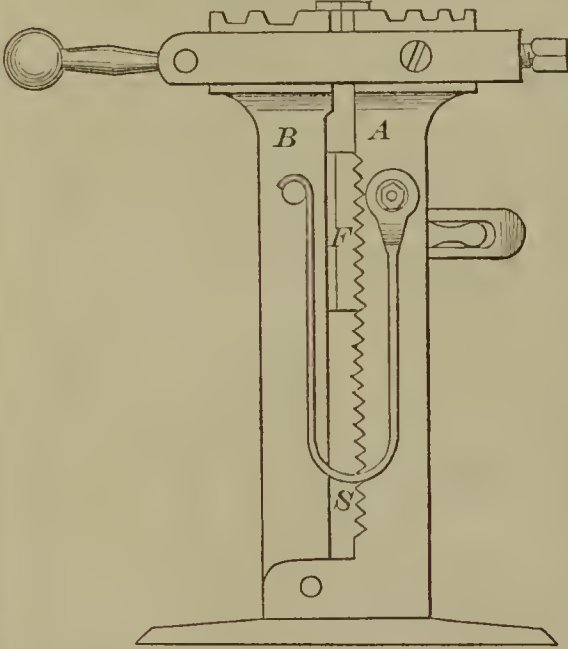

52387—W. J. Chaplin—*Sewing Machine Guide.*

52389—Clark & Syster—*Shank Luster.*

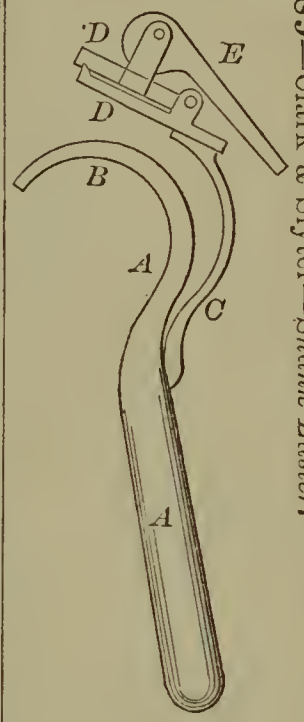

52392—E. Davidson—*Cable Stopper.*

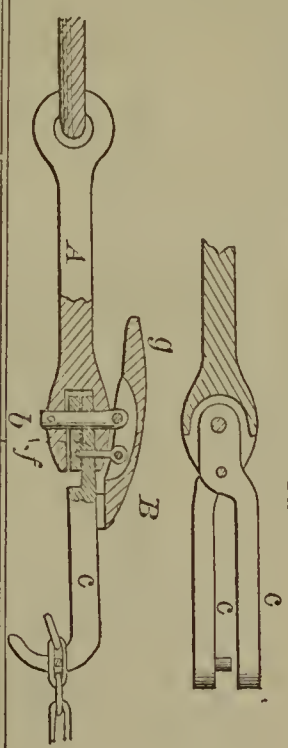

52394—N. Day—*Boot Crimp.*

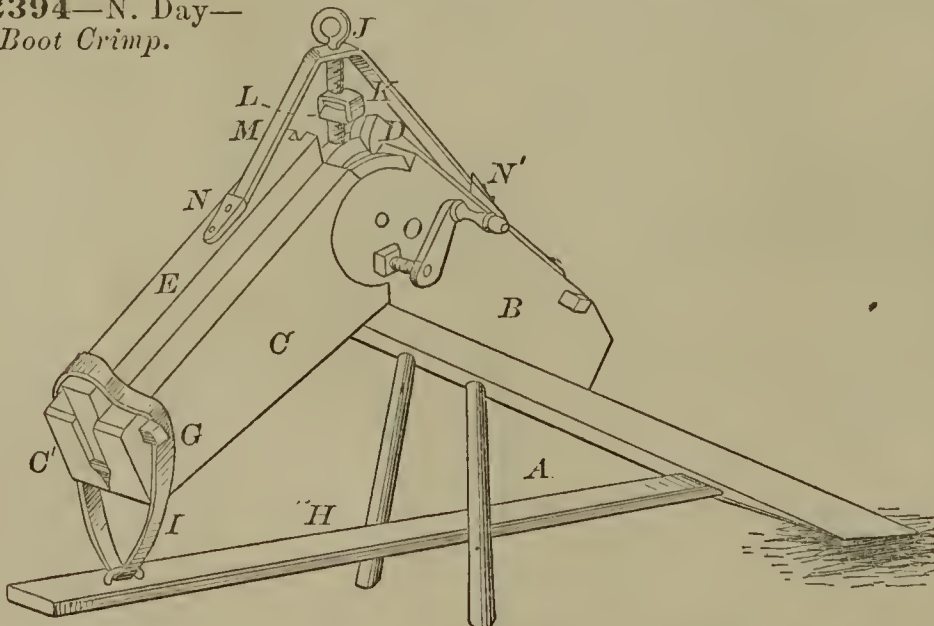

52395—N. A. Dederer—Harvesting Machine.

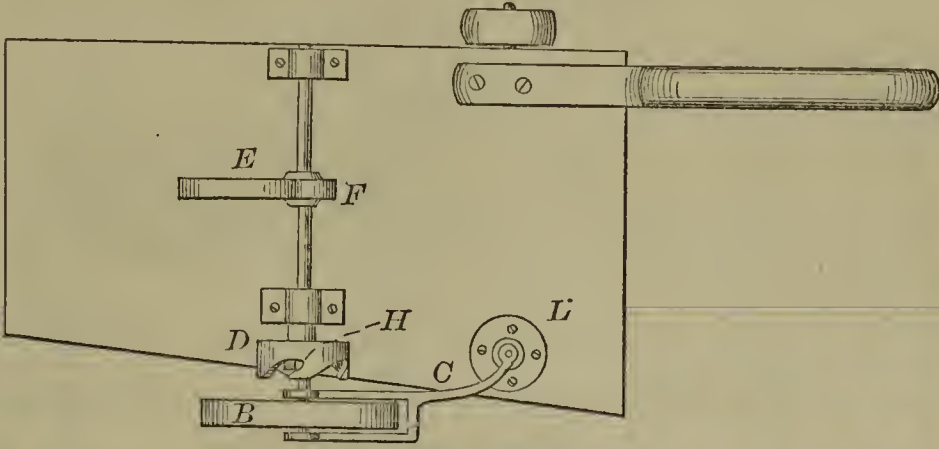

52396—N. A. Dederer—Harvester Rake.

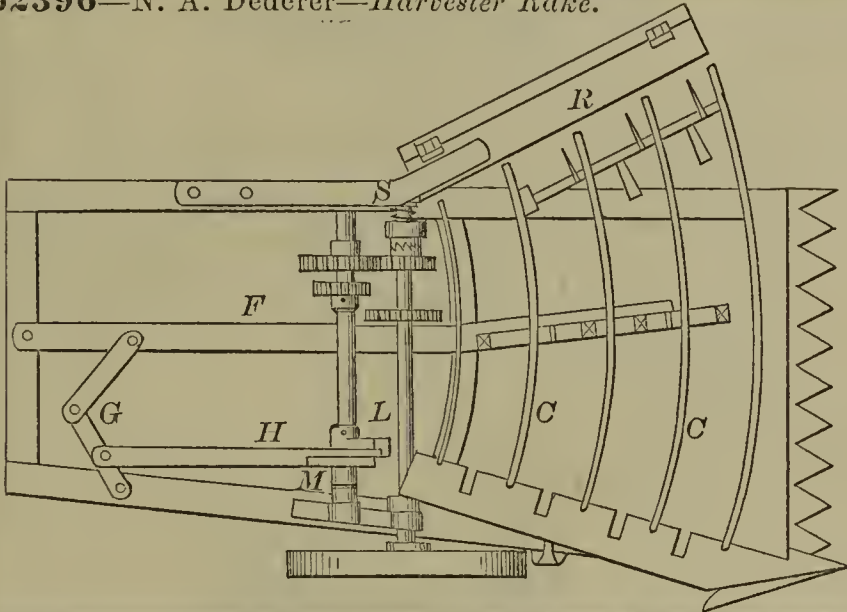

52400—F. Durand—Shoulder Brace.

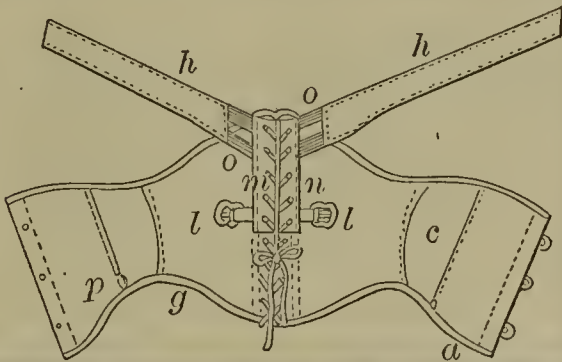

52403—A. Faber—Paper Clamp.

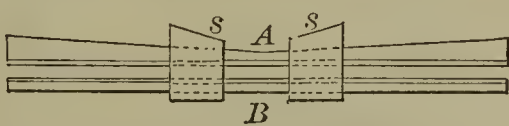

52401—A. P. Durant—Gang Plow.

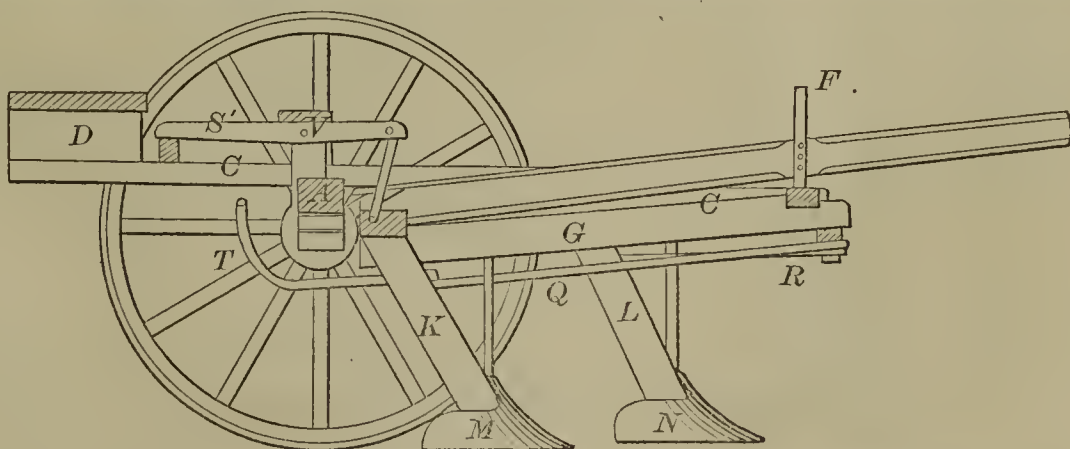

52402—J. H. Elward—Evaporator.

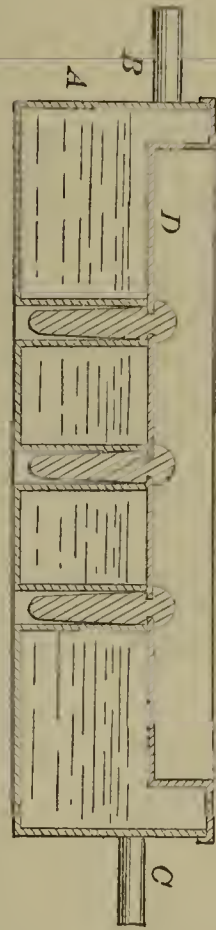

52399—R. H. Dewey—Chimney Holder and Fastening.

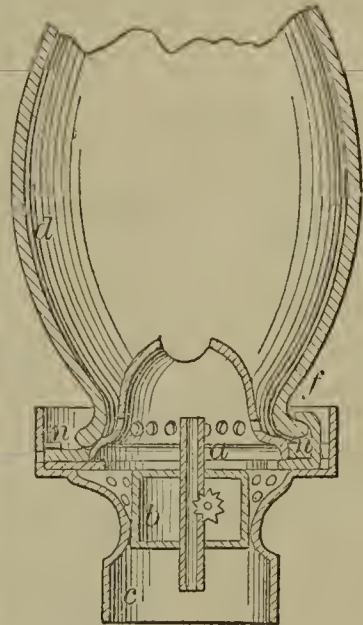

52398—Dennis & Baker—Sewing Machine Thread Cutter.

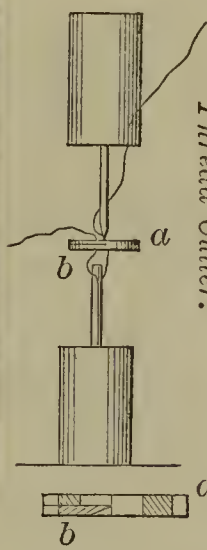

52404—G. Fleig—*Chair and Fan.*

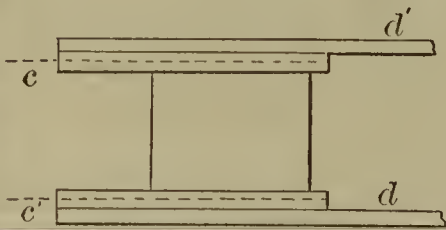
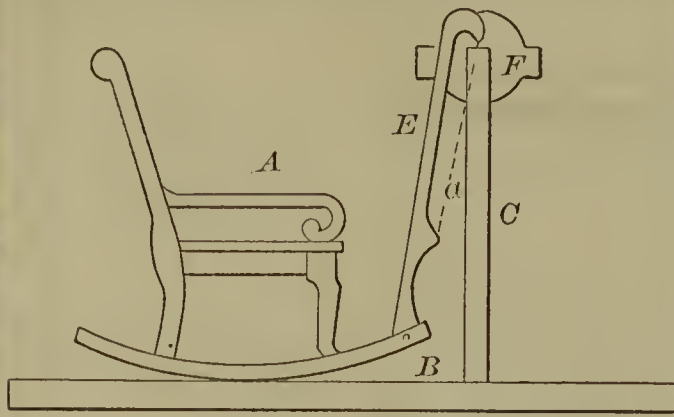

52407—J. Fowler—*Plow.*

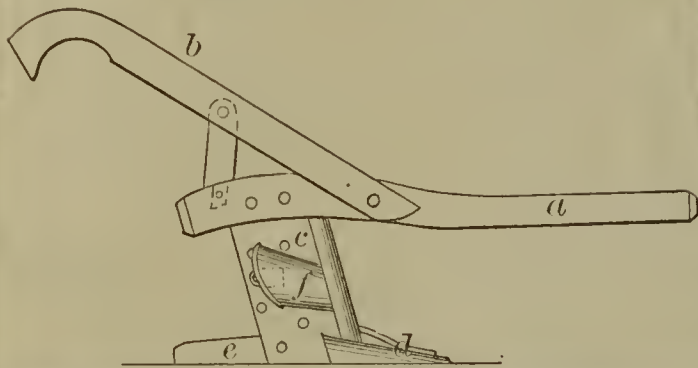

52405—J. A. Fogg—*Coffin.*

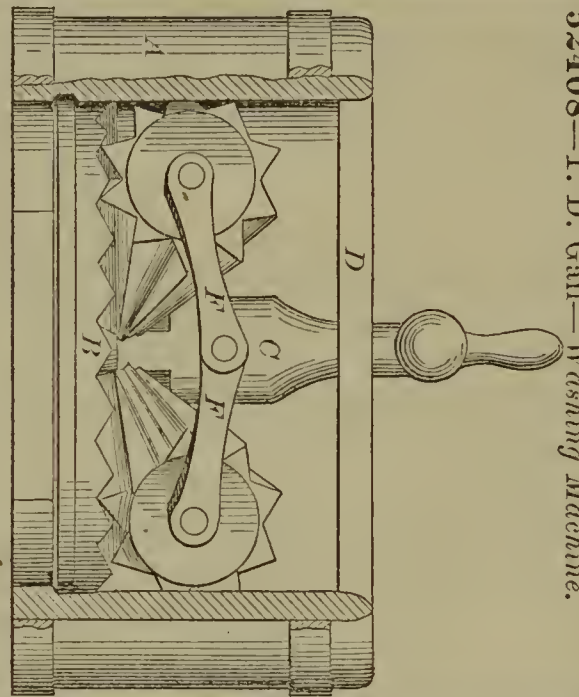
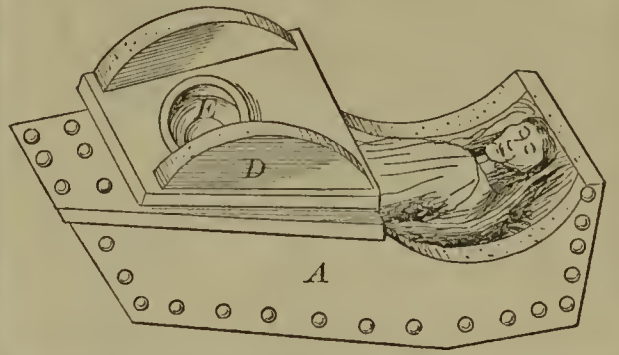

52408—T. D. Gail—*Washing Machine.*

52409—J. H. Gibbs—*For Boring Blinds.*

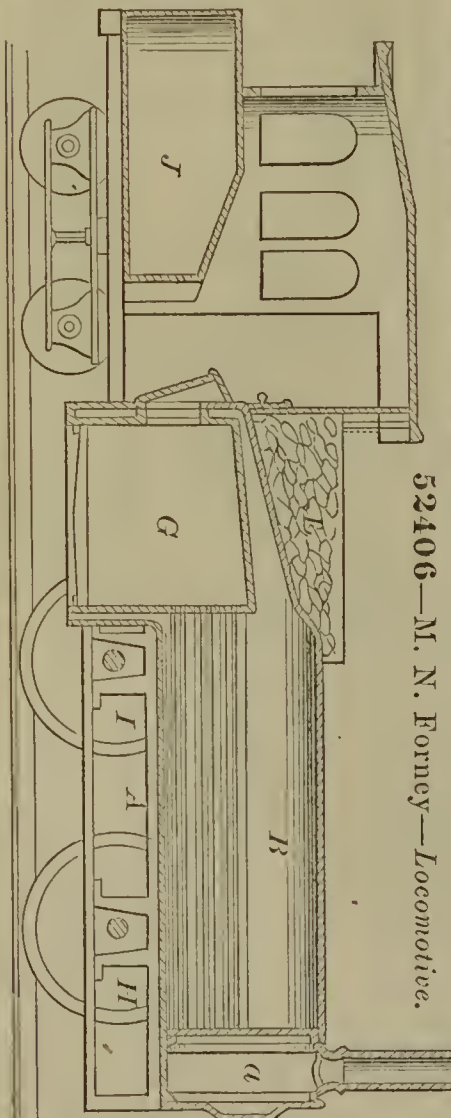
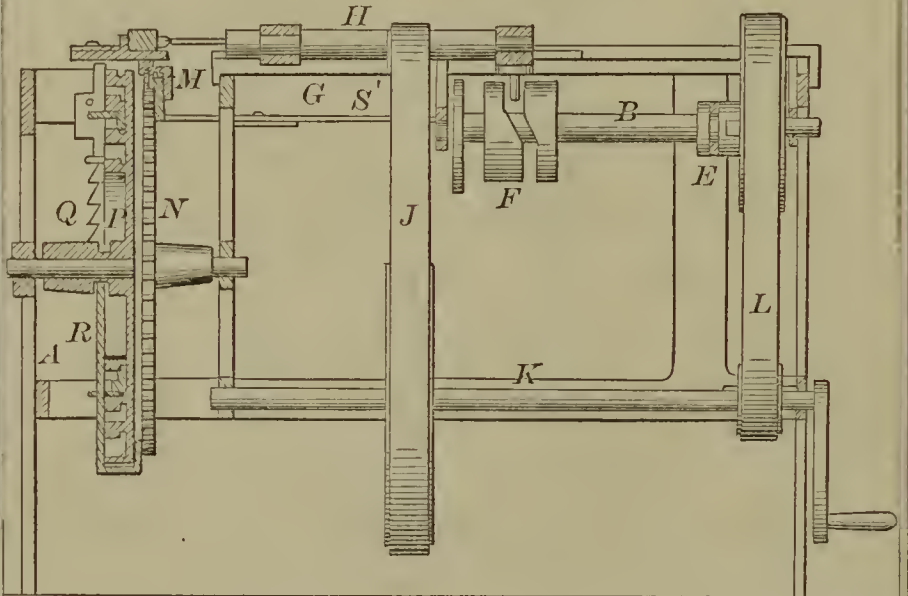

52406—M. N. Forney—*Locomotive.*

52410—J. Harris—*Car Coupling.*

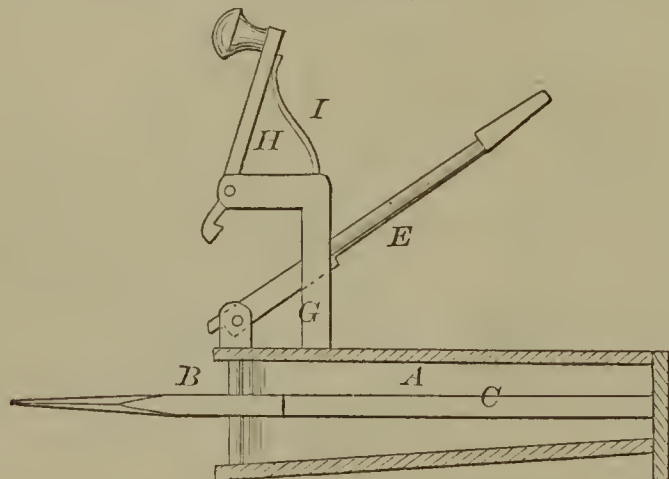



52411—L. J. Hawley—*Lightning Rod.*

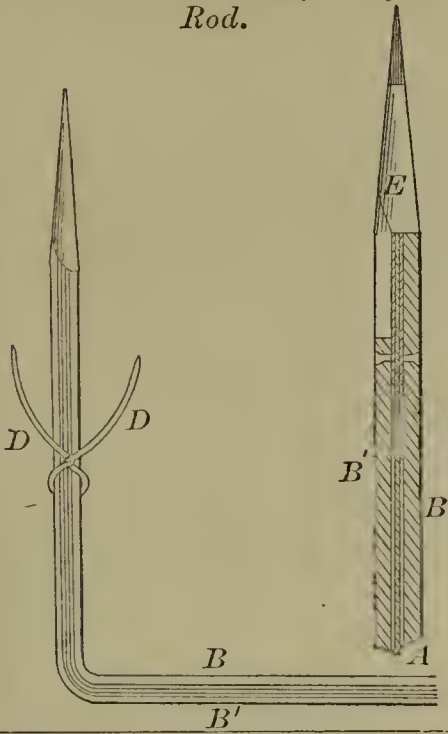

52412—C. G. Herbert—*Camp Stool.*

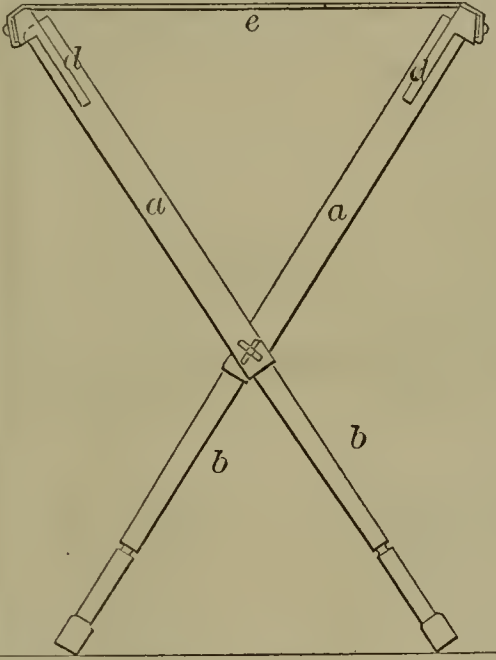

52413—T. M. Hill—*Corn Planter.*

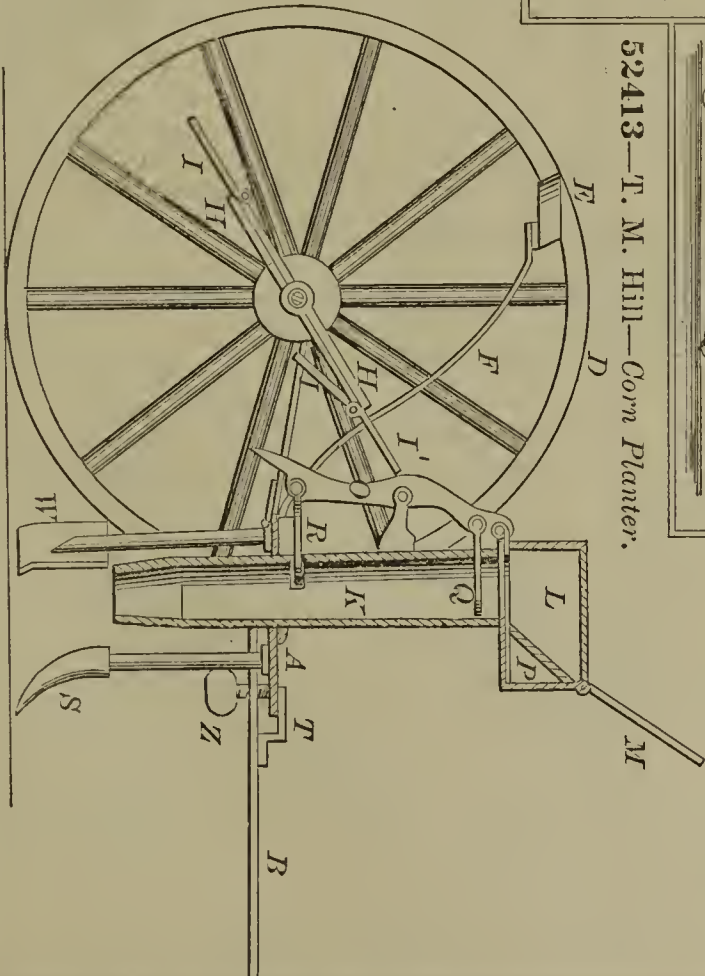

52415—W. W. Hubbard—*Bolt and Nut Machine.*

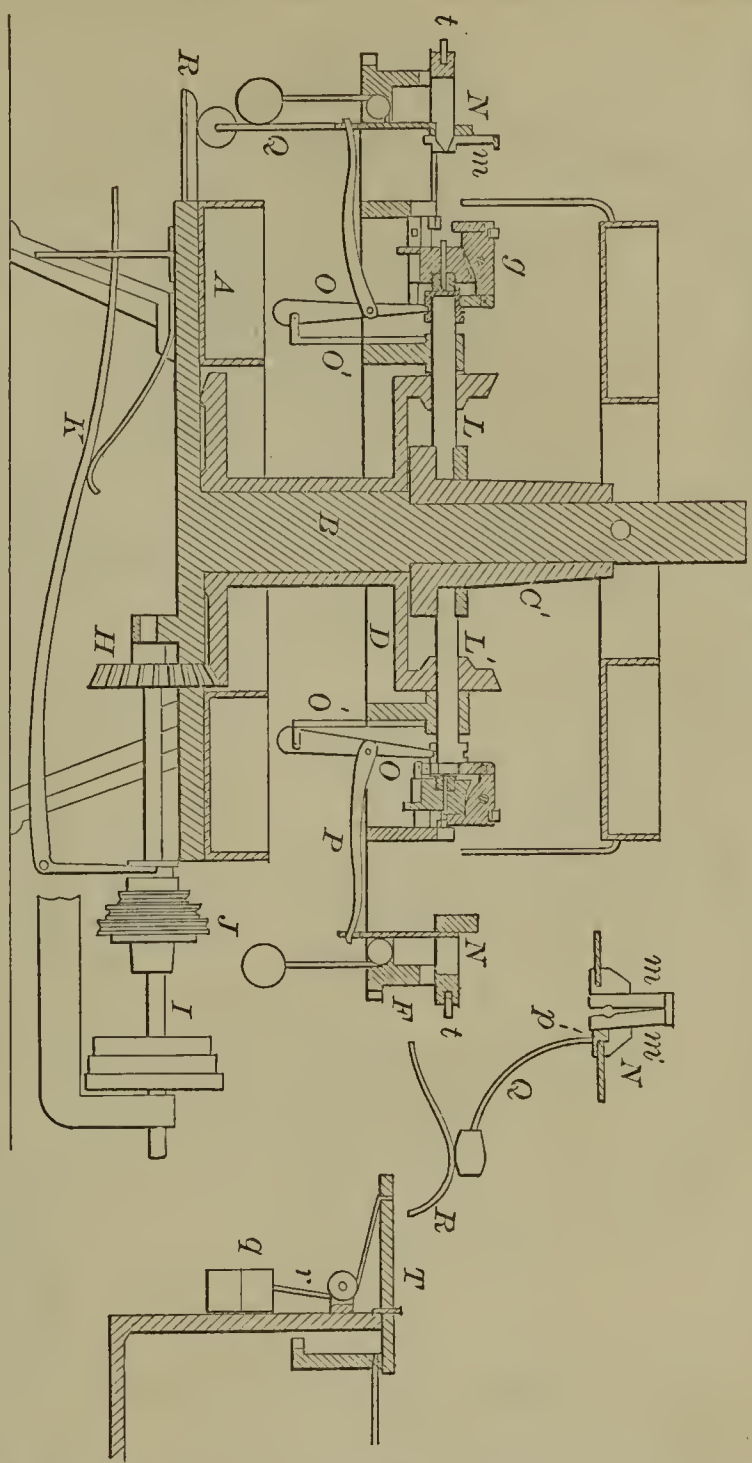

52416—G. Hunzinger—*Chair.*

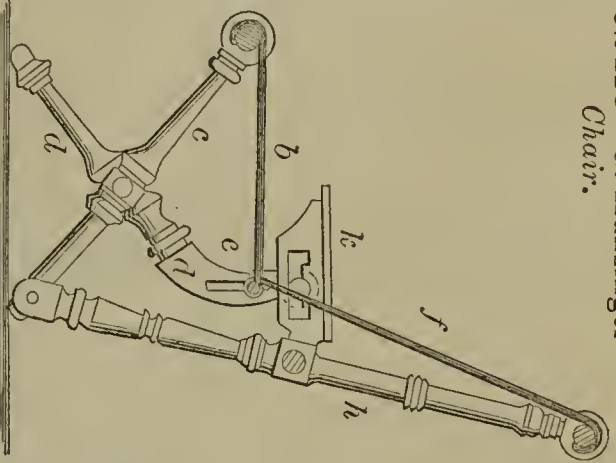

52414—J. A. & H. A. House—*Shield for Trunks.*

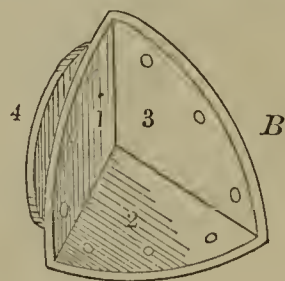

52417—R. H. Ingersoll—Billiard Register.

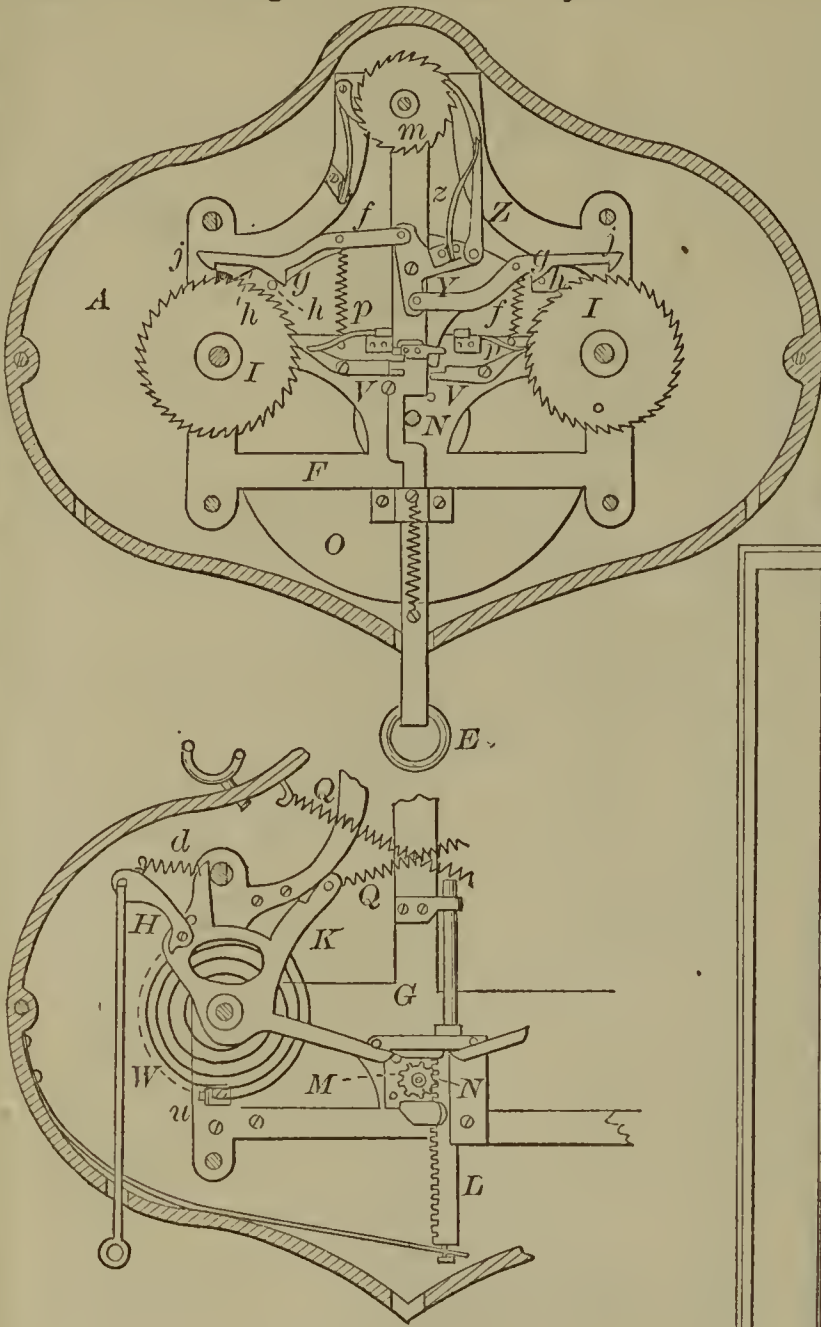

52420—Kane & Brown—Caster for Furniture.

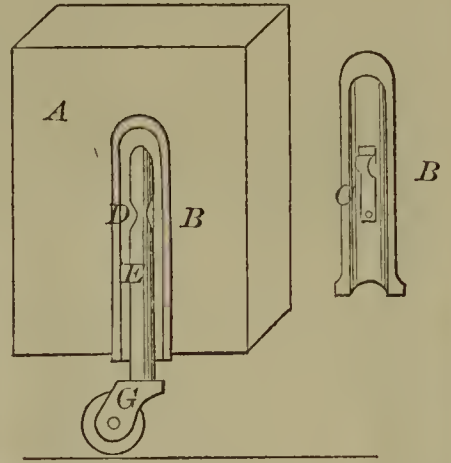

52418—E. C. Jayne—Printing on Glass, &c.

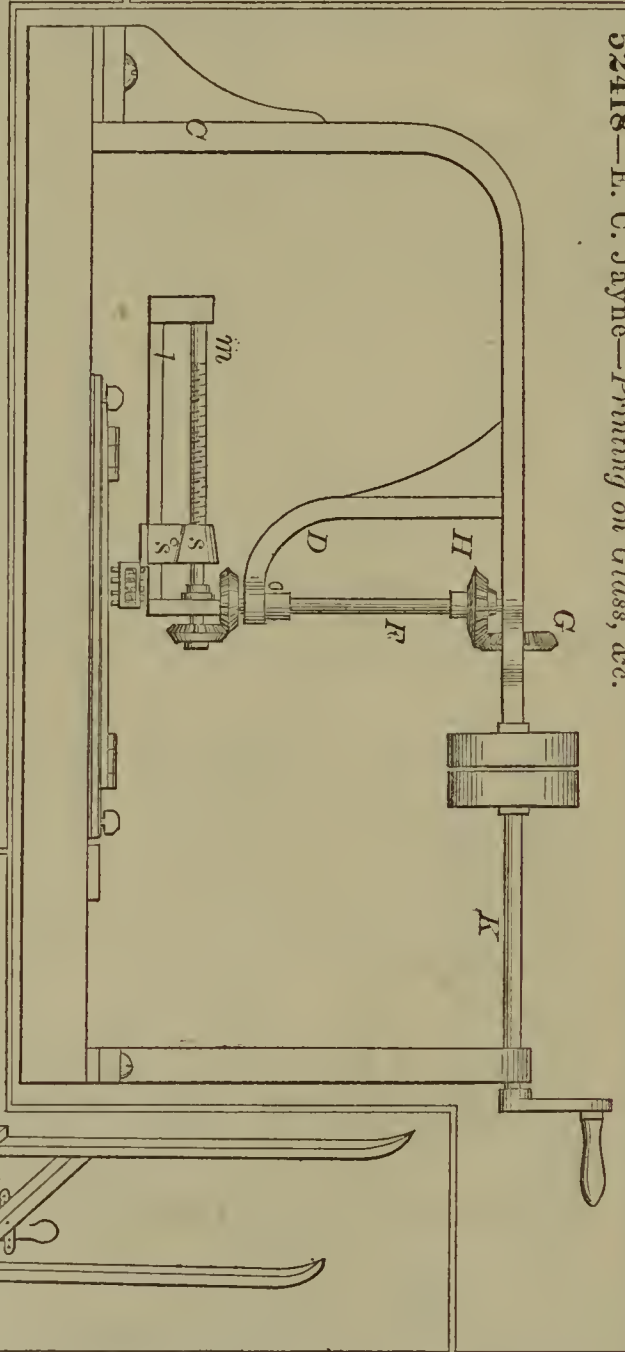

52421—A. Lamb—Cultivator.

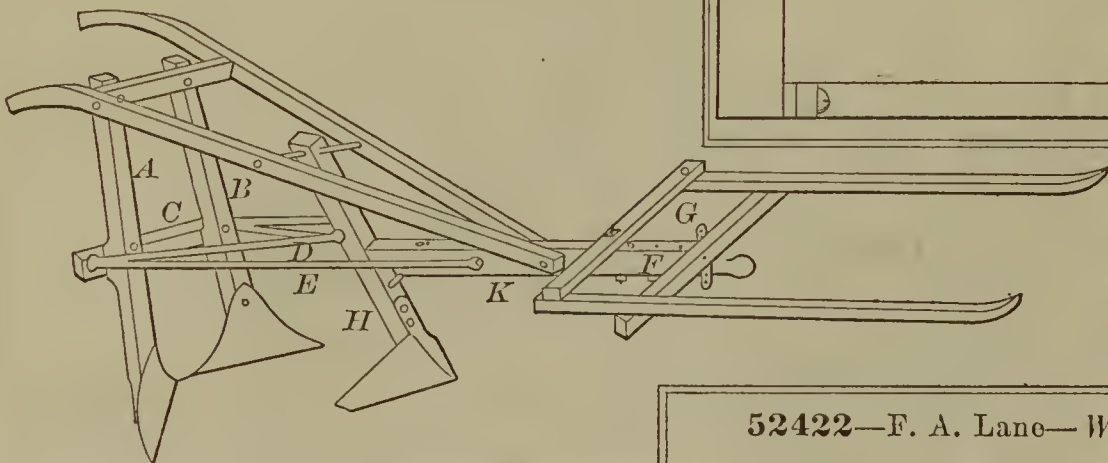

52419—P. Jeanne—Tobacco Pipe.

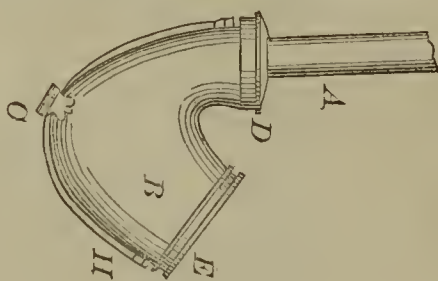

52422—F. A. Lane—Wheel and Axle.

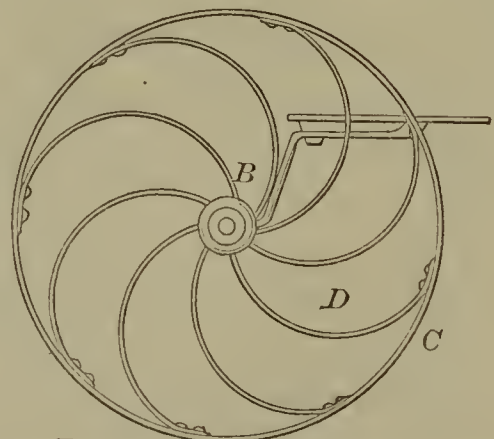

52423—J. Lee—Clothes Wringer.

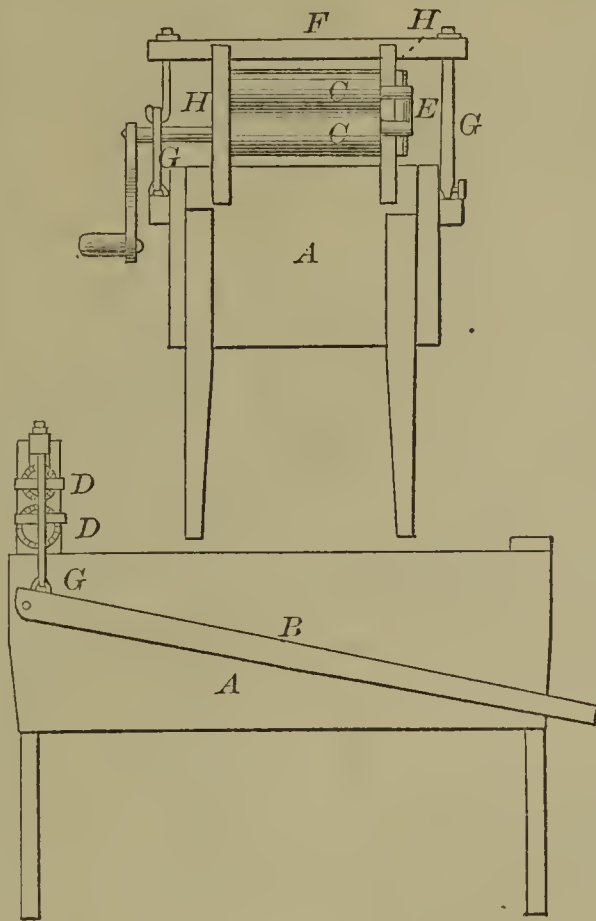

52426—T. Linfoot—Spring Bed Bottom.

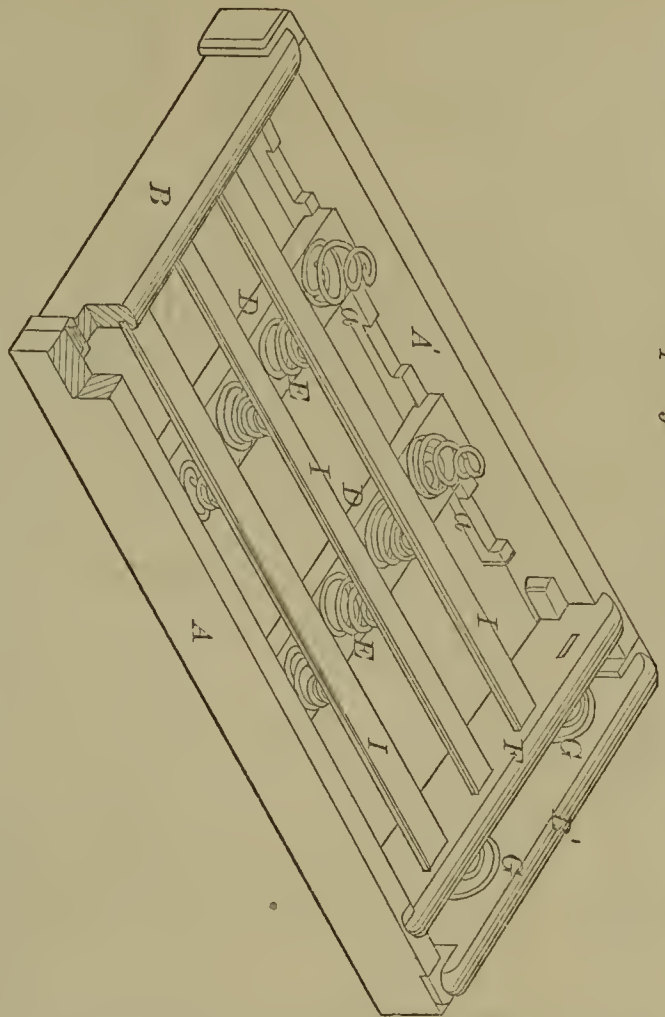

52427—L. Lobenstein—Hoop Skirt.

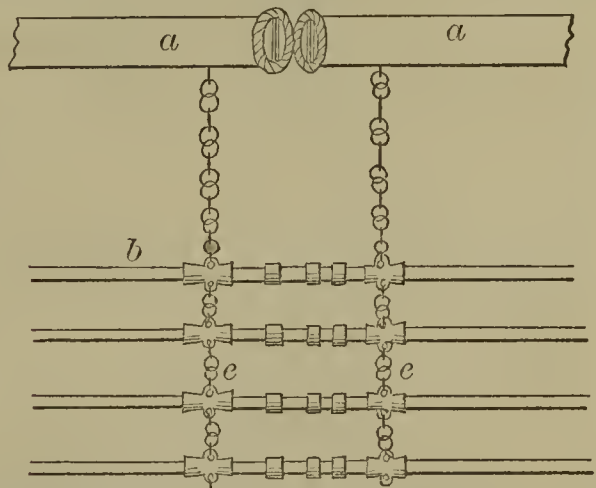

52425—R. R. Lewis—Well Borer.

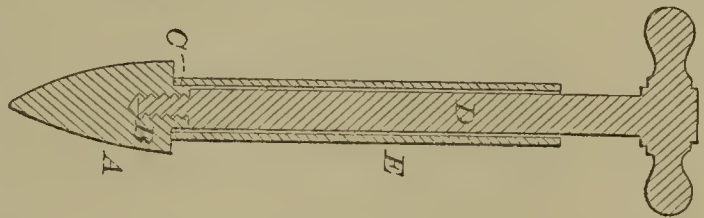

52428—A. Marcellus—Potato Digger.

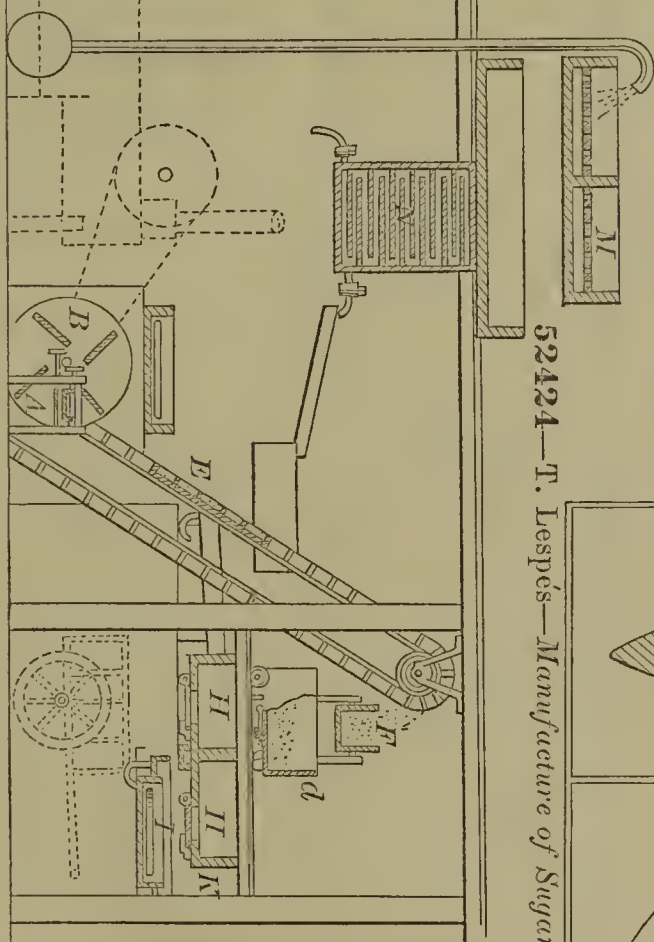
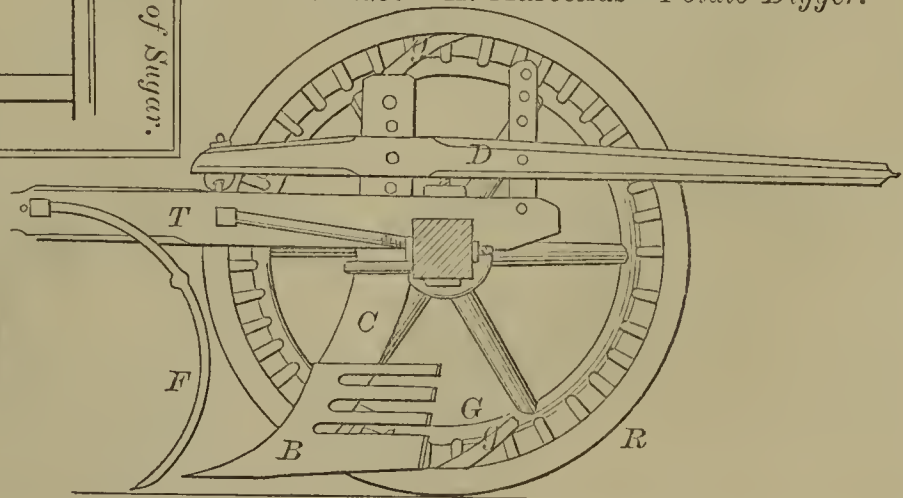

52424—T. Lespés—Manufacture of Sugar.

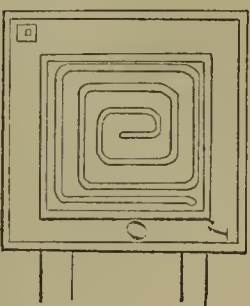

52432—C. A. Maxfield—Making Paper Boxes.

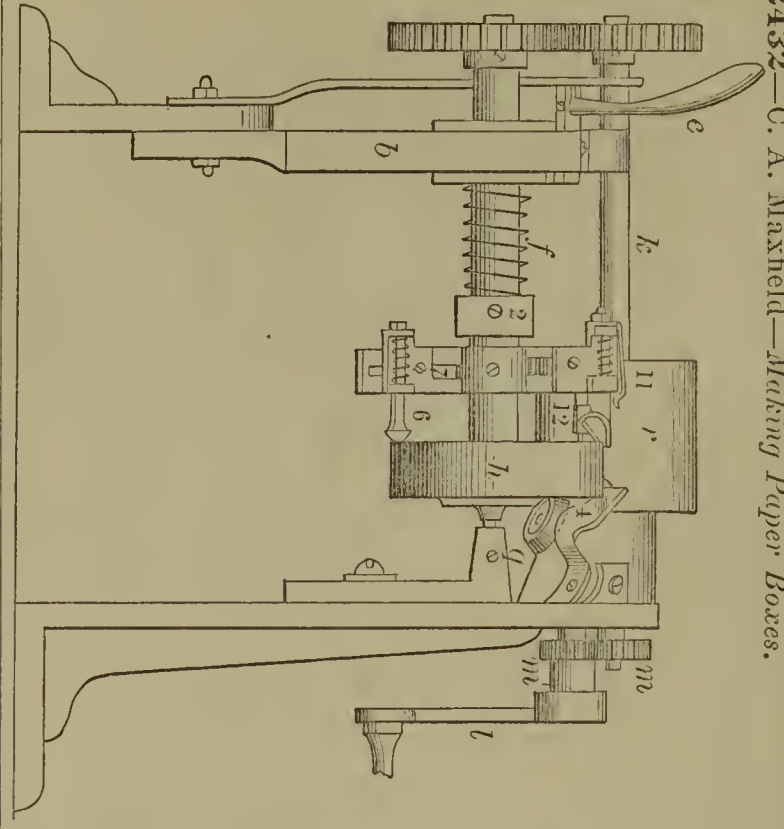

52429—A. S. Markham—Cultivator.

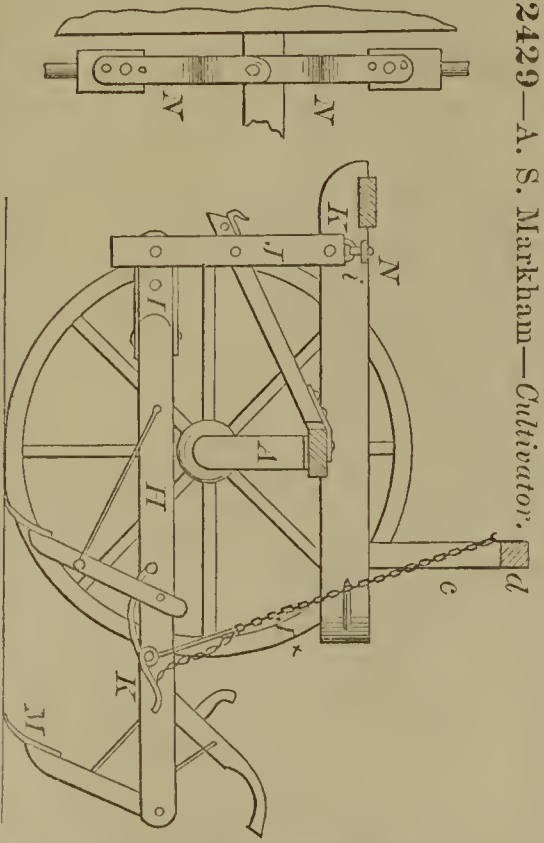

52431—Mason & Gill—Pump.

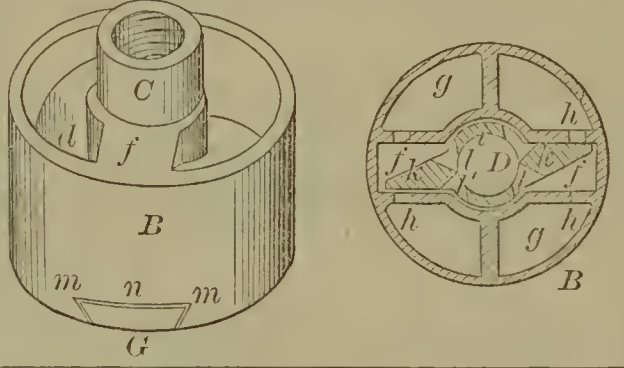

52430—O. H. & J. A. Marston—Heel Cutter.

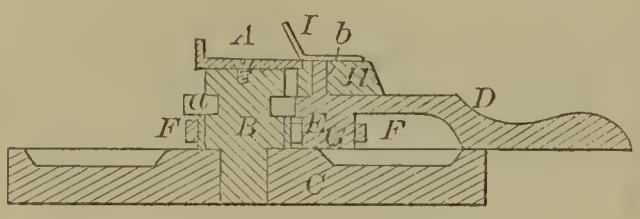

52433—J. W. McDermott—Bolt Heading Machine.

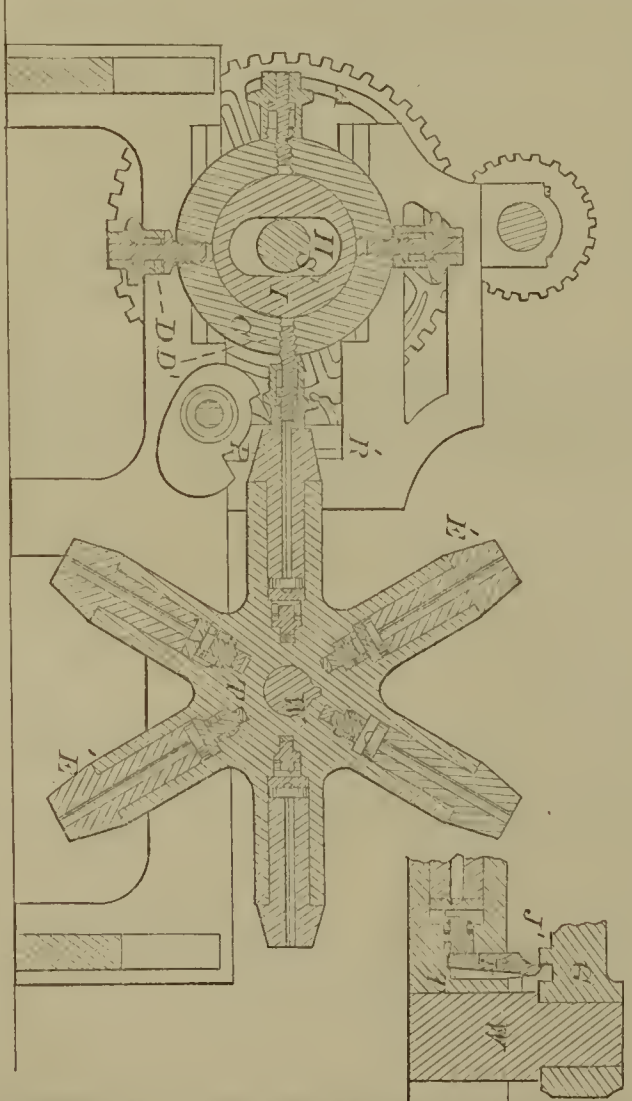
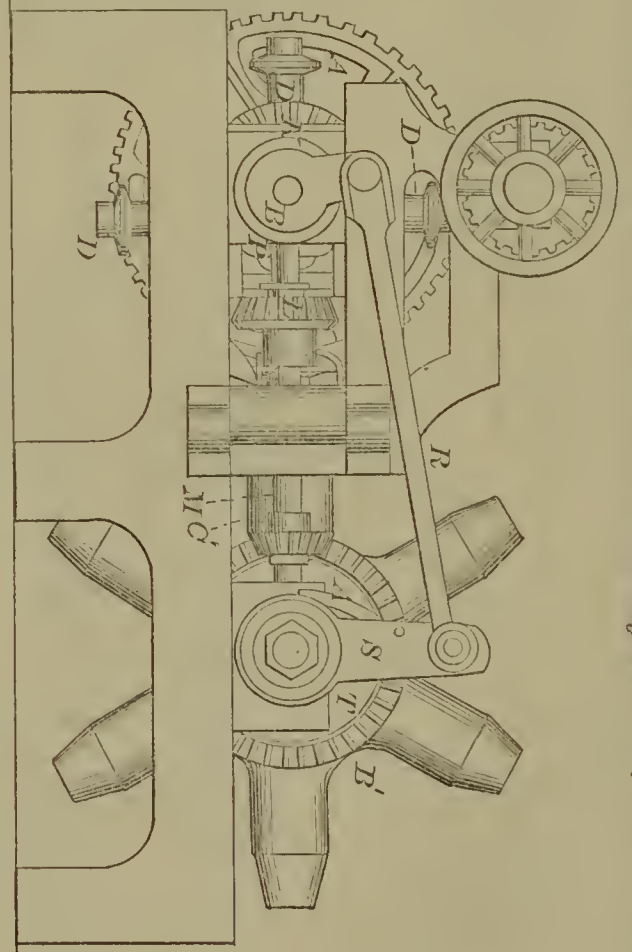

52434—A. McFarland—Sawing Machine.

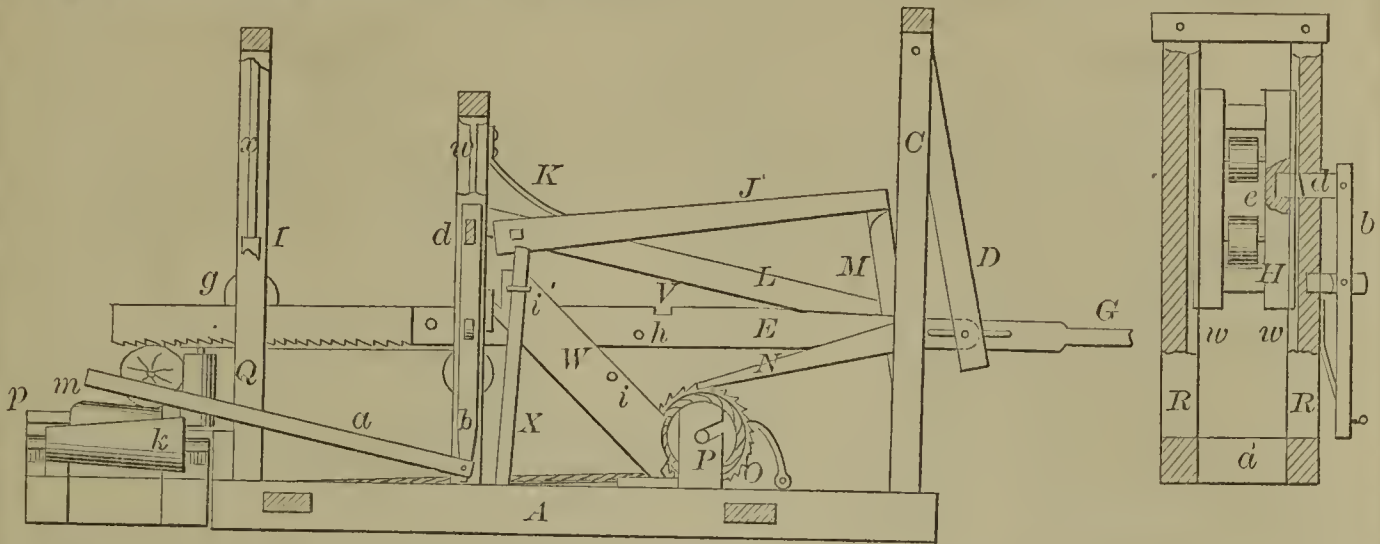

52436—J. McKelvey—Refrigerator.

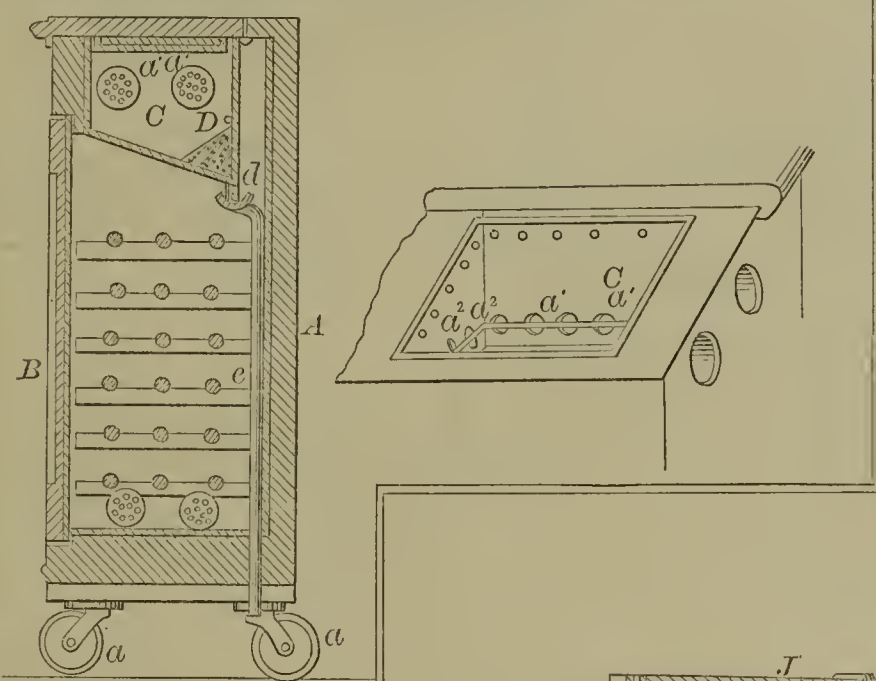

52435—W. A. McIntire—For Varnishing and Lining Percussion Caps.

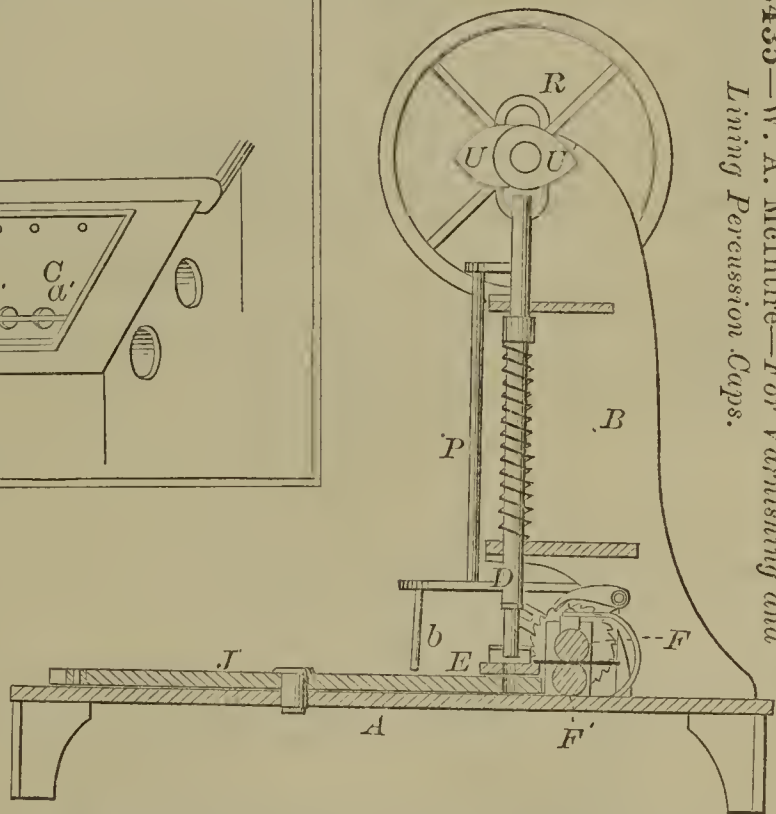

52437—D. F. Mellen—Grab for Oil Wells.

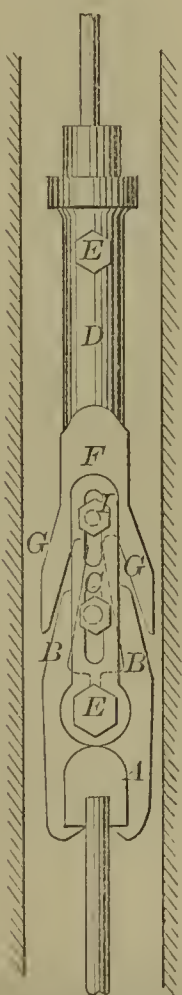

52438—T. C. Moore—Eaves Trough.

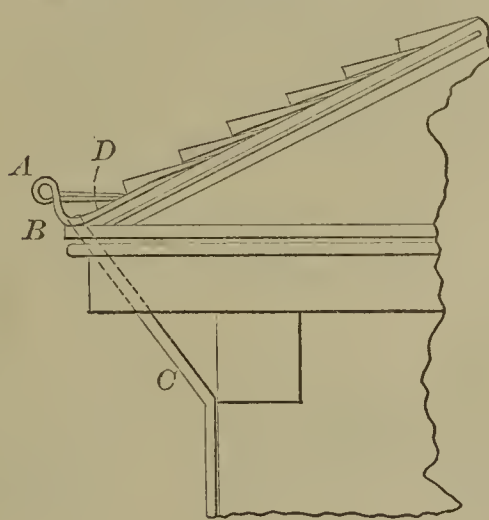

52439—C. B. Morehouse—Whip Socket.

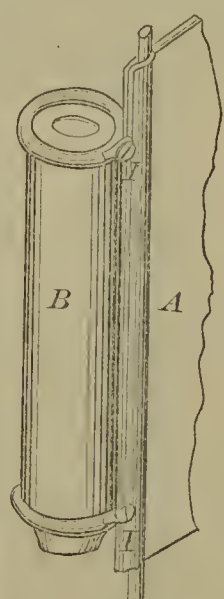

52440—F. B. Morse—Carriage Clip.

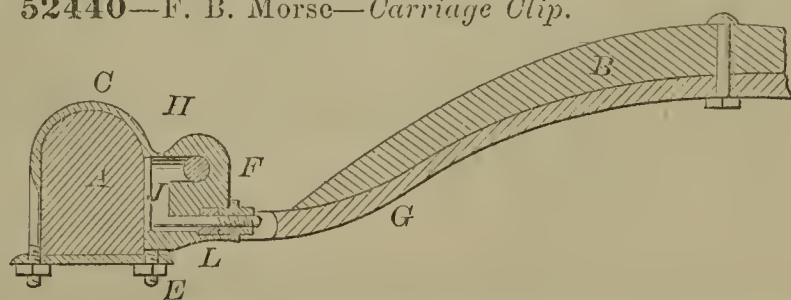

52441—W. H. Nichols—Washing Machine and Wringer.

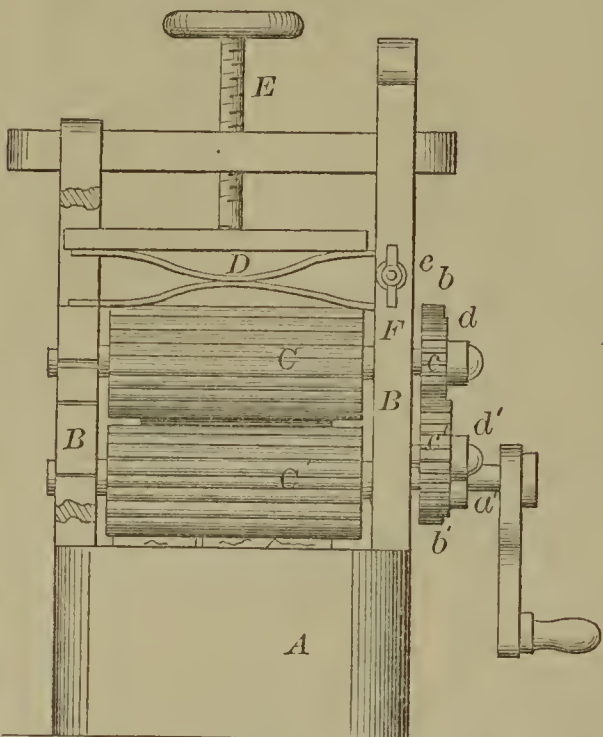

52442—C. A. Palmer—Blind Fastening.

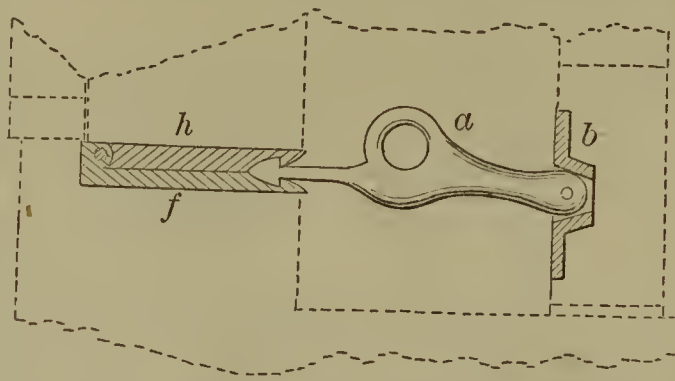

52443—H. L. Parker—Brad Awl Handle.



52444—W. Pirsson—Ratchet Wrench.

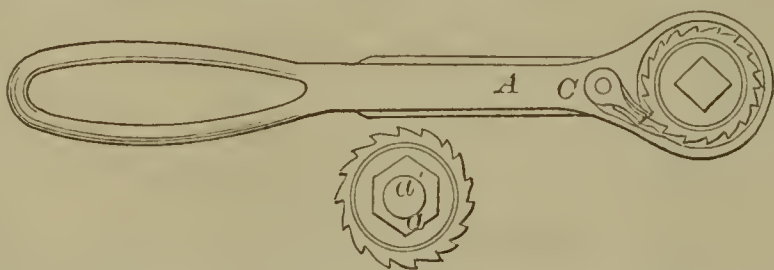

52447—A. Rix—Forging Apparatus.

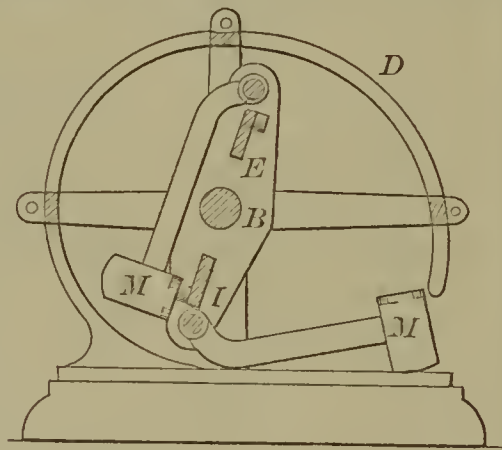

52445—J. B. Pitts—Seeding Machine.

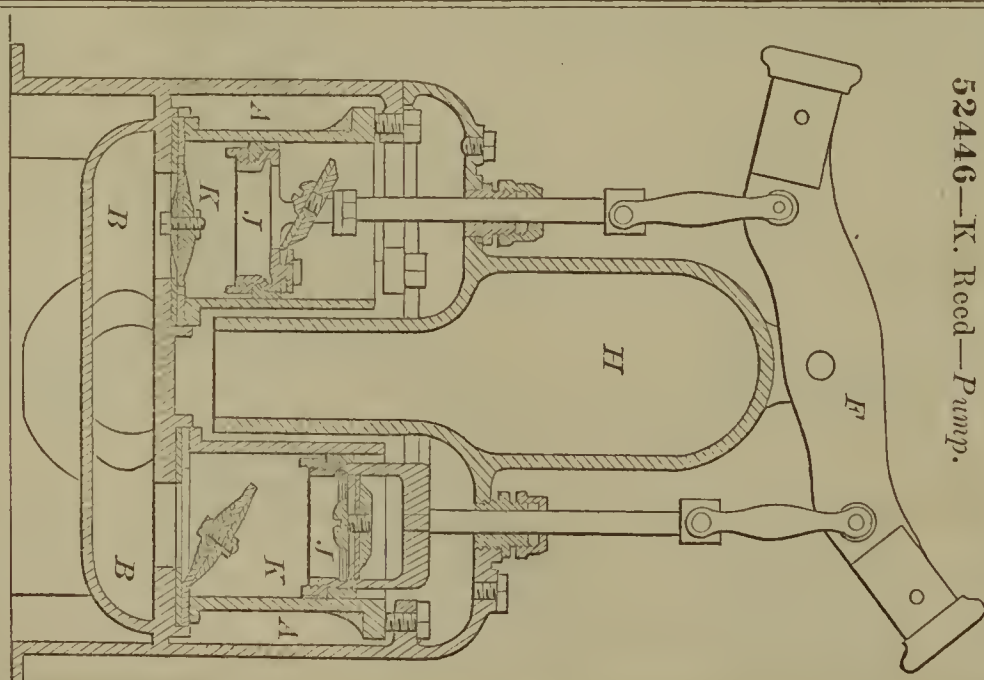
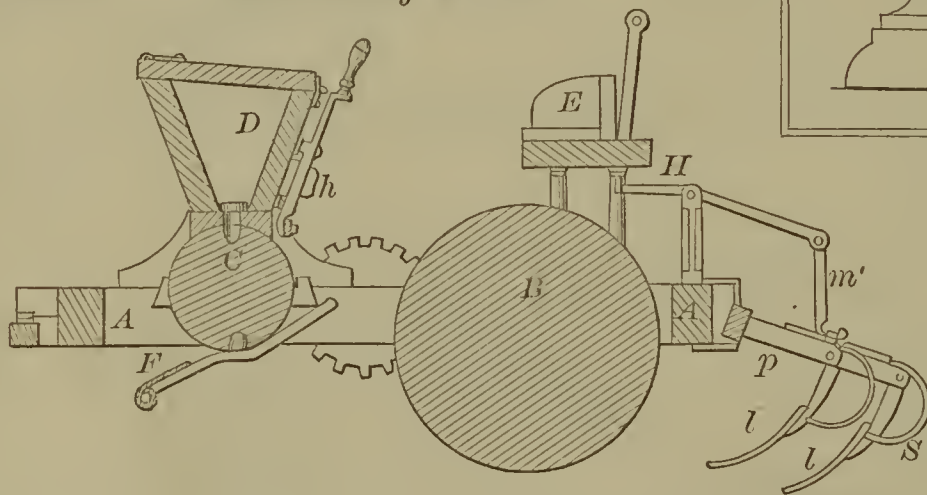

52446—K. Reed—Pump.

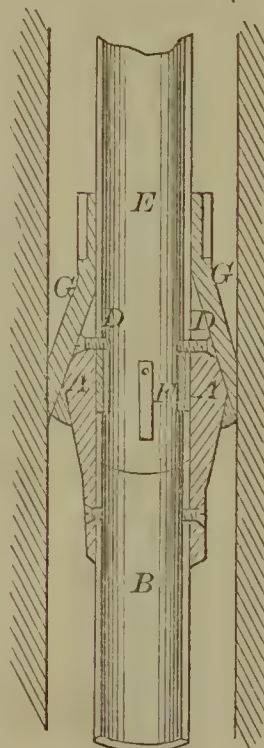

52448—Robinson & Strong—Packing for Deep Wells.

52449—H. W Russell—Chopping Machine.

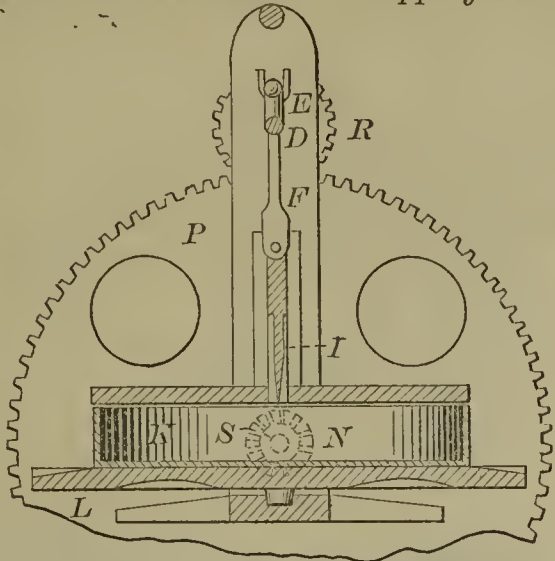

52450—J. Russell—For Hardening Files.

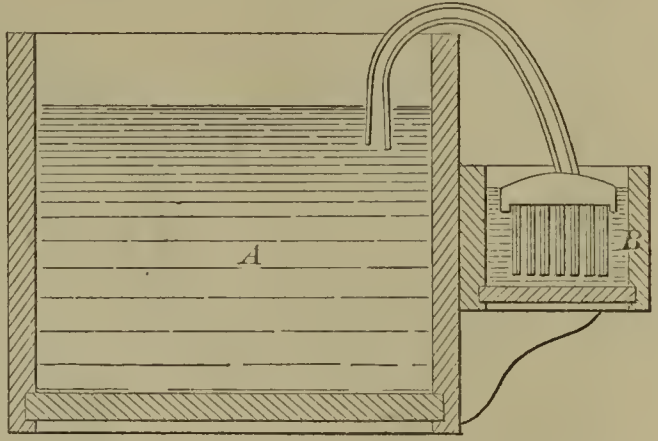

52451—E. Savoral—Steam Engine.

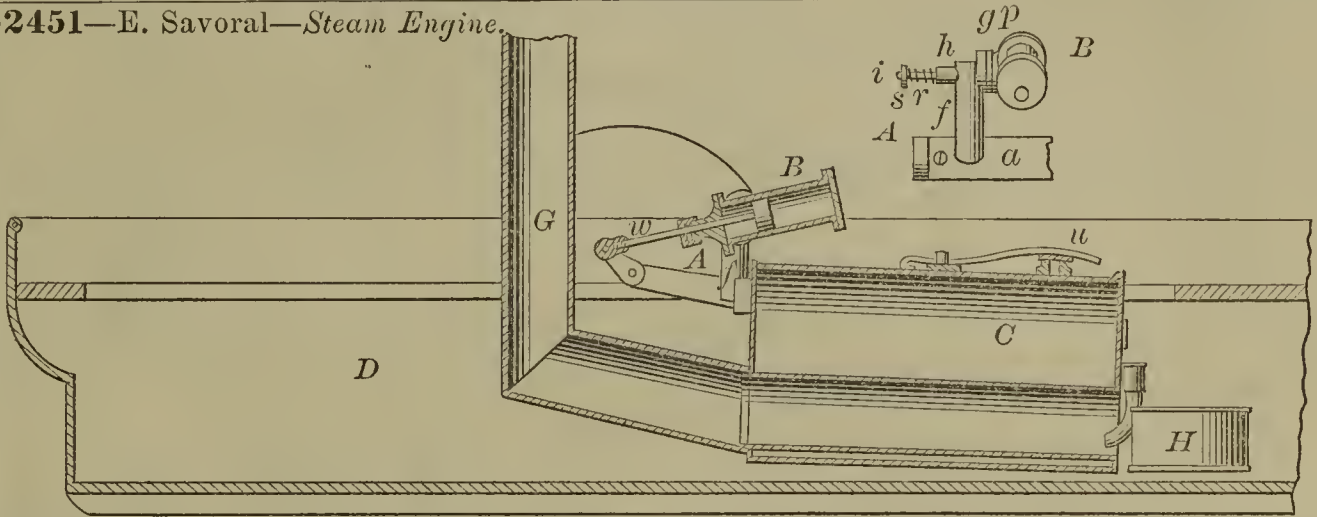

52452—J. C. Schaefer—Steam Gauge Cock.

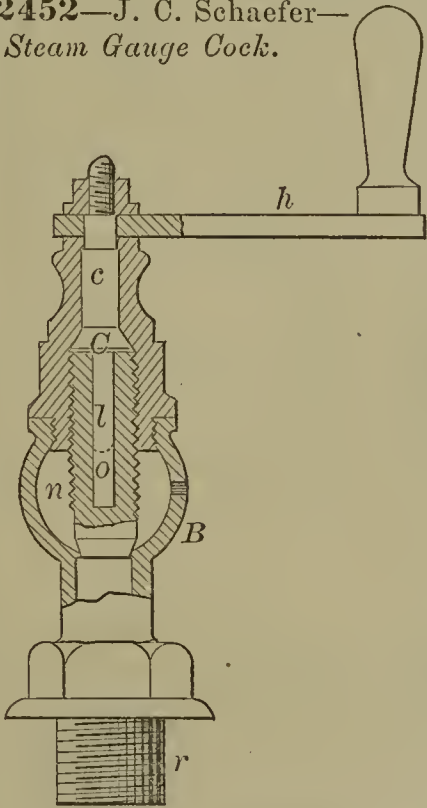

52453—G. W. Schramm—Ruler.

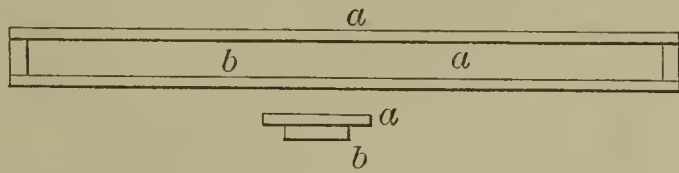

52455—T. Shaw—Connecting Rod Joint.

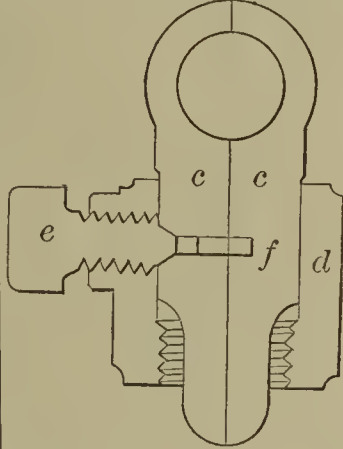

52454—J. F. Schuffenker—Lubricating Vertical Shafts.

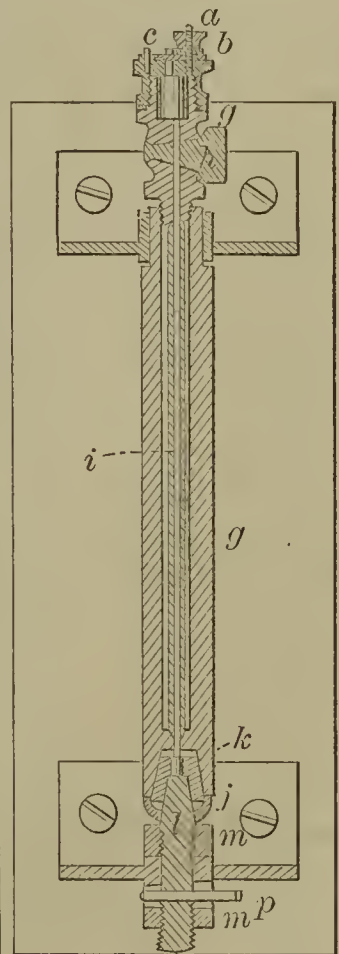

52456—G. B. Simpson—Amalgamating Gold and Silver.

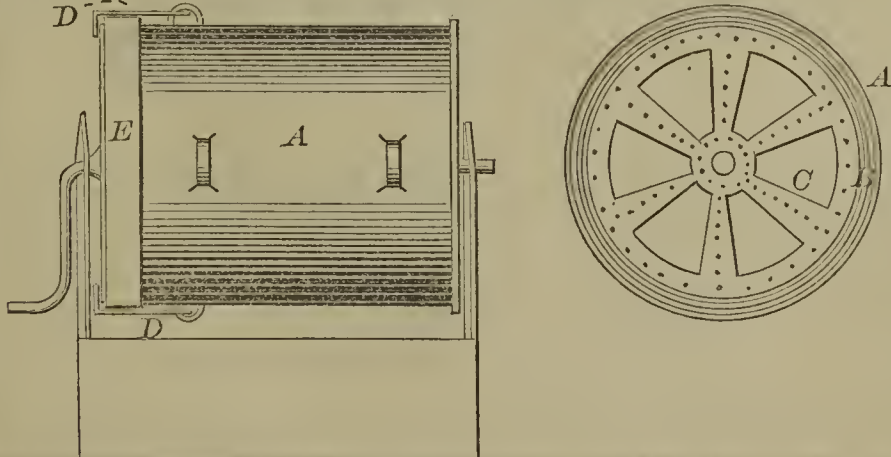

52457—Snow & Lewis—*Gas Jet Cigar Lighter.*

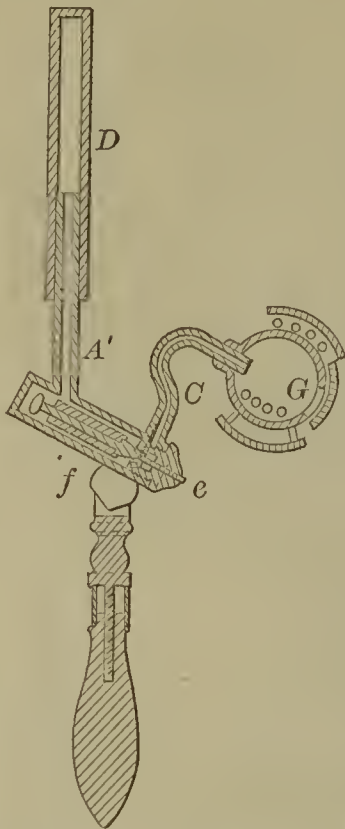

52458—F. Stewart—*Horse Rake.*

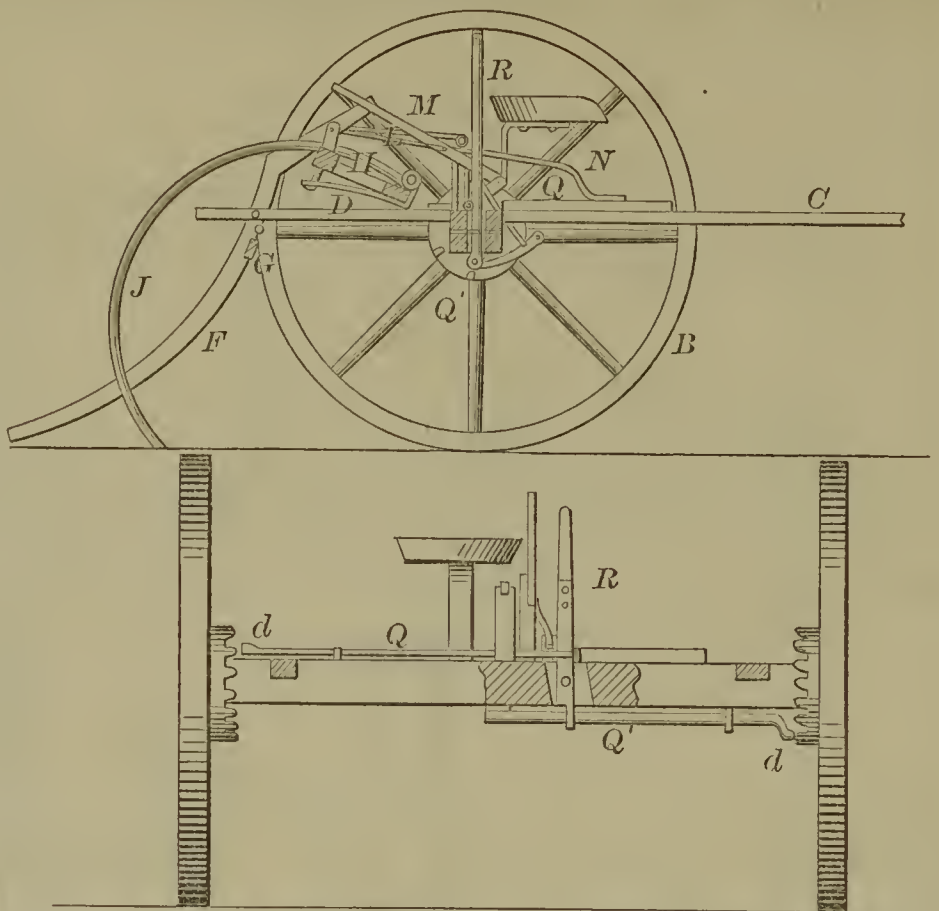

52459—H. B. Stiles—*Water Motor.*

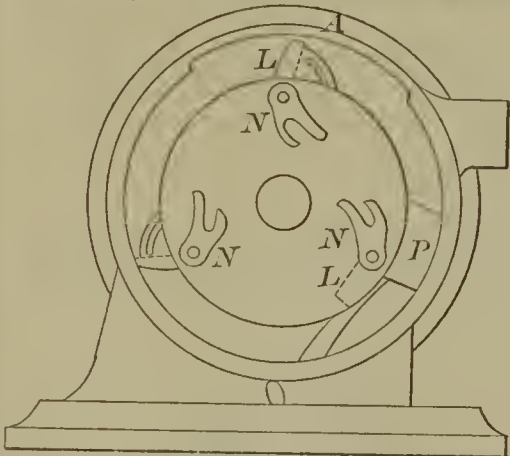

52460—W. W. St. John—*Stove Pipe Damper.*

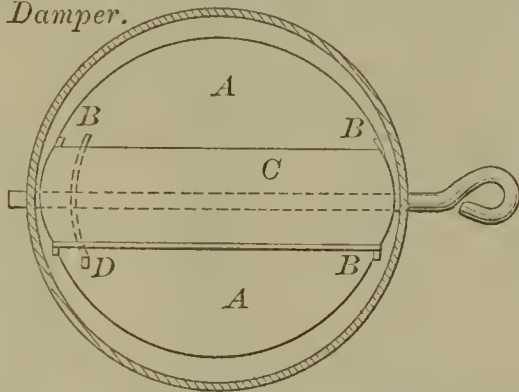

52462—J. S. Stukey—*Corn Cultivator.*

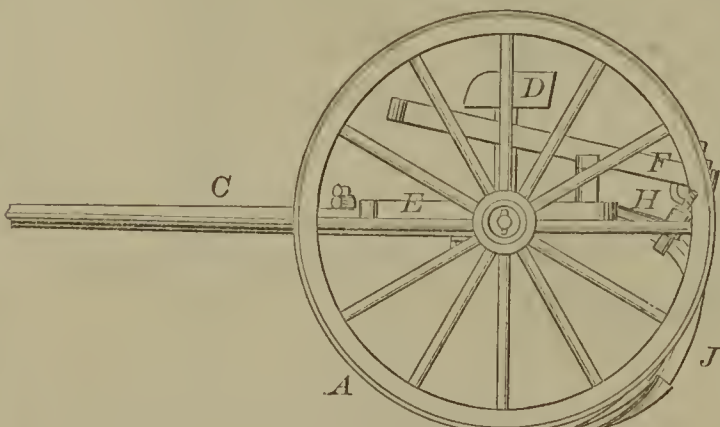

52461—G. W. Stoekel—*Graduated Bottle.*

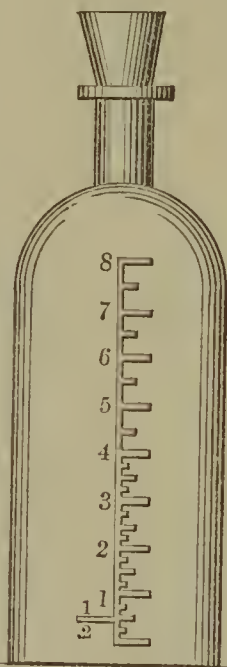

52463—J. Suggett—*Mode of Sinking Wells.*

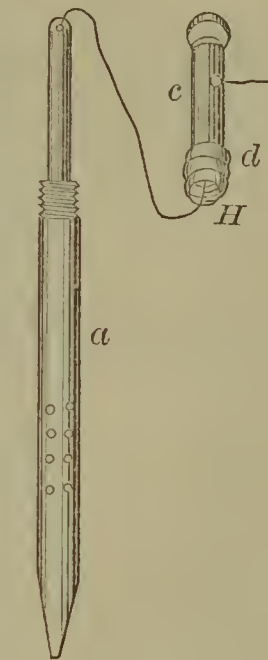

52465—T. C. Taylor—*Putting up Caustic Alkali.*



52466—T. C. Taylor—*Putting up Caustic Potassa.*

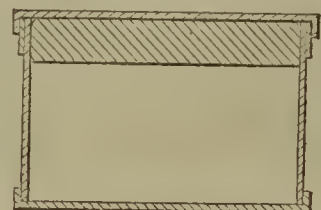



52467—D. E. Teal—Churn.

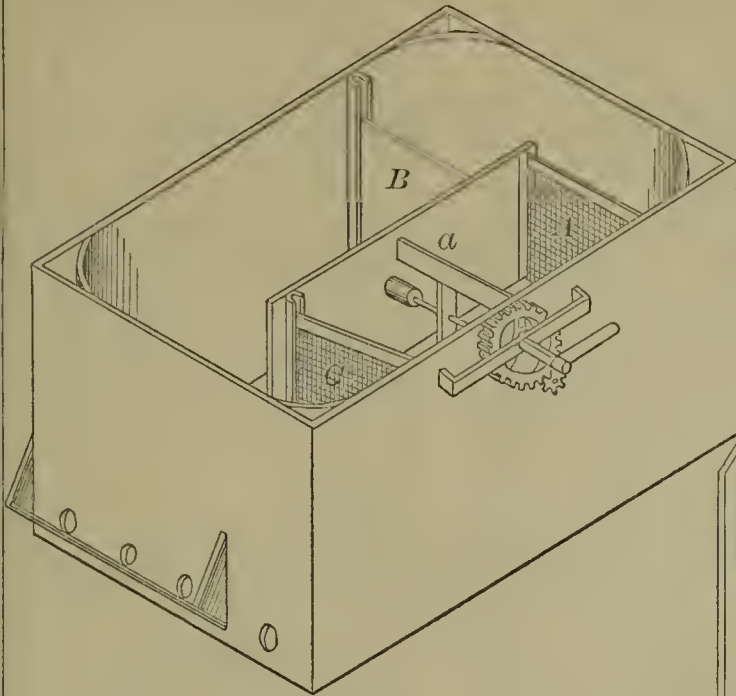

52472—T. J. Wells—Peat Machine.

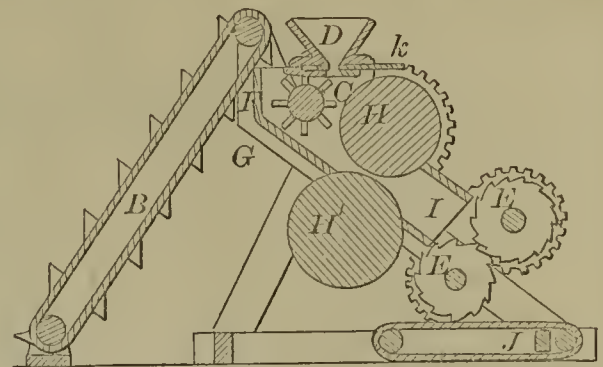

52470—S. D. Tripp—Heel Polishing Machine.

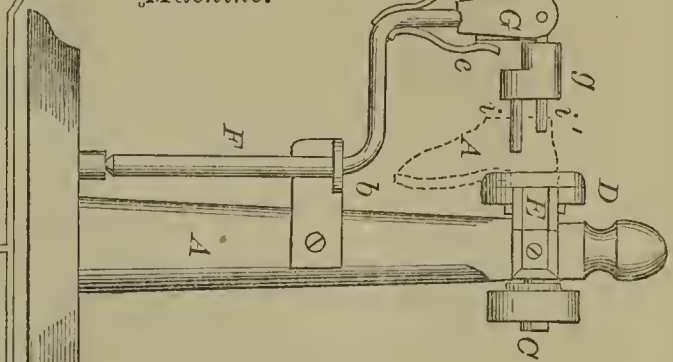

52471—A. J. Van Boekel—Corn Planter.

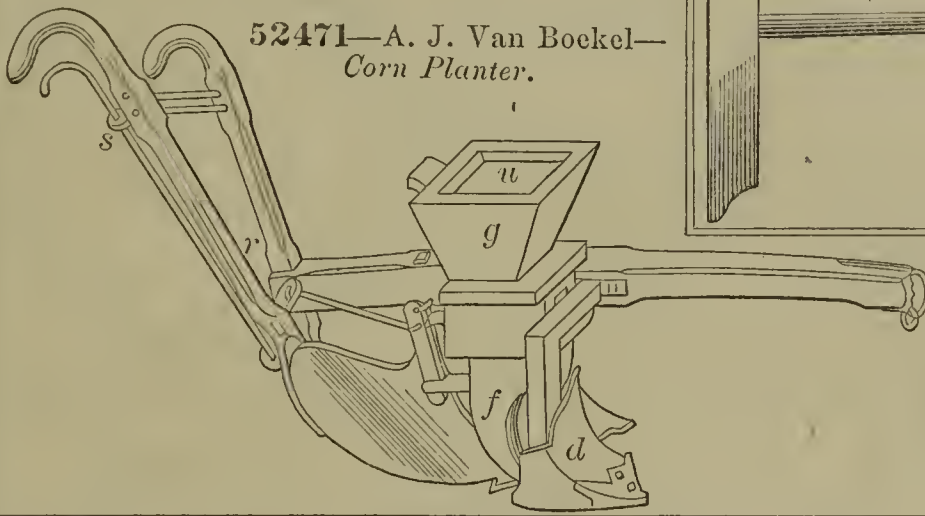

52469—G. E. Thompson—Door Fastener.

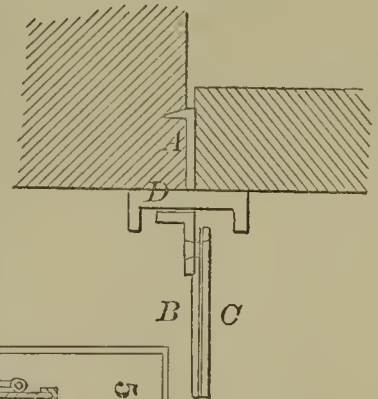

52474—N. W. Wheeler—Steam Engine.

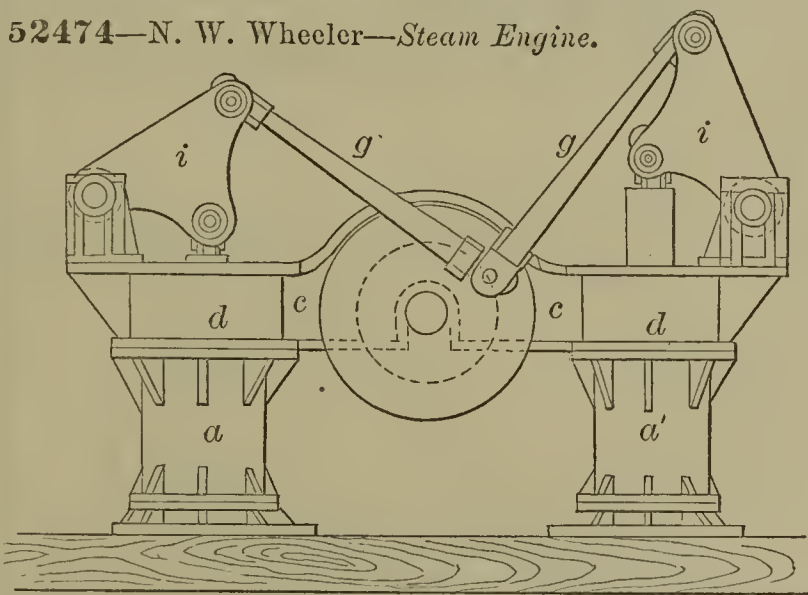

52468—K. Thoman—Canteen and Lunch Box.

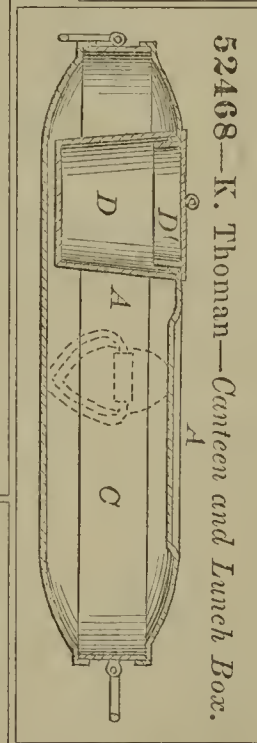

52473—J. A. Welsh—Blind Splint Machine.

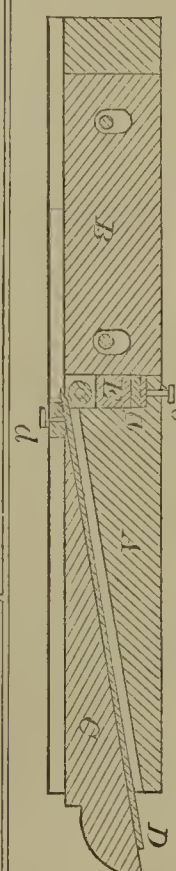

52475—N. W. Wheeler—Valve Gear for Steam Engine.

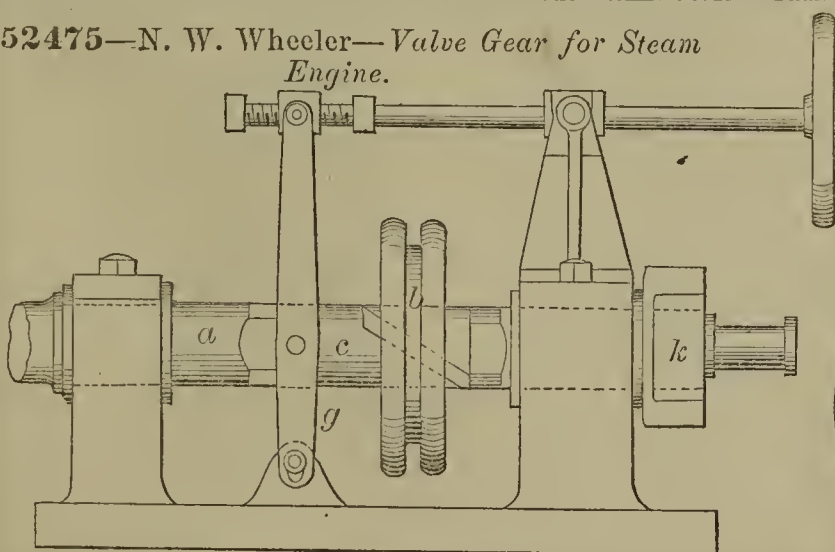

52476—N. W. Wheeler—For Distilling Salt Water.

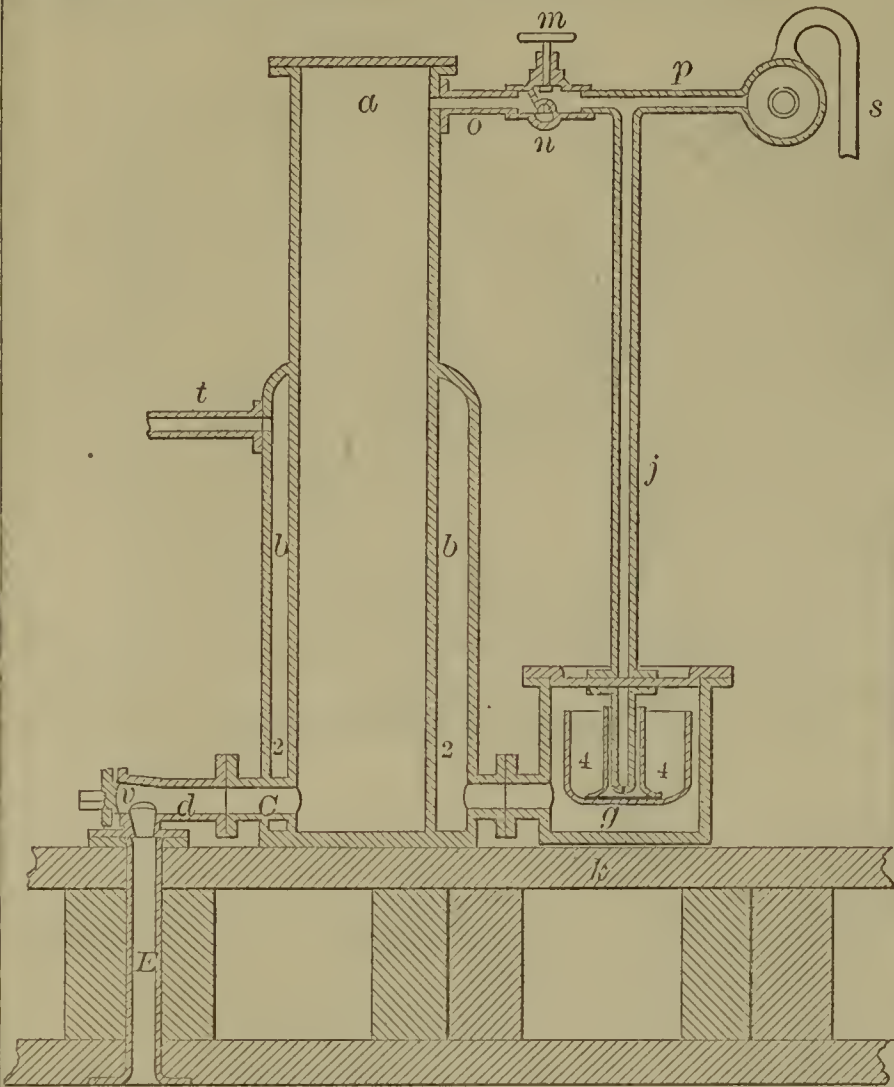

52478—D. D. Whitker—Saw Rebate Plane.

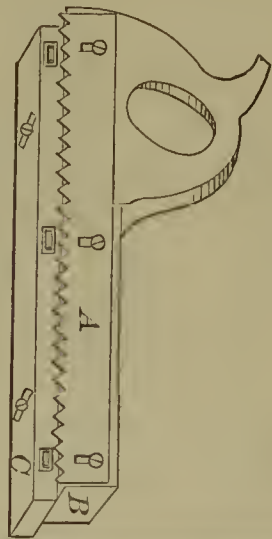

52480—C. Wilhelm—Lamp.

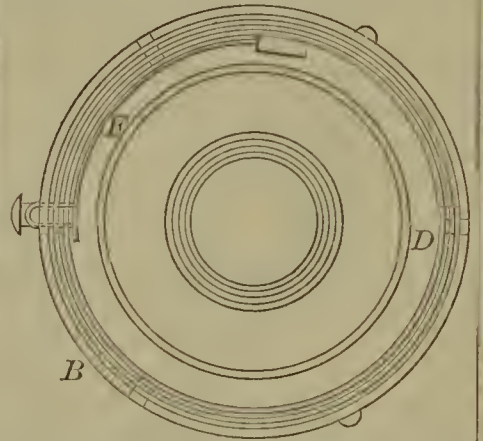

52477—N. W. Wheeler—Relieving Liquids of Gases.

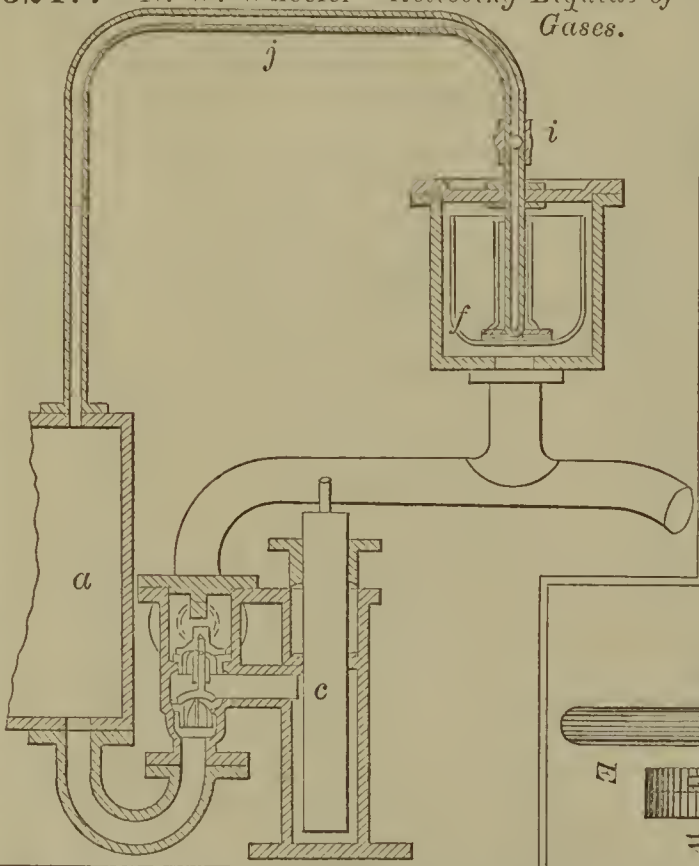

52481—E. Wilson—Sounding Telegraph.

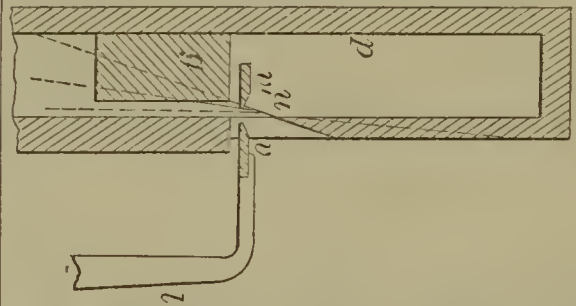

52479—W. Wickersham—Nail Machine.

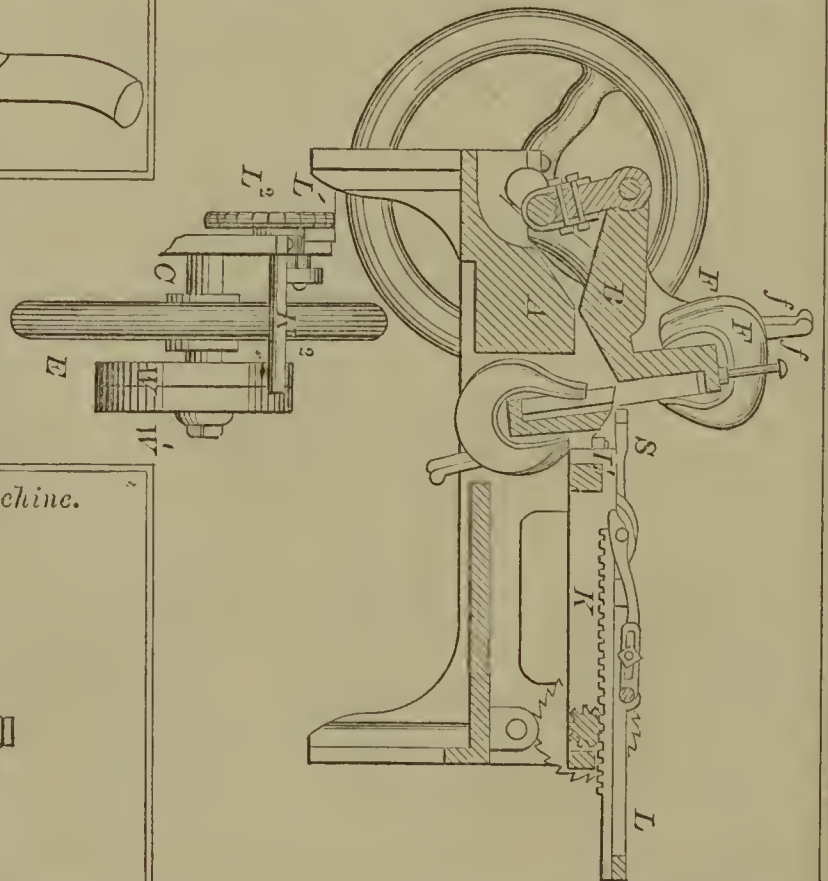

52482—J. I. Wilson—Furrowing Machine.

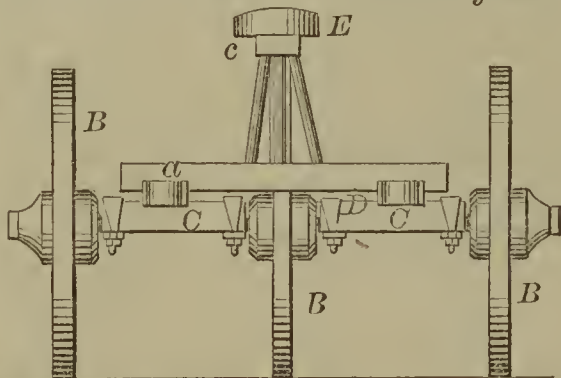

52483—W. C. Wright—*Bending Wood.*

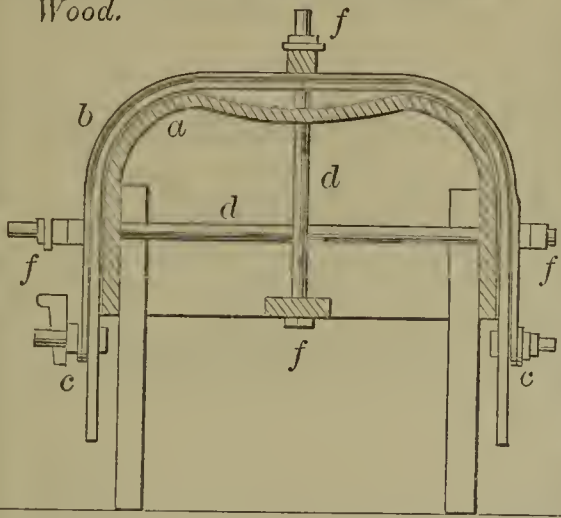

52484—L. Yale, Jr.—*Safe.*

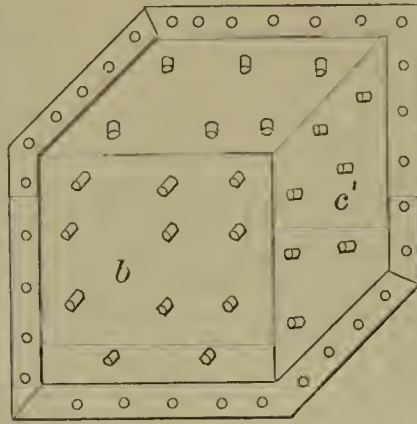

52487—J. C. Conner—*Wrench.*

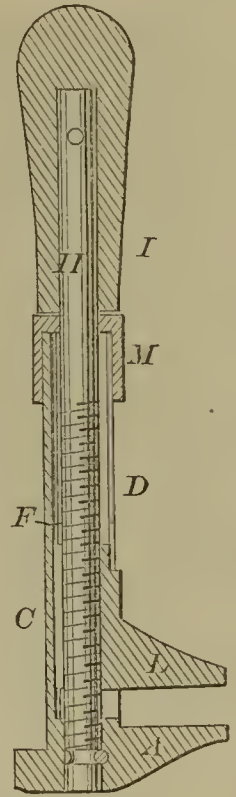

52488—I. N. Dann—*Folding Chair.*

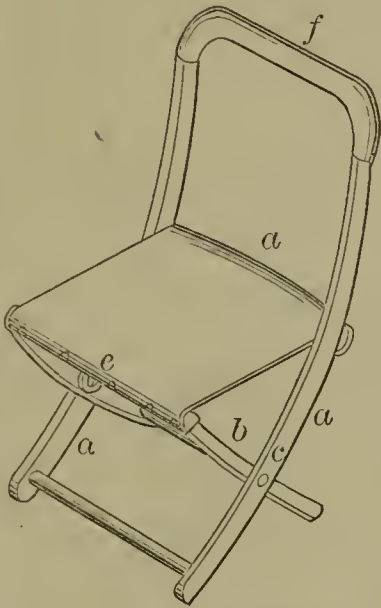

52486—J. W. Campbell—*Coal Ash Sifter.*

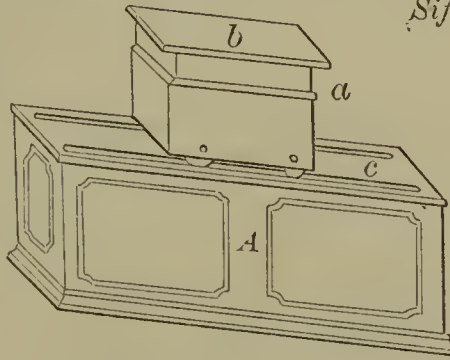

52485—L. Beemer—*Pump.*

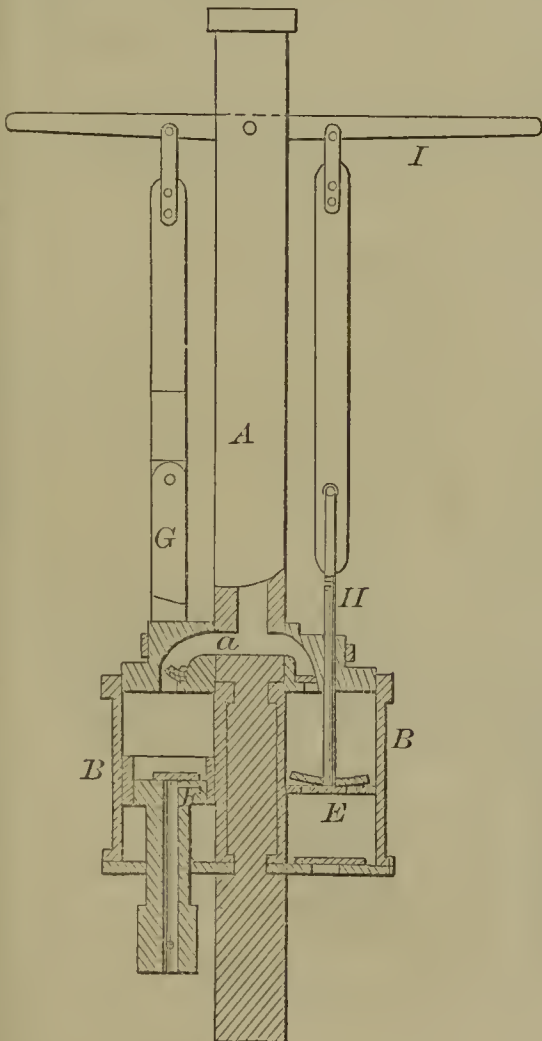

52492—J. Hollingsworth—*Sash Lock.*

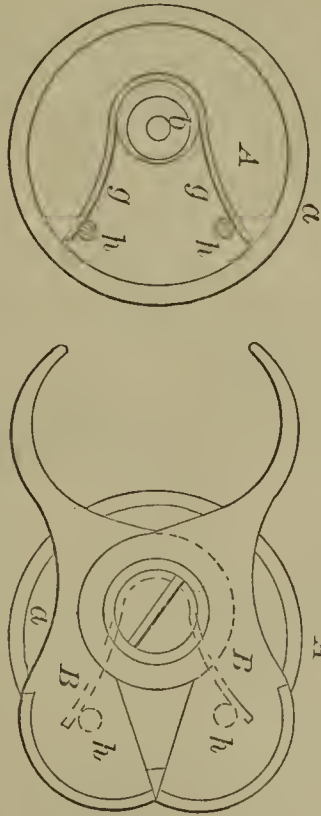

52489—C. Faure—*For Felling Hat Bodies.*

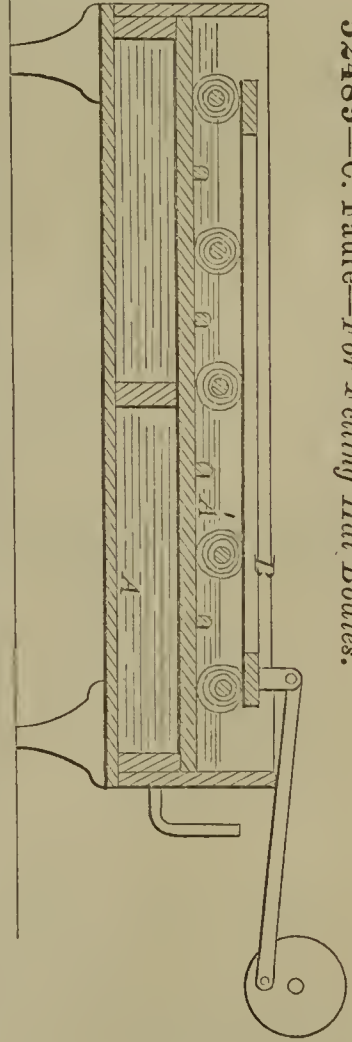

52491—J. Hankey—*Carrier's Scourer.*

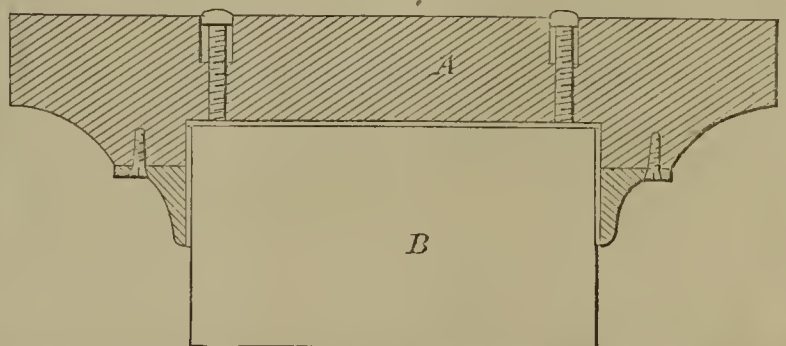

52493—Hopson, Manville & Brooks—Machine for Pointing Wire.

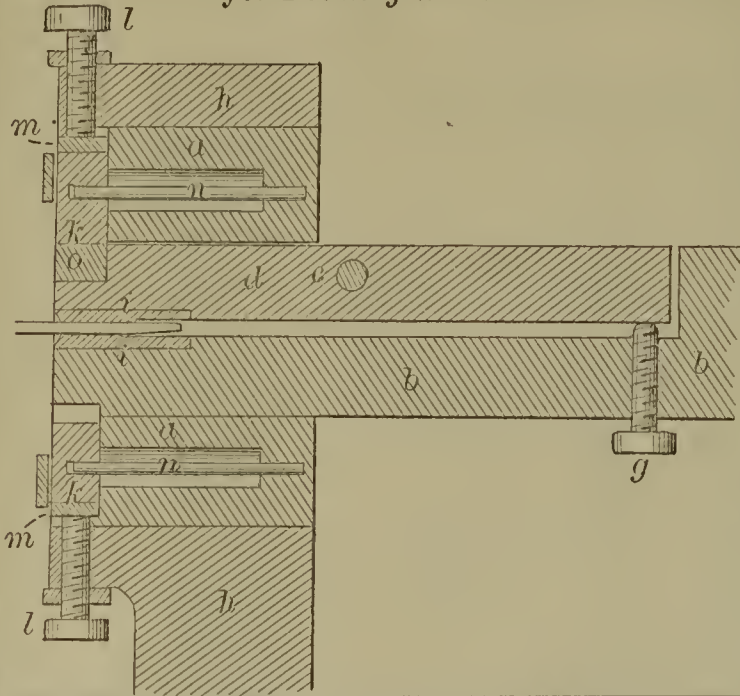

52496—D. Myers—Rotary Plow.

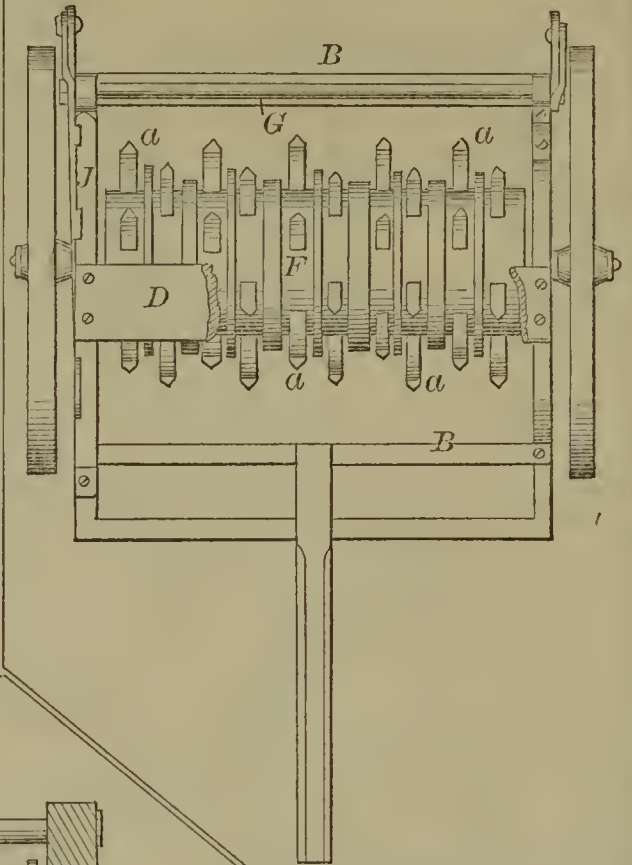

52494—L. Kirkup—Bolt-Heading Machine.

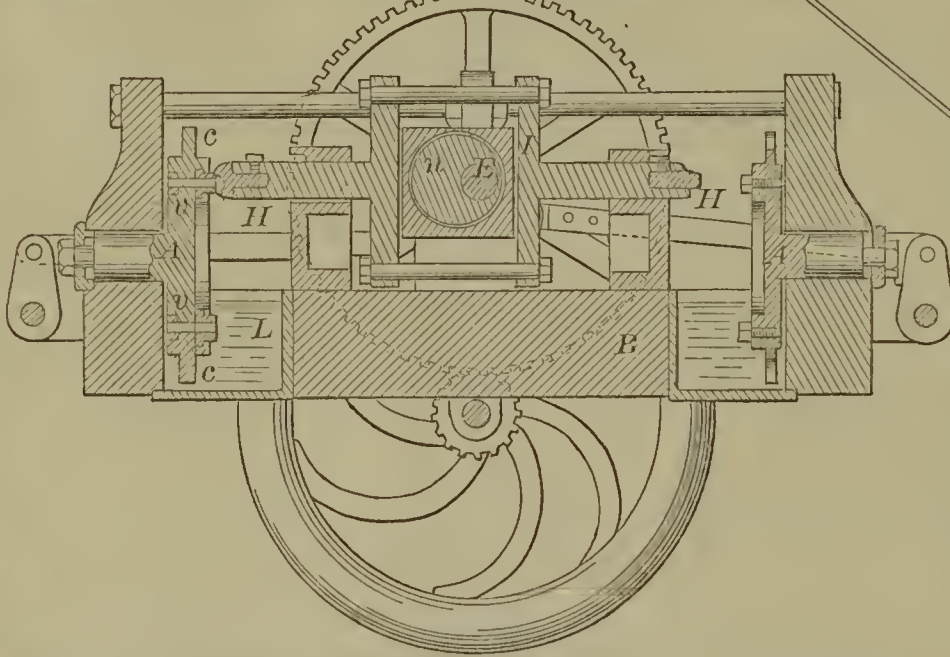

52497—Perry & Gladding—Door Guard.

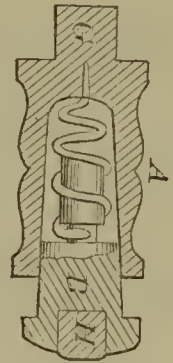

52495—M. D. Moore—Hay and Cotton Press.

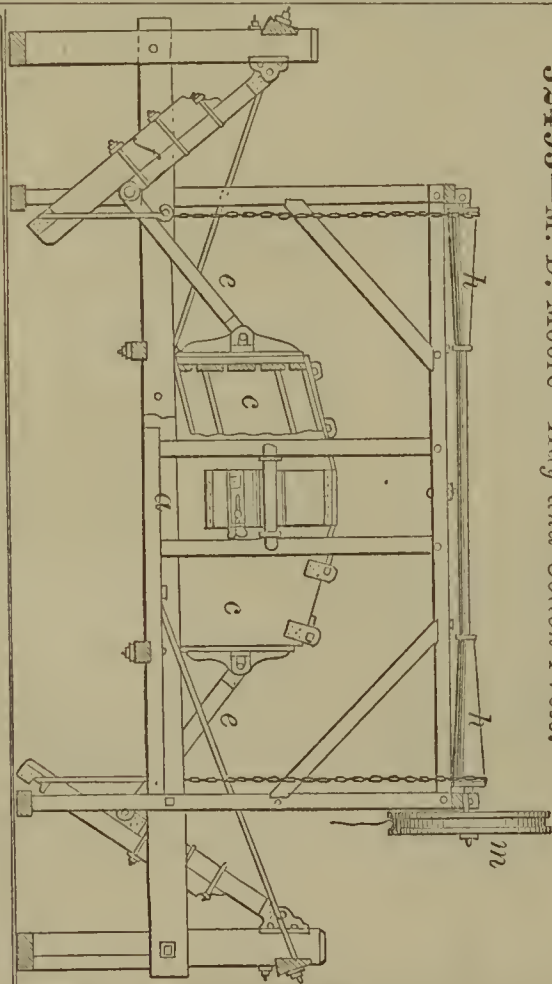

52498—Thompson & Tripp—Heel Polishing Machine.

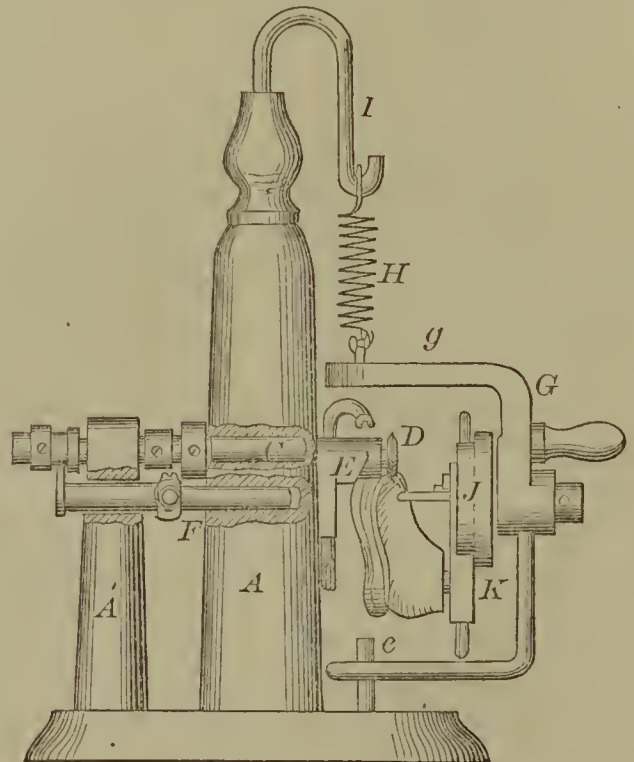

52499—Thompson & Tripp—  
—Heel Polishing Machine.

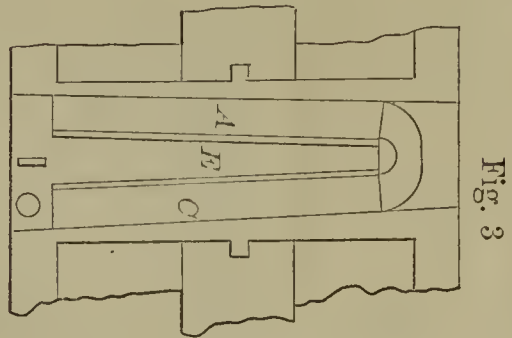
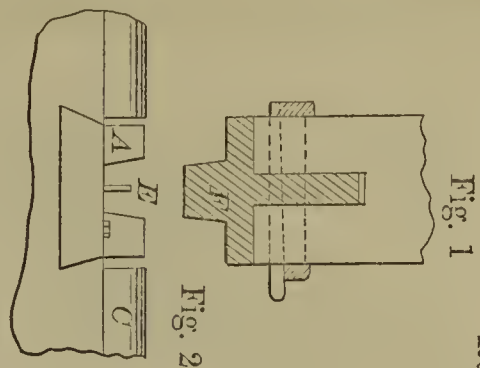
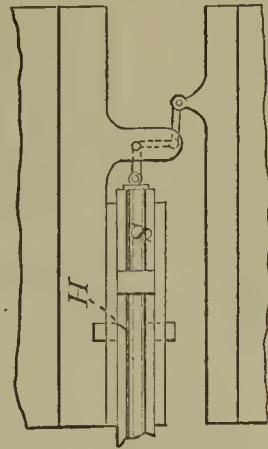
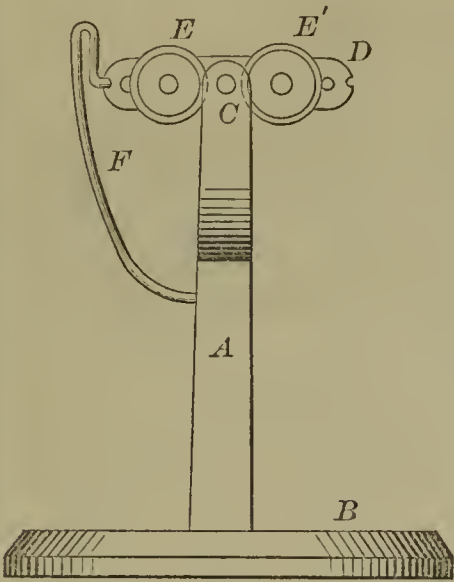

52502—H. Baines—For Welding Ends of Railroad  
Rails.  
Fig. 1  
Fig. 2  
Fig. 3

52500—H. H. Webster—Planter and Seeder.

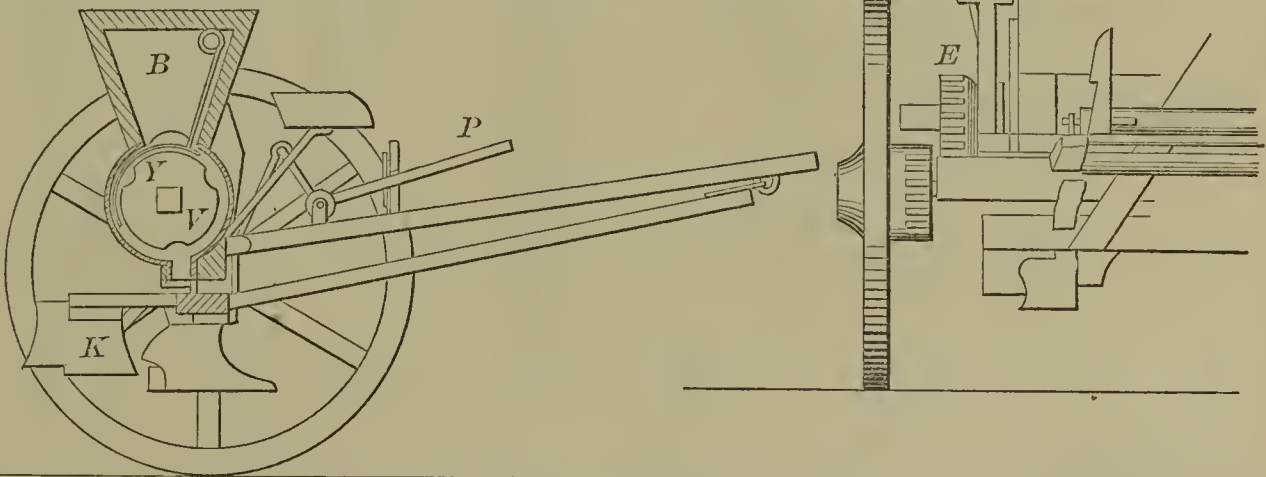

52501—W. E. Wilcox—Car Brake.

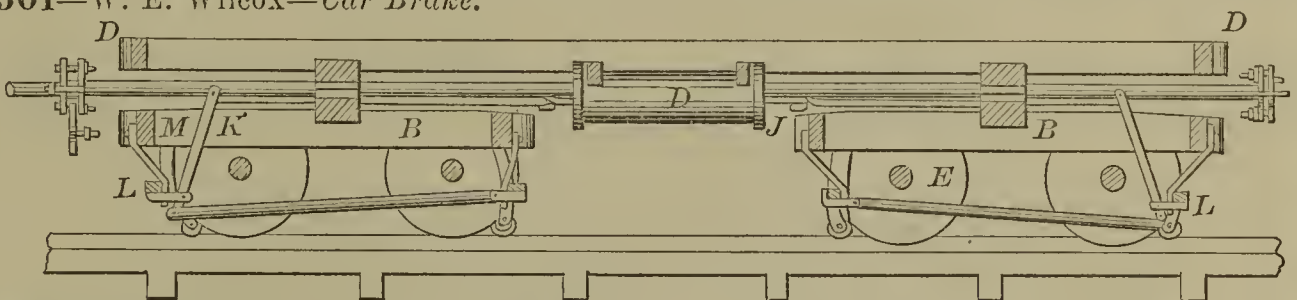

52504—A. Rauh—Combined  
Sword and Pistol.

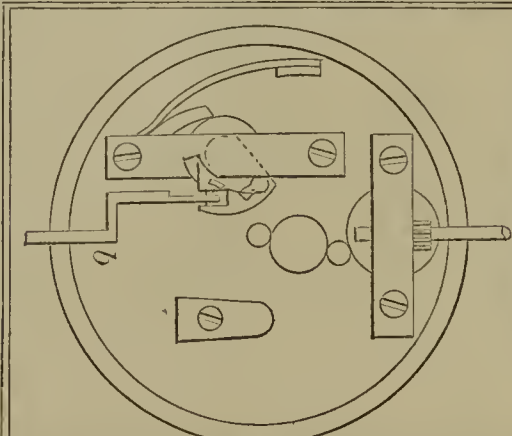
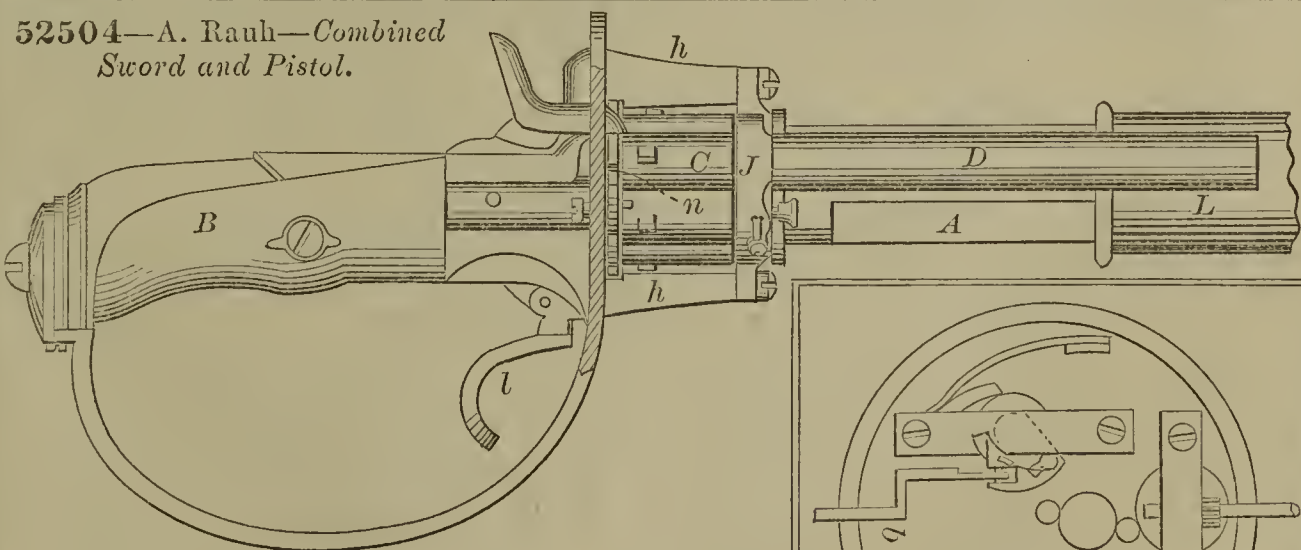

52505—F. R. Theurer—  
Self-Winding Watch.

52506—L. Skeels—*Flax Spinning Machine.*

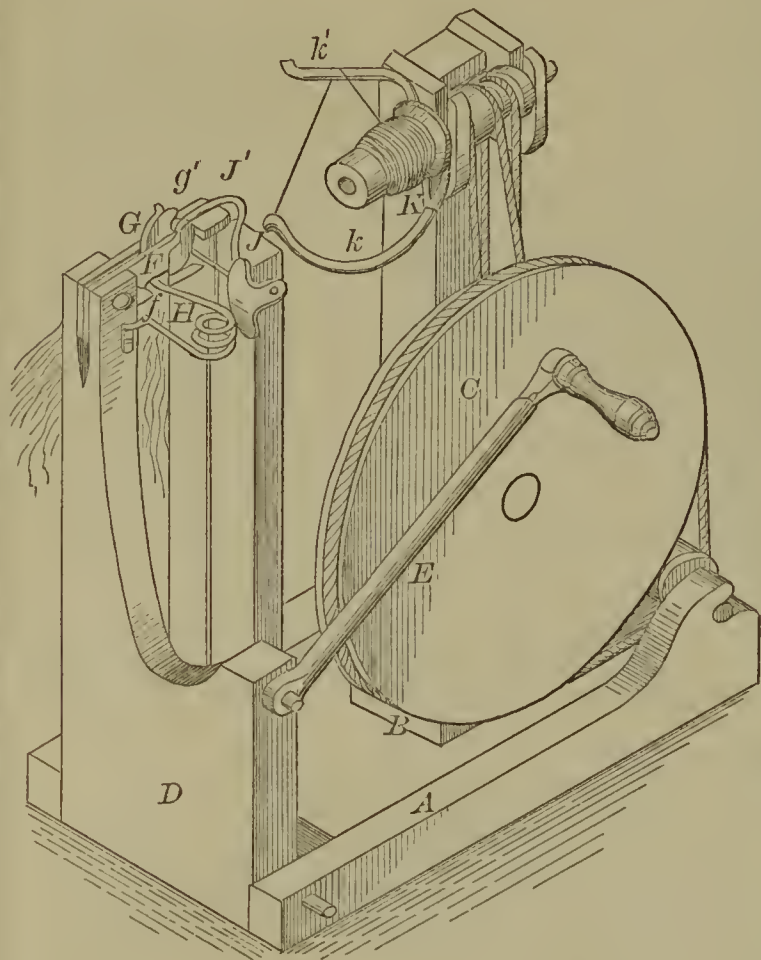

52508—E. Koons—*Tuyere.*

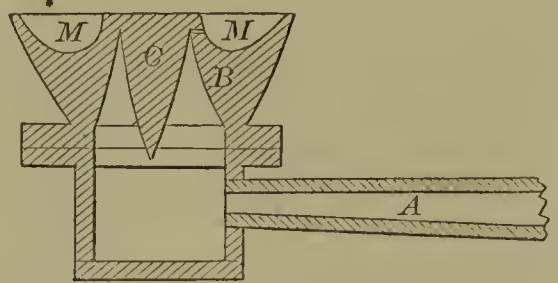

52510—S. W. Adams—*Hoe.*

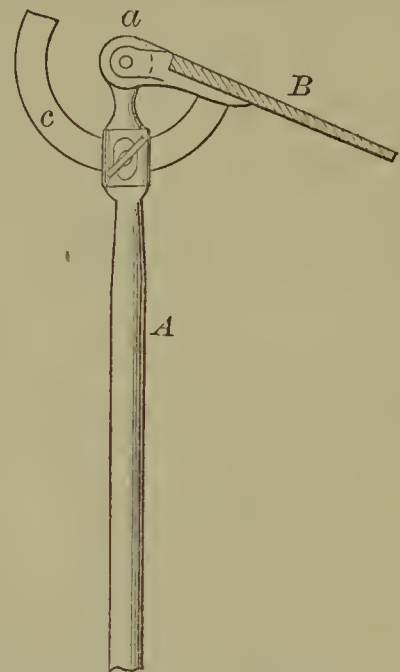

52509—C. Adams—*For Bleaching Oil, &c.*

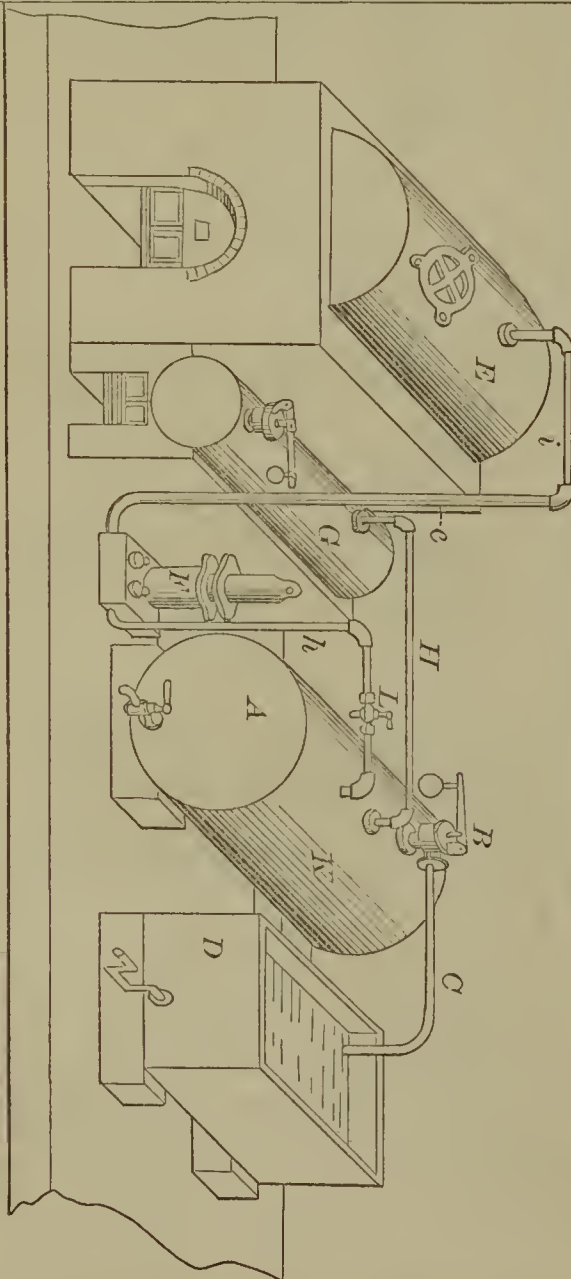

52507—T. H. Cox—*Shingle Mill.*

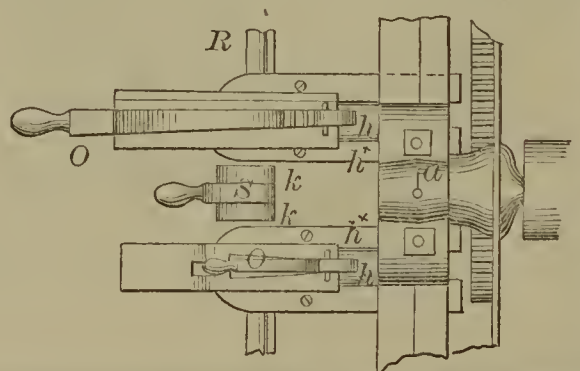
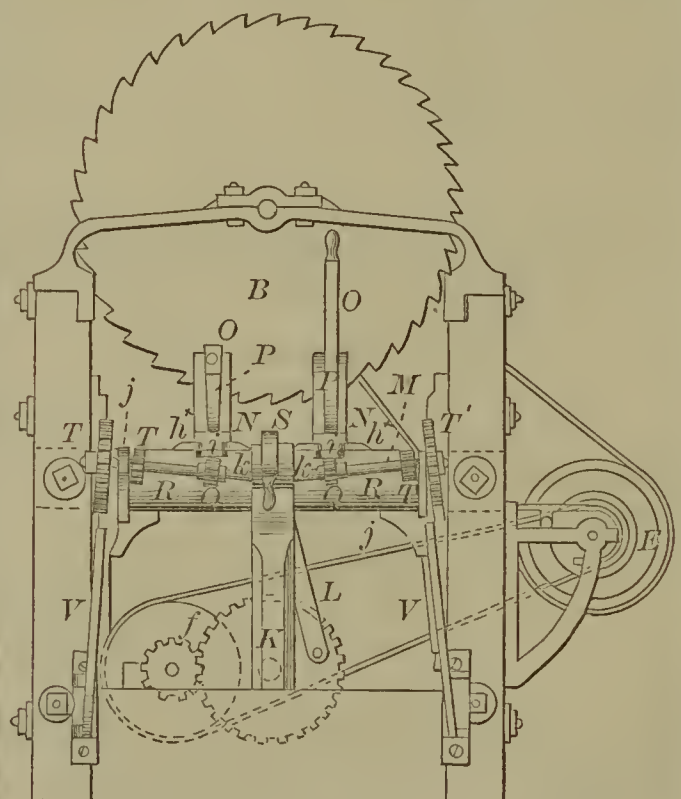

52511—W. H. Akins—*Plug Valve for Steam Engine.*

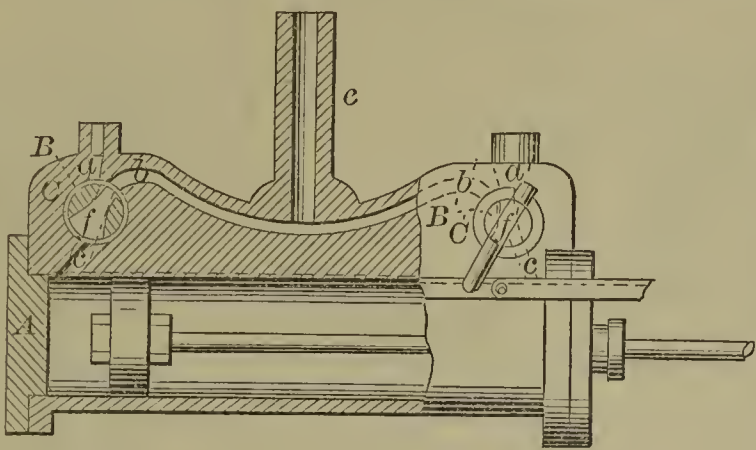

52512—J. Alexander—*Flat Iron.*

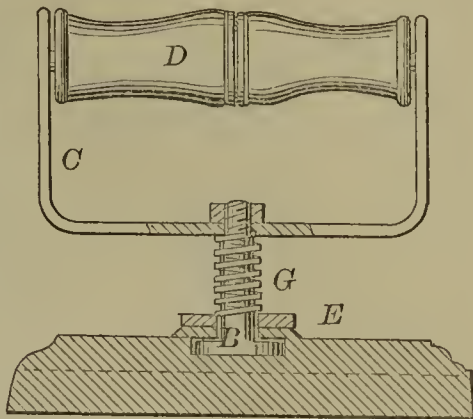

52513—Barry & Preston—*Sad Iron.*

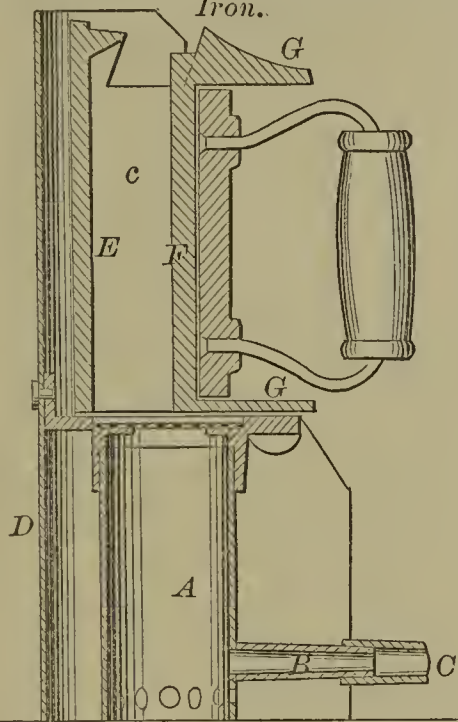

52514—J. Barton—*Store Pipe Damper.*

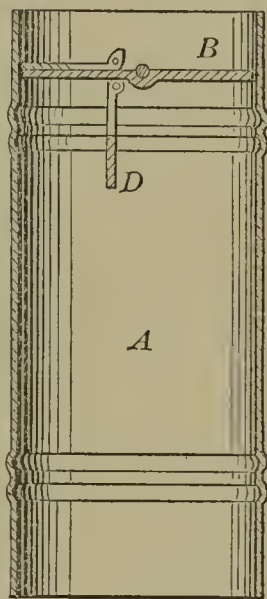

52515—C. Belden—*Cultivator.*

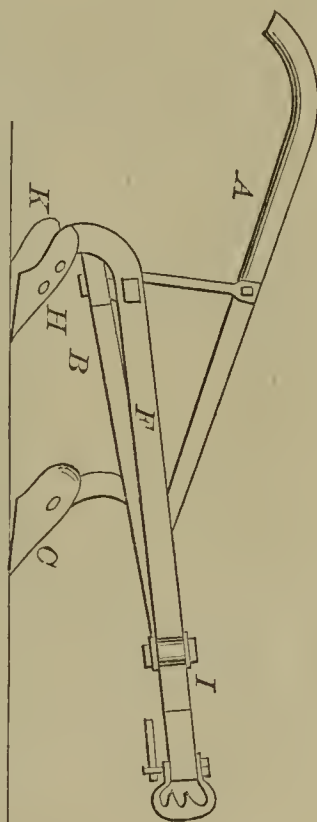

52516—S. A. Bemis—*Shirt Collar.*

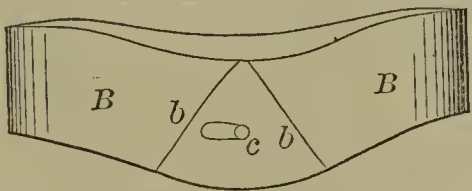

52517—G. A. Bigelow—*For Reefing Fore and Aft Sails.*

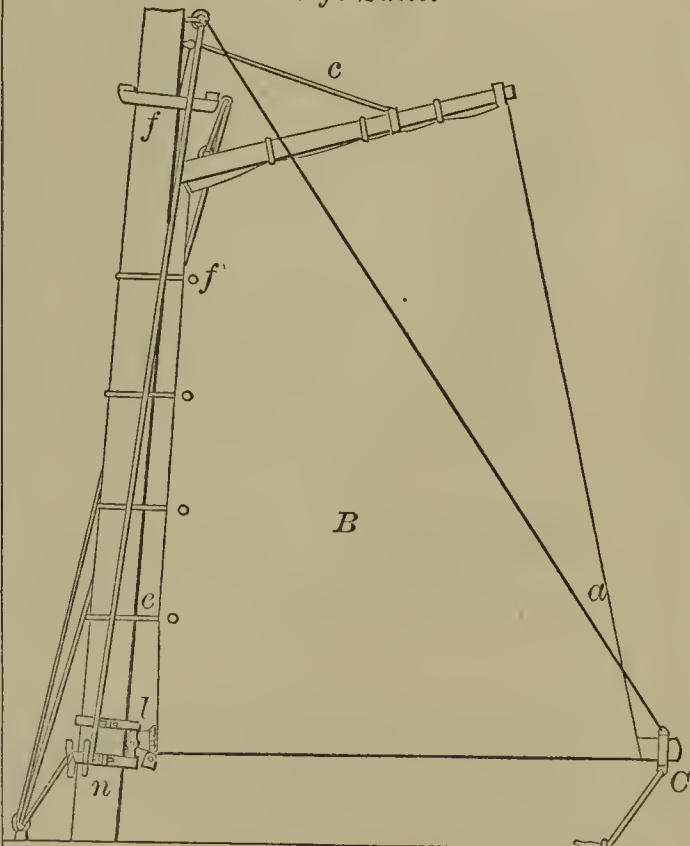

52518—A. R. Blasse—*Egg Beater.*

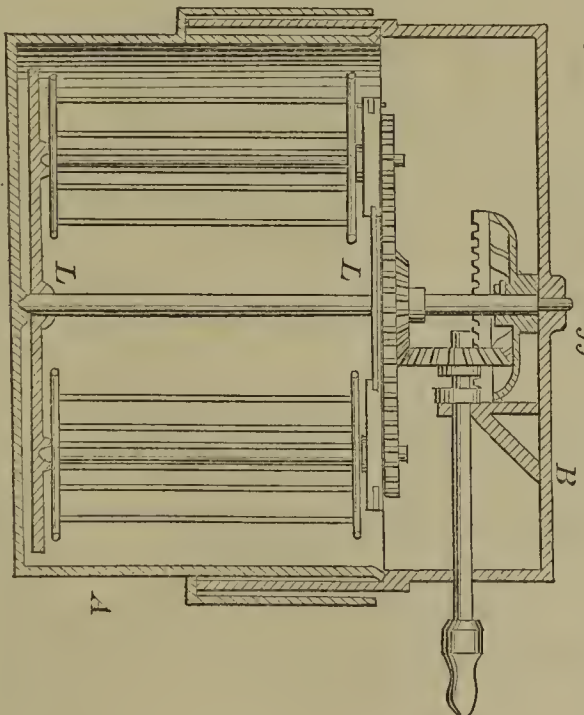

52522—G. W. Bowlsby—Ocean Telegraph.

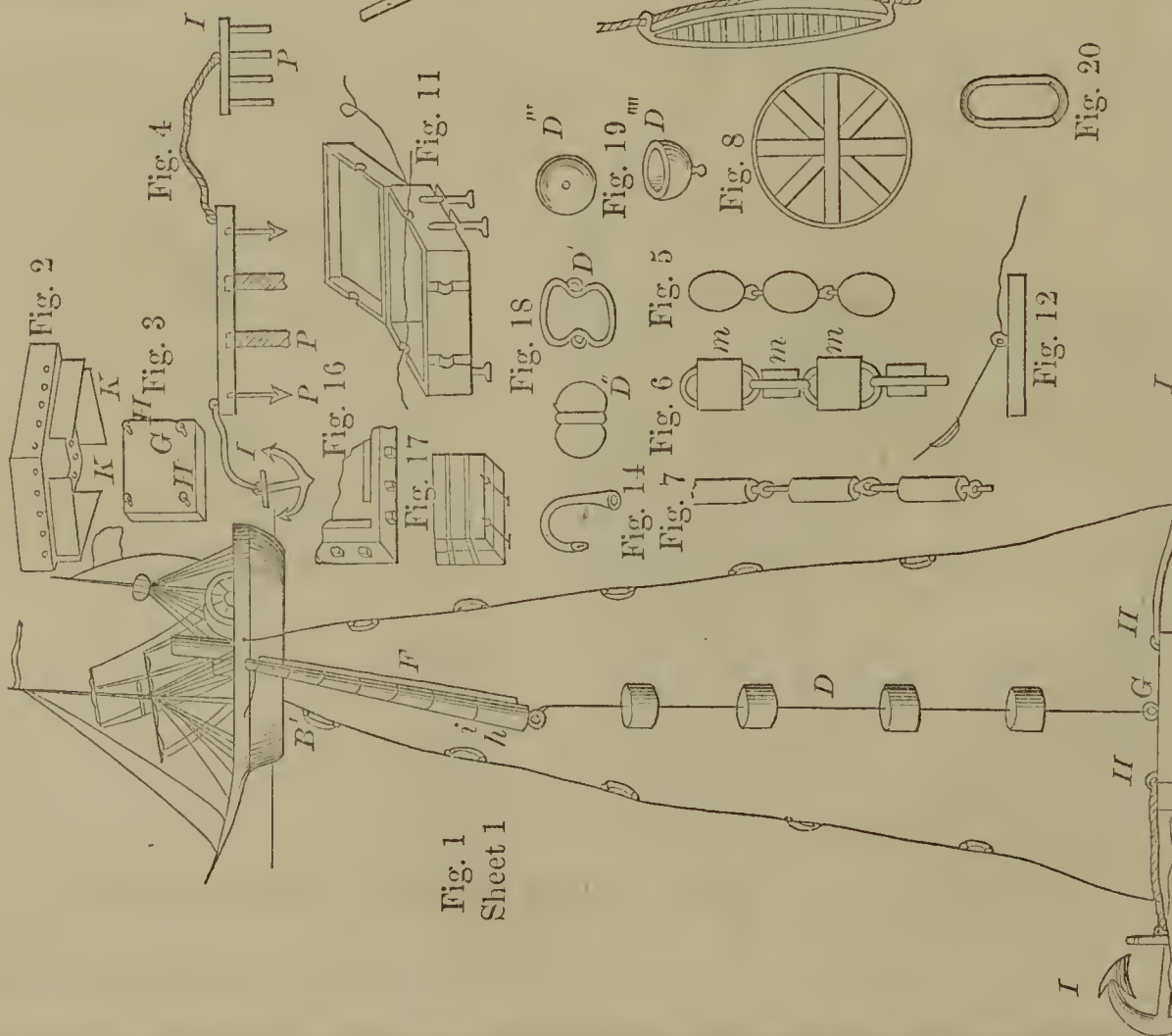

52521—J. Broughton—Steam Gauge Cock.

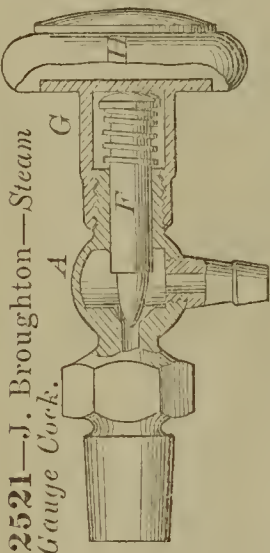

52519—N. O. Bond—Cooking Stove Brazier.

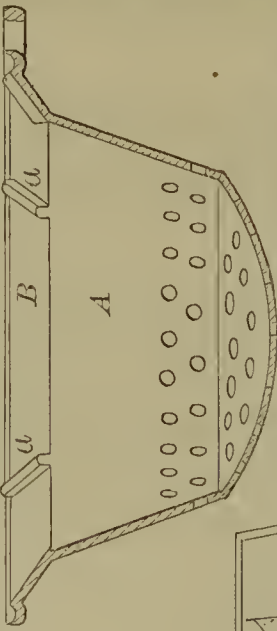

52520—F. Boshert—Stove Pipe Elbow.

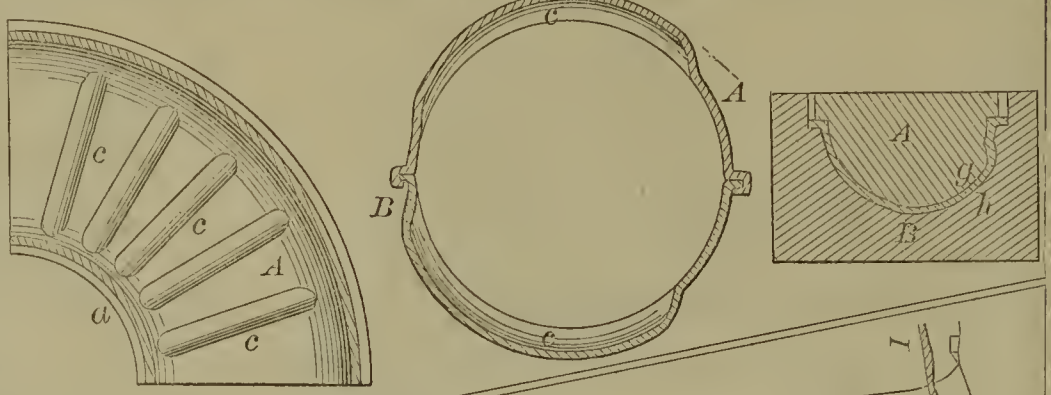

Fig. 1 Sheet 2

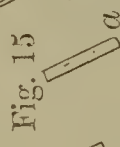

Fig. 10



Fig. 9



Fig. 20

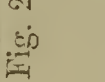
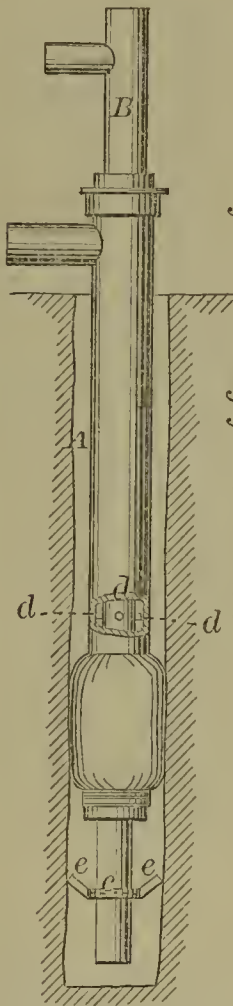

Fig. 1 Sheet 1





52523—J. D. Bryson—Tubing for Oil Wells.

52524—H. G. Bulkley—Drying Kibn.

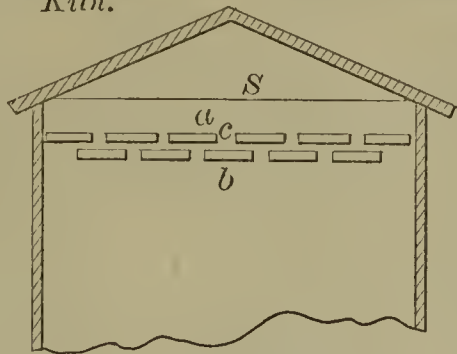

52526—W. H. Burkhart—Harvester.

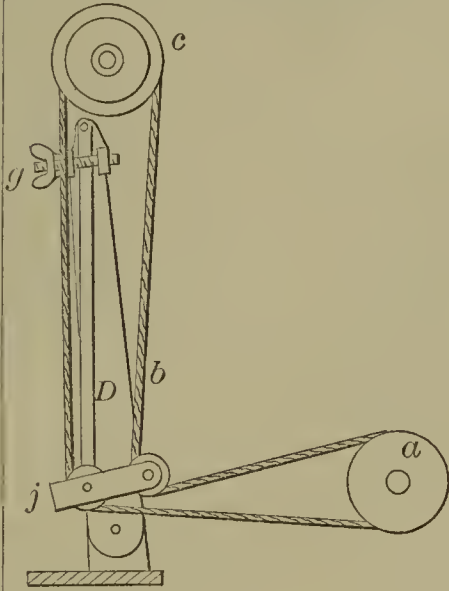

52525—F. A. Bunnell—Fruit Jar Cover.

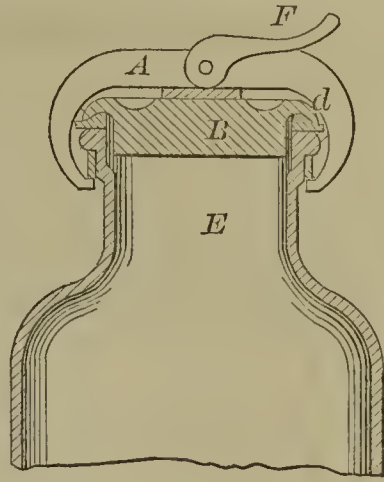

52529—T. Butters—Flat Iron.

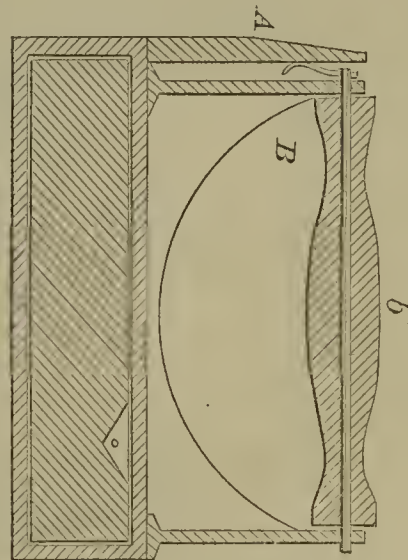

52527—B. J. Burnett—Ventilator.

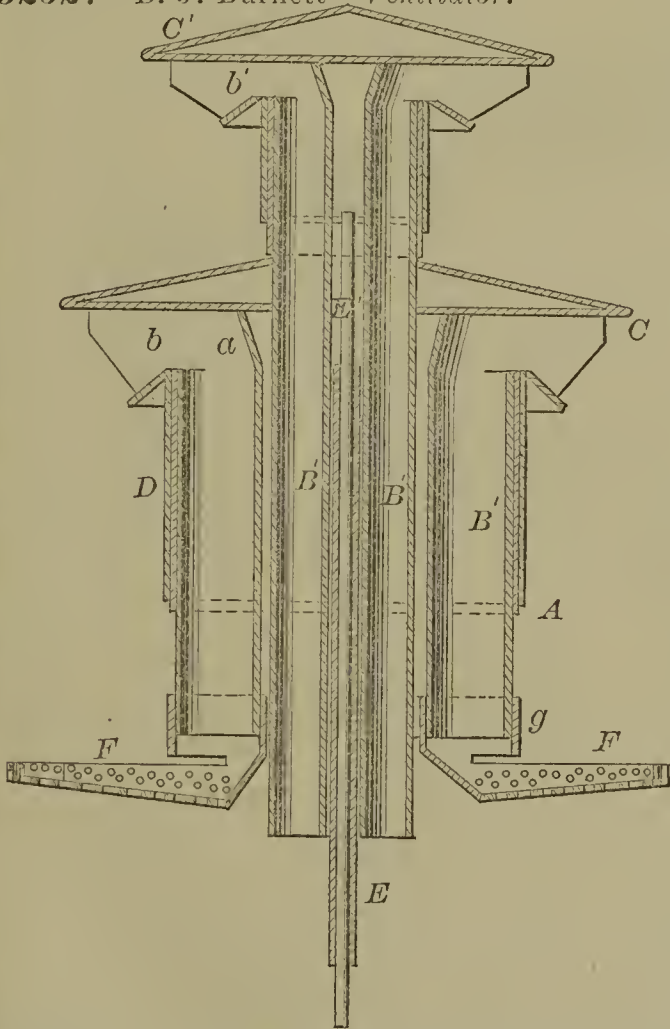

52528—B. J. Burnett—For Ventilating Houses, &c.

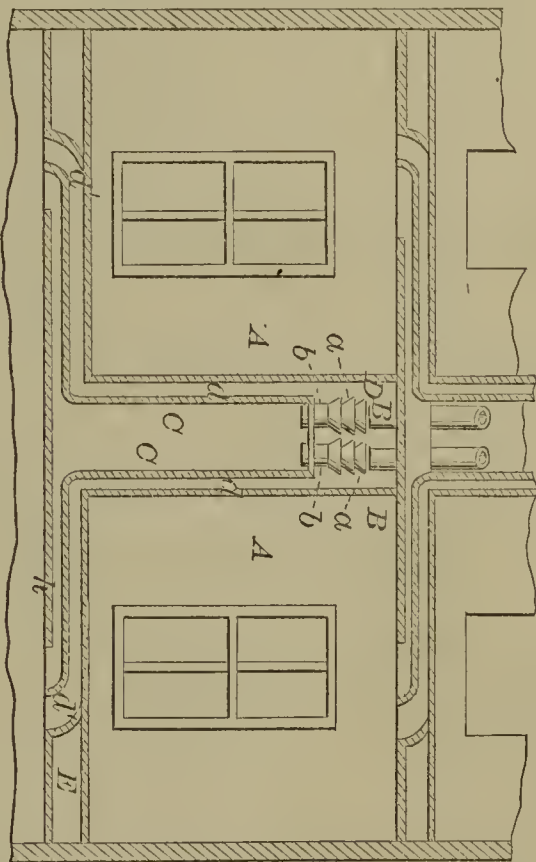

52531—G. Chappell—Adjustable Toilet Glass.

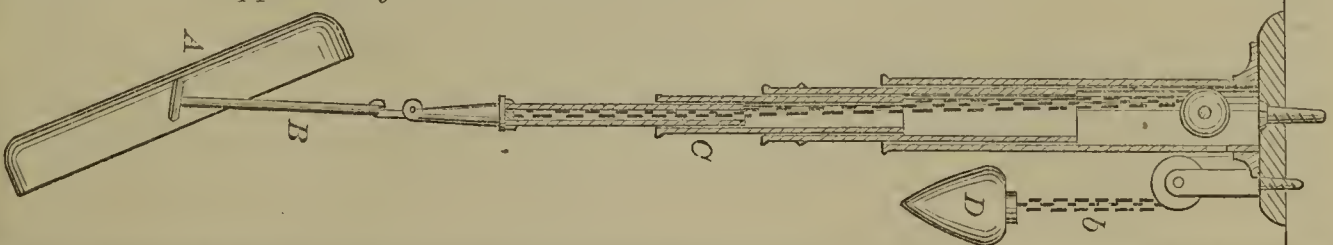

52532—T. J. Chubb—Quartz Mill.

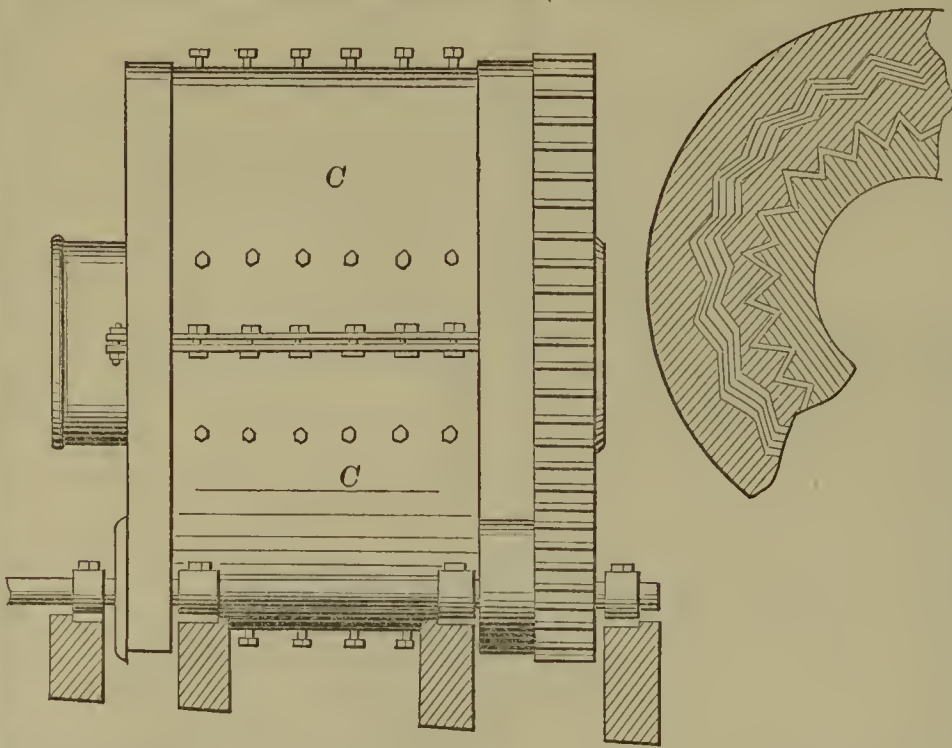

52534—J. C. Clime—Musical Staff.

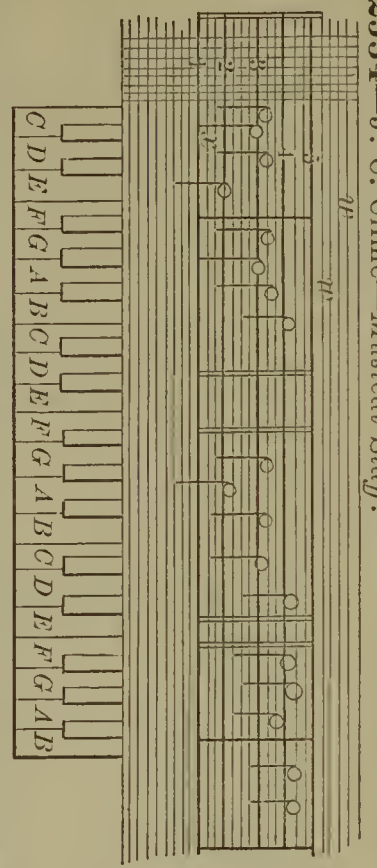

52533—G. H. Clemens—Head Block for Saw Mills.

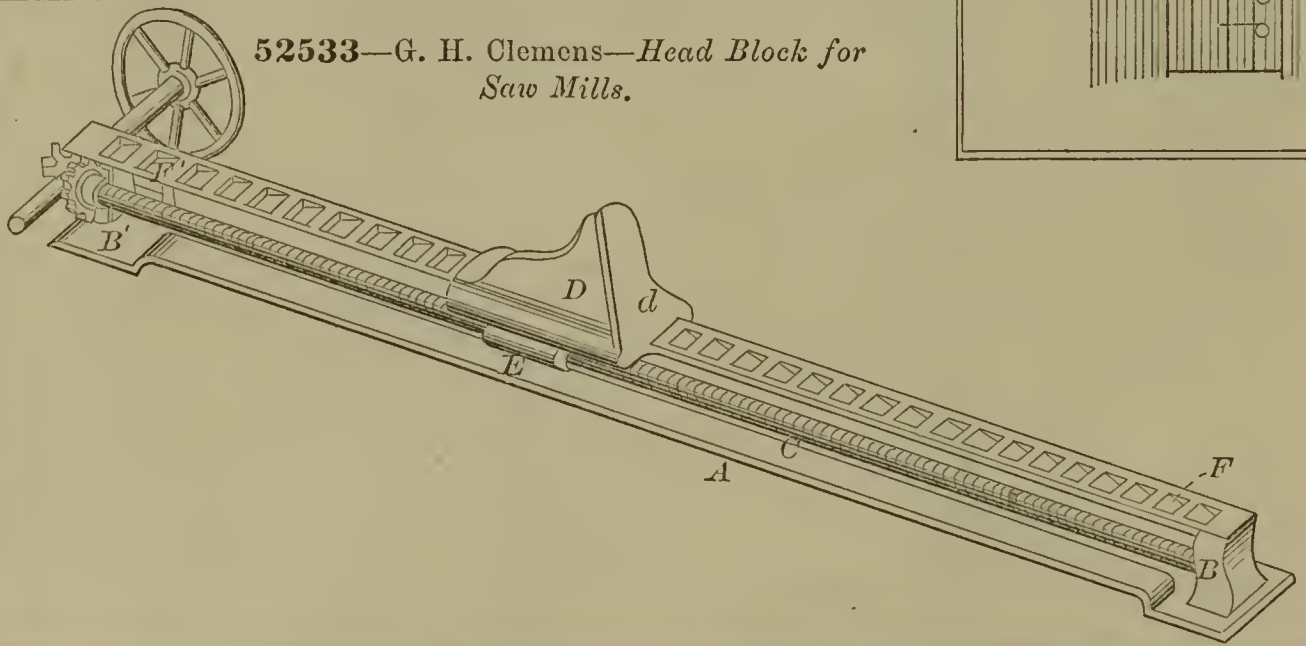

52536—Cole & Soule—Bridge.

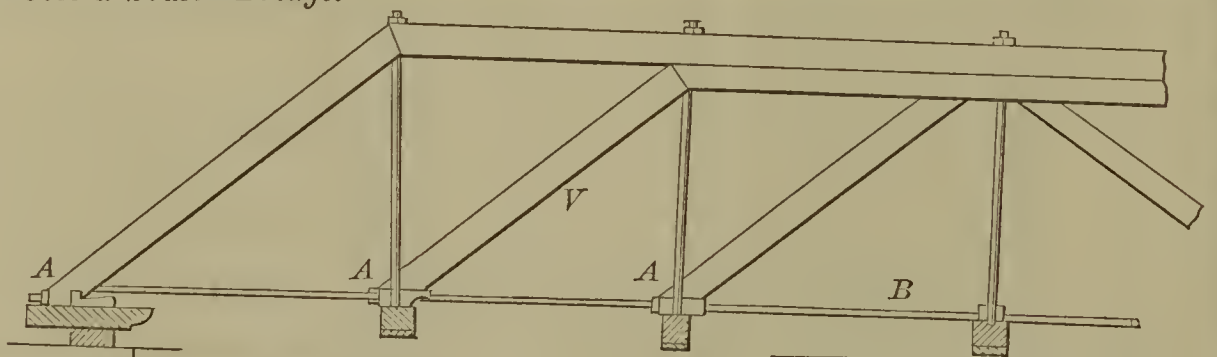

52535—J. C. Cochrane—Heating Stove.

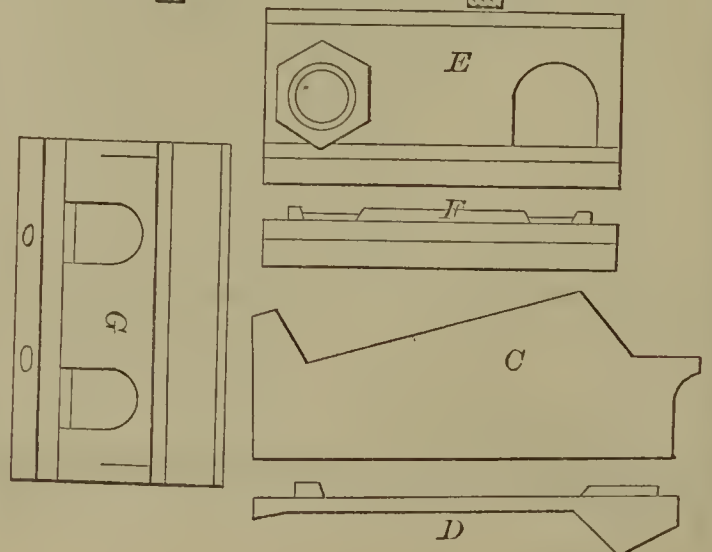
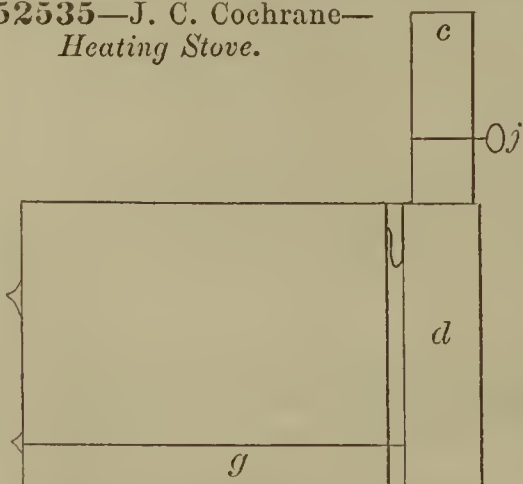

52537—J. Conner—*Straw Cutter.*

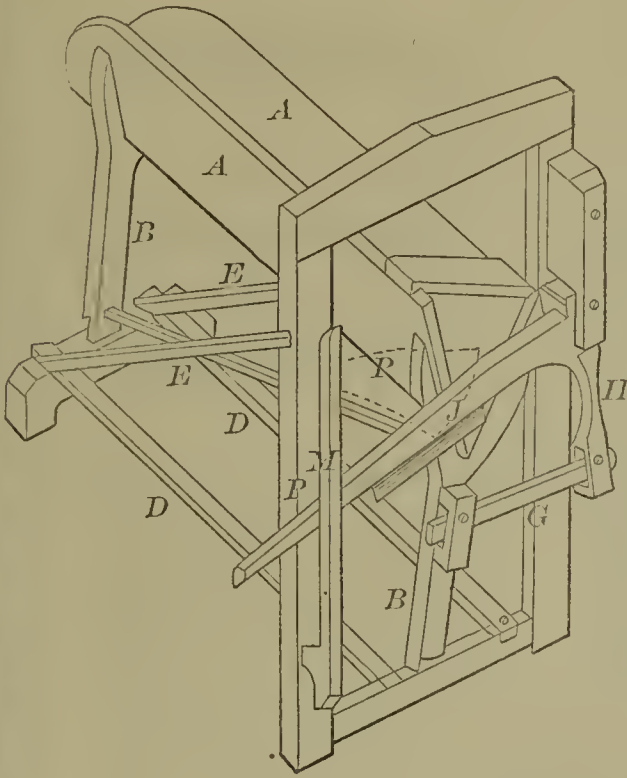

52538—Coon & Hill—*Horse Shoe Vise.*

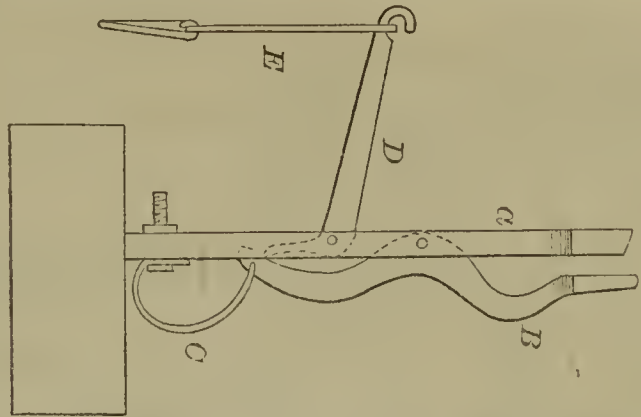

52543—J. W. Dixon—*For Making Paper Pulp.*

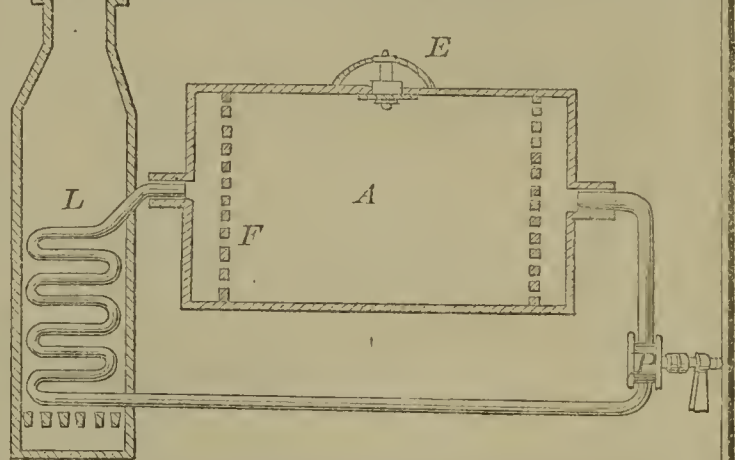

52541—S. D. Cushman—*Lightning Rod.*



52542—C. B. Deyo—*Cultivator.*

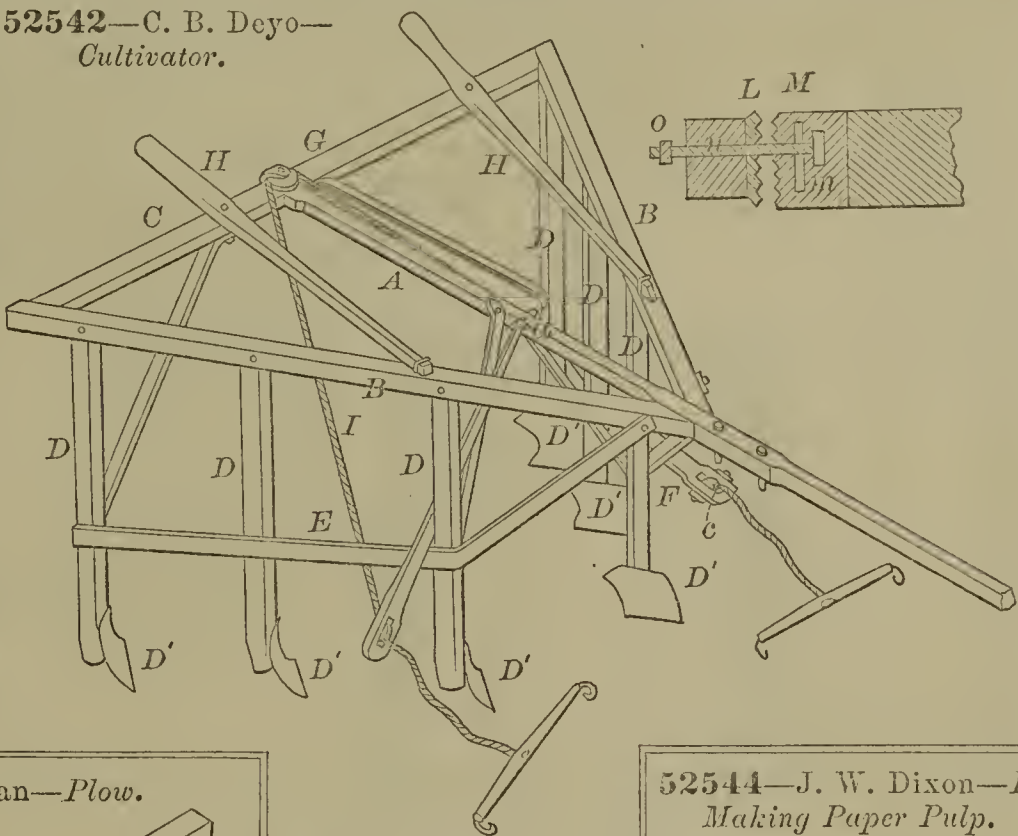

52539—T. Cottman—*Plow.*

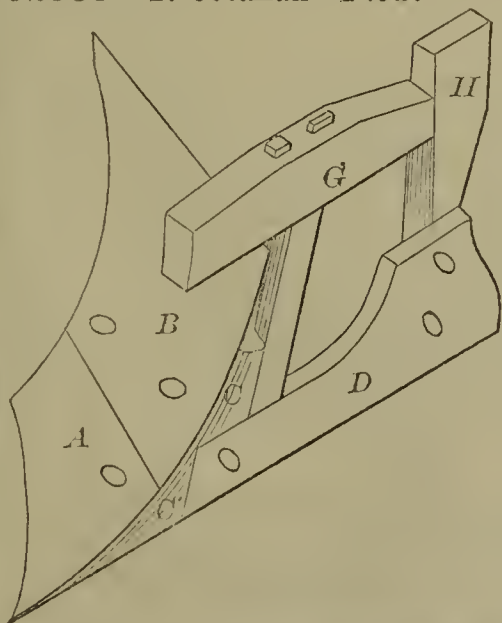

52544—J. W. Dixon—*For Making Paper Pulp.*

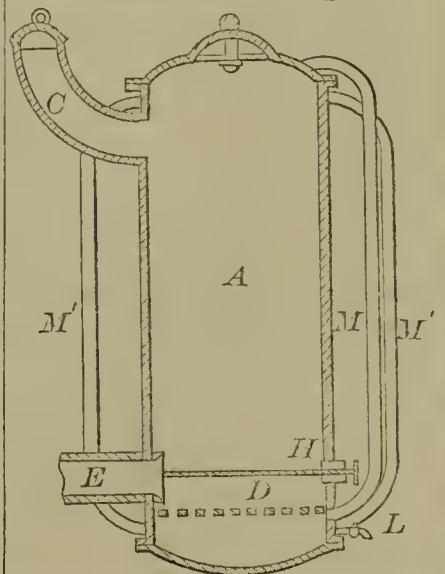

52540—J. W. B. Covington—*Paper Sock.*

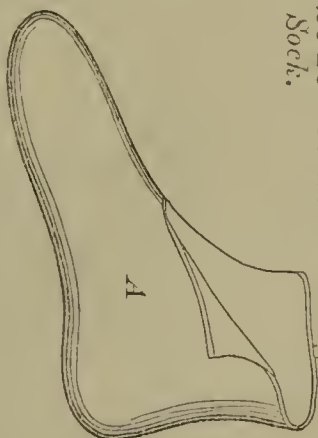

52547—W. C. Dodge—Breech-Loading Fire Arm.

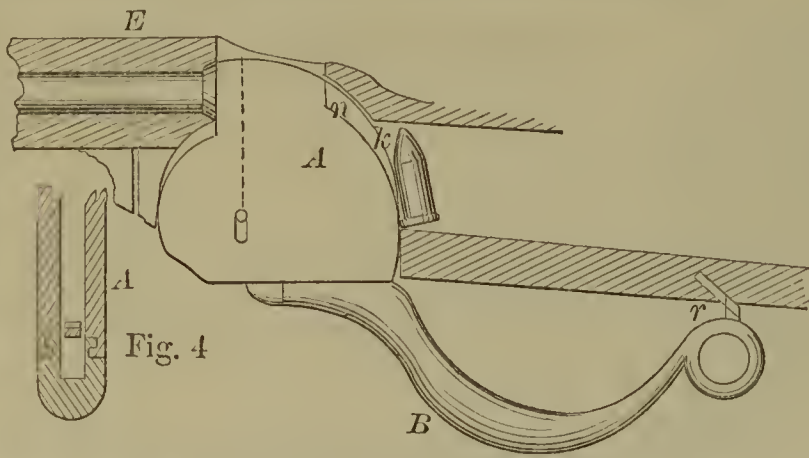

52555—H. Foster—Window Curtain.

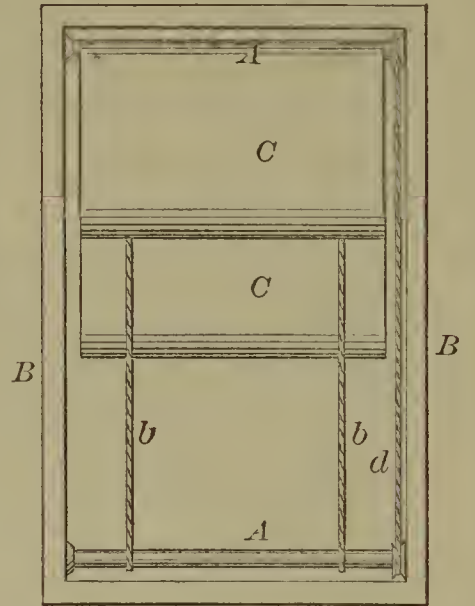

52548—E. Draper—Stove Grate.

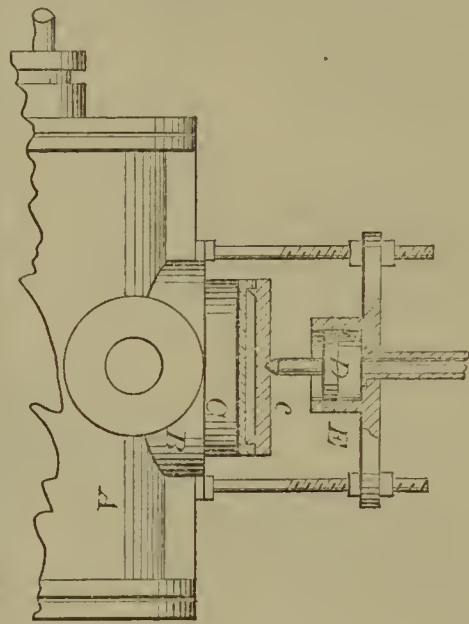
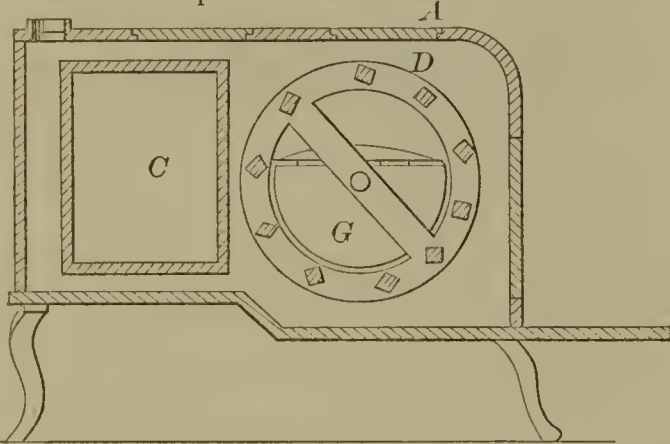

52556—J. Gallatin, Jr.—Valve for Steam Engine.

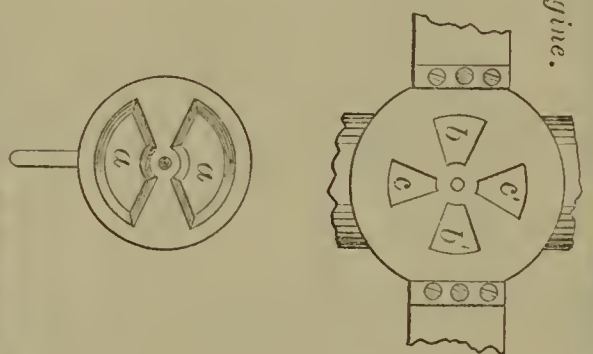

52550—J. & J. Ehart—Washing Machine.

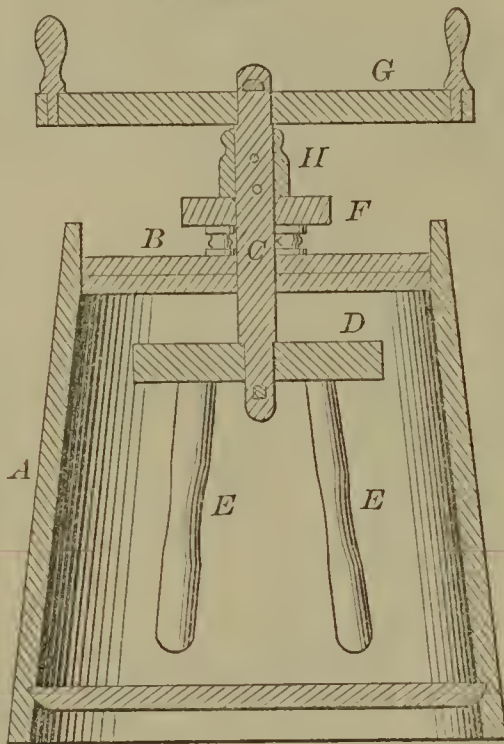

52551—J. E. Paris—Hand Mirror.

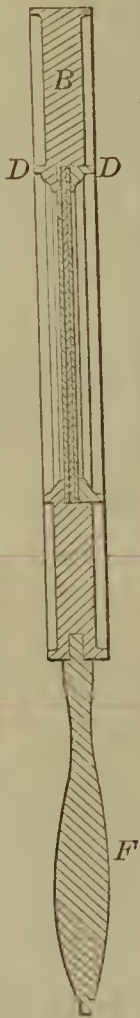

52549—O. Eaton—Roofing.



52552—D. Fitzpatrick—Cutlery.

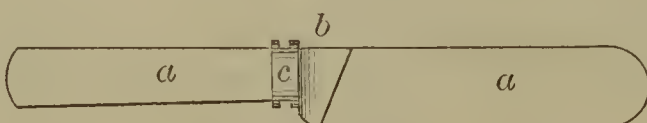

52557—J. B. Gardiner—Neck Tie.

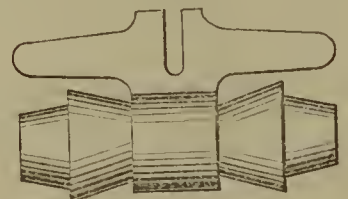

52558—R. R. Gaskill—Gang Plow.

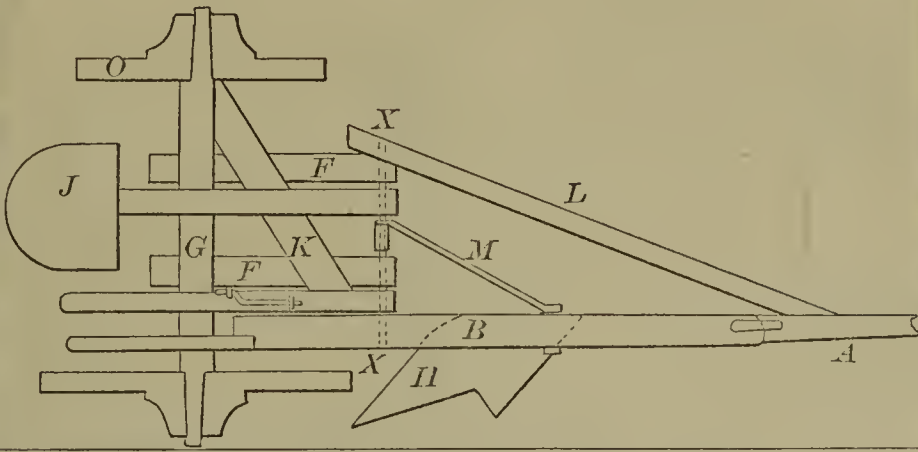

52562—W. H. Greer—Washing Machine.

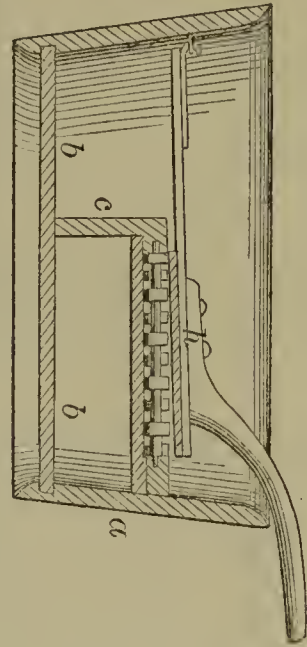

52559—W. Gerhardt—Manufacture of Iron and Steel.

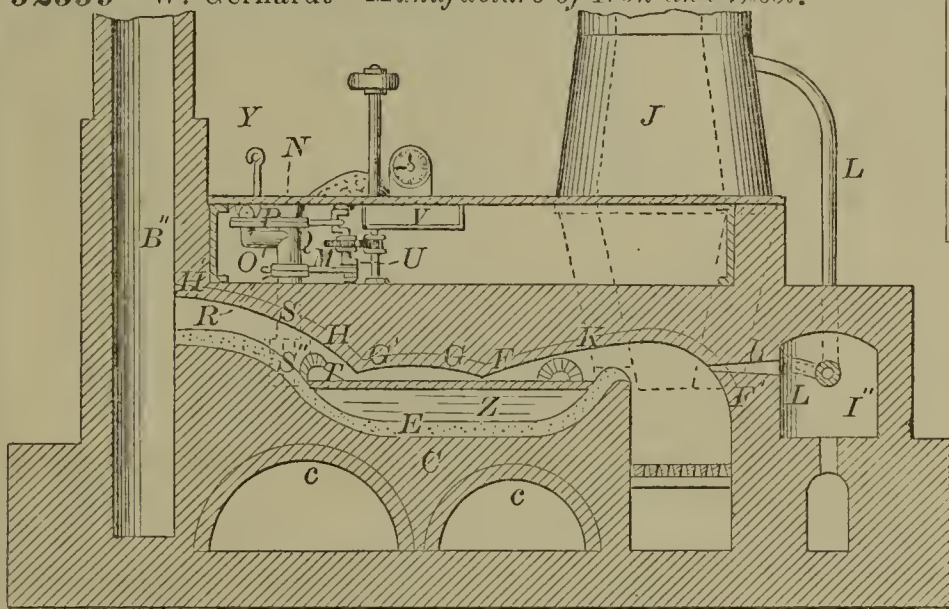

52561—R. P. Gillett—Axle and Journals.

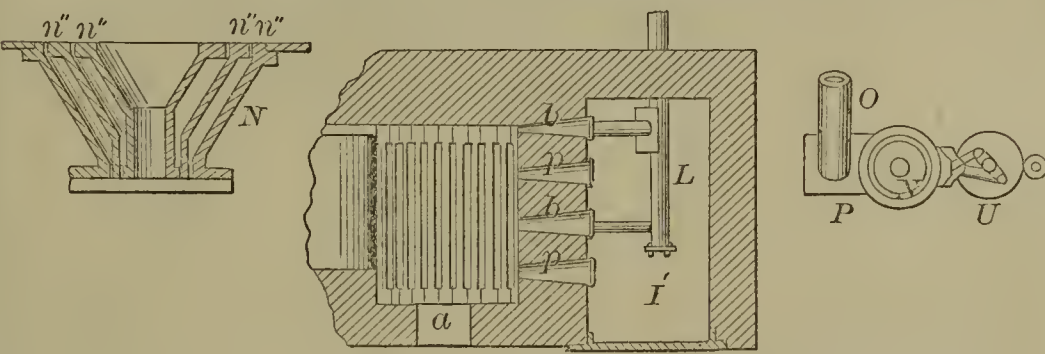

52560—W. Gerhardt—Manufacture of Iron and Steel.

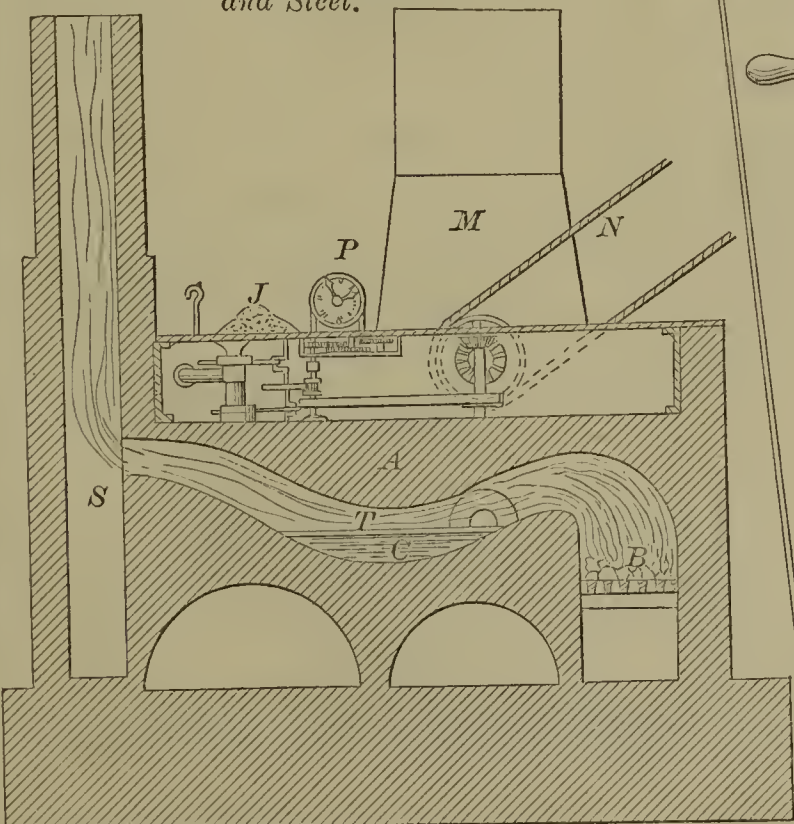

52563—S. Guild—Seeder and Fertilizer Combined.

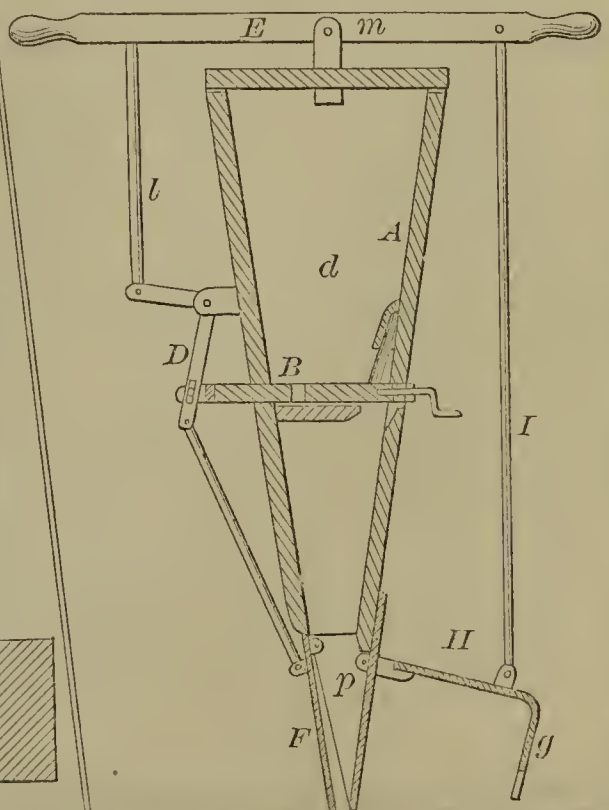

52564—H. J. Hale—Smoking Device.

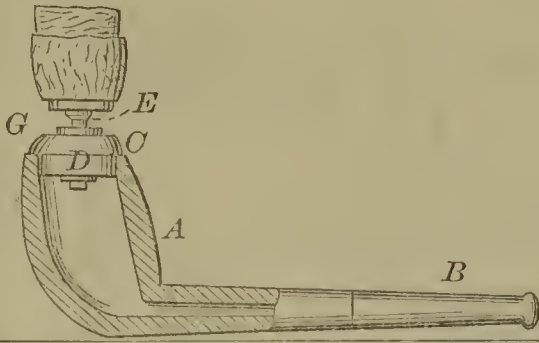

52565—A. Hallowell—For Washing Tumblers.

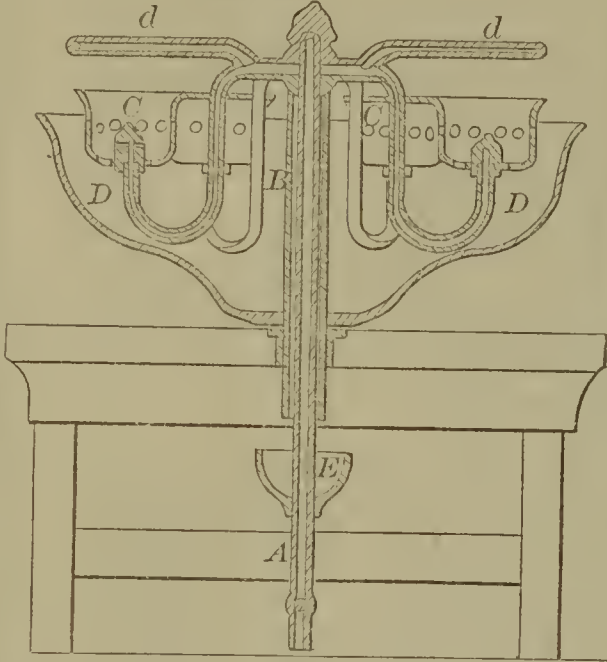

52569—Hartson & Woolsey—Centrifugal Machine.

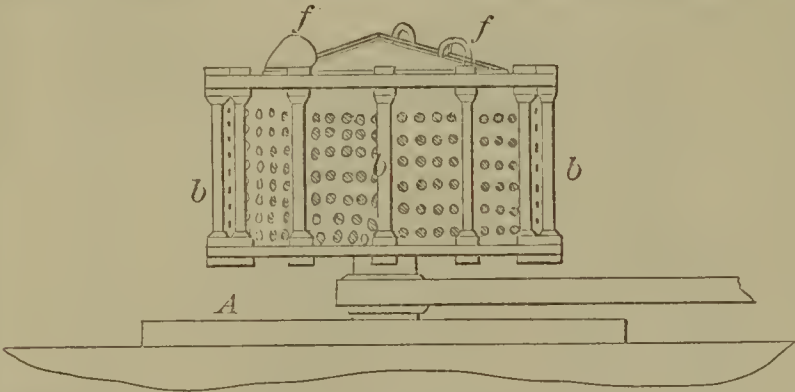

52570—G. Havell—Bolt.

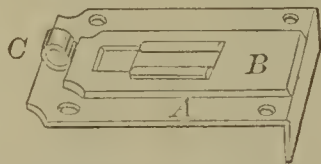

52568—S. S. Hartshorn—Buckle.

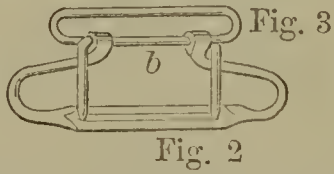

52572—J. L. Hutchinson—Evaporator for Hot Air Pipes.

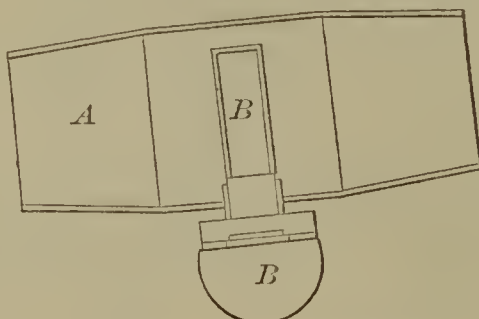

52566—G. W. T. Harley—Tailor's Measure.

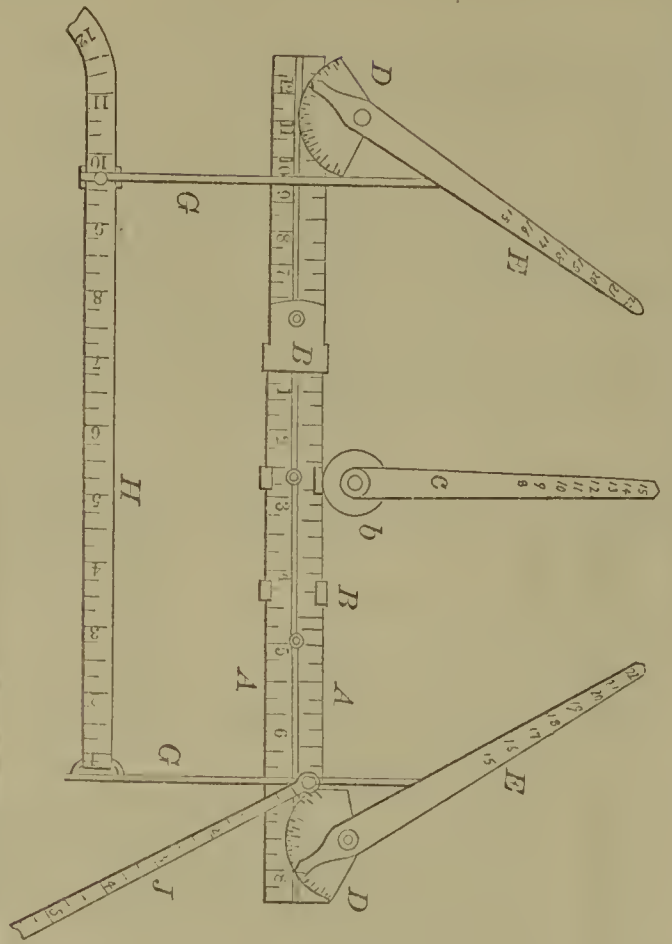

52567—M. S. Harsha—Weather Strip.

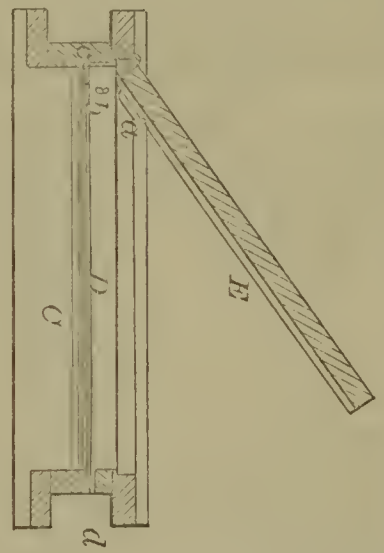

52571—H. Hodgson—Beehive.

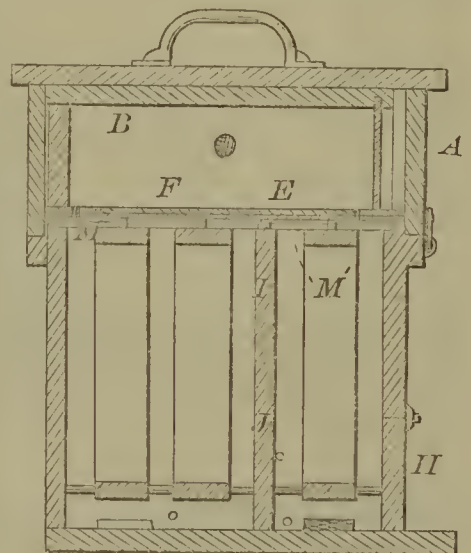

52573—O. M. Inman—*Braiding Machine.*

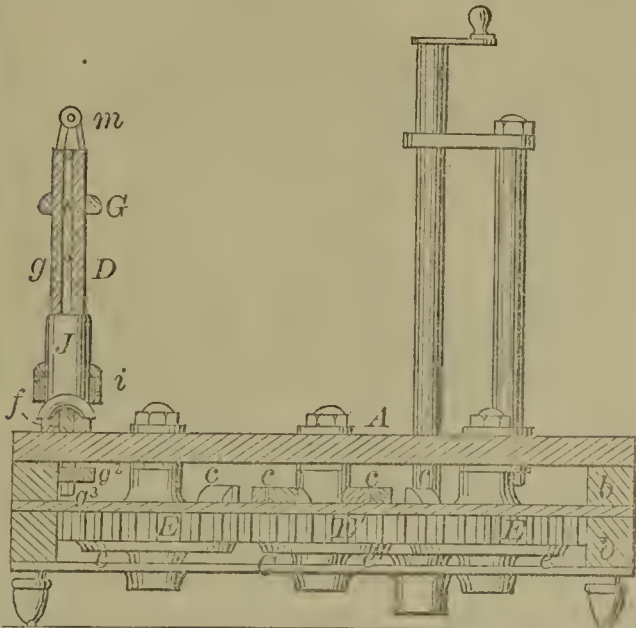

52577—J. F. Landis—*Hanging Curtains, &c.*

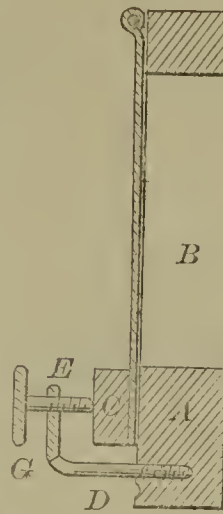

52576—I. W. Lamb—*Dish Stand.*

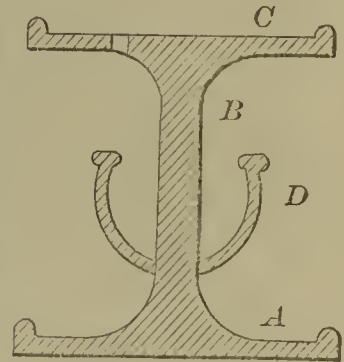

52575—C. F. Jauriet—*Metallic Packing for Stuffing Boxes.*

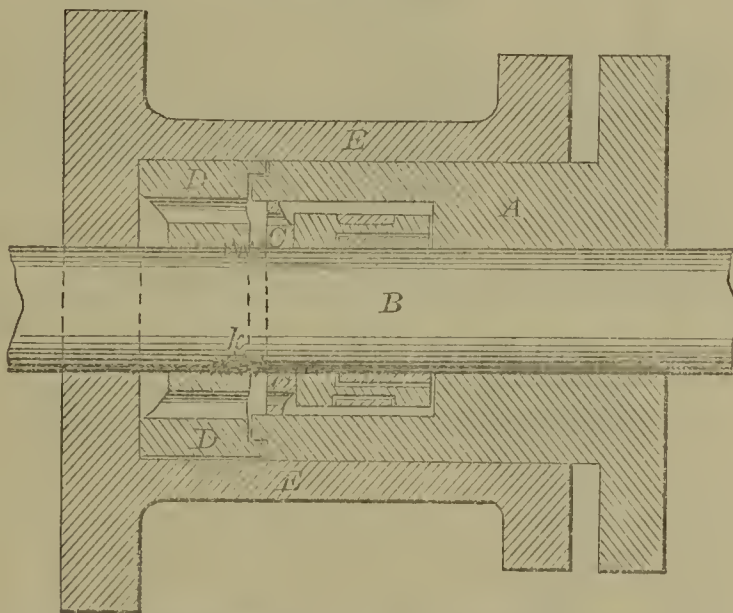

52578—L. M. Larsh—*Water Wheel.*

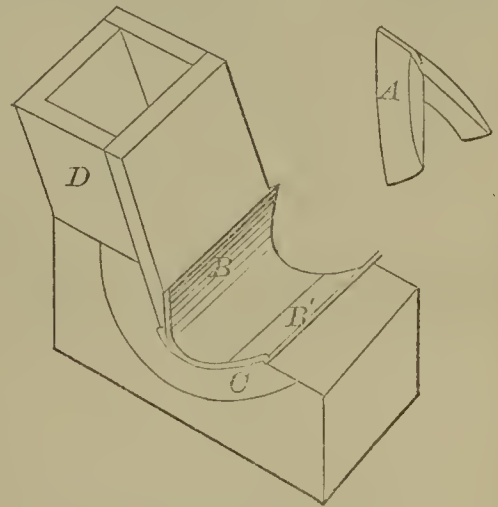

52581—L. H. Sondheim—*Seat for Water Closets.*

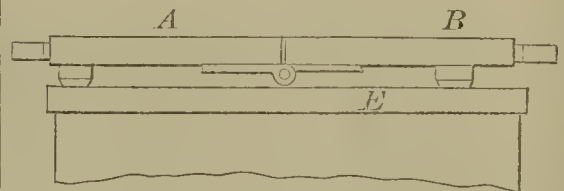

52579—R. Ledig—*Spirit Level.*

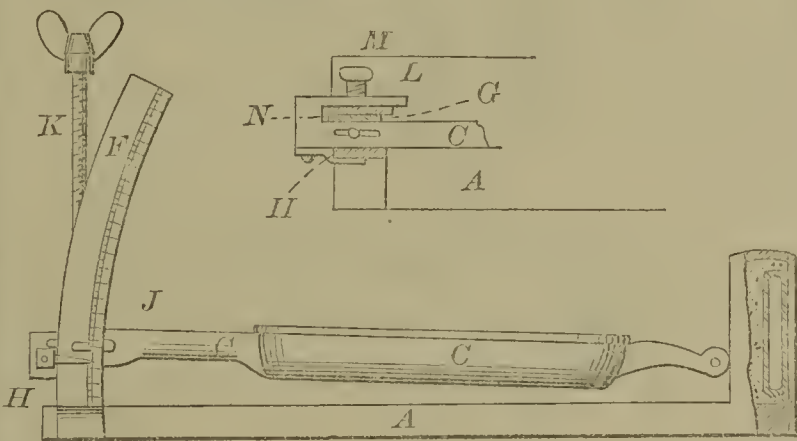

52580—H. G. Lehnert—*Bugles, Horns, &c.*

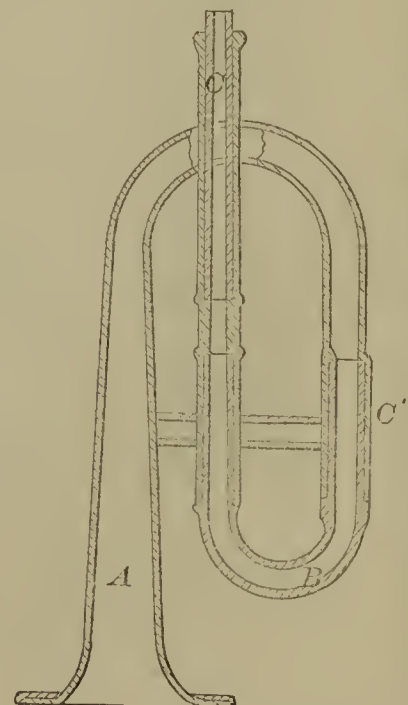

52582—B. T. Loomis—*Revolving Fire Arm.*

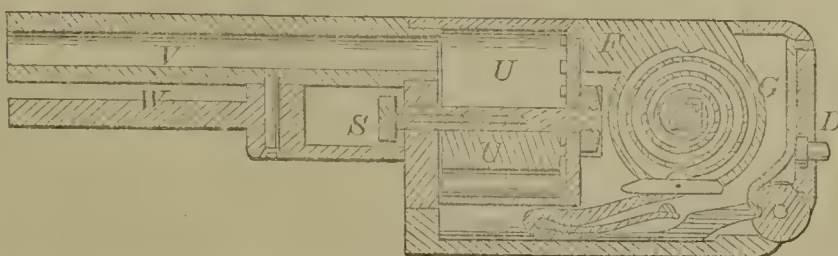

52583—S. Males—Cider Mill.

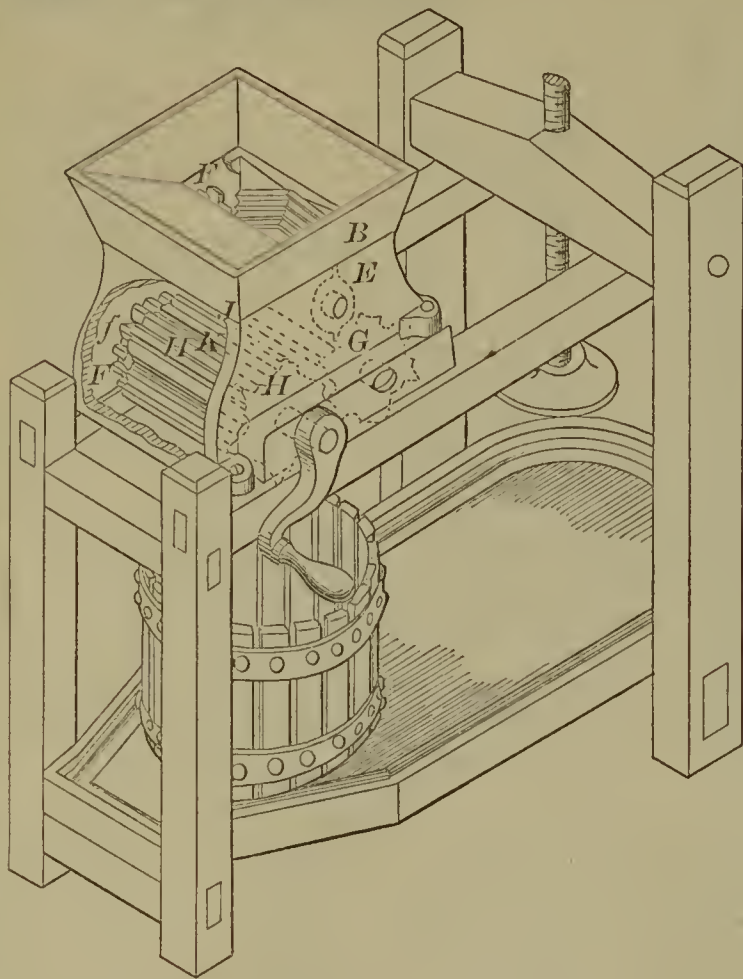

52585—J. B. McClanathan—Spring Bedstead.

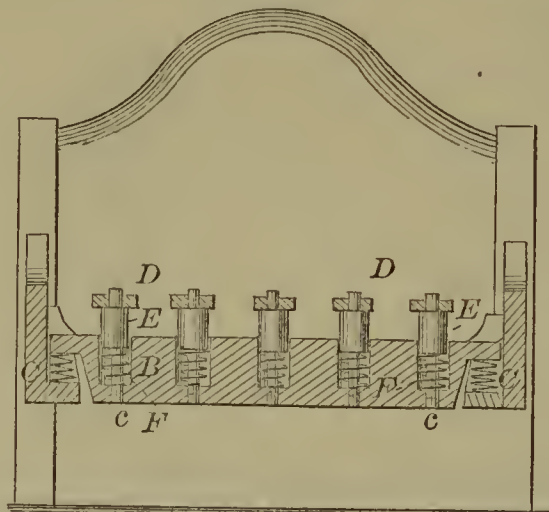

52589—B. T. Nichols—Stirrup.

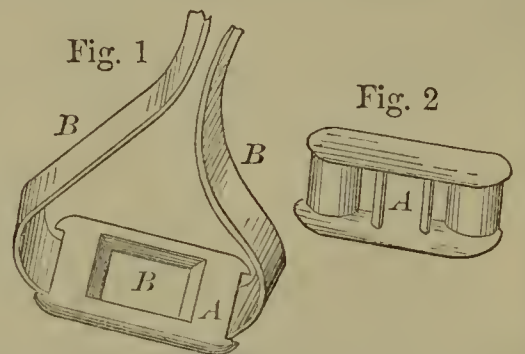

52584—G. Matthewman—Press.

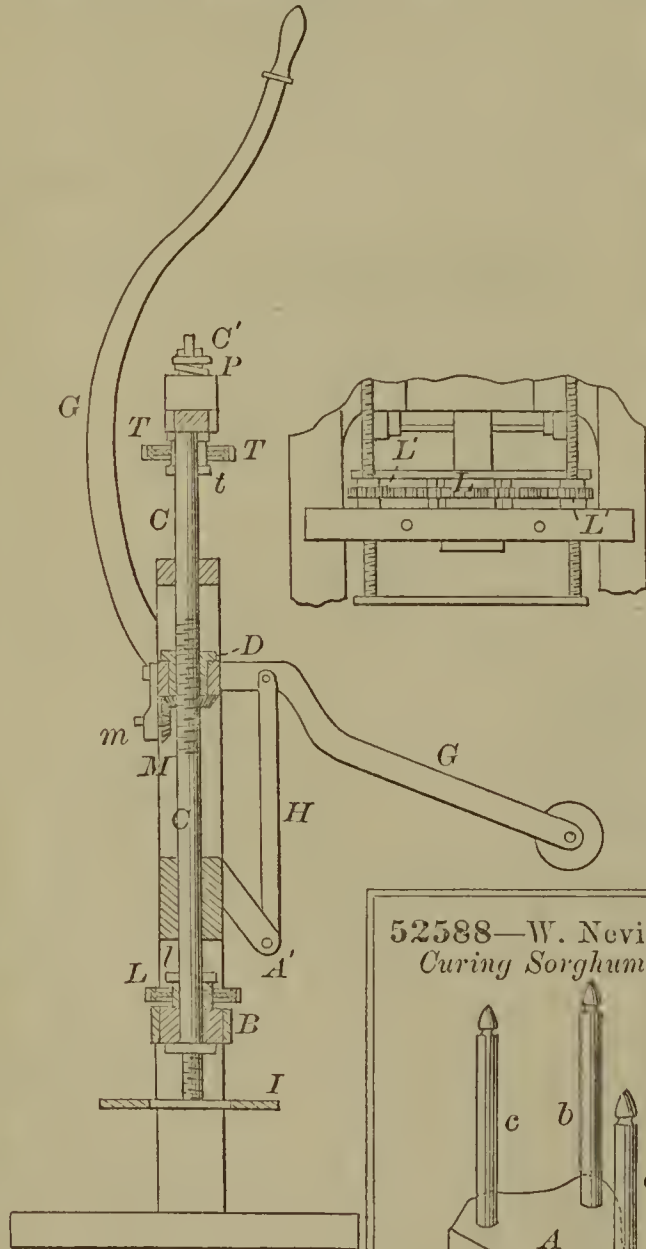

52587—W. Nash—Knife Sharpener.

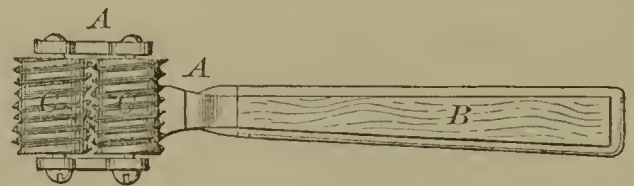

52586—J. McDermott—Thill Coupling.

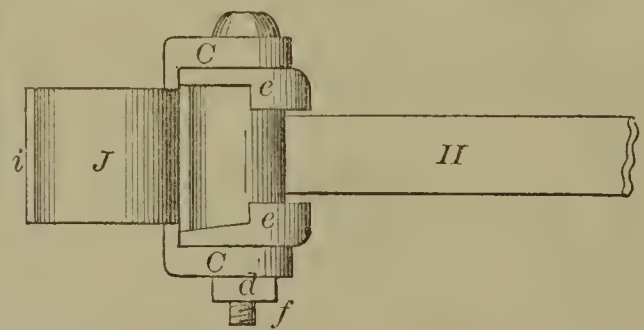

52590—H. Ogborn—Shovel and Tongs.

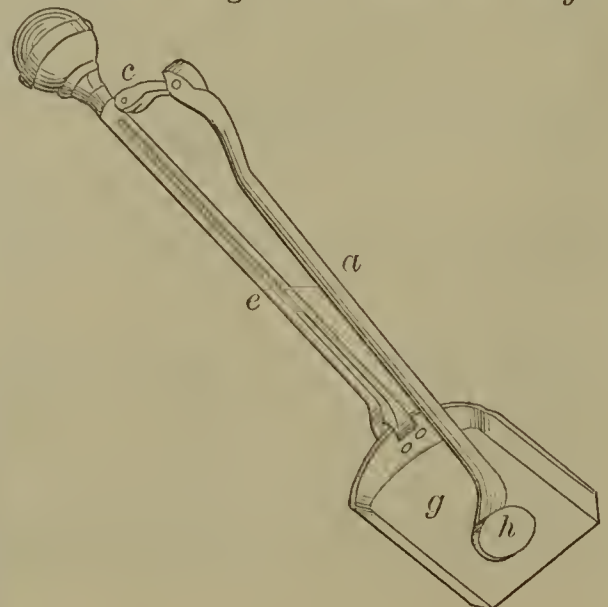

52588—W. Nevins—Curing Sorghum.

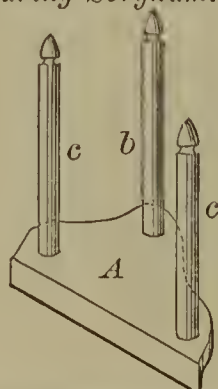



52591—E. Oppenheimer—Calendar Watch.

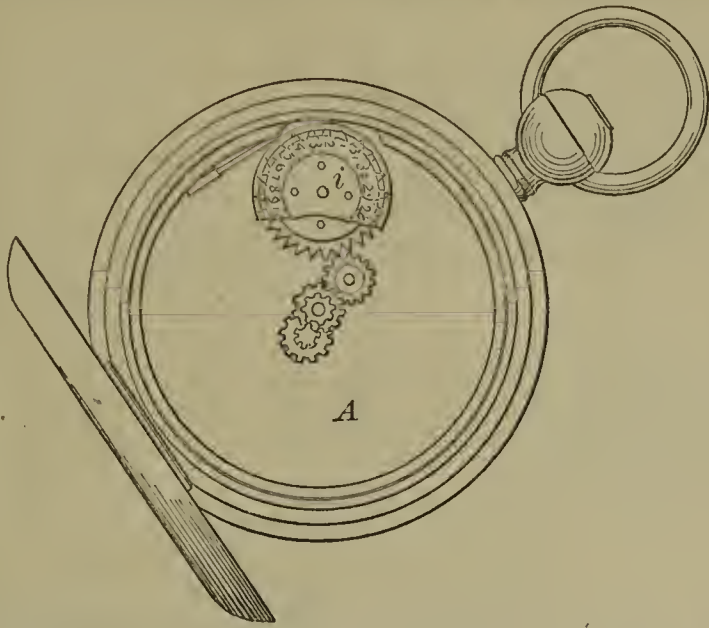

52596—J. W. Pettengill—Lifting Jack.

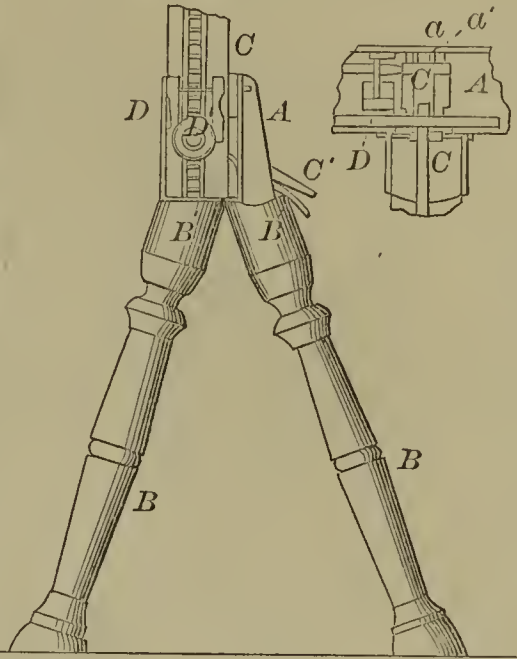

52592—J. H. Parsons—Car Coupling.

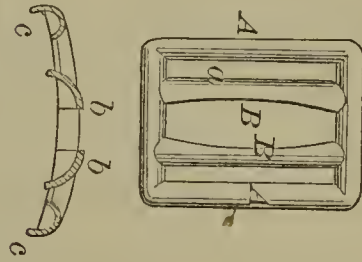
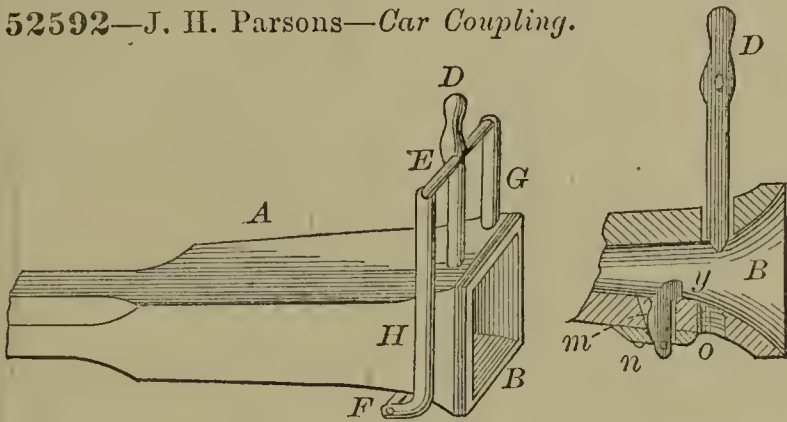

52597—I. N. Plotts—Buckle.

52595—L. C. Percival—Wagon Brake.

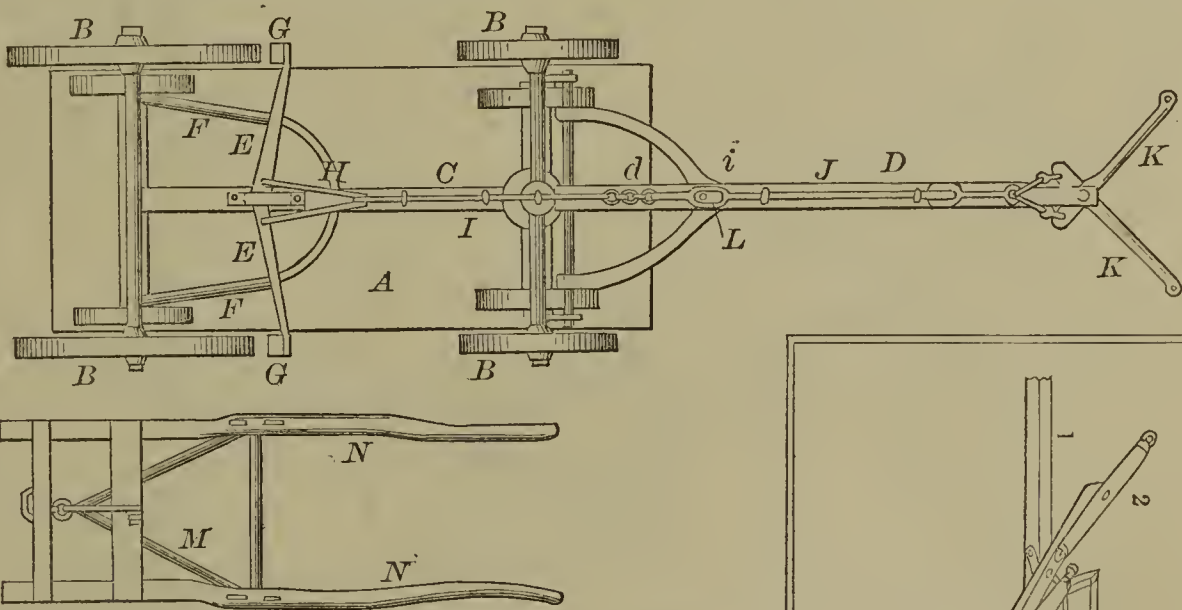

52593—J. H. Parsons—Foot Warmer.

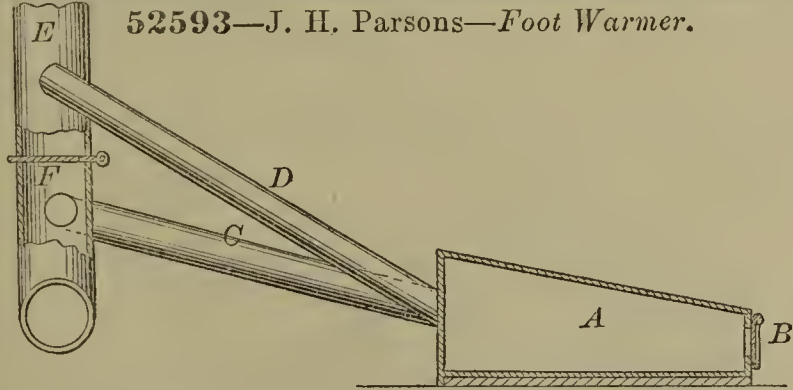

52594—W. Parsons—Securing Pipes in Oil Wells.

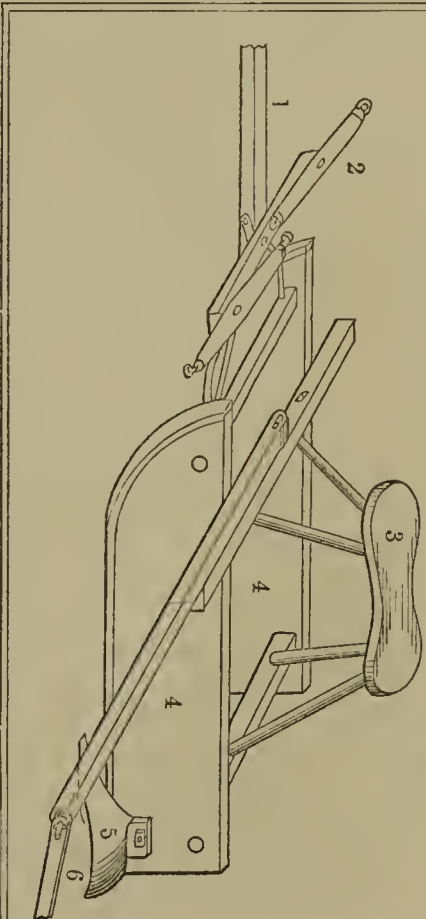

52598—J. Plumb—Furrower for Corn Planting.

52599—B. F. Porter—*Buttonhole for Paper Collars.*



52600—T. W. Porter—*Vehicle.*

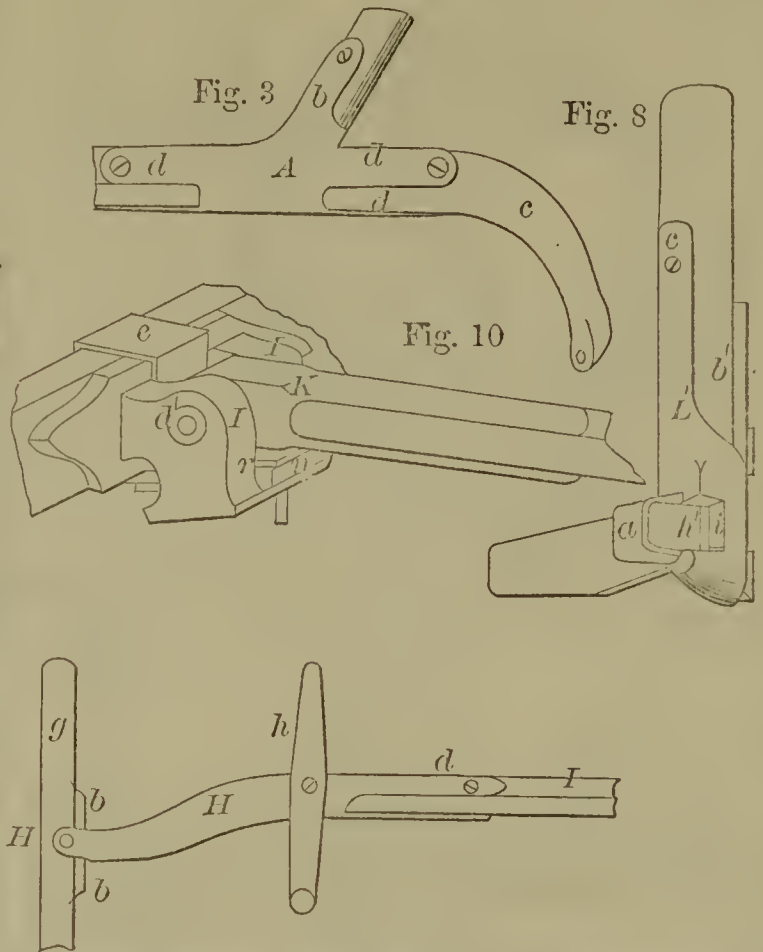

52604—J. Reynolds—*Dust Screen for Furnace Doors.*

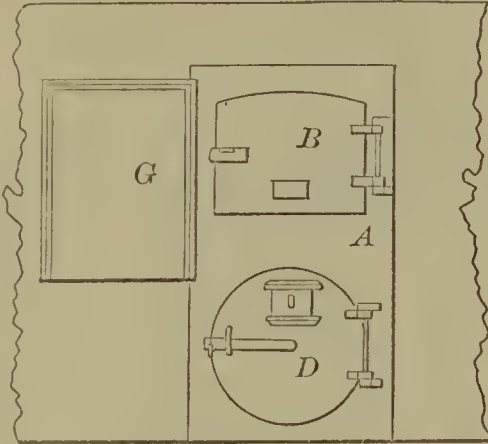

52601—J. S. Preston—*For Raking and Loading Hay.*

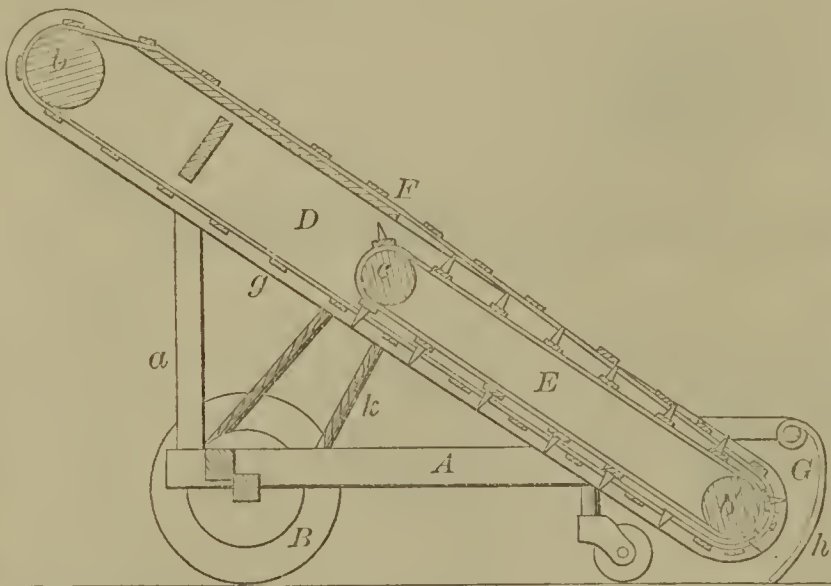

52603—W. R. Reece—*Attaching and Lubricating Car Wheels.*

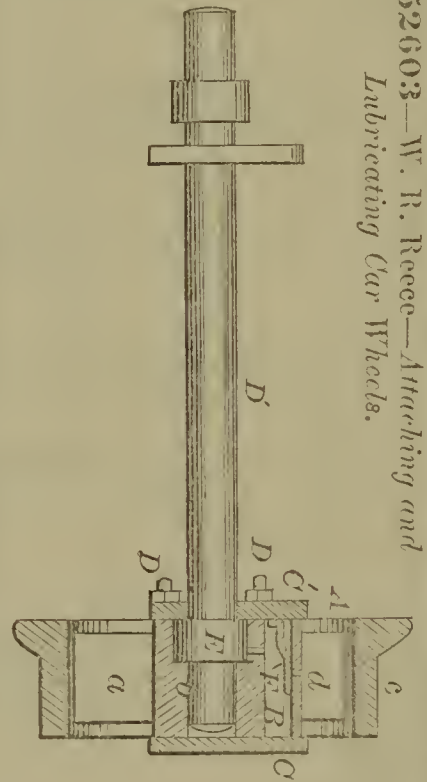

52602—A. Raffel—*Hoop Skirt Former.*

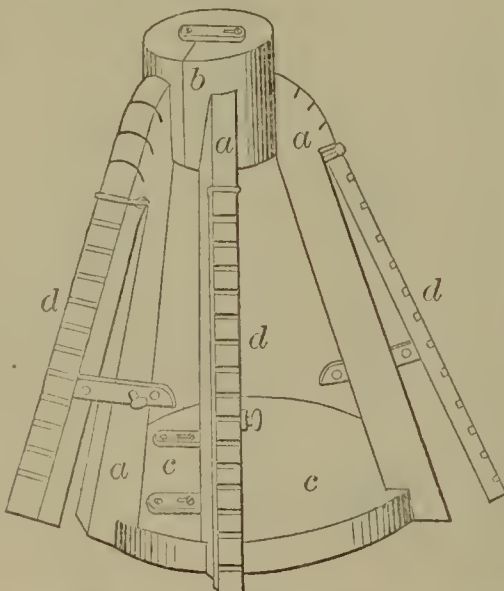

52605—S. Reynolds—*Oven for Annealing Iron.*

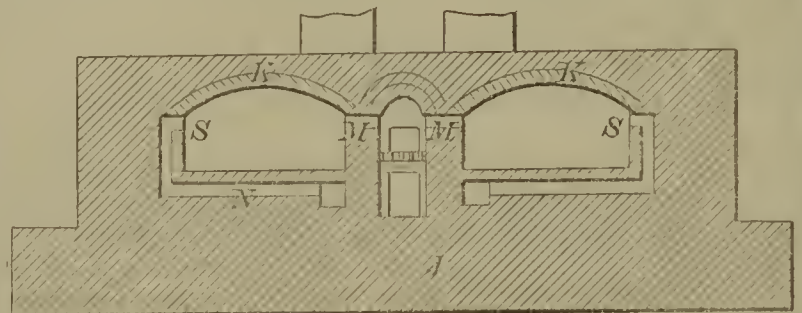

52606—H. Rice—Cultivator.

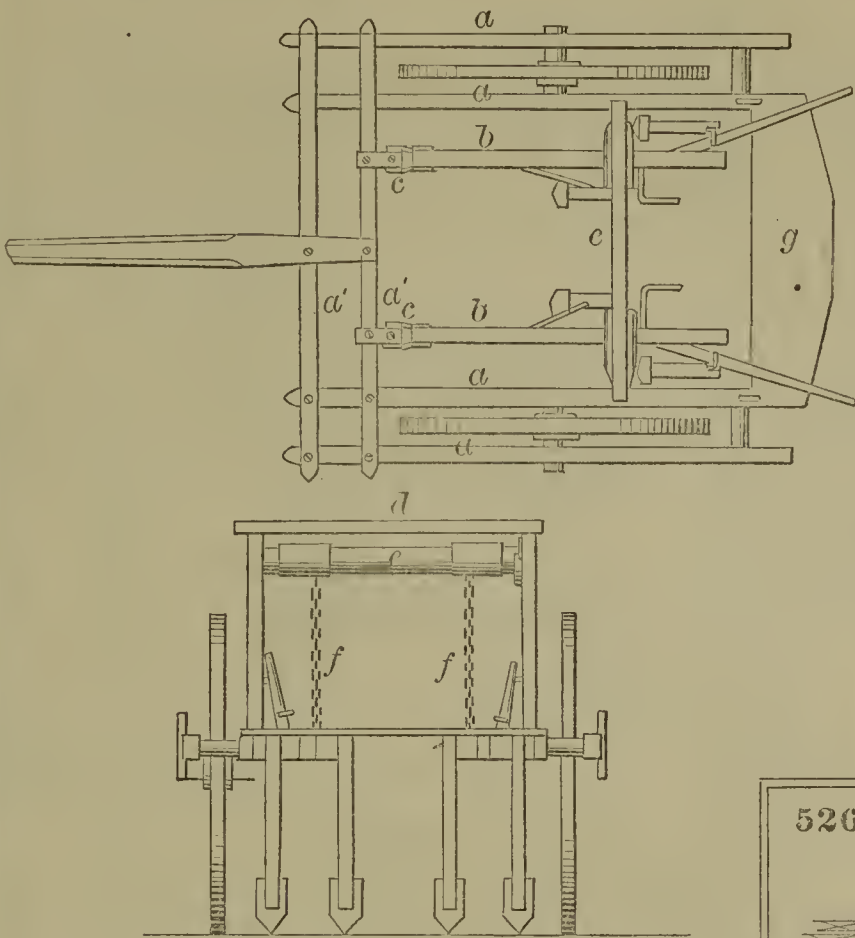

52609—F. H. Richards—Balanced Slide Valve.

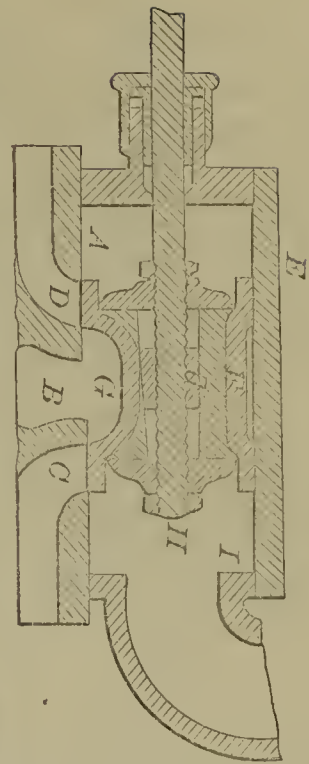

52608—C. E. Richards—Button.

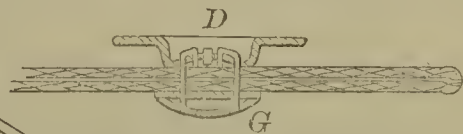

52607—C. E. Richards—Paper Collar.

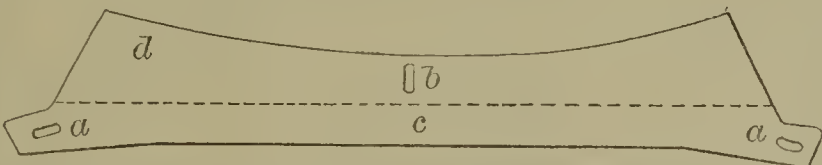

52611—S. Saunders—Fence.

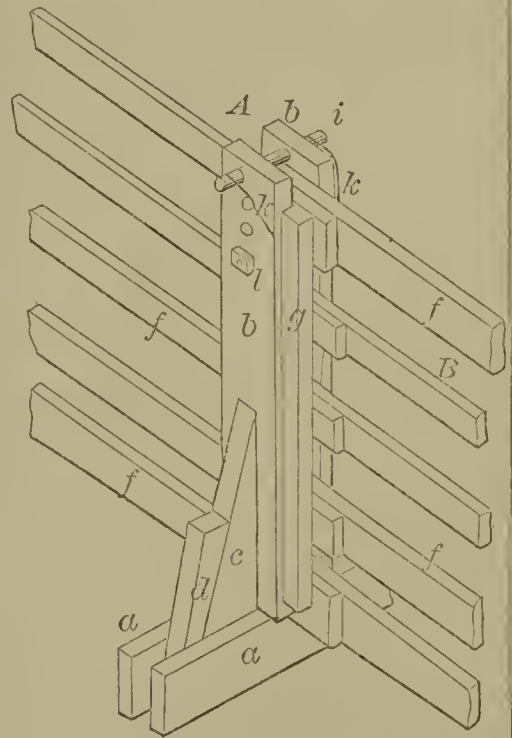

52610—C. Robbins—Piano.

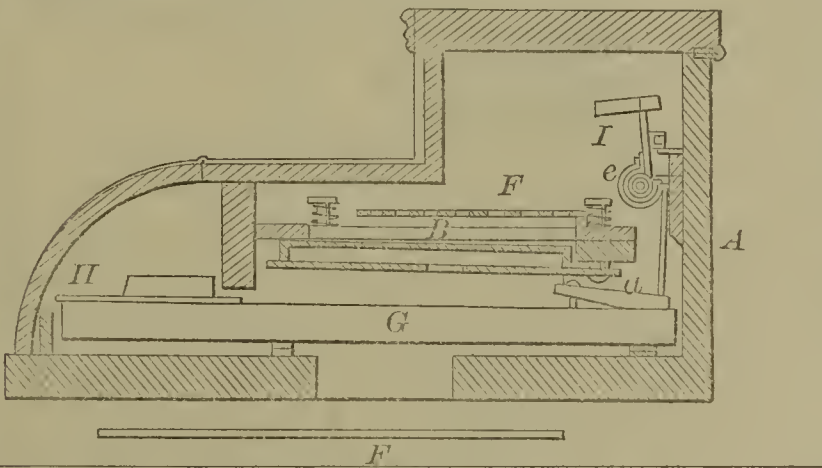

52613—M. Simmons—Roof.

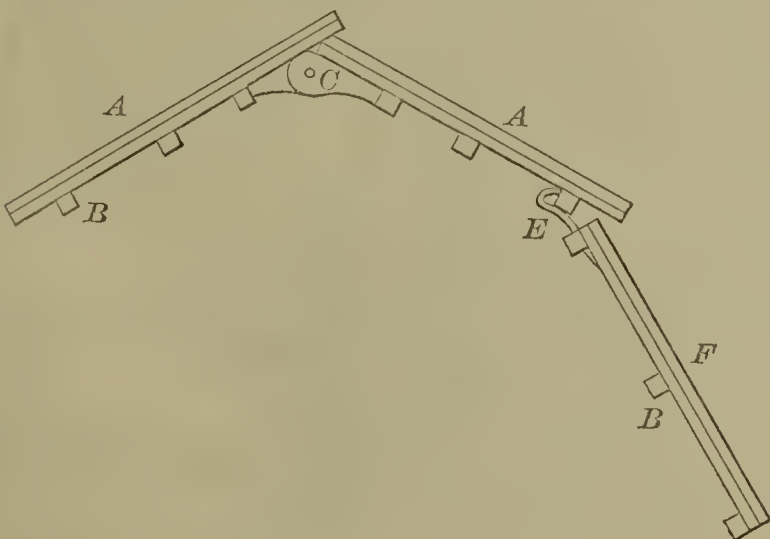

52614—C. D. Smith—Eyelet.

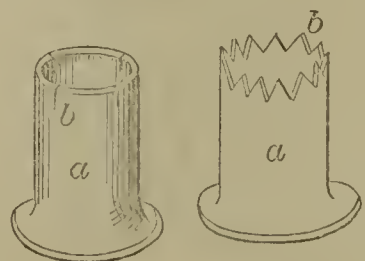

52615—H. E. Smith—Roll for Clothes Wringers.

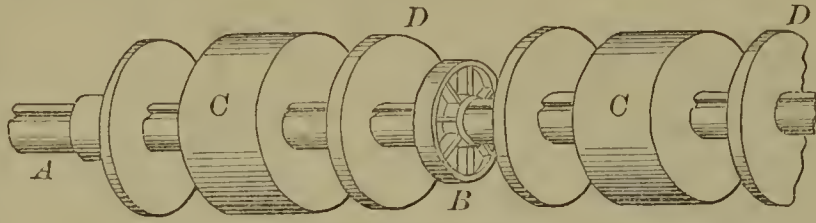

52621—H. L. Taylor—Pole and Thill Coupling.

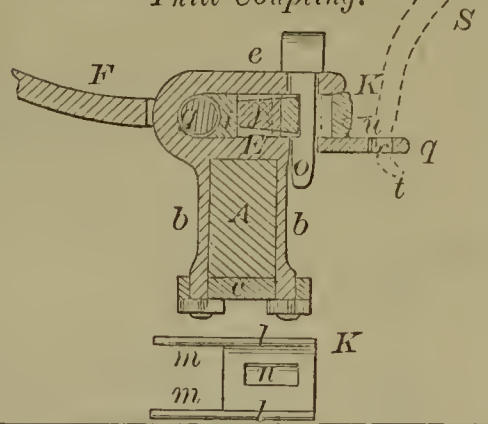

52616—U. Smith—Parallel Ruler.

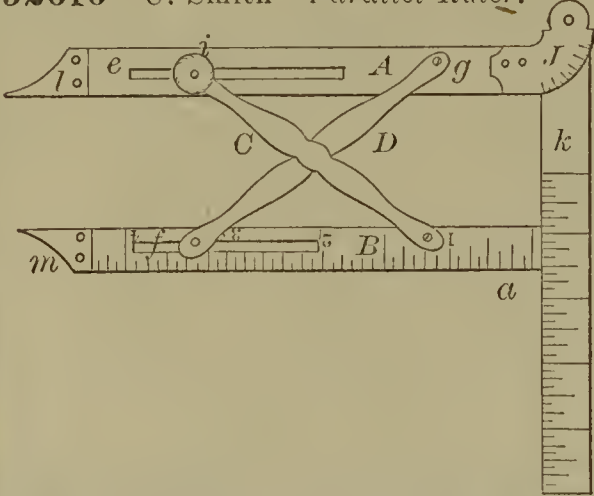

52619—J. L. Sesserott—Attaching Shafts to Vehicles.

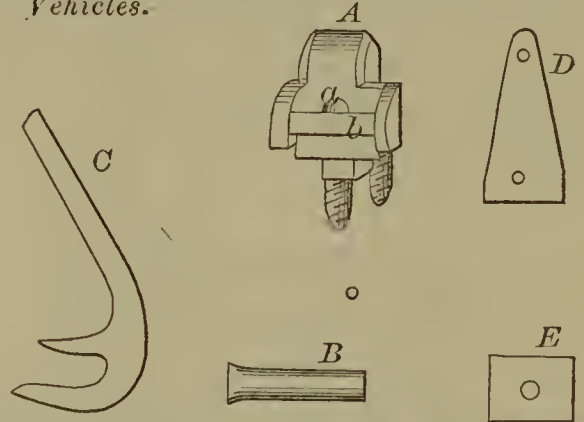

52618—C. C. Stansell—Lamp Wick Adjuster.

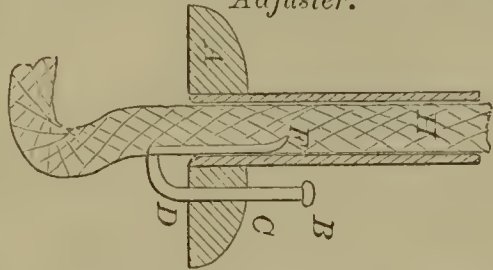

52617—H. Splittdorf—Galvanic Batteries.

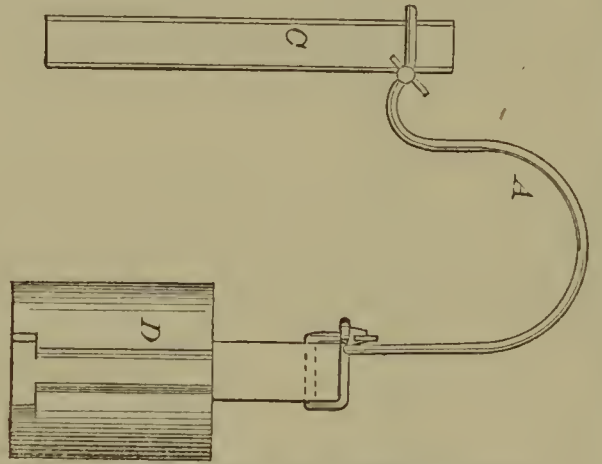

52620—F. C. Sumner—Shoe Lacing Cutter.

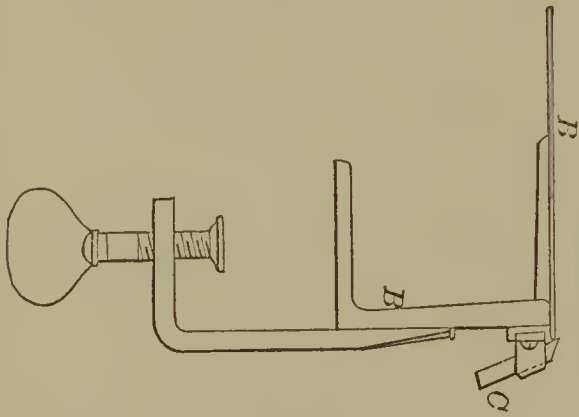

52623—S. Taylor—Organ and Melodcon.

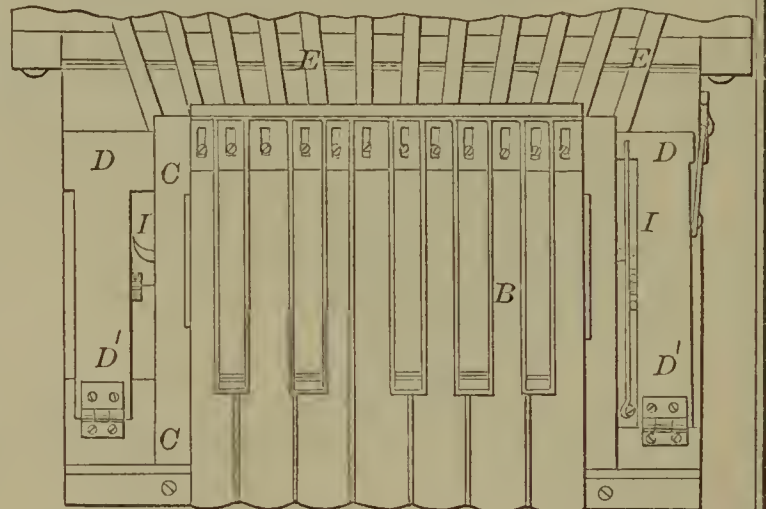

52622—Taylor, Taylor & Cox—Beehive.

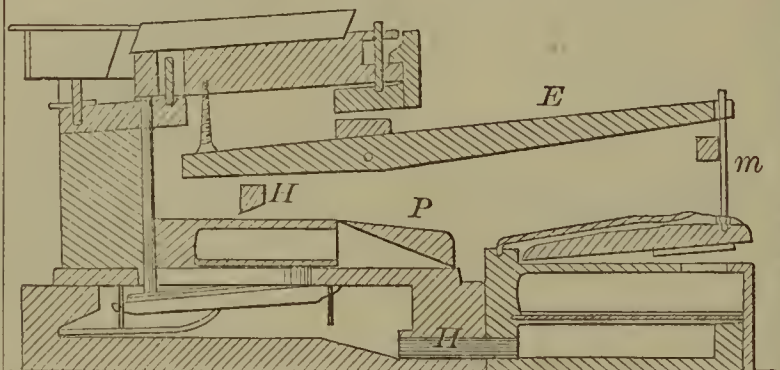
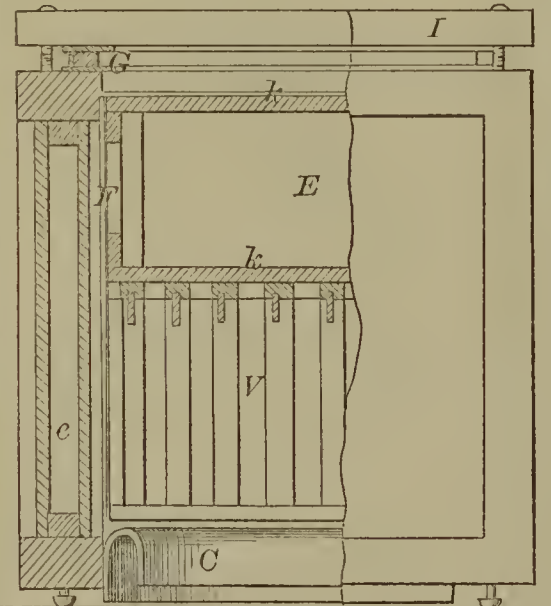

52624—J. R. Tempest—*Skate.*

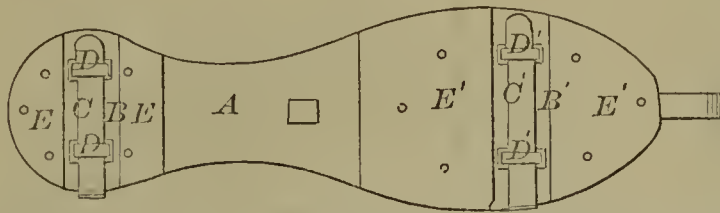

52625—J. Tyler—*Turbine Water Wheel.*

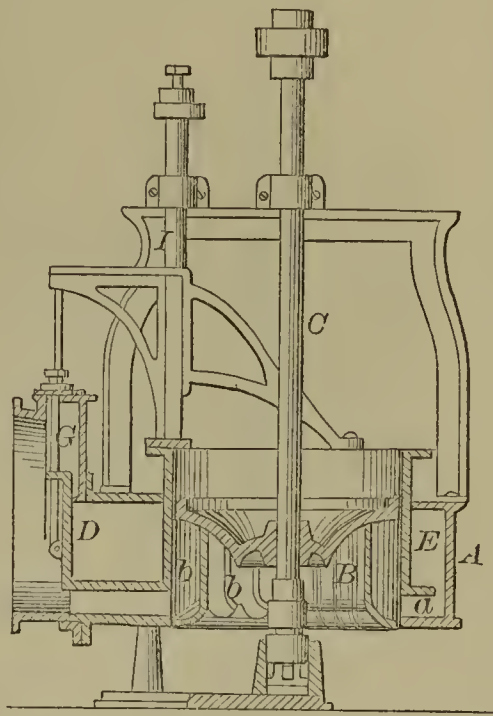

52627—W. B. Vincent—*For Cutting Bread, &c.*

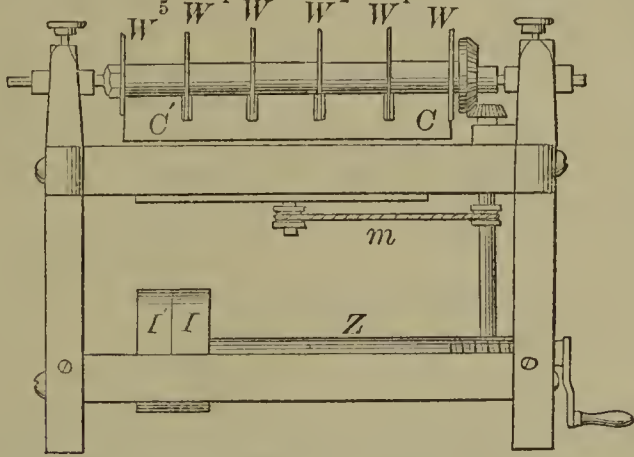

52626—C. Unverzagt—*Hand Loom.*

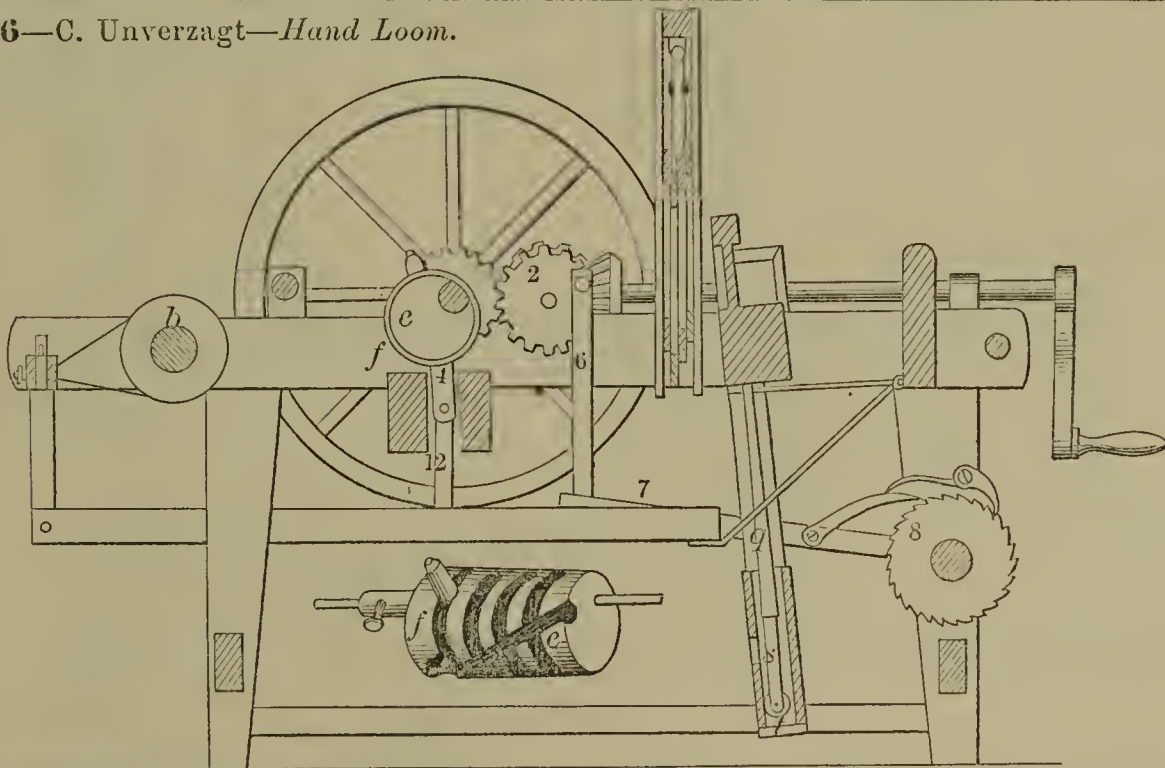

52628—A. Vrooman—*Faucet Measure.*

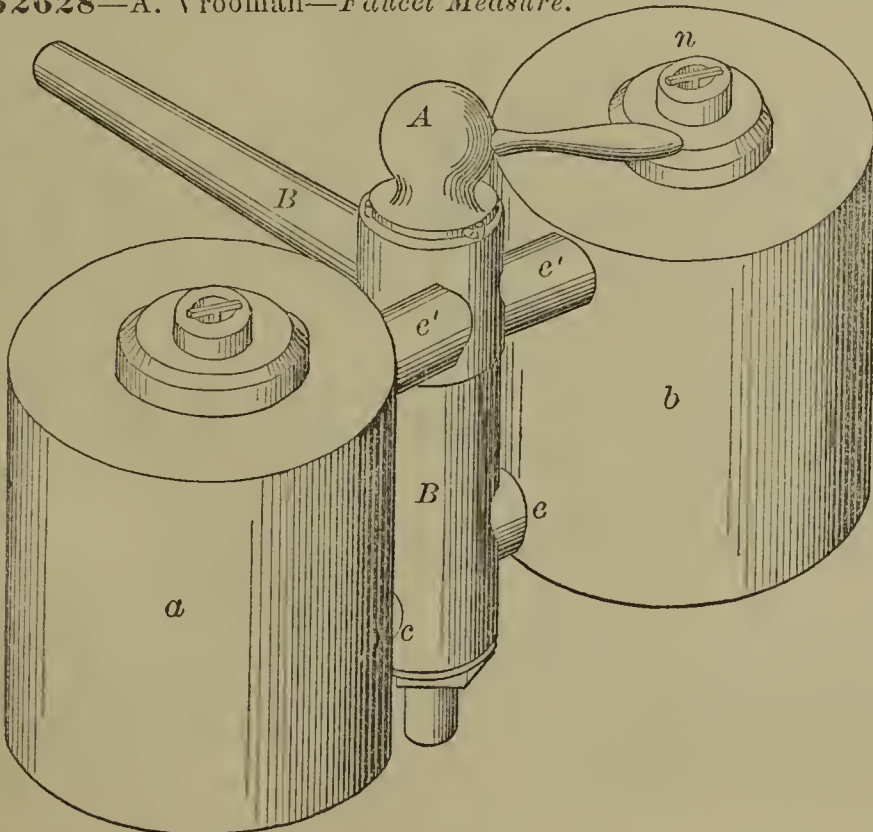

52629—J. F. Warner—*Fence.*

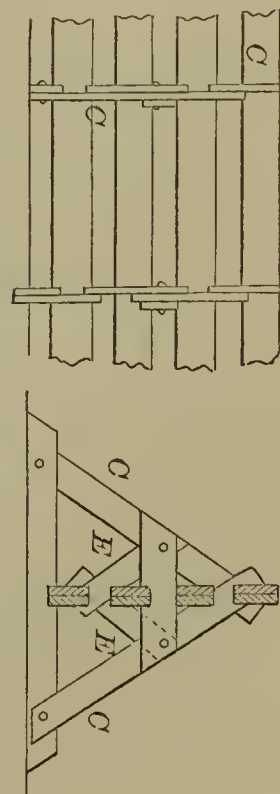

52630—H. Waters—For Rolling Metals.

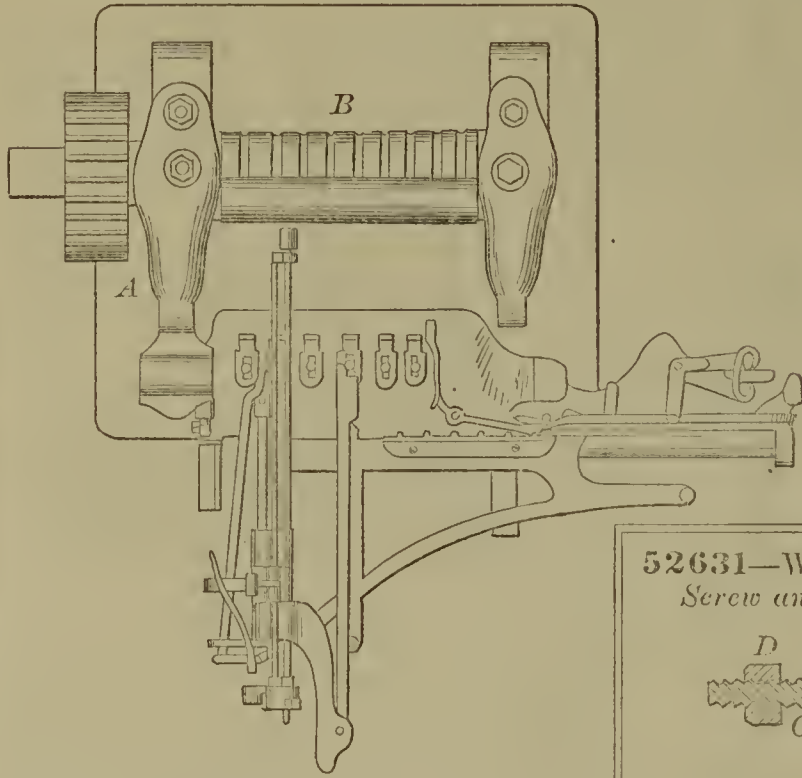

52634—W. Woodbury—Pulley for Fishing Boats.

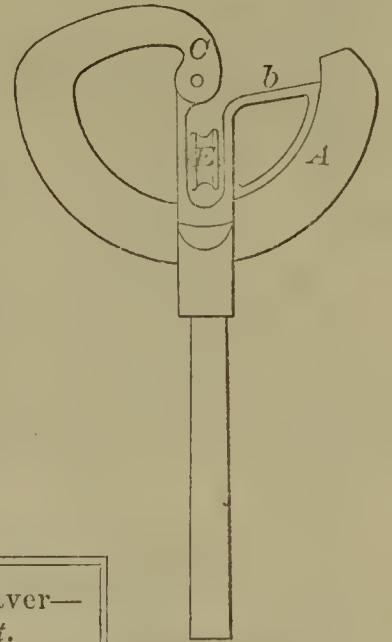

52631—W. Weaver—Screw and Bolt.

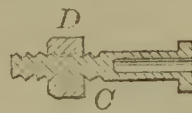

52633—Widman & Millica—Plow.

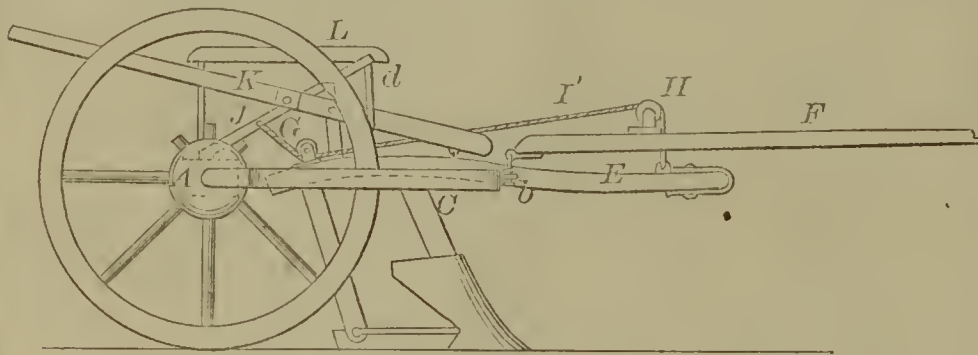

52632—S. H. Whittlesey—Well Borer.

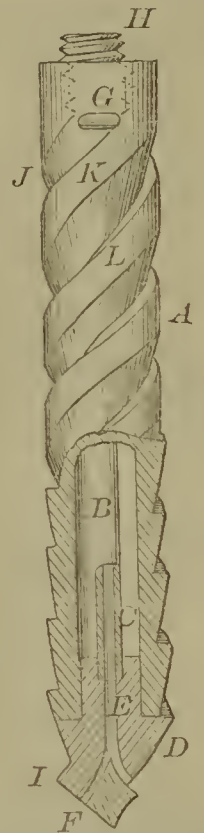

52635—J. H. Alexander—Seed Planter.

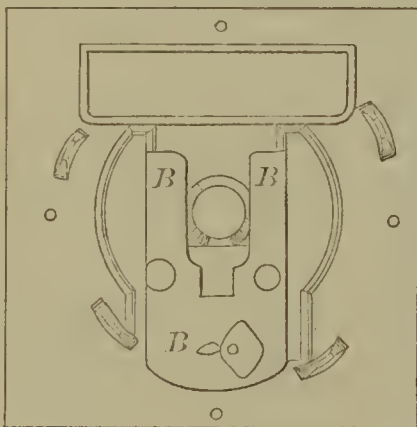

52637—J. P. Buzzell—Hoop Skirt.

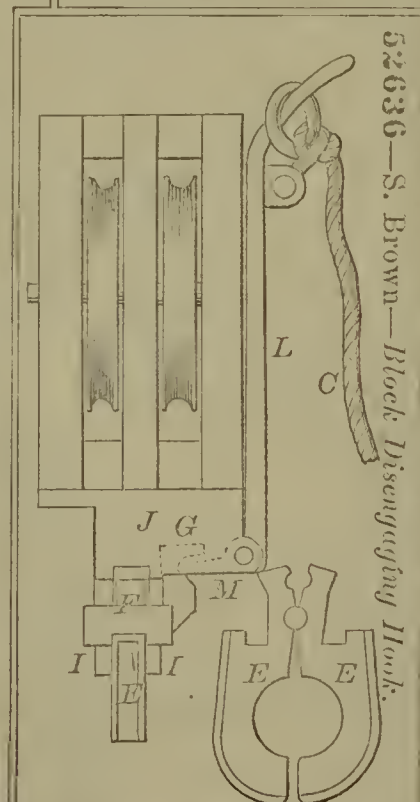
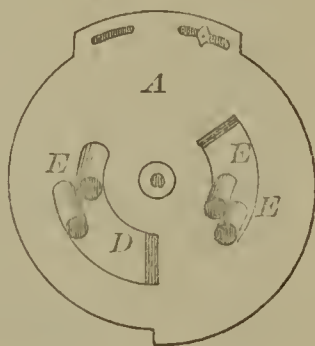
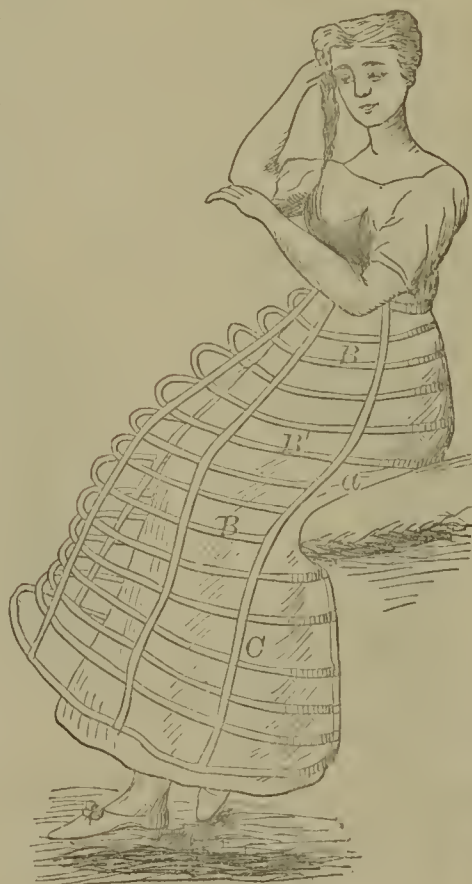

52636—S. Brown—Block Disengaging Hook.

52638—R. G. Chase—Saw Set.

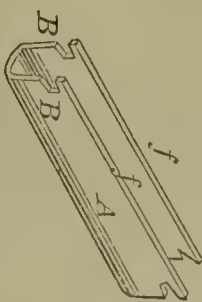
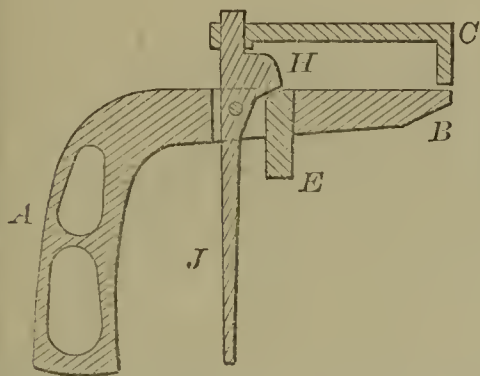

52639—G. W. Chesman—  
Clasp for Skirt Hoops.

52641—P. W. Gates—  
Stamping Head.

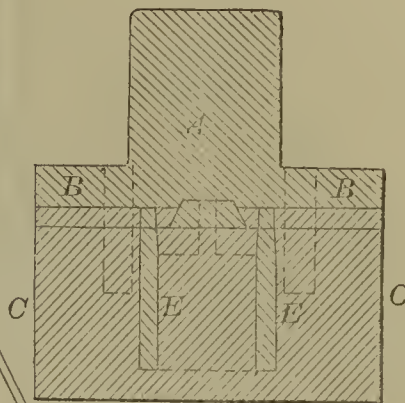

52640—C. J. Everett—Rendering Apparatus.

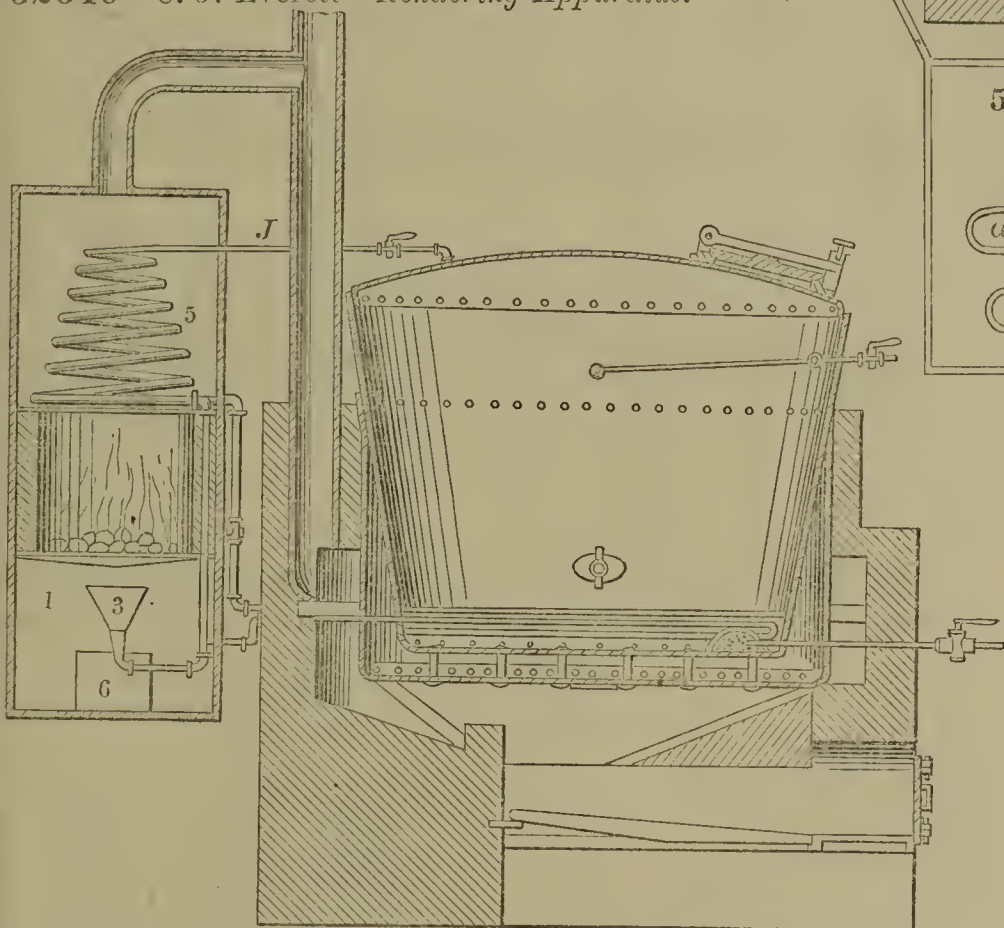

52644—T. J. Jones—  
Piston Packing.

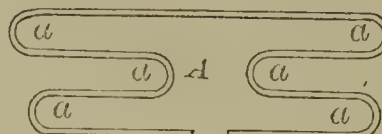

52643—J. H. Greenleaf—Darning  
Spool.

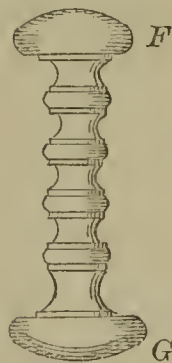

52642—S. J. Goucher—Well Boring Apparatus.

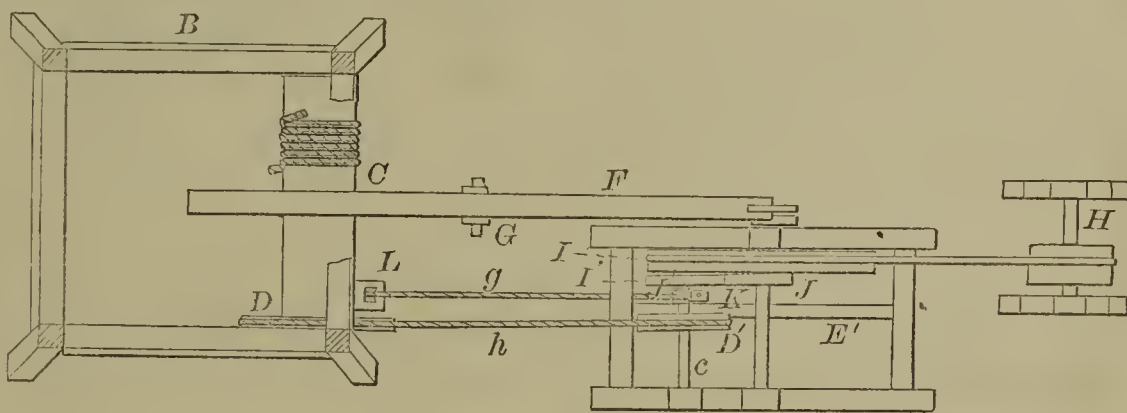

52645—E. C. C. Kellogg—Lacing Device.

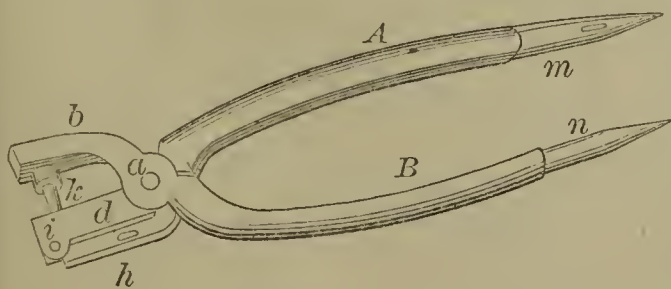

52646—G. C. Overhiser—Sewing Machine  
Hemmer.

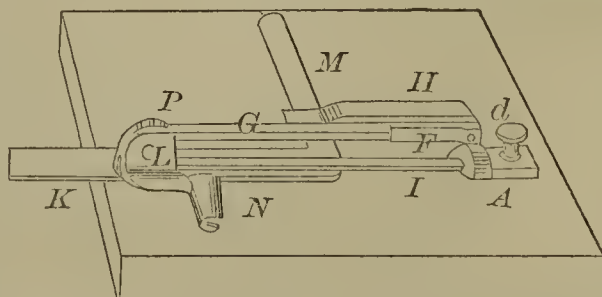

52648—J. H. Schwein—  
*Hot Air Furnace.*

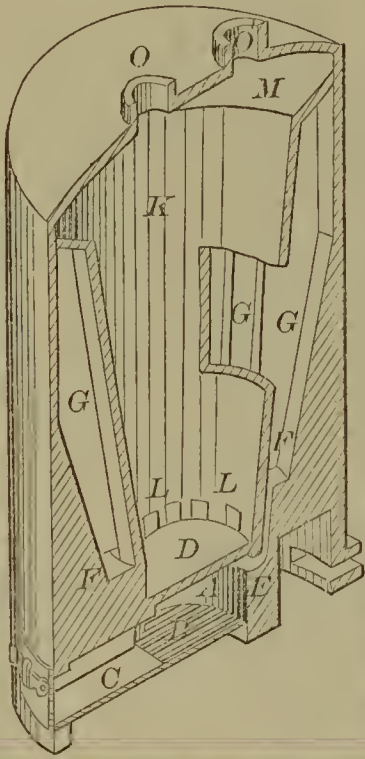

52650—A. Smith—*Preservatory.*

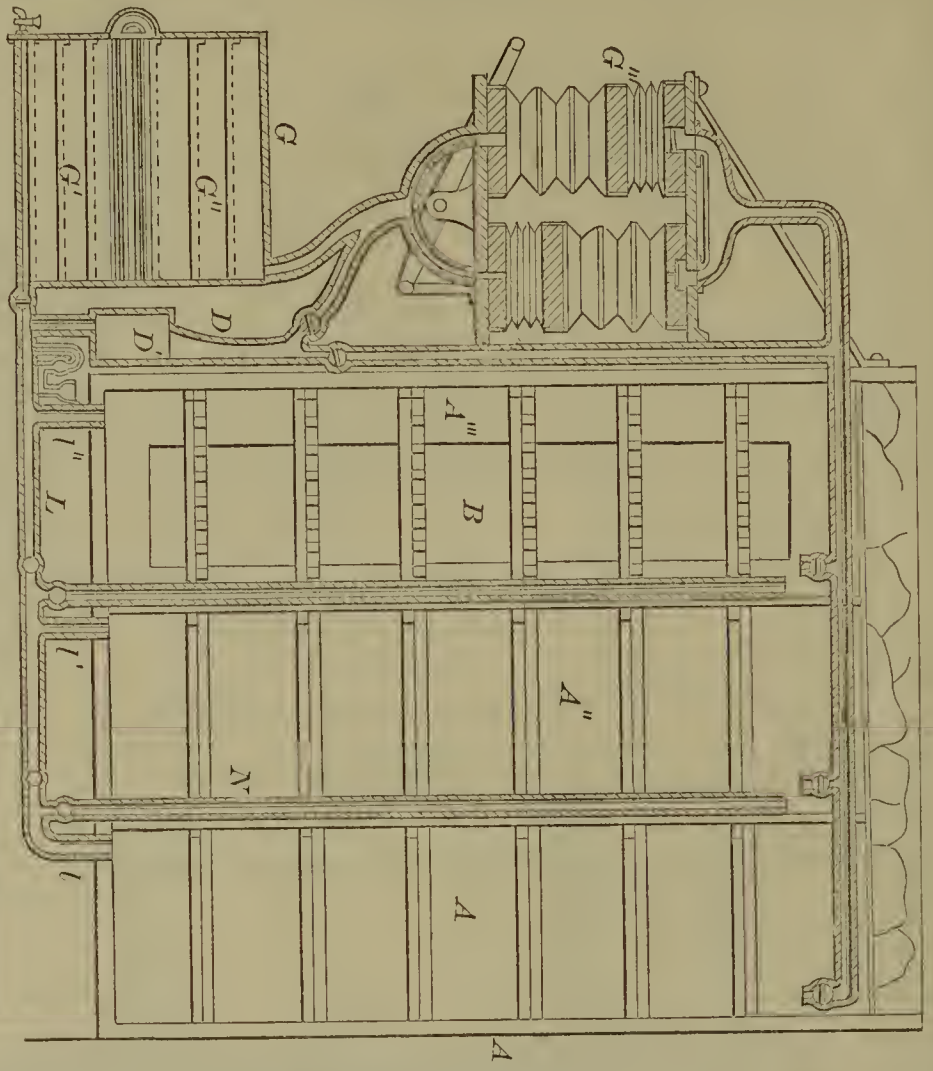

52649—S. Selden—*Hinge.*

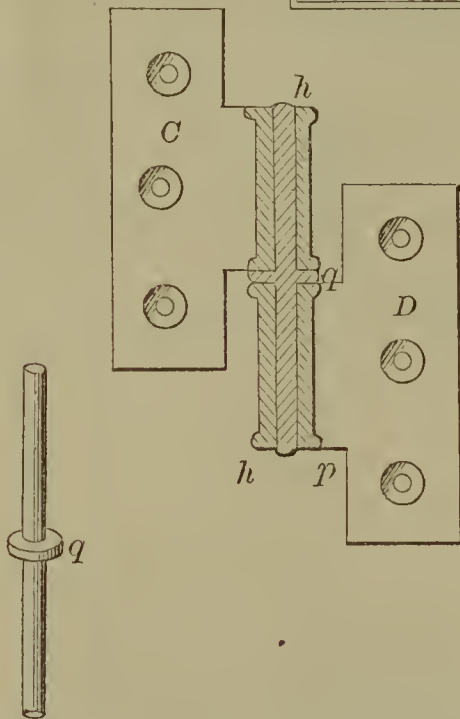

52651—J. E. Travis—*Gang Plow.*

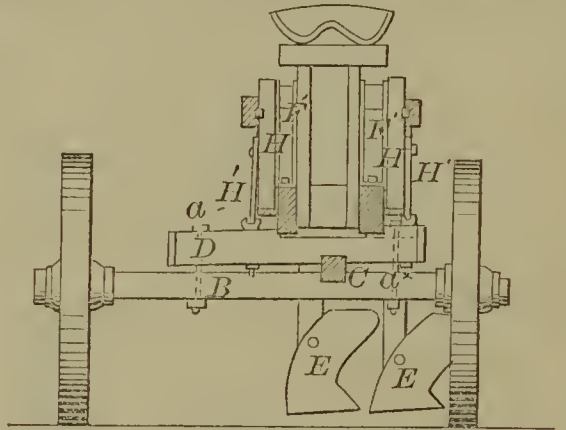

52653—J. H. Ehrhardt—*For Determining the Load of Car Axles.*

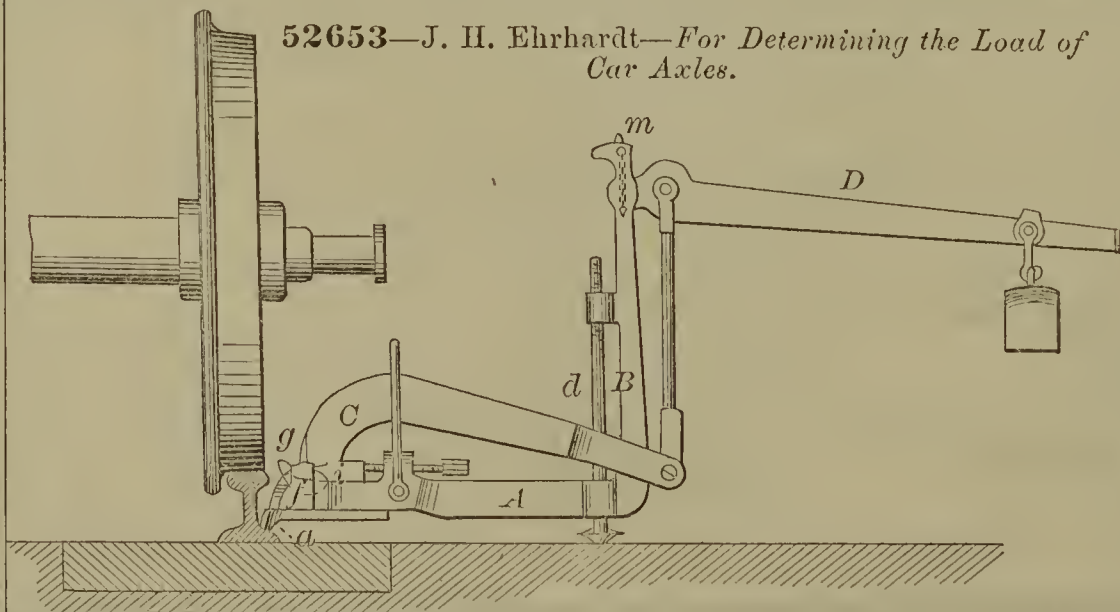

52652—J. Waterman—*Buckle.*

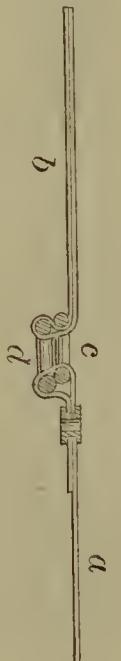



52654—A. Henry—Breech-Loading Fire Arm.

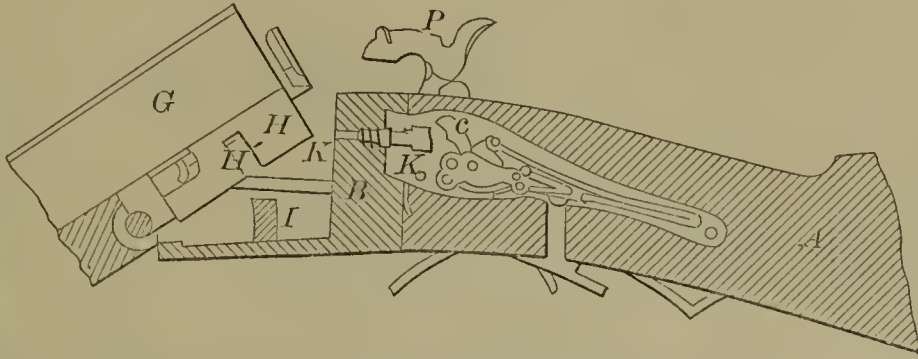

52659—J. Barton—Paper and Cloth Collar.

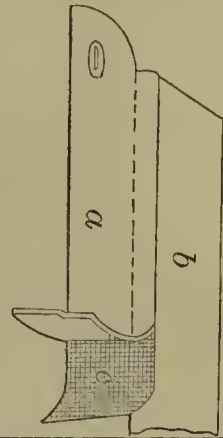

52660—J. Bean—Pump.

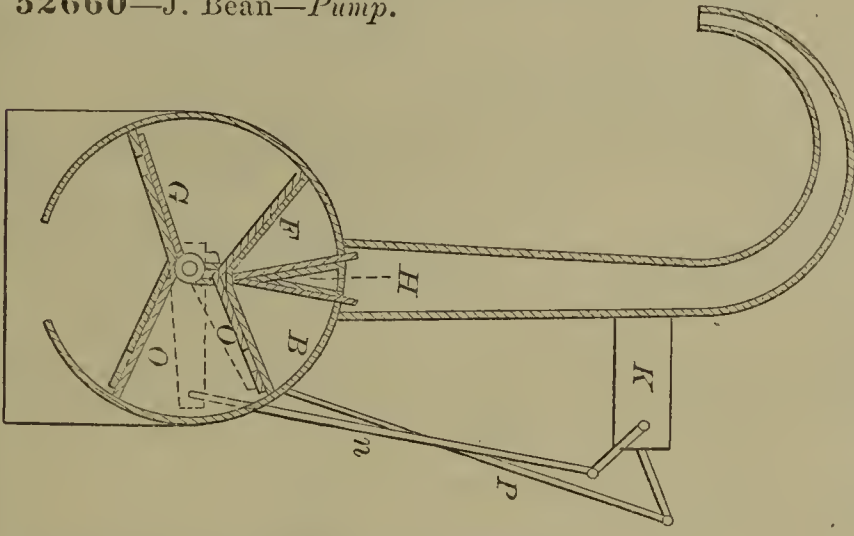

52657—I. E. Allen—Head Block for Holding Boots and Shoes.

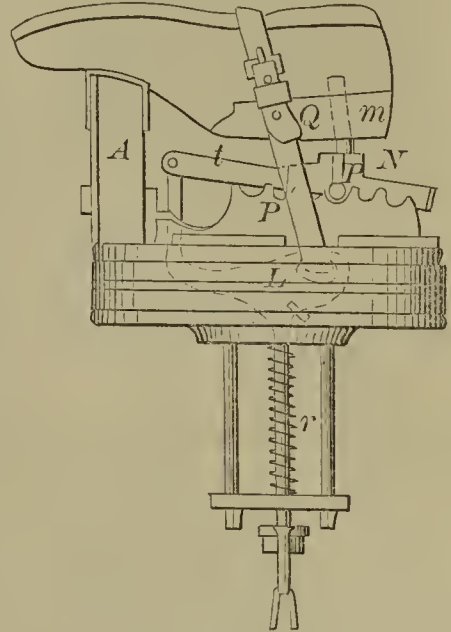

52661—L. Bishop—Press and Strainer for Cream Paste.

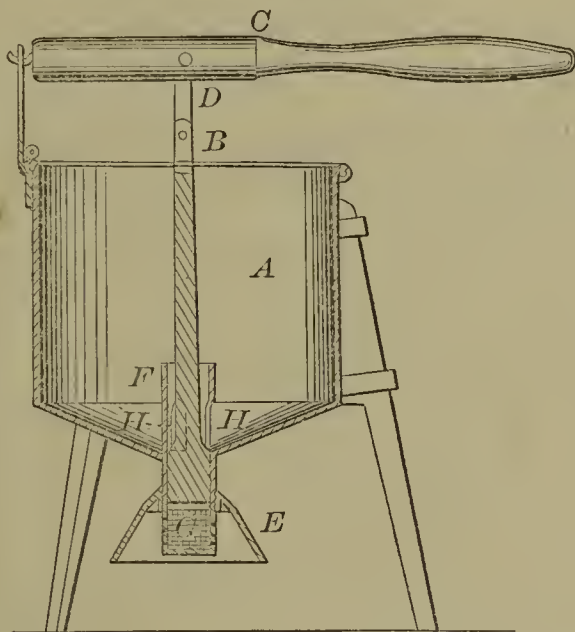

52658—J. Barnes—Spring Bed Bottom.

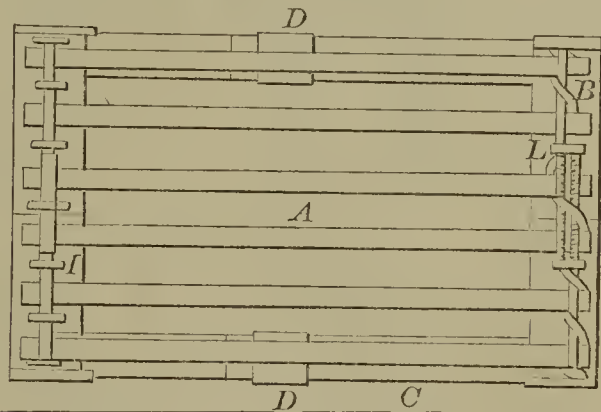

52663—S. R. Boure—Sled.

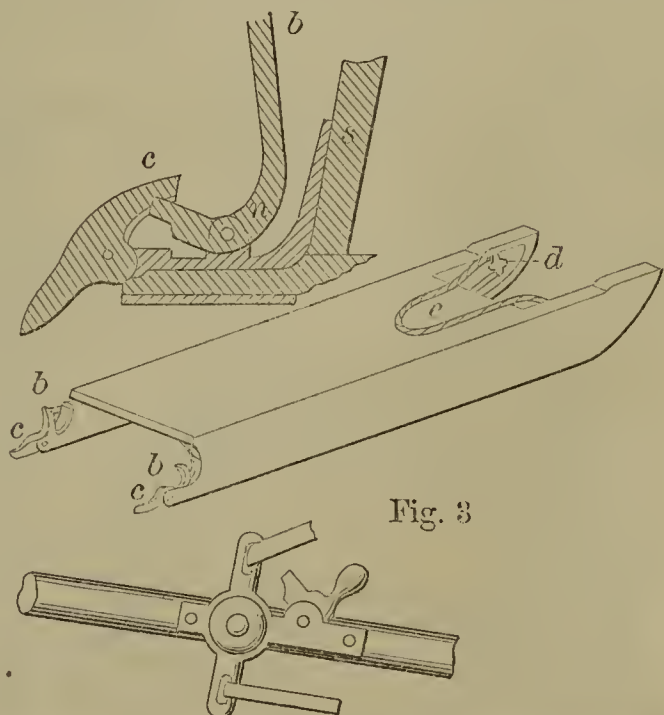

52662—A. M. Blanchard—Printers' Chase.

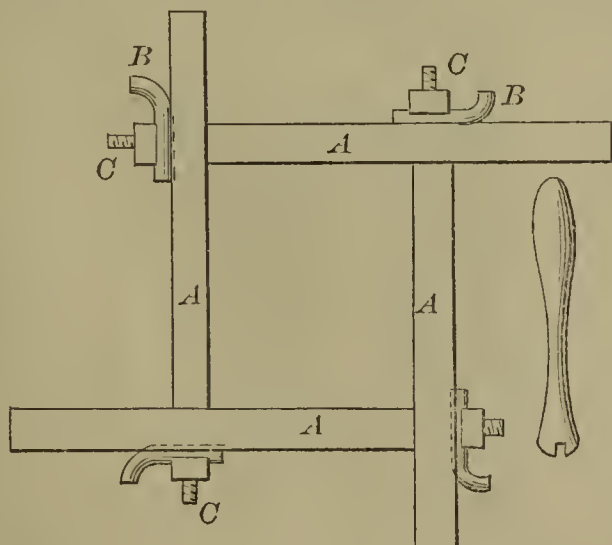

52664—W. Boynton—*Churn.*

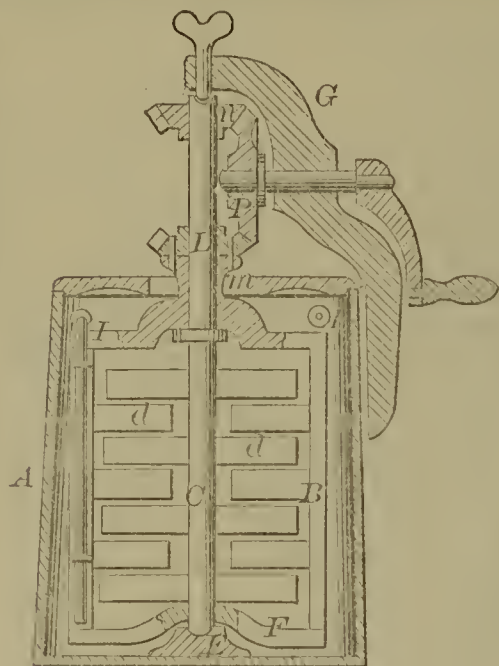

52667—S. B. Brague—*Sponge Cup.*

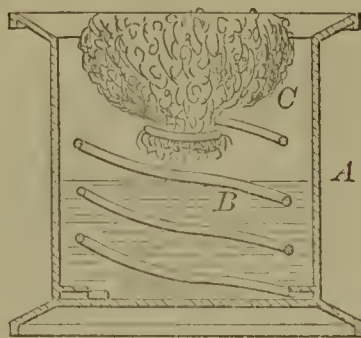

52665—J. W. Bradley—*Skirt Hoop.*

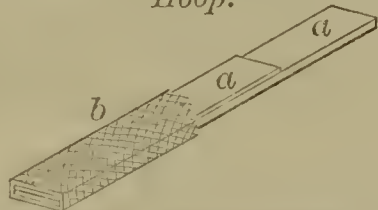

52669—F. F. Brailard—*Pocket Toilet Case.*

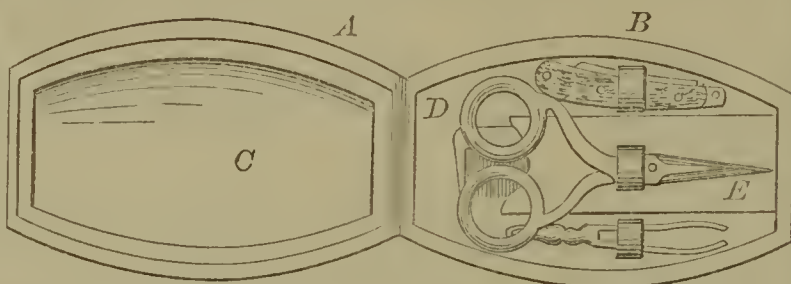

52666—S. B. Brague—*Hand Stamp.*

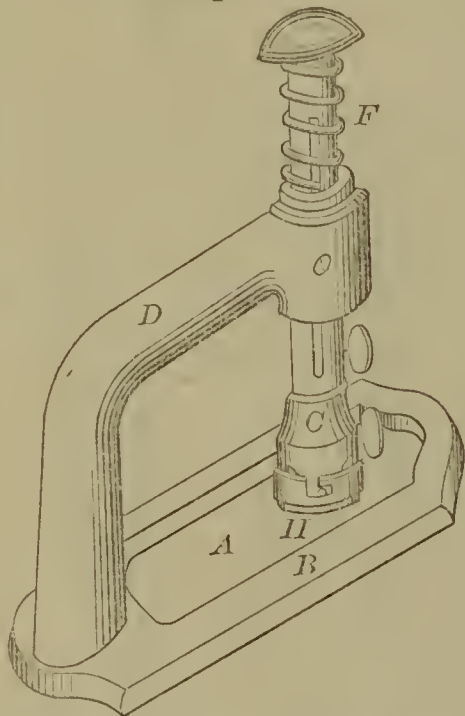

52670—C. N. Briggs—*Well Boring Machinery.*

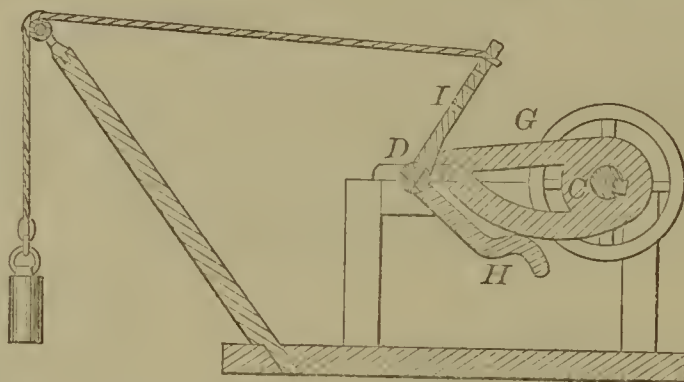

52672—C. B. Boyle—*Lens.*

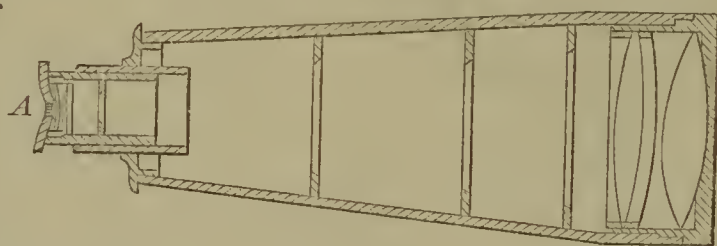

52671—Brown & Frankem—*Hot Air Furnace.*

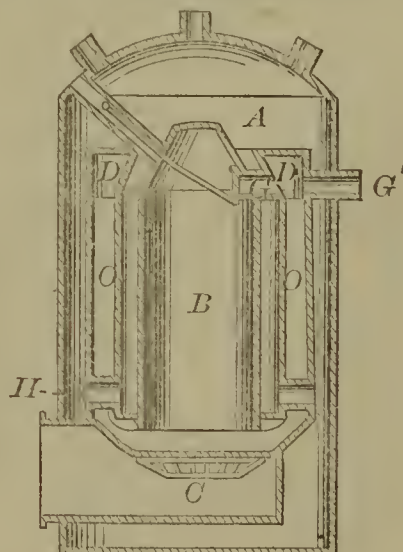

52668—Bragne & Starr—*Hand Stamp.*

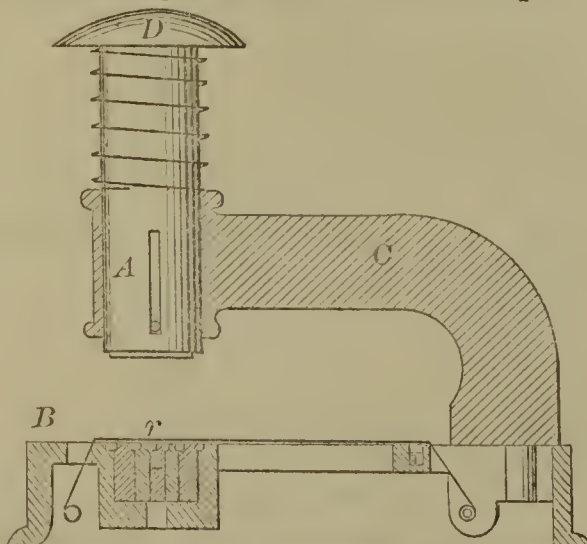

52674—H. C. Bull—*Brick Machine.*

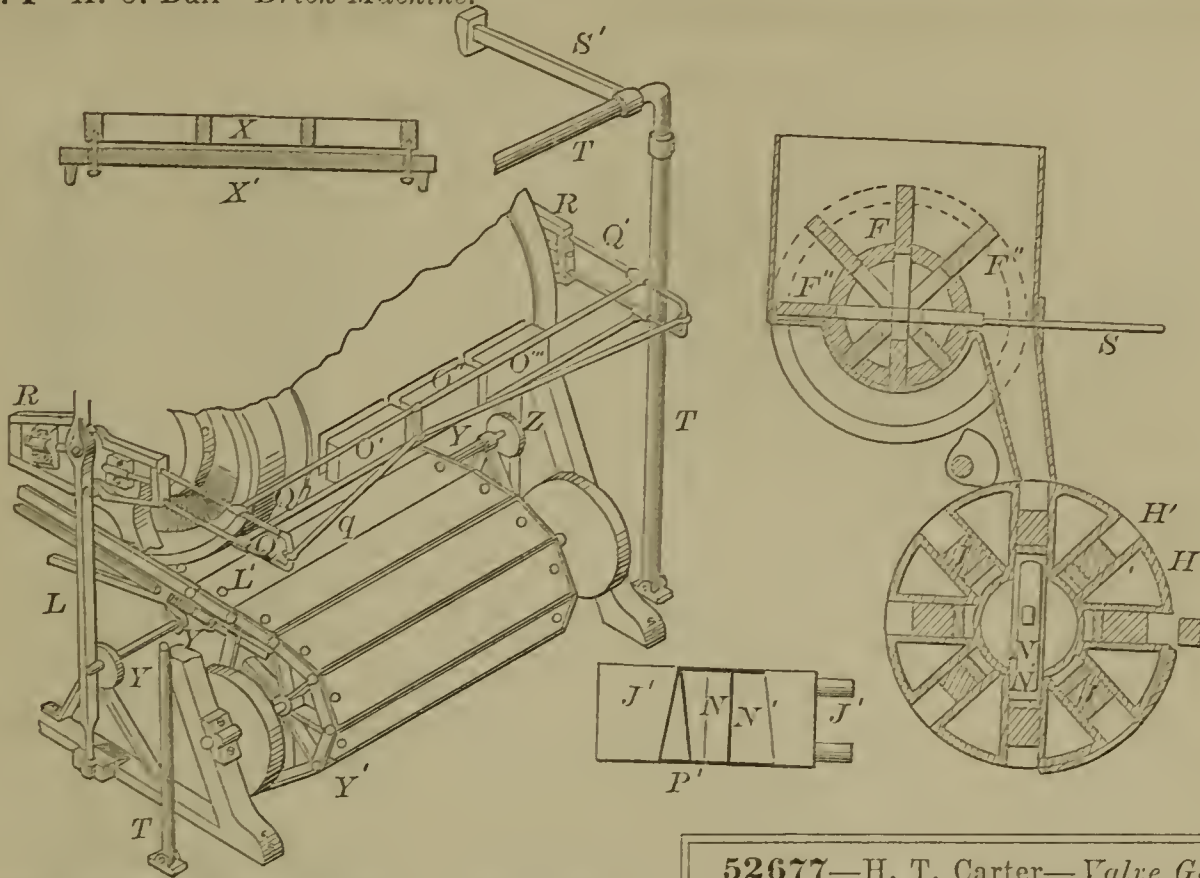

52675—C. Campbell—*Hen's Nest.*

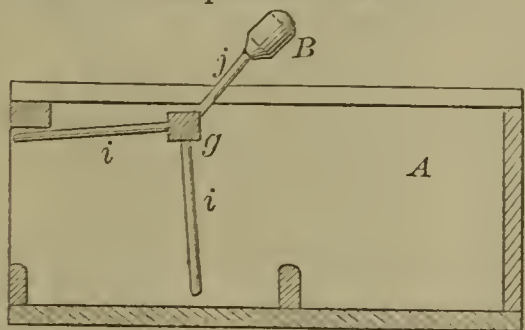

52677—H. T. Carter—*Valve Gear for Oscillating Engines.*

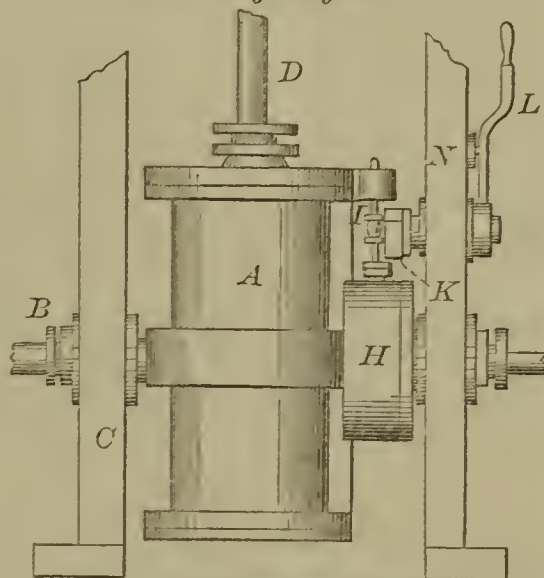

52678—Clark & Jenks—*For Mixing Dough.*

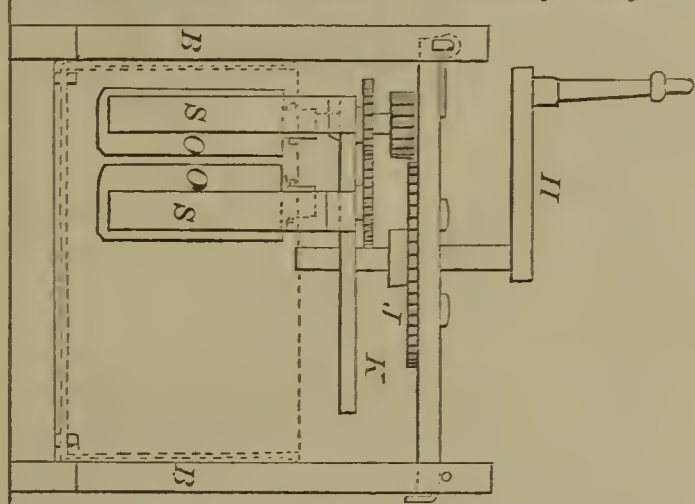

52679—J. W. Cochrane—*Cartridge Retractor.*

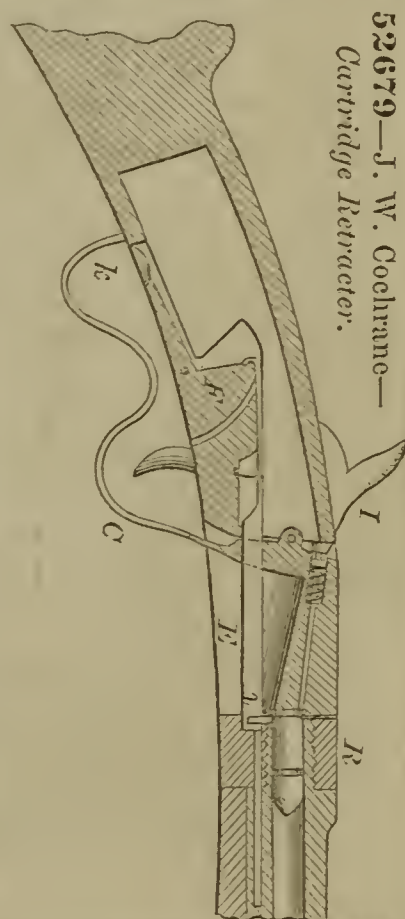

52676—E. H. Carpenter—*Track Rope Hay Elevator.*

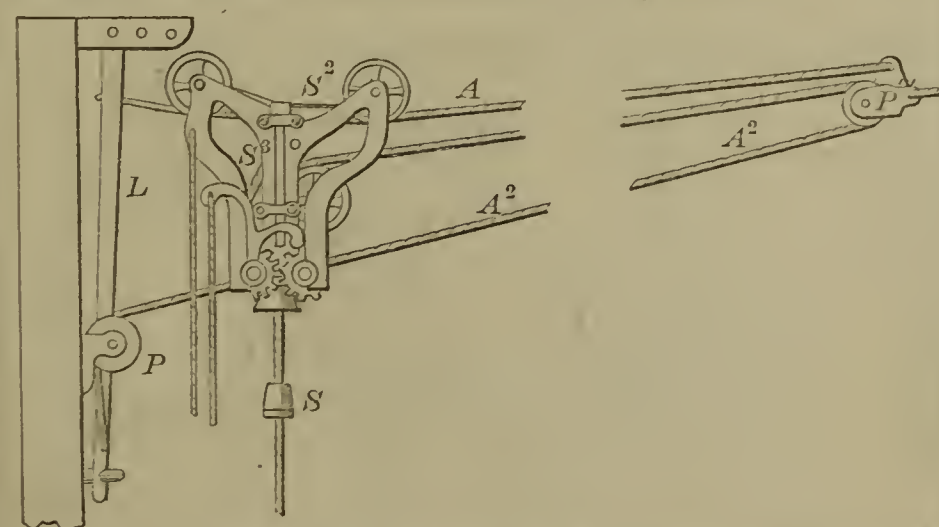

52681—S. Comfort—Counting Machine.

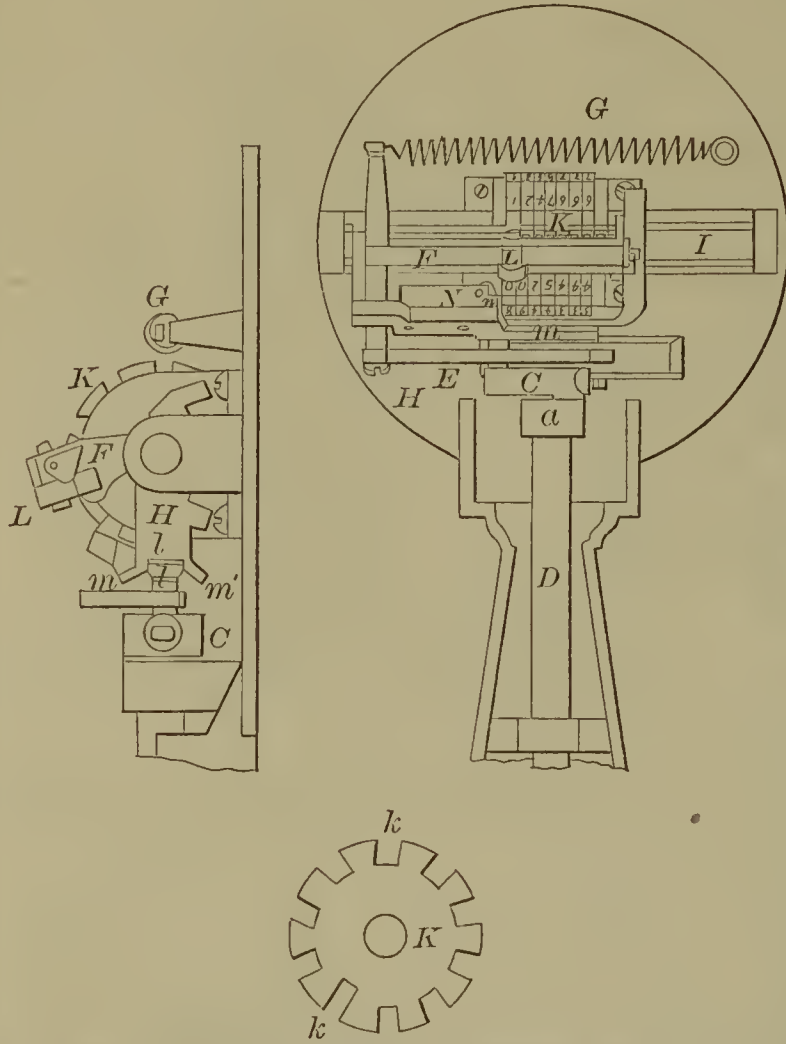

52684—A. G. Cook—Cupola or Blast Furnace

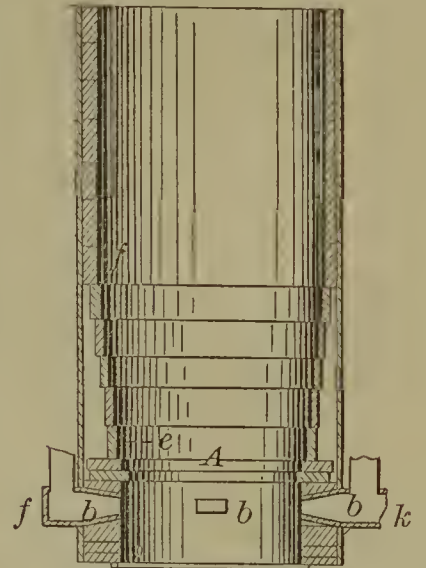

52685—H. Cook—Stove Pipe Drum.

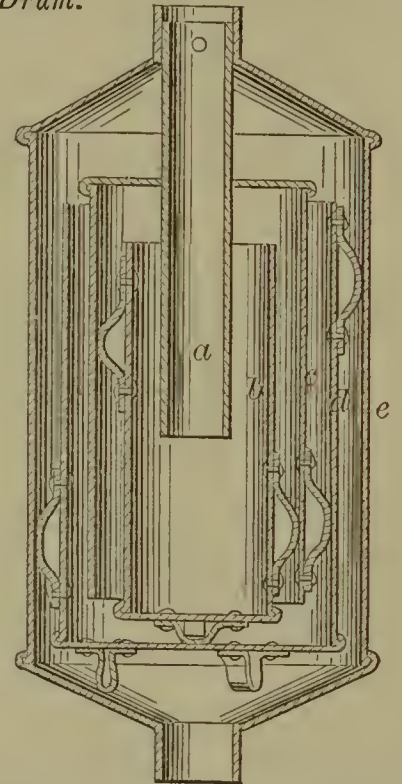

52682—N. Comstock—Self-Operating Gate.

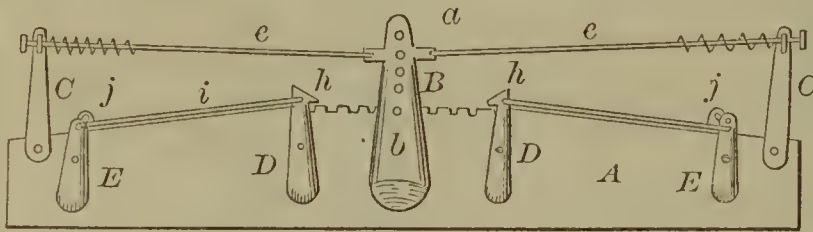

52683—J. L. Constable—Car Wheel.

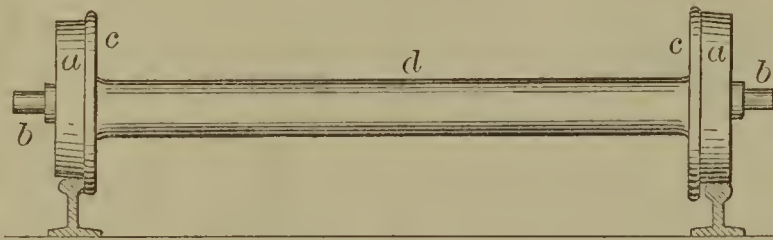

52686—R. Cross—Watch Key and Toggle.



52687—R. Cross—Watch Key, &c.



52689—W. H. Cutter—Vise for Carpenter's Bench.

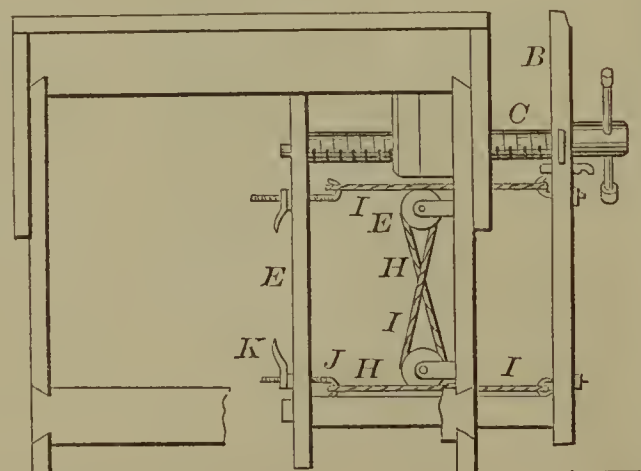

52688—C. Crossley—Mill Pick.

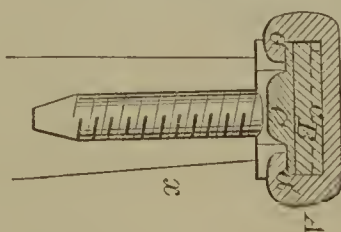

52690—J. Davis—Sheller.

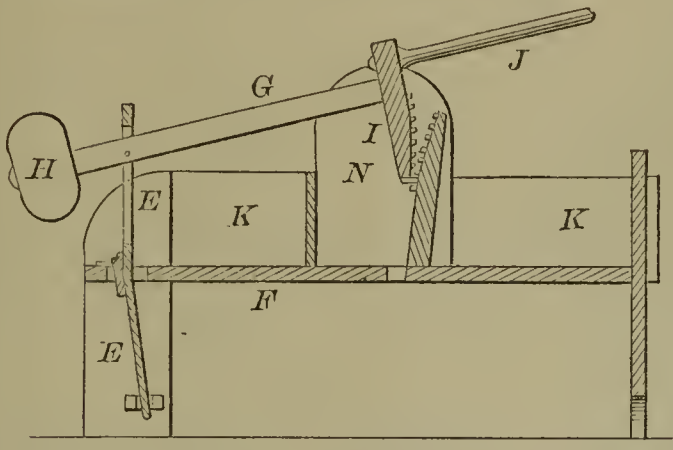

52695—O. A. Dodge—Furnace Door Regulator.

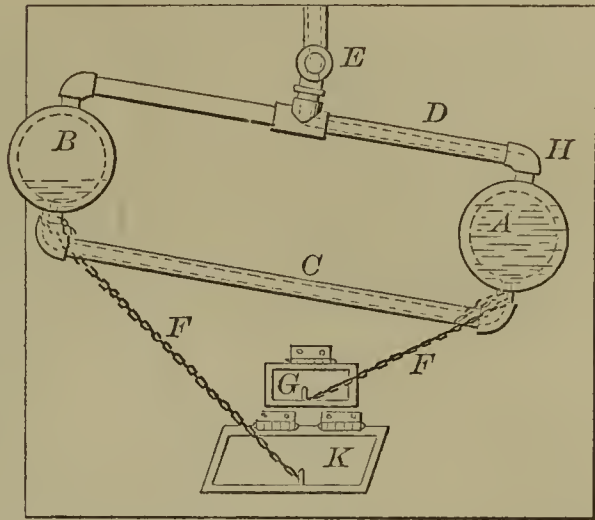

52691—J. Q. Davis—Milk Can.

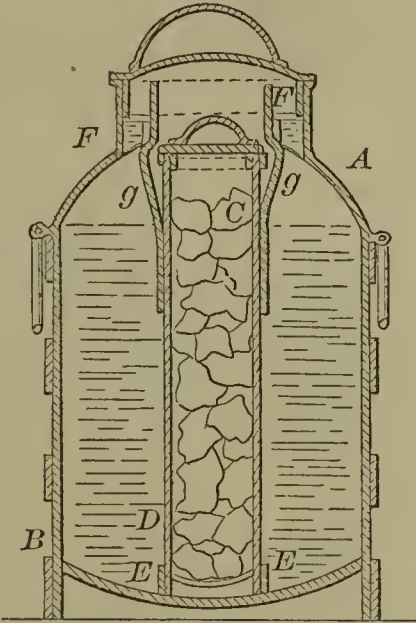

52694—J. W. Dixon—For Manufacture of Paper Pulp

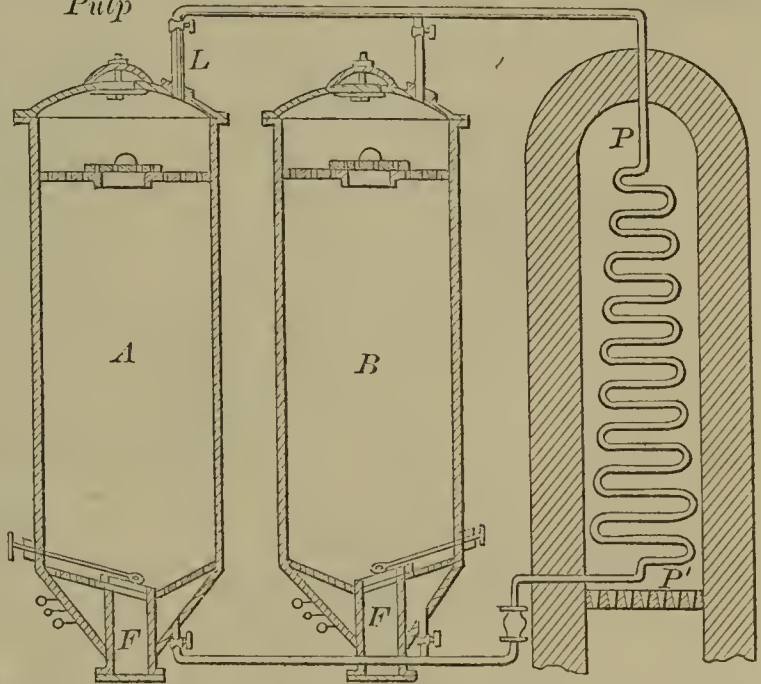

52692—T. D. Day—Skirt Wire.



52696—A. C. Eddy—Elastic Mallet.

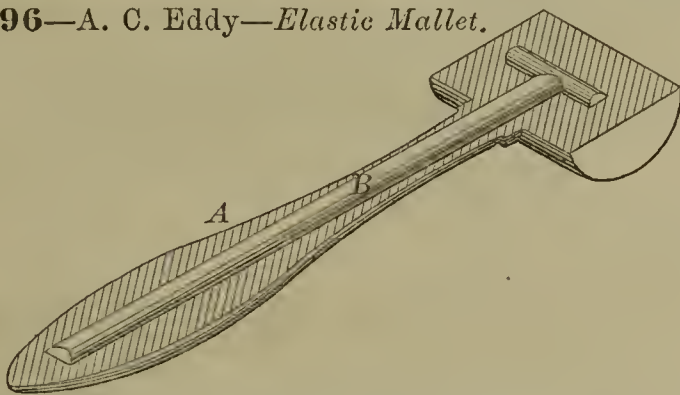

52698—R. Eickemeyer—Sewing Machine.

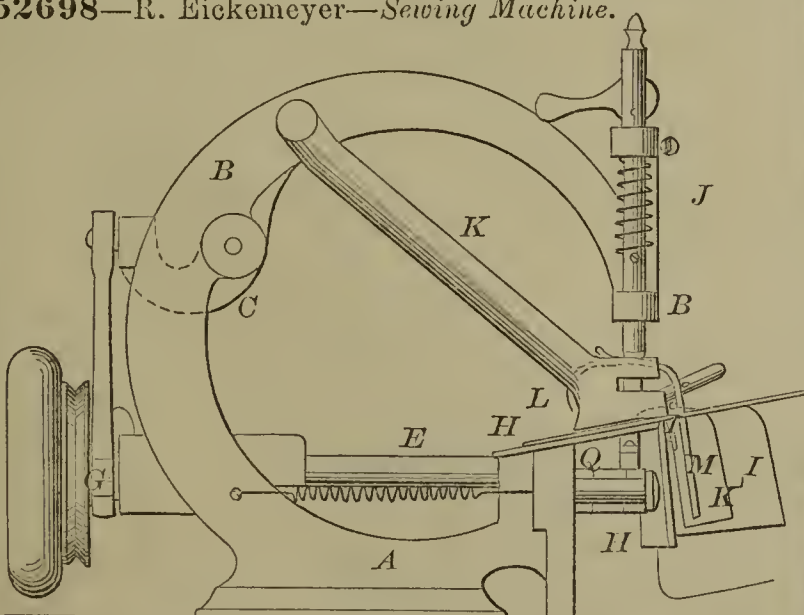

52693—W. Devines—Drug and Spice Sifter.

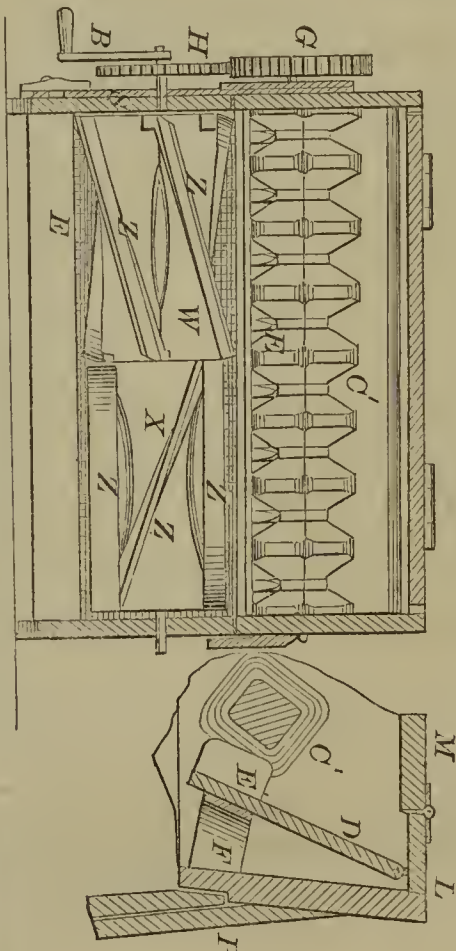

52700—E. T. Ford—Harvester Rake.

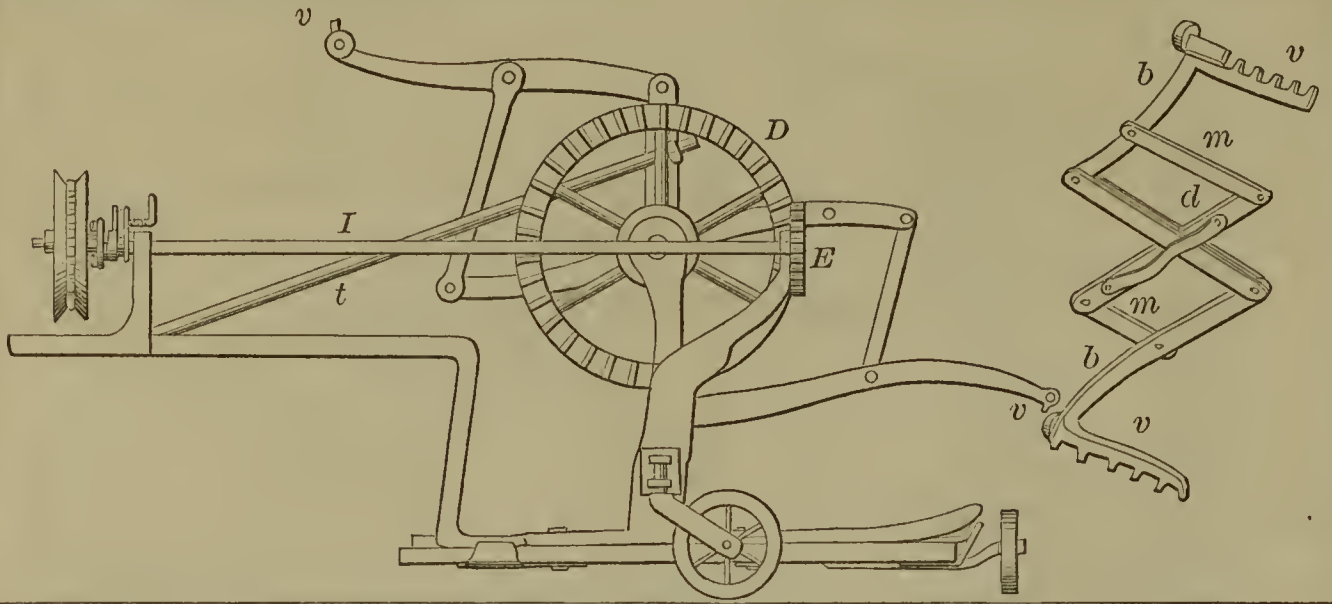

52701—E. T. Ford—Harvesting Machine.

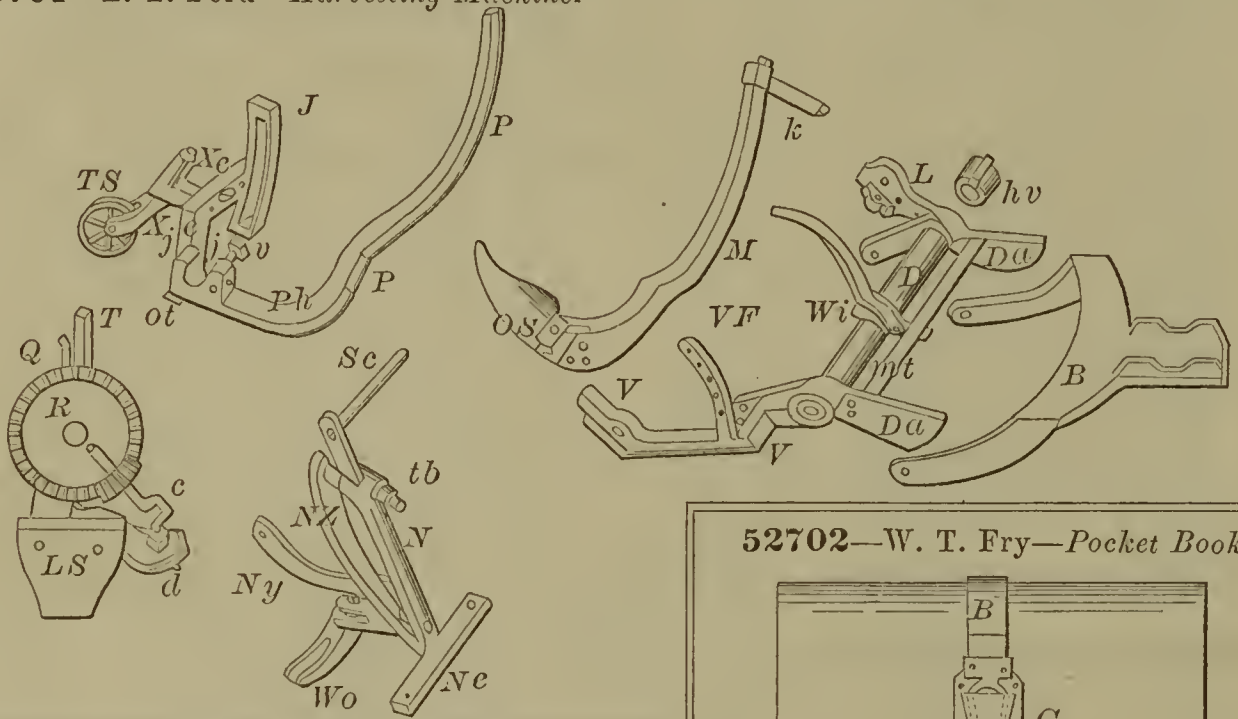

52702—W. T. Fry—Pocket Book.

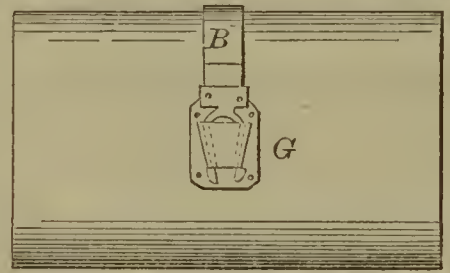

52703—C. W. Gage—Wagon Brake.

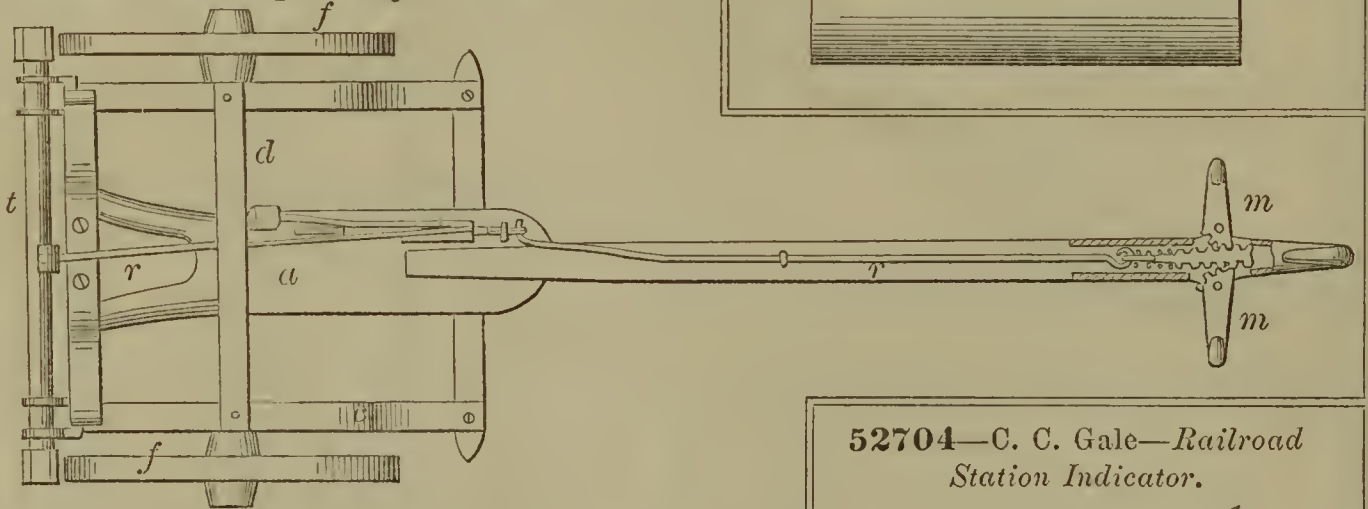

52704—C. C. Gale—Railroad Station Indicator.

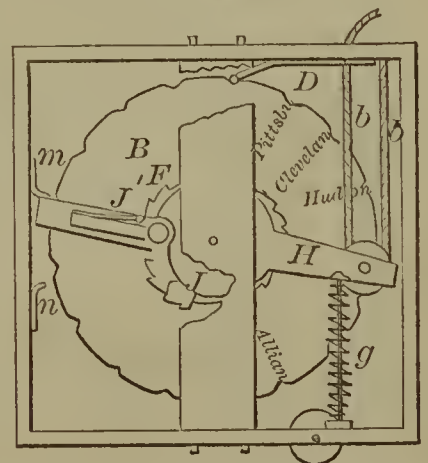

52705—W. T. Grant—Mop and Scourer.



52706—W. C. Grimes—*Grain Huller.*

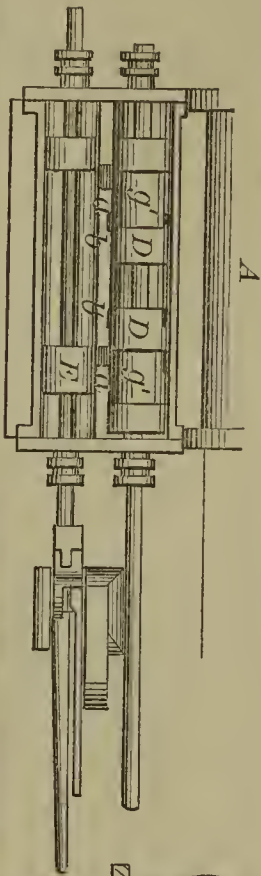
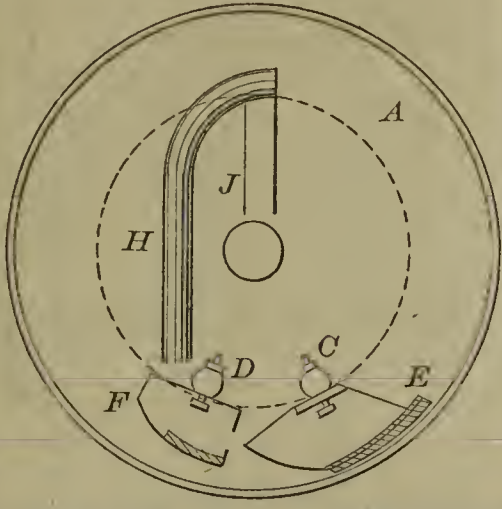

52707—E. E. Groom—*Steam and Out-off Valve.*

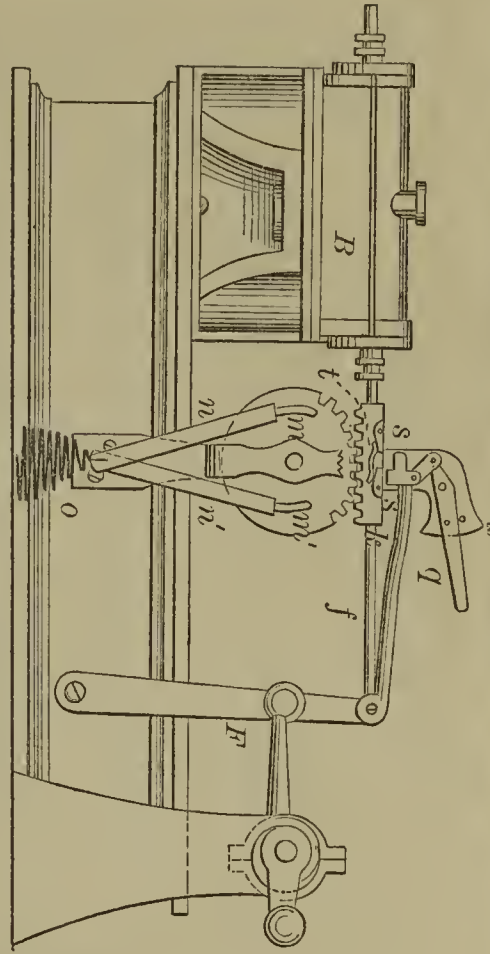

52710—J. H. Harris—*Railroad Alarm Signal.*

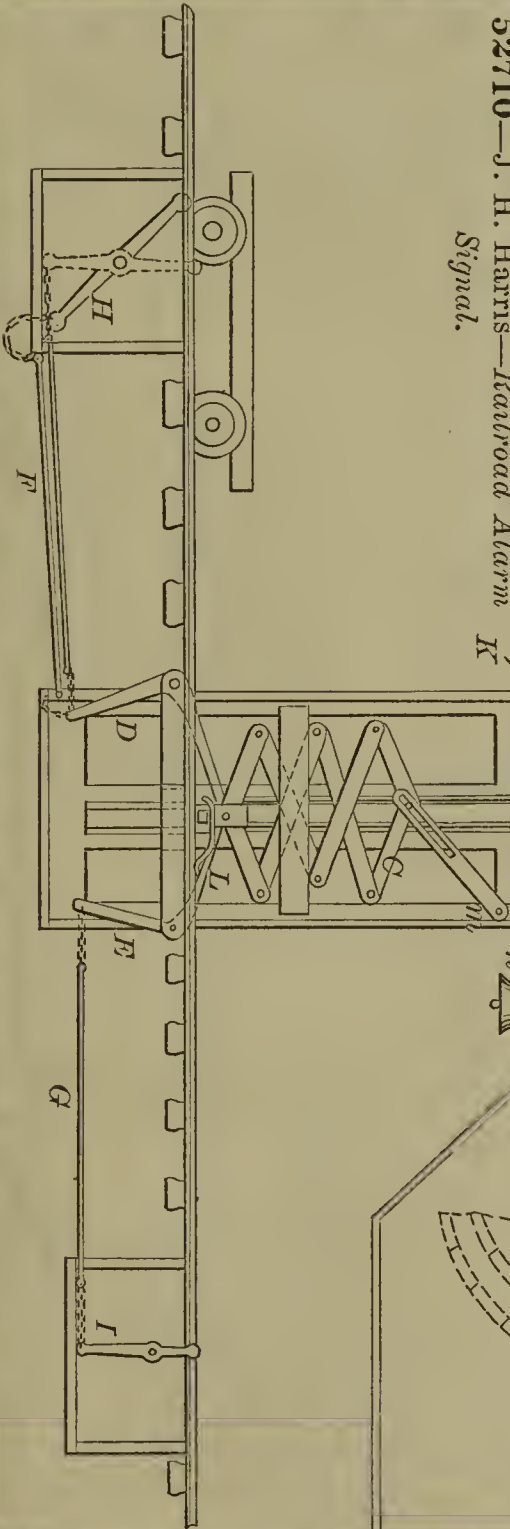

52711—A. Harroun, Jr.—*Lamp.*

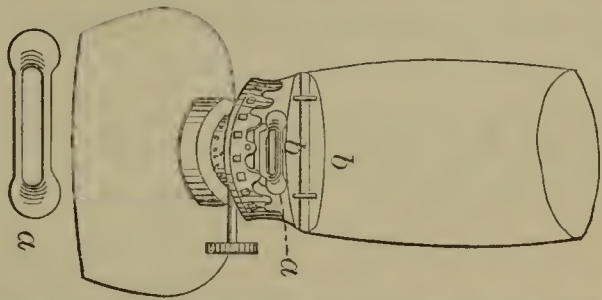

52708—J. F. Hall—*Hanging Centre Boards of Vessels.*

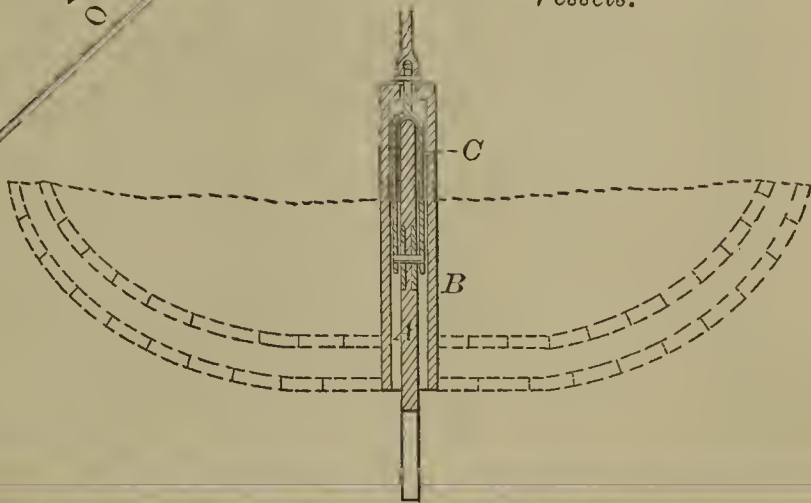

52709—H. A. M. Harris—*Pump.*

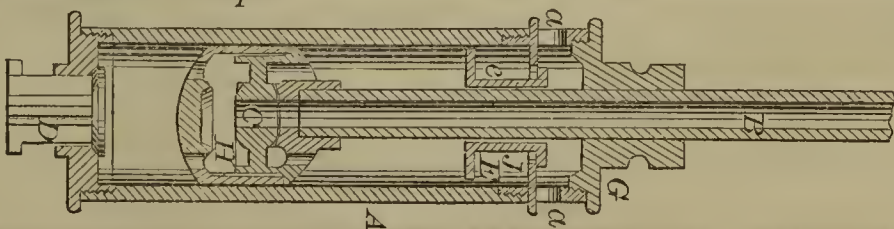

52716—D. Hughes—Quartz Crushing.

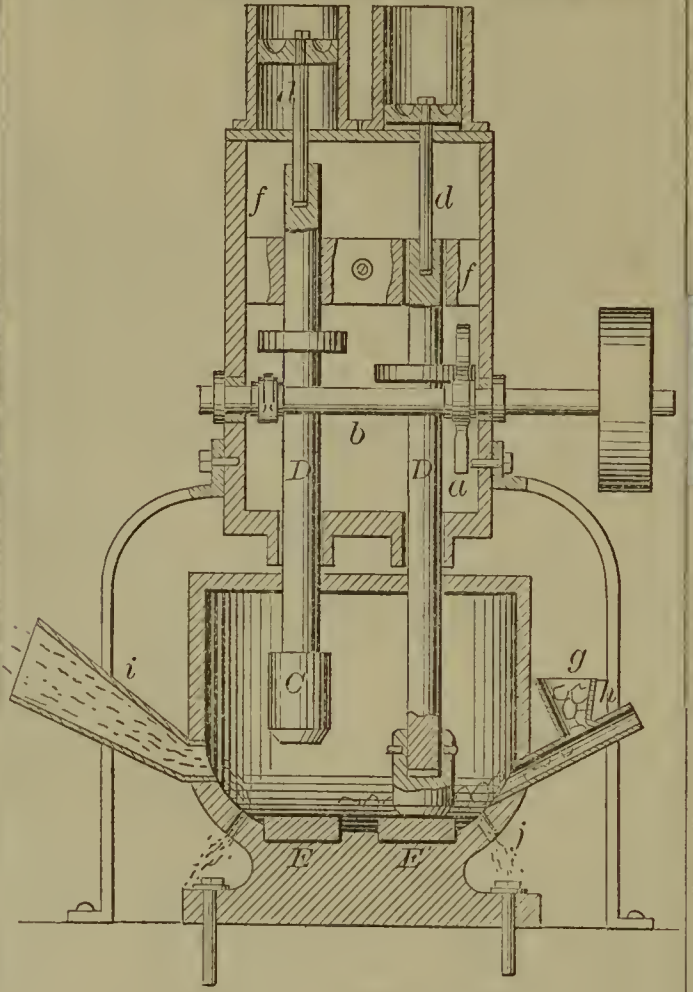

52713—W. G. Hermance—Farm Gate.

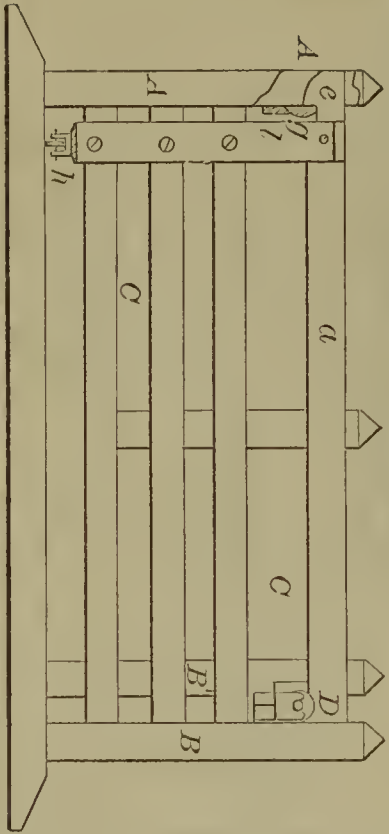

52712—W. H. Hartman—Molasses Faucet.

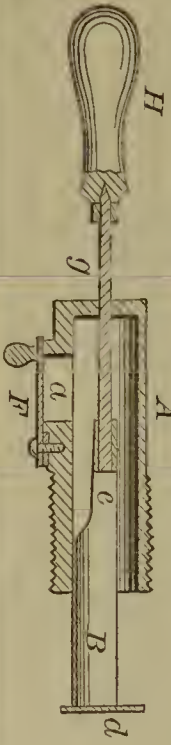

52717—C. B. Hunting—Fence.

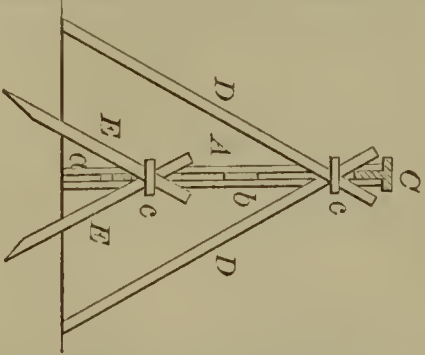

52715—W. S. Howarth—Tool for Cutting Gas Pipes, &c.

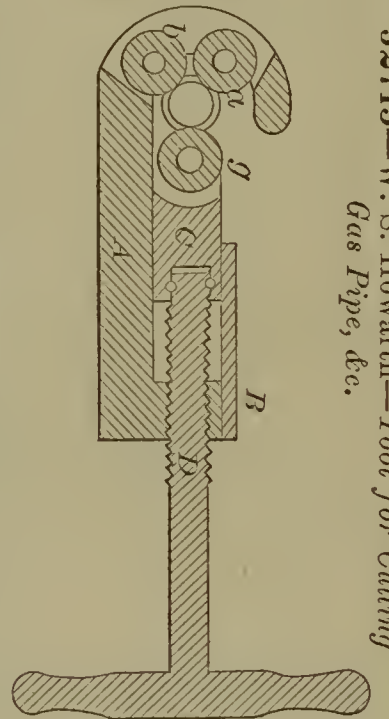

52714—D. H. Hickok—Shears for Cutting Bolts.

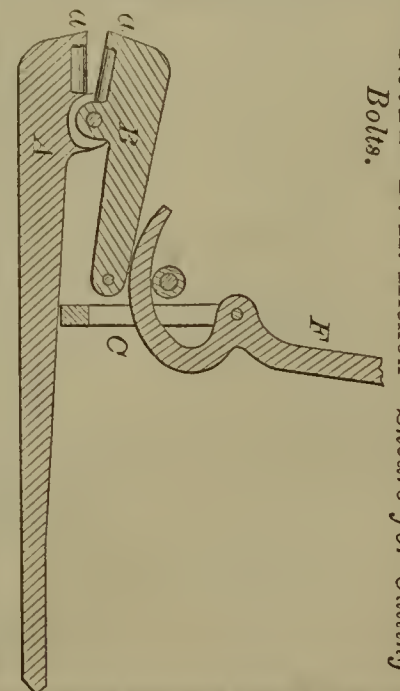

52718—L. Hull—Weaving Coverings for Whip Handles.

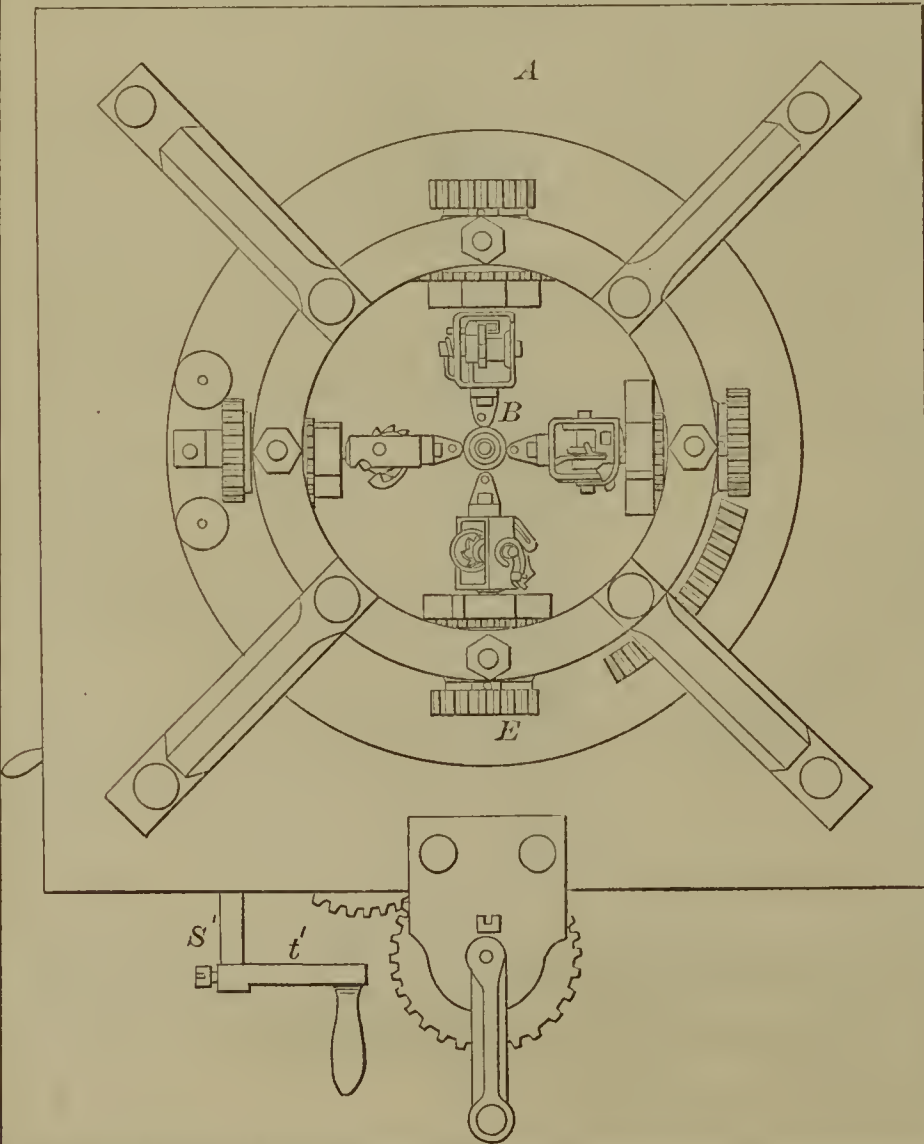



52719—J. Jones—Carpenter's Shooting Board.

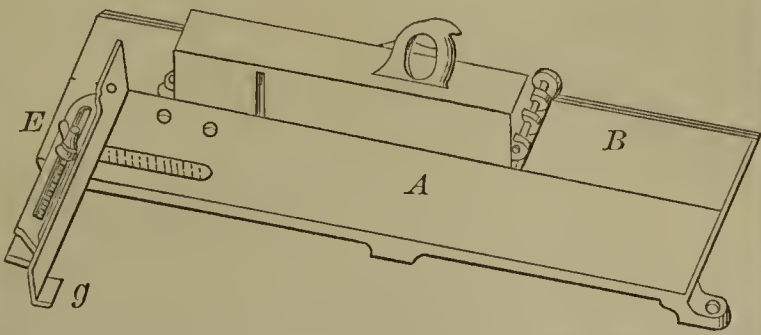

52721—H. S. Lansdell—Pump for Railroad Stations.

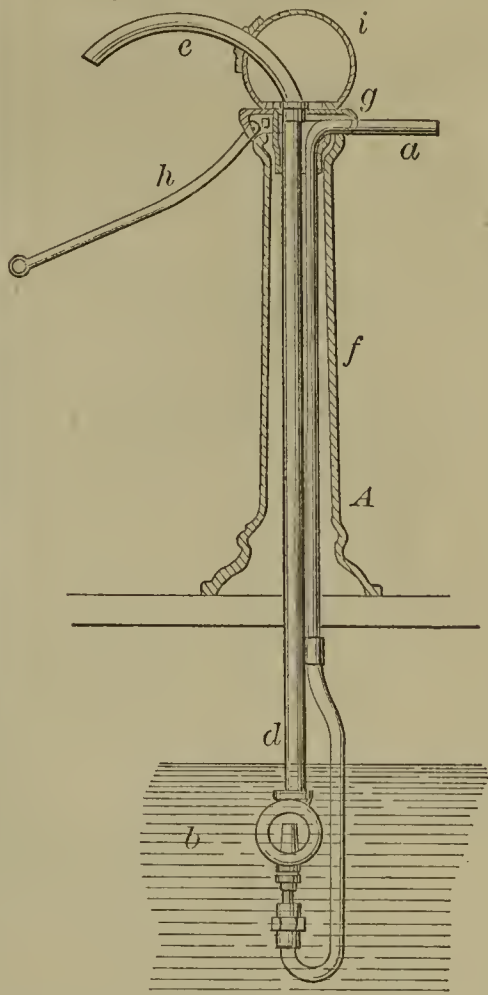

52722—S. D. Locke—Reel for Grain Binder.

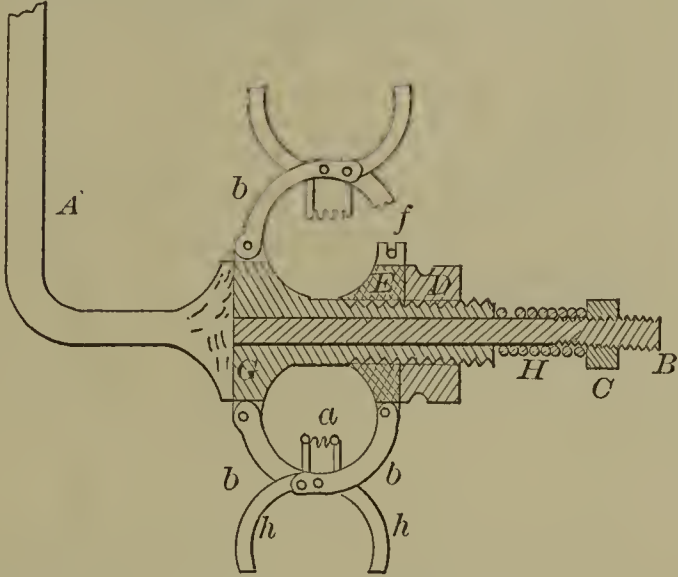

52720—E. F. Light—Journal Box.

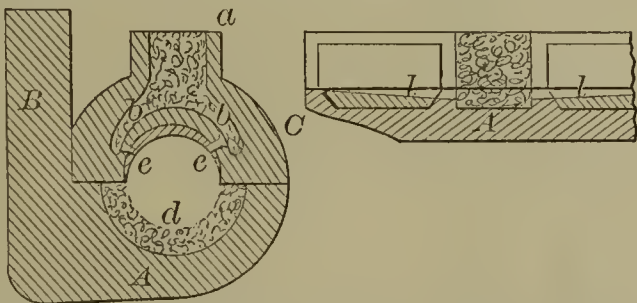

52724—A. Lowmiller—Harvester.

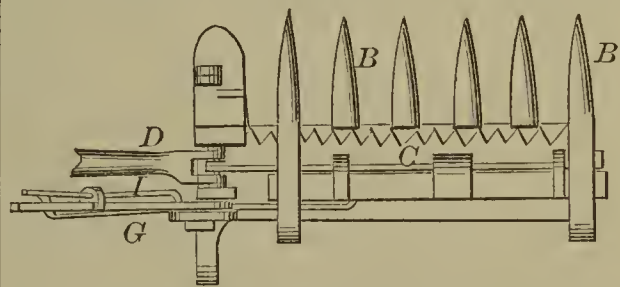

52723—H. Logan—Sluice for Quartz Mills.

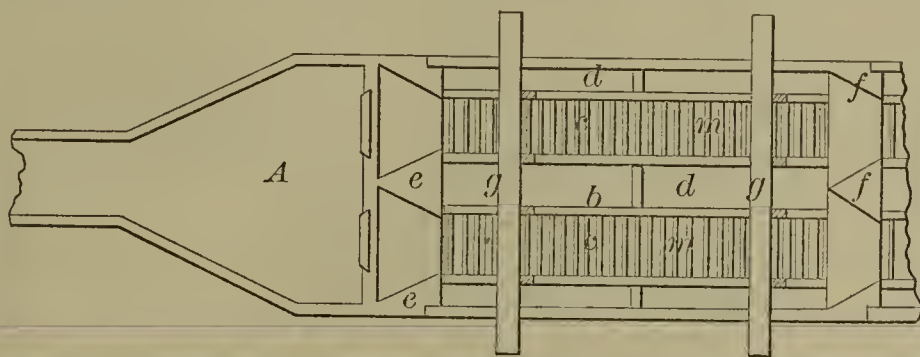

52726—A. B. Magoun—Window Screen.

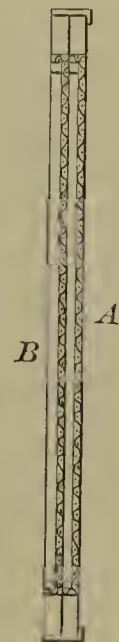

52725—A. Ludolf—Iron Frame for Piano Forte.

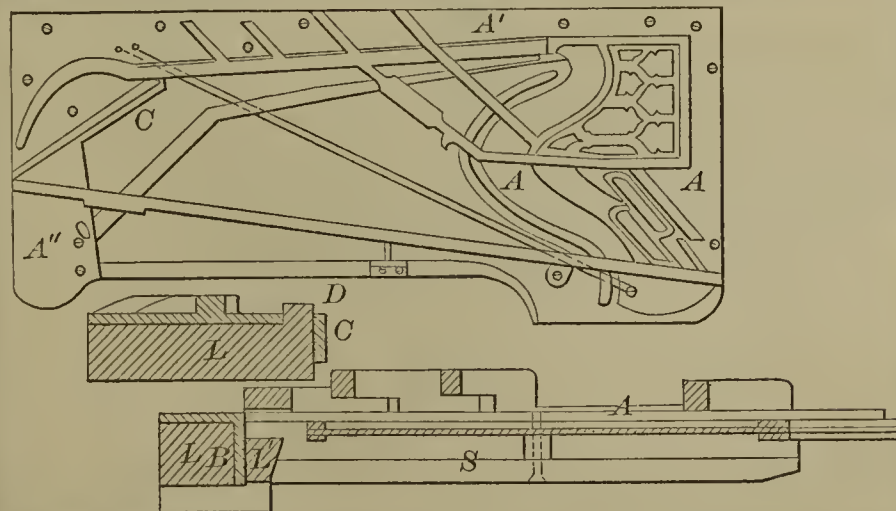

52727—M. D. Marcy—Bolt Heading Machine.

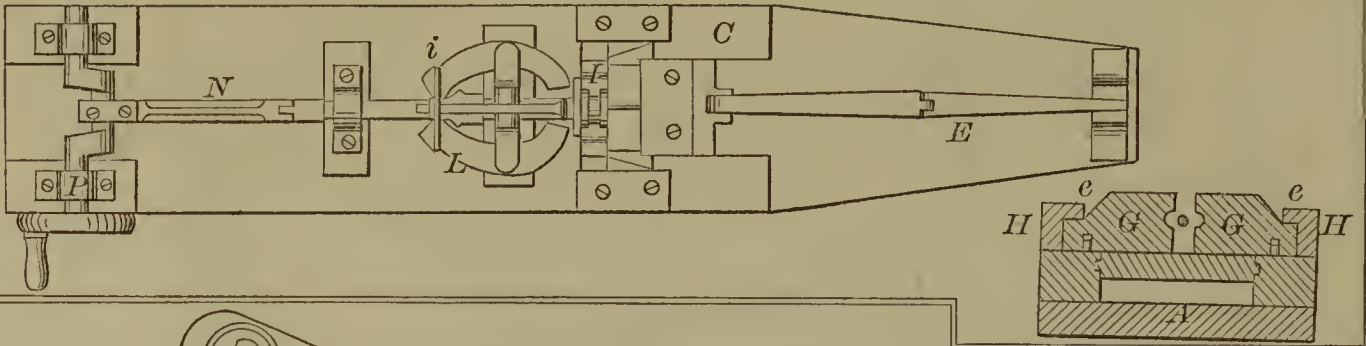

52728—W. P. Martin—For Rolling Leather.

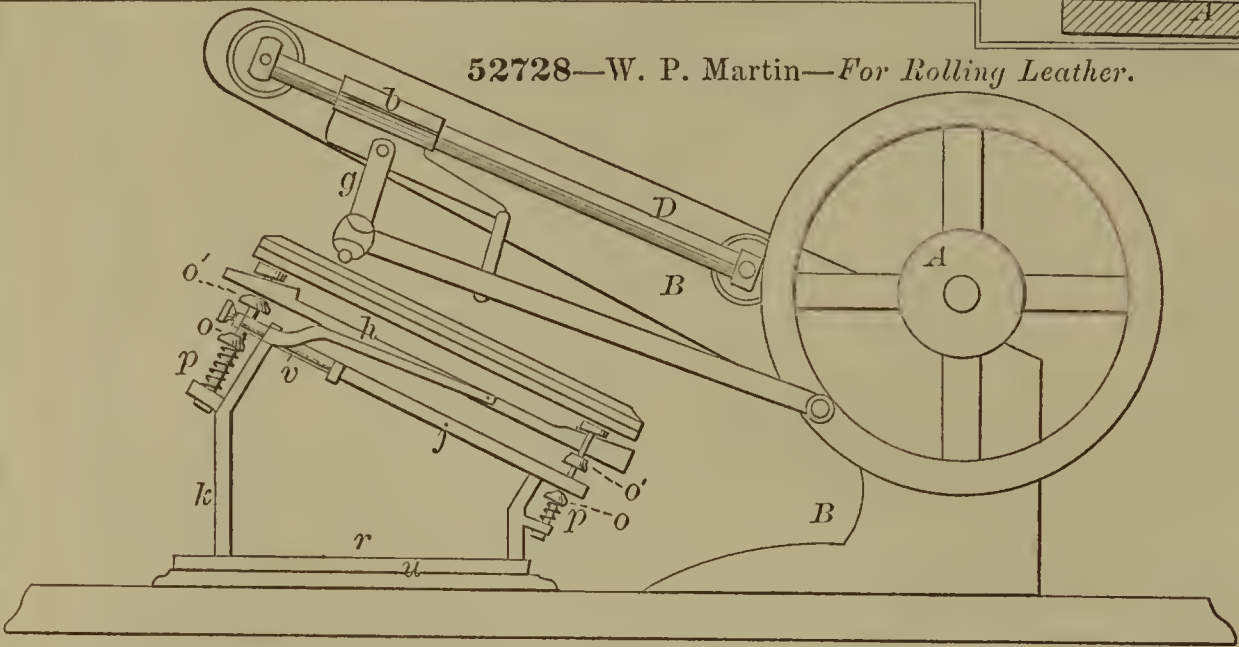

52731—J. McQuoad—Wagon Brake.

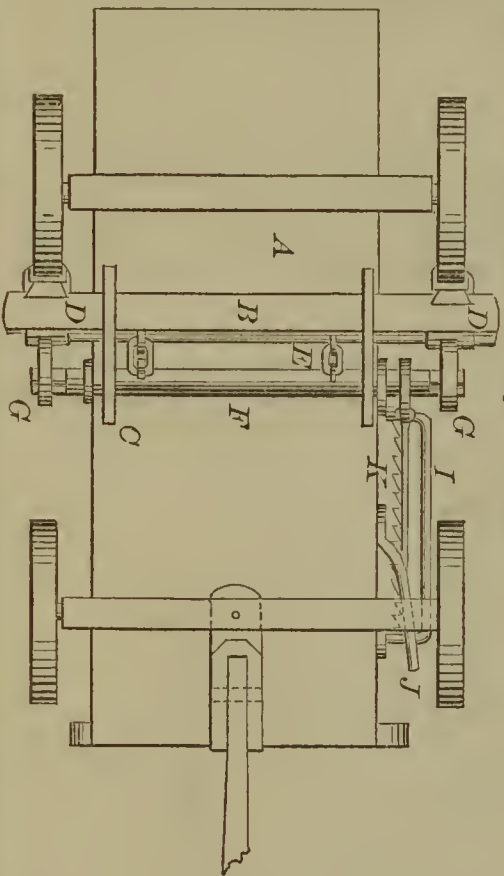

52730—J. S. McMillin—Working Capstan by Steam.

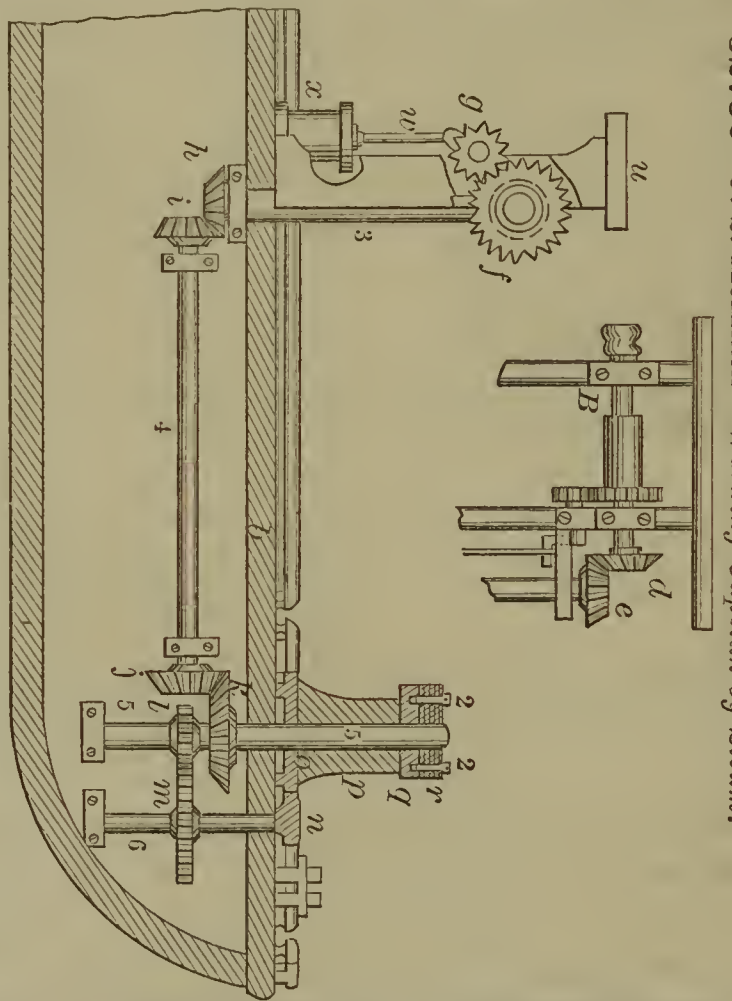

52732—F. Merkle—Shoe.

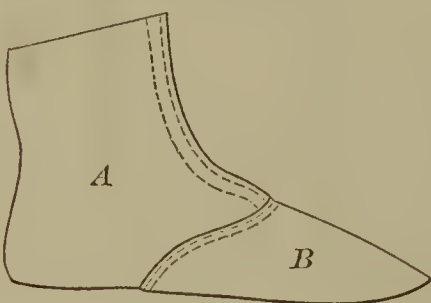

52729—W. C. McGill—Flour Sifter.

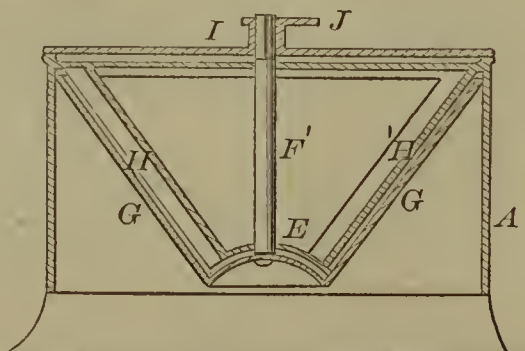

52733—J. M. Meschutt—*Washing Machine.*

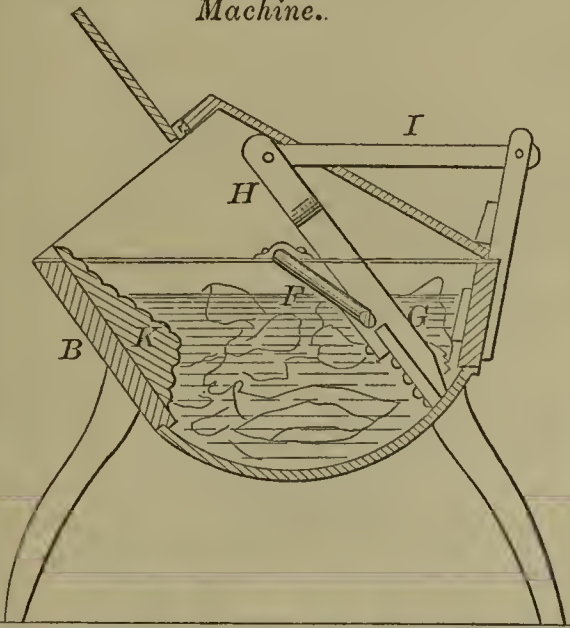

52737—I. Newhall—*Inner Sole.*



52739—E. Nougaret—*For Pouncing Hats.*

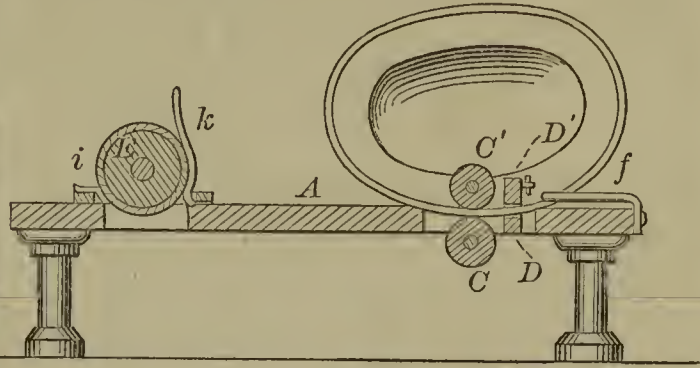

52738—S. W. Norton—*Hot Air Furnace.*

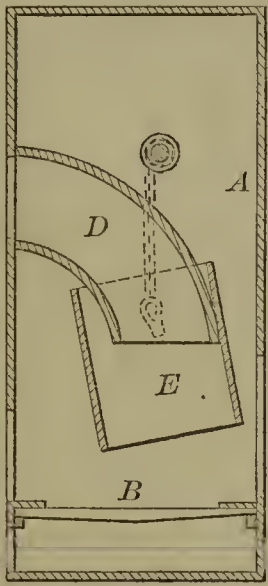

52736—Newell & Simmerman—*Car Coupling.*

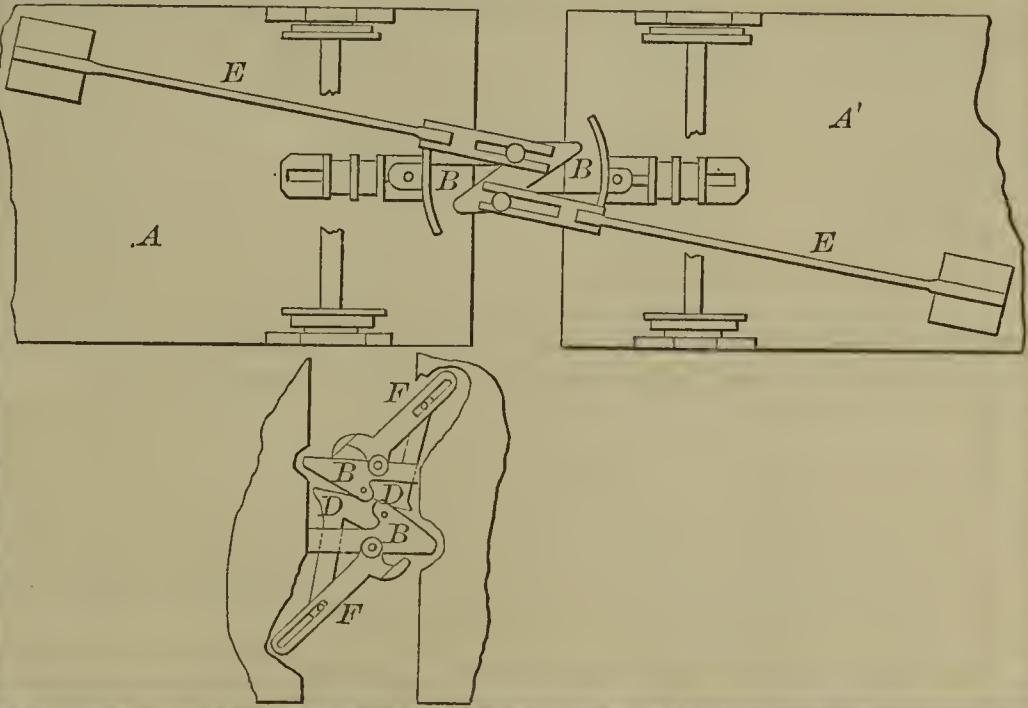

52735—A. Moon—*Fire Place.*

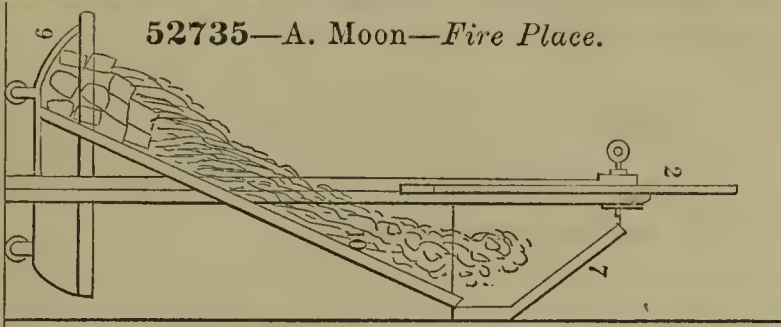

52740—R. Onderdonk—*Apple Corer and Slicer.*

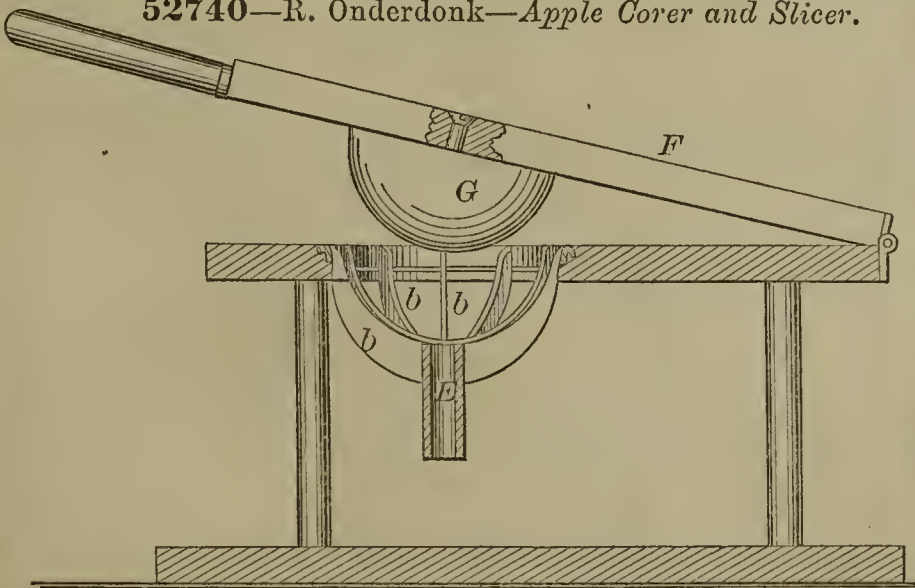

52734—I. M. Milbank—*Breech-Loading Fire Arm.*

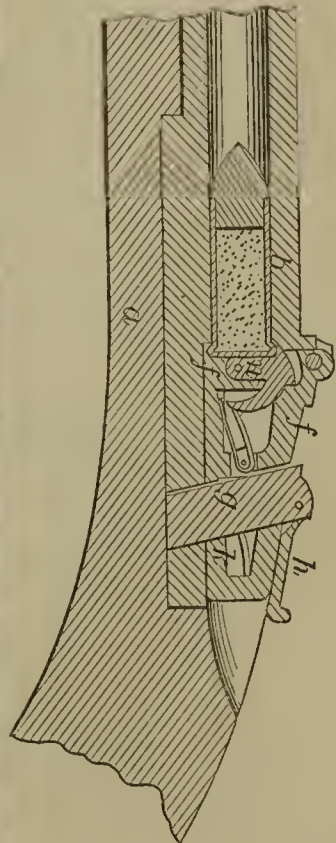

52741—W. Pinkerman—Rocker for Chairs.

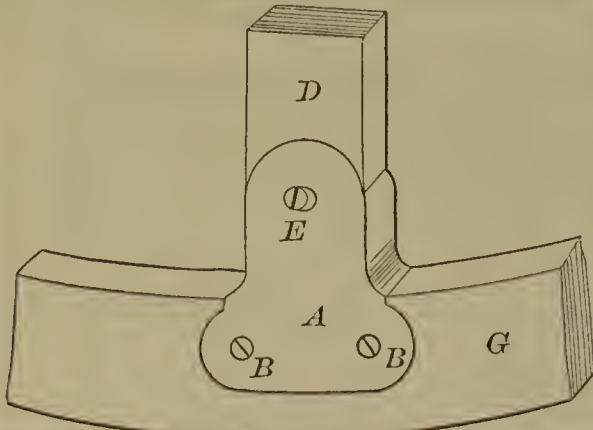

52747—F. W. Ritterhoff—Tobacco Cutting Machine.

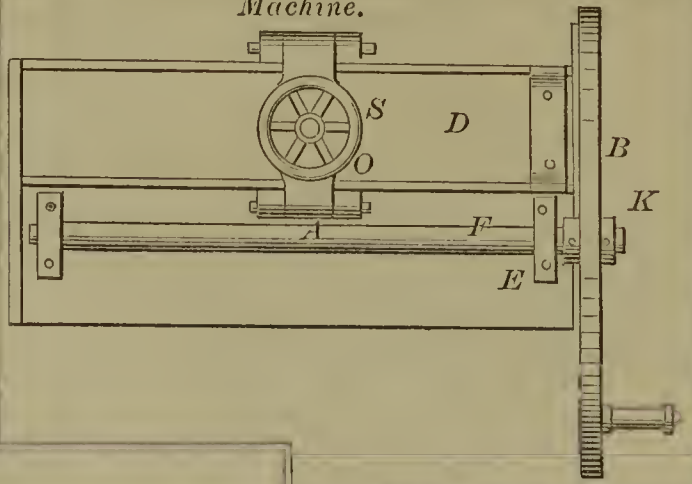

52744—A. Quirolo—Stereoscope.

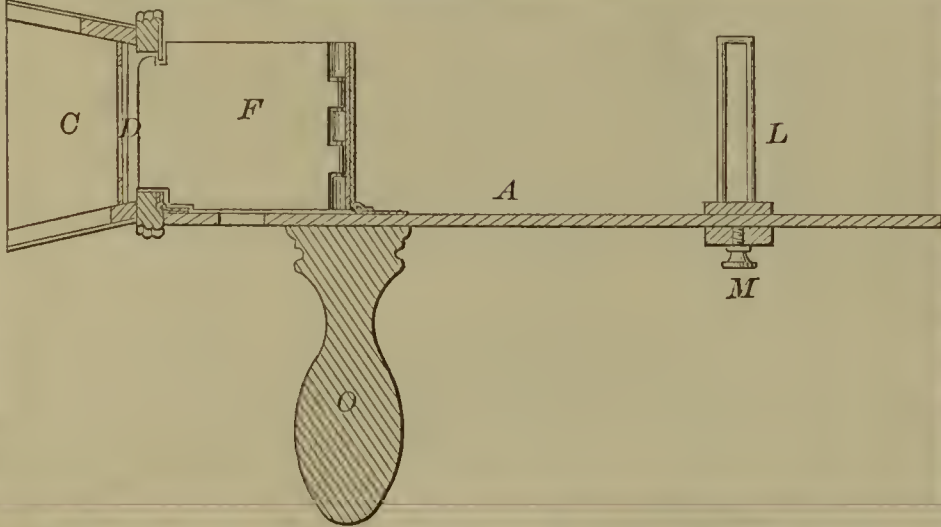

52742—G. S. Prindle—Piston Rod Packing.

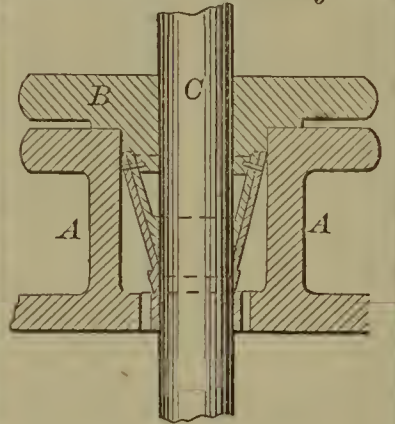

52743—Prugh & Beard—Cultivator.

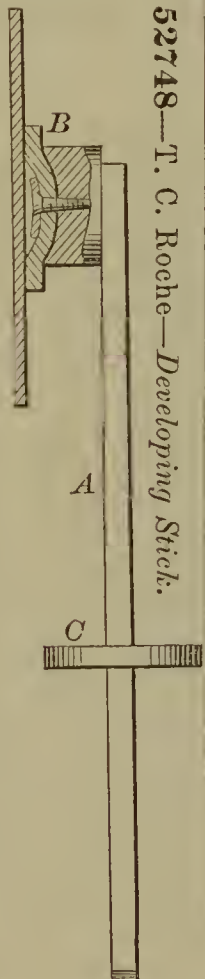
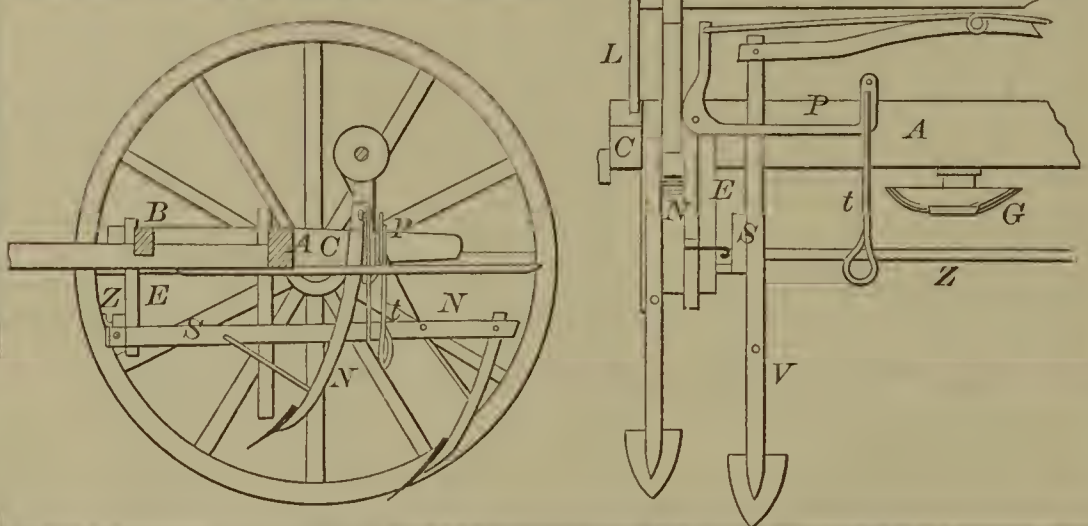

52748—T. C. Roche—Developing Stick.

52745—A. Rankin—Manacle.

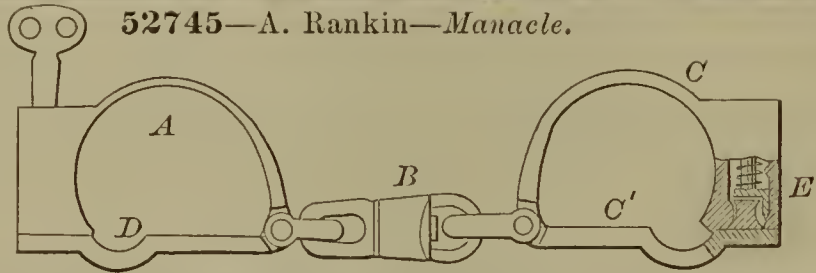

52746—H. F. Read—Flour Sifter.

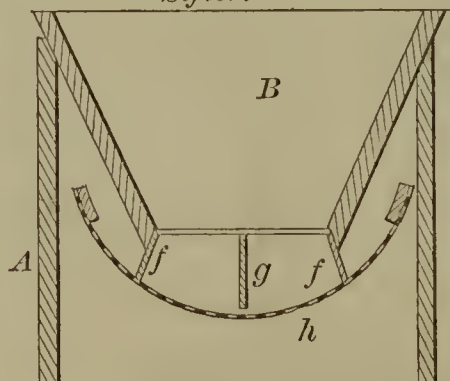

52749—I. M. Rose—Uniting Edges of Cloth, &c.

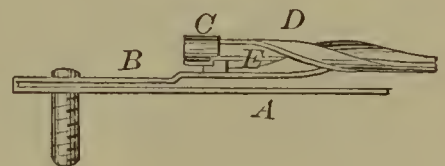

52750—A. H. Rowe—Door Latch.

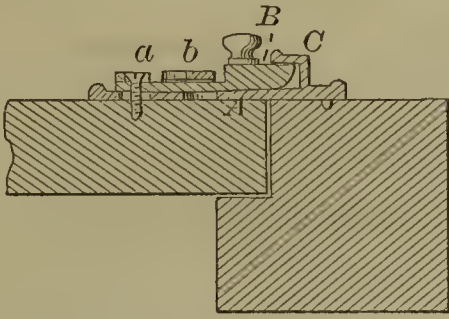

52751—T. Sabbaton—Manufacture of Gas.

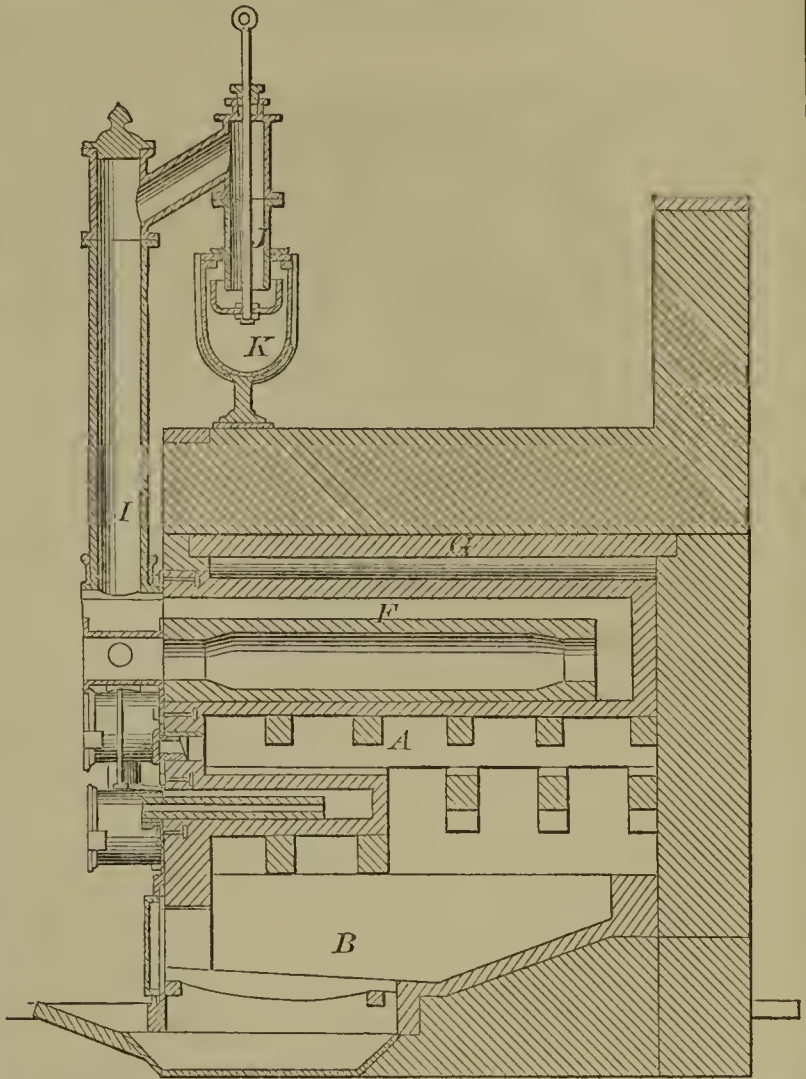

52753—Sanor & Stoffer—Horse Power.

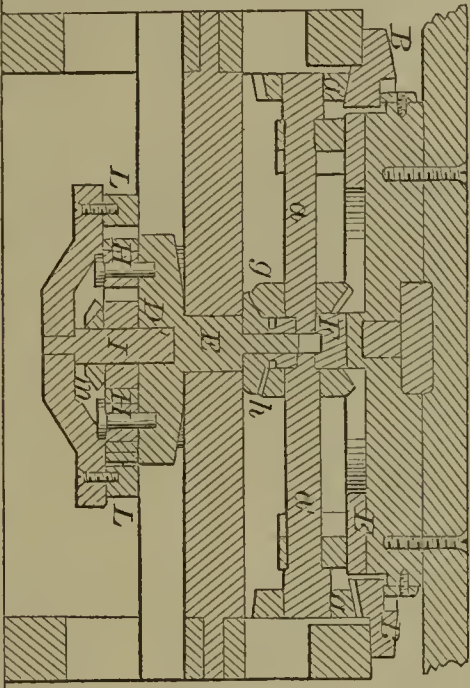

52752—A. Saeger—Wool Packer.

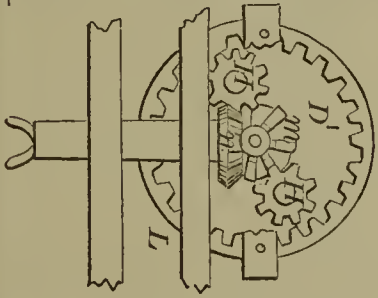
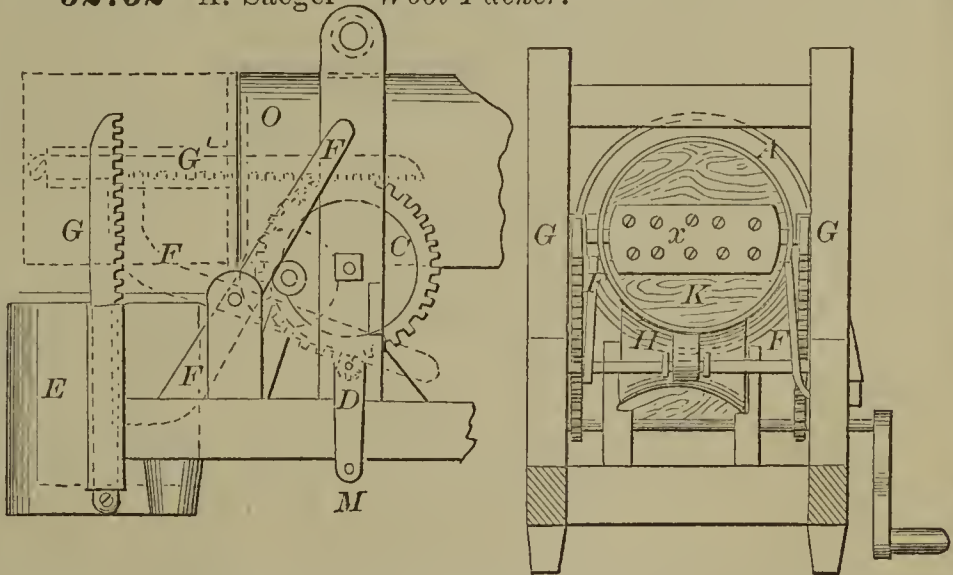

52754—J. Savill—Cultivator.

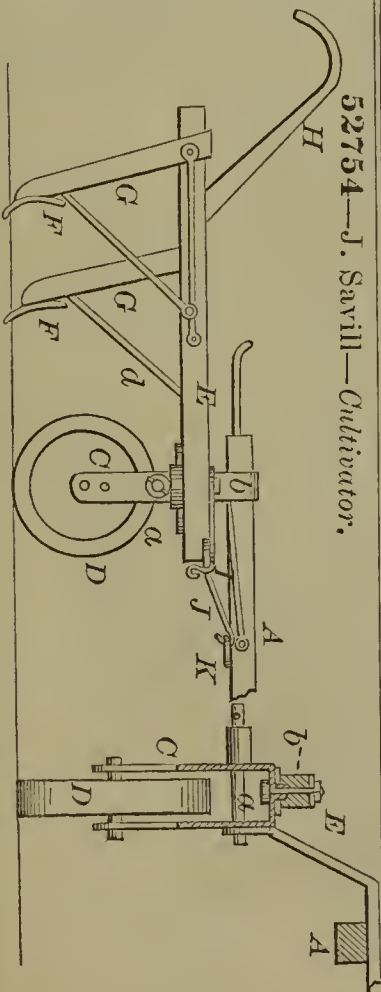

52756—G. W. Scollay—Burial Case.

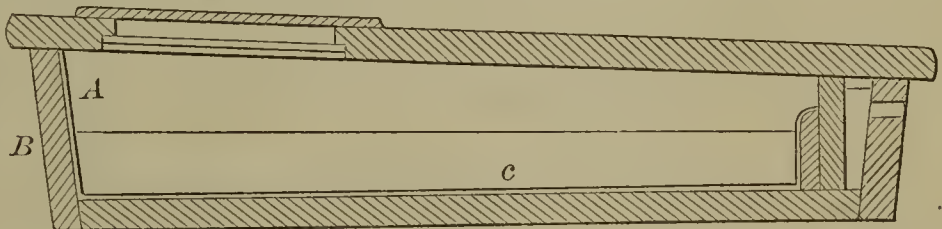

52755—A. Searlett—Bottle Stopper.

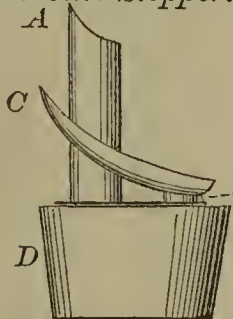

52757—W. H. Seymour—Clamp for Stages.

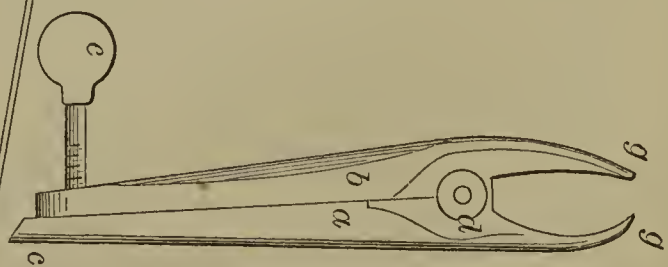

52758—H. Skinner—For Teaching Spelling.

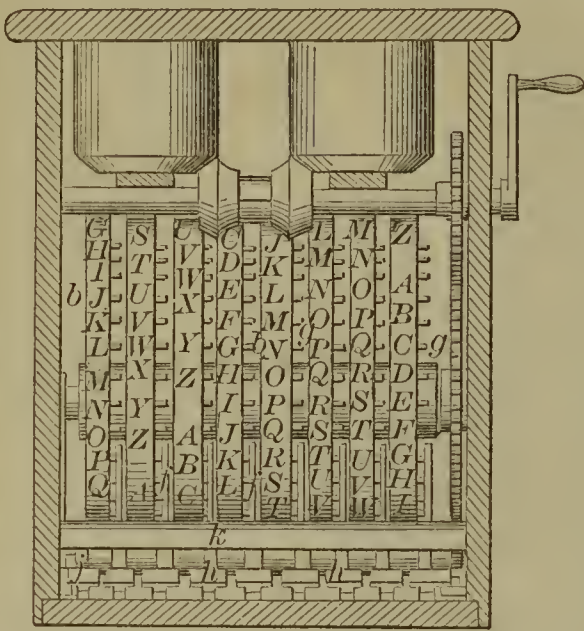

52762—H. Soggs—Water Wheel.

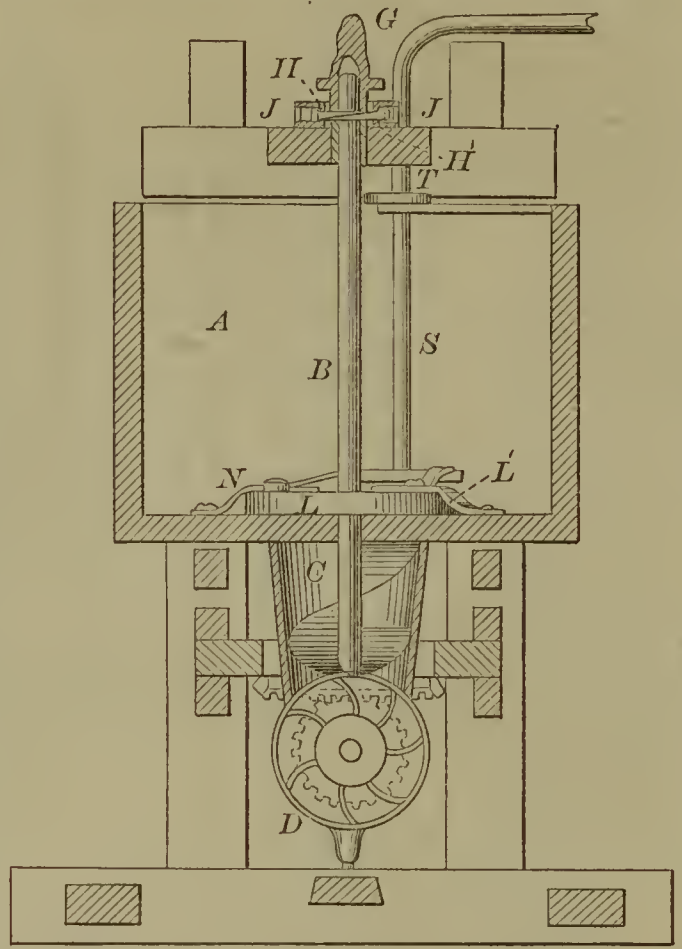

52759—Smith & Hudson—Farm Gate.

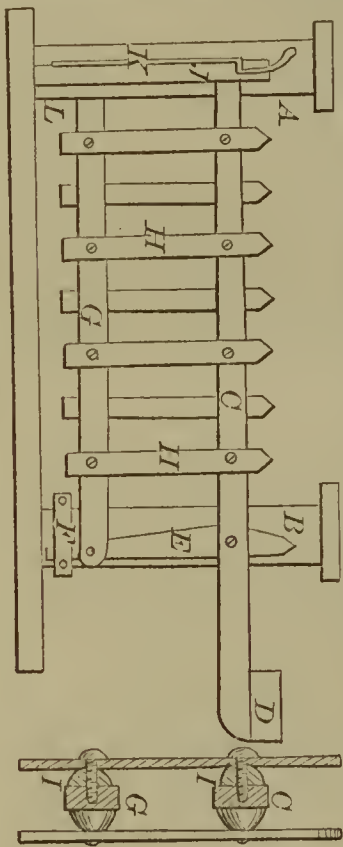

52761—W. W. Smith—Telegraph Insulator.

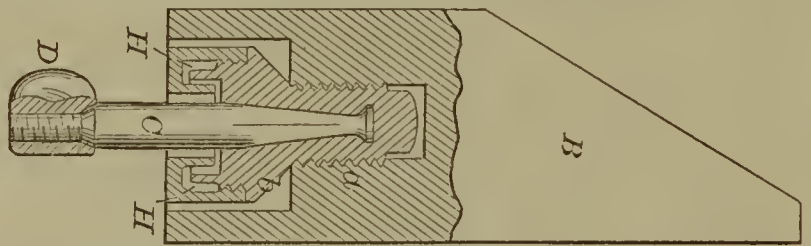

52764—V. Squarza—For Extracting Essential Oils.

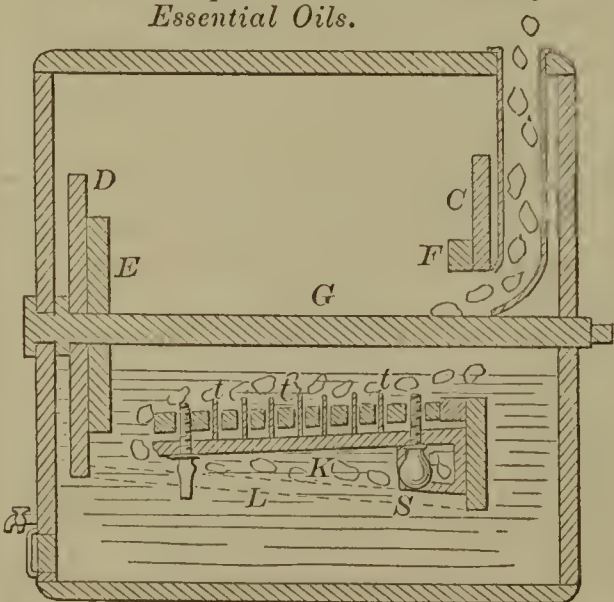

52763—N. H. Spafford—For Separating Bristles.

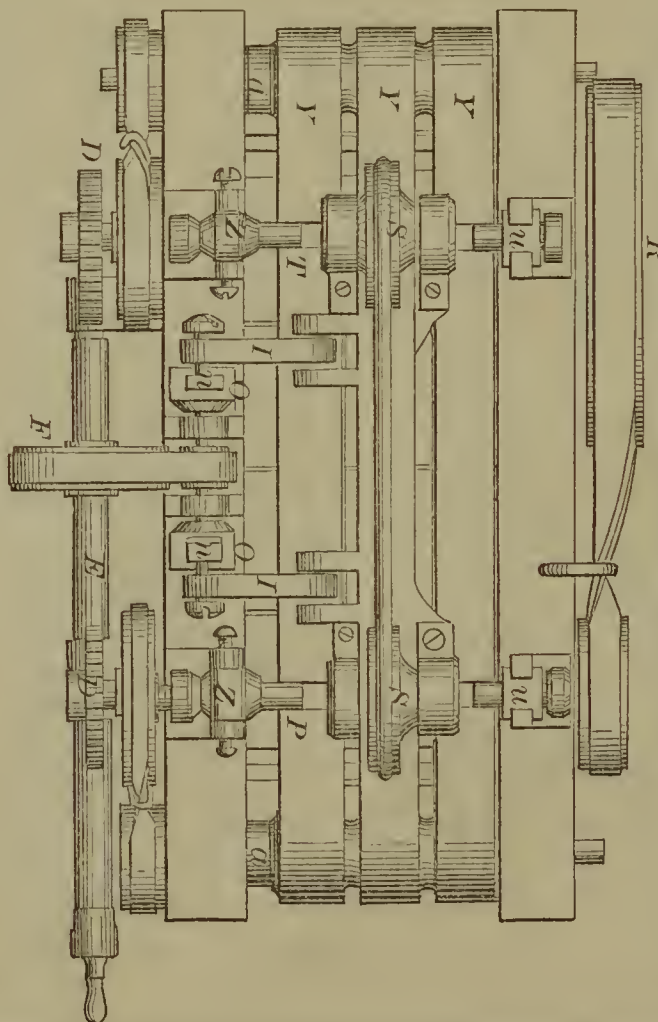

52765—C. W. Stafford—Quartz Crusher.

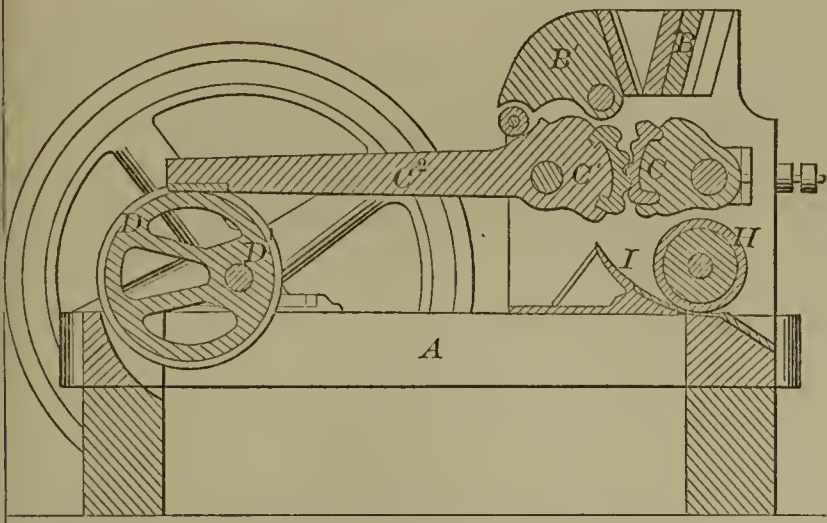

52768—M. Stewart—Lamp Shade.

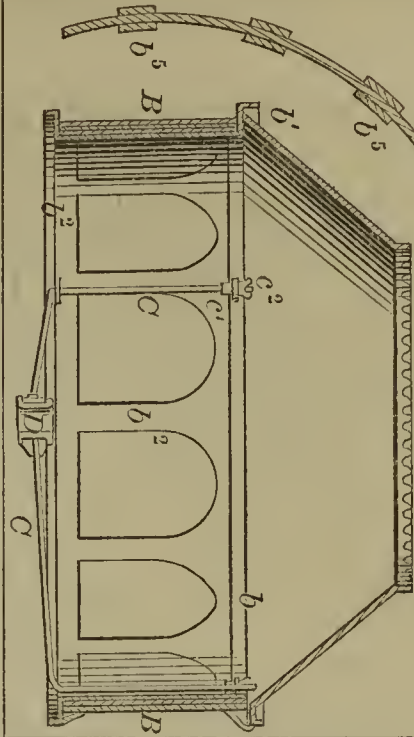

52767—J. S. Stewart—Churn.

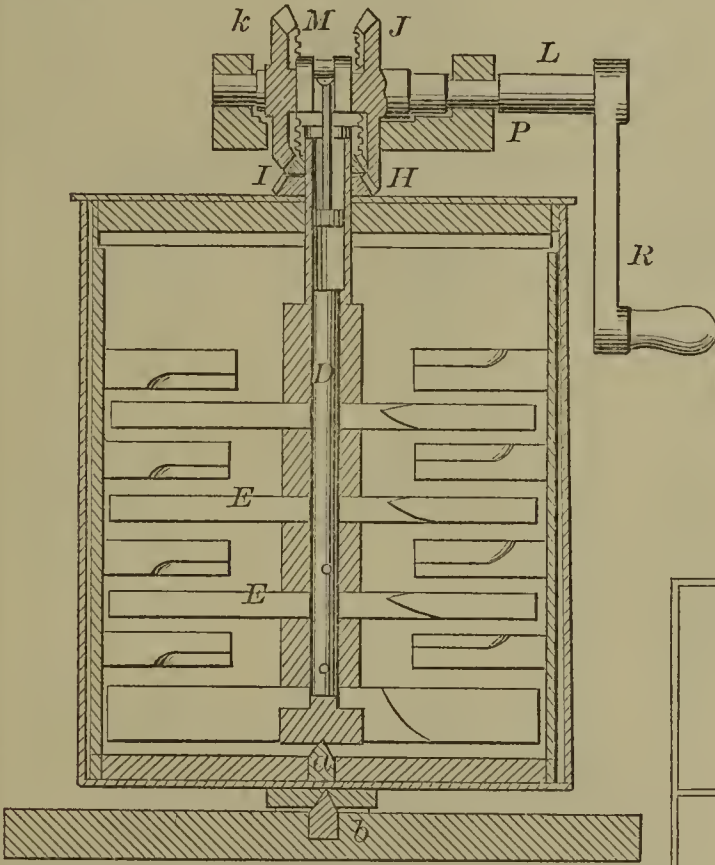

52770—D. C. Teller—Cultivator.

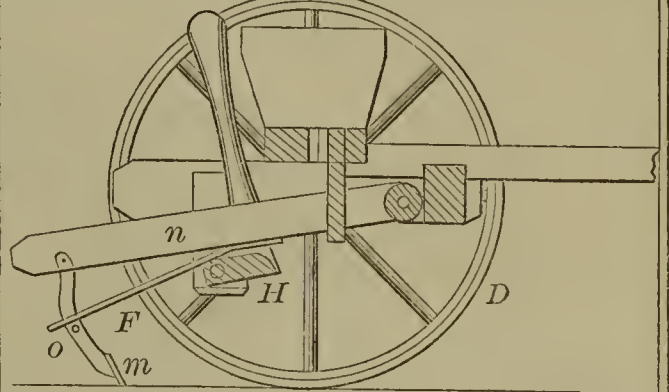

52769—F. R. Stockton—Graver.



52766—N. P. Stevens—Link Motion for Steam Engines

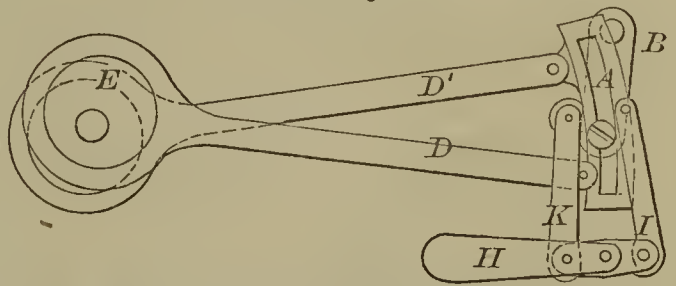

52771—A. E. Thompson—Operating the Swell of Organs.

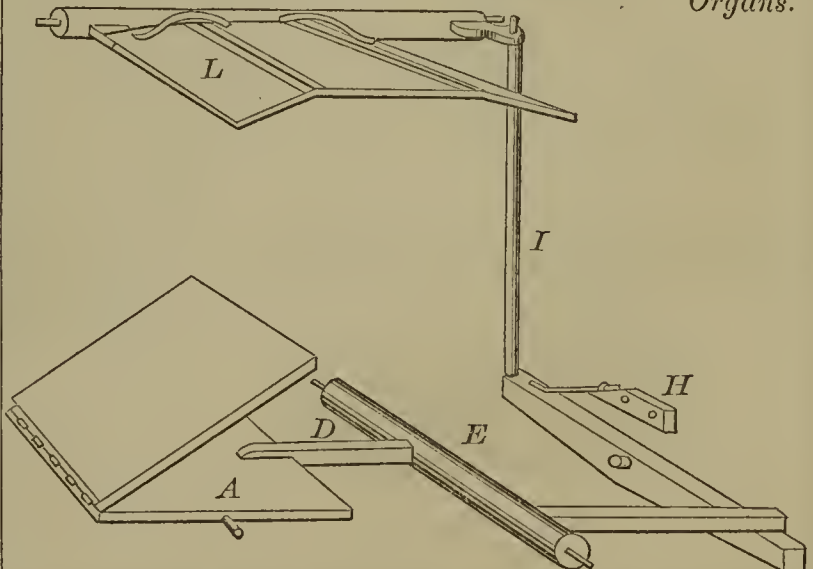

52772—J. S. Thompson—Barrel Head Machine.

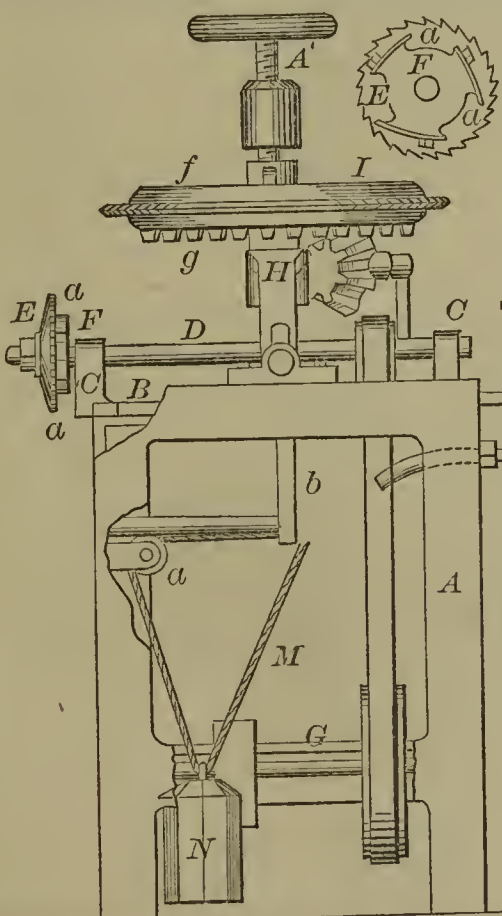

52773—H. C. Thrall—Wind Wheel.

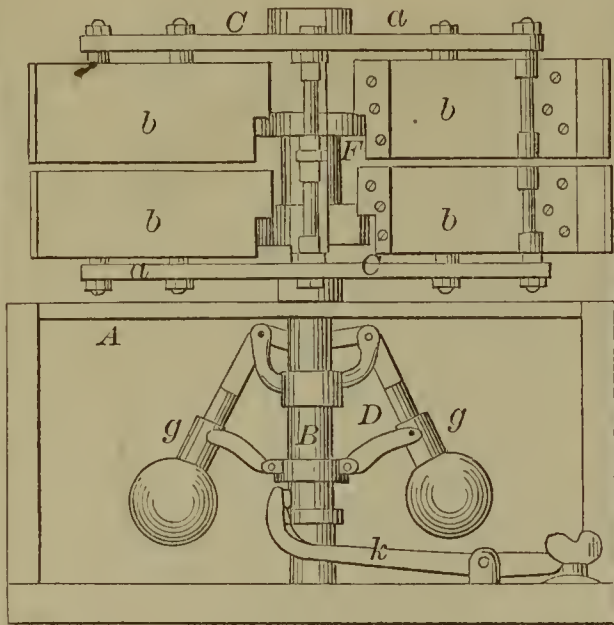

52774—R. W. Van Peyma—Grain Huller.

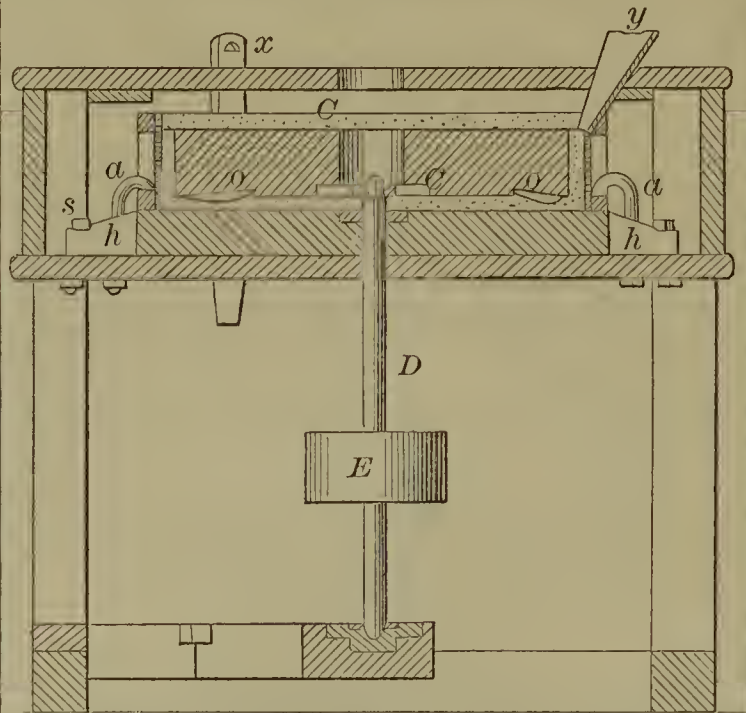

52775—R. E. Washburne—Sluice Box.

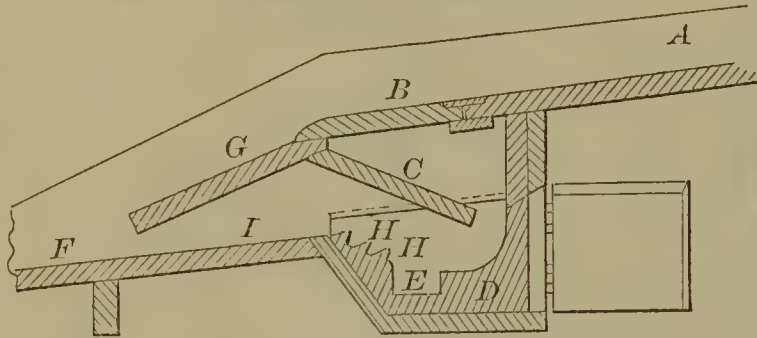

52780—E. Wright—Let-off for Looms.

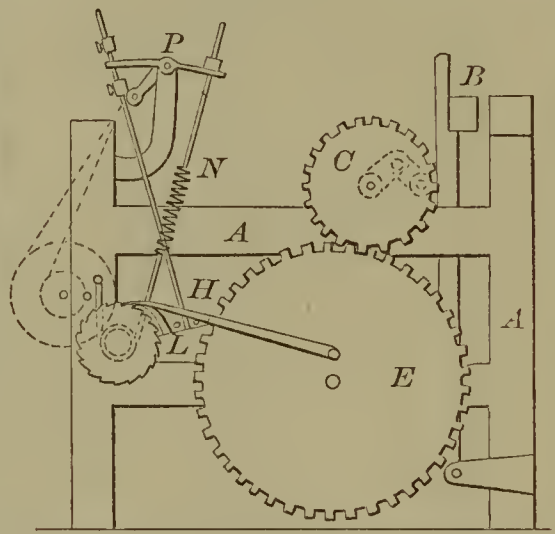

52776—A. Williams—Countersink.

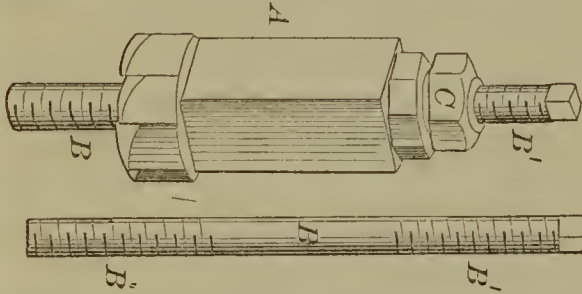

52782—D. Checkeni—Fancy Doll.

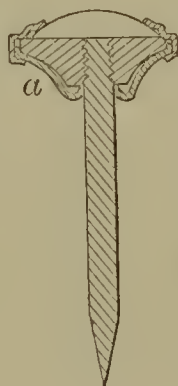
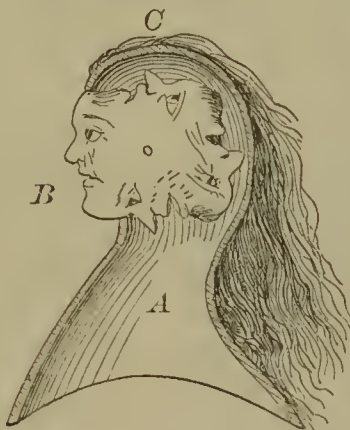

52781—H. P. Brooks—Picture Nail.

52783—C. G. Cross—Screw Cutting Die.

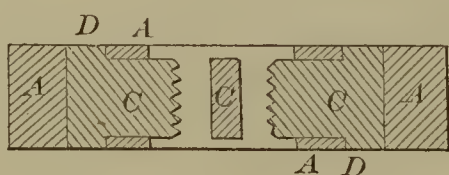

52777—D. D. Winant—Derrick.

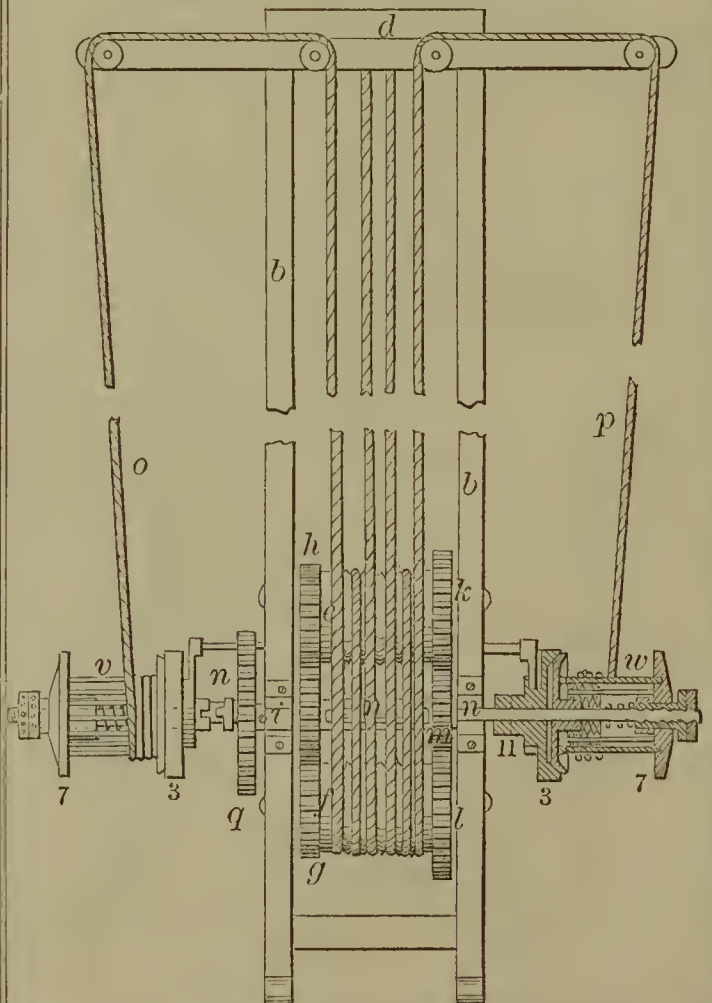



52784—T. A. Curtis—Paper Shirt Bosom.

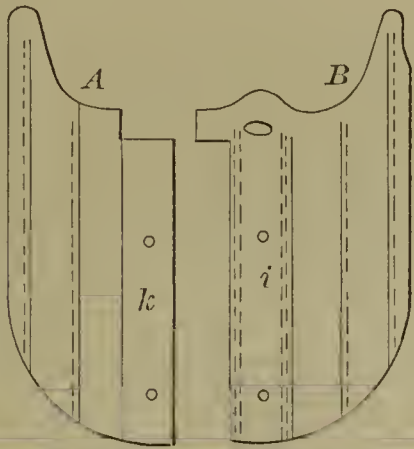

52785—J. H. Darlington—Pressing Paper Collars.

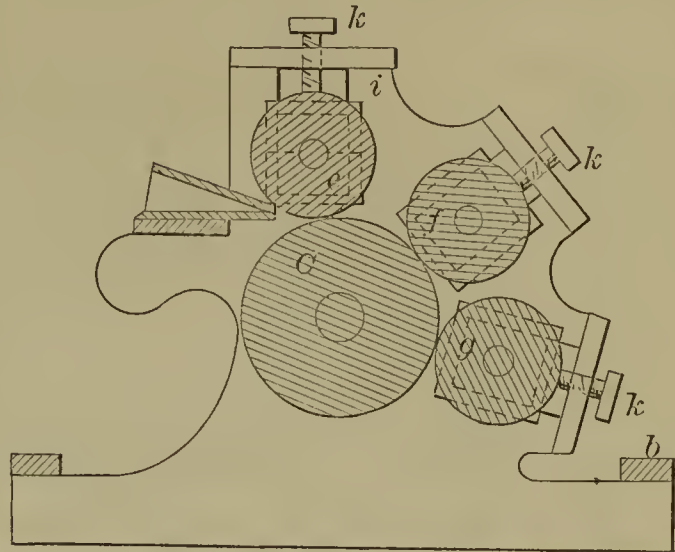

52789—A. Lawrence—Steam Engine Governor.

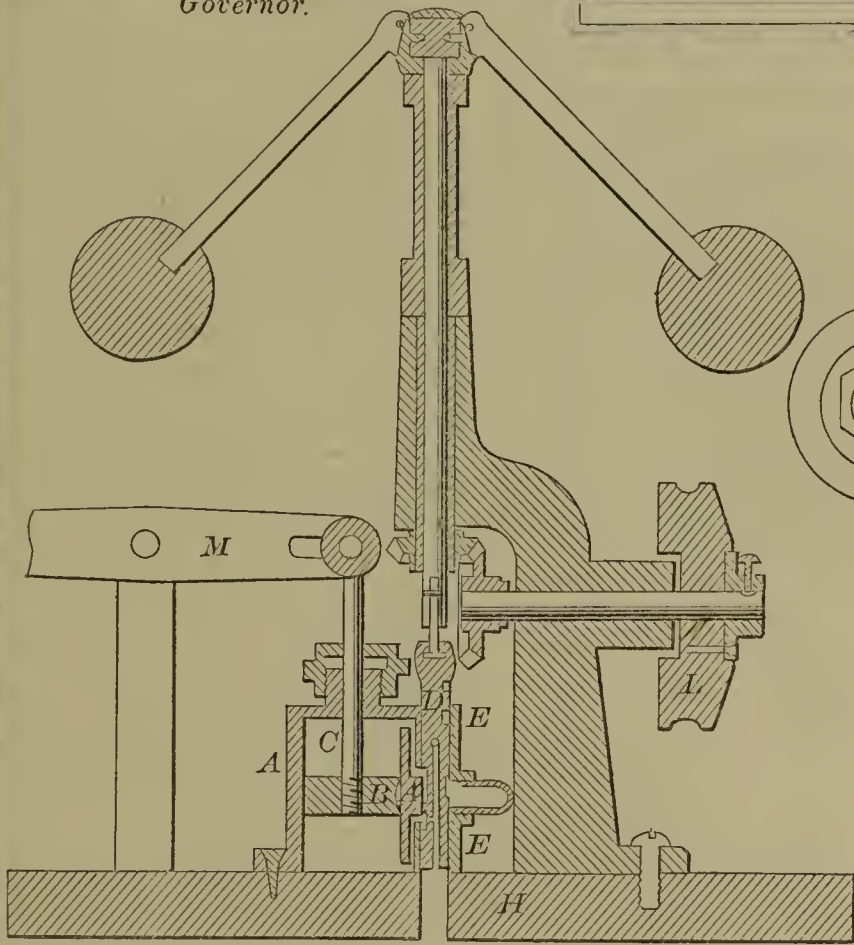

52790—D. McArthur—Mould for Casting Heads upon Screws, &c.

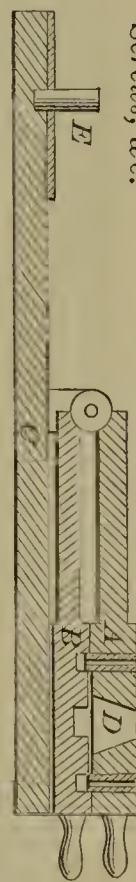

52786—Day & Noel—Hay and Cotton Press.

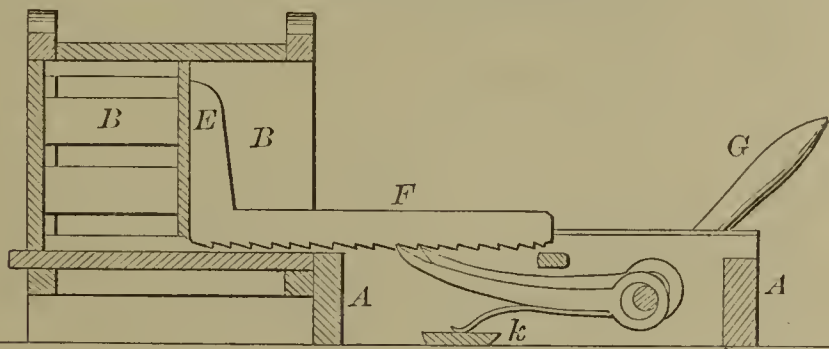

52791—E. Morris, Jr.—Bottle Stopper.

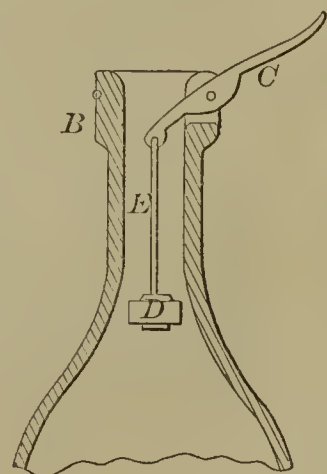

52787—S. Gissinger—Blacking Brush and Boot Jack.

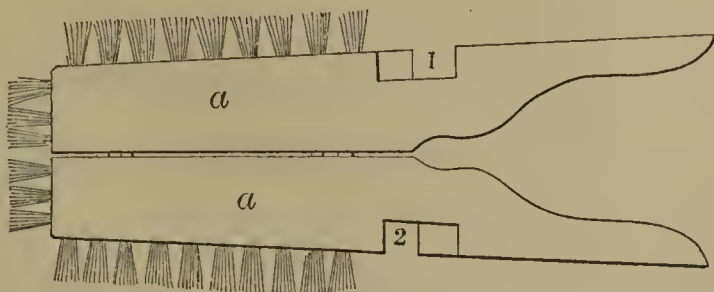

52792—R. F. Osgood—*Sinking Well Tubing.*

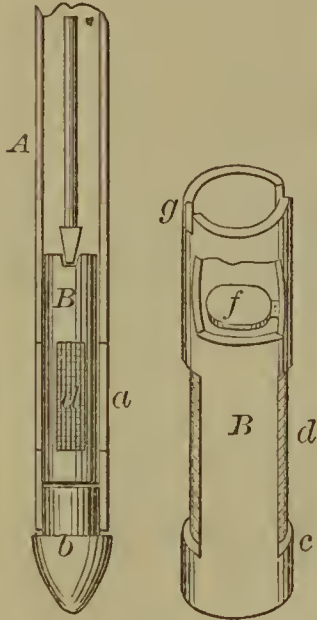

52795—R. Prouty—*Fence.*

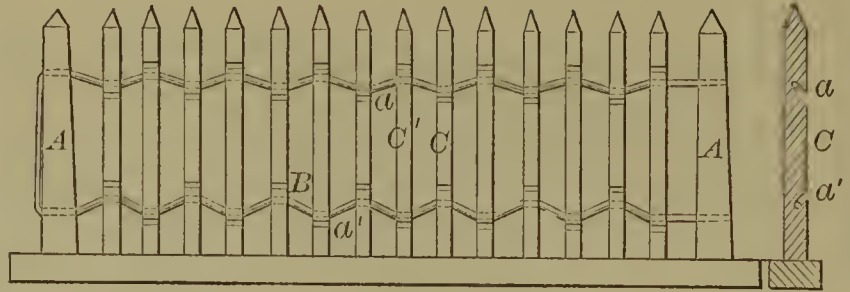

52794—N. Pike—*Fly Trap.*

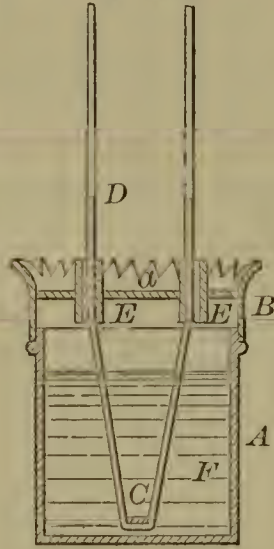

52793—H. D. Parker—*Pipe Coupling.*



52799—W. W. Winter—*For Driving Wood into the Ground.*

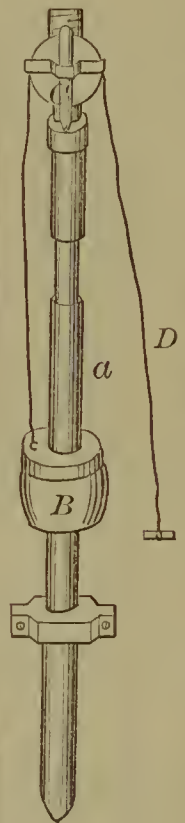

52797—E. Stocker—*Hydrant.*

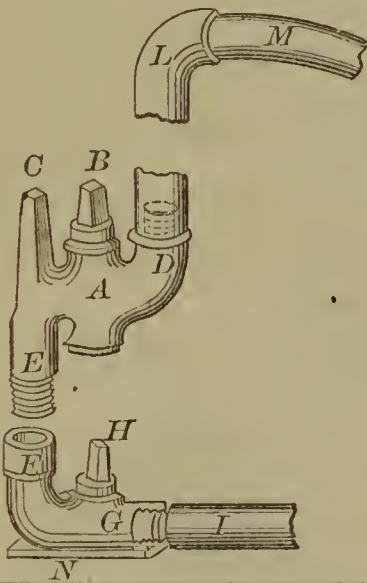

52798—Trask & Johnson—*Boots and Shoes.*

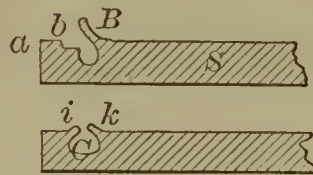

52800—G. F. Wright—*Fastening for Paper Boxes.*

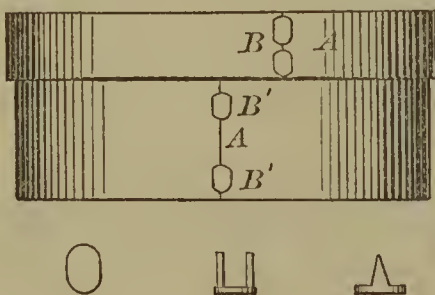

52801—T. M. Gisborne—*Brick Machine.*

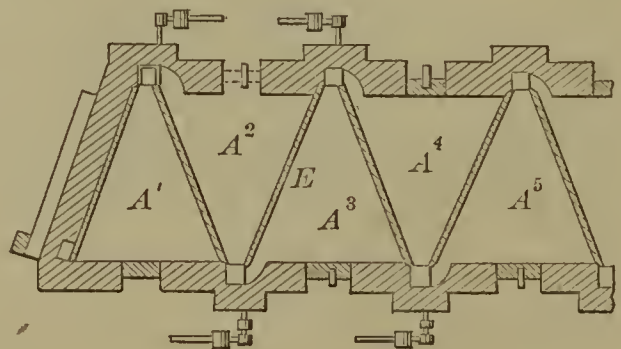

52802—Southall & Heap—Machine for Making Boots and Shoes.

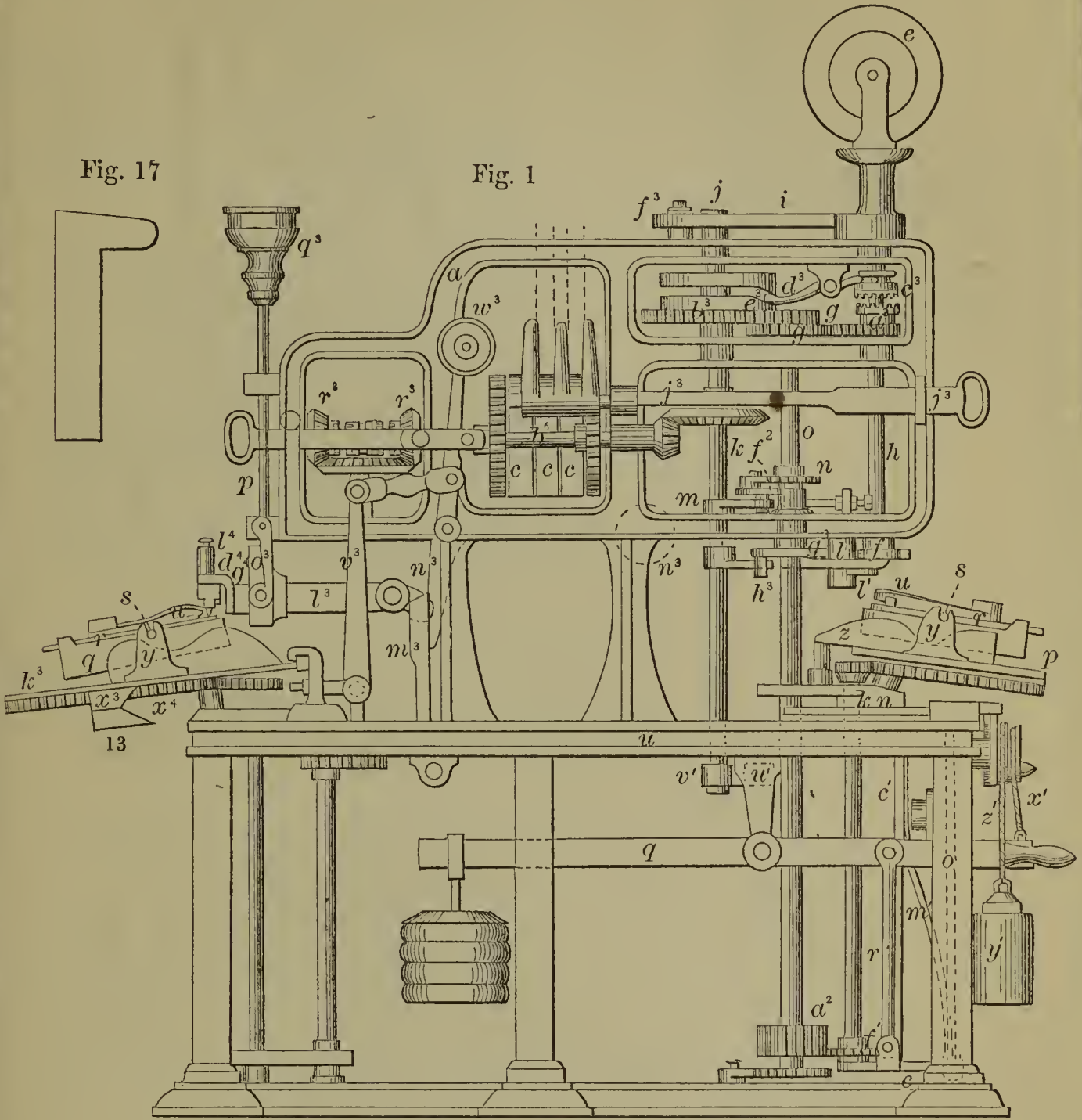
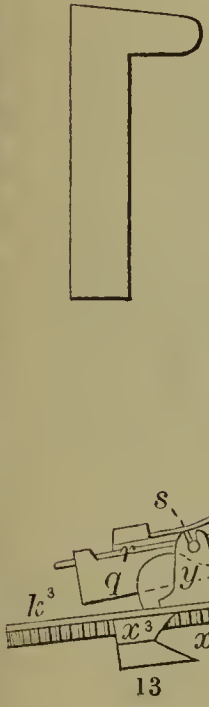

Fig. 17

Fig. 1



13

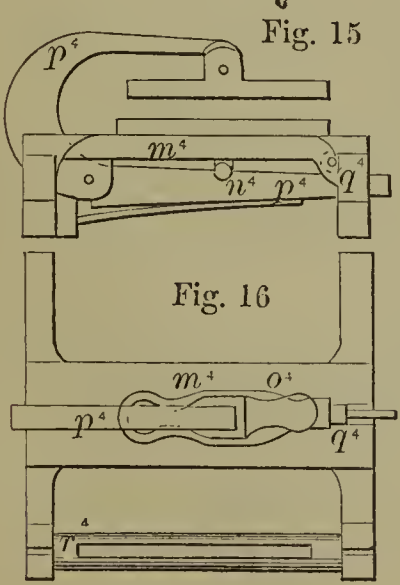

Fig. 15

Fig. 16

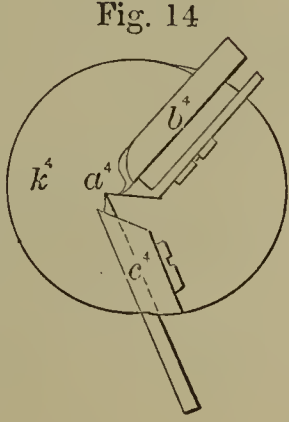

Fig. 14

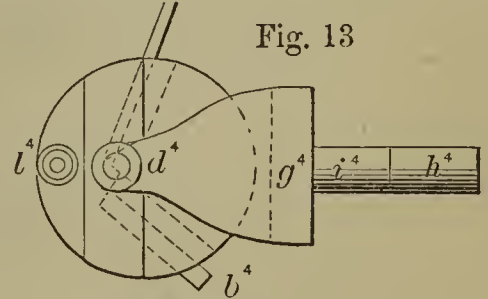

Fig. 13

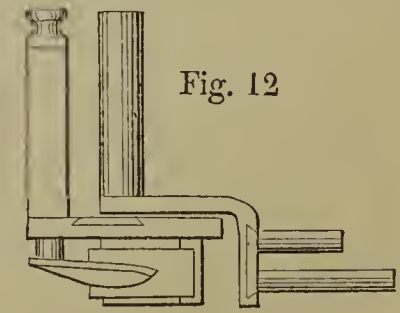
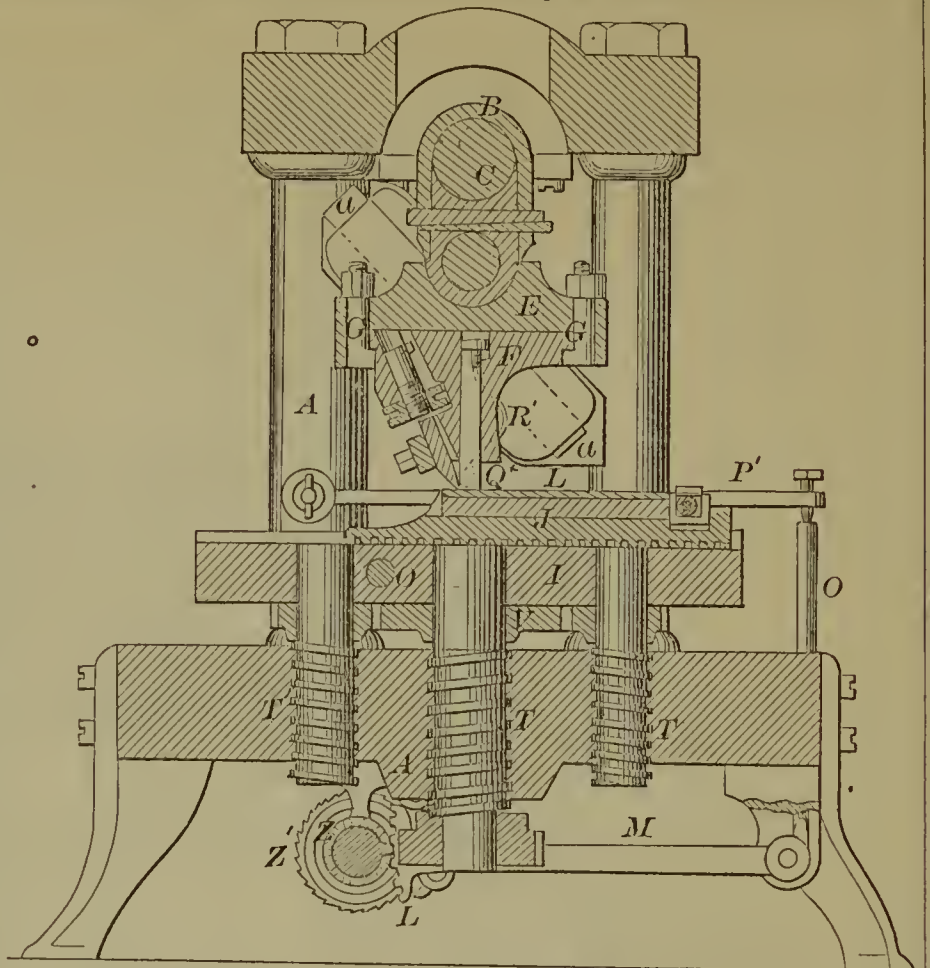
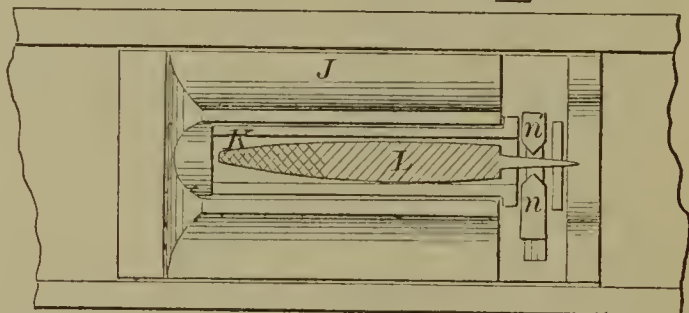
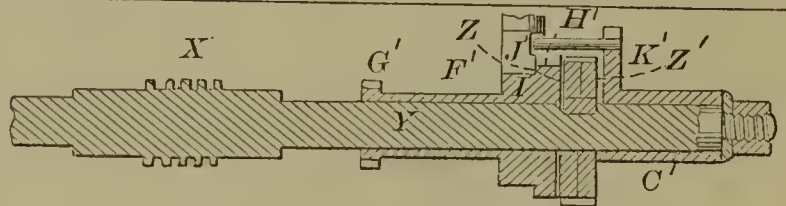
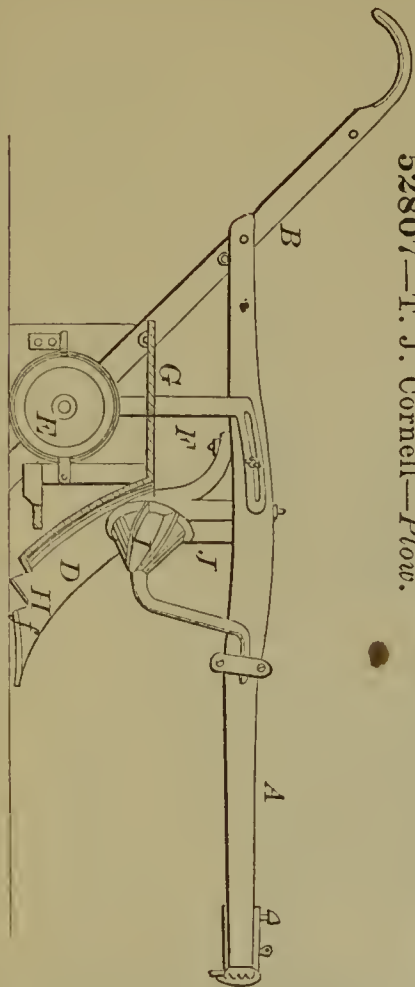

Fig. 12

52804—J. C. Cooke—File Cutting Machine.



52807—T. J. Cornell—Plow.



52806—A. O'Neill—Guard Plate for Boilers.

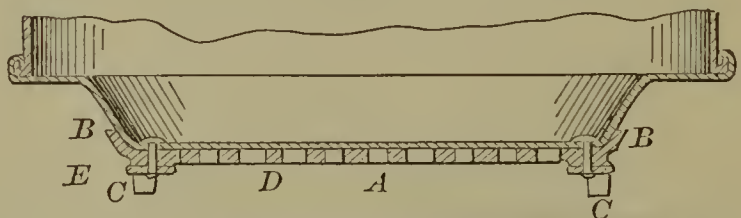

52808—H. Maycock—Operating Horse Hay Forks.

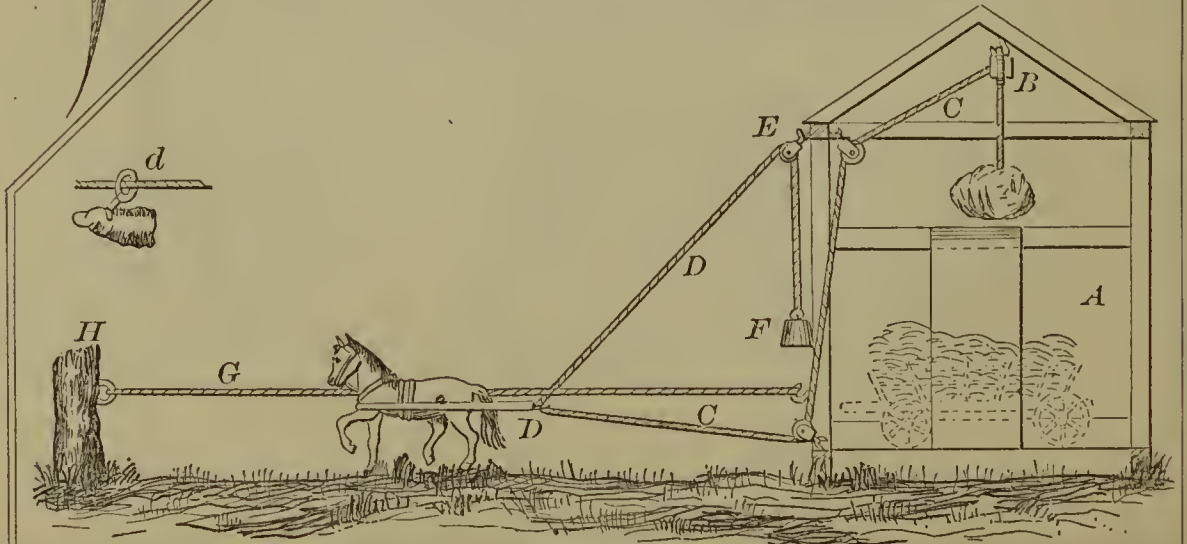

52805—B. F. Hisert—Horse Hay Fork.

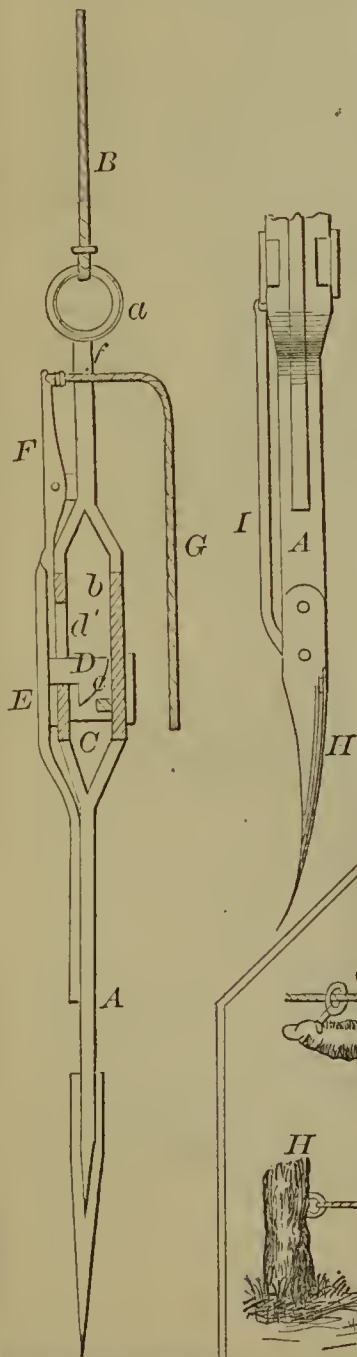

52809—A. S. Acker—Harvester.

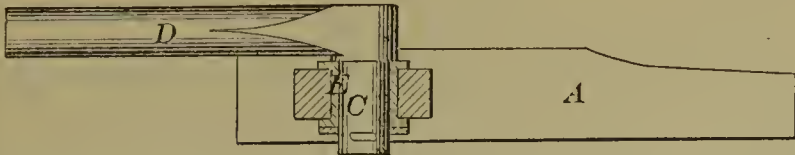

52810—J. F. Allen—Apparatus for Punching.

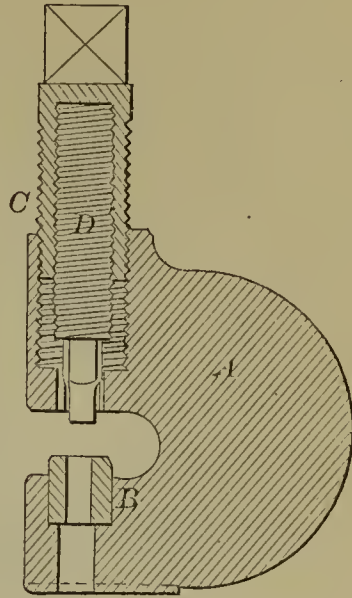

52811—J. Anderson—For Driving Fence Posts.

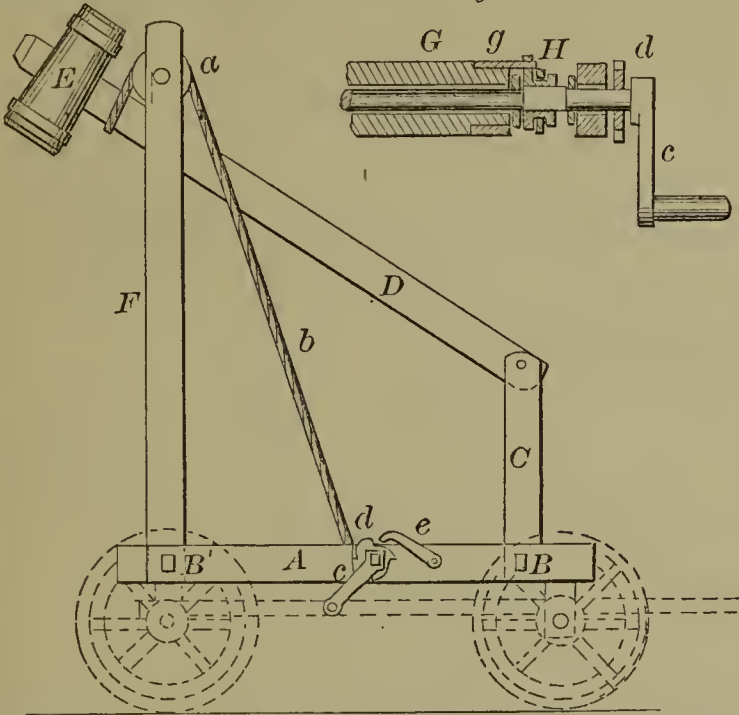

52812—J. C. Arms—Paper Sheet Bosom.

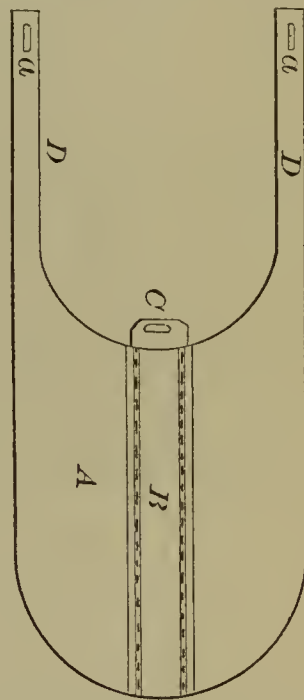

52814—W. W. Barnes—Machine for Raking and Loading Hay.

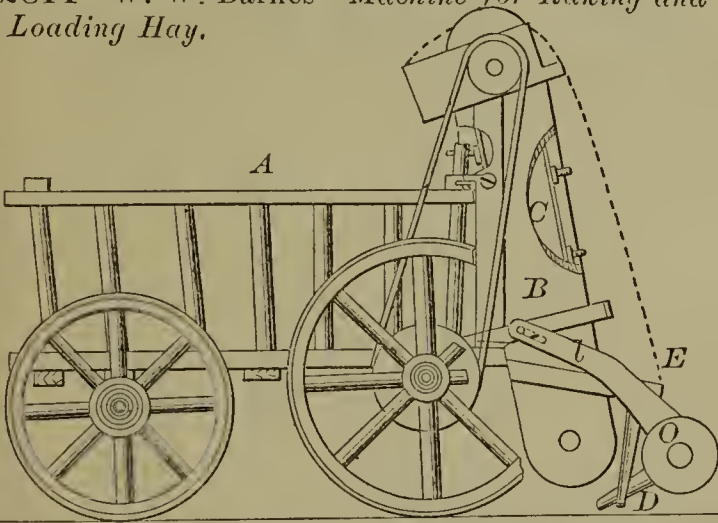

52813—C. D. Baker—Puddling Furnace.

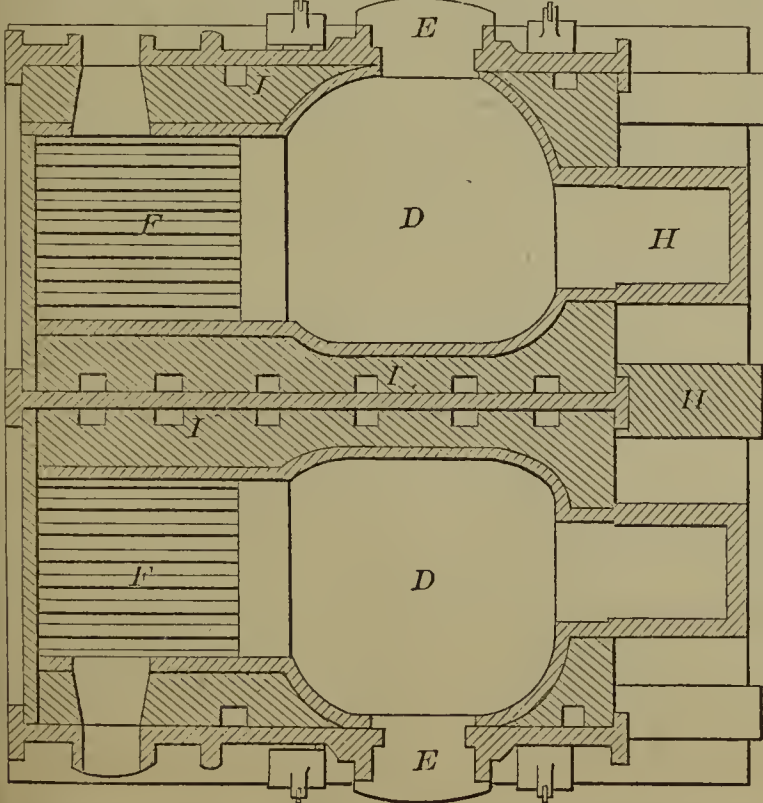

52815—T. P. Bashford—Drilling Machine.

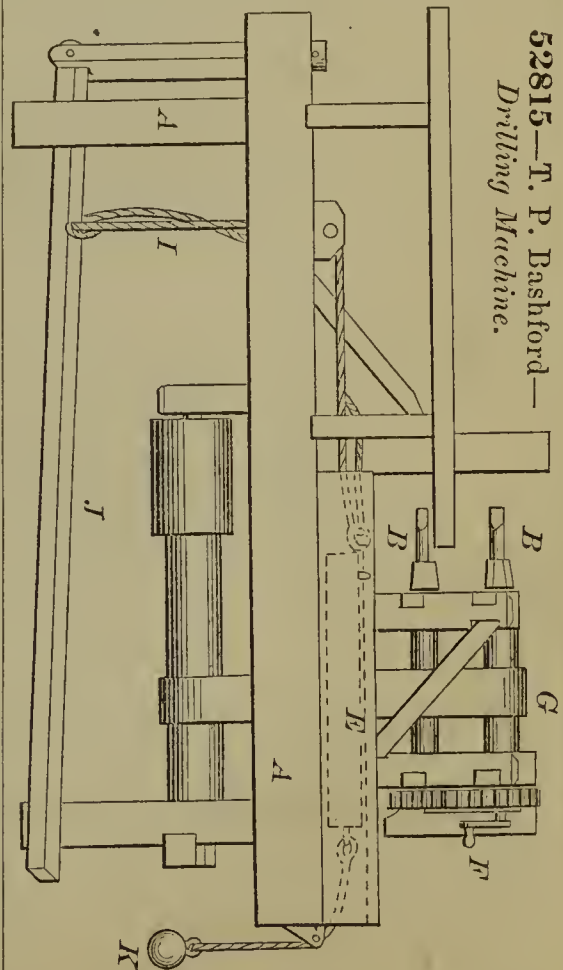

52816—Bateman & Cumming—Drill for Oil Wells.

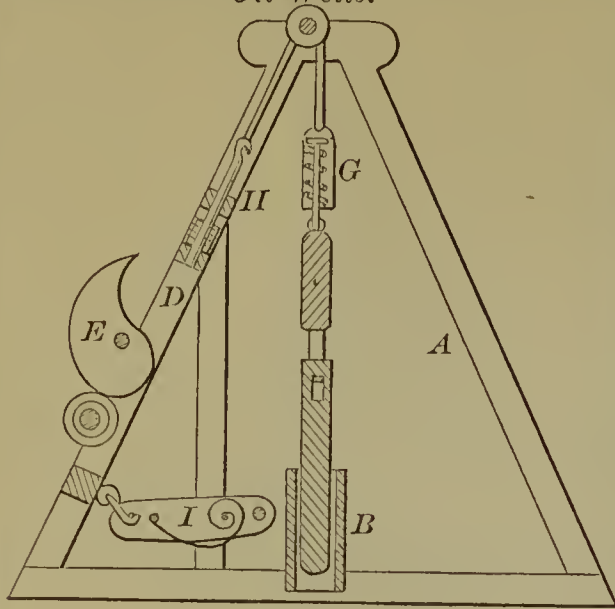

52821—G. M. Campbell—Hemp Brake.

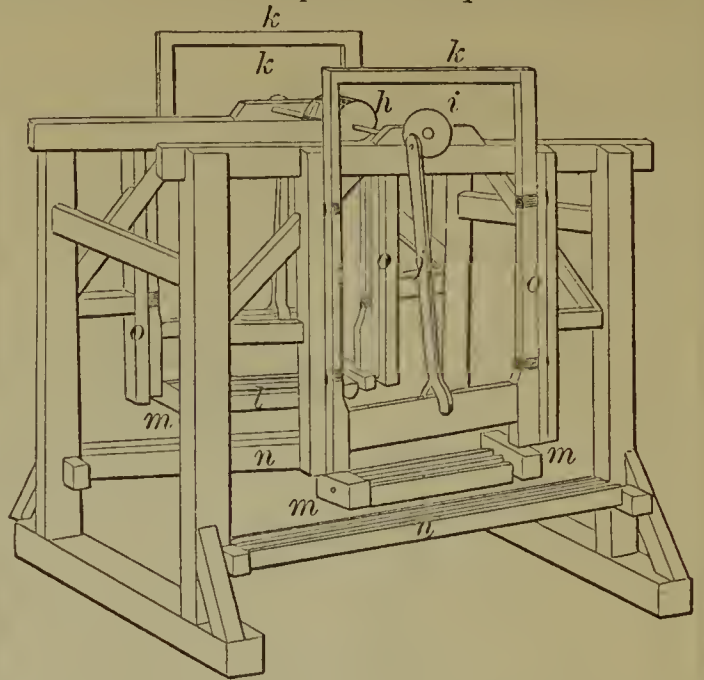

52820—E. R. Brown—Railway Brake.

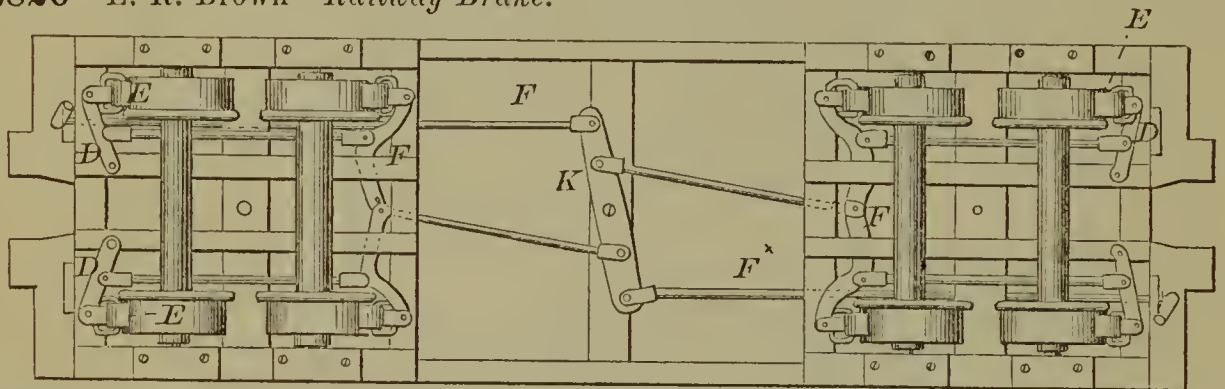

52819—T. Boyd—Corn Harvester.

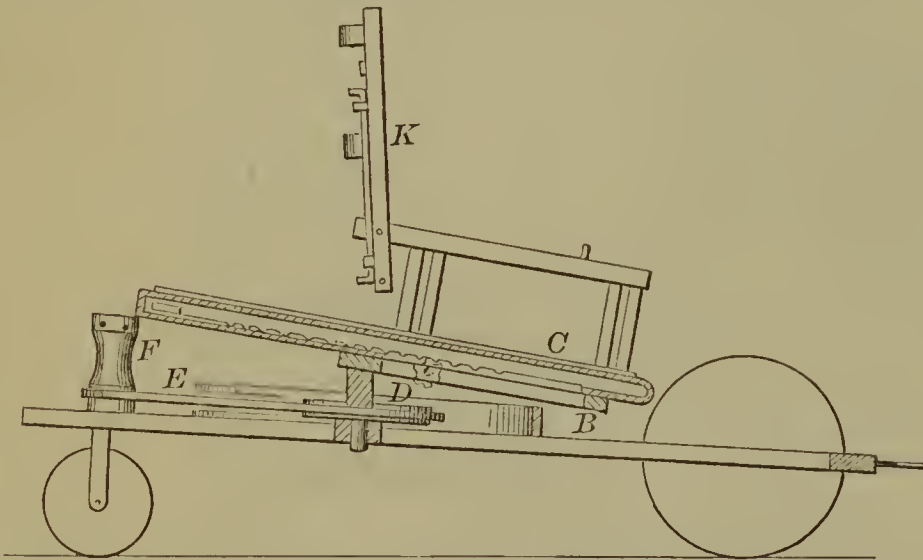

52822—H. H. Cole—Clasp for Looping Ladies' Dresses.



52818—H. Berdan—Metallic Cartridge.

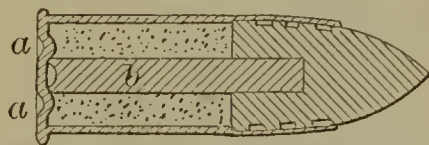

52817—H. Beebe—Apparatus for Folding Linen Bosoms.

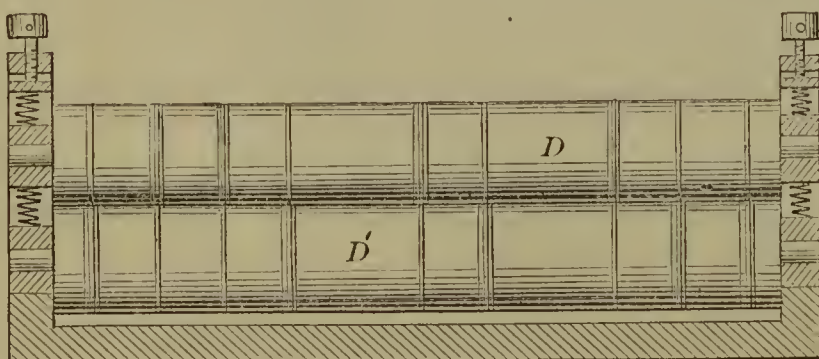

52823—N. B. Cooper—Broom Head.

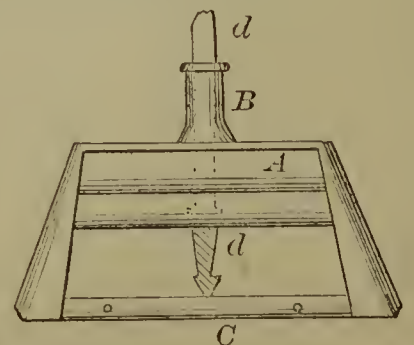

52824—J. E. Cronk—Water Elevator.

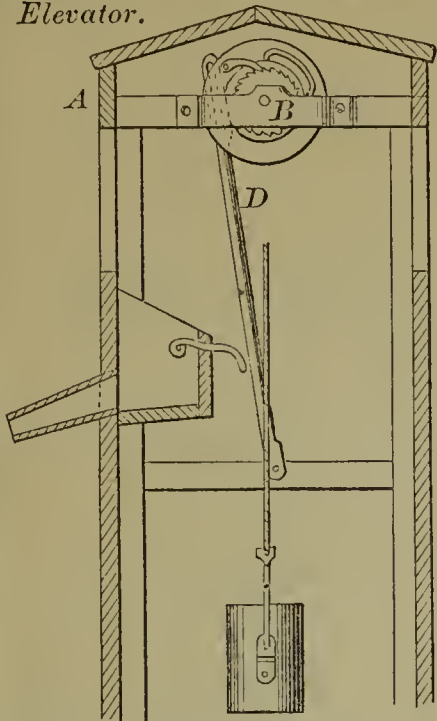

52826—F. Cunningham—For Forming Horse Collars.

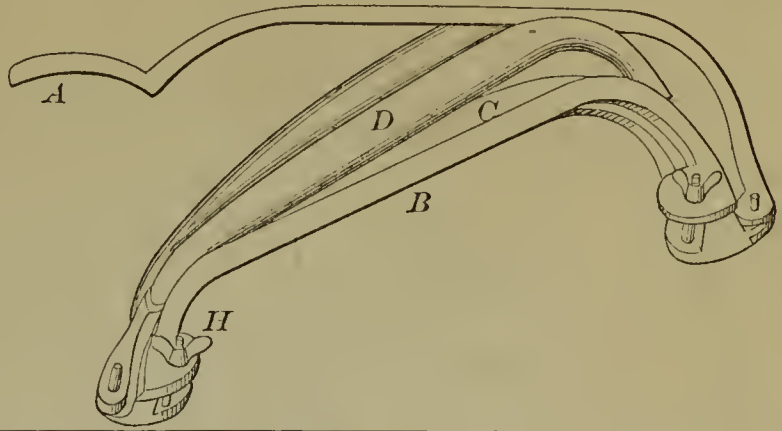

52831—E. C. Dow—Boring Tool for Oil Wells.

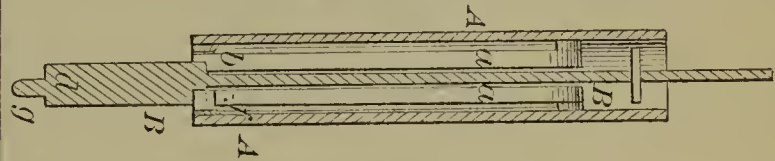

52830—A. Dolloff—Potato Digger.

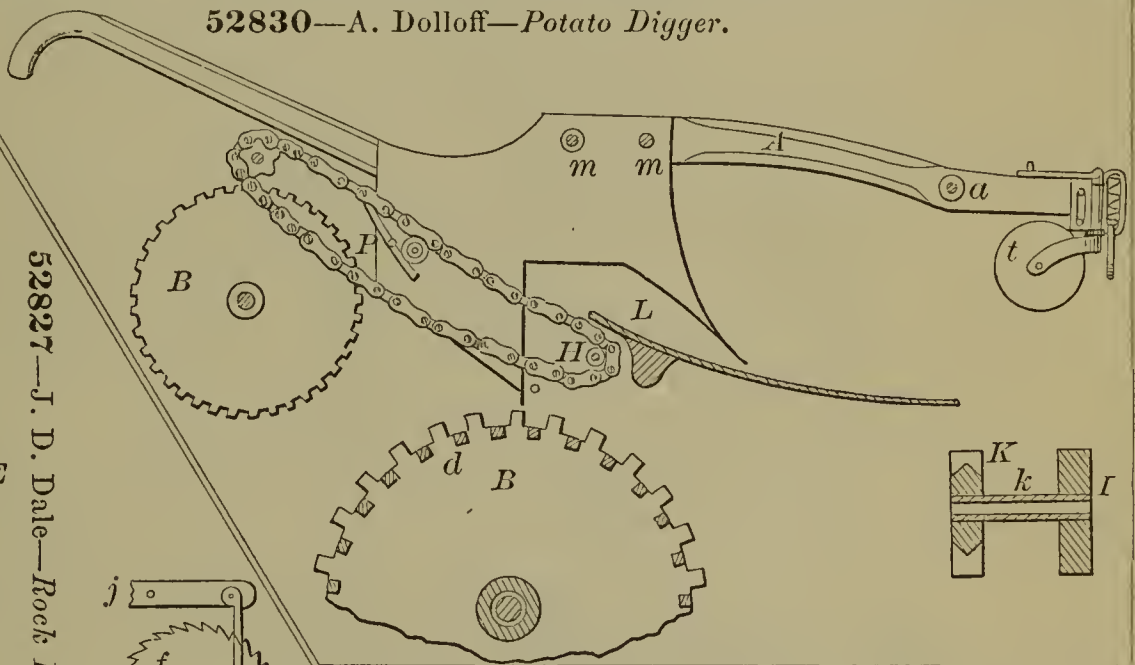

52827—J. D. Dale—Rock Drill.

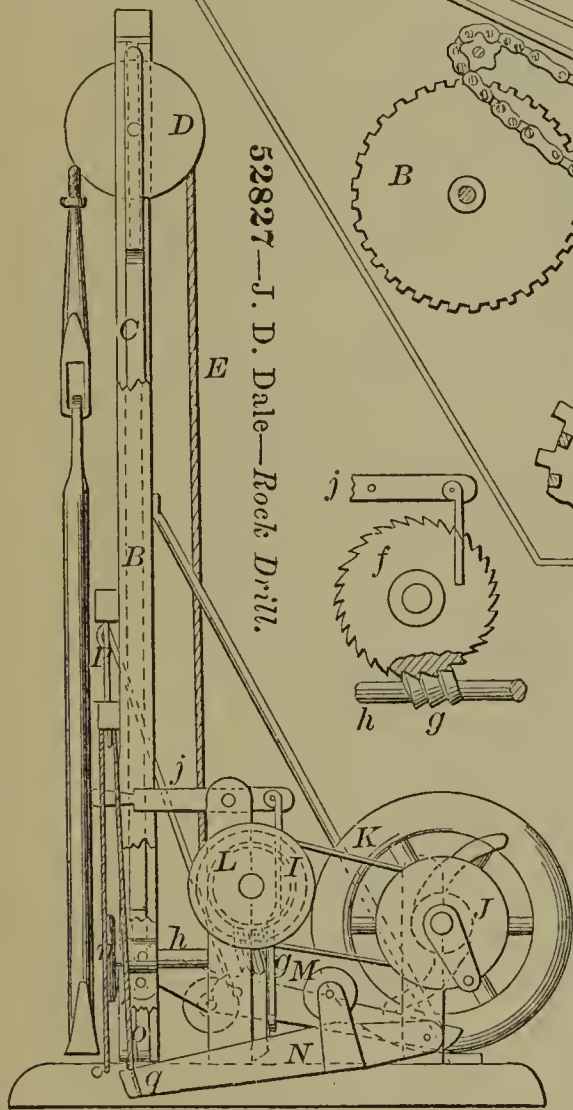

52832—H. C. & J. W. Drew—Carriage Wheel.

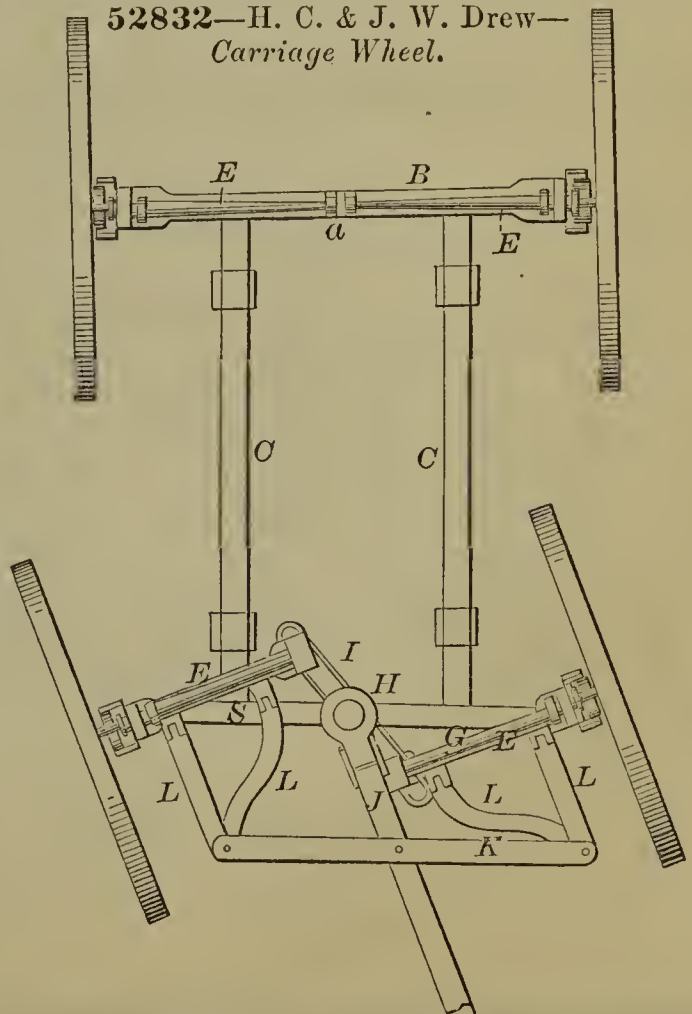

52828—M. Dickle—Fence.

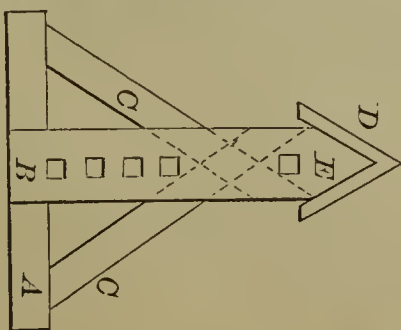

52833—R. N. Eagle—Flexible Brush.

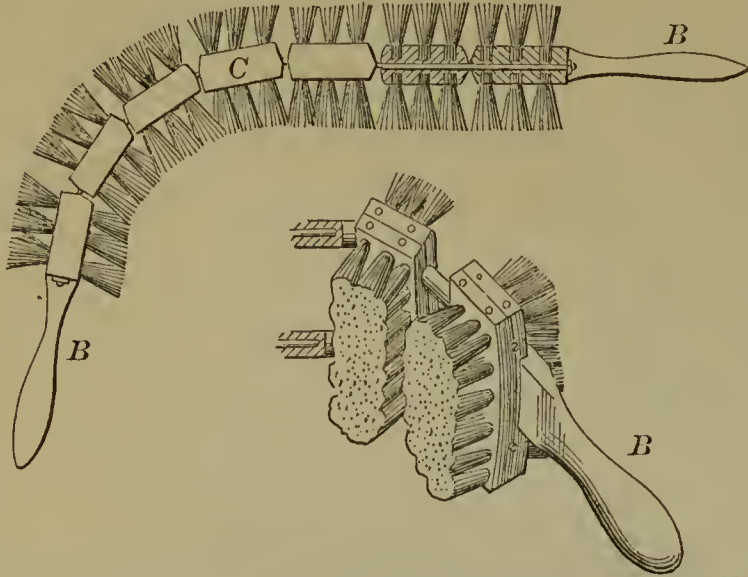

52835—J. F. Fales—Carpet Lining.

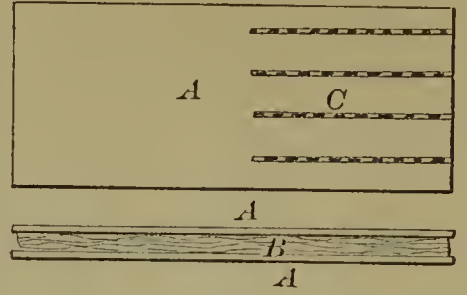

52837—J. Fleck—Quartz Crusher.

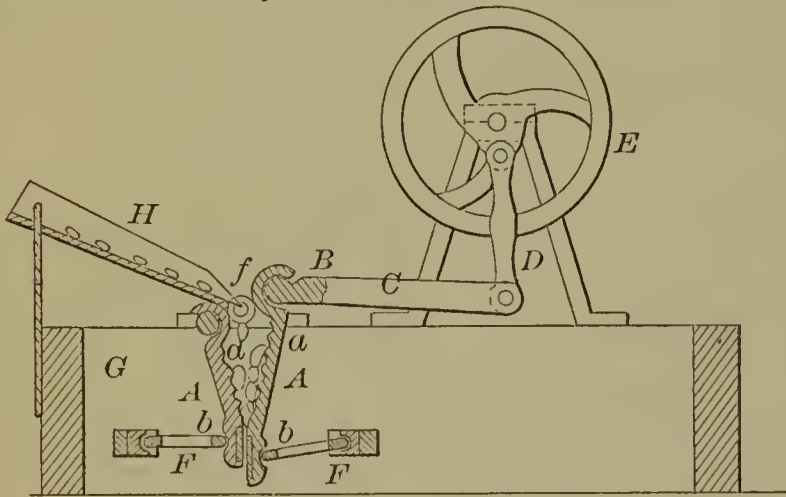

52839—J. E. Ford—Car Coupling.

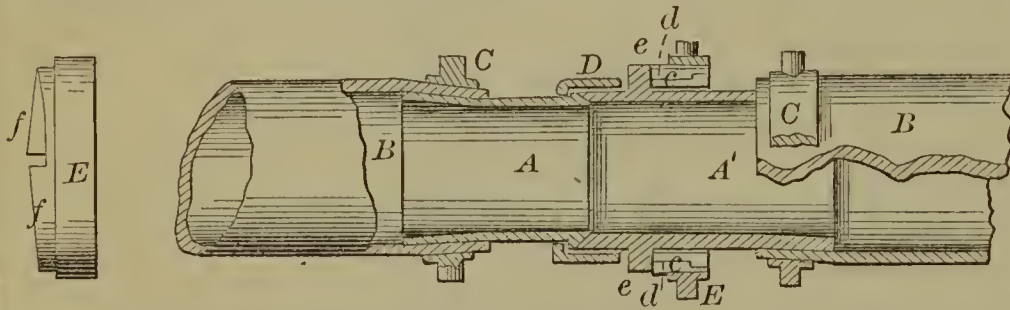

52838—E. T. Ford—For Pressing Straw.

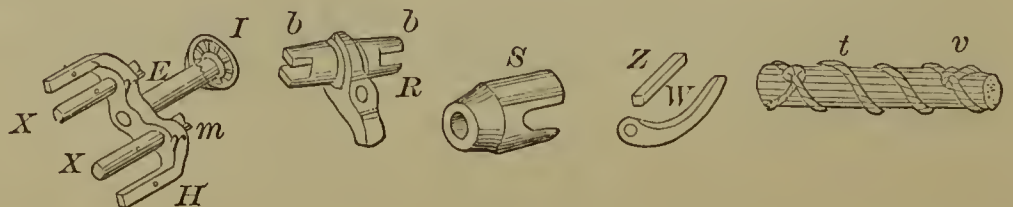
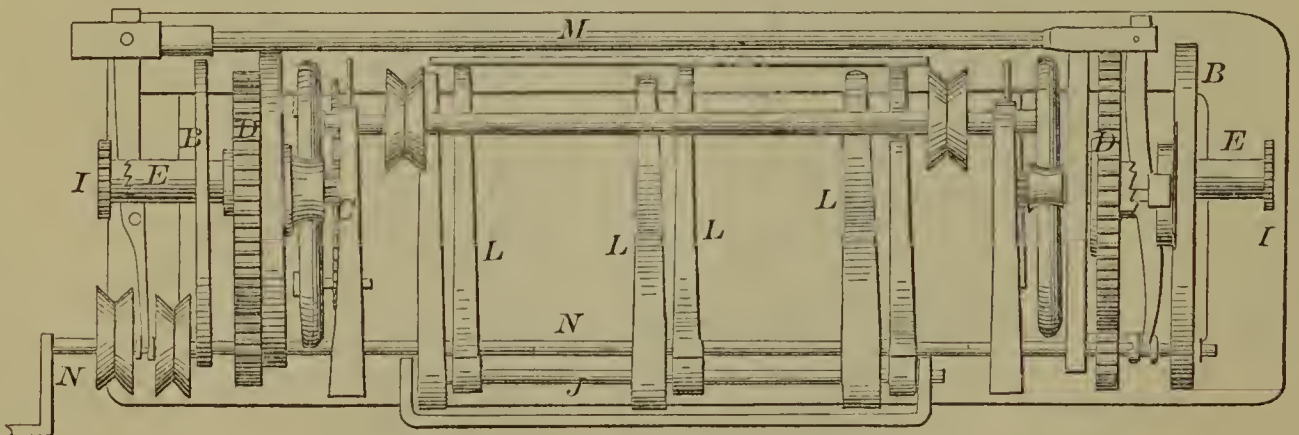

52836—G. H. Felt—Plug for Blasting.

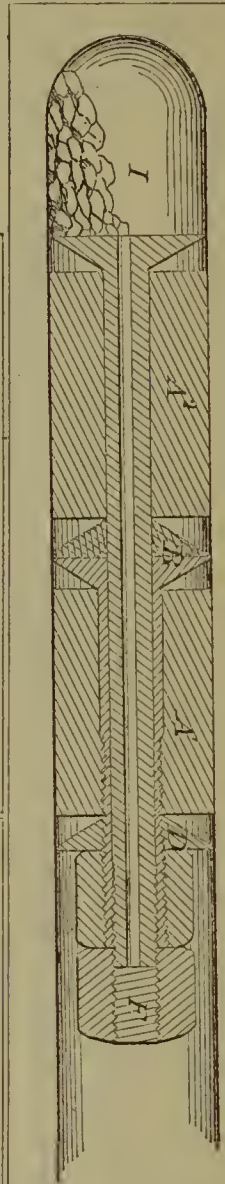



52840—J. W. Free—*Fanning Mill.*

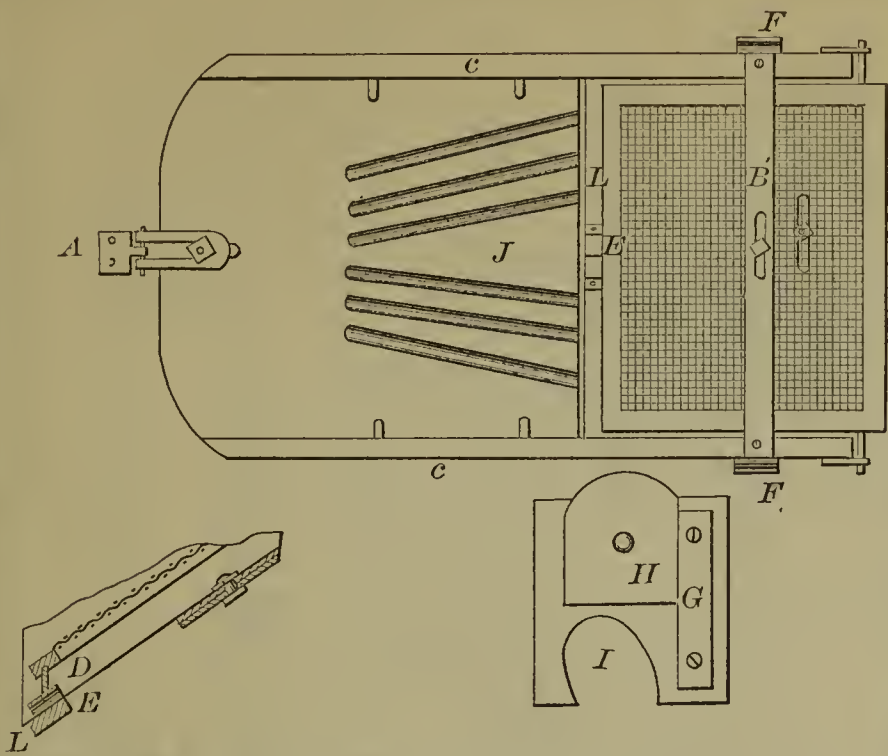

52842—N. T. & S. B. Gassette—*Cigarette Mould and Box.*

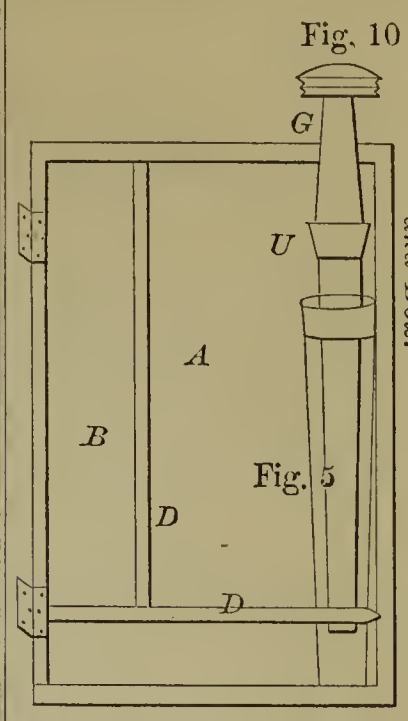

52841—J. W. Free—*Grain Separator.*

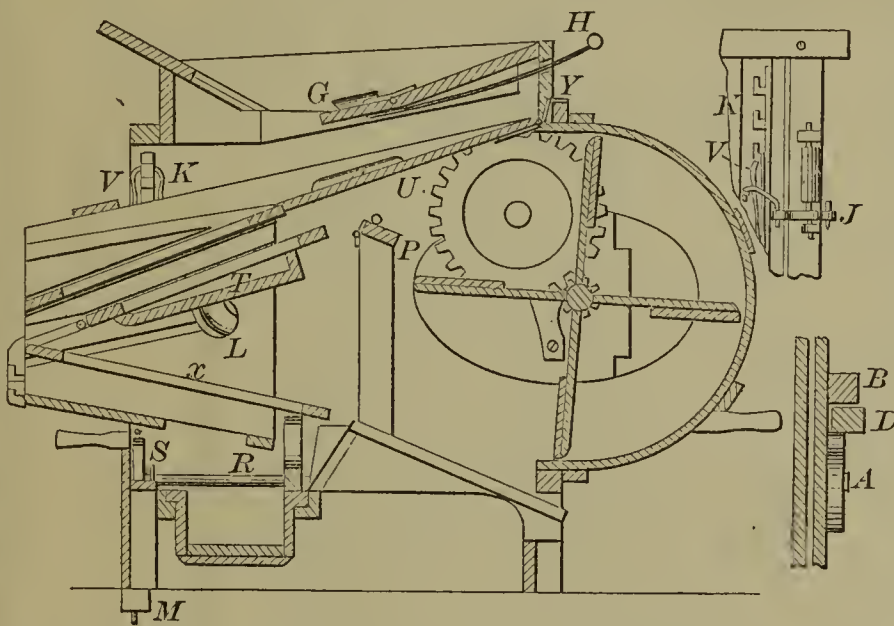

52845—J. C. Grün—*Edge Plane for Boots and Shoes.*

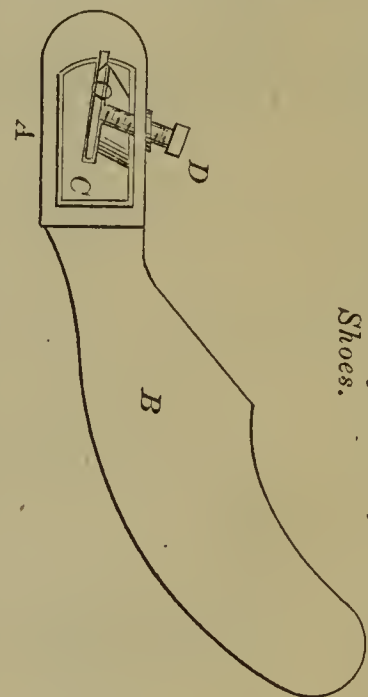

52846—E. Hamilton—*Amalgamator.*

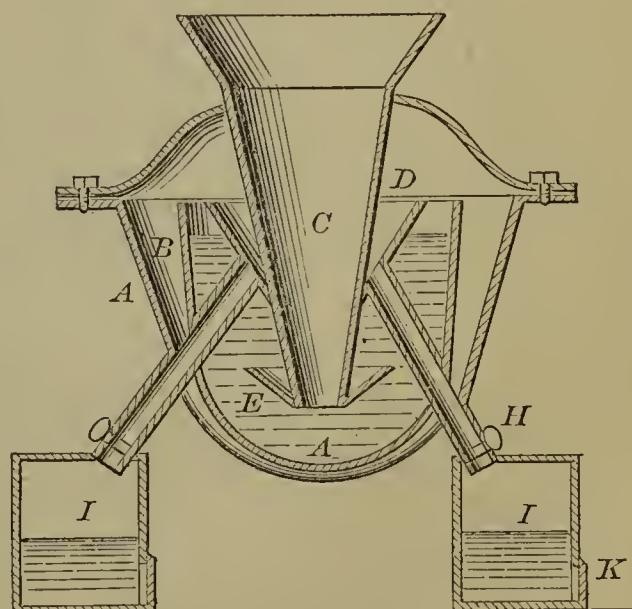

52843—D. D. Gitt—*Harvester.*

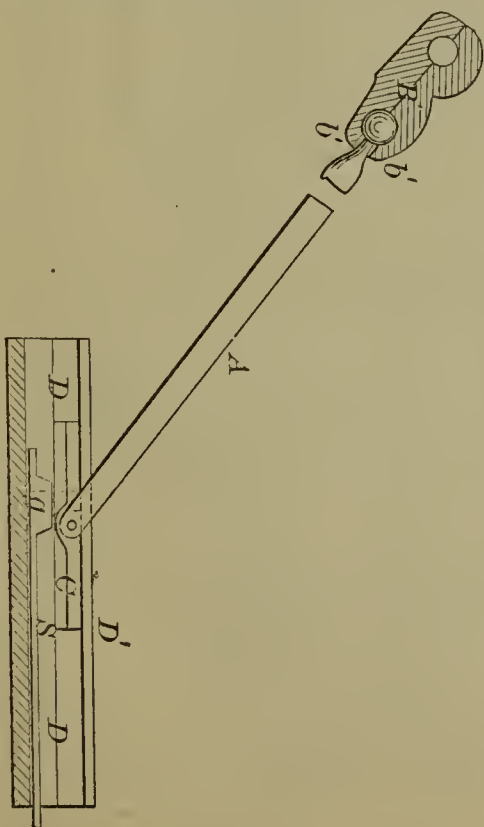

52847—J. Hanlon—Sewing Machine.

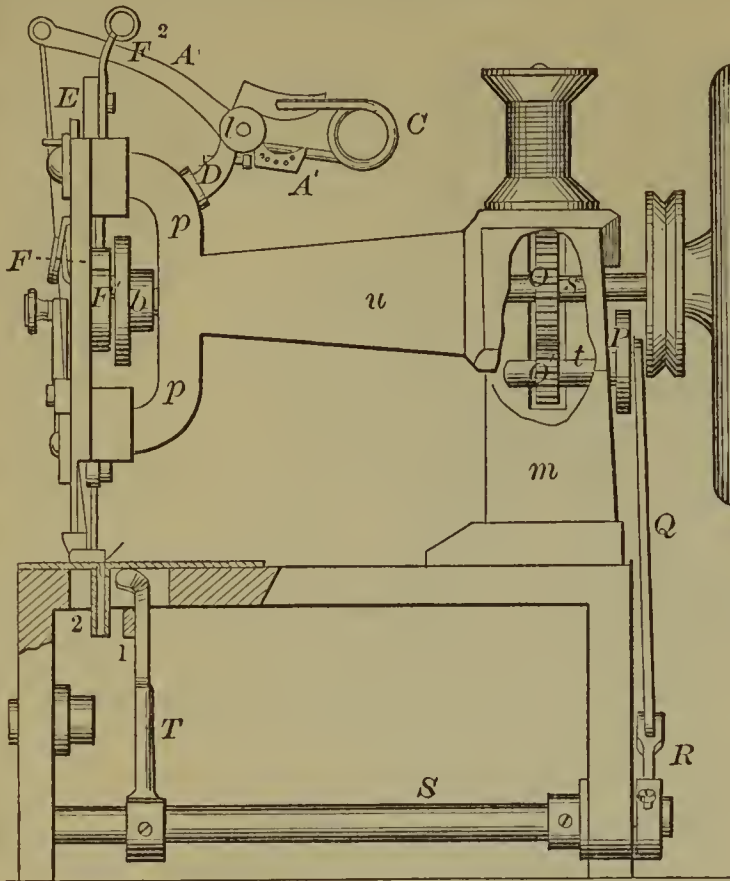

52848—O. J. Hardgrove—Car Brake.



52850—J. Hendy—Gold and Silver Washing.

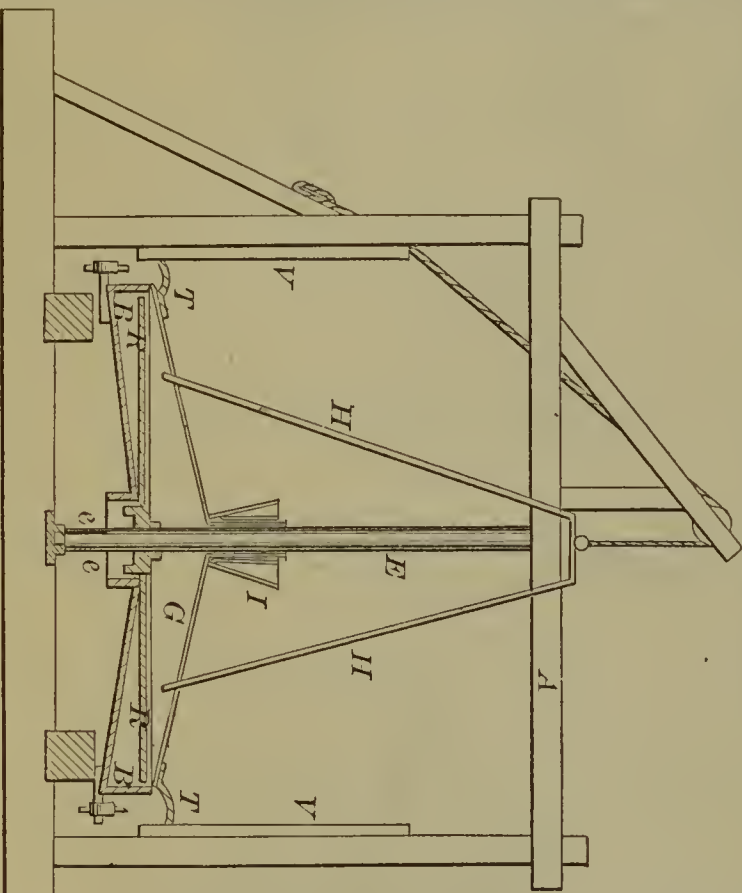

52851—B. Hess—Harvester.

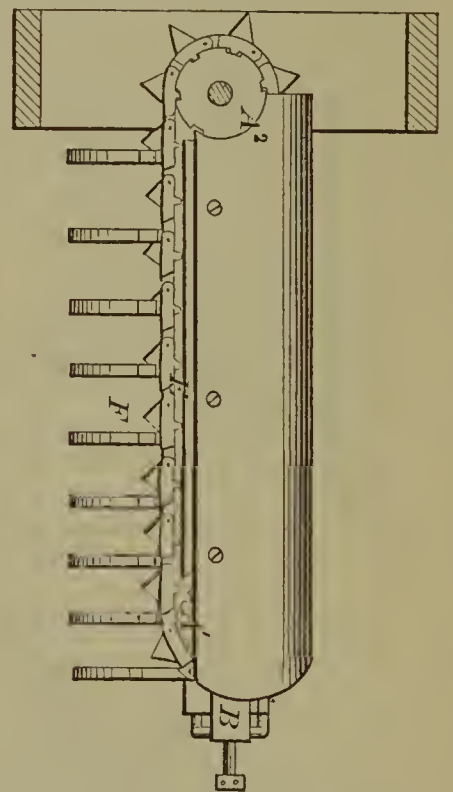

52849—G. Hastings—Watch Hand.

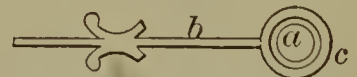

52852—W. H. Hovey—Brick Machine.

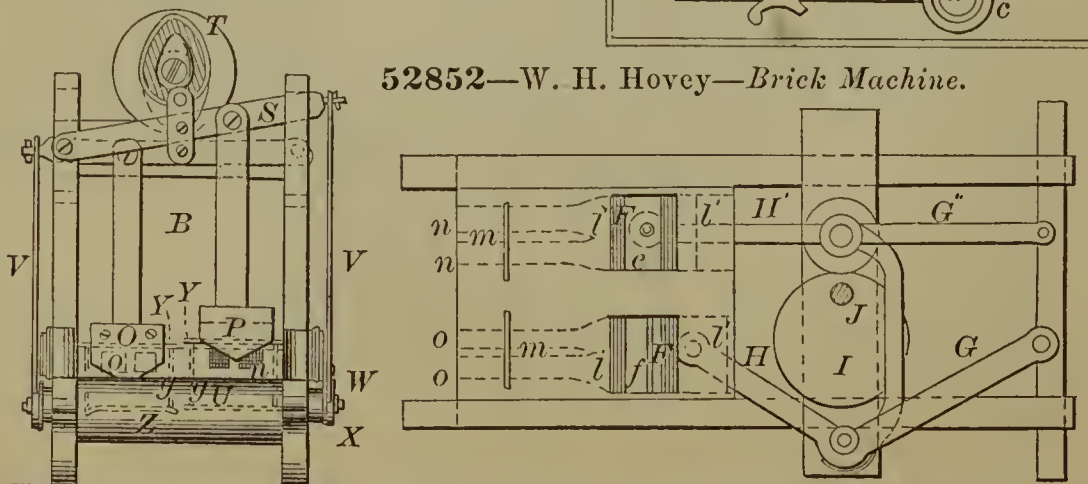

52854—E. B. Hungerford—*Window Blind.*

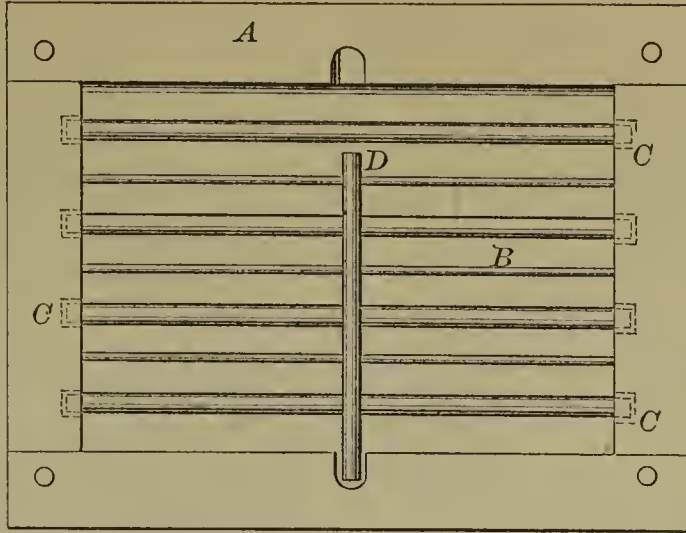

52859—J. S. Kingsland—*Car Wheel.*



52853—B. J. C. Howe—*Sinking Wells.*

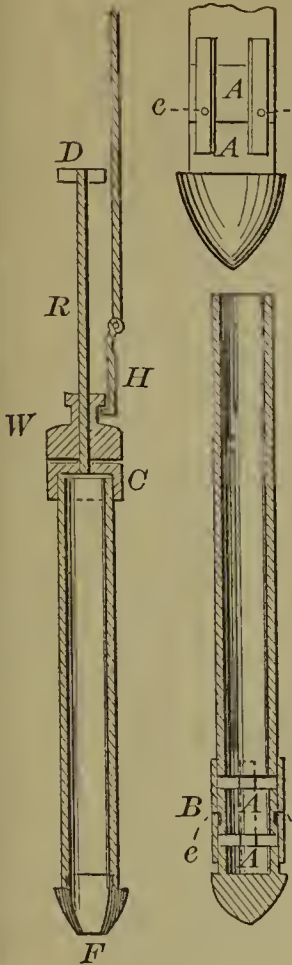

52856—E. A. Jeffery—*Coal Hod.*

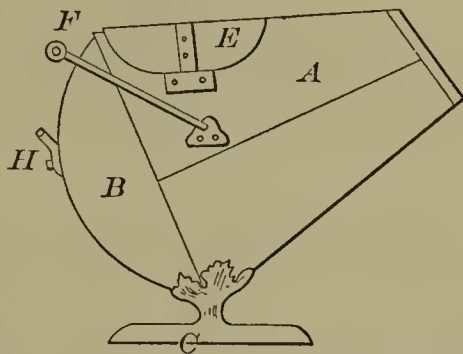

52857—A. D. Judd—*Tassel Hook.*

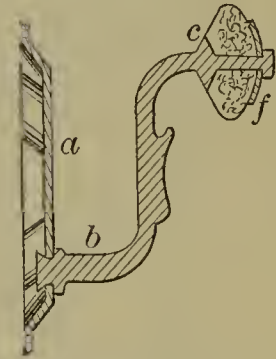

52861—H. B. Lansing—*Corn Planter.*

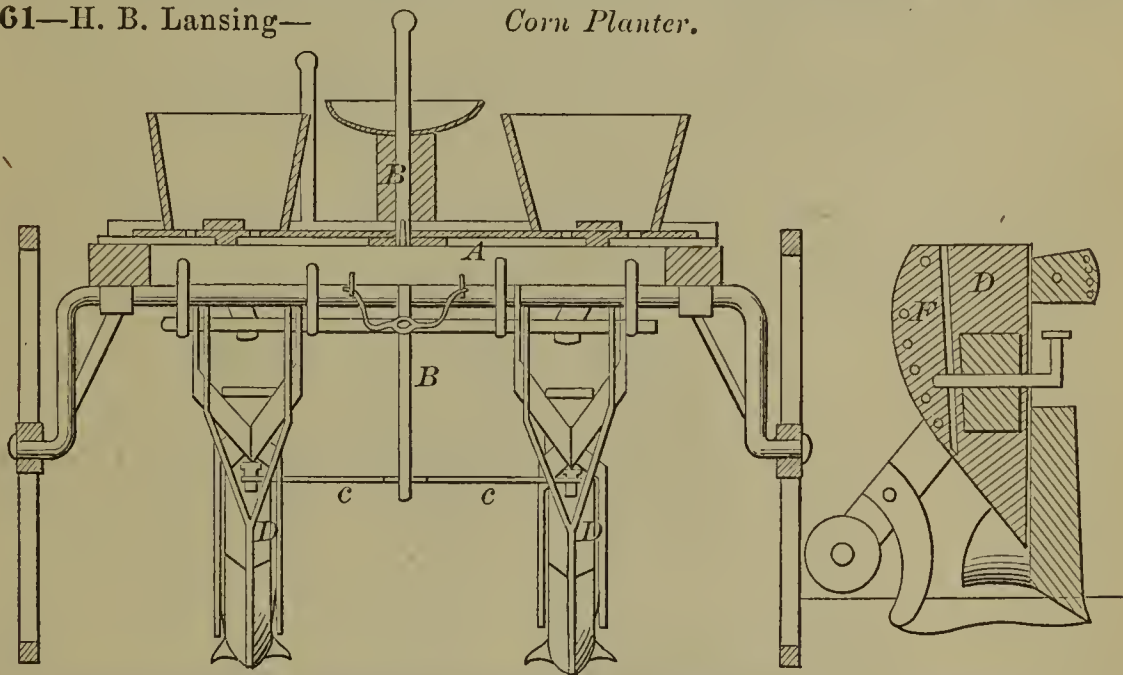

52862—Le Count & Chard—*Lamp Wick.*

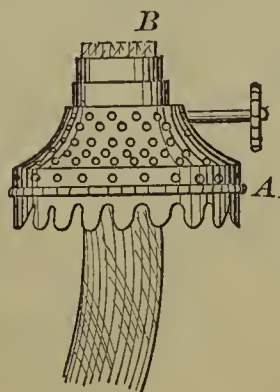

52860—M. Kremser—*Bridge.*

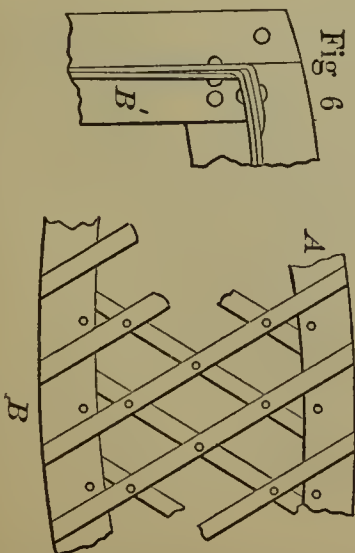
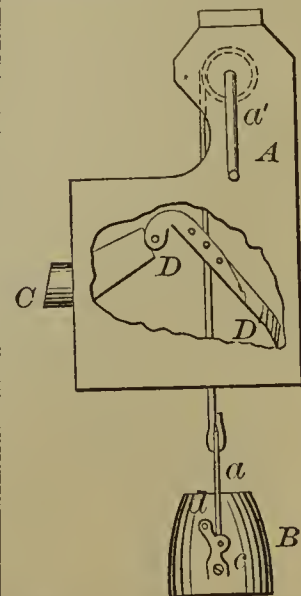
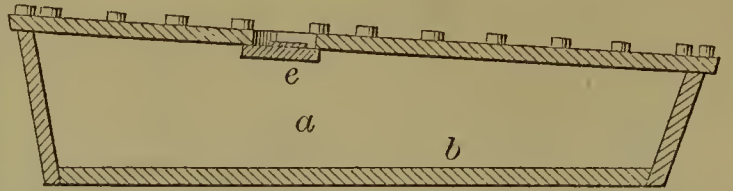

Fig 6

52858—L. King—*Water Drawer.*



52865—Lovett, Wippich & Wood—Burial Case.



52864—Loch & Bayer—Lock.

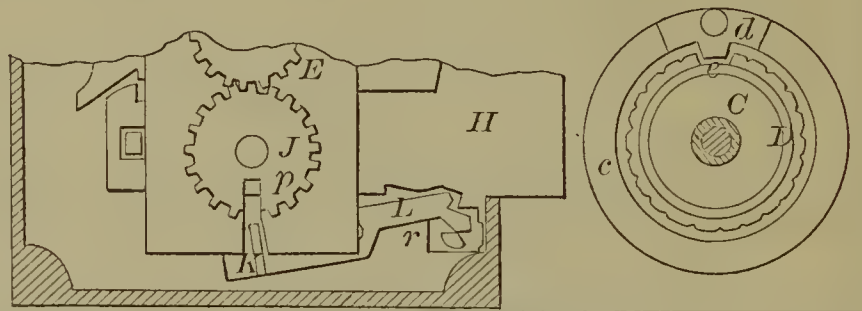
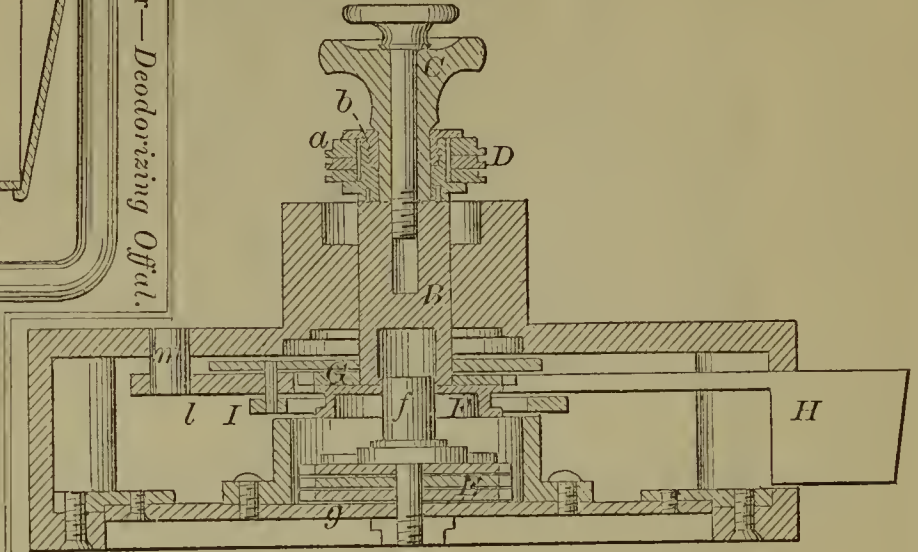

52863—A. & E. Lister—Deodorizing Offal.

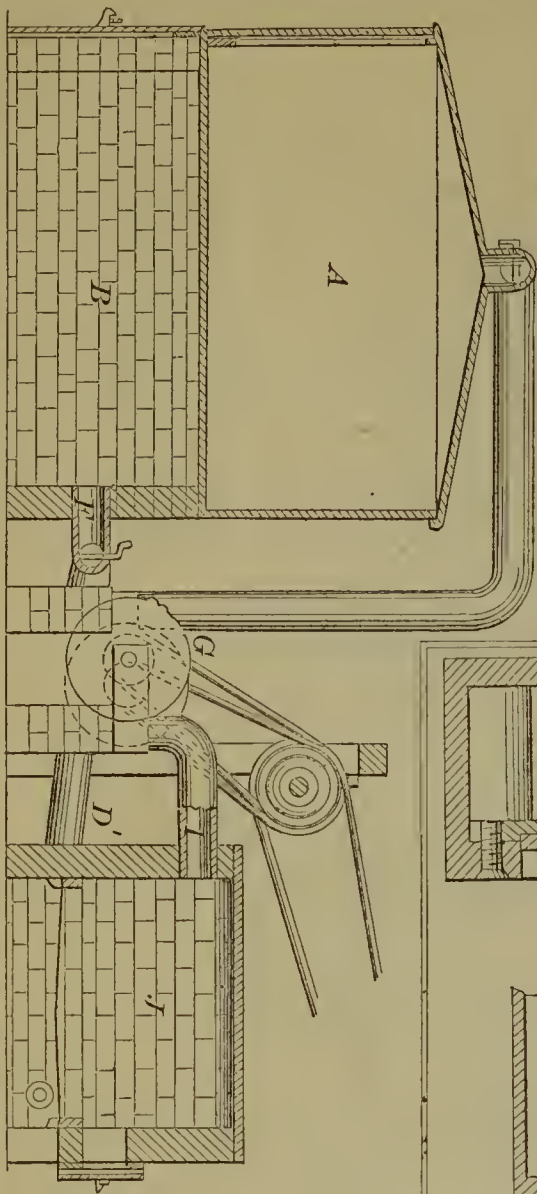

52867—D. Lyman—Clothes Wringer.

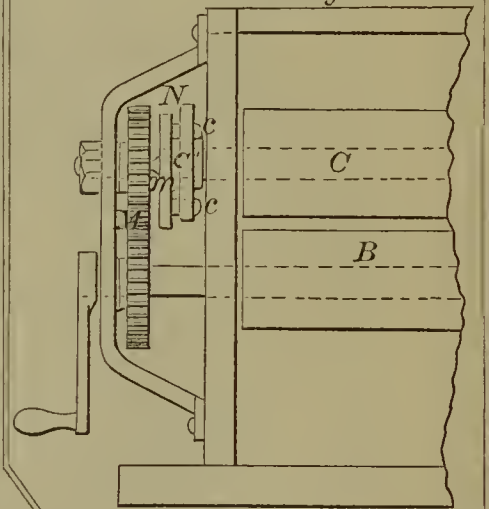

52868—V. H. Lyon—Device for Boring Wells.

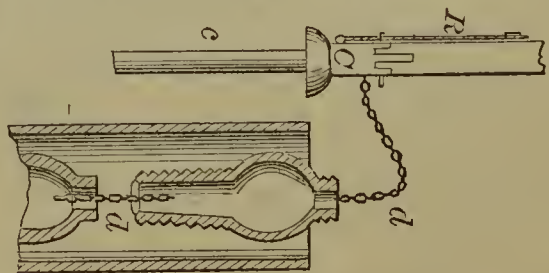
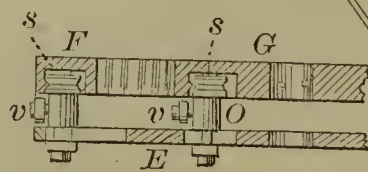
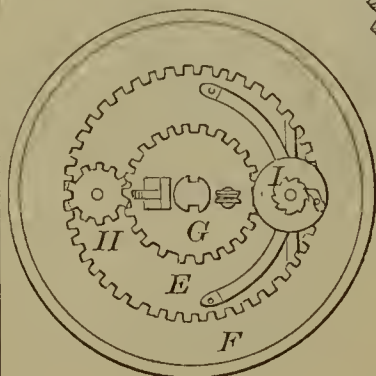
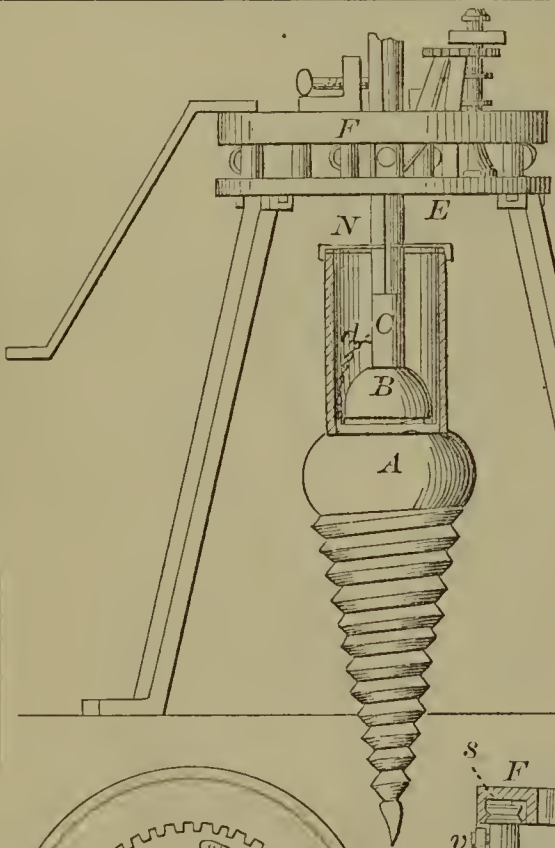

52866—J. H. Luther—Oil Well Tube Extractor.

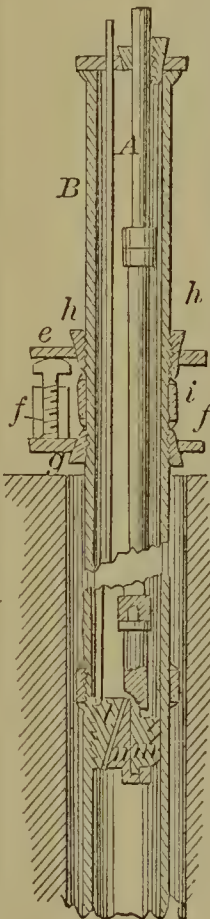

52870—J. S. McCurdy—Guide for Sewing Machines.

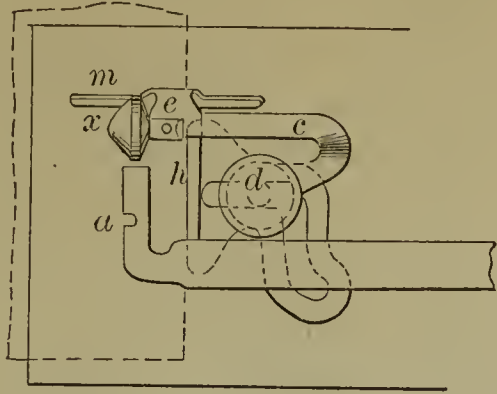

52873—J. Miller—Street Sweeping Machine.

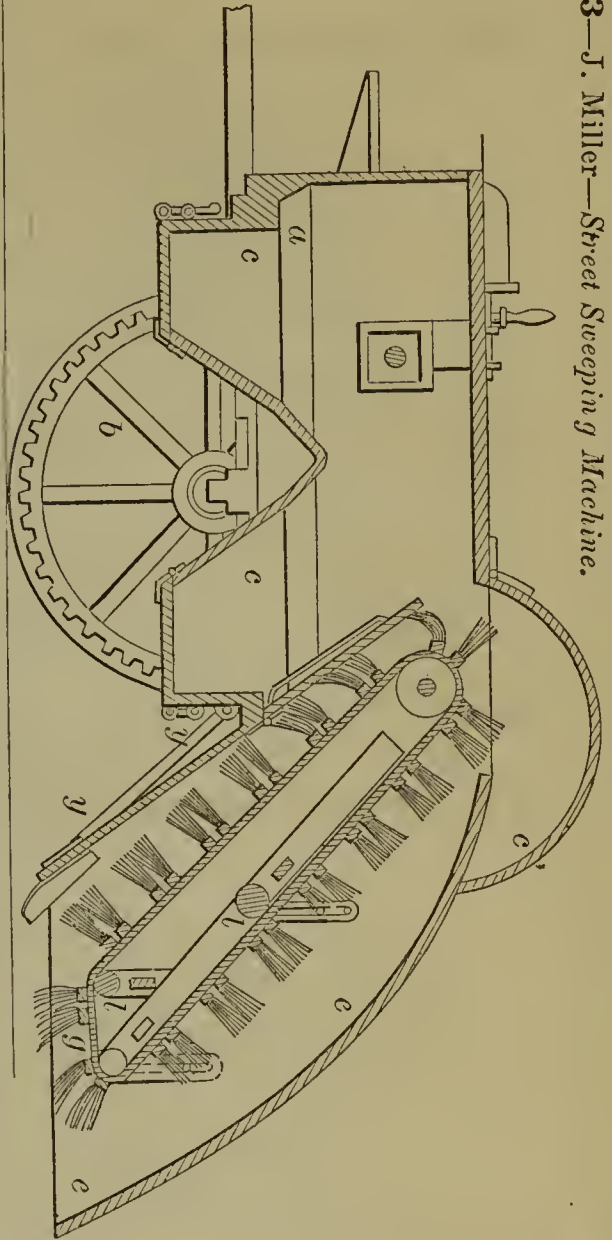

52871—J. E. Merritt—For Rolling up Leather.

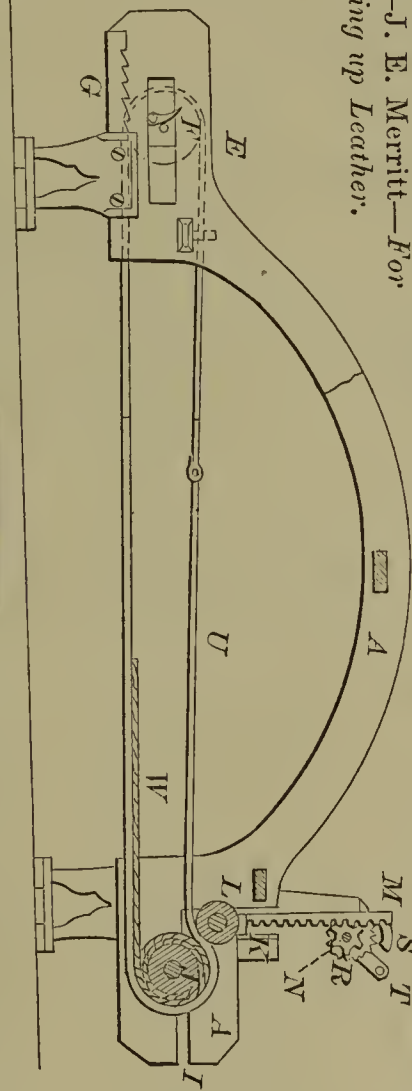

52872—W. W. Midrum—Toy Engine and Whistle.

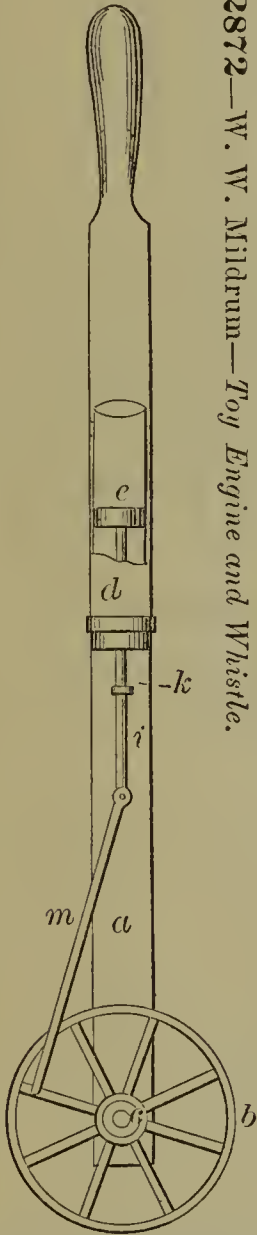

52874—G. Milsom—Tackle Block.

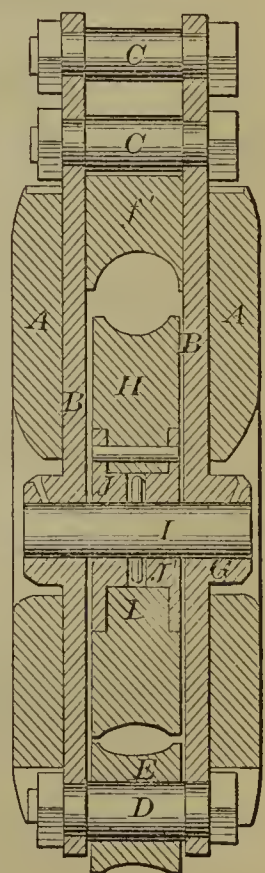

52875—D. Minthorn—Desulphurizing and Disintegrating Ores.

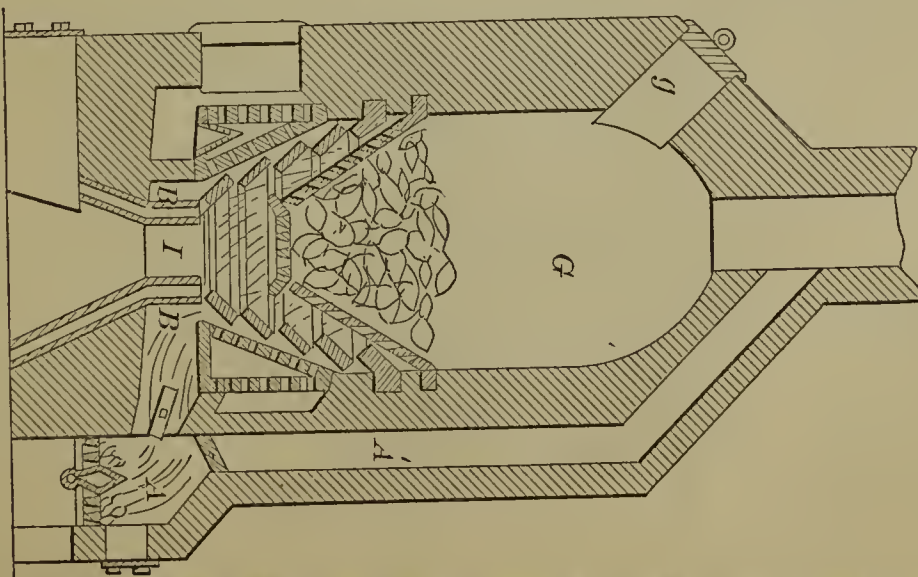

52877—C. W. & O. G. Newton—Treating Flax, Cotton, &c.

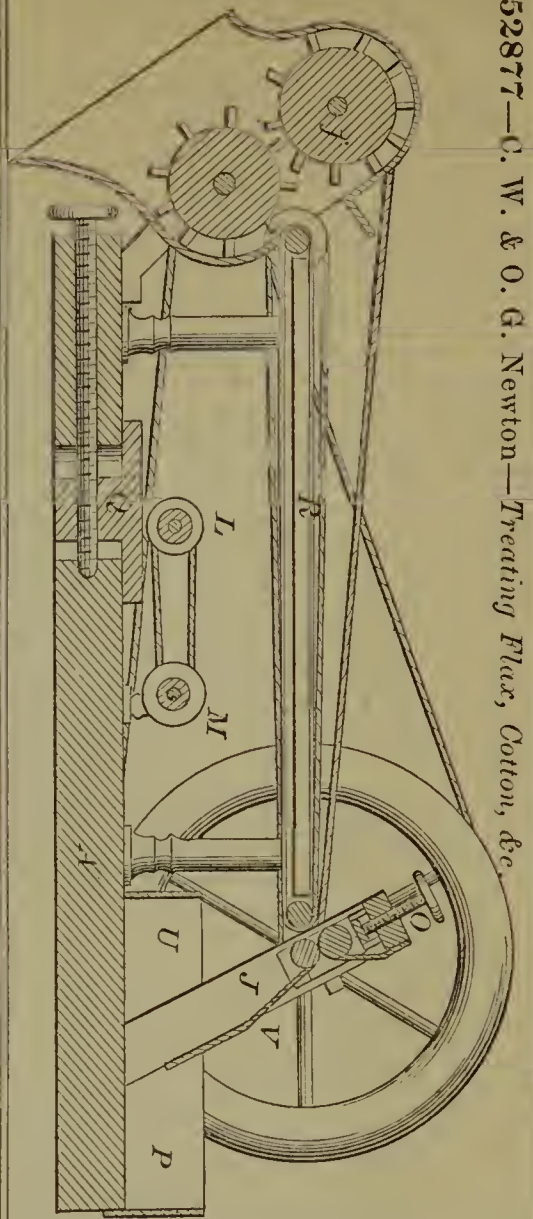

52876—H. B. Myer—For Charging Air with Hydro-Carbon.

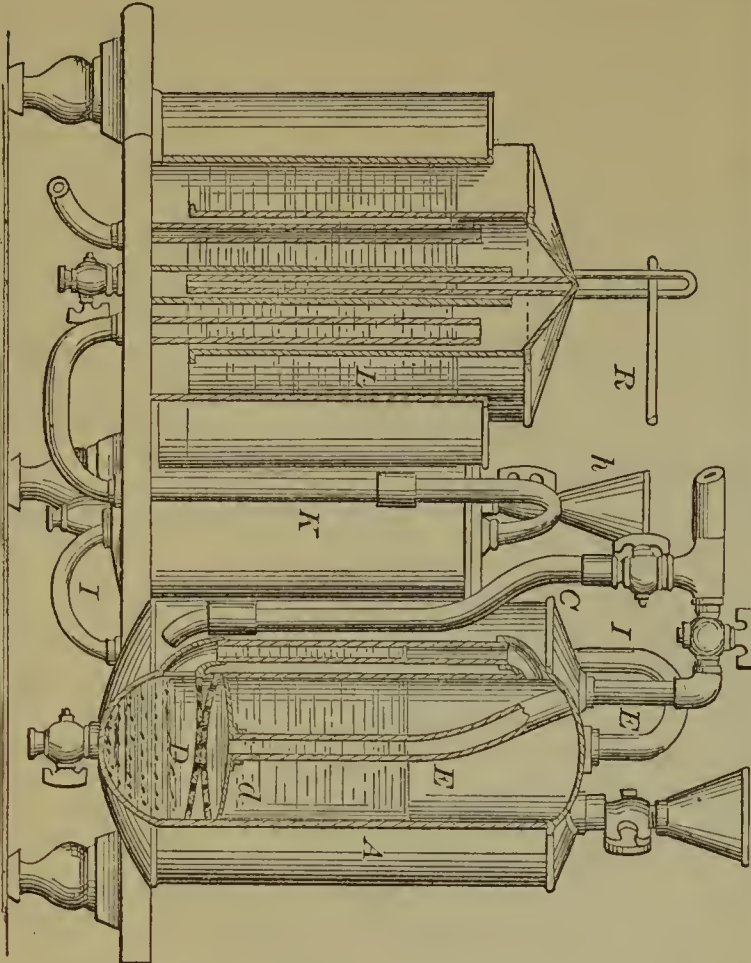

52879—C. Perley—Bedstead.

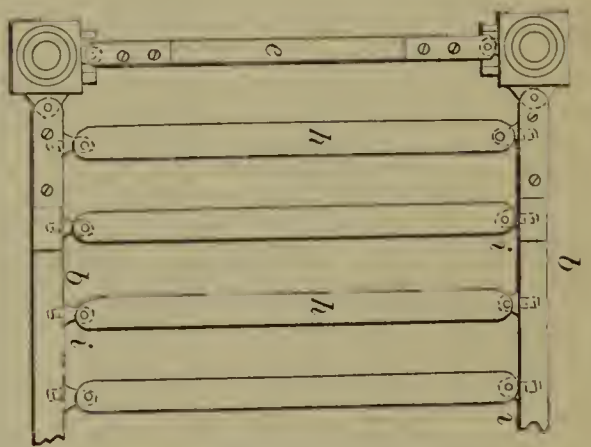

52880—W. E. Prall—For Picking Cotton.

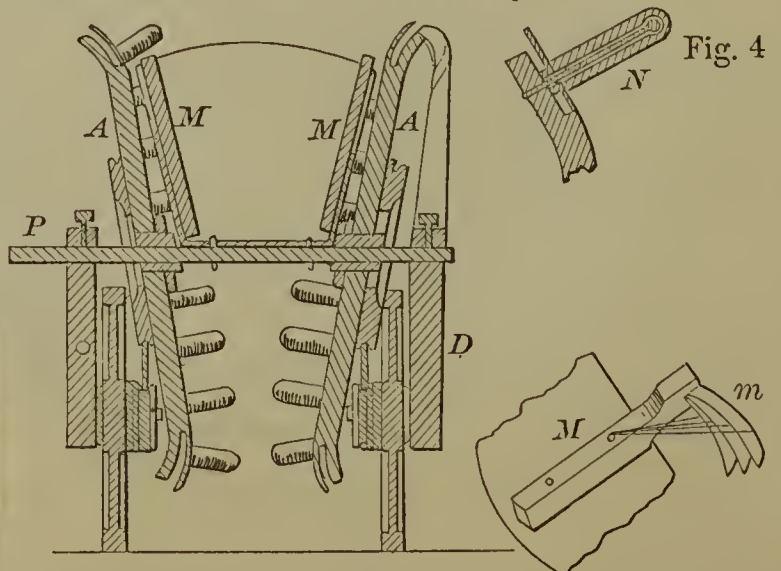

52881—Read & Wyckoff—Sewing Machine Shuttle.

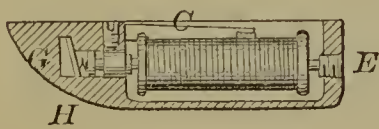

52882—R. Redfield—Cleaning Grain.

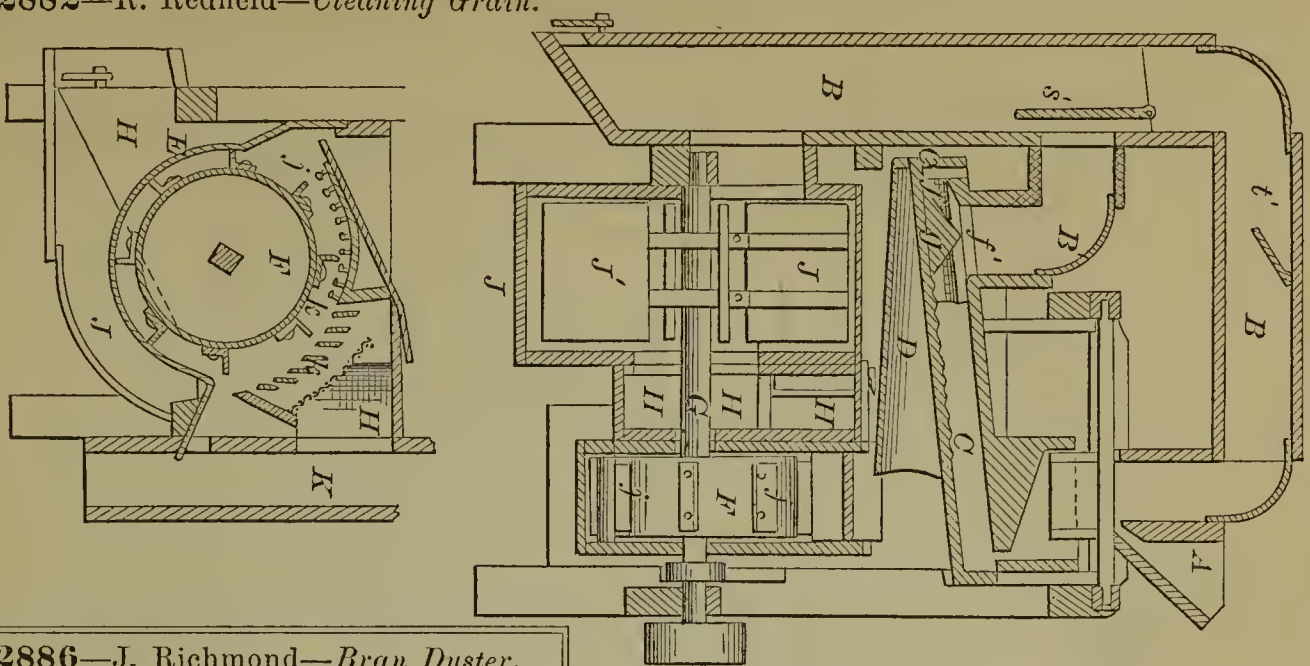

52886—J. Richmond—Bran Duster.

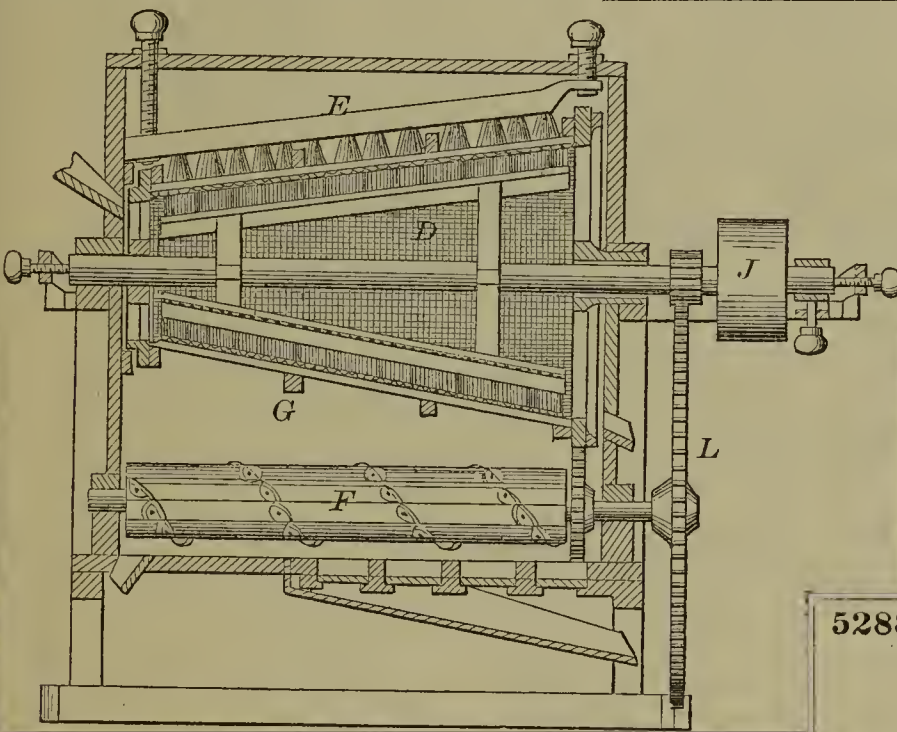

52883—T. K. Reed—Dressing Heel Face of Boots and Shoes.

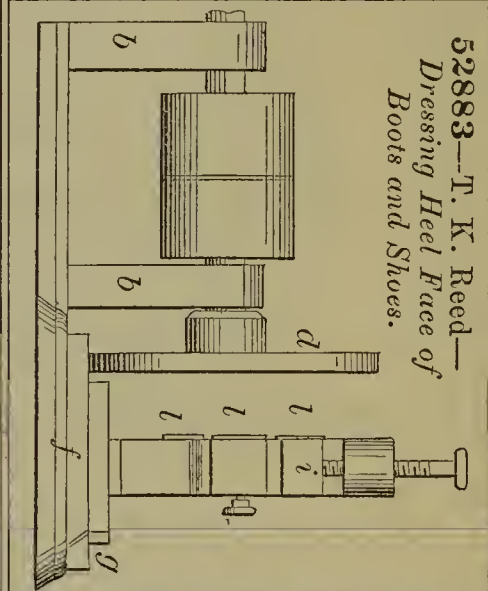

52884—G. Reh fuss—For Securing Buttons to Fabrics.

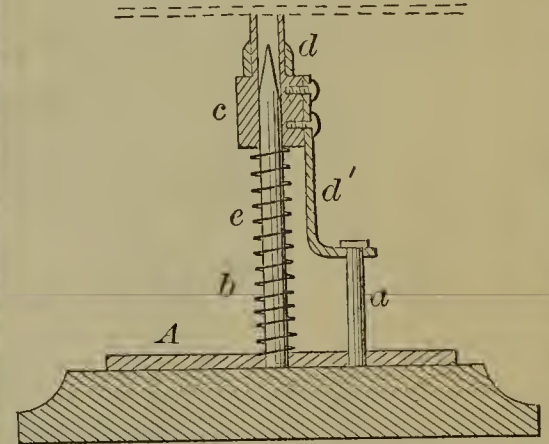

52885—G. Reh fuss—For Securing Buttons to Fabrics.

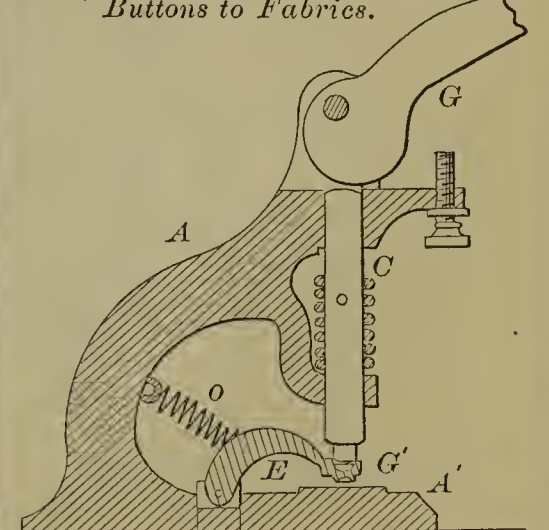

52887—B. S. Roberts—Breech-Loading Fire Arm.

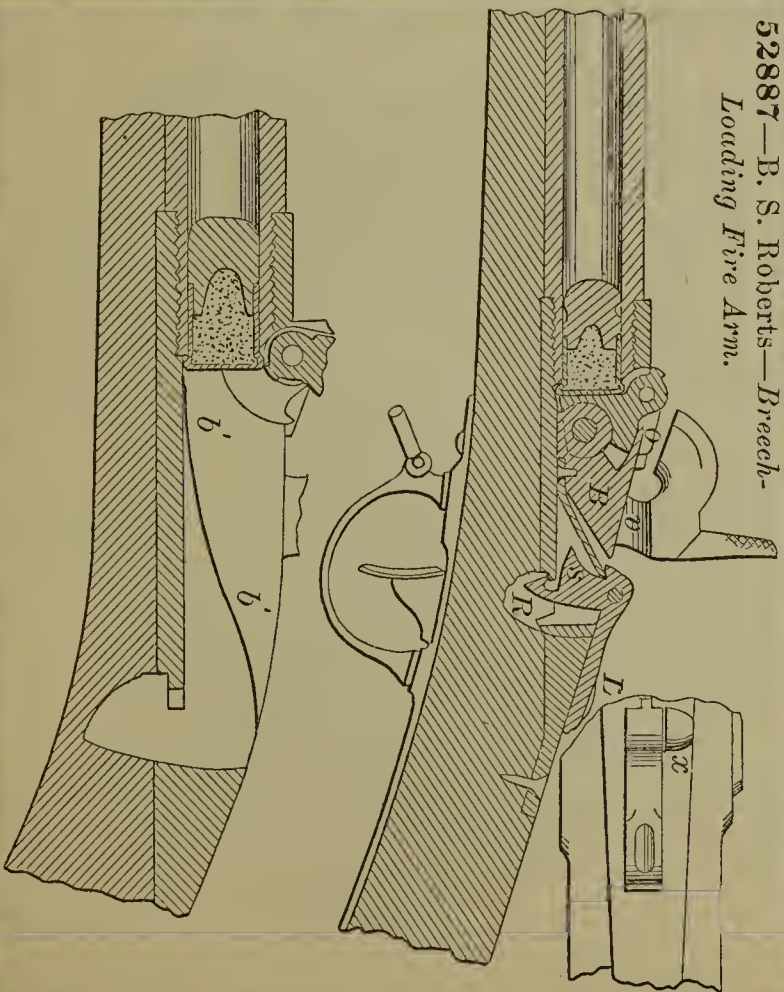

52888—M. Rosenthal—*Shirt Bosom Pattern.*

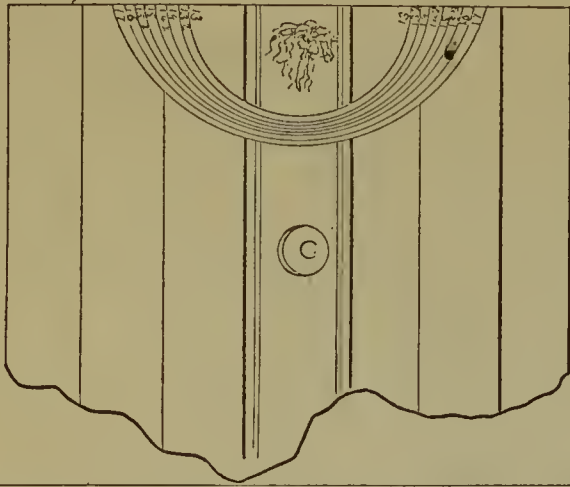

52893—W. D. Seal—*Manufacture of Gas.*

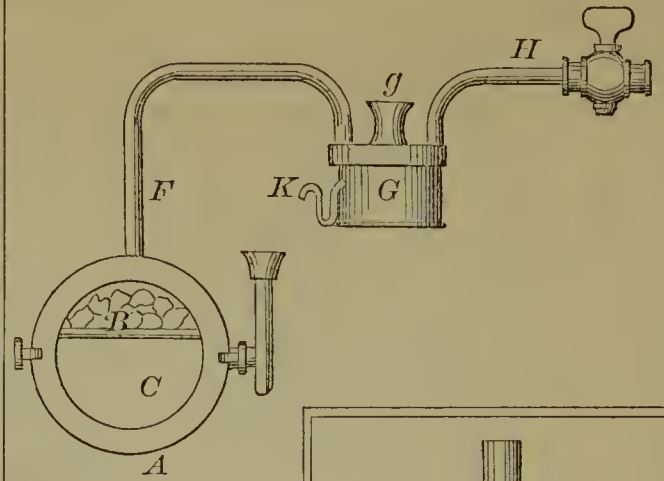

52892—D. Schuyler—*Organ.*

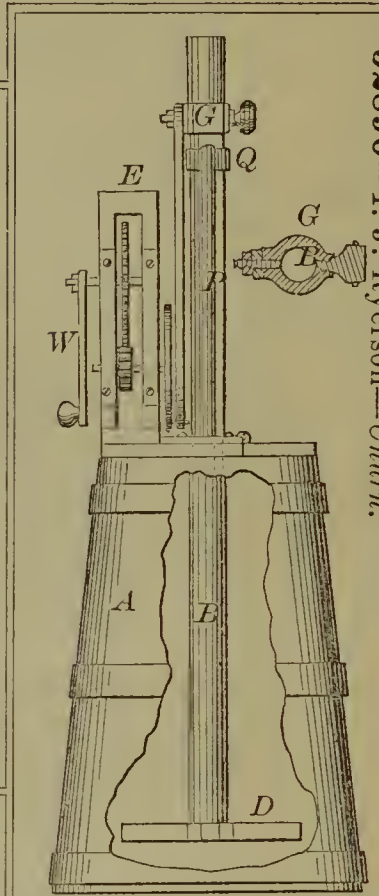
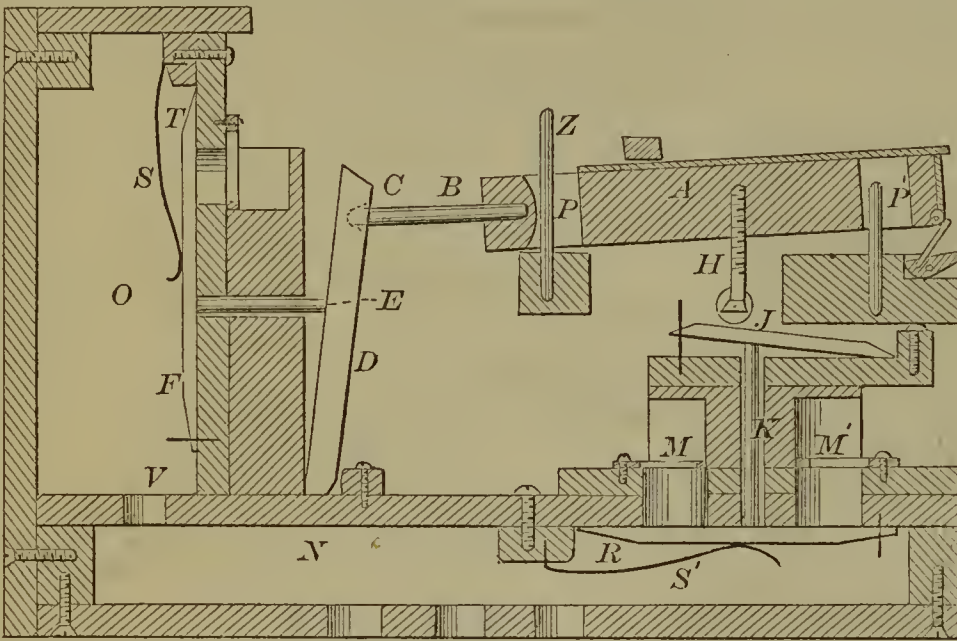

52890—I. J. Ryerson—*Churn.*

52889—Rowell & Briggs—*For Holding Carriage Springs.*

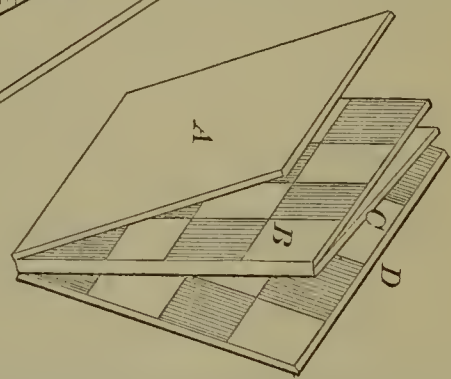
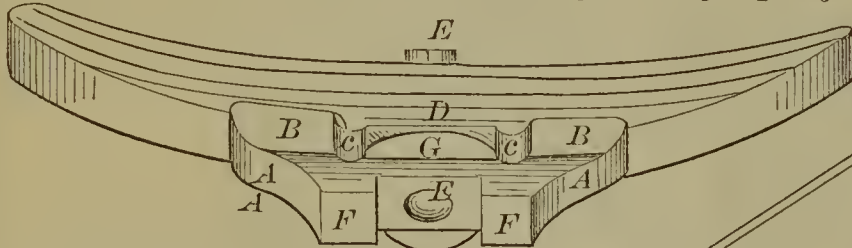

52891—F. C. Schaefer—*Chess Board.*

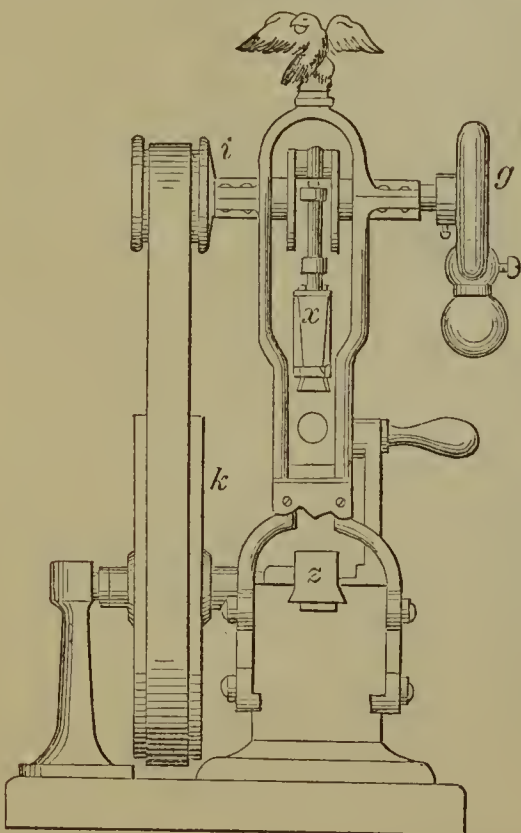

52894—T. Shaw—*Power Hammer.*

52895—Shedlock, Shedlock & Marshall  
*Stop Valve.*

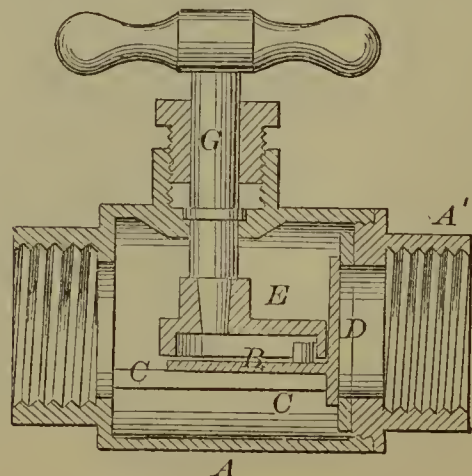



52896—D. Shive—*Photographic Printing Frame.*

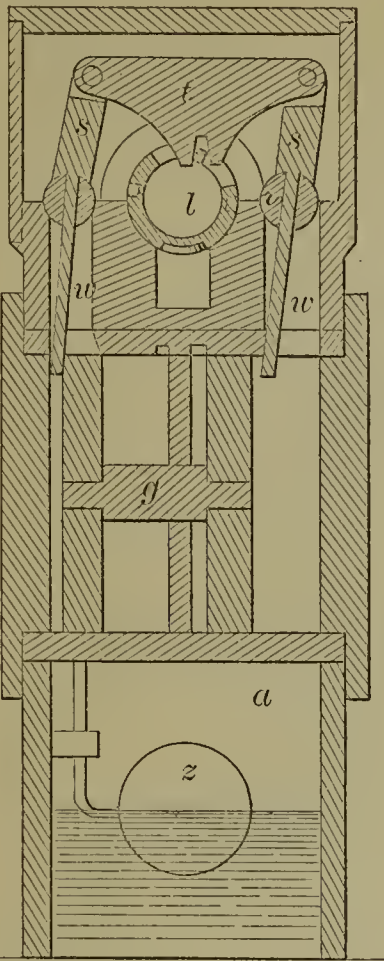

52898—T. J. Sloan—*Automatic Boiler Feeder.*

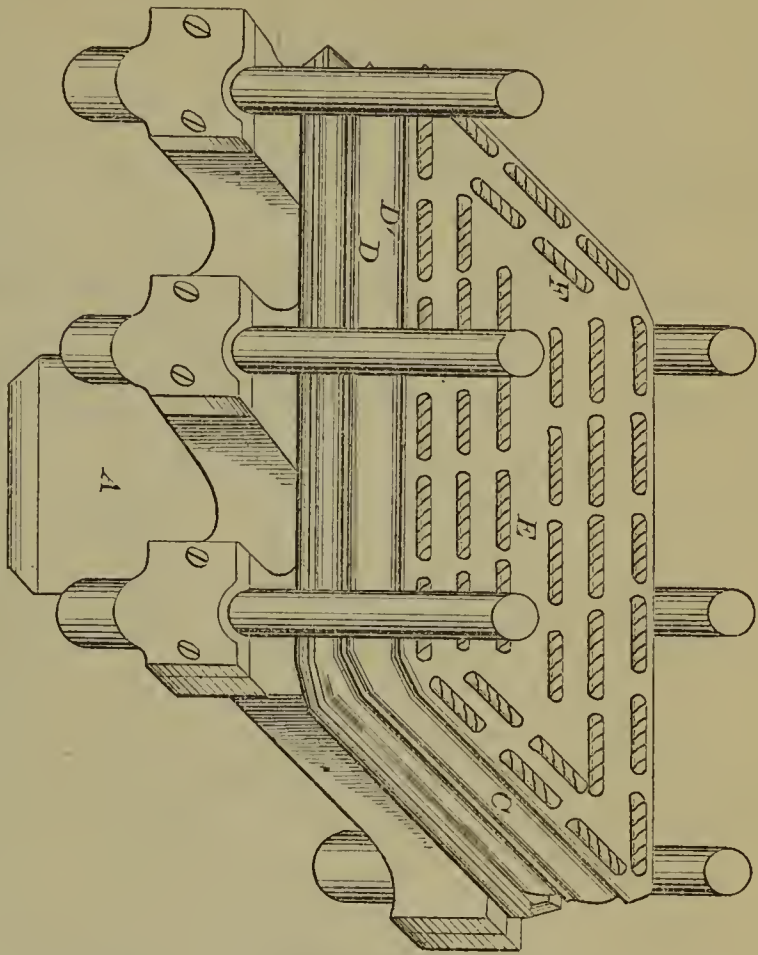

52899—A. Smith—*Press Plate.*

52900—F. Smith—*Lathe.*

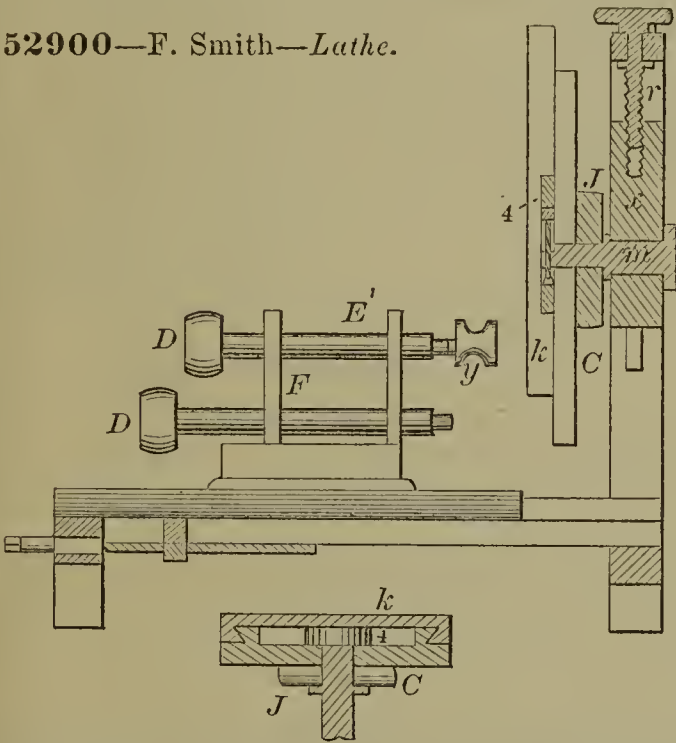

52901—H. L. Smith—*Microscope.*

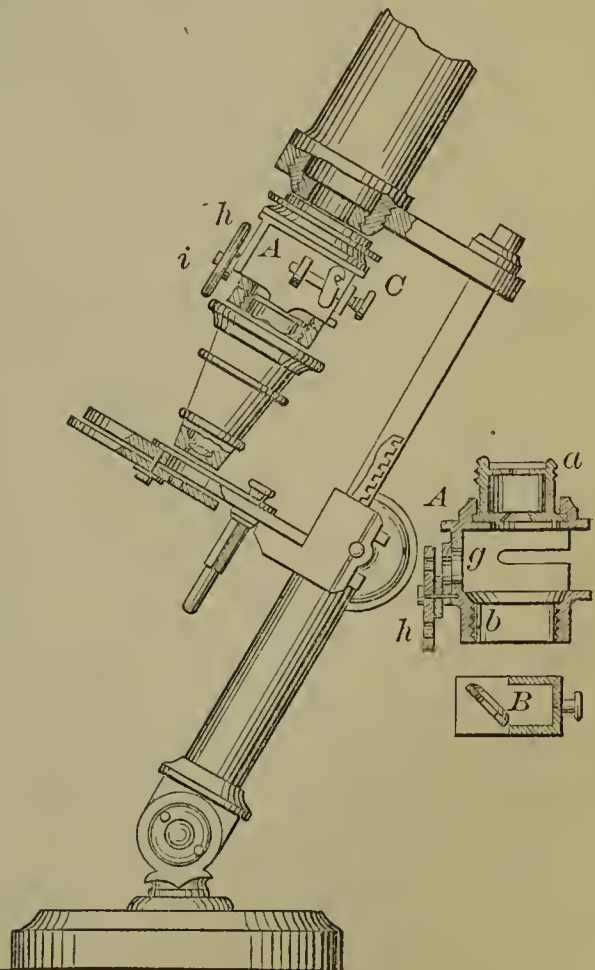

52902—Sonnekalb & Lieb—*Carpet Bag.*

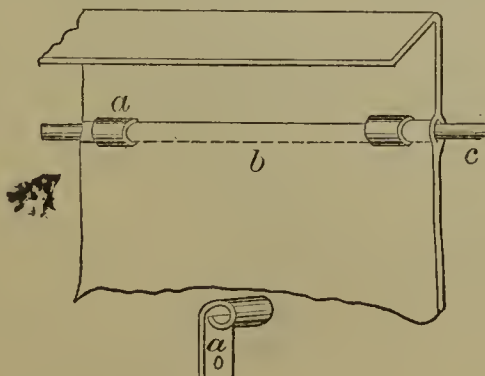

52903—T. A. Stansbury—Plow.

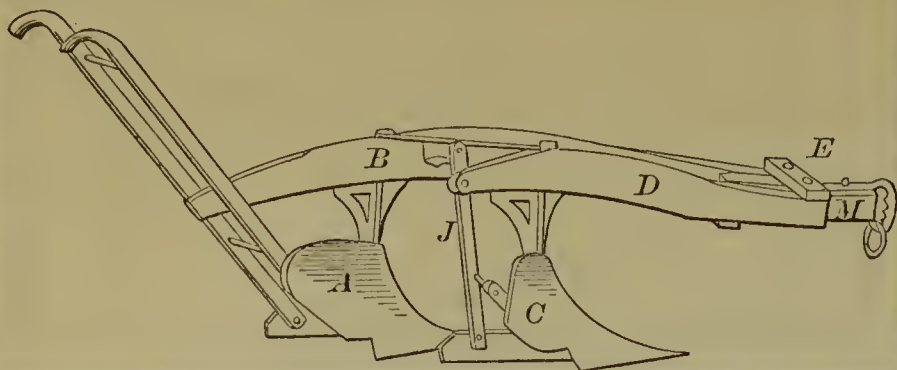

52910—T. C. Taylor—Putting up Caustic Alkali.

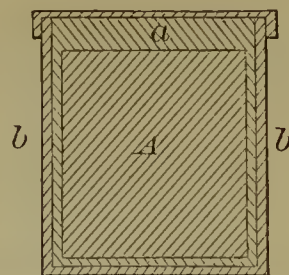

52904—E. H. Stearns—Head Block for Saw Mills.

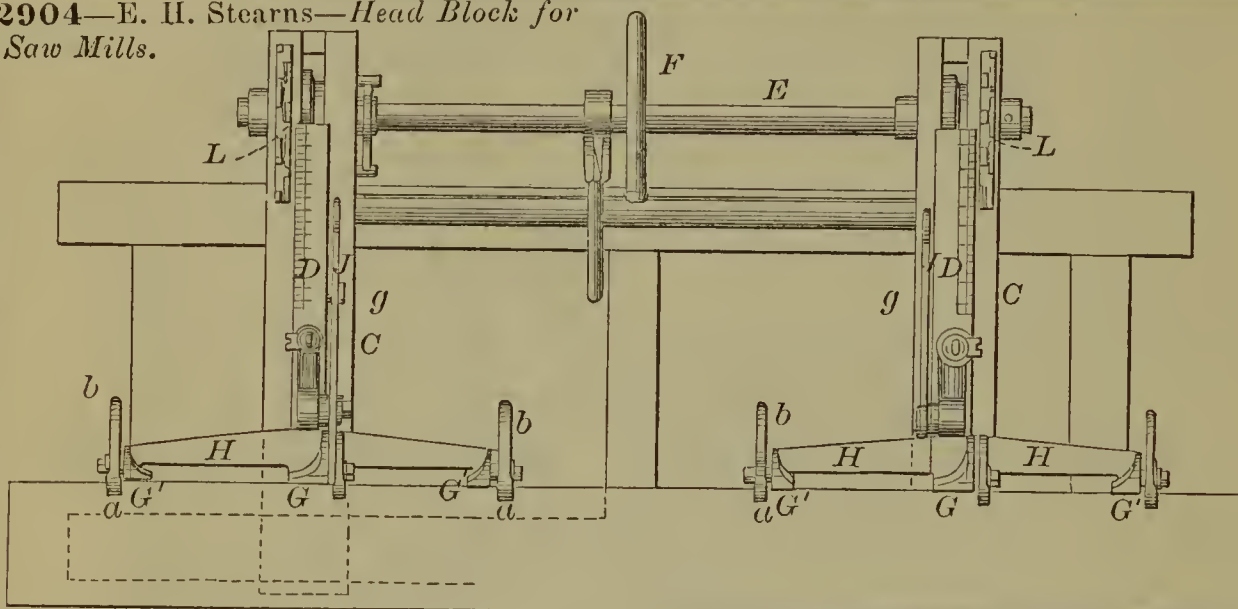

52905—A. J. Stover—Cultivator.

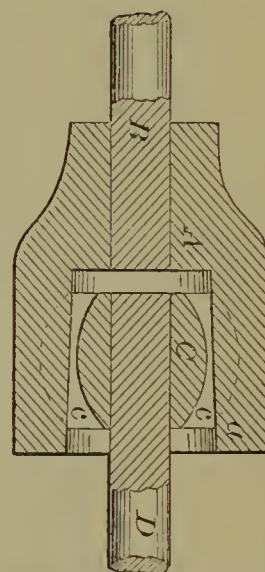
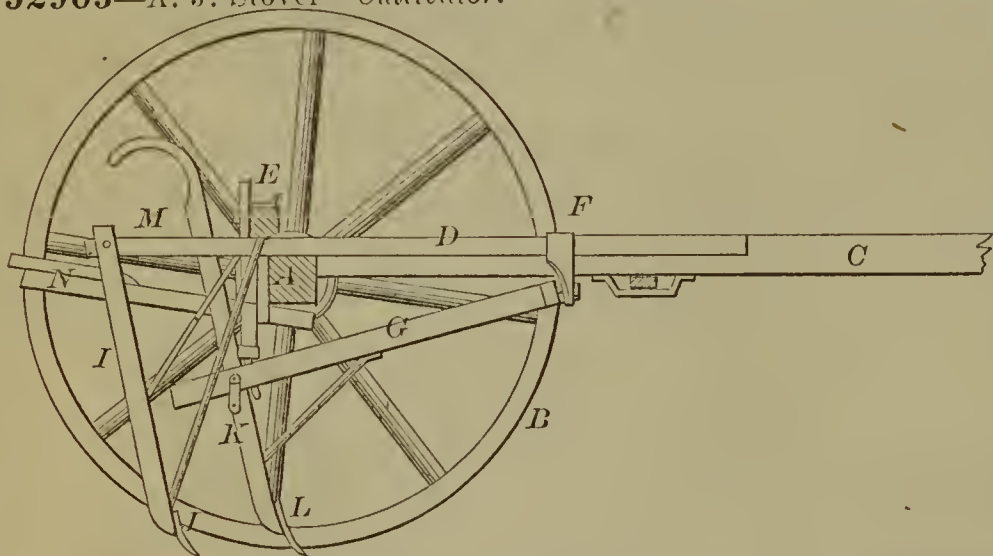

52908—S. N. Taylor—Knuckle Joint.

52907—C. C. Taylor—Paper Shirt Bosom.

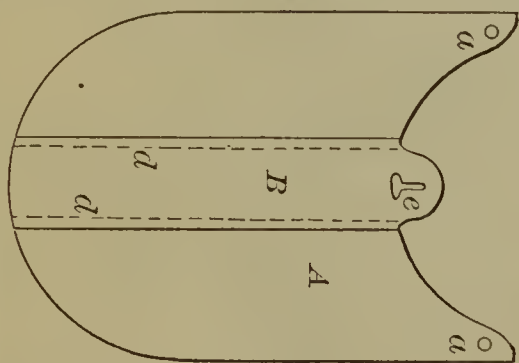

52911—C. H. Thatford—Baking Press.

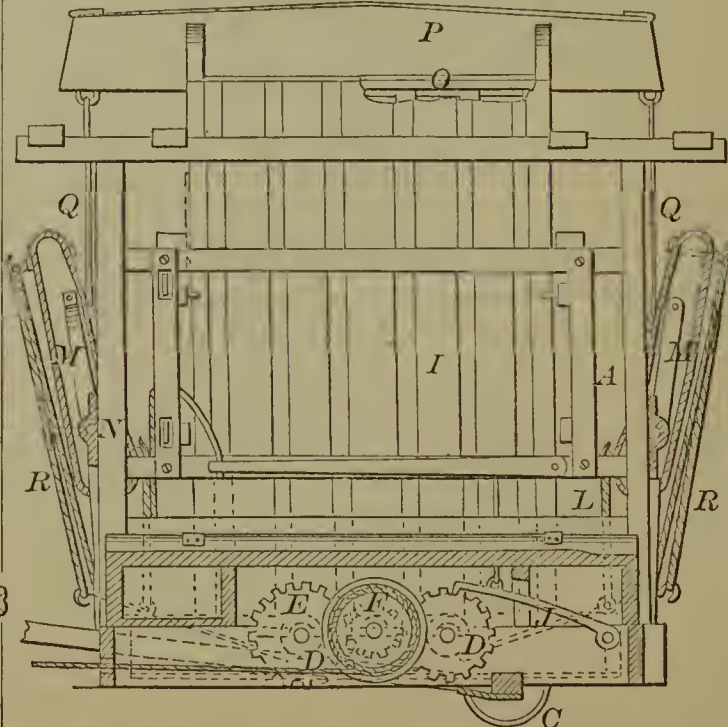

52909—T. C. Taylor—Air-tight Vessel.

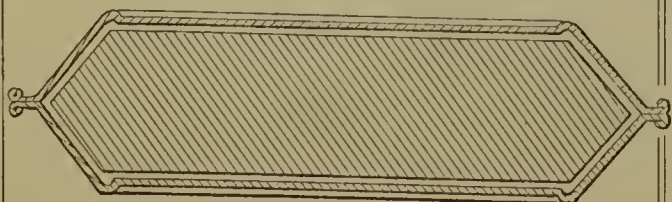

52912—A. Tucker—Bolt Heading Machine.

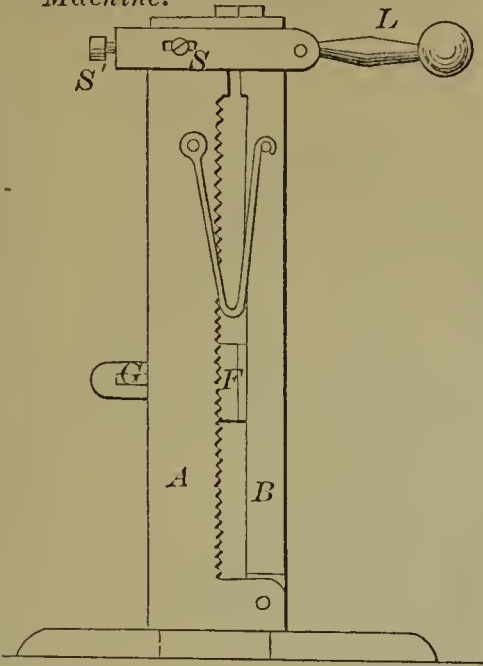

52915—L. Von Froben—For Levelling Streets.

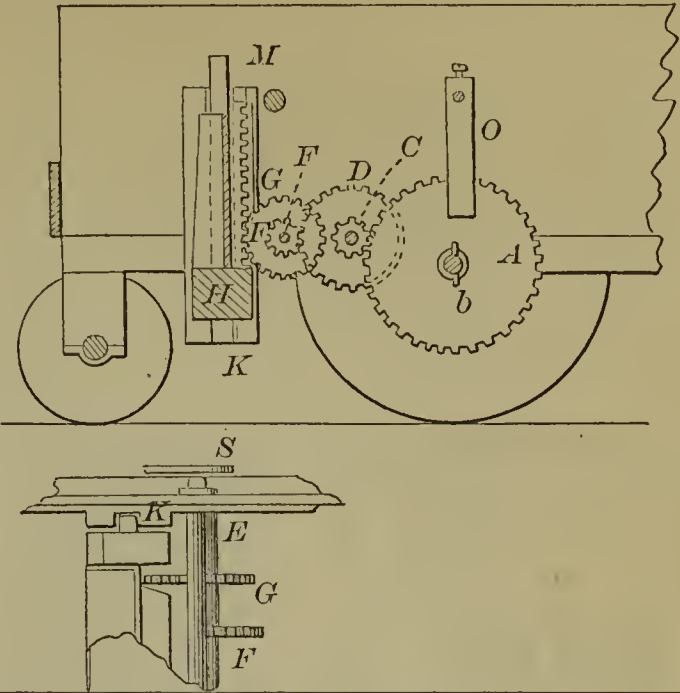

52916—E. Ward—Attaching Runners to Wheels of Wagons.

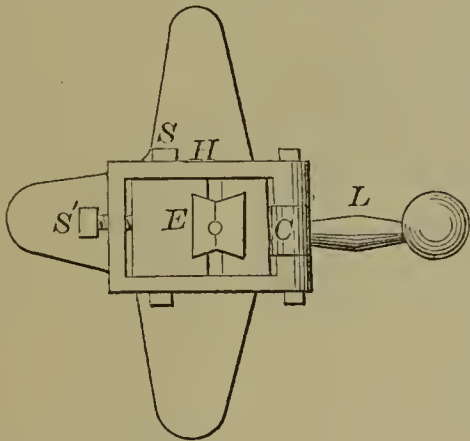
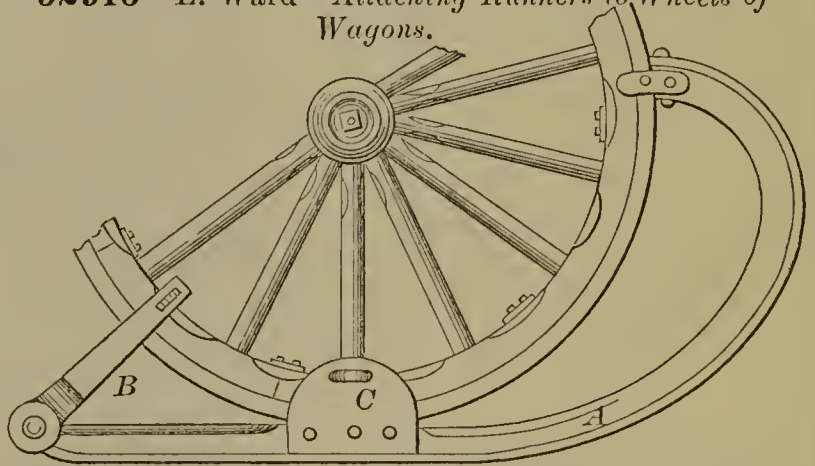

52913—L. B. Tupper—Grate Bar.

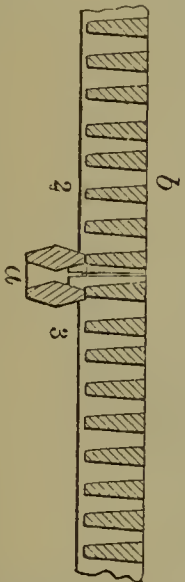

52918—M. J. West—Marking Attachment for Sewing Machines.

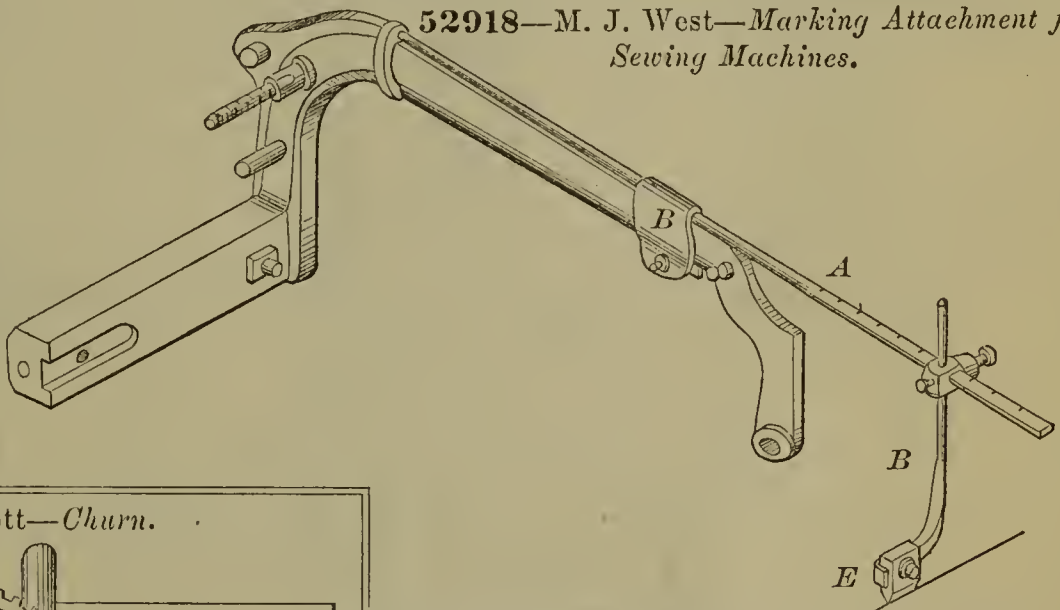

52919—A. Westcott—Churn.

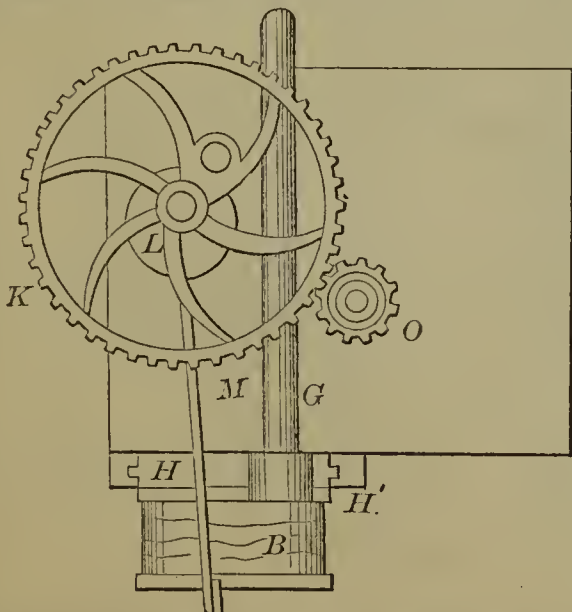

52914—G. Z. & W. A. Van Riper—Basket.

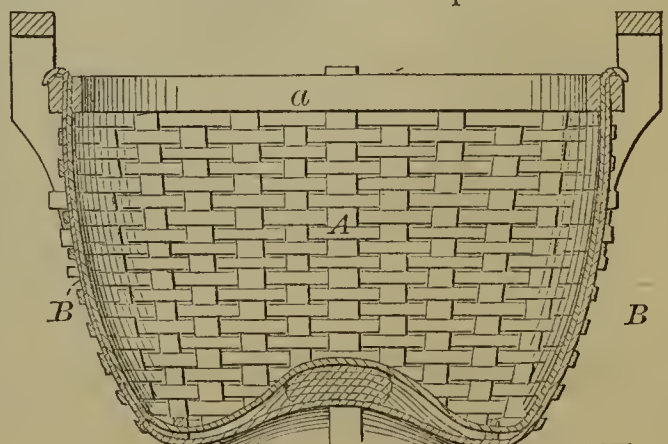

52921—A. Whittemore—Vaccinator.

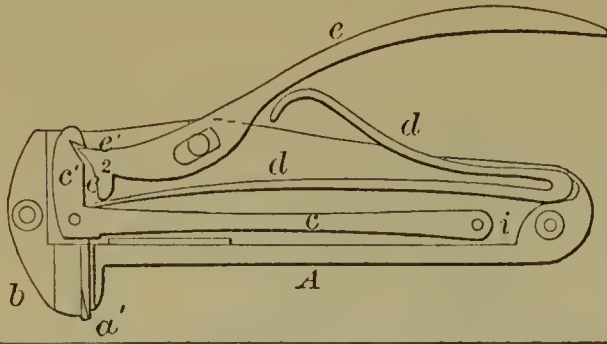

52924—J. C. Young—Crupper Loop for Saddle Trees.

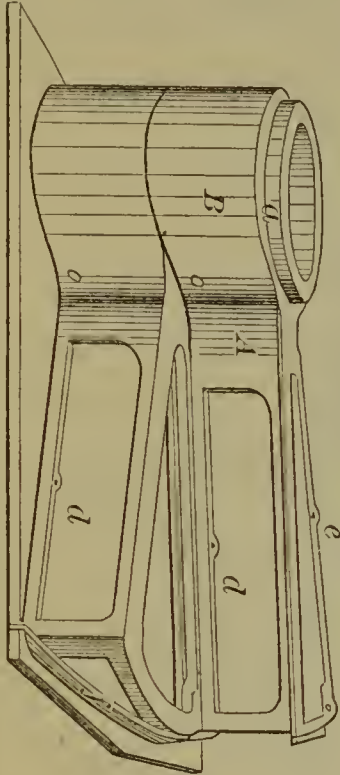
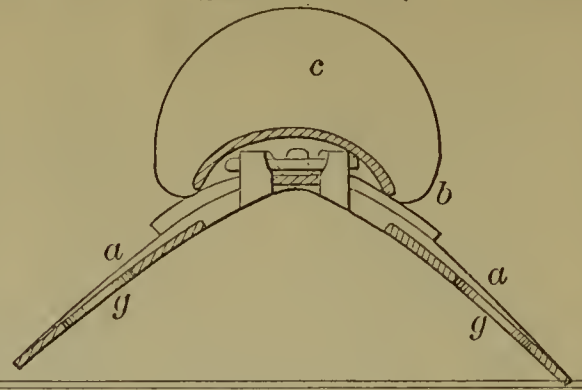

52922—W. Widmayer—Spiral Stair.

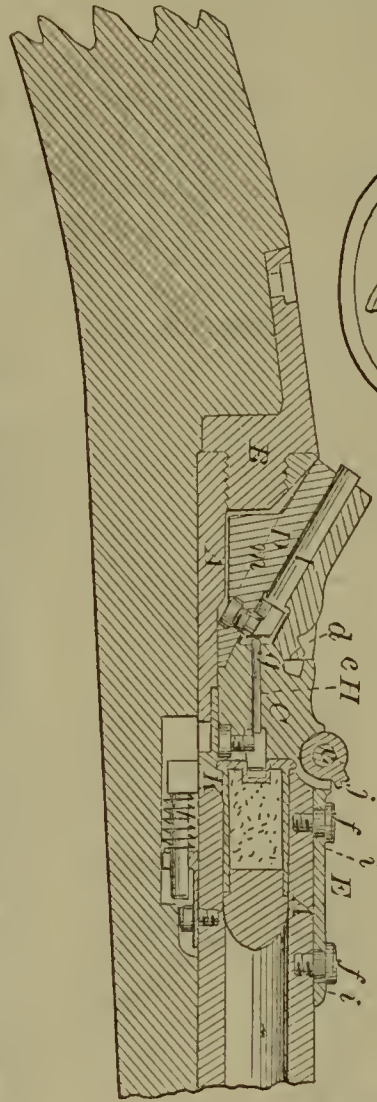
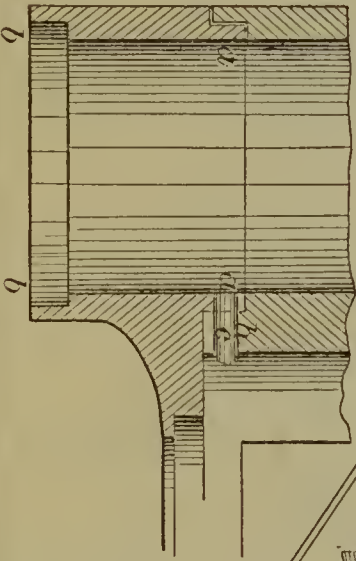

52925—

H. Berdan—Breech-Loading Fire Arm.

52926—E. Bueklin Jr—For Cutting Files.

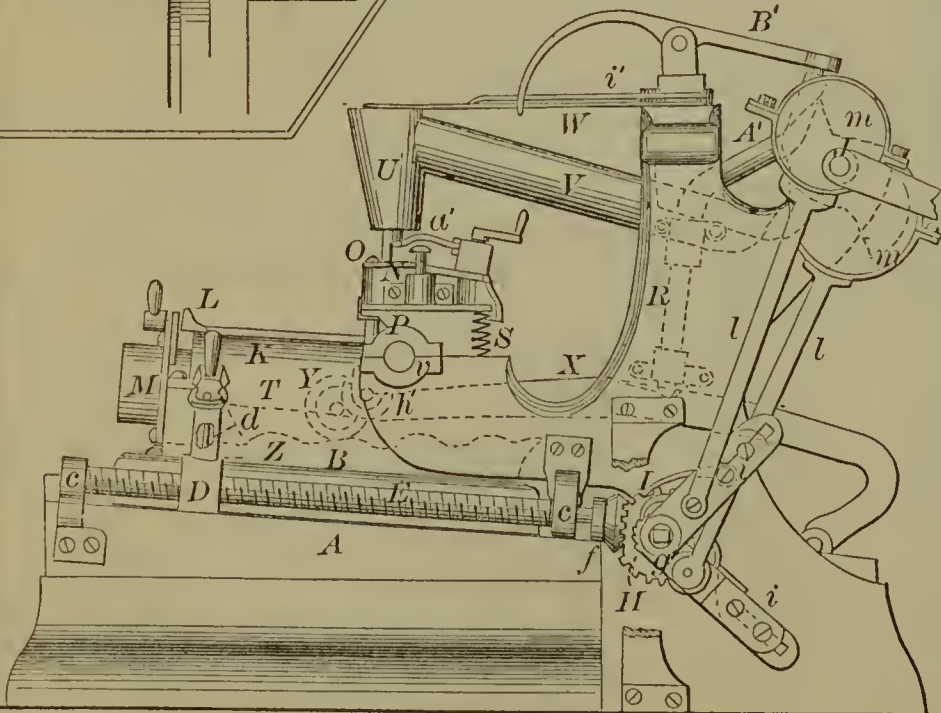

52923—E. S. Woodford—Ox Bow Pin.

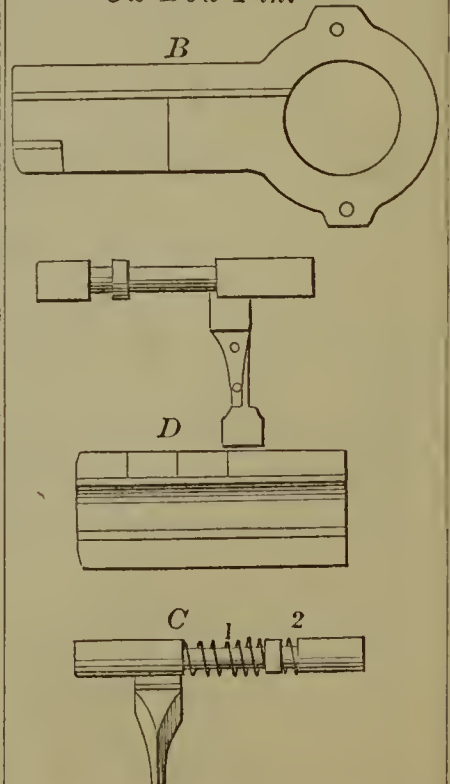

52927—O. H. Burdick—Harvester.

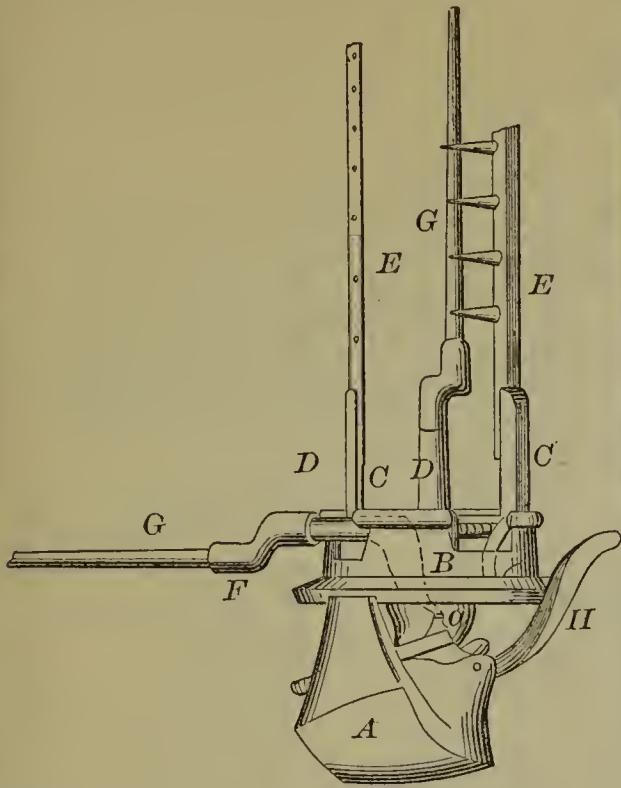

52929—E. Duffee—Gas Retort.

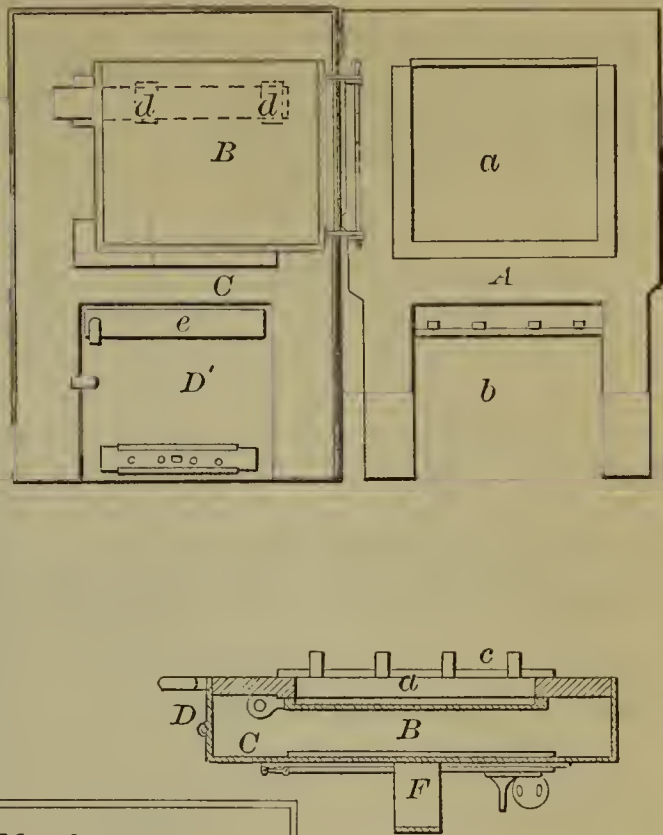

52928—V. Fogerty—Lemon Squeezer.

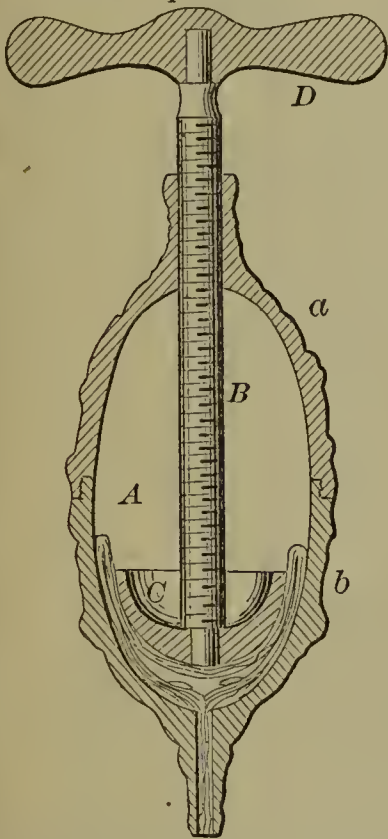

52930—W. Morehouse—Wrench.

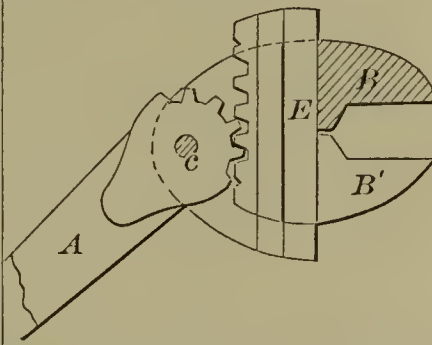

52933—J. D. Smith—Magazine Fire Arm.

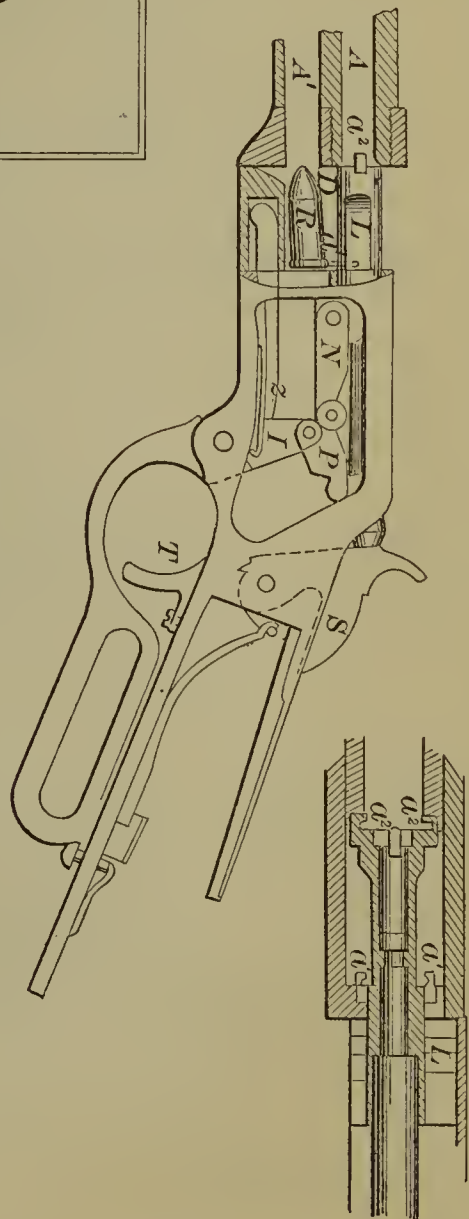

52931—M. V. Nobles—Sinking Tubular Wells.

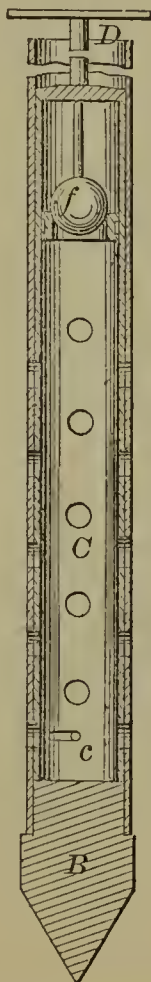

52932—G. Rehfuess—Sewing Machine Feed Adjuster.

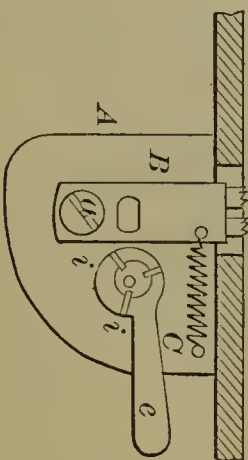

52934—J. D. Smith—Magazine Fire Arm.

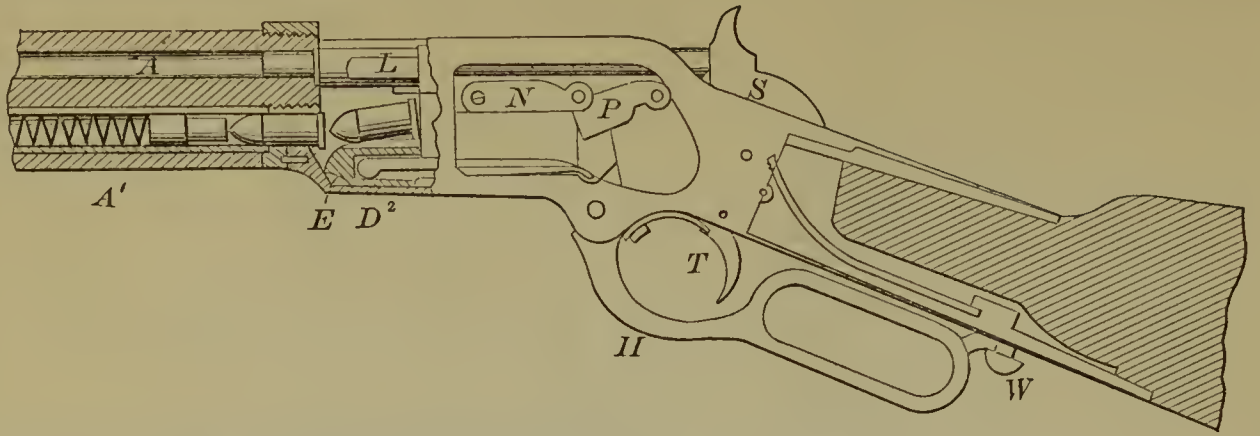

52935—W. E. Staniford—Clothes Sprinkler.

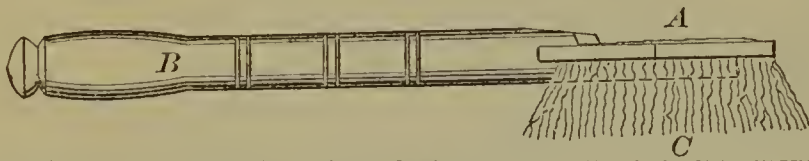

52936—J. Taggart—Braid Machine.

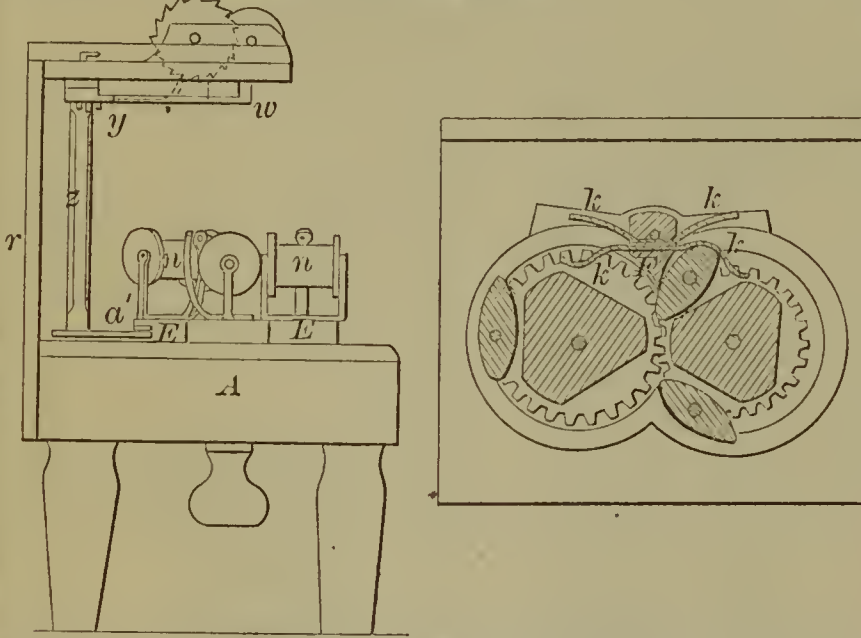

52937—N. J. Willis—Spring Bed Bottom.

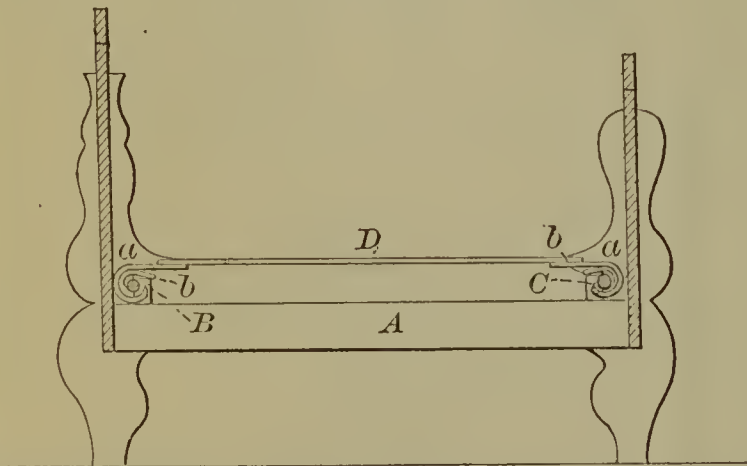

52938—J. F. C. Carle—Breech-Loading Fire Arm.

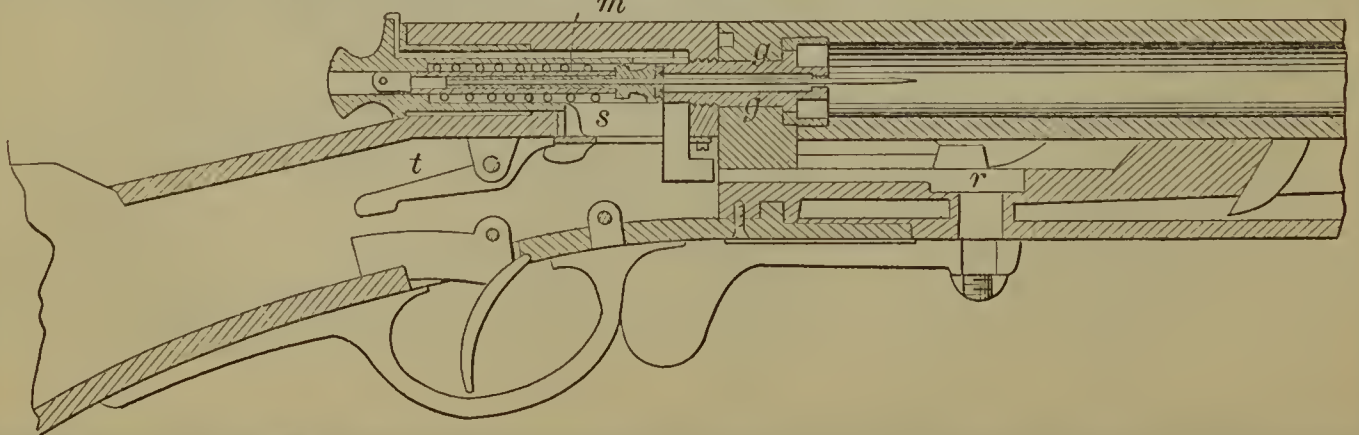

52939—P. Coombes—For Separating Whey from Curd.

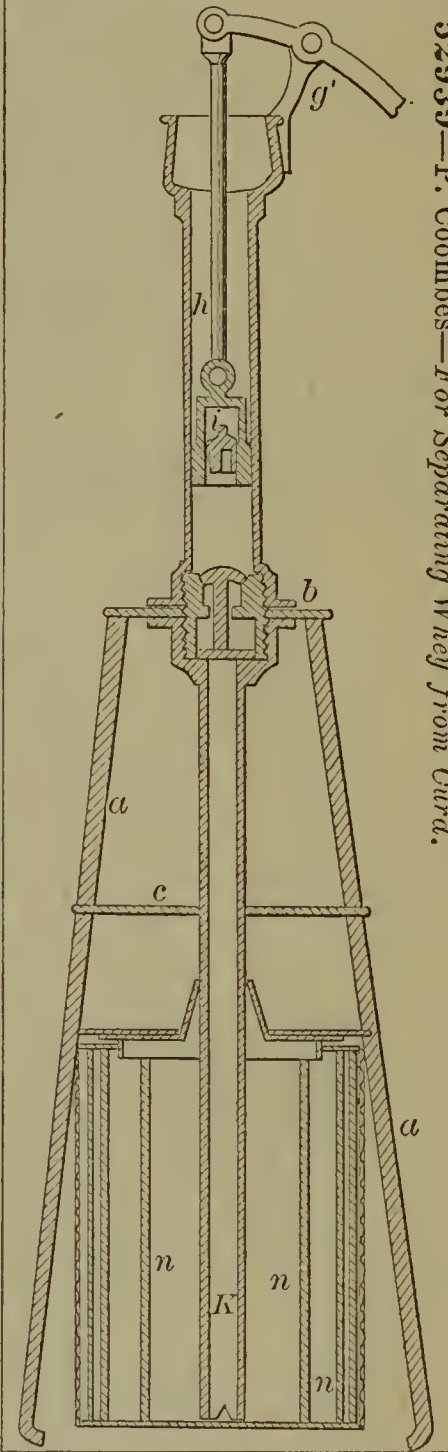

52941—Easton & Thiry—For Manufacturing Paper Pulp.

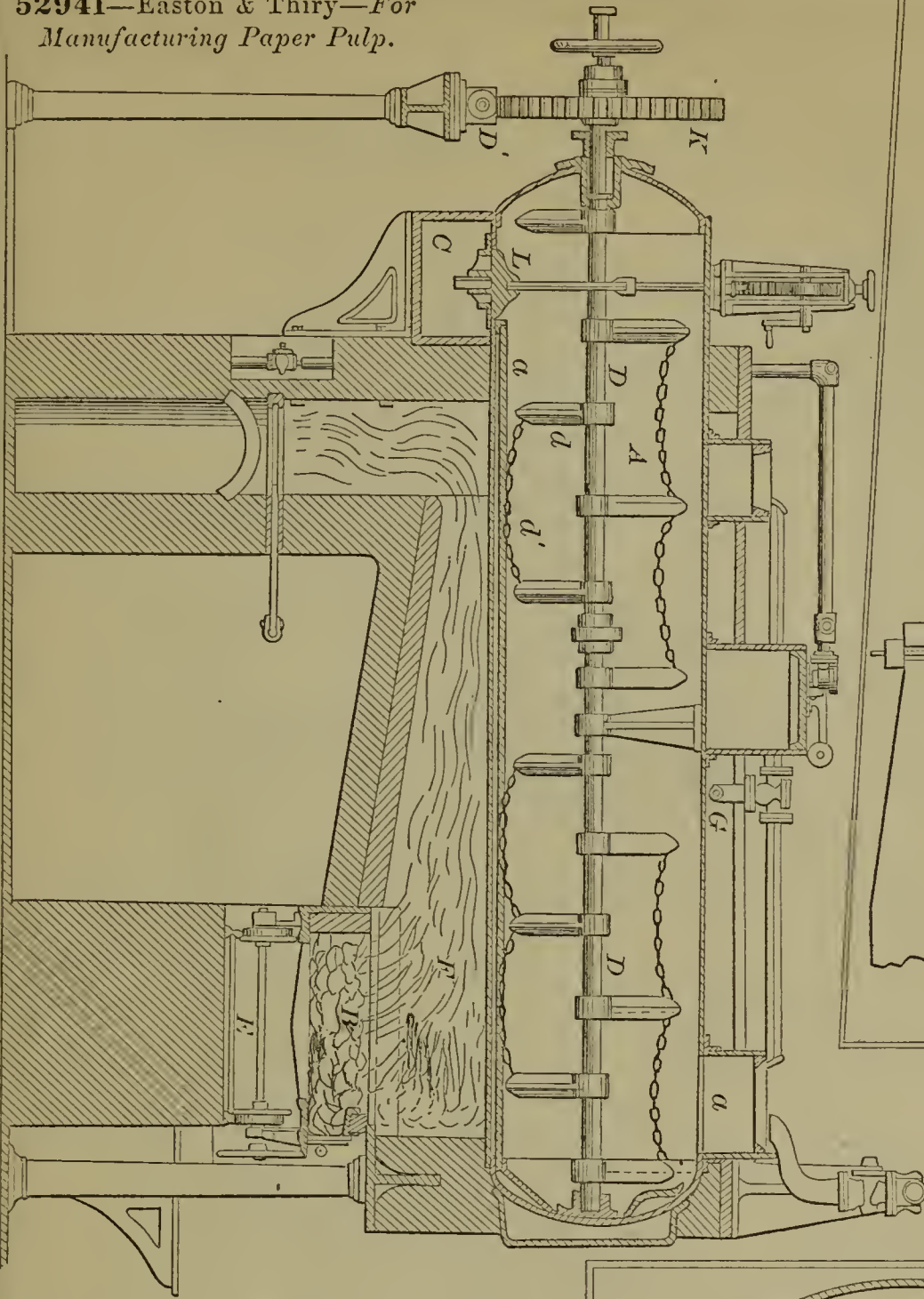

52940—W. Dawes—Organ, &c.

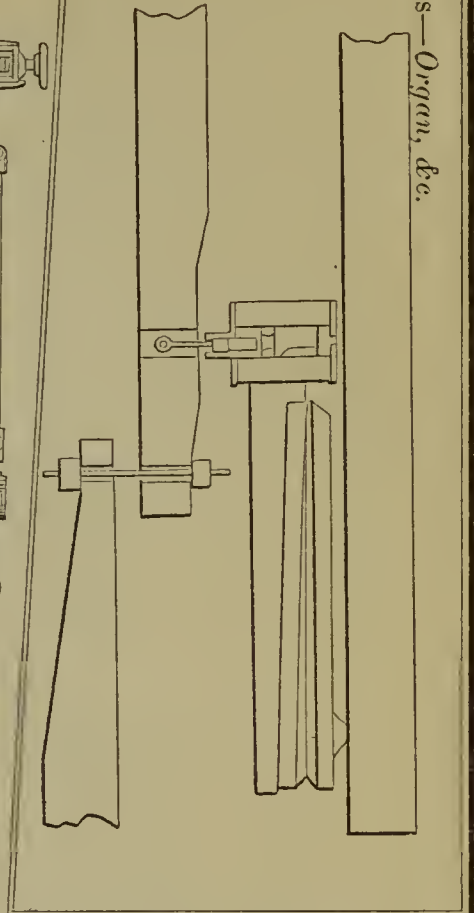

52945—C. F. Jauriet—Fire Box of Steam Generators.

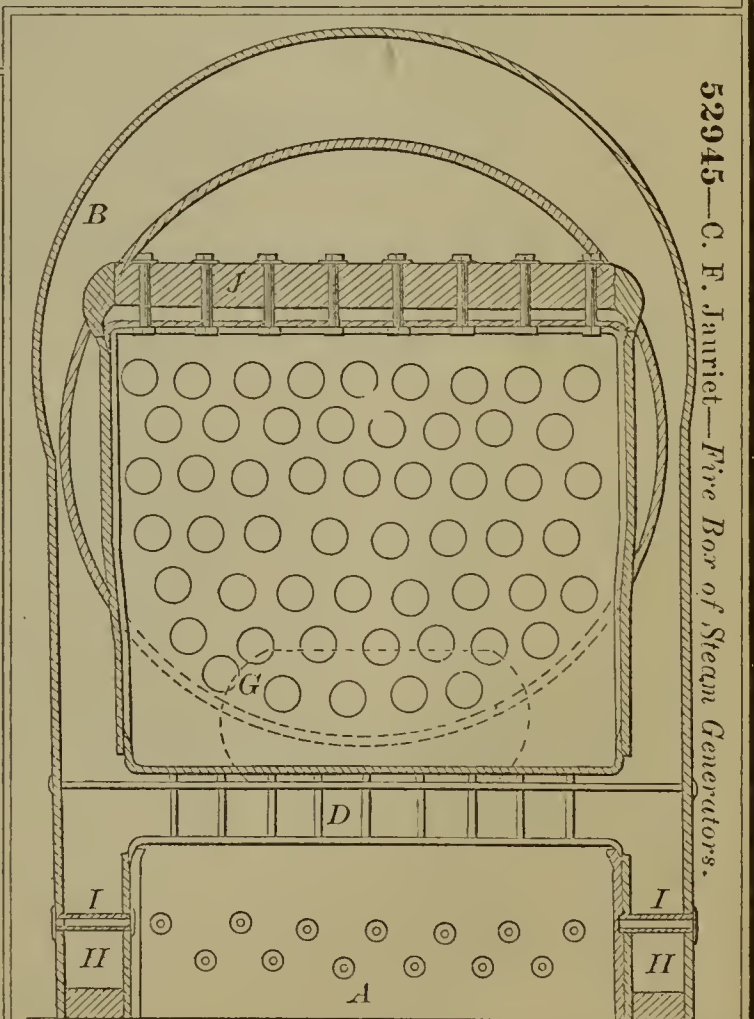

52944—E. C. Harris—Wood Bending Machine.

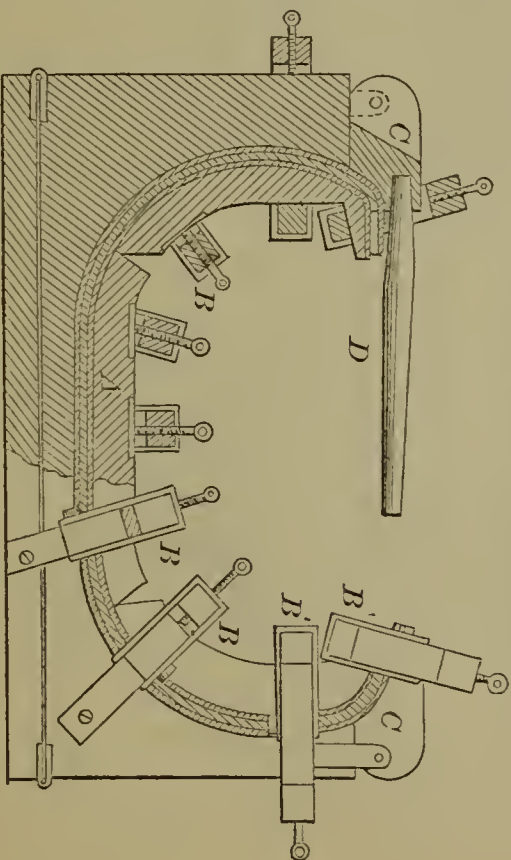

52946—S. N. Chamberlin—*For Generating Gas for Illuminating.*

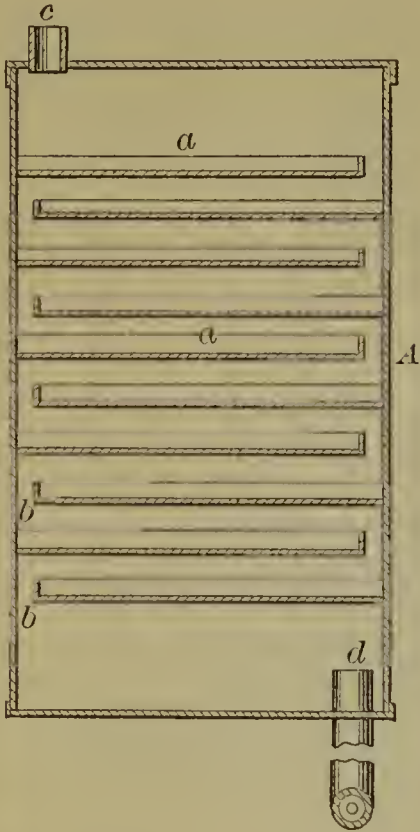

52948—R. L. Allen—*Plow.*

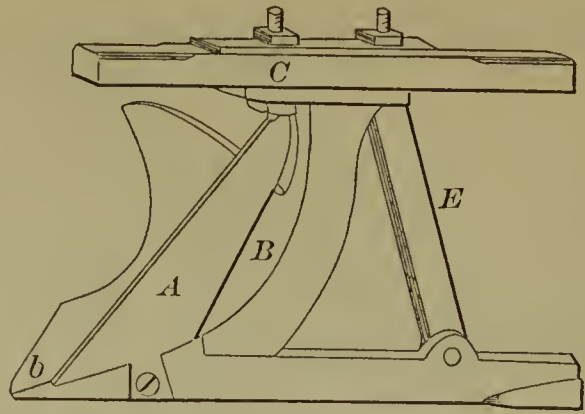

52949—D. Babson, 2d—*Wheels and Axles of Railway Cars.*

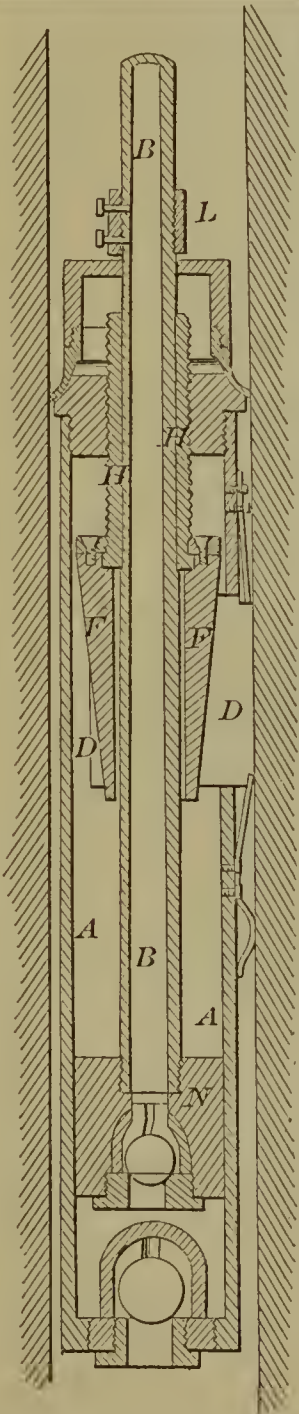
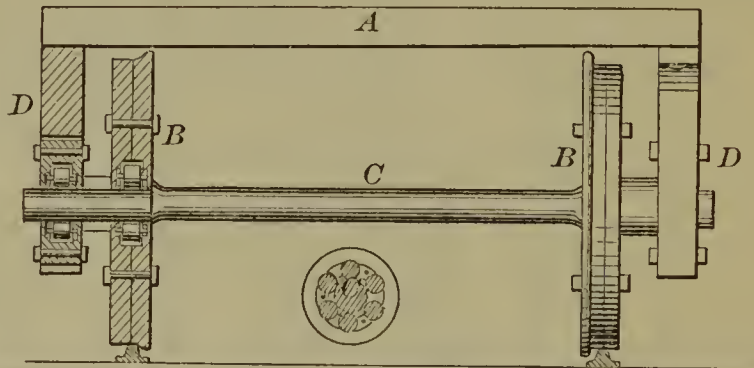

52947—W. S. Wilkinson—*Pump for Oil Wells.*

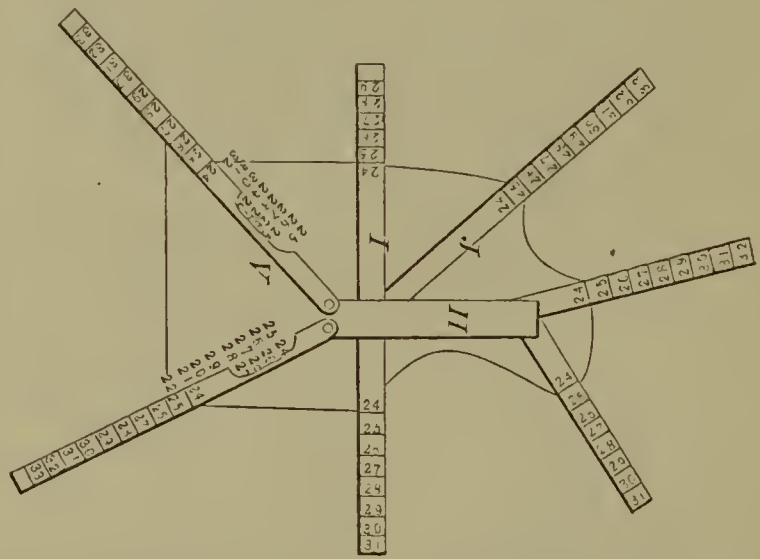

52950—G. Beard—*Taylor's Measure.*

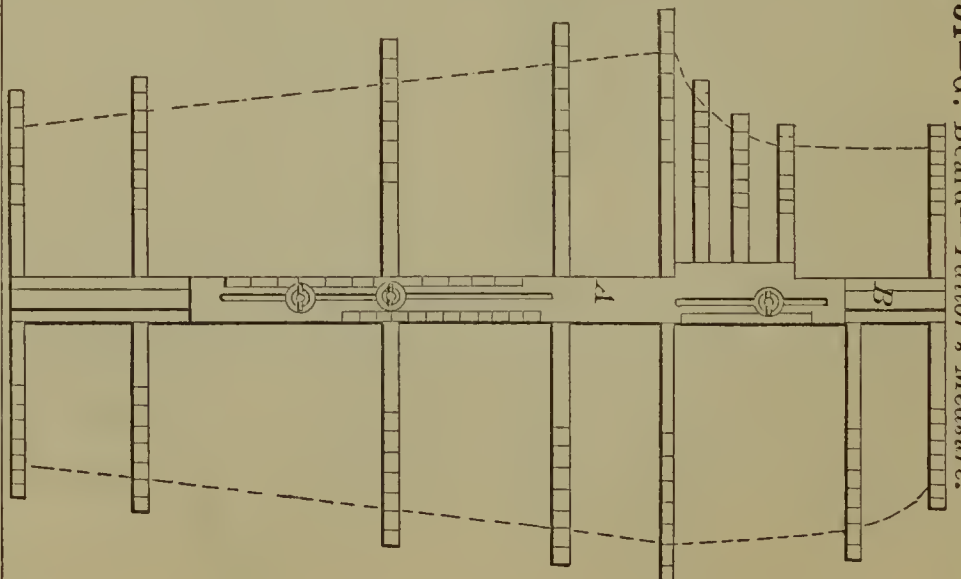

52951—G. Beard—*Taylor's Measure.*



52952—J. Beechley—*Evaporator.*

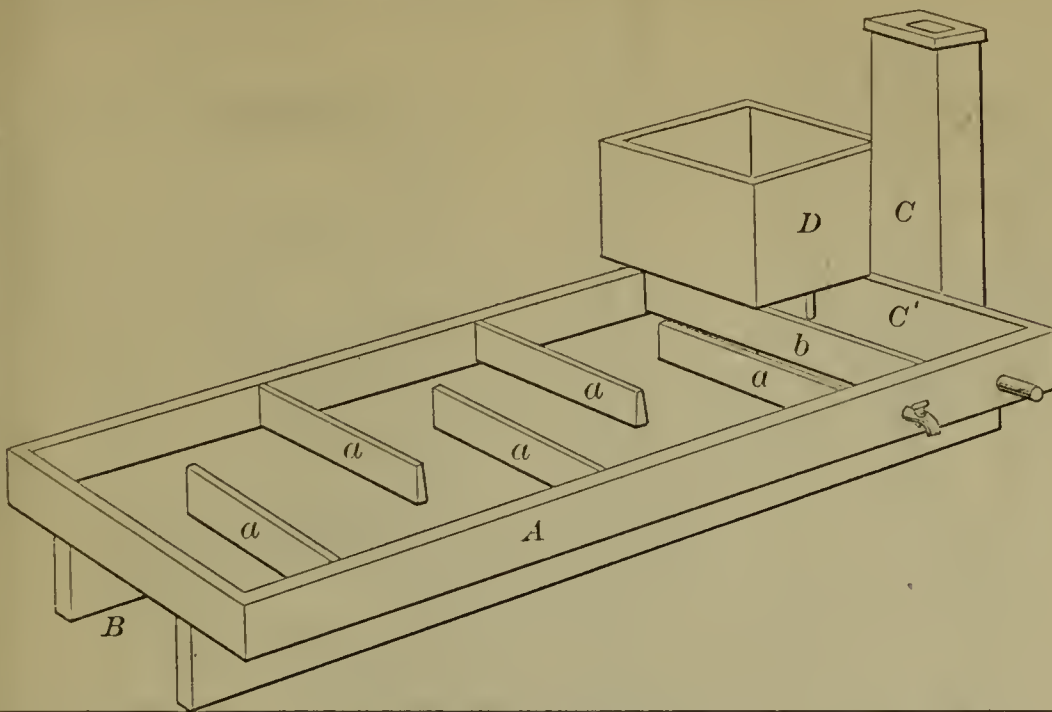

52955—S. Boyer—*Window.*

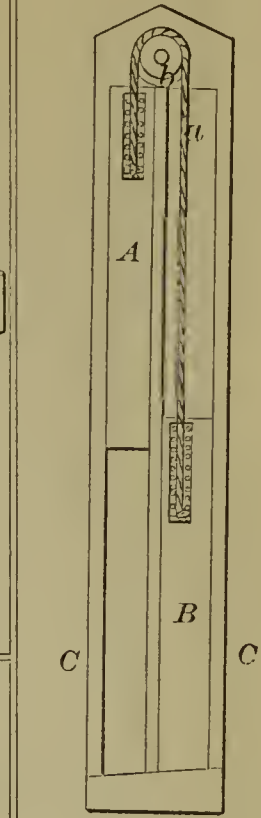

52954—F. Borchardt—*Lacing Boots.*

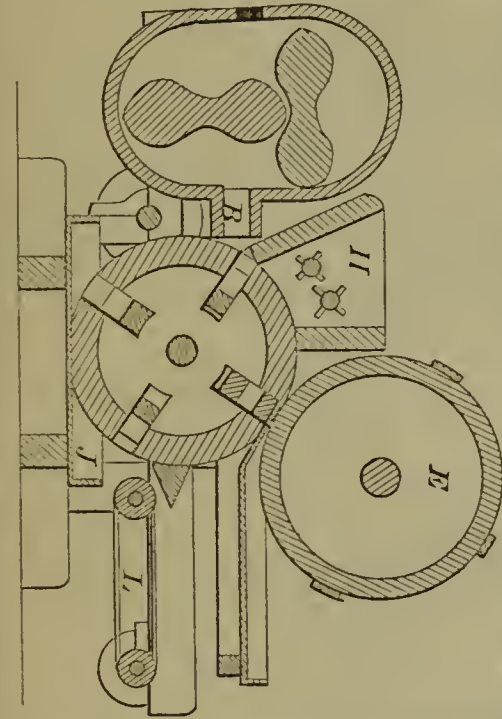
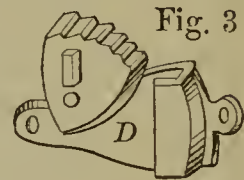
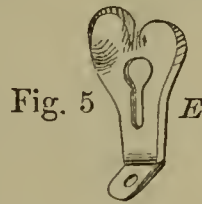

52956—L. W. Boynton—*For Making Cube Sugar.*

52959—J. Broughton—*Oiler.*

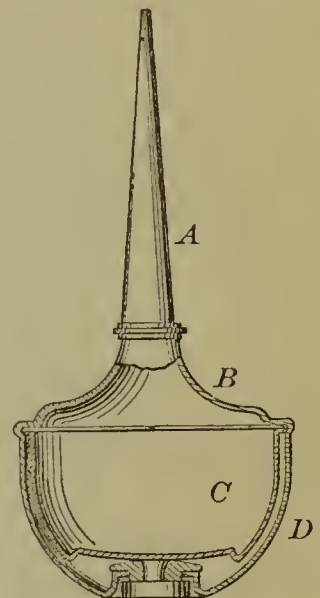

52953—M. Bishop—*Paint and Drug Mill.*

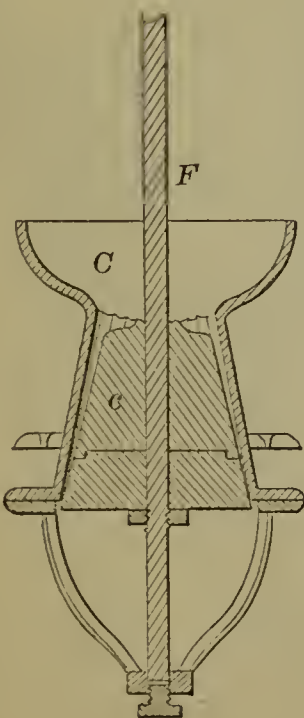

52957—R. Bridge—*To prevent Barrels from Bursting.*

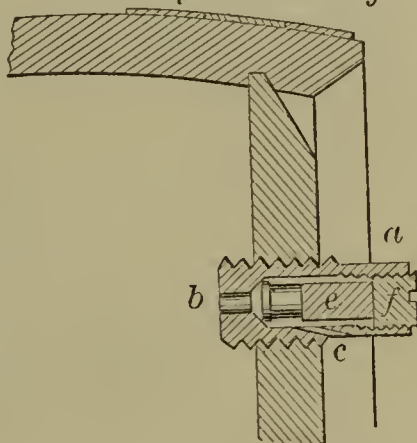

52958—A. P. Briggs—*Clamp for Furnace Men's Use.*

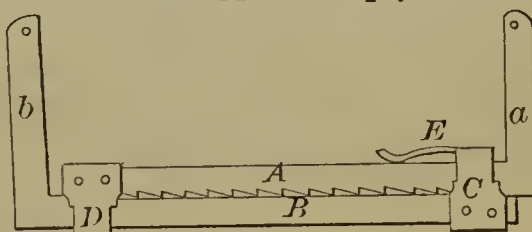

52962—C. O. Burns—*Car Coupling.*

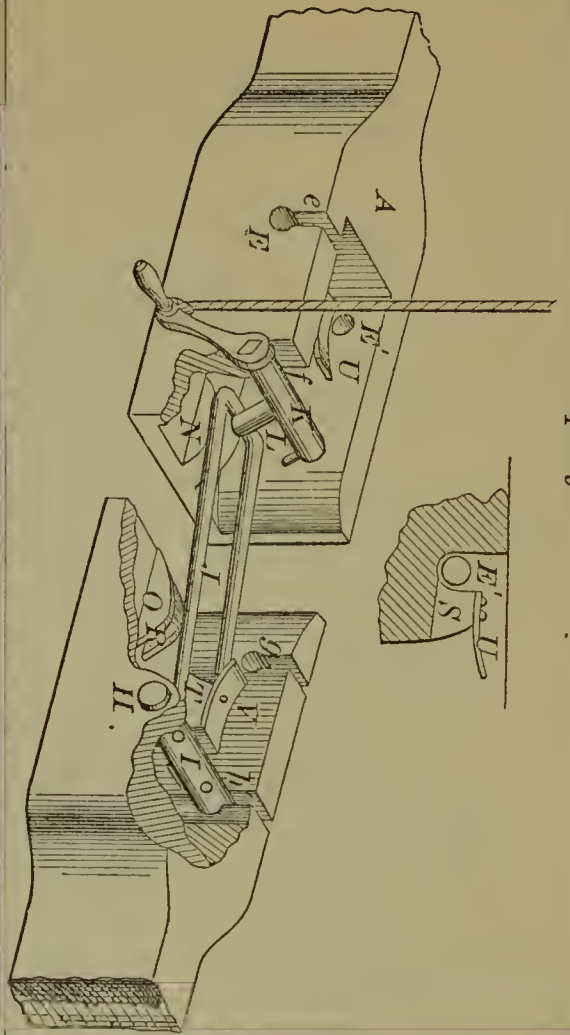

52960—Brooks, Gates & Burleigh—*Rock Drill.*

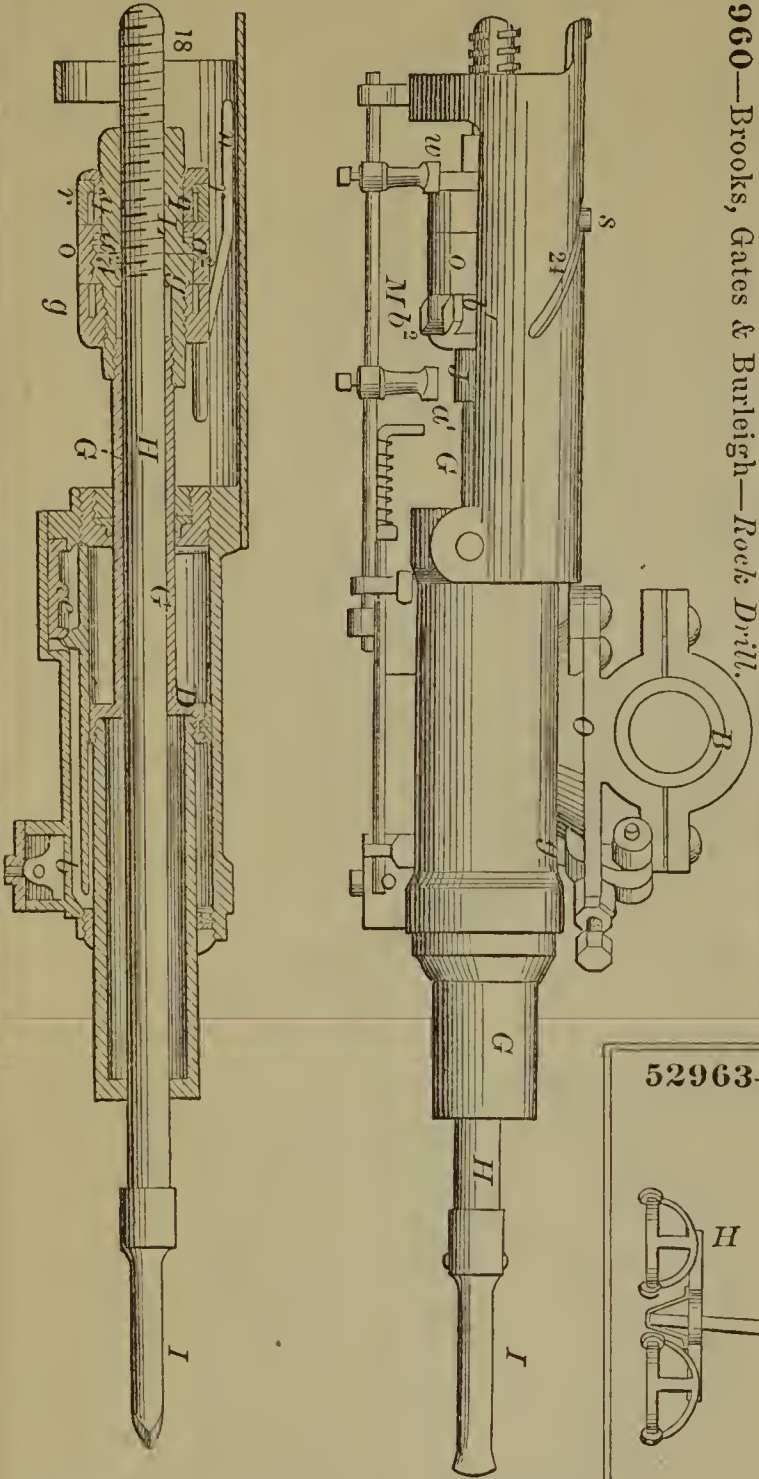

52963—Z. Butt—*Cart.*

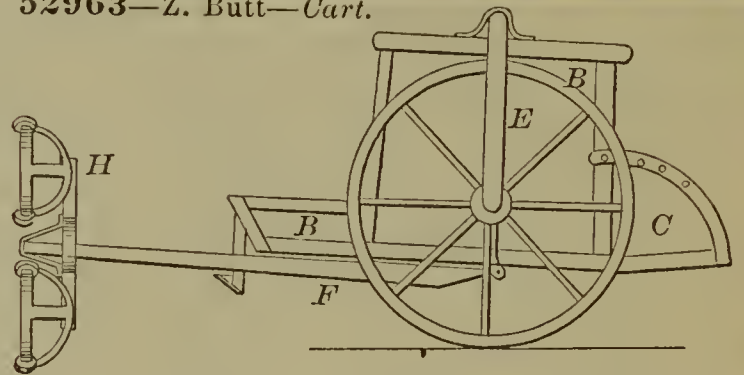

52965—F. A. Calvert—*Steam Engine.*

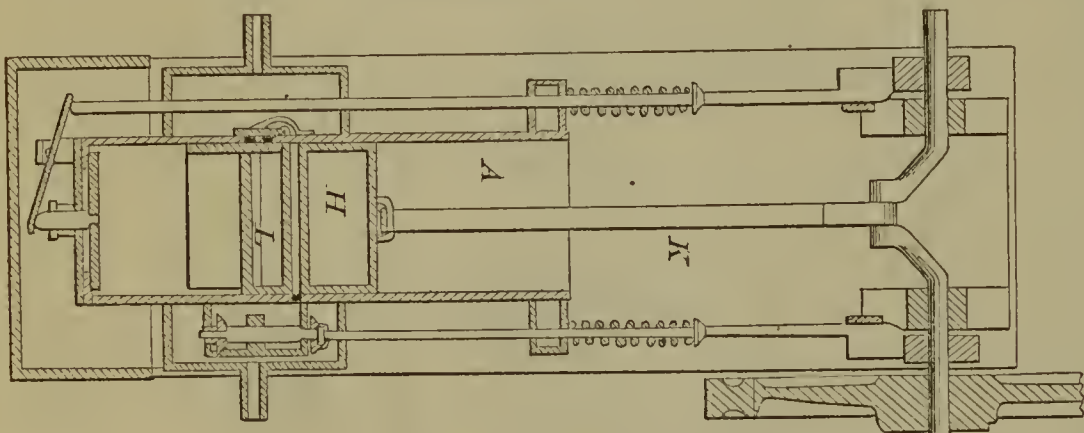

52964—H. L. Byrd, M. D.—*Artificial Leg.*

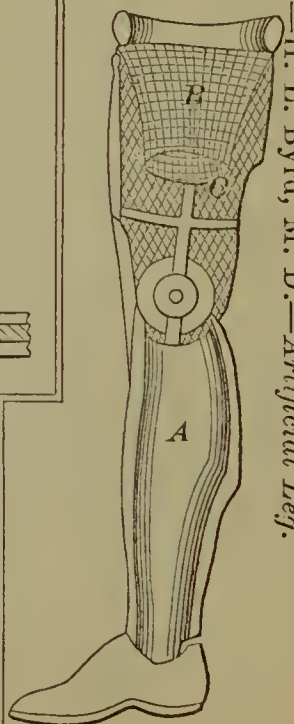

52961—C. Burleigh—*For Drilling Rocks.*

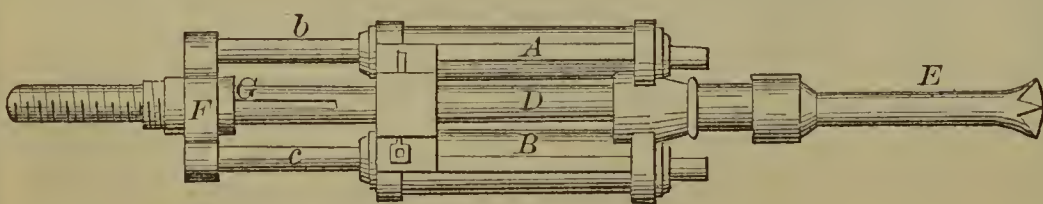

52966—J. P. Chaplin—*Stove Pipe Drum.*

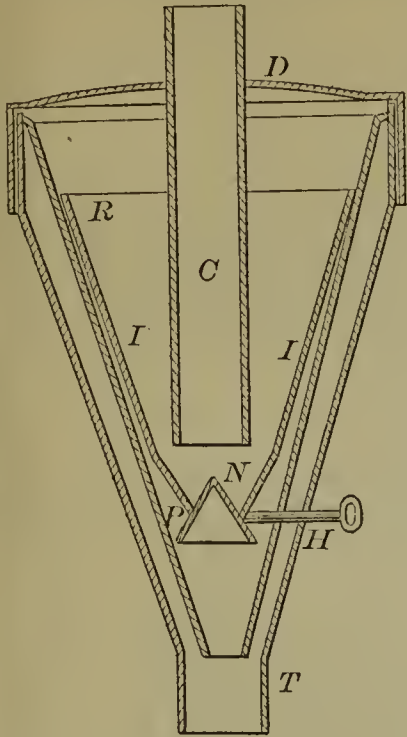

52967—O. A. Cheney—*Grubbing Machine.*

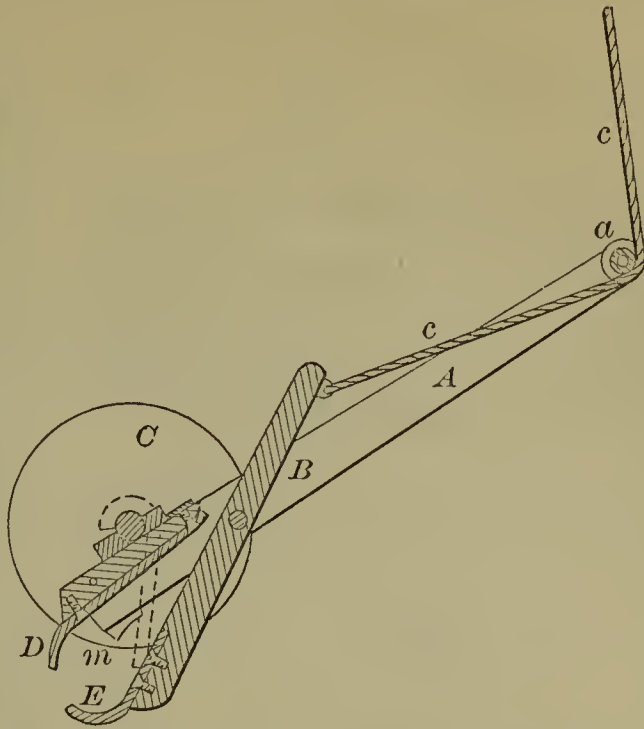

52968—A. G. Coes—*Wrench.*

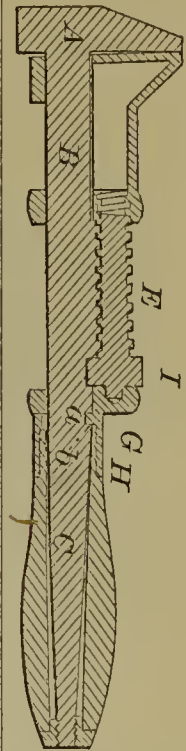

52969—J. K. Collins—*Knuckle Joint.*

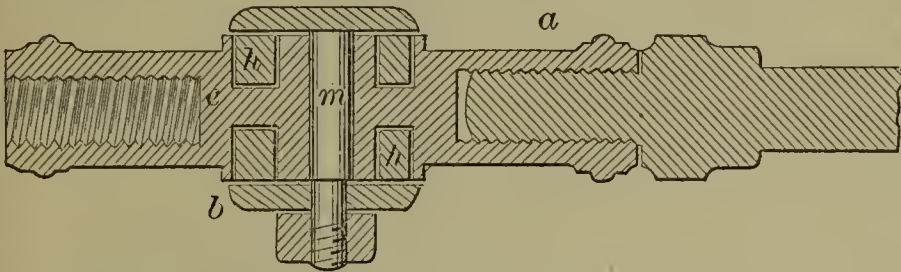

52972—E. T. Covell—*Sheet Metal Can.*

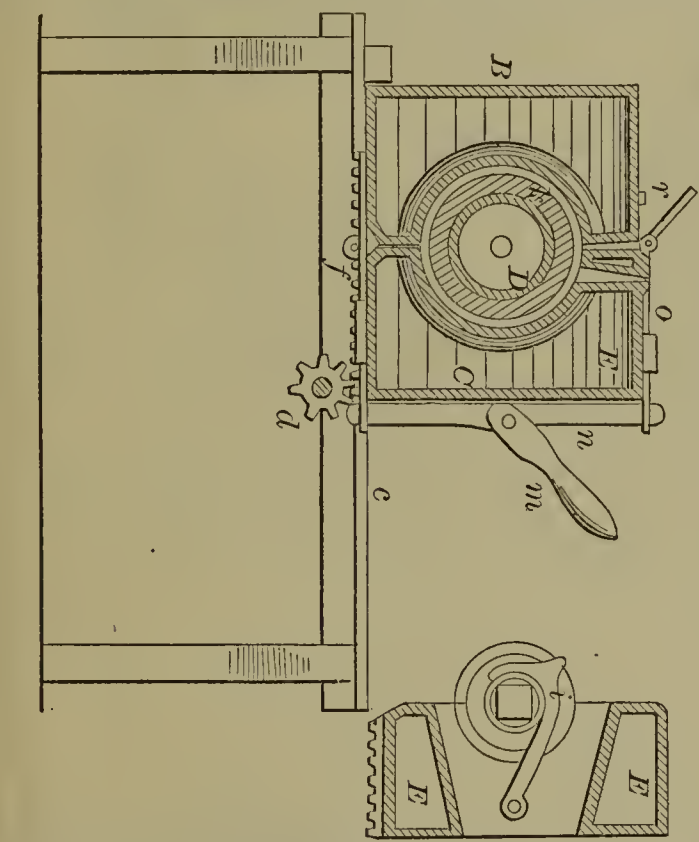
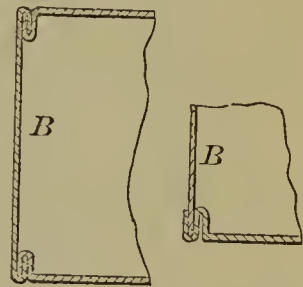

52971—Cornell & Quinn—*Pipe Mould.*

52970—H. O. Cook—*Hydraulic Steering Apparatus.*

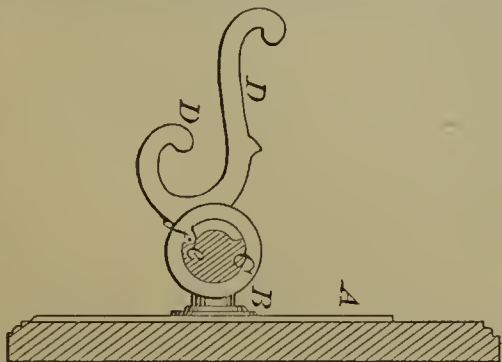
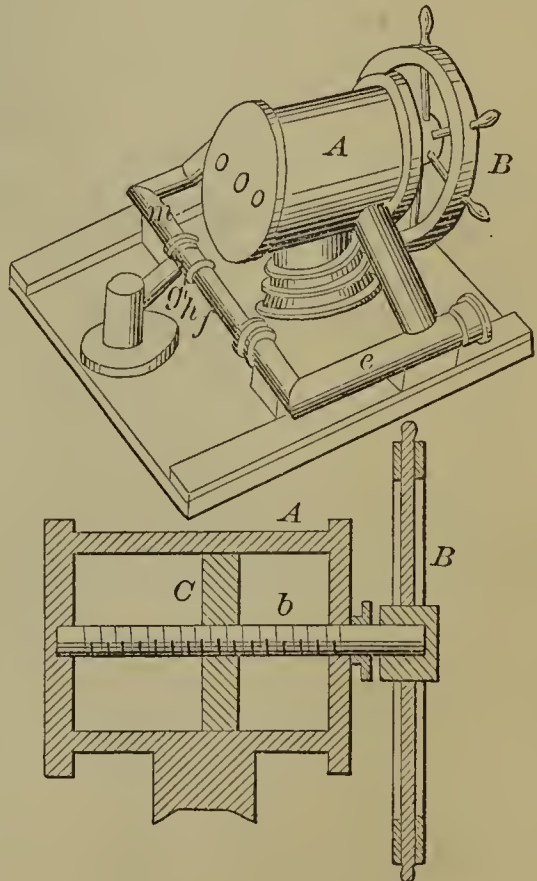

52974—J. Danner—*Coat and Hat Hook.*

52975—S. W. Davis—Horse Power.

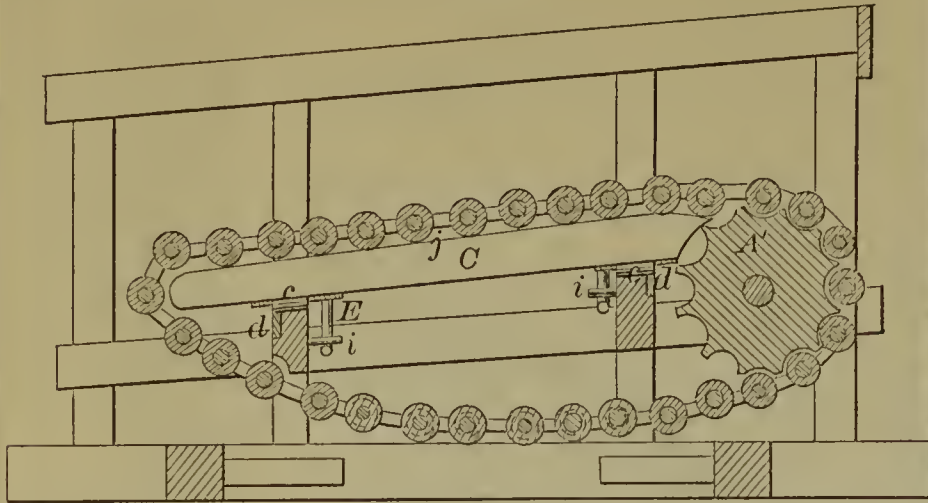

52980—A. Eckert—Preparing Fruit, &c., for Preserving.

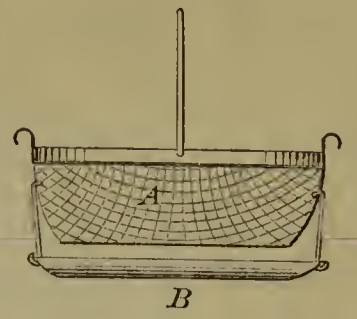

52977—H. H. Dodge—Boot Blacking Apparatus.

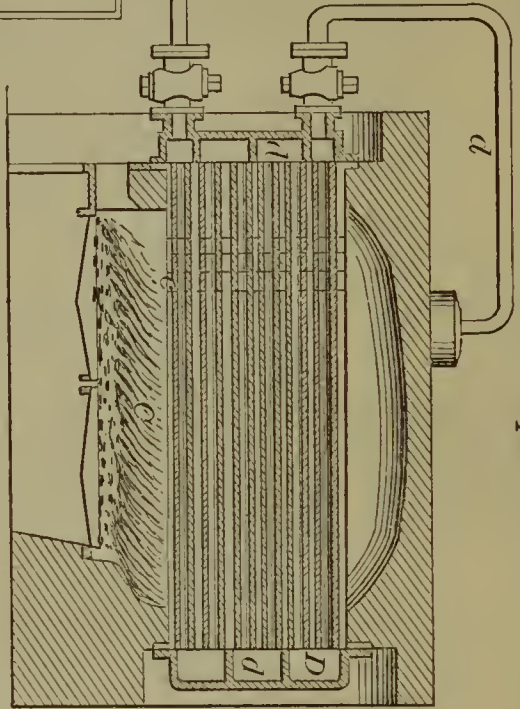
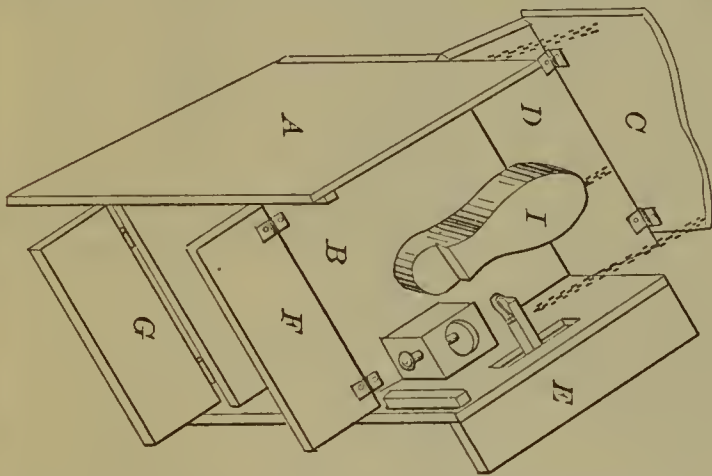

52982—L. V. Fichet—Steam Superheater.

52979—S. Easter—Traveling Trunk.

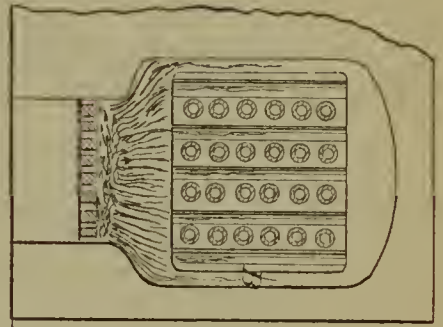
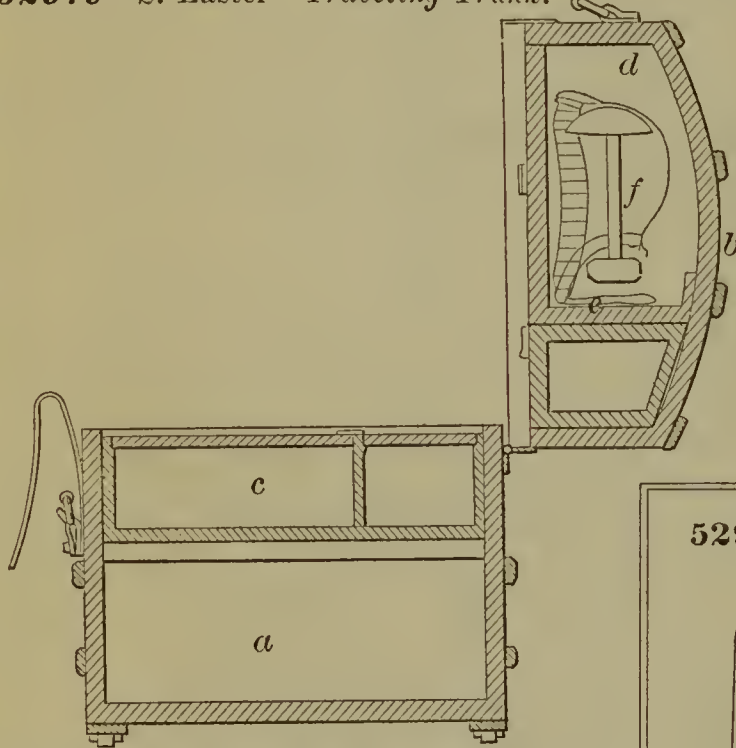

52983—W. G. Floyd—Adjustable Clamp.

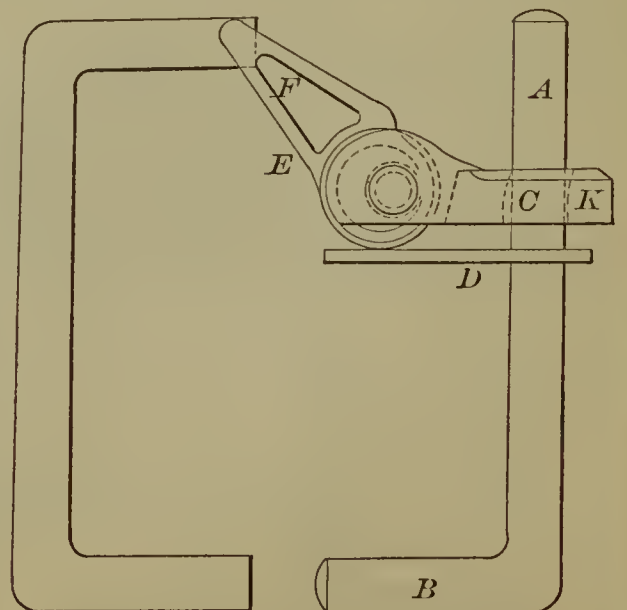

52981—J. Edmunds—Fence.

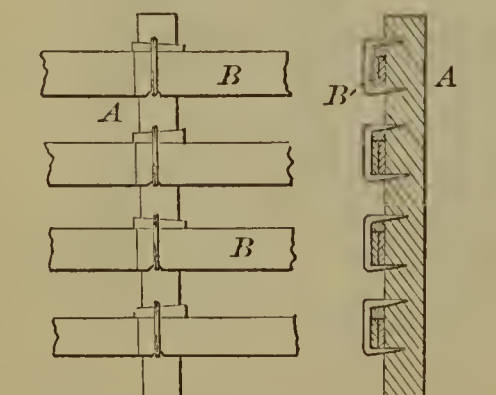

52984—Ford & Penquite—Potato Digger.

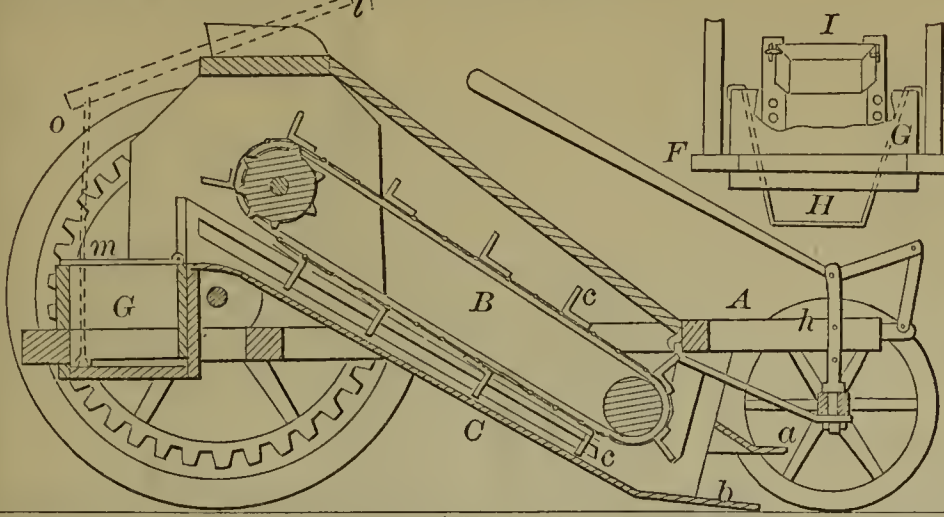

52987—C. D. Gibson—Reflector for Head Lights.

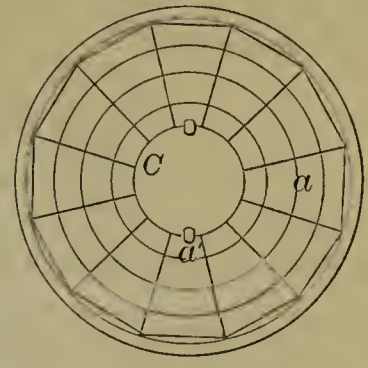

52991—L. A. Gould—Pump.

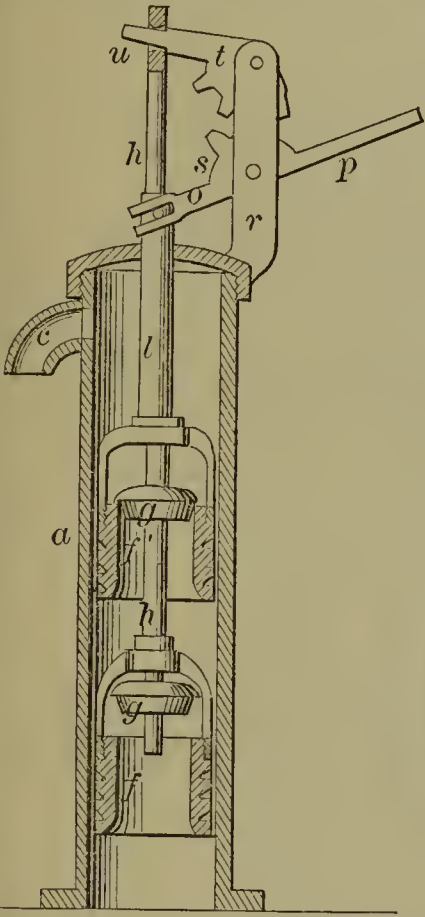

52989—R. Gillaspie—Seed Planter.

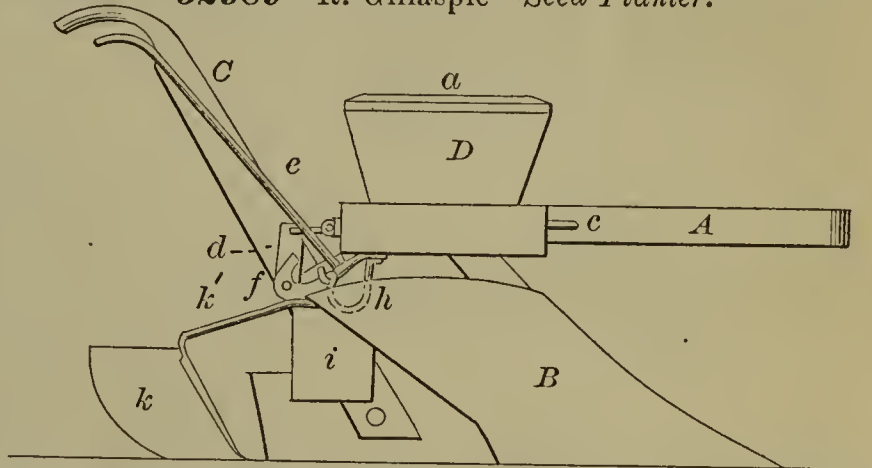

52985—J. H. Friederich—Carpet Fastener.

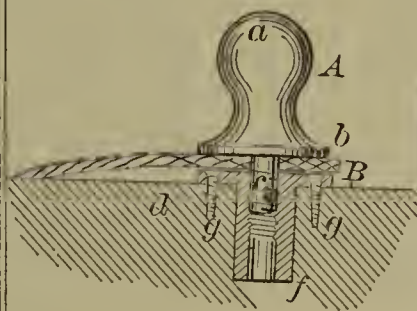

52986—Fryer & Freeborn—Railroad Car Wheel.

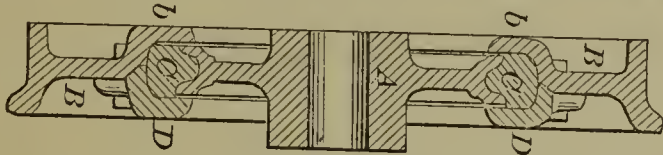

52992—W. Green—Cutting Box.

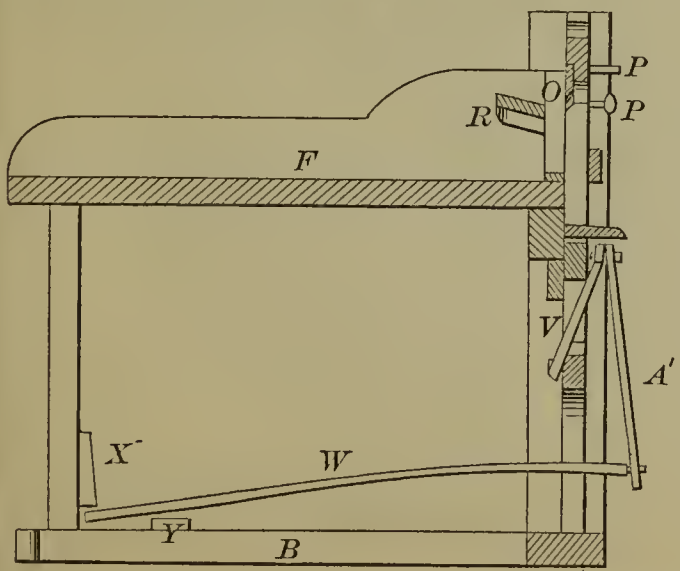

52990—A. L. & B. F. Gilliland—Gang Plow.

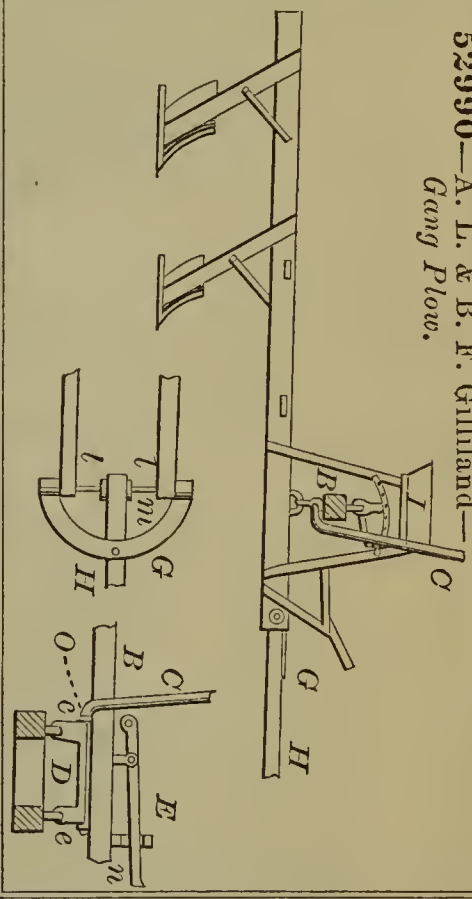

52988—J. H. Gibson—Invalid Bedstead.

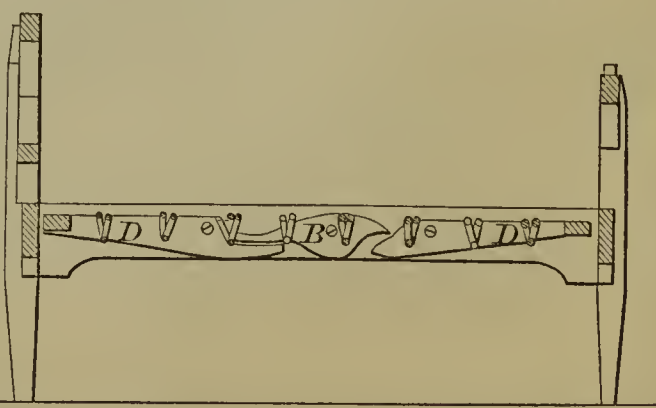

52993—J. Guttman—Artificial Teeth.

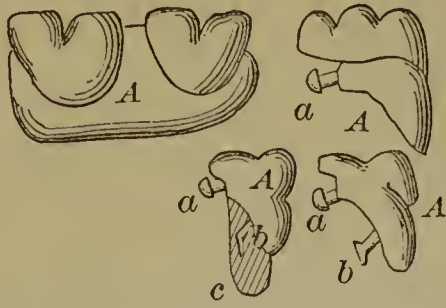

52996—Hebard & Brown—Moulding Bullets.

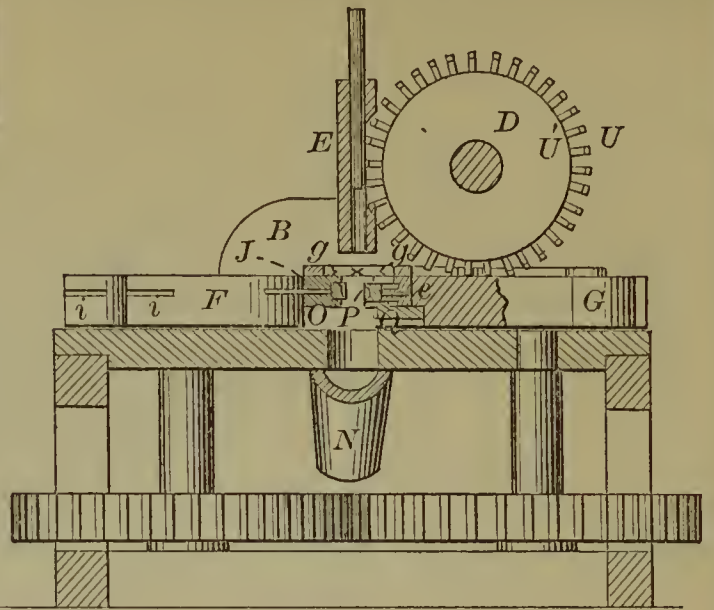

52995—Hardy, Walker & Walker—Lock.

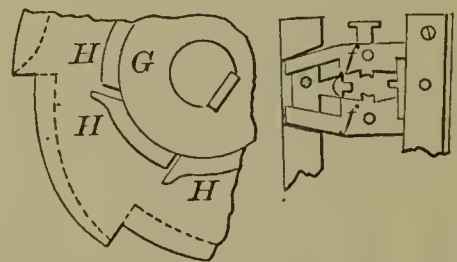
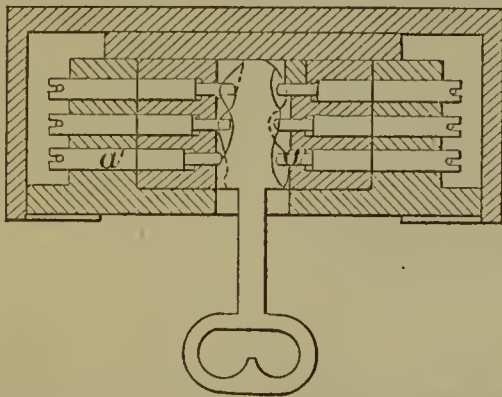

52997—C. H. Helms—Heel Breasting Machine.

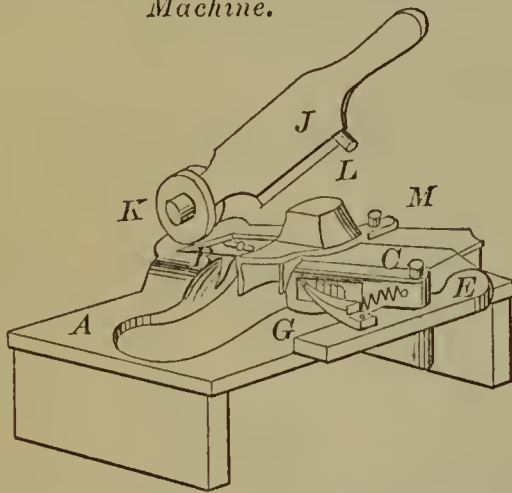

52998—I. Henton—Cultivator.

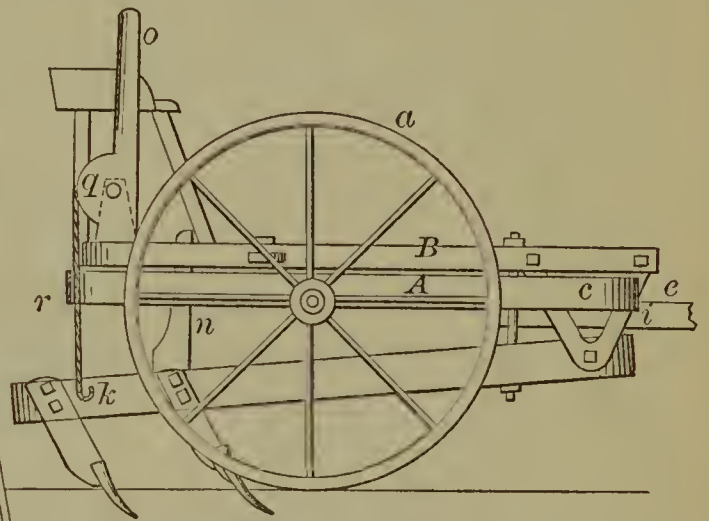

53000—J. Hollen—Rotary Knitting Machine.

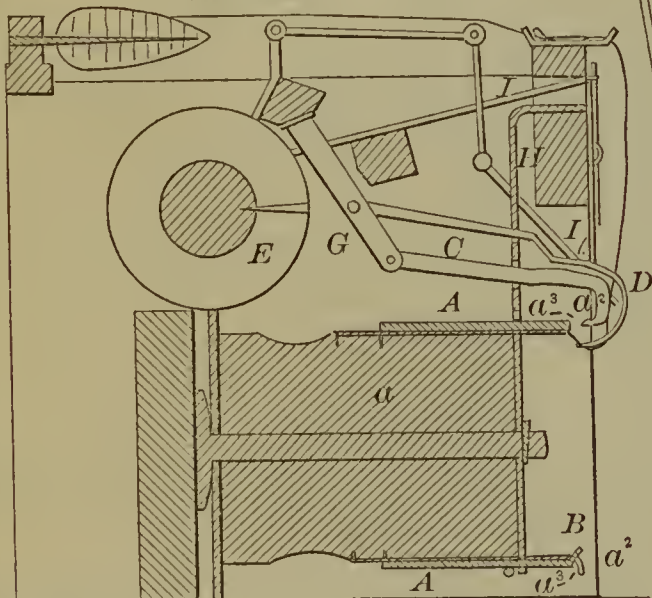

52999—W. O. Hills—Burglar Alarm.

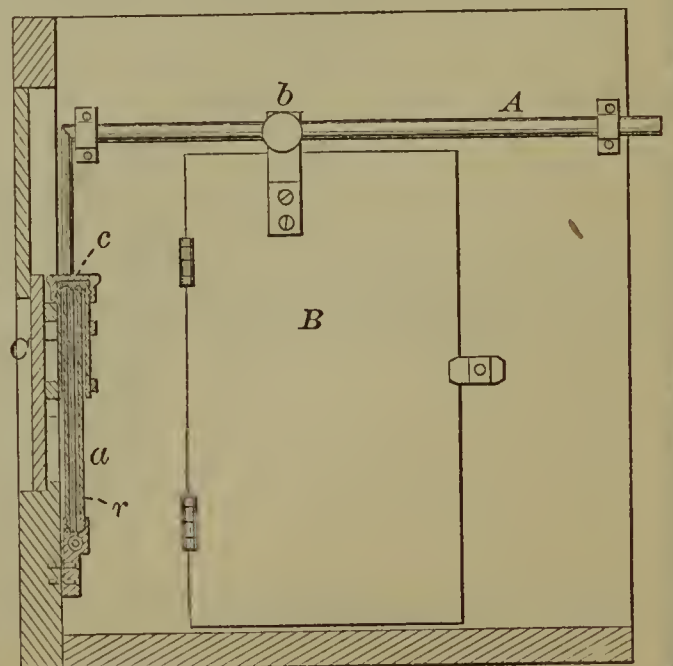

53001—R. B. Hugunin—Roller for Clothes Wringers.

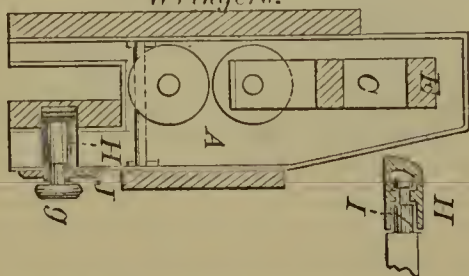

53002—R. B. Hugunin—*Making Bottle Stoppers, Caster Wheels, &c.*

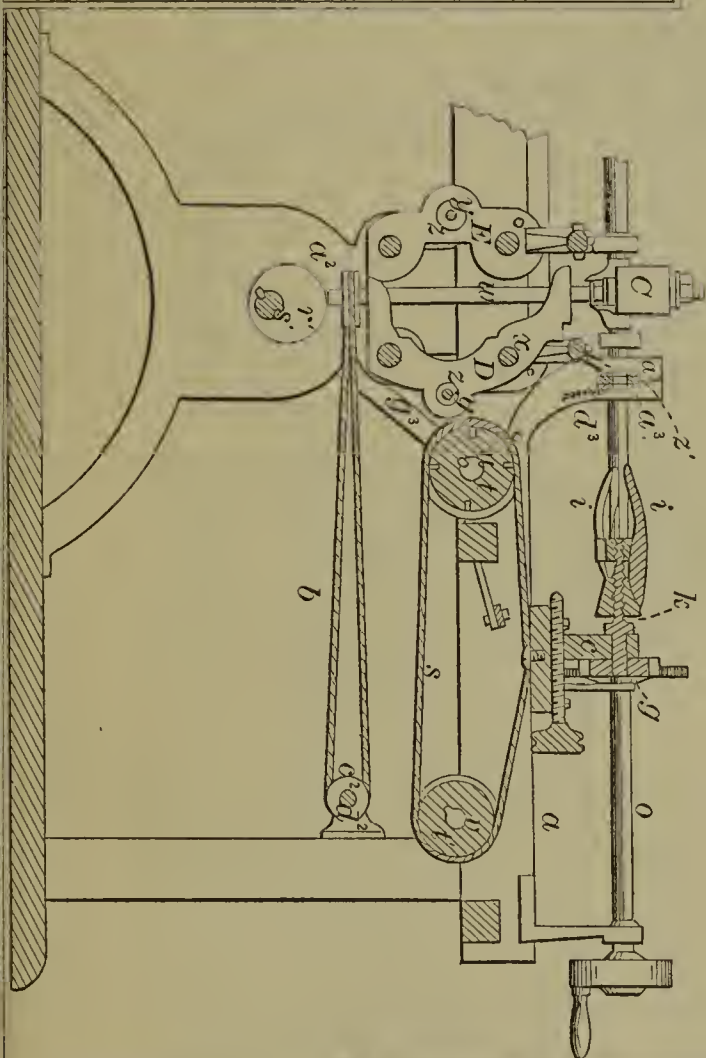
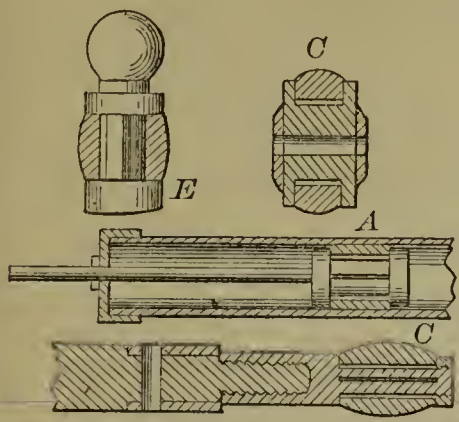

53003—L. Hall—*Turning Lathe for Wood.*

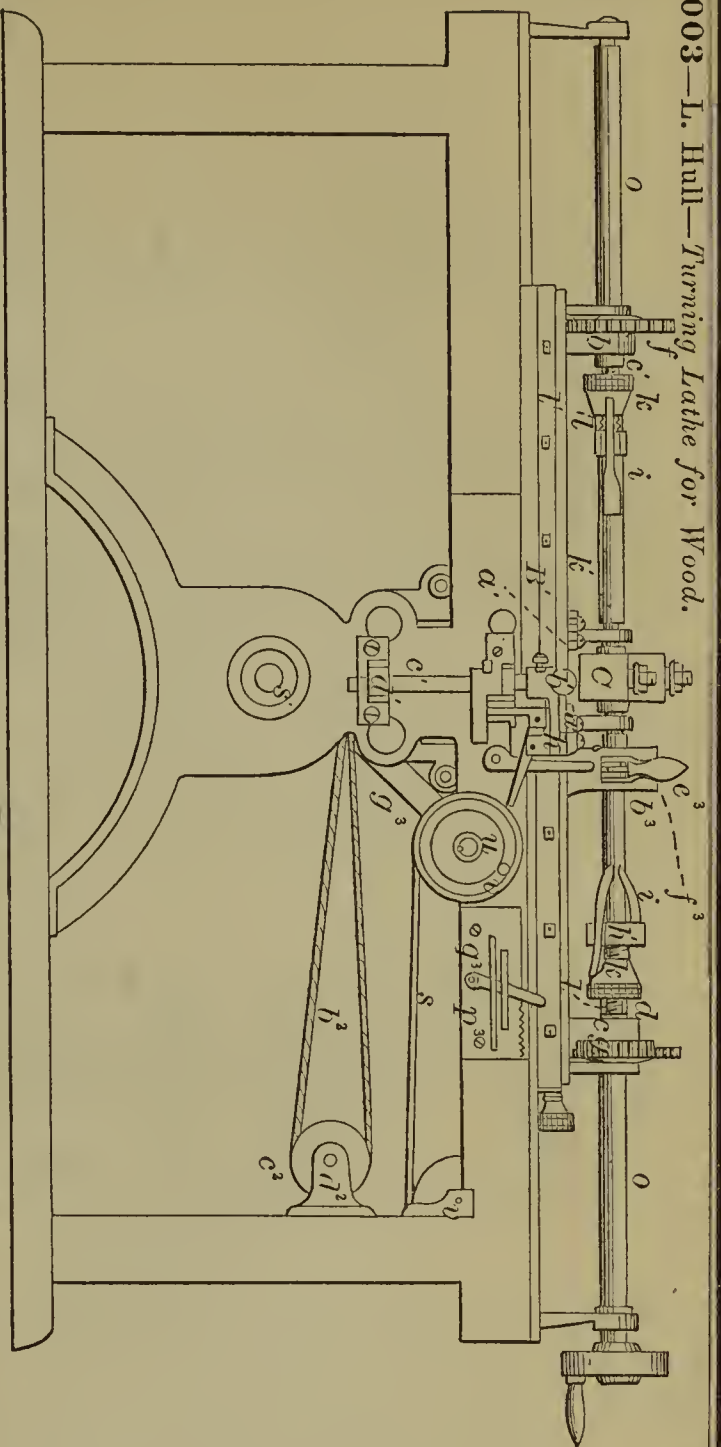

53005—J. Ingels—*Grain Drill.*

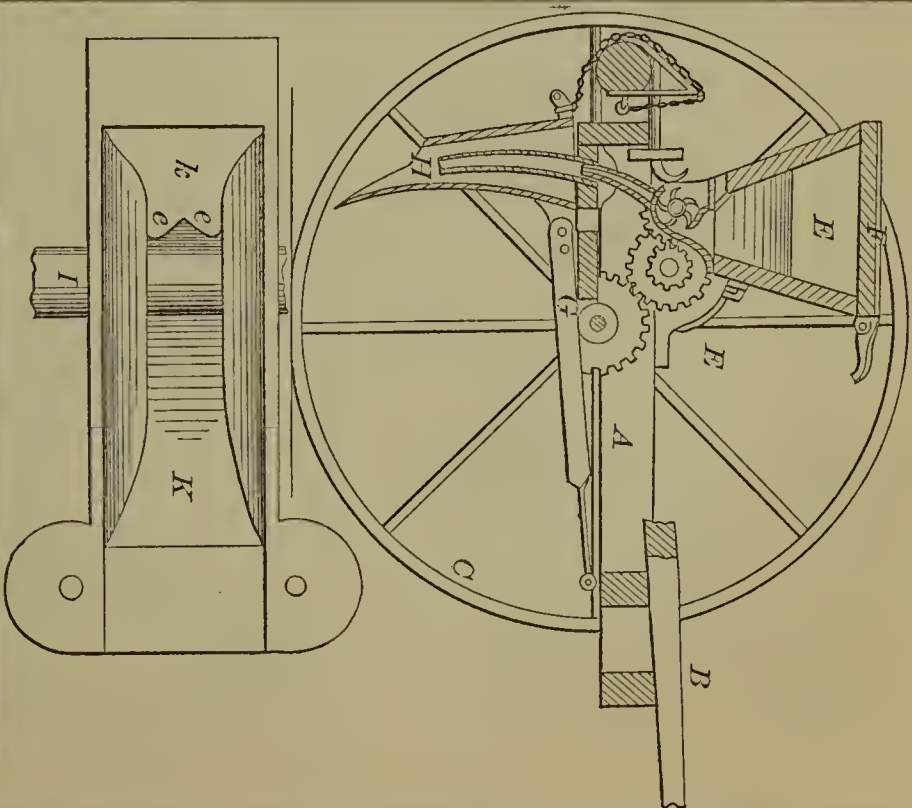

53004—C. S. Hutchinson—*Building Blocks.*

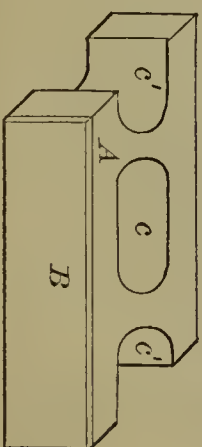

53006—M. Ingersoll—*Railroad Car Brake.*

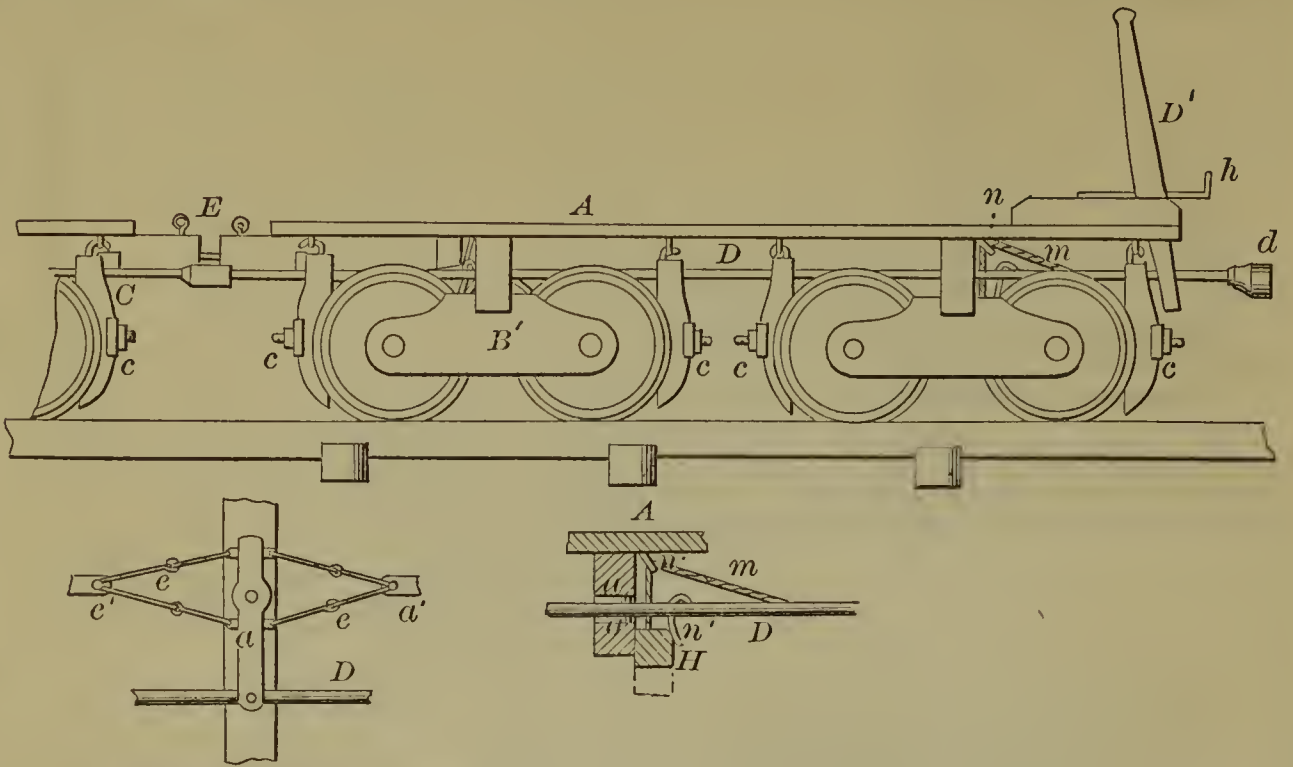

53007—Johnson & Singer—*Pump.*

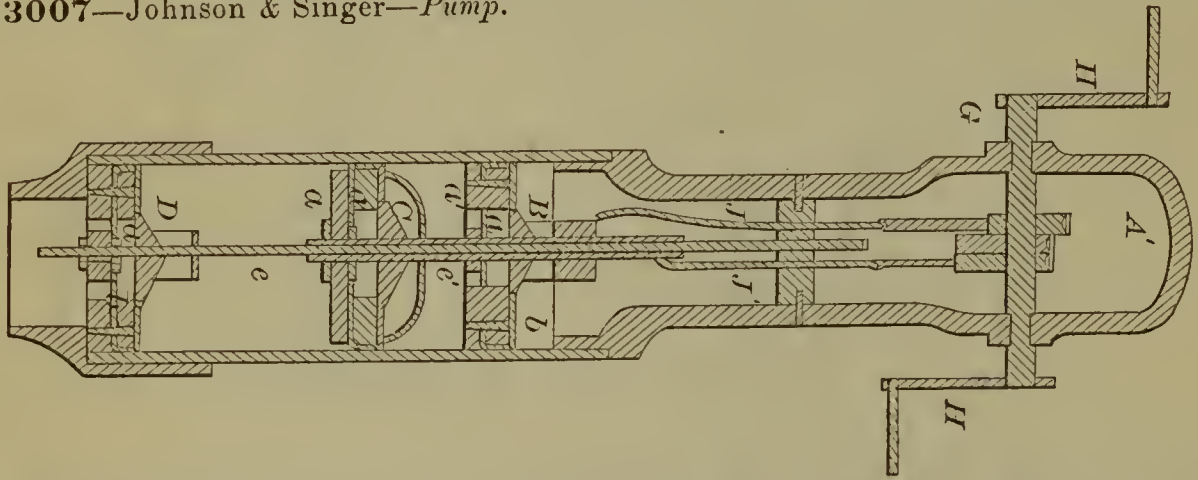

53008—E. Jones—*Paddle Wheel.*

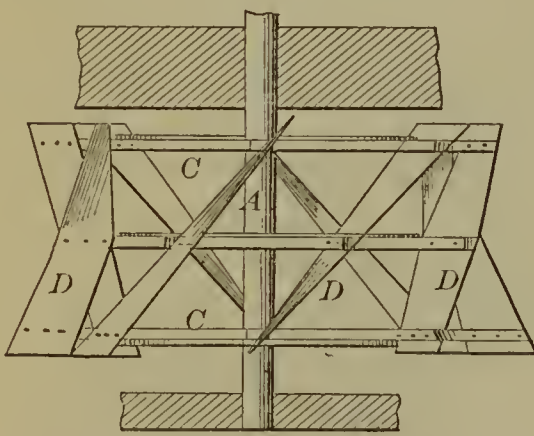

53011—T. H. Leavitt—*Peat Machine.*

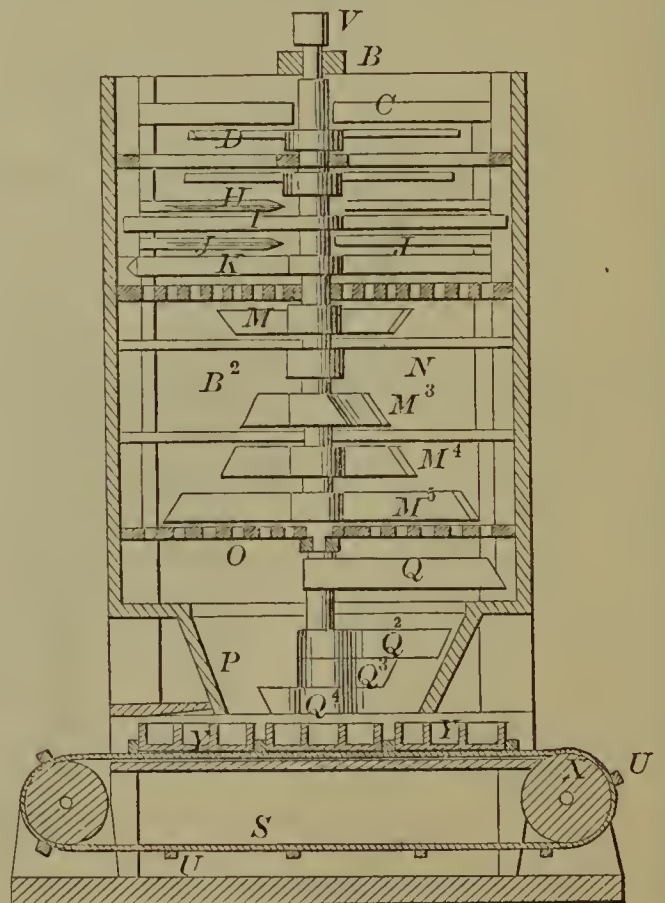

53009—J. P. Laird—*Bearings of Locomotive Axles.*

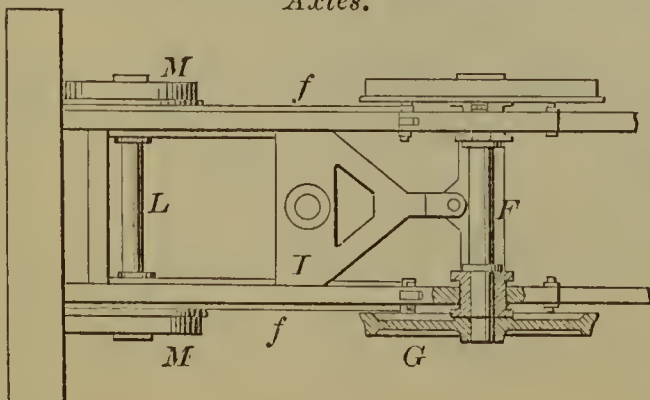



53013—T. Langham—*Knitting Machine.*

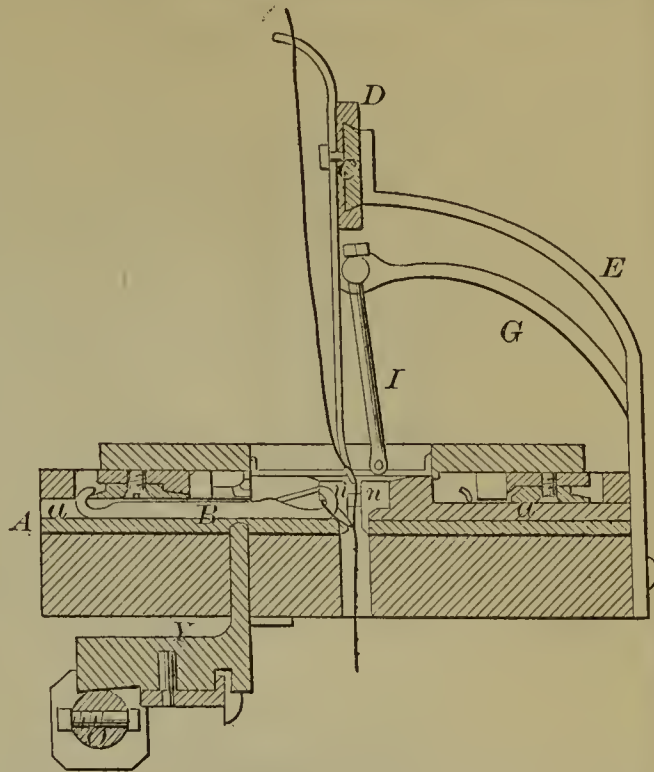

53016—H. W. Love—*Screw Wrench.*

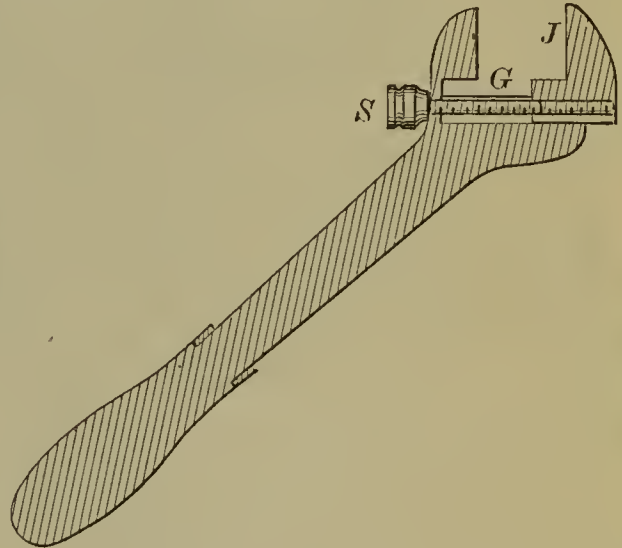

53015—J. F. Lewis—*Thief Alarm.*

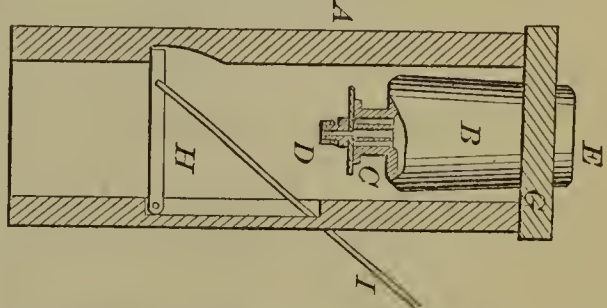

53018—F. B. Marble—*For Jointing Tops and Leaves of Tables.*

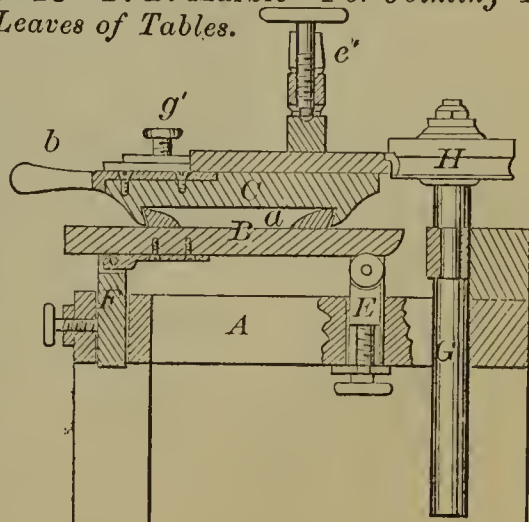

53012—J. F. Lauth—*For Rolling Iron.*

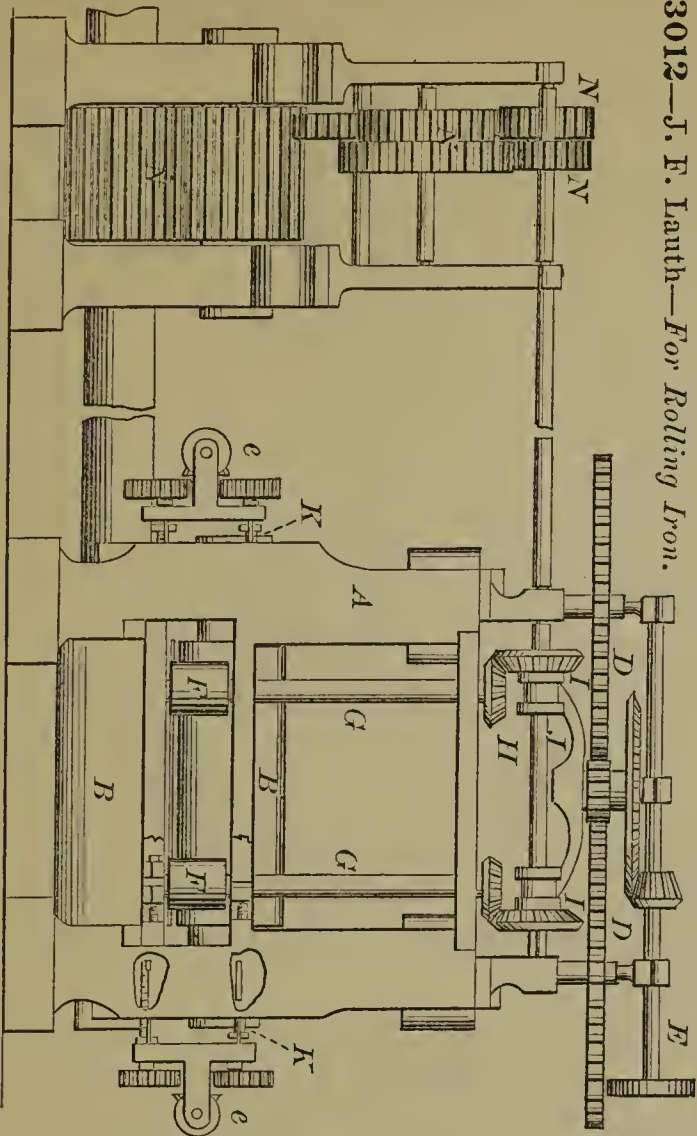

53017—C. A. Mallory—*Buckle.*

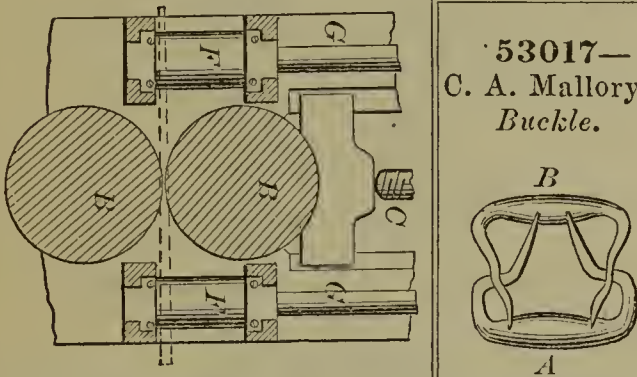

53019—J. Mathews, Jr.—*For Bottling Liquids.*

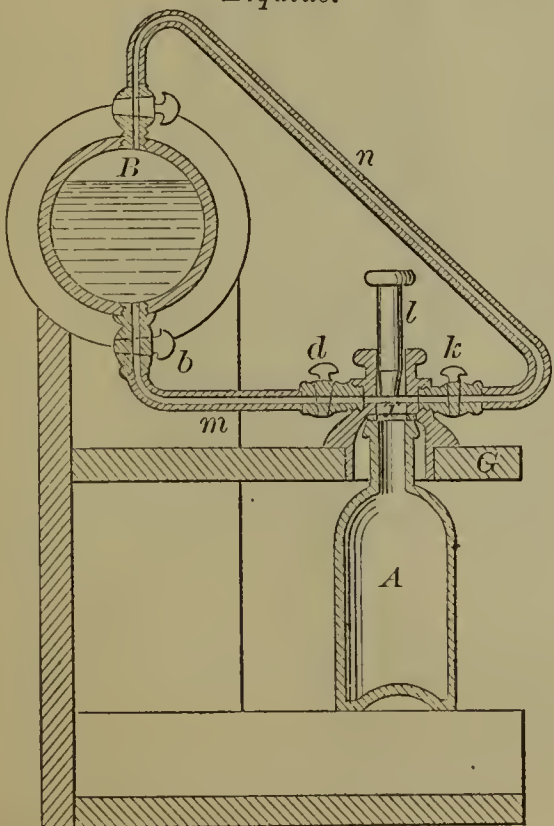

53020—A. Y. McDonald—*Balance.*

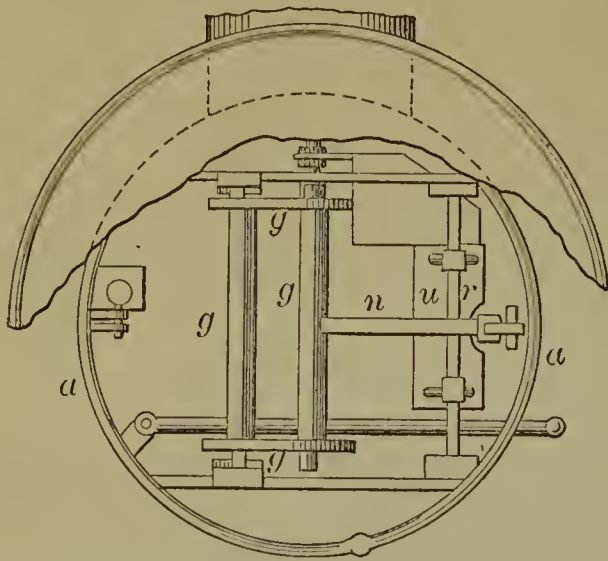

53022—McGill & Gibson—*Drilling and Hoisting Apparatus.*

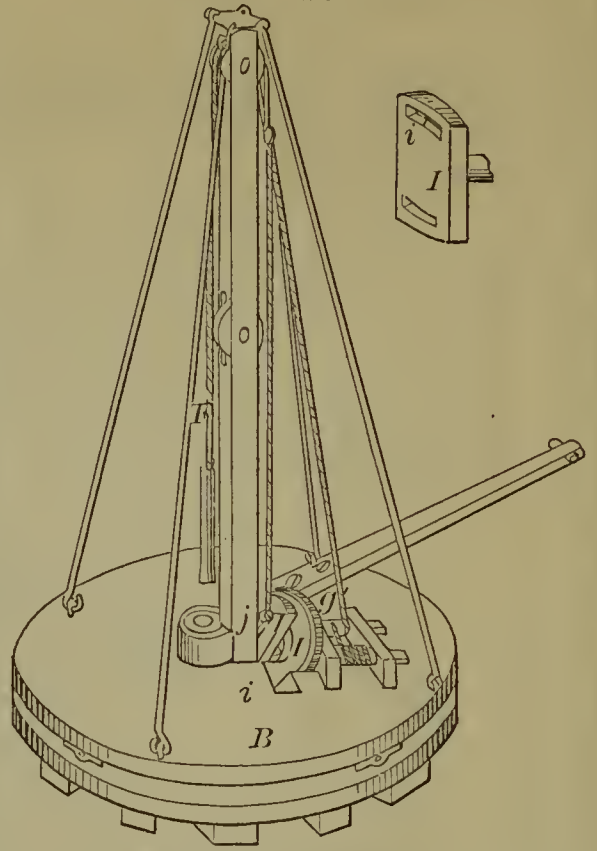

53021—S. A. McGill—*Vegetable Grater.*

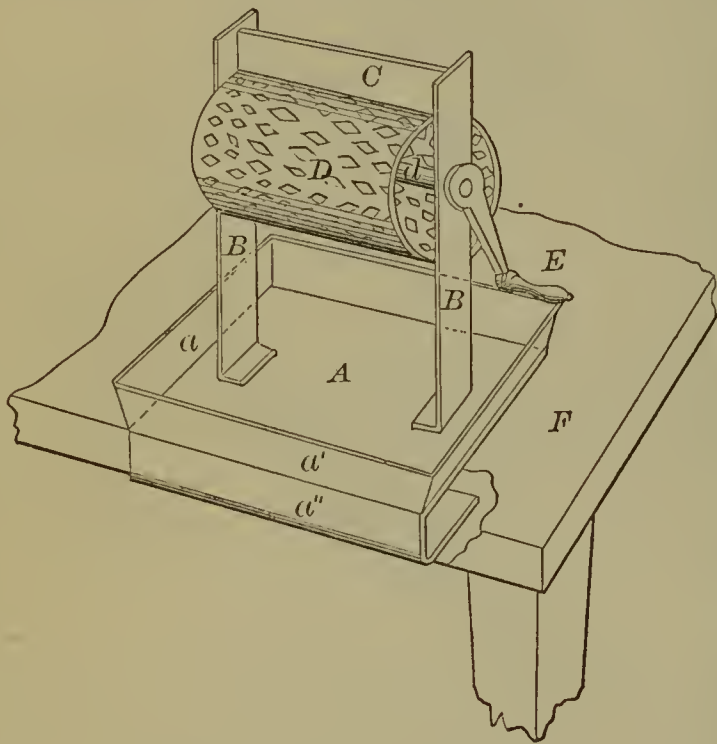

53023—W. S. Mead—*Journal and Box.*

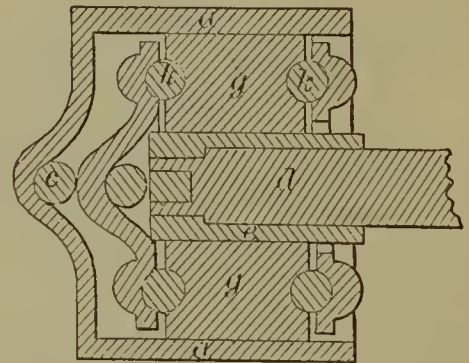

53024—J. C. Merritt—*Stove Pipe Damper.*

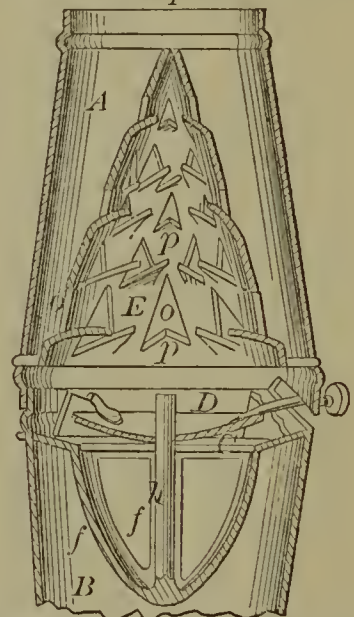

53026—J. B. Moody—*Breech-Loading Ordnance.*

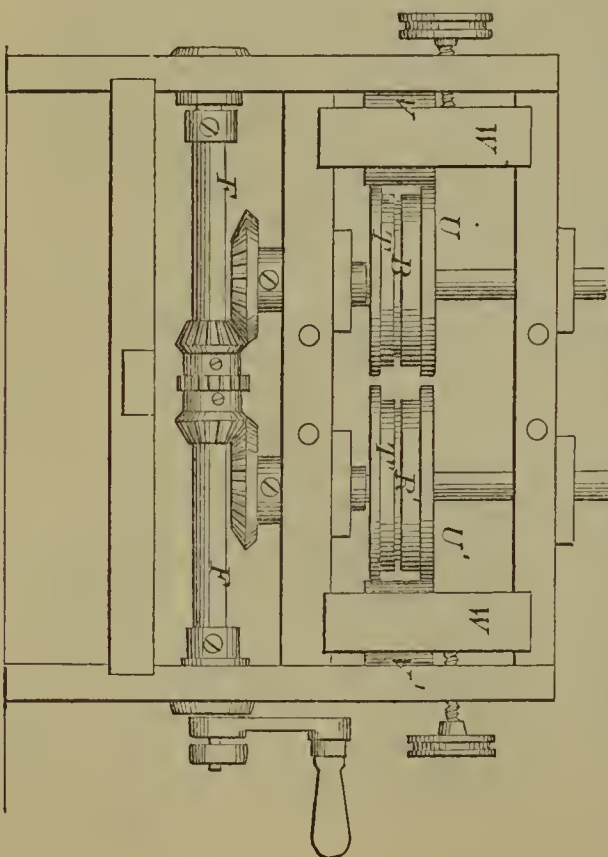
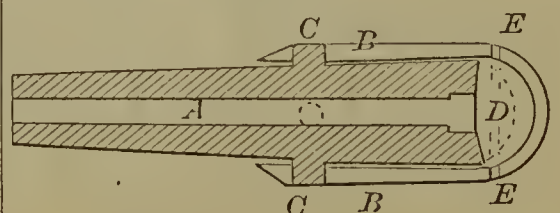

53025—J. B. Mignault—*For Rolling Wire Blanks.*

53027—J. C. Moore—Lantern.

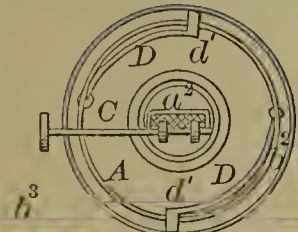
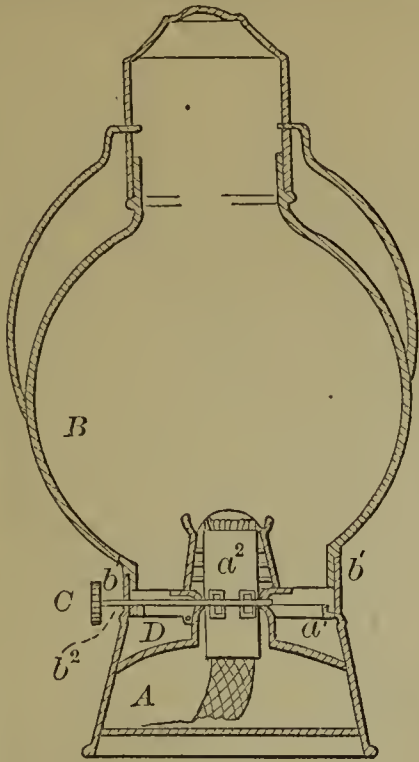

53028—C. T. & E. W. Moorman—Sorghum Evaporator.

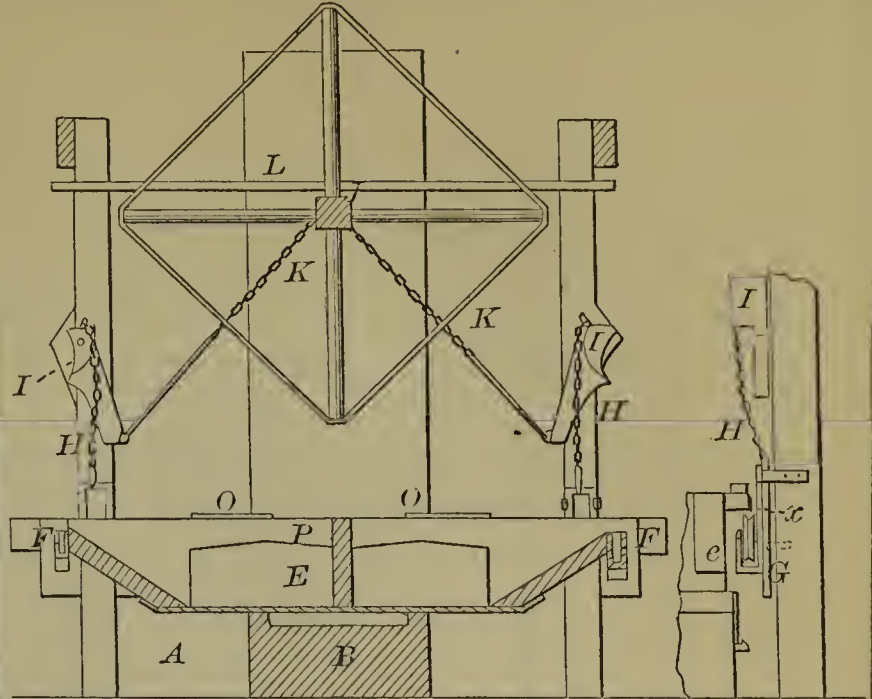

53033—D. Oliver—Hedge Cutting Machine.

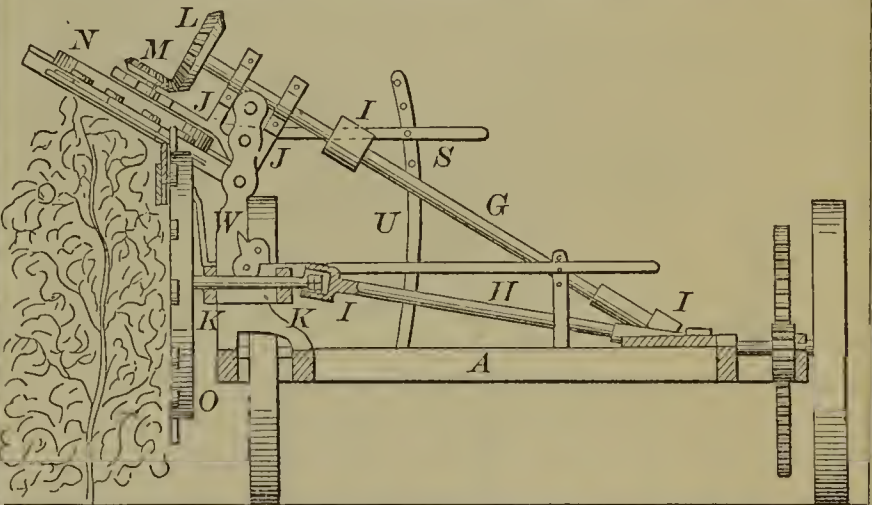

53031—J. Naylor—Steam Trap.

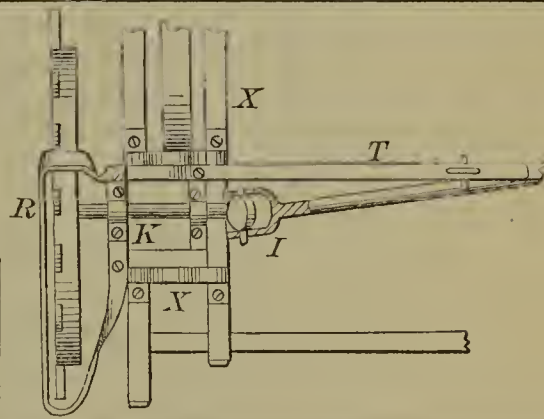
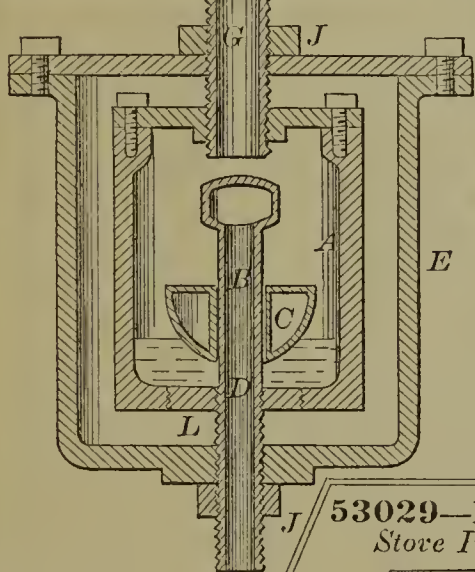

53029—E. P. Morse—Stove Pipe Drum.

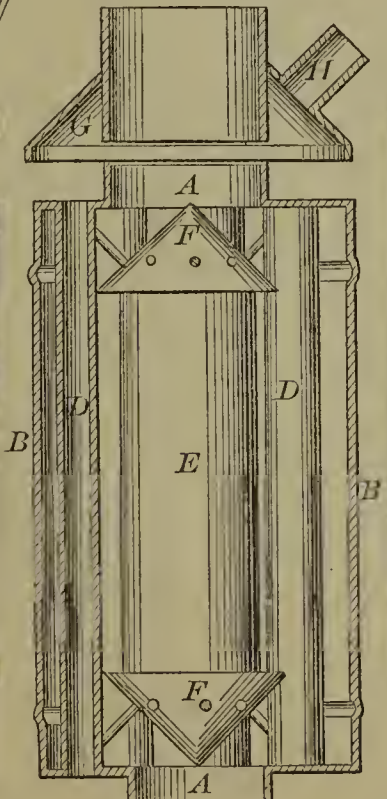

53035—A. B. Parsons—Washing Machine.

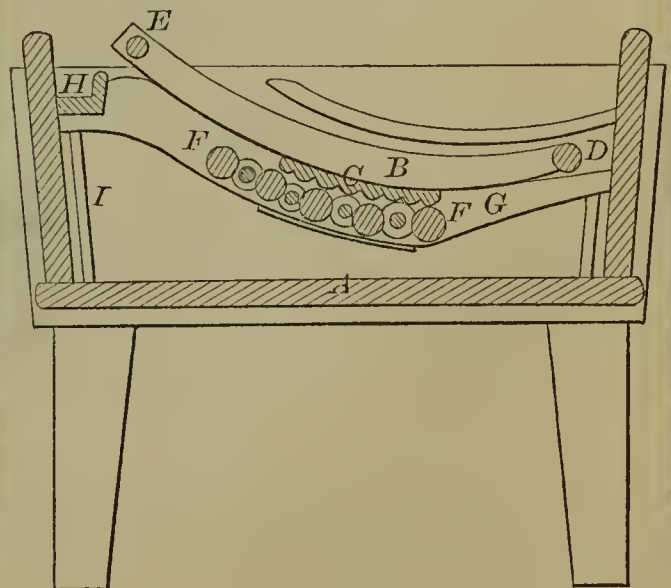

53030—M. P. Murphy—Burglar Alarm.

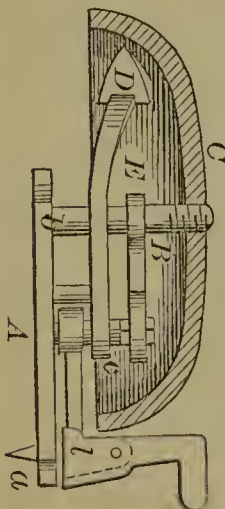

53036—S. D. Paul—Mule for Spinning.

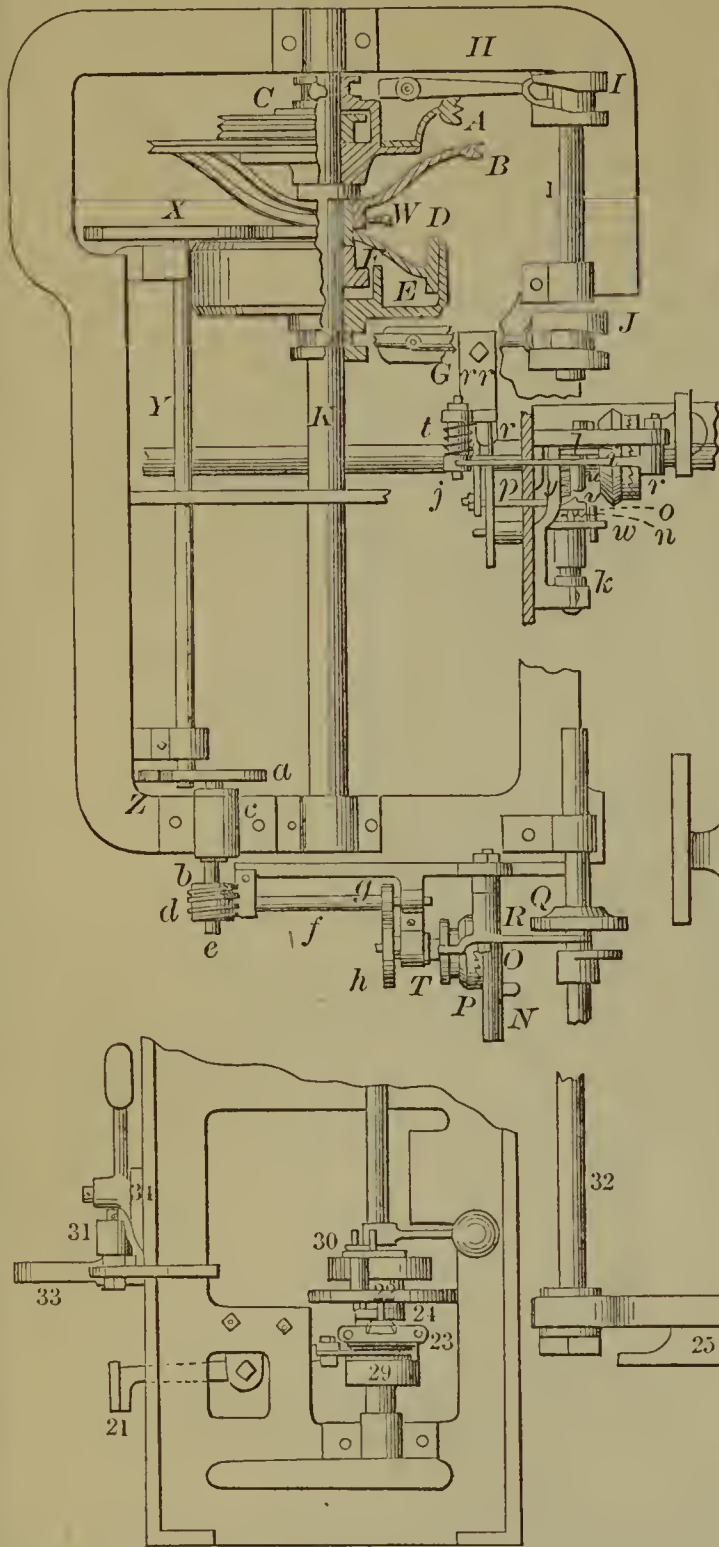

53037—Payne & Boxley—Car Coupling.

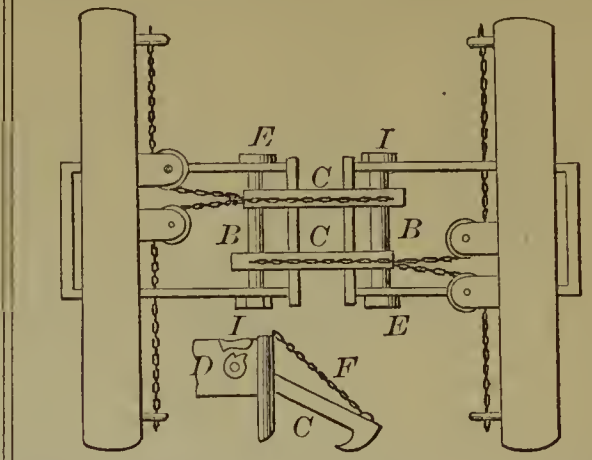

53038—C. G. Pease—Photographic Chair.

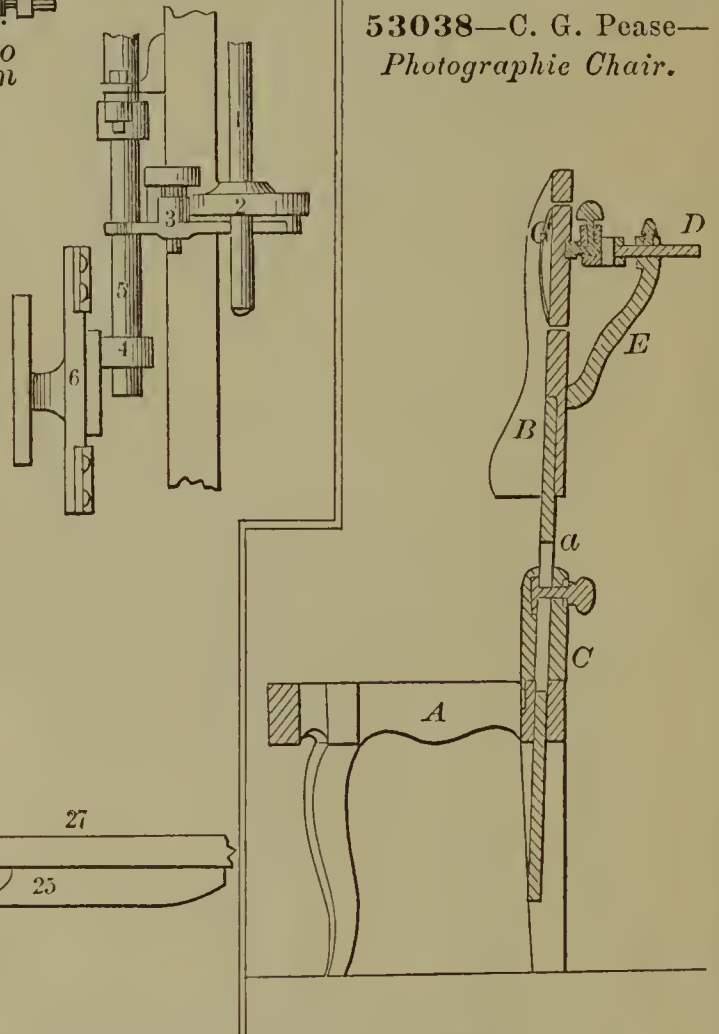

53040—J. G. Perry—Reaping and Mowing Machine.

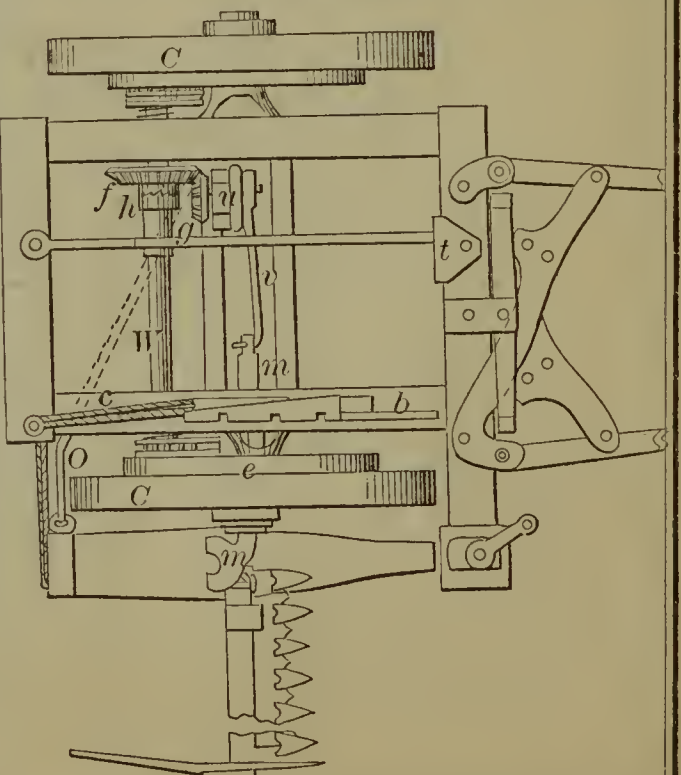

53039—J. G. Perry—Mowing Machine.

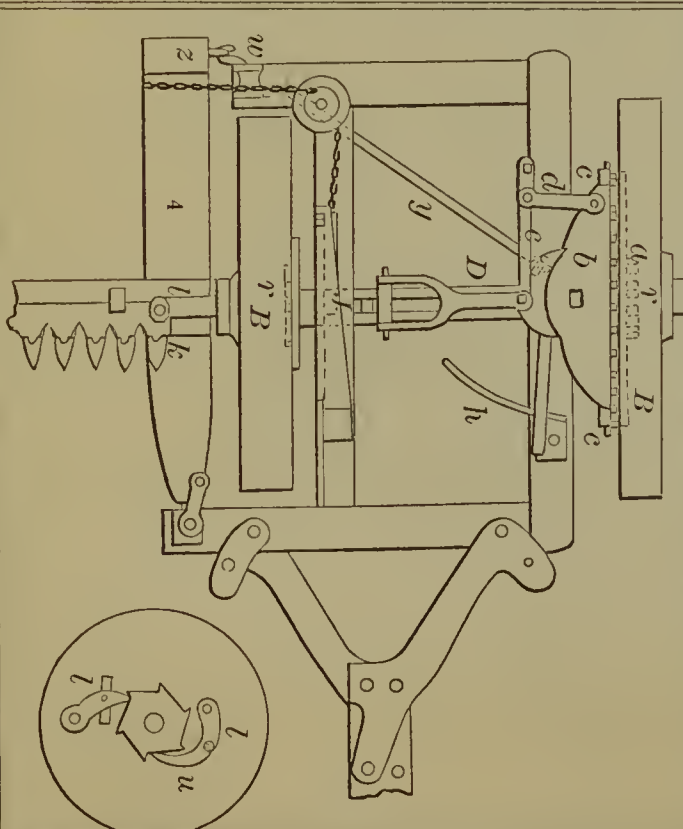

53041—S. Puffer—*Invalid Bedstead.*

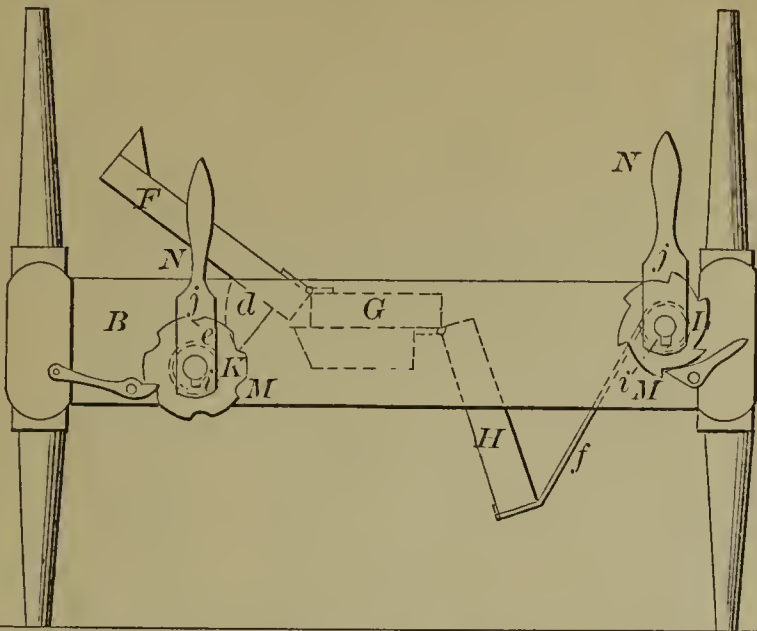

53043—L. J. Randall—*Preparing Cheese for Market.*

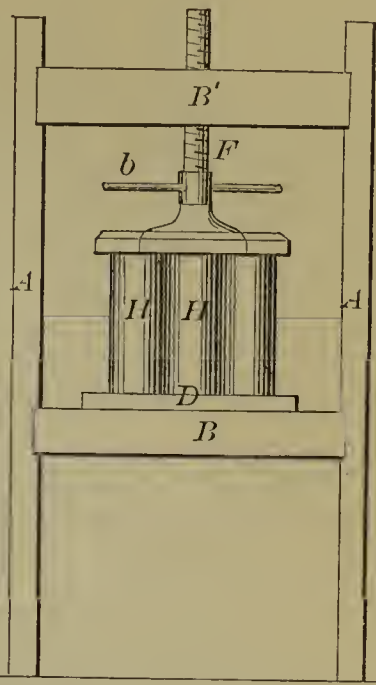

53042—E. Quinn—*Automatic Boiler Feeder.*

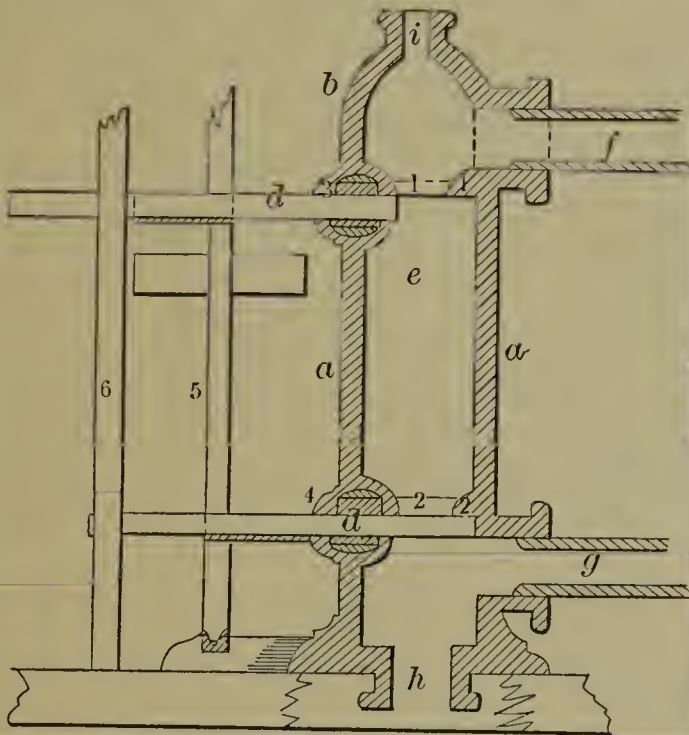

53045—A. V. Ryder—*Trunk and Bureau.*

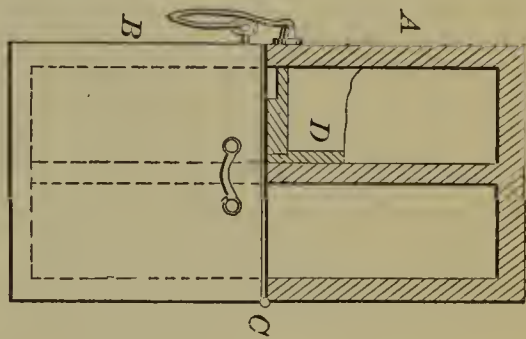

53046—E. P. Ryder—*Treadle Motion.*

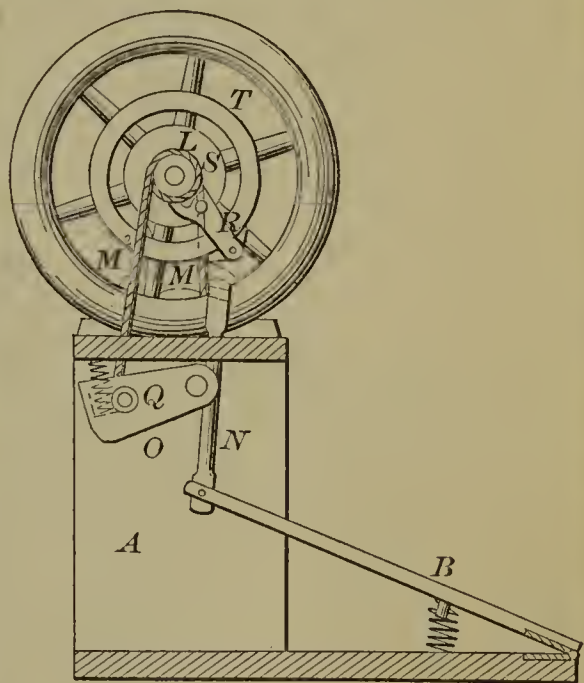

53044—F. Rumpf—*Crane.*

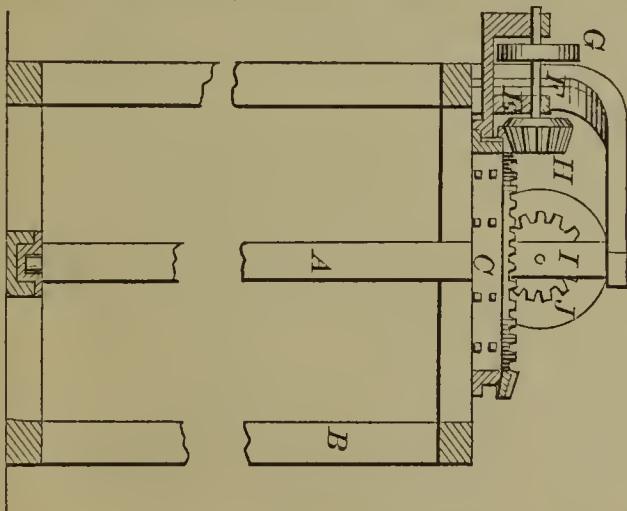

53047—P. A. Salvotti—*Telegraph Cable.*

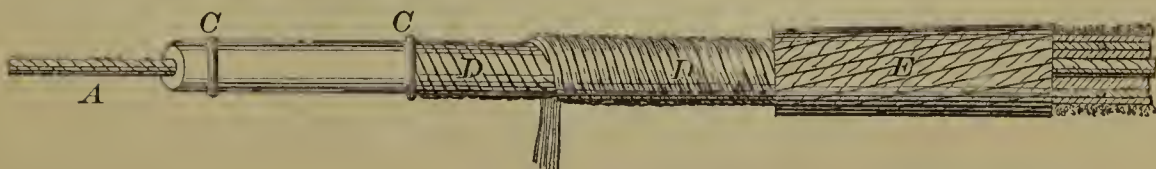

53048—R. Scott—Turning Cheese.

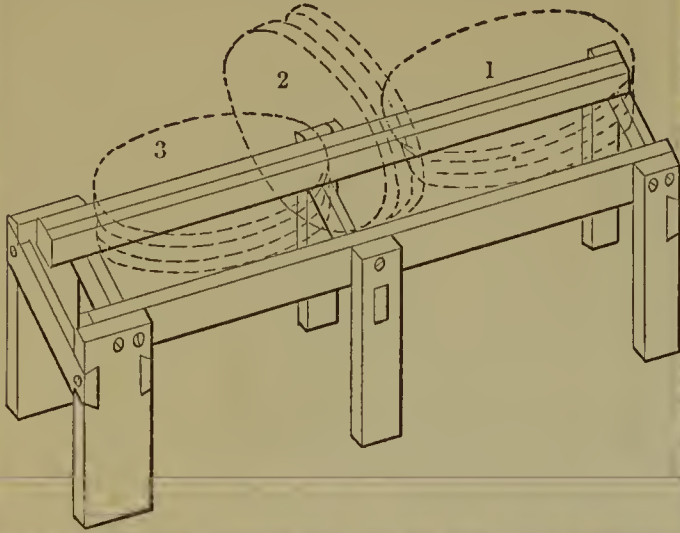

53051—S. & J. G. Sherman—Harvester Rake.

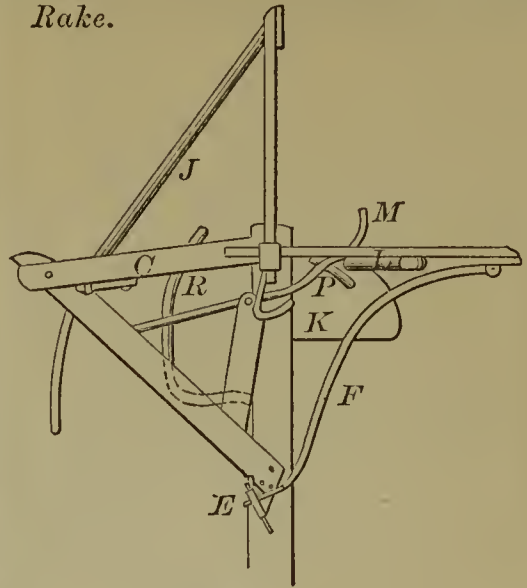

53050—L. Shepard—Scale for Weighing.

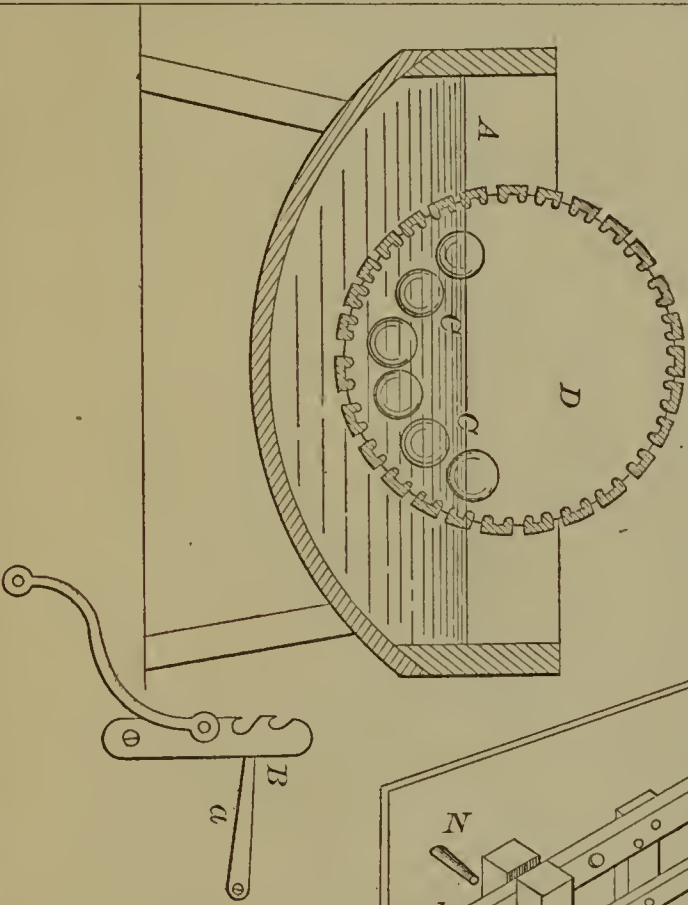
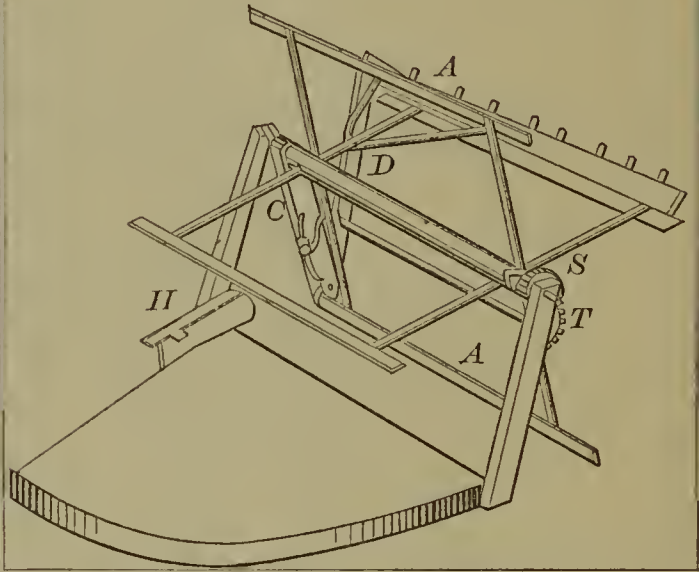
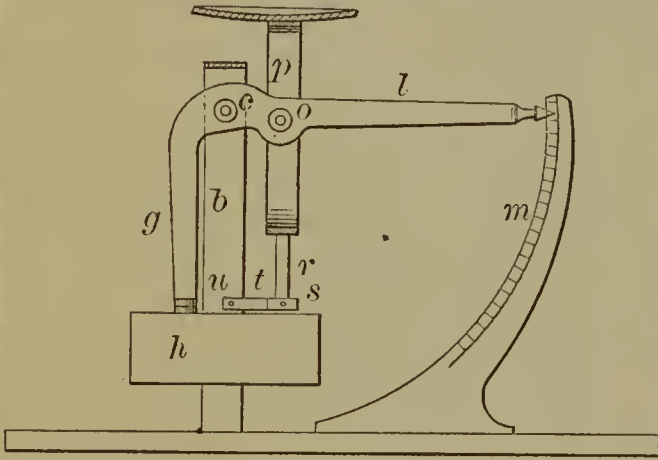

53052—L. E. Smith—Washing Machine.

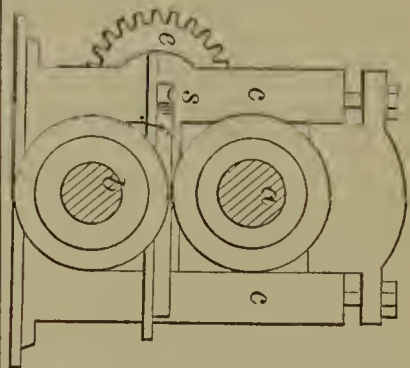

53049—J. S. Seaman—Rolling Metals.

53053—W. Snyder—Farm Gate.

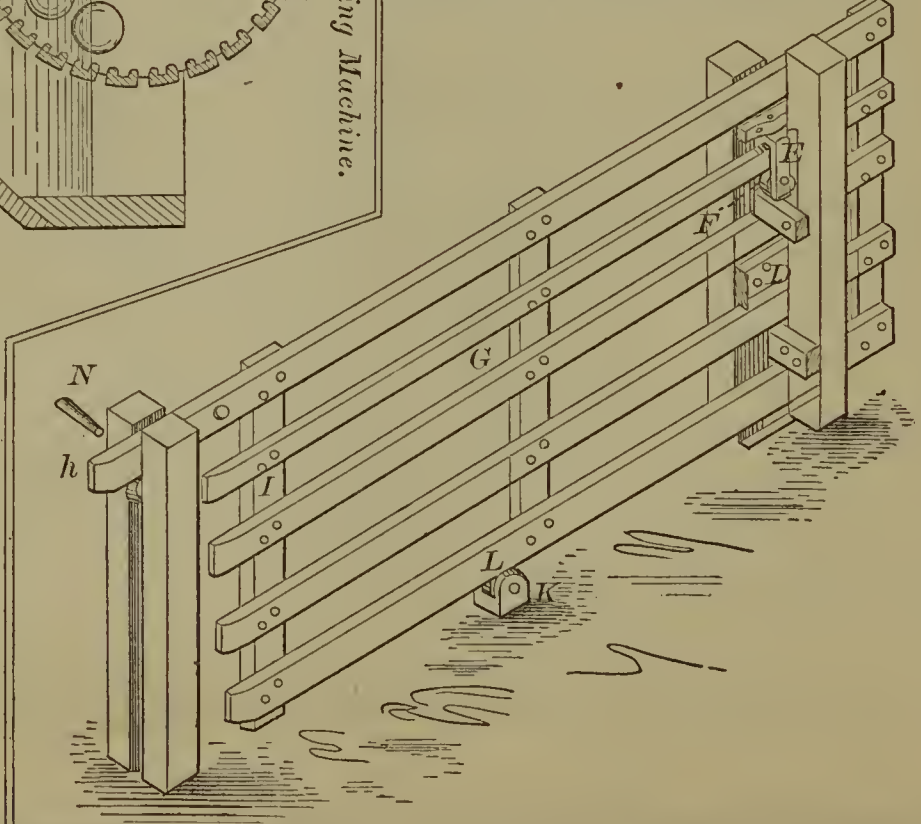

53054—G. W. Spear—Well Boring.

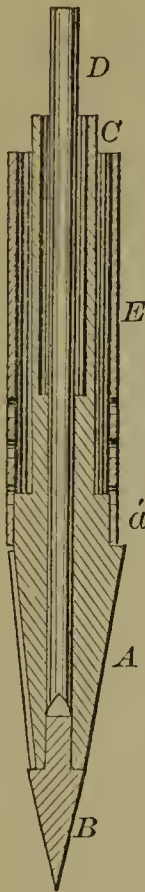

53058—A. Thomas—For Securing the Tail Stocks of Lathes.

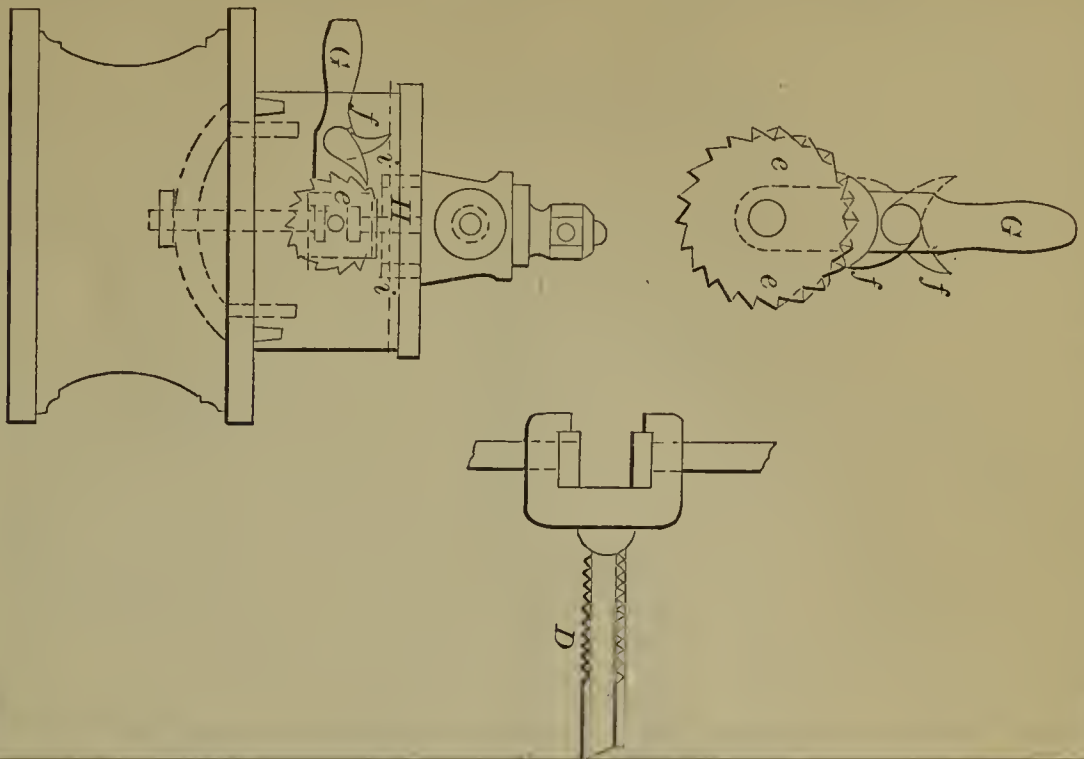

53055—Stone & Kendrick—Dish Drainer and Dryer.

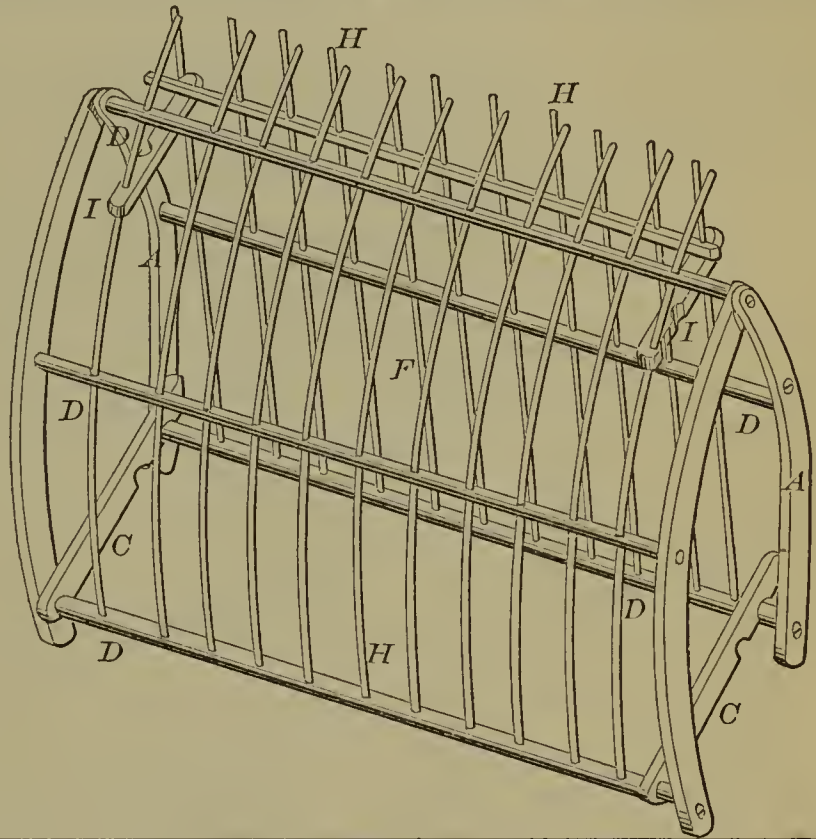

53059—W. B. Treadwell—Grate and Grate Bar.

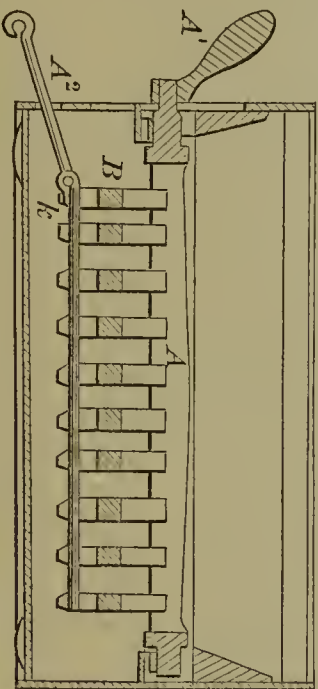

53060—E. A. Tyler—Hair Crimping Pin.



53057—C. Tompkins—Harvester.

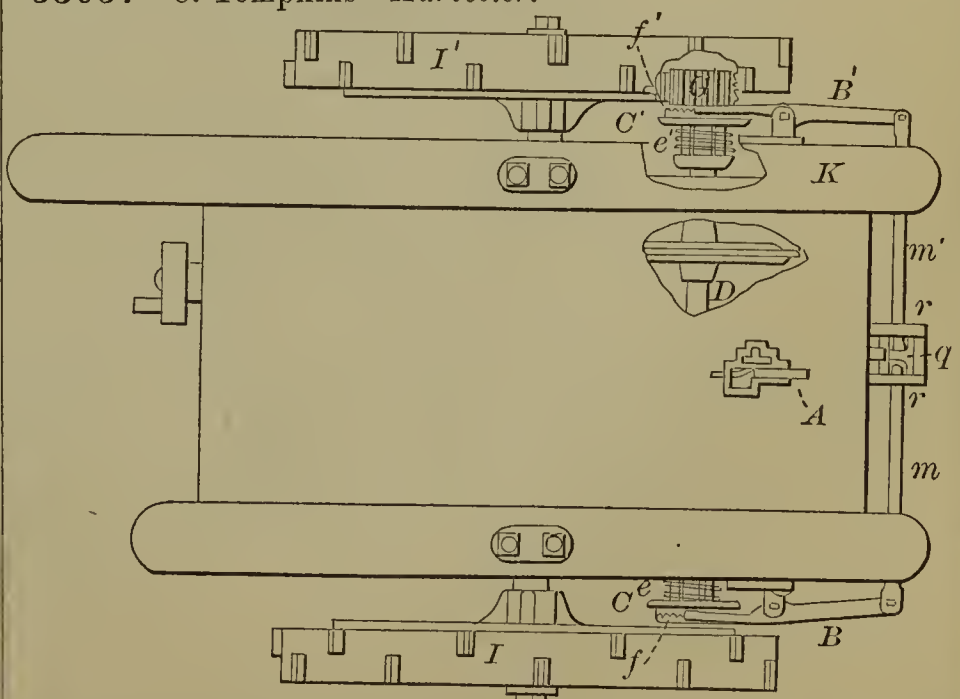

53061—J. Von Achen—*Hand Garden Plow.*

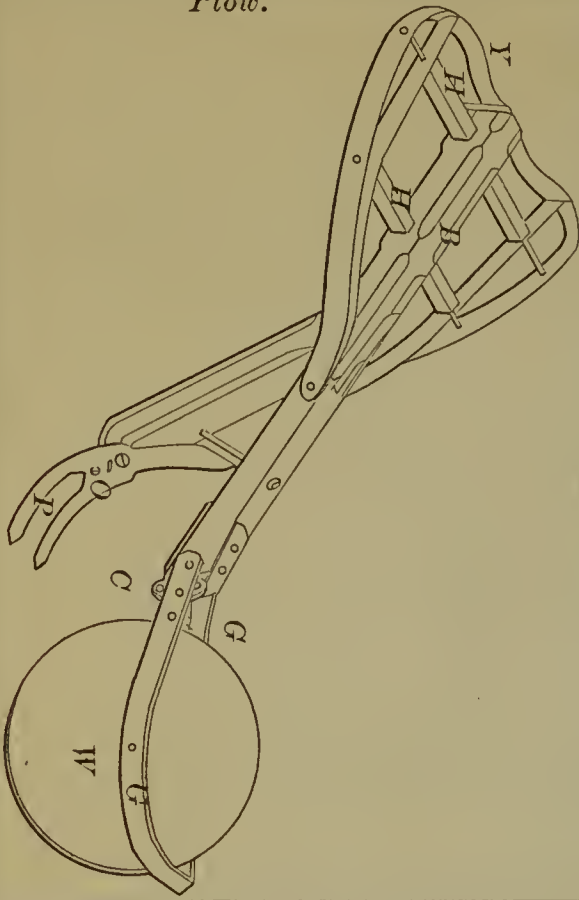

53063—J. J. Vankersen—*For Coring and Quartering Apples.*

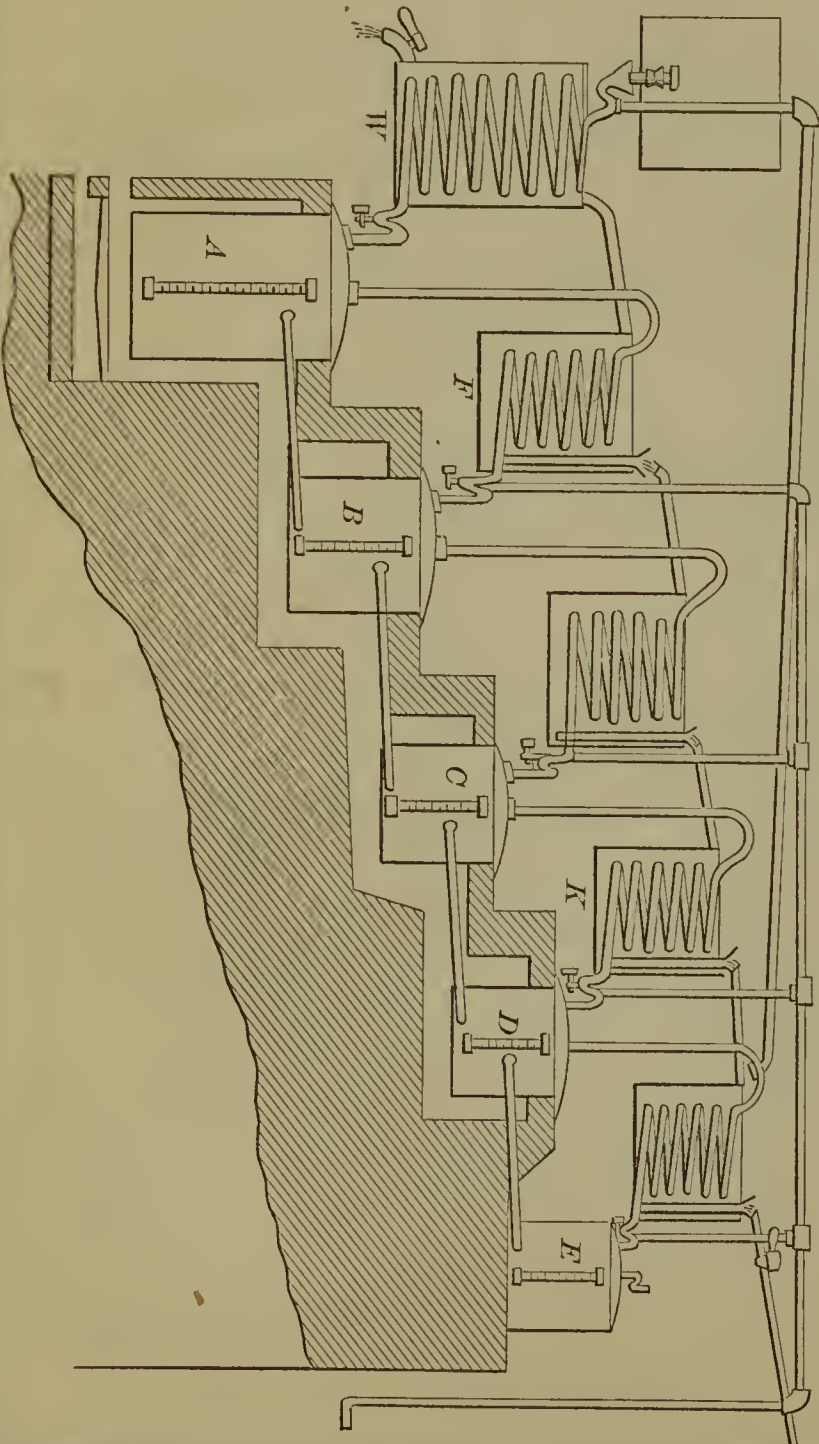
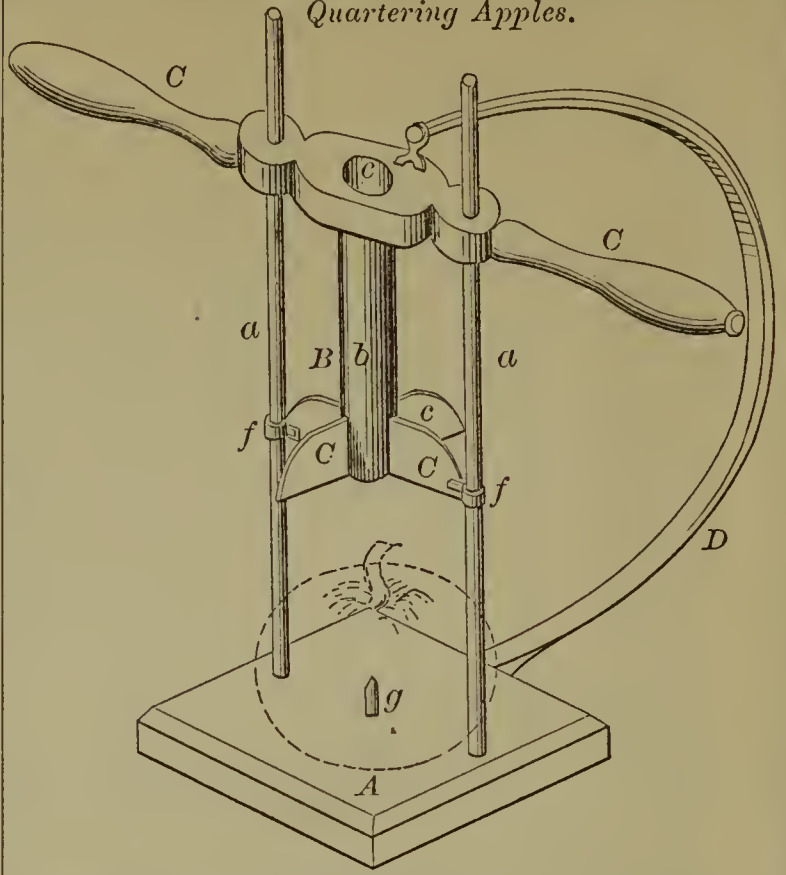

53062—P. H. Vander Weyde, M. D.—*Still for Petroleum.*

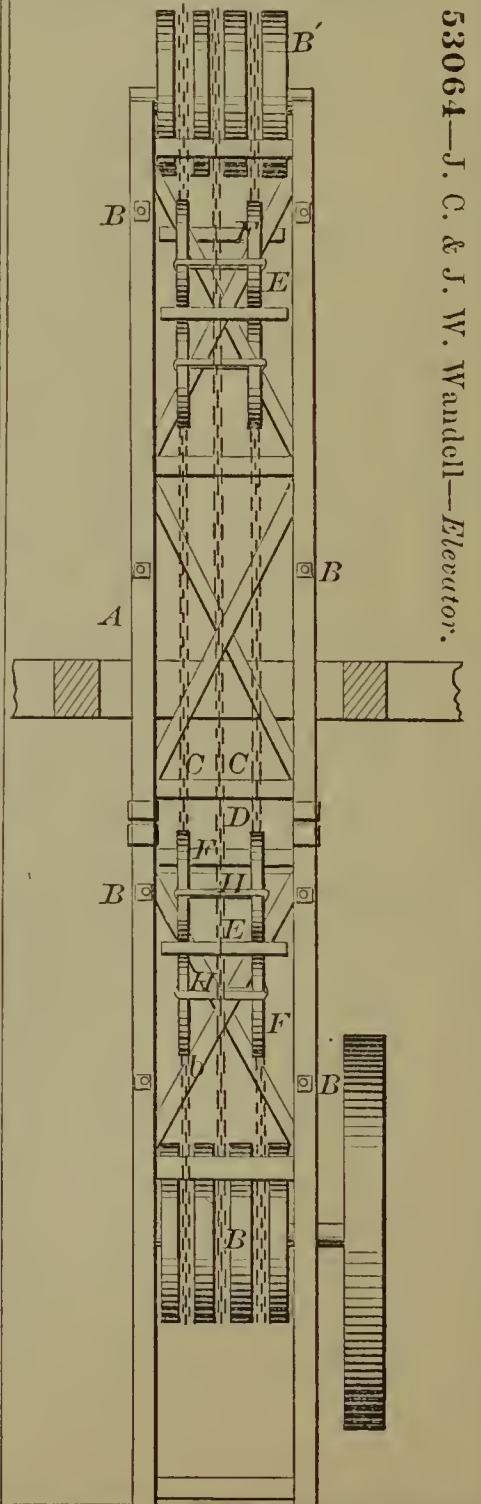

53064—J. C. & J. W. Wandell—*Elevator.*



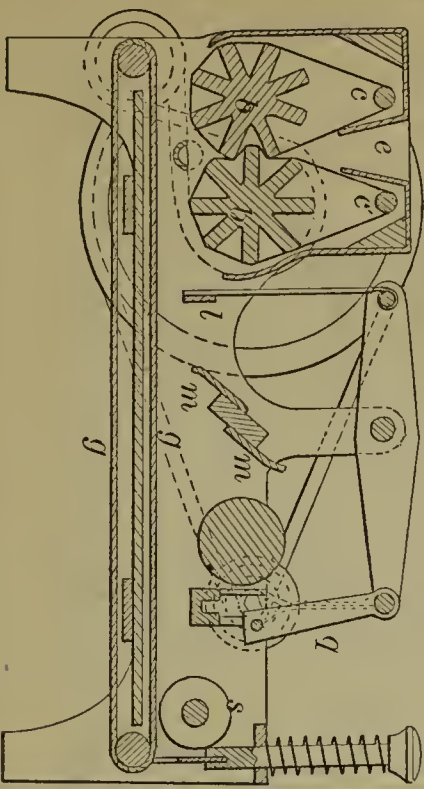

53065—D. Wellington—Peat Machine.

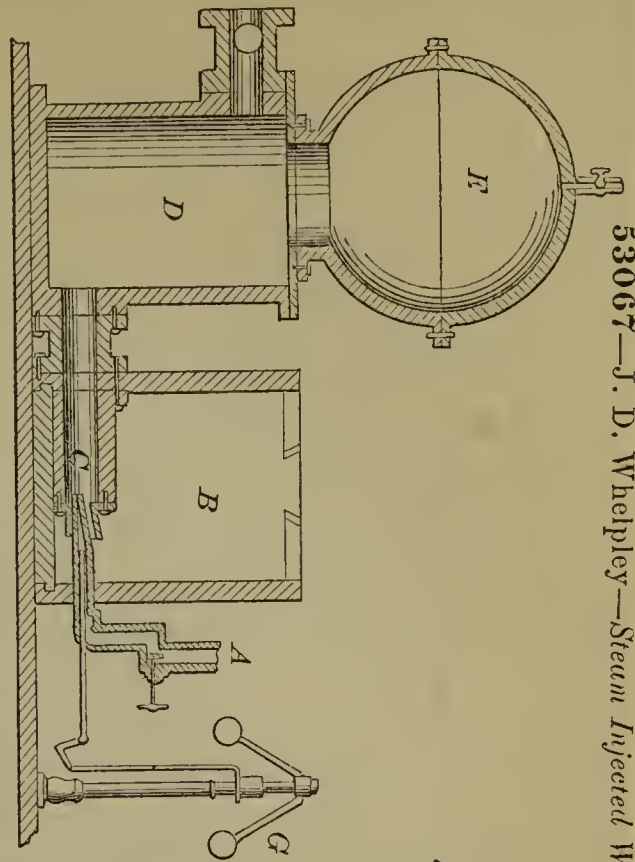

53067—J. D. Whelpley—Steam Injected Water Motor.

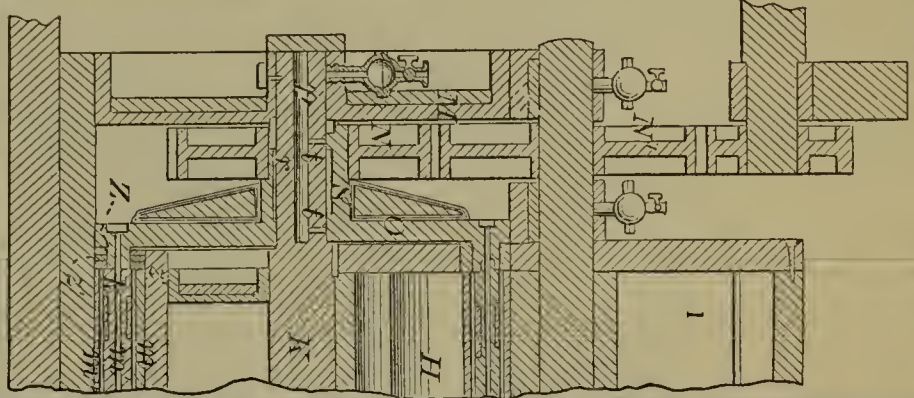

53069—J. H. Whitenack—Harvester.

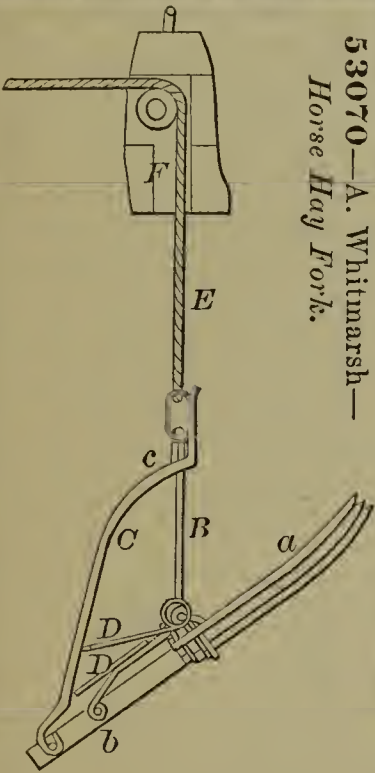
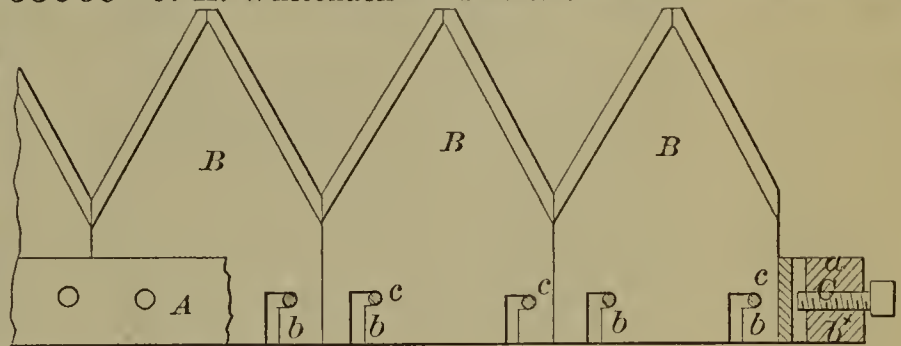

53070—A. Whitmarsh—Horse Hay Fork.

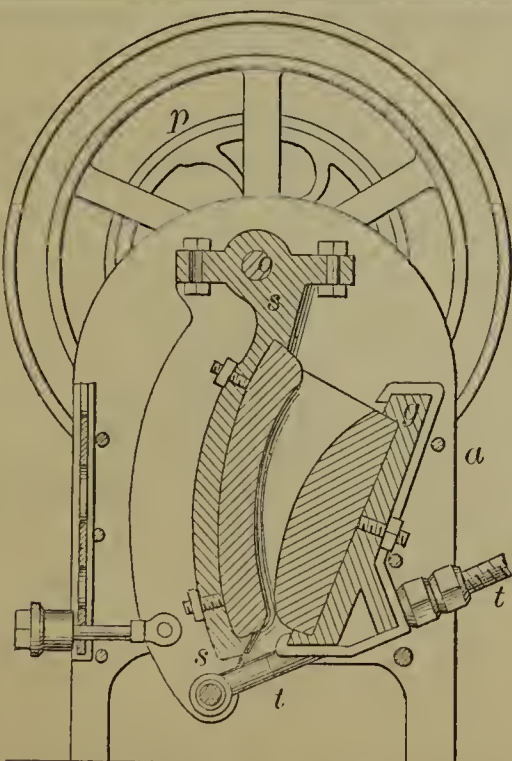

53066—Z. Wheeler—Ore Crusher.

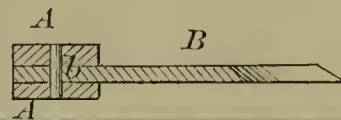

53068—Whelpley & Storer—For Removing Dust and Gas from Air.

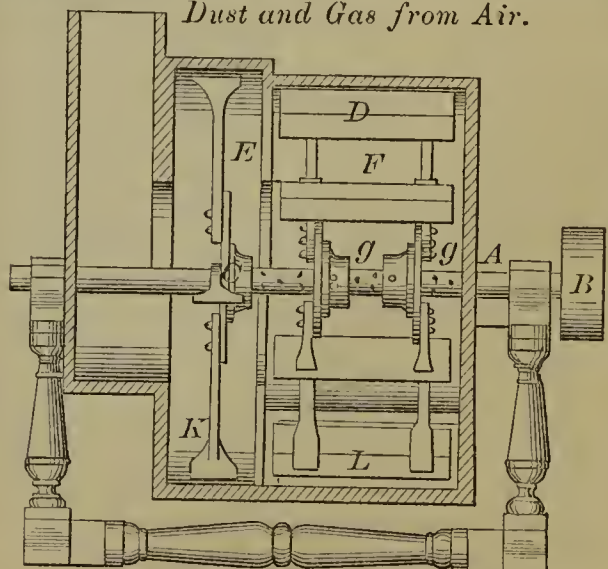

53071—R. Wildman—*Fur Blower.*

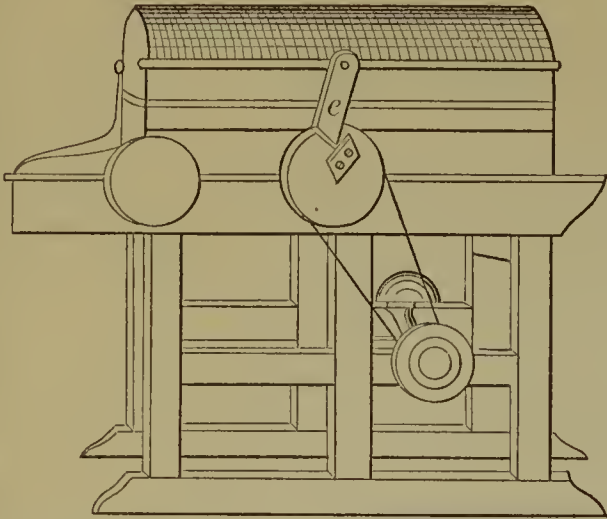

53074—A. G. Wilson—*Combined Funnel and Cock.*

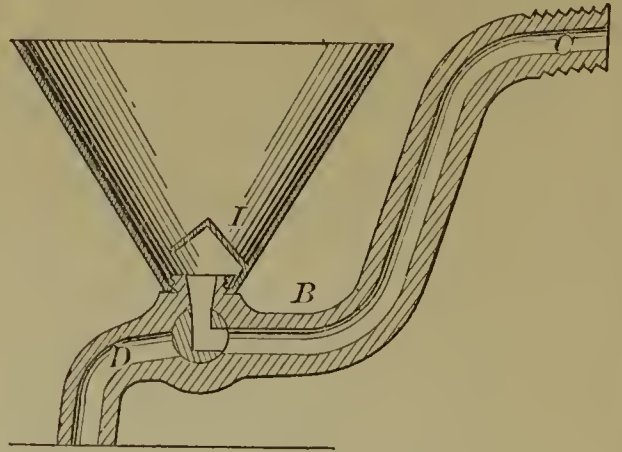

53072—W. W. Wiley—*Combined Seeding Machine, &c.*

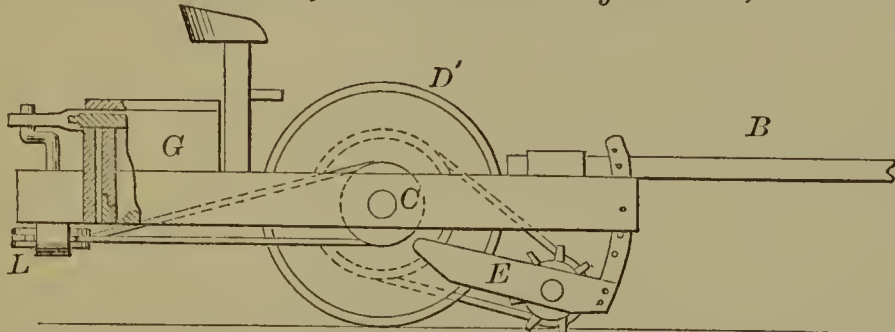

53076—H. Wright—*Jug Top.*

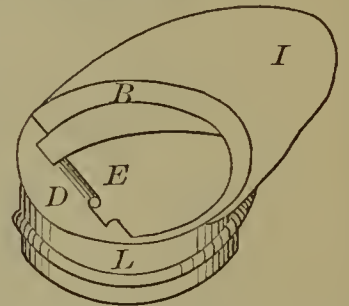

53073—W. S. Wilkinson—*Packing for Oil Wells.*

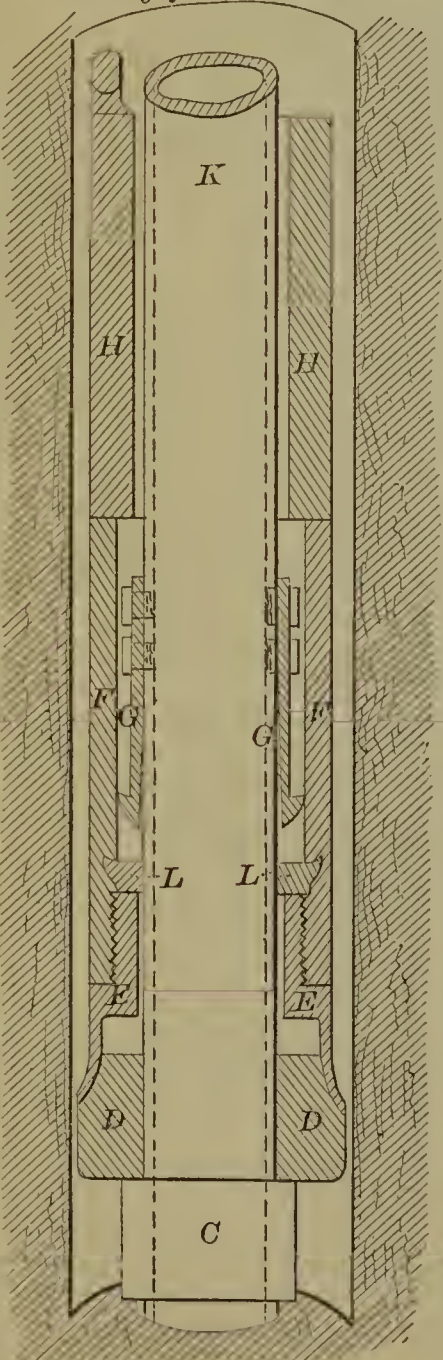

53075—F. Wood—*Landan Carriage Door.*

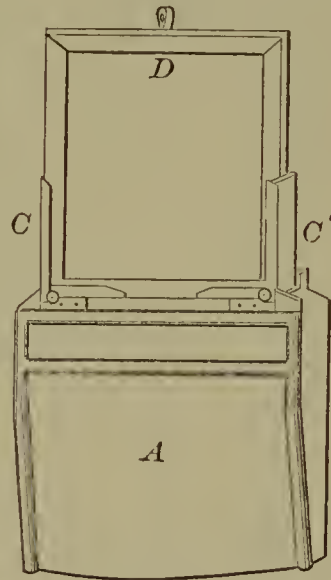

53077—J. Beebe—*Stove Pipe Drum and Oven.*

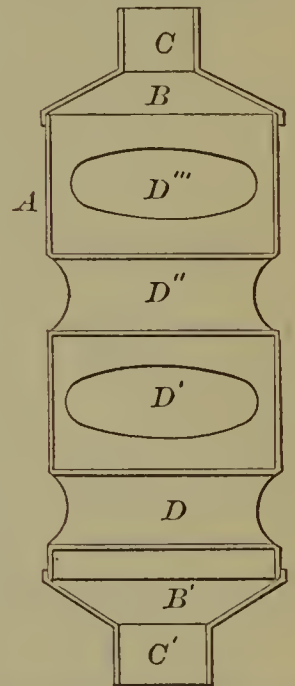

53079—J. Holderaft—*Gauge Cock for Steam Boilers.*

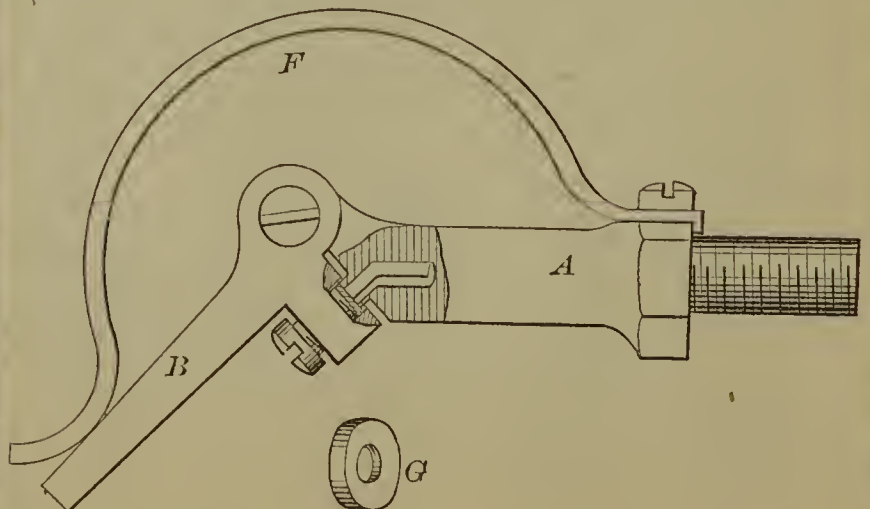

53080—W. R. Landfear—Eyelet Machine.

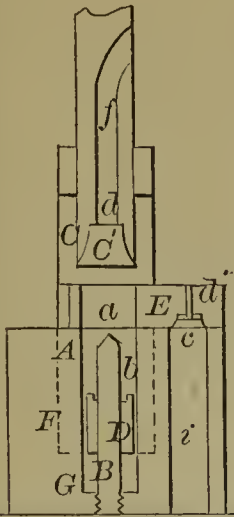

53083—M. Morse—For Pressing Hats.

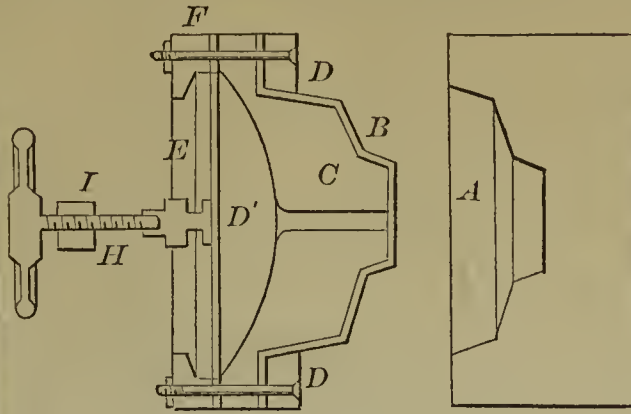

53086—A. Selkirk—Button.

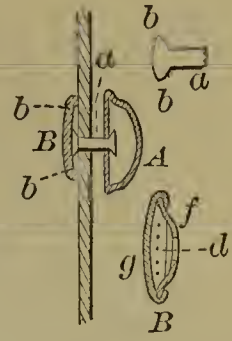

53084—F. Müller—Farm Gate.

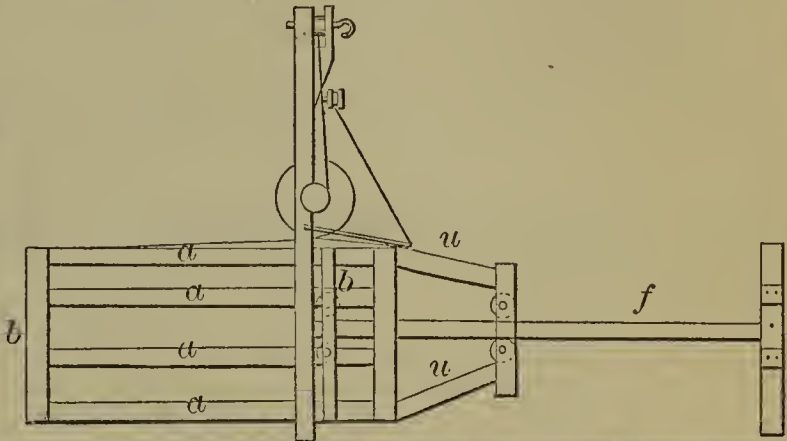

53082—B. G. Martin—For Cooling Liquids.

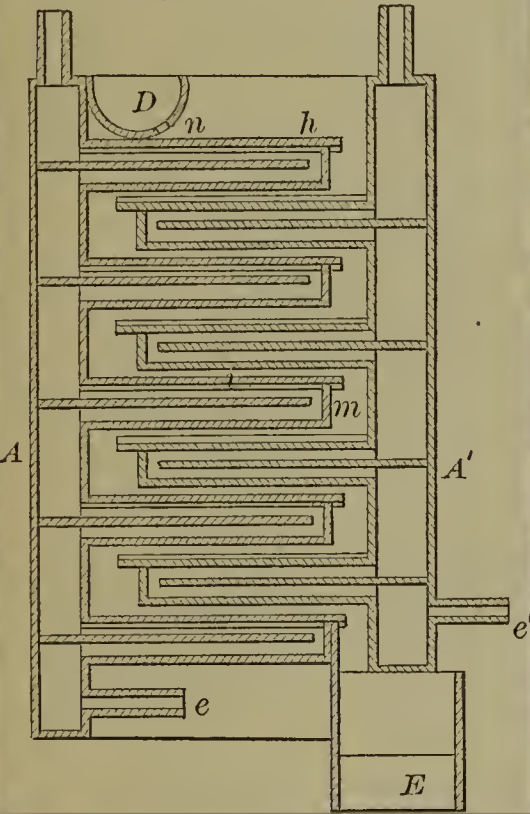

53087—J. Simmonds—Steam Blower.

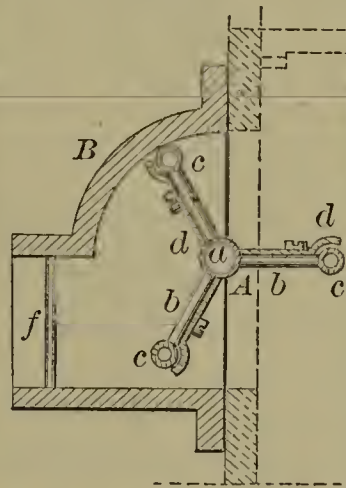

53085—J. F. Pierce—Horse Hay Fork.

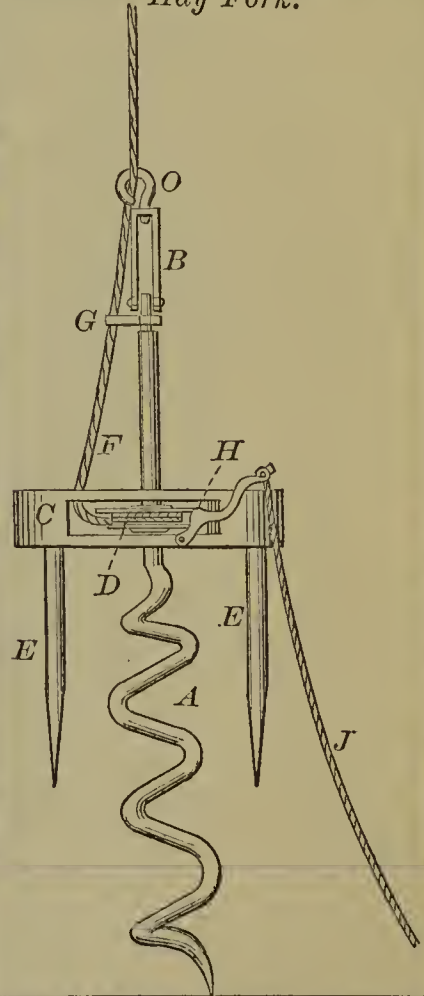

53088—G. Stackpole—For Canal Propulsion.

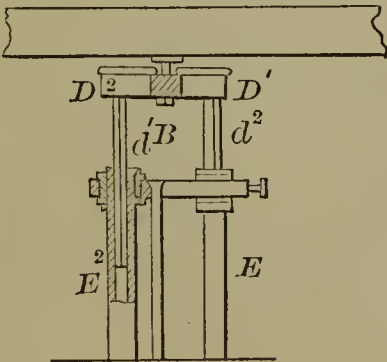
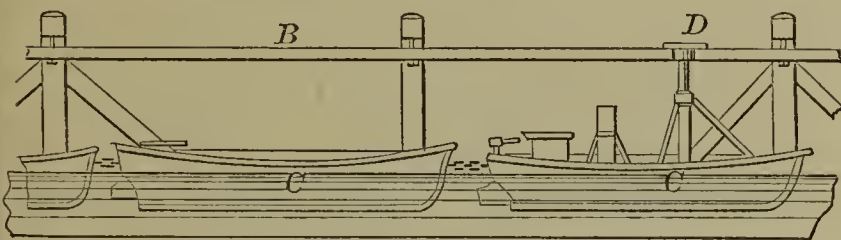

53089—O. D. Woodbury—Lamp.

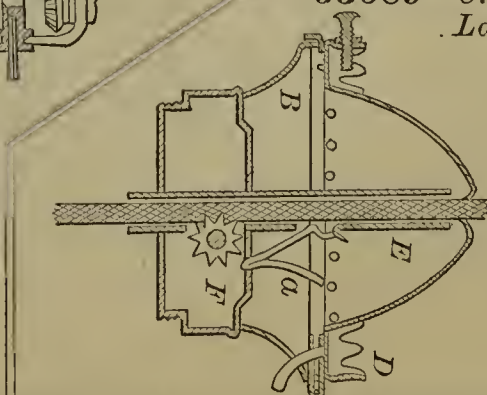

**53090**—G. Bousigues—  
*Fastening Corks in Bottles*

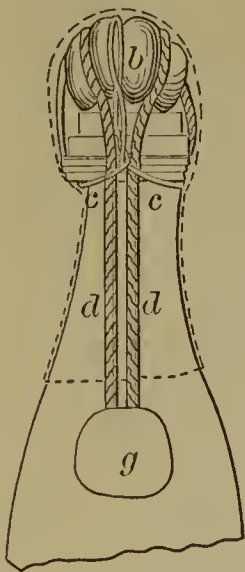

**53091**—D. Mc Dowell—*For Cleaning Tubes of Boilers.*

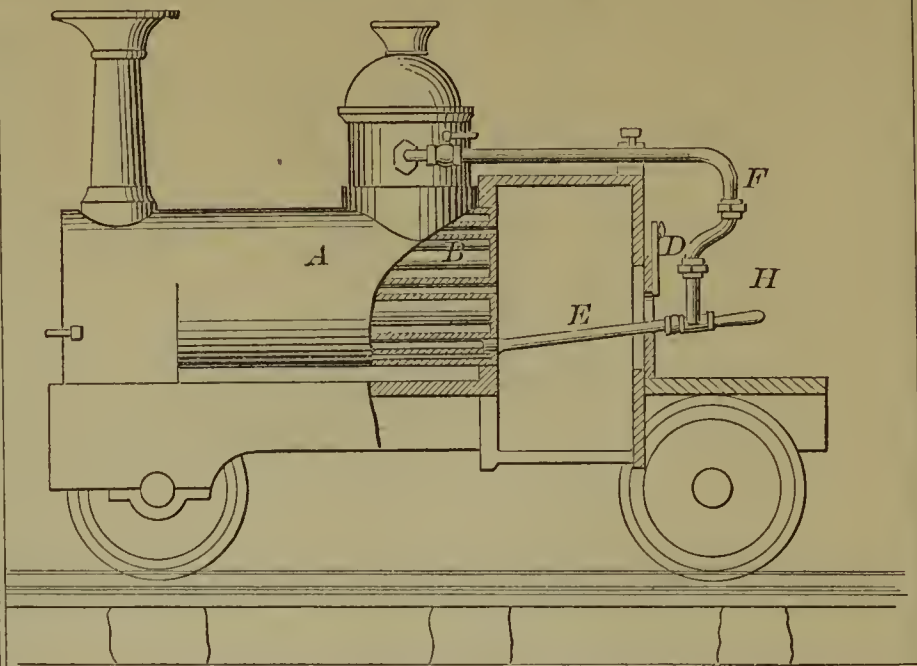

**53096**—T. Ascherfield—*Mail Lock.*

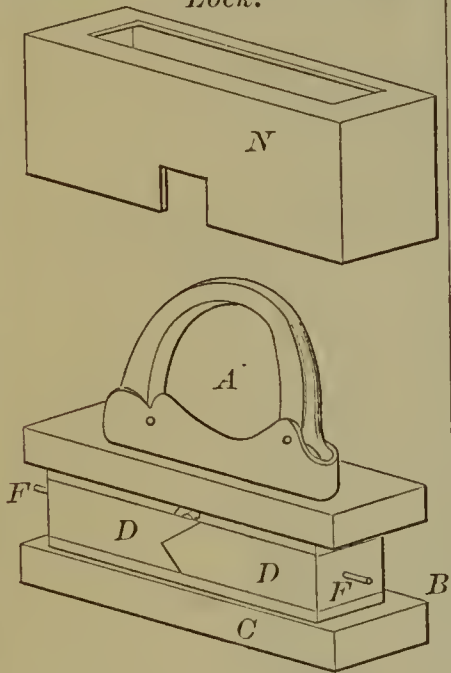

**53098**—S. A. Bailey—*Clothes Wringer.*

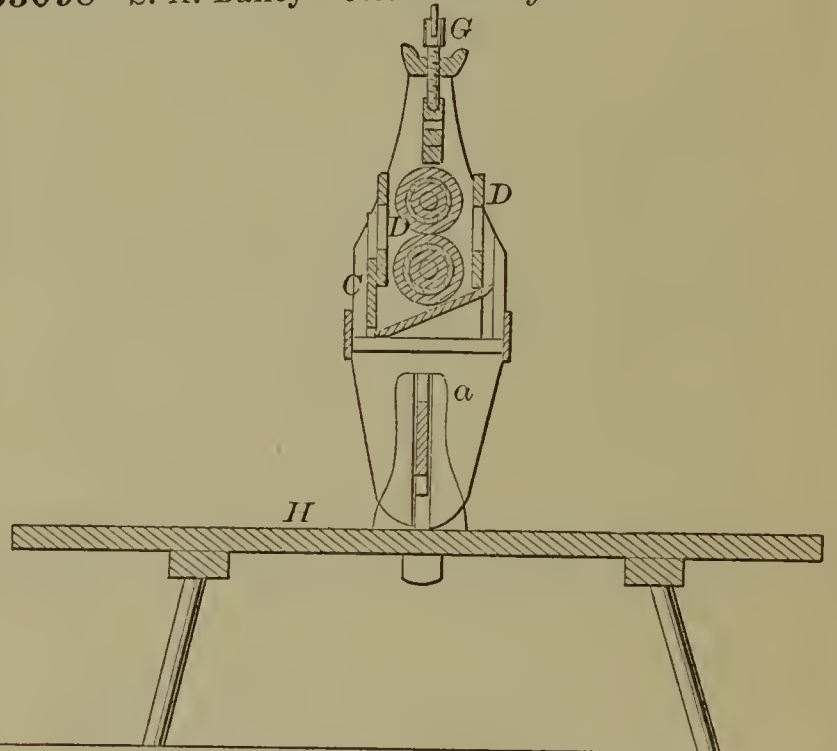

**53097**—J. B. Atwater—*Air Engine.*

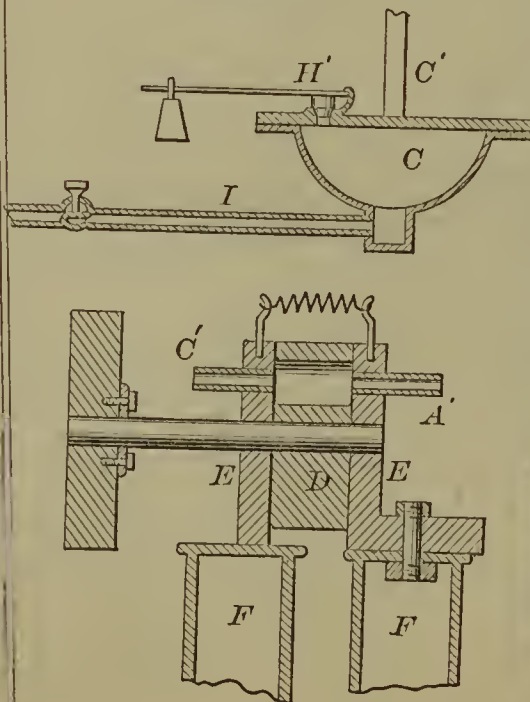

**53099**—S. A. Bailey—*Bench for Clothes Wringer.*

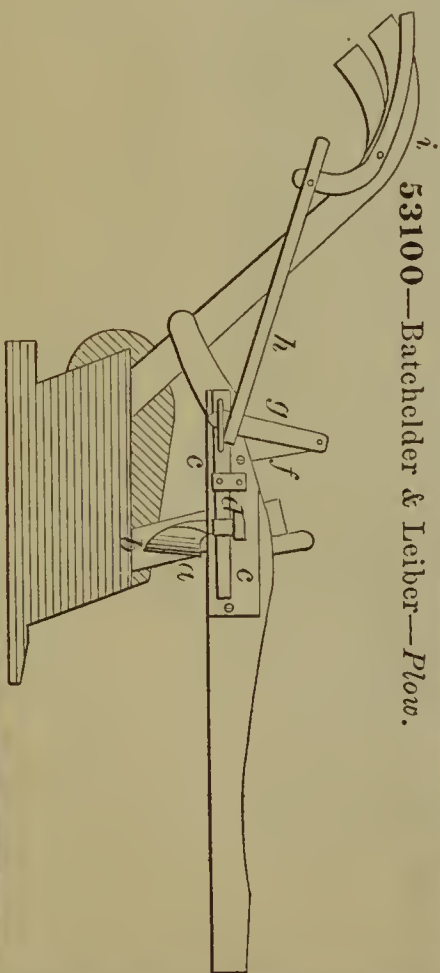
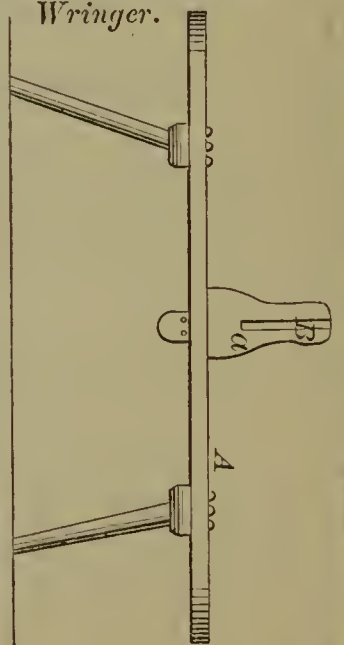

**53100**—Batchelder & Leiber—*Plow.*

53101—S. R. Beckwith—  
Granary, Fruit House, &c.

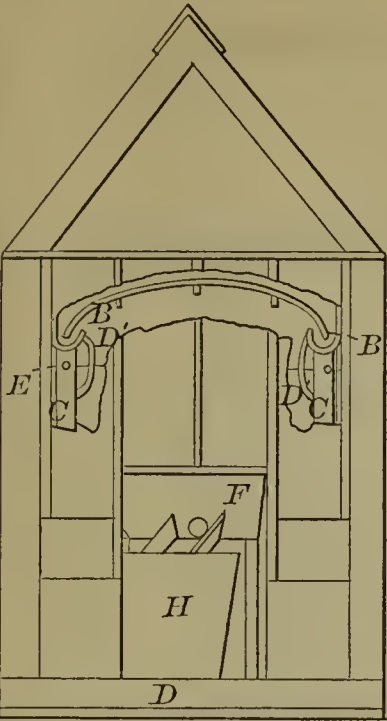

53104—J. F. Bennett—Raising  
Heat by the Combustion of Fuel.

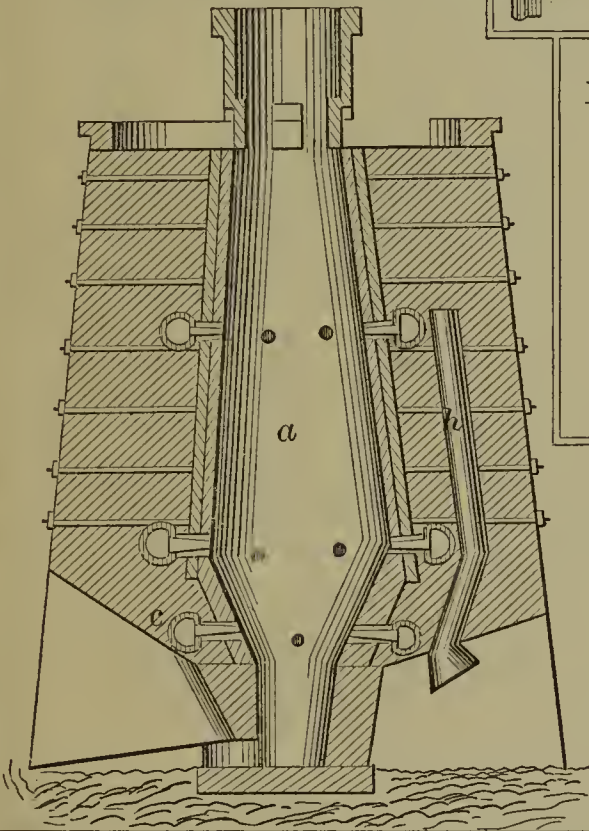

53107—L. W. Boynton—For Making  
Skewers.

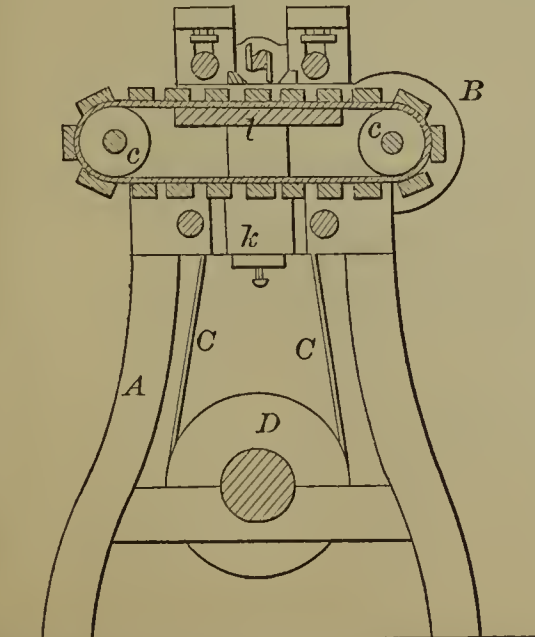

53106—V. W. Blanchard—Car Brake.

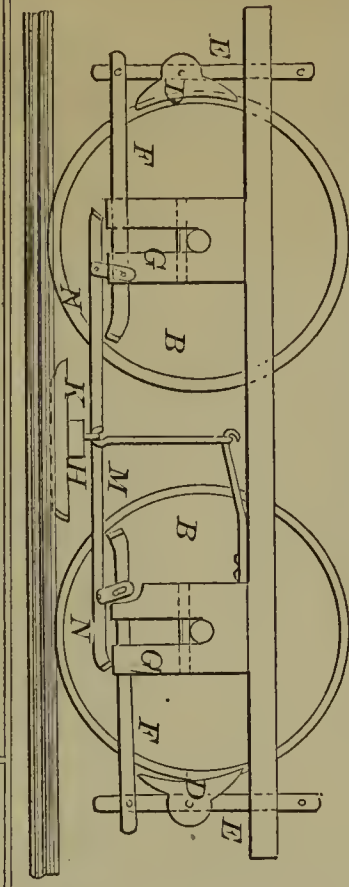

53102—  
Bendix & Fleisch—  
Neck Tie.

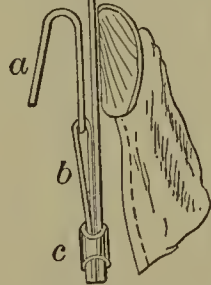

53105—J. Blackie—For Making  
Plug Tobacco.

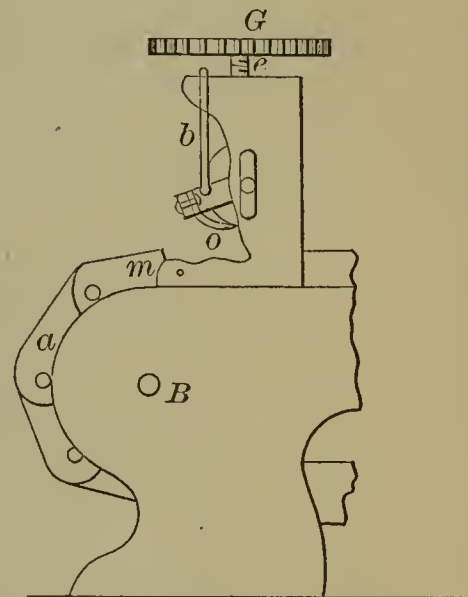
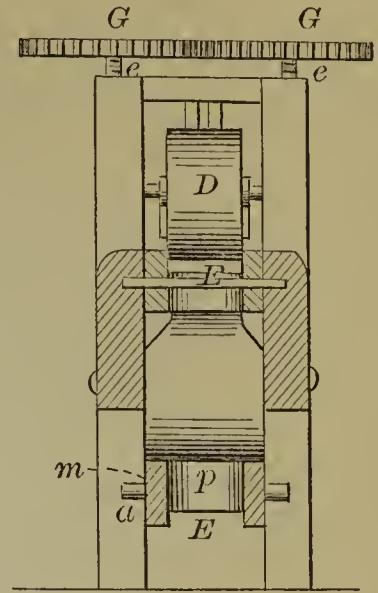

53103—Beidler & Crihfield—Kerosene Lamp.

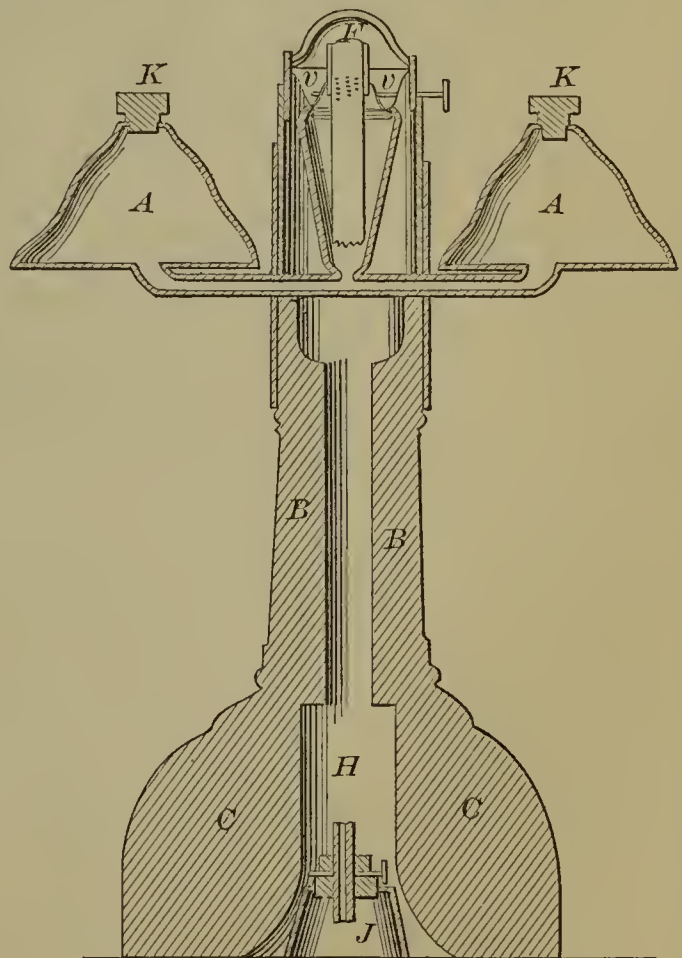

53108—L. W. Boynton—For Pointing  
Skewers.

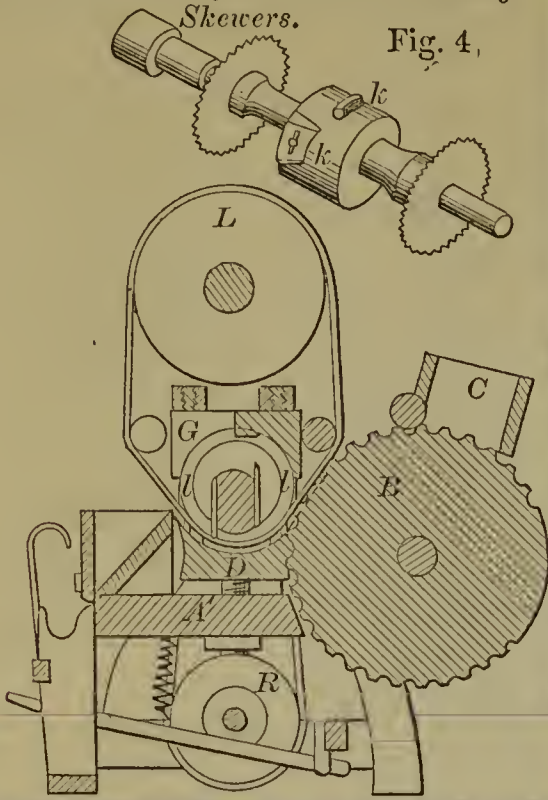

53109—C. Burchardt—Nozzle for Fire Engines.

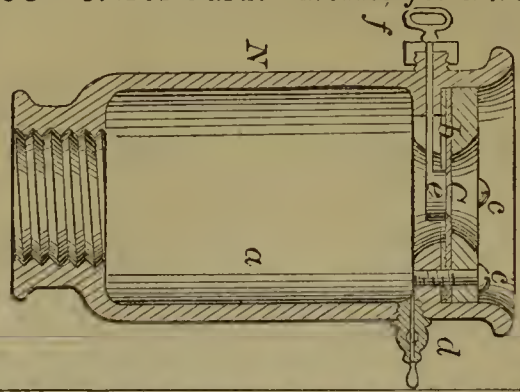

53111—E. S. Carter—Boot Blacking Case.

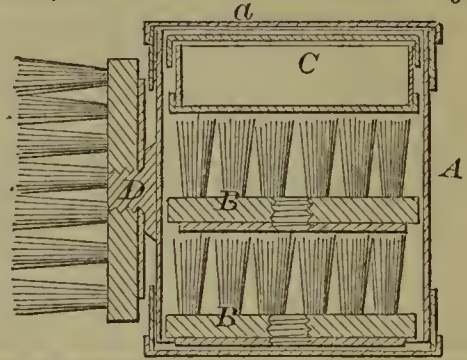

53113—A. Chambers—Machine for Cutting Files.

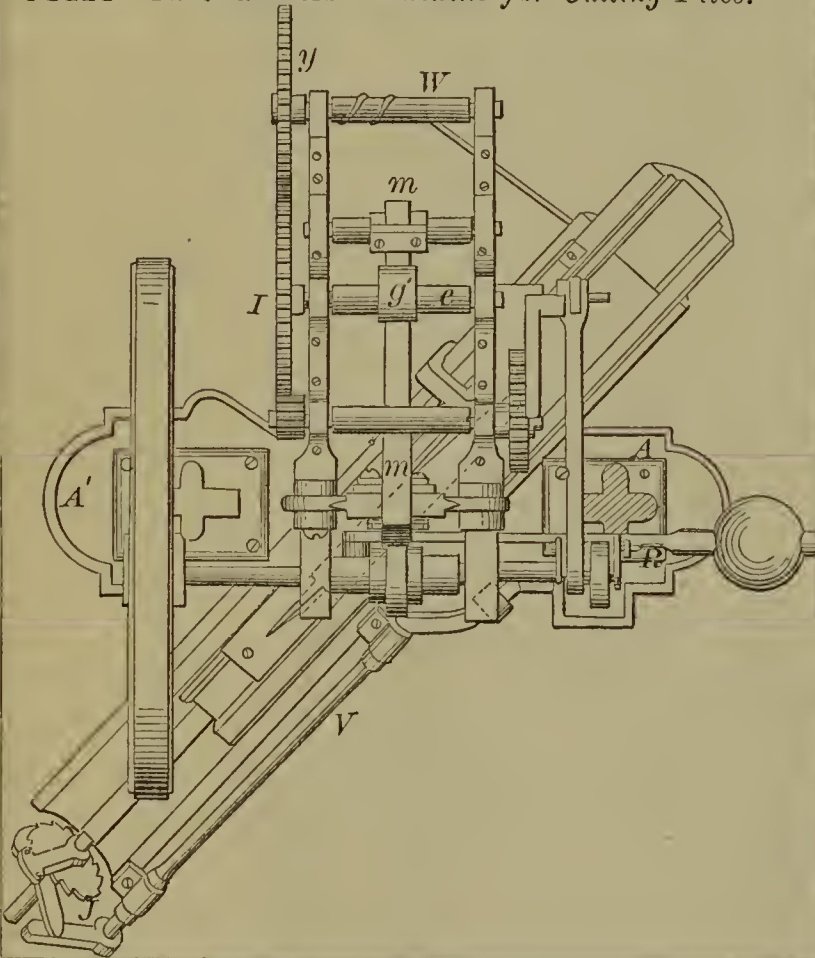

53110—Canfield, Coleman & Wheeler—Reaping and Mowing Machine.

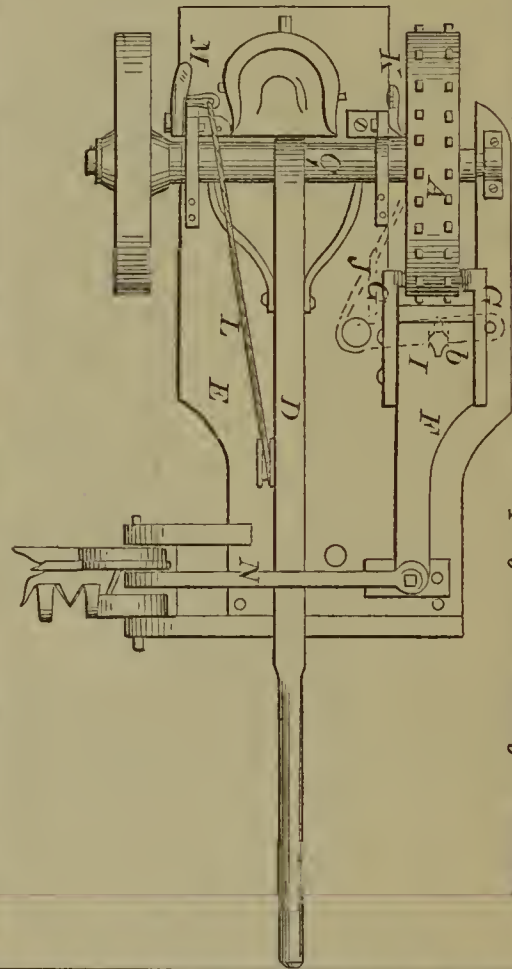

53112—J. Catt—Washing Machine.

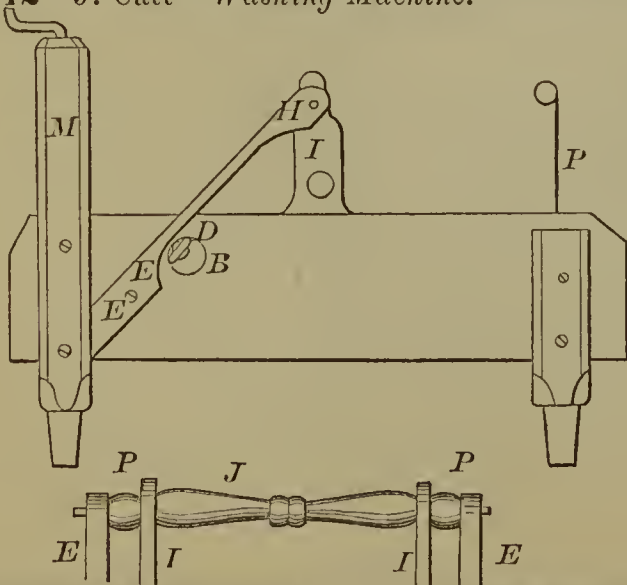

53114—W. C. Choate—Letter File.

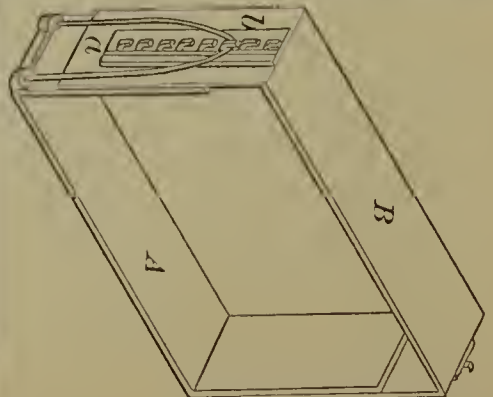

53115—J. Clarke—*Altiscope.*

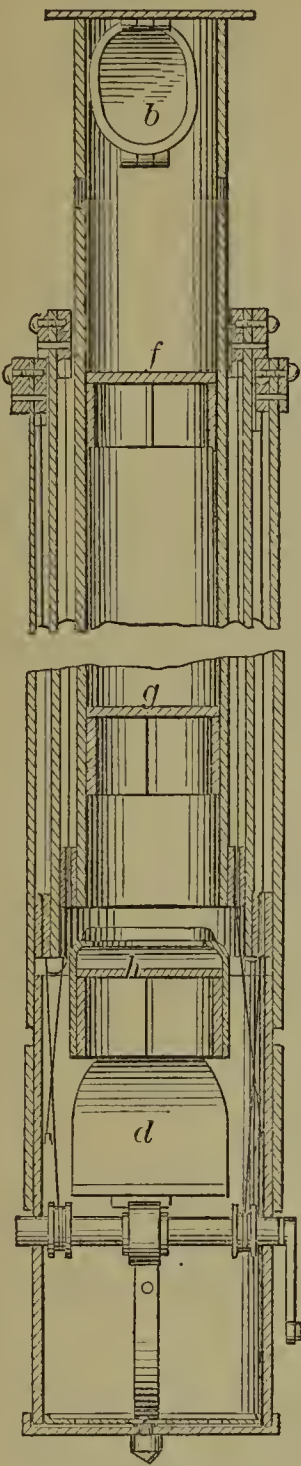

53116—T. Cogswell—*Holding Strap for Street Railway Cars.*



53118—I. E. Craig—*Steam Generator for Heating Purposes.*

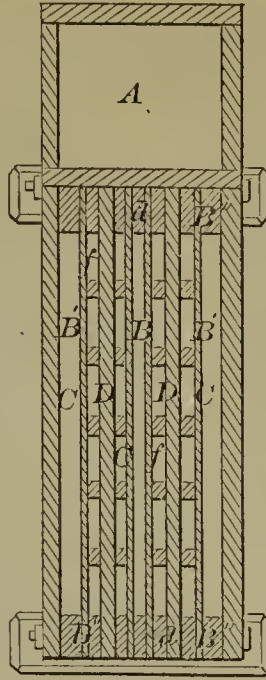

53117—R. Cornelius—*Pump for Deep Wells.*

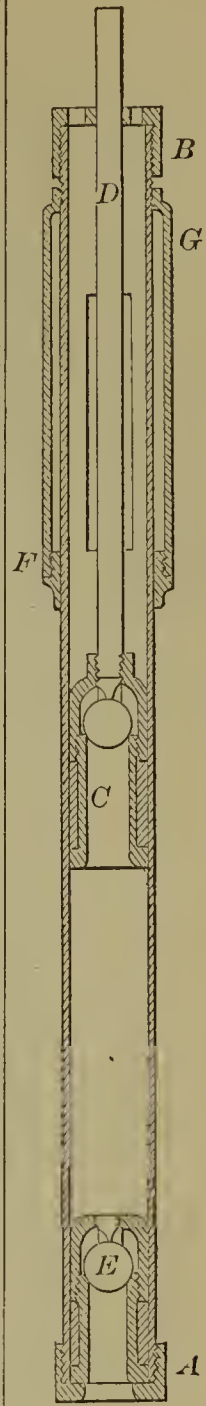

53120—J. Crookes—*Saw Grinding Machine.*

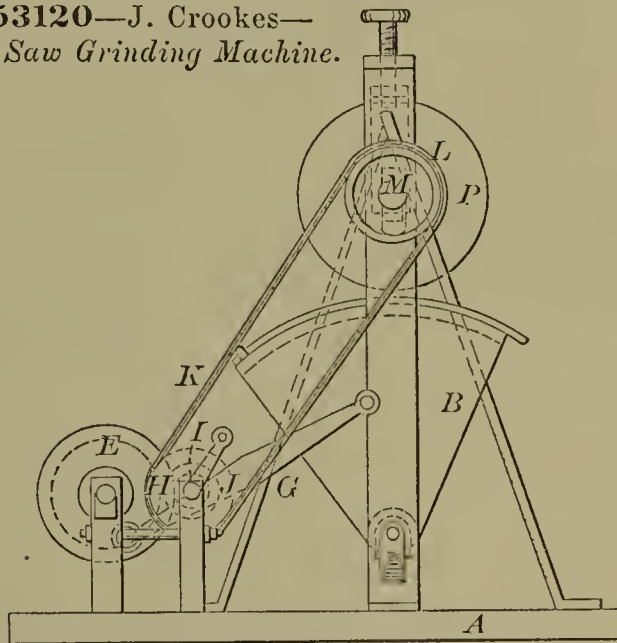

53119—H. H. Craigie—*Water Closet.*

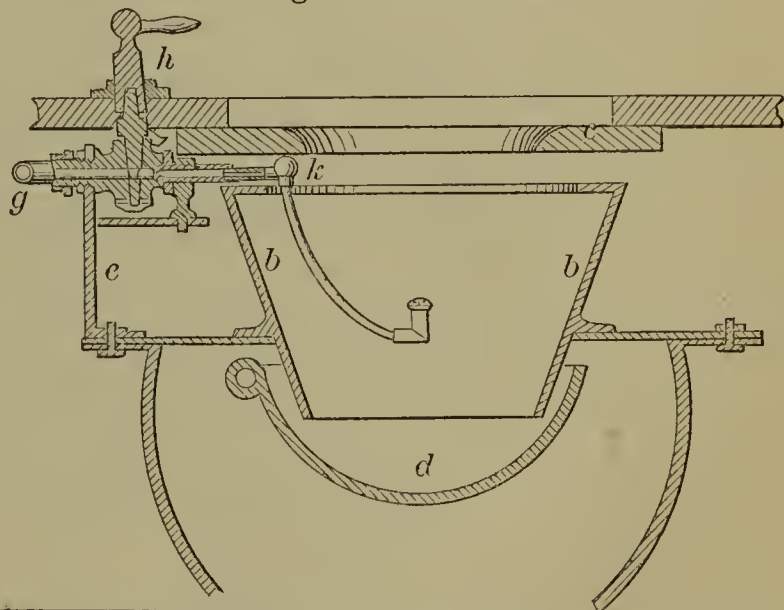

53121—S. H. Crossman—*Bed Bottom.*

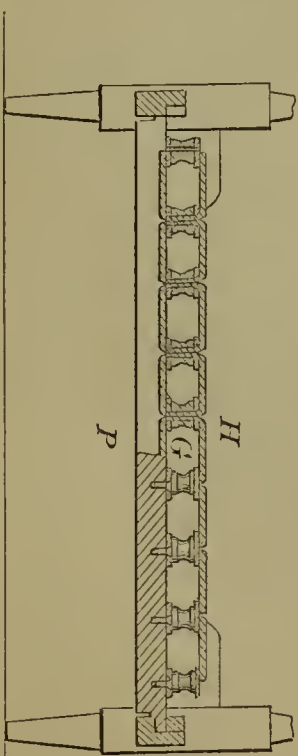

53122—E. S. Dawson—*Snap Hook.*

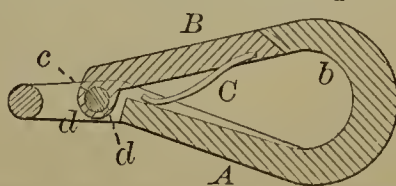

53123—J. Davis, 2d—Churn.

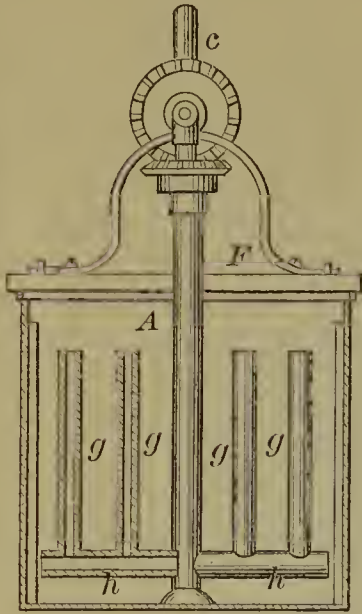

53125—Dickerson & Wilbur—Stump Extractor.

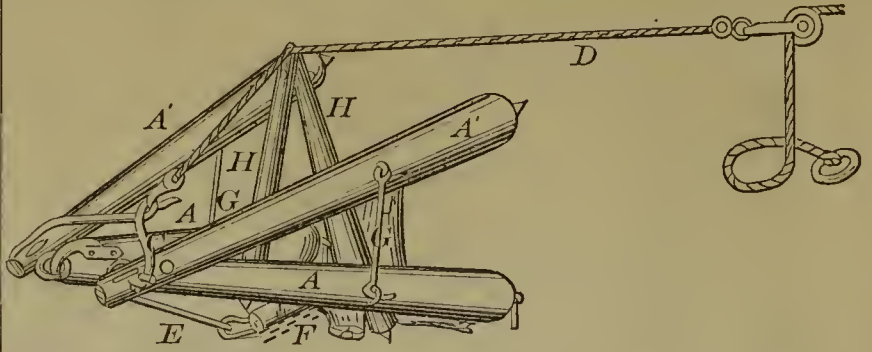

53127—L. Duvall—Combined Spade and Fork.

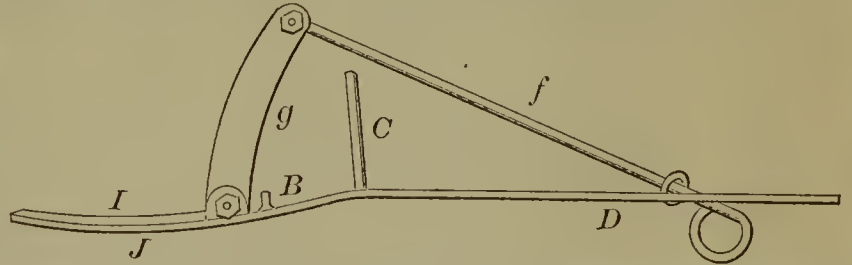

53126—K. W. Doudna—Broom Corn and Sorghum Stripper.

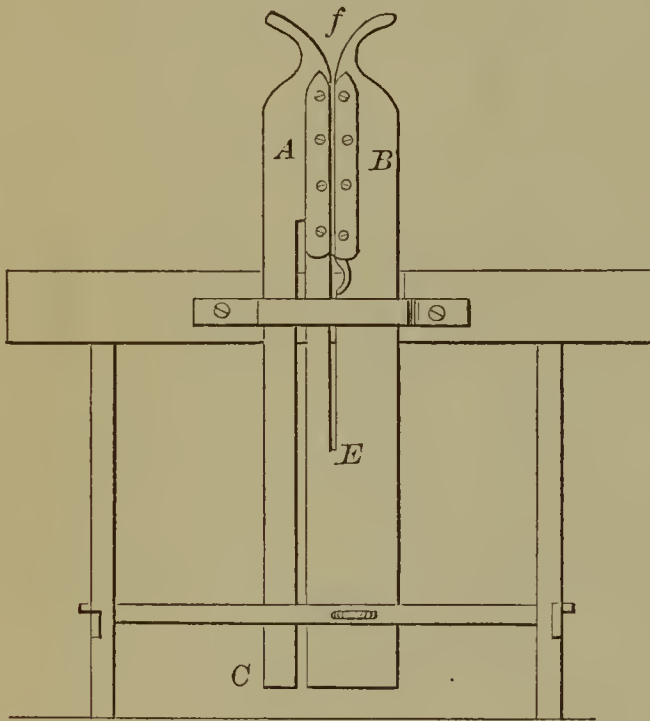

53129—C. R. Edwards—Coffee Mill.

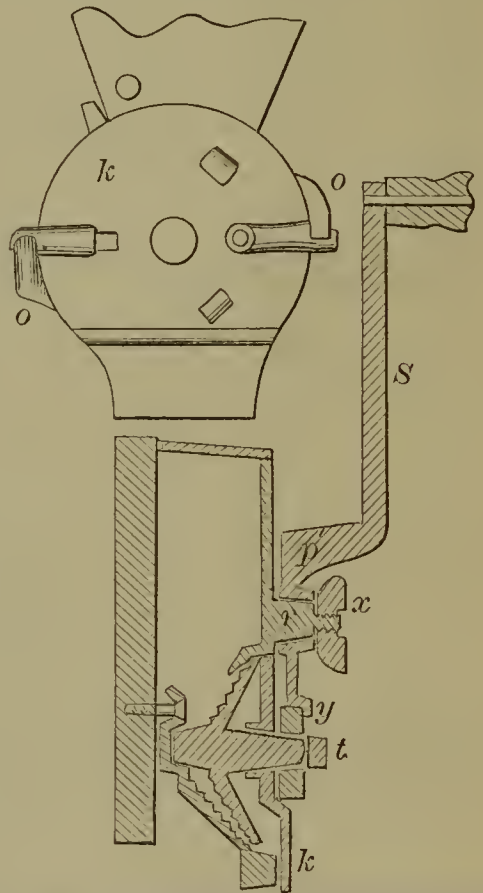

53128—S. H. Early—Pump for Deep Wells.

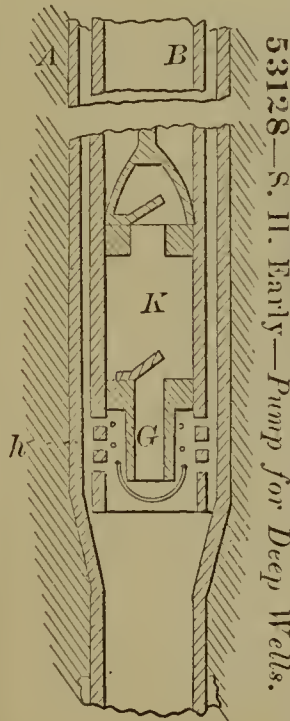

53130—E. C. Evans—Weather Strip.

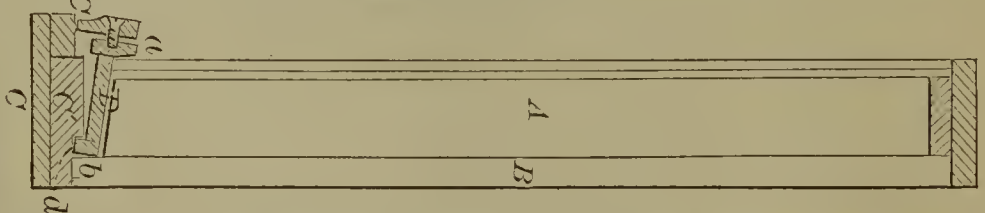

53131—F. L. Faulkner—Spittoon.

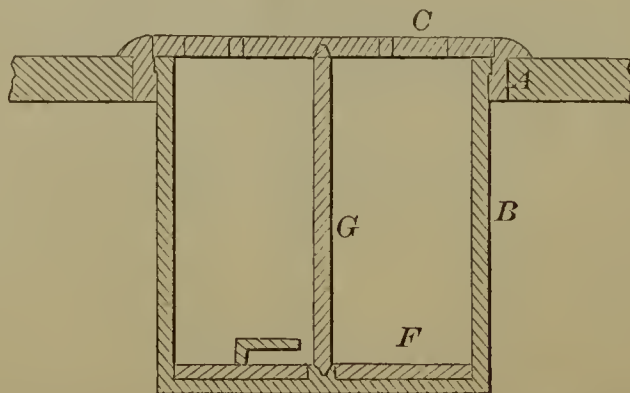



53132—Fisher & Ball—Washing and Wringing Machine.

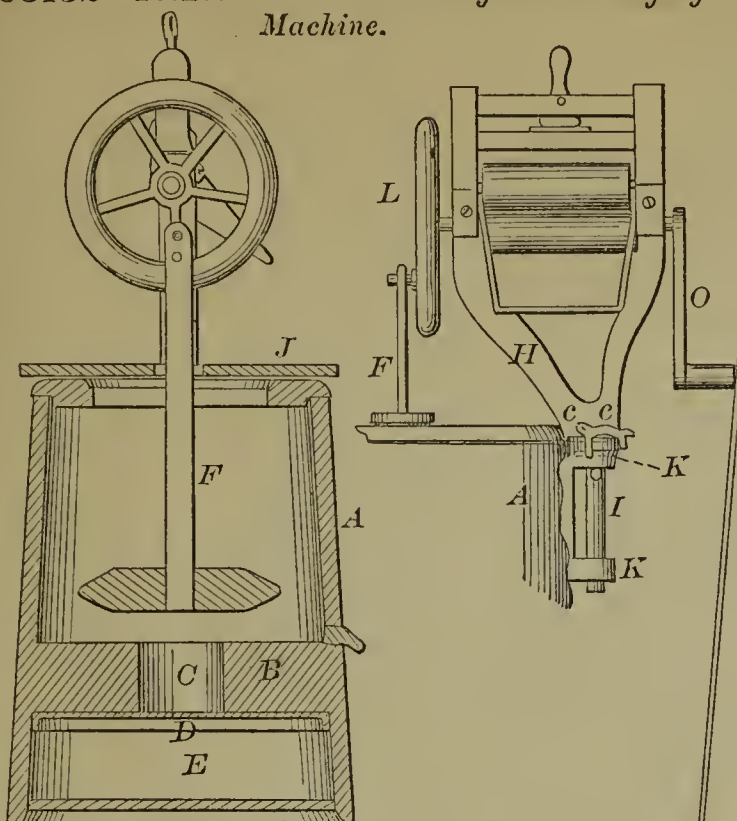

53137—W. F. Goodwin—Harvester.

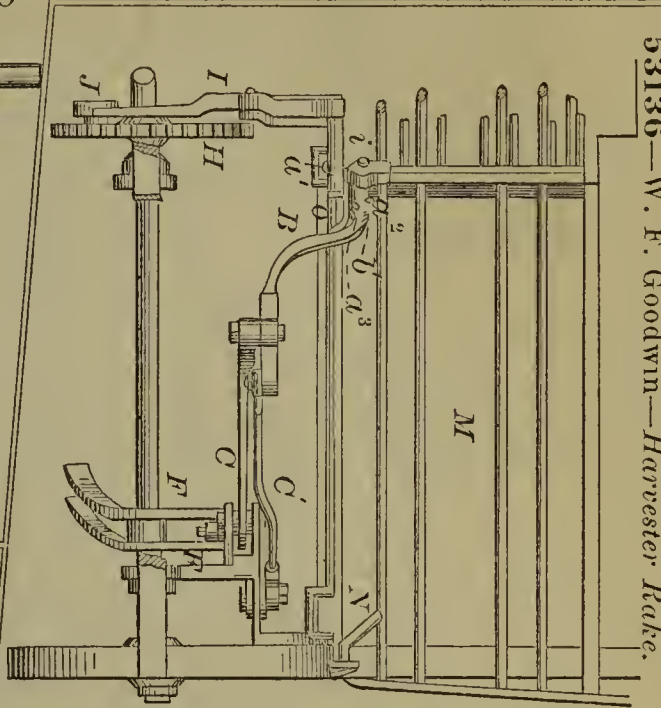
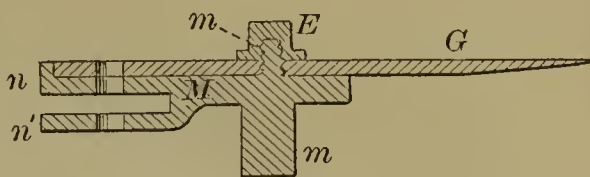

53136—W. F. Goodwin—Harvester Rake.

53133—T. B. Fitch—Sand Paper Holder.

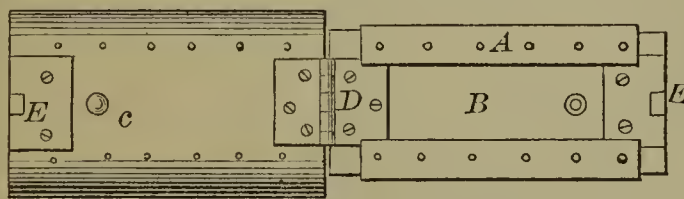

53135—J. Geemen—For Sprouting Malt.

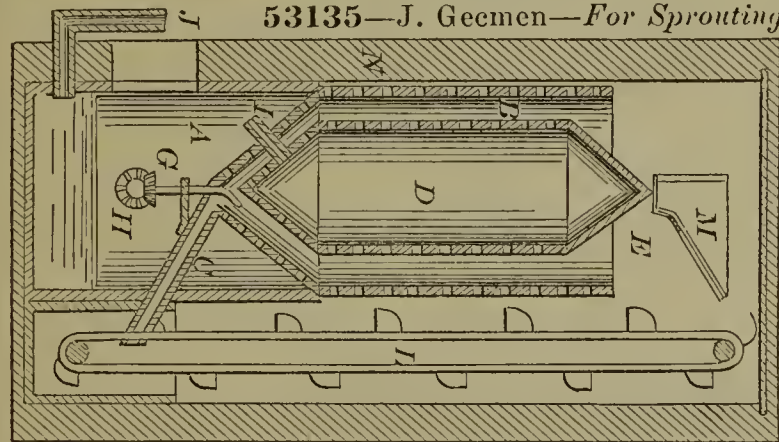

53134—P. T. Gates—Wristband.

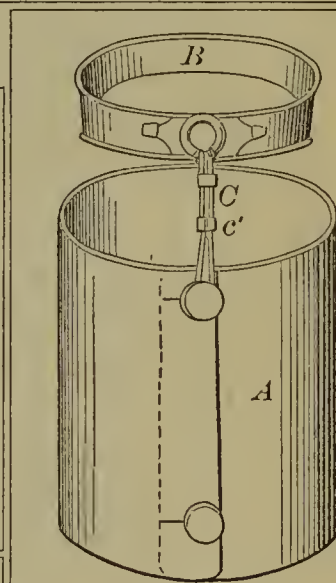

53138—W. F. Goodwin—Grain Binder.

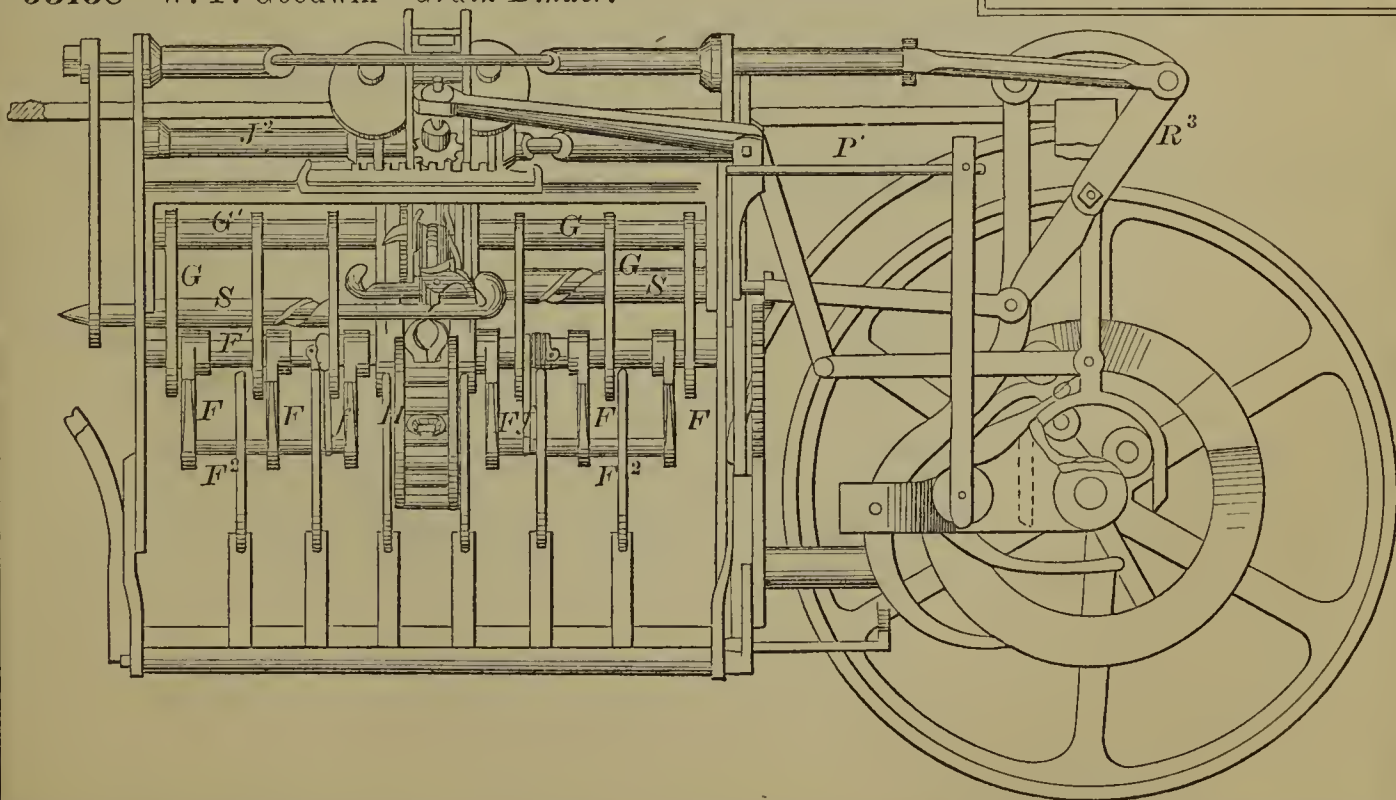

53139—J. C. Gove—*Coffee Pot.*

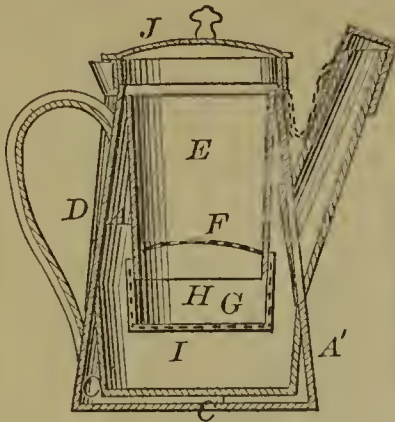

53141—A. Hamlin—*Churn.*

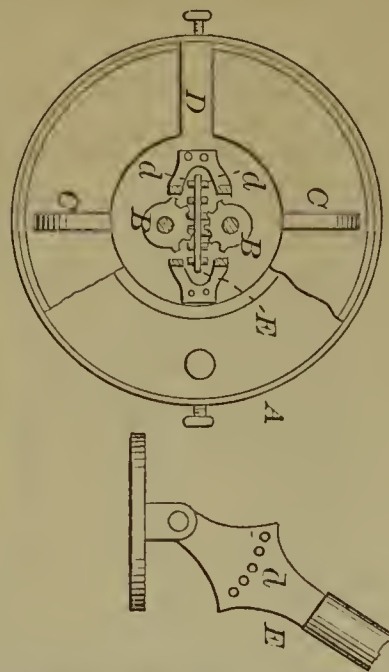

53144—M. C. Heptinstall—*Burglar Alarm.*

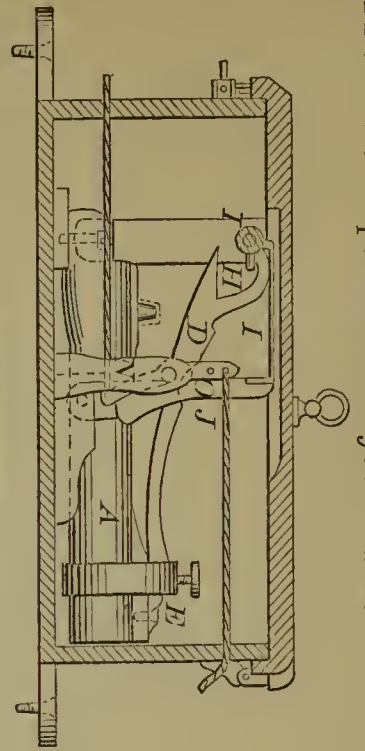

53145—J. G. Hizzell—*Drilling Machine.*

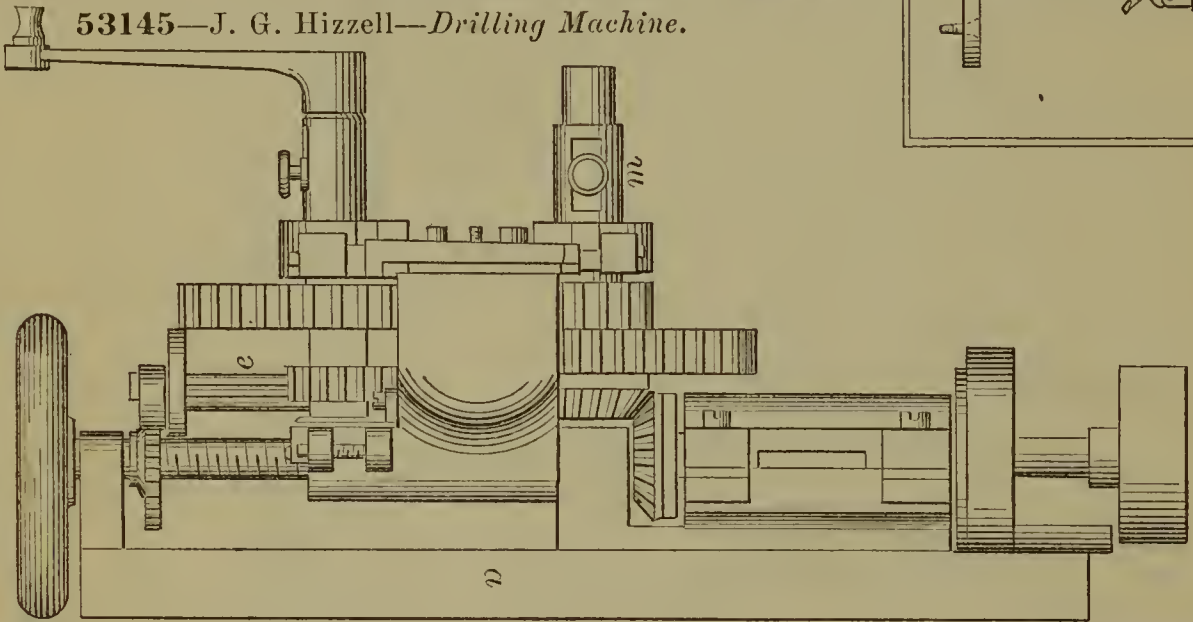

53147—G. A. Howe—*Cotton Picker.*

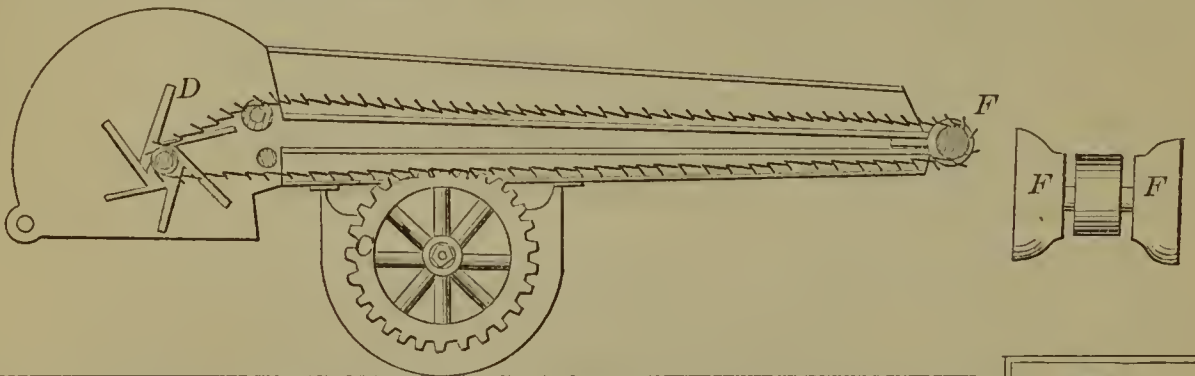

53148—F. Humphrey—*Coffee Roaster.*

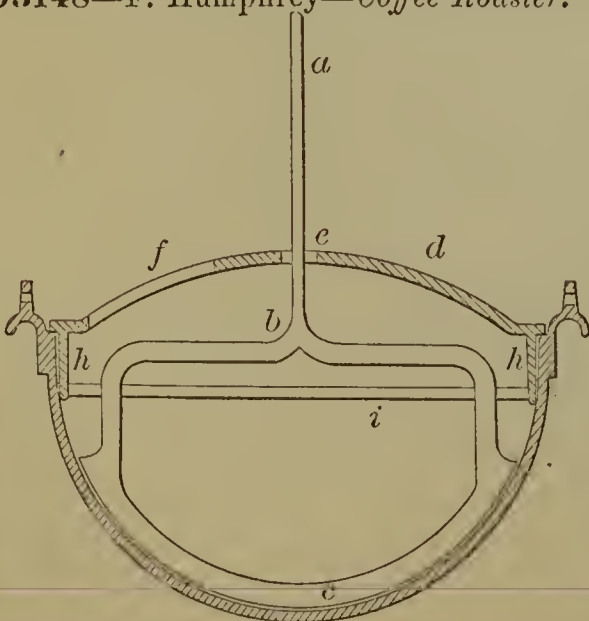

53146—H. J. Holden—*Time Piece.*

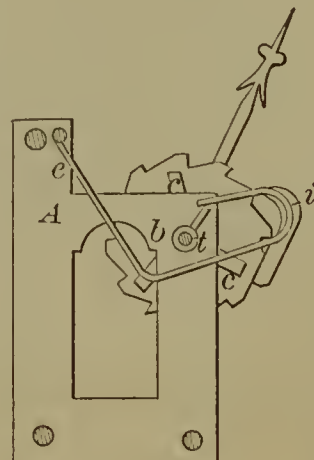

53143—M. Hawkins—*Shaft Coupling.*

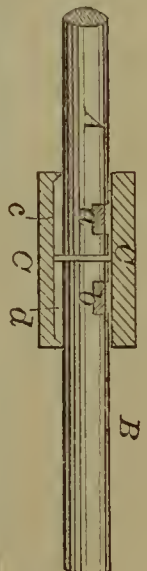

53149—J. H. Jennings—*Musquito Bar.*

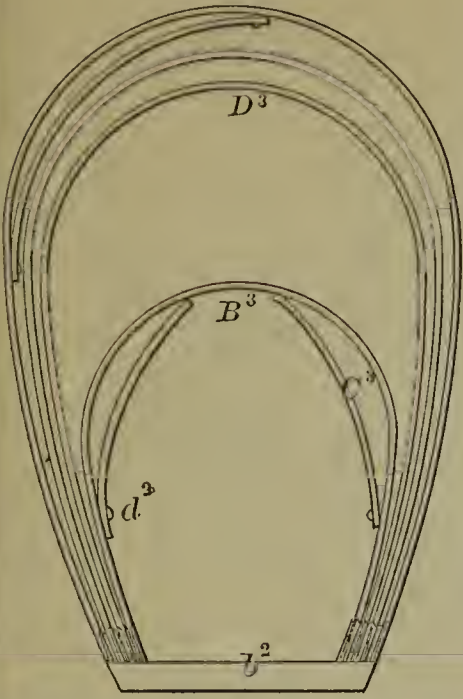

53151—J. Johnson—*Fruit Jar.*

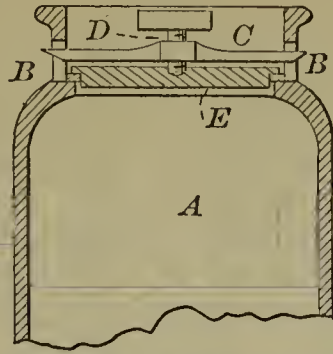

53155—J. L. Lewis—*Making Axes.*



53150—J. H. Jennings—*Securing Tips to Boots and Shoes.*

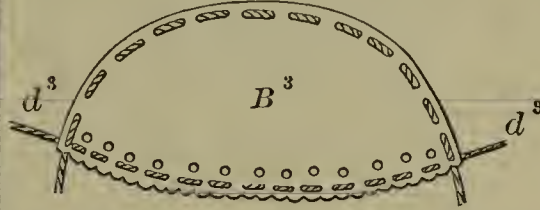

53152—Jones & Farquharson—*For Bleaching Paper Pulp.*

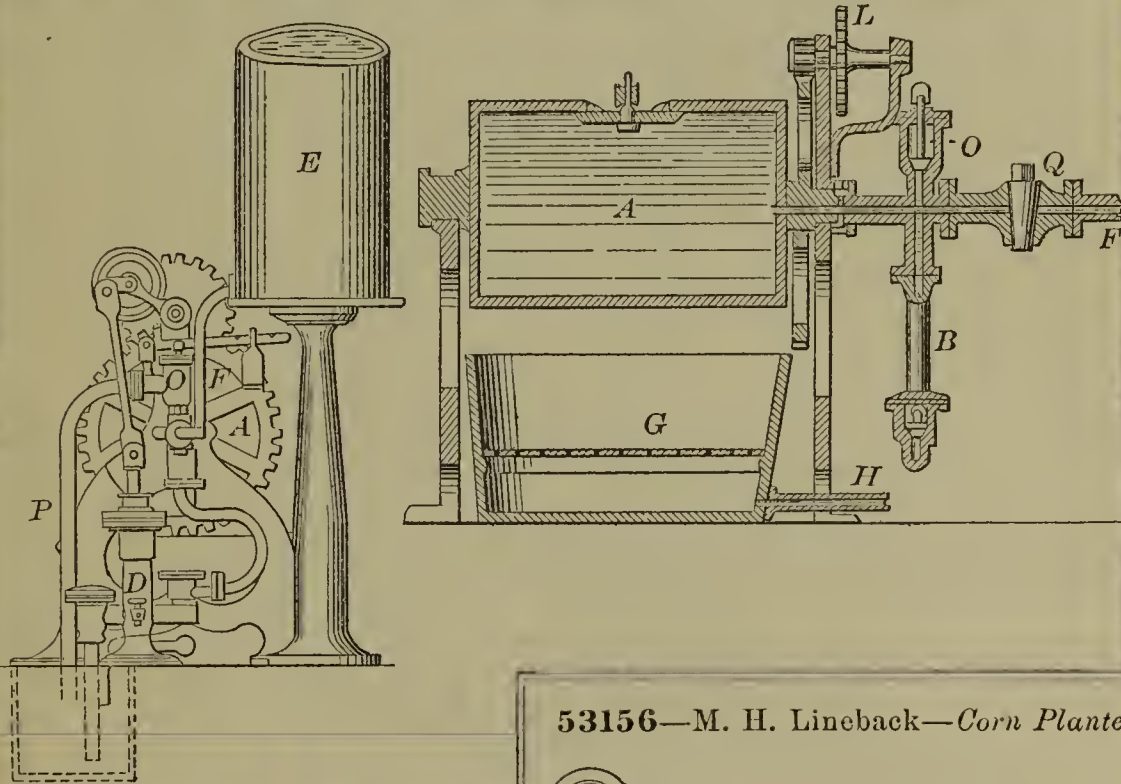

53153—J. E. Kendeigh—*Fence.*

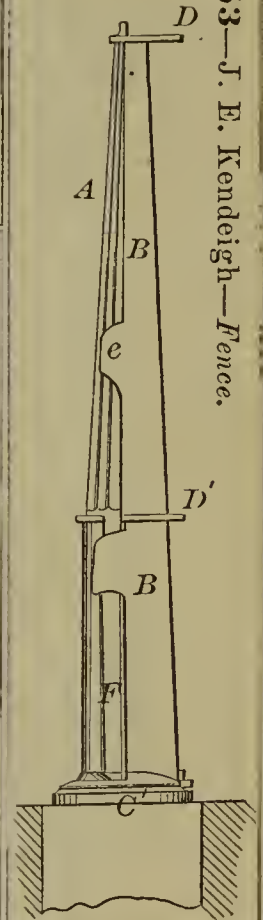

53156—M. H. Lineback—*Corn Planter Cultivator.*

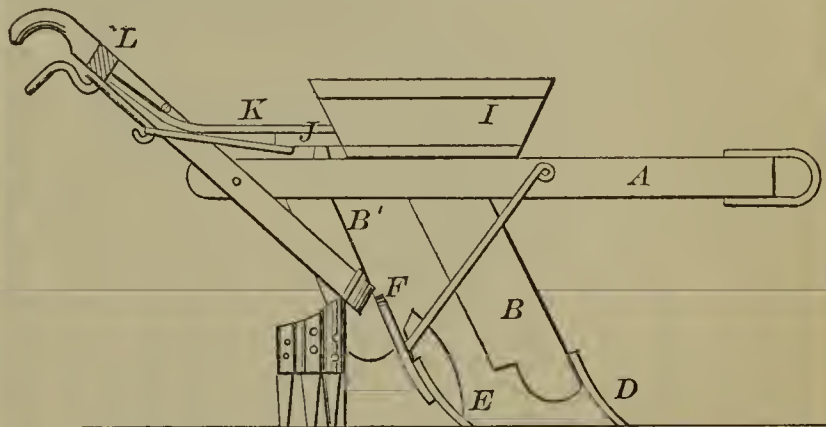

53154—N. & N. H. Leonard—*Tack and Nail Machine.*

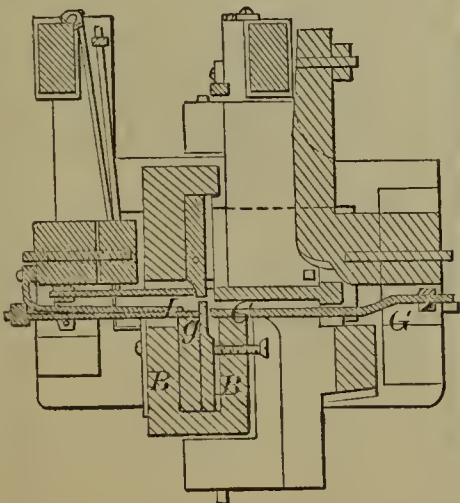

53157—J. Lippincott—*Saw.*

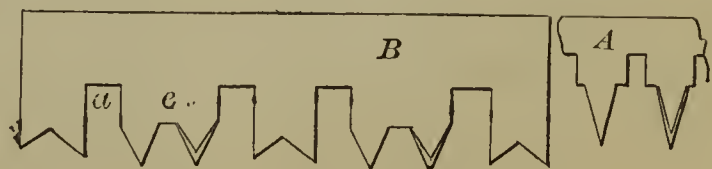

53161—McAuley & Cheney—  
Covering for Hose.

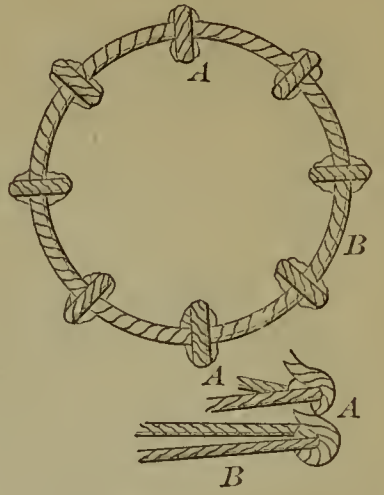

53160—D. F. Masnata—Rotary Steam Ship.

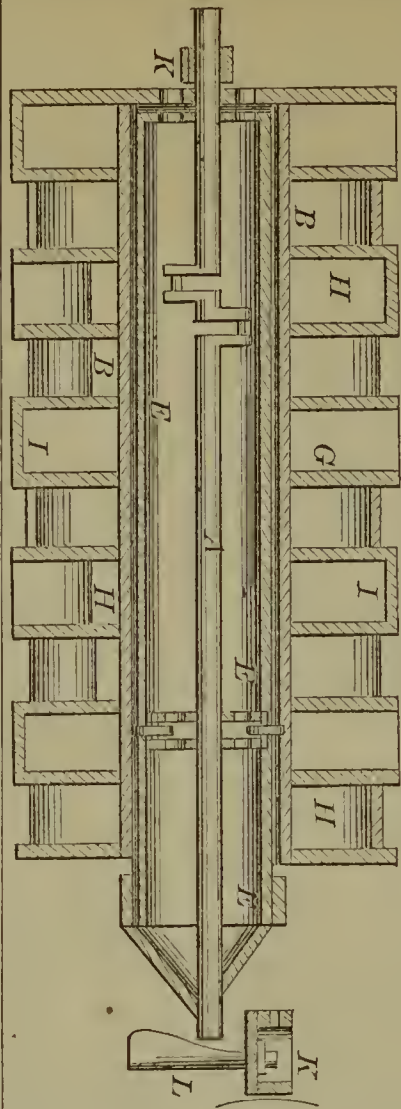

53158—T. R. Lovett—Fan Attachment for Sewing Machines.

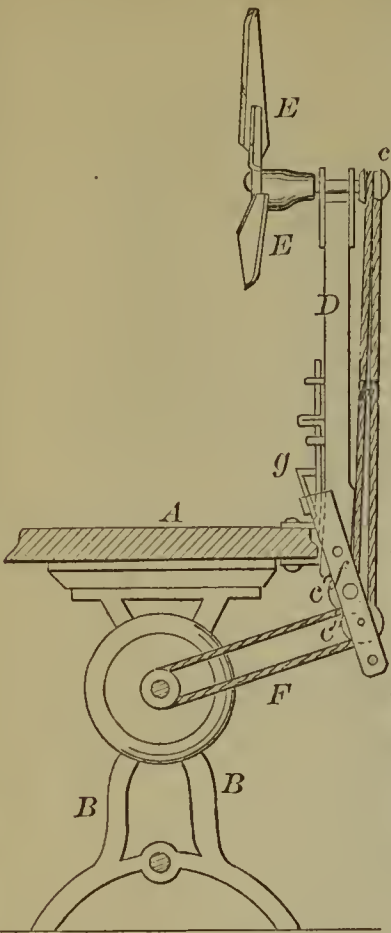

53166—T. D. Miller—Pencil Pocket.



53162—J. McVay—Roofing.



53167—A. Millochau—Distillation of Petroleum.

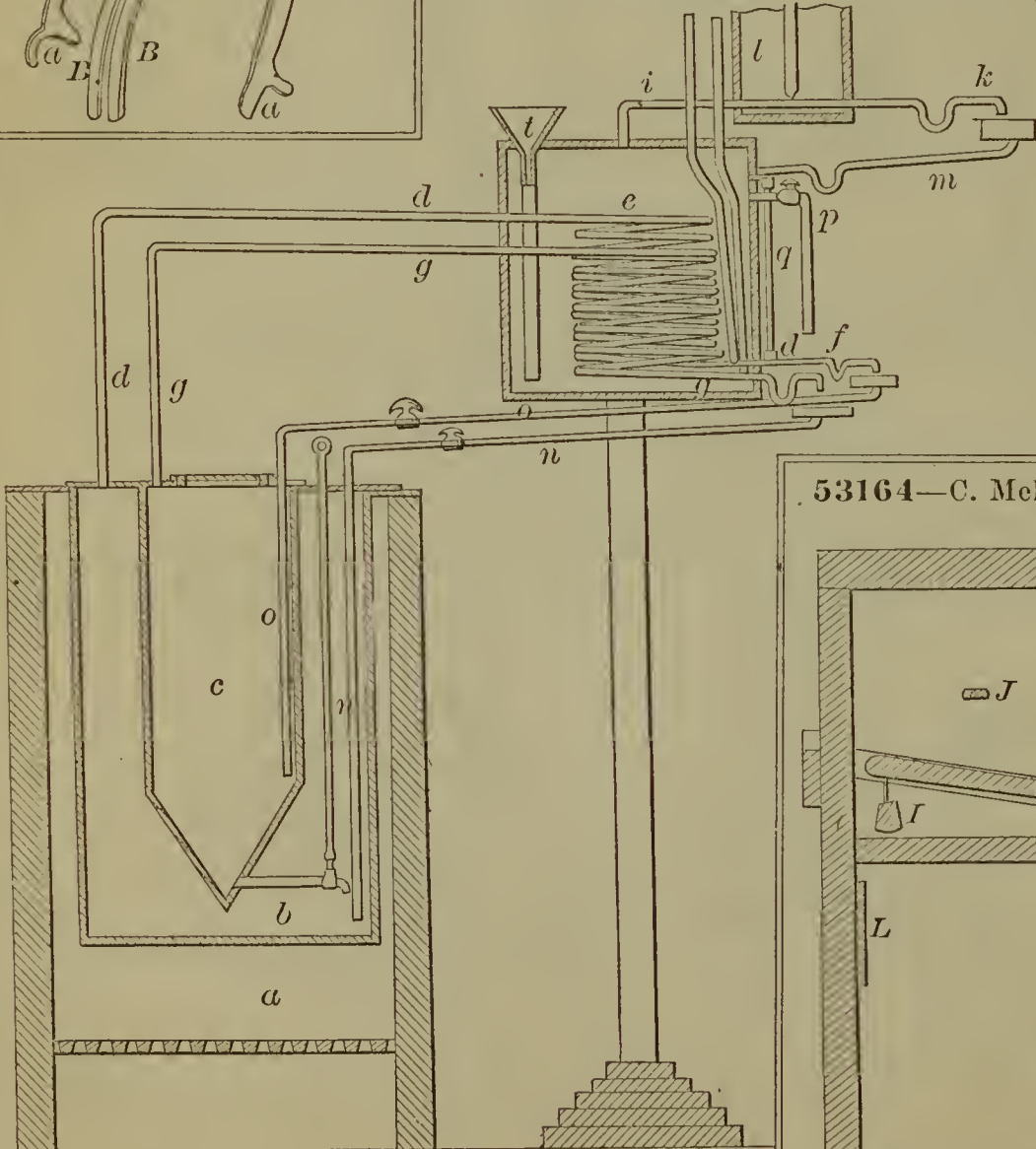

53163—J. L. Meek—For Parting Ladies' Hair.

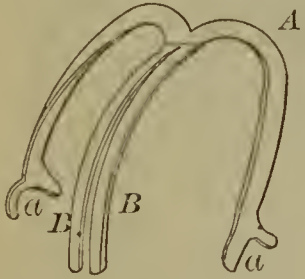

53164—C. Melone—Animal Trap.

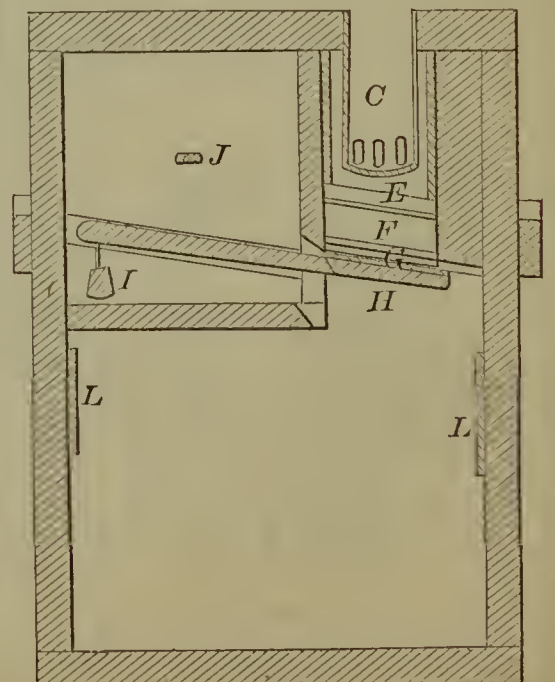

53170—J. C. Morgan—*Steam Pump.*

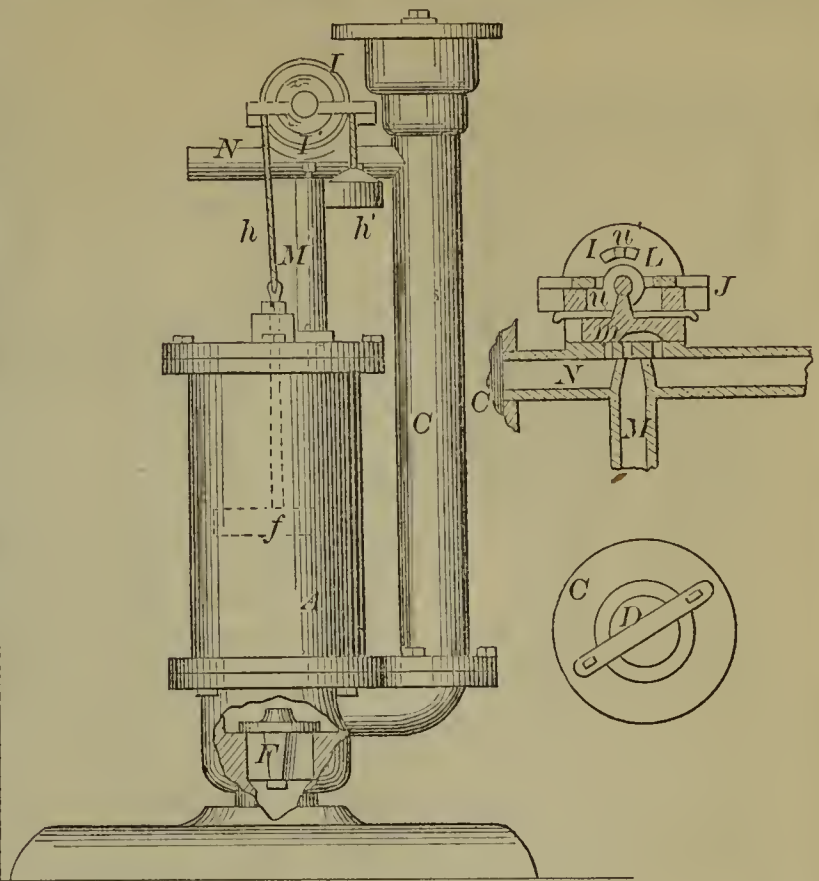

53168—A. Moffatt—*Priming Cartridge.*



53173—E. T. Orme—*Tin Can Opener.*

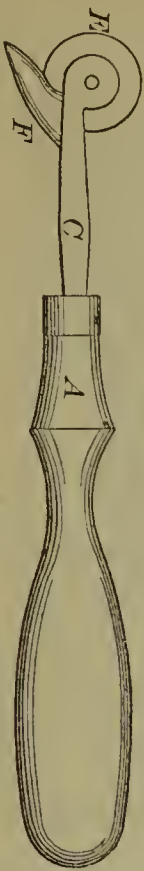

53171—J. Muma—*Harvester Reel.*

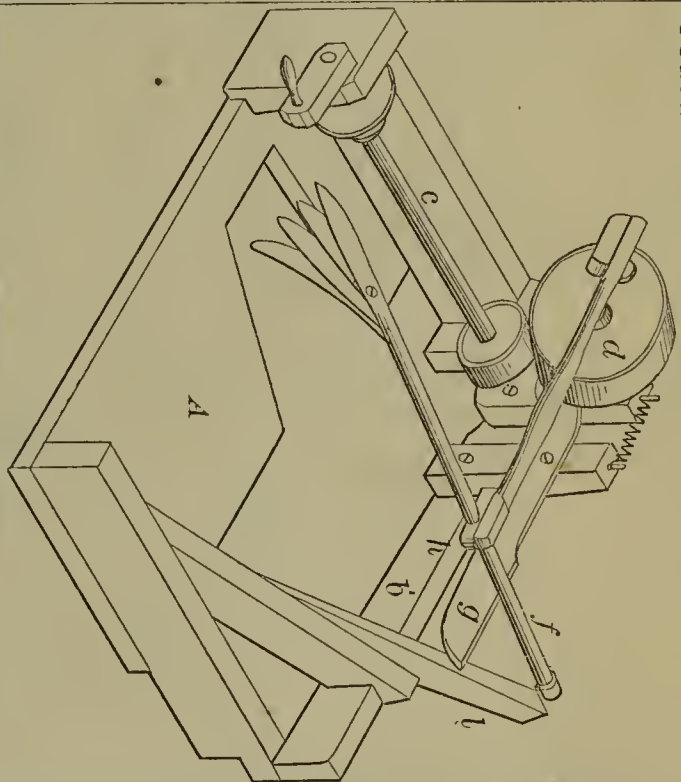

53172—S. R. Nye—*Horse Rake.*

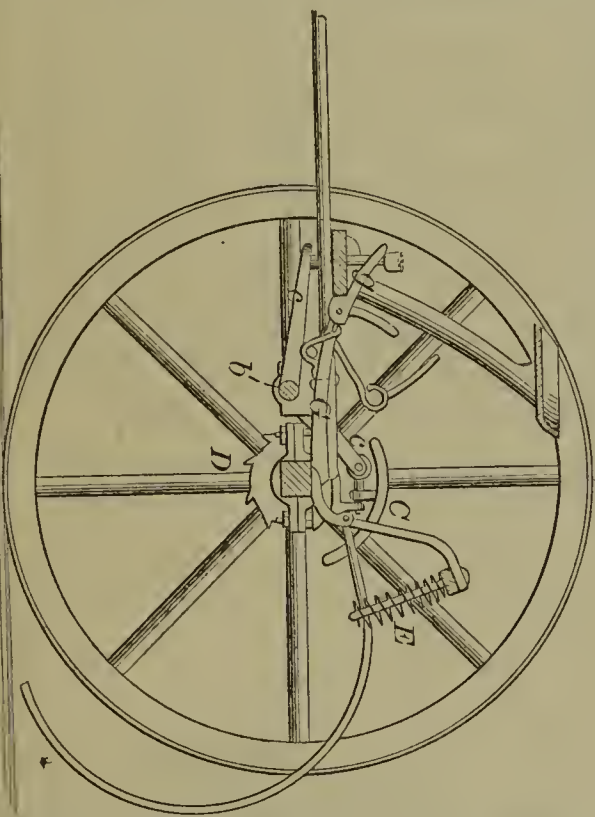

53174—F. Ortlieb—*Fan Blower.*

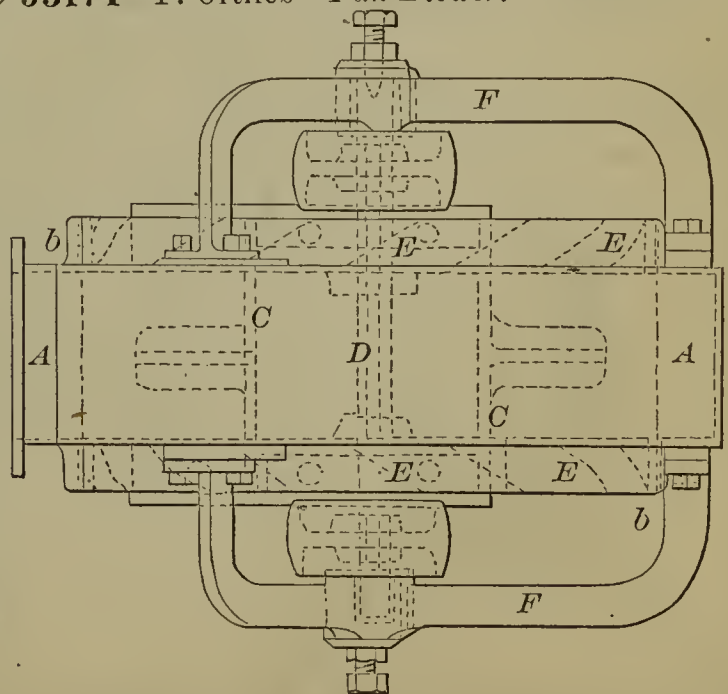

53169—C. Montague—*Paper Cutting Machine.*

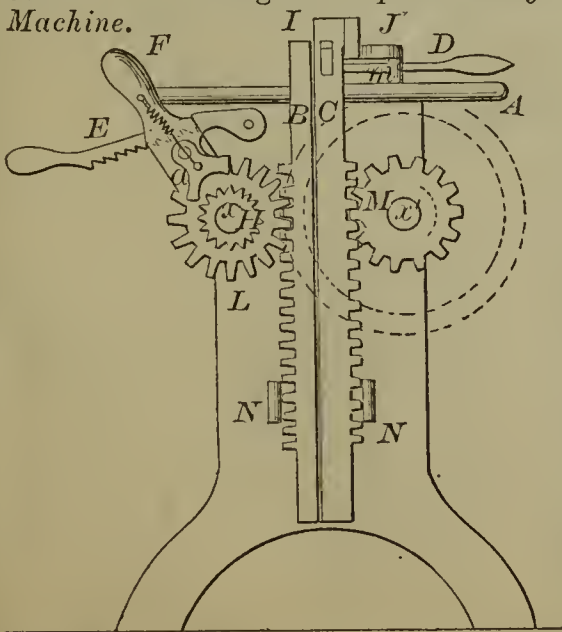

53175—C. Oyston—  
Nozzle for Fire Engines.

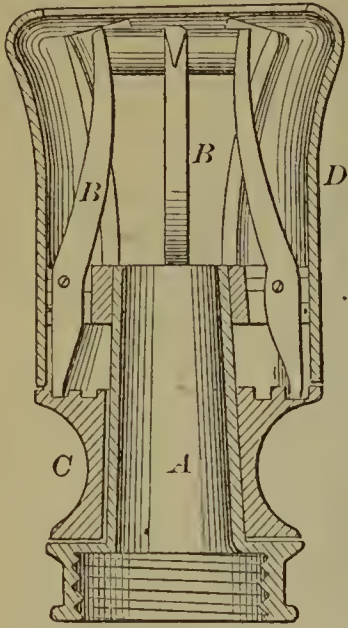

53176—E. C. Patterson—Washing and Wringing Machine.

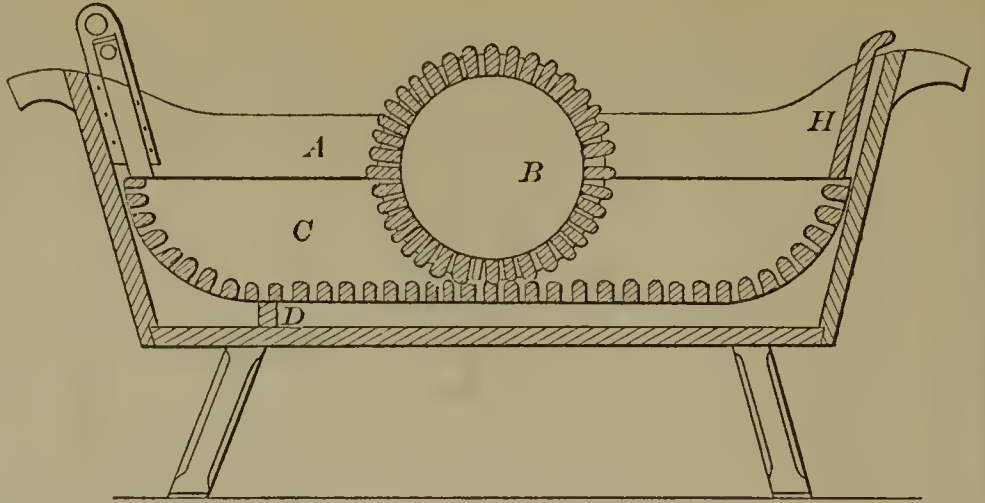

53177—J. Peacock—Barrel Washing Machine.

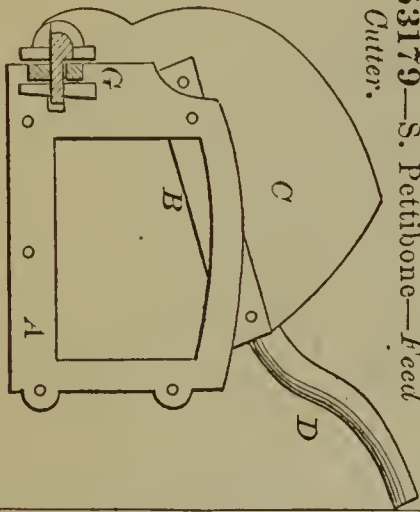
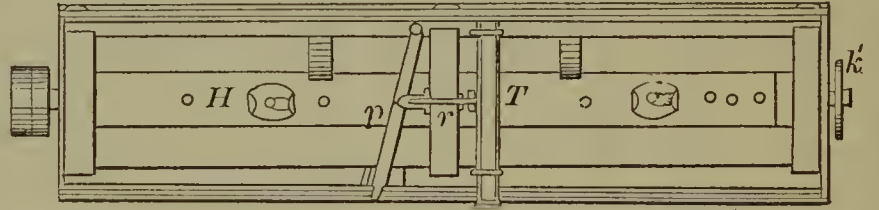

53179—S. Pettibone—Feed  
Cutter.

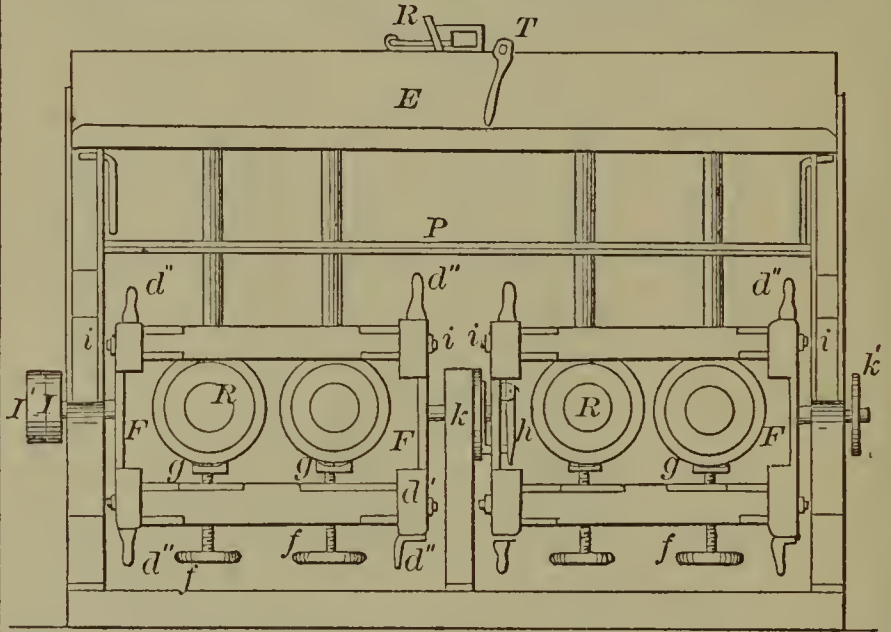

53178—C. Perley—Vertical  
Windlass.

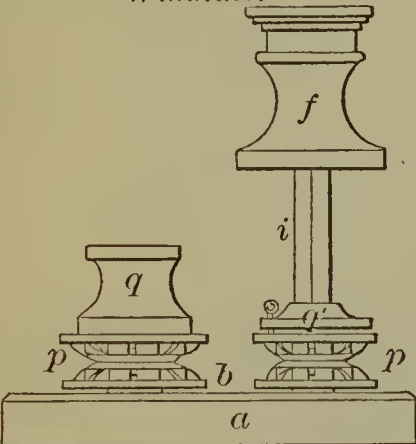

53180  
I. Philbrook—  
Corn Husker.

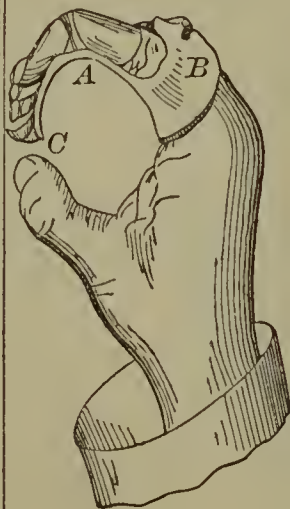

53181—M. Pinner—Self-Acting  
Blow Pipe.

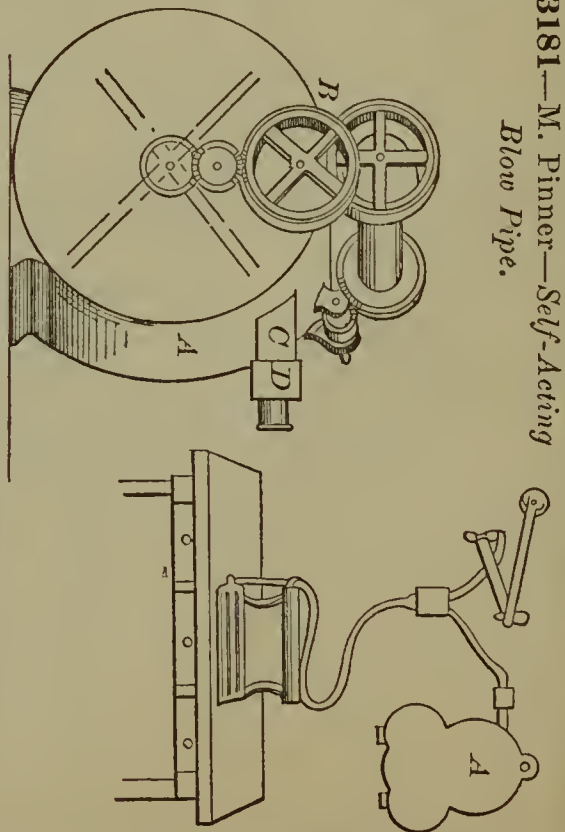

53182—Price & Wilson—Sand  
Box for Locomotive Engines.

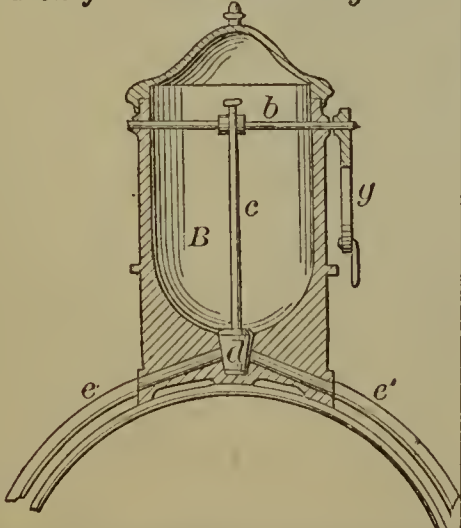

53183—E. Quinn—*Steam Gauge.*

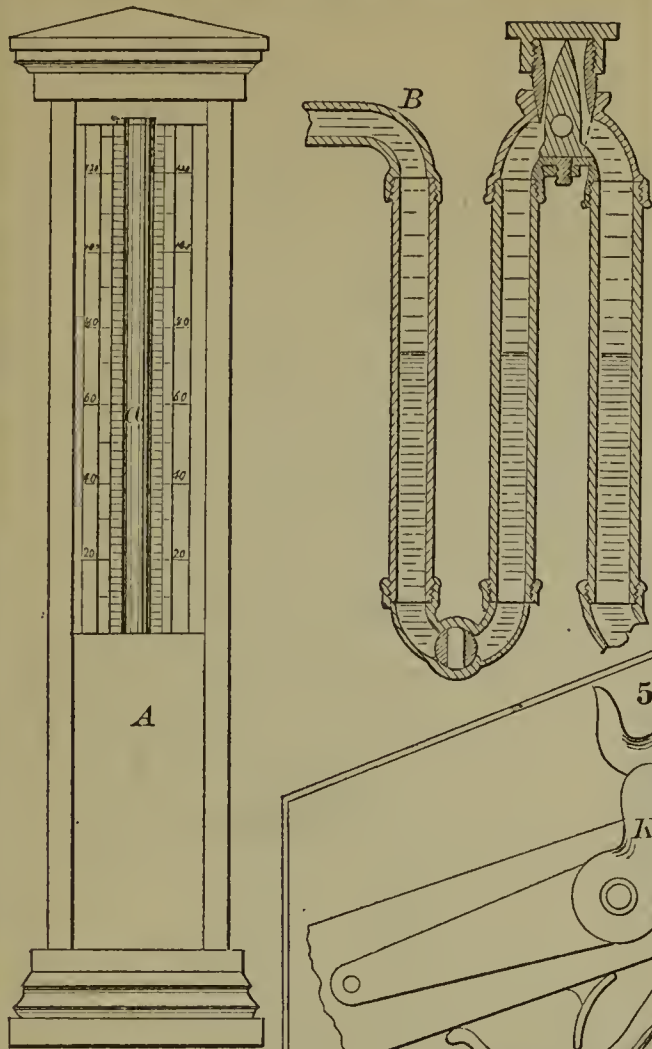

53188—H. S. Rose—*Sofa Bedstead.*

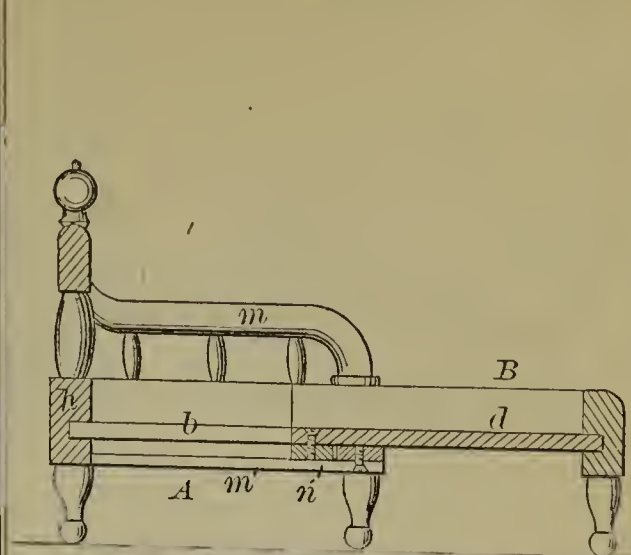

53187—Robertson & Simpson—*Breech-Loading Fire Arm.*

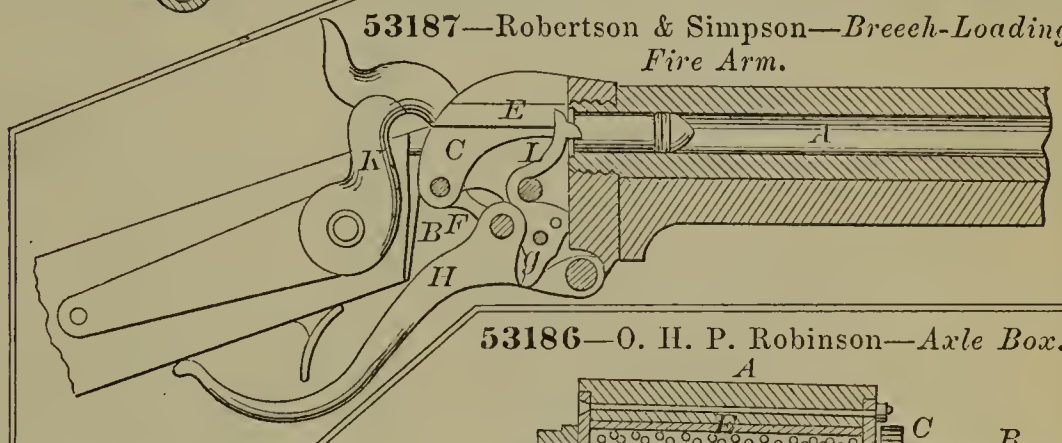

53186—O. H. P. Robinson—*Axle Box.*

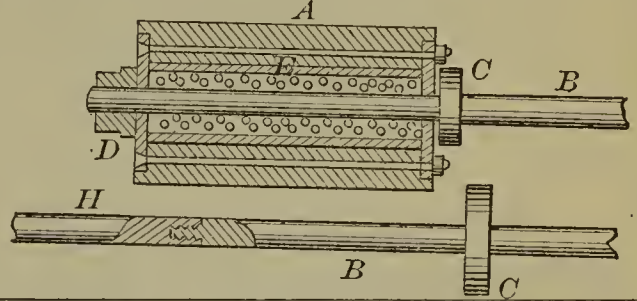

53185—A. Rewerick—*Pump.*

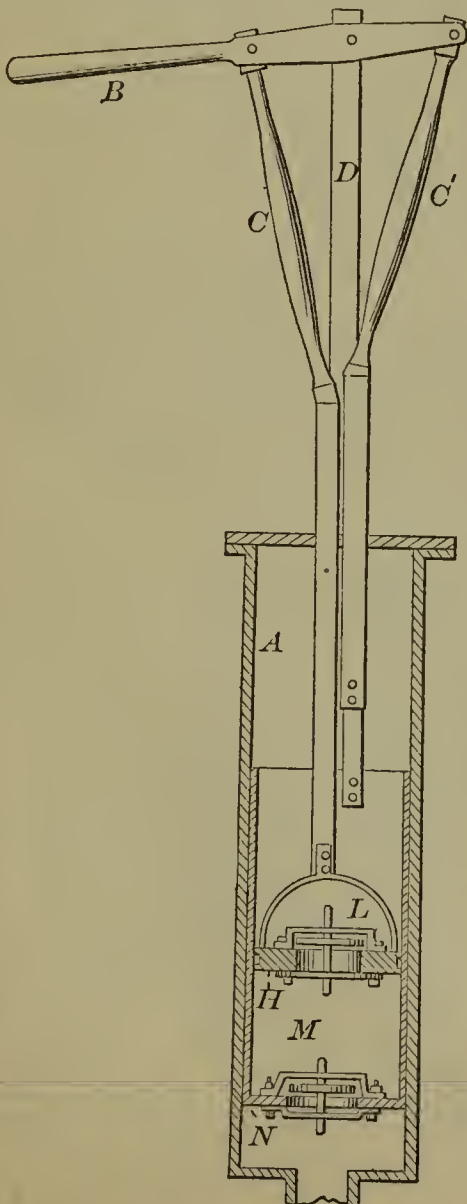

53189—I. M. Rose—*Drilling and Driving Machine.*

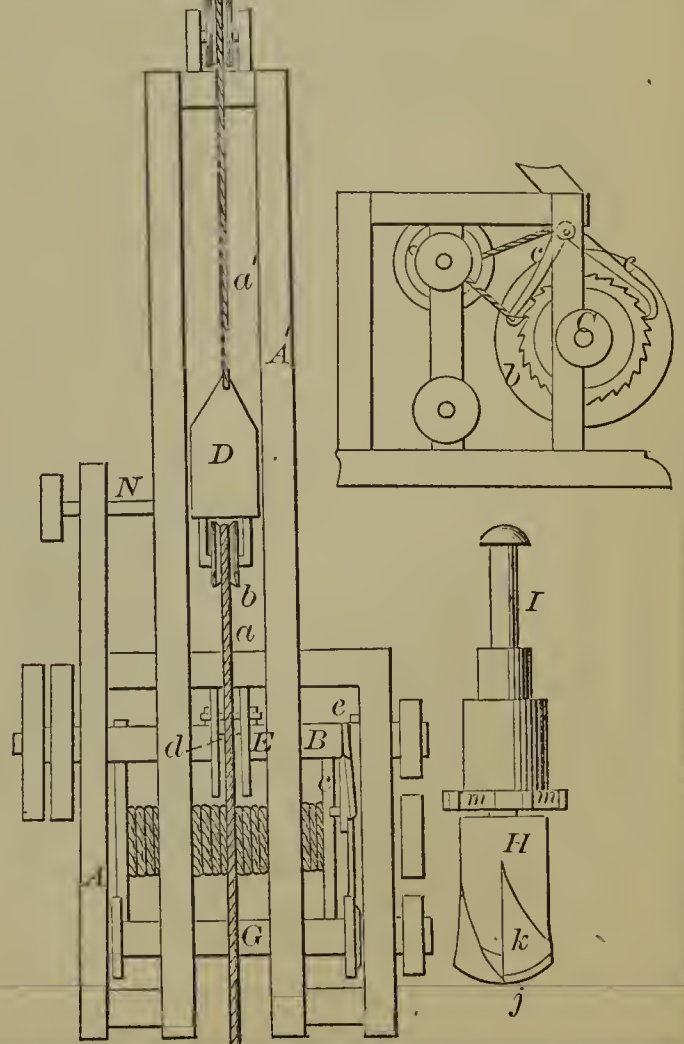

53190—G. Scott—*Lubricator.*

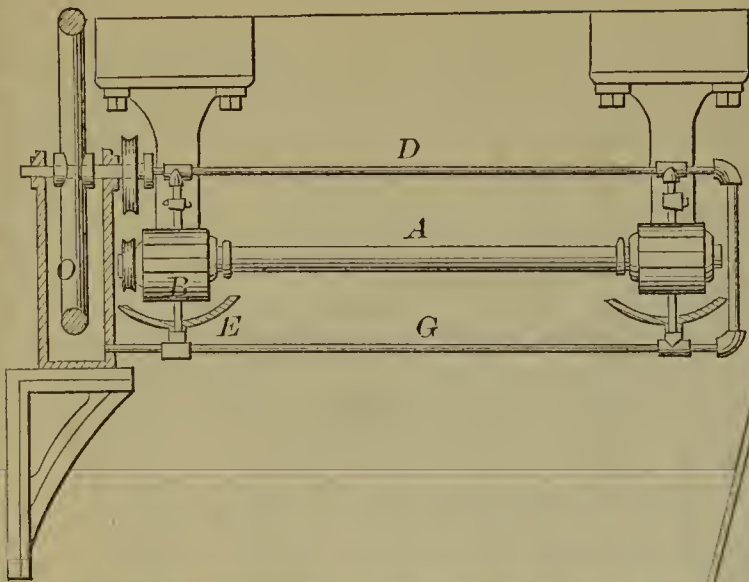

53191—S. Shreffler—*Brick Mould.*

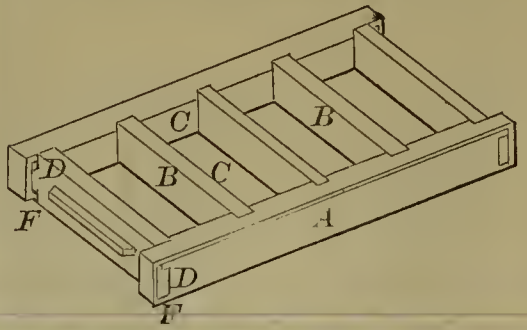

53193—O. Snow—*Facing for Stair Treads.*

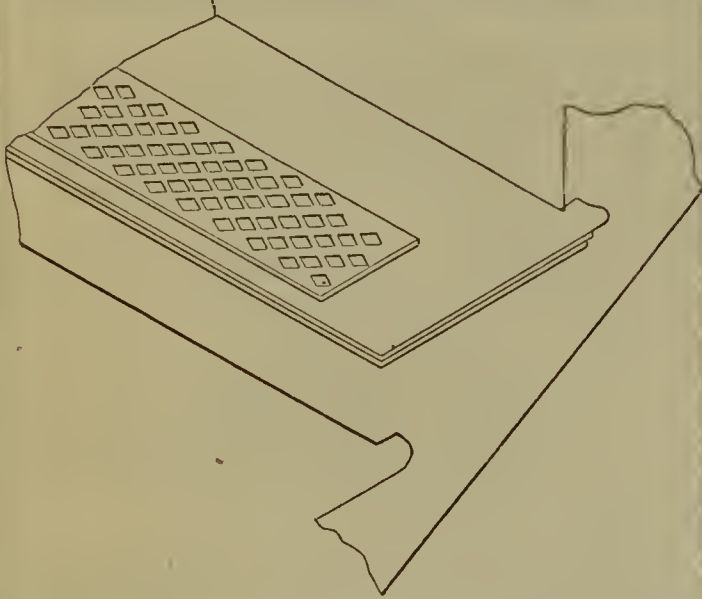

53192—C. F. Smith—*Butter Worker.*

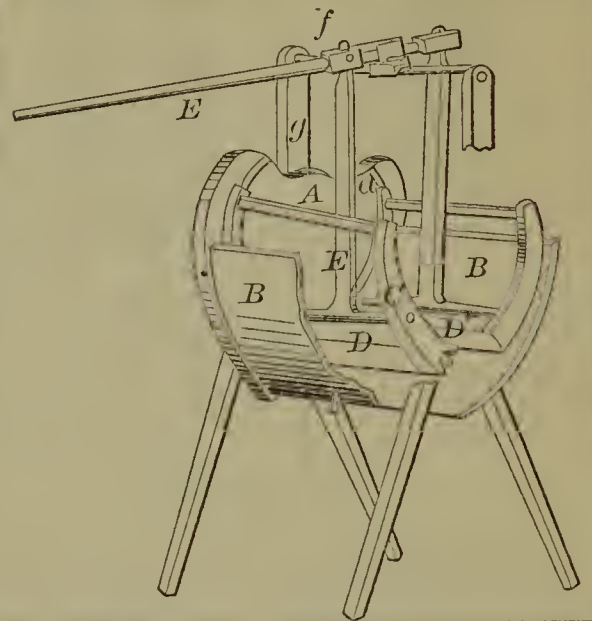

53194—J. F. Staats—*Amalgamator.*

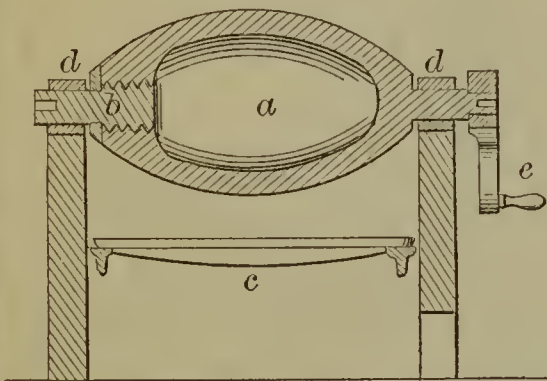

53195—J. Storer—*Lubricator for Steam Engines.*

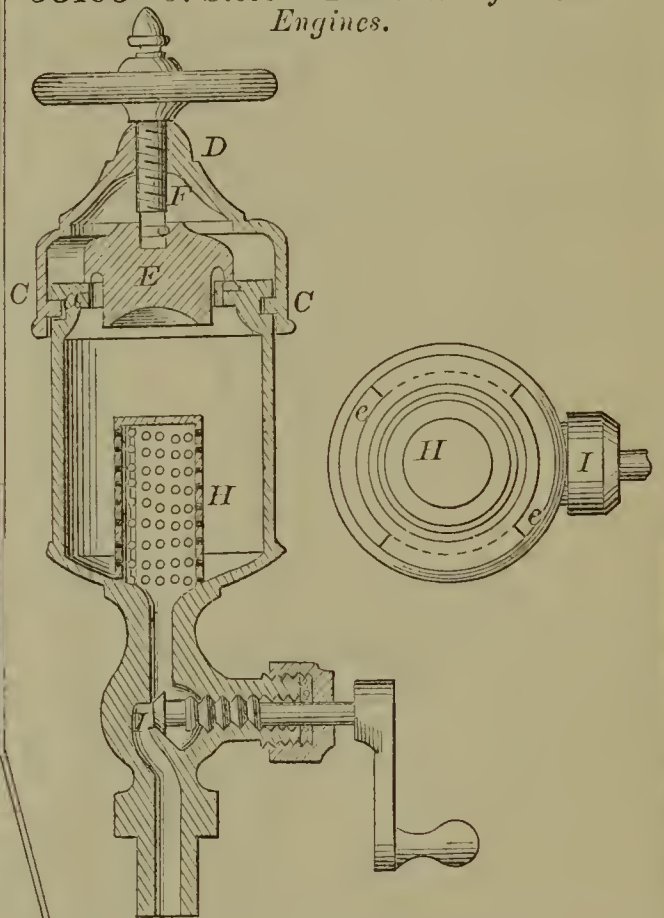

53196—H. N. Swift—*Hat Forming Machine.*

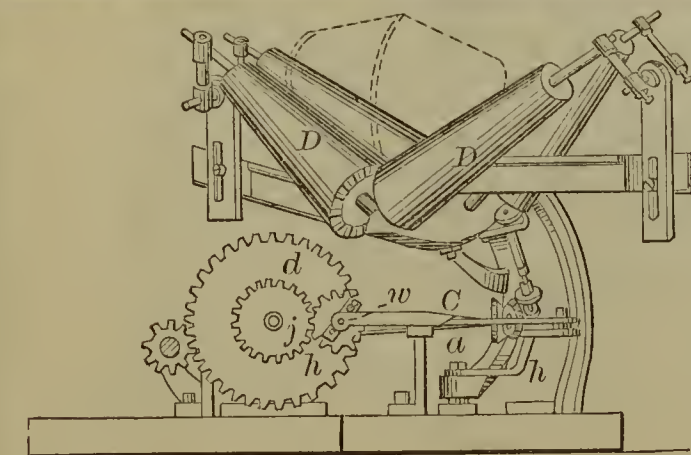

53197—G. B. Taylor—*Neck Tie.*

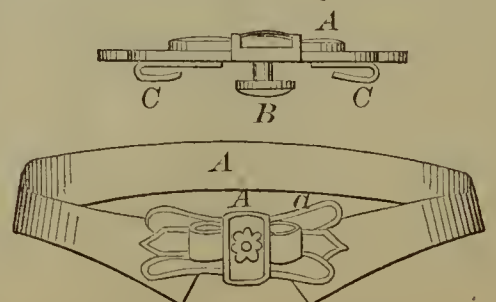



53198—D. H. Thayer—*Reaping and Mowing Machine.*

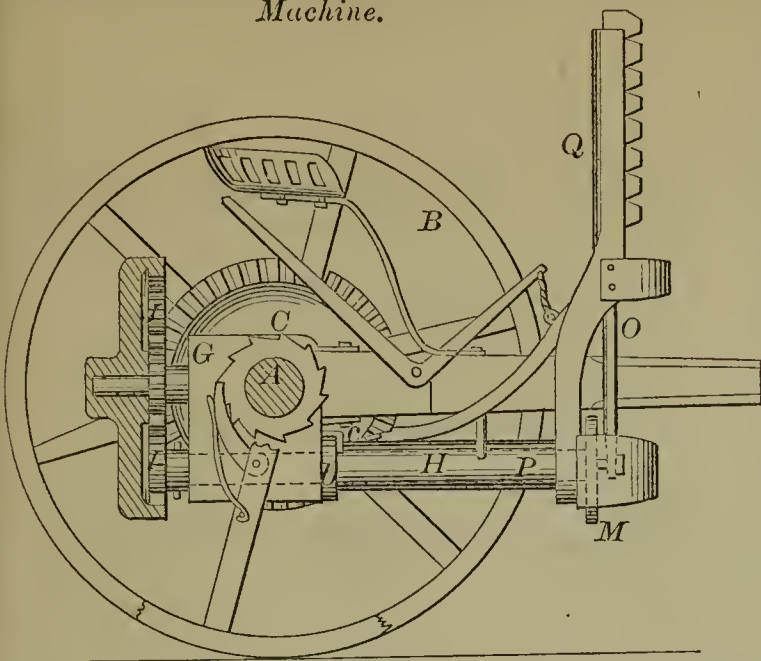

53201—W. W. Waddell—*Telegraph Insulator.*

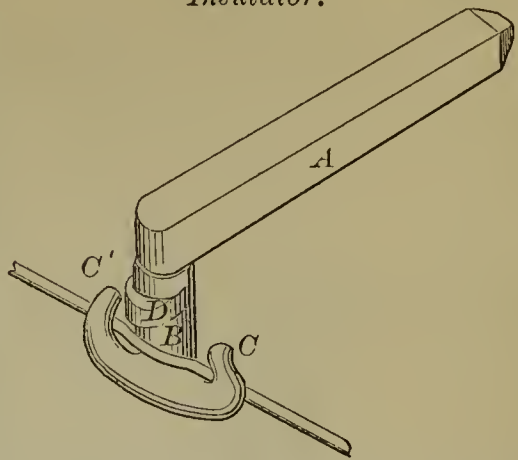

53200—E. Townsend—*Peg Rasper.*

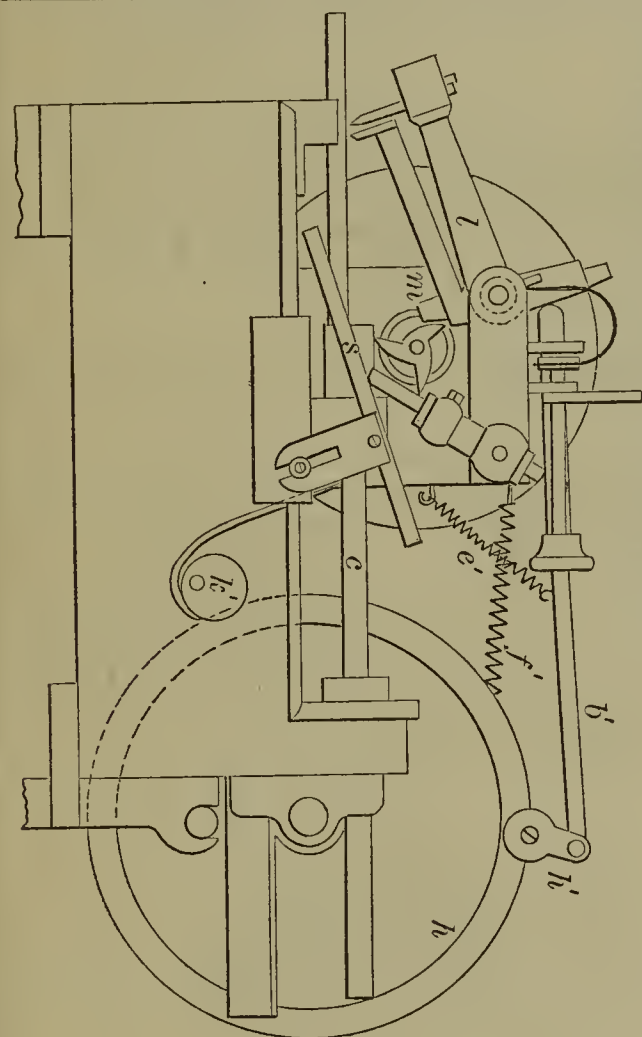
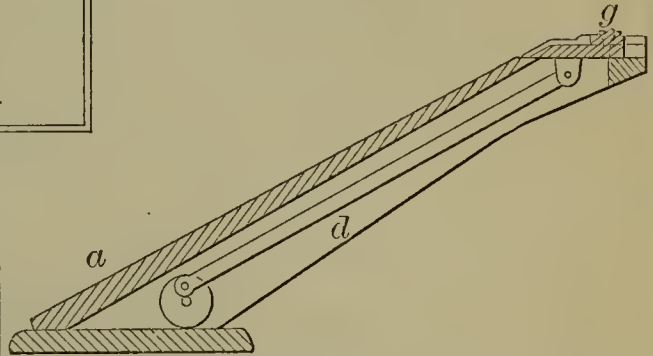

53204—A. Weed—*File Cutting Machine.*

53199—C. L. Topliff—*Pin Feeding.*

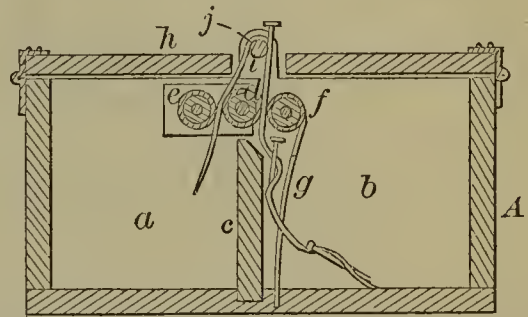

53203—H. Waterman—*Cleaning Boiler Tubes.*

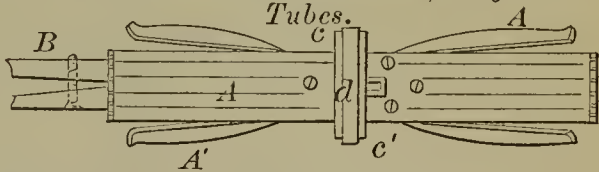

53205—W. S. Weir, Jr.—*Cultivator.*

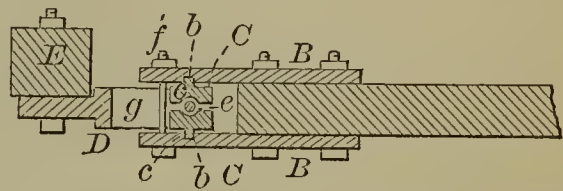

53202—J. H. Wait—*Device for Changing Speed.*

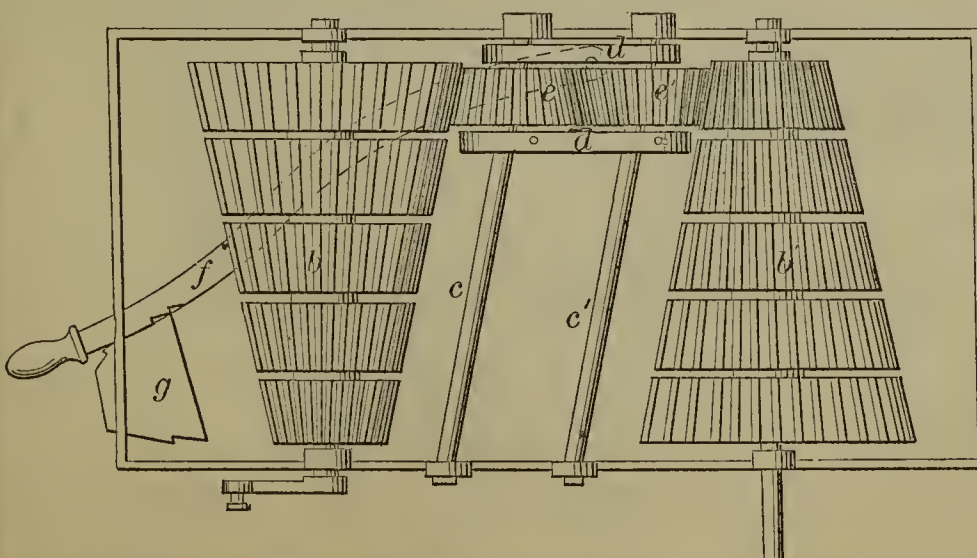

53206—J. W. Weston—*Lining for Artificial Limbs.*

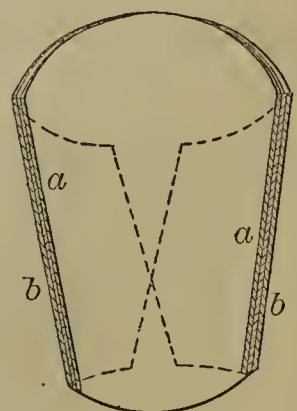

53207—O. Wheedon—Watering Cattle.

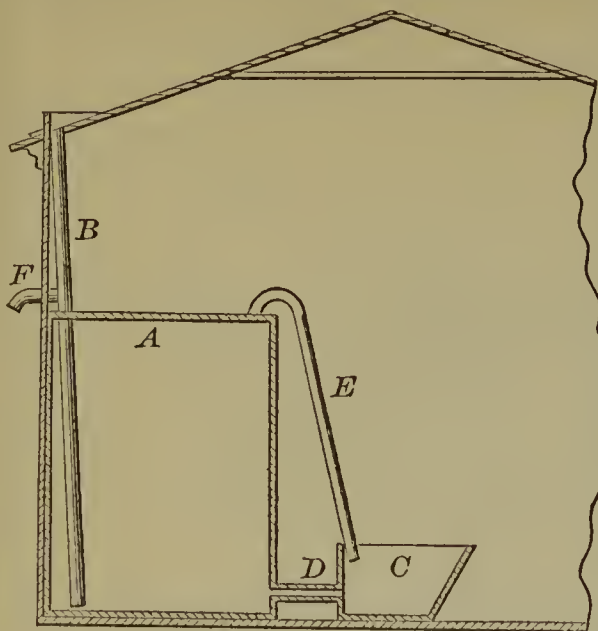

53209—J. G. Wilkison—Propelling Wheeled Vehicles.

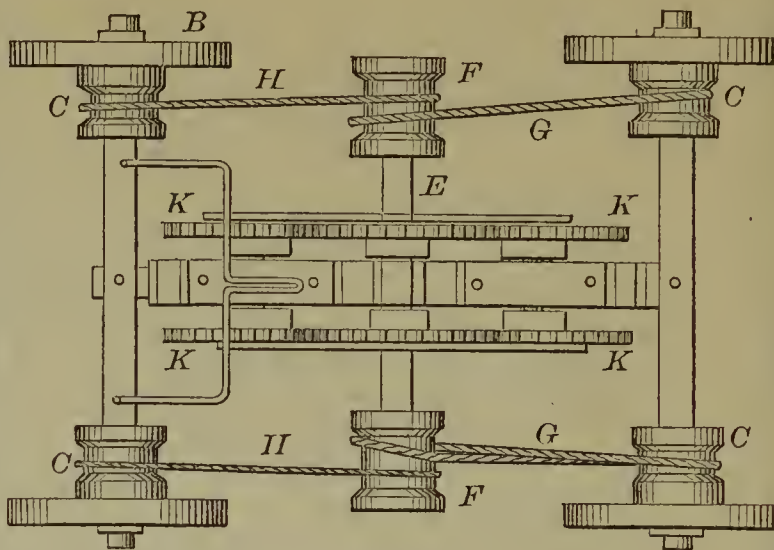

53210—J. H. Wilkison—Wagon Brake.

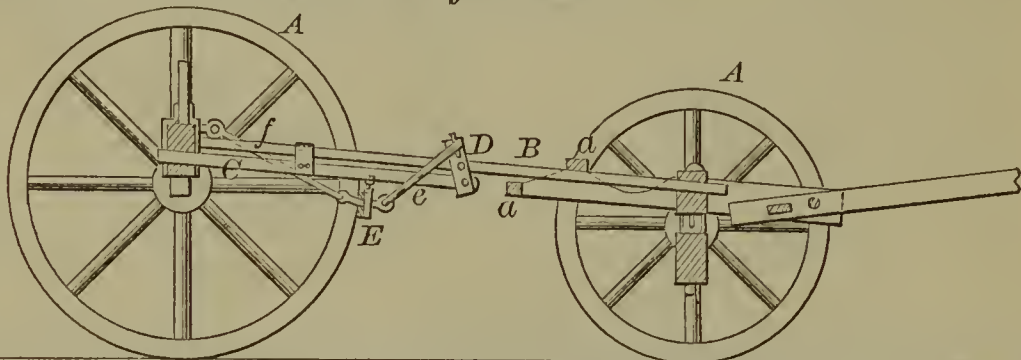

53211—Winfield & Colwell—Stave Machine.

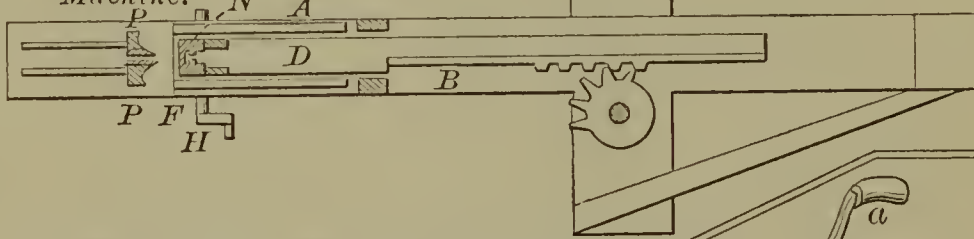

53213—J. W. Zinn—Railroad Switch.

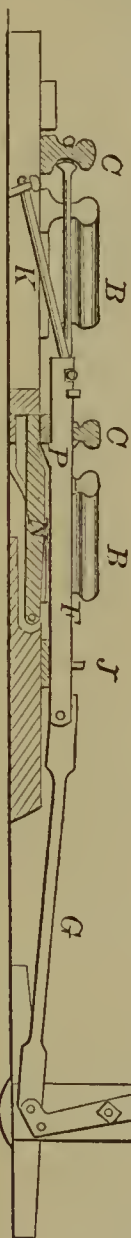

53212—G. W. Zeigler—Cultivator.

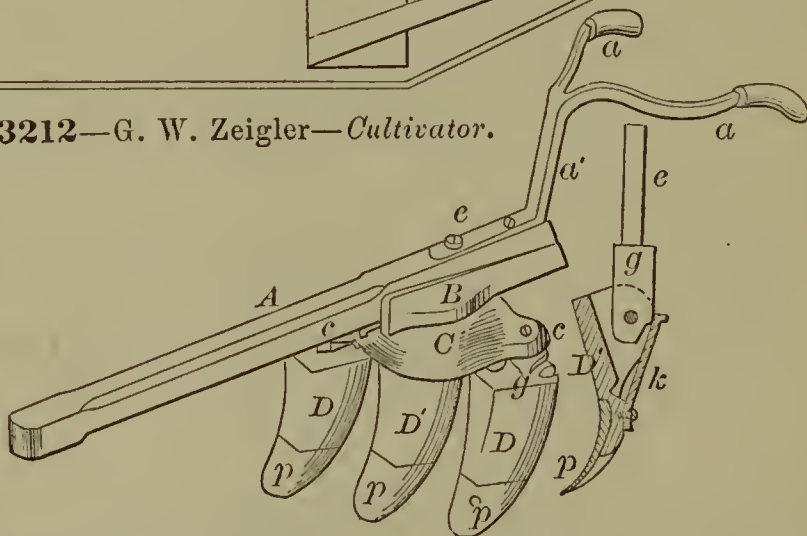

53214—C. K. Bradford—Propelling Carriages.

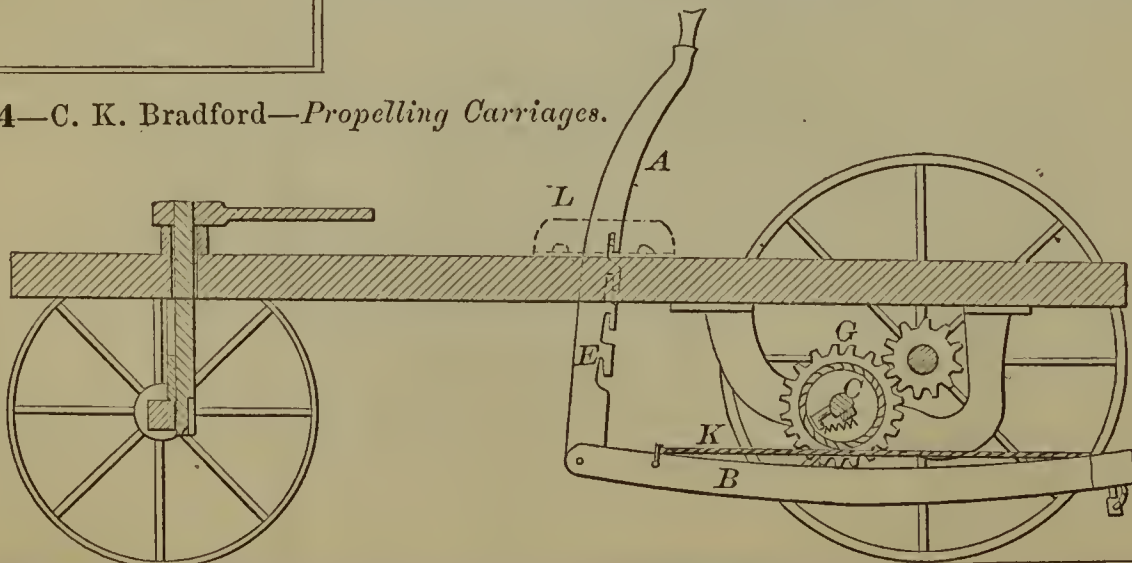

53215—E. Cary—Car Coupling.

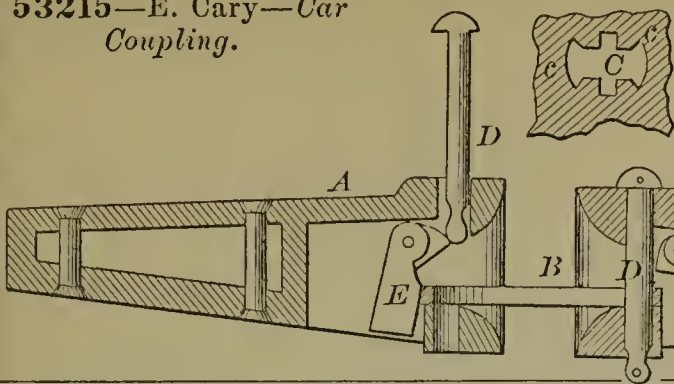

53219—S. Fawcett—Coupling Shaft for Boring Tools.



53216—L. A. Dole—Machine For Boring Hubs.

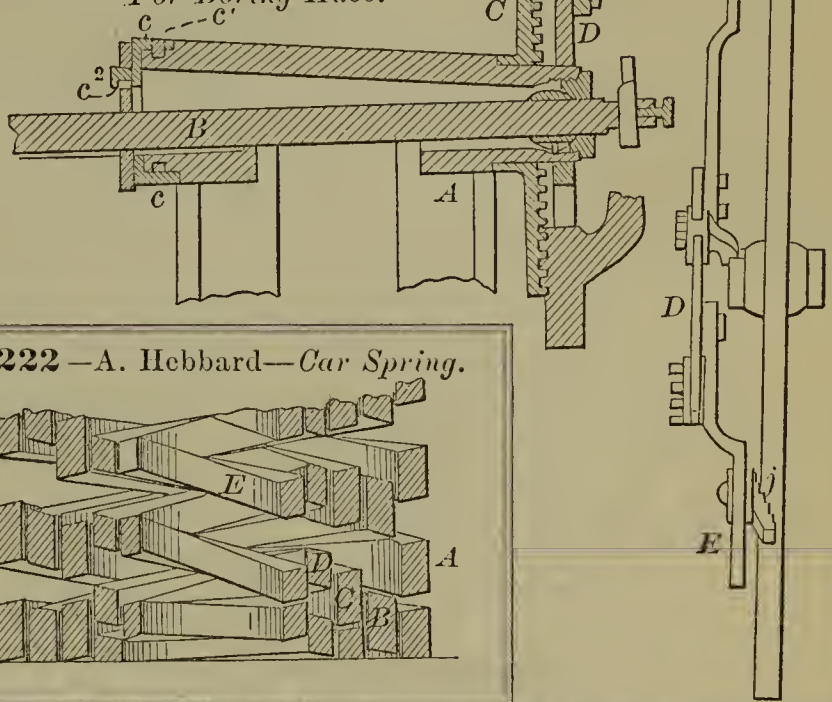

53218—O. O. G. Elliott—Grinding the Mouth Edges of Glass Lenses.

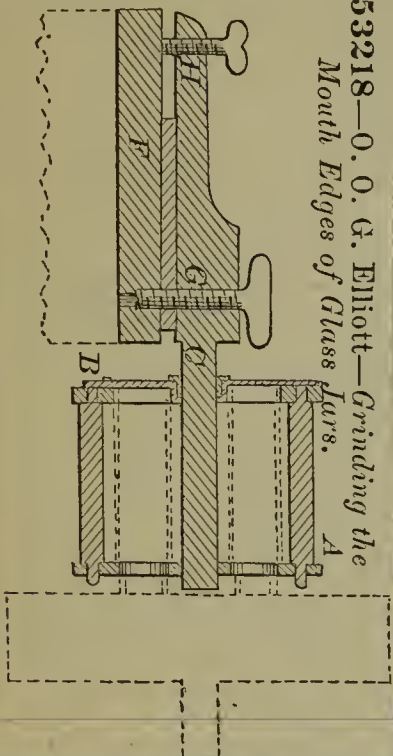

53222—A. Hebbard—Car Spring.

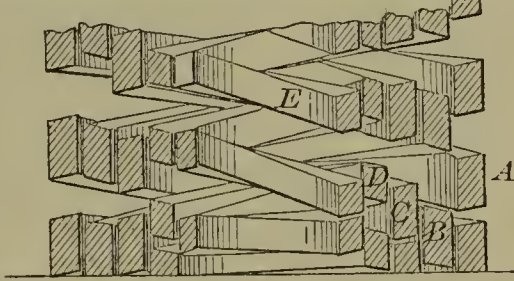

53220—L. B. Gusman—Linch Pin.

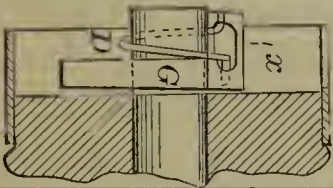

53223—J. Hotchkiss—Brick Machine.

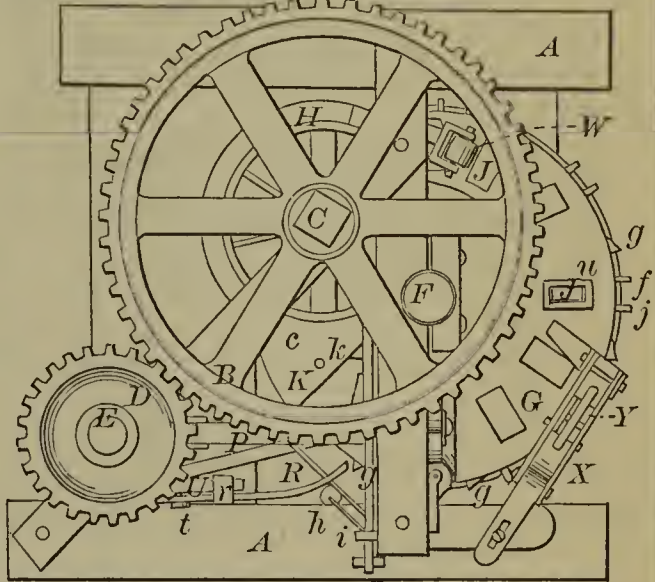

53221—G. B. Hamilton—Ore Washer.

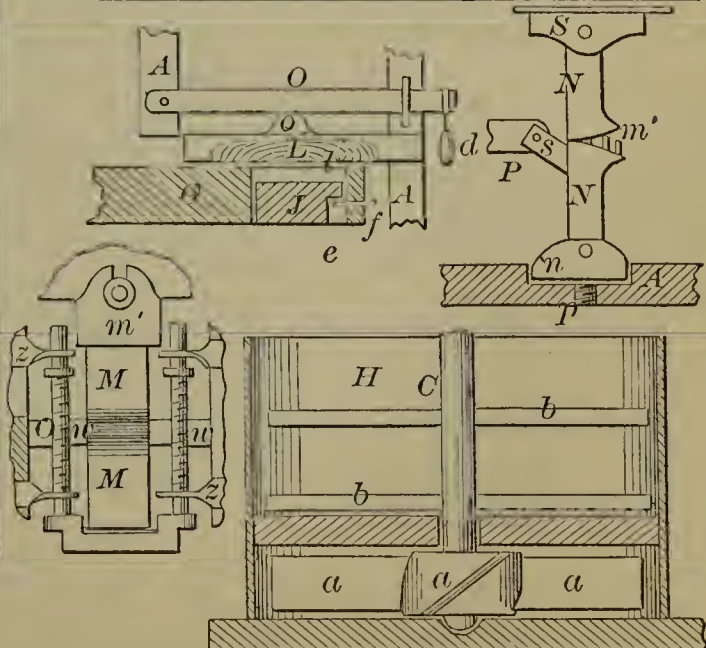
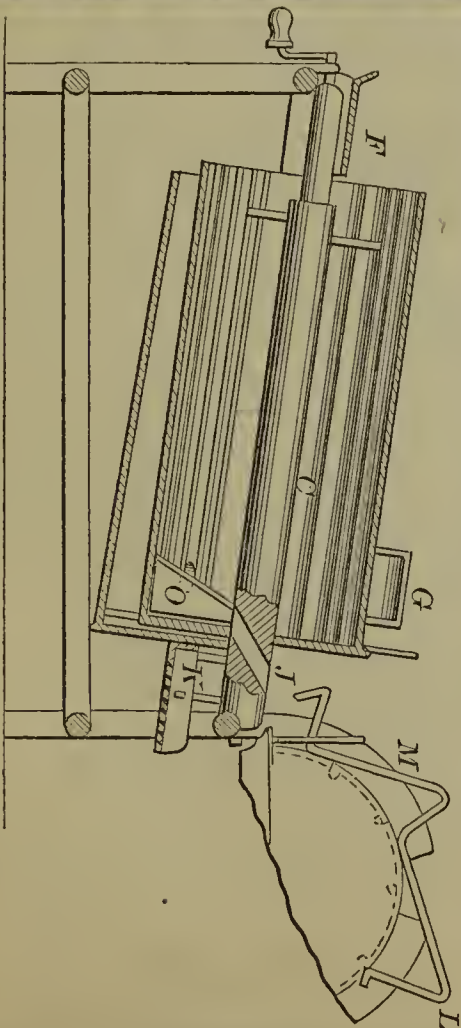

53224—J. A. & H. A. House—*Knitting Machine.*

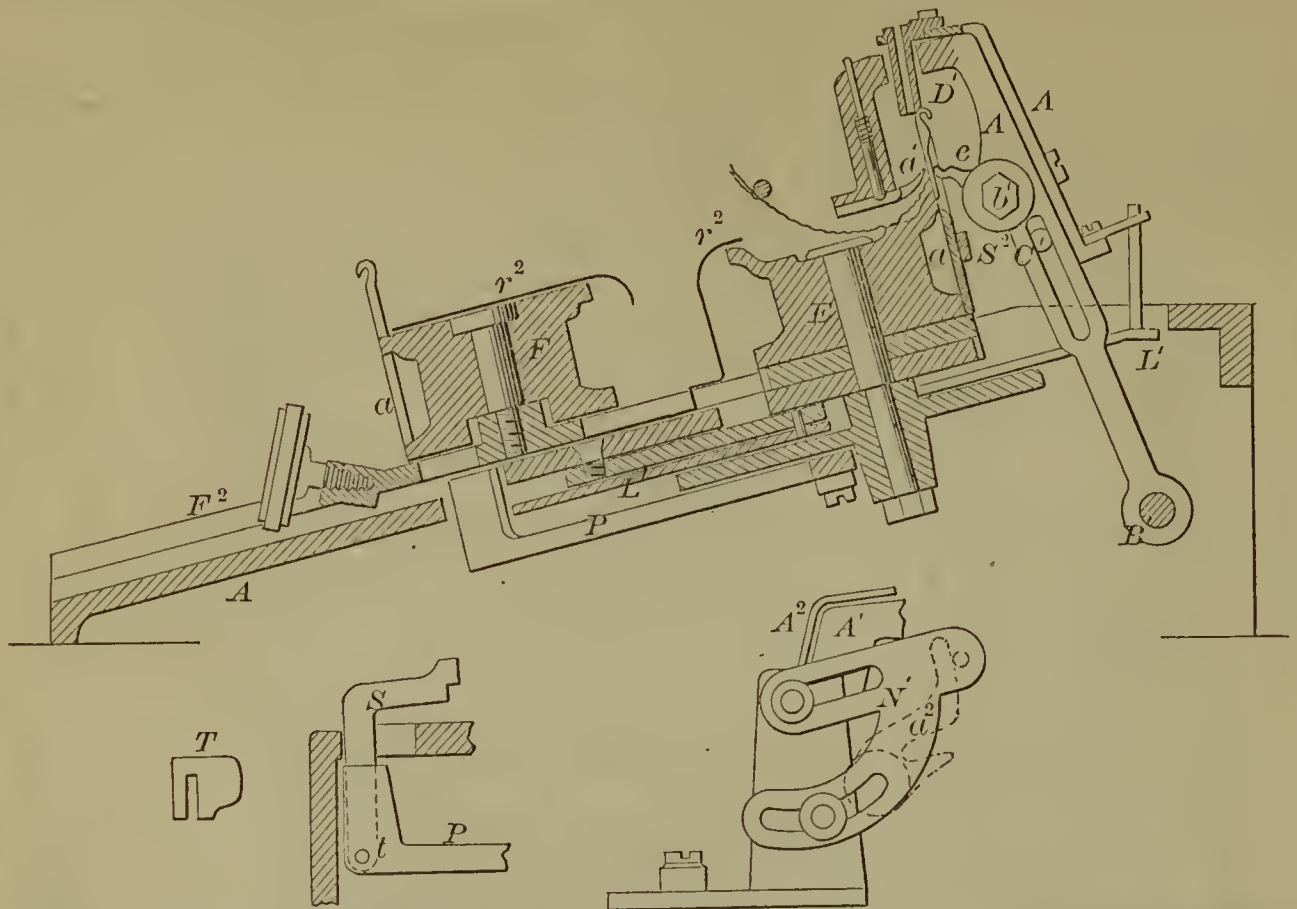

53226—H. Koehly, Jr.—*Evaporator and Cooler.*

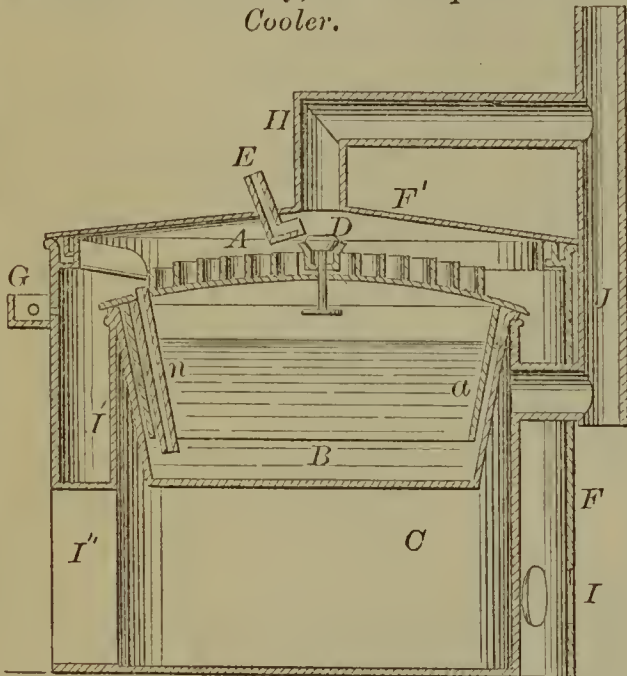

53227—A. Lawrence—*Pie or Plate Tongs.*

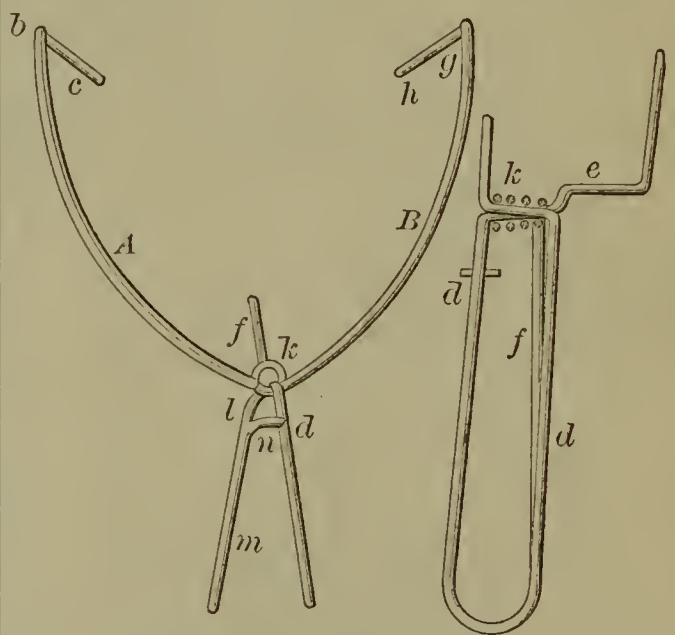

53228—A. Leland—*Perforating Metal Bands.*

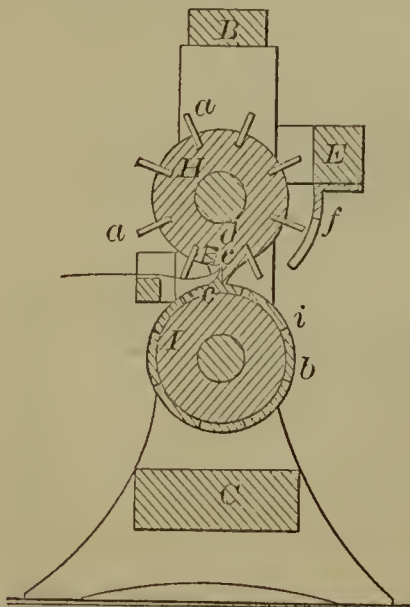

53229—C. & D. Mercer—*Evaporator.*

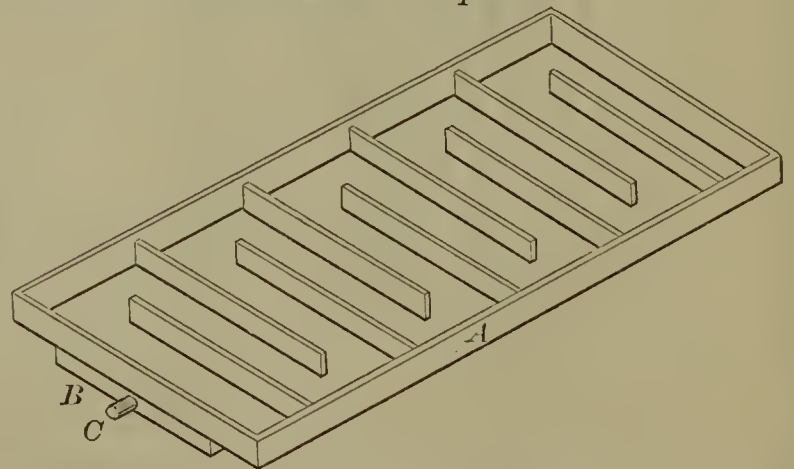

53230—J. F. Milligan—*Fastening for Bale Hoops.*



53231—A. L. Munson—*Leggings.*

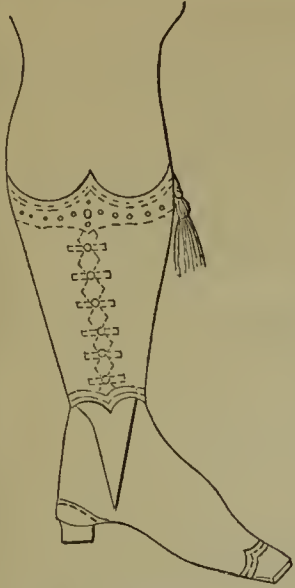

53234—  
J. F. Richards—*Eyelet.*



53235—J. B. Rumsey—*Car Brake.*

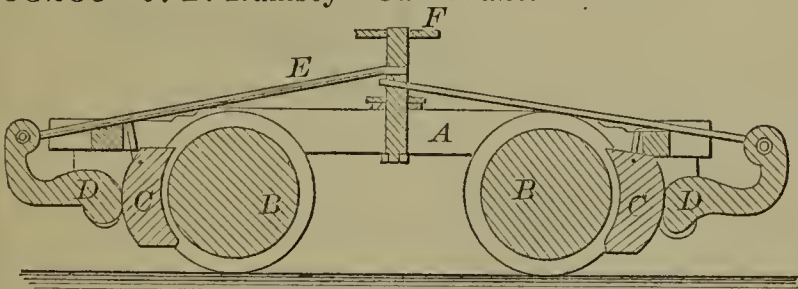

53240—H. Baines—*Railroad Track.*

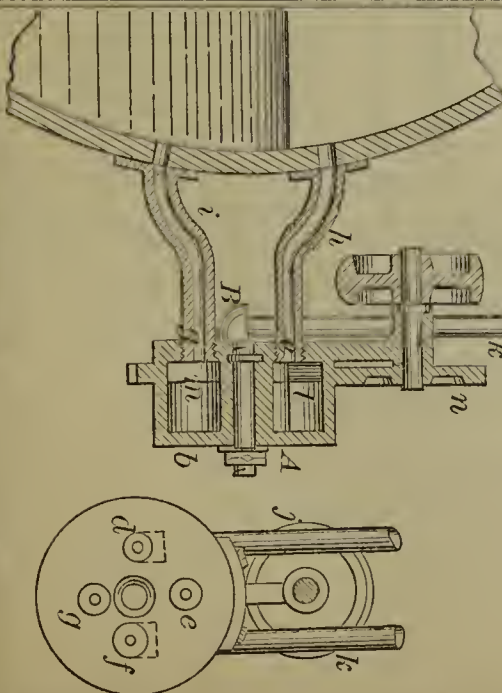
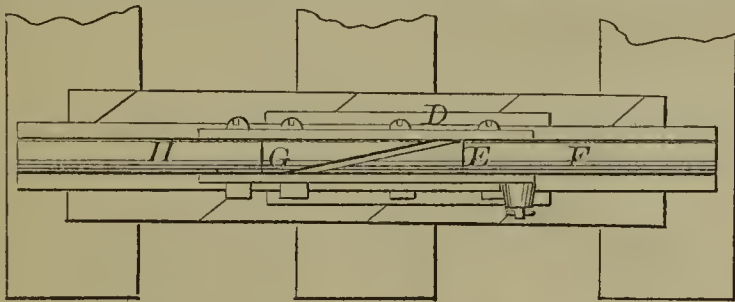

53238—J. R. Widgeon—*Automatic Boiler Feeder.*

53233—  
M. J. Proctor—*Direction Label.*

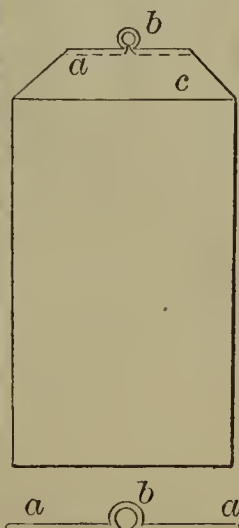

53239—W. H. Winans—*Burglar Alarm for Windows.*

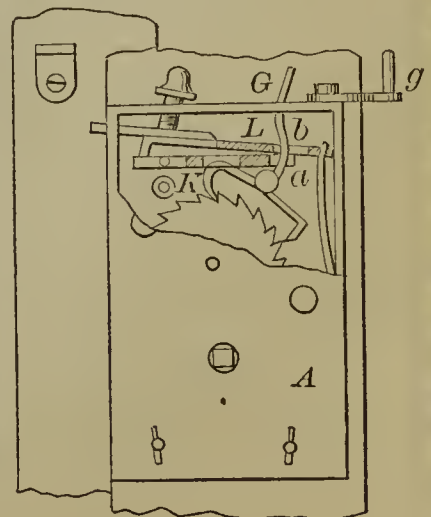

53236—W. E. Sibley—*Gearing for Grinding or other Rollers.*

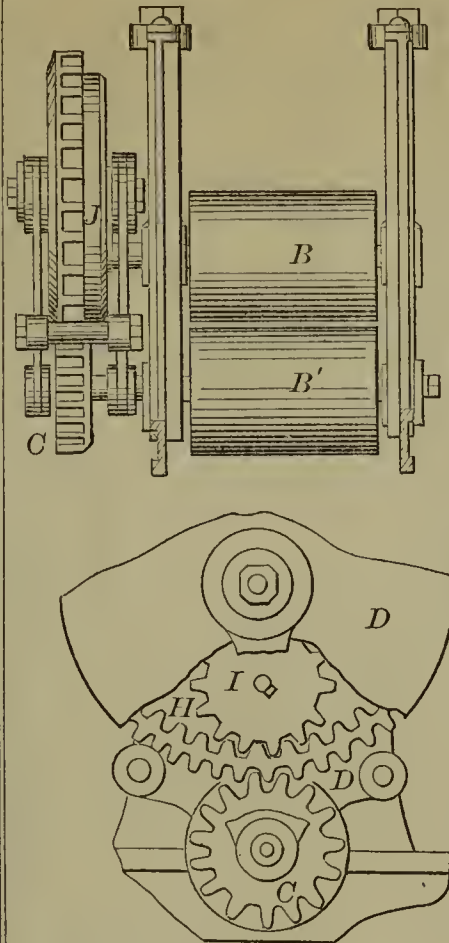

53237—F. Sundell—*Quartz Mill.*

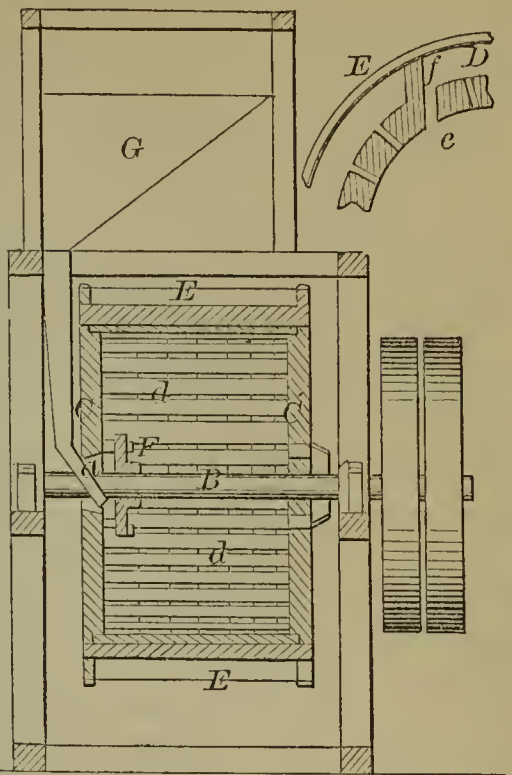

53232—T. J. Parke—*Well Boring Apparatus.*

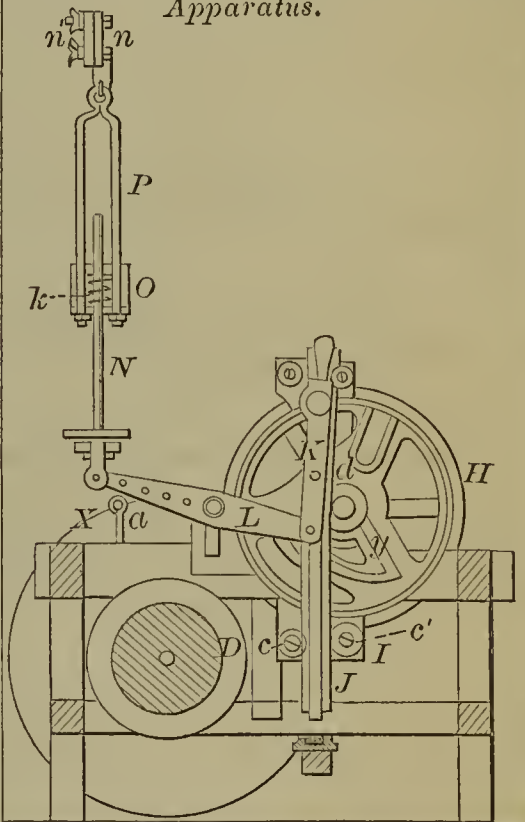

53252—F. E. Adam—*Stove.*

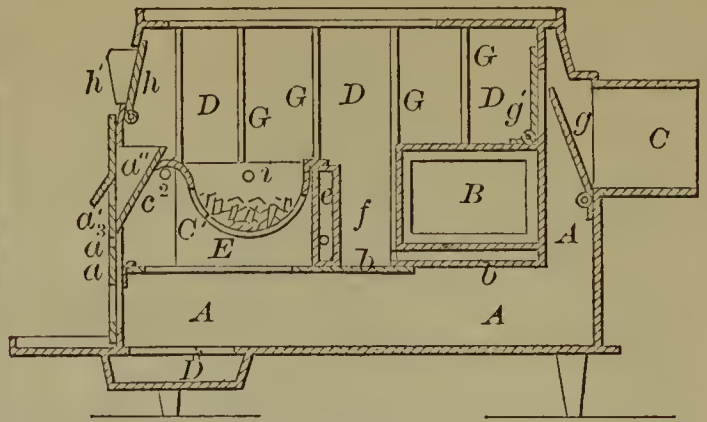

53242—E. Lord—*For Bending Cranks on Rods.*

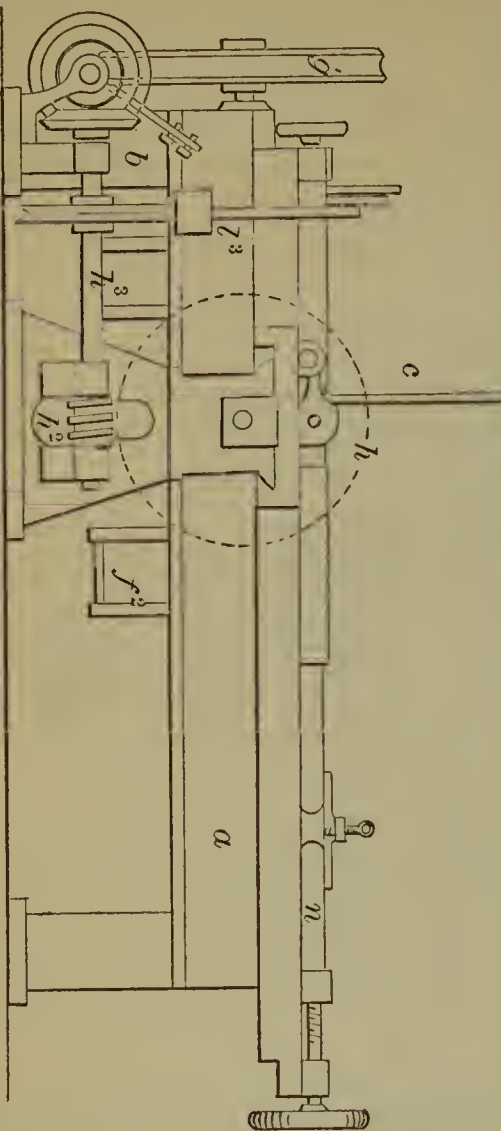

53254—E. G. Anthony—*Coal Sifter.*

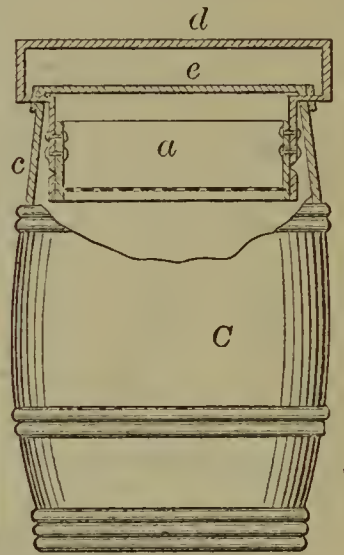

53243—T. Rogers—*Binder Guide for Sewing Machines.*

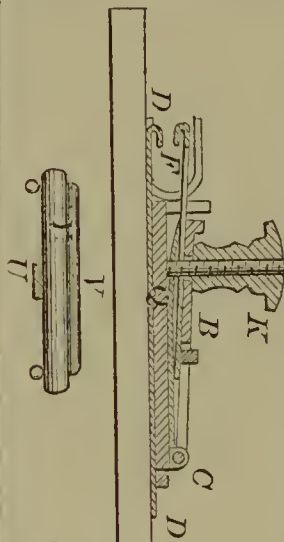

53246—W. W. Smith—*Telegraph Insulator.*

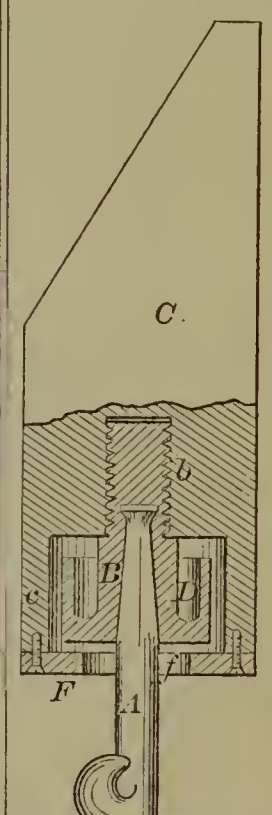

53245—P. Soper—*Dental Drill.*

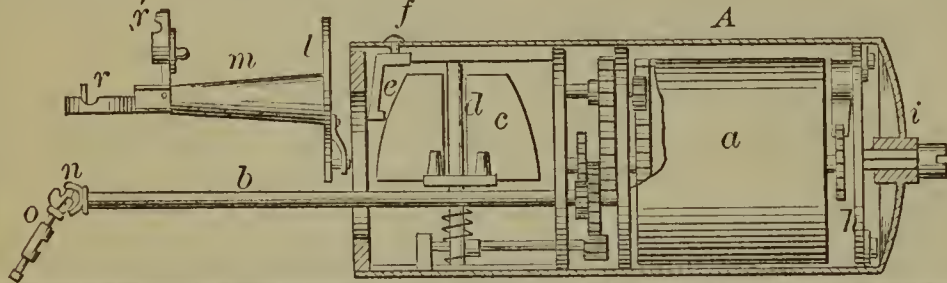

53251—D. J. Littlefield—*Attaching Covers to Stoves, &c.*

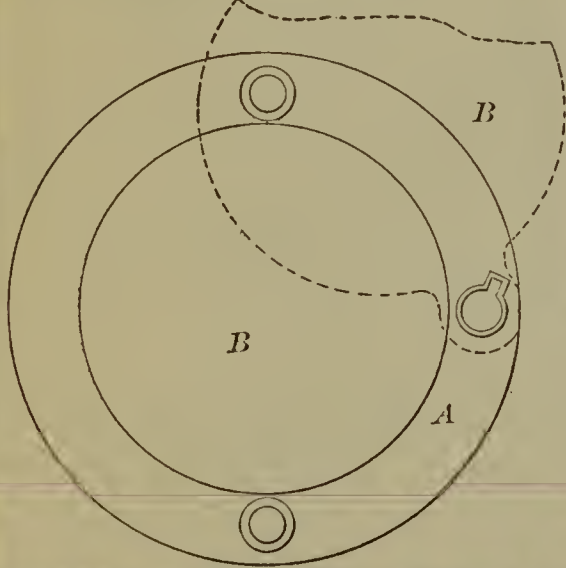

53256—N. P. Barnes—*Milk Can.*

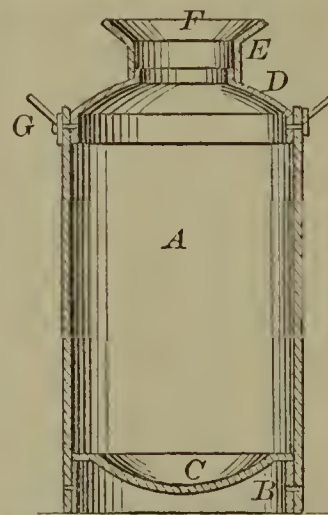

53257—J. Barnett—*Clothes Dryer.*

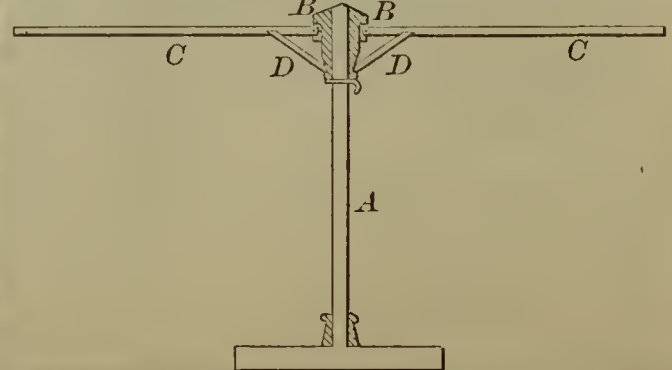

53255—W. Armstrong—*Snap Hook.*

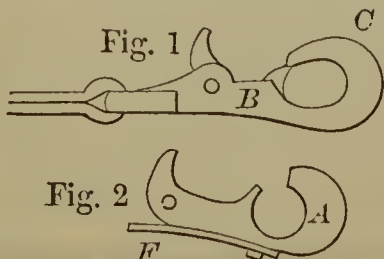

53558—J. C. Batcheller—Forming Shoulders on Forks.

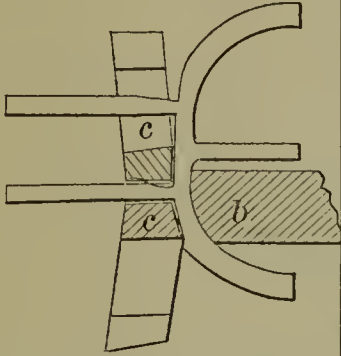
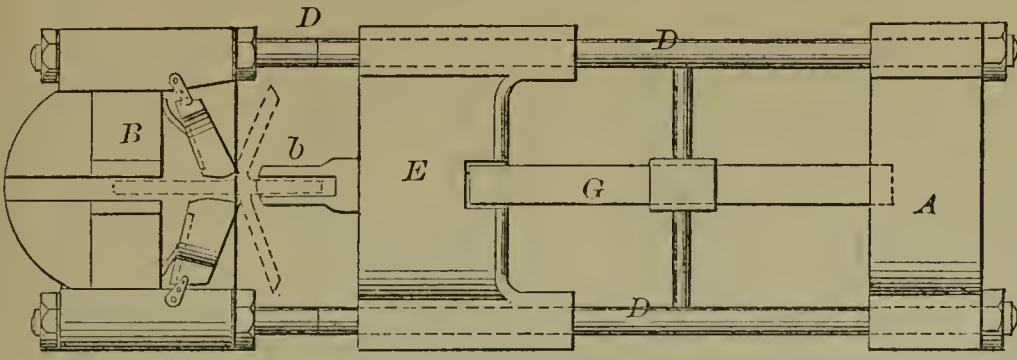

53262—A. T. Bleyley—Vegetable Cutter.

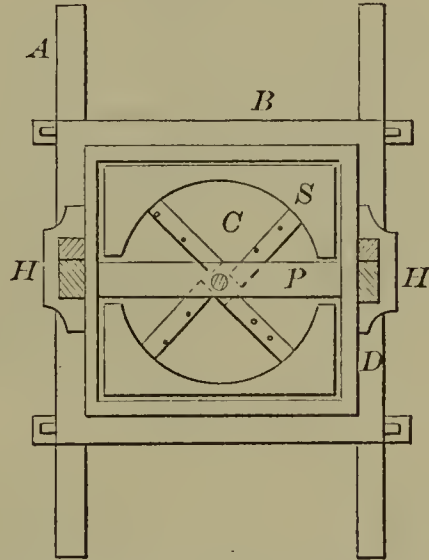

53261—II. Bishop—Pitman Coupling for Harvesters.

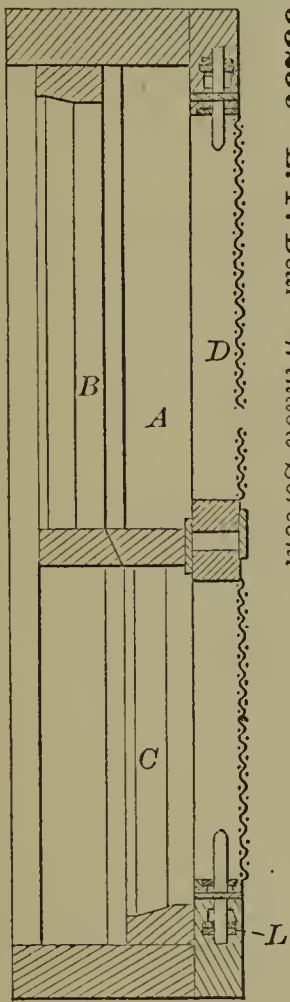
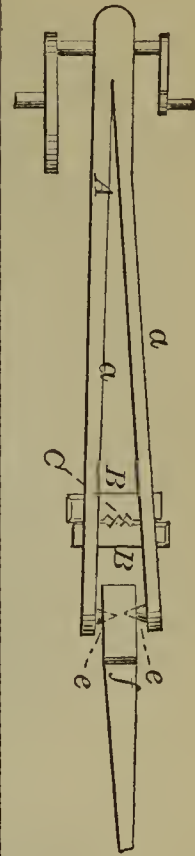

53259—E. F. Beal—Window Screen.

53260—J. Billings—Culinary Cabinet.

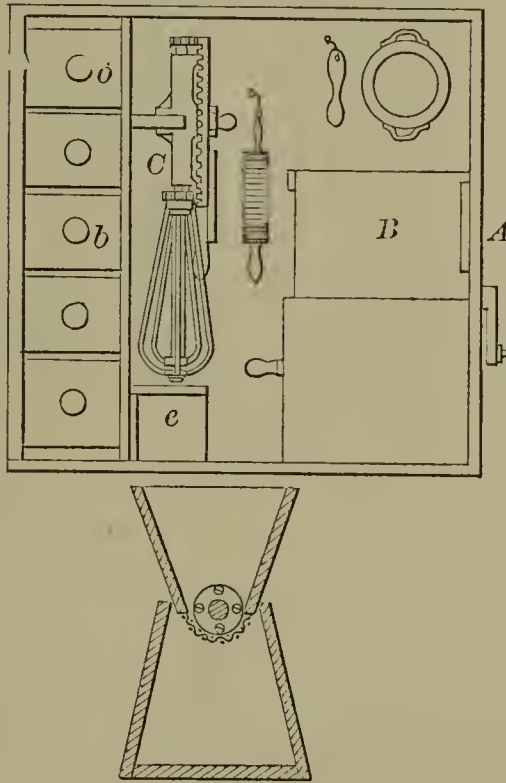

53263—A. T. Boon—Gate.

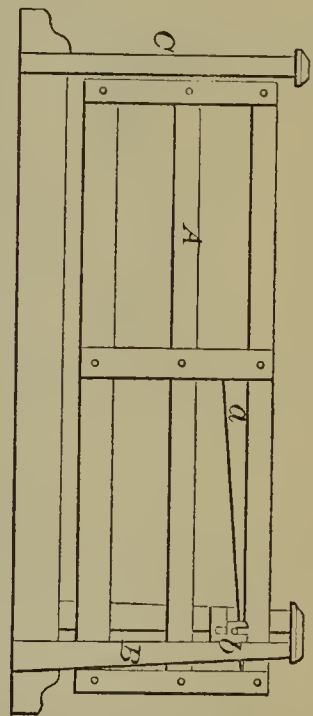

53264—J. C. Boyd—Ditching Machine.

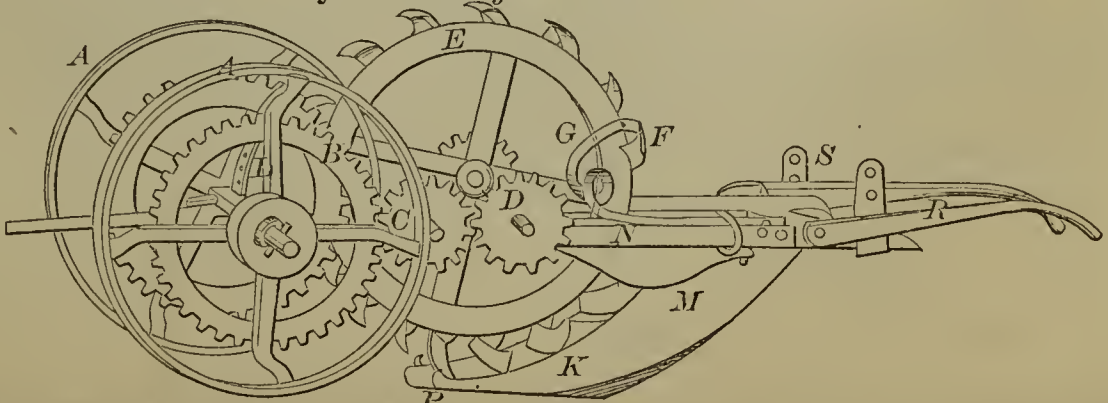

53265—J. Braun—Loom.

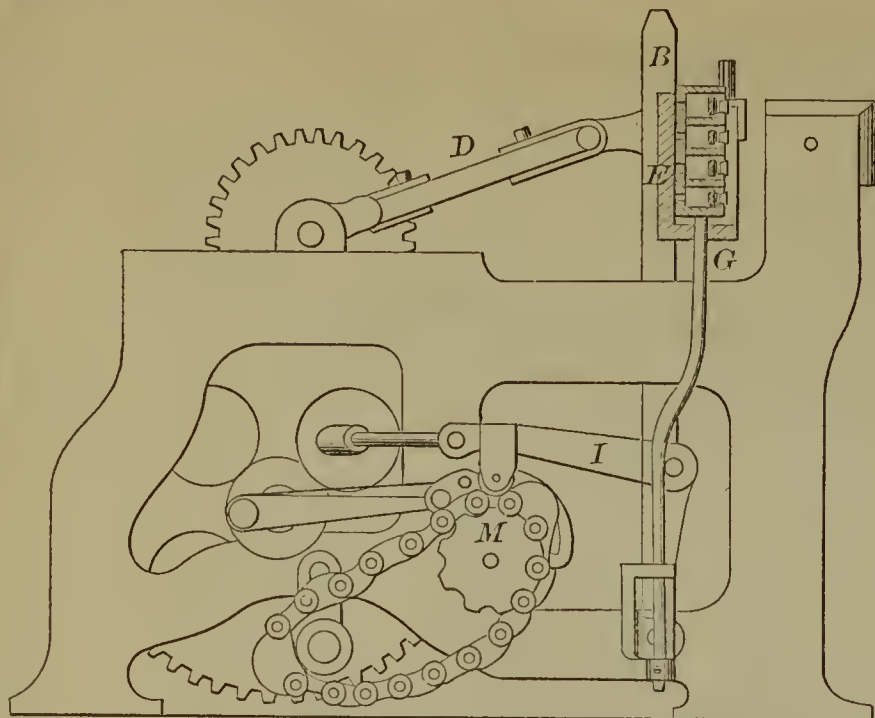

53268—A. Burbank—Flour Bolt and Bran Duster.

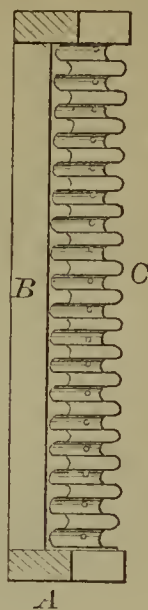

53274—Cooper & Southworth—Bonnet Frame.



53266—J. S. Briggs—For Desulphurizing Ores.

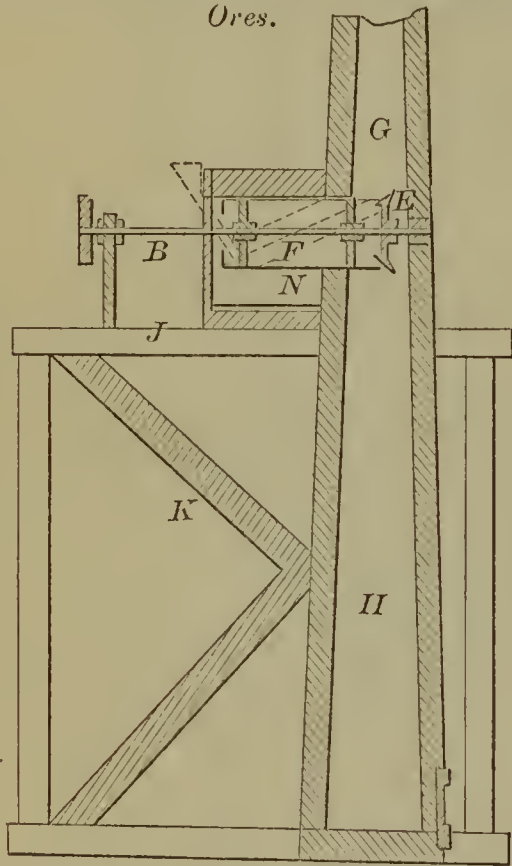

53269—W. H. Butler—Steam Pump for Railroad Stations.

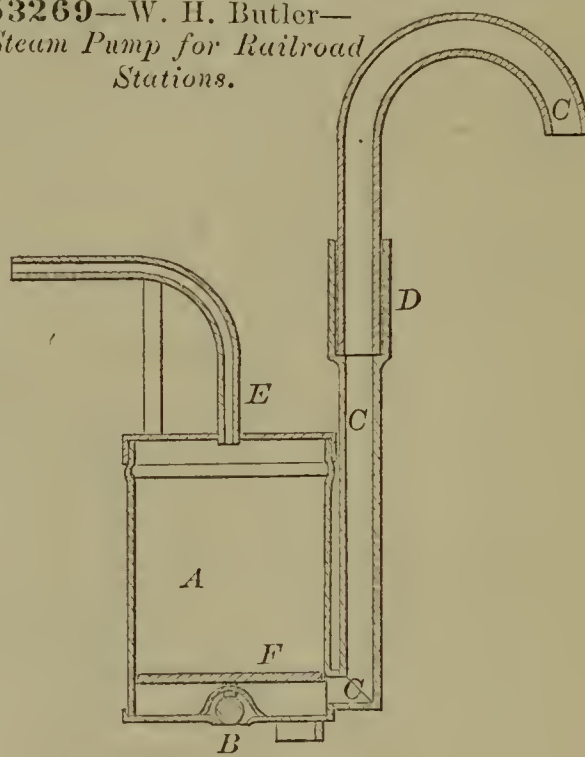

53271—W. Cleveland—Stop Faucet.

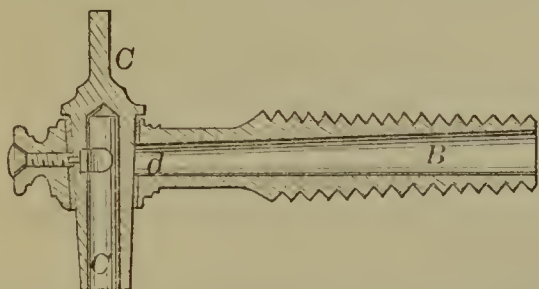

53275—C. D. Copeland—Knife Cleaning Box.

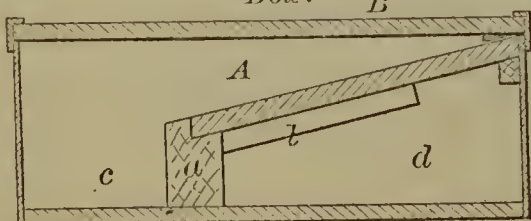

53272—J. R. Cluxton—Neck Tie.

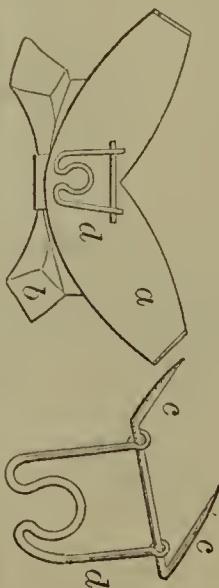

53276—R. Cunningham—Ankle Supporter.

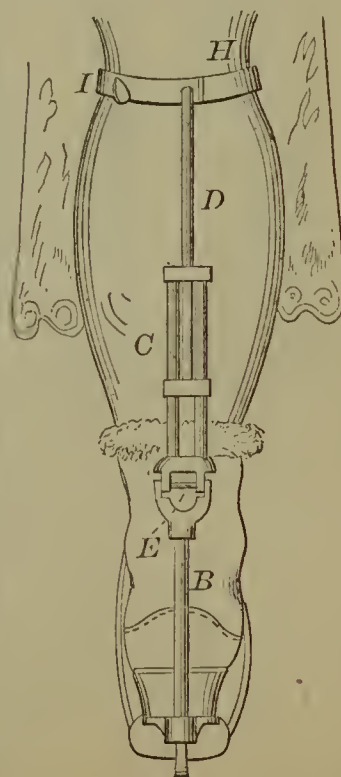



53278—D. Dishart—Washing Machine.

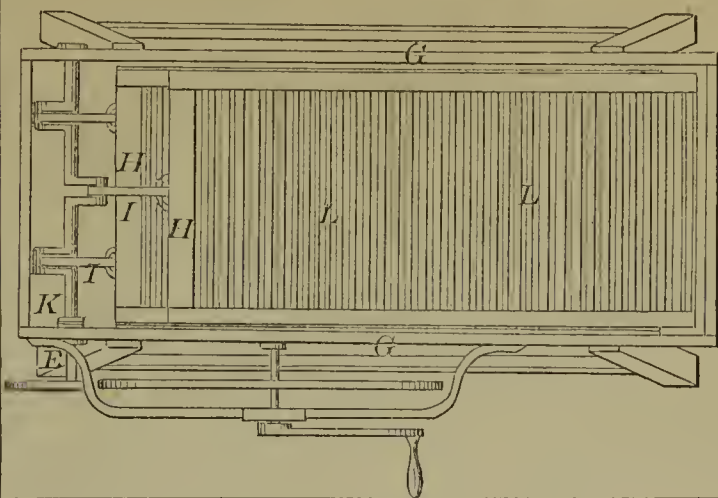

53284—J. Firmenich—Steam Generator.

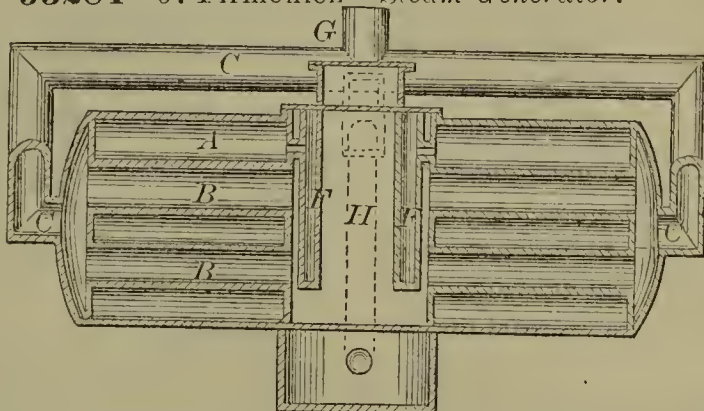

53285—A. Fischer—Beer Cooler, &c.

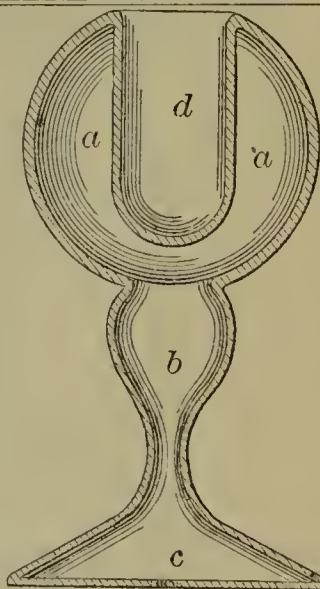
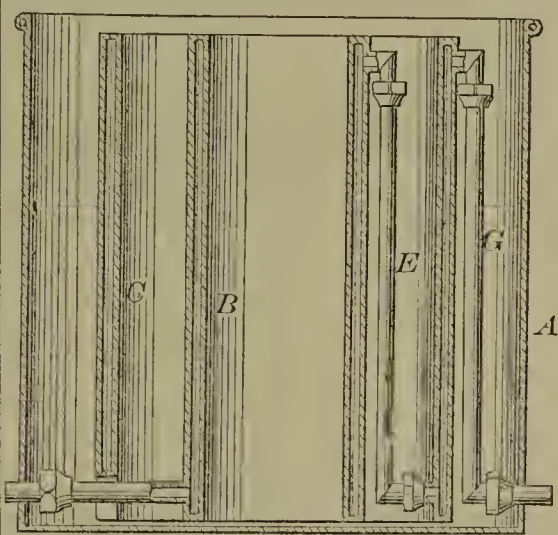

53279—E. Dithridge—Bouquet Holder.

53277—M. C. Davis—Sheep Shearing Machine.

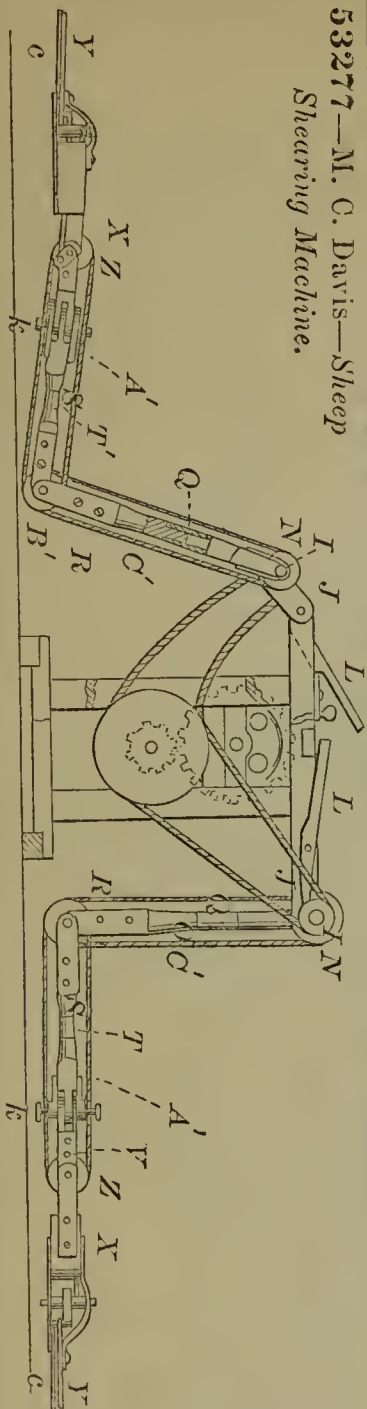

53288—T. Foster—Horse Hay Fork.

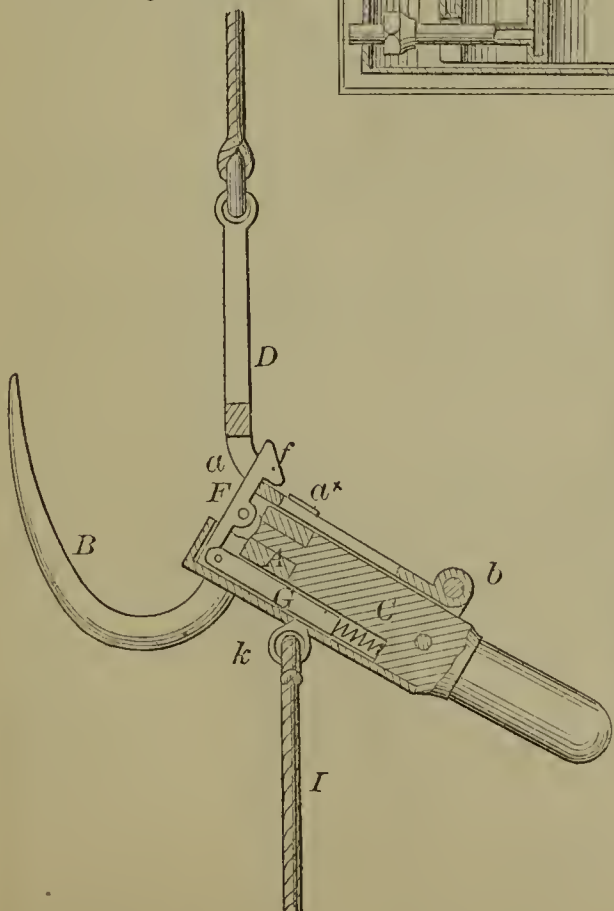

53282—A. L. Eckert—Hand Punch.

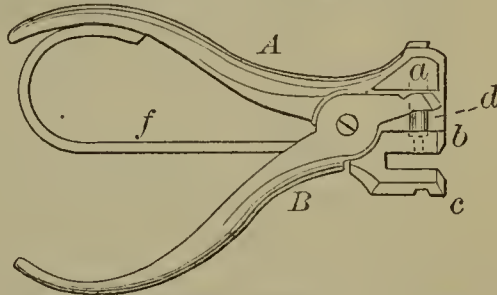

53283—J. Firmenich—Beer Faucet.

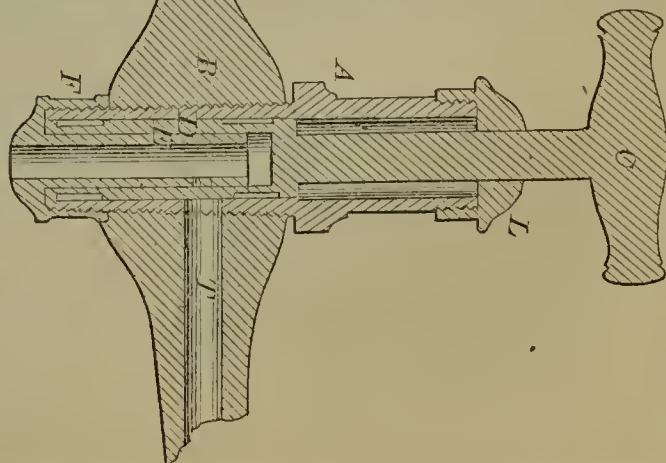

53289—G. B. Fowler—Wood Splitter.

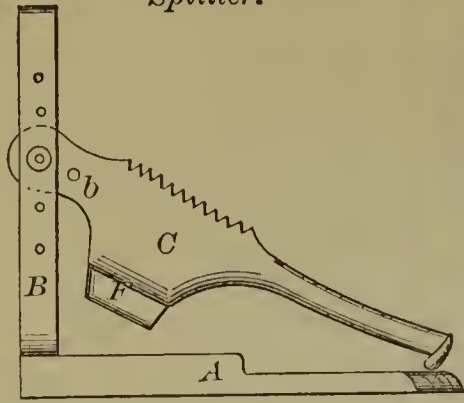

53291—J. J. Gest—Car Spring.

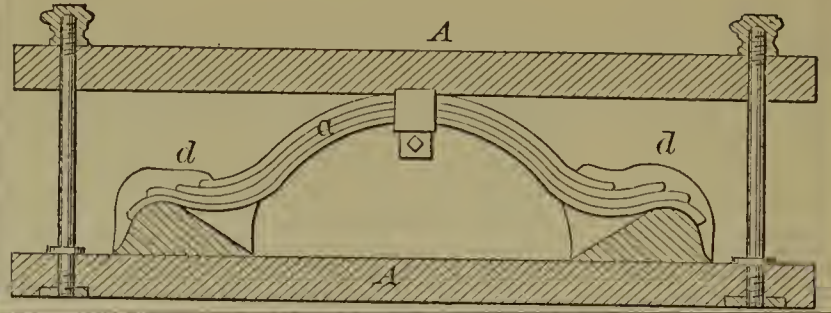

53290—C. Fownes—Kettle Cover Fastening.

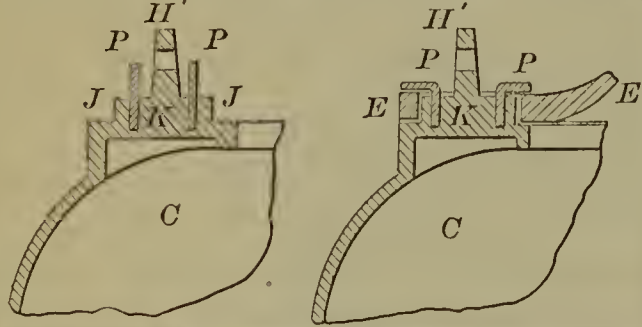

53294—J. H. Green—Stump or Stone Extractor.

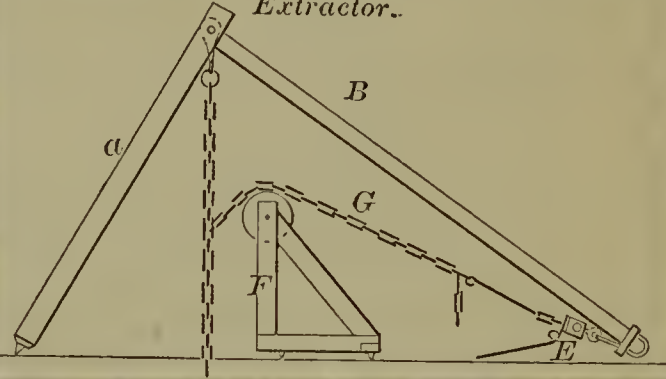

53293—S. Godfrey—Grain Drying.

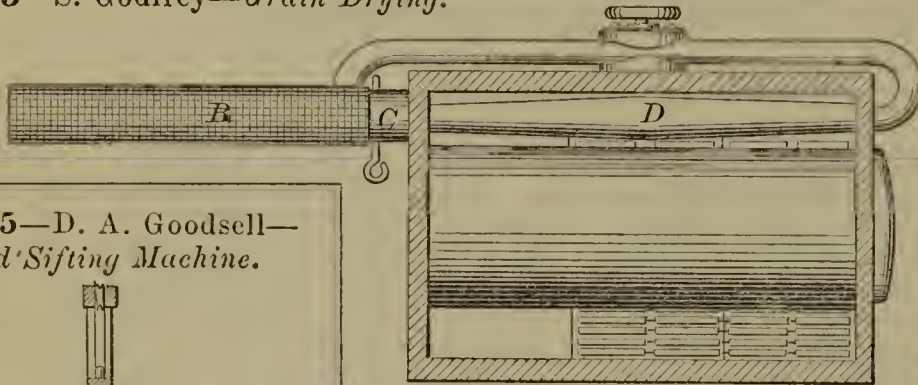

53297—Harrington & Caffrey—Propeller Wheel.

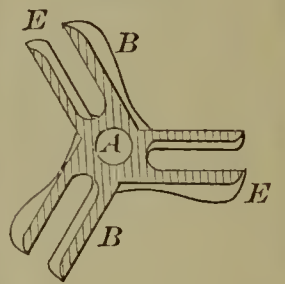

53295—D. A. Goodsell—Sand Sifting Machine.

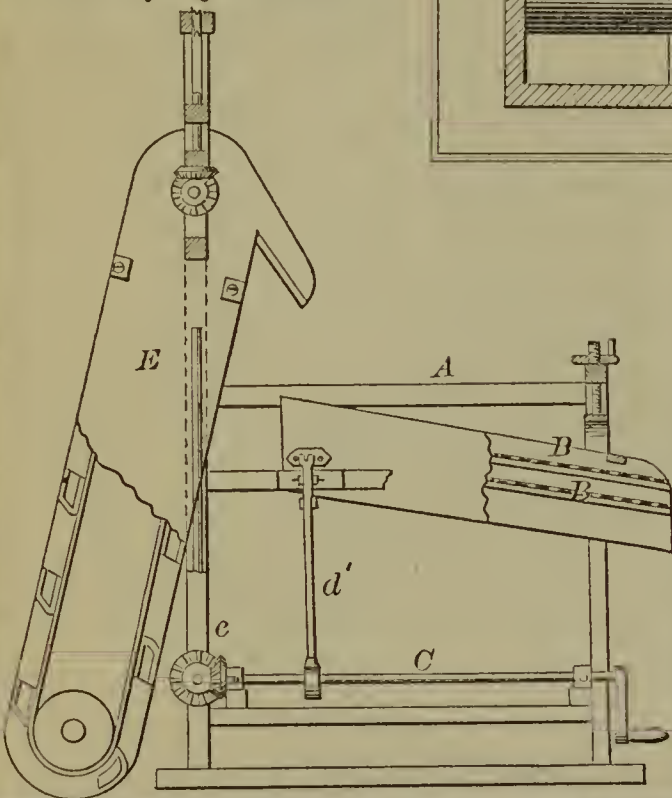

53296—N. Hall—Broom Head.

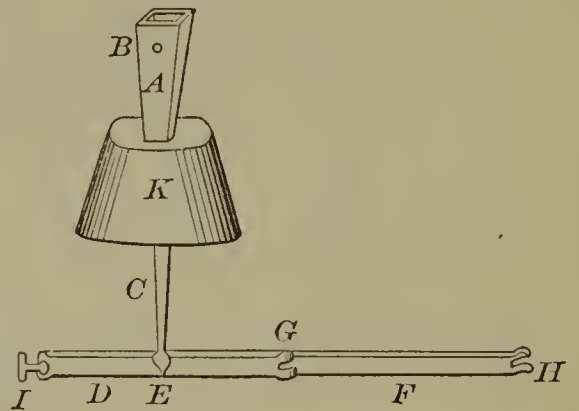

53292—J. J. Gest—Car Spring.

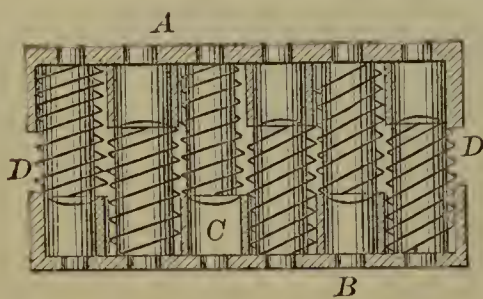

53299—L. Heyl—Portfolio.

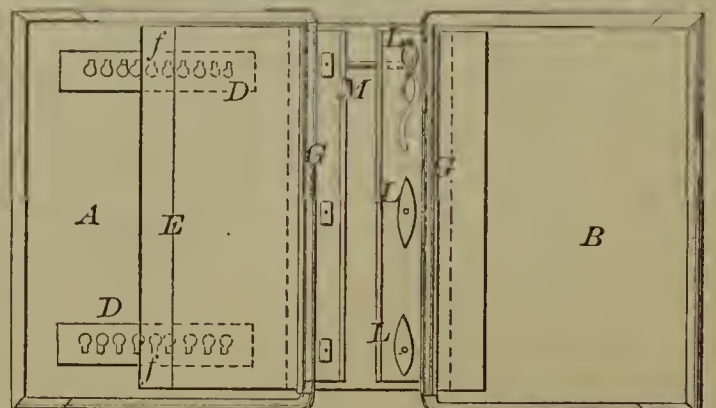

53300—J. M. Hicks—*Steam Generator.*

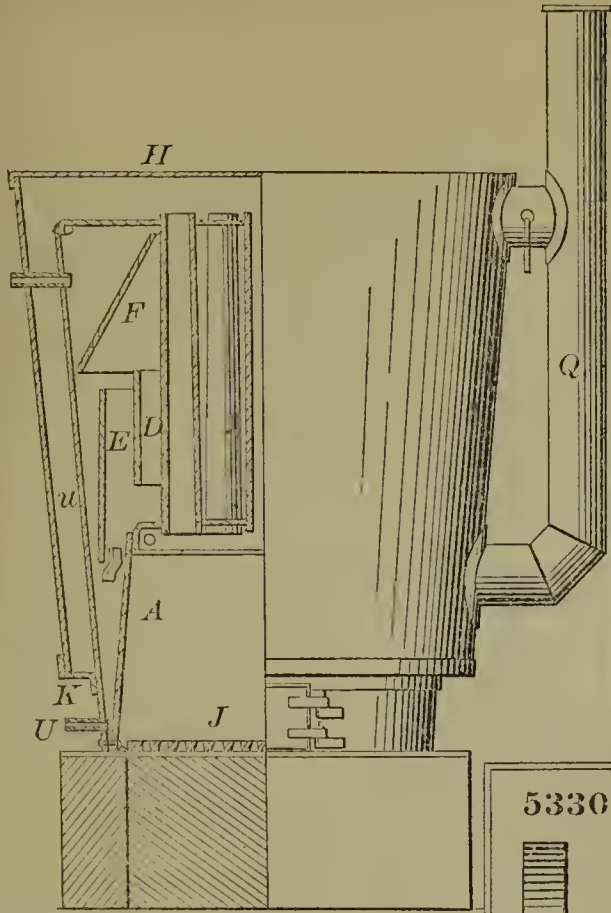

53301—W. H. Horton—*Chimney Cap.*

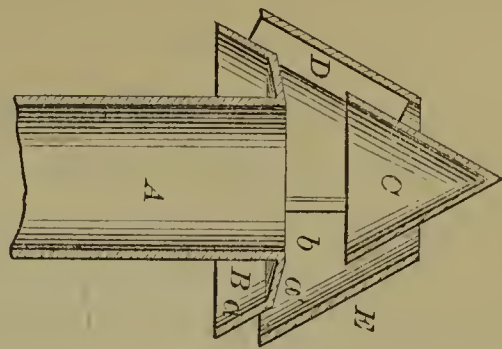

53302—P. F. Hulbert—*Step Block for Carriages.*

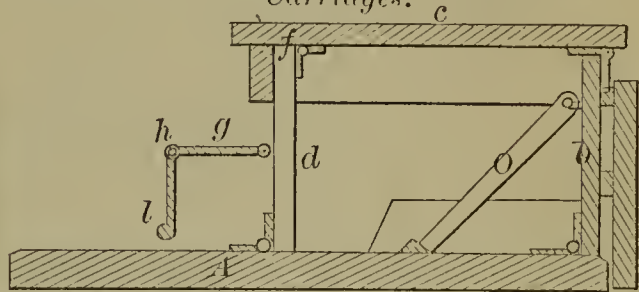

53304—R. Ketcham—*Seed Planter.*

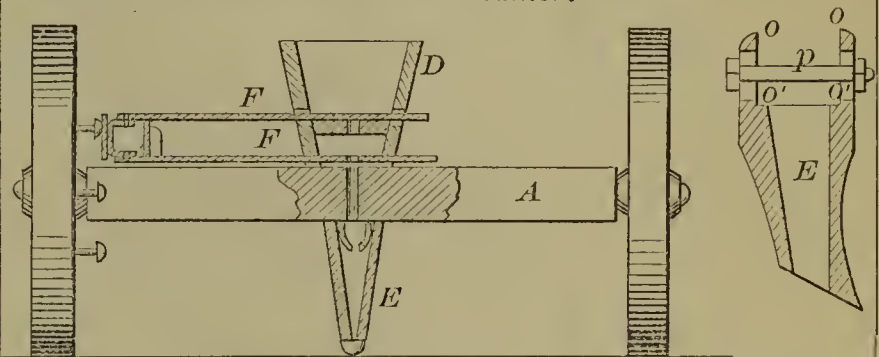

53305—W. R. King—*Rock Drill.*

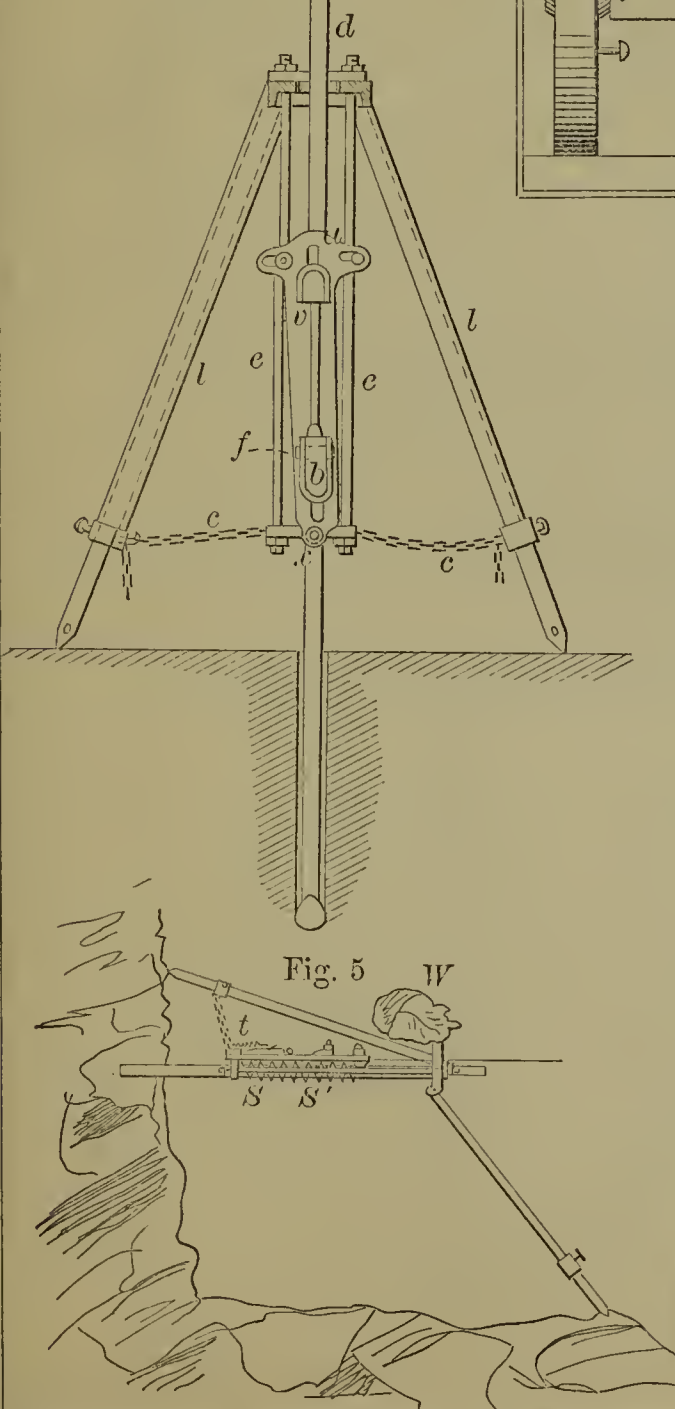

53303—M. H. Hullinger—*Cultivator.*

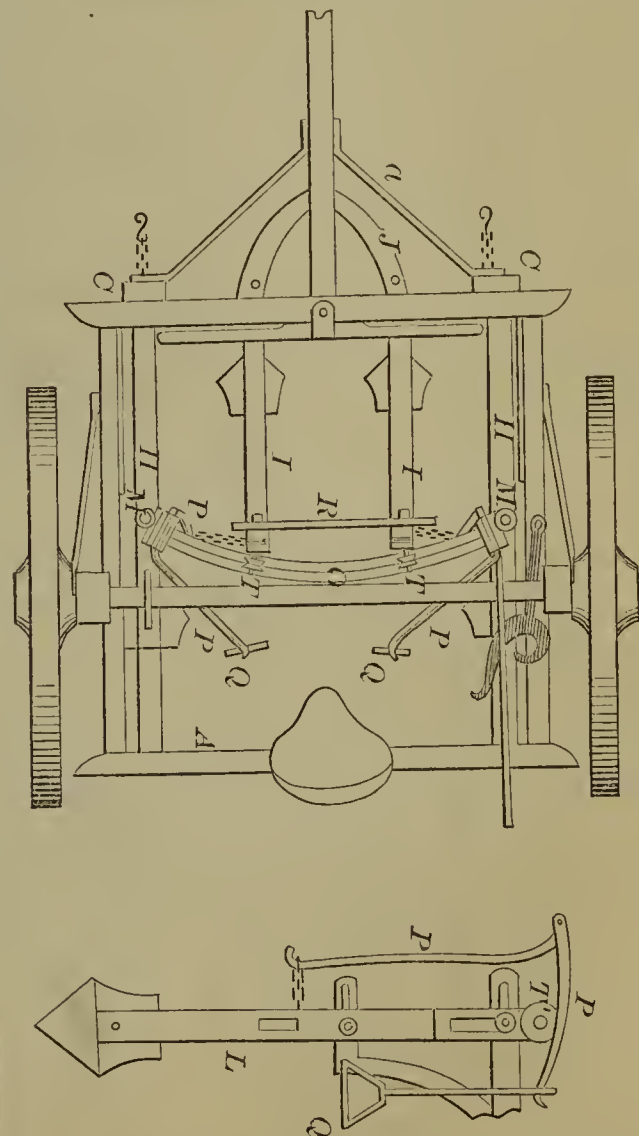

53306—E. C. Kirk—*Gun Lock.*

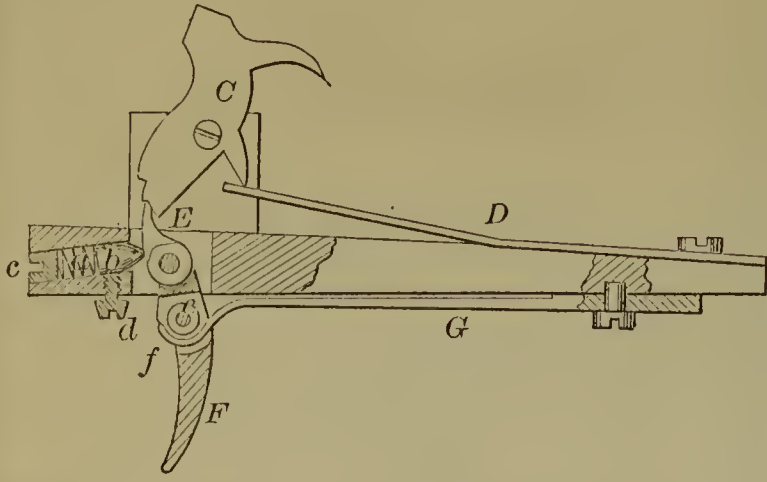

53308—L. J. Knowles—*Obtaining Intermittent Rotary Motion.*

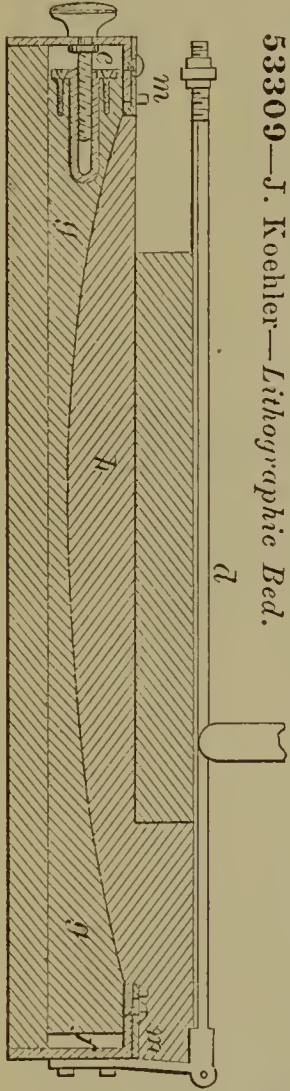
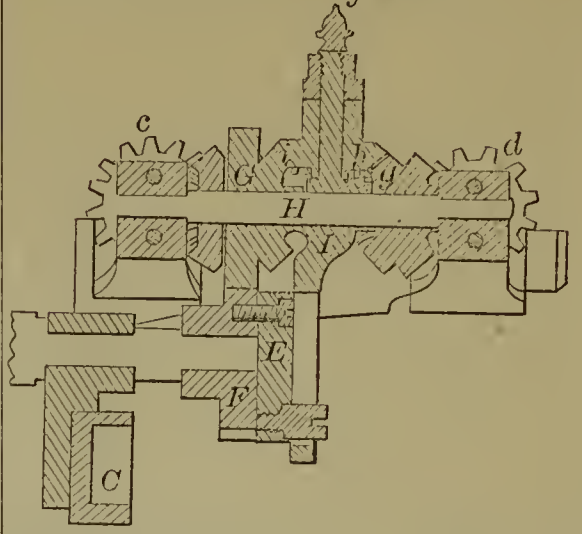

53309—J. Koehler—*Lithographic Bed.*

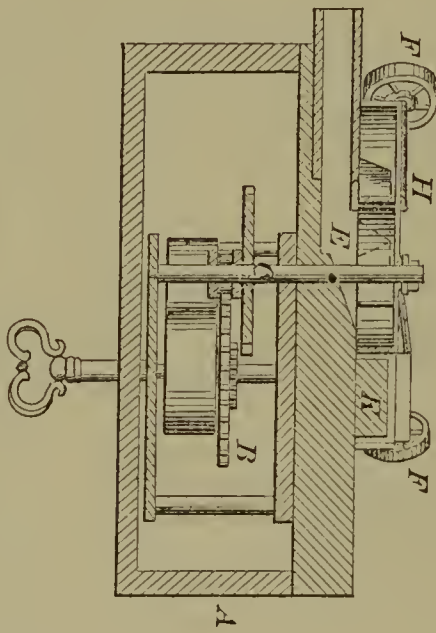

53310—D. Lake—*Fly Trap.*

53312—C. B. Lewis—*Mechanical Movement.*

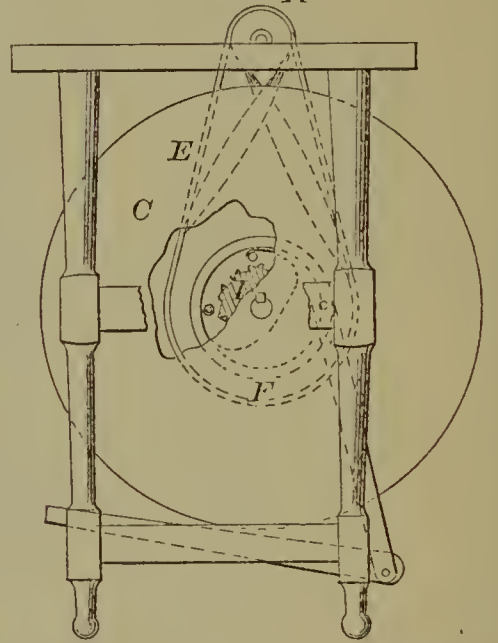

53313—D. S. Loy—*Tuyere.*

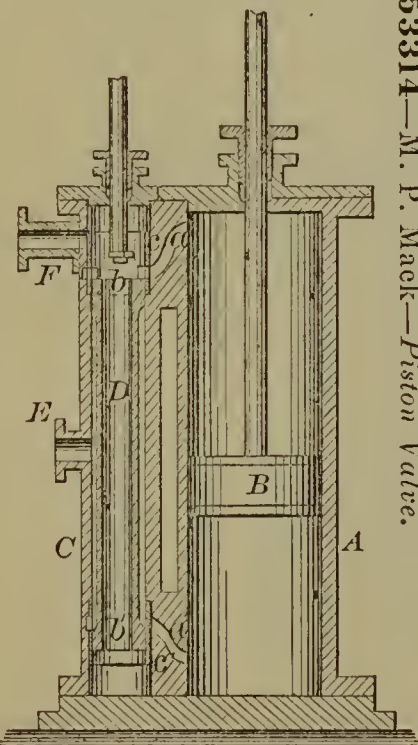
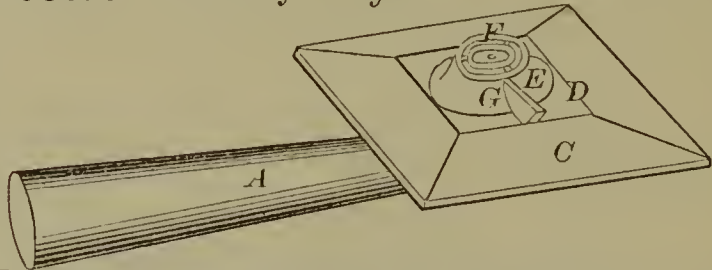

53314—M. P. Mack—*Piston Valve.*

53311—J. S. Lash—*Washing Machine.*

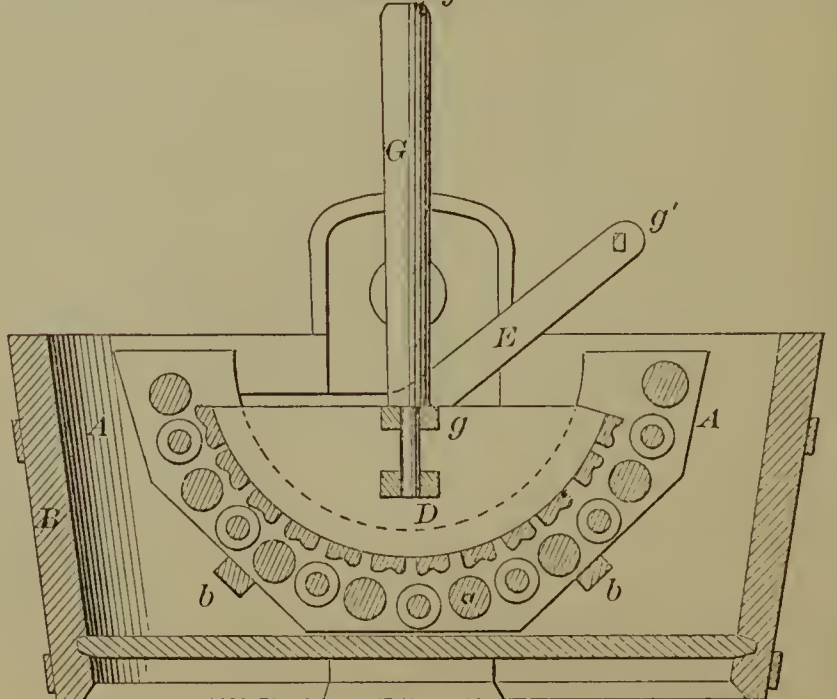

53315—D. J. Martin—*Tuyere.*

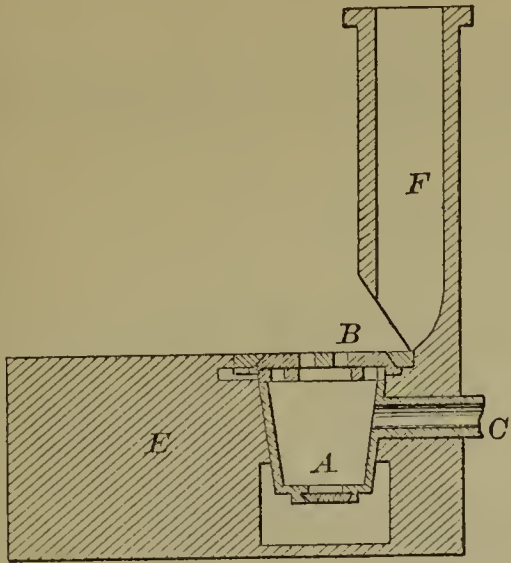

53319—J. M. May—*Quartz Crusher.*

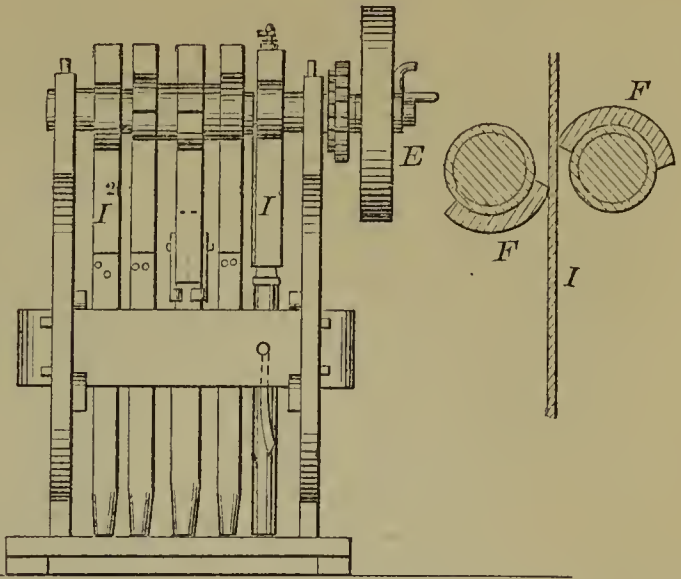

53320—J. McFarland—*Lamp Shade.*

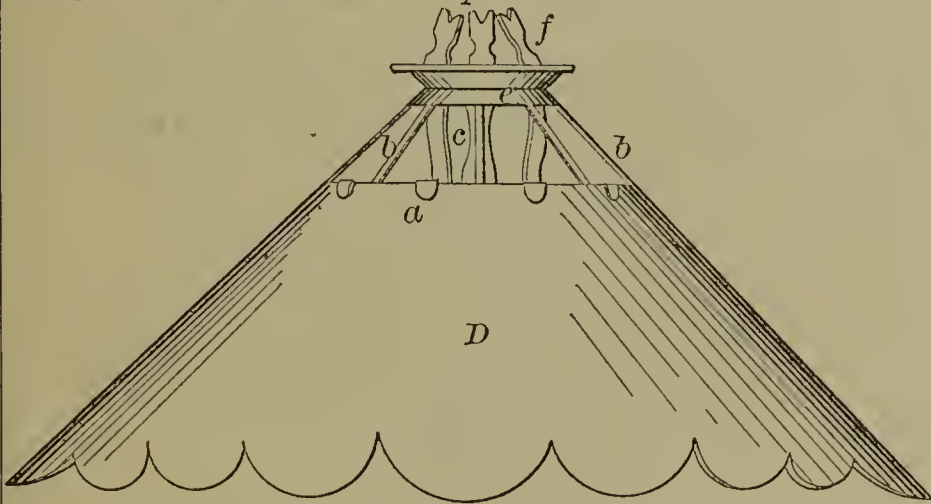

53317—J. A. Mathews—*Railway  
Track Cleaner.*

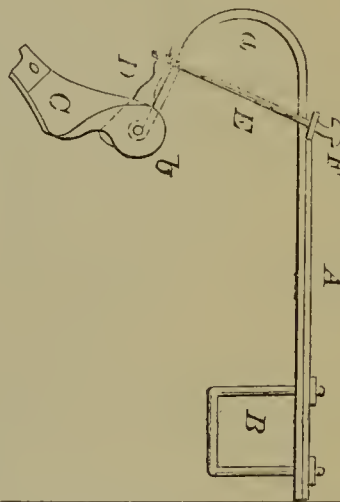

53316—D. E. Masnata—*Revolving Screw Steamship.*

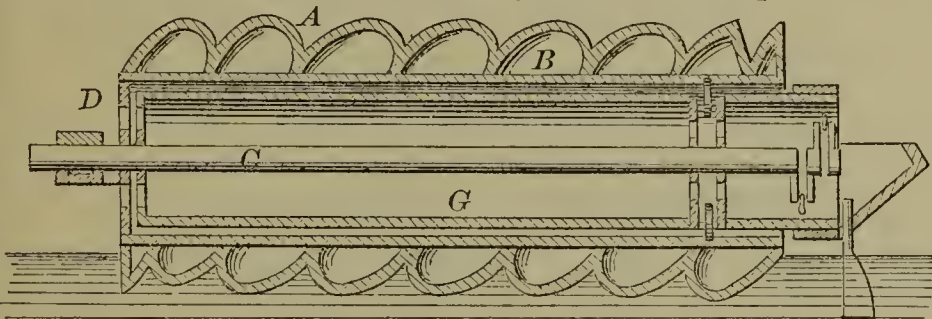

53323—D. P. Myers—*Broom Head.*

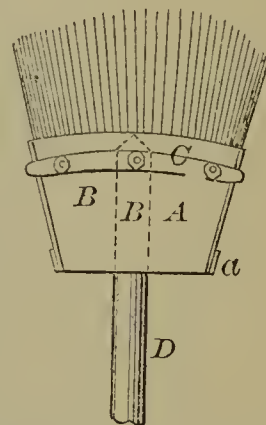

53318—S. B. Maulsby—*Evaporator.*

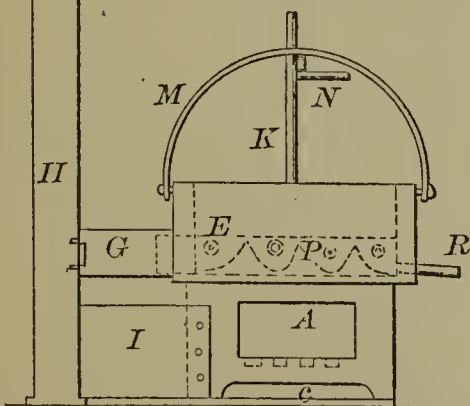

53322—Miner & Heavenridge—*Cultivator Plow.*

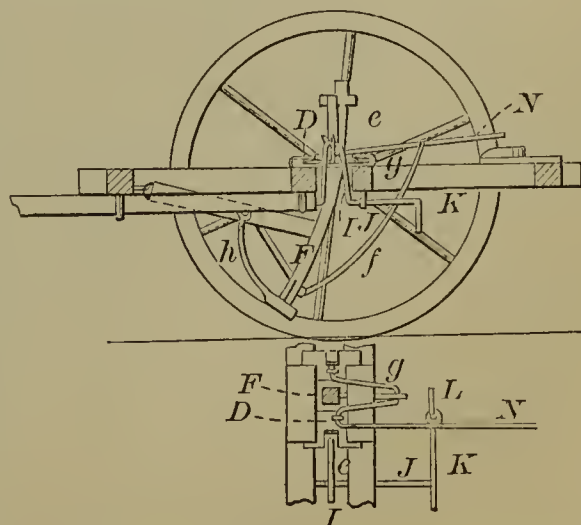

53321—H. L. Meservey—*Washboard.*

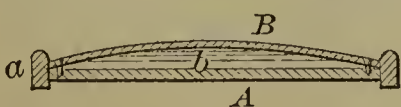

53325—D. M. Nichols—Tool for Cutting Boiler Tubes.

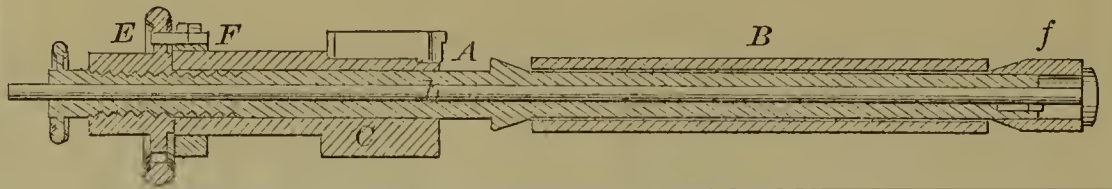

53324—I. Nathan—Dress Elevator.



53328—L. M. Patterson—Gang Plow.

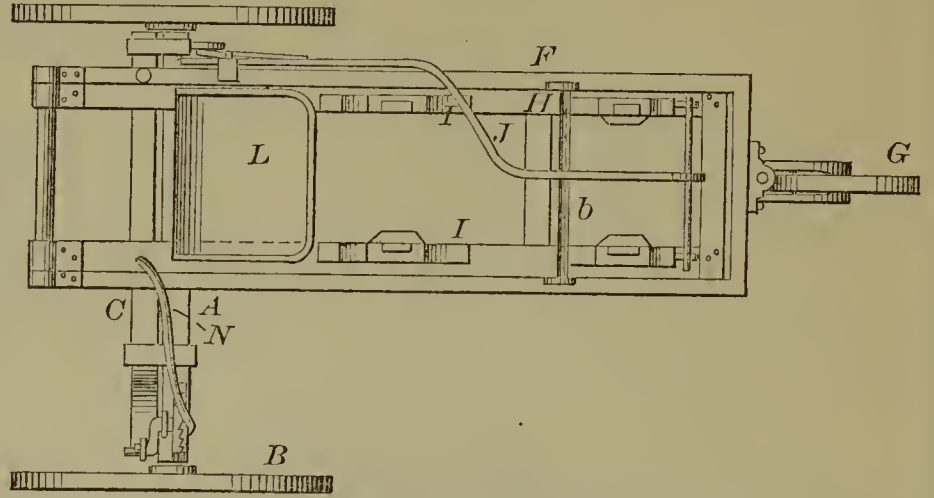

53327—J. K. O'Neill—Weighing Scoop.

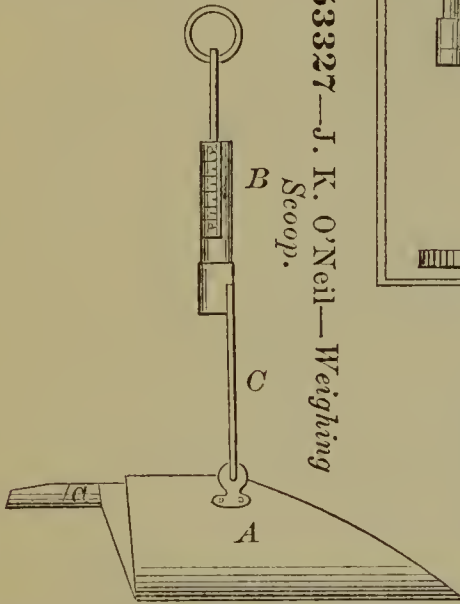

53326—D. J. Noble—Cultivator.

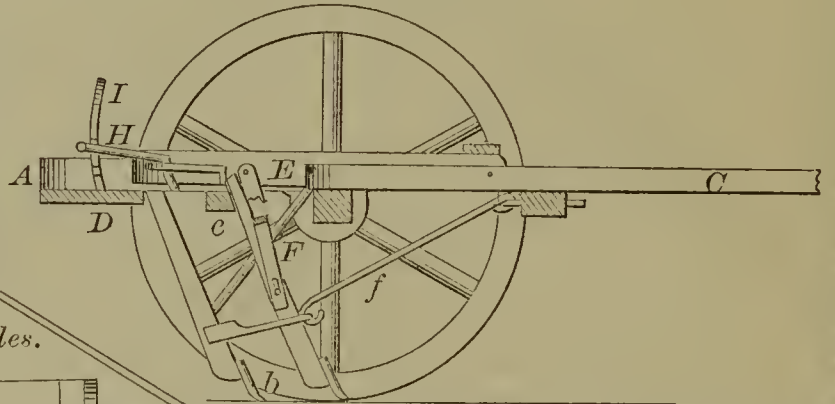

53329—J. I. Peck—Seat for Vehicles.

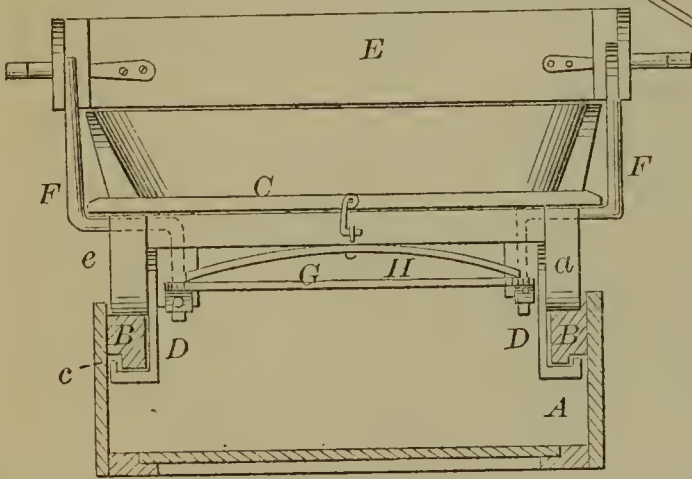

53331—R. S. Pickett—Fastening for Garments.

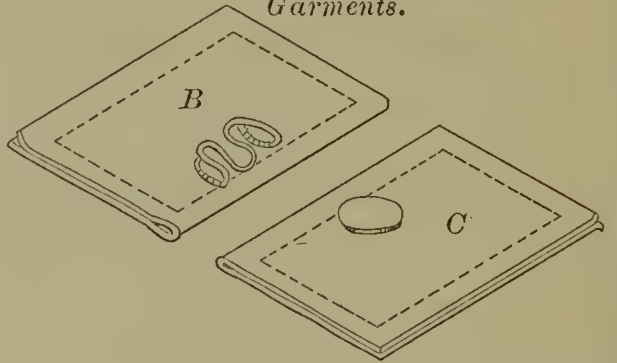

53330—J. Pelsor—Hand Loom.

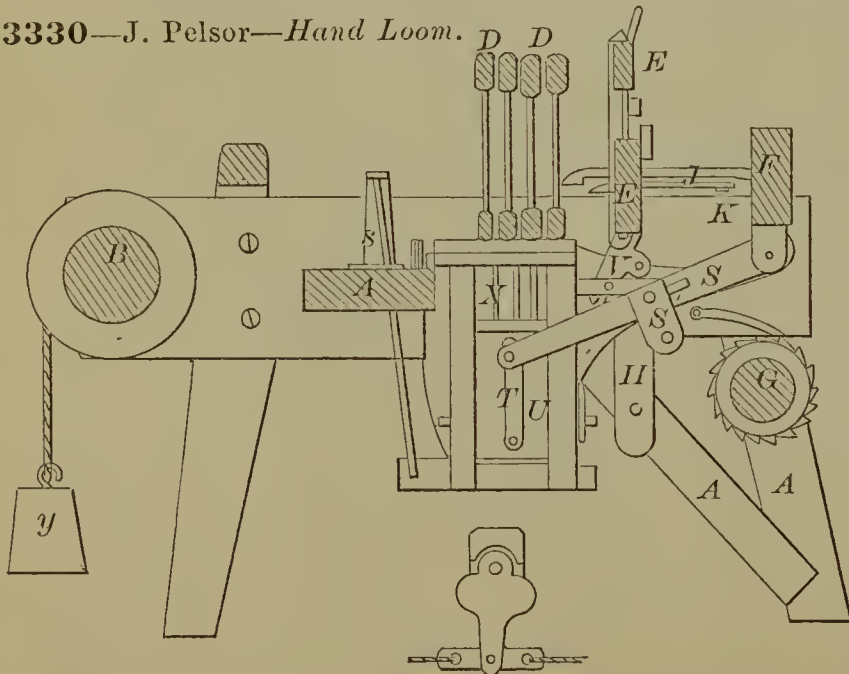

53332—J. C. Plummer—Hoe.

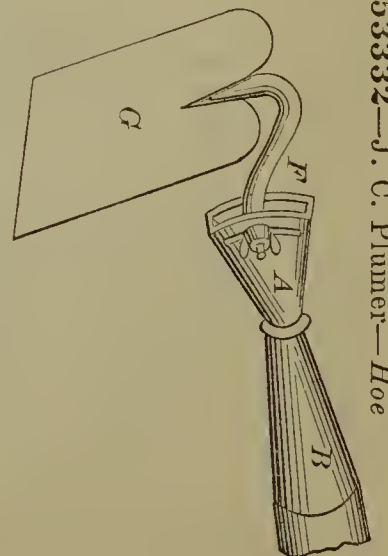

53335—J. Rankin—Churn.

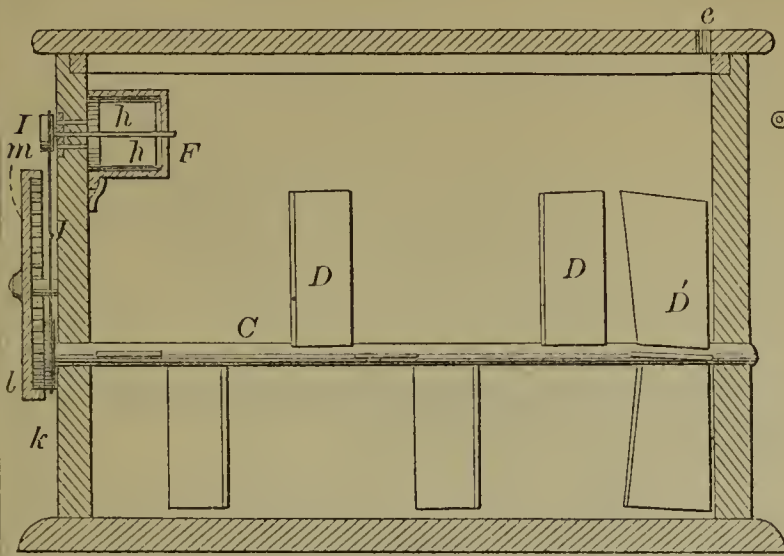

53333—E. H. Porter—Swivel Button.

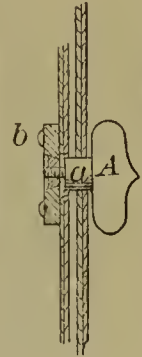
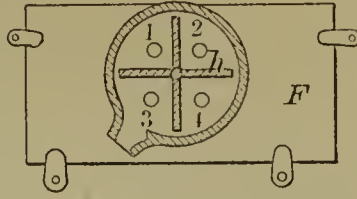

53338—L. Reinauer—For Preparing Oval Frames for Gilding.

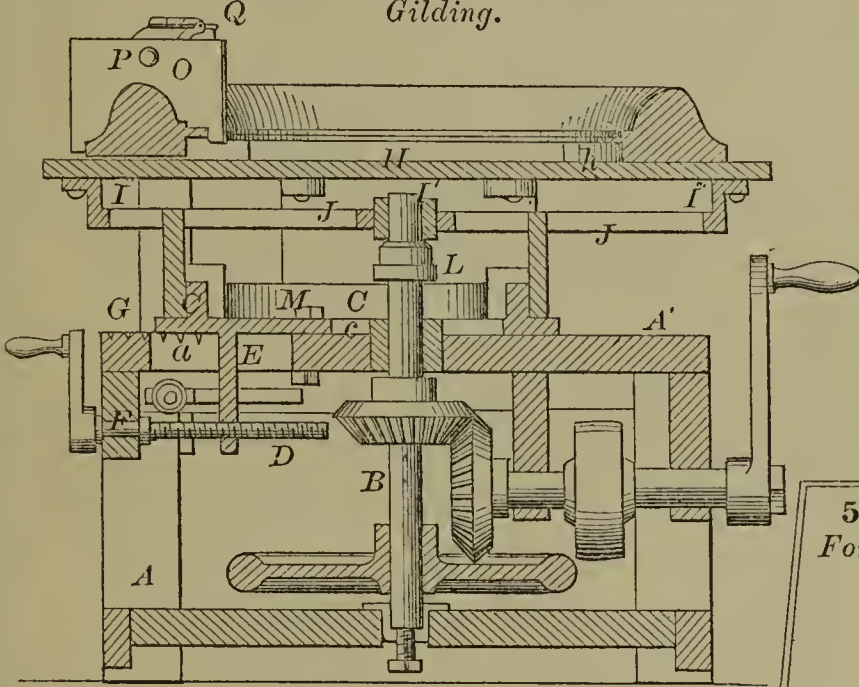

53334—A. D. Puffer—Mosquito Guard.

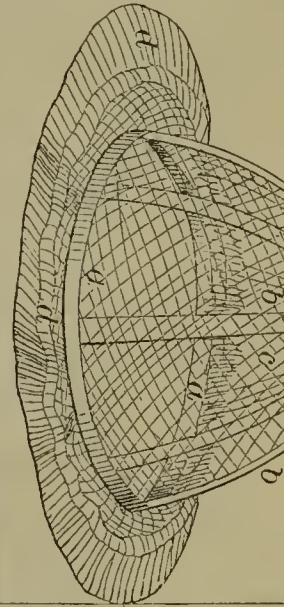

53339—G. L. Reynolds—Fastening For Blinds and Windows.

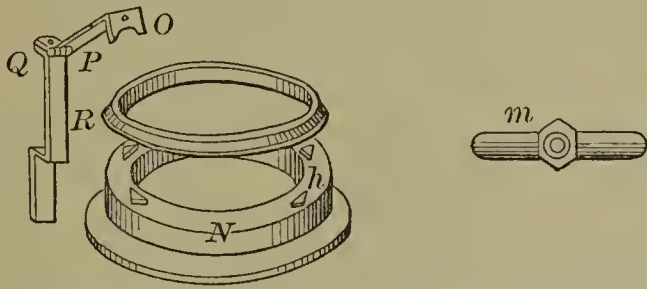
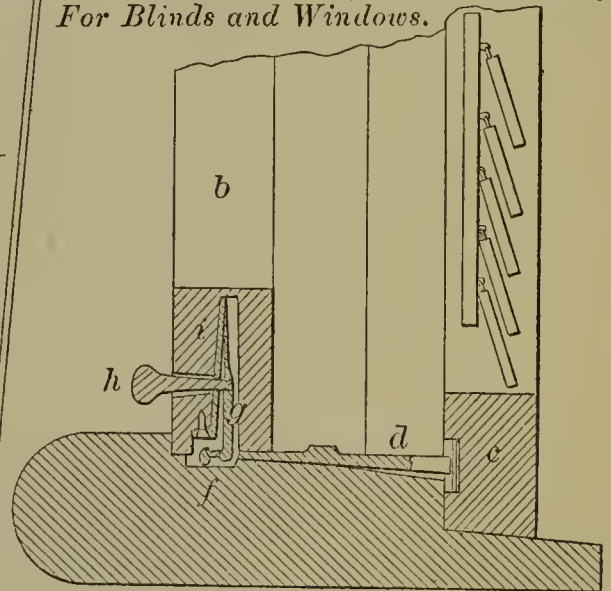

53343—E. Robinson—Portable Water Closet.

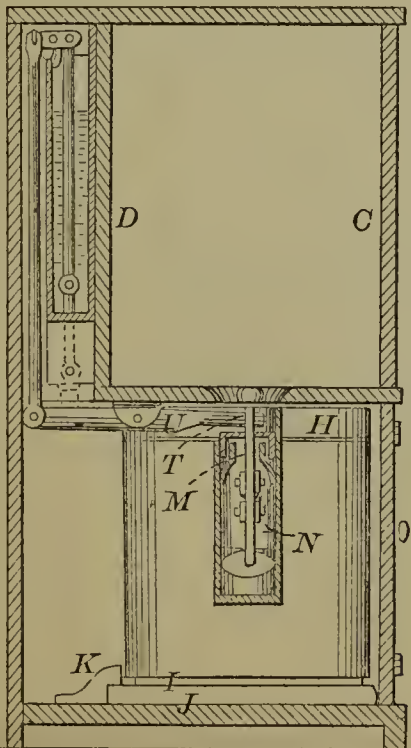

53337—J. Register—Try Cock for Steam Generators.

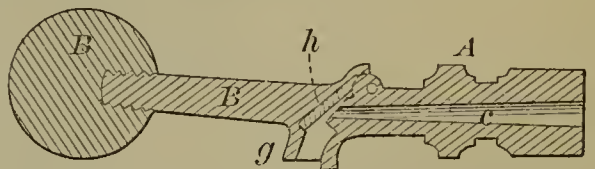

53341—T. C. Richards—Self-Stopping Pulley.

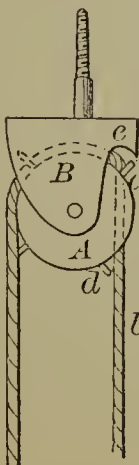

53342—D. T. Robinson—Bottle Stopper Fastener.

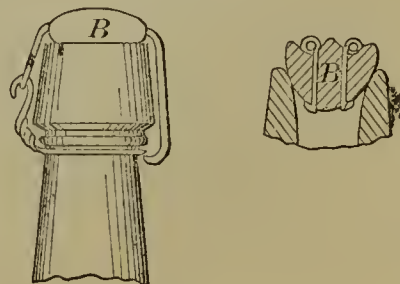

53344—M. M. Robinson—Gauge  
Cock for Steam Generators.

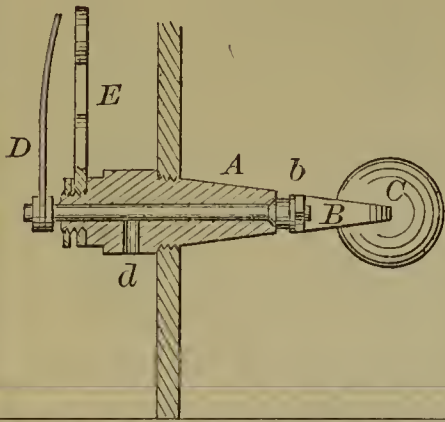

53350—J. Schottenfels—Operating Shuttles in Looms.

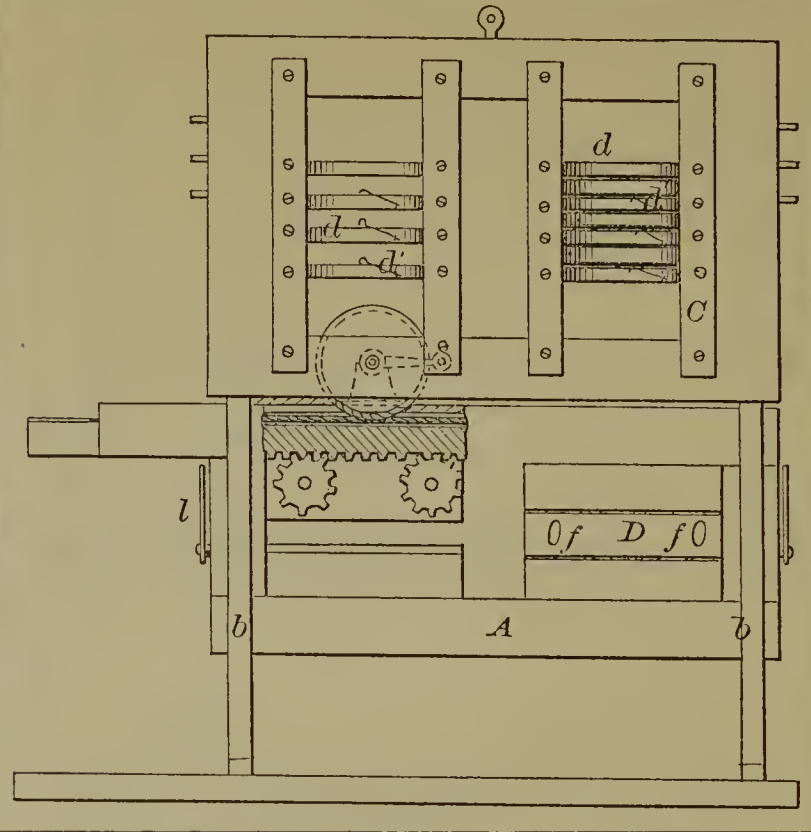

53351—F. Schweizer—Bolt  
Heading Machine.

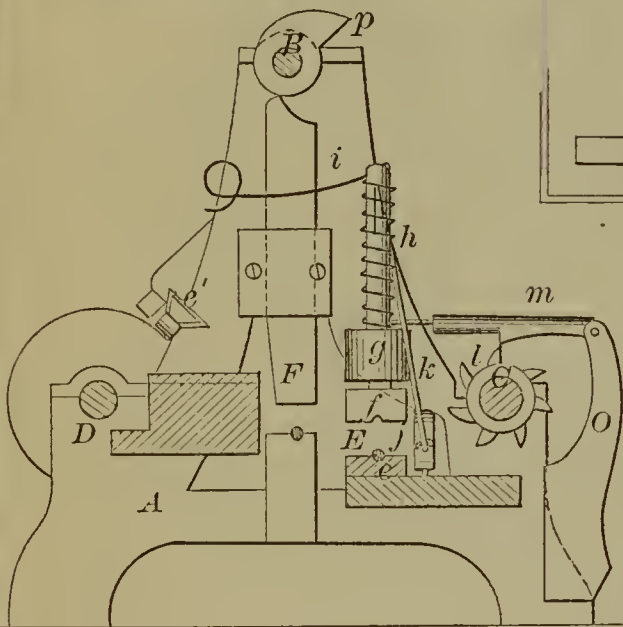

53349—L. F. Schanck—Potato Digger.

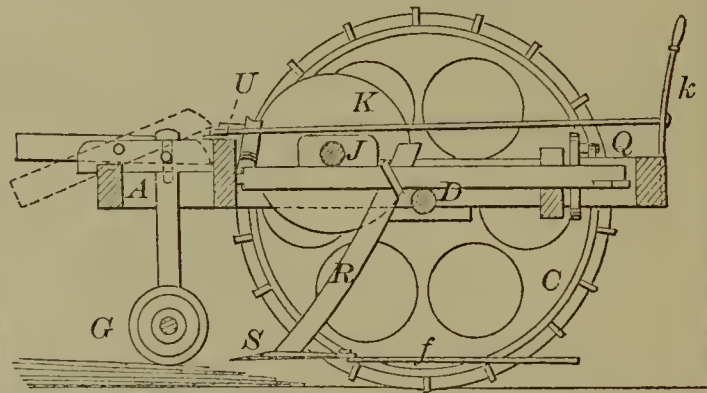

53347—G. T. Schaffer—  
Dental Impression Cup.

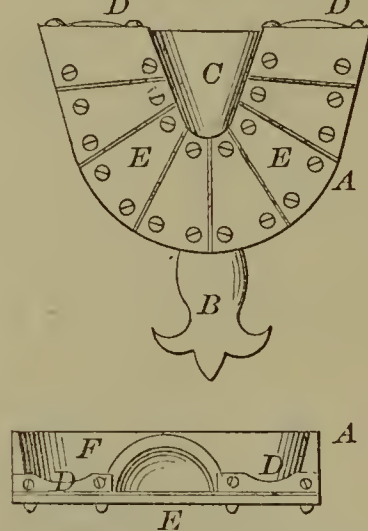

53345—S. Rogers—Horse Hay Fork.

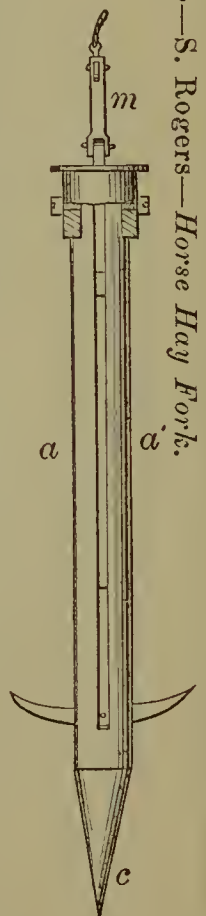

53346—J. Romans—  
Sheep Rack.

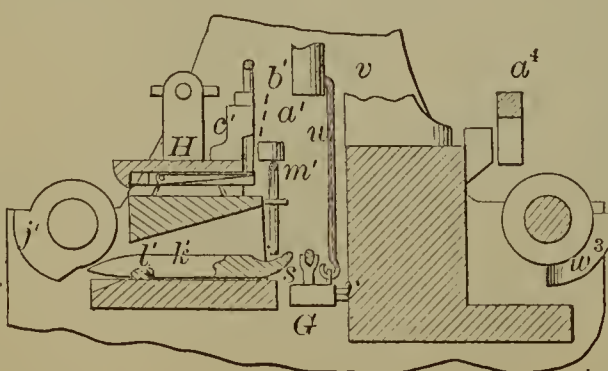
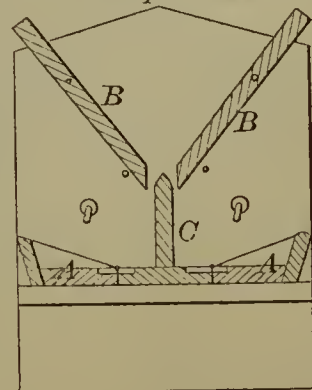



53351—Continued.

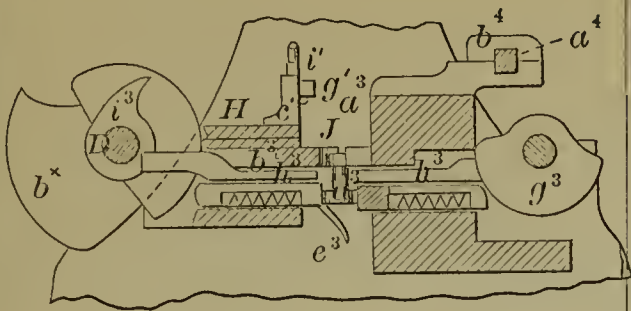

53354—J. C. Spooner—Porcelain and Card Album.

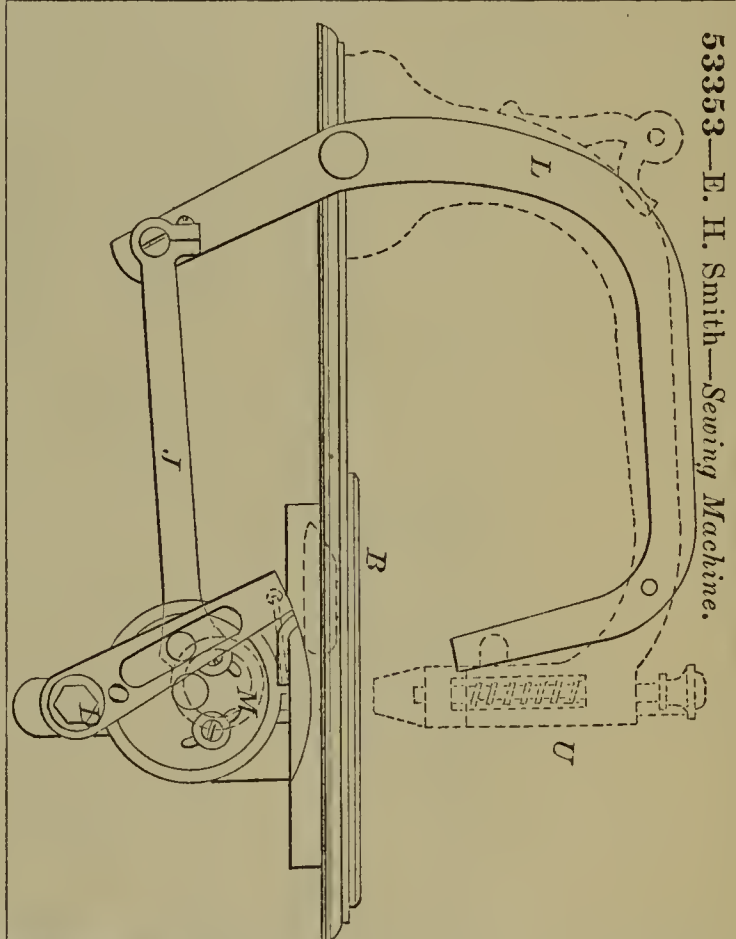
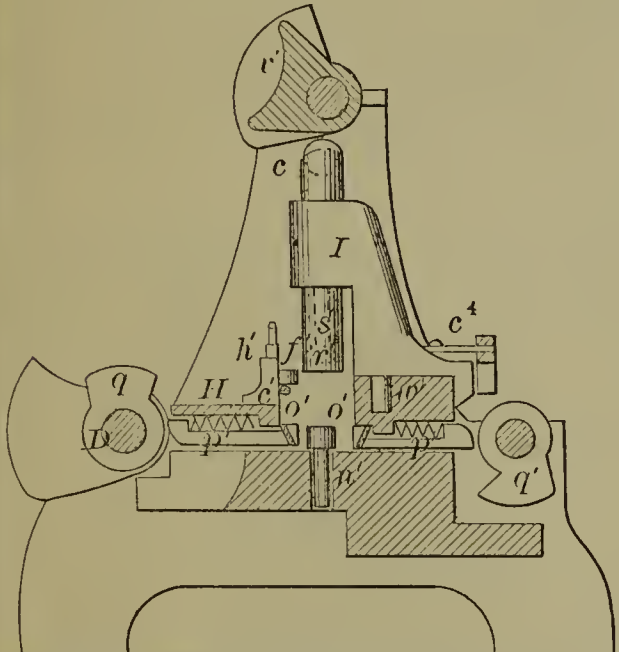
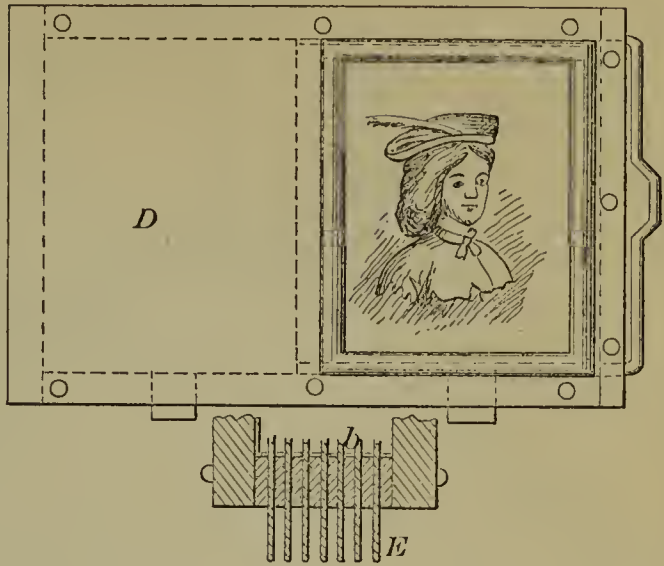

53353—E. H. Smith—Sewing Machine.

53352—J. C. Scribner—Churn.

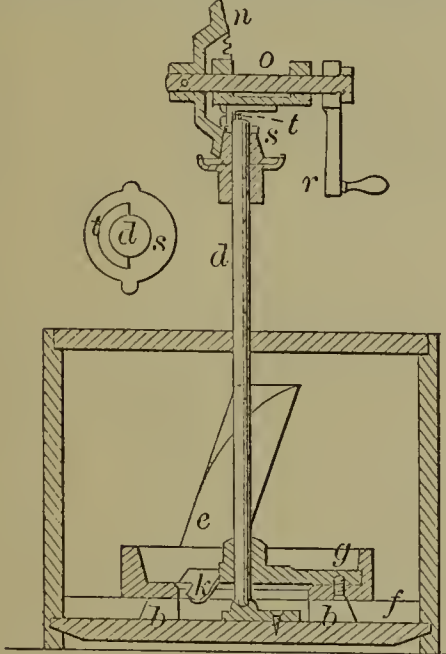

53355—F. Stabler—Packing Animal and Vegetable Substances.

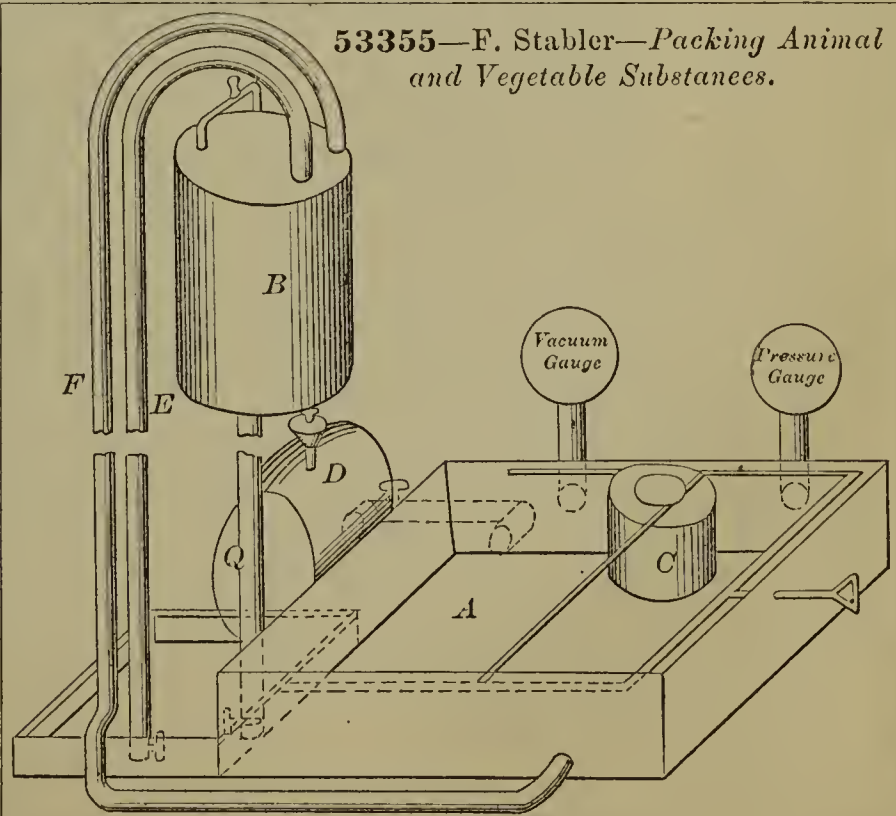

53356—G. Stimpson, Jr.—Pen.

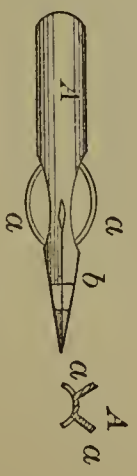

53357—

W. J. Stowell—*Railway Switch.*

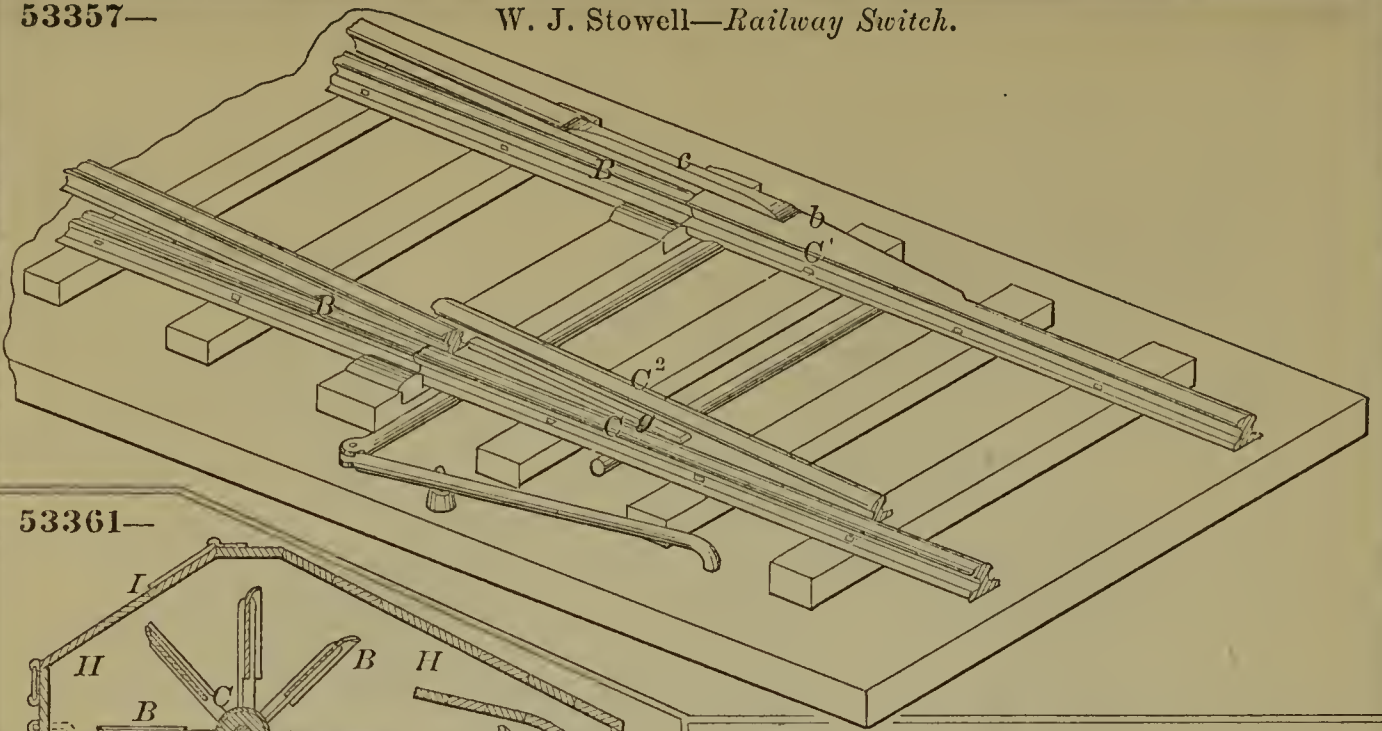

53361—

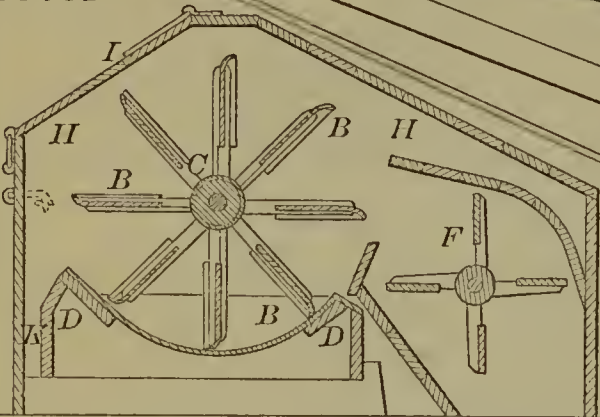

J. B. Thompson—*Desiccating Eggs, &c.*

53359—Tait & Avis—*Distilling Apparatus.*

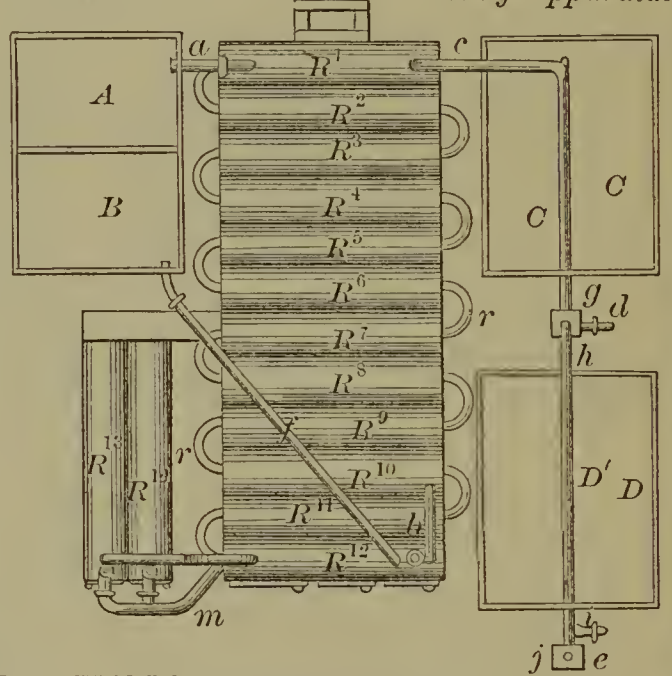

53360—G. C. Thomas—*Baggage Check.*

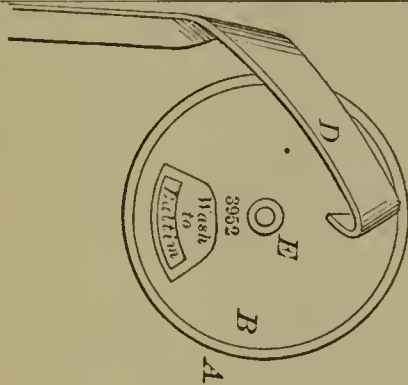

53358—II. P. Straub—*Grinding a Mill.*

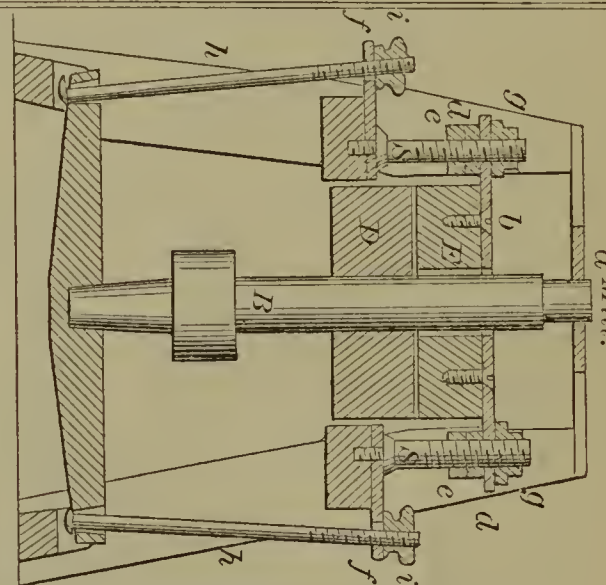

53363—D. J. Tittle—*Potato Digger.*

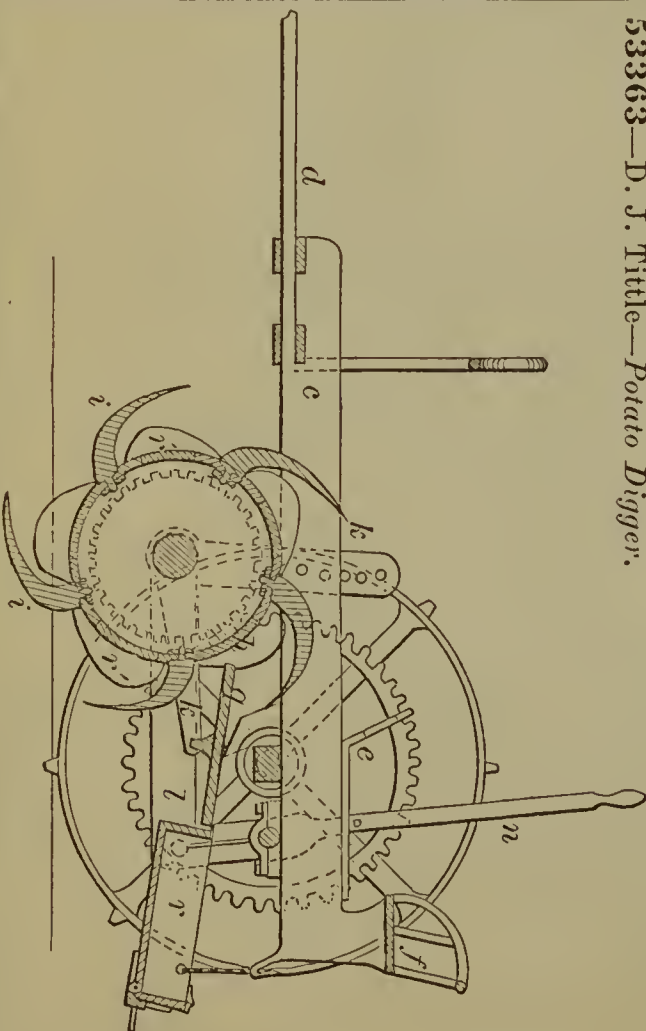

53362—S. Timmins—*Timman's Furnace.*

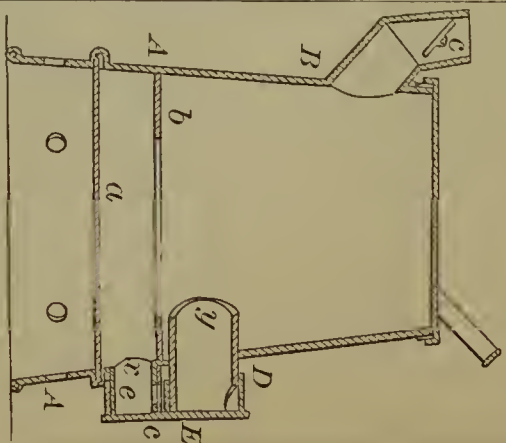

53364—A. W. Upton—  
*Knob Latch.*

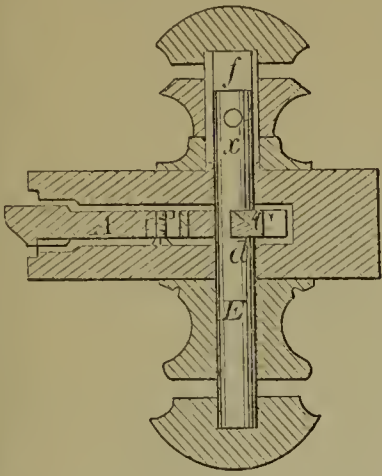

53365—W. Warner—*Car Brake.*

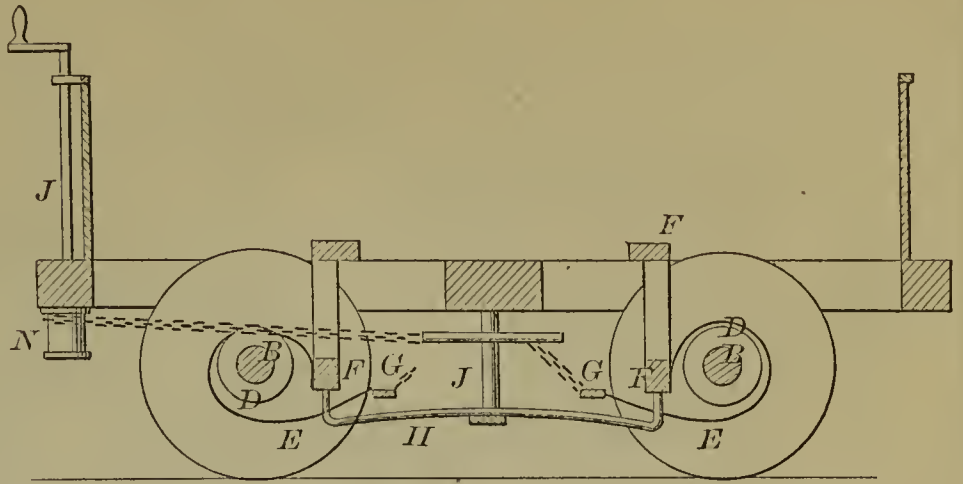

53366—W. H. Watrous—*Door Bell.*

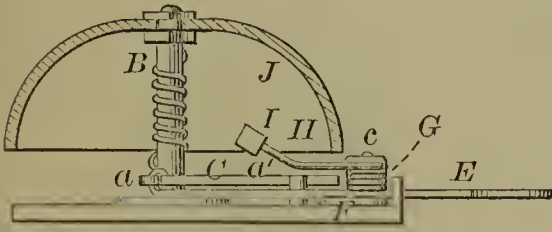

53367—J. H. Webster—*Steam Boiler Furnace.*

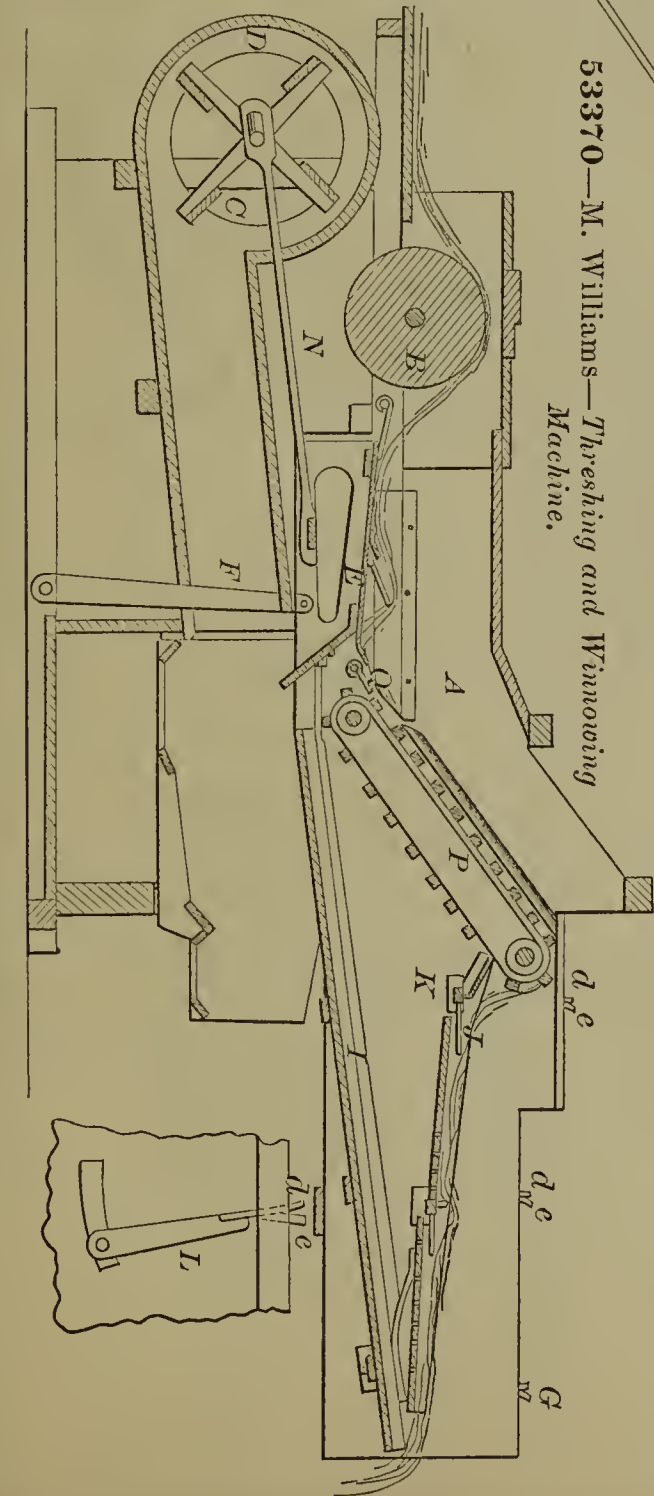
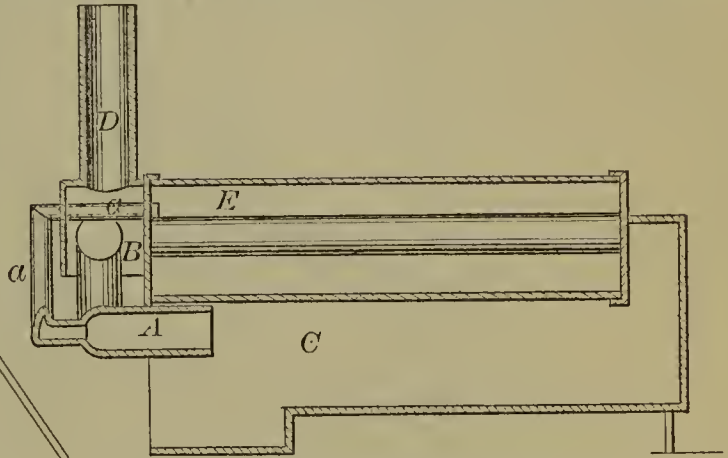

53370—M. Williams—*Threshing and Winnowing  
Machine.*

53368—Wells & Mayott—*Drill Chuck.*

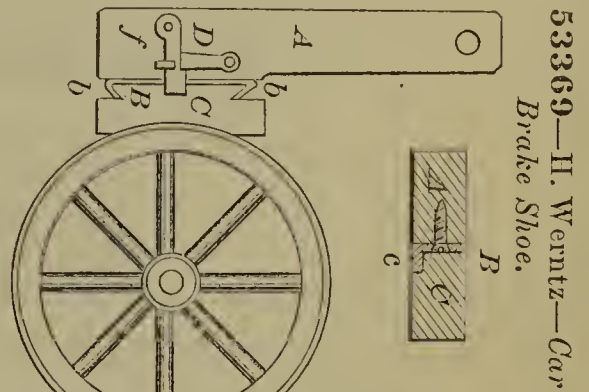
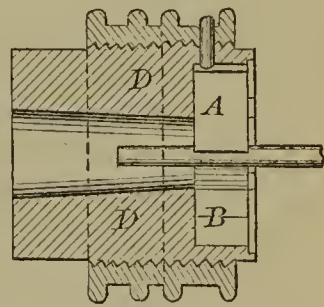

53369—H. Wertz—*Car  
Brake Shoe.*

53371—W. Bench—*Attaching Seats to the  
Beds of Vehicles.*

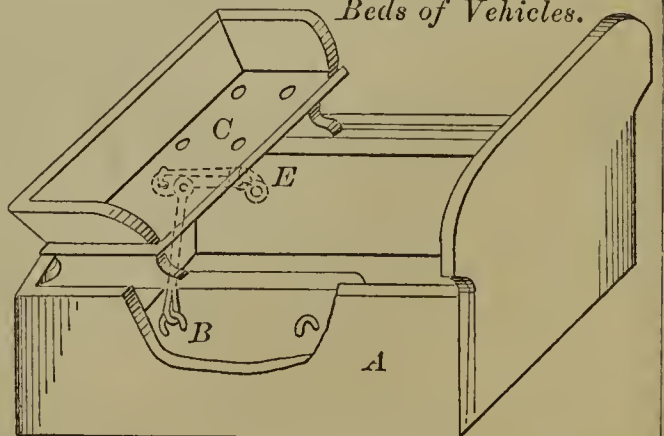

53372—J. Danby—For Weaving a Covering for Cords.

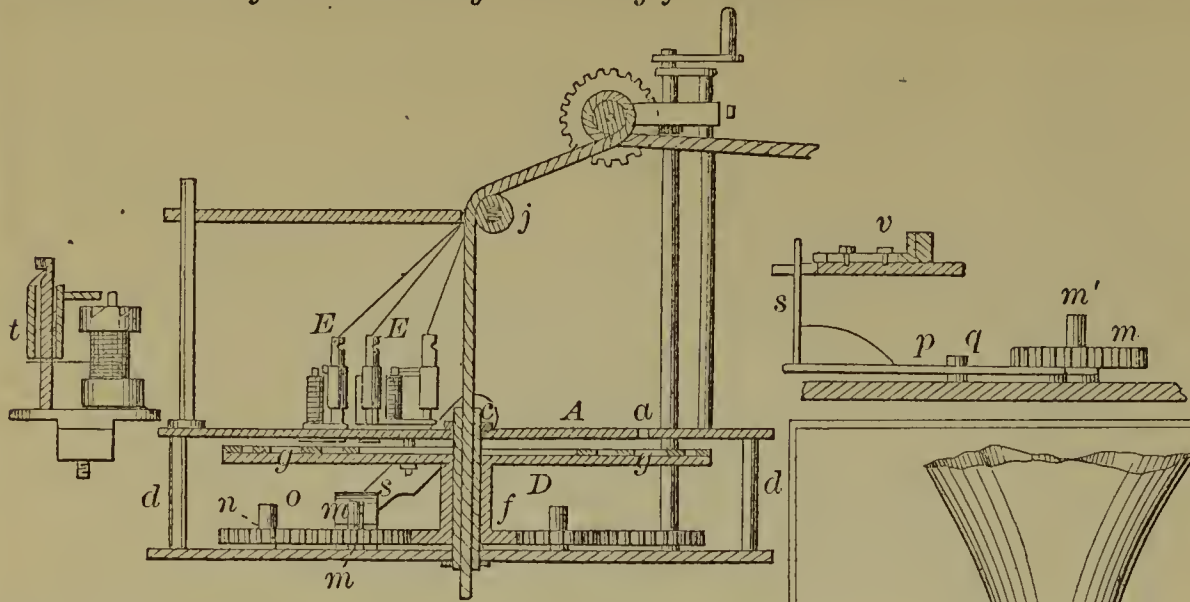

53374—A. Hatch—Lathe.

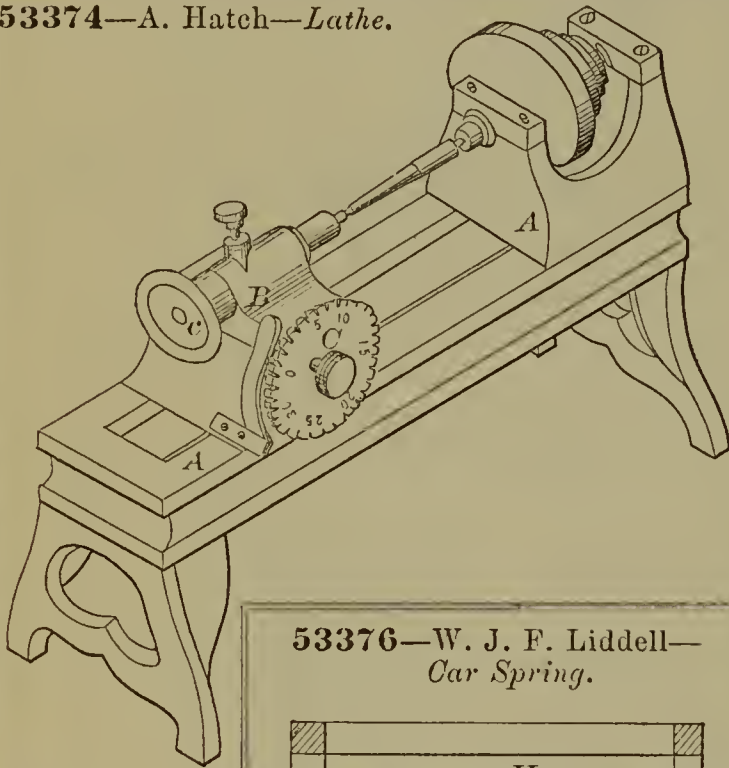

53376—W. J. F. Liddell—Car Spring.

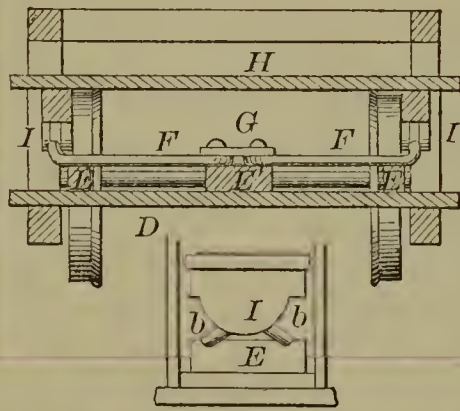

53375—L. Marques—Musical Instrument.

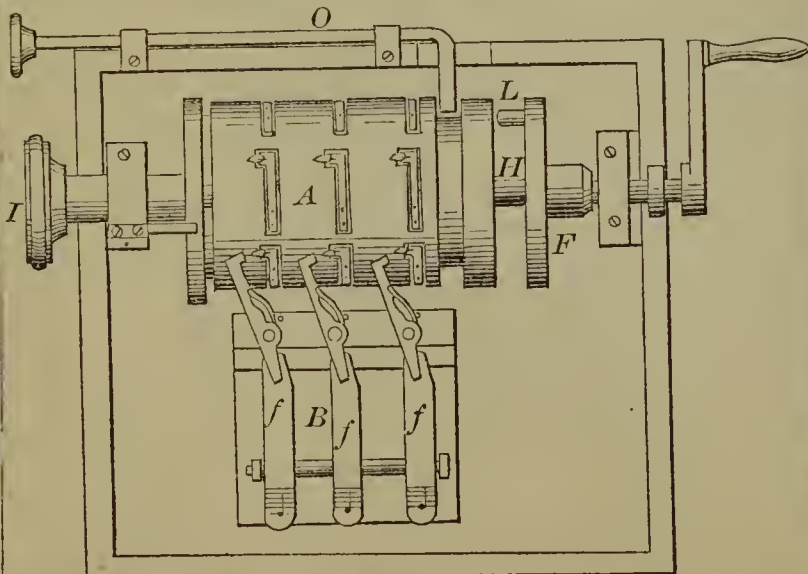

53373—J. E. Hallet—Oscillating Pump.

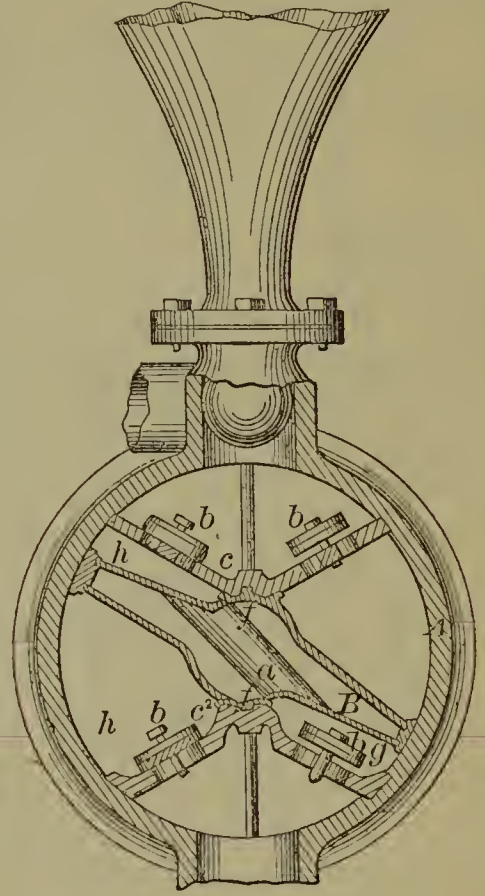

53377—B. Owen—Cotton Seed Planter.

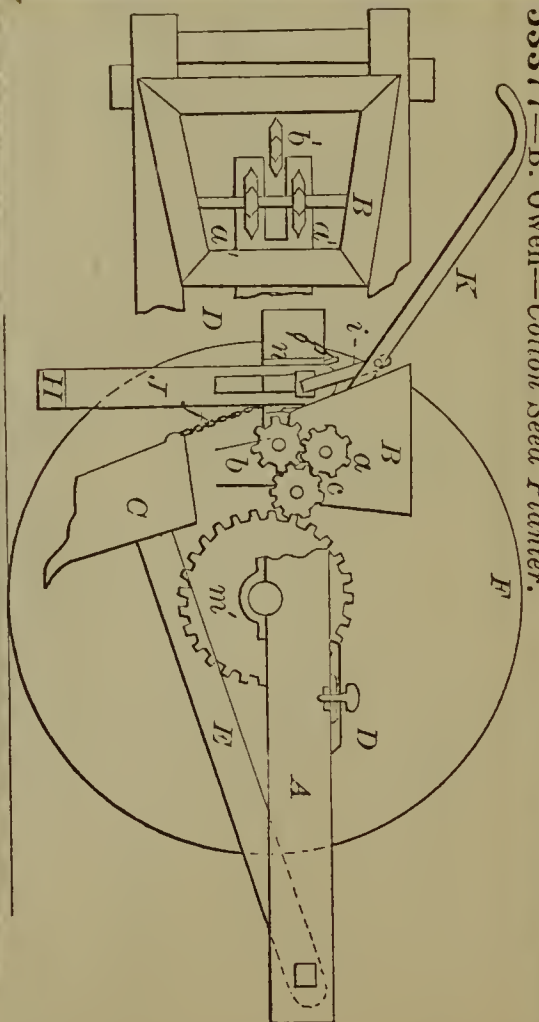

53378—J. M. Randle—Horse Power.

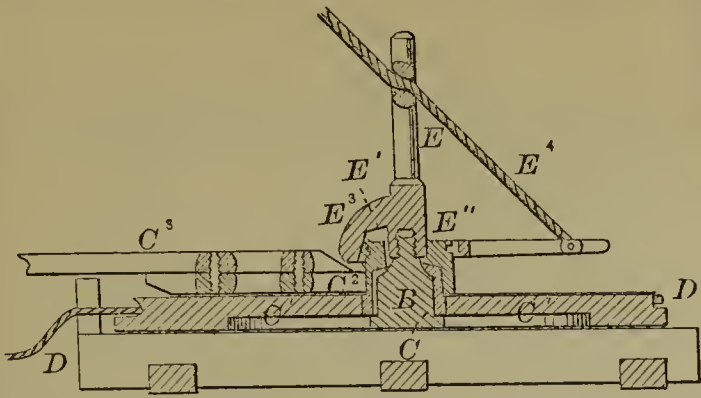

53381—A. Shipley—Stair Rod.

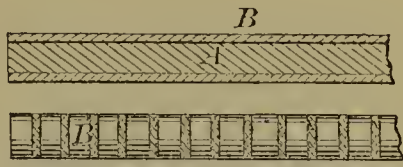

53380—J. W. Sefton—Churn.

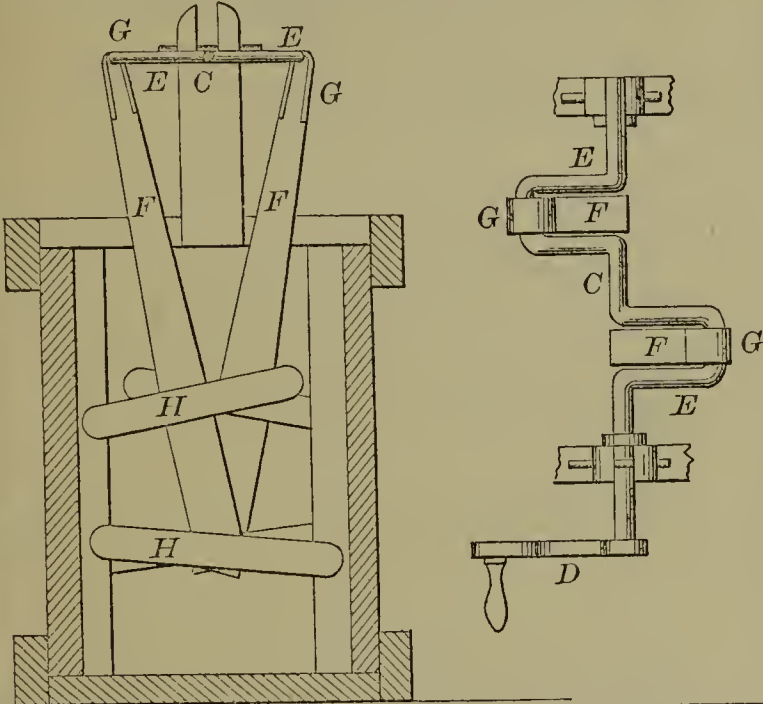

53383—J. Stratton—Hydro-Carbon Burner.

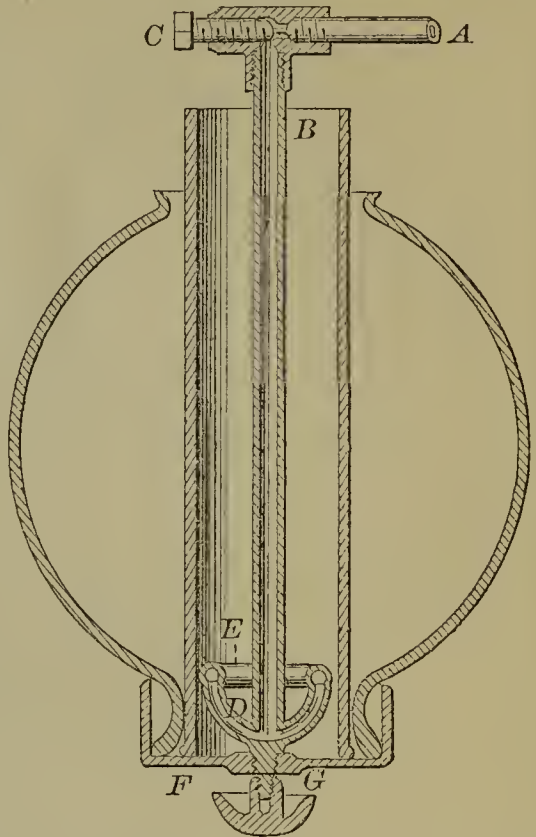

53382—H. C. Sisco—Lathe for Turning Wagon Hubs.

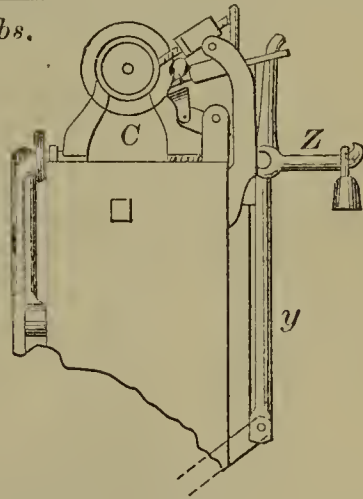
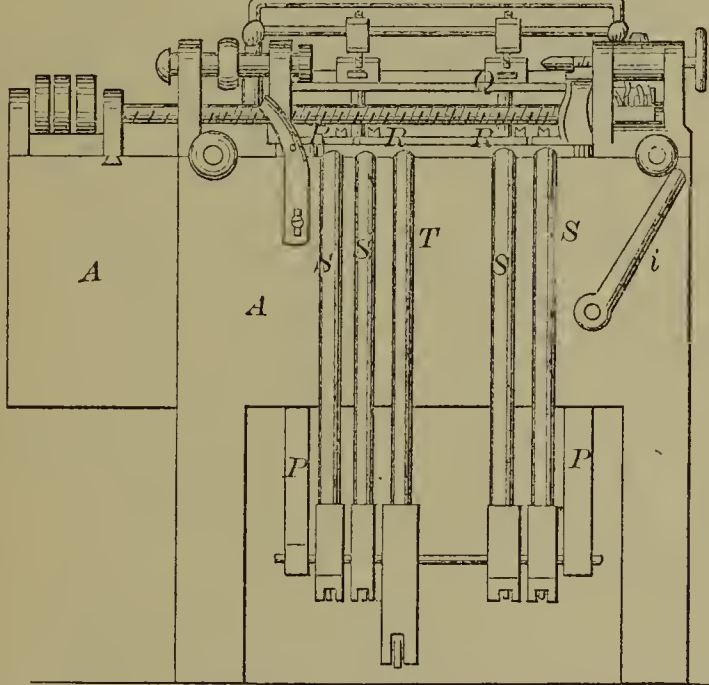

53386—H. Thornton—Knitting Machine.

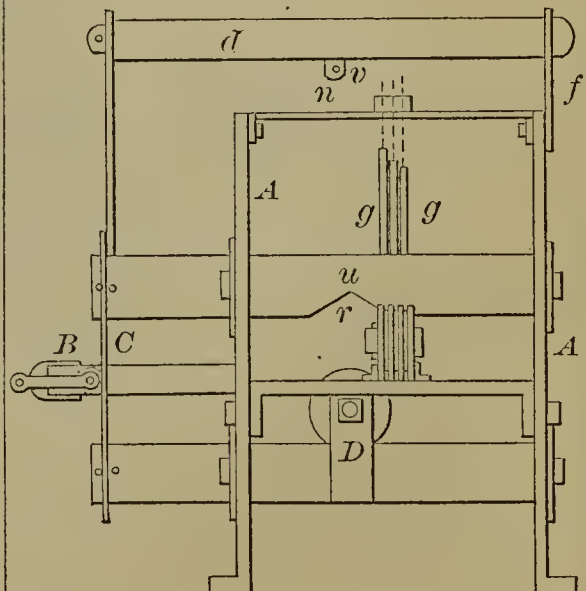

53384—Thompson, Smith & Jennings—Coal Hod.

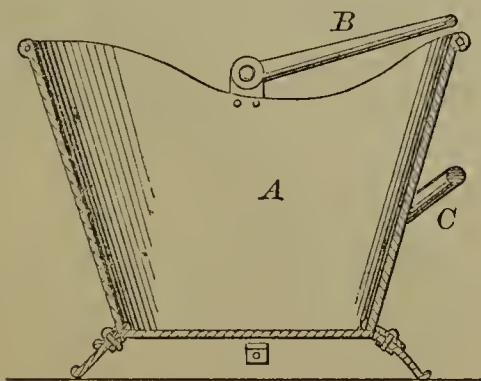

53388—H. Berdan—*Priming Metallic Cartridges.*

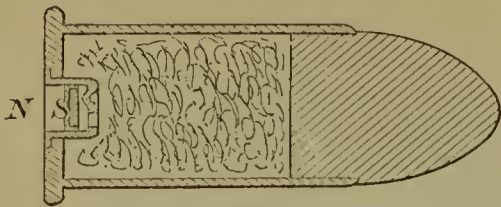

53389—J. W. Allen—*Hinge.*

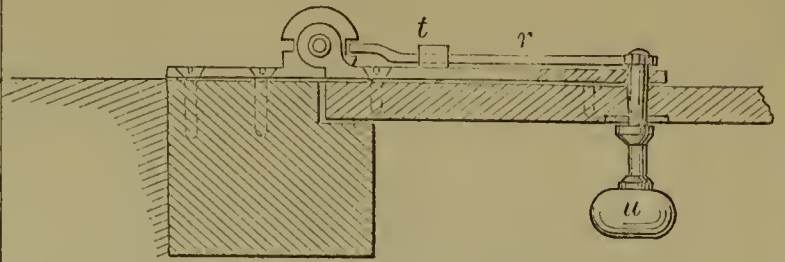

53390—M. Ames—*Stopper for Ink Bottle.*

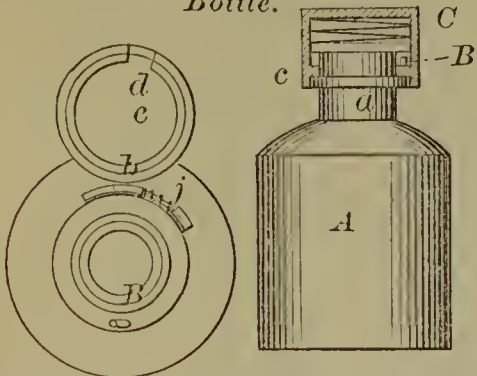

53394—J. S. Benedict—*Fence Gate.*

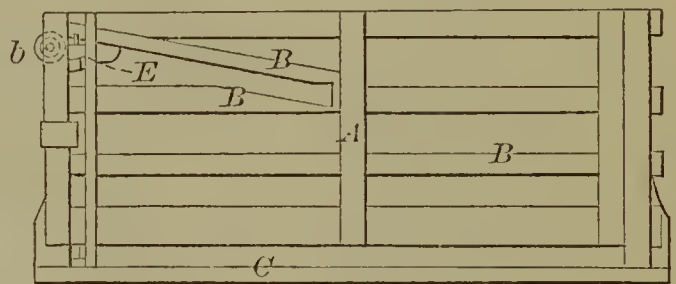

53391—B. F. Barker—*Door Spring.*

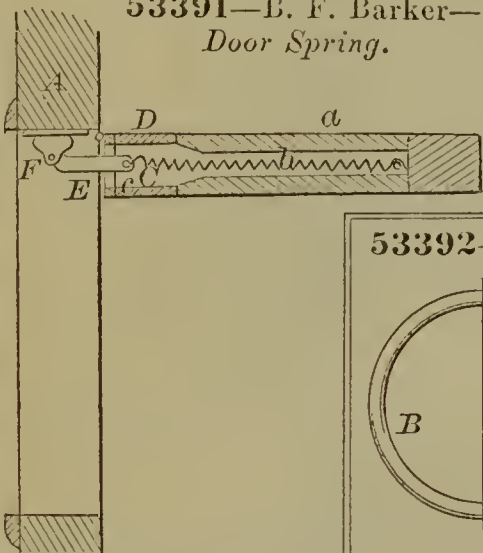

53392—C. T. A. Bauder—*Vegetable Cutter.*

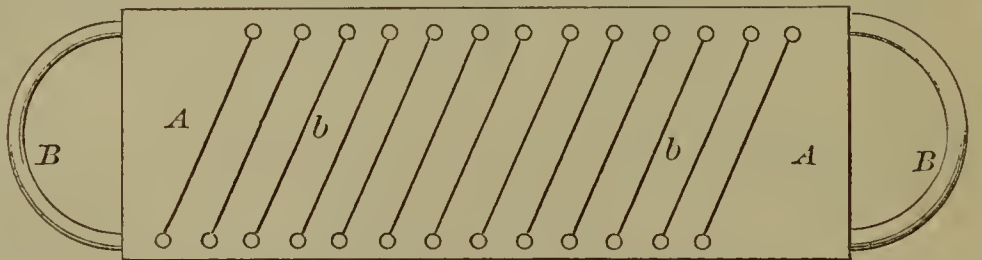

53395—B. Best—*Filter.*

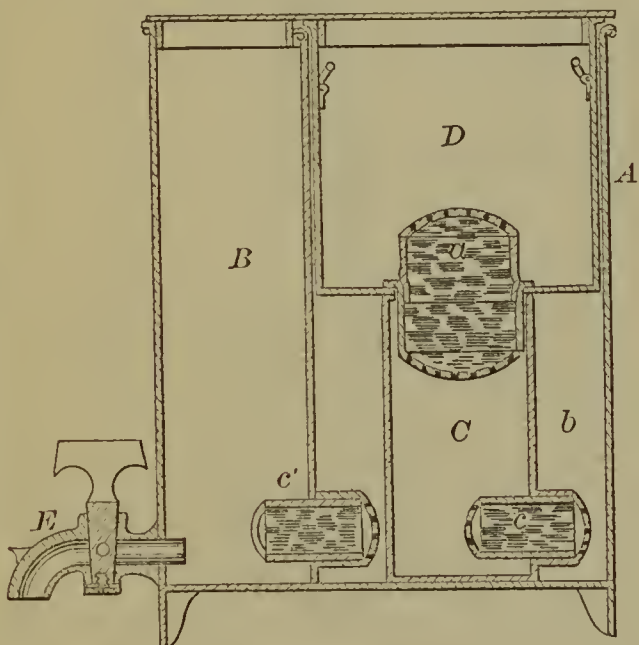

53396—H. P. M. Birkinbine—*Valve for Pumps.*

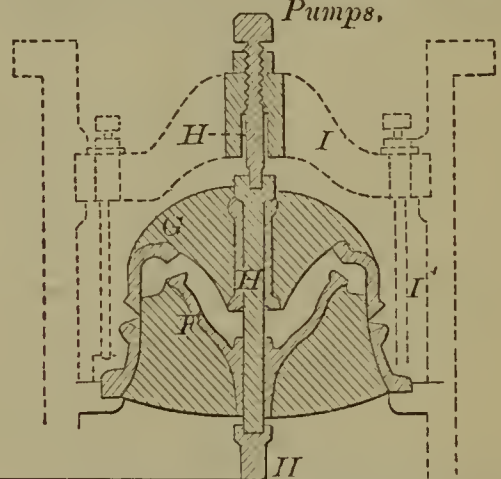

53397—W. W. Branch, Jr.—*Protracting Bevel.*

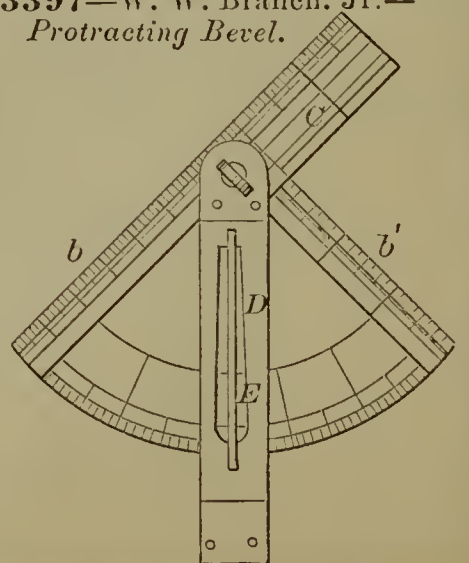

53393—D. C. Baughman—*Head Block for Saw Mills.*

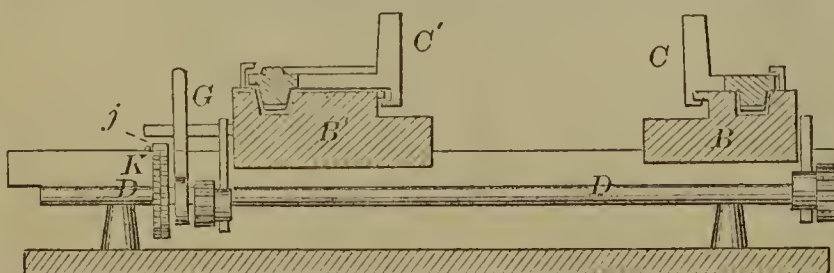

53398—J. L. Branson—*Hand Loom.*

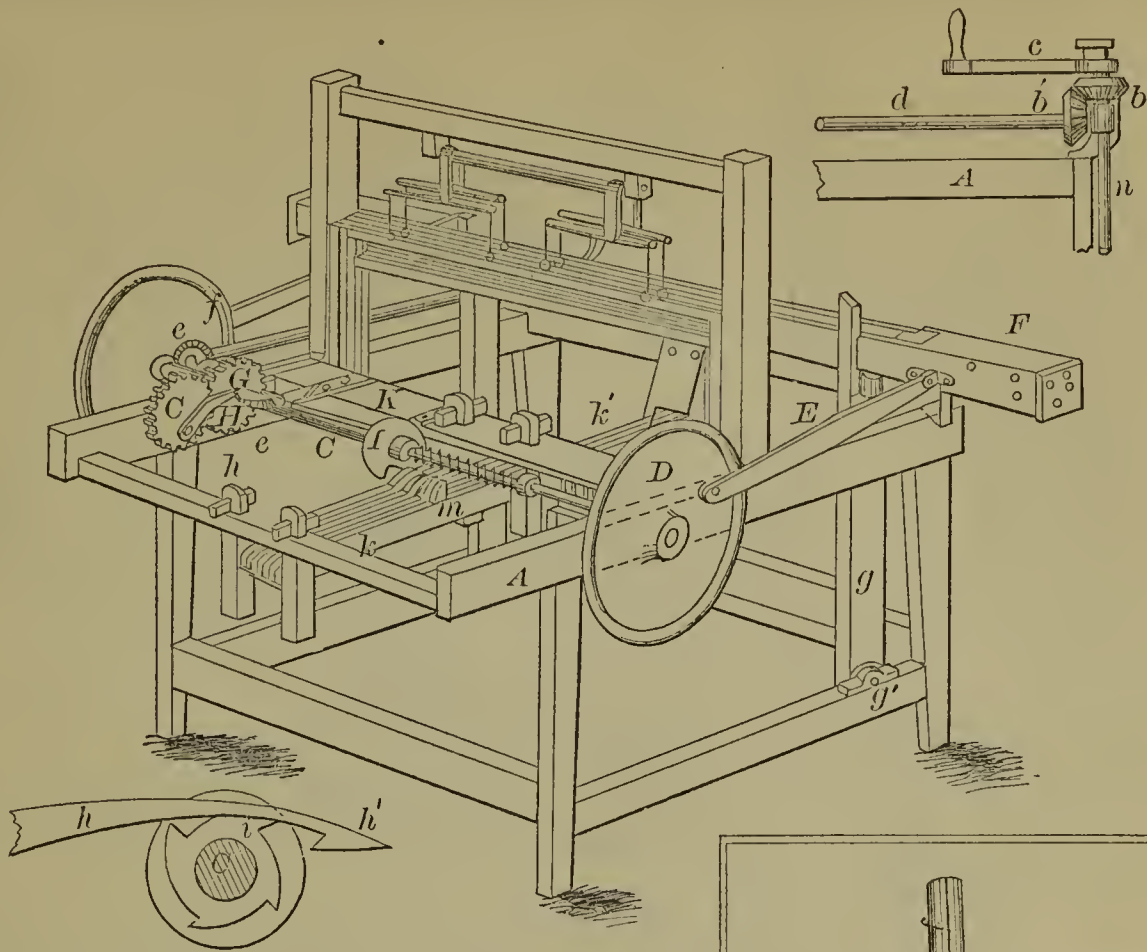

53399—G. B. Brayton—*Steam Generator.*

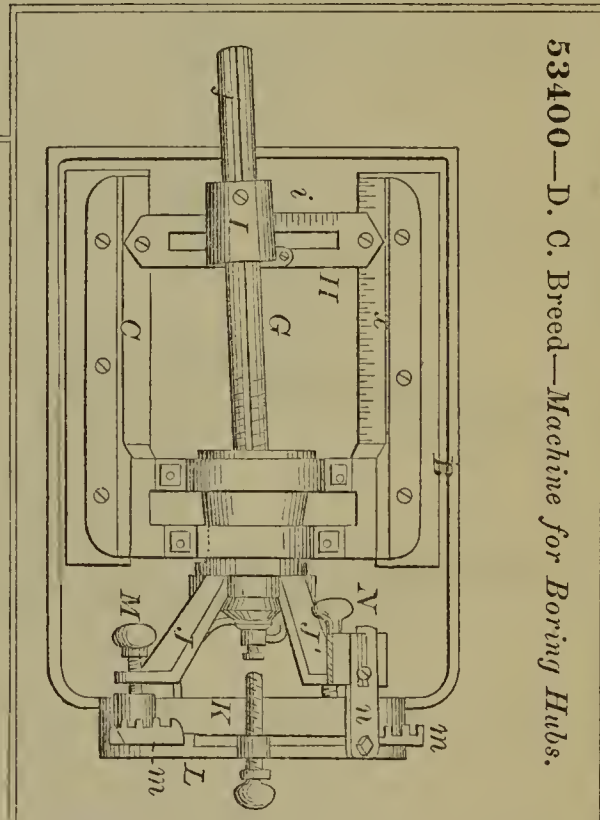
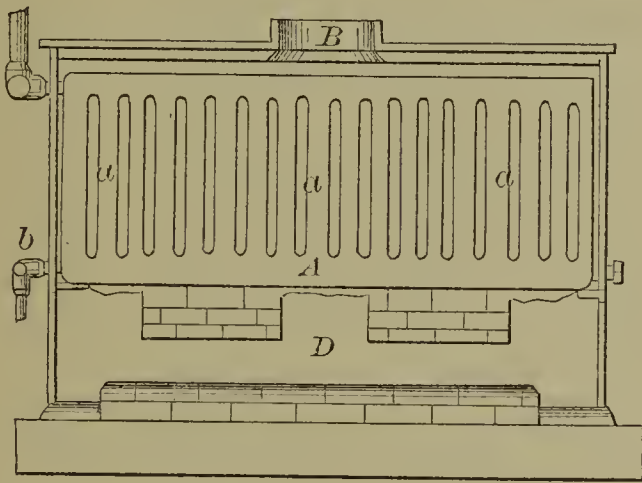

53400—D. C. Breed—*Machine for Boring Hubs.*

53401—W. Best—*Machine for Ironing Hats.*

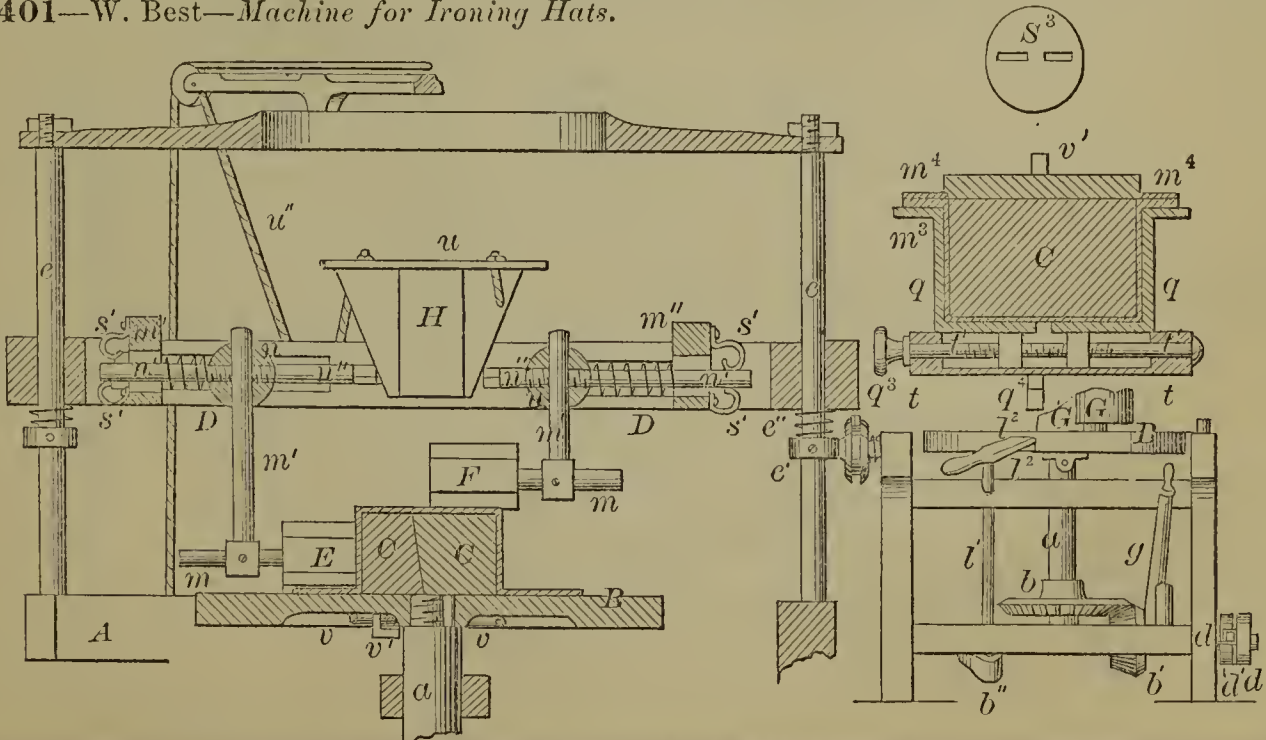

53402—N. W. Brewer—Wooden Pin Machine.

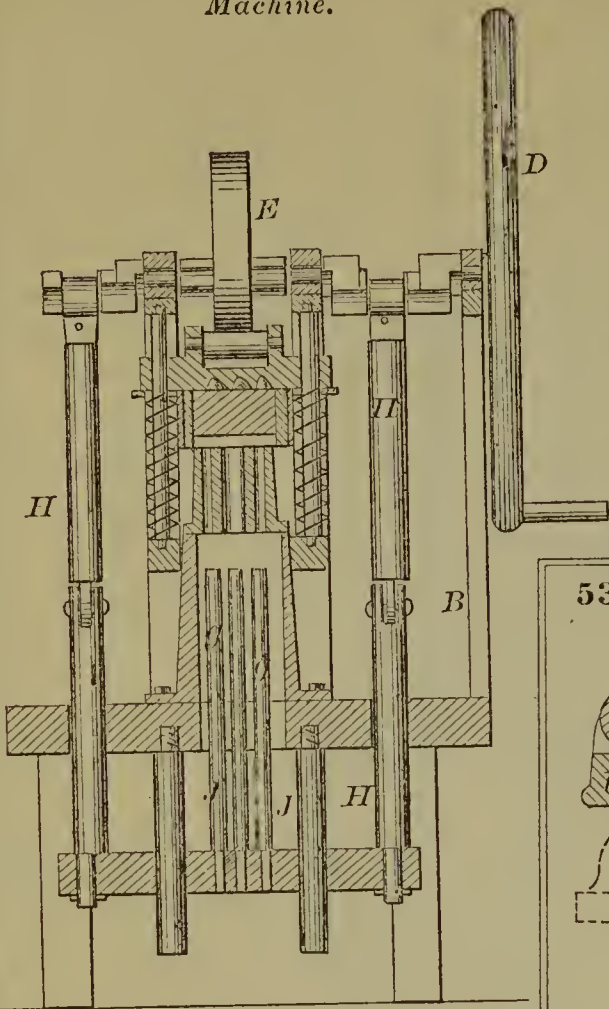

53408—Canfield & Hess—Cultivator.

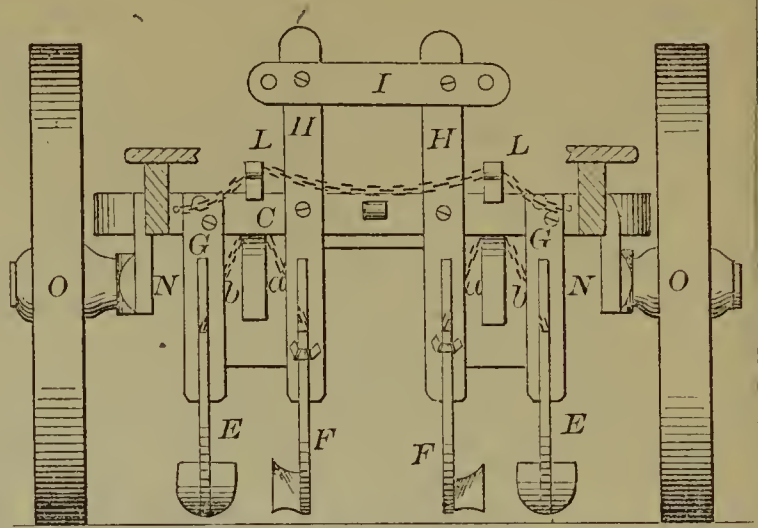

53403—W. R. Brooks—Wick Trimmer.

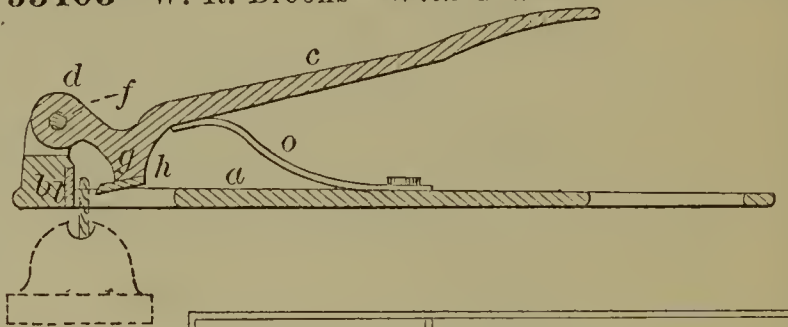

53404—T. H. Brymer—Burner for Gas Stoves.

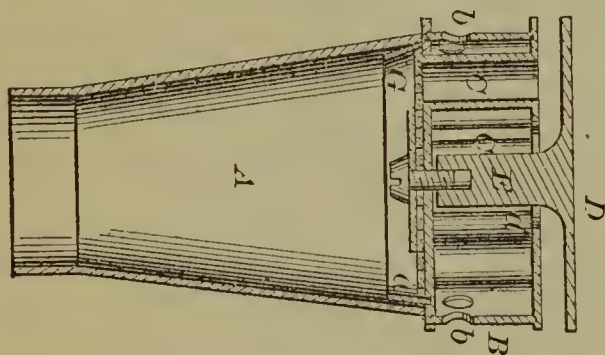

53406—B. J. Barnett—Hat Ventilator.

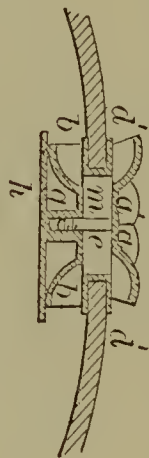

53405—J. A. Bunce—Lathe Chuck.

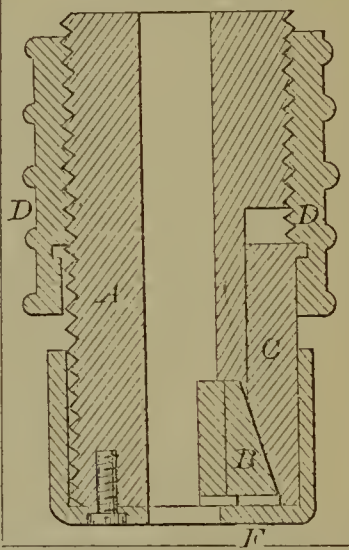

53409—Canfield, Still & Wheeler—Harvester.

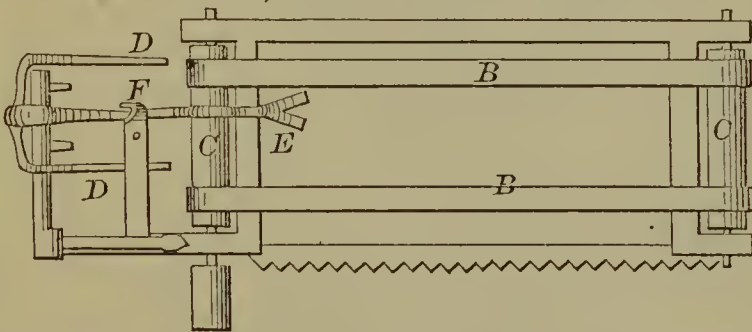

53411—H. P. Castle—Water Drawer.

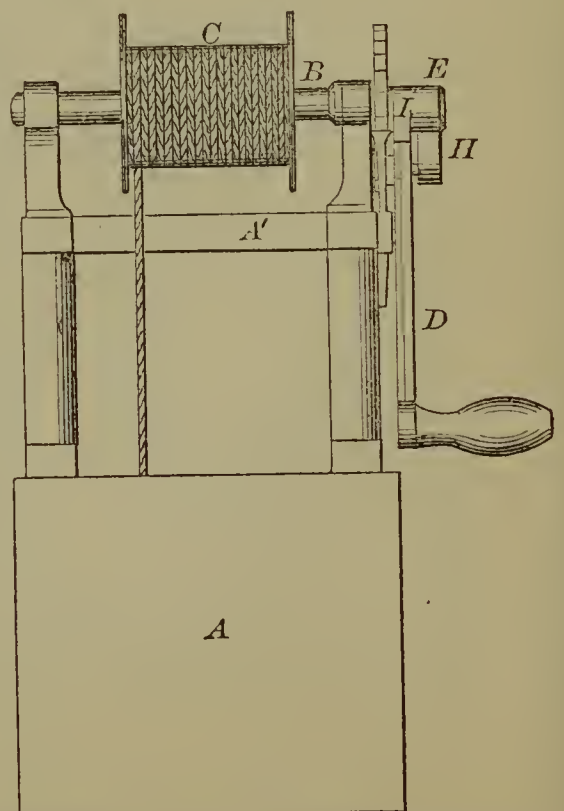

53410—J. W. Carhart—Balance Valve for Steam Engine.

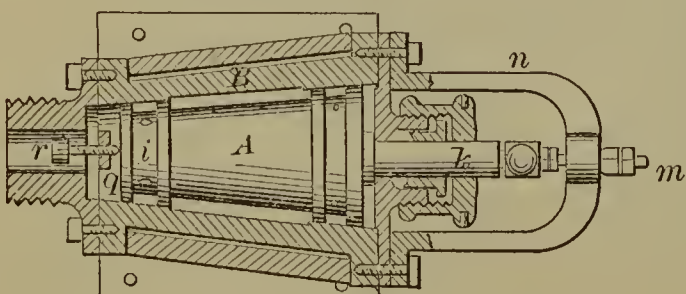



53412—L. W. Chase—Window Blind.

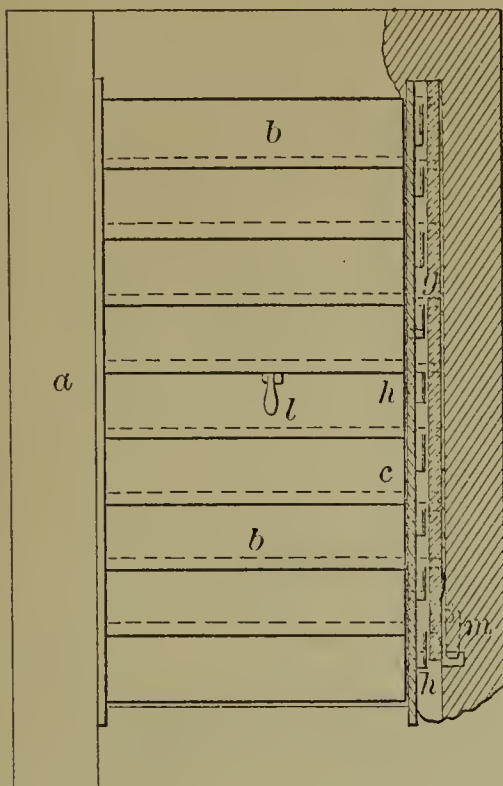

53417—J. J. Cooper—Receiving and Delivering Mail Bags.

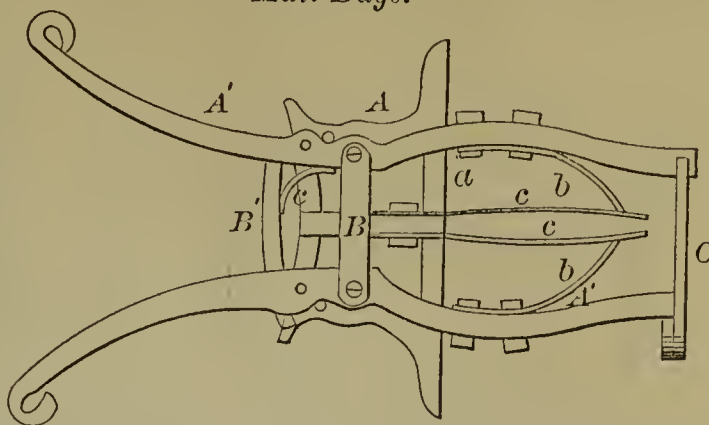

53418—E. Cozad—Fence.

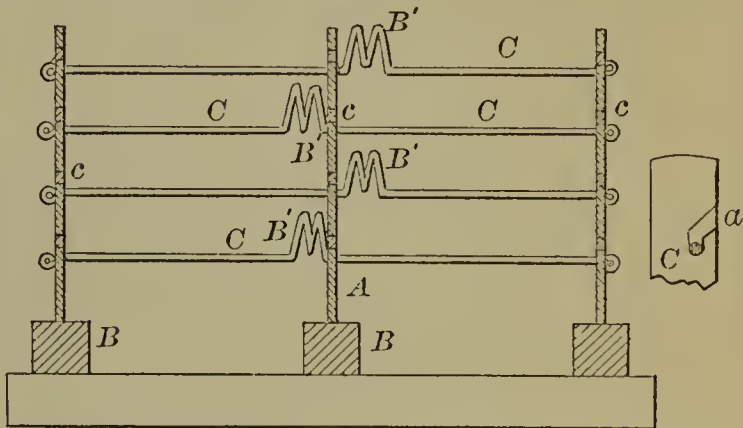

53416—M. Cole—Straw Cutter.

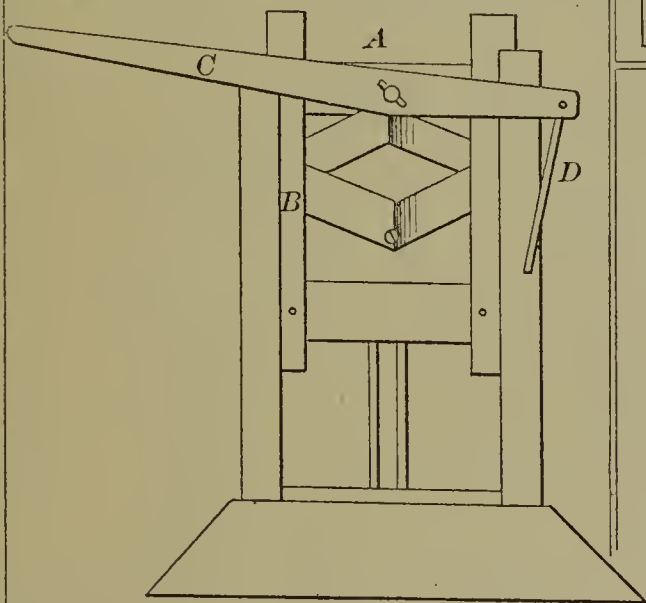

53413—H. Christian—Hair Crimping Apparatus.

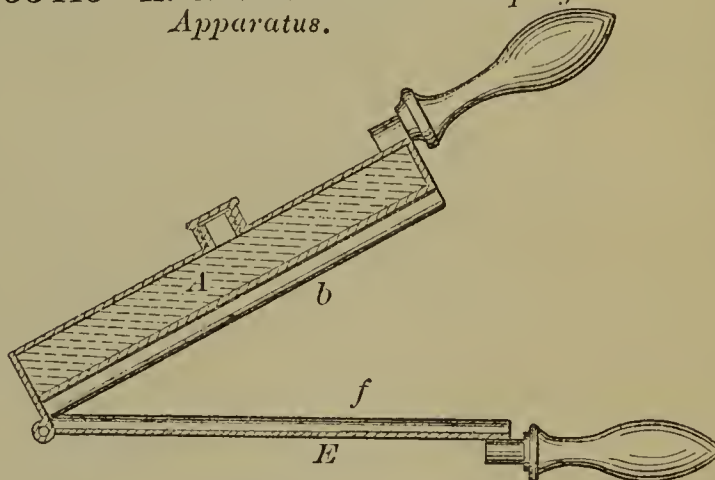

53415—H. Cole—Floor Attachment for Furniture.

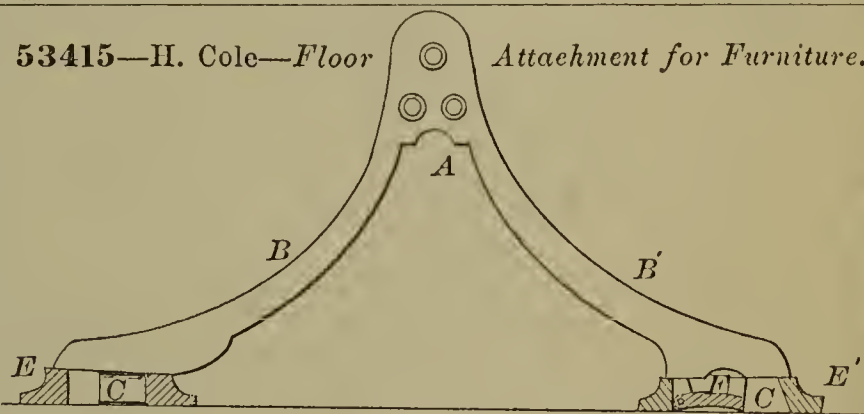

53414—H. Clark—Skate.



53419—Crawford & Birch—Carriage Curtain Fastener.

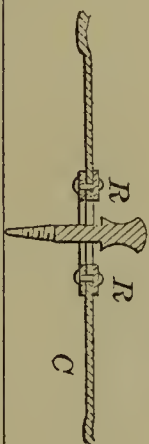

53420—J. J. Daly—For Measuring Distances.

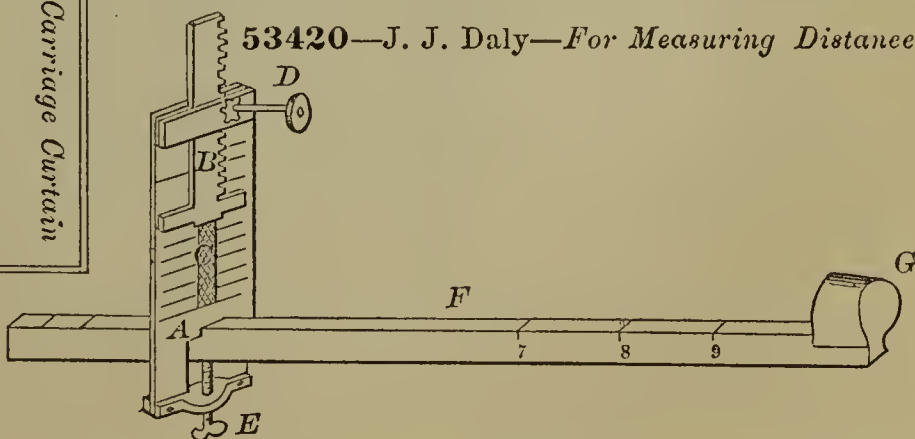

53421—F. W. Dembois—Boiler for Cooking.

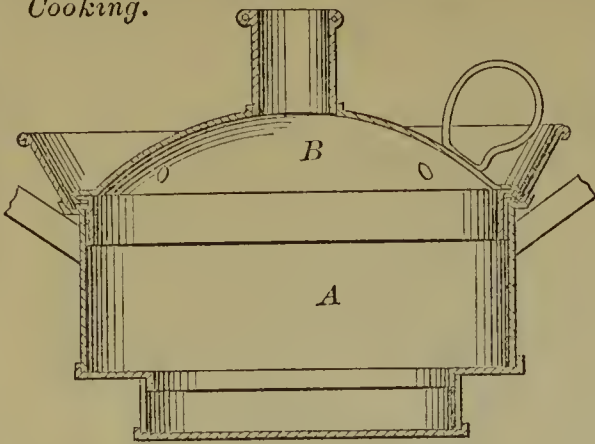

53425—Elder & Baker—Sheep Shearing Table.

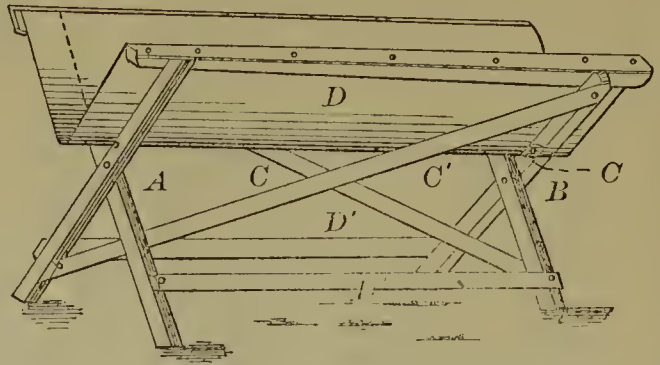

53424—J. H. Eckert—Gang Plow.

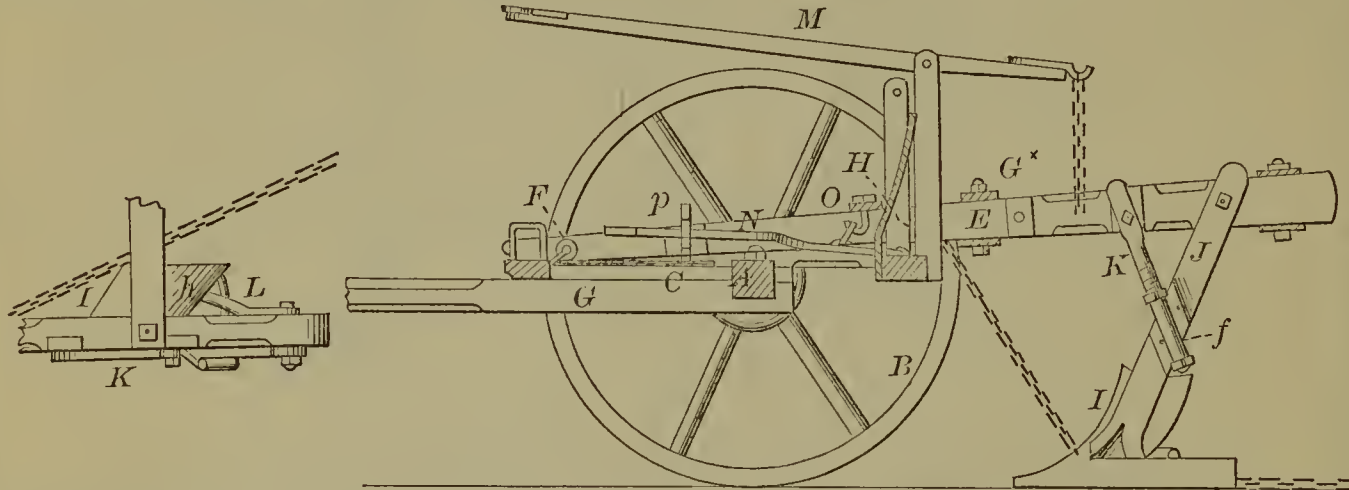

53423—W. W. Dutcher—Roller Temple for Looms.

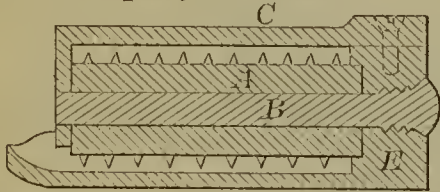

53422—J. A. De Tar—Adjuster for Evaporator.

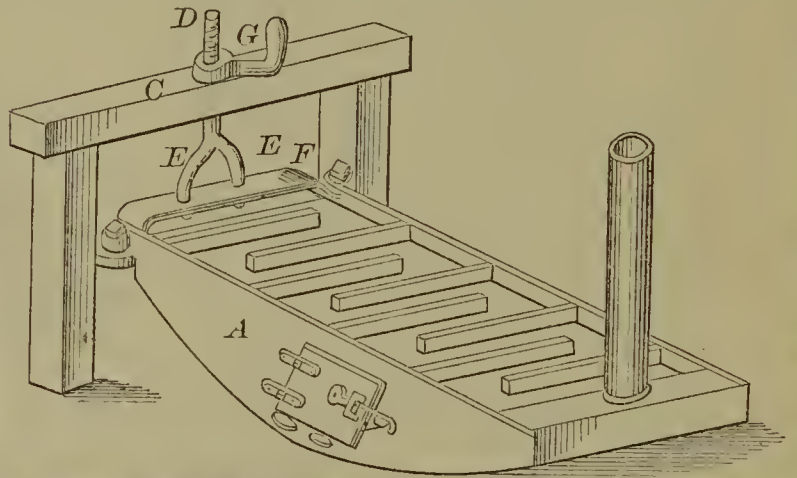

53428—O. Ernst—Cravat.

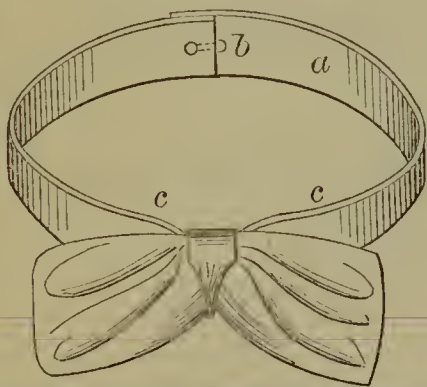

53429—H. D. & J. H. Felthouse—Egg Beater.

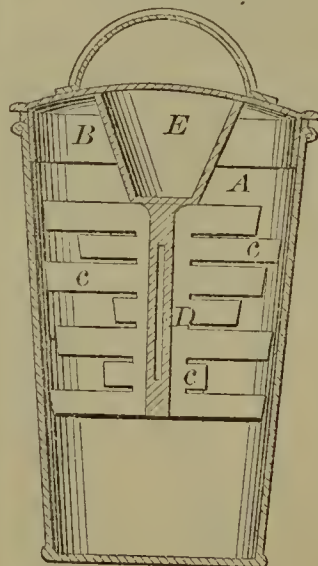

53426—A. B. Ely—Telegraph Insulator.

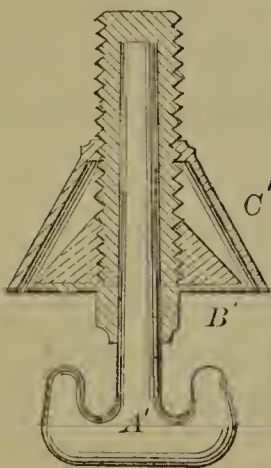

53427—A. B. Ely—Telegraph Insulator.

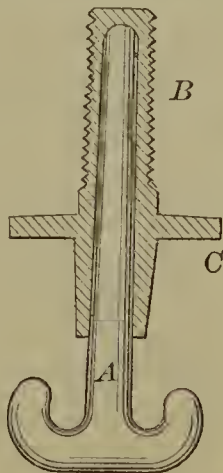

53430—S. T. Field—Telegraph Cable.



53432—D. A. Fiske—Churn.

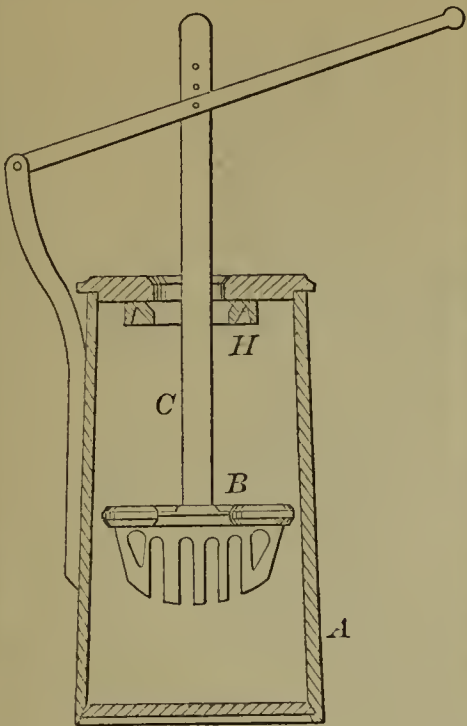

53434—Frazier & Wickes—Balanced Beam for Boring Wells.

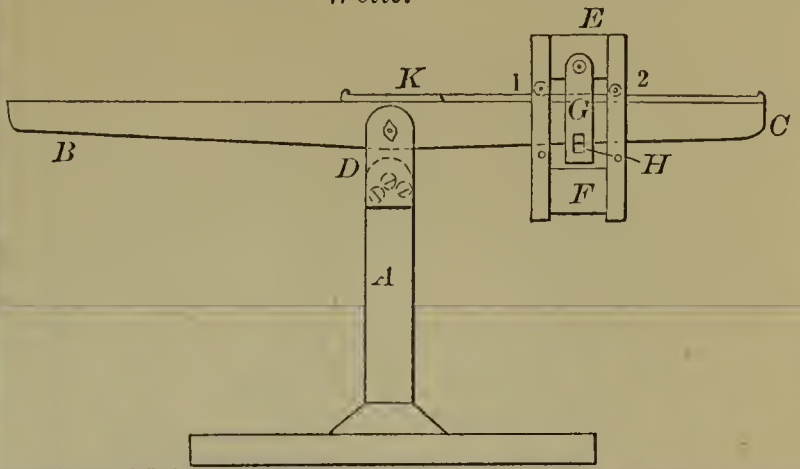

53437—W. Gilbert—Crate for Carrying Fruit.

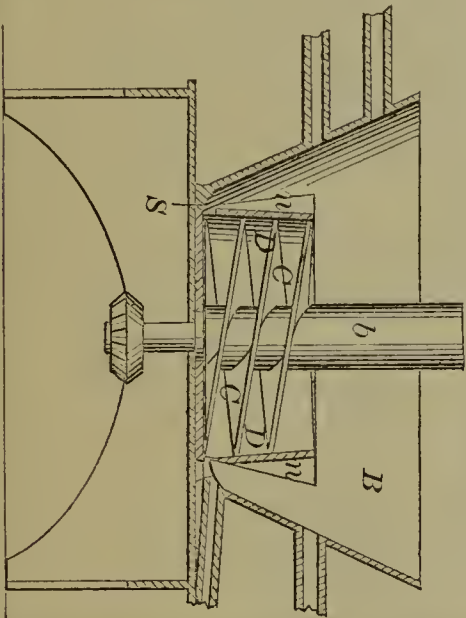
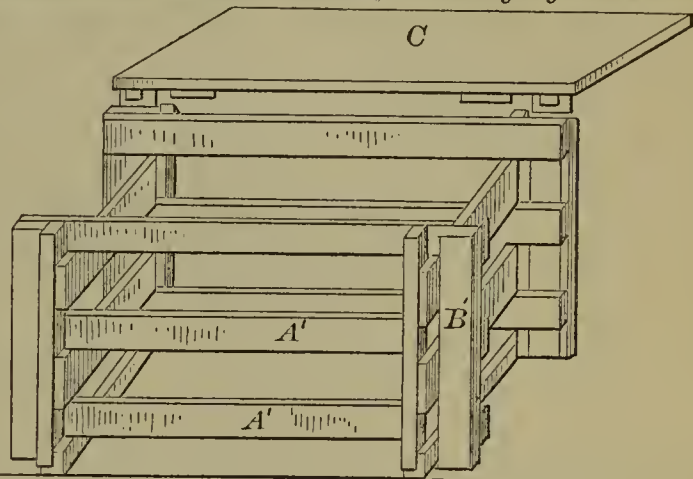

53435—H. A. Gaston—Amalgamator.

53433—N. W. Foye—Scraper and Knife and Fork Cleaner.

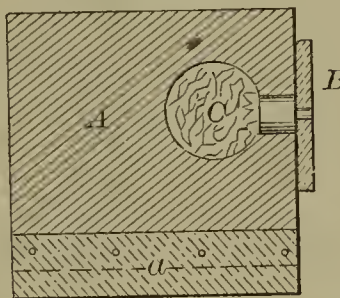

53438—L. R. Gleason—Evaporator.

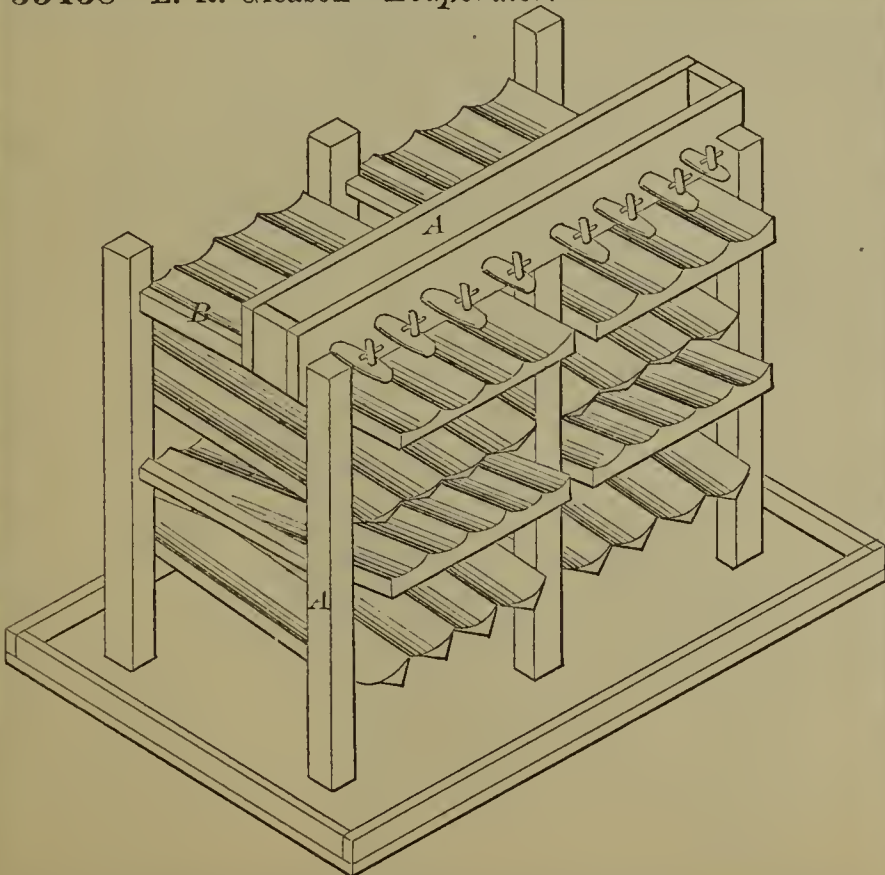

53436—Gibson & Newcomb—Whiffletree.

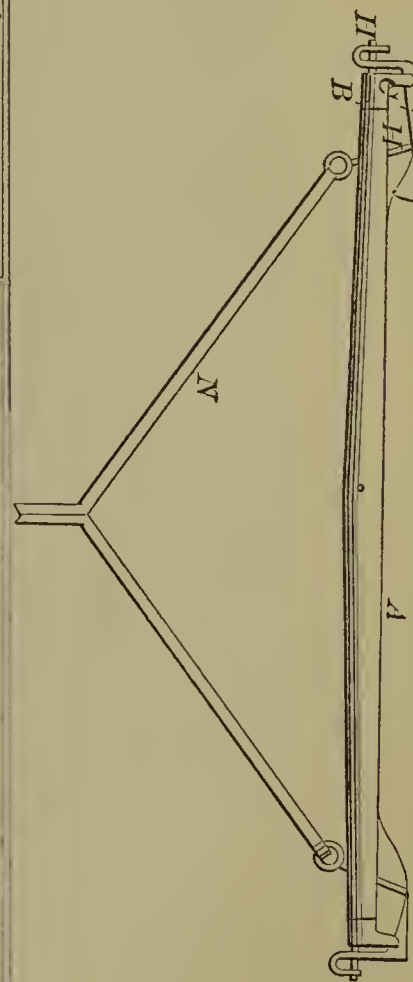

53440—A. E. Griffiths—Furnace for Treating Auriferous Ores.

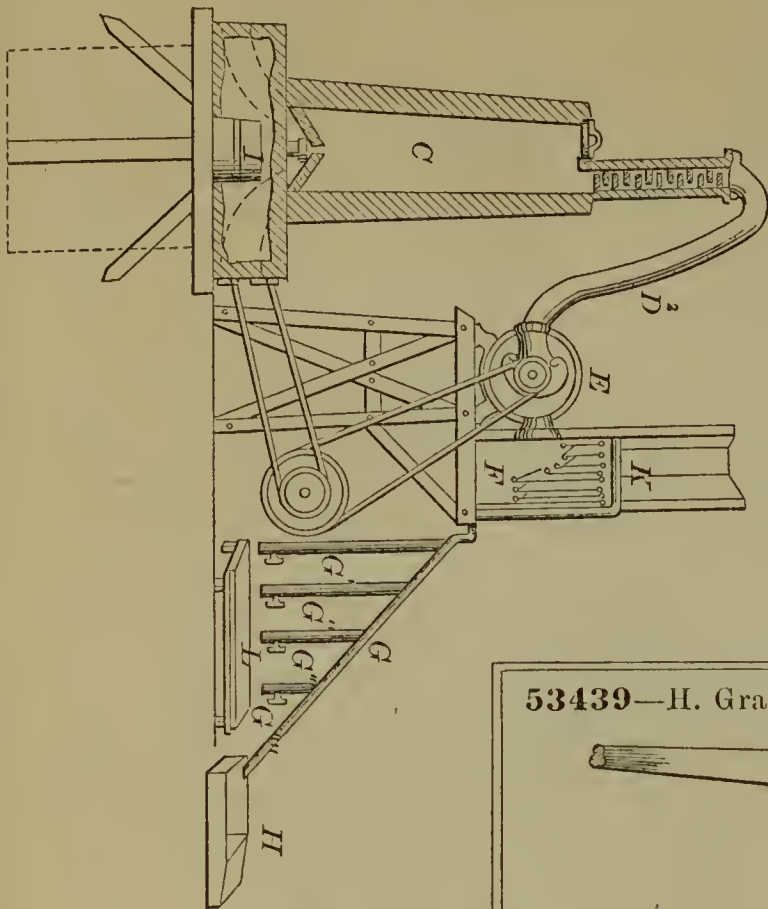

53441—J. Gulliford—Rack and Store Shelf.

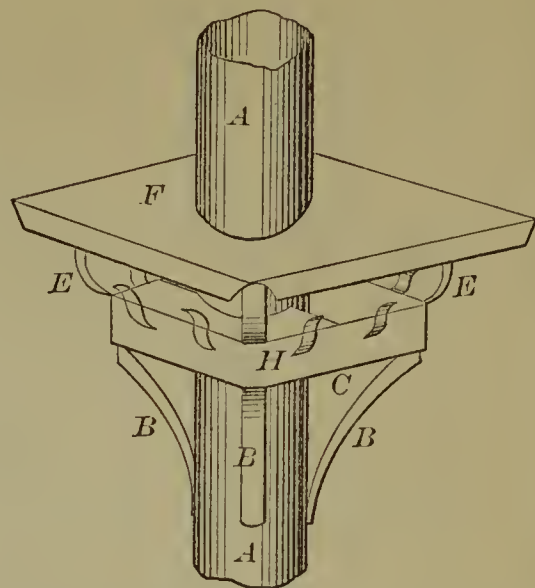

53439—H. Gray—Garden Roller for Destroying Insects.

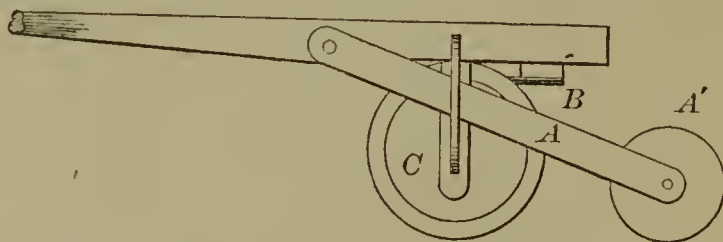

53442—H. Hamilton—Valve Gear for Steam Hammers.

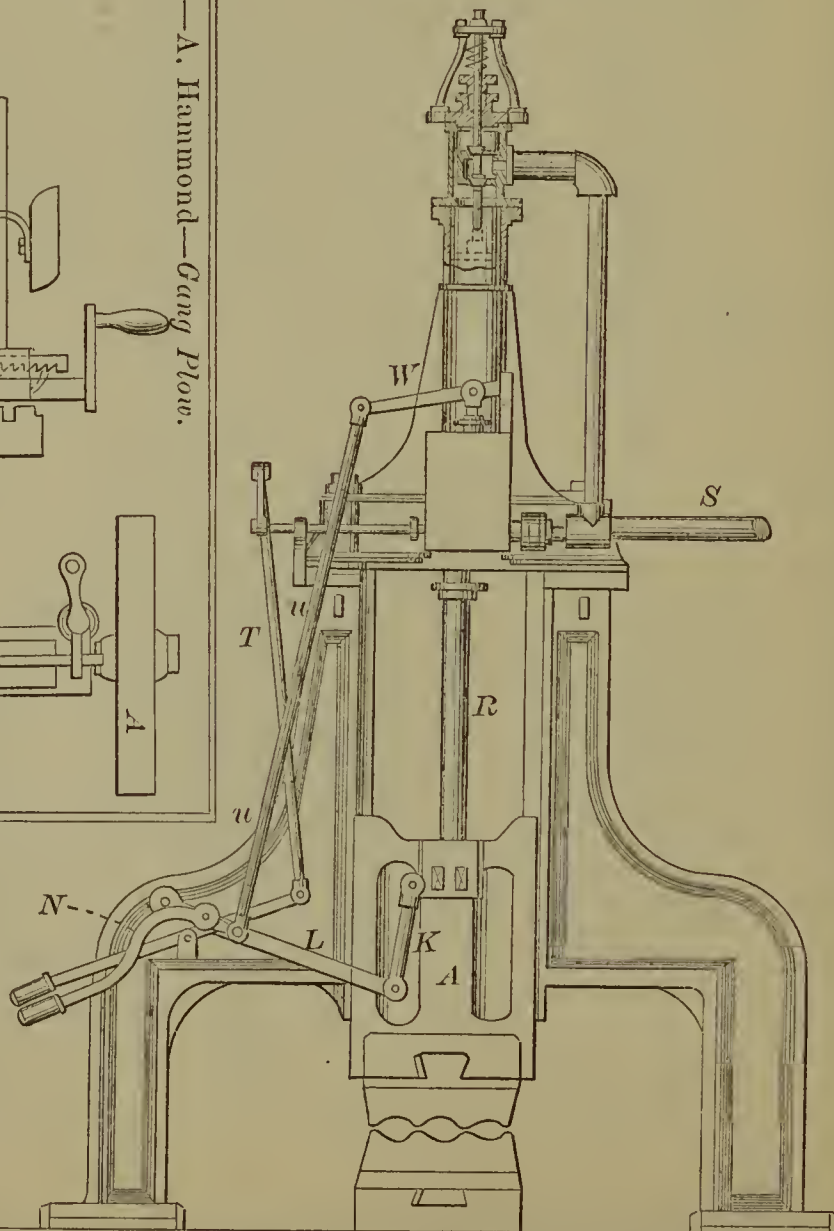

53443—A. Hammond—Gang Plow.

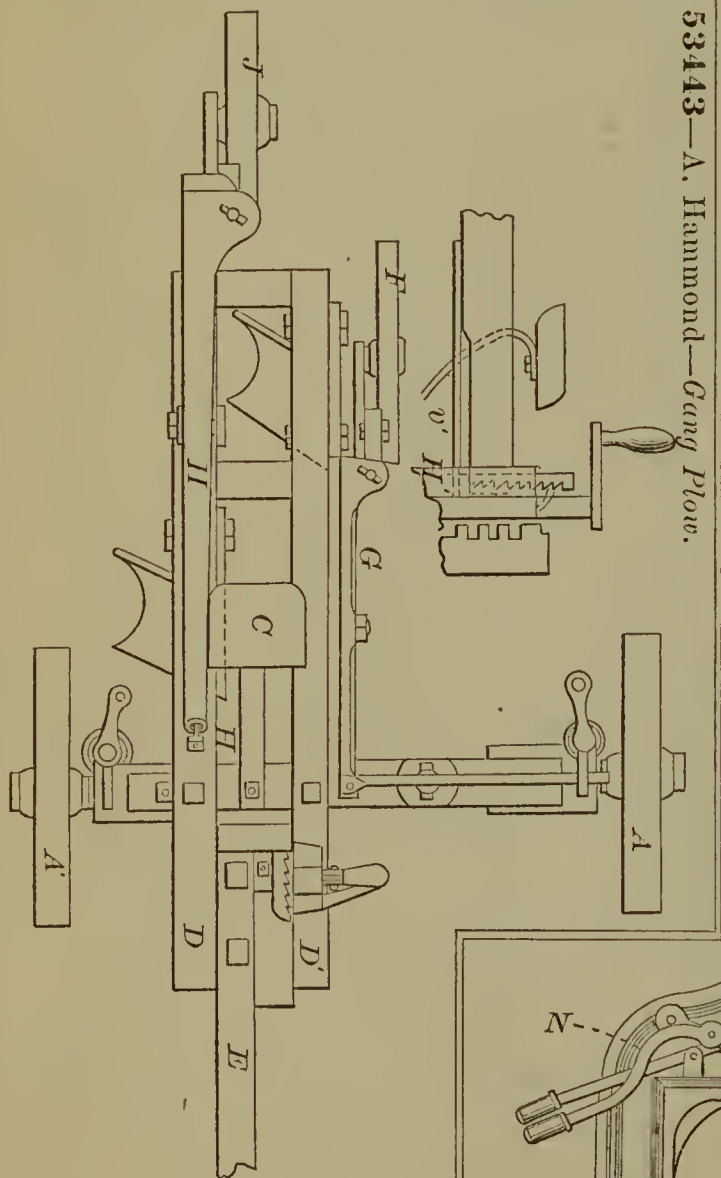

53445—P. Hildreth—Cultivator.

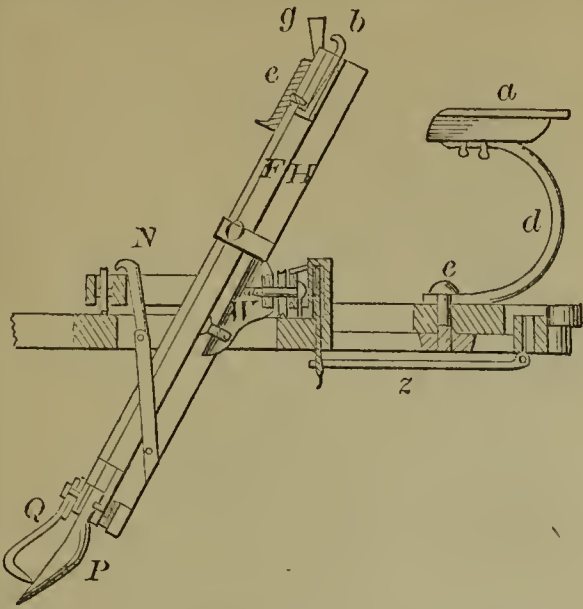

53448—H. Hunt—Centrifugal Machine.

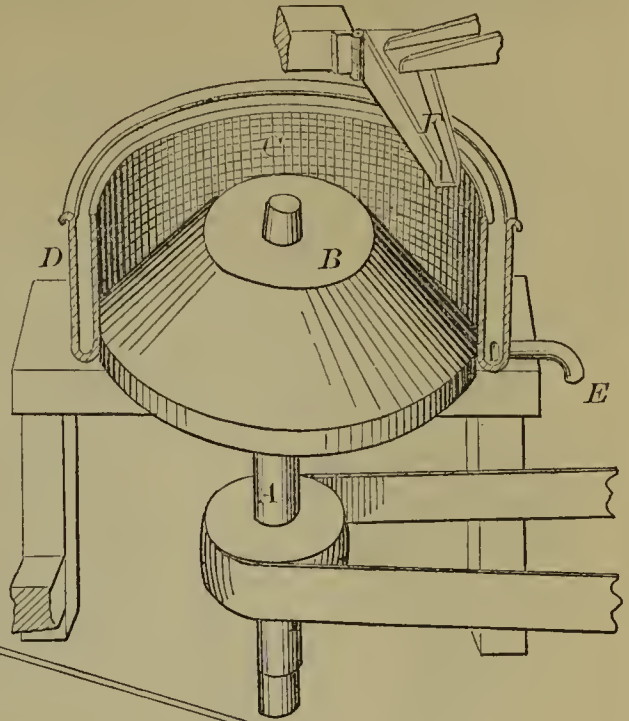

53446—C. Holman—Cultivator.

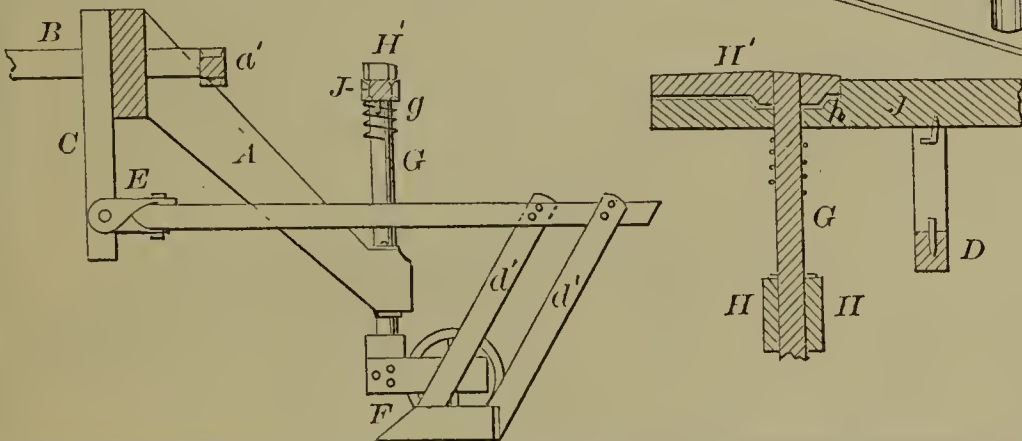

53449—O. Hyde—Flyer for Spinning Machinery.

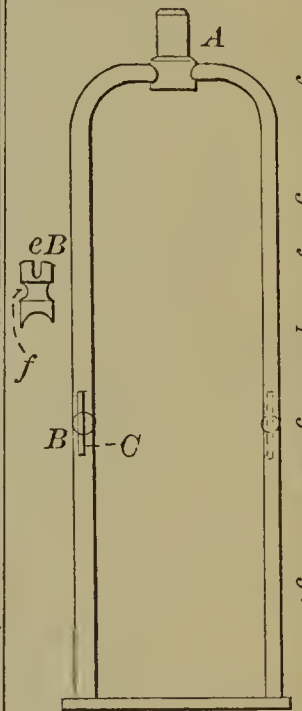

53451—J. F. Keeler—Portable Tank for Oil, &c.

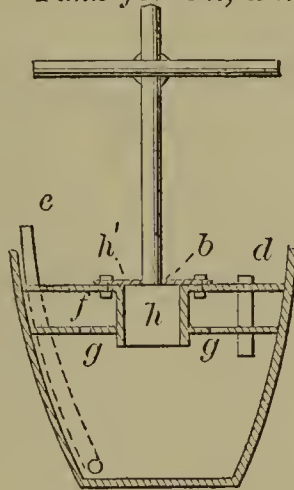

53447—G. A. Howe—Cotton Picker.

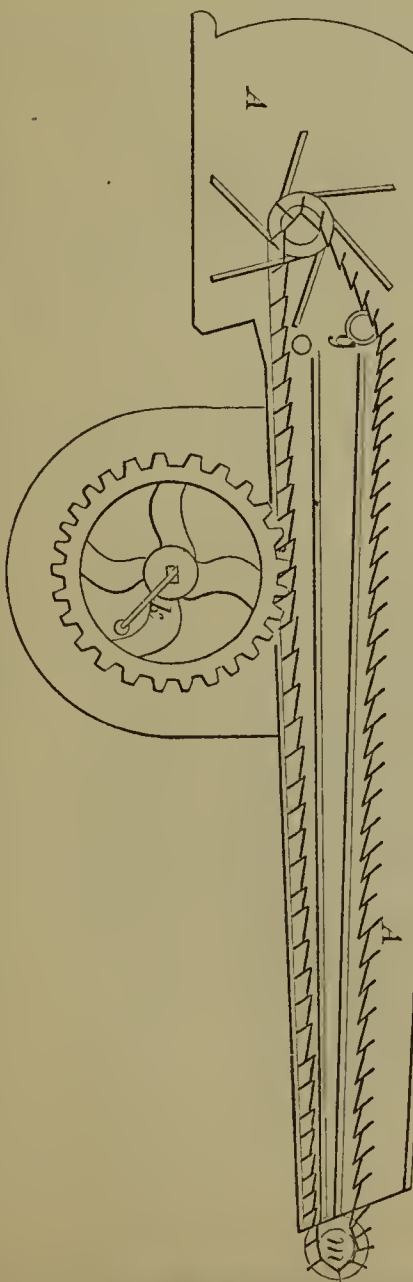

53450—J. H. Jones—Harvester Rake.

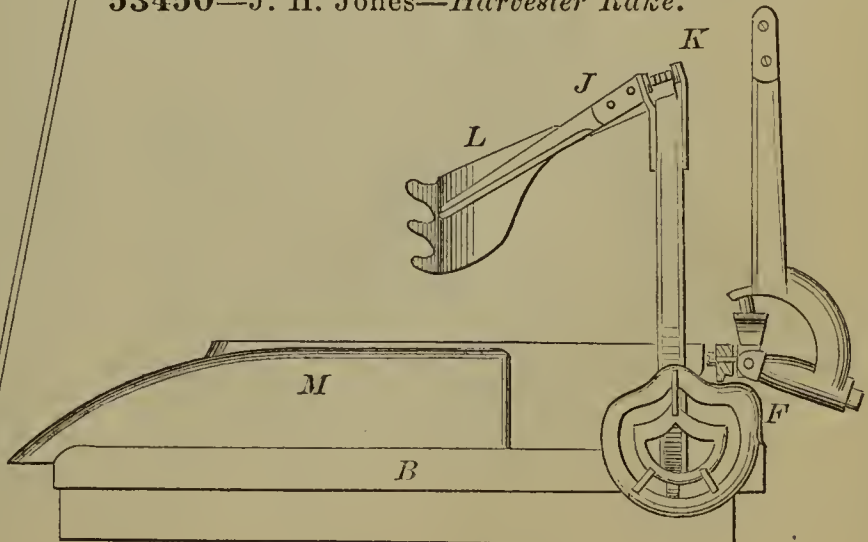

53452—A. B. King—*Broom Head.*

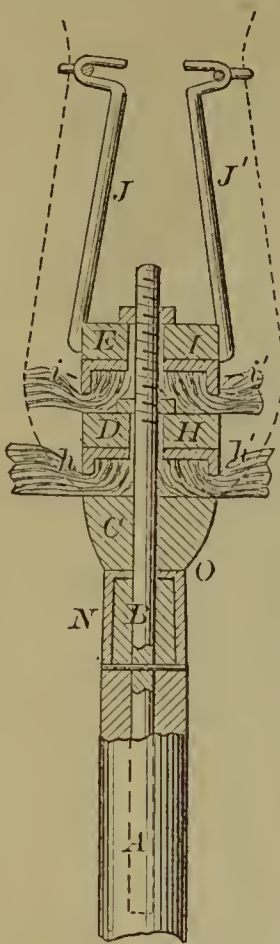

53453—J. Kunz—*Sawing Machine.*

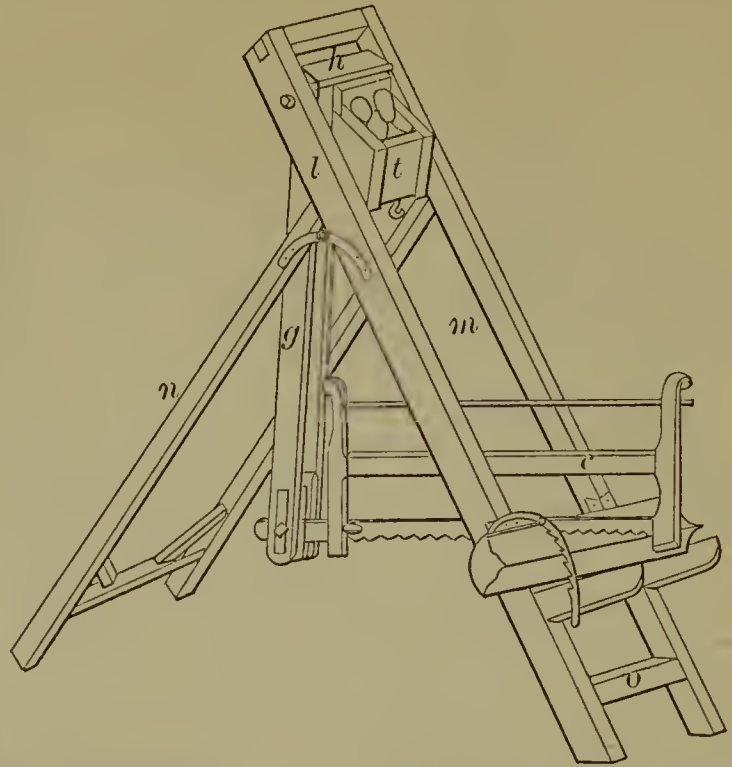

53457— S. M. Lockwood—*Sulkey Plow.*

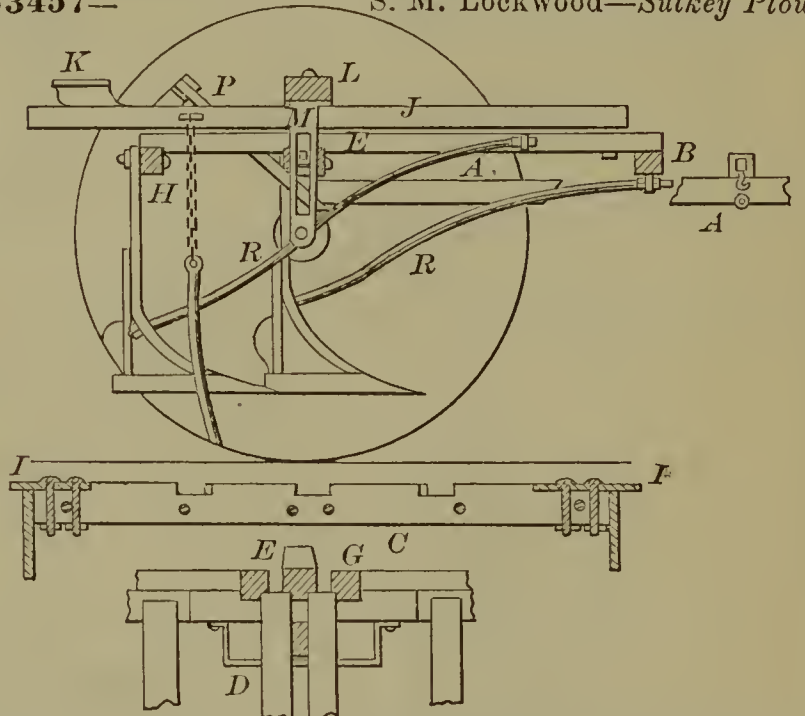

53455—C. M. Lee—*Paper Shirt Bosom.*

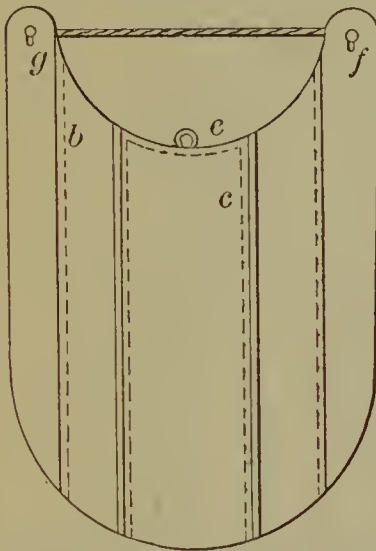

53456—A. H. Lochman—*Shade for Gas Burners.*

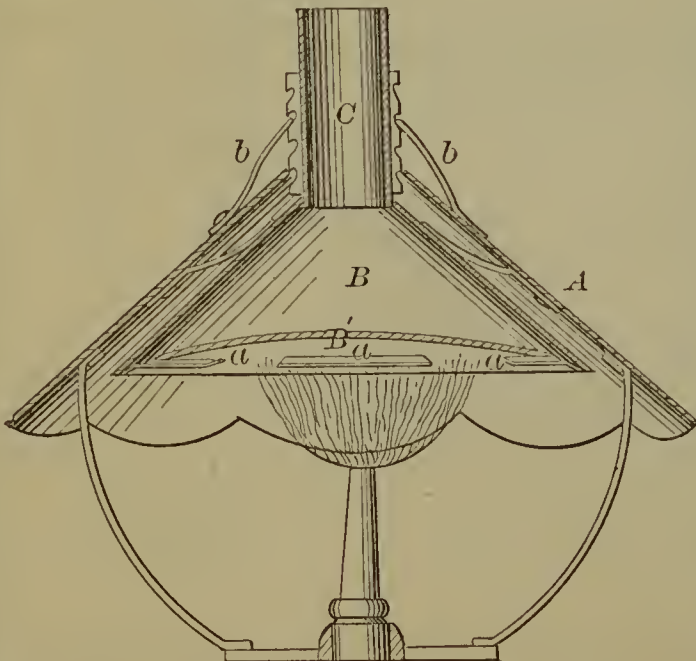

53458—P. Löffler—*Wind Mill.*

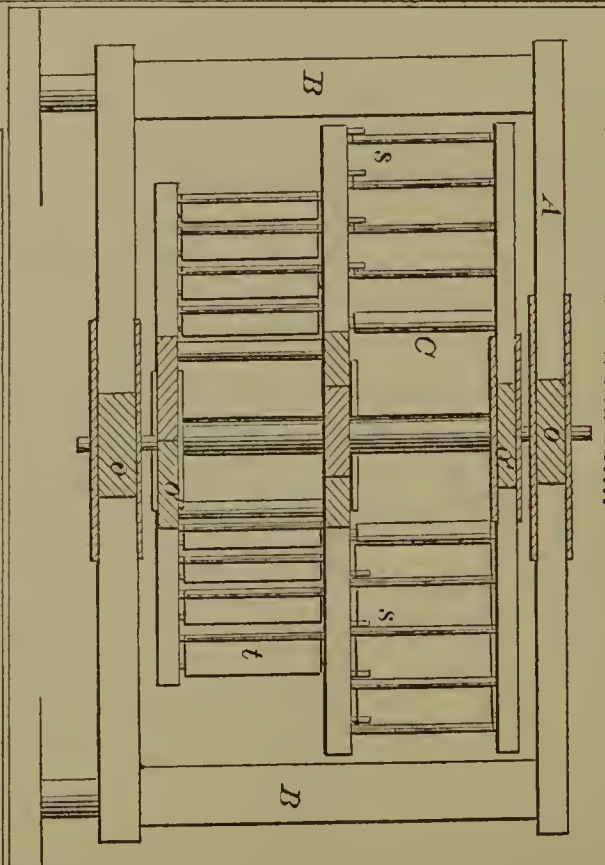

53459—D. & D. F. Lusc—  
Corn Planter.

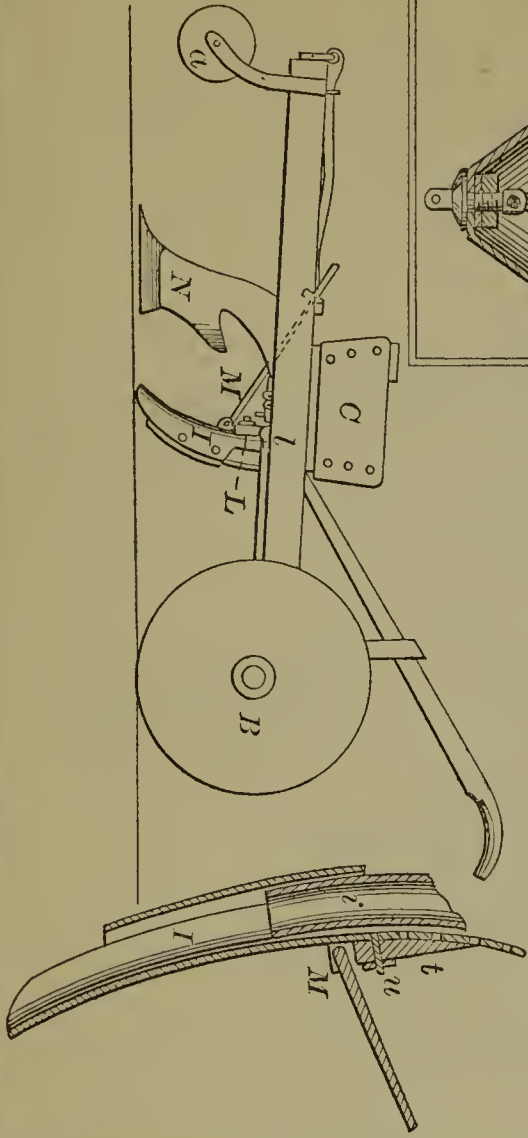

53461—J. Mac Donough—*Collapsible Float for Boats.*

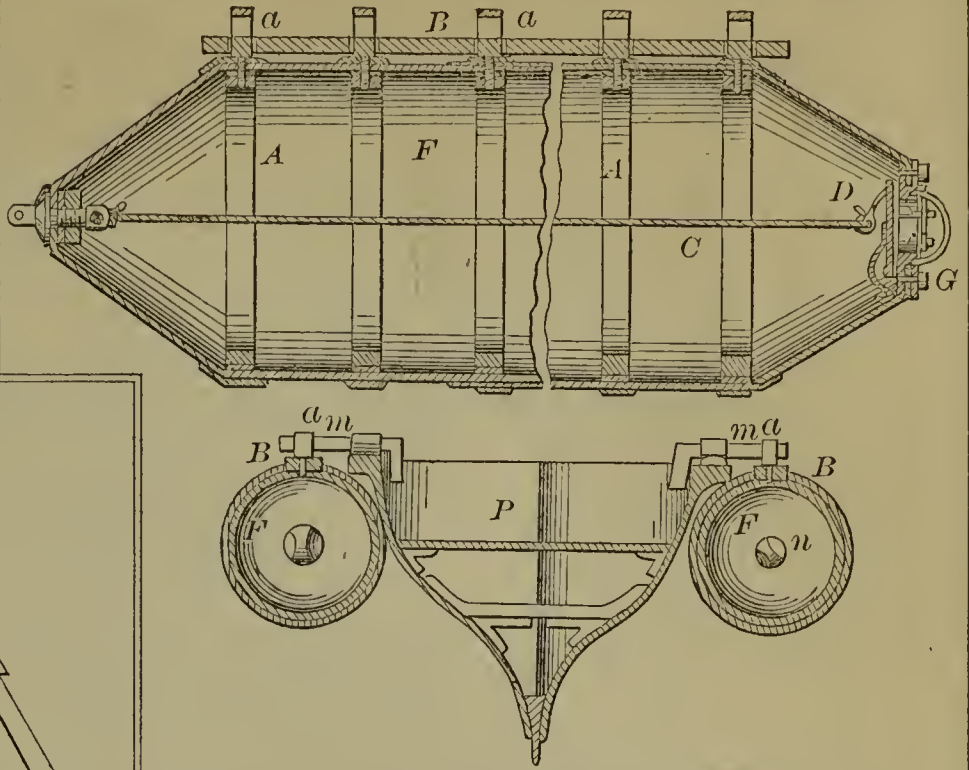

53464—W. D. Mayfield—*Machine for Raking and Loading Hay.*

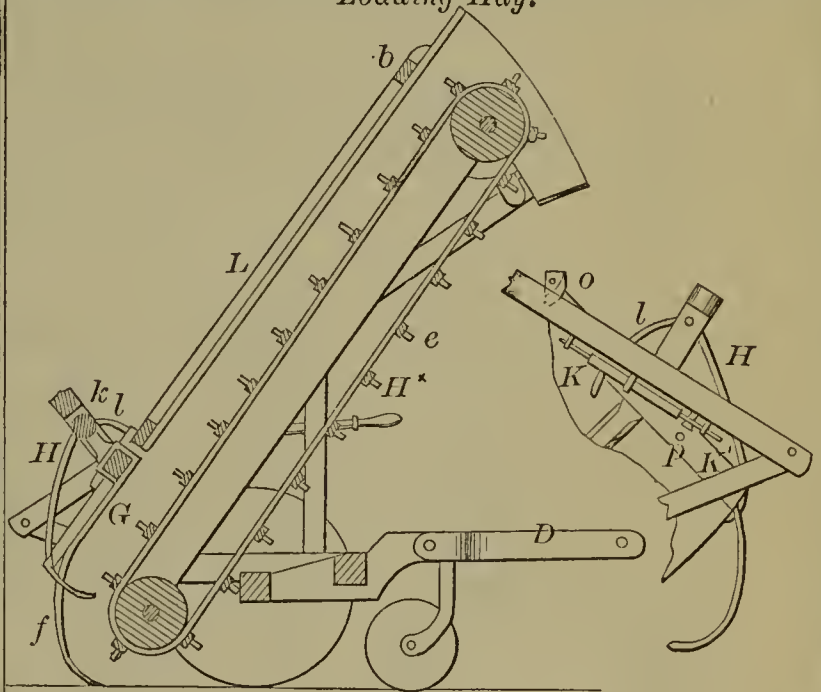

53462—D. Mackay—*Men's Collar.*

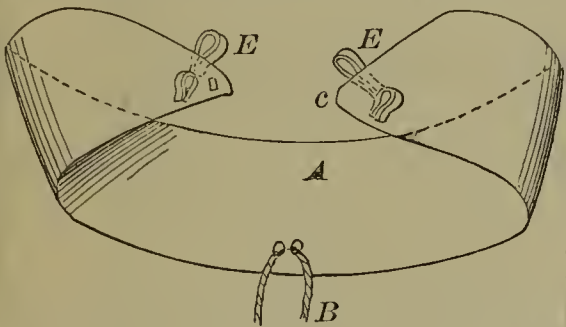

53466—W. B. McIver—*Planing Machine.*

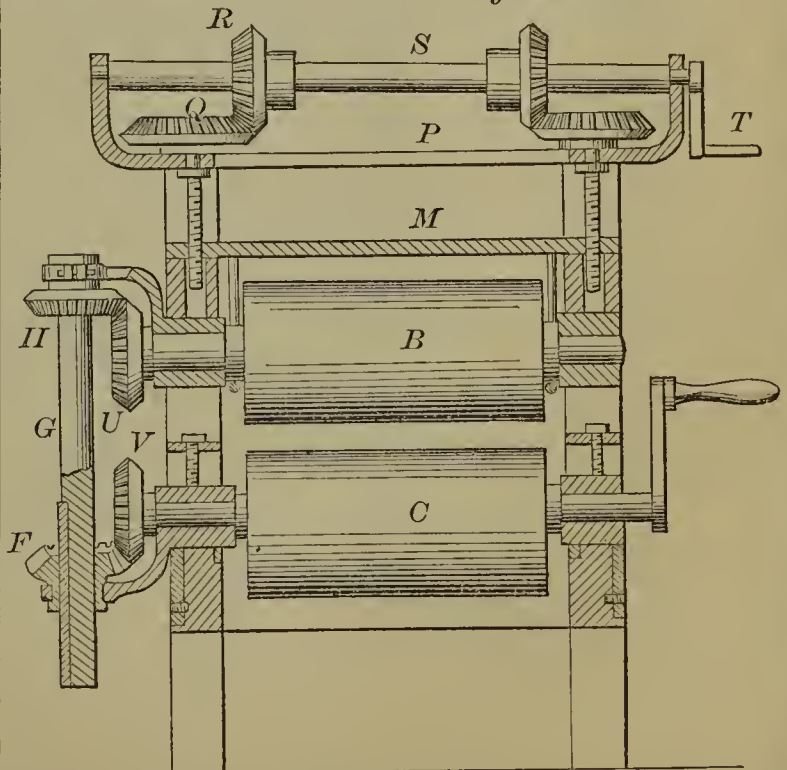

53463—Mackey & Müller—*Centrifugal Machine.*

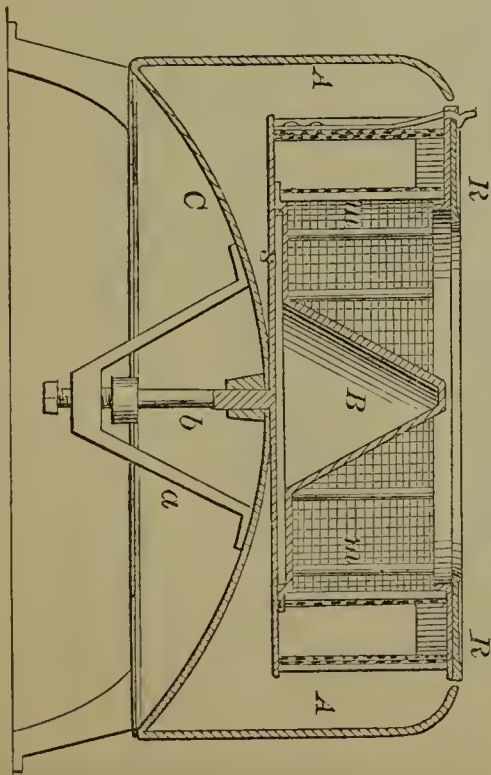

53467—J. Michel—*Pump.*

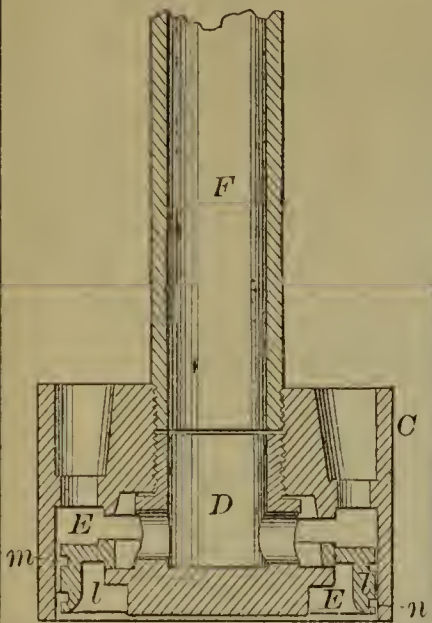

53471—F. I. Palmer—*Button.*

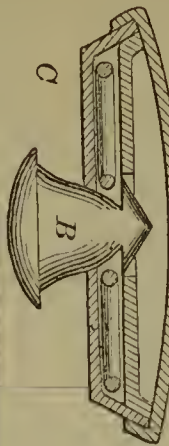

53468—A. L. Munson—*Table Napkin.*



53470—O. T. Manny—*Hay Loader.*

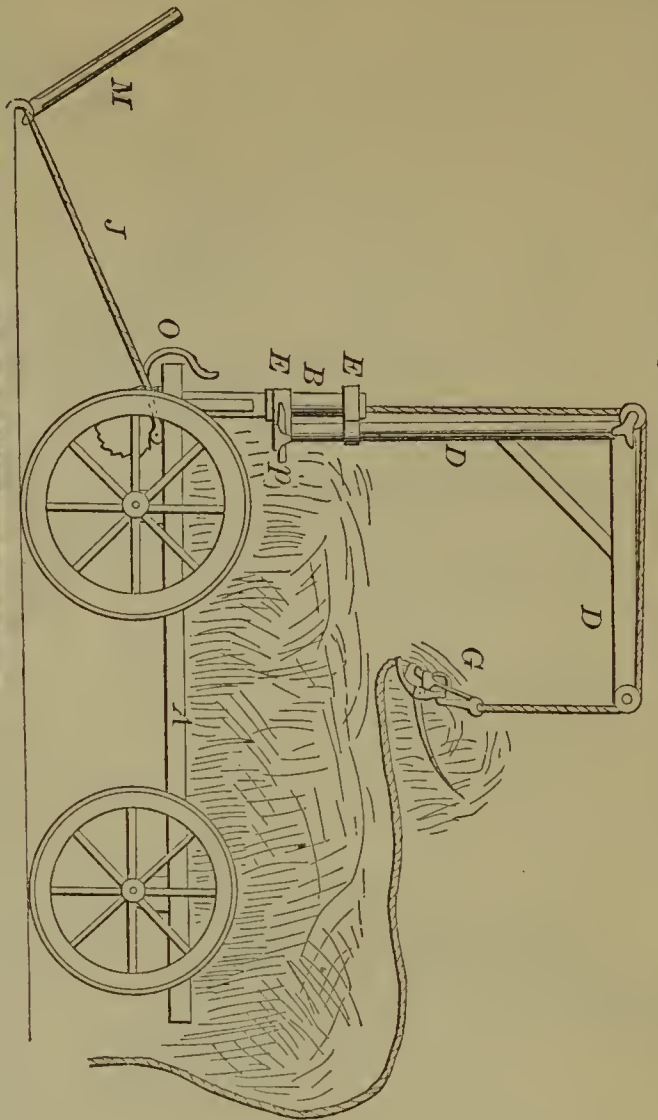

53469—Myers & Noble—*Steam Water Elevator.*

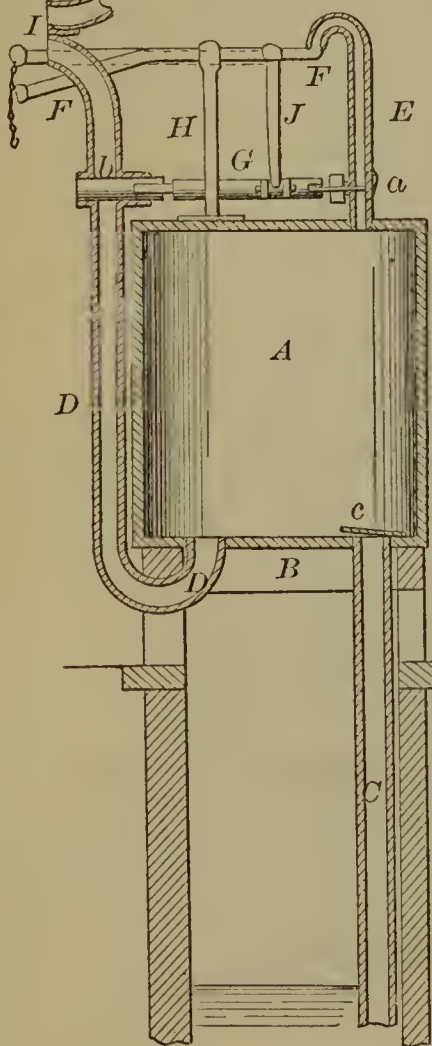

53473—A. J. Peavey—*Combined Pistol and Pocket Knife.*

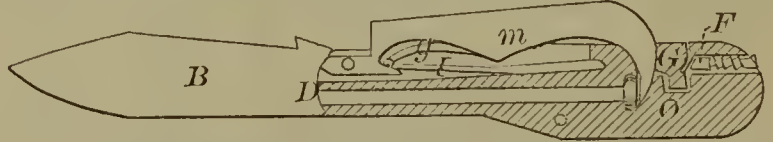

53474—I. N. Peirce—*Seat and Desk for Schools.*

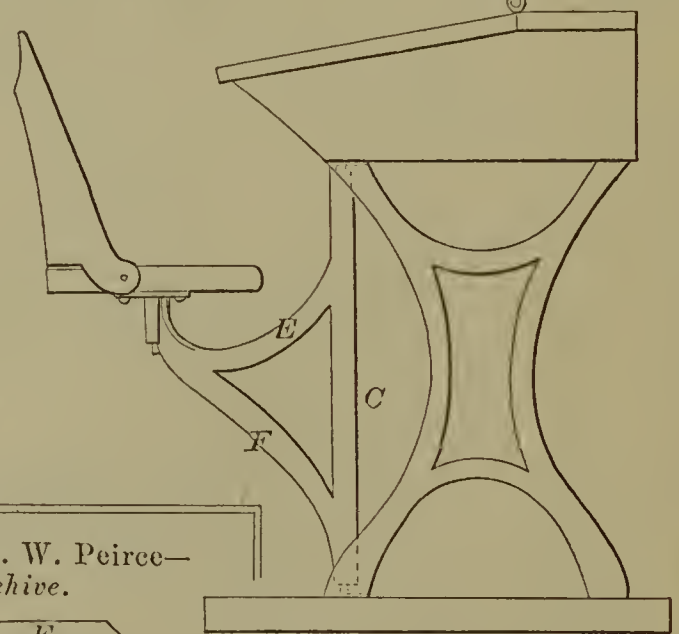

53475—T. W. Peirce—*Beehive.*

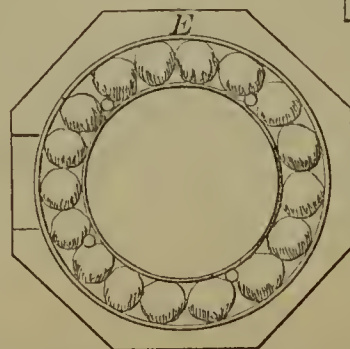

53472—F. I. Palmer—*Fastening for Garmets.*





53477—F. L. Perry—*Box for Propagating Plants.*

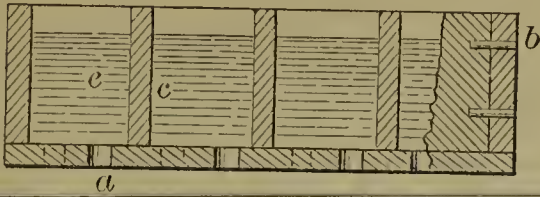

53478—J. G. Perry—*Pole and Thills for Carriages.*

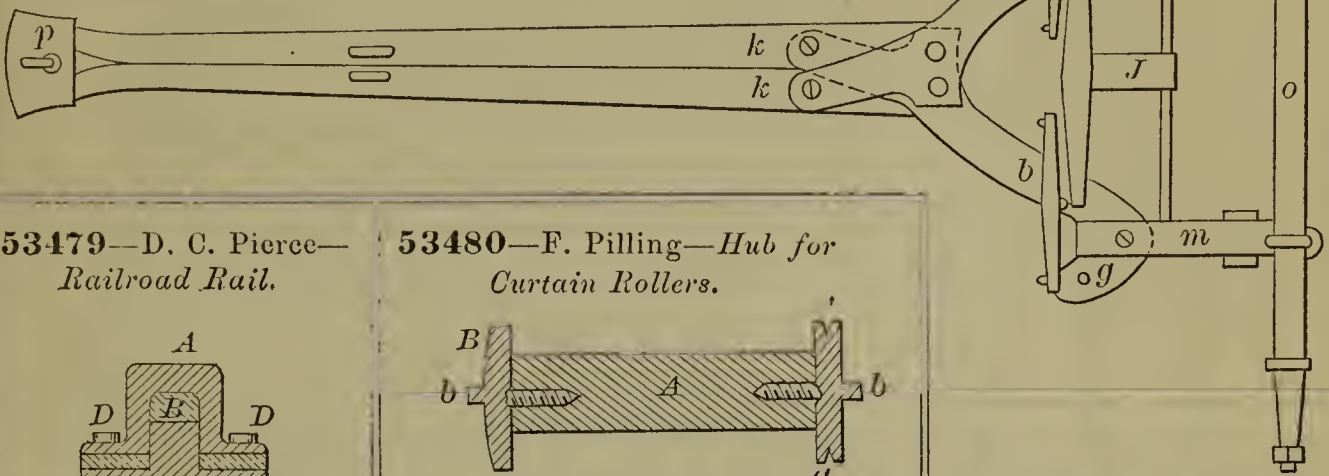

53479—D. C. Pierce—*Railroad Rail.*

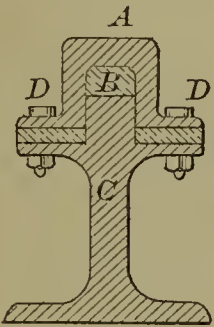

53480—F. Pilling—*Hub for Curtain Rollers.*

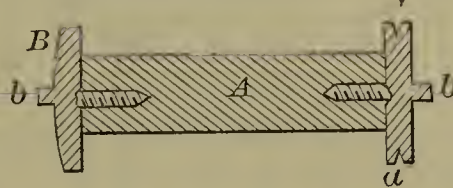

53482—Pond & Richardson—*Gas Apparatus.*

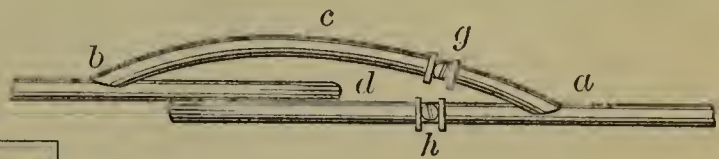

53481—Pond & Richardson—*Apparatus For Carburetted Air.*

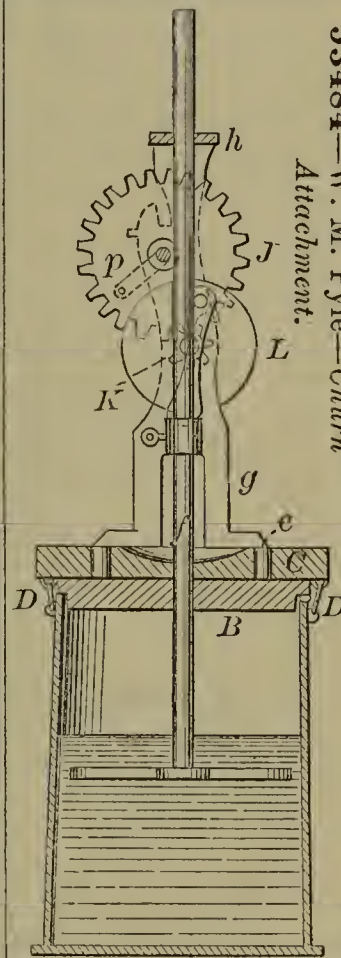
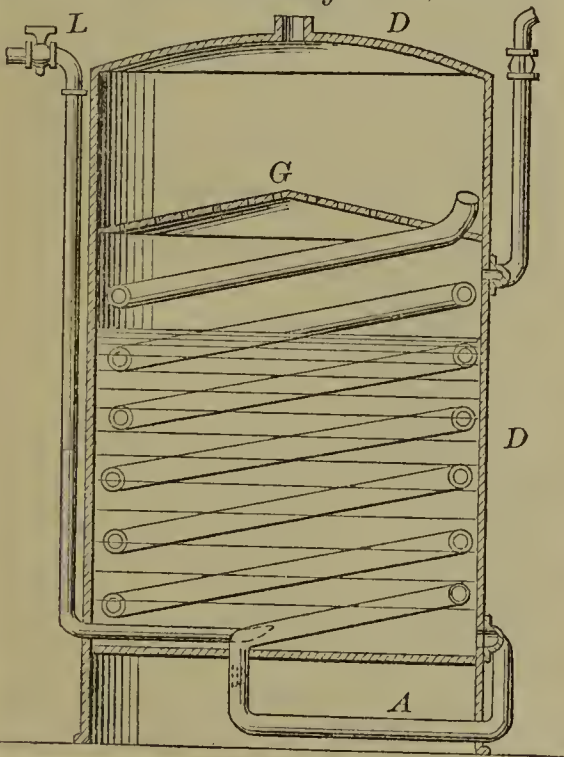

53484—W. M. Pyle—*Churn Attachment.*

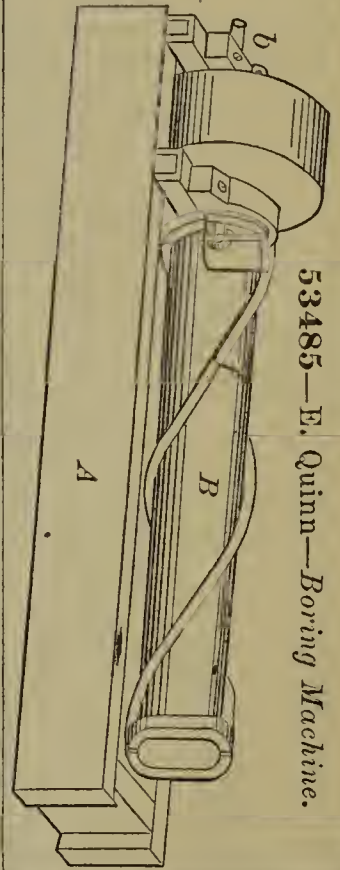

53485—E. Quinn—*Boring Machine.*

53483—A. M. Preble—*Gaiter Shoe.*

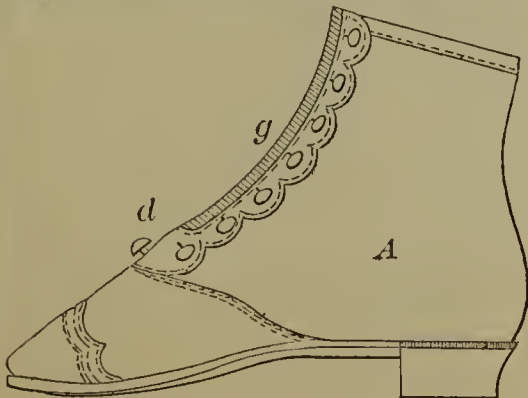

53486—E. Quinn—*Tool for Turning Wood.*

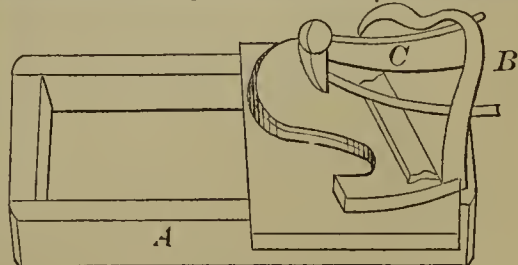

53487—D. B. Randall—*Churn.*

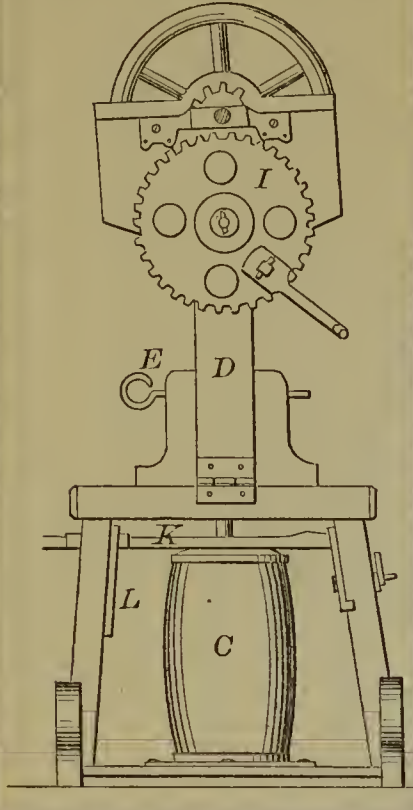

53488—A. Rankin—*Urinal.*

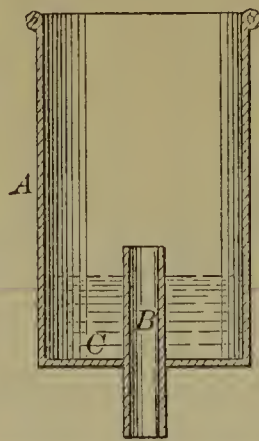

53489—F. Rhines—*Mop Wringer.*

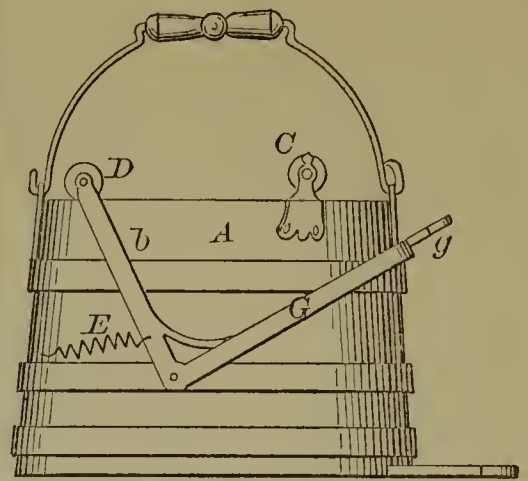

53496—J. F. Smith—*Milling Tool.*

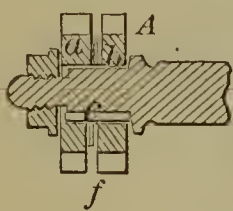

53490—W. H. Riskey—*Metallic Cartridge.*

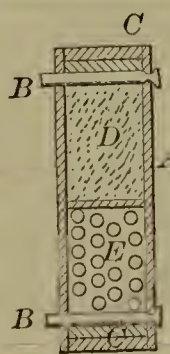

53493—H. C. Sergeant—*Steam Generator.*

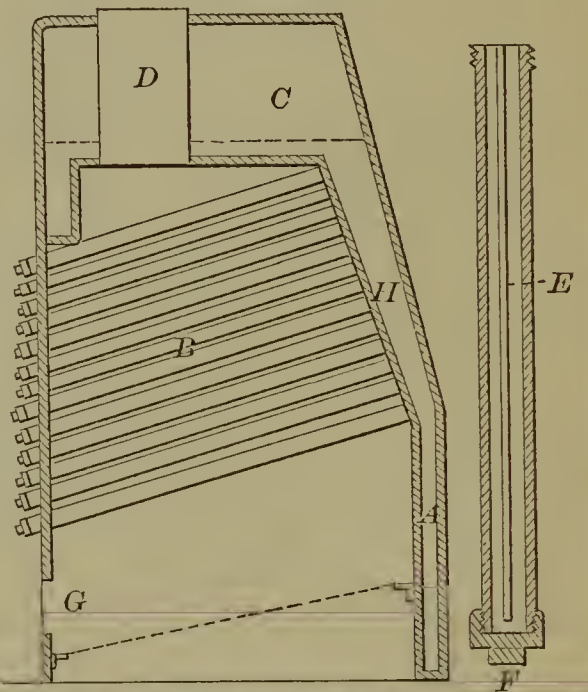

53491—Saladee & Simpson—*Plow Point.*

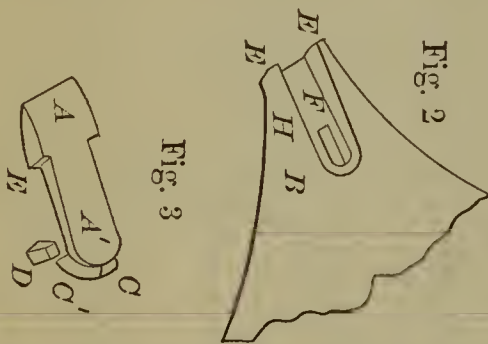

53492—C. A. Scott—*Bed Bottom.*

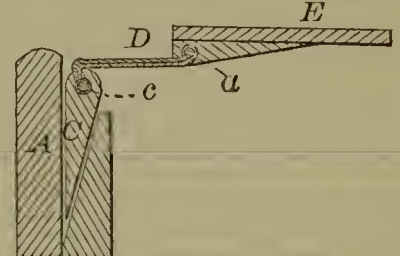

53494—Sheldrake & Bready—*Soda Water Apparatus.*

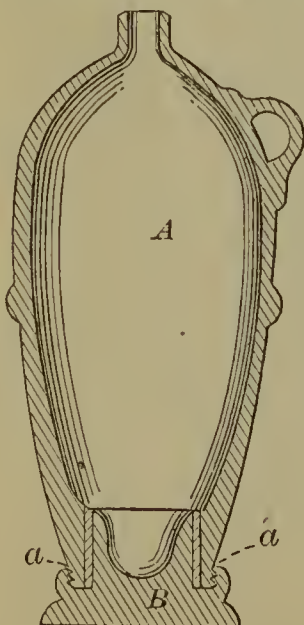

53495—F. Shenton—*Slate Frame.*

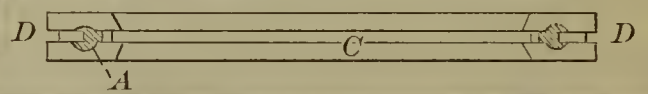

53497—J. Spear—*Cooking Stove.*

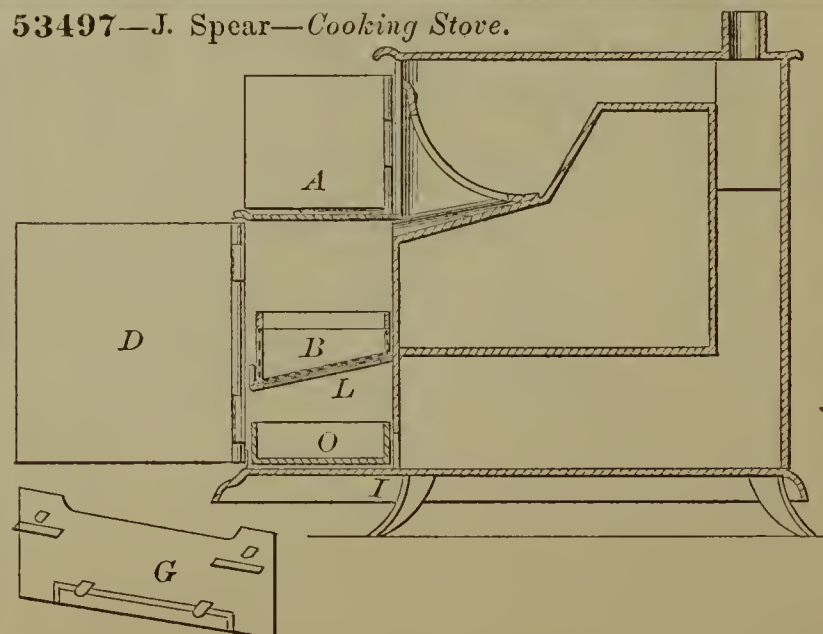

53498—J. F. Spence—  
Condenser.

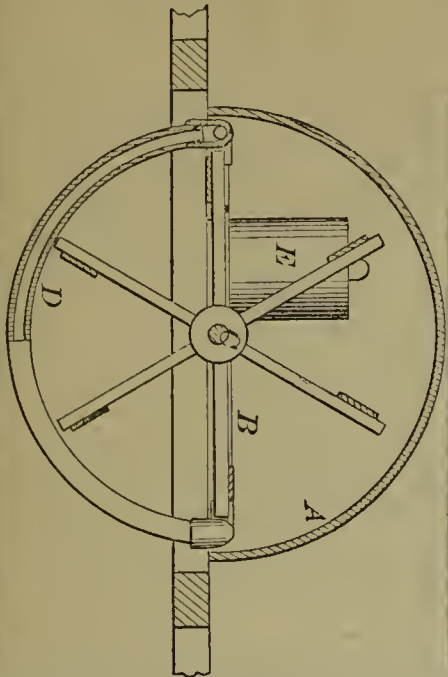

53499—N. C. Stiles—*Foot Press.*

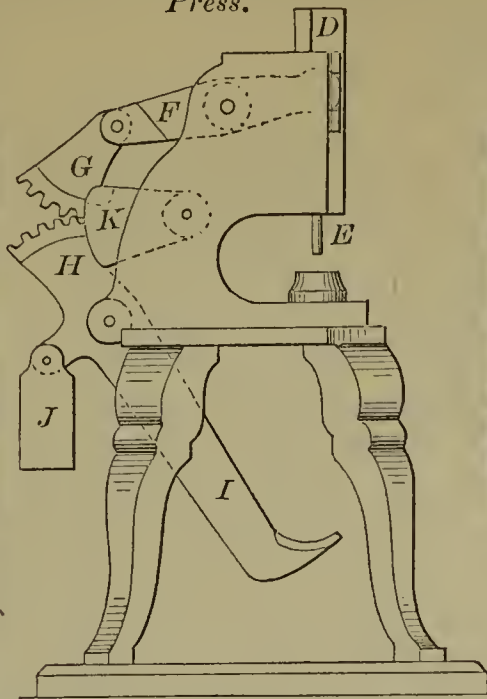

53503—J. A. Talpey—*Cooking Stone.*

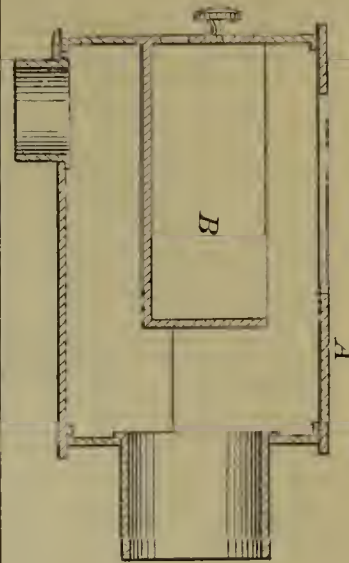

53500—Sturdevant, Parsons & Wheeler—  
*Milk Shelves.*

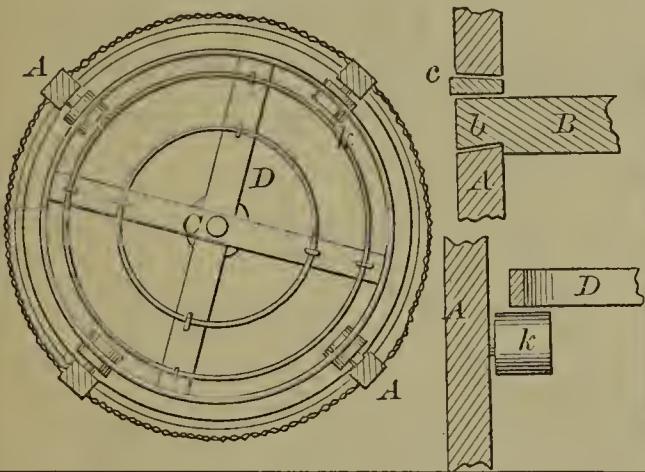

53502—E. Sweetland—*Machine for Cleaning Grain, &c.*

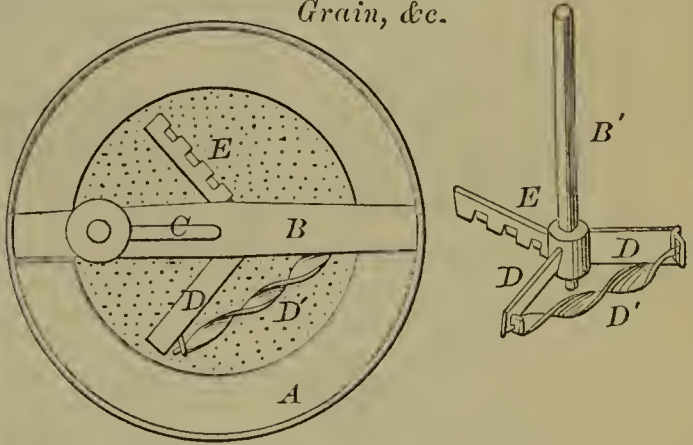

53504—W. Thompson—*For Carburetting Air.*

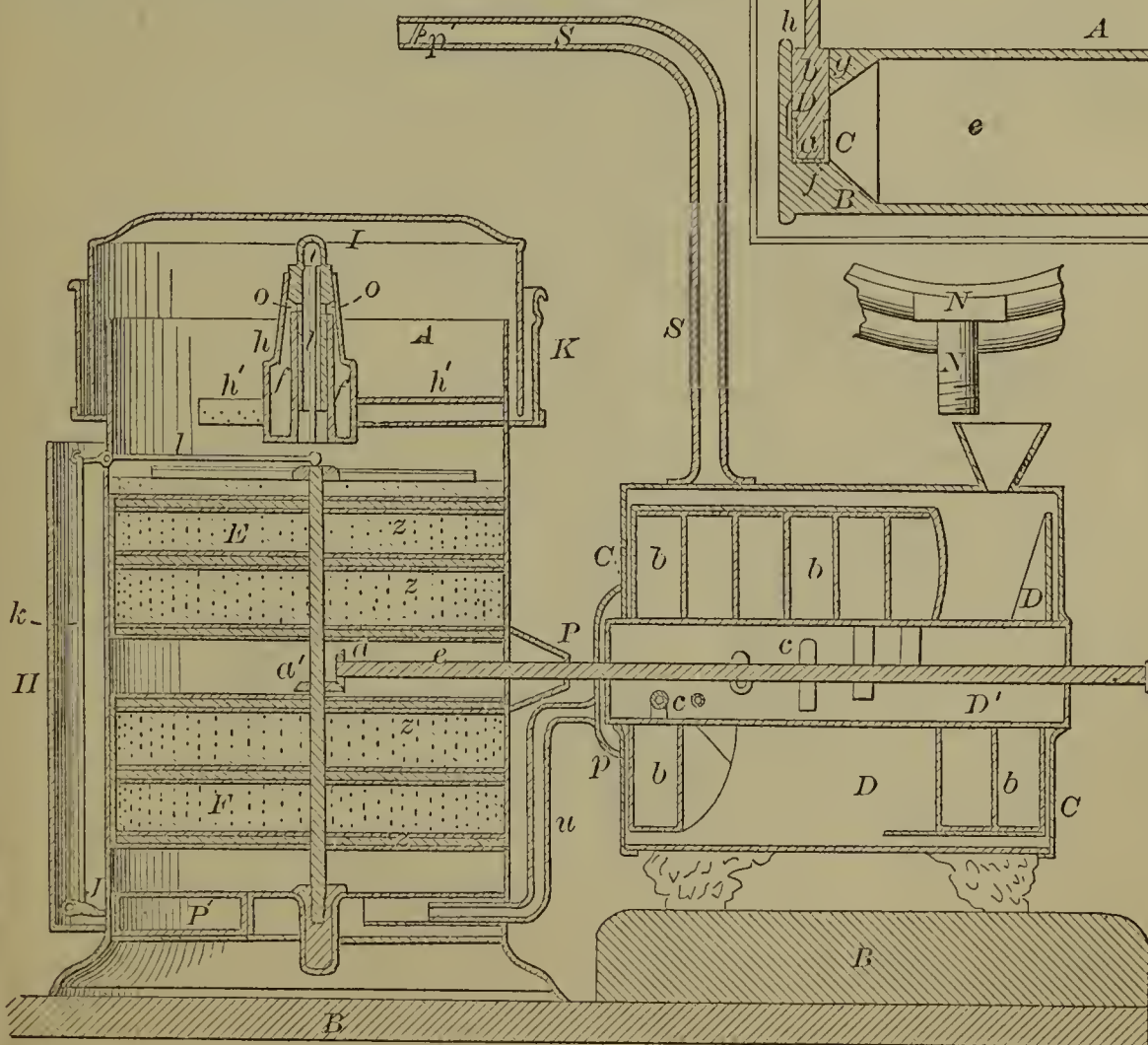

53501—T. L. Sturtevant—*Priming Cartridges.*

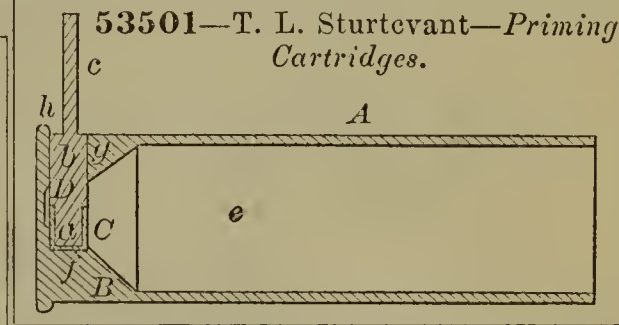

53505—J. Tilley—Water Elevator.

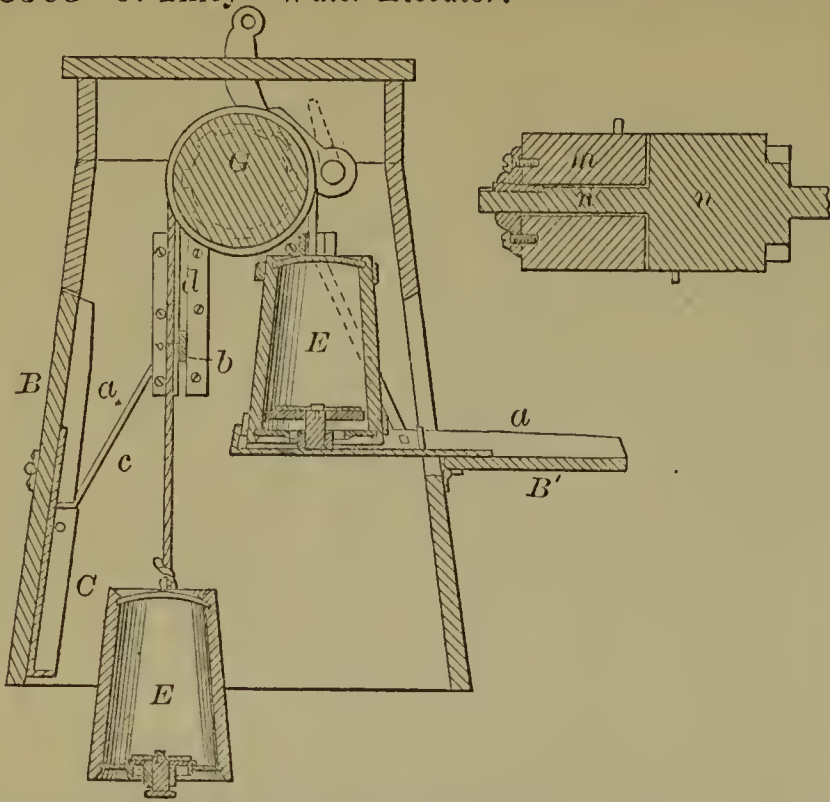

53510—W. Wells—  
Last.

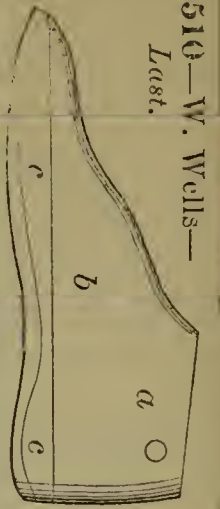

53507—H. Vester—Iron Railway Sleeper.



53511—J. Wheeler—Disk Washing Machine.

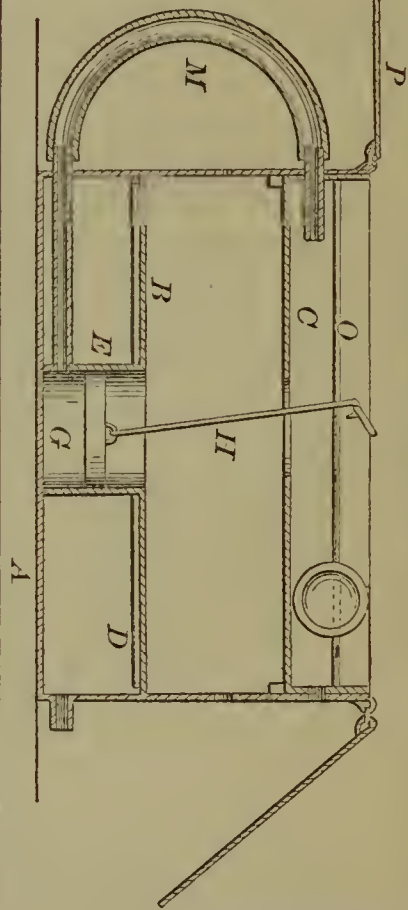

53506—C. N. Tyler—Lamp.

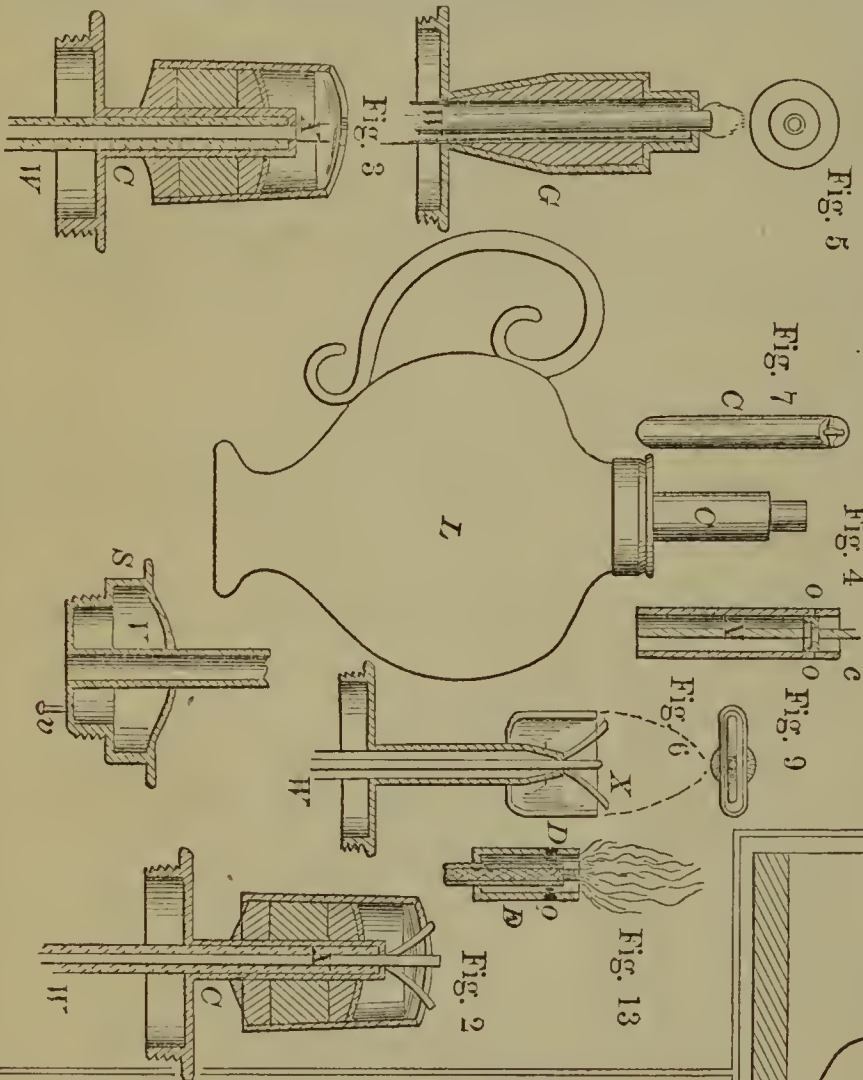

53508—O. J. Warren—  
Crimping Boots.

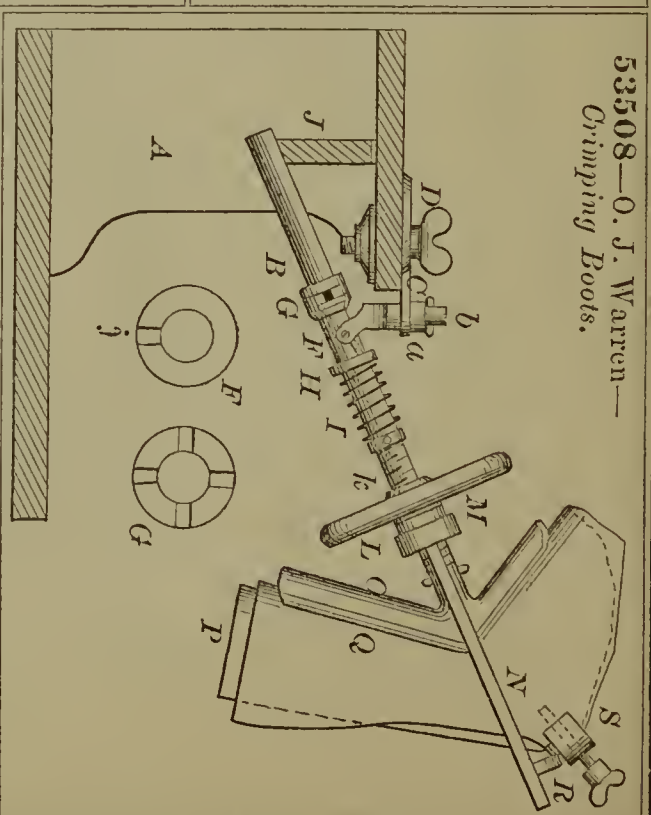

53509—C. Weed—Water Meter.

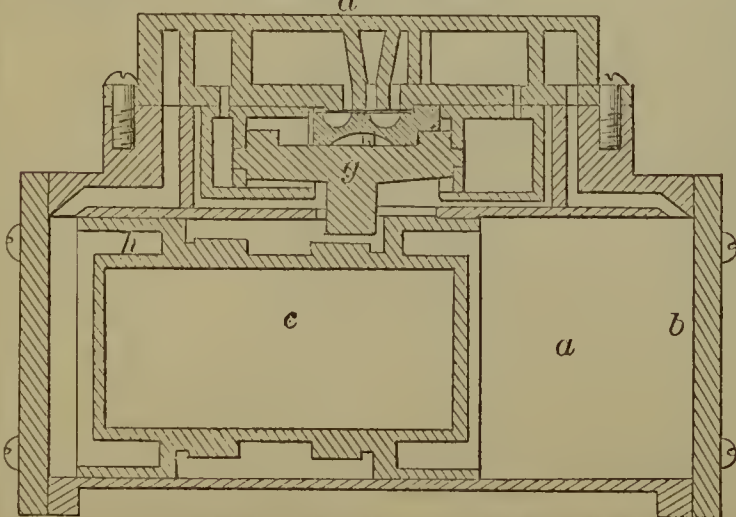

53512—J. White—Churn.

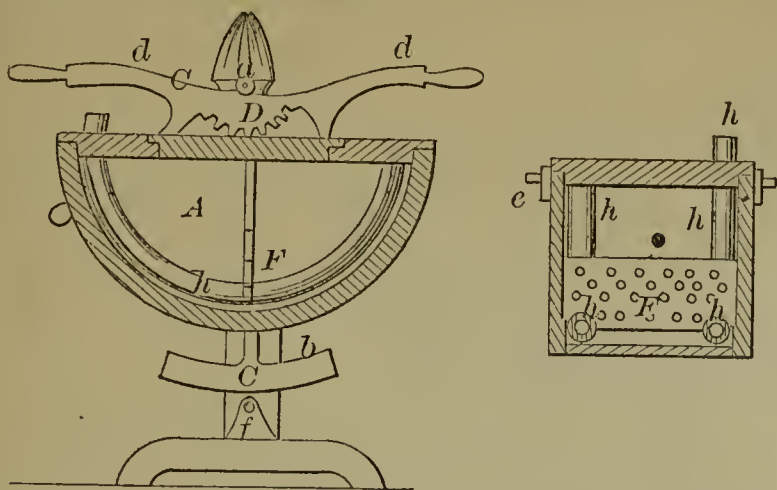

53515—S. F. Woodworth—For Swaging Sheet Metal Spouts.

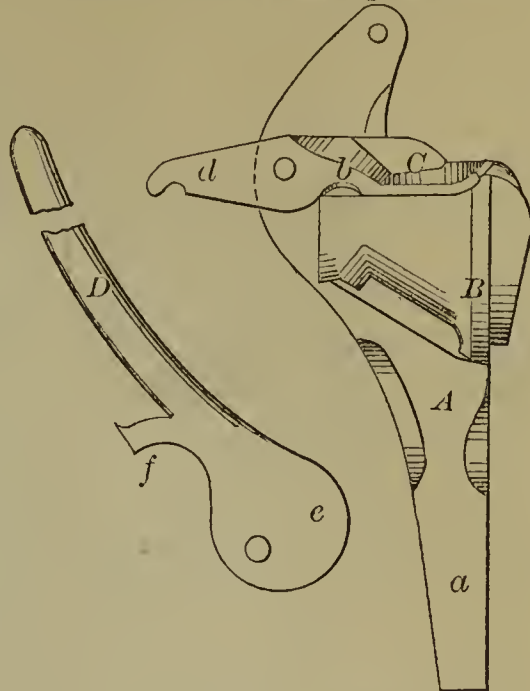

53513—L. B. White—Truss.



53516—S. D. Yerks—Dairy House.

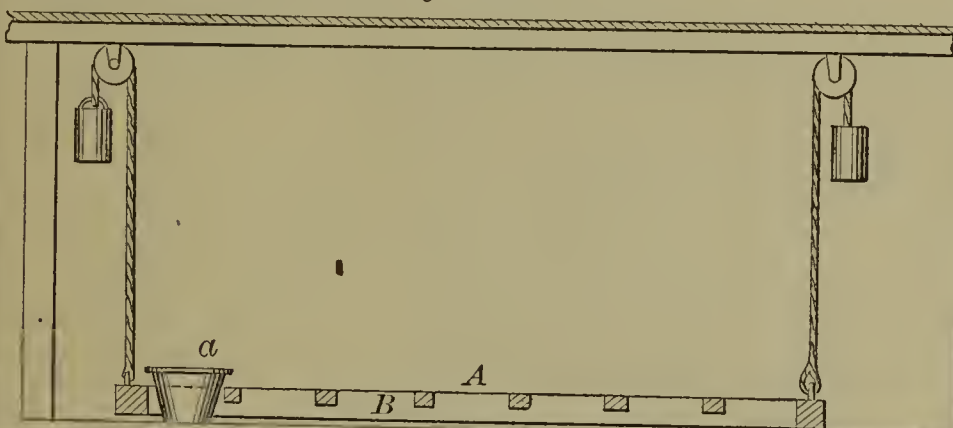

53514—J. Williams—Feeding *B* Device for Sewing Machines.

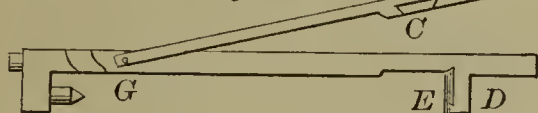

53517—R. M. Bartlett—Sealing Box, &c.

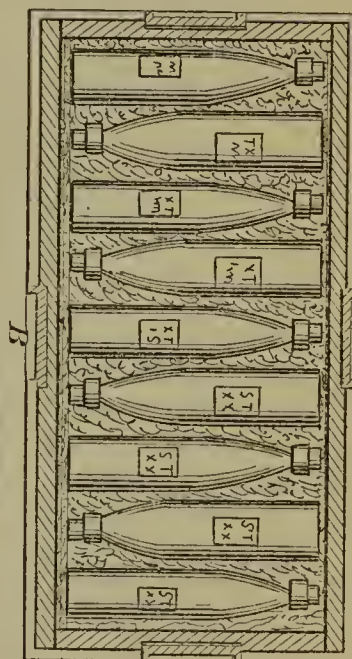

53518—Best & Drake—Machine for Ironing Hats.

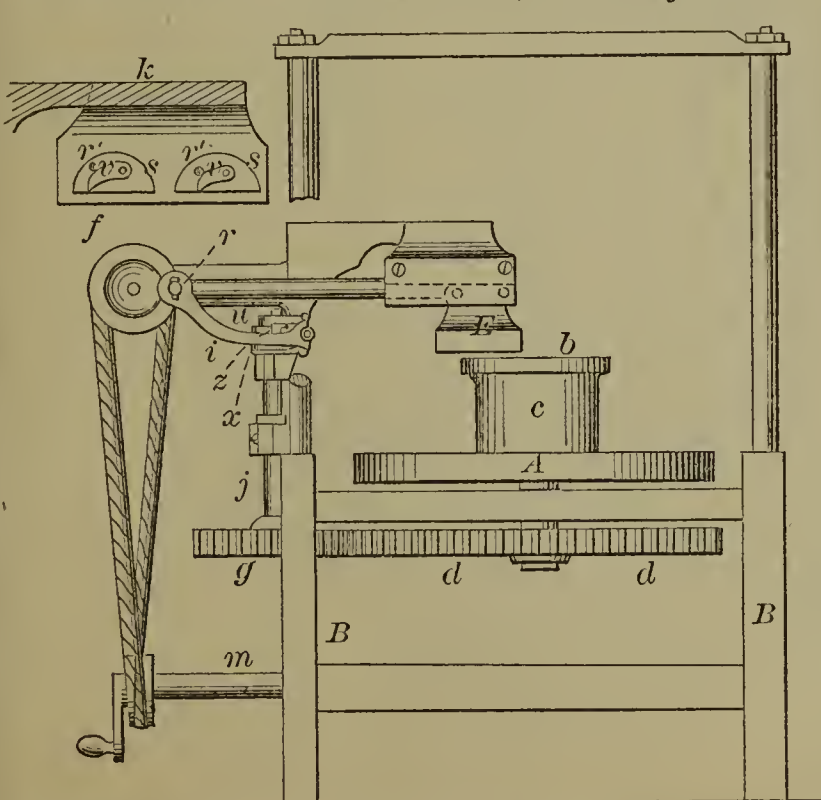

53519—C. M. Brown—Bed Bottom.

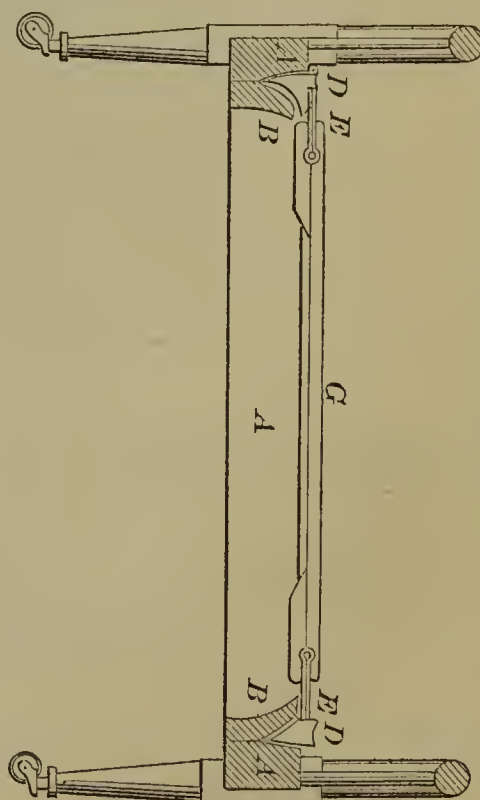

53520—Brown & Rice—Clasp For Pocket Books.

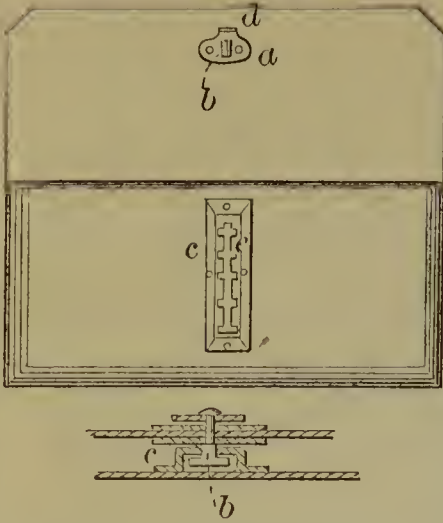

53522—F. Clark—Breech-Loading Fire Arm.

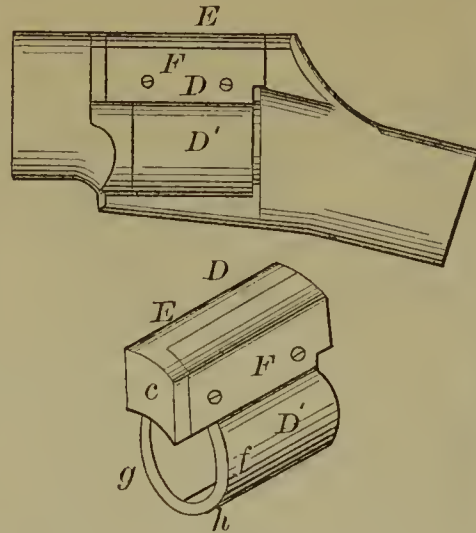

53523—J. W. Coburn—Water Proof Sole.



53524—C. Crow—Trammel for Ellipses.

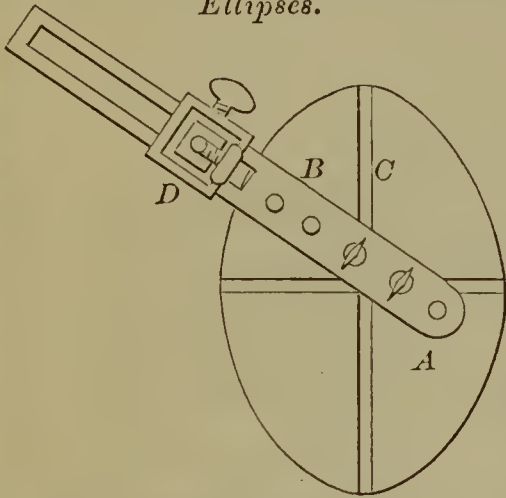

53521—J. E. Casey—Churn.

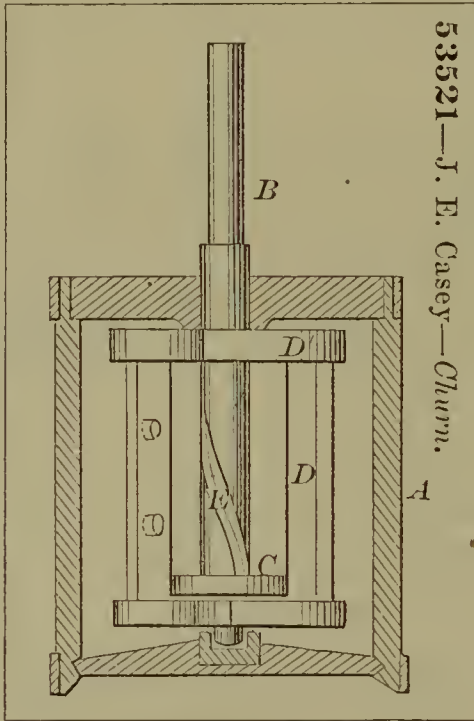

53527—P. Evens, Jr.—Thread Tension for Sewing Machines.

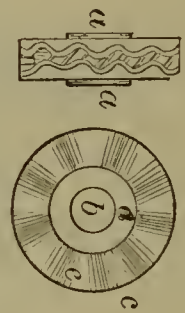

53525—C. Denton—Cultivator and Seeding Machine.

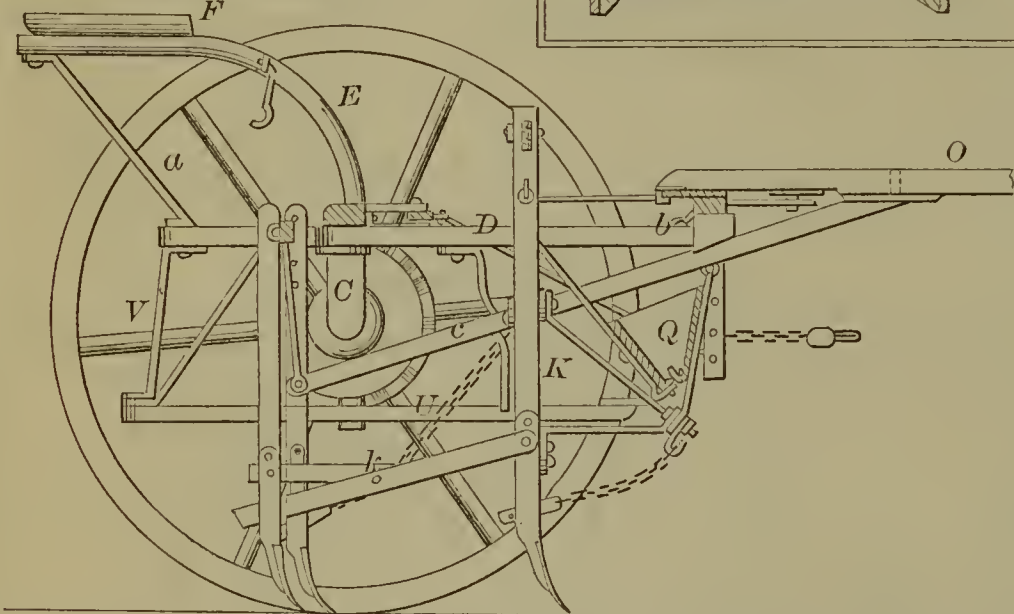

53529—J. W. Gardner—Manufacture of Table Cutlery.



53526—H. H. Elwell—Knob Latch.

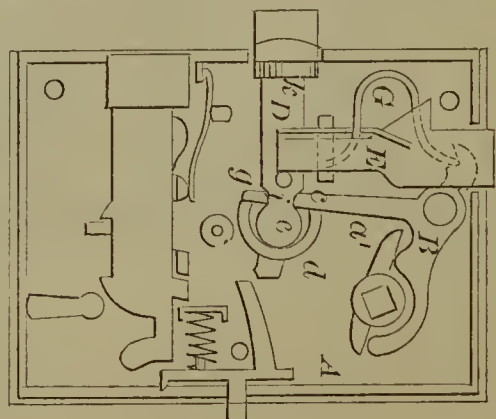

53528—J. H. Fairchild—Condenser.

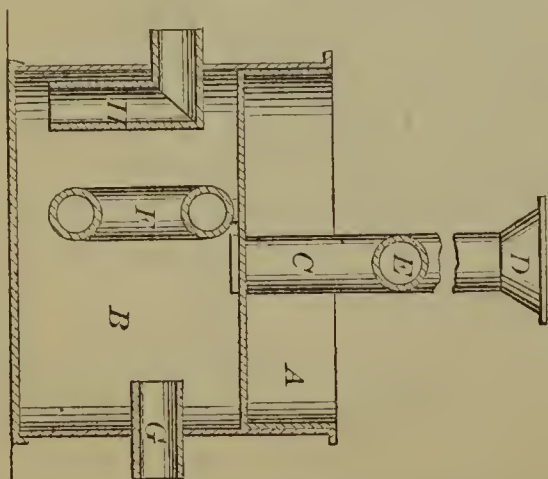

53530—J. Goodman—Knitting Machine.

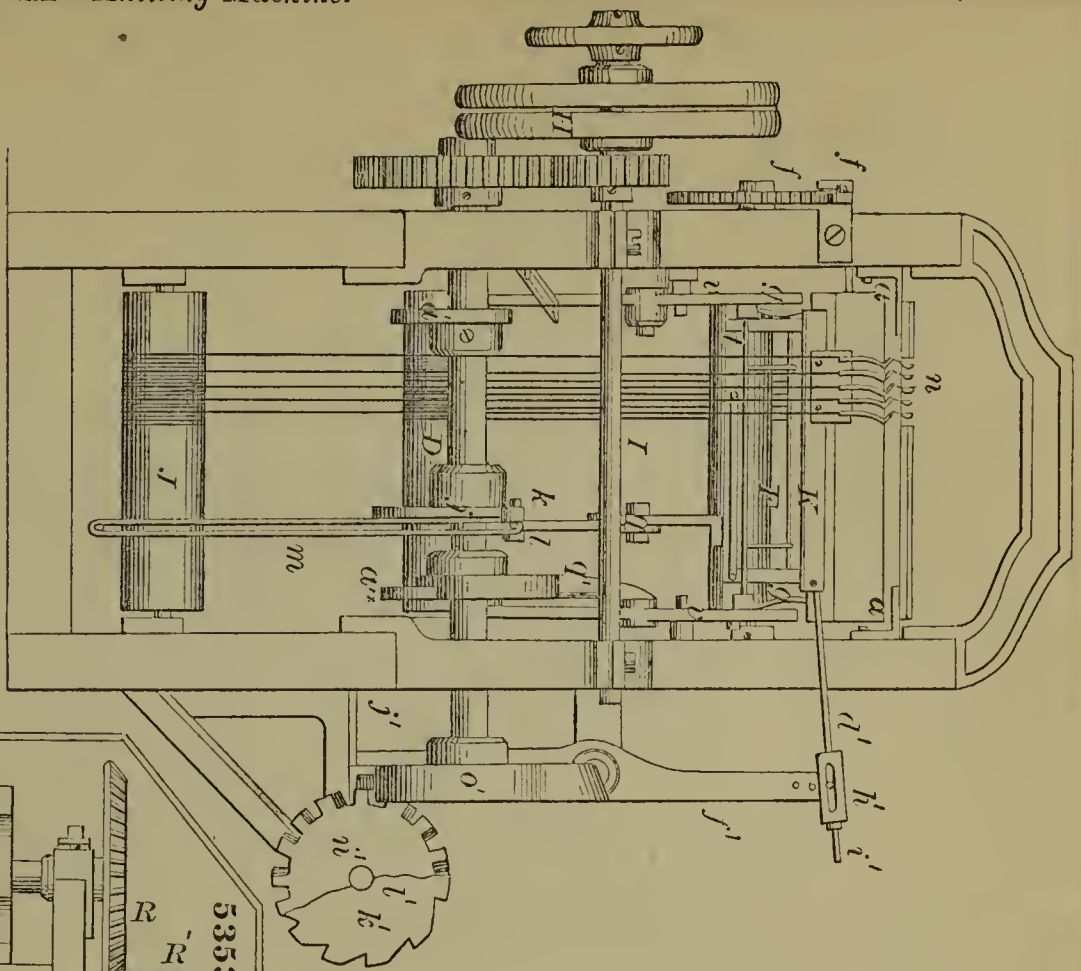

53532—A. M. Hansen—Pump Valve.

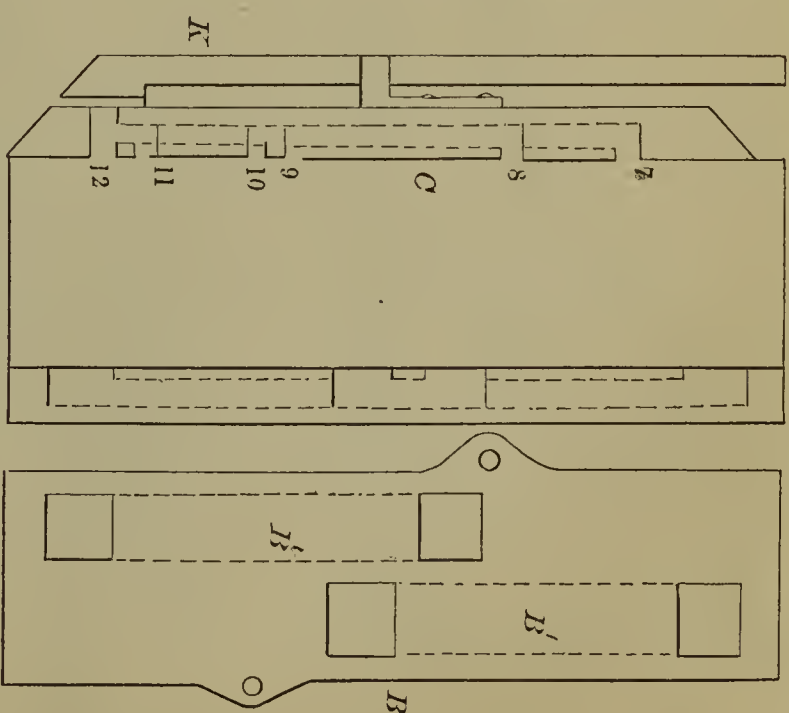
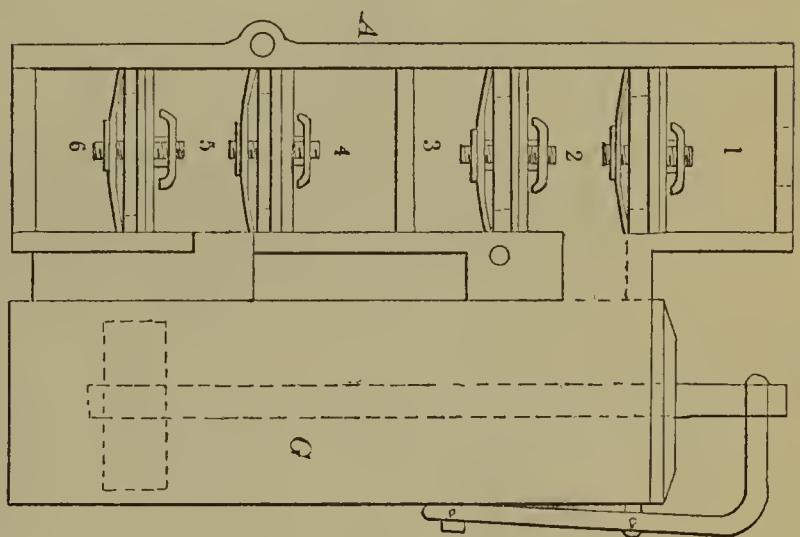

53531—Hall & Hubner—For Making Bolts.

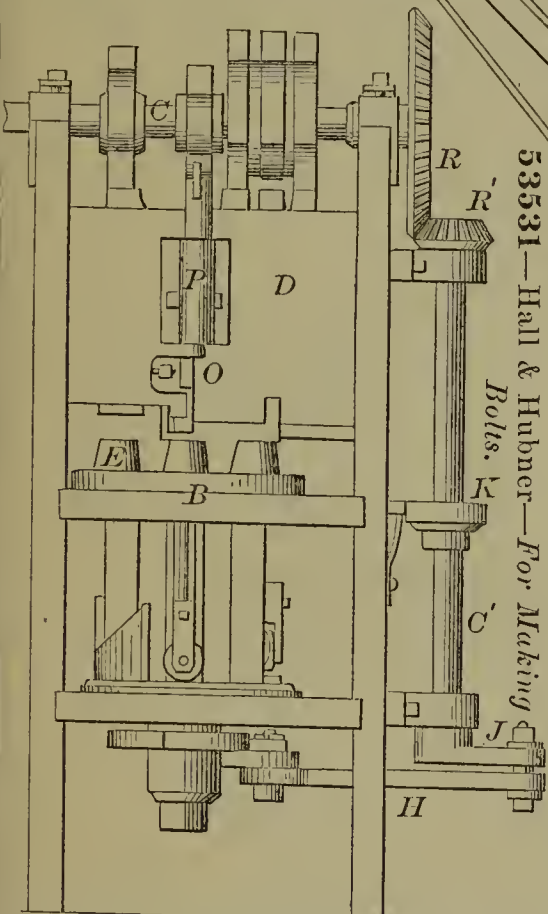

53533—W. S. Hill—Invalid Bedstead.

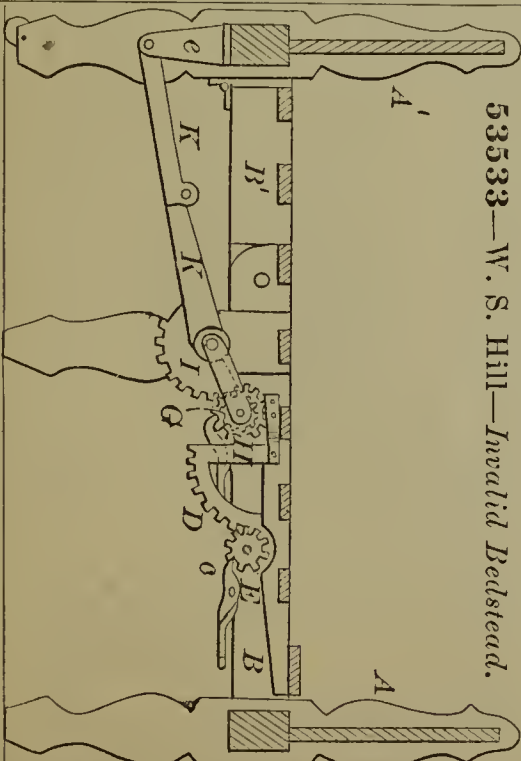

53536—T. J. Lovegrove—Drill Feed for Artesian Wells.

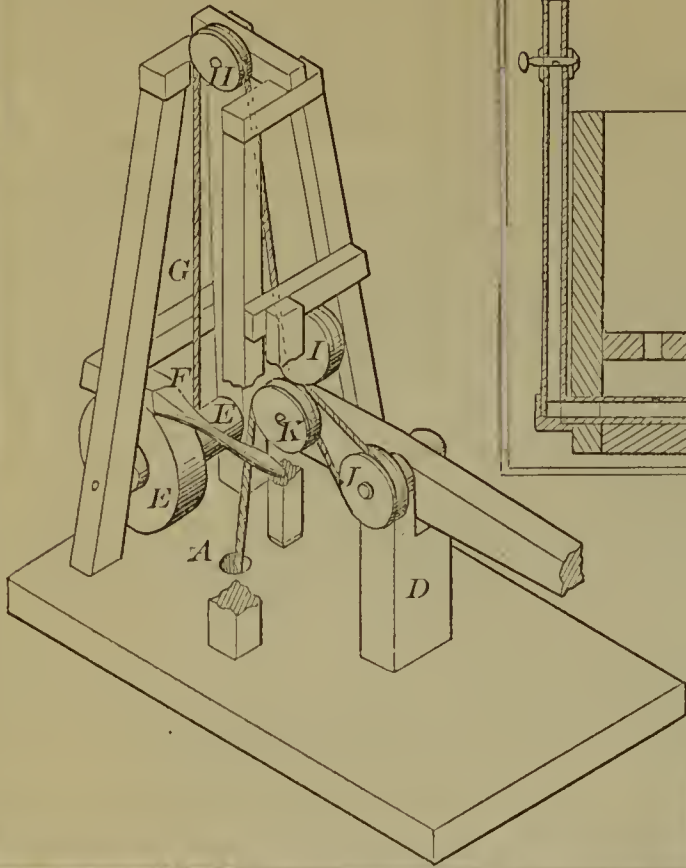

53534—G. A. Jasper—Cleansing Animal Chareoul.

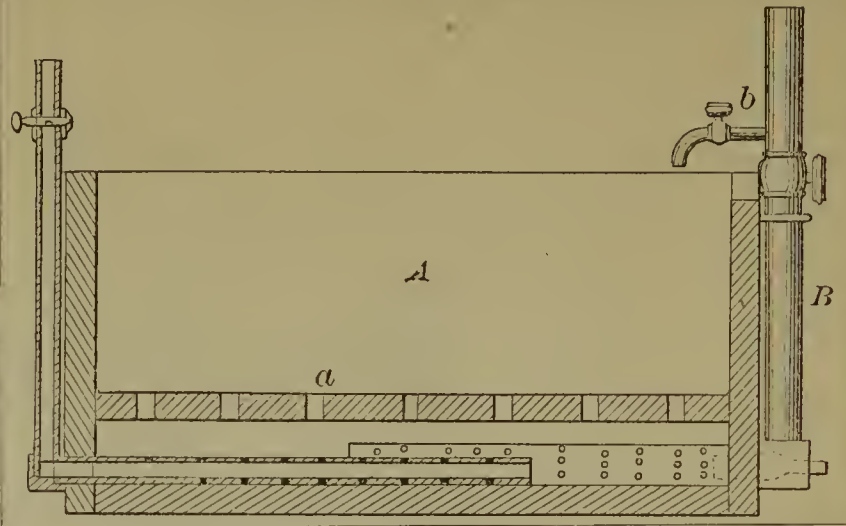

53538—S. Marden—For Preparing Peat For Fuel.

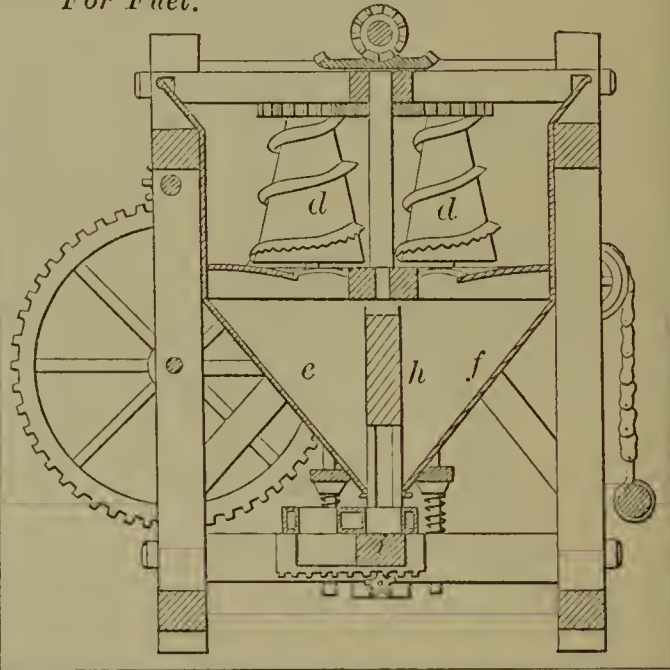

53535—R. D. Kincaid—Tuyere.

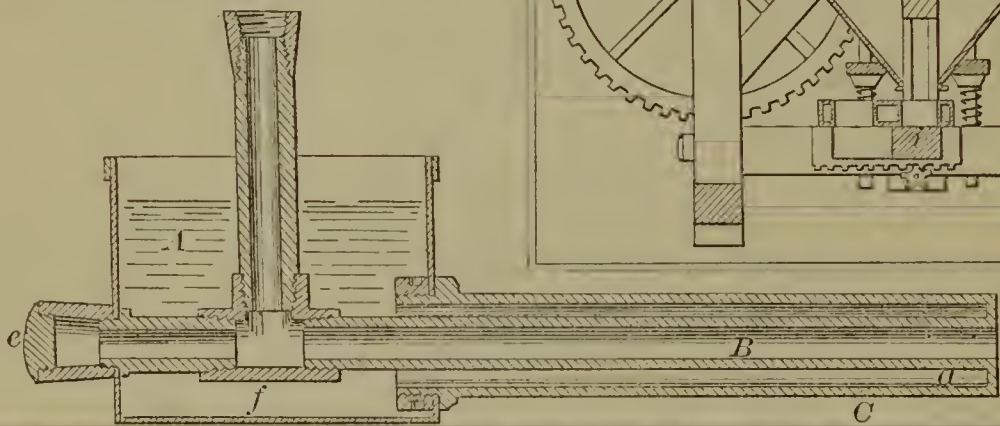

53537—J. Lyle—Spring Punch.

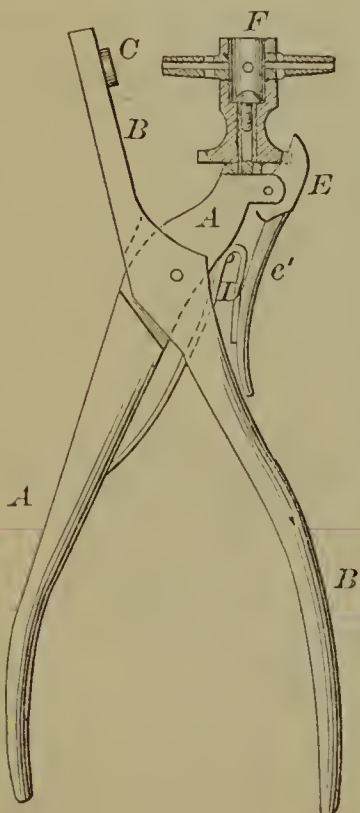

53539—W. Mason—Revolving Fire Arm.

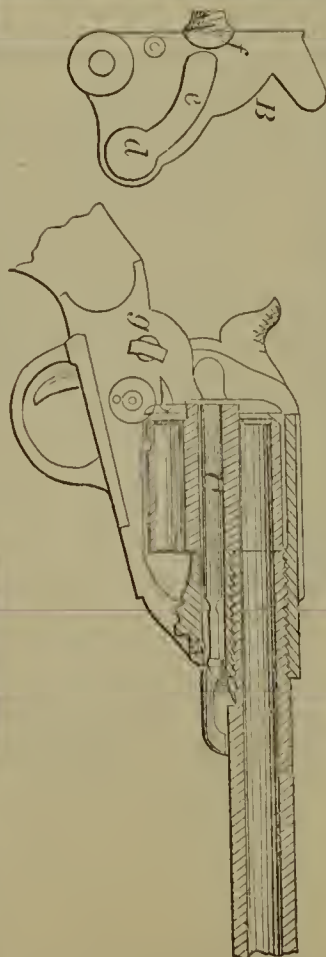

53540—F. J. Miller—Frame for Seuring Liquor Bottles.

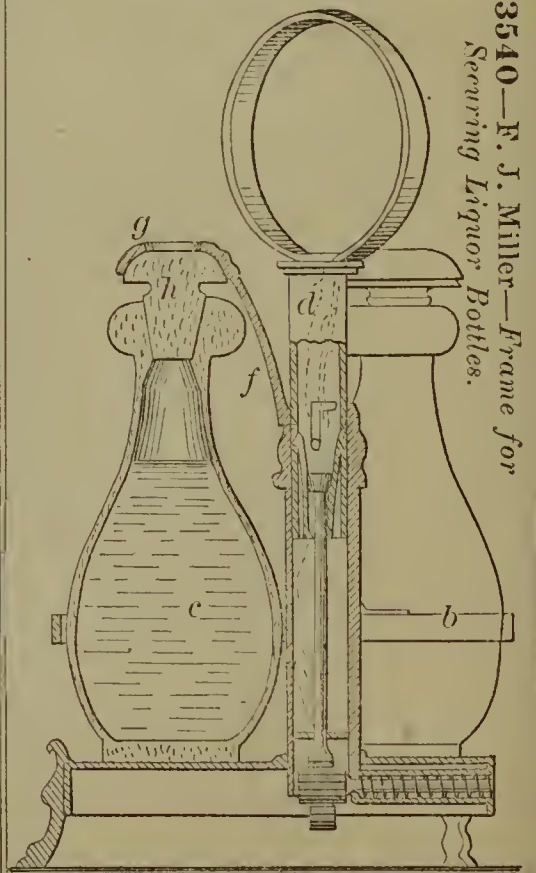



53541—S. Parker—*Clothes Dryer.*

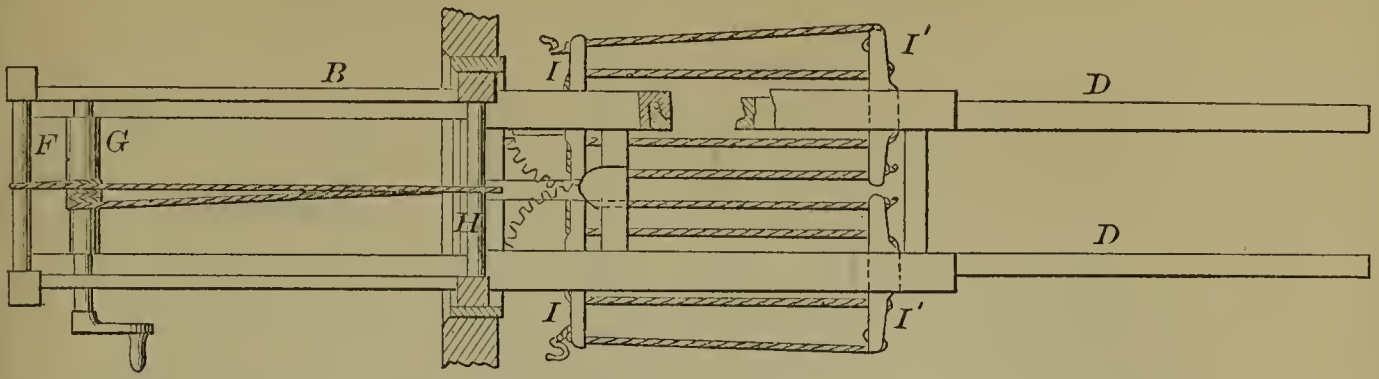

53544—D. T. Robinson—*Car Brake.*

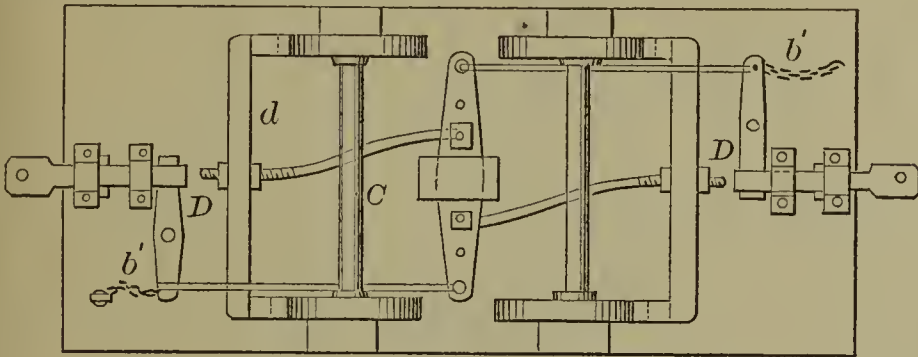

53542—E. T. Prindle—*Piston Rod Packing.*

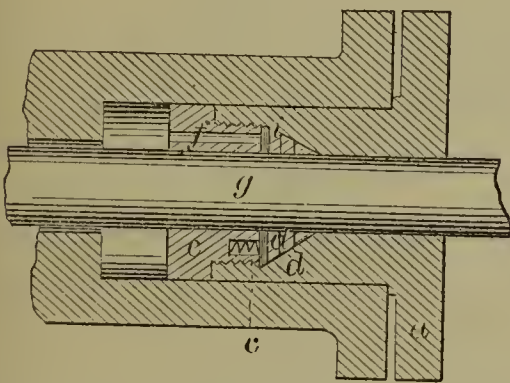

53547—H. Y. Hind—*For Preparing Peat.*

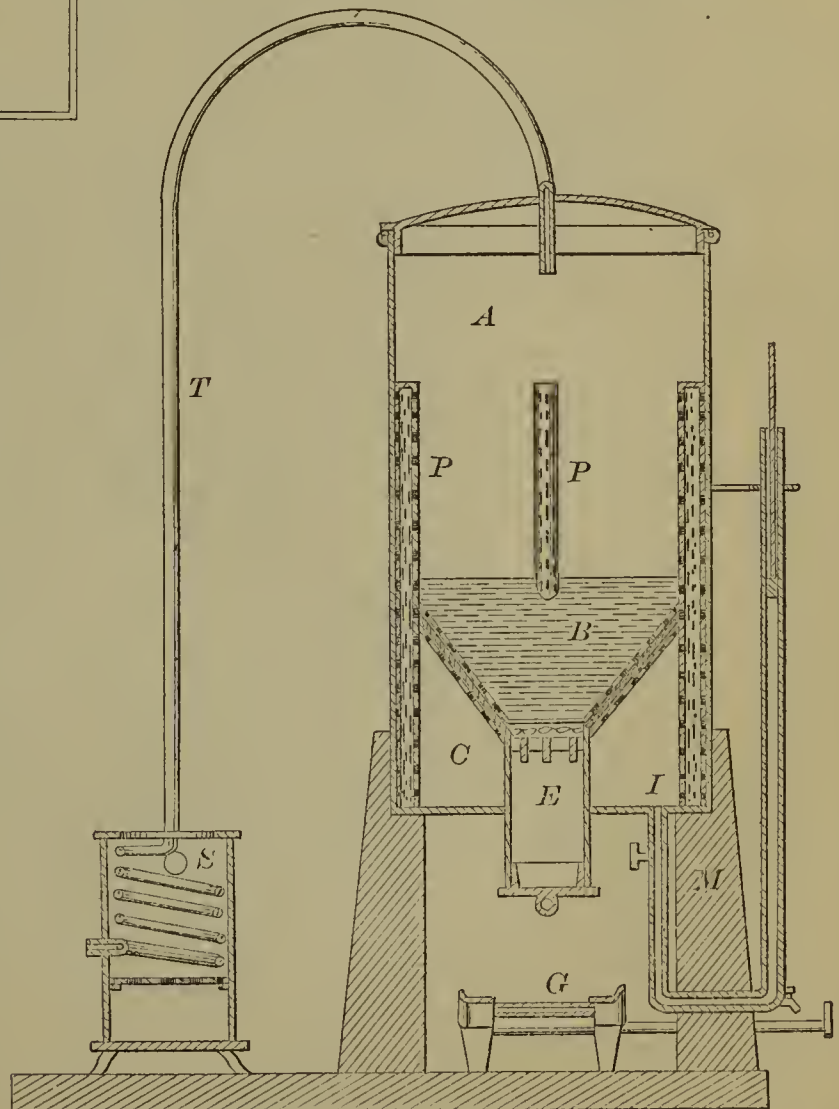

53543—J. Rider—*Breech-Loading Fire Arm.*

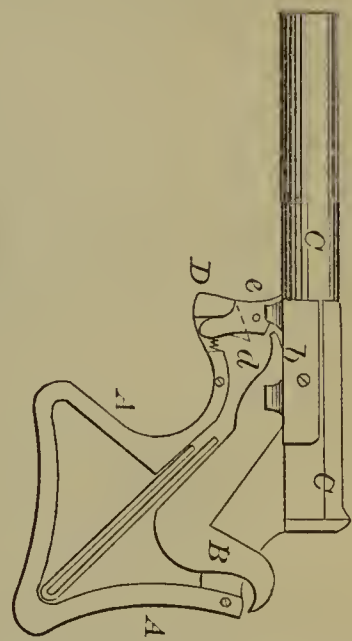

53546—L. S. White—*Metallic Handle for Cutlery.*



53545—J. H. Trowbridge—*Soldering Iron.*

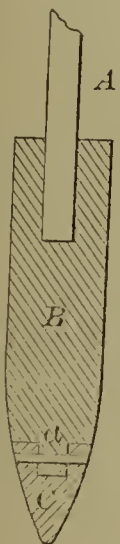

53548—P. Polain—*Revolving Fire Arm.*

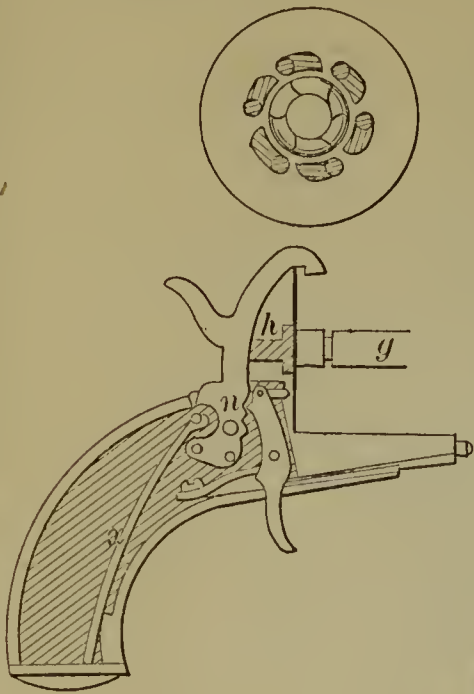

53552—S. F. Ambler—*Quartz Crusher.*

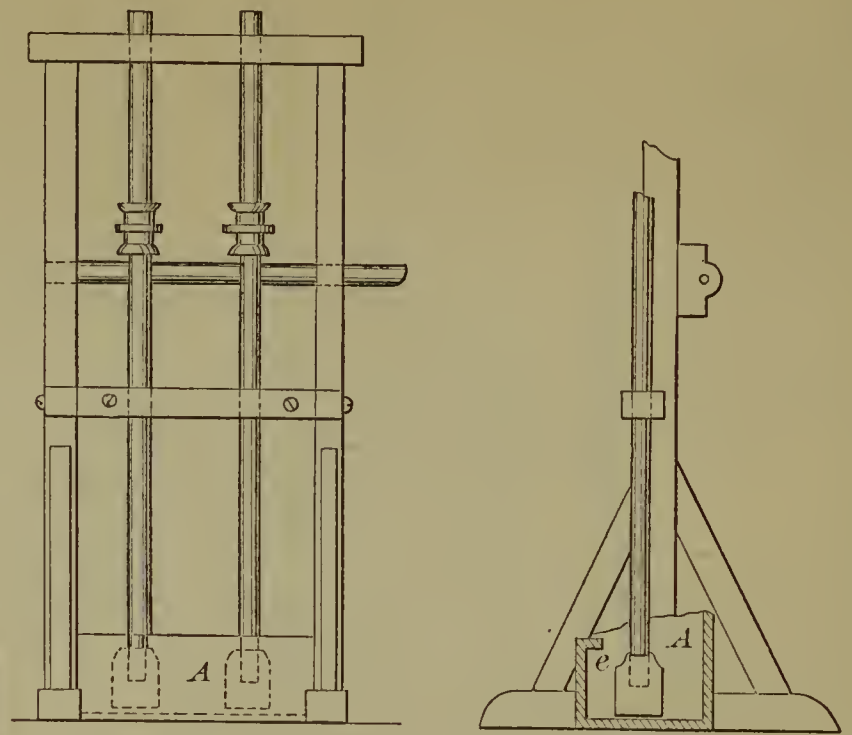

53550—Oliver & Myers—*For Disengaging Boats from Davits.*

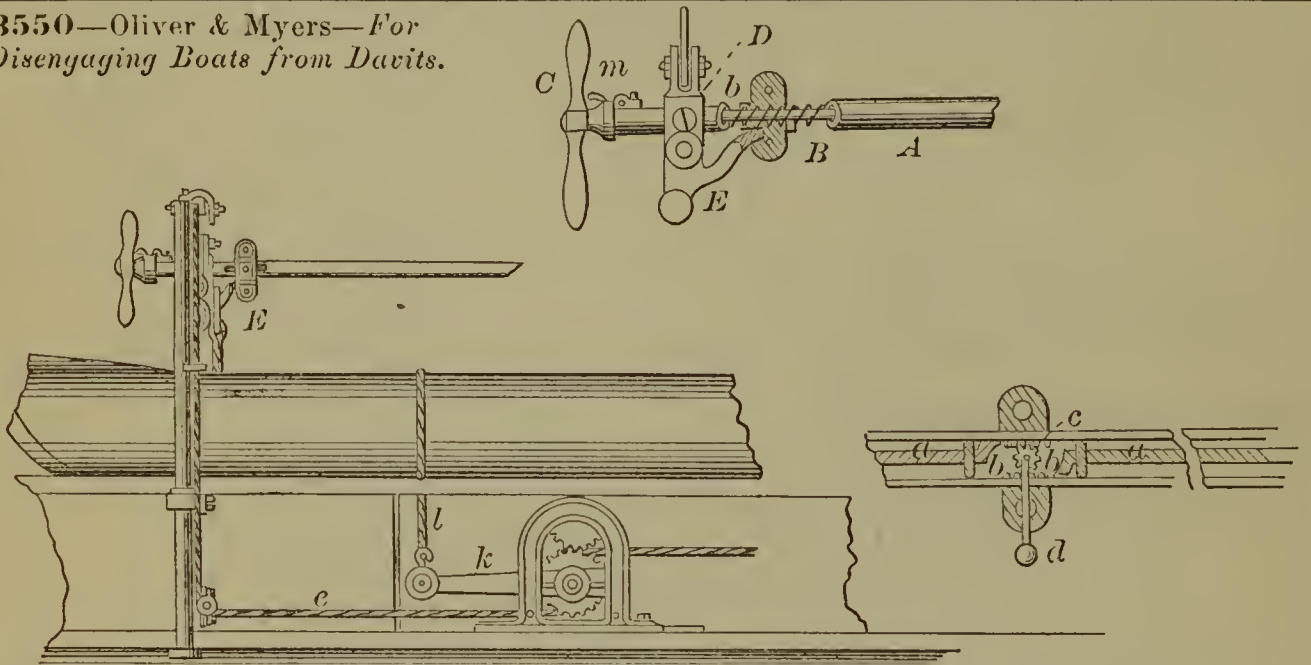

53553—D. D. Armes—*Weighing and Measuring Grain.*

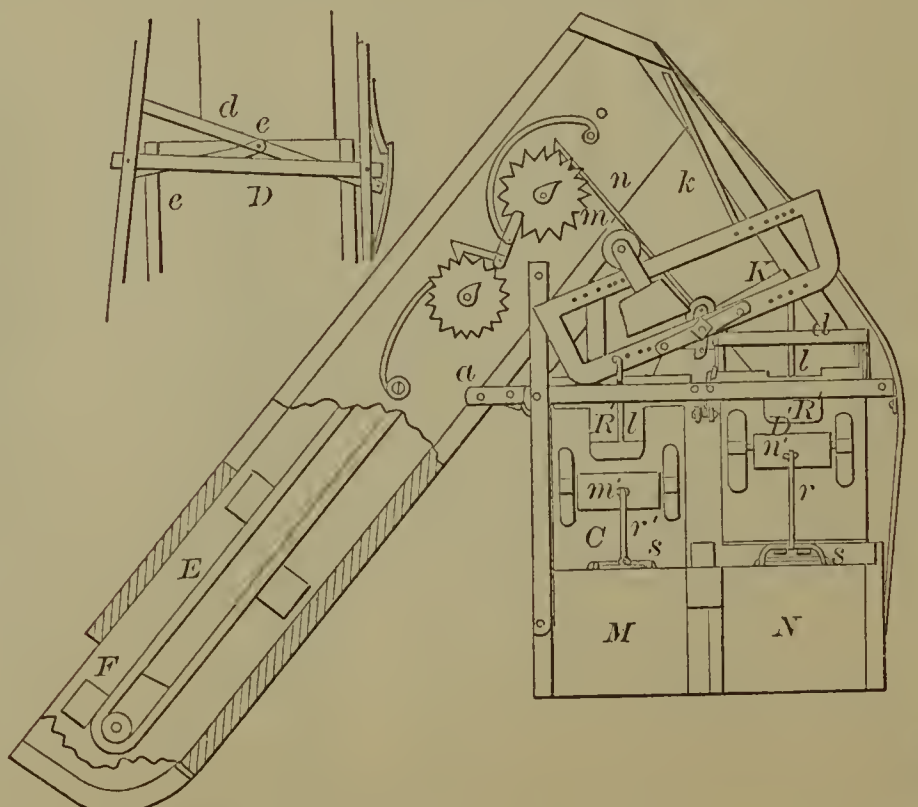

53551—J. Miller—*Dropper for Harvesters.*

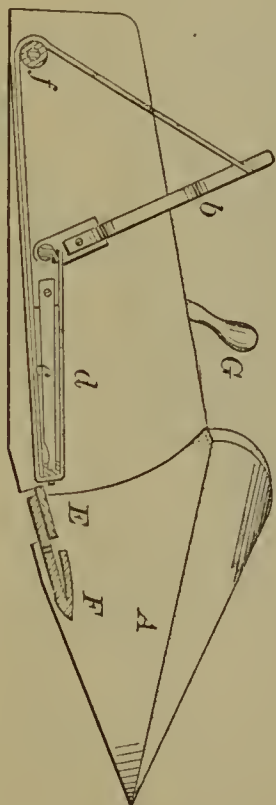

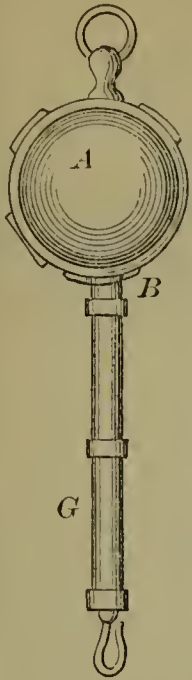

53554—E. F. Badgley—Safeguard for Watches.

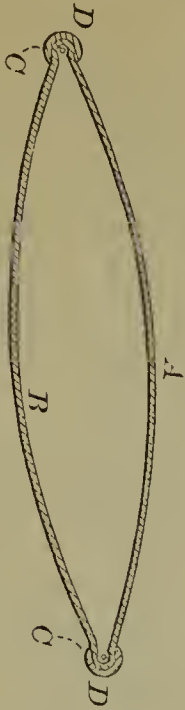

53556—M. L. Ballard—Carriage Springs, &c.

53555—P. Ball—Gauge Cock.

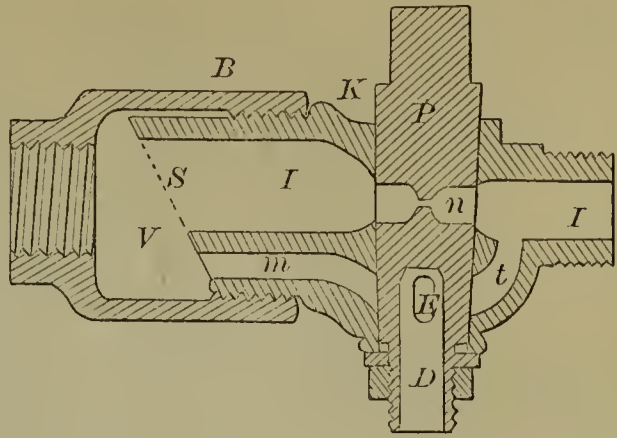

53558—S. C. Bedell—For Trimming Boot and Shoe Heels.

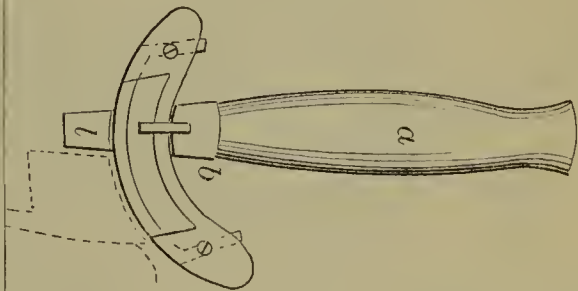

53557—L. F. Bancroft—Street Sprinkler

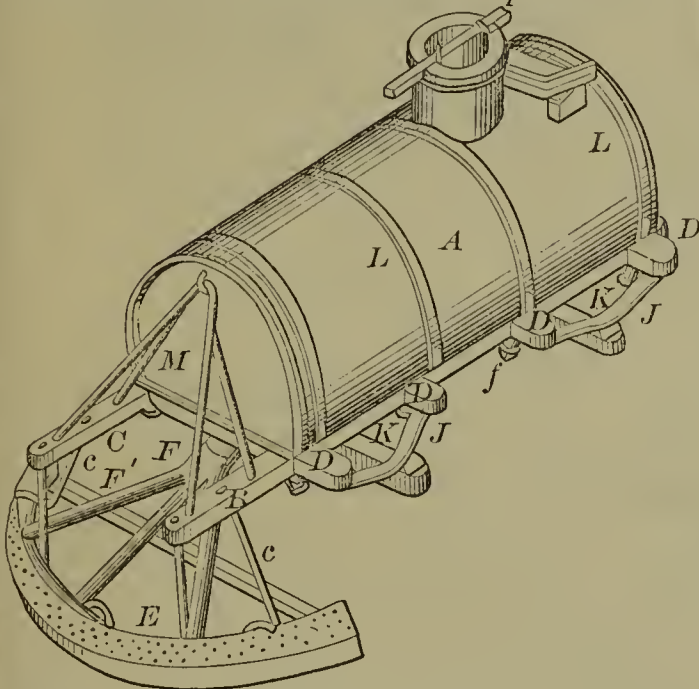

53560—J. W. Boughton—Car Coupling.

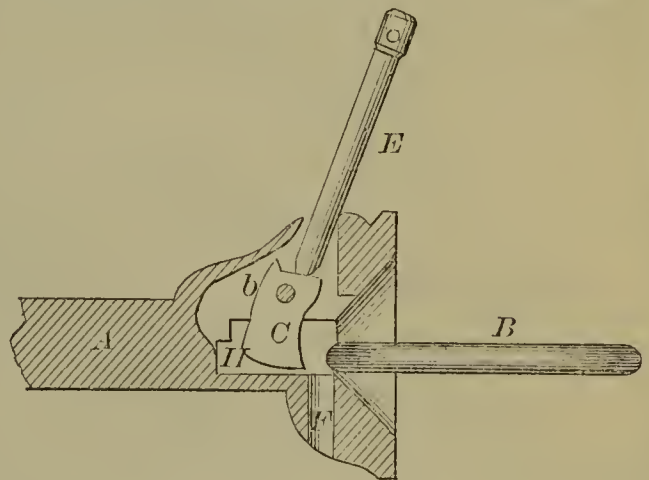

53561—M. Bradley—Social Game.

THE CHECKERED GAME OF LIFE.

WEALTH <b>10</b> WEALTH	MATRIMONY 	GAMBLING 	HAPPY OLD AGE <b>50</b> HAPPY OLD AGE
PERSEVERANCE 	TRUTH 	POLITICS 	INTEMPERANCE 
CRIME 	HAPPINESS 	IDLENESS 	SUCCESS <b>5</b>
CONGRESS <b>5</b> CONGRESS	HONOR <b>5</b> HONOR	GOVERNMENT 	RUIN 
HONESTY 	AMBITION 	SUICIDE 	FAT OFFICE <b>5</b> FAT OFFICE
POVERTY 	SCHOOL 	INFLUENCE 	FAME 
INFANCY 	DISGRACE 	JAIL 	PRISON Where You Lose One Move PRISON

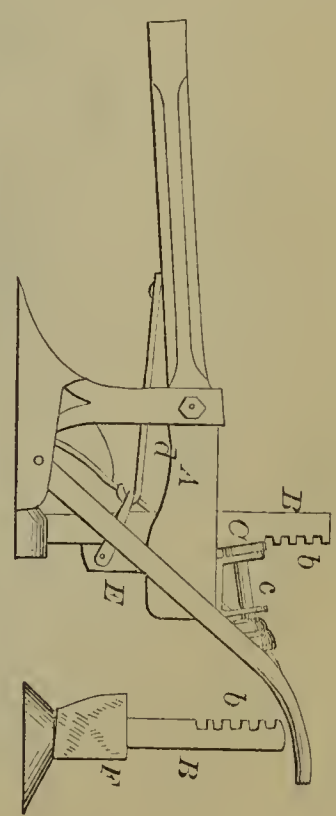

53559—A. T. Boon—Plow.

53562—W. H. Bramble—*Letter Box.*

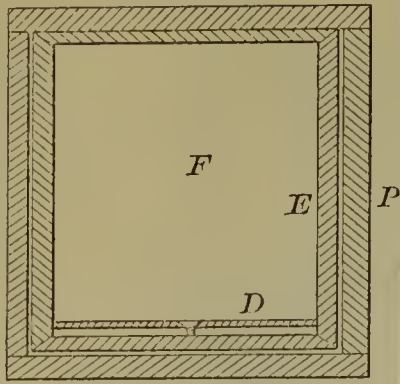

53568—C. T. Bush—*Carriage.*

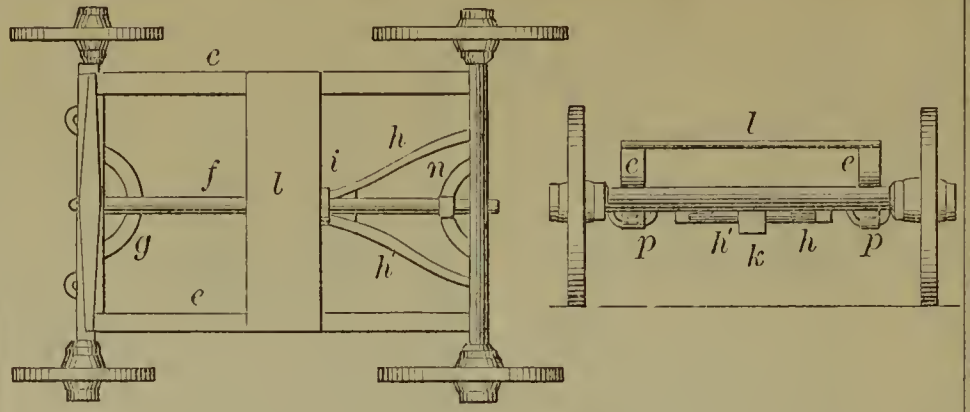

53564—L. C. Bristol—*Drill Cable Meter.*

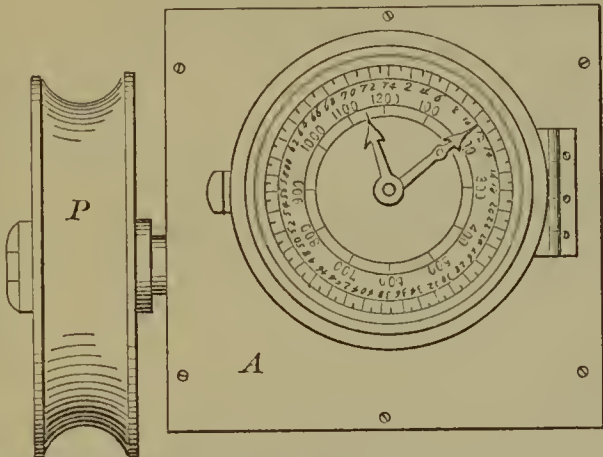

53567—W. R. Burns—*Corn Sheller.*

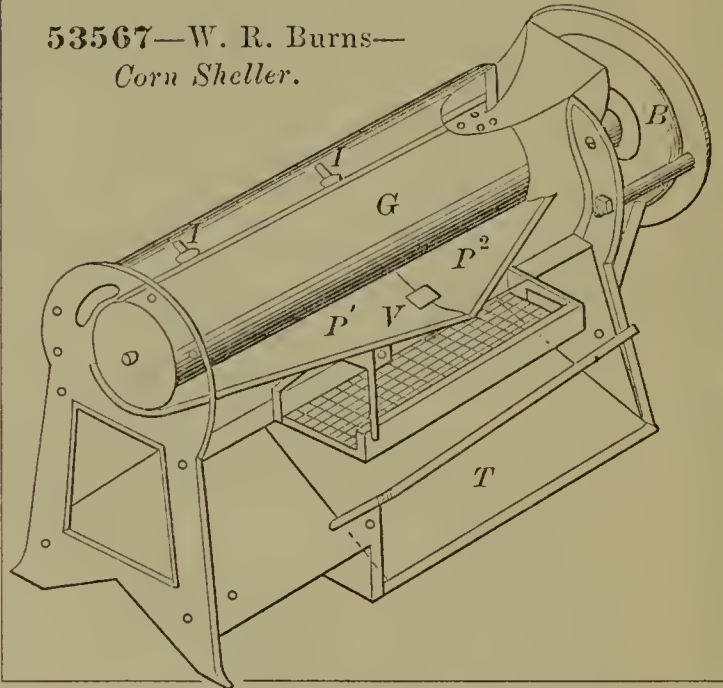

53570—H. T. Carter—*Valve Gear for Oscillating Engines.*

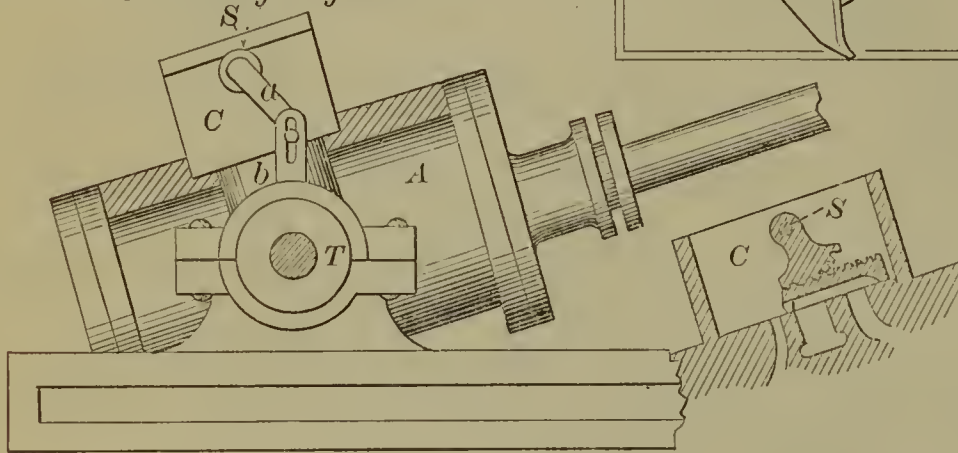

53566—C. W. Brown—*Step Ladder.*

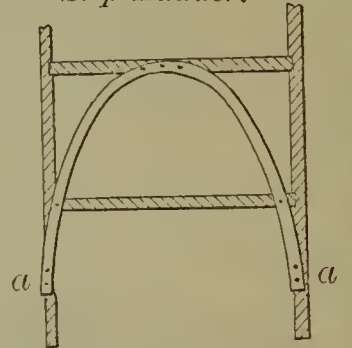

53571—E. D. Castelow—*Means of Attaching Legs to Music Stools.*

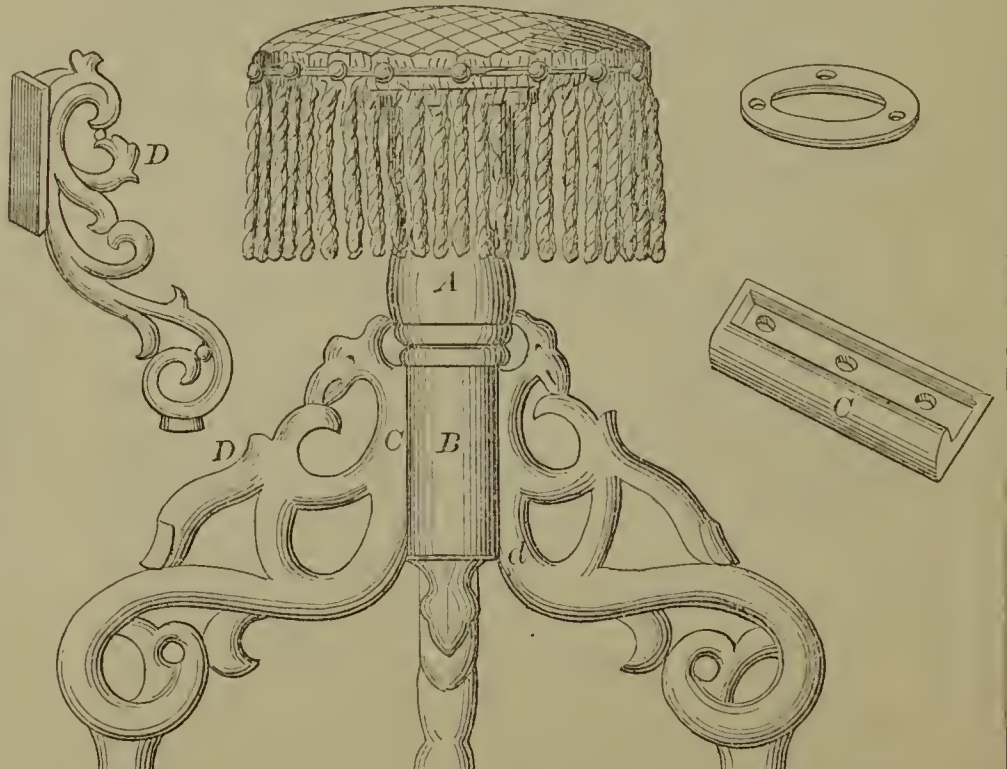

53565—P. K. Bronson—*Plowshare.*

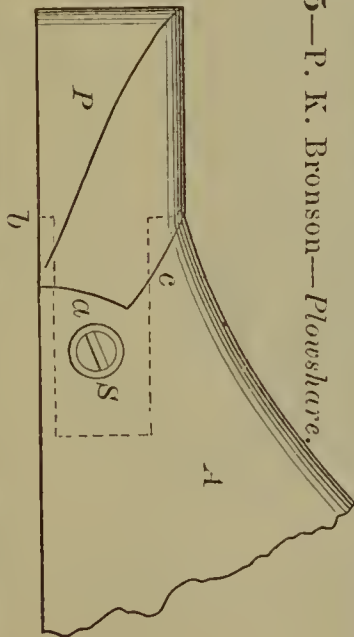

53572—W. K. Chase—Spring Power for Propelling Carriages.

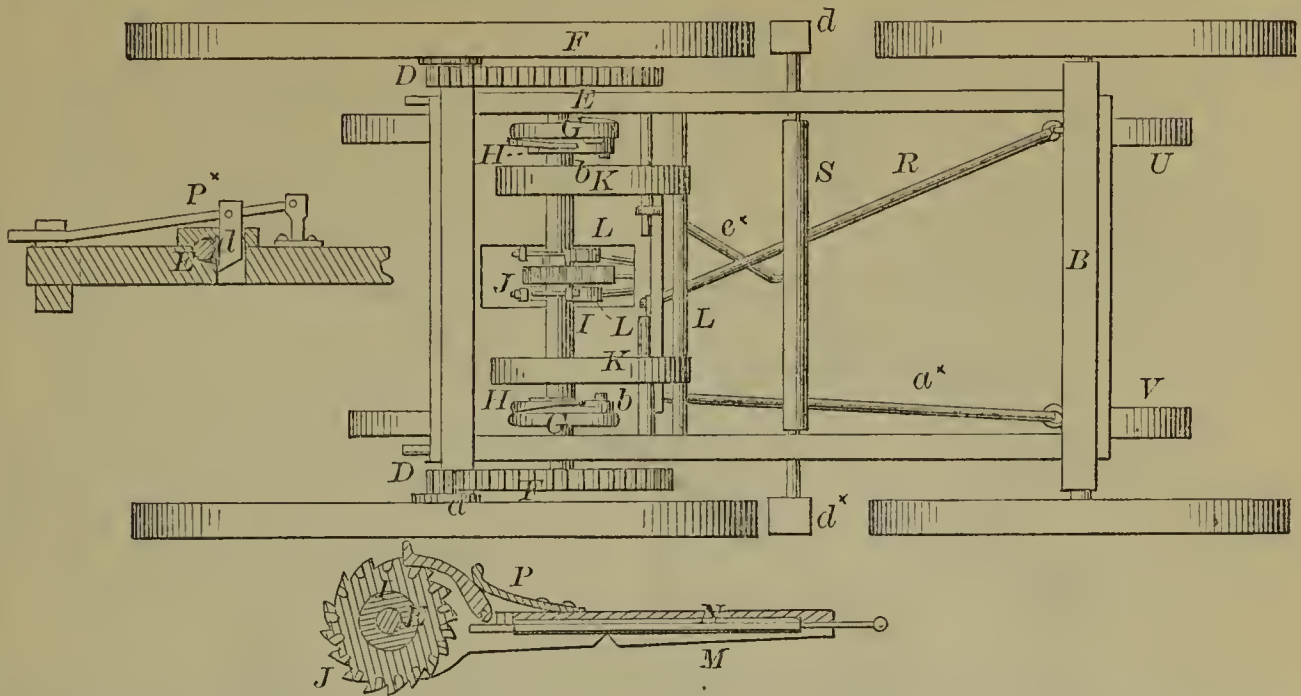

53577—L. H. Colburn—Rotary Plow.

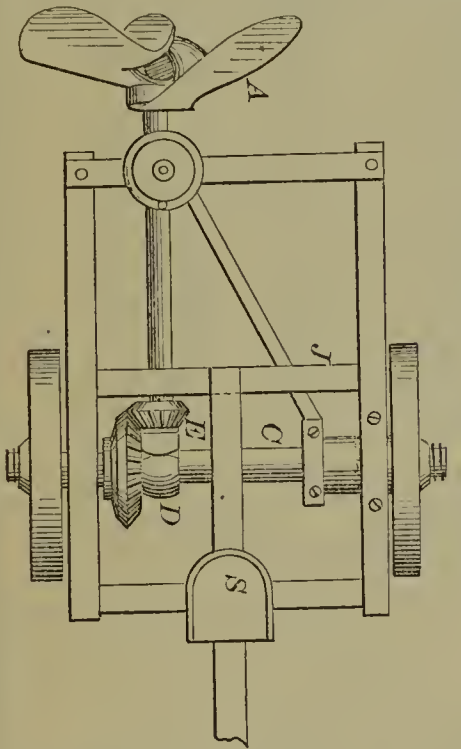

53575—G. Clarke—Grain Dryer.

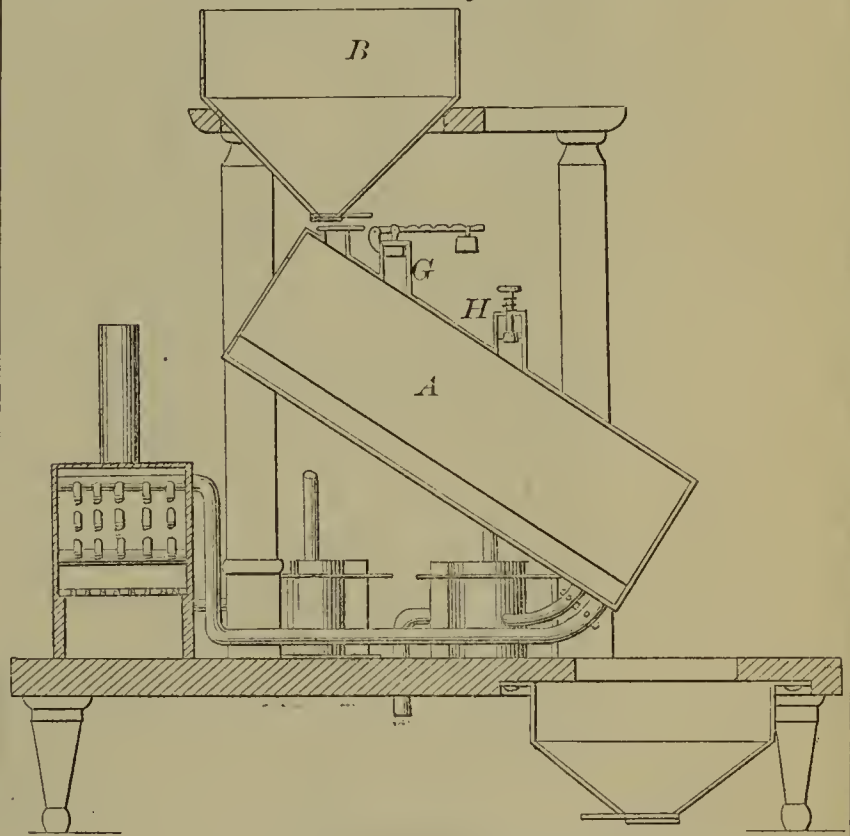

53574—T. J. Christy—Car Coupling.

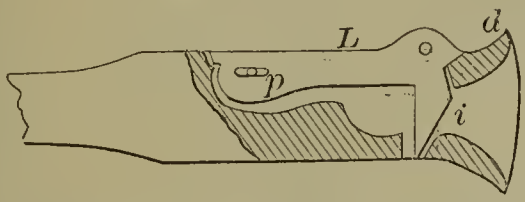

53578—E. A. Cooper—Gig Tree

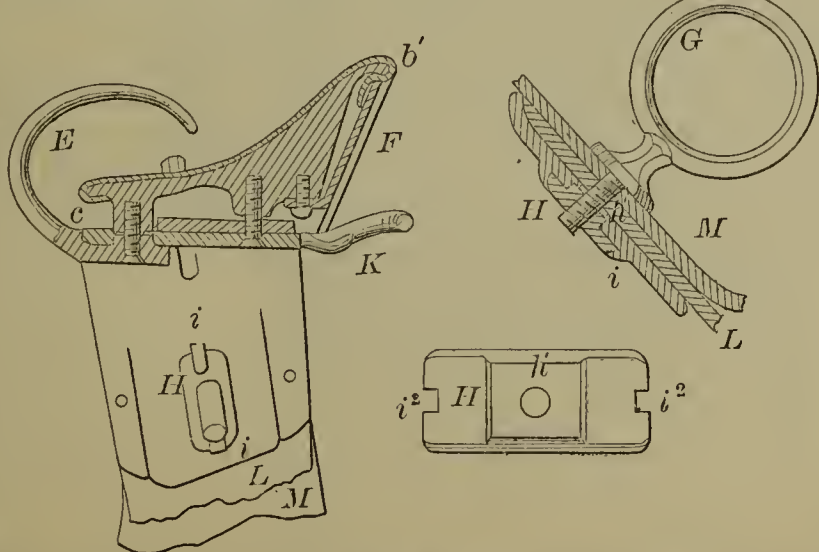

53573—G. W. Chipman—Stair Carpet Pad.



53576—J. O. Clay—Broom Head.

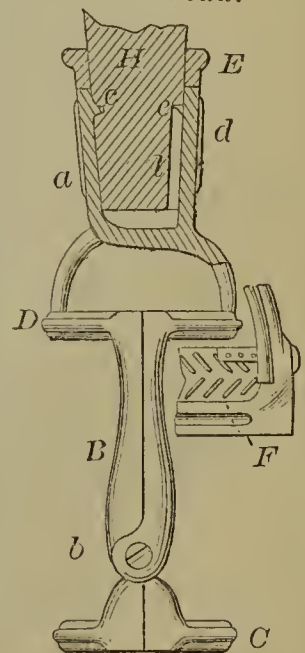

53579—D. V. Crandall—*Bed Spring.*

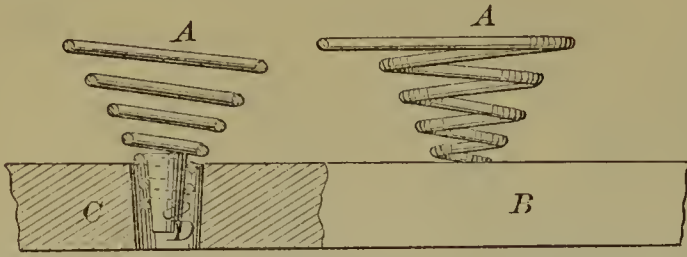

53581—H. G. Dayton—*Distilling Spirits.*

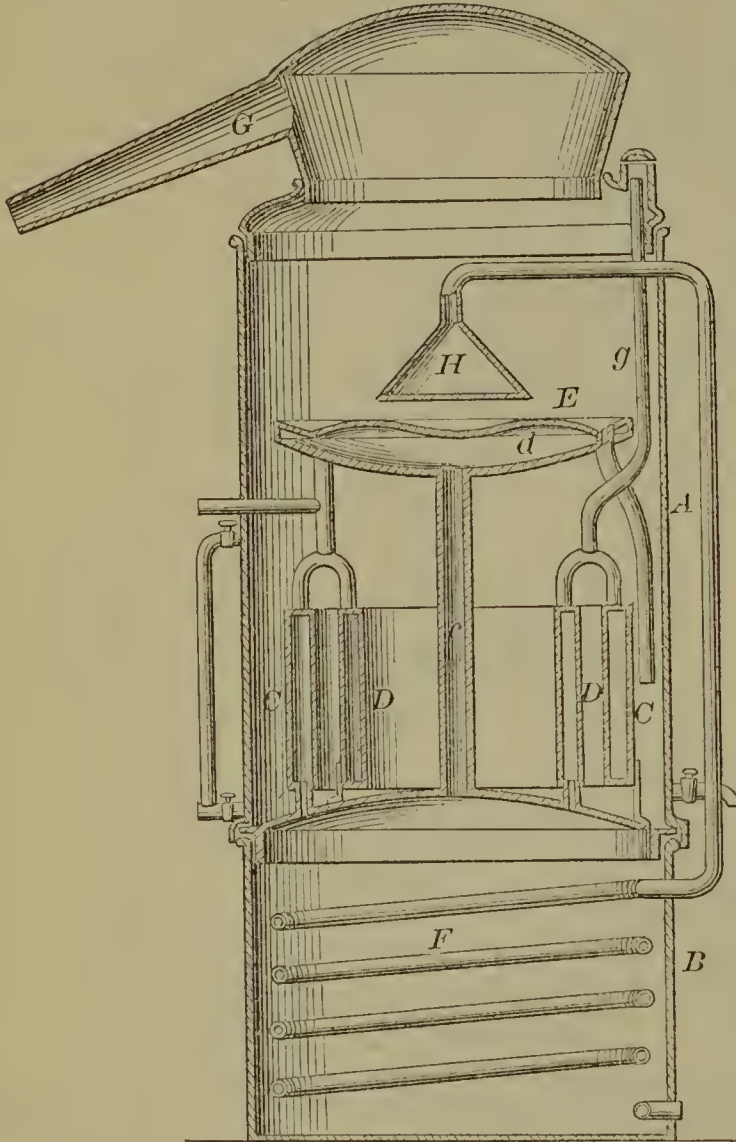

53580—D. Cumming, Jr.—*Mangle and Wringer.*

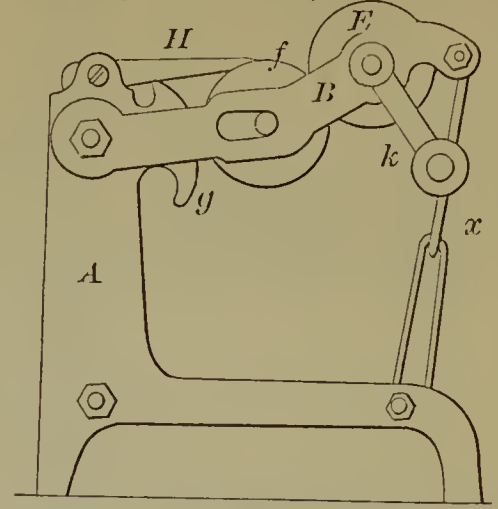

53584—Dewey & Tillotson—*Reservoir for Wells.*

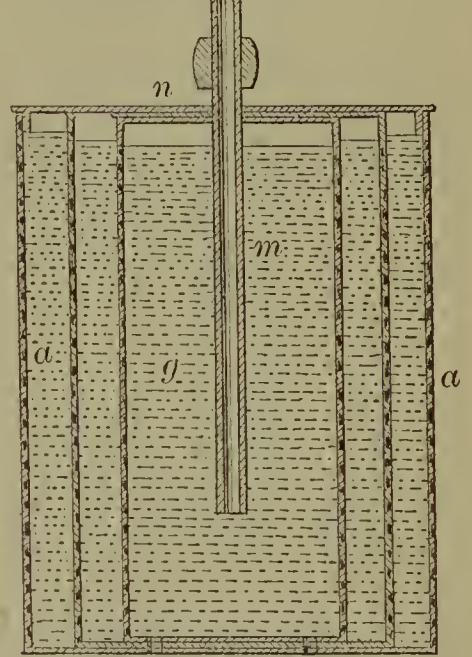

53587—J. Donlevy—*Typographic Printing.*

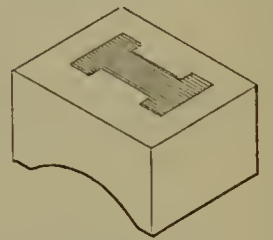

53582—*J. G. De Coursey—  
Bullet for Small Arms.*



53586—J. C. Dickey—*Rock Drill.*

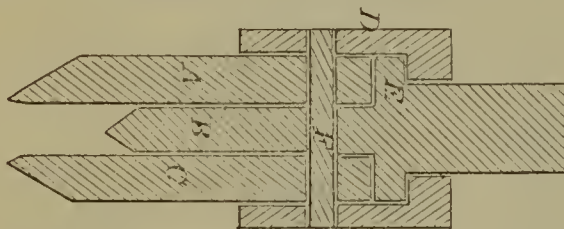

53585—H. L. De Zeng—*Door Latch.*

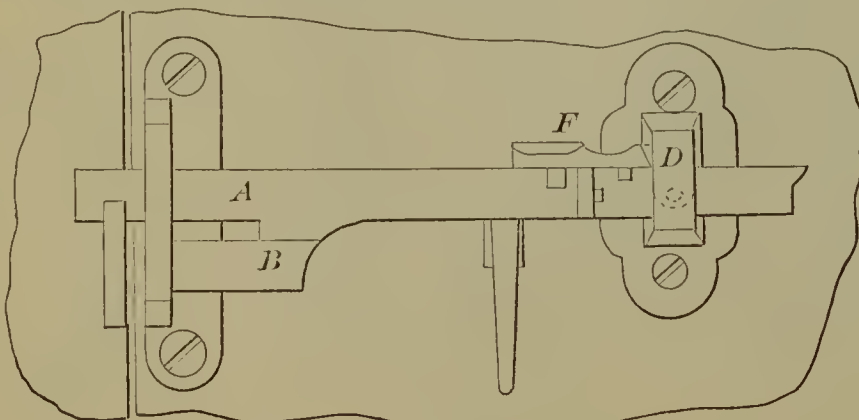

53588—D. H. Dotterer—*Axle Box.*

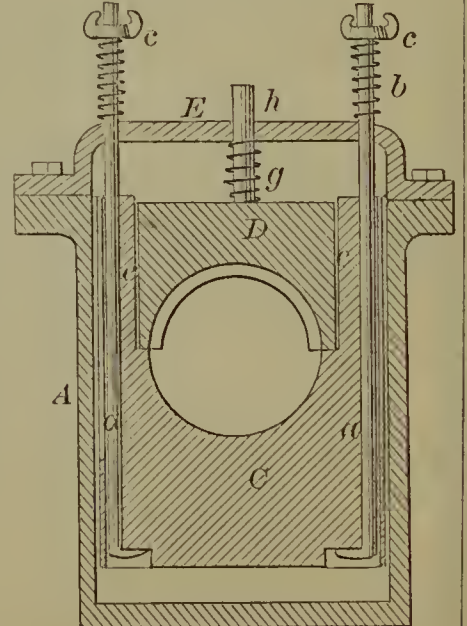

53589—J. B. Dow—Pen for Weaning Calves.

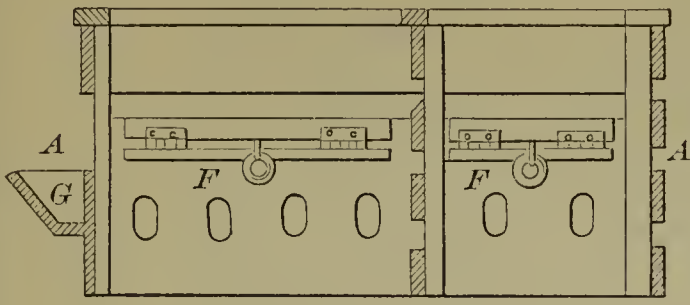

53590—F. N. Du Bois—Process for Amalgamating Gold, &c.

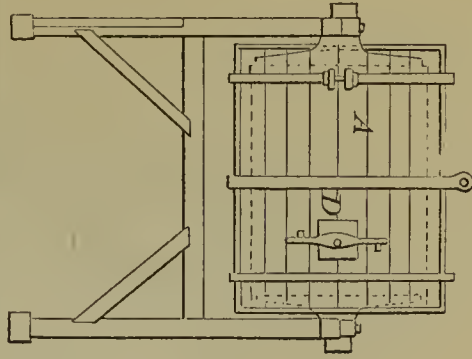

53592—S. Dwight—Cultivator.

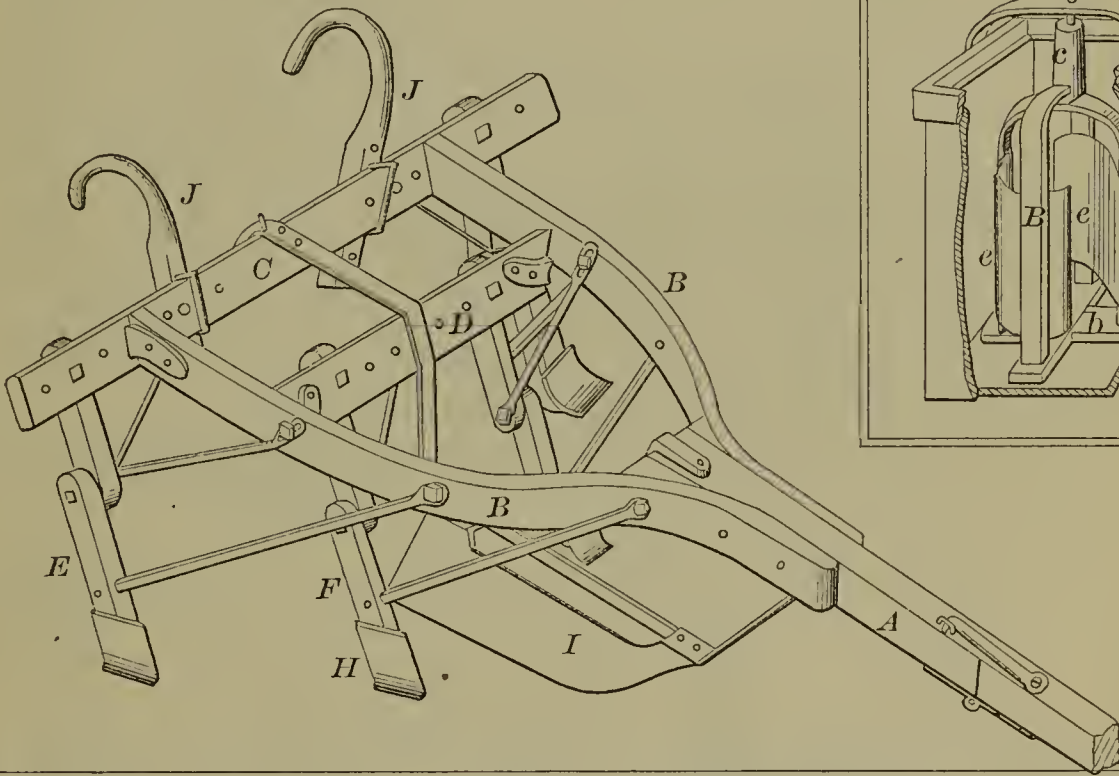

53591—D. Dunton—Churn.

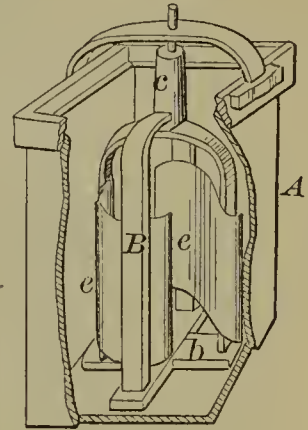

53594—A. F. Erich—For Draining Cellars.

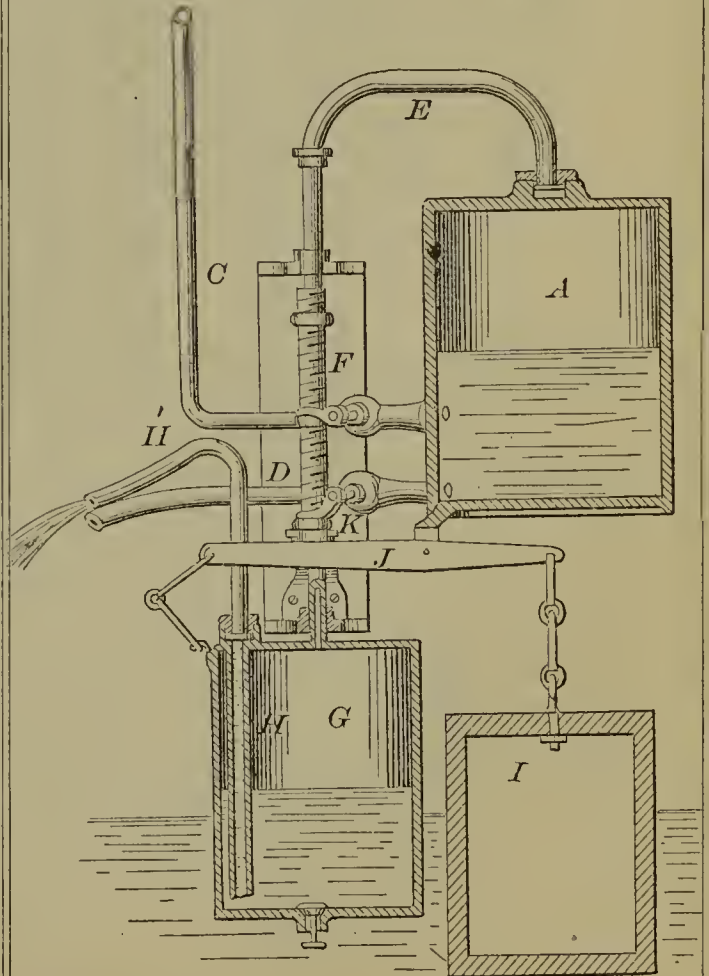

53593—Emery & Prince—Railway Switch.

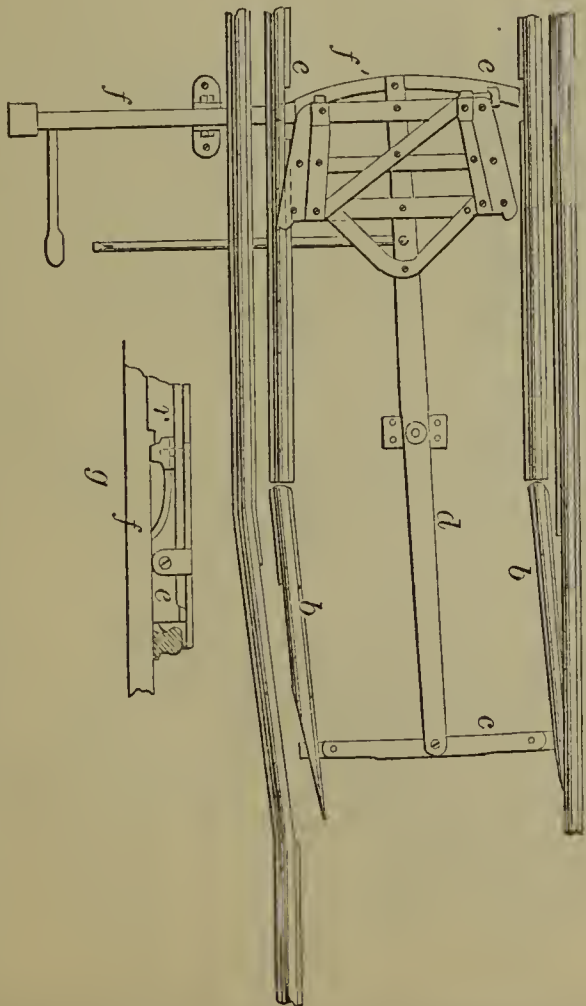

53596—I. Ferris—Steam Engine

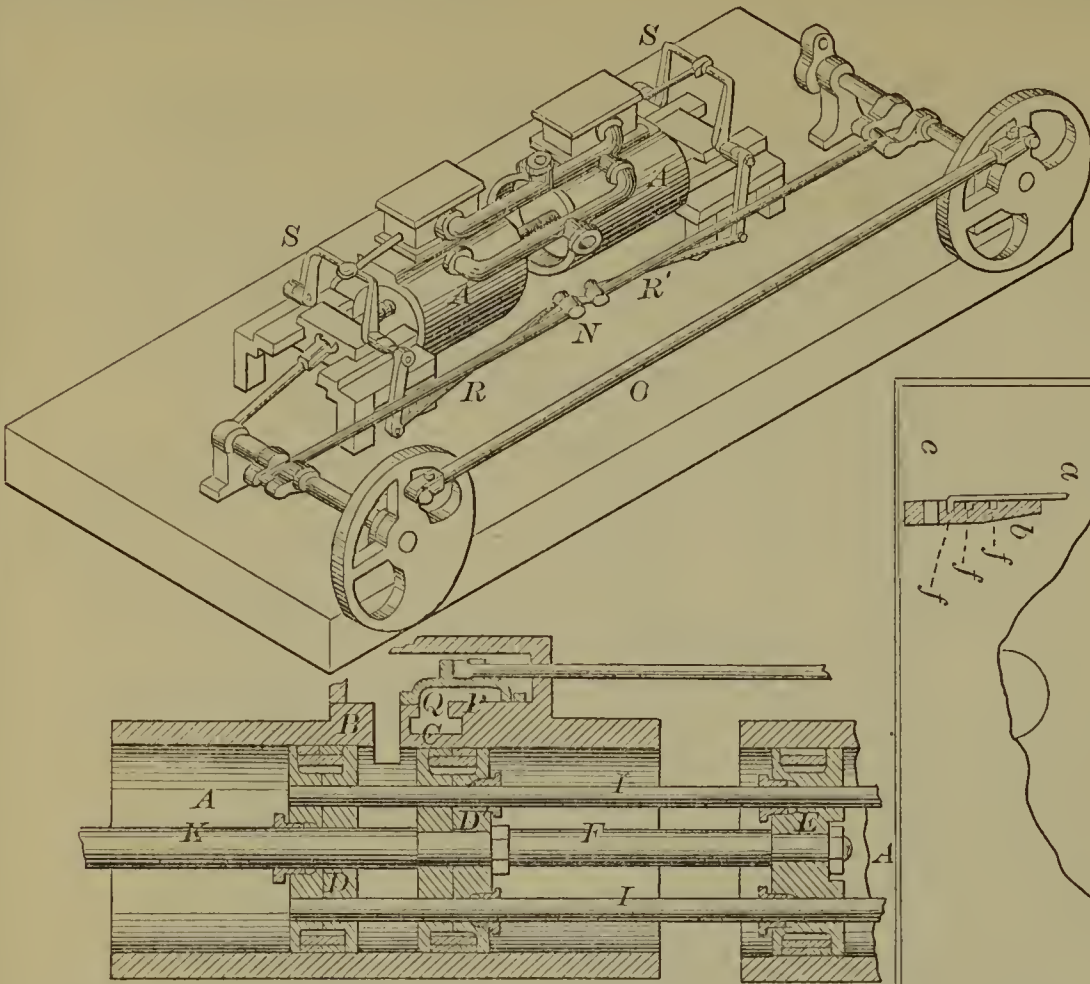

53598—C. T. Frost—Grinding Cylinder of Paper Engines.

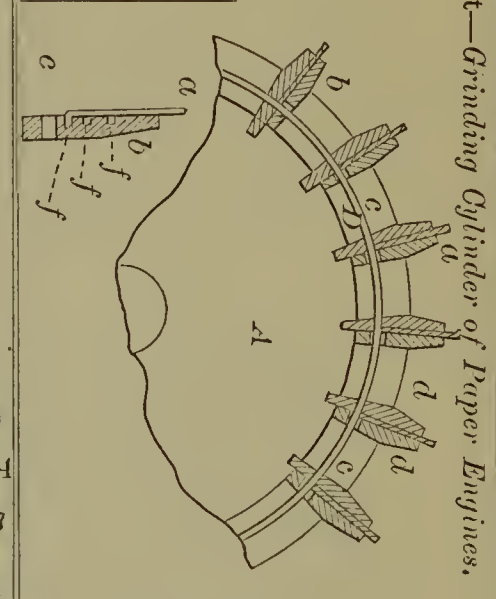

53597—J. T. Forrer—Mash Machine.

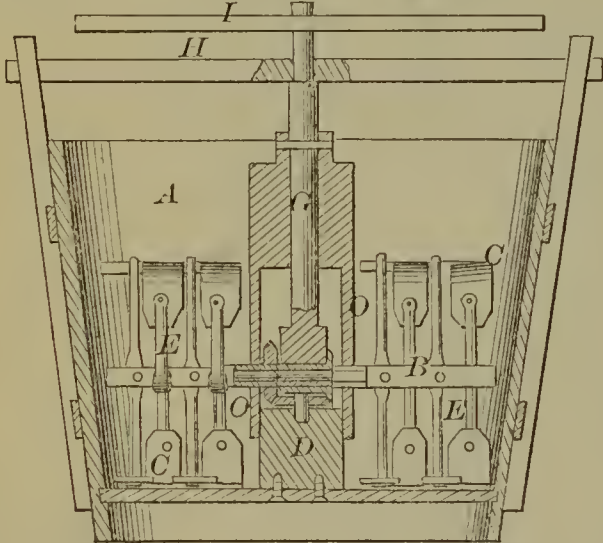

53599—G. P. Ganster—Rock Drill.

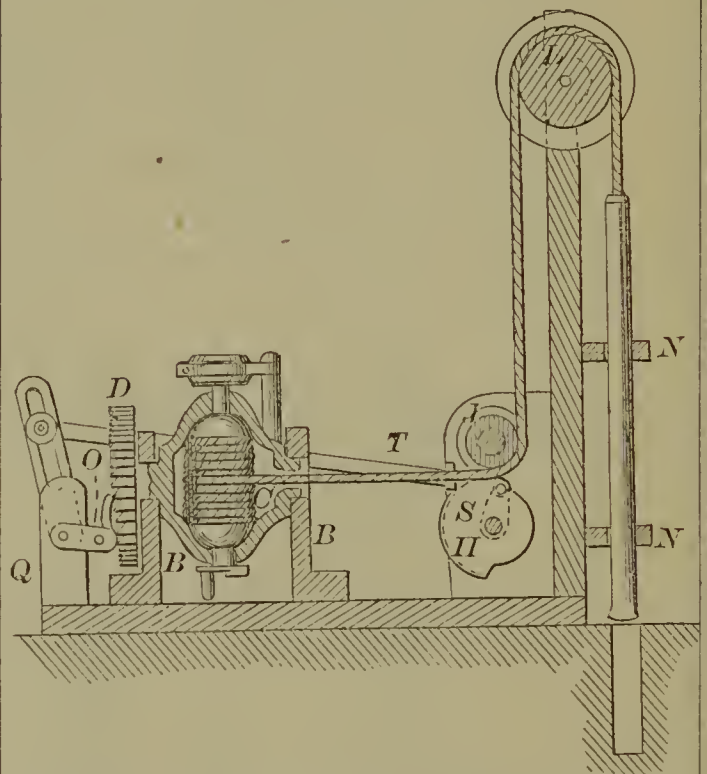

53600—George & Hague—Brick Machine.

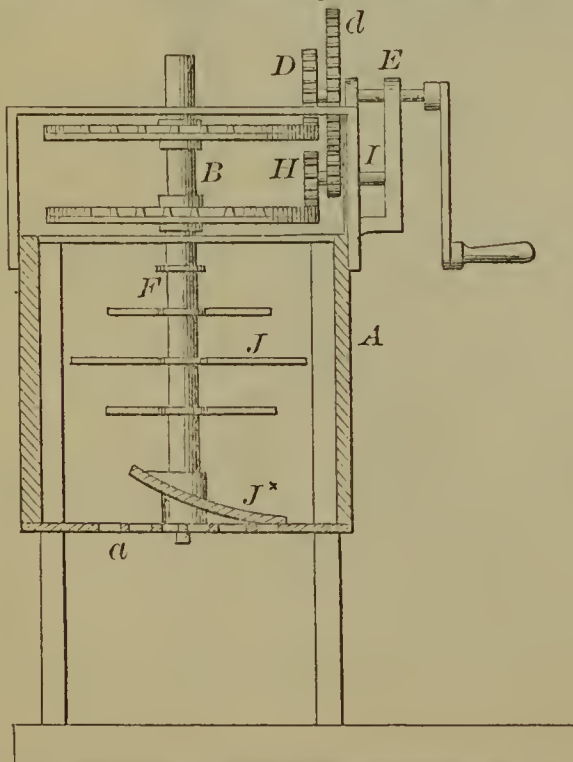

53601—C. H. Gilman—Shutter and Blind Fastening.

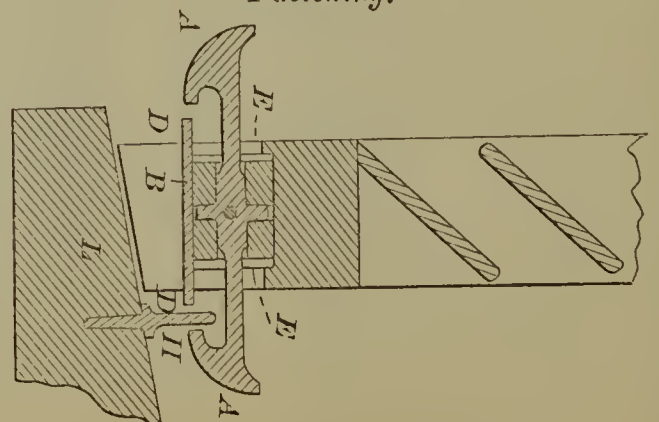



53602—L. M. Gilmore—Rock Drill.

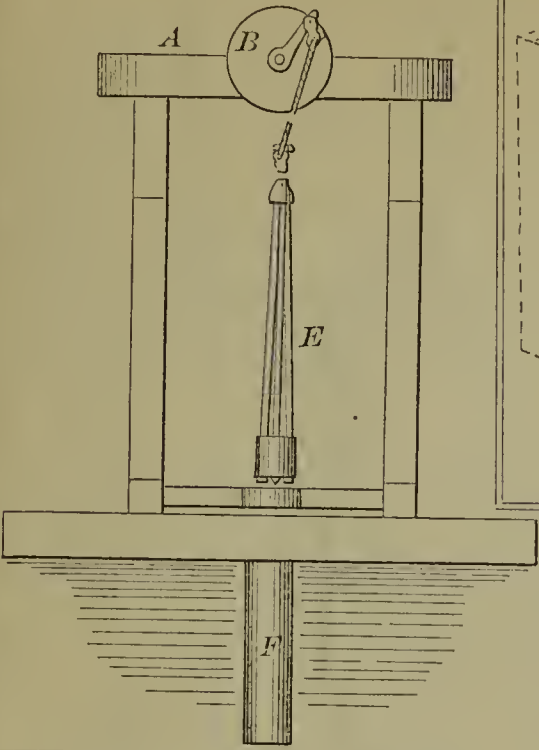

53607—P. E. & J. P. Gruger—Railroad Station Indicator.

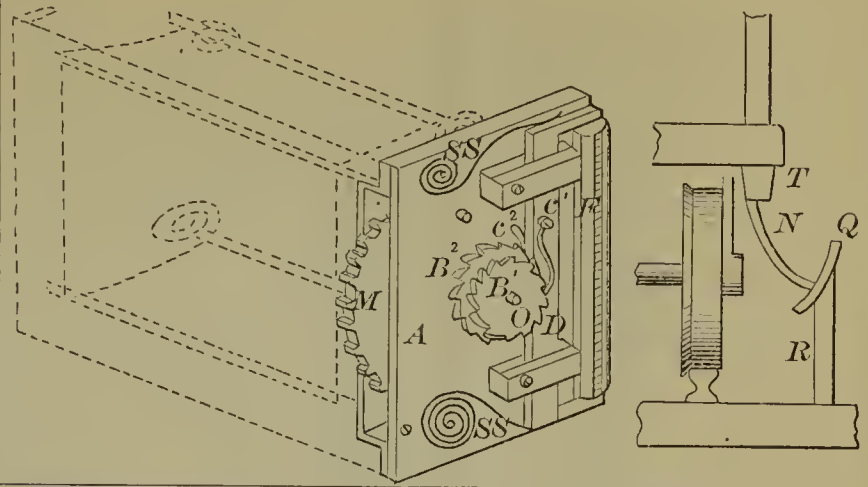

53604—J. T. Greenwood, Sr.—Washing Machine.

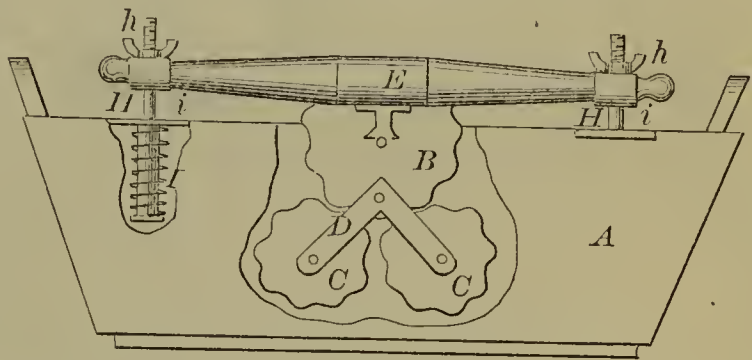

53603—S. Godfrey—Grinding Mill.

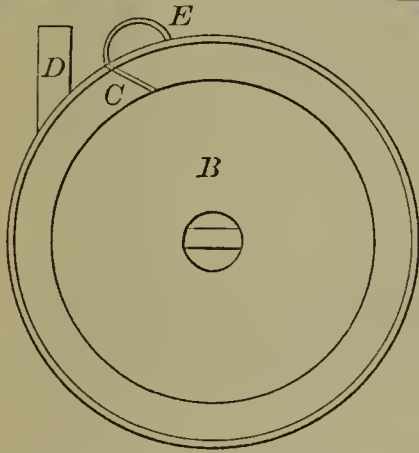
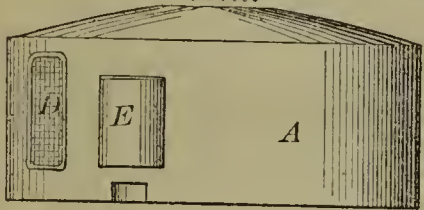

53606—J. P. Gruber—Filtering Apparatus.

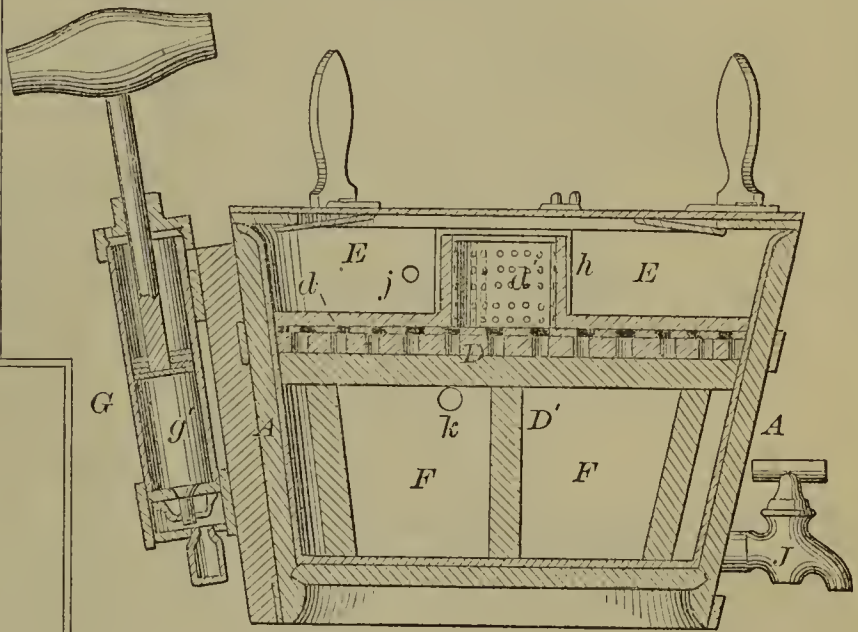

53605—D. L. Grover—Stove Pipe Damper.

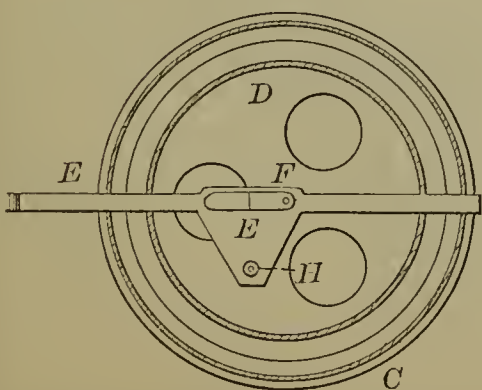
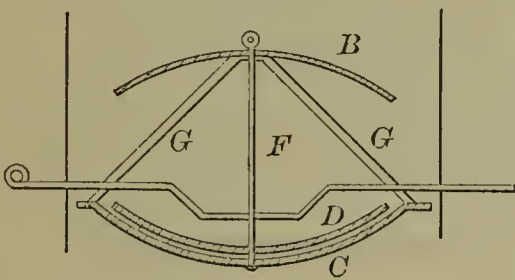

53609—F. Hainsworth—Rotary Blower.

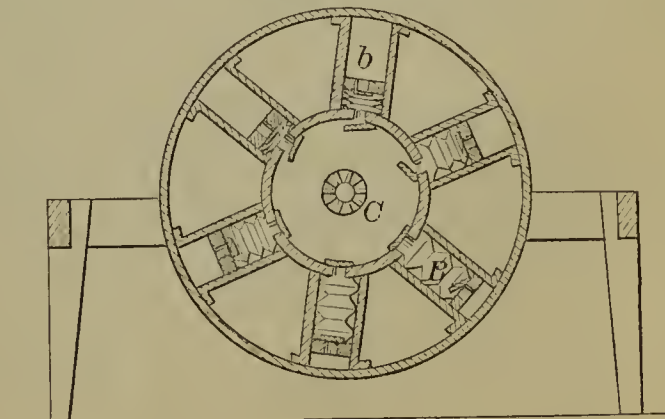

53611—J. Hayden—Hominy Mill.

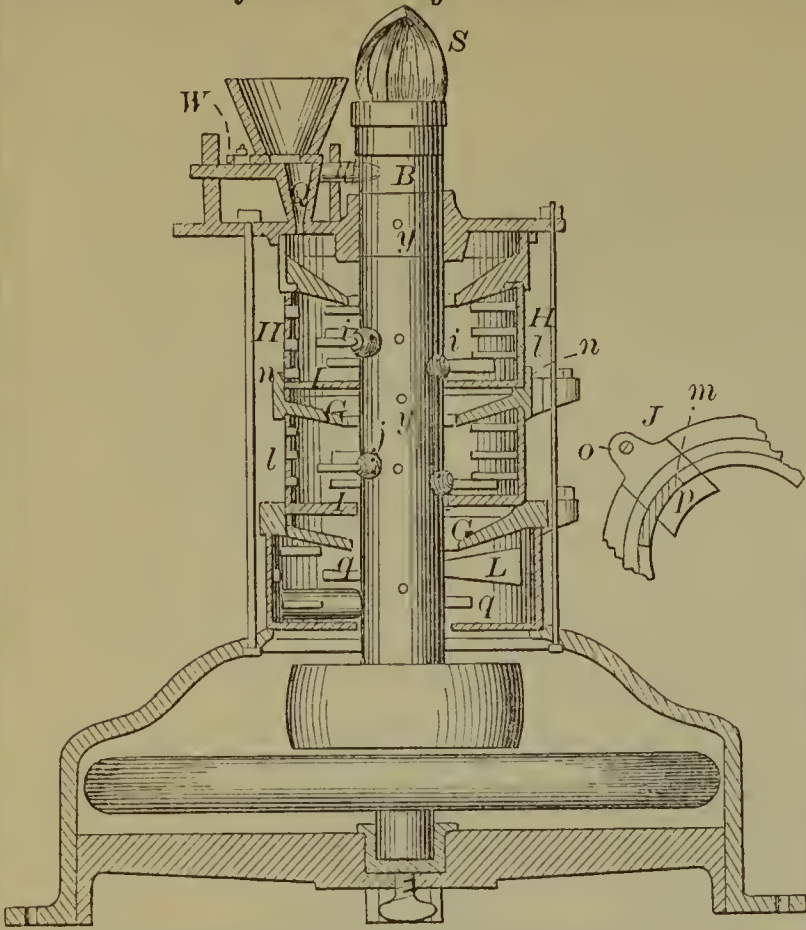

53613—

W. M. Henderson—Steam Engine.

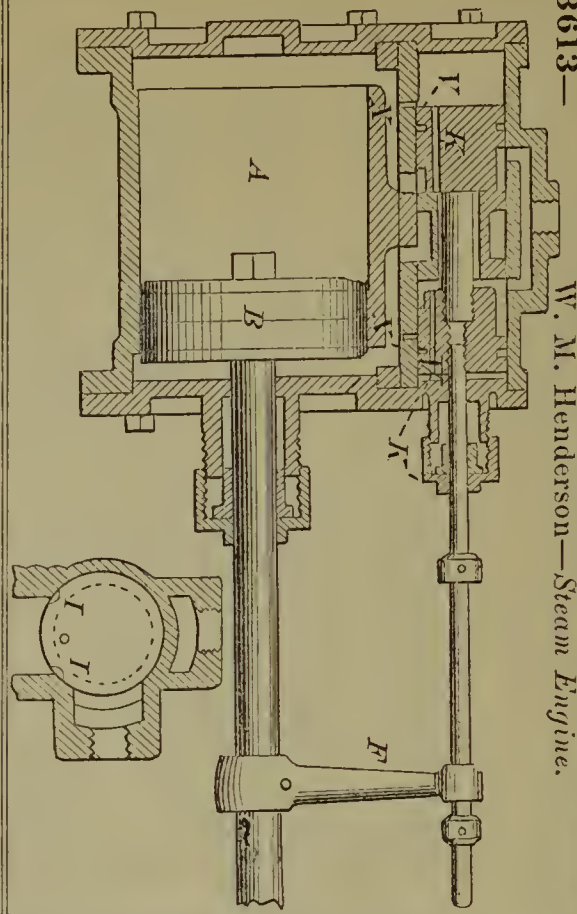

53614—W. Henshaw—Hay and Straw Cutter.

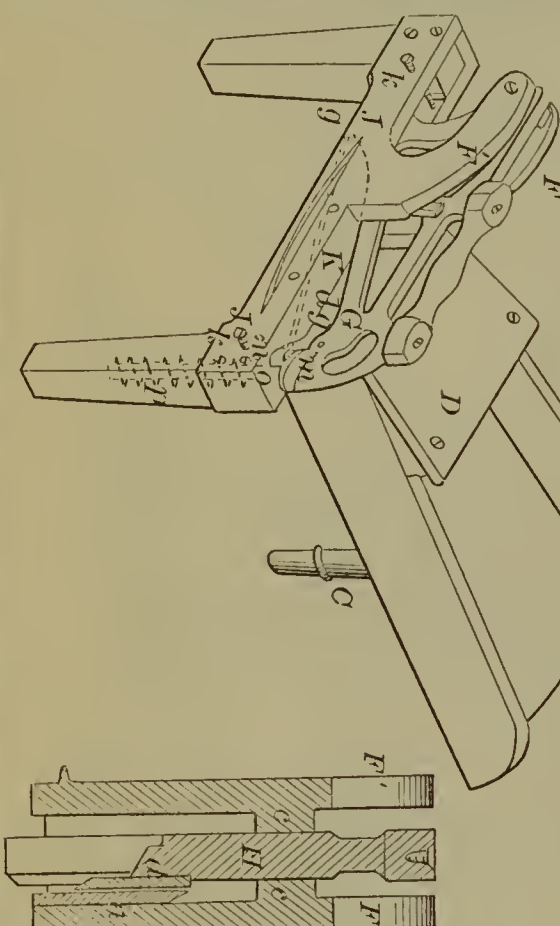

53612—G. E. Hayes—Vulcanizing Vessel for Dentists' Use.

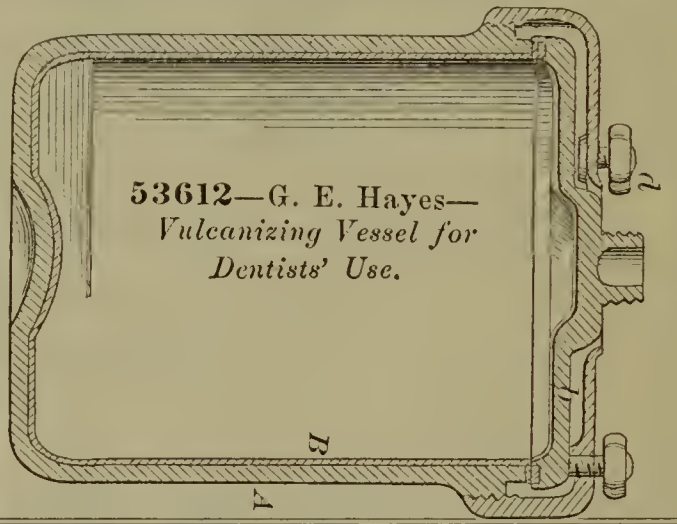

53615—S. B. Hill—Paper Bosom Machine.

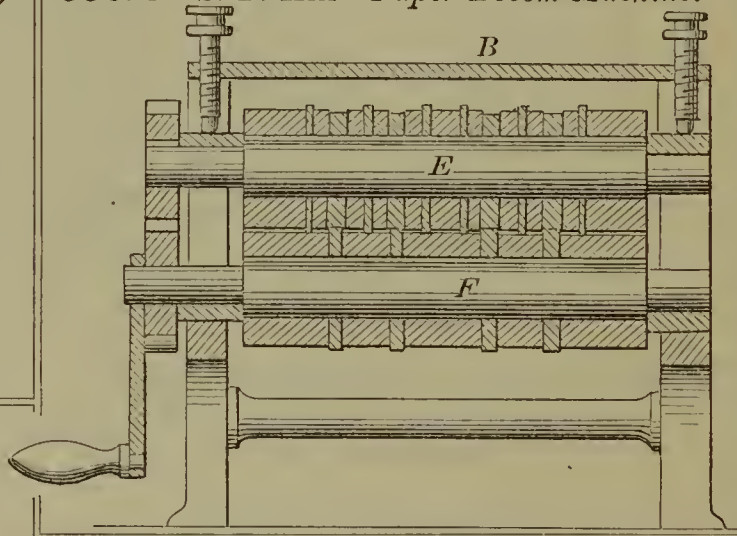

53616—W. D. Hillis—Fence.

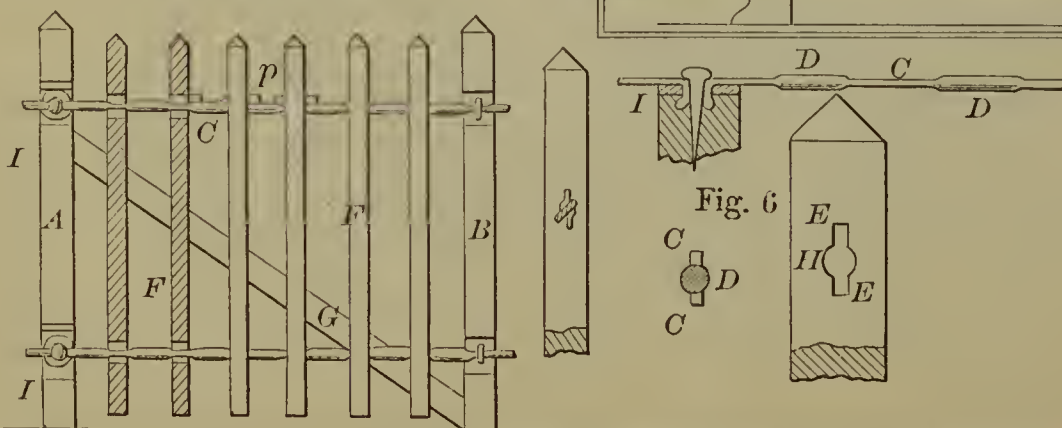

53617—B. Holly—*Steam Generator.*

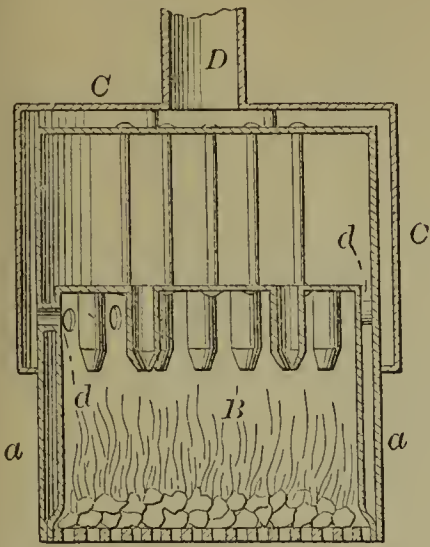

53621—E. Hoyt—*Water Elevator.*

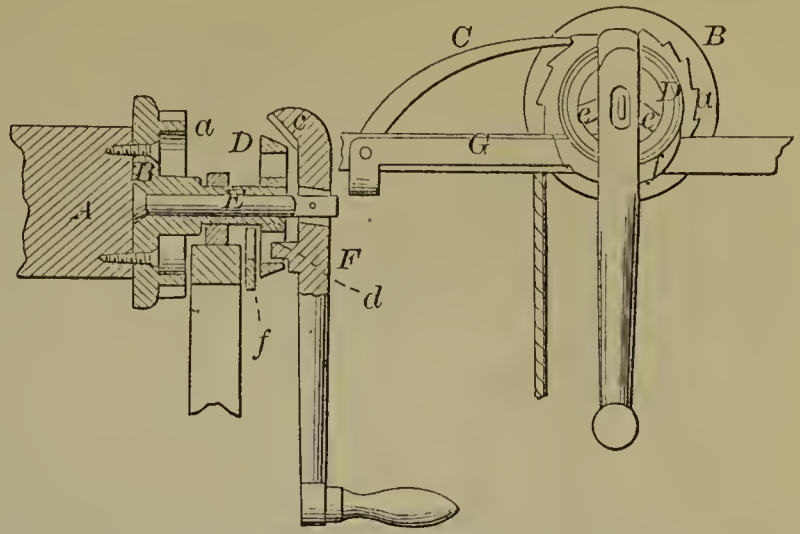

53622—T. S. Hudson—*Pen.*

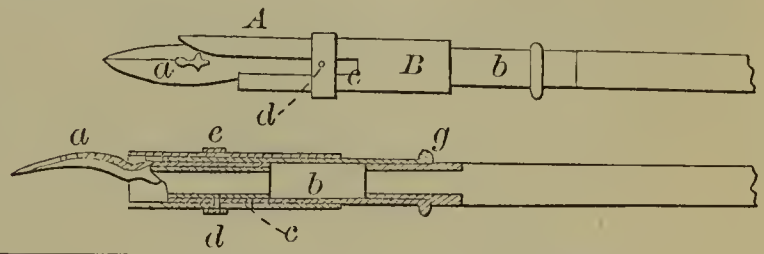

53618—A. H. Hook—*Stave Machine.*

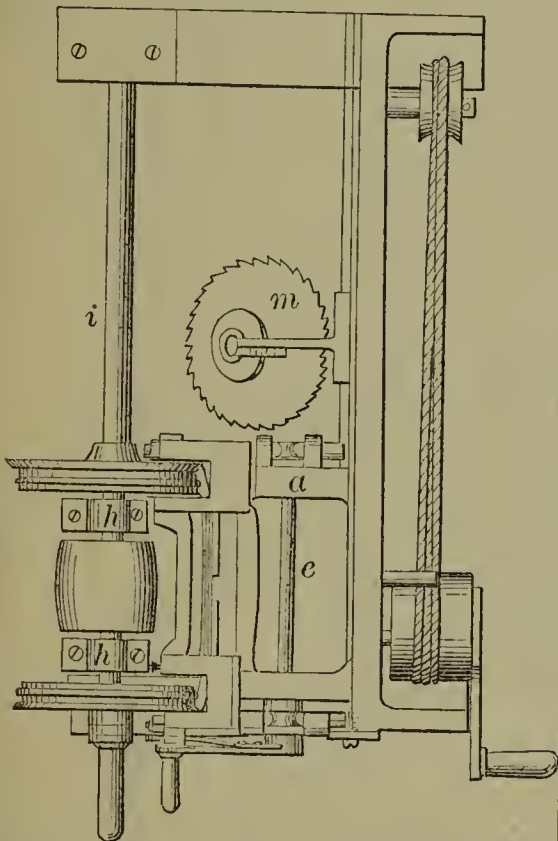

53624—J. E. Hunter—*Broom Head.*

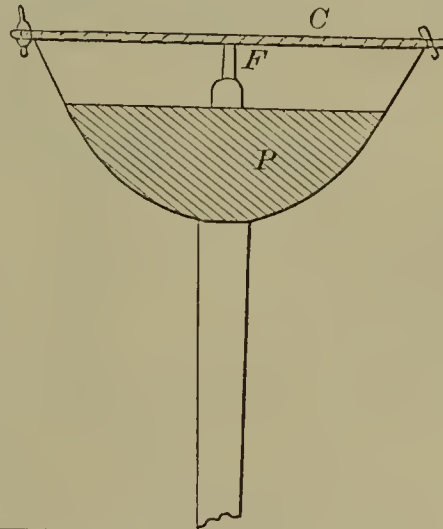

53620—T. Howe—*Folding Bedstead.*

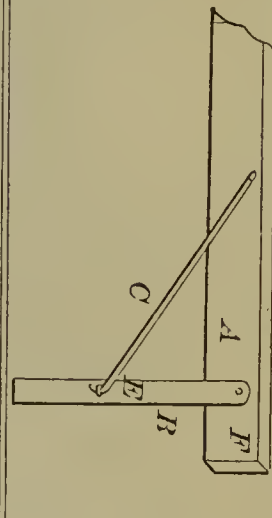

53619—J. A. & H. A. House—*Button Hole Cutter.*

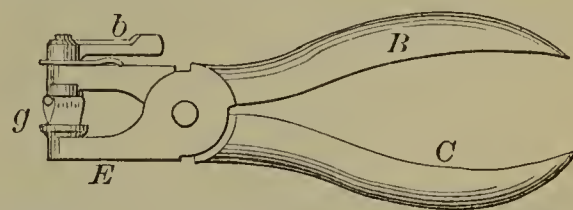

53623—J. G. Hunt—*Lamp Burner.*

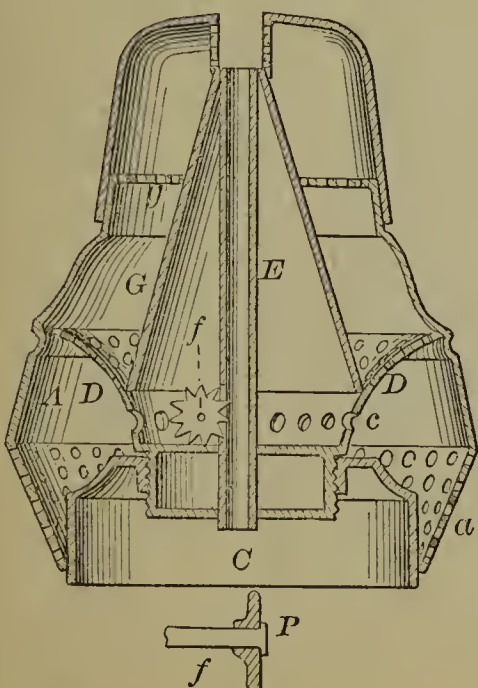

53626—W. Kenderline—*Washing Machine.*

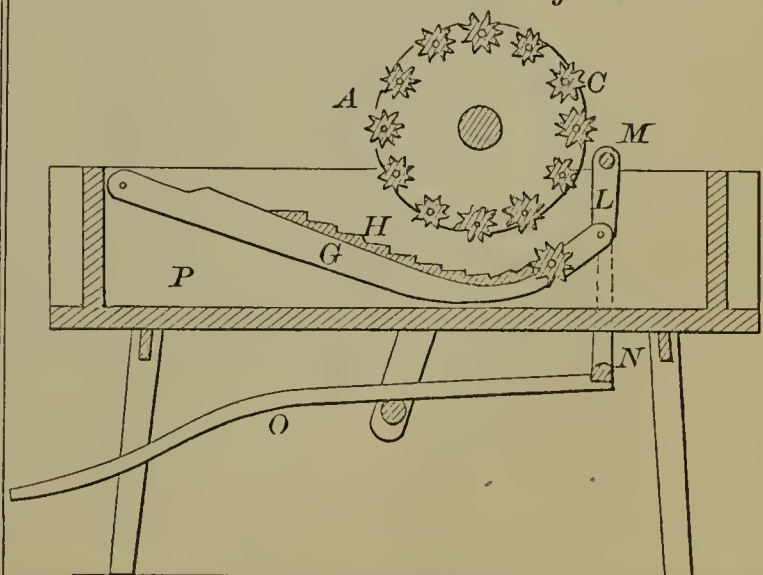

53627—M. C. Kilgore—  
Stop Cock.

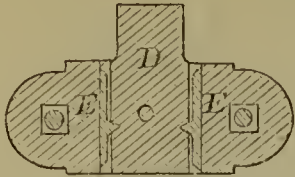

53632—W. W. Knight—*Chamber  
Bucket.*

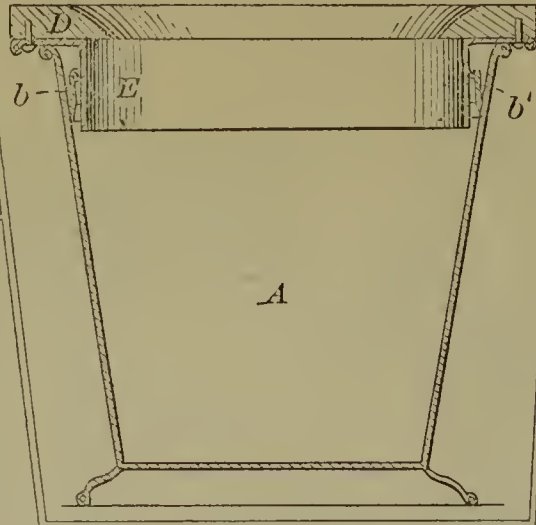

53631—E. H. Knight—*For  
Moulding Articles from Paper  
Pulp.*

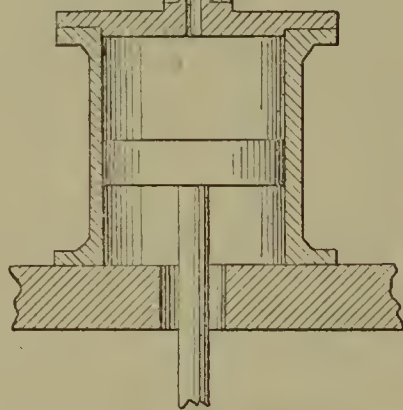
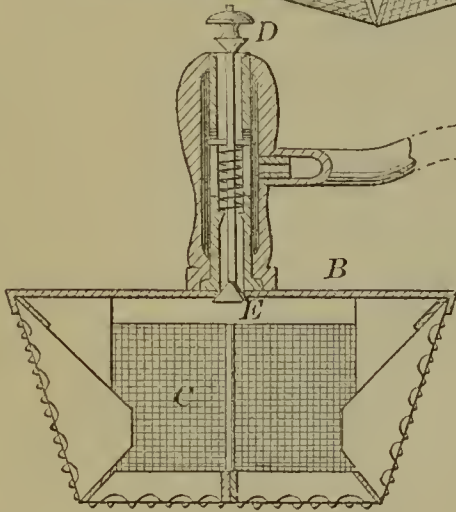
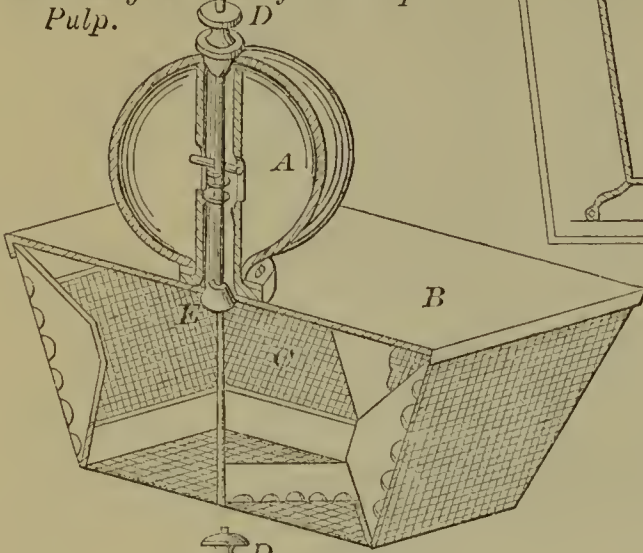

53630—E. Y. Kneeland—*Piston for Deep Well Pumps.*

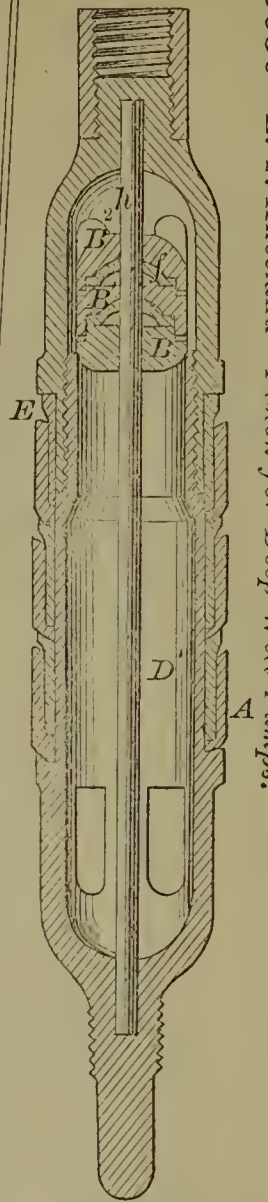

53629—N. W. Kingsley—*Blow Pipe.*

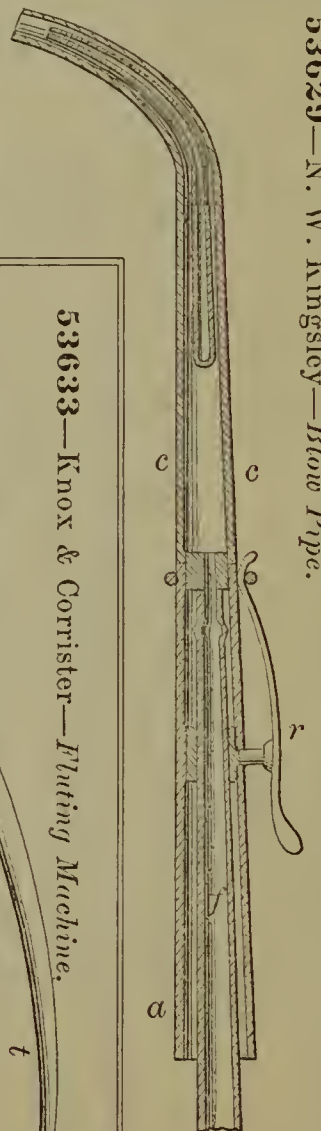

53634—C. W. Lamb—*Portable  
Feed Rack.*

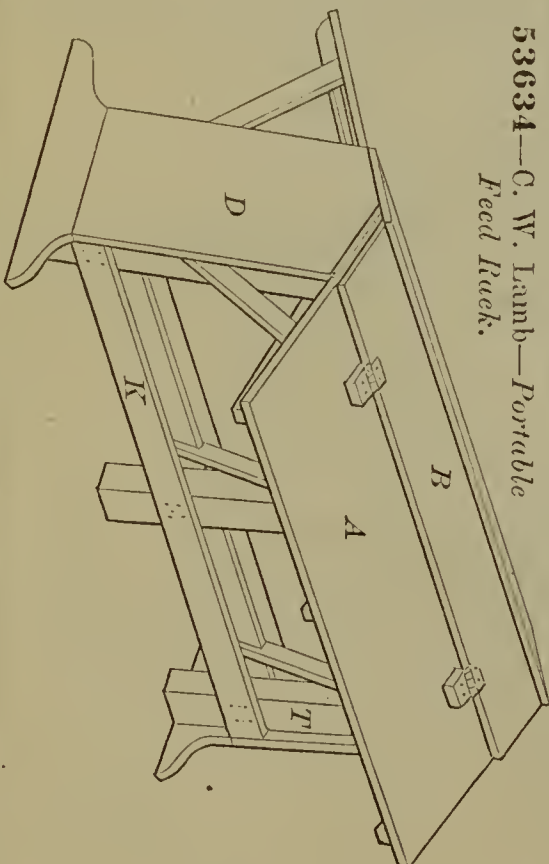

53633—Knox & Corrister—*Fluting Machine.*

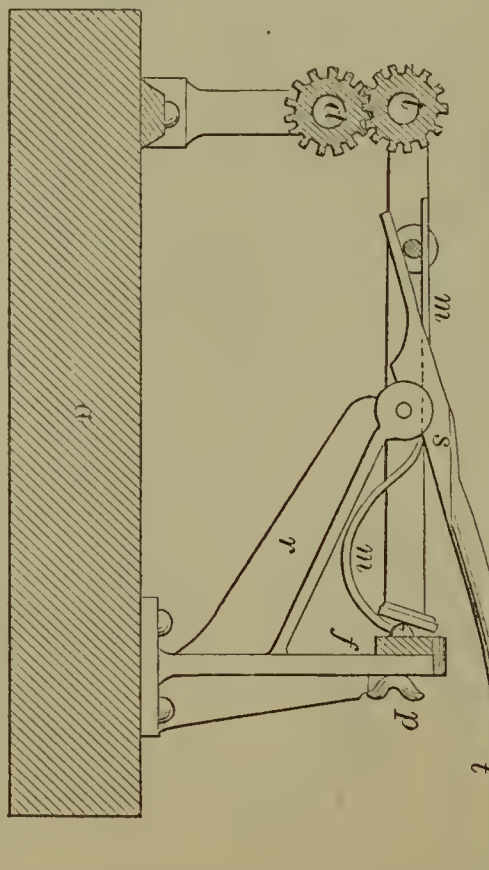

53635—J. N. Lane—Seed Planter.

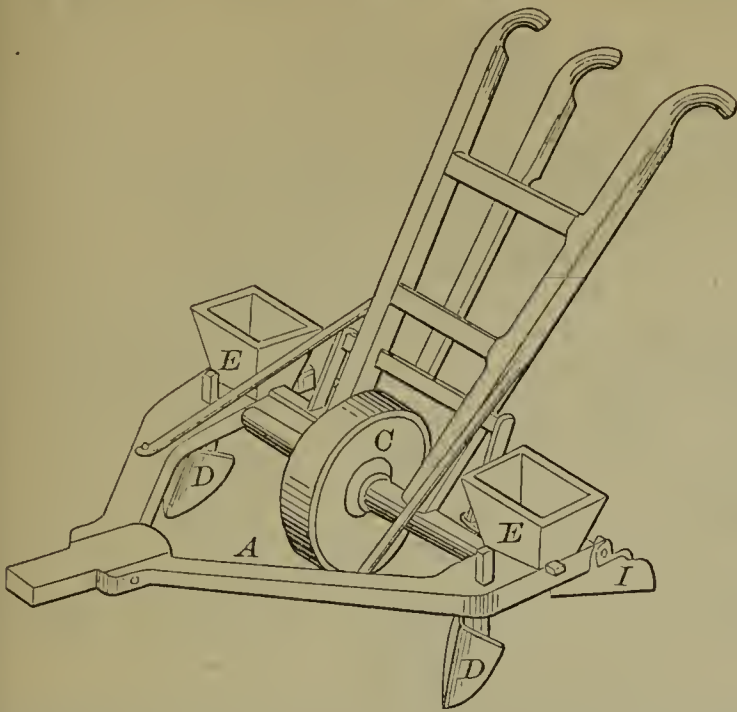

53641—J. A. Mattocks—Distilling Pine Wood.

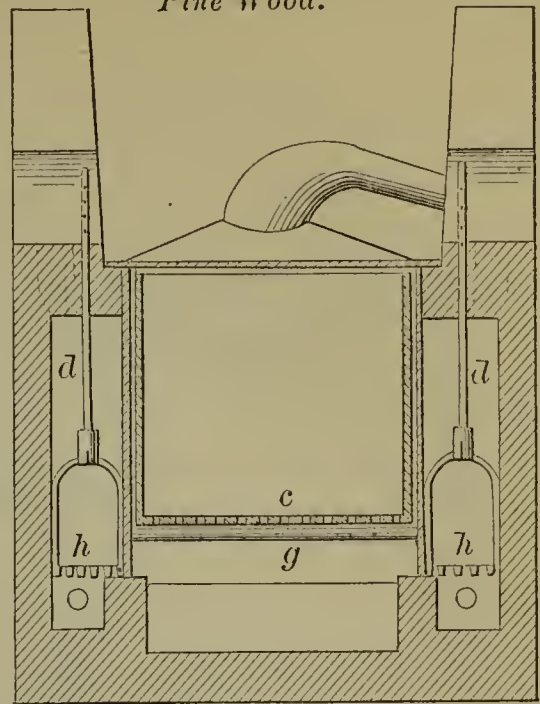

53638—O. Low—Tug Needle.



53639—Lusk & Wells—Car Coupling.

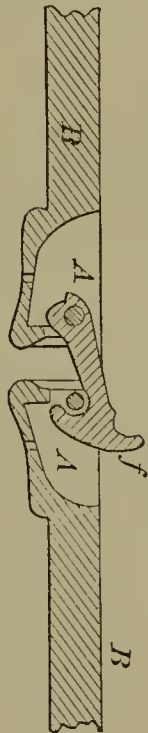

53642—W. D. Mayfield—For Cutting and Stoning Peaches.

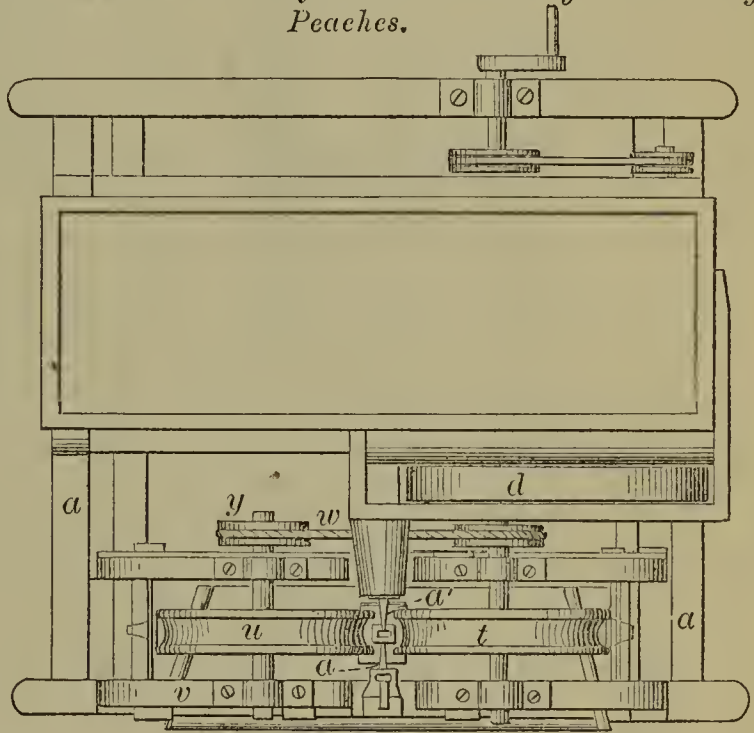

53637—J. R. Lomas—Hinge.

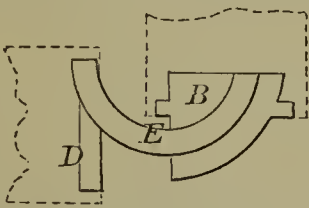

53645—

J. McRoberts—Soap Mould.

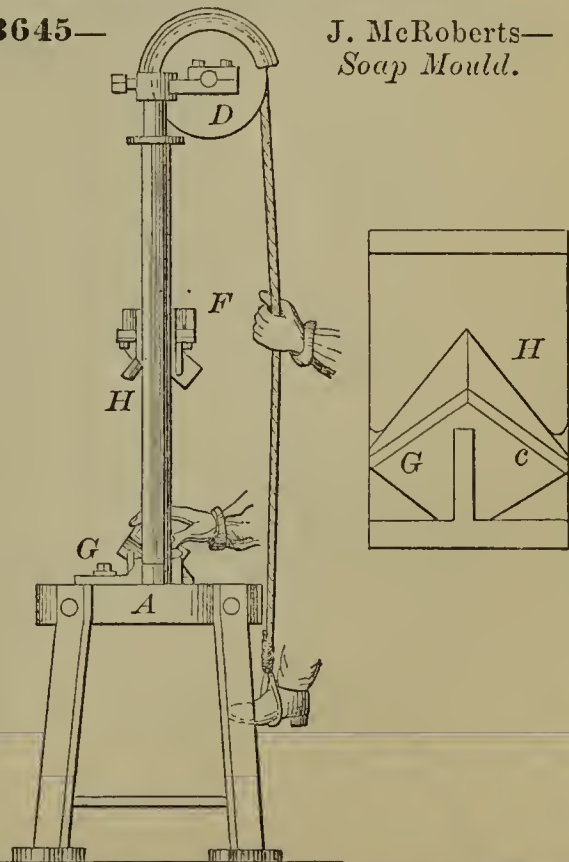

53644—W. C. McGill—Flour Sifter.

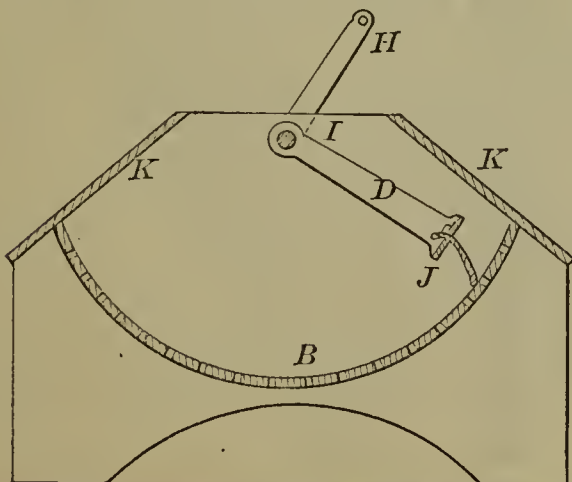

53647—D. F. Mellen—*For Shaving Wood Screws.*

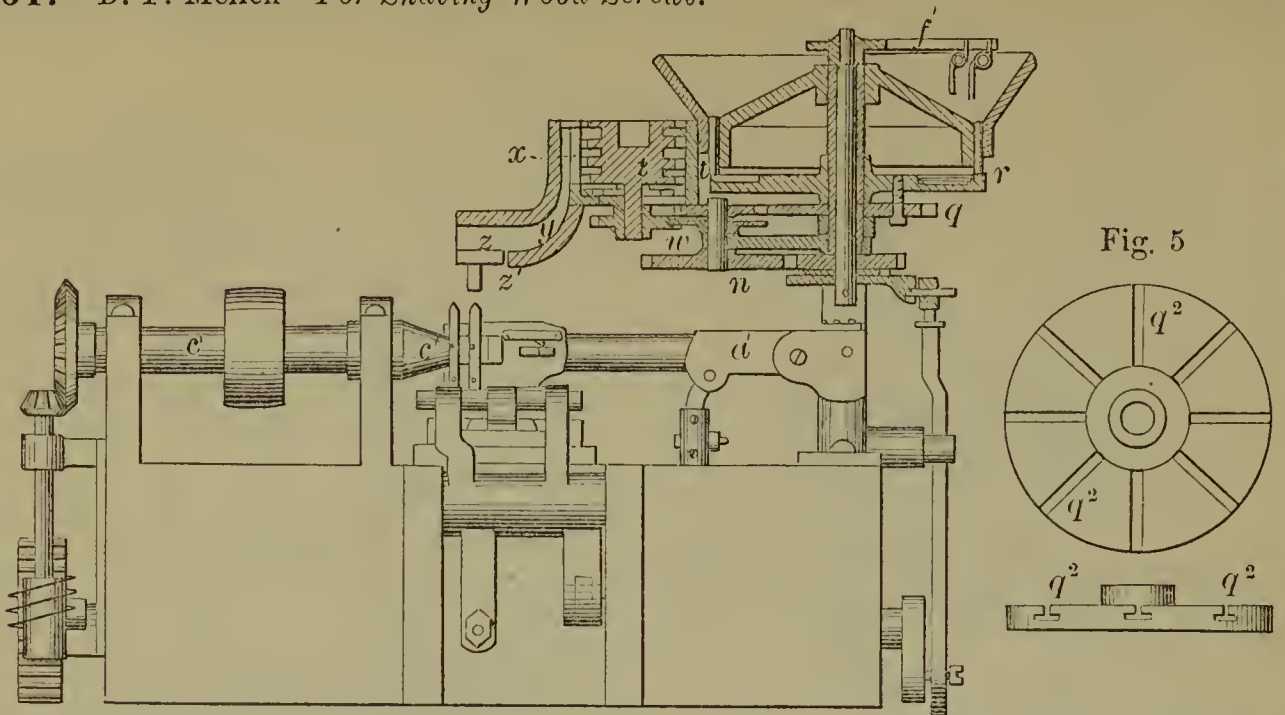

53648—D. F. Mellen—*For Nicking Screws.*

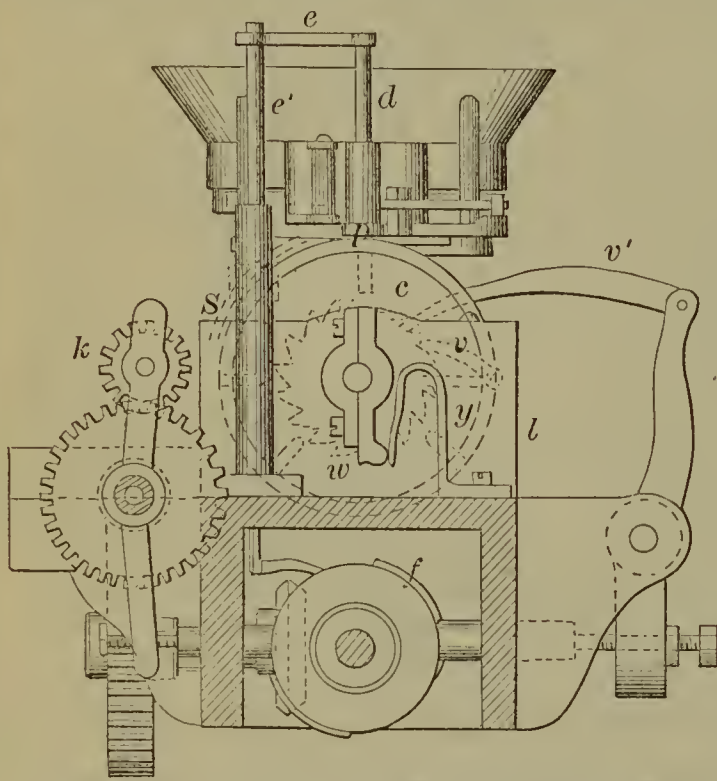

53651—P. F. Milligan—*Railway Signal.*

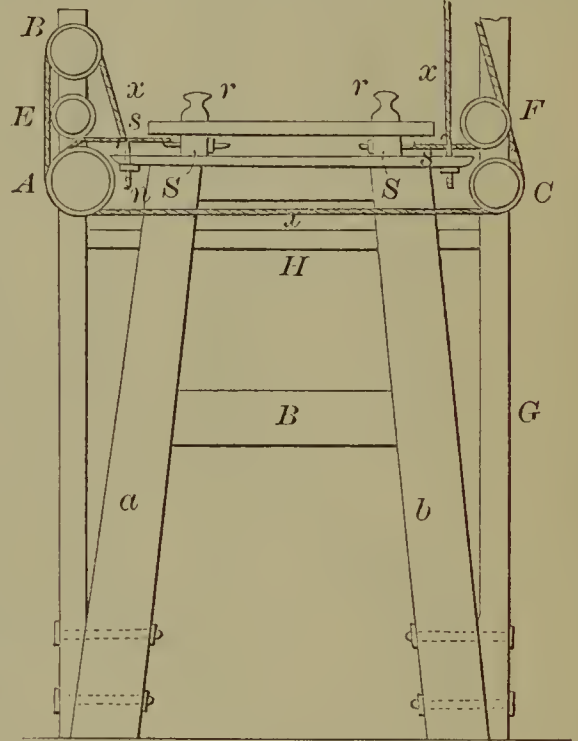

53650—G. Miller—*For Cutting Files.*

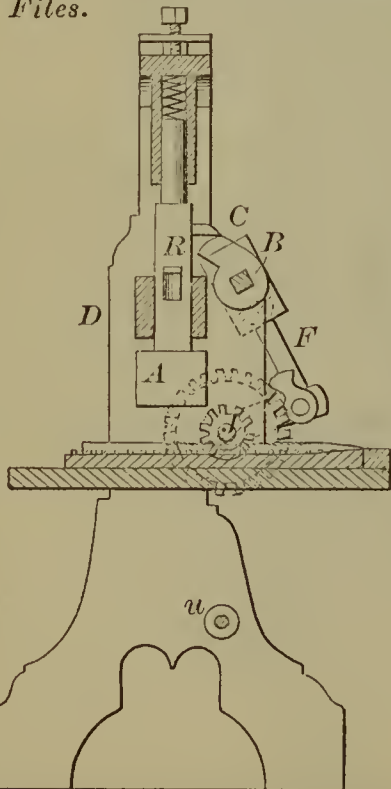

53649—C. Millar—*Handle for Milk Cans, &c.*

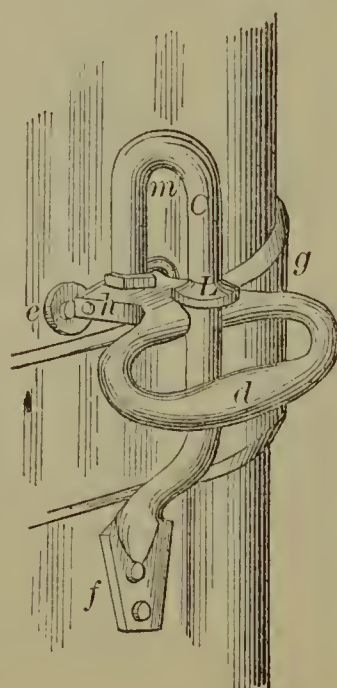

53652—H. C. Moody—*Washing Machine.*

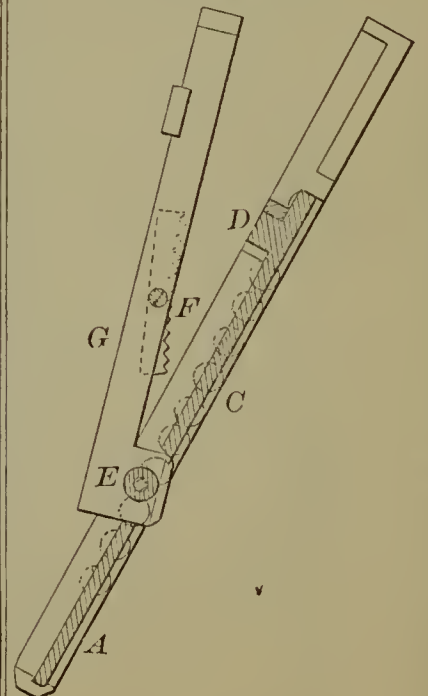

53653—C. Moul—Harvester Rake.

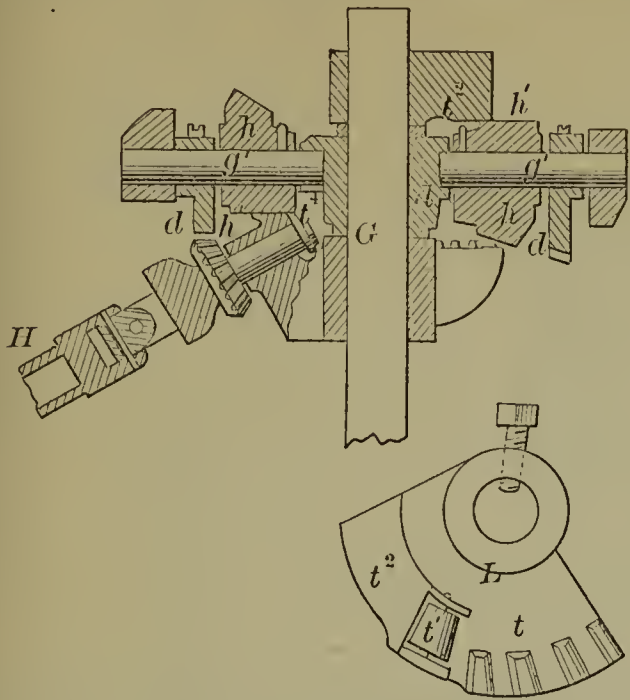

53654—J. H. Mumma—Broom Head.

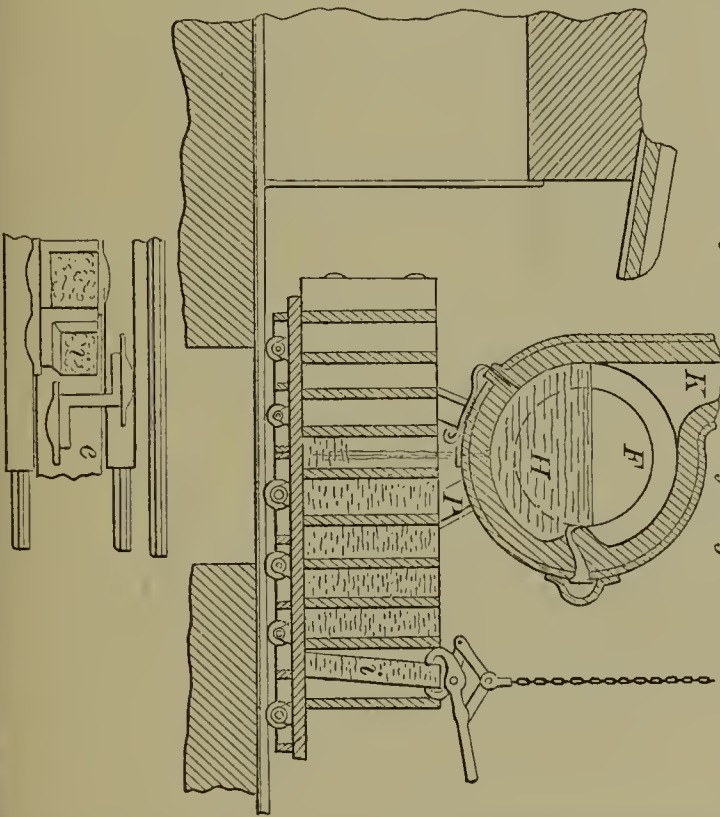
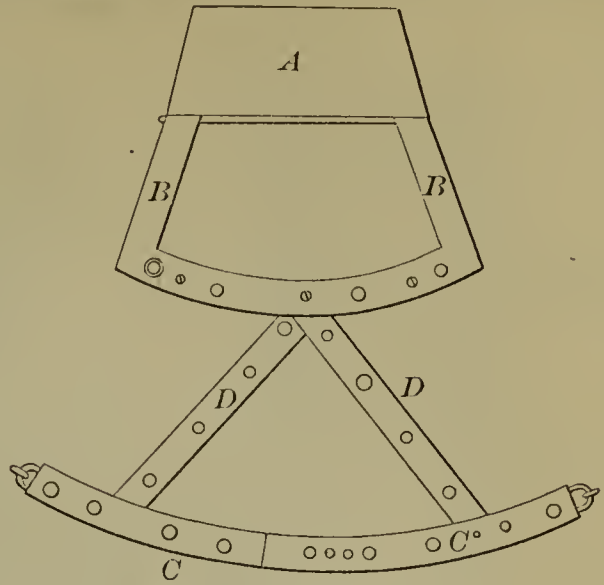

53658—J. W. Nystrom—For Refining Iron.

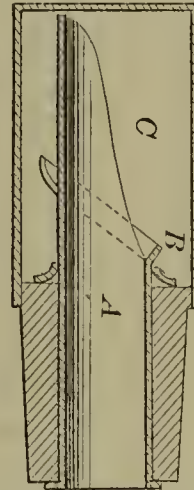

53655—L. B. Myers—Stopper For Bottles.

53659—T. O. Oliver—Stopper for Jars and Bottles.

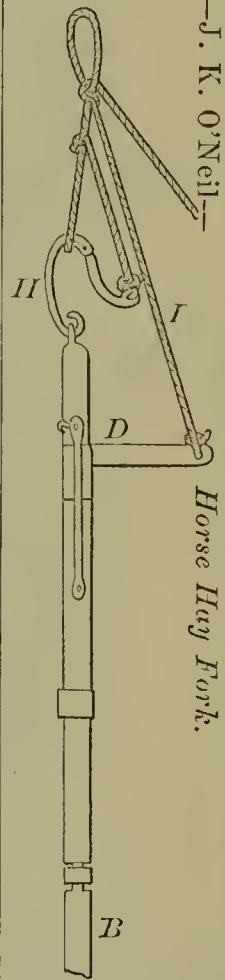
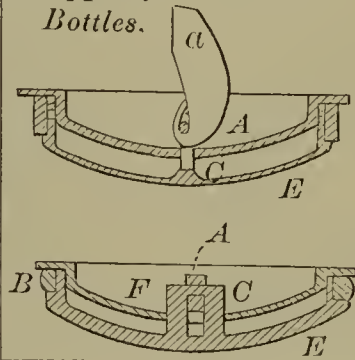

53660—J. K. O'Neil—

Horse Hay Fork.

53657—W. Norman—Press.

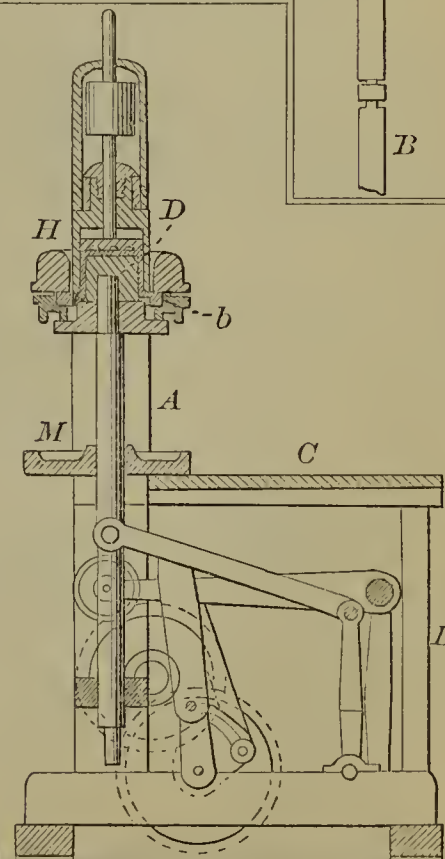
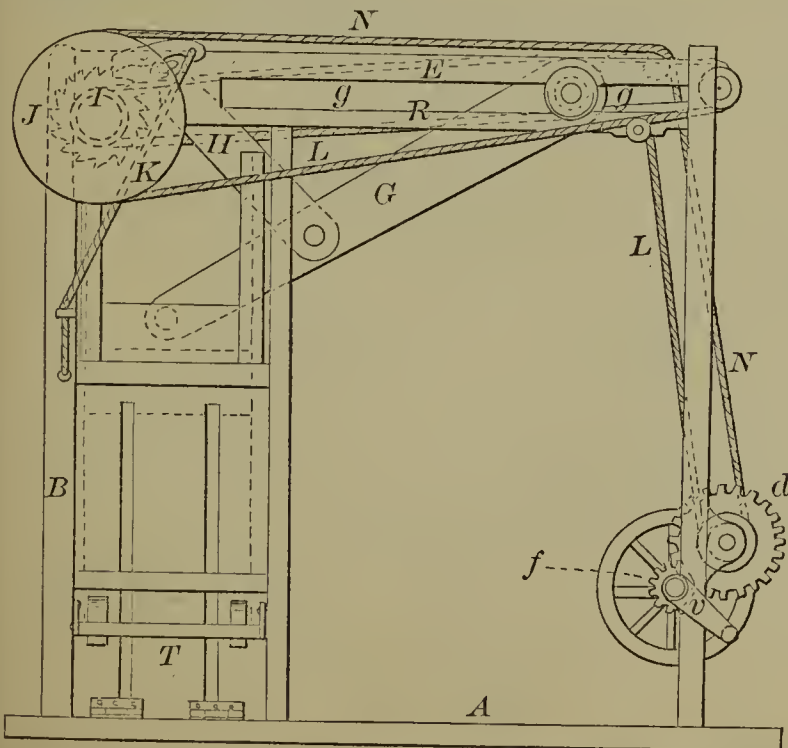

53661—Osterheld & Eickmeyer—Machine for Blocking and Shaping Hats.

53662—E. W. Packer—For Setting Out Plants.

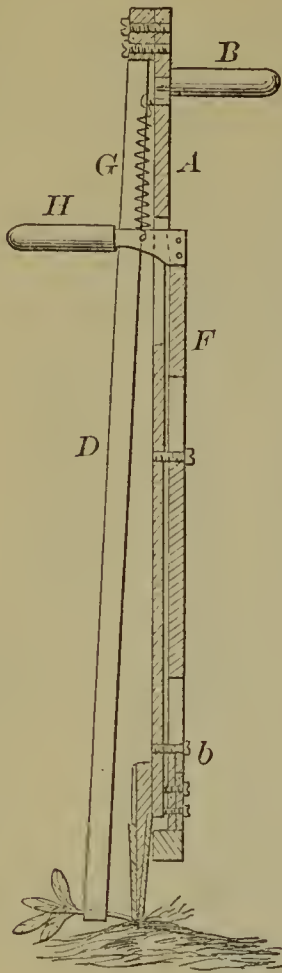

53664—Partridge & Johnson—Horse Power.

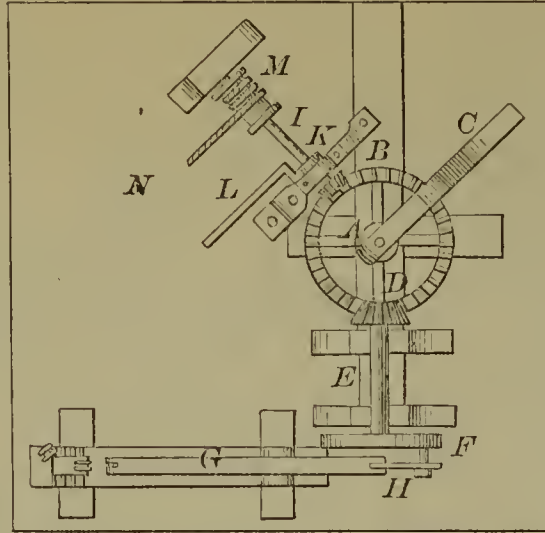

53665—O. Pearl—Wet Bobbin.

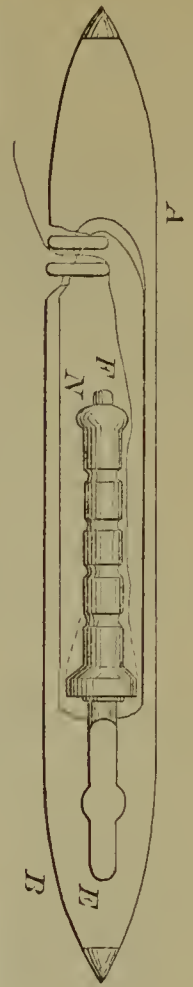

53666—D. J. Peer—Dental Vulcanizing Heater.

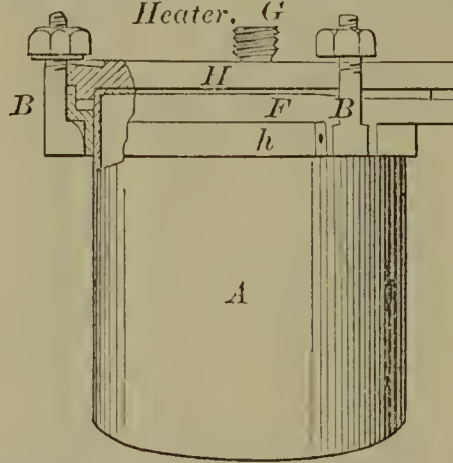

53669—G. G. Percival, M. D.—Electrical Lamp.

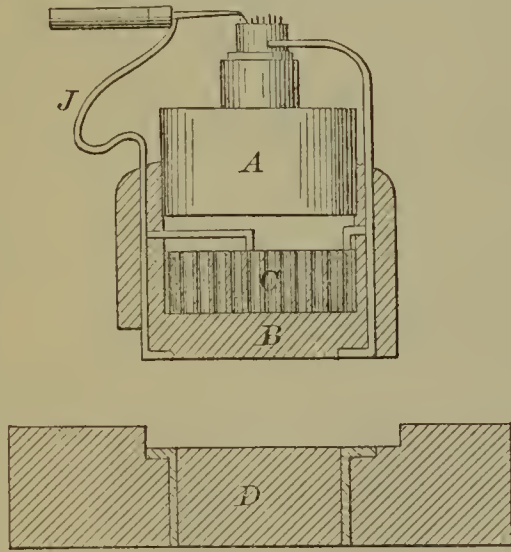

53667—D. J. Peer—Vulcanizing Flask.

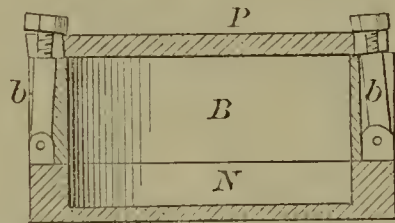

53663—Pangborn & Beers—Cultivator.

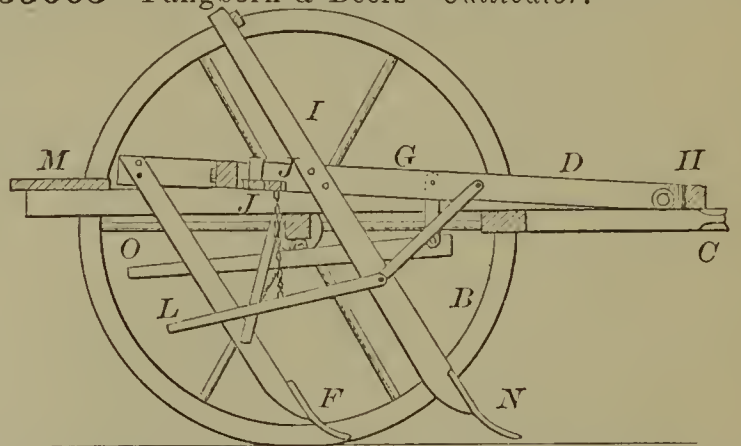

53668—G. G. Percival, M. D.—Secondary Electric Pile.

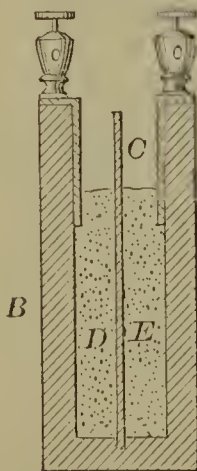

53670—C. L. Pierce—Sawing Machine.

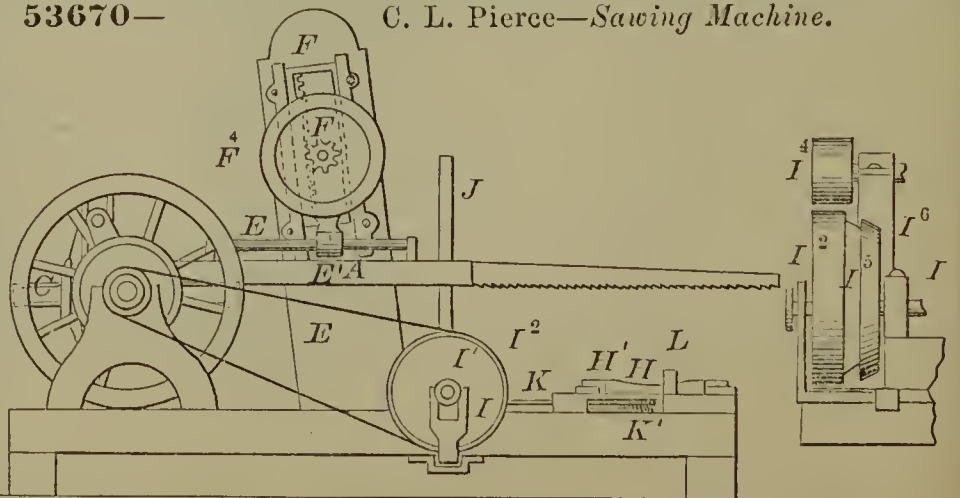



53672—J. L. Piper—Tree Protector.

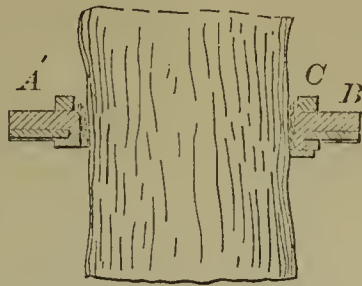

53678—H. Reimann—Box for Cigar Fuses.

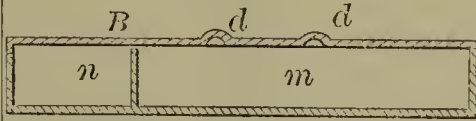

53674—P. Quinn—Railway Switch.

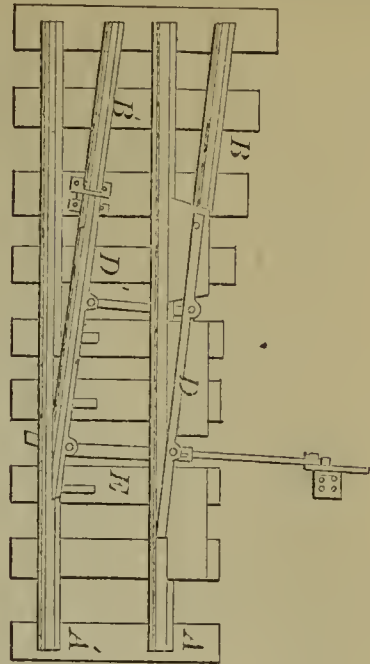

53671—G. D. Pike—Spring Lever Clasp.

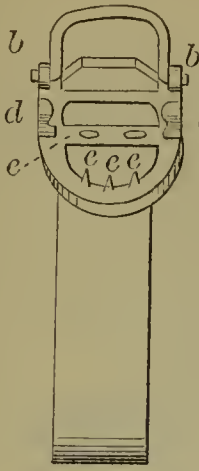

53675—P. Quinn—Combined Switch and Frog for Railways.

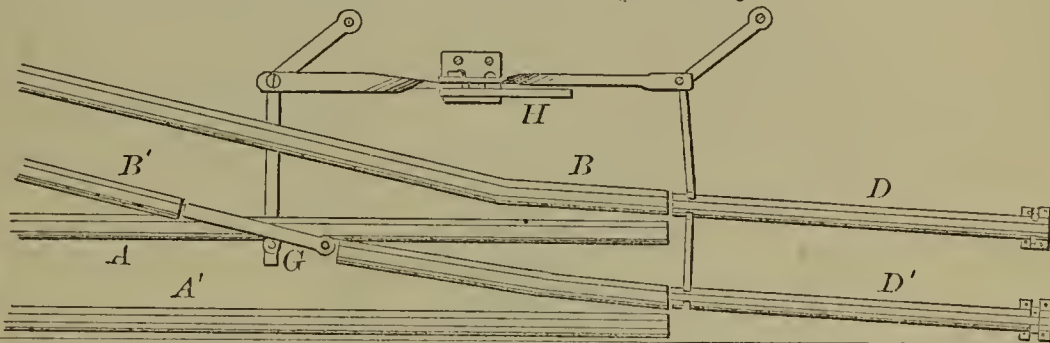

53676—G. Race—Water Elevator.

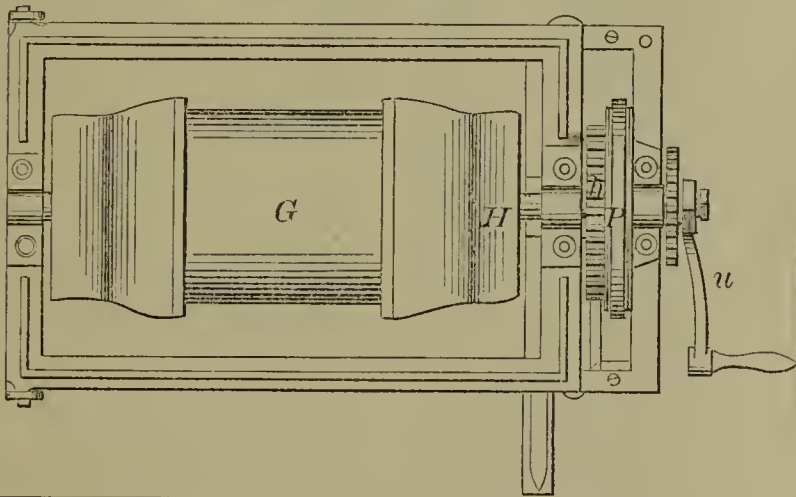

53673—P. Quinn—Railway Frog.

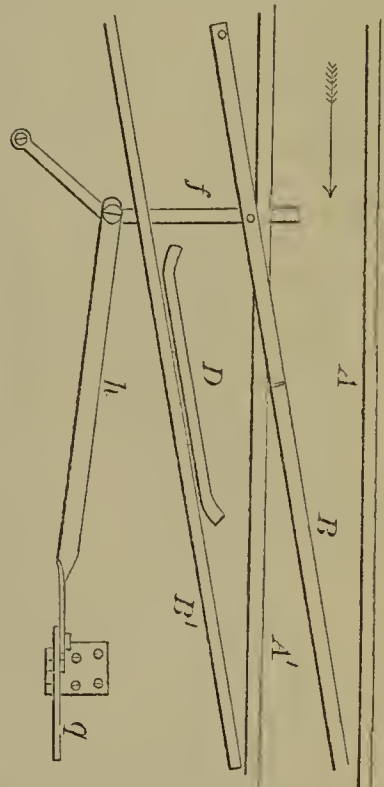

53677—L. Reich—Cooler for Brewing and Distilling.

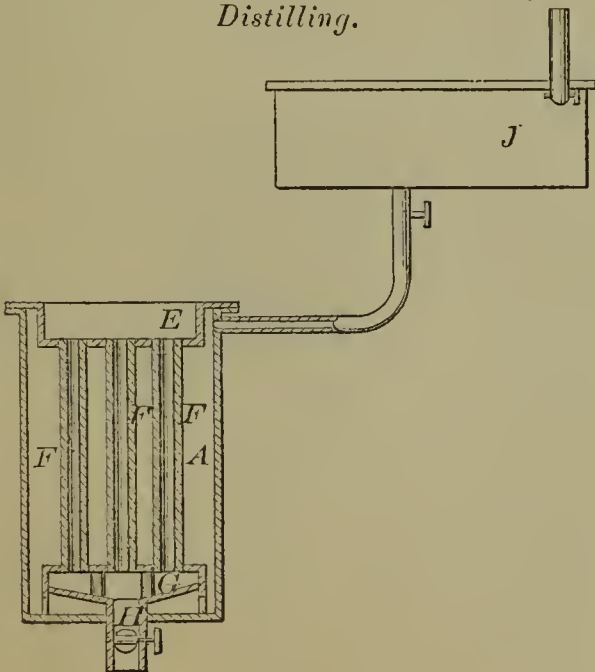

53679—Richardson & Ward—Lamp Extinguisher.

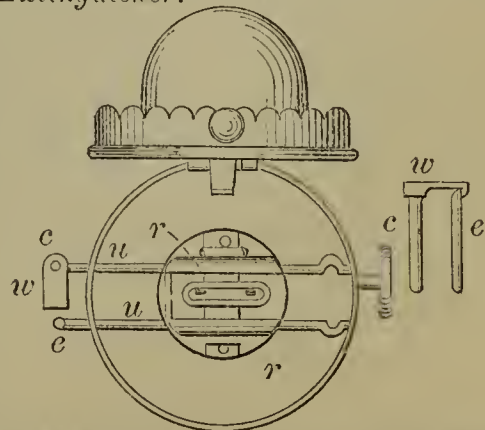

53680—J. T. Rich—Cut-off Valve Gear.

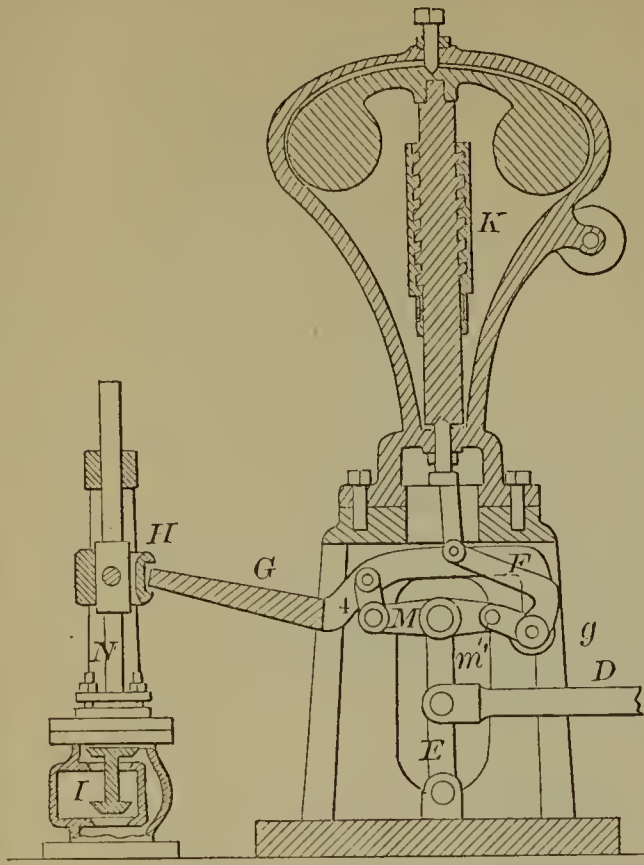

53683—R. Rothwell—Lathe Chuck.

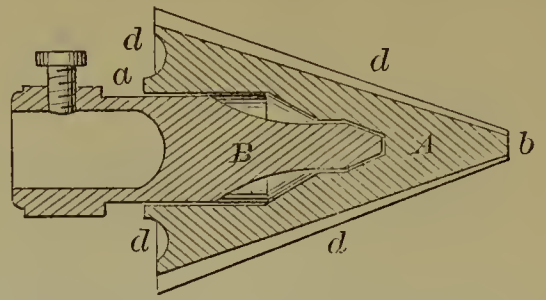

53685—G. H. Russell—Fruit Jar.

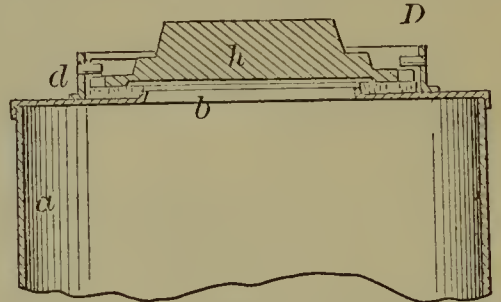

53681—S. S. Rockwell—Bag Holder.

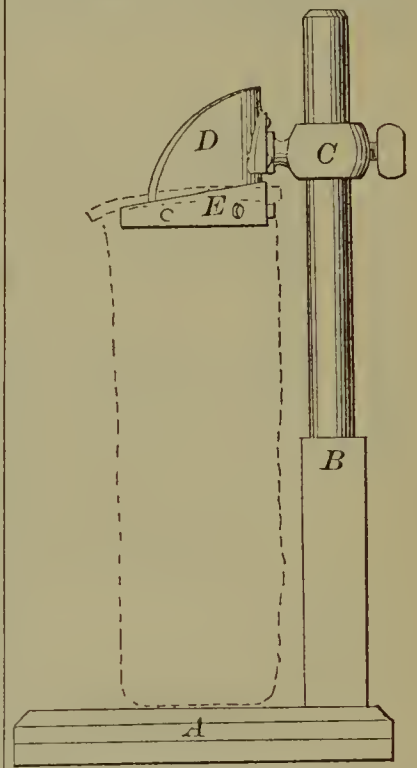

53682—W. Rose—For Cooling Beer.

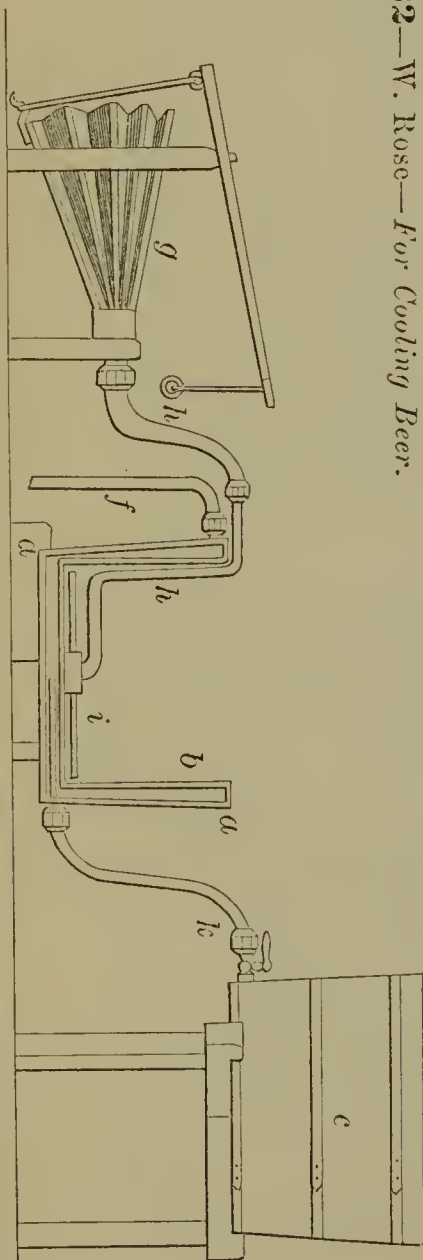

53686—A. Saffer—Boring Artesian Wells.

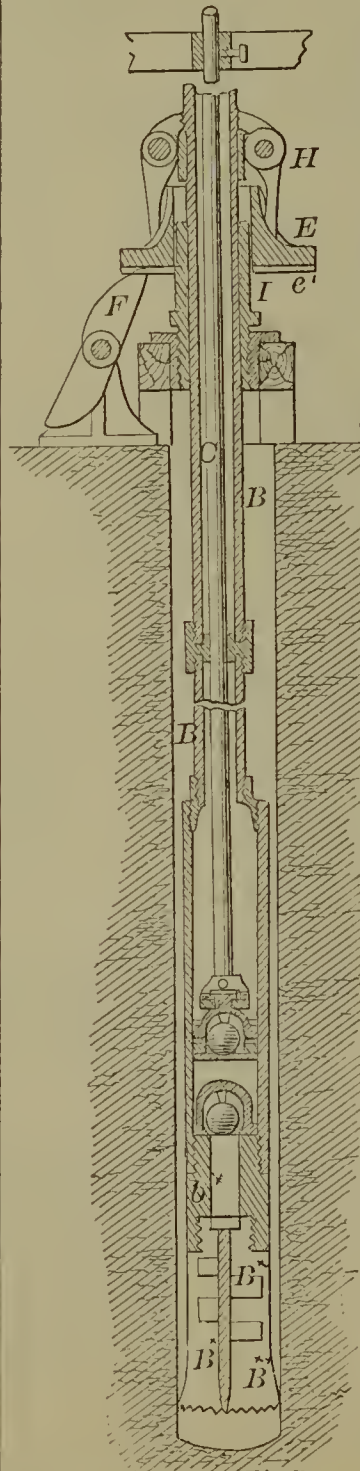

53684—T. W. Roys—For Raising Sunken Whales and other Bodies.

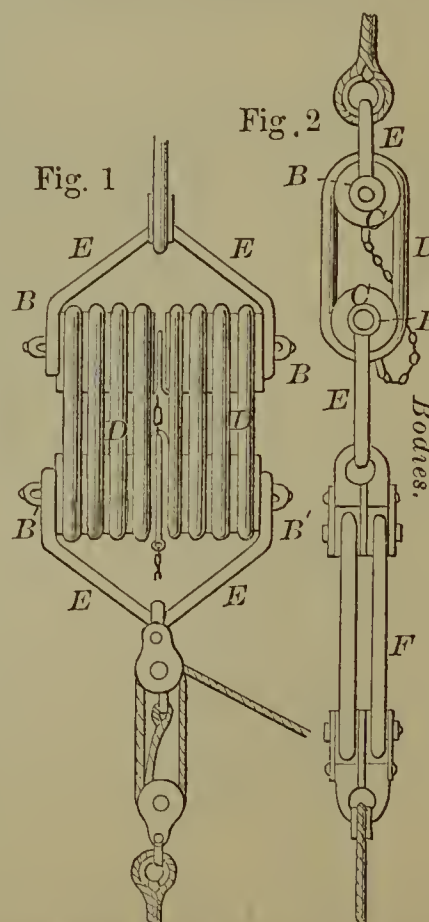

53687—P. Schuler—*Sound Board for Pianos.*

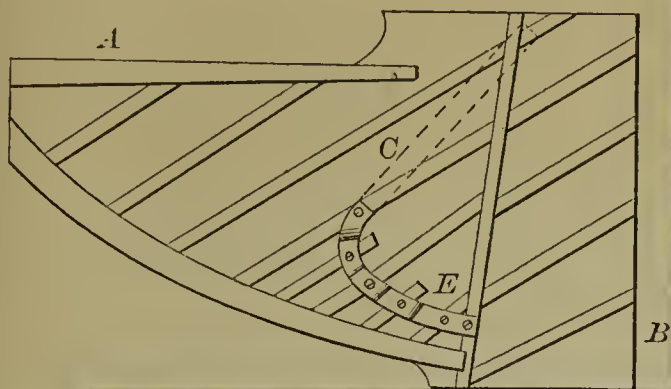

53691—S. J. Sherman—*Skeleton Skirt.*

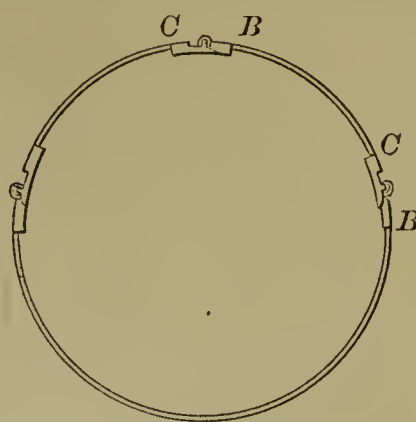

53692—E. Sirret—*Beer Faucet.*

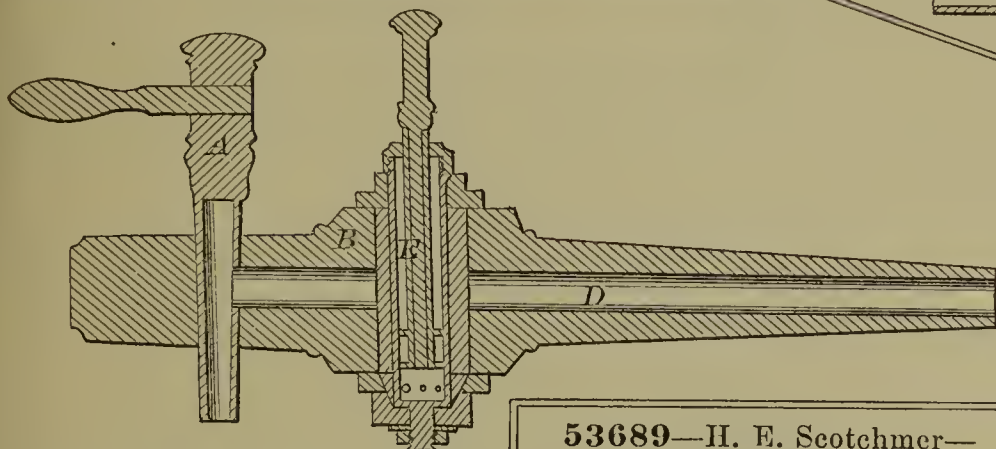

53693—J. L. Smith—*Syrup Filter.*

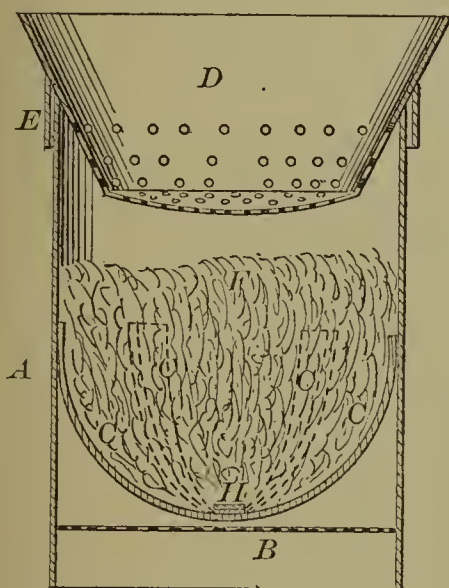

53689—H. E. Scotchmer—*Shoe Brush.*

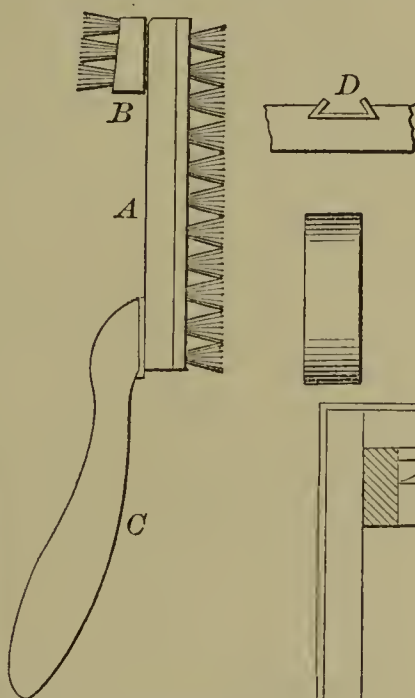

53690—G. T. Sheldon—*Mould for Casting Flanged Pipe.*

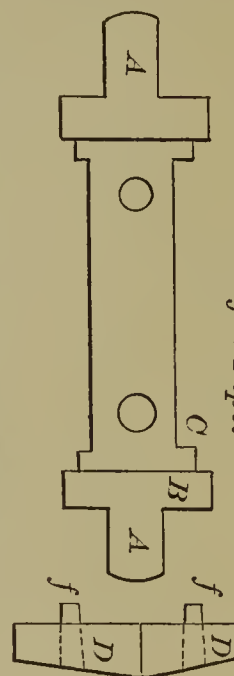

53694—J. P. Smith—*Threshing Machine.*

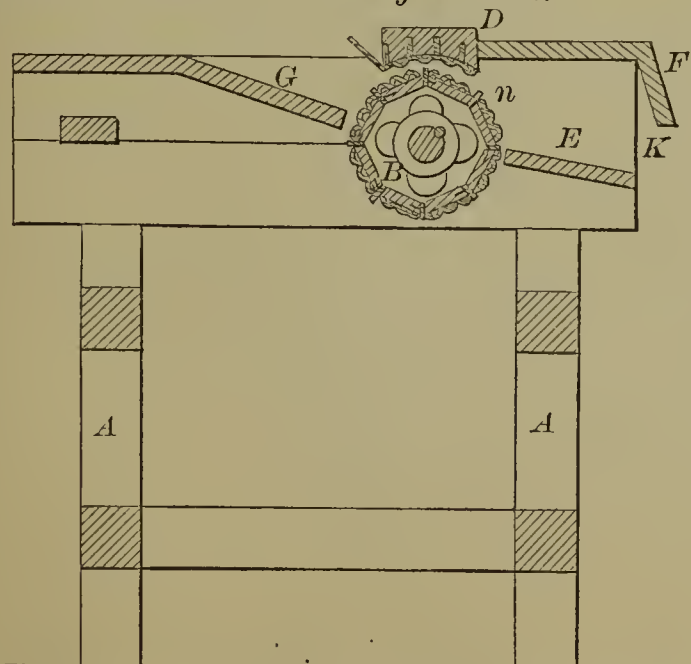

53696—J. M. Spencer—*For Stripping Sorghum.*

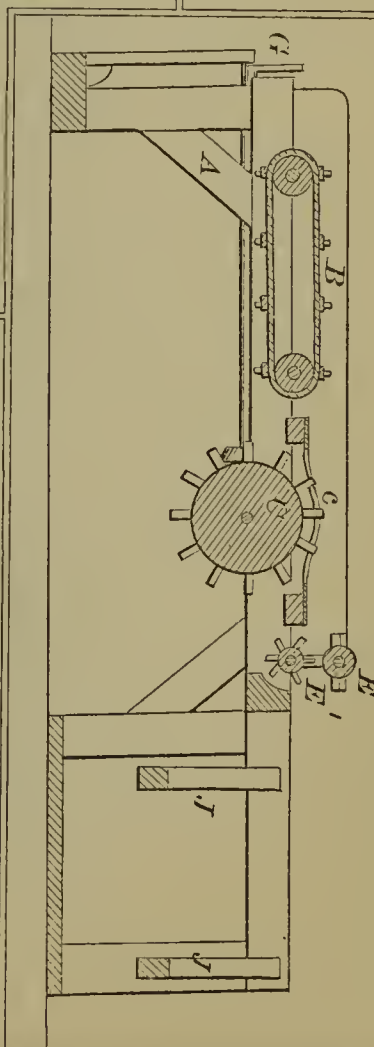

53697—H. Squyer—*Laundry Stove.*

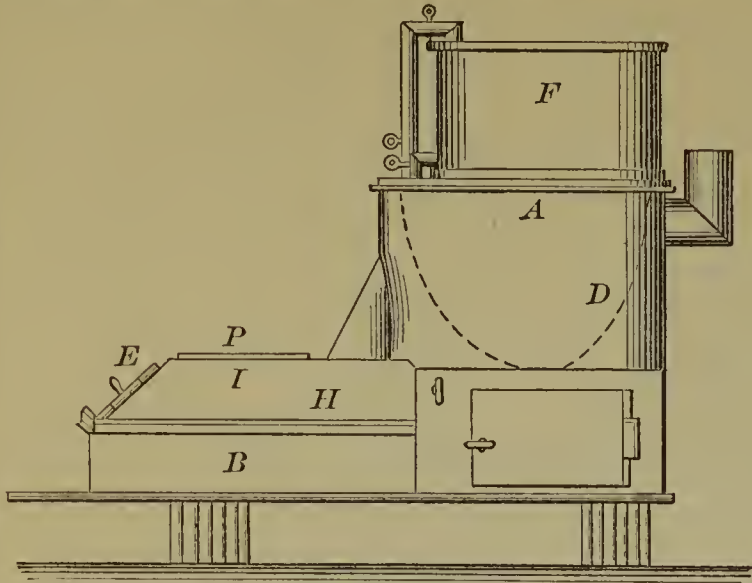

53704—L. H. Thomas—*Mop Head.*

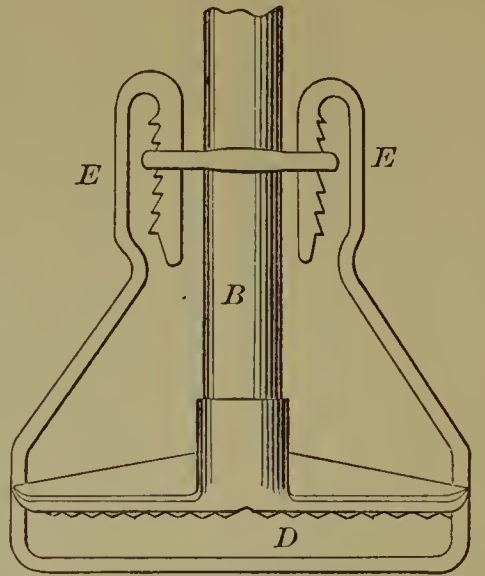

53702—G. Styles—*Umbrella.*

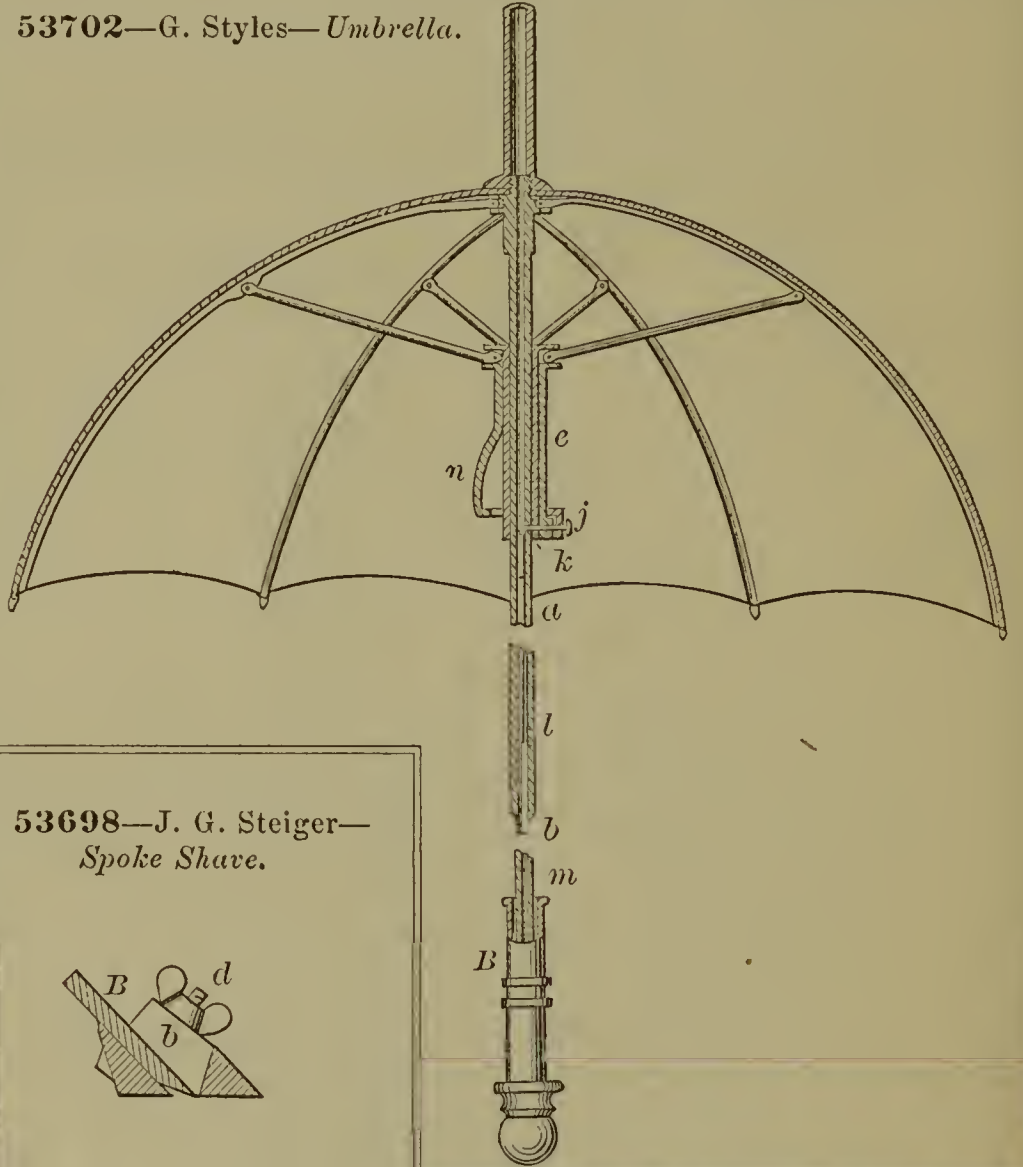

53700—J. Story—*Telegraph Cable.*

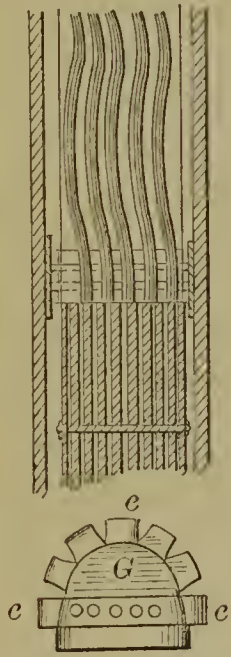

53698—J. G. Steiger—*Spoke Shave.*

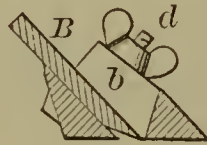

53699—C. Stone—*Piping for Boots and Shoes.*



53705—S. I. Trask—*Clothes Dryer.*

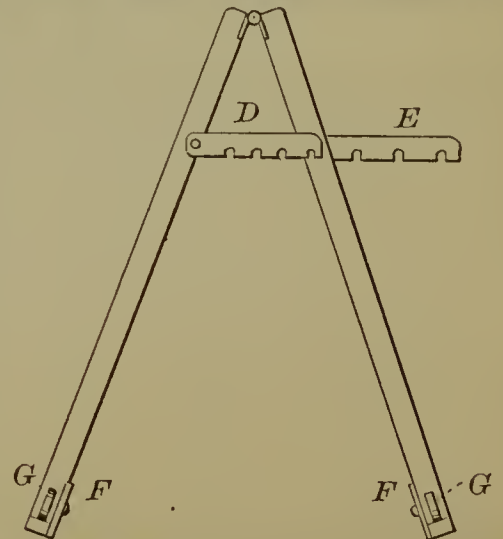

53703—J. B. Tarr—*Curtain Fixture.*

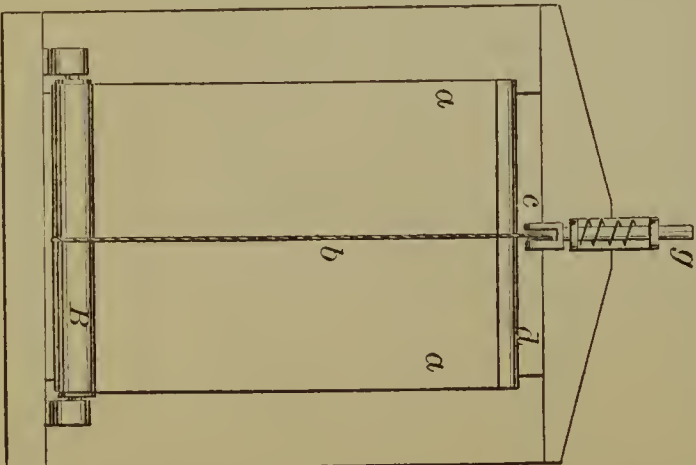

53706—E. W. Tucker—*Bed Bottom.*

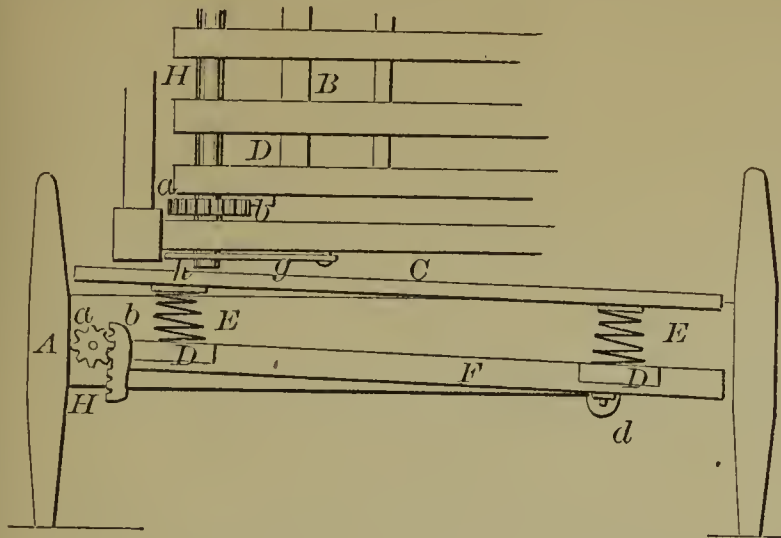

53708—Vanbebber, Sallee & Britton—*Balanced Slide Valve.*

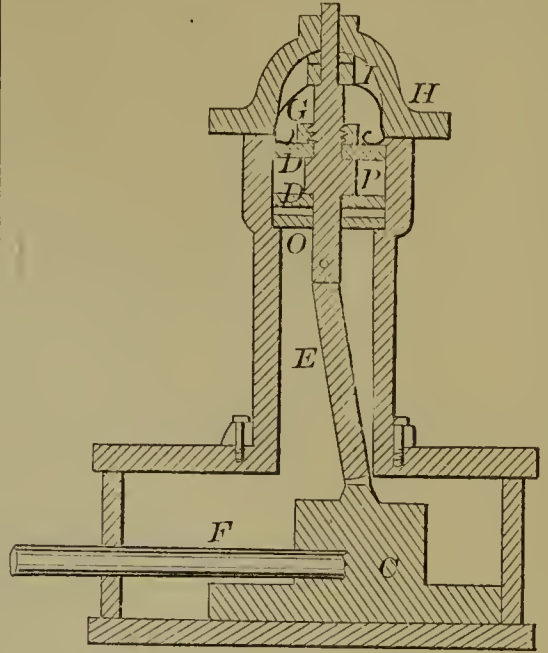

53707—R. D. Turner—*Slide Valve.*

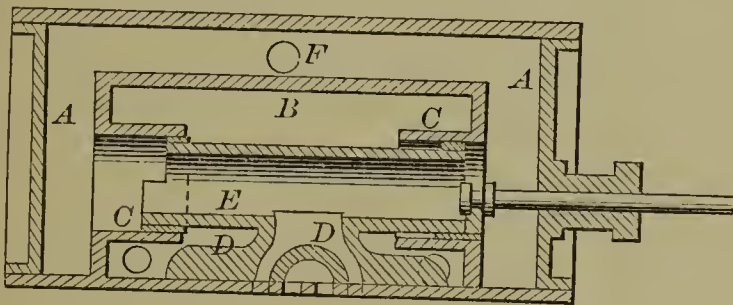

53712—F. Wegrather—*Egg Holder.*

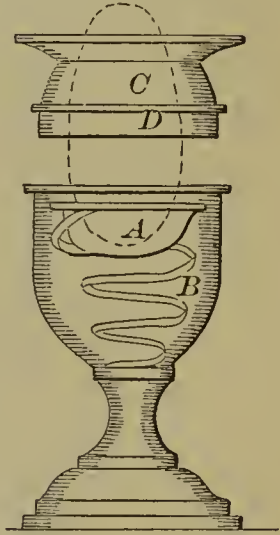

53710—Wallis & Miller—*Corn Harvester.*

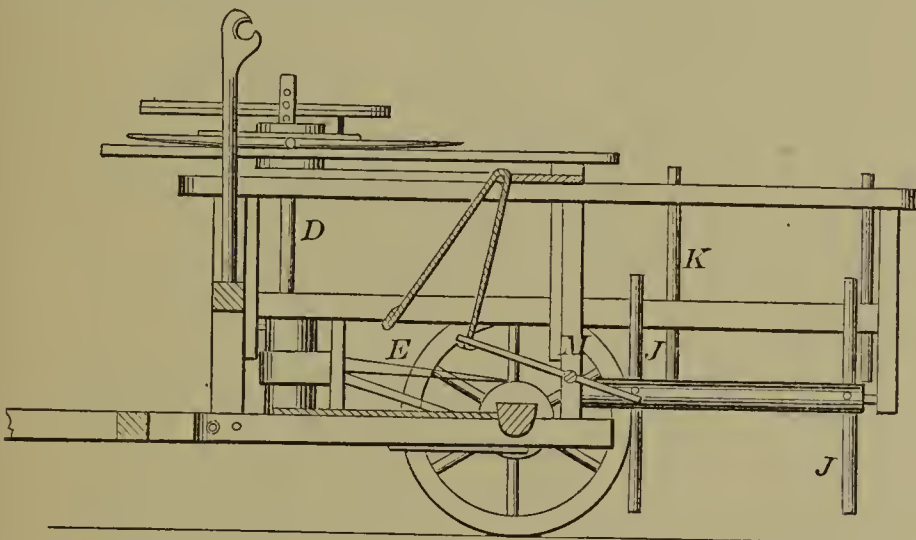

53714—T. Welham—*Fan.*

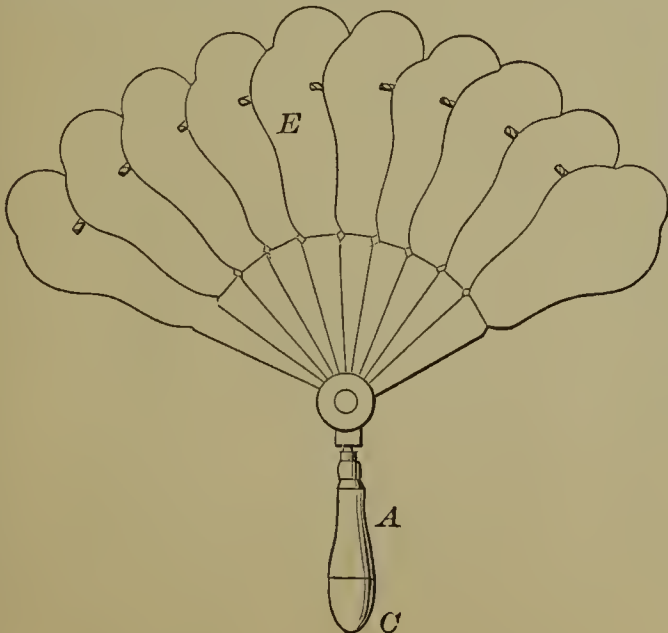

53711—A. Warth—*Pulley.*

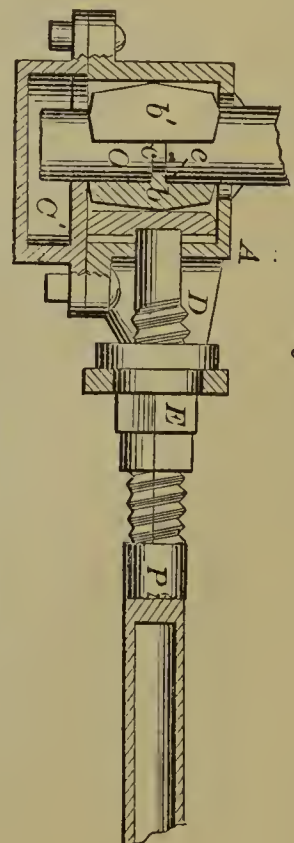
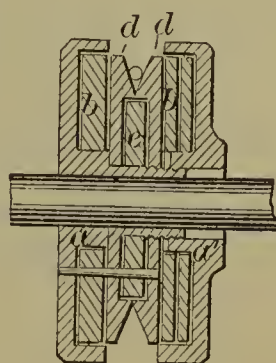

53713—T. Welch—*Harvesting Machine.*

53715—D. Wheeler—*Boring Wells.*

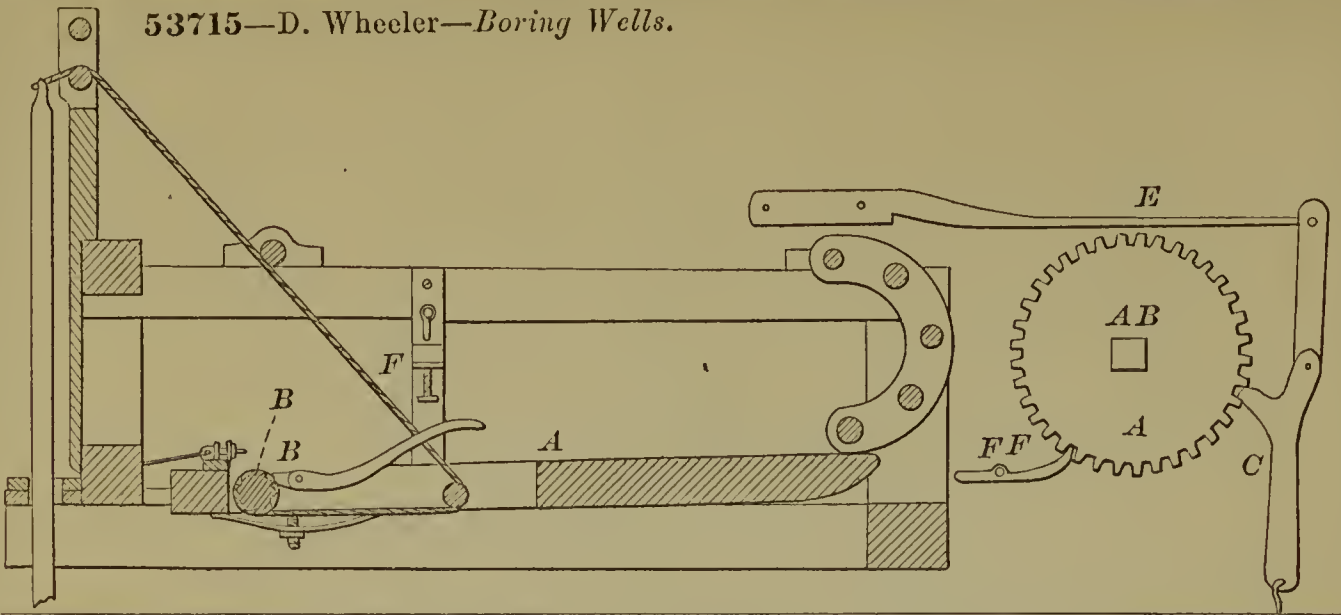

53717—J. D. Whelpley—*Friction Gearing.*

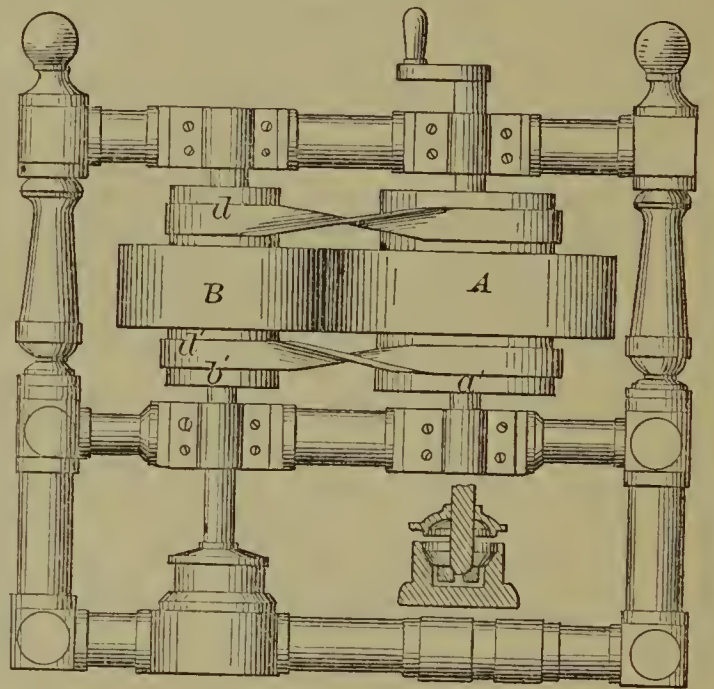

53718—Whelpley & Storer—*Separating Ores.*

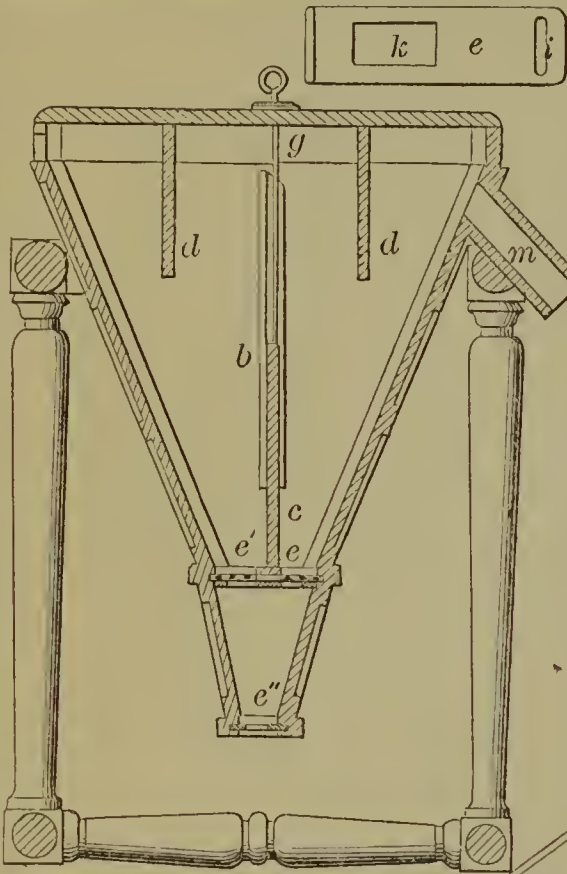

S. B. Williams—*Smut Machine.*

53720—

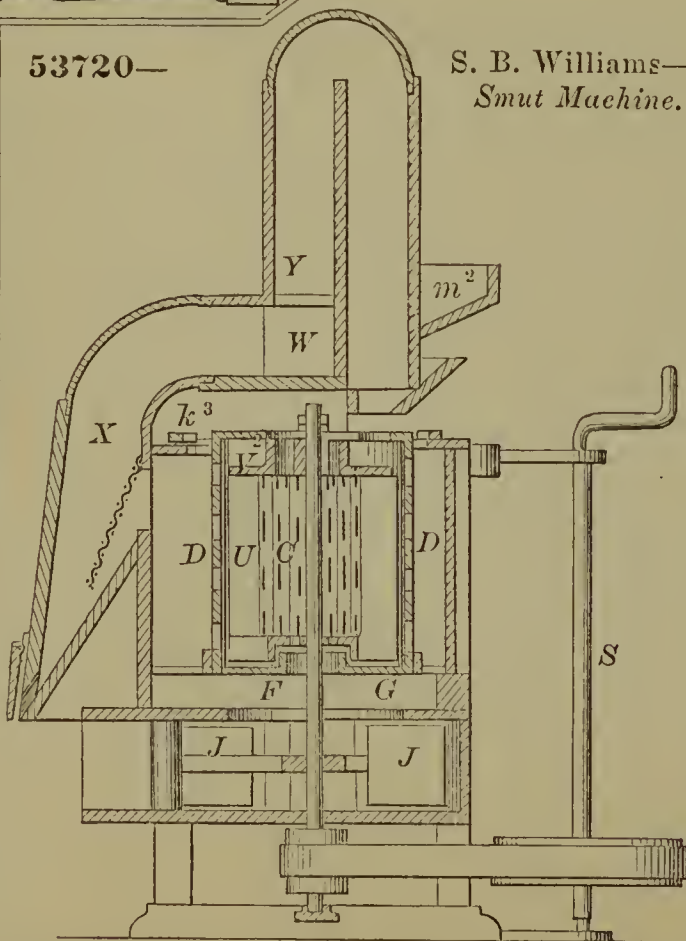

53719—L. C. White—*Scissors.*

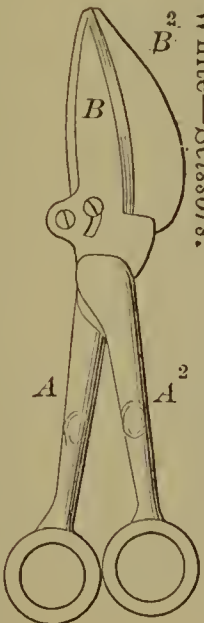

53721—C. A. Wilson—*Steam Gauge.*

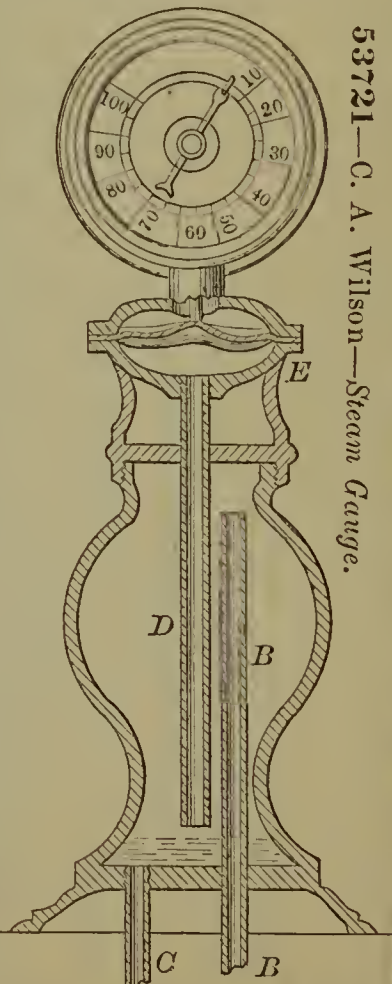

53722—A. Wyckoff—Hollow Auger.

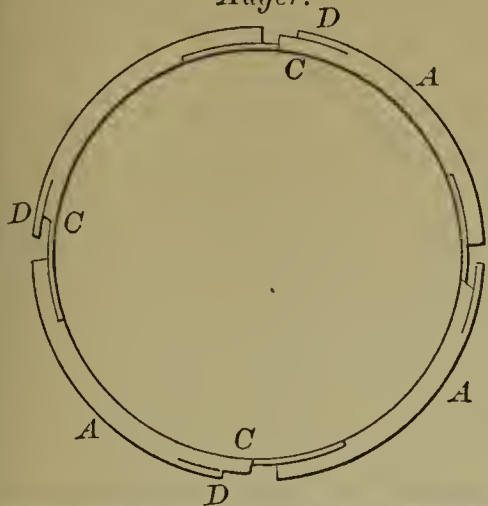

53728—M. Baumgarten—Organ Key Board.

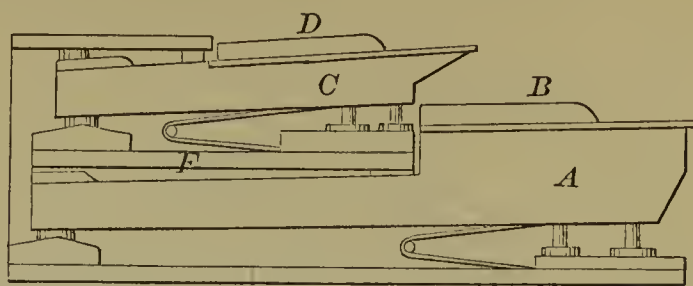

53726—C. A. Ball—Check Hook.

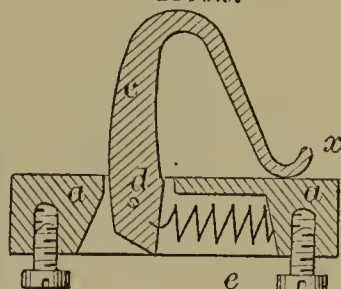

53730—R. Chandler—Clamp Pulley.

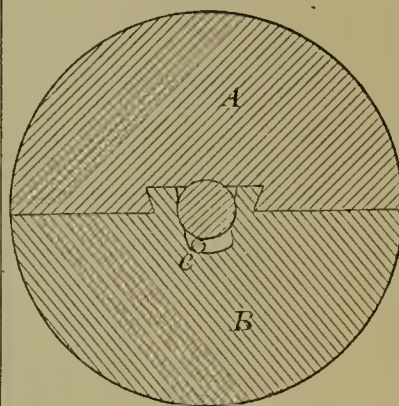

53723—W. C. Wyckoff—Postage Stamp.



53724—W. W. Armington—Stove Blacking Cutter.

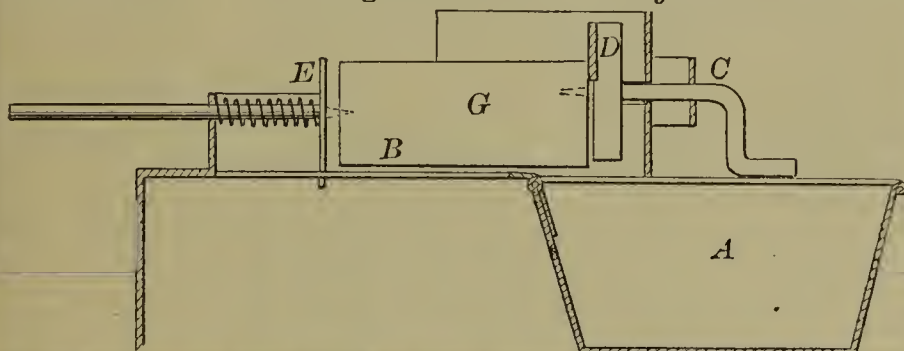

53725—J. G. Baker—Saw Grinding Machine.

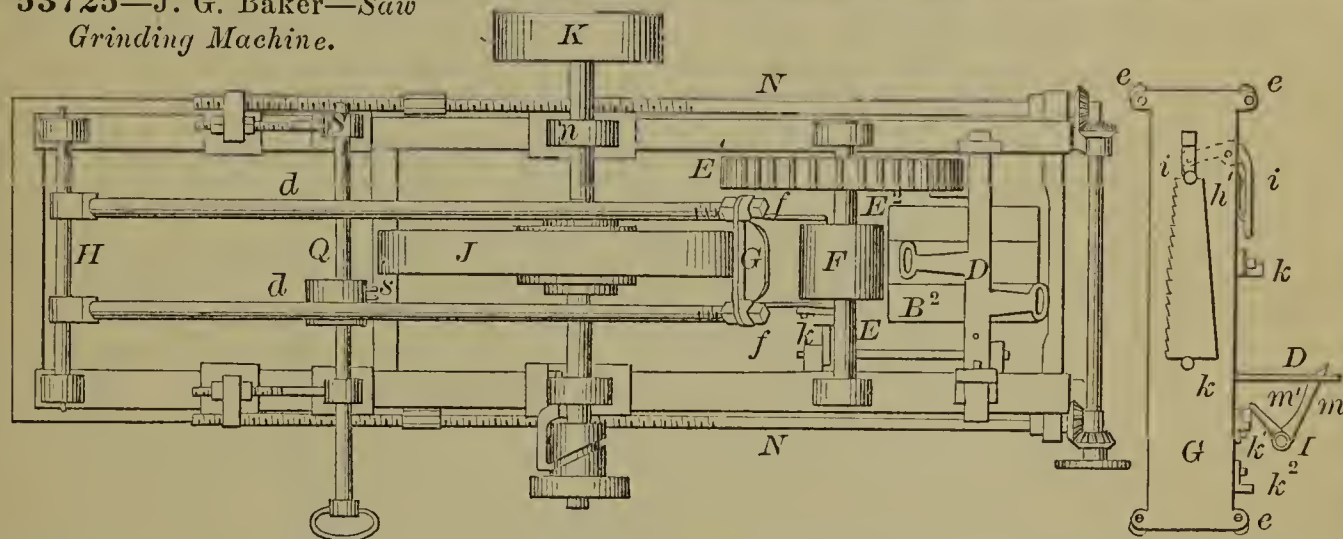

53729—H. Bradford—Inkstand.

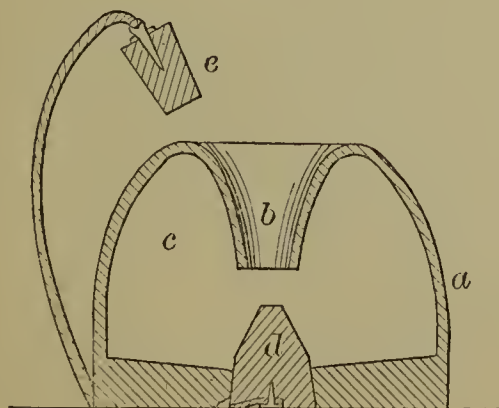

53727—Barnes & Brown—Curtain Fixture.

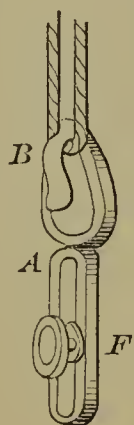

53731—J. Collicott—Rotary Steam Engine.

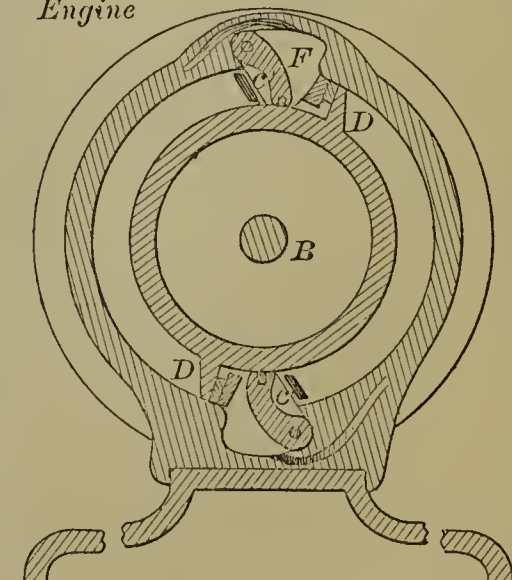

53732—J. B. Crowley—Cooking Stove.

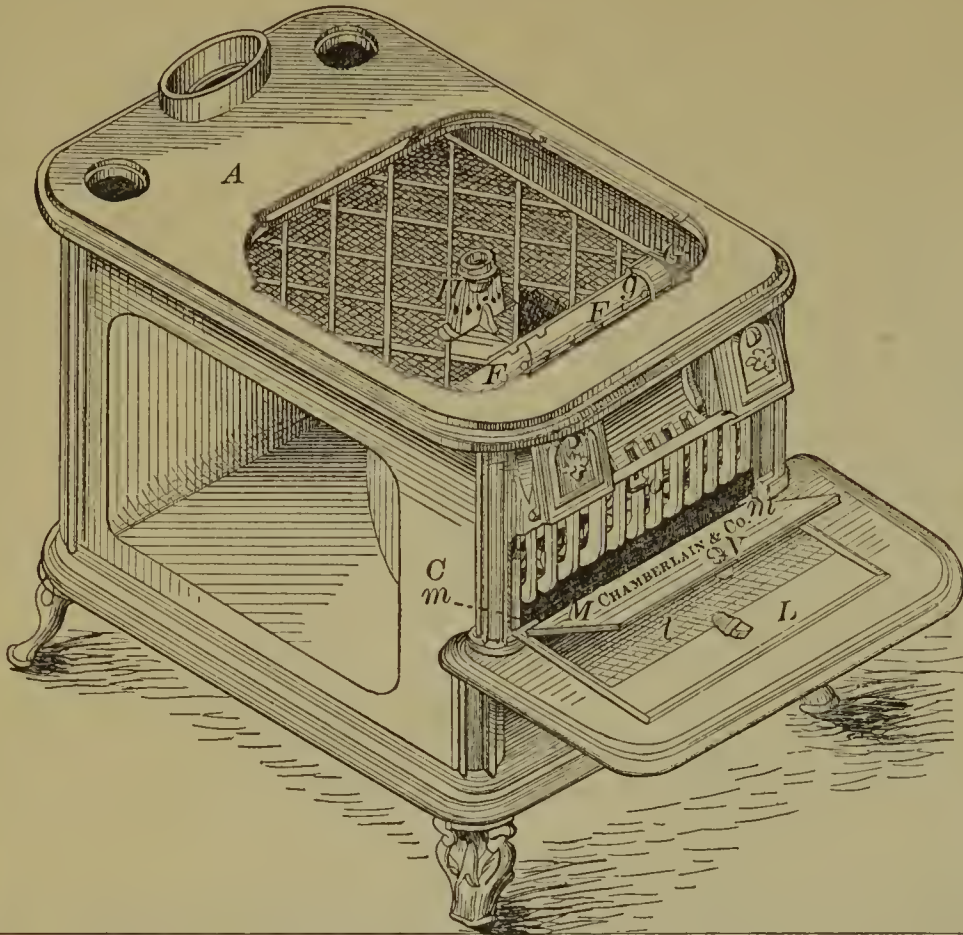

53733—W. Delano—Calking Vise.

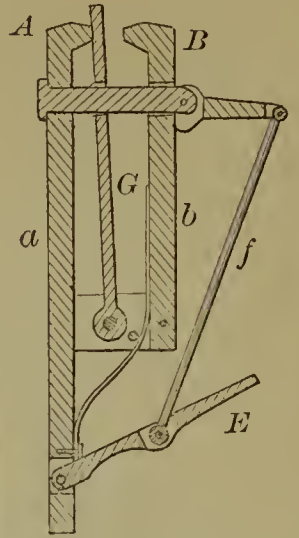

53736—H. L. Frailey—Hydrant Stop Cock.

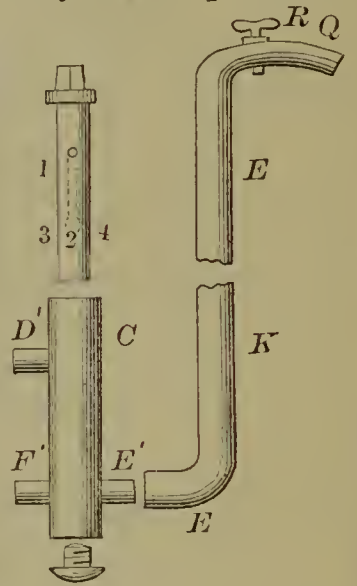

53737—C. Freese—Ditching Machine.

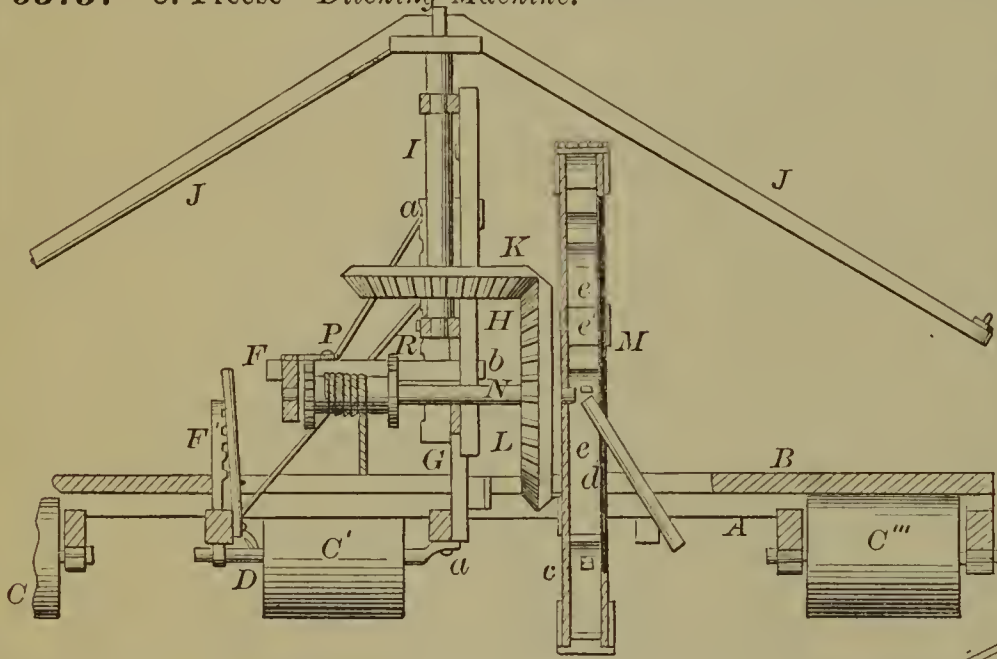

53738—R. Jones—Vise.

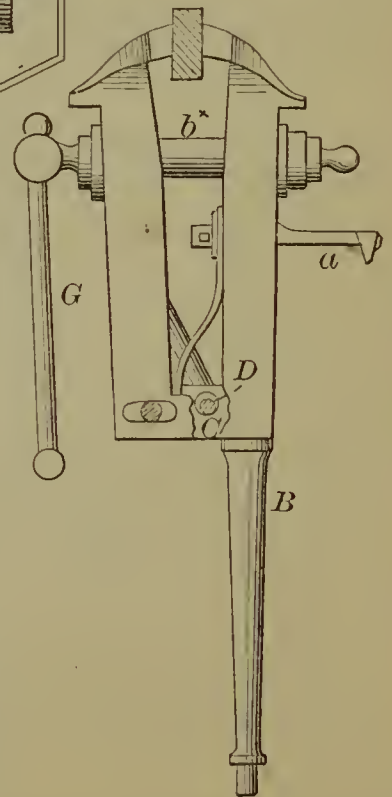

53735—J. H. Fairchild—Grain Separator.

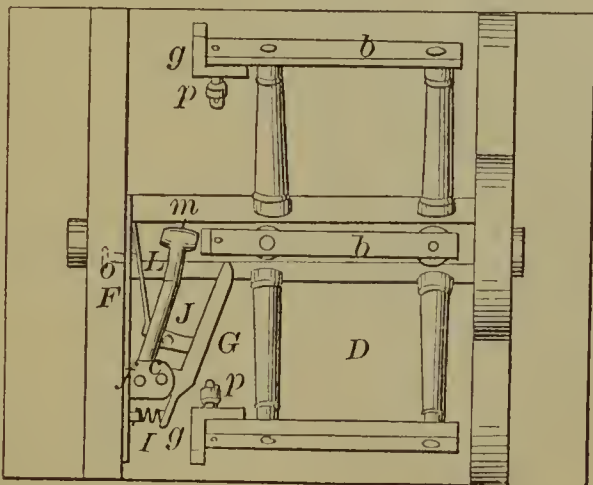

53734—W. Devines—Corset Busk Clasp.





53743—J. S. McCurdy—Sewing Machine.

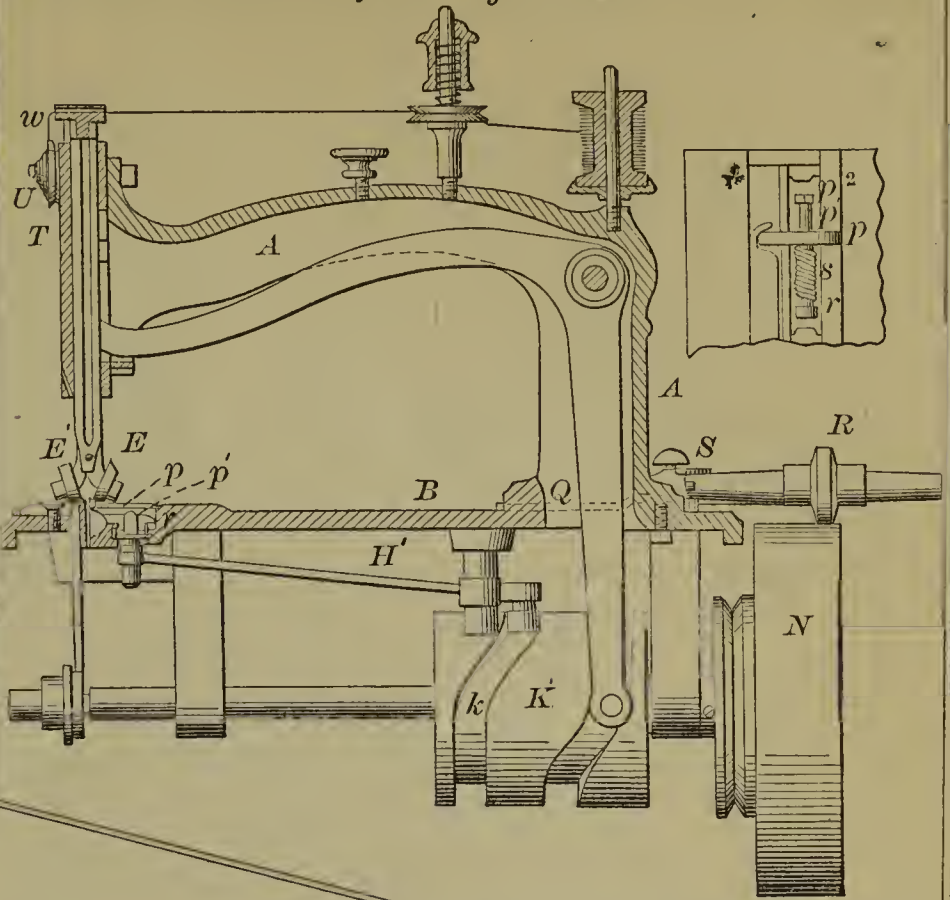

53739—L. L. Knight—Hay Spreader.

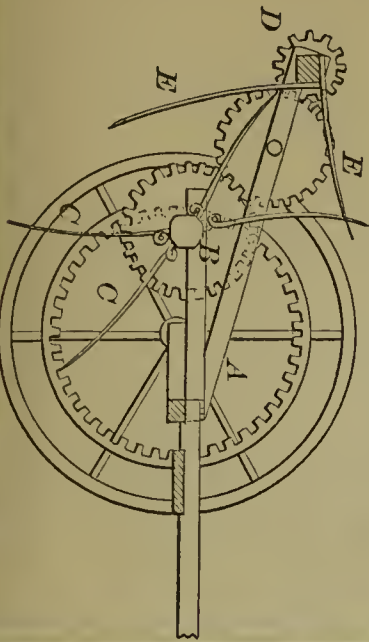

53745—W. T. Munger—Knob Latch.

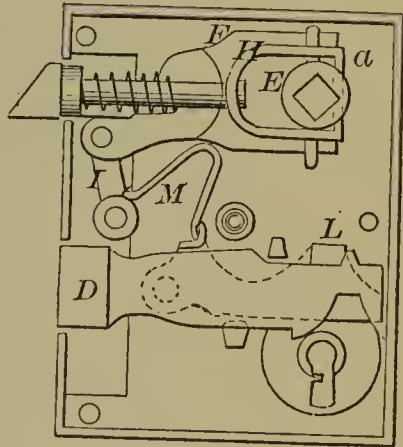

53740—J. D. Loveland—Harvester Rake.

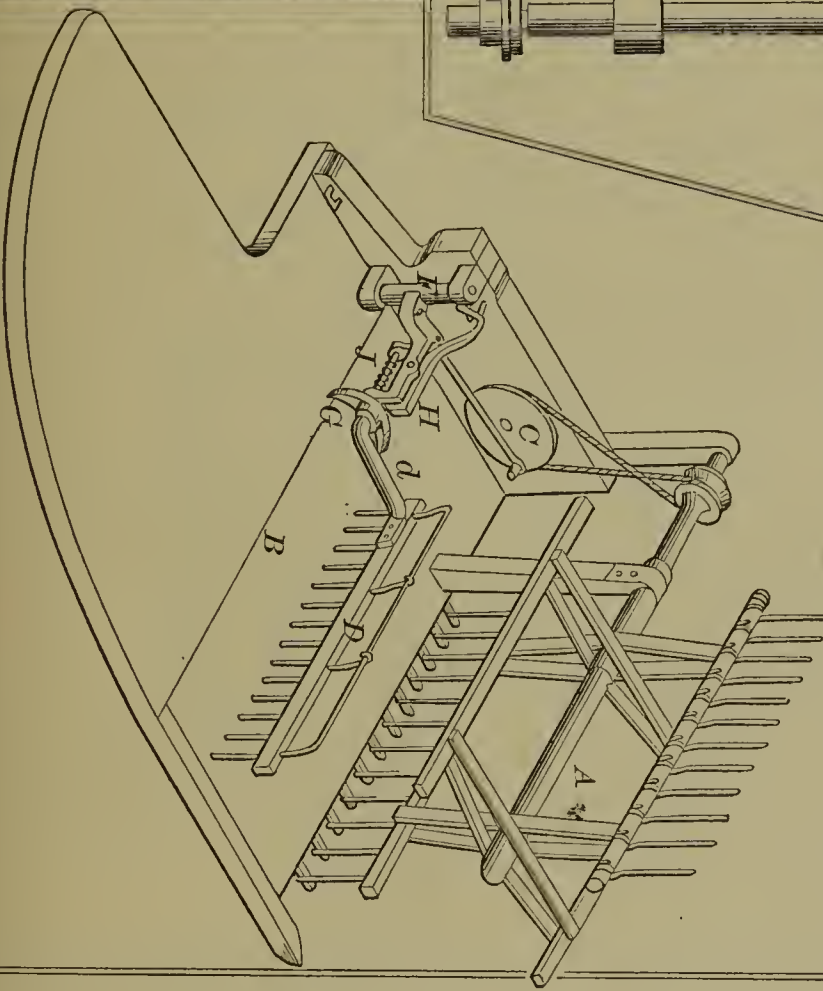

53744—J. Mull—Griddle Cake Baker.

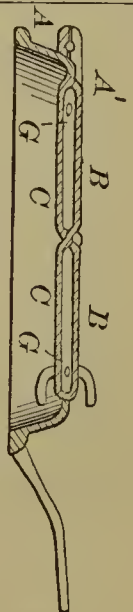

53741—J. A. Marden—Leather Splitting Machine.

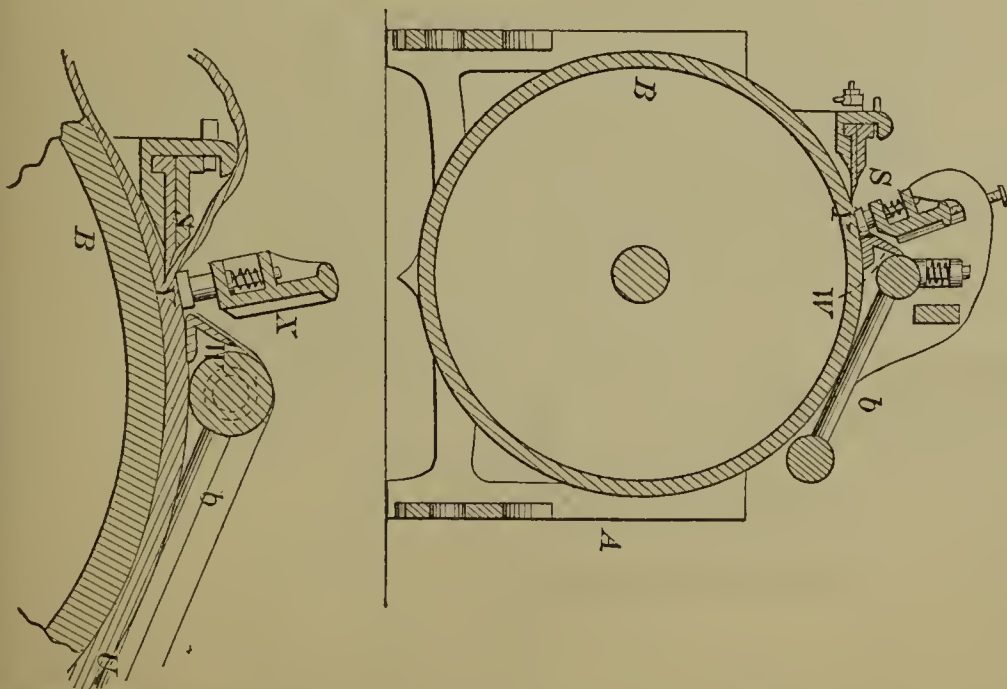

53746—W. Orr Jr.—For Winding Yarn.

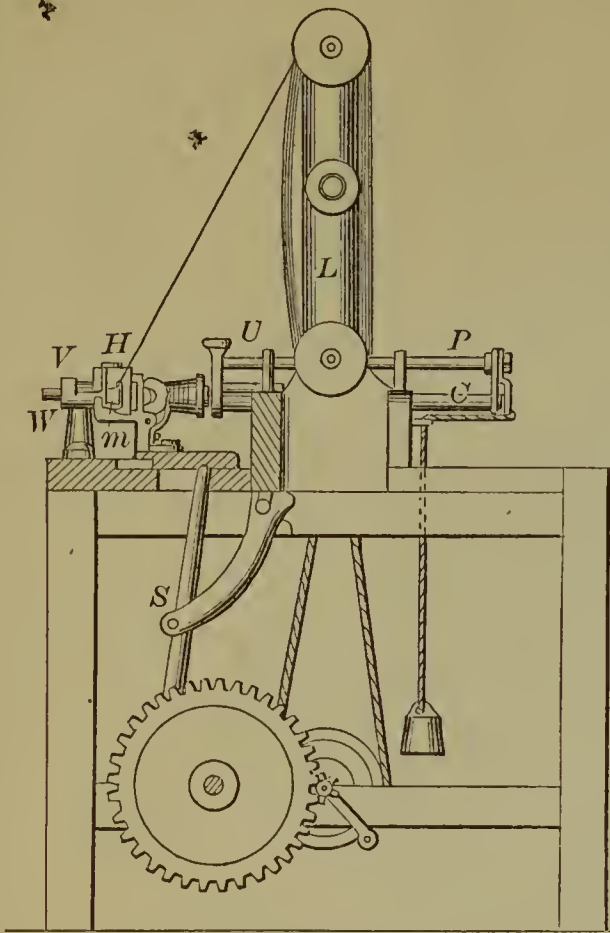

53748—L. T. Richer—Water Can for Cars.

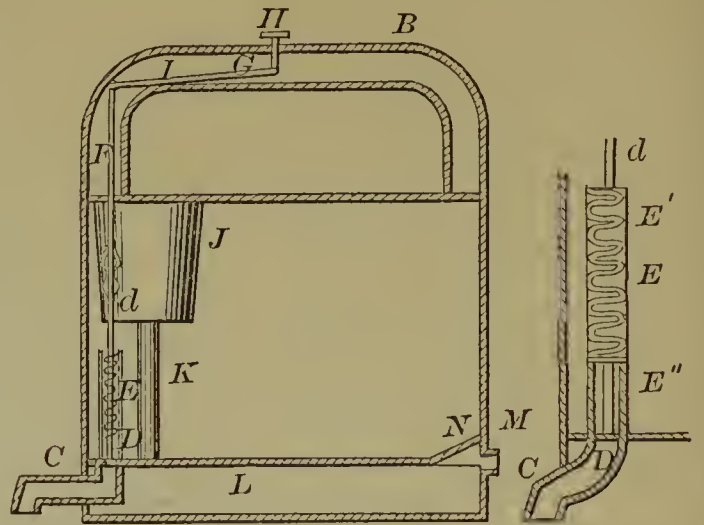

53751—G. F. Stone—Sheet Metal Can.

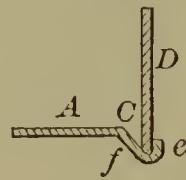

53750—H. M. Stoker—Pump.

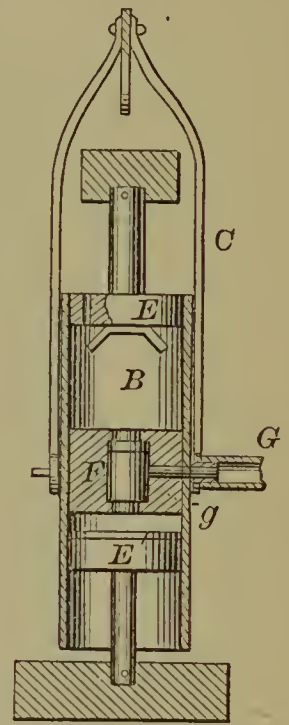

53747—J. Richardson—Machine for Holding and Grinding Edge Tools.

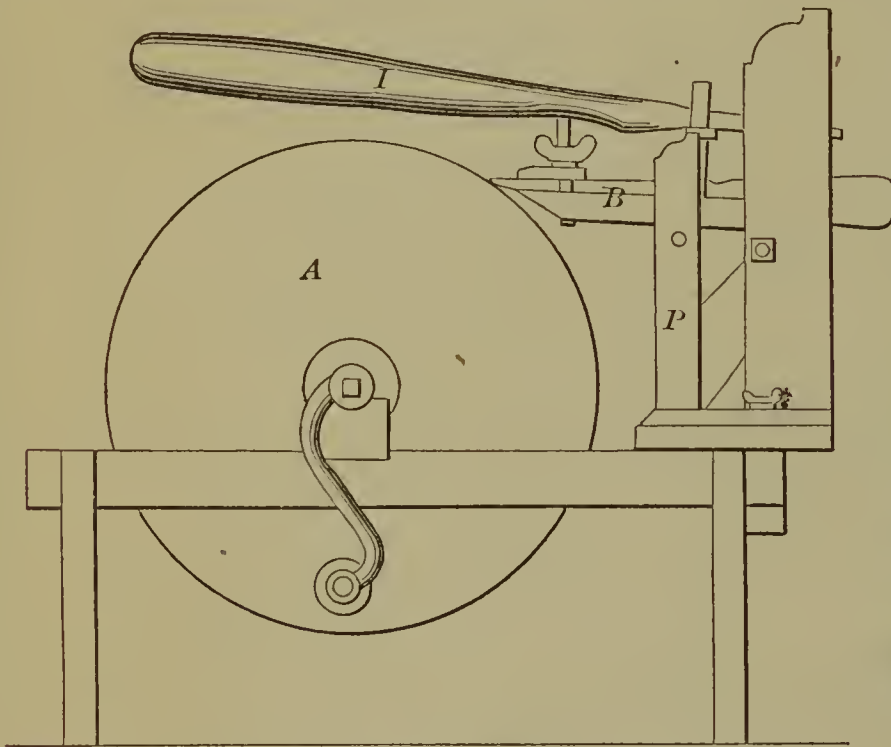

53752—Tyler & Tattershall—Hand Corn Planter.

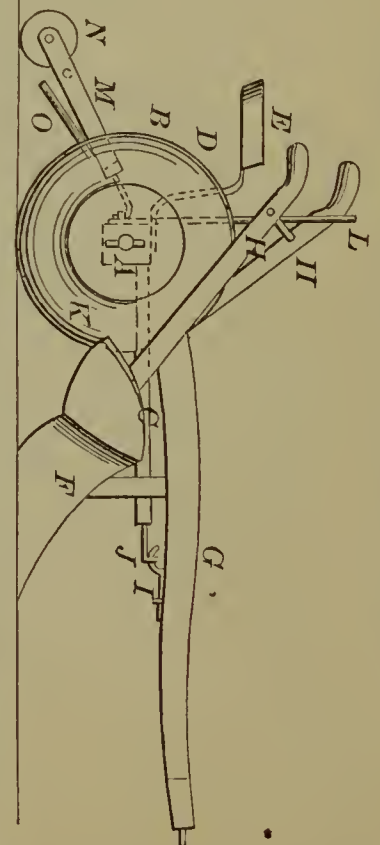
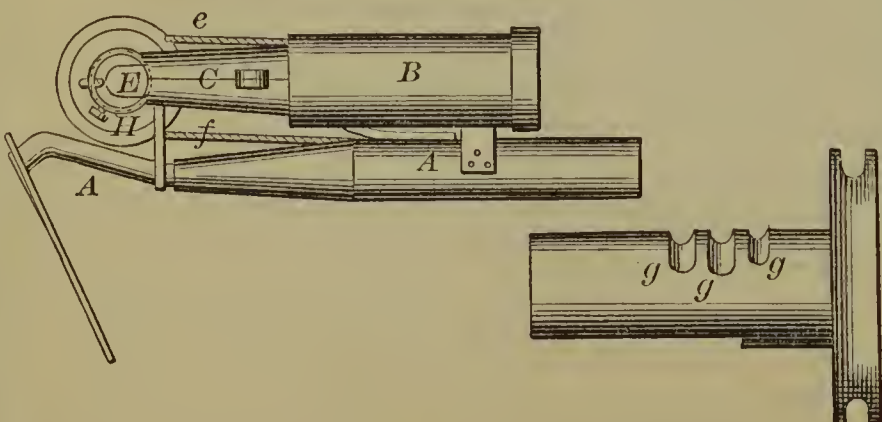

53749—M. Roberts—Attachment in Plows.

53753—E. A. Cowper—Cotton Gin.

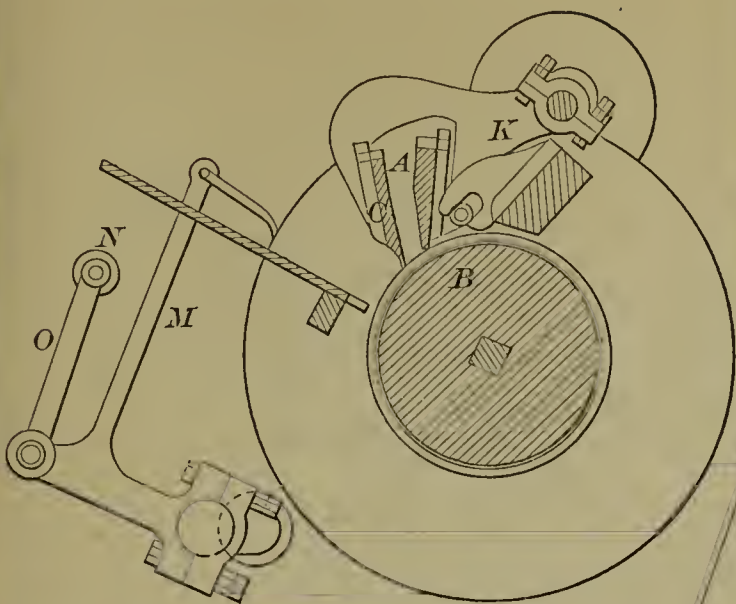

53755—R. D. Wright—Rotary Engine.

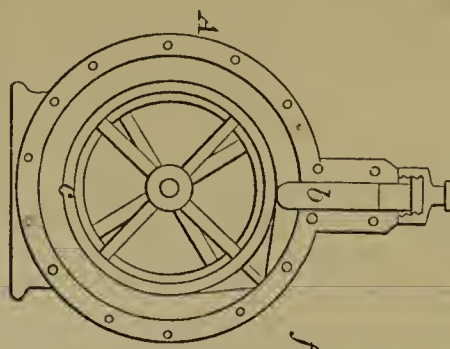

53754—W. Weaver—Paring, Cutting and Coring Machine.

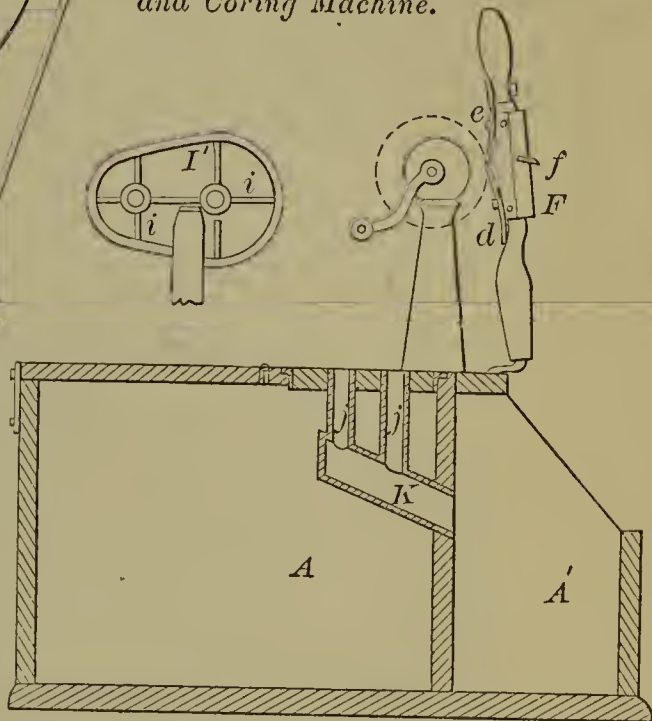

53758—J. Gros—Compressed Gas Generator.

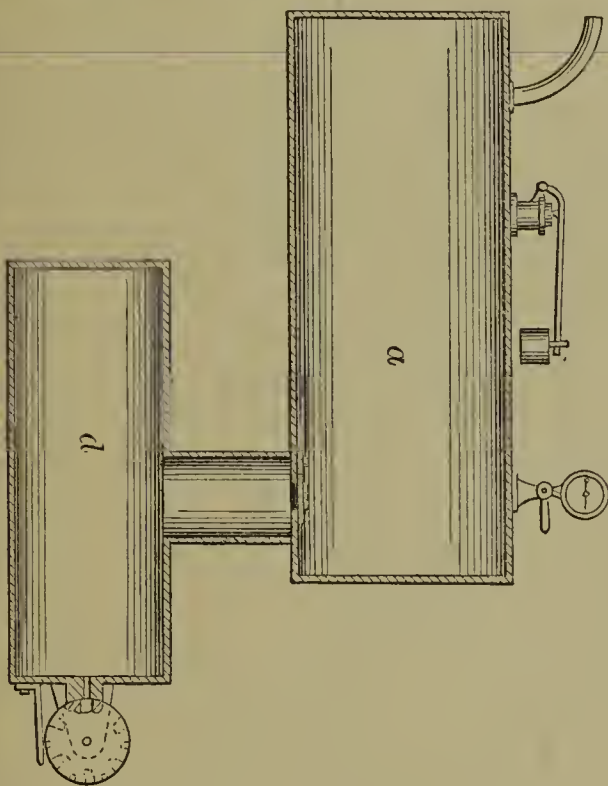

53756—C. P. Coles—For Protecting the Bottoms of Ships.

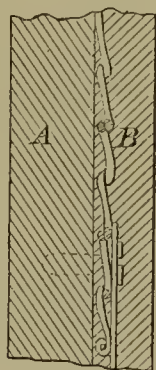

53757—C. Dion—Fire Alarm.

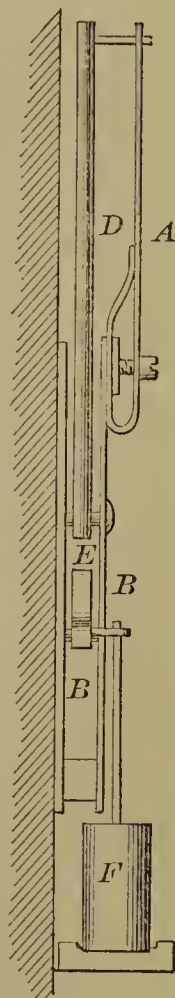

53759—J. Jopling—Propelling and Steering Apparatus.

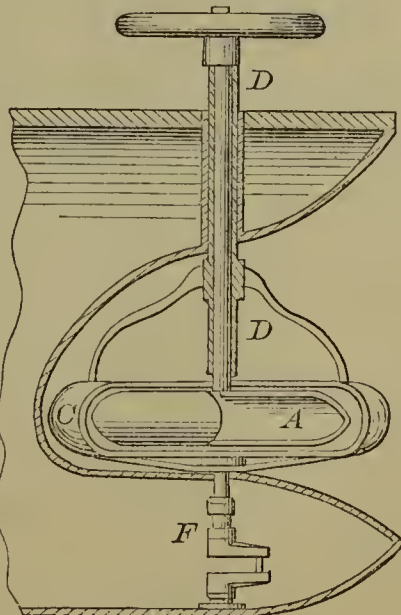

53760—M. Mahler—Muff.

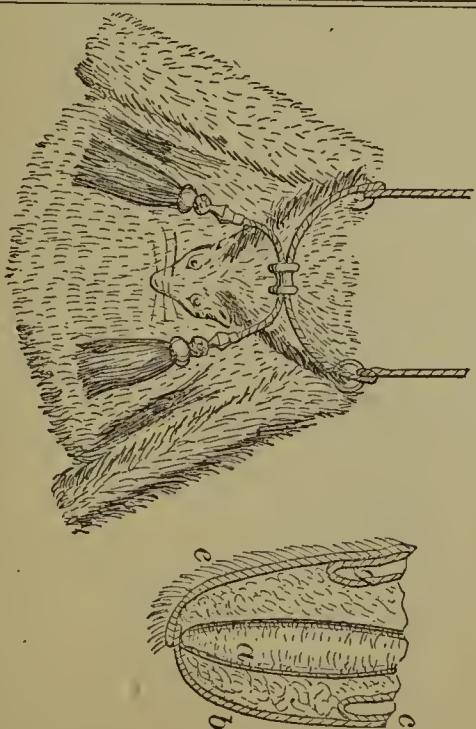

53761—P. C. Moller—Steam Generator.

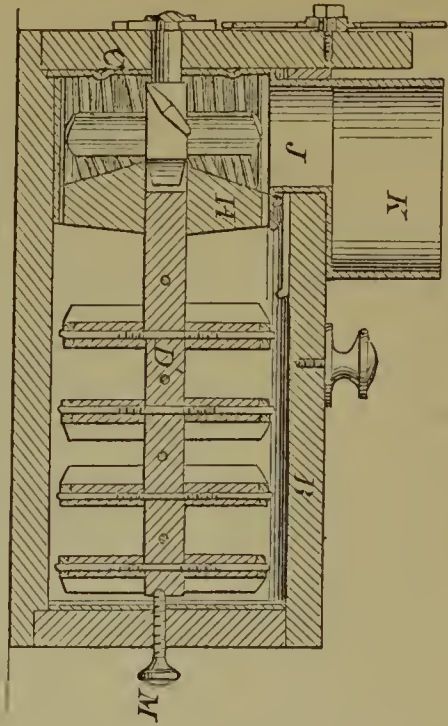
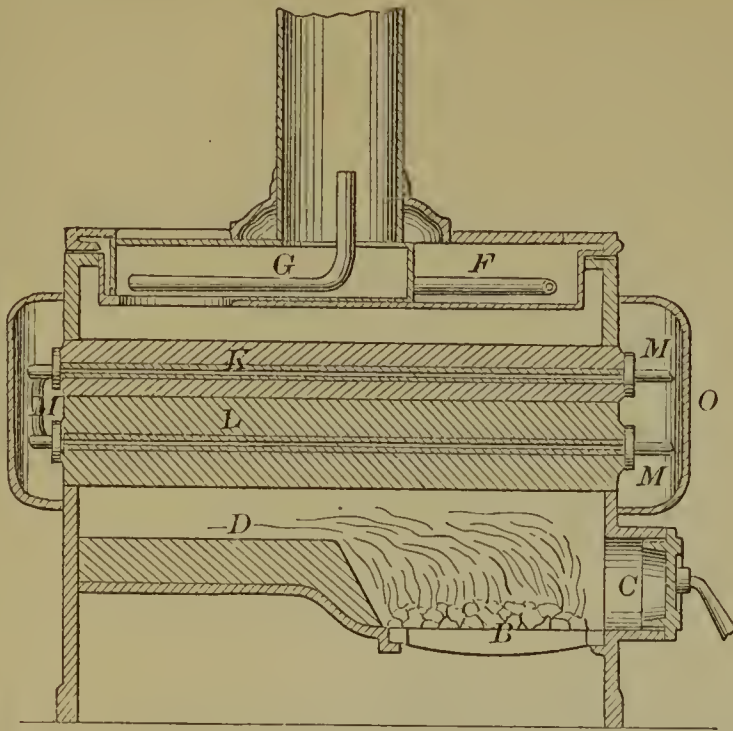

53766—L. O. Allen—Churn.

53762—A. Raphin—Propeller for Vessels.

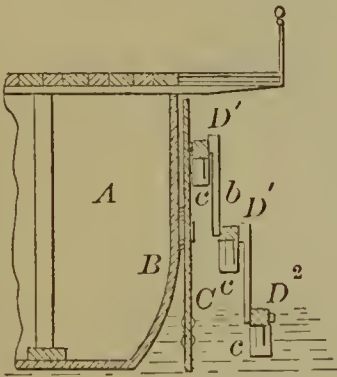

53764—A. B. & F. S. Taft—Car Coupling.

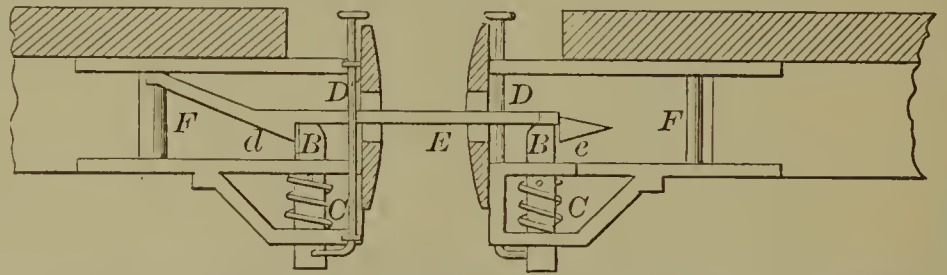

53763—A. Schpakofsky—Burning Liquid Hydro-Carbon.

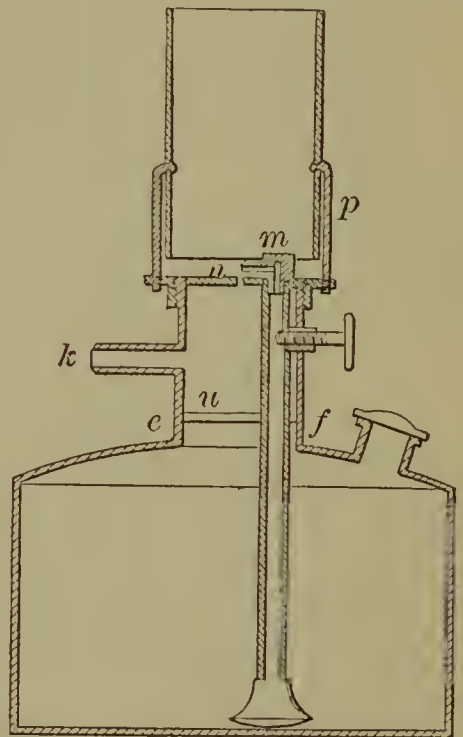

53765—Ackley & Truax—Manufacture of Cans.

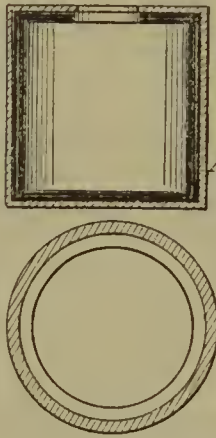

53767—E. S. Alvord—Well.



53769—E. H. Ashcroft—Cistern for Draining Peat.

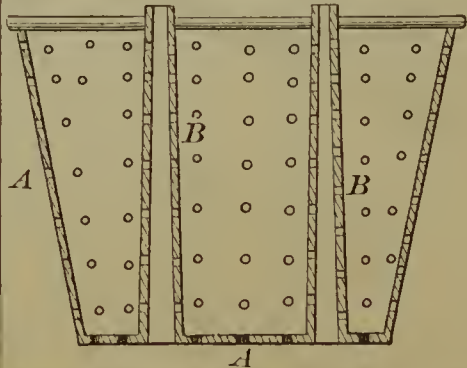

53768—W. Arrounquier—Staging.

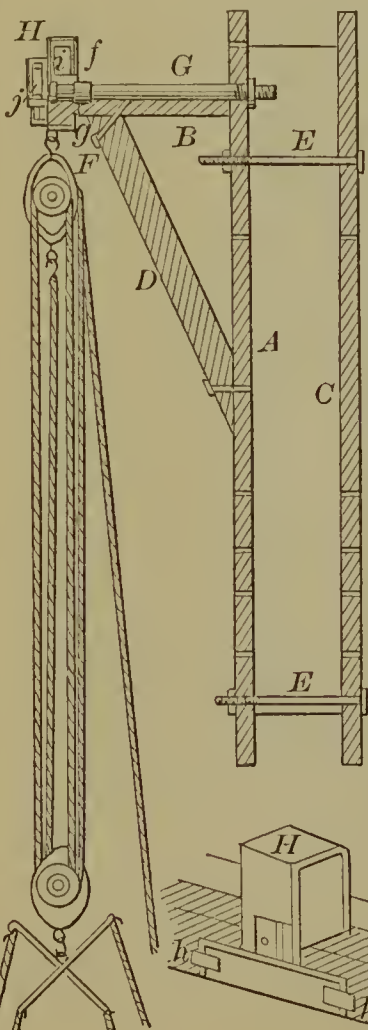

53770—Aspinwall & Whitlock—*Chimney.*

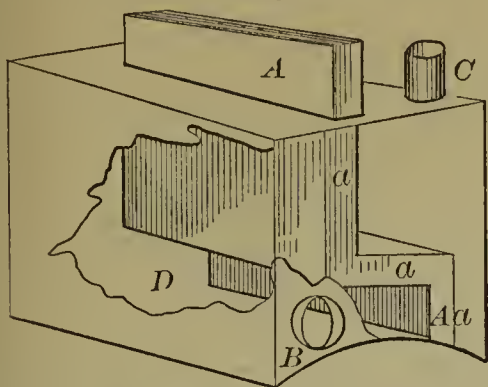

53777—J. Budlong—*Manufacture of Cheese.*

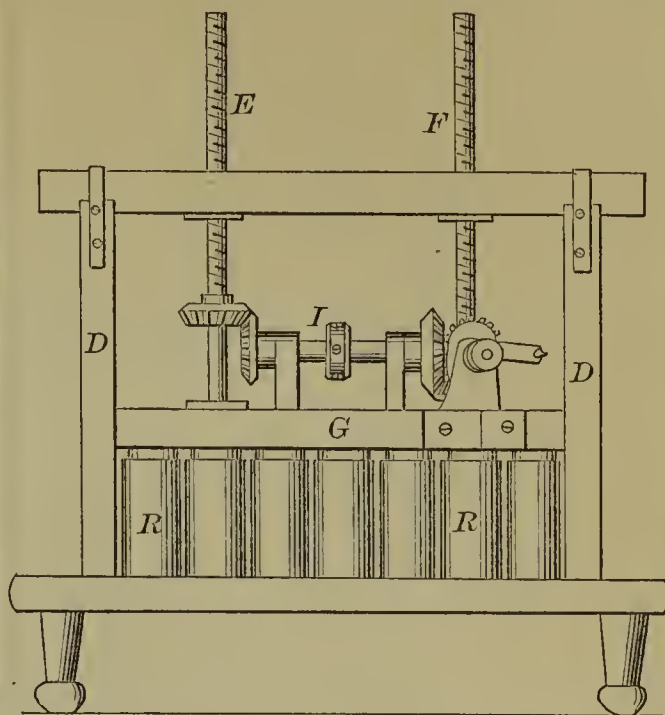

53772—B. Beach—*Tree Protector.*

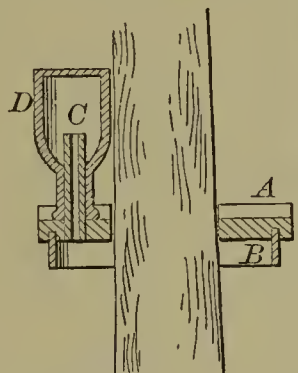

53774—W. Bedle—*Table.*

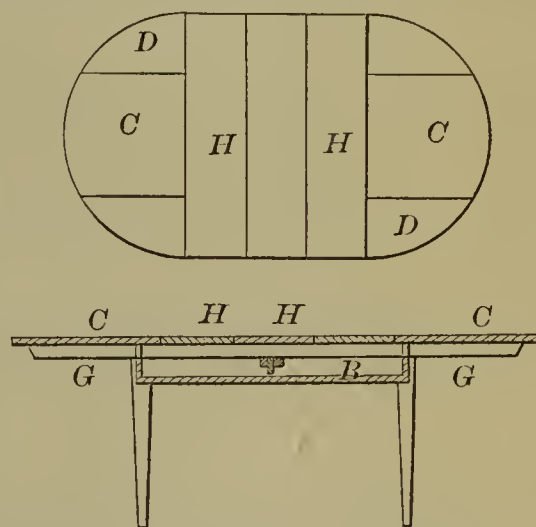

53775—A. T. Boon—*Float for Boats.*



53776—T. F. Boyer—*Clamp for Brooms.*

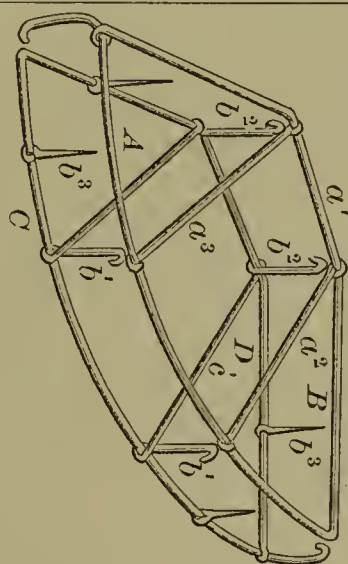

53771—Baldwin & Hawkins—*Leather Splitting Machine.*

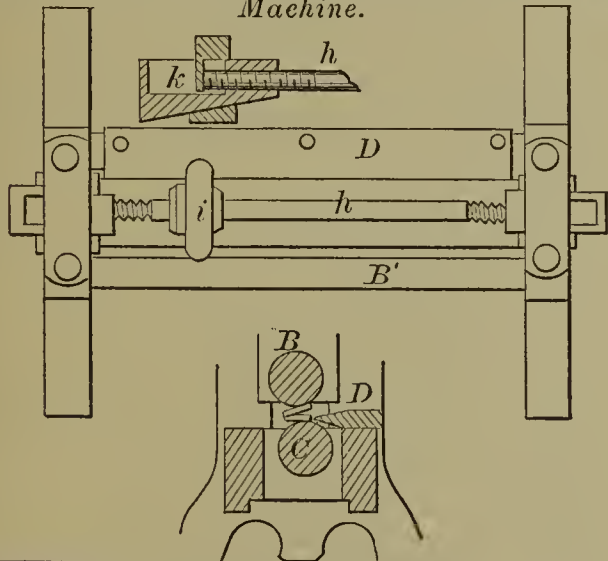

53778—P. T. Brownell—*Combined Umbrella and Cane.*

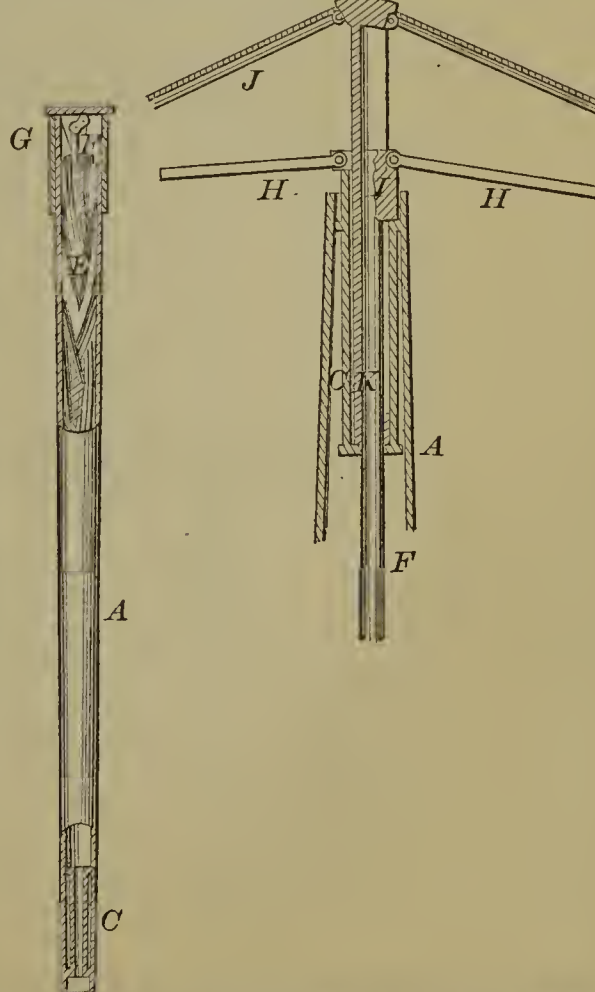

53773—J. S. Beals—*Plow.*

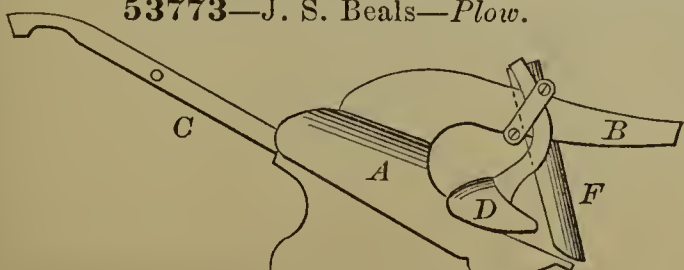

53780—O. C. Burdick—Die for Nut Machines.

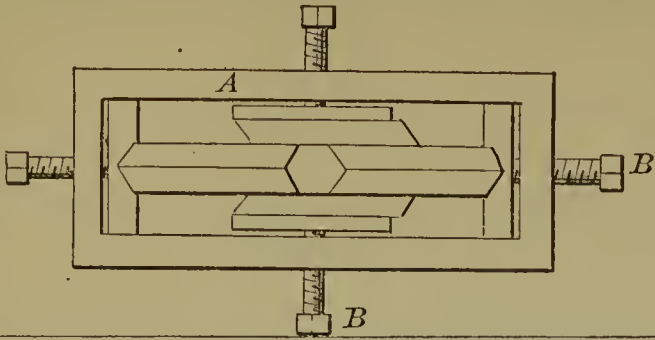

53784—T. Cheshire—Stave Machine.

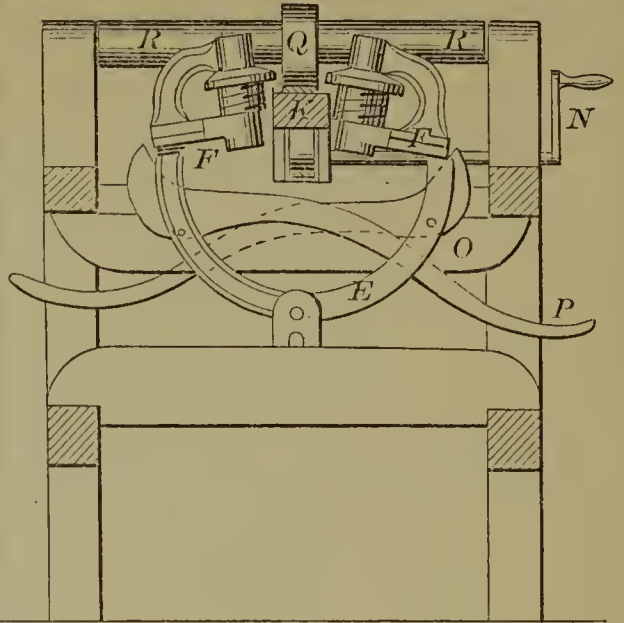

53781—O. C. Burdick—Die for Punching.

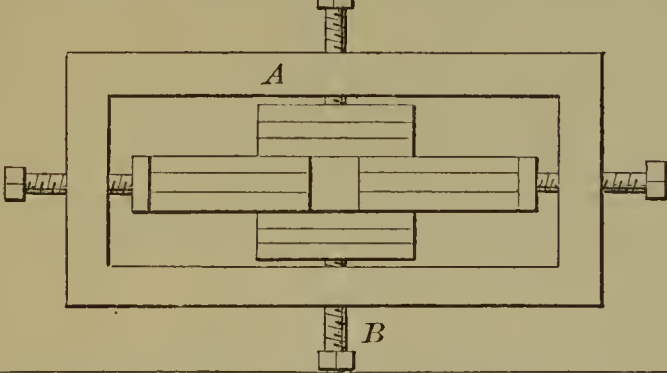

53782—O. C. Burdick—Nut Machine.

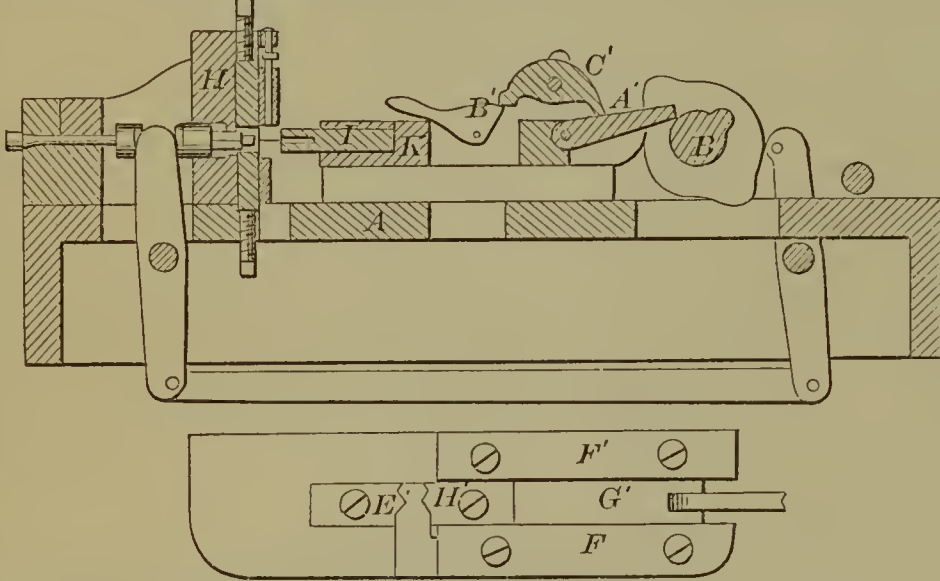

53785—J. B. Child—Beehive.

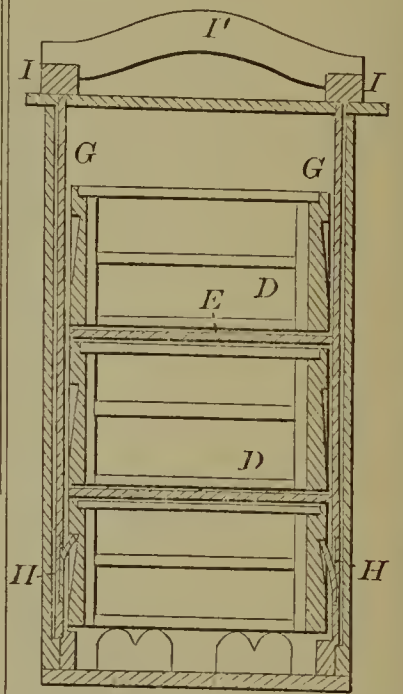

53786—L. A. Colbert—Paper Window Shade.

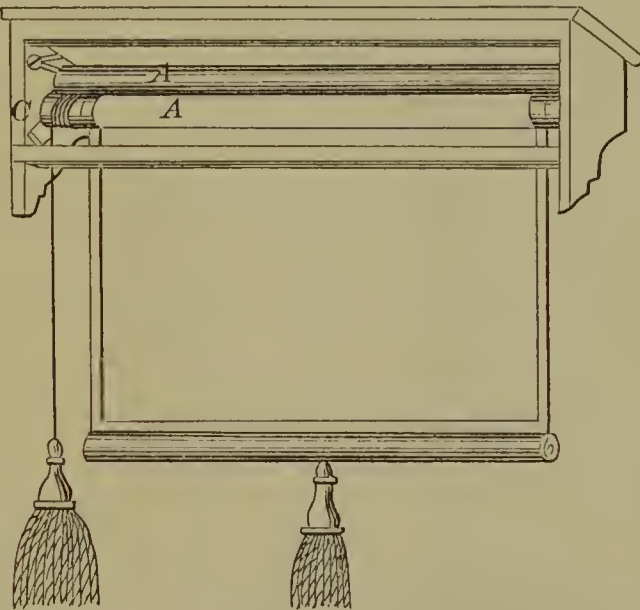

53783—Chandler & Goodrich—Thread Tension Device for Sewing Machines.

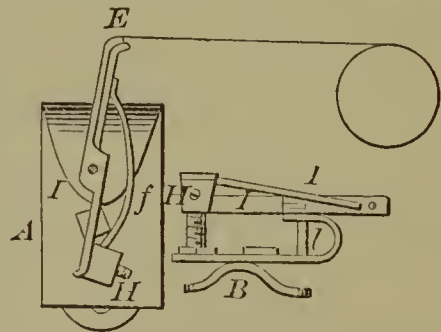

53787—Colby & Thomas—Toy Boat.

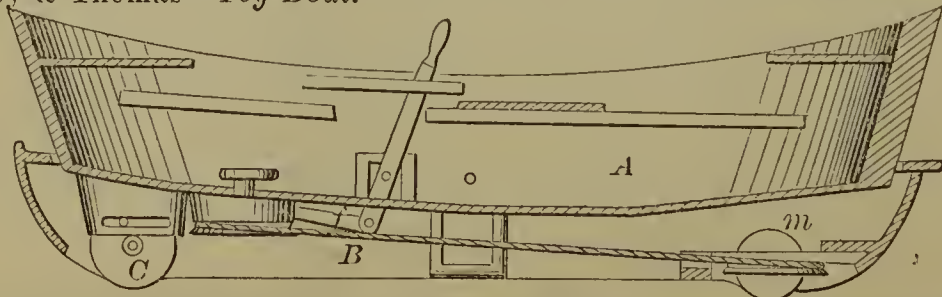

53788—A. P. Conant—Water Wheel.

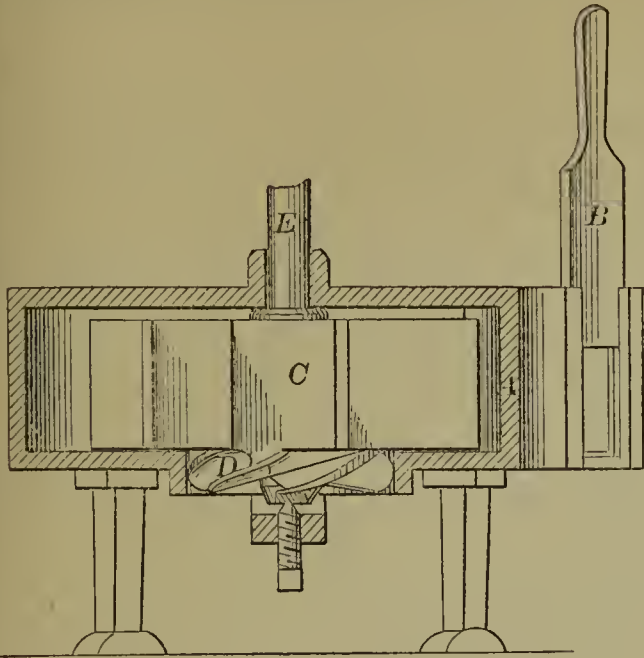

53790—S. Curtiss, Jr.—For Administering Medicine.

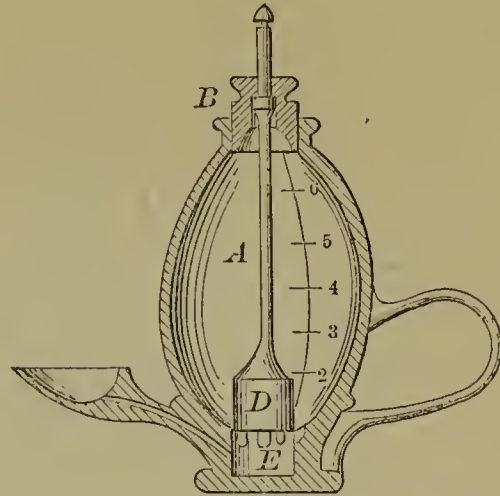

53789—T. R. Cook—Stove Pipe Drum.

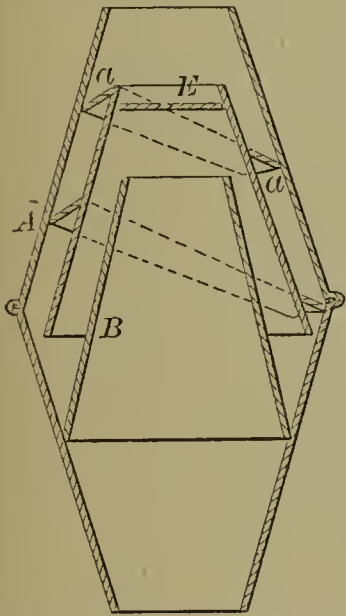

53791—J. Danner—Broom Head.

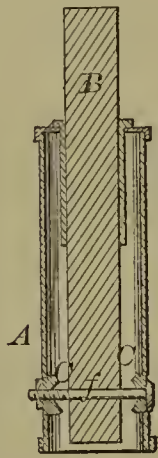

53793—D. Dennison—Washing Machine.

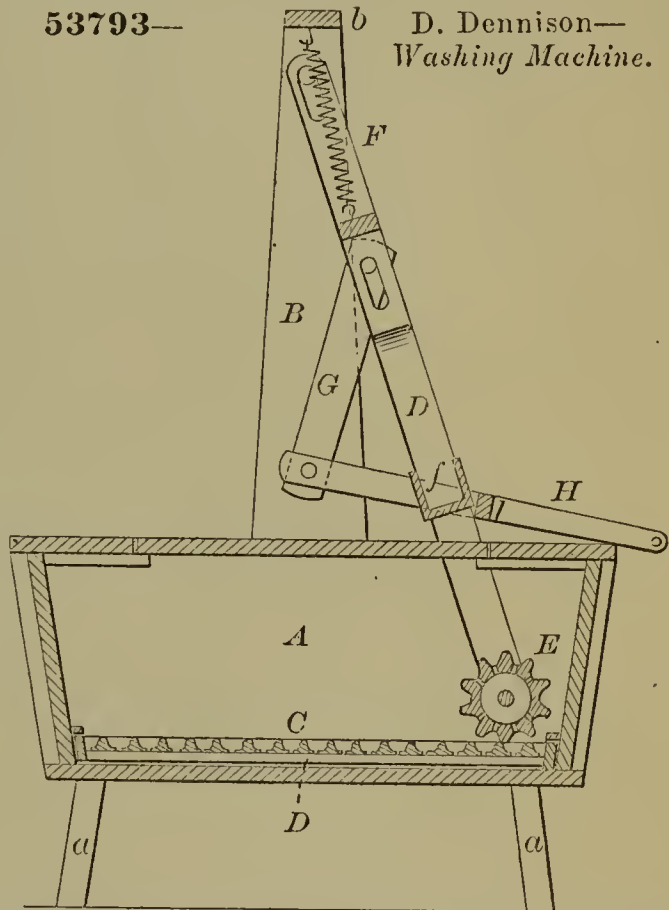

53792—N. A. Davis—Harrow.

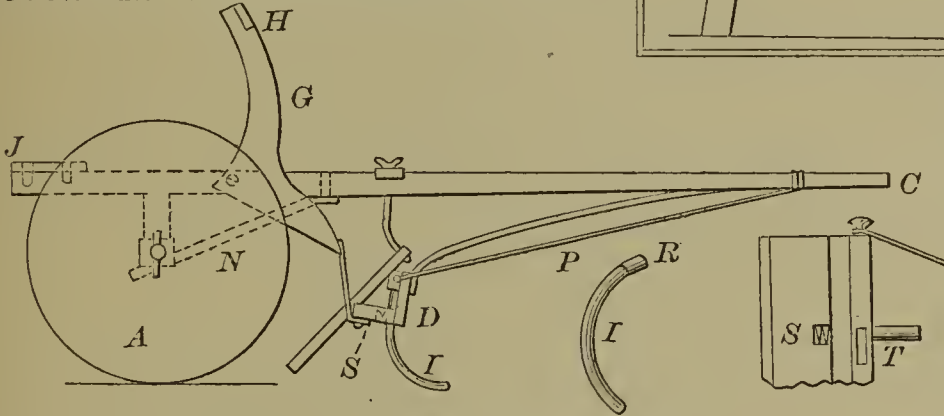

53795—M. W. E. Doran—Plumb Level.

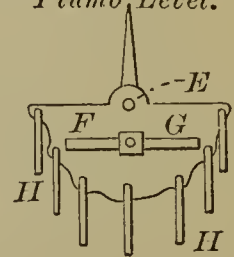

53794—J. & A. Densmore—Car for Transporting Petroleum.

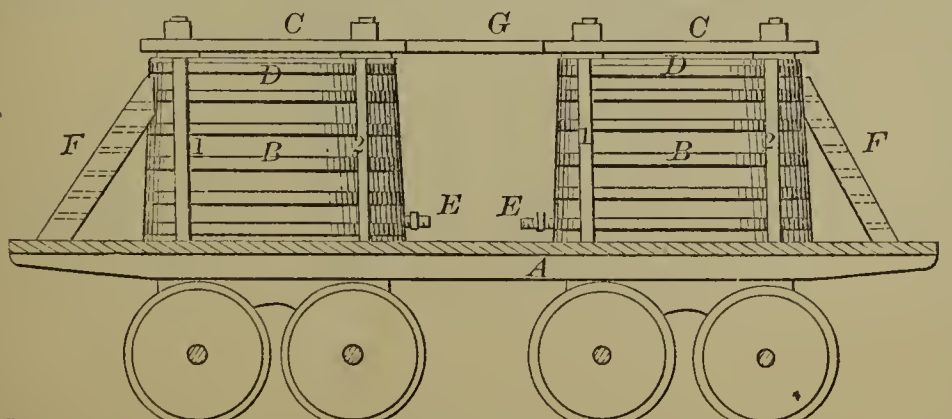

53796—F. Douglas—Button.

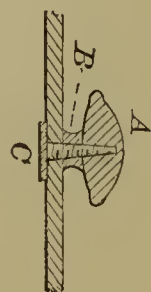

53797—Epperson & Farrell—*Clothes Dryer.*

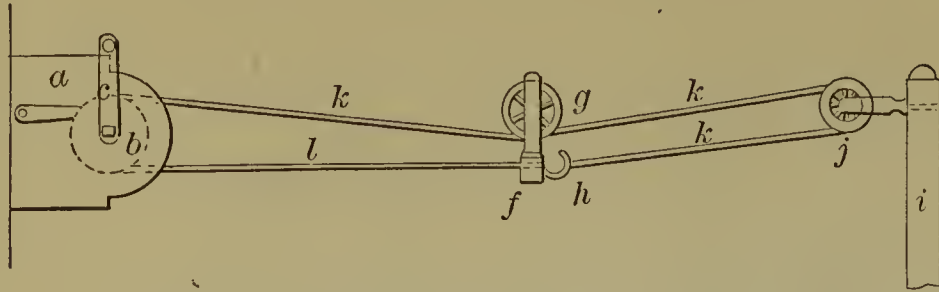

53802—F. Fohr—*Well Borer.*

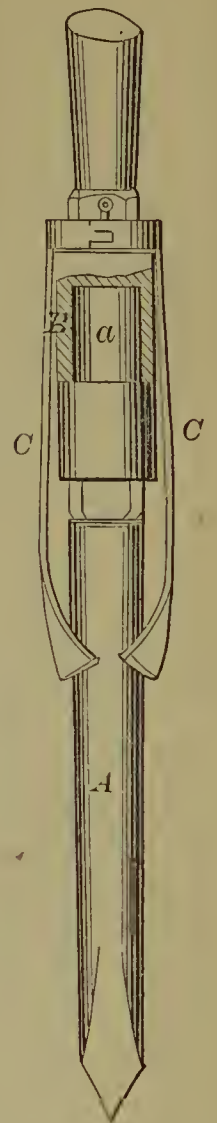

53798—H. Fairbanks—*Carbureting Air.*

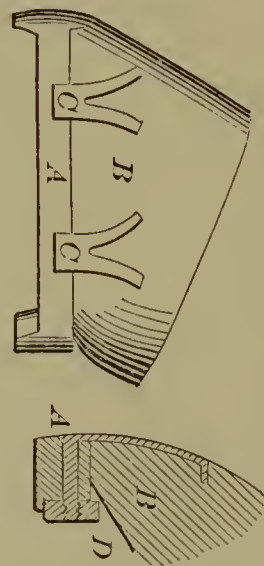
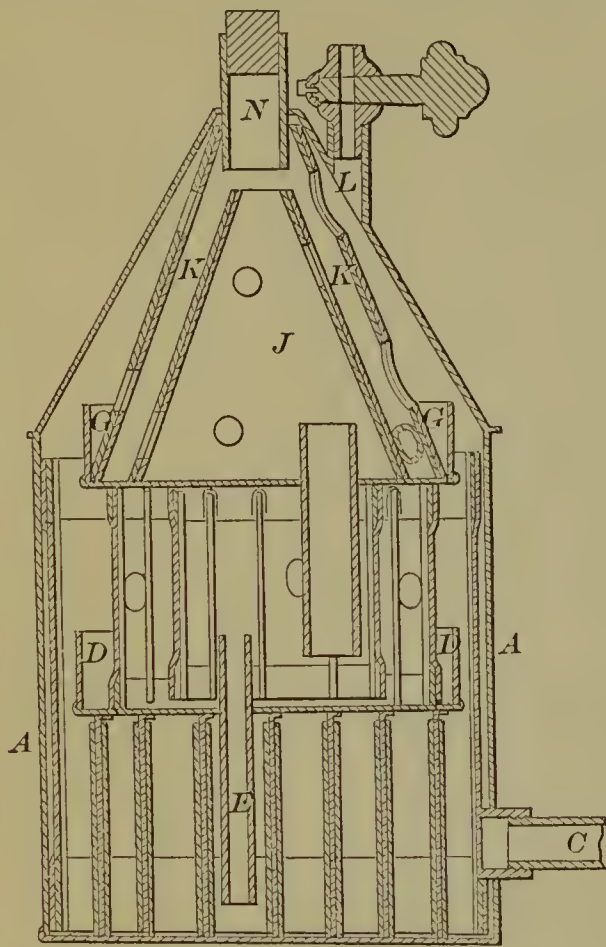

53801—J. W. Faulkner—*Horse Shoe.*

53803—J. & E. Foster—*Musical Instrument.*

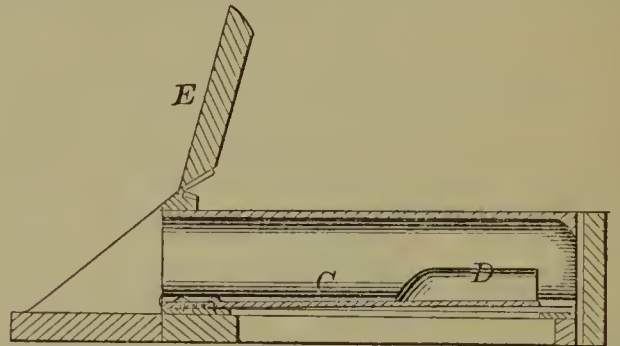

53804—Fryatt & Edmonds—*Sawing Machine.*

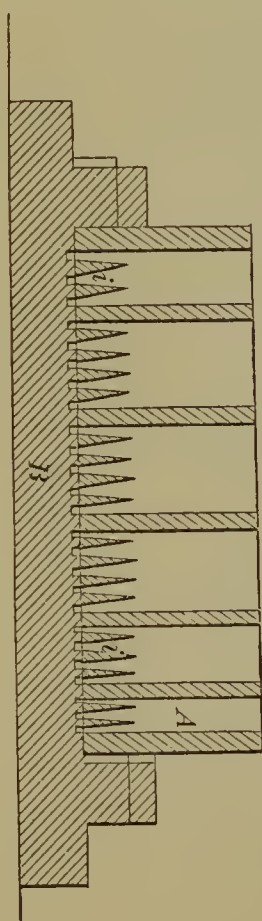
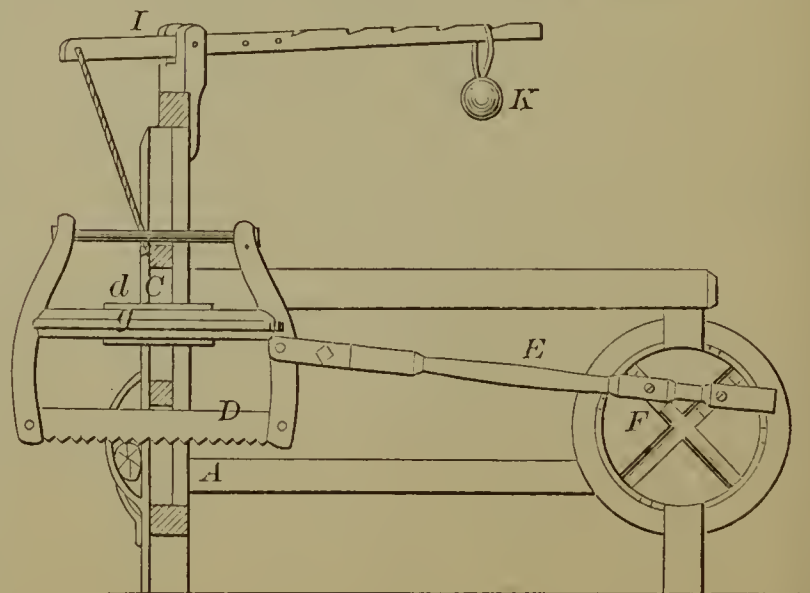

53799—G. P. Farmer—*For Sticking Needles into Paper.*



53805—W. M. Fuller—*Amalgamator.*

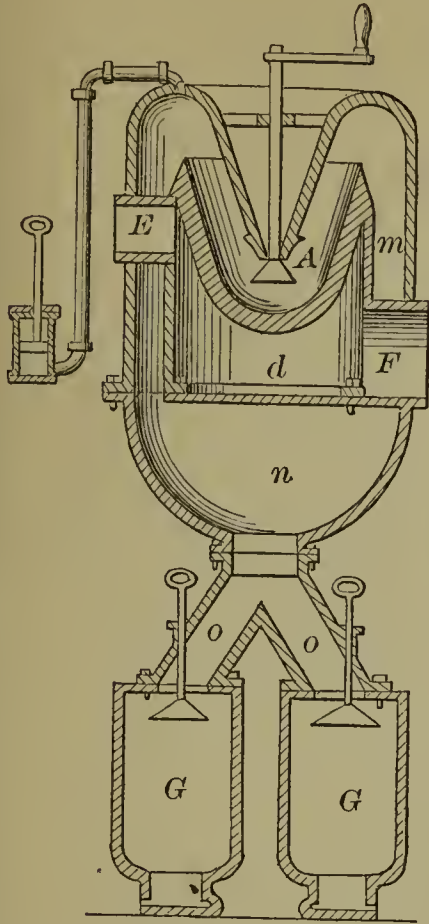

53806—M. Gage—*Stove Pipe Drum.*

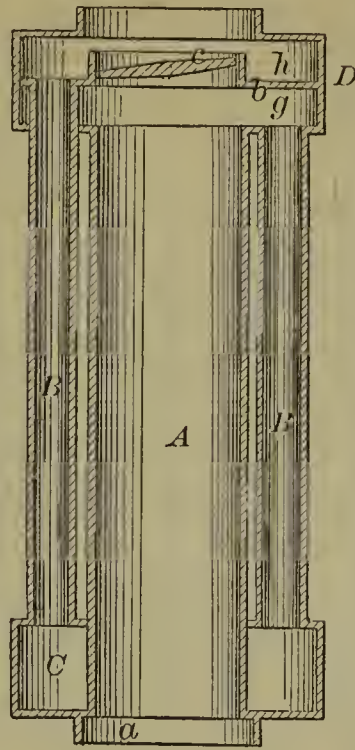

53810—J. Goodyear—*Pump.*

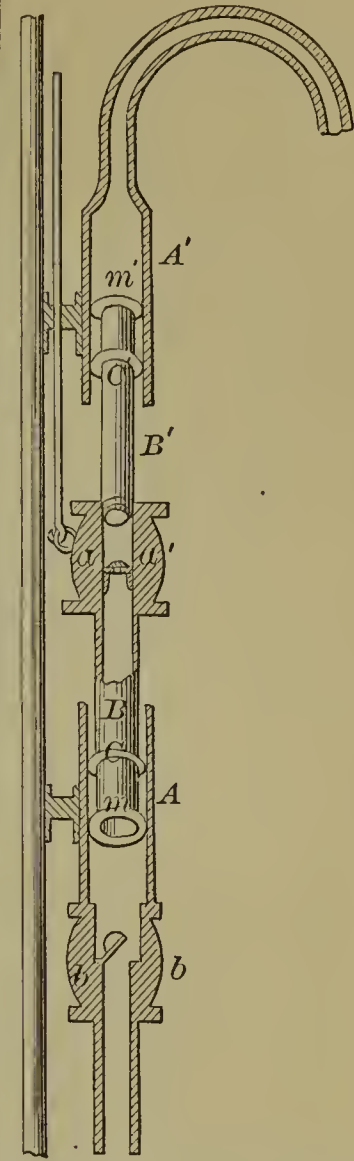

53809—C. F. Gillett—*Bag Holder.*

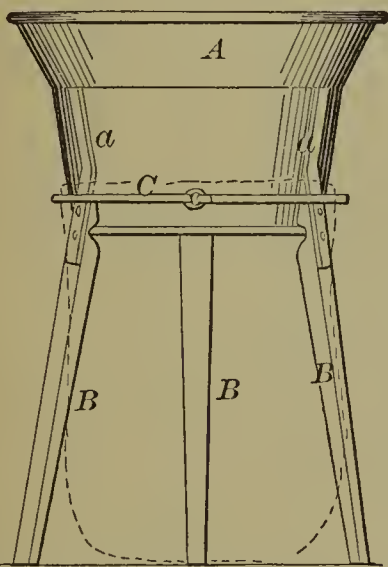

53808—H. C. Gibson—*Water Proof Collar.*

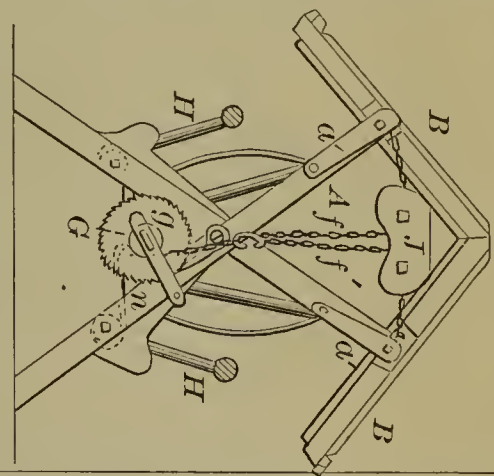
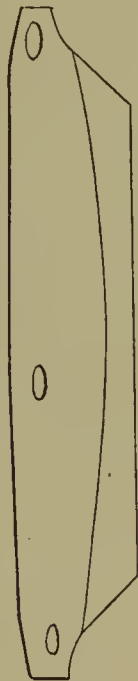

53811—G. F. & T. M. Goudy—*Sheep Rack.*

53812—J. Granger—*Paddle Wheel.*

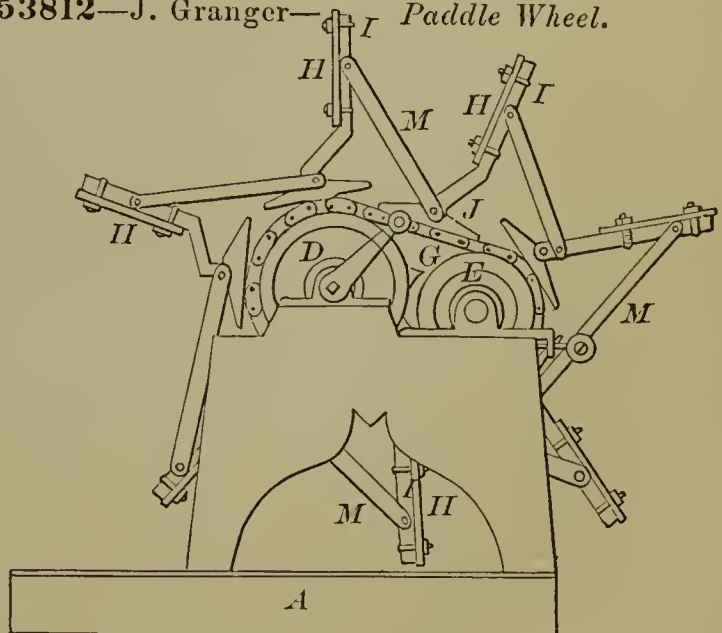

53807—F. Garrick—*Eyelet Machine.*

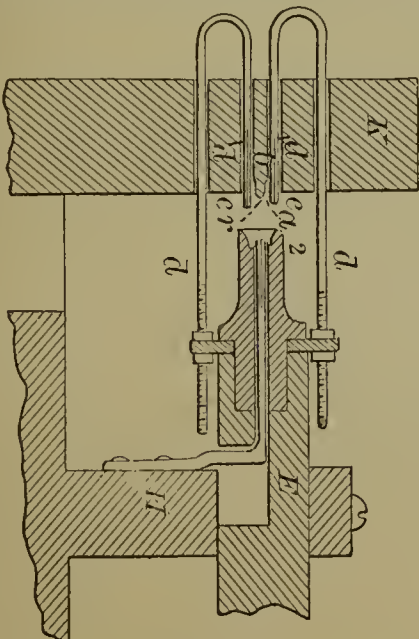

53813—Griffin & Marsh—Step for Spindles.

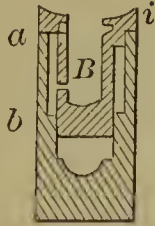

53814—W. E. Grimes—Hay Rack.

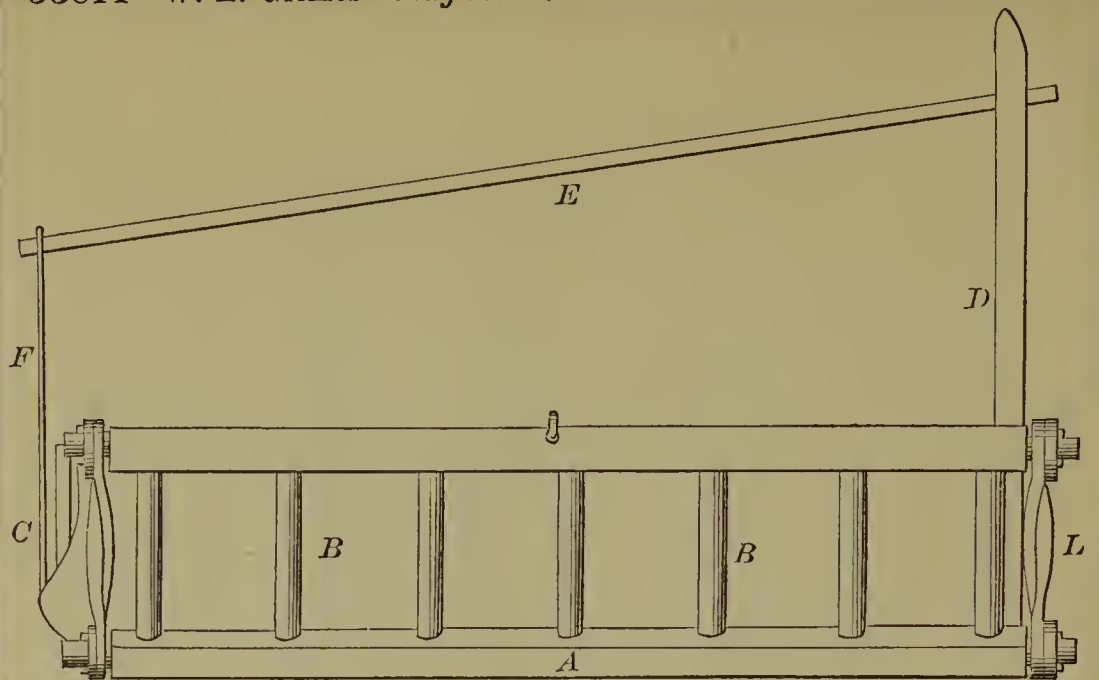

53819—J. O. Harris—Lantern.

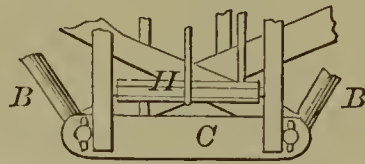
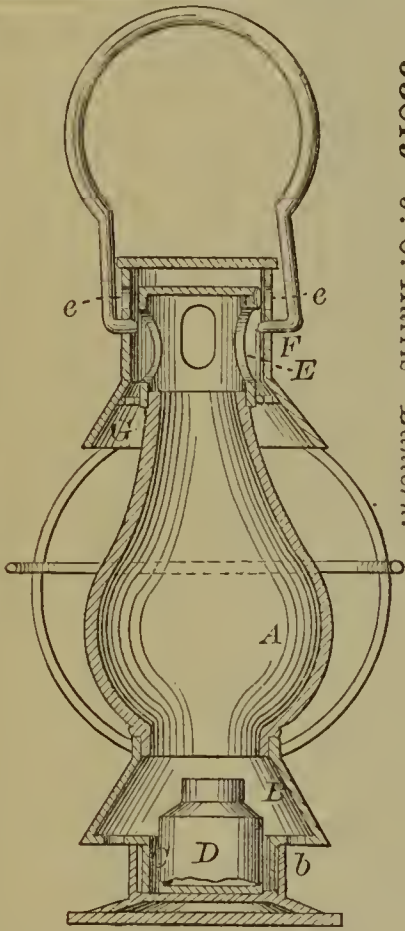

53817—J. C. Hadden—Letter File.

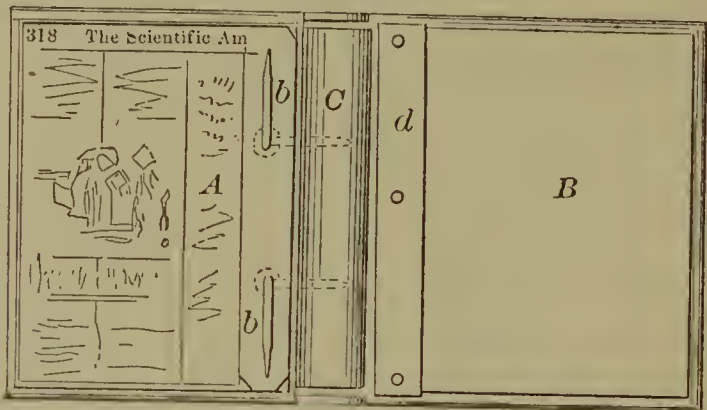

53818—J. A. Hull—Cane Stripper.

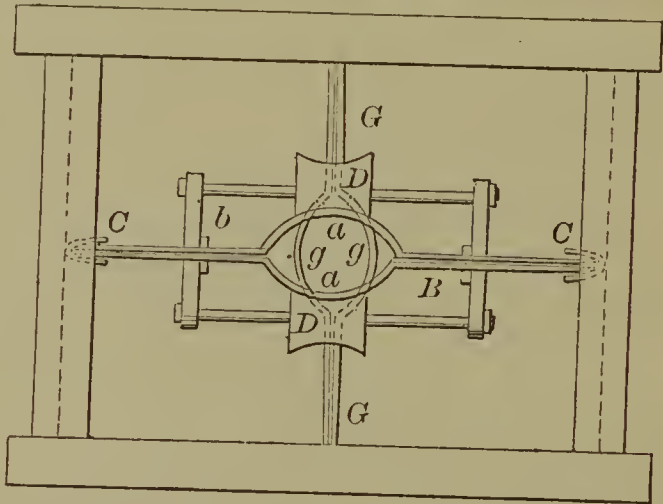

53816—T. Guilford—Machine for Pressing Glass Buttons.

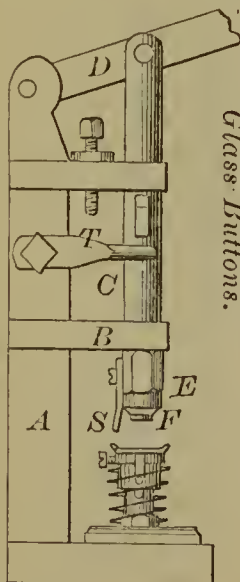

53820—D. G. Haskins—Gas Heating Apparatus.

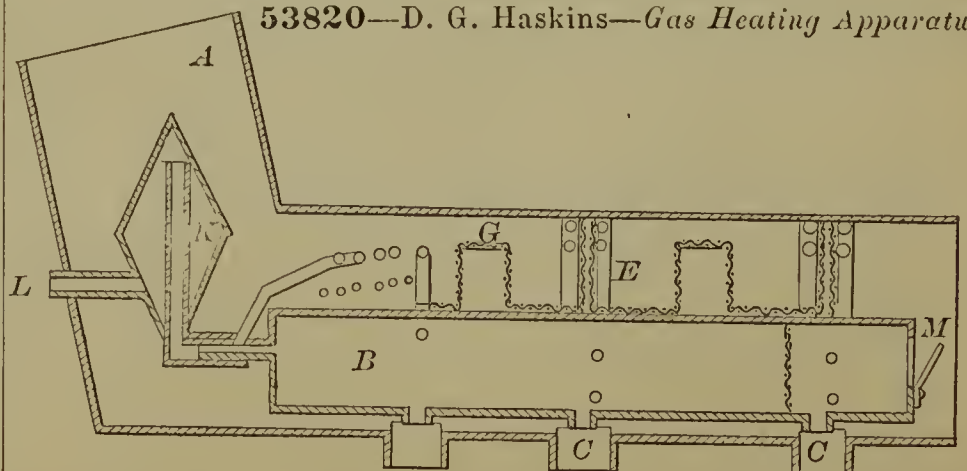

53821—S. S. Hepworth—*Smith's Vise.*

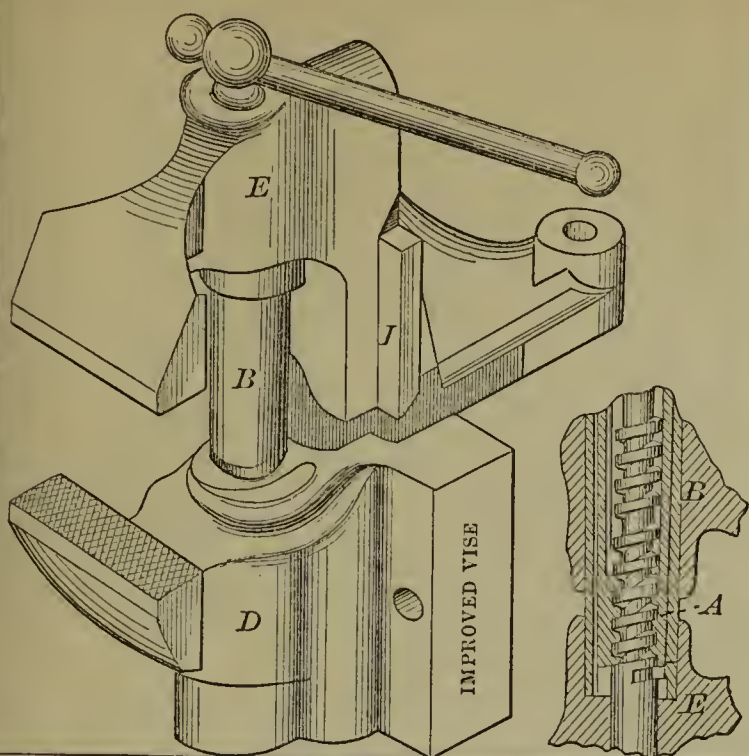

53827—S. Hubbell, Jr.—*Catch for Money Drawers.*

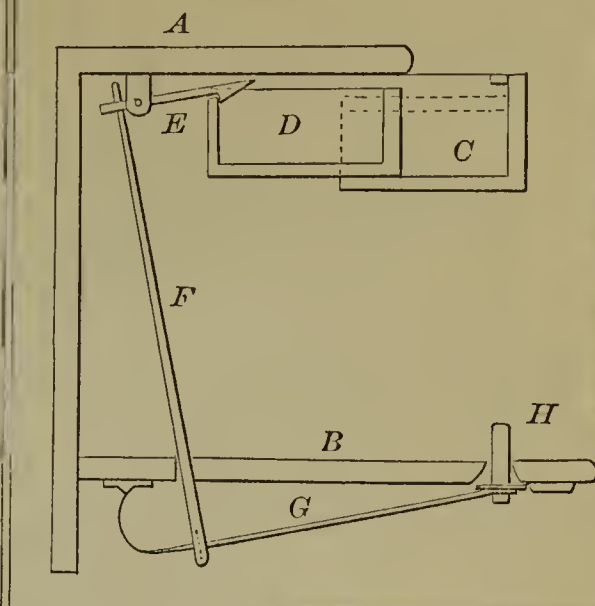

53822—J. A. Heyl—*Switch for Street Cars.*

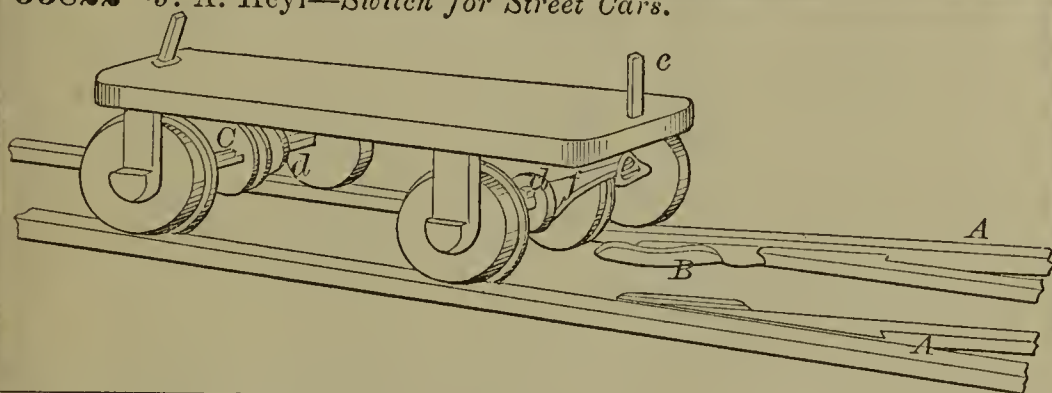

53823—S. Heywood—*Shingle Machine.*

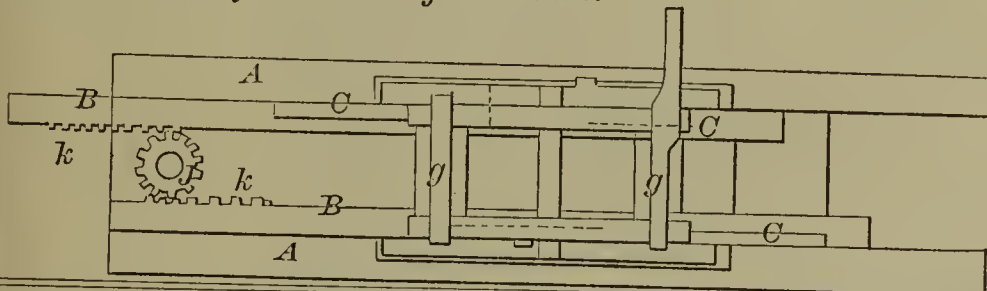

53825—L. Holtzschetter—*Polishing Wheel.*

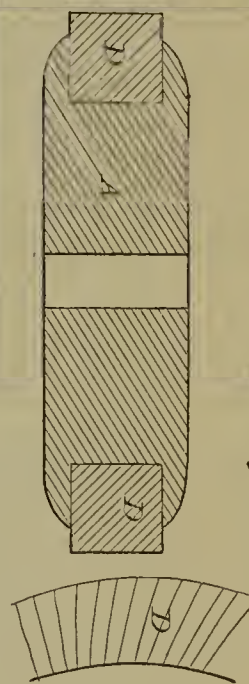

53824—G. Hillegrass—*Lamp Burner.*

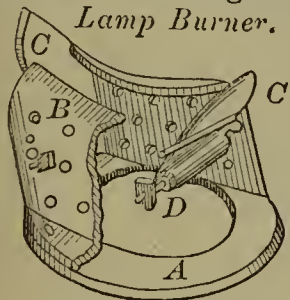

53826—N. B. Hooper—*Hat Pressing Machine.*

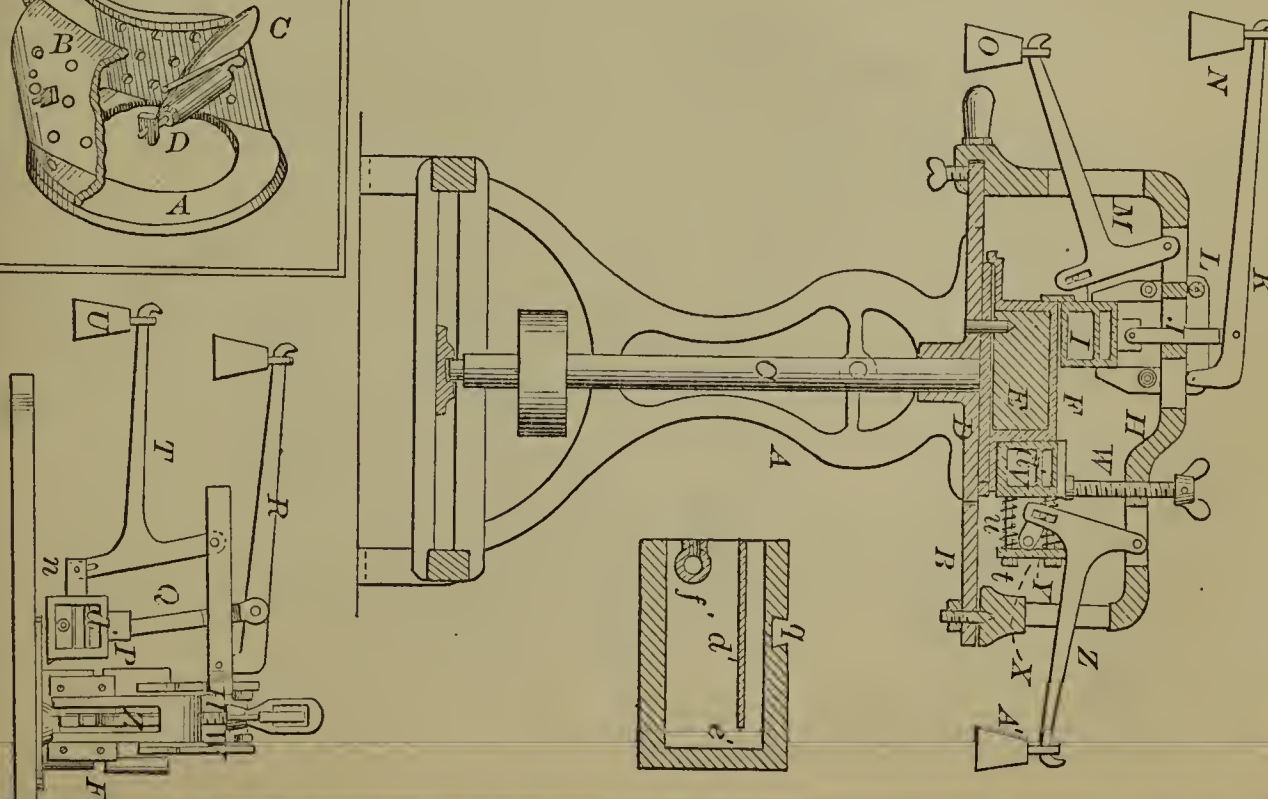

53828—W. R. S. Hunter—Attaching Thills to Carriages.

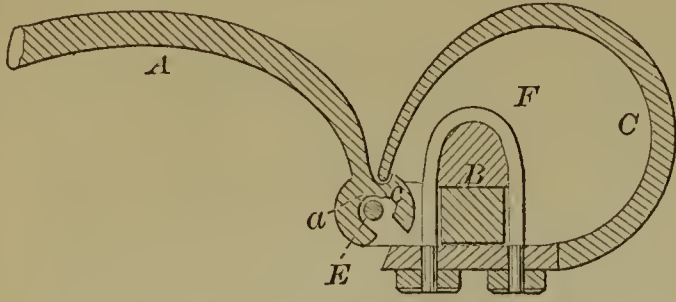

53830—F. X. Kaffer—Hame.

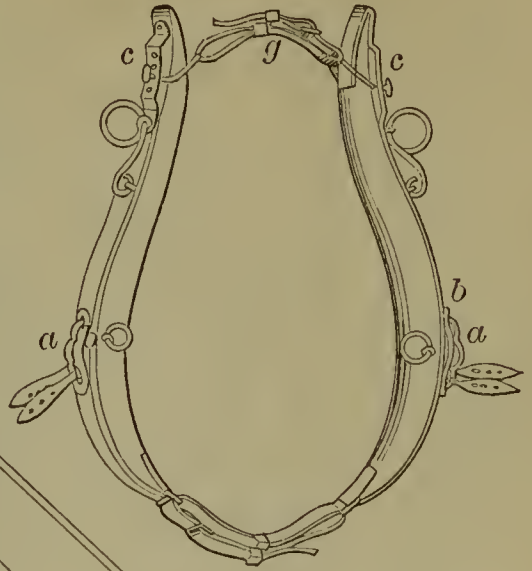

53831—C. & J. Kane—Bolt Heading Machine.

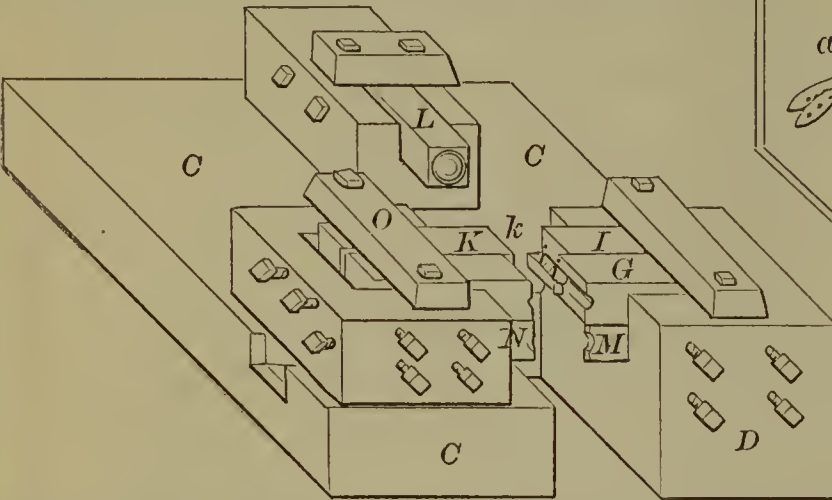

53832—C. & J. Kane—Bolt Machine.

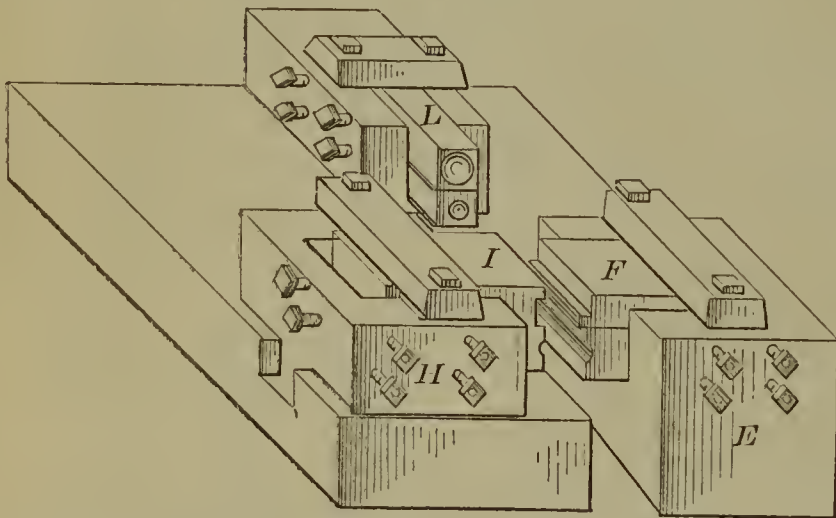

53833—L. Katen—Ruler, Blotter and Paper Cutter.

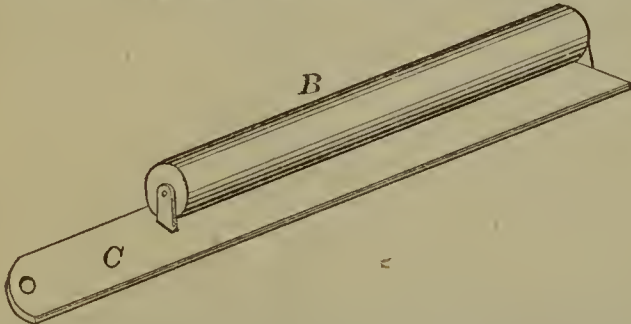

53829—J. K. Ingalls—Oil Tank.

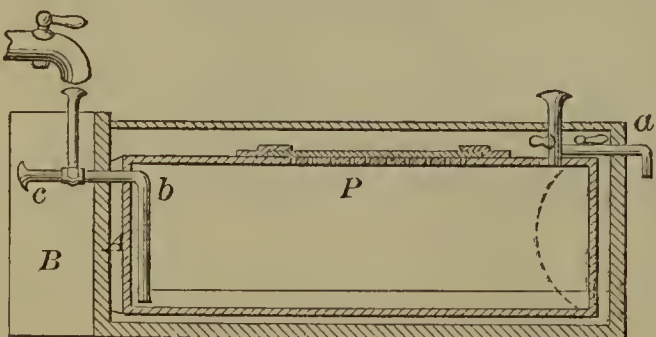

53835—S. Kepner—Bread and Meat Cutter.

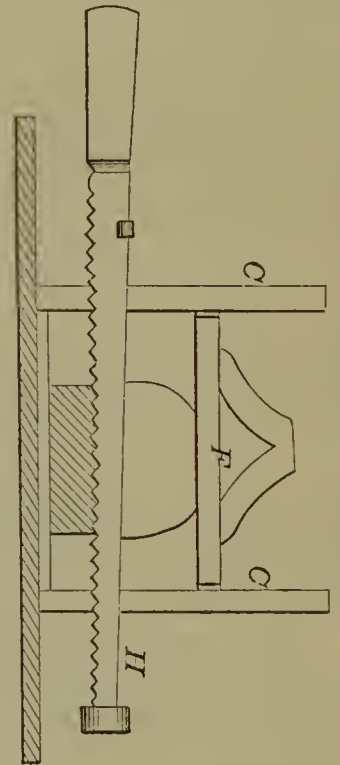

53836—D. Knowlton—Tree Protector.

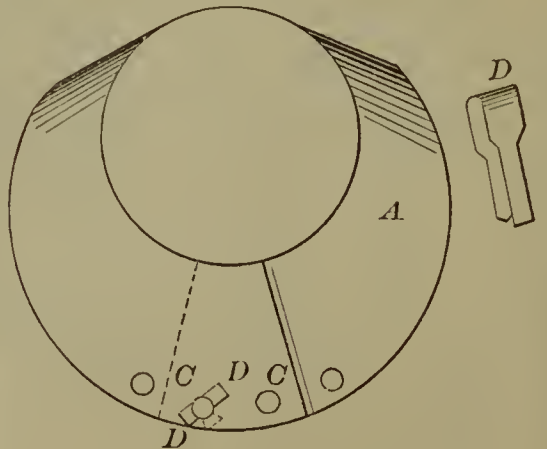

53840—F. Liburn—Steering Screw.

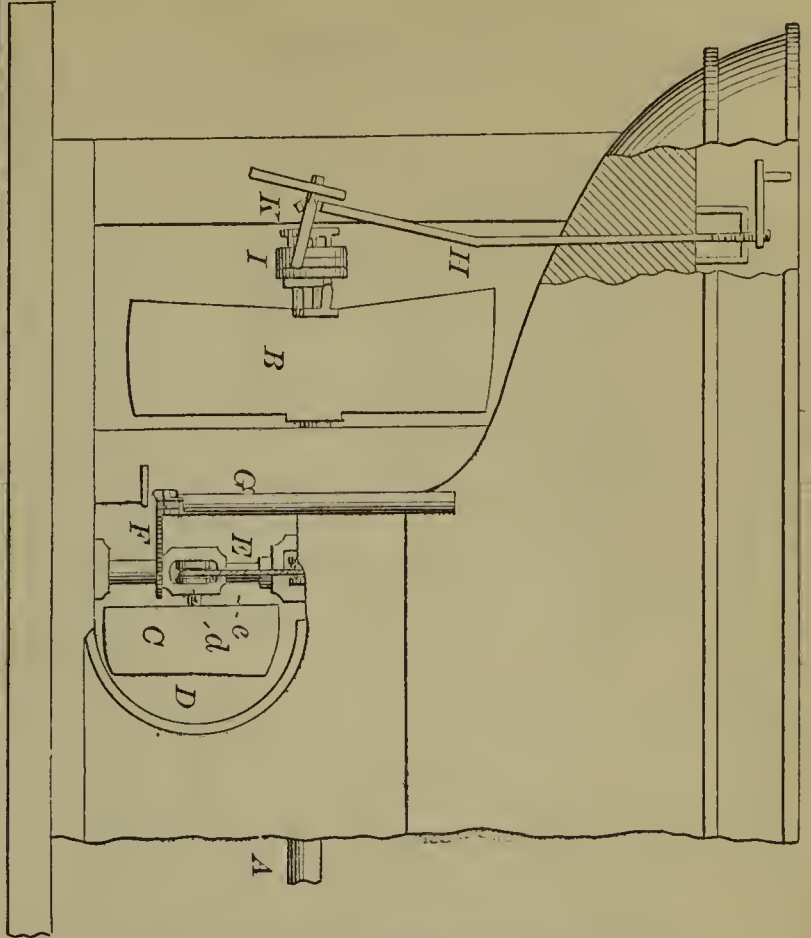

53841—J. Lloyd—Measuring Funnel.

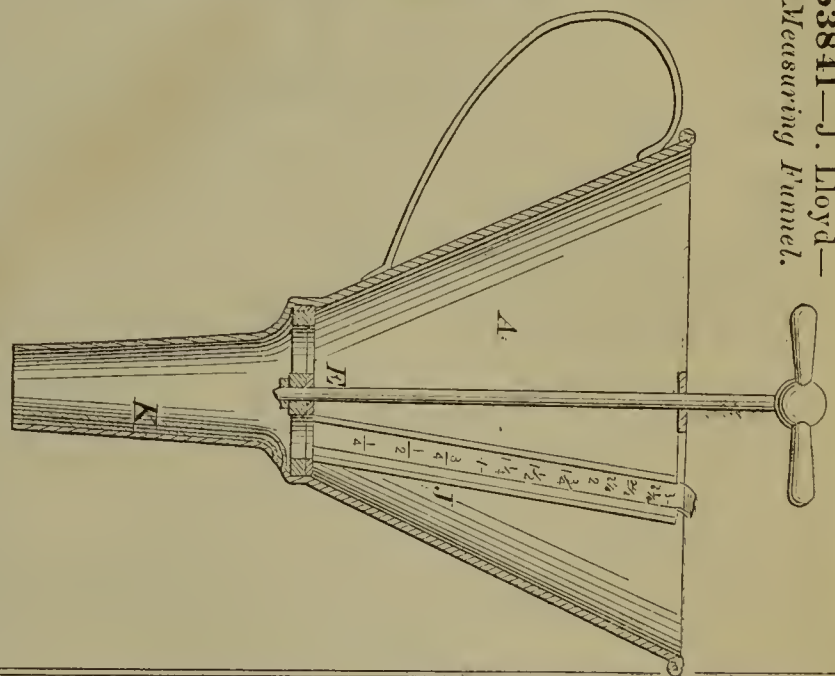

53837—J. Lacey—Cultivator.

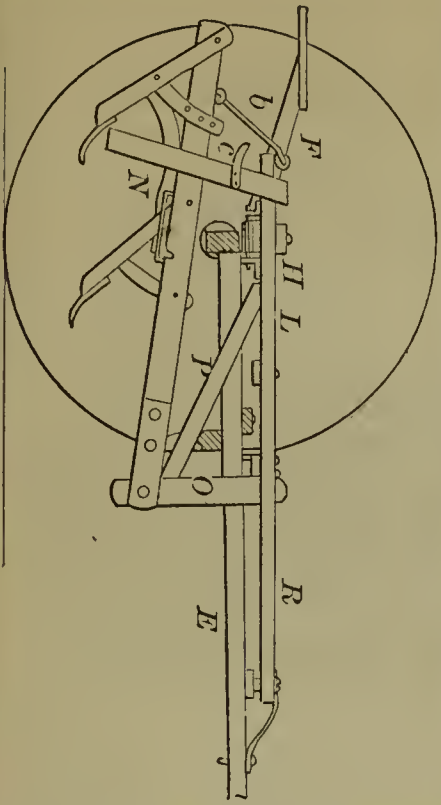

53838—R. Lambert—Hand Corn Planter.

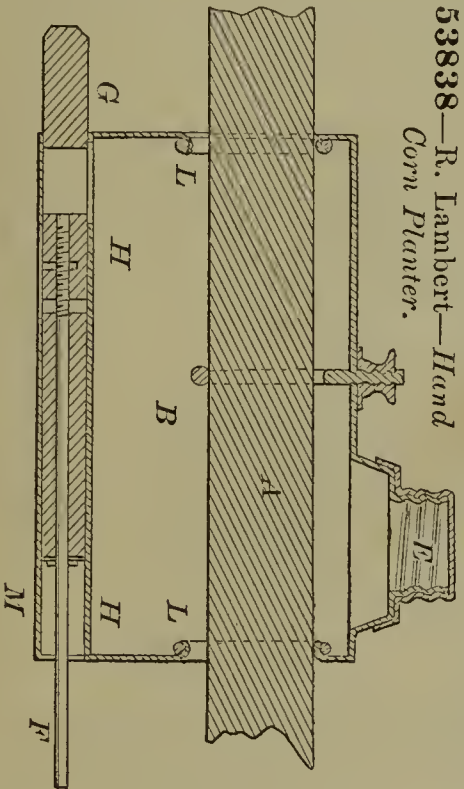

53842—Lockwood & Pitman—Car Seat.

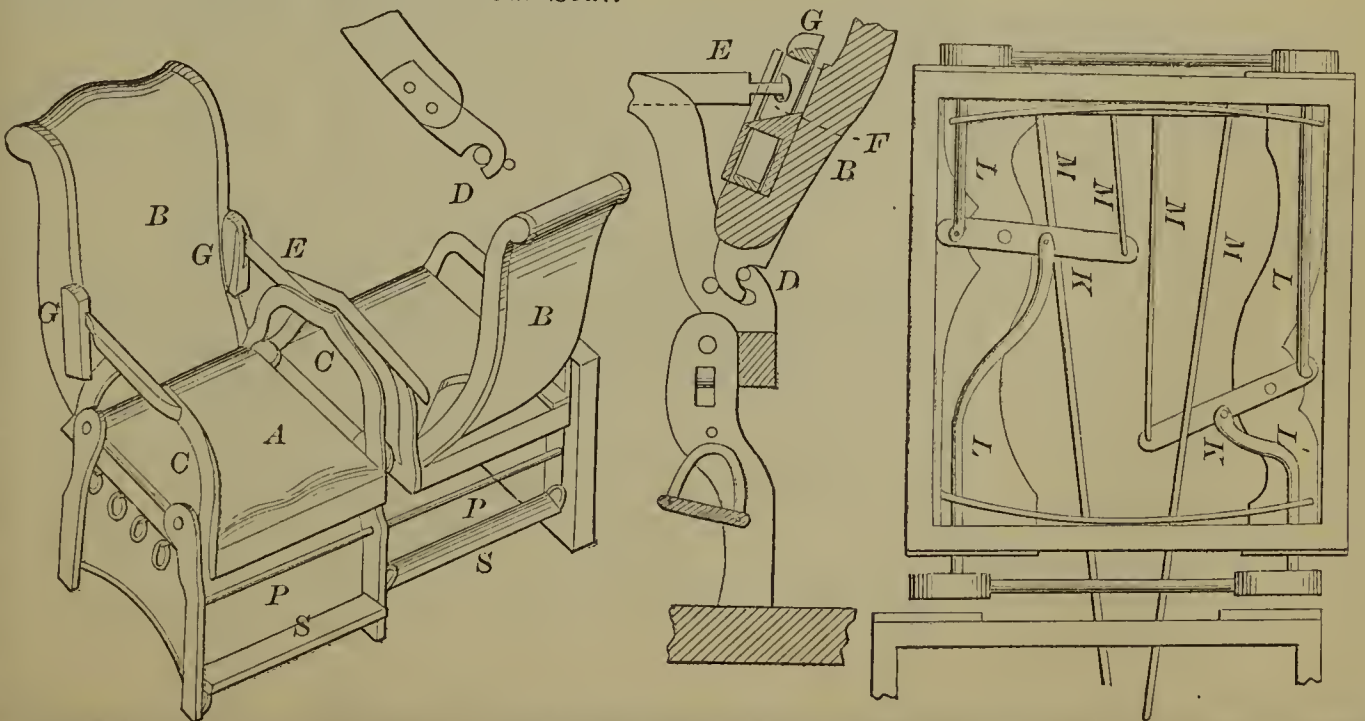

53843—C. B. Loveless—For Carburetting Air.

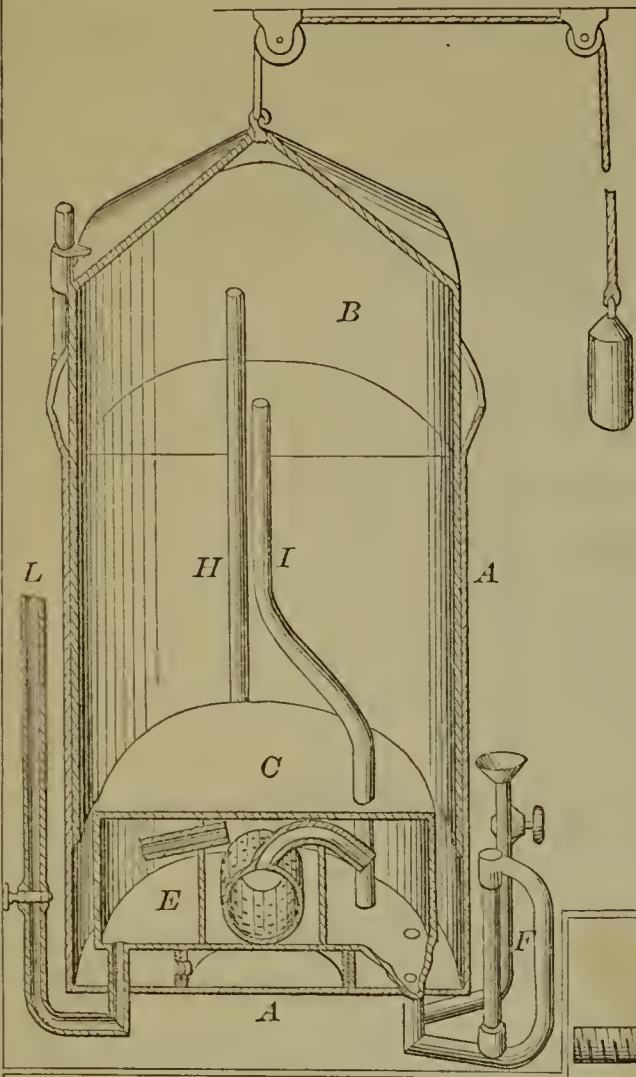

53844—P. Lutes—Washing Machine.

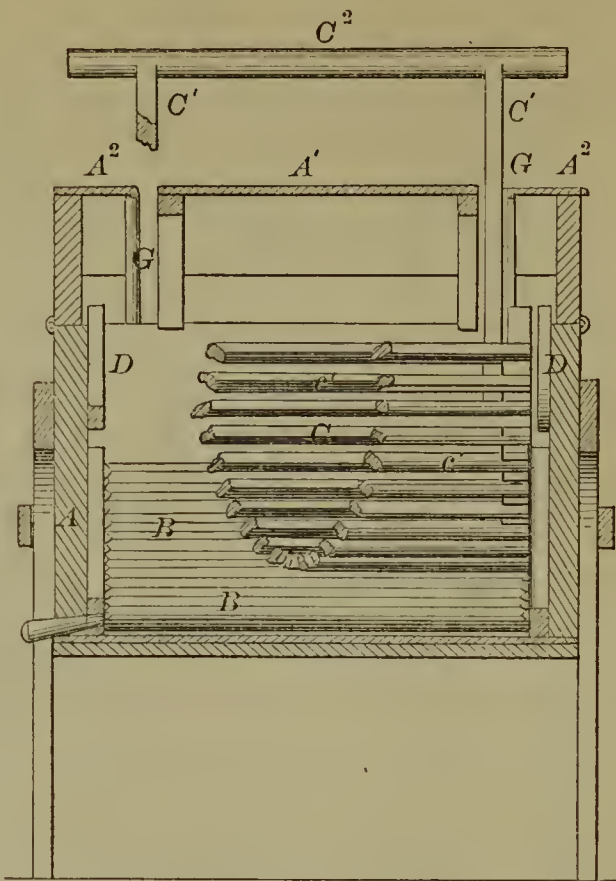

53846—J. Mattison—

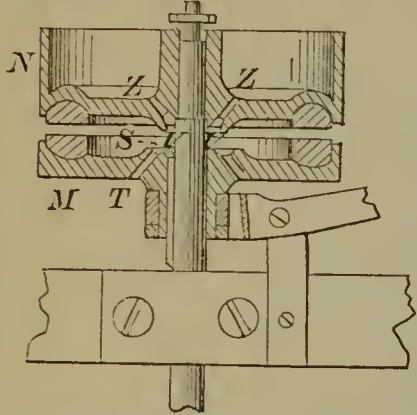

Friction Coupling.

53848—G. D. McClure—Corn Shale Cutter.

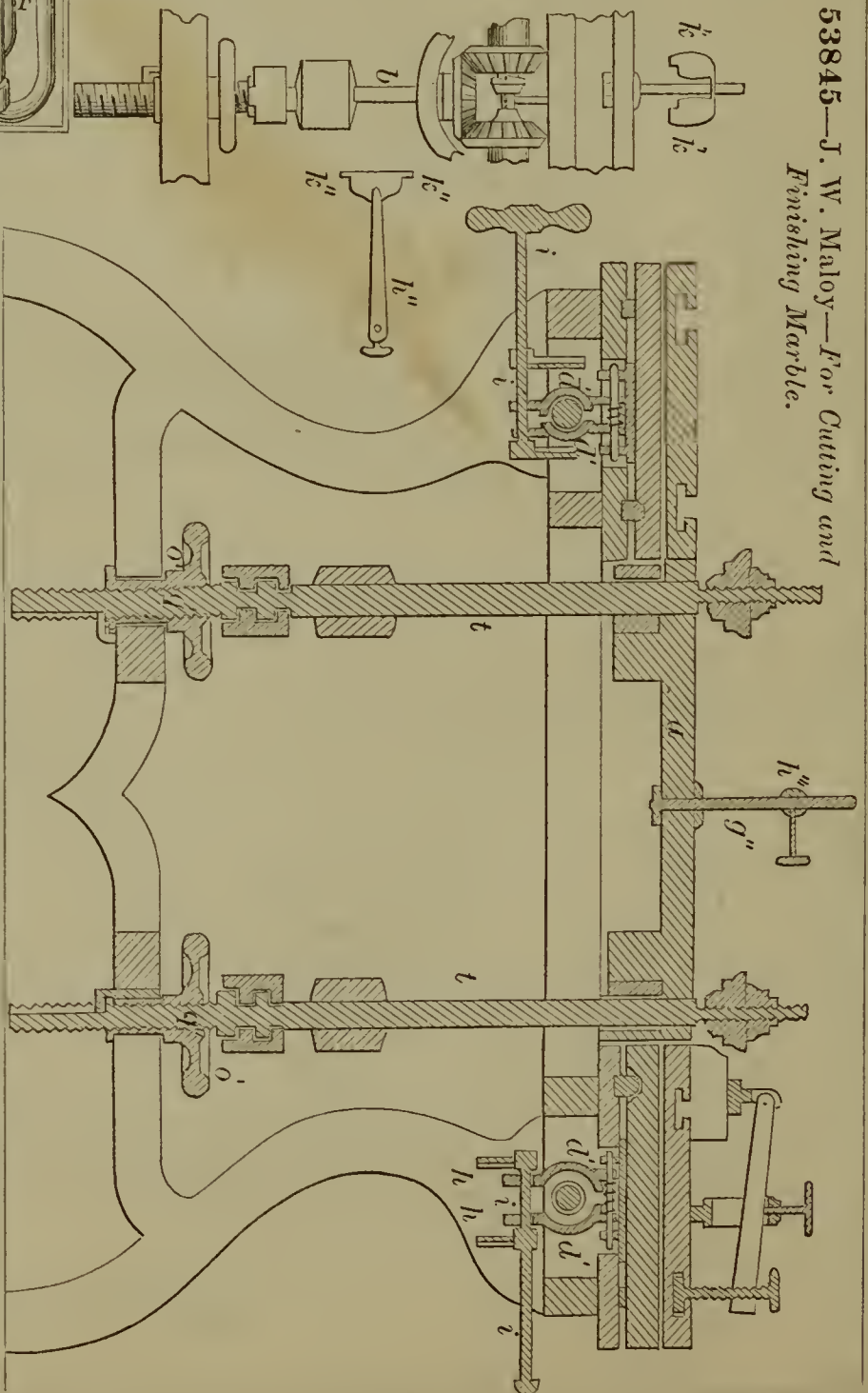
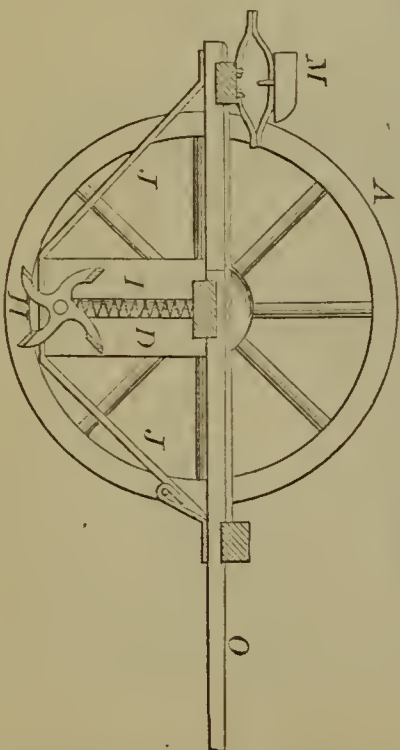

53845—J. W. Maloy—For Cutting and Finishing Marble.

53849—W. C. McGill—Stripping Corn from the Cob.

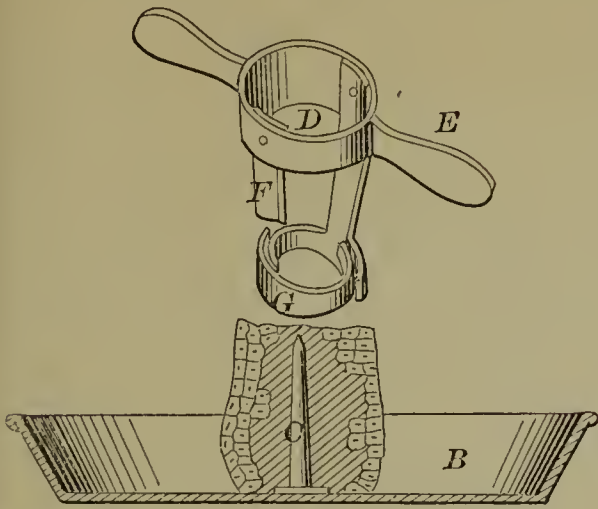

53853—F. Metz—Bed Bottom Connection.

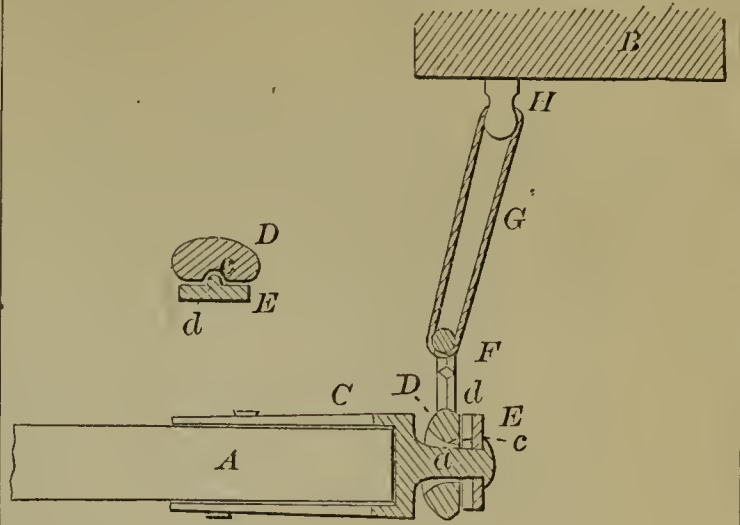

53850—A. Mero—Harrow.

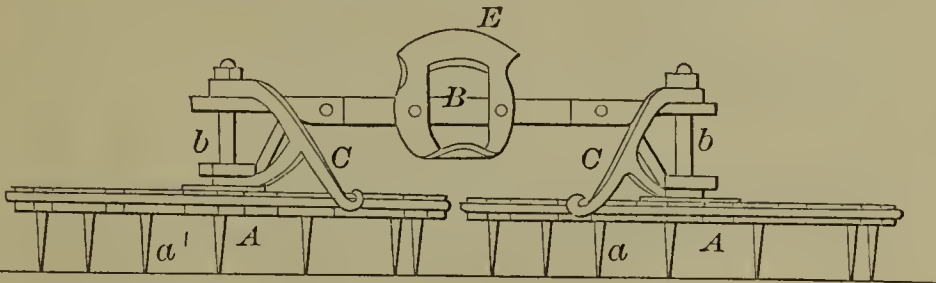

53851—I. H. Merritt—Cotton Bale Tie.

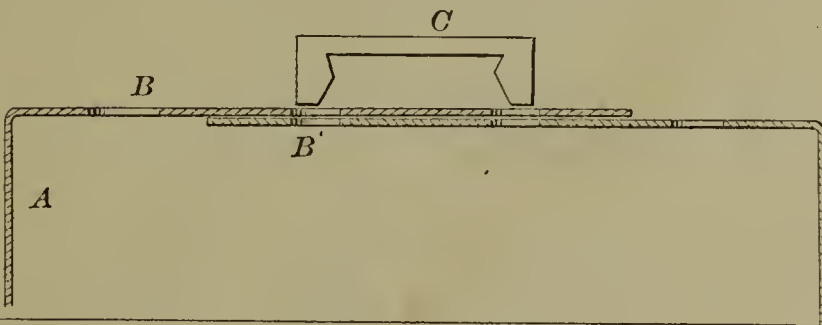

53855—S. C. Moore—For Seeding Raisins.

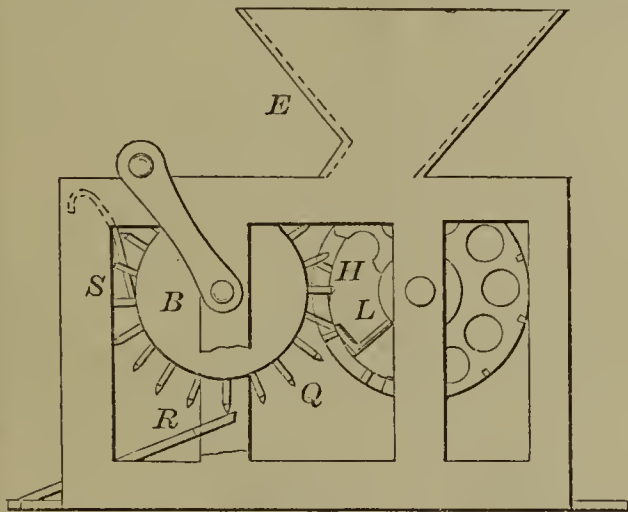

53856—J. C. Murphy—Farm Gate.

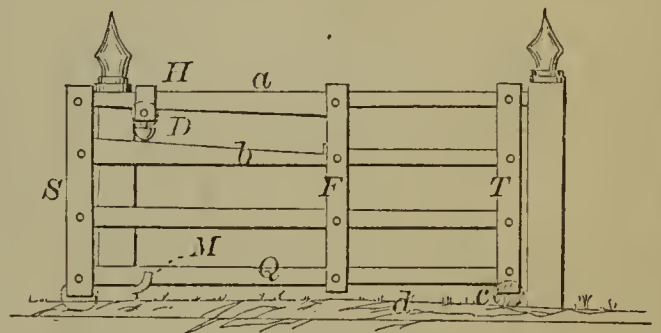

53857—I. Orndorff—Loom.

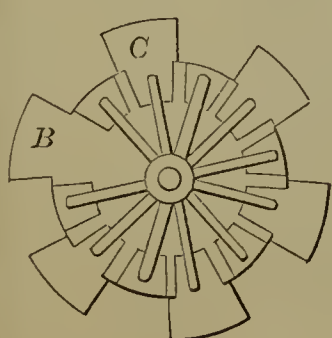

Fig 7

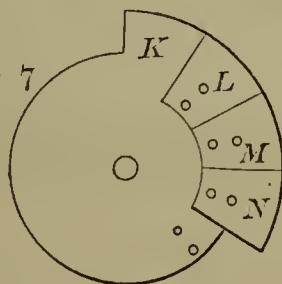
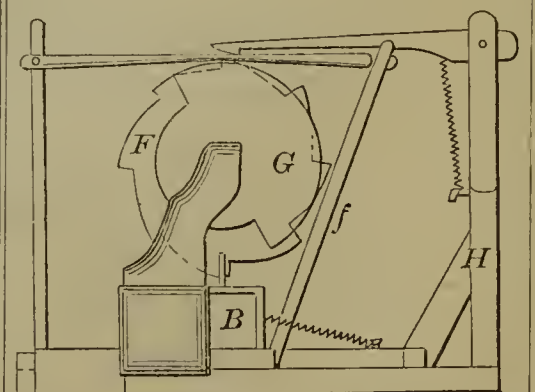

Fig 8



53858—I. Orndorff—Loom.



53854—J. C. Miller—Spring Saddle.







53867—G. Perry—Cultivator.

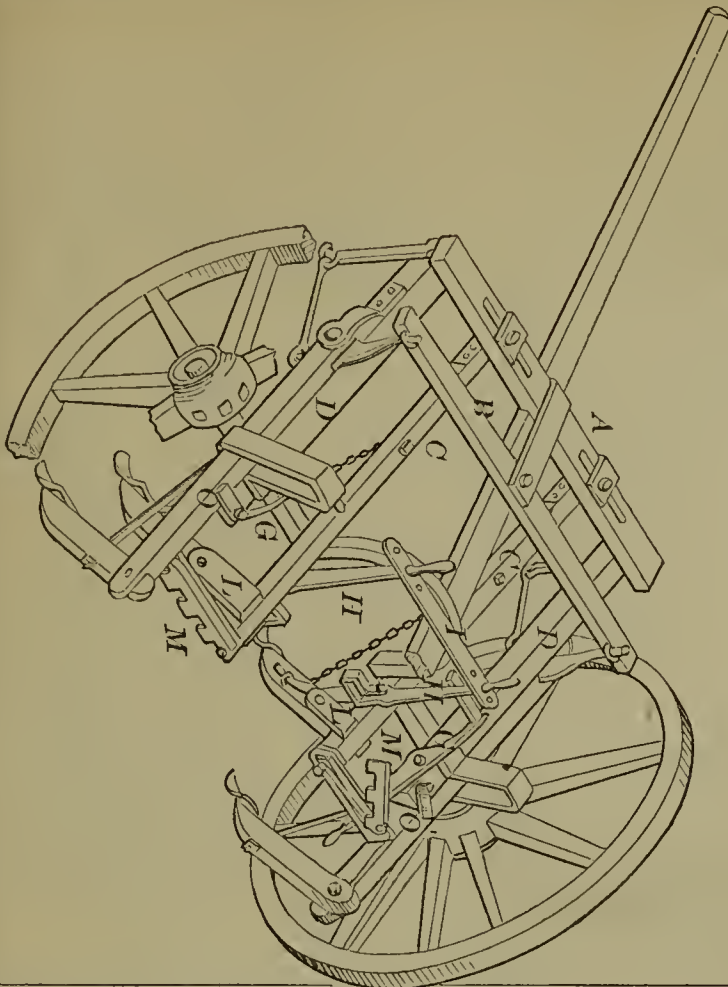

53870—J. C. Rankin—Sash Fastener.

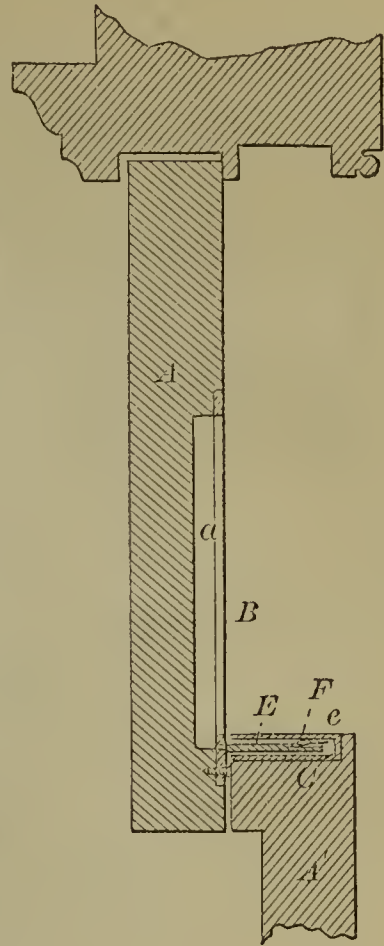

53869—R. Ralston—For Seizing and Holding Small Animals.

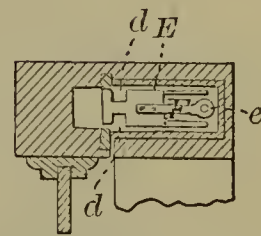
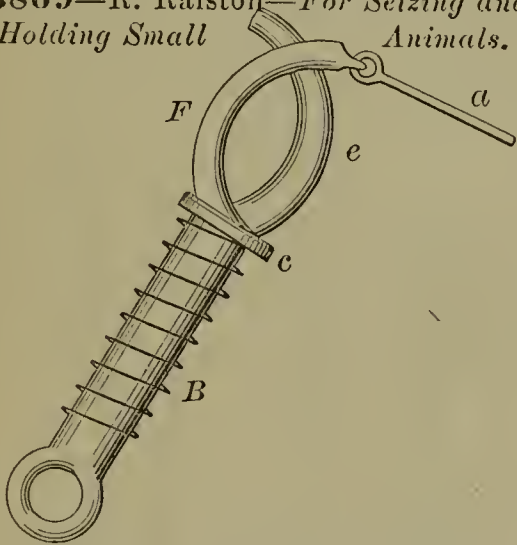

53868—B. Porter—For Grinding Clay.

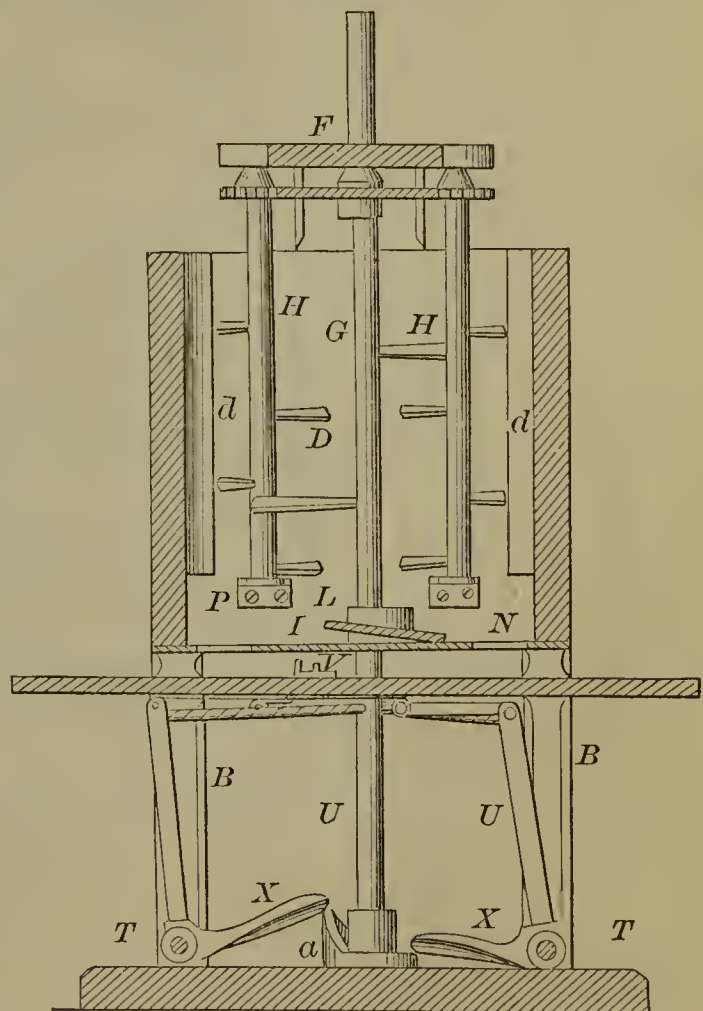

53871—Ray & Cleveland—Locomotive Head Light.

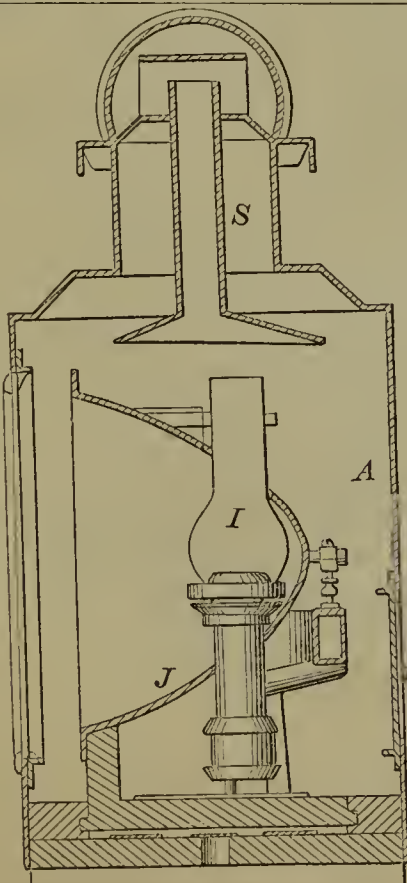

53872—O. Redmond—Harvester.

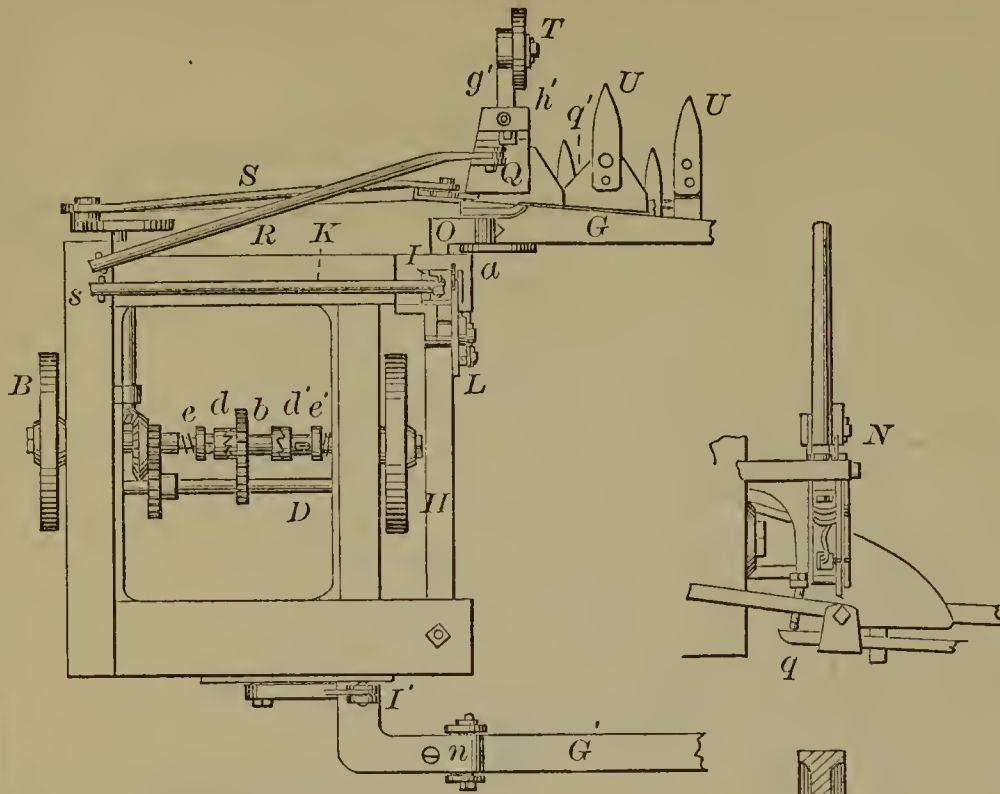

53874—G. Richardson—Flyer for Spinning.

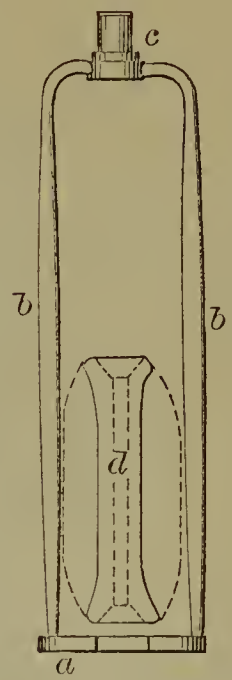

53877—J. S. Robinson—Safe and Table.

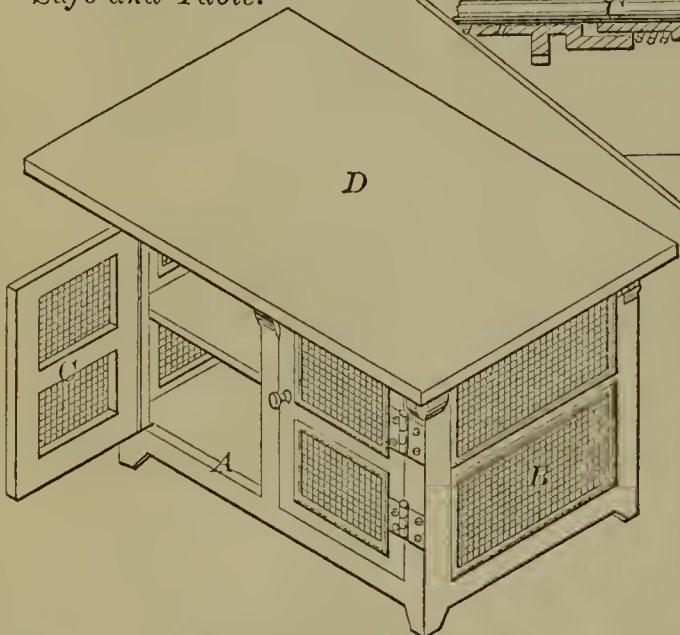

53873—D. Reeves—Evaporator.

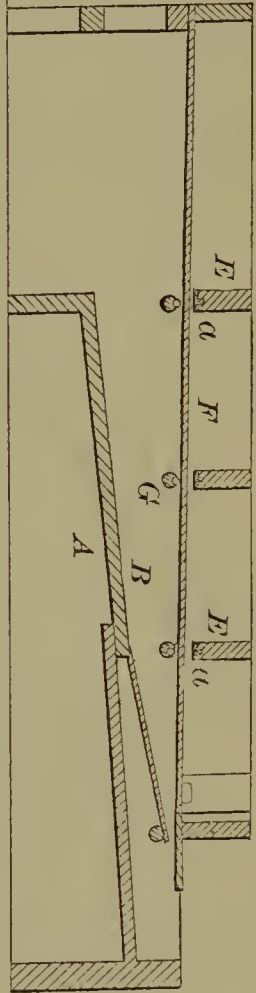

53875—E. S. Ritchie—Compass.



53876—F. J. Robinson—Churn.

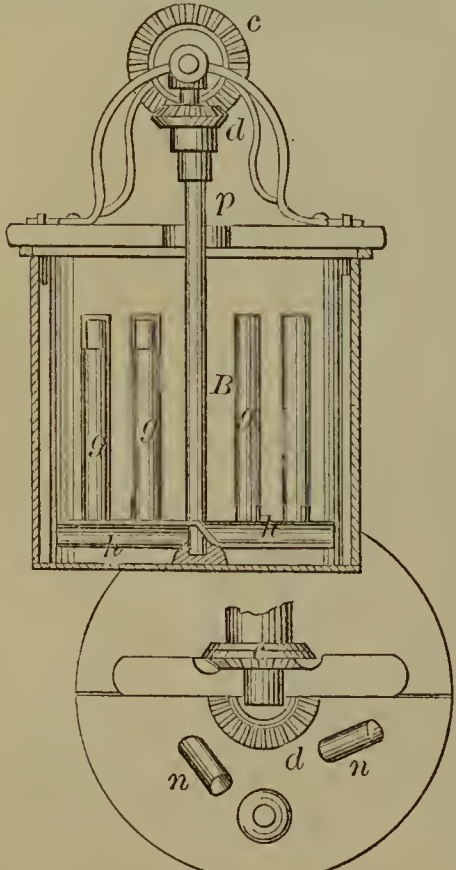

53878—L. M. Roby—Horse Hay Fork.

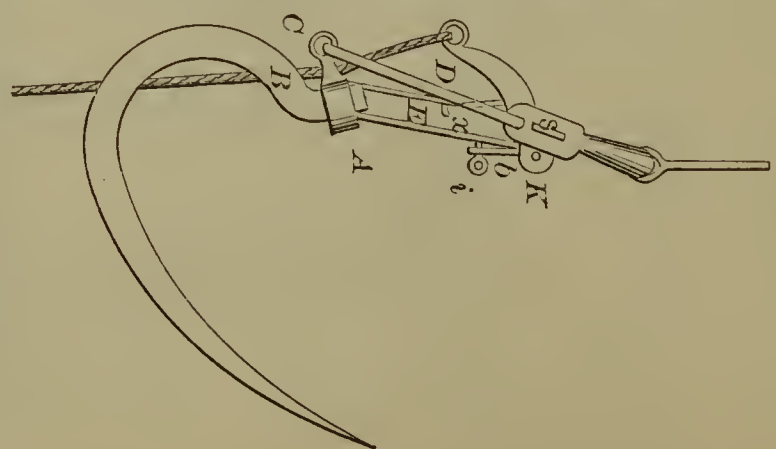

53882—Rosenberry & Tanner—Vegetable Slicer.

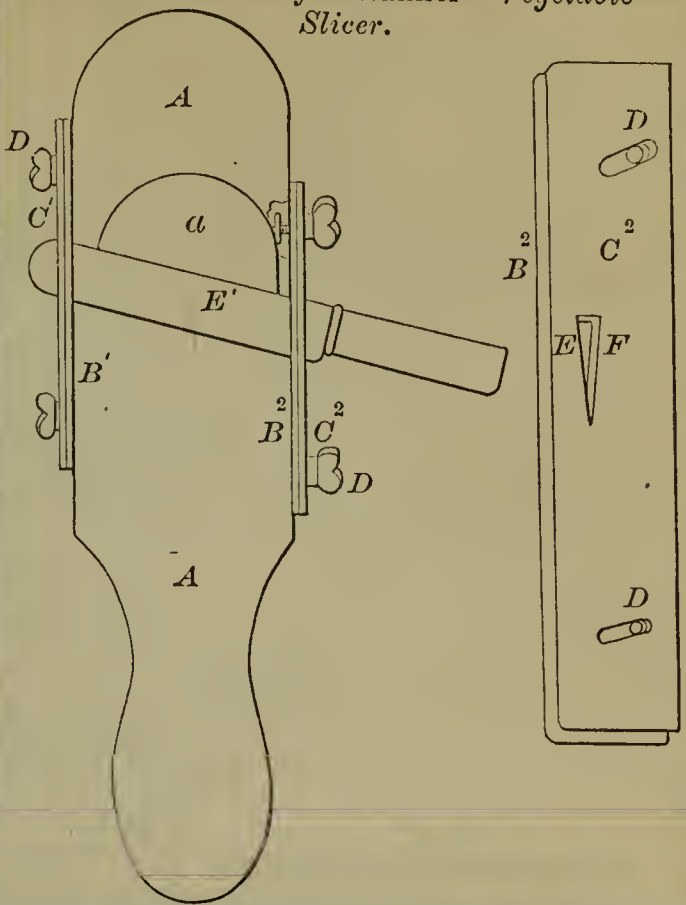

53879—T. H. Rodgers—Brick Machine.

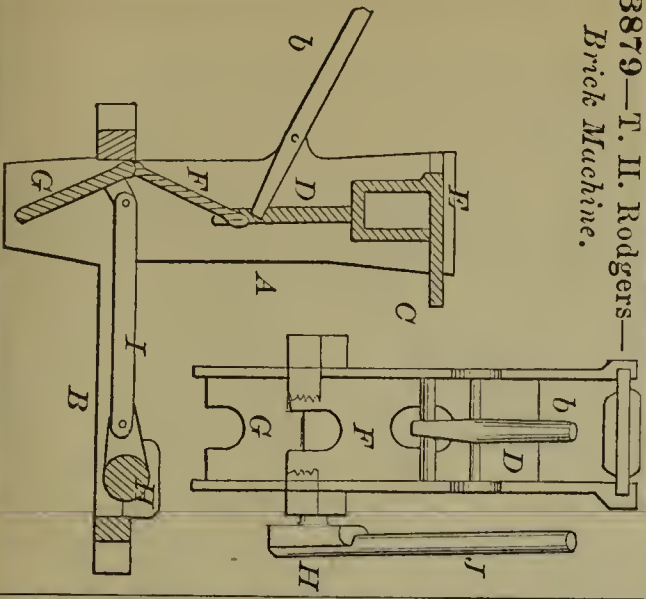

53881—S. H. Roper—Renovating Fire Arm.

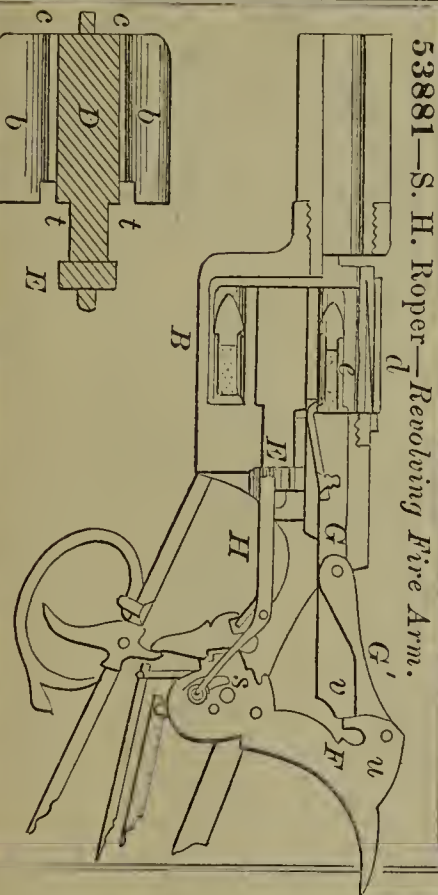

53880—F. M. Rogers—Fireplace.

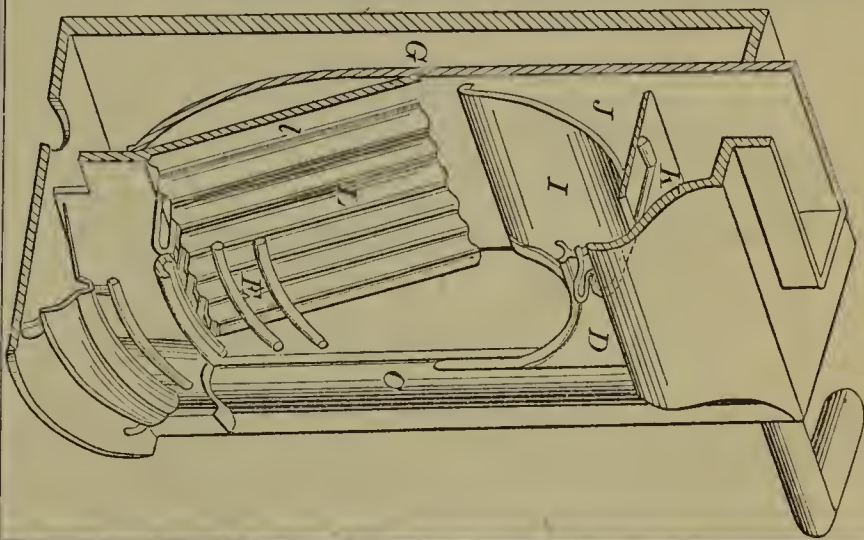

53883—G. Ross—Moulding and Casting Apparatus.

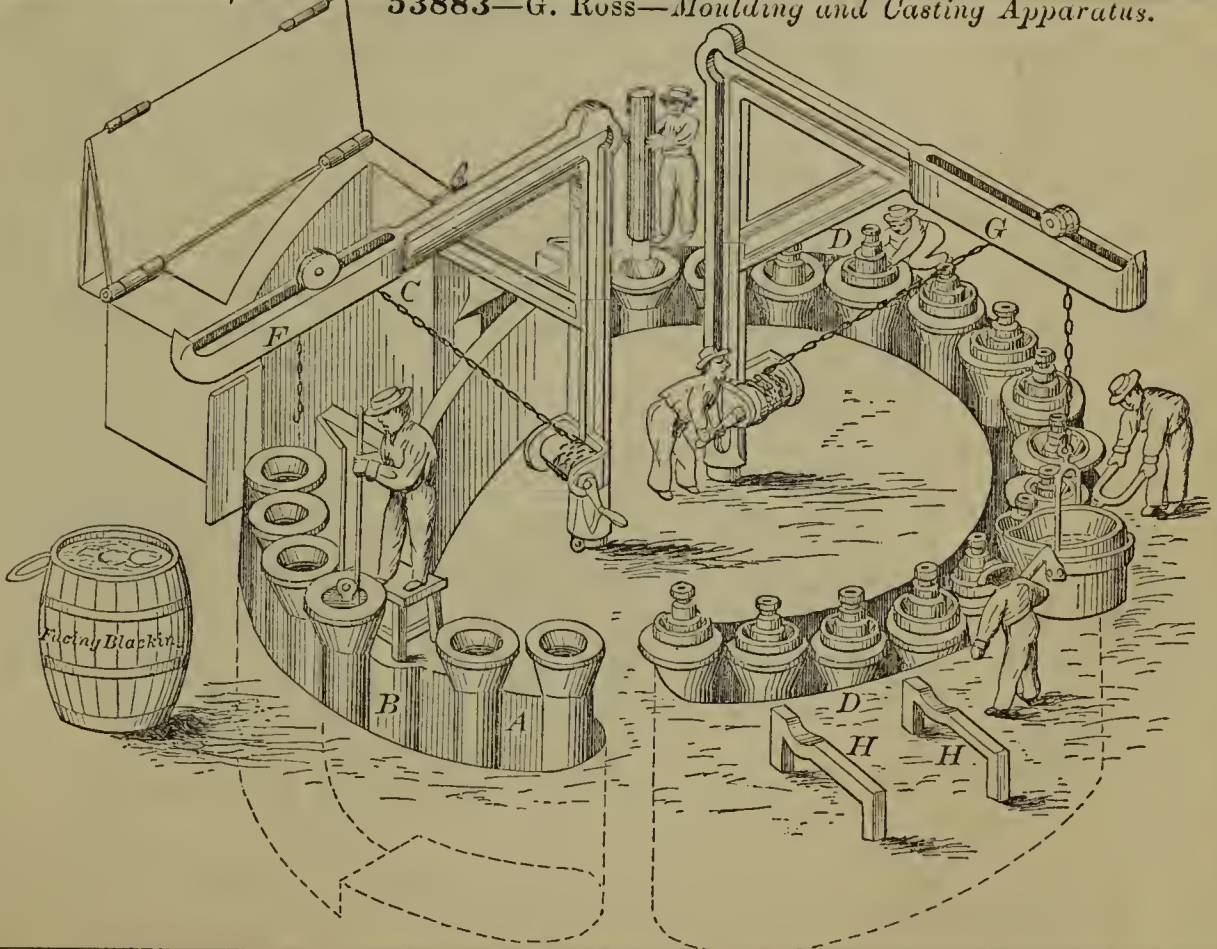

53884—J. Russell—Holder for Chisels

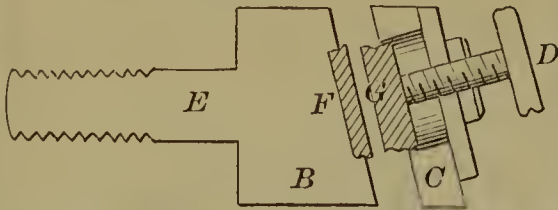

53888—F. Schimming—Bed Bottom.

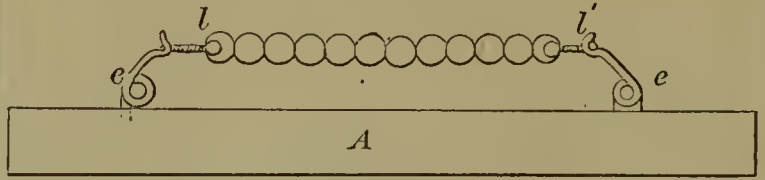

53885—V. B. Ryerson—Separating the Precious Metals from other Substances.

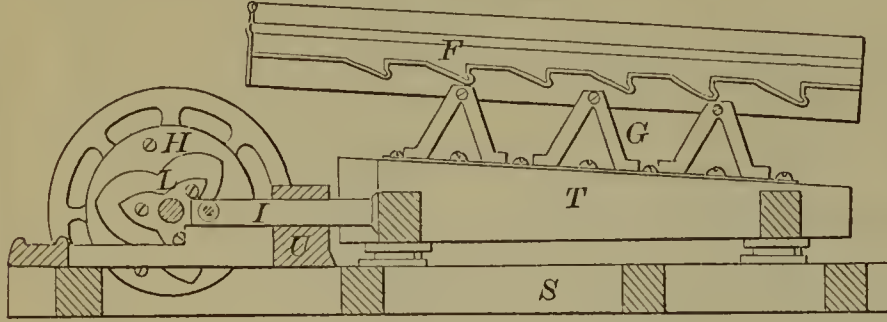

53890—K. Schou—Lamp Snuffer.

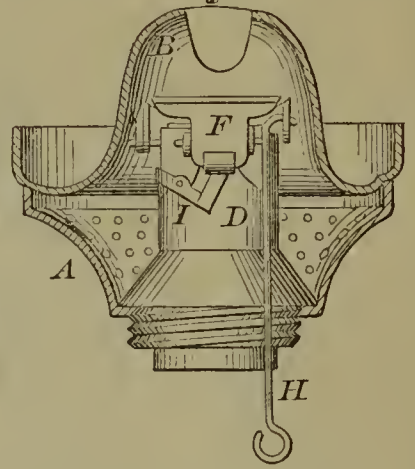

53886—Sanborn & Bennett—Stove Pipe Damper.

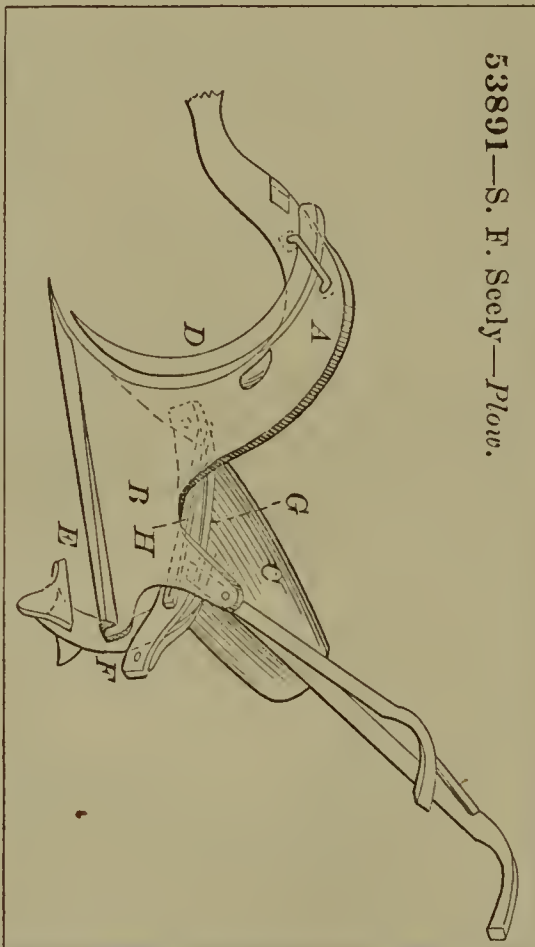
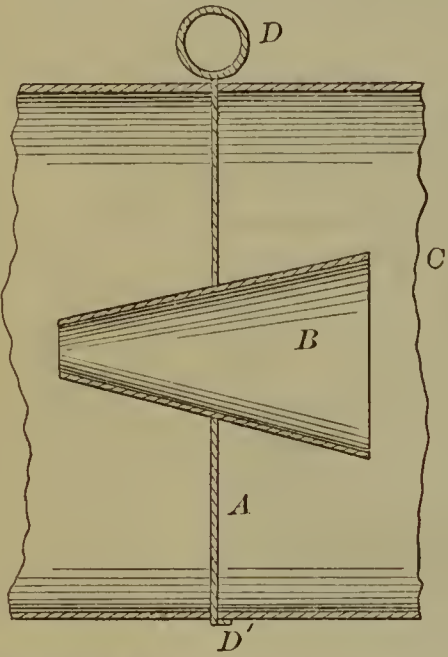

53891—S. F. Seely—Plow.

53889—P. L. Schmandt—Wetchman's Register.

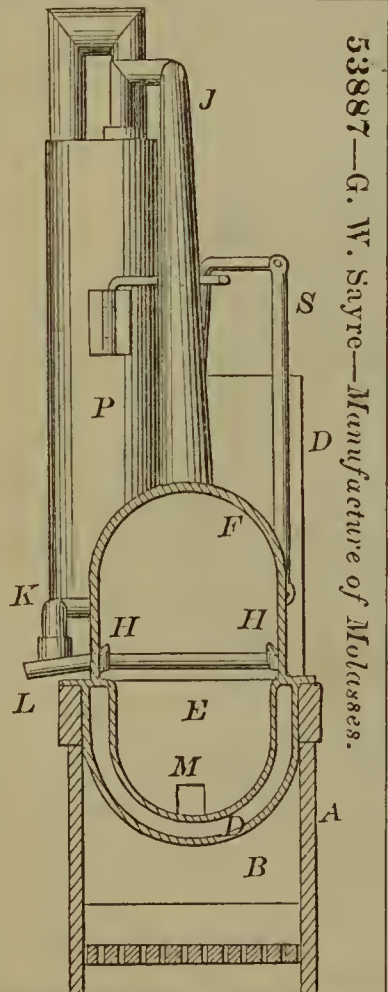
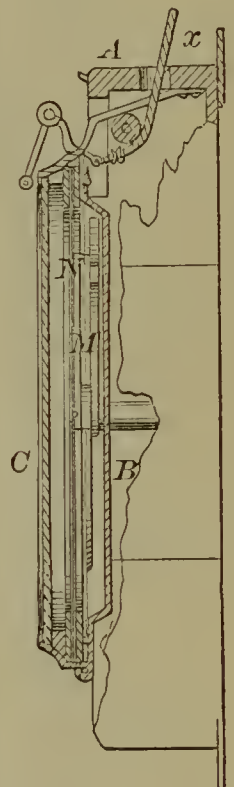

53887—G. W. Sayre—Manufacture of Molasses.

53892—Sherman & Baxter—Operating the Picker Staff for Looms.

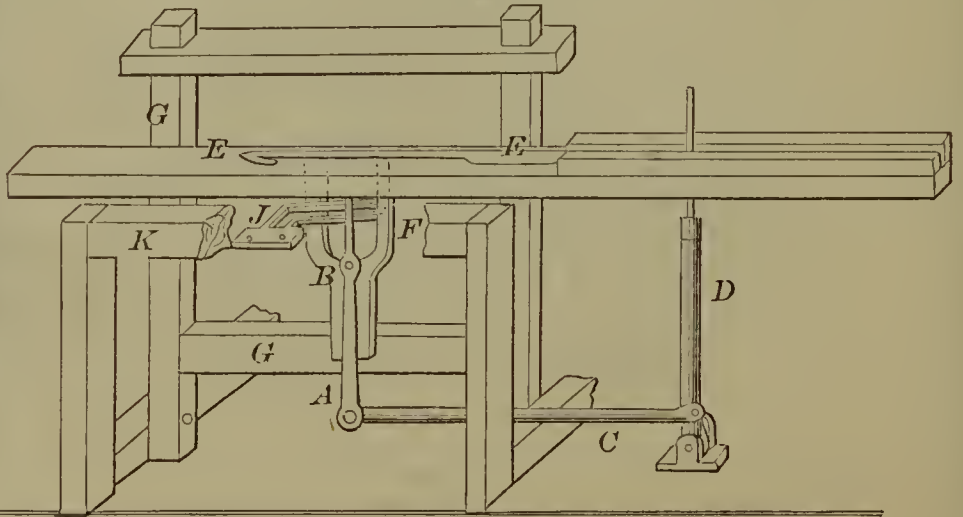

53893—S. S. & J. G. Sherman—  
Broom Head.

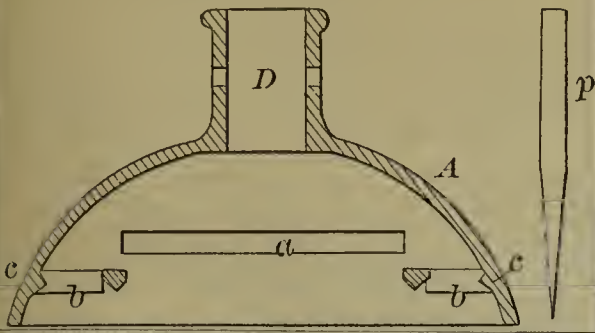

53896—R. Stewart—Annular Auger.

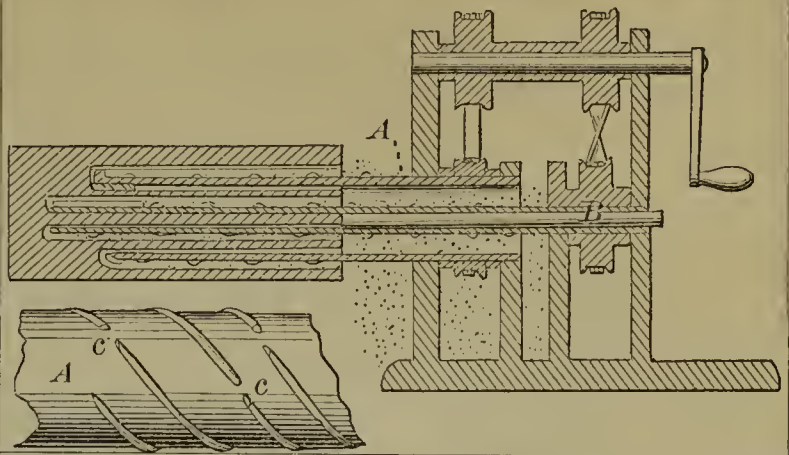

53899—Thomas & Anderson—Plane  
for Making Blind Slats.

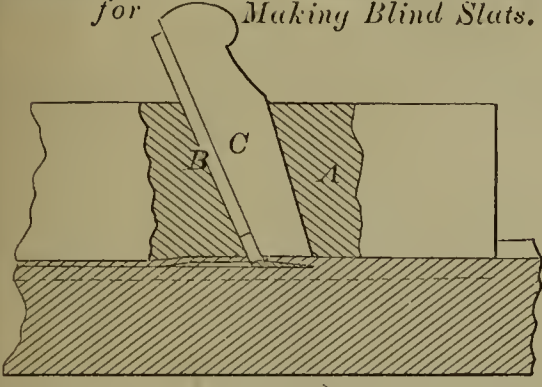

53900—T. P. Thorpe—Exercising Machine.

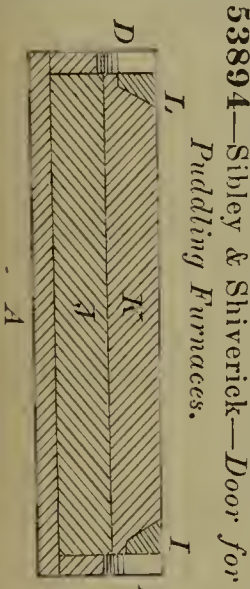
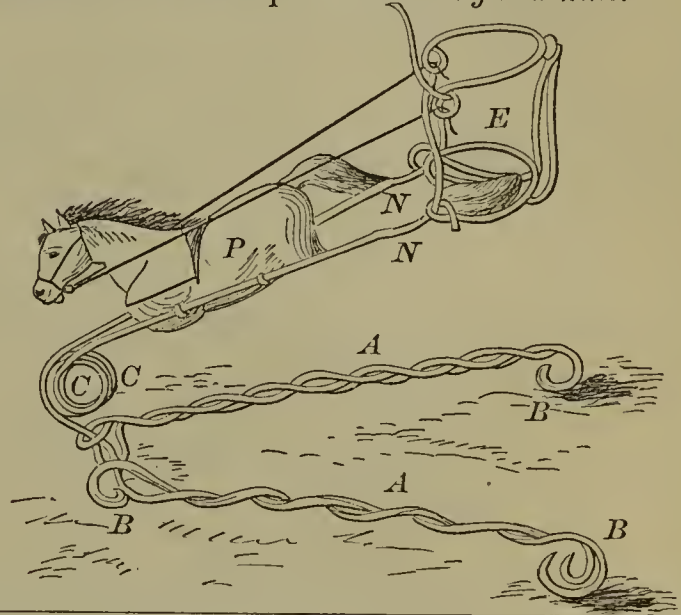

53894—Sibley & Shiverick—Door for  
Puddling Furnaces.



53897—D. Stoner—Button Hole for  
Paper Collars.

53895—T. Simmons—Rectifying Apparatus.

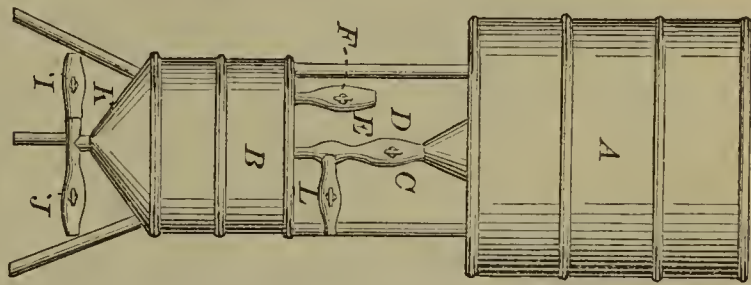

53901—A. Tiensch—Cotton Picking Machine.

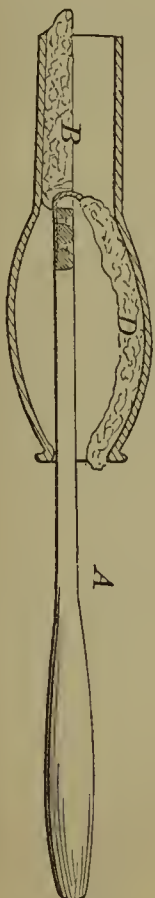
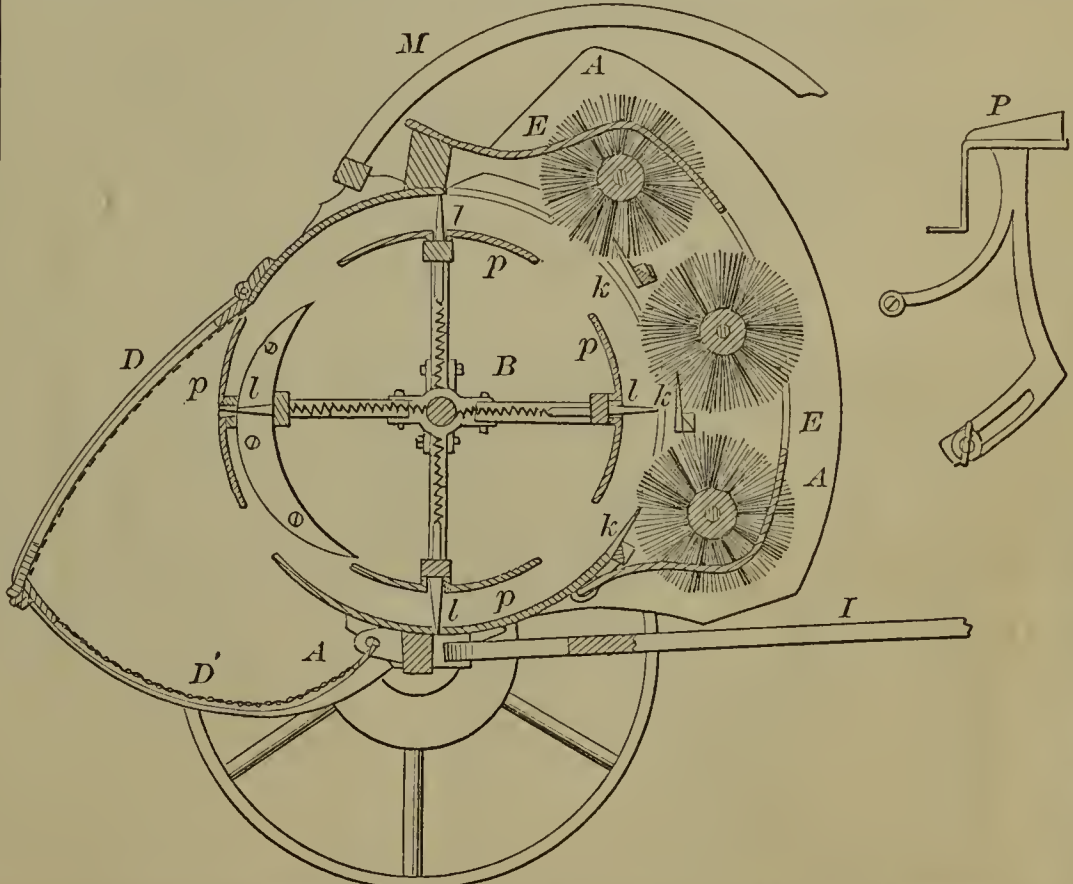

53898—E. F. Sutton—Lamp Cleaner.

53902—T. Tripp—Propeller Wheel.

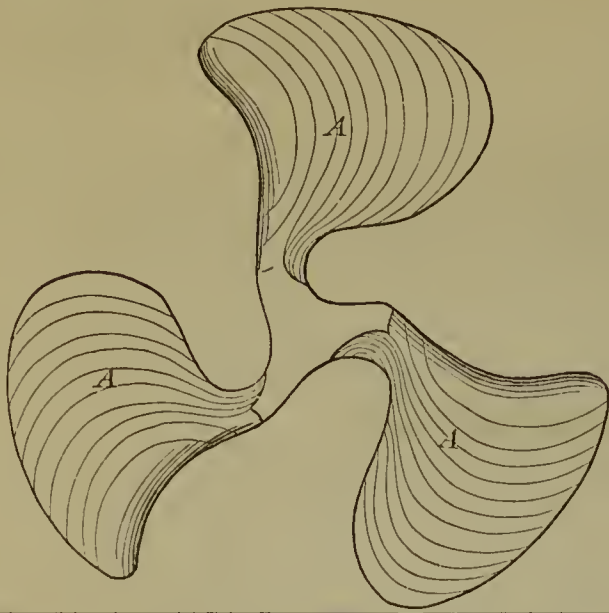

53903—G. O. Tupper—Furnace Grate Bar.

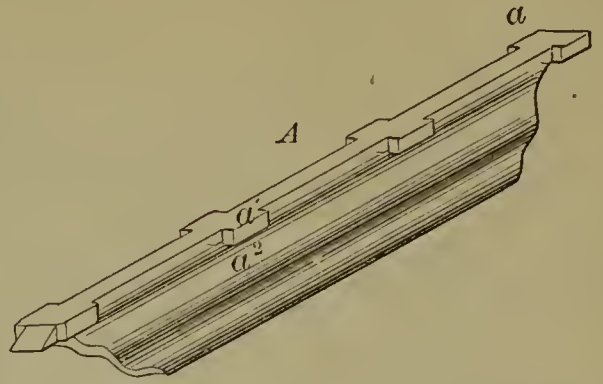

53904—O. Tufts—Steam Hoisting Apparatus.

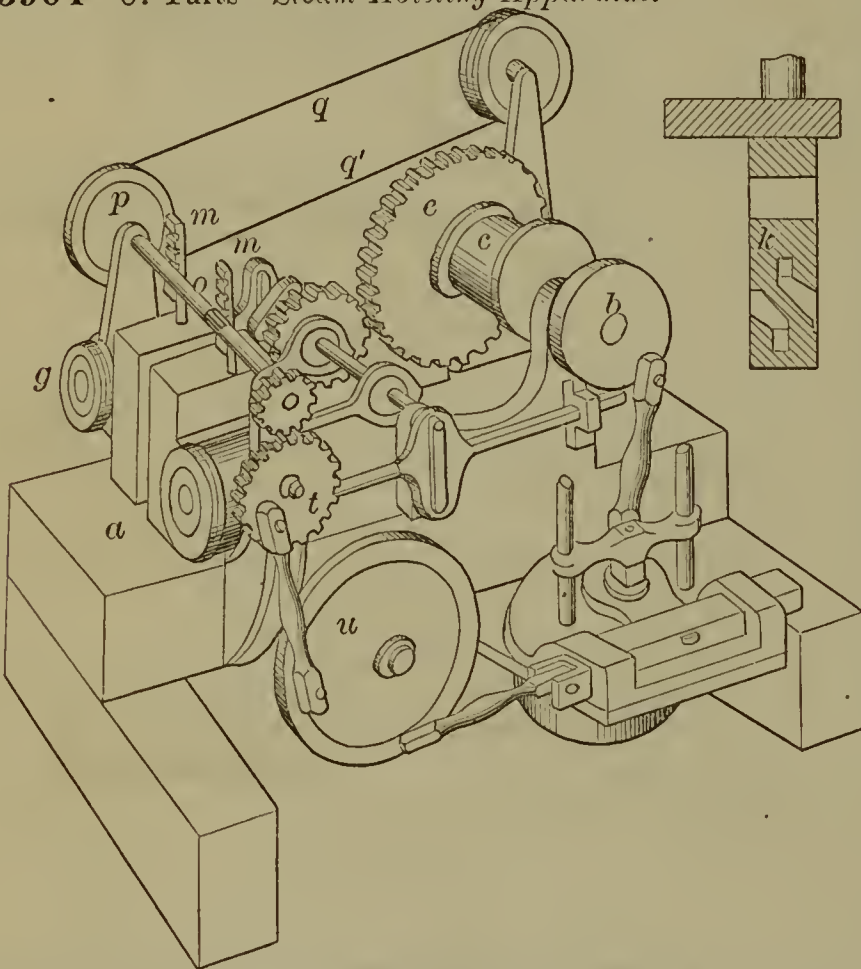

53905—P. H. V. Weyde—Percolator.

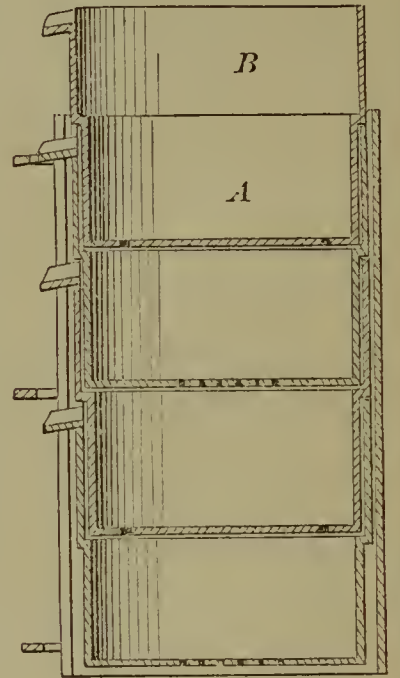

53906—H. V. Dewater—Water Wheel.

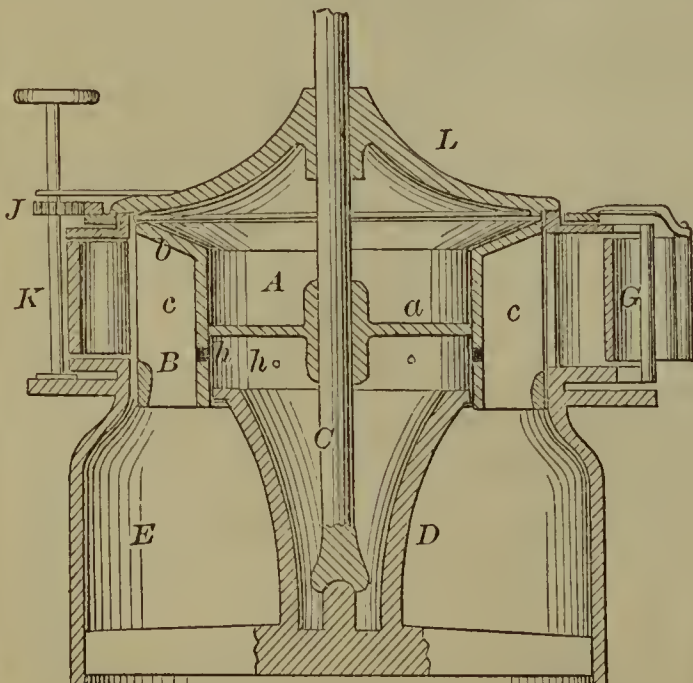

53908—Wakenshaw & Dunham—Trunk Hinge.

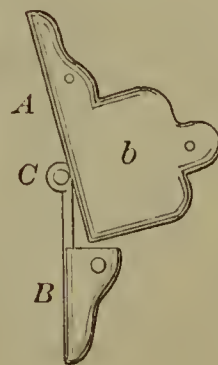

53907—I. H. Wait—Sash Supporter and Fastener.

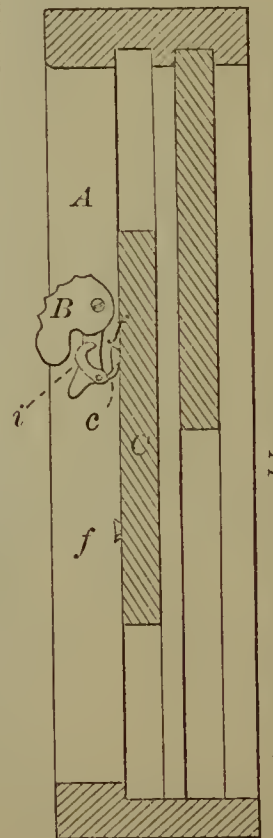

53909—Z. D. Waters—Seeding Machine.

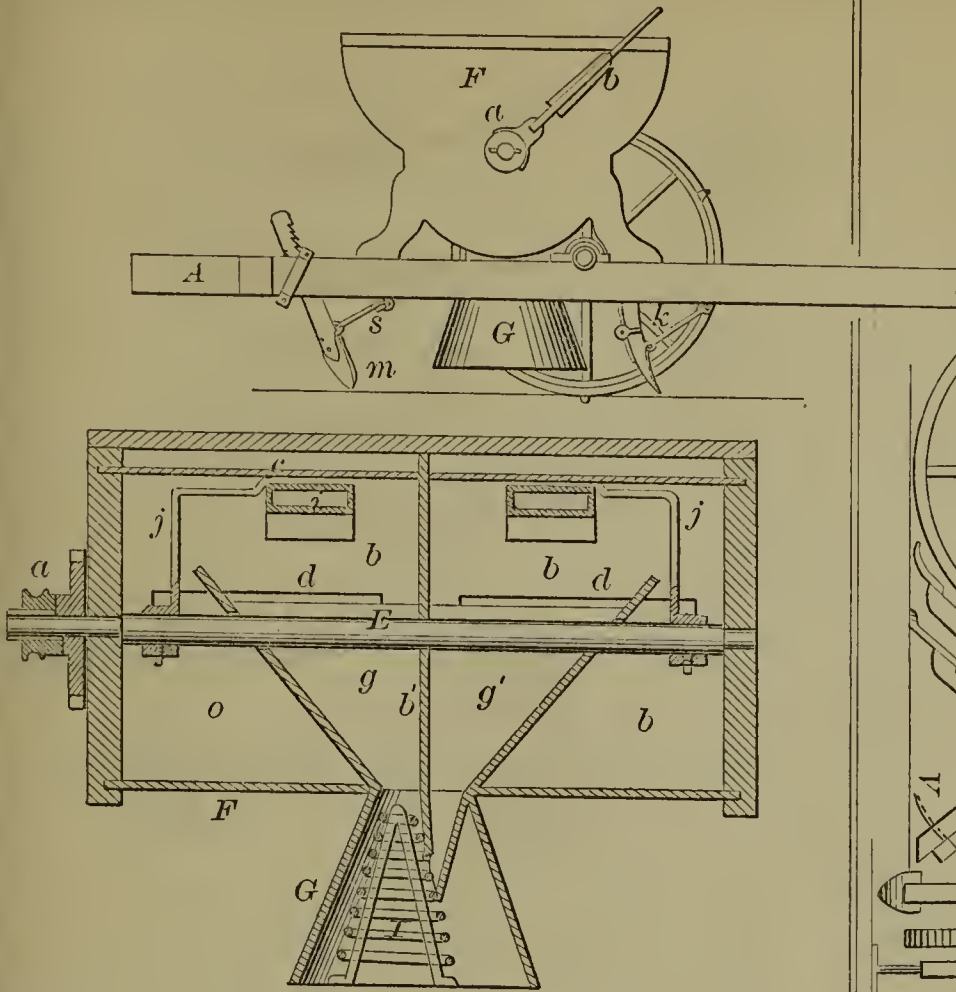

53911—E. P. Wheeler—Cultivator.

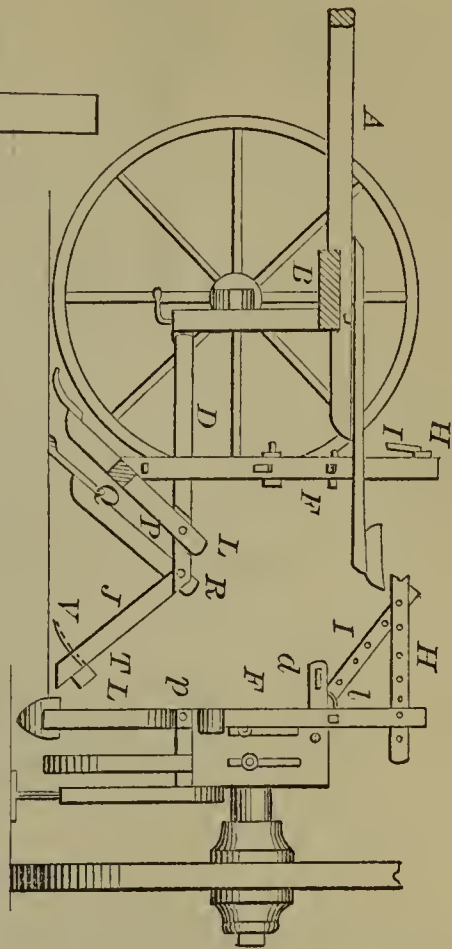

53910—J. Watrous, Jr.—Cotton Gin.

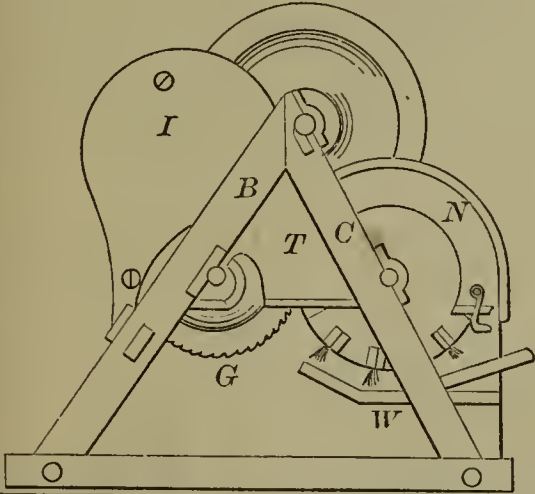

53914—J. Woolf—Transmitting Power.

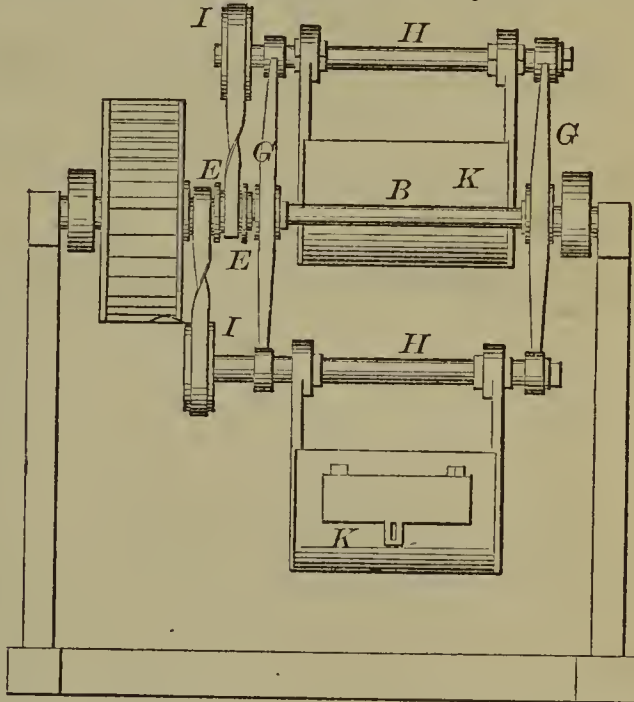

53912—E. P. Whitecomb—Churn.

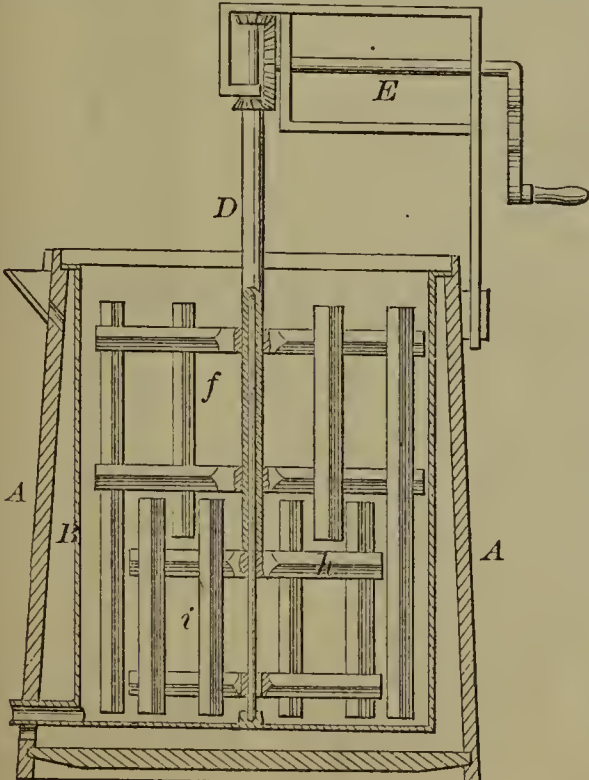

53915—H. I. Behrens—Rotary Engine.

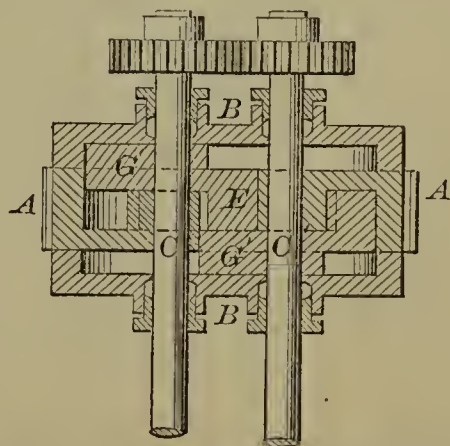

53916—J. E. Brown—Hame for Horse Collars.

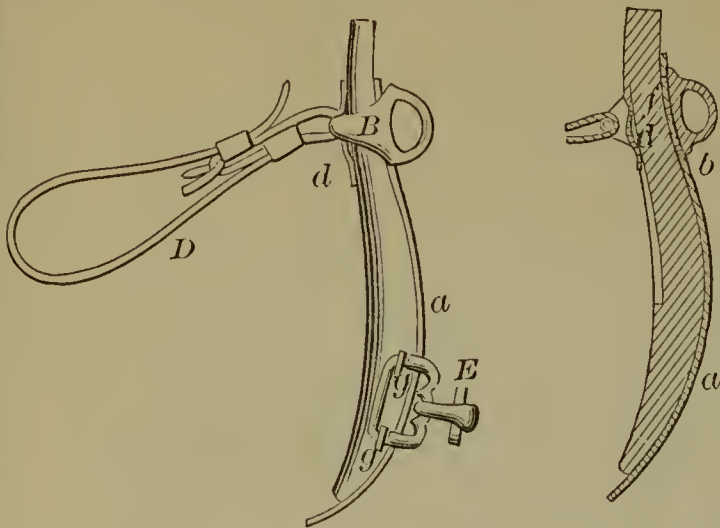

53921—Halsey & Fitzgibbons—Hard Rubber Article of Dress.

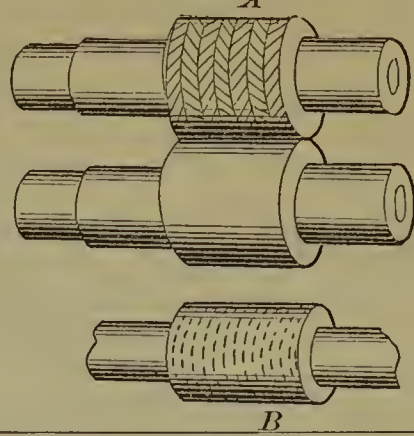

53917—J. B. Gridley—Baling Press.

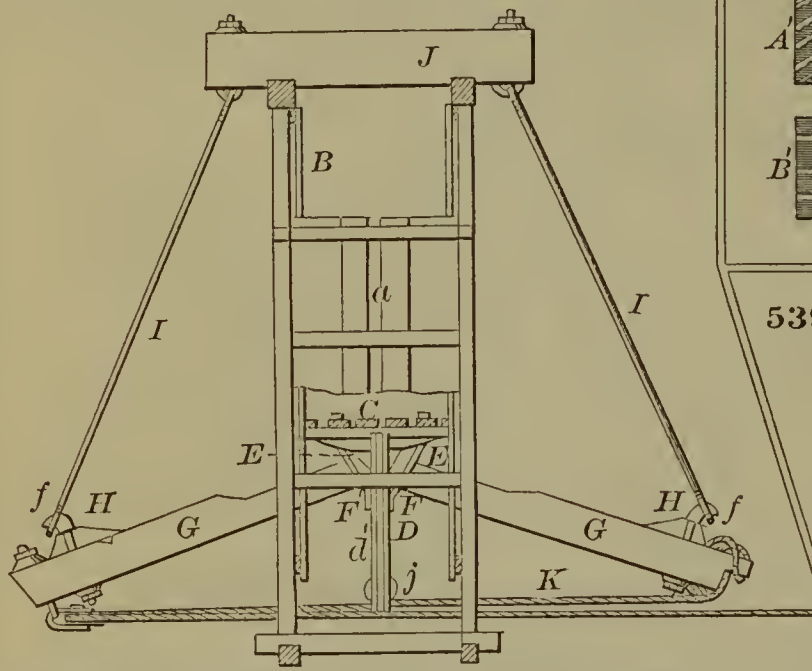

53922—Halsey & Fitzgibbons—Hard Rubber Articles of Dress.

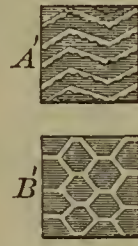

53920 W. H. Halsey—India Rubber Hat Band.

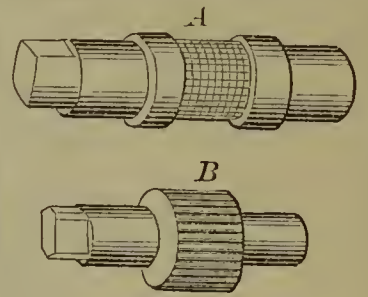

53918—L. Gibbs—Metallic Fastening for Plow Beams.

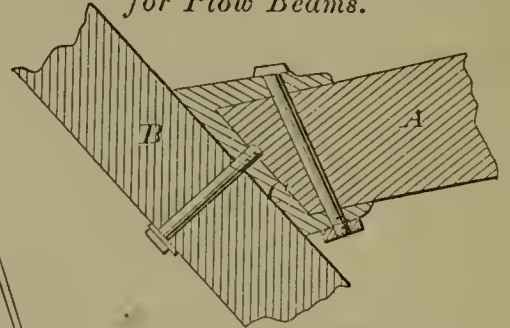

53919—A. Gilmore—Coffer Dam.

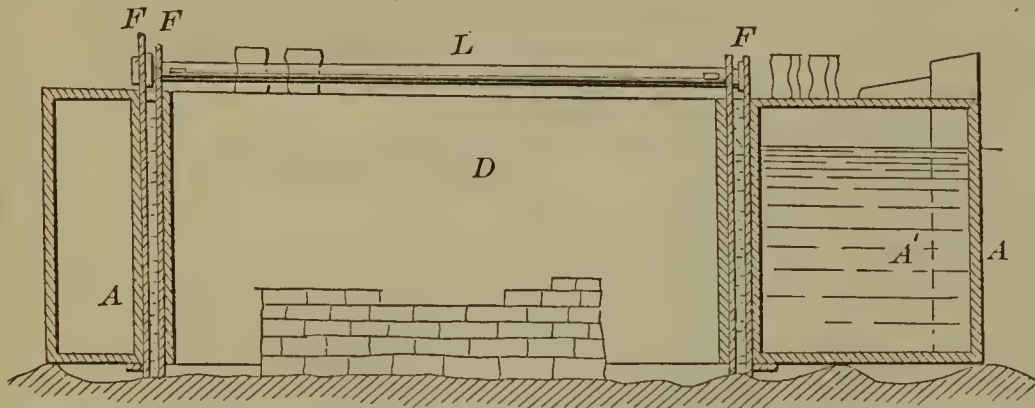

53924—C. D. Hunt—Nail Plate Feeder.

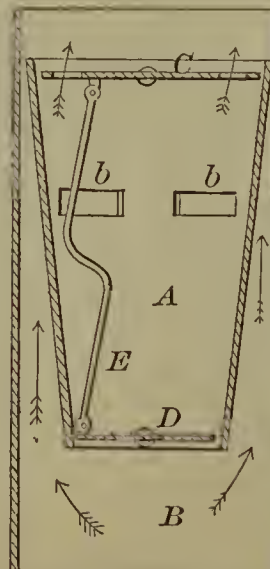
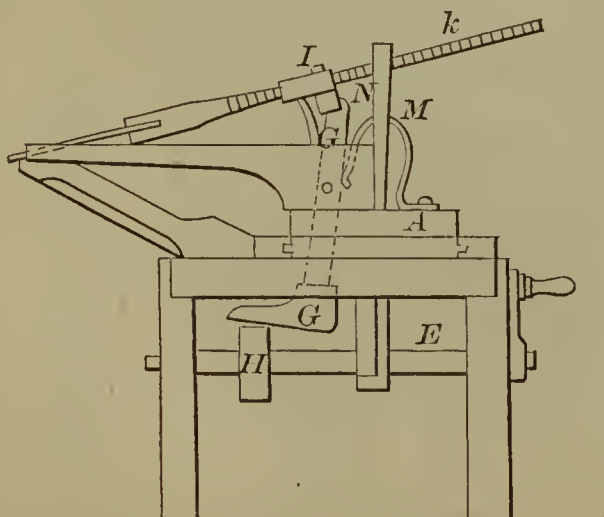

53925—S. Marvin—Stove Pipe Damper.

53923—D. K. Herr—Stencil Brush.

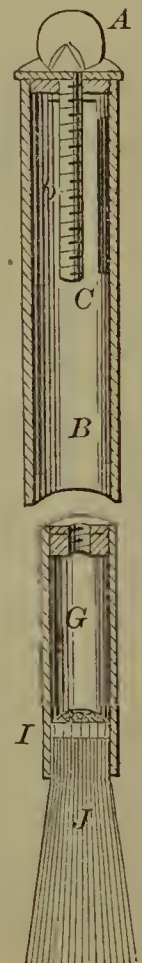



53926—A. A. Reed—*Eyleting Machine*

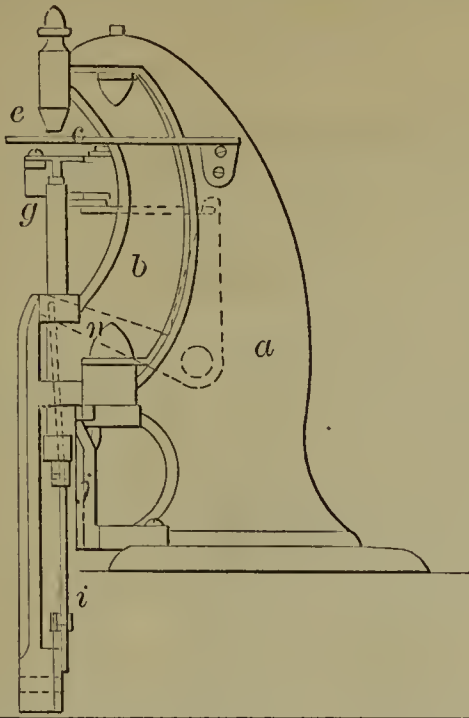

53929—T. Taylor—*Harvester Rake*.

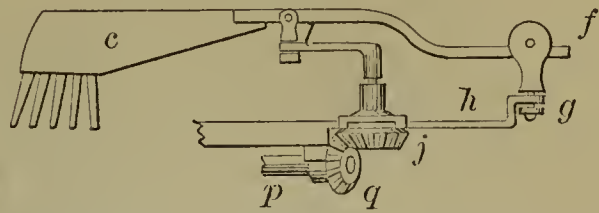

53930—C. M. Werner—*Horse Shoe*.

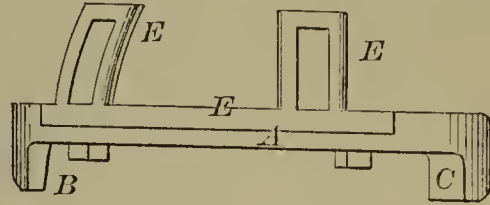

53927—Sanford & Wheeler—*Sewing Machine*

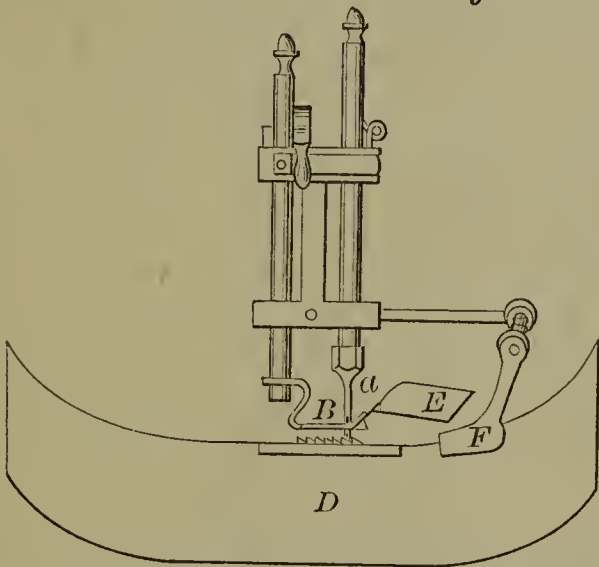

53931—Weston & Buchner—*Artificial Leg*.

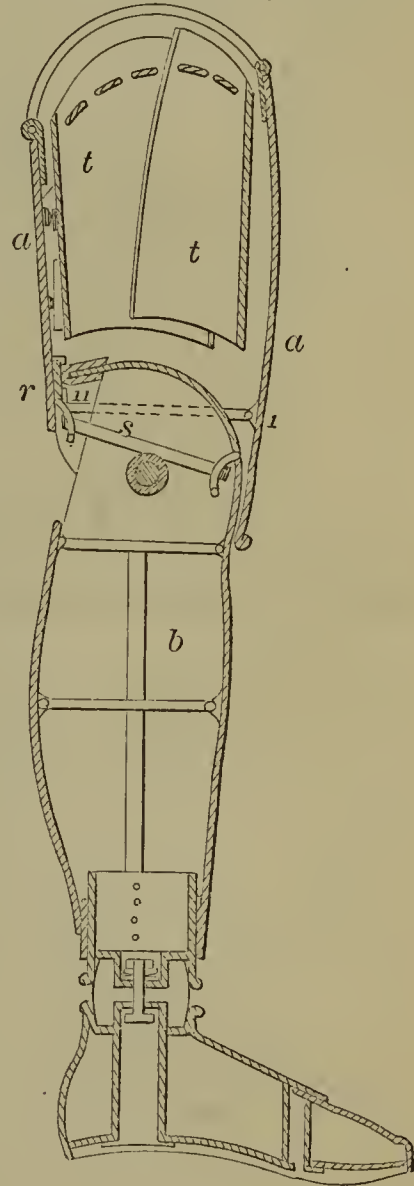

53932—A. Angeline—*Saddle and Harness*.

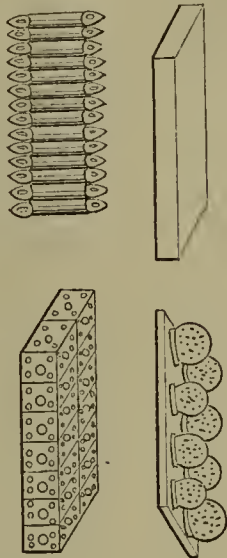

53933—W. Hale—*Rocket*.

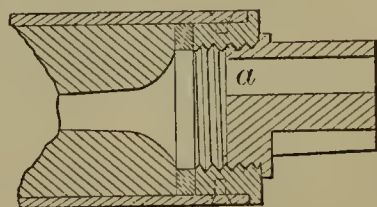

53928—Sheffield & Palmer—*Device for Detaching Bolts from Davits*.

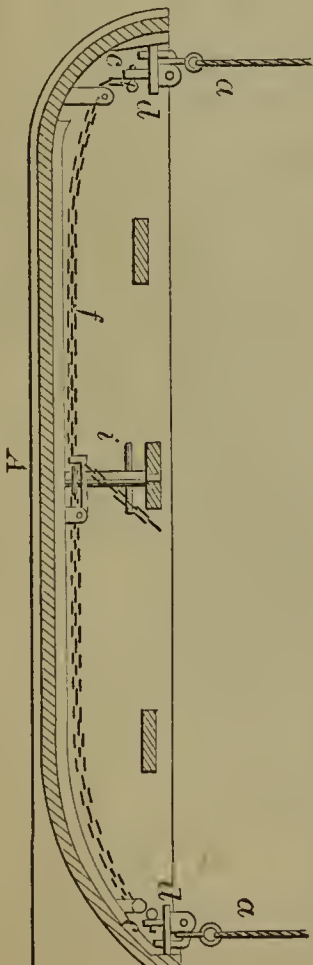

53934—M. W. Ruthven—*Steering Apparatus.*

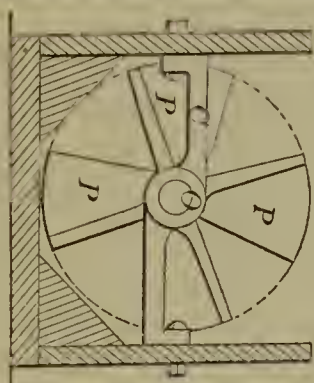
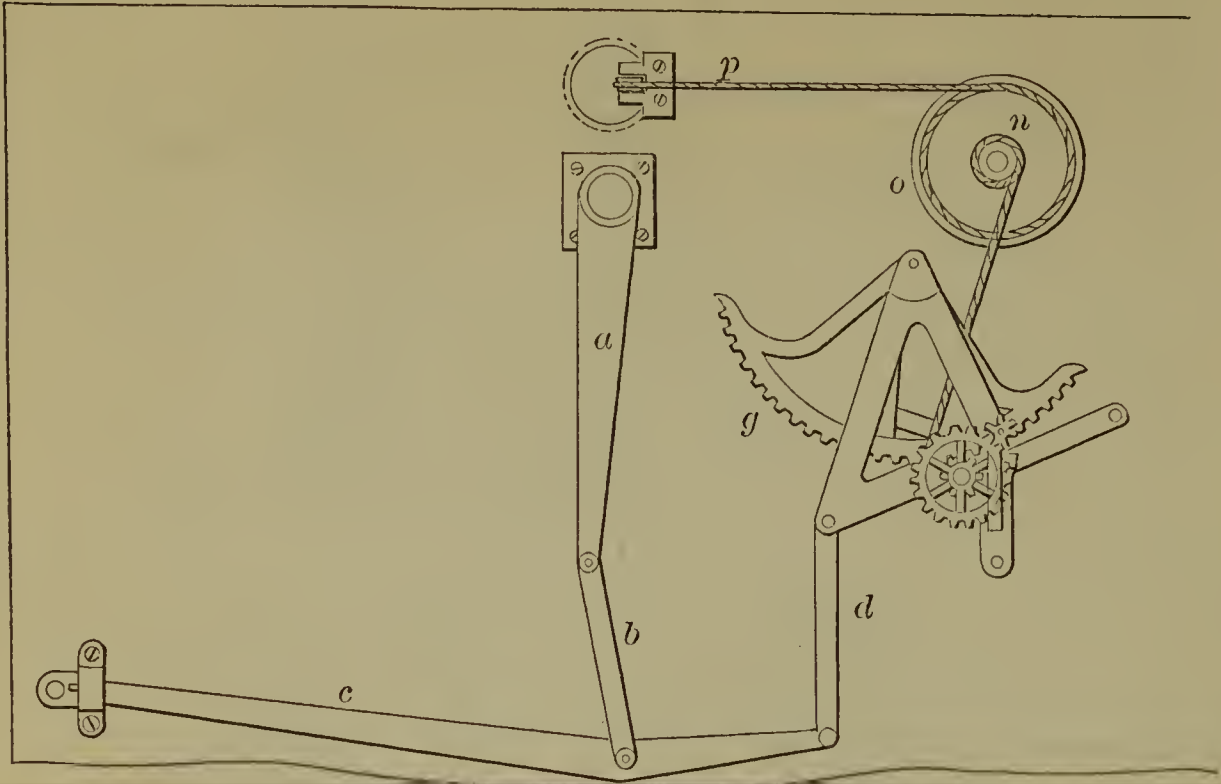

53936—M. W. Ruthven—*Rudder.*

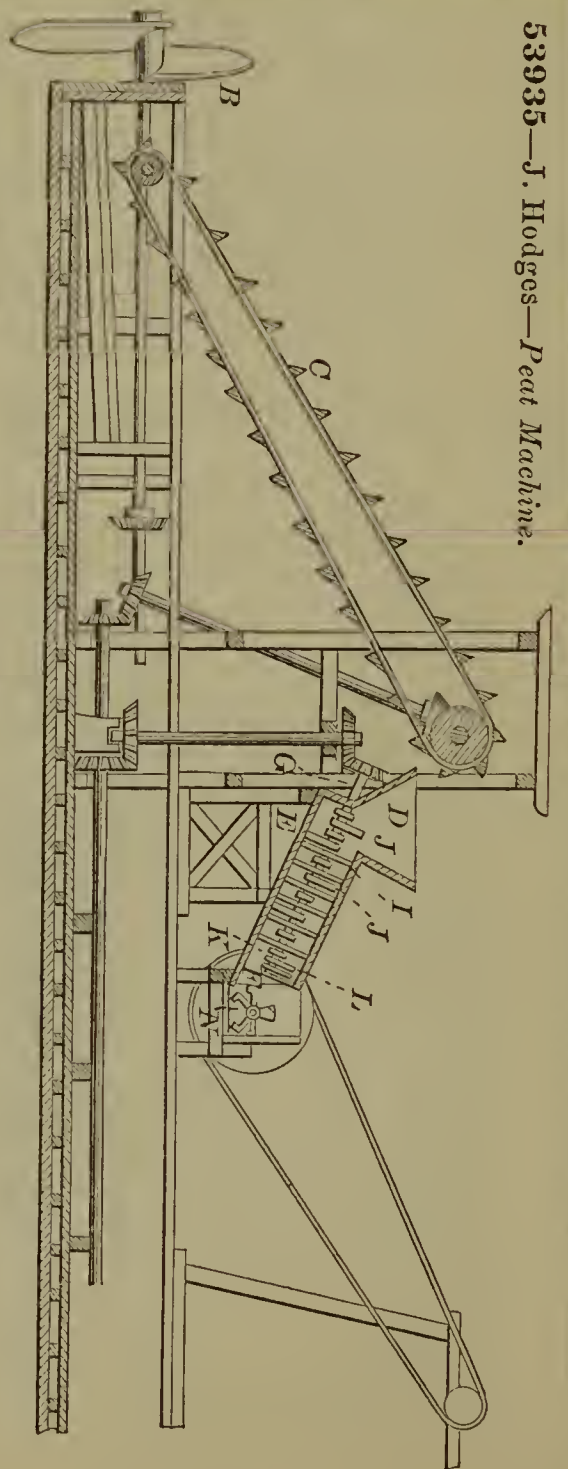
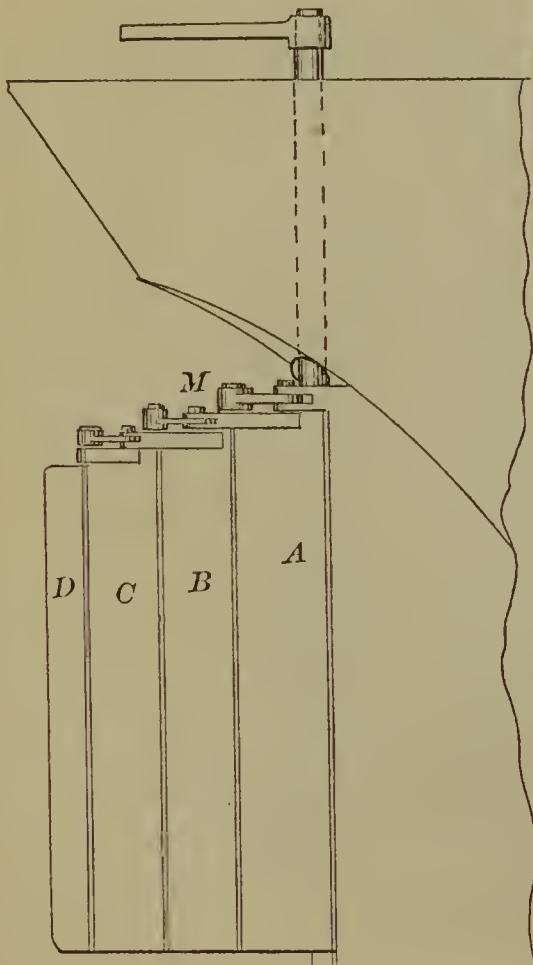

53935—J. Hodges—*Peat Machine.*

53937—M. W. Ruthven—*Sluice for Propelling Vessels.*

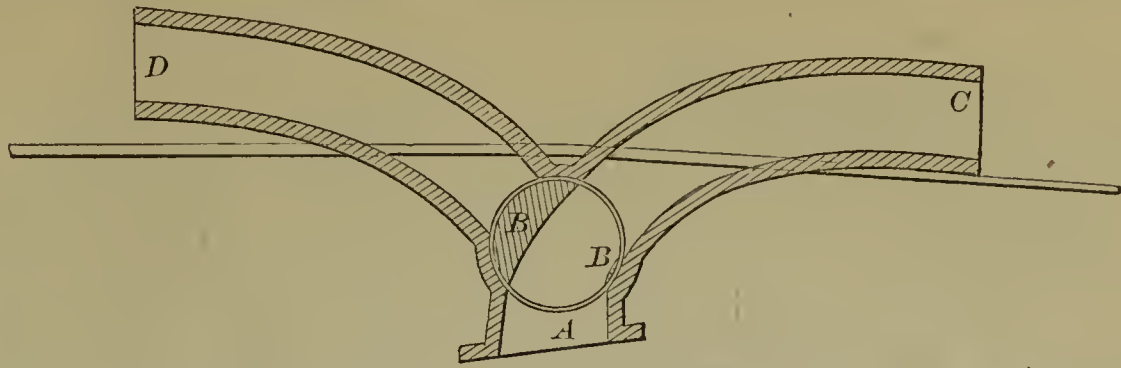

53938—J. F. Hartman—*Swing.*

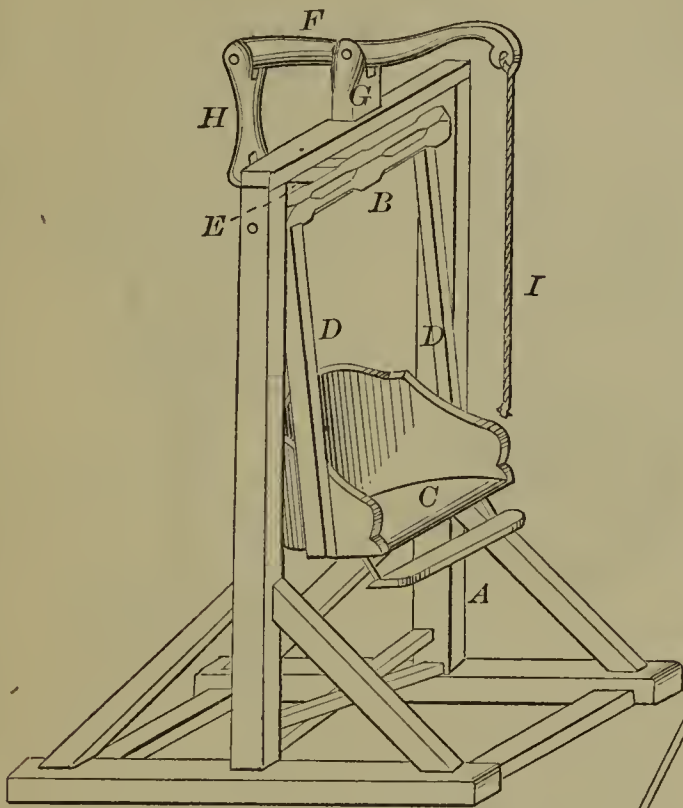

53939—A. Leuchtweiss—*Pump.*

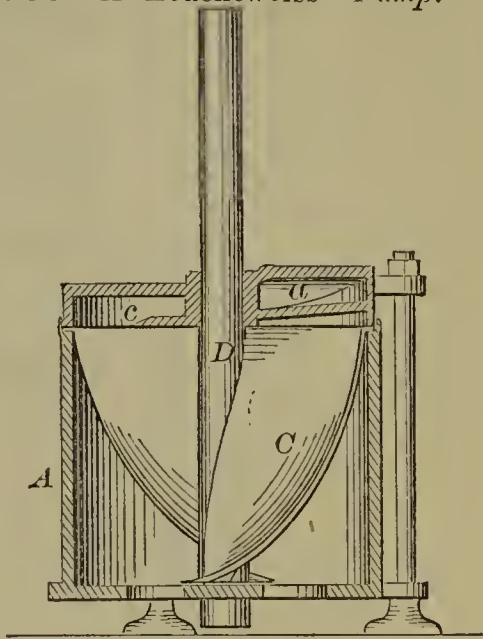

53940—J. Armstrong—*Stone Dressing Machine.*

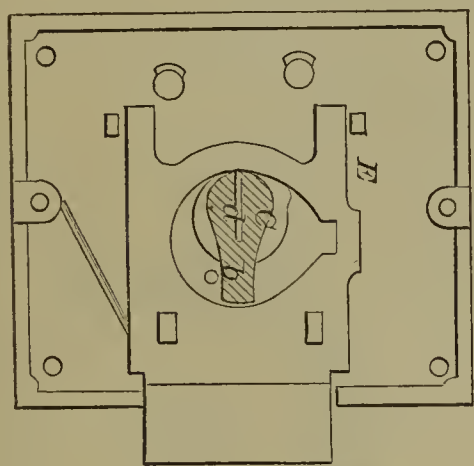
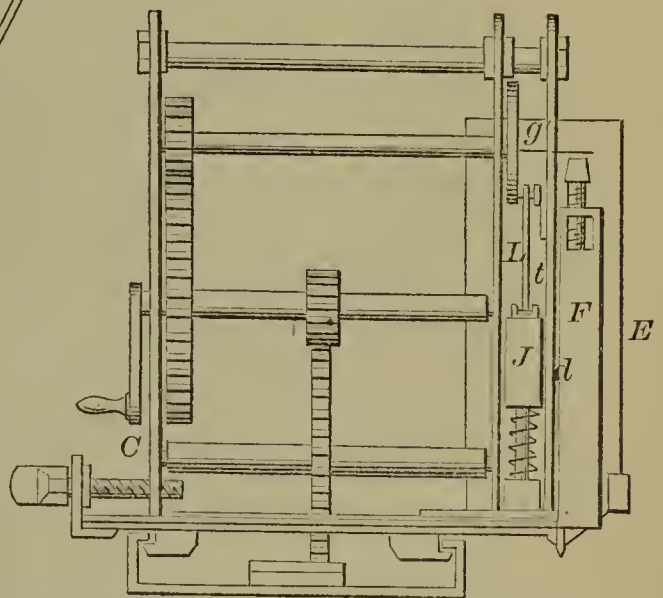

53941—T. A. Auferlin—*Lock.*

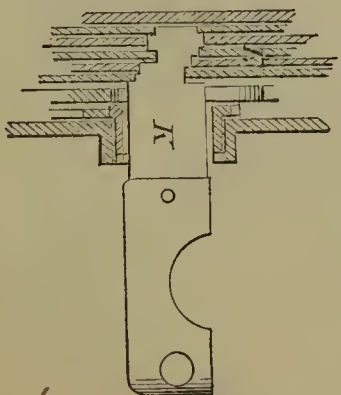

53942—J. Barnes—*Harvester Rake.*

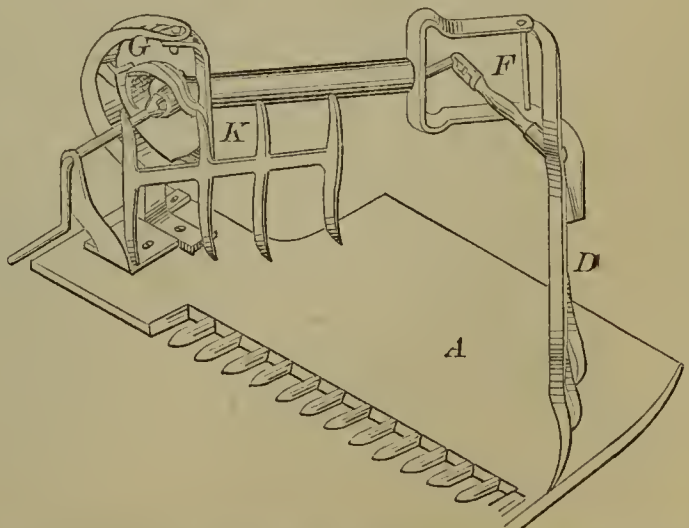

53943—C. F. Bartling—Loom.

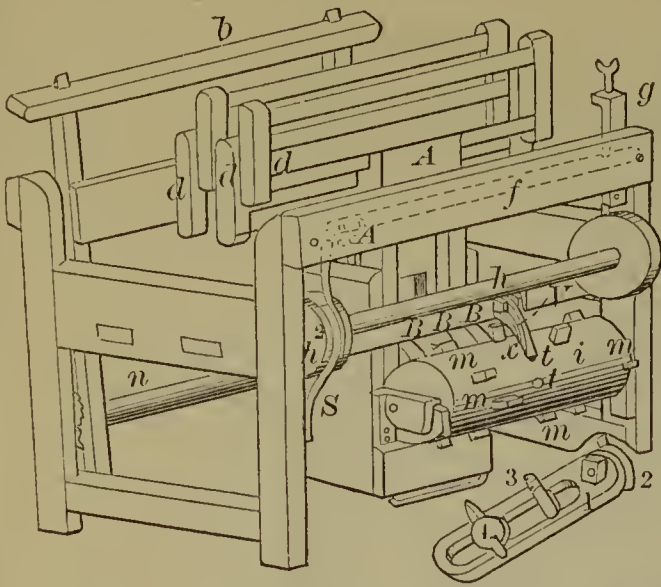

53947—J. Case—Cultivator.

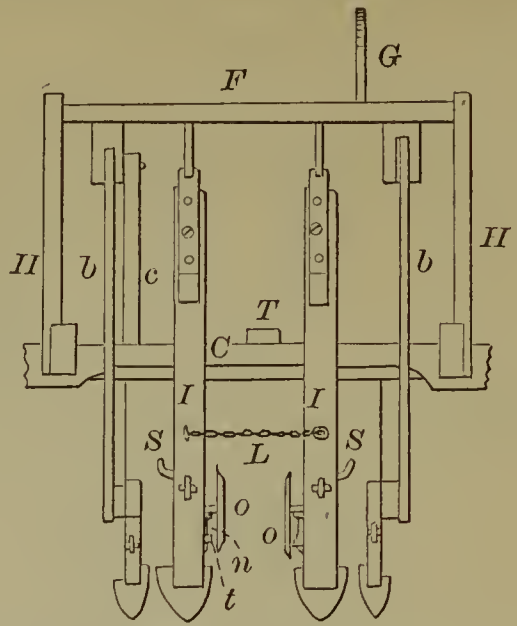

53945—E. Brown—Lamp.

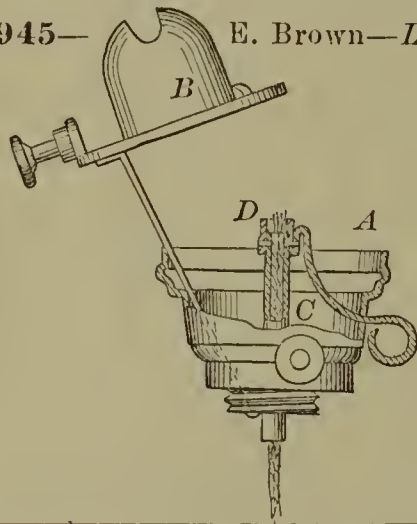

53949—C. H. Clarke—Piston Packing.

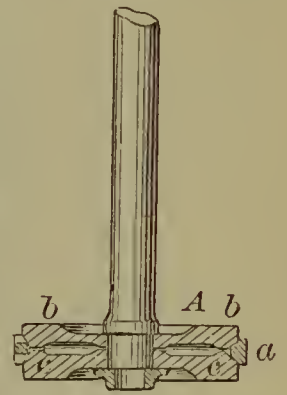

53944—Biggs & Flinn—Hydrant.

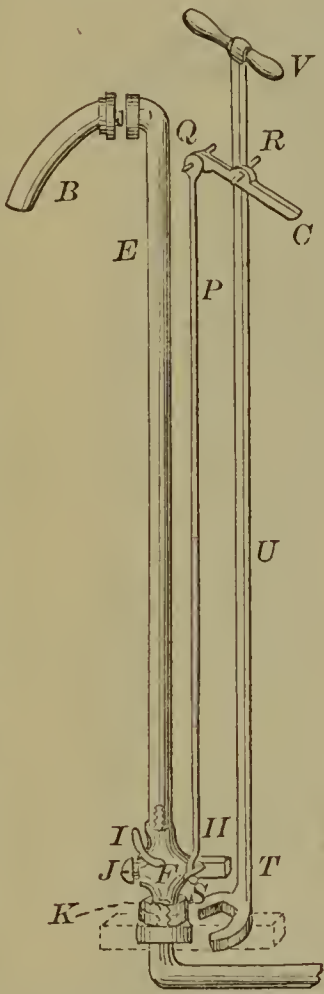

53950—T. R. Cook—Ditching Machine.

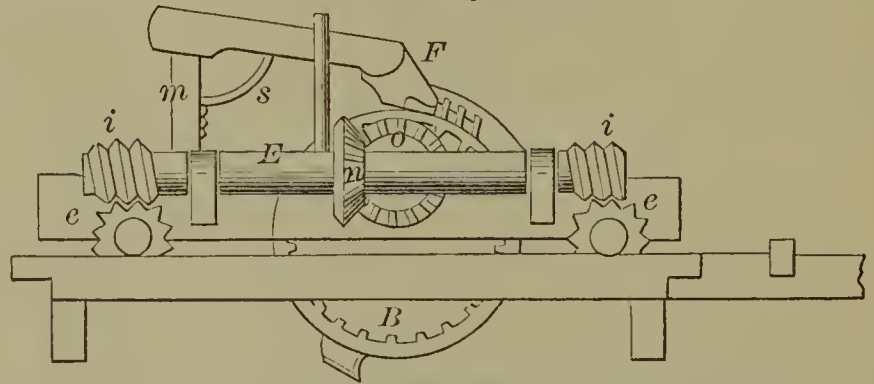

53948—F. Catlin—Bottle Stopper.

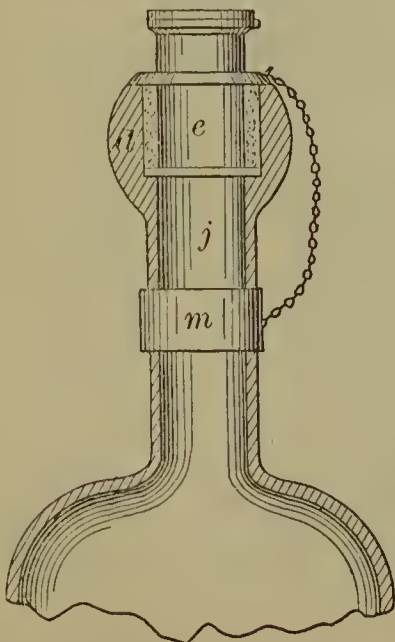

53951—Coult & Roach—For Separating Volatile Metals from Ores.

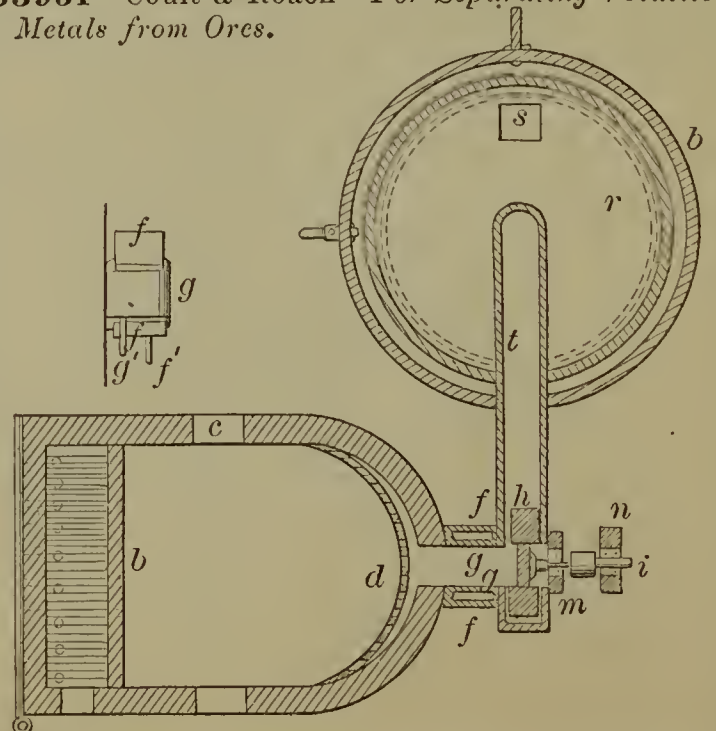

53952—E. Cox—*Churn Top.*

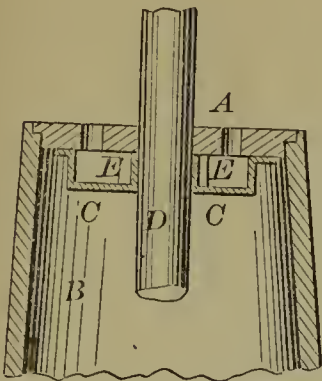

53956—L. Cutting—*Pea and Bean Sheller.*

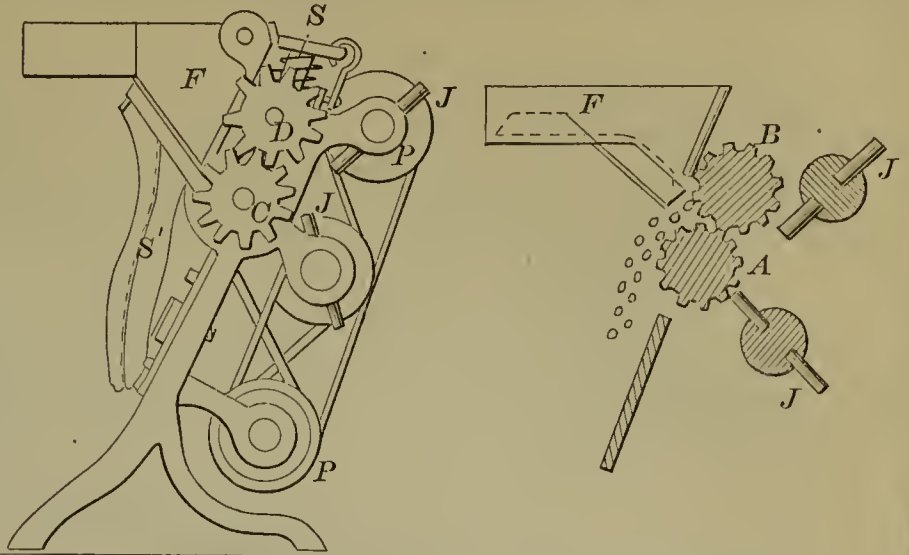

53953—P. Crans, Jr.—*Lamp Burner.*

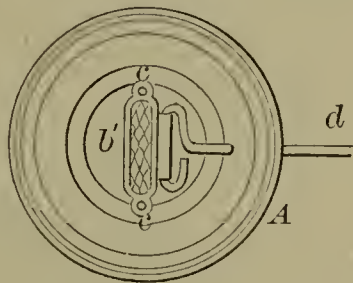
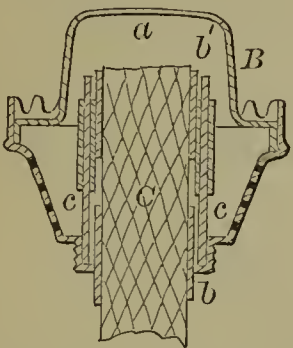

53957—P. Daniels—*Tire Tightener.*

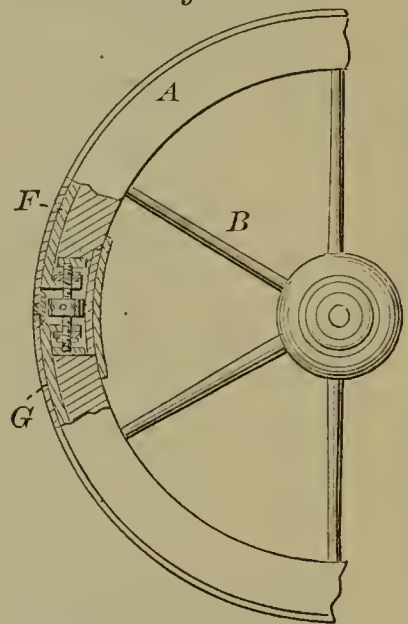

53958—W. P. Dillman—*Harvester Rake.*

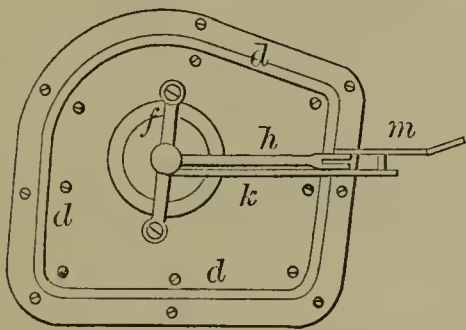
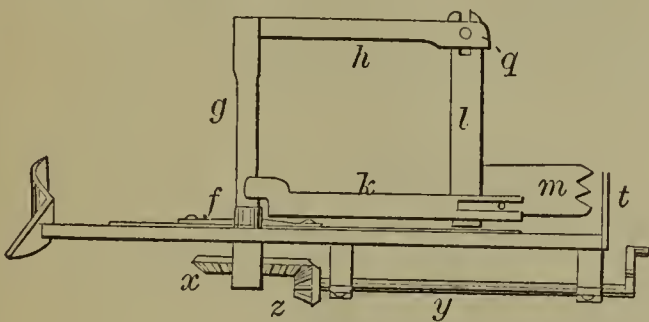

53955—G. G. Crowell—*Revolving Fire Arm.*

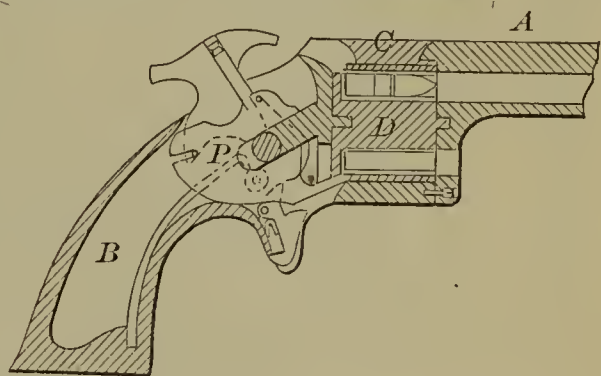

53954—J. Crimmmins—*Stove Pipe Drum.*

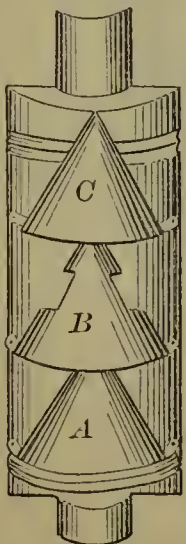

53959—W. B. Dodds—*Lock.*

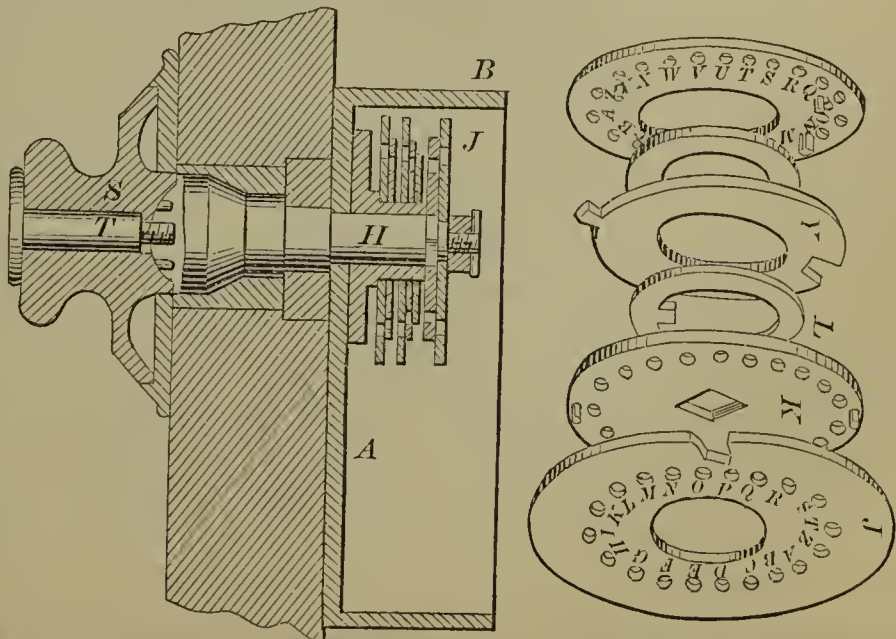

53960—A. Dodge—Combined Cultivator and Seeding Machine.

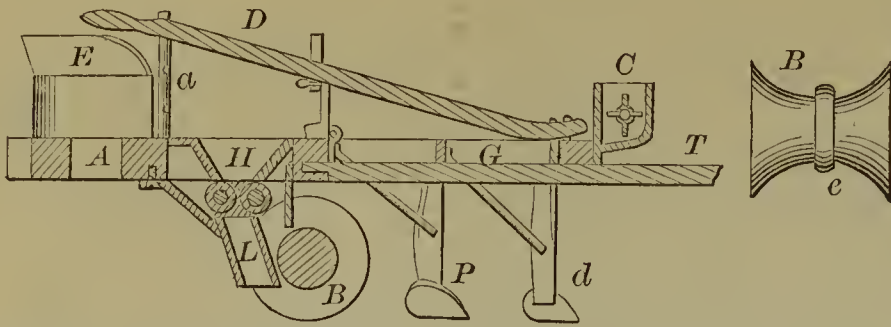

53962—J. S. Elkins—Broom Head.

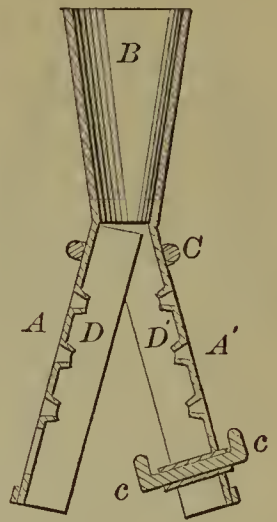

53961—R. N. Eagle—Ruler.

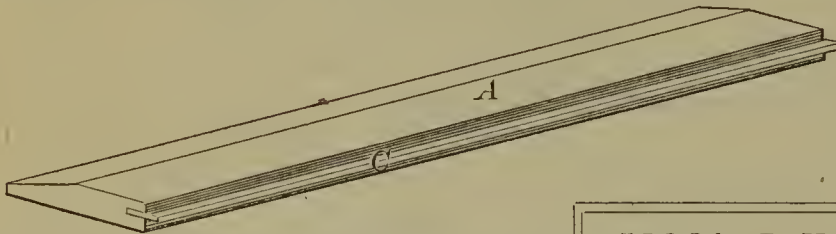

53966—A. C. Fletcher—Grate Bar.

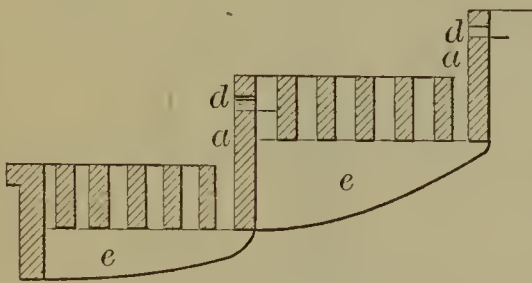

53964—L. V. Fiehet—Distilling Petroleum.

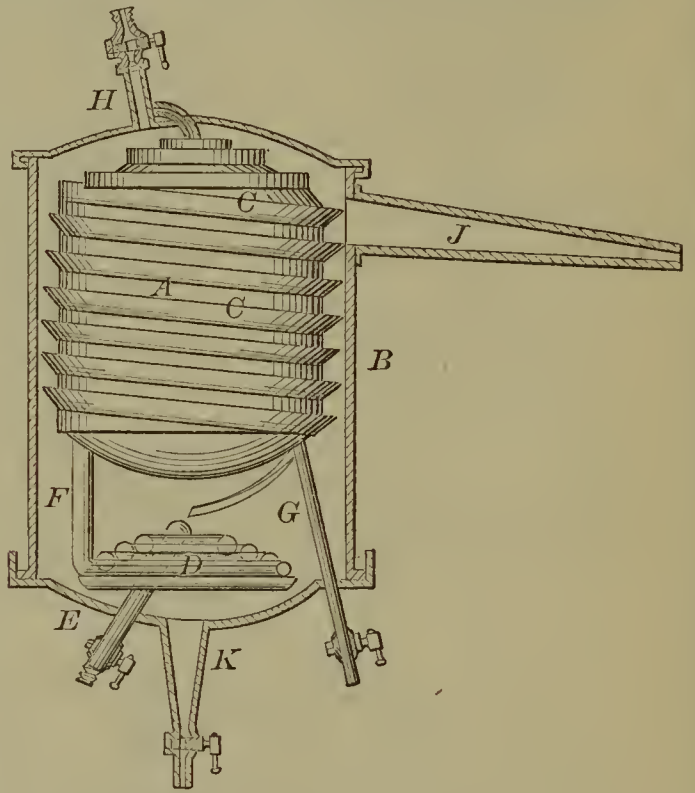

53967—A. C. Fletcher—Surface Condenser.

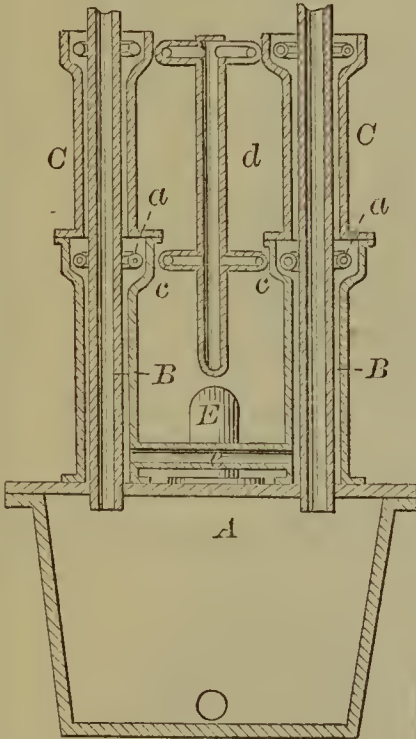

53963—H. Ferris—Hedge Plant Grab.

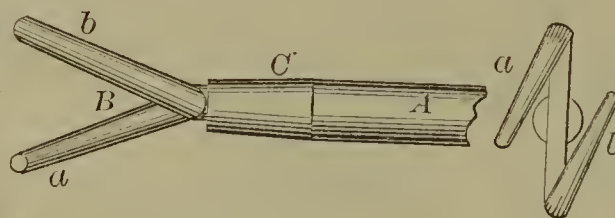

53965—T. Fislser—Punch Mixer and Egg Beater.

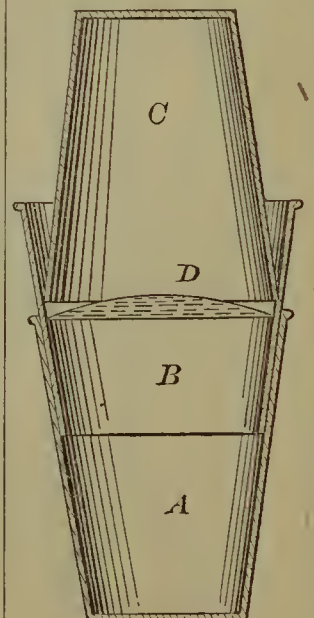

53968—B. Folsom—Snow Scraper for Railroads.

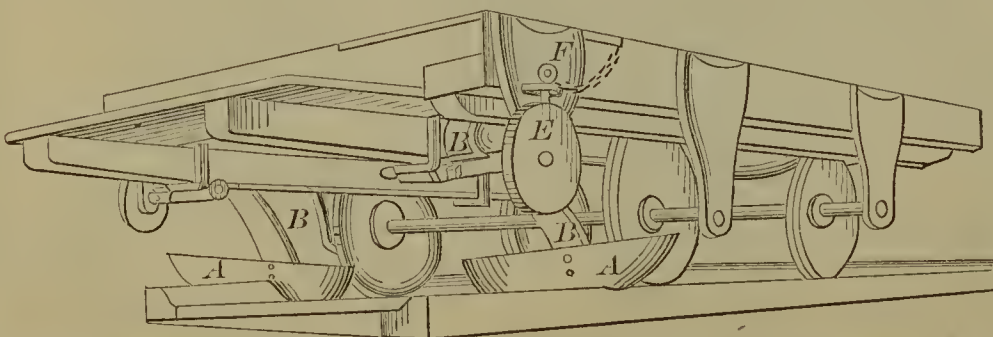

53969—Fox & Ridgaway—Harvester.

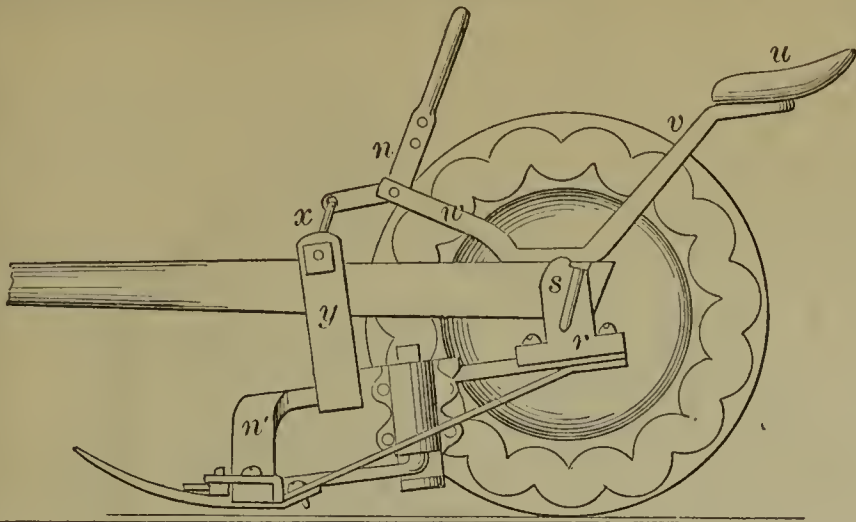

53973—G. Hagenmeyer—Grease Cup.

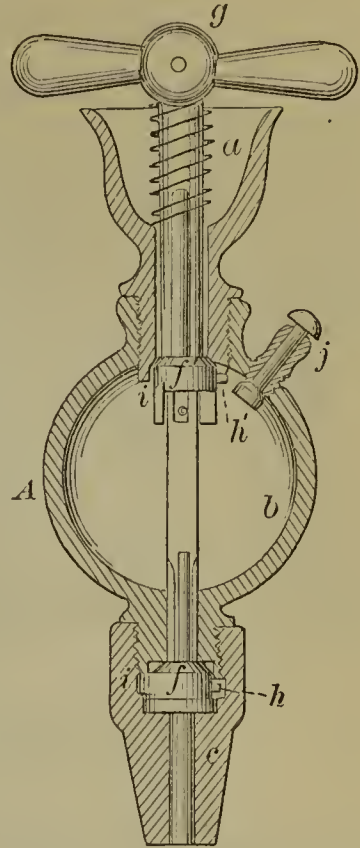

53970—Frey, Allen & Smith—Barrel and other Vessels.

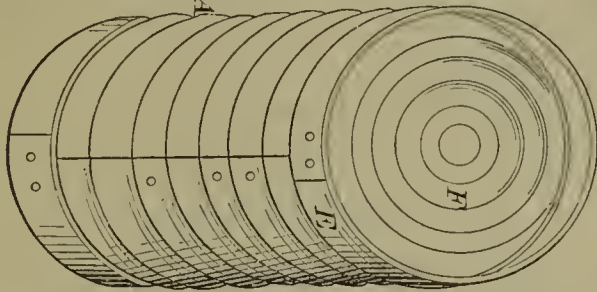

53974—J. Harrison—Deep Well Pump.

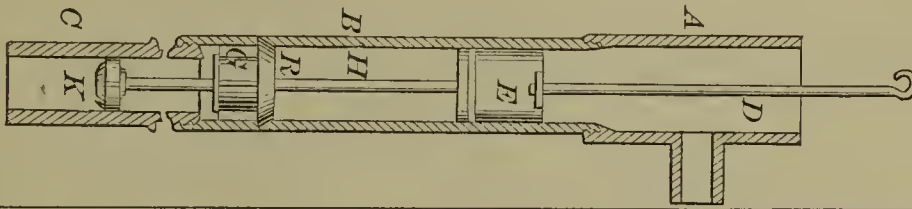

53971—J. W. Gibbs—Car Brake.

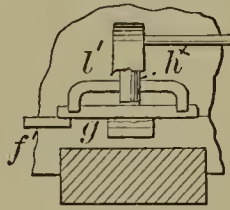
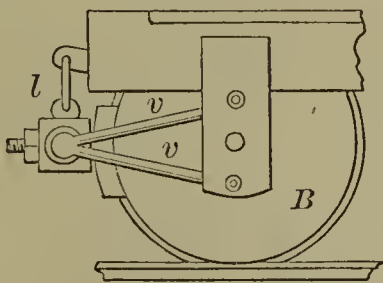
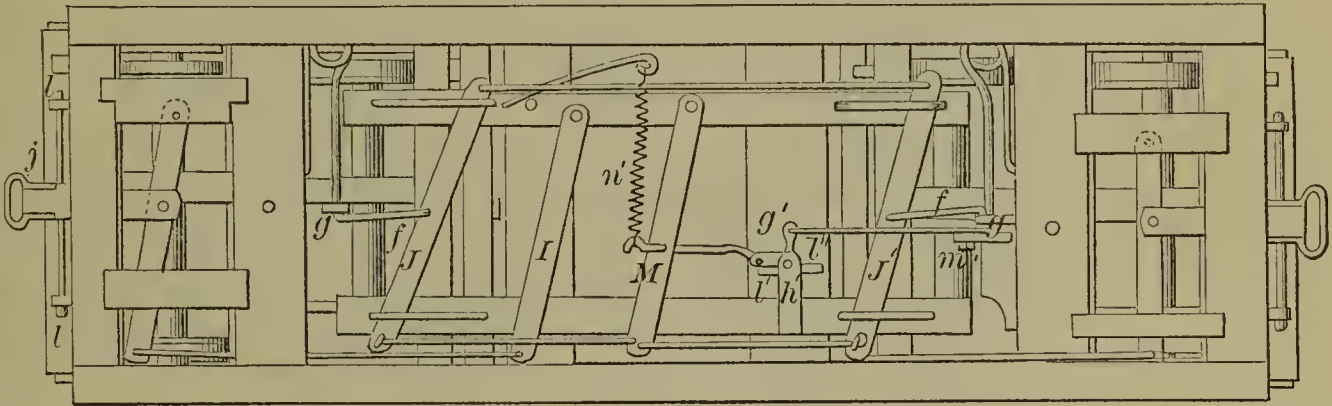

53975—G. W. L. Hazen—Evaporator.

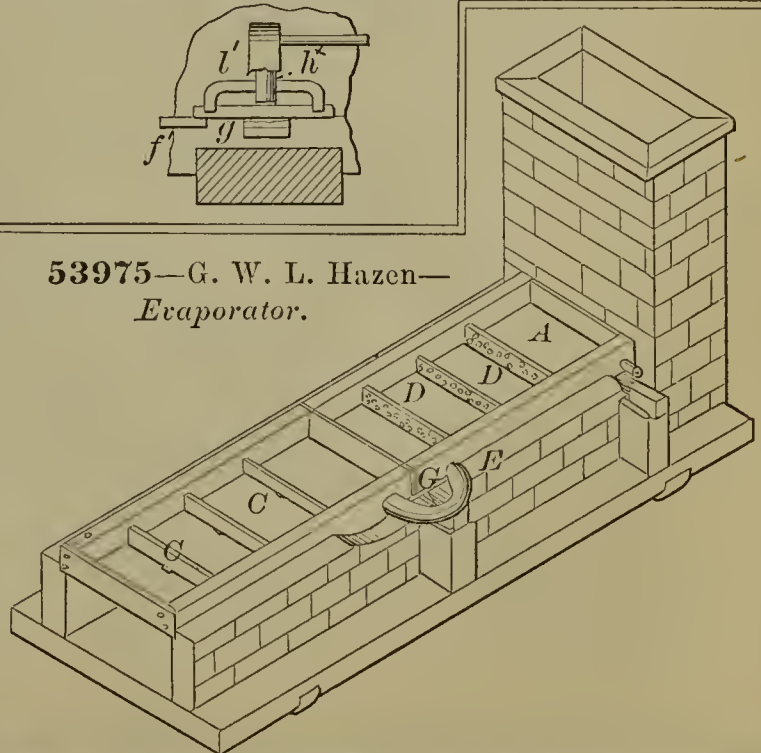

53972—C. M. Gilbert—Bedstead Fastening.

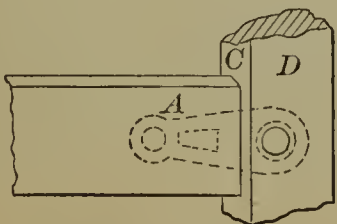

53976—J. Hendy—Concentrator.

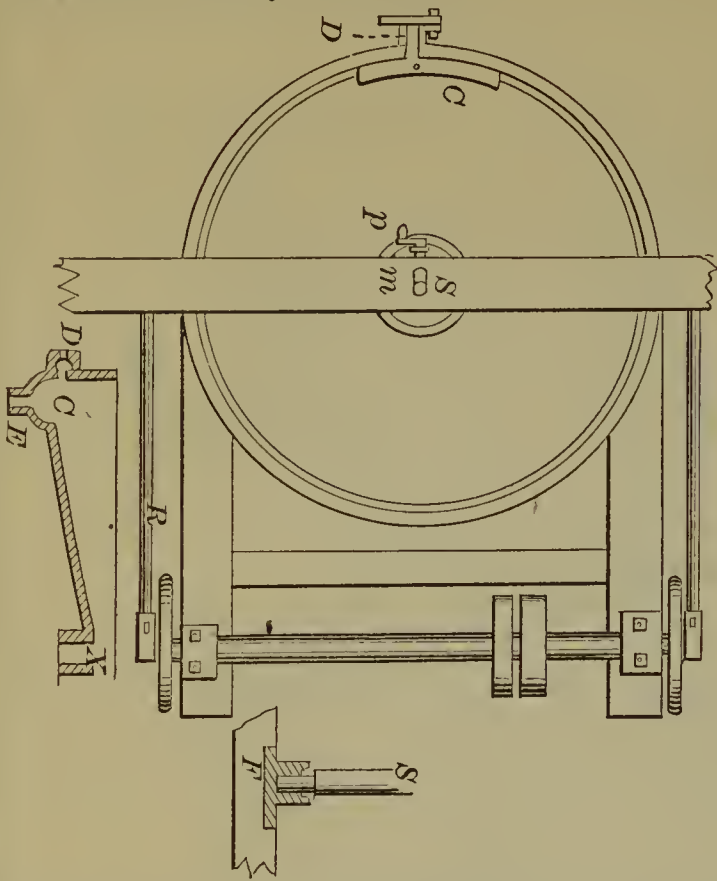

53979—P. Hogan—For Carburetting Air.

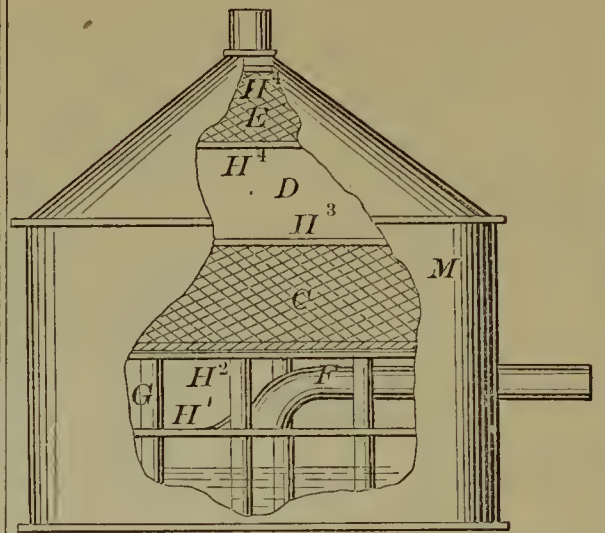

53980—Hotchkiss & Buss—Brick Machine.

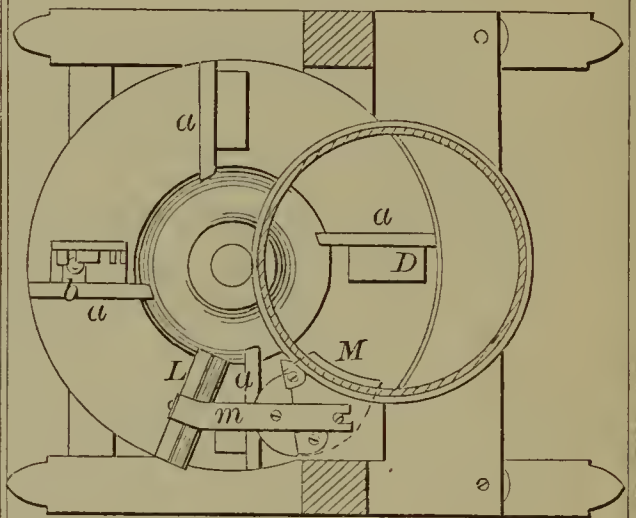

53977—J. Hendy—Saw Mill.

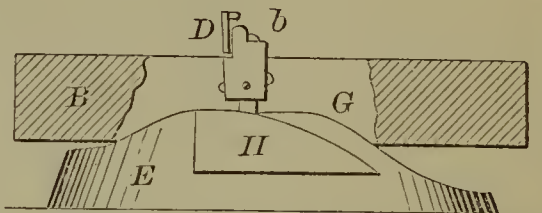
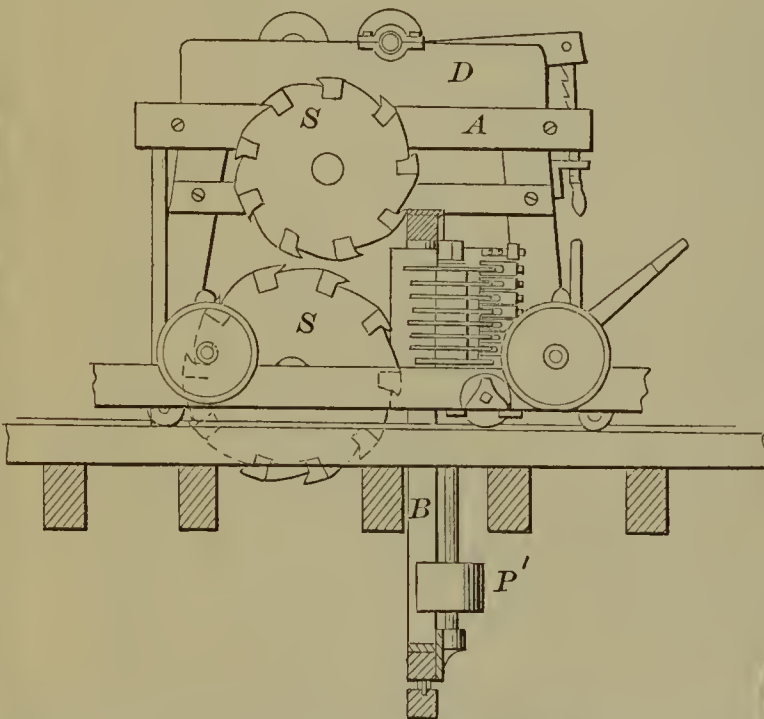

53981—T. M. Howard—Drilling Machine.

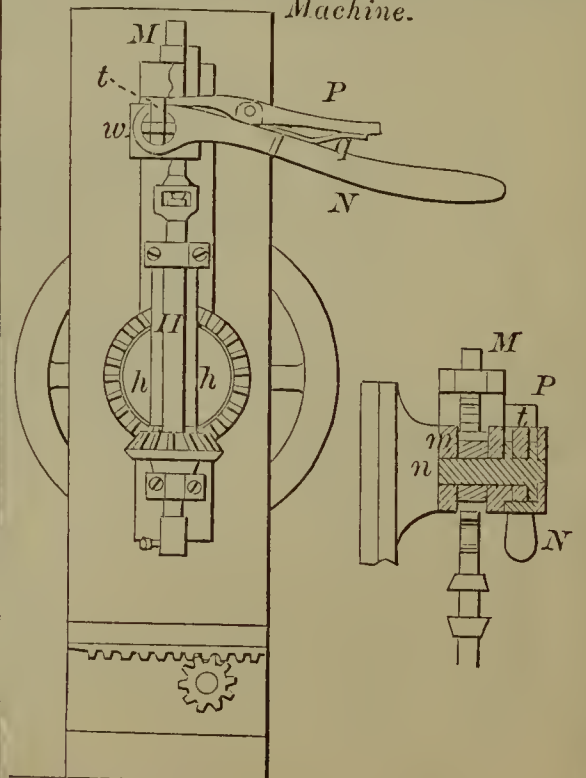

53978—A. Hildebrand—Washing Machine.

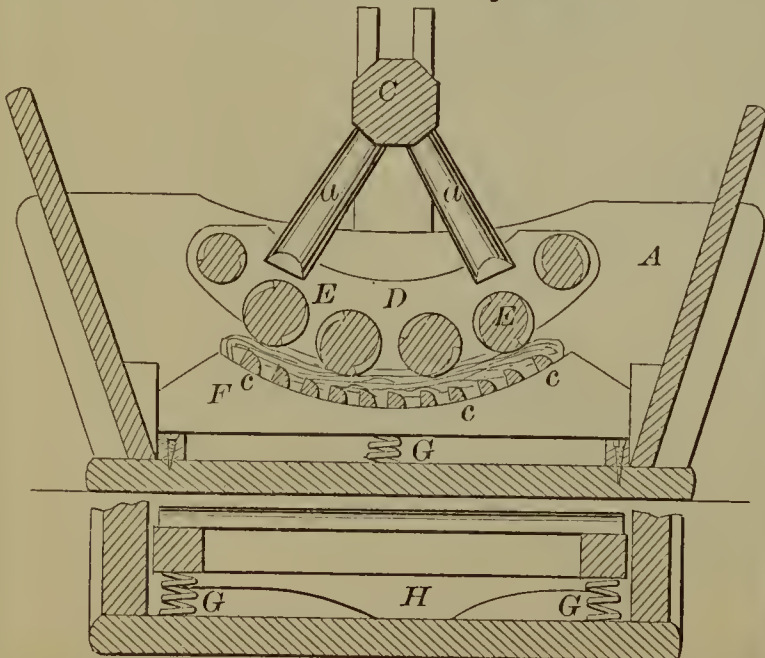



53982—C. B. Hutchinson—For Chamfering and Crozing Staves.

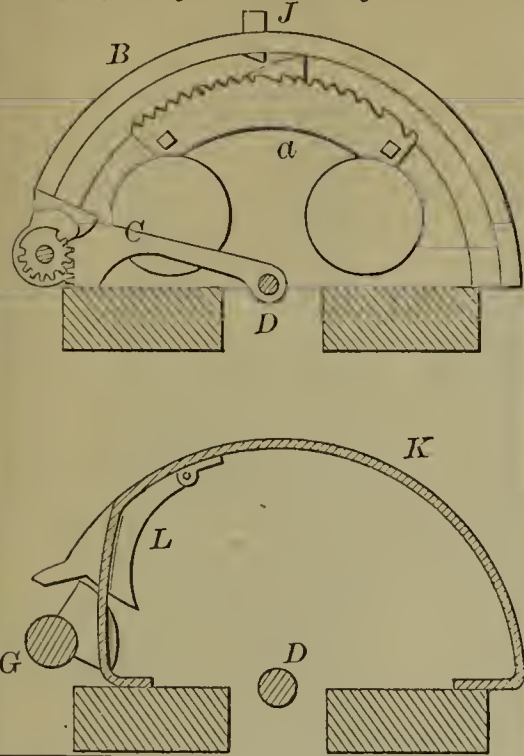

53983—C. B. Hutchinson—Machine for Bending Staves.

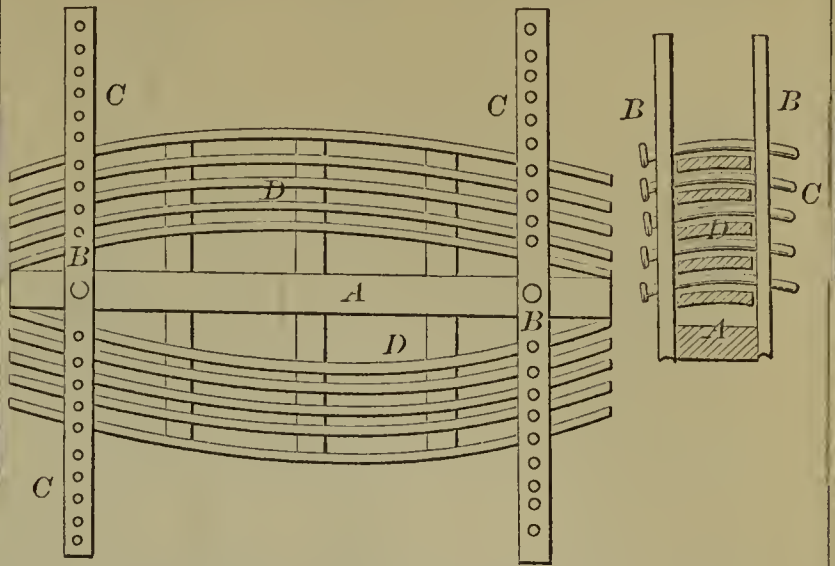

53984—J. Jacoby—Eaves Trough.

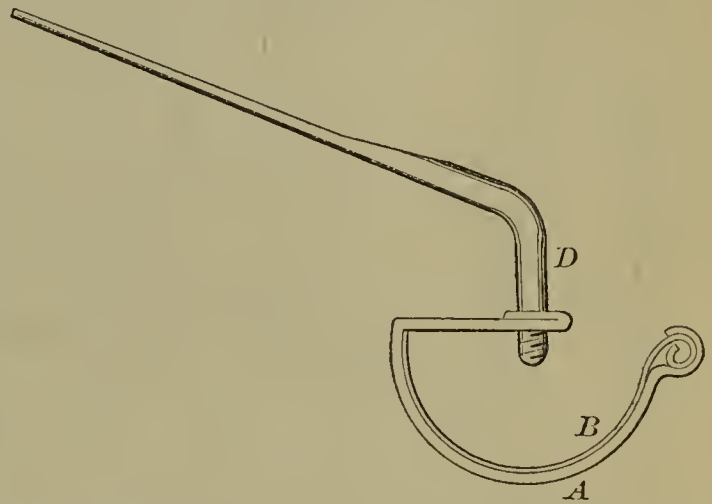

53988—W. O. Jones—Steering Apparatus.

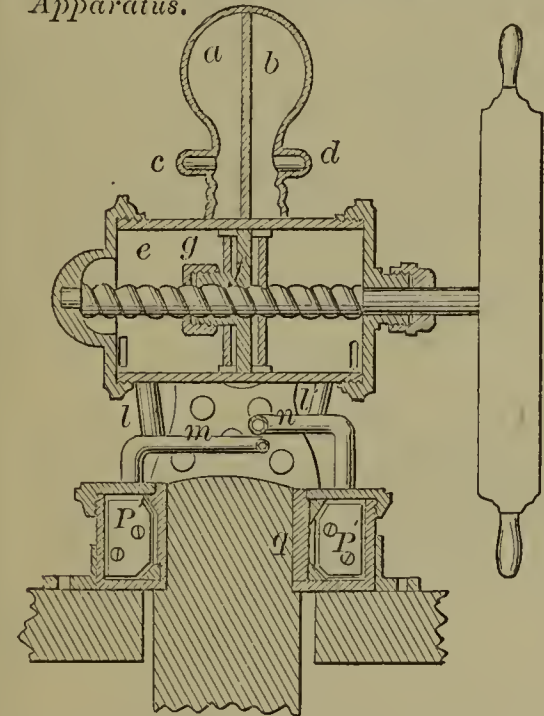

53985—Jenkins & Landis—Slide Valve for Steam Engines.

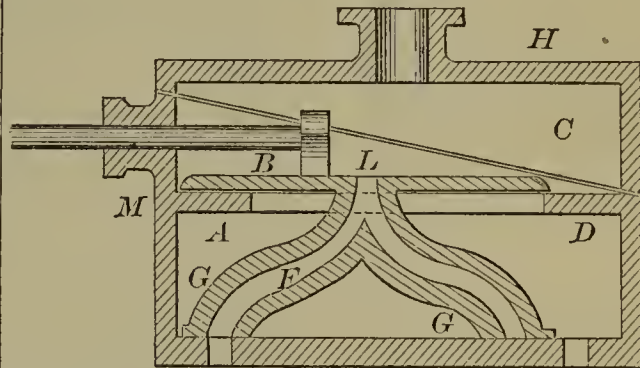

53986—J. M. Johnson—Button.

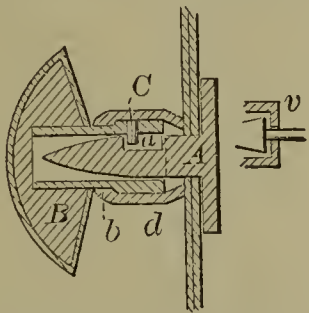

53987—S. D. Jones—Flour Sifter.

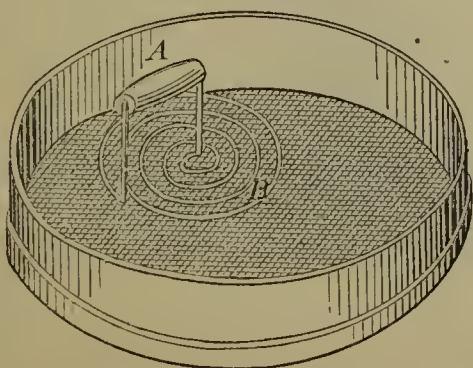

53989—C. & A. Kaestner—Grinding Mill.

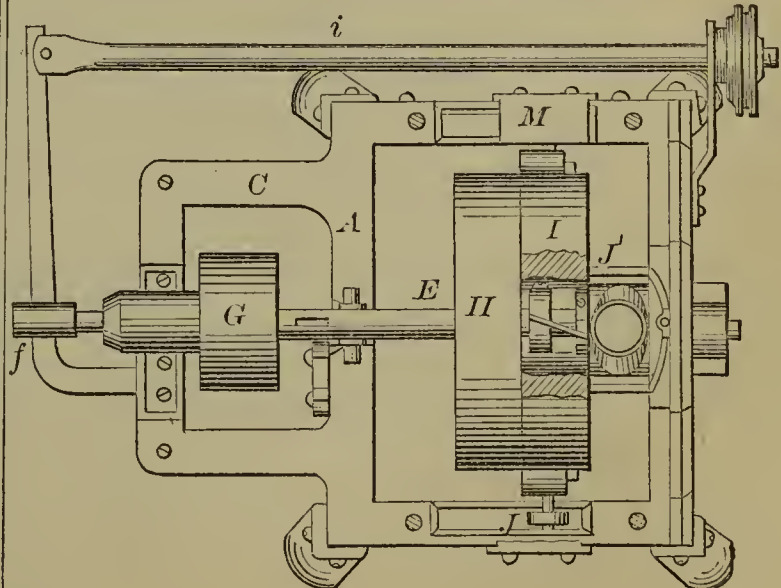

53990—W. S. Kelly—*Pump for Deep Wells.*

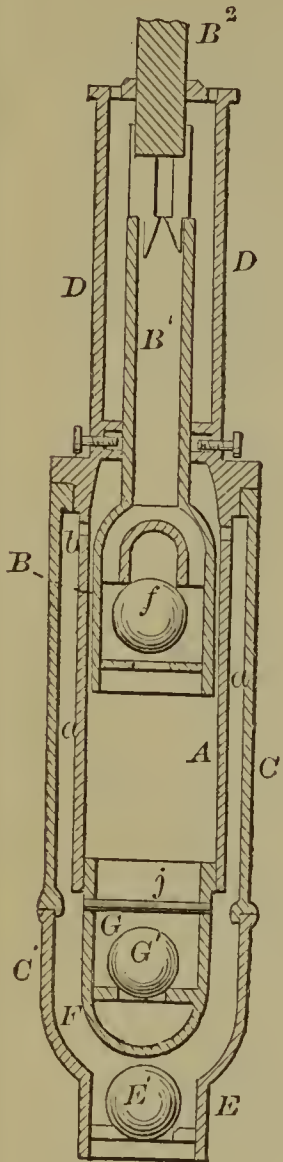

53991—C Lang—*Lace Paper.*

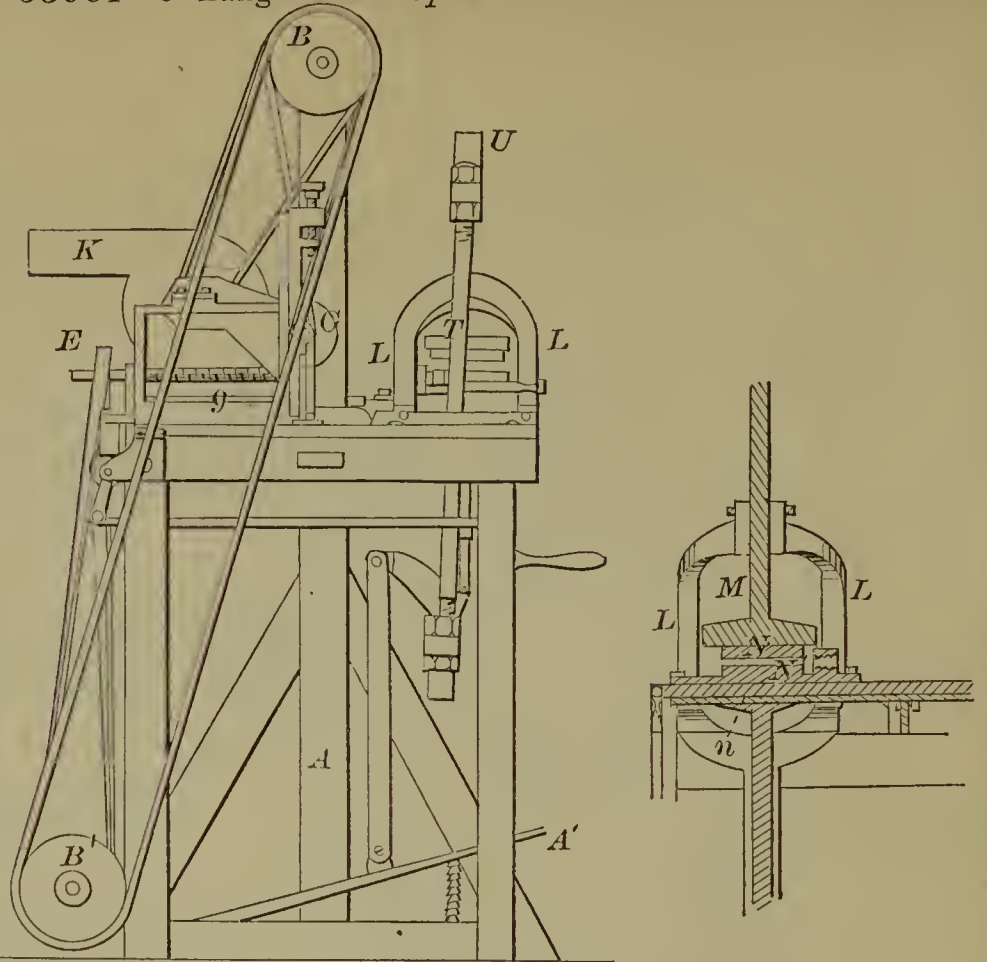

53992—I. S. Lauback—*Drill and Crane Attachment.*

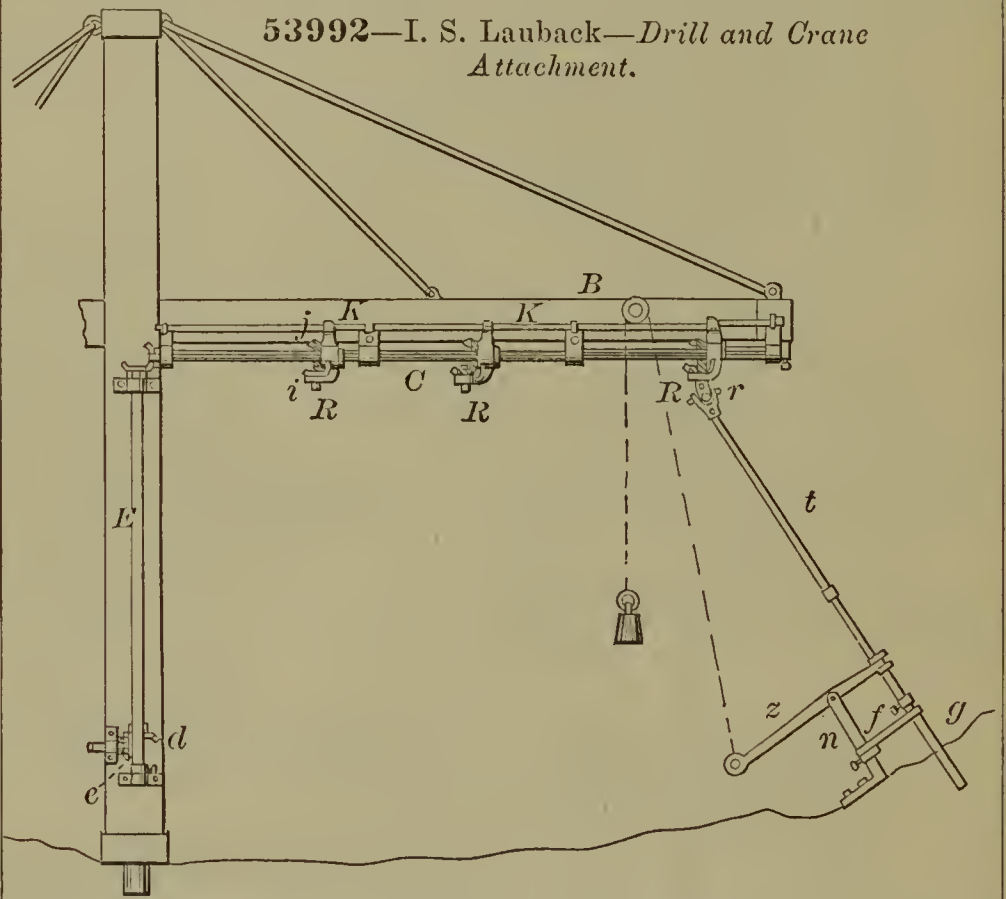

53994—R. Lissenbee—*Pivot Lathe.*

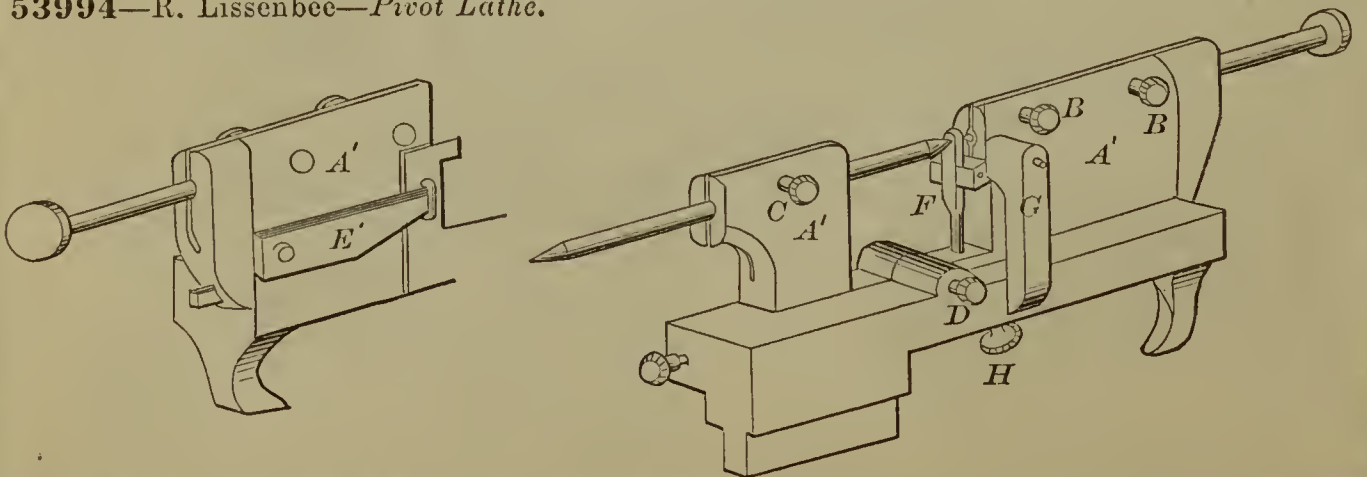

53995—D. G. Littlefield—  
Base Burning Stove.

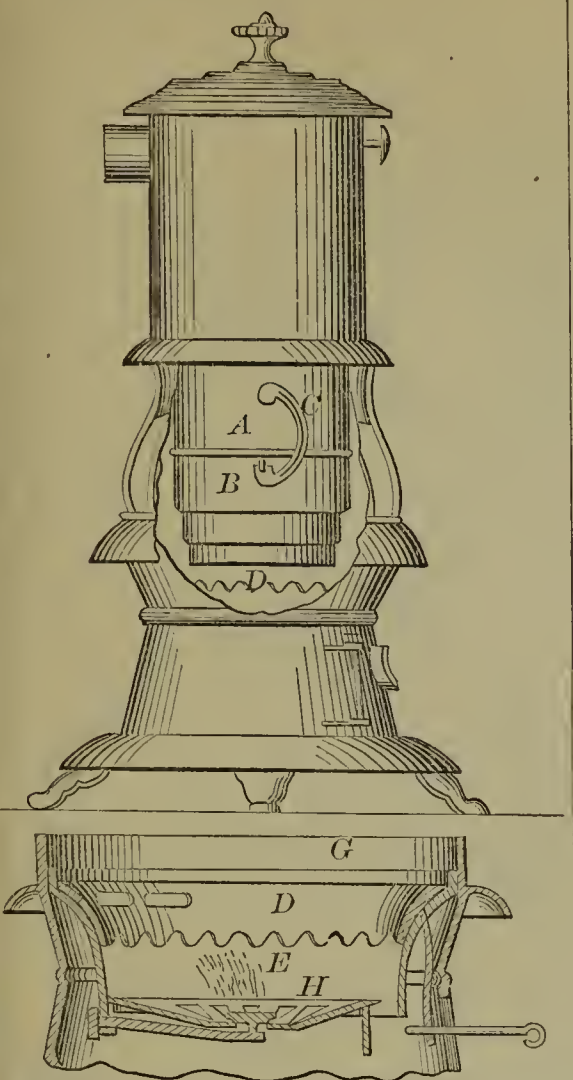

53997—G. T. Lozier—*Foot Scraper.*

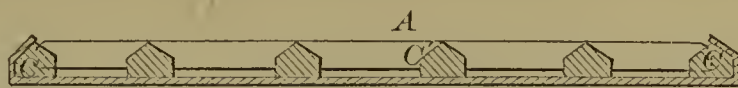

53999—McBurney & Forsyth—*India Rubber Tube, &c.*

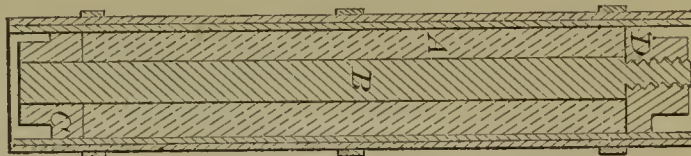

53996—B. T. Loomis—*Expanding Tap and Reamer.*

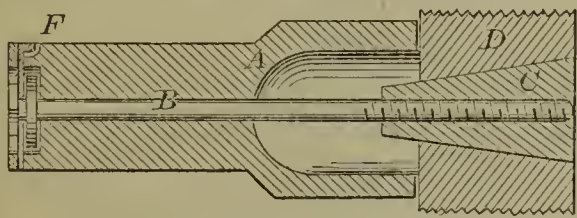

53998—T. T. Markland, Jr.—  
*Water Cooler.*

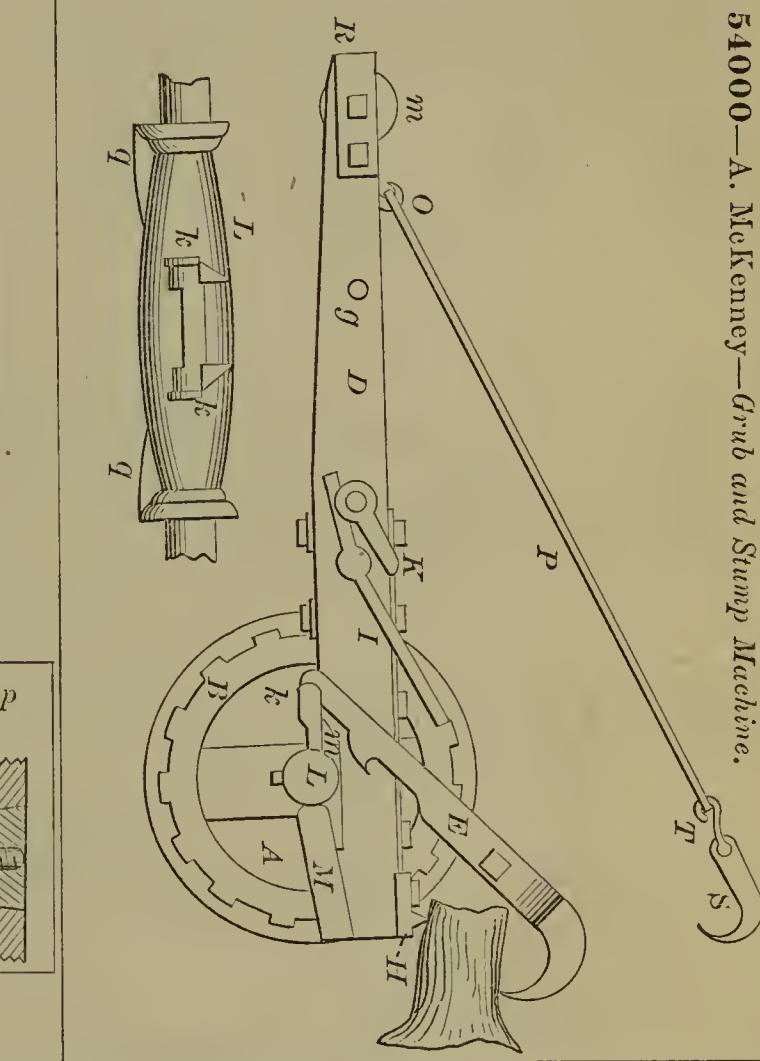
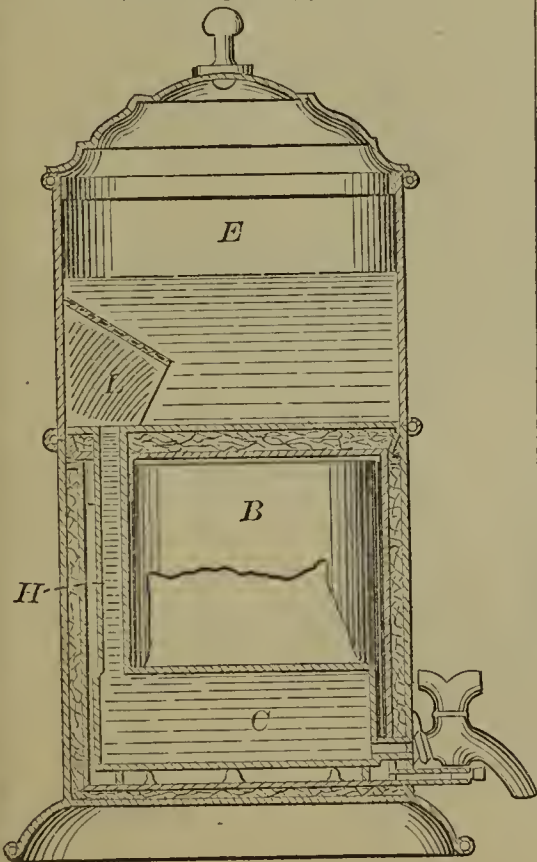

54000—A. McKenney—*Grub and Stump Machine.*

54001—O. E. Miles—*Wagon.*

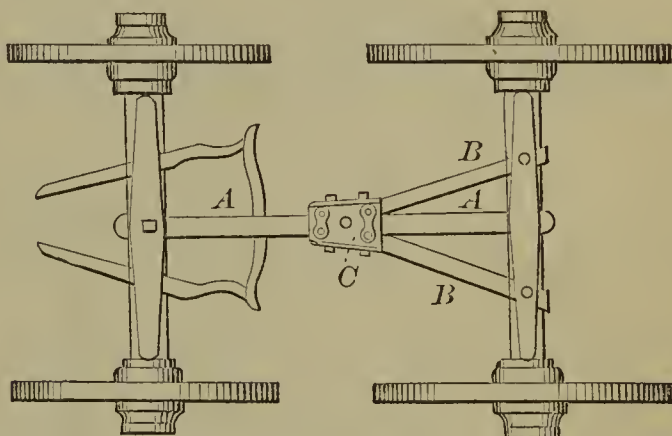

54002—W. J. Millar—*Rudder for Steering Vessels.*

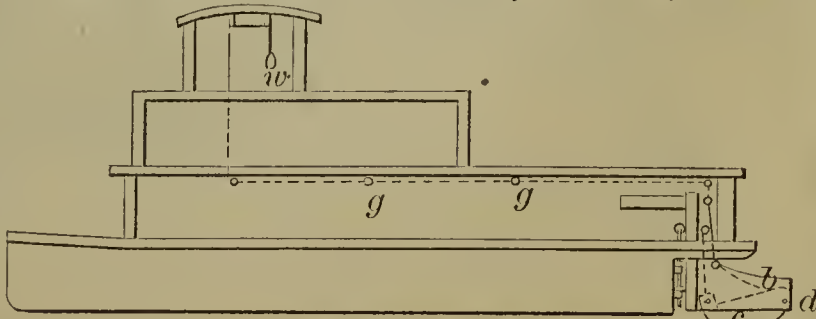

54003—F. Monroe—*Land Leveler.*

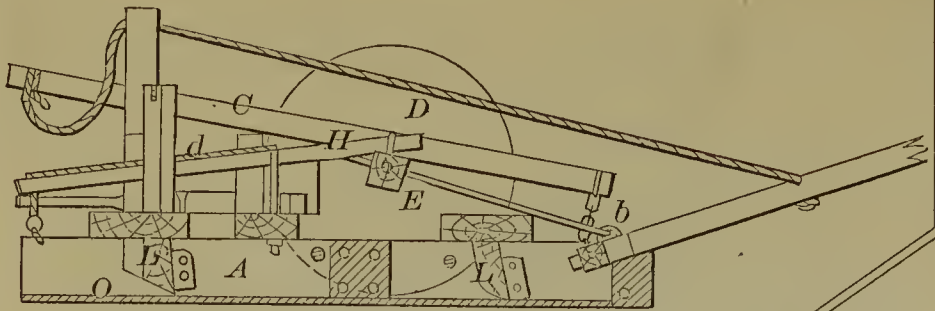

54004—F. Monroe—*Bridge.*

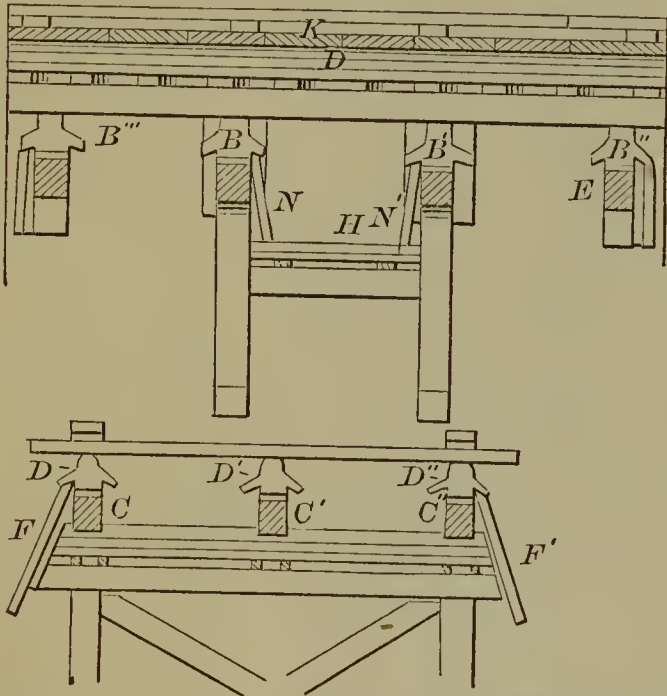

54008—Osborn & Crandell—*Boot Jack, Nut Cracker, Tack Hammer and Tack Puller.*

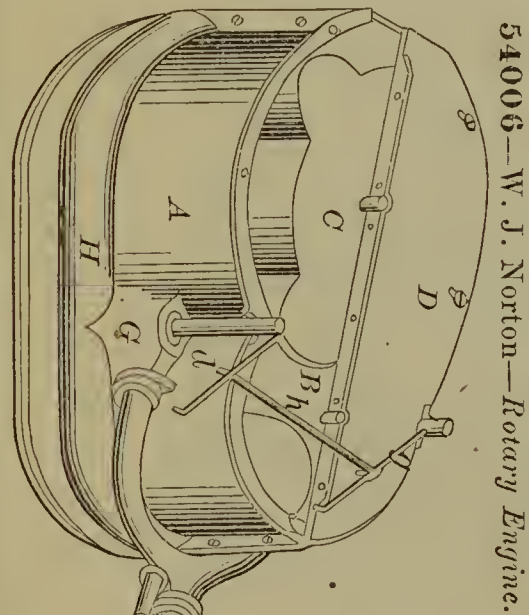
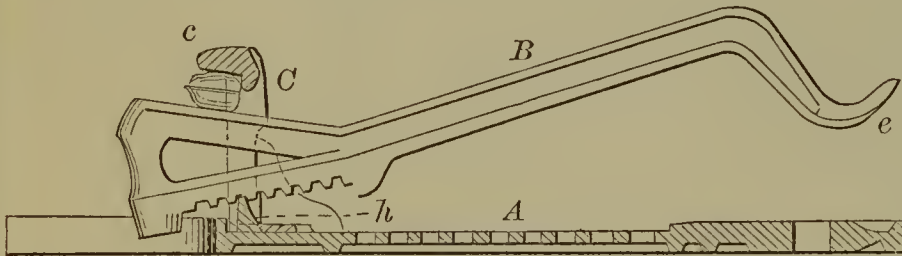

54006—W. J. Norton—*Rotary Engine.*

54009—R. S. Pickett—*Self-feeding Water Tank.*

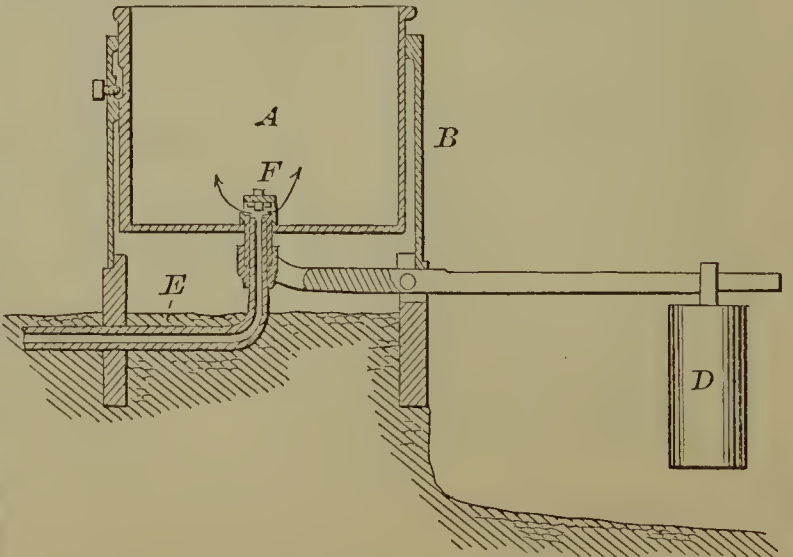

54007—J. K. O'Neil—*Horse Hay Fork.*

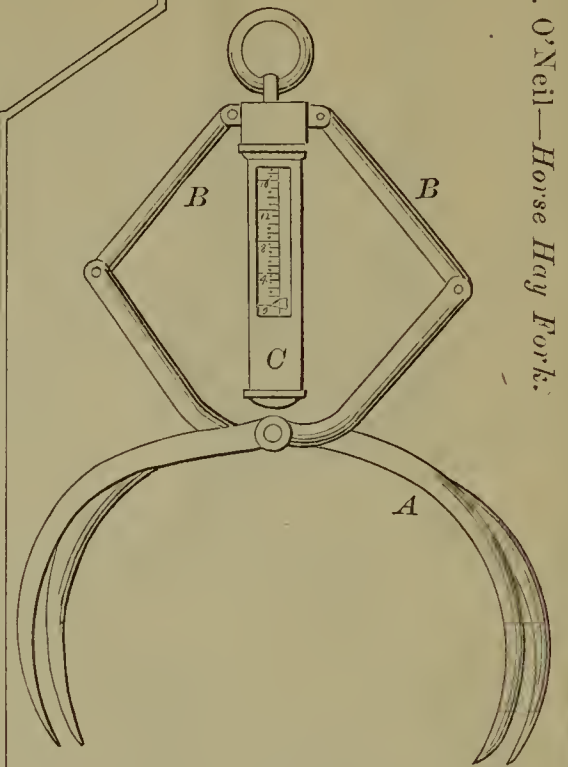

54005—T. Moore—*Feeding Hay Rack.*

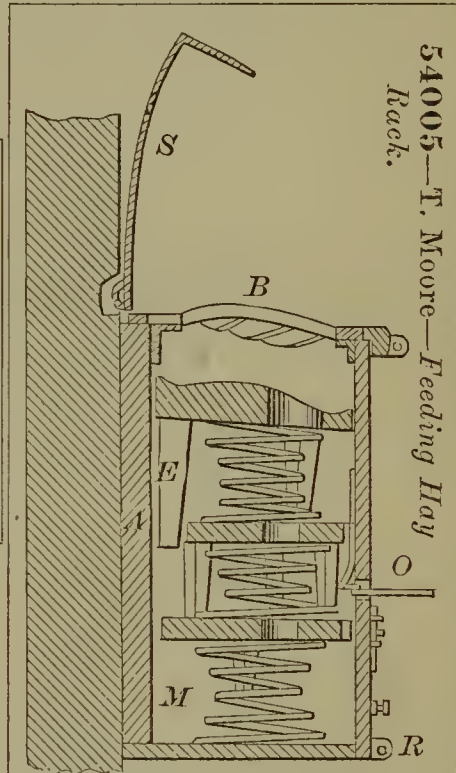

54010—C. L. Pierce—*Shingle Machine.*

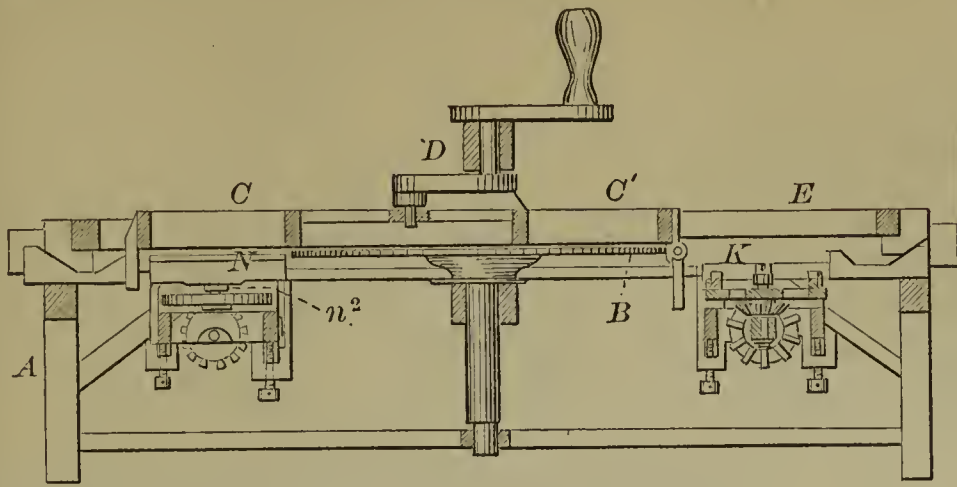

54012—C. Prudden—*Wood Bending Machine.*

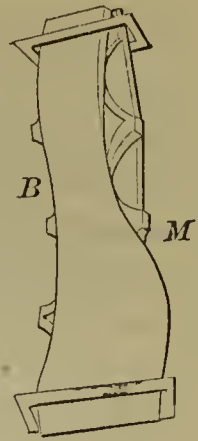

54014—A. Ralston—*For Collecting Floating Oil.*

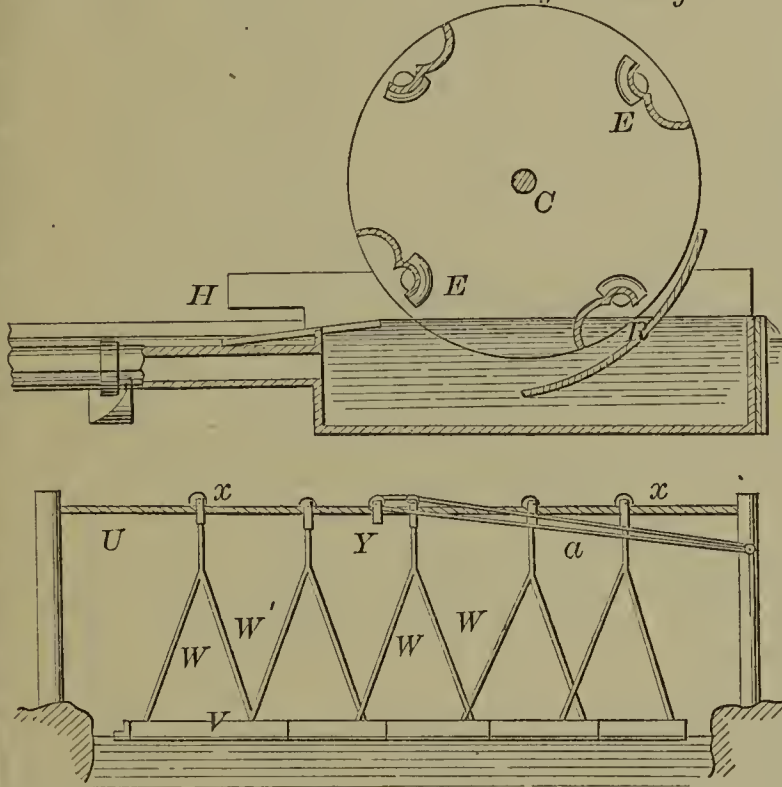

54013—J. F. Quimby—*Churn.*

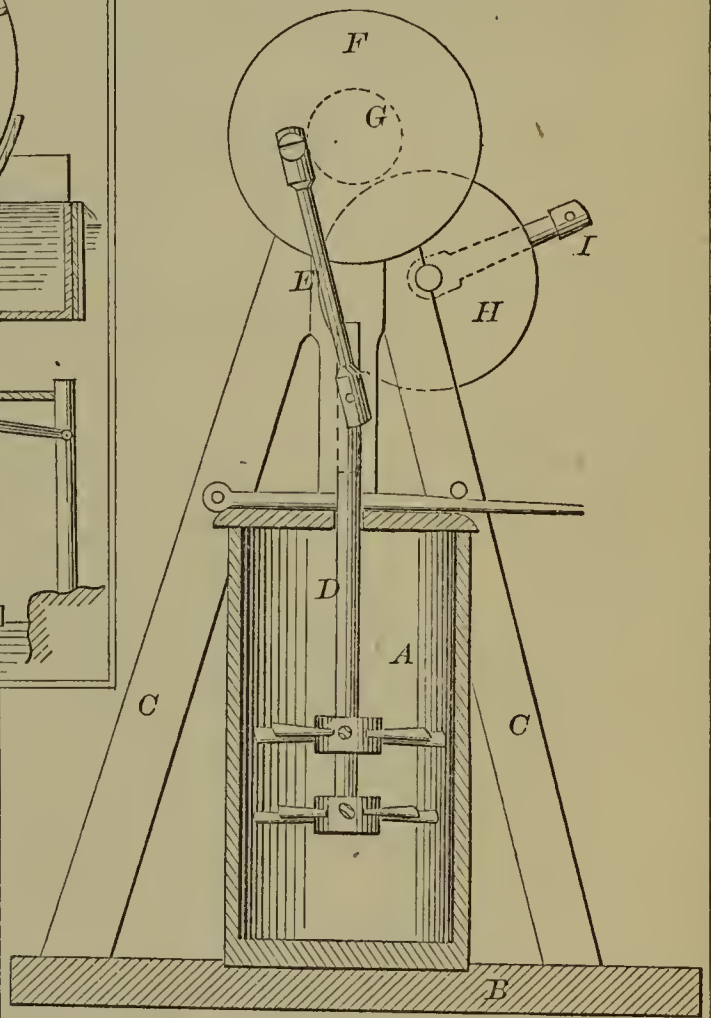

54011—G. R. Platt—*Oil Well Drill.*

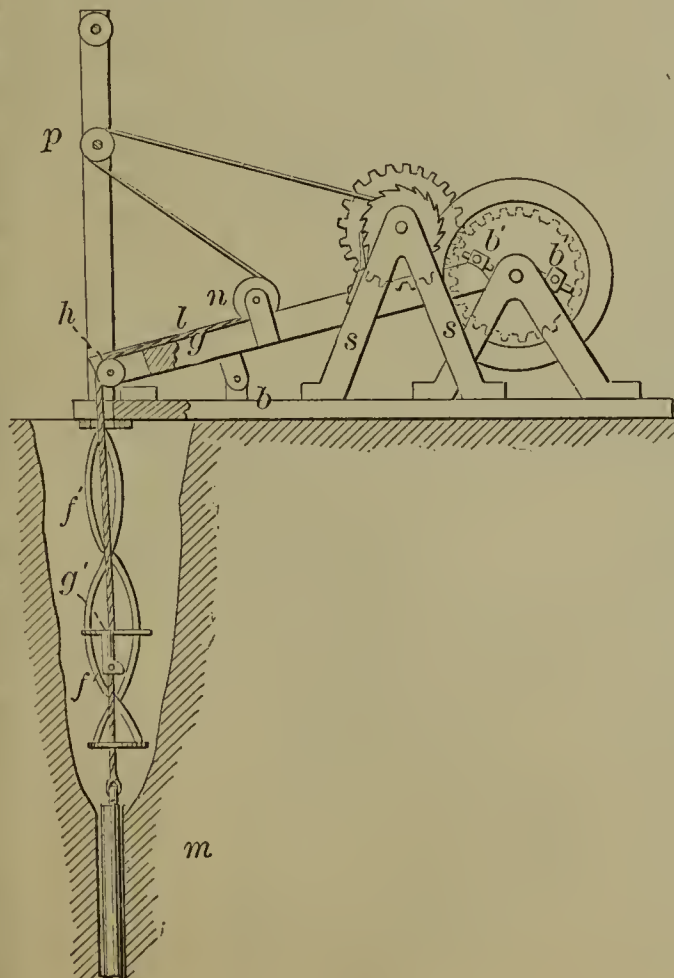

54015—G. M. Ramsy—*Constructing Fruit Jars.*

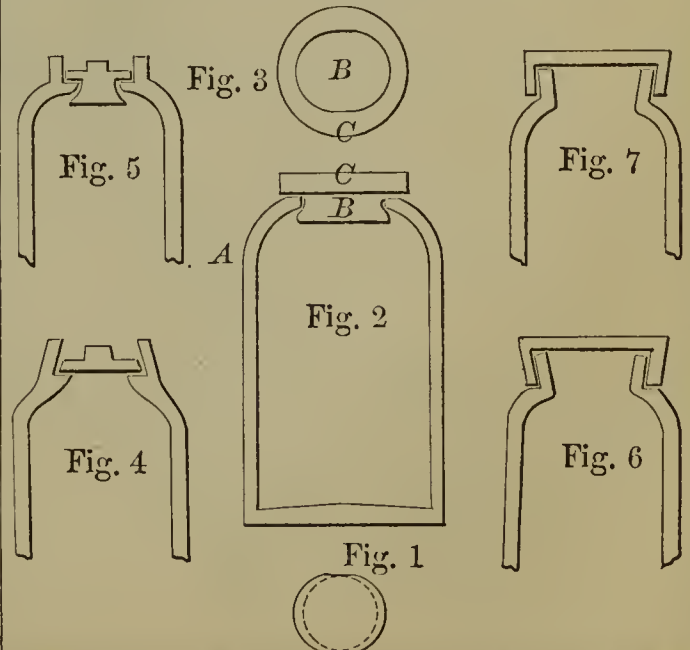

54016—Reutlinger & Herbert—Liquid Cooler.

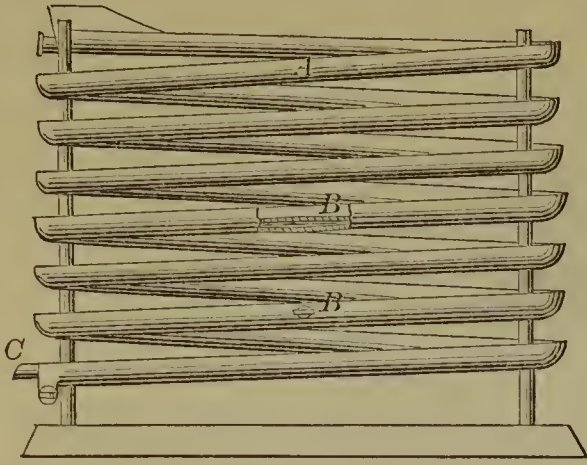

54020—M. M. Rounds—Head Light.

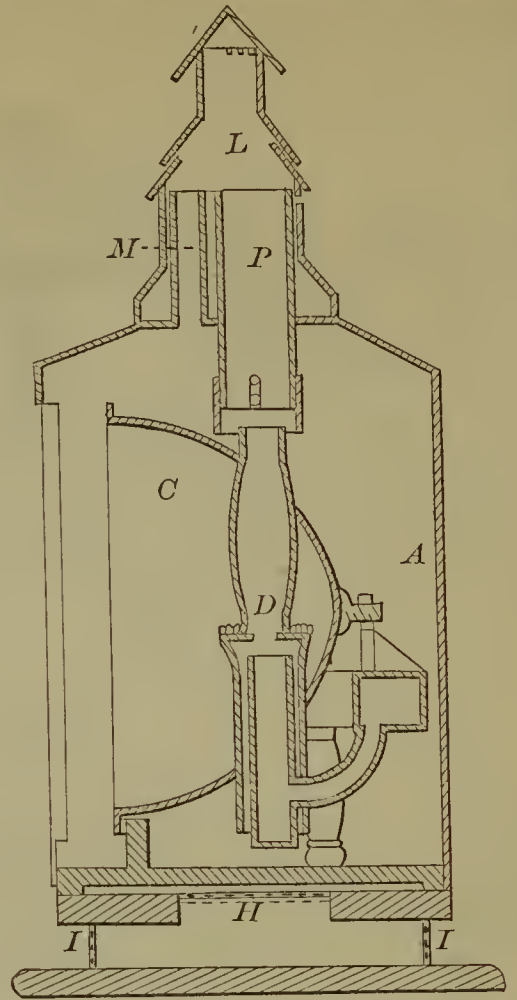

54018—A. A. Rockwell—Trimming for Wearing Apparel.

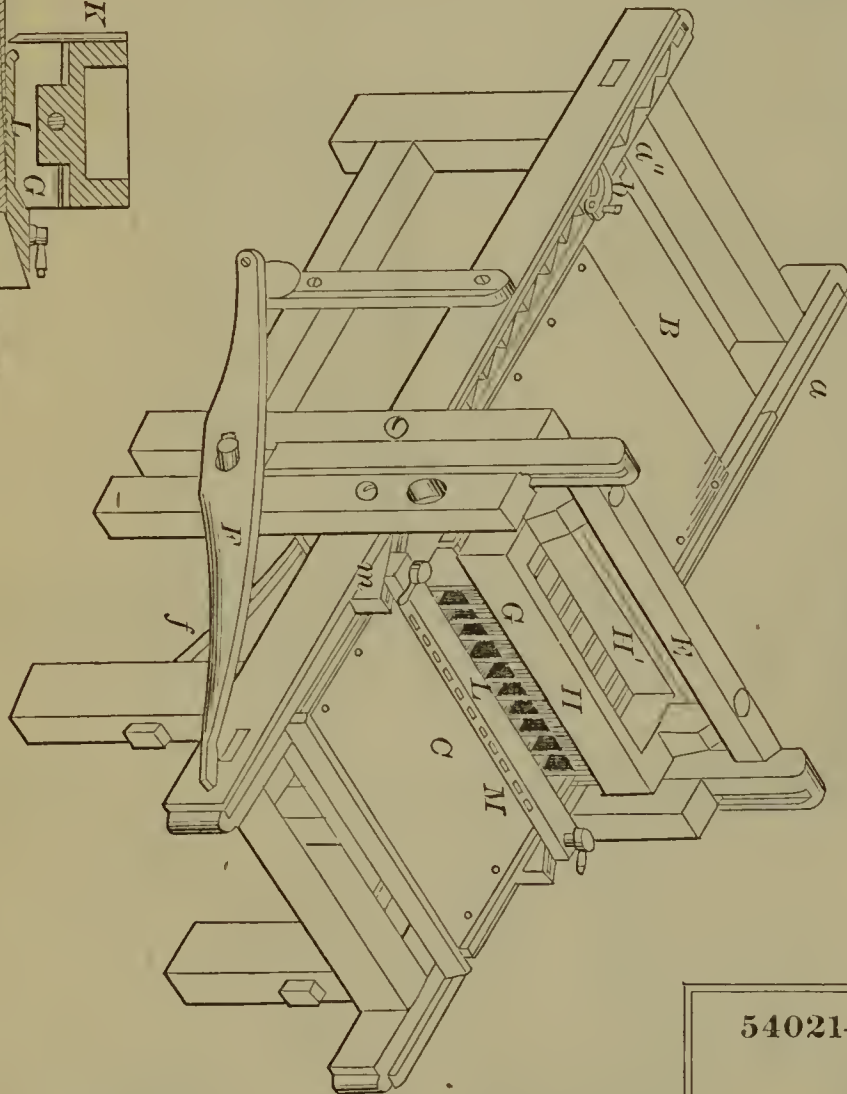
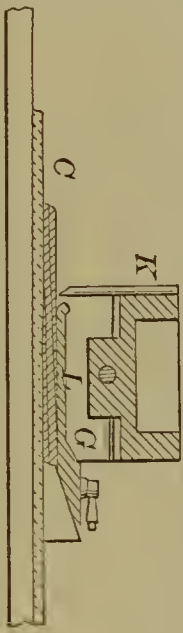
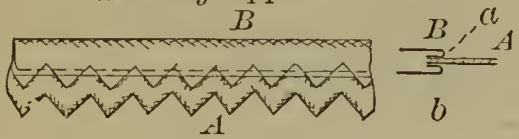

54017—J. I. Robbins—Tobacco Cutting Machine.

54019—H. Rogers—Shingle Machine.

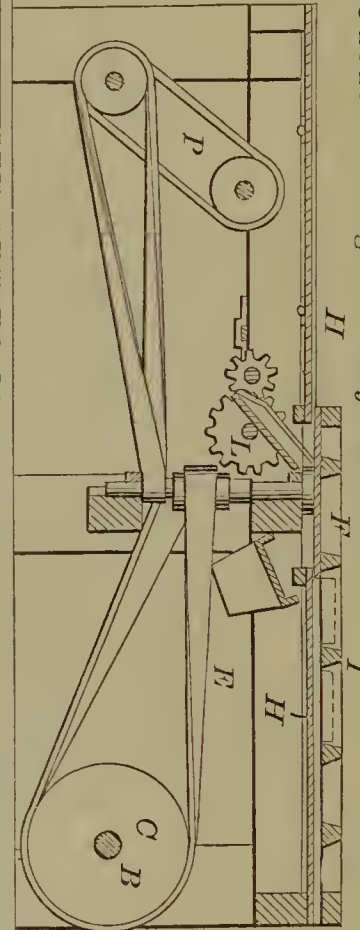

54022—J. B. Rumsey—Button Fastening.

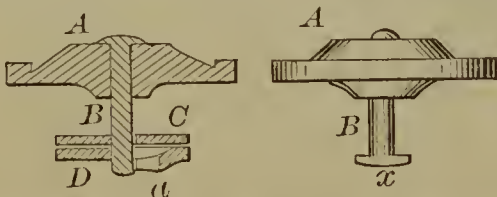

54021—Rudolph & Braun—Gun Lock.

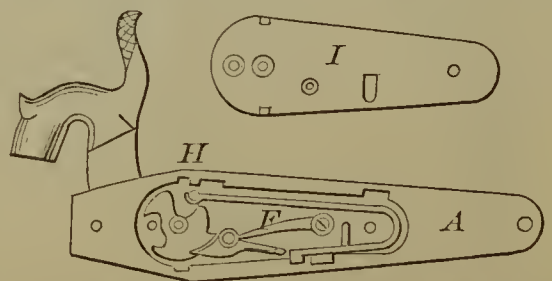

54023—S. L. Sage—*Sheep Holder and Shearing Table.*

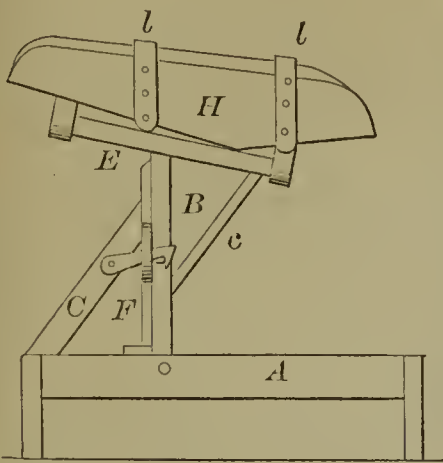

54024—Scharit & Oppenheimer—*Trunk Lock.*



54025—T. A. Searle—*Globe Valve.*

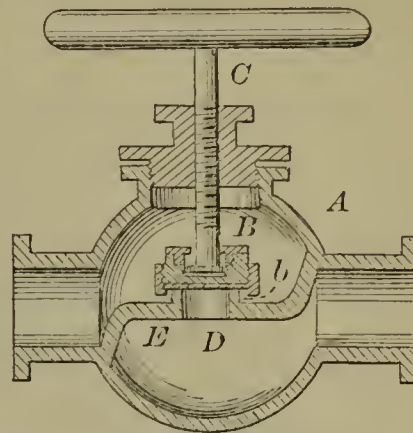

54026—Seely & Cabbell—*Valve Gear.*

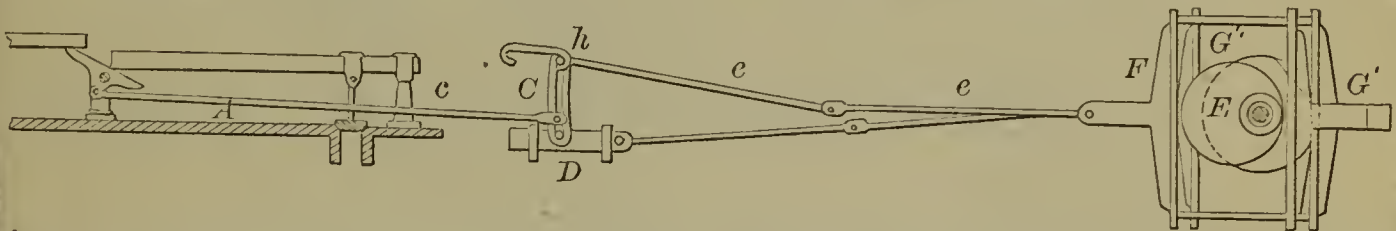

54028—G. B. Simpson—*Amalgamator.*

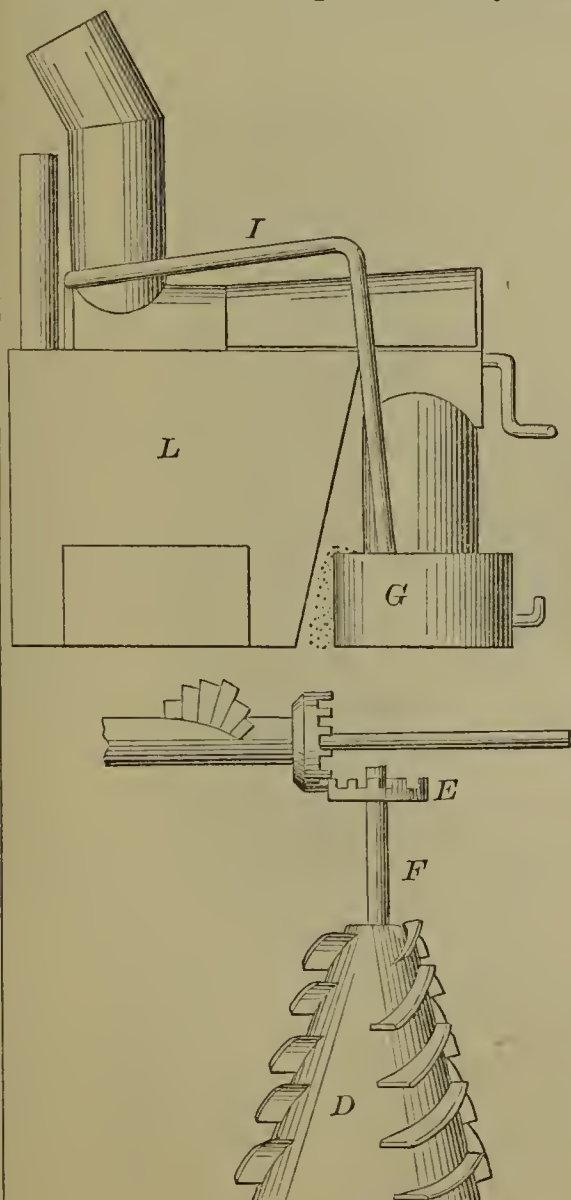

54027—J. F. Sherman—*Percussion Fuse for Explosive Shells.*

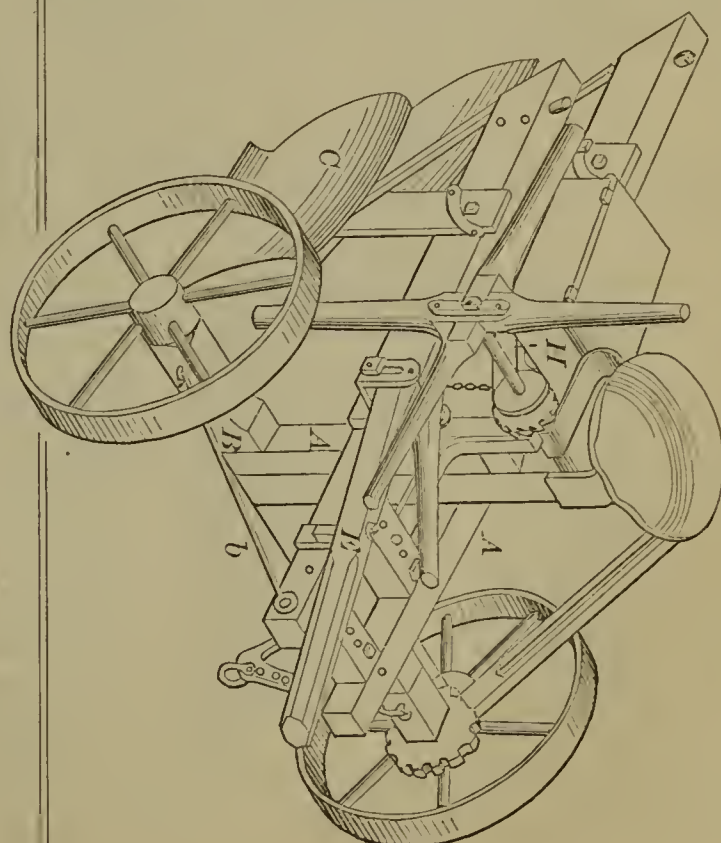
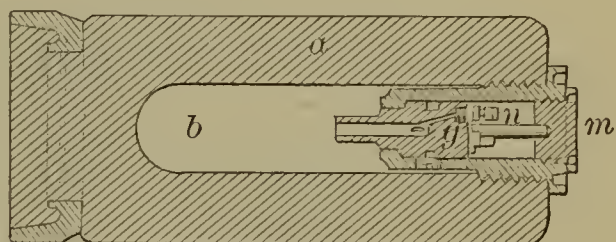

54029—J. B. Skinner—*Gang Plow.*

54030—

C. F. Smith—*Stone and Root Digger.*

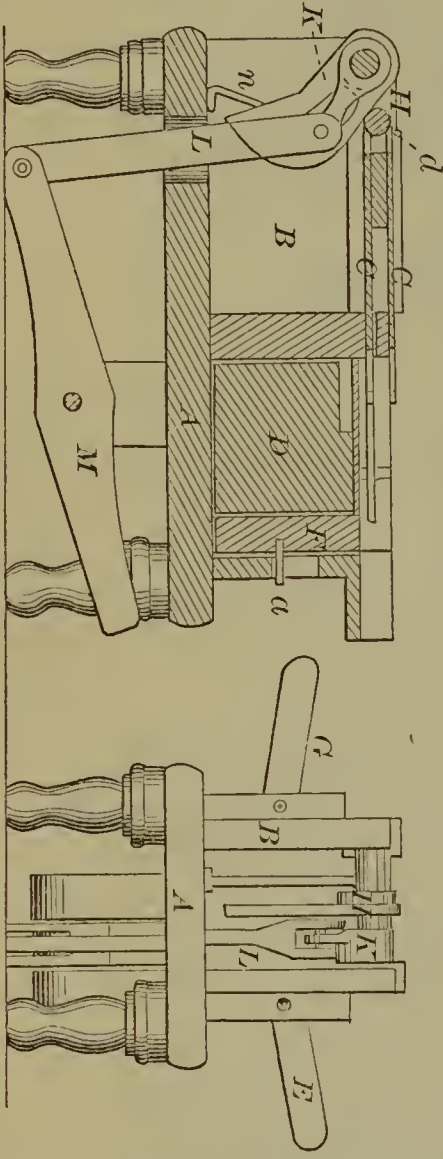
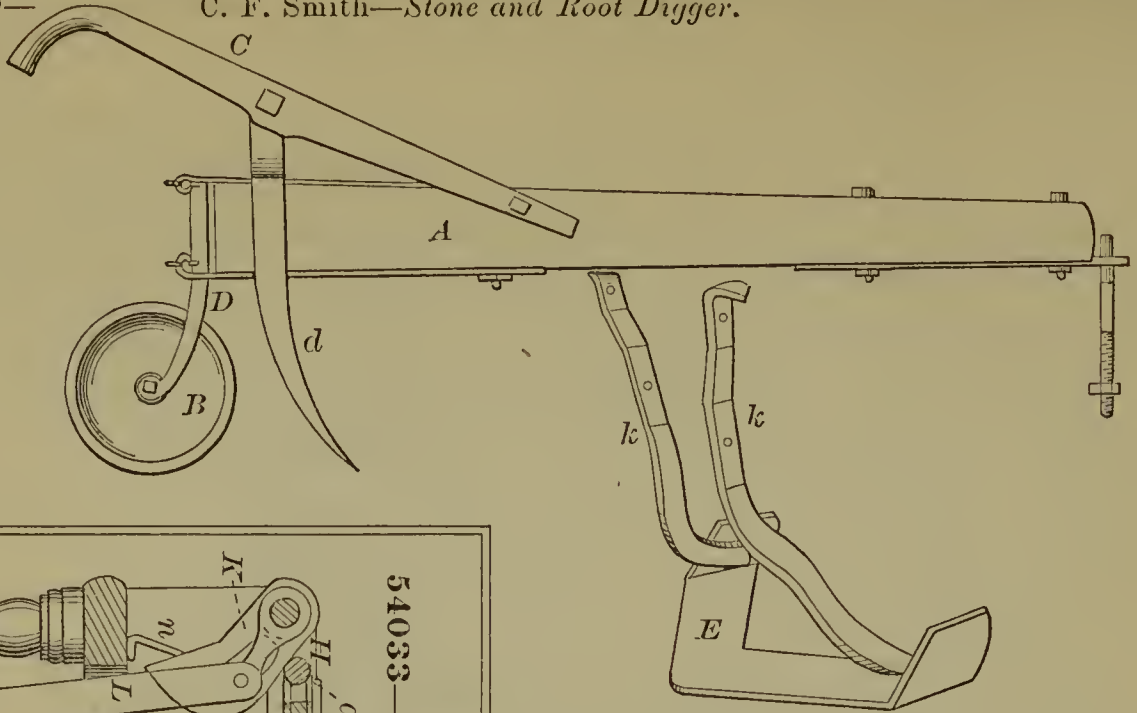

54033—N. H. Spafford—*For Bundling Bristles.*

54032—W. Snyder—*Sliding and Swinging Gate.*

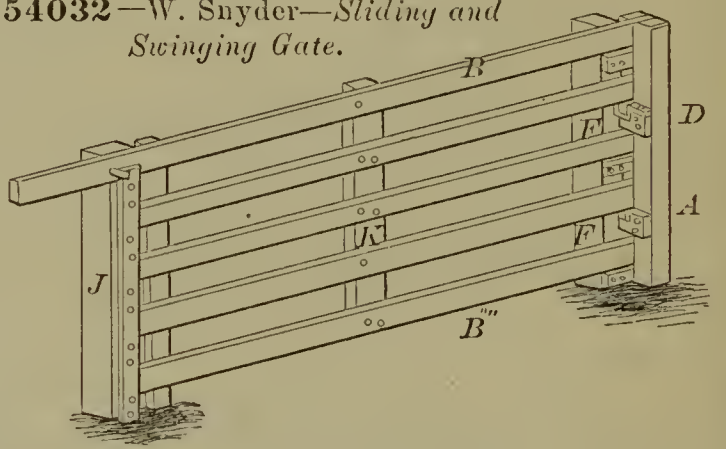

54034—N. H. Spafford—*For Combing Bristles.*

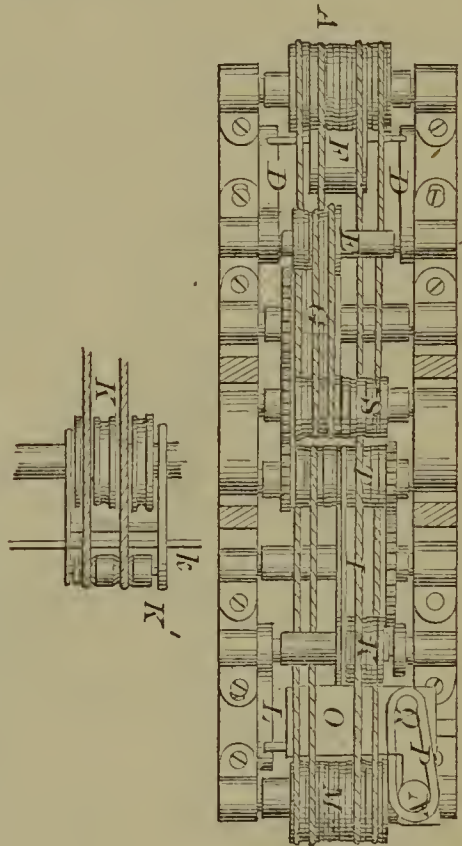

54031—S. Smith—*Heating Stove.*

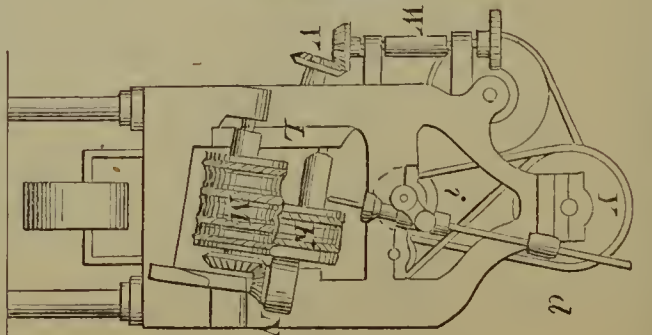
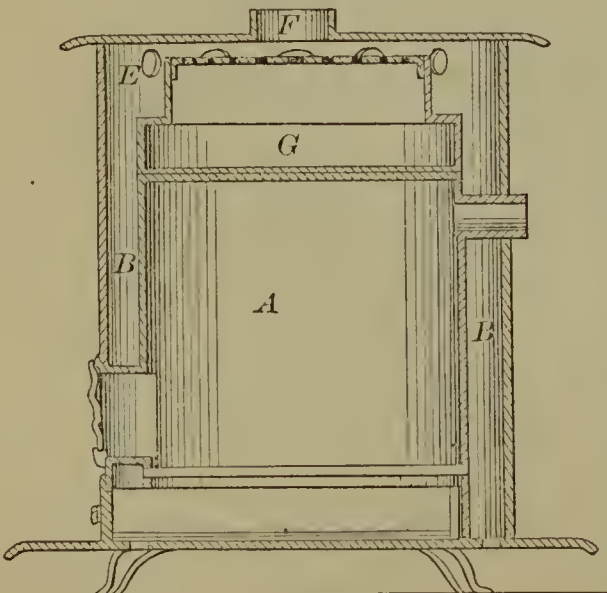



54035—G. T. Spaulding—  
Broom Head.

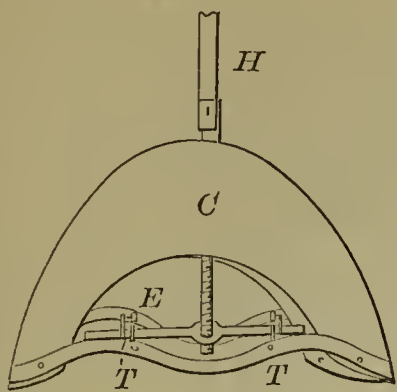

54036—N. F. Stone—Cutter Grinder.

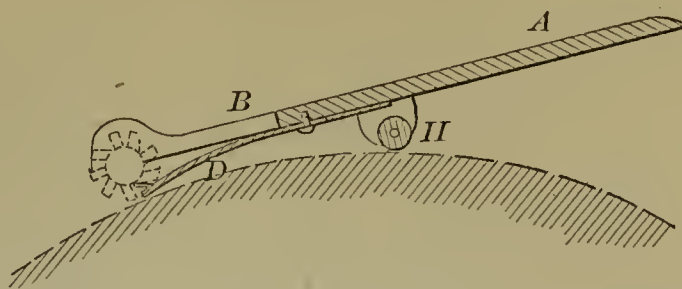

54039—S. Swartz—Removing Stoppers from Oyster Kegs.

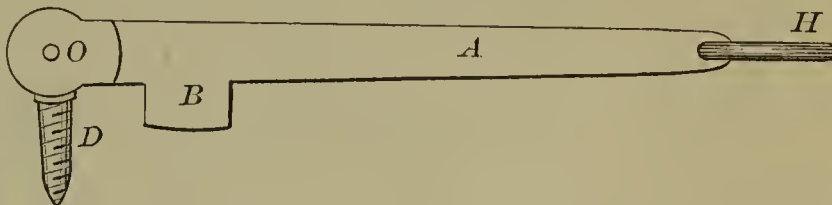

54041—Tiffany & Wilson—Manufacture of Vinegar.

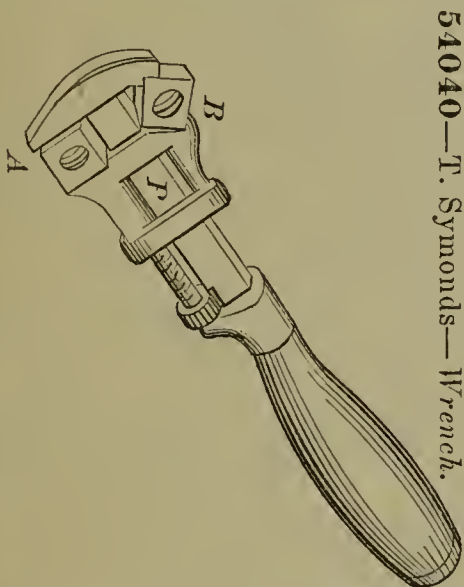
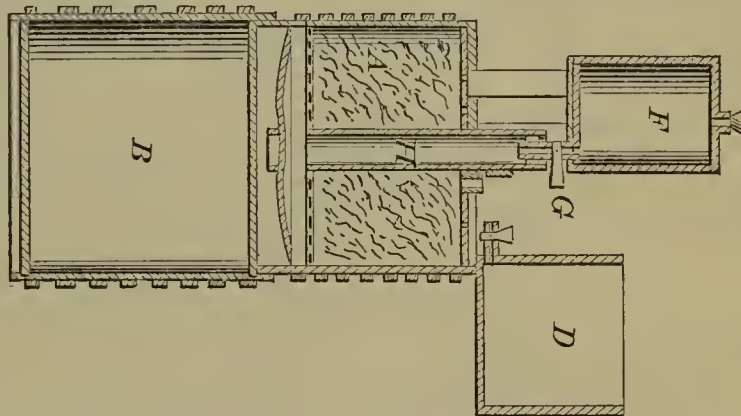

54040—T. Symonds—Wrench.

54043—A. H. Van Gieson—Leather Splitting Machine.

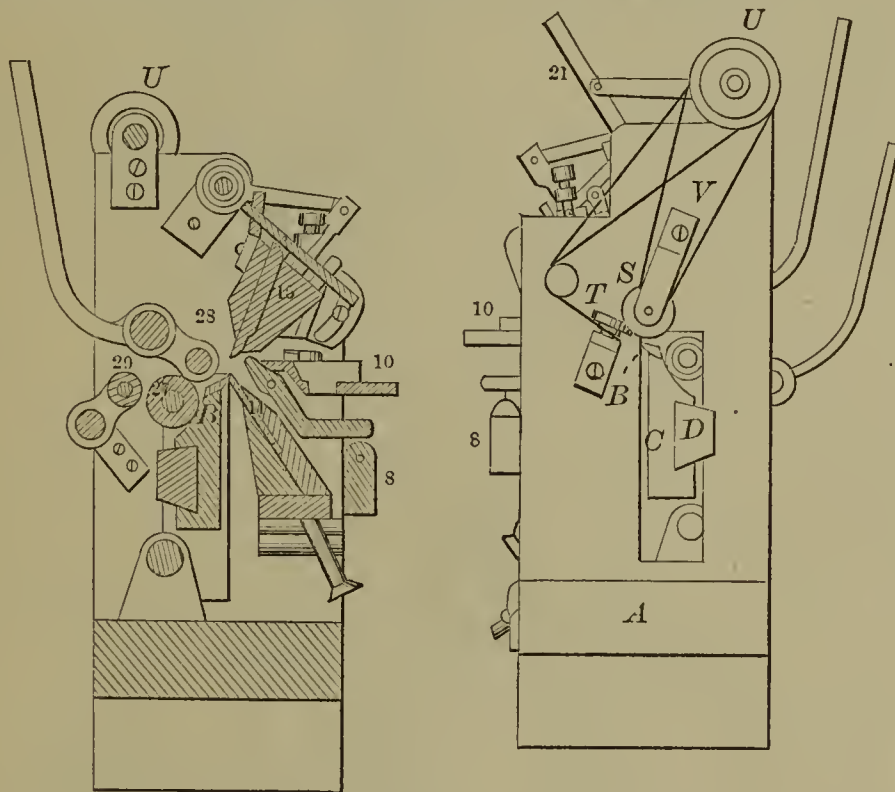

54037—N. F. Stone—  
For Upsetting Saw Teeth.

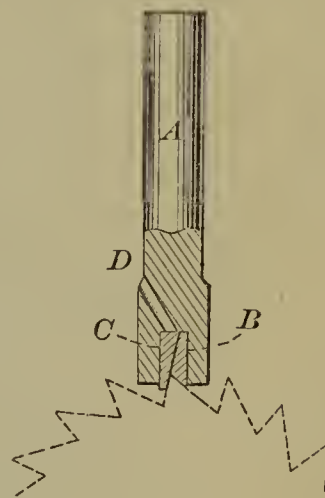

54042—A. Upson—Corn Planter.

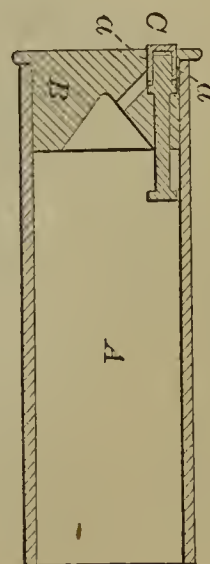
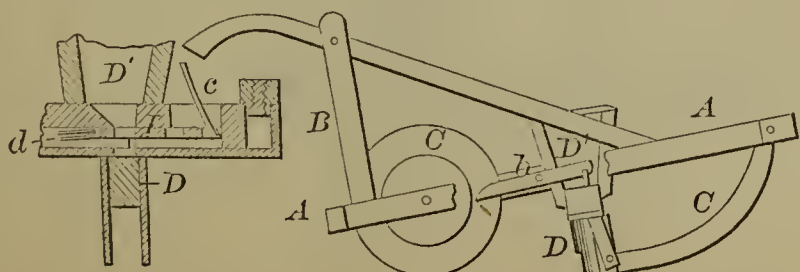

54038—T. I. Sturtevant—Priming  
Metallic Cartridges

54044—E. L. Walker—Horse Hay Fork.

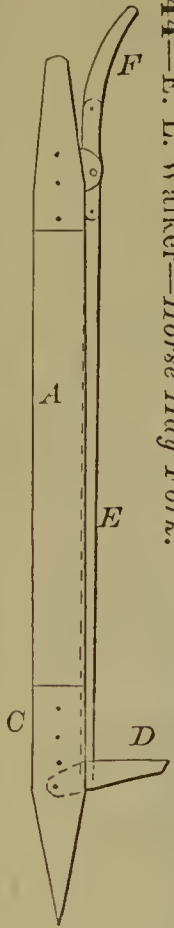

54045—O. G. Warren—Quartz Comminutor.

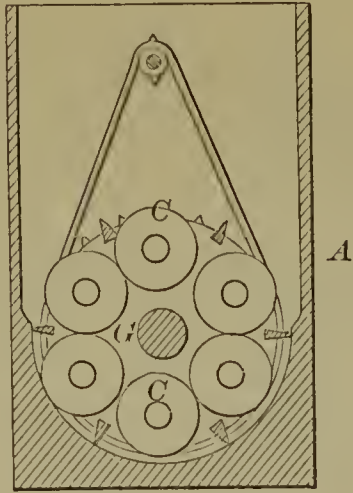

54046—W. J. Wells—Sawing Machine.

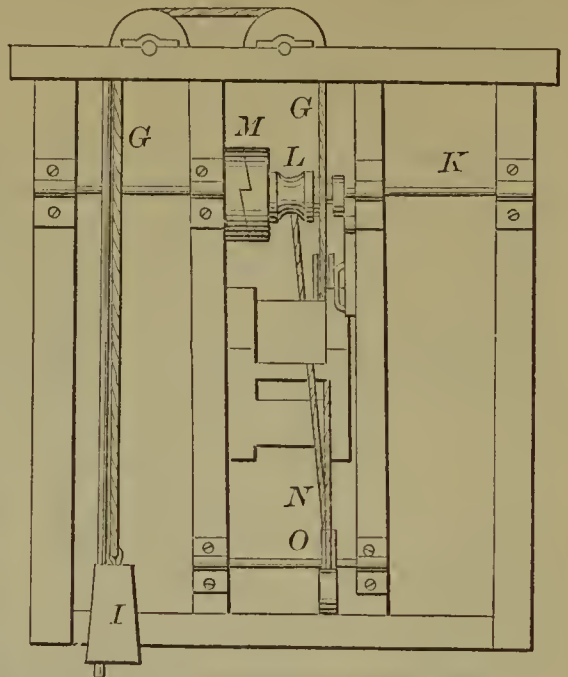

54049—W. H. White—Hat and Cap.

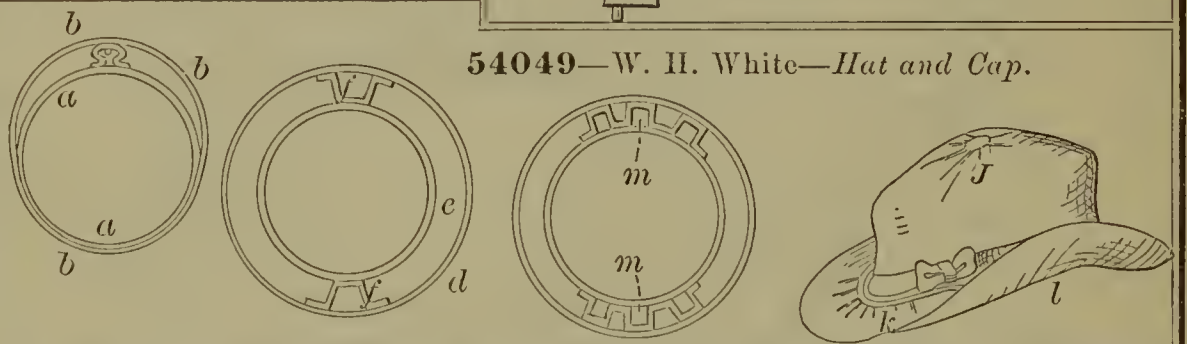

54048—White & Warren—Gripe Band.

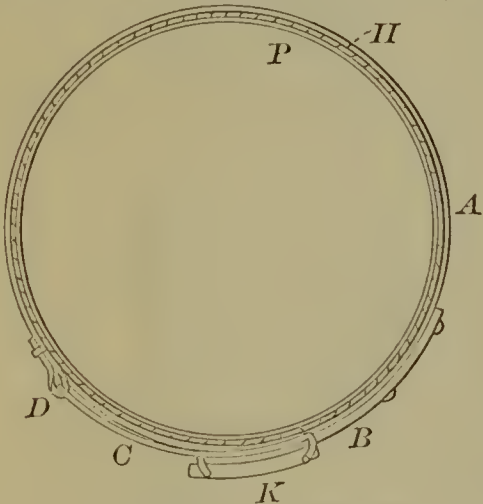

54050—Willis & Stephenson—Horse Hay Fork.

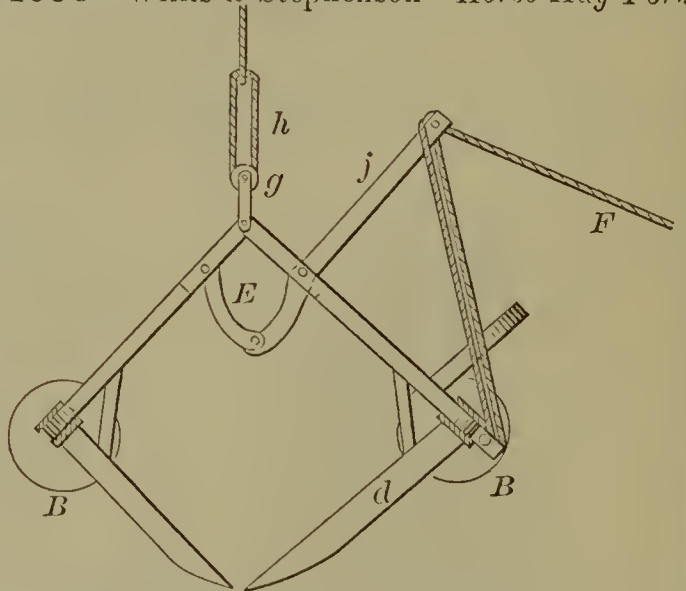

54047—J. F. West—Wood Turning Lathe.

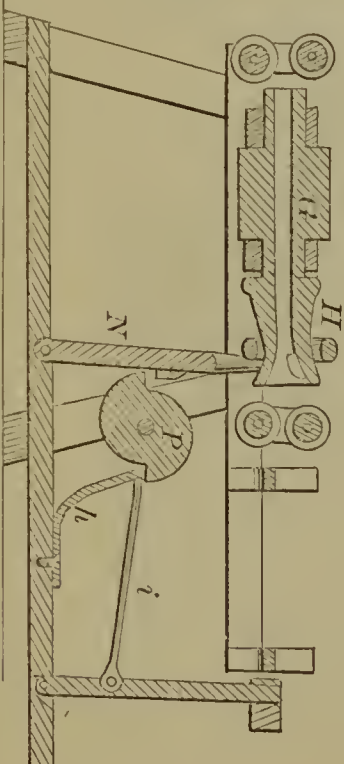

Fig. 1 1' and 2

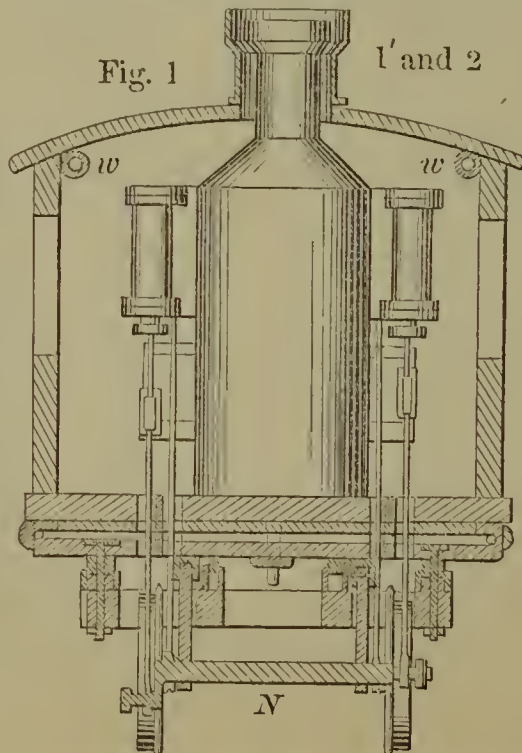
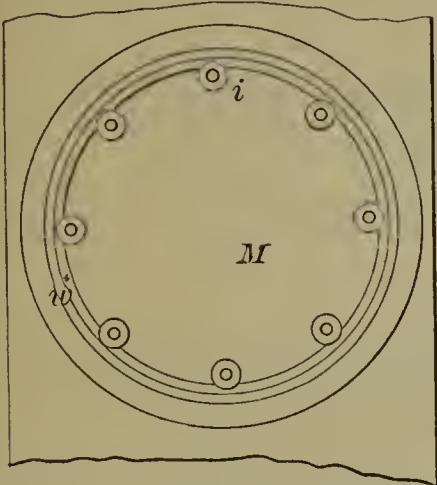
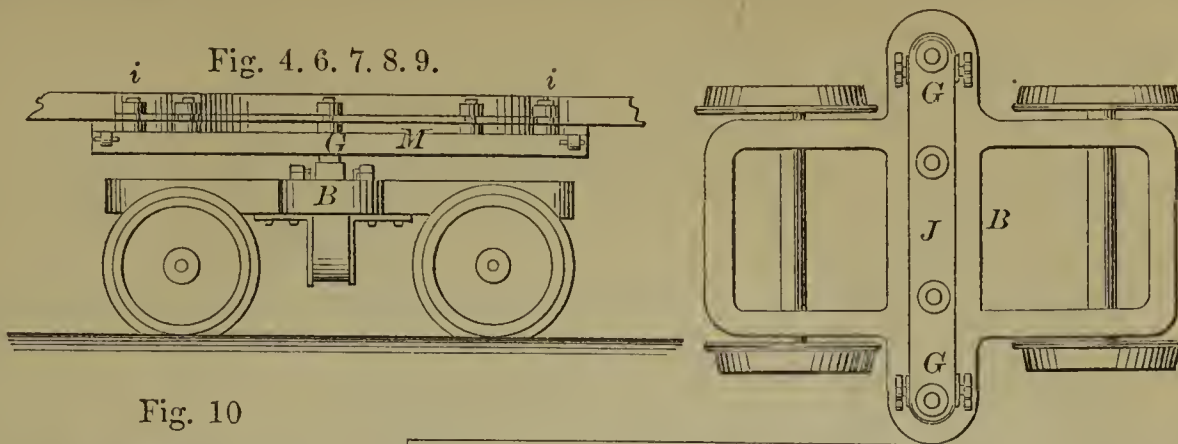

Fig. 6'

54051—J. P. Woodbury—Locomotive Car Truck.

54051—Continued.



54053—A. & O. A. Bingham—  
Construction of Chains.

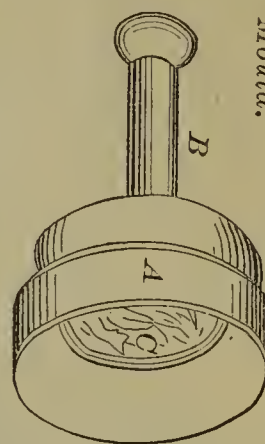
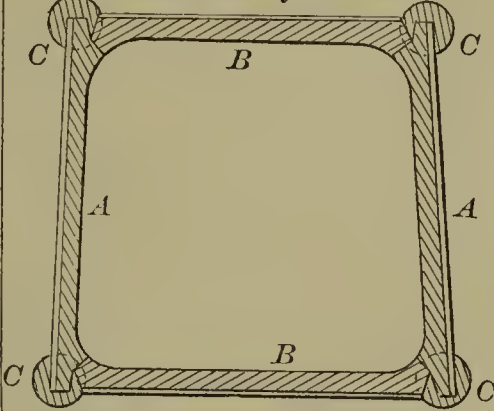

54054—J. S. Bullard—Butter  
Mould.

54052—J. Yates—  
Preparing Peat.

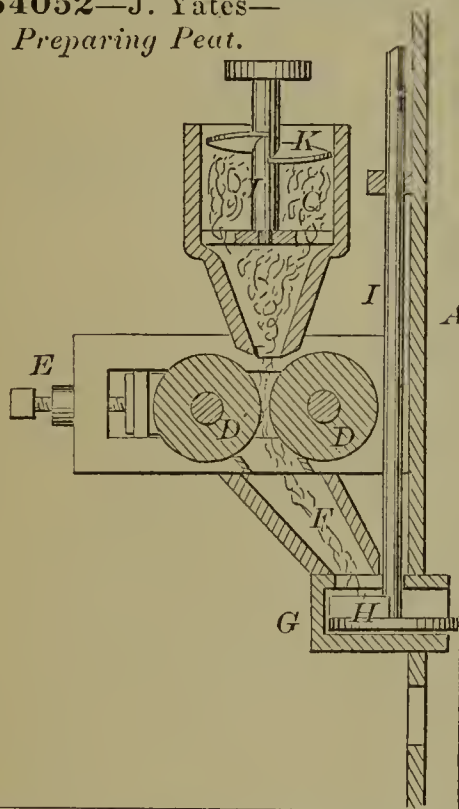

54057—J. C. Cline—Steam  
Engine Governor.

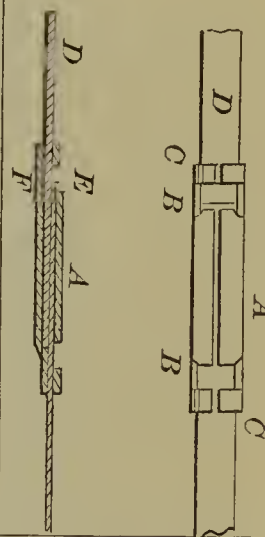
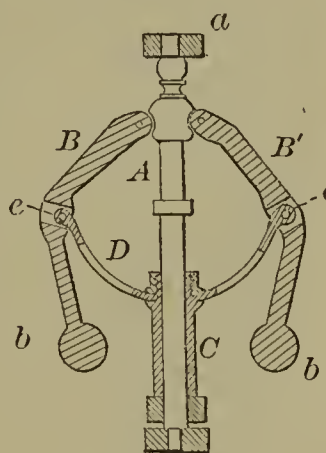

54055—Cheesman & Durand—  
Clasp for Skirt Hoops.

54059—E. Conrad—Lantern.

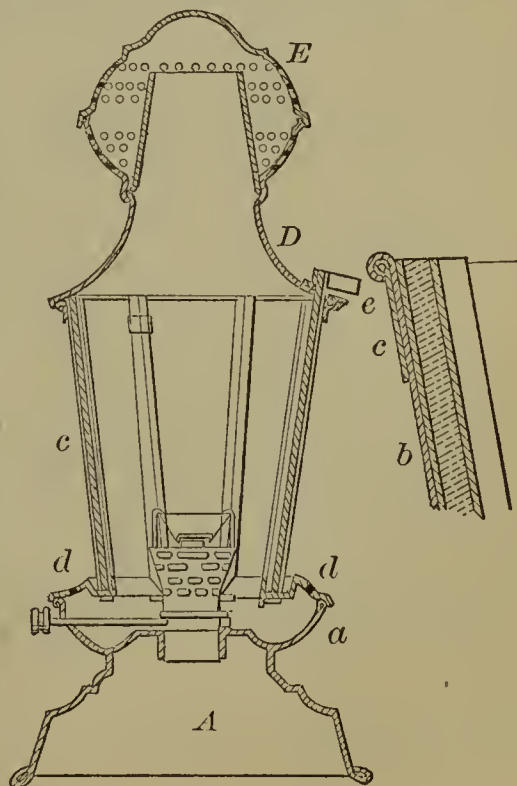

54058—R. Collins—Harness  
Motion for Looms.

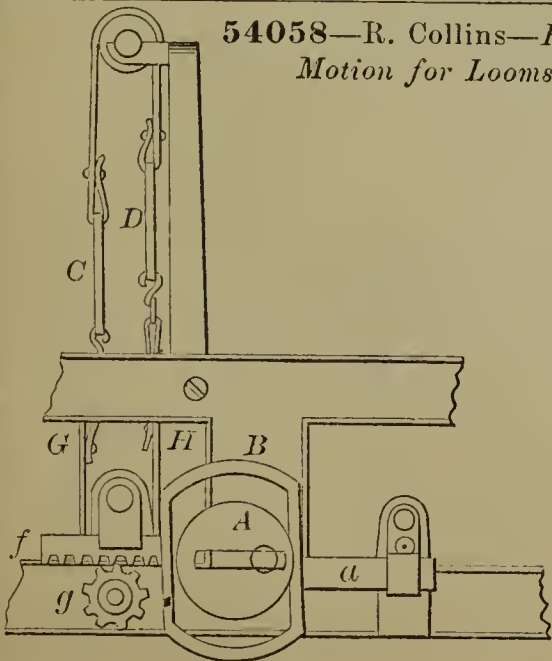

54060—W. Corfield—  
Manufacture of Burning Fluid.

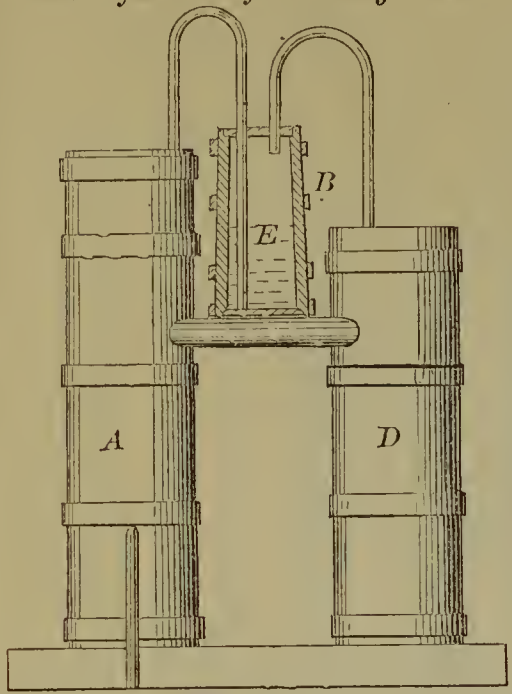

54065—J. B. Doolittle—*Revolving Fire Arm.*

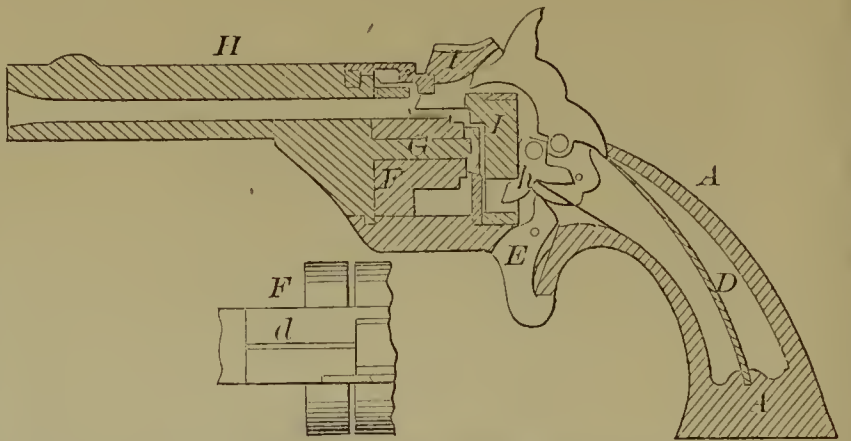

54063—R. W. & D. Davis—*Steam Generator.*

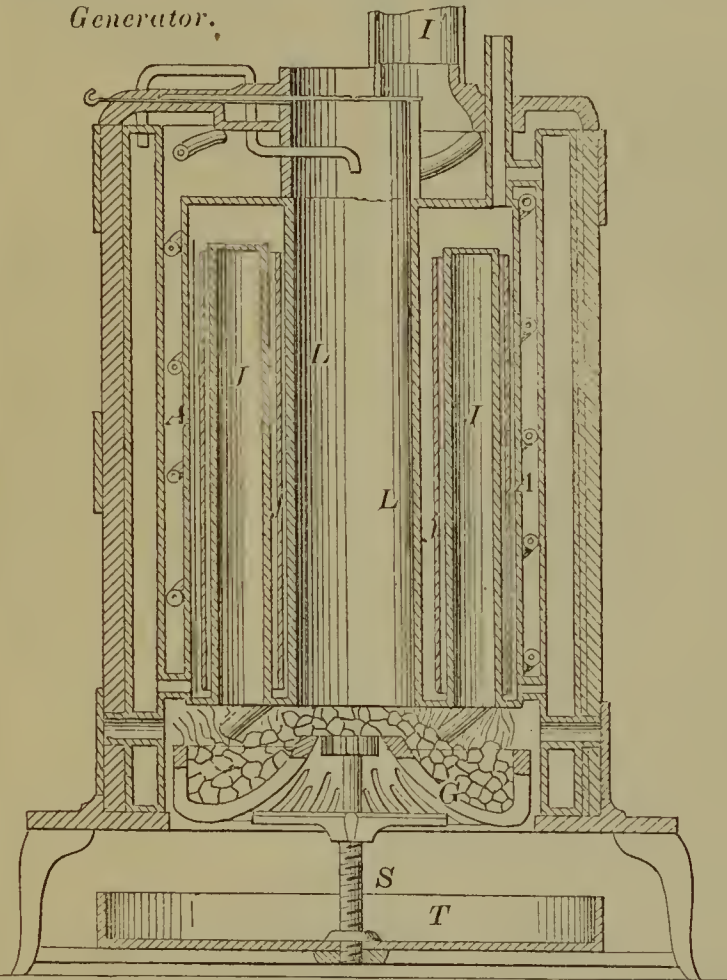

54062—Curtis & Tripp—*Analyzer*

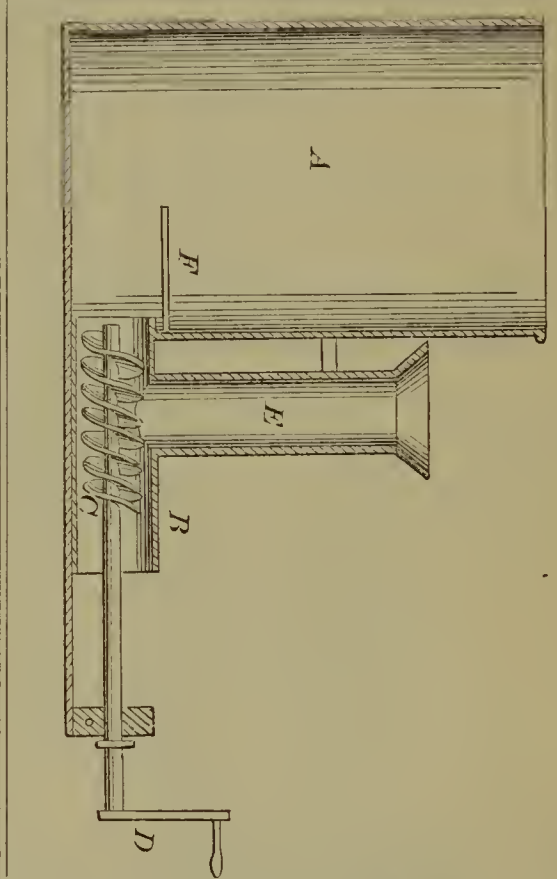

54061—W. Corfield—*Manufacture of Burning Fluid.*

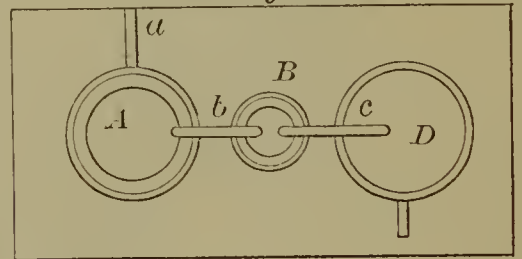

54064—R. W. & D. Davis—*Grate for Furnaces, &c.*

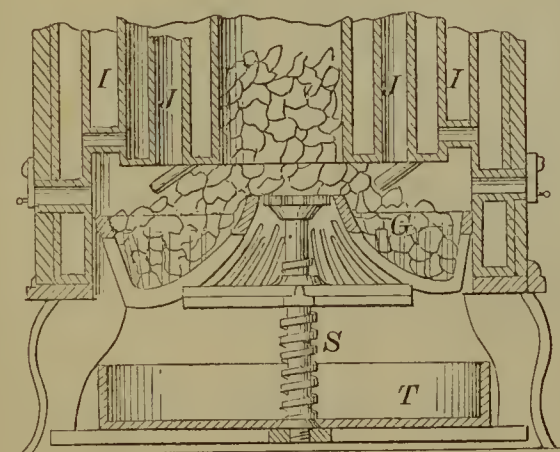

54066—S. Estes—*Let-off for Looms.*

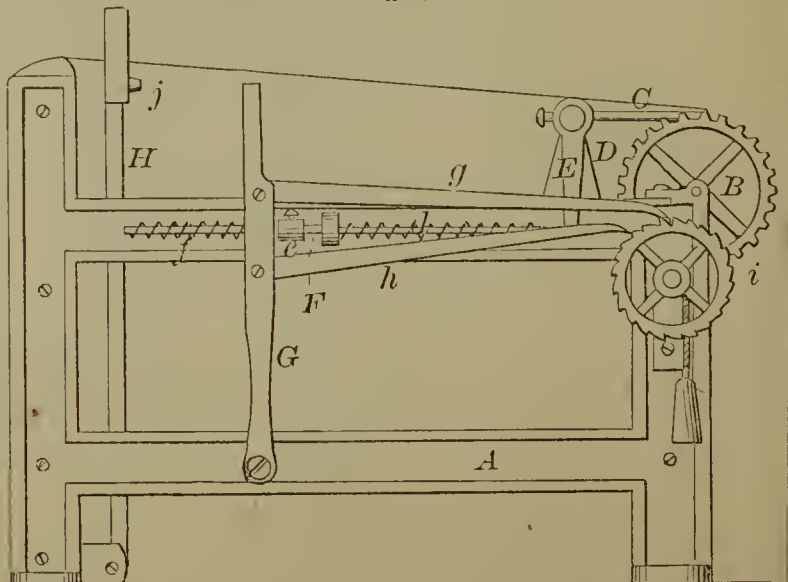

54067—J. B. Fuller—Roller for Spinning Machines.

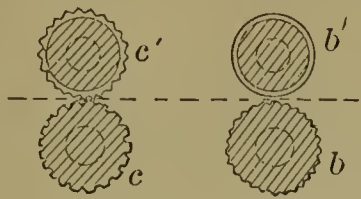

54071—C. Robitaille—Button.

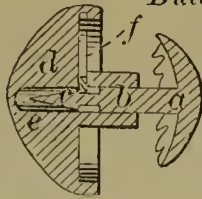

54072—W. S. Sampson—Grain Meter.

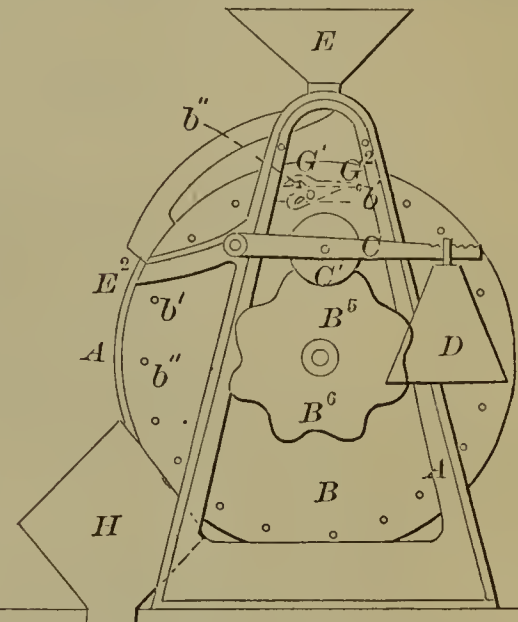
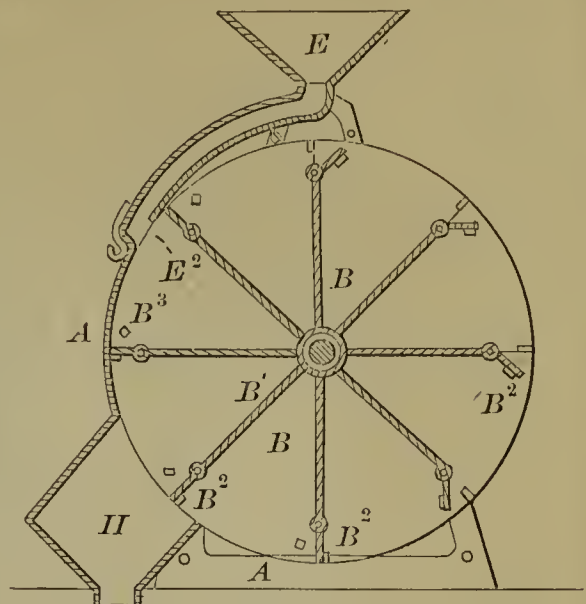

54068—J. Gray—Magazine Fire Arm.

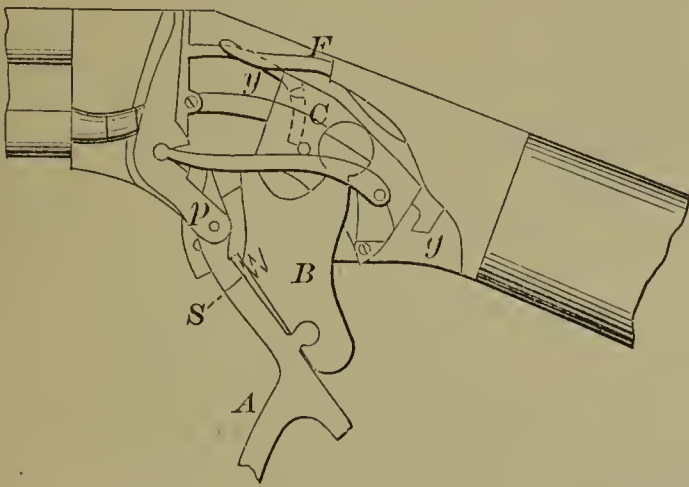

54069—D. F. Hartford—Drill Stock.

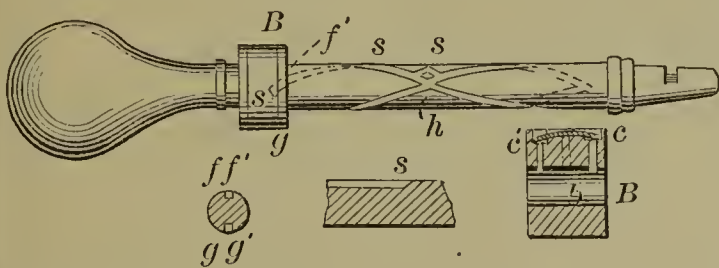

54070—J. H. Palmer—Lubricating Oil Cup.

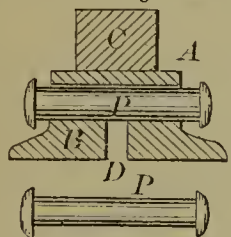

54074—T. Tripp—Amalgamator.

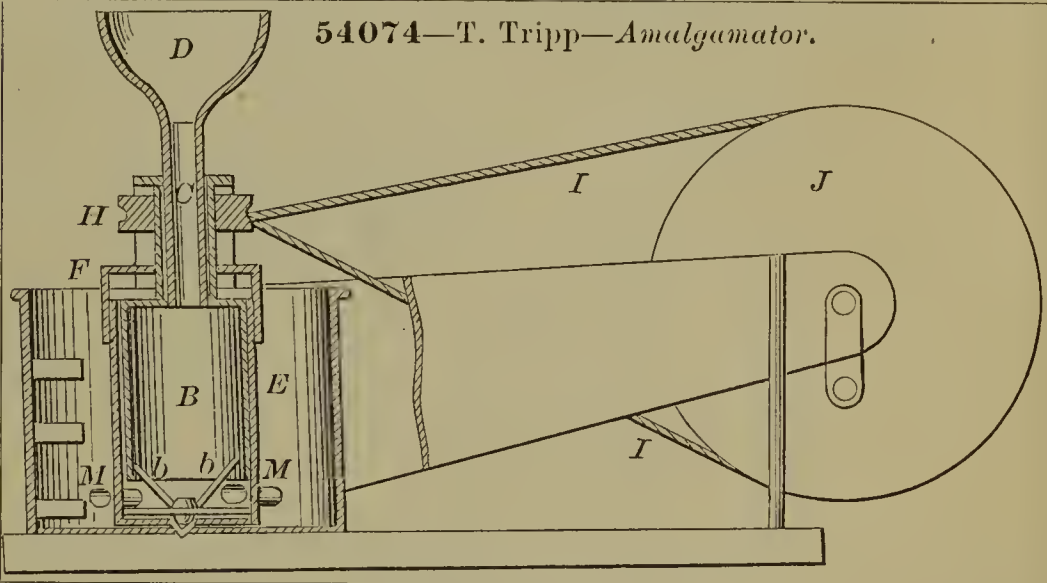

54075—Tripp & Curtis—Amalgamator.

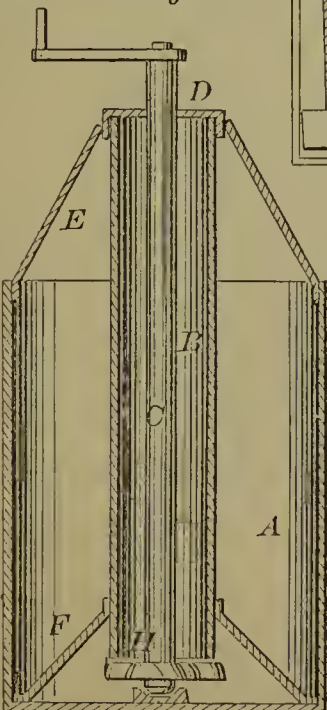

54073—G. Sewell—Saline Meter Pot.

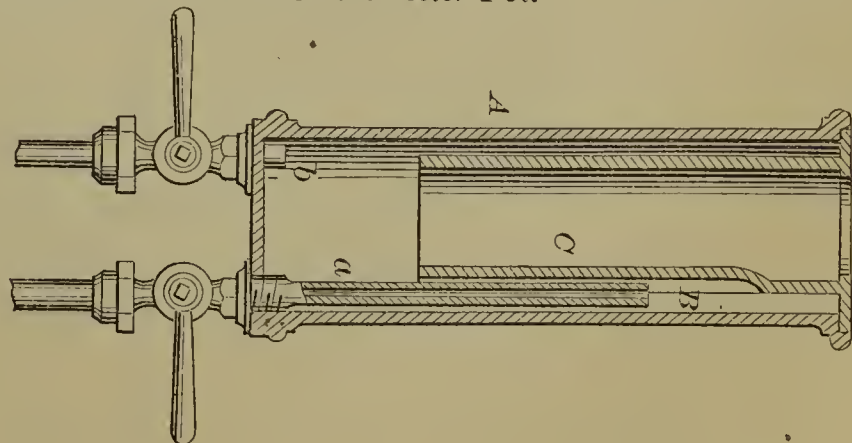

54076—Tripp & Curtis—Amalgamator.

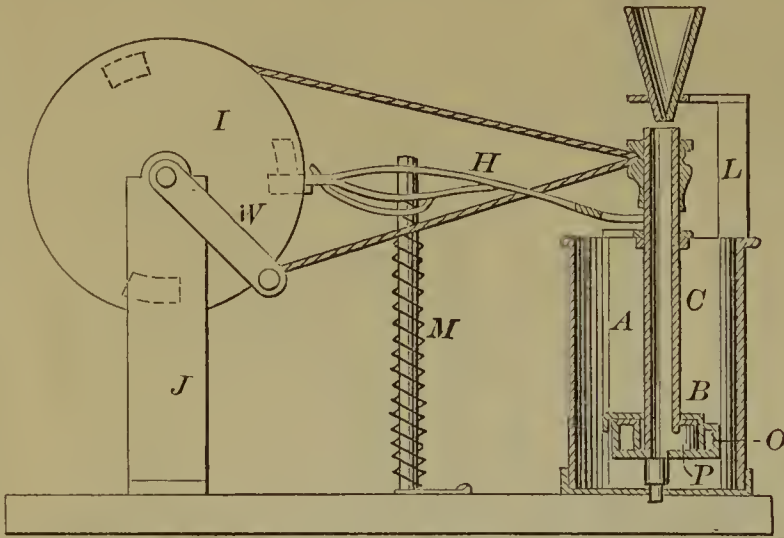

54080—G. Clark—Envelope for Bottles and Jars.

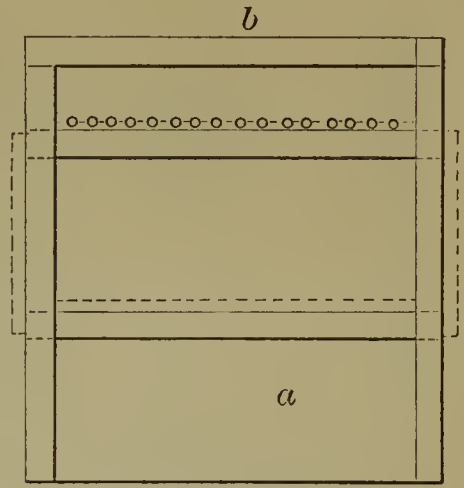

54081—J. A. Pastorelli—Extracting Turpentine from Wood.

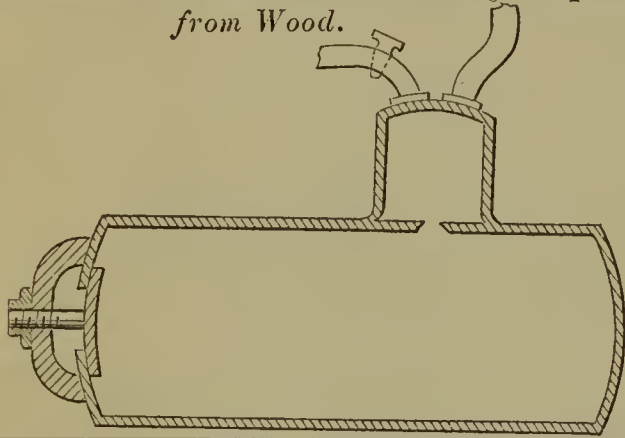

54078—W. Bowman—Boiler Feeder.

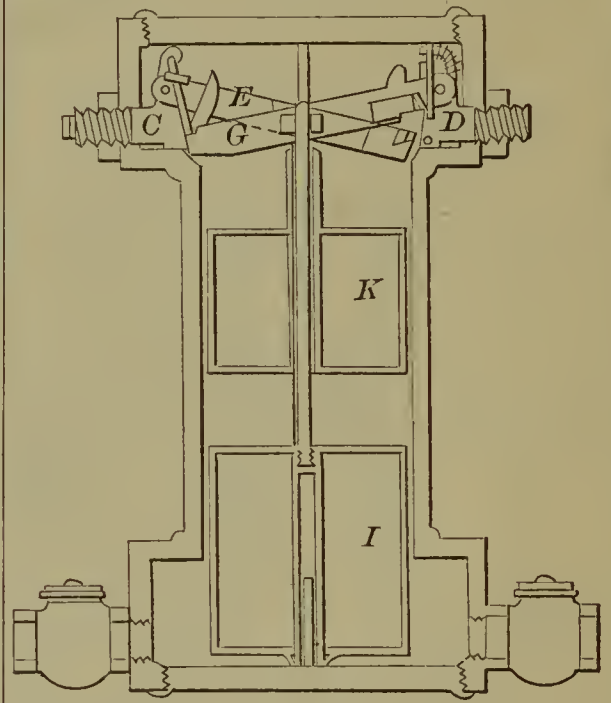

54079—F. Chatelain—Rotary Engine.

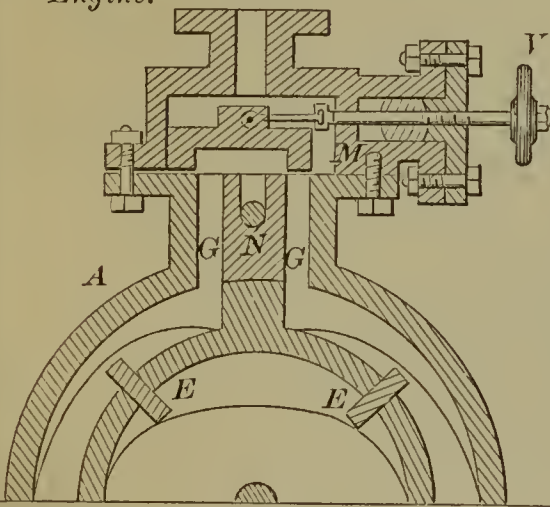

54083—F. P. Warren—Sheathing for Iron Vessels.

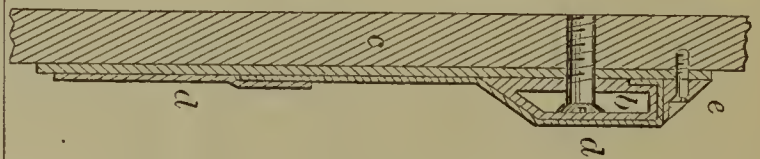

54084—G. Race—Hay Loader.

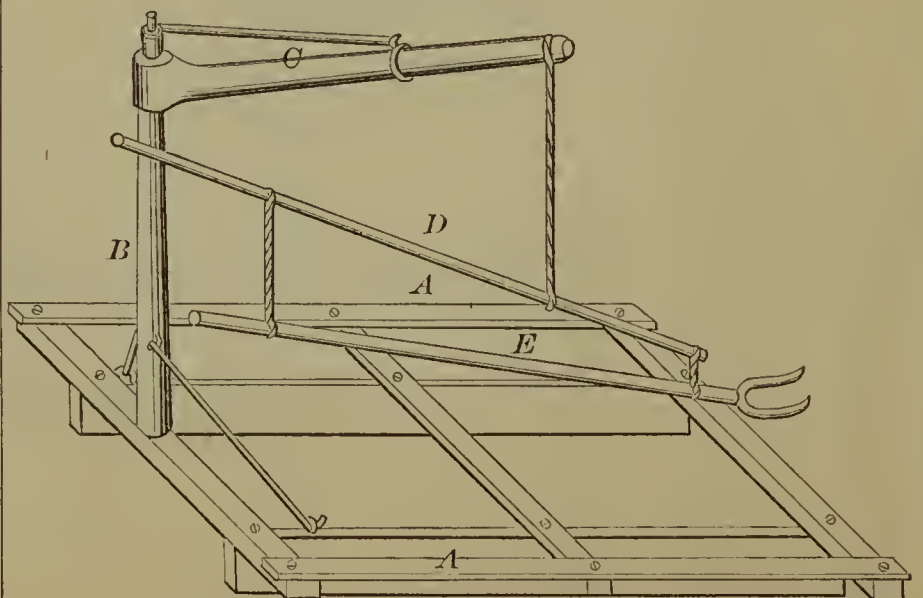

54077—S. W. Woodward—For Opening and Closing Window Blinds.

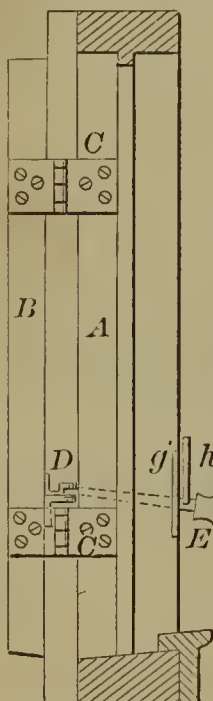

54085—C. F. Allen—*Car Truck.*

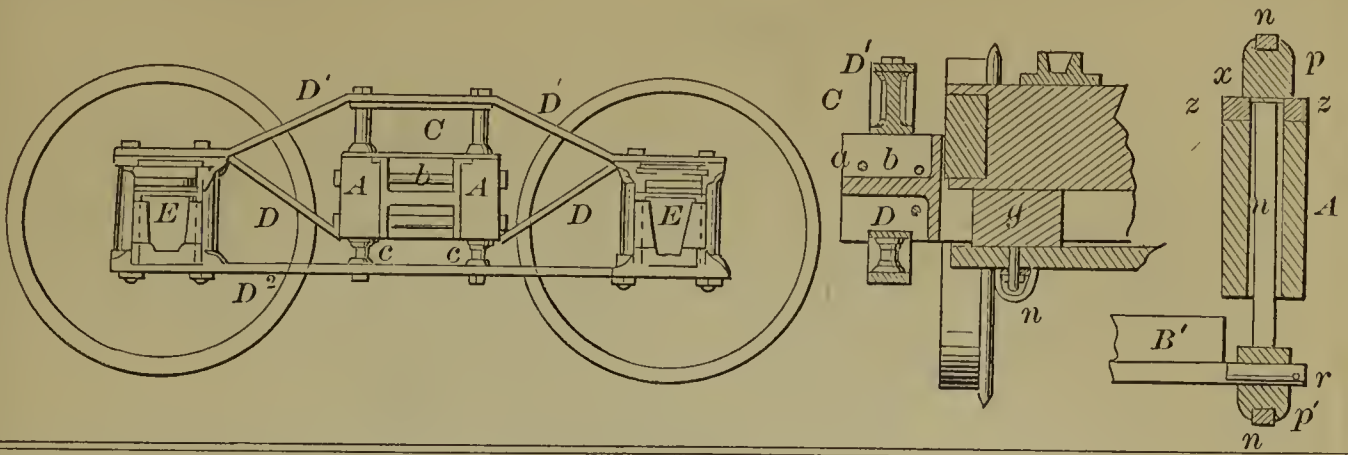

54088—E. H. Ashcroft—*Preparing Peat.*

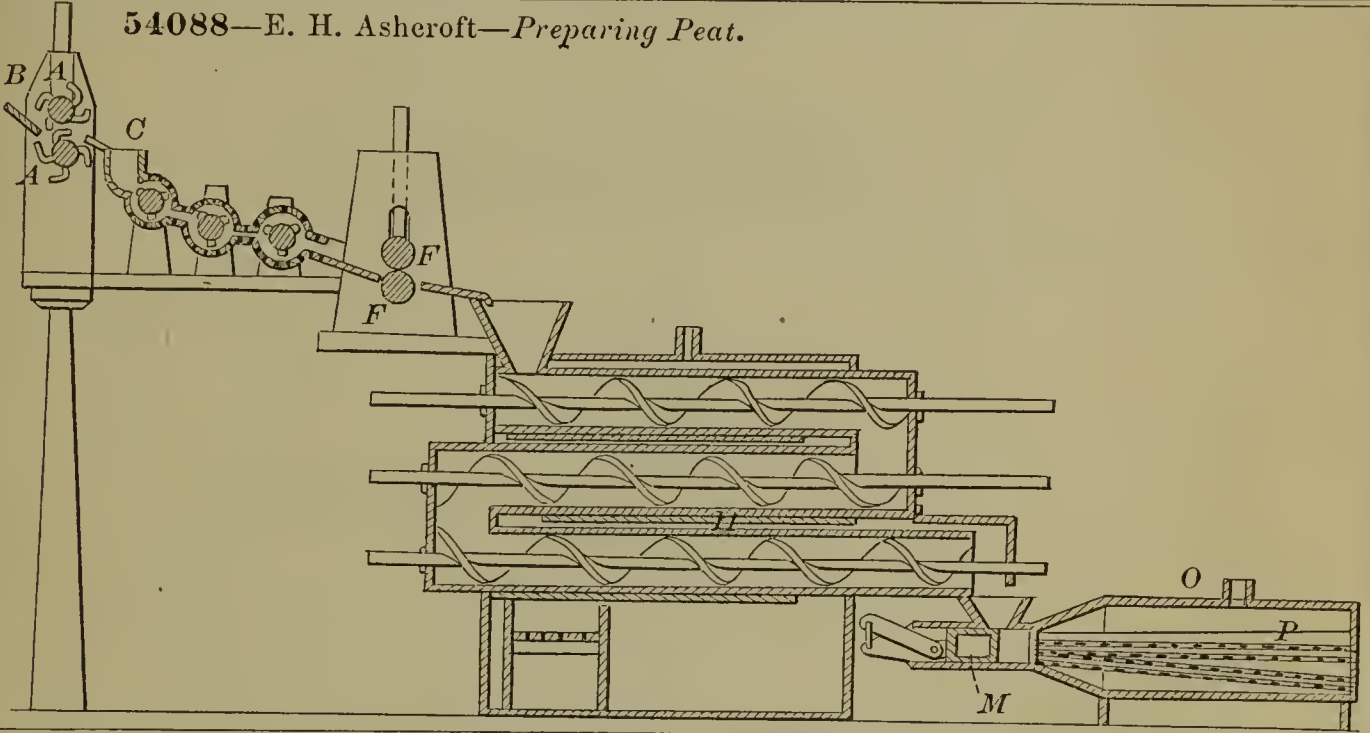

54086—E. G. Allen—*Railway Frog.*

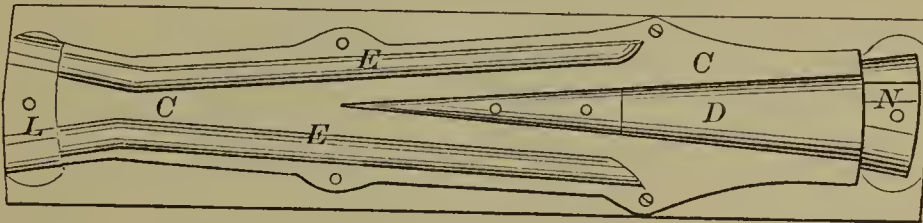

54089—C. Atwood—*Gang Plow.*

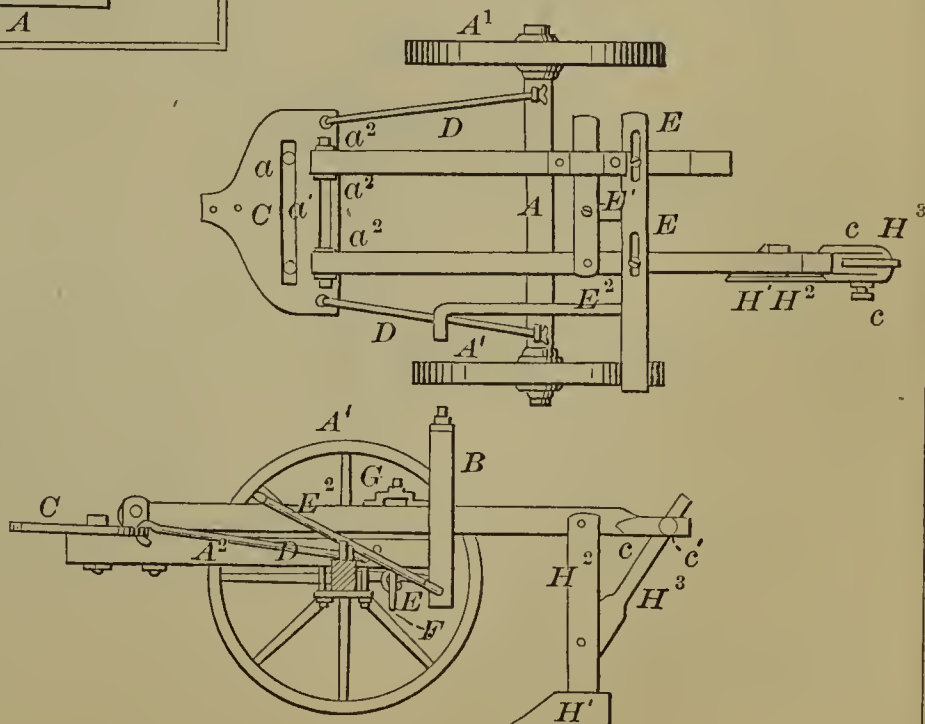

54087—G. P. Allen—*Weeding Hoe.*

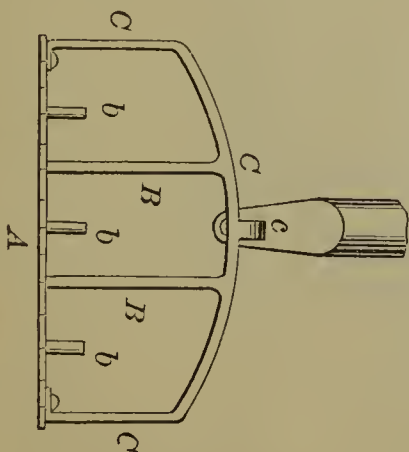

54090—Babcock & Wilcox—*Cut-off Valve.*

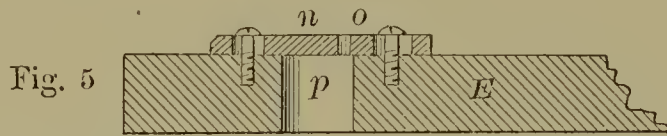
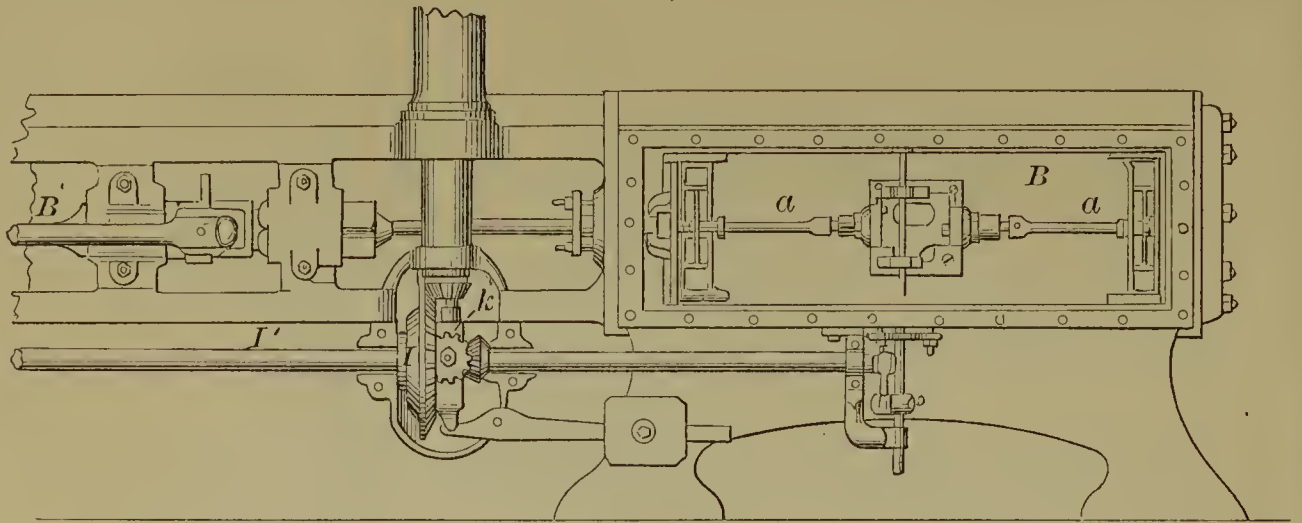

54091—J. C. Baer—*Beer Faucet.*

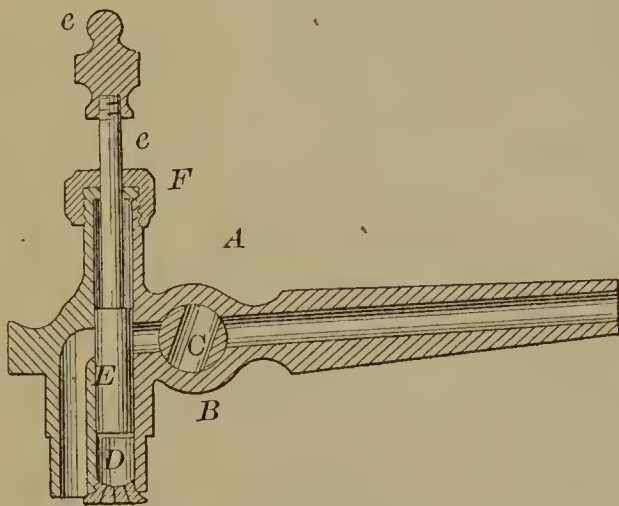
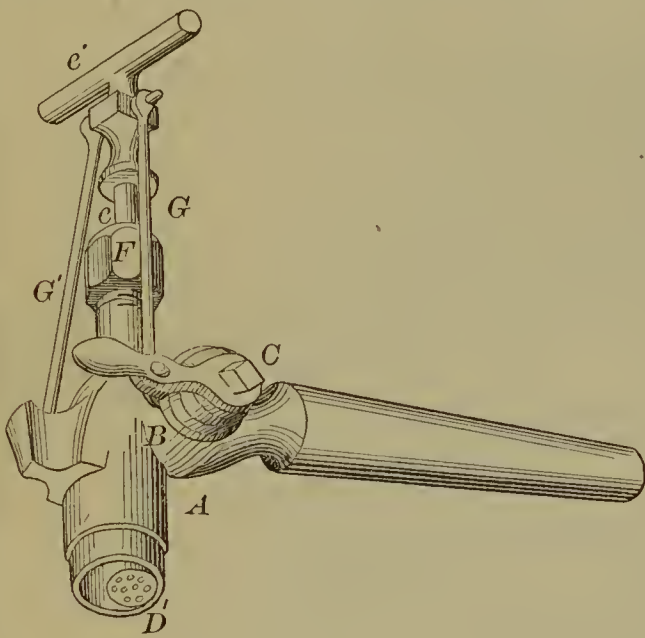

54092—T. K. Bailey—*Churn.*

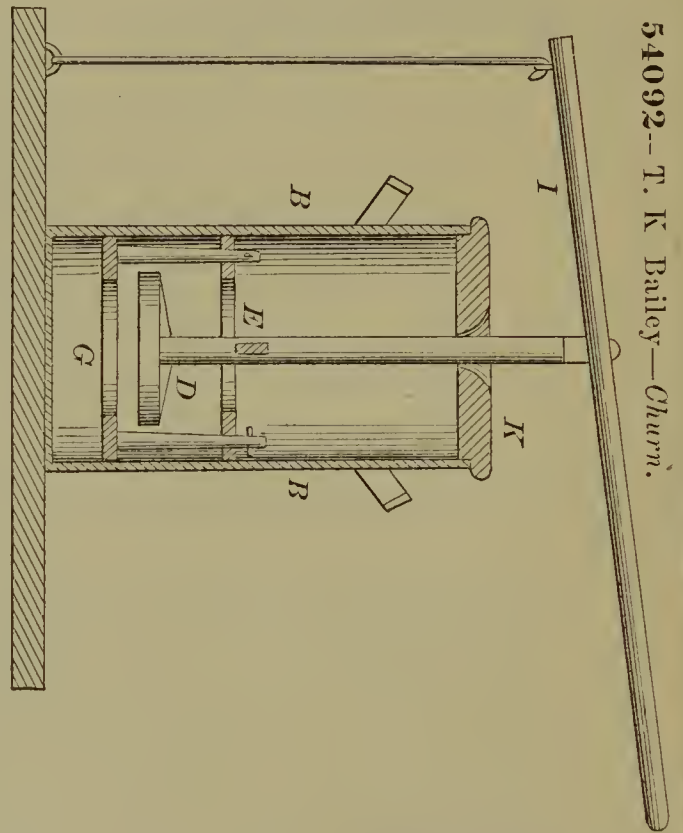

54094—S. J. Baker—*Stocking Heel Protector.*

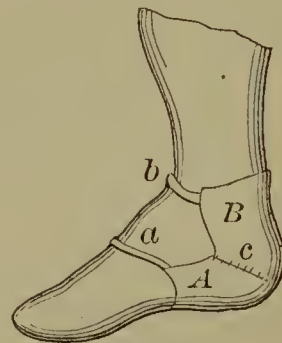

54095—L. M. Bates—*Plow.*

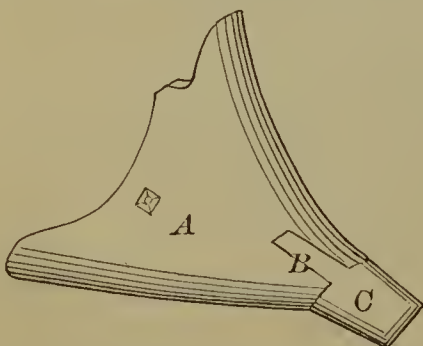

54096—B. F. Bee—*Screw Tap.*

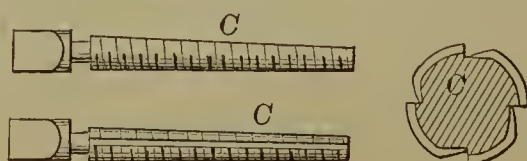



54099—Bertrand & Sames—Cultivator.

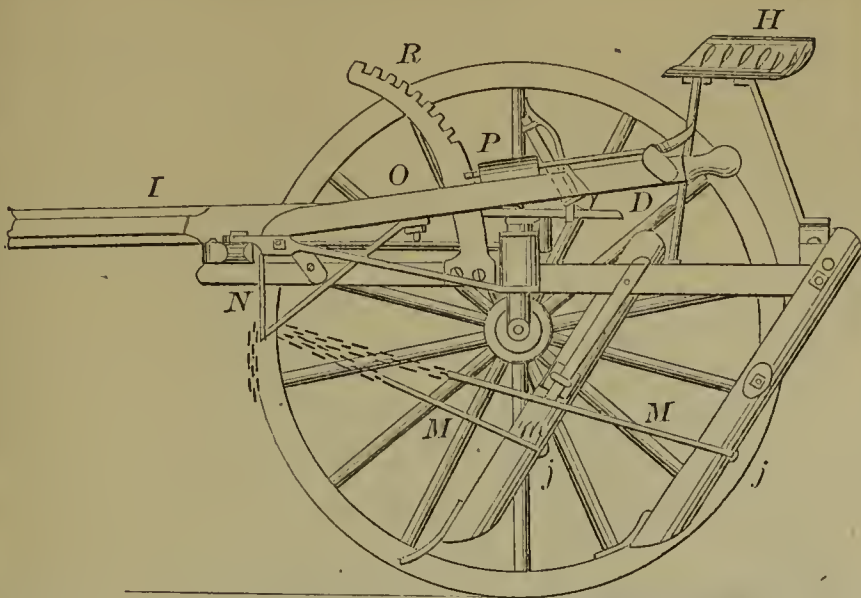

54103—H. I. Brown—Wool Press.

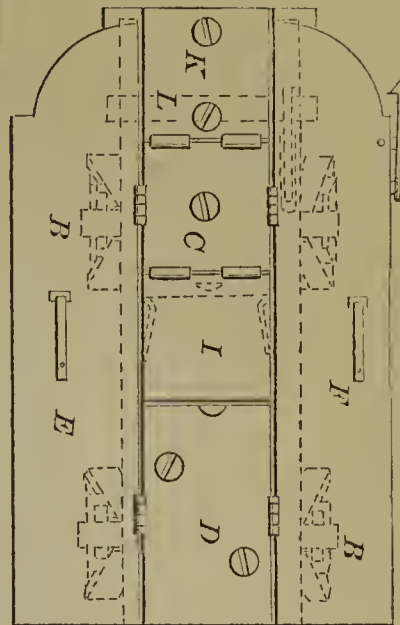

54101—P. S. Bishop—Machinery for Stamping Chain Links.

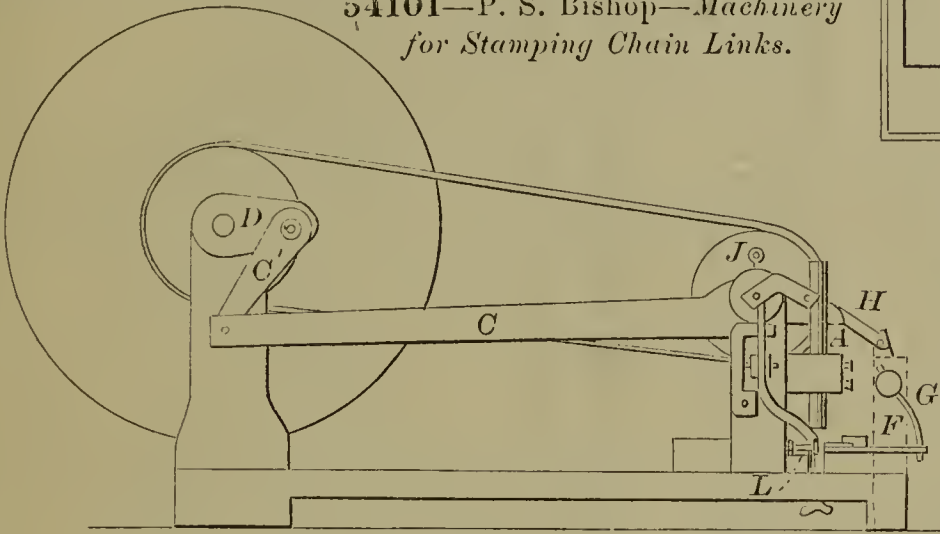

54100—C. E. Billings—Breech-Loading Fire Arm.

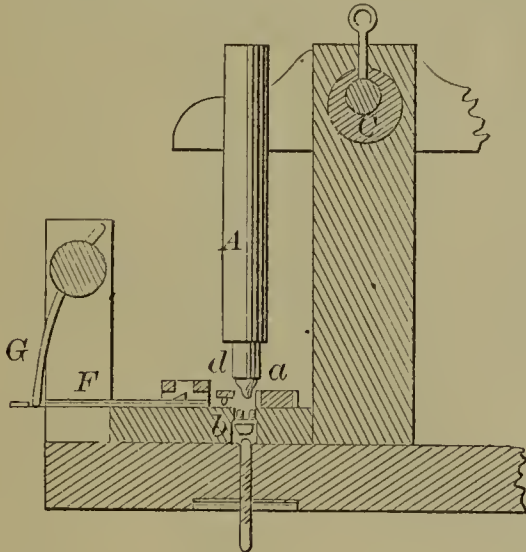
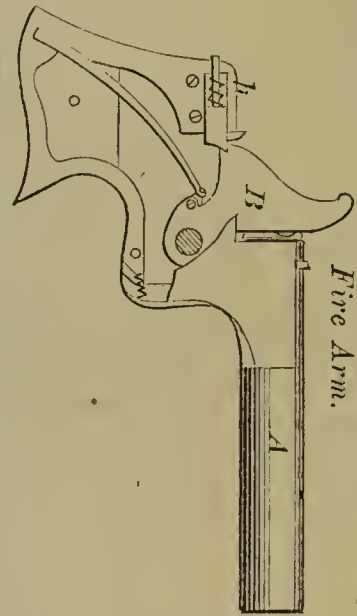

54102—Bridge & Ruby—Heating Stove.

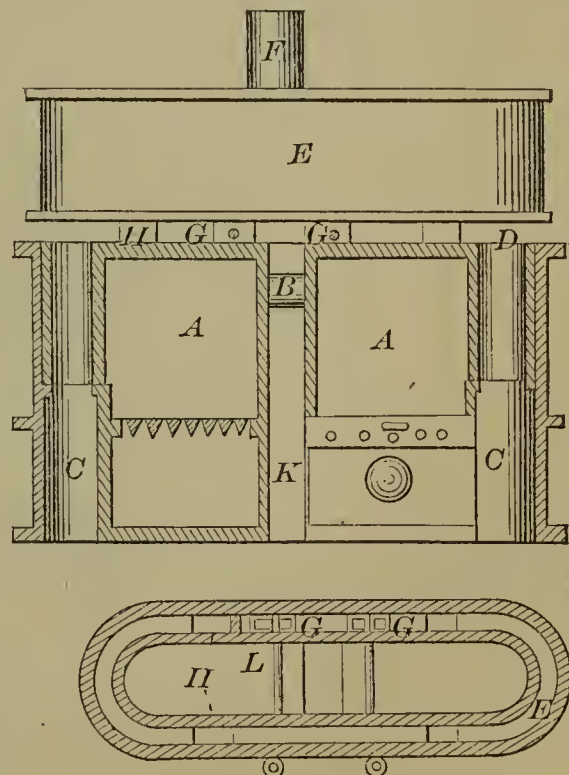

54104—J. Buchanan—Broom Head.

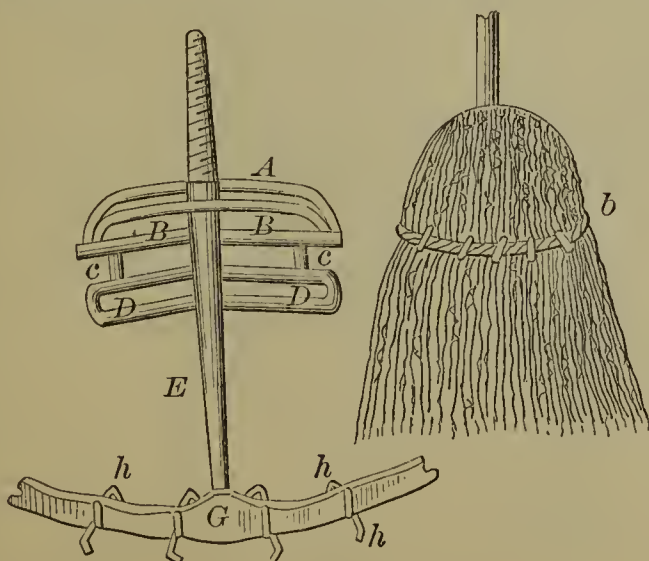

54105—Burchnall & Johnson—Milk and Cream Refrigerator.

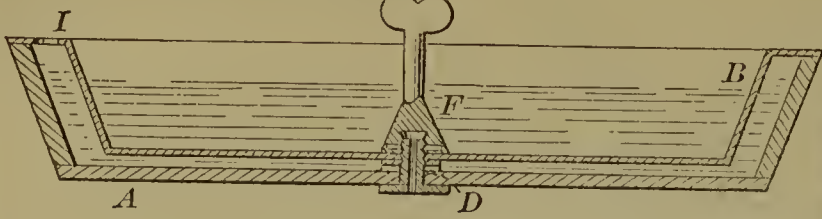

54108—A. C. Carey—Knitted Mitten.



54106—C. Burnham—Flour Sifter.

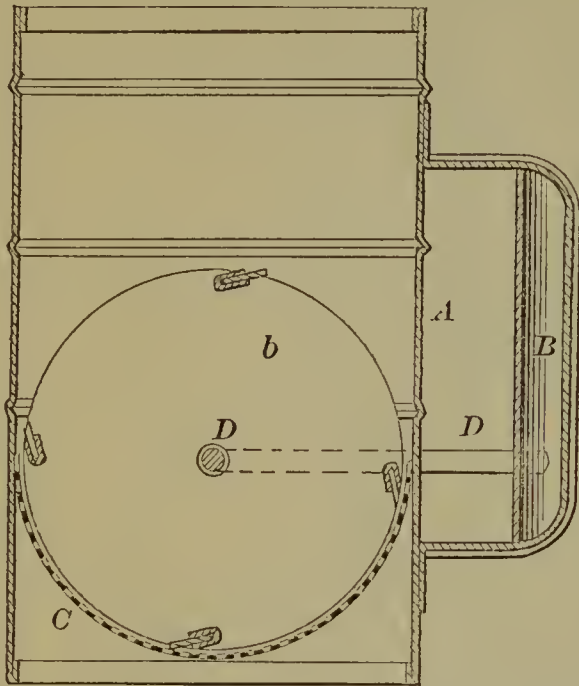

54112—J. H. Clapham—Shaft for Drilling.



54107—C. W. Cahoon—Wave Power Propulsion.

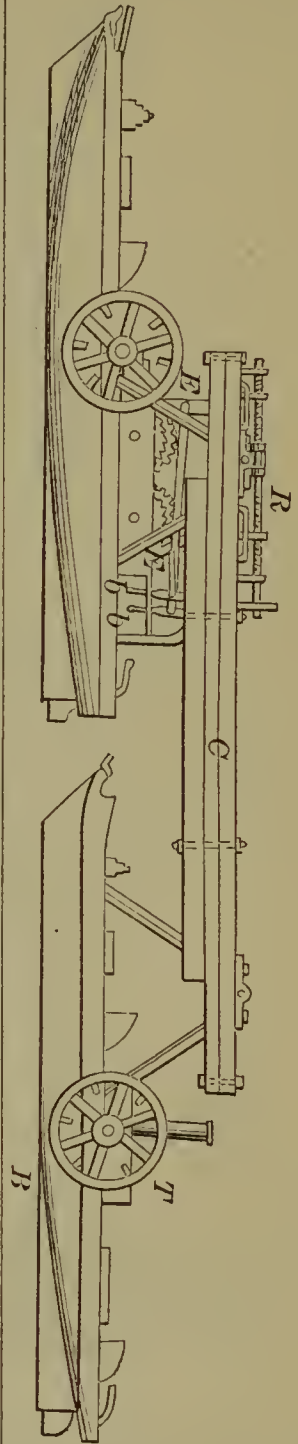

54110—A. Case—Stereotype Block.



54111—A. Christian—Children's Carriage.

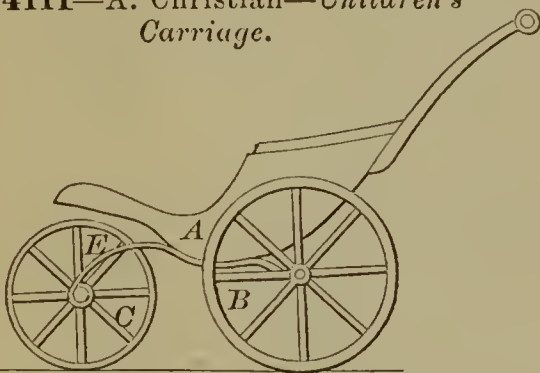

54113—E. Clark—Bolt Fastening for Boiler Heads.

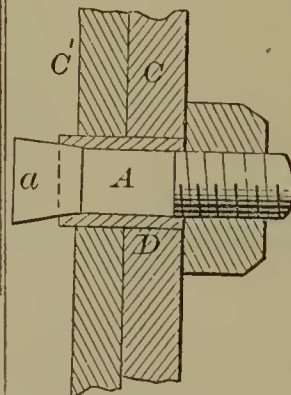

54109—Machine-made Stocking.

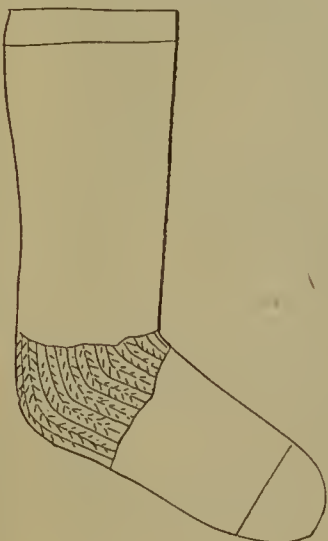

54116—S. E. Cook—Imitation of Braided Hair.



54117—W. F. Corpe—Fruit Jar.

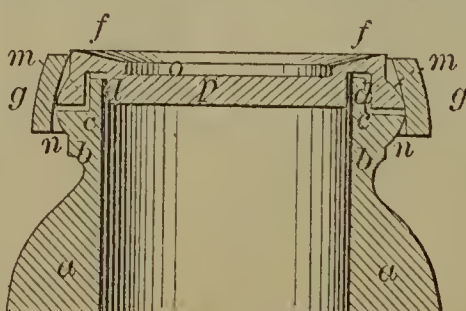

54114—Clark & Savage—Burner for Gas Stoves.

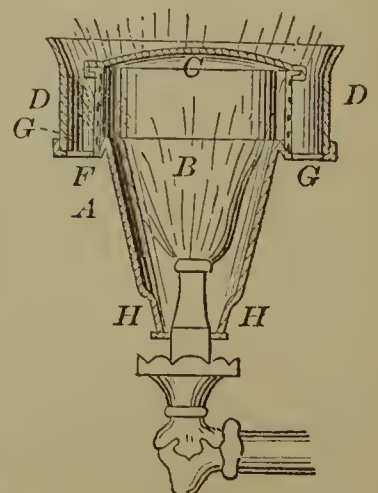

54118—Crane & Pease—Solar Mirror for Photographic Purposes.

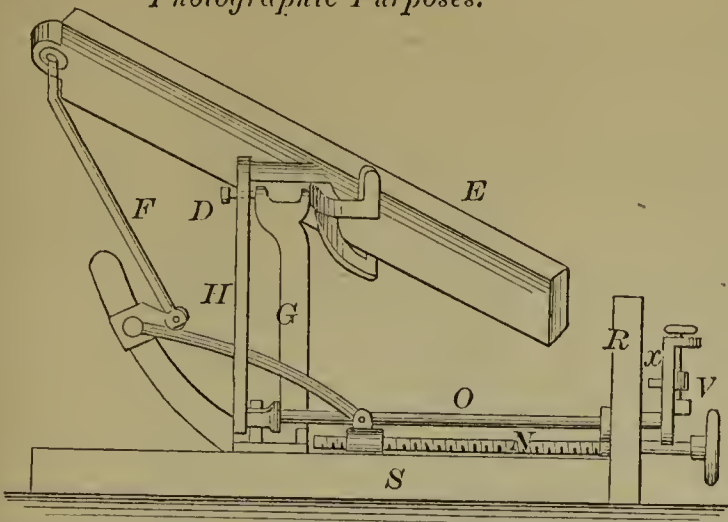

54120—L. & R. Crooke—Compressed Rod Solder.

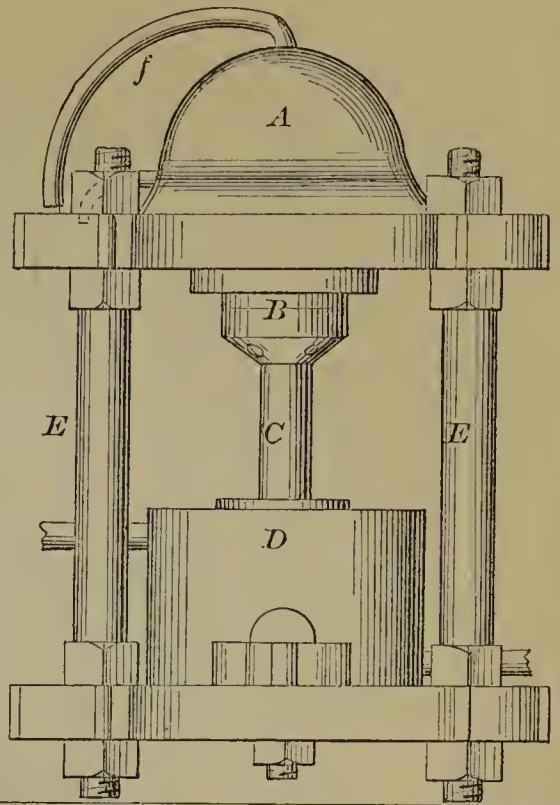

54119—P. S. Crawford—For Tightening Wire Fences.

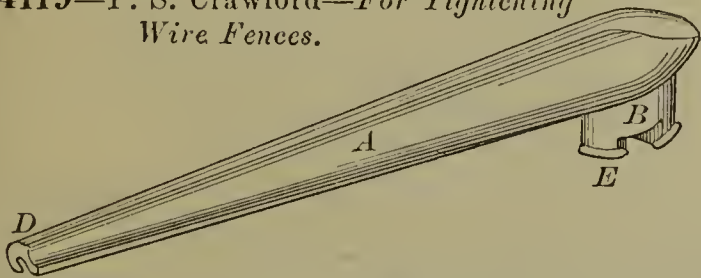

54121—L. & R. Crooke—Manufacture of Rod Solder.

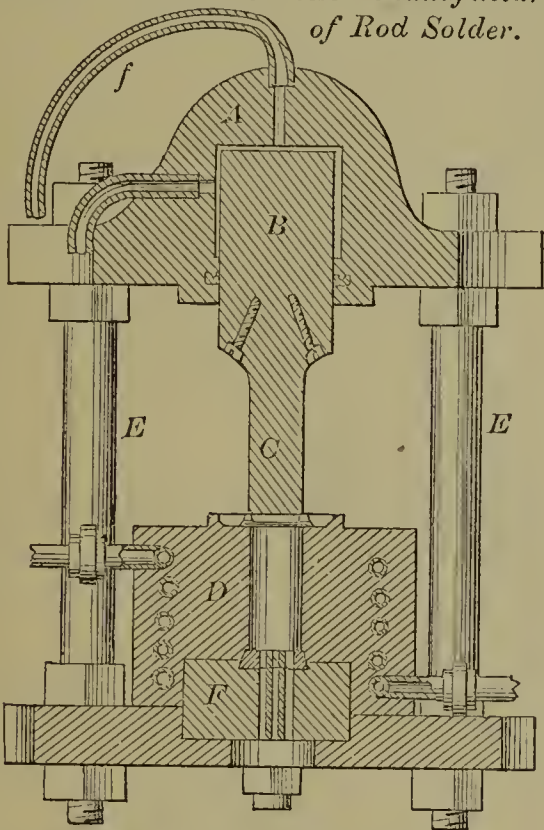

54122—H. W. Curtis—Cultivator.

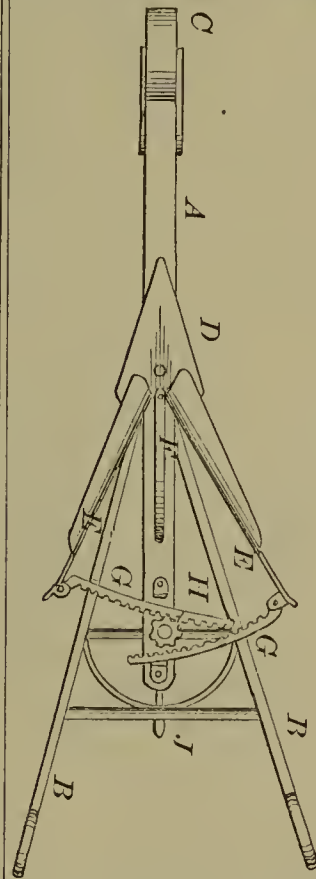

54125—W. Dawson—Car Trucks.

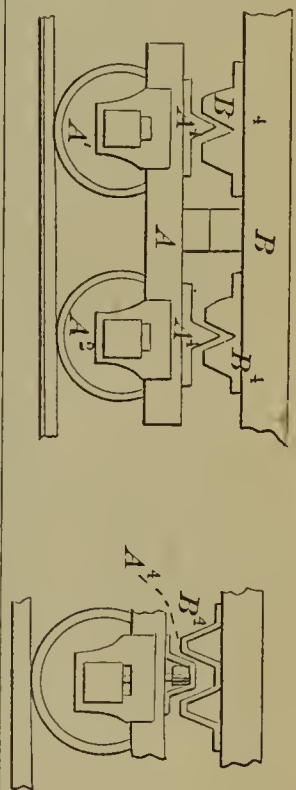

54123—D. Cushman—Water Wheel.

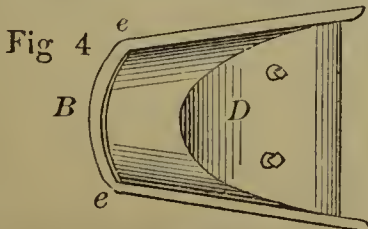
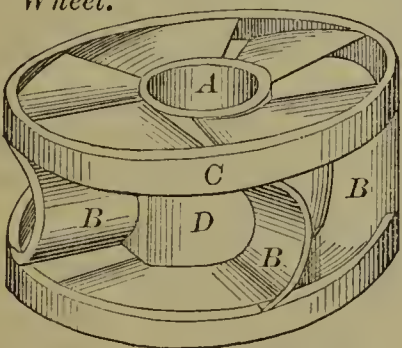

54124—J. M. Davis—Track Cleaner for Mowing Machines.

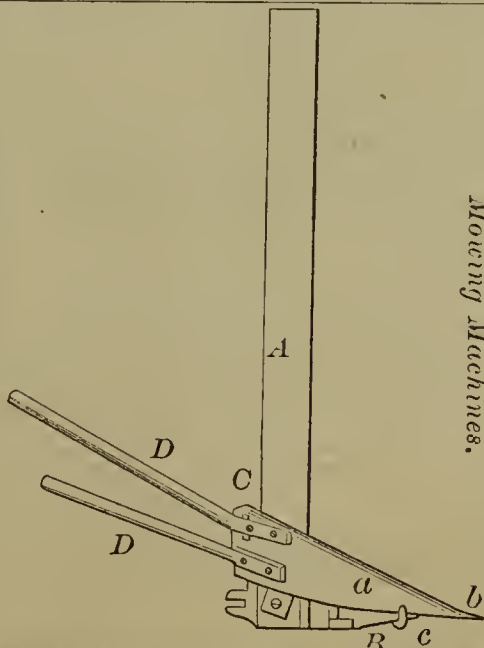

54126—M. Decamp—Revolving Grain Feeder.

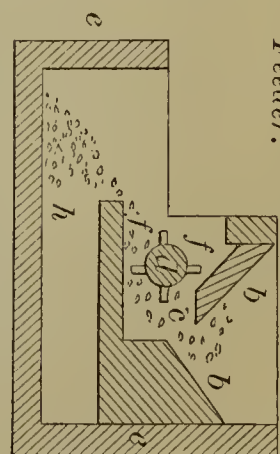

54127—G. W. Devin—  
Marking Stock.

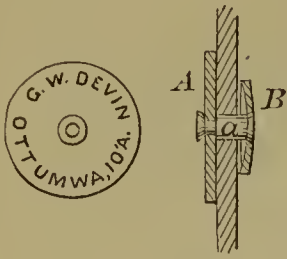

54128—M. Devoe—Water Wheel.

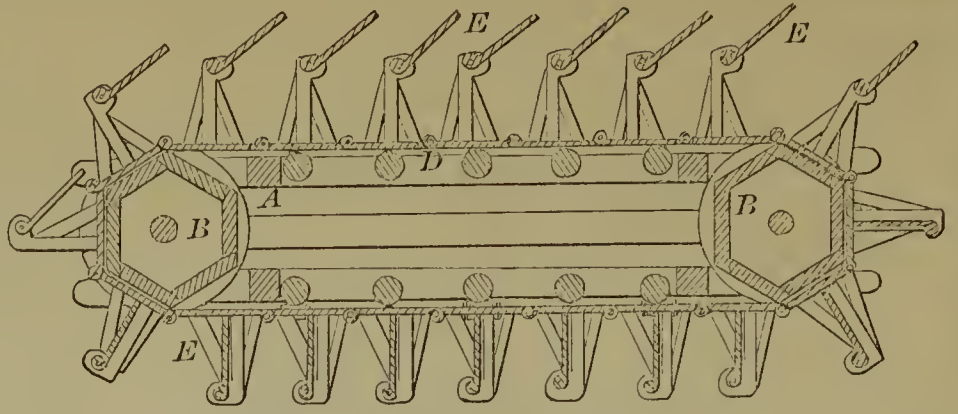

54130—P. Dickson—Lever Power  
of Windlasses, &c.

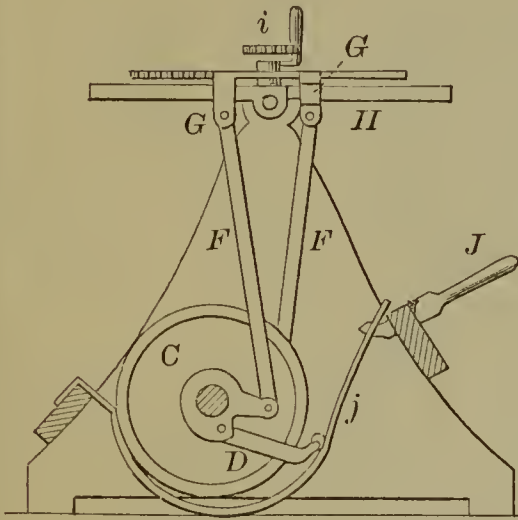

54131—

J. Downing—For Cutting  
Shoe Soles.

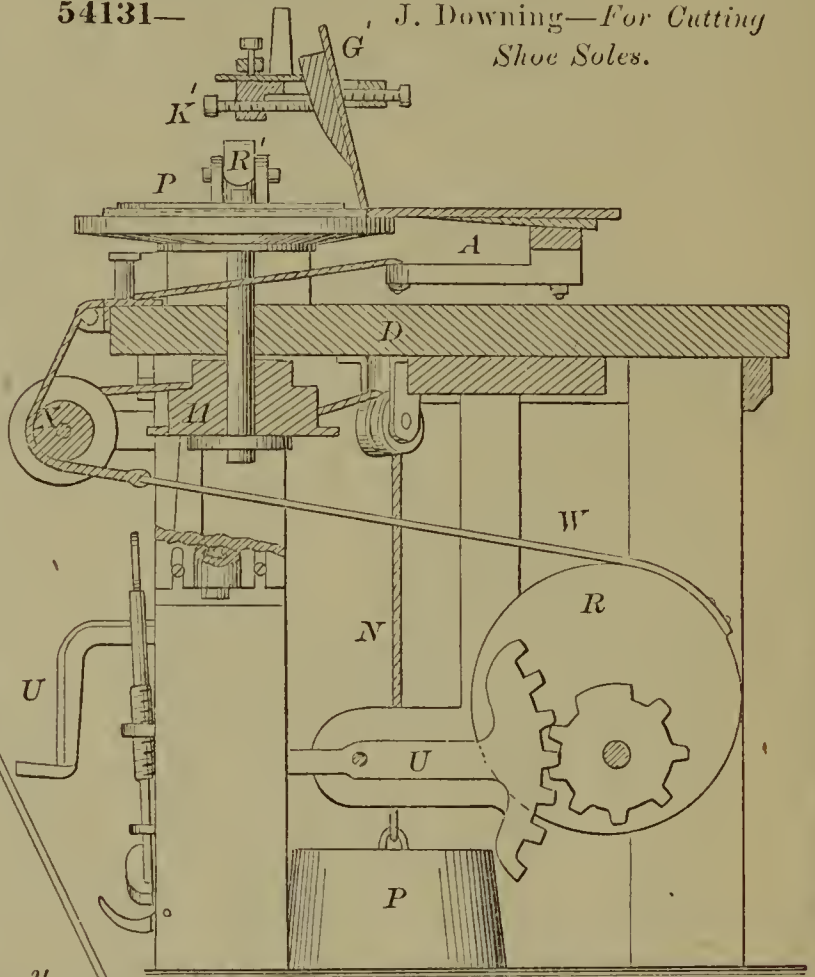

54132—O. P. Drake—For  
Carbureting Air.

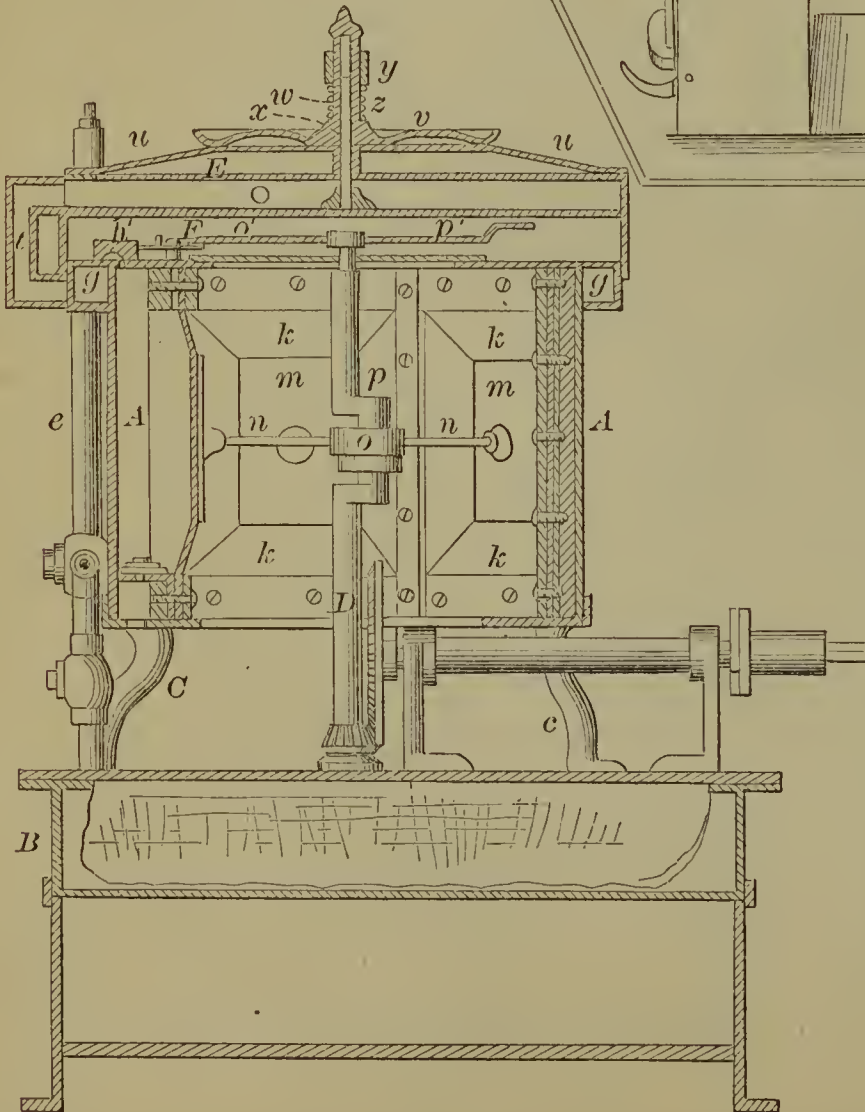

54129—T. B. Dexter—  
Steam Valve.

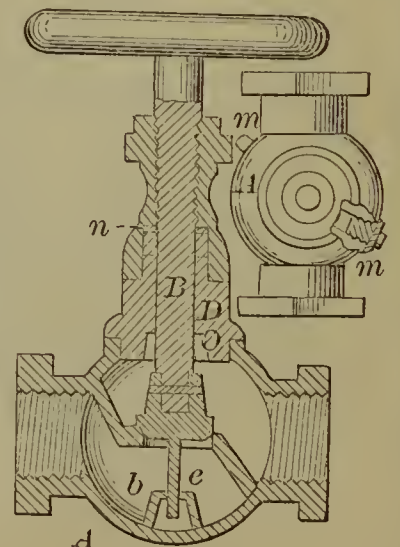

54132—Continued.

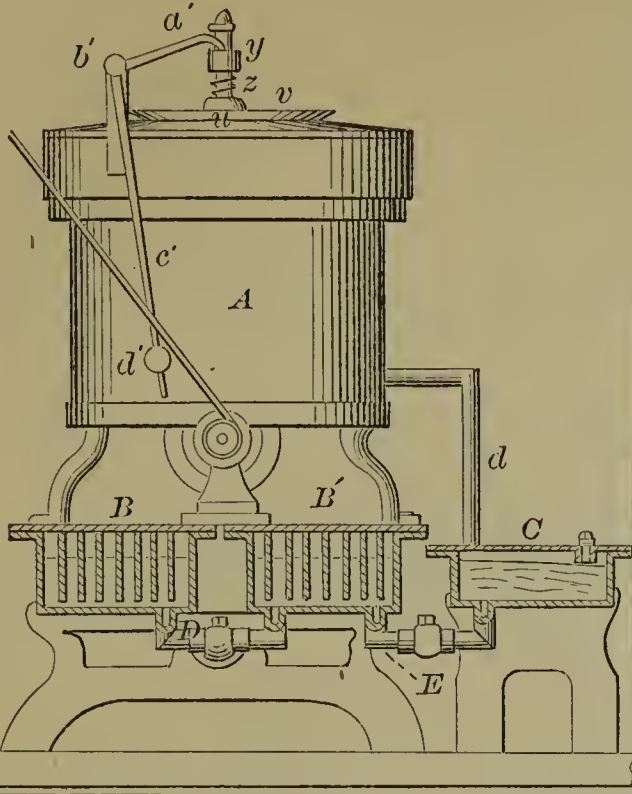

54135—S. D. Engle—Watch.

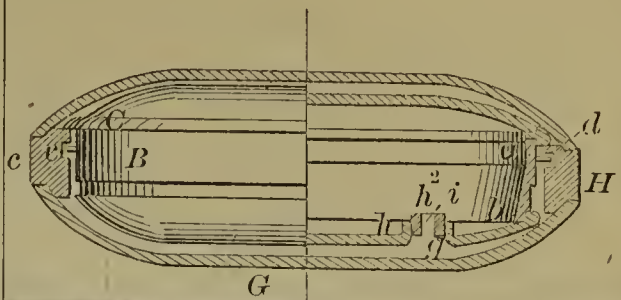

54137—C. H. Field—Watch Back.

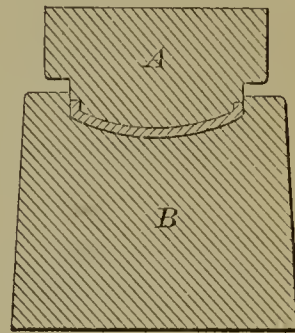

54133—W. A. Duncan—For Raking and Loading Hay.

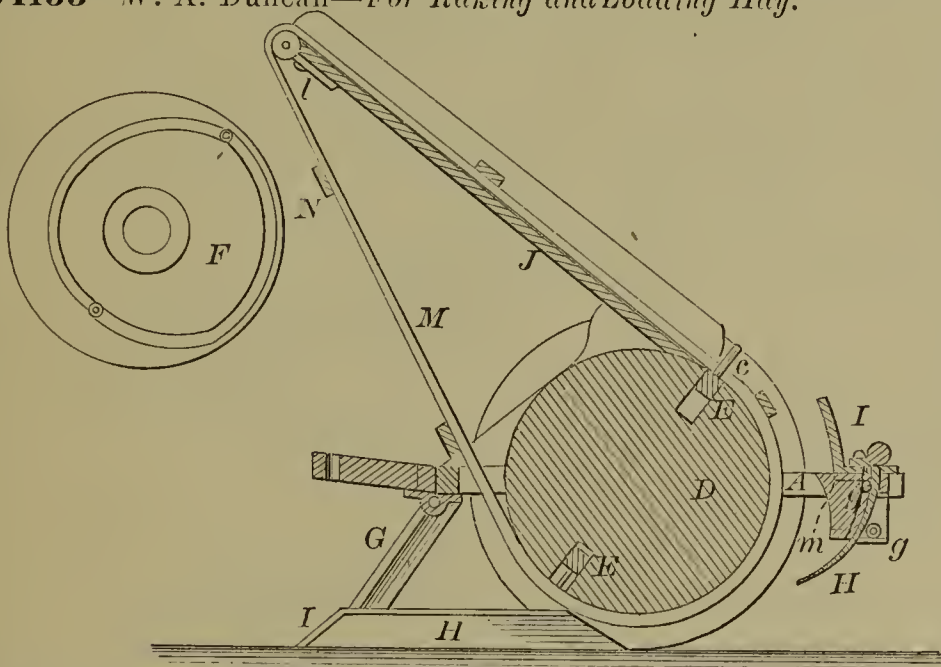

54134—T. Earle—Egg Beater.

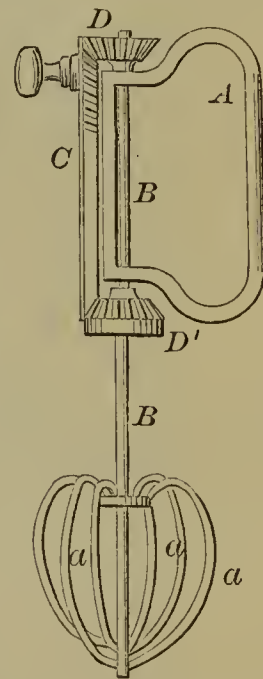

54136—C. H. Field—Watch Rim.

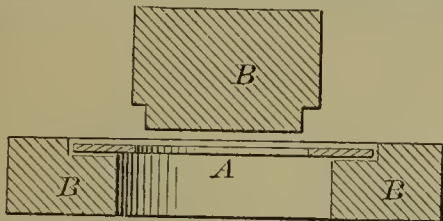

54139—J. L. Fountain—Combined Seeder and Cultivator.

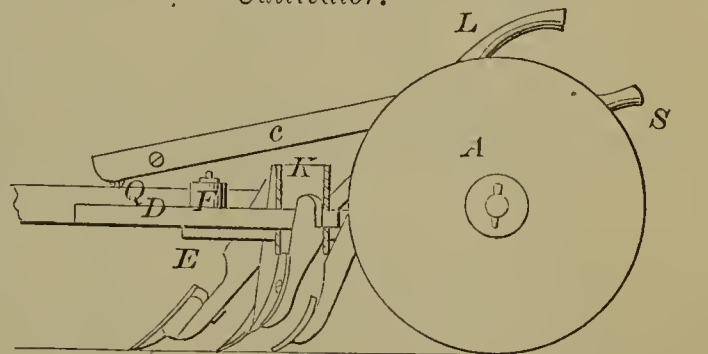

54138—M. Foreacre—Sheep Rack.

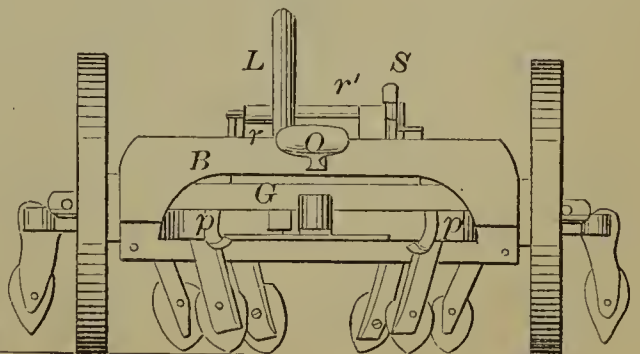
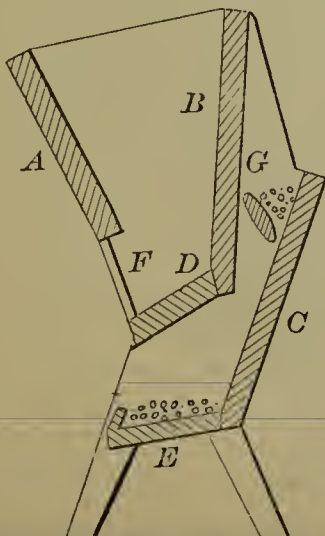

54140—E. Fowler—*Settee and Table.*

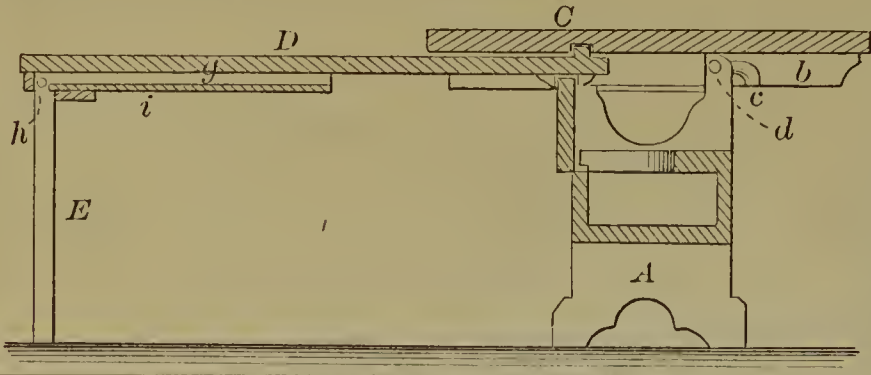

54141—G. Frost—*Tree Protector.*

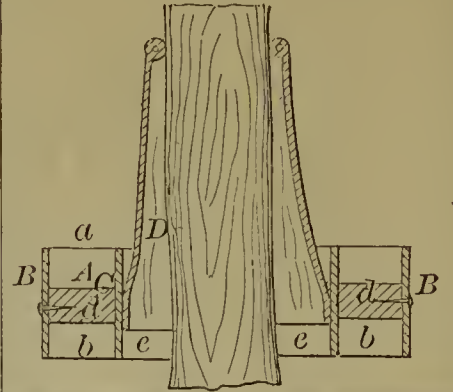

54142—R. Gibbons—*Adjustable Back Strap for Vests.*

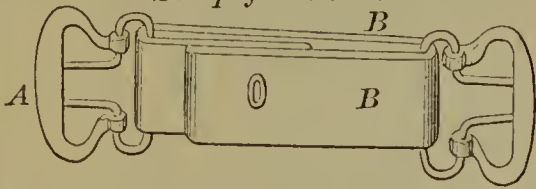

54144—A. Hamar—*Boring Artesian Wells.*

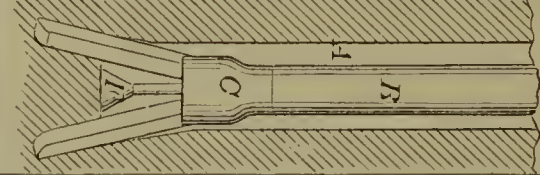

54145—T. J. Halligan—*Waxed Thread Sewing Machine.*

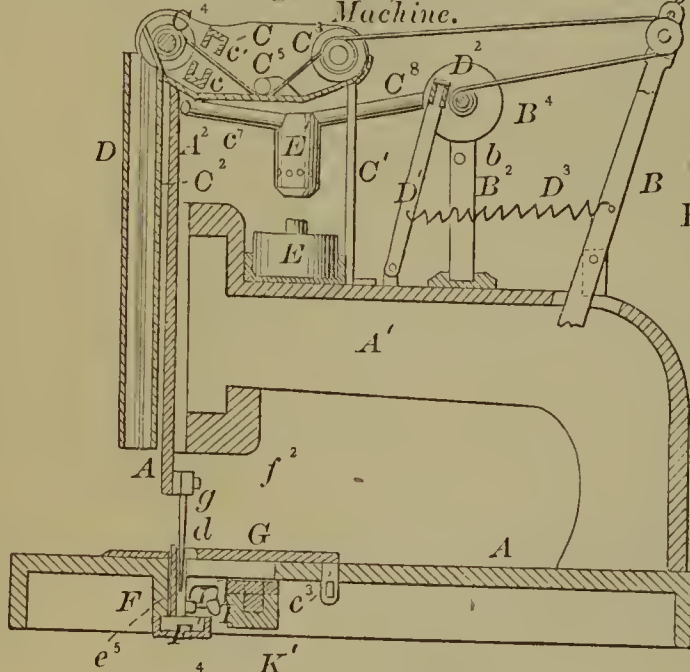

Fig. 5  $t^2 t^2$

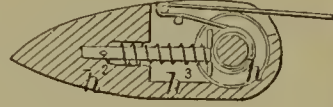

Fig. 6

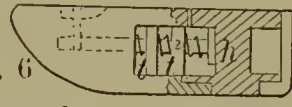

Fig. 6<sup>1</sup>

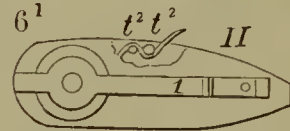
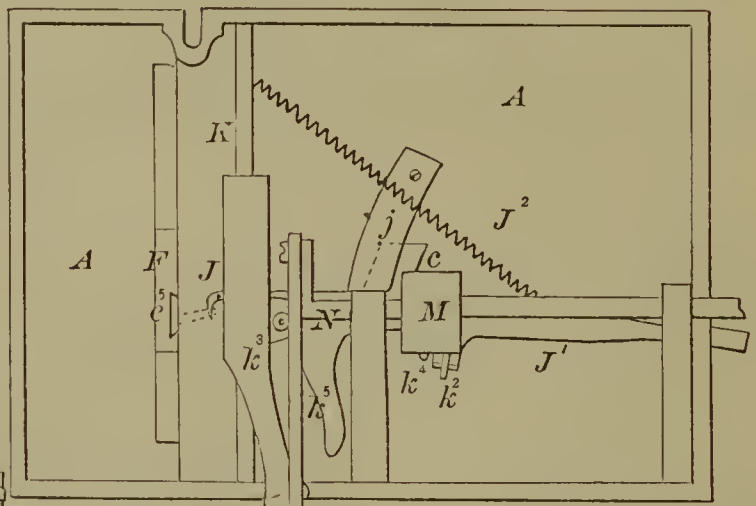
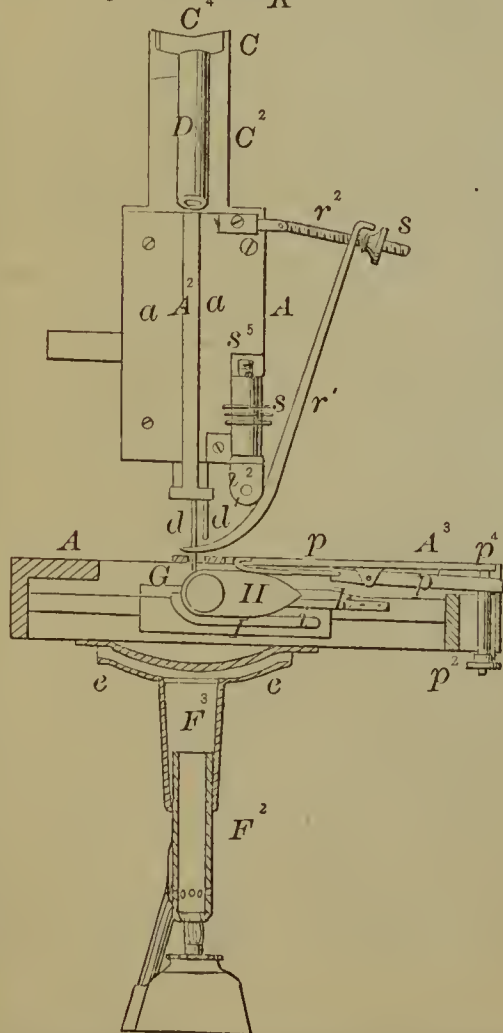
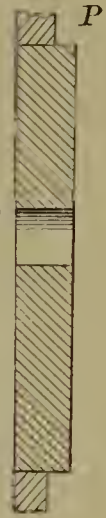
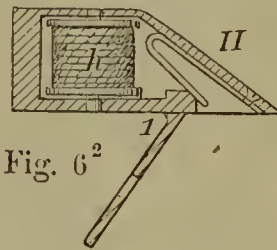
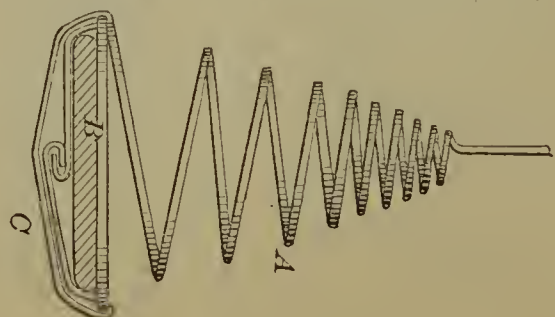

Fig. 6<sup>2</sup>



54143—W. H. Goodale—*Upholstery Spring.*



54146—G. H. Hammer—*Mop Head.*

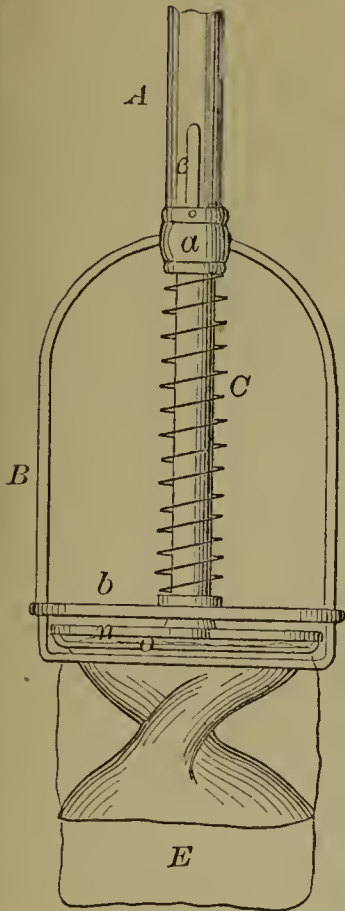

54148—D. R. Harder—*Boring Oil Wells.*

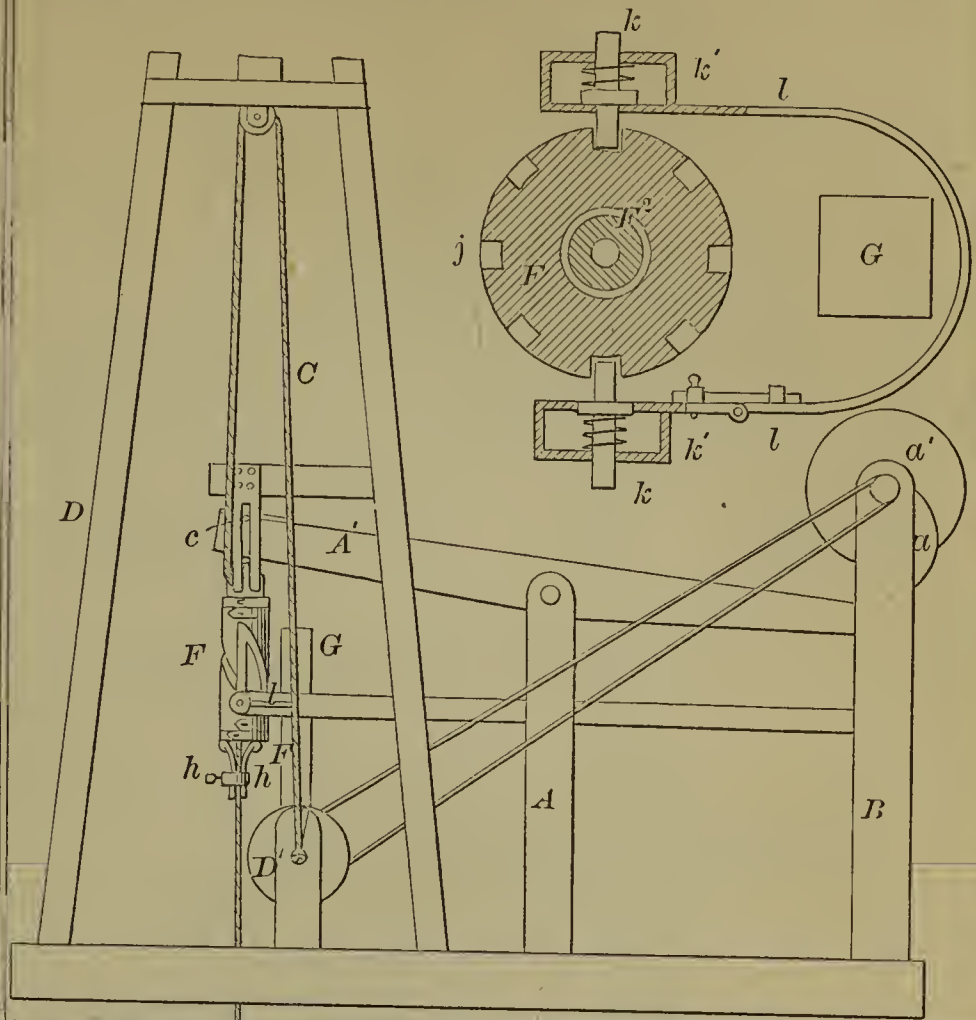

54147—H. Hammond—*Shot and Cartridge Pouch.*

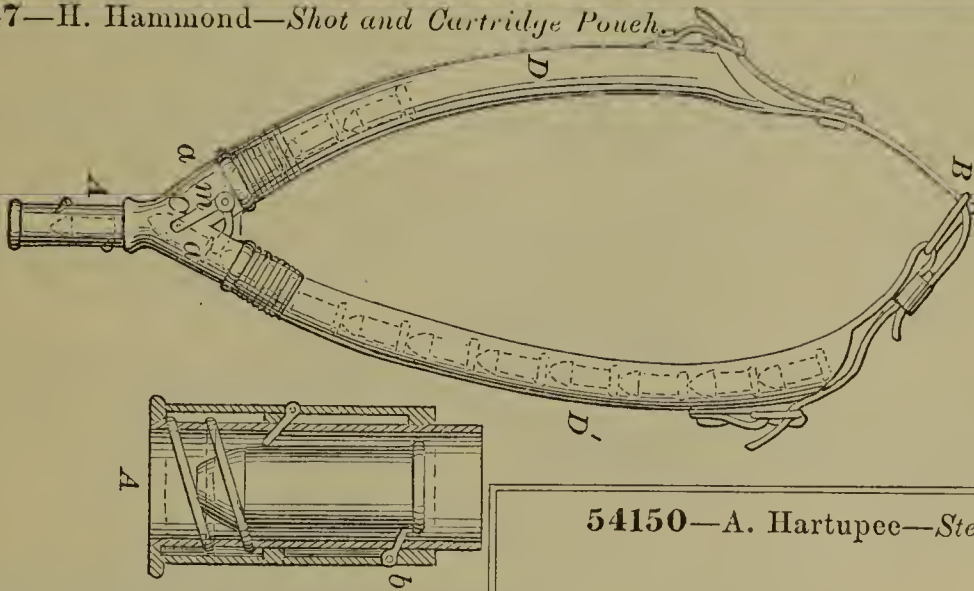

54150—A. Hartupce—*Steam Engine.*

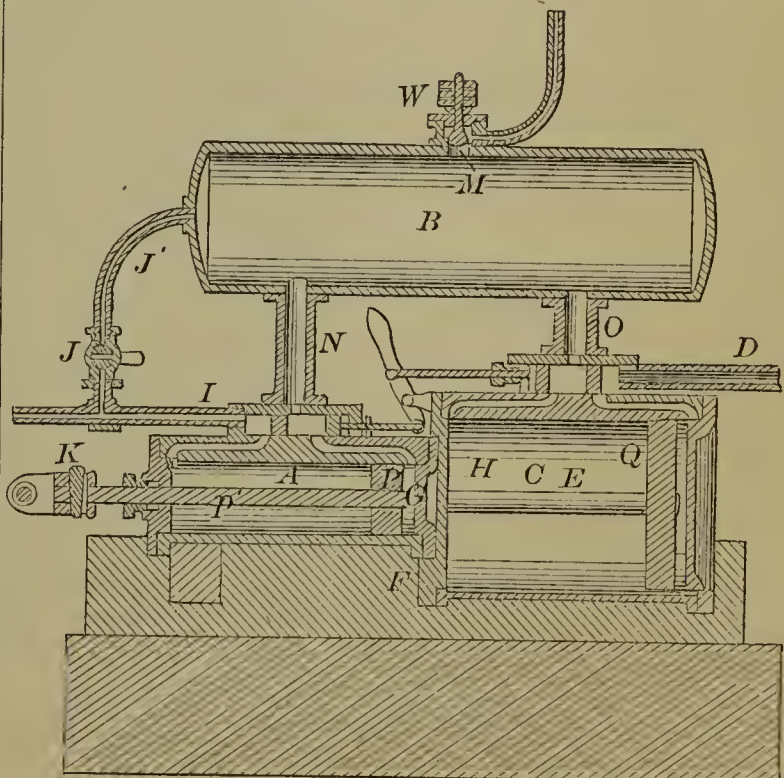

54149—P. Harlow—*Ash Sifter.*

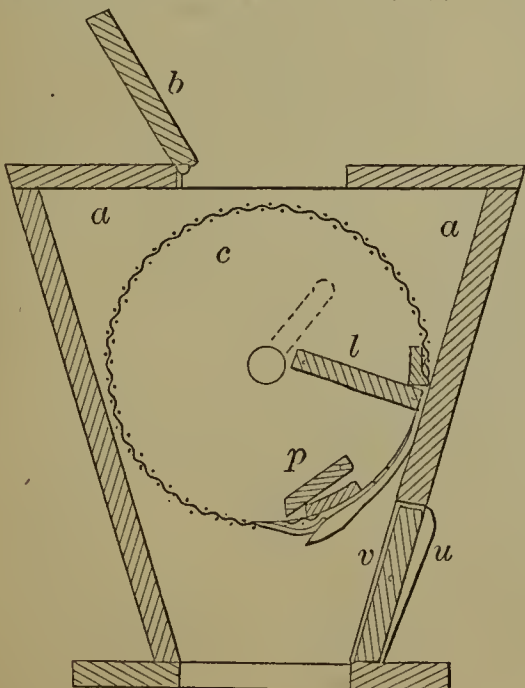

54151—H. R. Hawkins—Horse Rake.

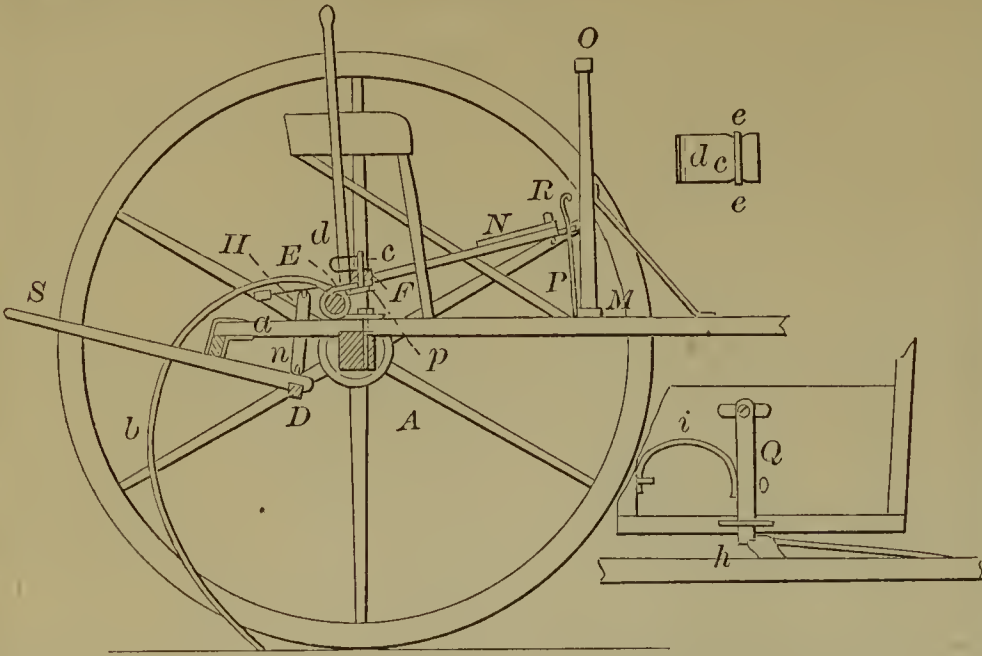

54152—G. H. Henkel—Car Brake.

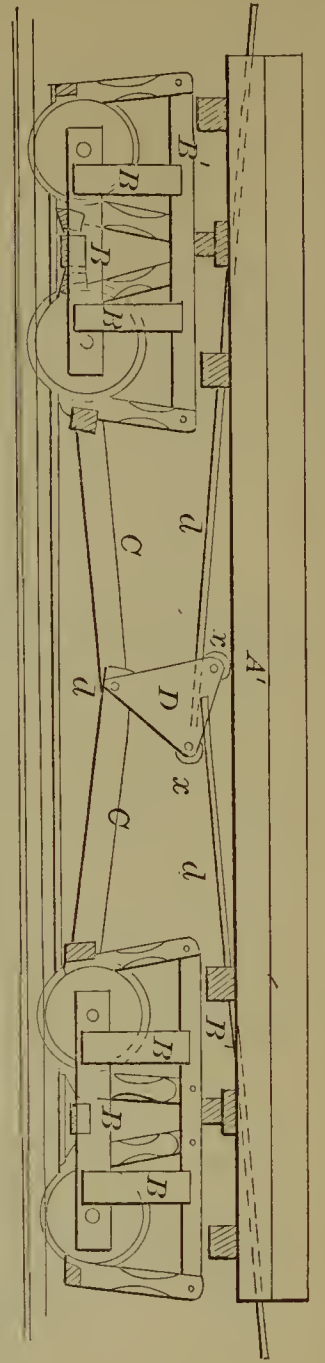

54154—C. Hewitt—Corrugated Wrought Iron Plates for Railroad Wheels.

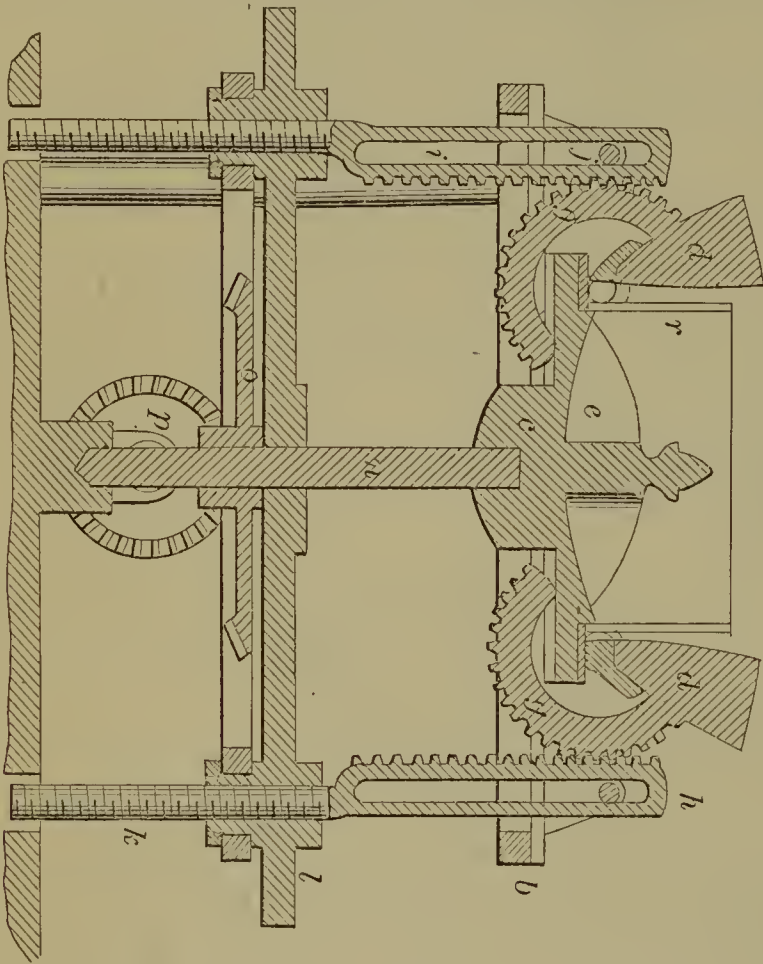

54156—D. K. Hickok—Journal Box.

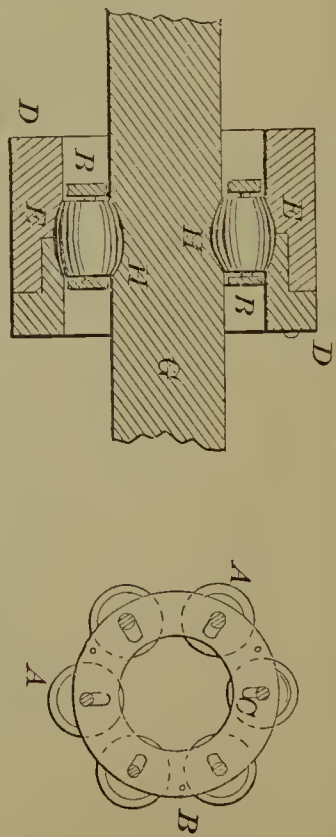

54153—J. L. Hewes—Cut-off Valve.

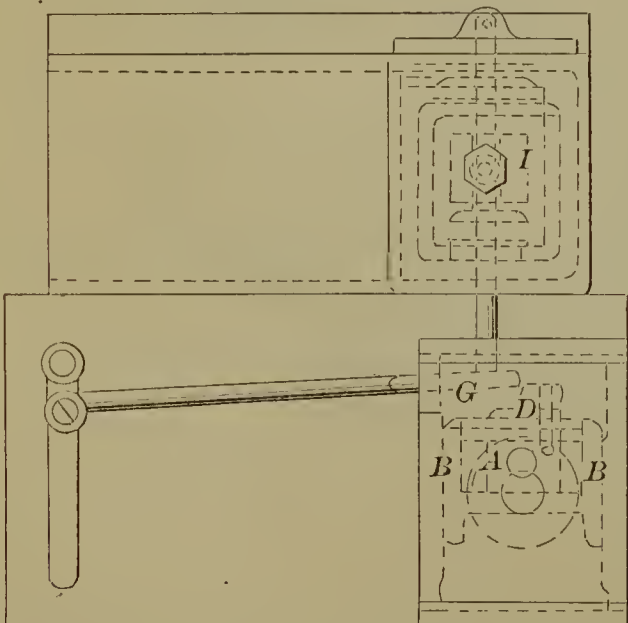

54155—G. G. Hickman—Carriage Wheel.

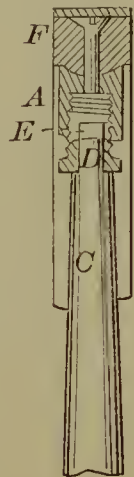



54157—A. D. Higham—*Distilling Petroleum.*

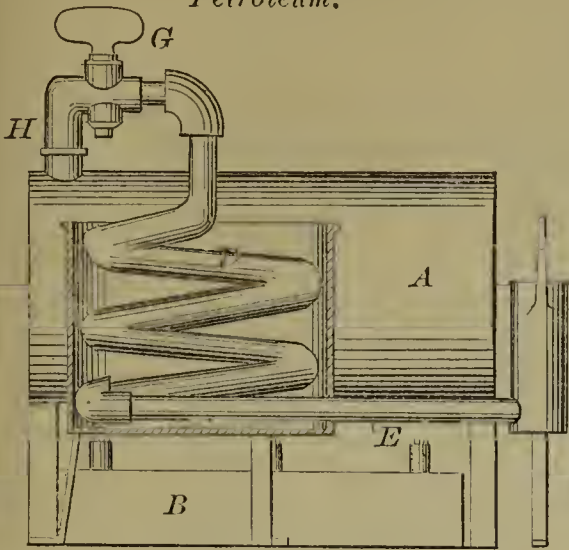

54158—W. F. Hill—*Sash Supporter and Fastener.*

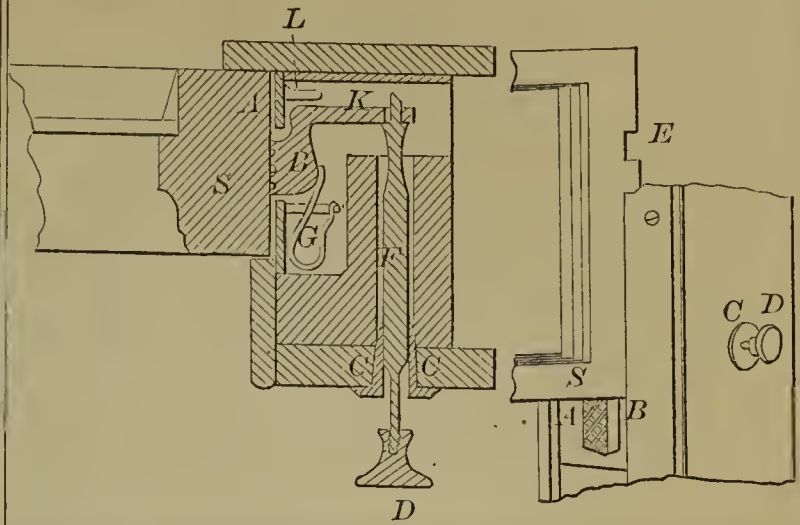

54160—S. Hoffheins—*Cultivator.*

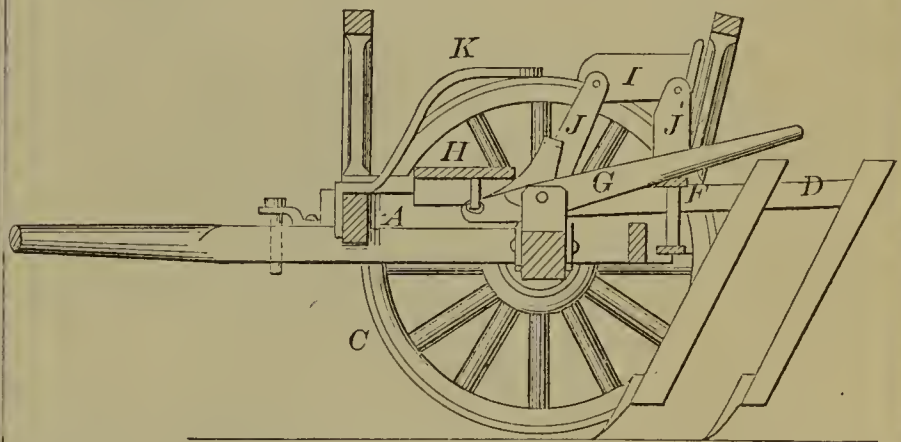

54162—L. G. Hoffman—*Lock.*

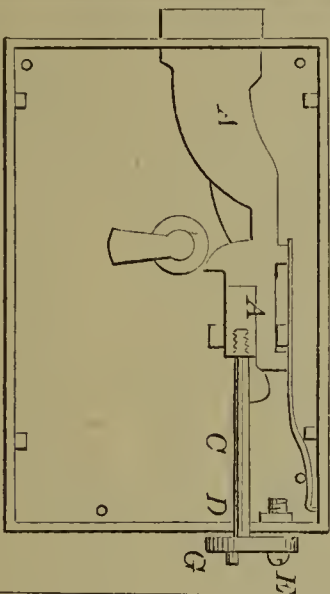

54161—F. Hoffman—*For Polishing Wood.*

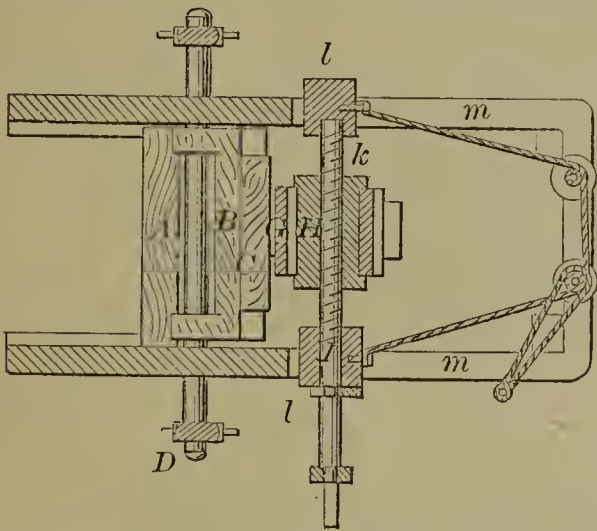

54159—G. Hillegrass—*For Tightening Wagon Tires.*

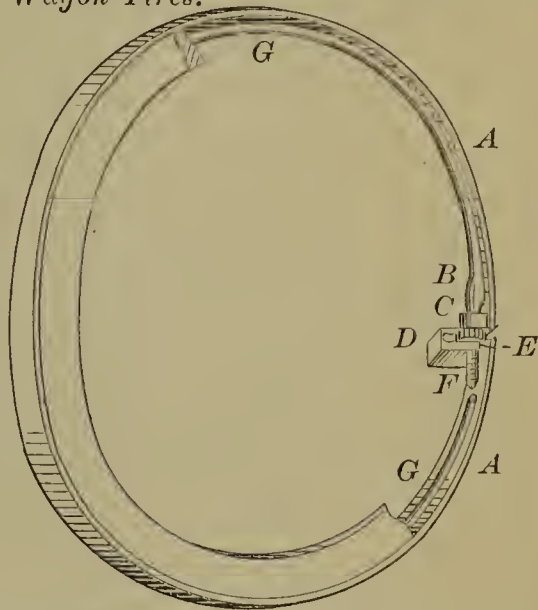

54163—A. J. Homan—*Slide Valve.*

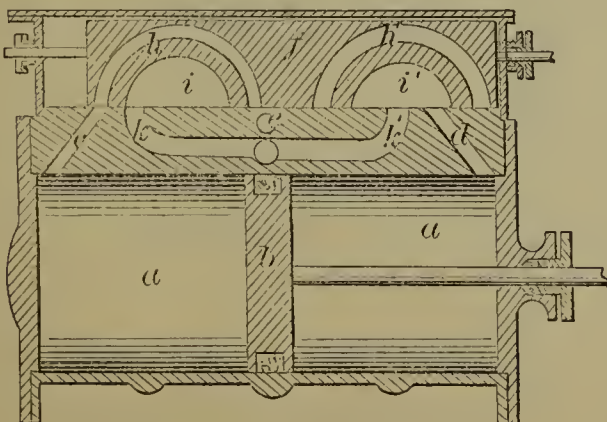

54164—L. Hover—*Sad Iron Holder.*

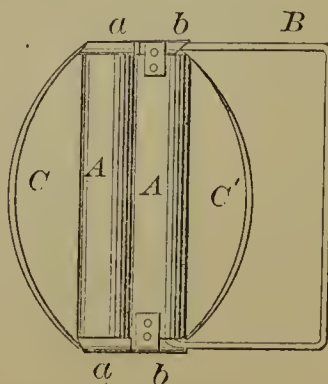

54165—J. P. Howell—*Tire Shrinker.*

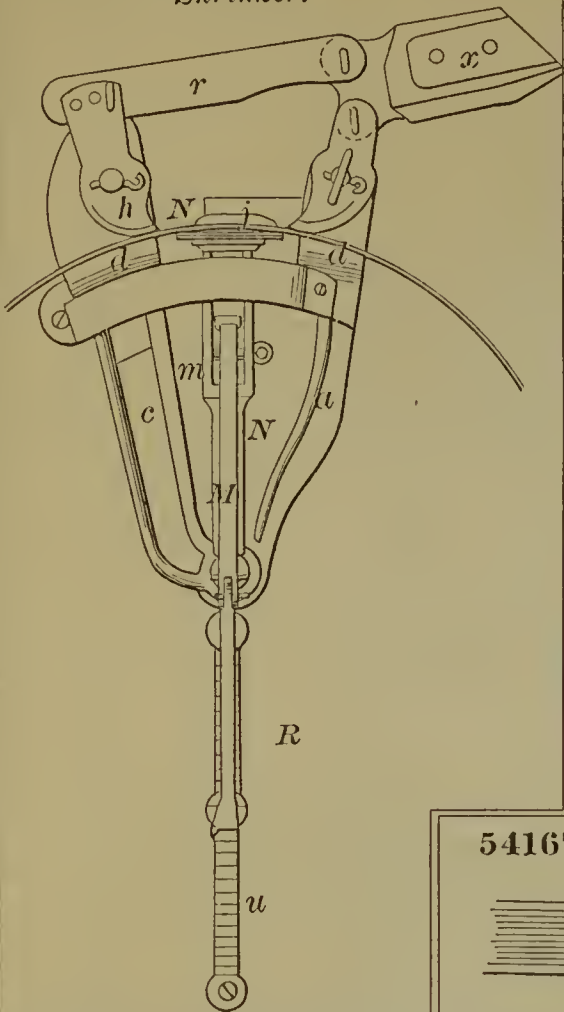

54168—W. Hunter—*Collar and Neck Tie.*



54167—L. Hull—*Elastic Webbing.*



54169—S. Johns—*Shifting Rails for Carriage Tops.*

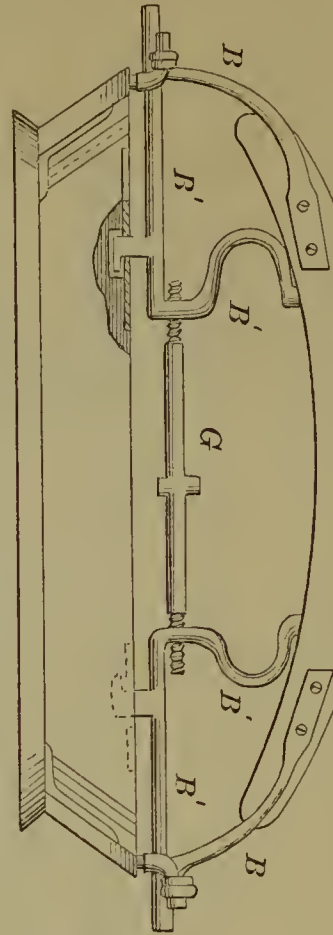

54166—W. W. Hubbard—*Corn Planter.*

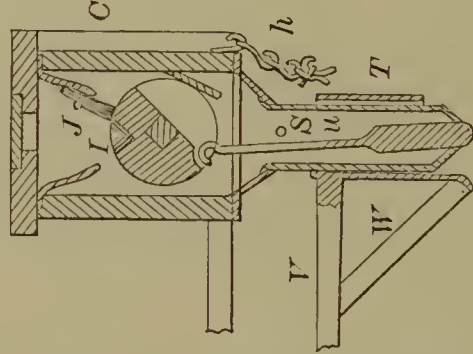
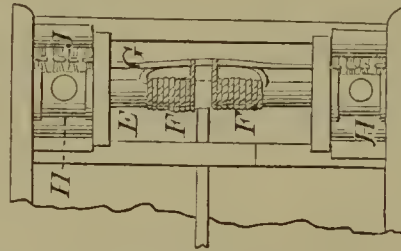
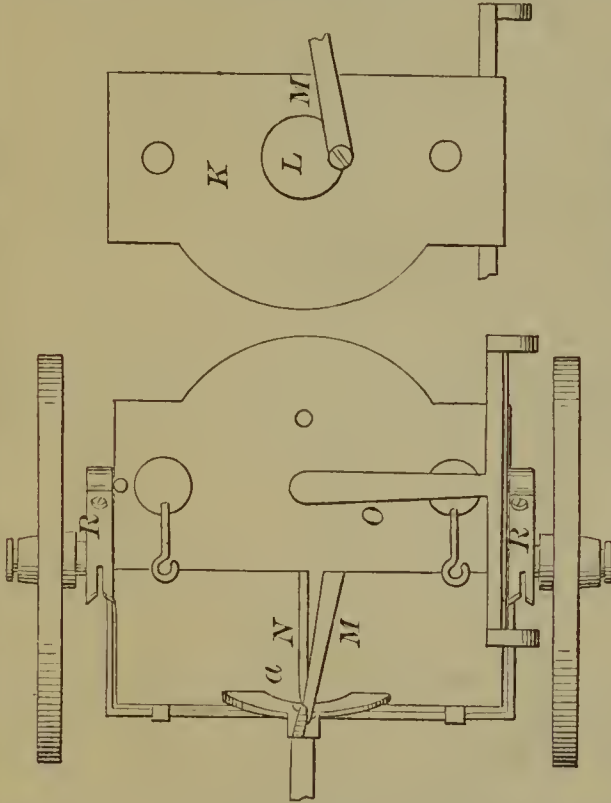

54170—J. W. Jones—*Knife for Removing Corn from the Cob.*



54172—Kee & Sloan—*Ash Box.*

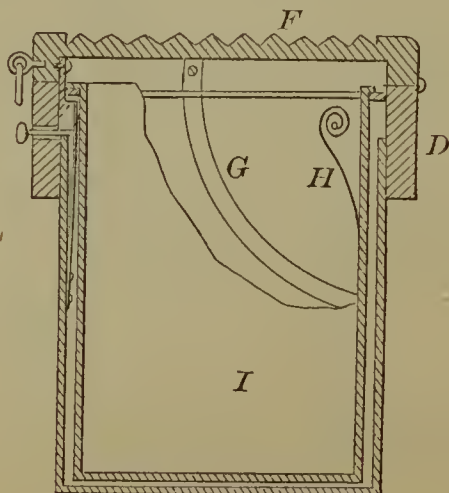

54171—D. C. Jordan, Sr.—*Hinge.*

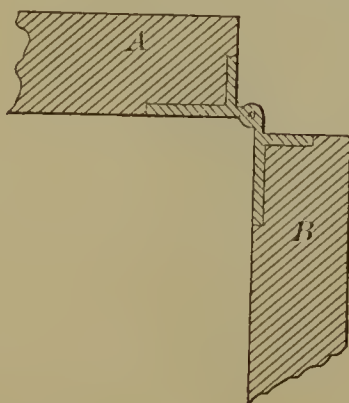

54173—W. Kendrick—Evaporating and Drying Apparatus.

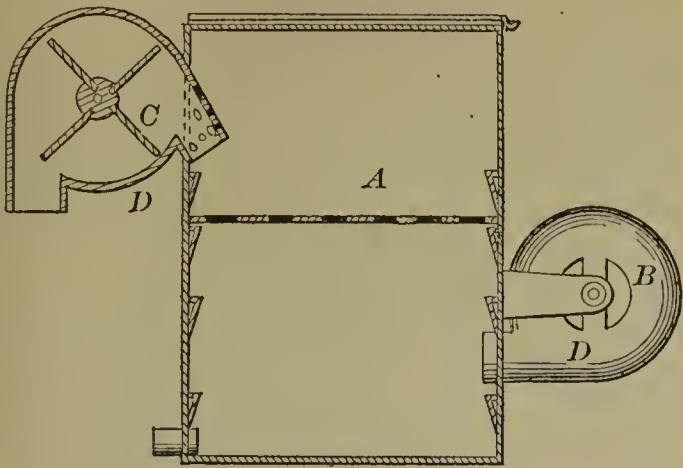

54176—W. B. Krum—Ox Yoke.

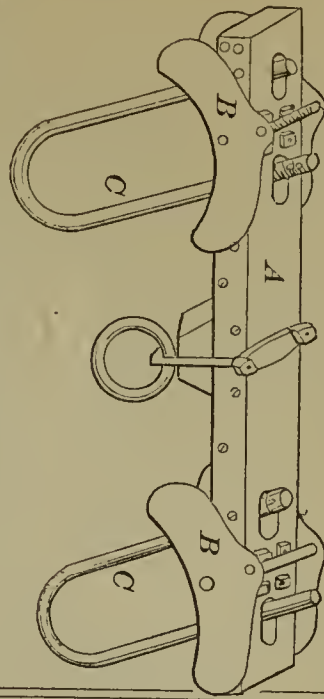

54175—T. A. Kohn—Musical Clock.

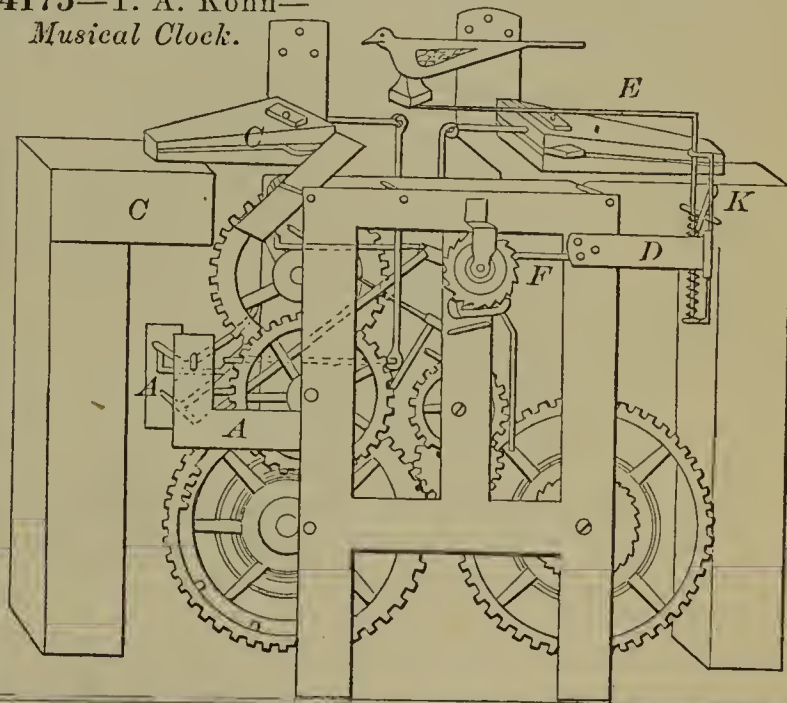

54174—G. G. Kniffin—Sad Iron.

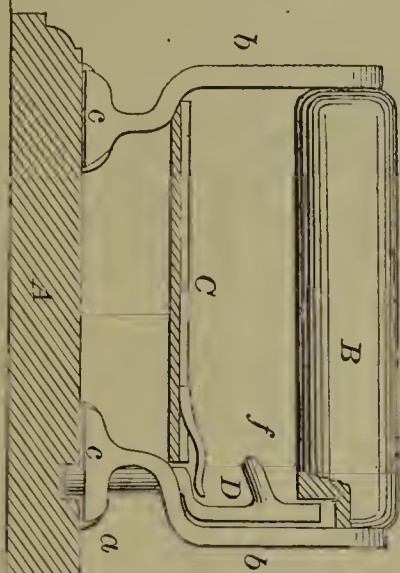

54177—I. Lancaster—Grain Binder.

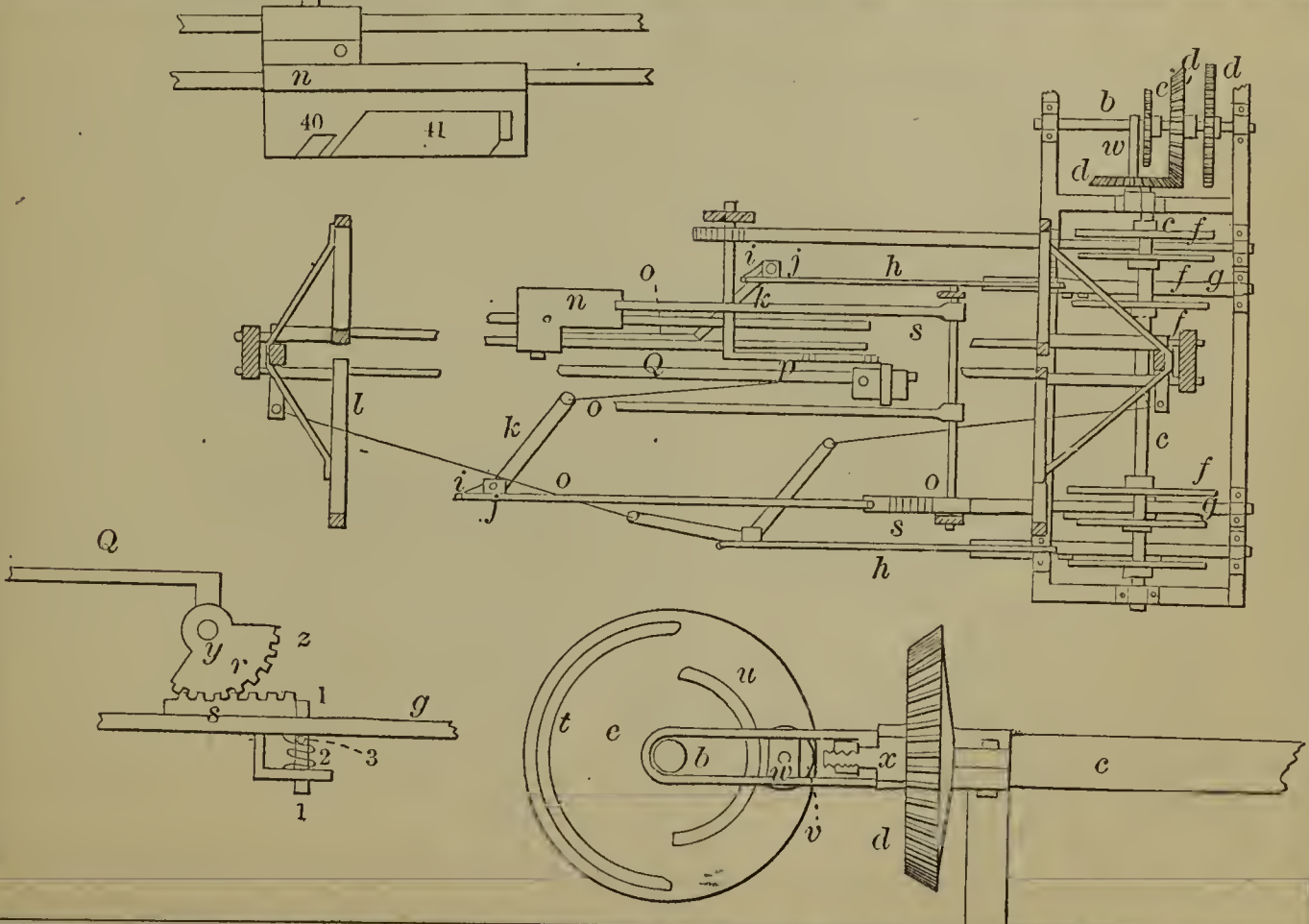

54177—I. Lancaster—*Grain Binder—Continued.*

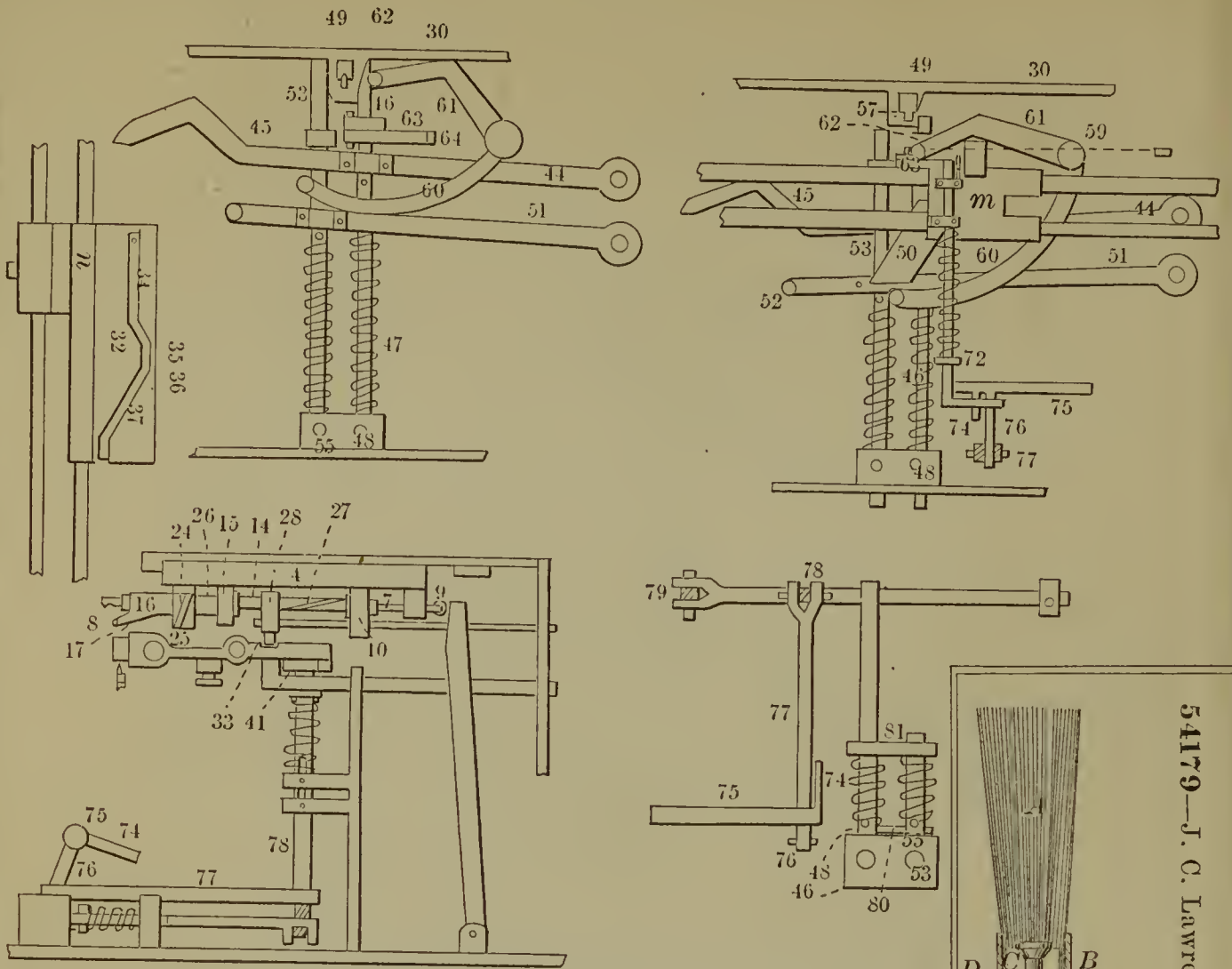

54179—J. C. Lawrence—*Brush.*

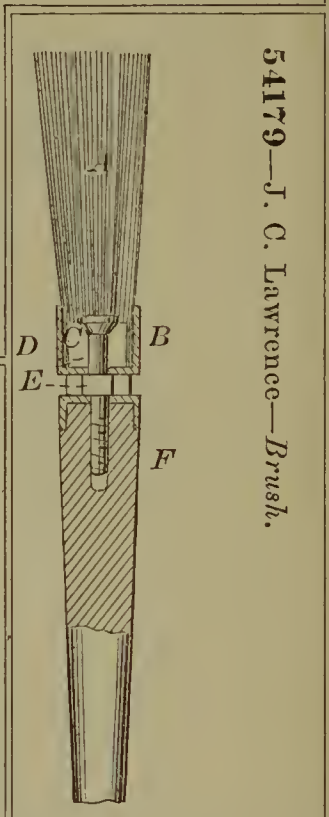

54178—W. H. Landbeck—*Wrench.*

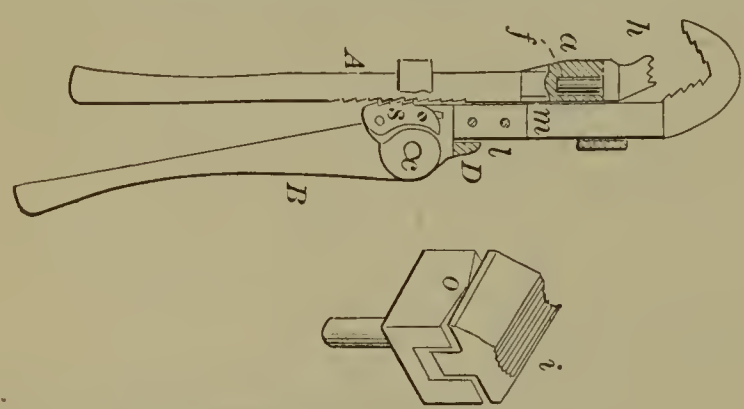

54182—Lewis & Bailey—*Sealing Fruit Cans.*

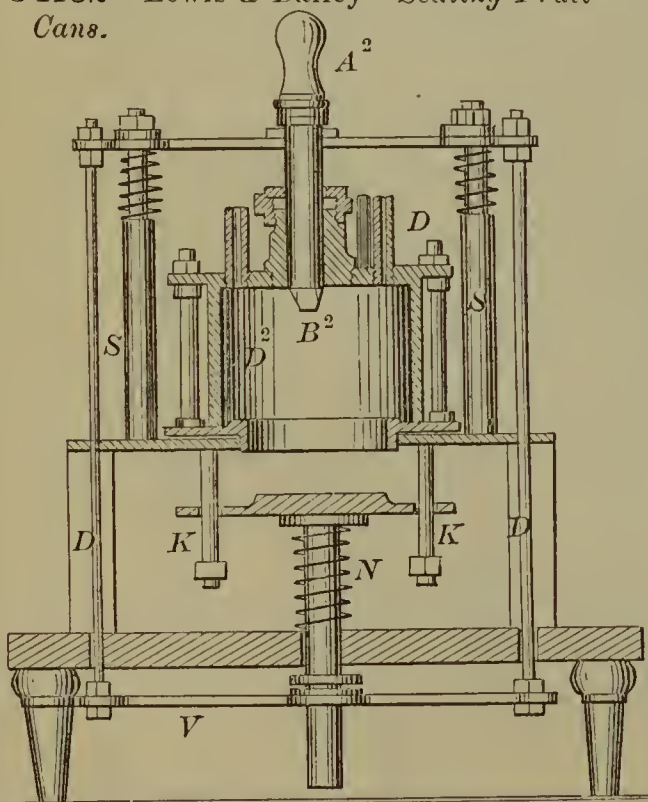

54180—C. Learned—*Cutting Lath.*

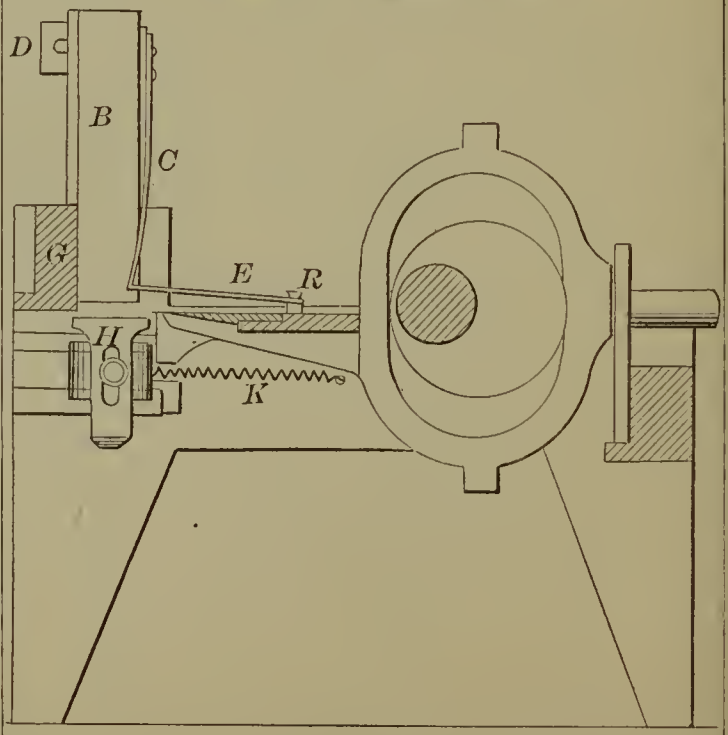

54183—J. Mae Donough—*Submarine Torpedo.*

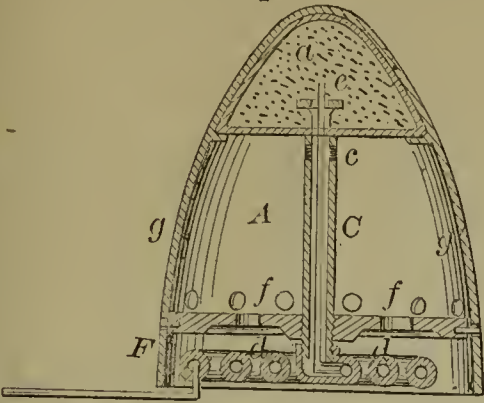

54186—S. Marden—*Peat Machine.*

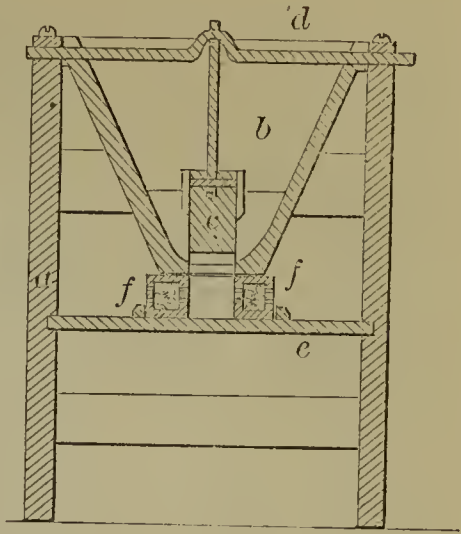

54185—Mann & Hisc—*Ventilating Car Windows.*

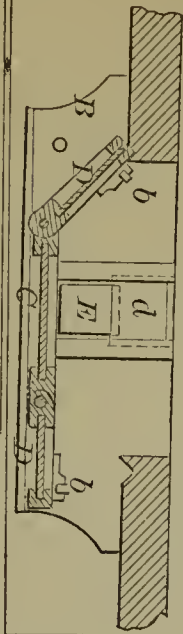

54184—G. Mallory—*Fan.*

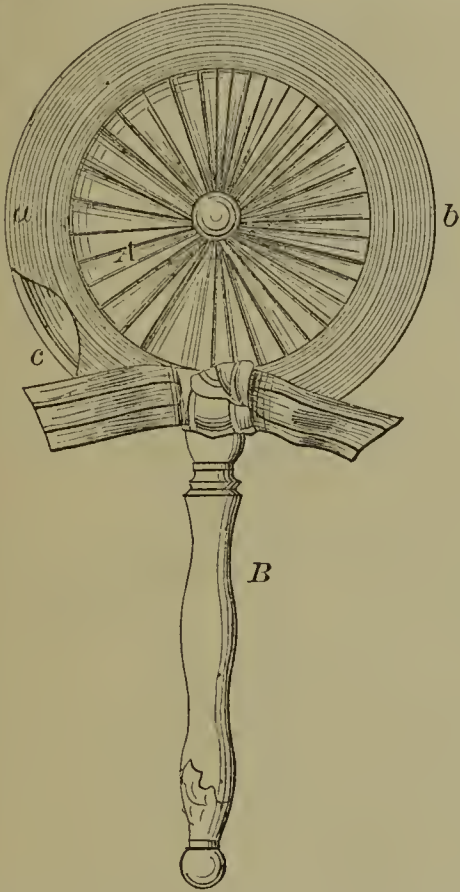

54187—D. W. Maurice—*Lathe.*

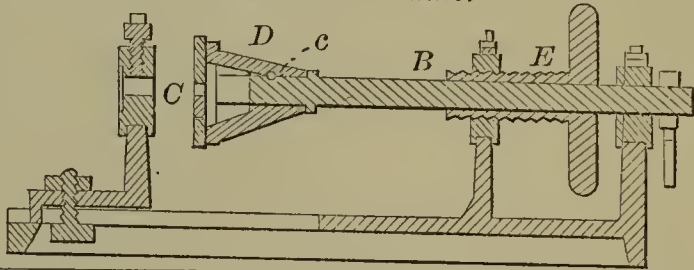

54190—

T. Mersereau—*Bag Frame.*

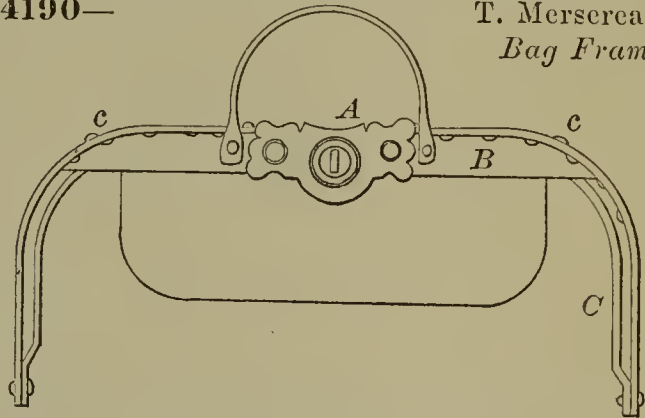

54188—D. F. Mellen—*For Threading Screw Blanks.*

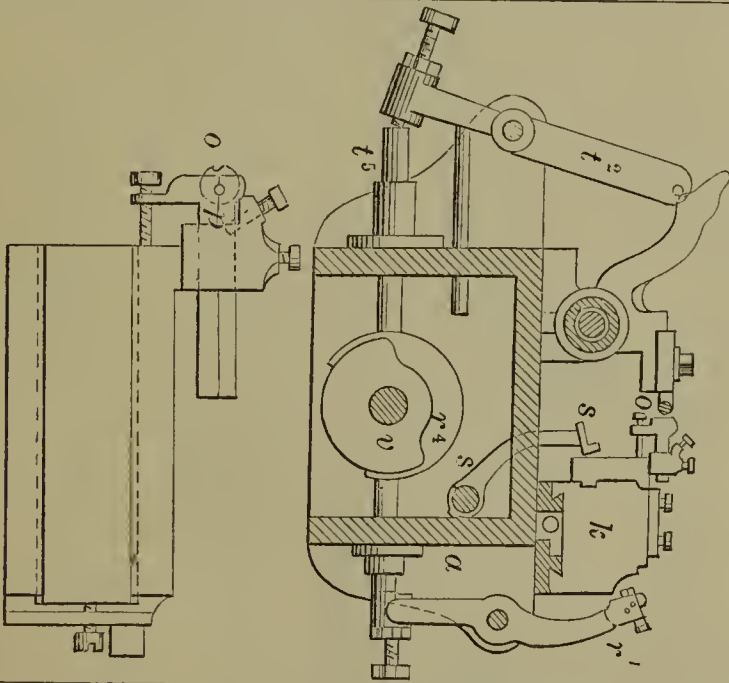

54191—J. E. Morrison—*Cultivator.*

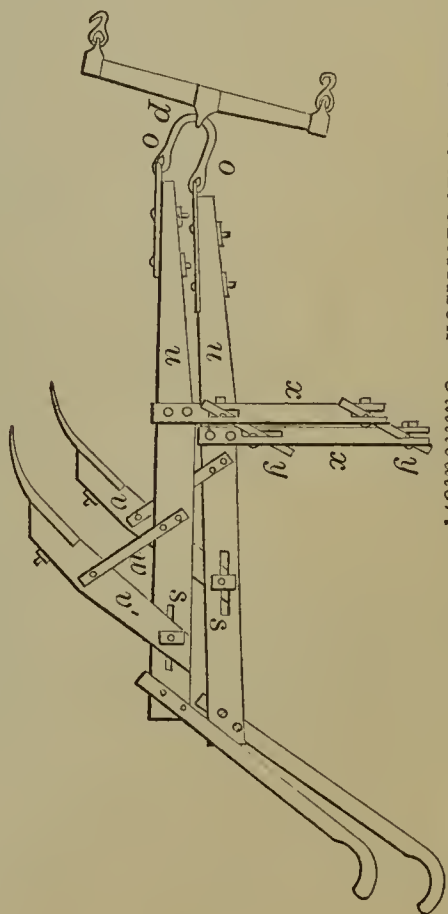

54189—D. H. Merriam—*Knife Handle.*

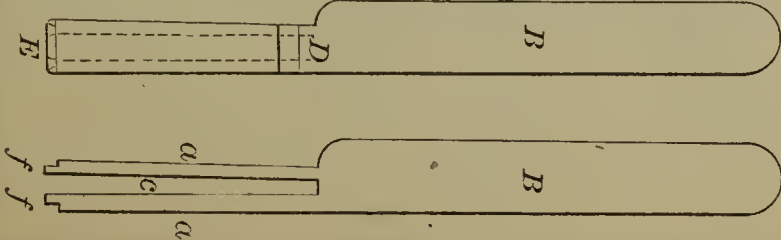

54193—Murray & Oakes—Argand Gas Burner.

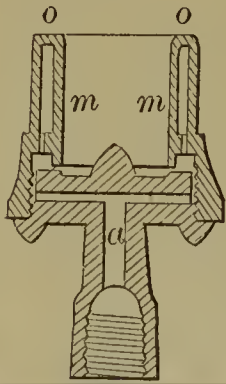

54195—P. H. Niles—For Soldering Tin Cans.

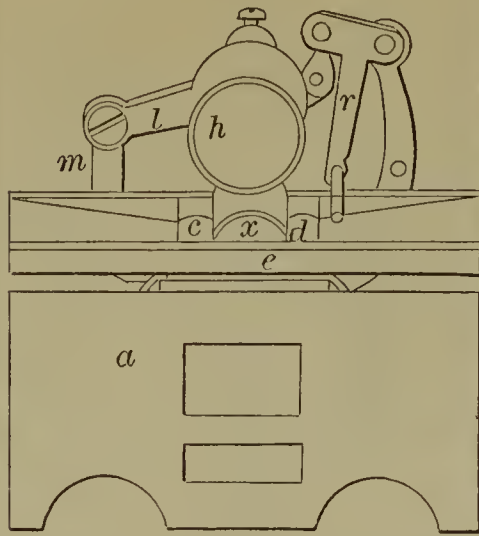

54196—H. P. Nide—Sorghum Evaporator.

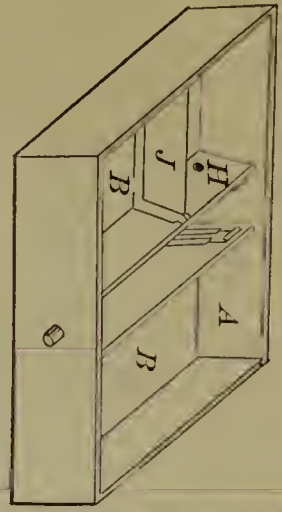

54201—R. G. Pike—Stopper for Bottles.

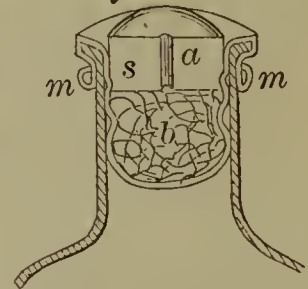

54200—G. W. Parsons—Broom Head.

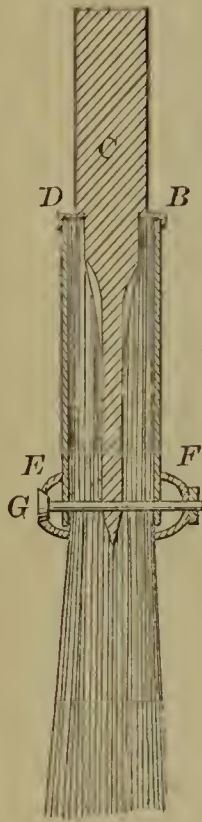

54202—R. Powers—Fire Alarm.

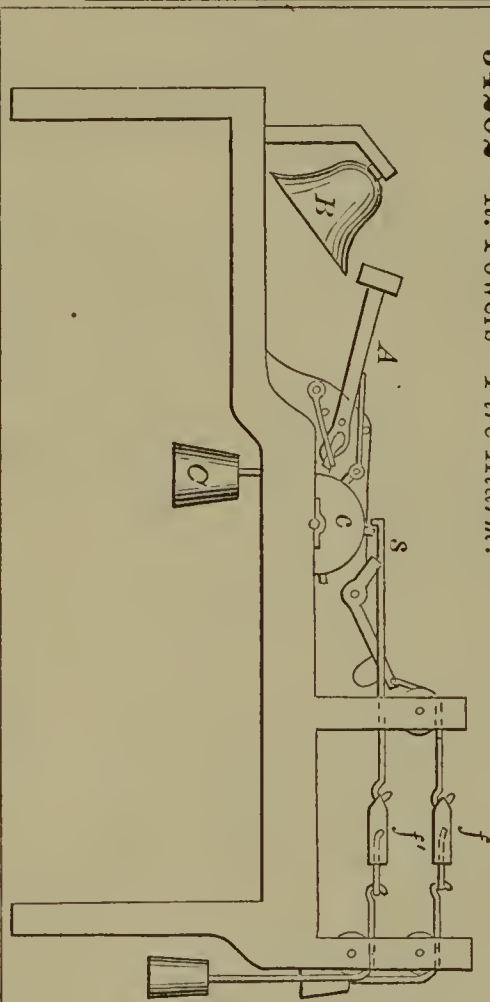

54198—G. B. Owen—Calendar Clock.

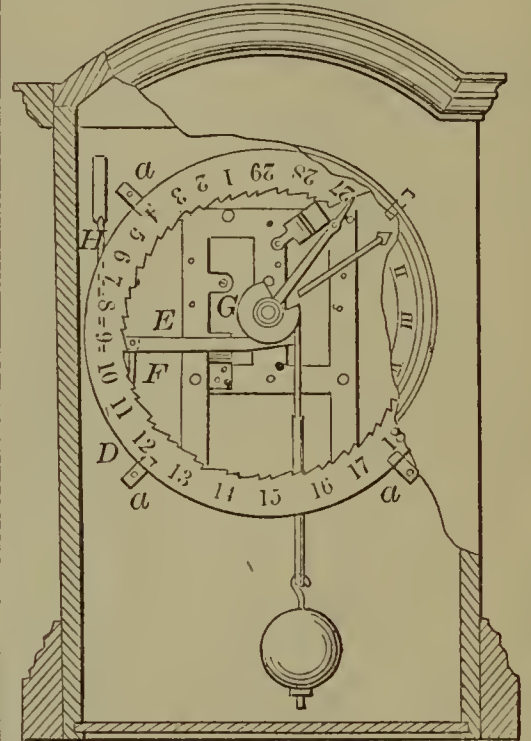

54199—H. Palmer—Drill for Artesian Wells.

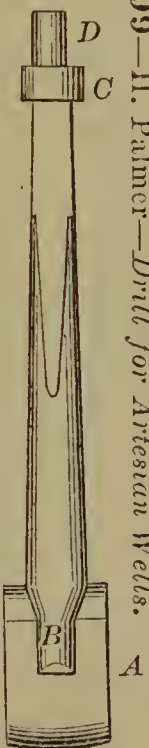

54197—S. R. Nye—Stove Pipe Damper.

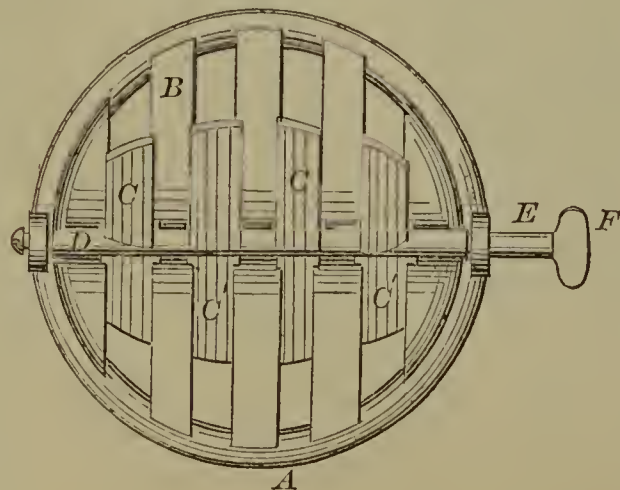

54204—J. L. Presby—For Moulding Crucibles.

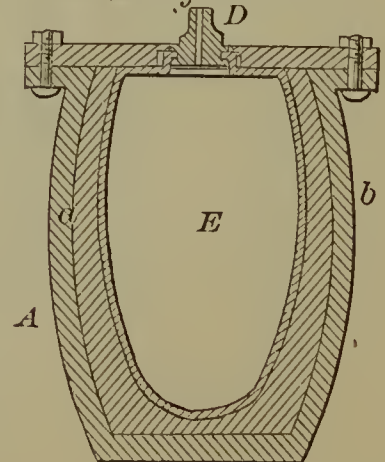

54205—R. Rafael—*Steam Generator.*

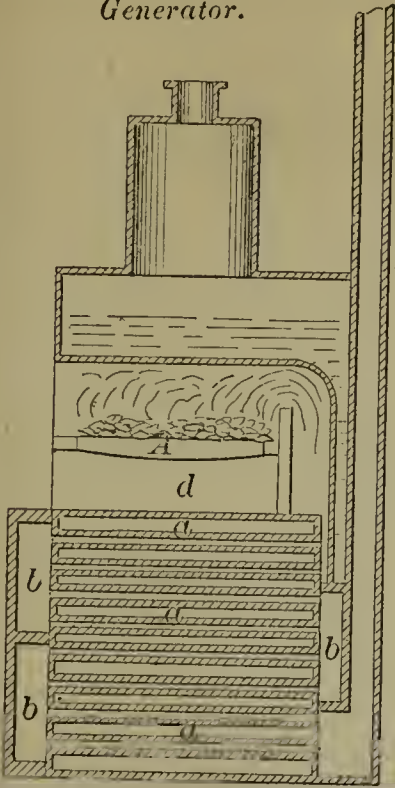

54207—H. A. Reynolds—*Velocipede.*

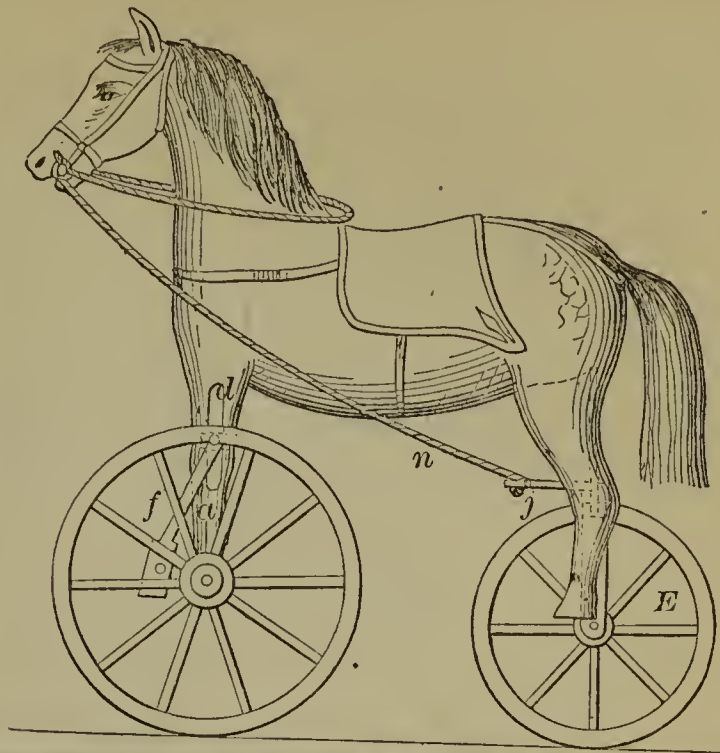

54206— J. H. Rector—*Saw Filing Machine.*

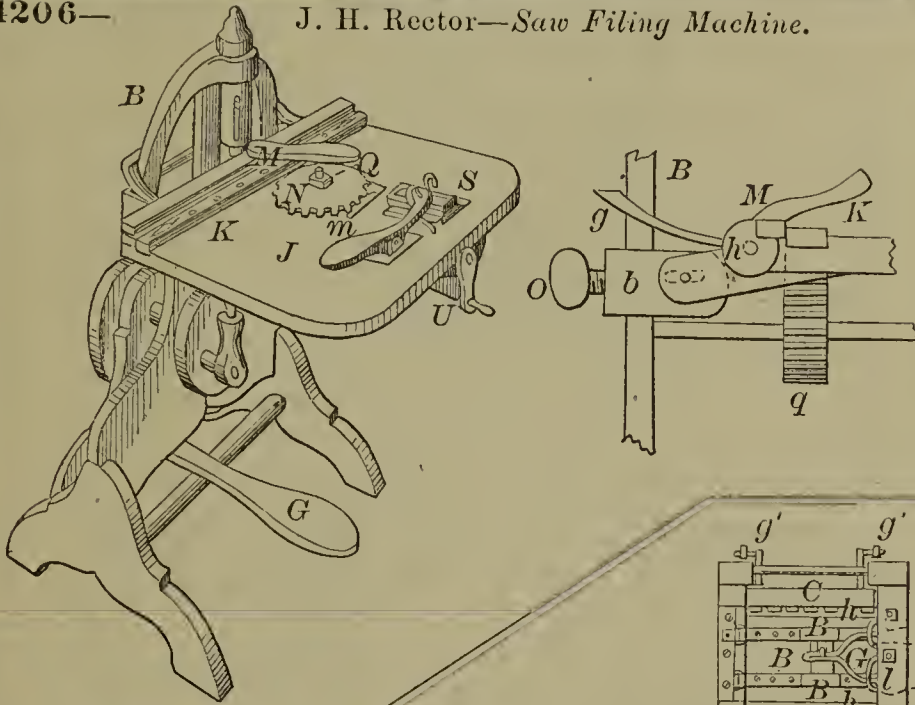

54208—J. E. Rice—*Picture Frame.*



54209—B. Roberts—*Hay Press.*

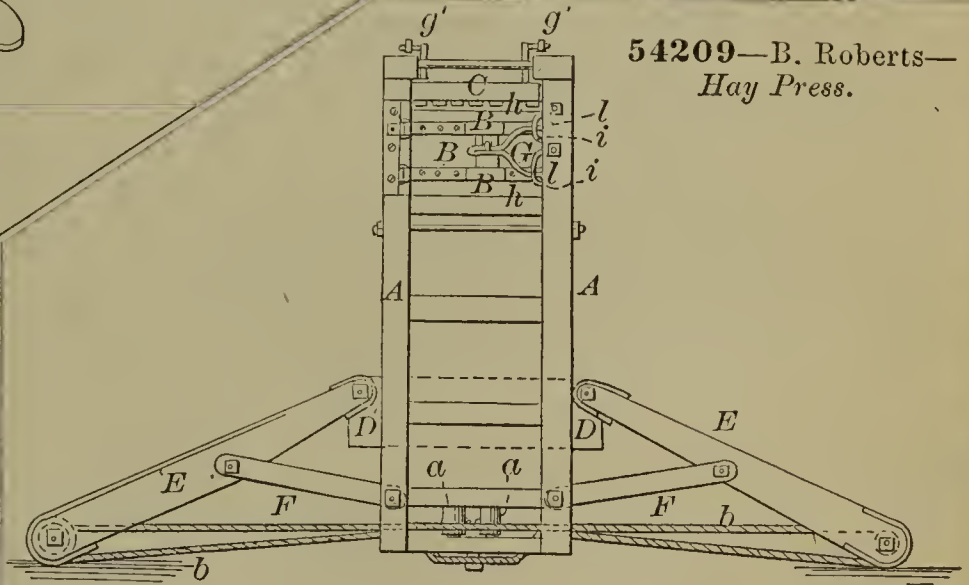

54210—D. T. Robinson—*For Cutting Tobacco.*

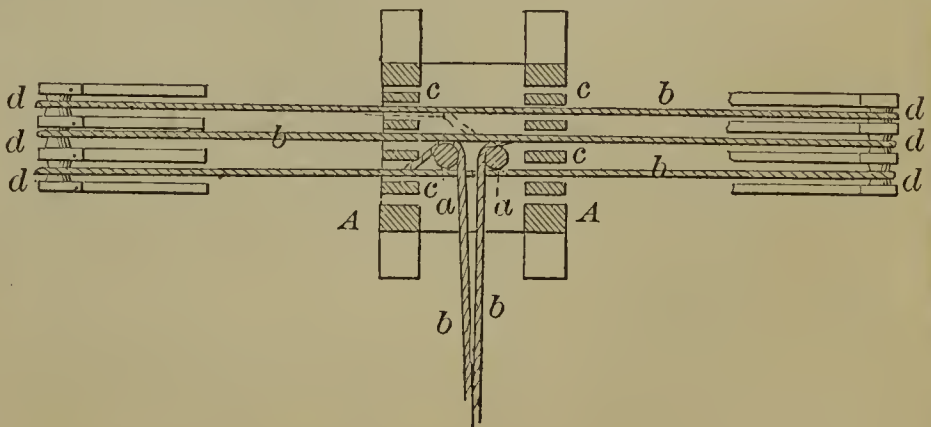
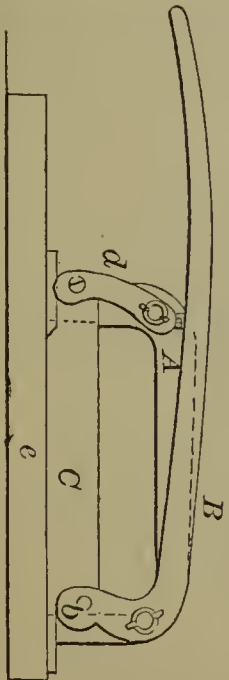

54211—Roys & Lillendahl—*Rocket Harpoon.*

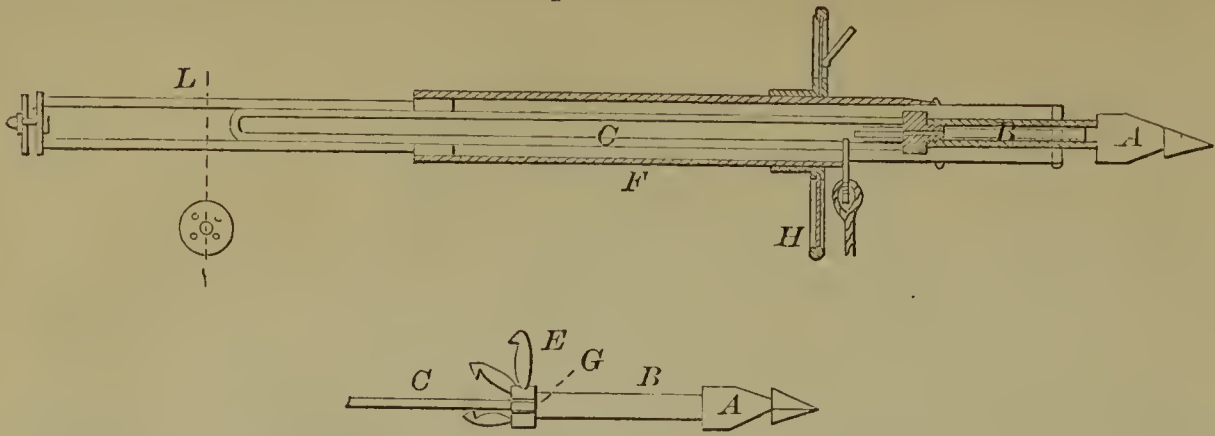

54213—C. Rundell—

*Hay and Straw Stacker.*

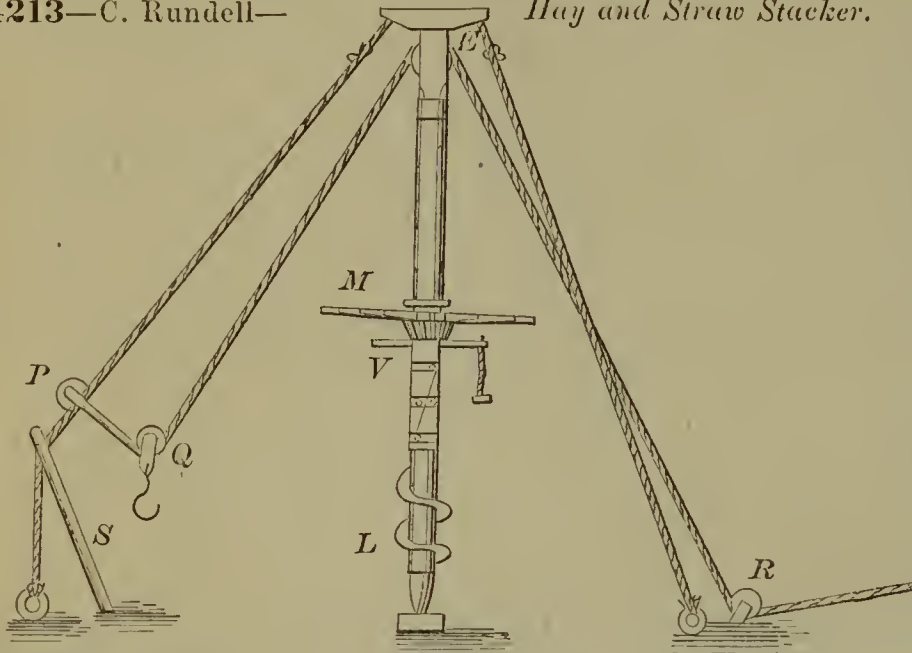

54212—S. P. Ruggles—*Shaft Coupling.*

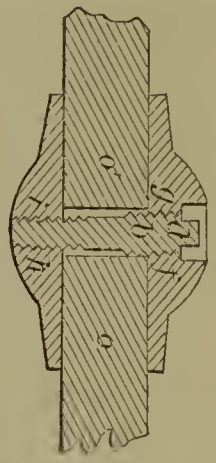

54214—S. C. Salisbury—*Retort for Generating Gas.*

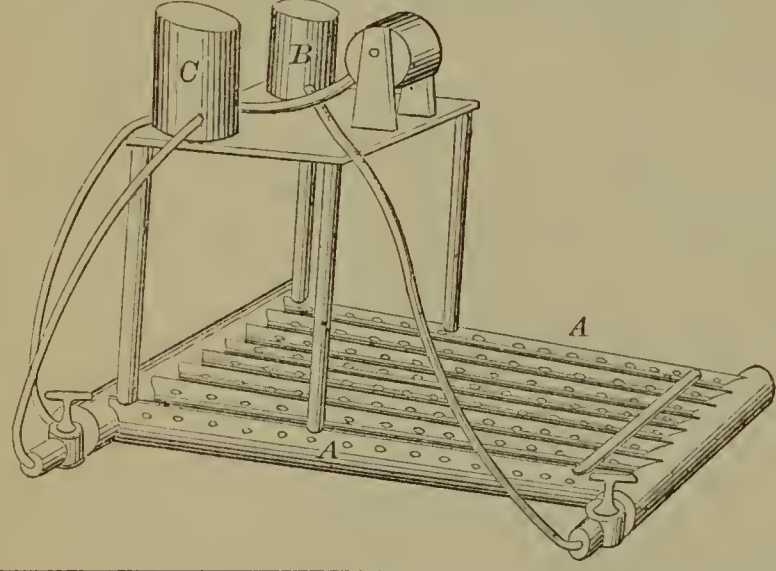

54216—S. C. Salisbury—*For Applying Oil and Water to Assist Combustion.*

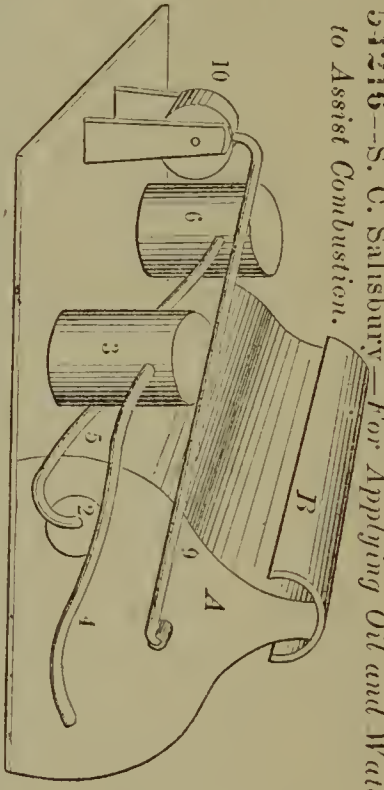

54215—S. C. Salisbury—*Blast Furnace.*

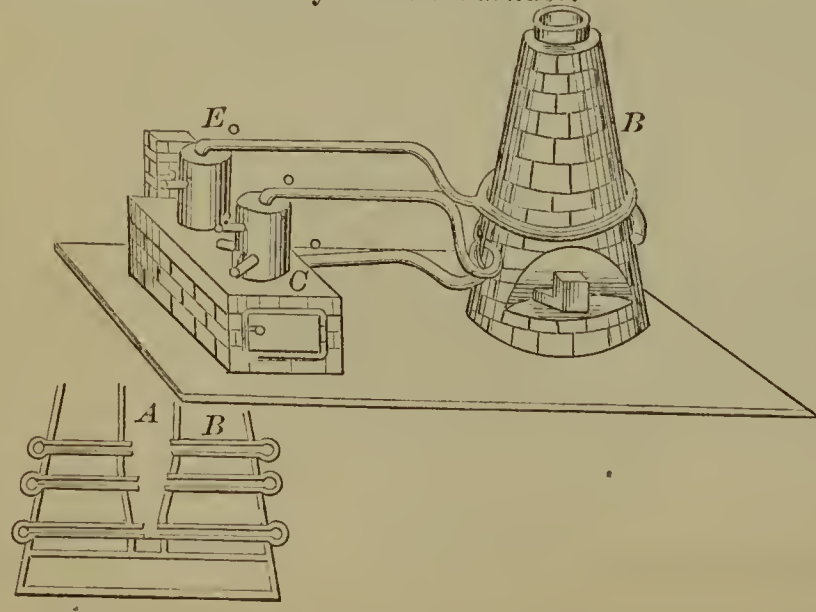

54217—J. F. Sargent—*Chair.*

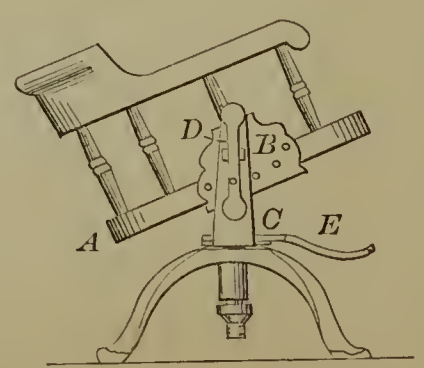



54218—H. A. Schesch—*For Distilling.*

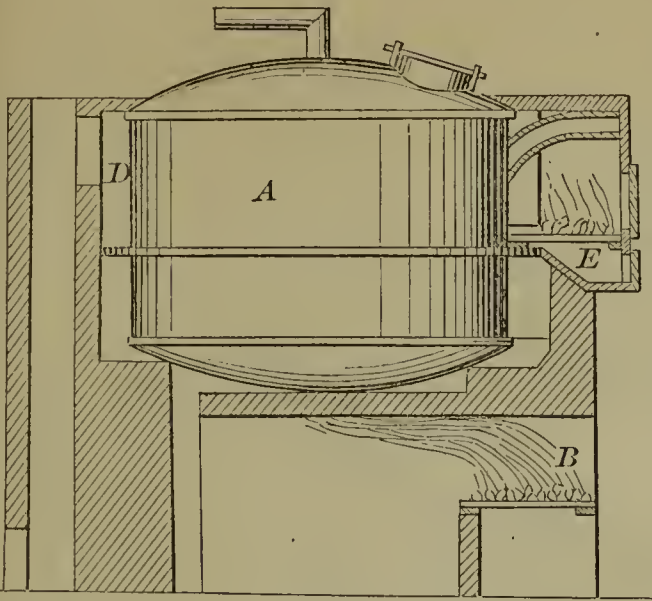

54219—P. & P. J. Schmitt—*Grain Drill.*

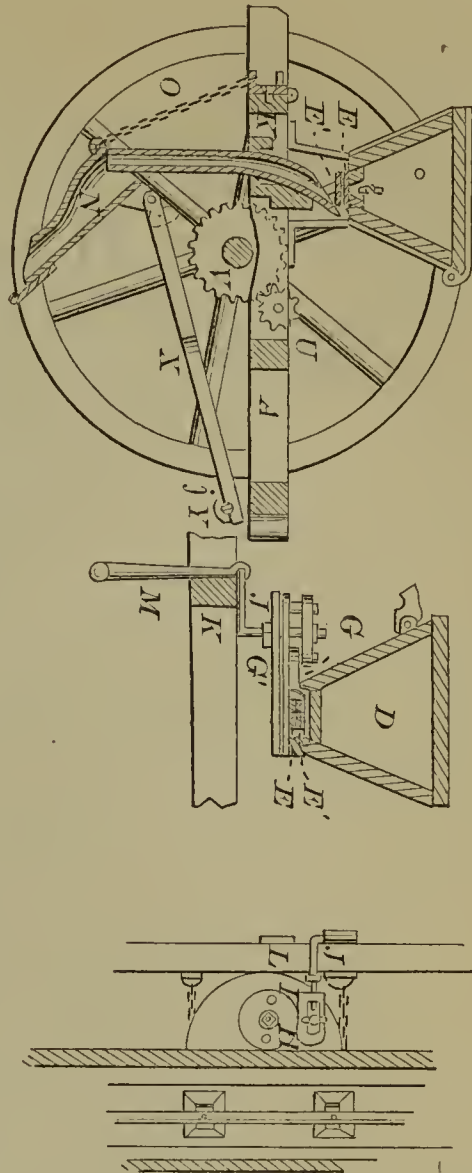

54220—J. A. Schule—*Motive Power.*

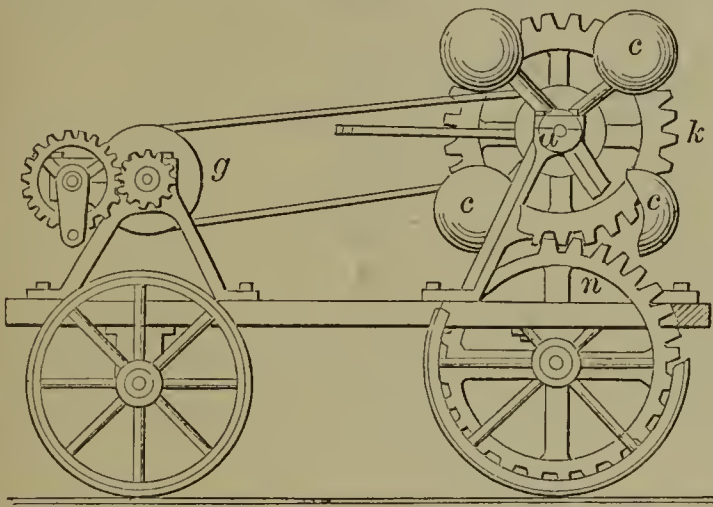

54221—J. M. Seudder—*Disinfecting Apparatus.*

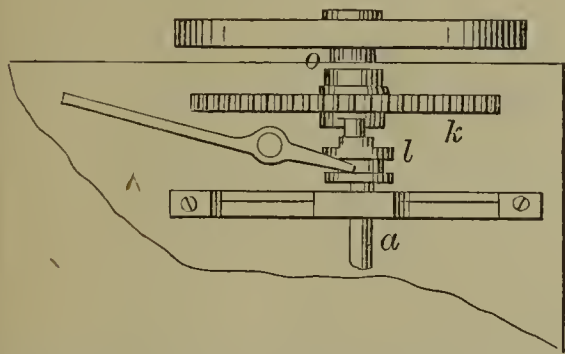
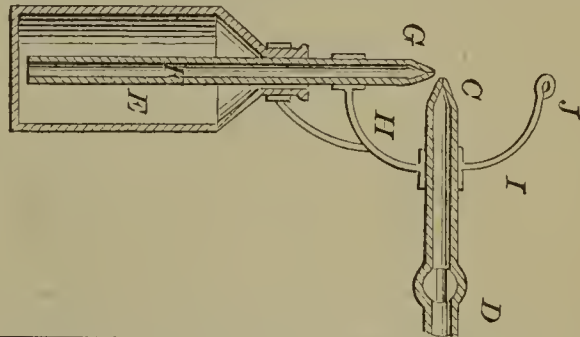

54222—J. M. Seymour—*For Tenoning Blind Slats.*

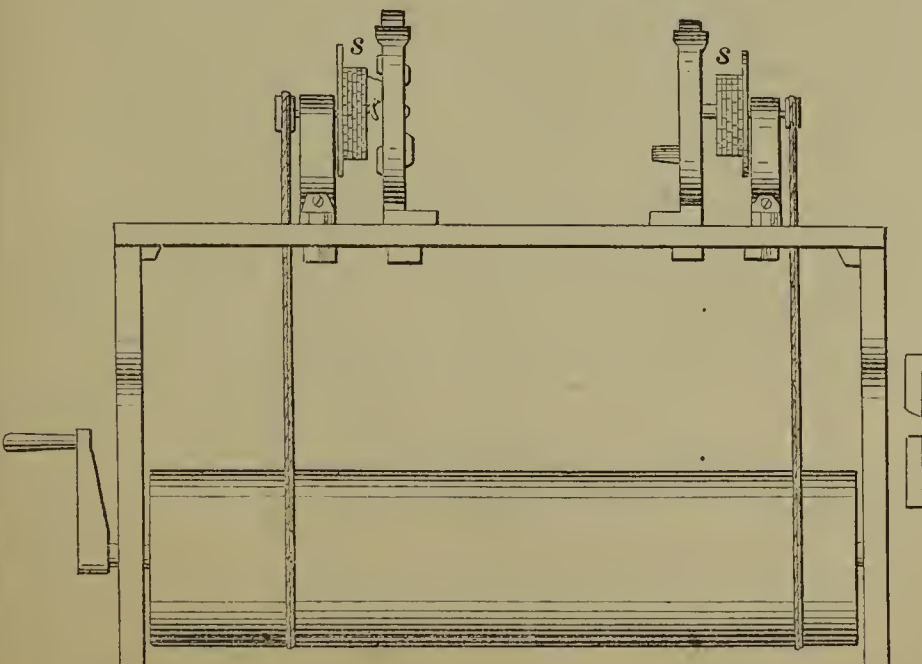

54223—J. Shepard—*Meat and Vegetable Cutter.*

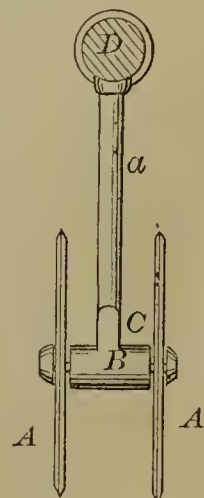

54224—G. Simonson—*Steam Plow.*

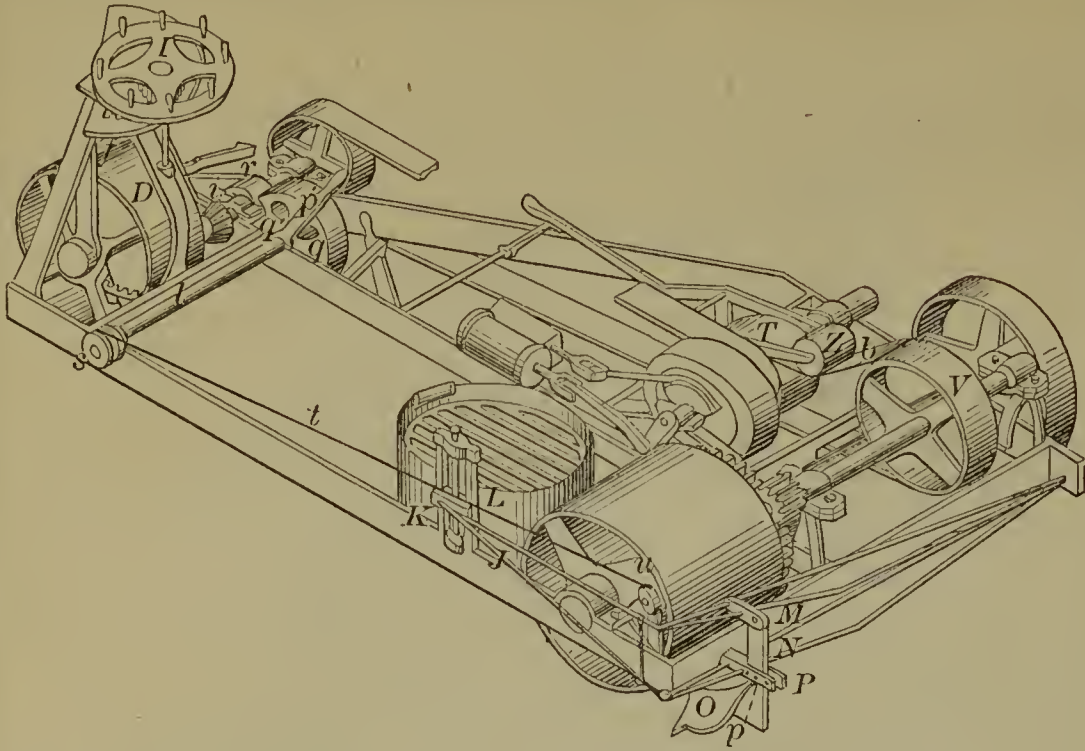

54226—J. V. Smith—*Rock Drill.*

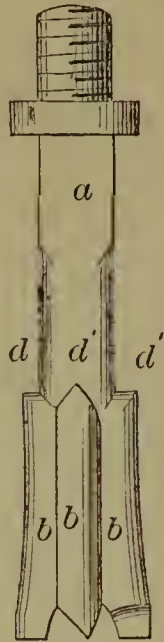

54227—J. B. Smyth—*Car Spring.*

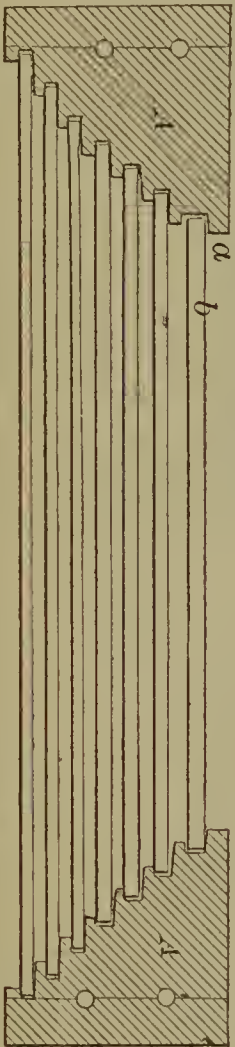

54228—E. R. & W. P. Spear—*Horse Rake.*

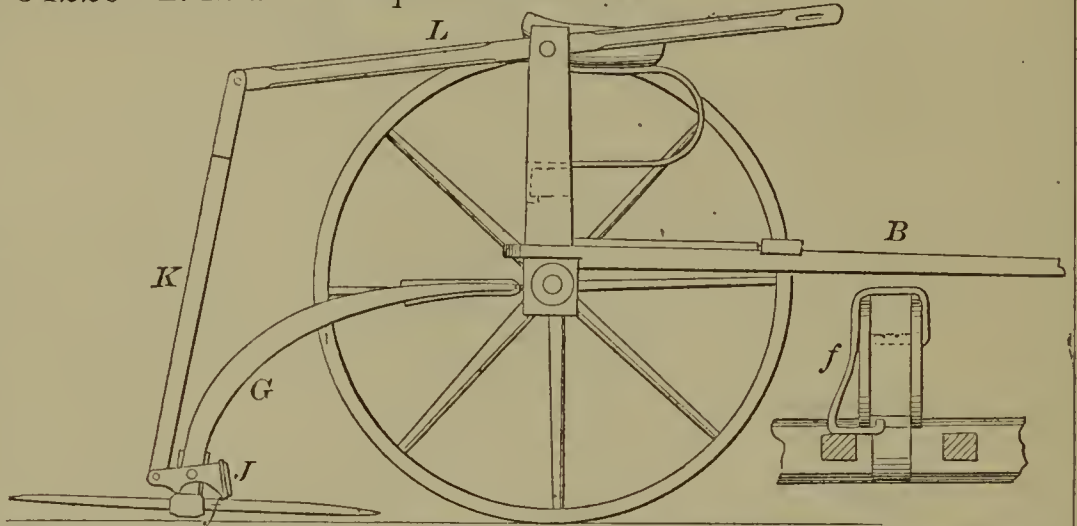

54225—H. M. Smith—*Water Elevator.*

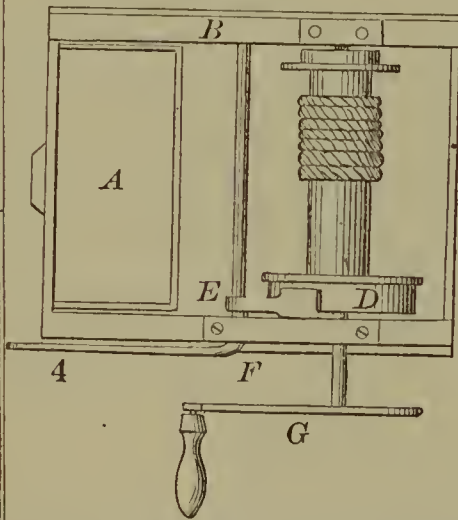

54229—W. J. Tait—*Gauging Rod.*

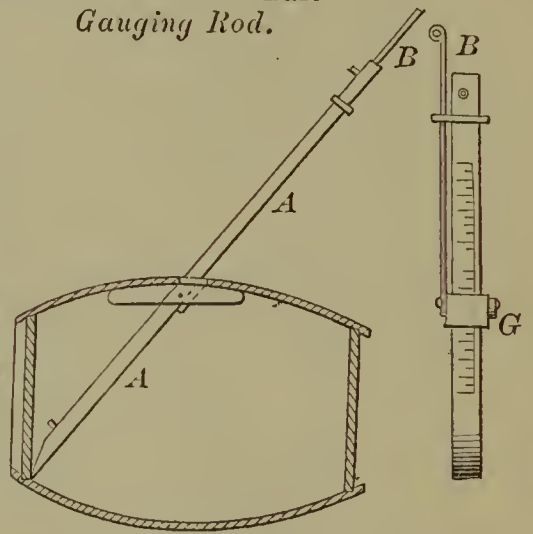

54230—E. A. Thomas—

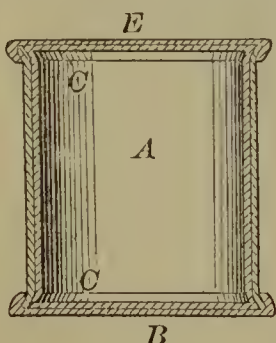

*Can for Caustic Alkali.*

54231—T. Thomasson—*Evaporator.*

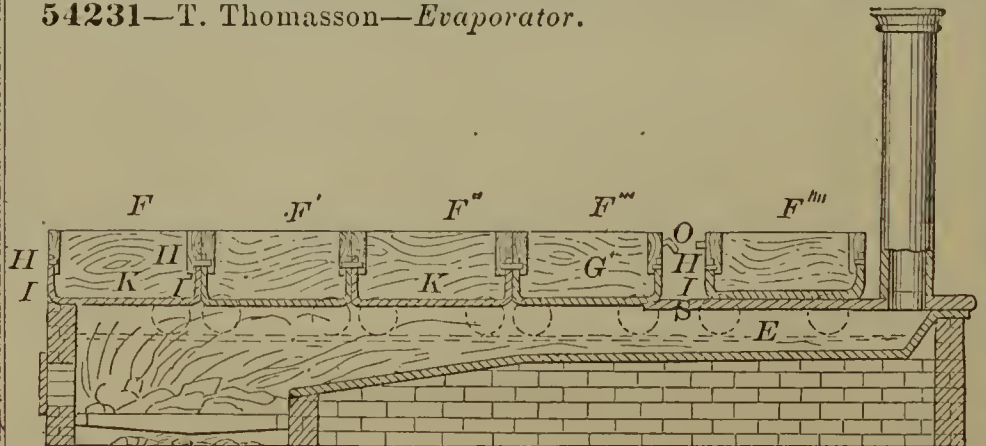

54232—T. Tufts—*Tree Protector.*

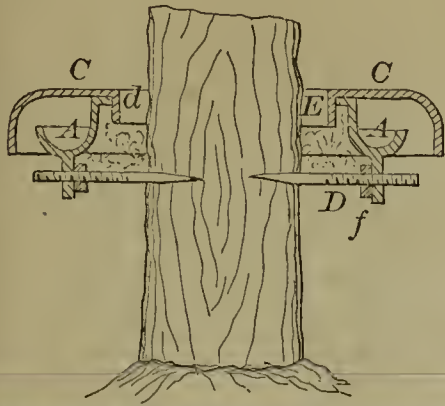

54234—A. T. Watson—*Railroad Car Spring.*

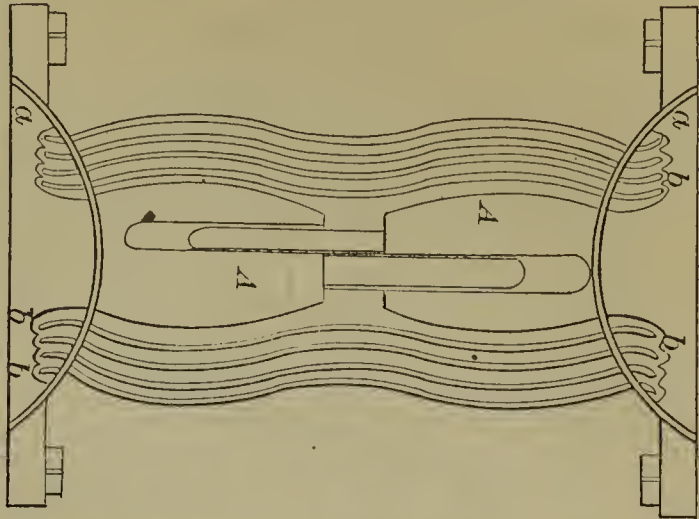

54233—W. Van De Sande—*Heating Stove.*

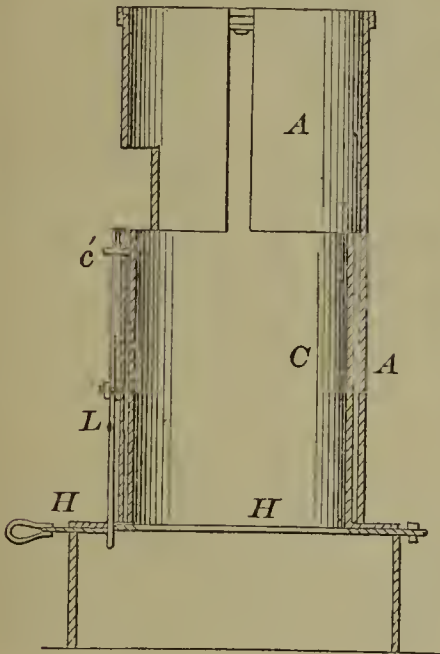

54236—J. W. Wetmore—*Railroad Chair.*

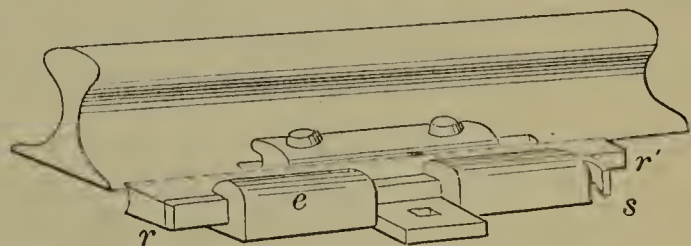

Fig. 2

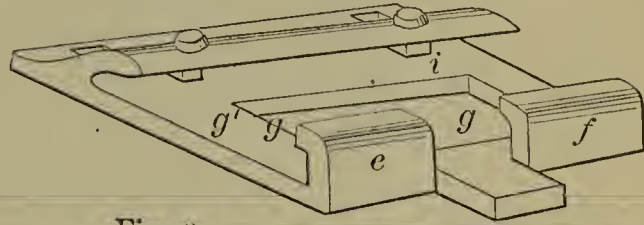
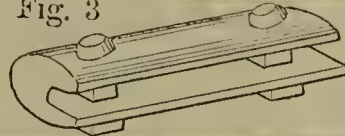
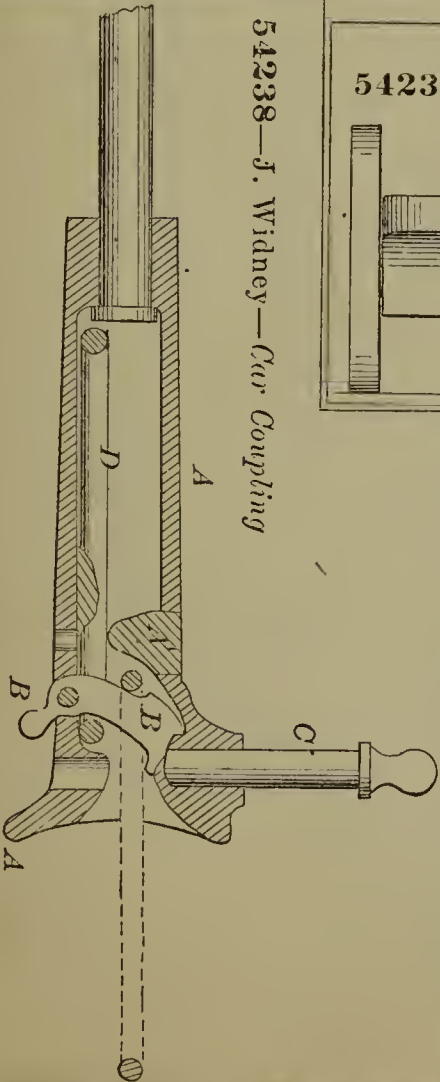

Fig. 3



54238—J. Widney—*Car Coupling.*



54235—G. Wellhouse—*Harvester Rake.*

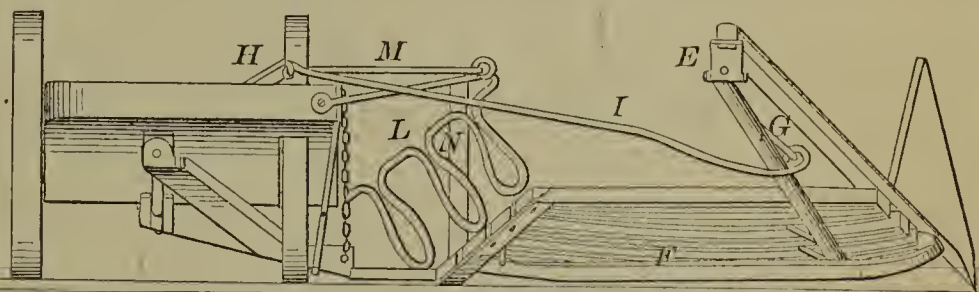

54237—C. O. Wheeler—*Car Coupling.*

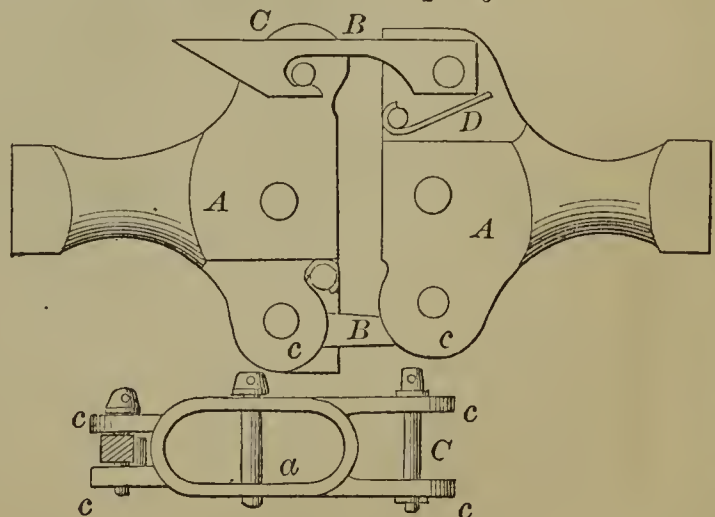

54239—Wilhelm & Larimore—Lamp Chimney Lifter.

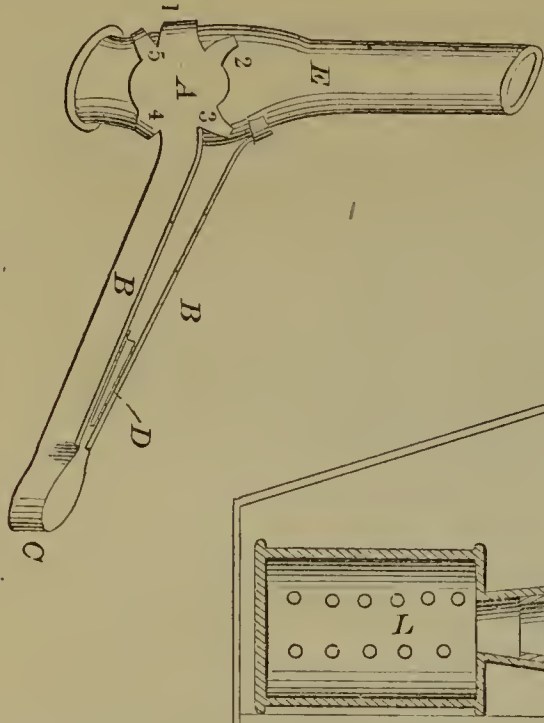

54243—R. Yoilding—For Burning Tar.

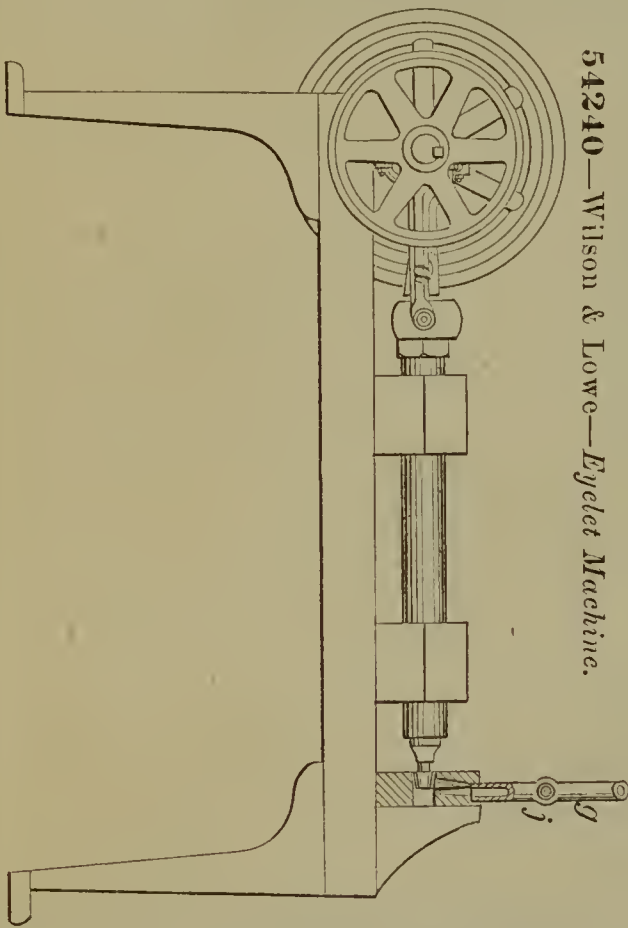
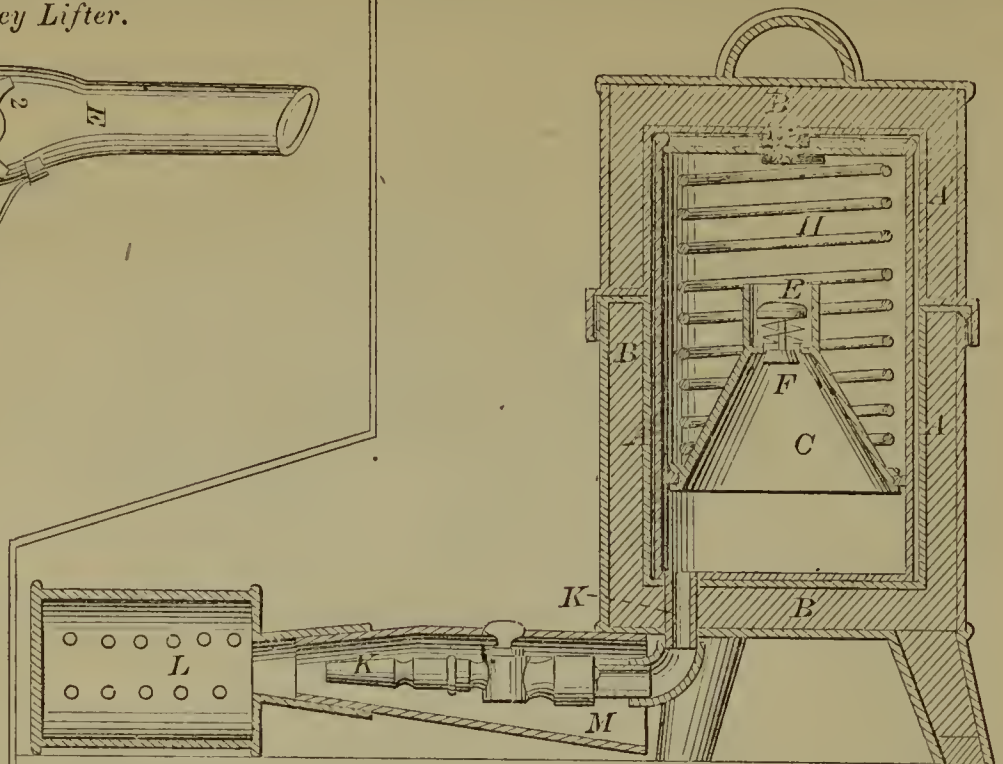

54240—Wilson & Lowe—Eyelet Machine.

54241—G. Wolf—Animal Trap.

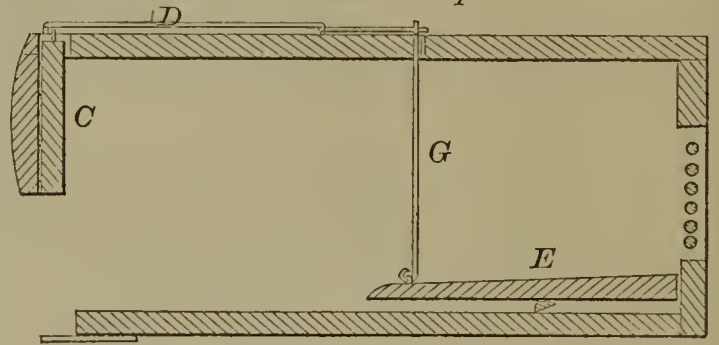

54242—T. J. Wrangham—Well Windlass.

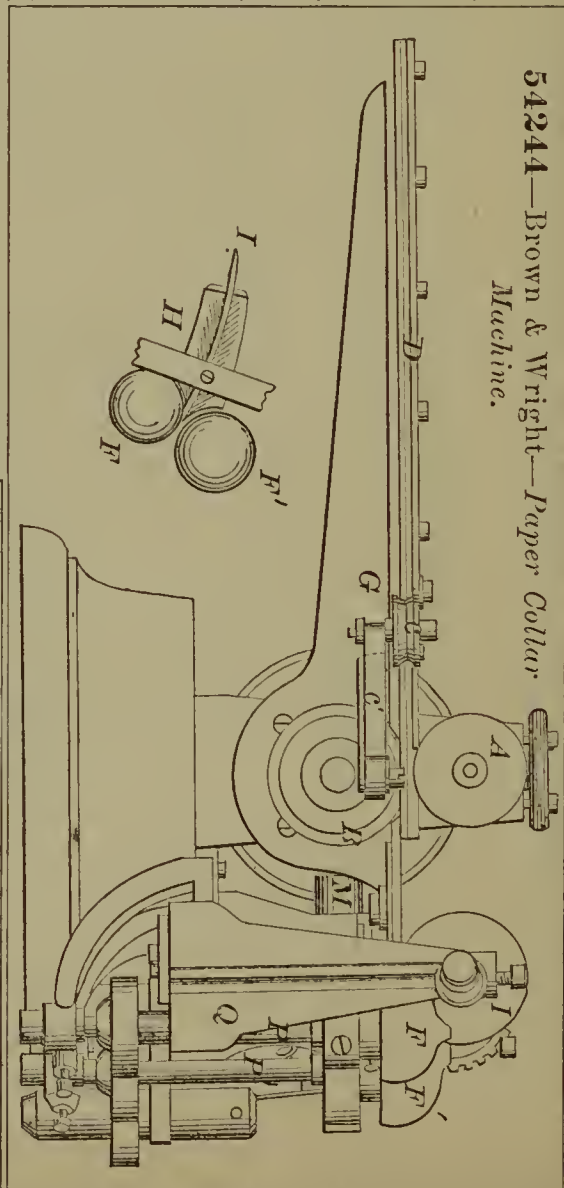
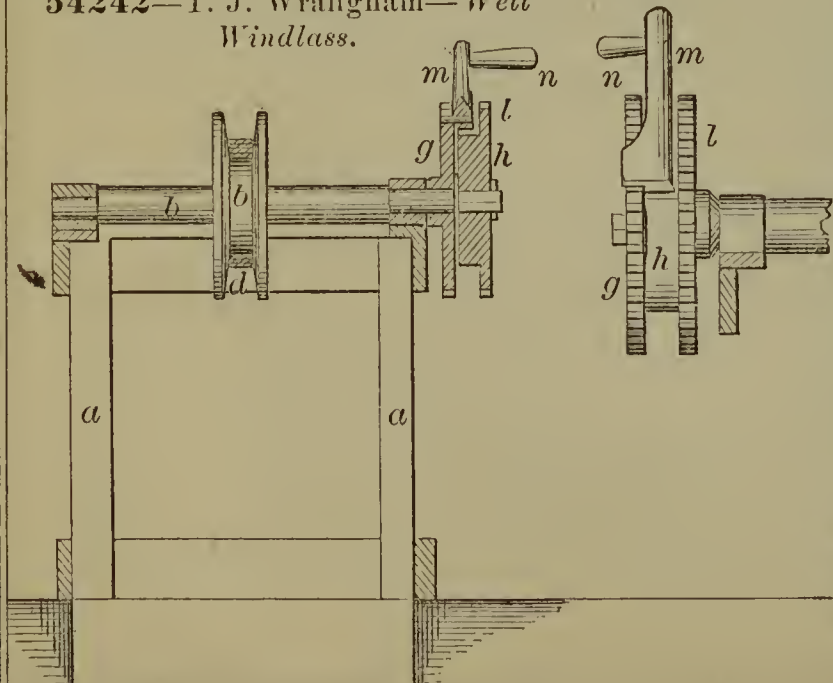

54244—Brown & Wright—Paper Collar Machine.

54245—T. S. Brown—*Seat for Harvester.*

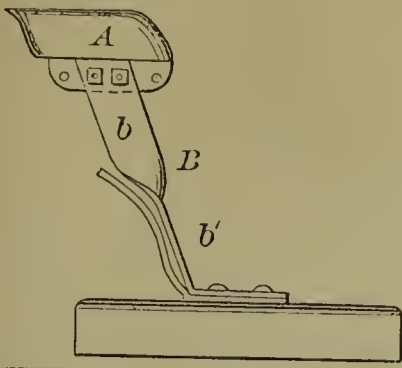

54247 J. N. Dennisson—*Fire Engine and Pump.*

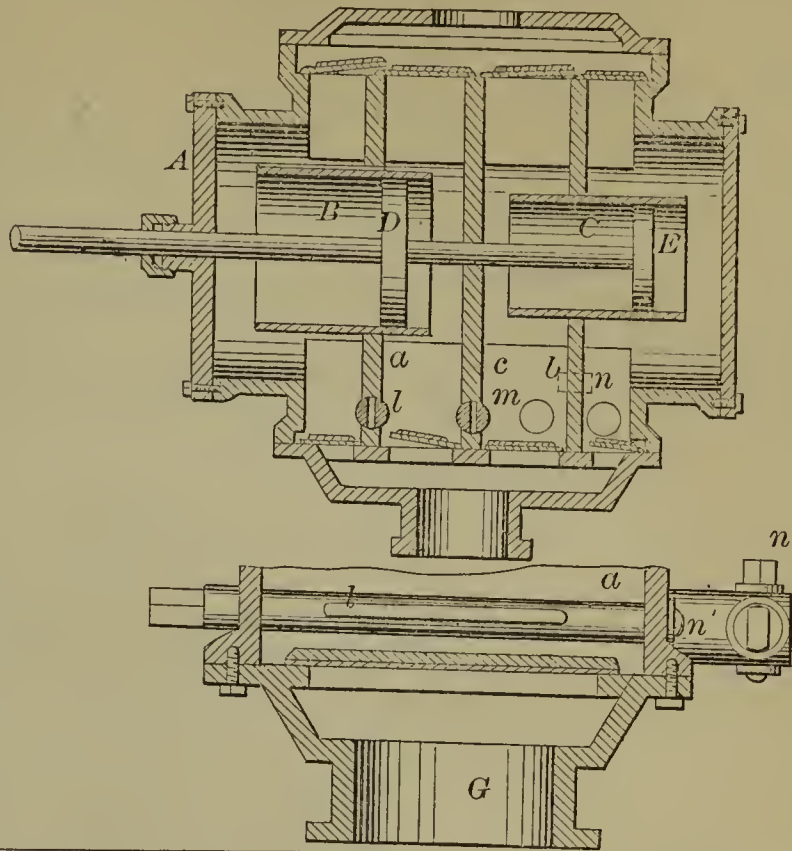

54246—N. B. Brown—*Device For Lubricating Axles.*

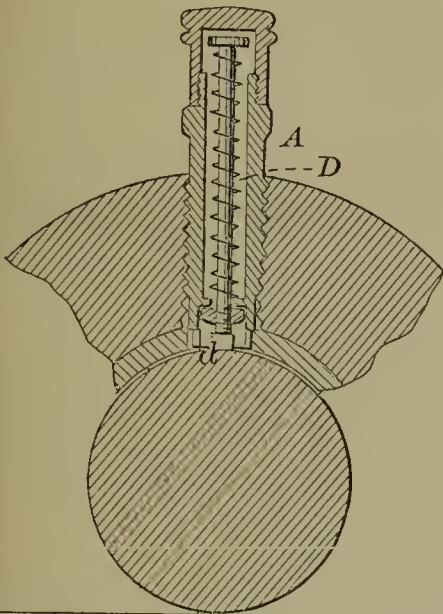

54249—D. P. Farnham—*Broom.*

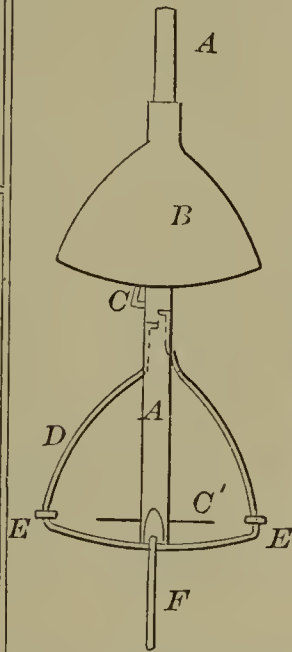

54250—G. L. Holt—*Oil Can.*

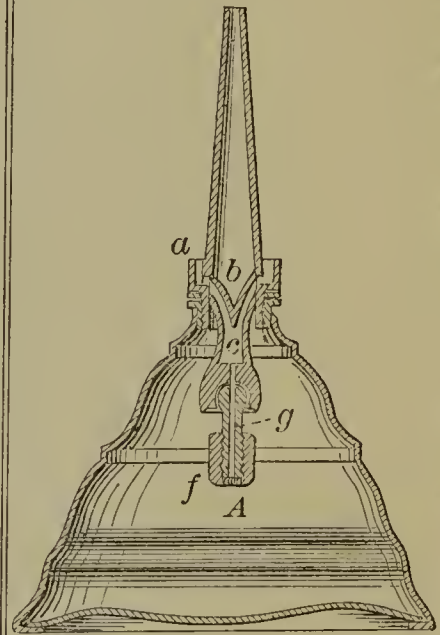

54248—N. P. Eddy—*Machine Drill.*

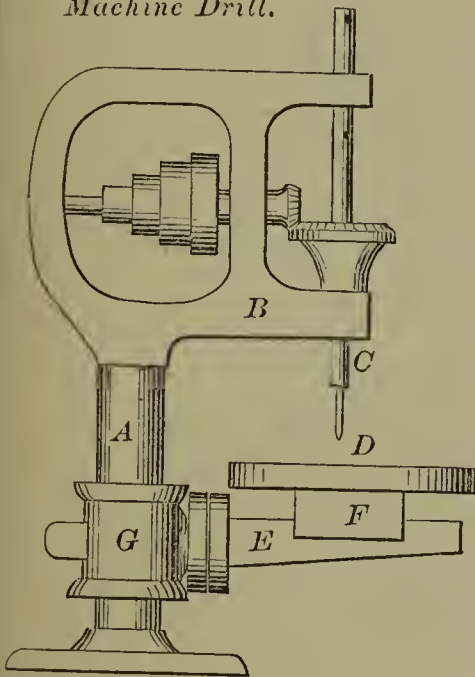

54252—Knight &

Millward—*Syrup Fountain.*

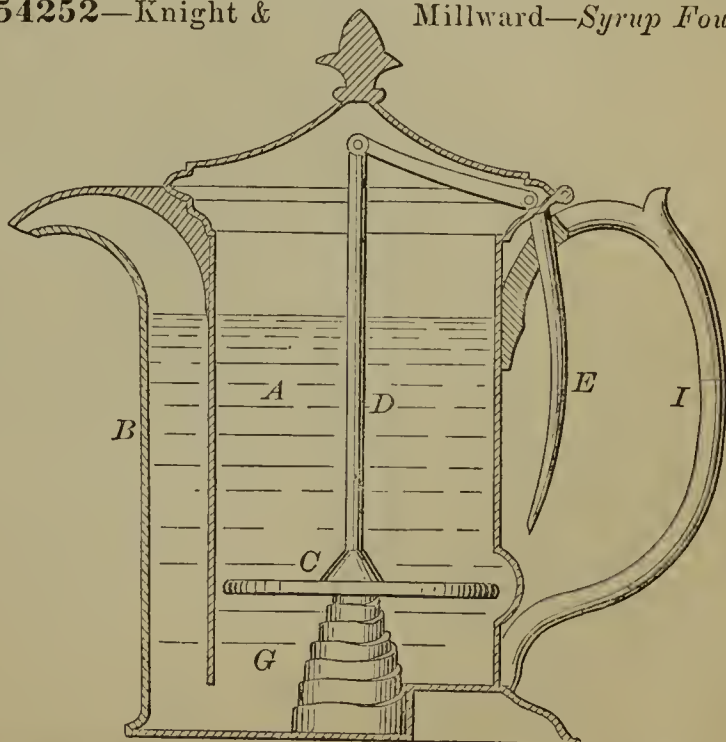

54251—Johnson & Howarth—*Fish Hook.*

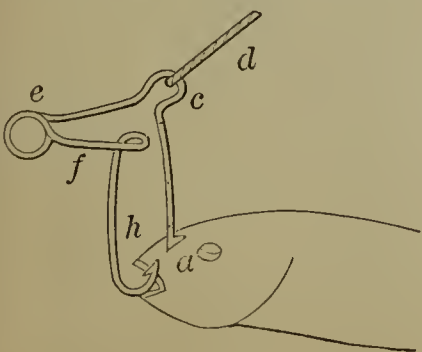

54253—W. W. Knowles—*Carriage Shackle.*

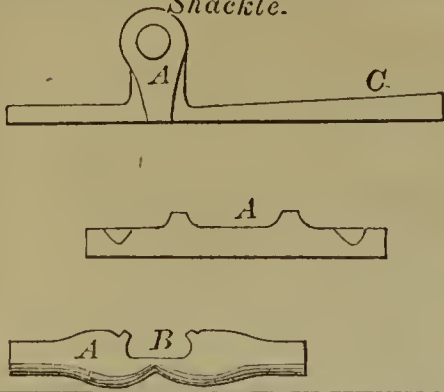

54254—T. J. Powers—*Priming Metallic Cartridges.*

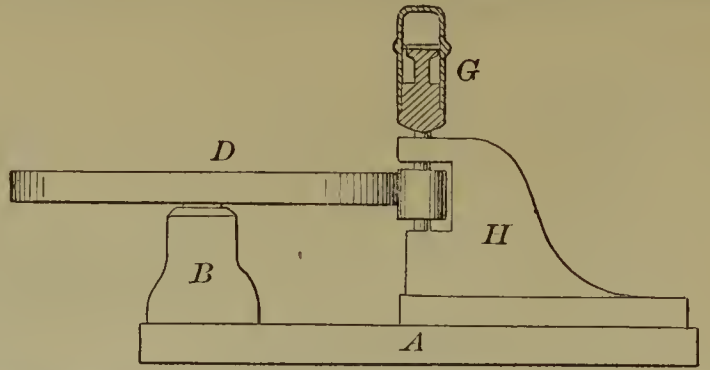

54257—G. W. Remington—*Watch Key.*

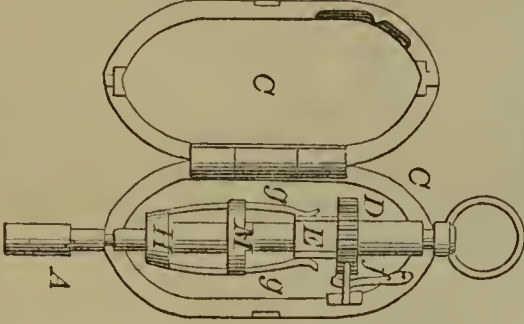

54258—L. Sauers—*Furrowing Hammer.*

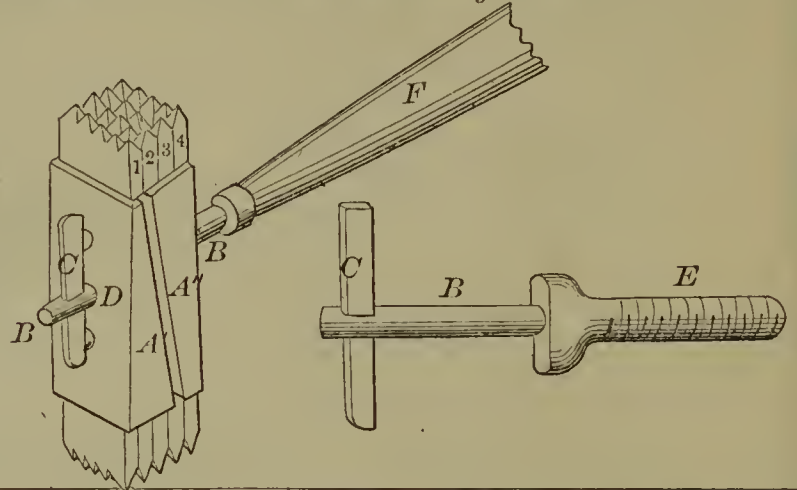

54255—T. J. Powers—*Making Cartridge Cases.*

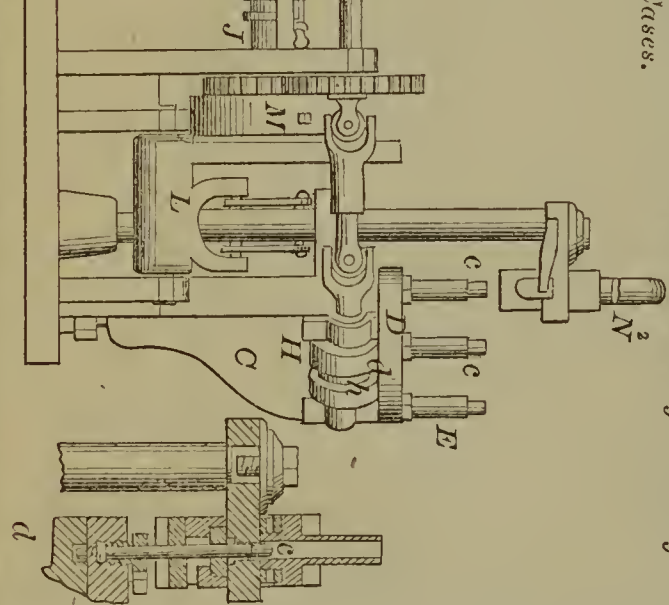

54256—Putnam & Dwelley—*Horse Shoe Nail Machine.*

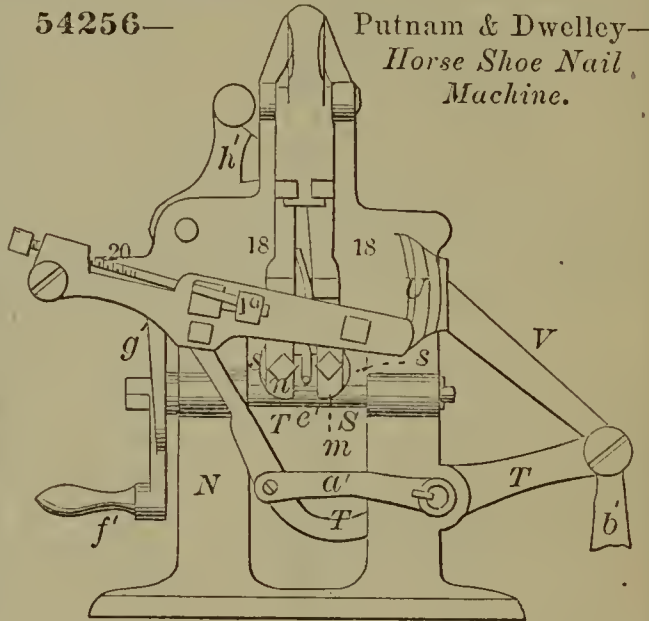

54259—L. Sawyer—*Mosquito Bar.*

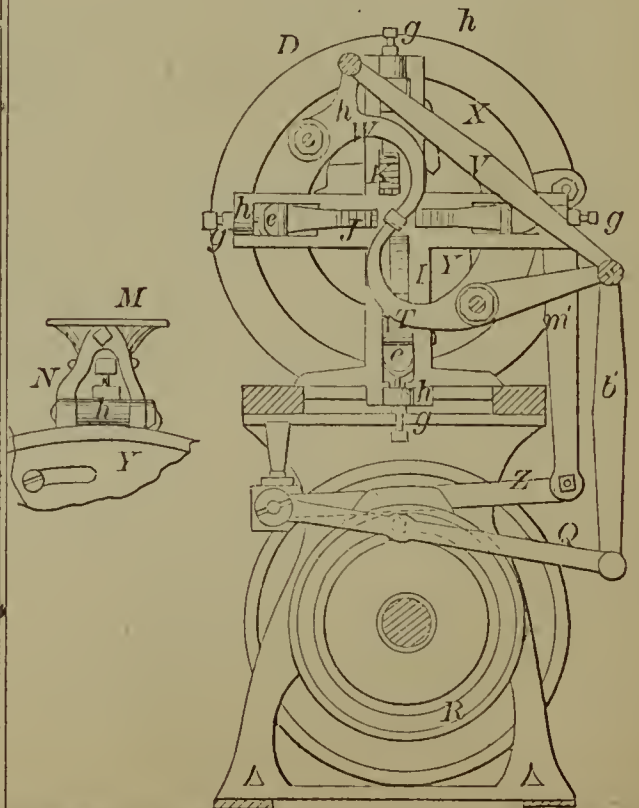
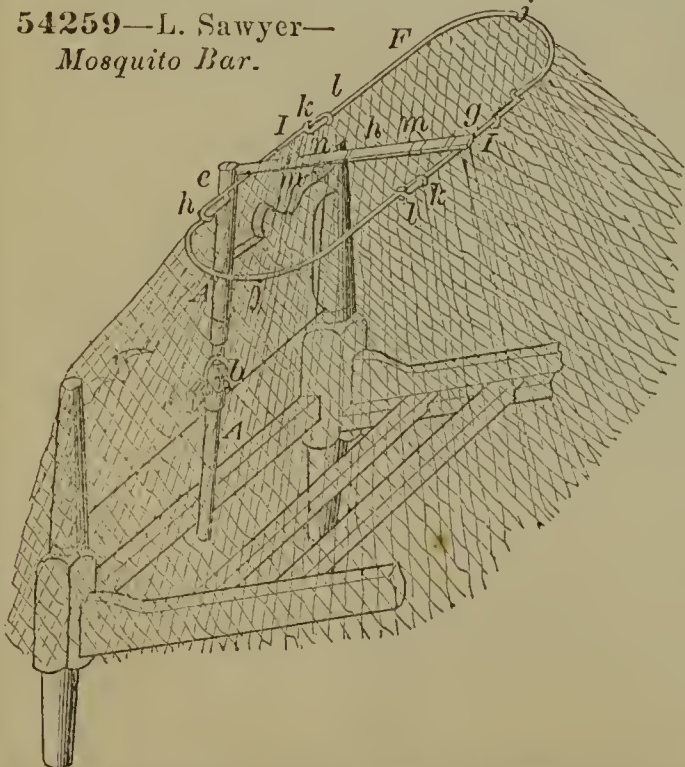

54260—T. J. Sloan—Grinding Mill.

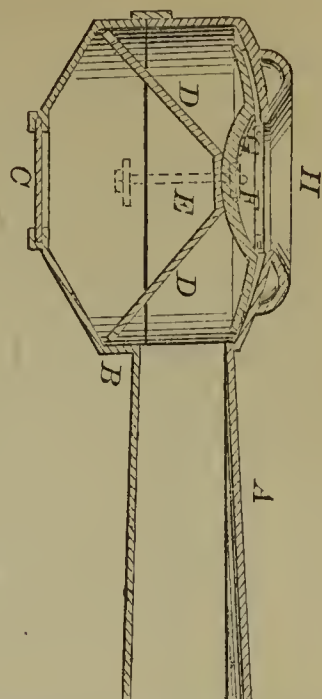
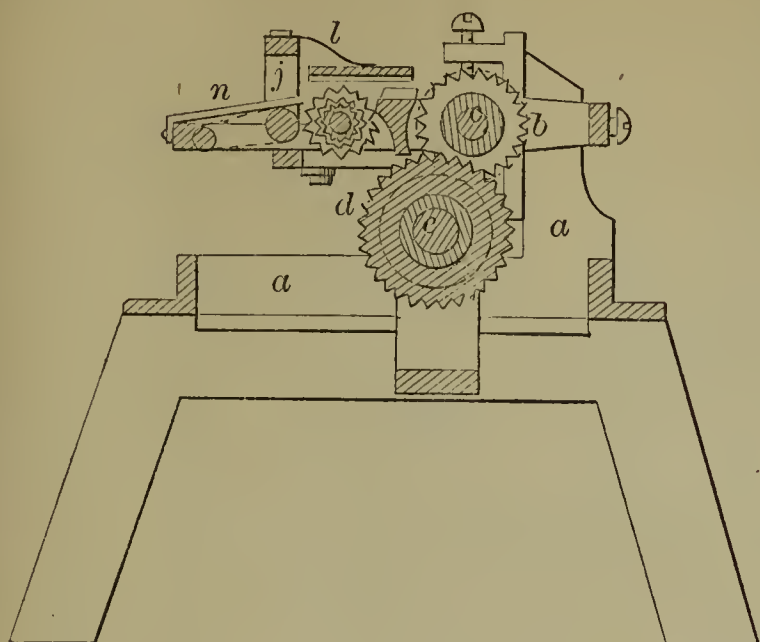

54265—J. M. White—Tugere.

54261—T. J. Sloan—Grinding Mill.

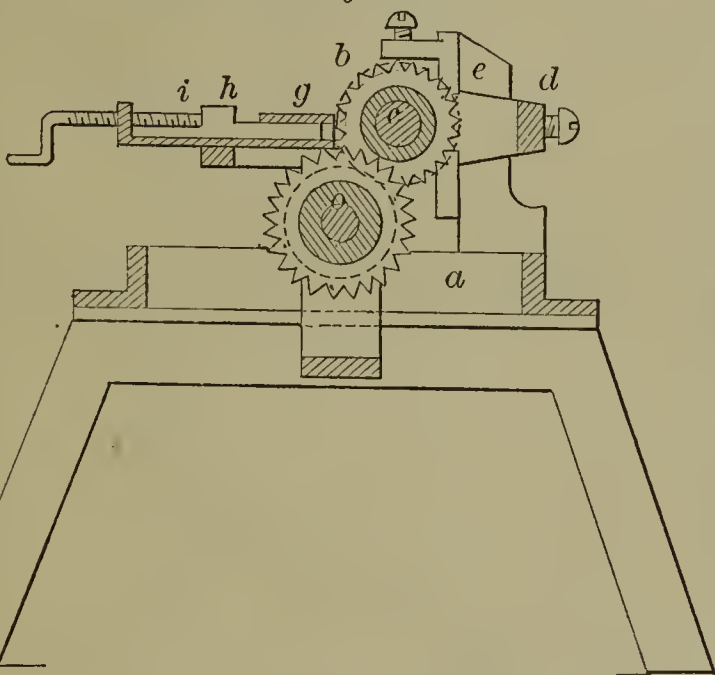

54264—W. B. Tilton—Banjo.

54262—T. J. Sloan—Grinding Mill.

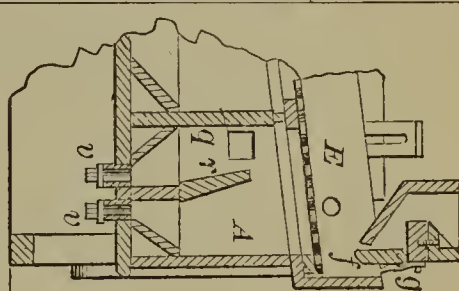
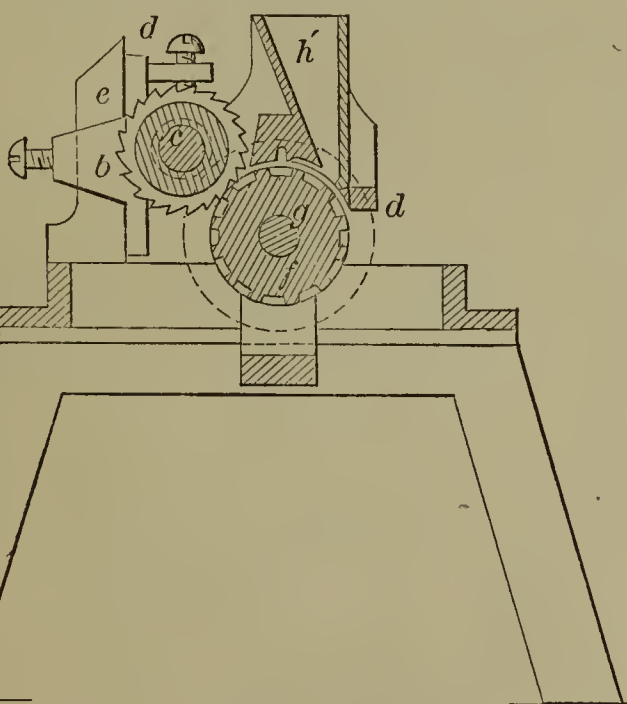

54263—C. G. & W. Stoll—Grain Separator.

54266—C. H. Wing—Preparing Magnesium for Burning.

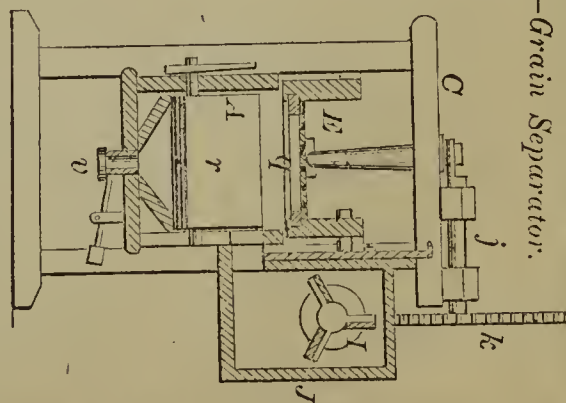

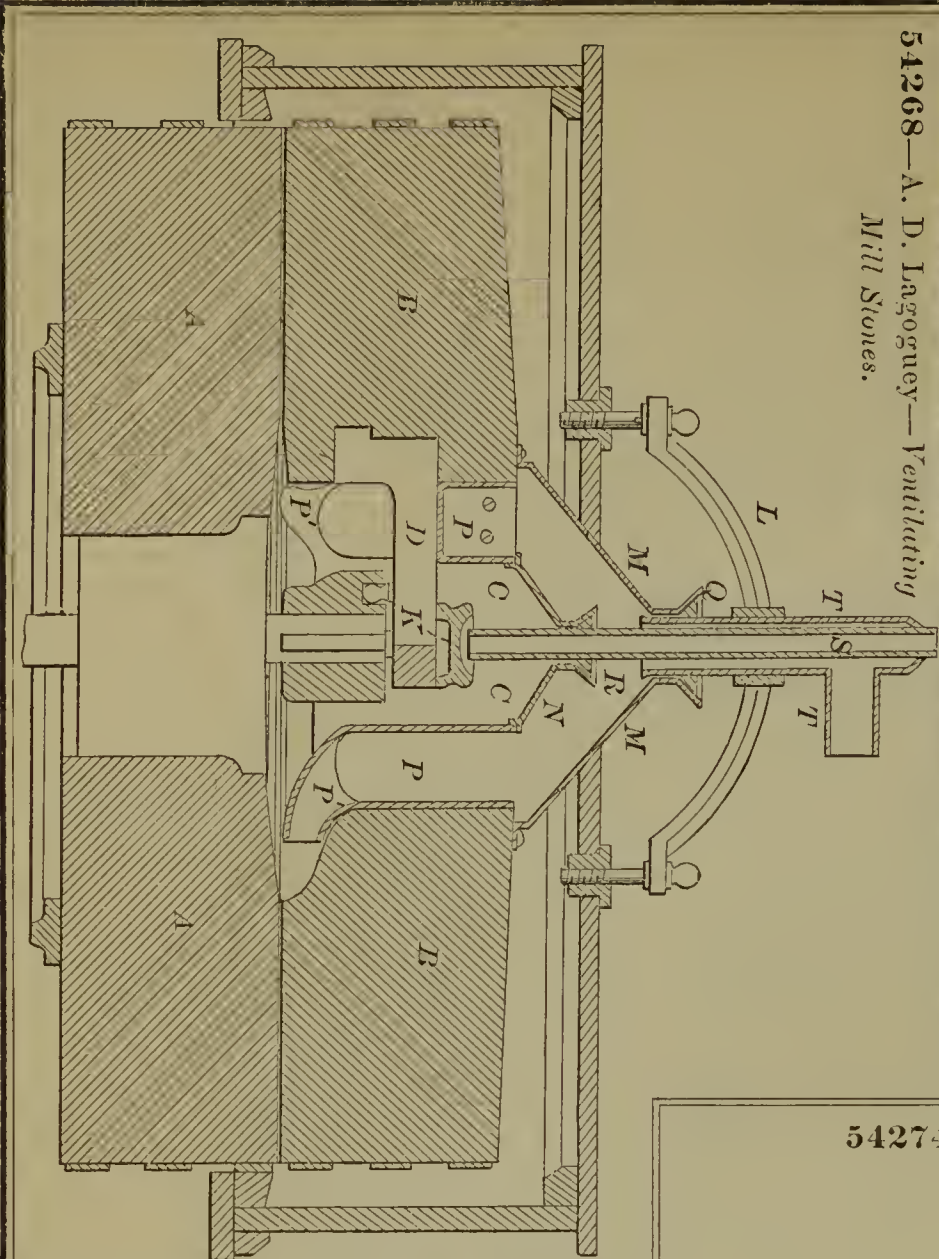

54268—A. D. Lagoguey—Ventilating Mill Stones.

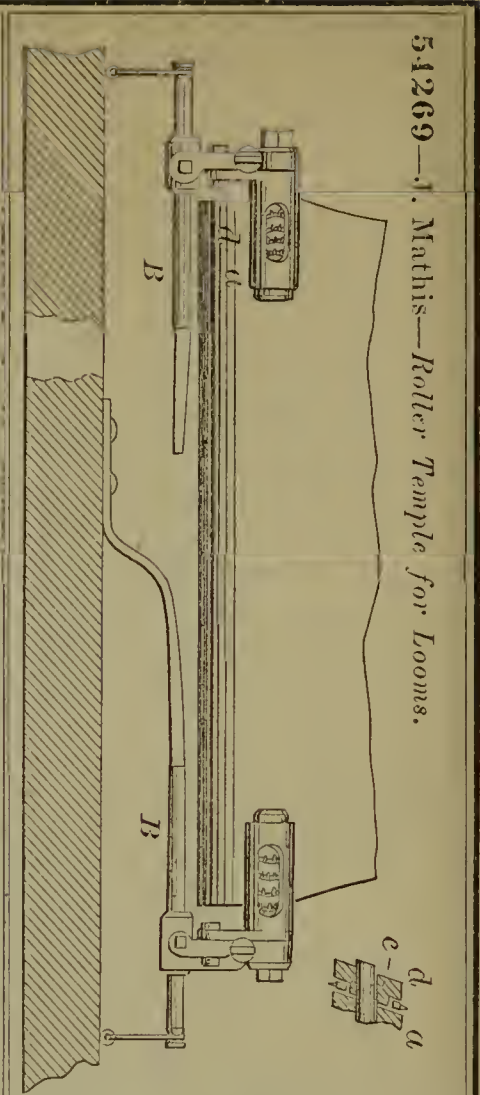

54269—J. Mathis—Roller Temple for Looms.

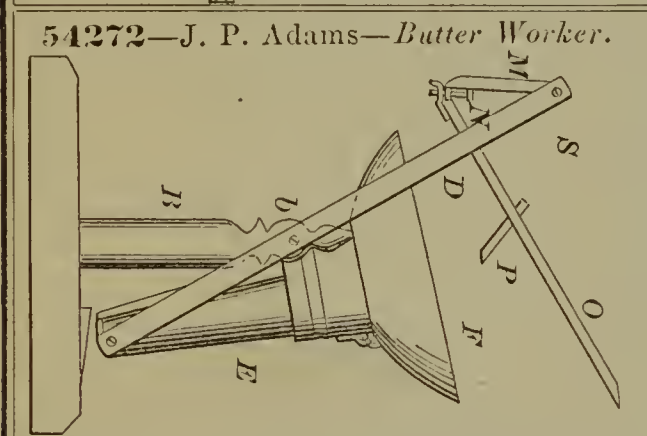

54272—J. P. Adams—Butter Worker.

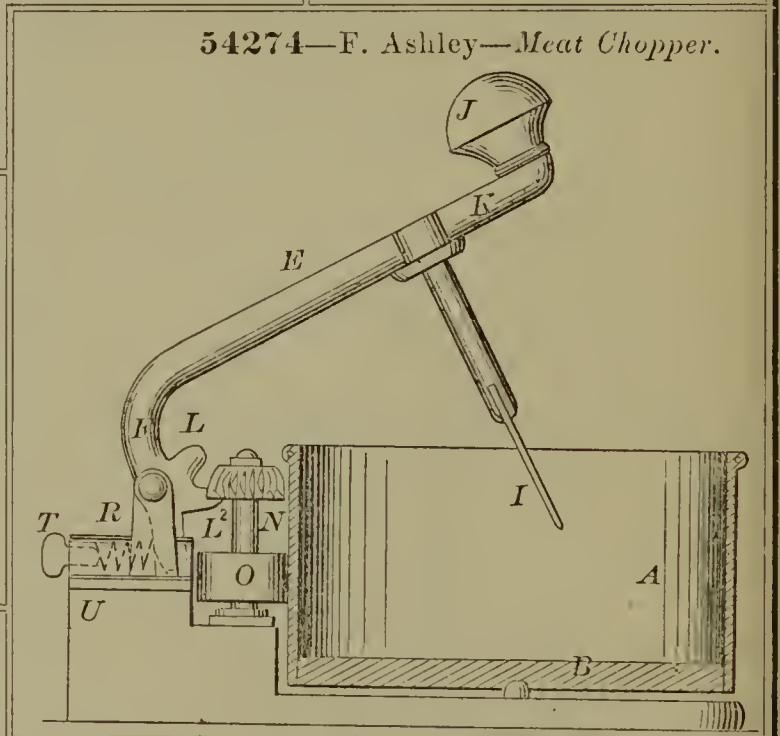

54274—F. Ashley—Meat Chopper.

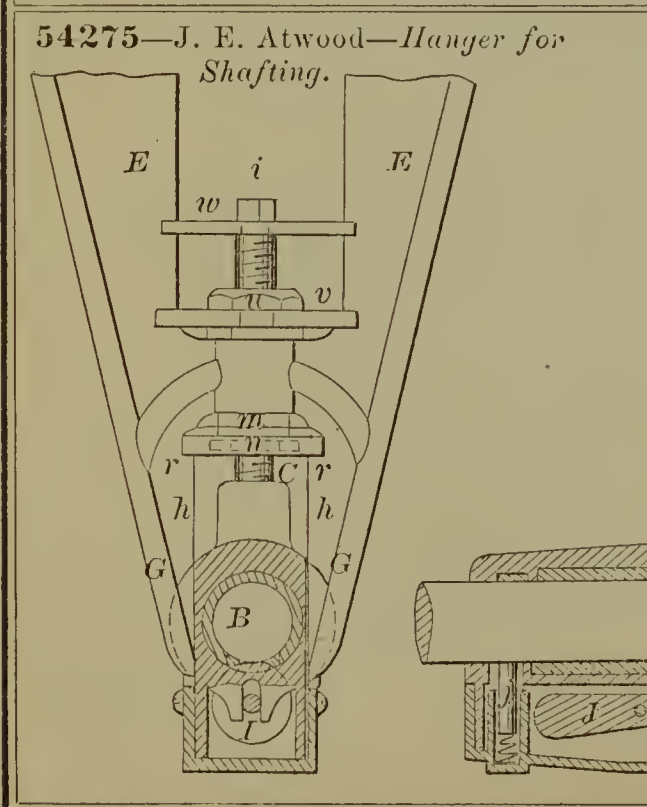

54275—J. E. Atwood—Hanger for Shafting.

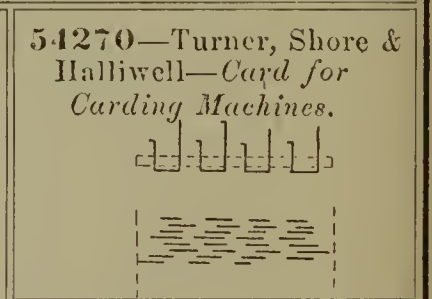

54270—Turner, Shore & Halliwell—Card for Carding Machines.

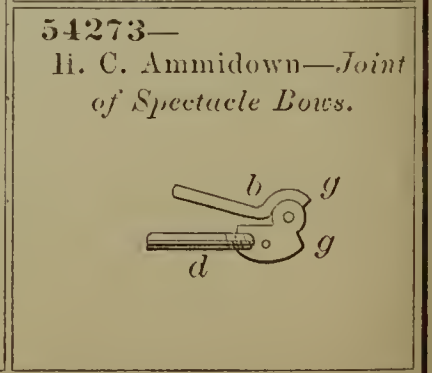

54273—H. C. Ammidown—Joint of Spectacle Bows.



54276—S. L. Avery—Water Elevator.

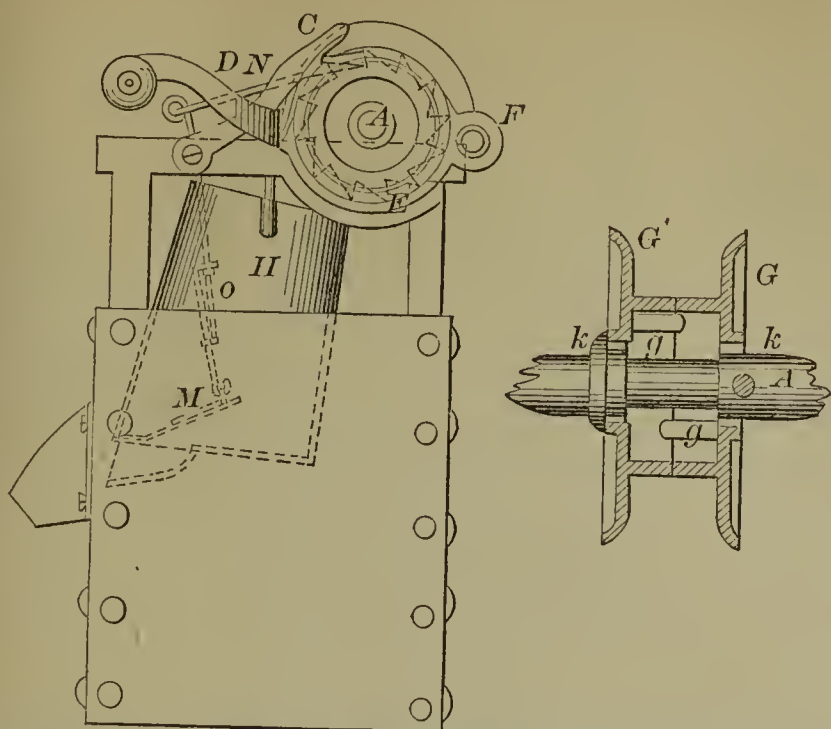

54279—A. Bare—Sorghum Funnel.

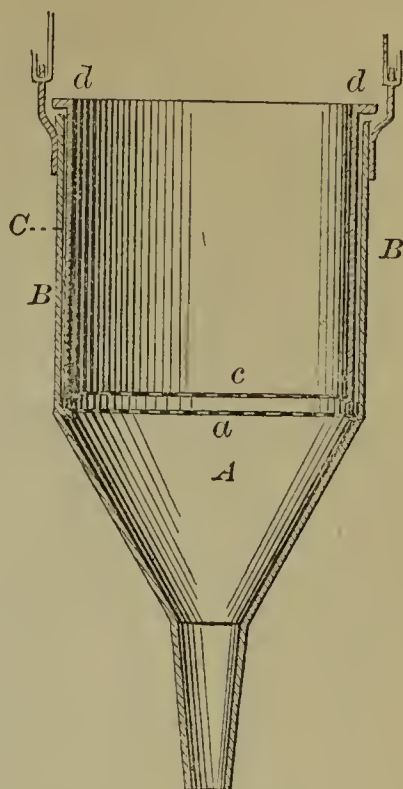

54282—E. Bigelow—Measuring Faucet.

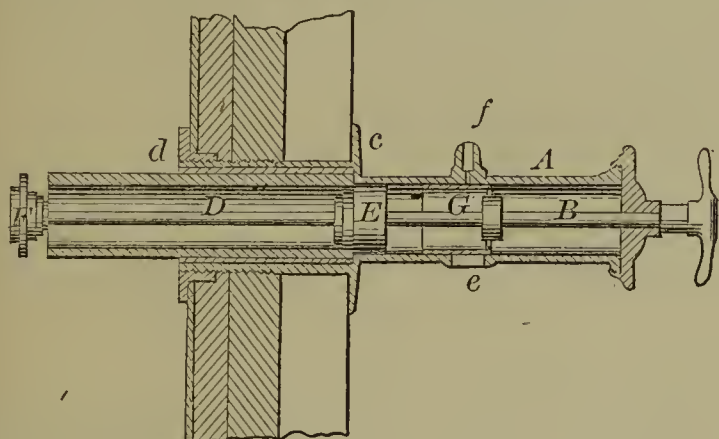

54277—B. Bacon—Clock Escapement.

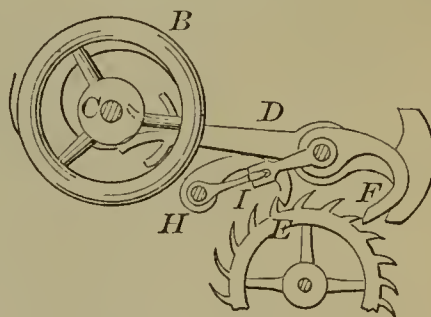

54278—D. Bannister—Gas Pipe Tongs.

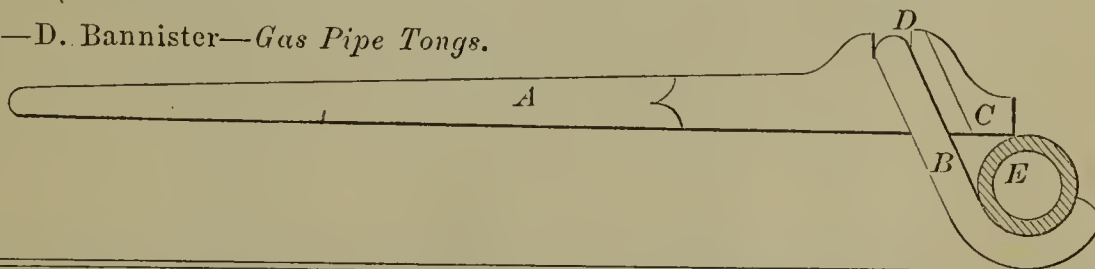

54280—H. Barnes—Cultivator.

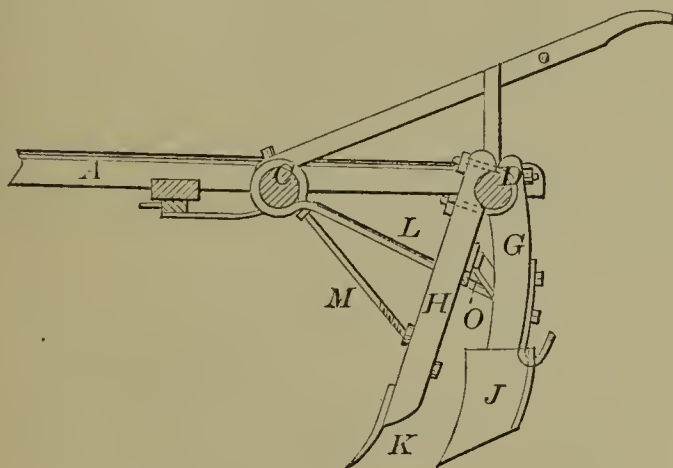

54283—B. Boardman—Staple.



54281—S. W. Beach—Bed Bottom.

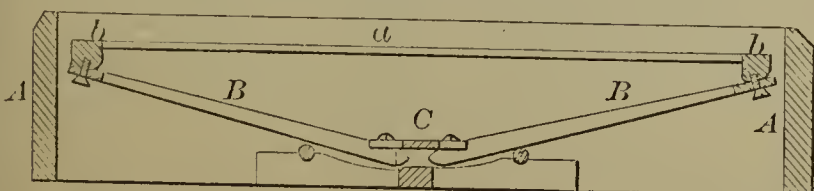

54284—J. Boggs—Brush.

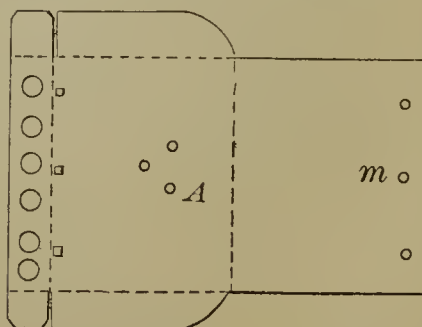

54285—G. W. Boynton—*Sheep Rack.*

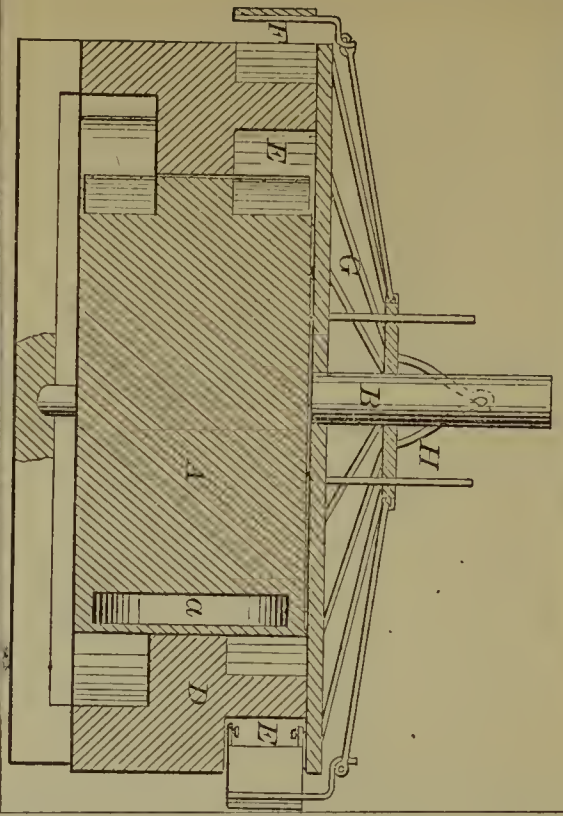
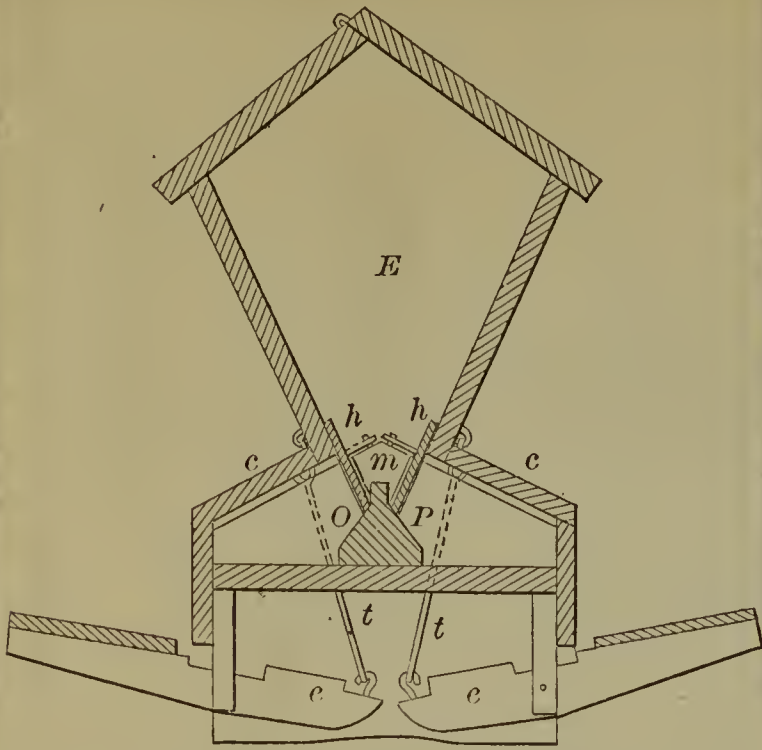

54288—H. Brown—*Water Wheel.*

54290—R. B. Butler—*Wrench.*

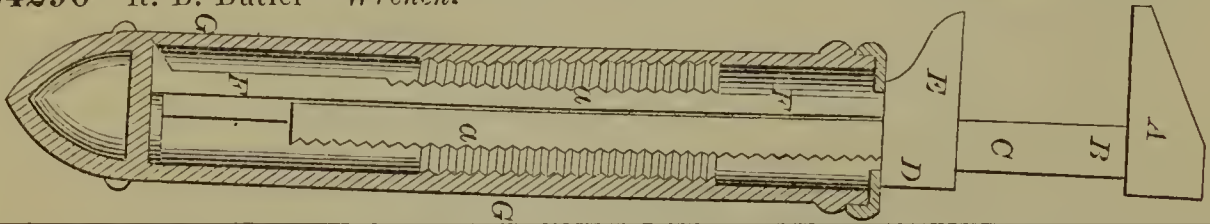

54289—A. Burr—*Pump.*

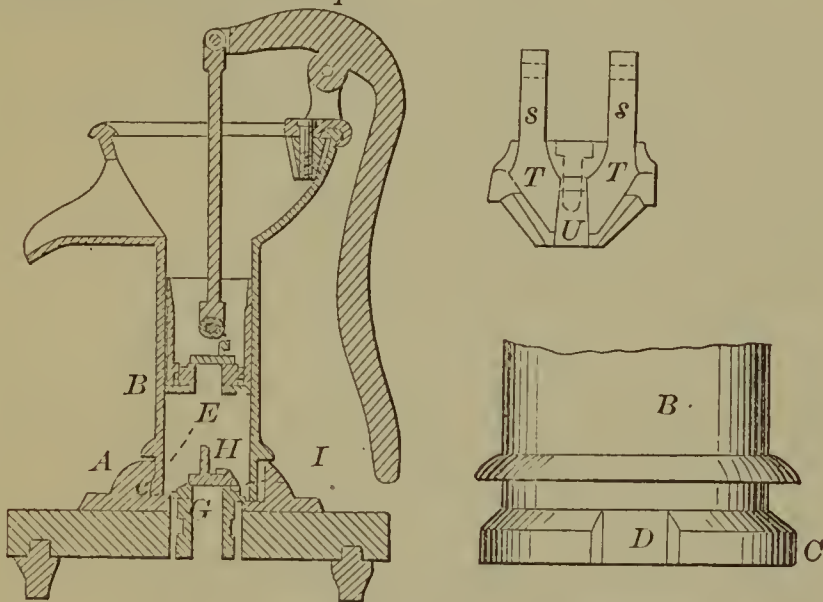

54286—B. Bray—*Sash Fastener.*

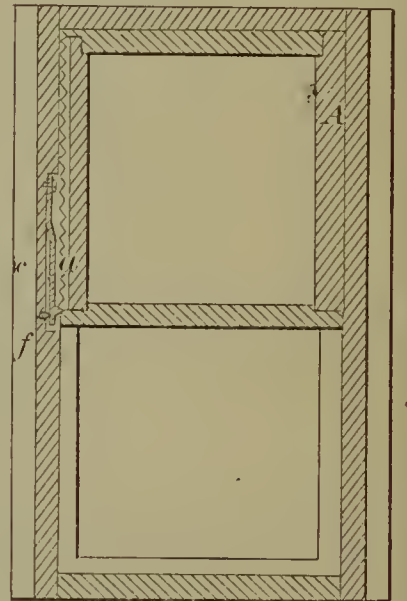

54291—A. S. Cameron—*Pump.*

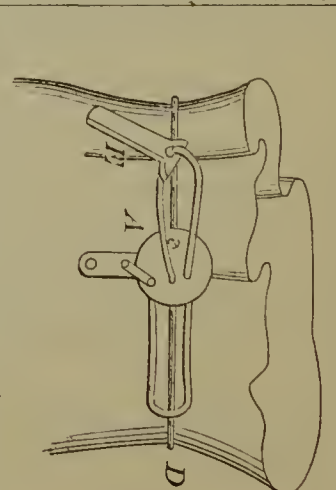
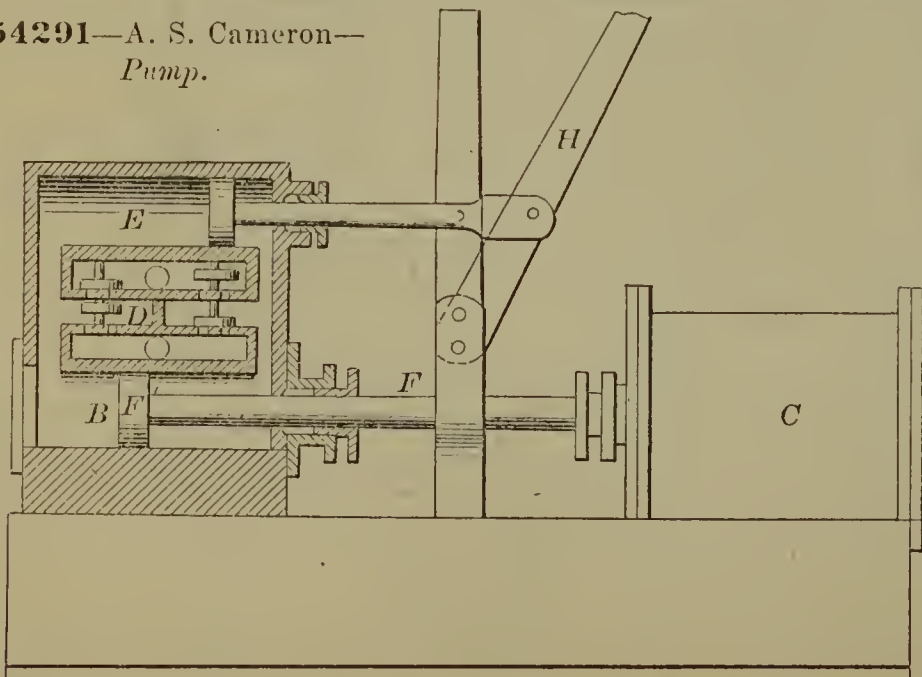

54287—W. P. Brooks—*Bag Fastener.*

54292—S. A. Canfield—*Bed Bottom.*

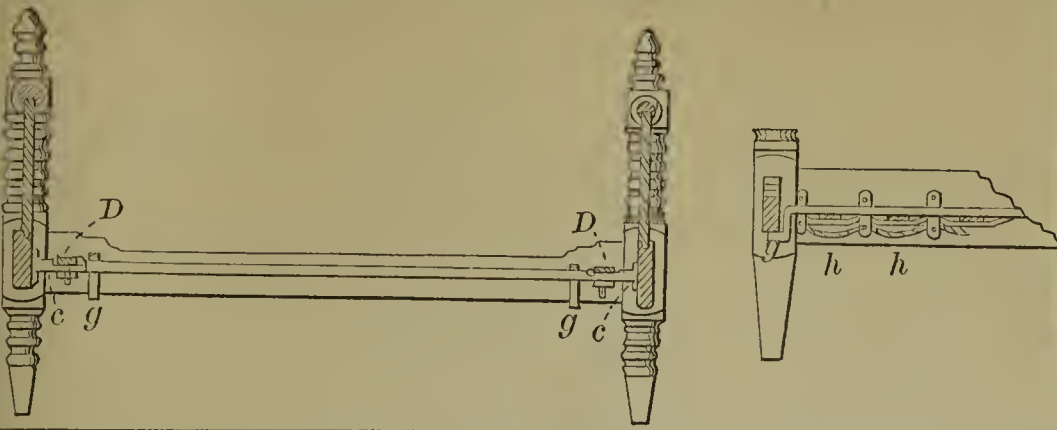

54295—J. Carter—*Packing for Pump Pistons.*

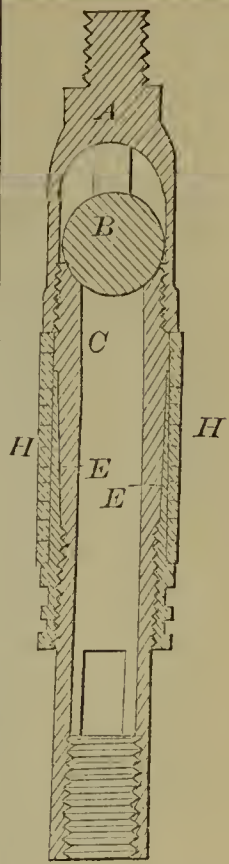

54293—N. B. Carr—*Sugar Cane Mill.*

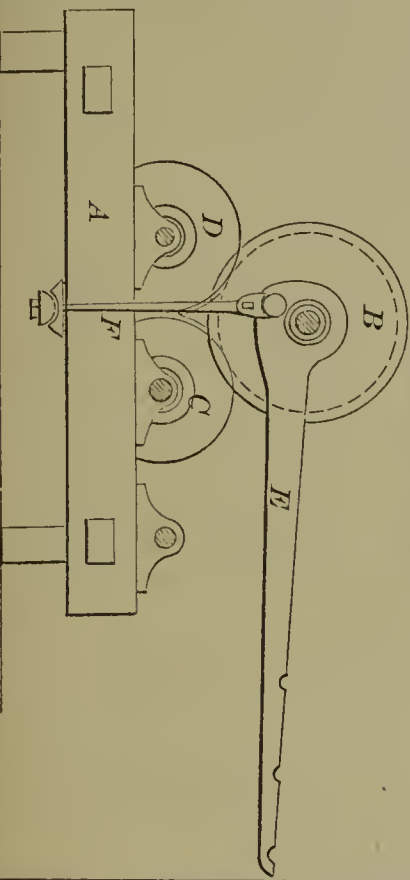

54294—C. L. Carter—*Harvester Rake.*

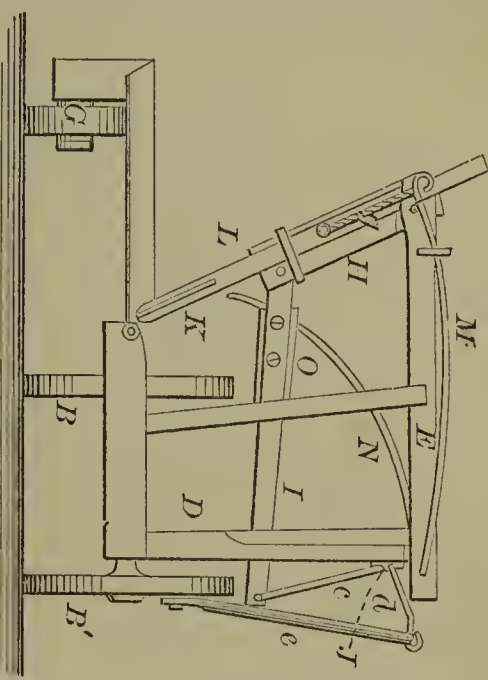

54297—C. Claude—*Lock.*

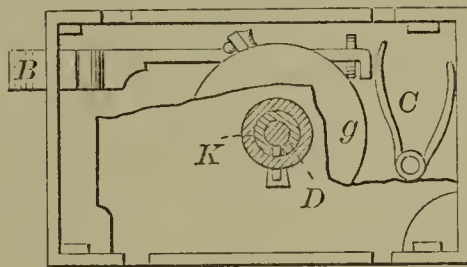

54300—R. Cornelius—*Pump for Deep Wells.*

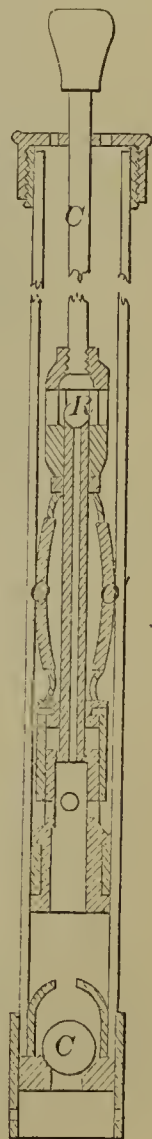

54299—J. Coop—*Truss.*

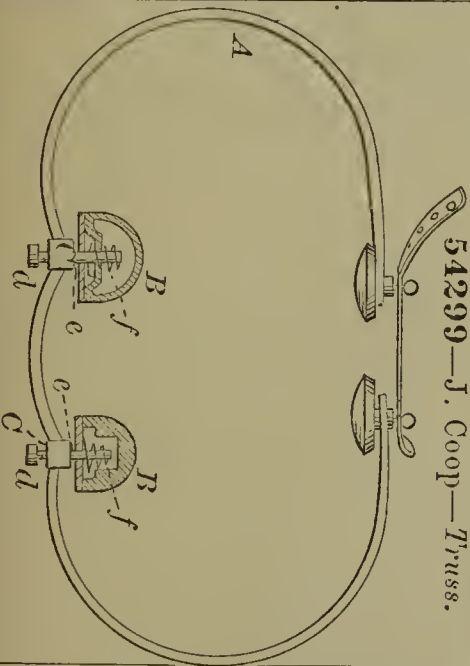

54298—H. Clymo—*Harvester Rake.*

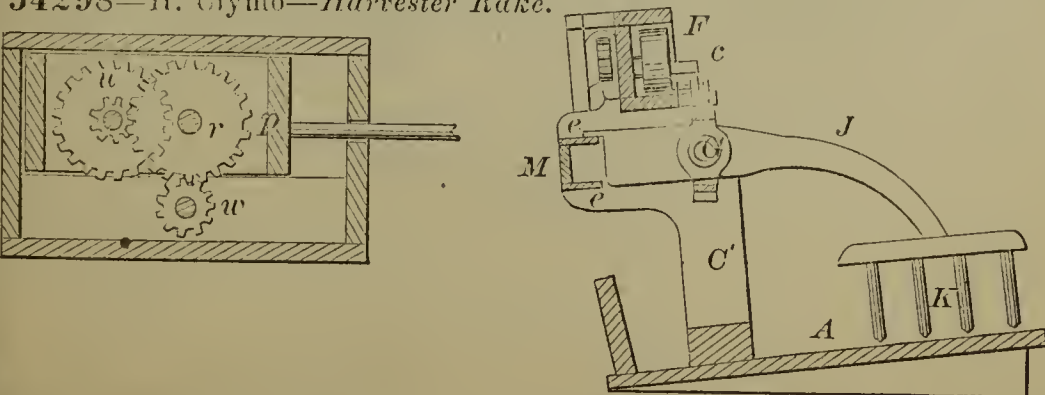

54302—J. S. Davis—*Grape Vine Protector.*

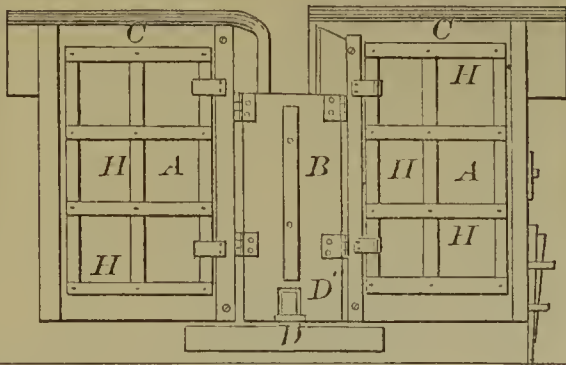

54307—J. B. Dixon—*Tile Kiln.*

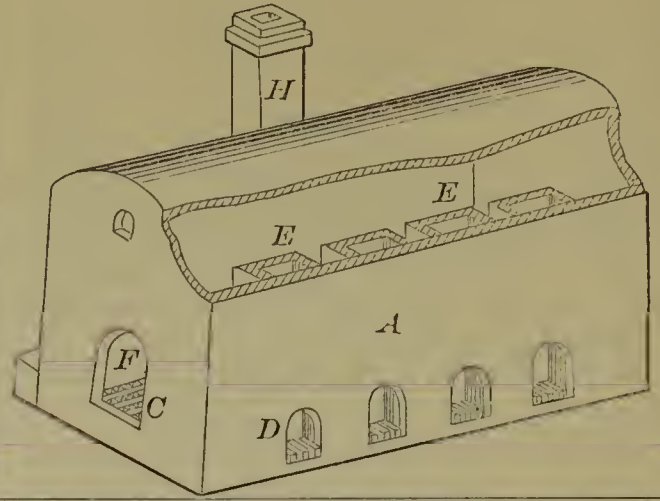

54306—J. Dietschy—*Water and Wine Cooler.*

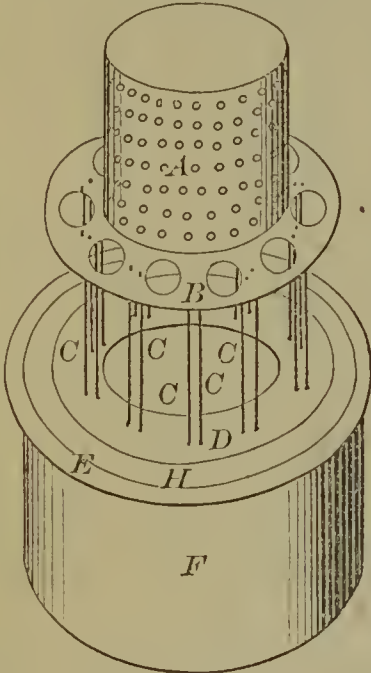

45308—J. W. Dixon—*Manufacture of Paper Pulp.*

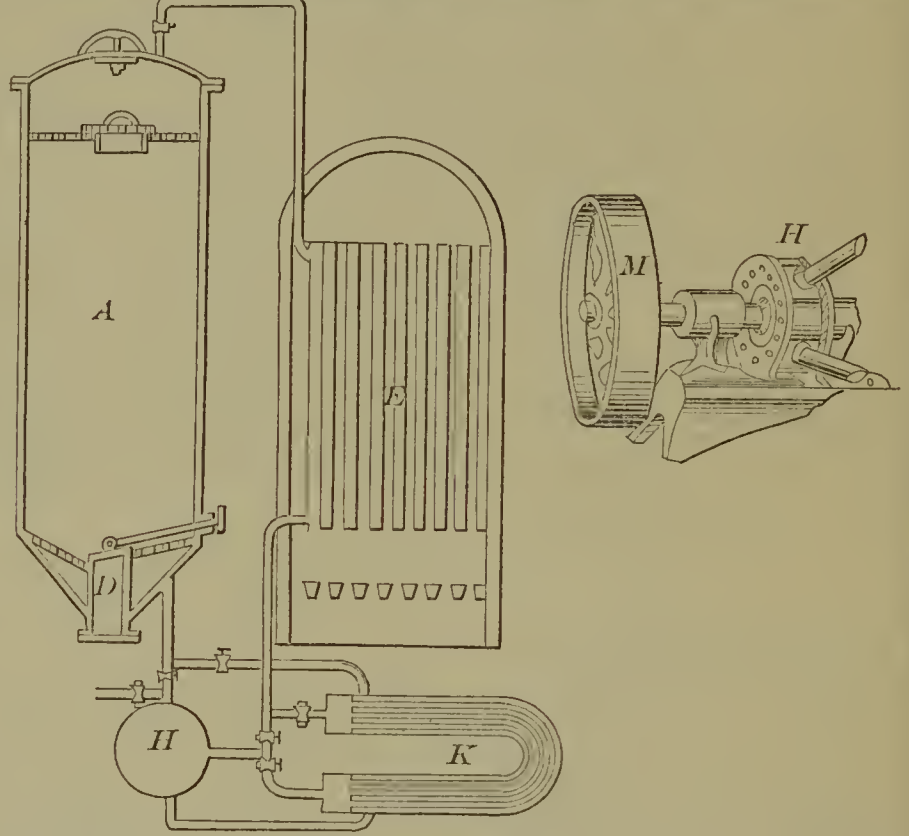

54305—W. H. De Valin—*Stop Cock.*

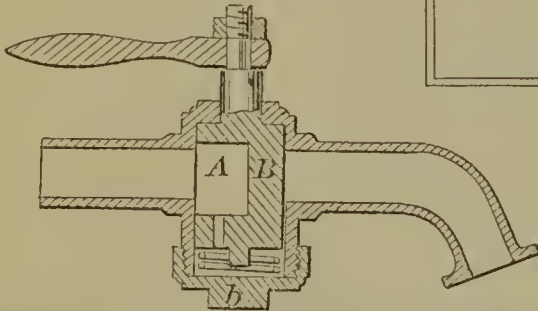

54310—J. Dodge—*Shaping File Blanks, &c.*

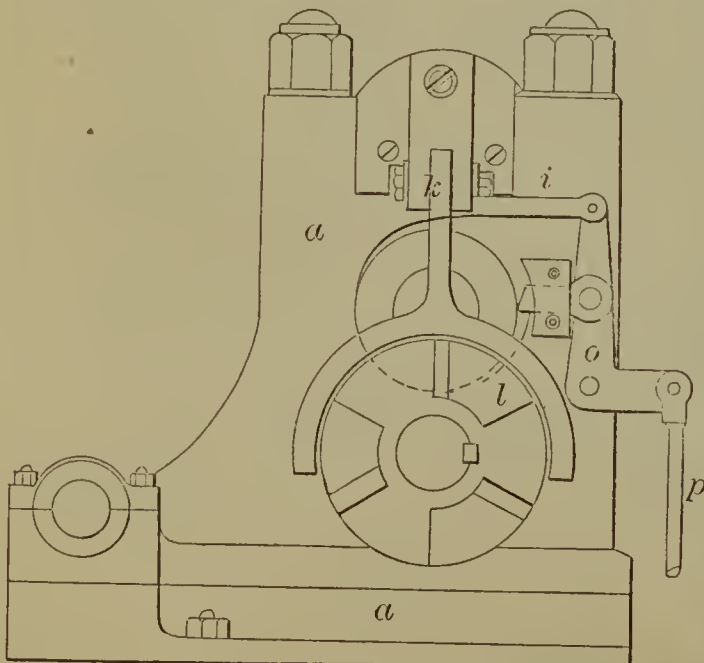

45311—L. Dodge—*For Hammering Heads of Axes.*

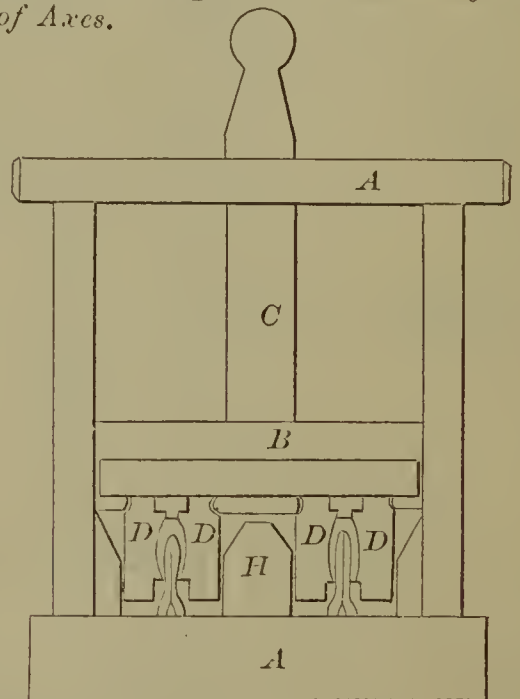

54313—A. R. Egbert—*Buckle.*

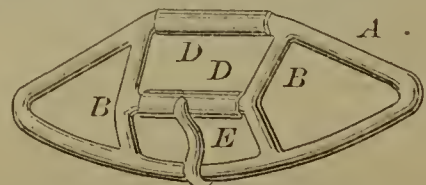

54314—W. S. Farmer—*Seat and Back for Chairs.*

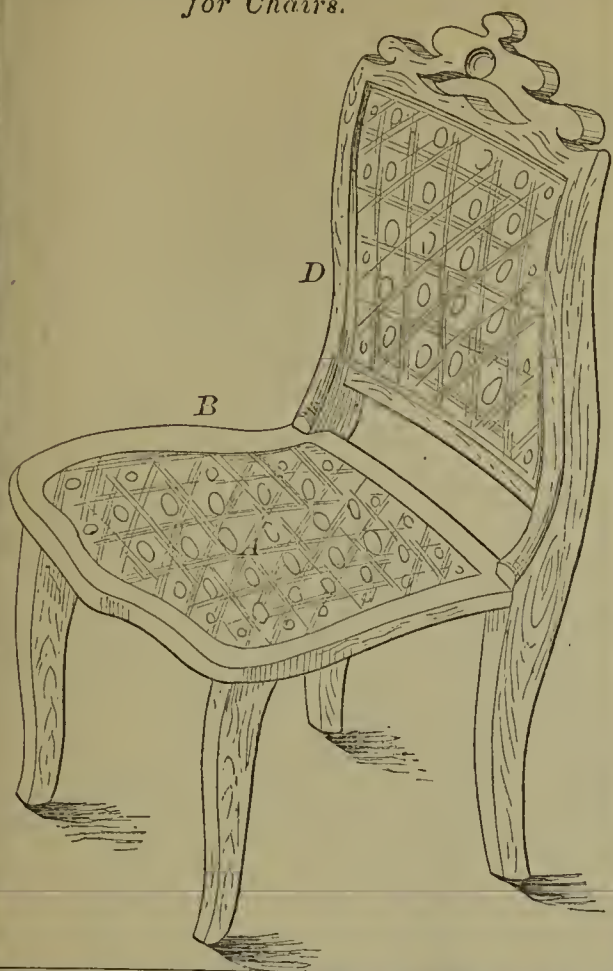

54317—W. D. Fisher—*Cultivator.*

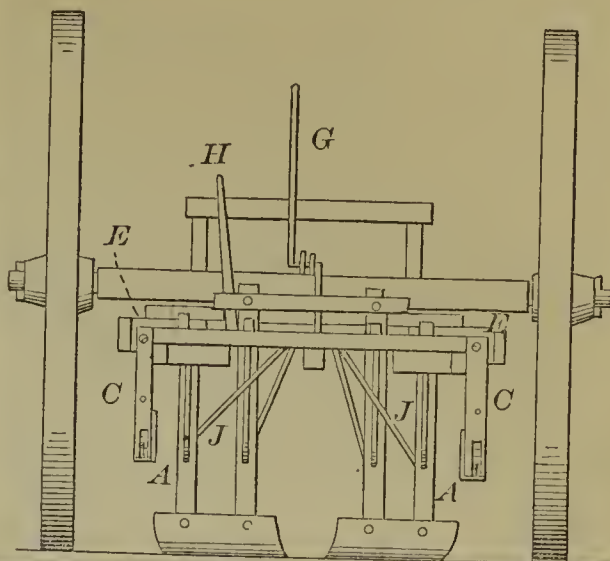

54316—J. Fishbaugh—*Wood Bending Machine.*

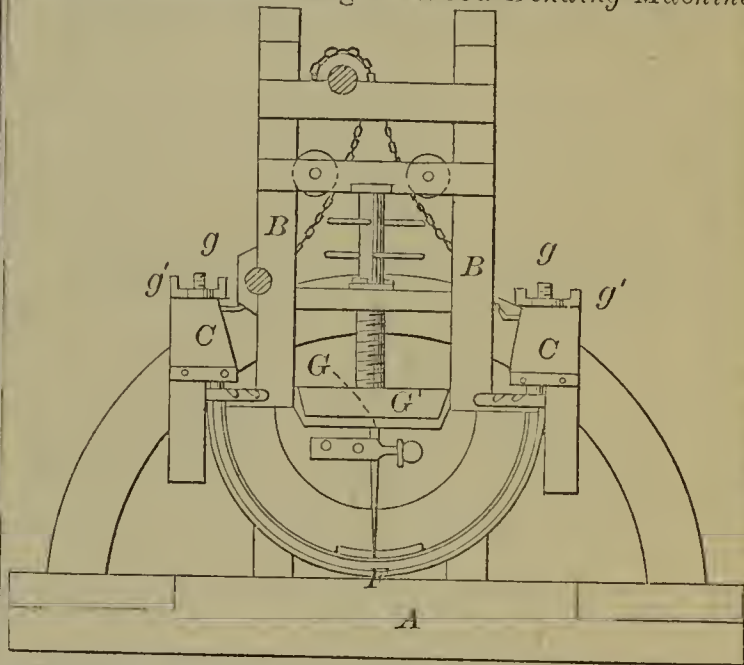

54318—B. Fitts—*Boiler Tube.*

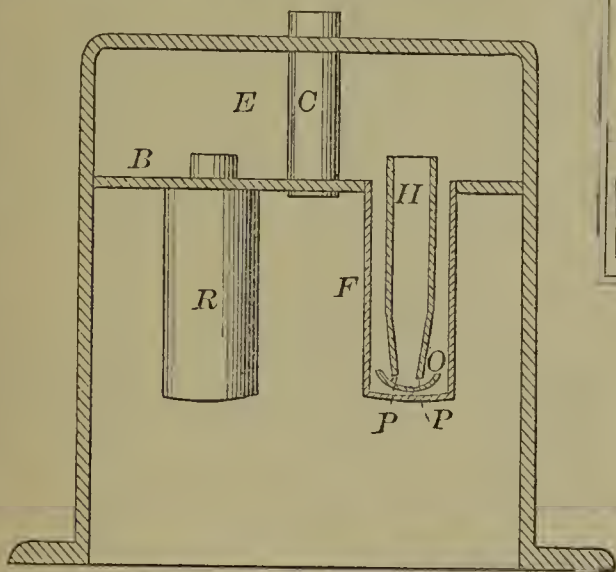

54319—J. H. Flagg—*Soap Stone Store.*

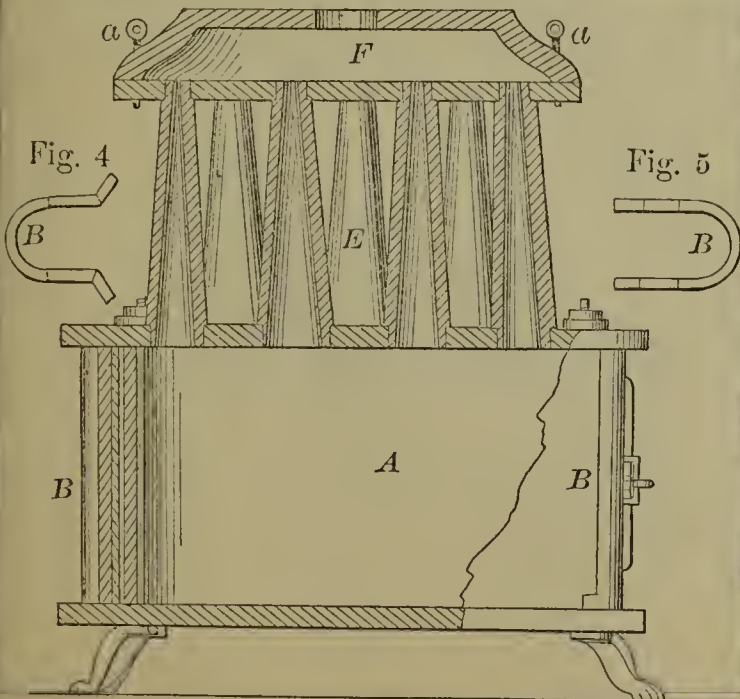

54320—J. W. Ford—*Newspaper File.*



54315—T. P. Fish—*Horse Hoe.*

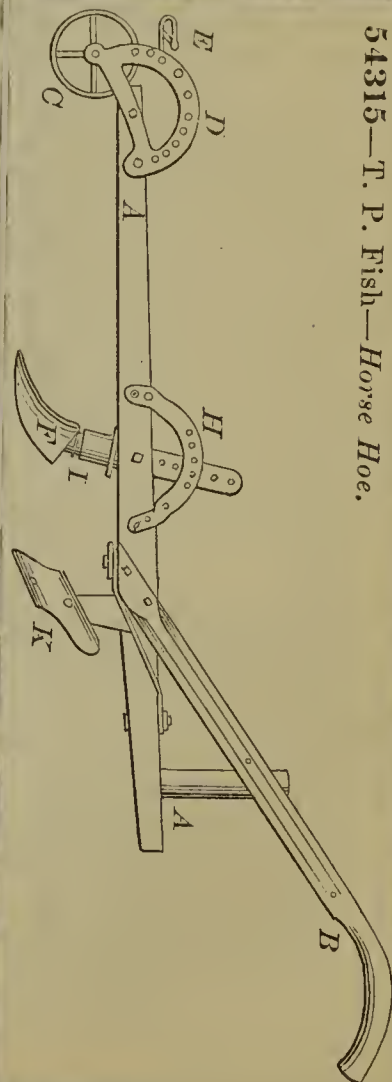

54324—C. A. French, 2d—Button.

54321—J. A. Fogg—Burial Casket.

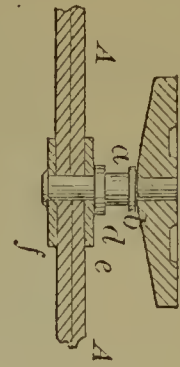
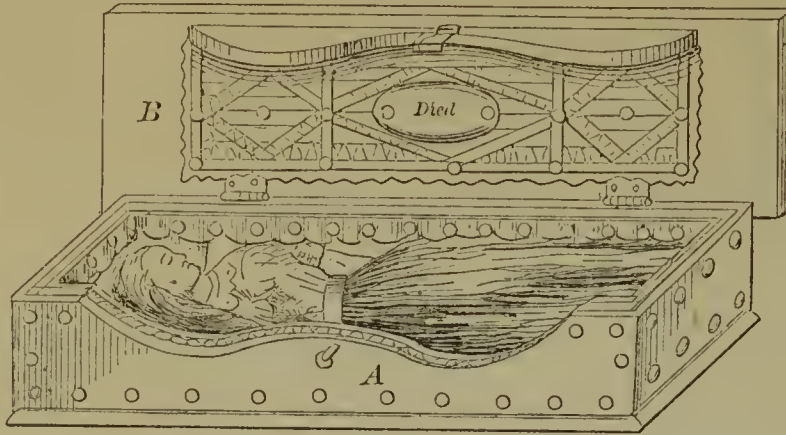

54322—A. D. Foote—Grain Spout.

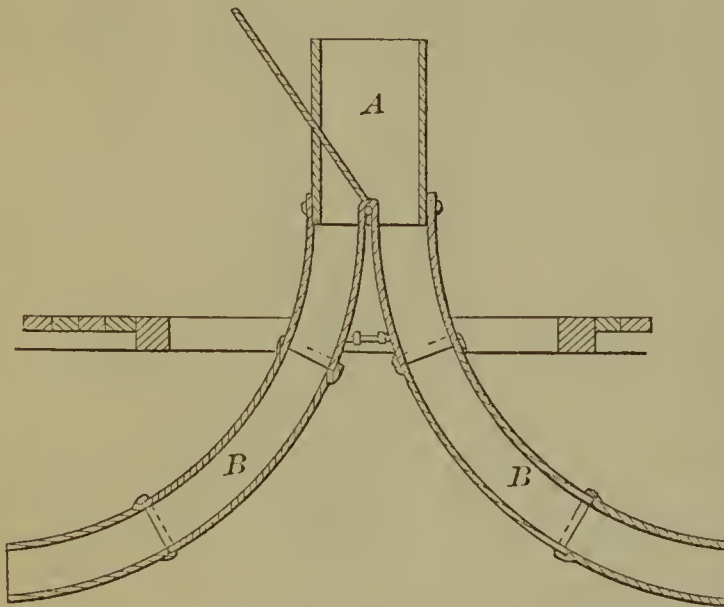

54323—L. H. Foy—Combined Corset and Bustle.

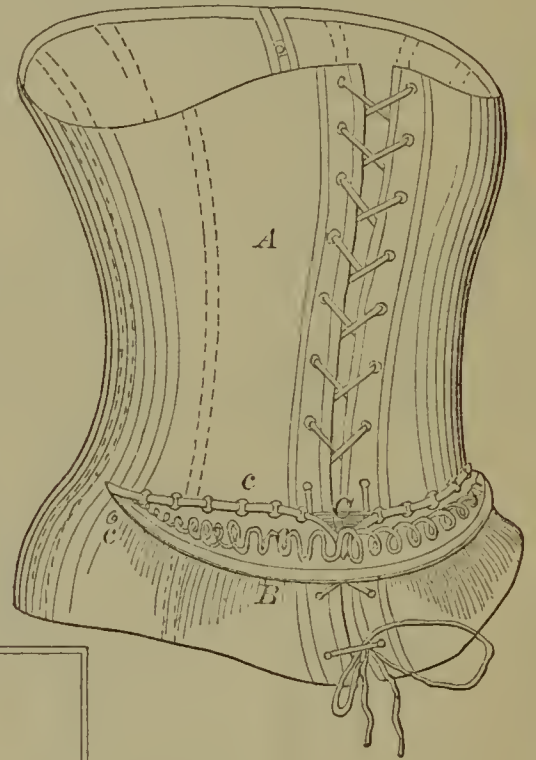

54325—A. Fuller—Beehive.

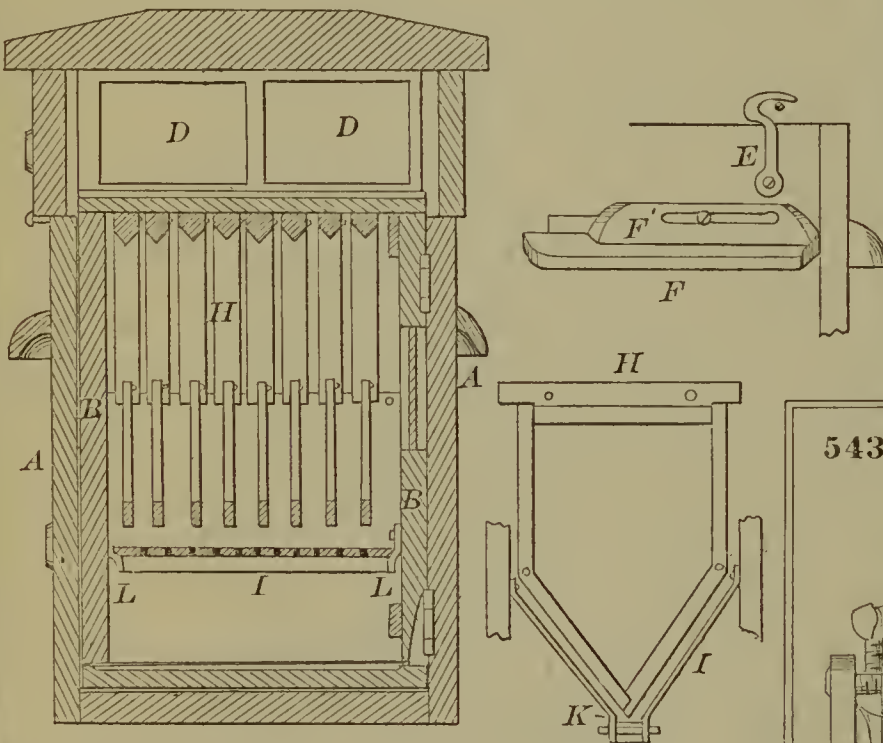

54327—W. Glenn—Planking Clamp.

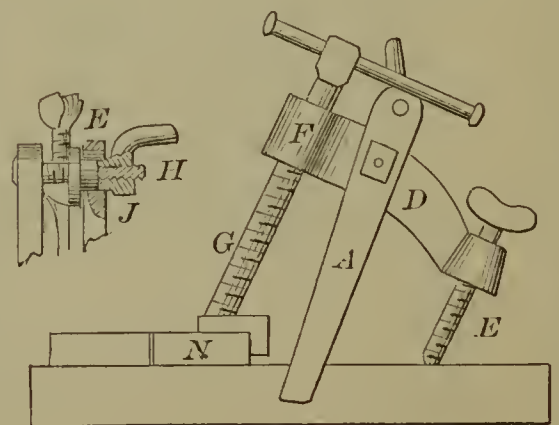

54328—H. Gottfried—Pneumatic Pump.

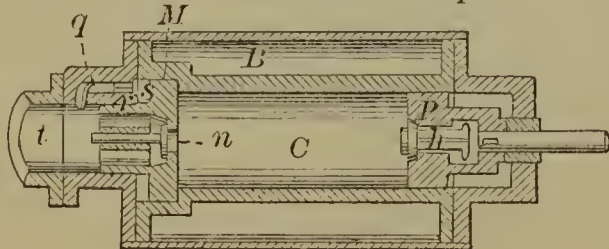

54329—J. Gower—Roll for Manufacturing Railroad Rails.

Fig. 1

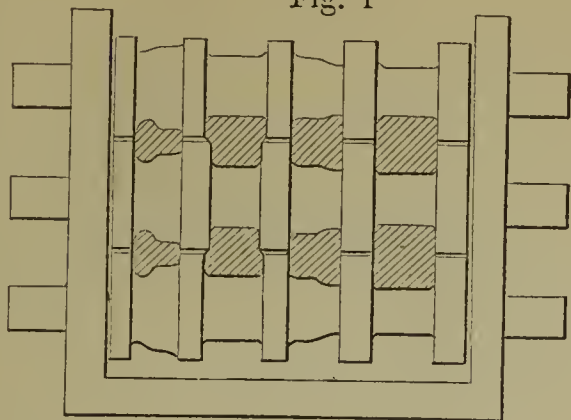
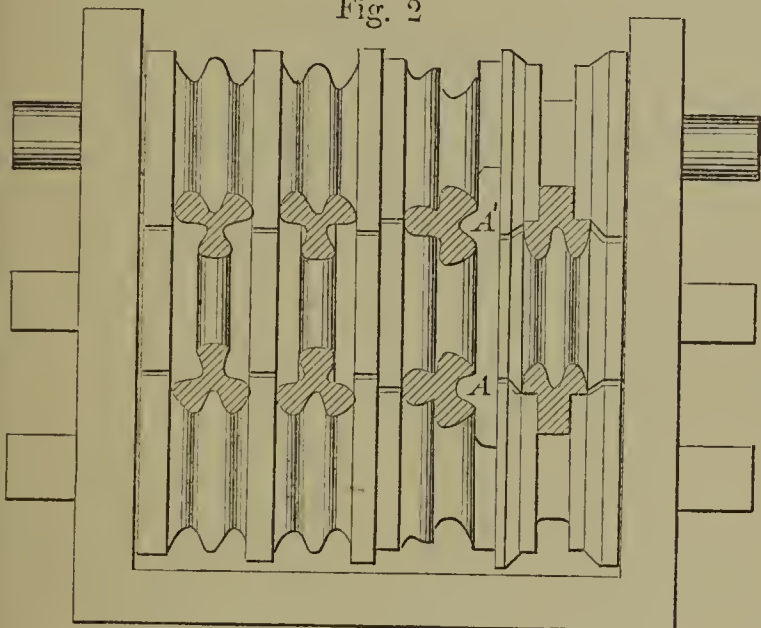
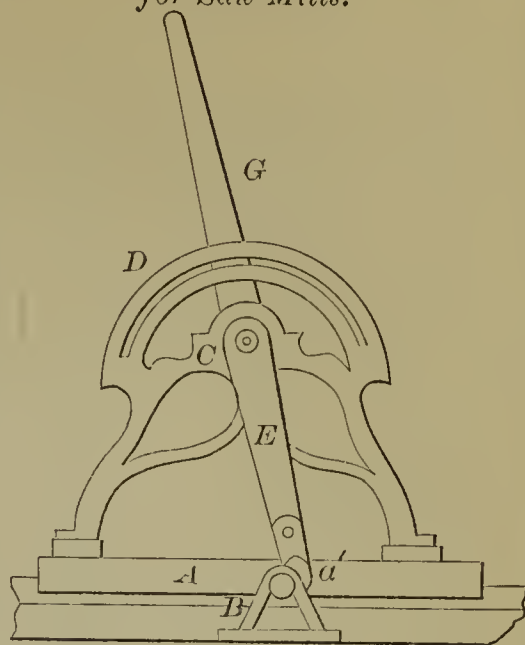

Fig. 2



54330—H. H. Gridley—Head Block for Saw Mills.



54331—J. R. Grout—Balanced Slide Valve.

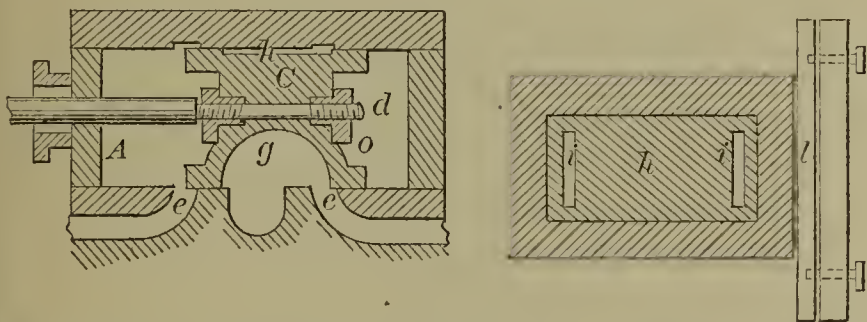

54334—C. Gullmann—Well Curb.

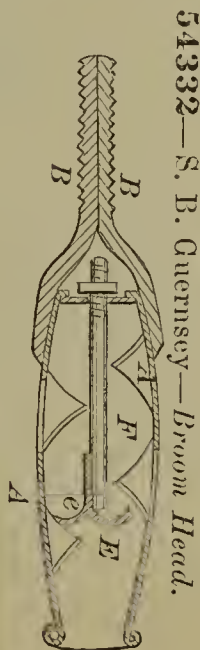
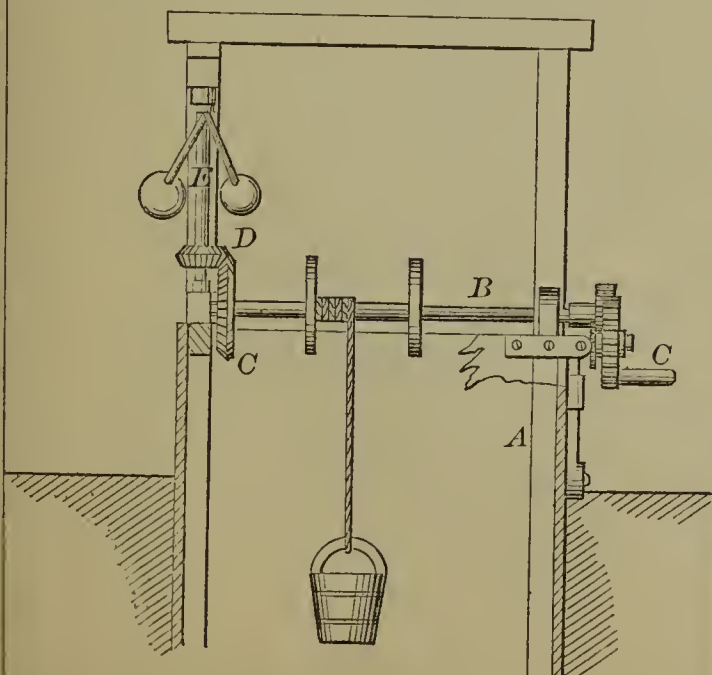

54332—S. B. Quernsey—Broom Head.

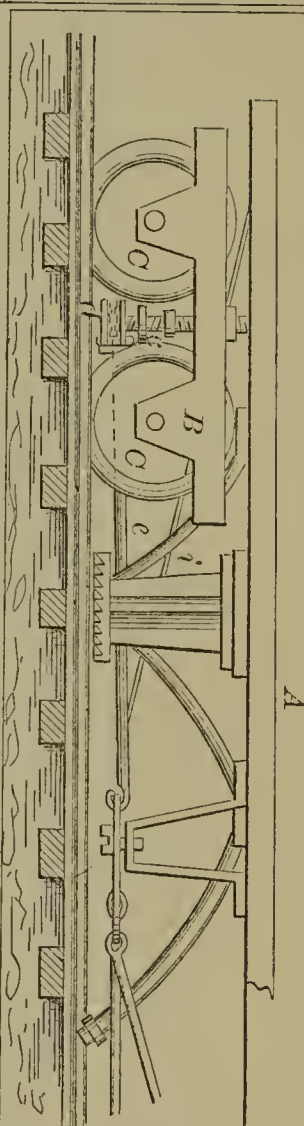

54333—S. Gibbert—Car Brake.

54335—W. H. Hall—Elastic Cushion for Horses' Feet.

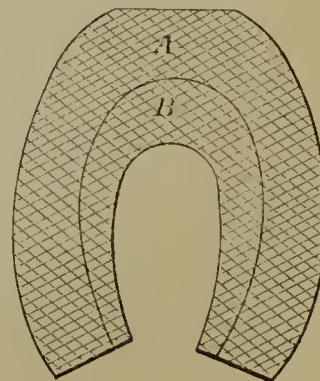

54336—W. J. Hallefas—*Engine Governor.*

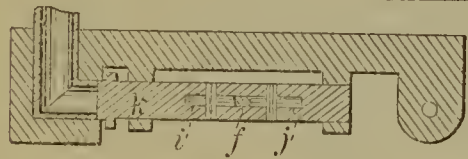
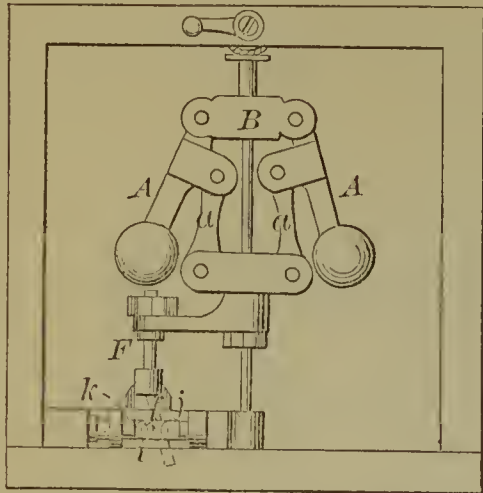

54340—B. R. Hawley—*Evaporator.*

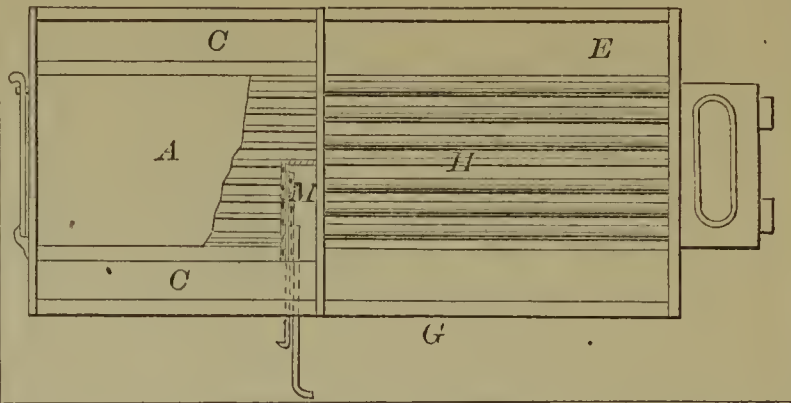

54341—W. H. Henderson—*Tinman's Forming Tool.*

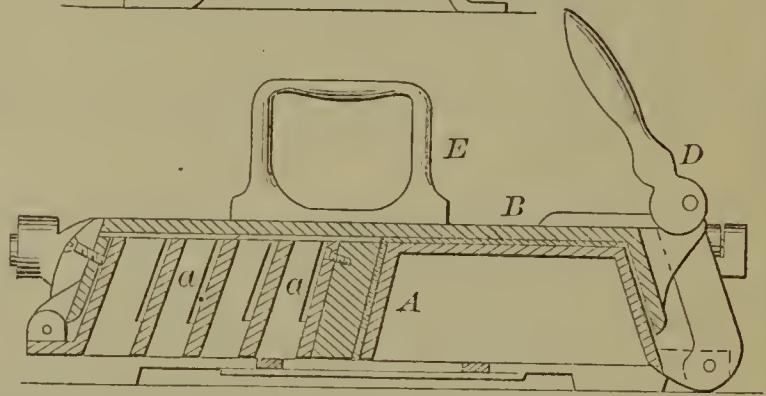
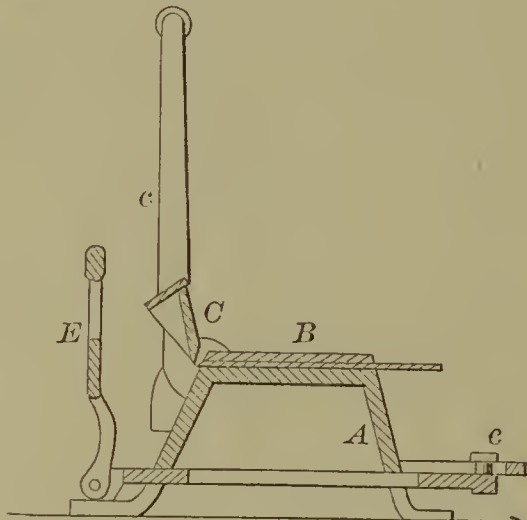

54337—C. A. Harper—*Portable Cooking Apparatus.*

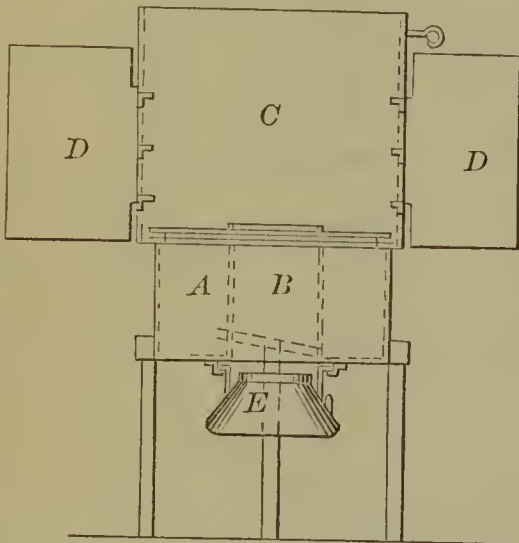

54338—J. Harris—*Broom Head.*

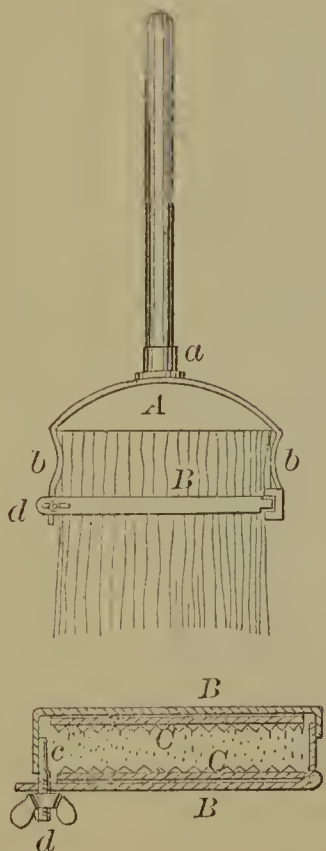

54342—W. H. Henderson—*Tinman's Edging Tool.*

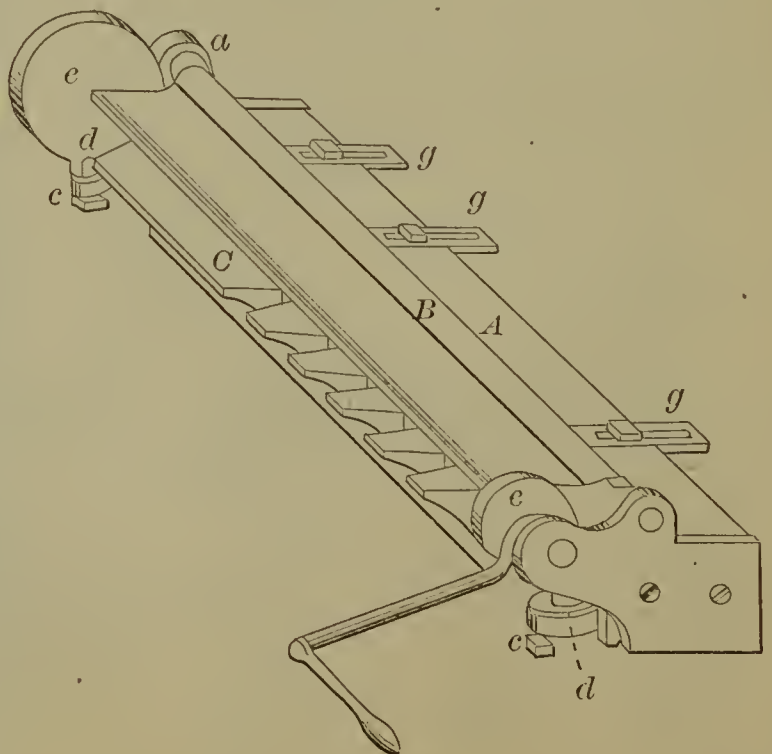



54343—S. Hewit—Churn.

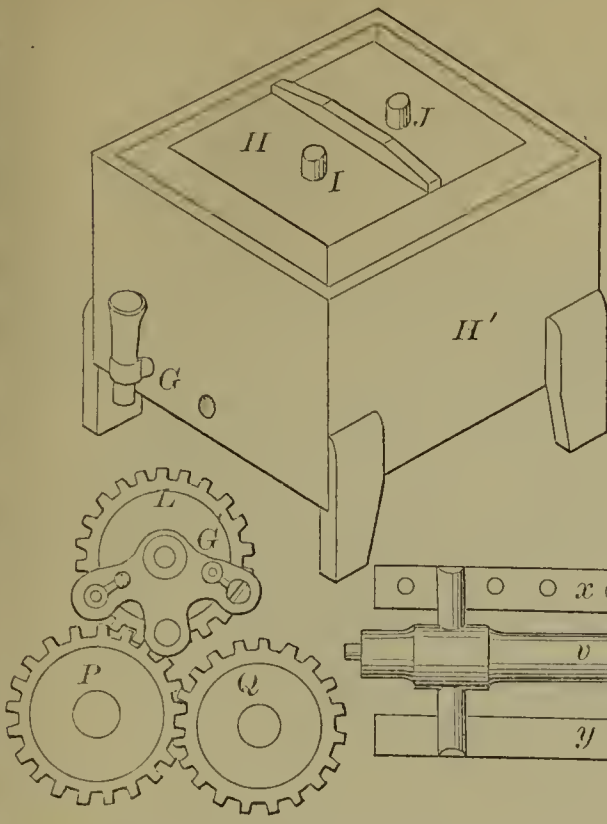

54346—E. H. Hill—Steam, Water or other Pipe.

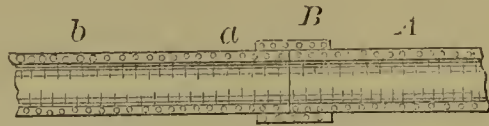

54347—G. Hillegass—Filtering Funnel.

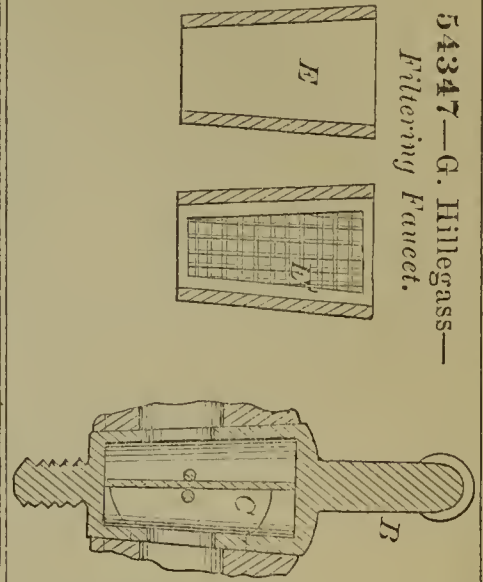

54351—L. B. Hoit—Straw Cutter.

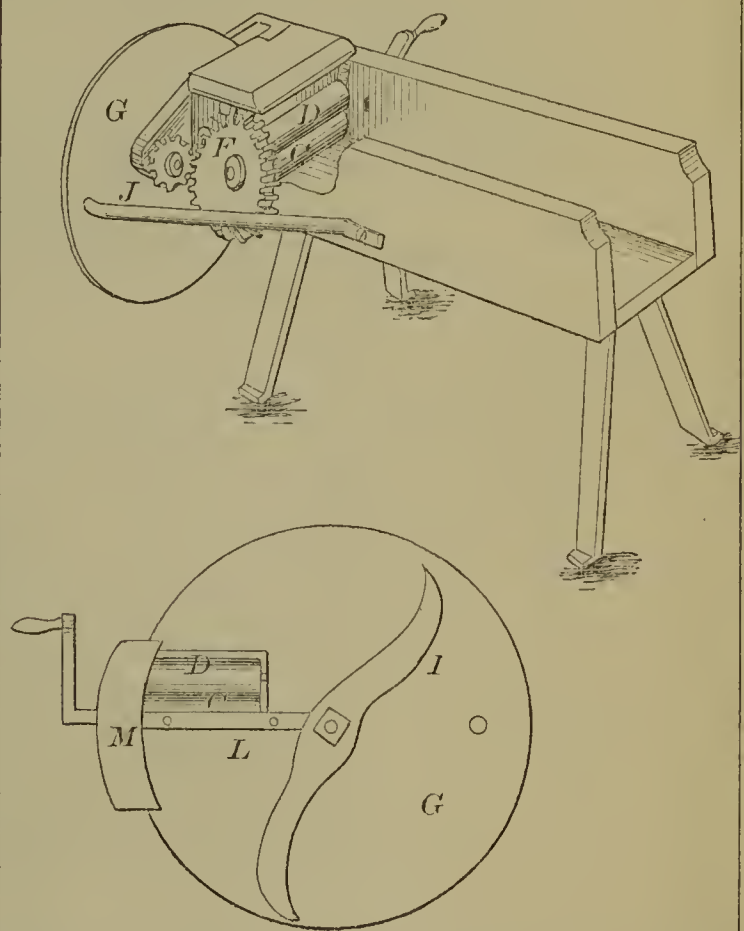

54348—J. M. Hopkins—Bolt Fastening.

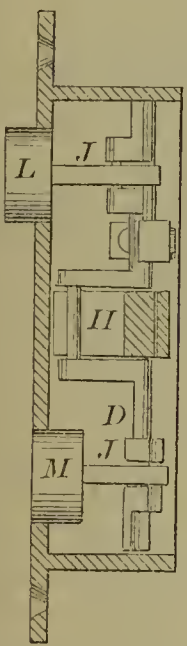

54349—D. Houston—Grate Bar.



54344—B. H. Hibler—Skate.

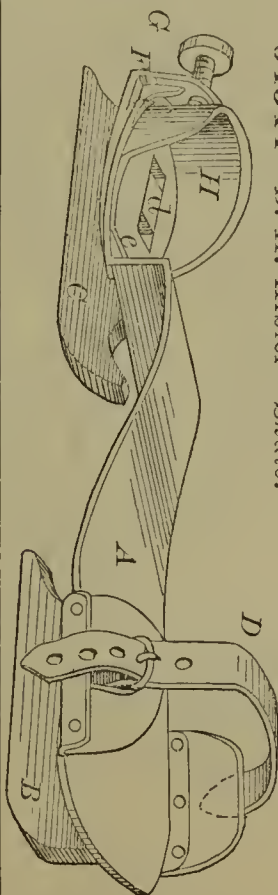

54350—J. M. Hopkins—Flush Bolt.

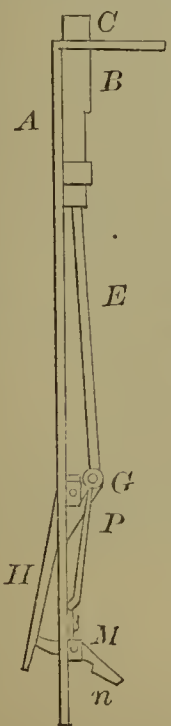

54352—H. P. Hood—Bench Vise.

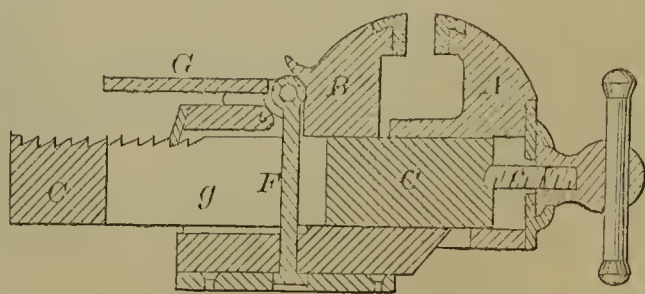

54354—J. Hopkins—Sash  
Supporter and Fastener.

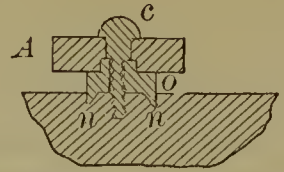

54357—M. G. Imbach—  
Printing Press.

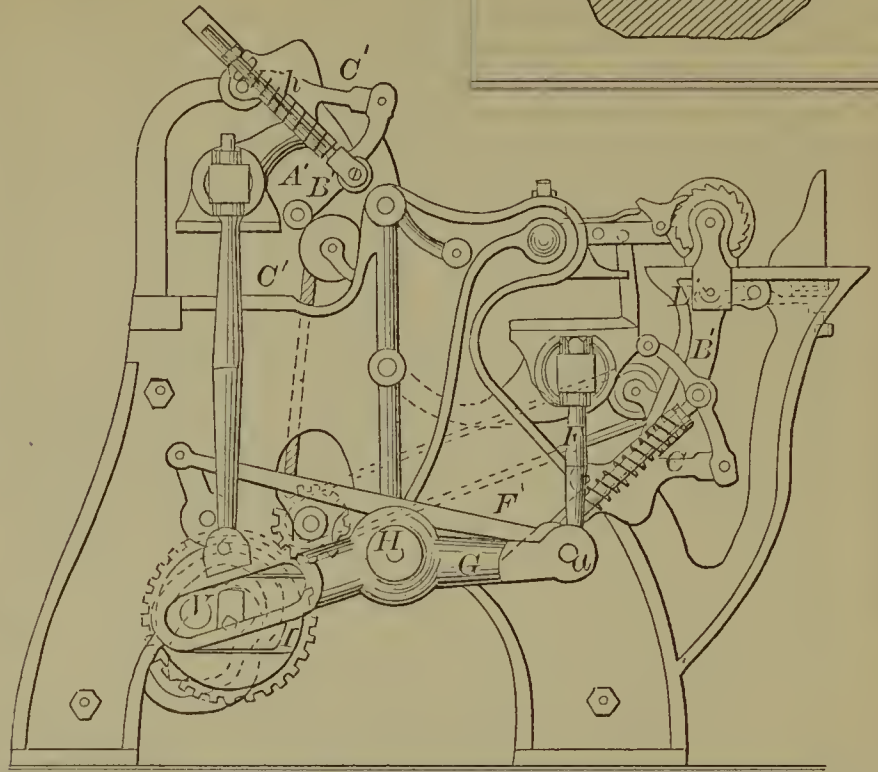

54358—W. G. W. Jaeger—For Continuous Distillation.

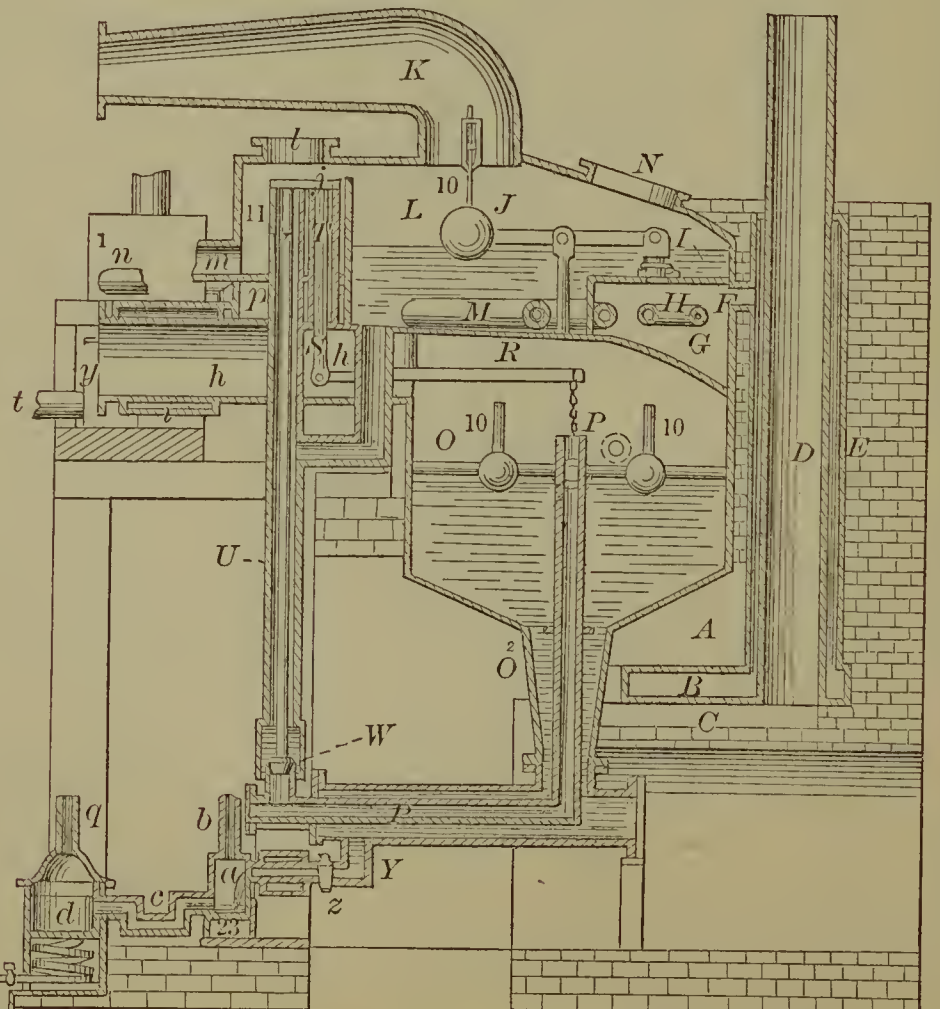
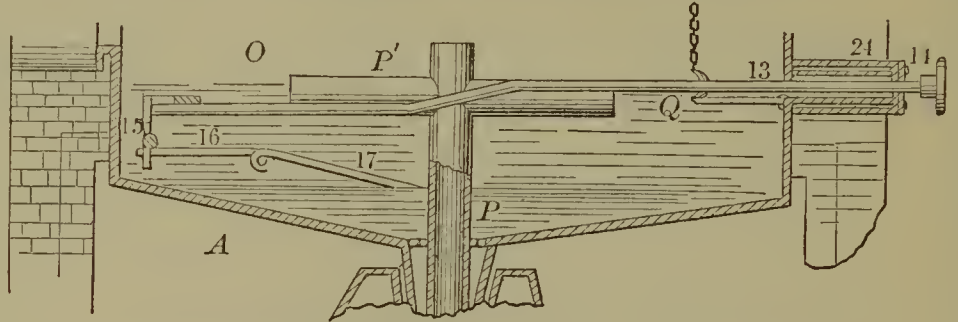

54353—E. Hoole—Burglar Alarm.

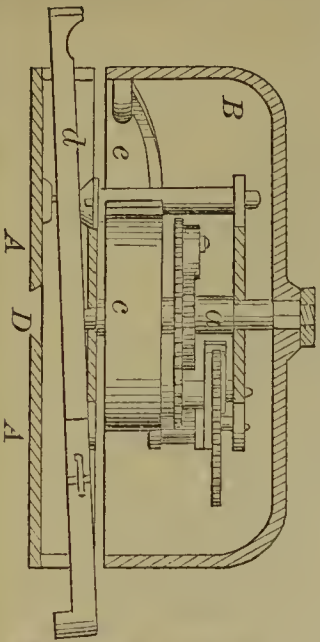

54356—B. Hull—Die for Making  
Hatters Irons.

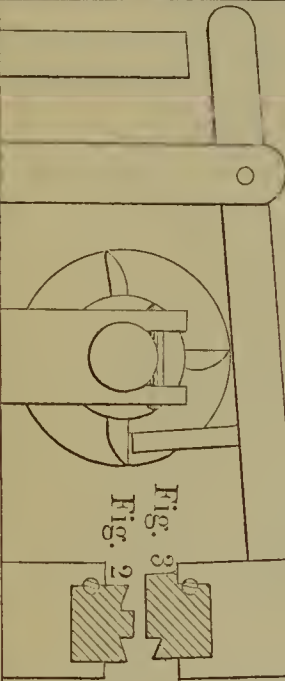

Fig. 3

Fig. 2

54355—D. Hull—For Washing Kaolin, &c.

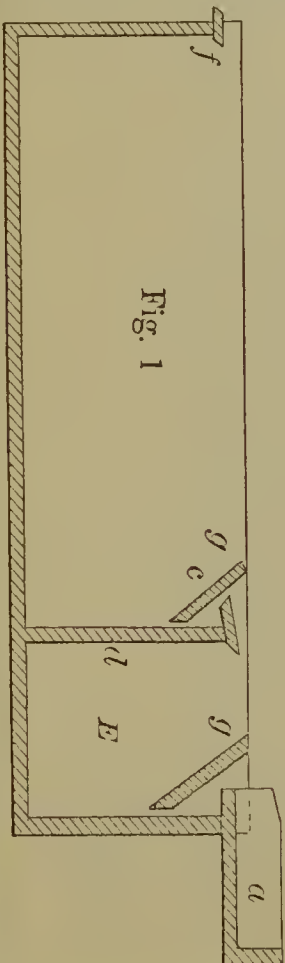
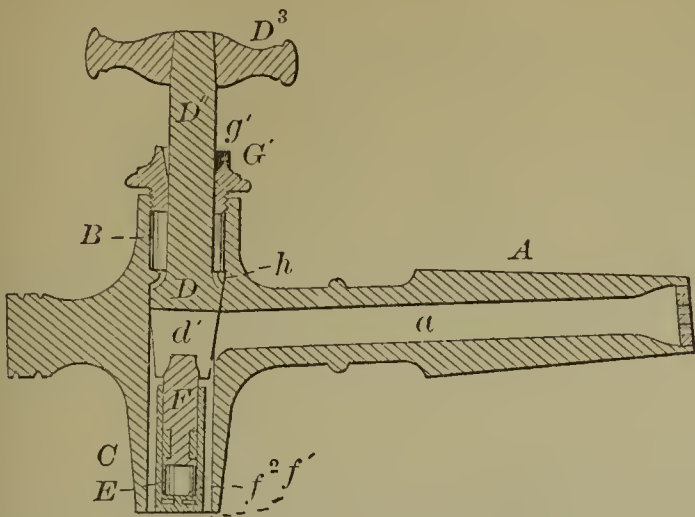
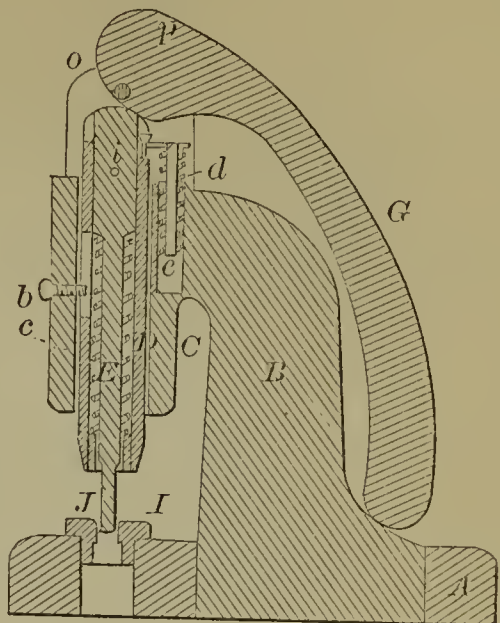

Fig. 1

54359—J. Jahraus—Beer Faucet.



54362—J. Keith—For Forming Pen Holder Springs.



54360—G. R. Johnson—Graining Morocco.

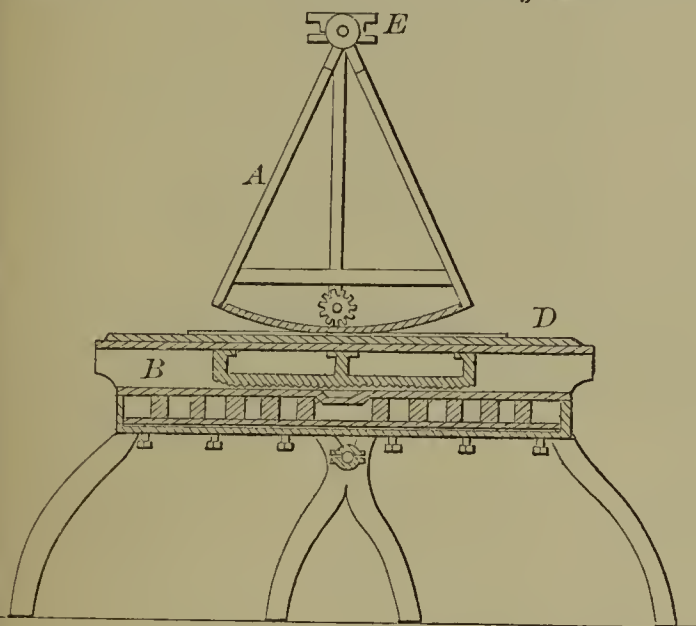

54364—Kimball & Lawrence—Artificial Leg.

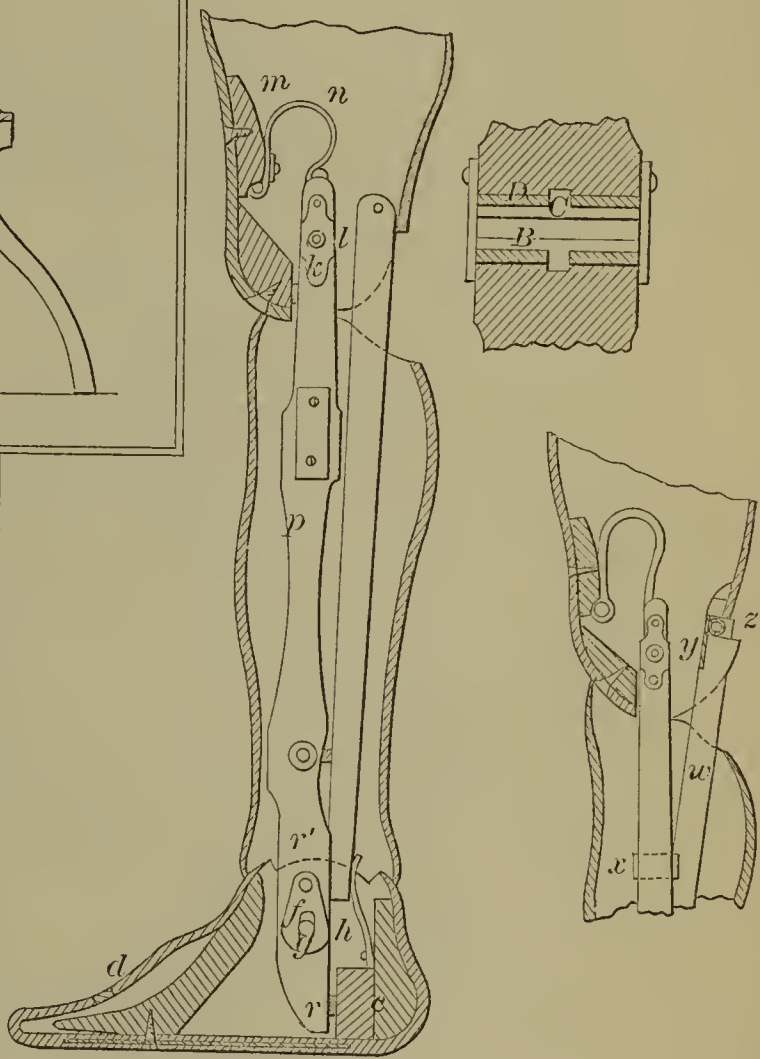

54361—S. F. Jones—Animal Trap.

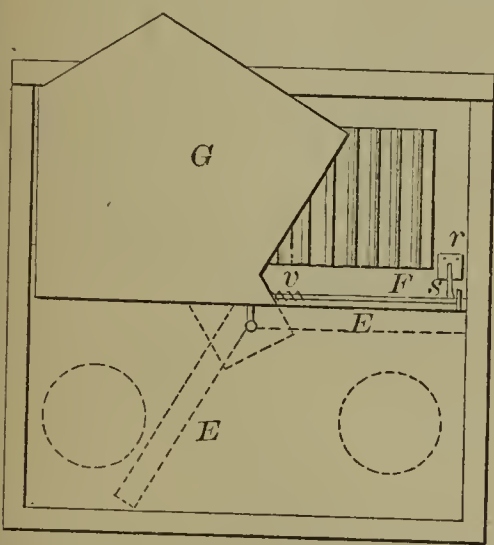

54363—J. E. Kelsey—Stopping and Starting Cars.

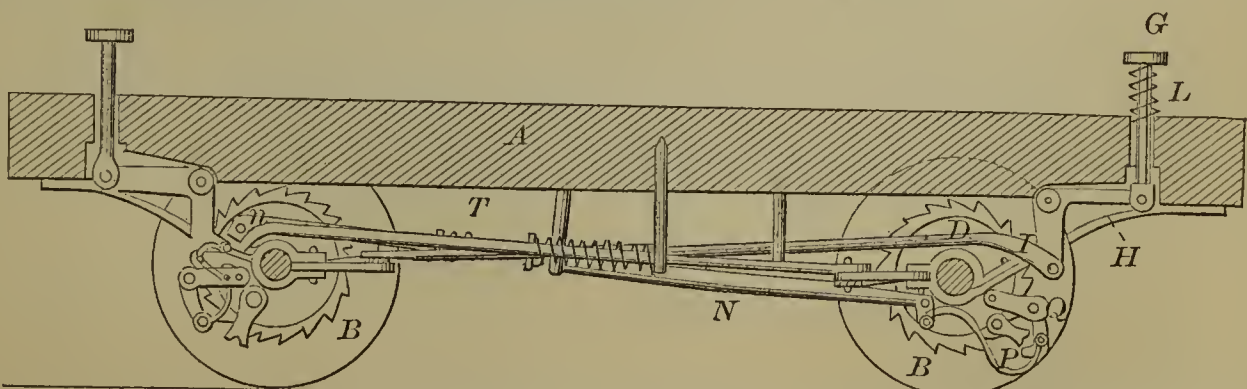

54366—T. T. Kneeland—Sorghum Evaporator.

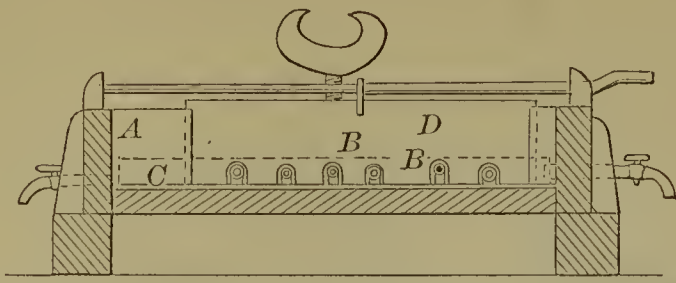

54367—E. H. Knight—Sewing Machine Guide.

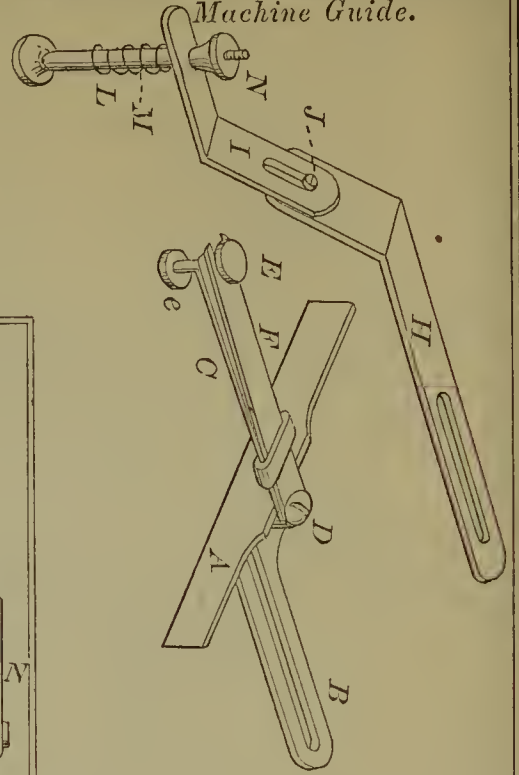

54370—E. Kramer—Clover Harvester.

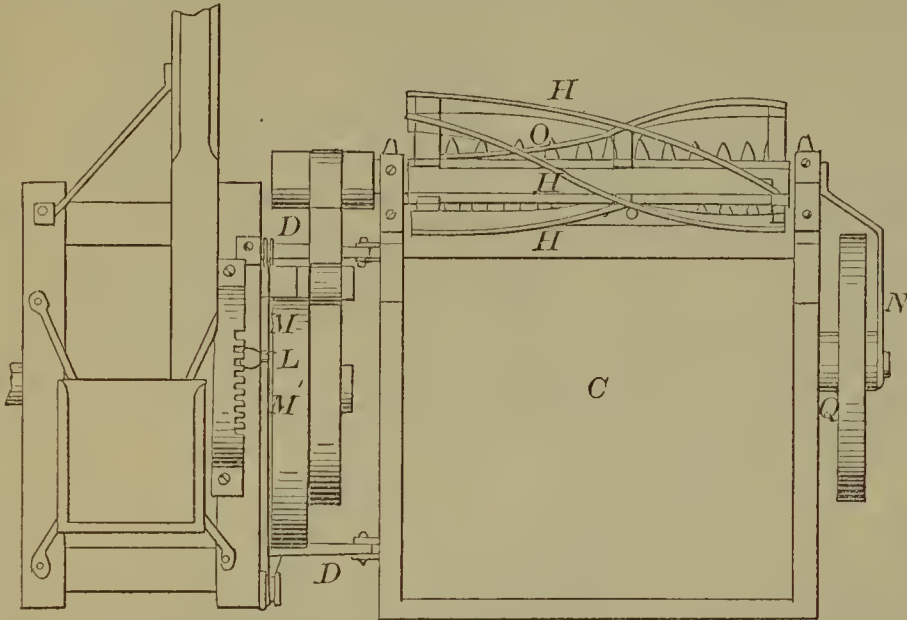

54369—G. A. Knowlton—Pegging Jack.

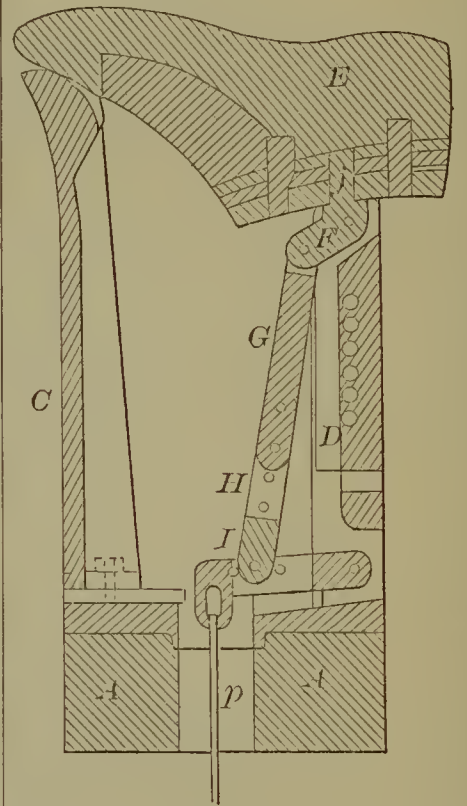

54368—E. J. Knowlton—Land Roller.

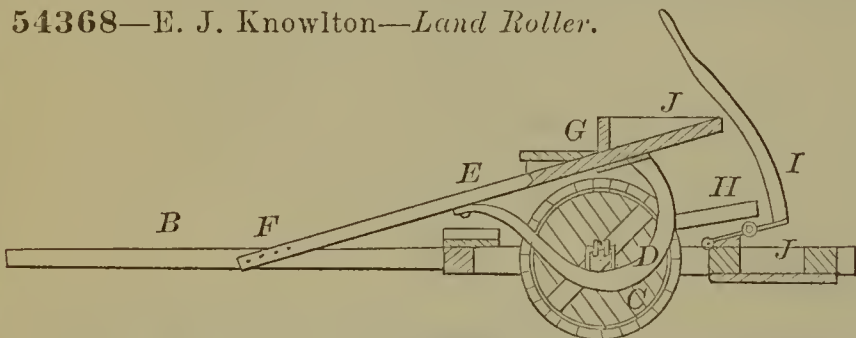

54372—E. M. Krum—Harvester.

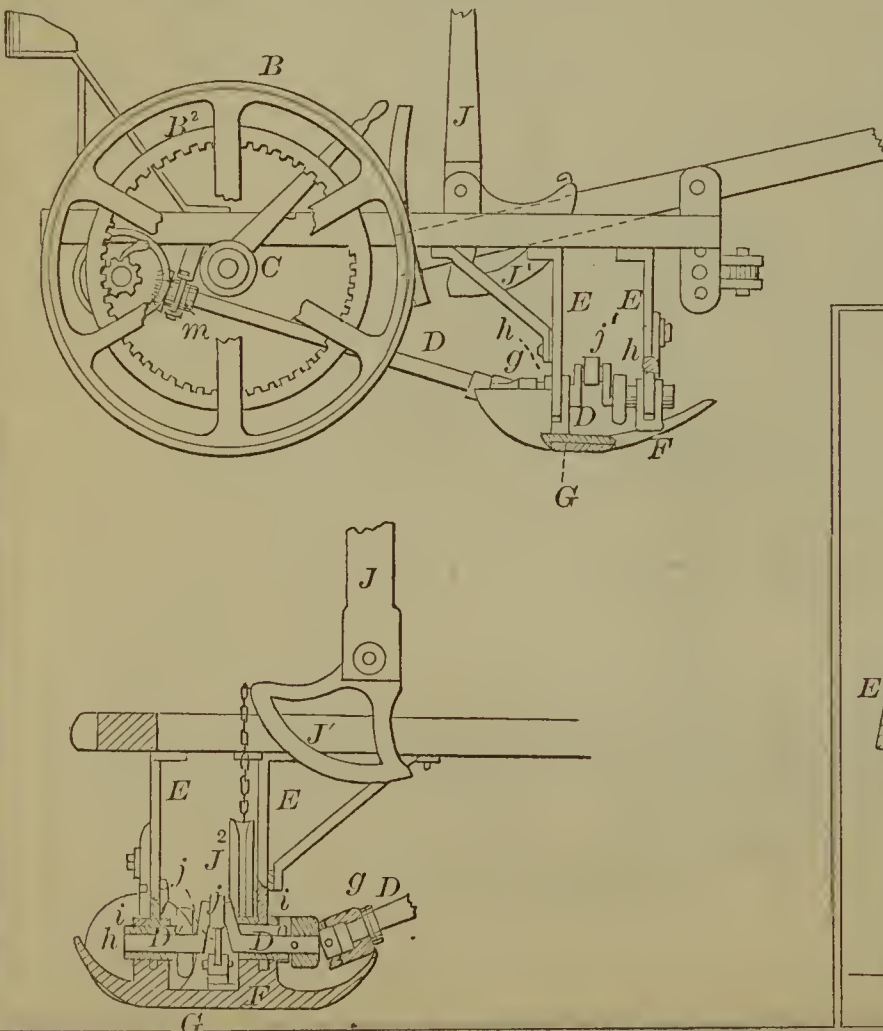

54371—S. Lahm—Sheep Ruck.

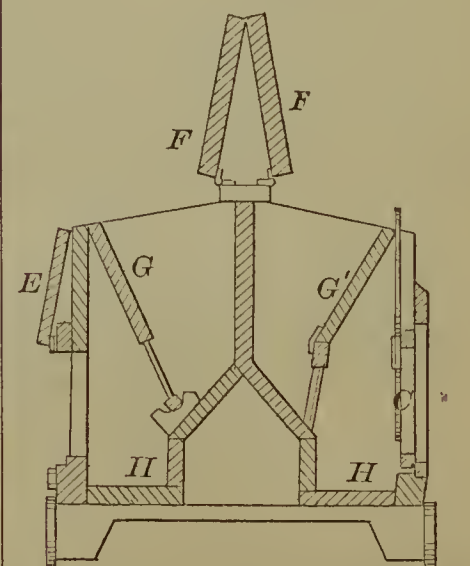

54373—S. W. Langdon—Barn Yard Scraper.

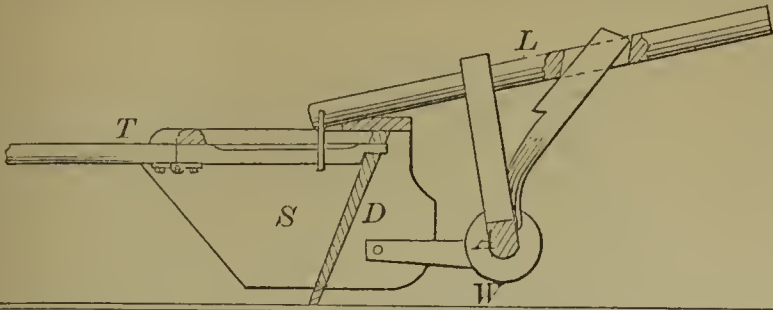

54374—H. R. Lavey—Reaping and Mowing Machine.

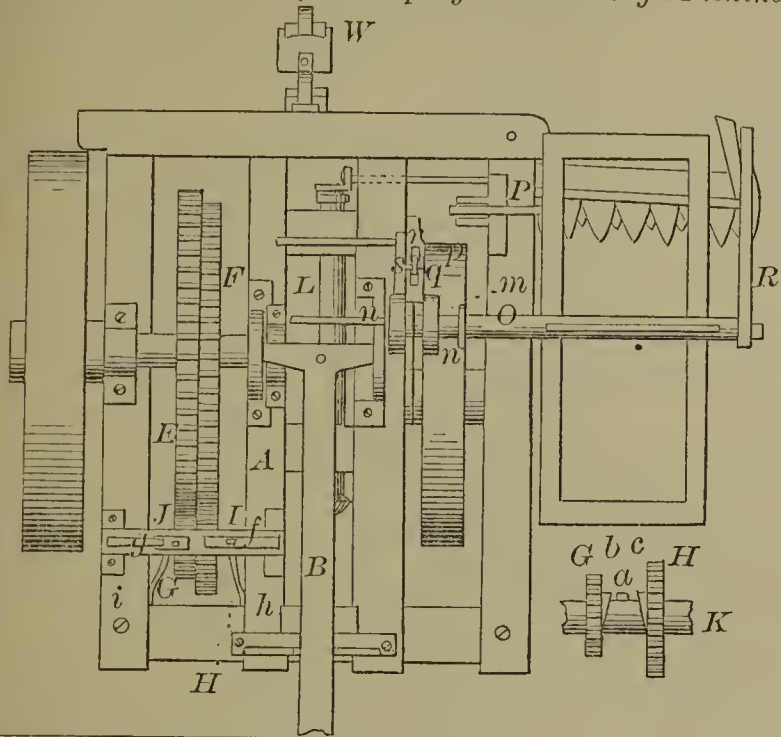

54376—J. C. Lewis—Annealing Box.

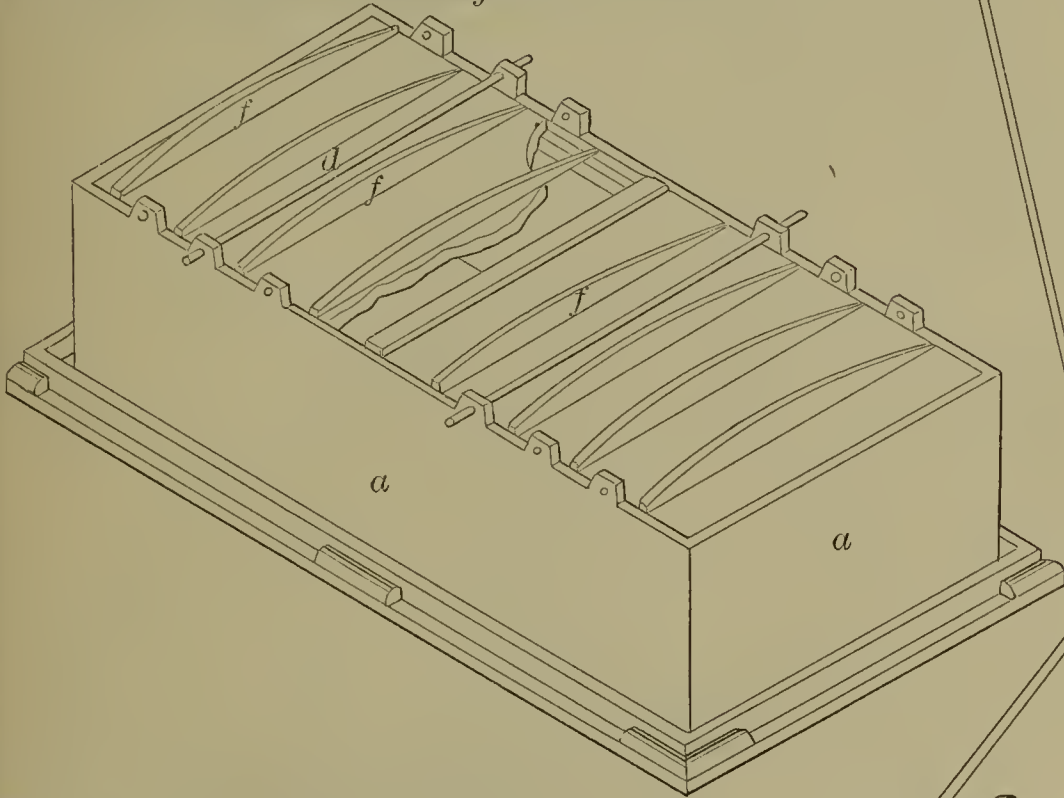

54378—E. A. Lucas—Washing Machine.

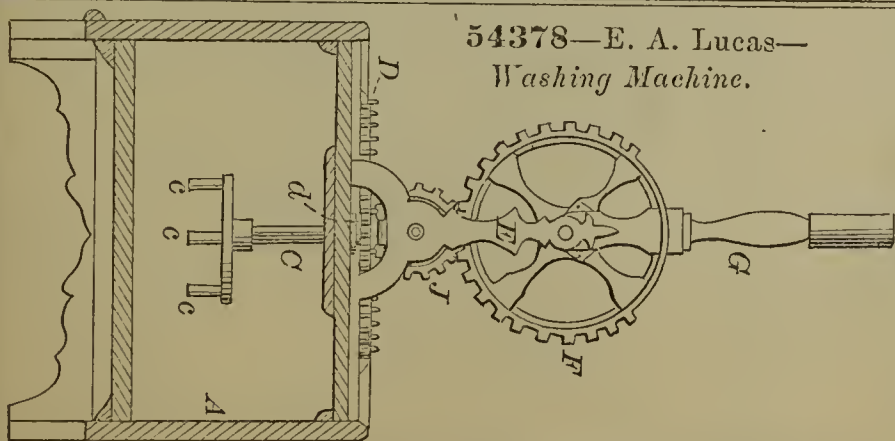

54375—J. Leinweber—Treating Hemp or Flax Waste.

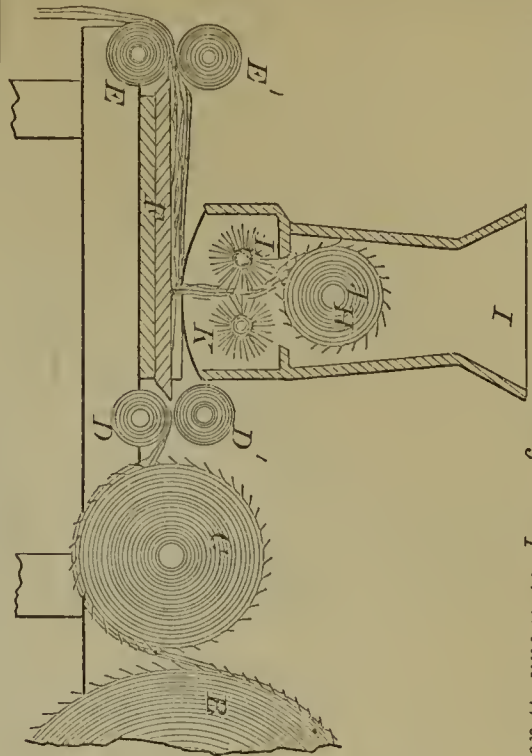

54377—W. J. Lewis—Die for Making T-Head Bolts.



54379—A. Manning—Jaw for Booms of Vessels.

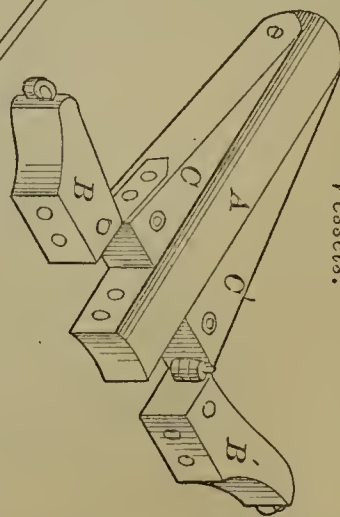

54380—F. N. Martin—*Stirrup.*

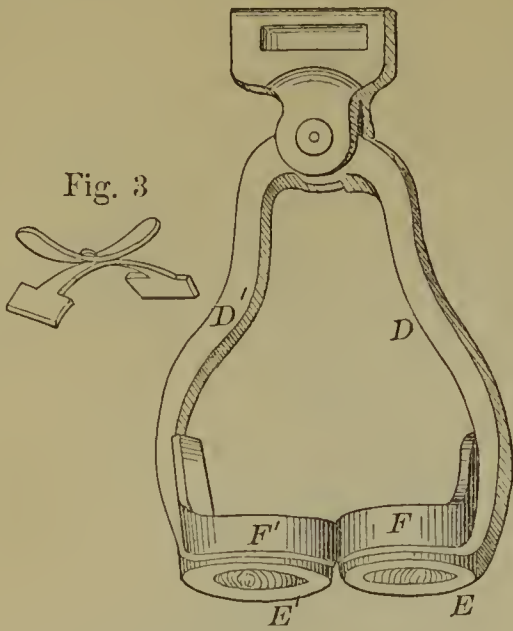

54384—E. Mentz—*Curtain Fixture.*

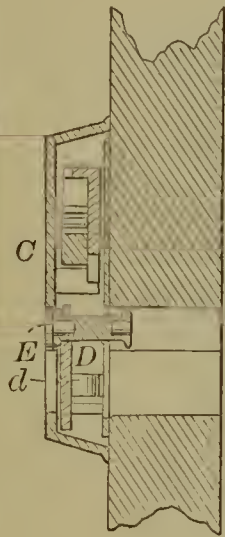
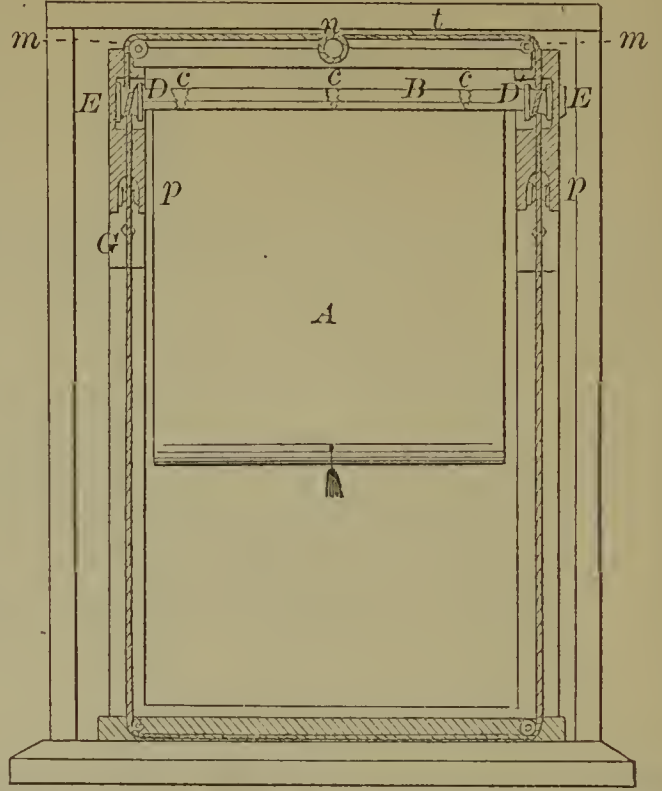

54383—W. C. McGill—*Lock.*

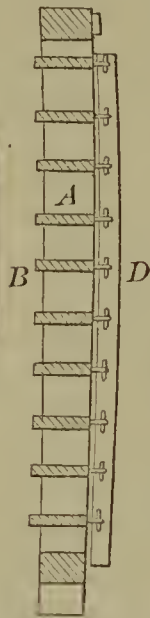

54385—S. W. Merrill—*Window Blind.*

54388—S. C. Moore—*Egg Beater, &c.*

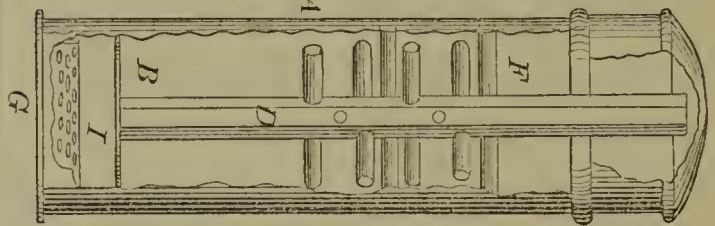

54386—F. Mohr—*Folding Table.*

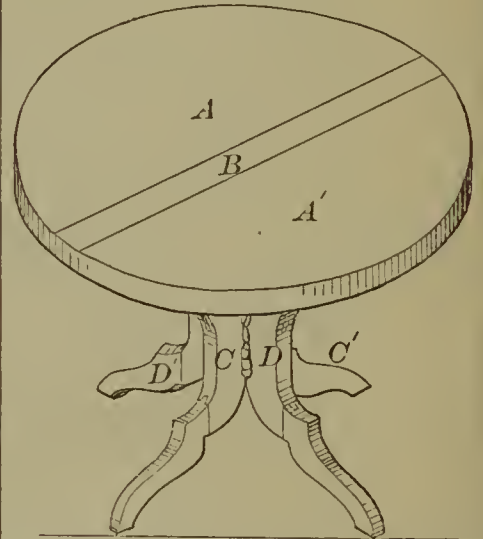

54381—J. Martin—*Gate.*

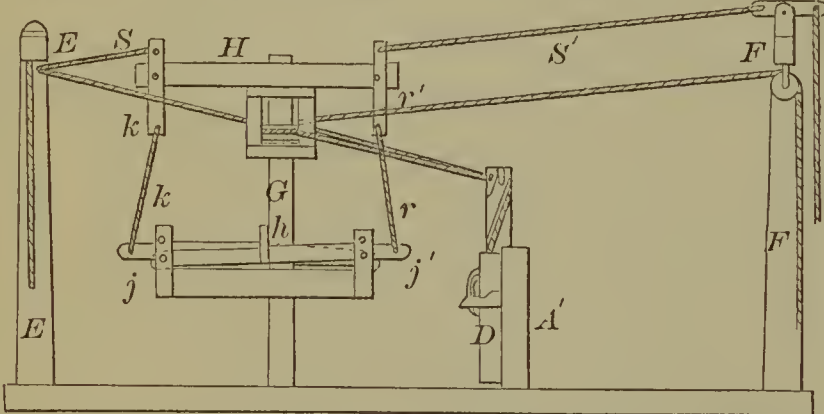

54387—A. Moore, Jr.—*Step Ladder.*

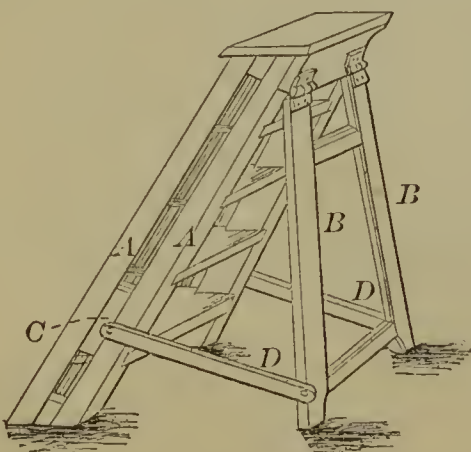

54389—C. H. Mosely—*For Preparing Nitrous H Oxide Gas.*

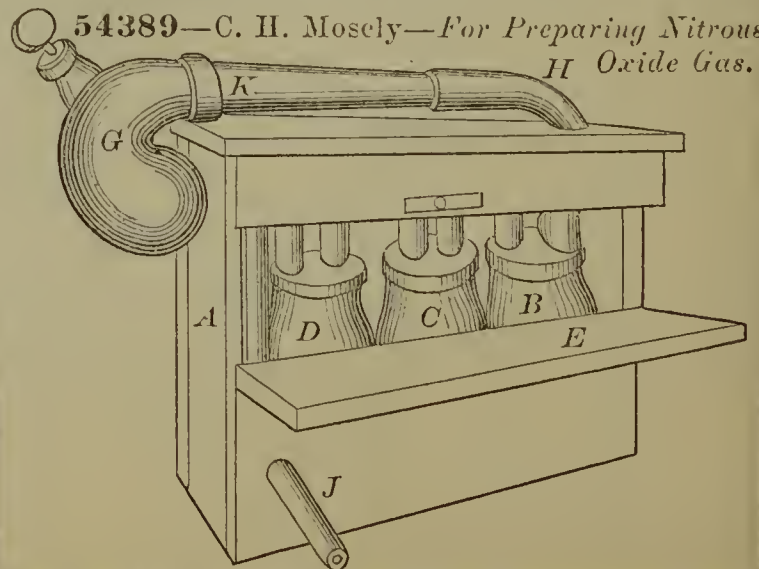

54390—A. L. Munson—*Table Cover.*



54396—A. Palmer—*Harvester.*

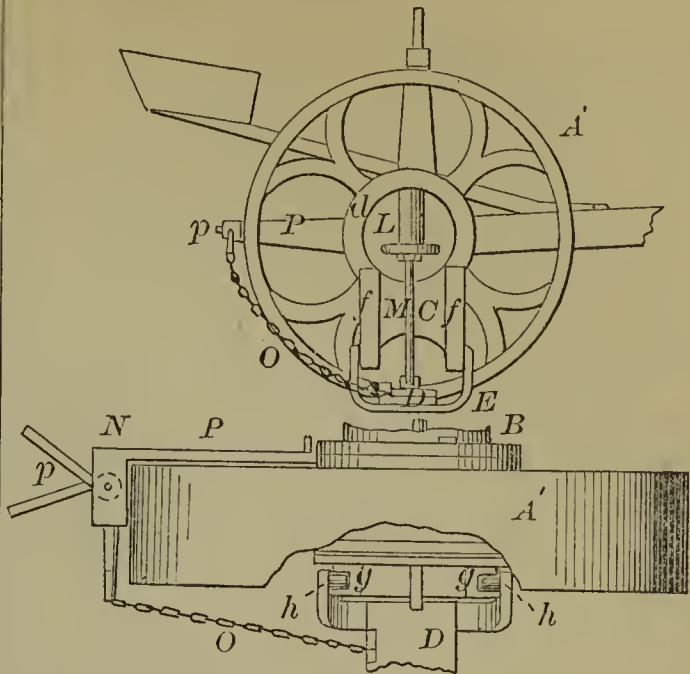

54393—W. H. Newby—*Animal Trap.*

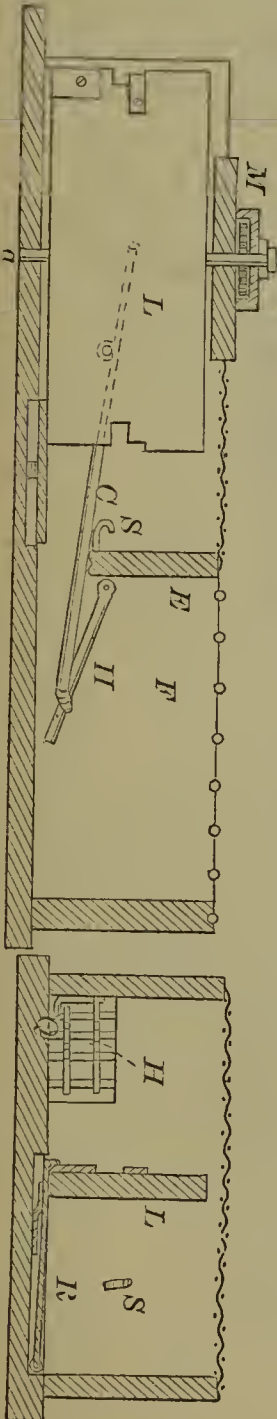

54392—Nevergold & Stackhouse—*For Raking and Loading Hay.*

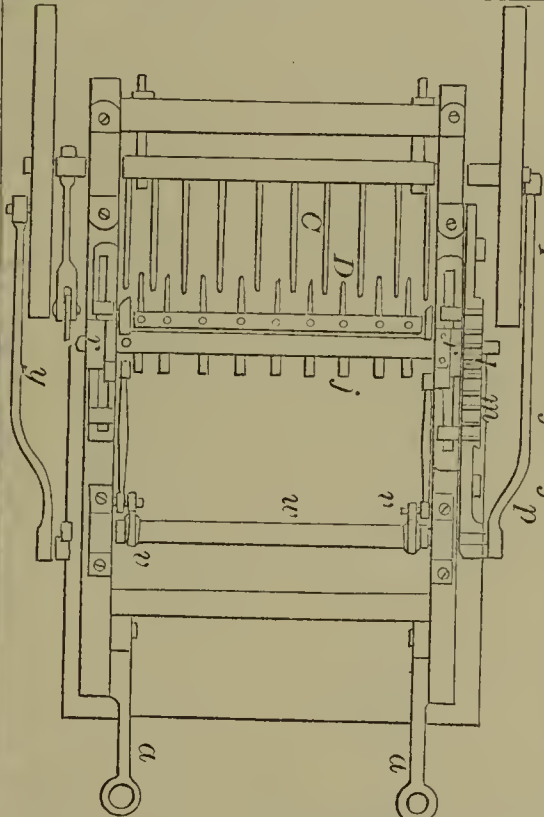

54394—L. H. Olmsted—*Oiler.*

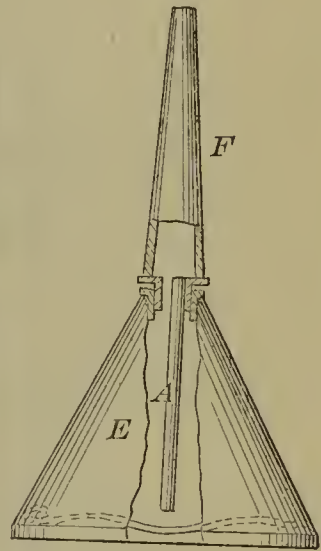

54395—I. T. Packard—*Reed Musical Instrument.*

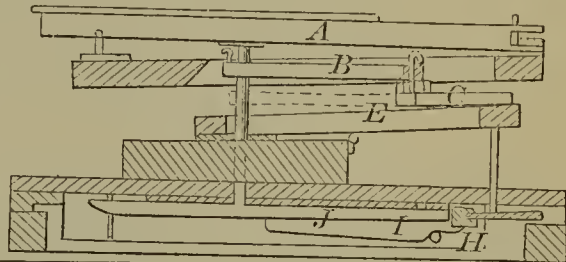

54397—A. Palmer—*Harvester Crank Motion.*

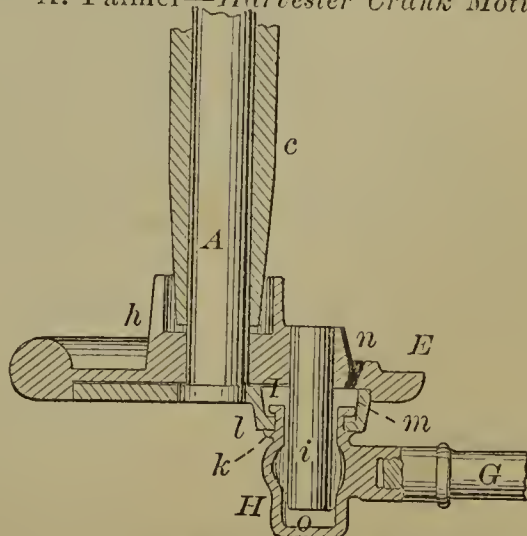

54391—G. R. Nebinger—*Broom Head.*

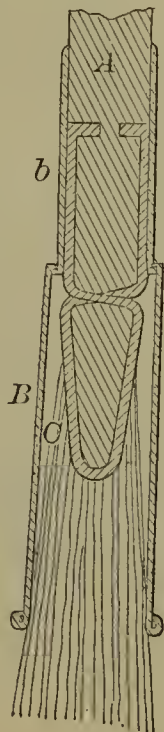

54398—N. Parrish—Stump Extractor.

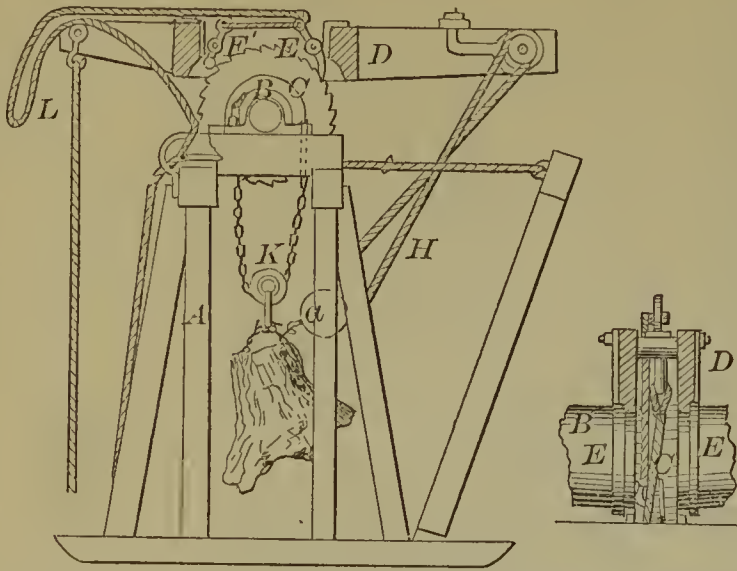

54399—J. S. Patric—Pump.

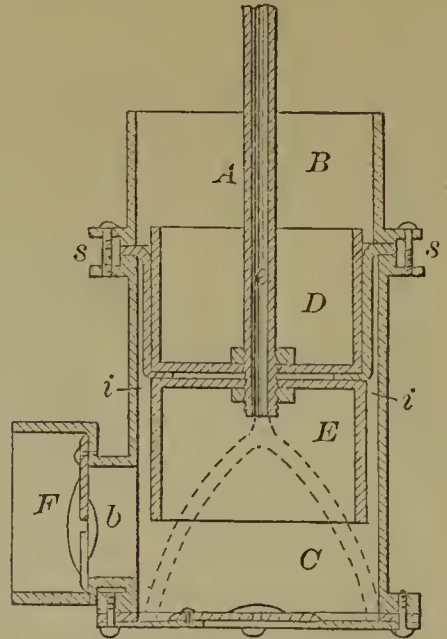

54400—S. Pierce—Cooking Stove.

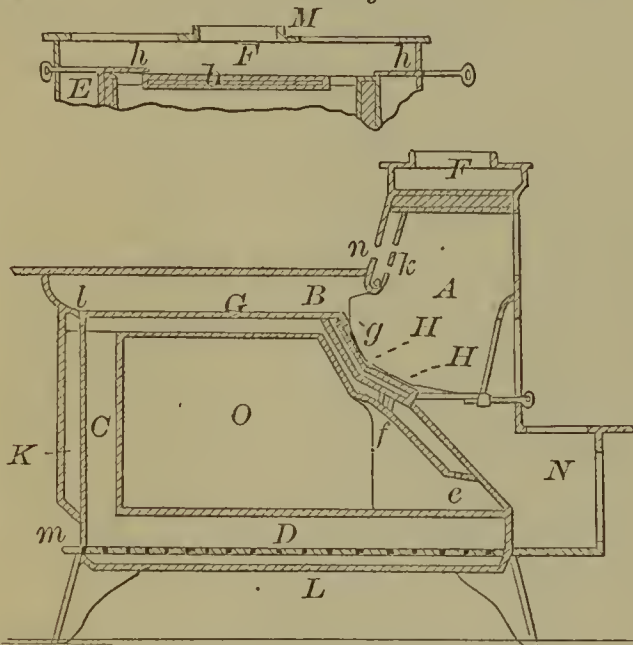

54401—Postawka & Krasiuski—Piano Seat.

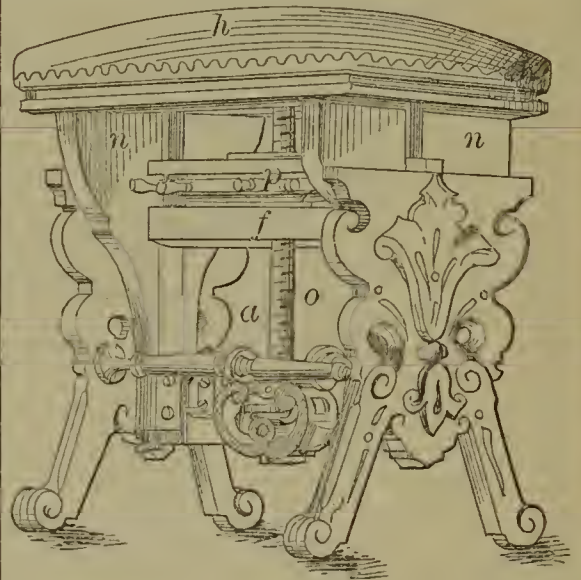

54403—T. J. Price—Grain Separator.

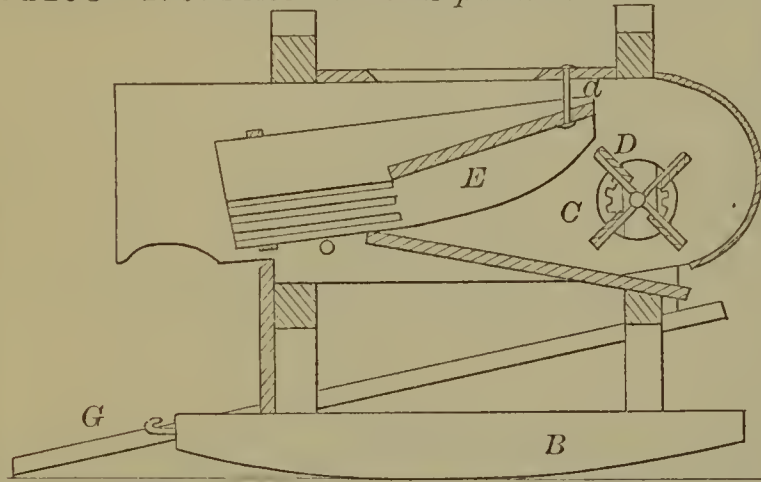

54405—J. N. Ray—For Bending Wood.

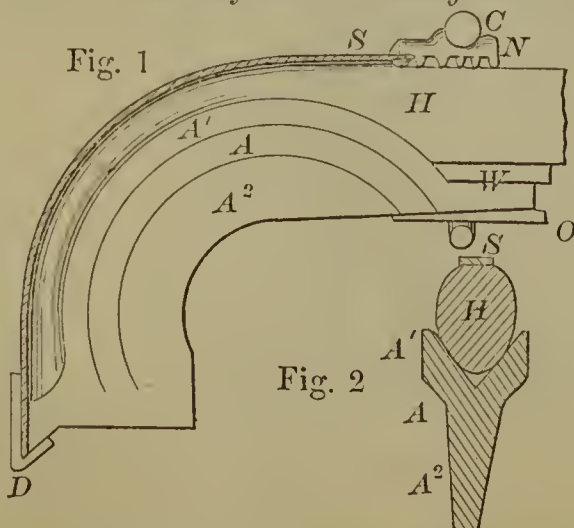

54402—N. F. Potter—Peat Machine.

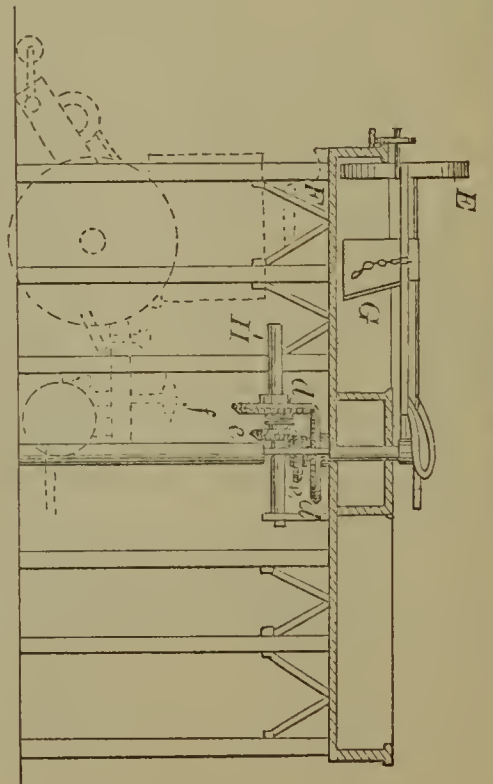



54406—A. R. Reese—Harvester Rake.

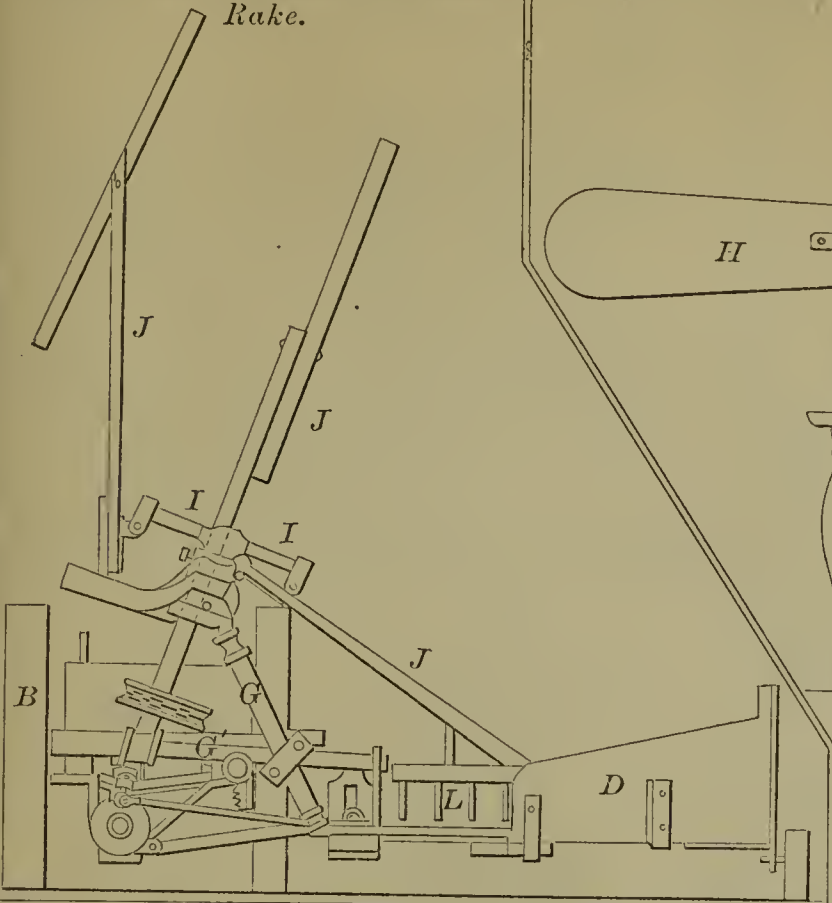

54407—L. Reese—Wind Mill.

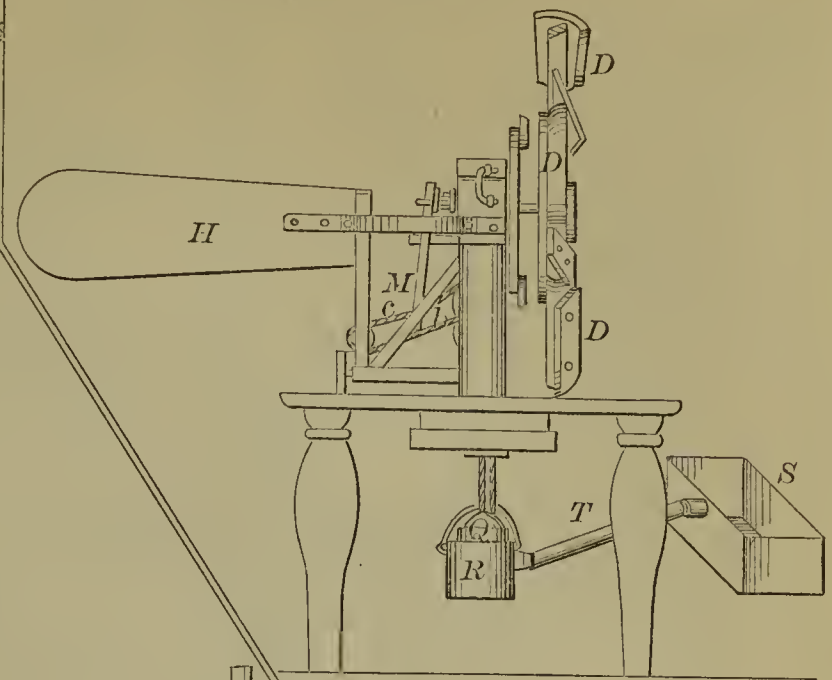

54410—M. Reynolds—Carriage.

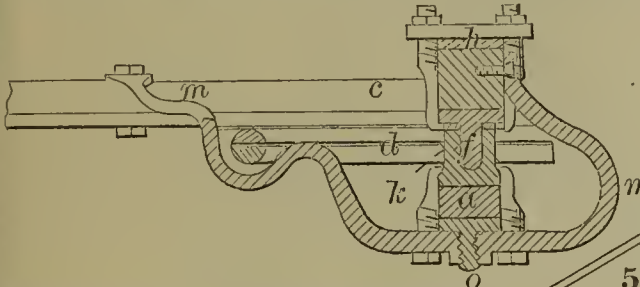

54408—H. M. Remington—Paper Shirt.

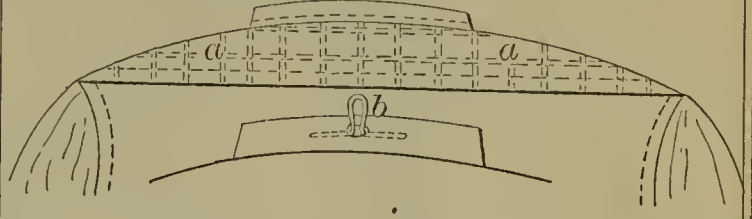

54412—V. B. Ryerson—Extracting Precious Metals.

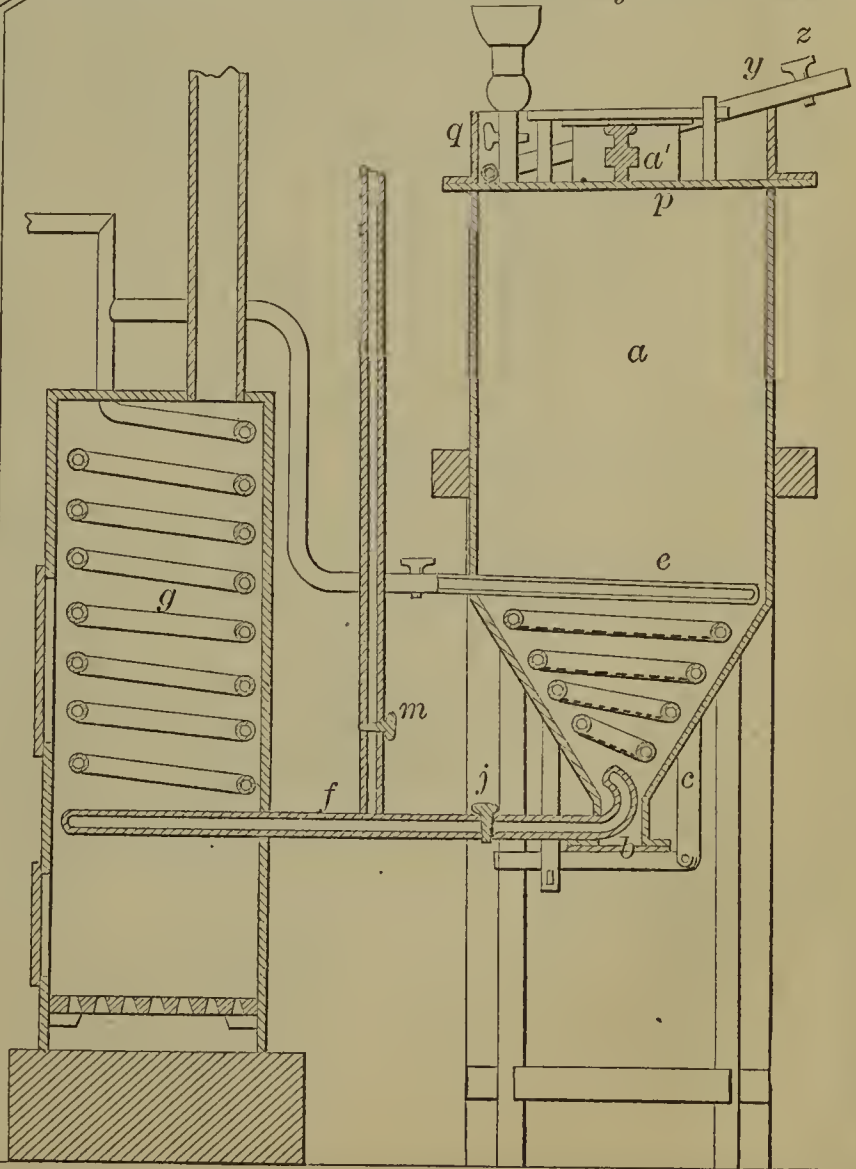

54409—G. E. Reynolds—Furnace.

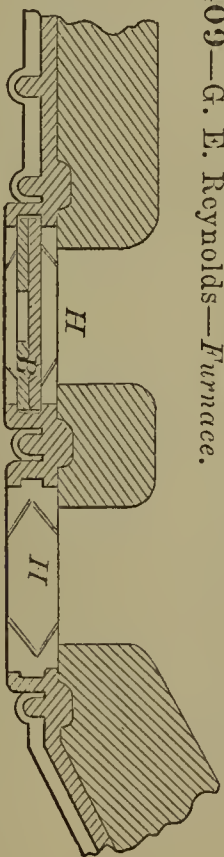

54411—C. E. Richards—Elastic Chain.



54413—J. Robertson—*Atmospheric Hammer.*

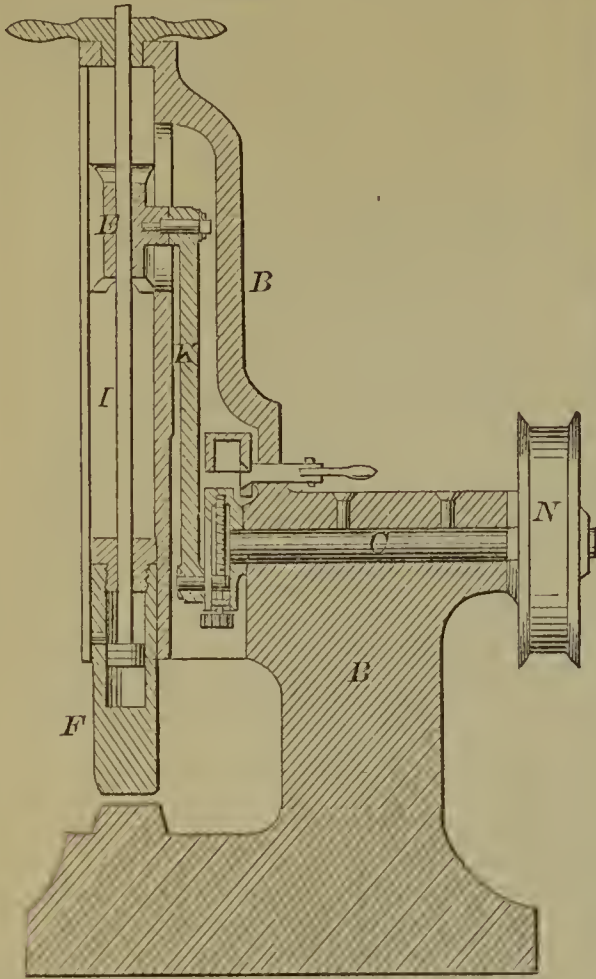

54416—T. E. Sexton—*Printing Photographic Pictures.*

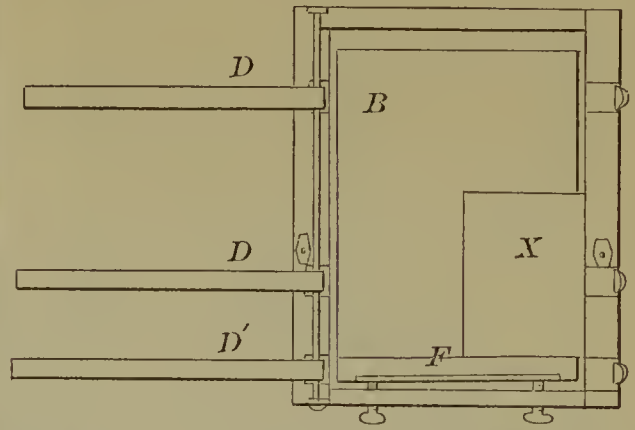

54418—A. N. Shattuck—*For Raising Water by Waves.*

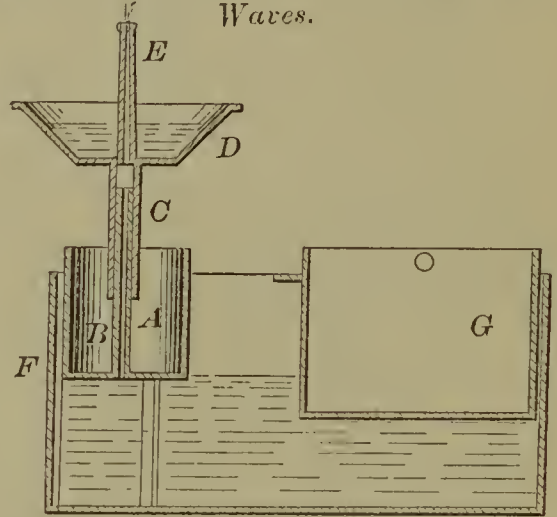

54414—W. H. Sangster—*For Refining Petroleum.*

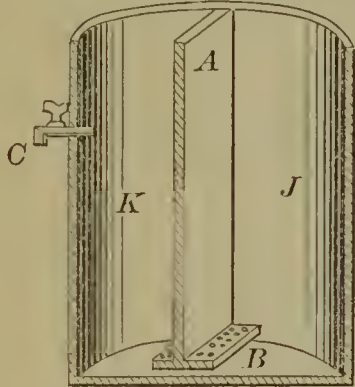

54415—H. B. Scofield—*Grate Bar.*

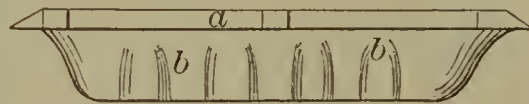

54420—J. W. Sheaffer—*Pump.*

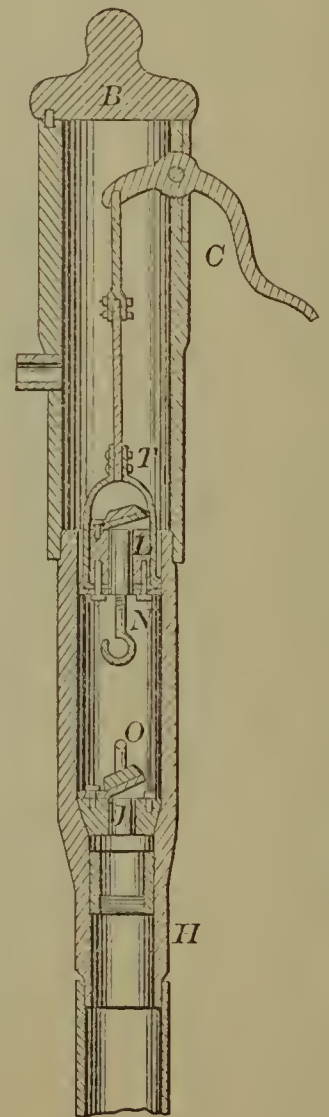

54419—H. F. Shaw—*Hoisting Apparatus.*

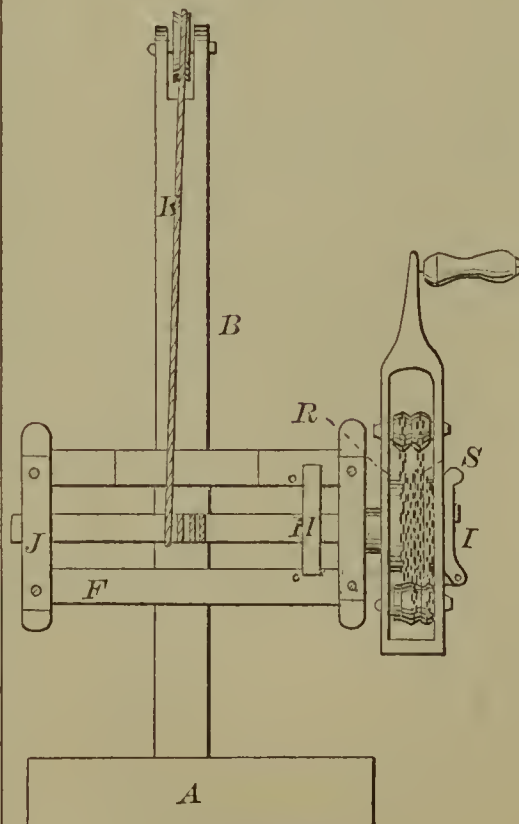

54417—W. A. Sharpe—*Filter for Well Tubes.*

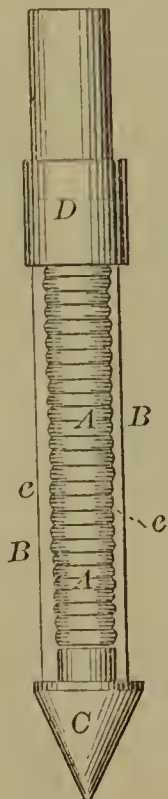

54421—A. H. Sheffer—*Harrow and Cultivator.*

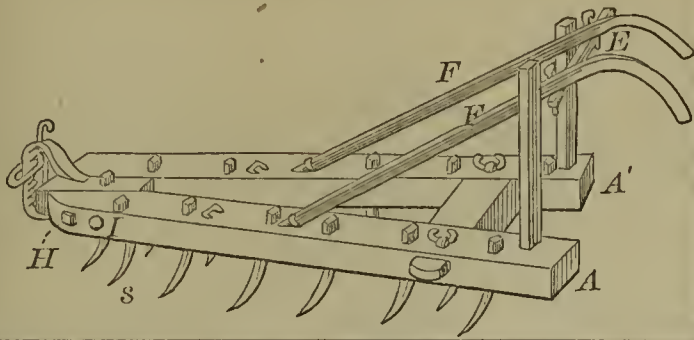

54422—P. B. Sheldon—*Fruit Basket.*

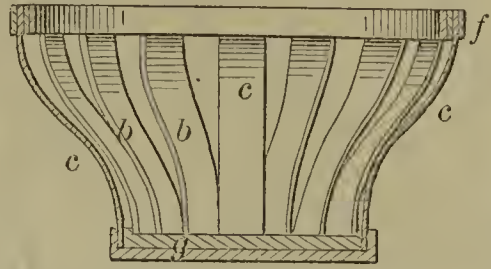

54424—W. A. Simonds—*Fluid Regulator.*

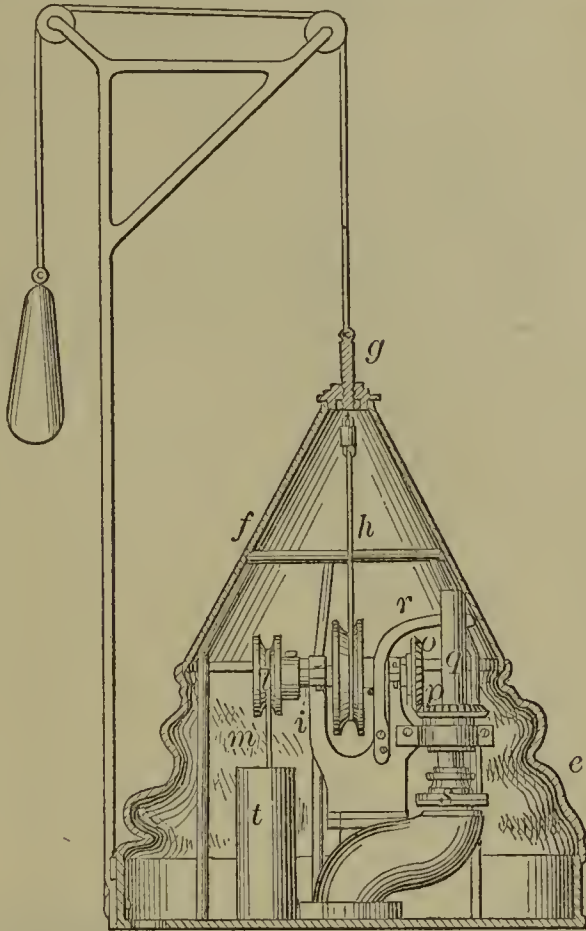

54425—A. S. Skiff—*Lead Roller.*

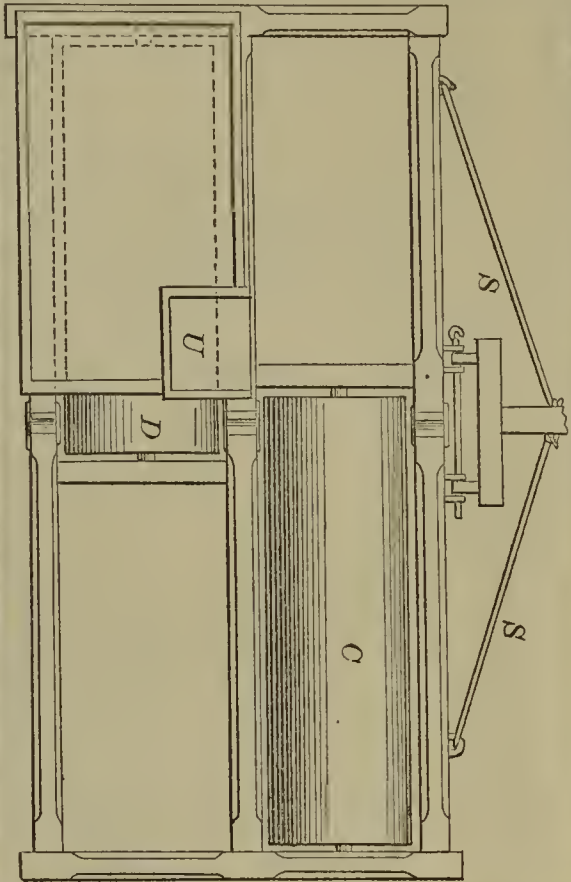

54423—D. Shive—*Steam Engine Governor.*

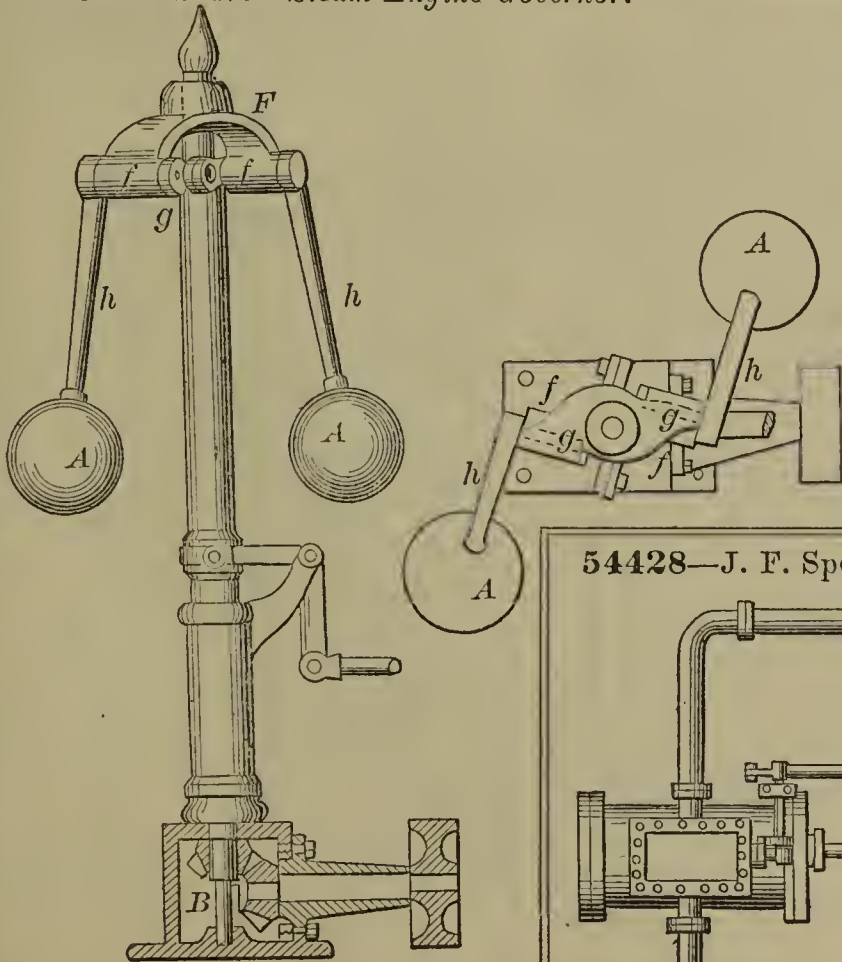

54427—O. Smith—*Cooking Range.*

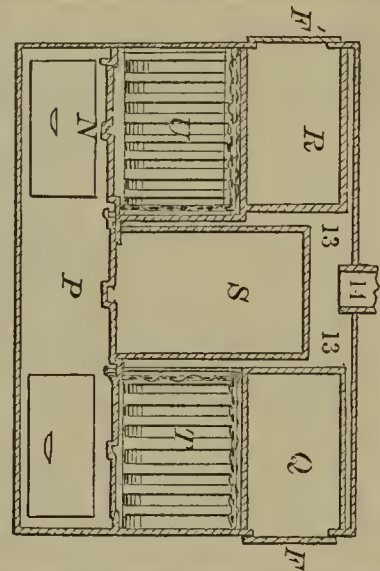

54428—J. F. Spence—*Revolving Condenser.*

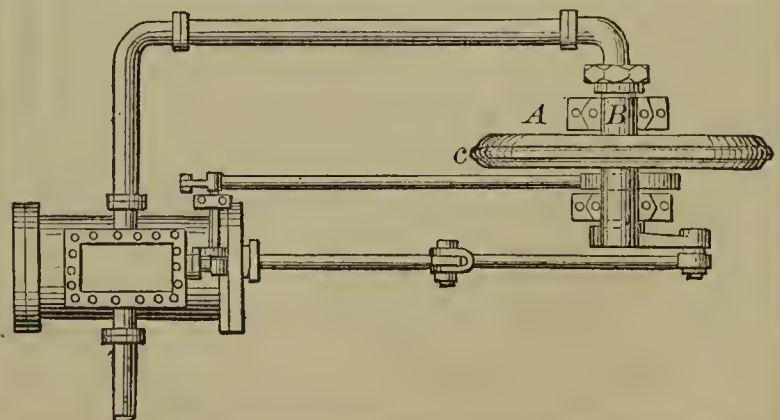

54429—A. B. Sprout—For Tempering Cast Steel.

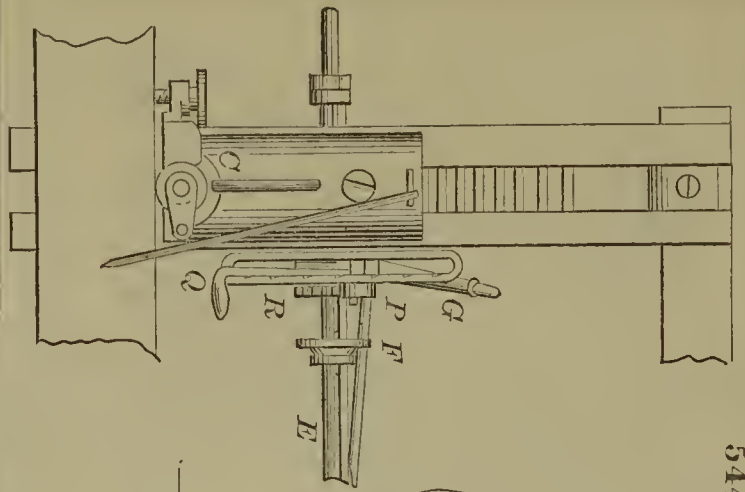
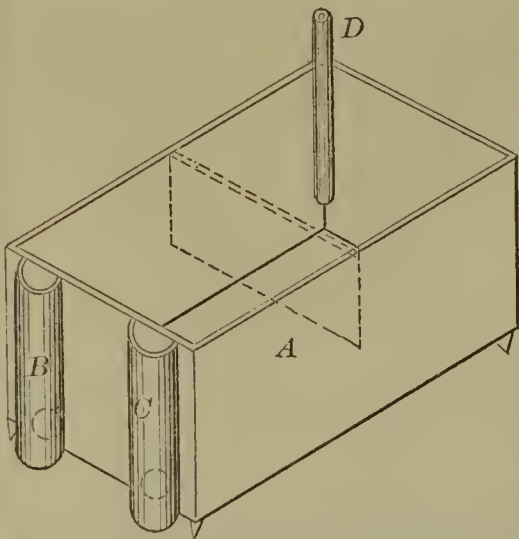

54432—J. M. & S. F. Stanton—Head Block to Saw Mills.

54430—A. B. Sprout—Horse Rake Teeth.

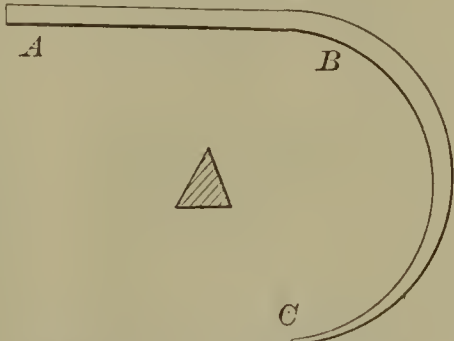

54435—J. B. Stewart—Hay Fork.

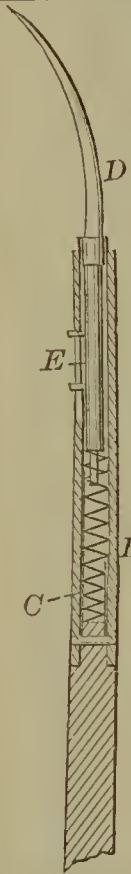

54434—Stevens & Fay—Curtain Fixture.

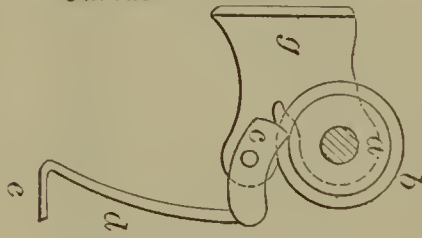

54436—J. C. Stoddard—Deflector for Car Windows.

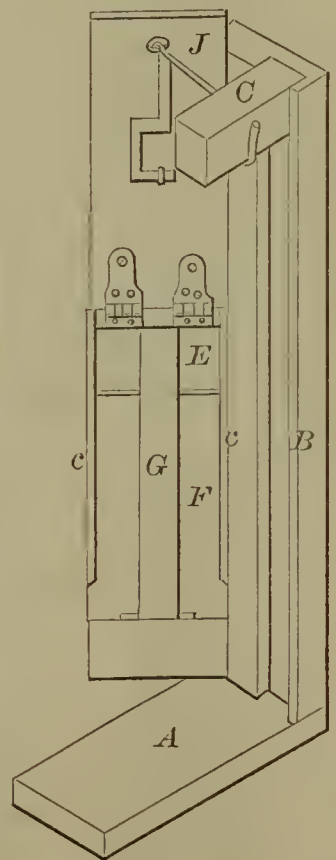

54431—A. B. Sprout—Horse Hay Fork.



54433—N. Starr, Jr.—Horse Power.

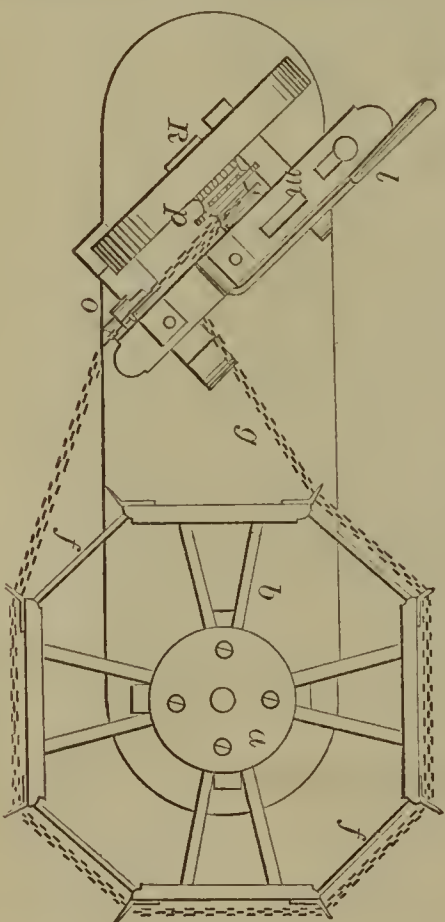

54440—J. Sweeney—For Bending Tubes.

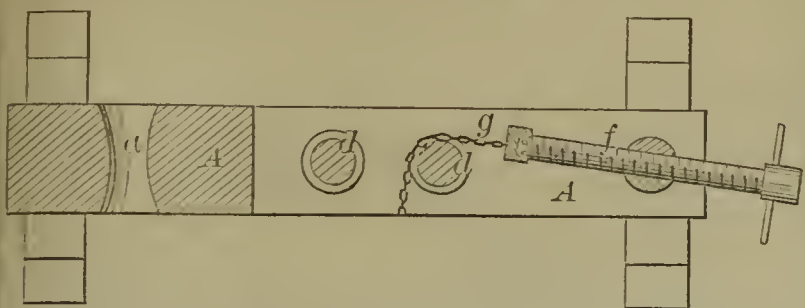

54437—C. Stoll—Cheese Box.

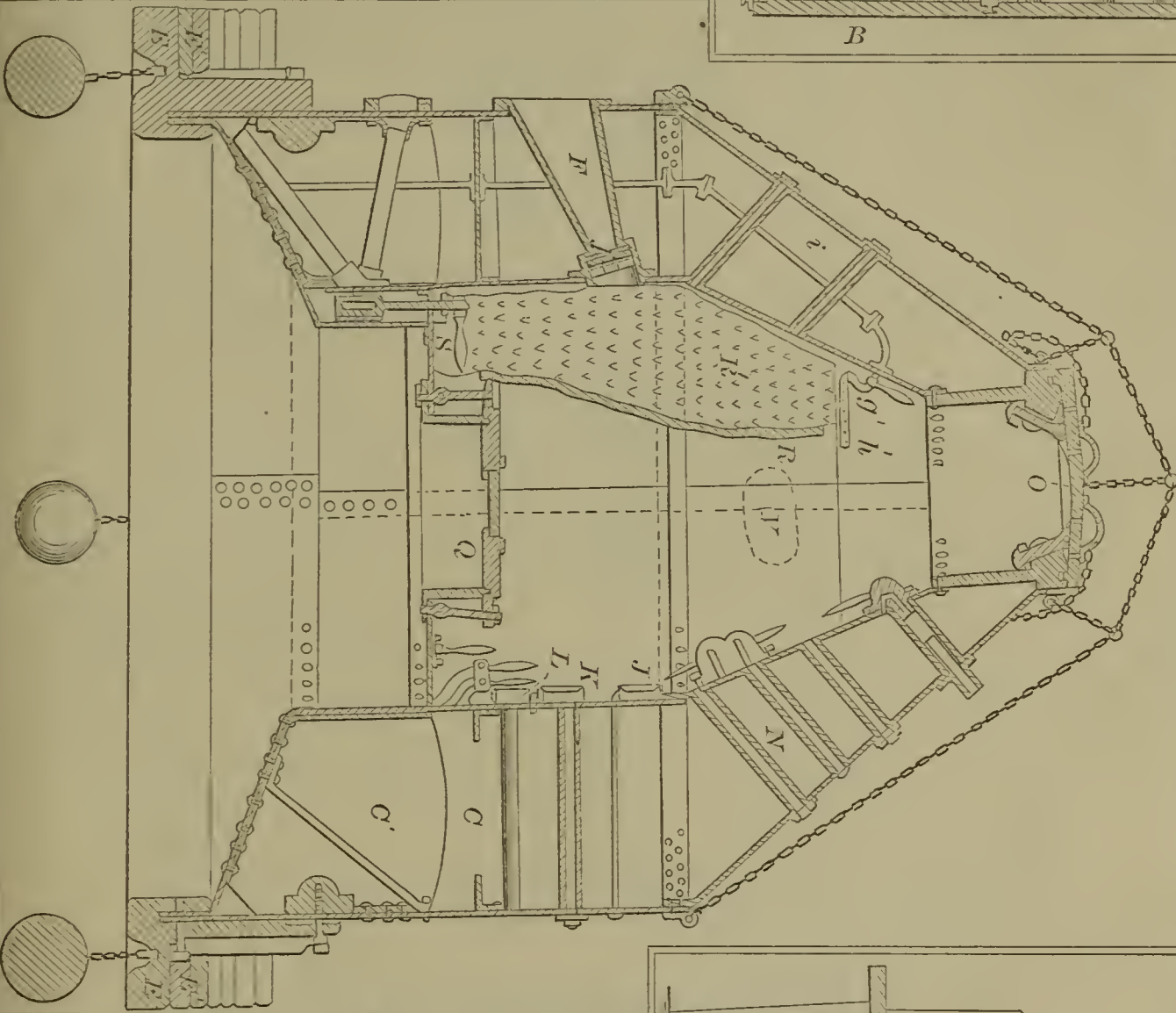
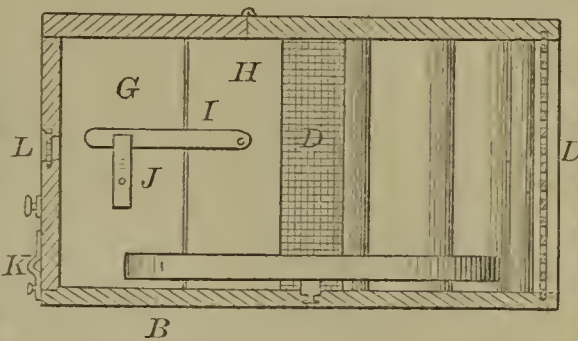

54438—W. M. Storm—Submarine Explorer.

54439—A. Stuckenkath—Horse Power Indicator.

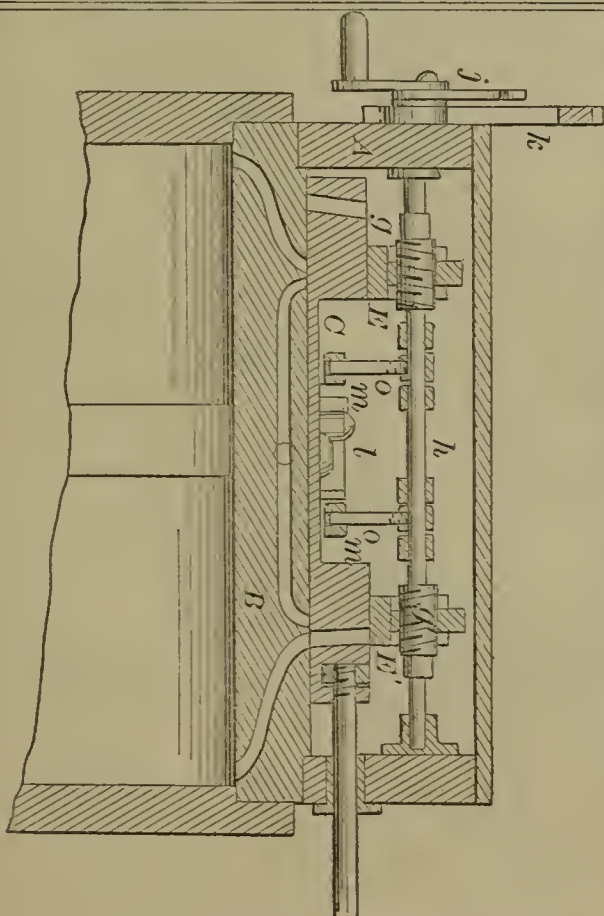

54441—S. J. Tallbot—Planing Machine.

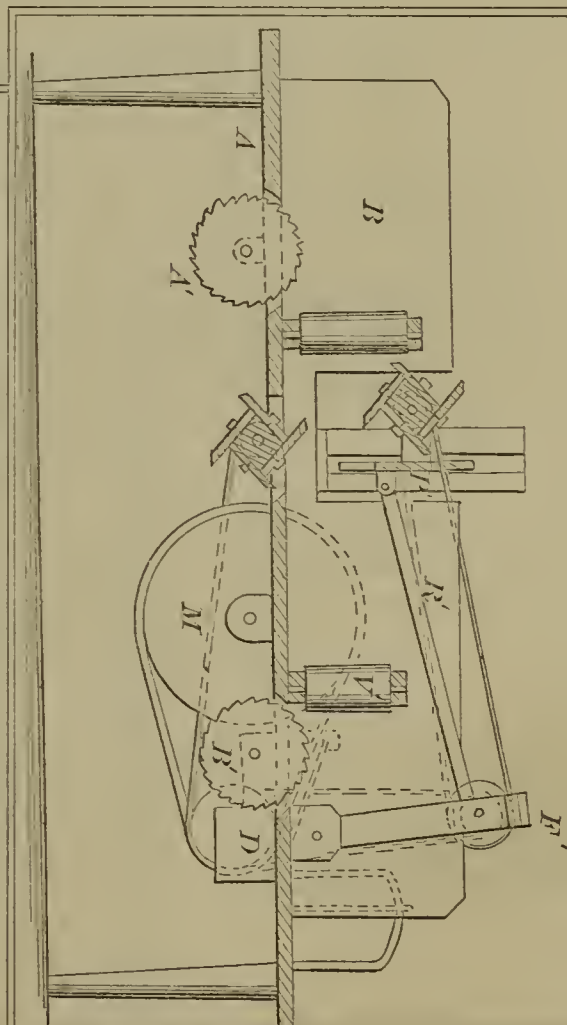

54442—R. H. Thurston—  
*Magnesium Lamp.*



54446—G. Utley—*Straw Cutting Knife.*

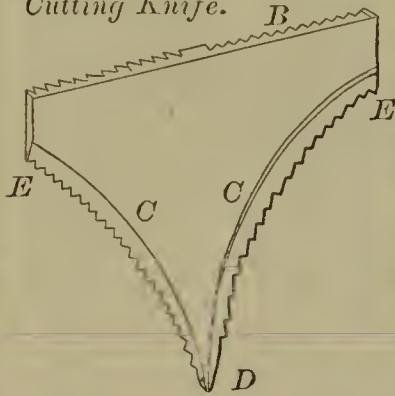

54449—G. Vedder—*For Elevating Straw from Threshing Machines.*

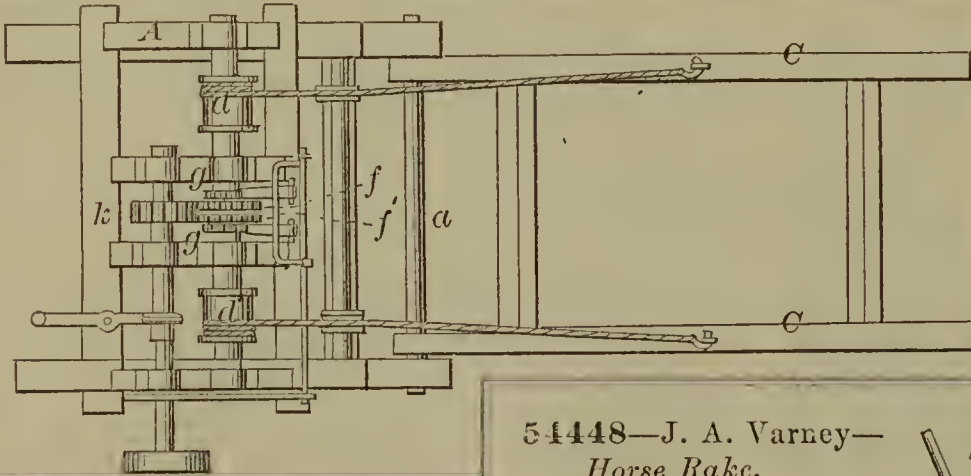

54450—E. Waite—*Card for Carding Machines.*

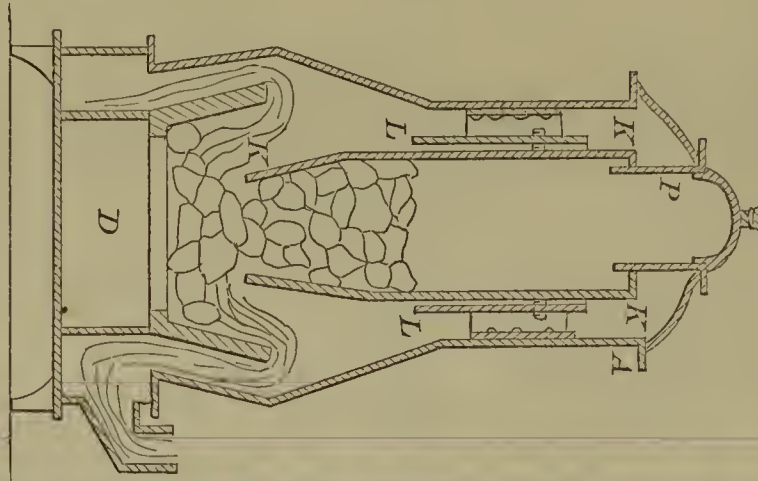
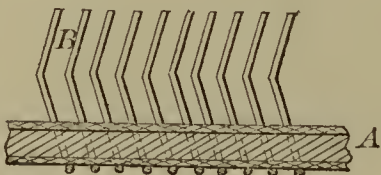

54447—Van Wormer & McGarvey—  
*Base Burning Stove.*

54444—W. H. Towers—  
*Flour Barrel.*

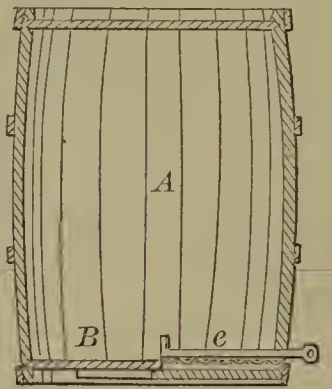

54443—L. L. Tingley—*Spring Bed Bottom.*

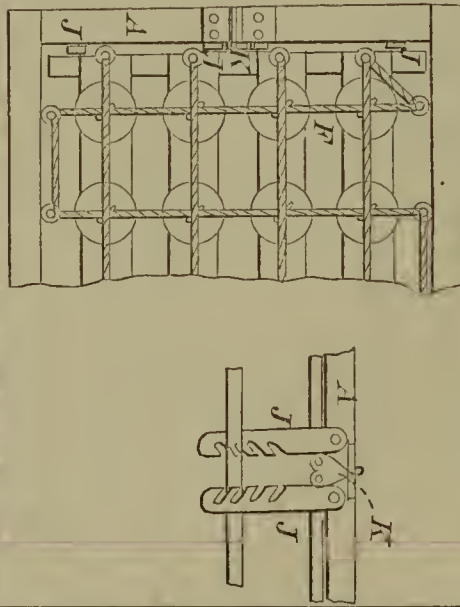

54445—C. Unverzagt—*Shuttle and Bobbin for Looms.*

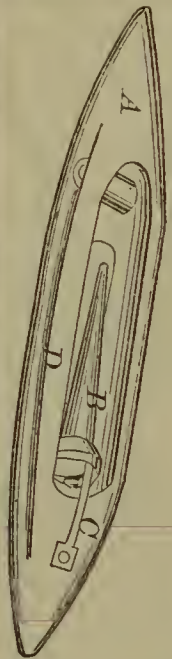

54448—J. A. Varney—  
*Horse Rake.*

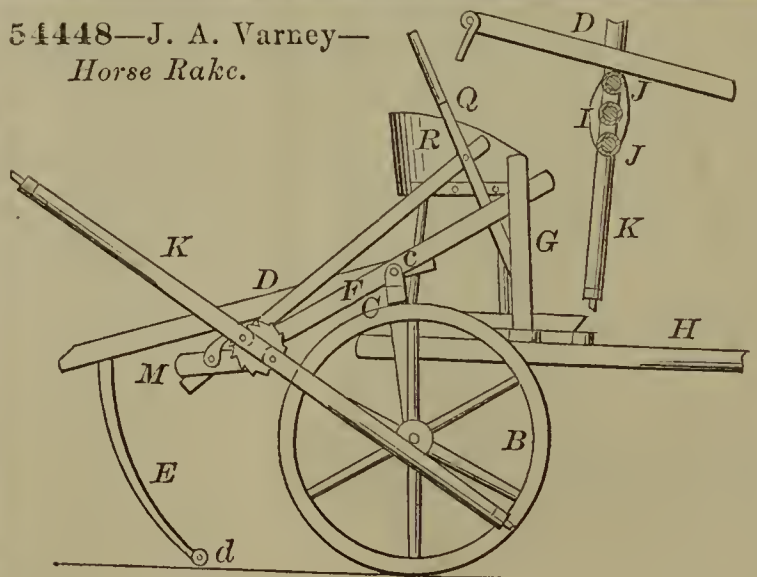

54451—E. M. Walker—*Corn Planter.*

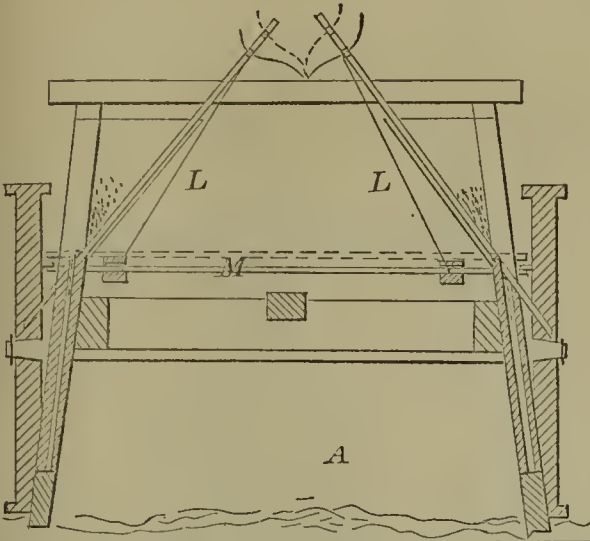

54452—W. Wallick—*Horse Shoe Machine.*

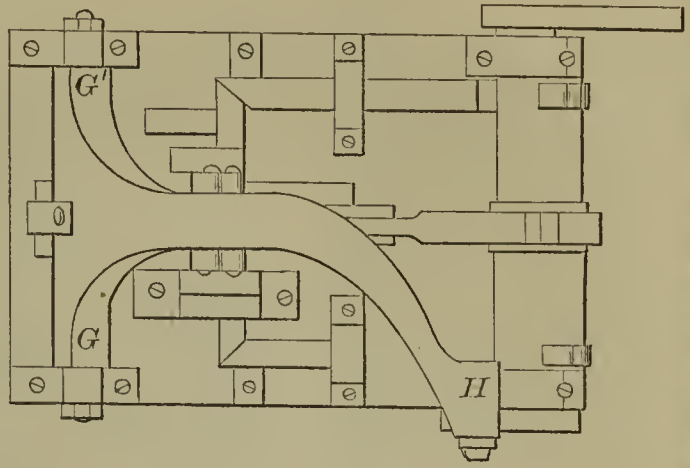

54453—W. M. Watson—*Gang Plow.*

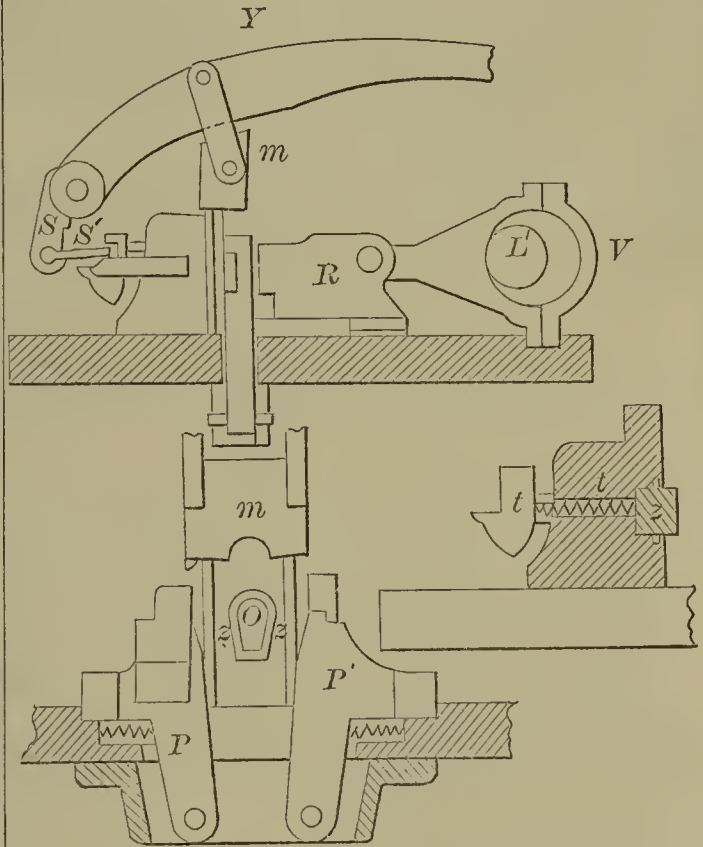
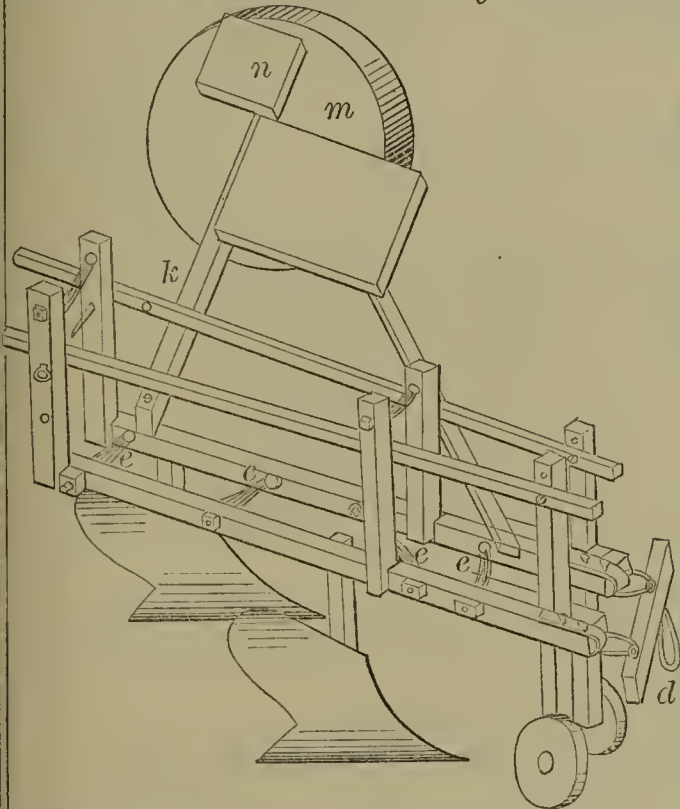

54455—S. Wesson—*For Finishing the Ends of Pen Handle Tubes.*

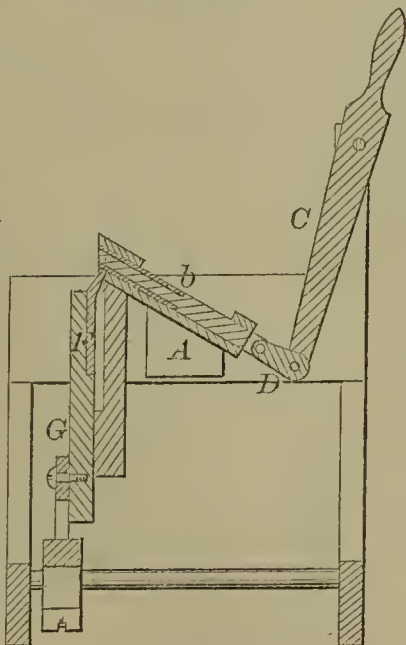

54454—O. H. Webb—*Rock Drill.*

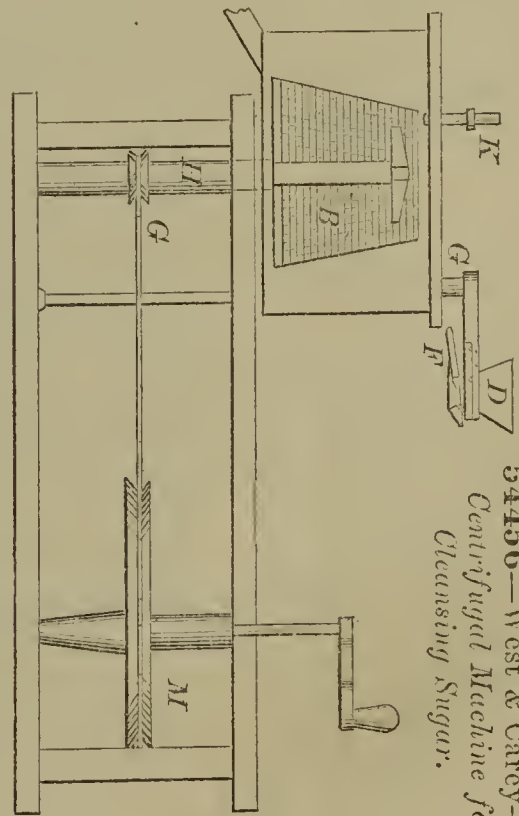
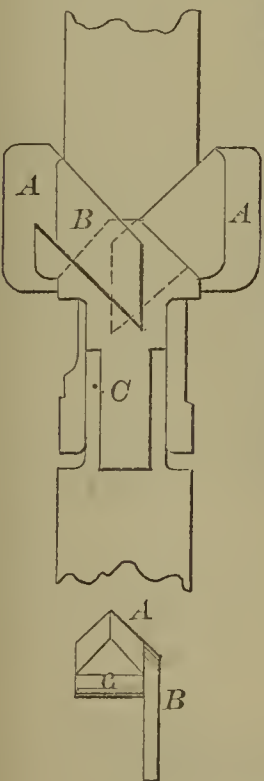

54456—West & Carey—*Centrifugal Machine for Cleansing Sugar.*

54457—J. West—*Cross Head.*

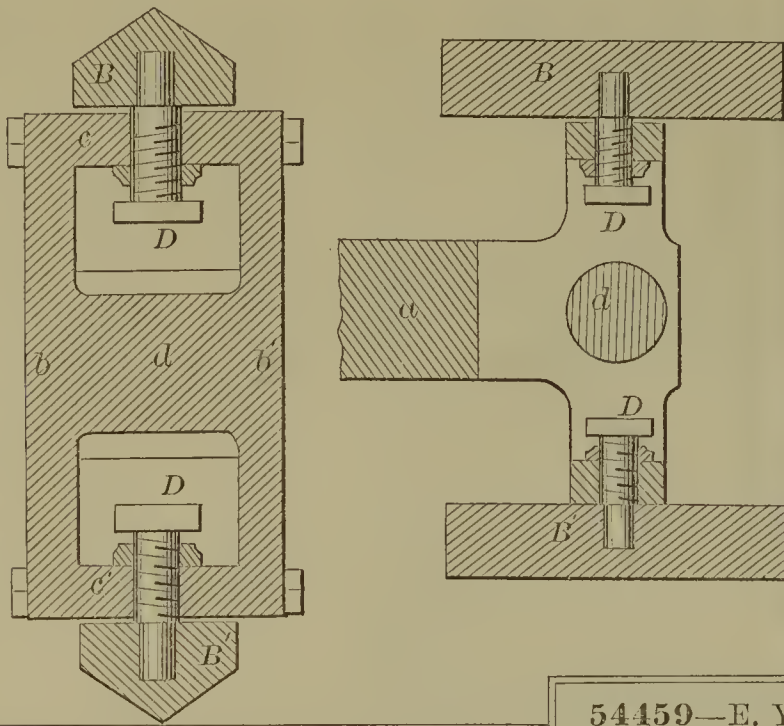

54464—L. P. Faught—*Brush.*

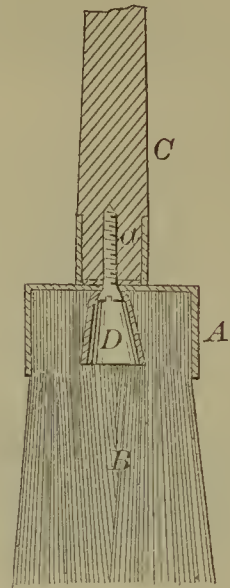

54458—A. C. Whittier—*Washing Machine.*

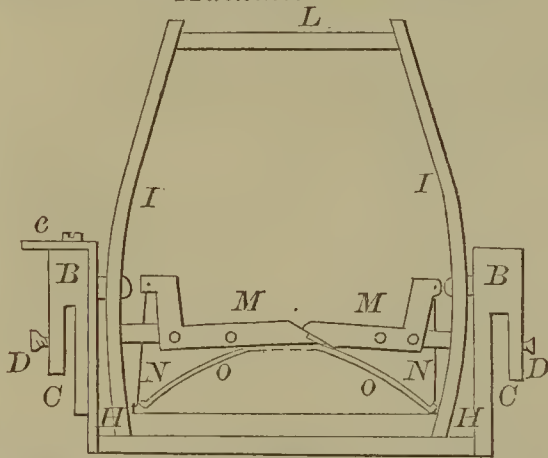

54459—E. York—*Fence.*

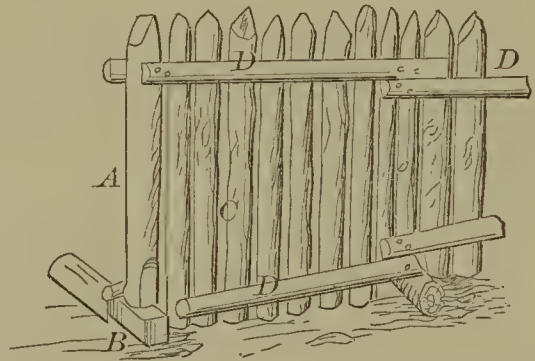

54465—L. Ferguson—*Bobbin for Spinning, &c.*

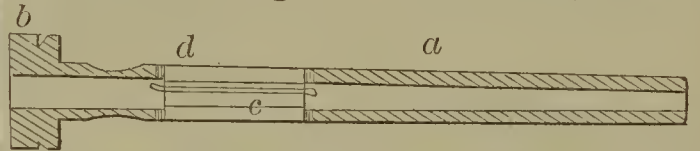

54460—Barker & Martin—*Brick Press.*

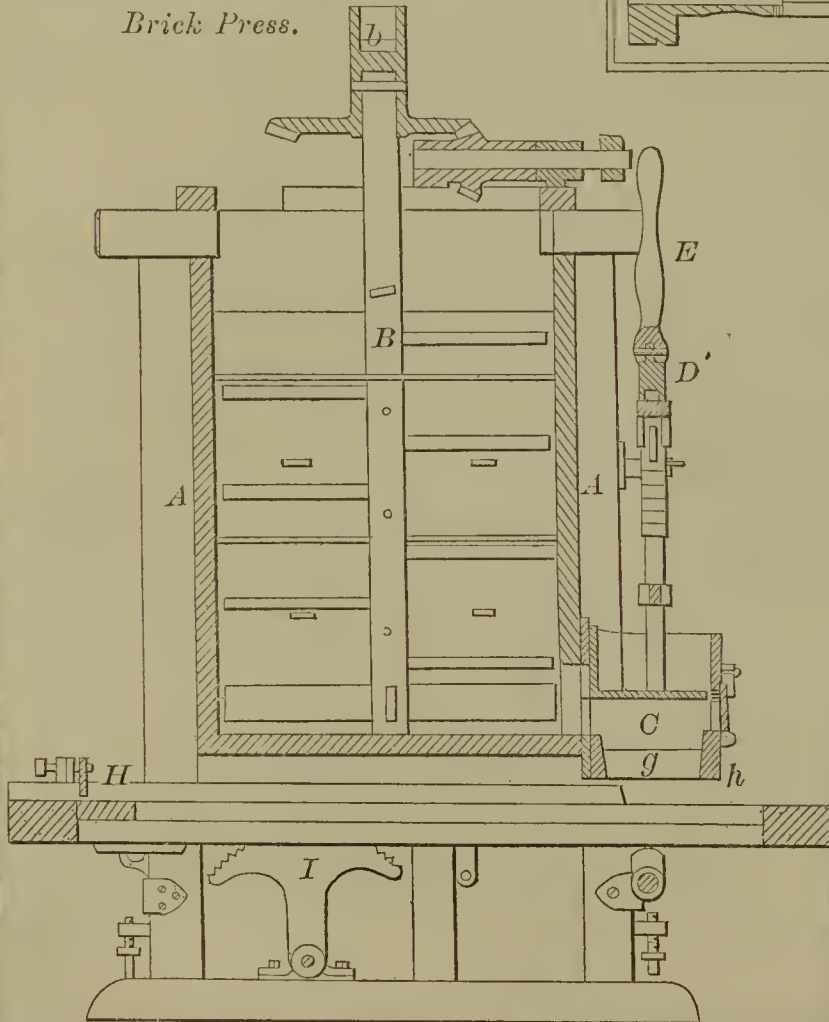

54463—J. A. H. Dunne—*Picture Frame Clamp.*

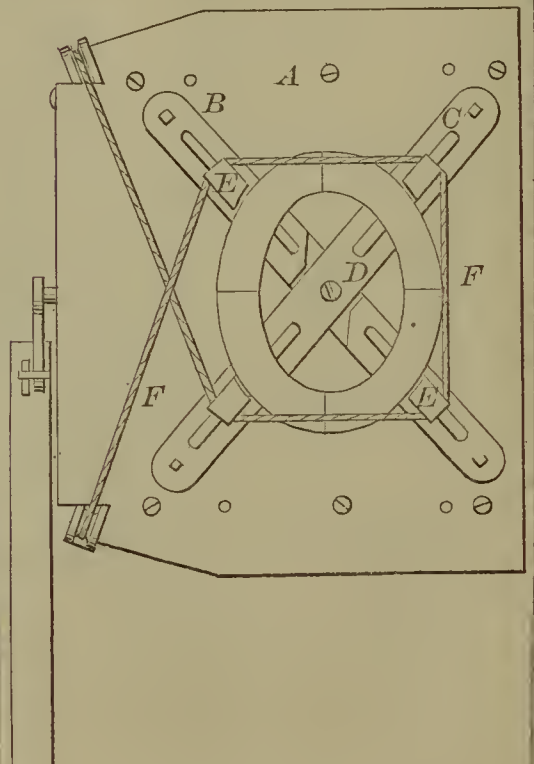



54466—B. G. Fitzhugh—*Harvester.*

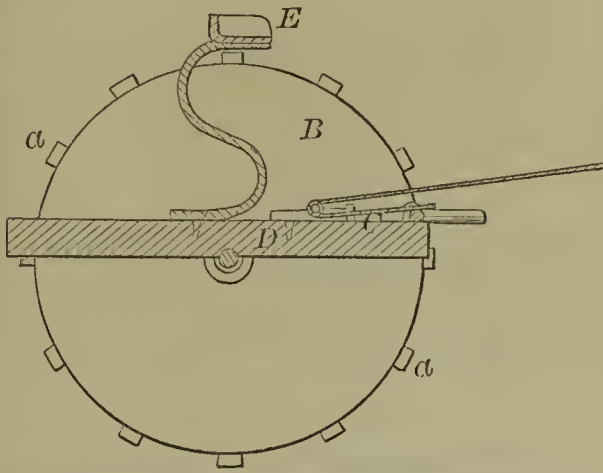

54469—F. Millward—*Steam and Water Motor.*

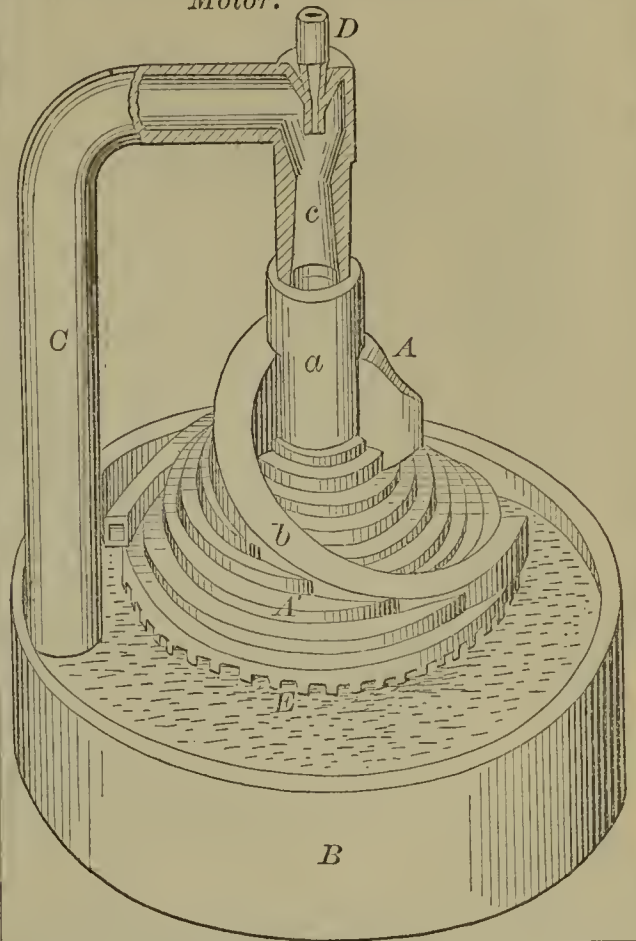

54472—N. G. Whitmore—*Blacking Brush.*

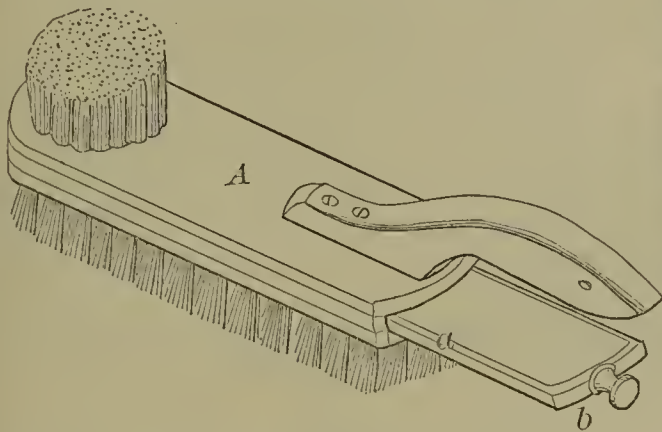

54470—C. Truesdale—*Cupola Furnace.*

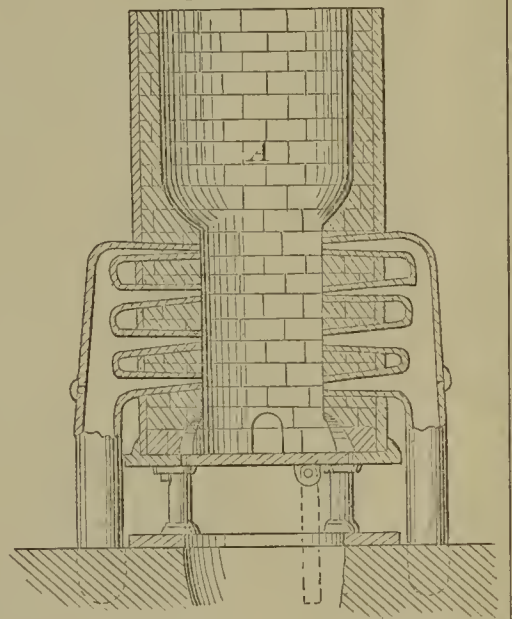

54467—Goodsell & Frisbie—*Hoisting Apparatus.*

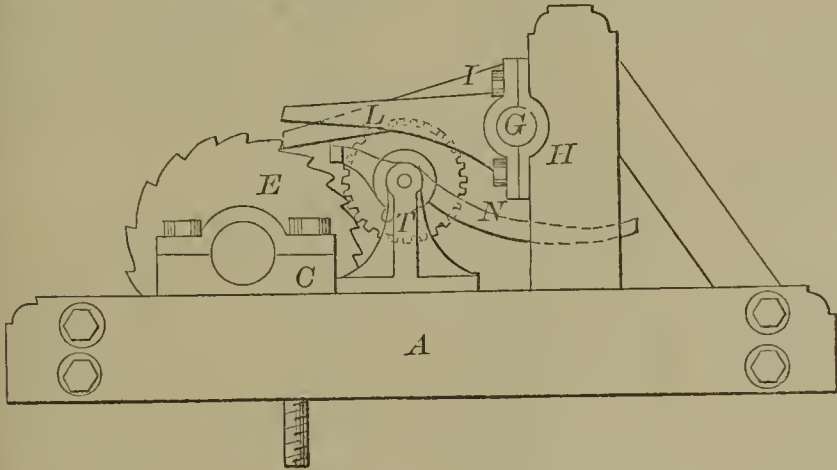

54468—E. E. Marsh—*Eyelet Machine.*

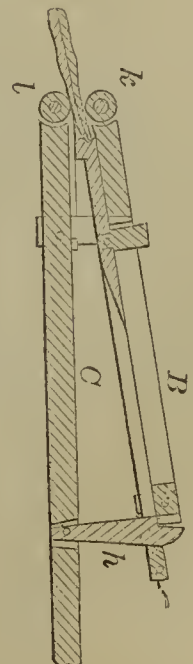
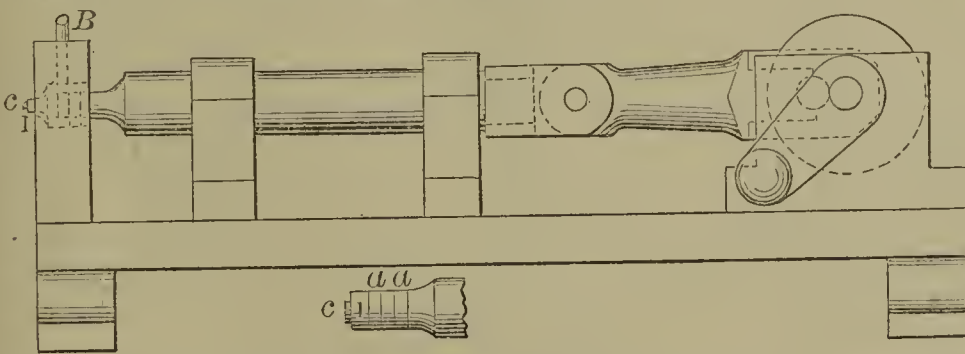

54473—M. H. Wiley—*Mop.*

54471—C. C. Webber—*Wrench.*

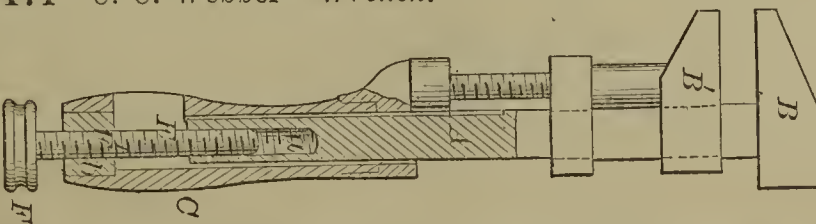

54474—J. Mc G. Croft—Rudder.

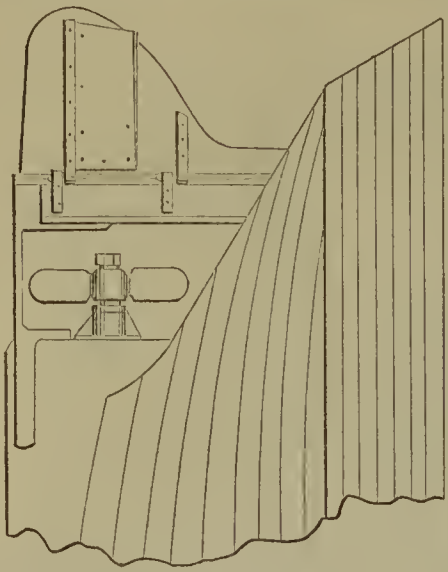

54475—C. Falck—Refrigerator.

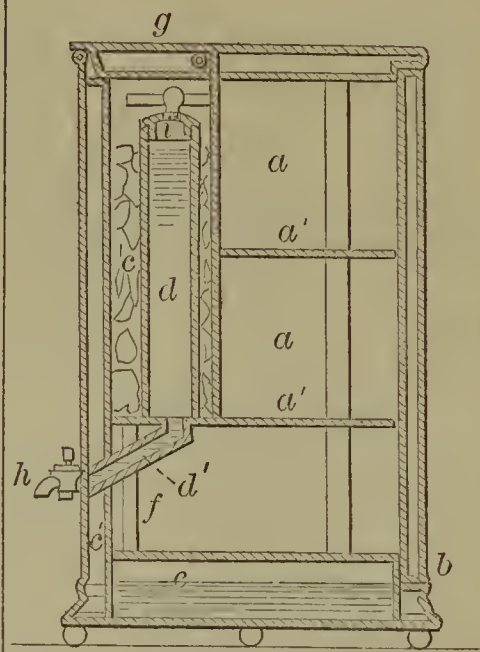

54476—G. A. Reiniger—For Making Fillers for Cigars.

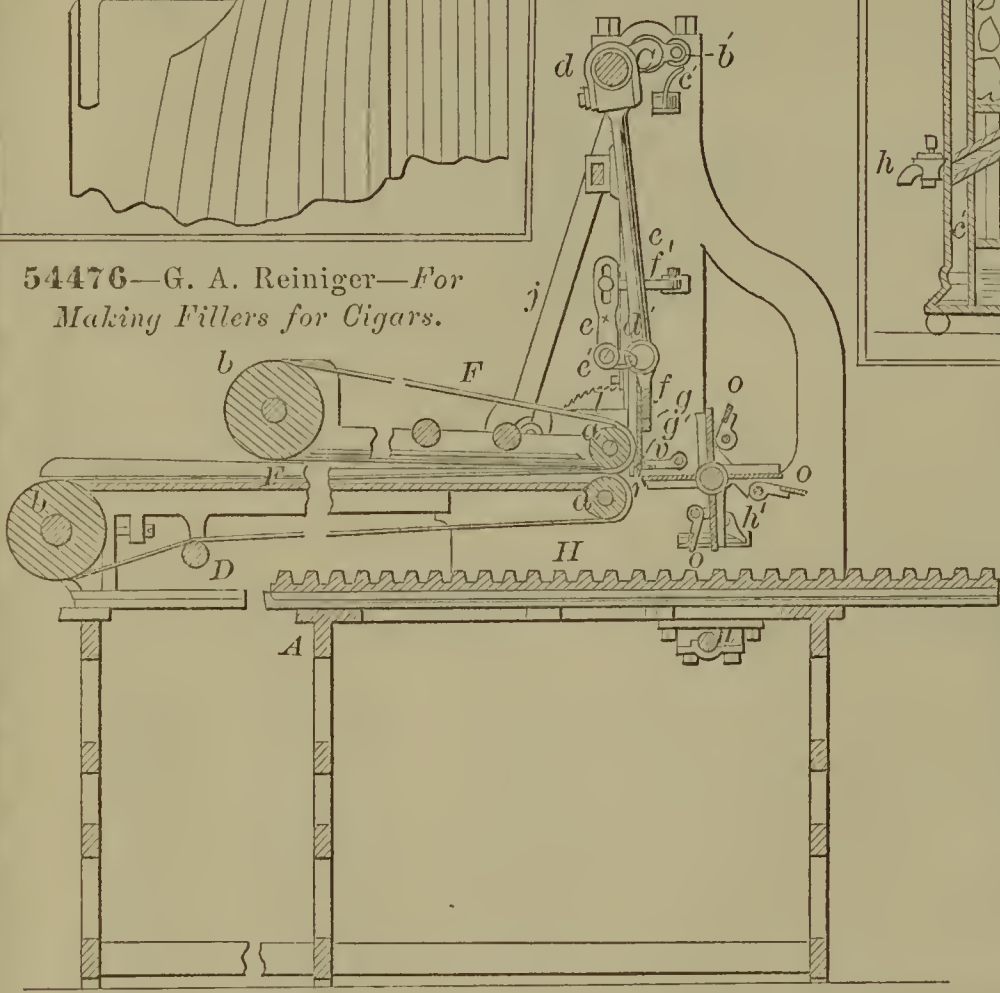

54477—F. Stoker—Composition for Fuel.

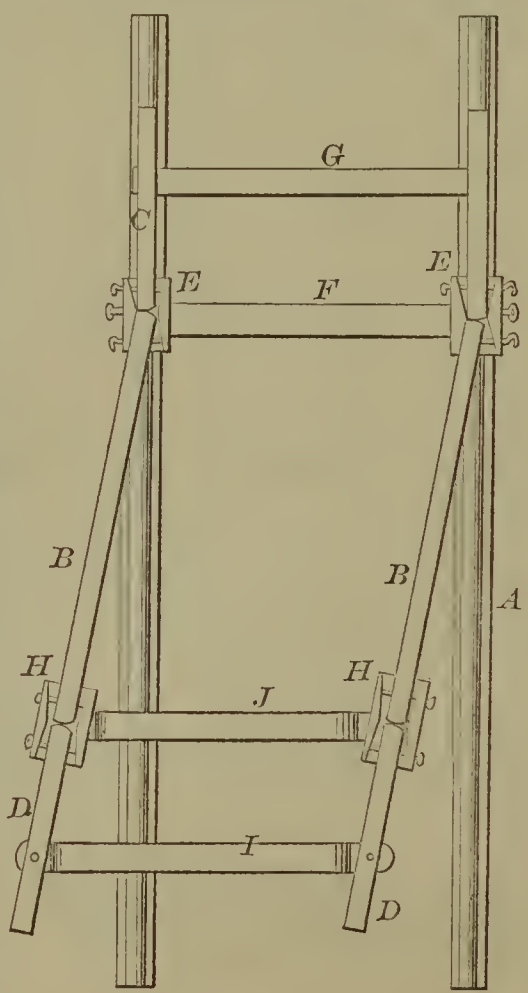
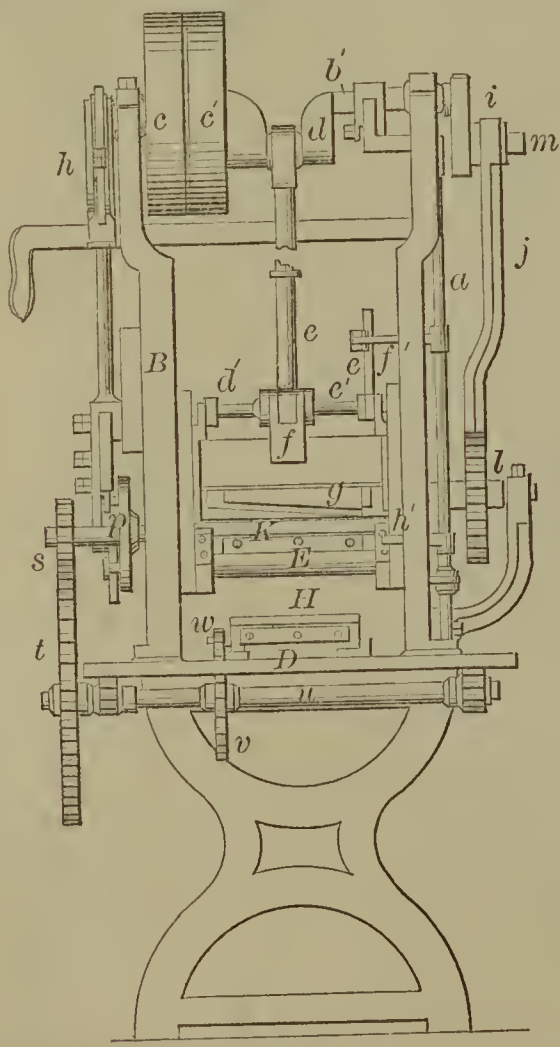
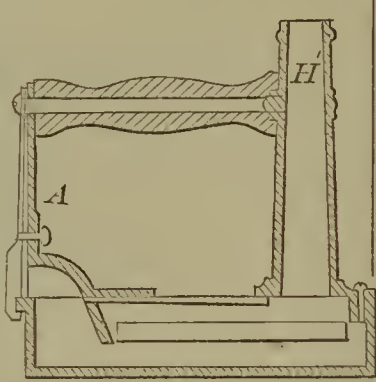

54478—N. Pullman—Switch for Replacing Cars.

54479—Albert & Shank—*Sheep Holder for Shearing.*

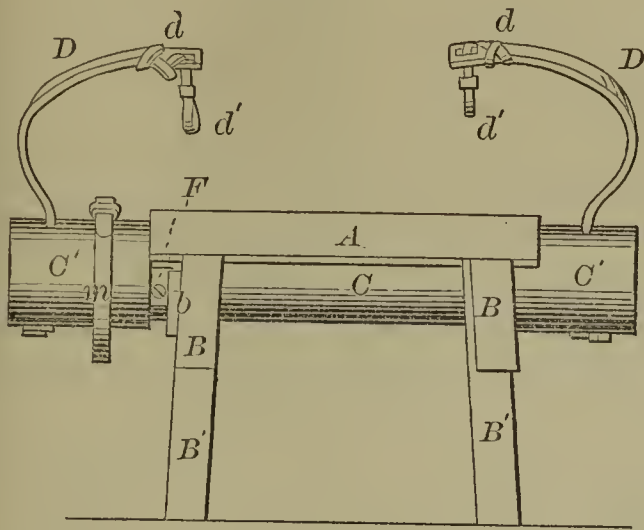

54481—J. F. Allen—*Propeller.*

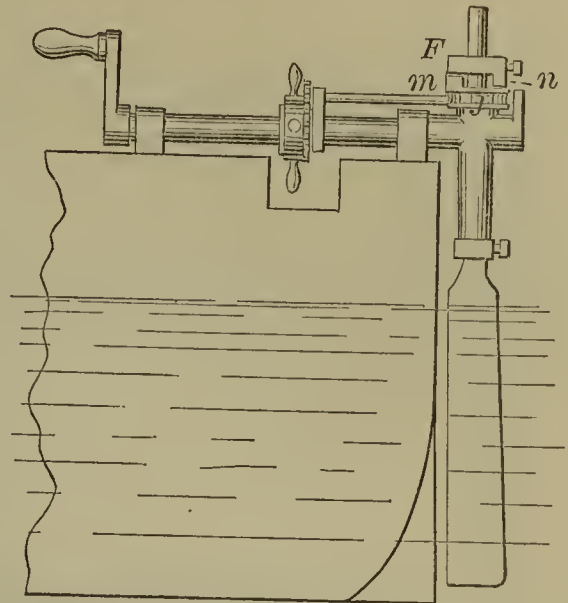

54480—L. Alexander—*Water Closet Seat.*

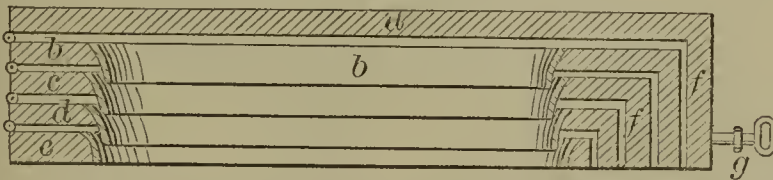

54482—A. H. Allison—*Scrubber and Tender.*

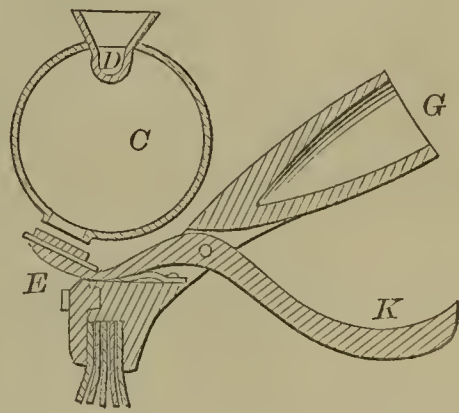

54483—R. H. Andrews—*Pump.*

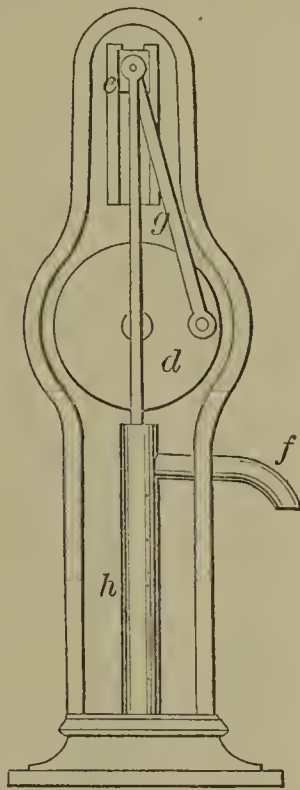

54484—F. Armstrong—*For Protecting Pumps in Deep Wells.*

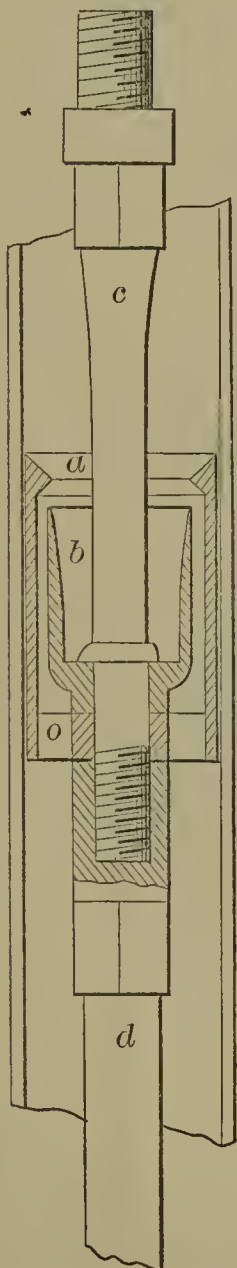

54485—H. Austin—*Coupling for Carriage Felloes.*

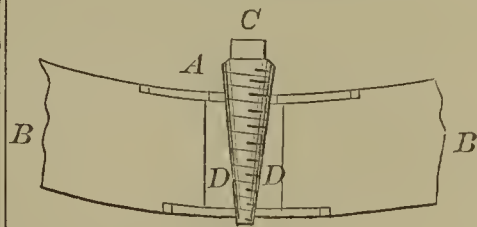

54486—J. W. Baldwin—*Grinding Mill.*

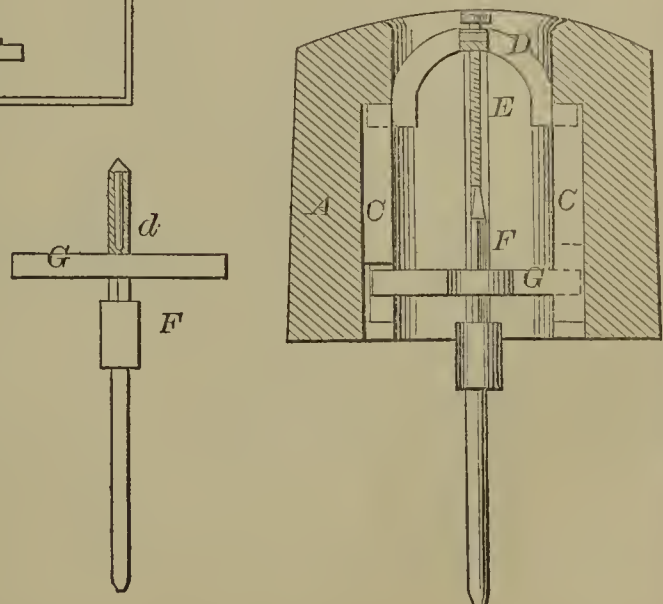

54487—A. G. Barnard—Fence Gate.

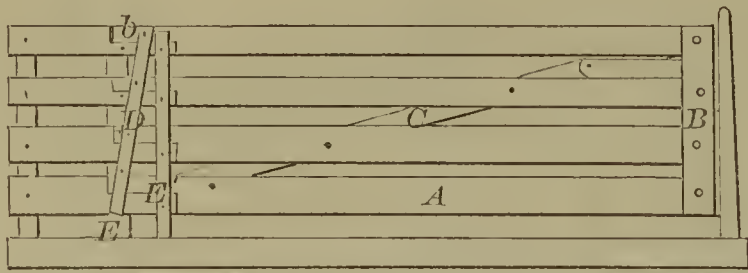

54491—J. F. Burchard—Forcing Air in Carburetted Machines.

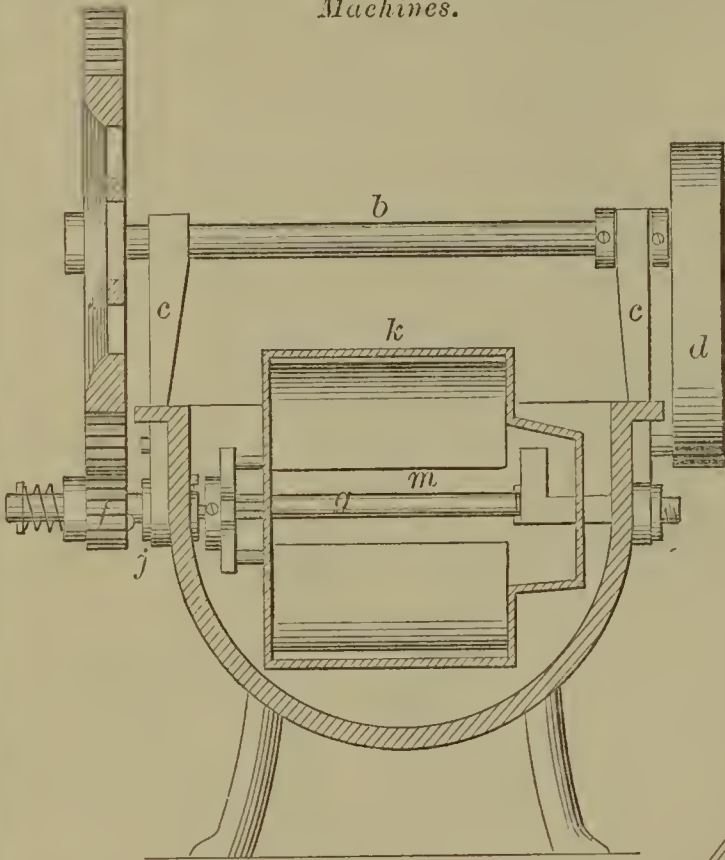

54493—J. Blayne—Hand Spinning Machine.

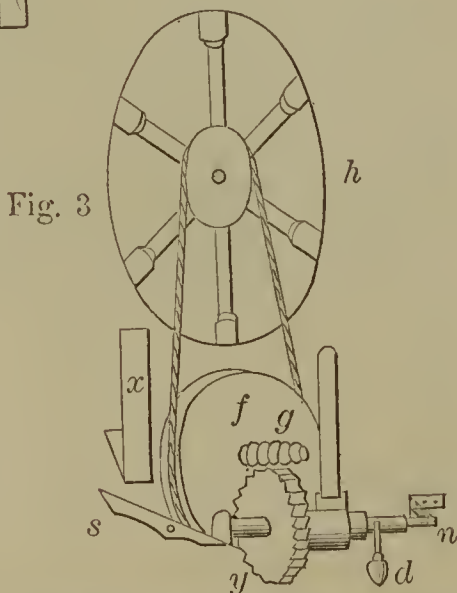
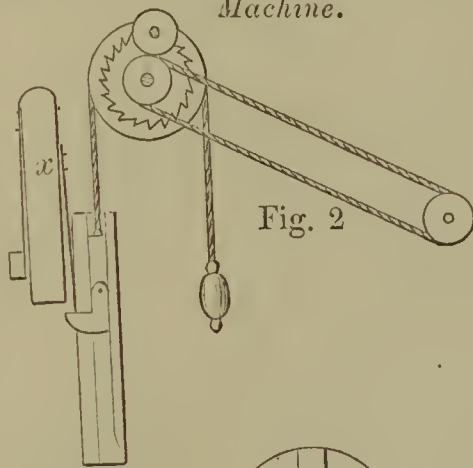

54489—E. Bell—Removing Sand Bars from Rivers.

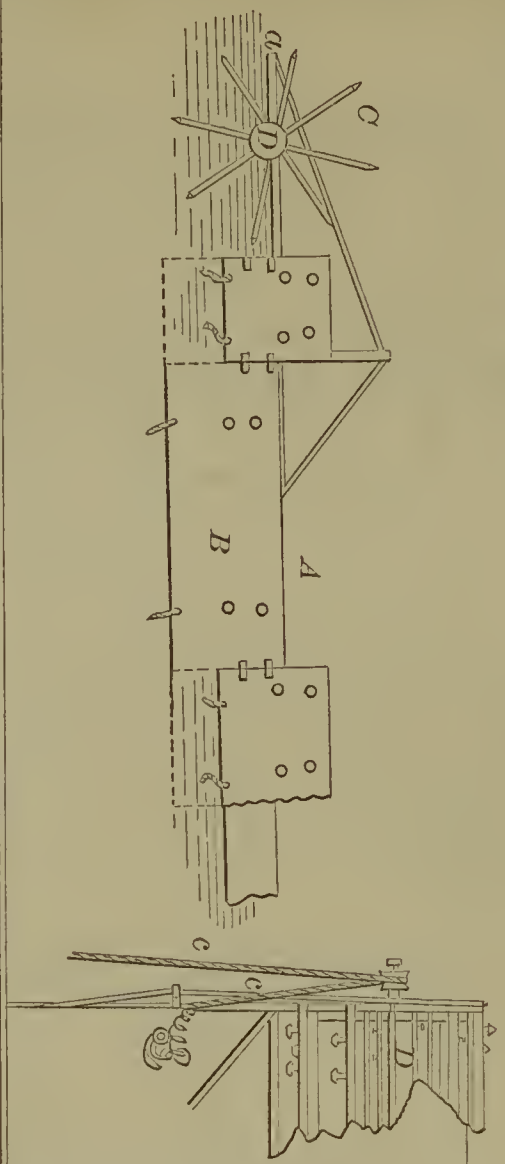

54490—Berry, Hochholzer & Denver—Cage for Hoisting.

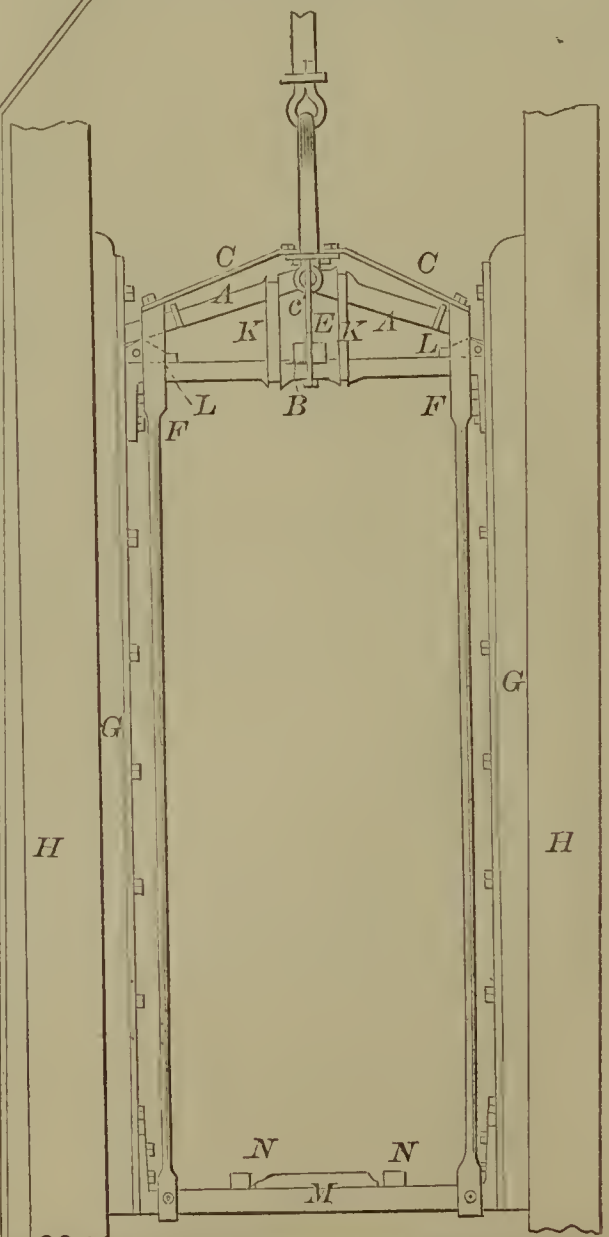

54494—T. H. Bonham—*Portable Fountain.*

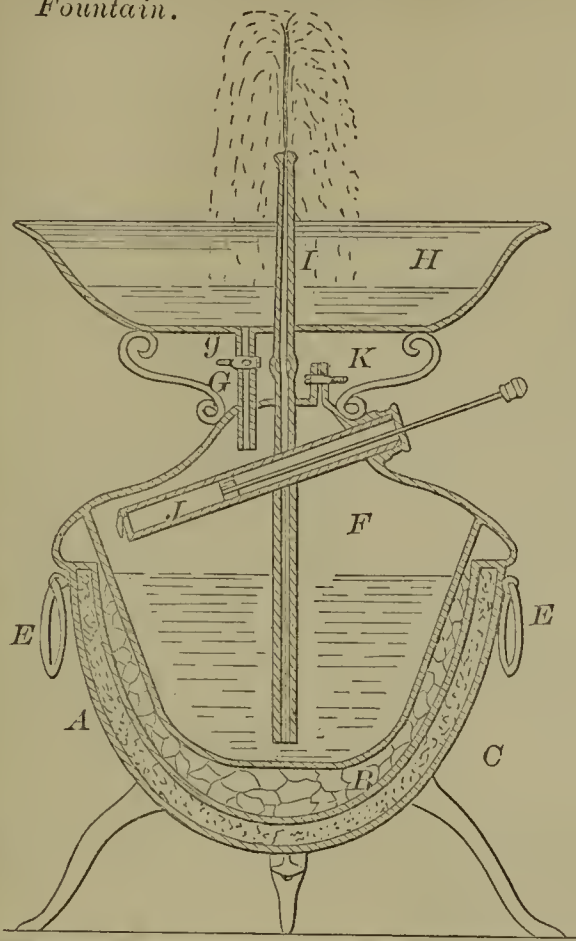

54498—H. Buck—*Broom Head.*

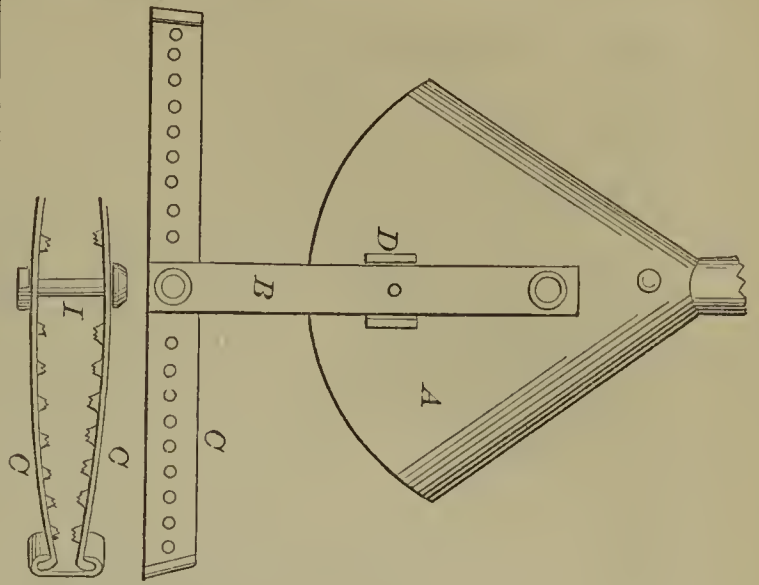

54496—T. H. Bradley—*Ladies' Skirt Lifter.*

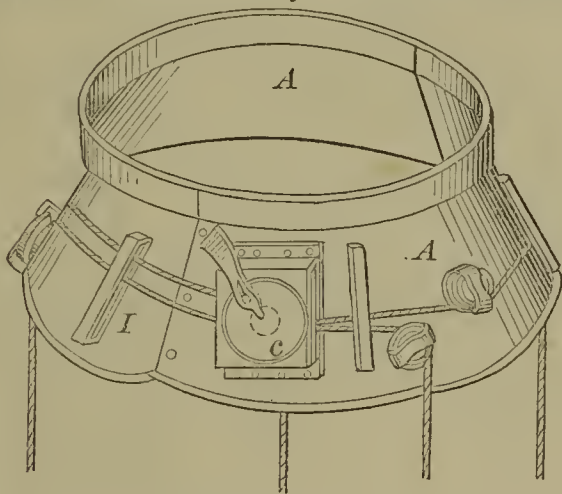

54500—E. P. H. Capron—*Brick Machine.*

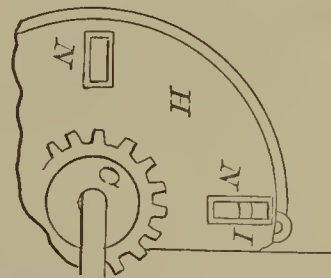
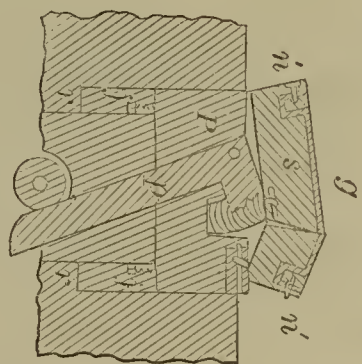
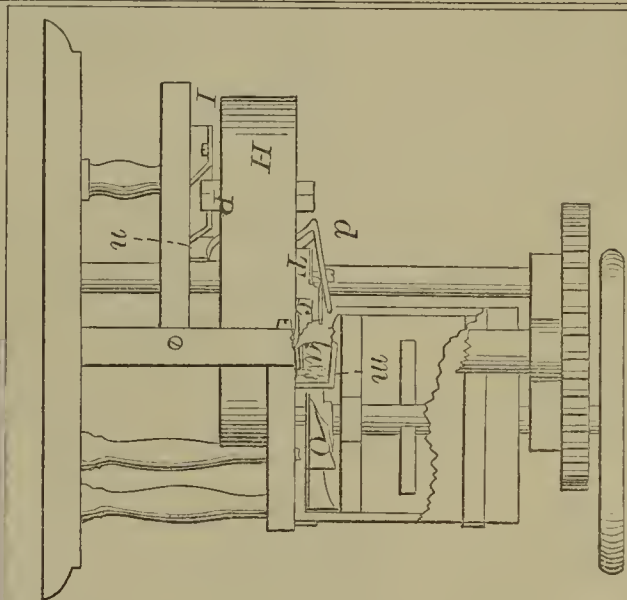

54501—Carter & Spake—*Hand Loom.*

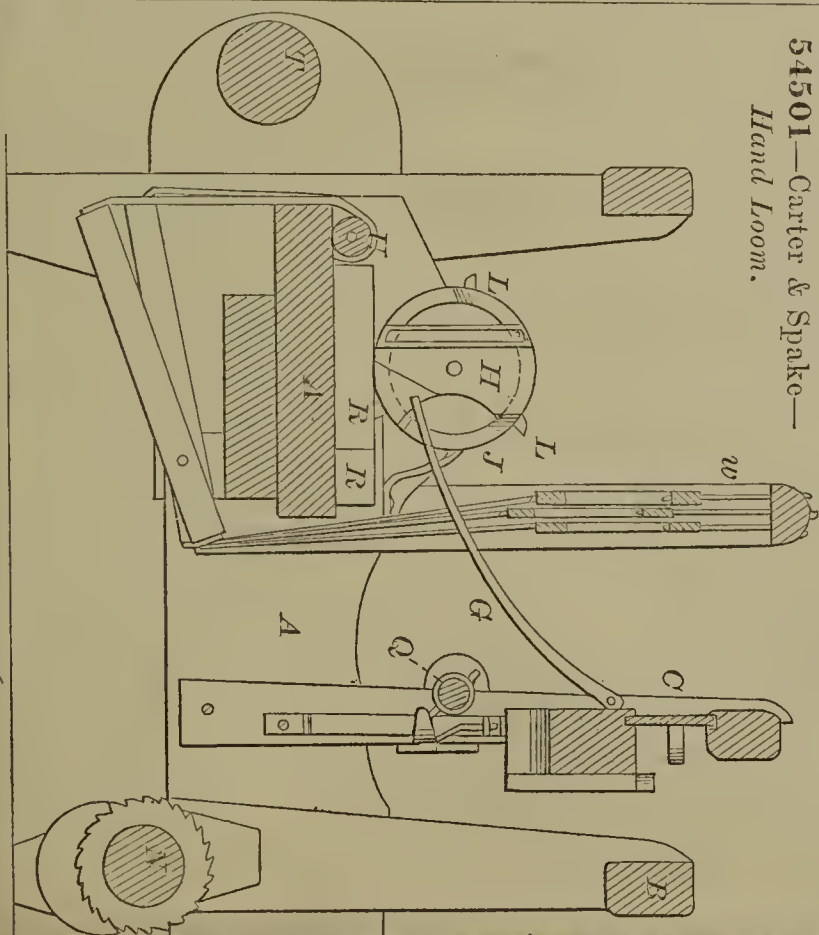

54497—H. A. Breed—*Quartz Pulverizing.*

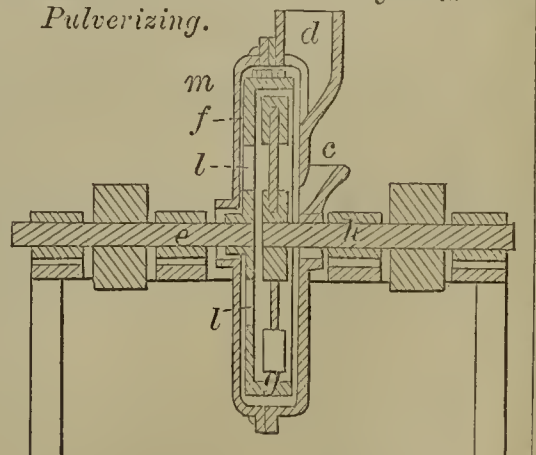

54502—W. Caven—Tea Kettle.

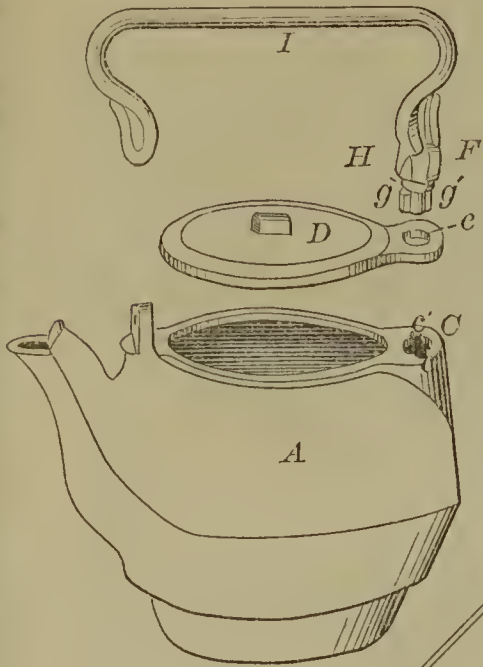

54503—O. R. Chaplin—Combined Square and Level.

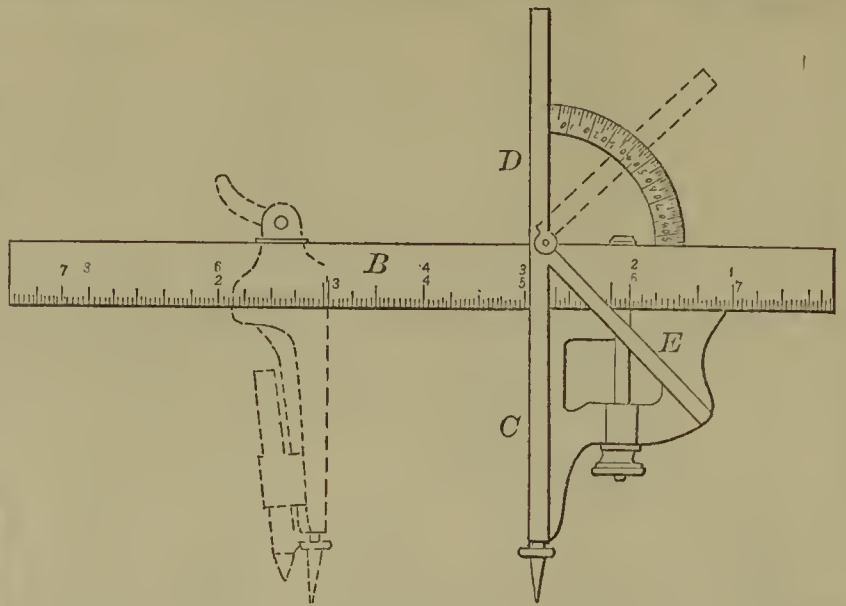

54507—J. D. Cochran—Corn Planter.

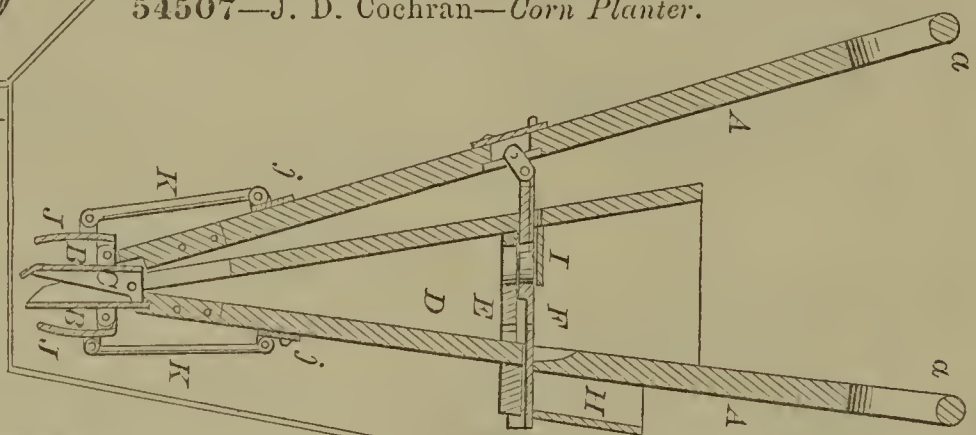

54506—J. D. Cochran—Seeding Machine.

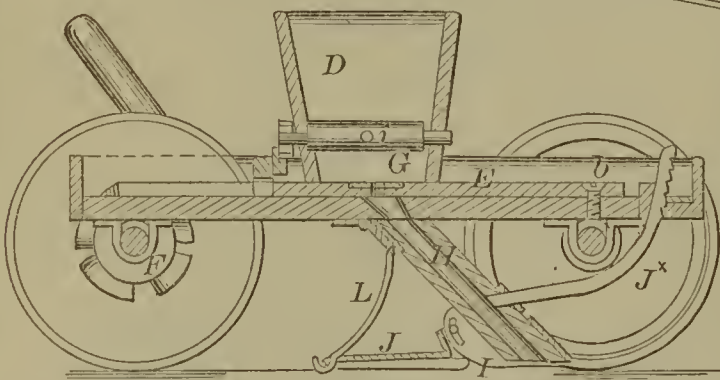
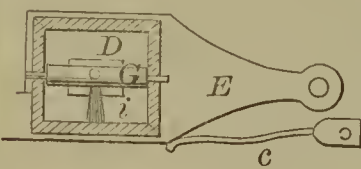

54504—C. S. Cissna—Buckle.

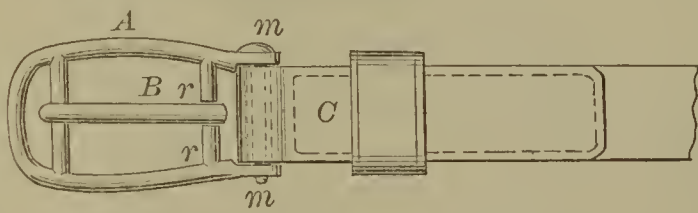

54505—W. C. Cleveland—Scrubbing Brush.

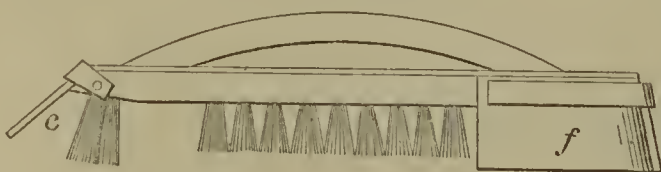

54508—P. F. Crouch—Shears.

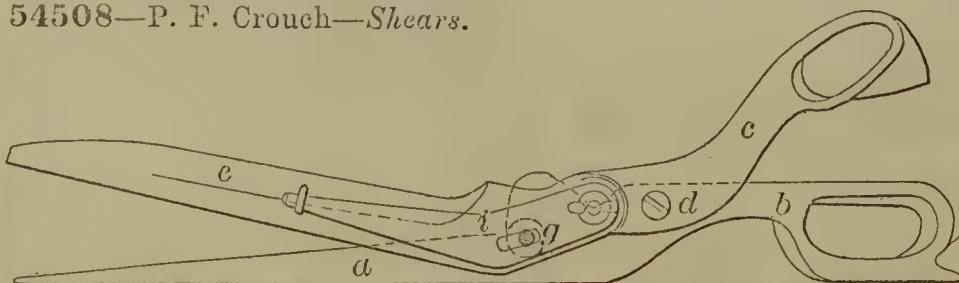

54509—H. S. Cushing—Scale Beam.

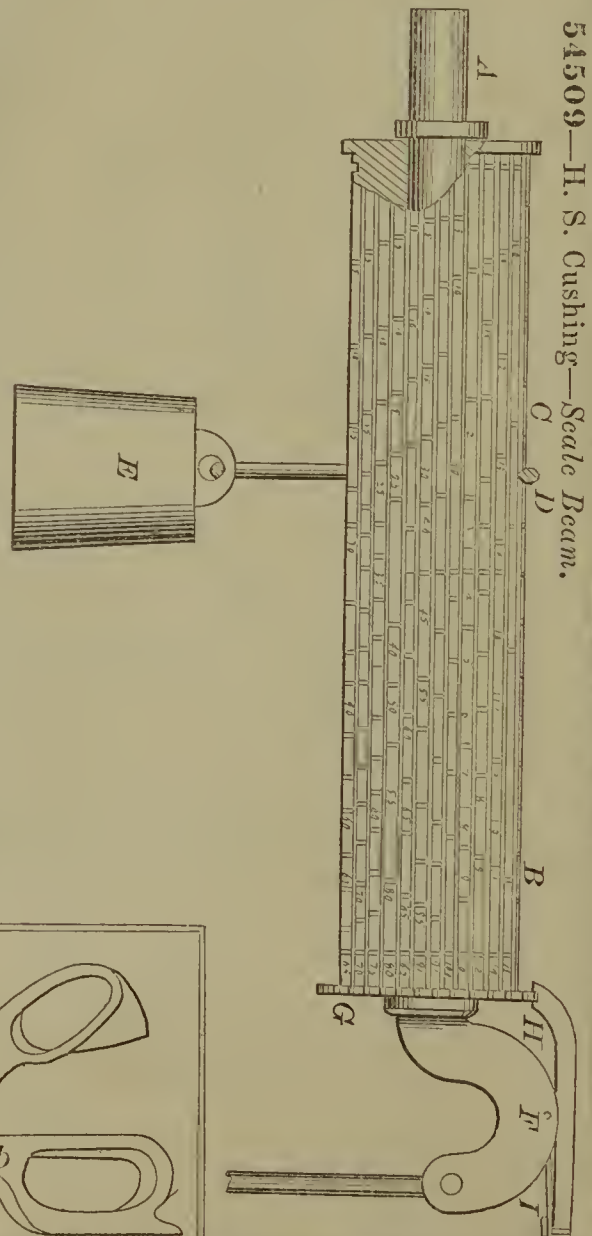

54510—Dixon & Harding—For the Manufacture of Paper Pulp.

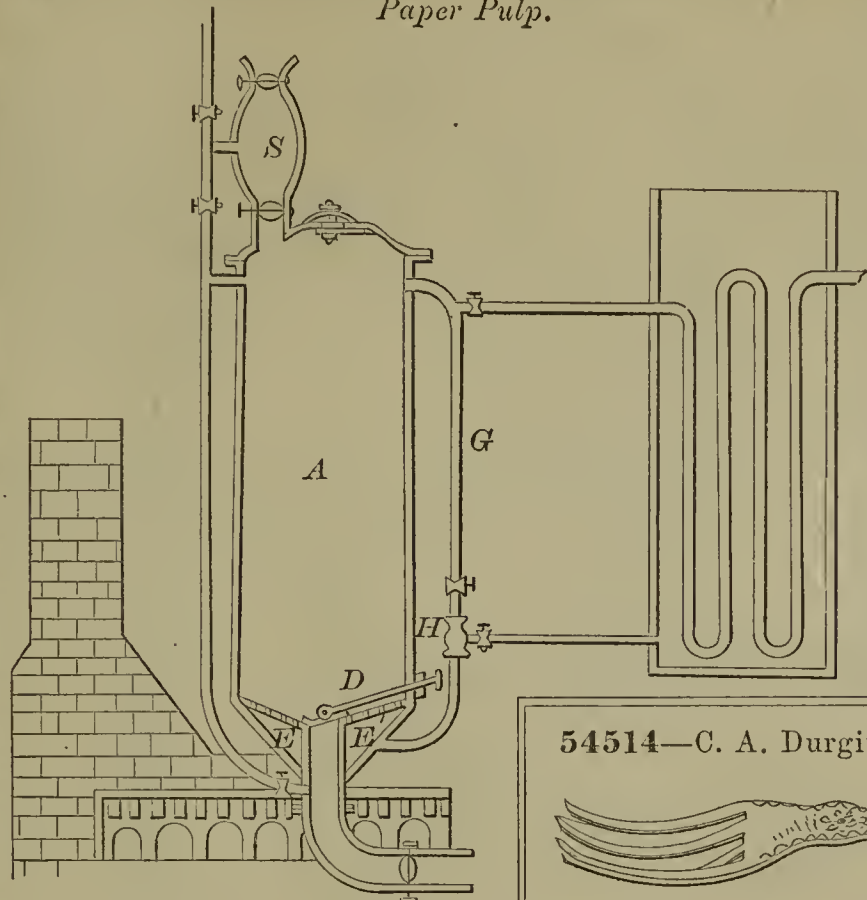

54512—M. B. Dodge—Quartz Crusher.

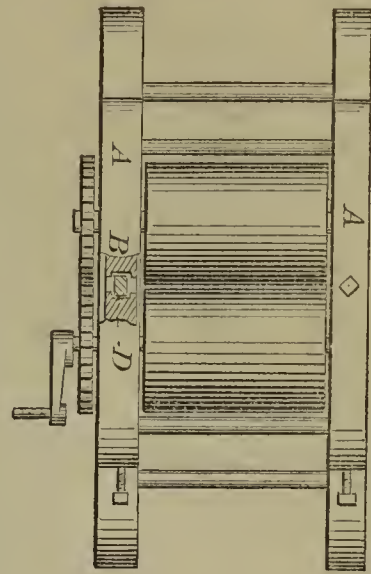

54514—C. A. Durgin—Table Fork.

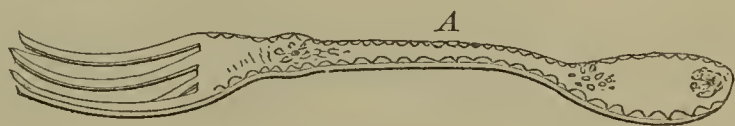

54513—J. E. P. Doyle—Railway Switch.

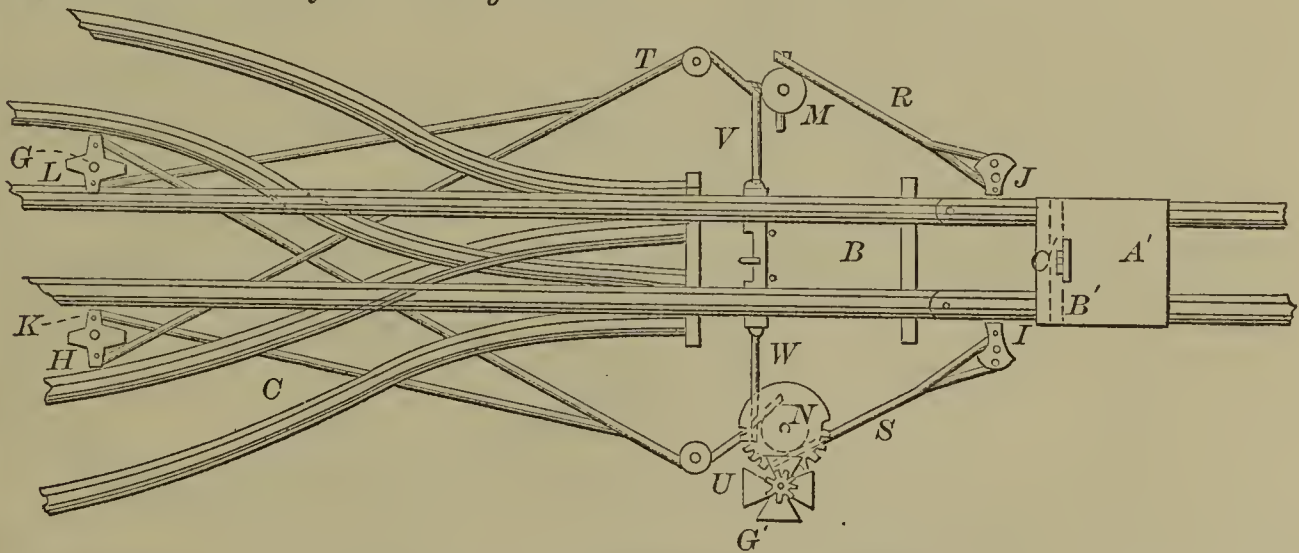

54511—J. Dixon—Planing Machine.

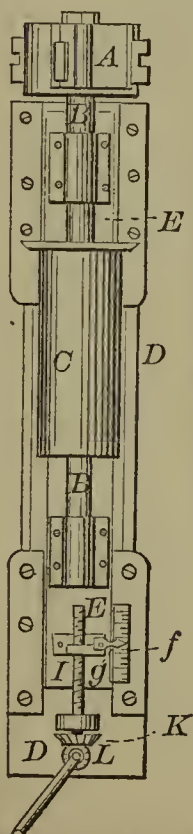

54516—J. Fallows—Sheet Metal Spoon.

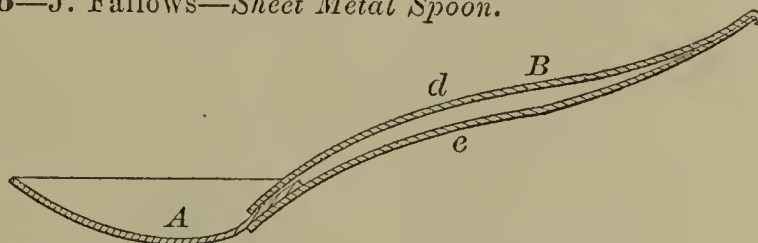

54515—E. H. Eldridge—For Embossing Napkin Rings.

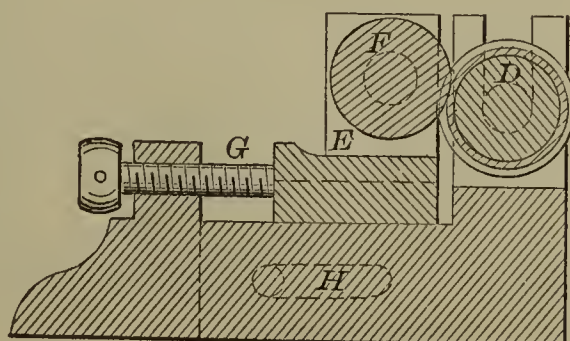

54517—J. Fallows—Pepper Box.

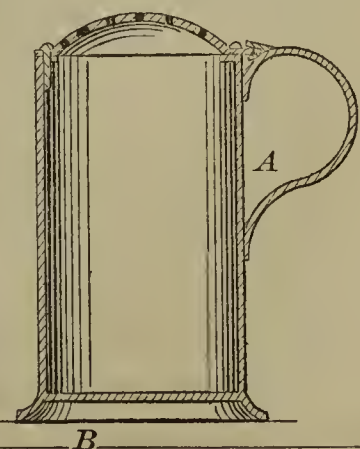

54518—J. C. Field—*Tile Mould.*

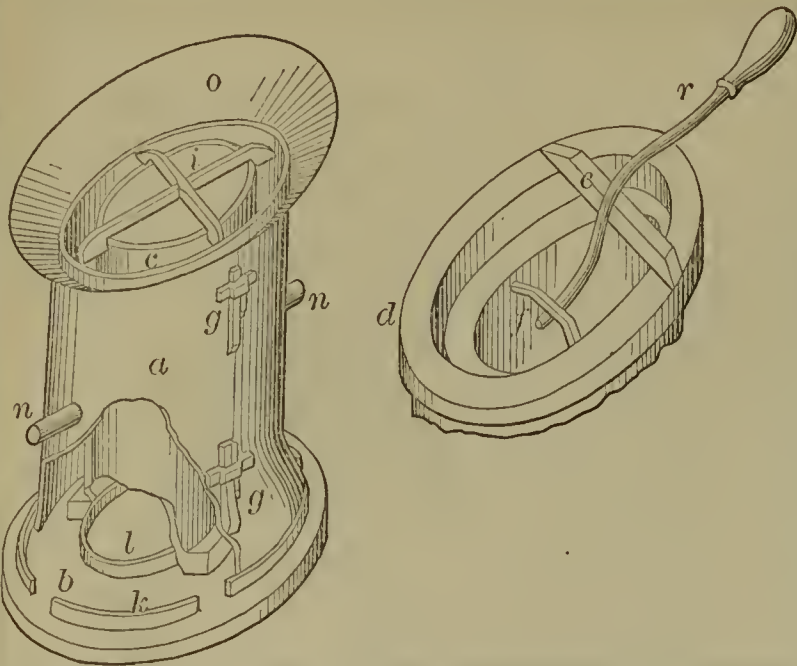

54519—W. Fitzgerald—*Gearing for Lathes, &c.*

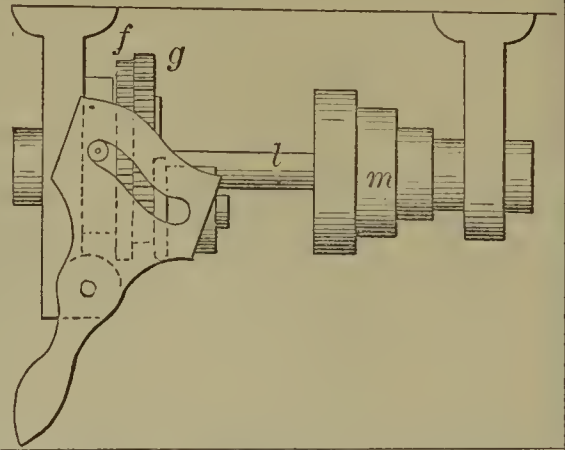

54522—J. L. Fountain—*Attaching Cultivator Blades.*

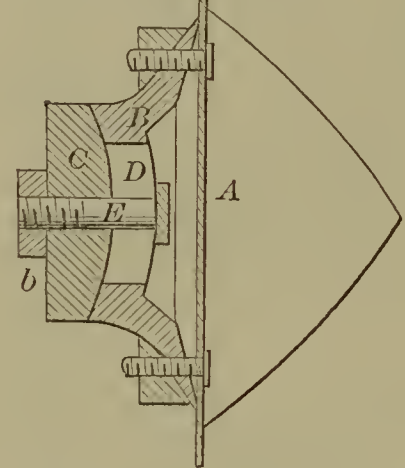

54520—W. H. Flinn—*For Cutting Wire.*

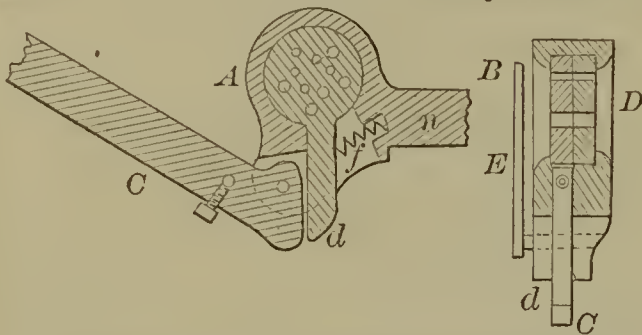

54521—A. O. Forsberg—*Hernial Truss.*

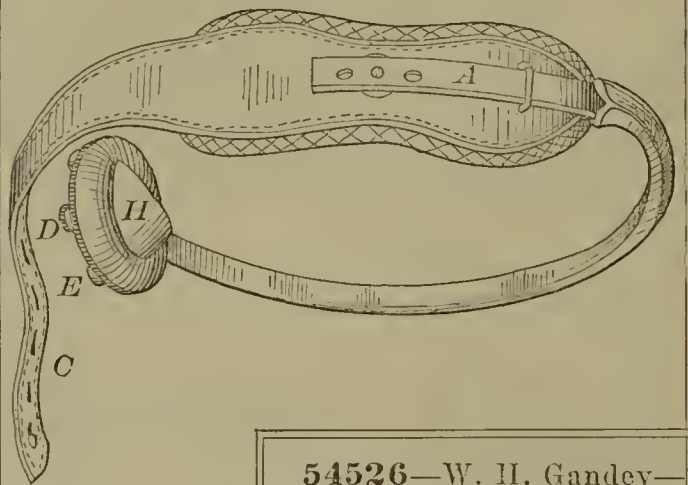

54524—C. R. Frink—*Hay Spreader.*

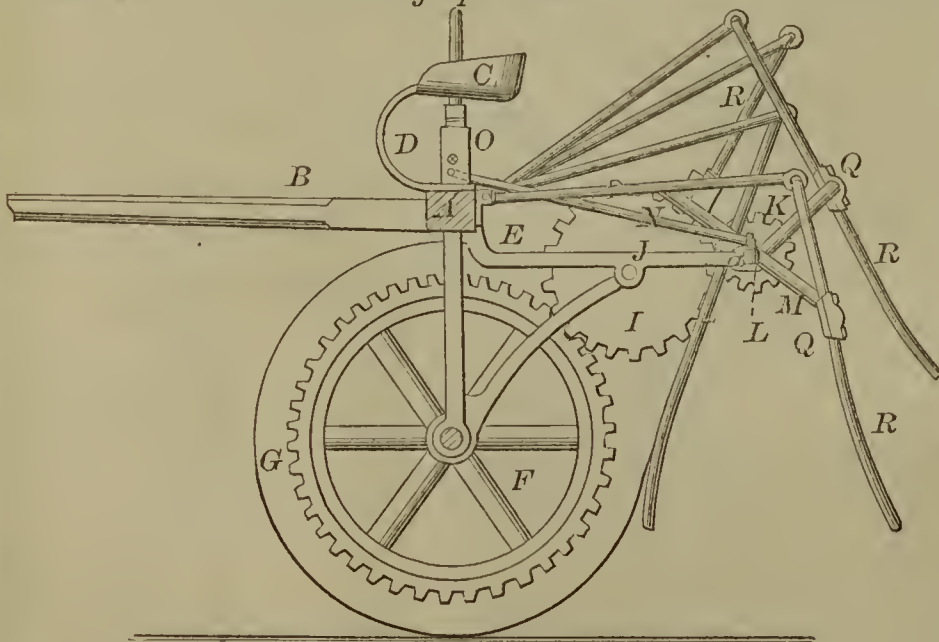

54526—W. H. Gandey—*Coal Store.*

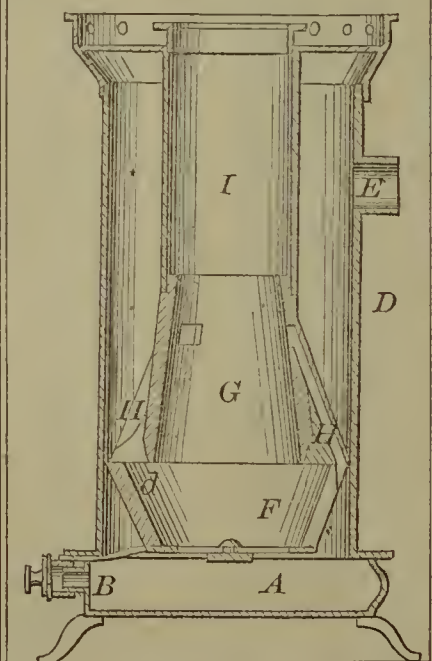

54525—C. T. Frost—*Screw Cutter.*

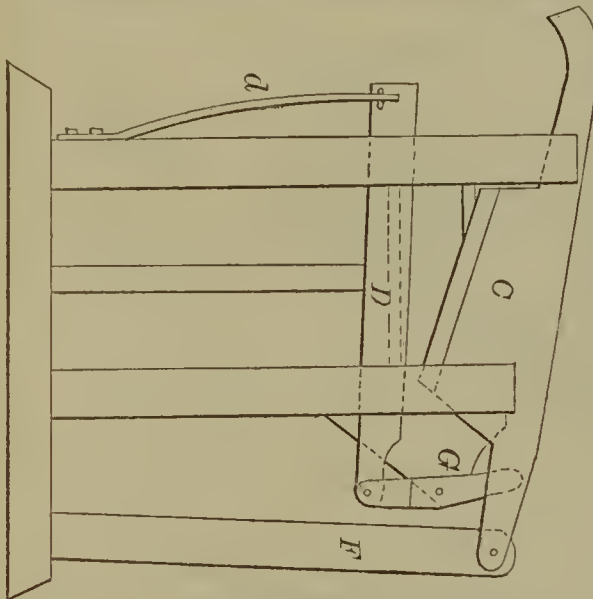



54527—E. Gilliam—*Fruit Gatherer.*

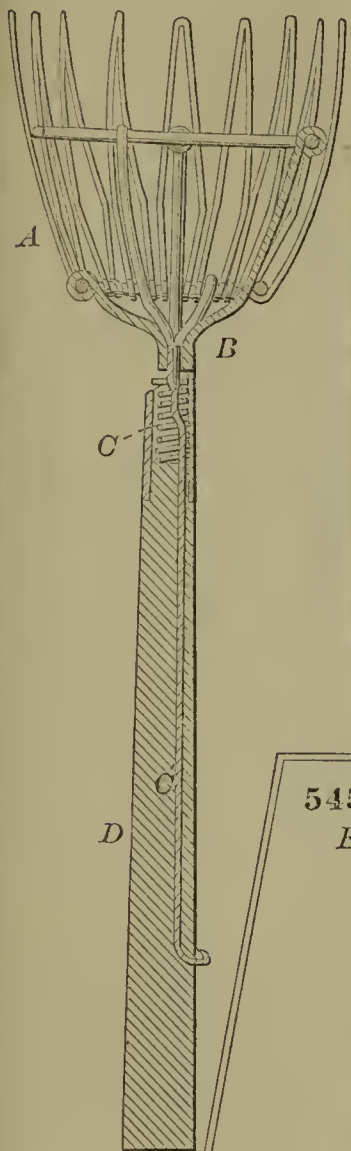

54530—G. Hadfield, M. D.—*Treating Diseases by Vacuum.*

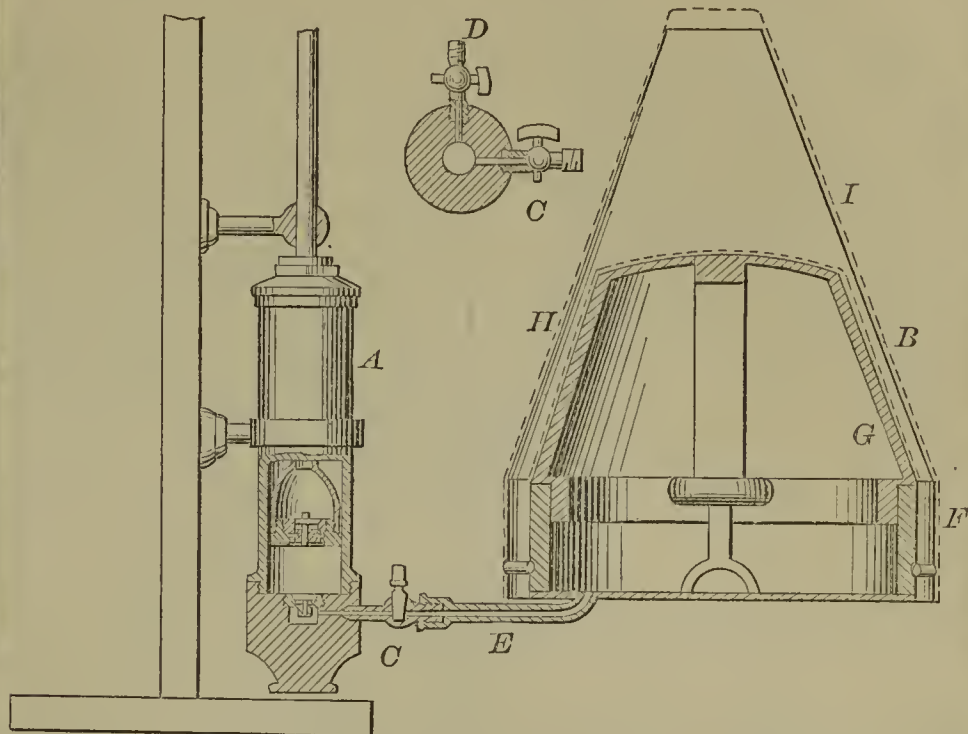

54528—E. Gilliam—*For Exterminating Insects.*

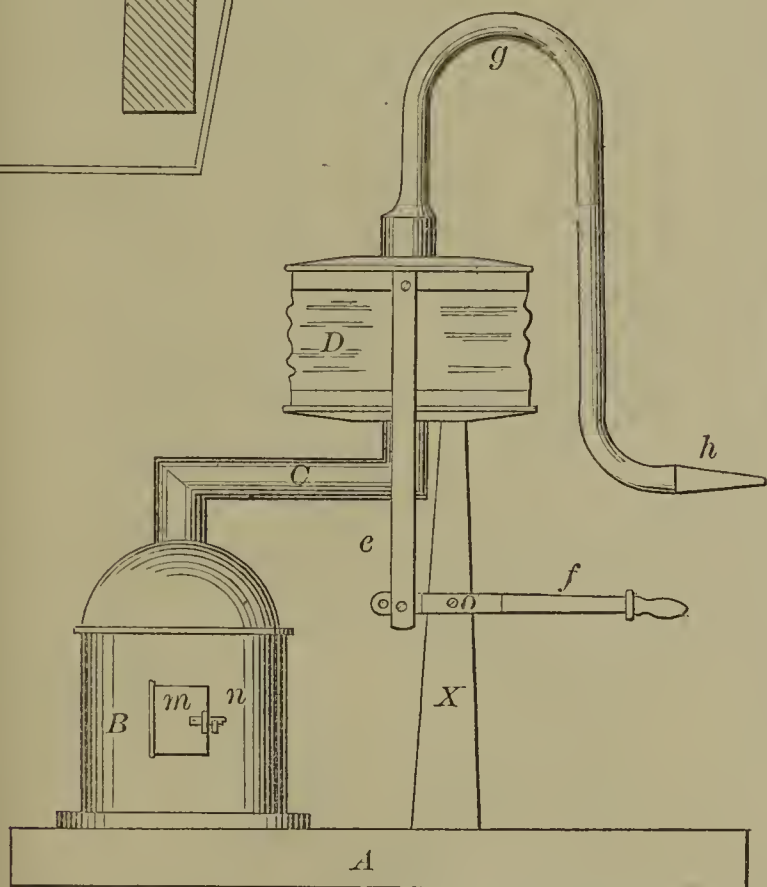

54531—A. F. Hammond—*Burglar Alarm.*

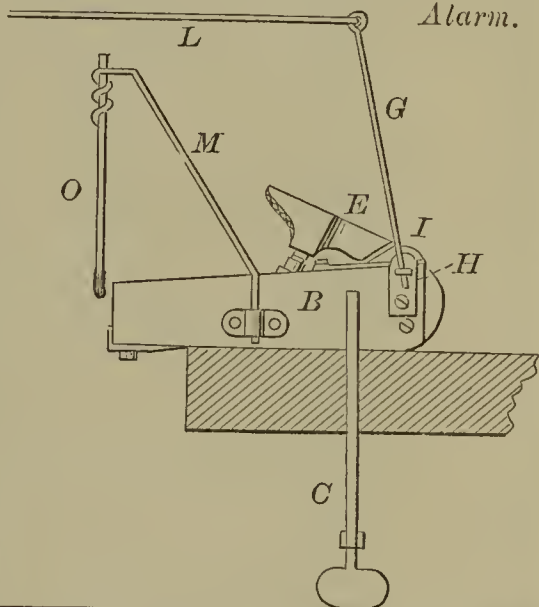

54532—W. H. Harbaugh—*Heating Stove.*

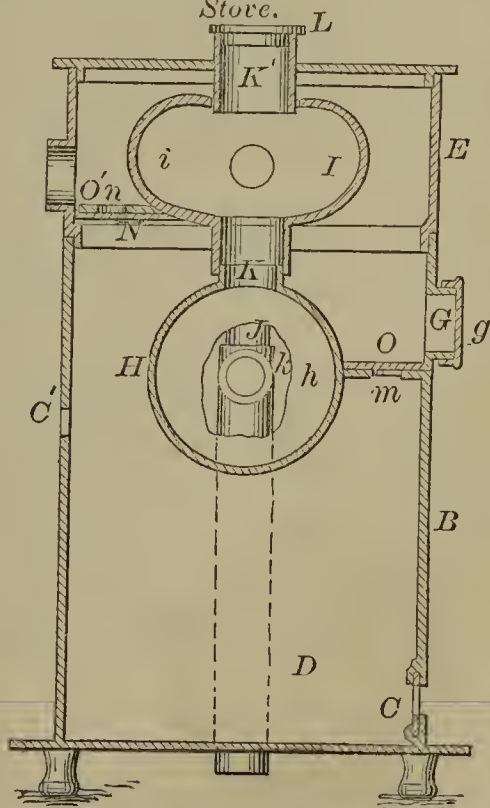

54529—W. Greenleaf—*Securing Boxes in Hubs.*

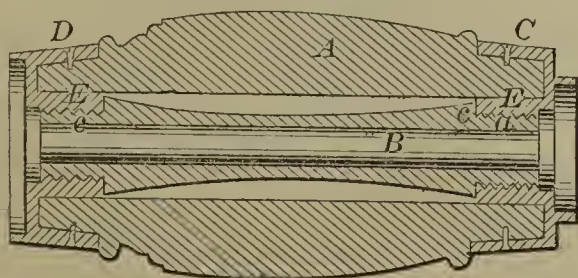

54533—P. W. Hardwick—*Invalid Bedstead*.

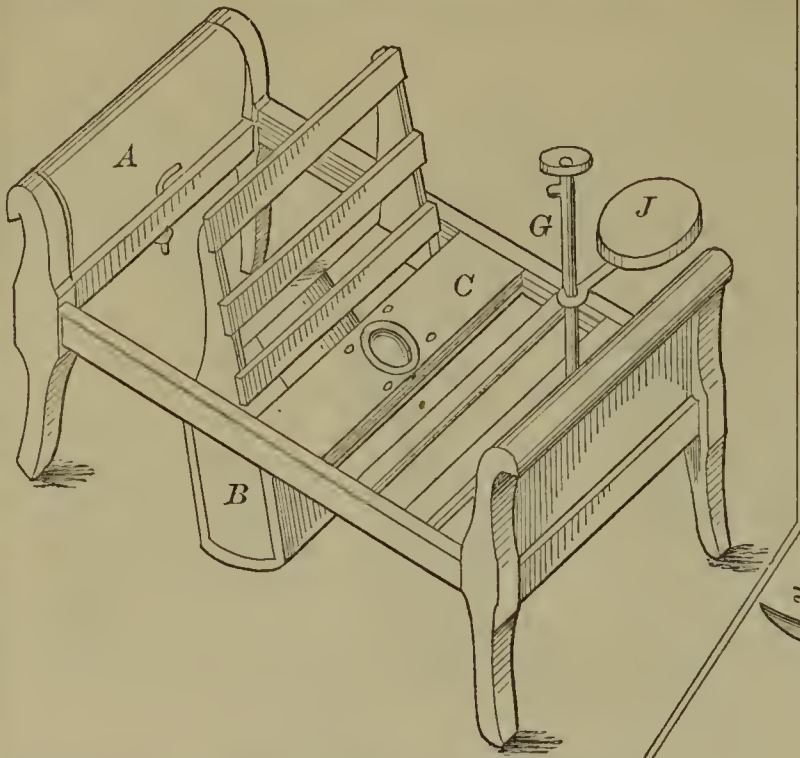

54536—W. H. Hart, Jr.—*Neck Tie*.

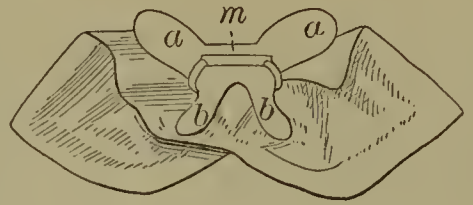

54535—E. Harrison—*Grinding Mill*.

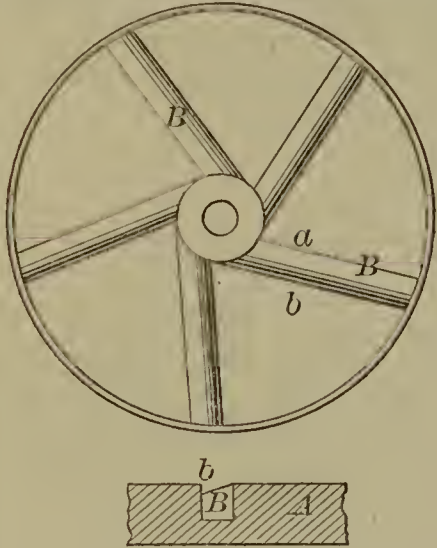

54534—A. T. Harrison—*Cultivator*.

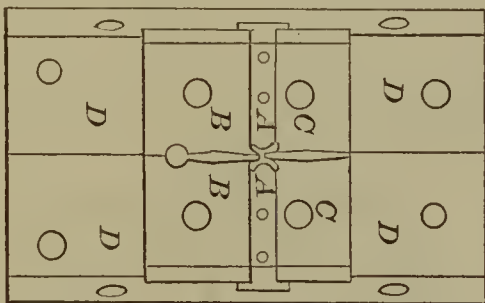
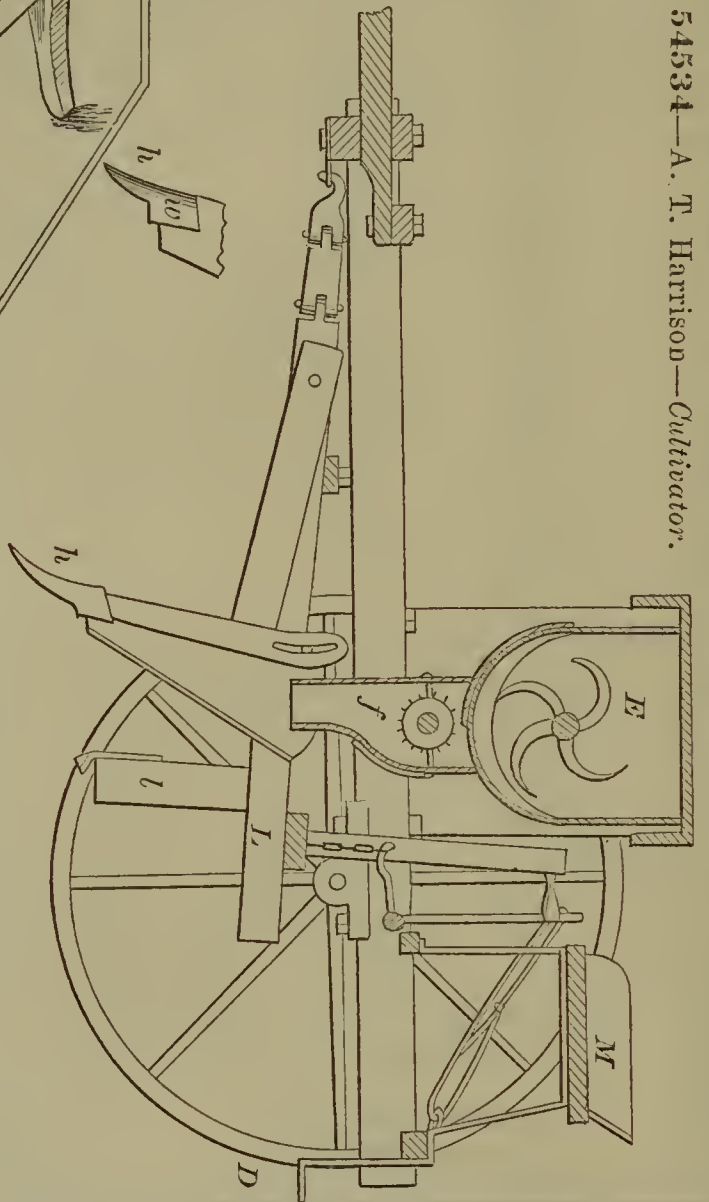

54539—G. Hastings—*Watch Die*.

54540—C. J. Hauck—*Oiler*.

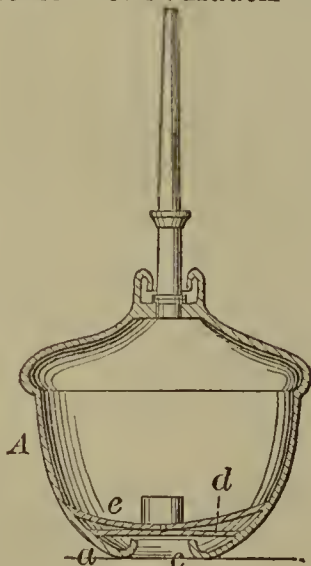

54537—C. T. Harvey—*Propelling Cars on Railways*.

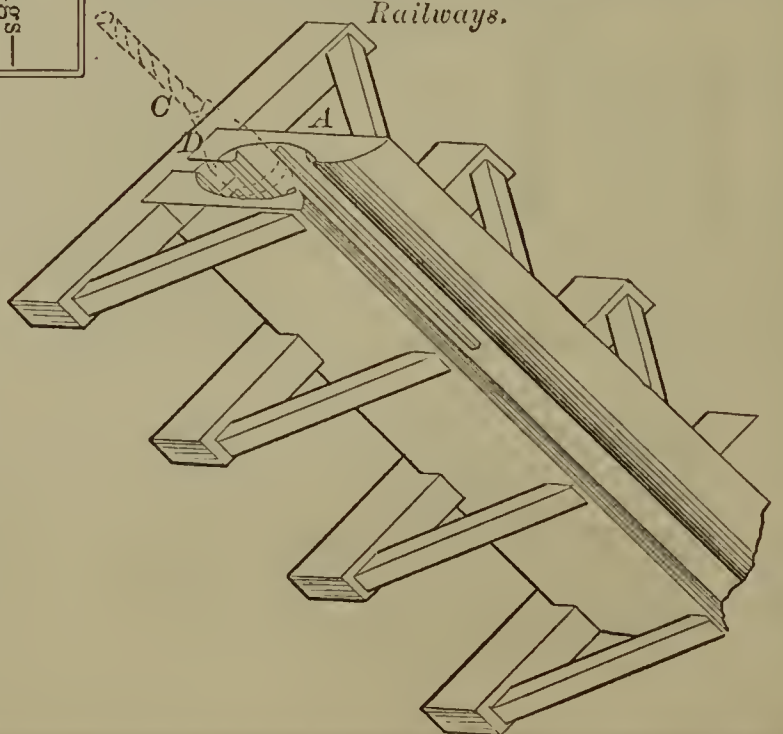

54541—J. B. Hawley—*Knife and Fork Rack.*

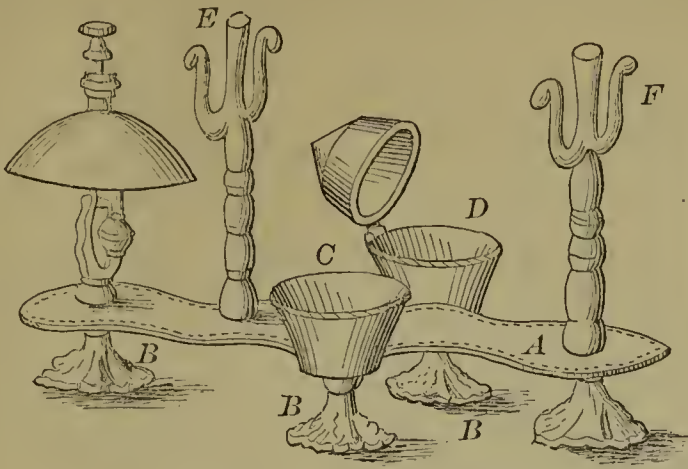

54546—C. Holtz—*Chair and Walker for Children.*

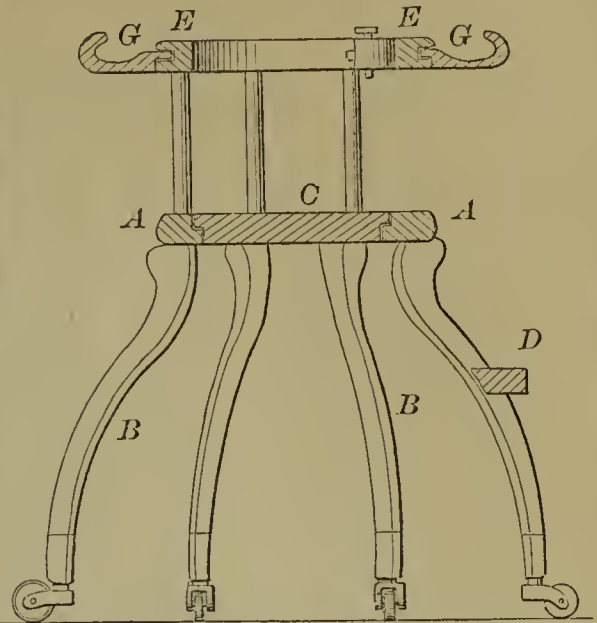

54543—A. Herman—*Mangle.*

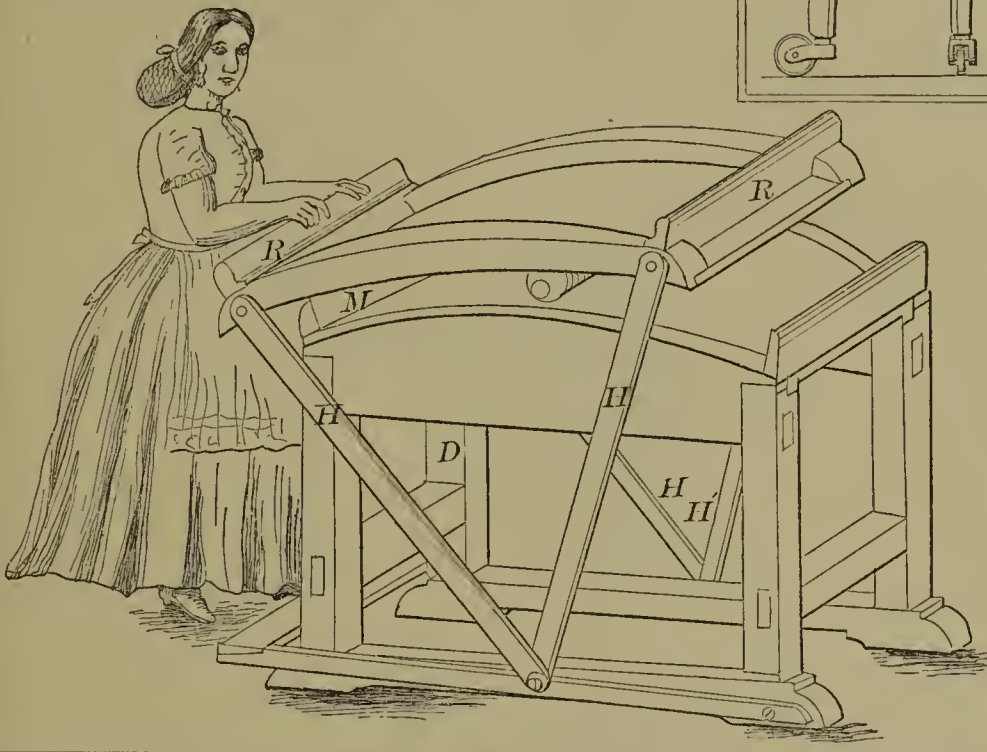

54544—Hewitt & Haley—*Low Water Detector.*

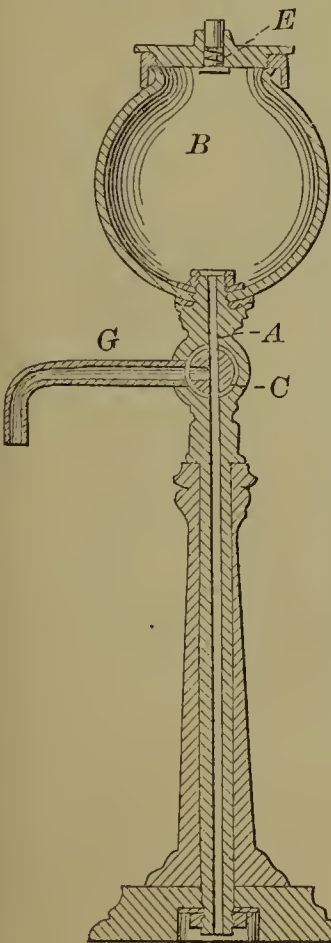
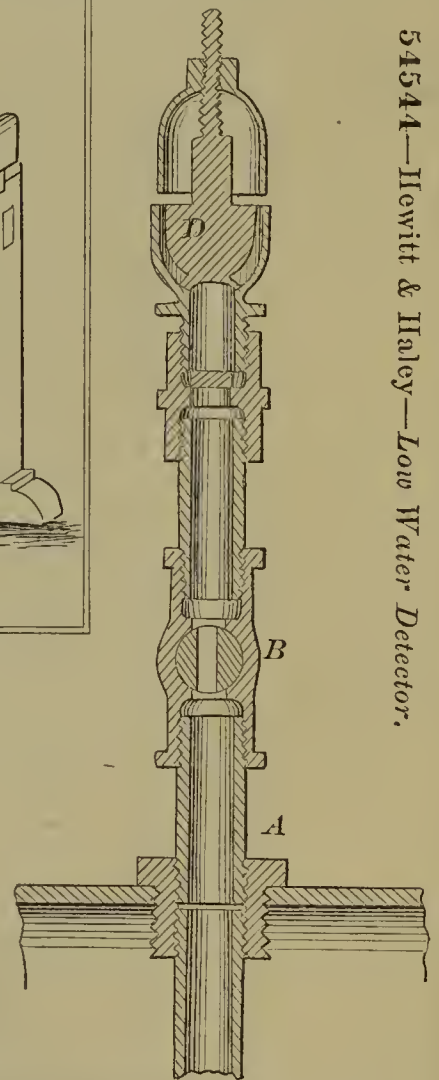

54548—F. H. Houghton—*For Measuring Liquids.*

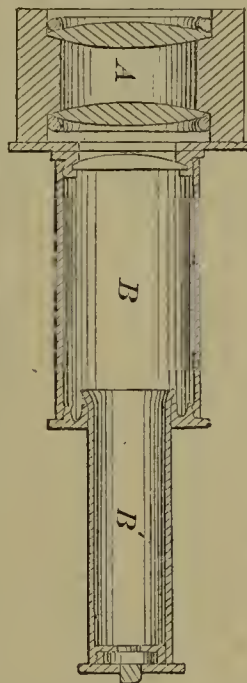

54542—L. Heath—*Optical Instrument.*

54545—A. Hitchcock—*Bed Bottom.*

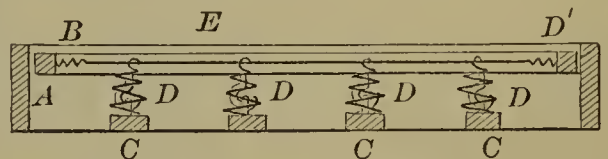

54547—J. A. Hopkins—*Saw Set.*

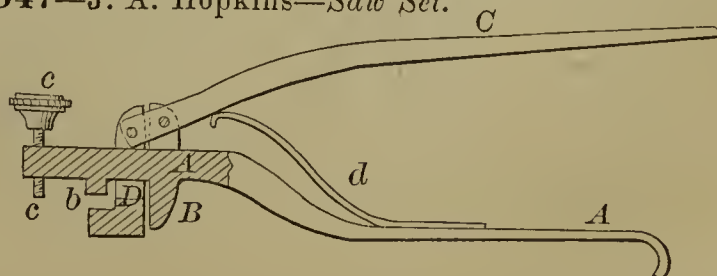

54549—D. Howarth—  
*Button.*

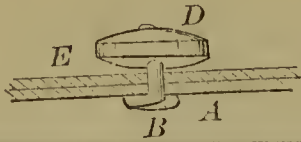

54552—J. & T. Insull—*Cupola Furnace.*

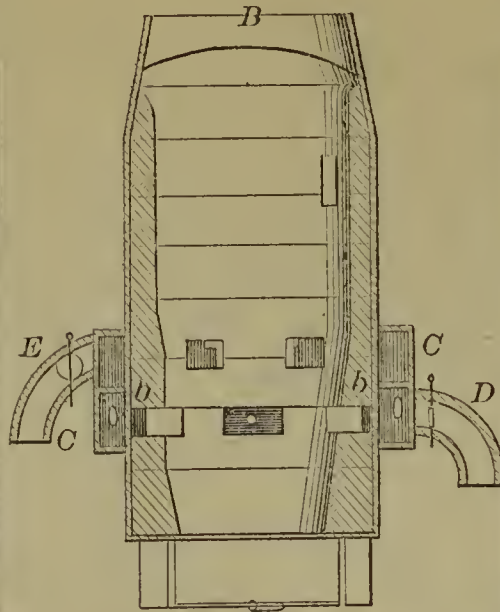

54559—M. C. Kilgore—  
*Broom Head.*

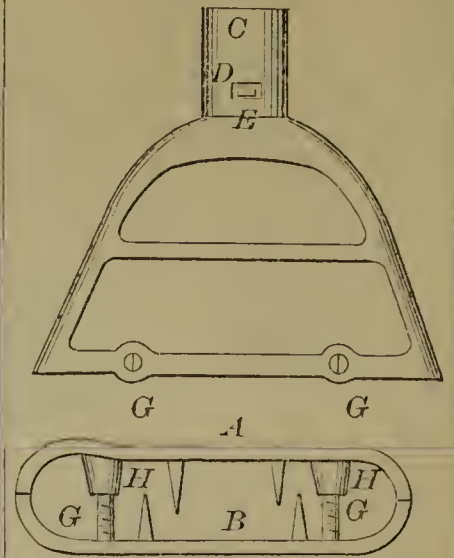

54551—W. A. Ingalls—  
*Piano Stool.*



54557—A. T. Jones—*Water Elevator for Wells.*

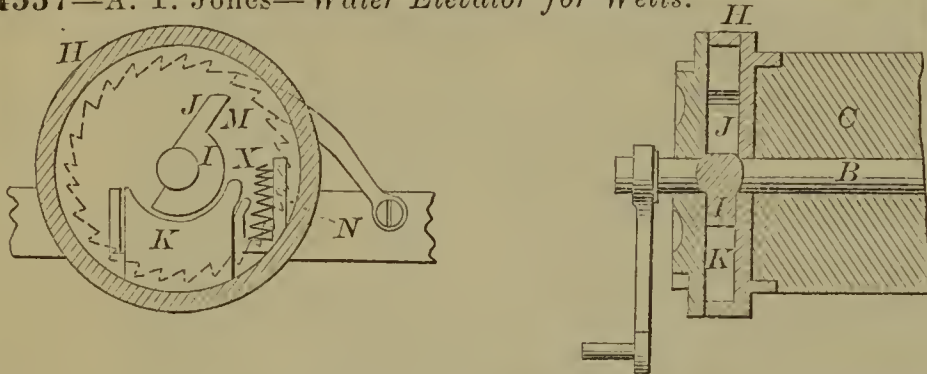

54553—J. H. Erwin—*Illuminating Apparatus.*

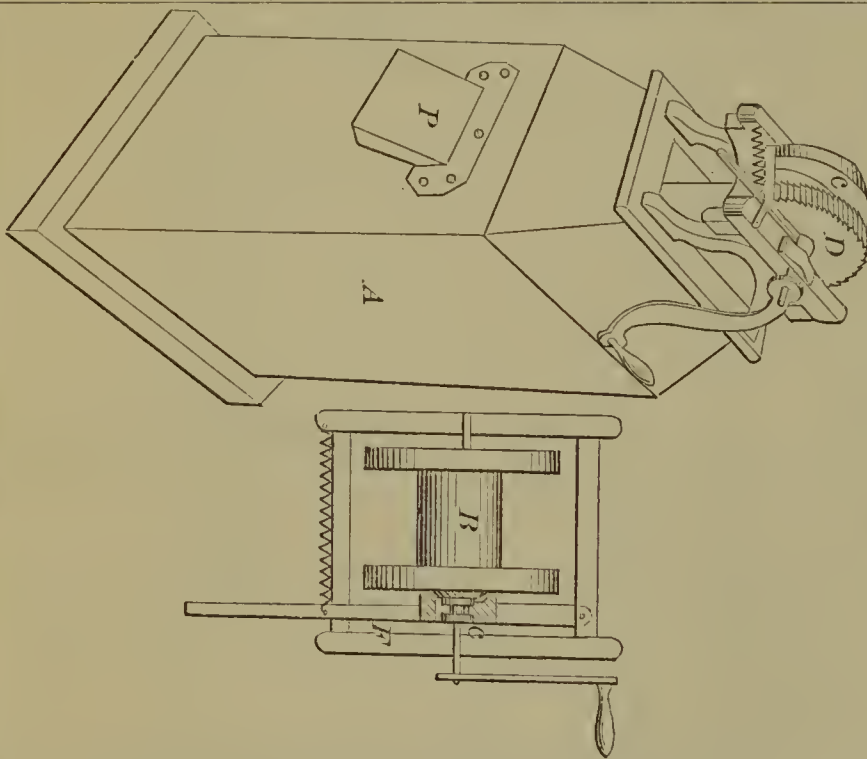
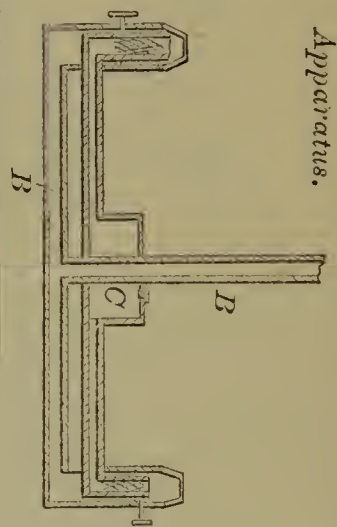

54558—F. H. Jones—*Water Drawer.*

54556—J. Johnson—  
*Fastening for Buttons.*



54560—E. L. Kinsley—*Steam Hammer.*

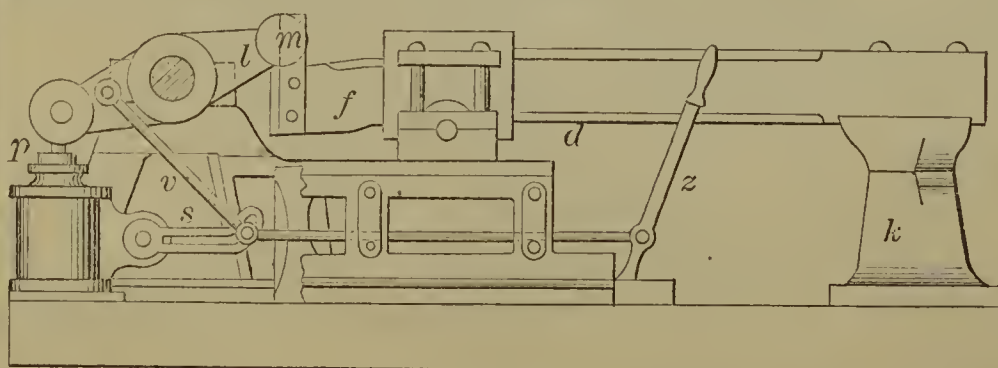

54555—E. Johnson—  
*Connecting Joints of Pipes.*

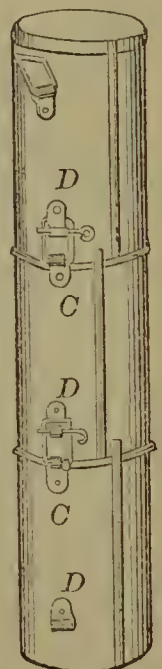

54561—H. F. Knapp—For Making Paper Collars.

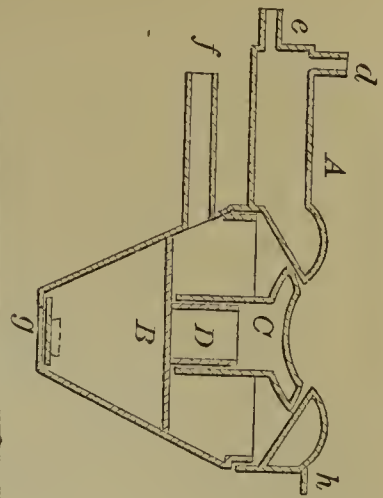
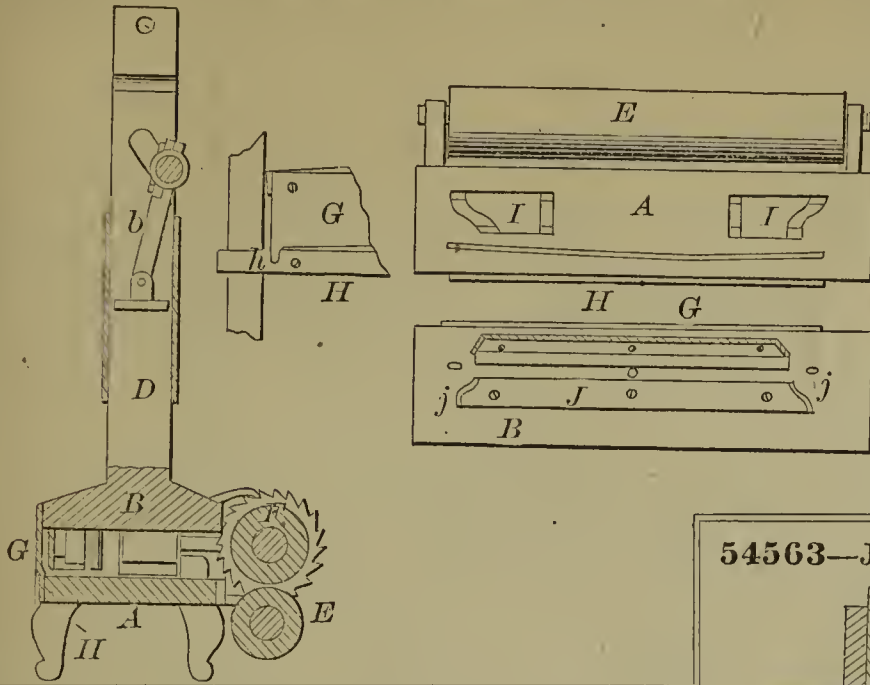

54562—J. Kriegbaum—Tugere.

54563—J. J. Lahaye—Railroad Axle Box.

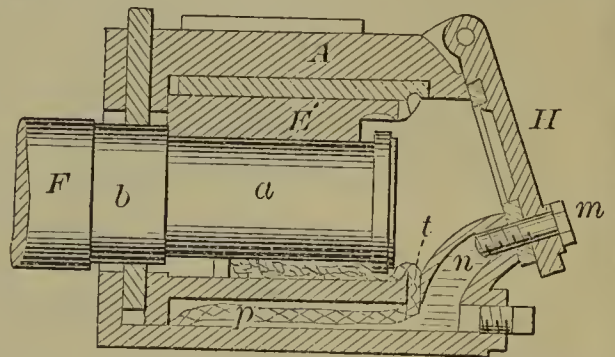

54564—Lannay & Parks—For Combing Bristles.

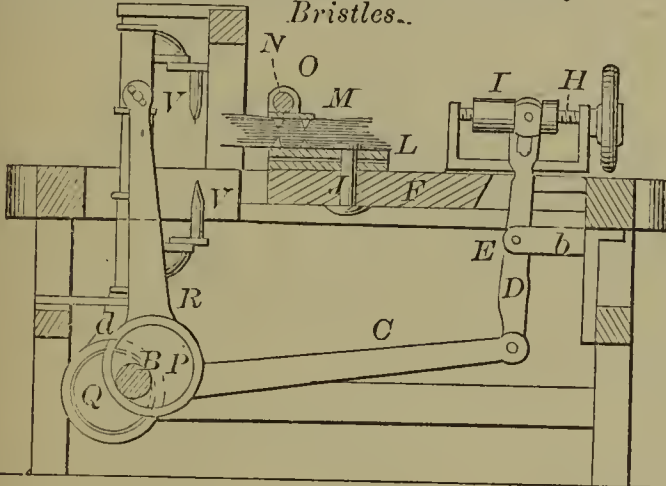

54565—H. B. Leach—Rotary Pump.

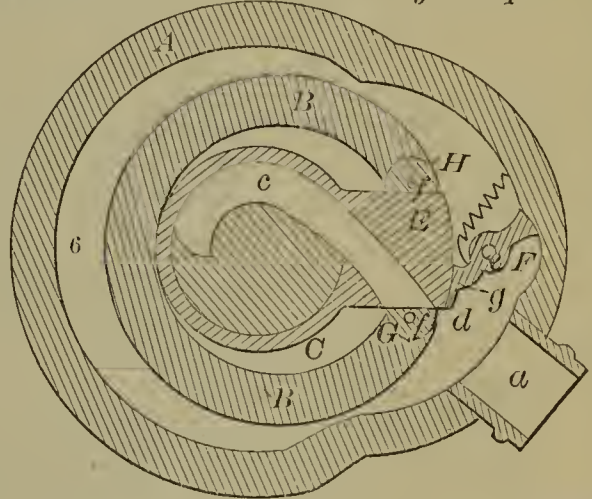

54566—W. P. Lyon—Oyster Cracker.

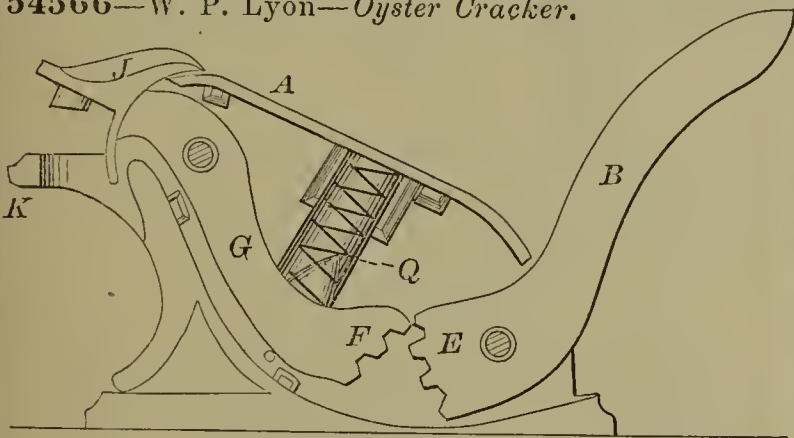

54567—Lynn & Crowell—Bed Bottom.

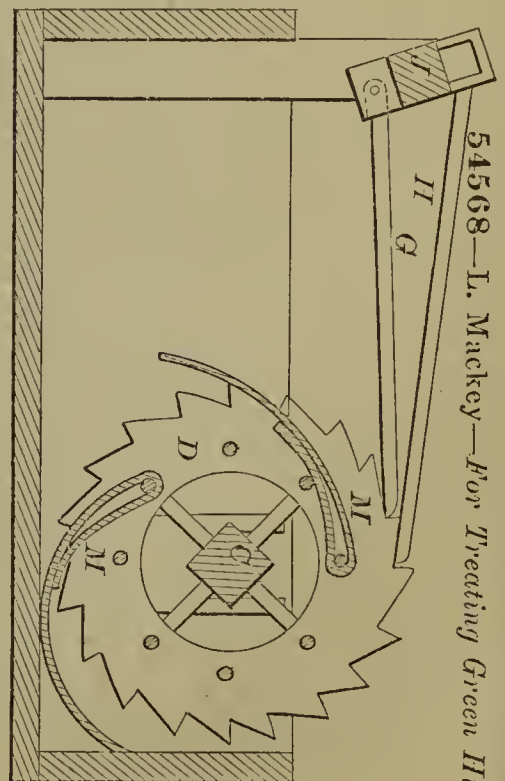
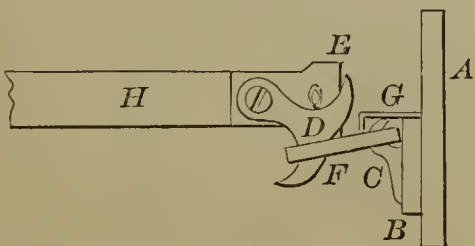

54568—L. Mackey—For Treating Green Hides.

54569—W. Mallerd—Attachment for Gas Burners.

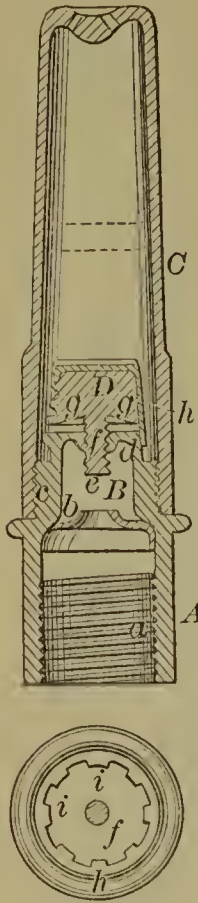

54570—C. J. Mallon—Sud Iron.

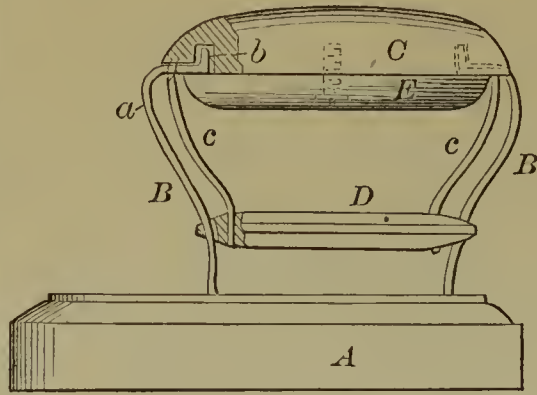

54572—E. McArdle—For Holding Glass Bottles.

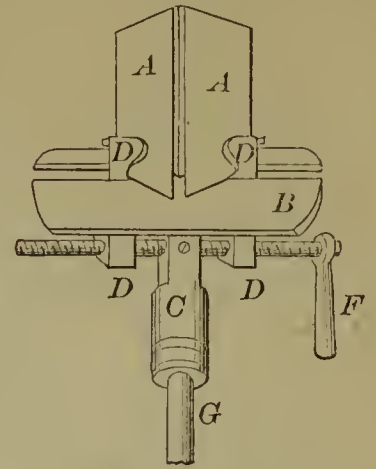

54571—J. A. Marden—Leather Splitting Machine.

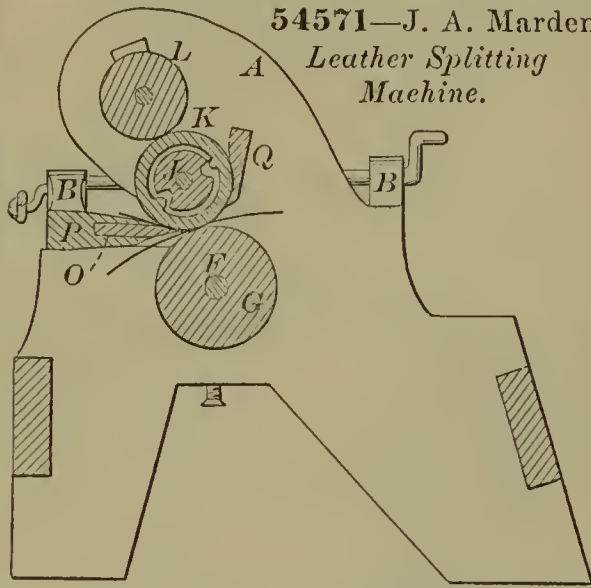

54573—S. McCambridge—Car Brake.

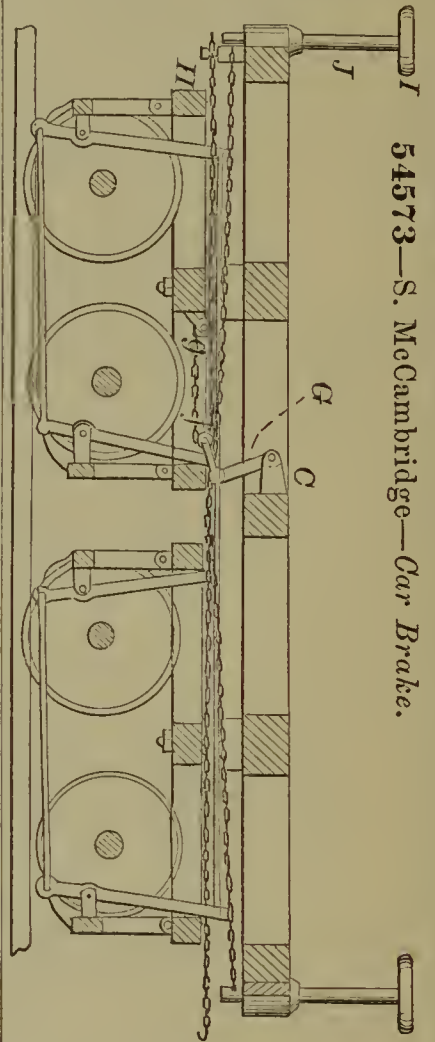

54574—F. McRoy—Attaching Thills to Vehicles.

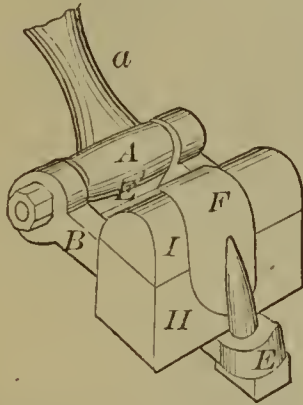

54575—W. C. McGill—Flour Sifter.

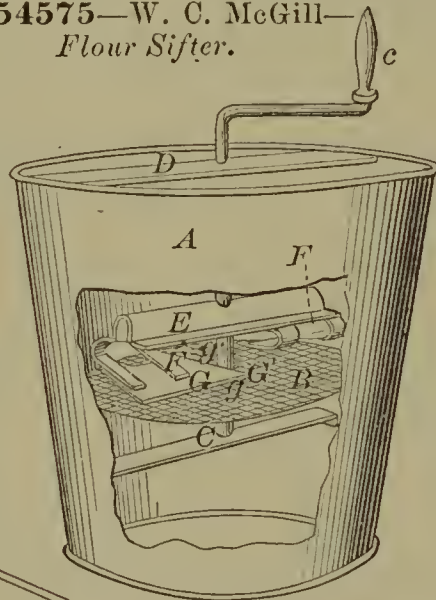

54576—S. McNamara Washing Machine.

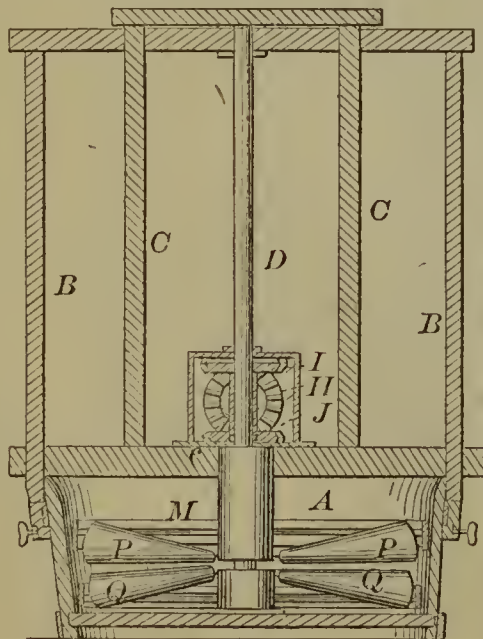

54577—T. L. Melone—Sewing Machine.

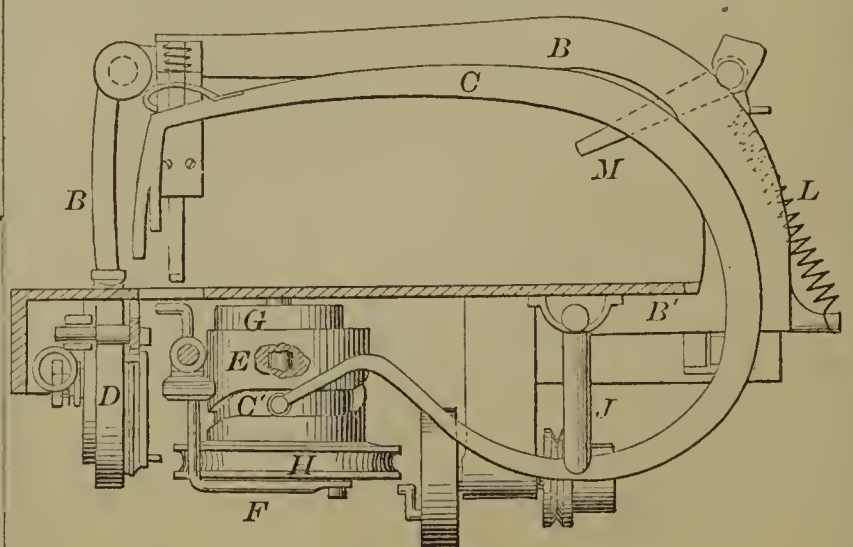

54578—B. F. Miller—*Washing Machine.*

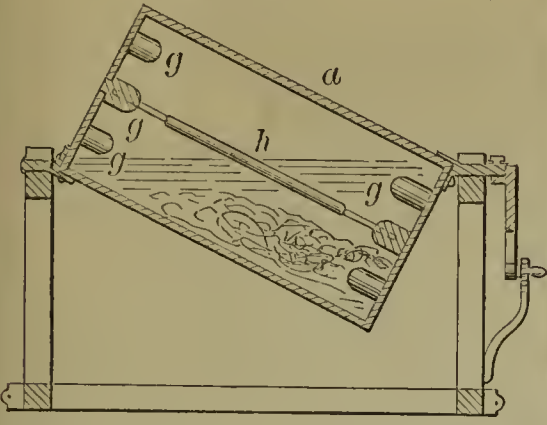

54579—I. & D. J. Miner—*Water Wheel.*

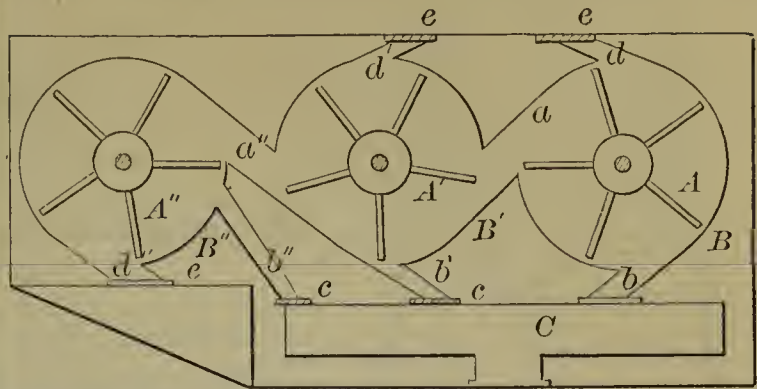

54580—M. J. Montgomery—*For Punching Corrugated Metal.*

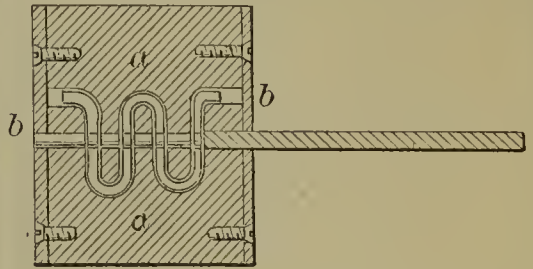

54583—H. Mott—*Churn.*

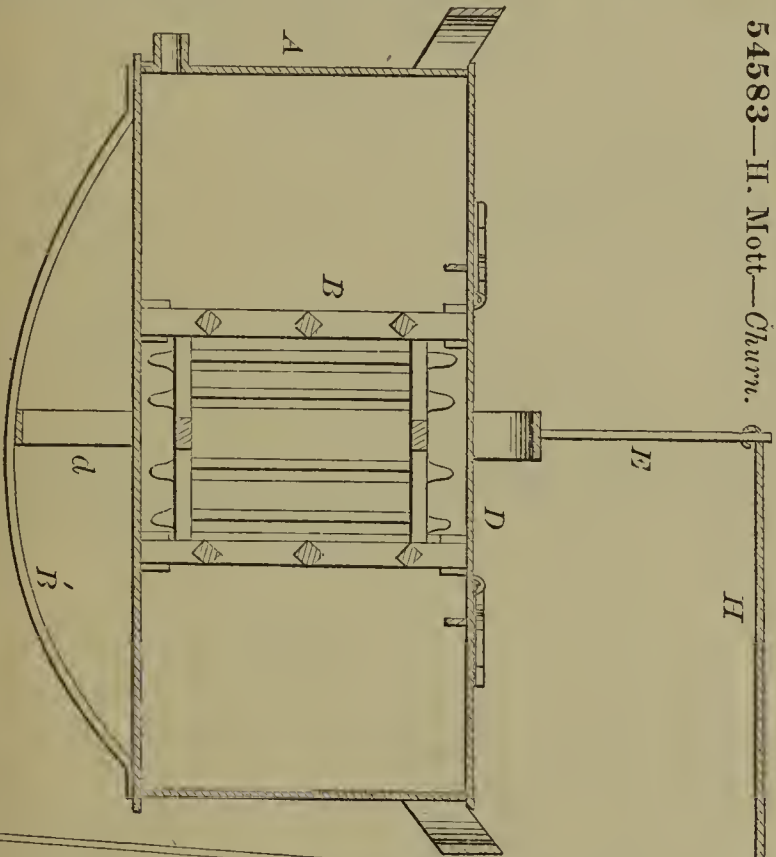

54582—W. Mosher—*Horse Rake.*

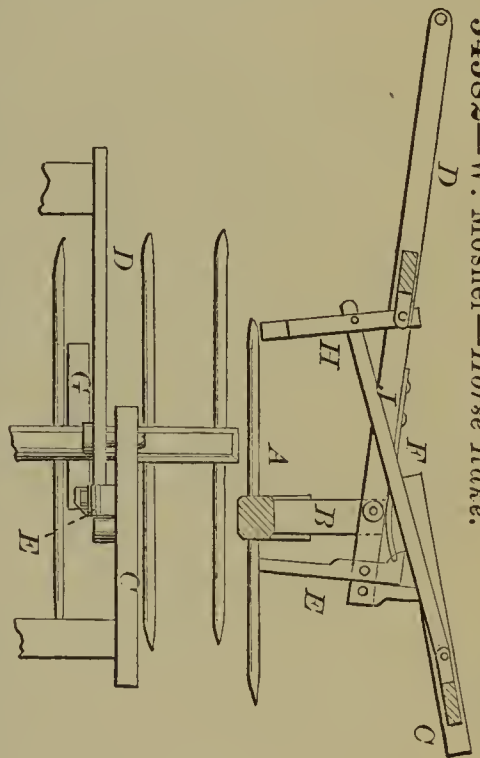

54584—E. P. Newbanks—*Shingling Gauge.*

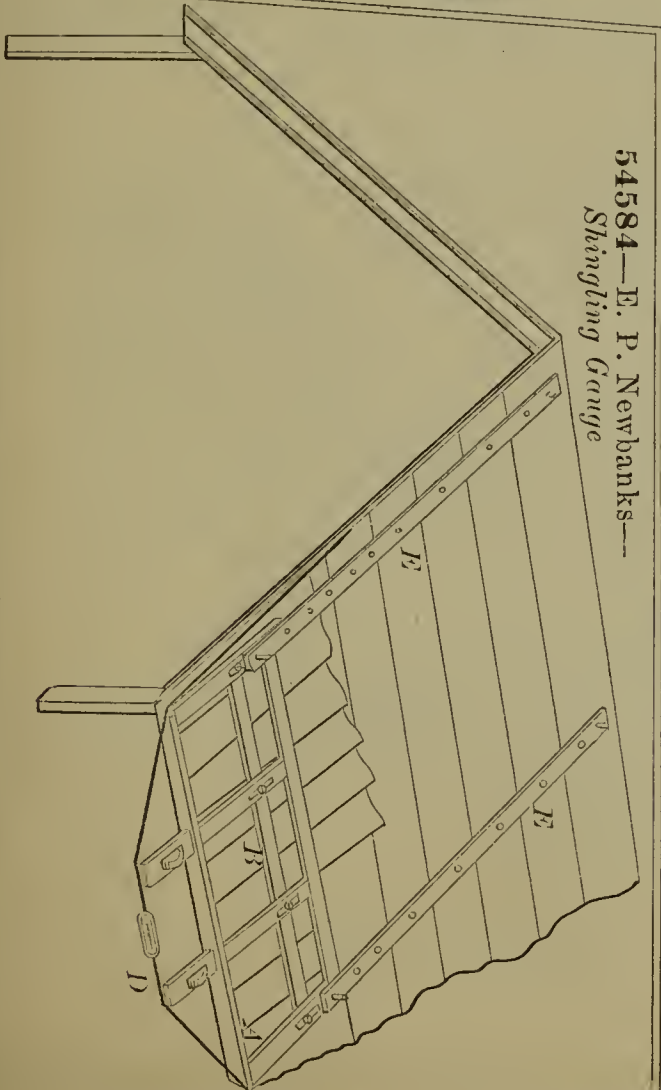

54581—J. J. Morris—*Rotary Pump.*

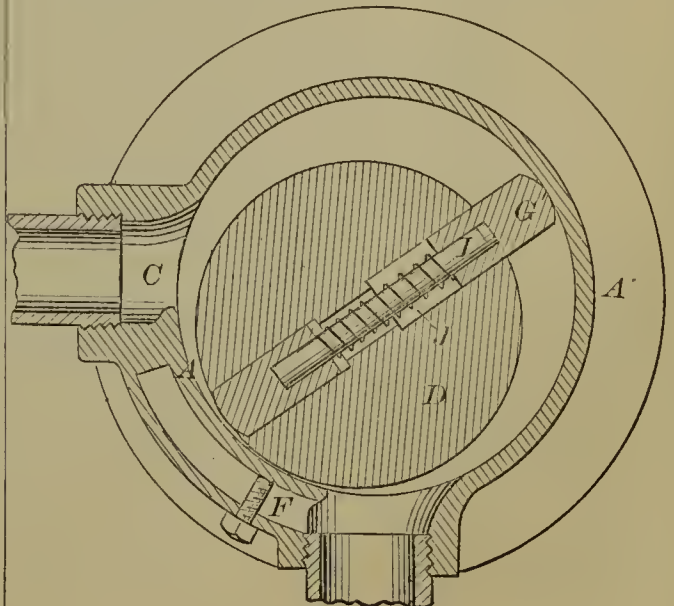

54585—J. K. O'Neil—Sleeves and Leggings.

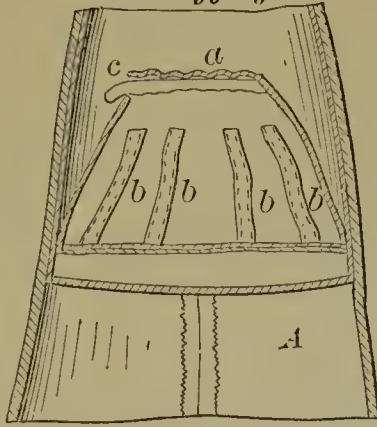

54589—S. W. & J. F. Palmer—Gearing.

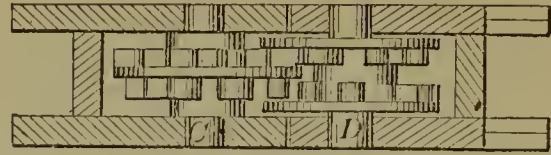

54590—C. C. Parsons—Cast Iron Apparatus for Superheating Steam.

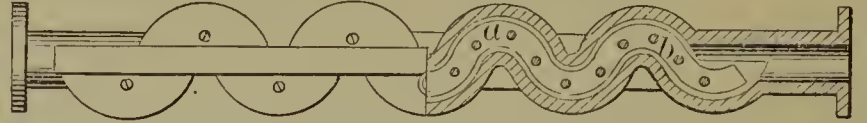

54593—M. L. Powell—Universal Index.

Universal Index

A

North Stations		South Stations	
M	F	M	F
Washgt	6 25	Baltimore	
Bladsby	9 40	M Clair	2
PBranch	12 50	Relay	9 25
Bells V	15 55	Elk R	10 40
WOakB	18 65	Hanover	12 45
Laurel	20 75	Dorsey	14 50
Savage	22 80	Jessup	16 00
AJunct	24 95	AJunct	18 70
Jessup	26 105	Savage	20 75
Dorsey	28 115	Laurel	22 85
Hanover	30 115	WOakB	25 95
Elk R	31 125	Bells V	28 105
Relay	32 125	PBranch	31 115
M Clair	38	Bladsby	37 125
Baltimore	70 150	Washgt	70 150

A

54592—J. F. C. Pickhardt—Sofa Bedstead.

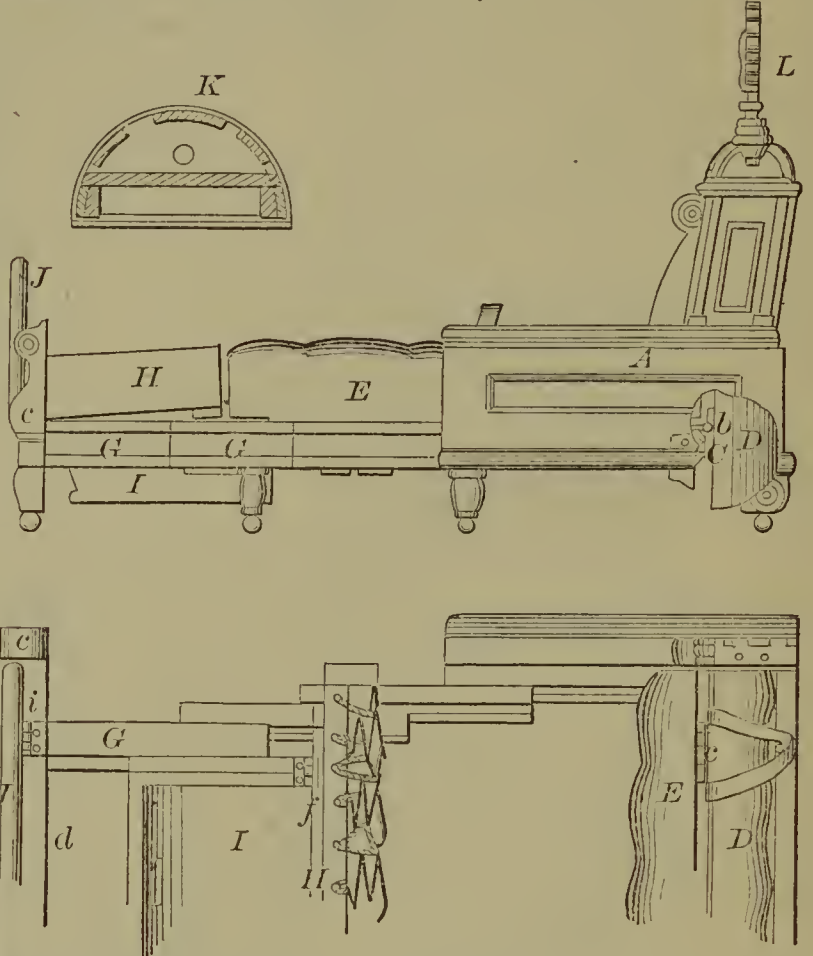

54594—D. H. Priest—Fruit Basket.

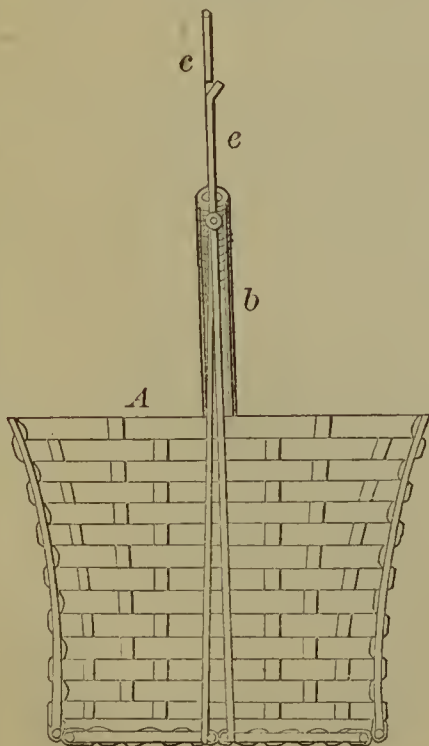

54595—A. D. Puffer—Mosquito Guard for Bedsteads.

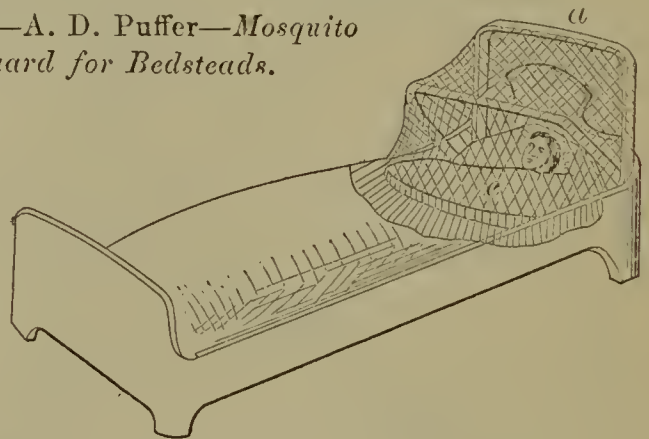

54596—C. Purdy—Gate.

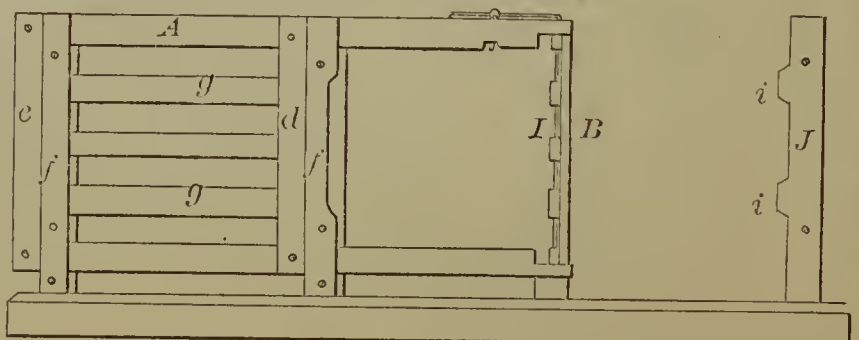



54597—T. H. Quick—*For Dissolving Sugar.*

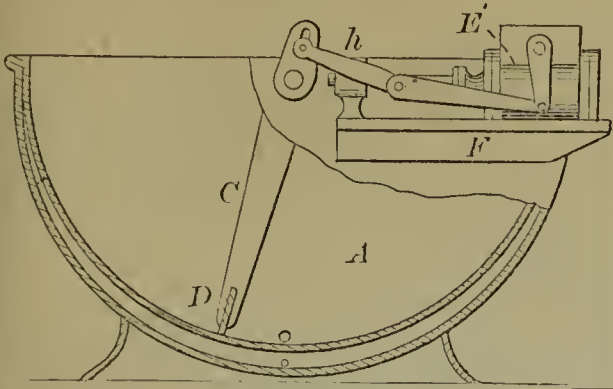

54598—T. F. Randolph—*Sewer.*

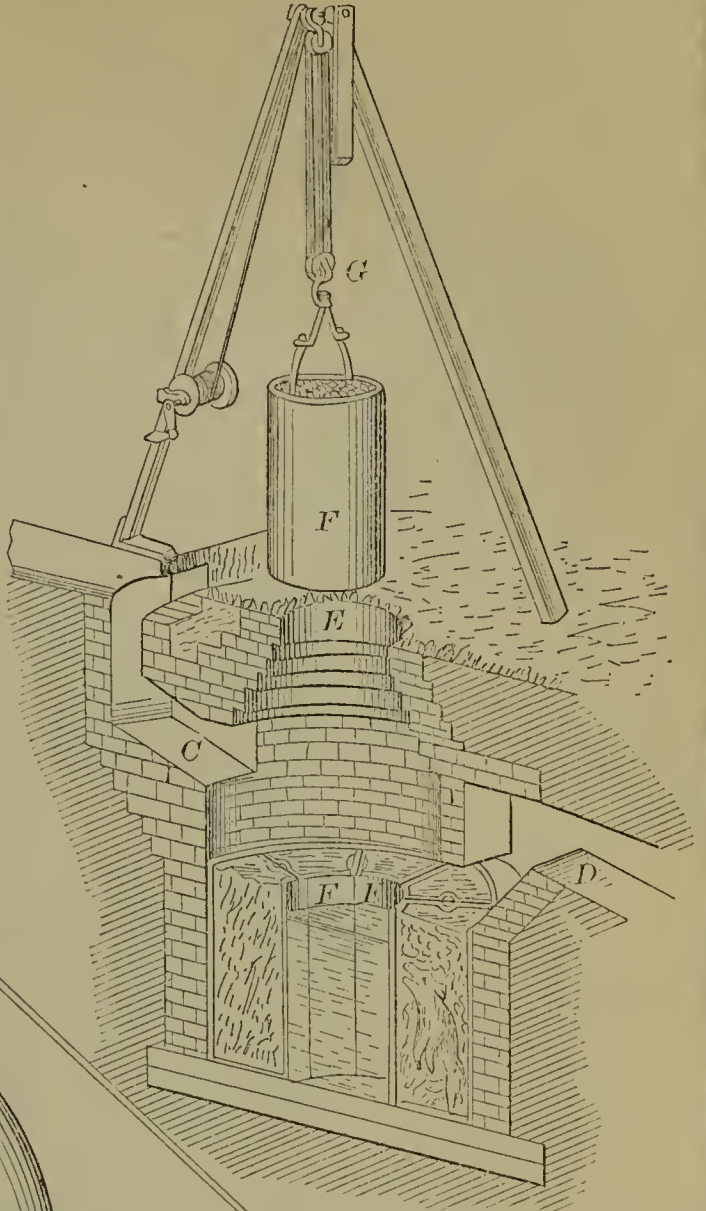

54602—T. Robjohn—*Sewing Machine Braid Guide.*

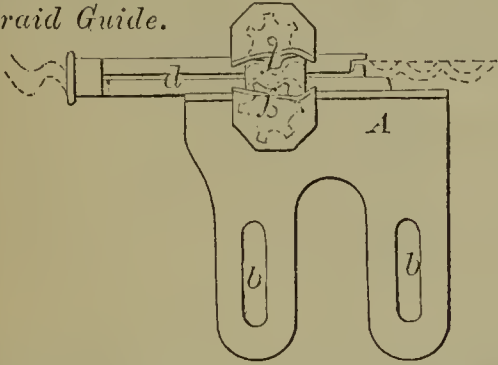

54500—H. Reynolds—*Breech-Loading Fire Arm.*

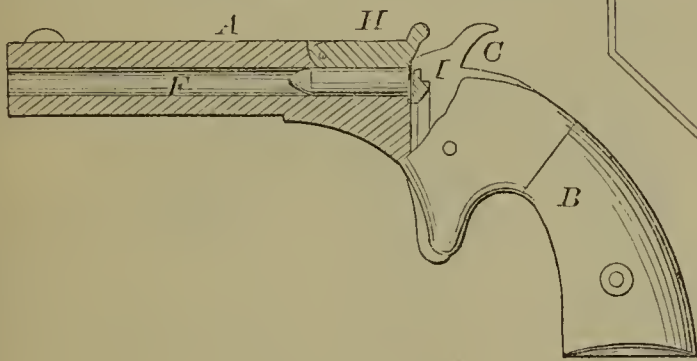

54603—W. Robjohn—*Organ.*

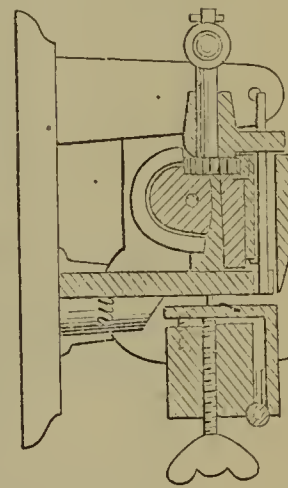
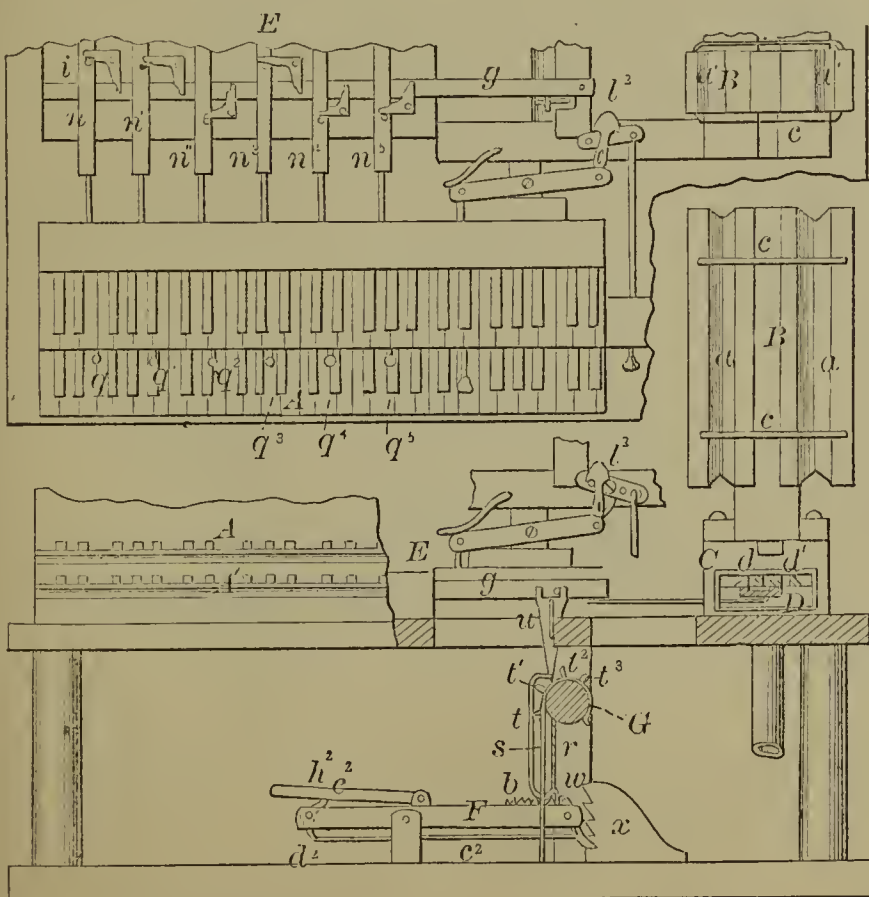

54599—C. H. Raymond—*For Folding Iron.*

54601—H. A. Robison—*Hat Block.*

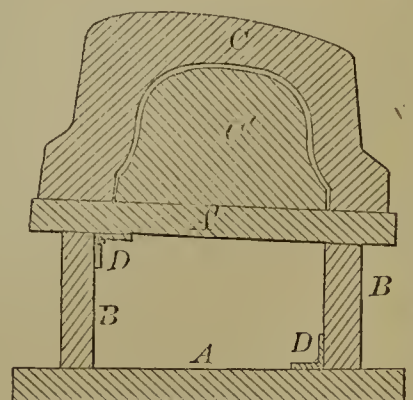

54604—C. Rosefield—*Tooth Brush.*

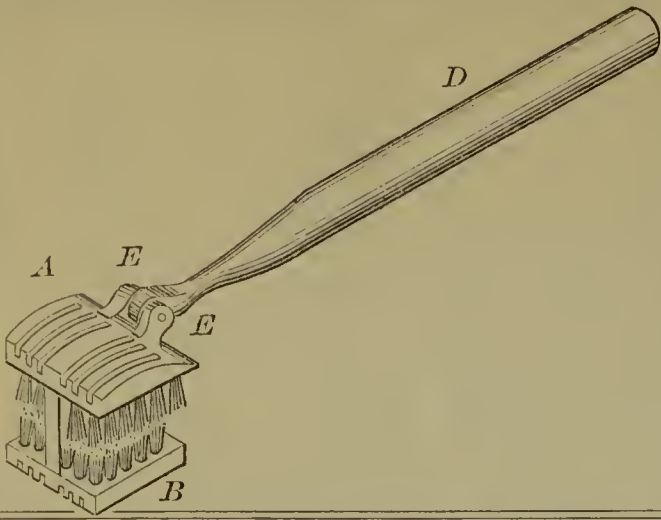

54605—A. J. Rogers—*For Rolling Spikes.*

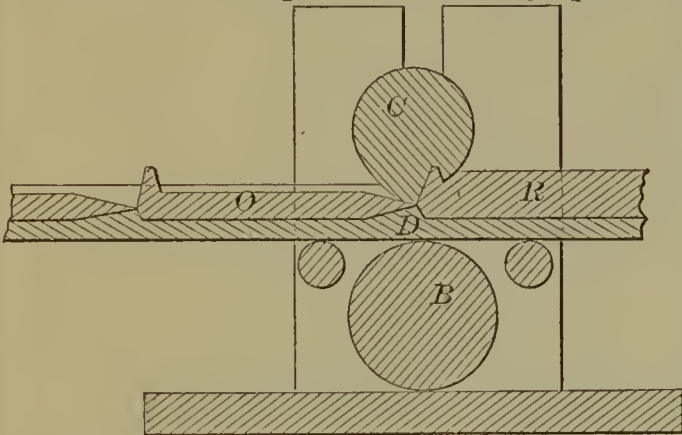

54610—Seeley & Jacobie—*Brick Machine.*

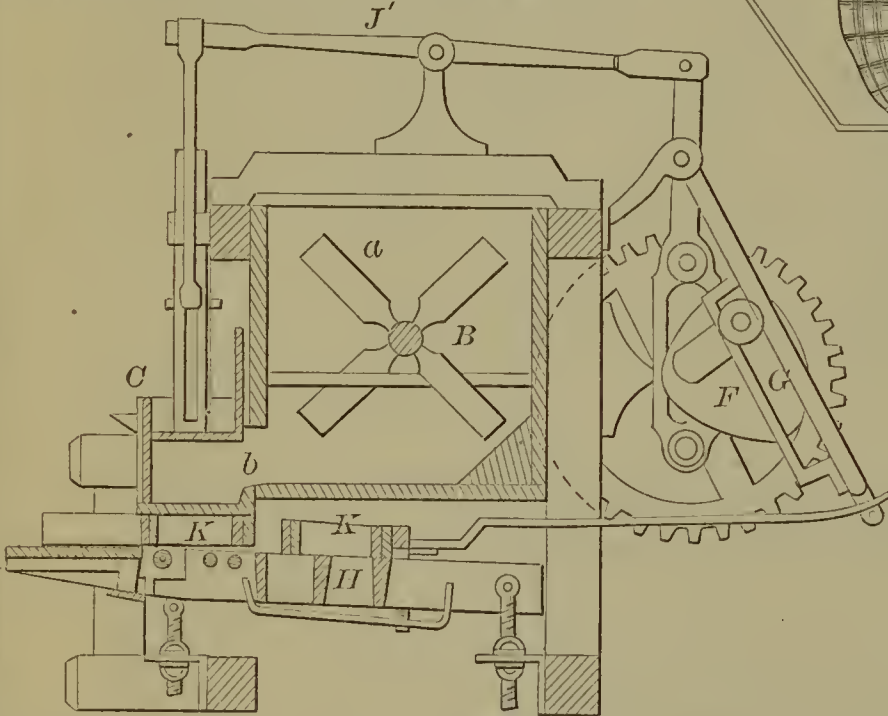

54608—Saur & Cotton—*Sawing Machine.*

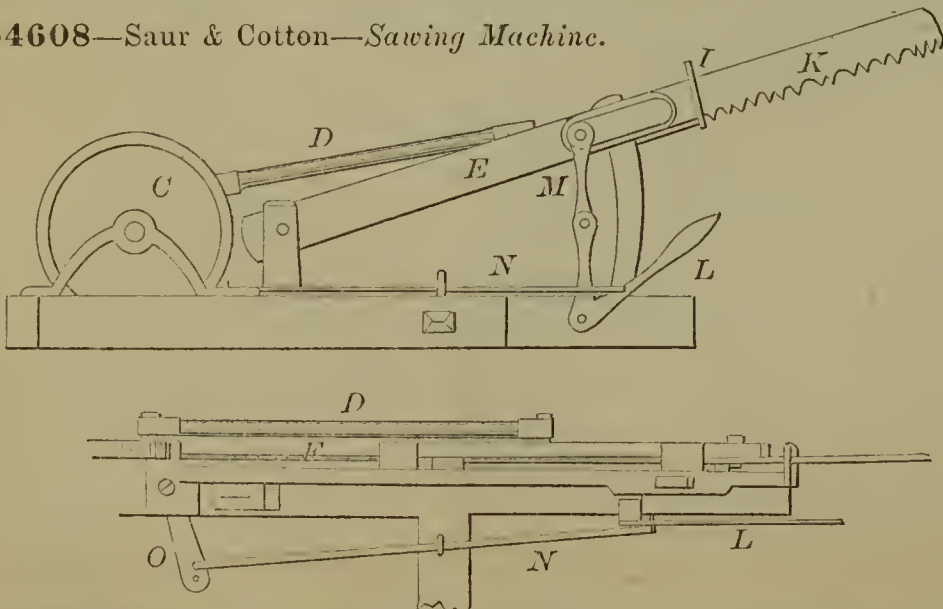

54606—Rotherham & Holden—*File Cutting Machine.*

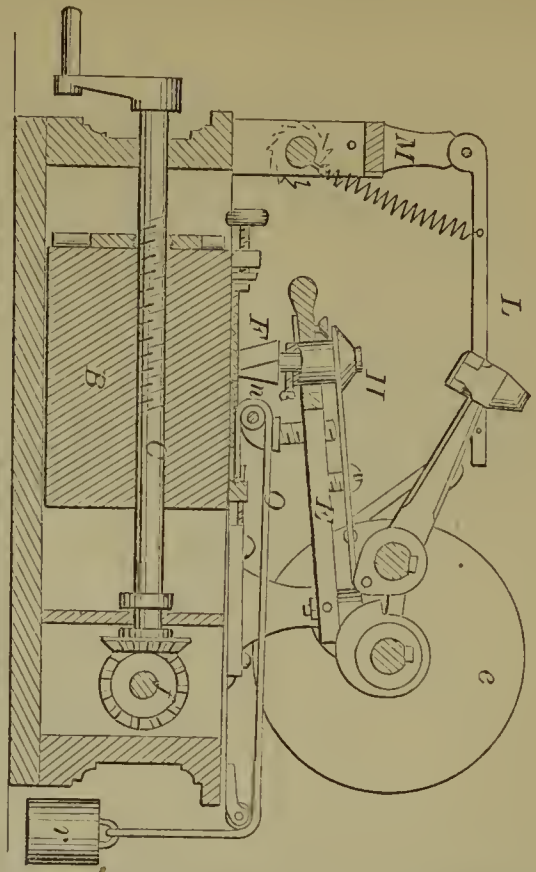

54607—Sangster & Seely—*Paper Neck Tie.*

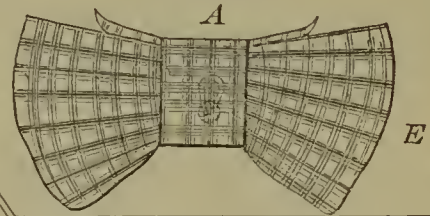

54609—E. C. Sears—*Flour and Meal Sifter.*

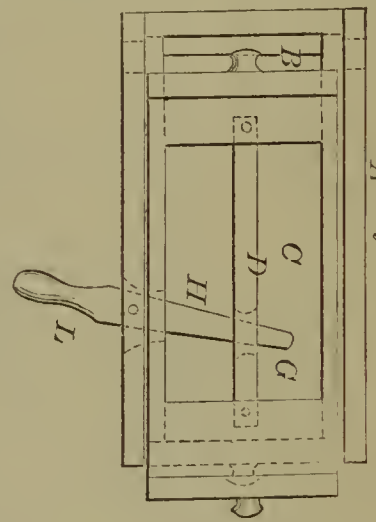

54611—J. F. Seiberling—*Harvester.*

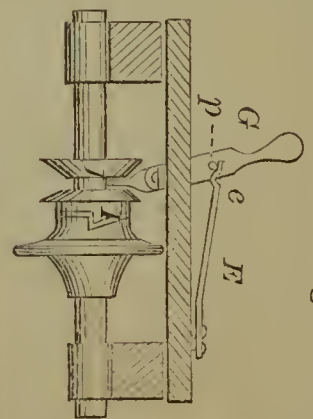

54612—A. J. Sellon—*Knife Cleaner.*

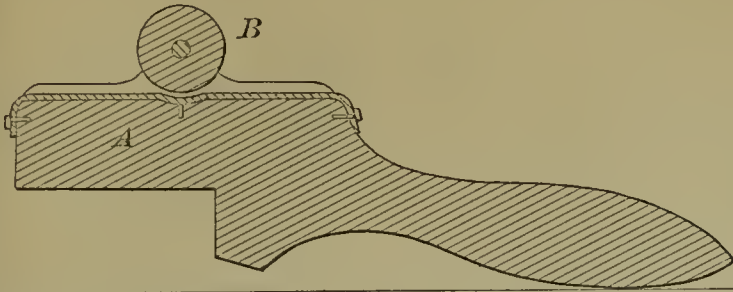

54614—Shepard & Lewis—*Fruit Box.*

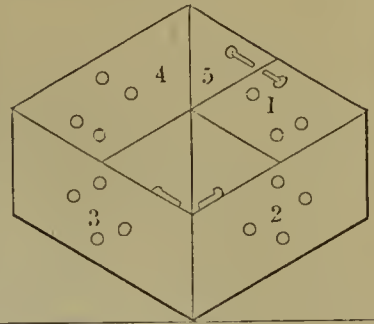

54613—J. H. Seymour—*Spittoon for Railroad Cars.*

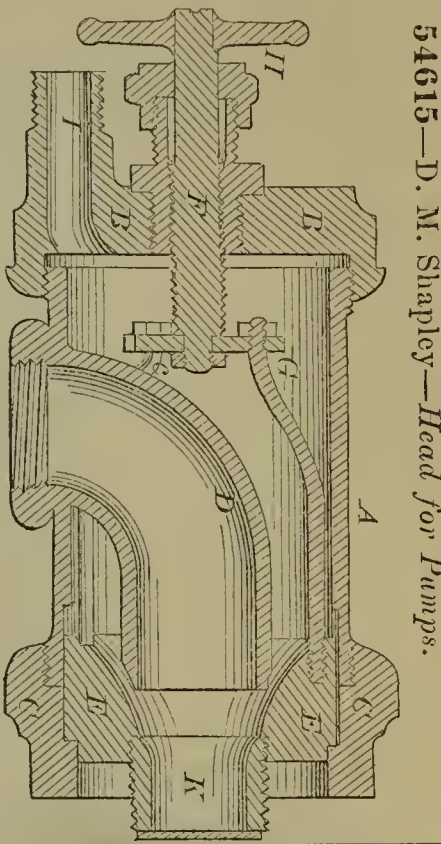
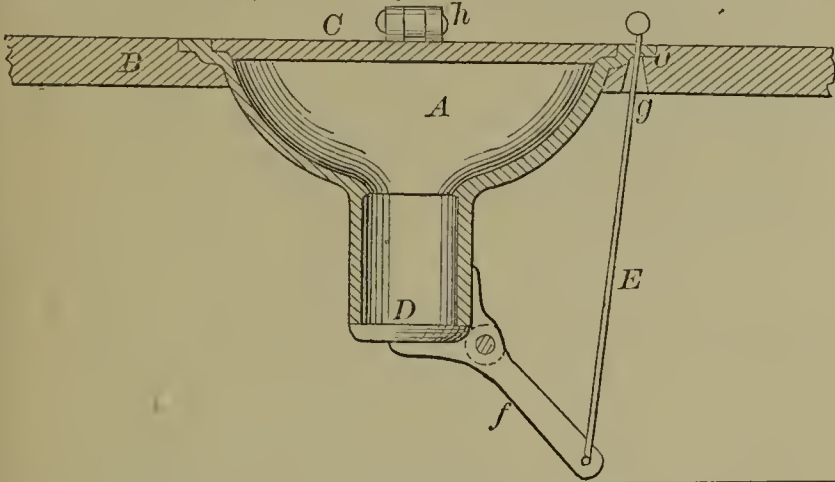

54615—D. M. Shapley—*Head for Pumps.*

54617—O. P. Shinkle—*Glass Blower's Mould.*

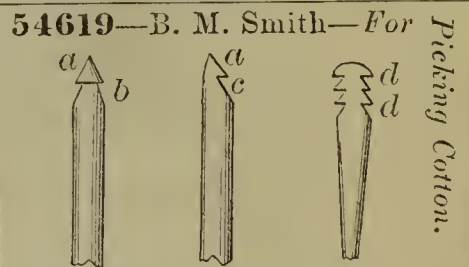
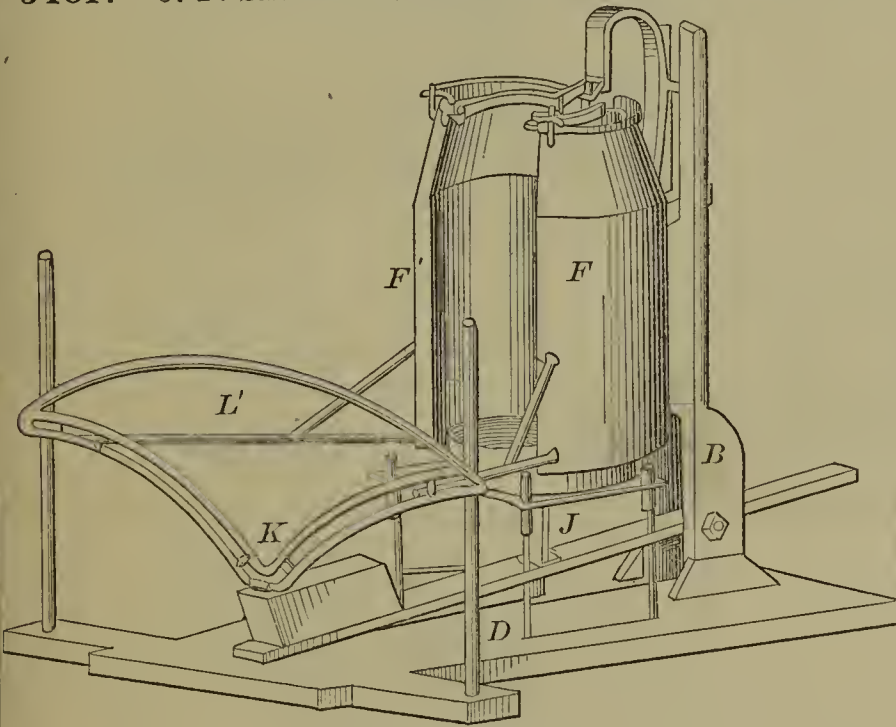

Picking Cotton.

54618—J. Slusser—*Shutter Hinge.*

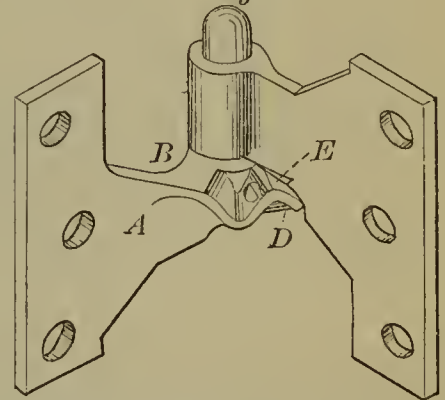

54621—C. F. Spaulding—*Spinning Metal.*

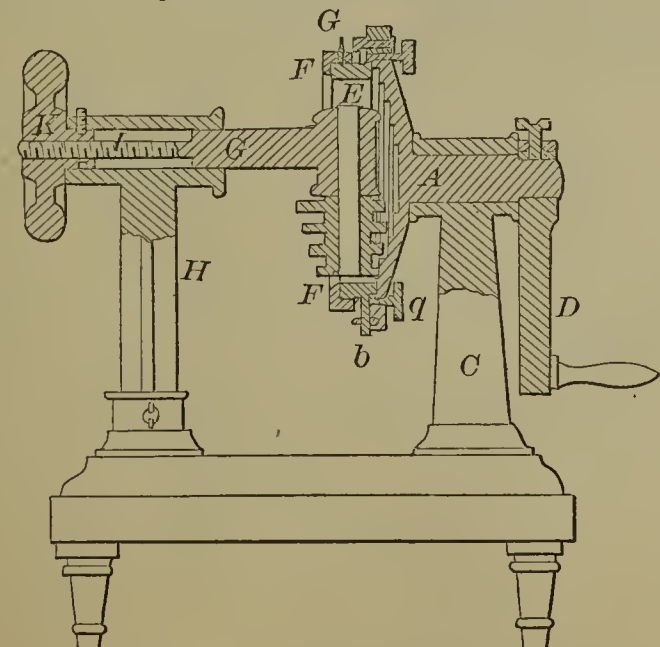

54620—Smith & Pomeroy—*Fastening Handles to Plated Ware.*

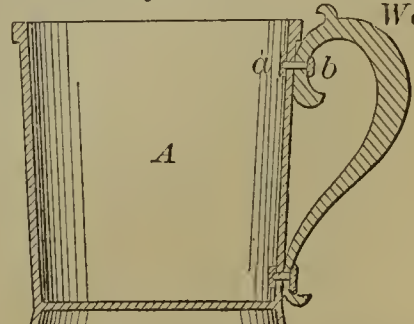

54622—M. W. Staples—Washing Machine.

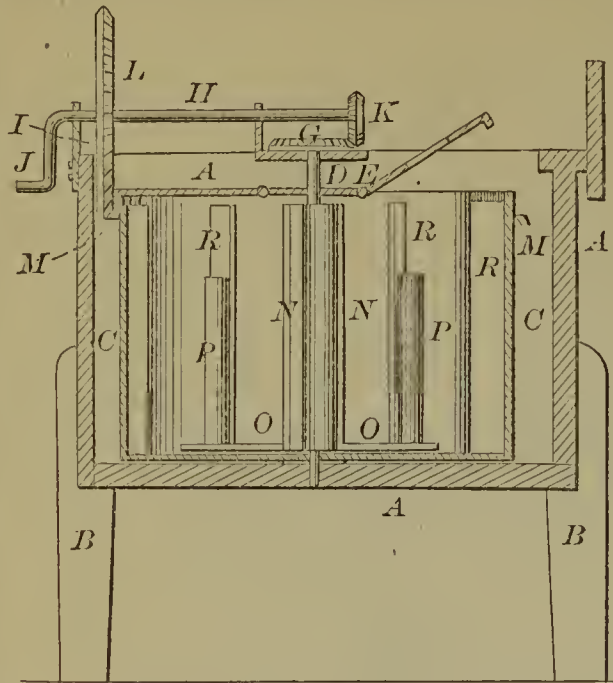

54624—D. C. Thresher—Gun Stock and Barrel Attachment.

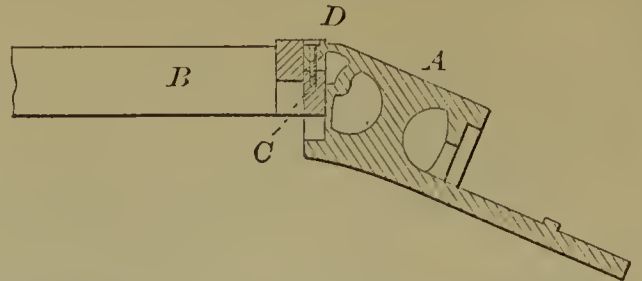

54626—A. J. Vandegrift—Spirit Level.

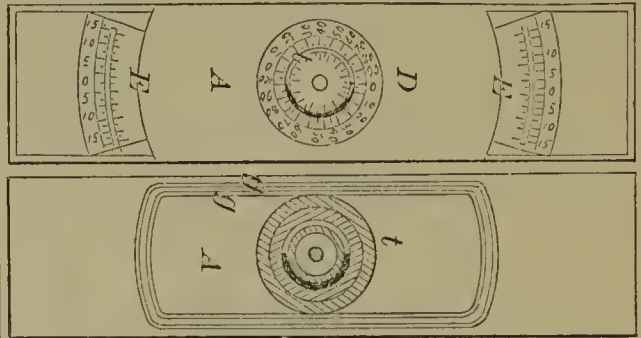

54623—T. Terrel—Shovel Plow.

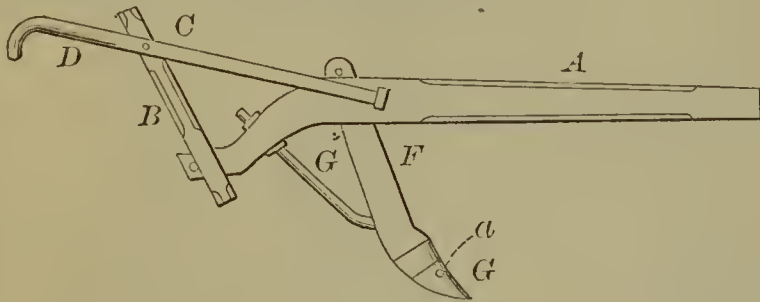

54629—C. Wahl—Vacuum Pan.

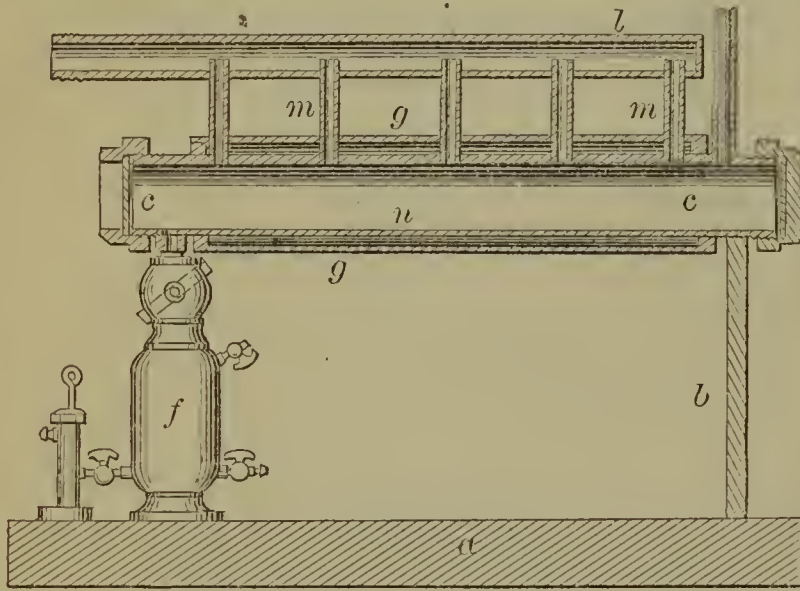

54625—E. Town—Cotton Gin.

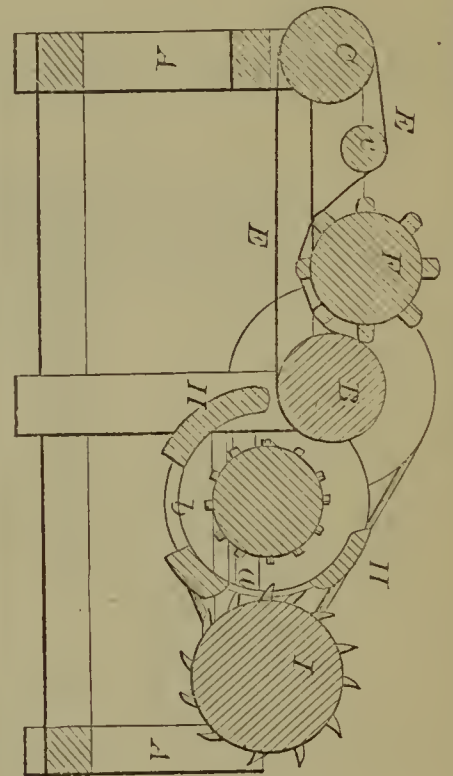

54627—F. Van Etten—Hay Loader.

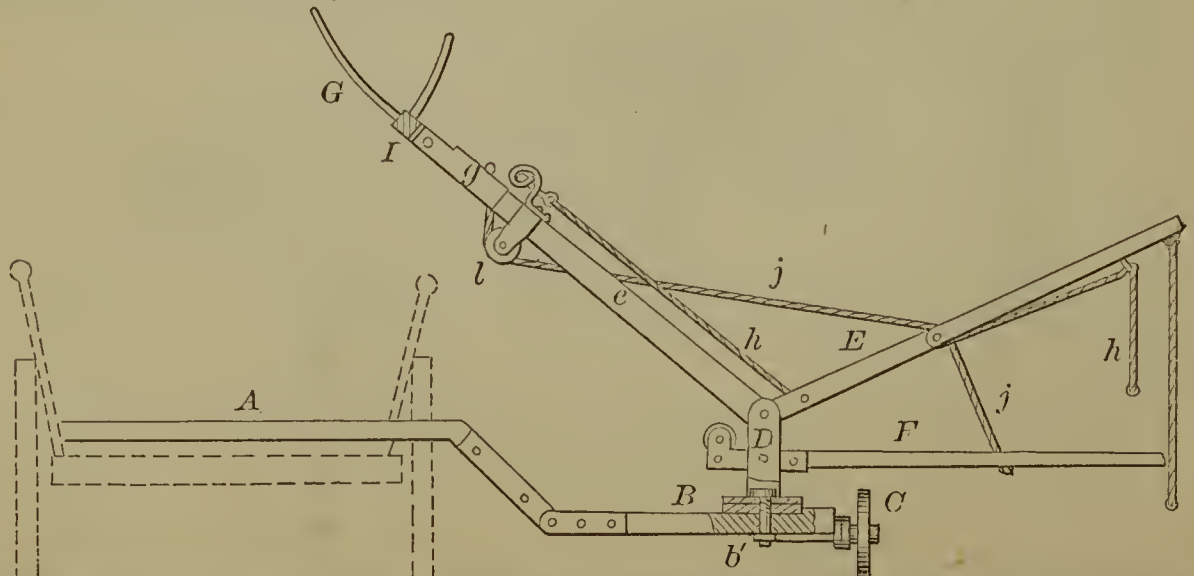

54630—A. Warth—  
*Attachment to Treadles.*

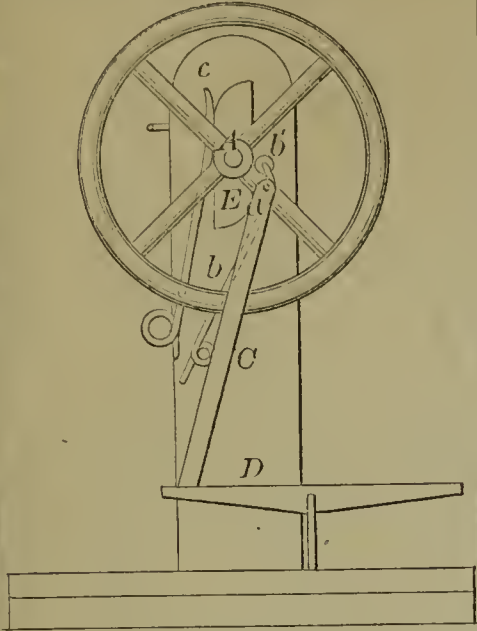

54632—H. W. White—  
*Churn.*

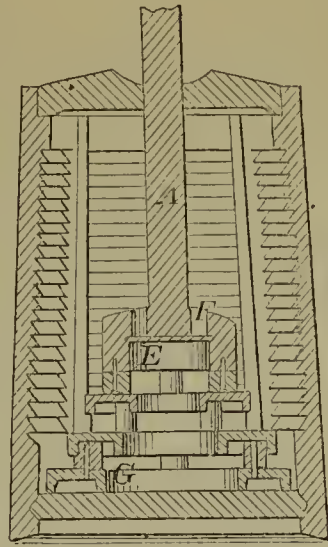

54636—D. S. Wood—*Pump.*

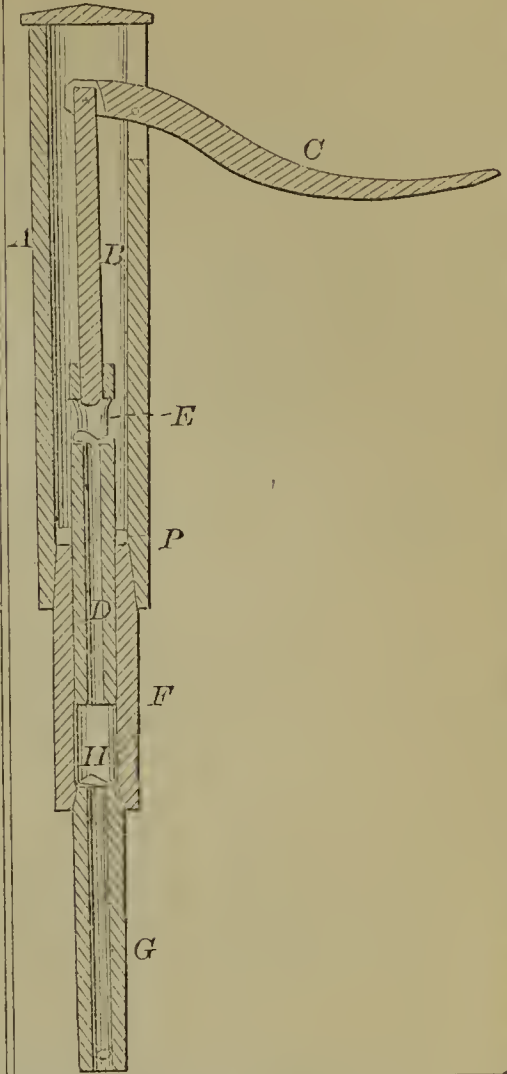

54631—H. Wehle—*Clothes  
Wringer.*

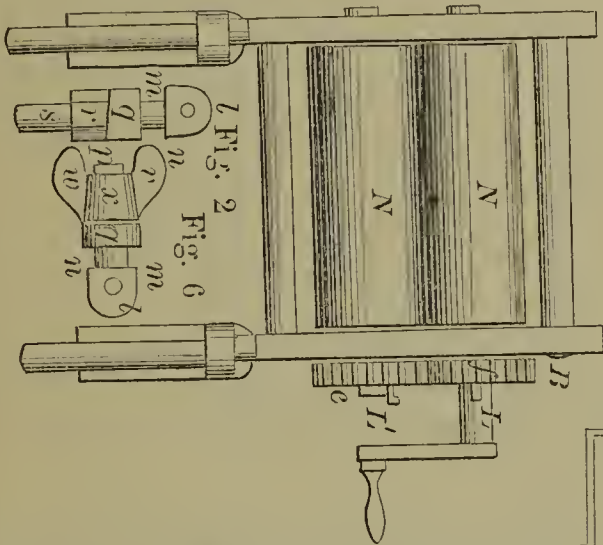

54634—N. E. Wilson—*Churn.*

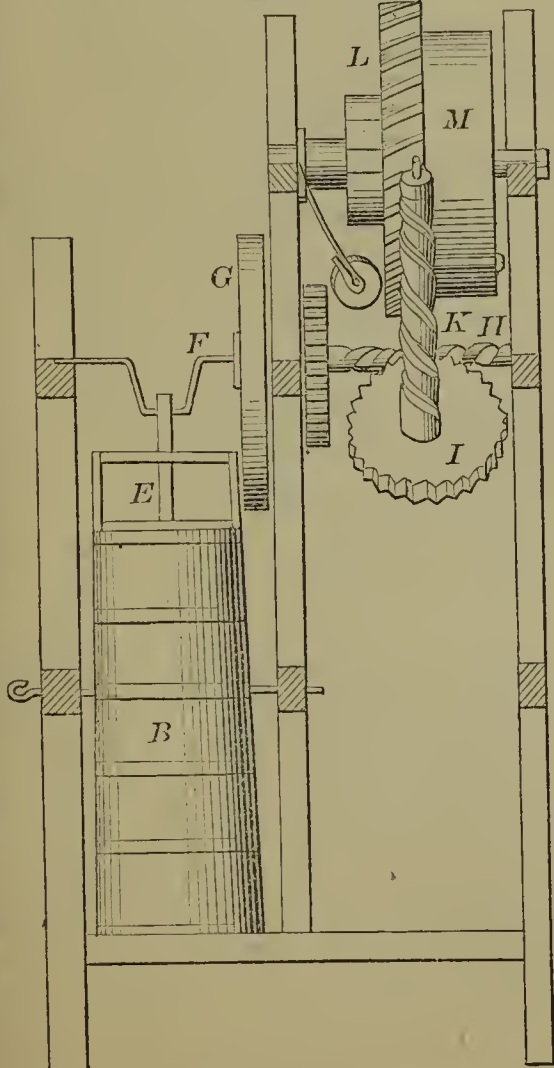

54633—M. Wilkinson—*Corn Planter.*

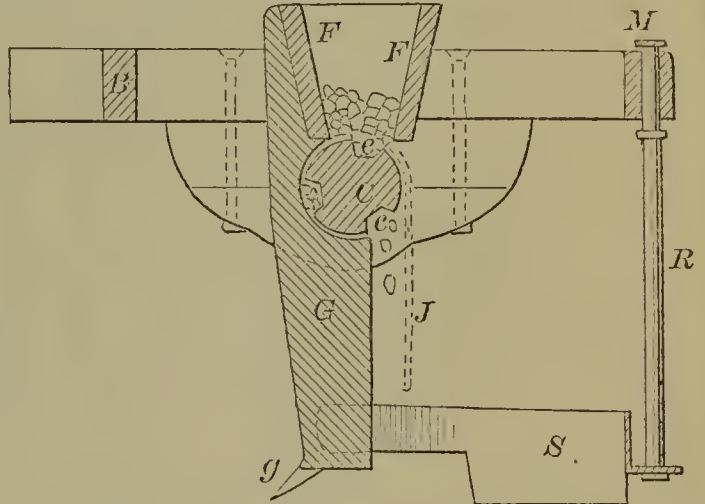

54637—B. F. Young—*Cultivator.*

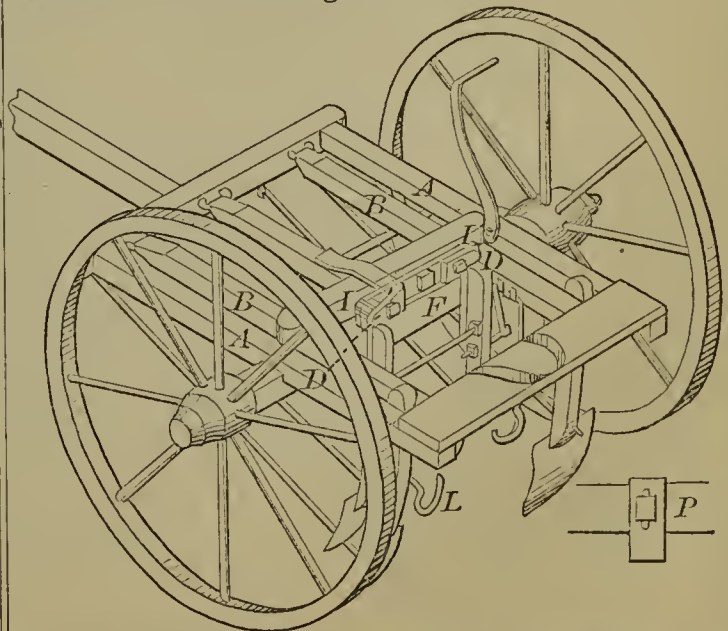

54638—C. Young—For Making Carriage Wheels.

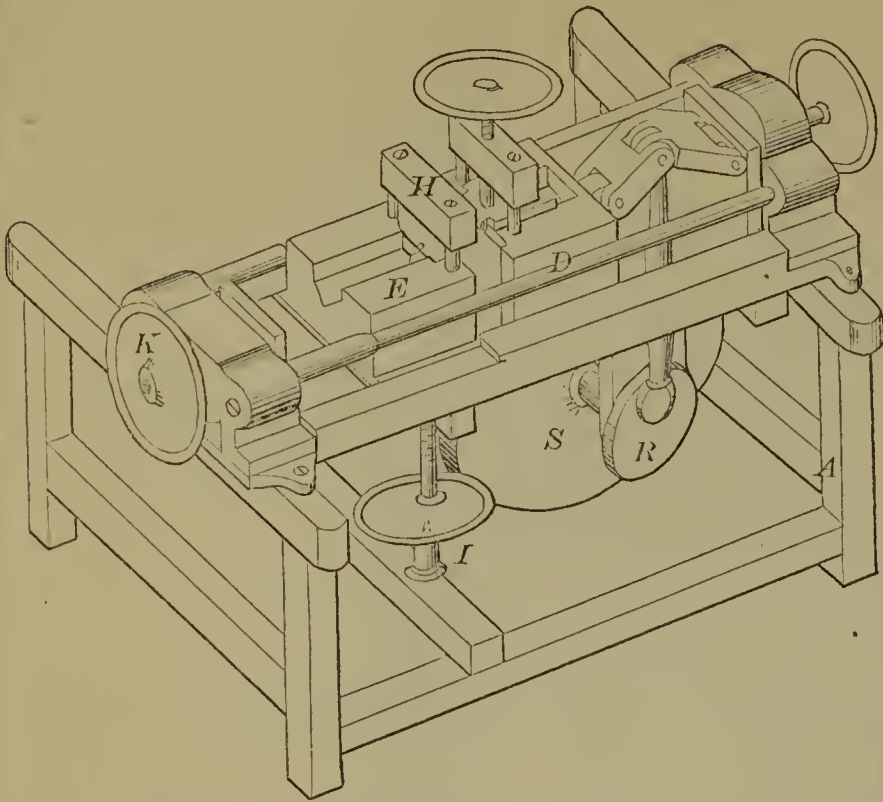

54640—J. Adt—Corkscrew.

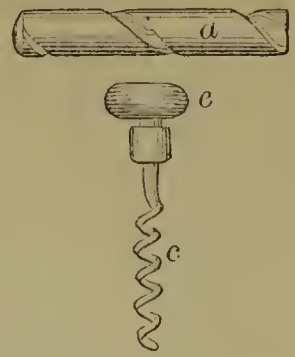

54643—J. Fieldhouse—Die for Forming Gas Pipes.

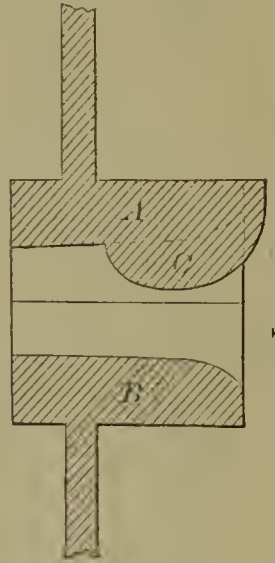

54642—J. Campbell—Corn Planter.

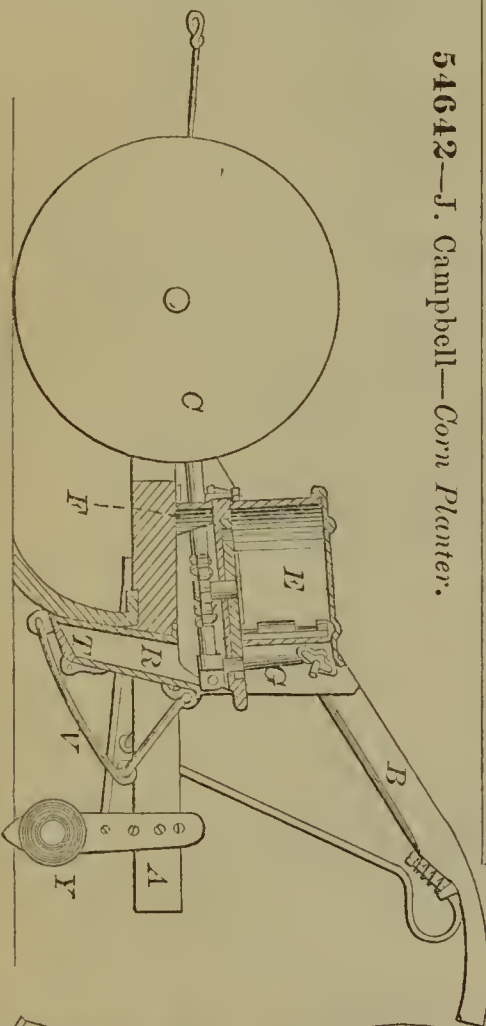

54639—C. Young—For Making Carriage Axles.

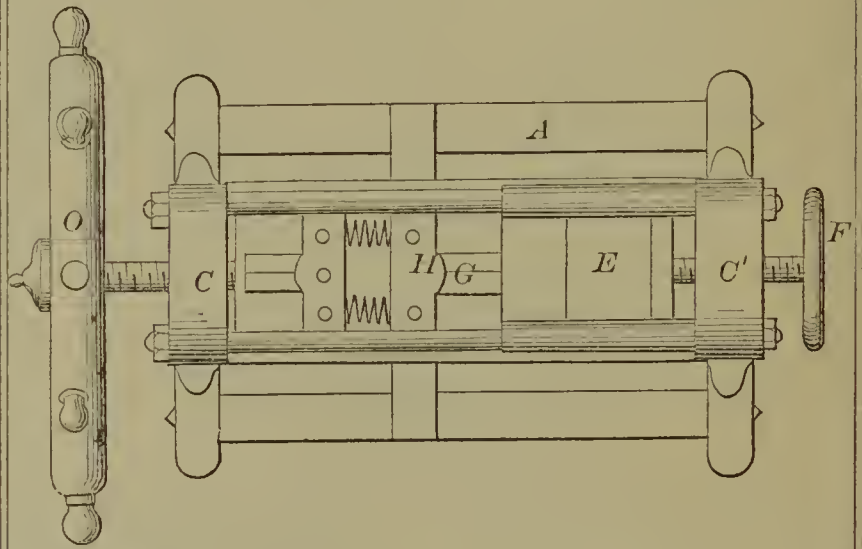

54641—D. B. Baker—Gate.

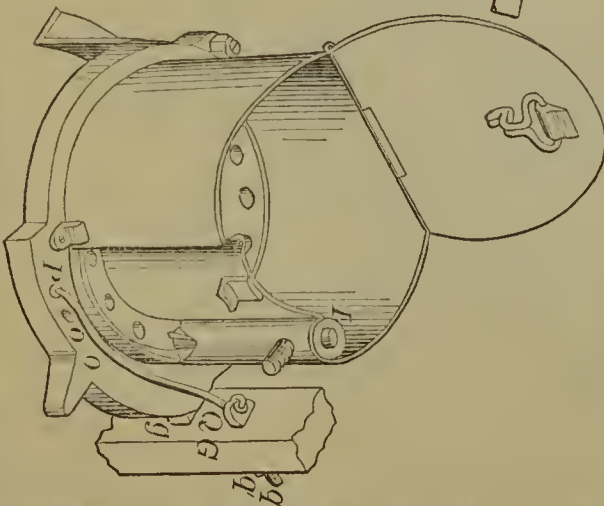
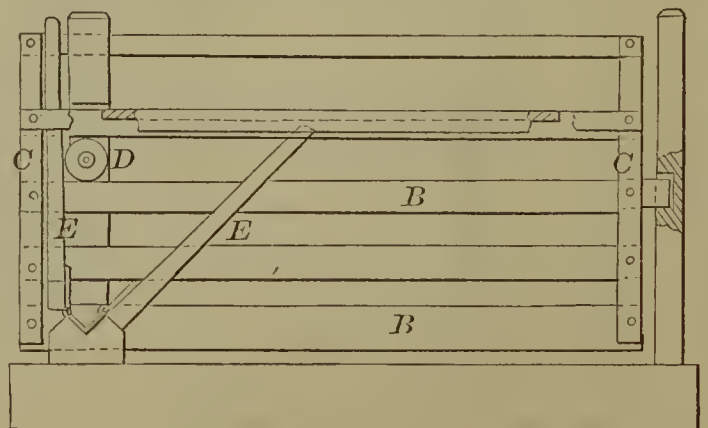

54644—Frisbie & Goodsell—*Baling Press.*

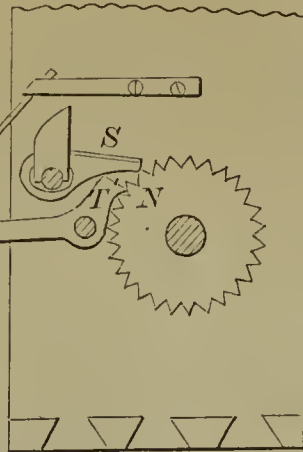
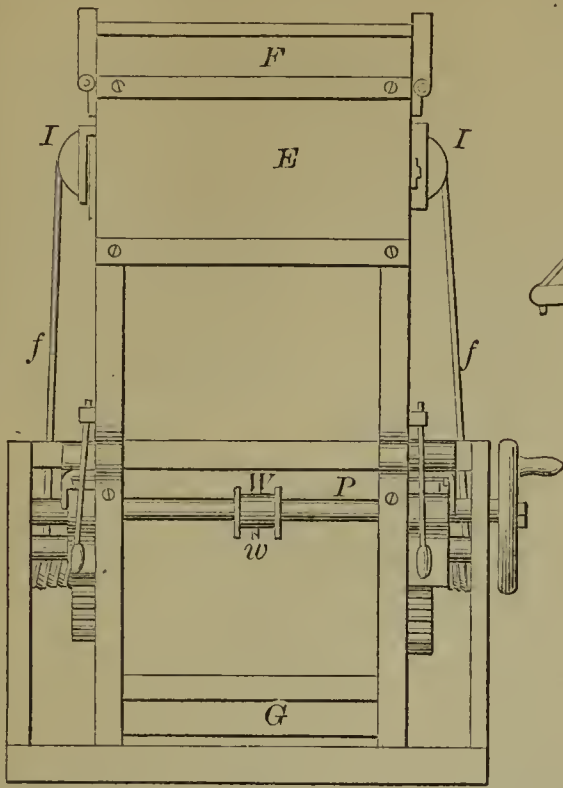

54646—J. W. Hoard—*Eyelet Stock.*

54647—W. La Dew—*Vat for Tanning.*

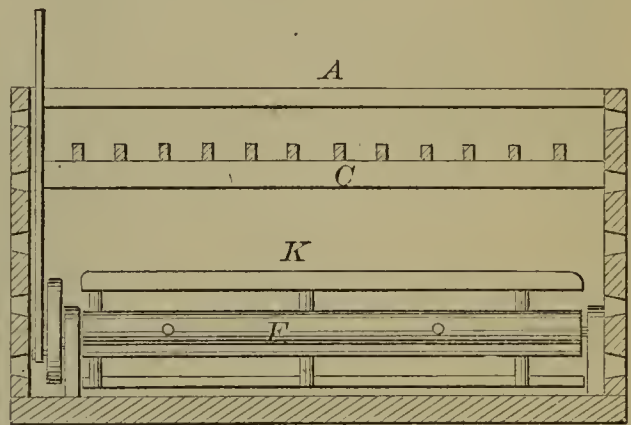

54645—J. A. Hanson—*Water Wheel.*

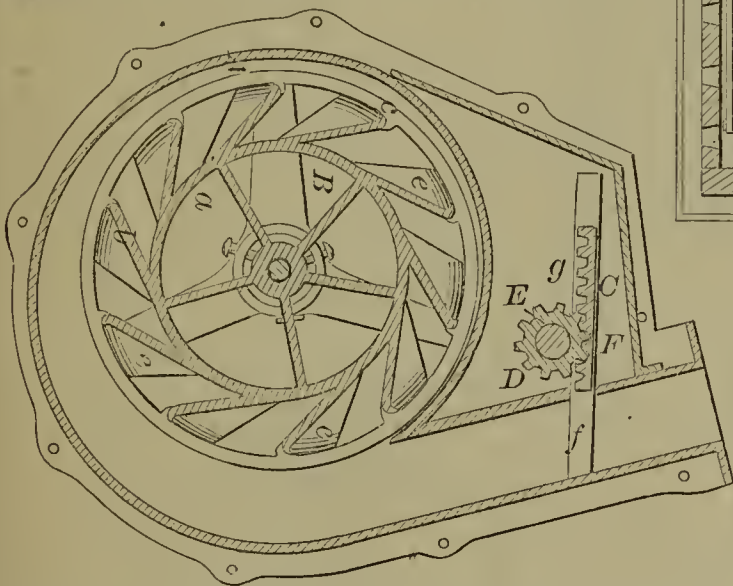

54650—O. Peck—*Bit Brace.*

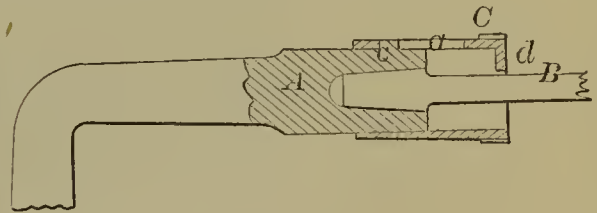

54648—J. K. Minich—*Harrow and Cultivator.*

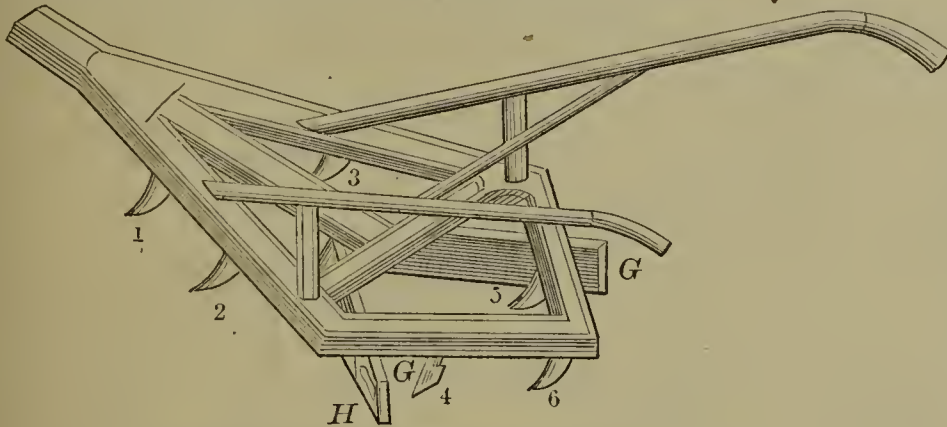

54649—A. T. Morris—*Scoop for Excavating.*

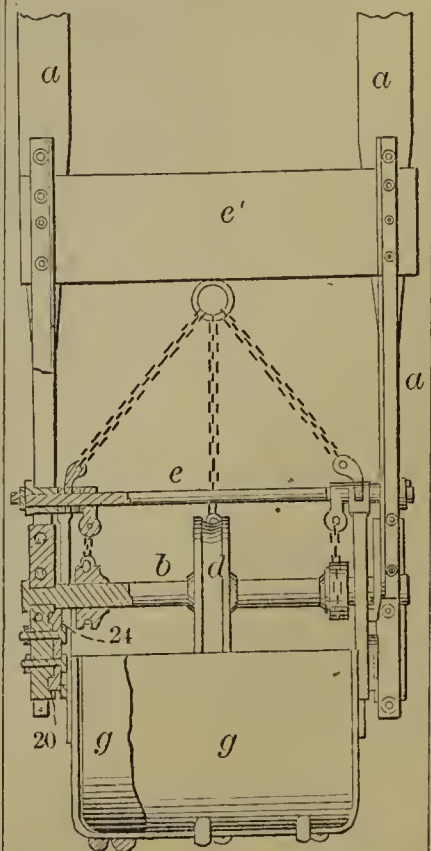

54651—H. Robbins—*Roll for Wringers.*

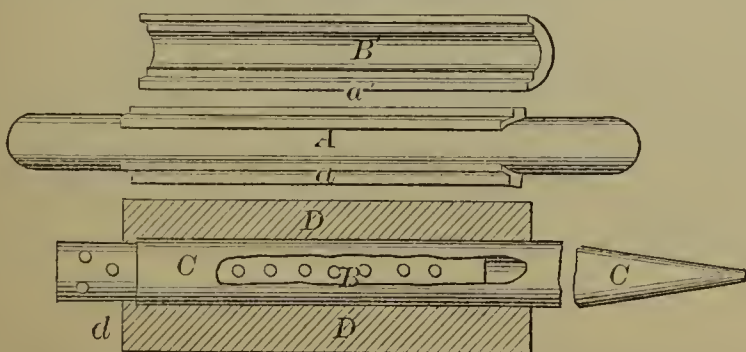

54652—A. Simonds—Moving Machine Guard.

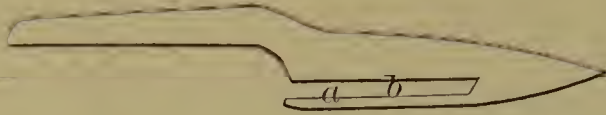

54654—W. Zellner—Steam Generator.

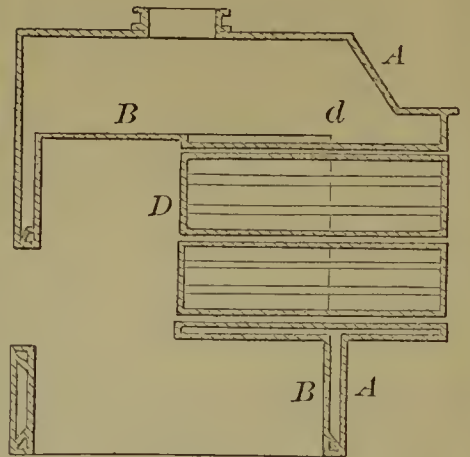

54655—P. F. Ware—Compressed Air Bath.

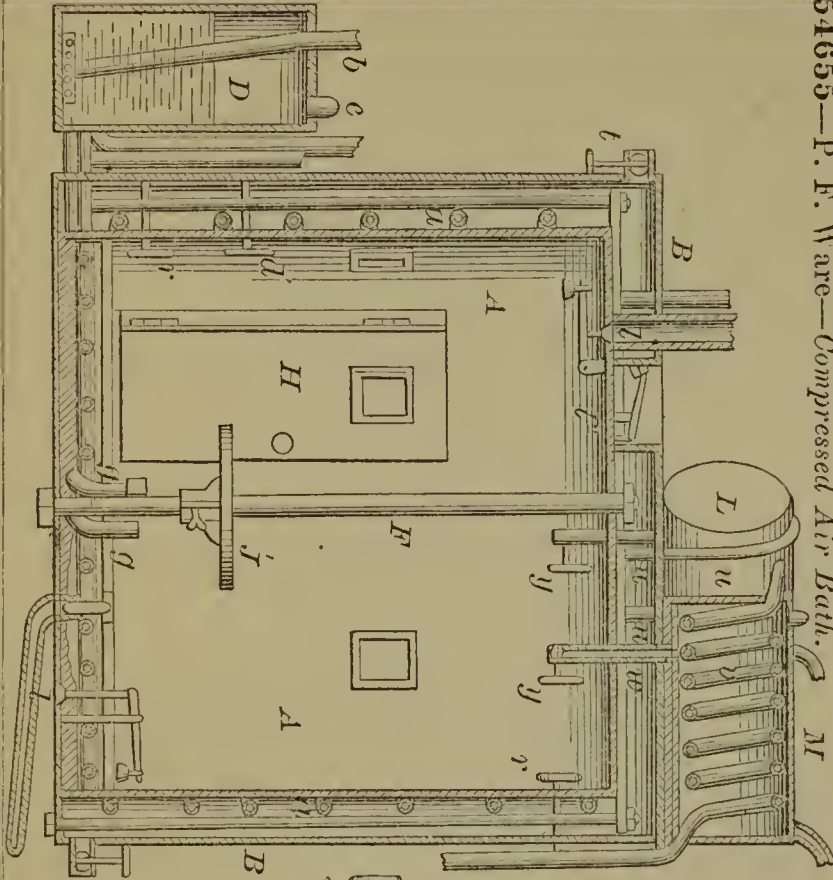

54656—J. H. Clapham—Boring Oil Wells.

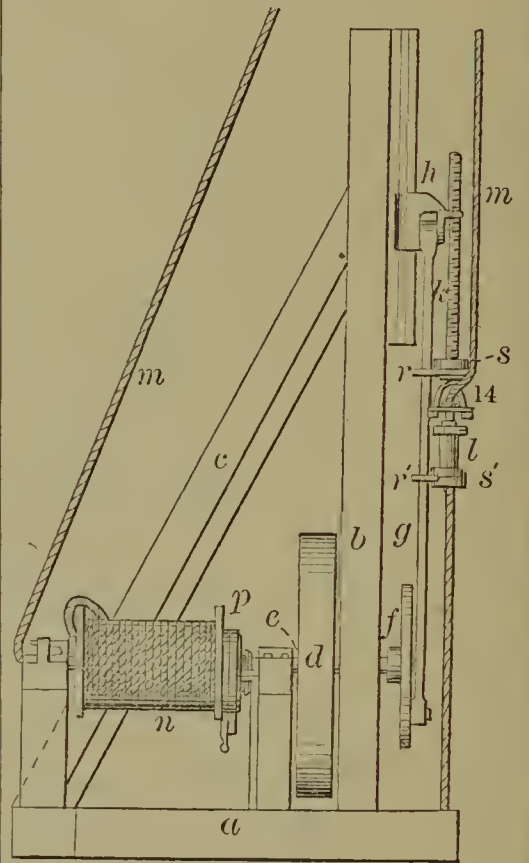

54653—G. L. Witsil—Ice Pick, Nut Cracker, &c.

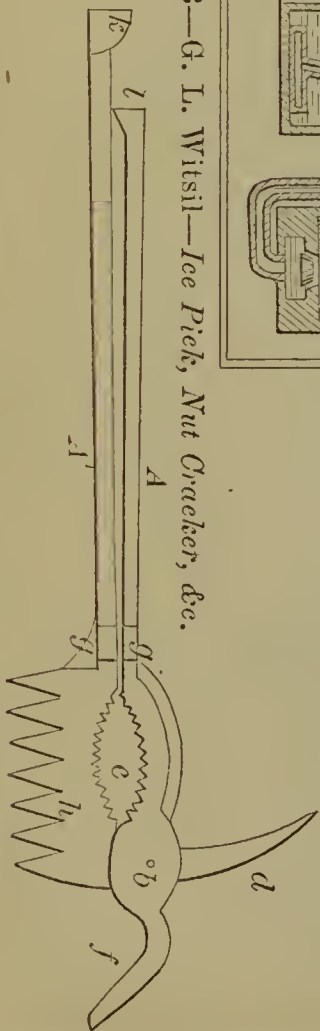

54657—E. L. Allen—Vessel for Petroleum, &c.

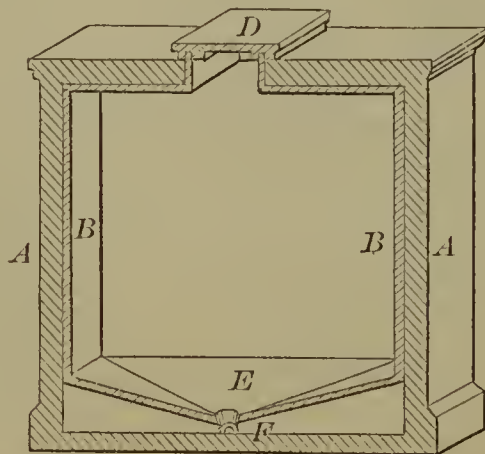

54658—J. A. Abbe—Bed Bottom.

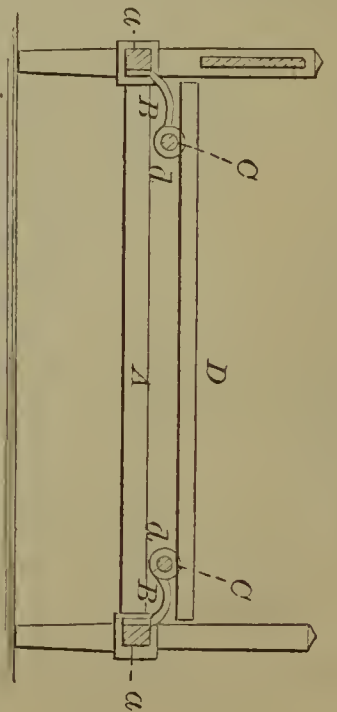



54661—A. L. Anderson—*Harness Motion for Looms.*

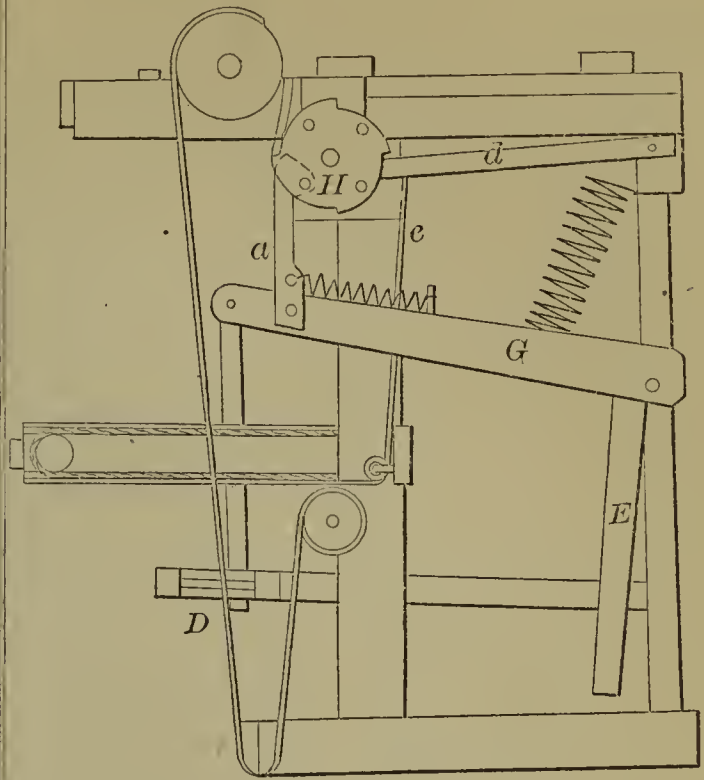

54659—A. Adams—

*Corn Sheller.*

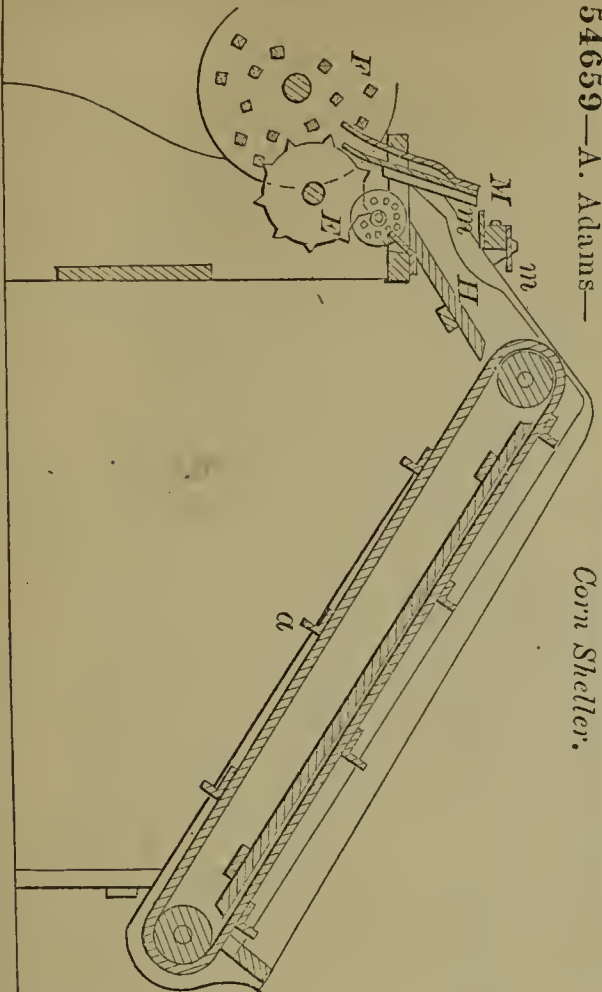

54660—I. J. W. Adams—*Water Wheel.*

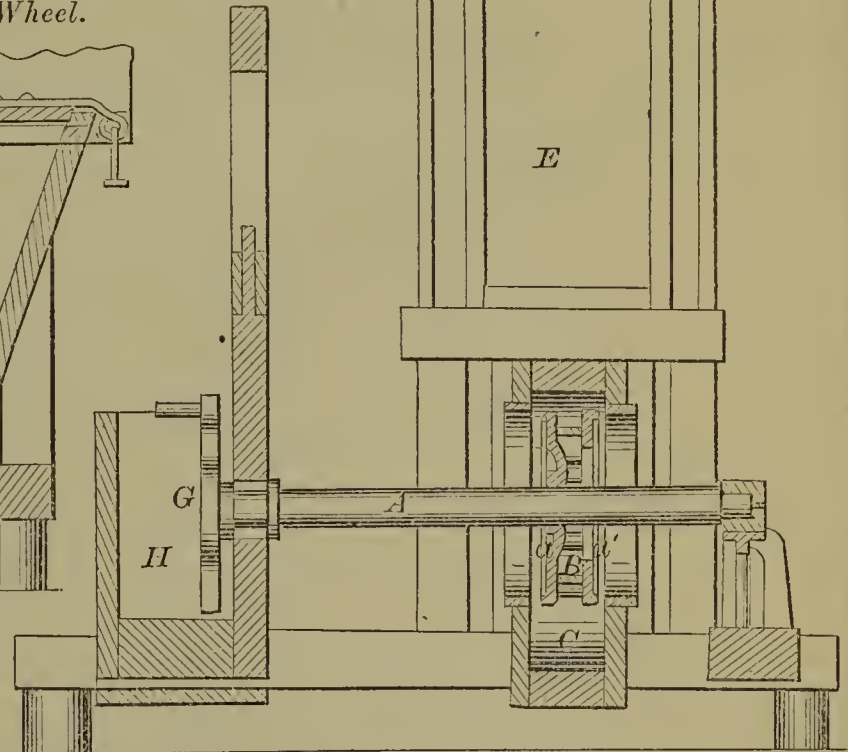
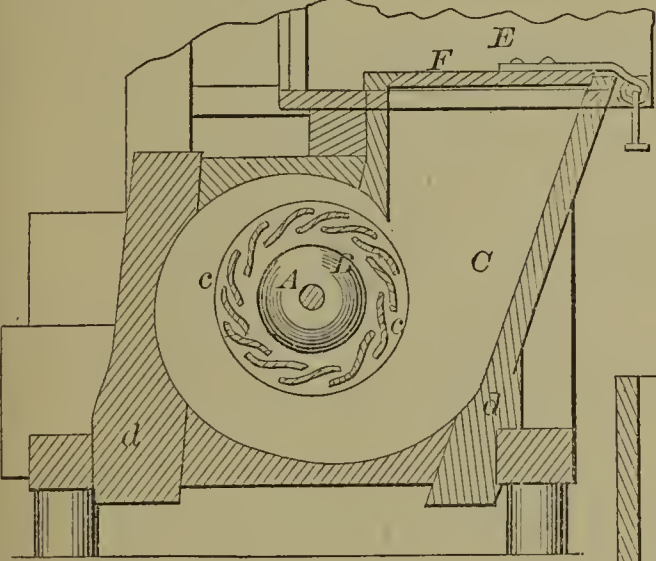

54663—E. H. Ashcroft—*For Moulding Peat.*

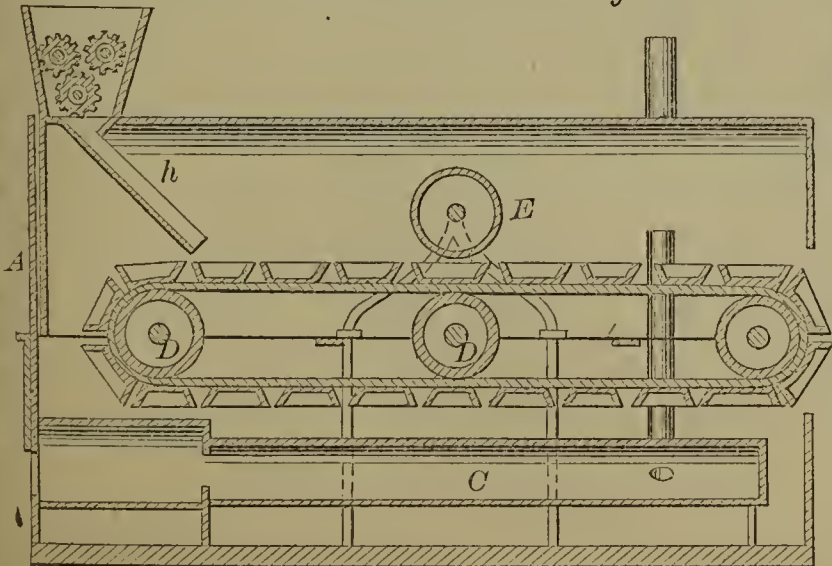

54662—E. H. Ashcroft—*Railway Car.*

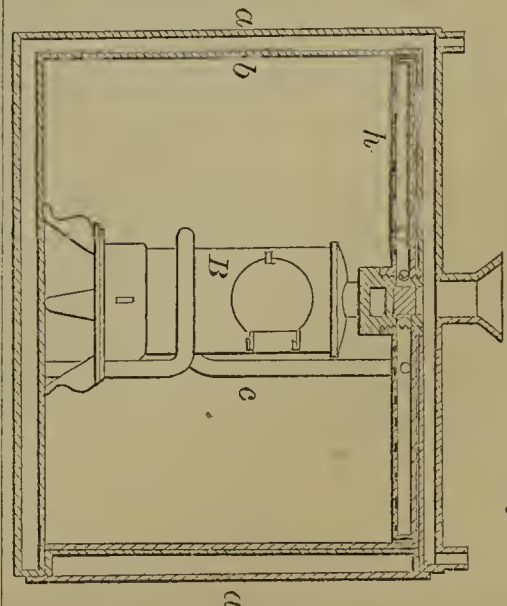

54666—W. S. Auchincloss—*Axle Box Cover.*

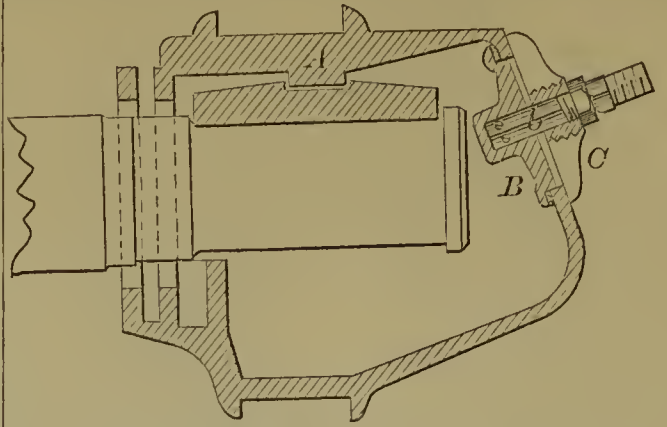

54664—W. S. Atchley—*Skiving Machine.*

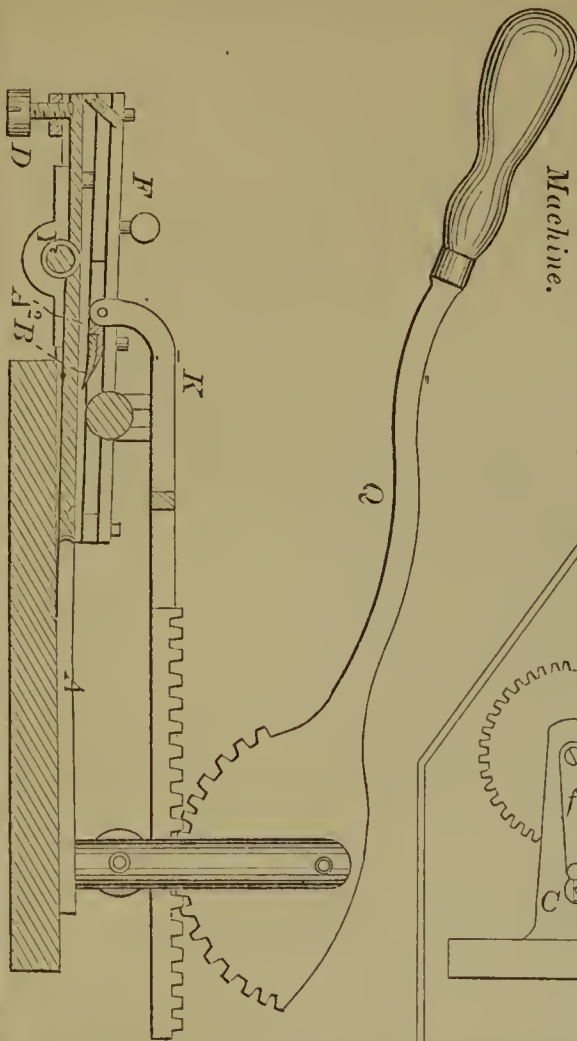

54667—D. W. Baker—*Meat Chopper.*

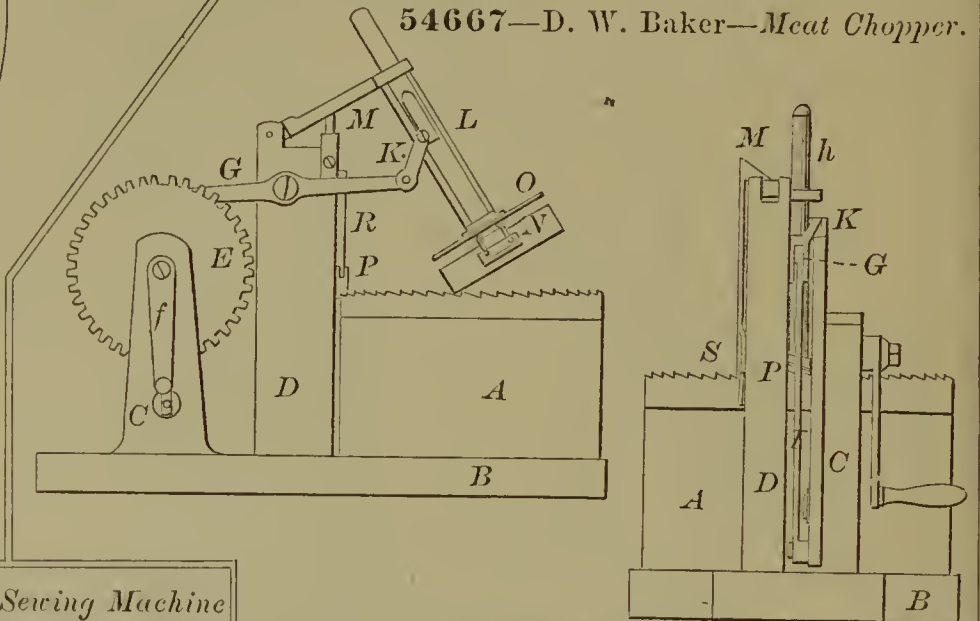

54670—W. B. Bartram—*Sewing Machine for Stitching Cord, &c.*

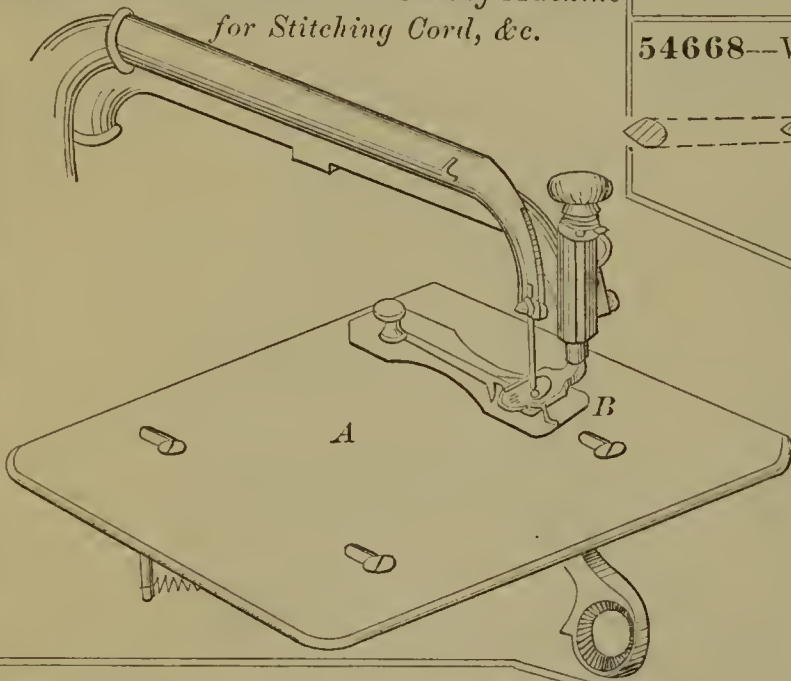

54668—W. K. Baldwin—*For Opening Tin Cans.*

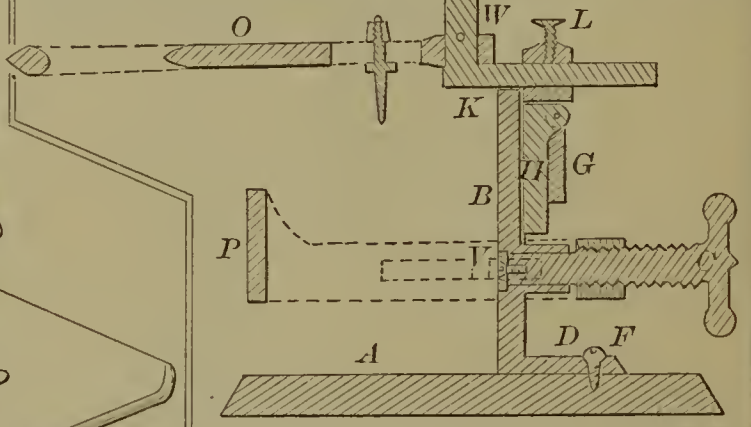

54665—*J. S. & T. B. Atterbury—Applying Labels to Bottles.*

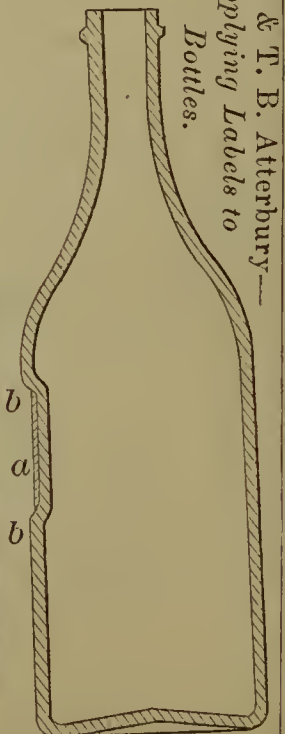

54671—W. B. Bartram—*Sewing Machine for Stitching Eyelet Holes.*

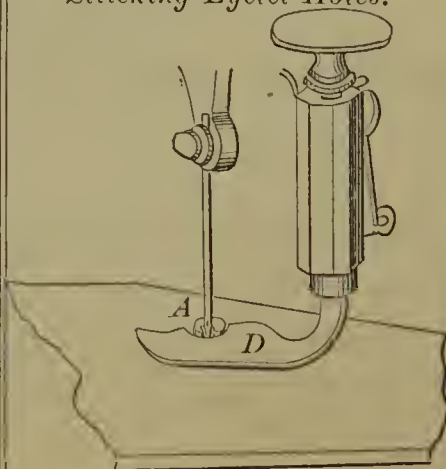

54669—Barr & Cox—*Cultivator.*

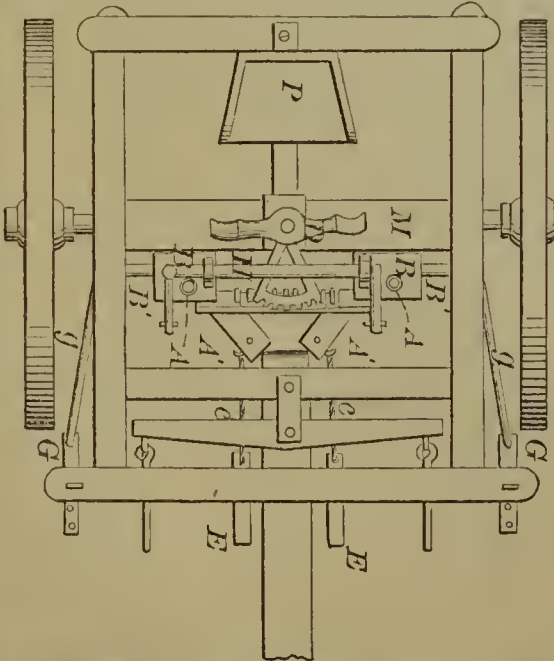

54672—J. Barta—*Raking and Binding Attachment.*

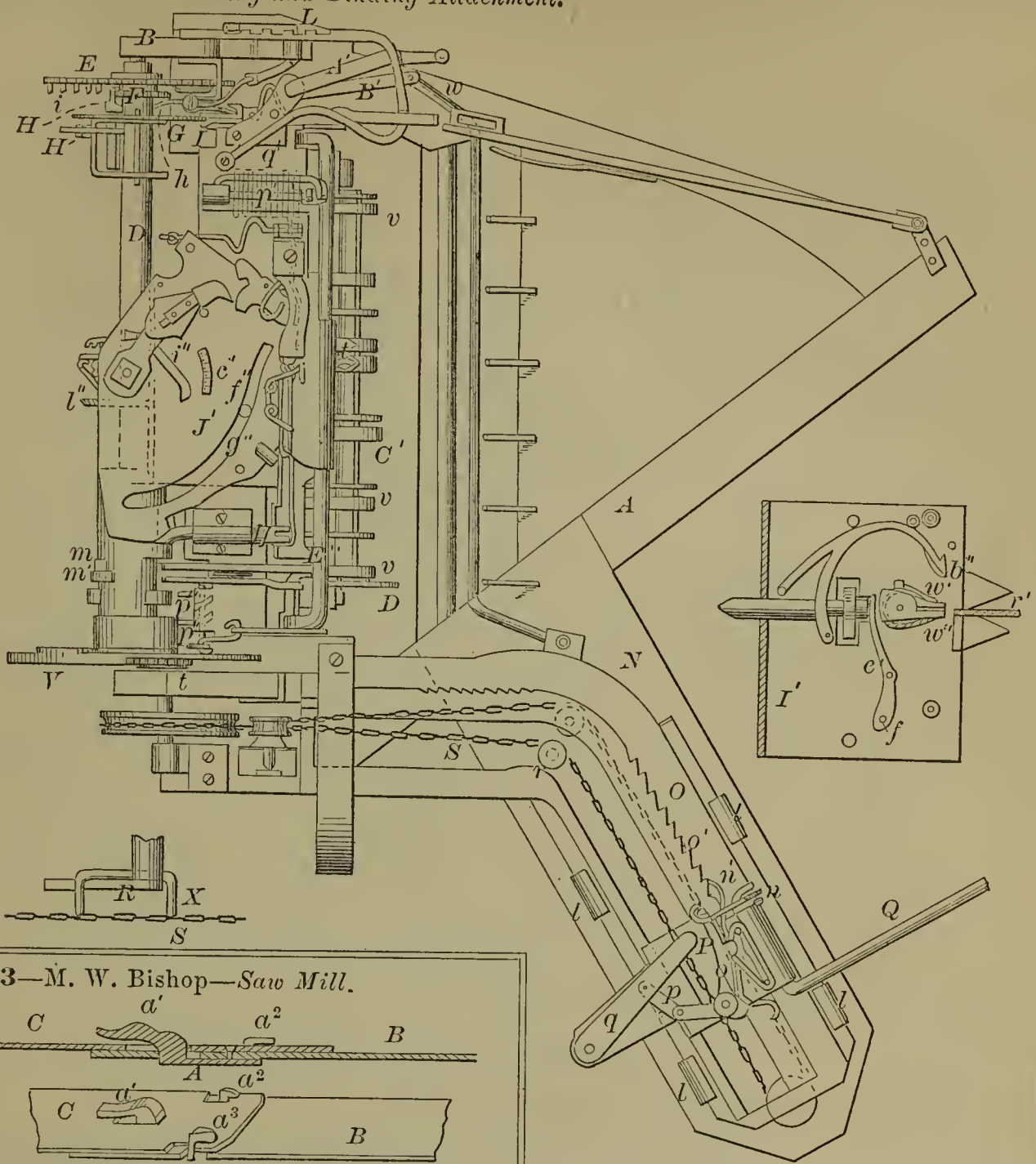

54673—M. W. Bishop—*Saw Mill.*

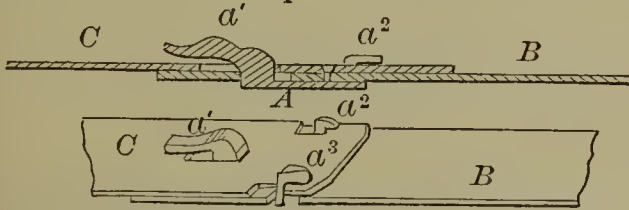

54675—J. Booth—*Cotton Bale Tie.*

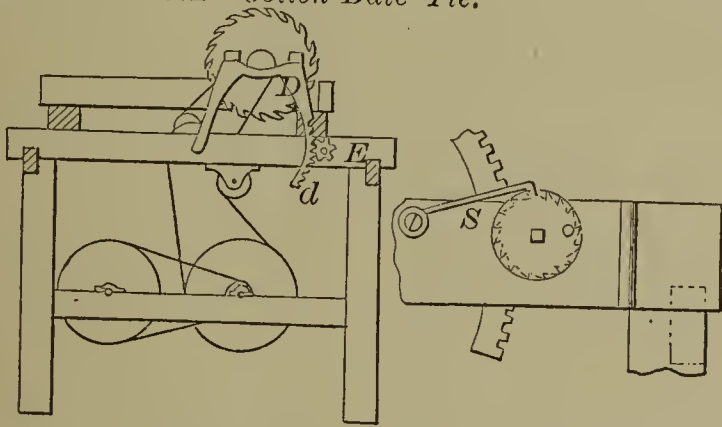

54676—E. H. Boswell—*Paper Tin.*

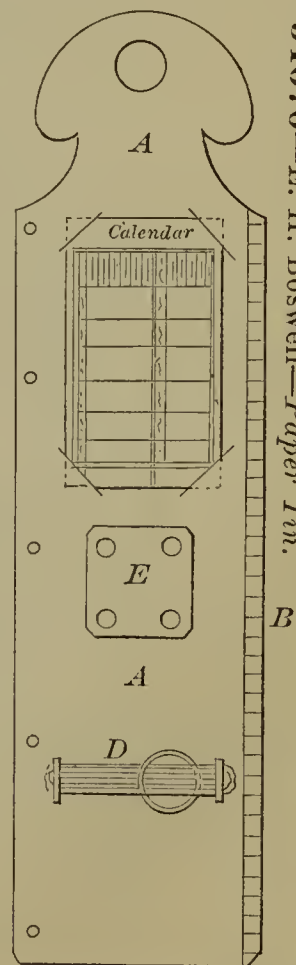

54674—M. Bliss—*Musquito Canopy.*

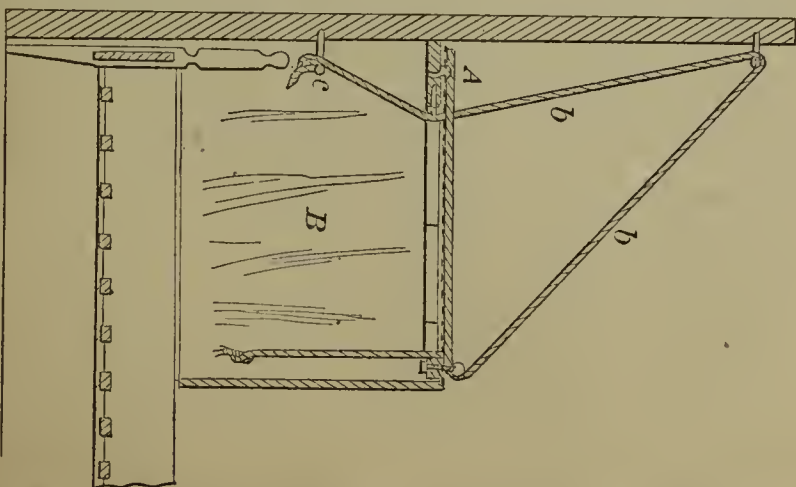

54677—E. H. Boswell—*Stair Rod and Fastening.*

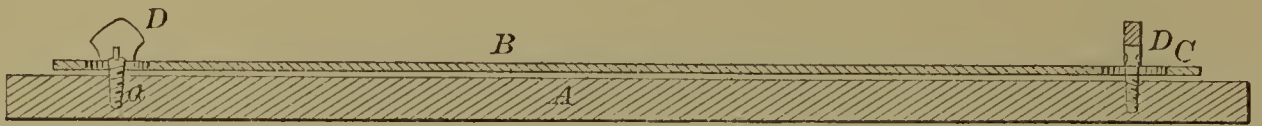

54679—F. Bucknam—*Scoop, Sifter, &c.*

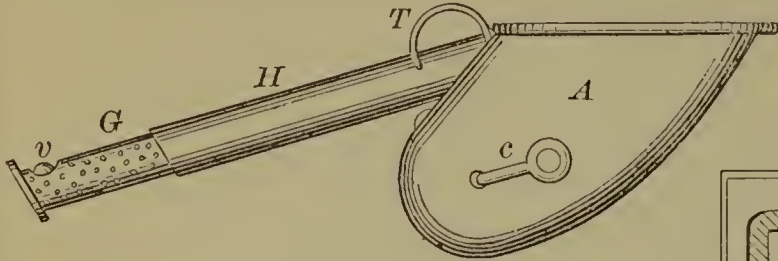

54678—T. S. Bowman—*Key.*

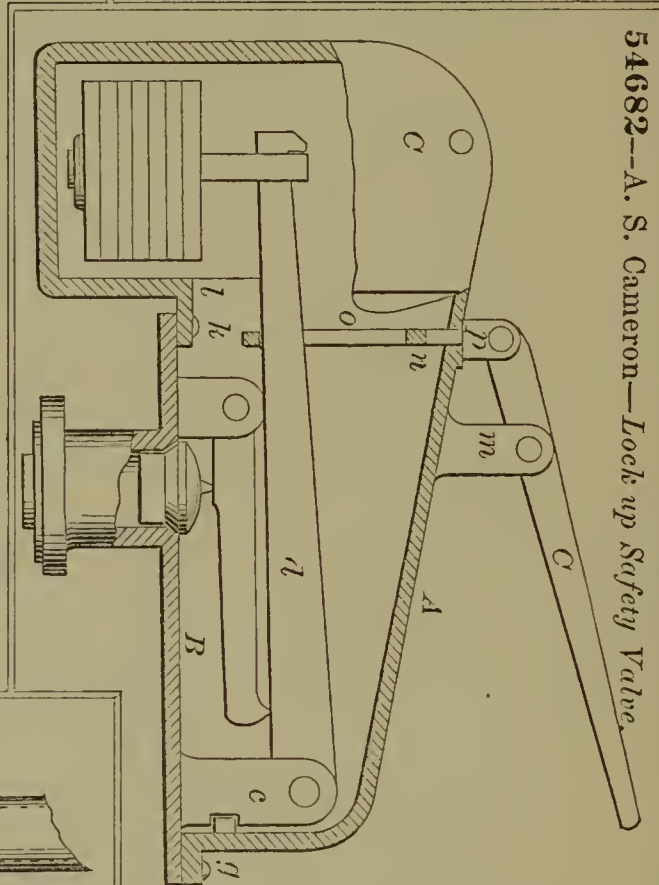
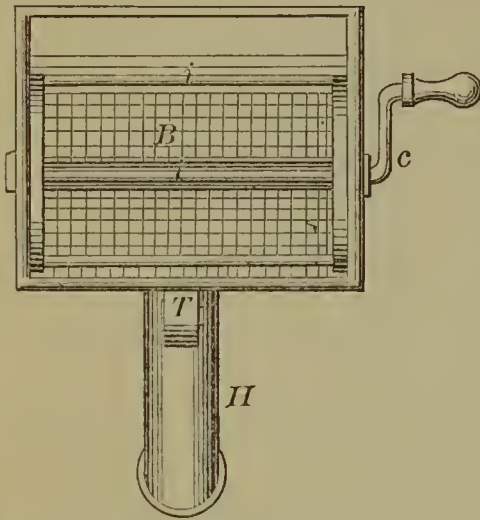
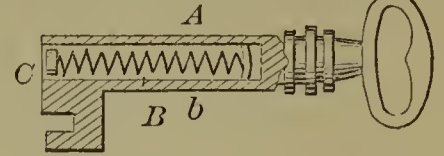

54682—A. S. Cameron—*Lock up Safety Valve.*

54680—J. Burke—*Breech-Loading Fire Arm.*

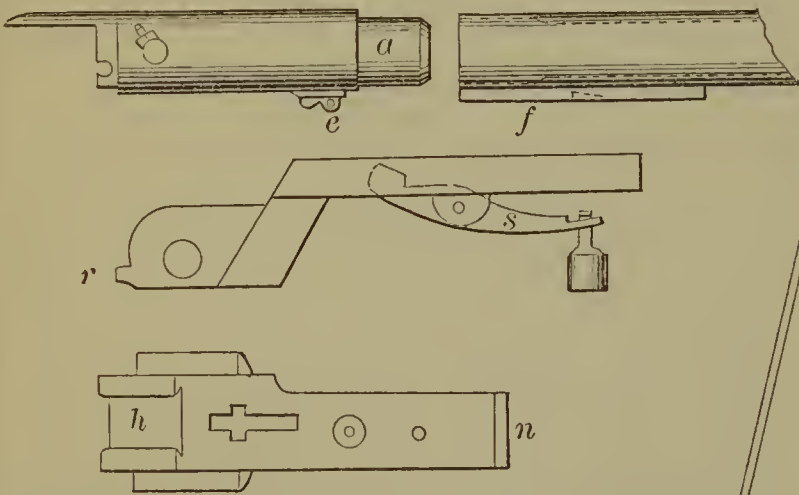

54681—V. H. Buschman—*For Cutting Cloth.*

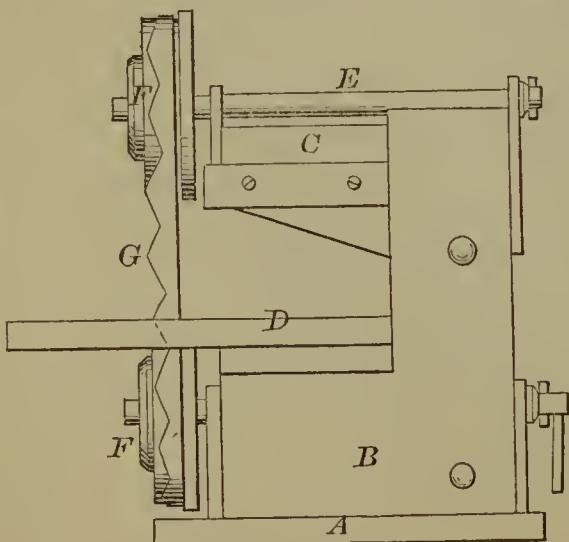

54684—W. D. Chapman—*Fishing Tackle.*

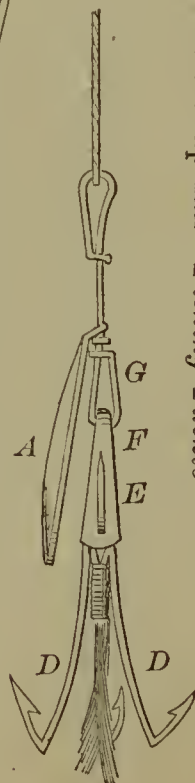

54683—Card & Stewart—*Car Coupling.*

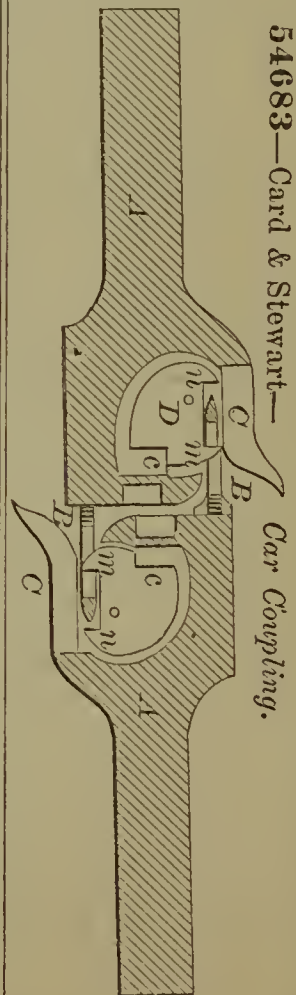

54685—W. F. Class—*Pump Sprinkler.*

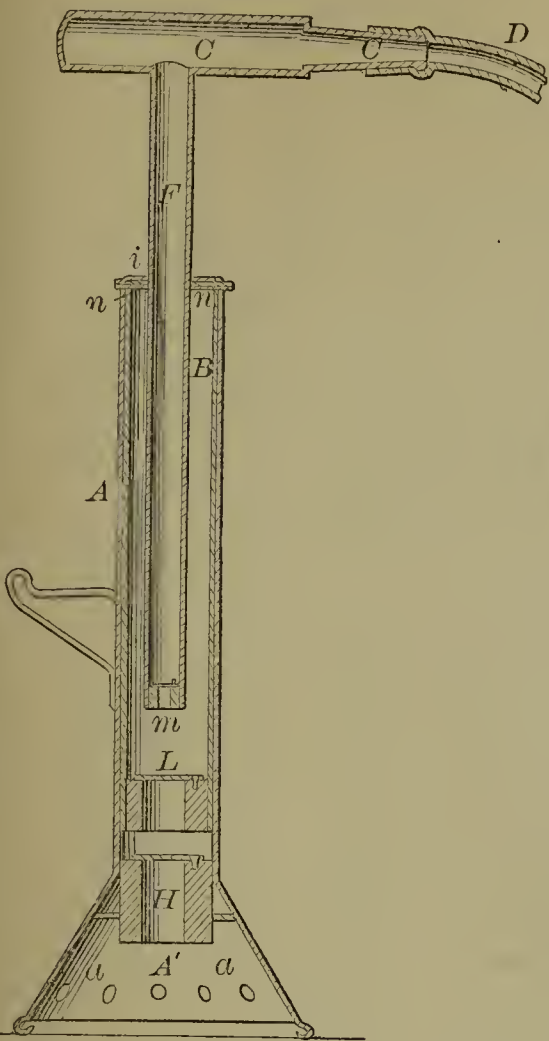

54686—D. Clavidge—*For Expelling Air from Cases.*

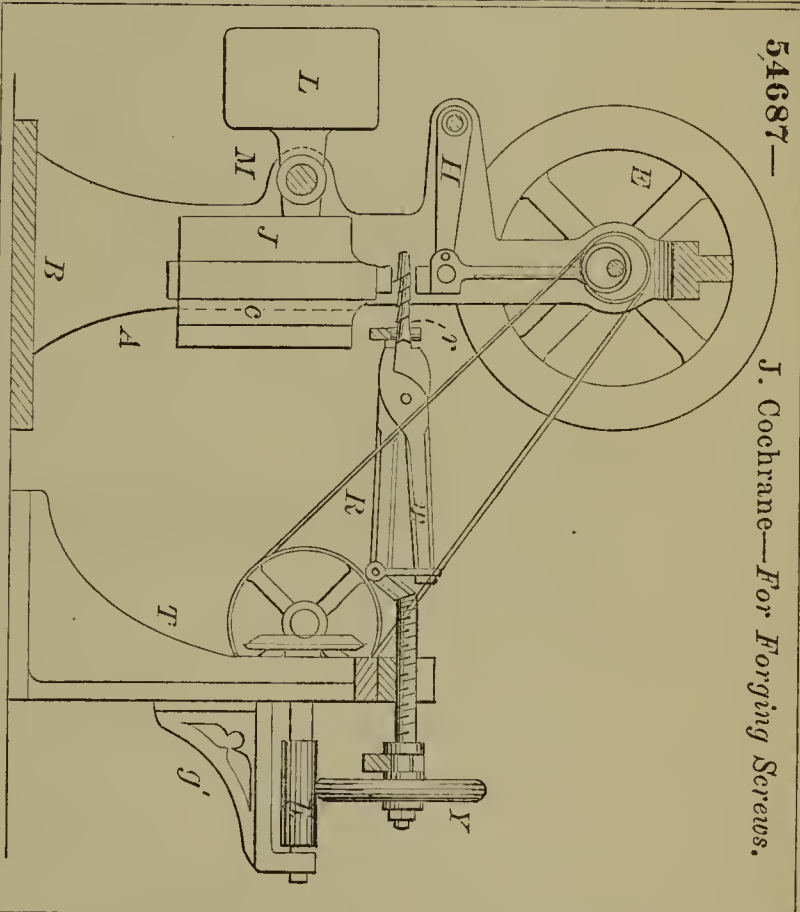
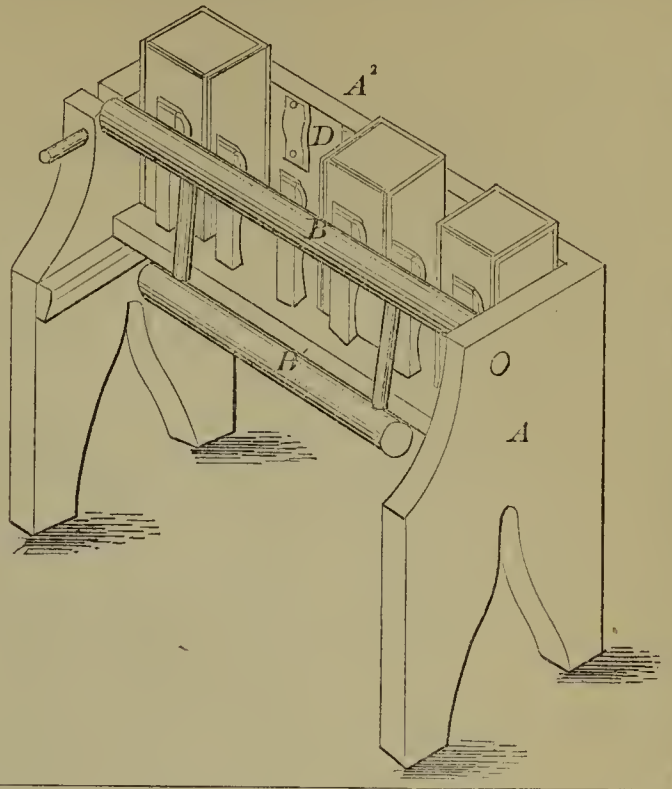

54687—

J. Cochrane—*For Forging Screws.*

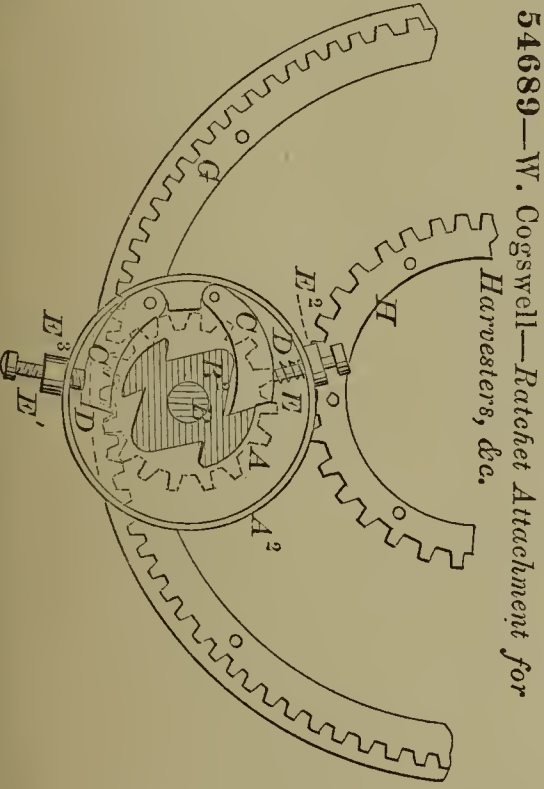

54689—W. Cogswell—*Ratchet Attachment for Harvesters, &c.*

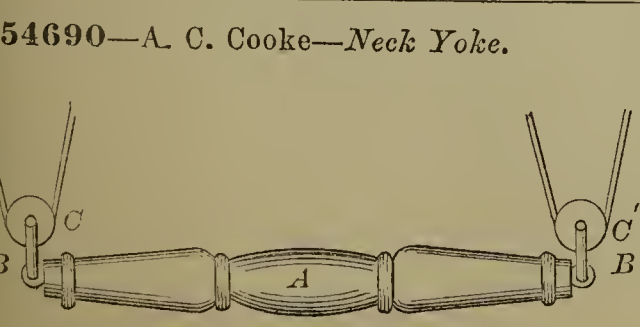

54690—A. C. Cooke—*Neck Yoke.*

54688—G. Coffin—*Operating Ship's Windlass.*

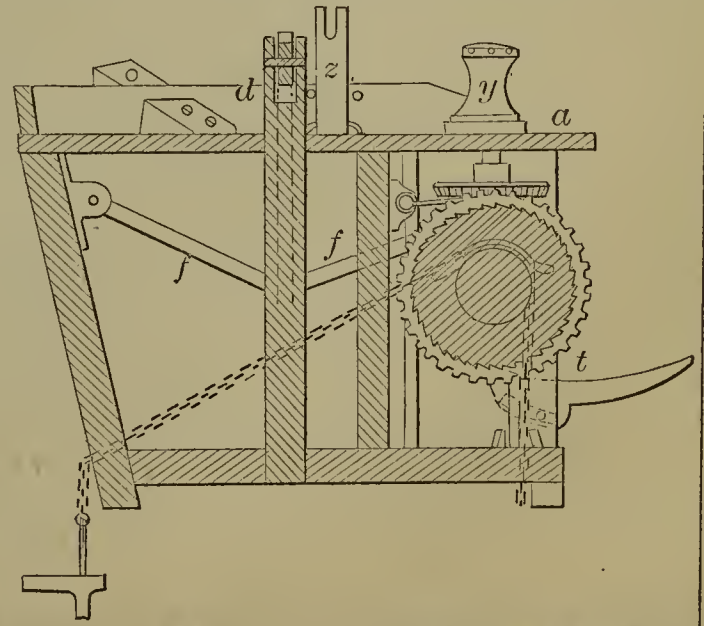

54691—L. L. Coon—*Shoemaker's Jack.*

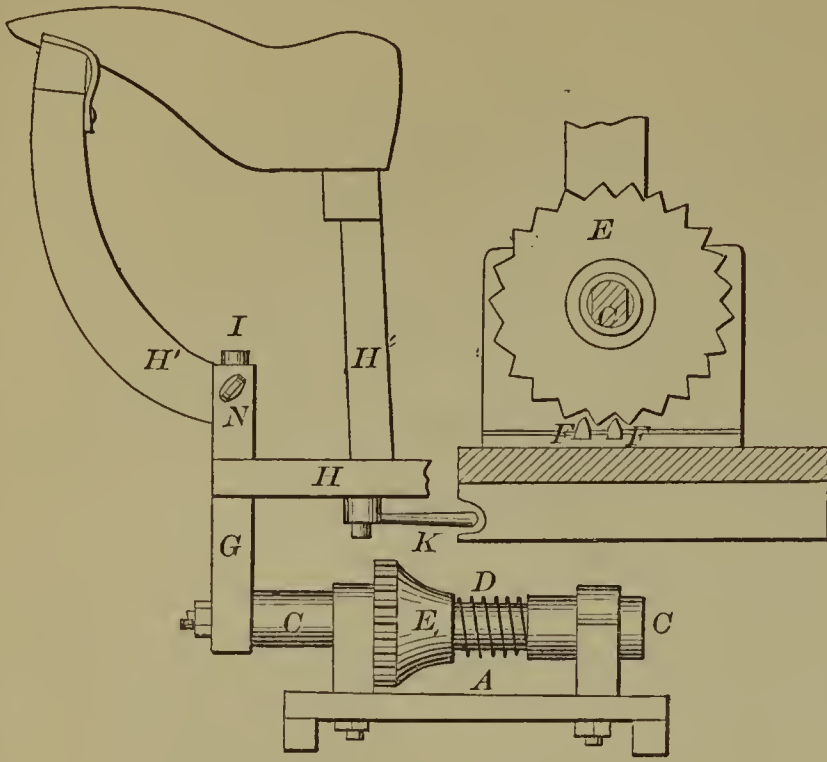

54694—R. Cox—*Pipe Tongs.*



54695—C. Grosman—*Folding Hair Brush.*

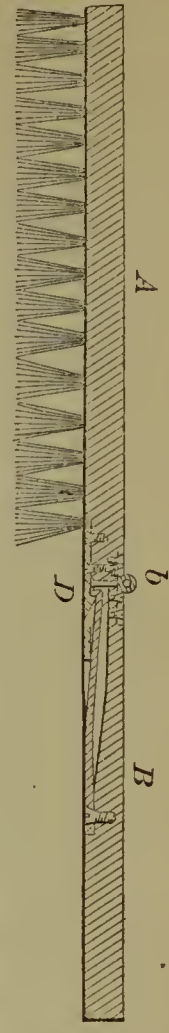

54692—T. Corey—*For Cutting Pegs out of Boots and Shoes.*

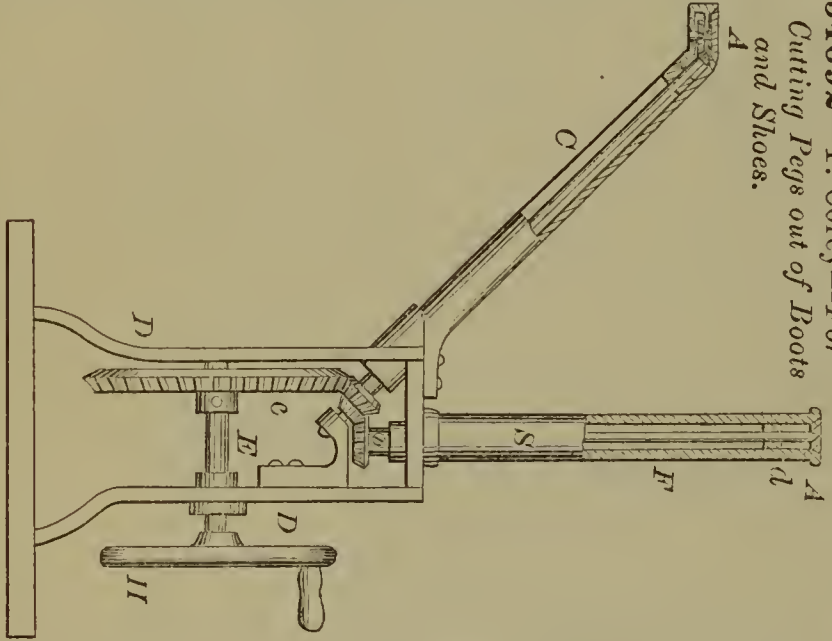

54693—T. J. Cornell—*Gang Plow.*

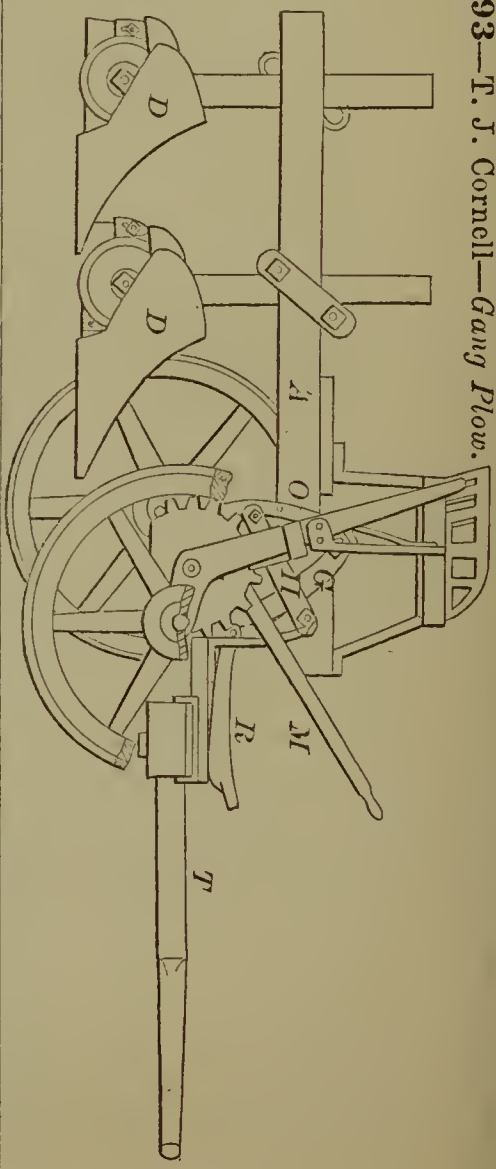

54696—J. A. Daum—*Fruit Gatherer.*

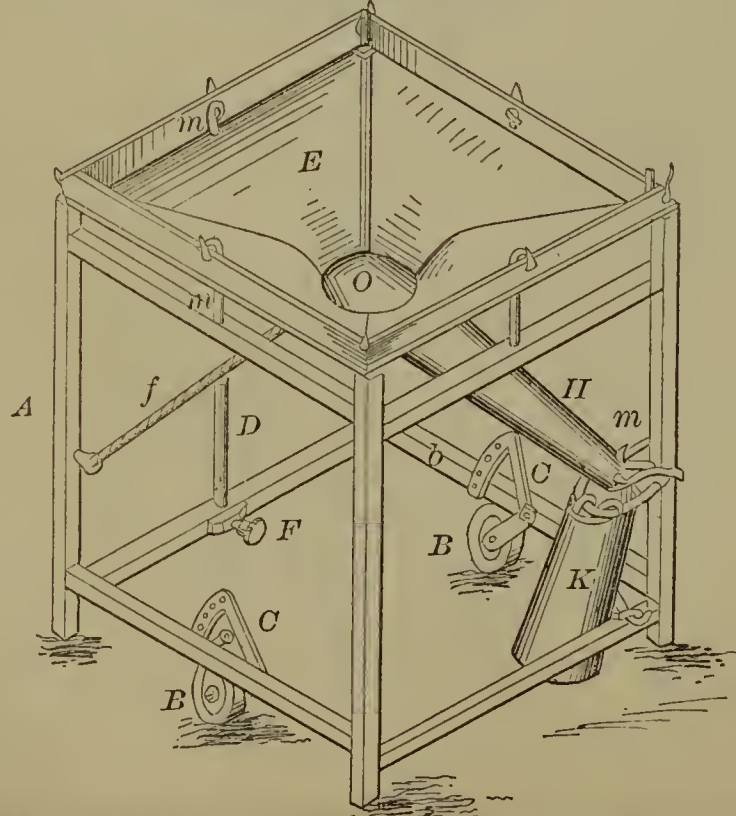

54697—T. Davey—Ore Separator.

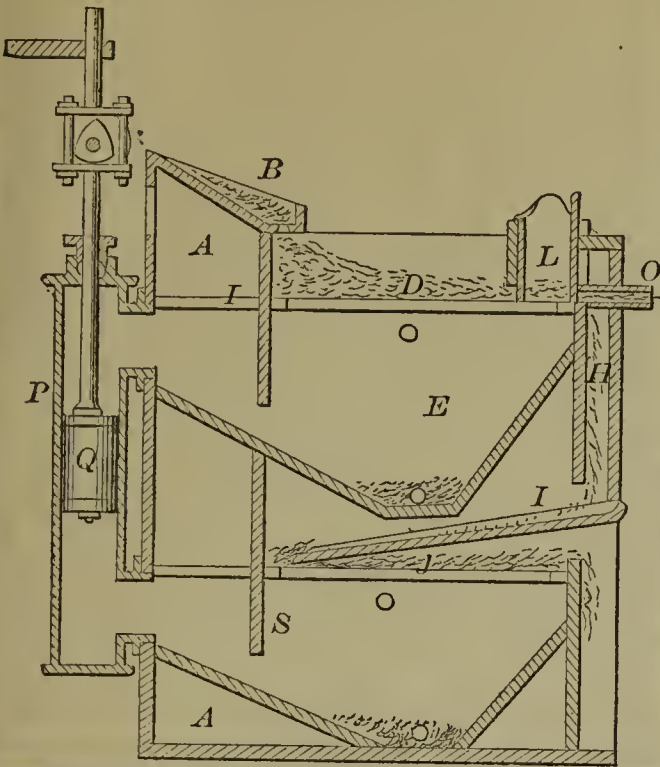

54701—E. Doty—Washing Machine.

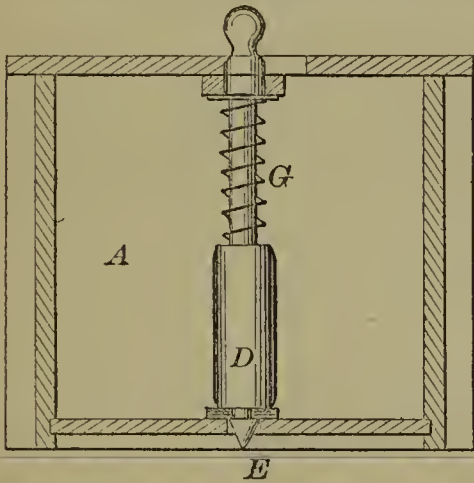

54698—G. Davidson—Sextant.

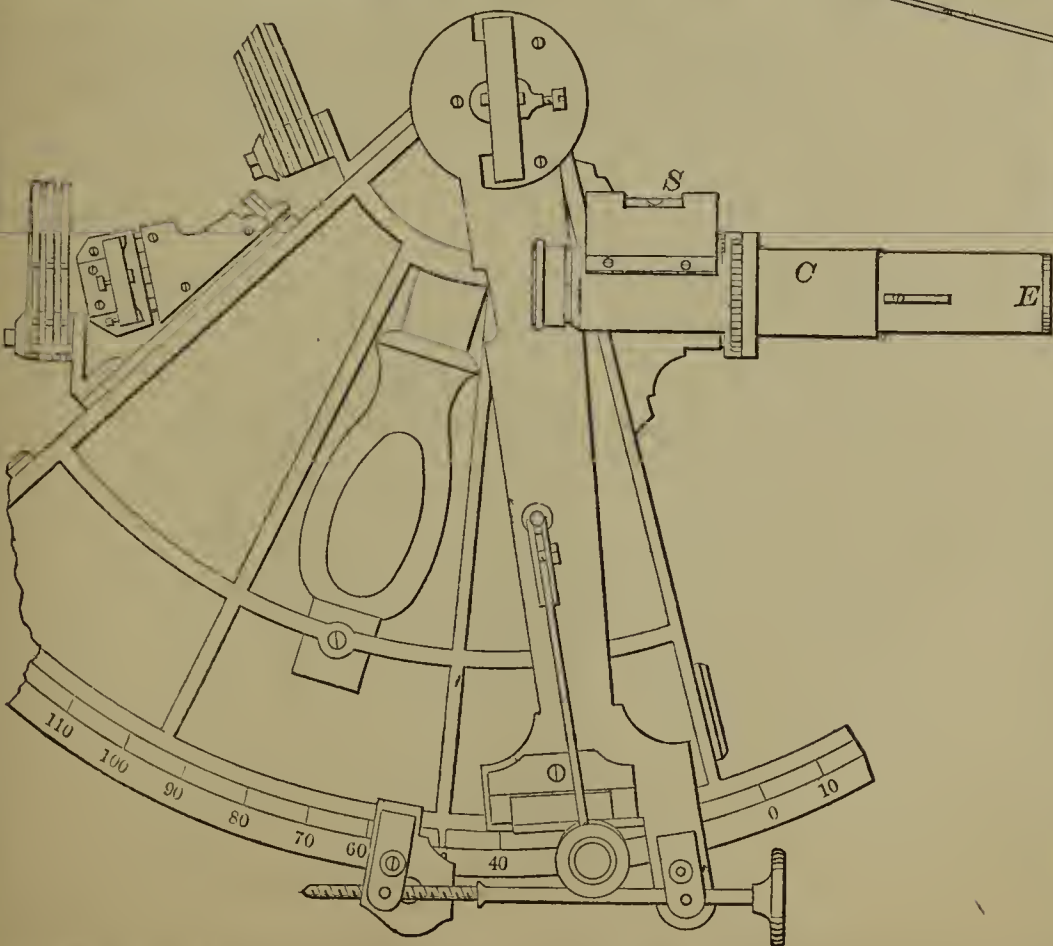

54700—G. W. Devin—Harness Stamp.

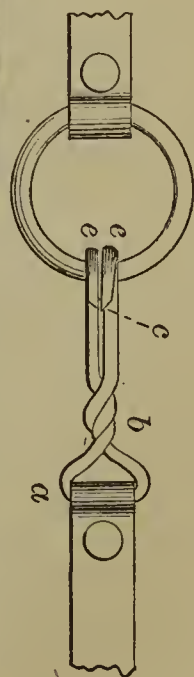

54699—W. C. Davol—Spinning Mule.

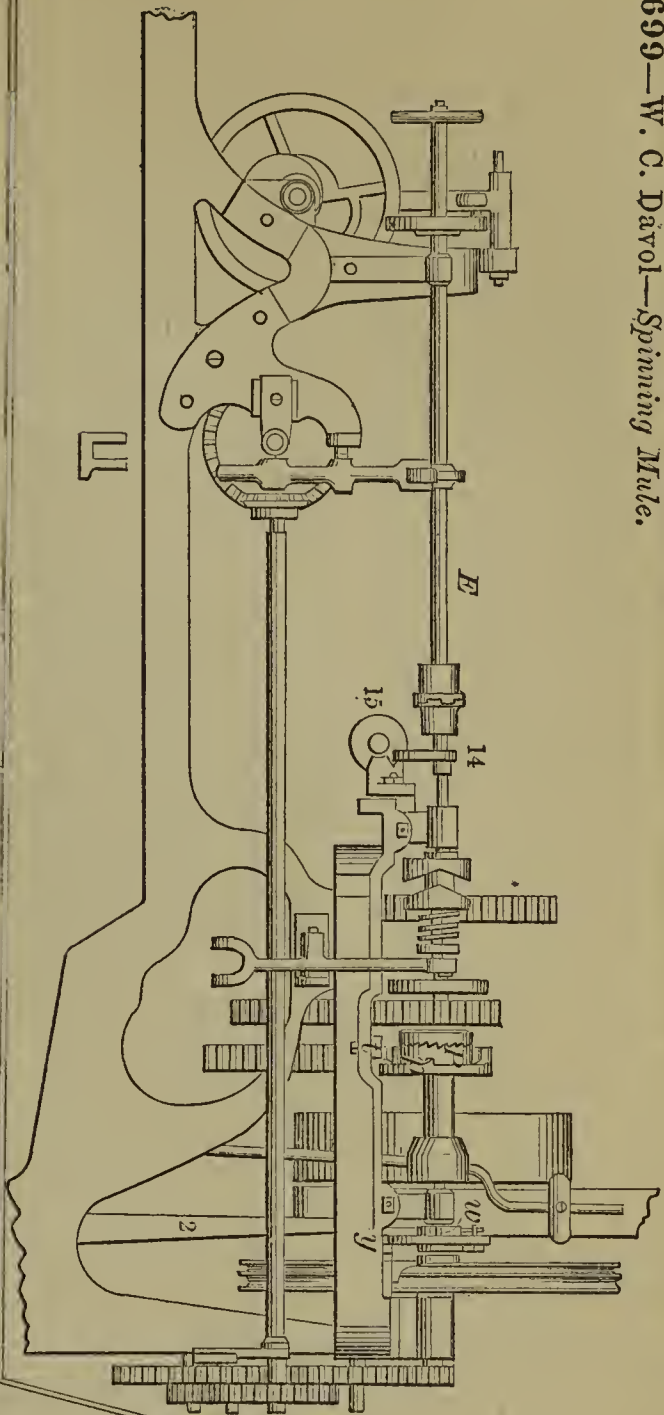

54704—W. Eberhard—*Spinning Machine.*

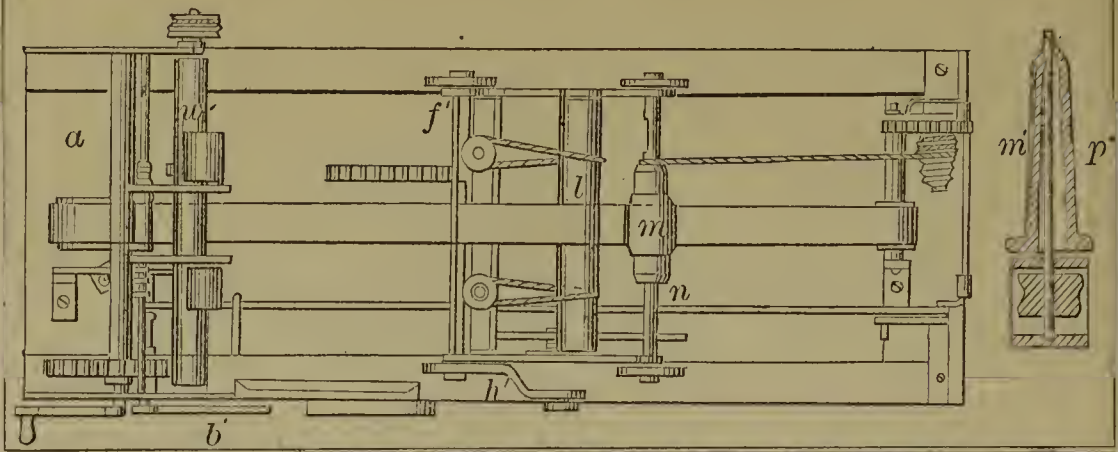

54702—R. Dutton—*Guard Finger for Harvesters.*



54705—G. W. Fair—*Smoke Consuming Heater.*

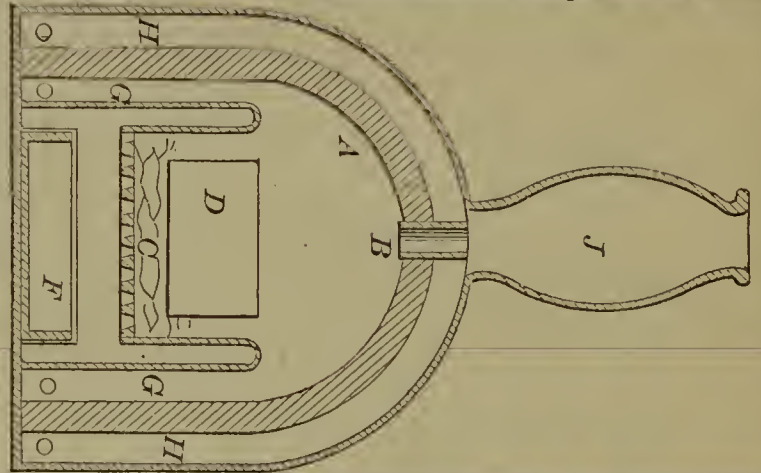

54703—G. W. Duvall—*Boiler Thimble.*

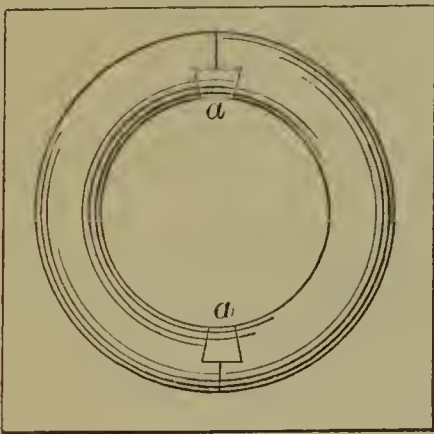
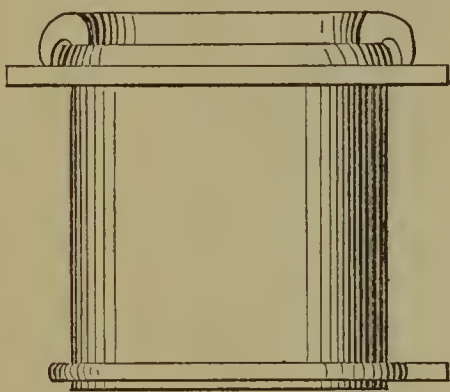

54707—J. Firmenich—*Beer Faucet.*

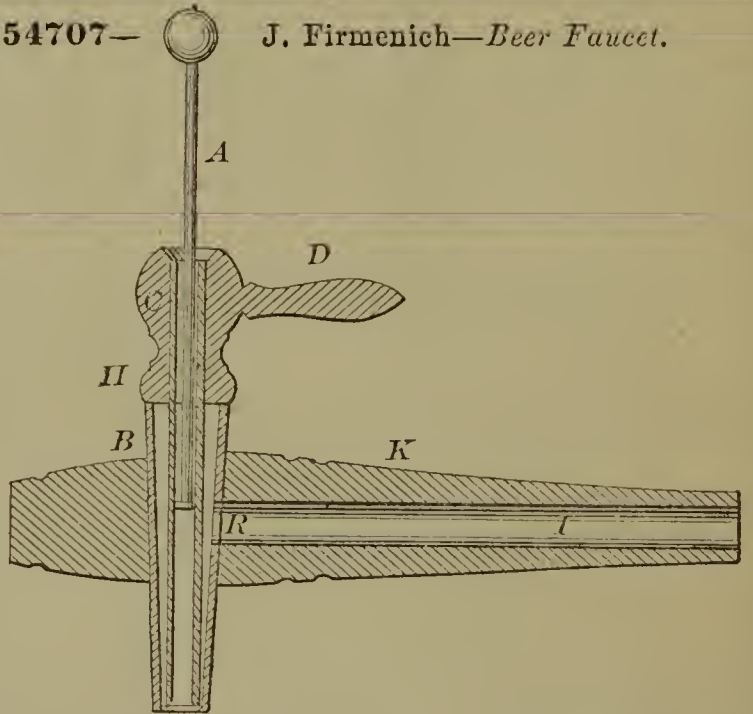

54706—D. Fasig—*Lifting Jack.*

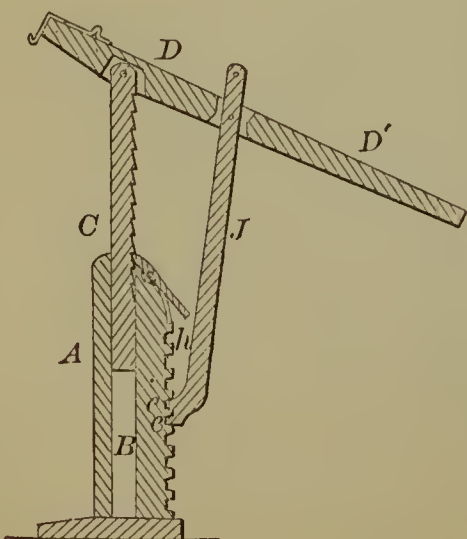

54708—A. Fischer—*Liquid Cooler.*

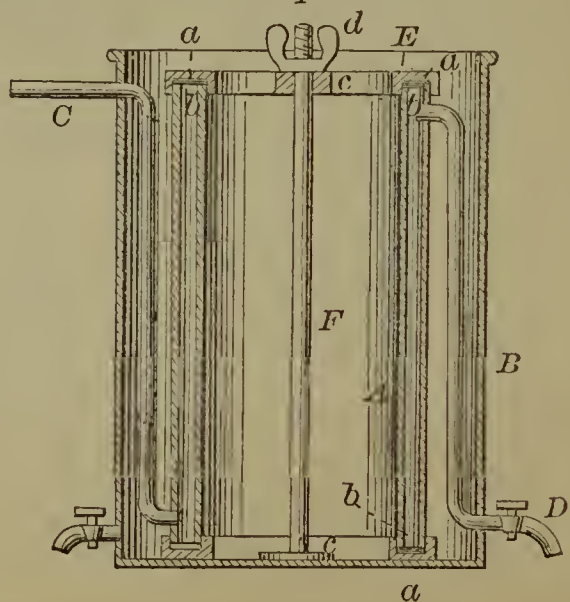



54709—Frazer & Hinchman—Saw Filing Machine.

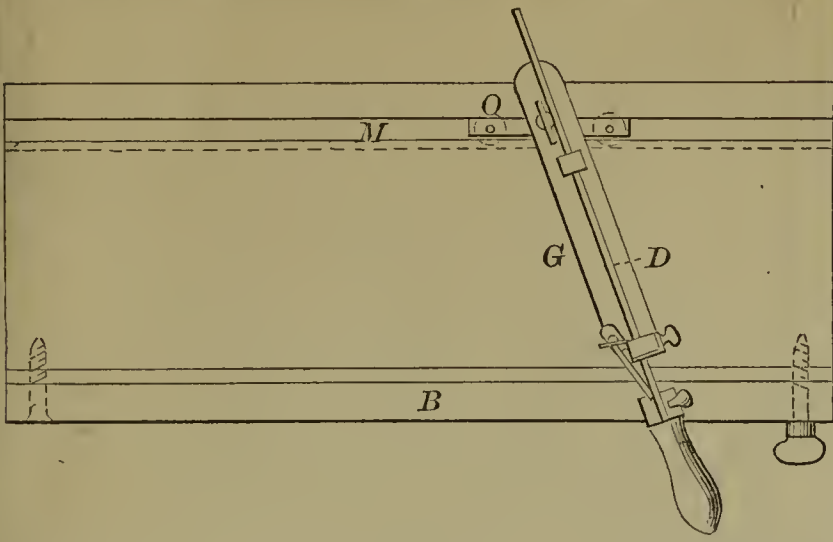

54711—R. R. Frohock—Garden Digger.

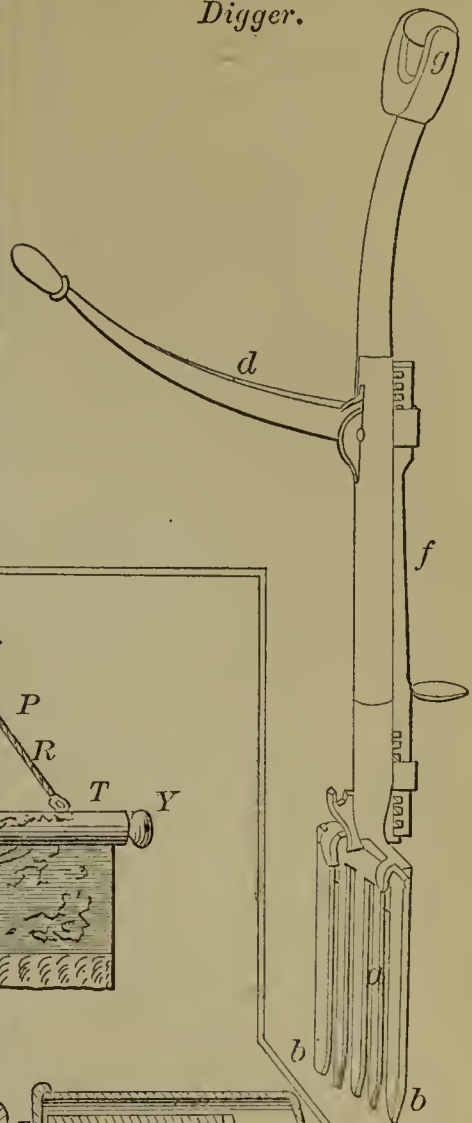

54713—H. P. Gengembre—Fire Screen.

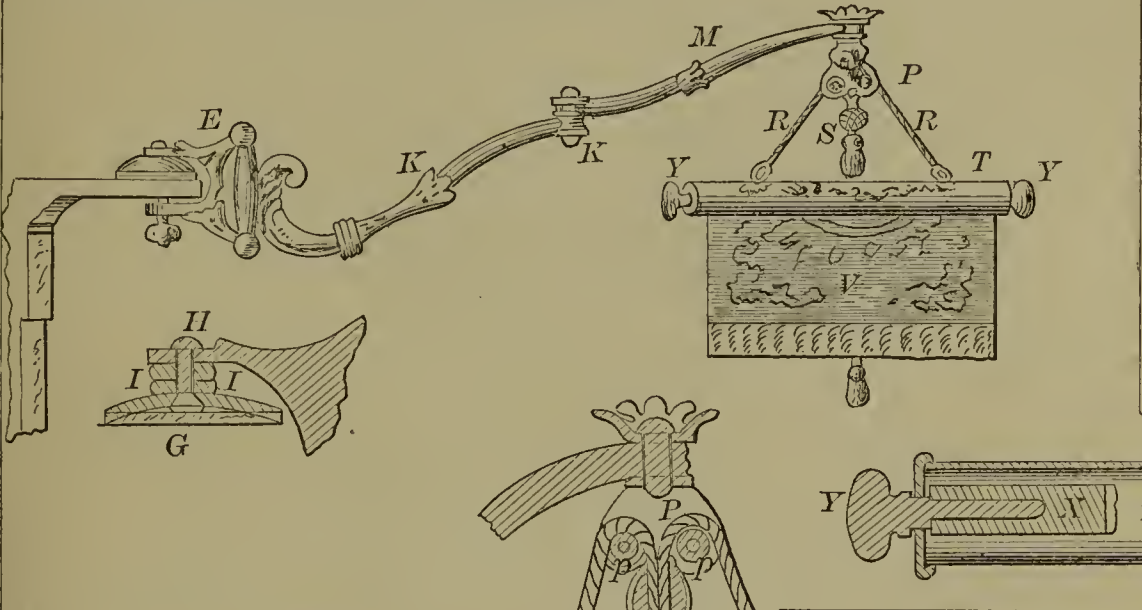

54715—J. C. Girardin—Tension Pulley for Sewing Machines.



54714—C. D. Gibson—Adjustment of Headlights.

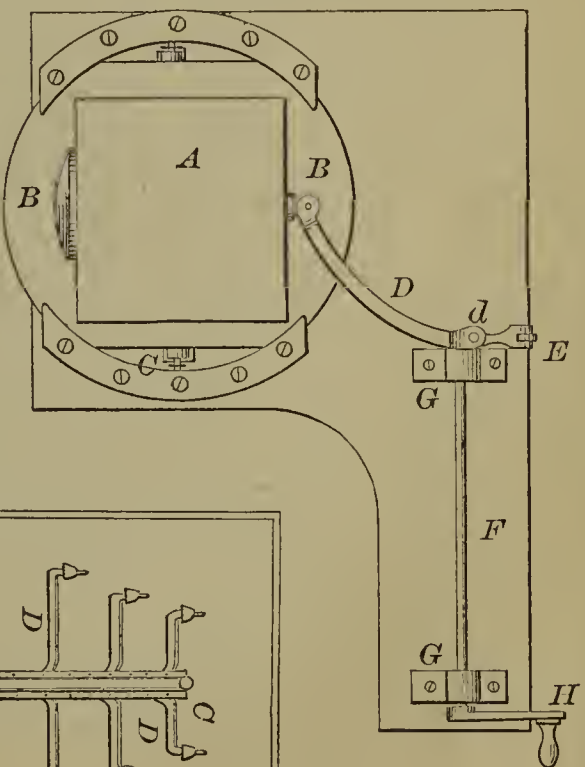

54710—Fredenburgh & Davidson—Delivering Mail Bags upon Cars.

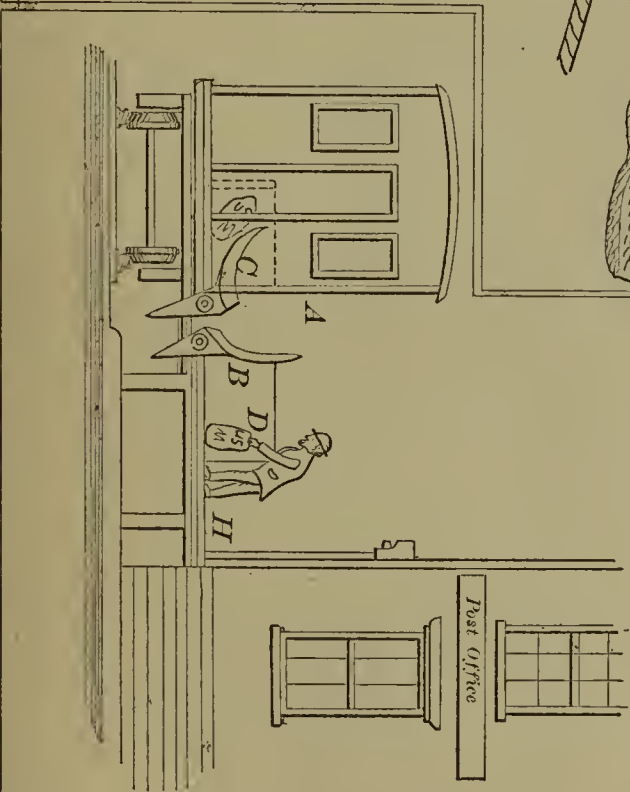

54712—W. J. Fryer, Jr.—Telegraph Post.

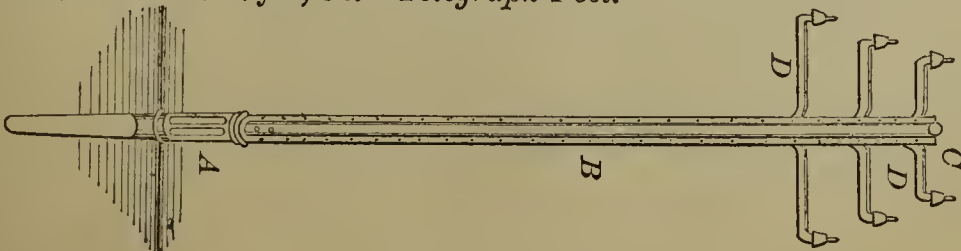

54716—V. D. Green—*Safety Valve.*

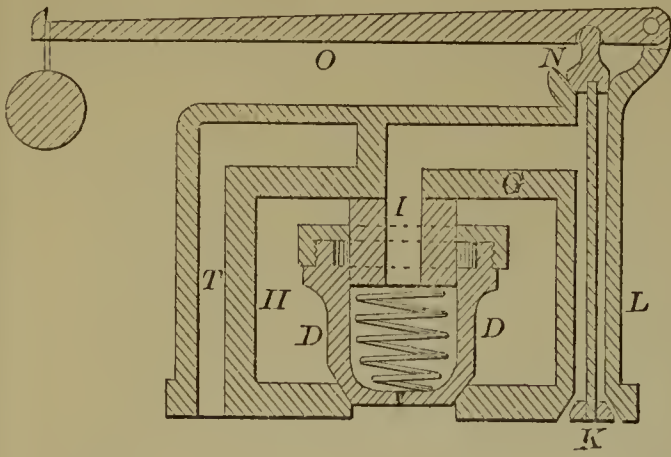

54721—D. Heilig—*Cooking Stove.*

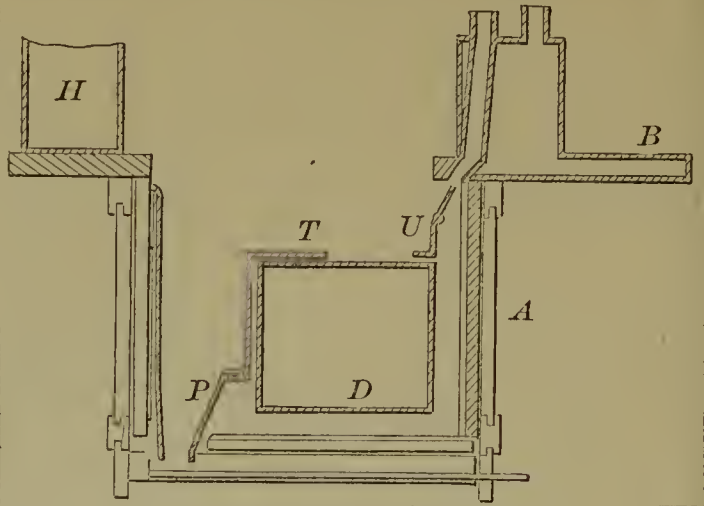

54718—E. Hambujer—*Wardrobe, Bureau, Bed, &c., combined.*

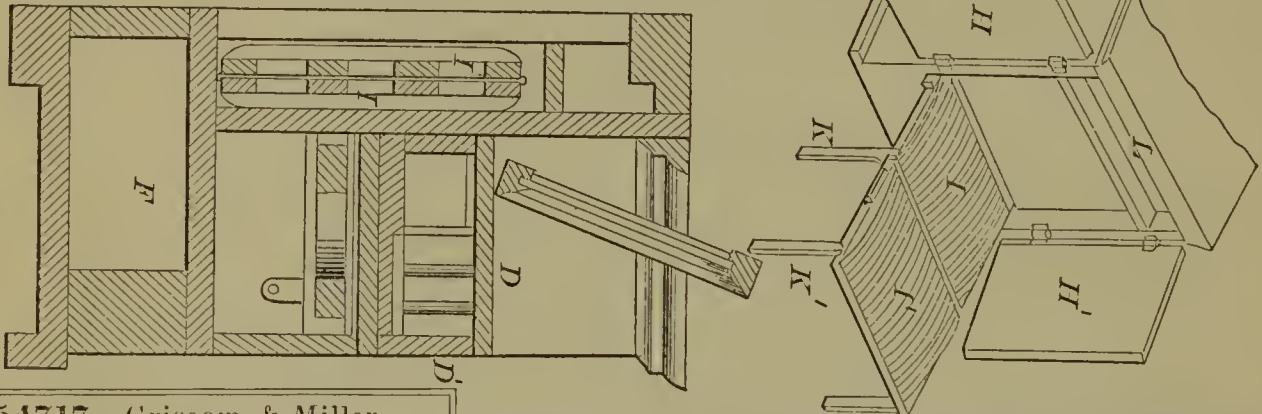

54717—Griseom & Miller—*Lime Kiln.*

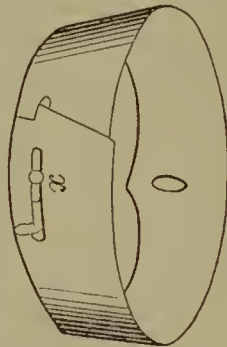
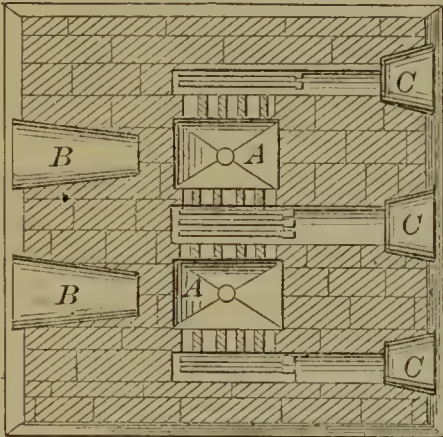

54720—W. B. Harris—*Paper Collar.*

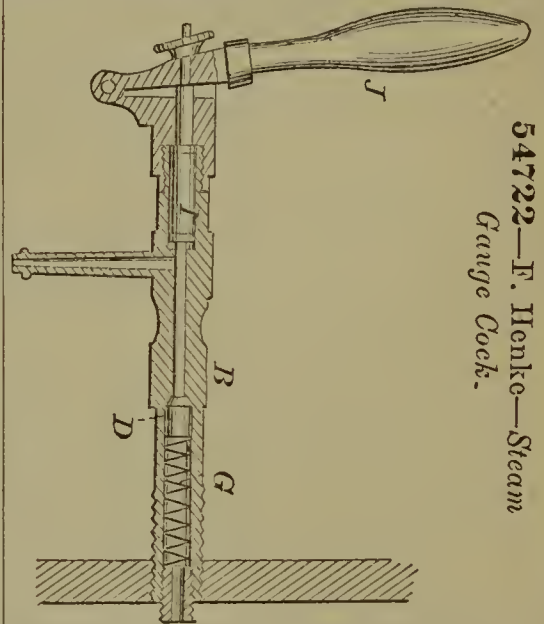

54722—F. Henke—*Steam Gauge Cock.*

54719—T. Hansbrow—*Pump.*

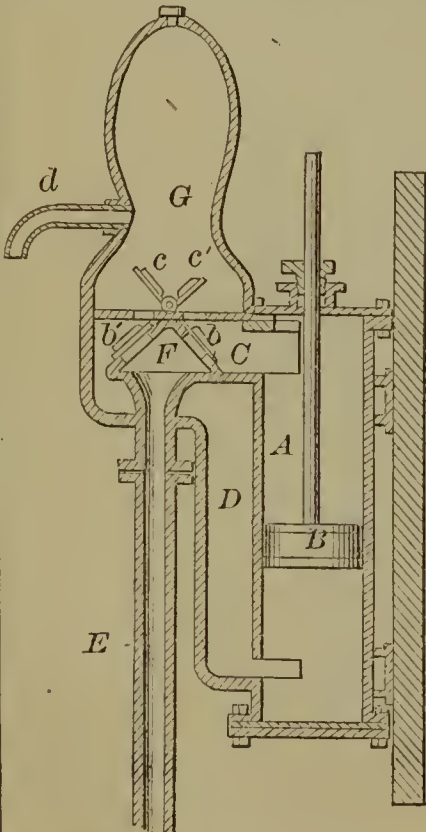

54723—S. R. Higgins—

*Hay Loader.*

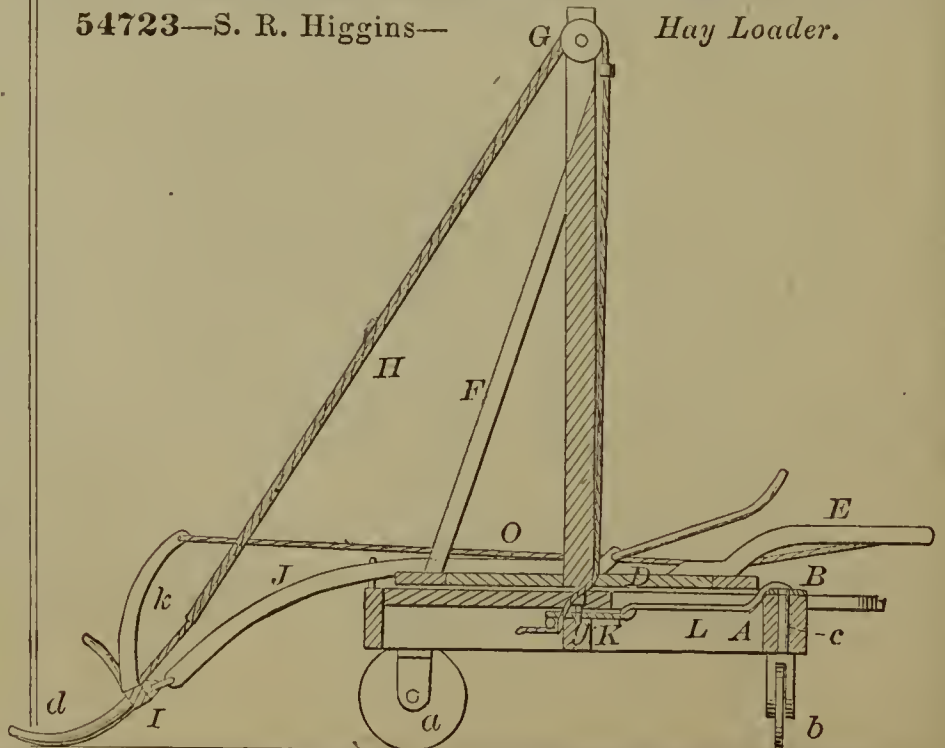

54724—J. J. Hill—Potato Harvester.

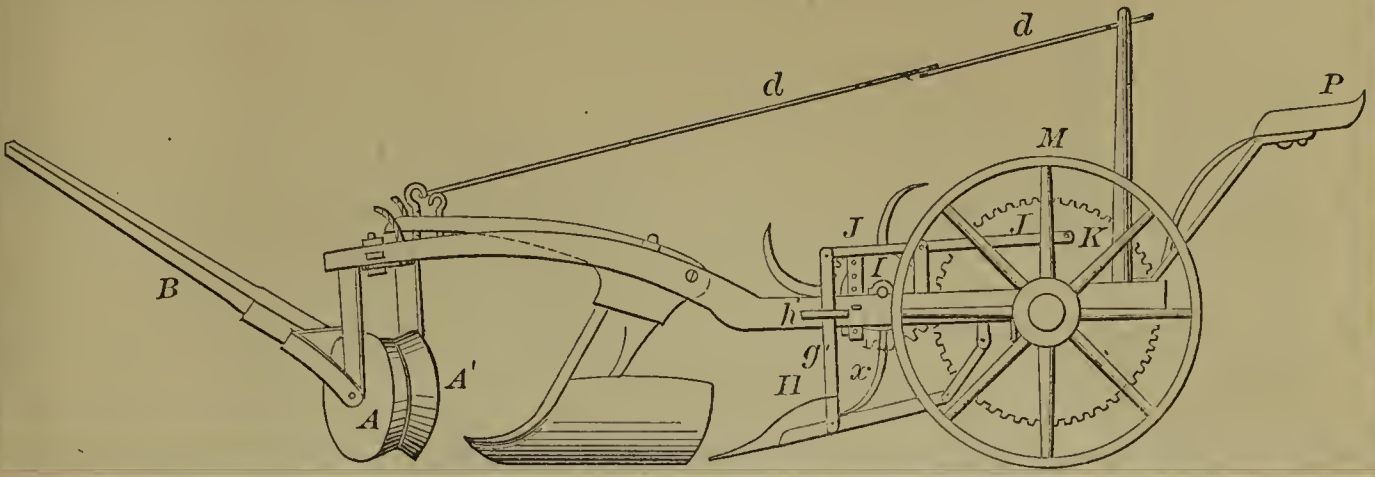

54726—J. A. Hitchings—For Separating Metal from Ores.

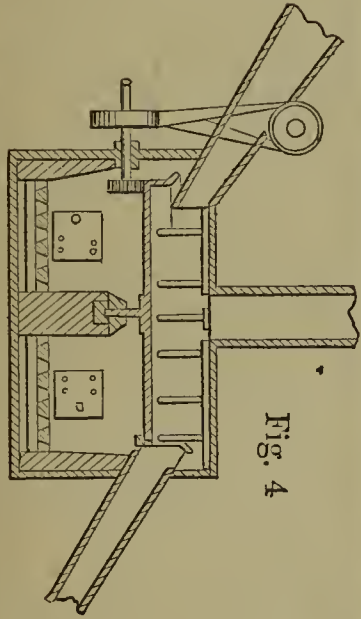
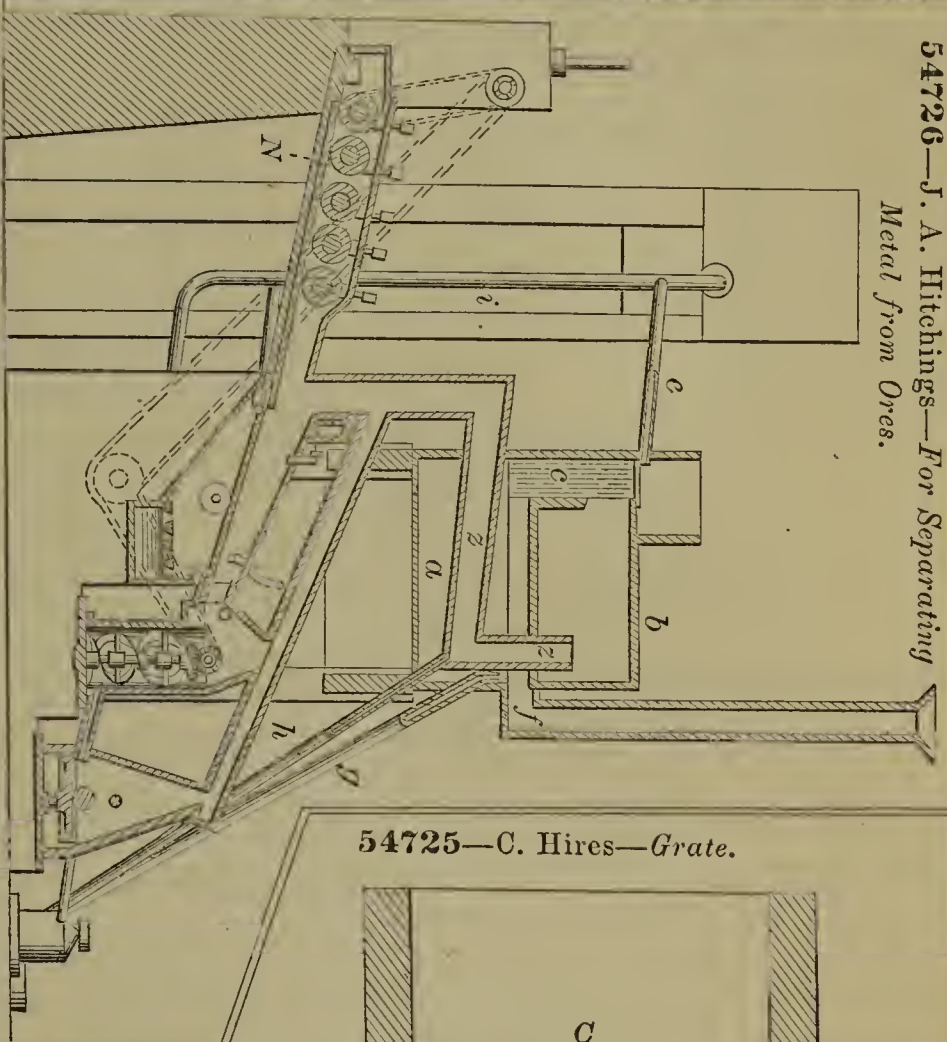

54725—C. Hires—Grate.

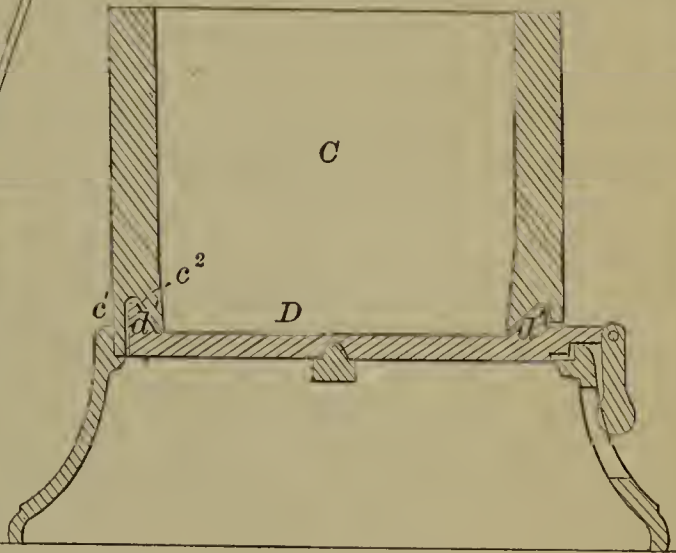

54728—C. Howard—Bayonet Attachment.

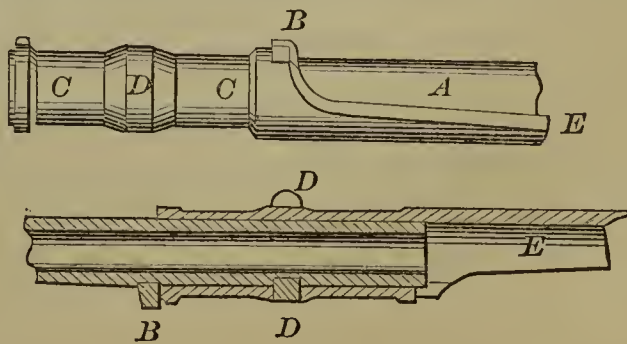

54727—M. D. Hotchkiss—Clothes Dryer.

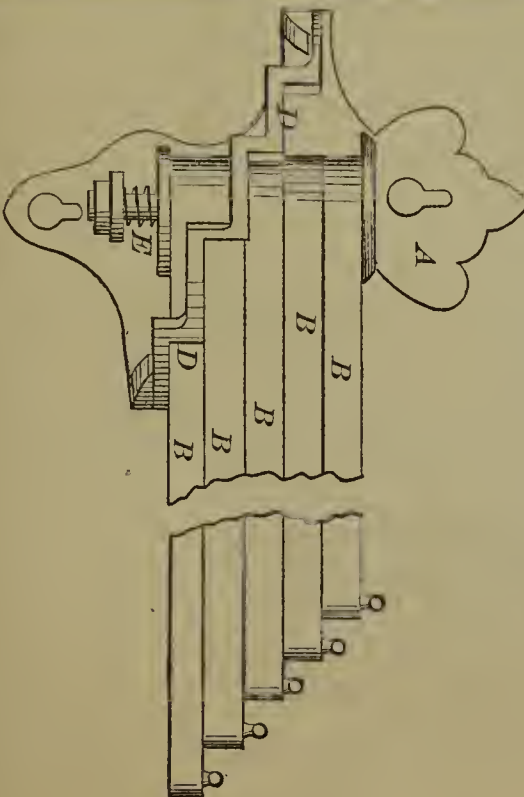

54729—E. Howe—Tethering Halter.

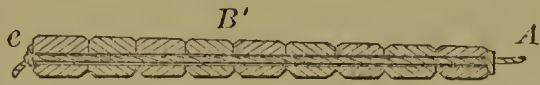

54730—D. C. Howell—Steam Generator.

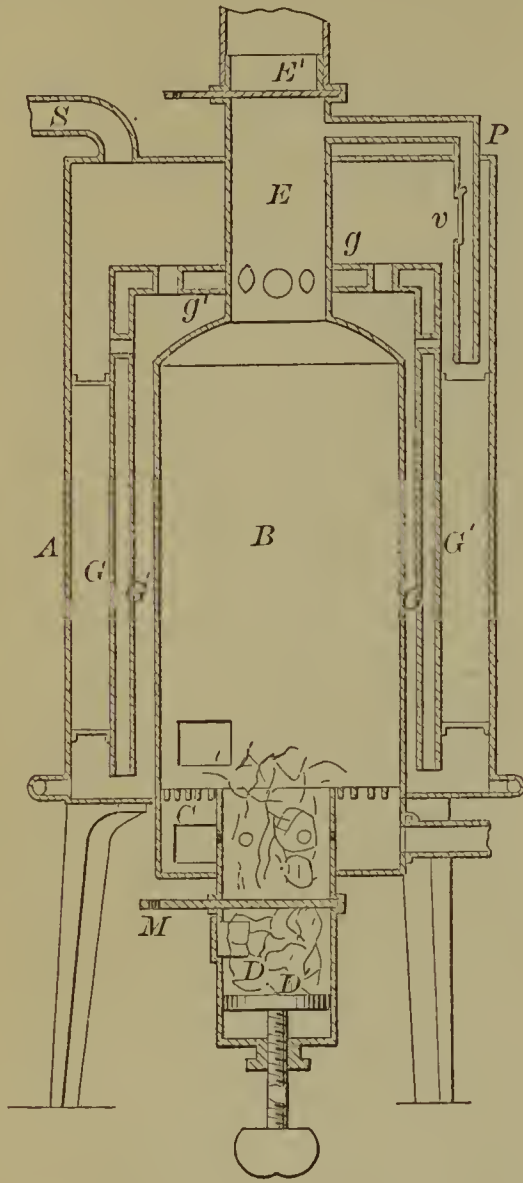

54731—L. Huntoon—Steam Engine.

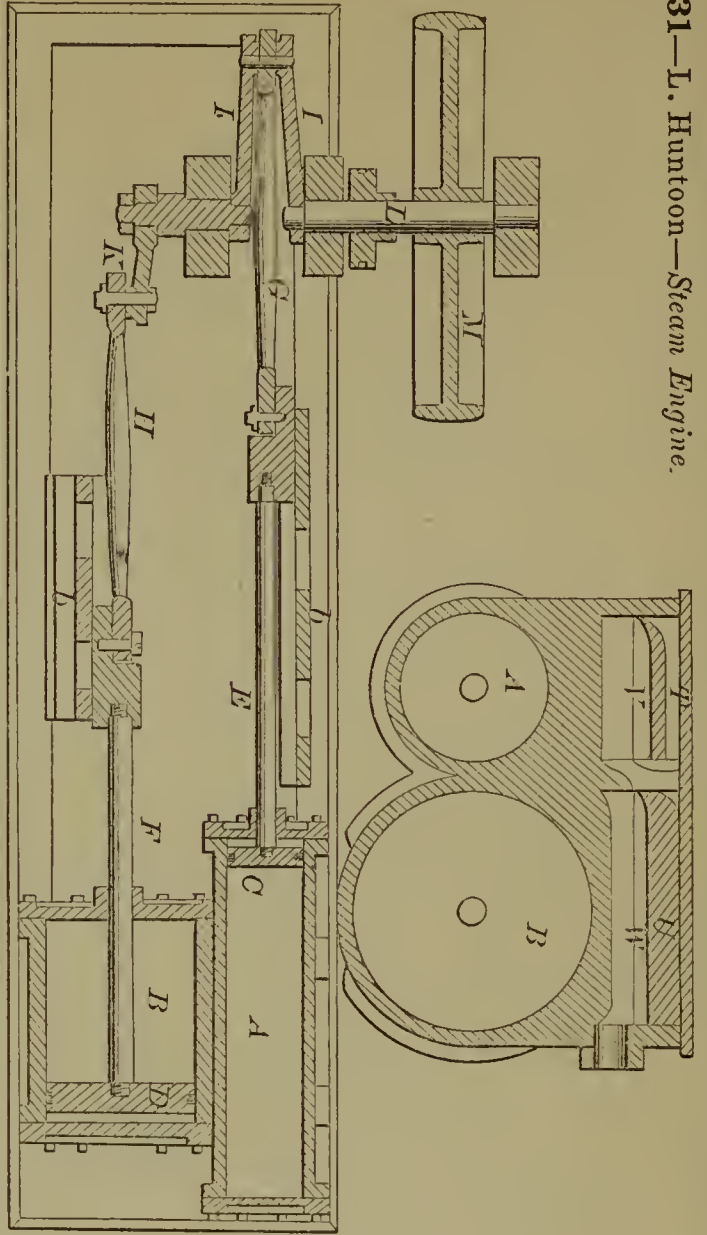

54733—W. A. Ingalls—Screw for Stools, &c.

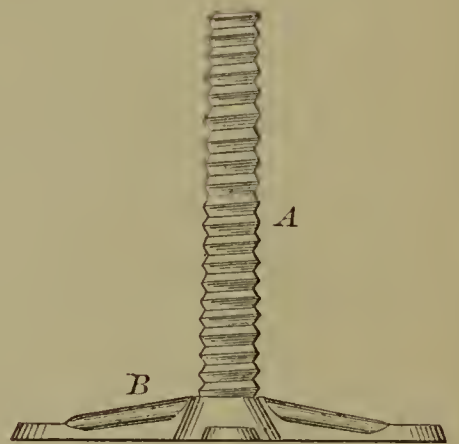

54734—T. James—Brick Mould.

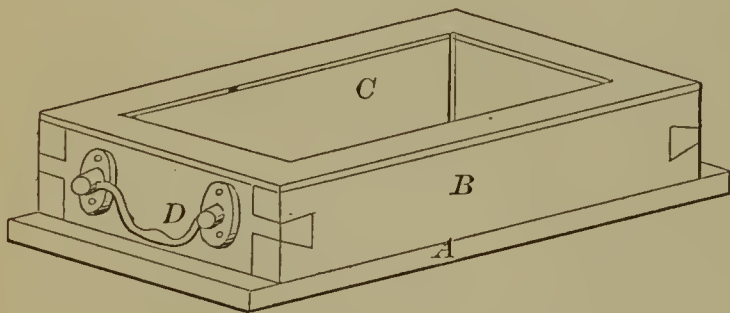

54732—D. Hussey—Drawing Rollers.

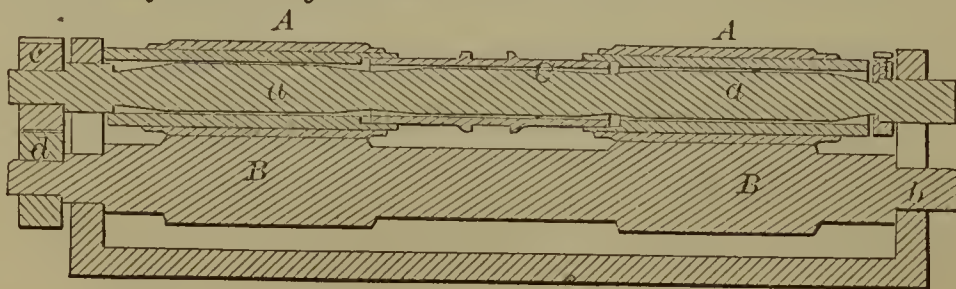

54735—J. P. Jamison—Crimping Machine.

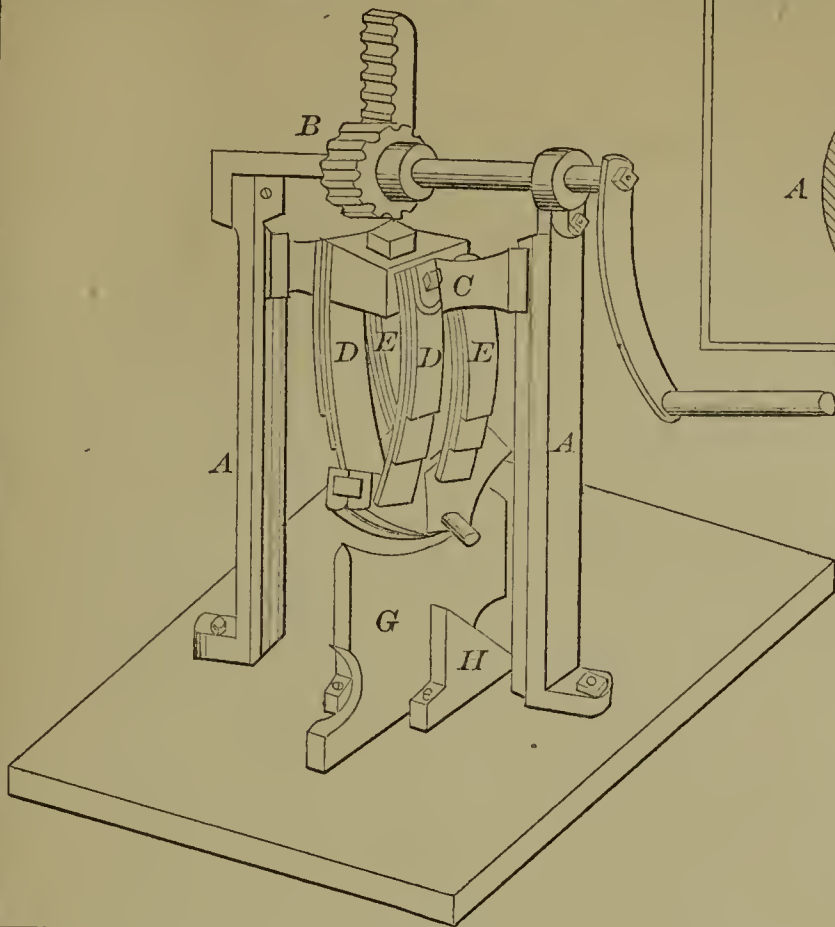

54736—J. M. Johnson—Button.

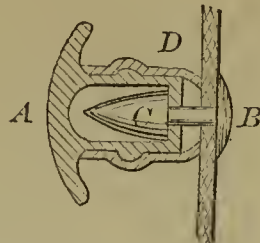

54738—C. Kane—Die for Heading Bolts.

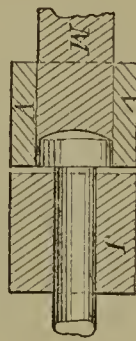

54739—J. P. Kibler—Sand Pump.

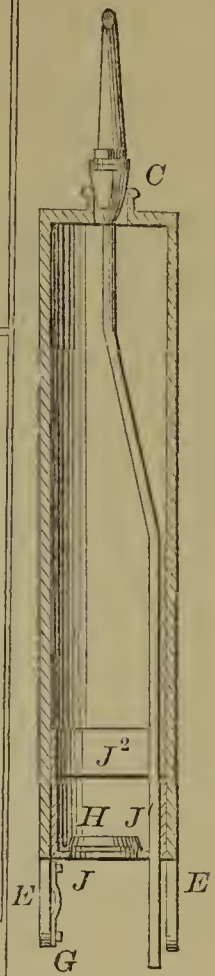

54740—J. Kinzer—Handle for Coffee Mills.

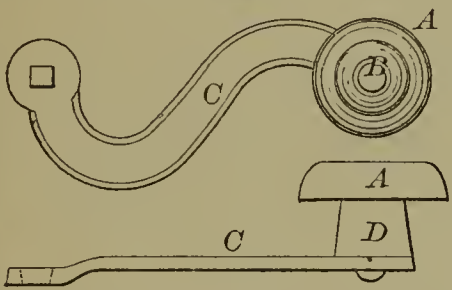

54741—J. C. Knoepke—Wash Basin.

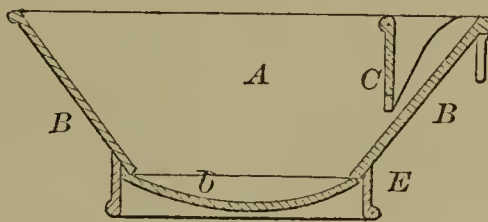

54742—L. J. Knowles—Loom for Weaving Tapes, &c.

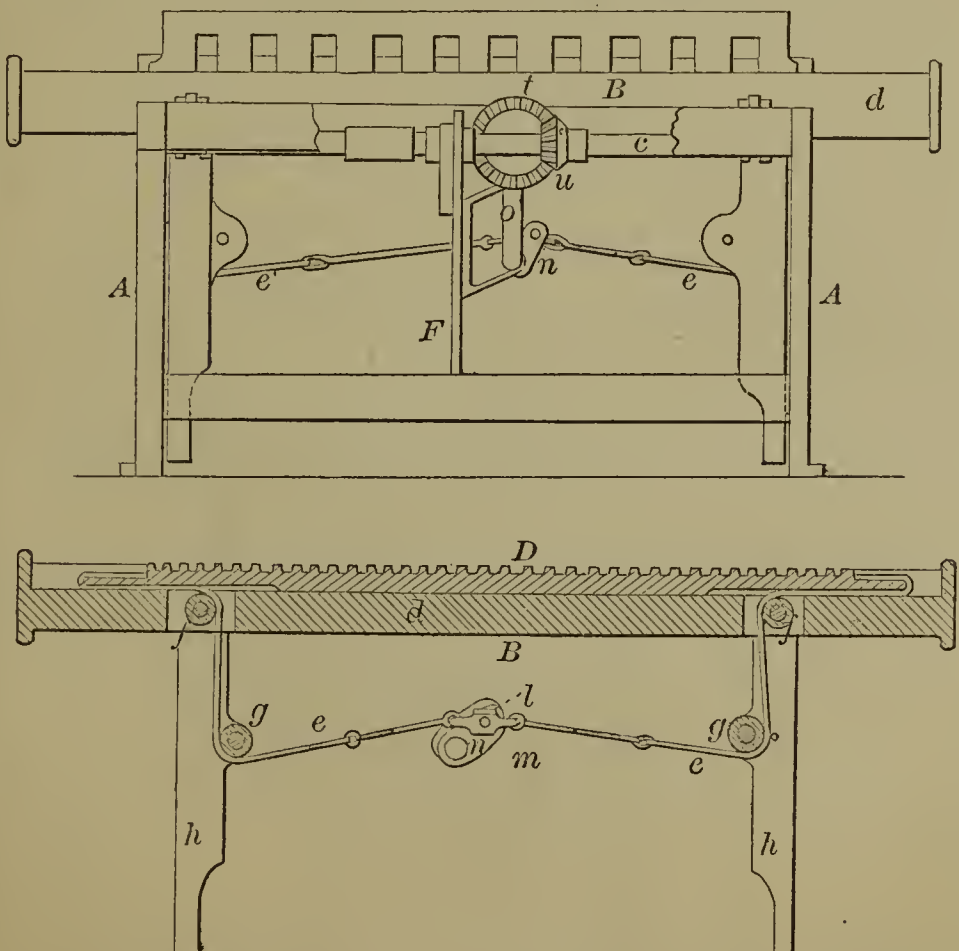

54737—W. Jones—Bed Bottom.

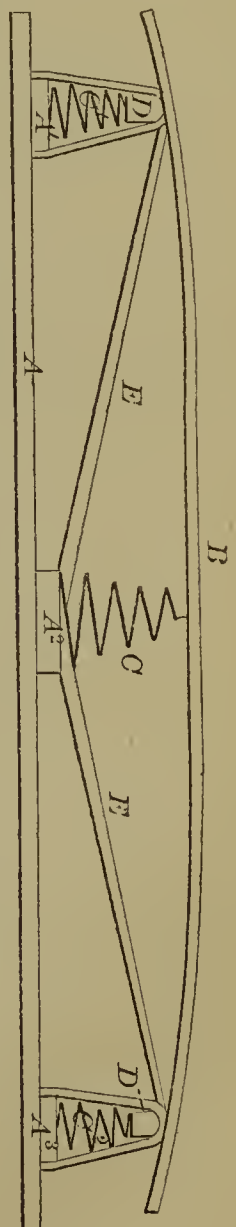

54743—Laidley & Emery—Breech-Loading Fire Arm.

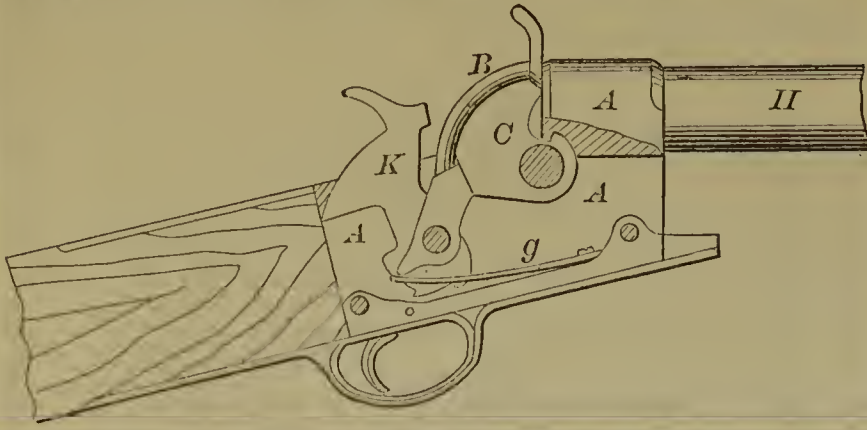

54744—J. Lee—Breech-Loading Fire Arm.

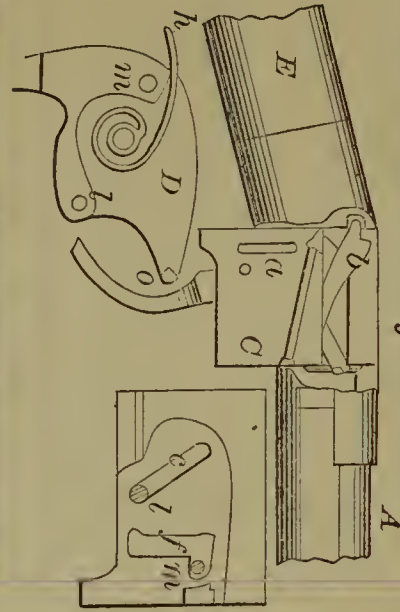

54745—R. Lovett—Cow and Sheep Rack.

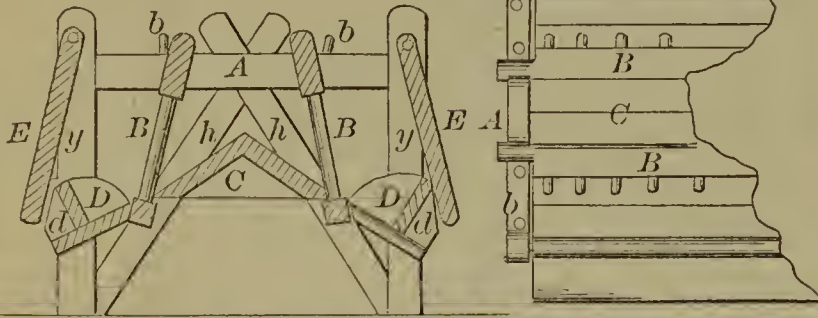

54747—A. D. Manley—Dumping Wagon.

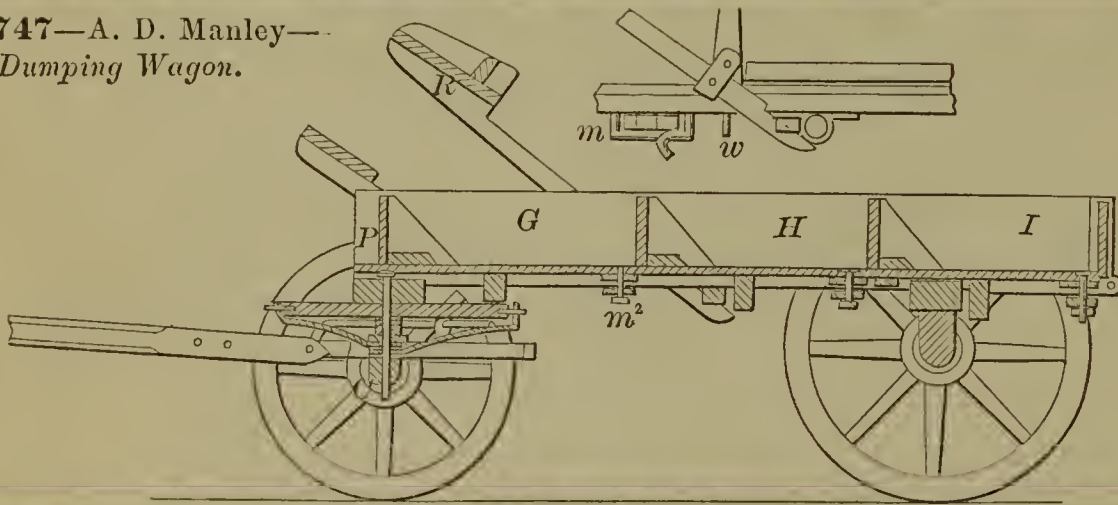

54746—O. Maedaniel—Evaporating Solutions.

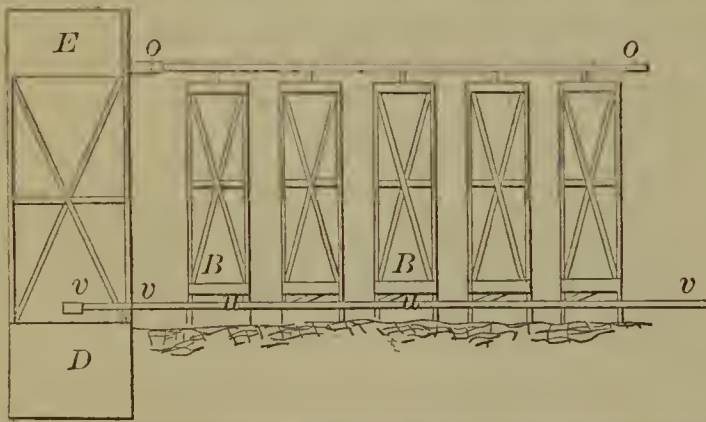

54749—L. Mason—Tenoning Machine.

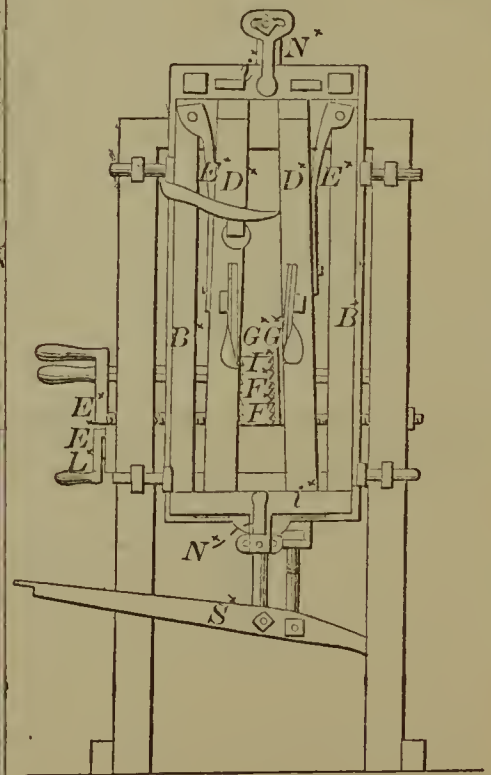

54748—W. C. Marshall—Extinguishing Fires.

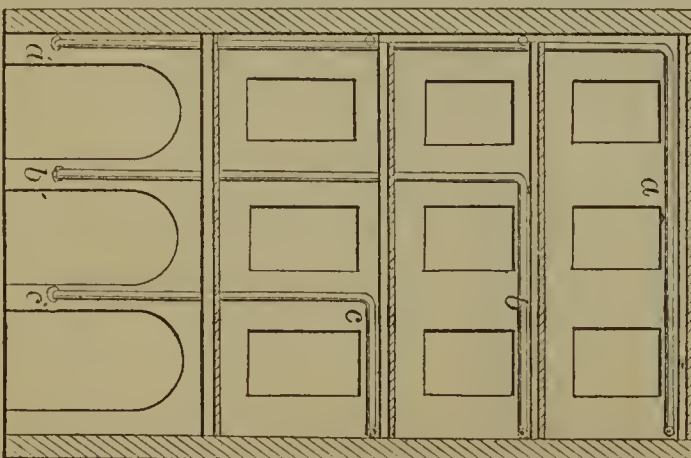

54750—L. Mason—For Boring Wagon Hubs.

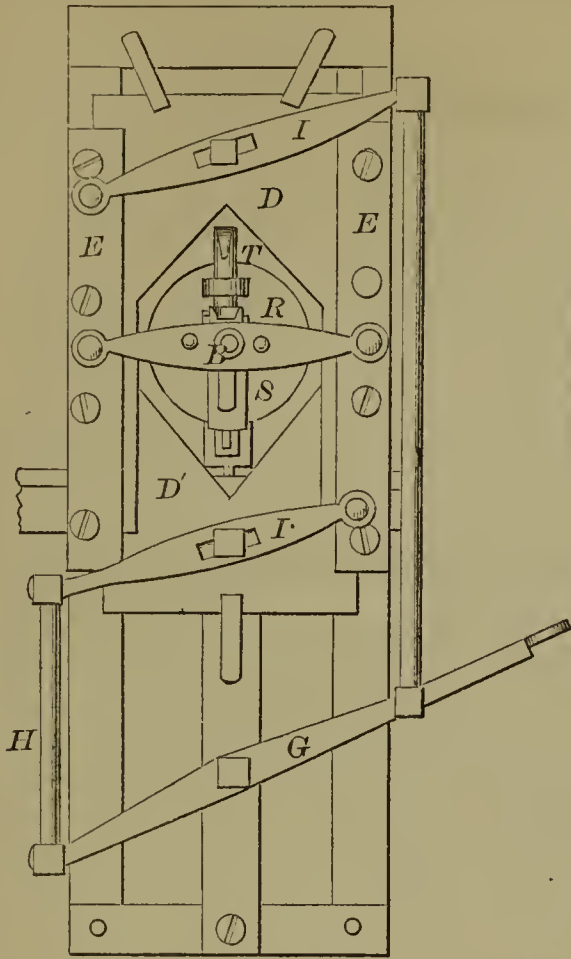

55753—J. Montgomery—Axle Box.

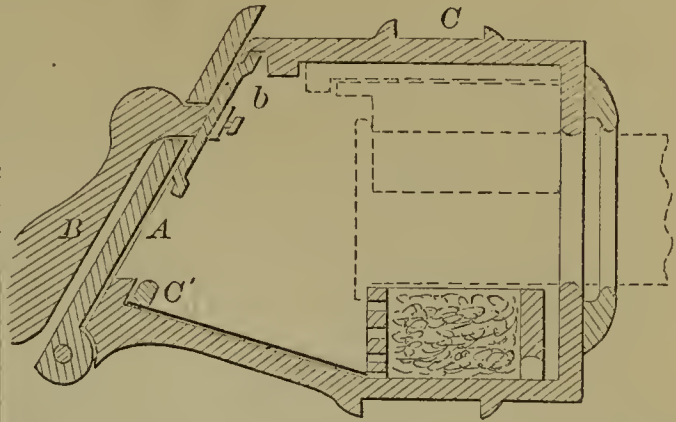

54754—E. D. Montrose—Portable Fence.

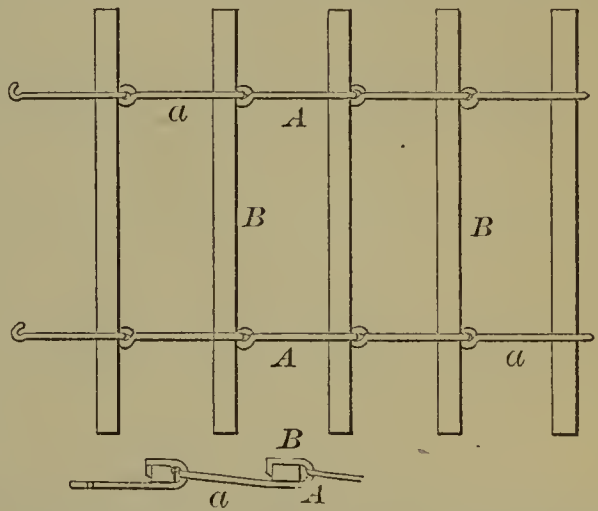

54752—A. R. McNair—Brick Machine.

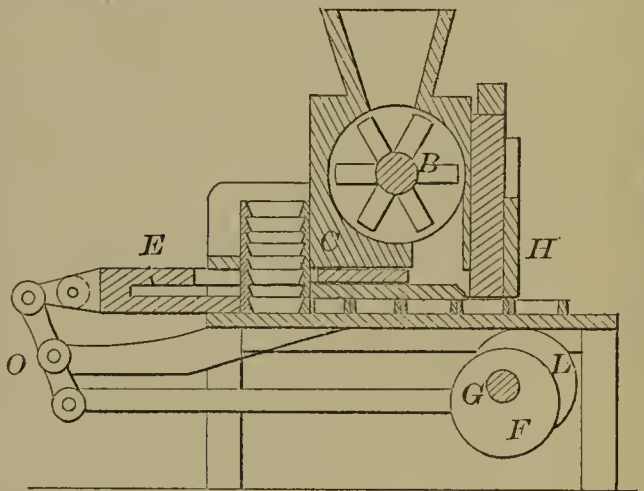

54751—W. McCormick—Cultivator.

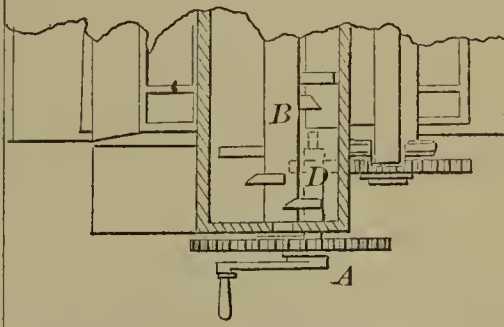
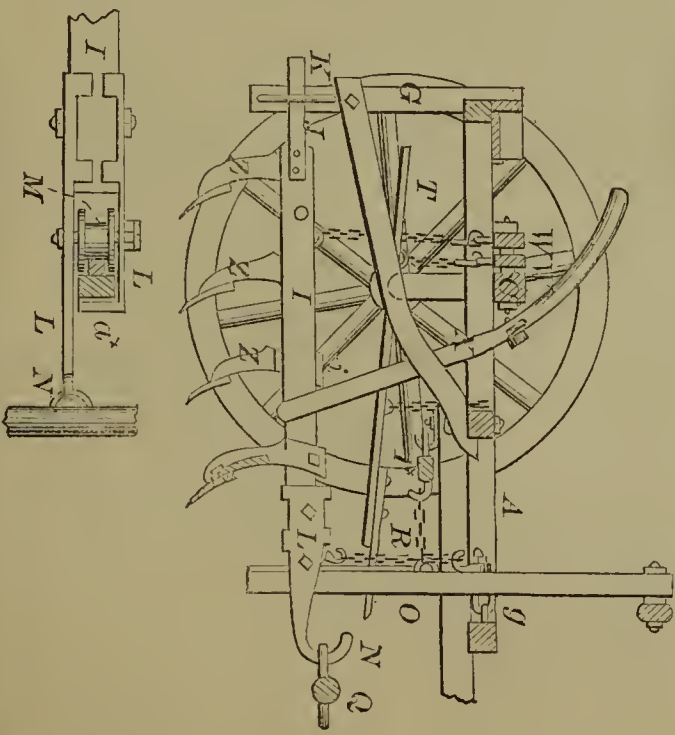

54755—F. B. Morse—Carriage Seat.

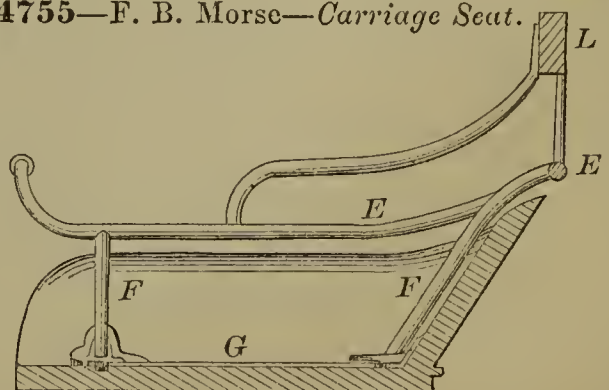

55760—L. H. Olmsted—Chuck.

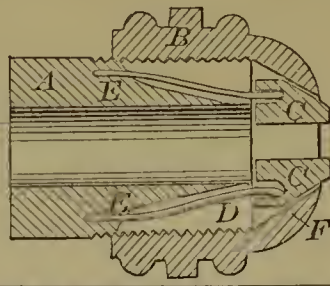

54757—I. Newton—Superheating Apparatus.

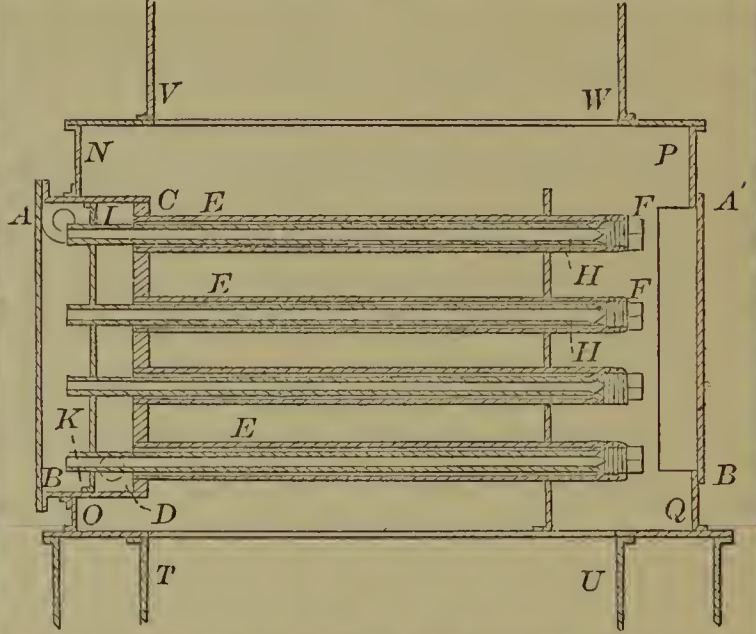

54759—E. Oldham—Pantographic Machine.

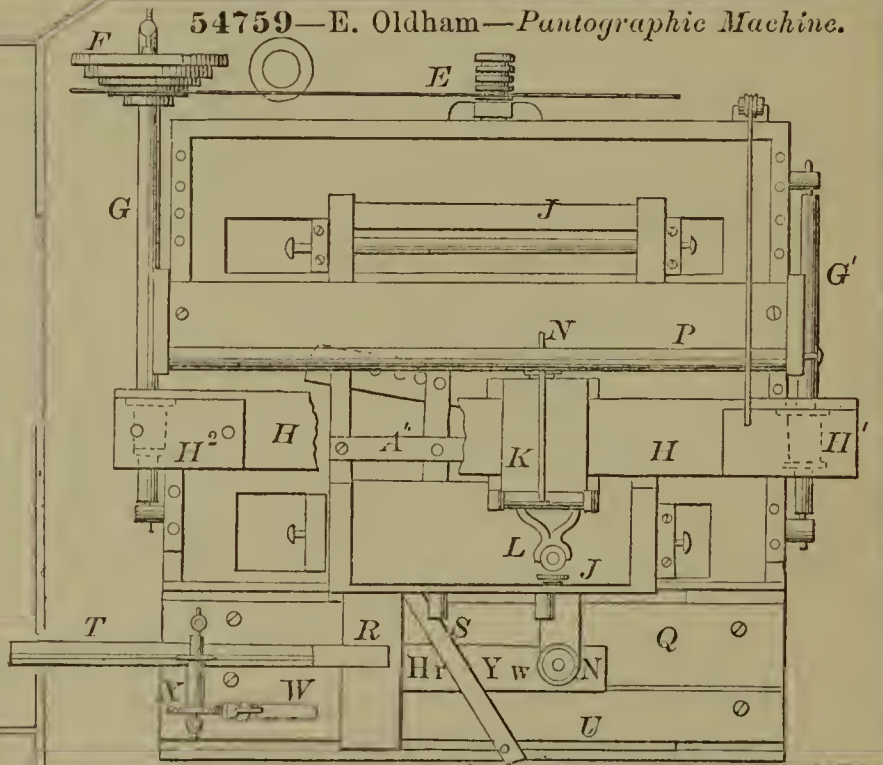

54761—Pangborn & Griffin—Egg Beater.

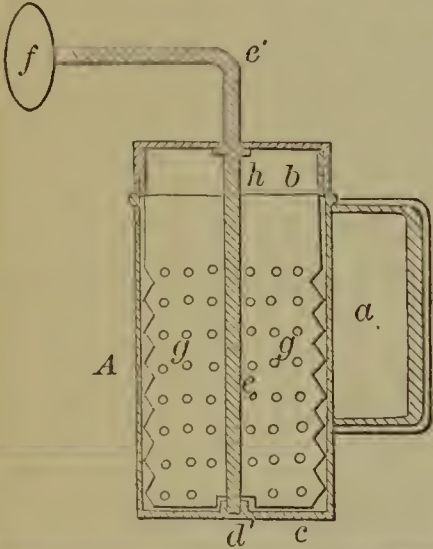

55758—O. W. Noble—For Making Eaves Troughs.

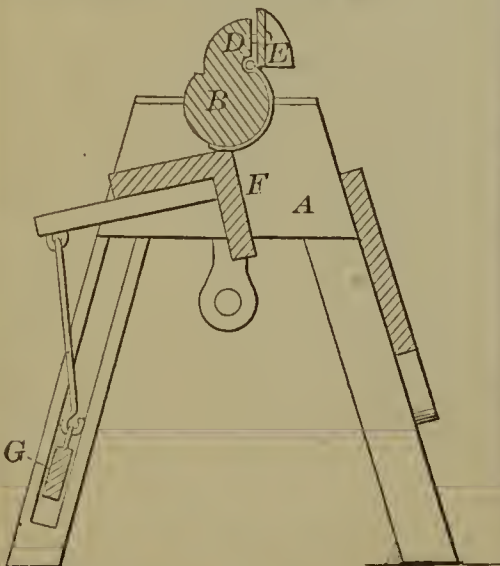

55762—V. P. Parkhurst—Chair.



55756—J. Mott—Plow.

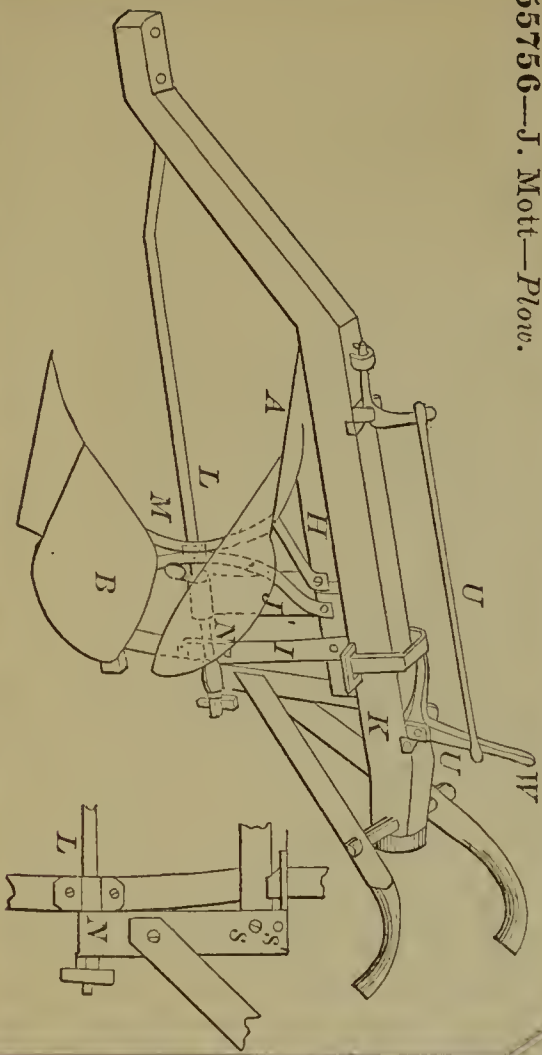



54763—Parmele & Patterson—Cultivator.

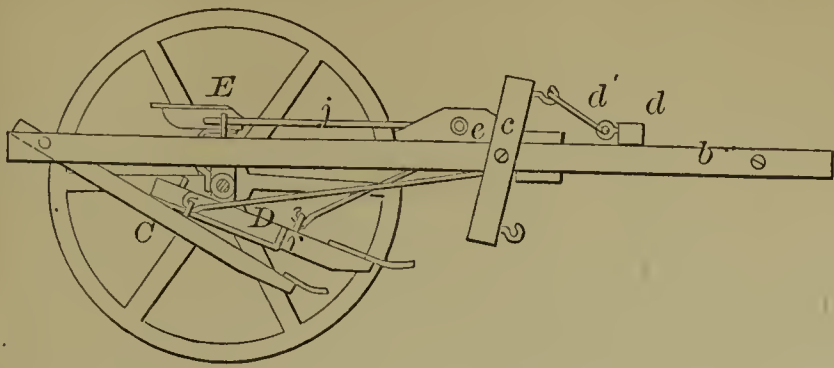

54767—B. Pickering—Ladder.

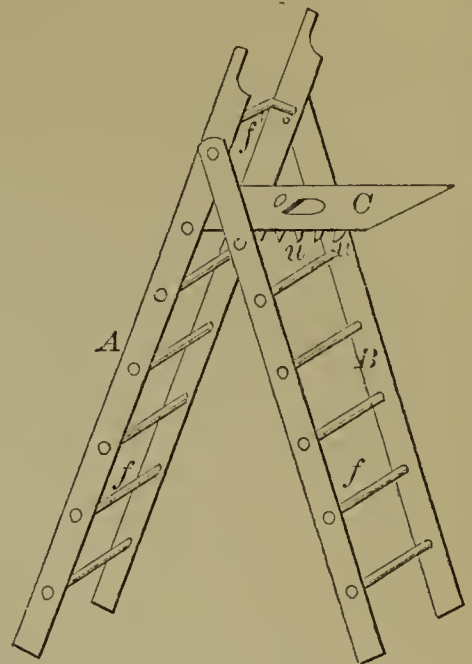

54765—D. Peters—Broom Head.

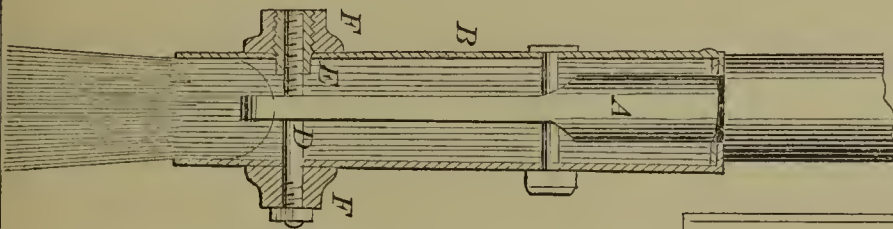

55766—O. S. Pettit—Water Closet.

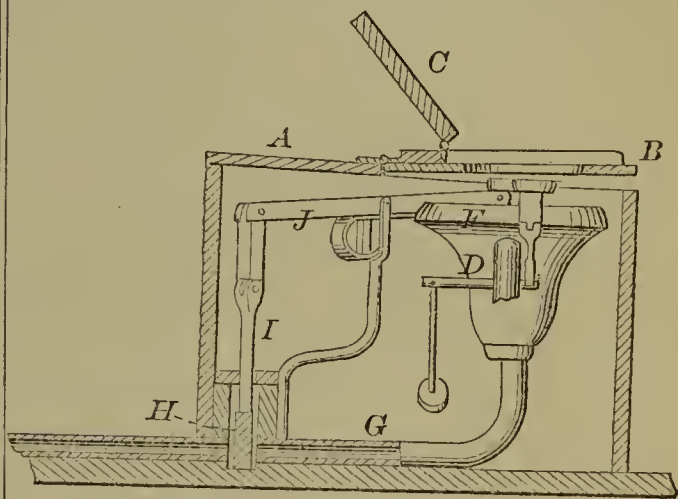

55768—A. Pollock—Safety Valve.

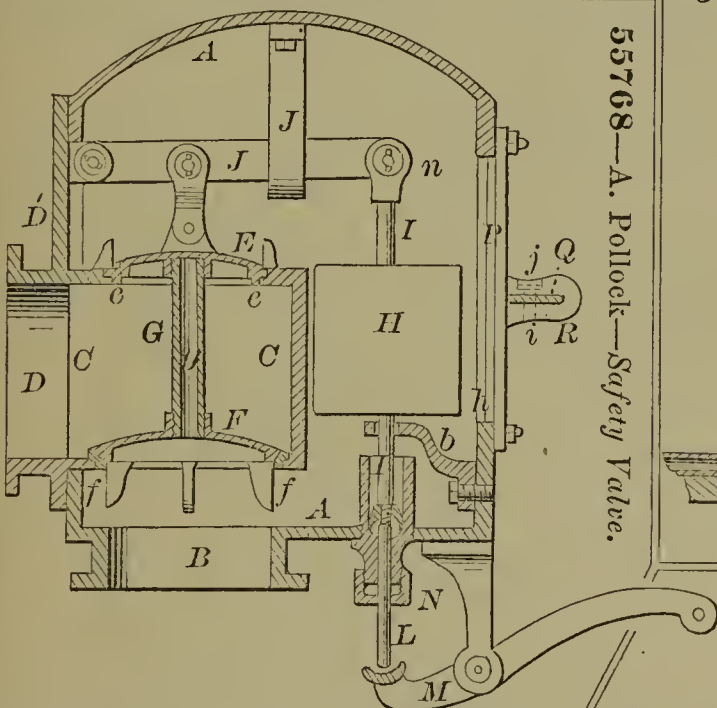

54769—G. H. Pool—Churn Dasher.

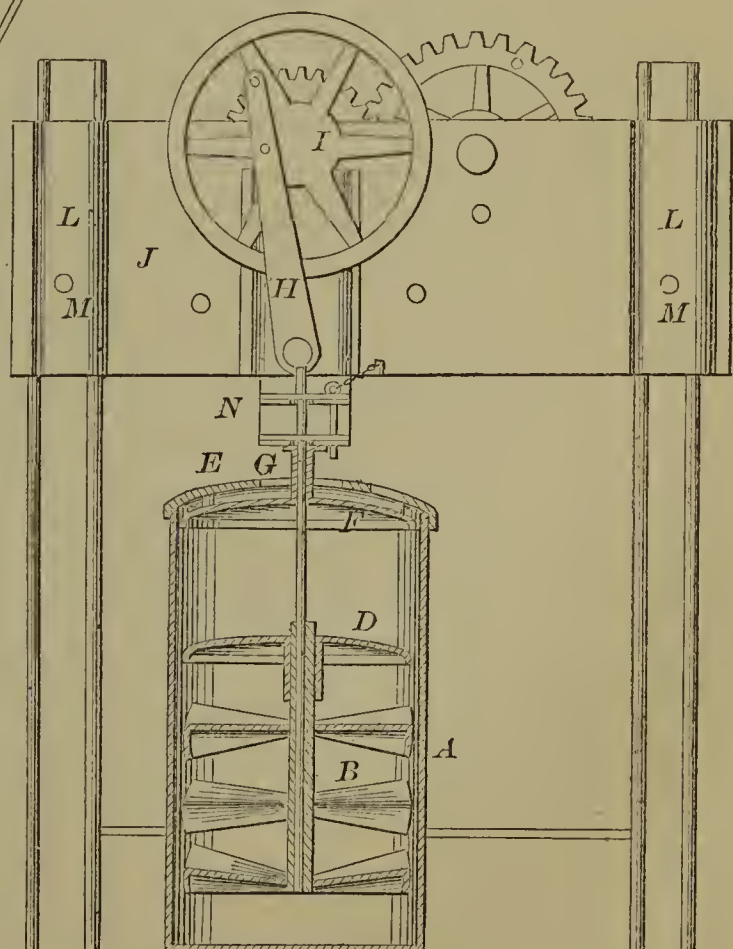

55764—J. N. Pease—Clothes Wringer.

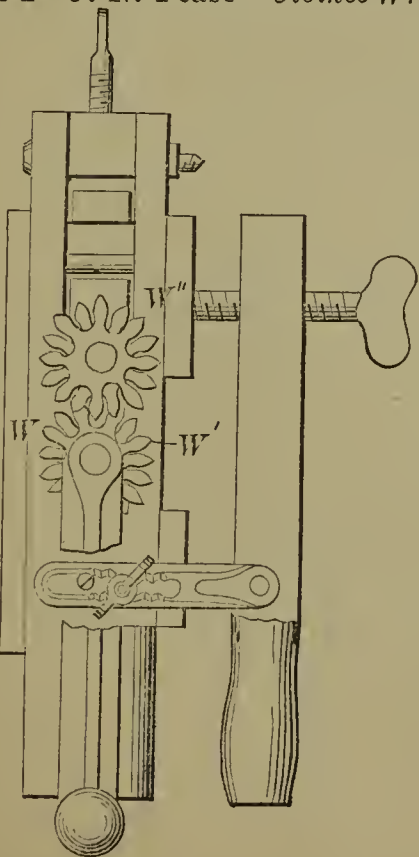

54770—T. B. Purves—*Railroad Switch.*

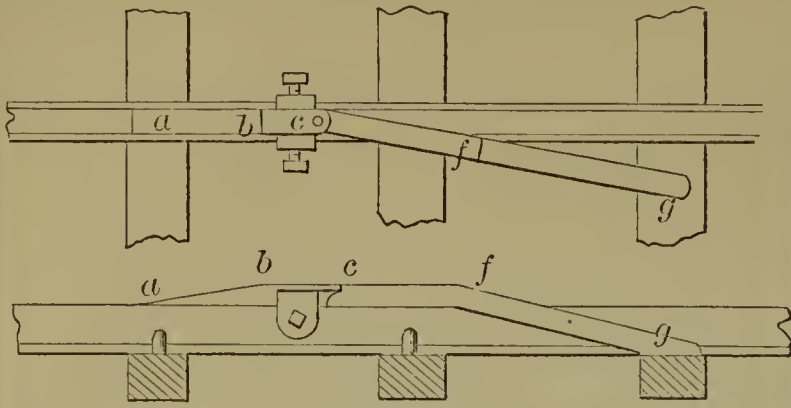

54773—H. M. Remington—*Paper Undersleeves.*

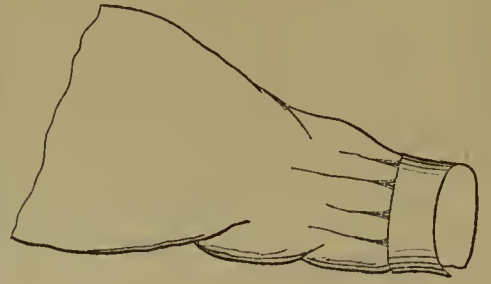

54772—J. Reedy—*Portable Fence.*

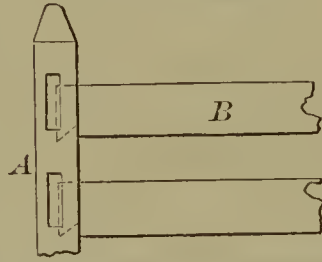

54775—W. F. Rippon—*Axle Box.*

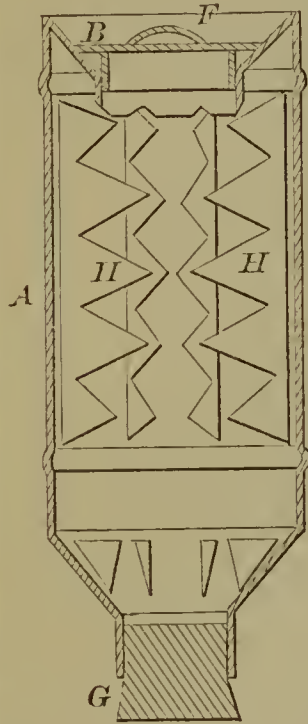
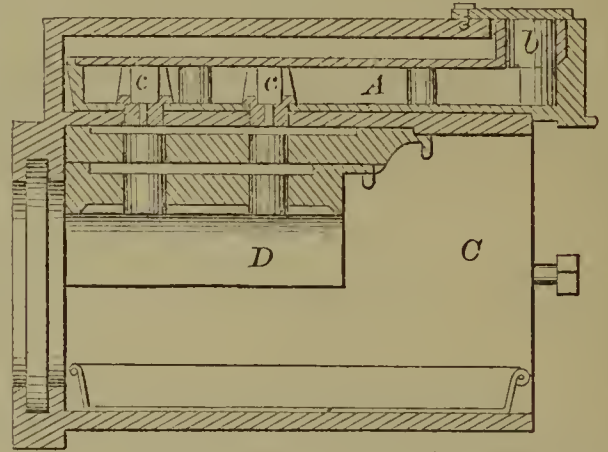

54776—A. M. Robinson—*Egg Beater.*

54774—A. L. Rice—*Attaching Circular Saws to Arbors.*

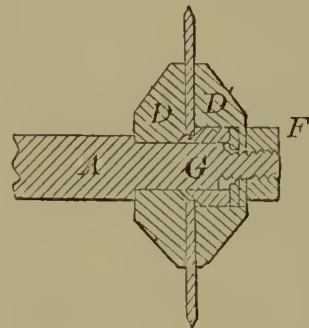

54771—T. H. Quick—*Purifying Bone Black.*

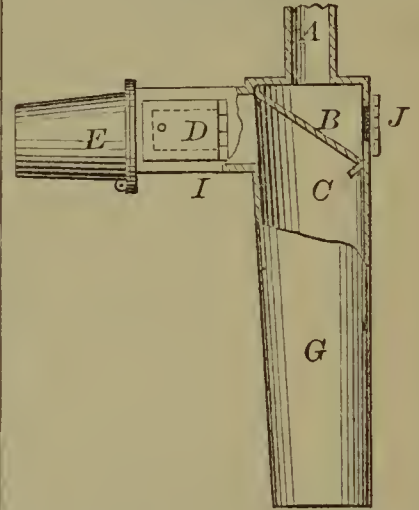

54778—A. Rogers—*Extension Fruit Ladder.*

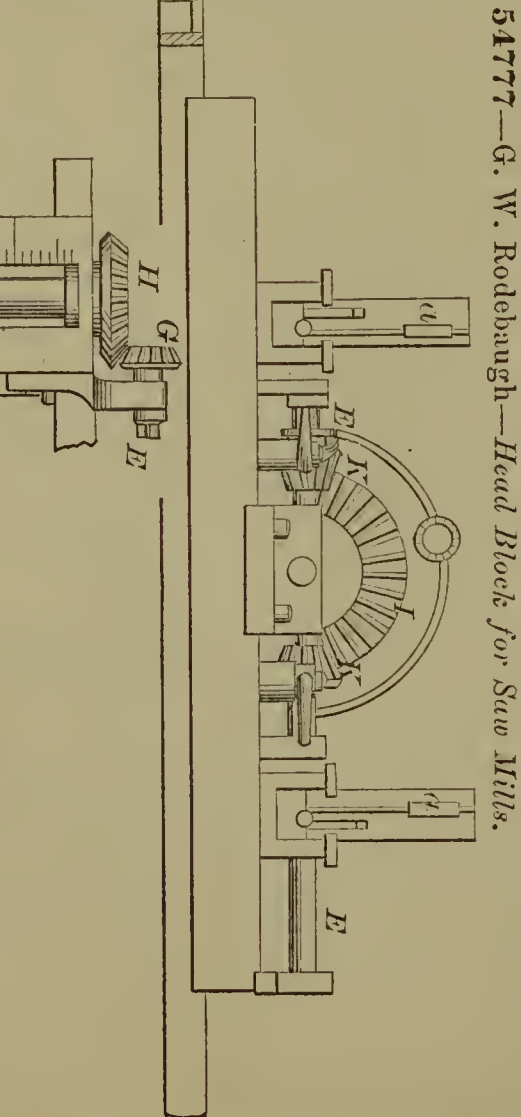
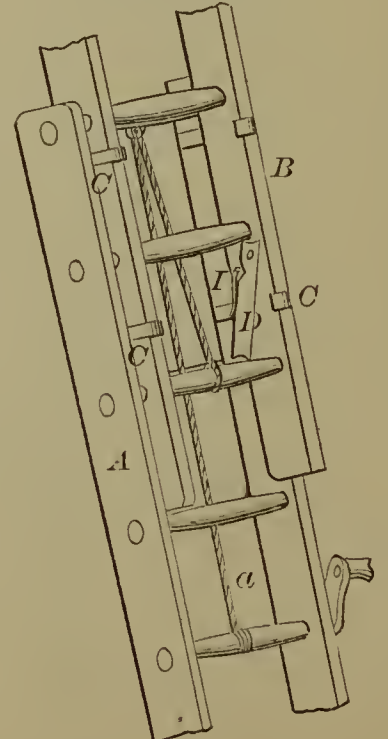

54777—G. W. Rodebaugh—*Head Block for Saw Mills.*

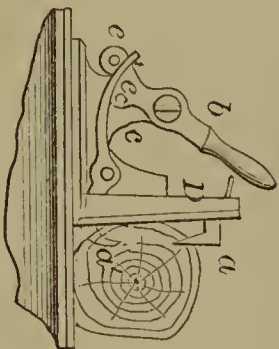
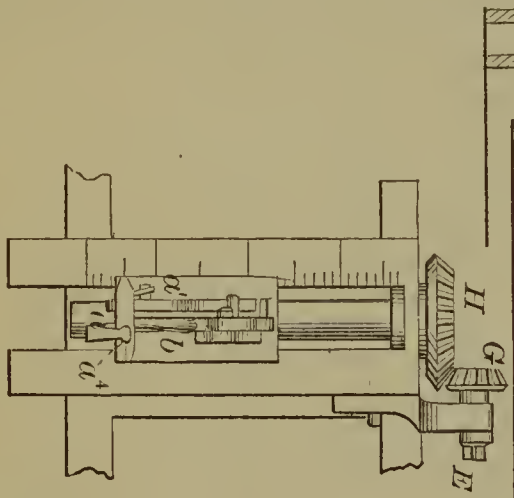

54779—J. Rouse—*Bed Bottom.*

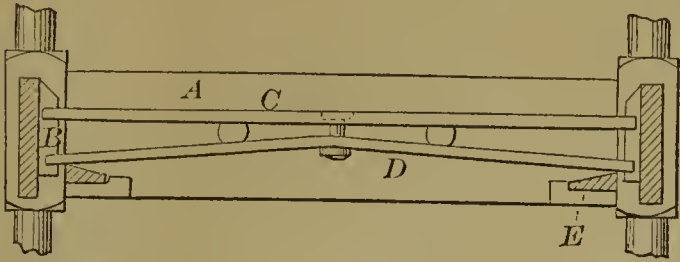

54782—L. Sawyer—*Attaching Props to Carriage Boxes.*

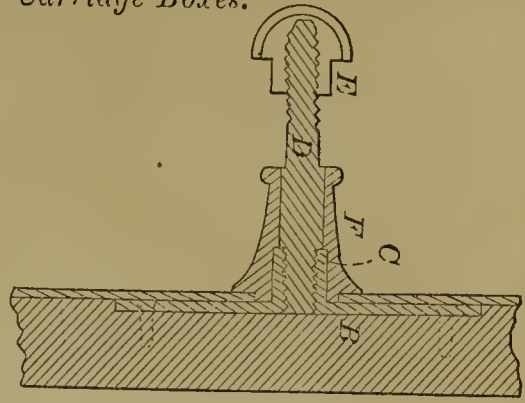

54784—J. Seibel—*Harvester.*

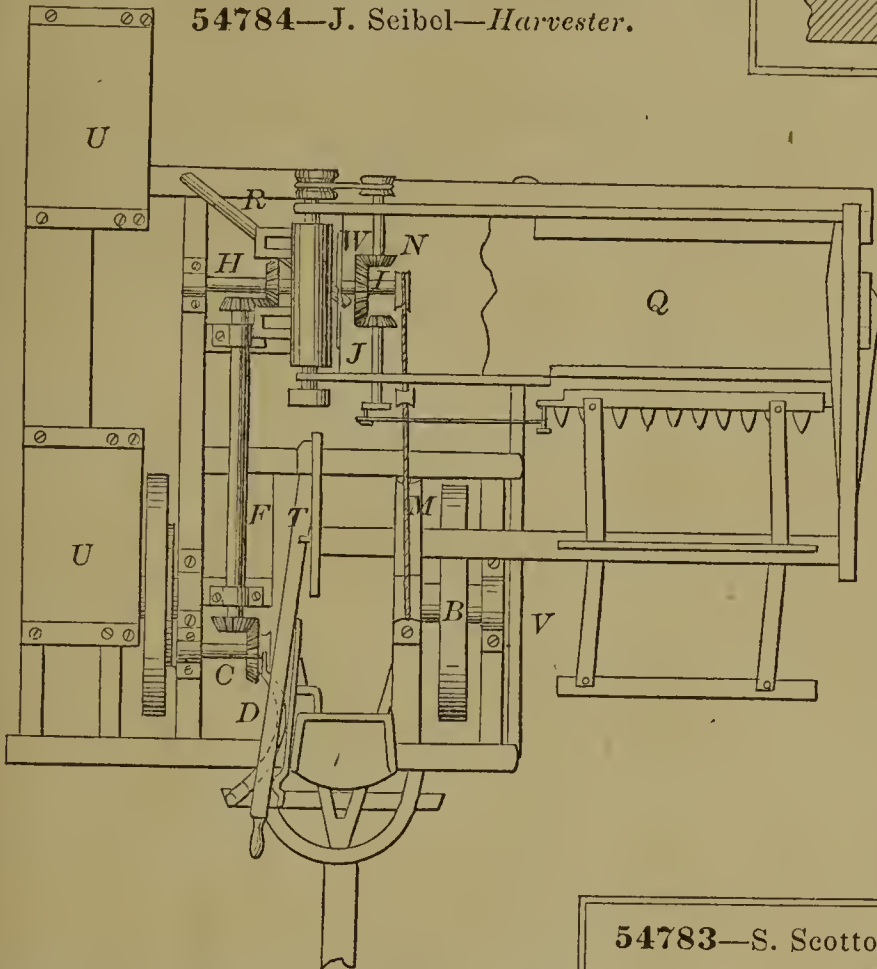

54780—S. P. Ruggles—*Steam Generator.*

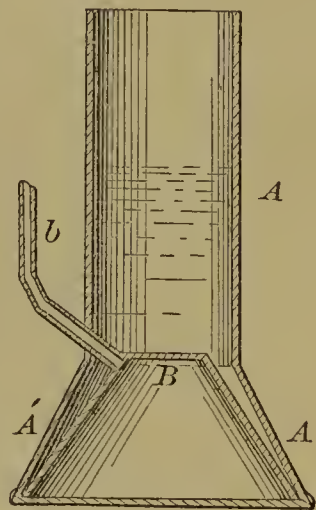

54781—W. H. Sargent—*Washing Machine.*

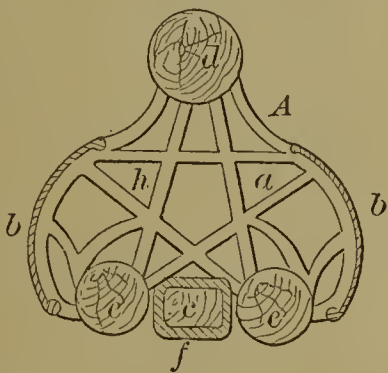

54783—S. Scotton—*For Shooting Gravel at Cows on Rail Road Tracks.*

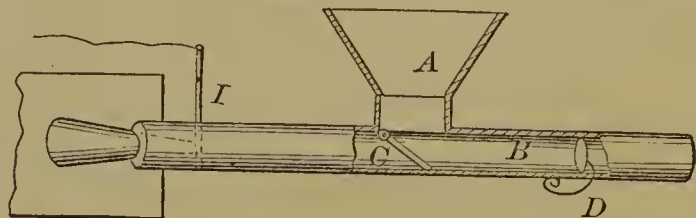

54785—P. E. Sheffield—*Hoop Skirt.*

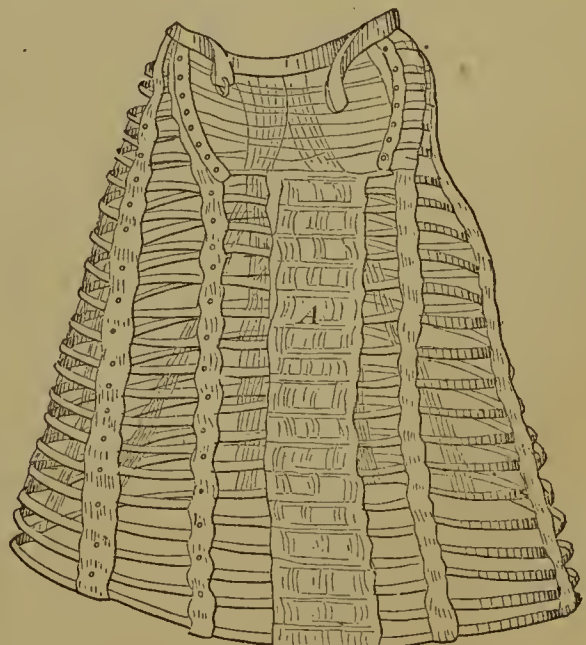

54786—J. Y. Smith—*Metallic Bar.*

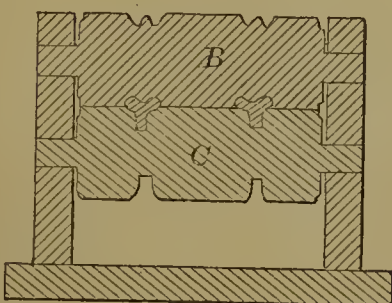

54787—M Smith—Mail Pouch.

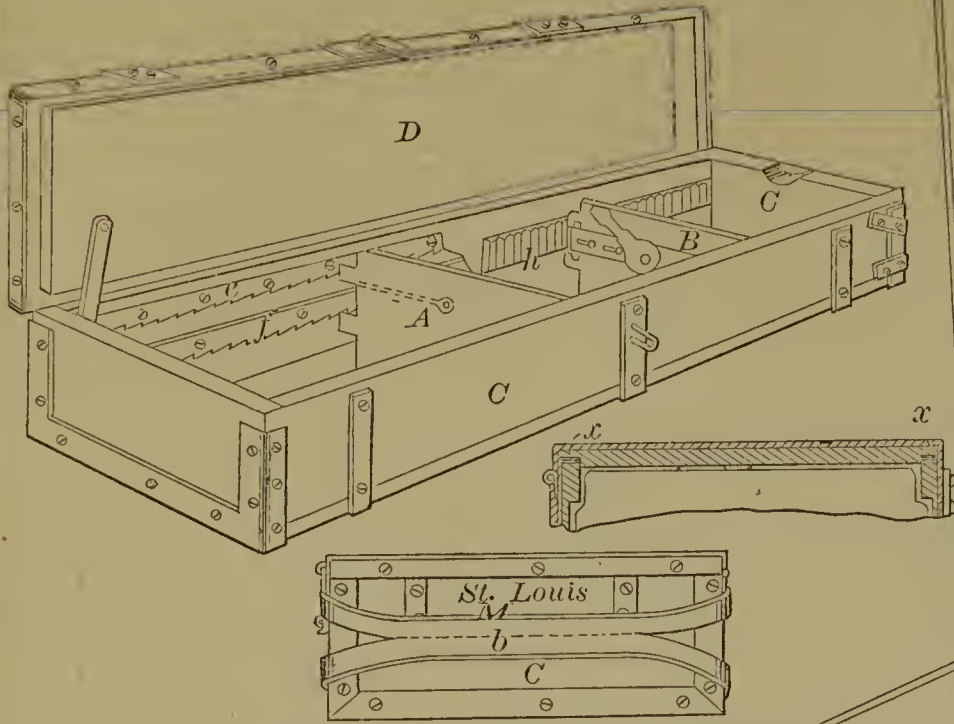

54791—A. P. Stephenson—Sorghum Stripper.

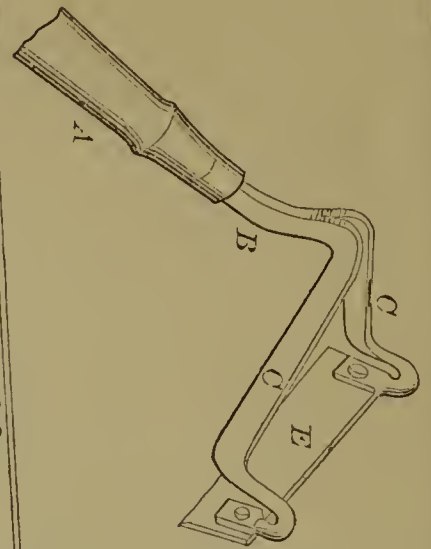

54790—Steiner & Miller—Harrow and Roller.

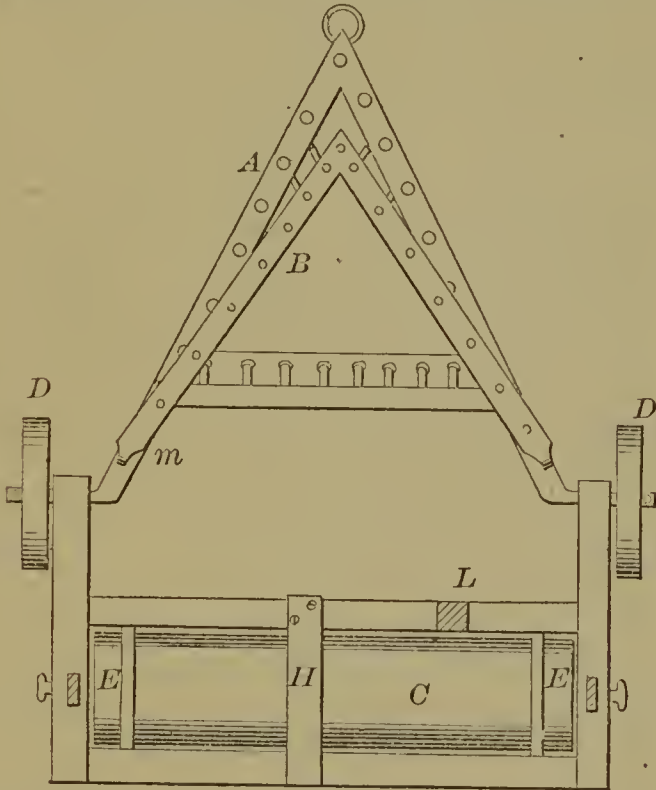

54789—Sprague & Dockum—Harvester Rake.

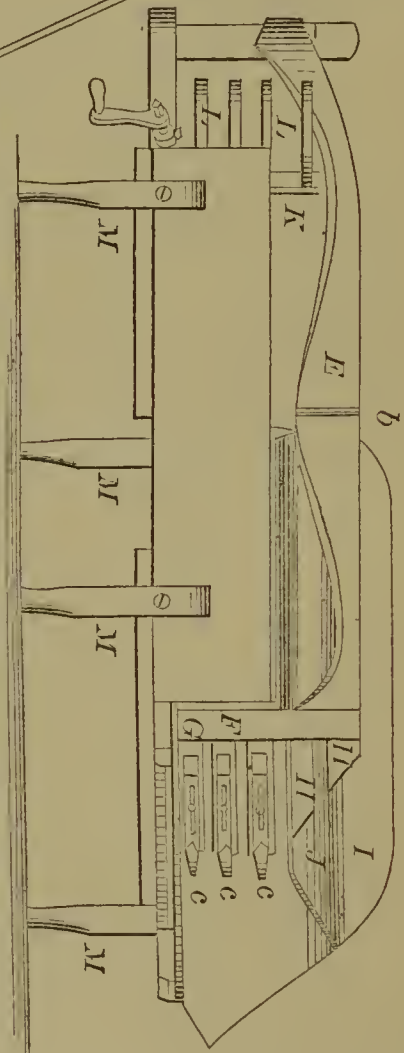

54792—C. C. Stillman—Water Wheel.

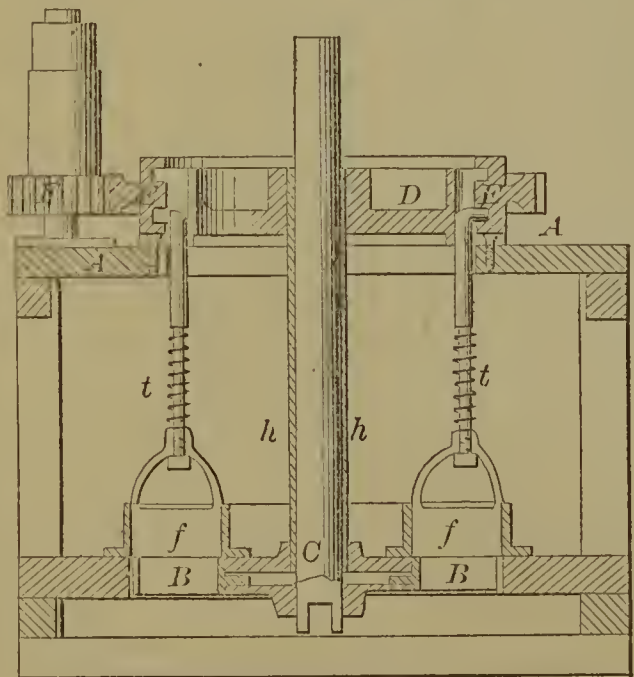

54788—E. Spencer—Flour Sifter.

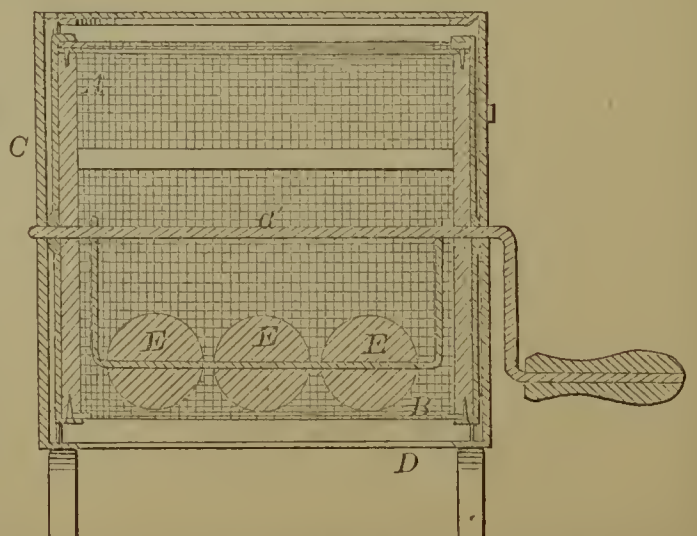

54793—A. E. Strobel—  
Weather Strip for Doors.

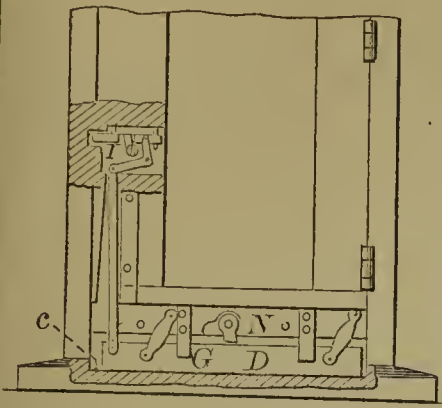

54794—J. Thompson—  
Portable Fence.

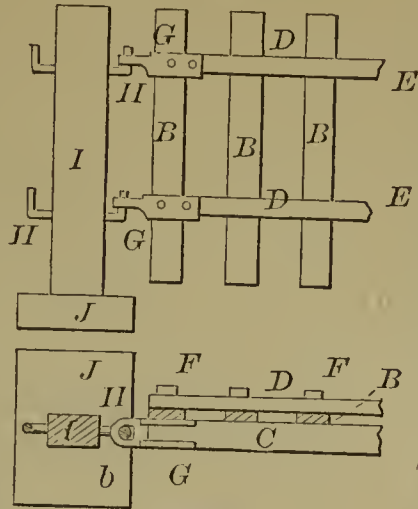

54799—W. H. White—  
Fan and Parasol.

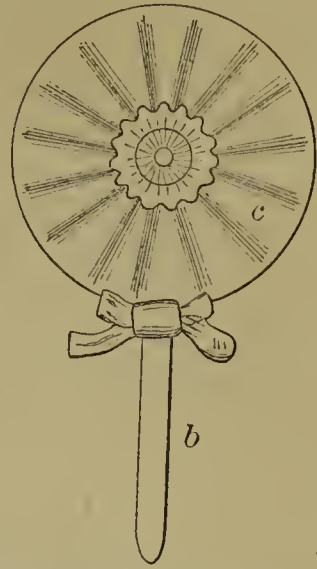

54795—T. Wallace—Hot Air Furnace.

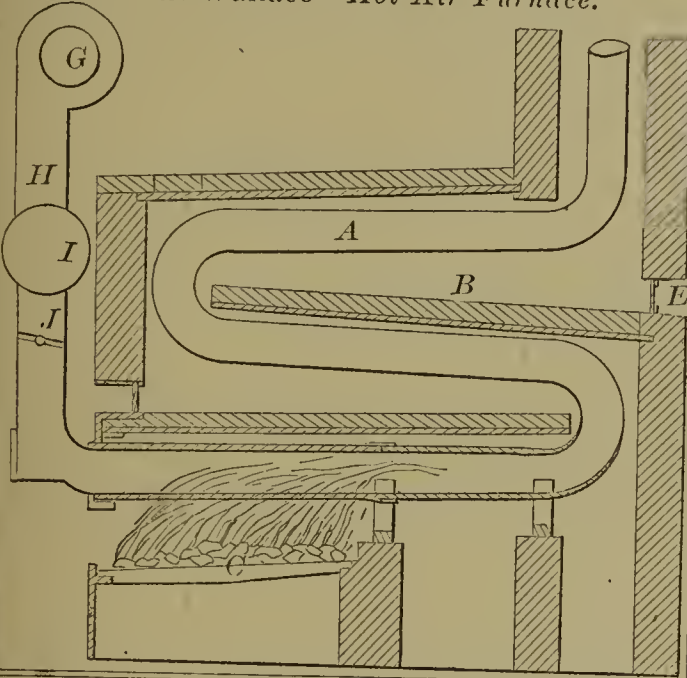

54796—H. M. Ward—Gate.

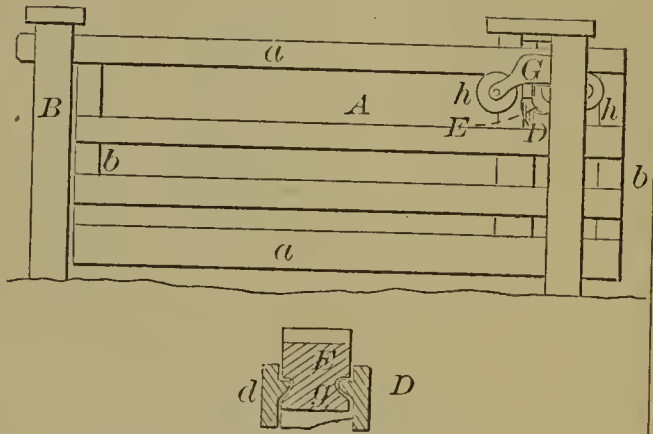

54798—W. S. & S. B. Wells—Boiler Feeder.

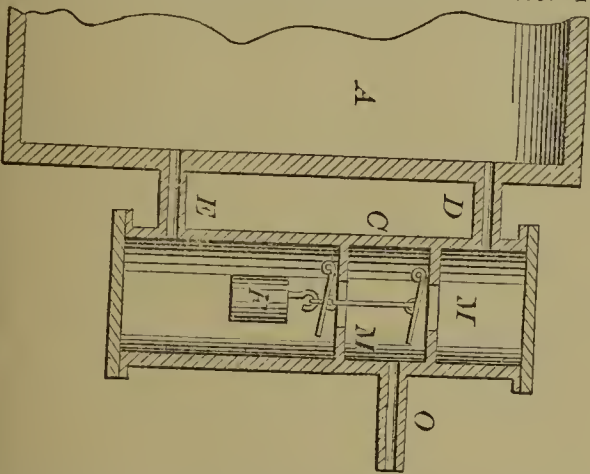

54797—W. Weaver—Cherry  
Stoner.

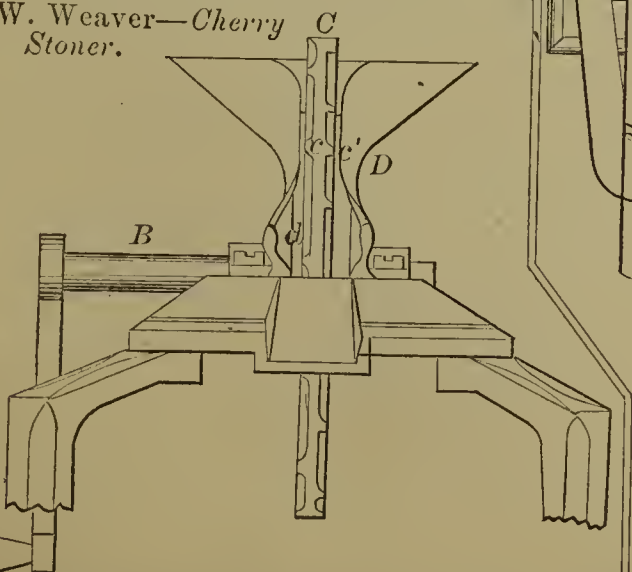

54800—D. White—  
Corn Plover.

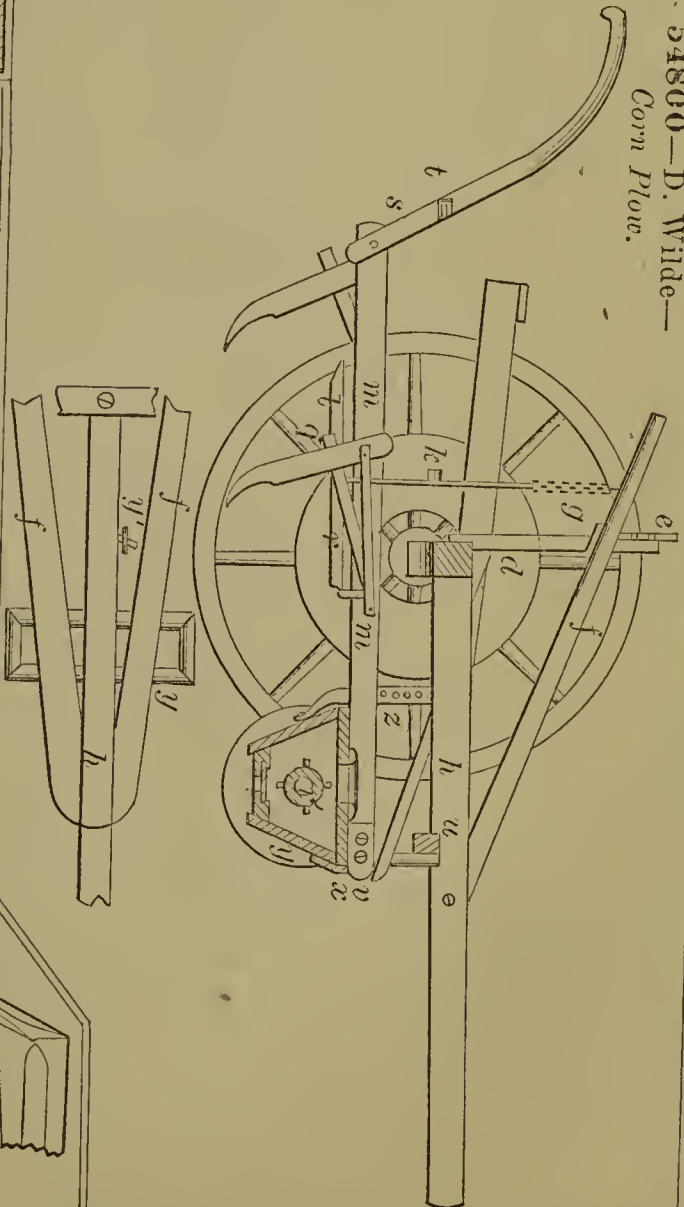

54806—Wirsching & Zoehle—  
Billiard Register.

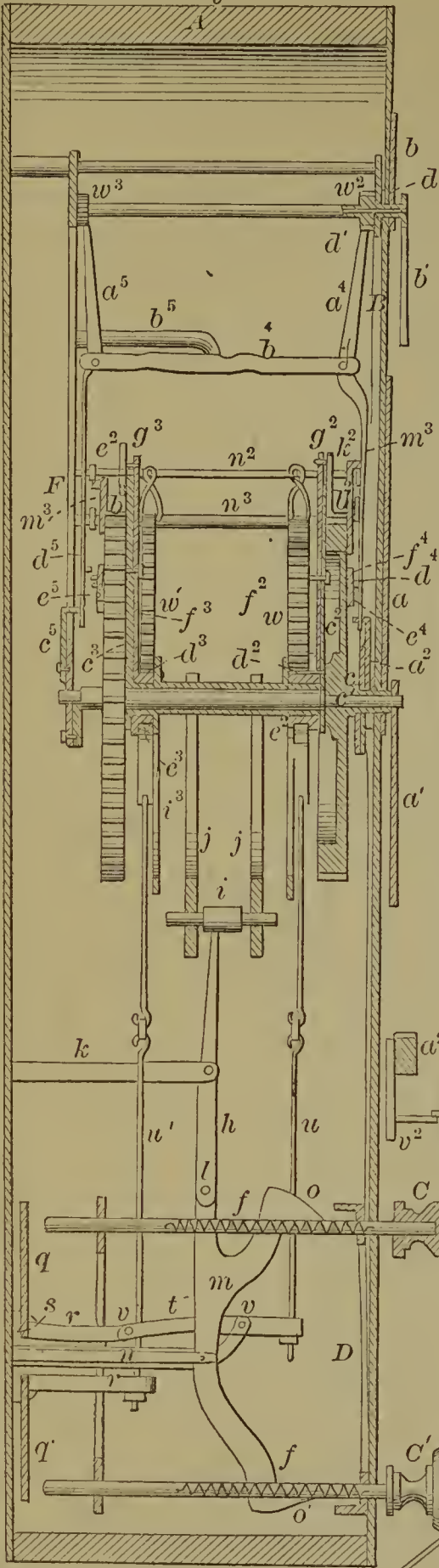

54801—A. A. Wilder—Propeller.

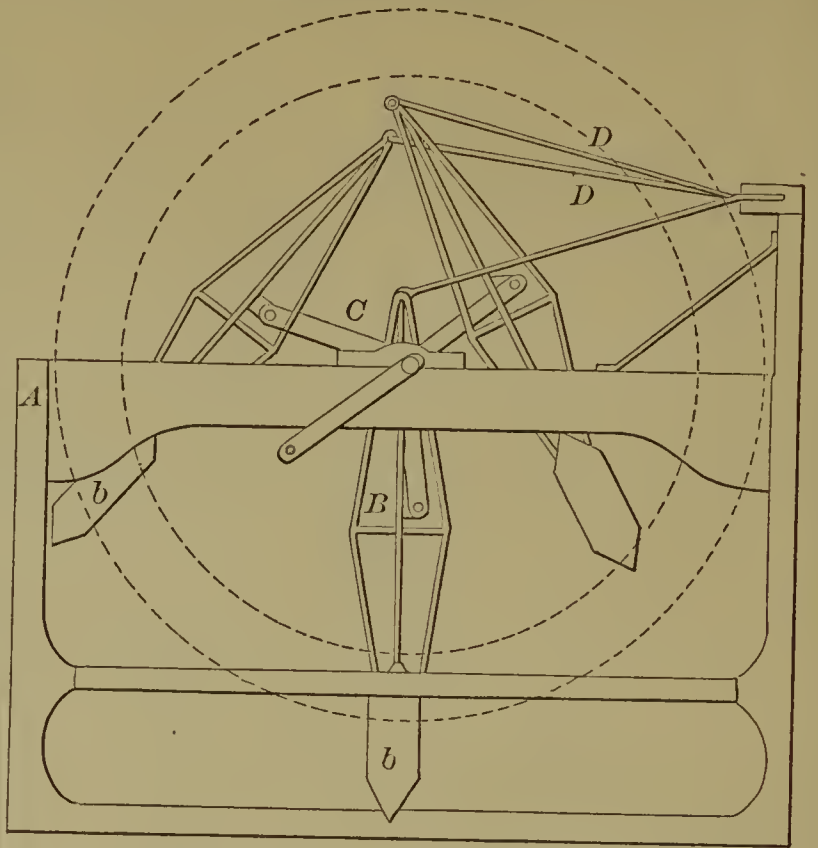

54805—S. C. & S. Winslow—Floor Clamp.

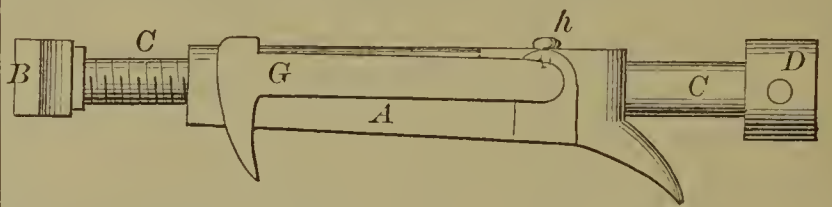

54803—J. J. Wilkins—Buckle.

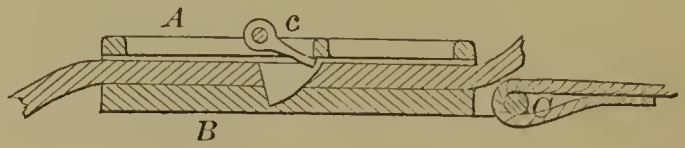

54804—J. M. Wilkinson—Adjustable Sandal.

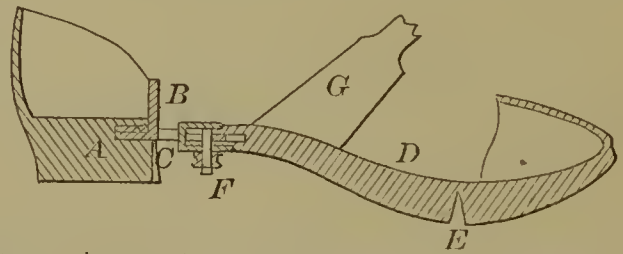

54807—O. E. Woods—Slings Arms.

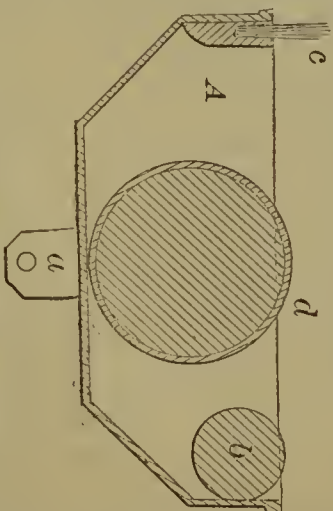
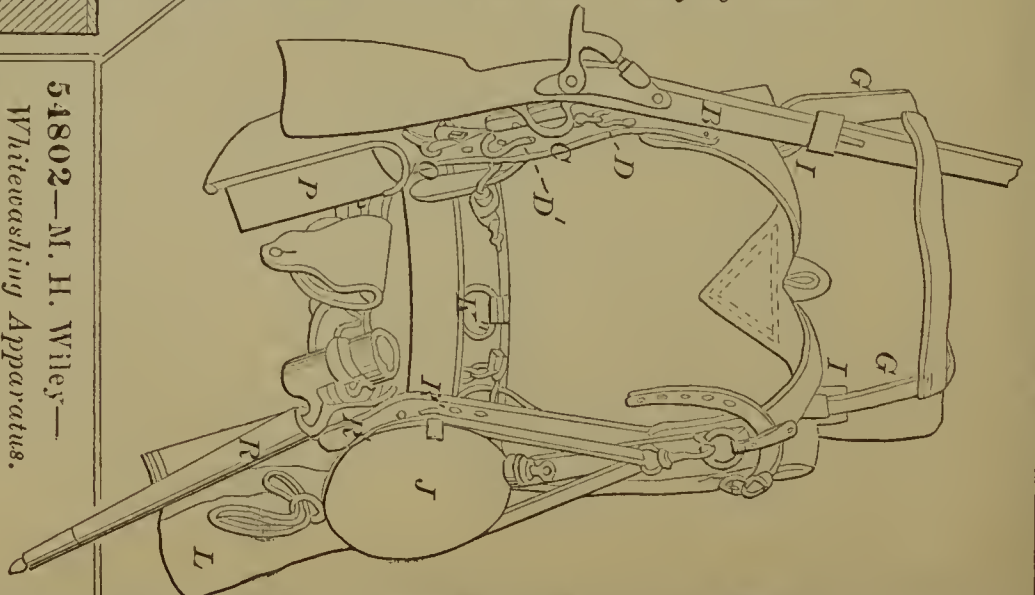

54802—M. H. Wiley—  
Whitewashing Apparatus.

54808—M. B. Wright—Foot Stove.

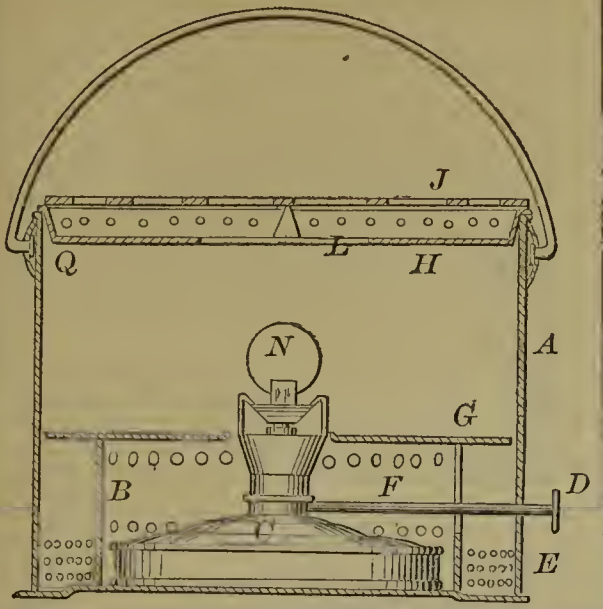

54810—R. S. Adams—For Securing Hoops of Bales.

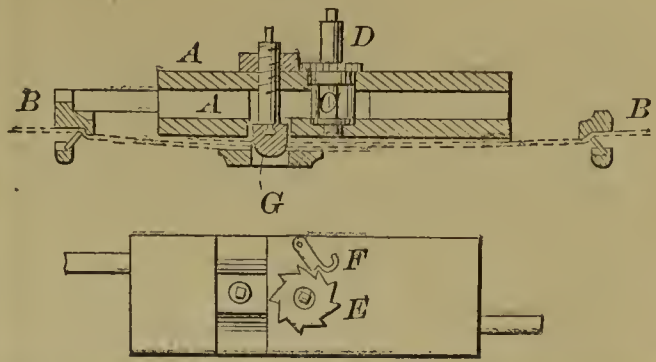

54809—L. Zitsel—For Coiling Hoops of Wood.

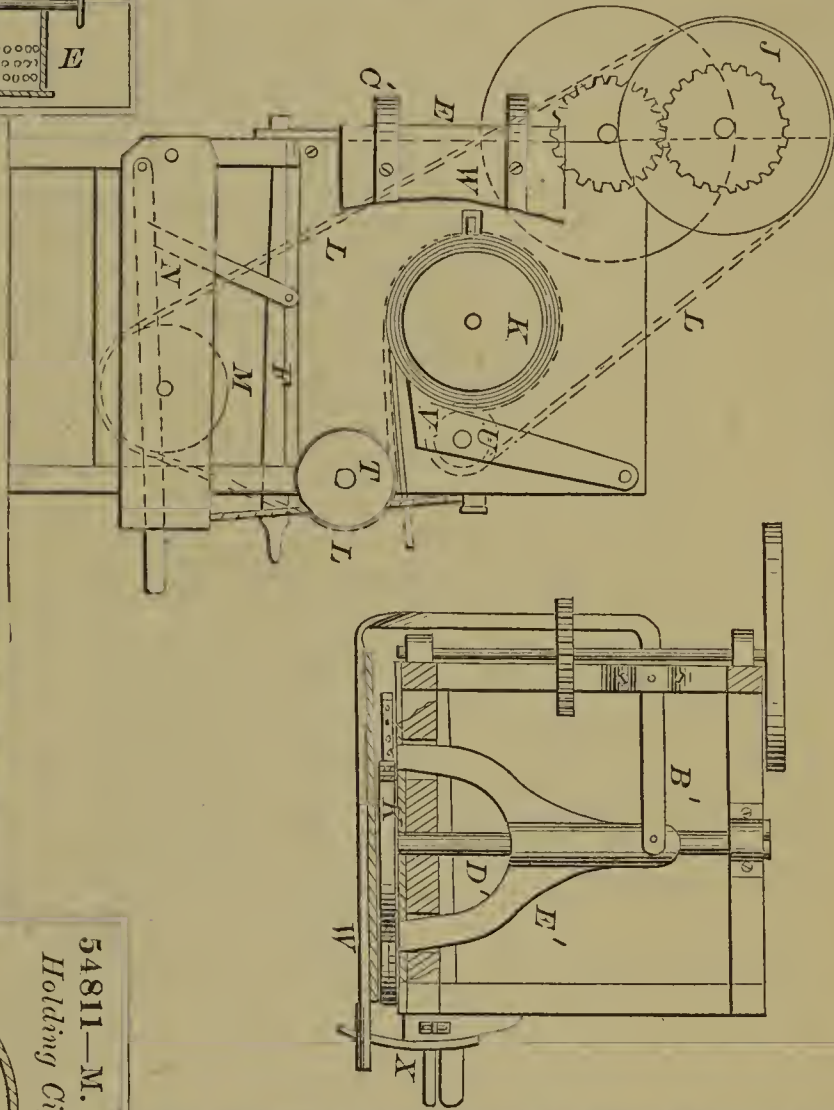

54812—J. M. Armour—Knitting Machine.

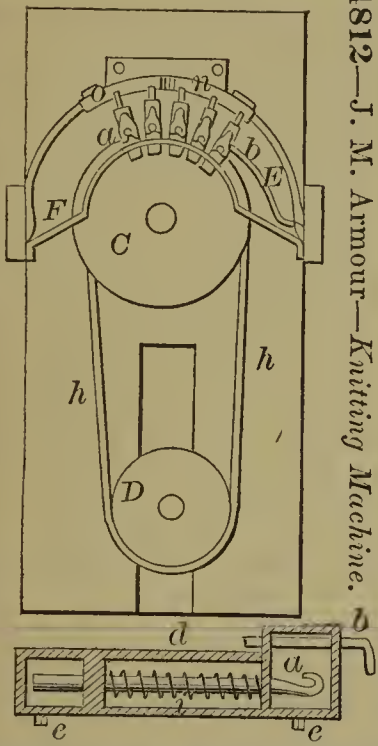

54811—M. Ali—Clamp for Holding Cigars for Tying.

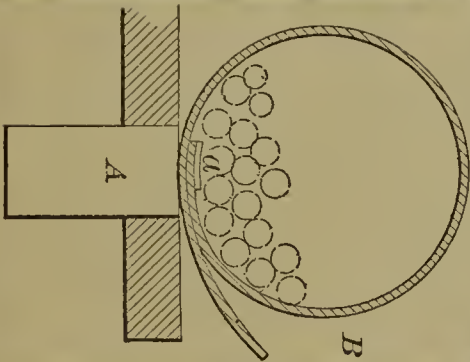

54814—A. N. Beach—Heating Stove.

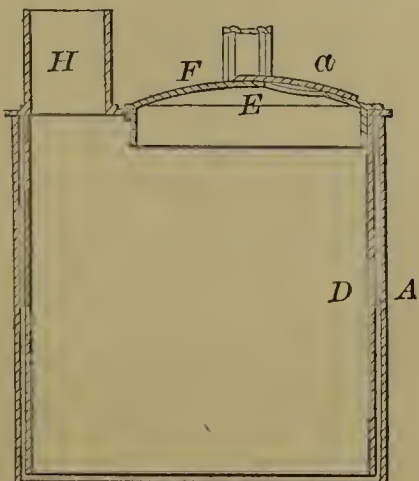

54813—J. G. Baker—Saw Grinding Machine.

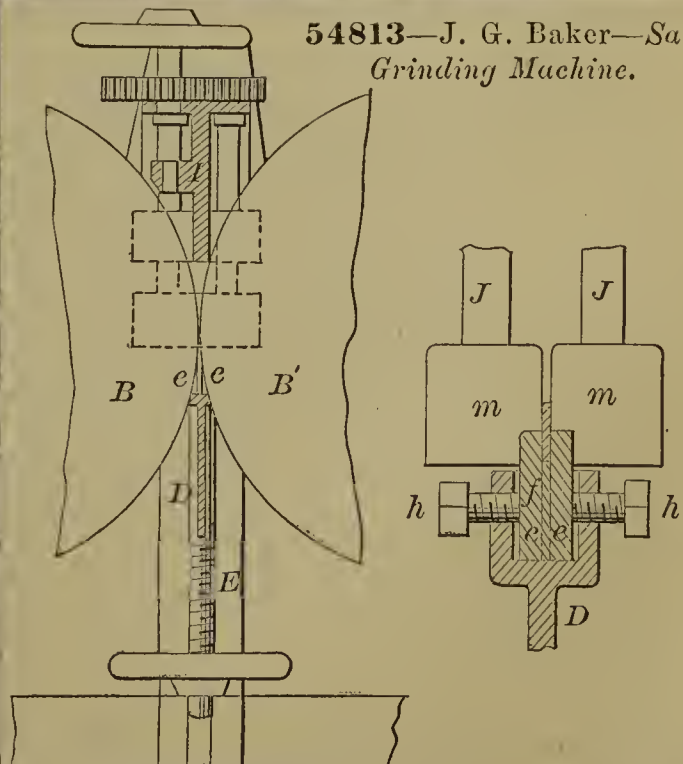

54815—B. Brazelle—Self-Rocking Cradle.

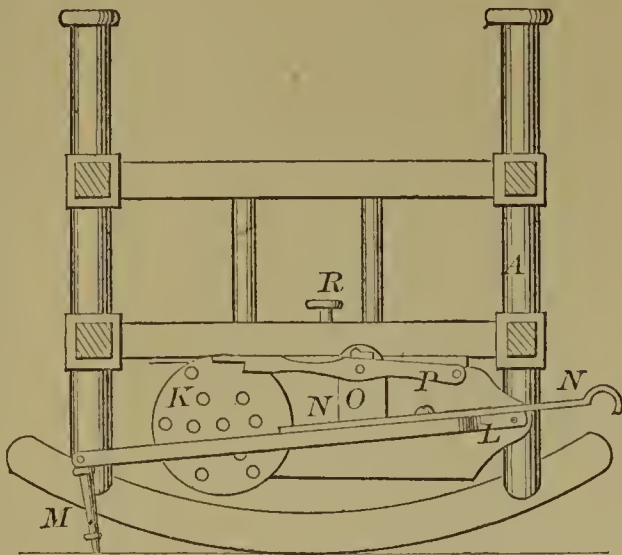

54817—D. Howarth—Dinner Pail.

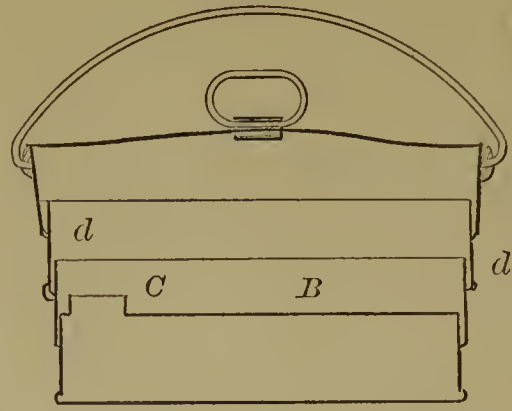

54819—M. Moriarty—Clothes Sprinkler.

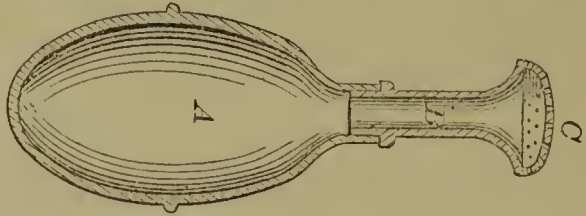

54816—G. N. Goodspeed—Feeding Mechanism for Sewing Machines.

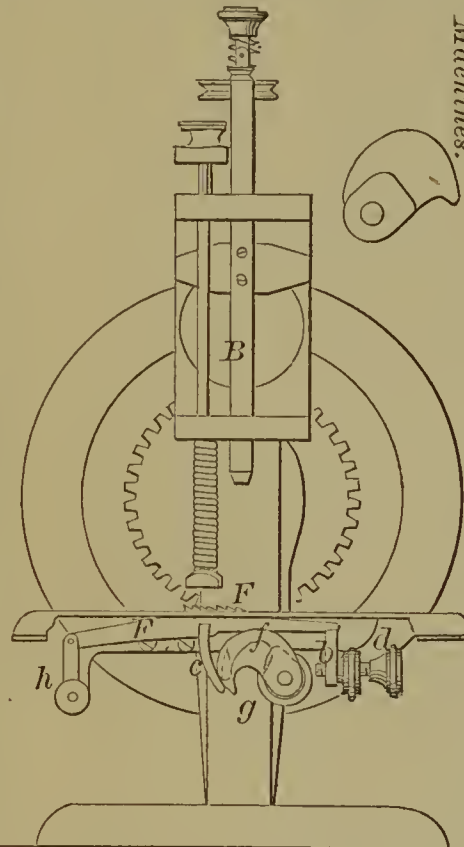

54820—A. G. Page—Pipe Tongs.

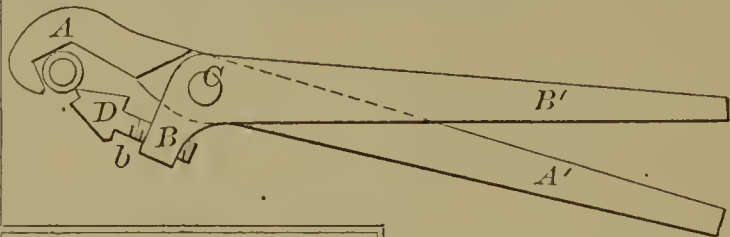

54818—E. Lockwood—Operating Sashes of Ventilating Windows.

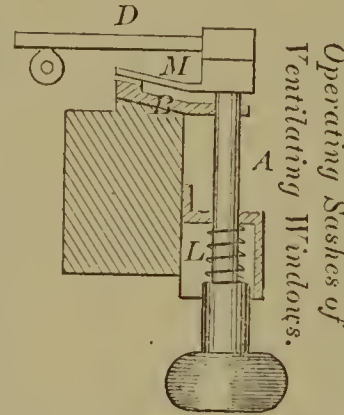

54823—Rees & Graham—Ditching Machine.

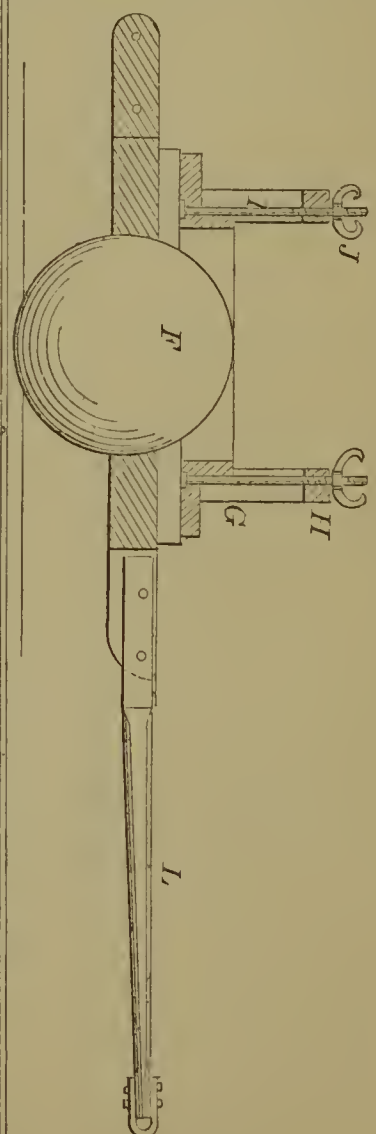

54822—J. T. Parbour—Grain Elevator.

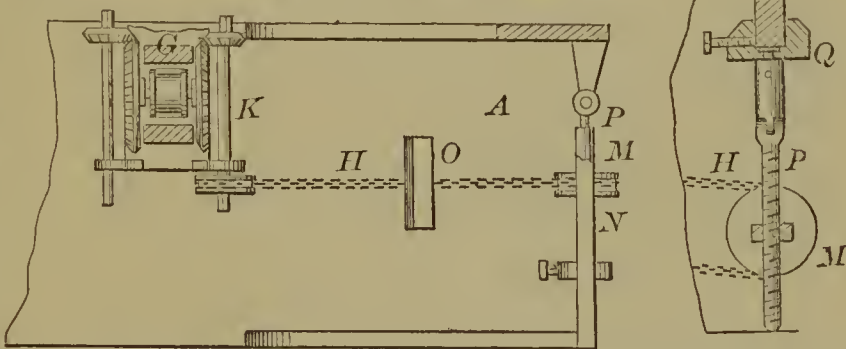

54821—J. Parker—For Boarding and Graining Leather.

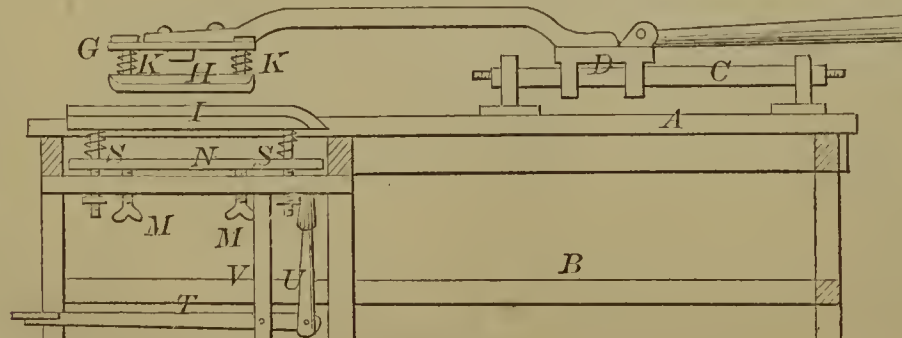



54824—E. A. Turner—Steering Apparatus.

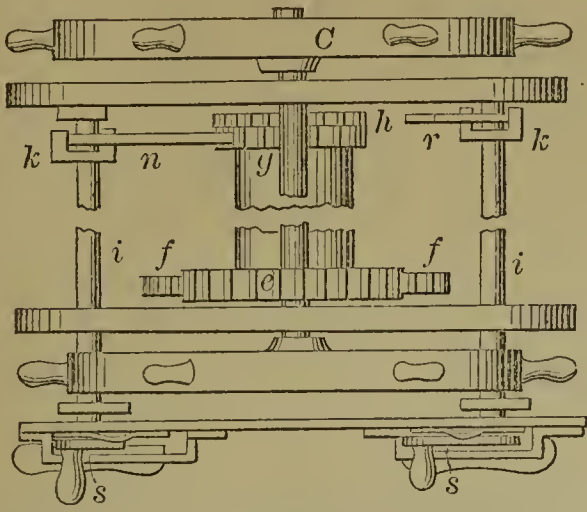

54827—J. Woodrough—Saw.

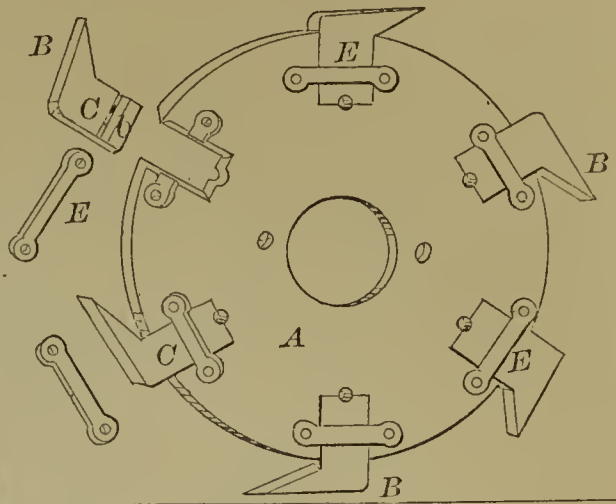

54831—F. A. Lange—Watch.

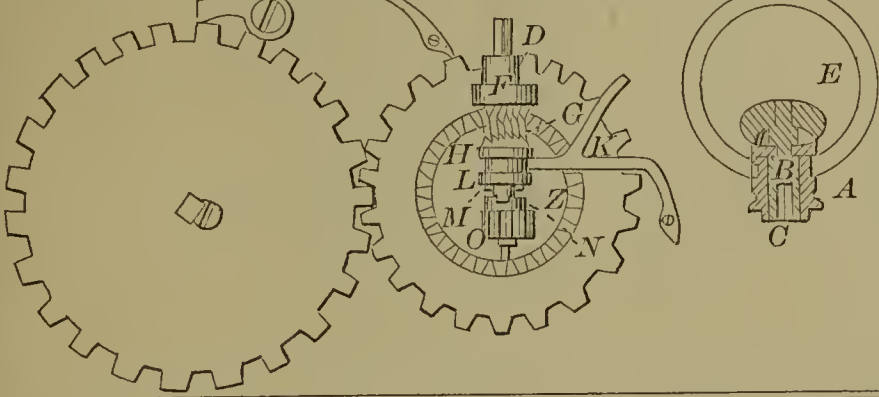

54830—R. Eaton—Store for Curs.

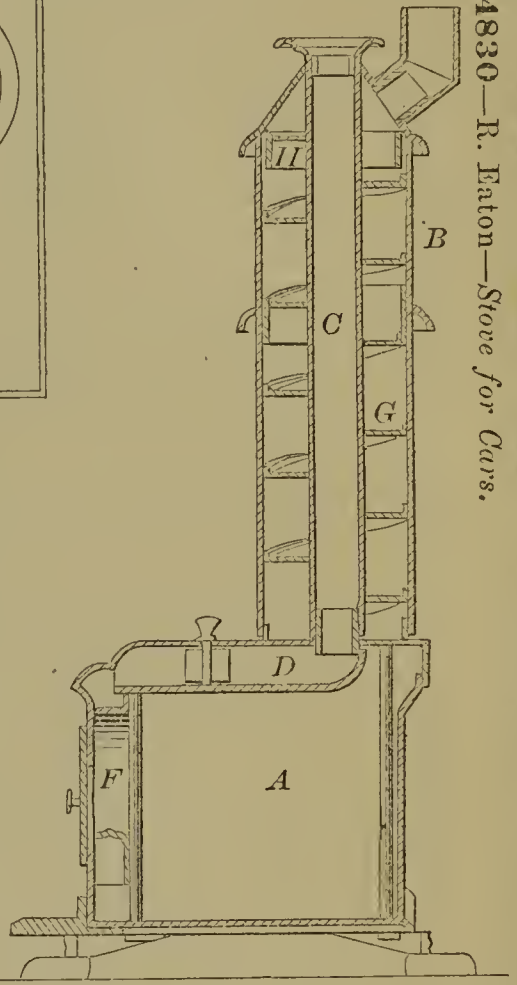

54828—F. Carrel—Seat and Back for Chairs.

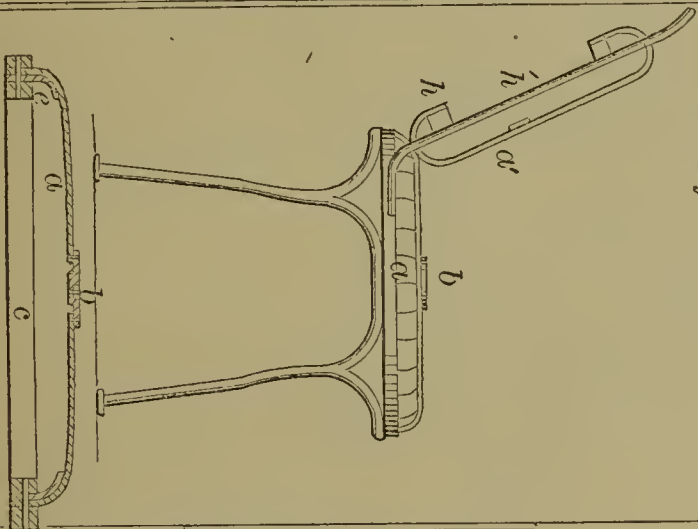

54826—S. Williams—Mould for Casting Curved Pipes.

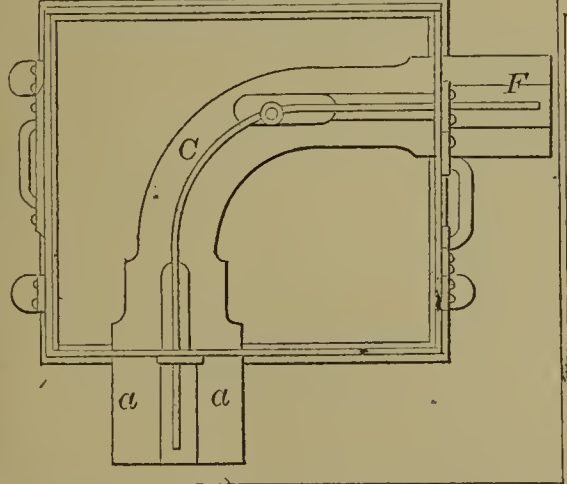

54825—G. W. Wait—For Making Spikes.

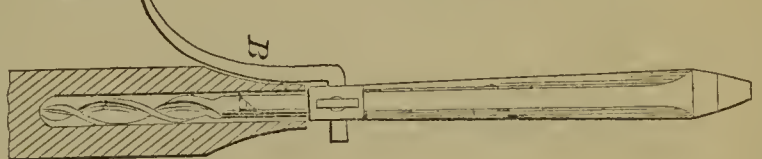

54833—Loeke, Warrington, Carrett, Marshall & Telford—Mining Coal, Minerals, &c.

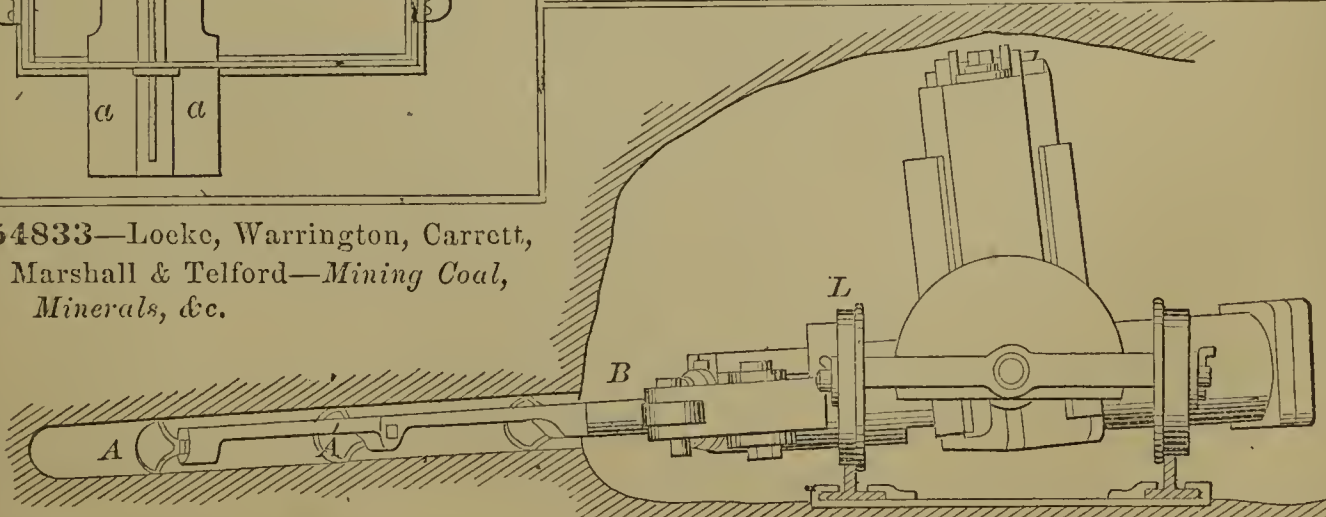

54834—G. T. Jones—Manufacturing Bank Notes.

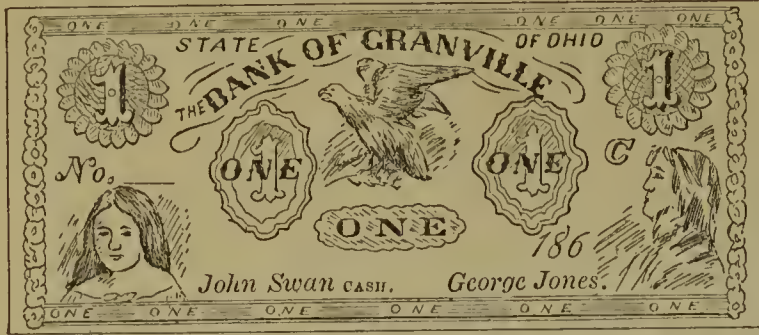

54840—C. H. Bassett—Coupling for Carriage Thills.

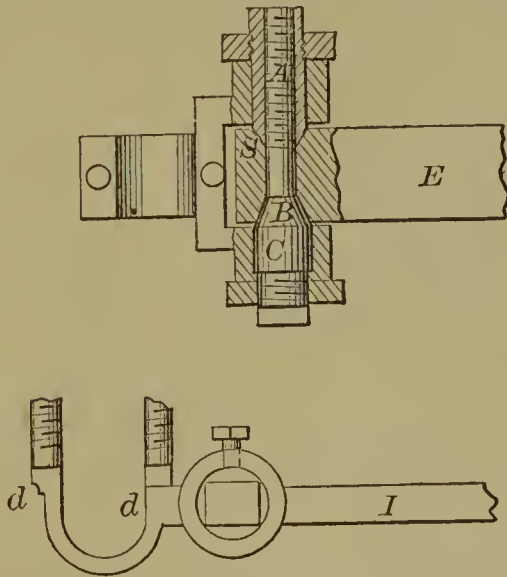

54839—

E. H. Ashcroft—For Preparing Peat.

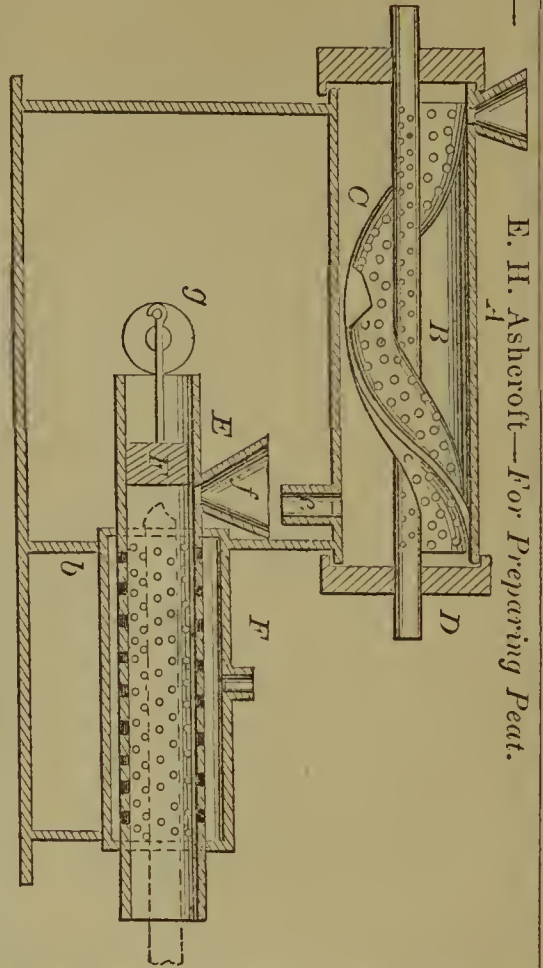

54836—M. E. Abbott—Drilling Machine for Wells.

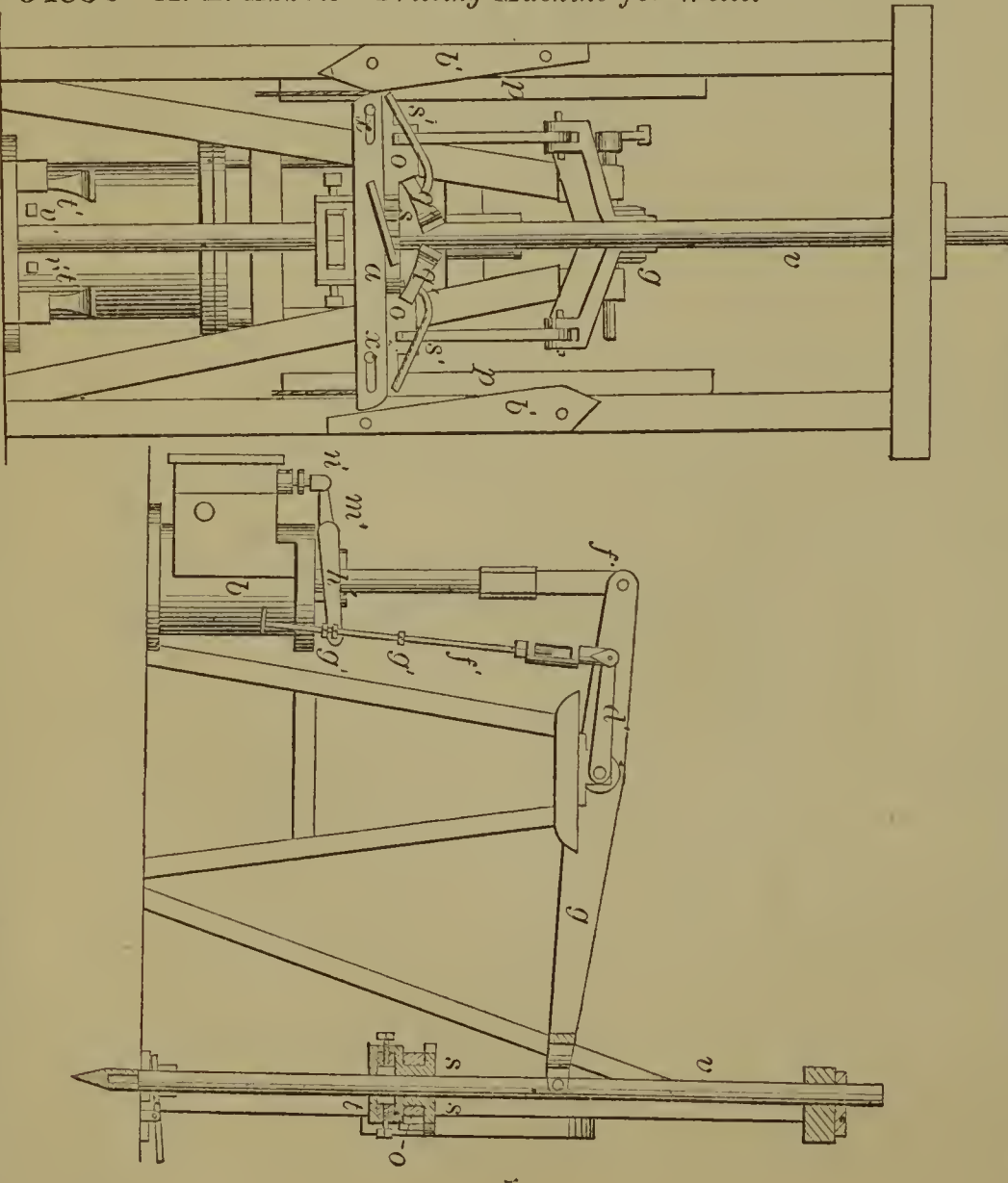

54837—J. Adt—Riveting Machine.

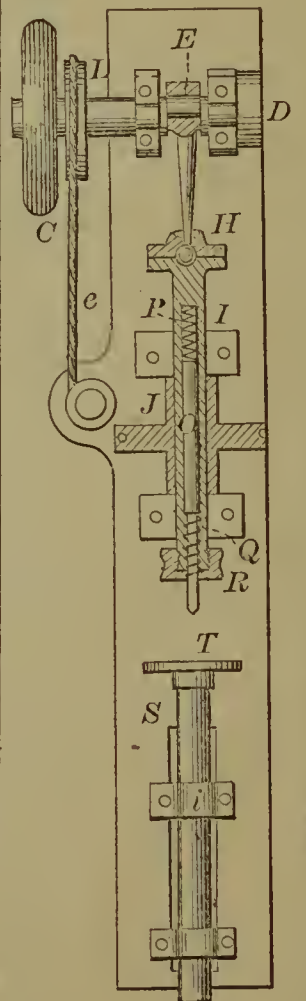

54841—J. R. Batey—*Hand Protector for Sad Irons.*

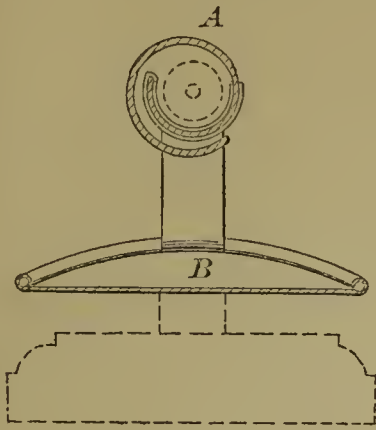

54842—F. M. Birdsall—*Furrowing Machine.*

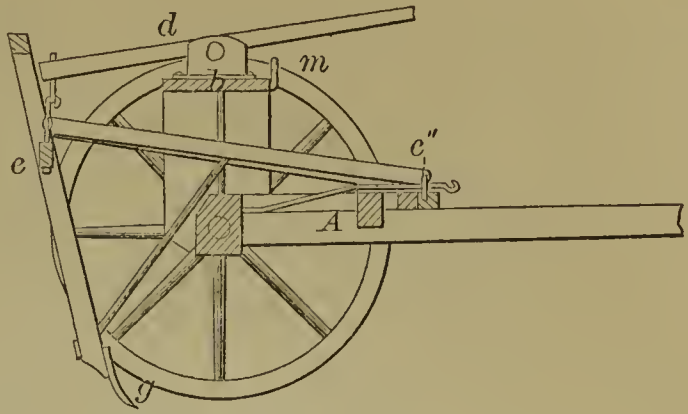

54843—E. S. Bitner—*Sash Fastening.*

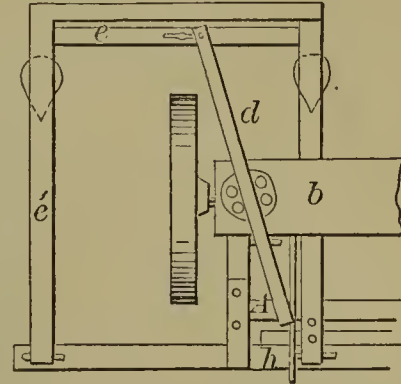
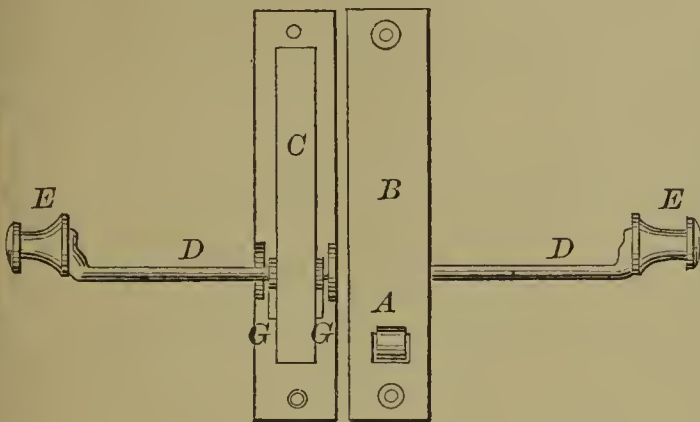

54844—H. E. Bodwell, Jr.—*Sewing Machine Guide for Stitching Hats.*

54845—B. P. Bower—*Hydrant.*

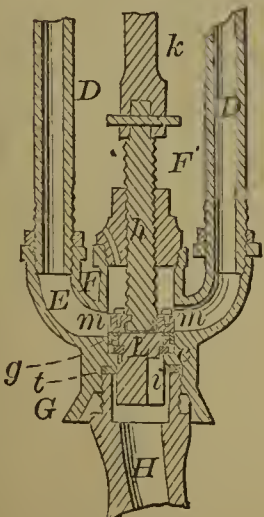
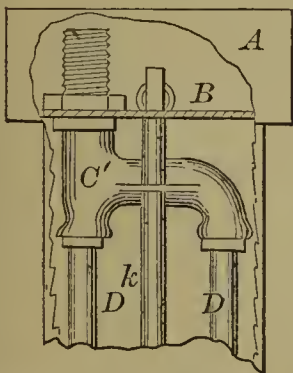
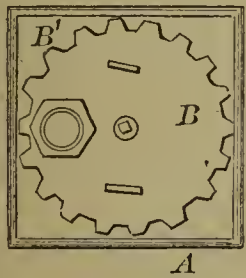

54846—J. C. Bridgman—*Churn.*

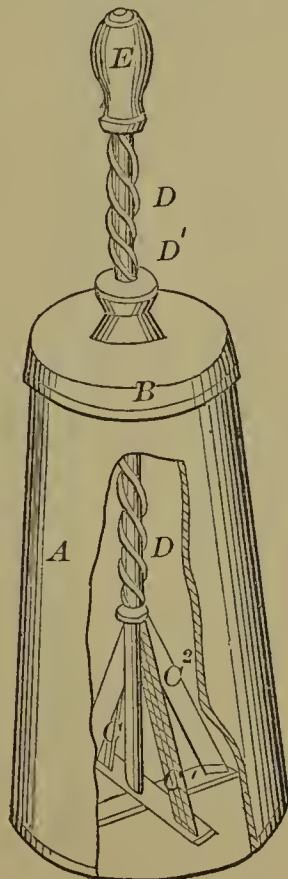
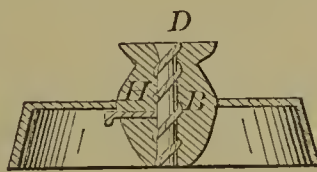

54847—C. F. Brown—*Anchor.*

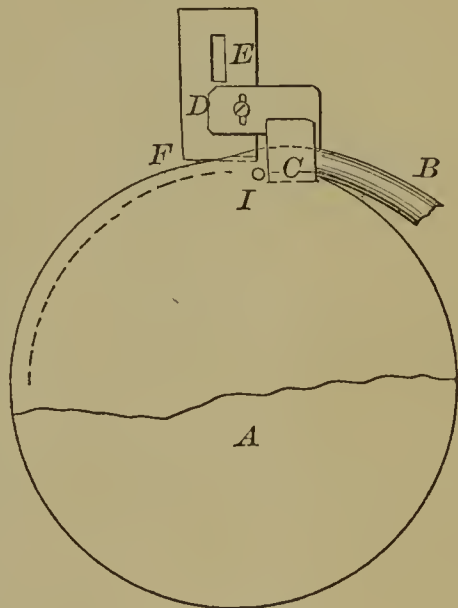

54847—C. F. Brown—*Anchor.*

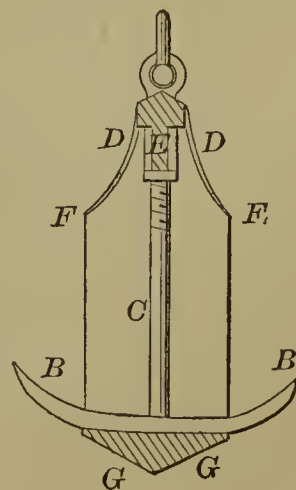

54848—L. & M. Bradley—*Croqueterie.*

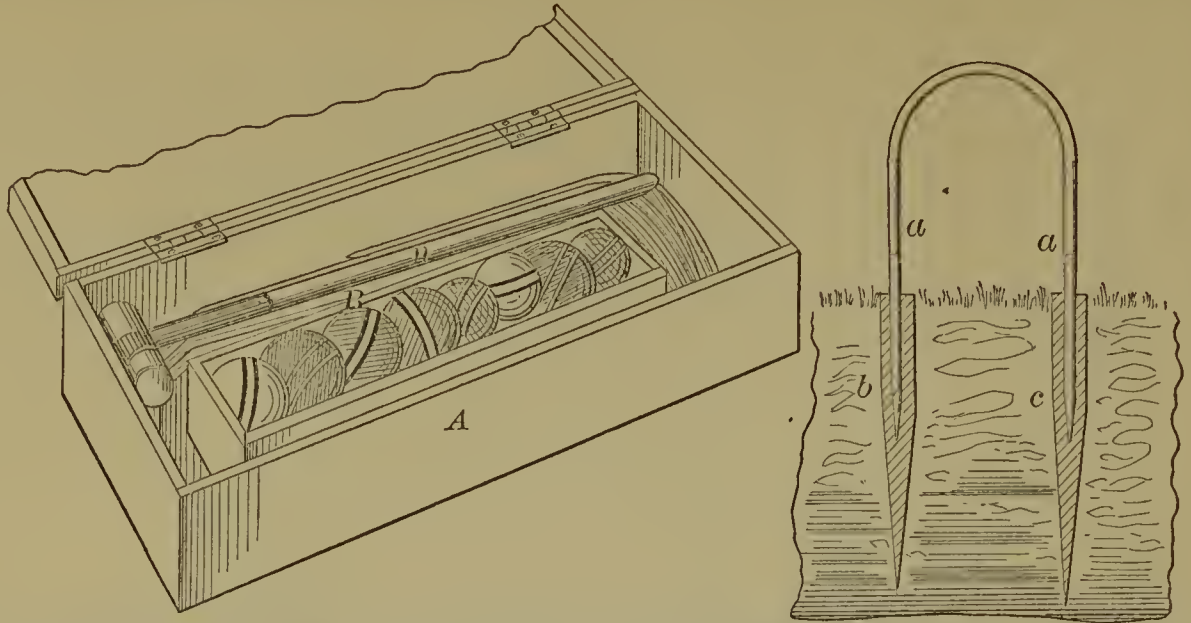

54849—T. S. Brown—*Trunk Lock.*

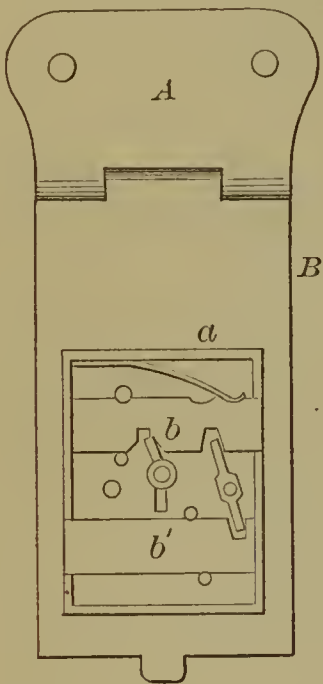

54850—P. Budenbach—*Headlight for Engines.*

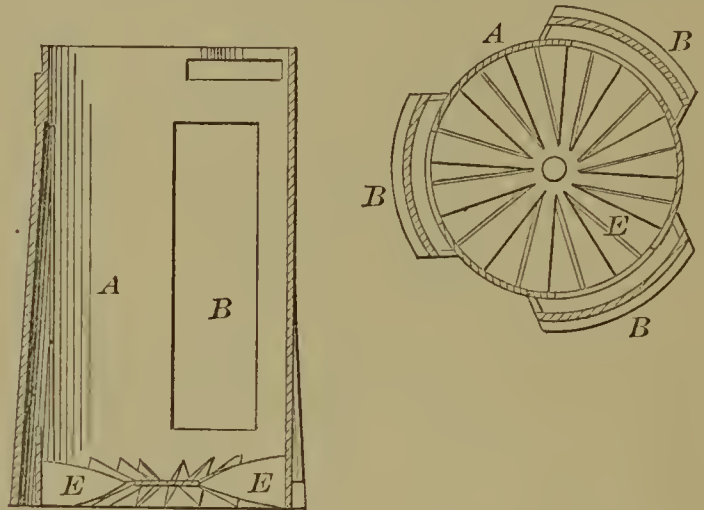

54853—Butterfield & Green—*Railroad Rail.*

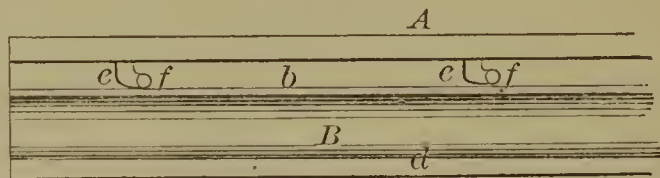

54851—Burnett & Comstock—*Steam Valve.*

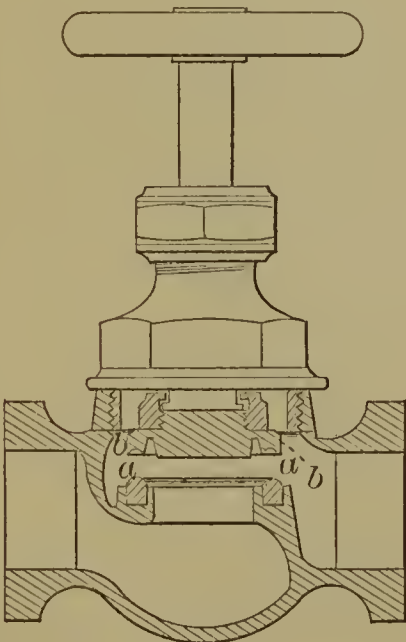

54852—E. G. Burnham—*Ice Pick.*

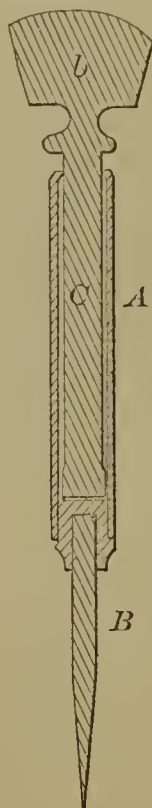

54854—H. F. Byerly—*Cultivator.*

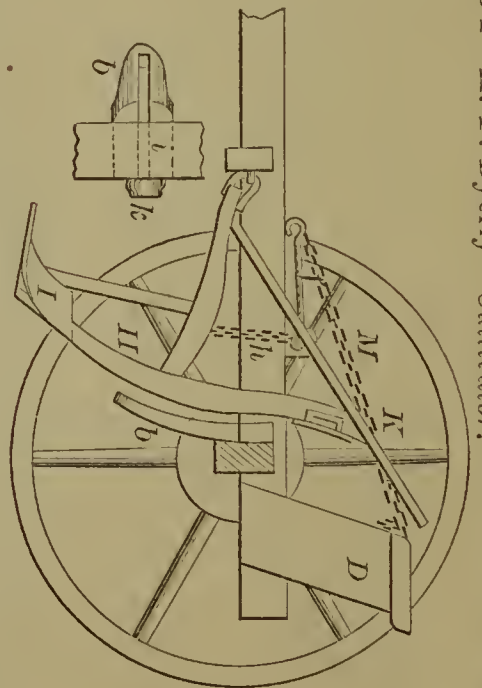

54855—C. E. Byers—*Switch Stand for Railroads.*

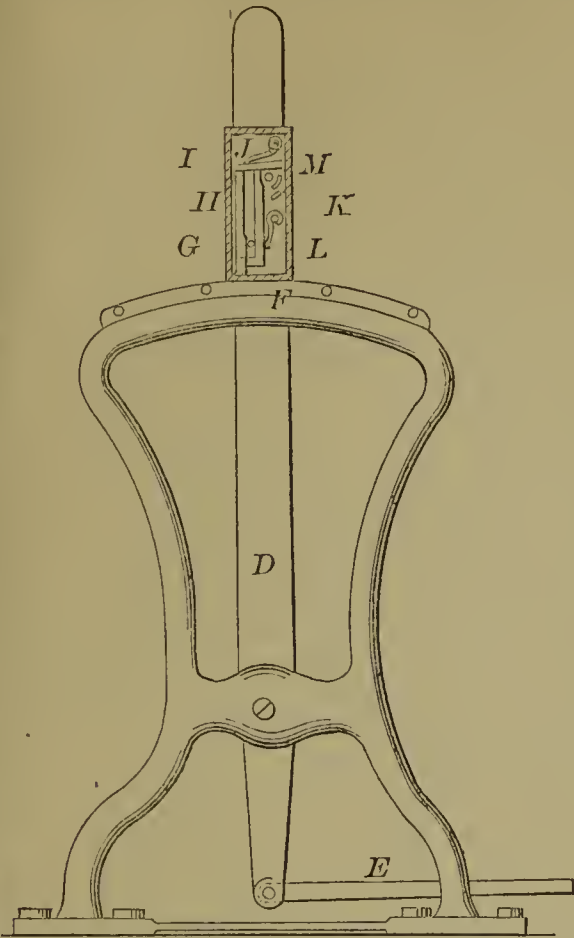

54860—Clark & Garretsen—*Mop Head.*

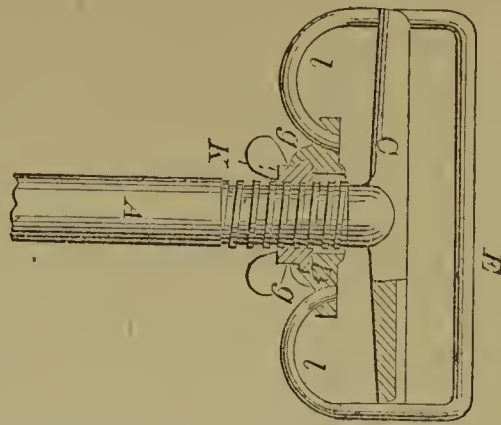

54859—J. B. Christian—*For Inducing the Flow of Oil.*

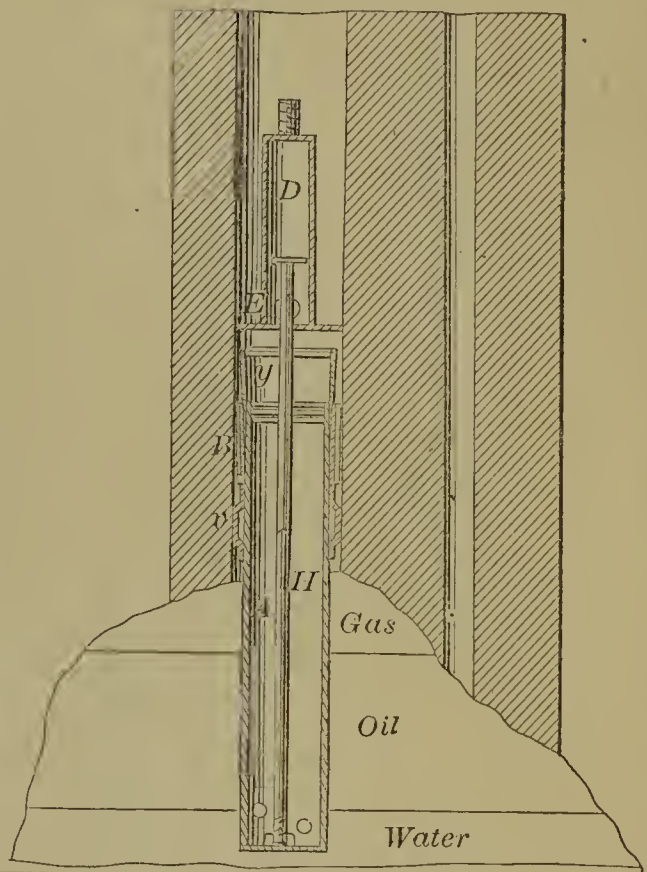

54857—G. C. Carver—*Flour Dipper, Measurer and Sifter.*

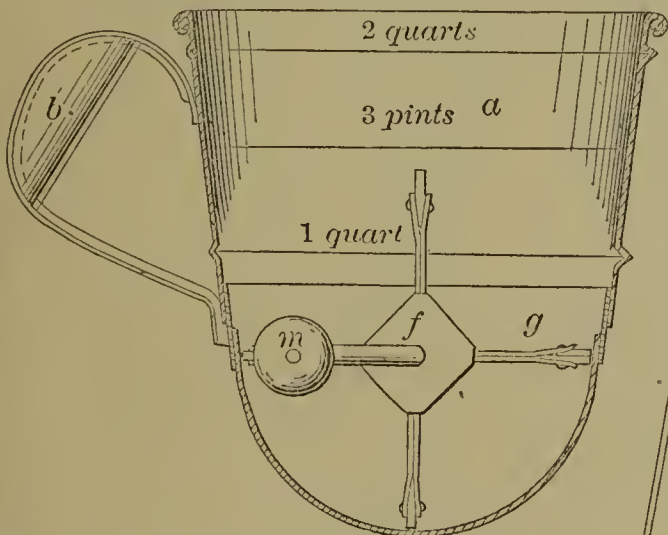

54861—A. Clift, Jr.—*Churn.*

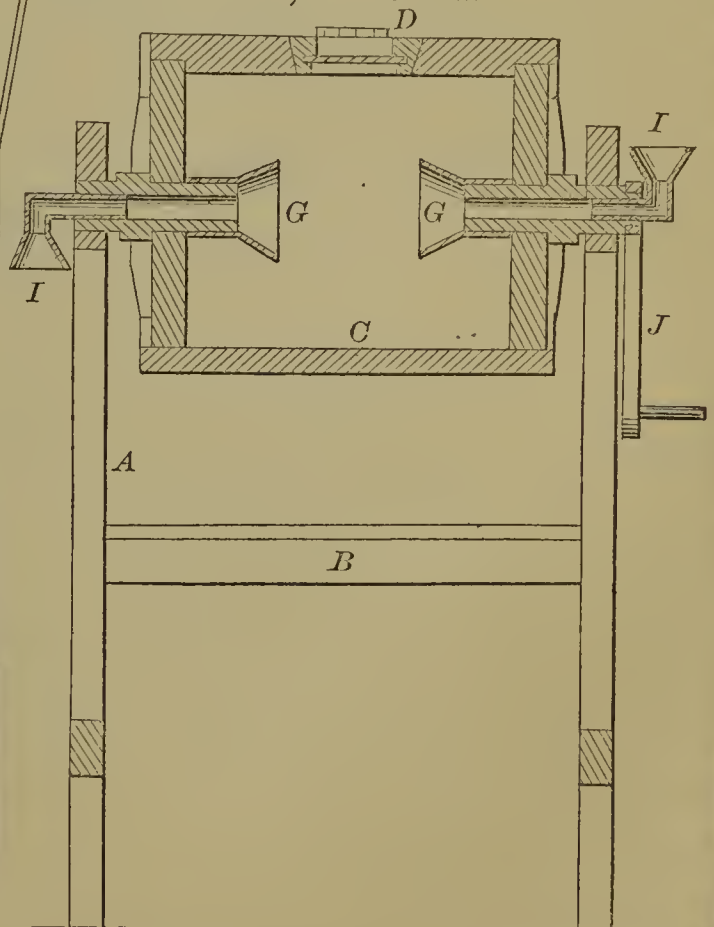

54856—W. Byfield—*Needle Wrapper.*

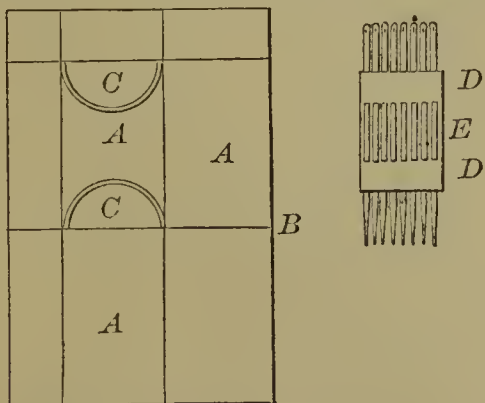

54858—E. Child, Jr.—*Paper Necktie.*

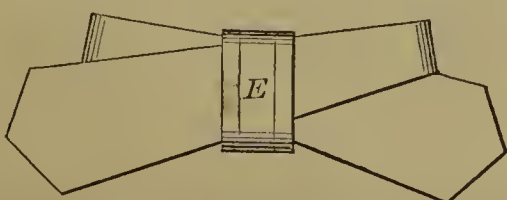

54862—Clinton & Munson—Horse Rake.

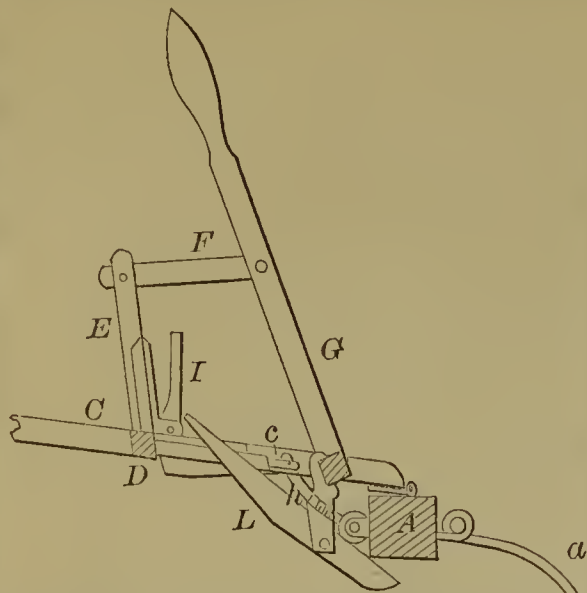

54864—S. Colahan—For Preparing Hay for Market.

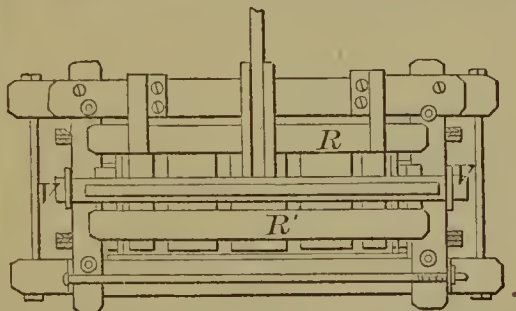
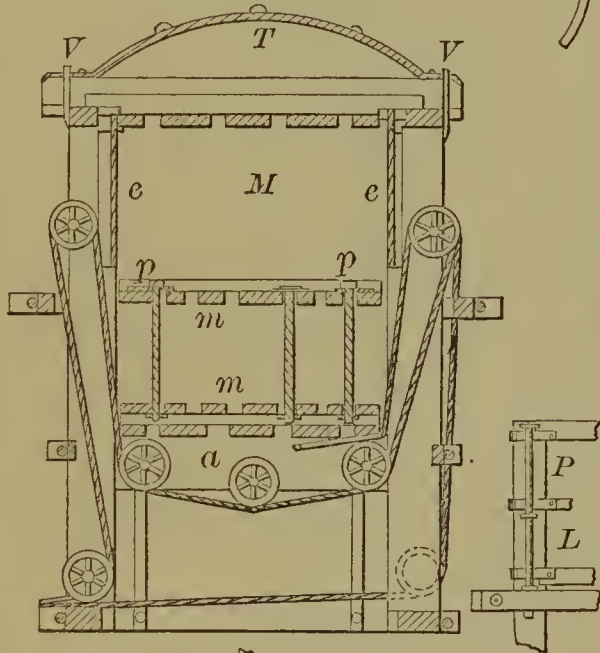

54868—D. W. Crocker—Railway Chair.

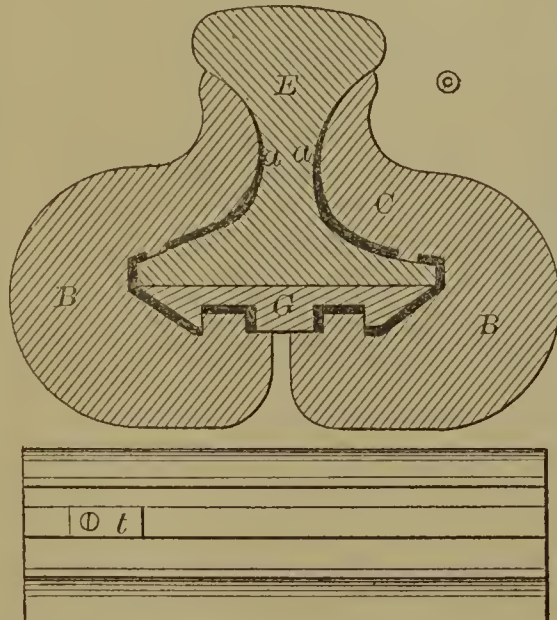

54863—J. W. Cochran—Chair, Sofa, and Car Seat.

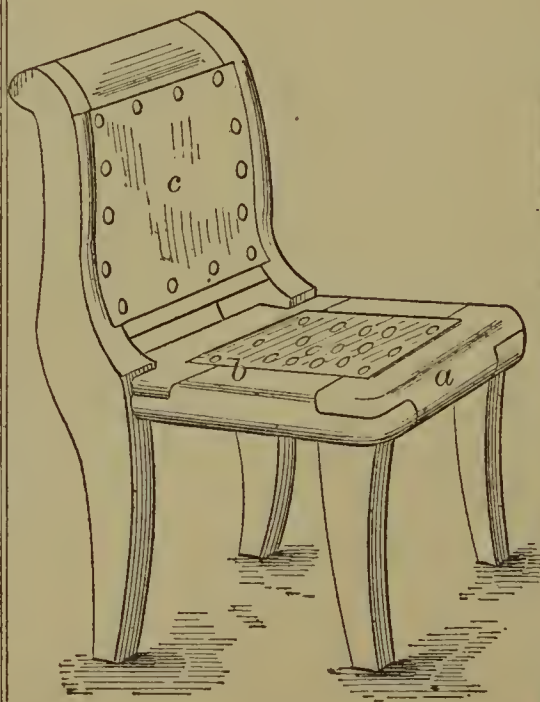

54866—J. P. Conkling—Detecting Check Box.

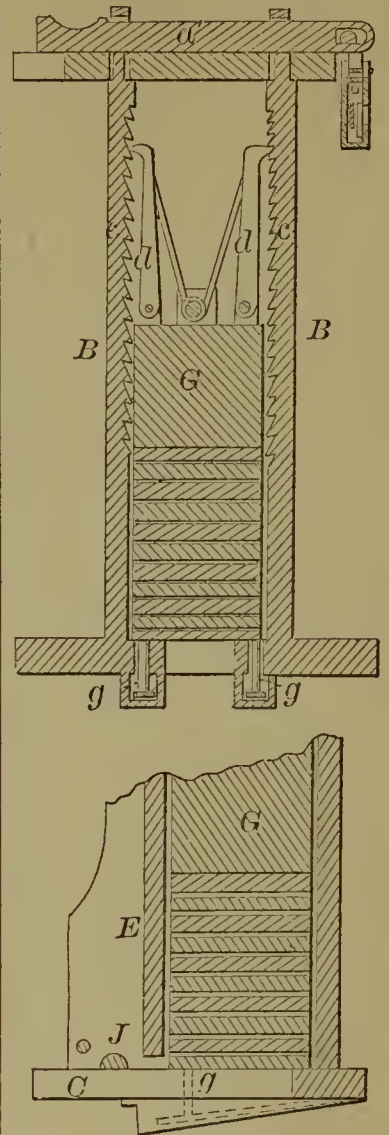

54865—L. O. Colvin—Cow Milker.

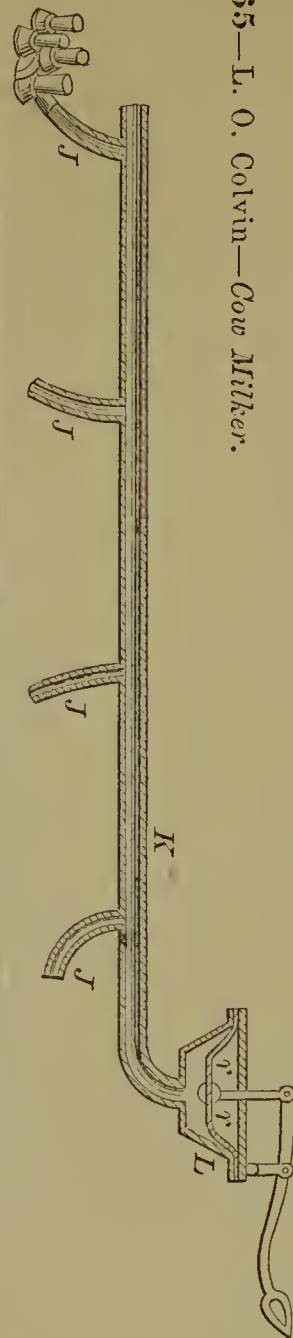

54867—R. Cornelius—Sand Pump.

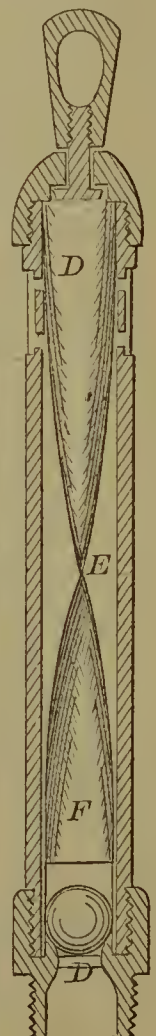

54869—M. C. Cronk—Chair.

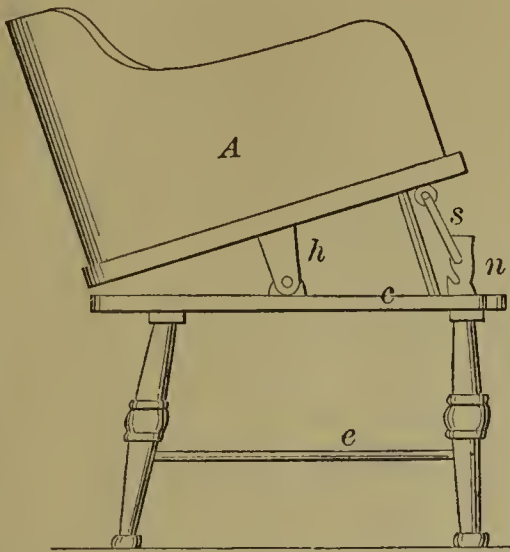

54871—C. F. Davis—Harvester Rake.

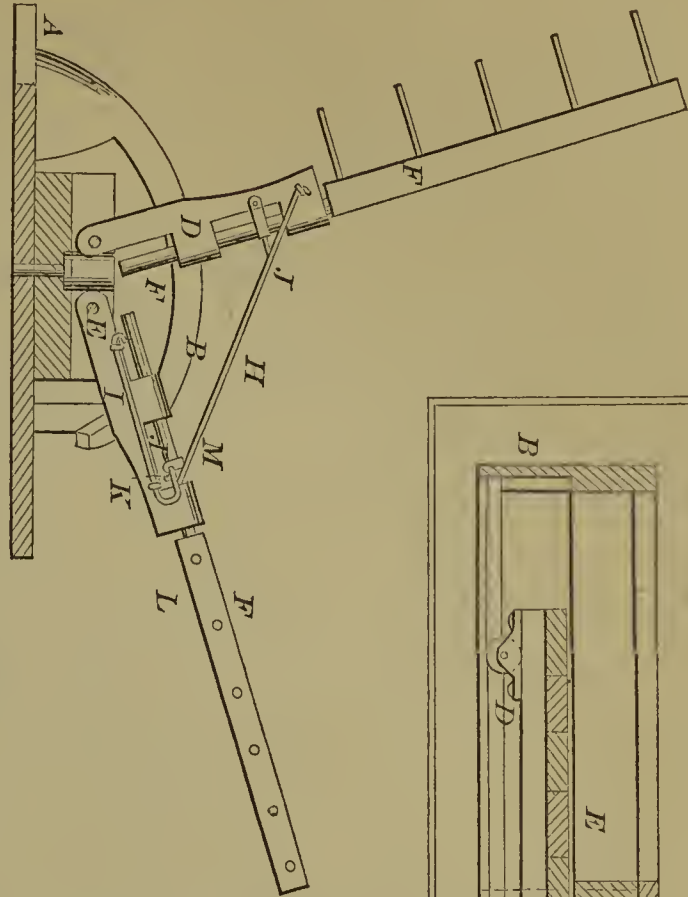

54872—H. G. Dayton—Stove for Cars.

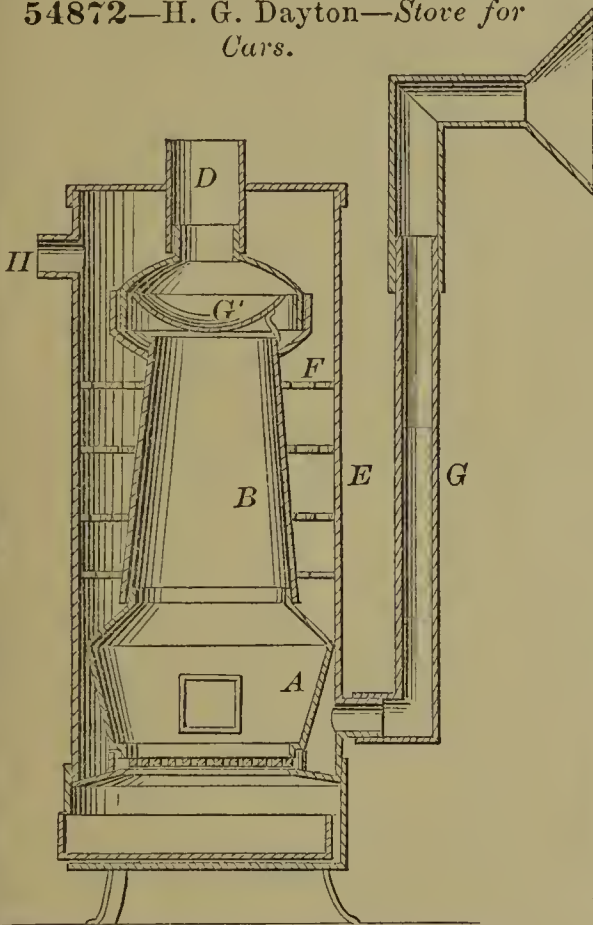

54870—J. W. Crossley—Making Pile Fabrics.

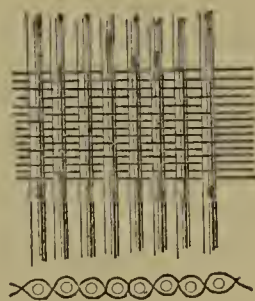

54874—M. S. Driggs—Hatchway Door.

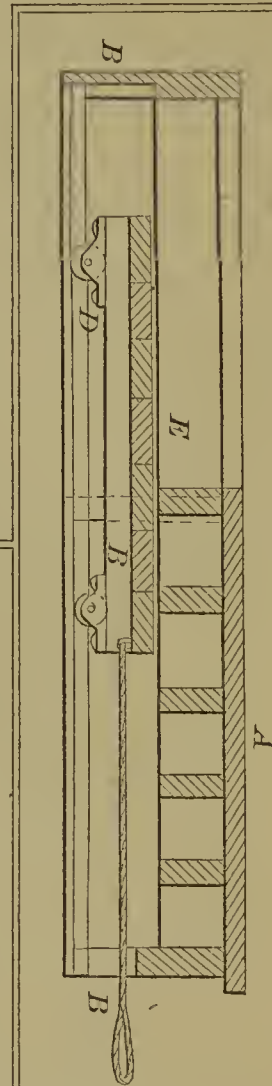

54875—M. Easterbrook—Reaping and Mowing Machine.

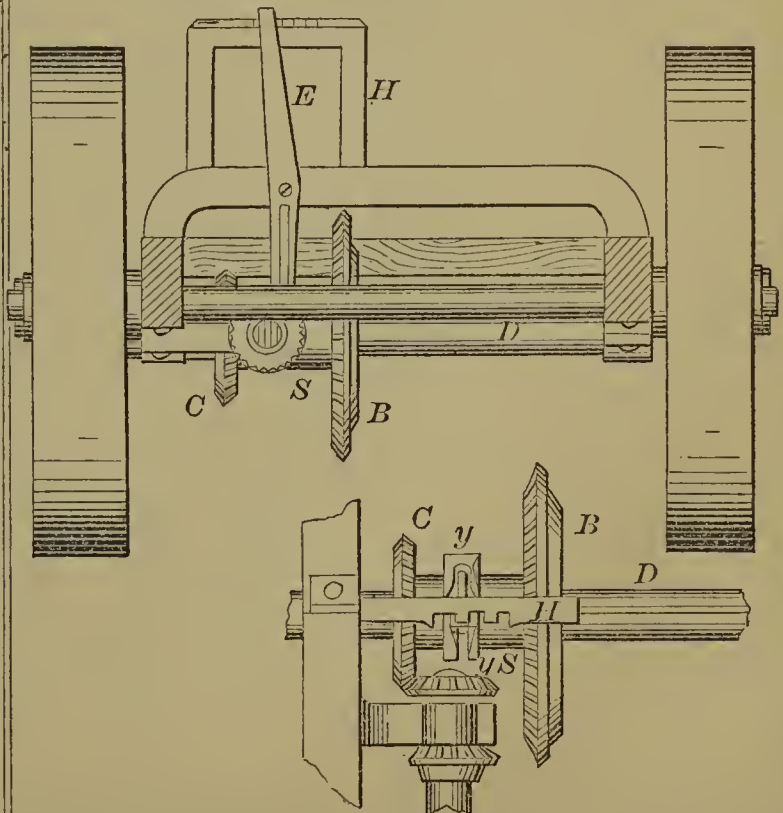

54873—J. Dennis, Jr.—For Turning and Pointing Screw Blanks.

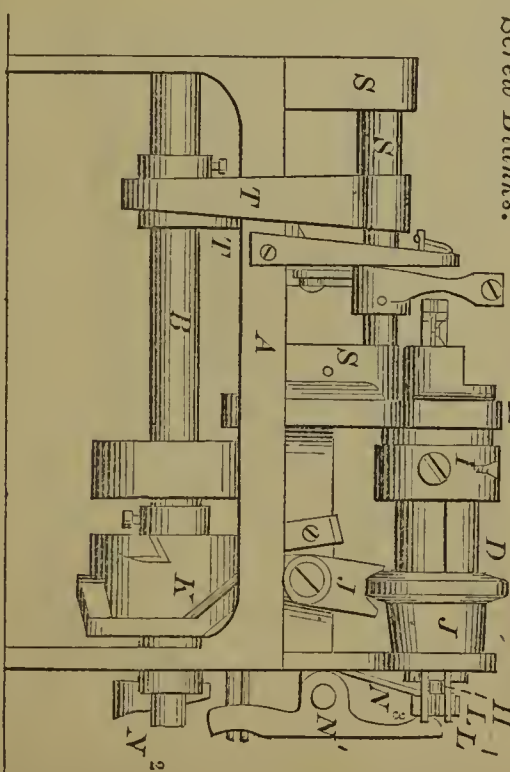

54876—M. Easterbrook, Jr.—Harvester.

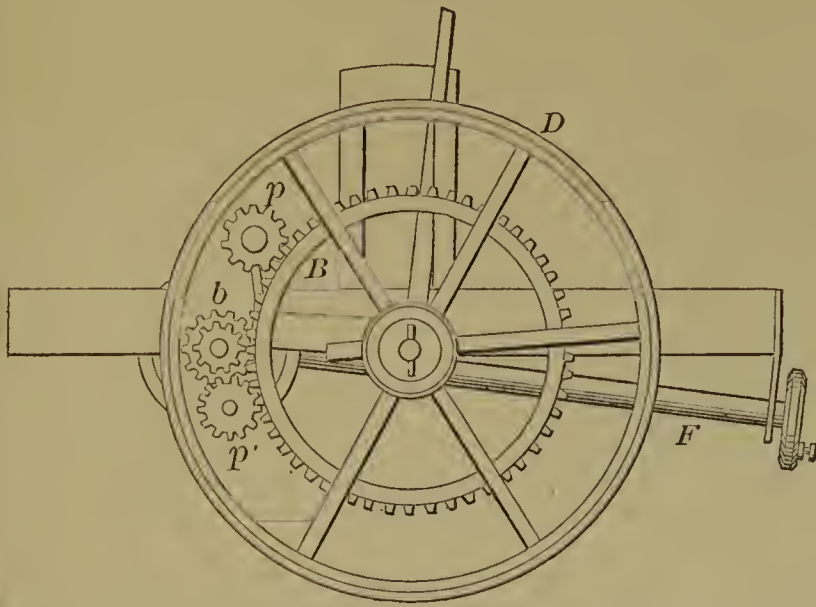

54881—N. T. Fogg—Pump.

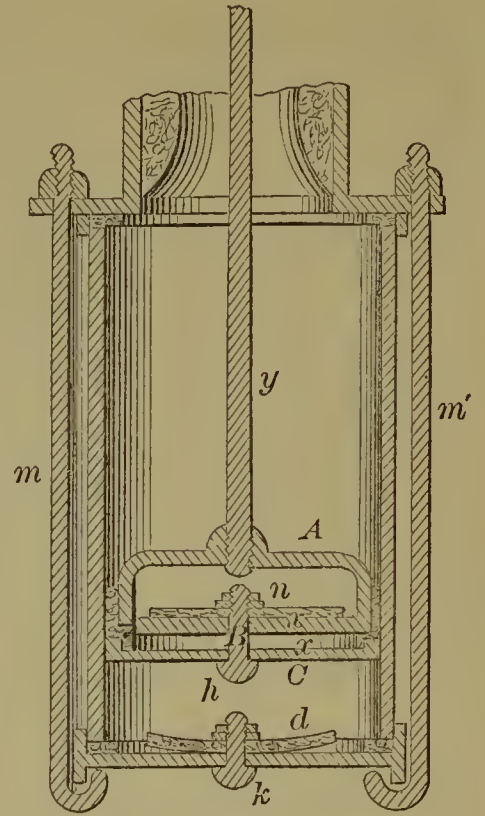

54877—T. Falloon—Bed Bottom.

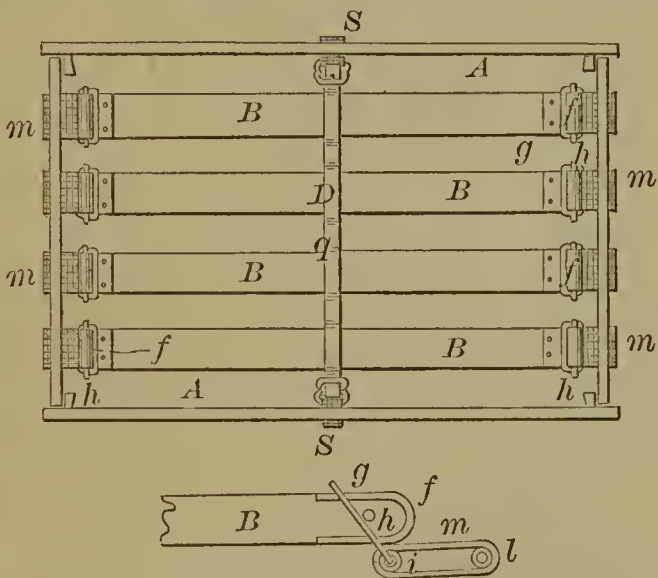

54878—B. S. Fletcher—Churn.

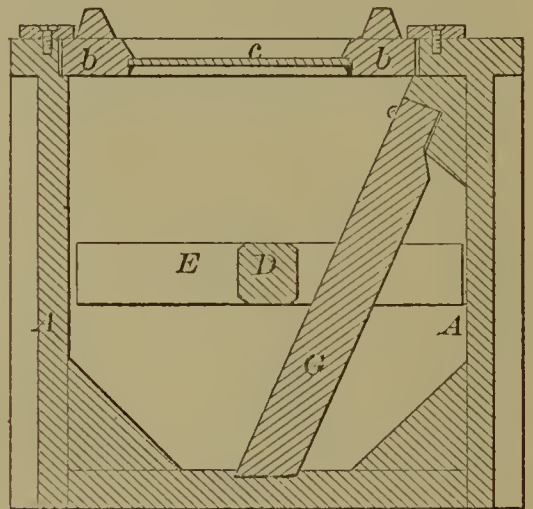

54880—D. C. Flint—For Stripping Cane.

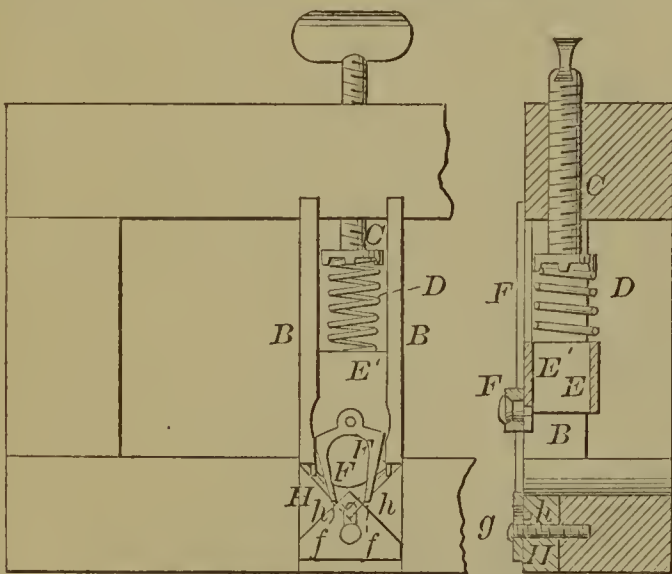

54879—J. H. Fletcher—Bed Bottom.

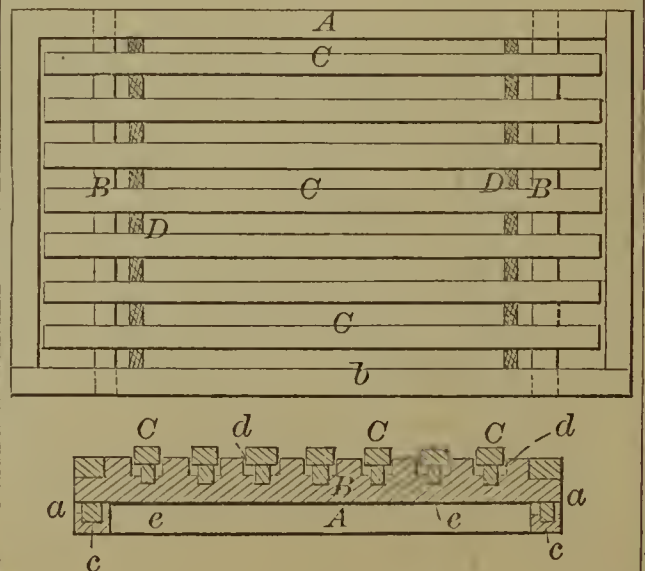

54882—G. F. Foote—Tool Holder for Dentists.

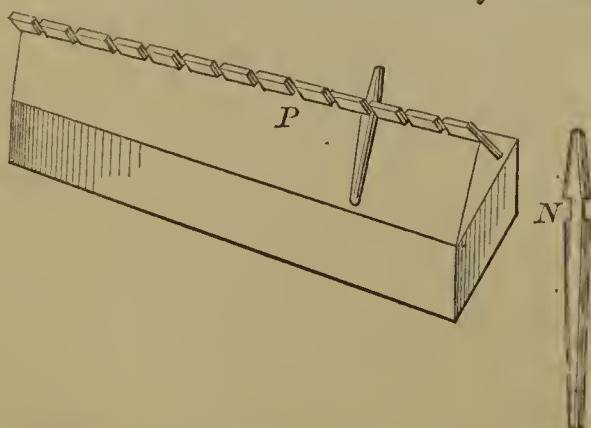



54884—J. Fowler—Ore Crusher.

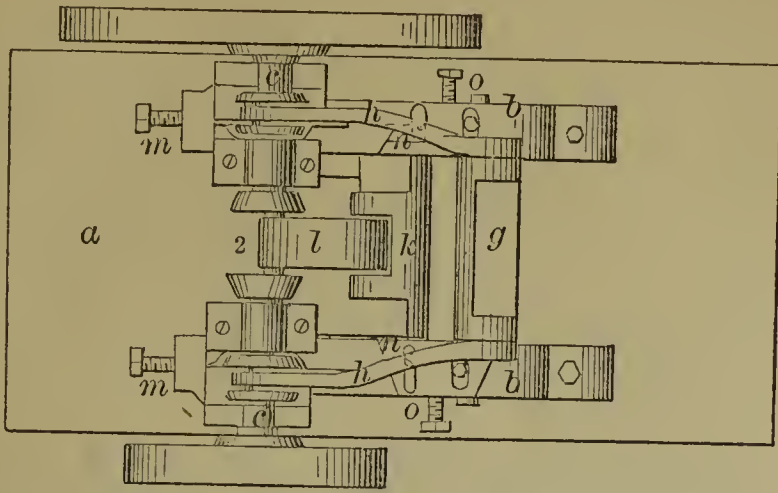

54888—G. P. Ganster—Wrench.

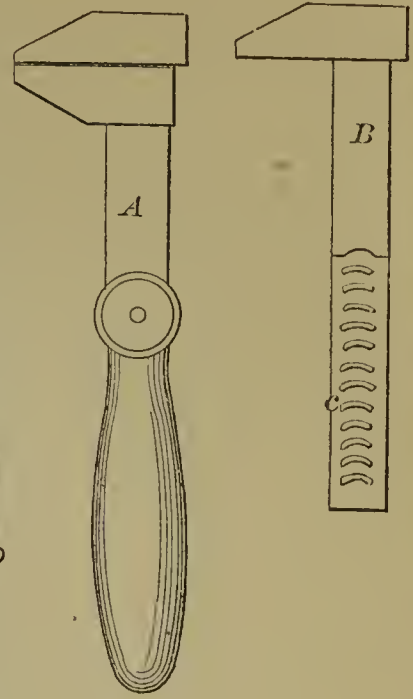

54886—W. Galaway—Clothes Dryer.

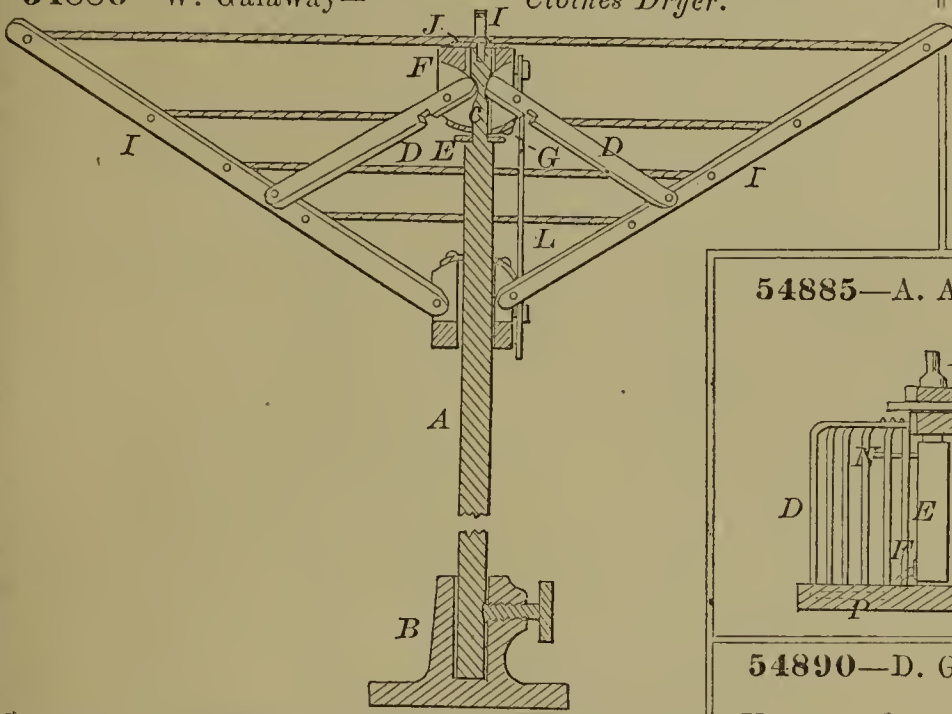

54885—A. A. Fradenburg—Animal Trap.

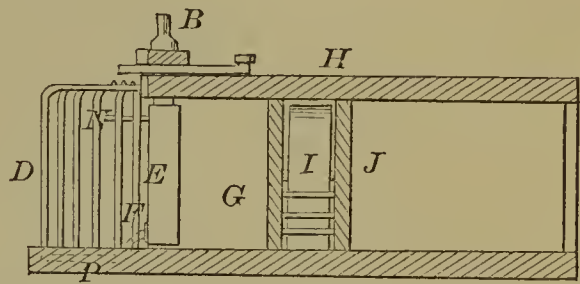

54887—E. H. Gammon—To Prevent Horses from Kicking.

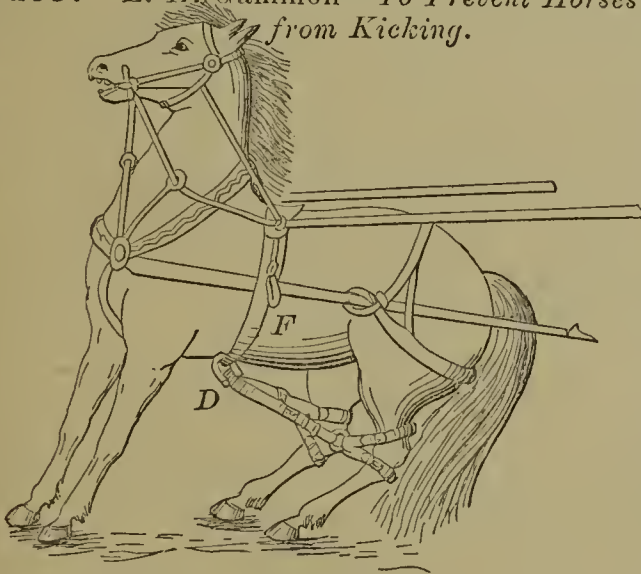

54890—D. Garrison—For Jointing Oval Frames.

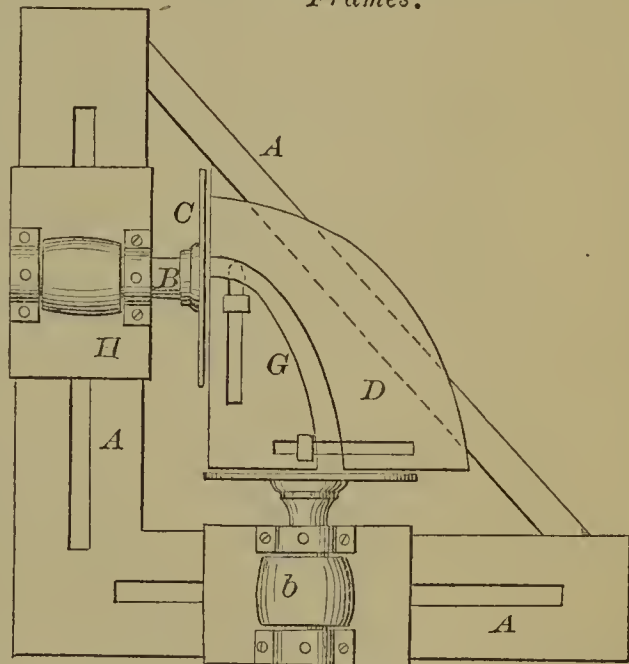

54889—J. C. Gardner—Shackles for Prisoners.

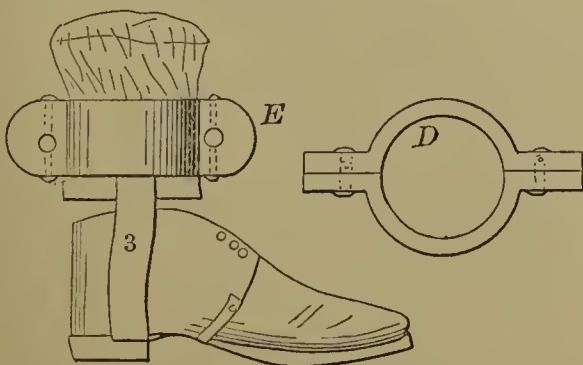

54891—J. Gelston—Churn Dasher.

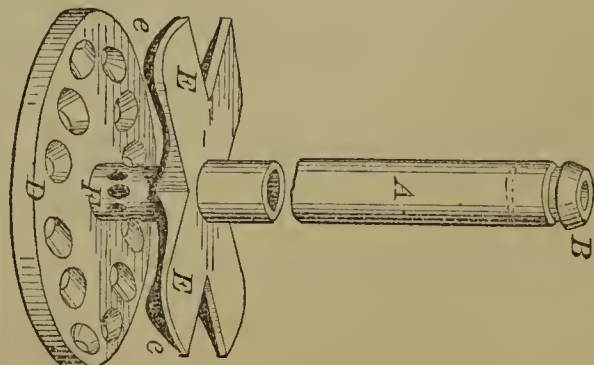

54892—F. A. Gleason—*Washing Machine.*



54893—Grier & Boyd—*For Making Auger Bits.*

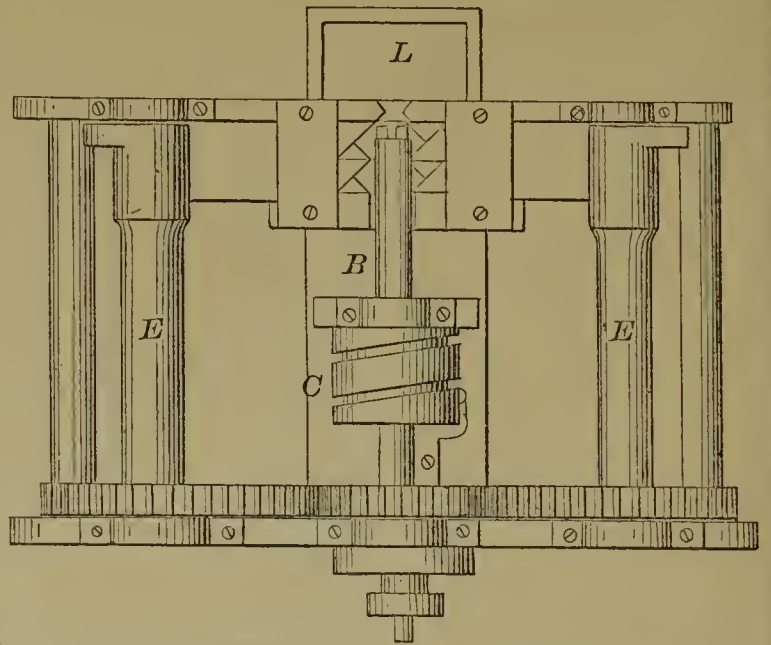

54895—P. Griswold—*Grain Separator.*

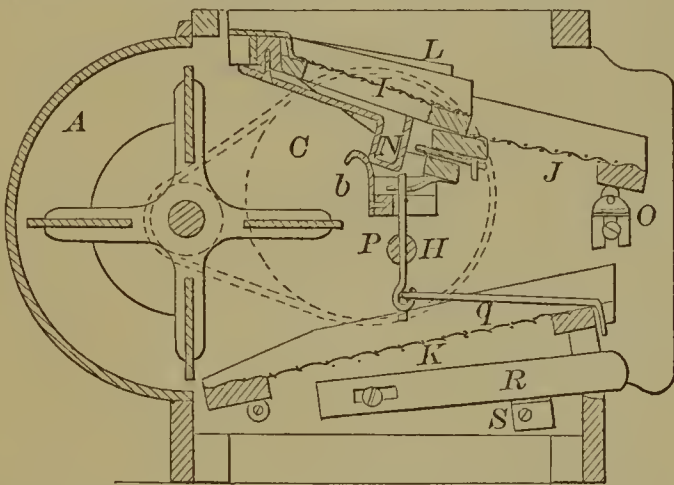

54896—G. Hammer—*For Cutting Corks.*

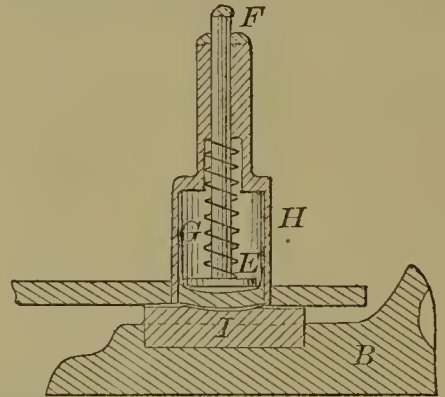

54897—A. L. Harwood—*Broom Clamp.*

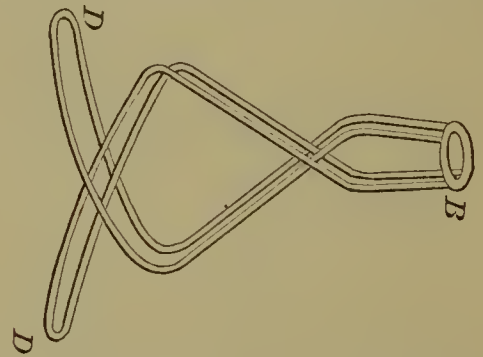

54898—G. Hastings—*Die for Swaging Hands for Watches.*

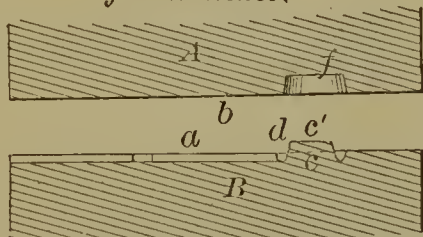

54894—F. P. Griffiths—*Filter.*

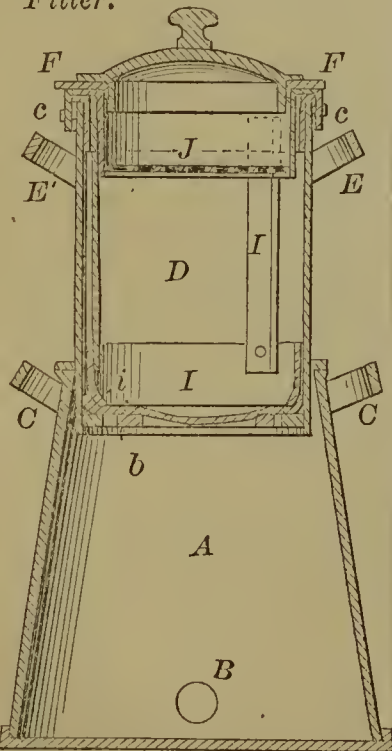

54899—T. Hazard—*Folder Cutter.*

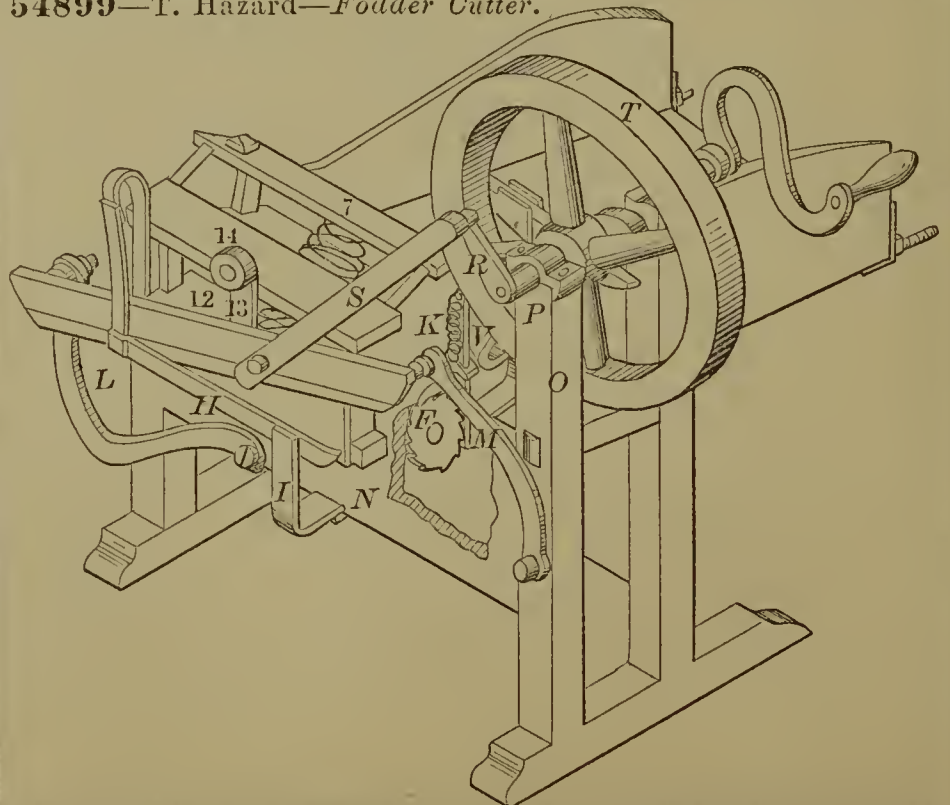

54900—I. A. Heald—*For Making Cigars.*

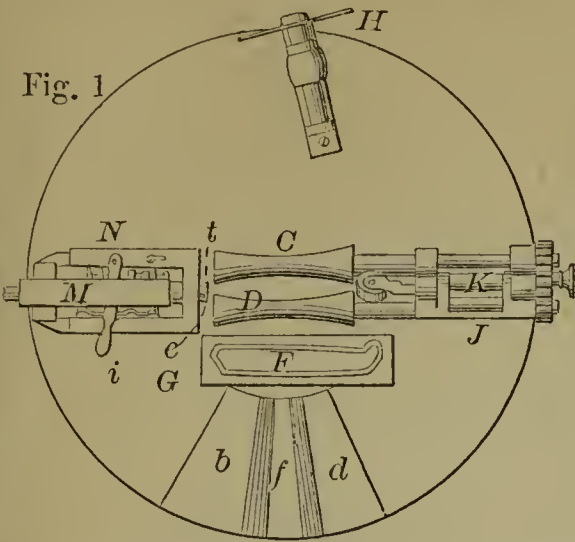

54906—W. Cleveland—*Steam Engine.*

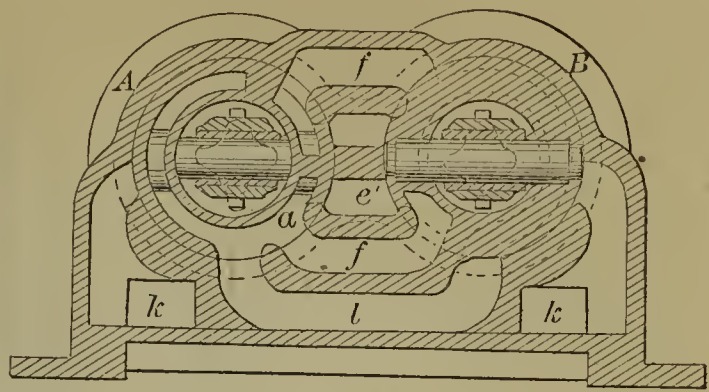

54901—J. L. Heisey—*Corn and Seed Planter.*

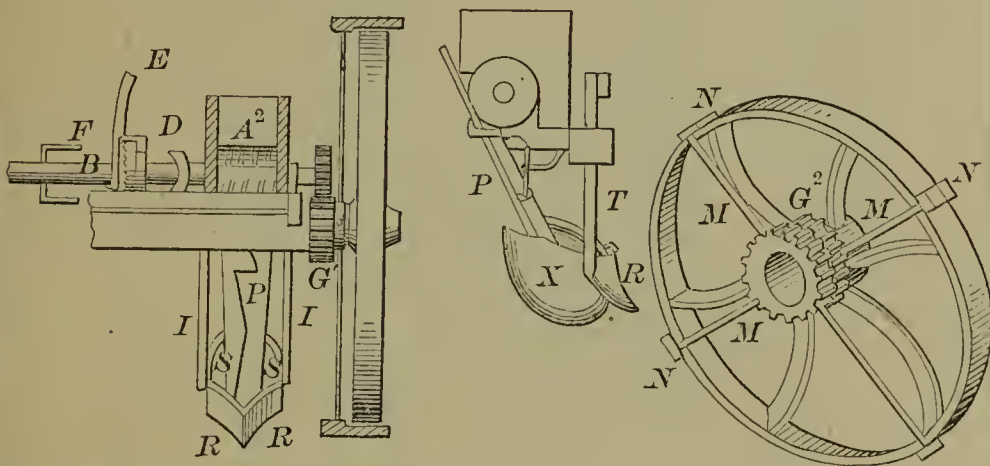

54903—F. Henshaw—*Window Sash Spring.*

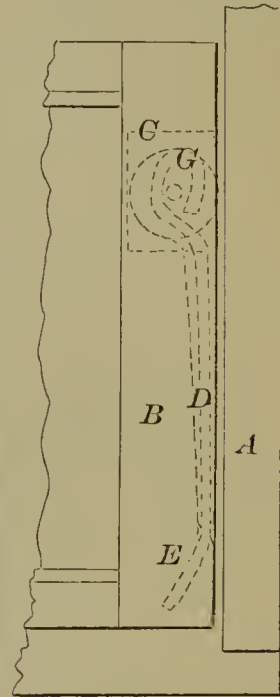

54904—M. Hey—*Bung for Beer Casks.*

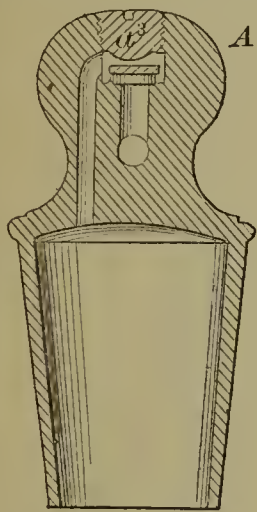
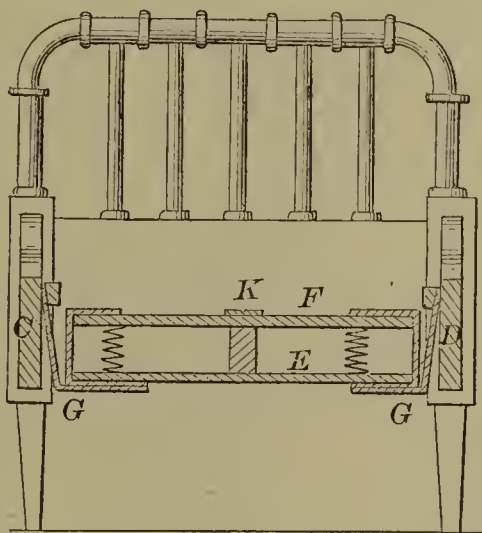
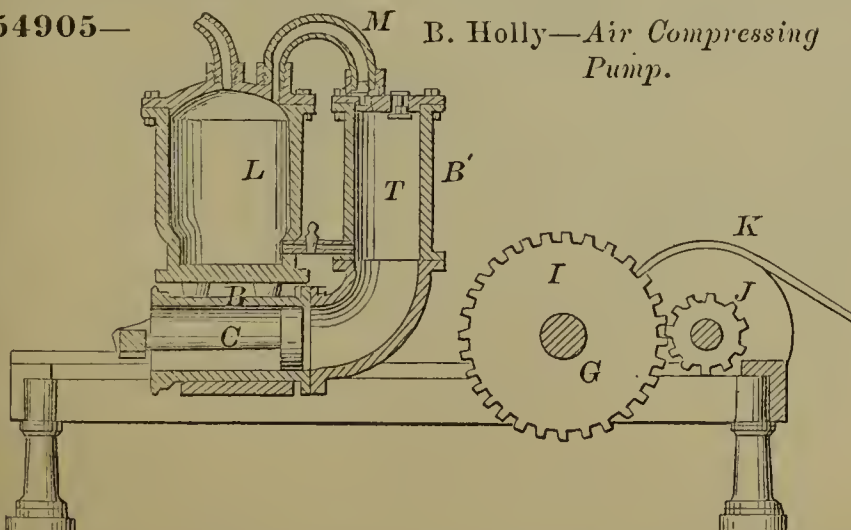

Fig. 3  $a^s$

54902—Henderson & Ford—*Bed Bottom.*



54905—B. Holly—*Air Compressing Pump.*



54908—Homer & Van Doren—*Window Shade Fixture.*



54909—Hoxsie & Reed—*Flexible Tubing.*



54910—E. Hunt—  
Concrete and Mortar  
Wall.

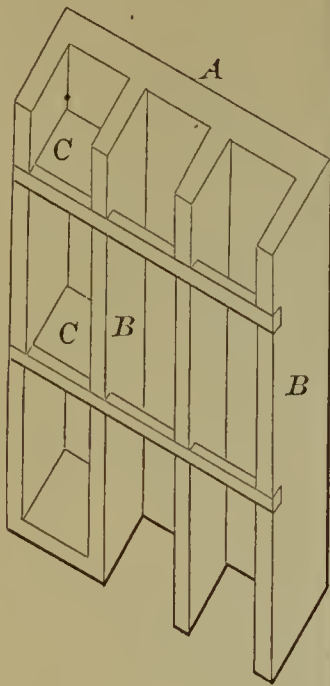

54911—F. P. Hunt—  
Stove Pipe Drum.

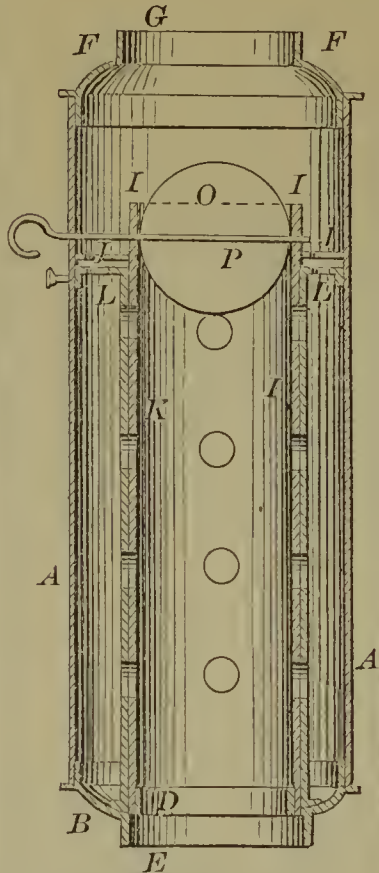

54912—J. B. Hyzer—Heat Radiator.

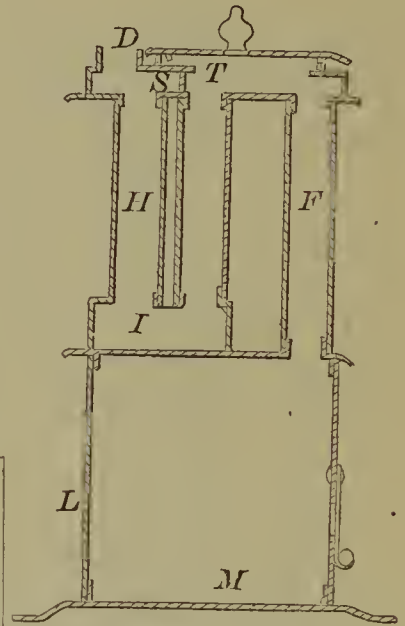
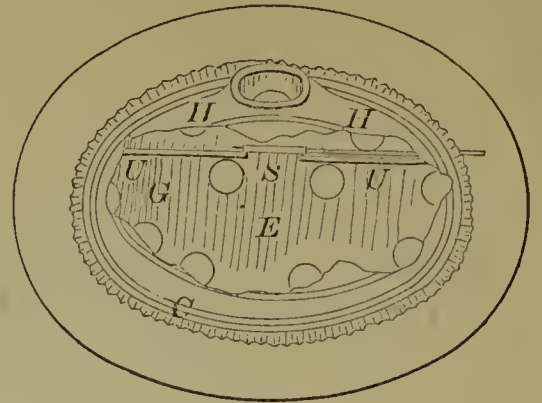

54914—A. Jackson—Hay Rack for Wagons.

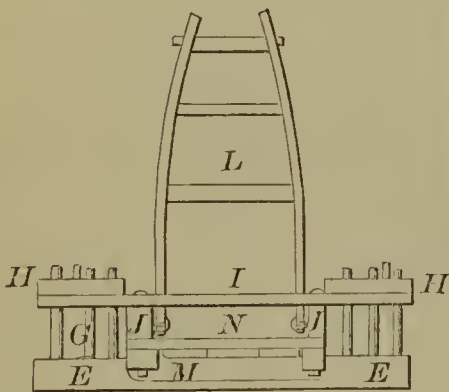
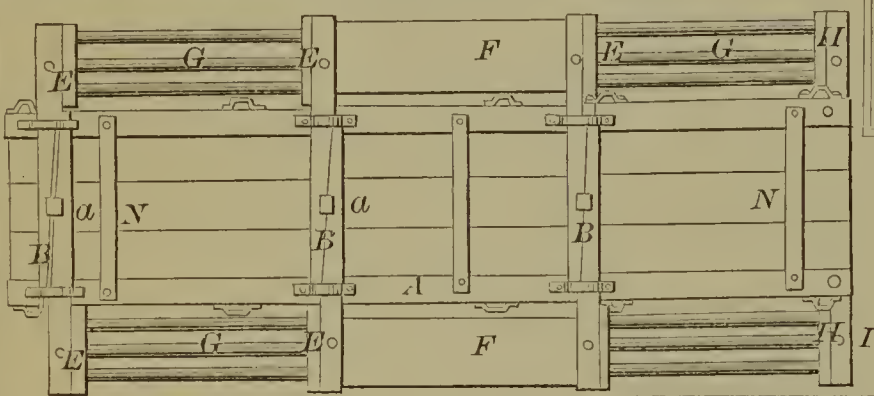

54915—B. Jacobs—  
Attachment to Gas  
Fixtures.

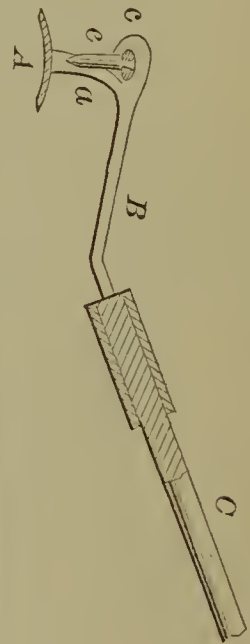
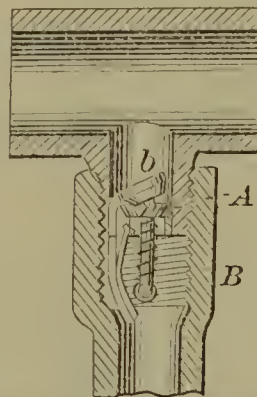

54916—J. D. Jenkins—Shuffle Hoe.

54913—M. Ingersoll—Car Coupling.

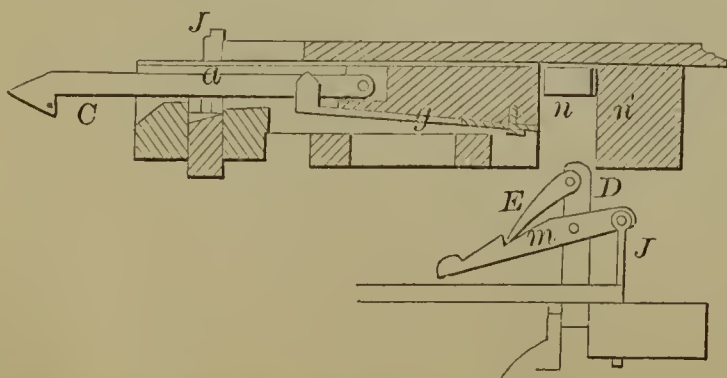

54918—F. Judson—Calk for  
Horse Shoes.

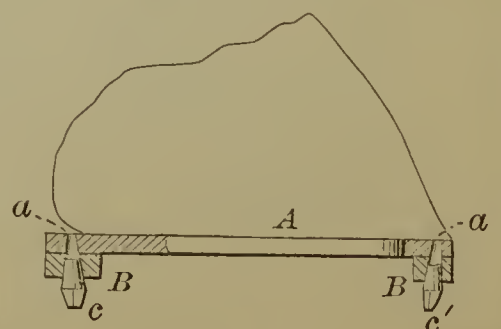

54919—E. Kast—*Reading Desk.*

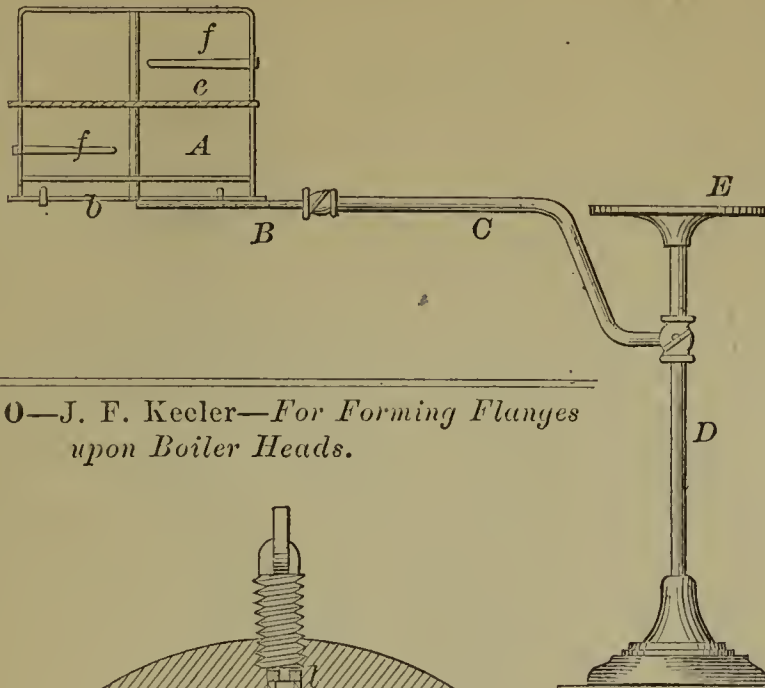

54921—J. Kiefer—*Broom Head.*

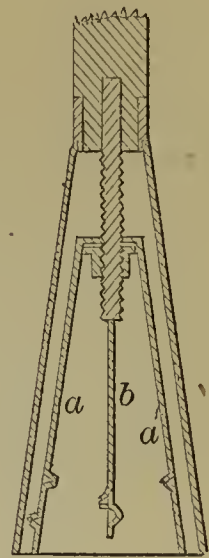

54920—J. F. Keeler—*For Forming Flanges upon Boiler Heads.*

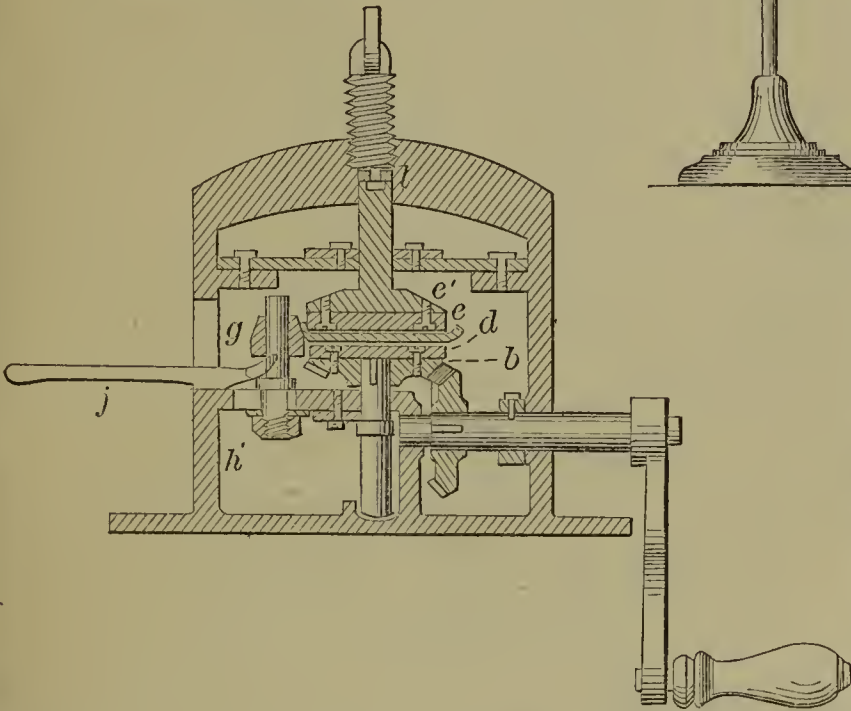

54924—Lakin & Hall—*Heating Stove.*

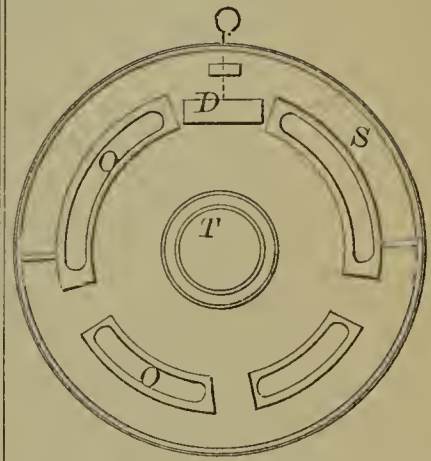

54923—A. Kollenberg—*For Making Tin Fruit Cans.*

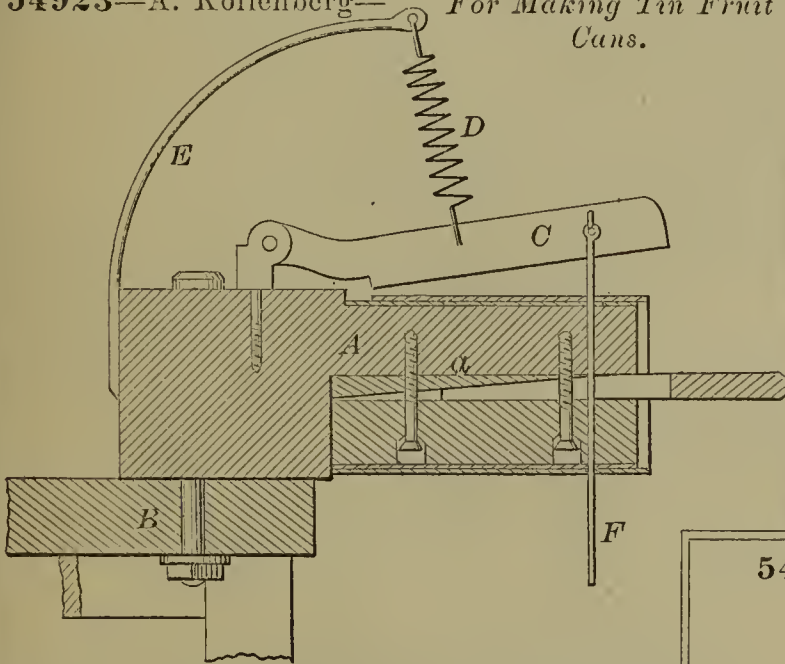

54925—J. W. Latcher—*Car Wheel.*

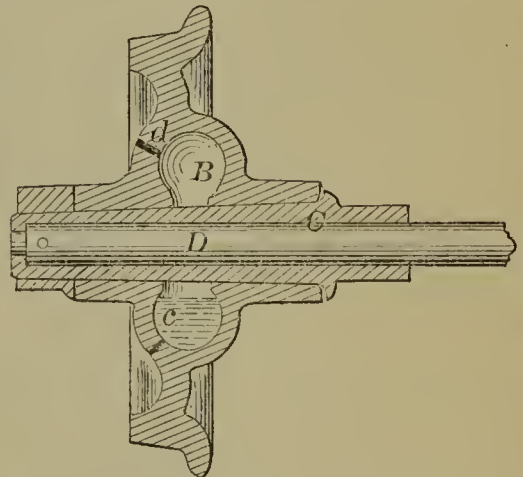

54922—P. Killin—*Alarm Whistle.*

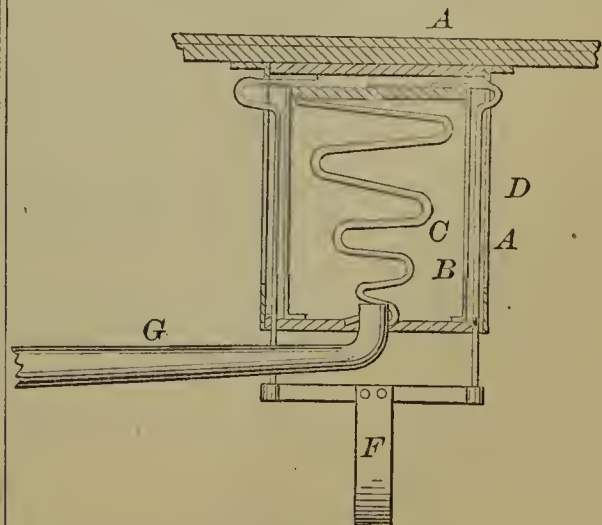

54926—W. M. Leavens—*Sewing Machine.*

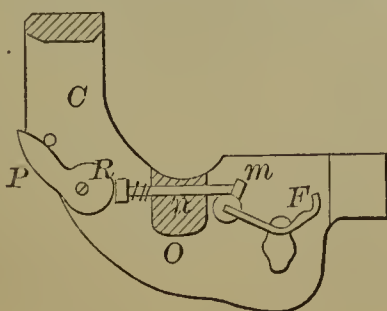

54927—W. K. Lewis—*Pea and Bean Sheller.*

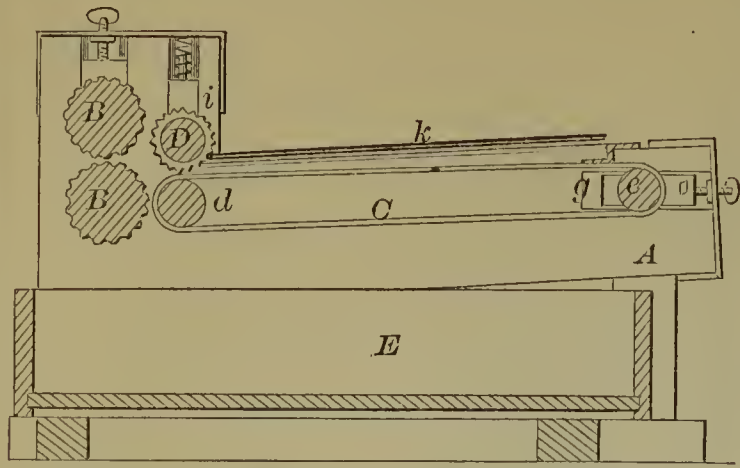

54935—R. S. Merrill—*Lamp.*

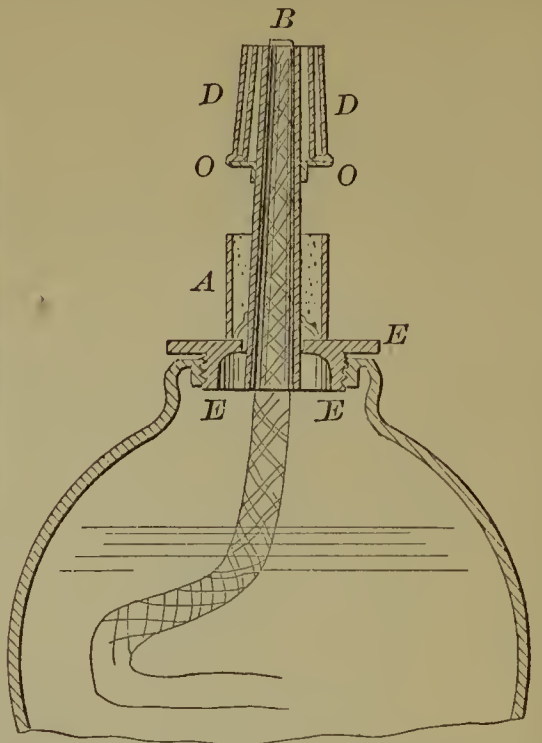

54930—D. W. Maurice—*Churn Dasher.*

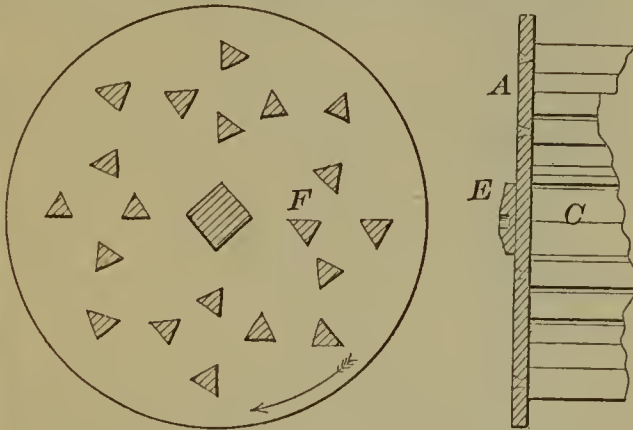

54929—W. W. Lyman—*For Opening Fruit Cans.*

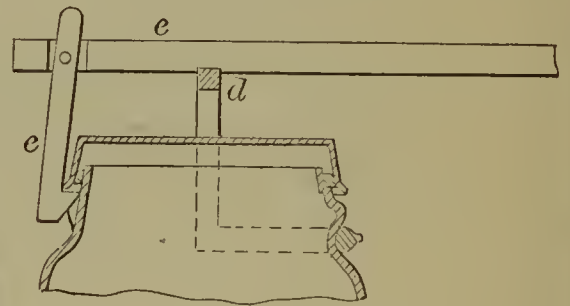

54928—H. Loewenberg—

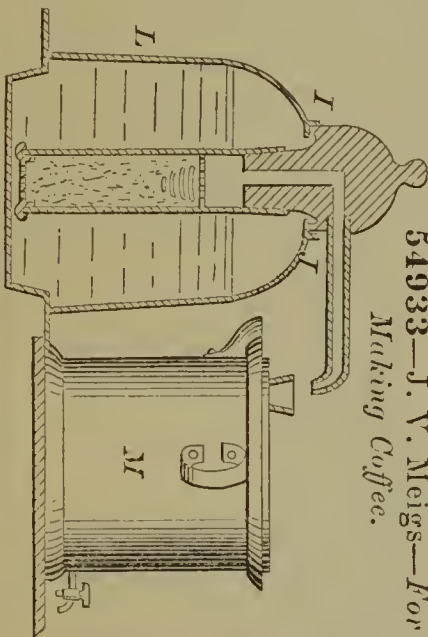
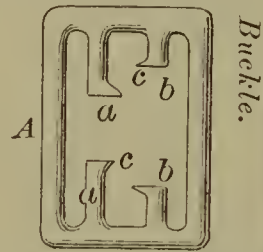

54933—J. V. Meigs—*For Making Coffee.*

54934—J. V. Meigs—*Breech-Loading Fire Arm.*

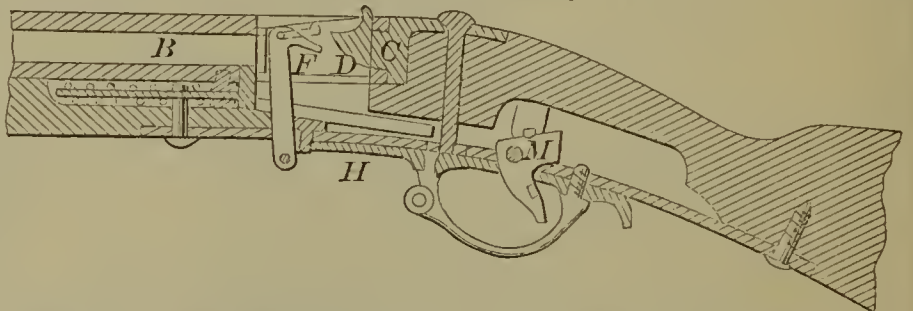

54931—J. McKelvey—*Refrigerator.*

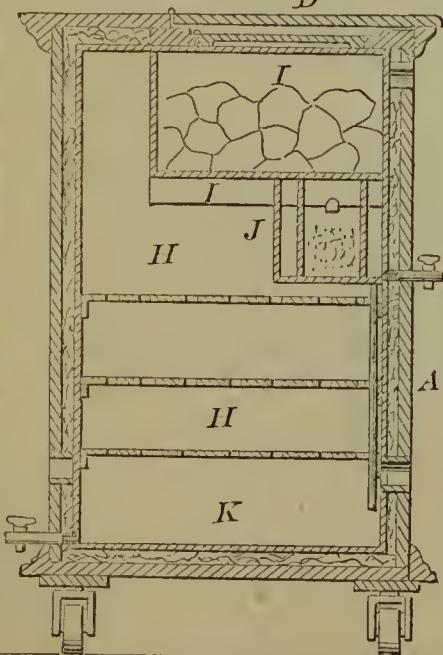

54936—J. M. Miller—*Loading Attachment to Hay Wagons.*

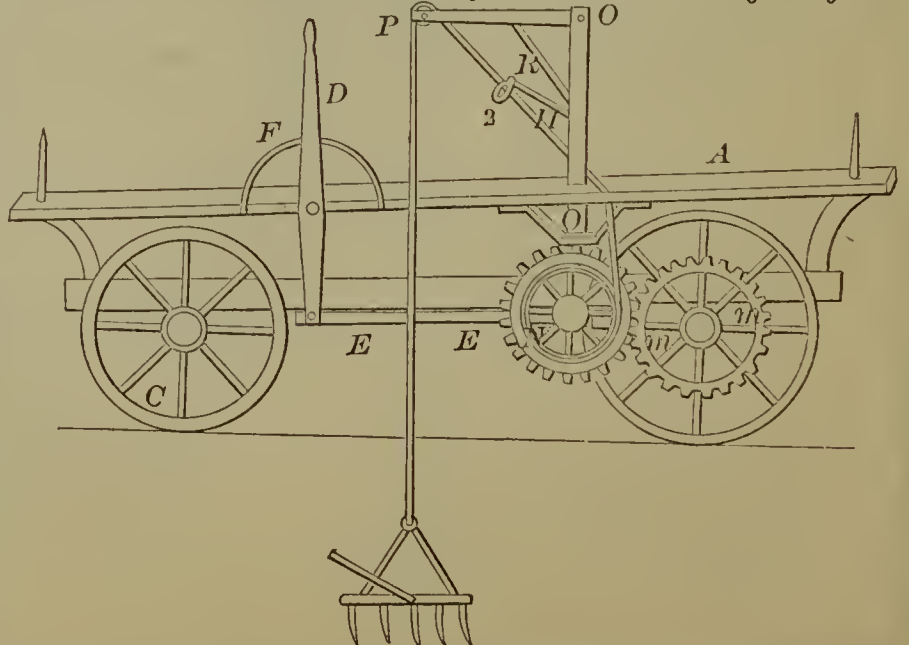

54937—J. C. Miller—*Water Wheel.*

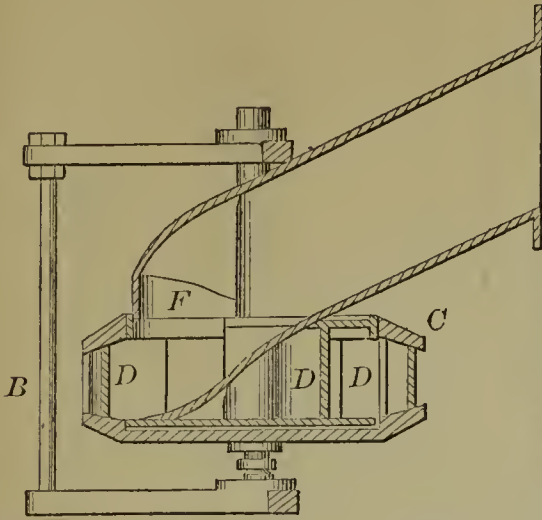

54939—C. Neuman—*For Attaching Clasps to Skirt Hoops.*

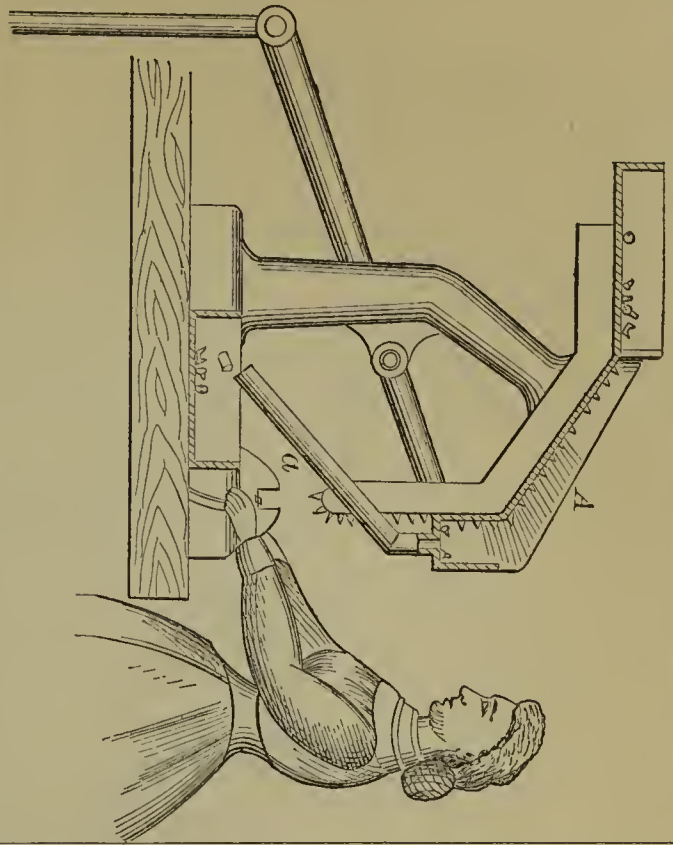

54942—A. Peckham—*Cotton Seed Planter.*

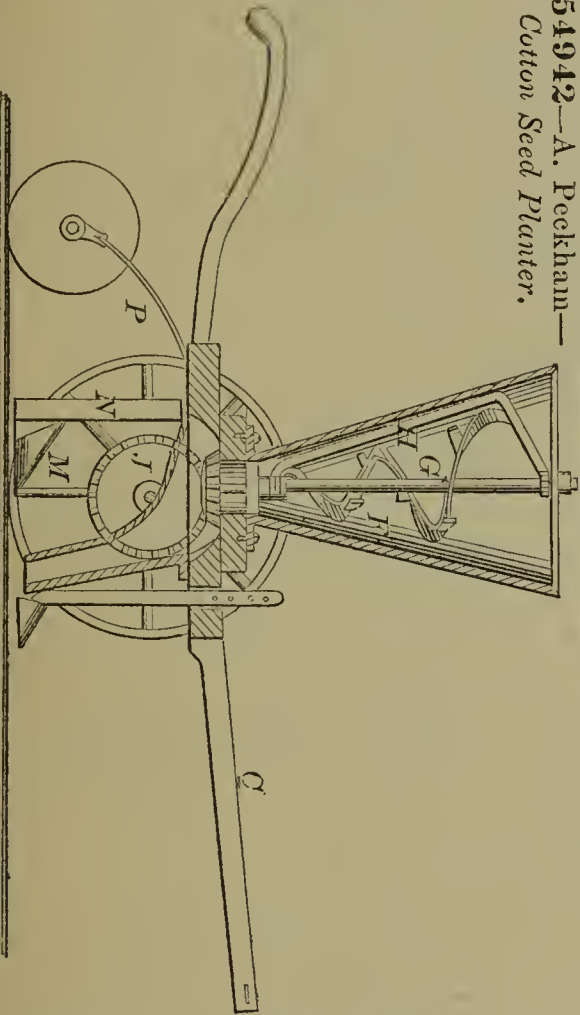

54938—G. R. Moore—*Heating Stove.*

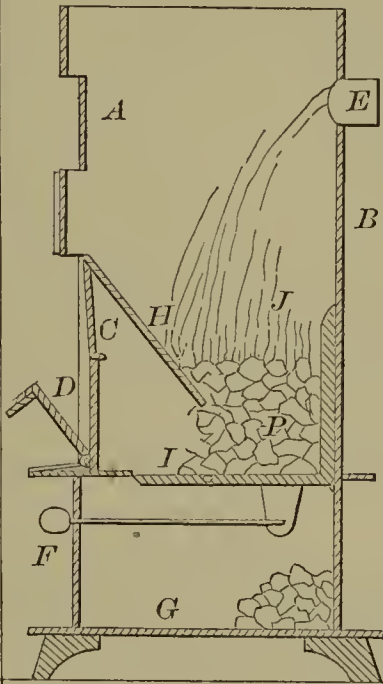

54941—J. K. O'Neil—*Spring Balance.*

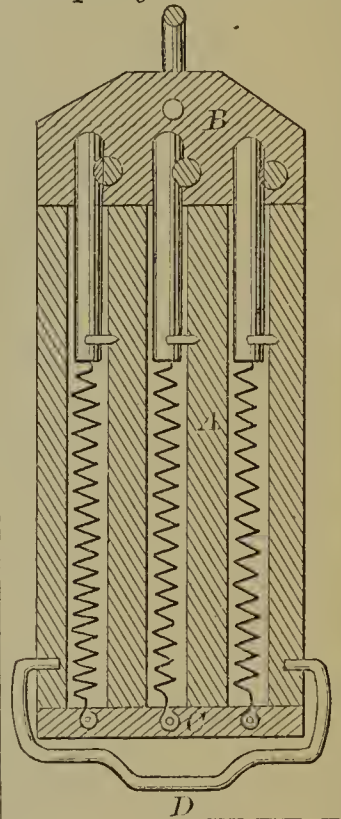

54940—J. Nicholson—*Feed Water Heater.*

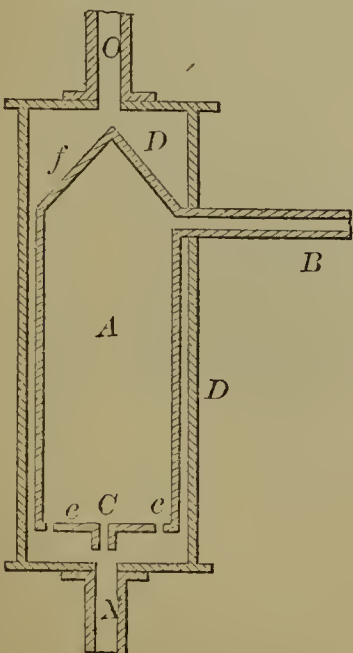

54943—H. Pelton—*Lime Kiln.*

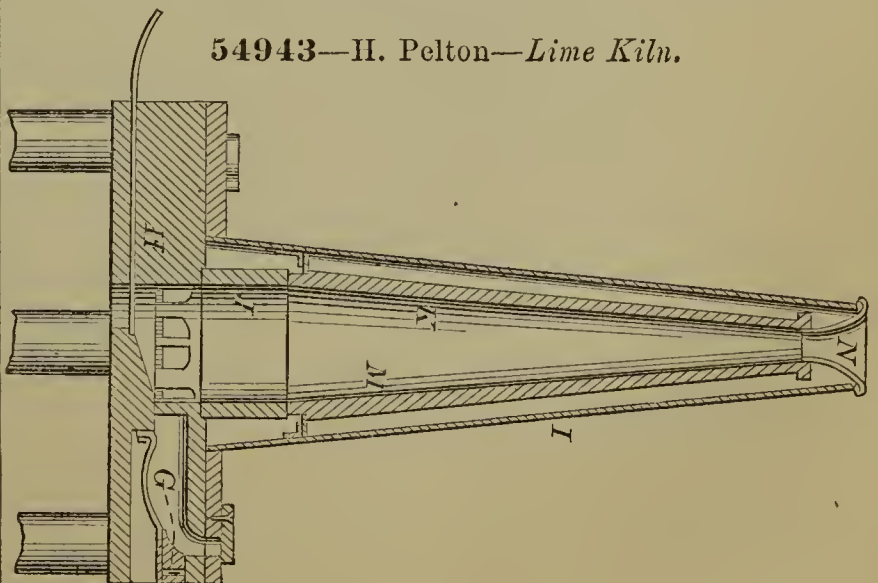

54945—Perry & Pierce—For Making Extracts from Bark, &c.

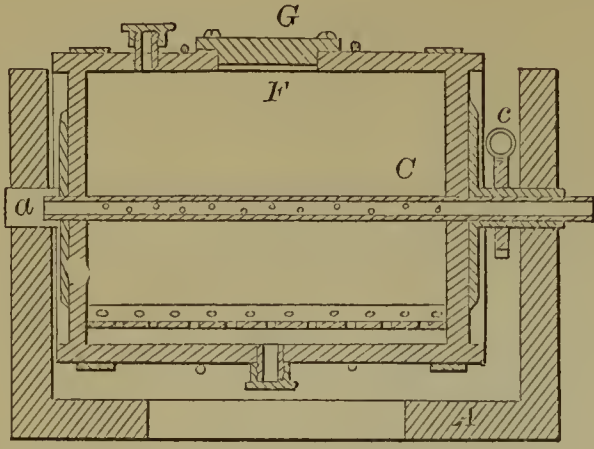

54946—J. G. Perry—Harvester.

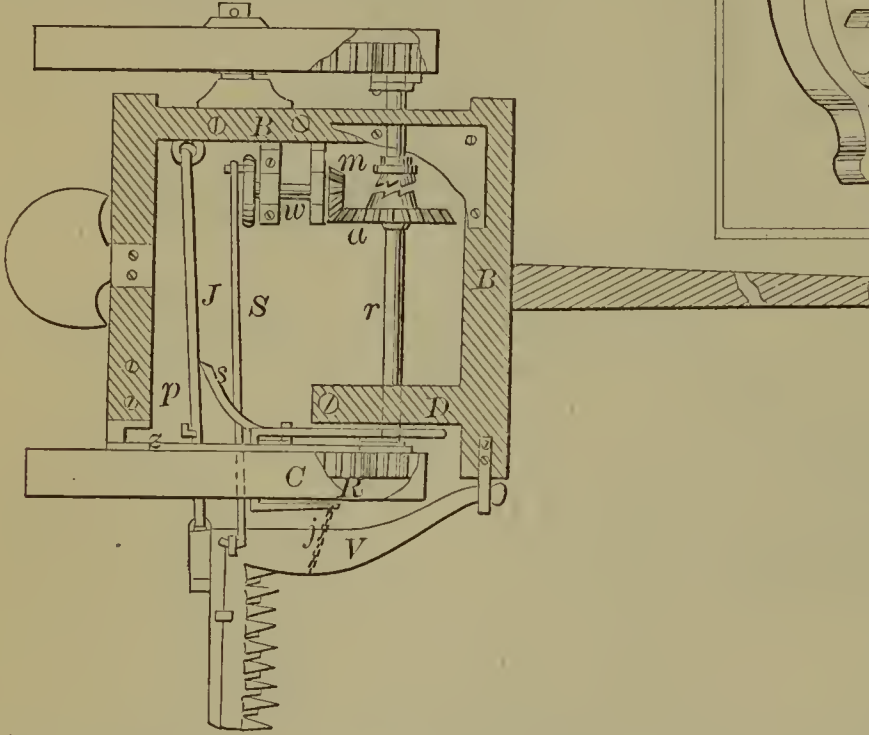

54951—W. E. Prall—Corn Harvester.

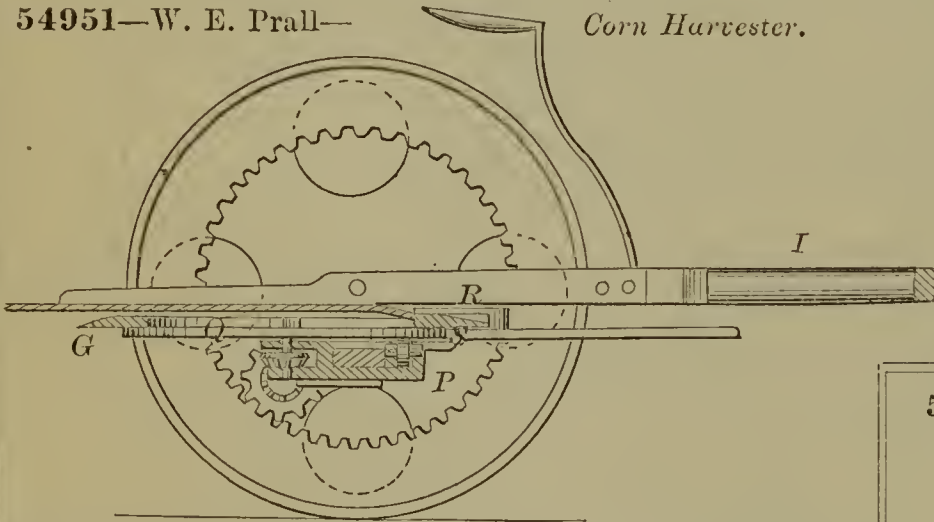

54947—W. M. Piatt—Horse Rake.

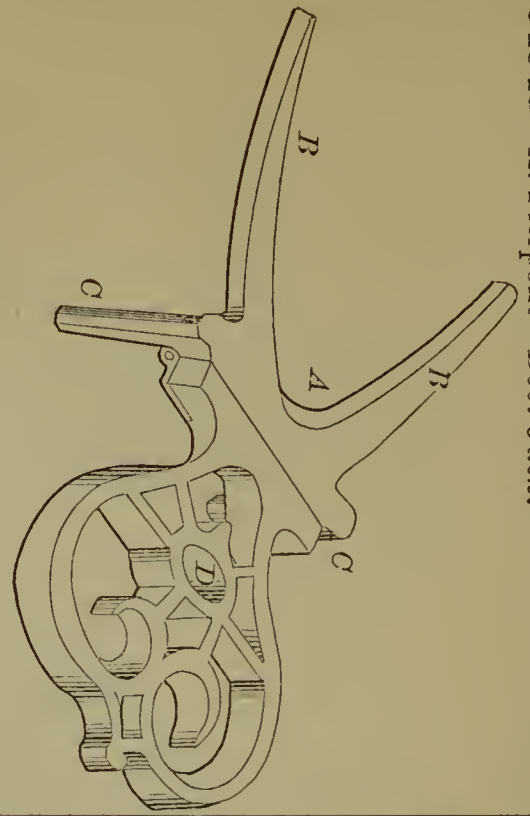
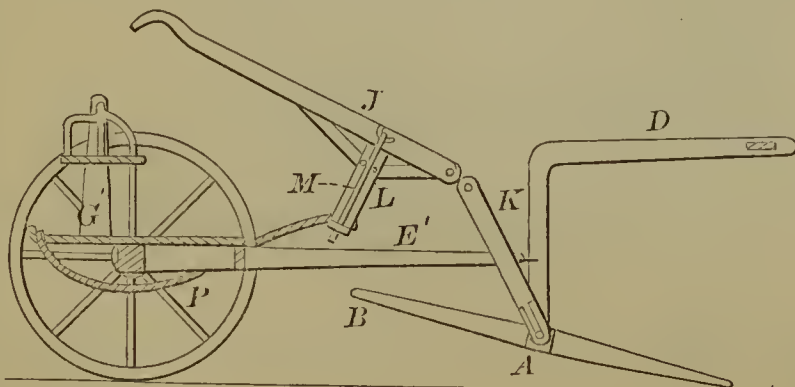

54948—A. Pierpont—Boot Jack.

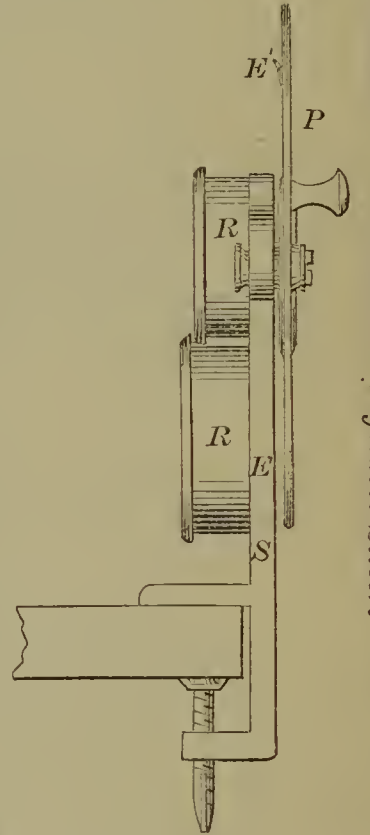

54949—J. C. Plummer—Vegetable Slicer.

54952—D. A. Pratt—Lock.

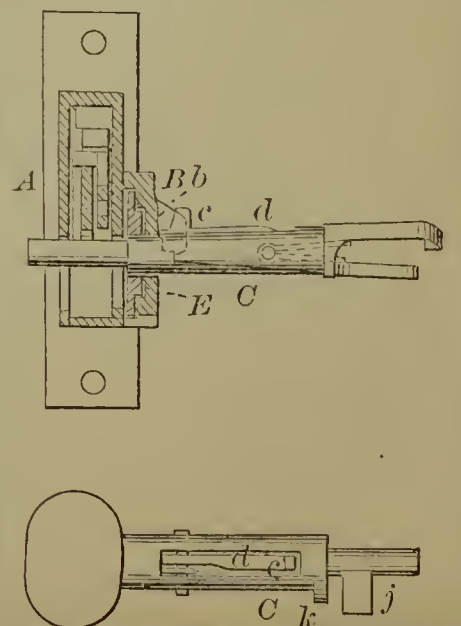



54953—D. A. Pratt—*Sash Fastening.*

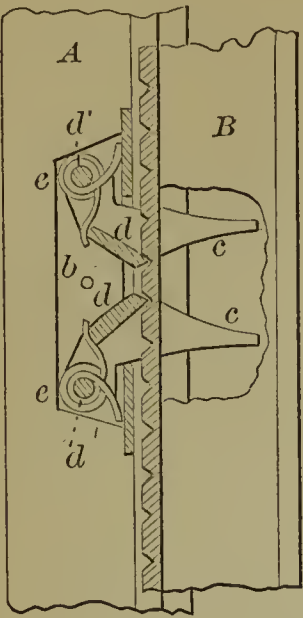

54956—Read, Read & Dorrell—*Hay and Cotton Press.*

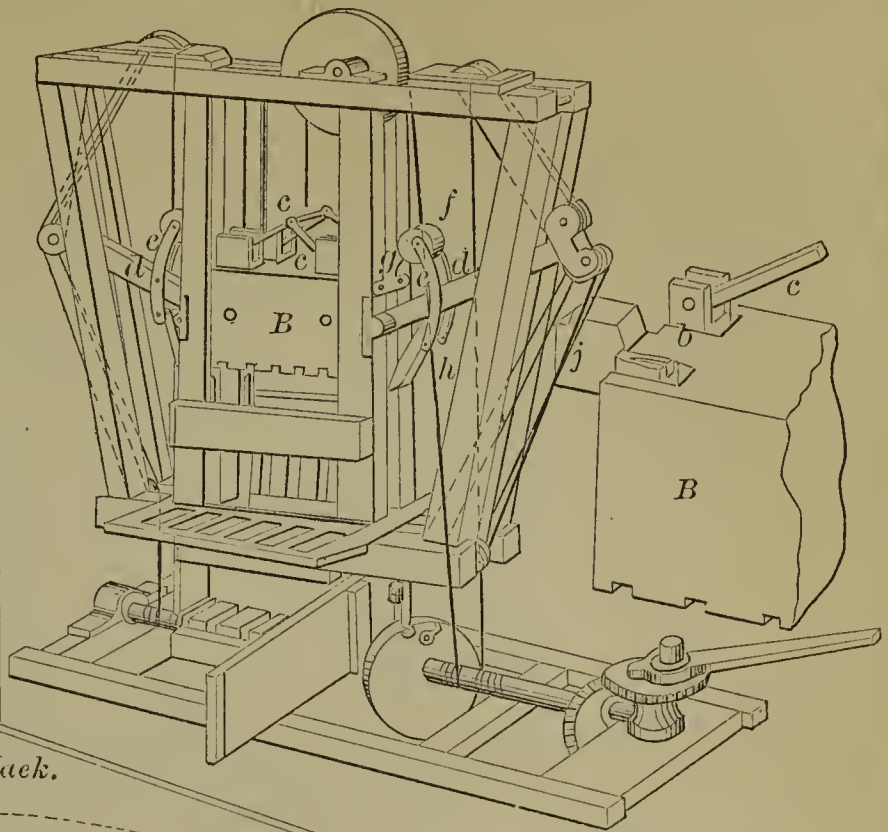

54954—L. H. Proctor—*Shoe Jack.*

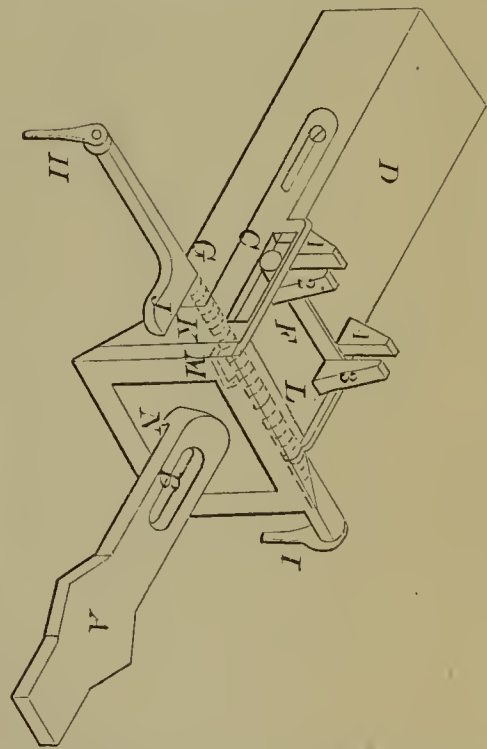
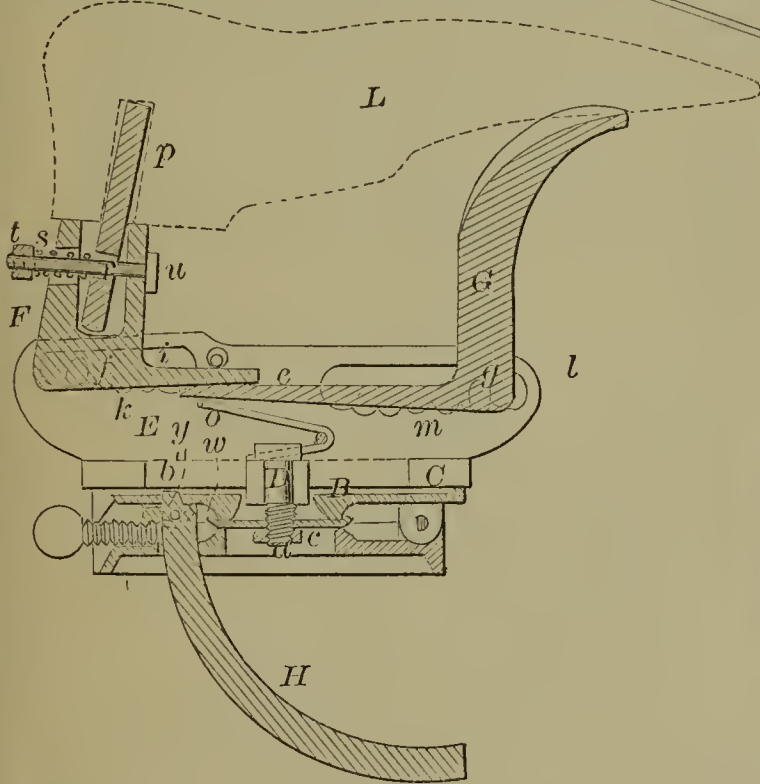

54955—Quick & Wallis—*Car Coupling.*

54958—U. Reynolds—*Fifth Wheel for Vehicles.*

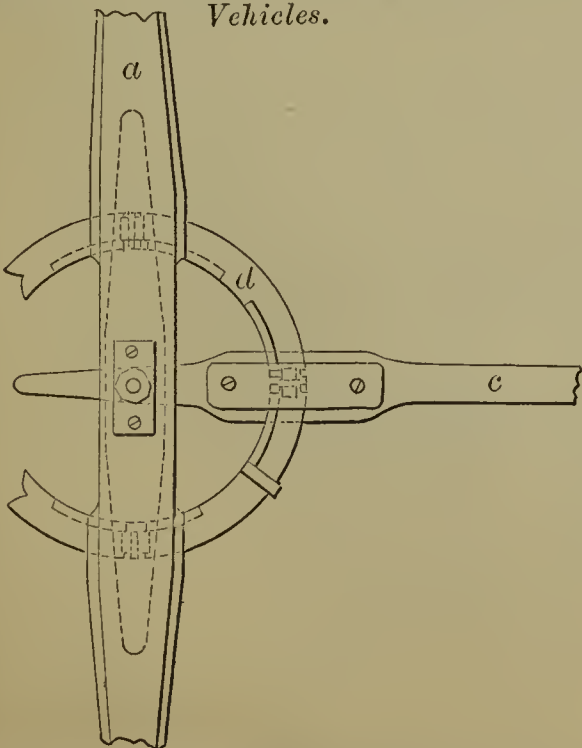

54959—T. Richards—*Balanced Valve for Steam Engines.*

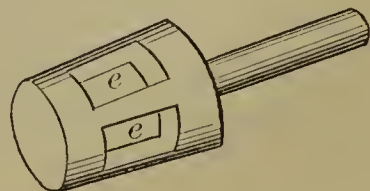
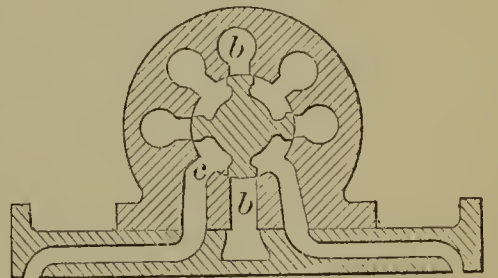

54960—Richardson, Davis & Howell—Cane Mill.

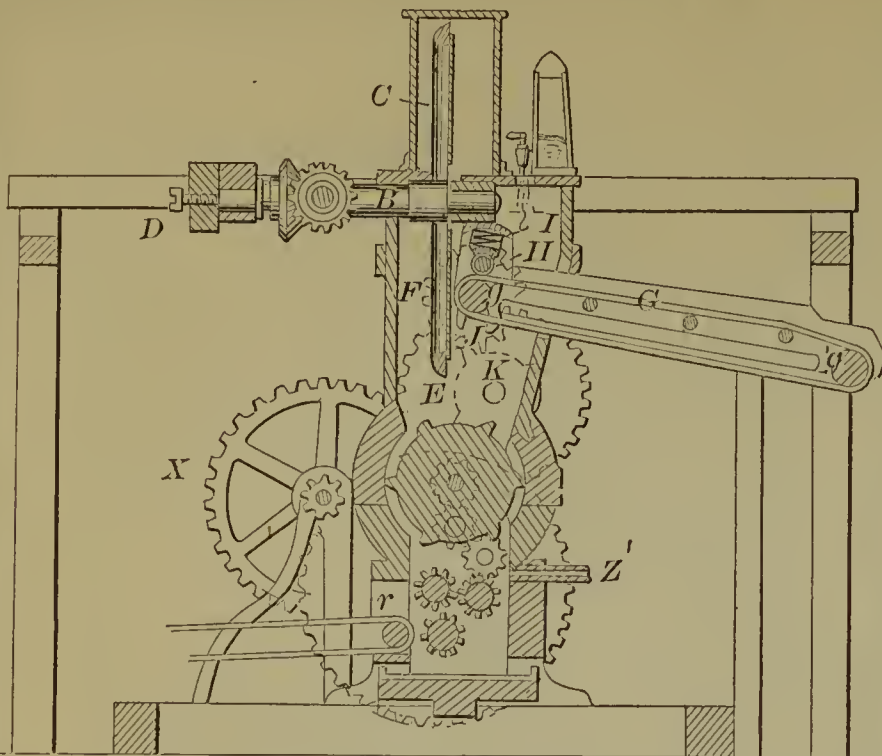

54961—W. J. Ross—Sash Fastener.

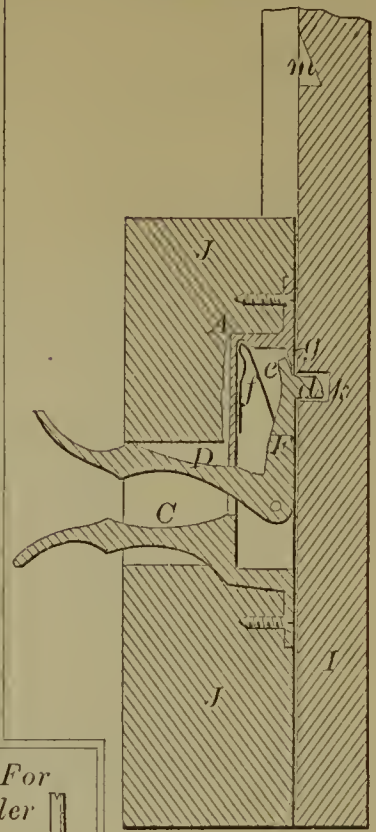

54964—S. E. Saul—Boiler for Culinary Purposes.

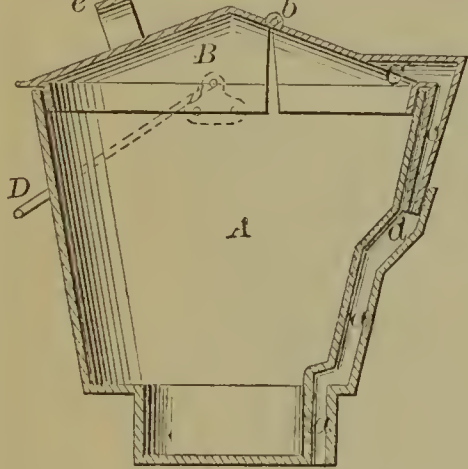

54962—P. C. Rowe—For Removing Scale in Boiler Tubes.

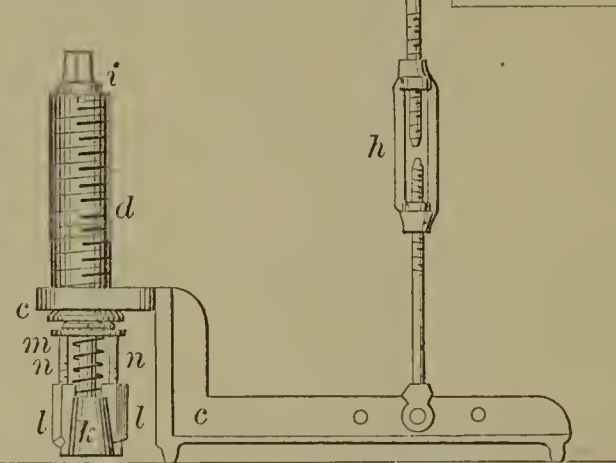

54963—Runk, Brown & Morgan—Gang Plow.

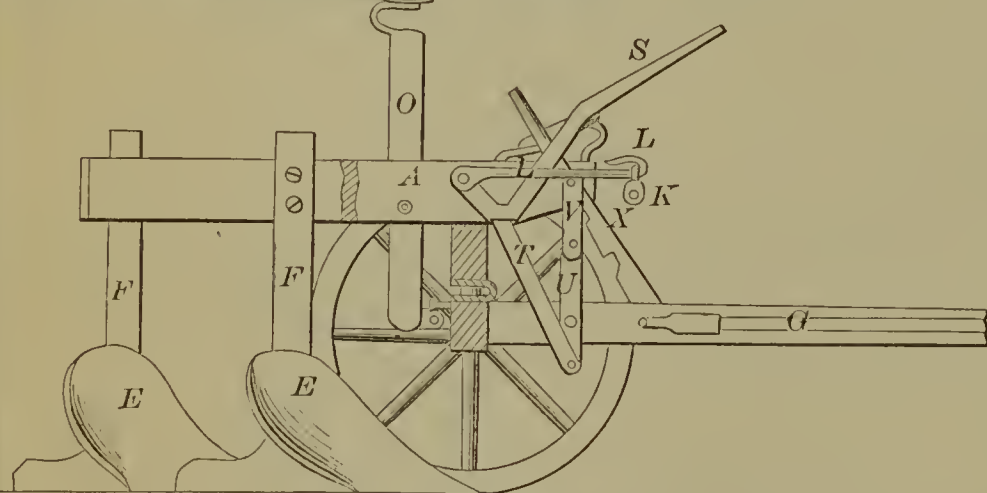

54965—E. Sawyer—Washing Machine.

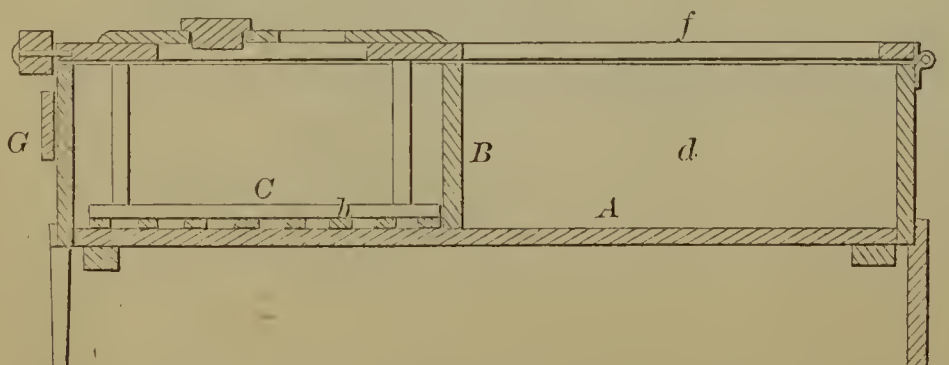

54966—C. C. E. Schwartz—For Cutting Finger Nails.

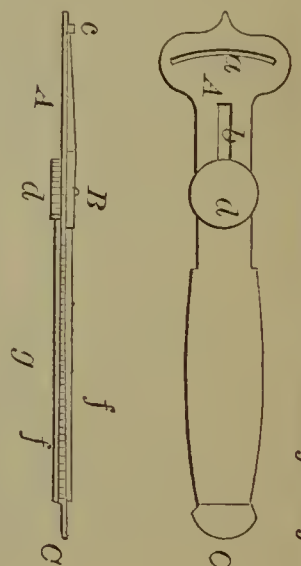

54967—D. W. Secley—*Brick Press.*

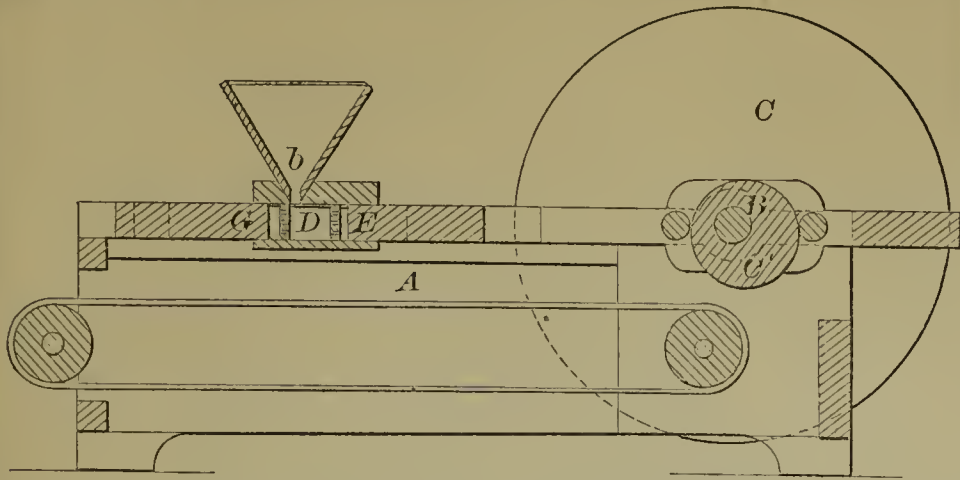

54971—J. L. Smith—*Gas Burner.*

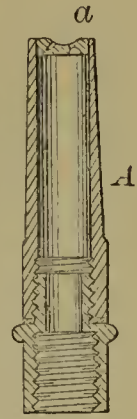

54968—J. F. Shearman—*Slide Valve for Steam Engines.*

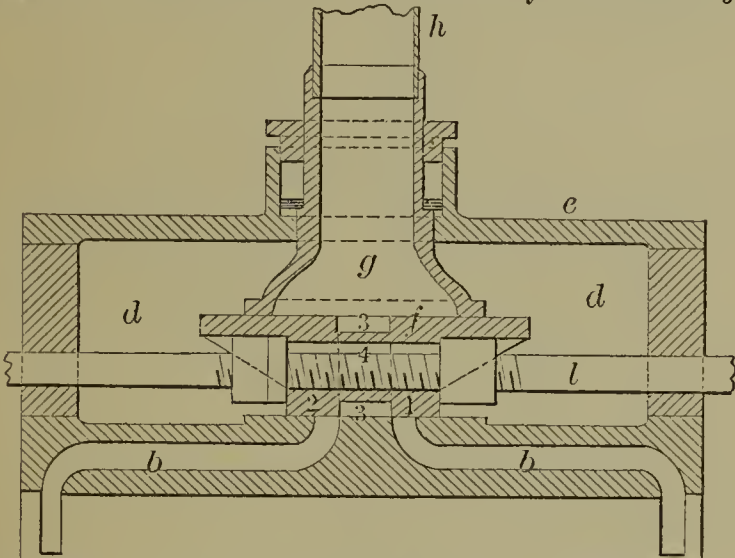

54970—S. P. Sleppy—*Artificial Leg.*

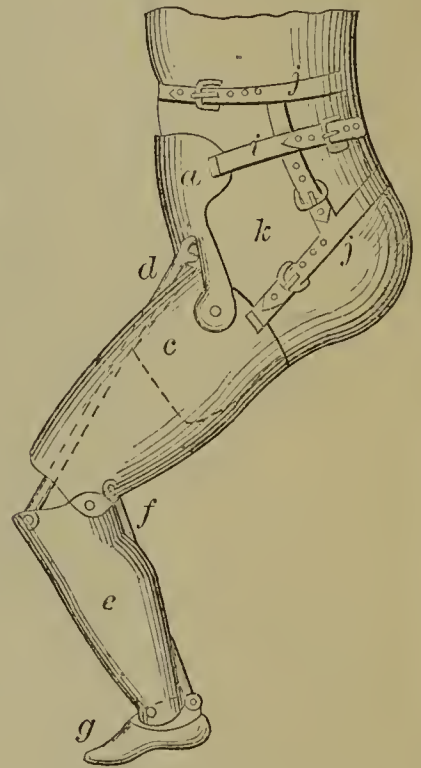

54969—J. Shone—*Ventilating Grain.*

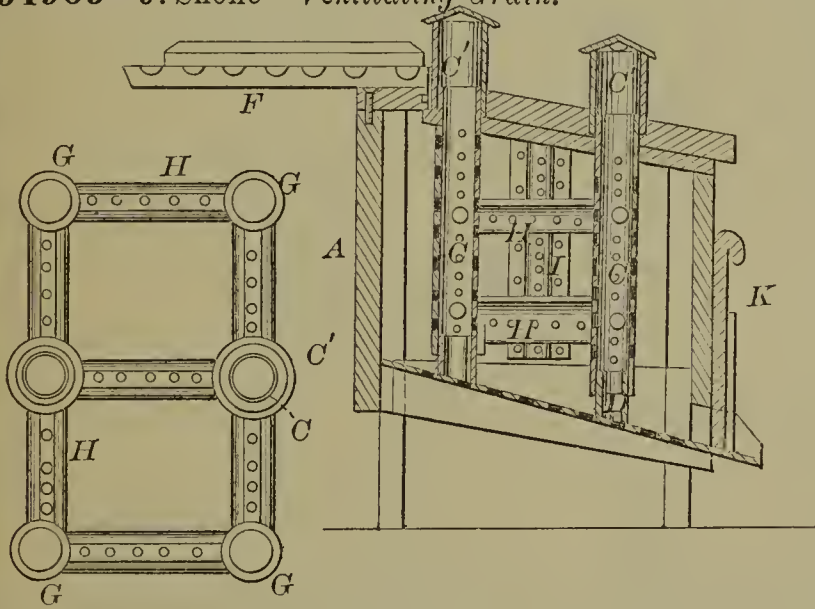

54972—P. J. Smith—*Mechanical Movement.*

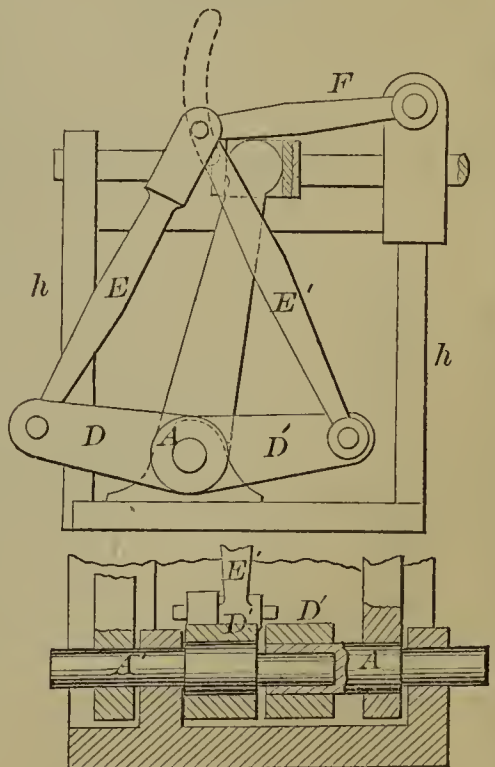

54973—D. M. Somers—*Tumbler Washer and Cooler.*

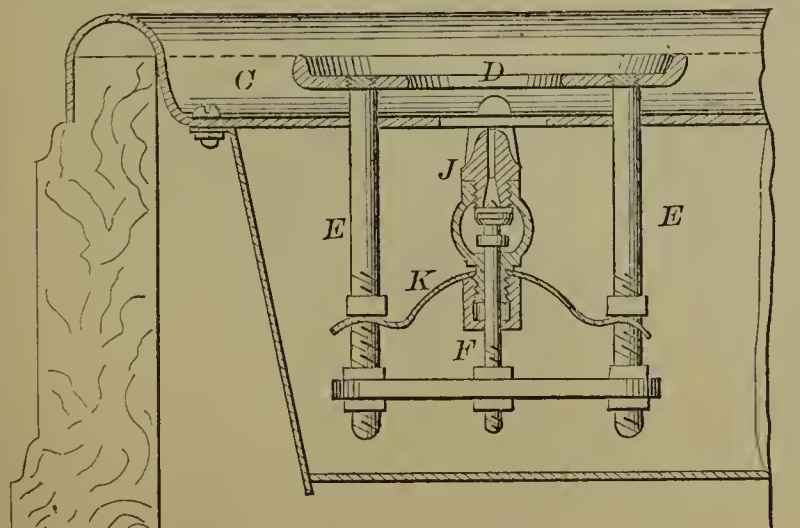

54974—H. Stevens—*Hen's Nest.*

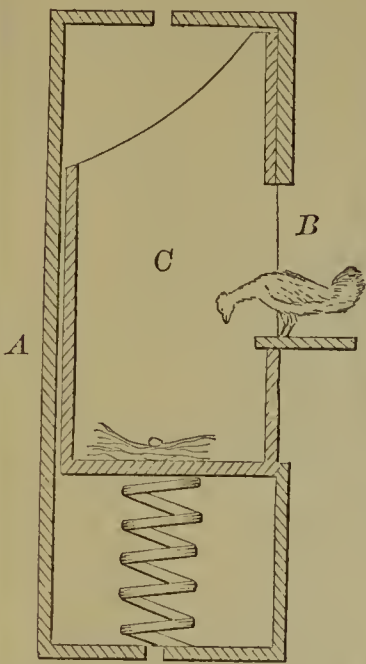

54975—H. Strait—*Railway Truck.*

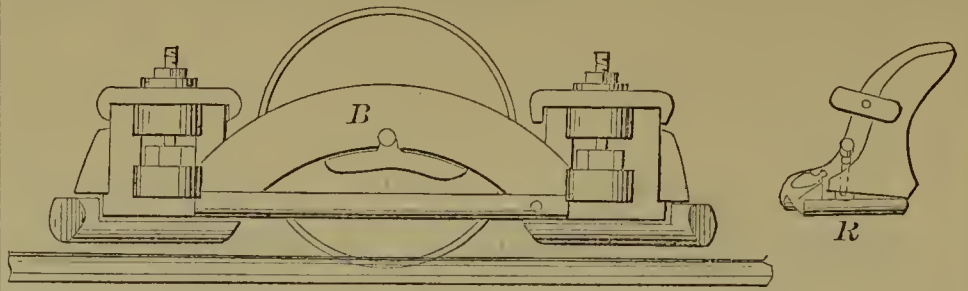

54977—B. C. Taylor—*Horse Rake.*

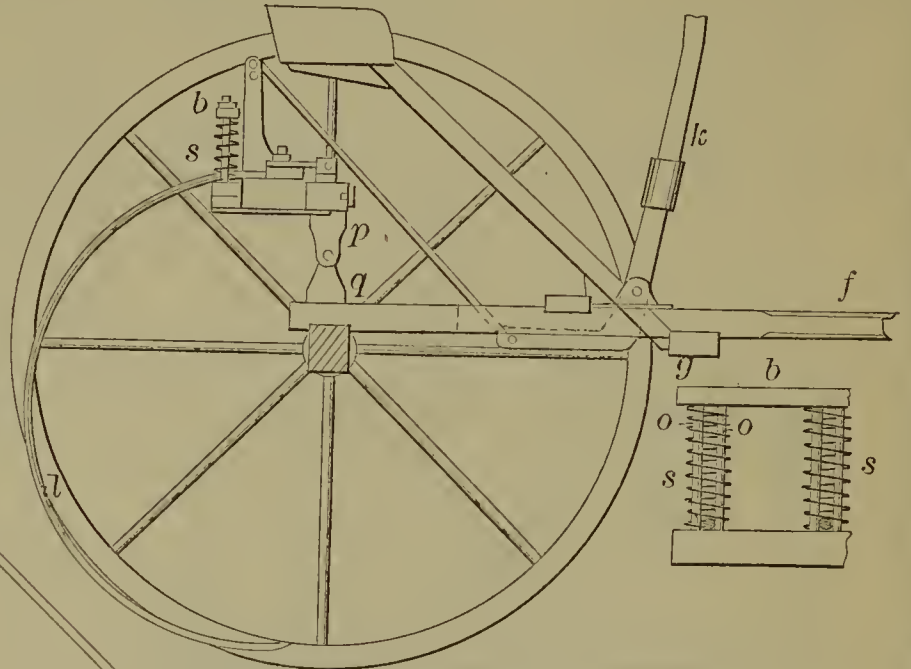

54980—P. A. Vogt—*Refrigerator.*

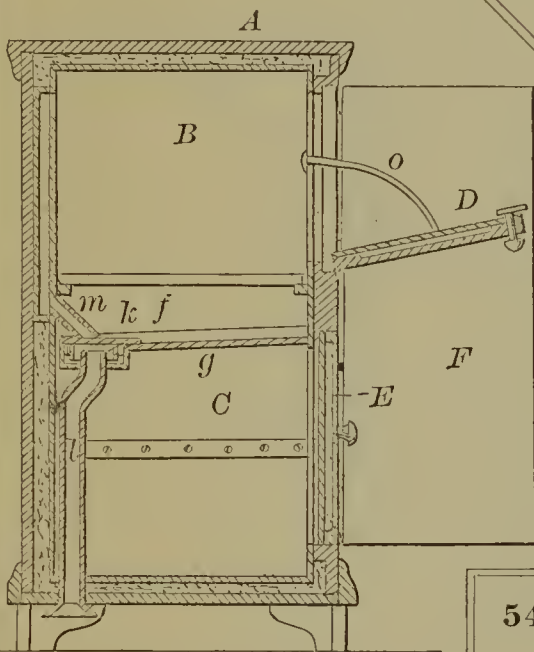

54979—W. T. Tillinghast—*Composing Stick.*

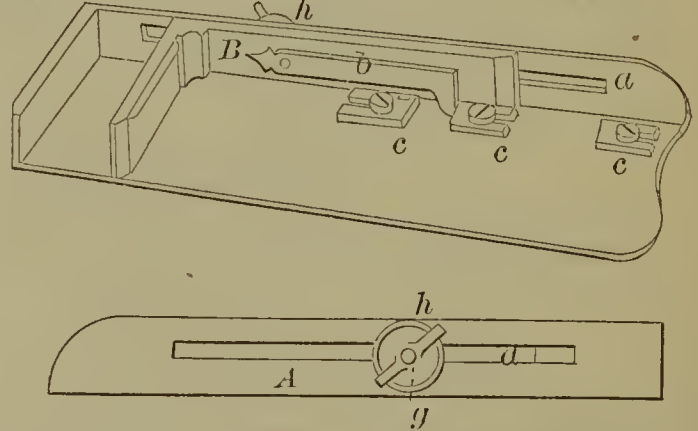

54981—R. Ward—*Nail Machine.*

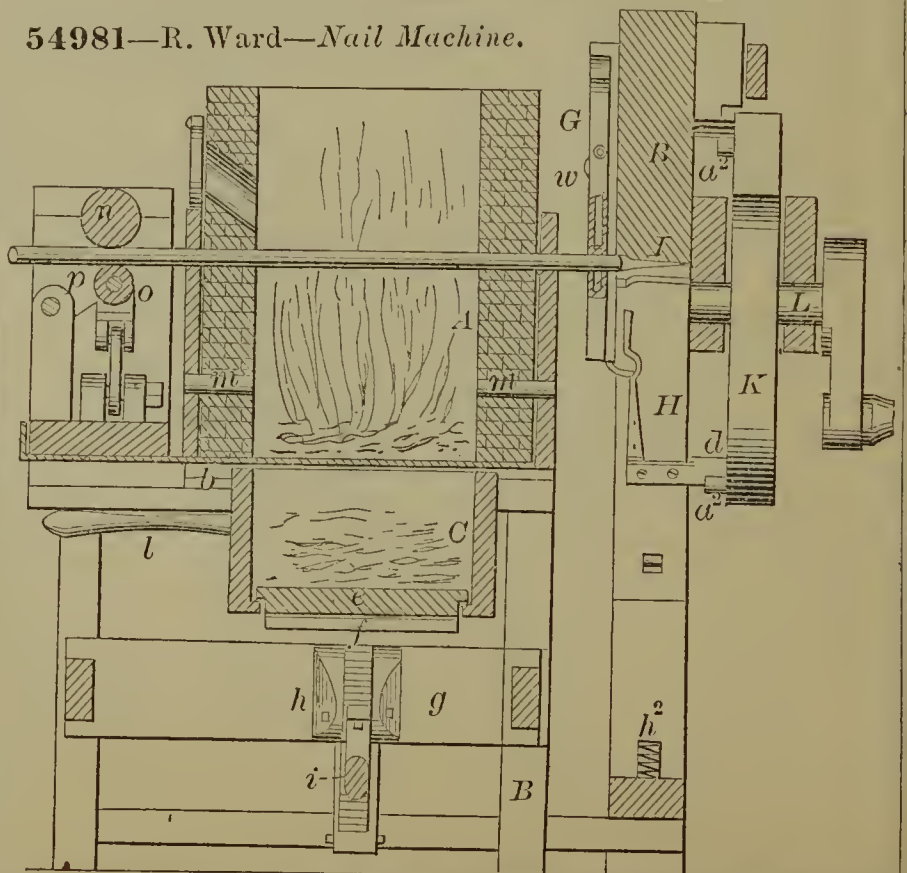

54976—D. & S. Sweeney—*Store Pipe Damper.*

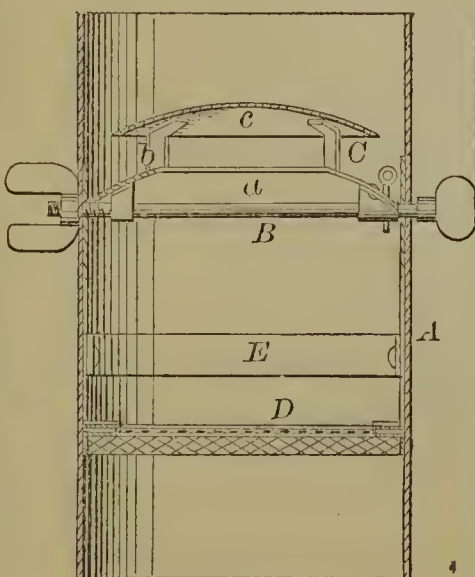

54982—O. G. Warren—Rock Drill.

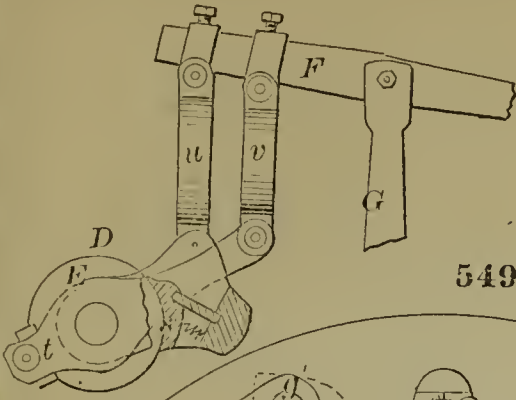
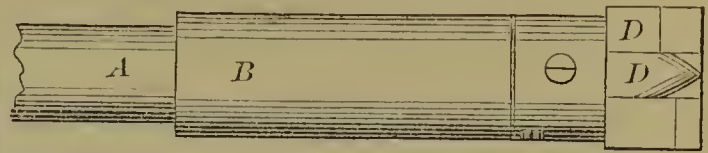

54981—Continued.

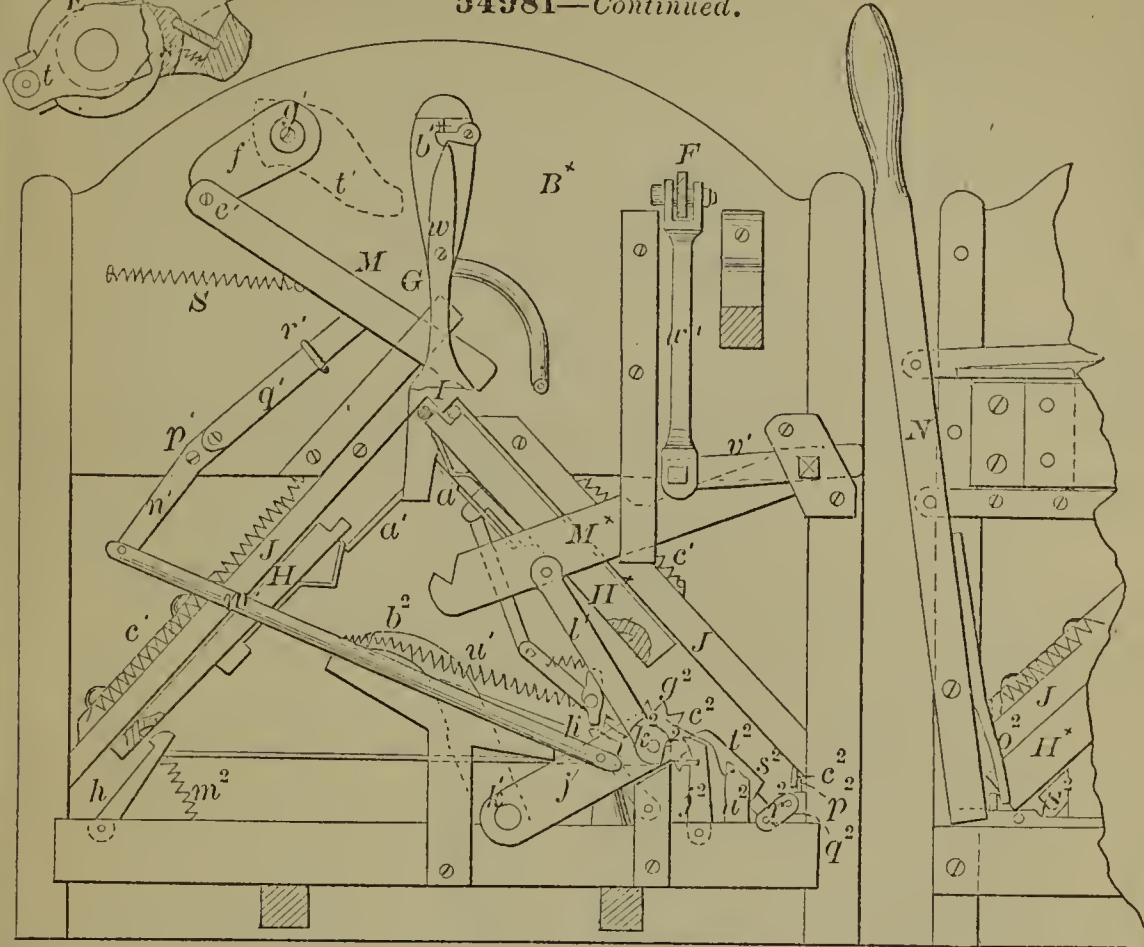

54988—L. Wilkinson—Tugere.

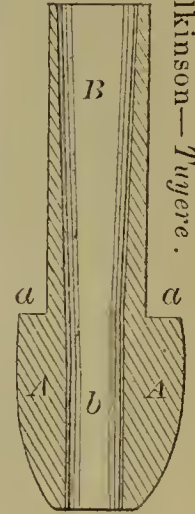

54983—G. I. Washburn—Steam Engine.

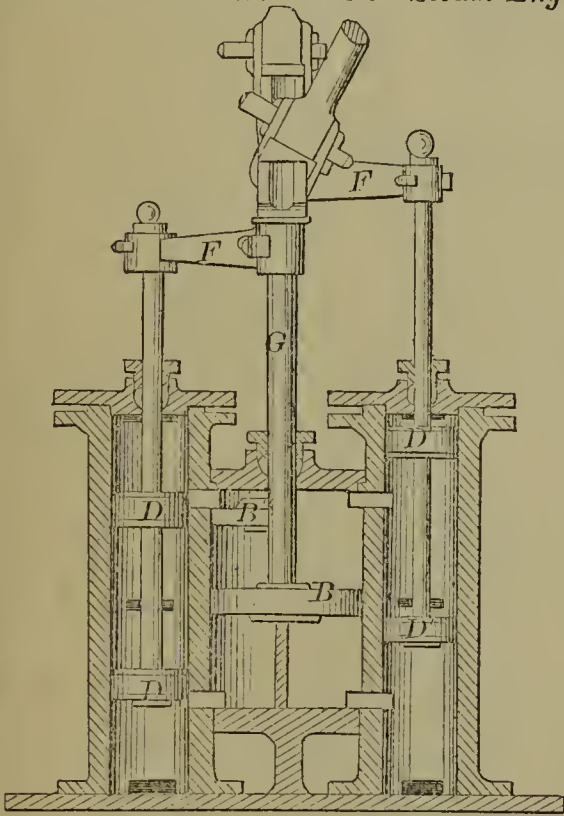

54985—S. White—Shade Hook.

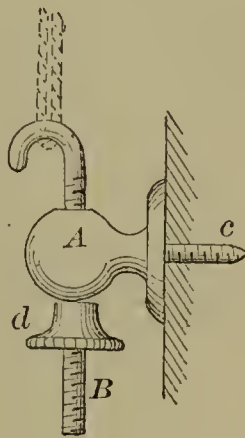

54987—A. L. Whitney—Potato Masher.

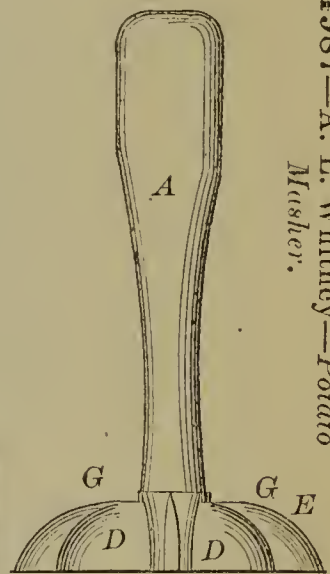

54989—S. P. Williams—Fence.

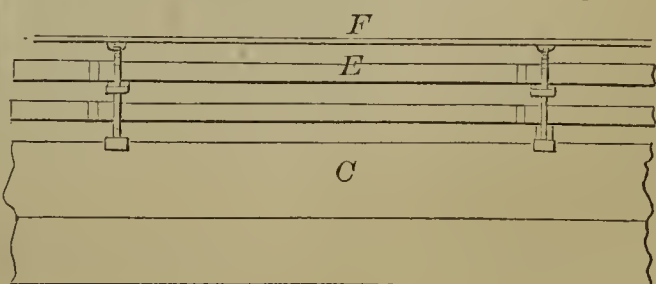

54986—W. H. White—Hats and Caps.

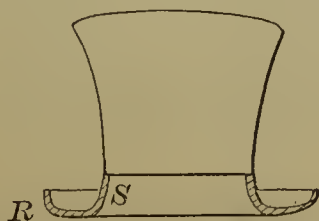

54990—W. Wimmer—  
*Securing Bits in Braces.*

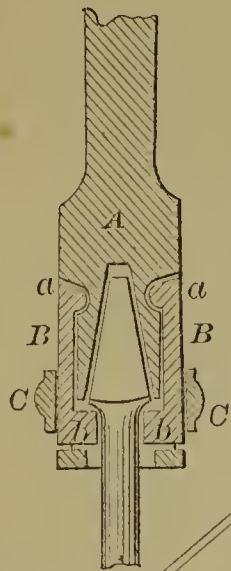

54995—E. Young—*Seed Drill.*

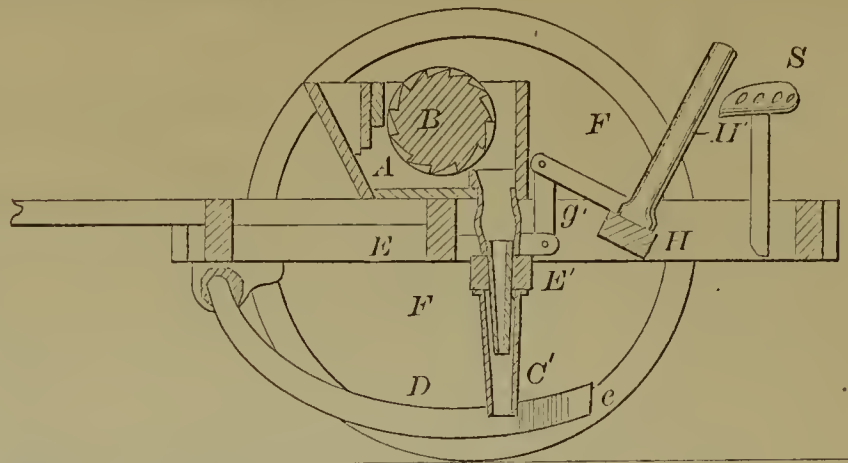

54992—J. Wootton—*Flying Machine.*

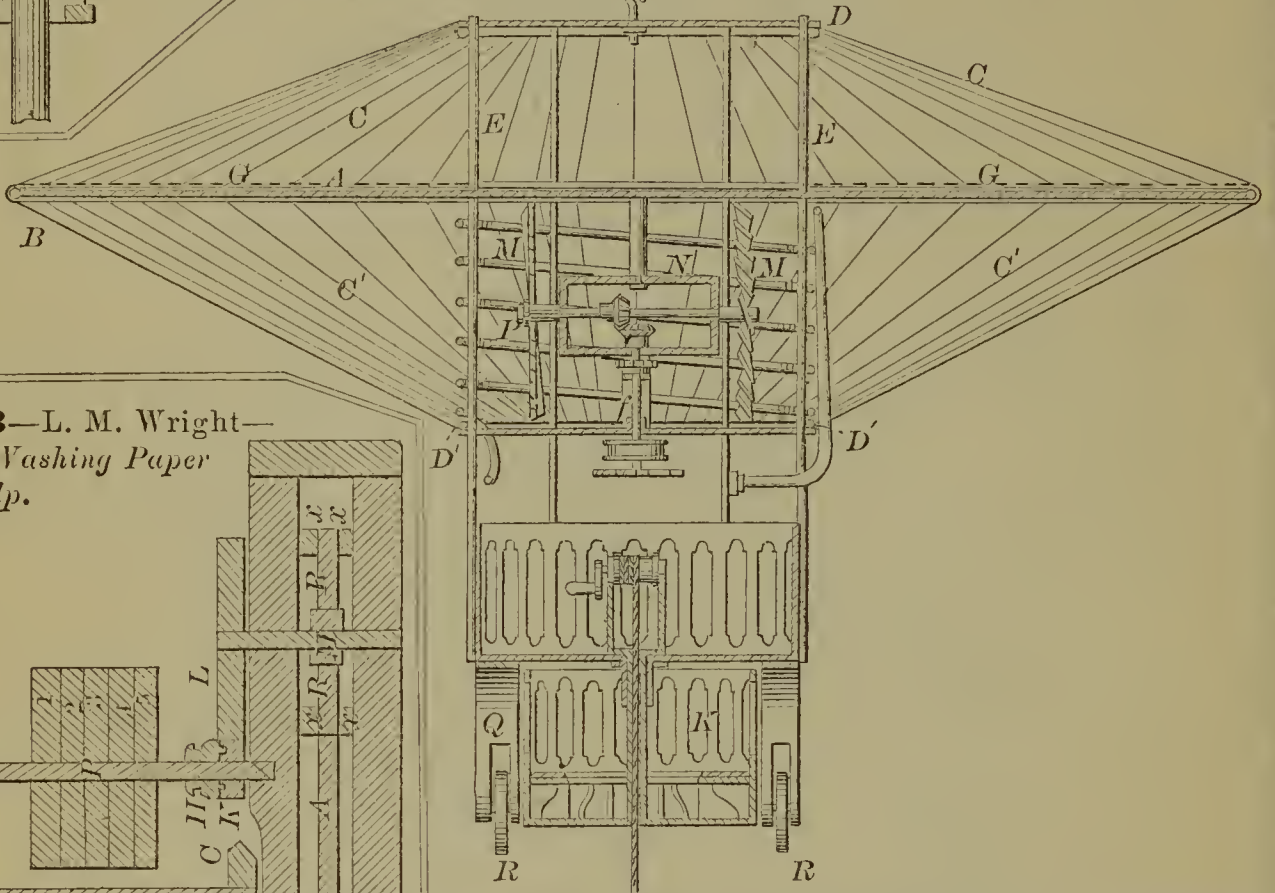

54993—L. M. Wright—  
*For Washing Paper Pulp.*

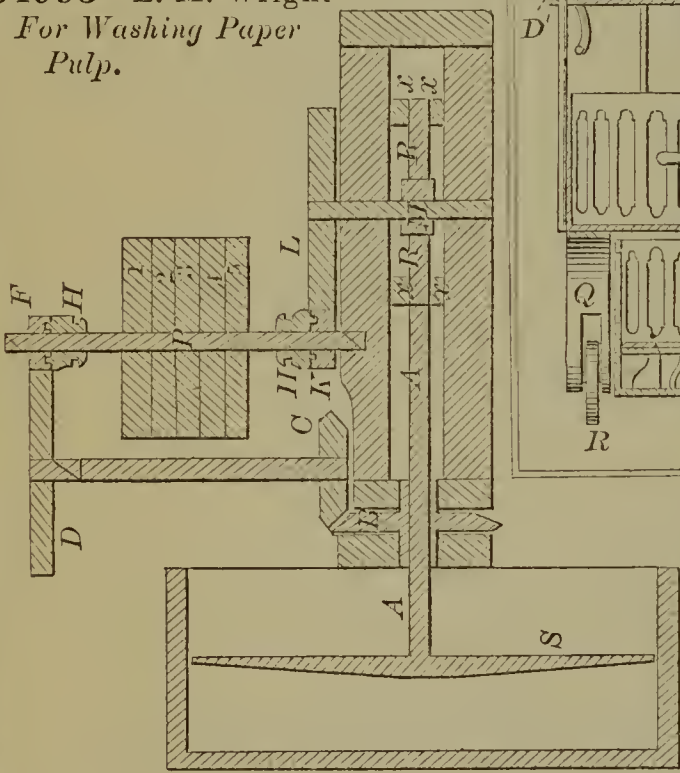

54994—C. E. Yager—*Flour Sieve.*

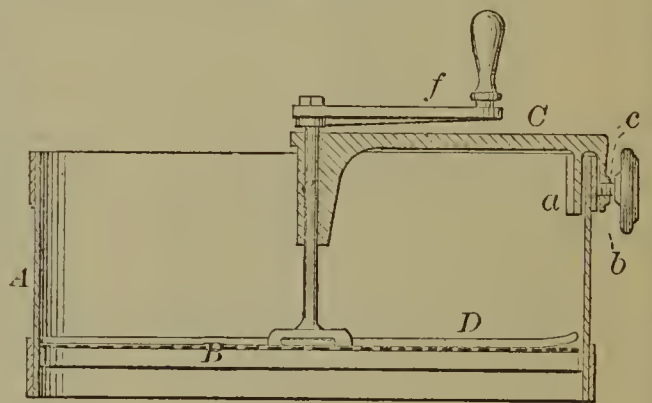

54991—J. Wood—*For Holding Glass Bottles.*

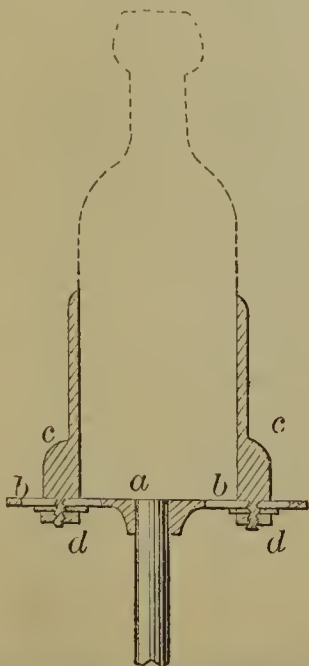

54996—J. Aborn—*Blind Fastener.*

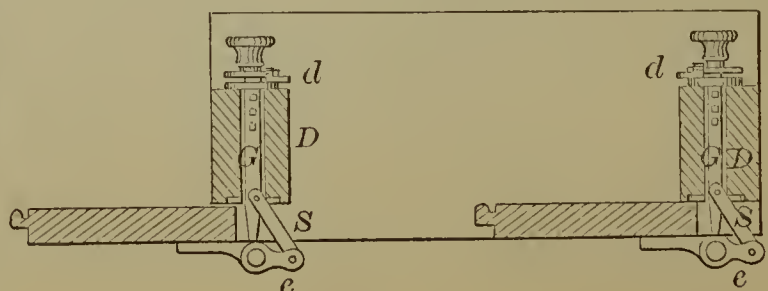

54997—G. A. Alger—*Punching Machine.*

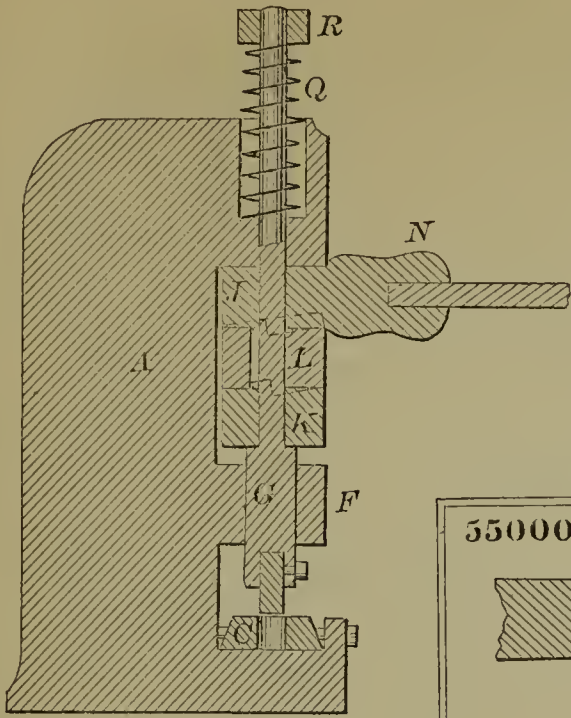

54998—A. W. Bardwell—*Hoop Skirt.*

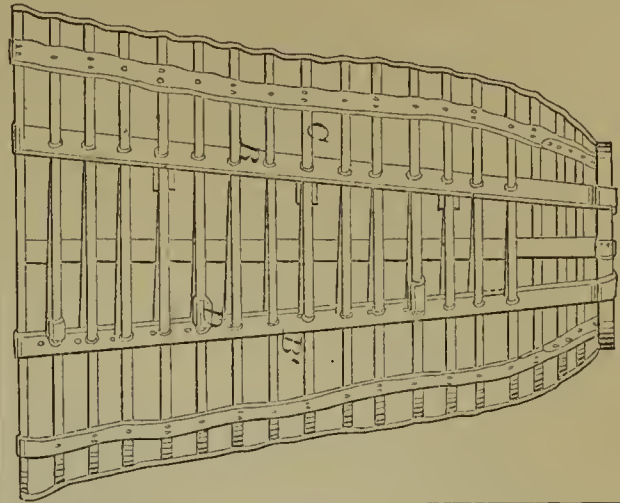

55000—A. Boyden—*For Attaching Handles to Rakes, &c.*

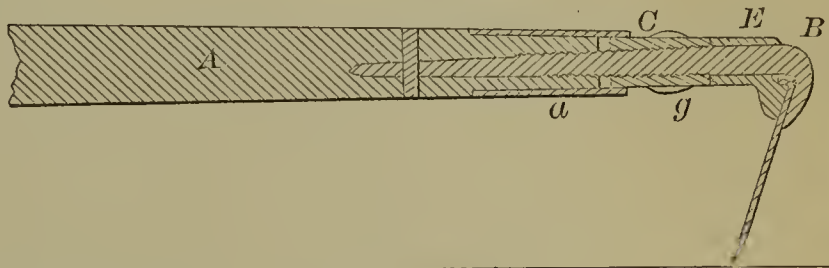

54999—O. Billings—*Hand Corn Planter.*

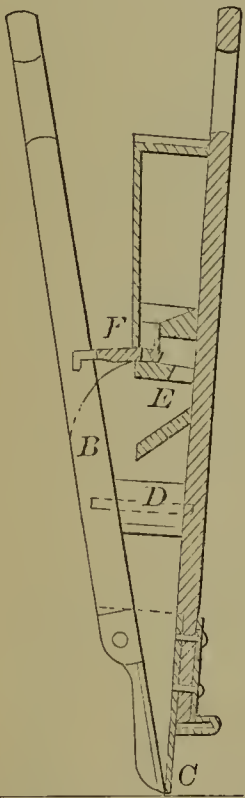

55001—M. Bray—*Guide for Jaws.*

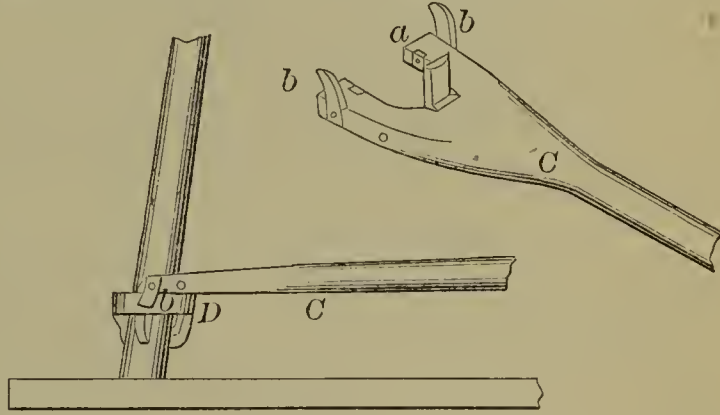

55002—J. Brooks—*Welt Trimmer.*



55004—C. B. Cottrell—*For Tempering Steel.*

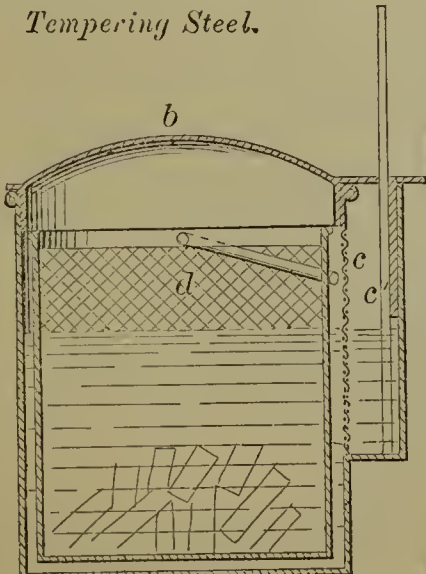

55005—J. J. Currier—*For Folding Paper Collars.*

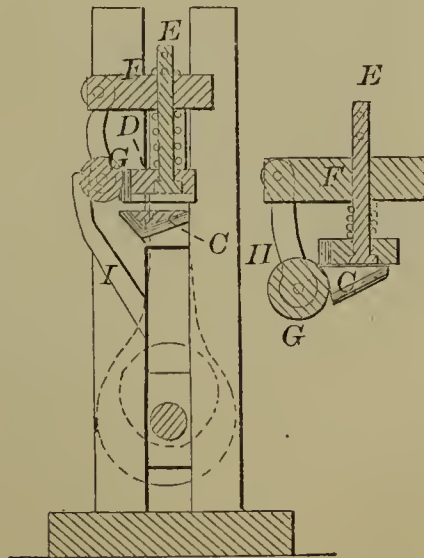

55003—C. E. Condon—*Sash Supporter.*

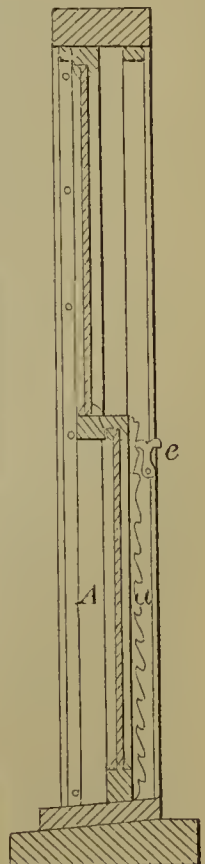

55006—J. Dane, Jr.—Wood Shaping Machine.

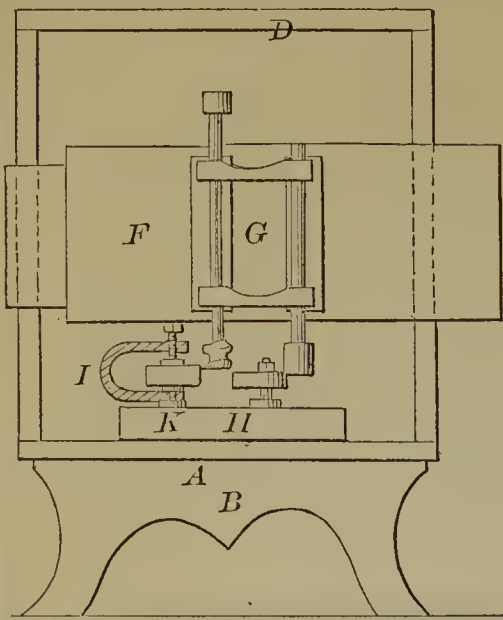

55009—W. Hyde—Rock Drilling Machine.

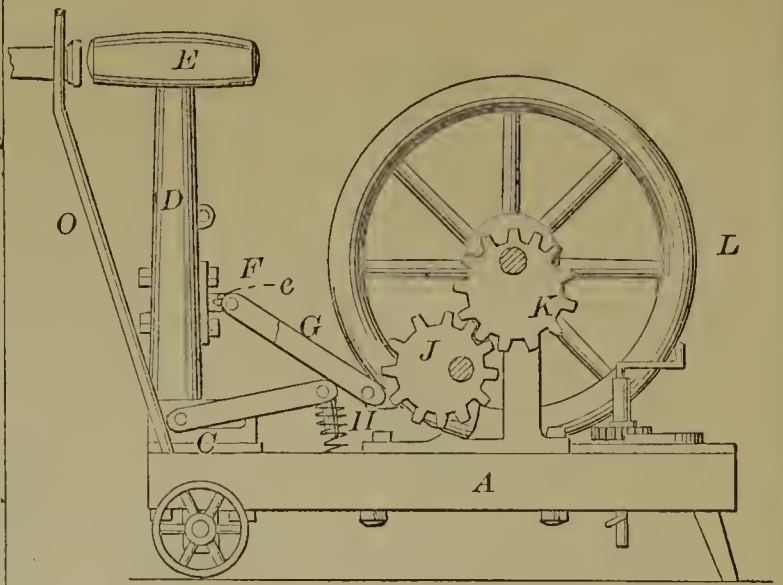

55010—Jenks & Goodyear—Heddle Motion for Loom.

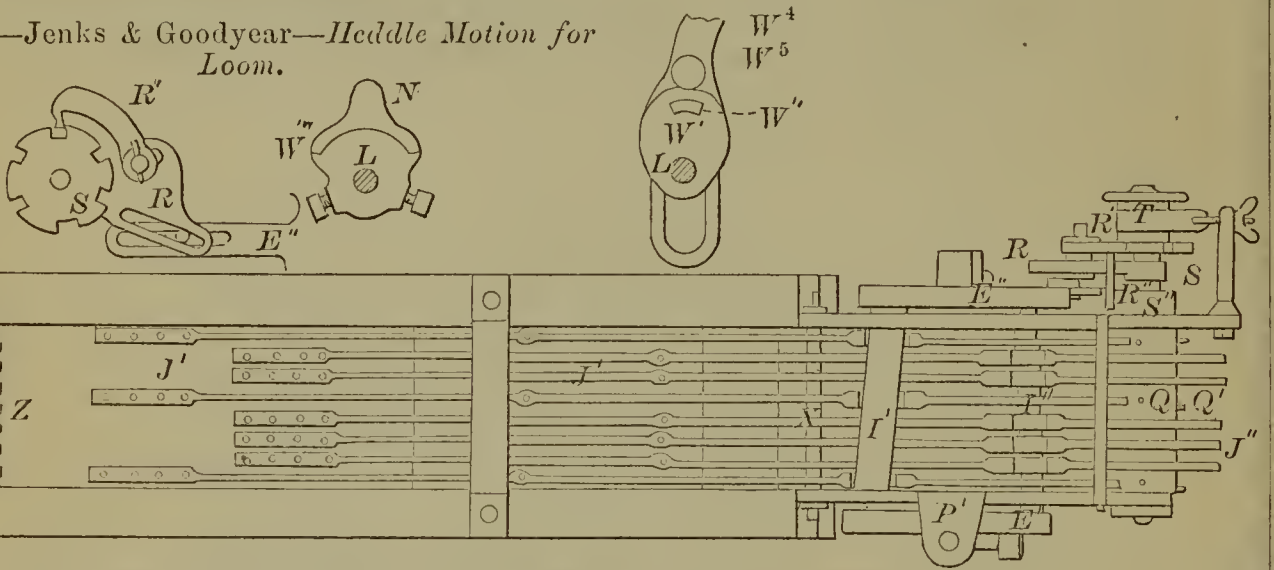

55007—Emery & Gott—Fly Trap.

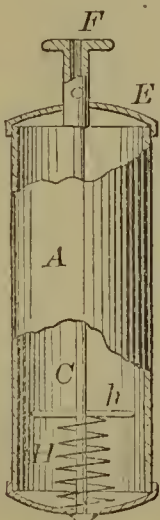
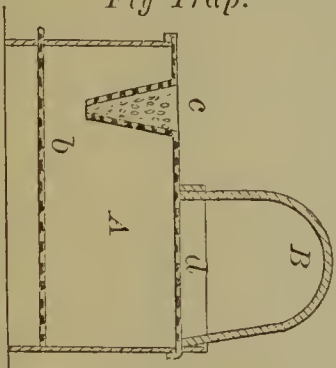

55008—W. P. Gannett—Clothes Sprinkler.

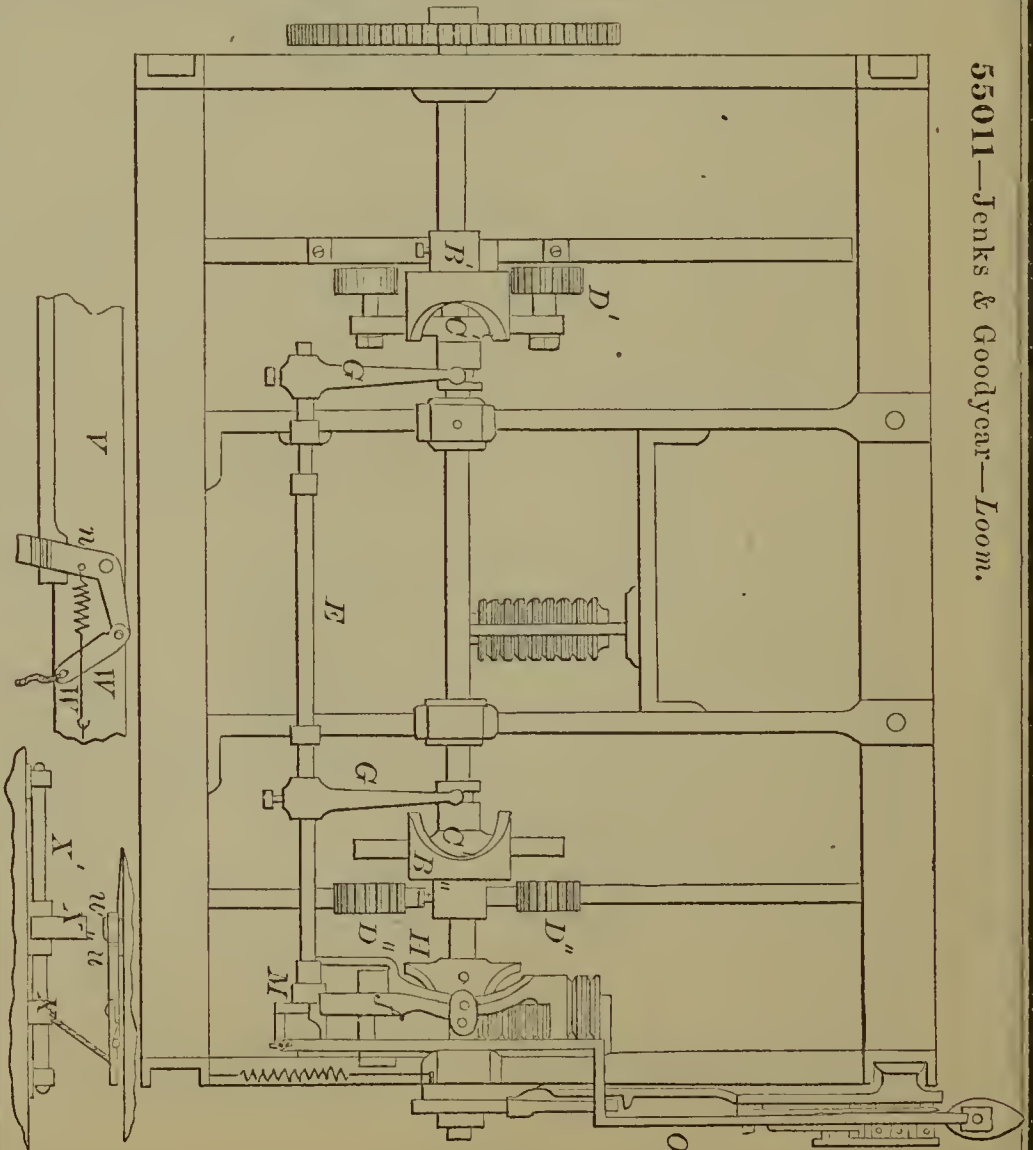

55011—Jenks & Goodyear—Loom.



55012—N. King—Magazine Fire Arm.

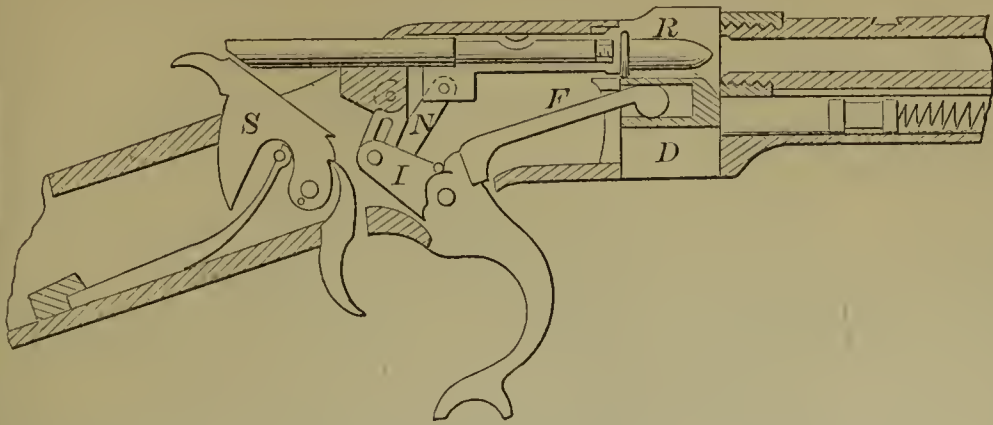

55015—P. H. Niles—Seam for Sheet Metal Ware.



55013—J. Kunsman, Sr.—For Preserving Dead Bodies.

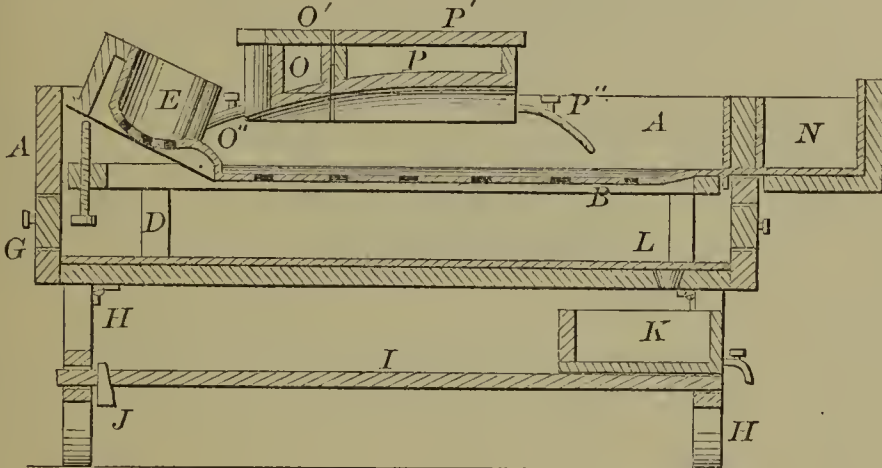

55016—P. H. Niles—Attaching Sides of Sheet Metal.

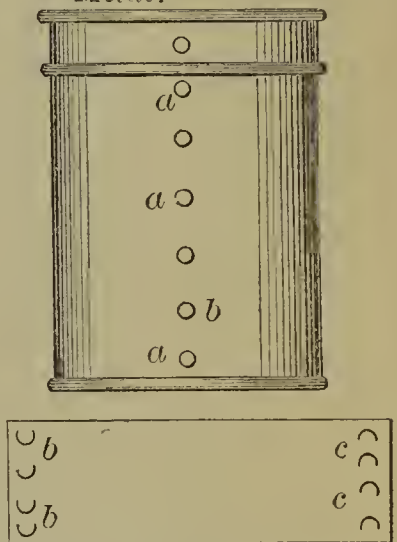

55017—E. Parker—Stove Pipe Damper.



55018—J. H. Rae—Peat Machine.

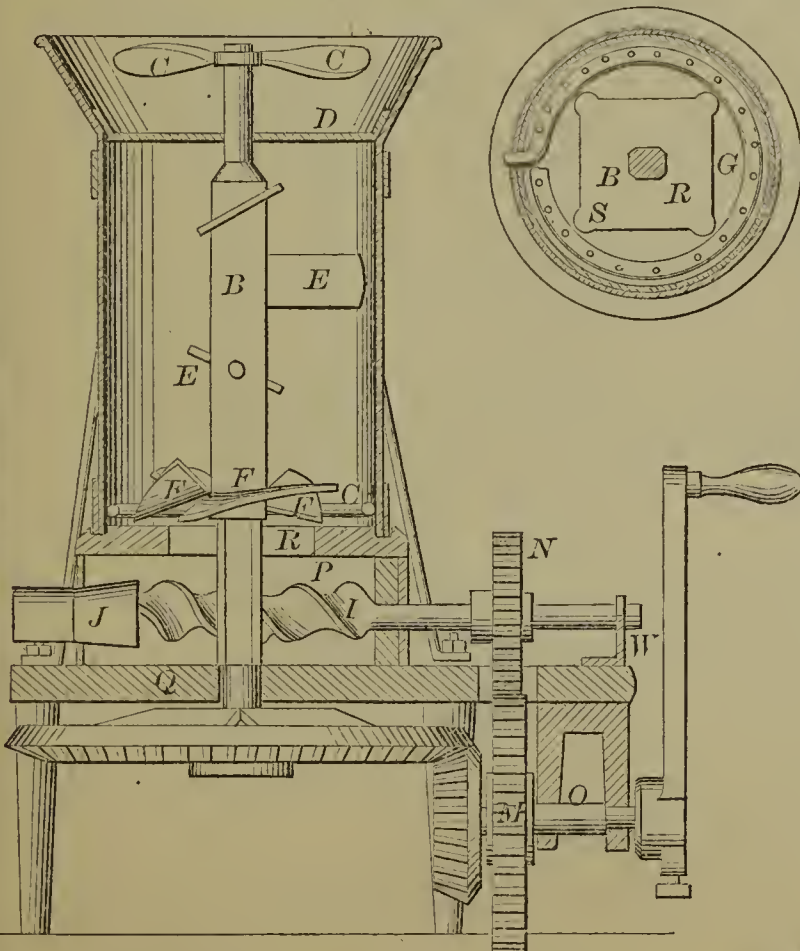

55014—J. Malone—For Annealing Sheet Iron, &c.

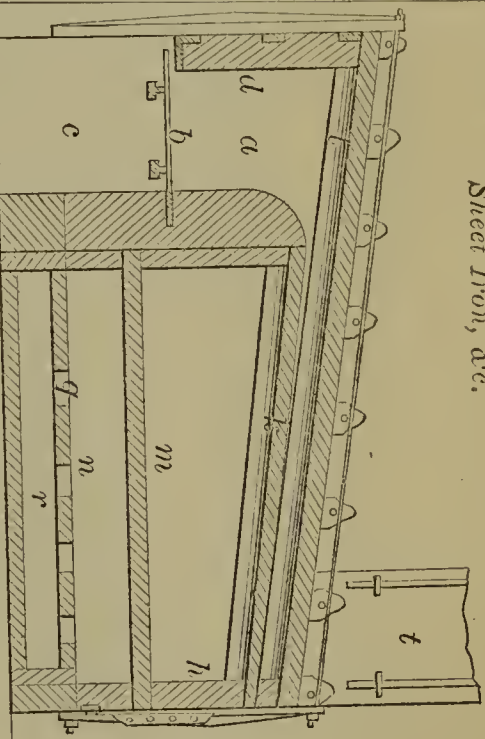

55019—H. Schreiner—Horse Shoe.

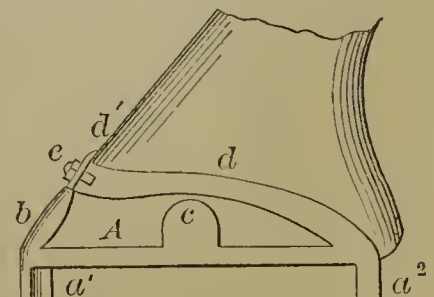

55020—R. Simpson—*Stove Door.*

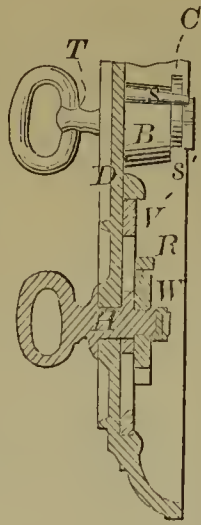
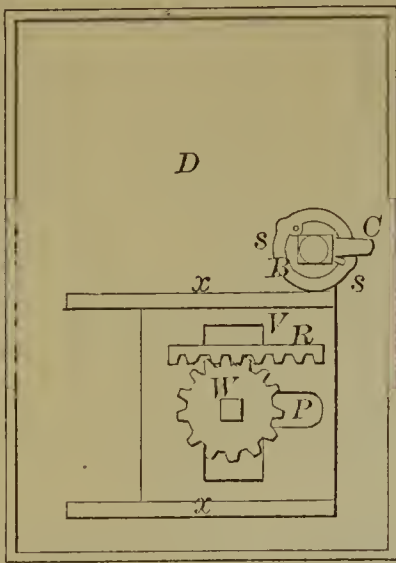

55021—L. Smith—*Spring for Beds.*

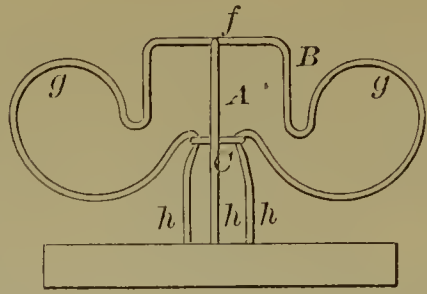

55024—H. Thompson—*Rotary Harrow.*

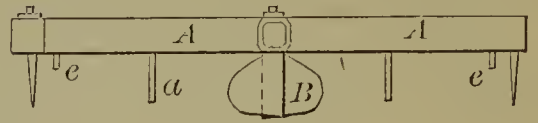

55022—E. L. Staples—*Pump.*

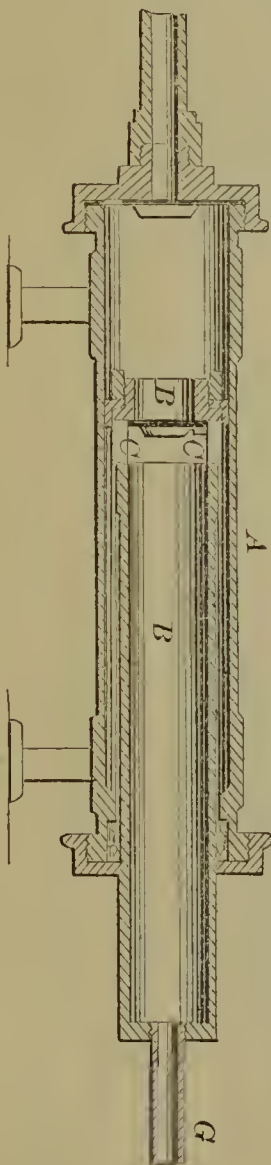
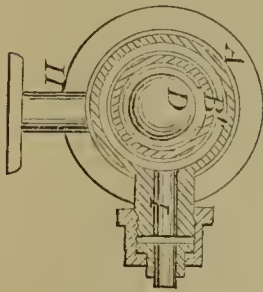

55023—A. J. Thompson—*Cover for Sewing Machines.*

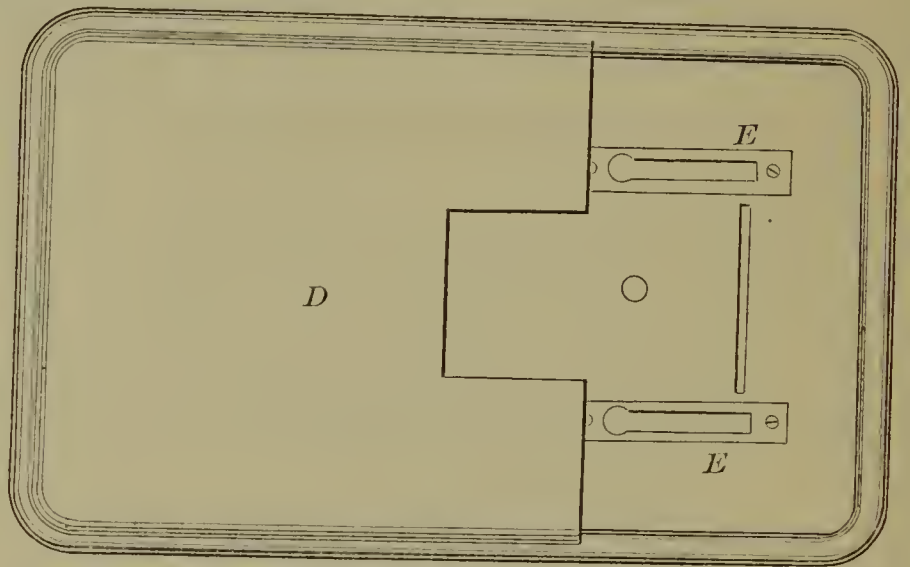

55026—T. Whittaker—*For Raising Sunken Vessels.*

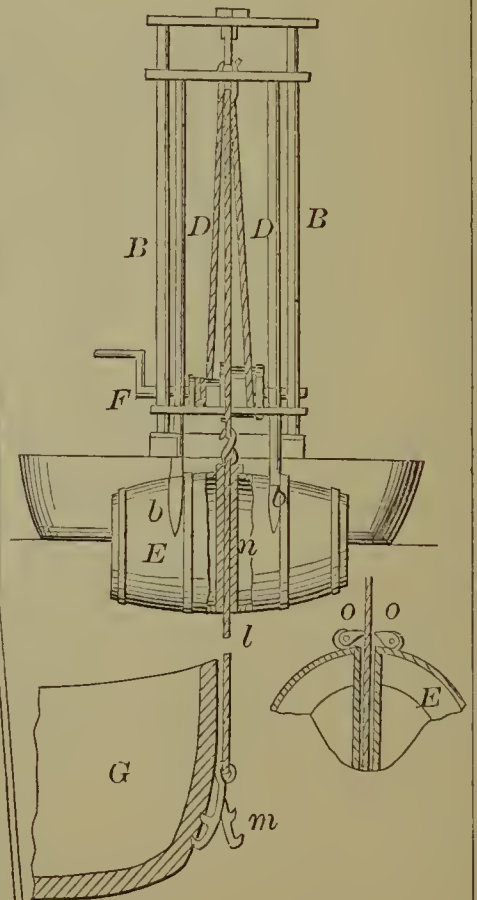

55025—J. W. Wheeler—*Water Drawer.*

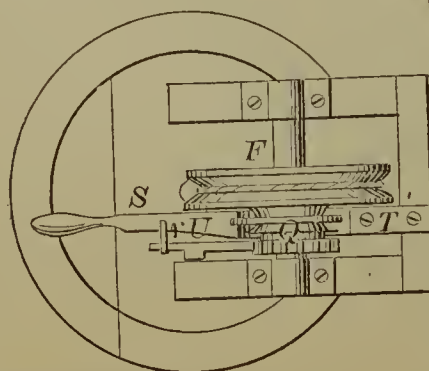
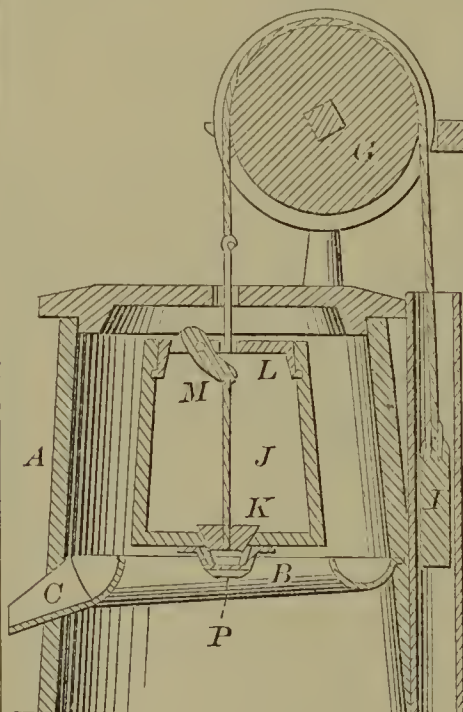

55027—J. G. Wilson—*Knitting Machine.*

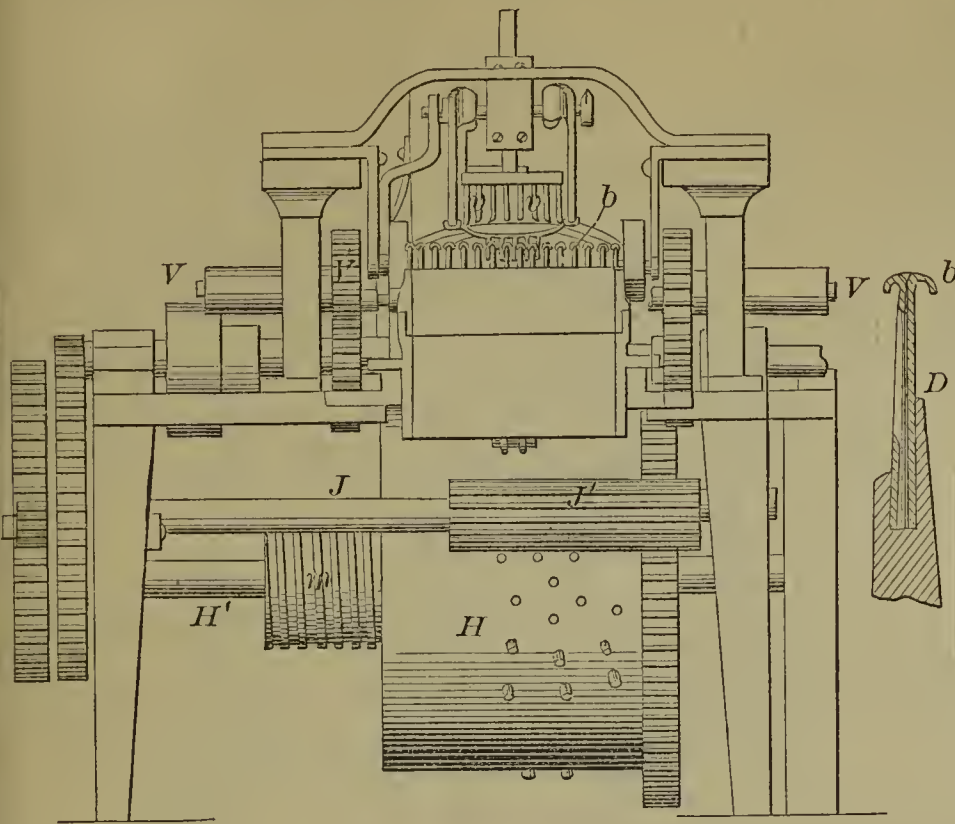

55028—P. Dinzey—*Rudder.*

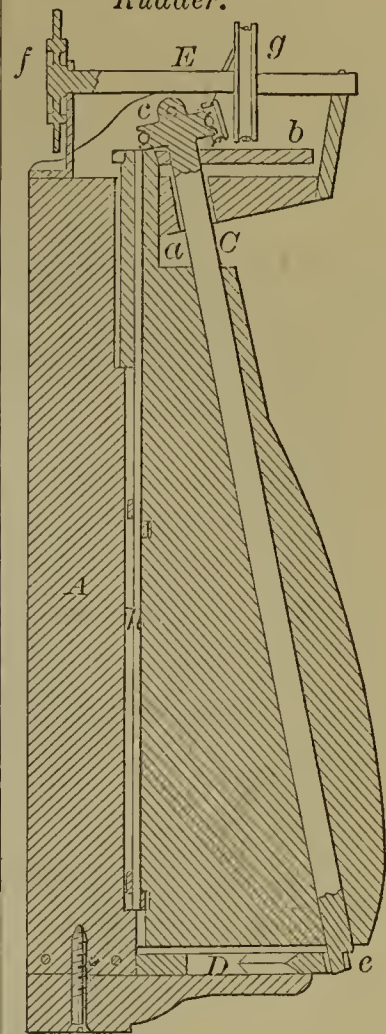

55030—R. W. Thomson—*For Obtaining Motive Power.*

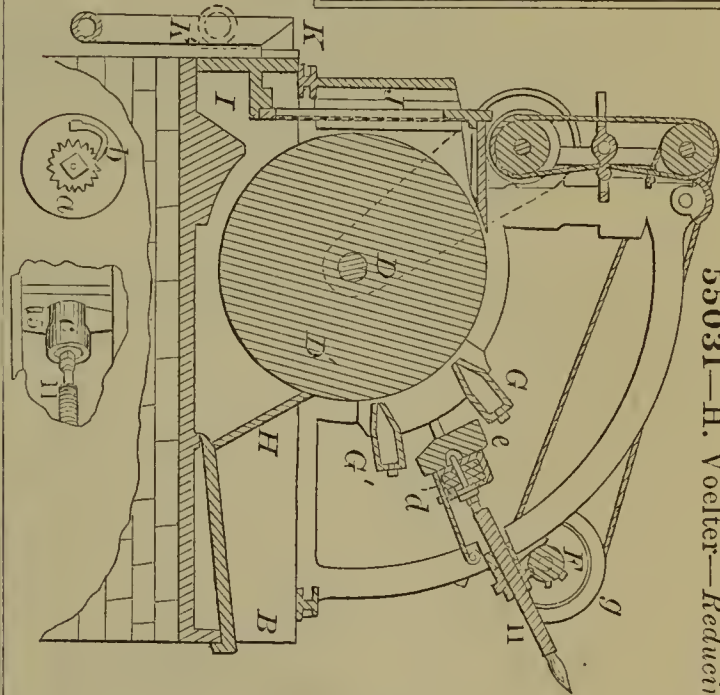
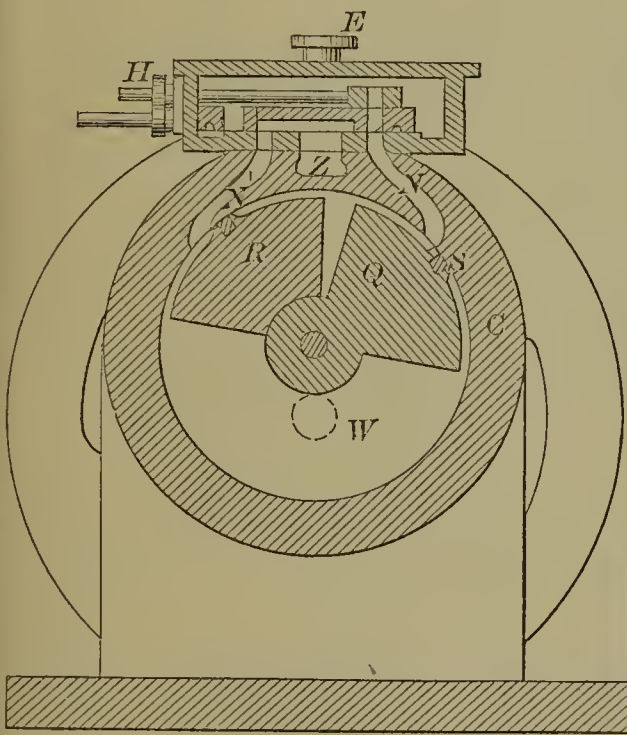

55031—H. Voelter—*Reducing Wood to Paper Pulp.*

55029—J. Hayes—*Sewing Machine.*

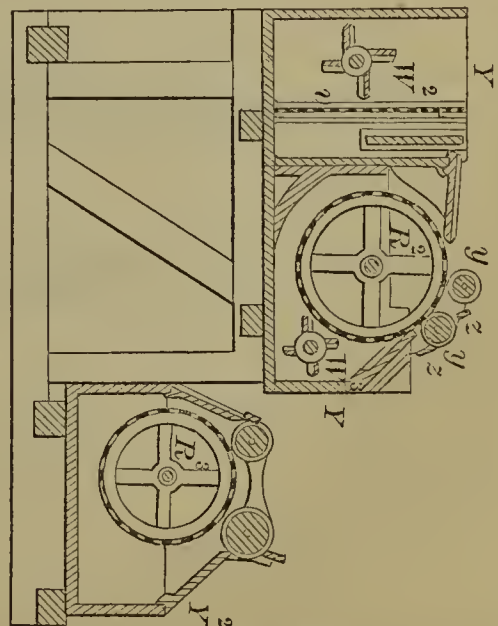
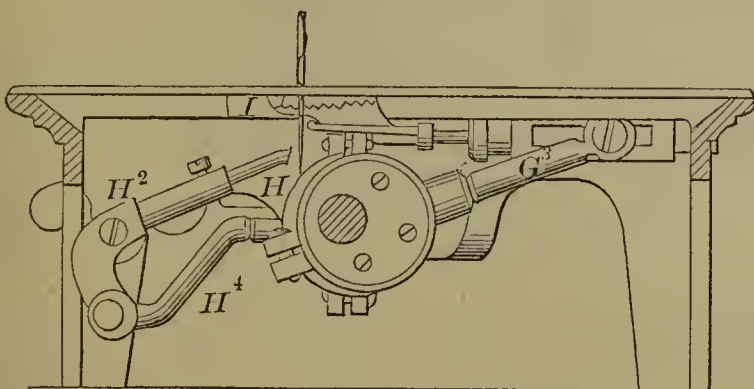

55031—Continued.

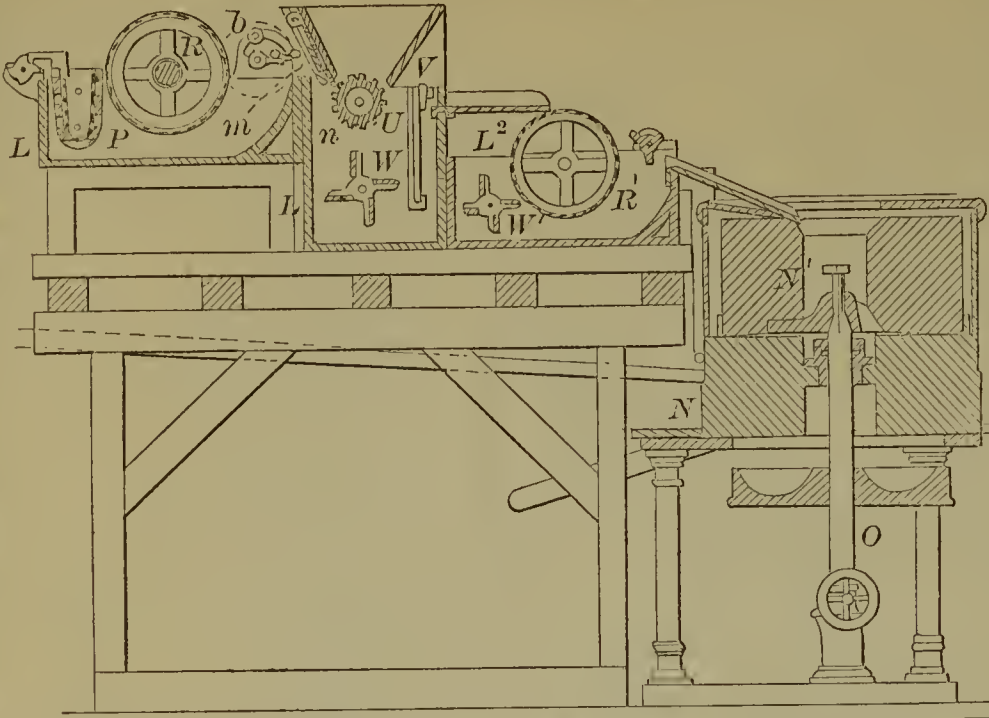

55034—C. Allardice—  
Knitting Machine Burr.

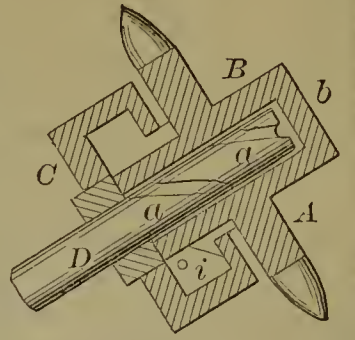

55035—T. H. Arnold—  
Horse Hay Fork.

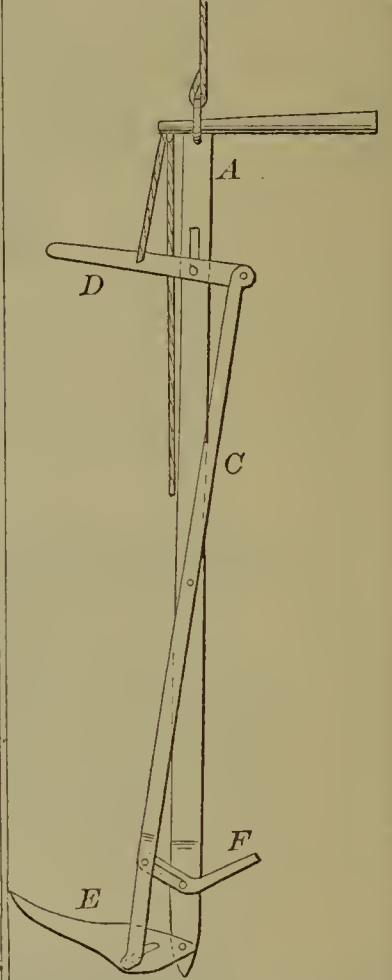

55032—O. F. Morrill—Petroleum Stove.

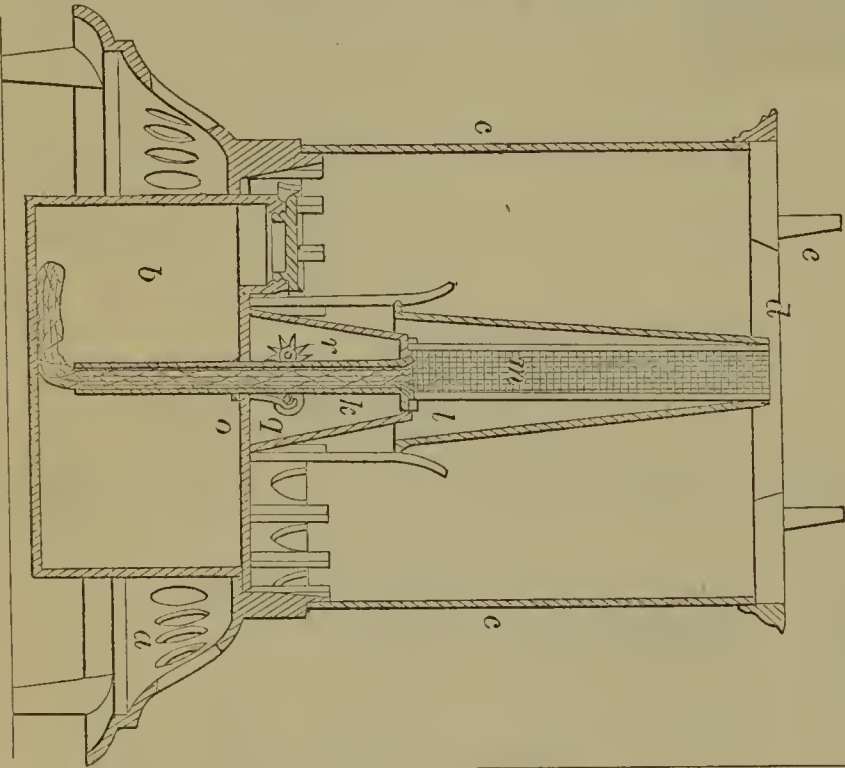

55033—O. F. Morrill—For Cooking by Coal Oil Burners.

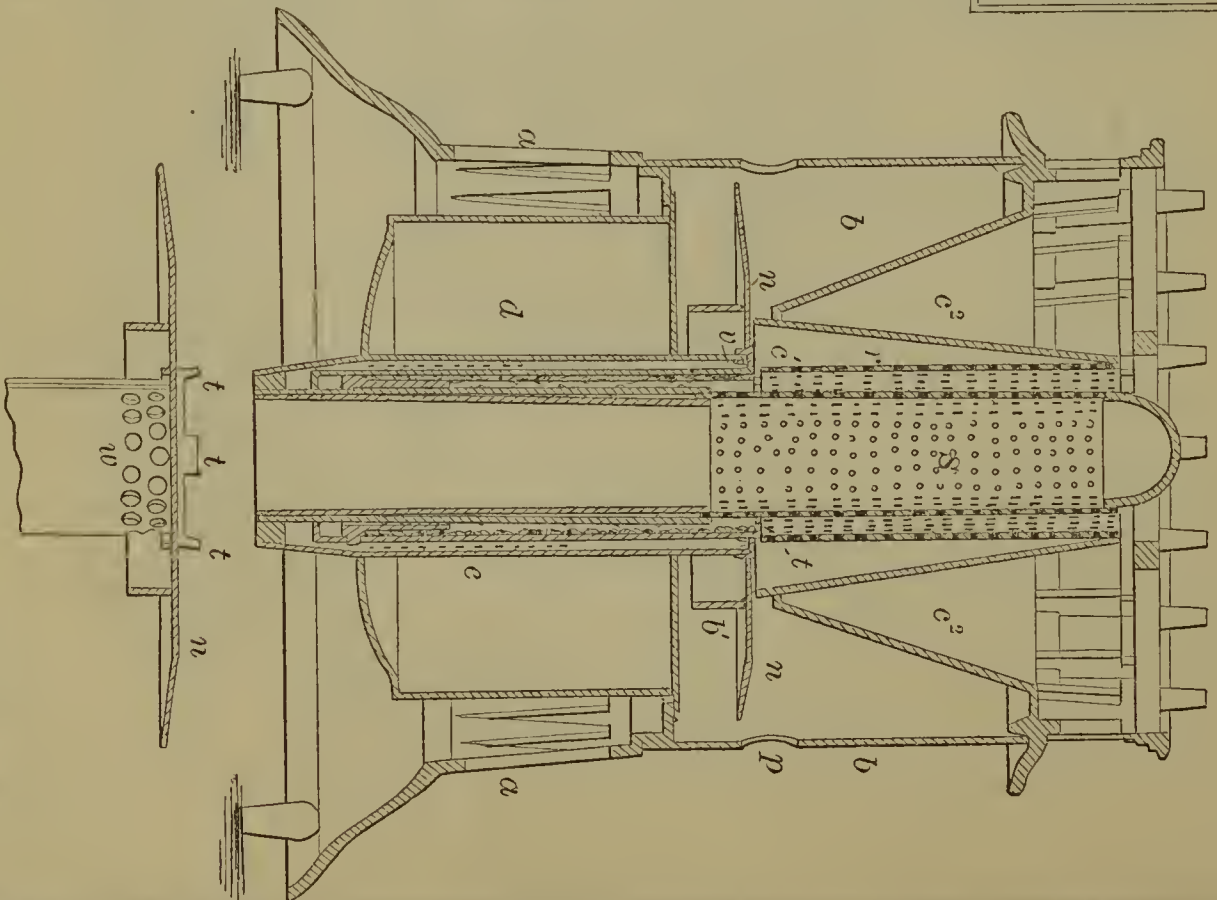

55036—A. J. Bailey—Cork Cutting Machine.

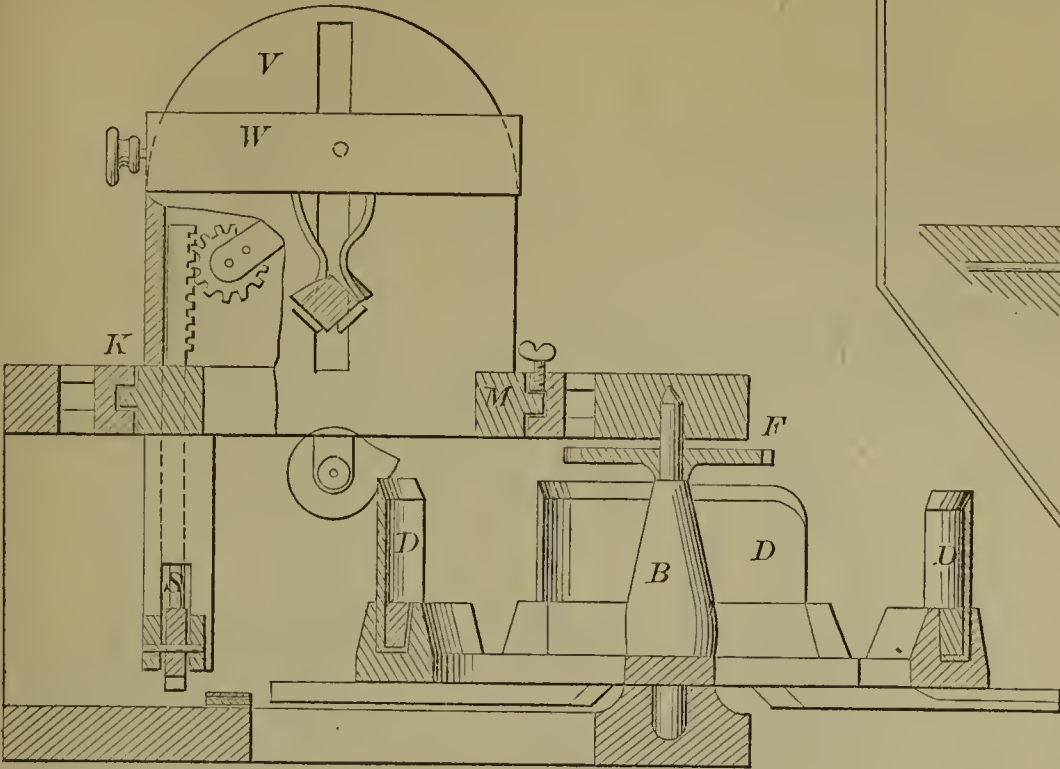

55037—J. M. Baird—Water Cooler and Purifier.

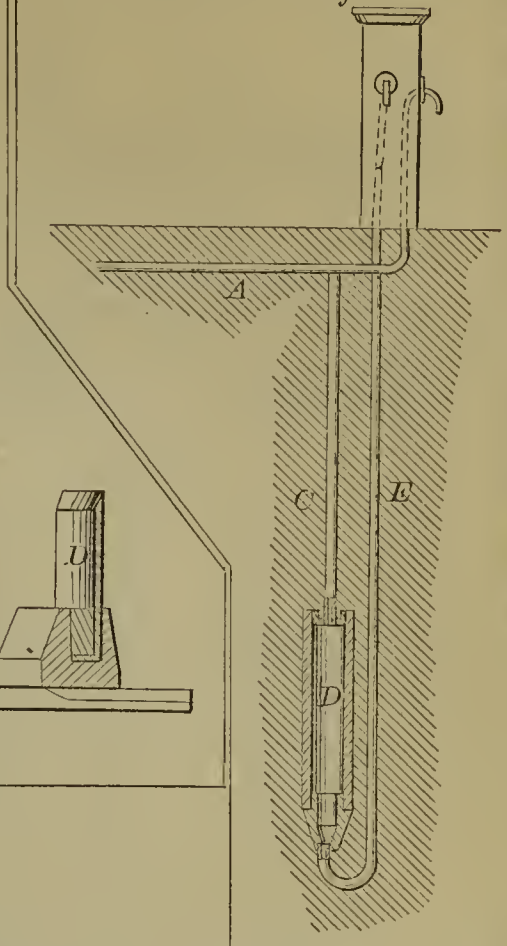

55038—J. S. Baldwin—Separating Carbonic Acid from Gases.

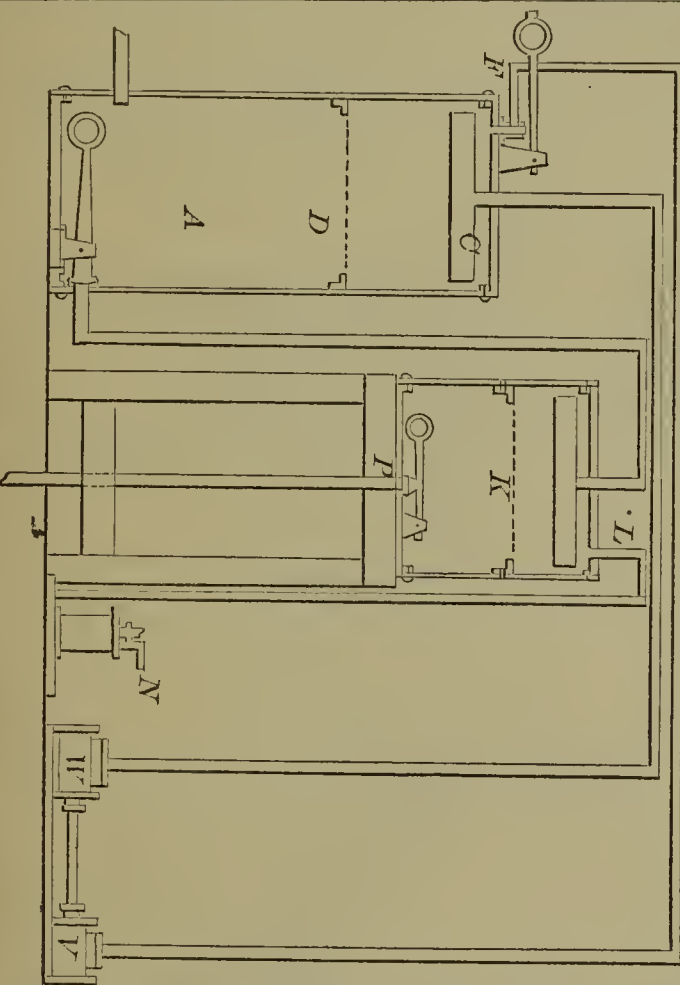

55040—J. S. Baldwin—Charging Water with Carbonic Acid.

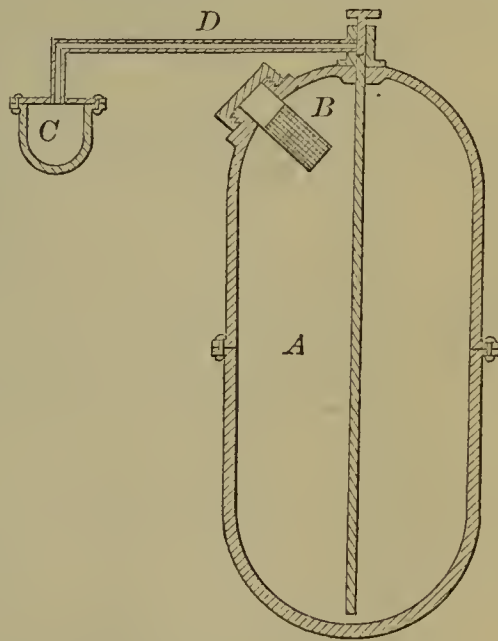

55039—J. S. Baldwin—Storing Carbonic Acid Gas.

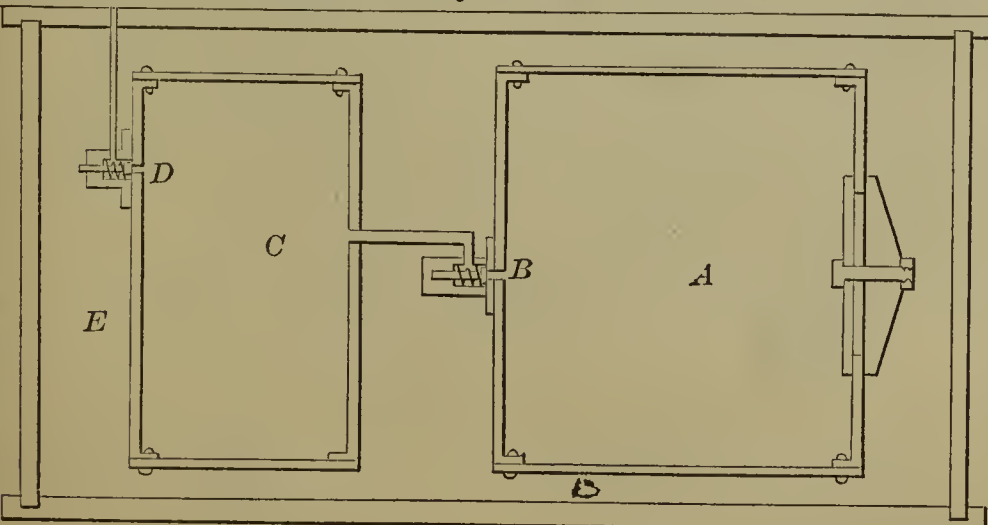

55041—A. Ballard—Shoe.

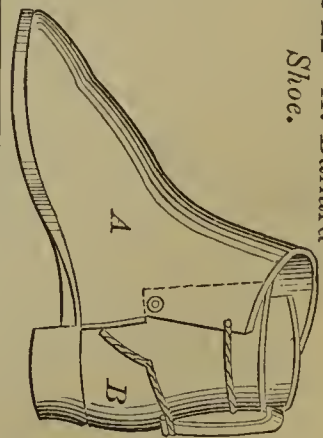

55042—H. J. Batchelder—*For Bending Horse Shoes.*

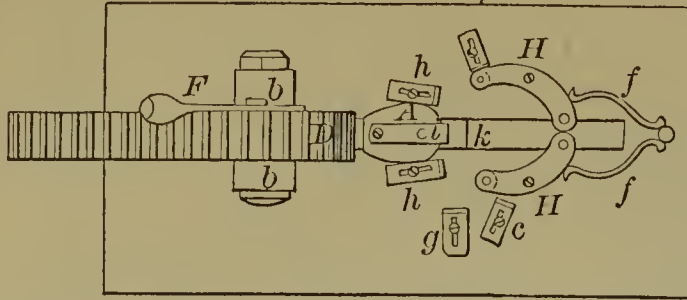

55047—W. Bohannon—*Lock.*

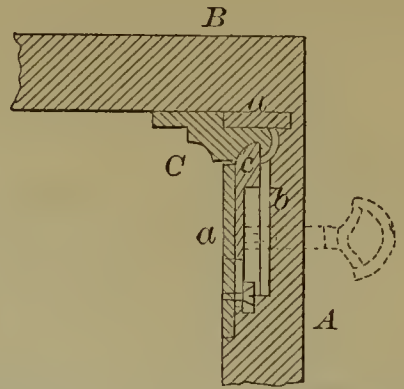

55043—A. Baumann—*Pruning Shears.*

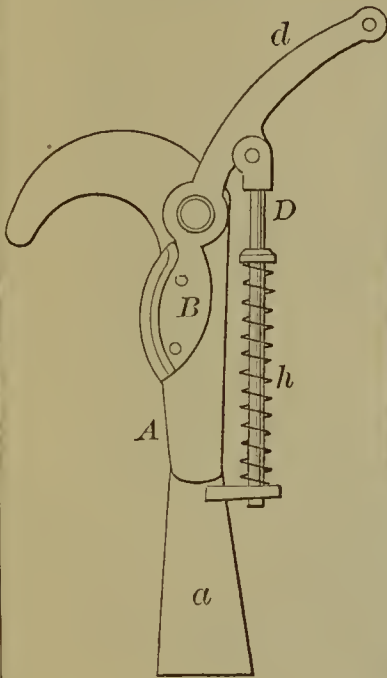

55045—Behel & Buell—*Horse Shoe.*

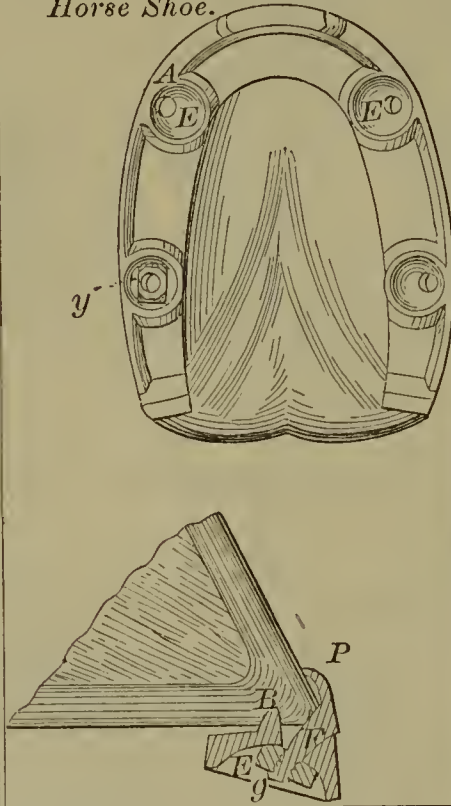

55048—Bohannon & Johnson—*Lock.*

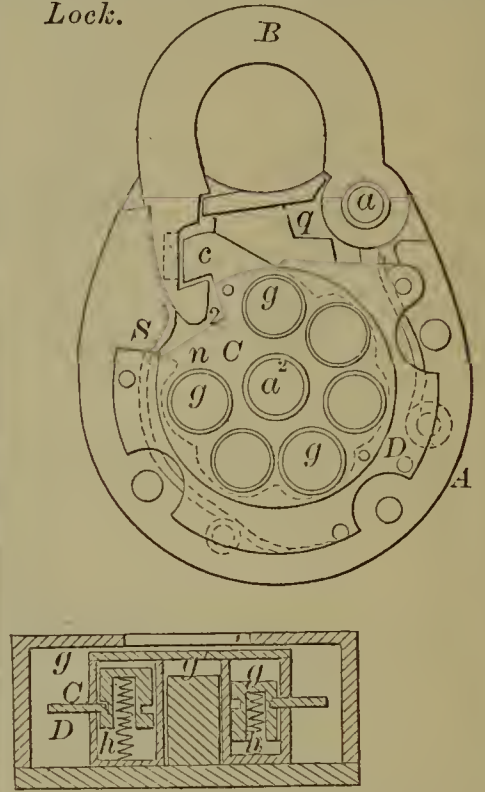

55044—A. Beckers—*Stereoscope.*

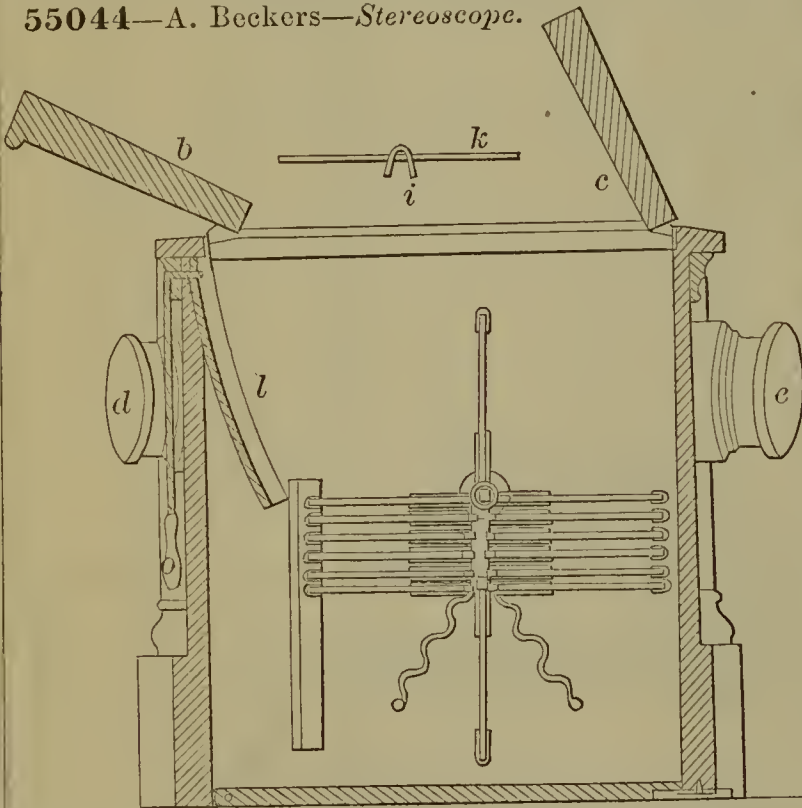

55049—J. E. Briggs—*Washing Machine.*

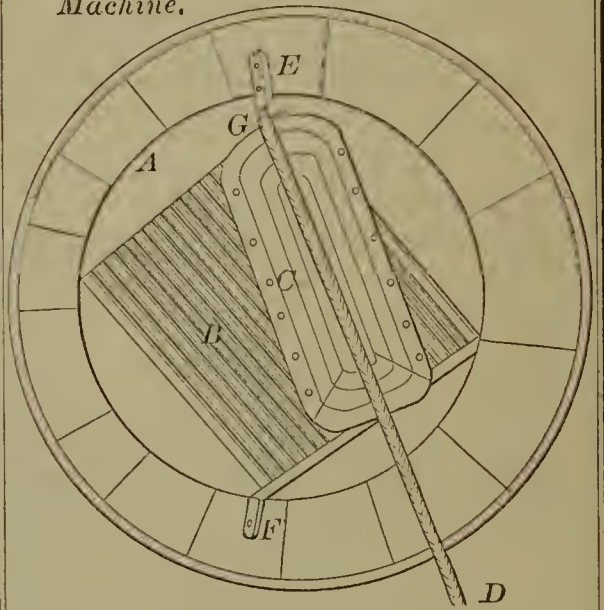

55046—A. A. Bennett—*For Operating the Doffer Comb of Carding Engines.*

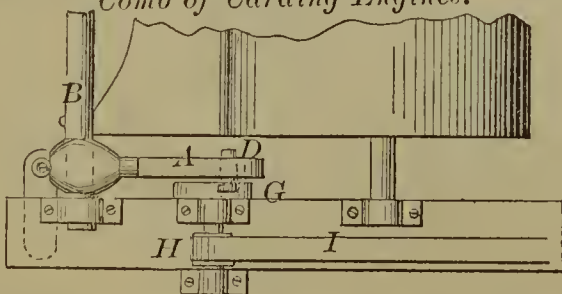

55050—C. B. Bristol—*Snap Hook.*

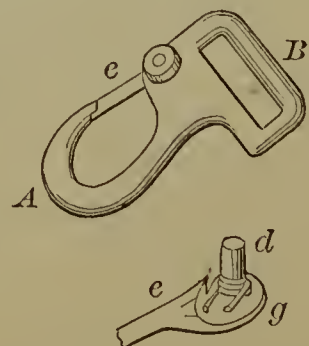

55051—A. Brooker—*Portable Fence.*

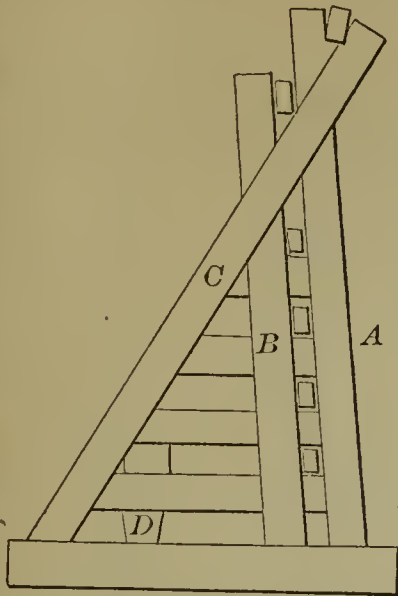

55052—Brown & Level—*For Lowering Ships' Boats.*

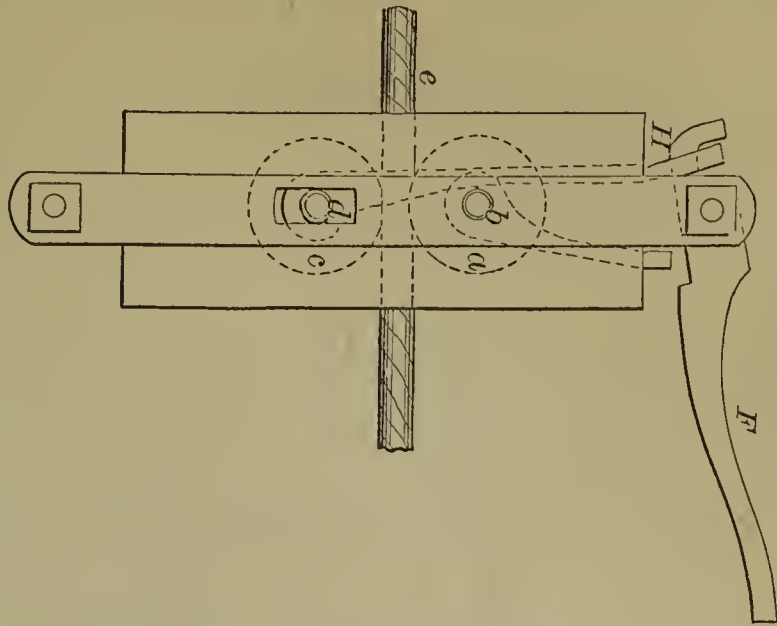

55054—Brown & Frankish—*Lamp Chimney.*



55056—E. A. Calahan—*For Punching Paper for Telegraph.*

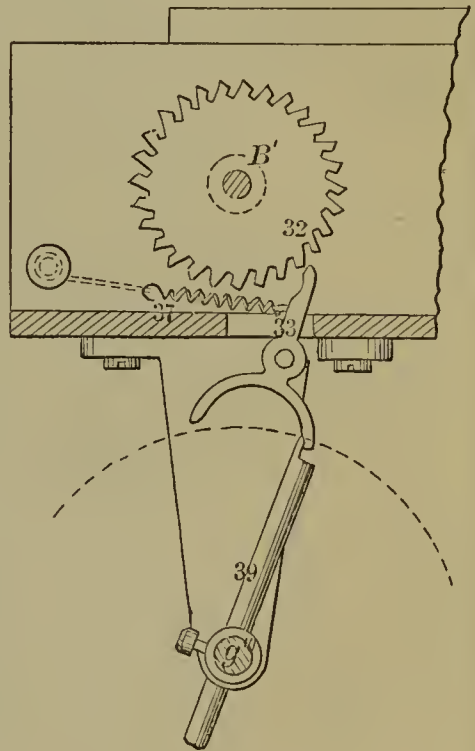

55052—A. T. Brooks—*Reversible Lock or Latch.*

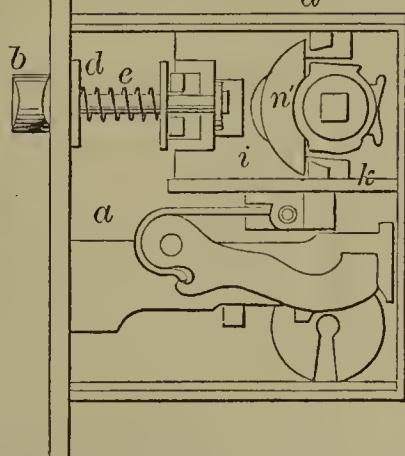

55058—J. Case—*Farm Gate.*

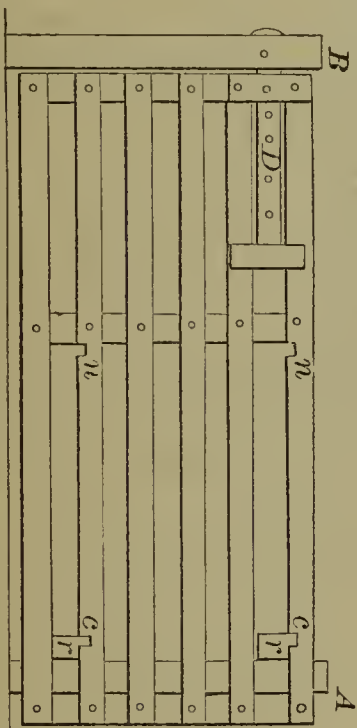

55059—W. J. & R. Case—*Harvester Rake.*

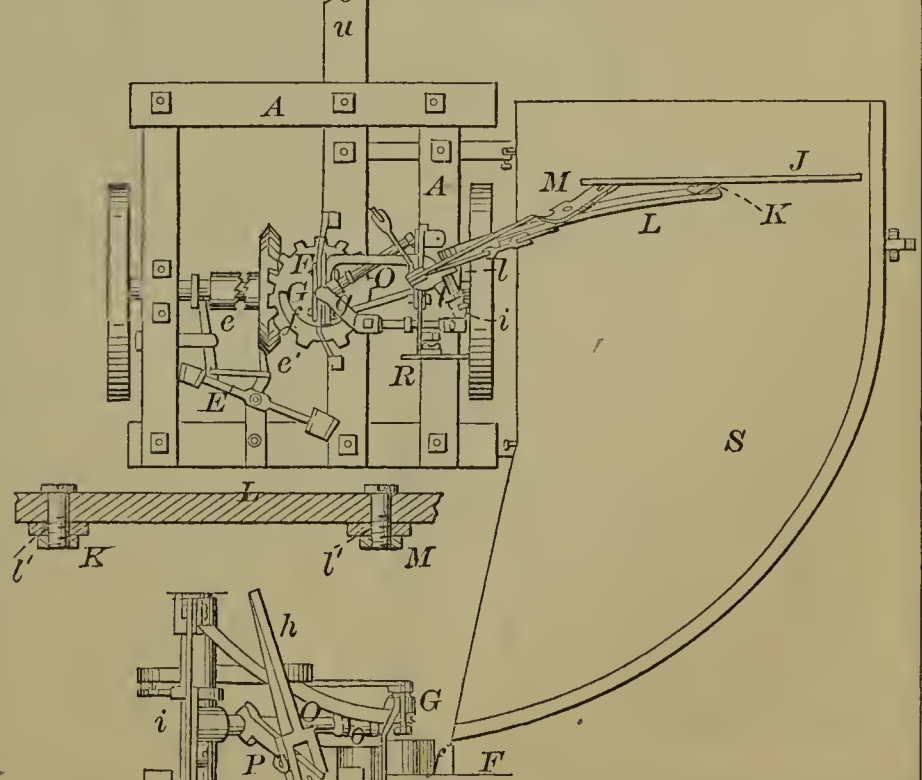

55057—E. A. Campbell—*Sash Supporter.*

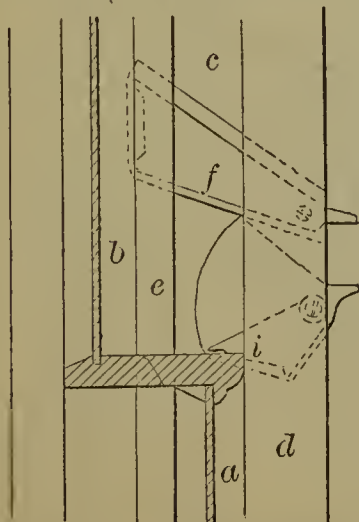

55060—P. C. Chipron—Harvester Rake.

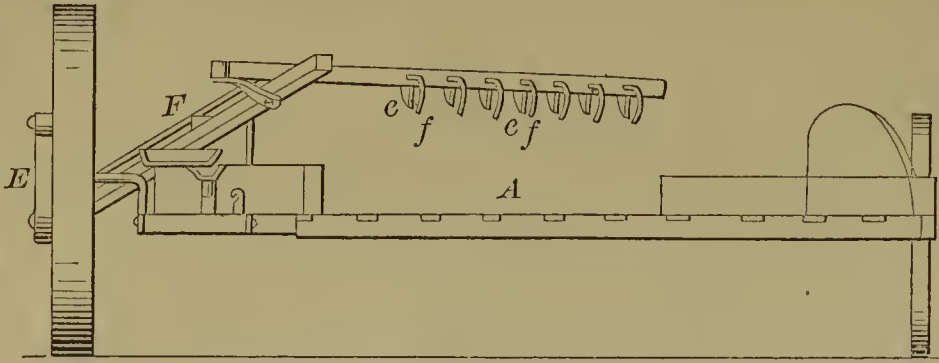

55063—I. Cook—Flour Packer.

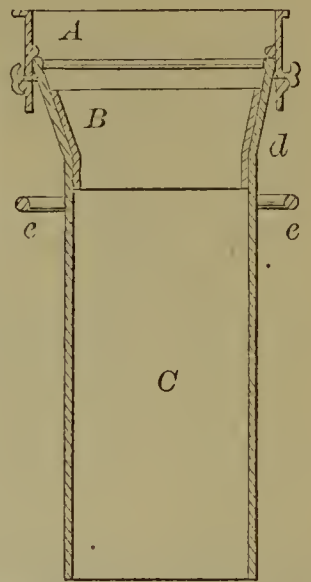

55061—W. Clement—Fruit Basket.

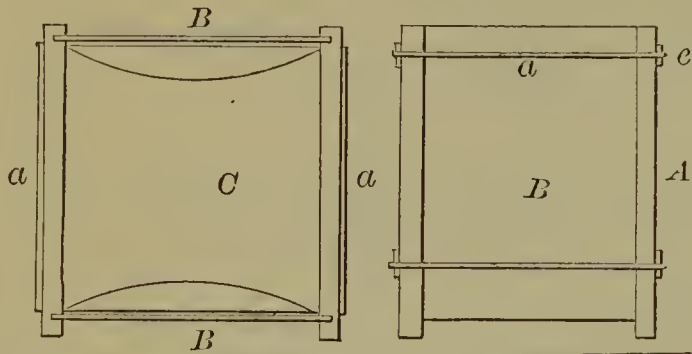

55064—W. G. Cook—Fastening for Garments.

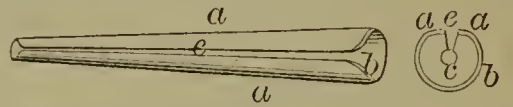

55062—A. J. Cook—Self-Tilting Bucket for Wells.

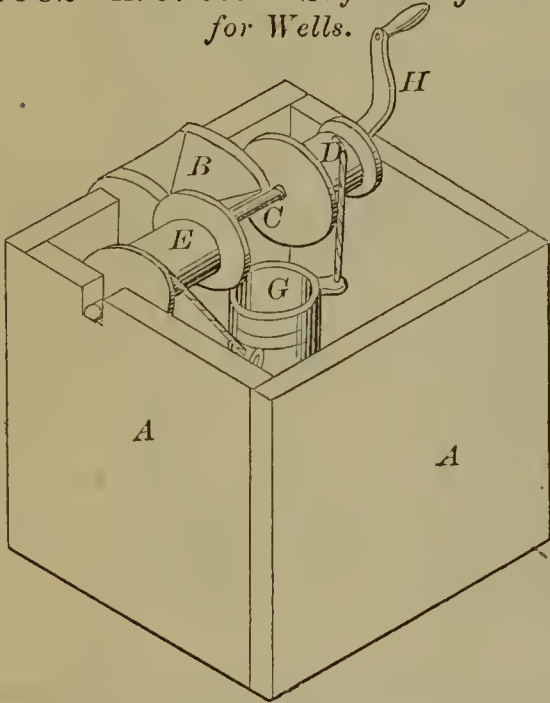

55067—J. Davis—Car Brake.

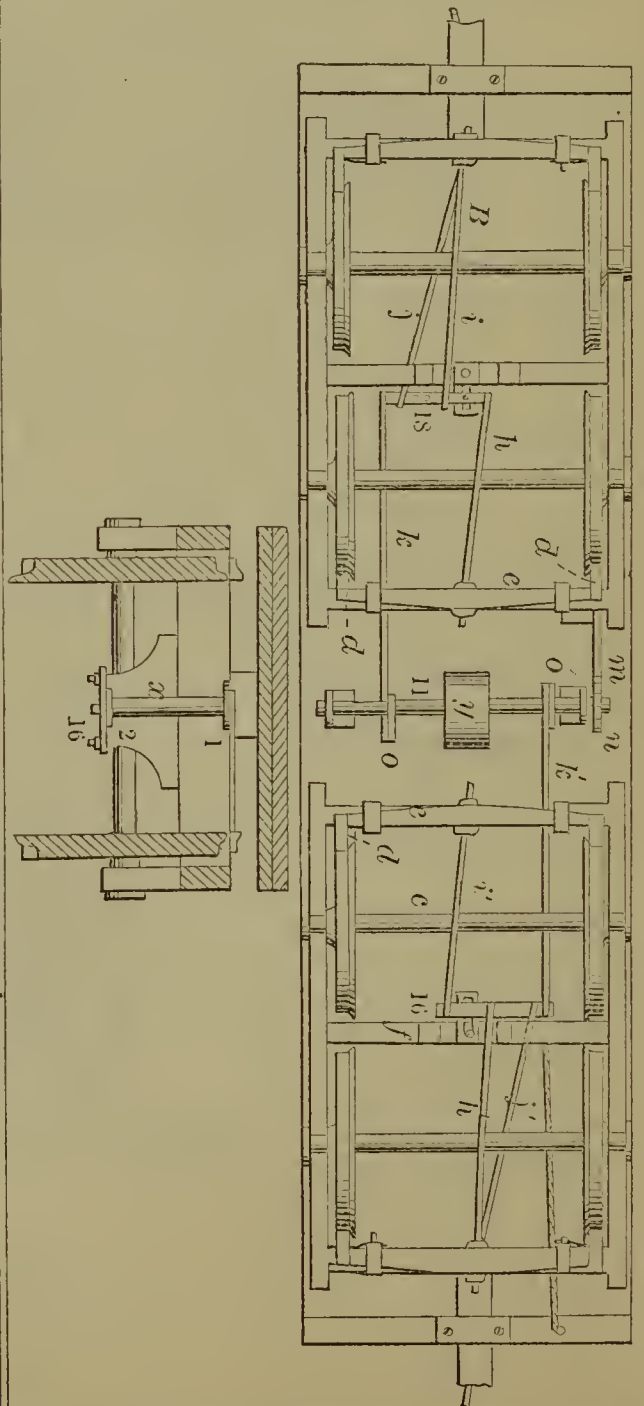

55065—C. Crawford—Open Coal Grate.

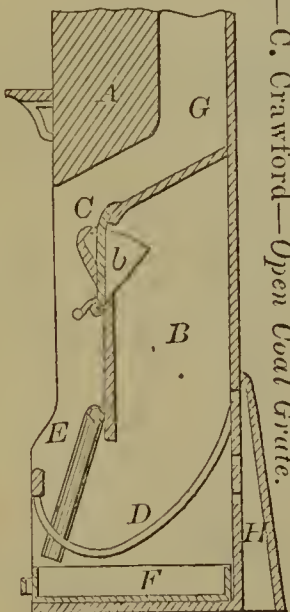

55066—J. L. Crist—Screw Wrench.

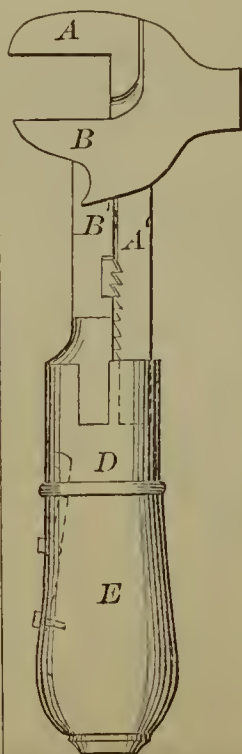



55068—G. M. Denison—Washing Machine.

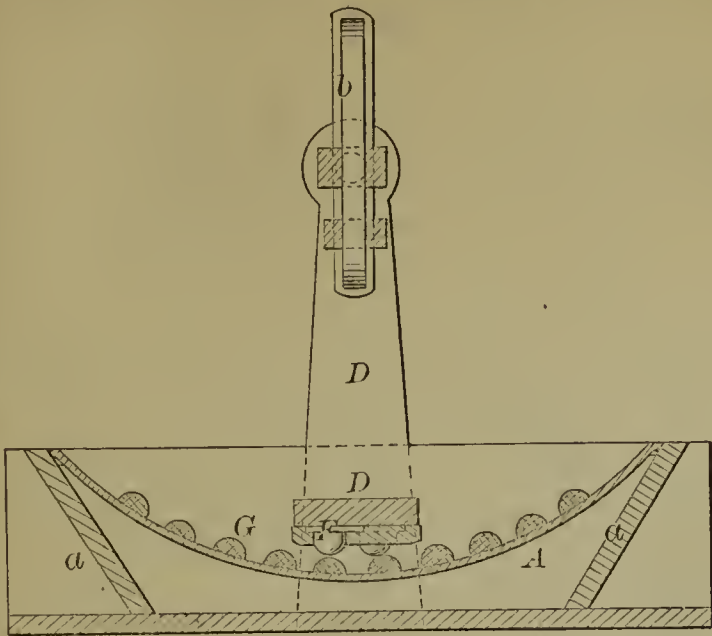

55075—M. B. Dyott—Lamp.

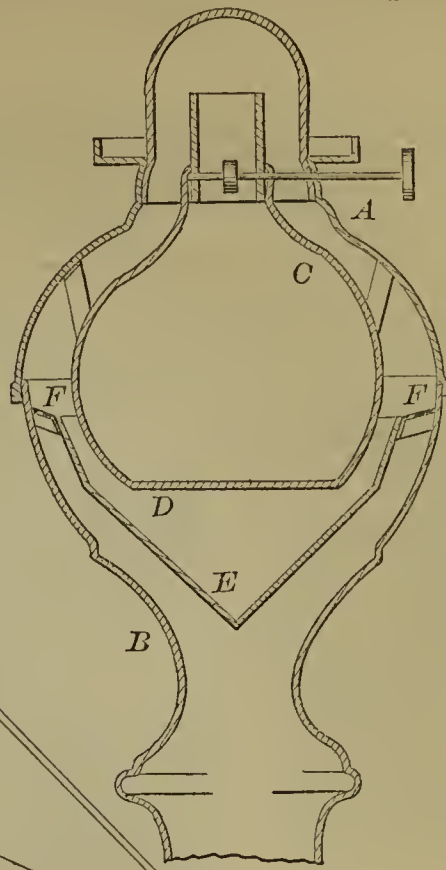

55069—L. B. Dennett—Plow.

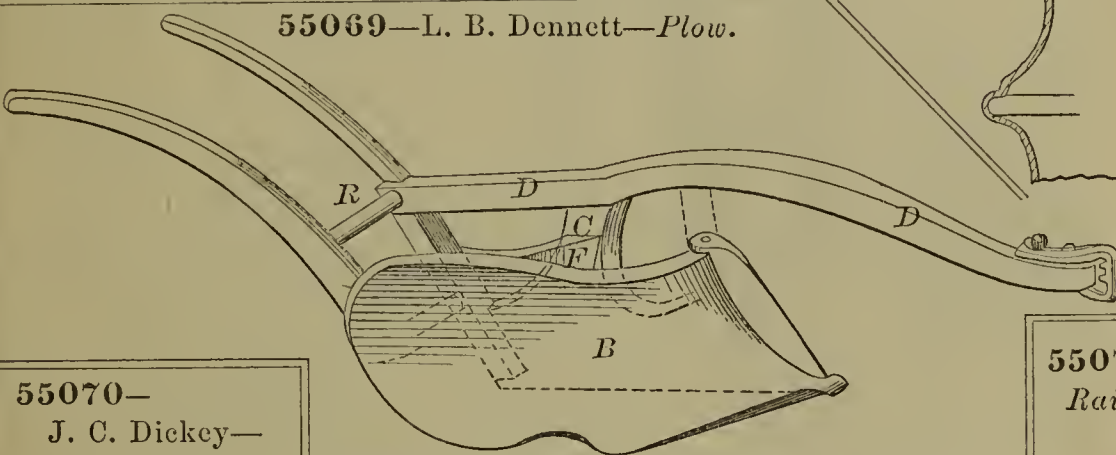

55070—J. C. Dickey—Rock Drill.

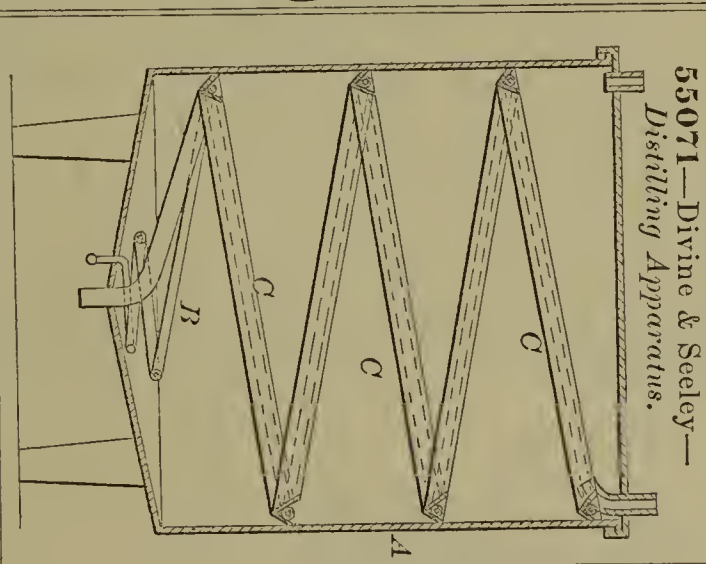
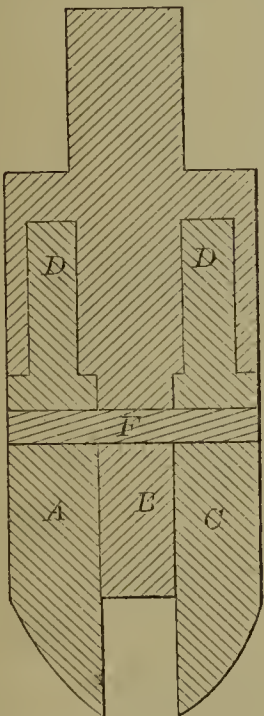

55071—Divine & Seeley—Distilling Apparatus.

55072—L. W. Doty—Rain Water Cut-off.

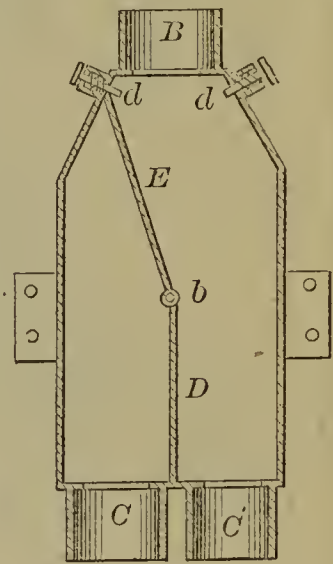

55074—R. Dutton—Harvester Finger Bar.

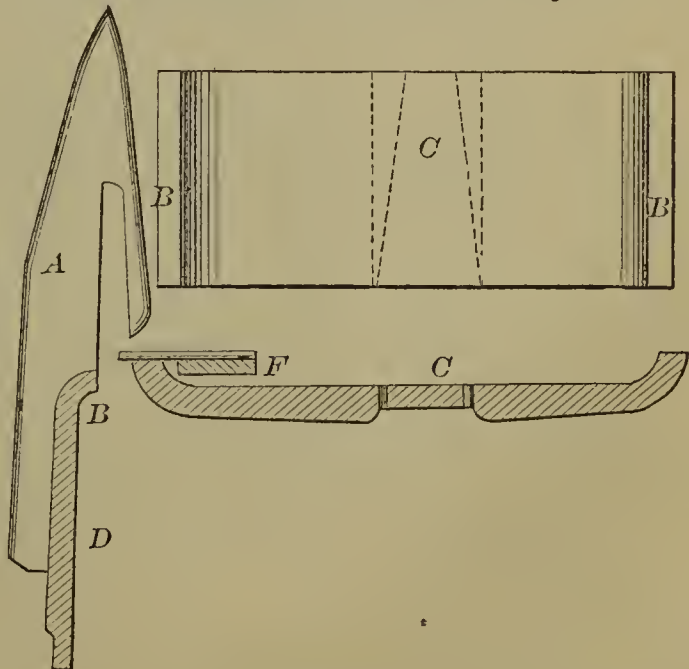

55076—W. P. Eayrs—Beer Pitcher.

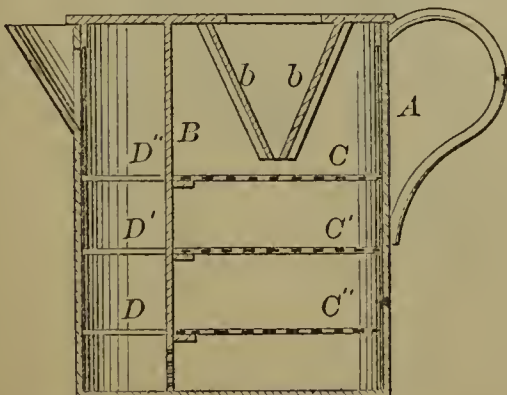

55077—S. F. Emerson—*Roller for Wringing Machines.*

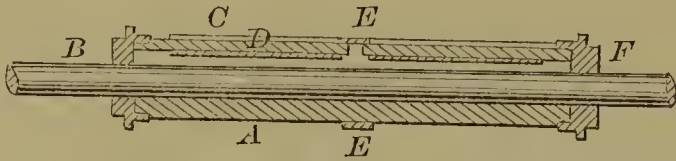

55082—J. H. A. Gericke—*Turbinate Force Pump.*

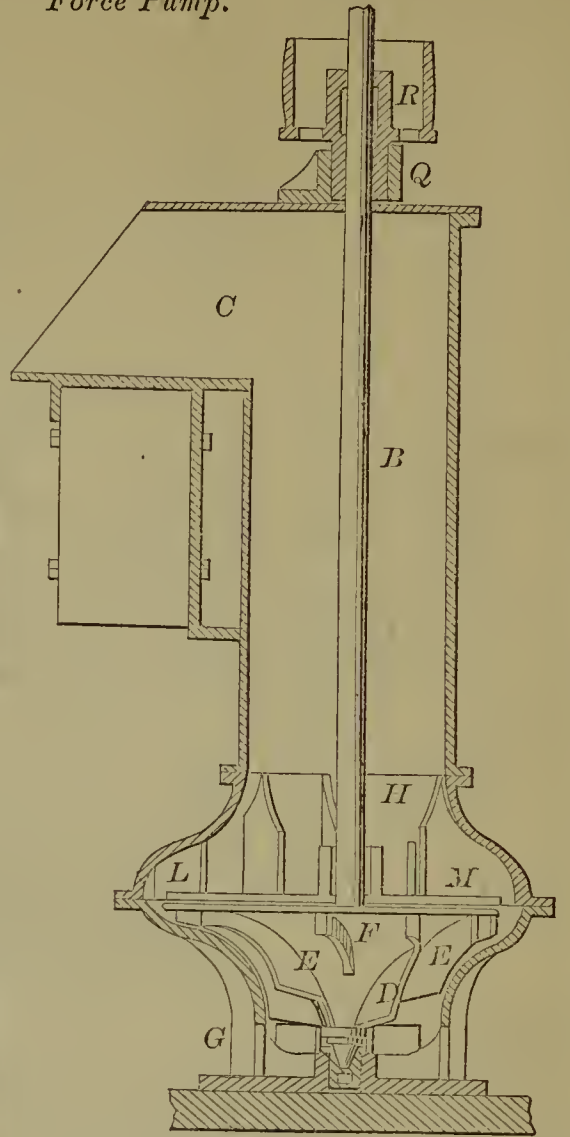

55078—D. Emonnot—*Numbering Stamp.*

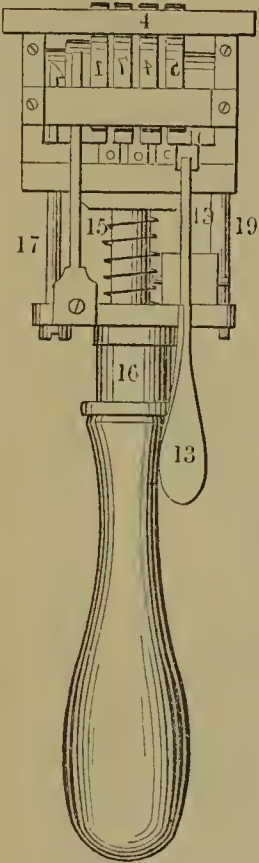

55081—W. Fuzzard—*Steam Trap.*

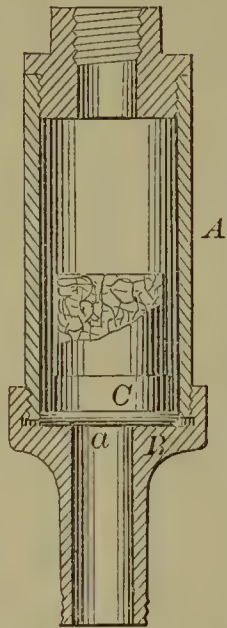

55079—W. Ennis—*Furnace.*

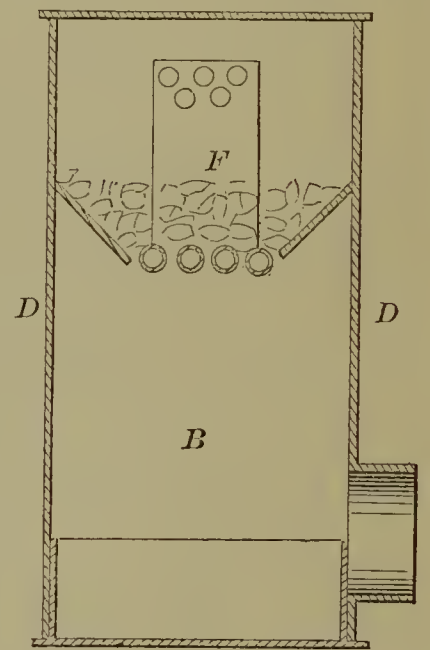

55080—C. G. Forshey—*Steering Apparatus.*

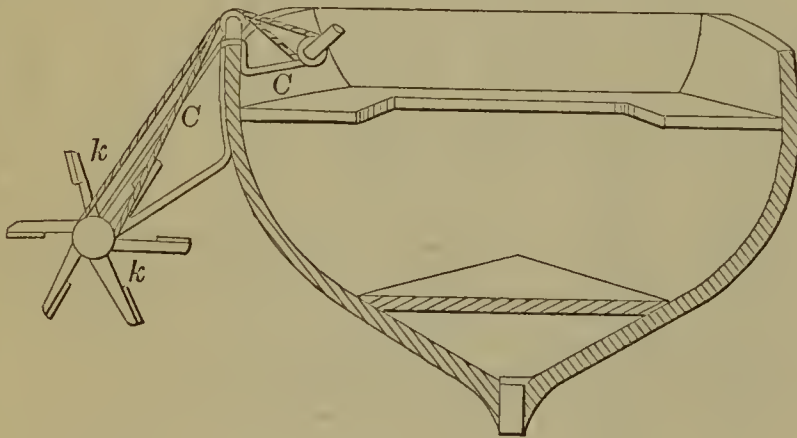

55083—C. Gibbs—*Hay Loader.*

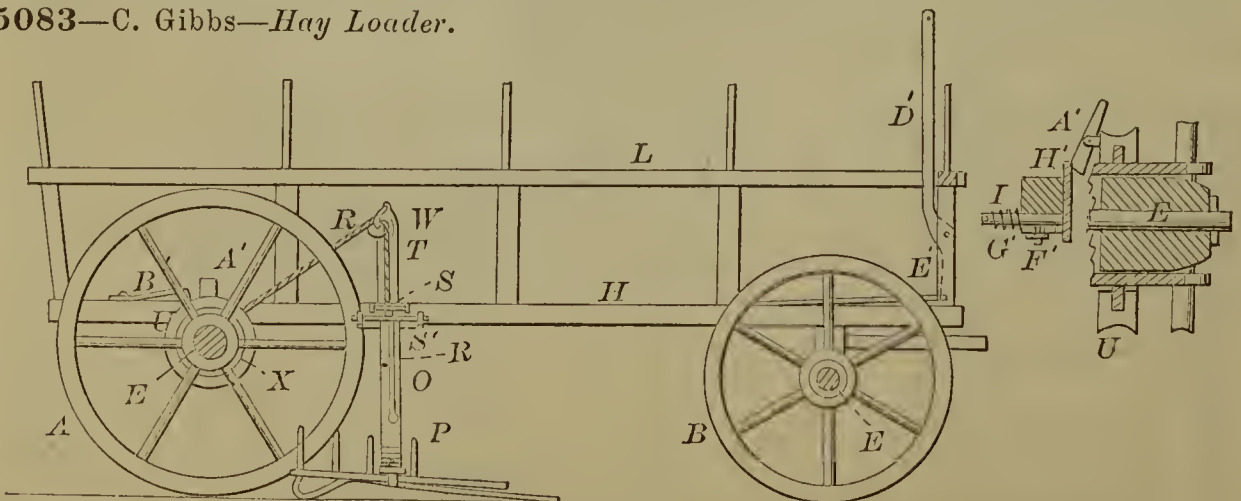

55084—S. Gillam—Harvester Cutter.

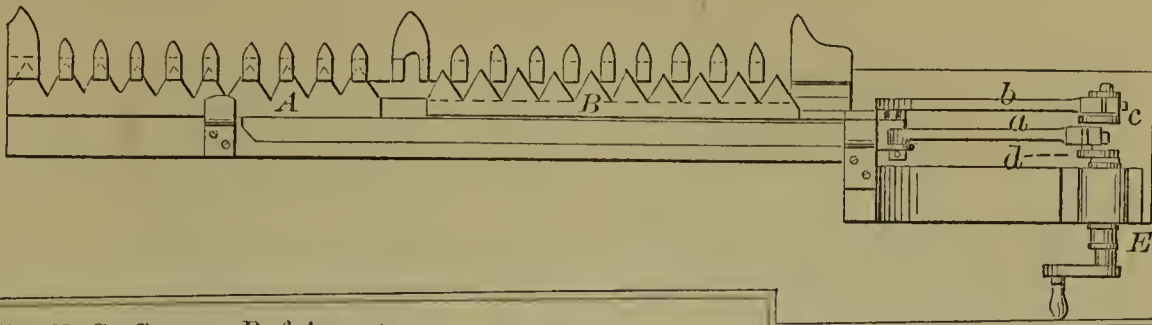

55085—J. C. Gove—Refrigerator.

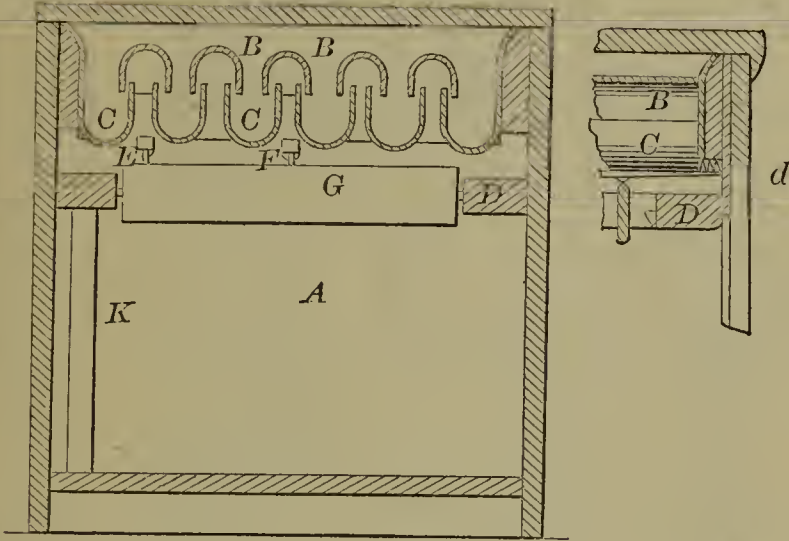

55086—R. Gracey—Joint for Oil Tools.

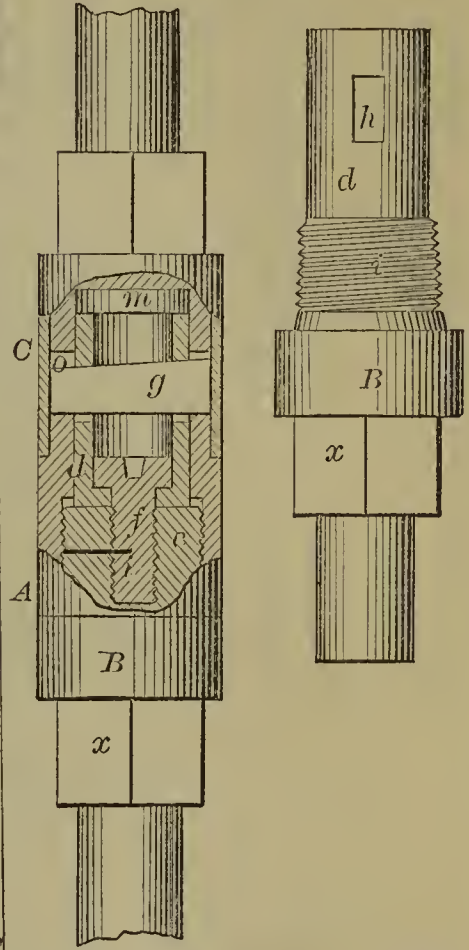

55091—M. Hall—Portable Fence.

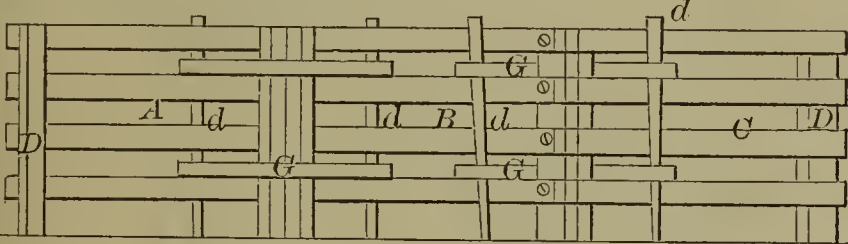

55090—L. Hall—Sheep Rack.

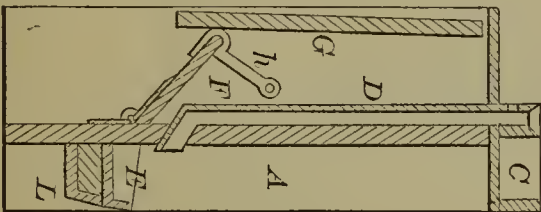

55089—A. Hall—Toy Spring Gun.

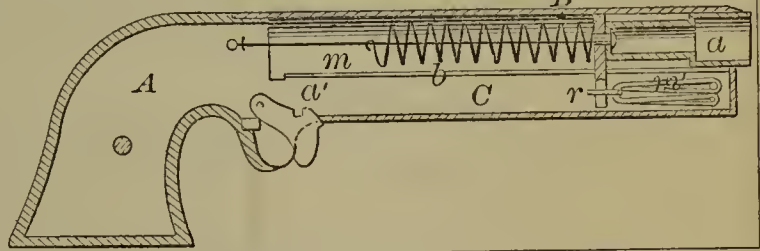

55092—Hall & Bugbee—Steam Engine.

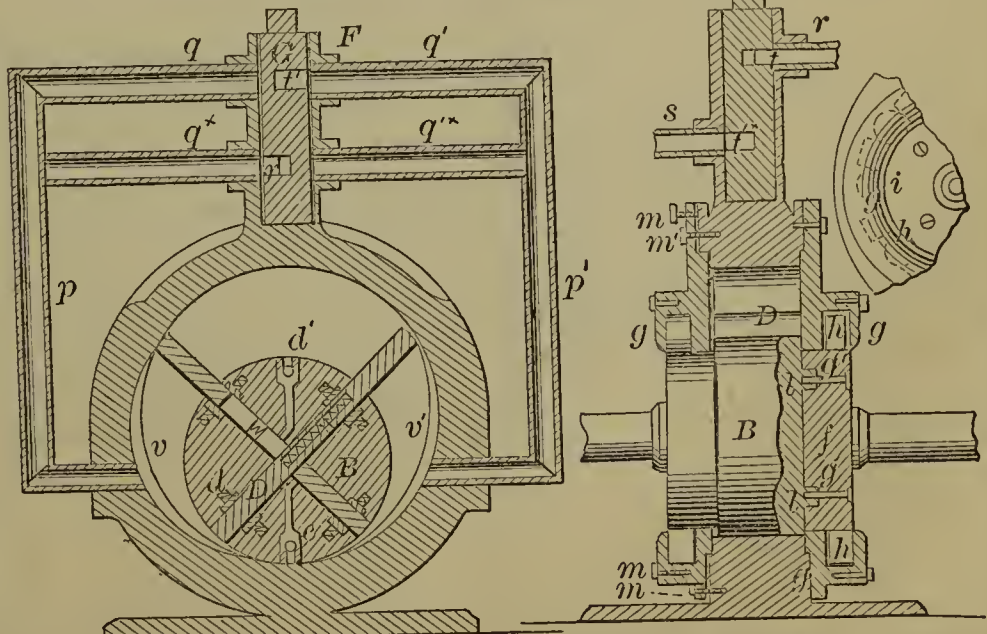

55088—A. Magny—Buckle.

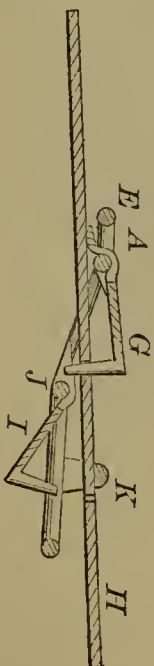

55093—W. Hammond—Cultivator and Plow.

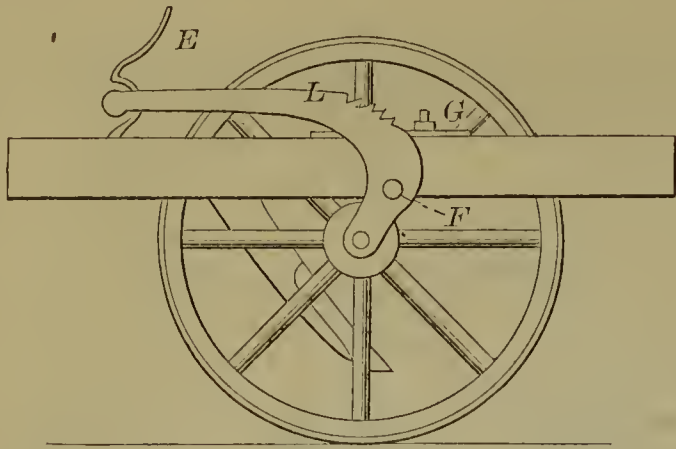

55094—G. Hardy—Car Ventilator.

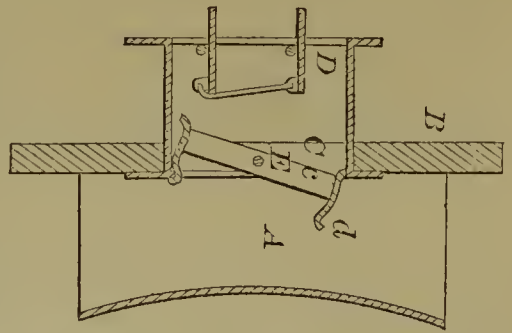

55095—J. Harrar—Shutter Fastening.

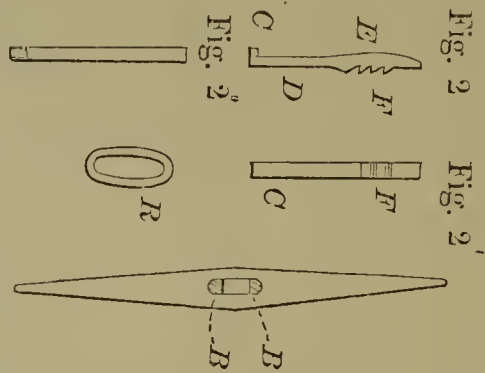
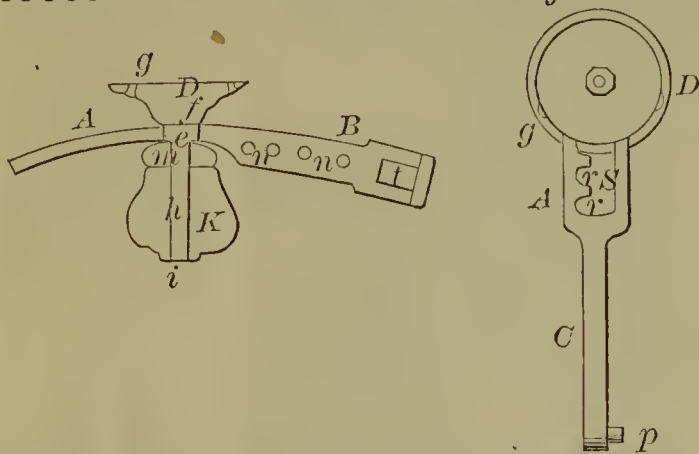

55096—Harris & Franz—Attaching Handles to Tools.

55099—L. F. Heath—Sawing Machine.

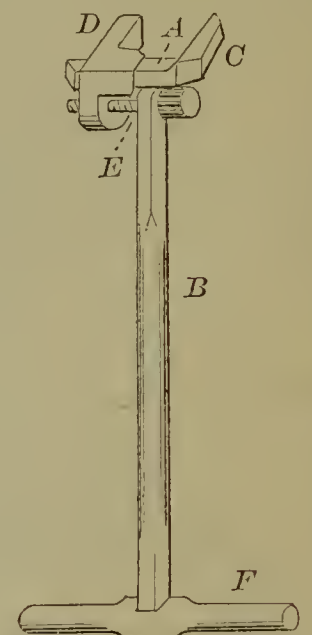
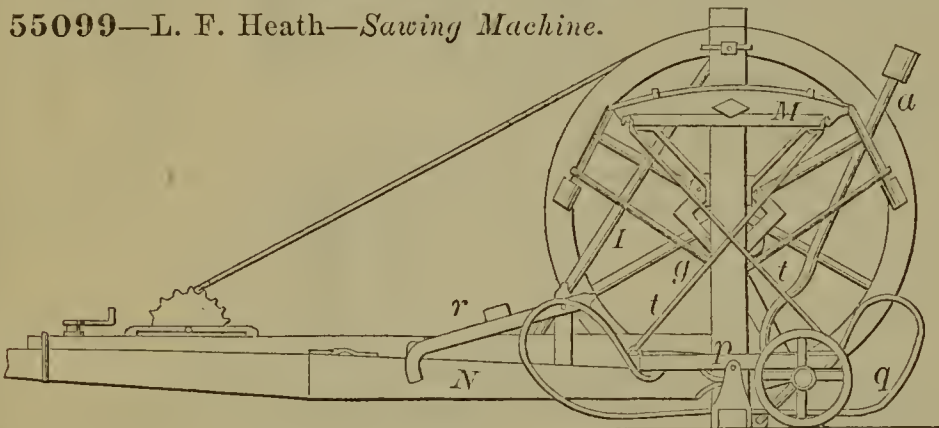

55100—J. Hogarty—Screw Wrench.

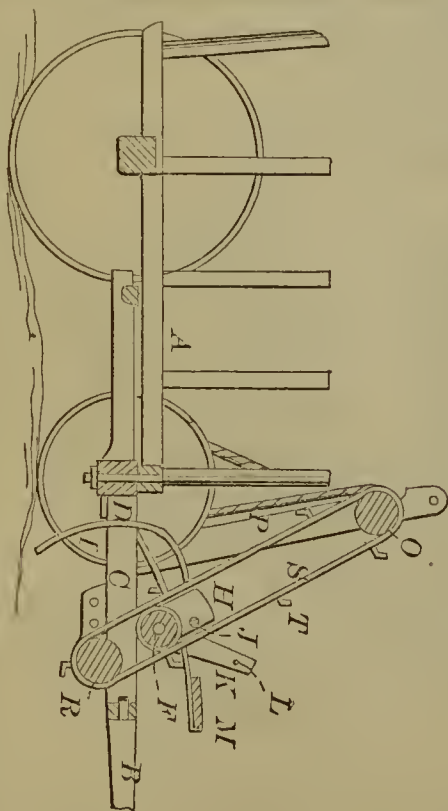

55098—A. W. Heany—For Raking and Loading Hay.

55097—G. Hastings—For Polishing and Glossing Watch Hands.

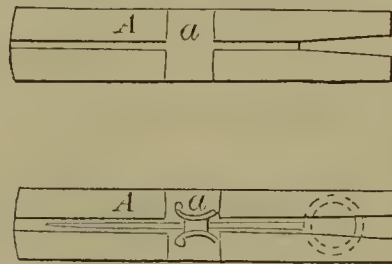

55101—W. Hicks—Stove Pipe Damper.

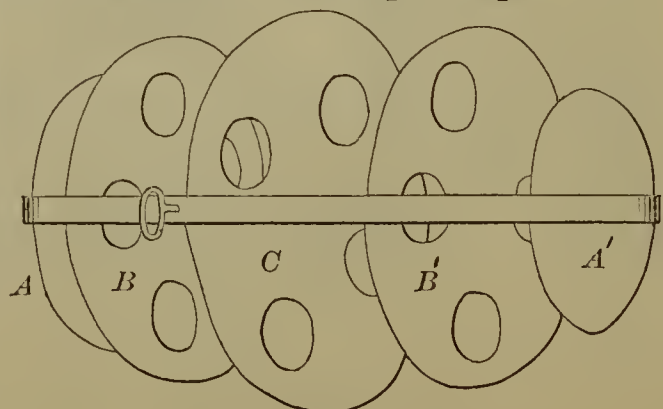

55102—A. Higley—*Lifting Jack.*

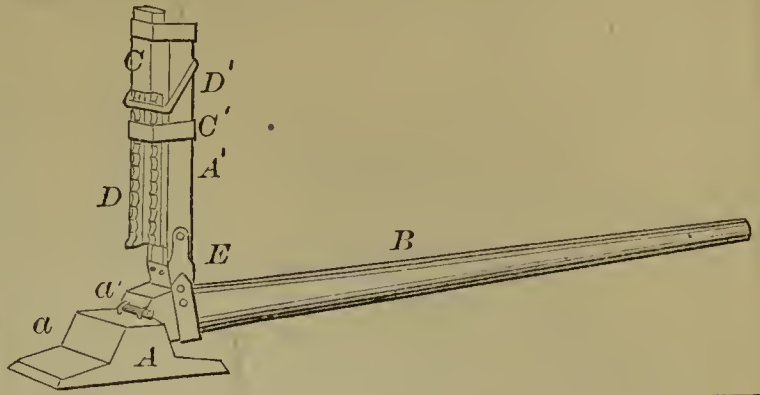

55103—J. Hinkley—*Knitting Machine.*

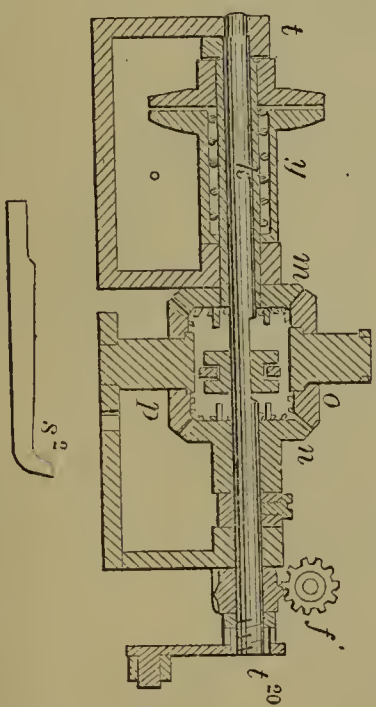
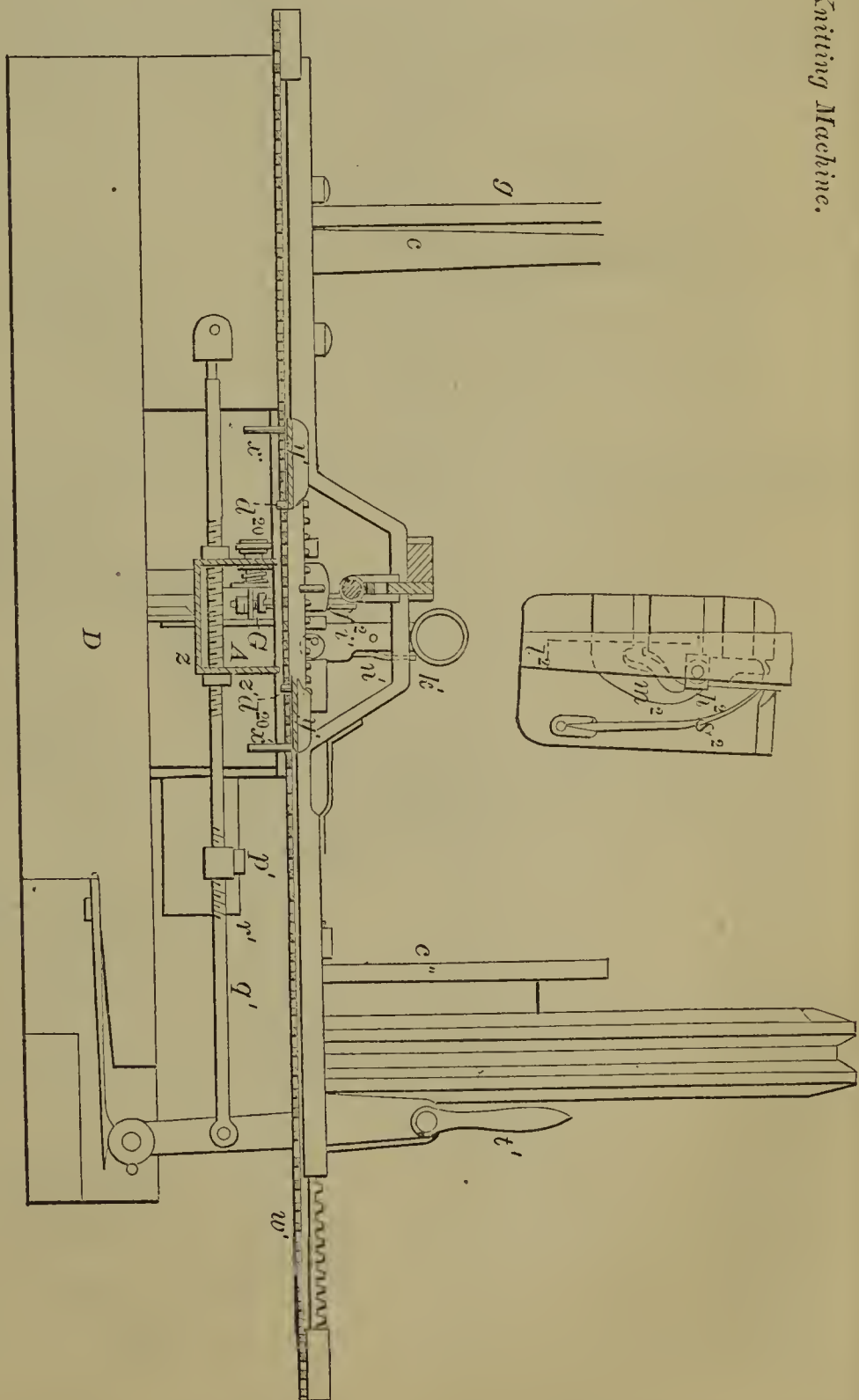
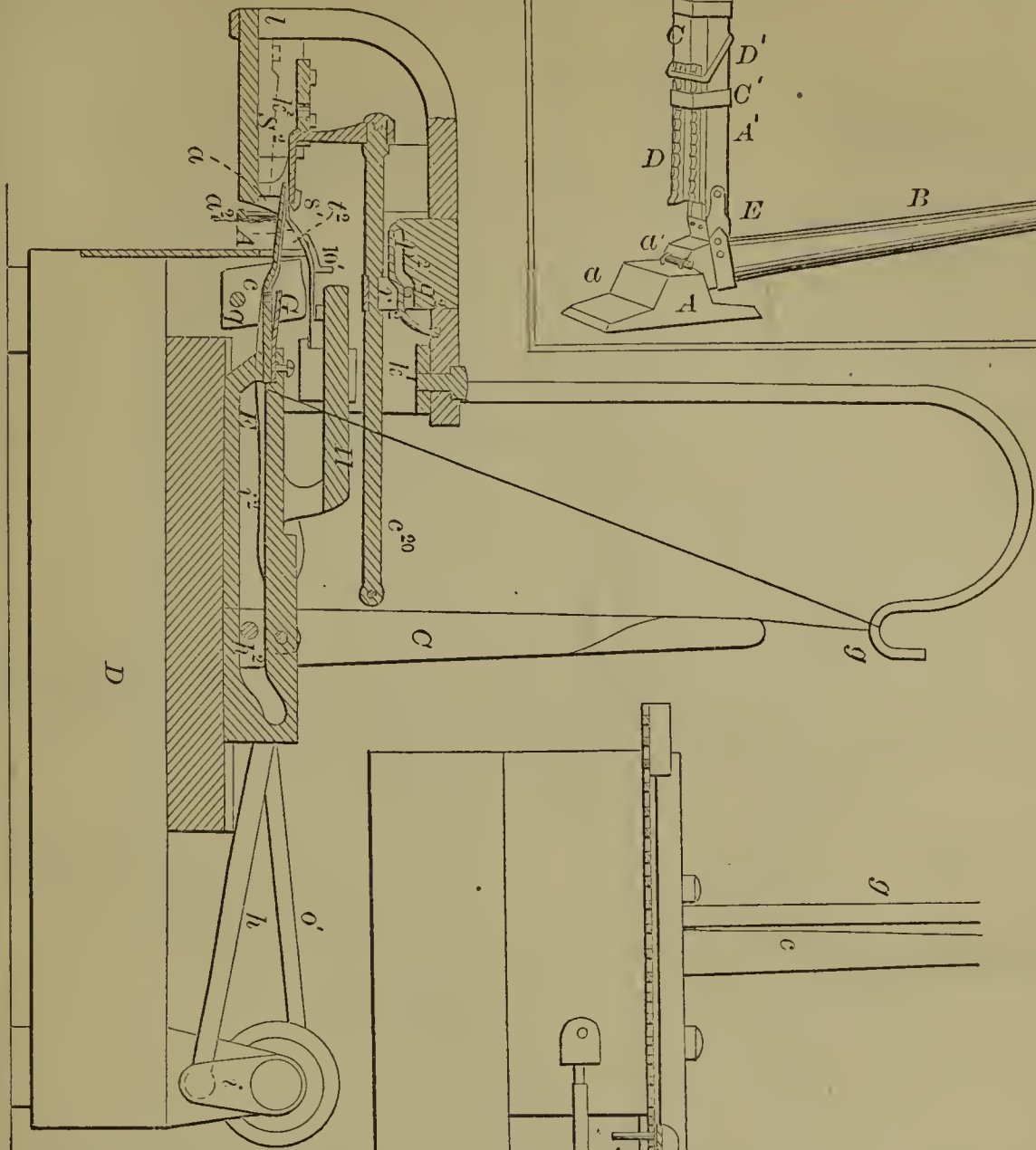

S<sup>2</sup>

55104—Hinman & Nevill—*Car Coupling.*

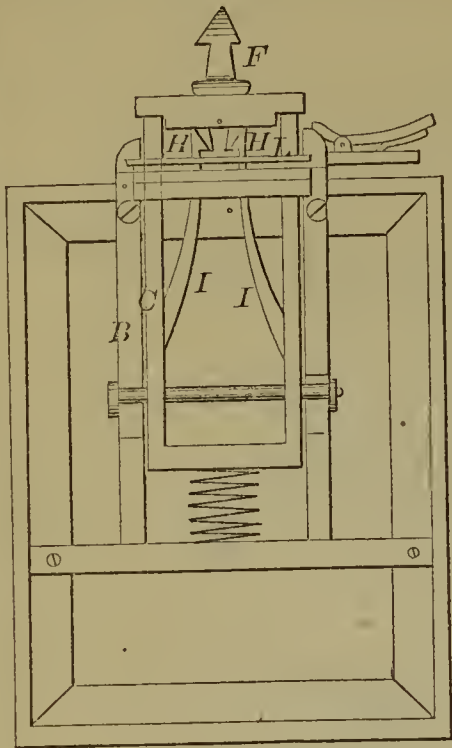

55105—J. H. Hogan—*Nail Extractor.*

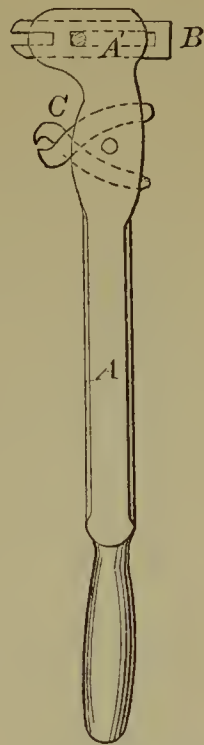

55107—S. S. & E. G. Hoyt—*Screw Wrench and Hammer.*

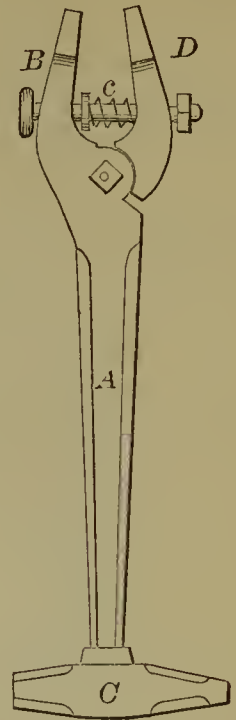

55108—A. Ingalls—*Carriage Plow.*

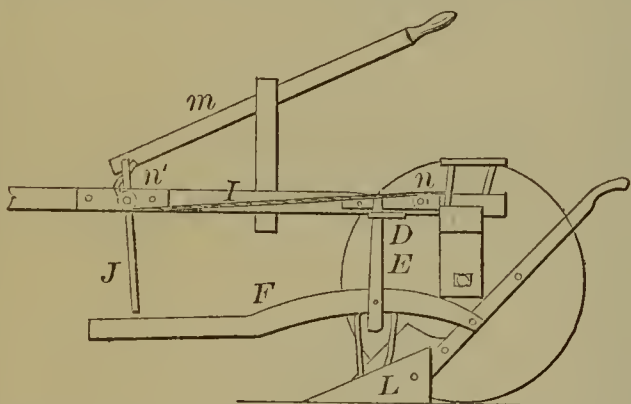

55112—N. Johnson—*Whiffletree.*

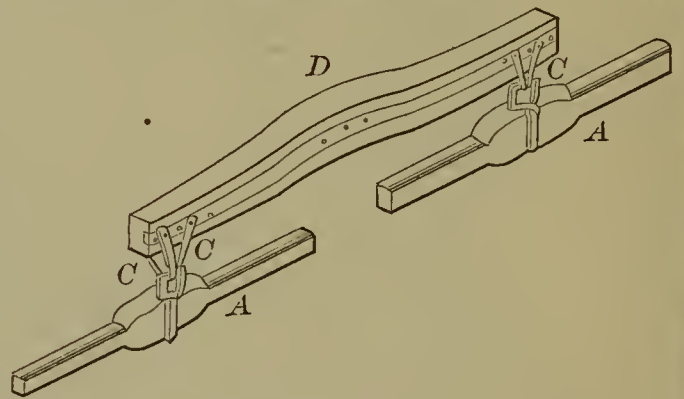

55109—J. C. Jackson—*Screw Wrench.*

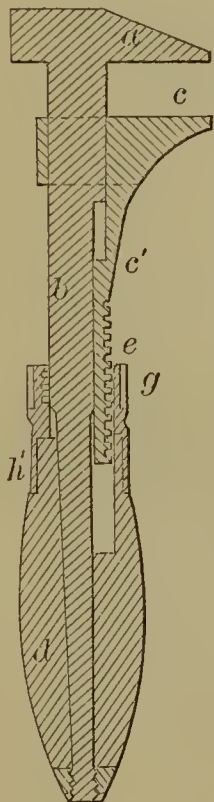

55111—B. H. Jenks—*Treating Wood for Carding Engines.*

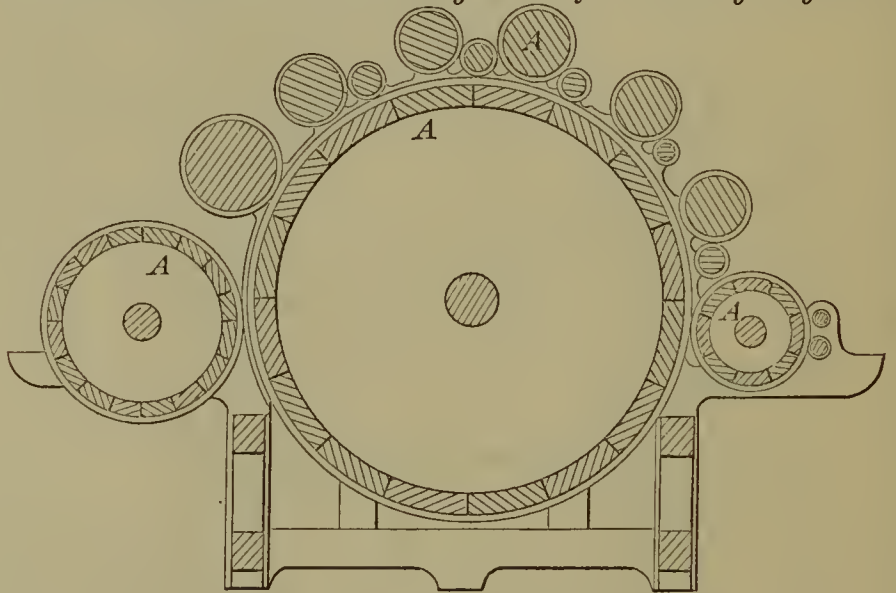

55113—G. R. Kelsey—*Buckle.*

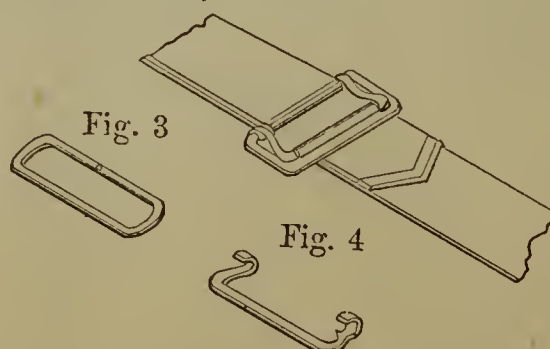

55114—W. Kendrick—Amalgamator.

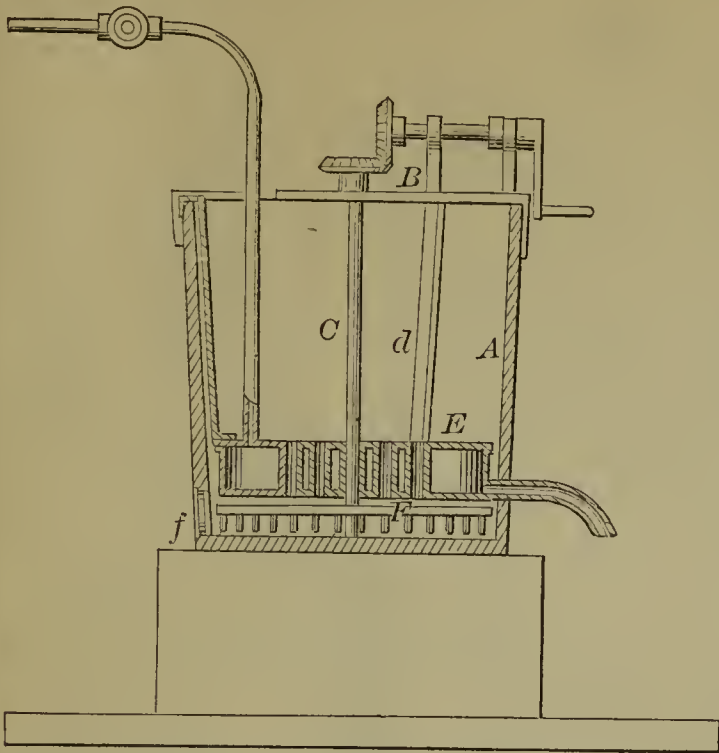

55116—P. B. Killam—Wool Press.

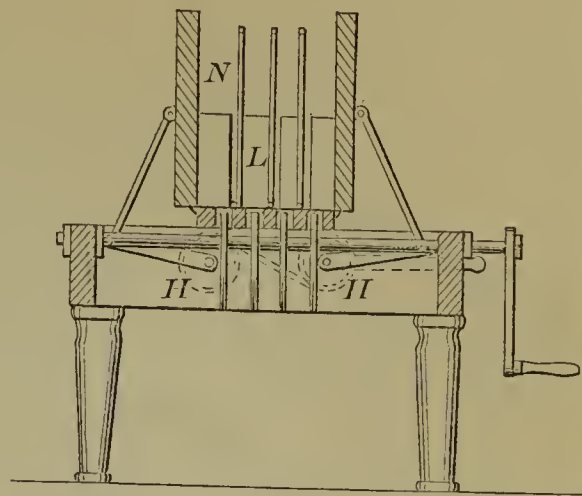

55118—R. Kitson—Picker House for Opening Cotton, &c.

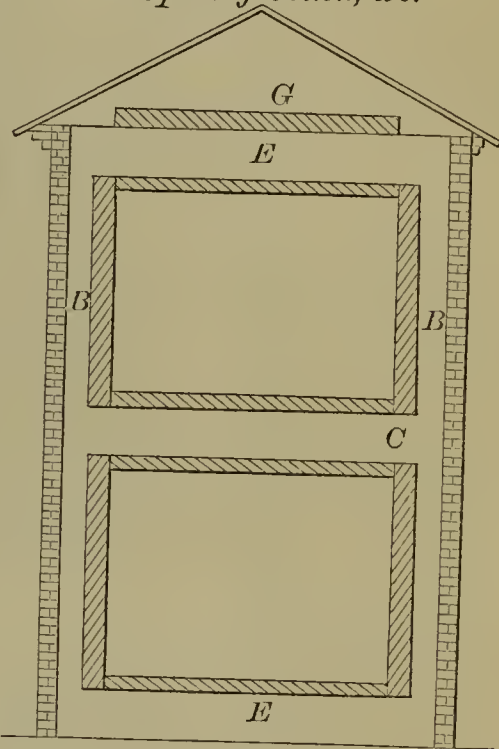

55117—J. King, Jr.—Bent Lever Scale.

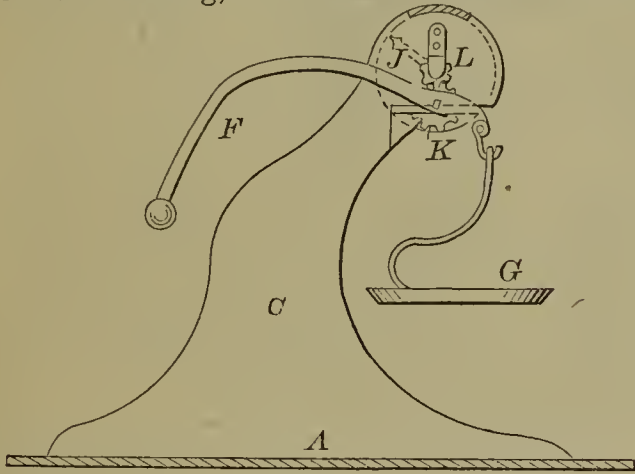

55120—D. J. Knapp—Churn Power.

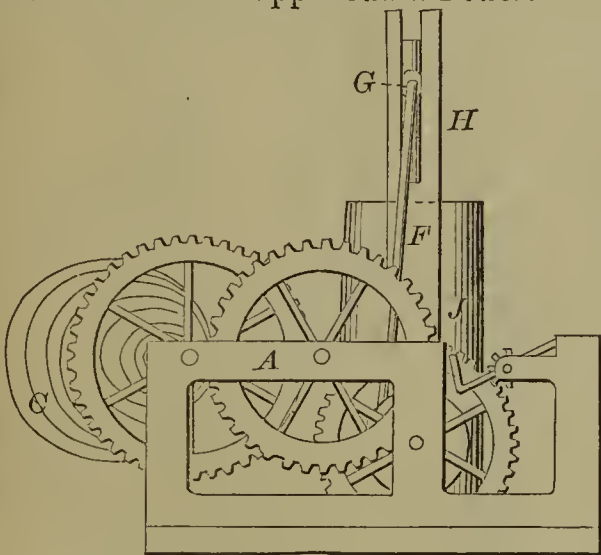

55115—T. Kennedy—Adjusting Knobs to Spindles.

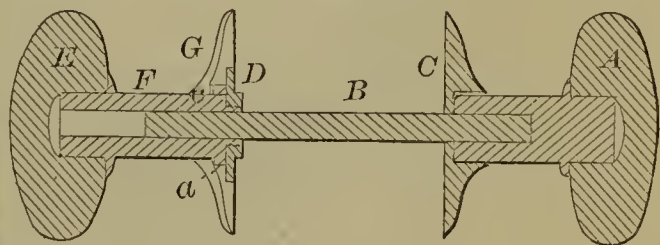

55119—A. H. Knapp—Attaching Soles to Horse Shoes.

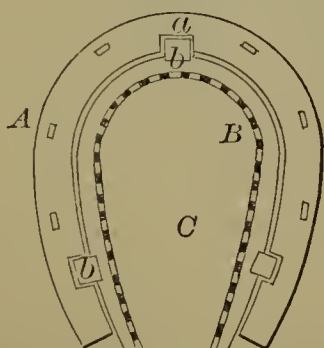

55121—N. Landry—Coin Holder.

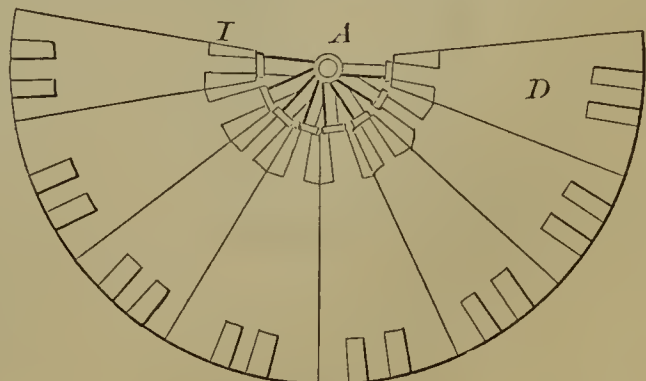

55122—F. Latta—*Steam Engine.*

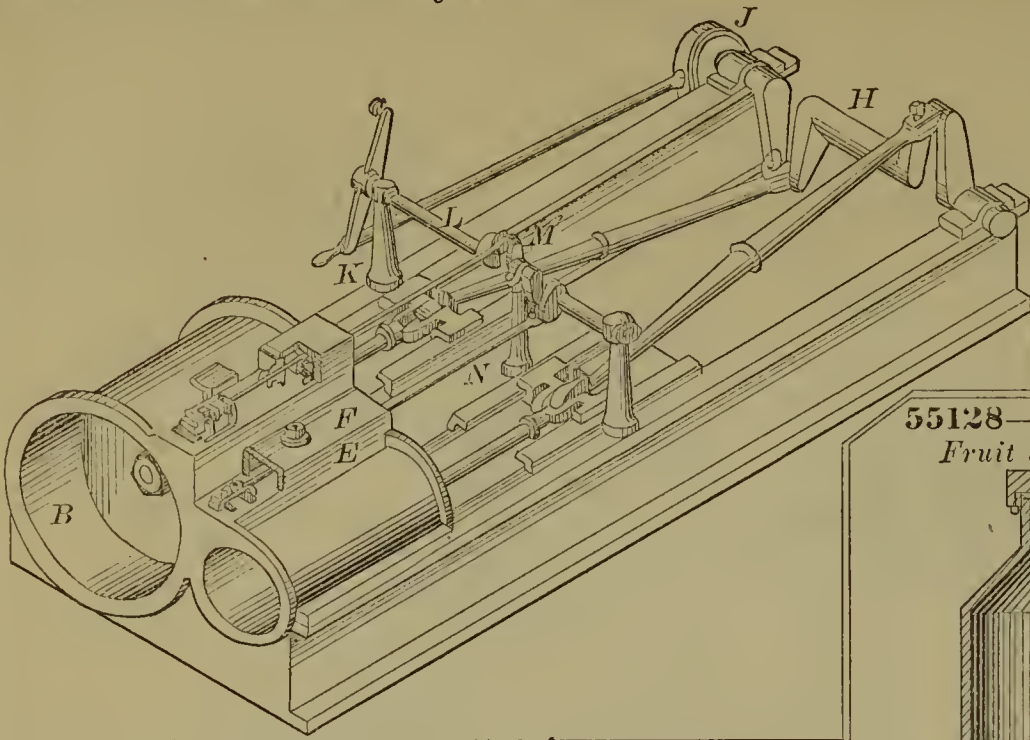

55124—L. Loeffler—*Decanter Stopper.*

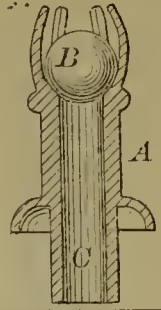

55128—J. R. & N. E. Lupton—*Fruit Jar.*

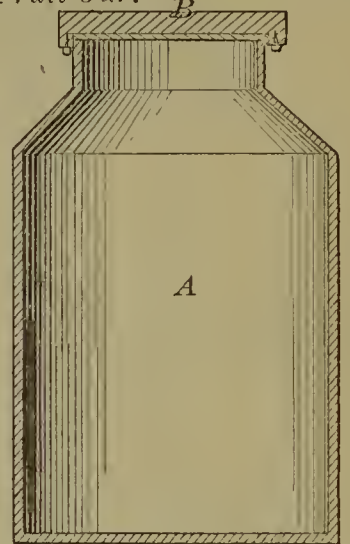

55127—A. Low—*Safety Valve.*

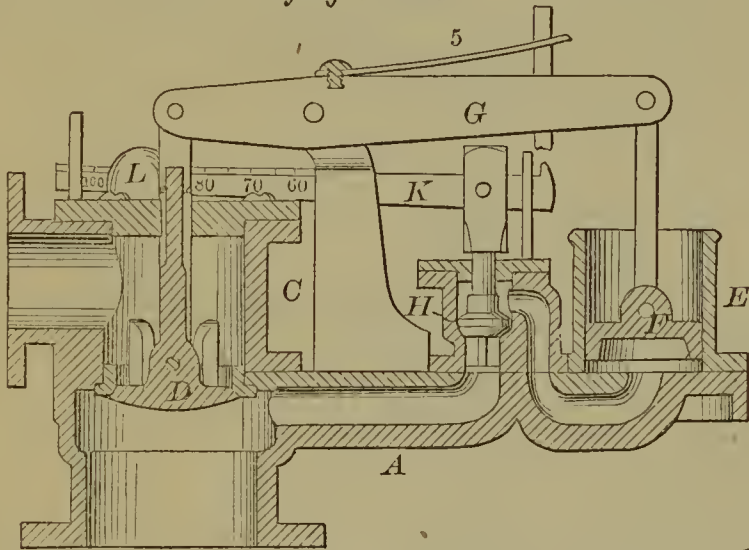

55126—S. B. Loughborough—*Fastening Keys in Locks.*



55130—G. Lutz—*Water Indicator for Steam Generators.*

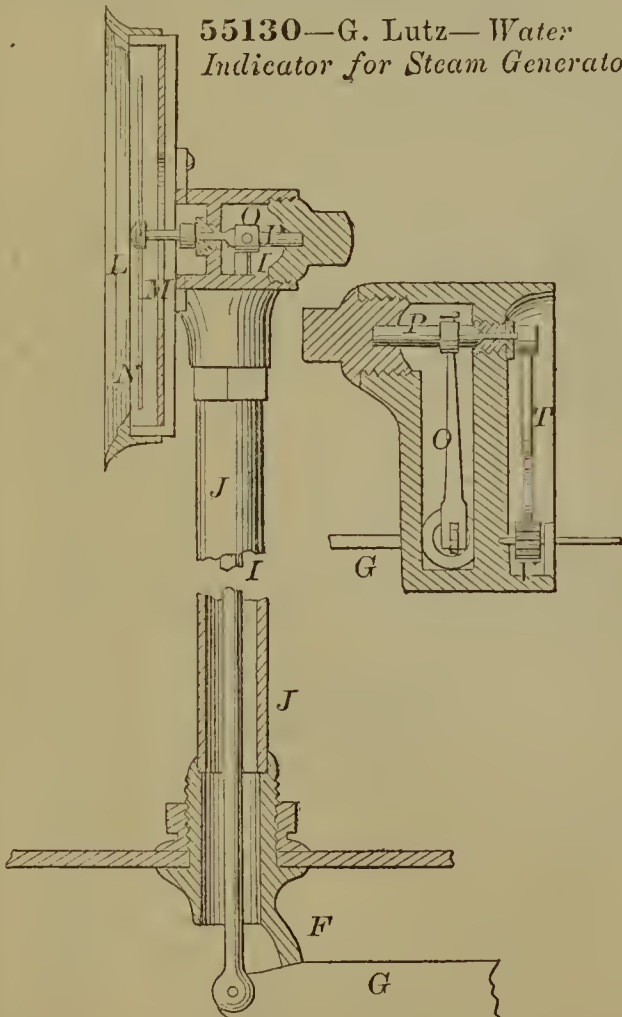

55129—D. F. Inuse—*Farm Gate.*

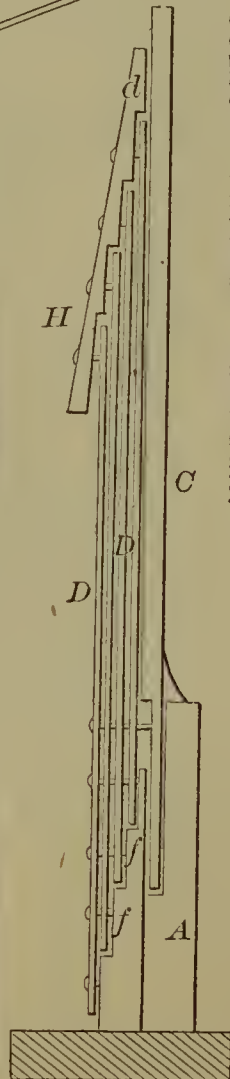

55131—J. Lydy—*Sash Fastening.*





55134—B. Mackerley—Atmospheric Governor.

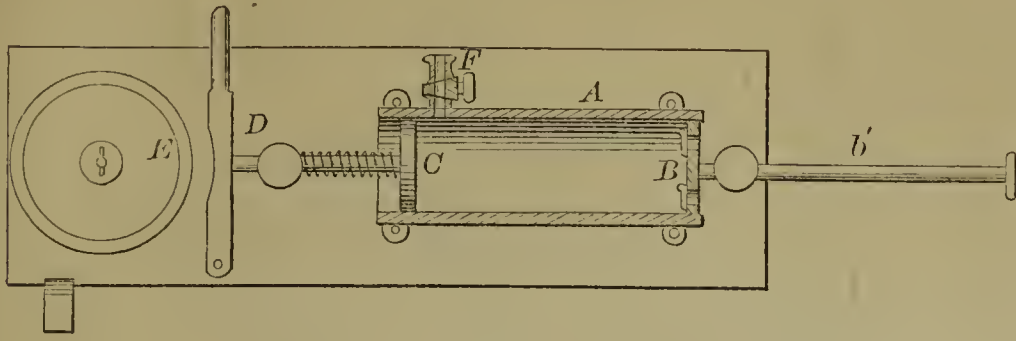

55132—S. L. Lyford—Gauge for Augers.

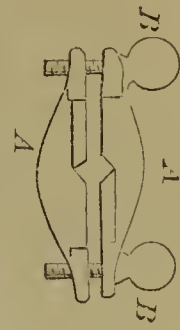

55133—T. Lyman—Car Truck.

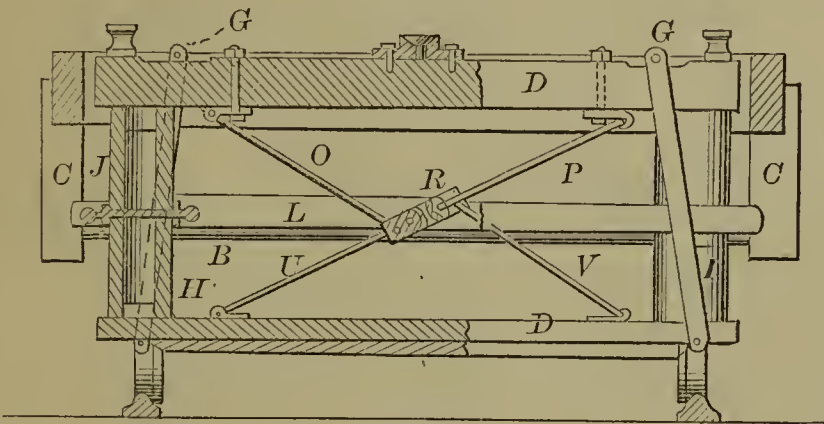

55136—R. A. McCauley—Hydrant.

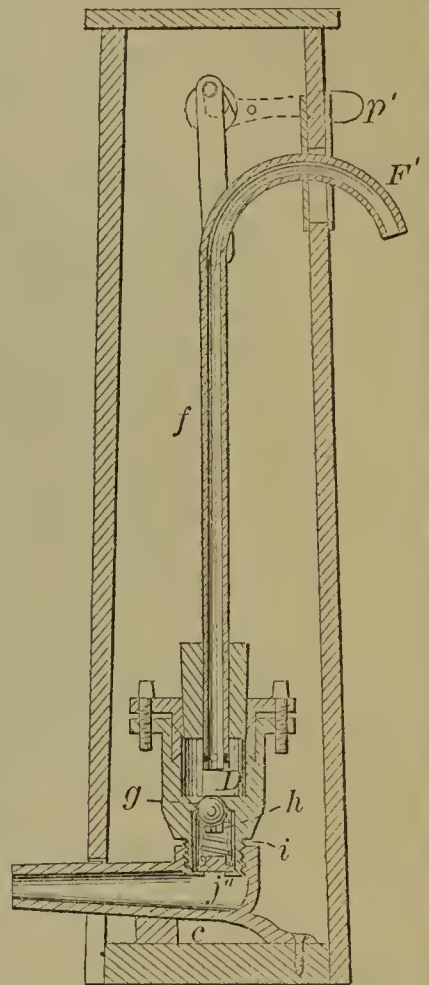

55135—H. B. Malbone—Mop Handle.

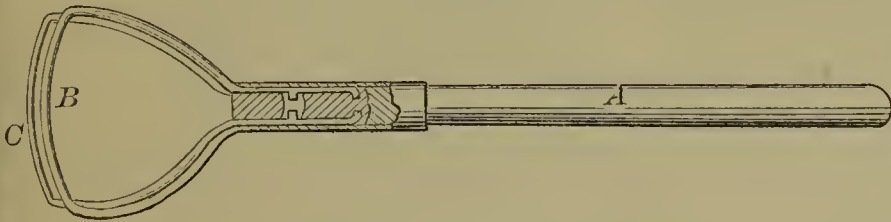

55138—A. H. Mershon—Regulating Draught of Furnaces.

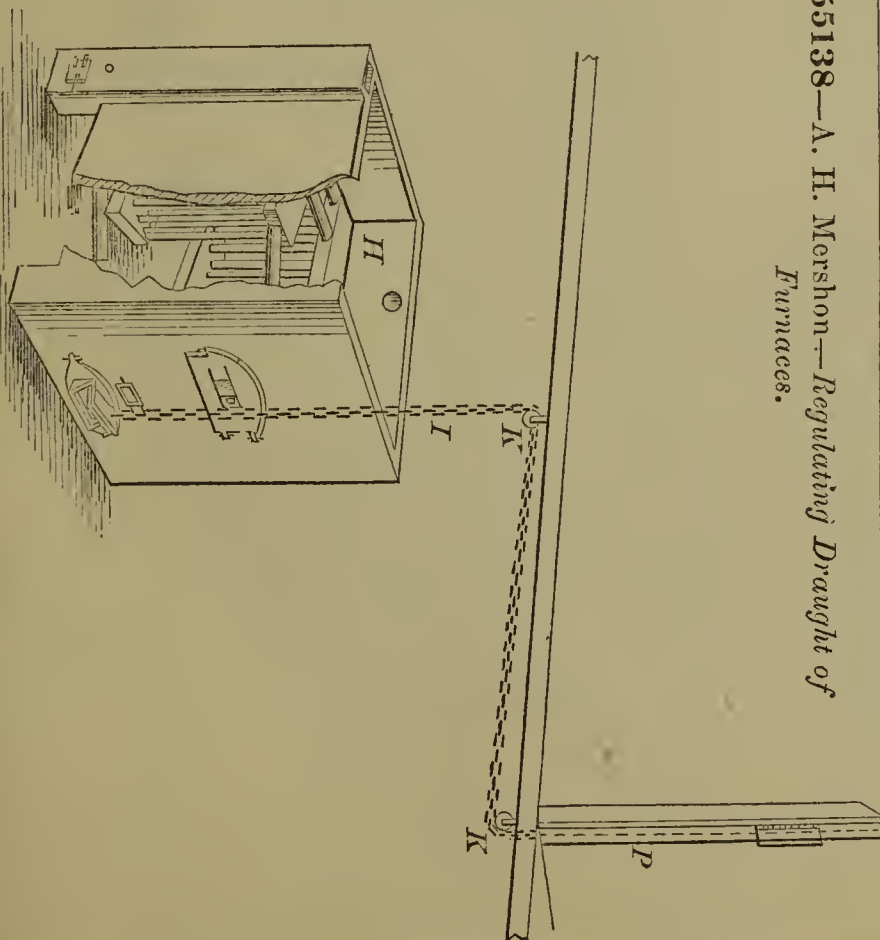

55137—J. Merrill—Cask, Barrel, and Keg.

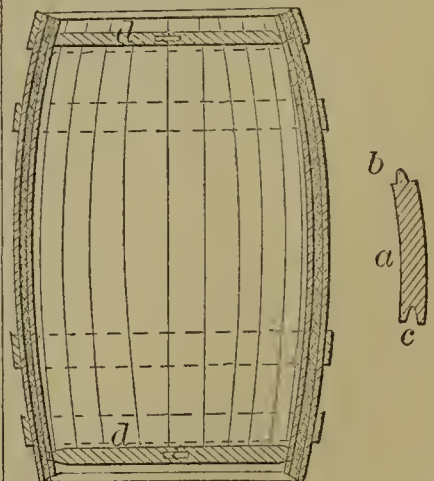

55139—W. S. Messinger—Parlor Croquet.

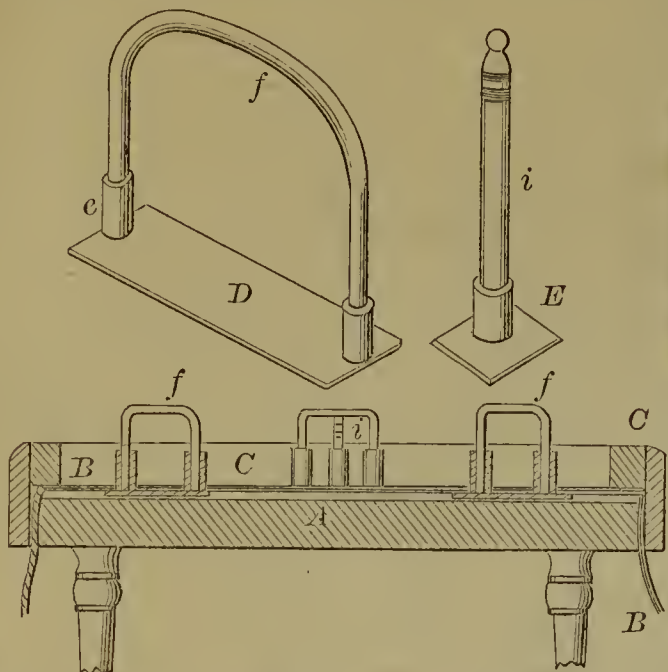

55143—J. G. Miner—Street Lamp.

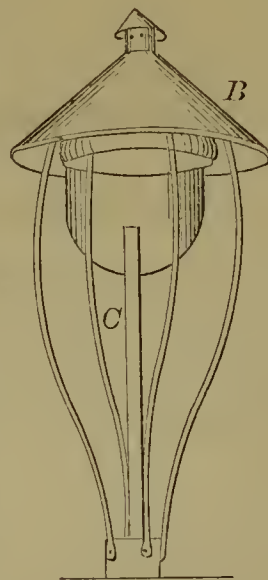

55142—J. Miller—Seeder and Cultivator.

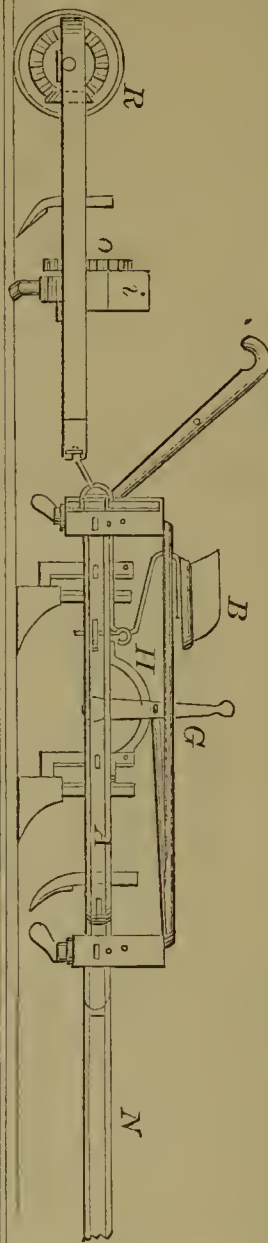

55145—C. A. Moore—Kettle Bottom.

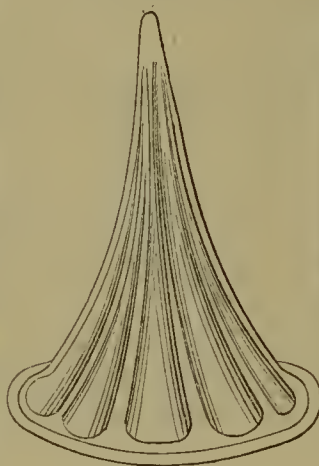

55141—J. Miller—Washing Machine.

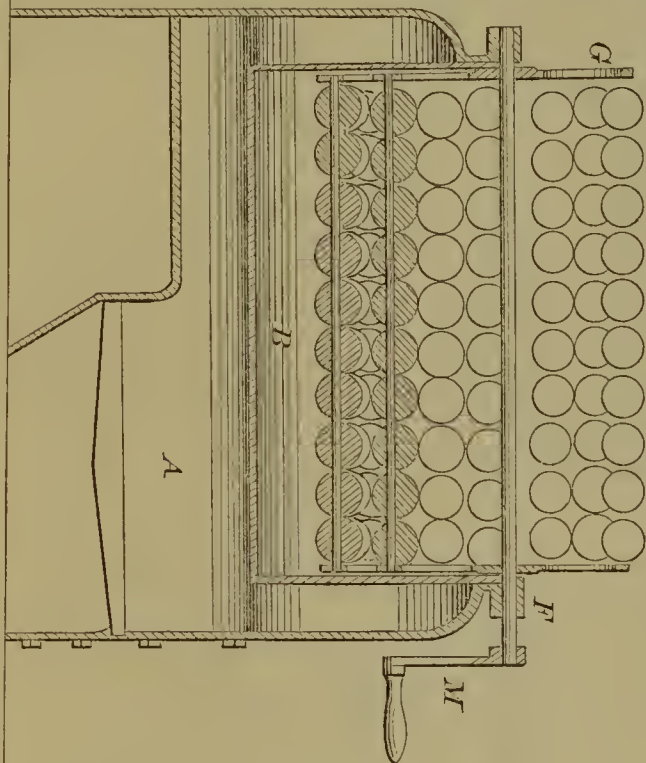

55140—H. W. Miller—Cheese Hoop.

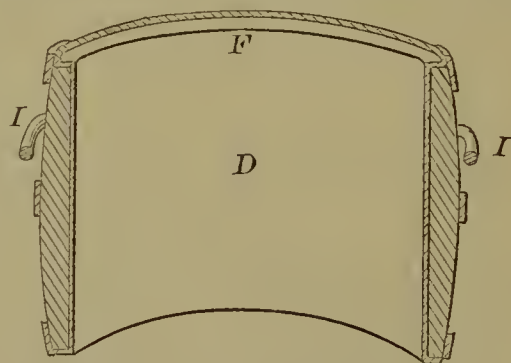

55144—H. T. Moody—Auger.



55146—I. Morley—Brick Machine.

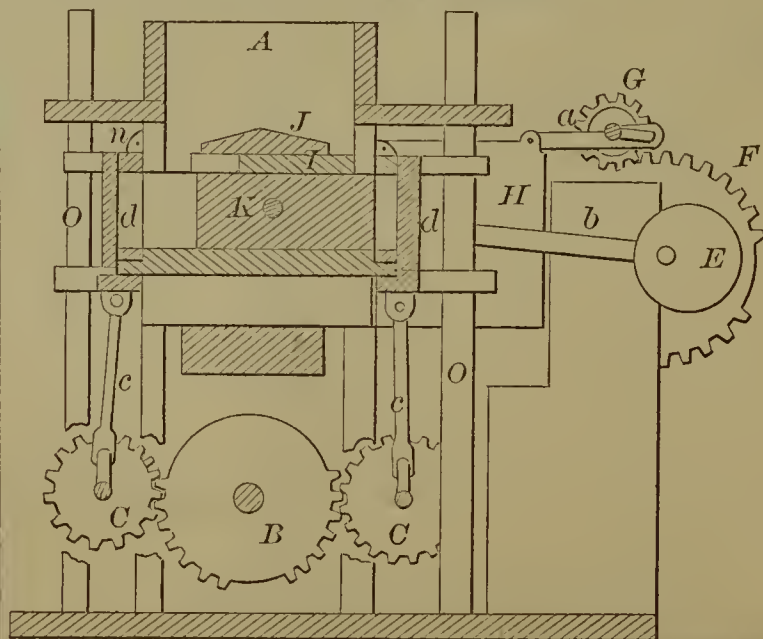

55147—G. Moulton, Jr.—*Ship's Pump.*

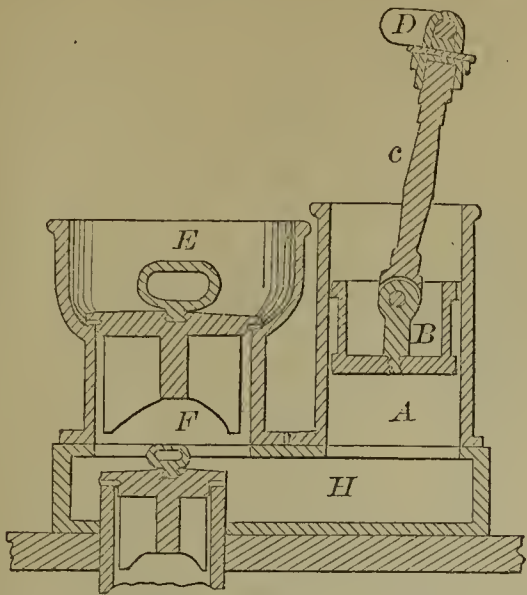

55148—C. Murtha—*Brick Machine.*

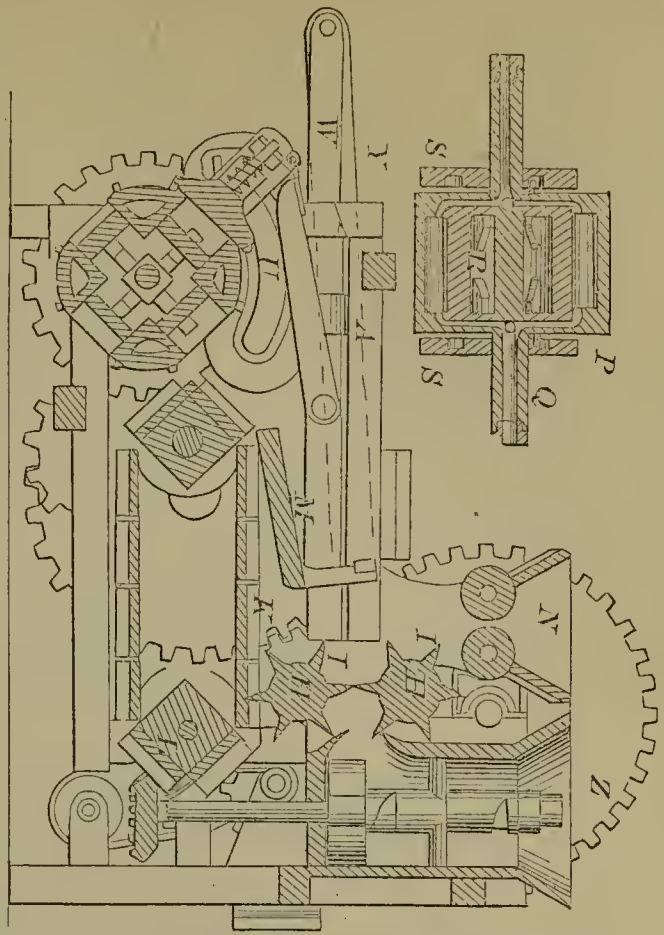

55149—J. Nason—*Surface Condenser.*

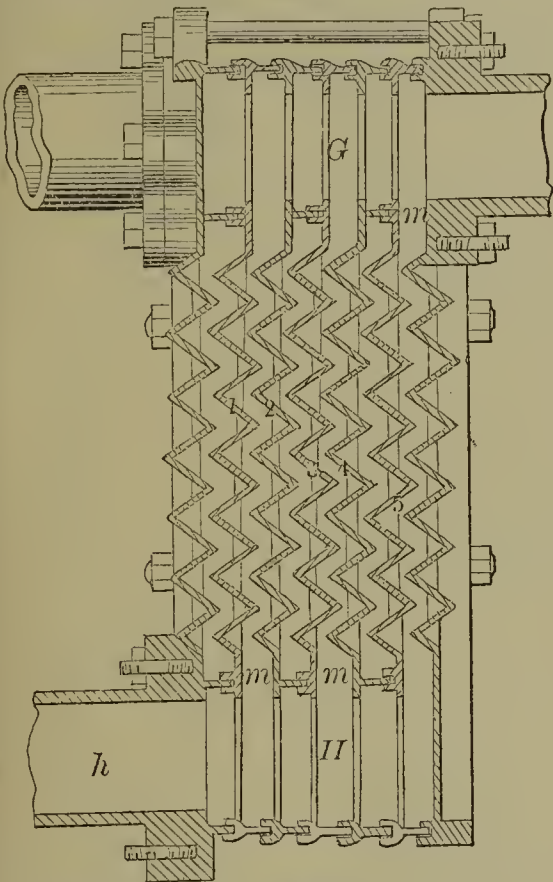

55150—A. F. W. Neynaber—*Preserving Beer.*

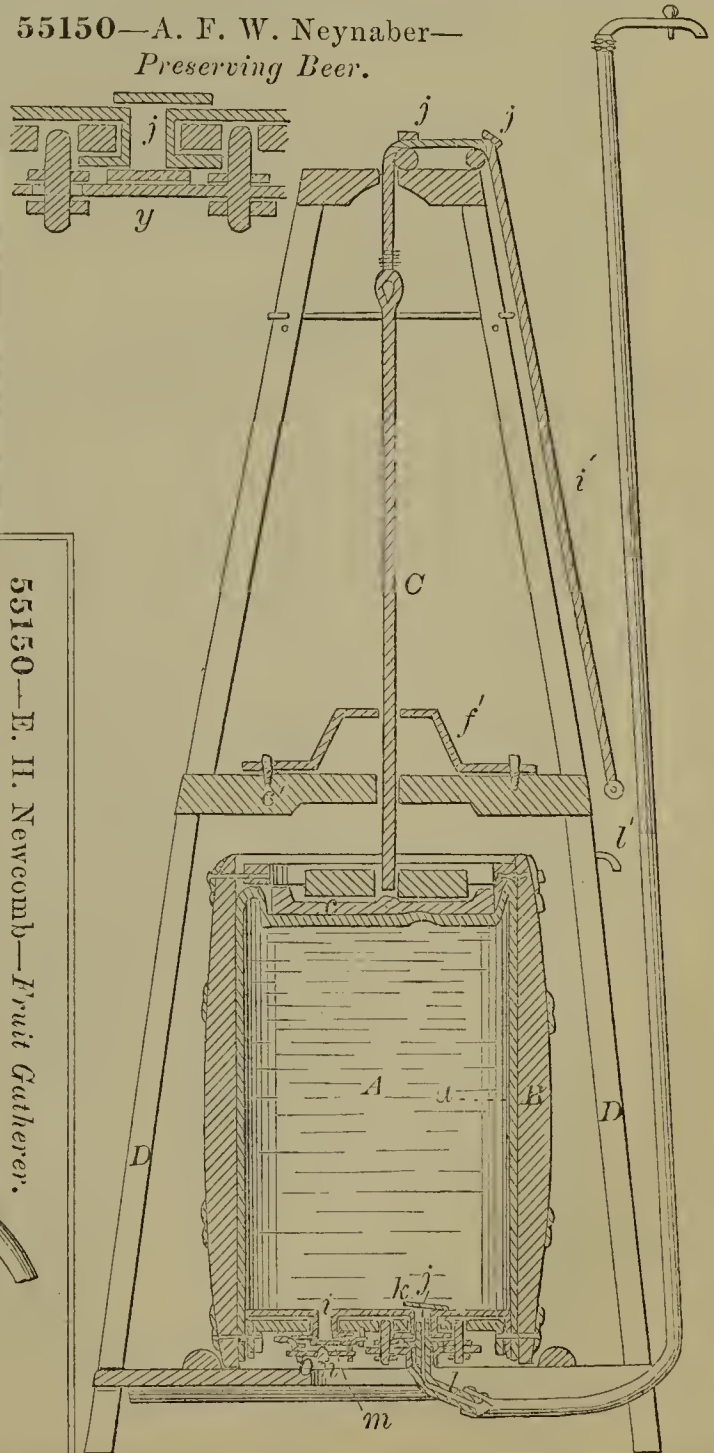

55150—E. H. Newcomb—*Fruit Gatherer.*

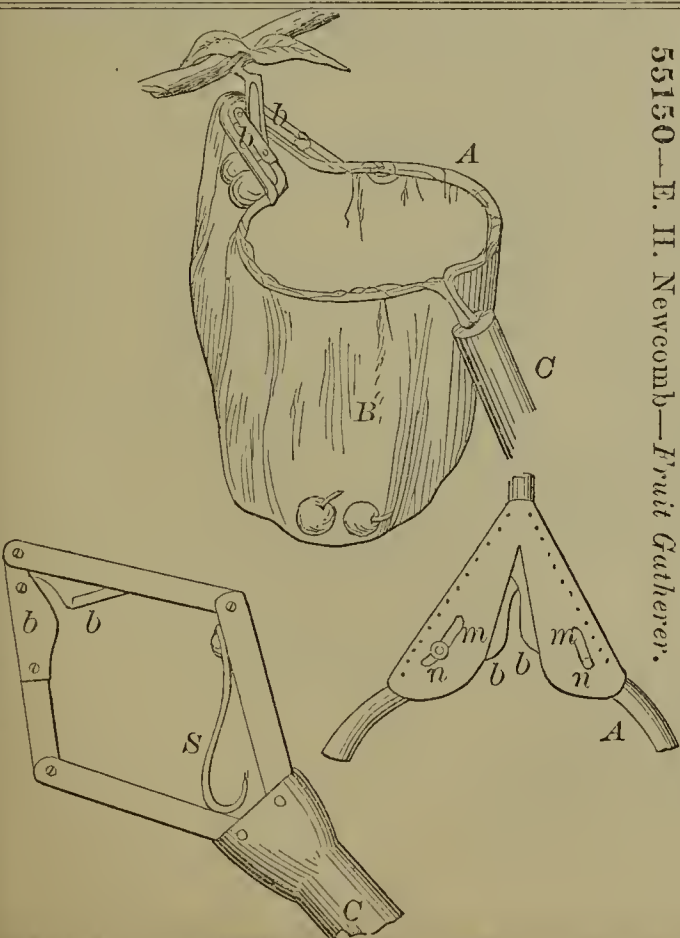

55152—H. Ogborn—Grain Screen.

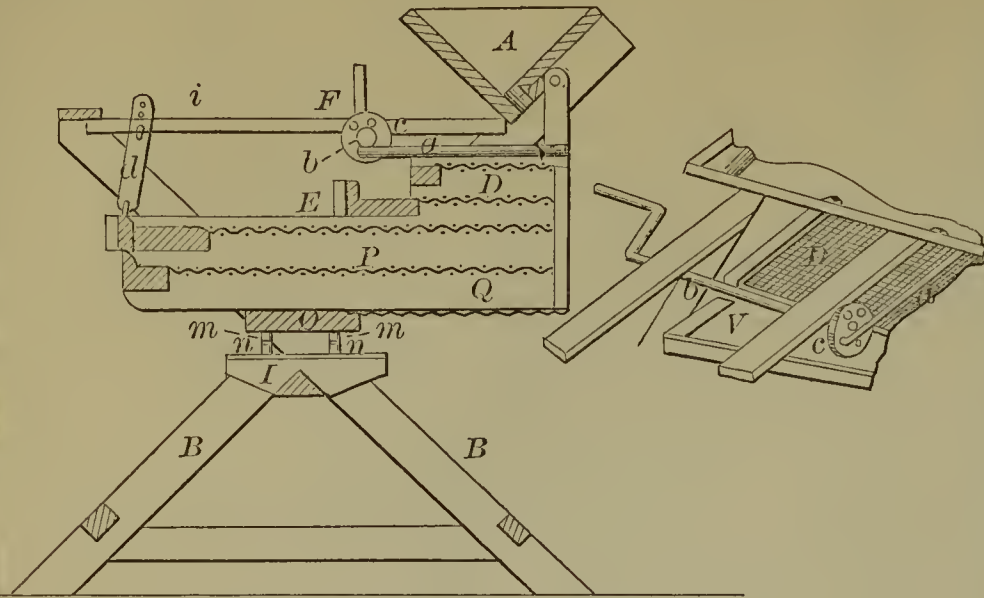

55156—Palmer & Gilliland—Stump Extractor.

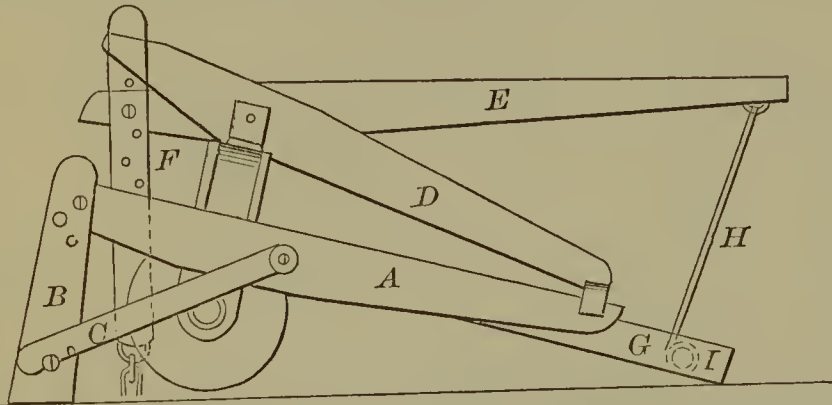

55155—Palmer & Bean—Reservoir for Wells.

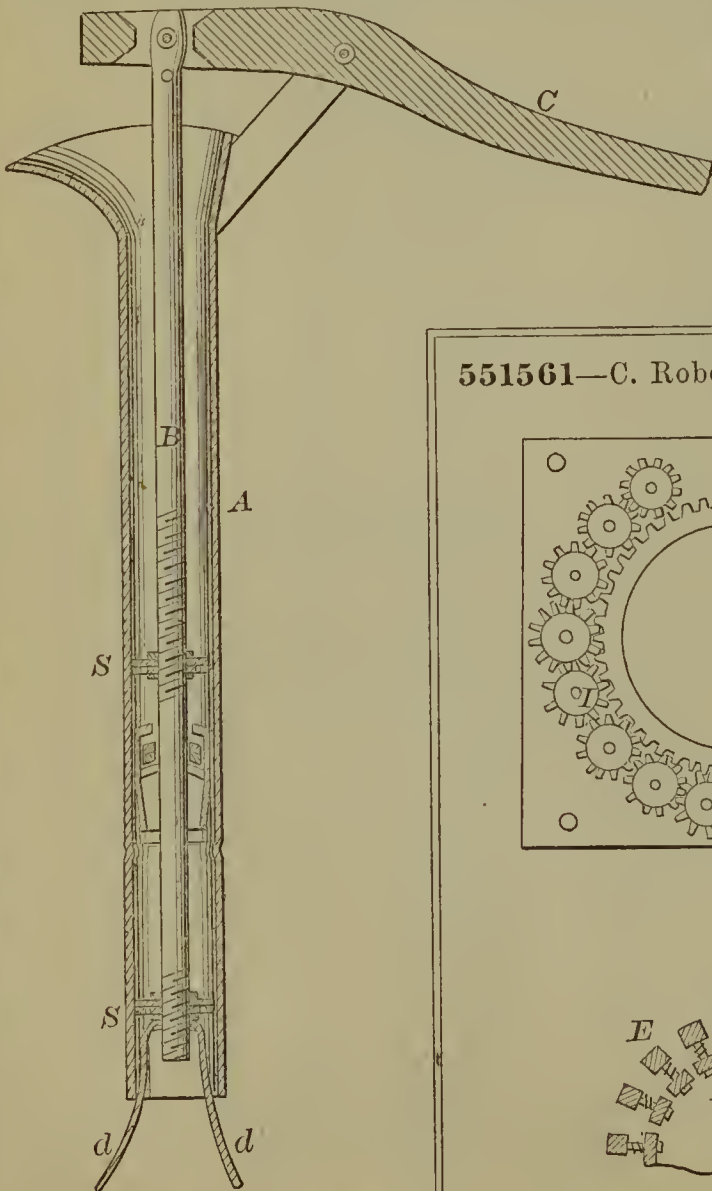

55159—S. Richards—Manufacturing Glass.

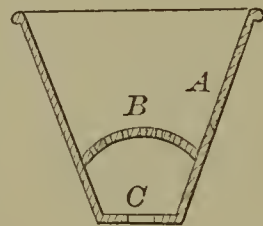

551561—C. Roberts—Washing Machine.

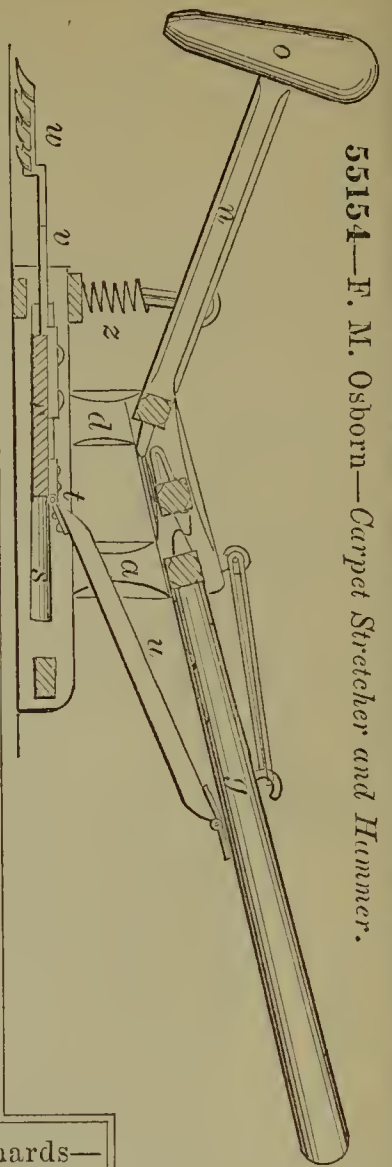
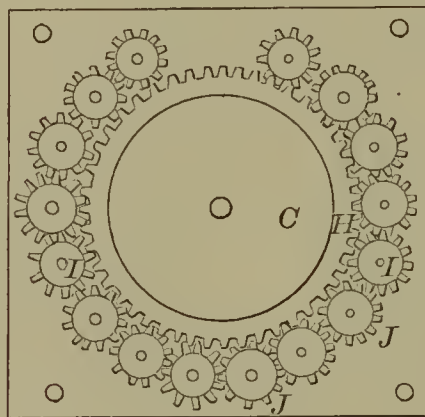

55154—F. M. Osborn—Carpet Stretcher and Hammer.

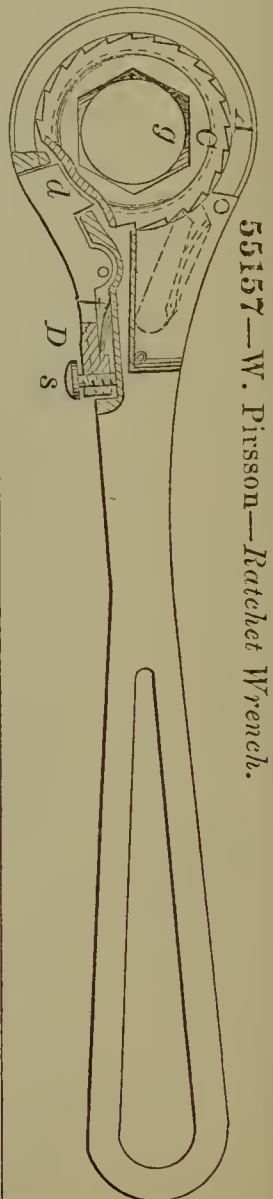

55157—W. Pirsson—Ratchet Wrench.

55162—T. B. Roche—Swivel Struckle.

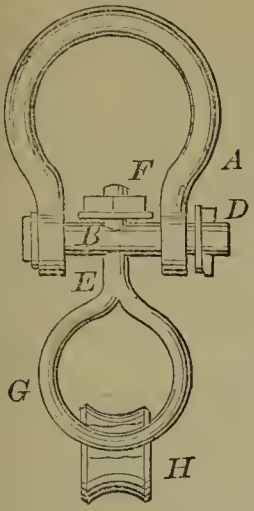

55163—B. C. Rogers—Training Hop Vines.

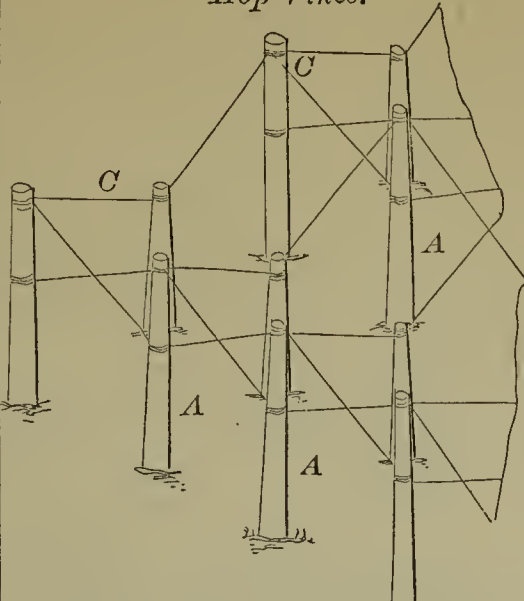

55165—A. J. Ross—Burglar Alarm.

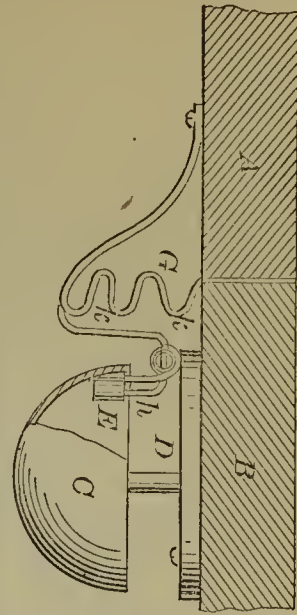

55164—E. J. Roosevelt—Cutting Roots for Feed.

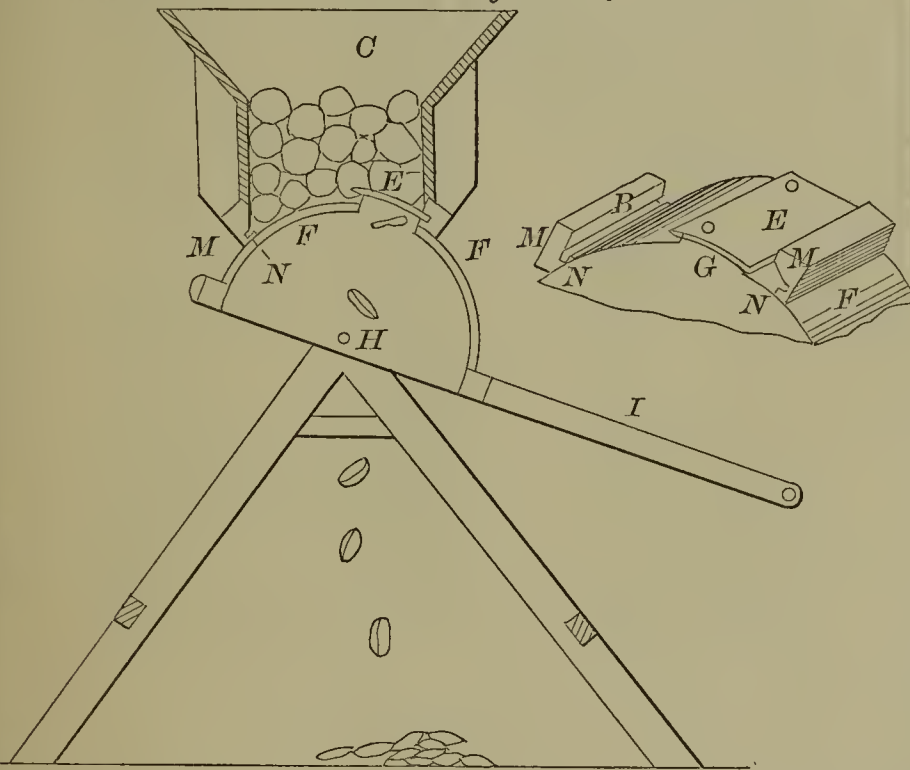

55166—C. W. Saladee—Padlock.

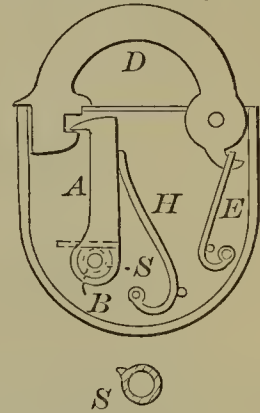

55167—C. W. Saladee—Padlock.

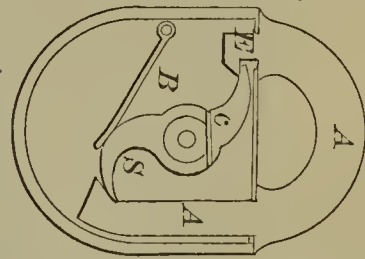

55168—T. H. B. Sanders—Heating and Ventilating Cars.

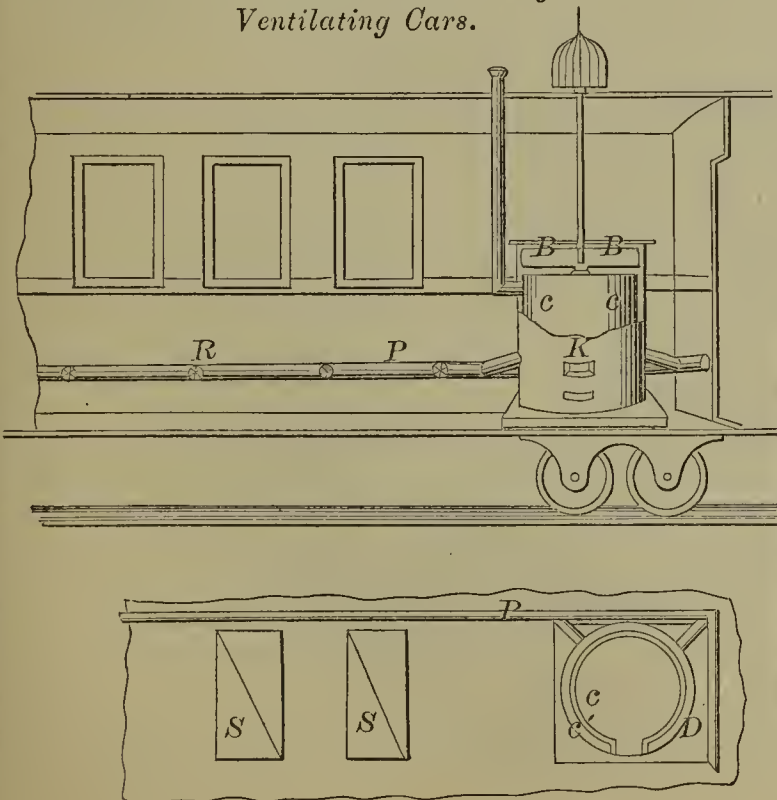

55169—J. F. Seaman—Churn.

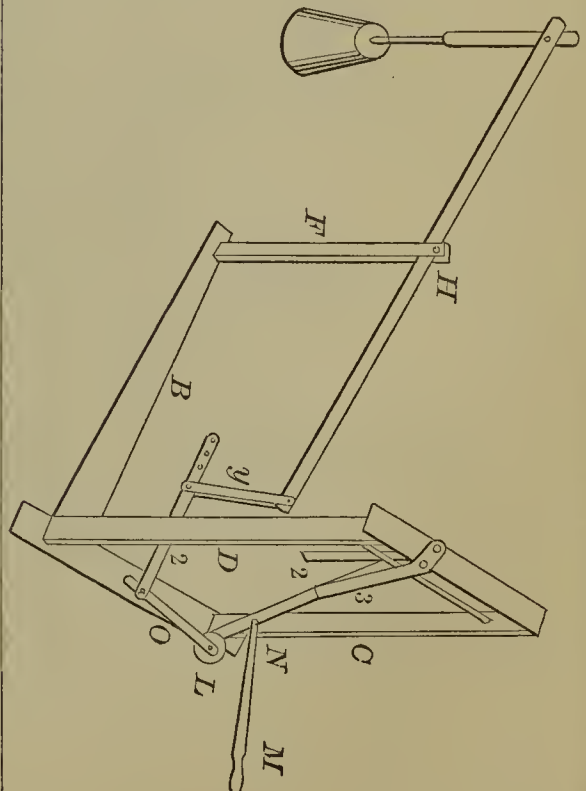

55170—E. Shopbell—Carpet Holder.

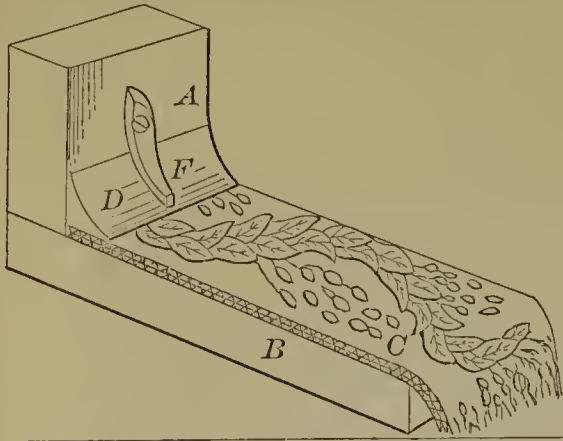

55173—H. M. Smith—For Cutting Tobacco.

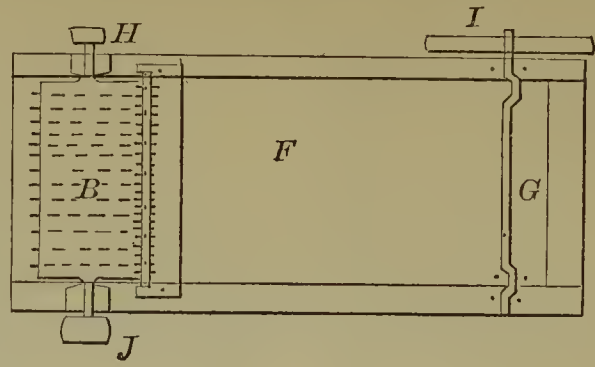

55171—A. B. Simonds—Screw Cutting Machine.

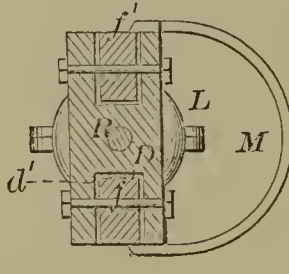
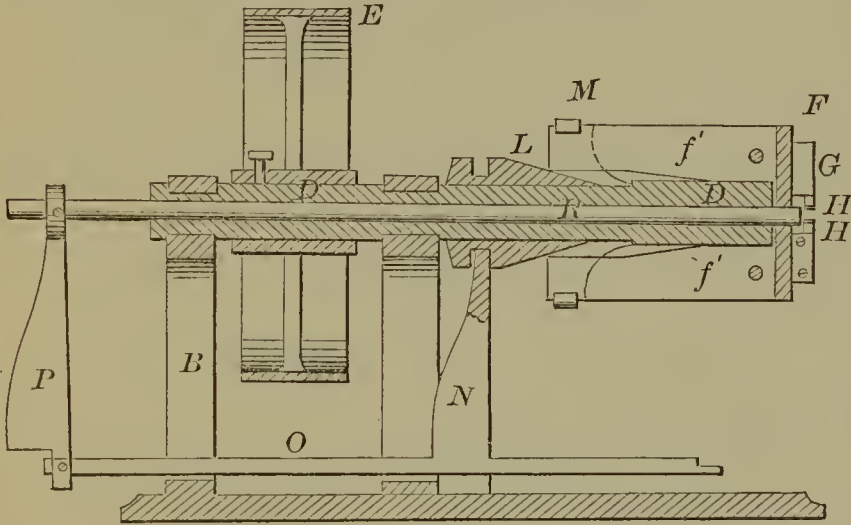

55172—A. J. Smith—Steam Generator.

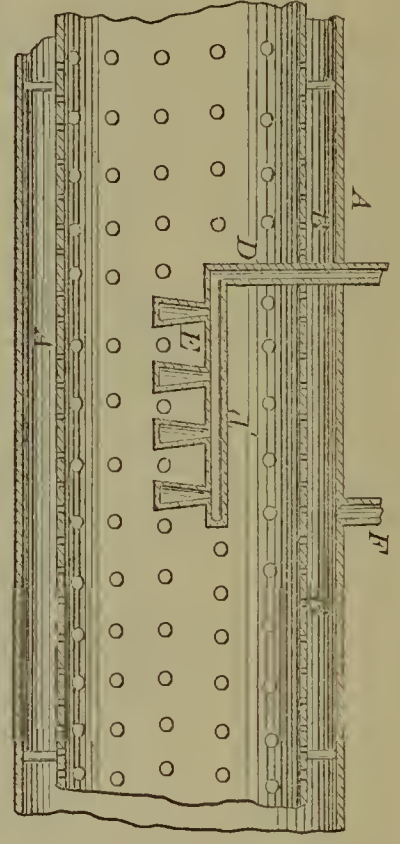

55174—Stevenson & Crider—Grain Cleaner.

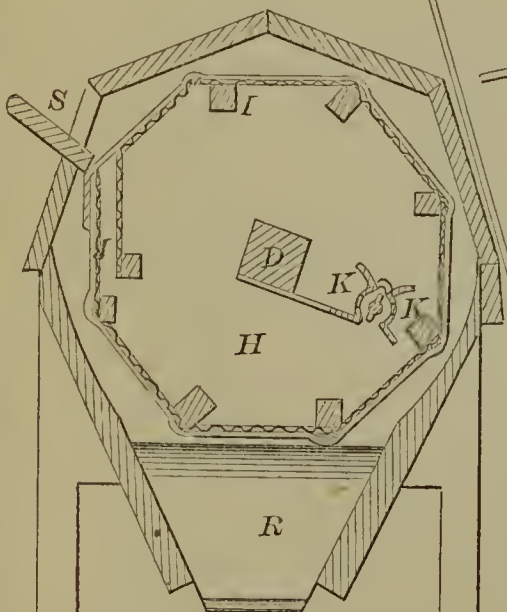

55175—A. D. Stocking—Cultivator.

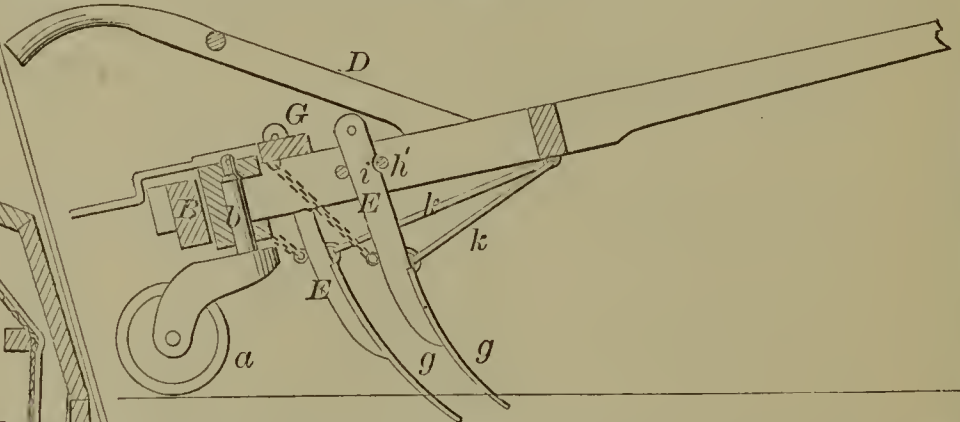

55176—S. Stuart—Rotary Brush.

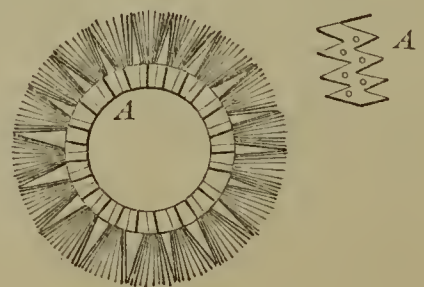

55177—H. Tilden—Tobacco Cutter and Nut Cracker.

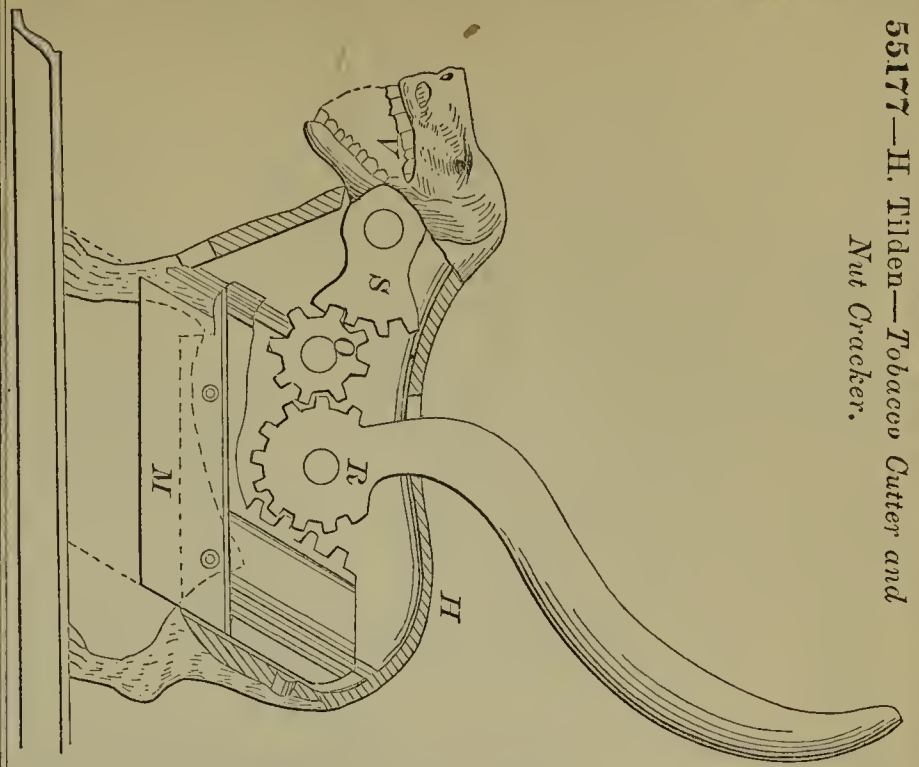

55178—H. E. Towle—Collecting Floating Oil.

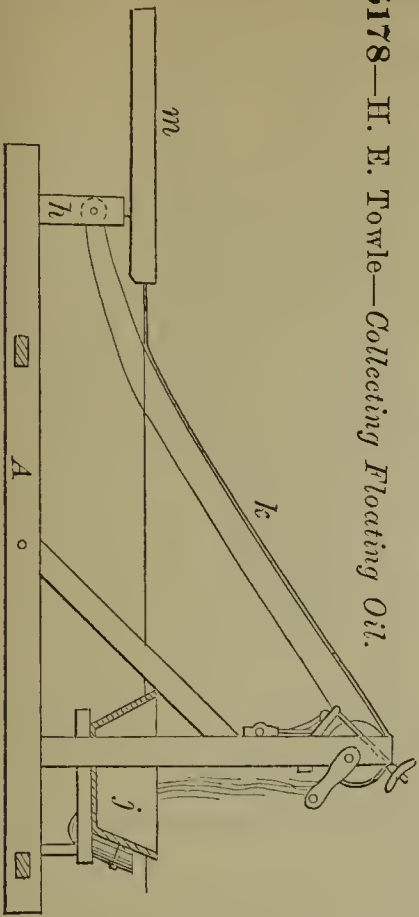

55179—B. T. Trimmer—Grain Cleaner and Separator.

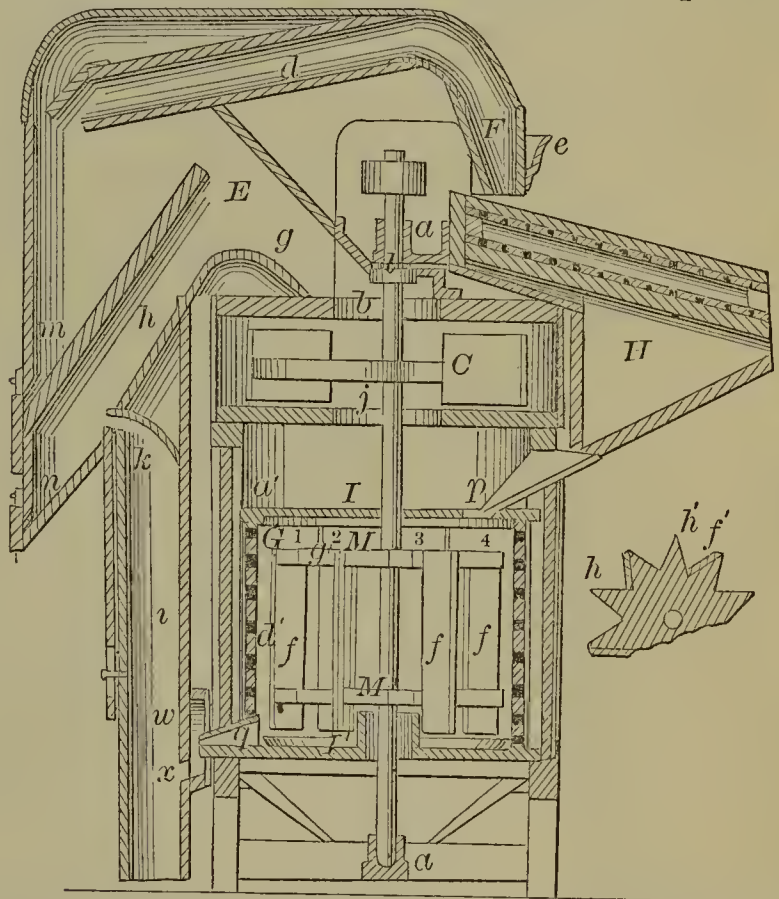

55180—F. Villard—Ventilator.

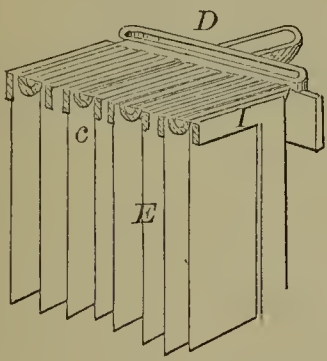
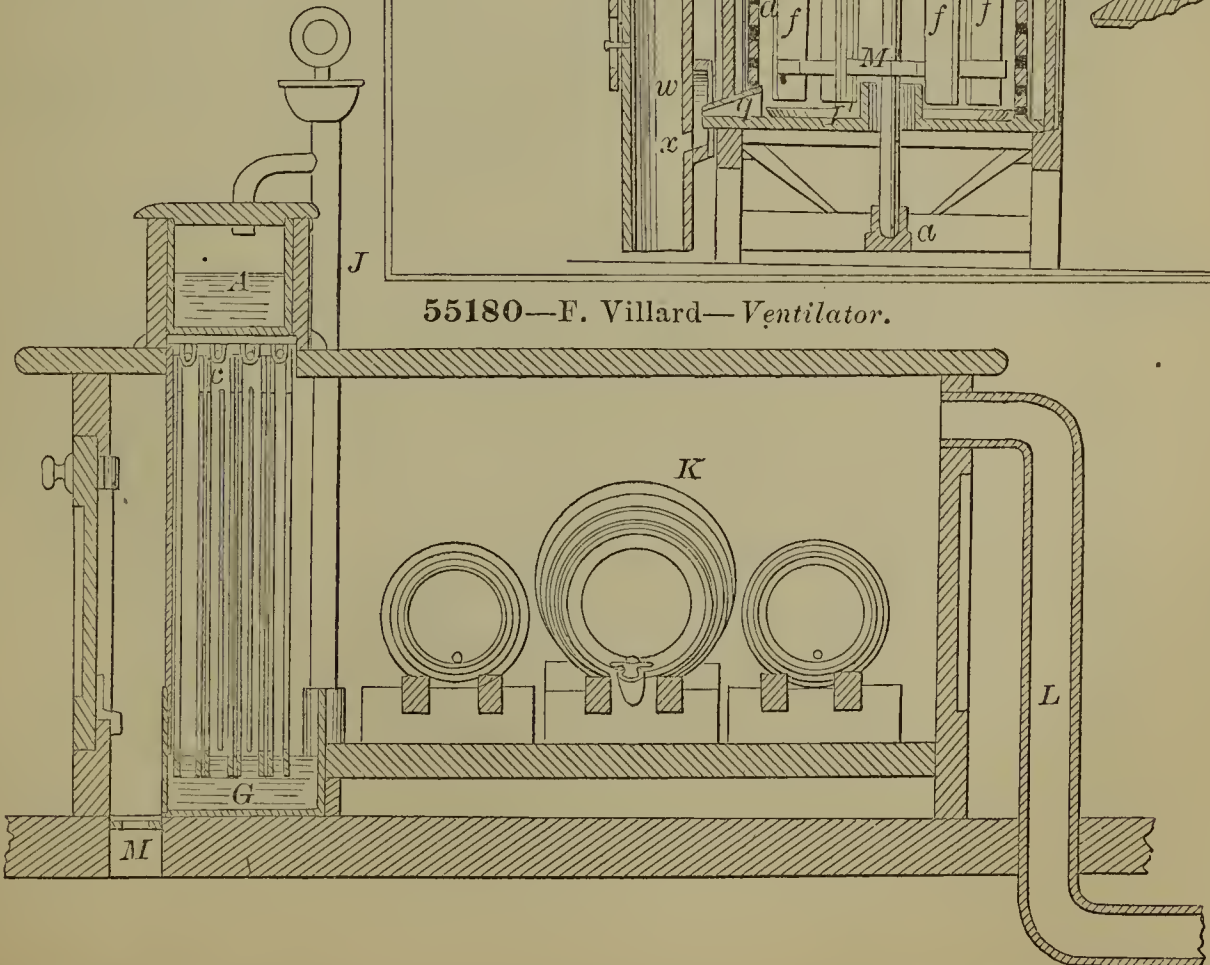

55184—L. N. Warren—*Grain Drill.*

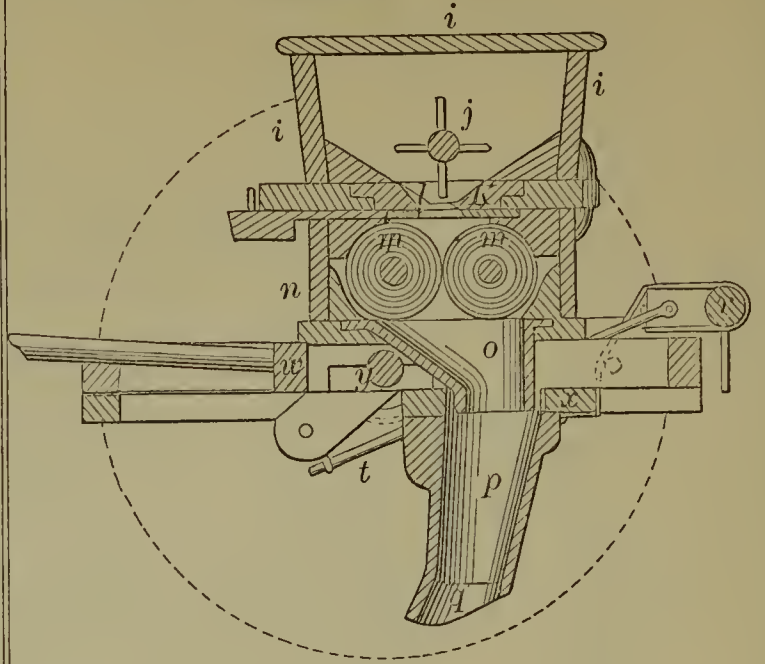

55181—C. Ph. Wagner—*Quartz Mill.*

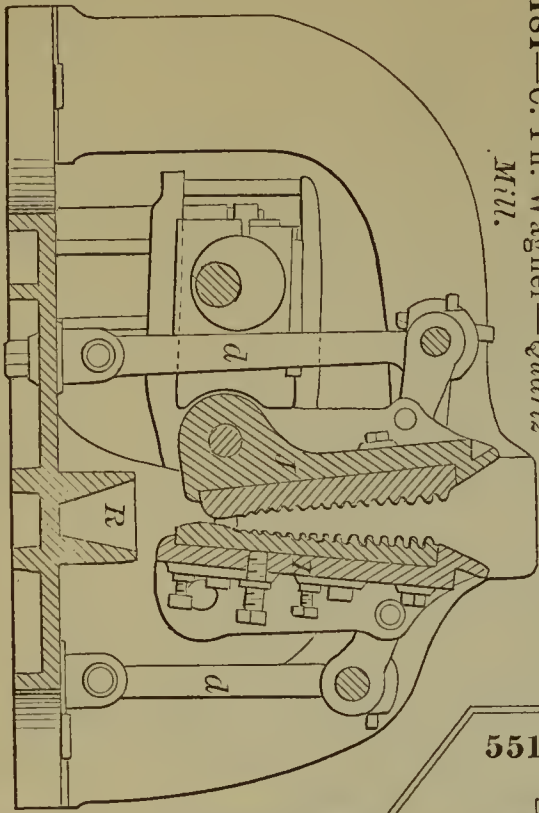

55182—A. Warth—*Sewing Machine.*

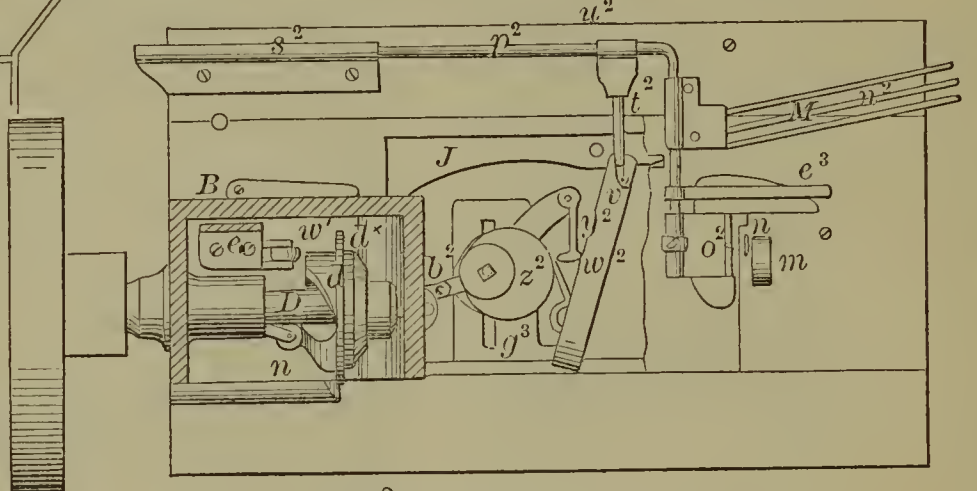

55183—Walters & Wilson—*Torch.*

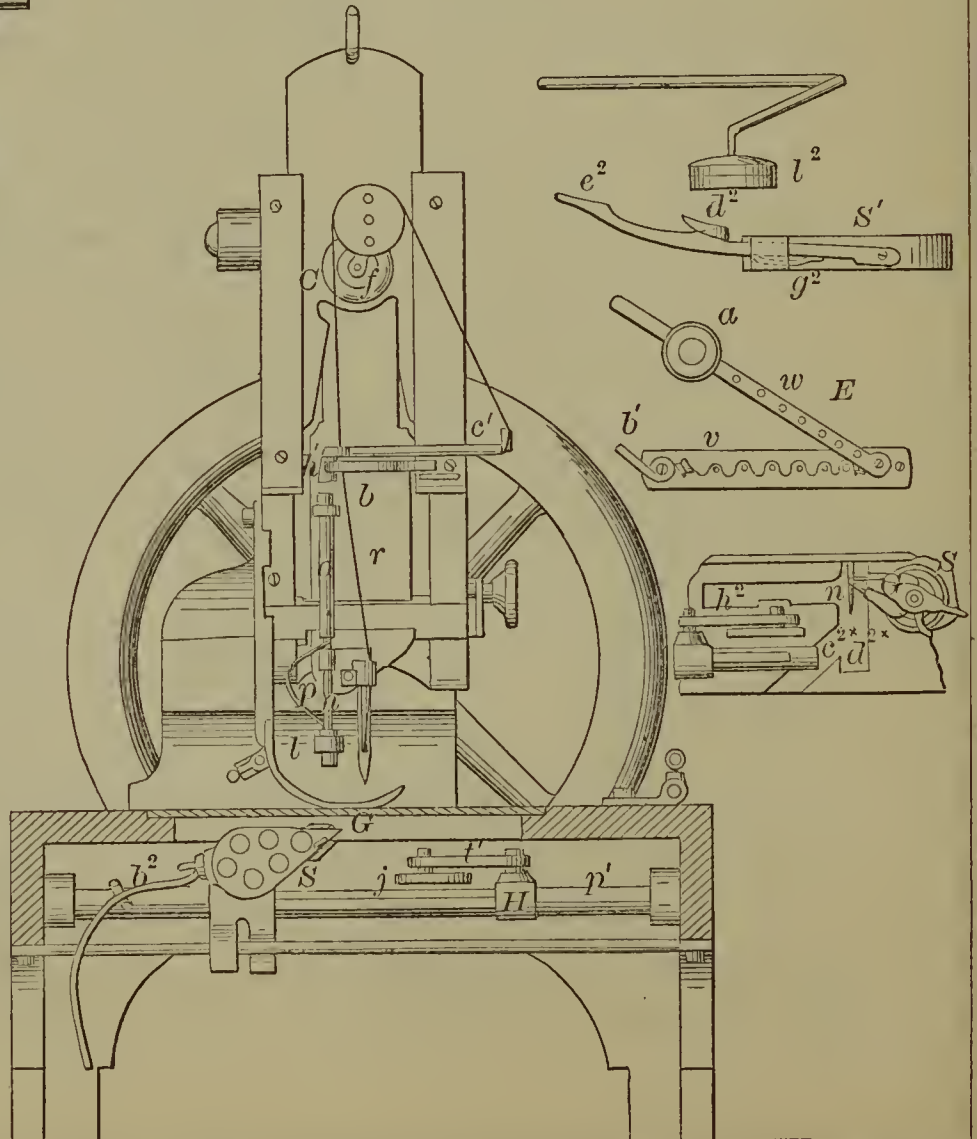
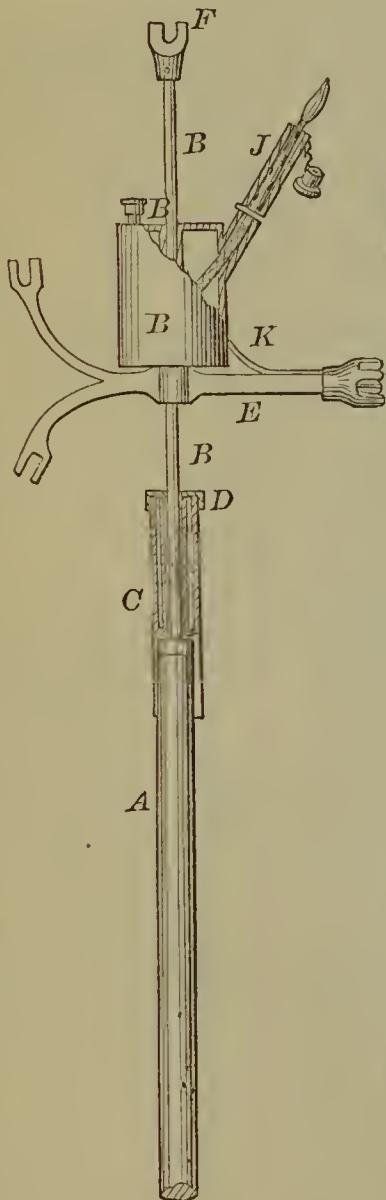



55185—T. U. Webb—Cultivator.

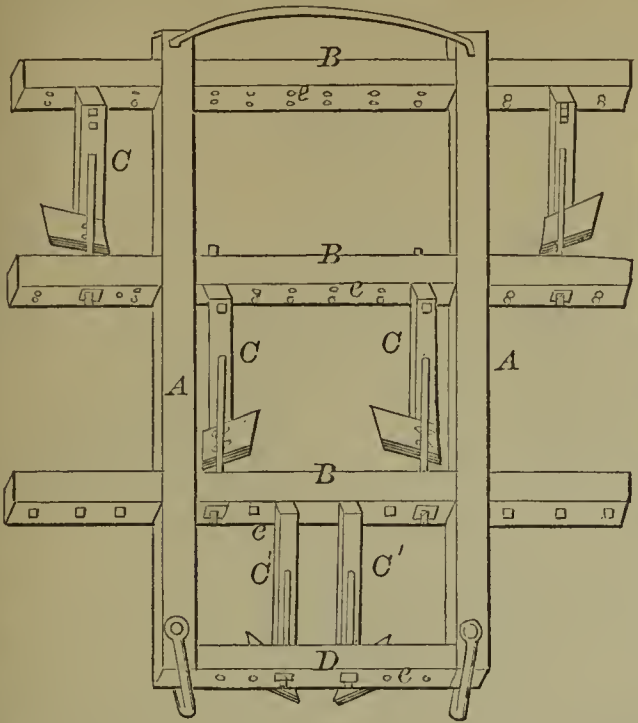

55186—J. Weller—Tuyere.

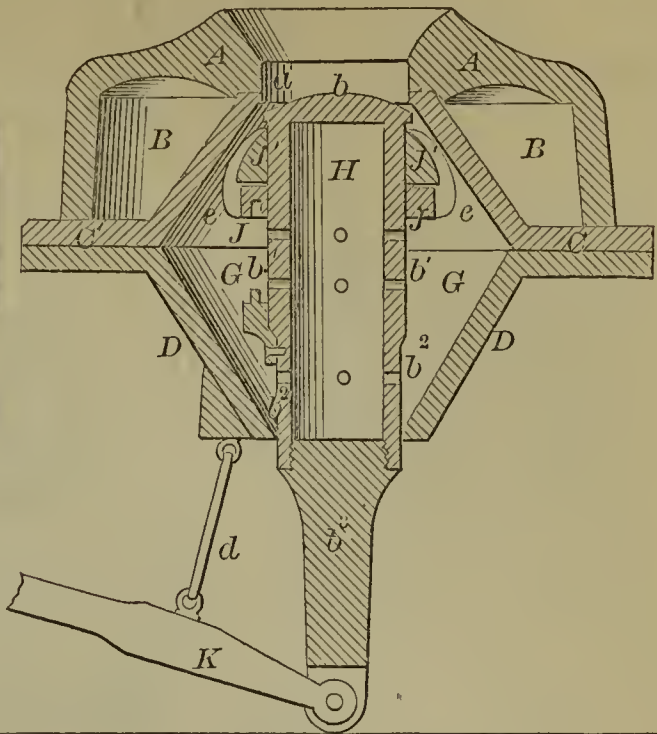

55187—G. D. Whitmore—Spring Bolt.

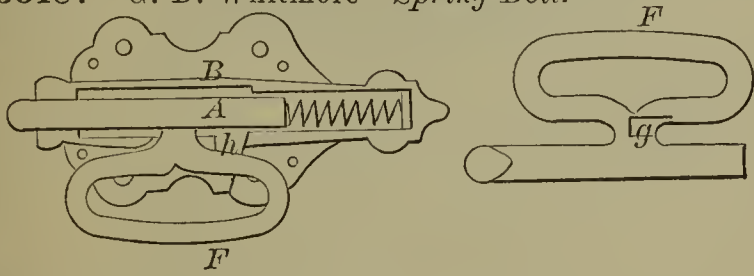

55188—H. Wight—Boots and Shoes.

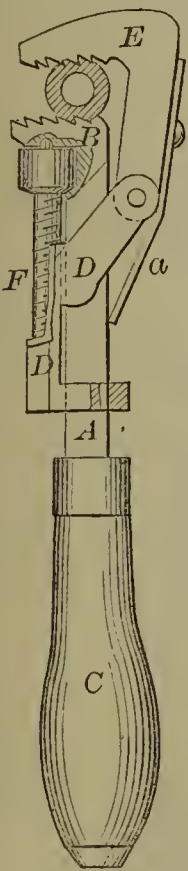
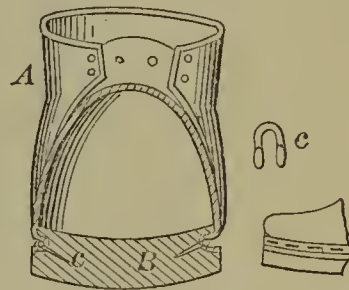

55190—W. W. Wills—Pipe Wrench.

55192—A. & G. Woerber—Thill Coupling.

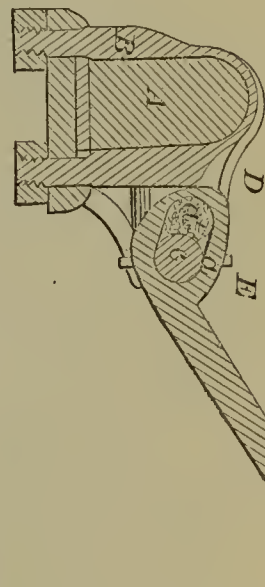
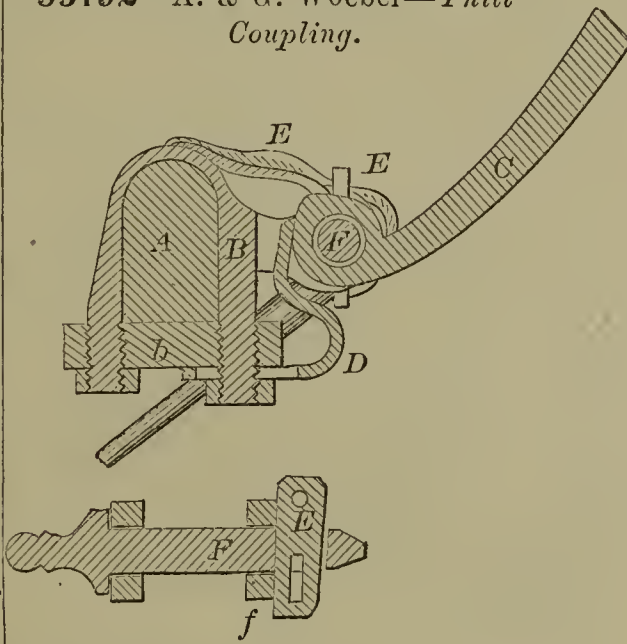

55191—A. & G. Woerber—Thill Coupling.

55193—L. W. Wright—Ordnance.

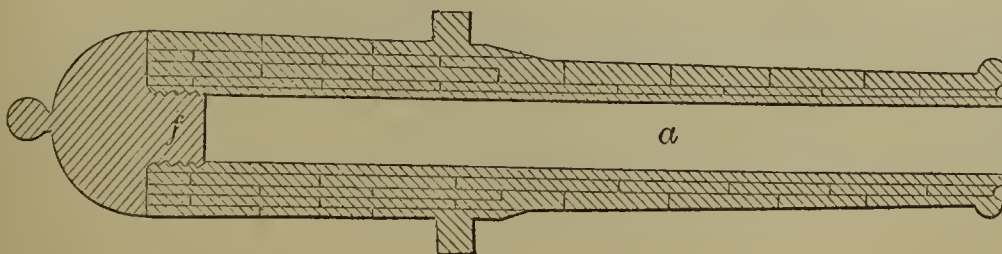

55189—D. H. Williams—Clinching Iron.

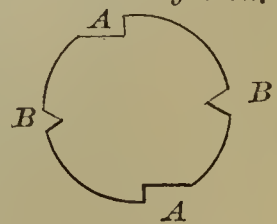

55194—J. Young, M. D.—*Steam Bath.*

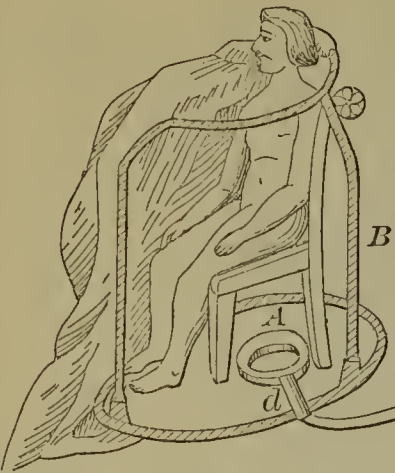
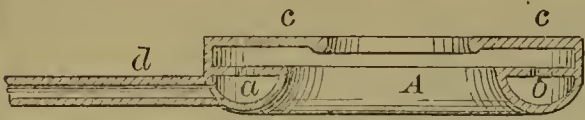

55195—J. Zentmayer—*Photographic Lens.*

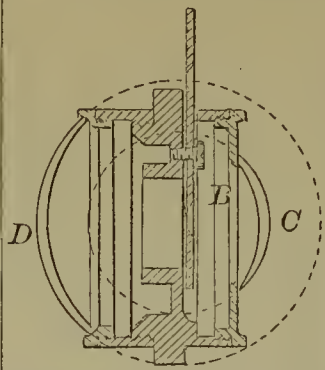

55197—F. D. Ballou—*Buckle Clasp.*

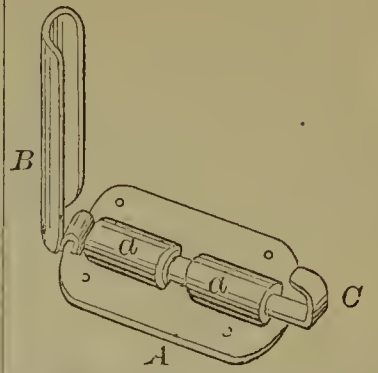

55198—G. L. Baum—*Shaft Coupling.*

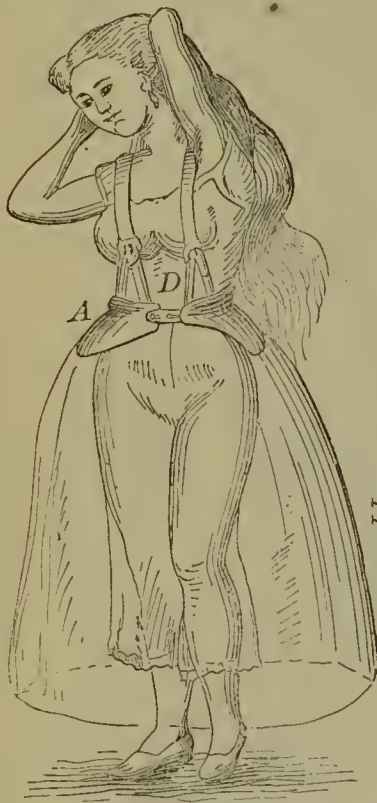
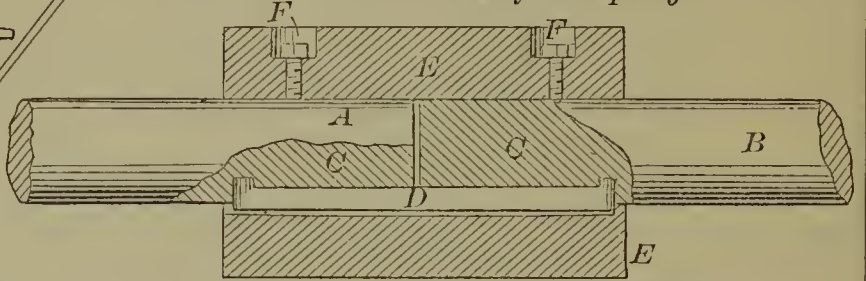

55196—W. Baeheller—*Skirt Supporter.*

55200—P. Crowl—*Vise.*

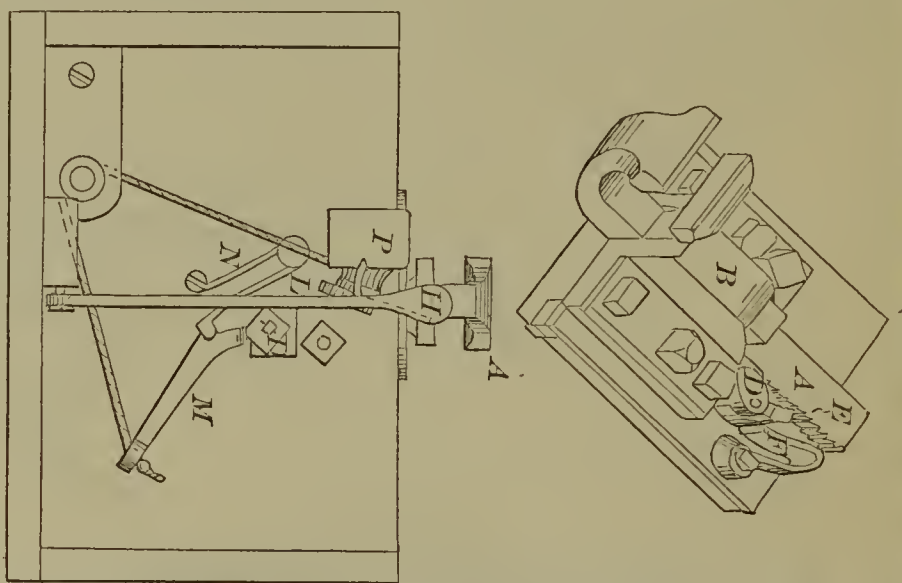

55201—W. T. Cushing—*Printing Railroad Tickets.*

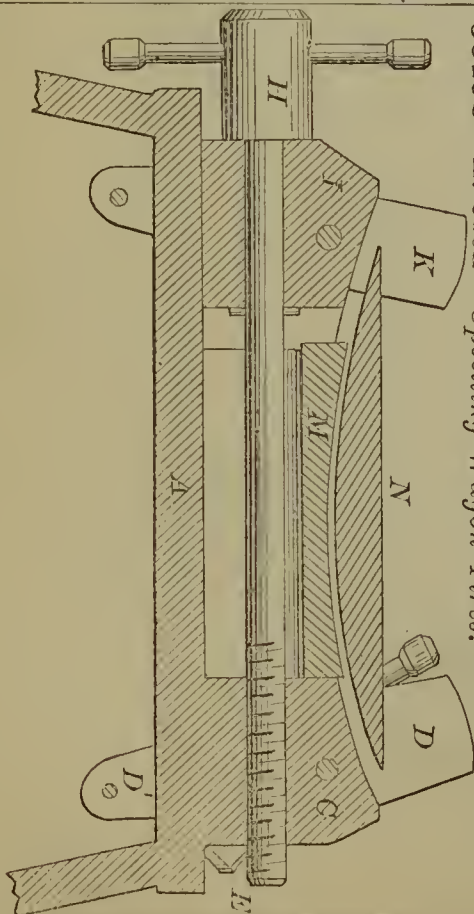
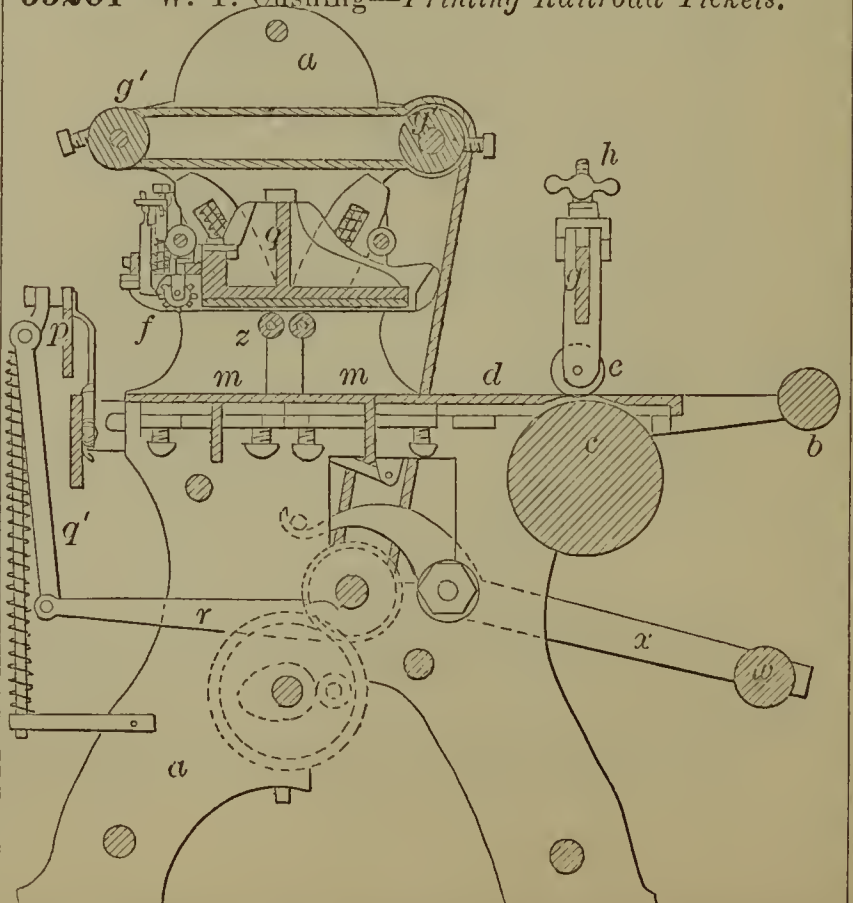

55199—E. Cook—*Upsetting Wagon Tires.*

55205—S. Marden—For Preparing Peat.

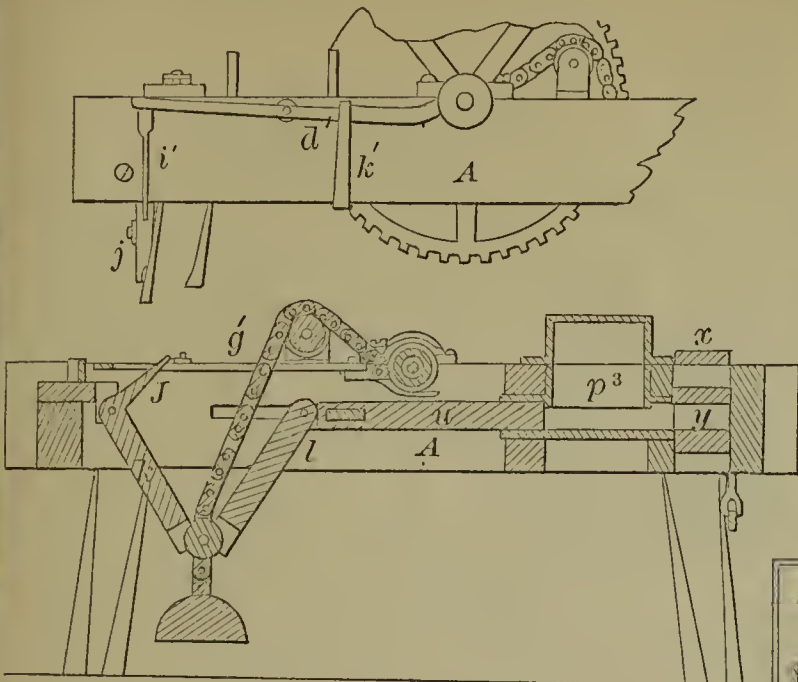

55202—B. W. Durkee—Sawing Machine.

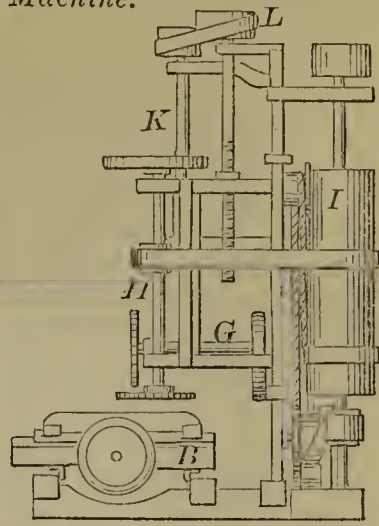

55204—Mackenzie & Isbell—Cupola and other Furnaces.

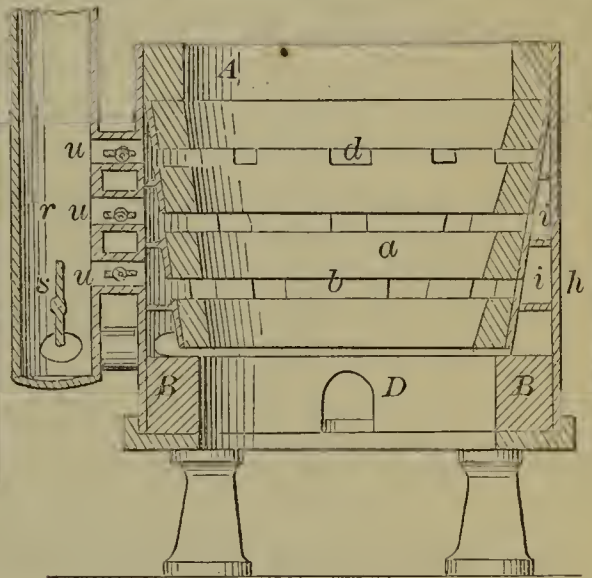

55206—F. A. Morley—Potato Digger.

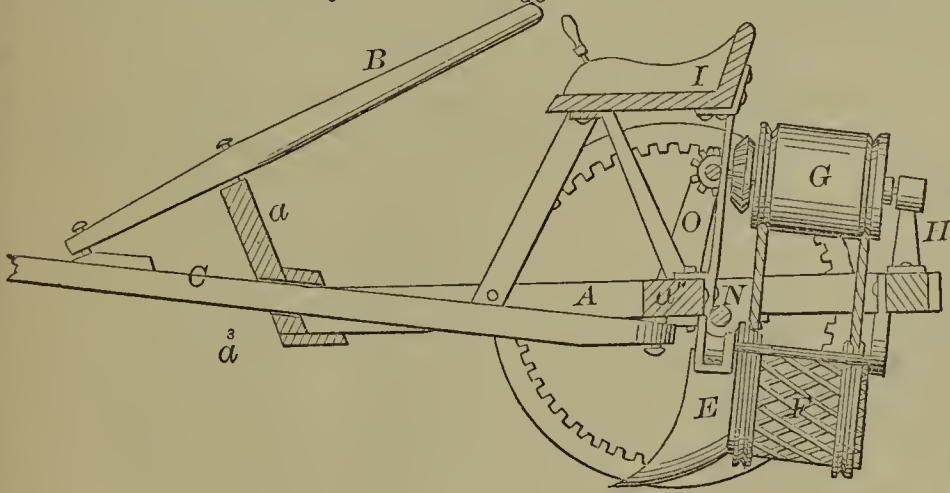

55207—G. Miller—Carpenter's Plane.

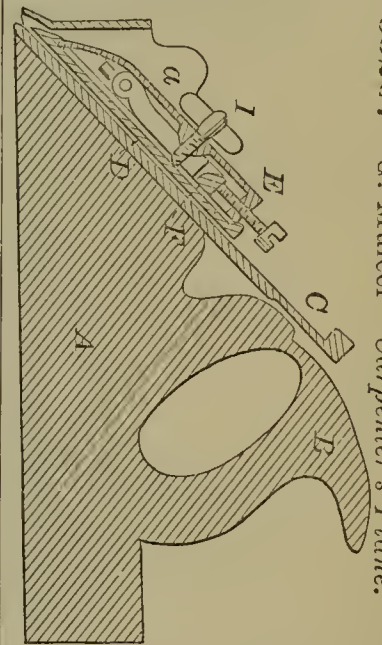

55208—W. W. S. Orberton—Clothes Dryer.

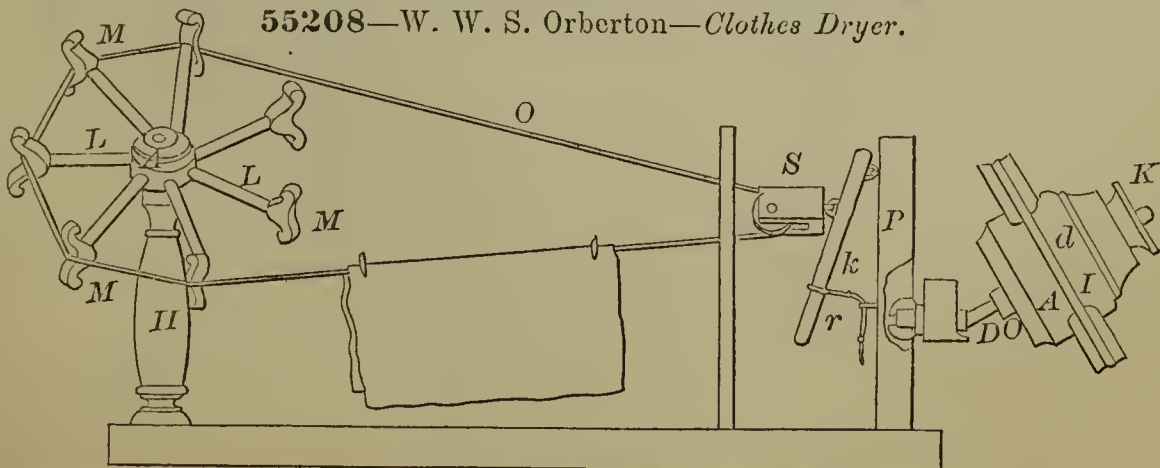

55209—E. Paye—For Turning Boiler Flanges.

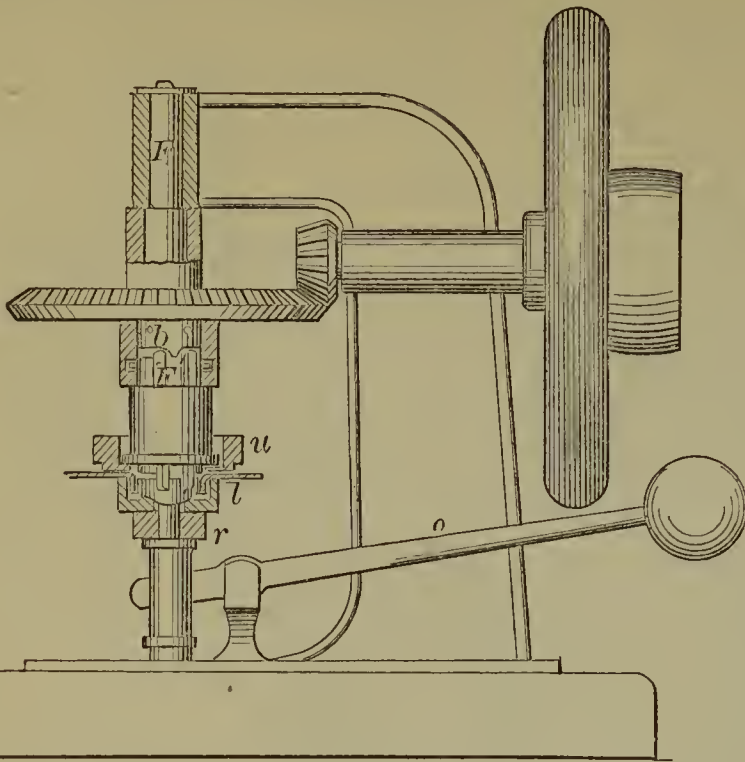

55215—T. H. Ince—Attaching Shoes to Horses.

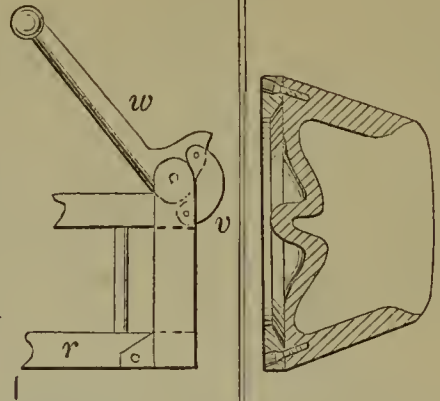

55210—J. F. Severance—Stove Pipe Thimble.

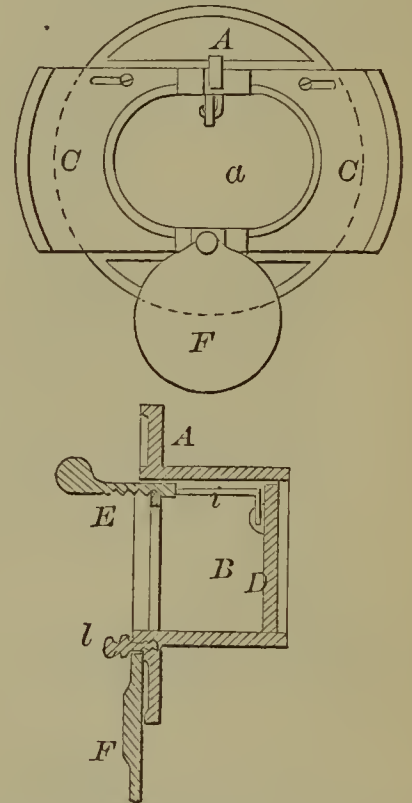

55211—J. Sutherland—Driving Spindles in Spinning Frames.

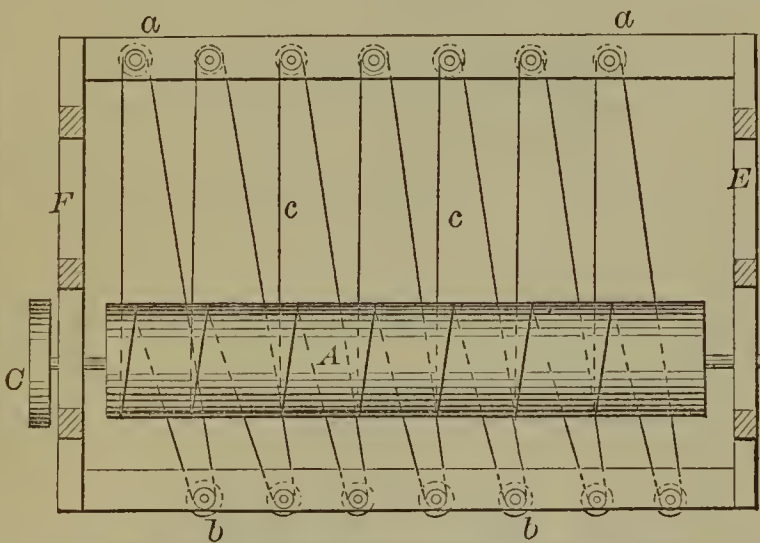

55212—Vance & Smith—Drop Light Fixture.

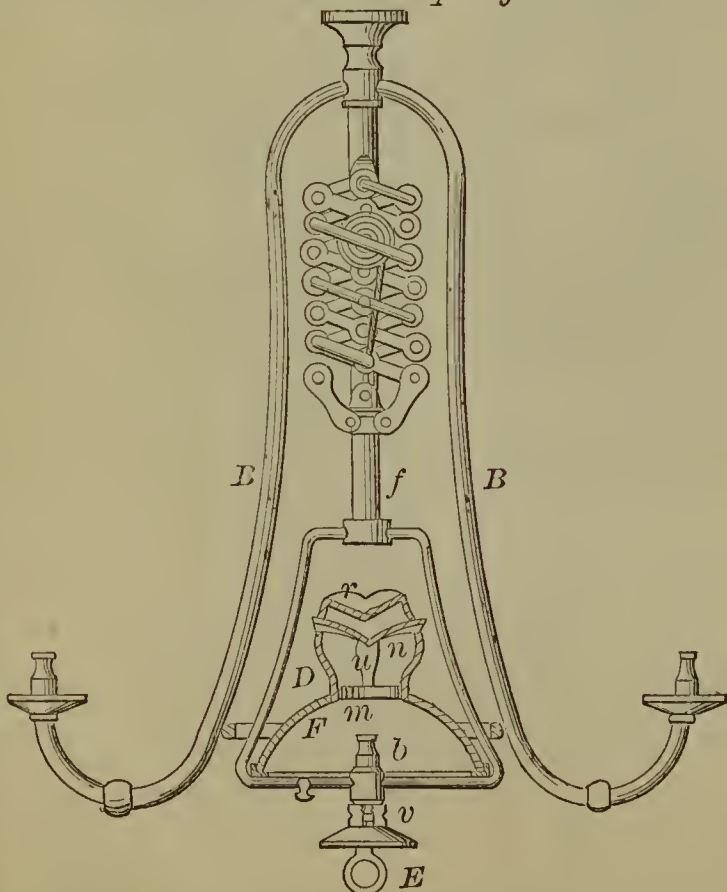

55213—W. Woodbury—Bending Fore and Aft Sails.

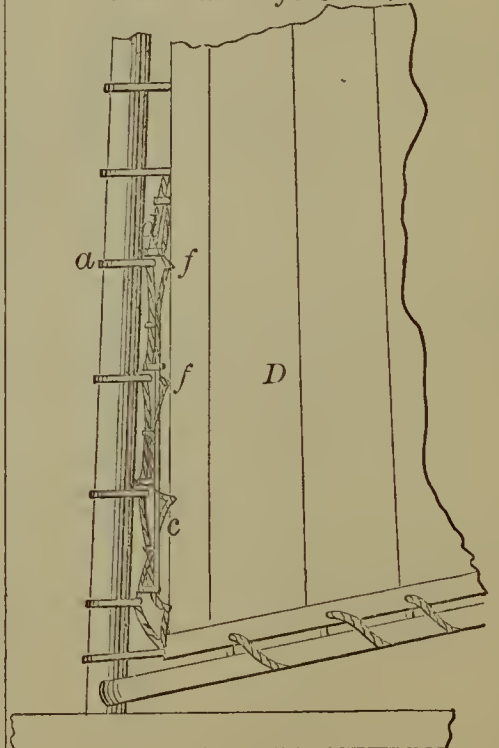

55217—G. A. Reiniger—Cigar Machine.

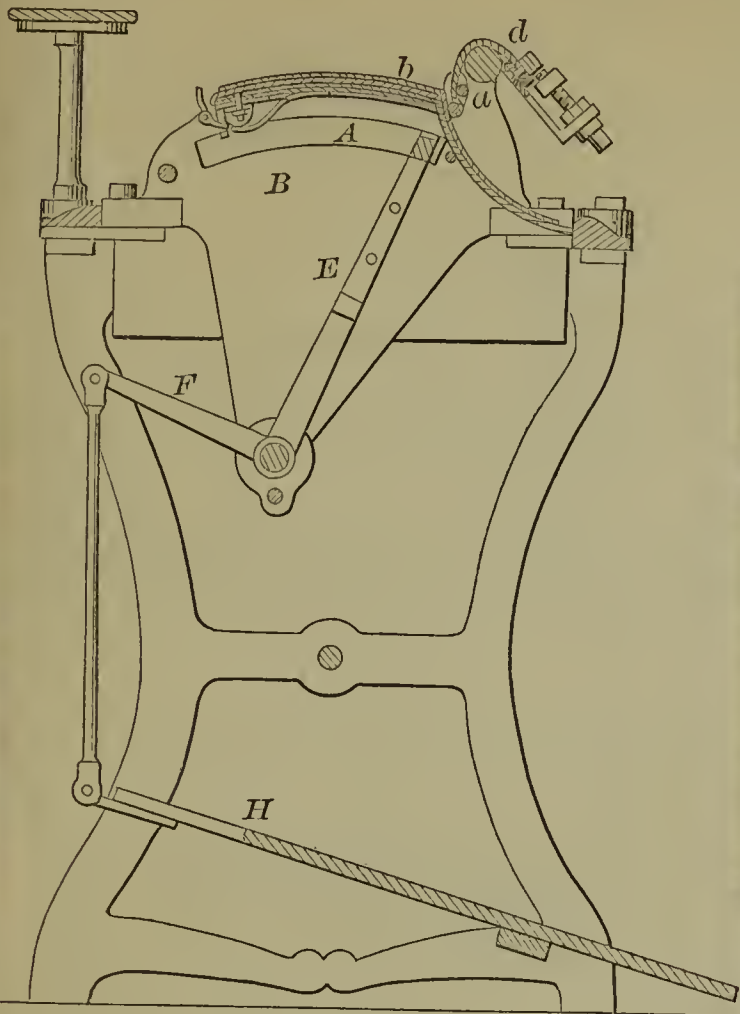

55220—H. Armstrong—Horse Shoe.

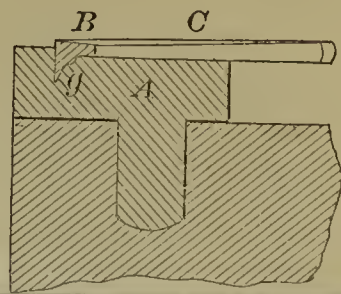

55221—J. Ashcroft—Low Water Detector.

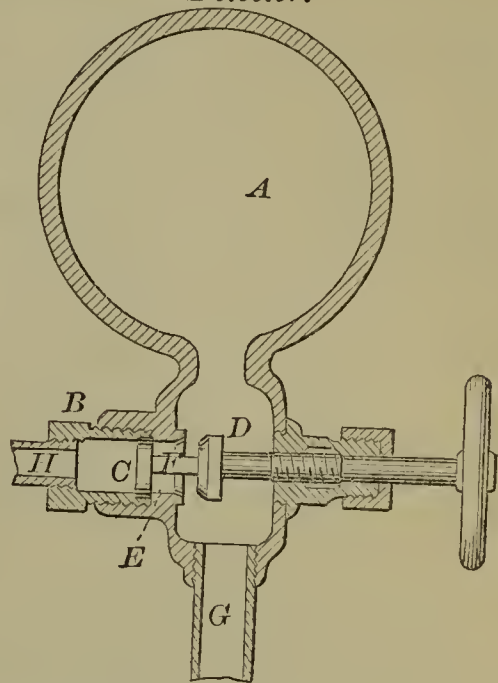

55219—E. A. Andrews—Snap Hook.

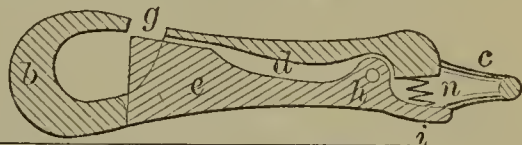

55222—A. T. Atherton—Tuyere.

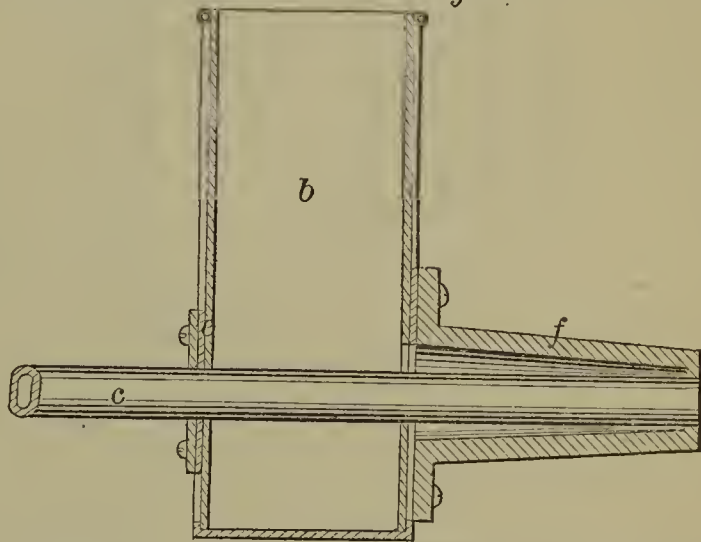

55223—J. S. L. Babbs—Dovetailing Machine.

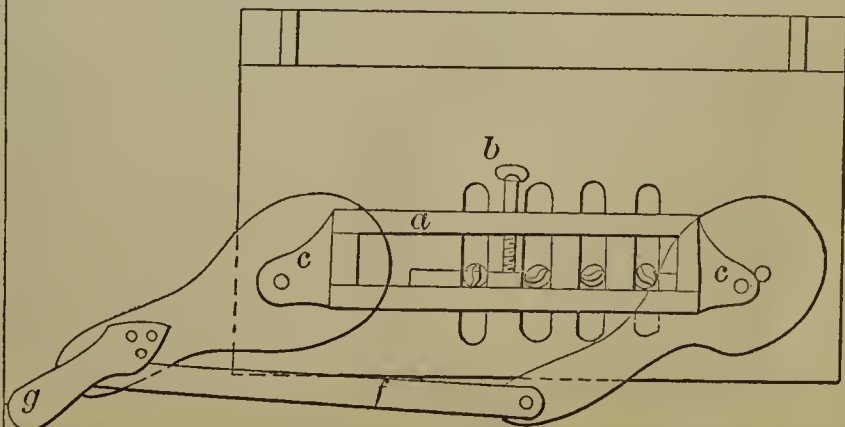

55218—Robinson & Gresham—Water Injector.

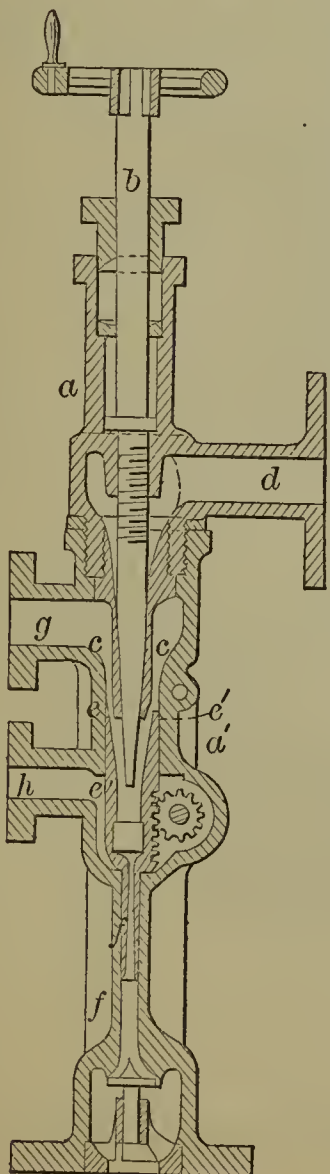

55224—D. Ballou—*Tire Bending Machine.*

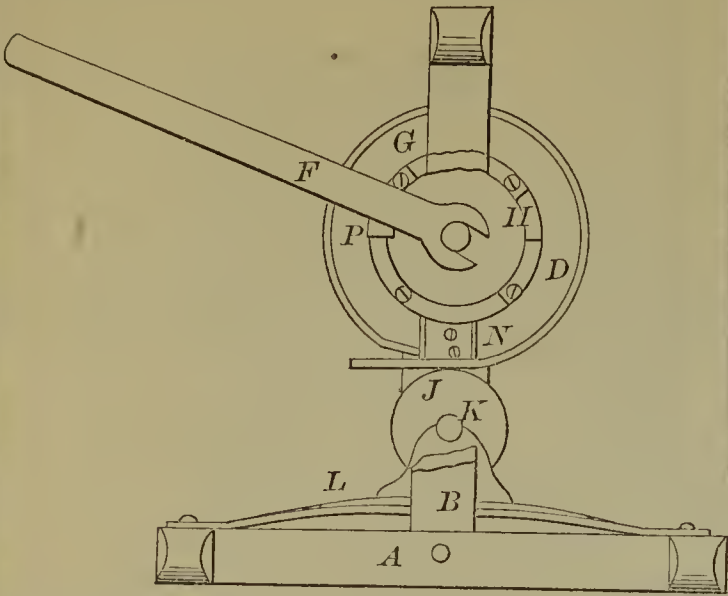

55225—A. C. Barstow—*Cooking Stove.*

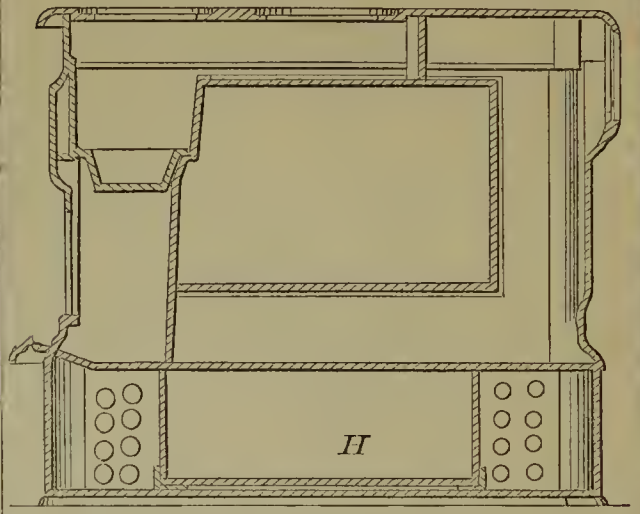

55226—W. O. Bartlett—*Bridle.*

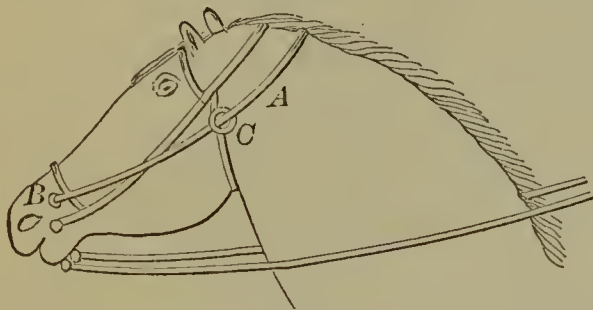

55227—W. Bedle—*Cradle.*

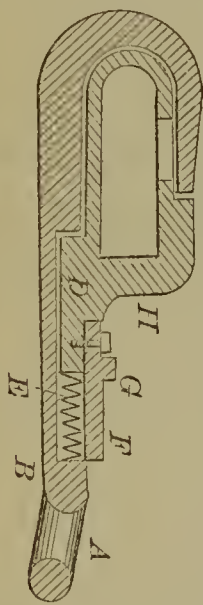
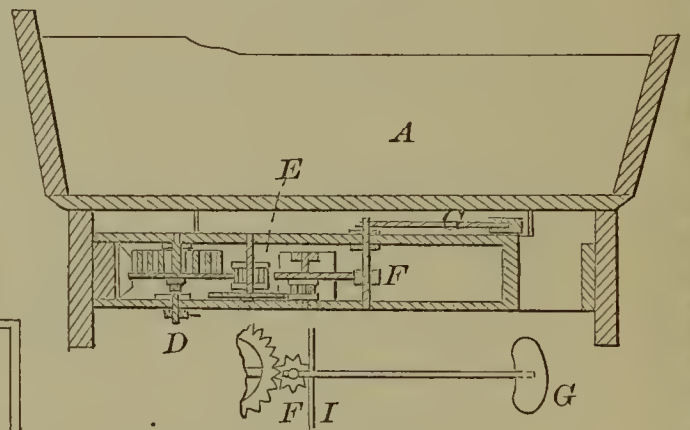

55229—Bellairs & Barto—*Snag Hook.*

55228—C. T. Belbin—*Dredge Roller for Oyster Boats.*

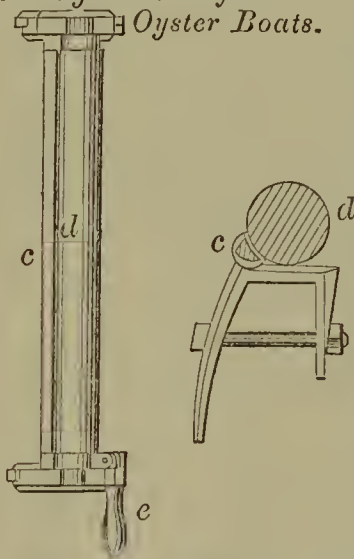

55231—W. N. Berkeley—*Turning Bridges.*

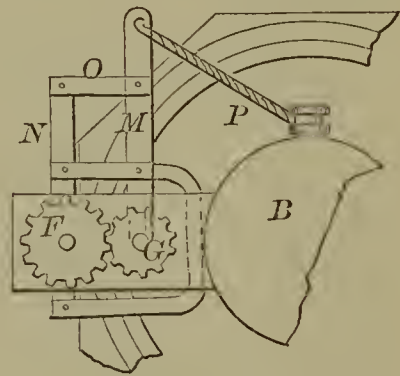

55230—W. N. Berkeley—*Turning Bridges.*

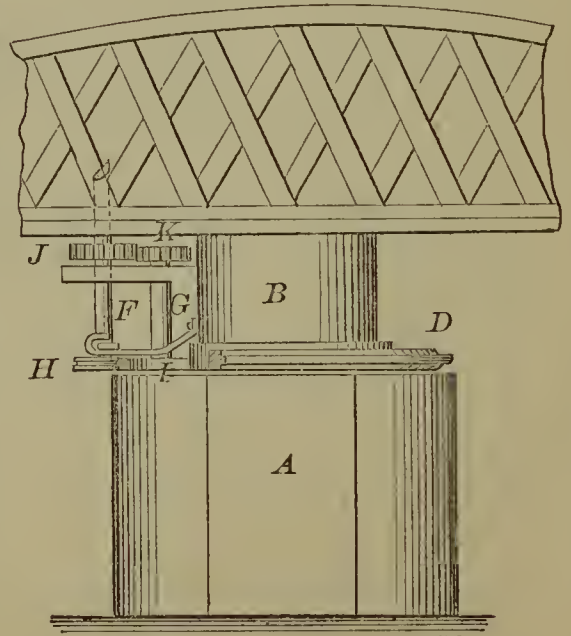
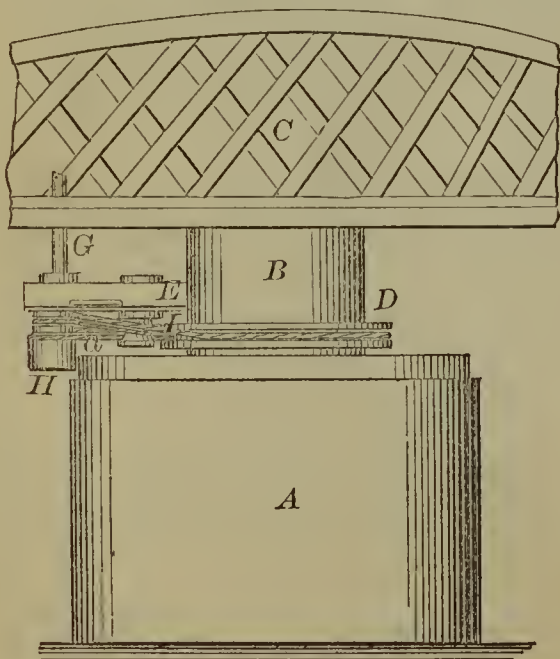

55232—H. Black—For Scutching Flax.

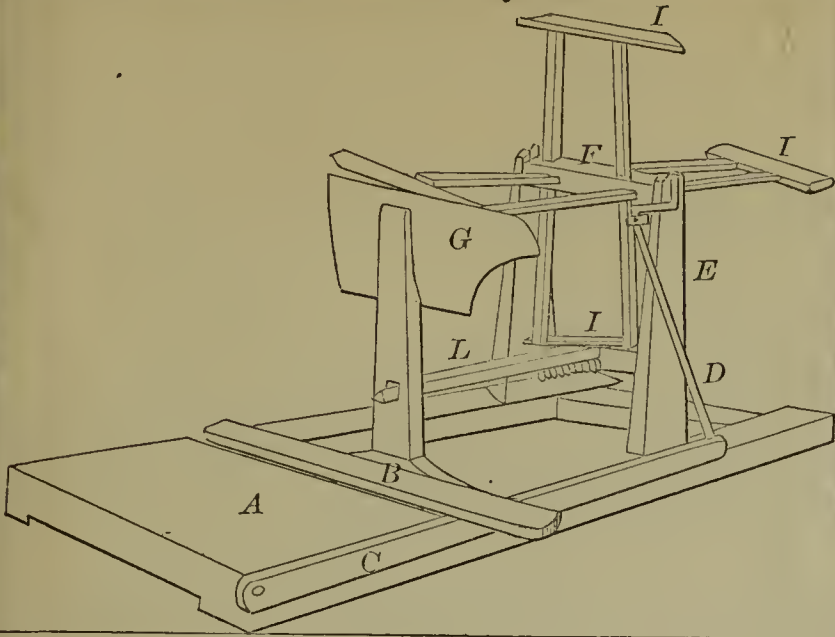

55235—J. Braidwood—Coffer Dam.

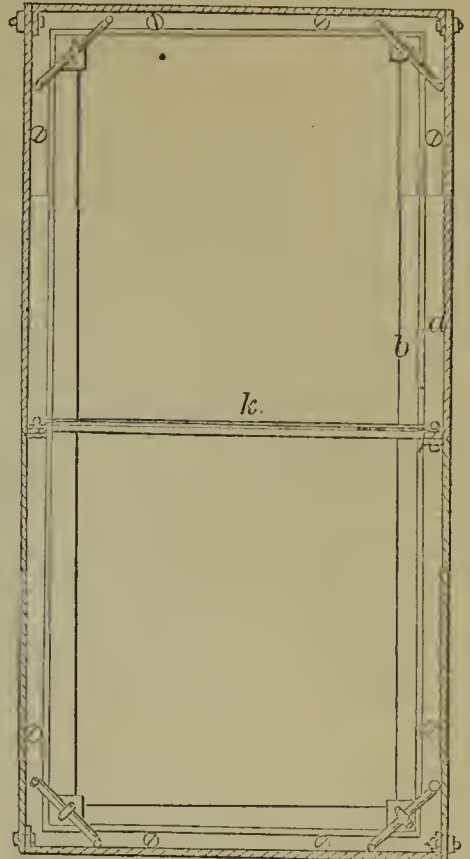

55236—H. Brown—Sail.

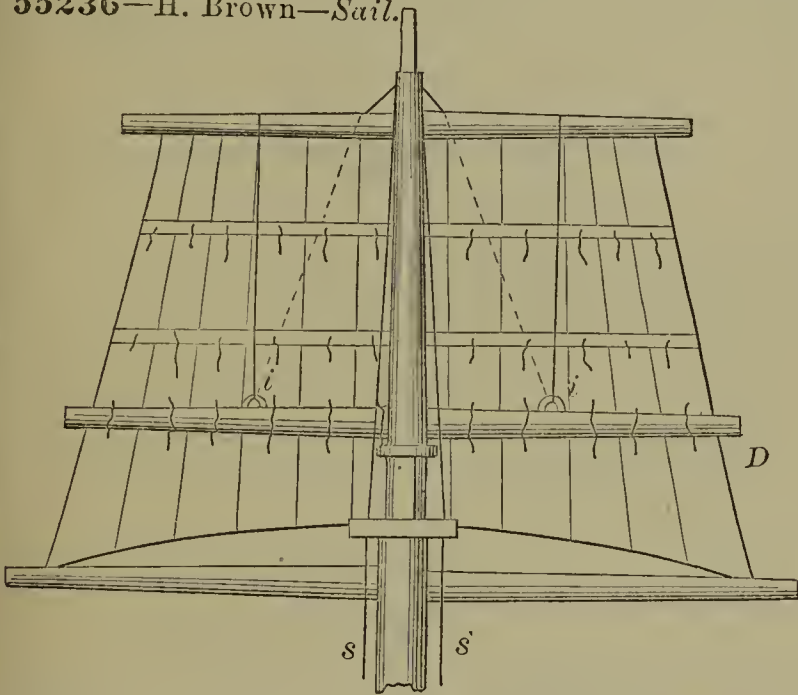

55233—A. S. Blake—Metallic Cartridge.

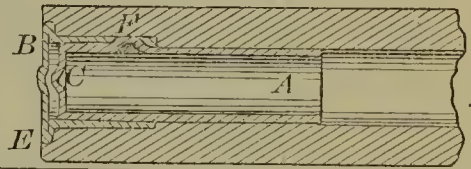

55238—A. Casebeer—For Jointing Staves.

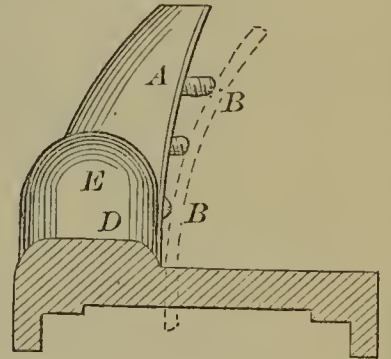

55237—J. A. Campbell—Steam Generator.

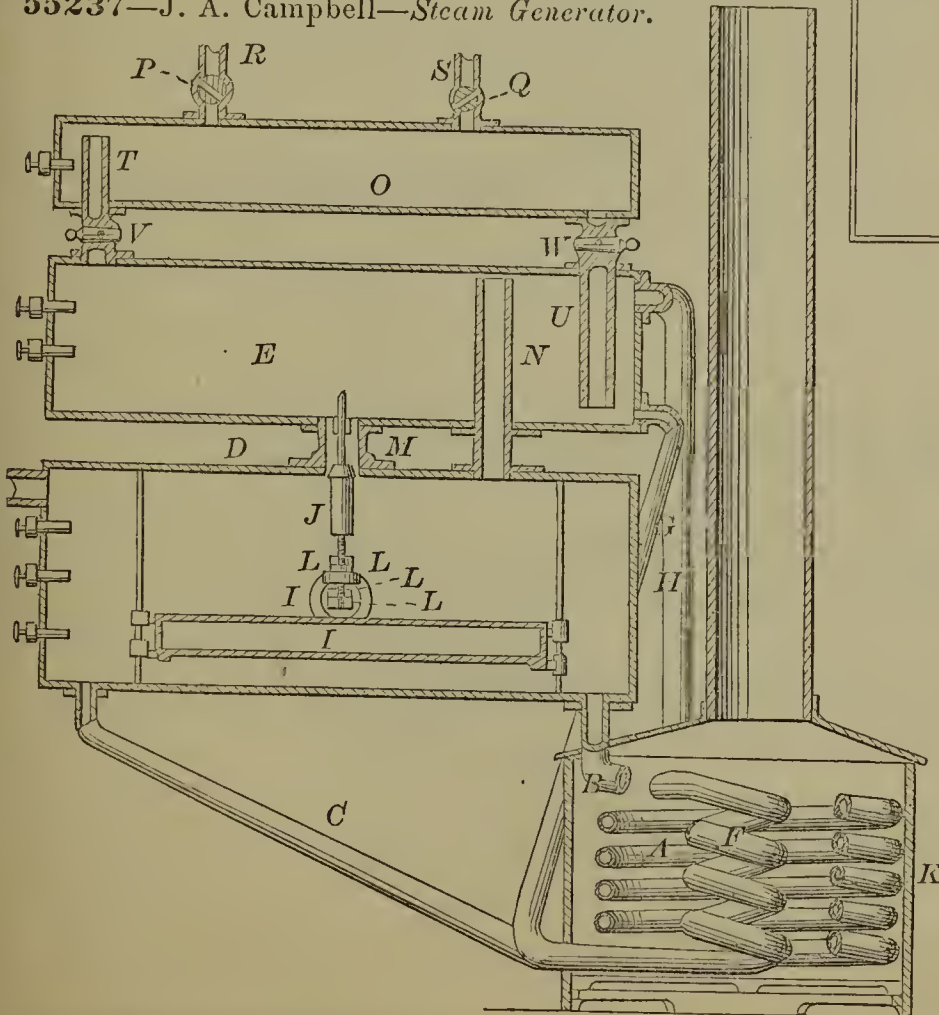

55239—Chambers & Robinson—Yarn Delivery for Braiding Machines.

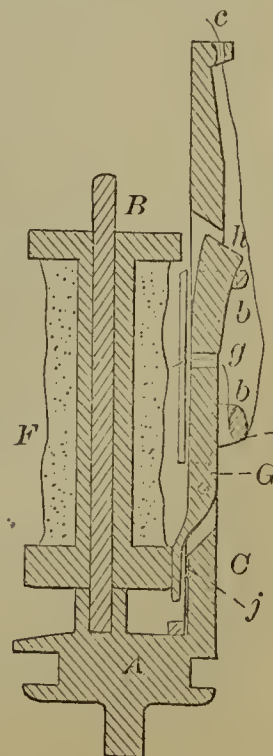

55241—W. W. Clay—*Knitting Machine.*

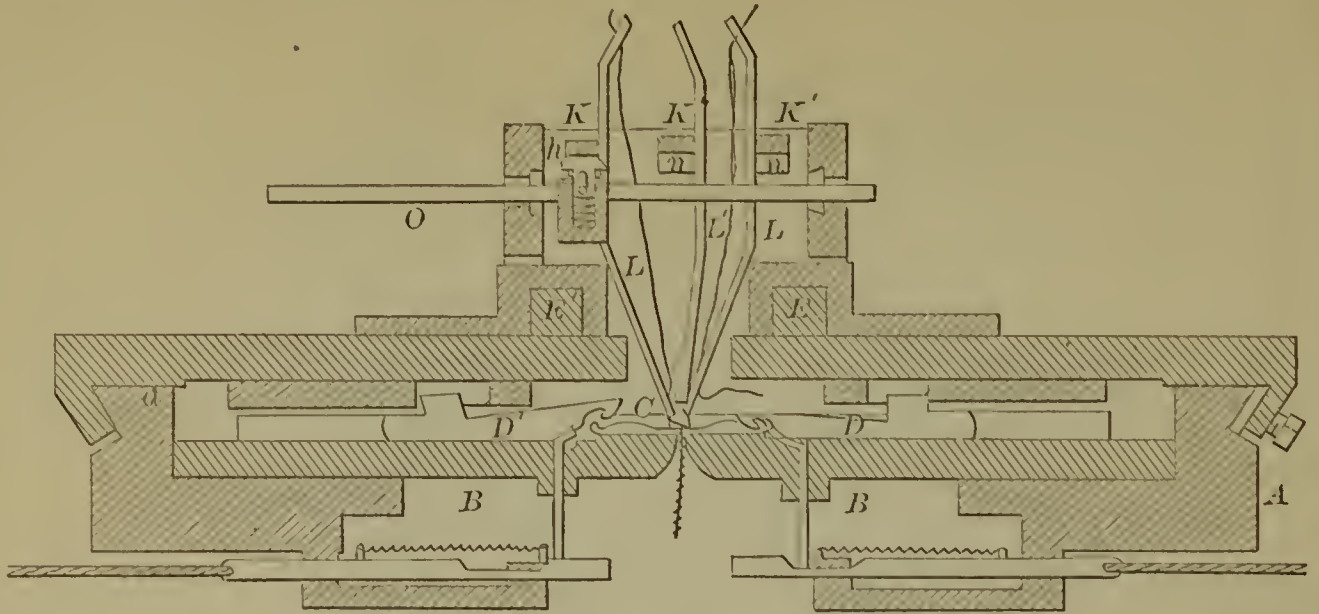

55242—T. Cochen—*Bottle Filler.*

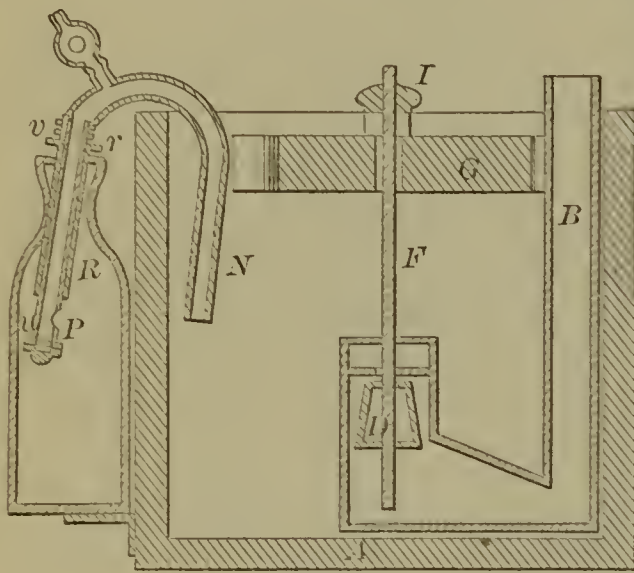

55244—Corbett & Burns—*Lock.*

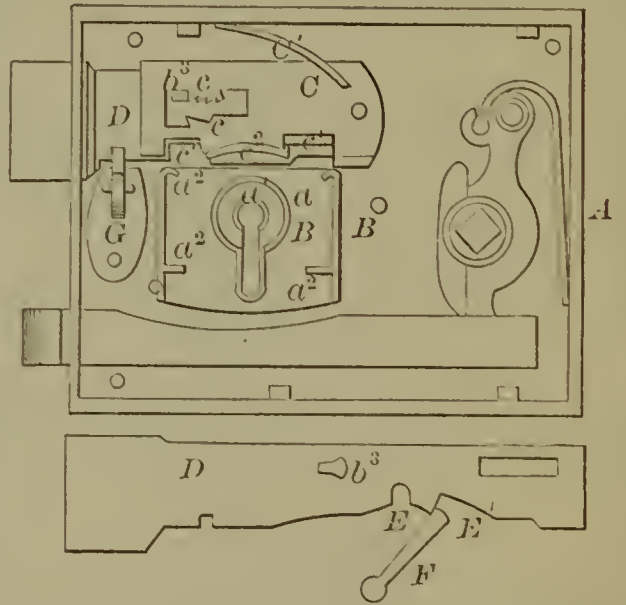

55243—G. E. Cooper—*Drill and Fertilizer.*

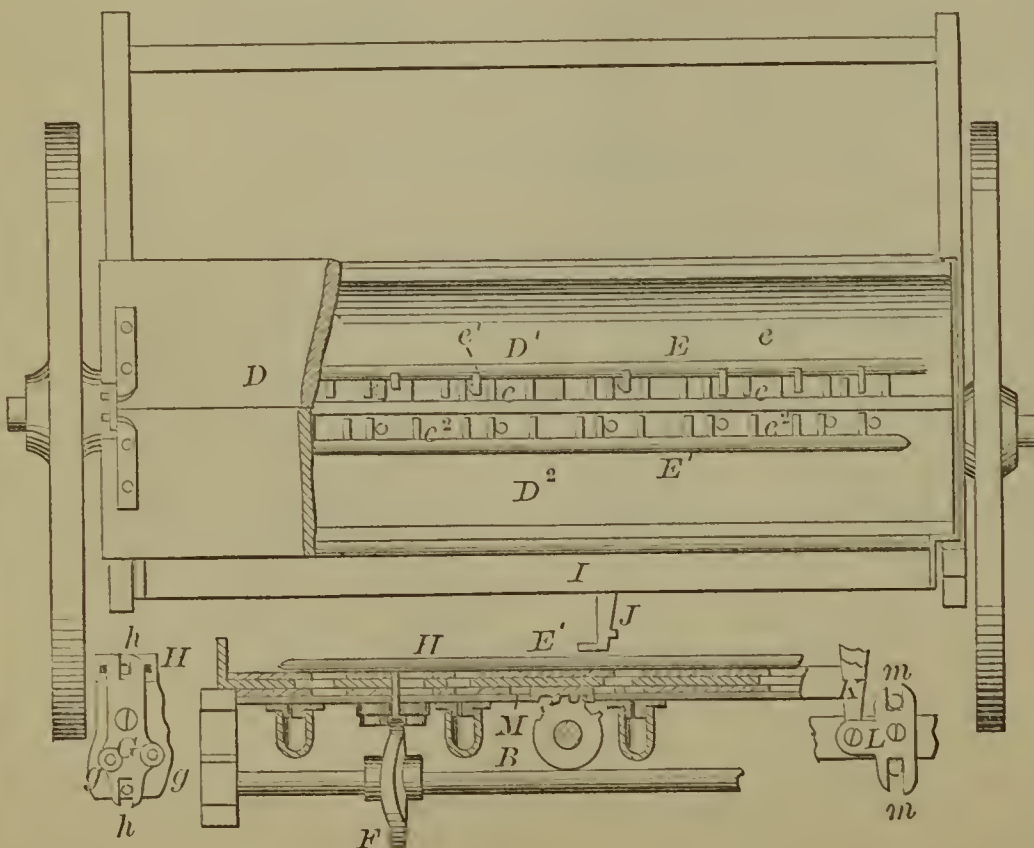

55245—G. G. Cottrell—*Animal Trap.*

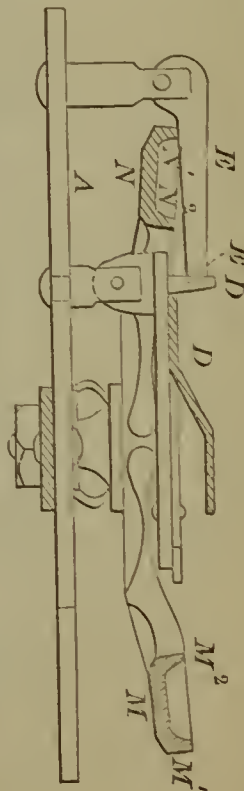



55246—C. N. Culver—Horse Hay Fork.

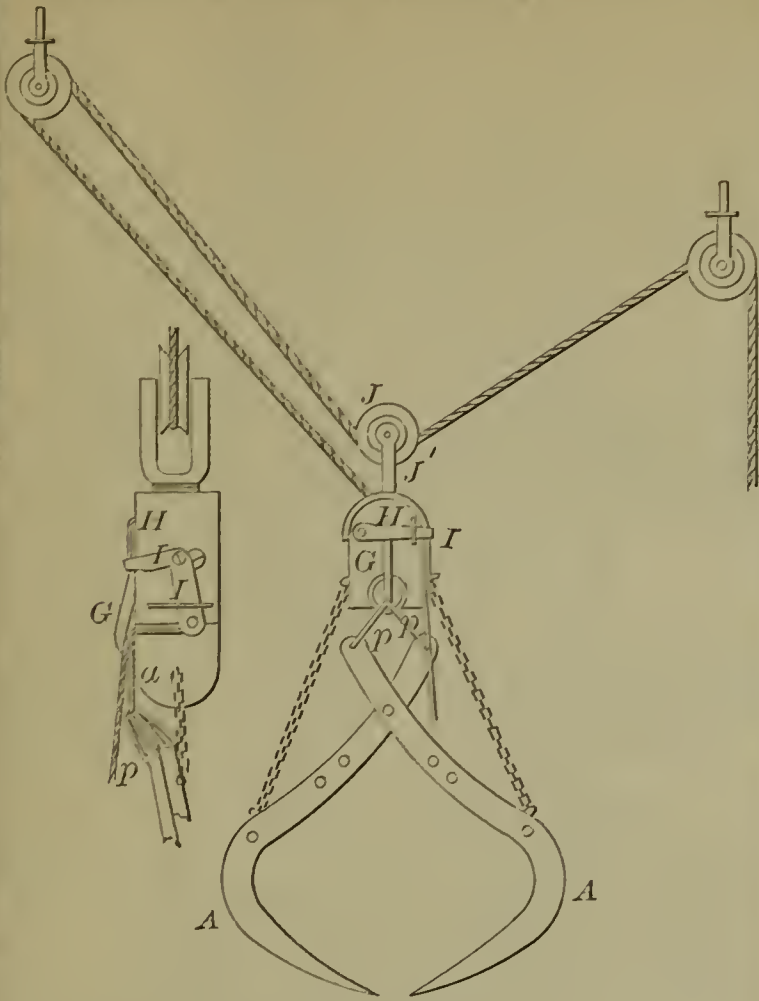

55251—J. Derr—Meat Cutter.

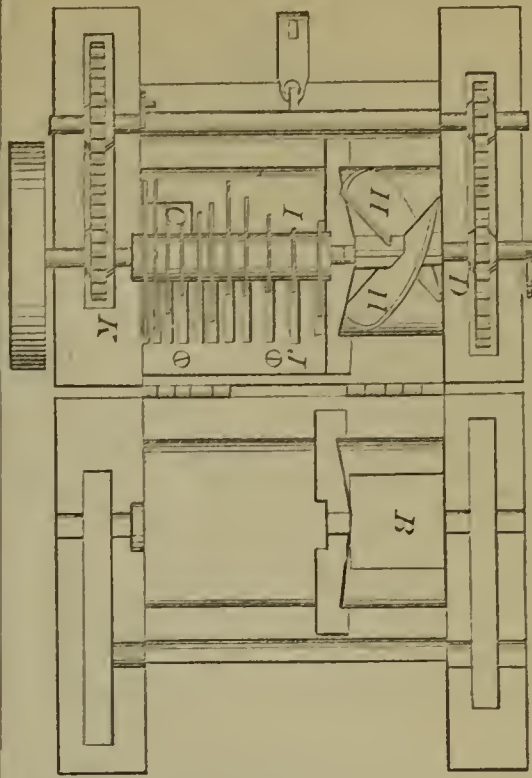

55247—L. Daggett—Inner Sole.



55250—M. Depue—Wind Power.

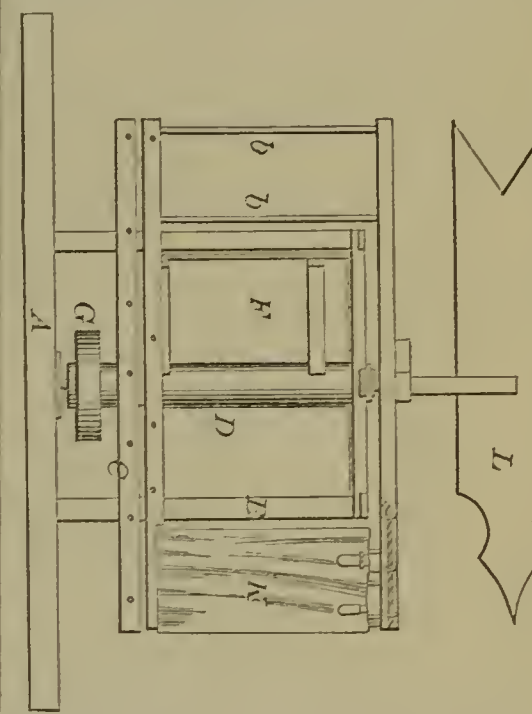

55248—R. M. Dalbey—Fruit Jar.

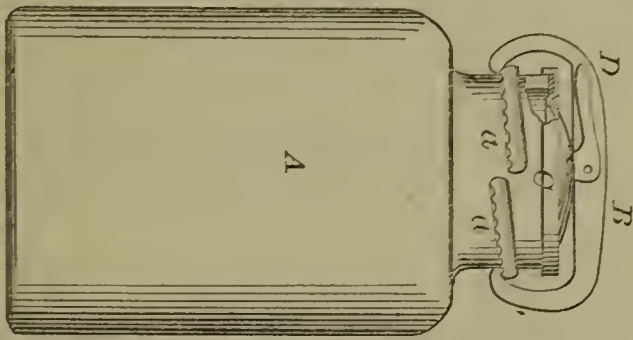

55252—E. Dexter—Abdominal Supporter.

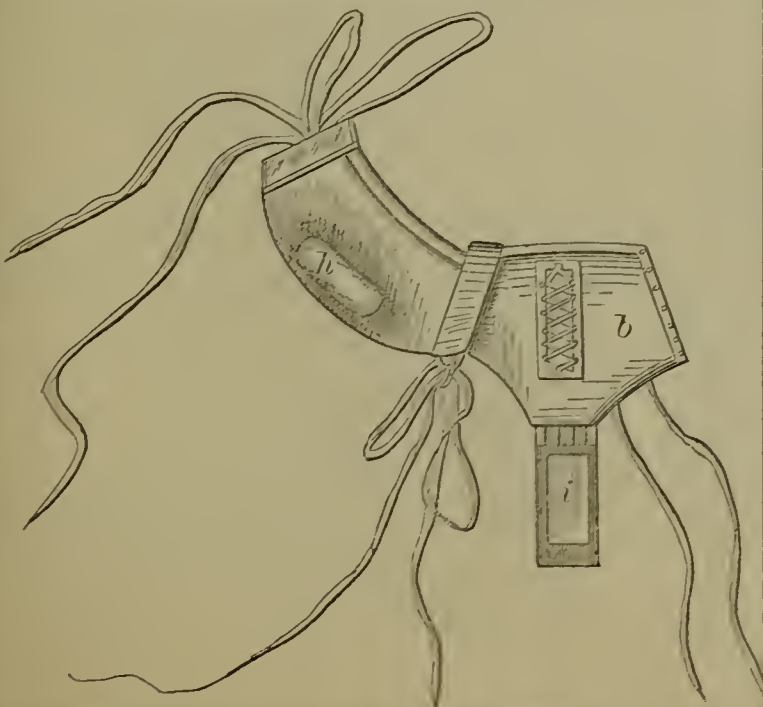

55253—J. W. Dixon—For Pulping Wood.

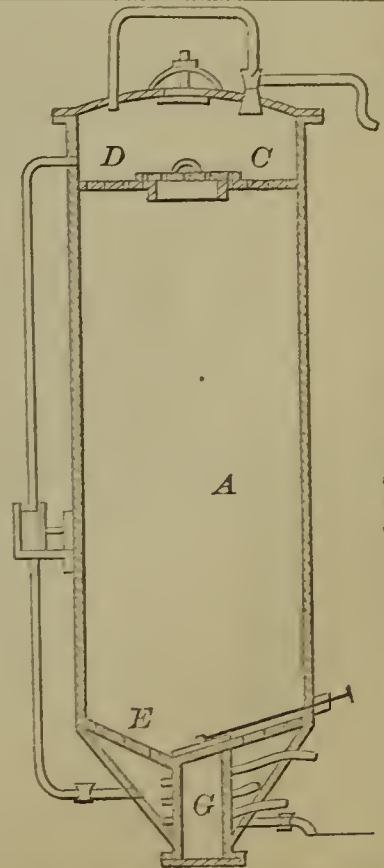

55254—A. Dobrowsky—*Tatting Shuttle.*

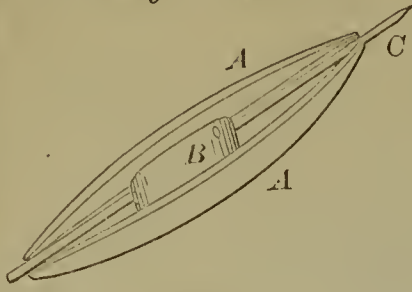

55257—Dumont, Dupraz & Dickason—*Steering Apparatus.*

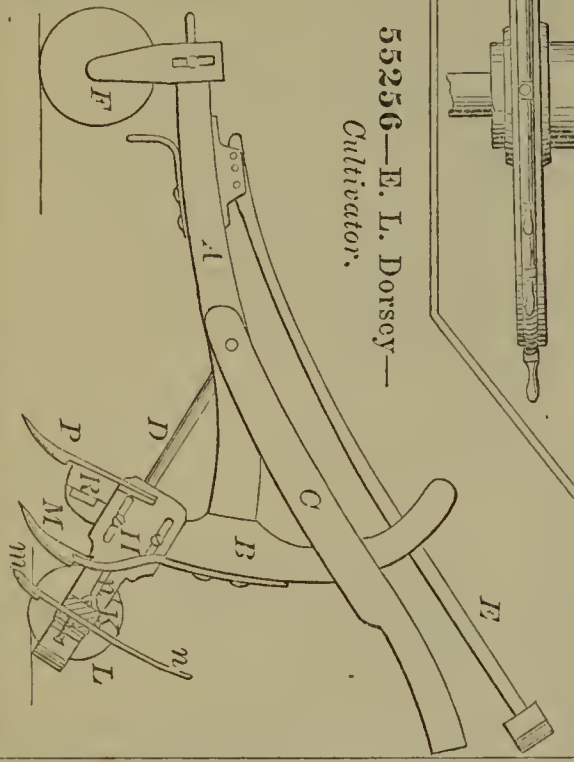
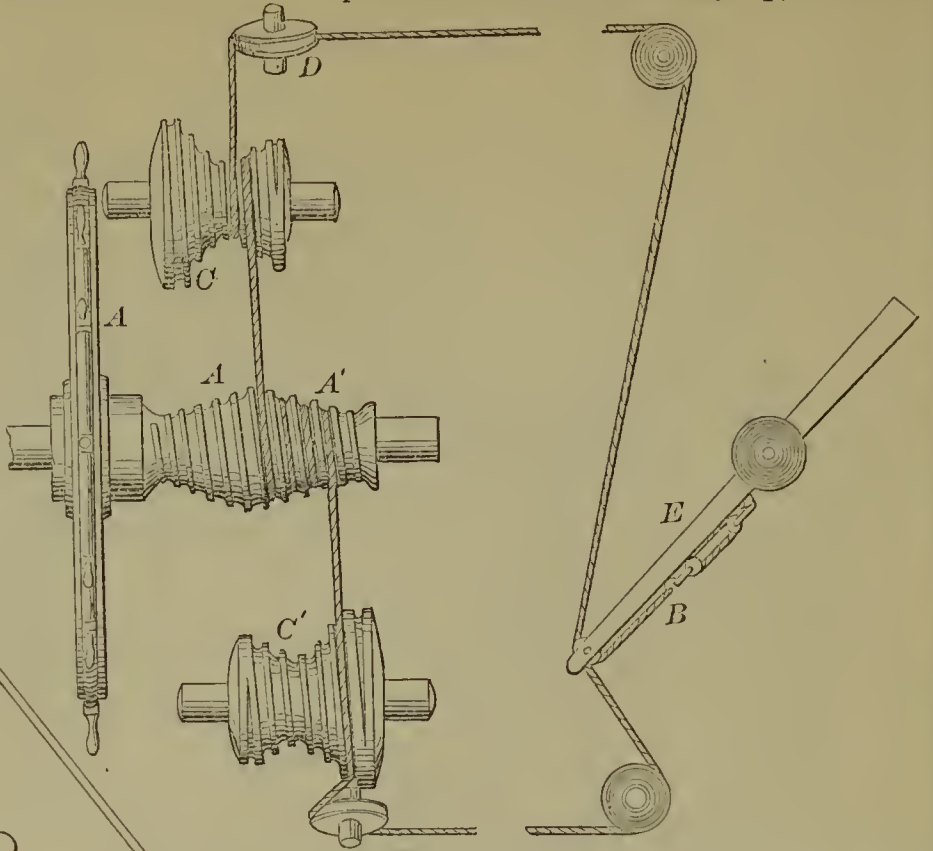

55256—E. L. Dorsey—*Cultivator.*

55258—J. E. Earle—*Attaching Hoop Skirt Wire.*

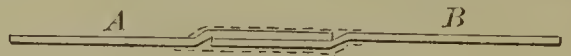

55255—S. P. Dodge—*Lamp.*

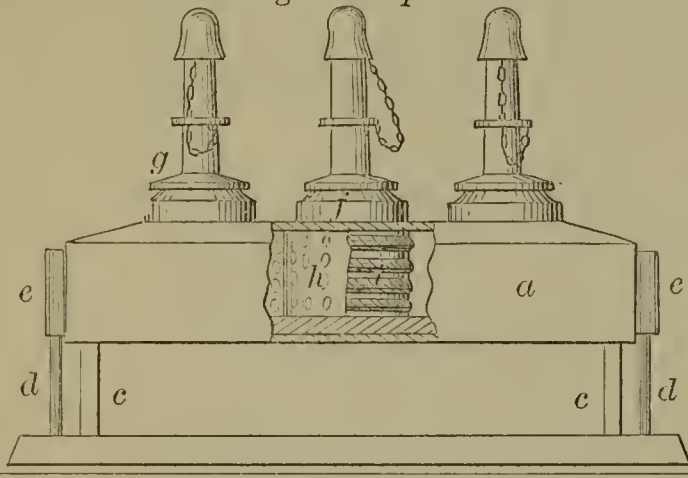

55260—T. Eckert—*Ladies' Muff.*

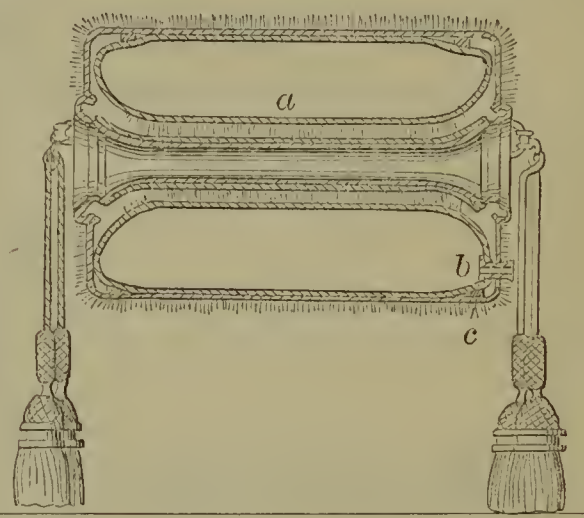

55261—J. H. Elward—*For Separating Metals from Ores.*

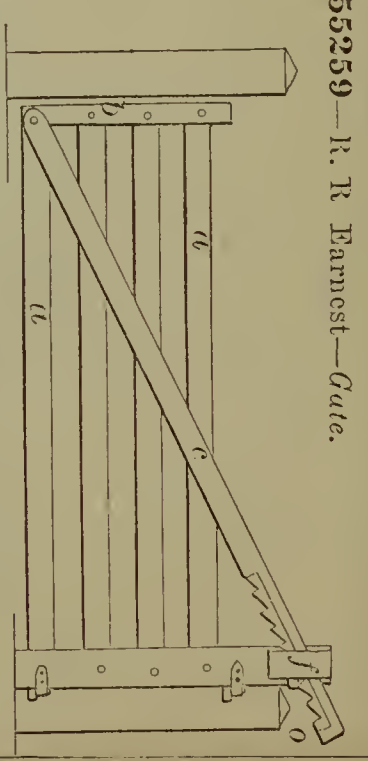
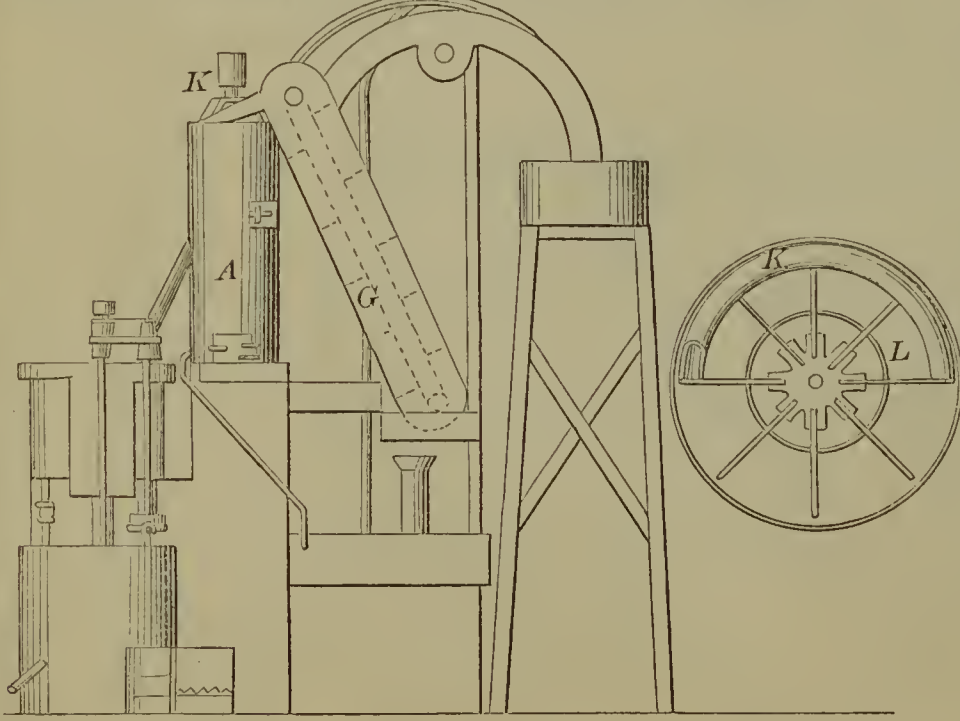

55259—R. R. Earnest—*Gate.*

55264—O. Evans—Wood Bending Machine.

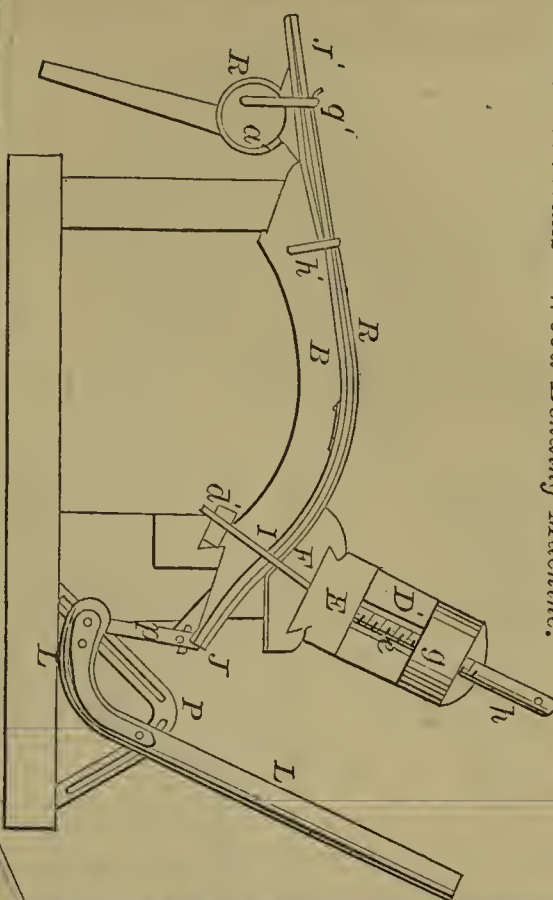

55263—J. E. Emerson—Forging, Shearing and Punching Device.

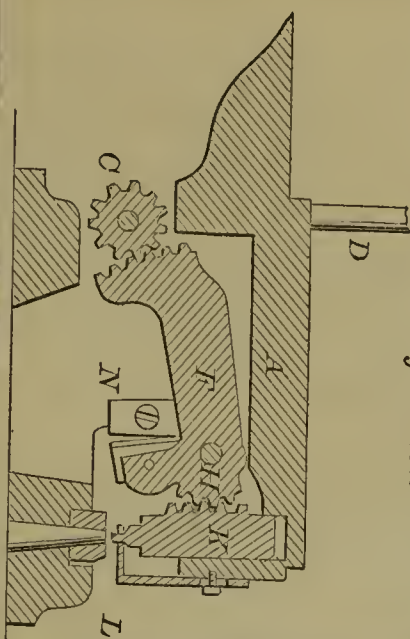

55262—J. E. Emerson—Storage for Sharpening Saw Teeth.



55265—E. E. Everett—Sofa and Crib.

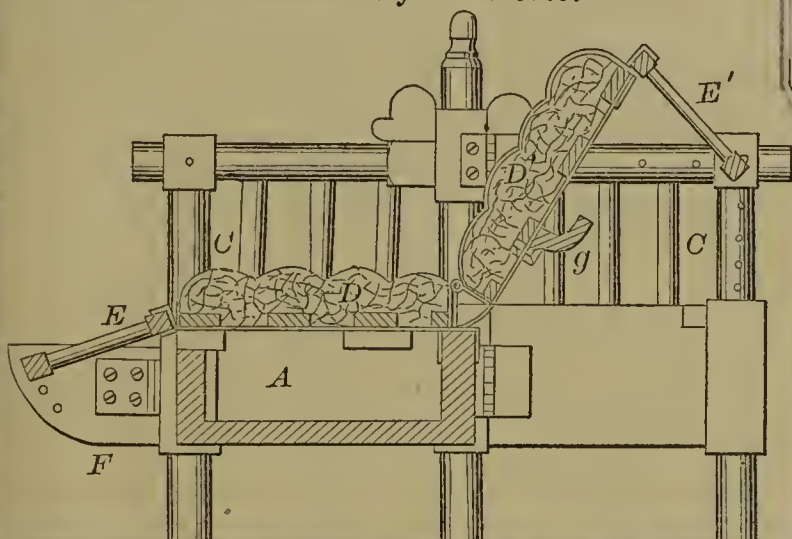

55266—M. Fishel—Hoop Skirt.



55268—C. H. Fitch—Stove Pipe Thimble.

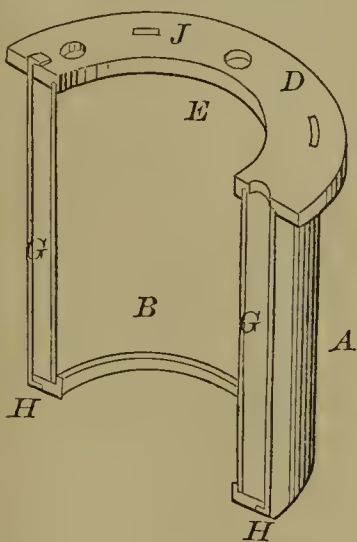

55270—T. Fowler—Horse Shoe Nail.

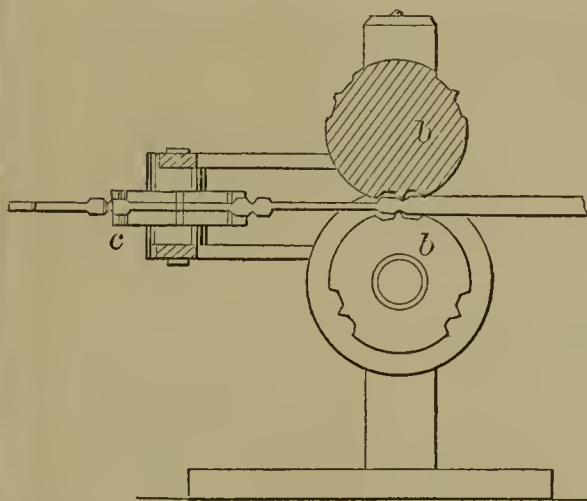

55267—M. Fishel—For Punching Fabrics and introducing Flat Skirt Wire therein.



55271—E. J. Frazier—Car Coupling.

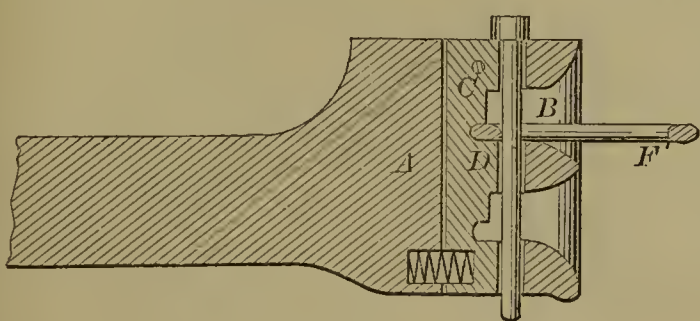

55269—A. D. Forbes—Stock for Broom Head.

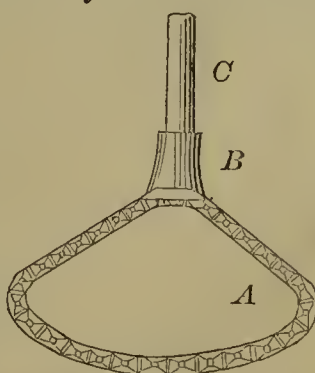

55272—A. Fuller—*Planing Machine.*

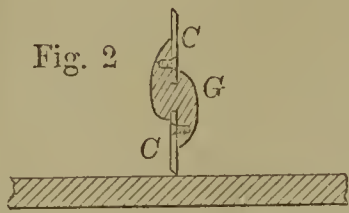

55274—B. M. Gard—*Brick Machine.*

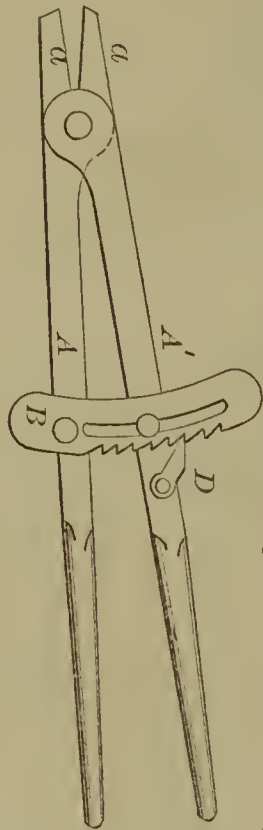
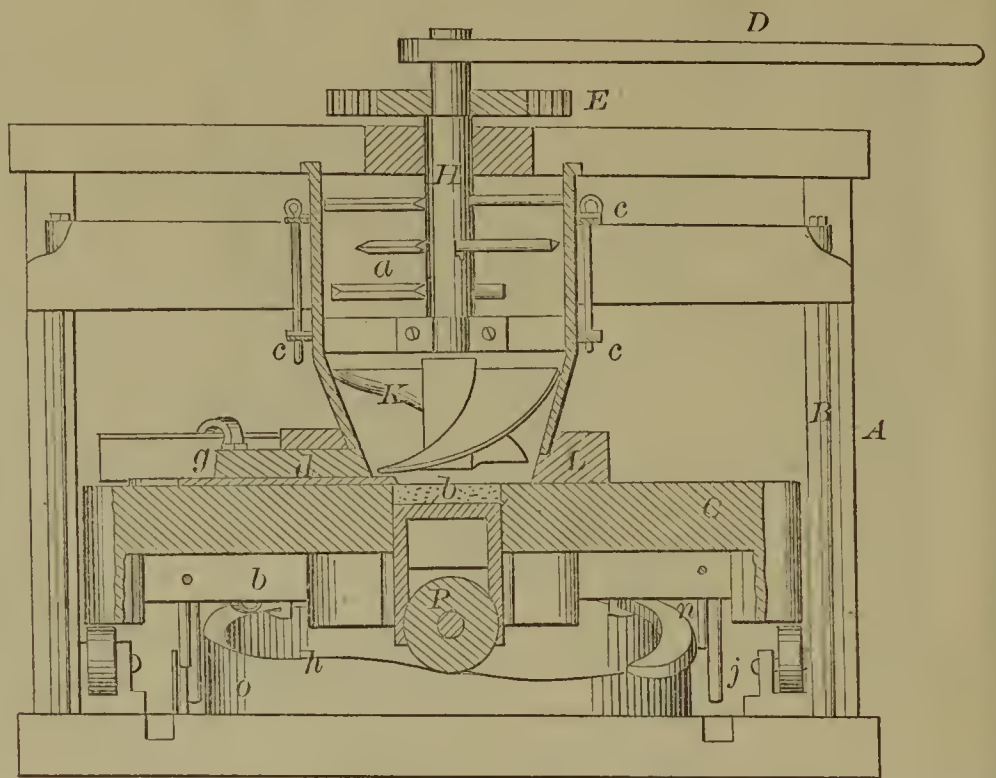

55275—J. C. Gardner—*Smith's Tongs.*

55276—W. M. Garrison—*Cracker Machine.*

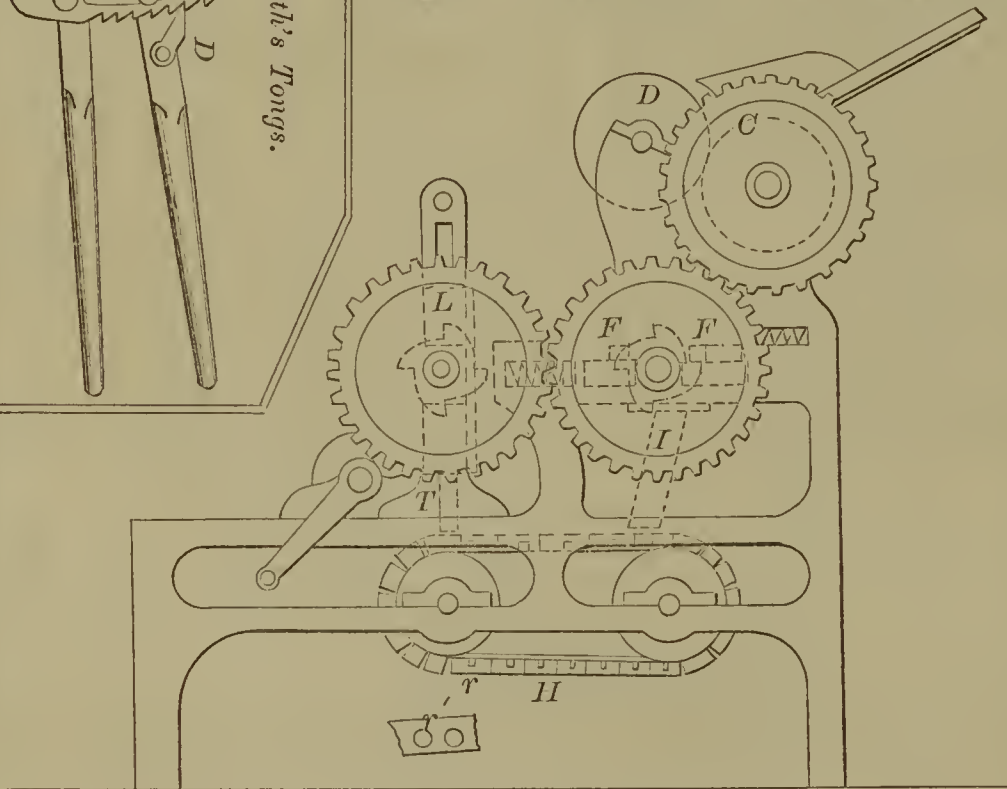

55277—S. F. Gates—*Rock Drill.*



55278—E. Gilliam—*Horse Hay Fork.*

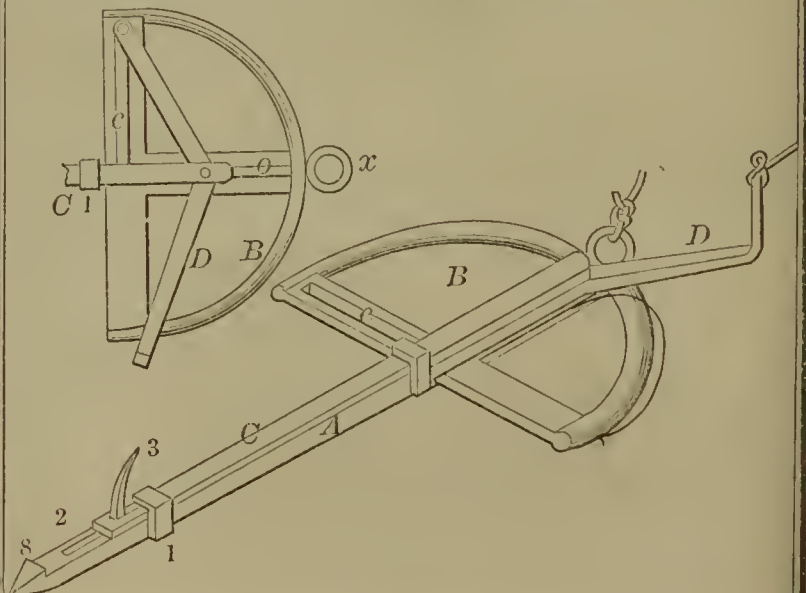

55273—H. L. Fulton—*For Amalgamating Gold and Silver with Lead.*

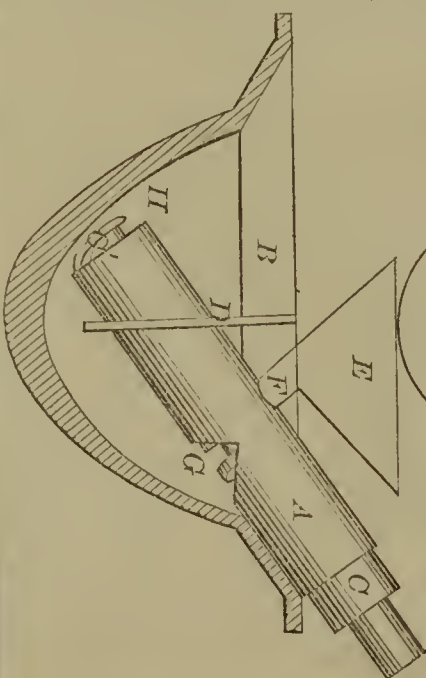

55279—Gilson & Martin—*Plow.*

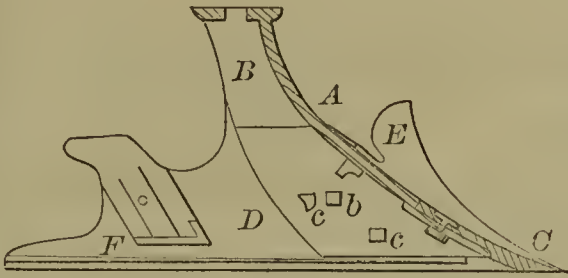

55280—R. A. Goodyear—*Lamp.*

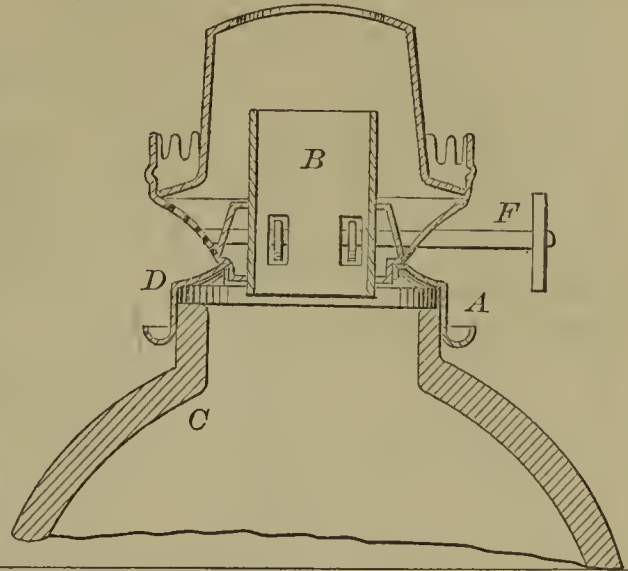

55281—B. Graham—*Churn.*

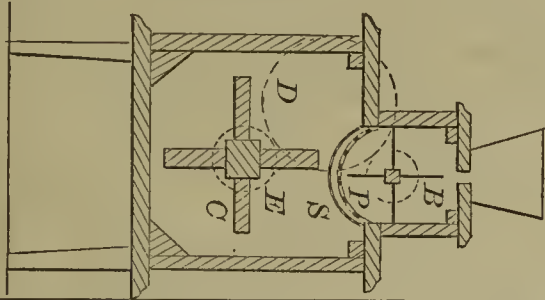

55283—J. Griffin—*For Picking Cotton.*

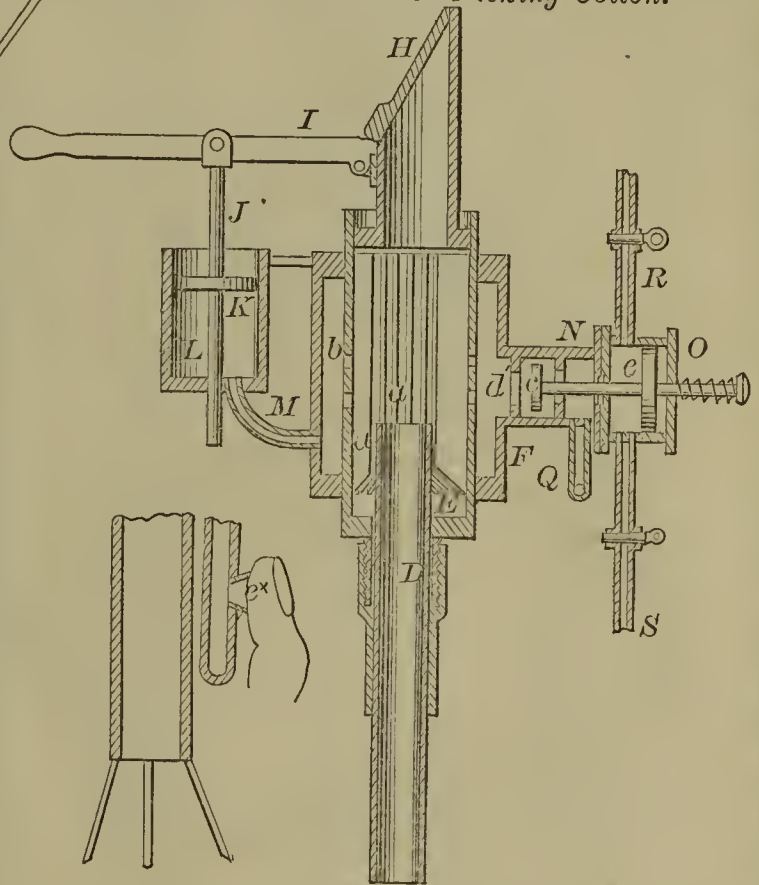

55284—C. T. Grilley—*Capping Wood Screws.*

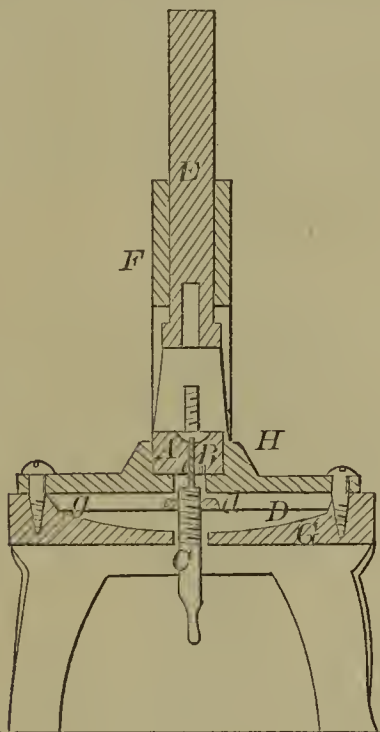

55285—W. Gurley—*Water Spreading Nozzle for Fire Engines*

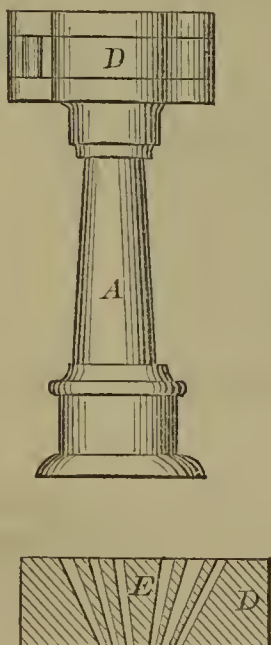

55282—D. A. Greene—*Wood Bundling Machine.*

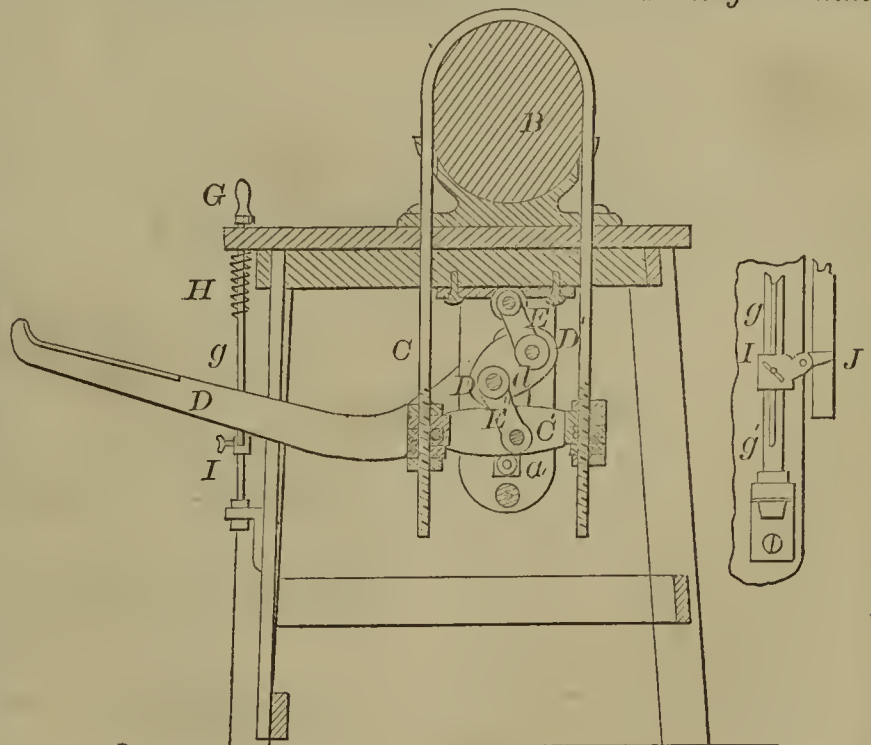

55286—S. N. Haight—  
*Self-Inserting Faucet.*

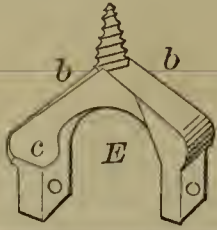

55287—A. W. Hall—*Churn.*

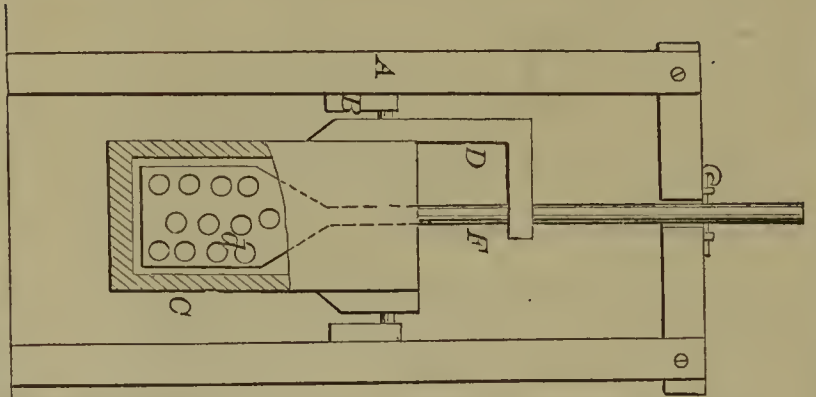

55288—Hammond &  
Hathaway—*Step Ladder.*



55289—T. Hanson—*Transmitting  
Motive Power.*

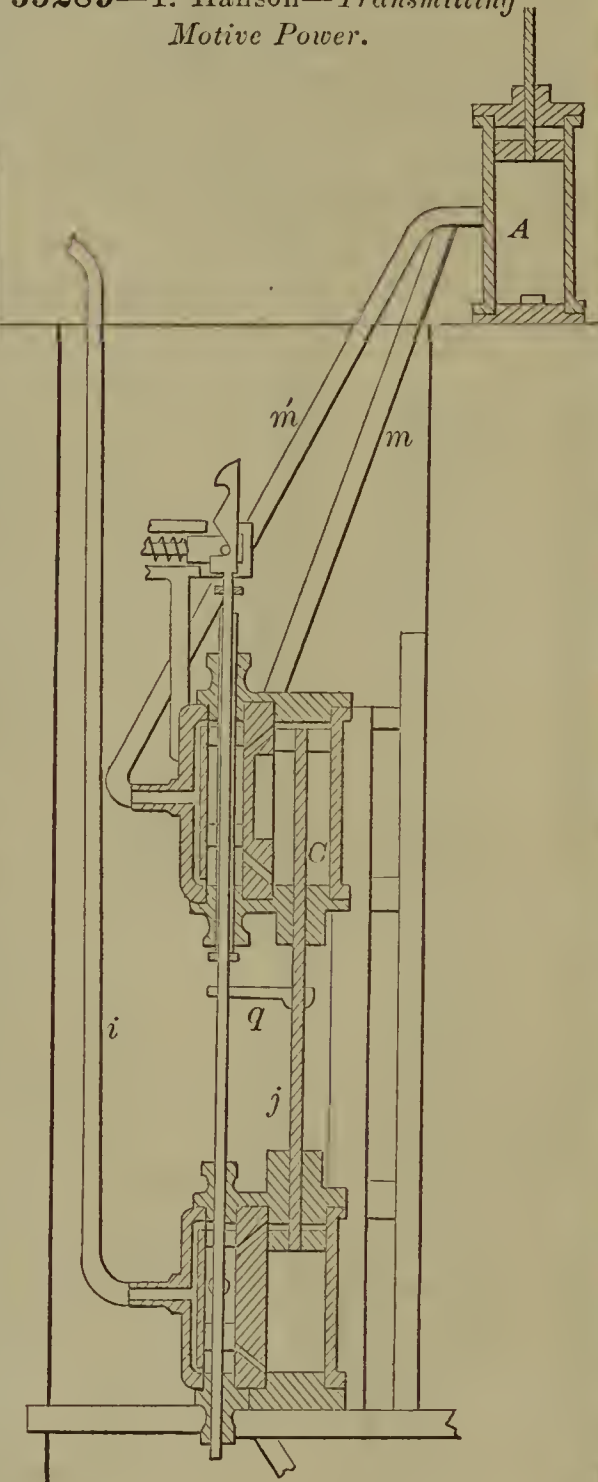

55290—G. Havell—*Carpet Bag Frame.*

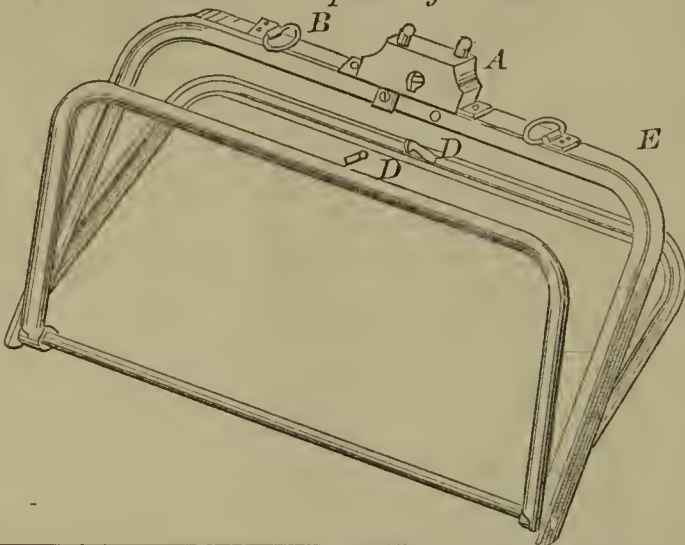

55293—G. W. Hildreth—*School Desk and Seat.*

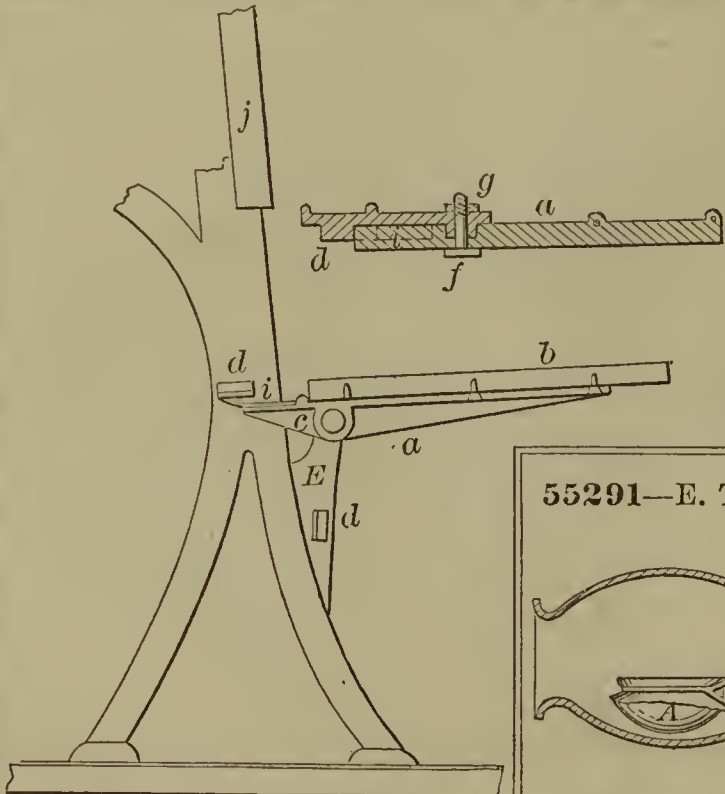

55291—E. T. Hazeltine—*Lamp Chimney Cleaner.*

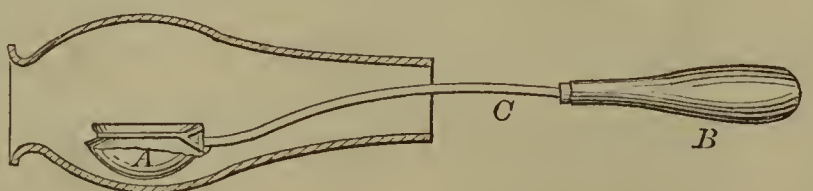

55295—J. G. Holt—For Preparing Axle Skein Moulds.

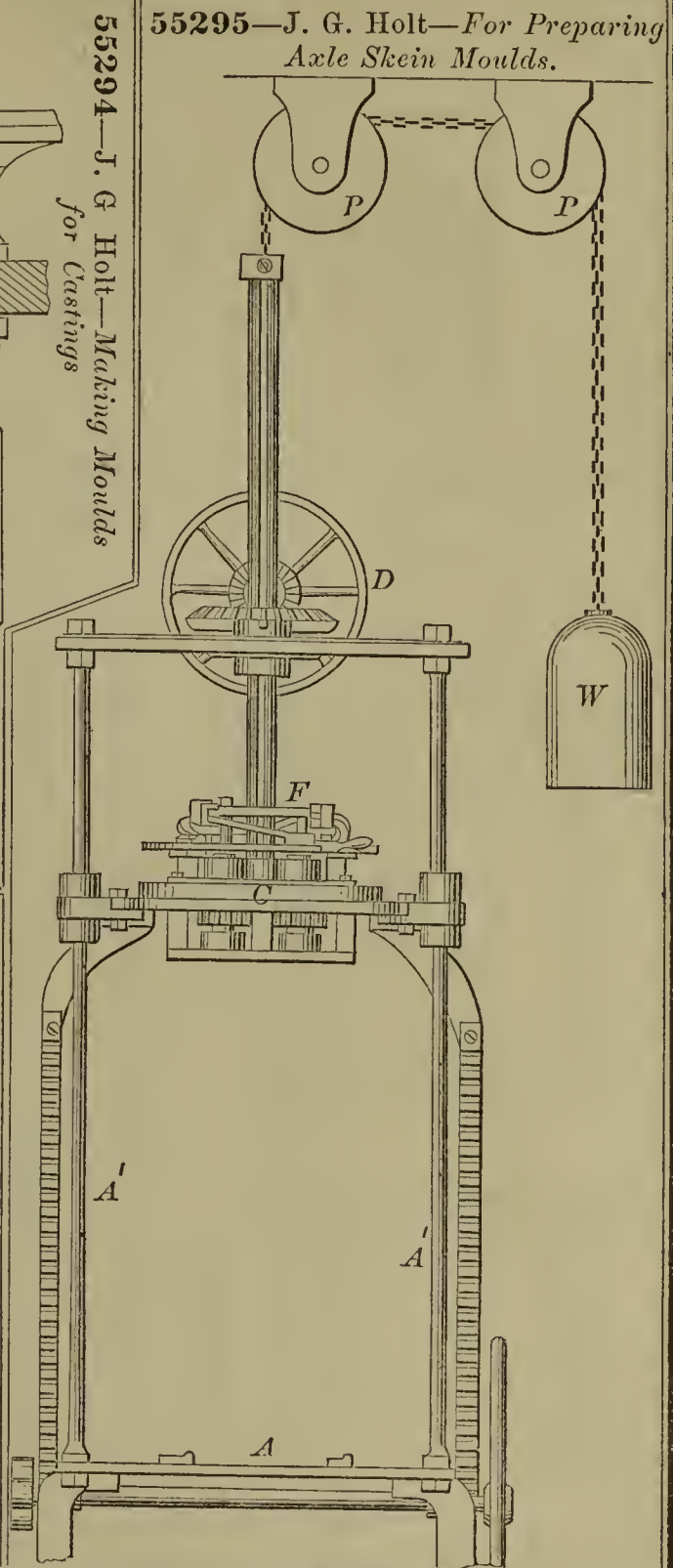

55294—J. G. Holt—Making Moulds for Castings

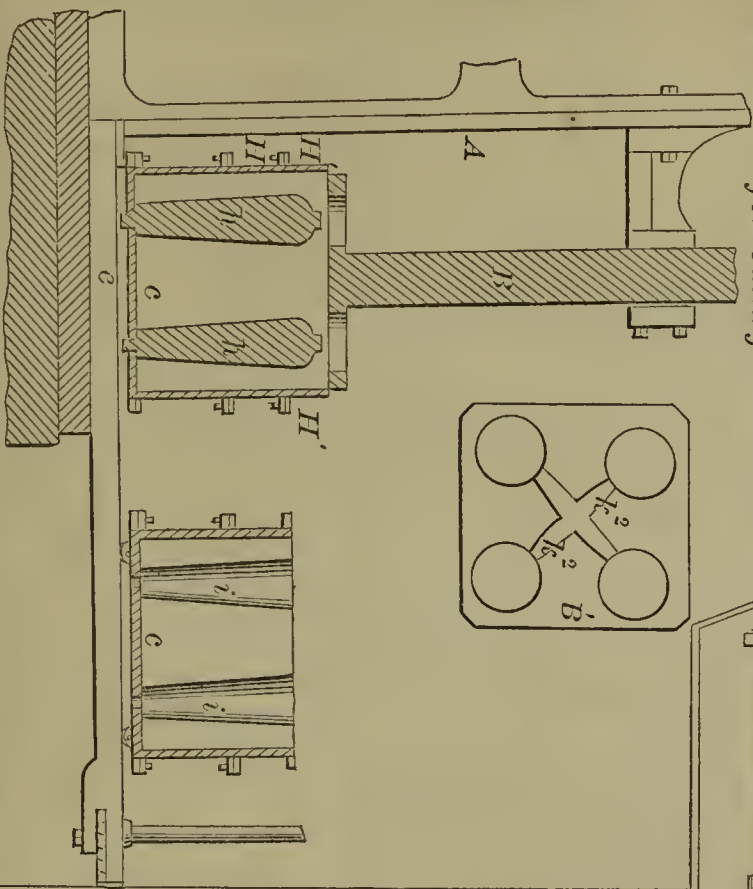

55296—J. G. Holt—Preparing Moulds for Hub Boxes.

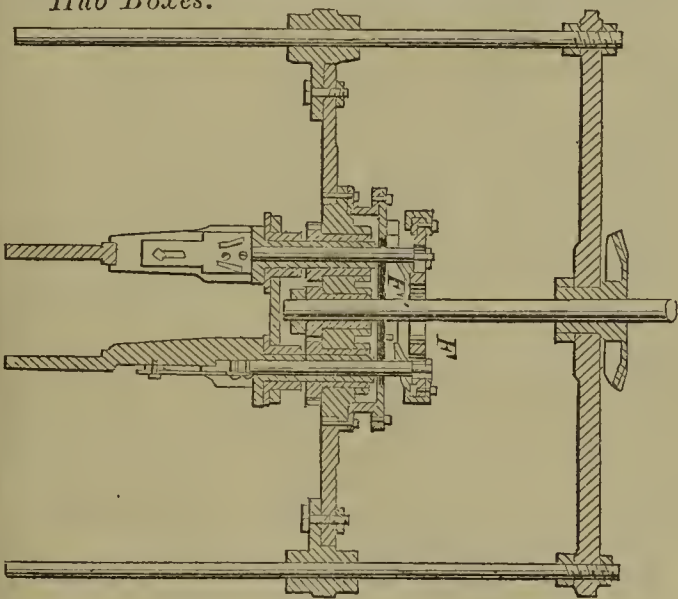

55297—S. J. Homan—Cider Mill.

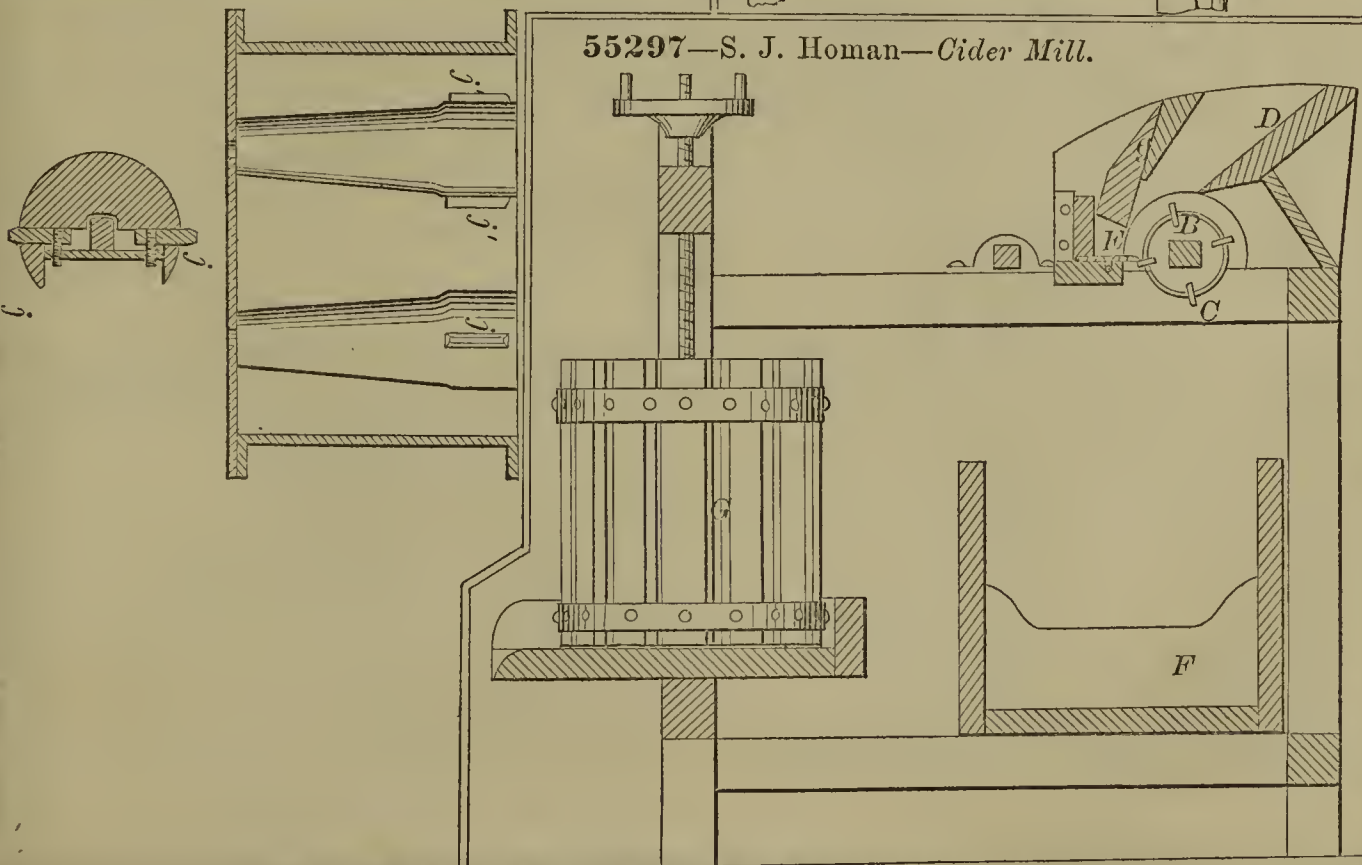

55298—W. W. Hosford—*Sash Fastening.*

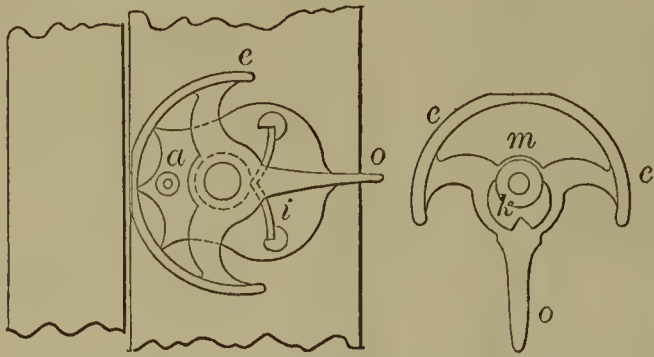

55302—P. F. Hulbert—*Clamp.*

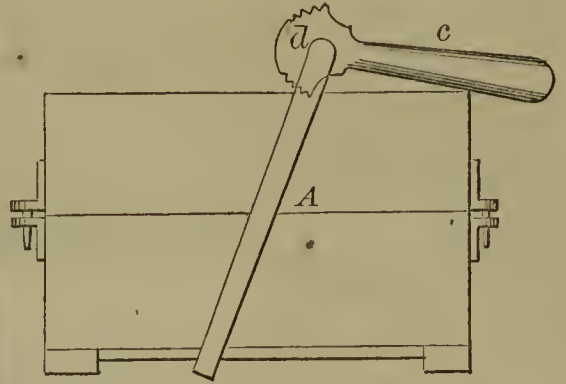

55301—R. Hughes—*Rotary Engine.*

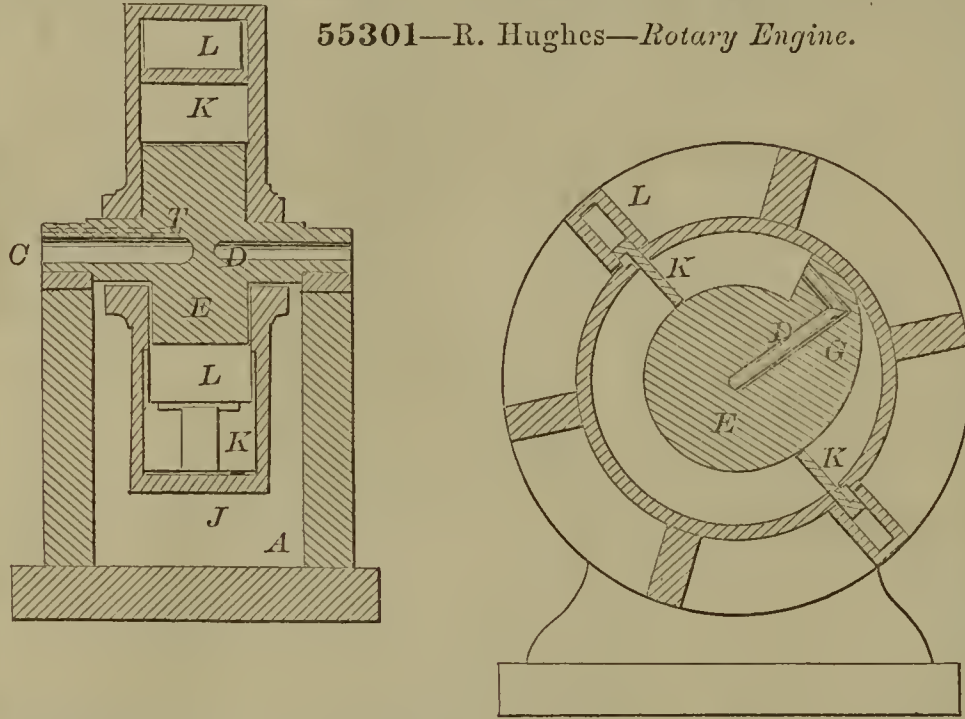

55300—T. S. Hudson—*Printing Wheel.*

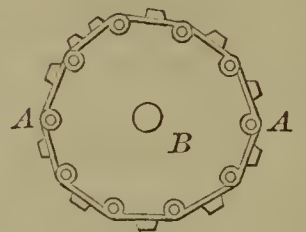

55304—J. Jann—*Harvester.*

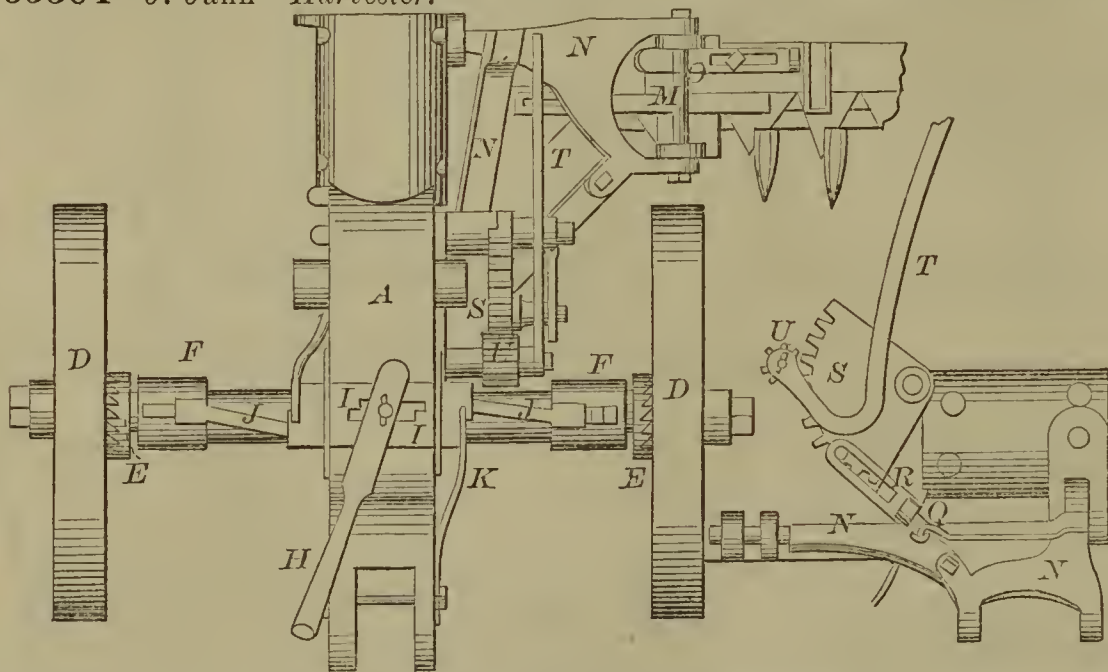

55299—T. S. Hudson—*Printing Type.*



55303—T. Huntington—*For Detaching Boats from their Davits.*

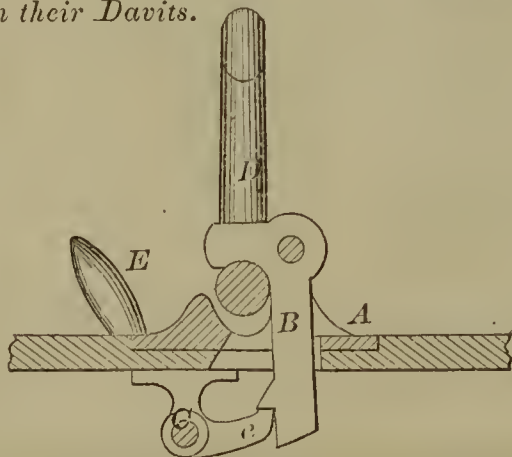

55305—Janney & Hamilton—*Door Fastener.*

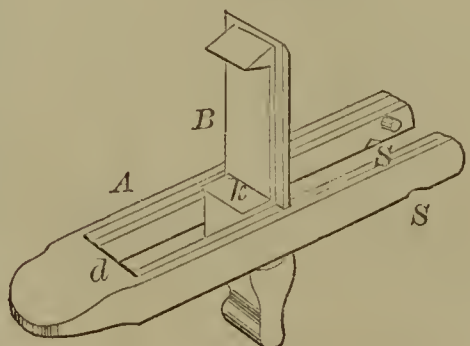



55306—J. H. Jenkins—Washing Machine.

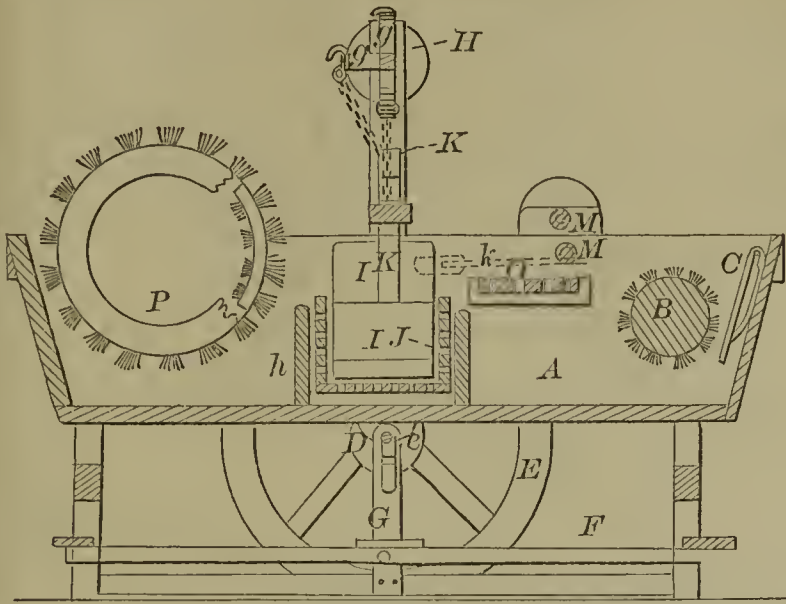

55309—J. B. Kelly—Row Lock.

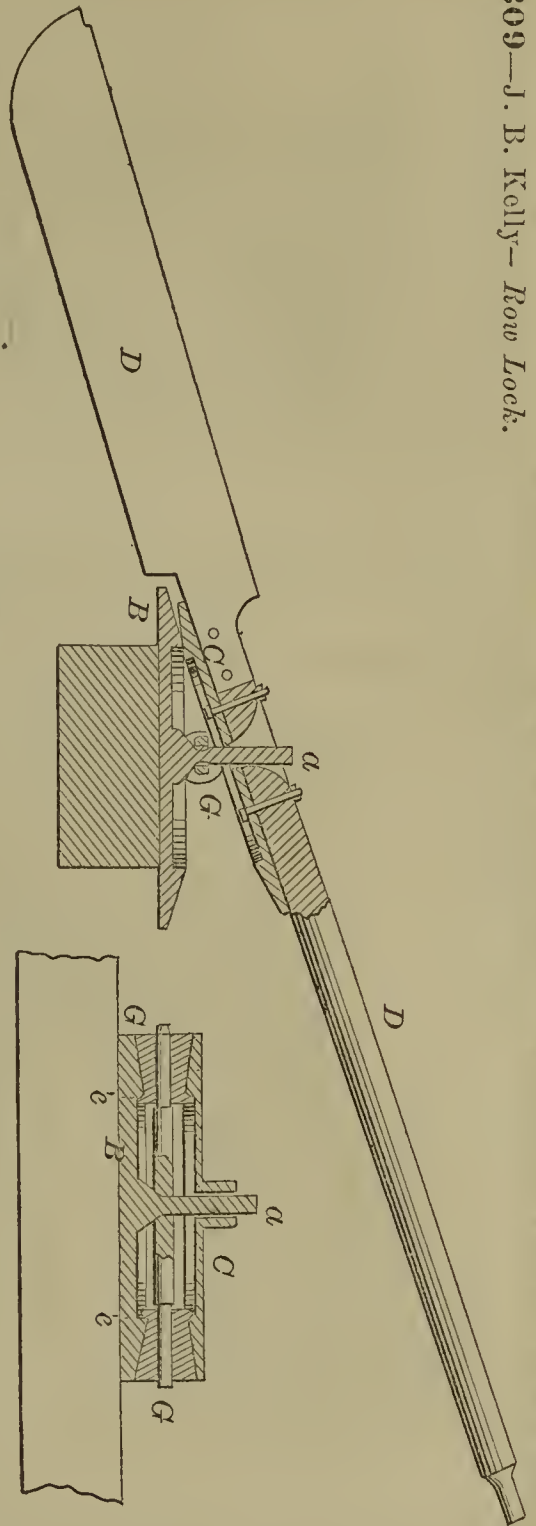

55307—Jenks & Gardner—Rock Drill

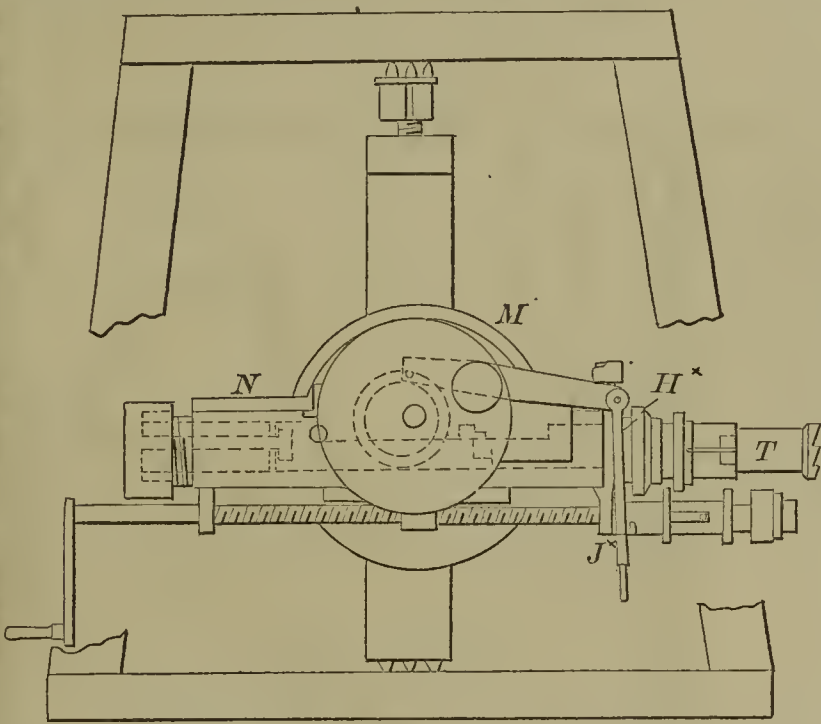

55308—E. Kay—*Stop Motion for Knitting Machines.*

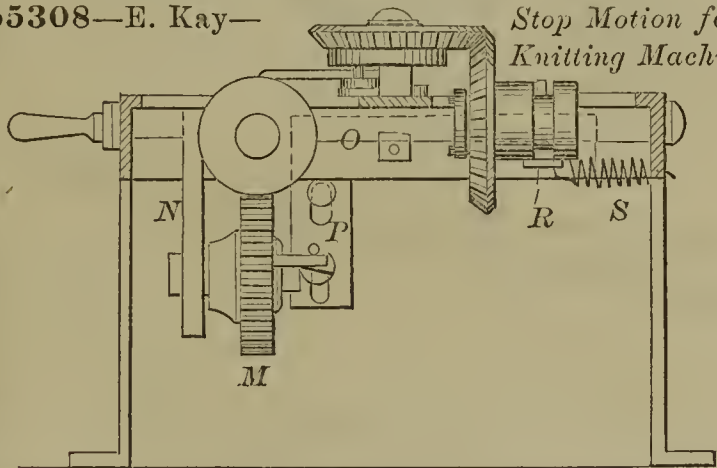

55310—W. Kelly—Washing Machine.

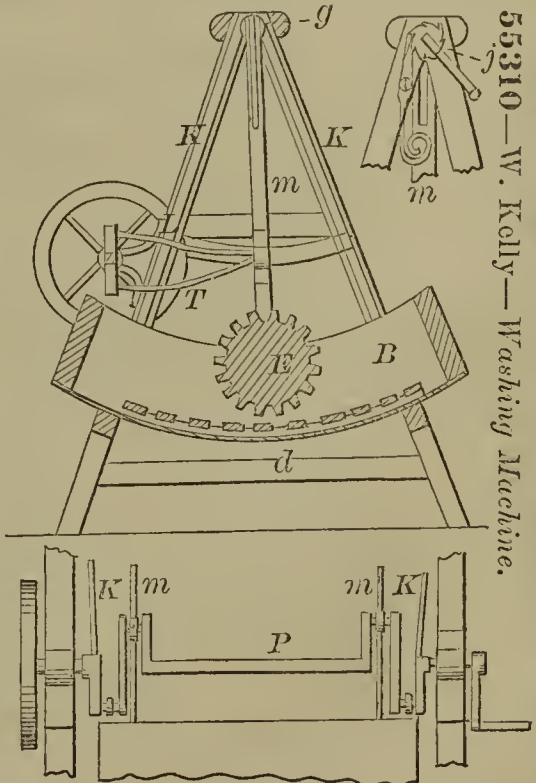

55311—G. R. Kelsey—Buckle.

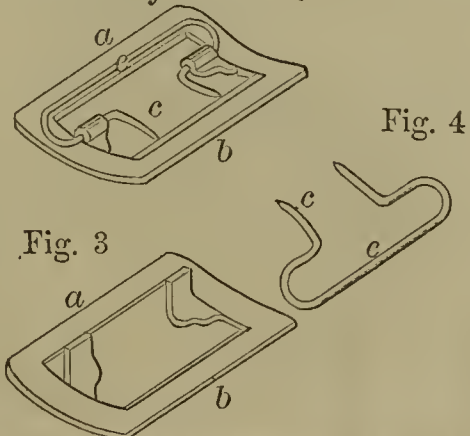

55312—M. Kennedy—*Plow.*

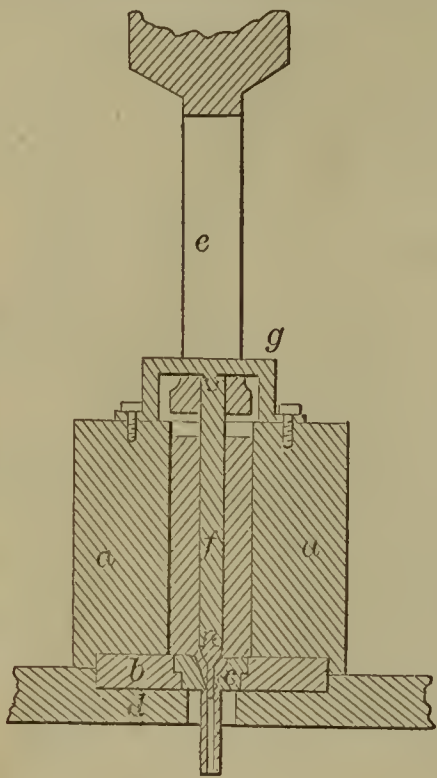
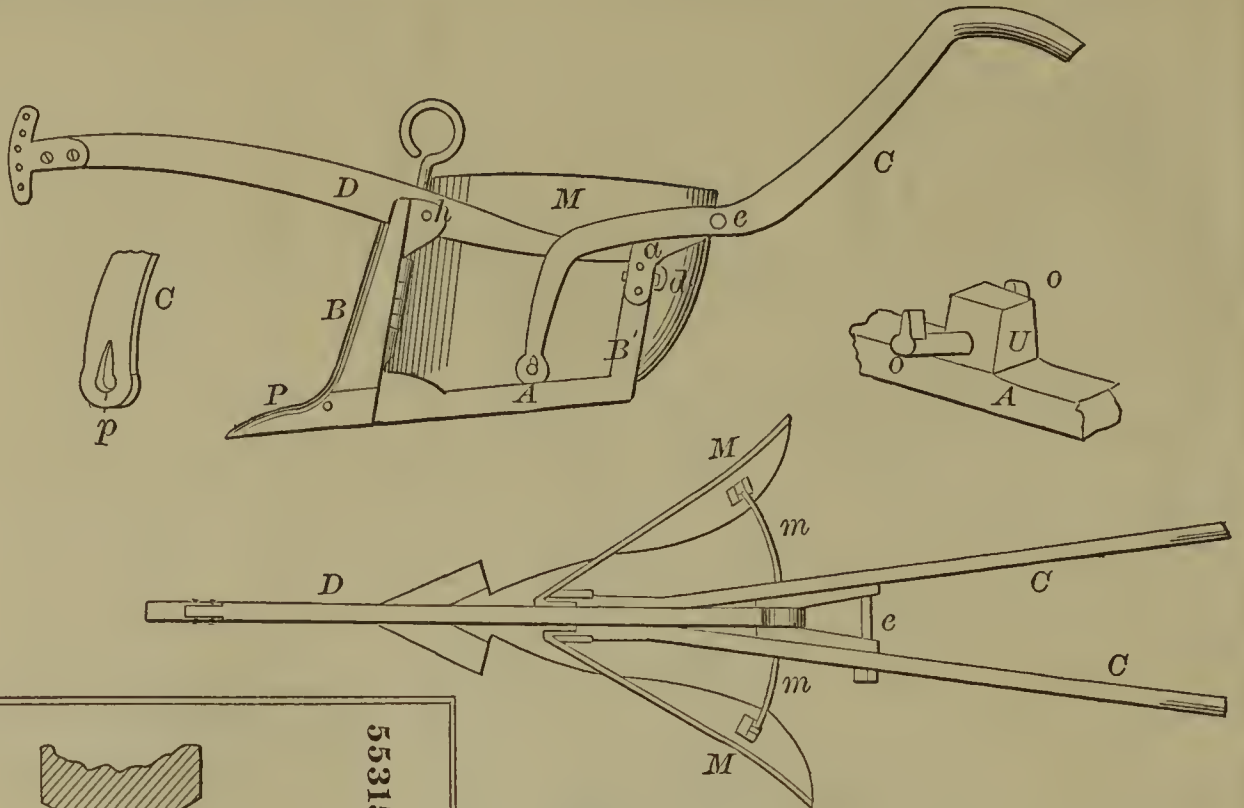

55315—R. Layng—*For Pressing Lead Pipe.*

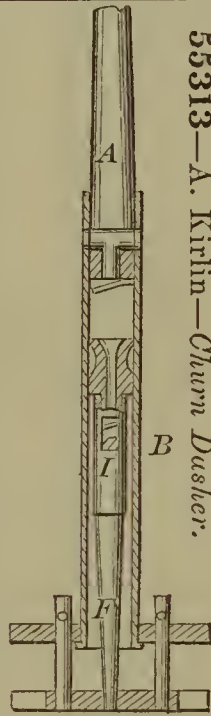

55313—A. Kirlin—*Churn Dasher.*

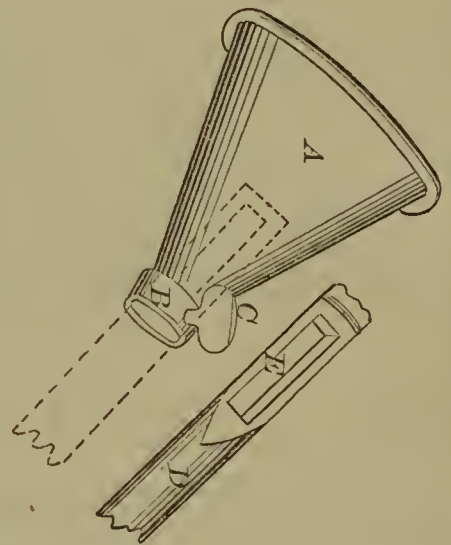

55316—J. Liget—*Broom Head.*

55314—W. Langdon—*Stump Extractor.*

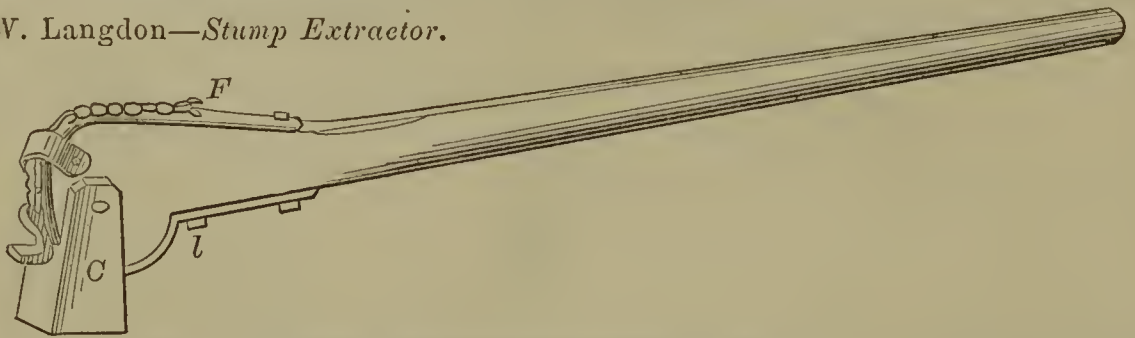

55317—C. L. Lockwood—*Neck Tie Supporter.*

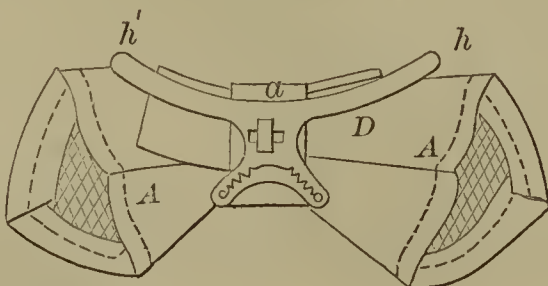

55318—H. Maas—*Pump.*

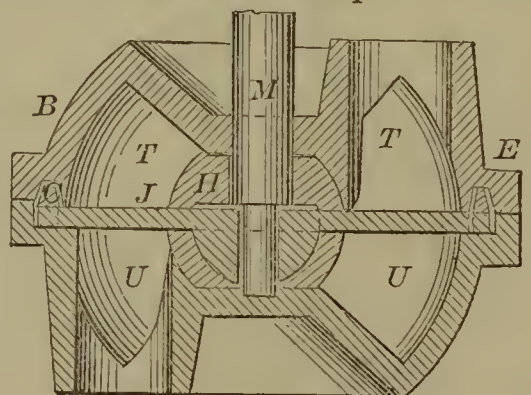

55320—D. Marshall—Churn.

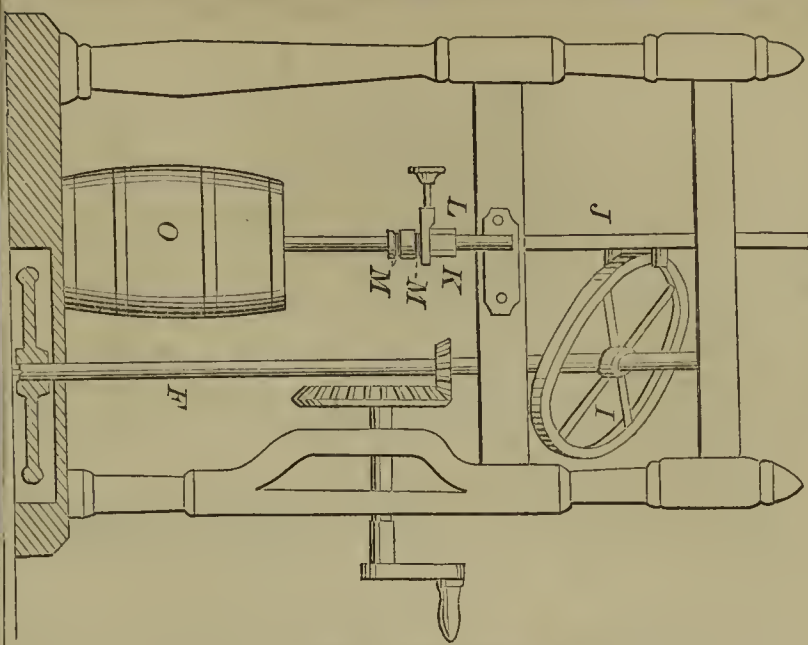

55321—R. Masson—Pipe.

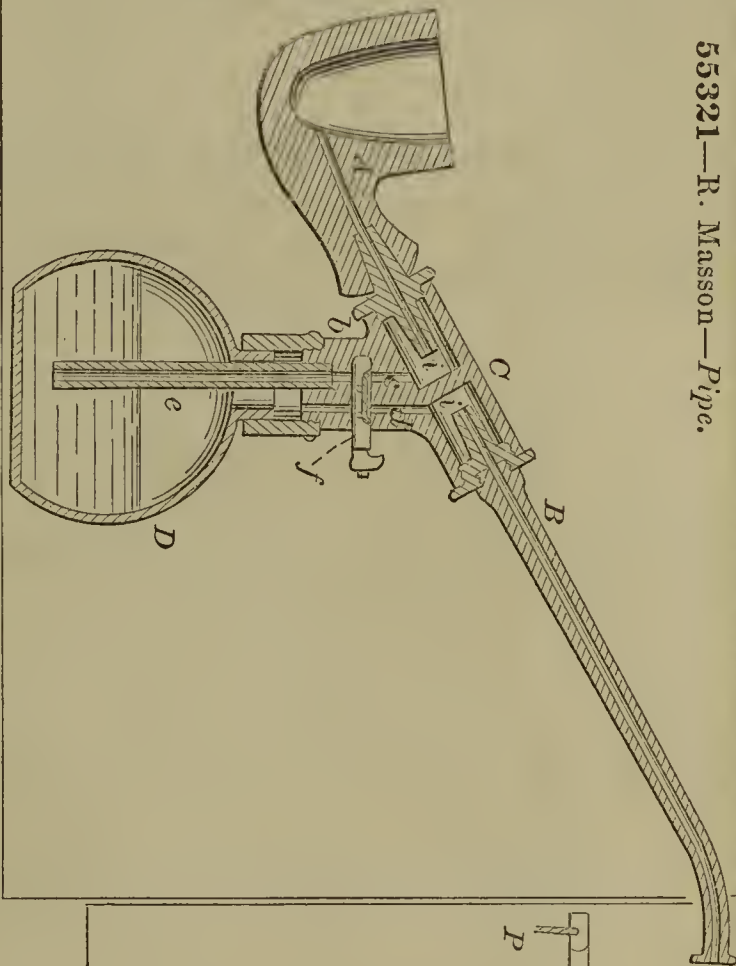

55324—S. T. McDougall—Carbureting Air.

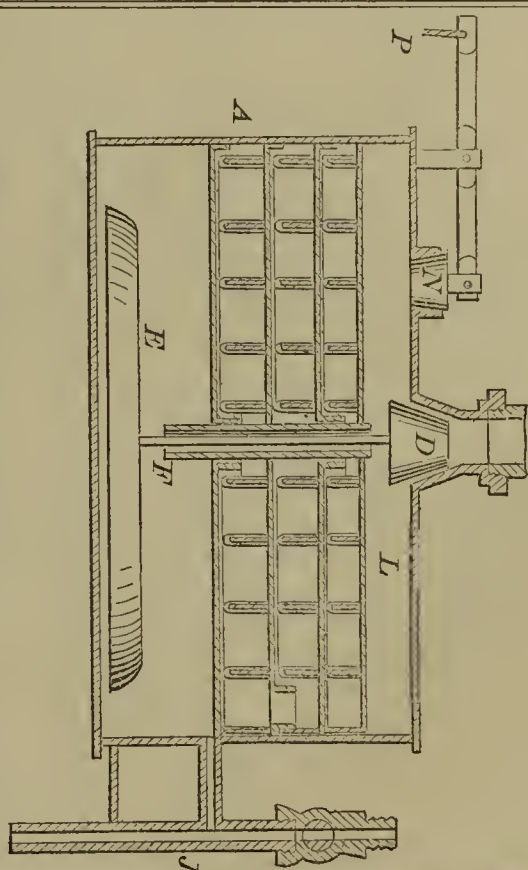

55319—G. S. Manning—Carriage Spring.

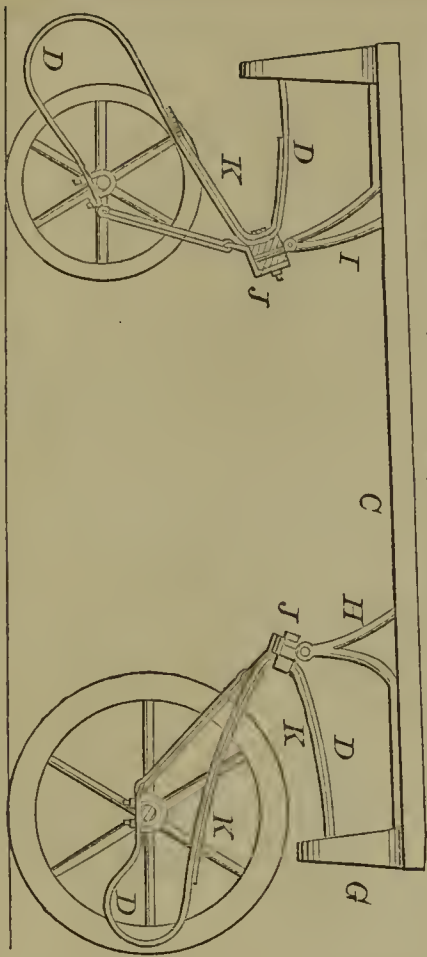

55322—H. Maxell—Gate.

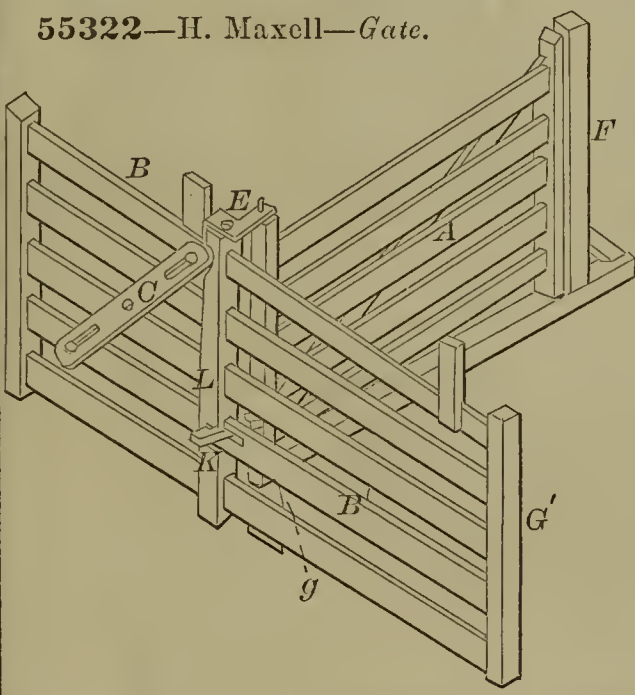

55323—T. McAuley—Water Wheel.

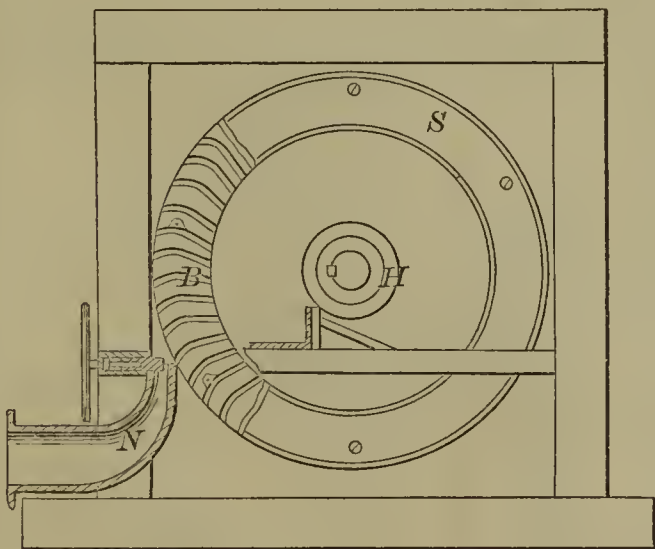

55325—McKnight & Deisher—Motive Power.

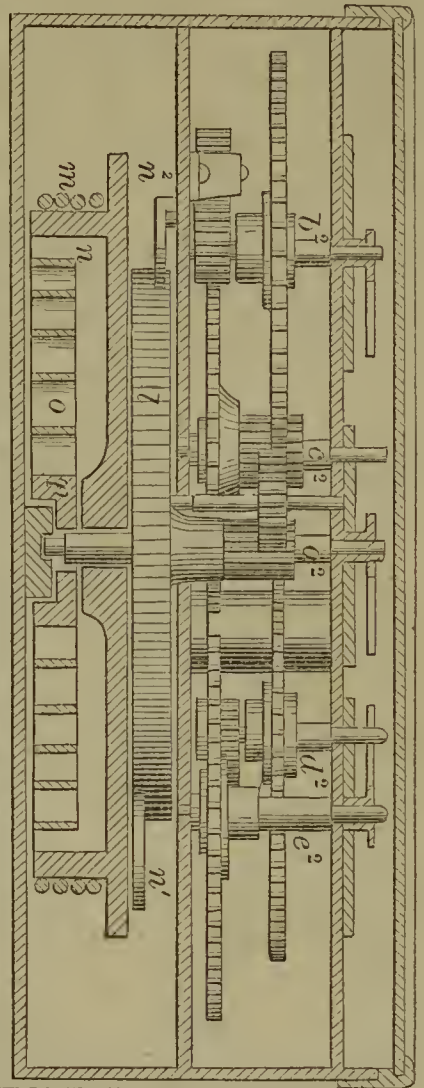
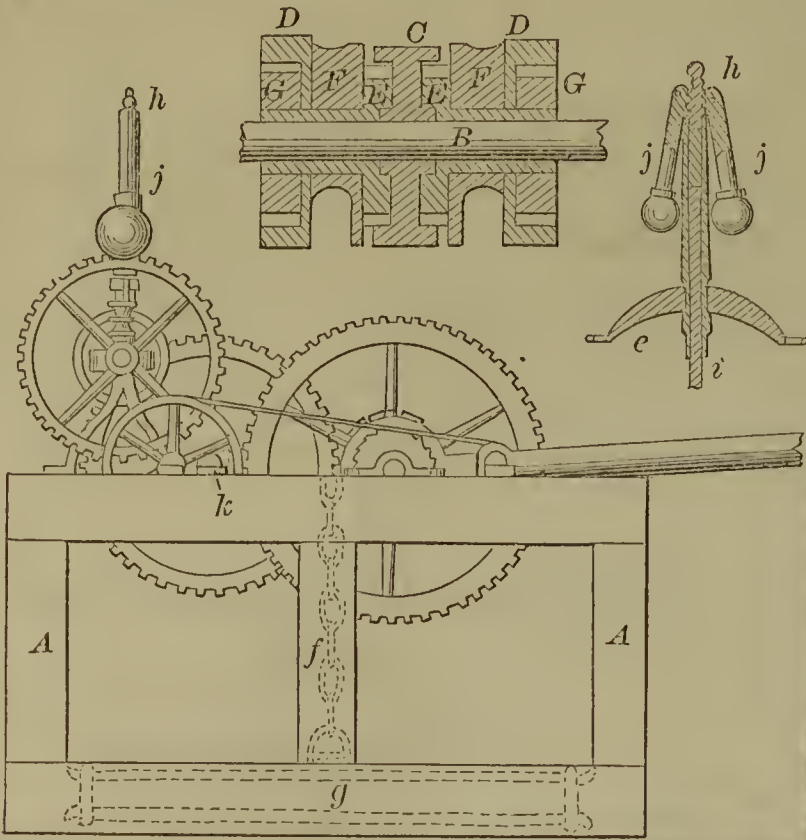

55327—F. McManus—Lumber Register.

55328—J. McWilliams—Gas Generator.

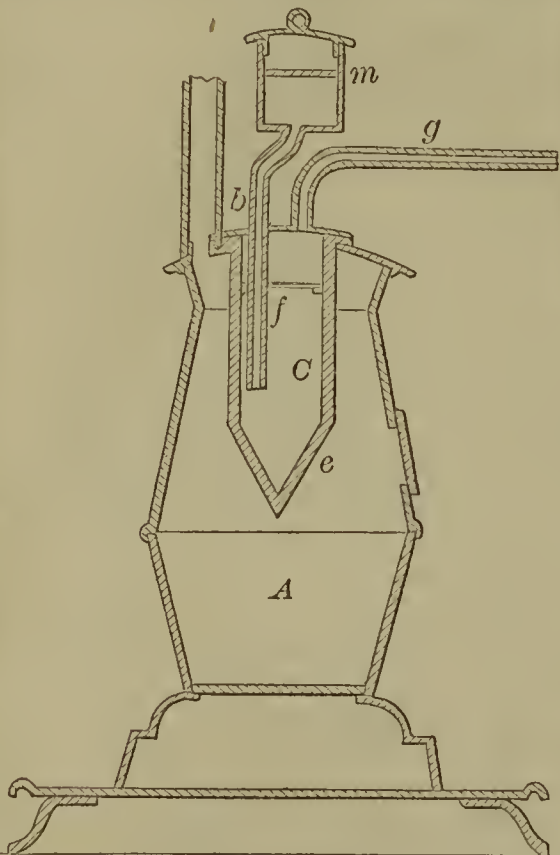

55330—Merriam & Norton—Slitting Machine.

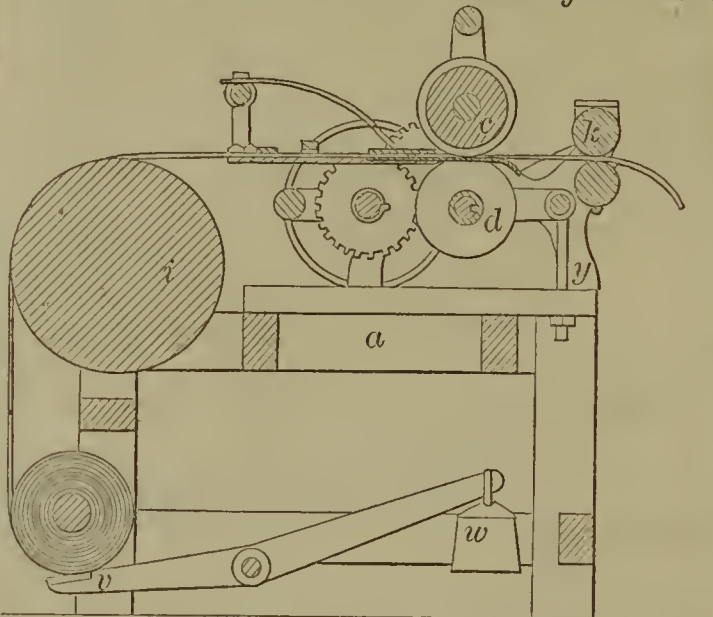

55331—Merriam & Norton—Sorting Machine.

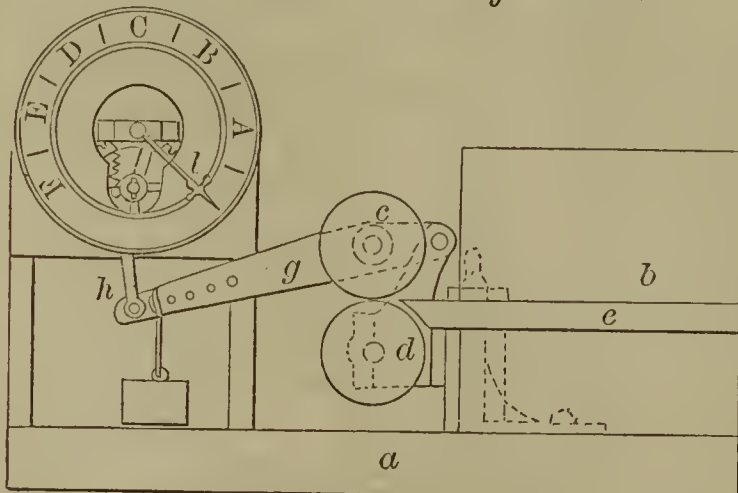

55326—J. W. McLean—Gate Latch.

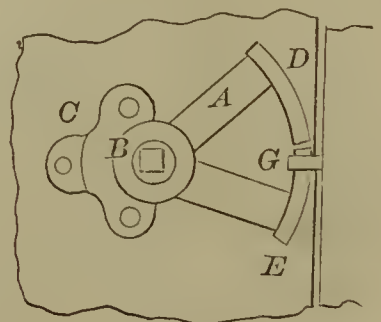

55332—Merriam & Norton—Winding Shoe Binding, Tape, &c.

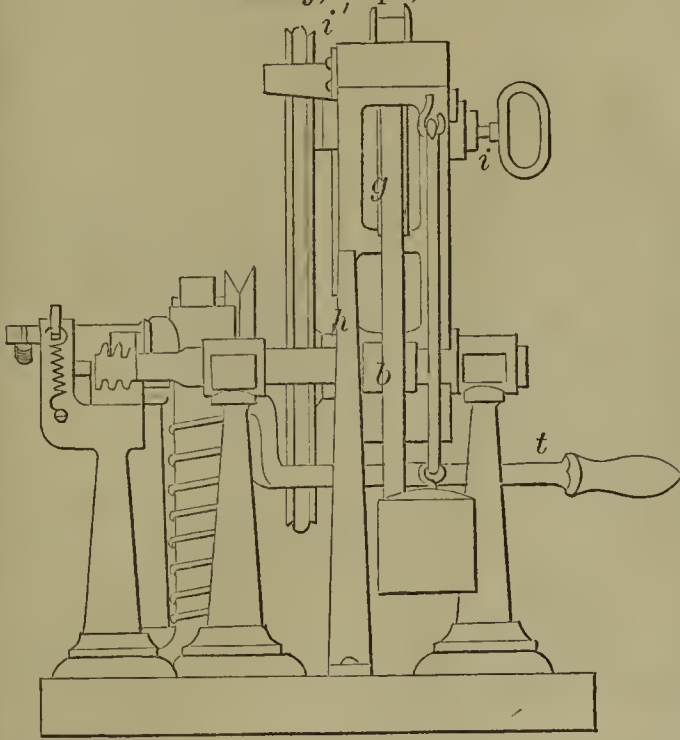

55333—Merriam & Norton—Drying Hides.

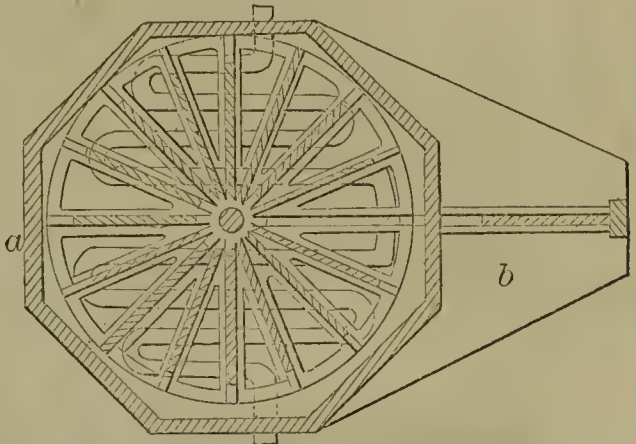

55334—Merriam & Norton—Glueing Press.

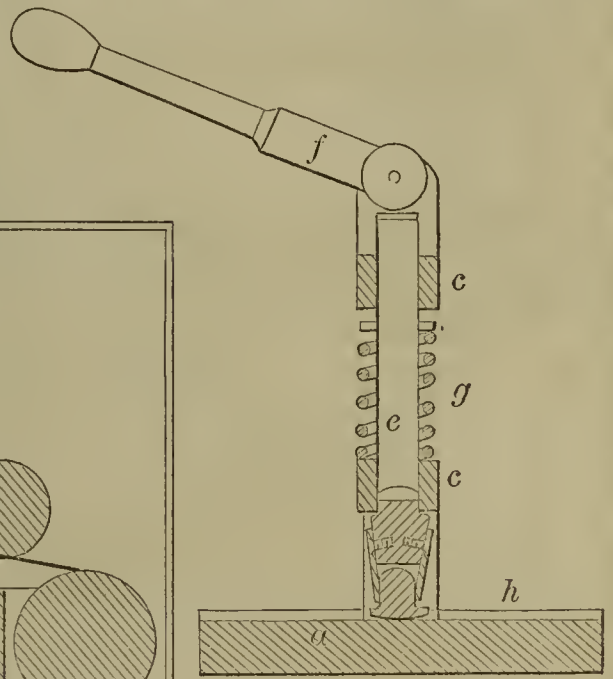

55336—Merriam & Norton—Cutting Machine.

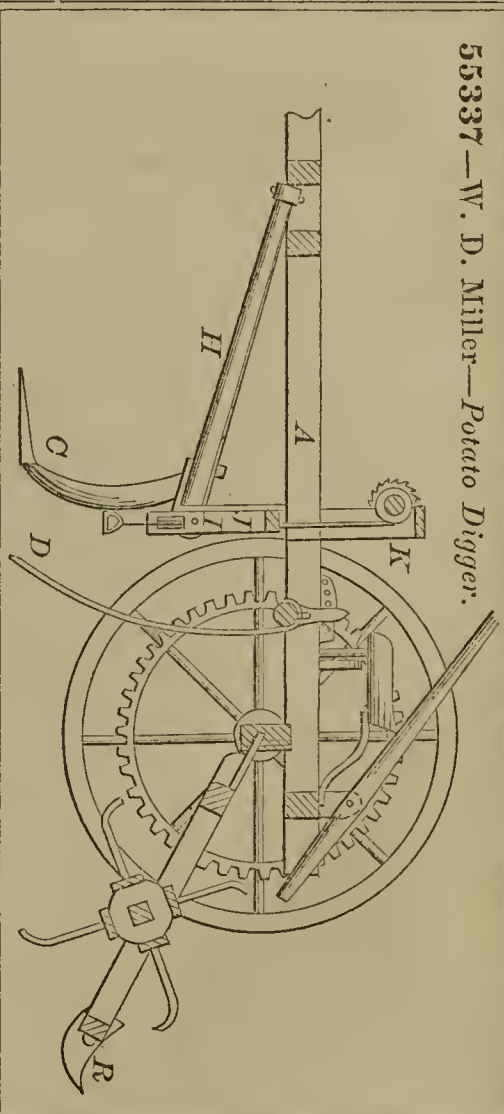
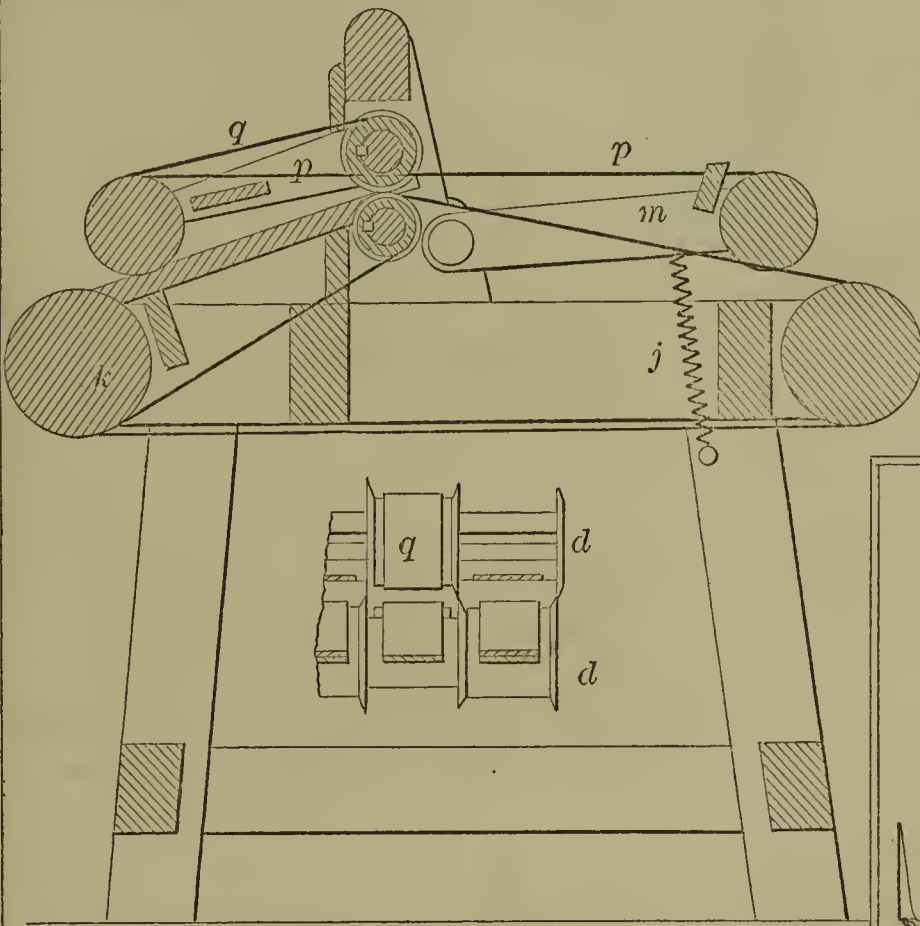

55337—W. D. Miller—Potato Digger.

55335—Merriam & Norton—Glueing and Cementing Machine.

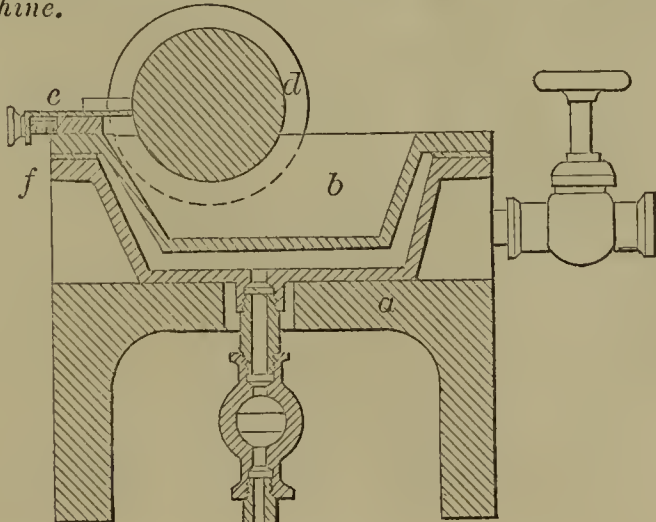

55338—W. Moore—Automatic Boiler Feeder.

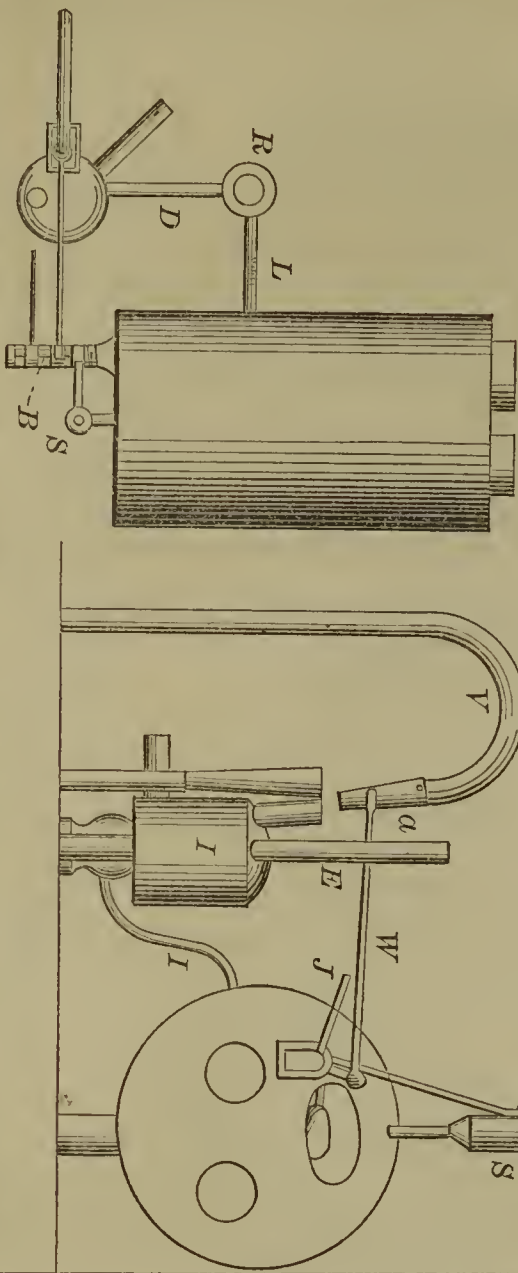

55341—C. H. Morse—Vial.

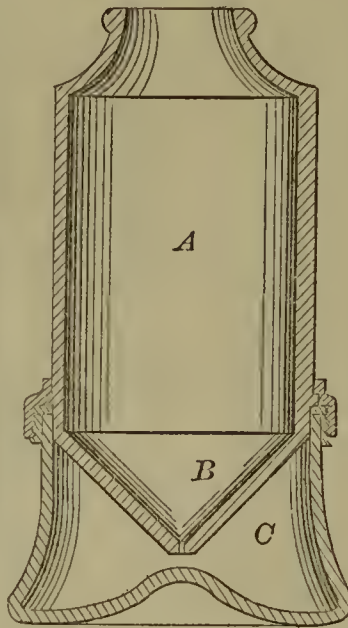

55343—P. Murray—Cable Stopper.

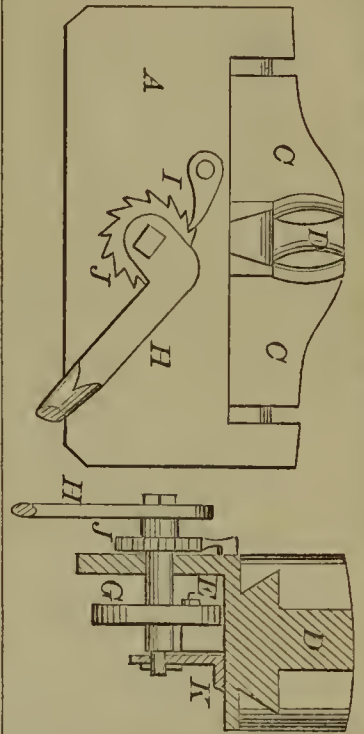

55339—A. Moffat—Peat Machine.

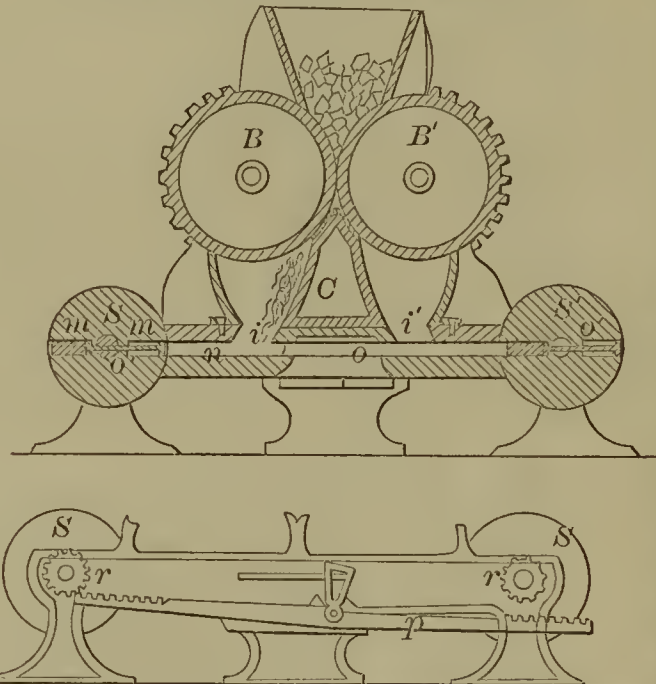

55344—G. W. Nell—Curtain Fixture.

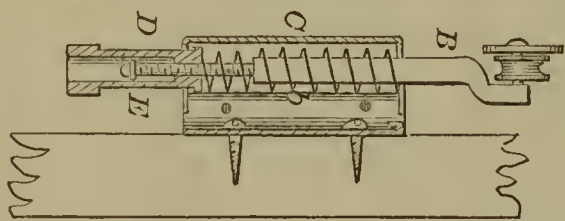

55340—O. F. Morrill—Generating Heat for Cooking Purposes.

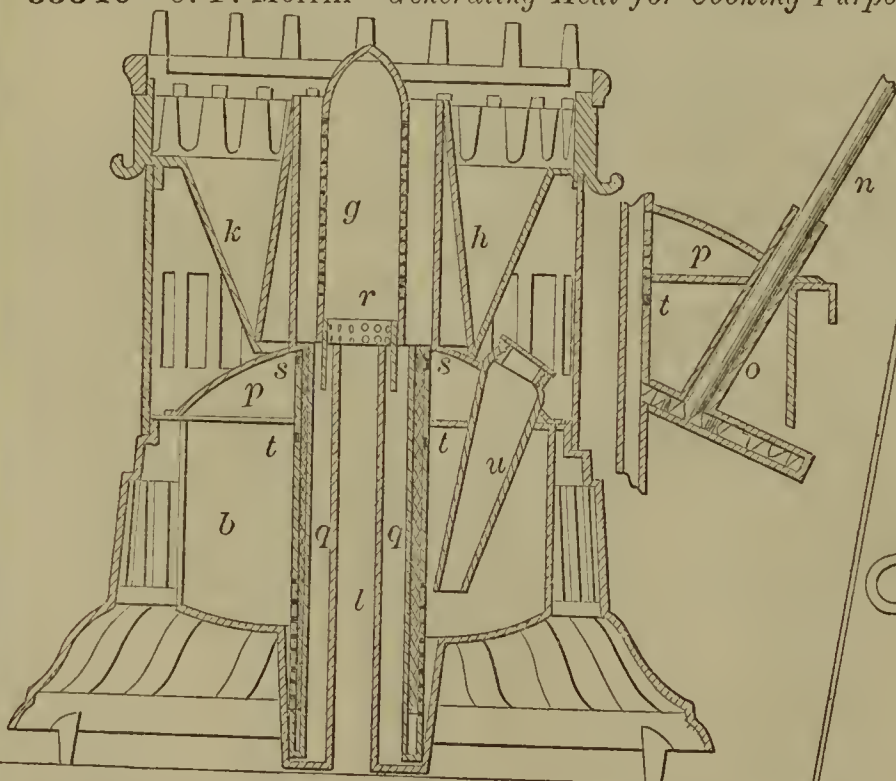

55345—P. H. Niles—Broom Clasp.

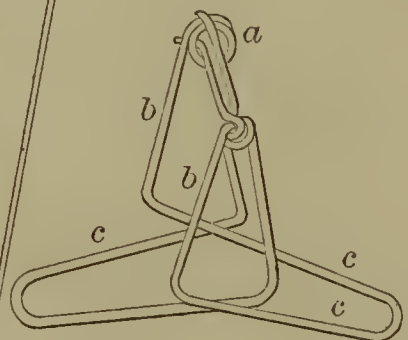

55346—W. H. Nobles—Dredging Boat.

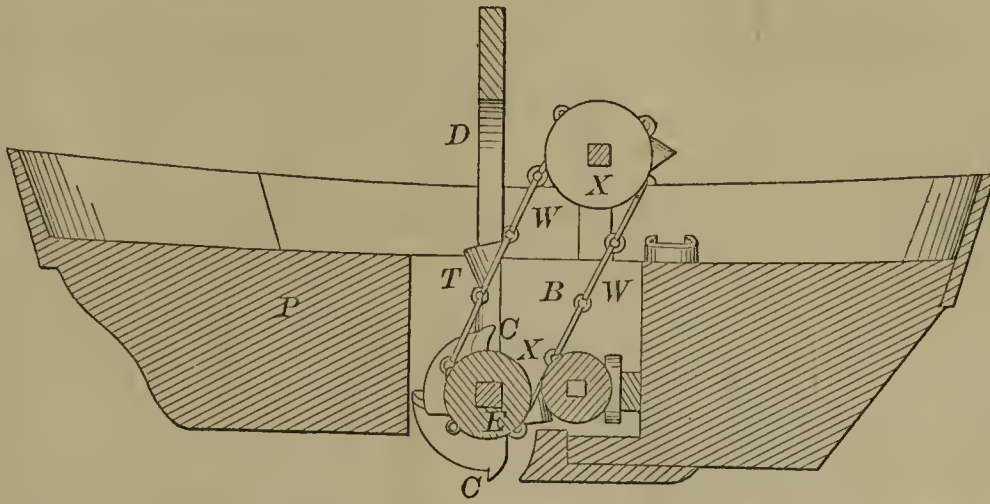

55349—J. P. Noyes—Comb.

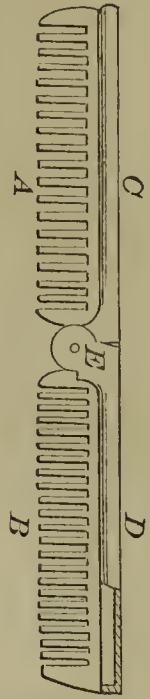

55347—W. H. Nobles—Steam Dredging Boat.

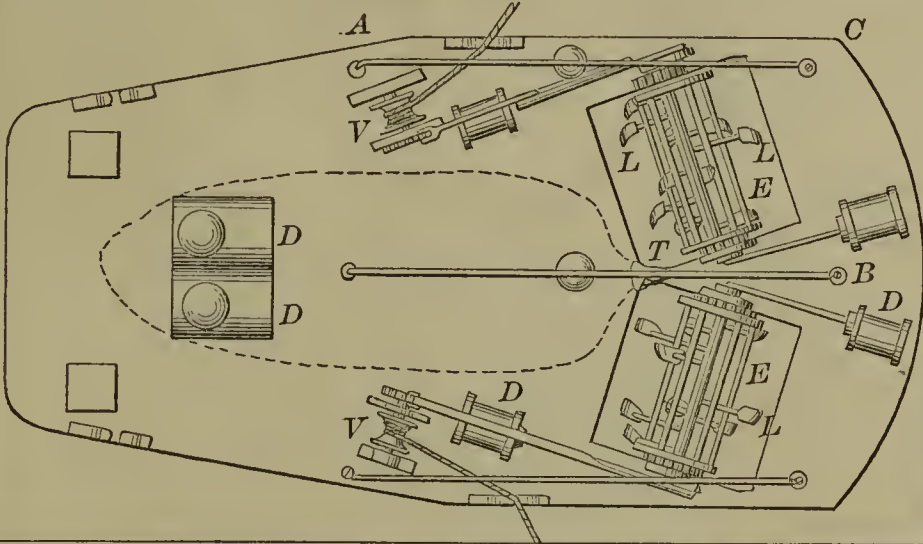

55348—O. B. North—Harness Saddle Seat.

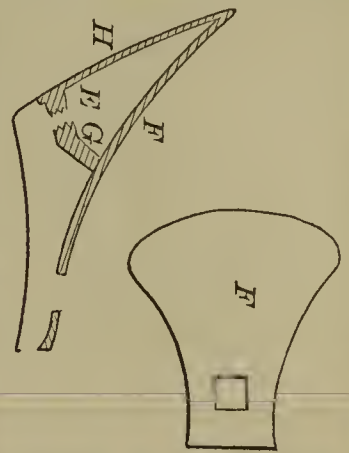

55350—J. Nusbaum—Car Truck.

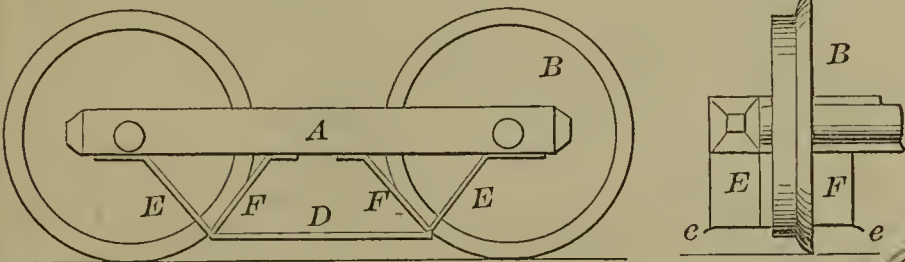

55351—W. S. O'Brien—Harrow.

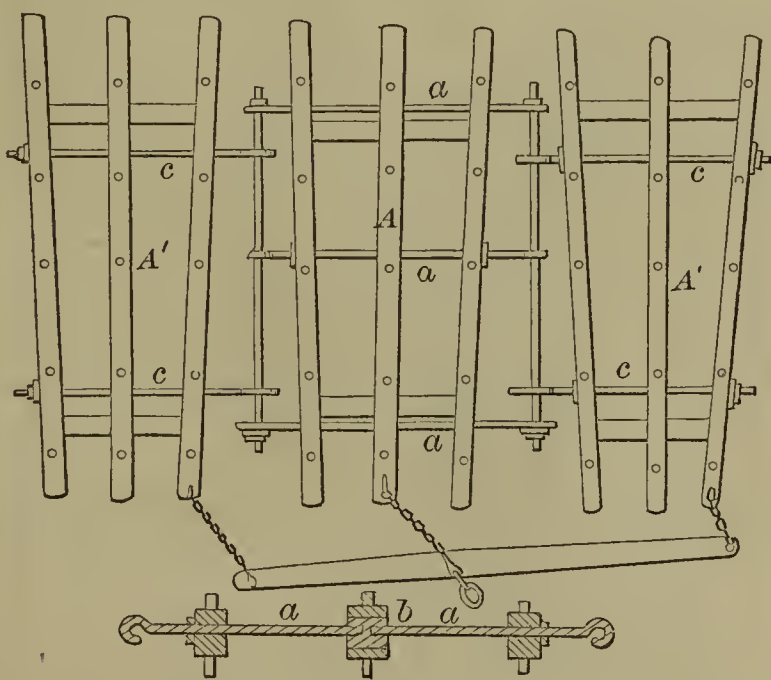

55353—A. W. Olds—Fence.

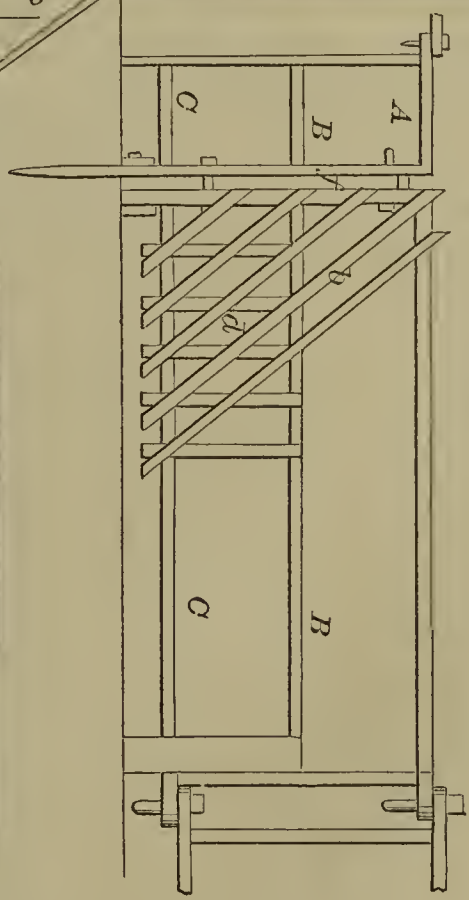

55353—W. Onions—Cotton Bale Tie.

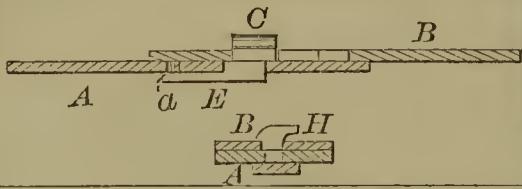

55354—J. C. Osgood—Hose Coupling.

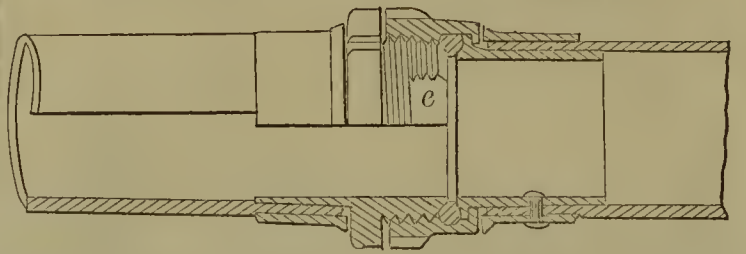

55357—Paudler & Bauschtliker—Hydrant.

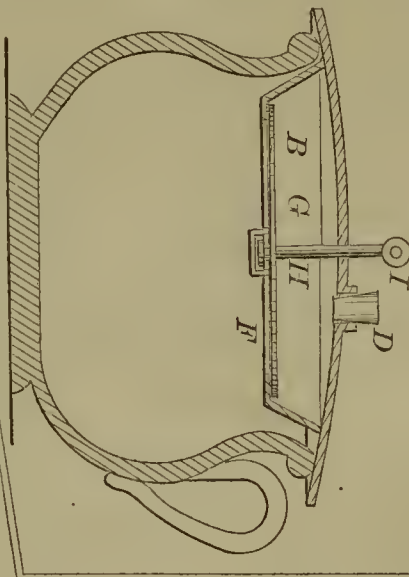
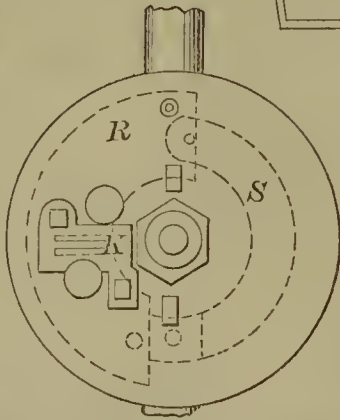
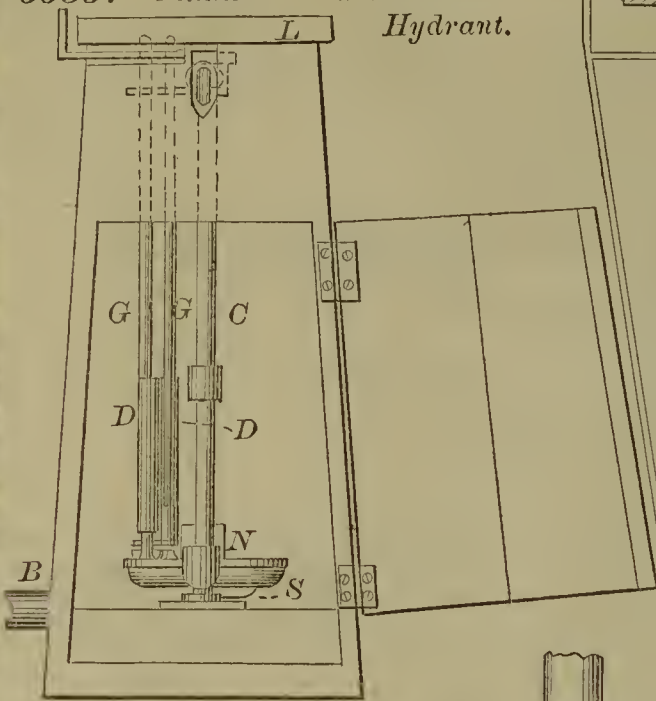

55361—A. Rankin—Chamber Vessel.

55355—S. E. Parsons—Vaginal Syringe.

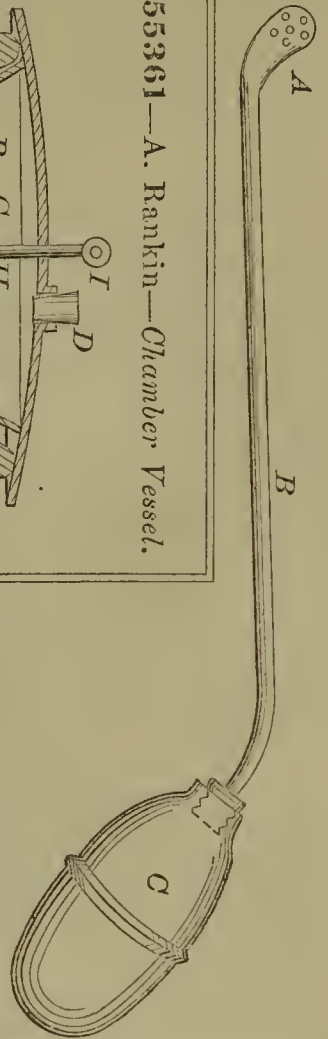

55356—J. S. Patric—Cattle Pump.

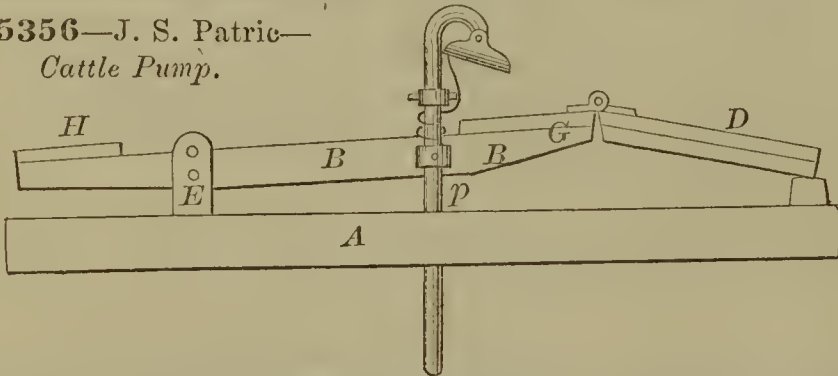

55360—S. T. W. Potter—Churn.

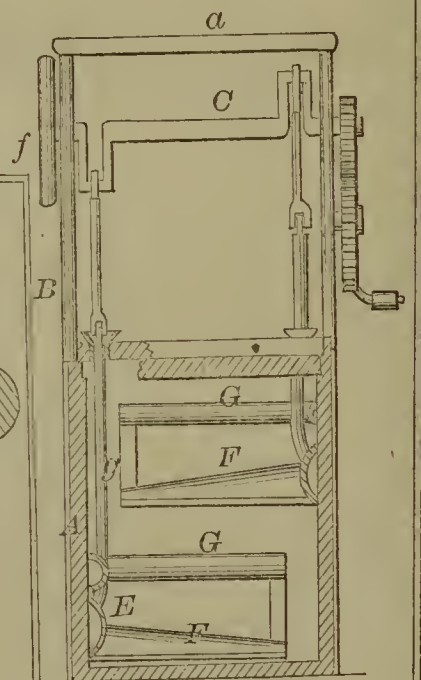

55362—D. K. Reeder—Corn Sheller.

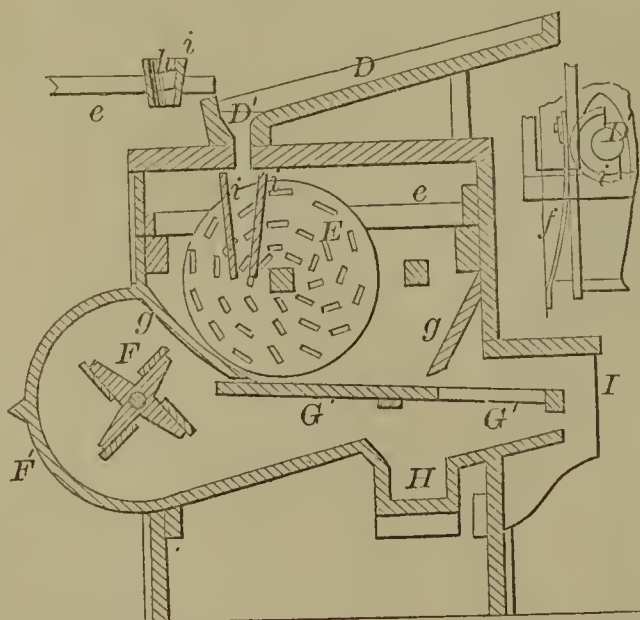

55358—J. C. Plumer—Furniture Caster.

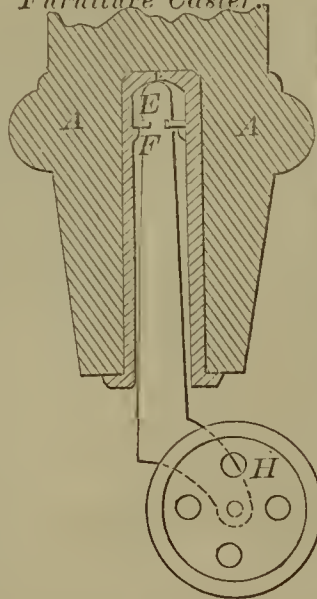



55363—W. Reid—Barrel Head.

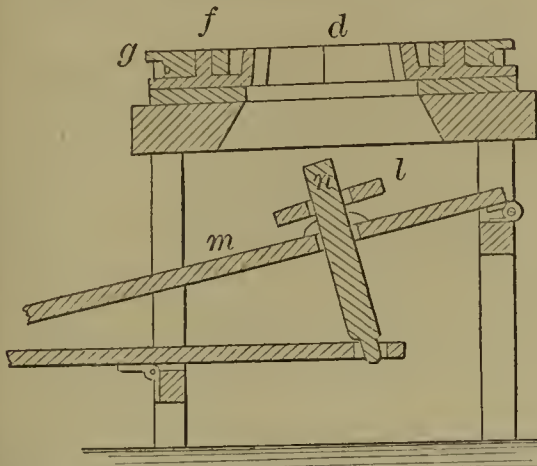

55364—C. O. Richey—Bit Braee.

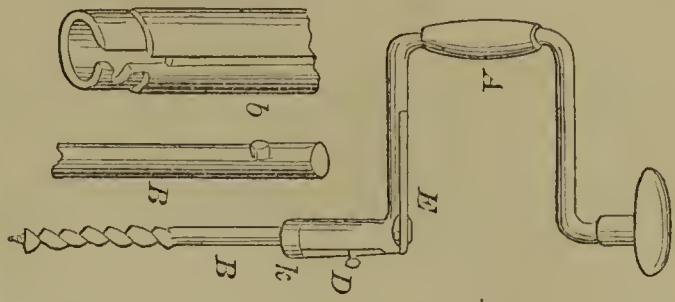

55368—I. A. Salmon—Dentist's Chair.

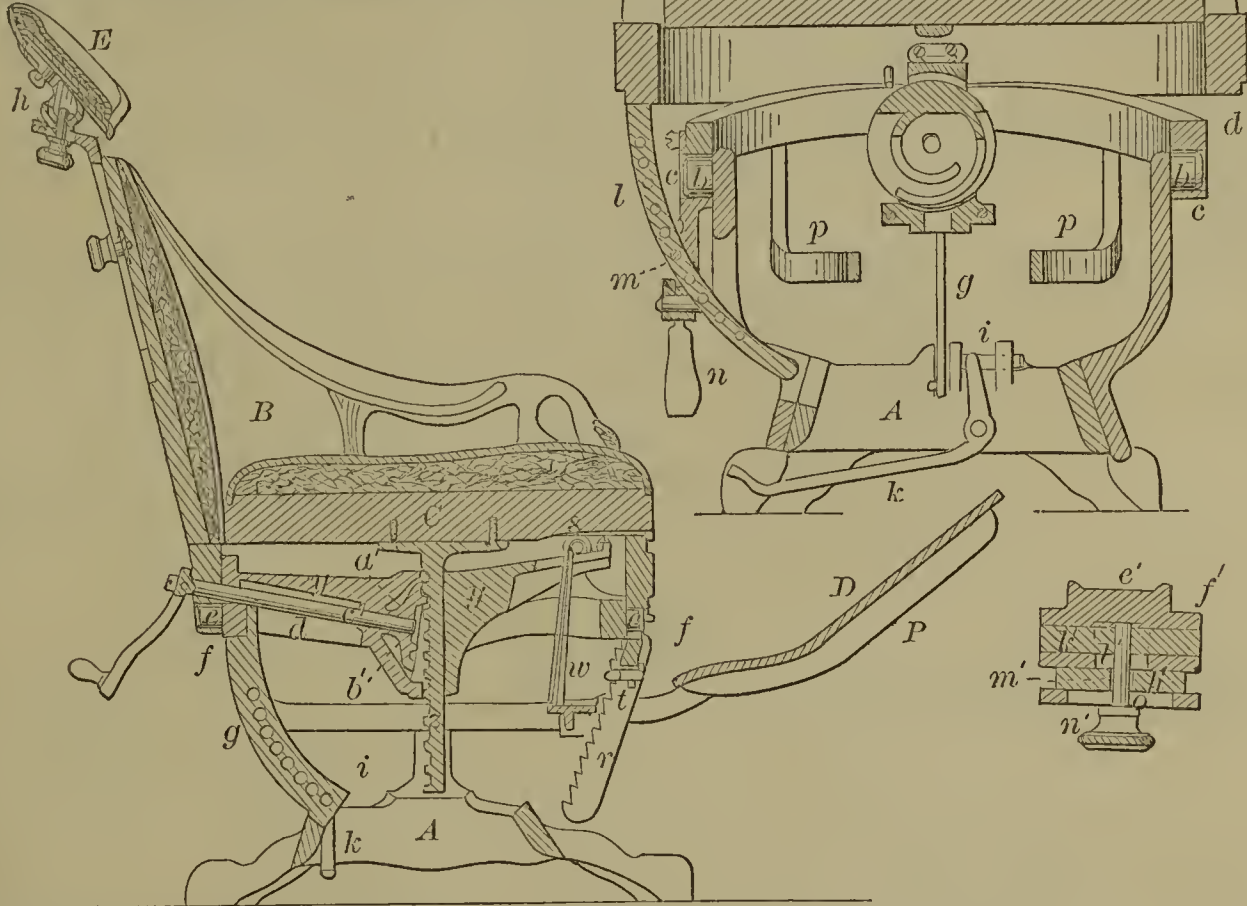

55366—D. D. Robinson—Rivet or Bolt Cutter.

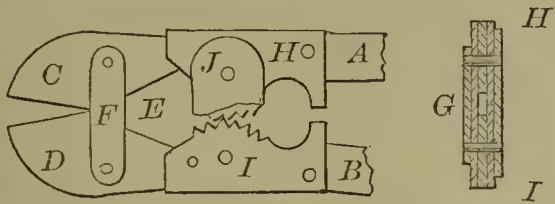

55369—H. Sargent—Truss.

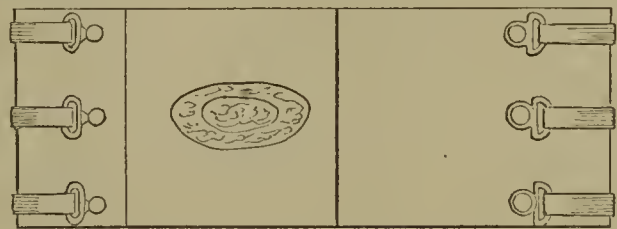

55365—Ritson & Brigg—Hoe.

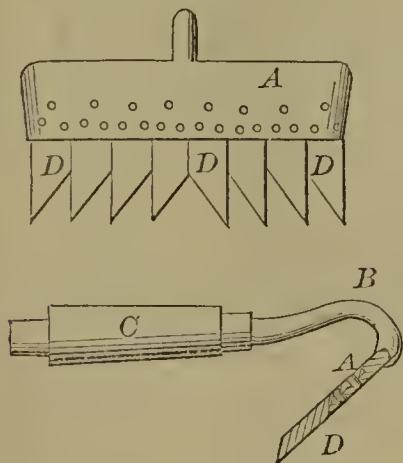

55370—D. F. Sexton—Sheep Rack.

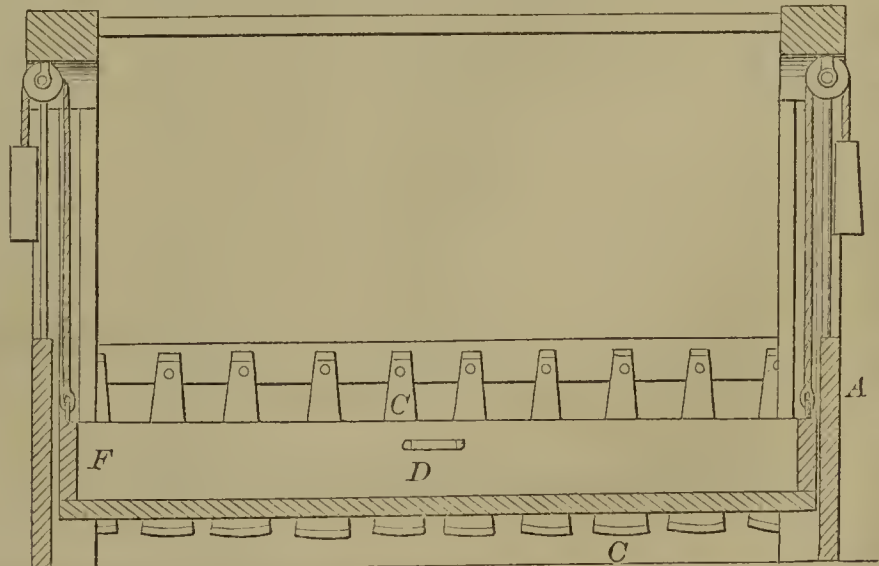

55372—N. B. Sherwood—Cotton Seed Planter.

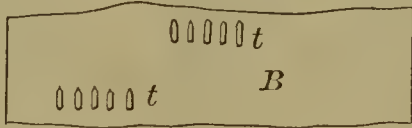
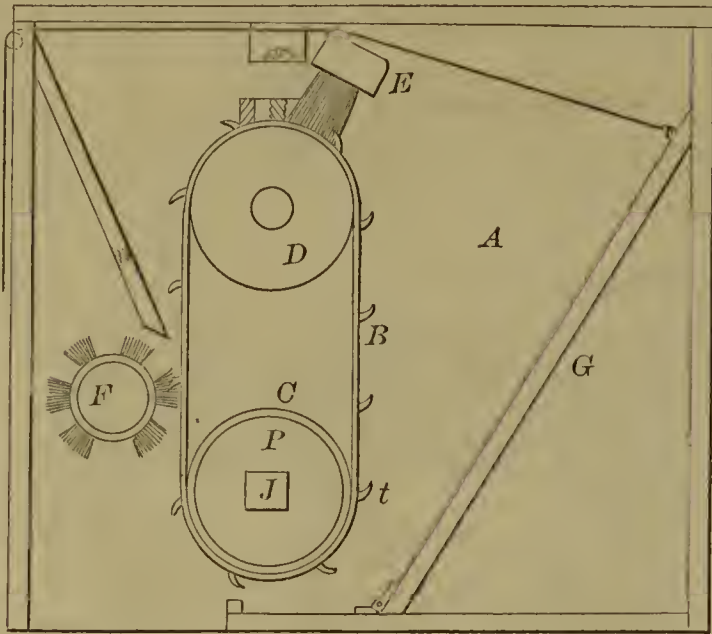

55373—N. B. Sherwood—Cotton Seed Planter.

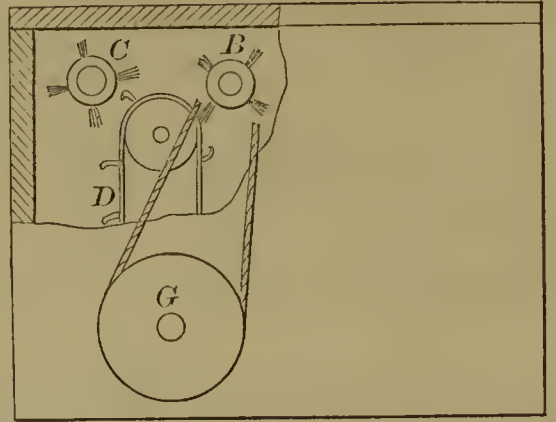

55374—F. Shinn—Horse Shoe.

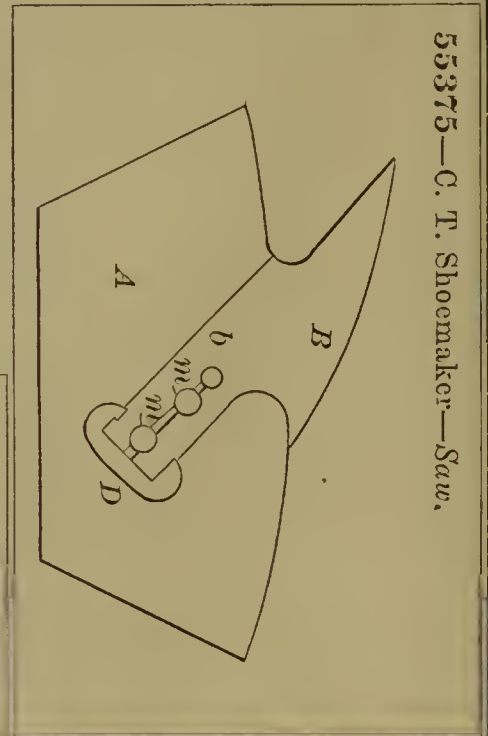
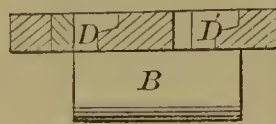
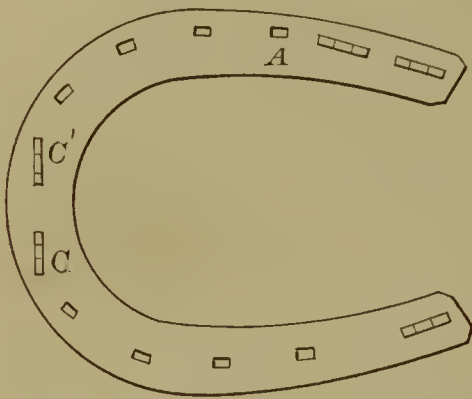

55375—C. T. Shoemaker—Saw.

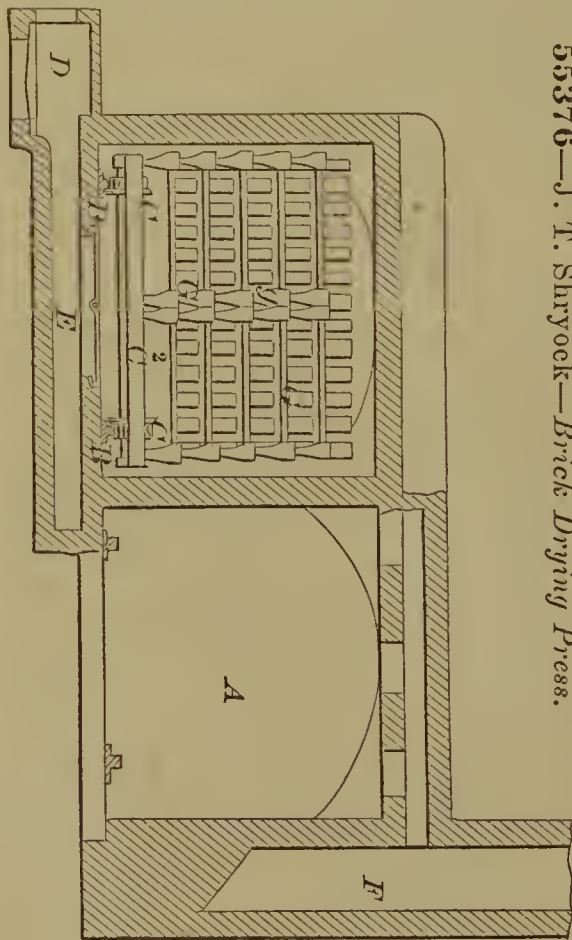

55376—J. T. Shryock—Brick Drying Press.

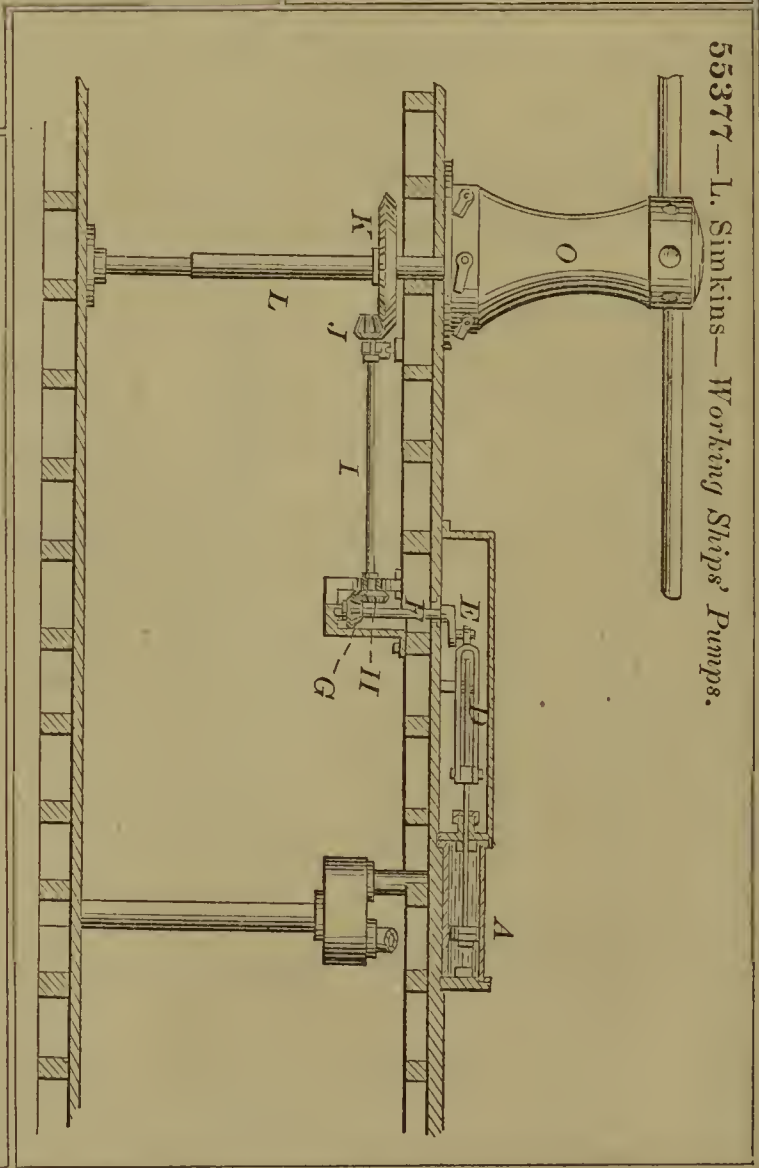

55377—L. Simkins—Working Ship's Pumps.

55378—G. Simpson—*Burglar Alarm.*

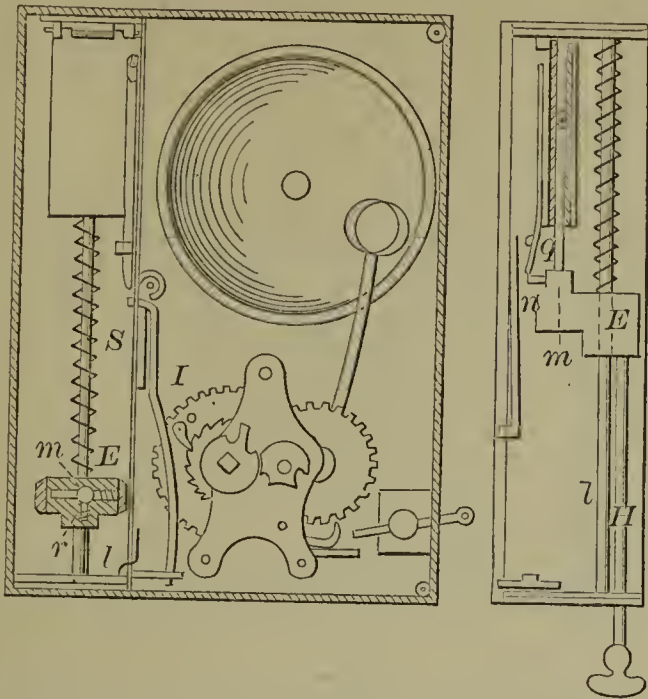

55381—H. B. Smith—*Cultivator.*

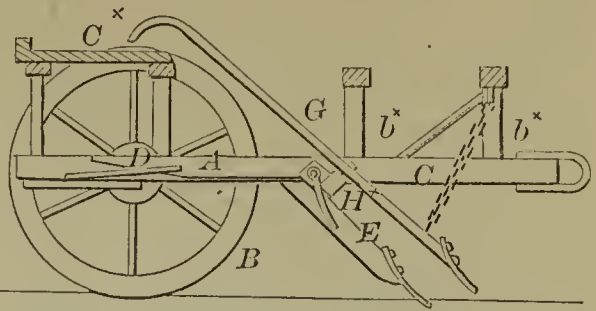

55382—J. M. Smith—*Hollow Auger.*

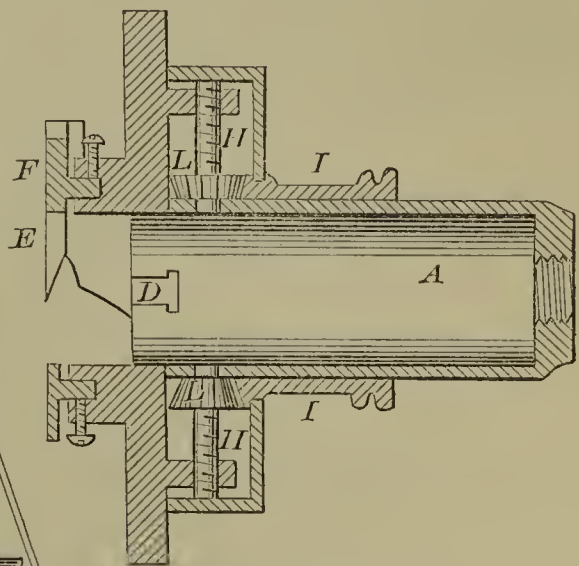

55379—E. W. Skinner—*Sugar Cane Mill.*

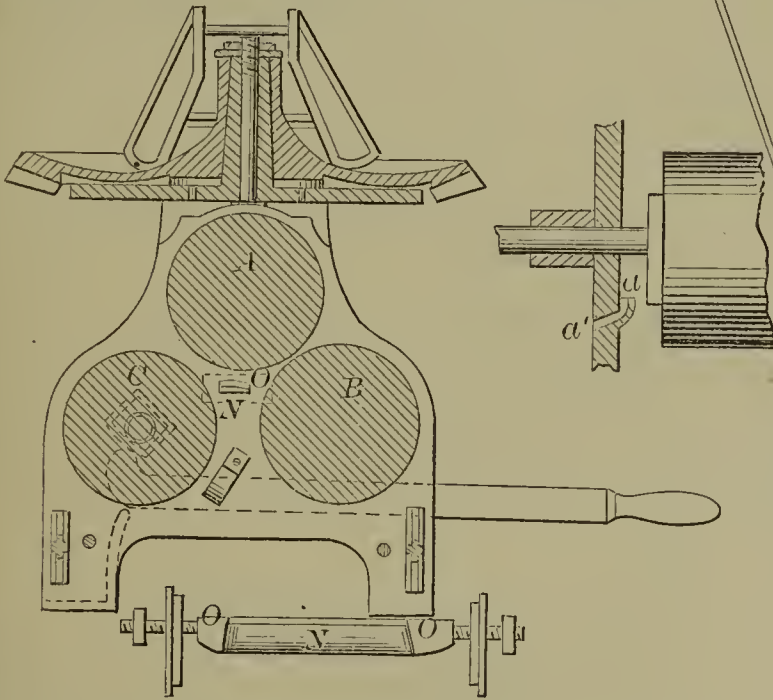

55383—W. H. Smith—*Vapor Burner.*

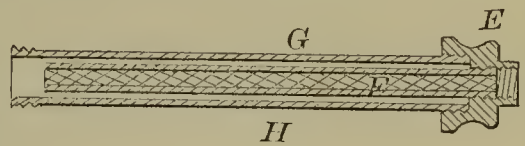

55380—E. Smith—*Rake Attachment to Harvesters.*

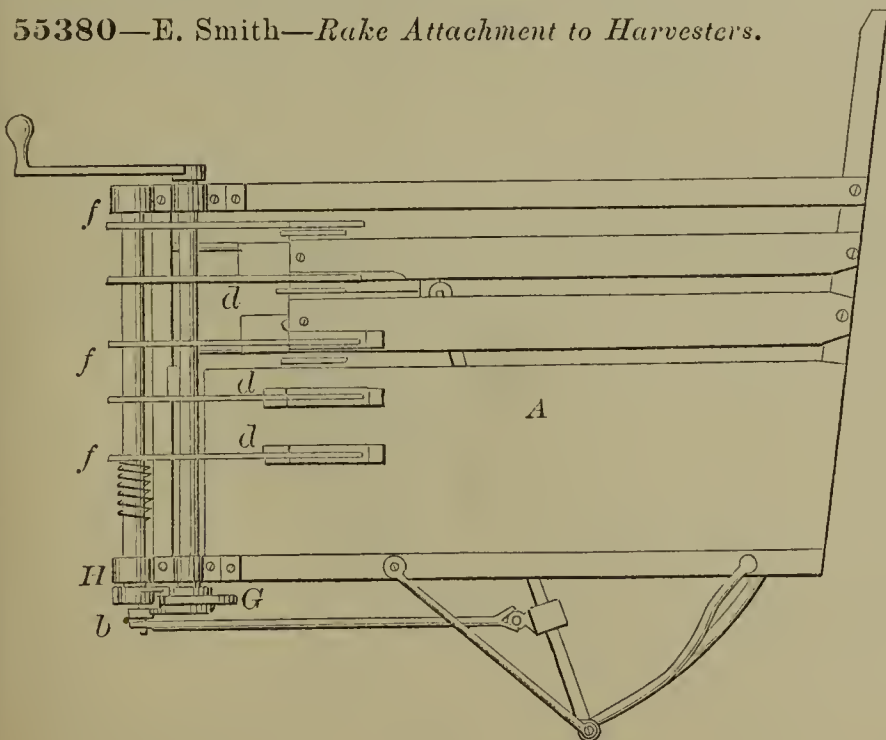

55384—S. Soules—*Potato Digger.*

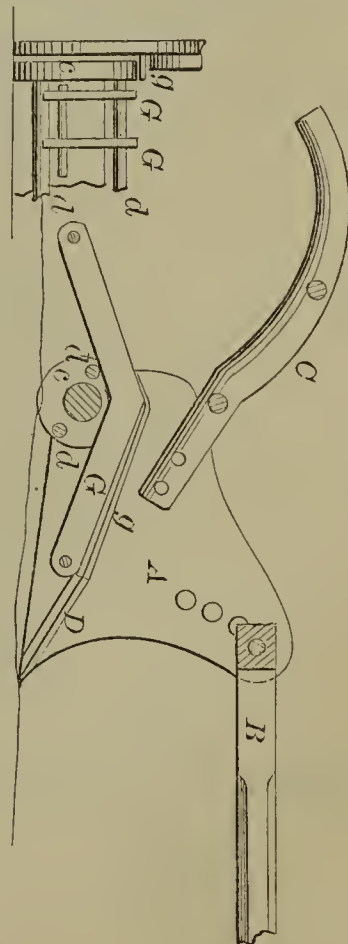

55385—W. Steinway—*Piano Forte.*

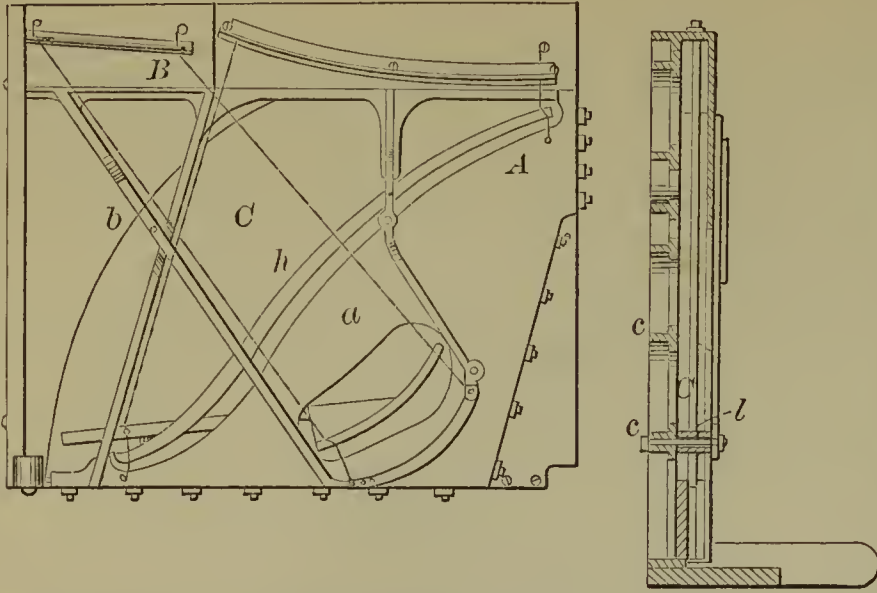

55386—J. J. Stevenson—*Lubricating Journal.* G

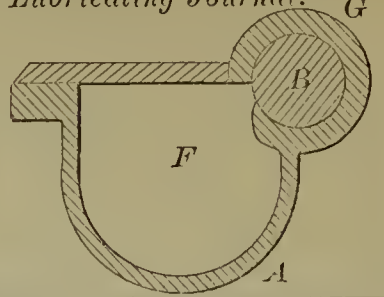

55387—E. Sullivan—*Piston Head for Steam Engines.*

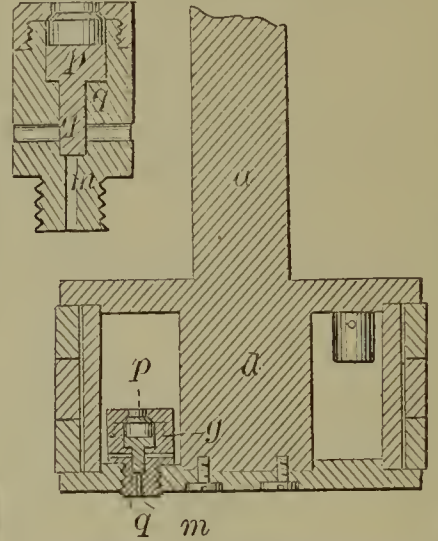

55388—E. C. Summers—*For Collecting Floating Oil.*

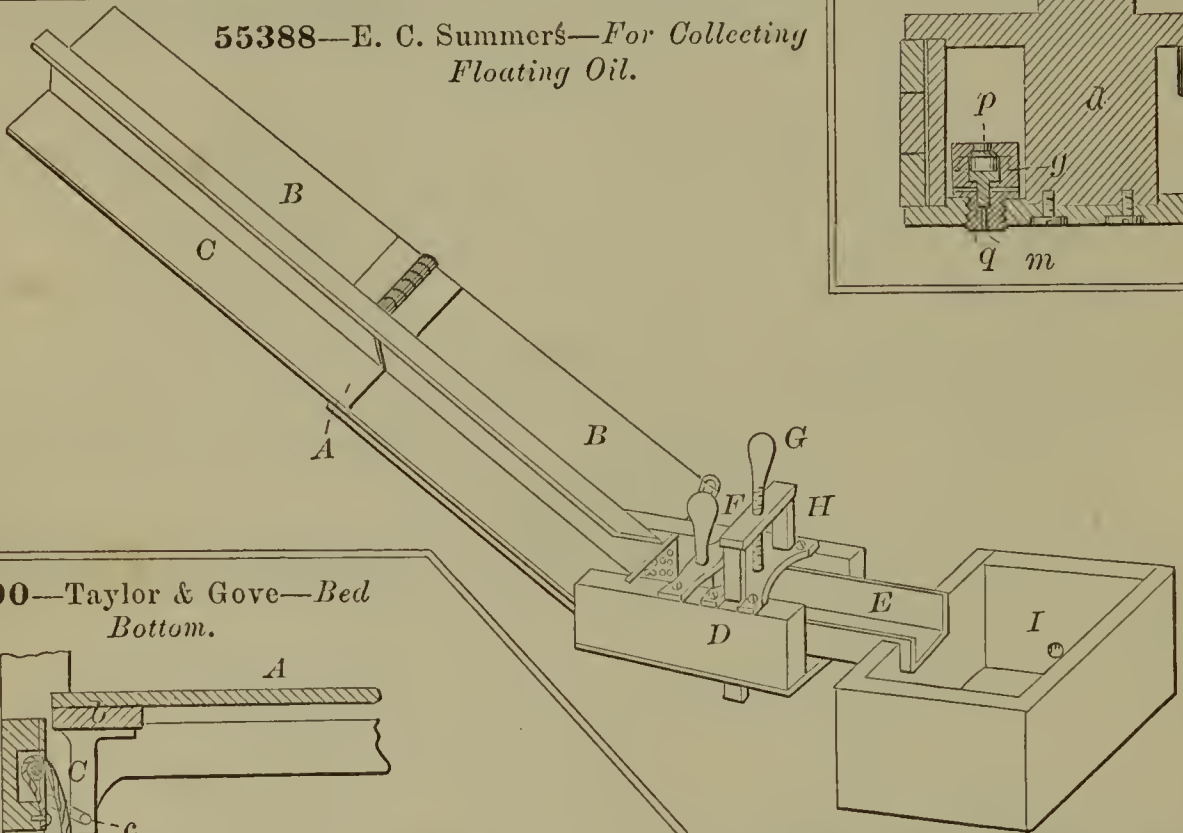

55390—Taylor & Gove—*Bed Bottom.*

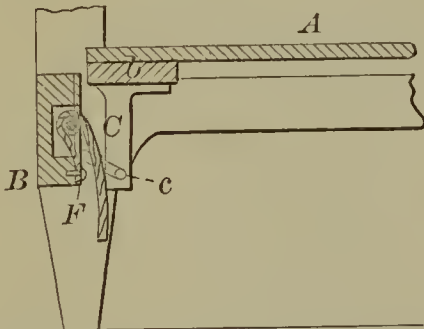

55389—J. B. Tarr—*Planing Machine.*

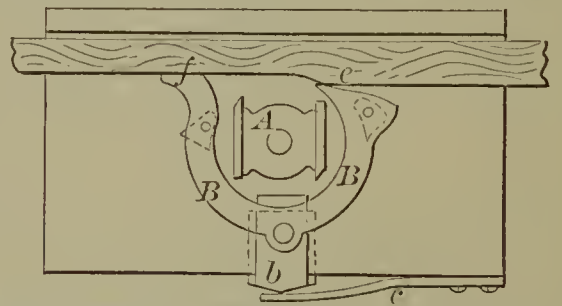

55391—N. Thomas—*For Cutting Off Boiler Tubes.*

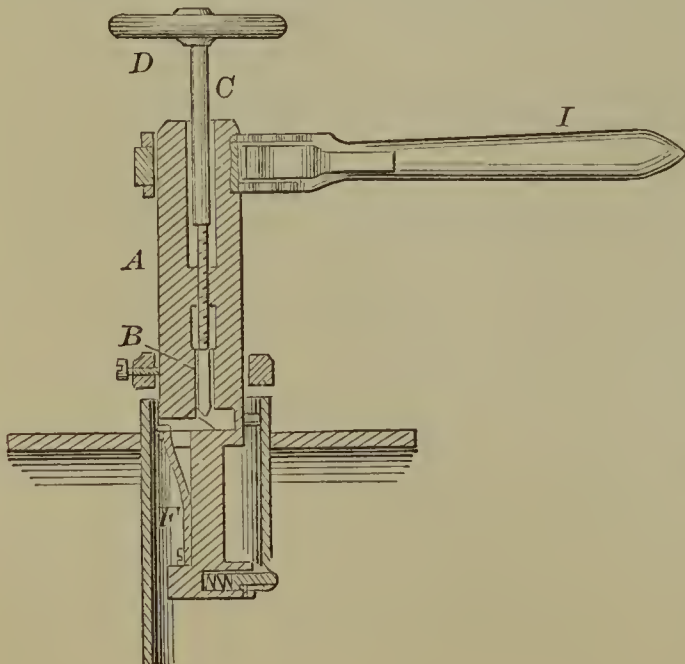

55392—H. A. Thompson—*Call Bell.*

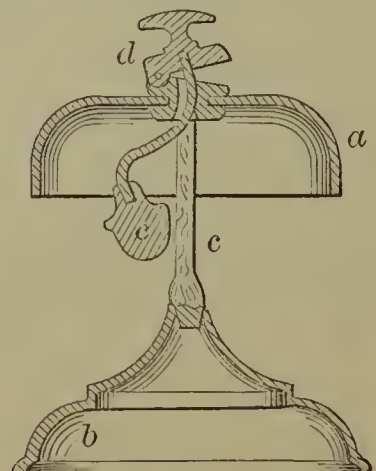

55393—R. H. Thurston—Magnesium Lamp.

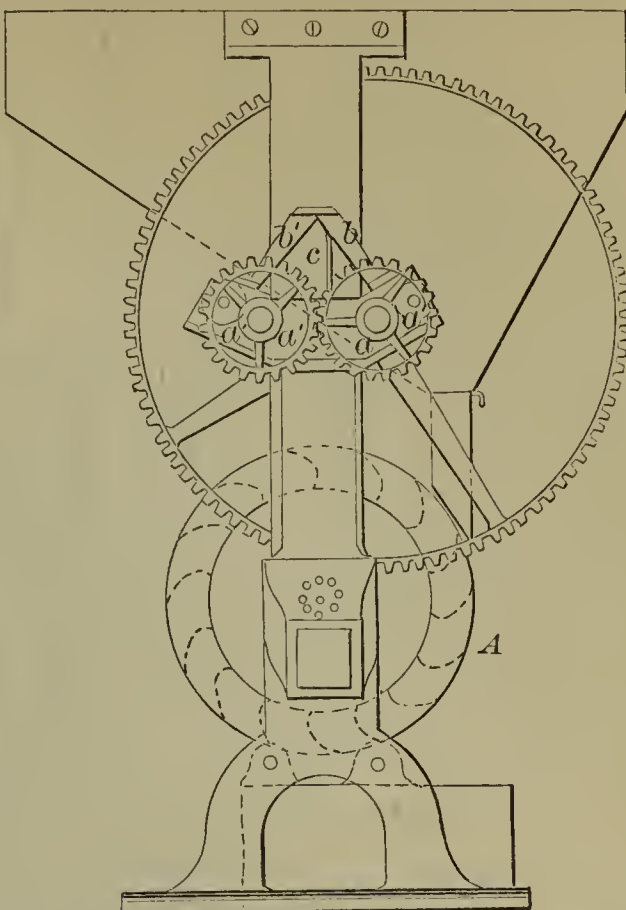

55396—W. S. Trowbridge—Transit Instrument.

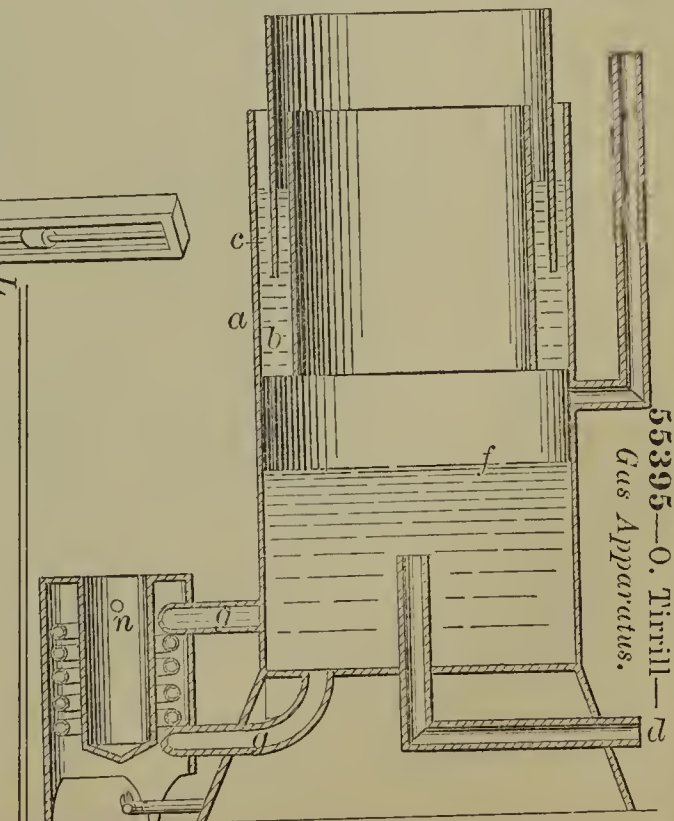
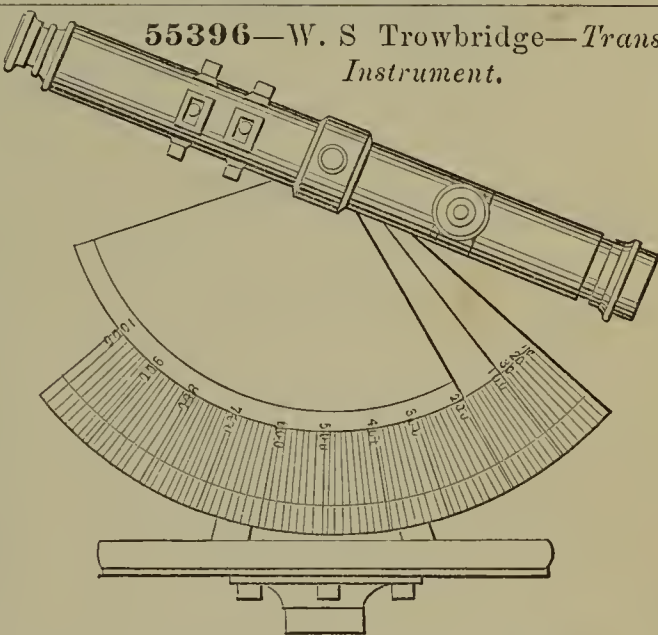

55395—O. Tirrill—Gas Apparatus.

55397—O. Tucker—Till Lock.

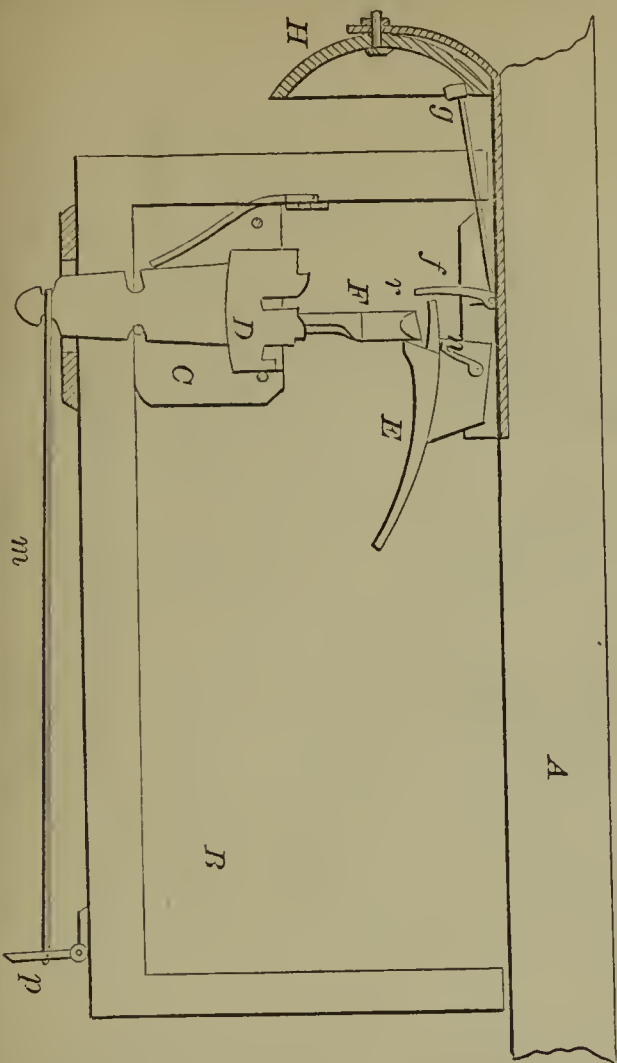

55394—H. Tilden—Broom Clasp.

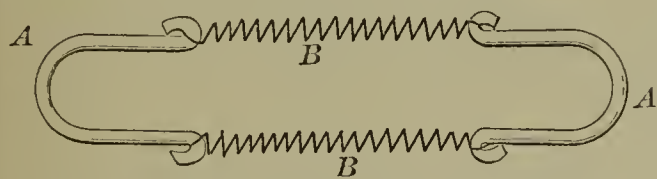

55398—P. H. V. Weyde—For Inhaling Gas.

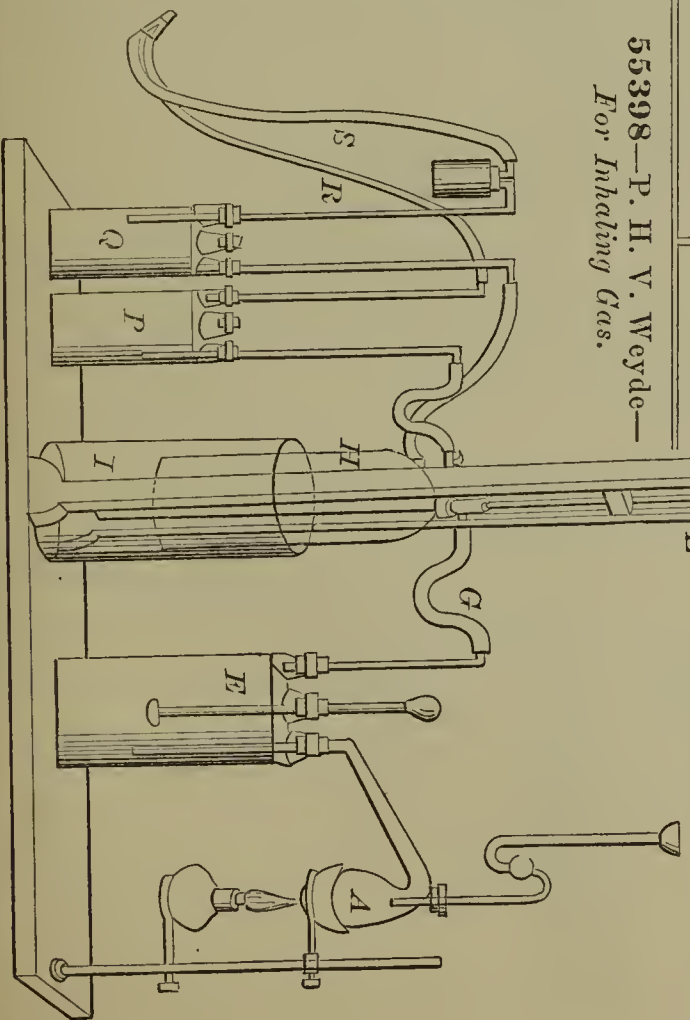

55399—C. A. Wakefield—*Hand Corn Planter.*

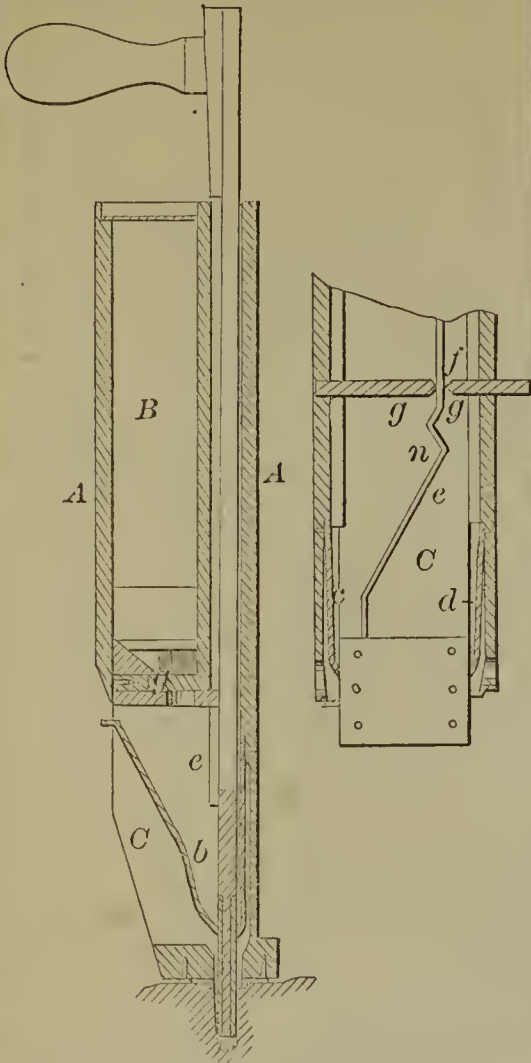

55400—P. N. Woliston—*Brick Machine.*

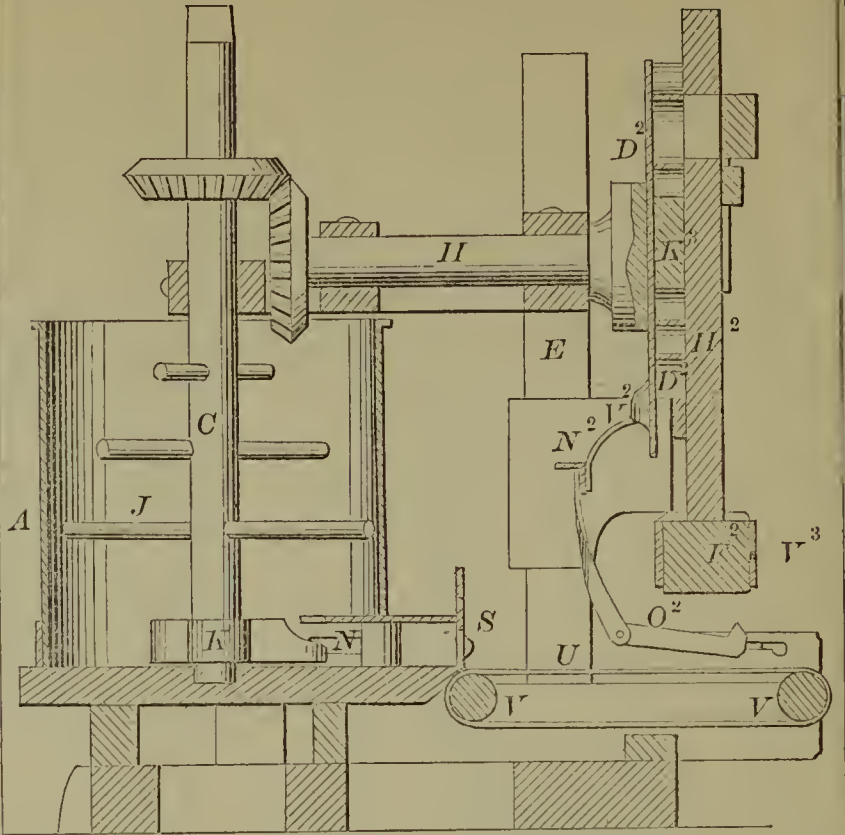

55402—C. Weber—*Table Mat.*



55405—N. W. Wheeler—*Steam Generator.*

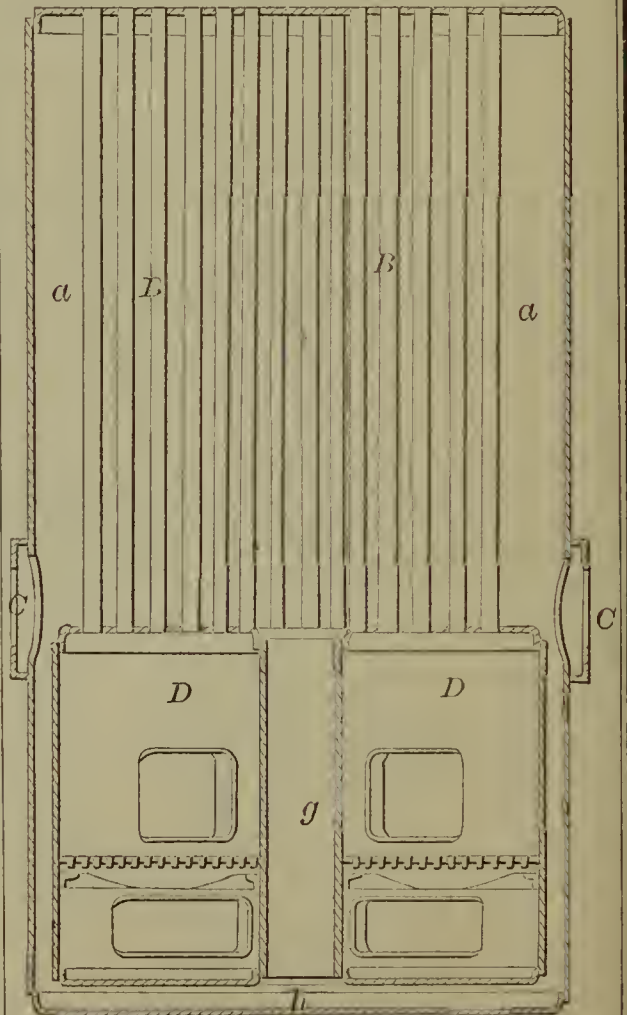

55401—J. B. Warren—*Cradle, Stool, and Chair.*



55404—J. Wheeler—*Knife and Scissors Sharpener.*

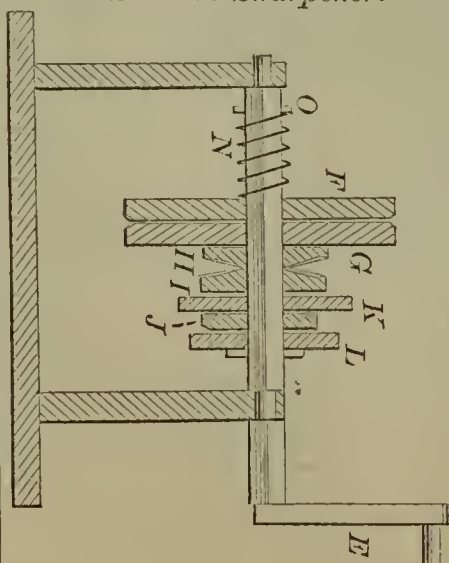

55403—L. H. West—*Car Truck.*

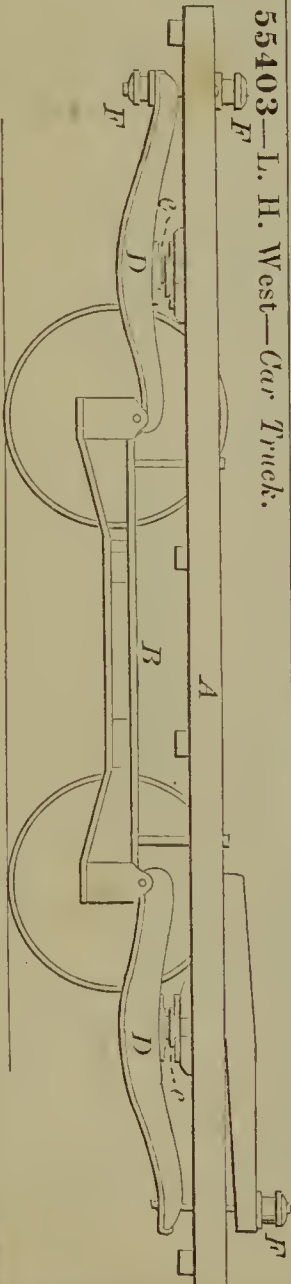

55408—P. A. Wise—Horse Hay Fork.

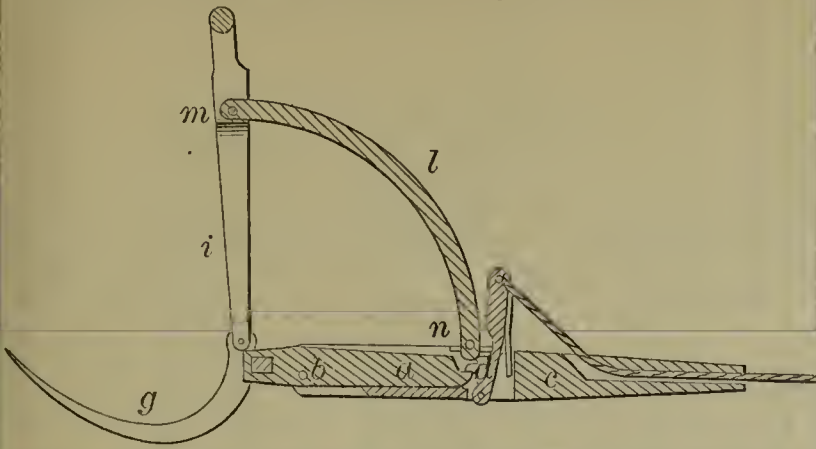

55406—N. W. Wheeler—Packing Slide Valves.

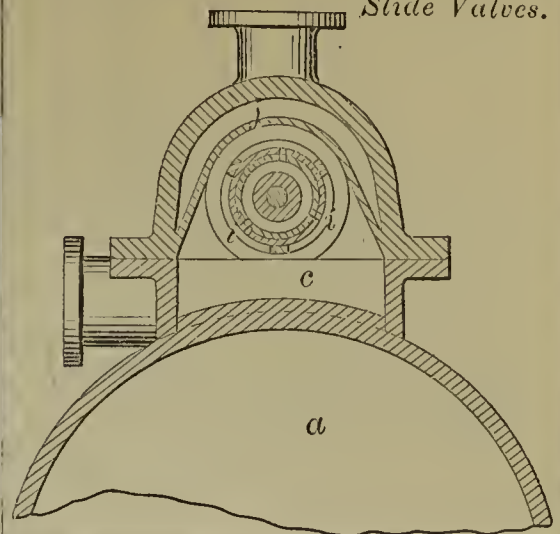

55407—H. Whisler—Churn.

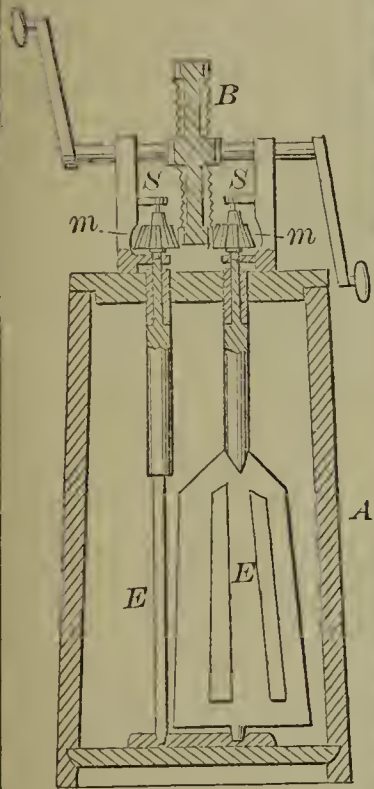

55411—Bigelow & Waters—Making Wire Sieves.

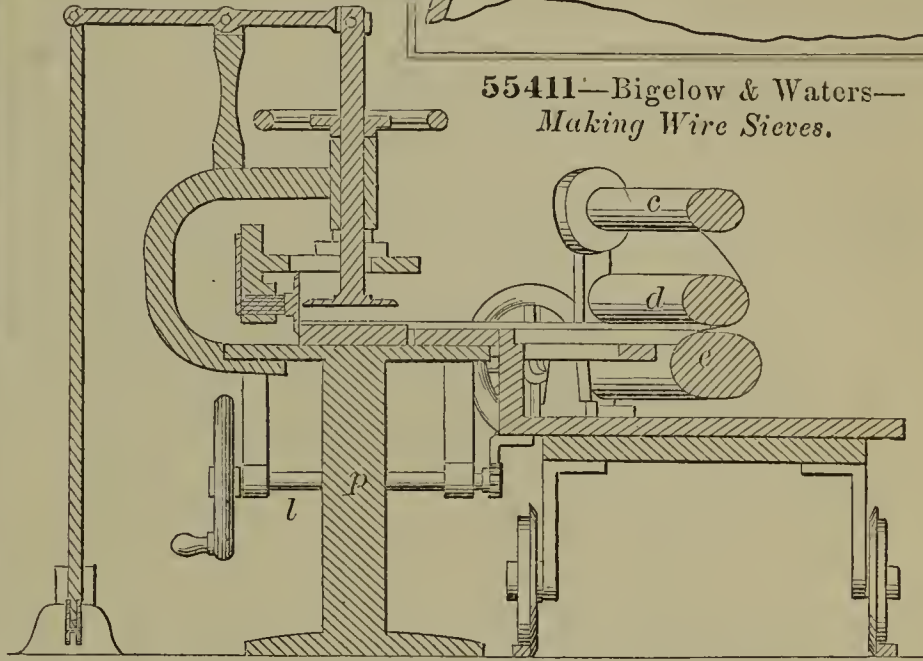

55410—H. T. Woodman—Sash and Door Bolt.

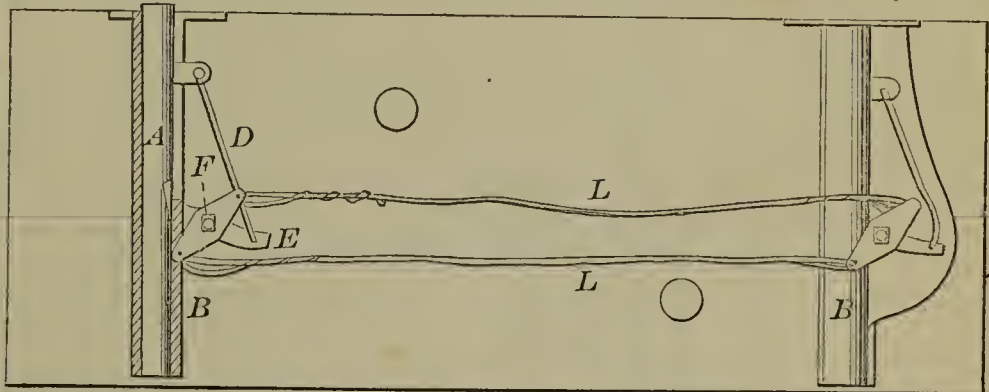

55412—L. L. Crane—Lathe.

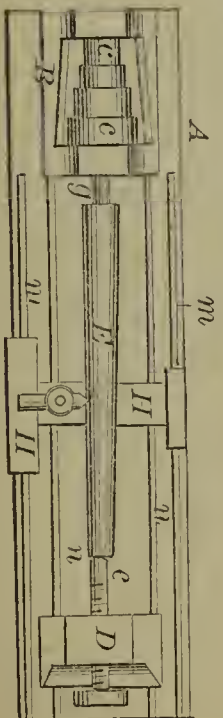

55409—J. Wisner—Broom.

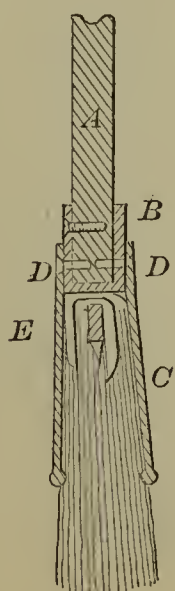

55413—J. M. Enos—Mop and Wringer.

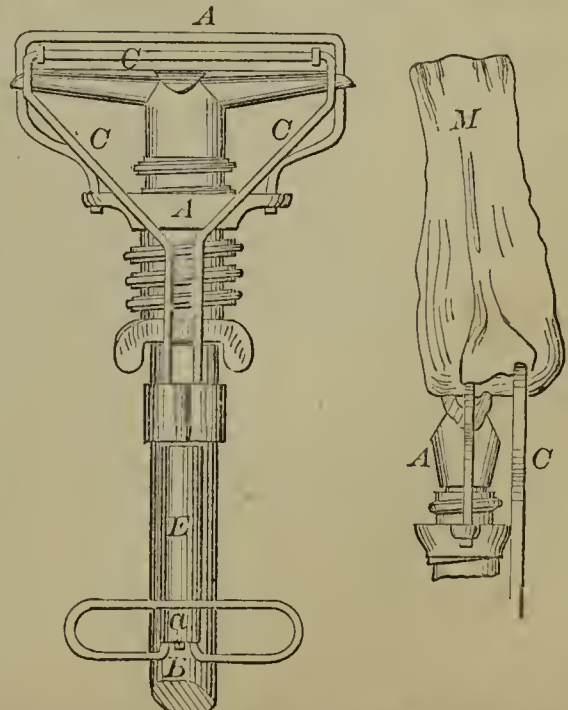

55414—C. A. Foster—Meat Chopper.

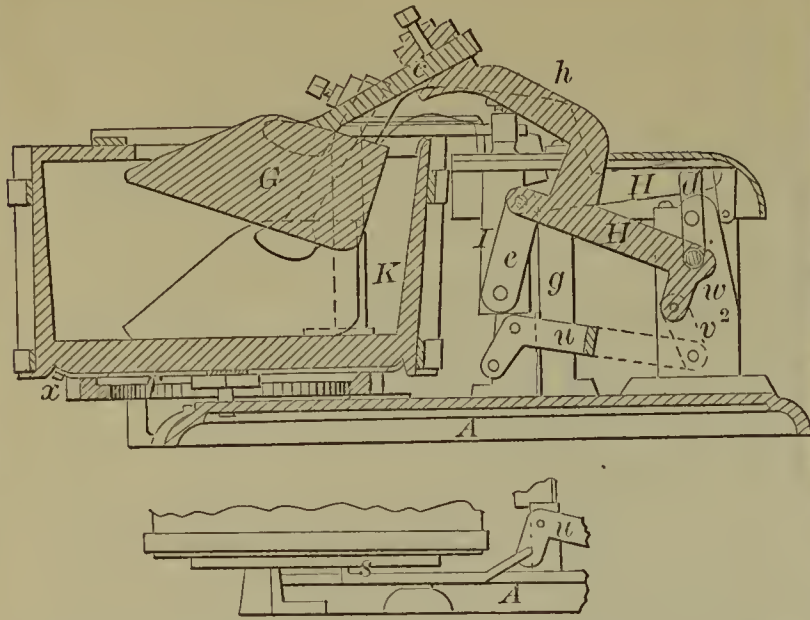

55417—W. H. Hawkins—Spool Thread Regulator.

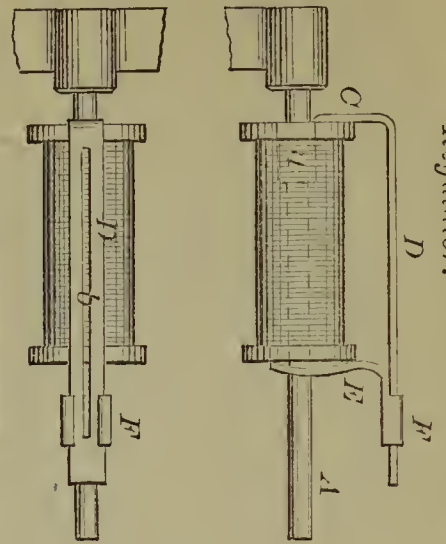

55418—Jones & Farquharson—Treating Wood, Straw, &c., for Paper Pulp.

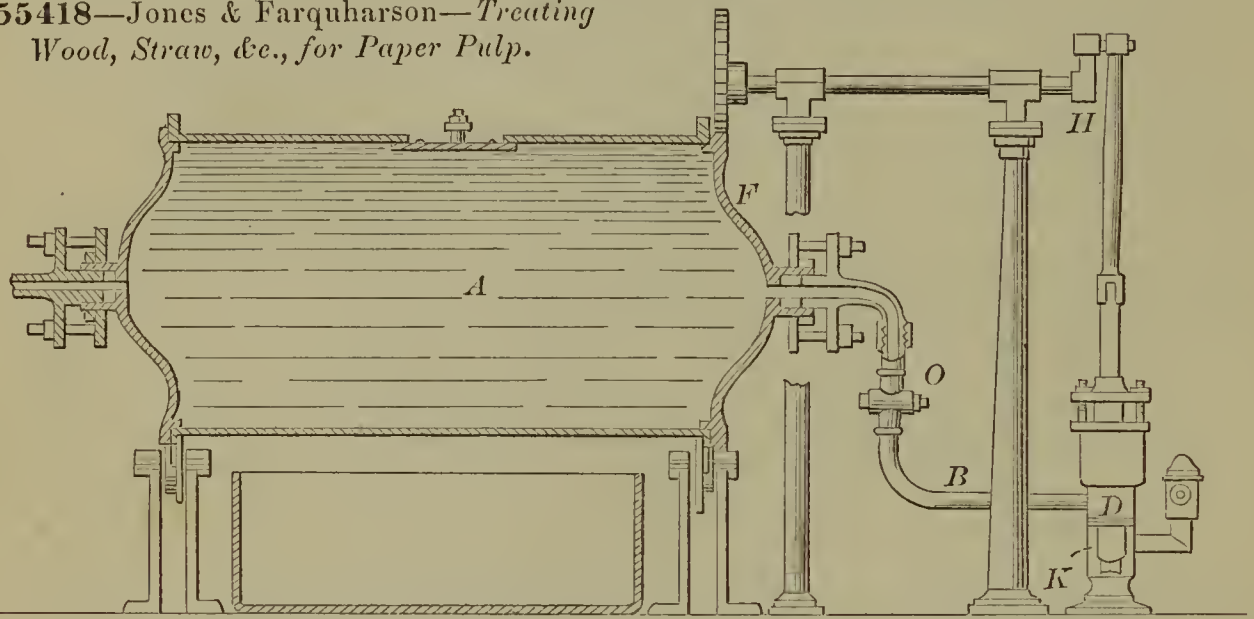

55419—W. Kroeger—Stove Pipe Drum.

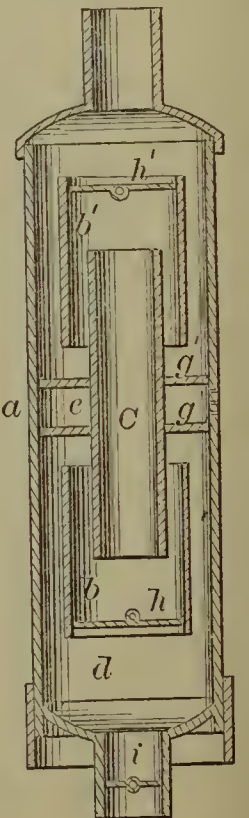

55416—J. Fye—Mail Bag.

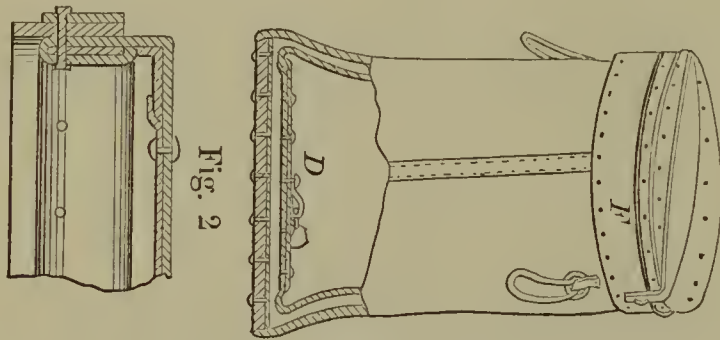
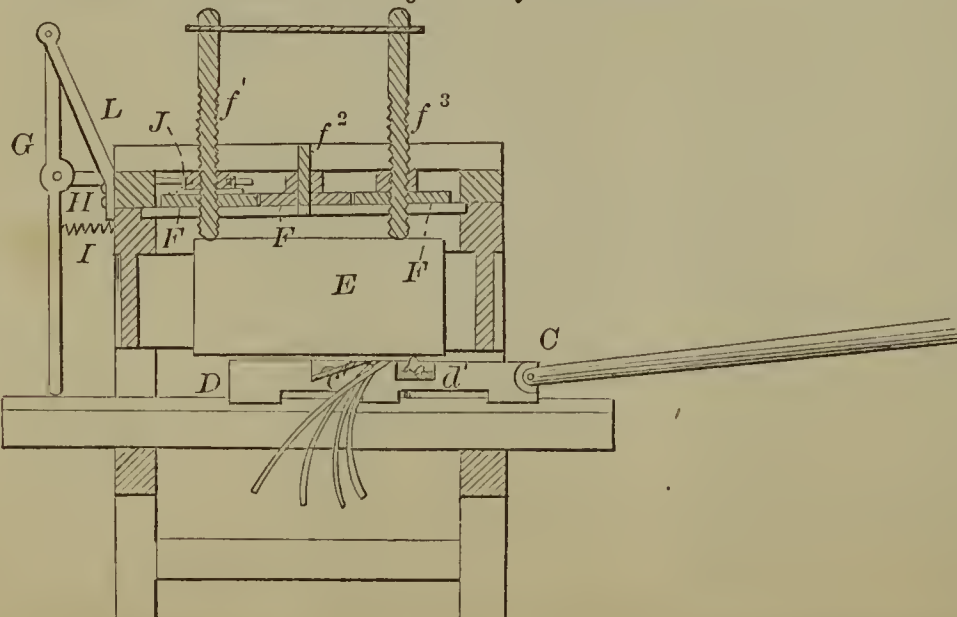
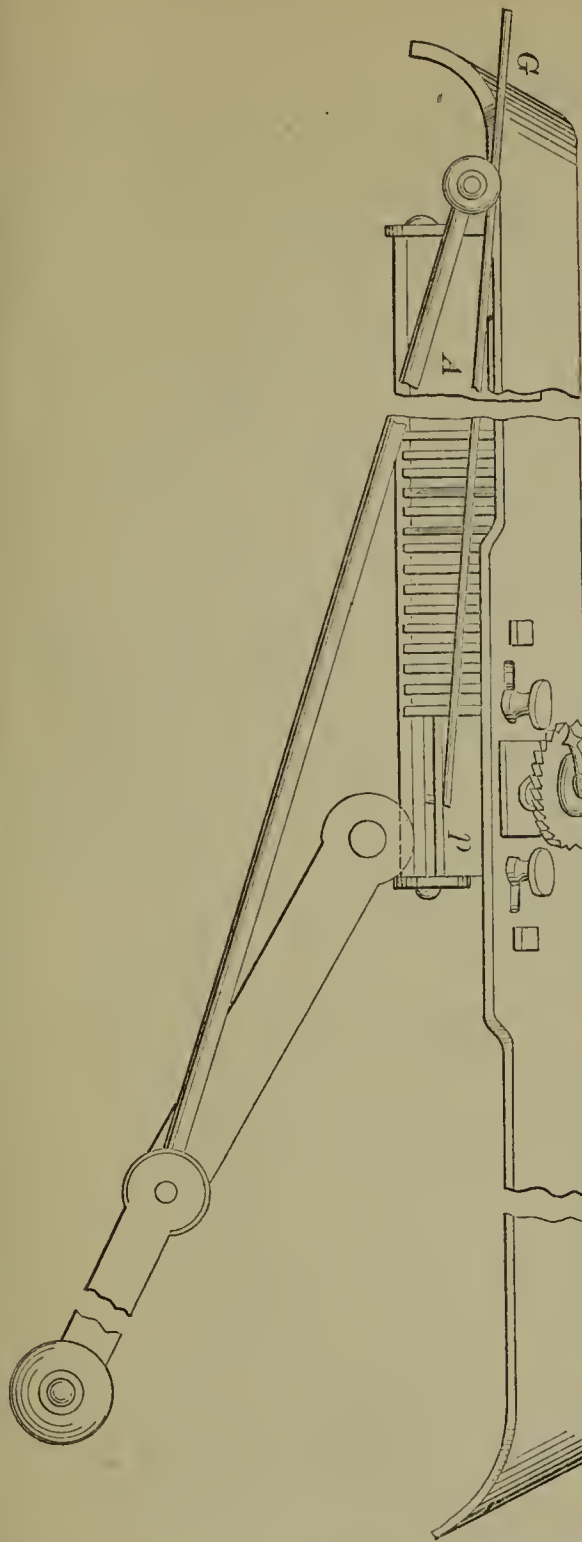

Fig. 2

55415—M. Free—For Cutting Slats for Blinds.







55420—M. T. Lamb—Knitting Machine.

55422—J. Lessels—Circular Knitting Machine.

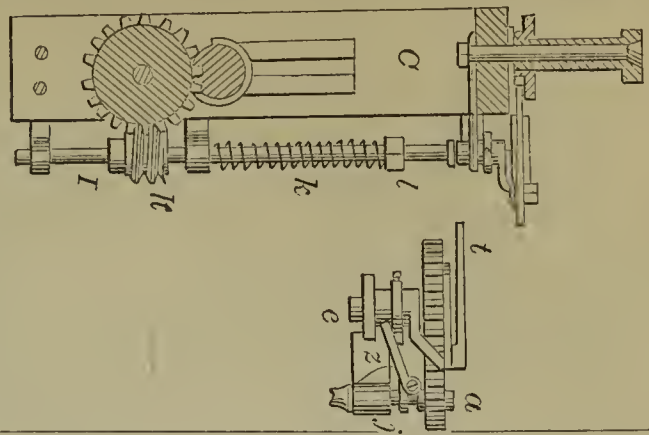

55421—W. R. Landfear—Making Eyelets.

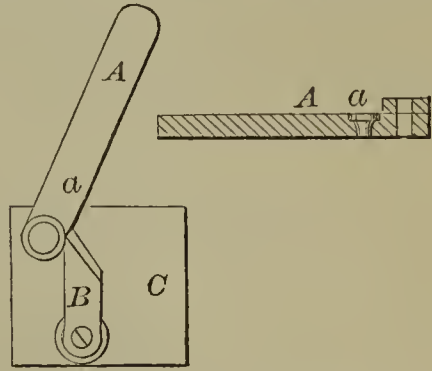

55424—A. Lloyd—Floor Clamp.

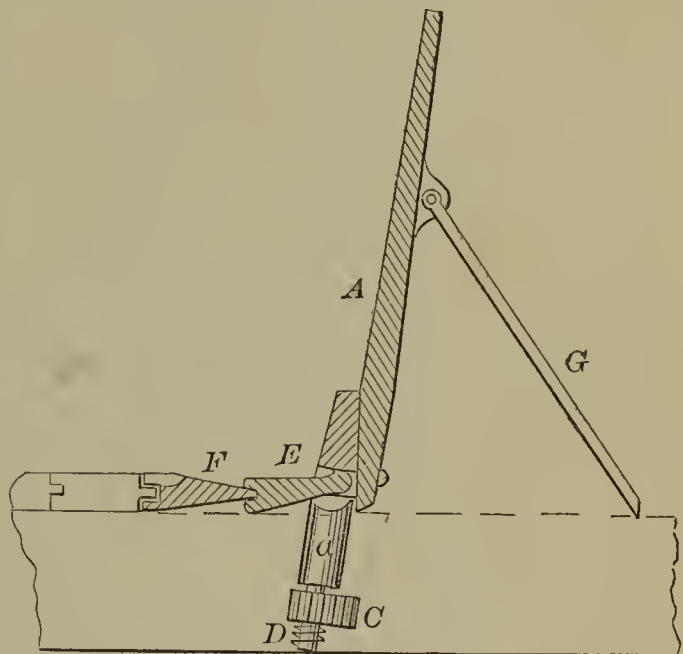

55423—J. Lippincott—Saw.

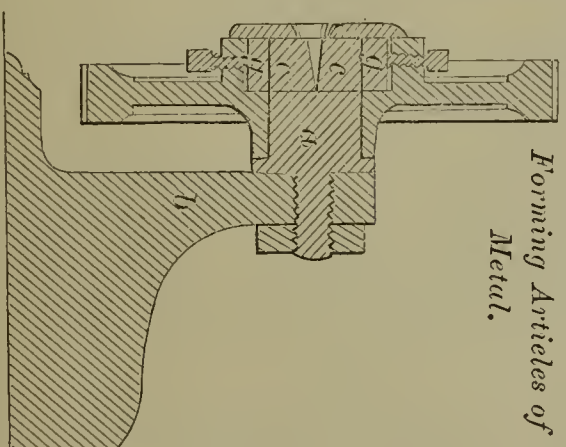
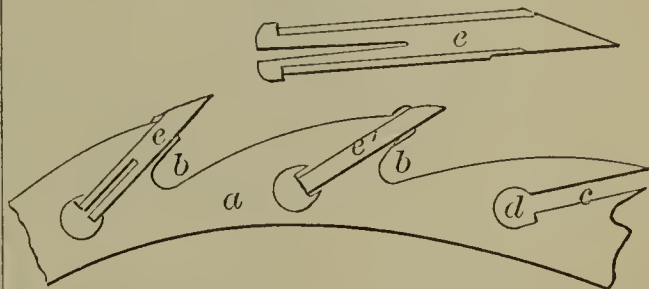

55425—E. J. Manville—Forming Articles of Metal.

55427—D. R. Paiste—Harvester.

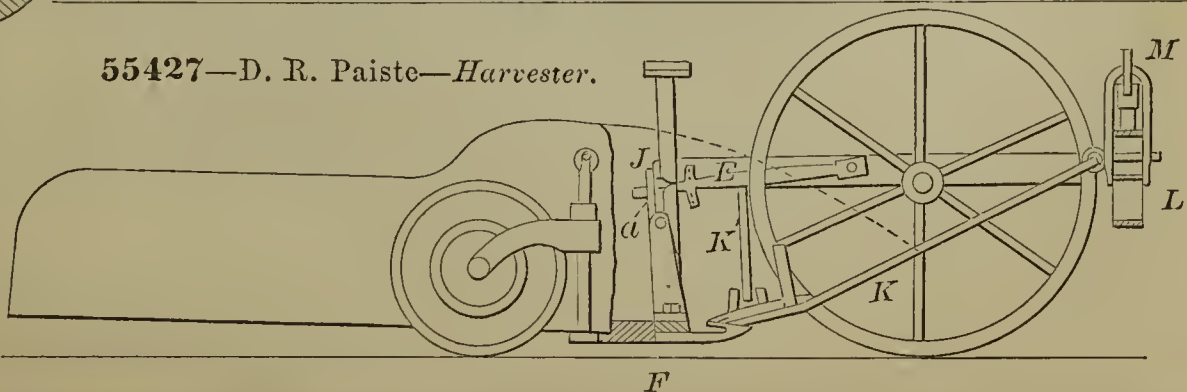

F

55433—S. H. Wheeler—Measuring Pump.

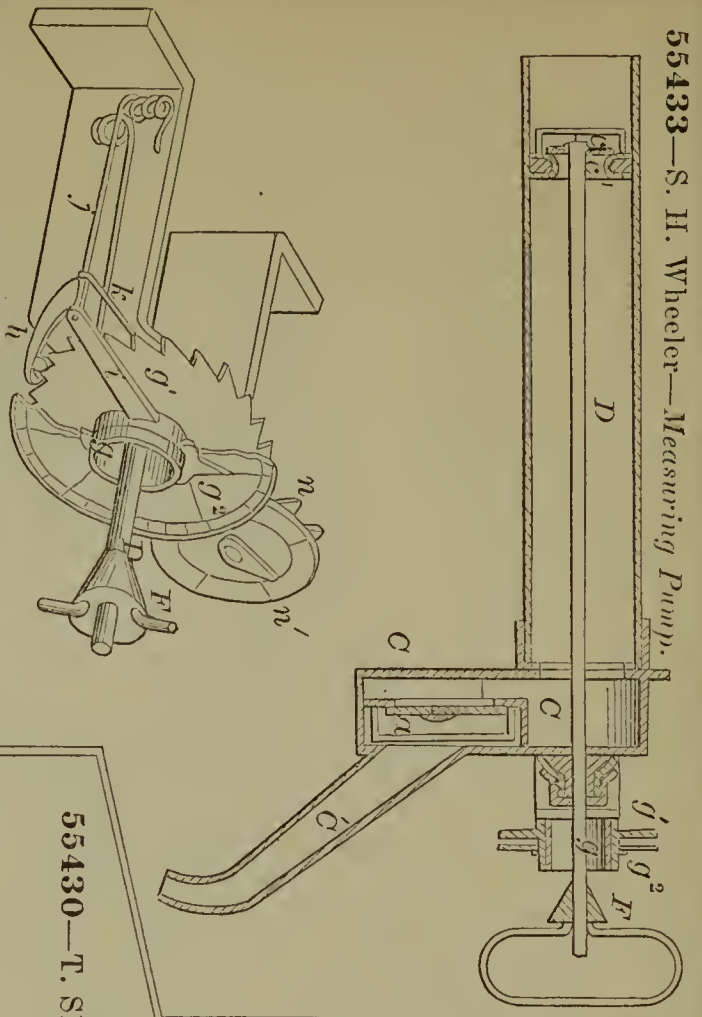

55429—Sangster & Boyd—Mop.

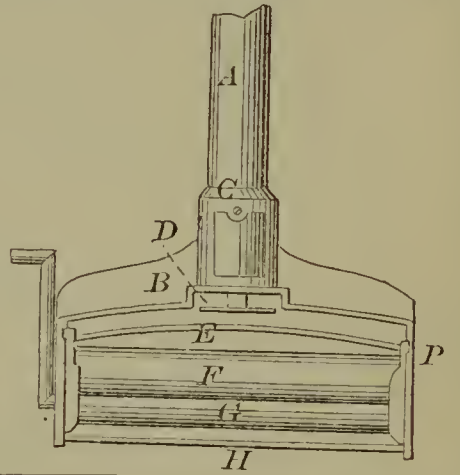

55434—J. G. Wilson—Knitting Machine.

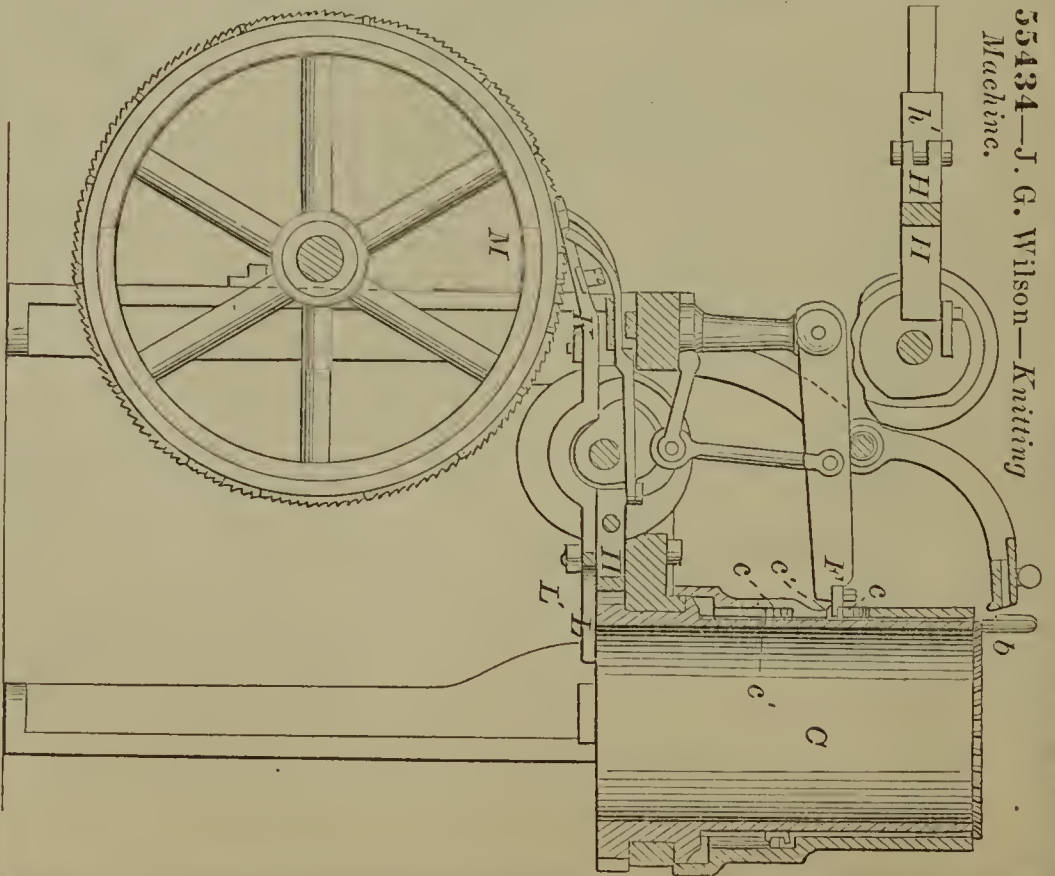

55428—S. H. Roper—Hot Air Engine.

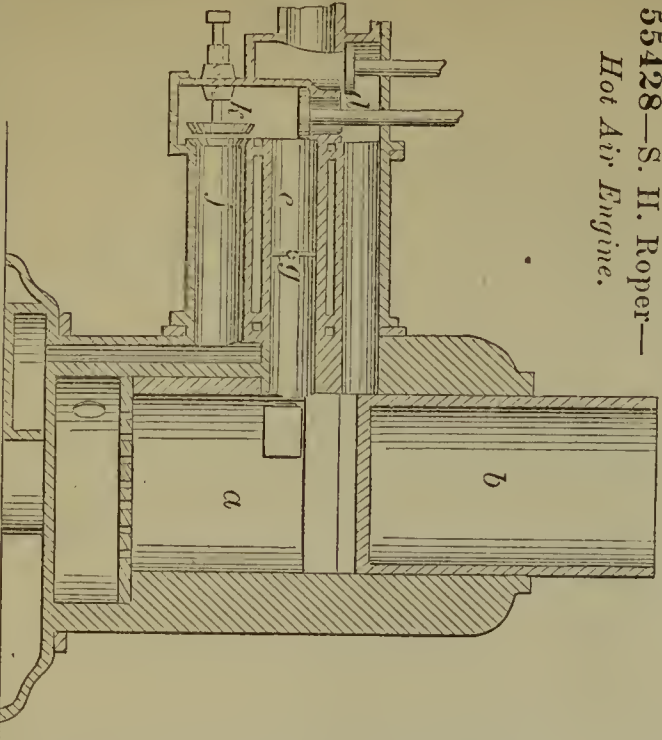

55430—T. Sheldon—Lifting Jack.

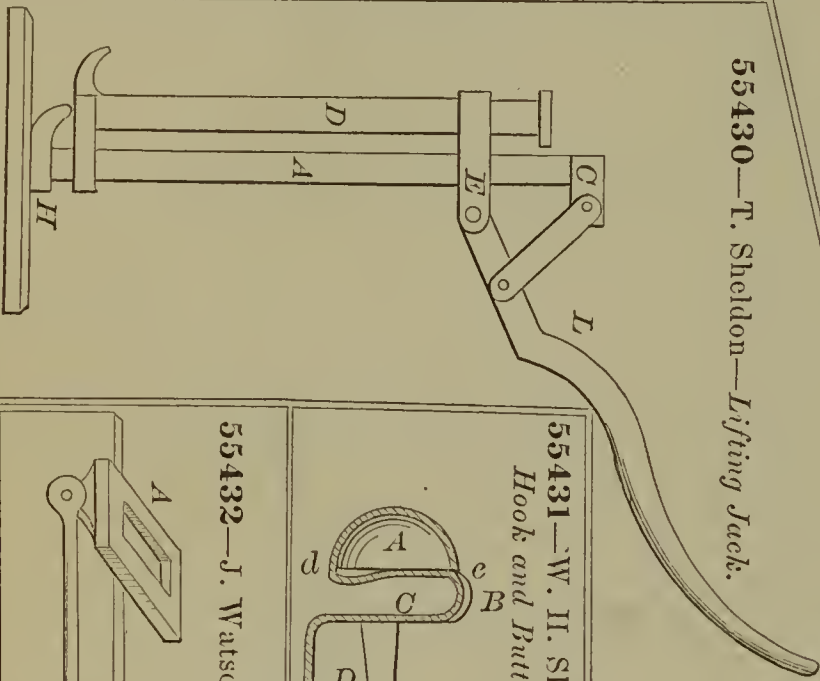

55431—W. H. Shurtleff—Hook and Button.

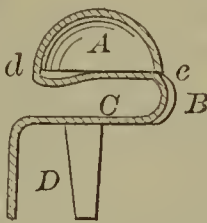

55432—J. Watson—Brick Machine.

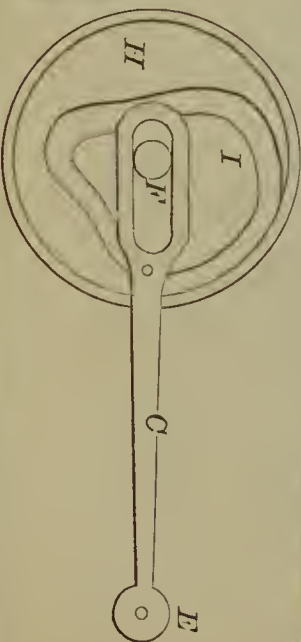

55435—S. H. Wilson—*Pitman Head for Harvesters, &c.*

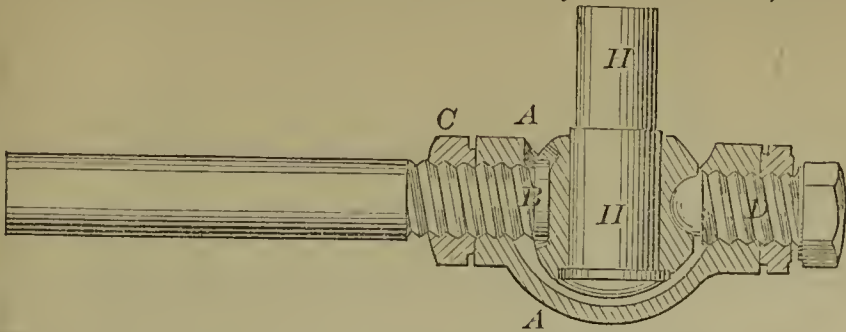

55437—H. C. Wooding—*Attaching Axes to Handles.*

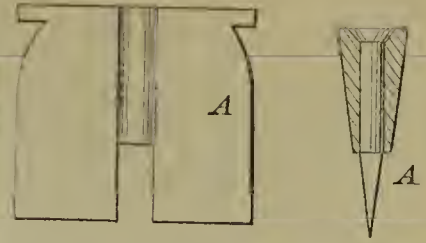

55440—R. Hornsby—*Reaping Machine.*

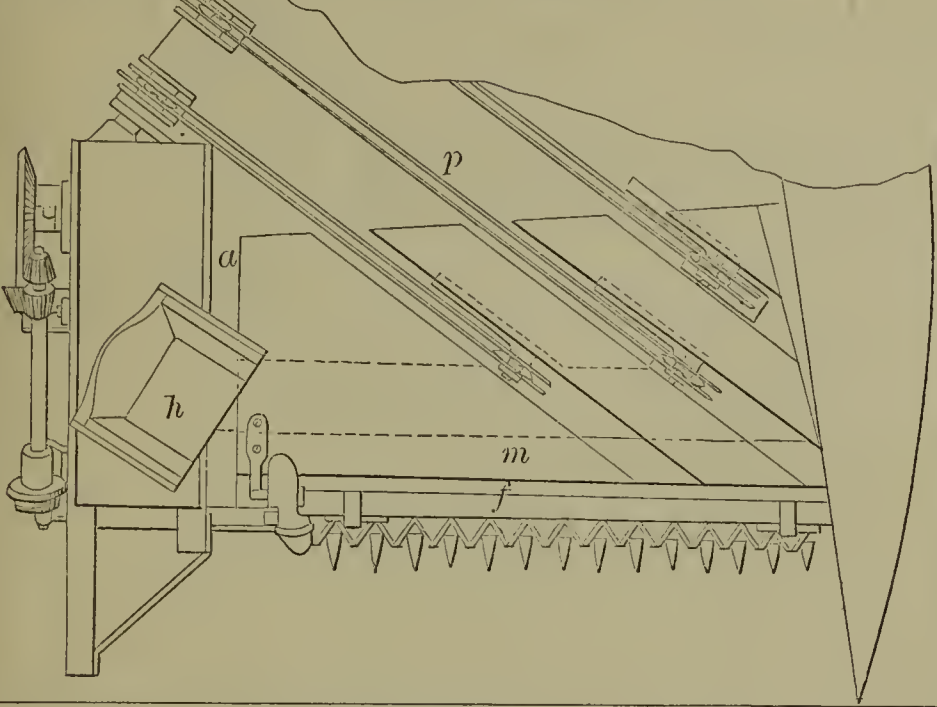

55439—Goodier & Kilshaw—*Paddle Wheel.*

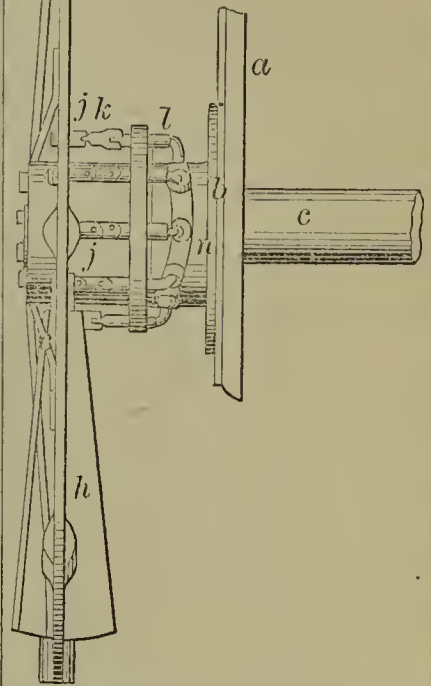

55436—G. L. Witsil—*Lamp Chimney.*



55442—

A. Lohage—*Casting Steel.*

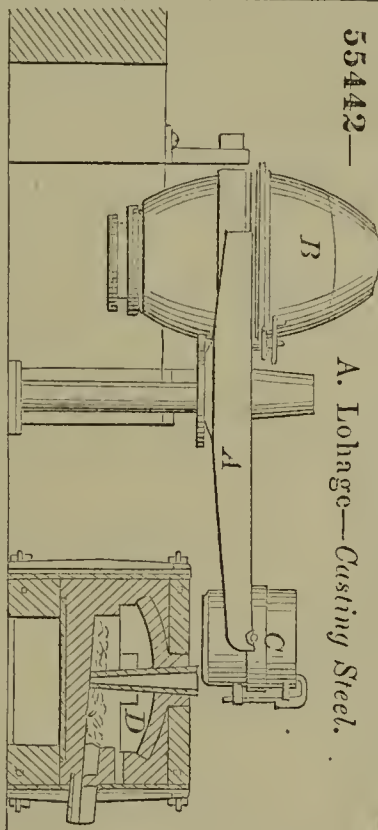

55443—O. Sarony—*Photographic Rest.*

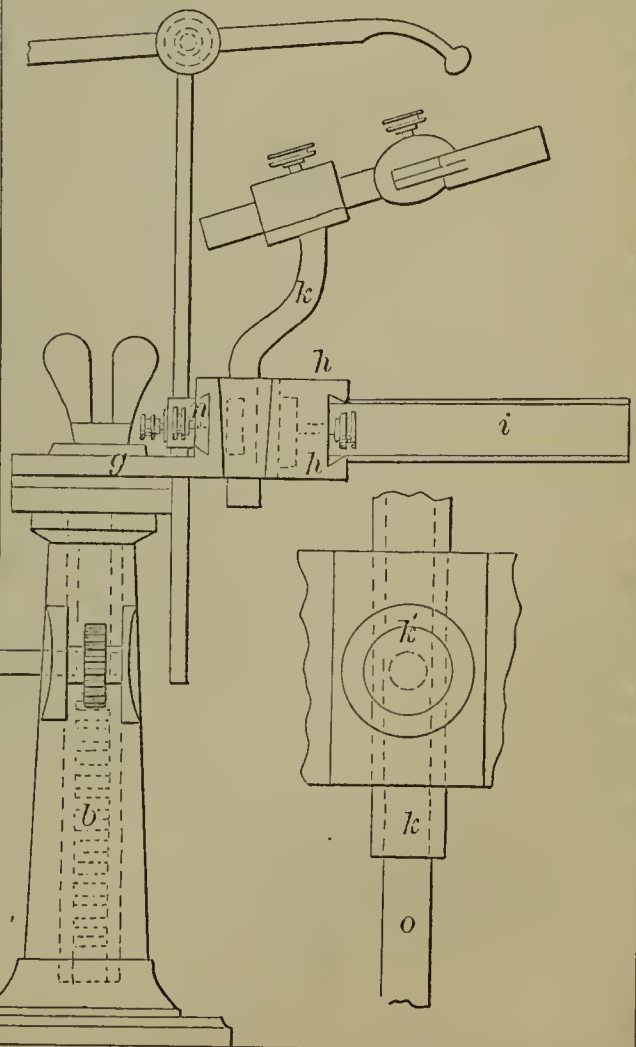

55441—G. L. Leclauche—*Galvanic Battery.*

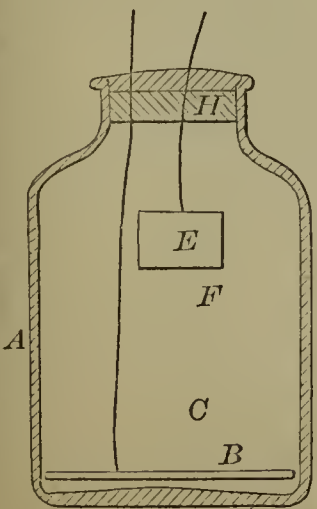

55438—H. B. Fox—*Bottle Stopper.*

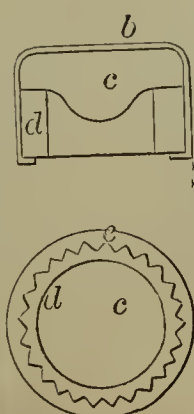

55444—J. & W. Thornton—*Knitting Machine.*

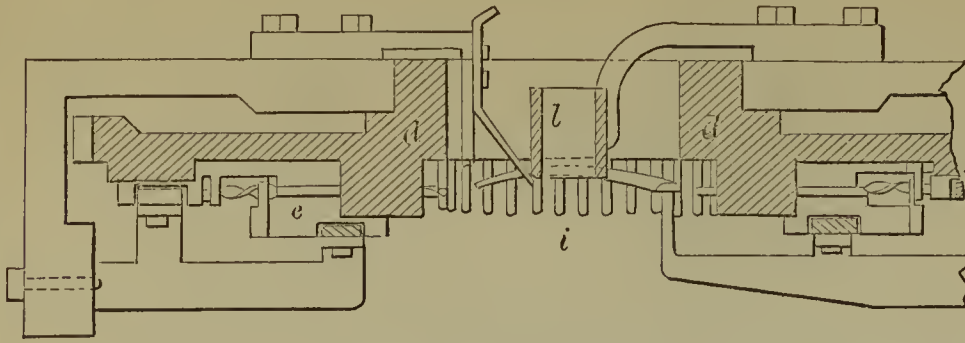

55445—V. Ward—*Hitching Post.*

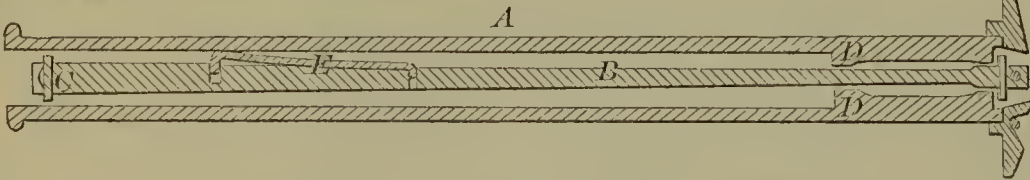

55446—D. S. Abbot—*Flax Dressing Machine.*

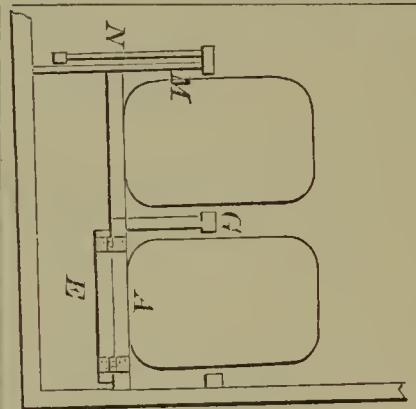
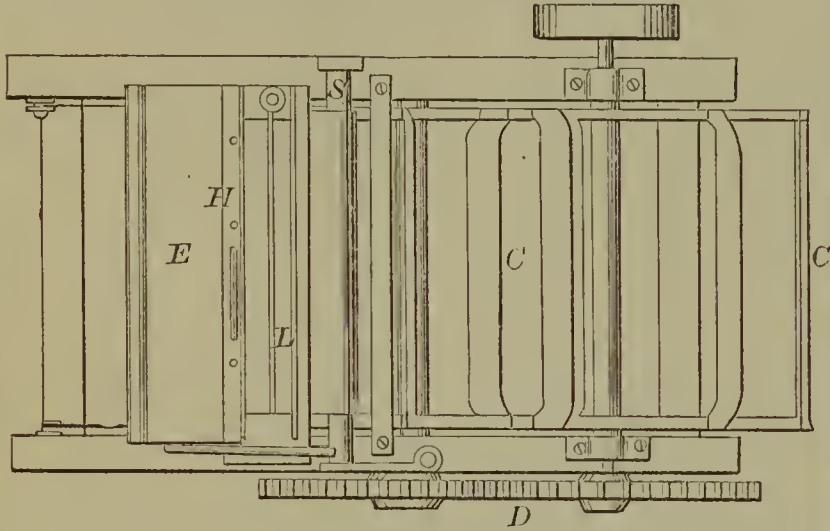

55448—H. Allen—*Seat and Couch for Railroad Cars.*

55451—J. C. Arms—*Paper Bosom and Collar.*

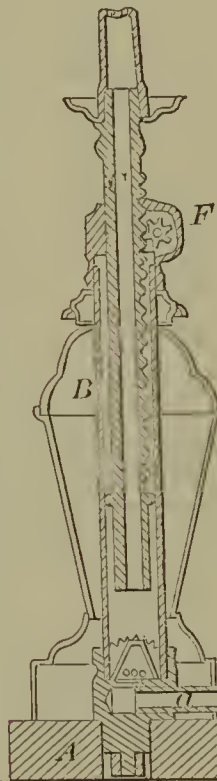
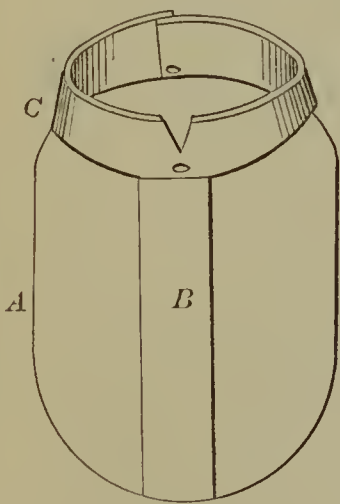

55447—Allen & Riddell—*Portable Gas Stand.*

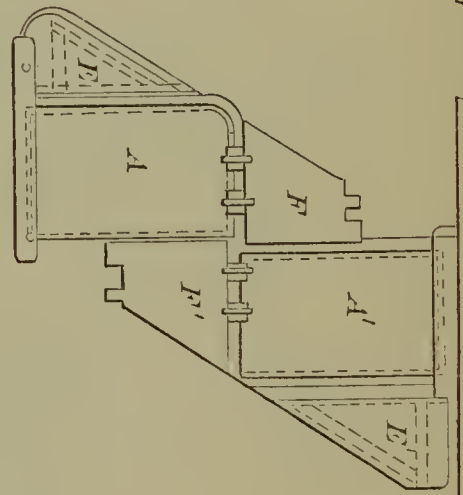

55453—D. L. Babcock—*Bolster for Wagons*

55454—J. B. Bailey—*Curtain Fixture.*

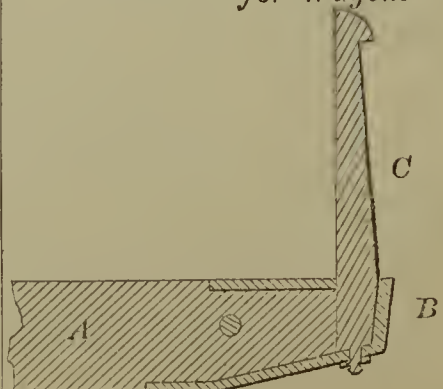
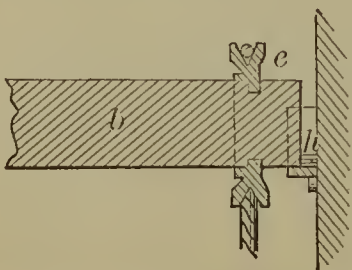

55450—H. C. Appleby—*Lamp Chimney.*



55455—H. T. Barker—Fastening for Fruit Boxes.

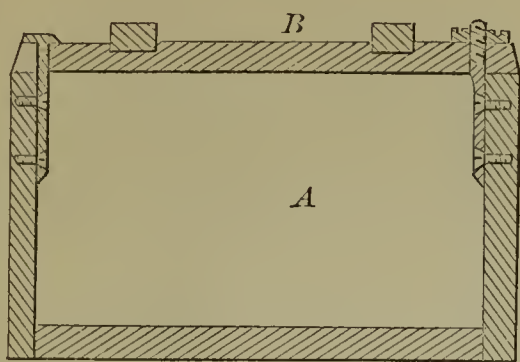

55456—Bradt & Hayes—Railroad Switch.

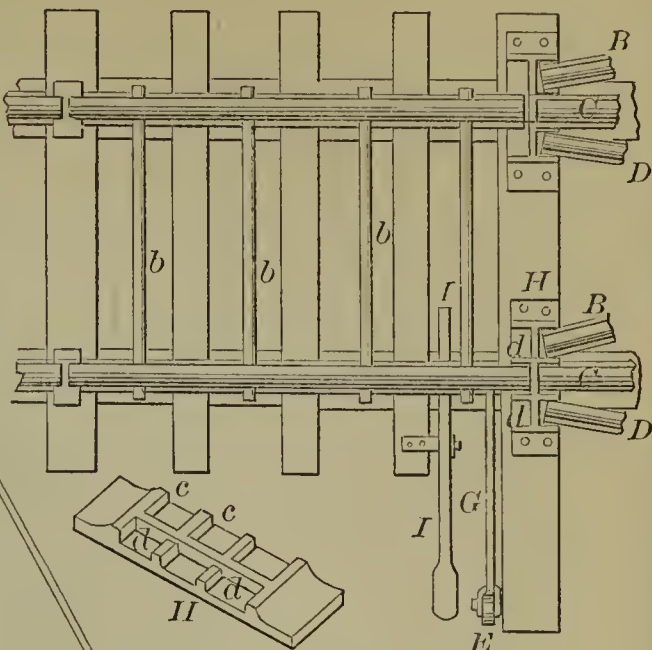

55460—B. V. M. Brouse—Lock.

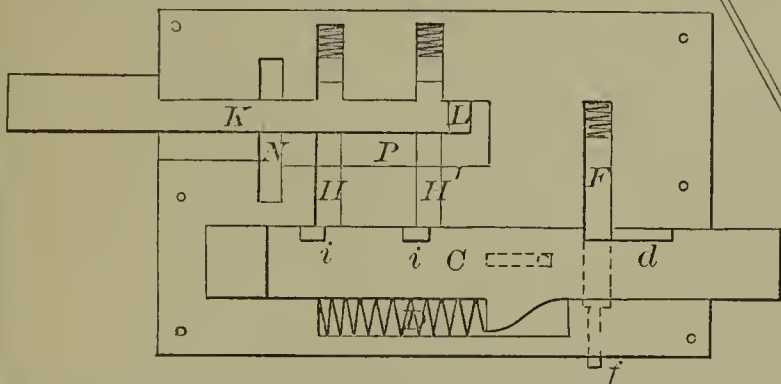

55457—A. Bridges—Suspending Cars upon Springs.

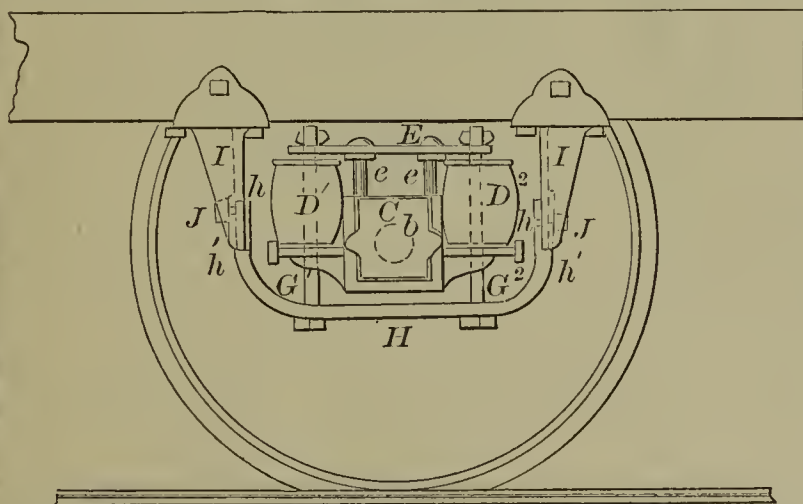

55461—J. D. Browne—Centrifugal Machine.

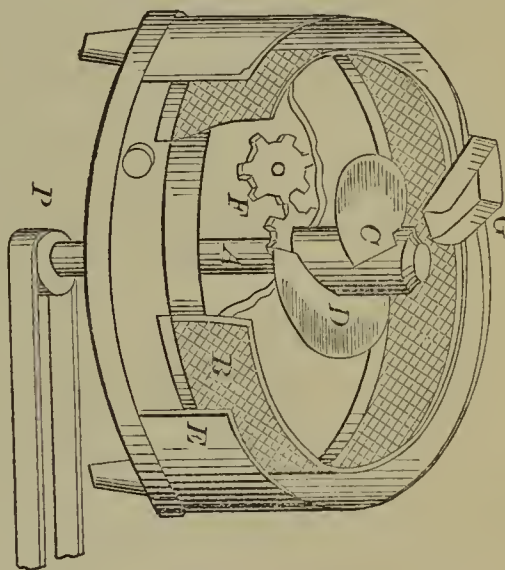

55458—A. Brigham—Dust Receptacle.

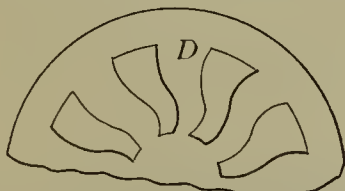
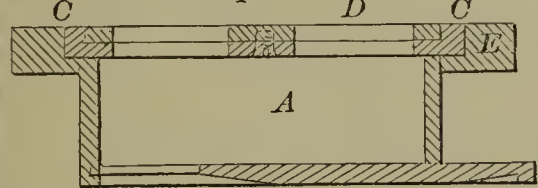

55462—D. W. Burbank—Bed Bottom.

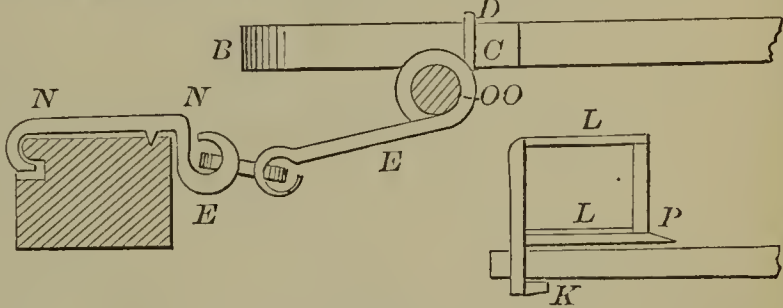

55463—J. Burgum—For Keeping Meat and Brine.

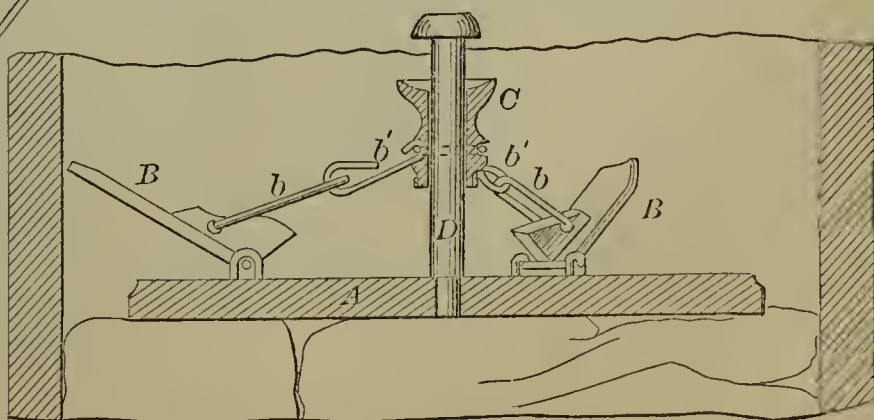

55459—J. Bringhurst—Artificial Leg.

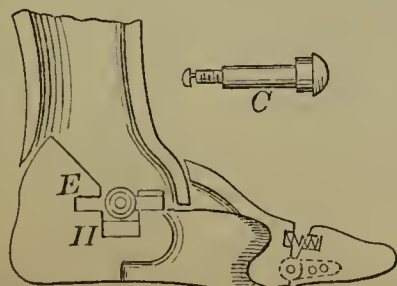

55464—Butler & Hatfield—Starting Cars.

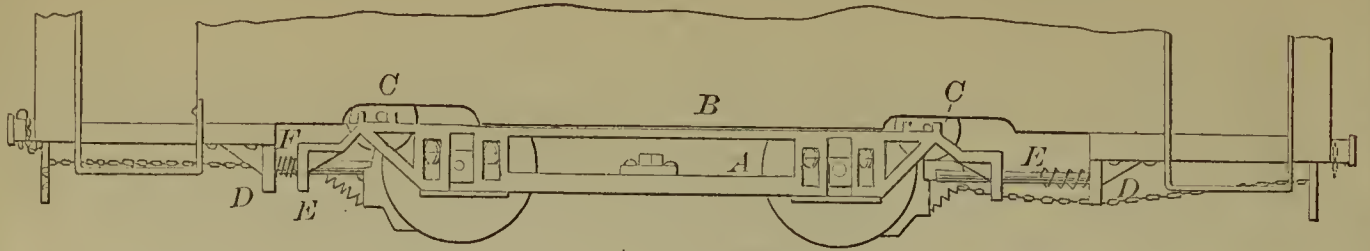

55468—J. E. Coffin—For Curving the Backs of Books.

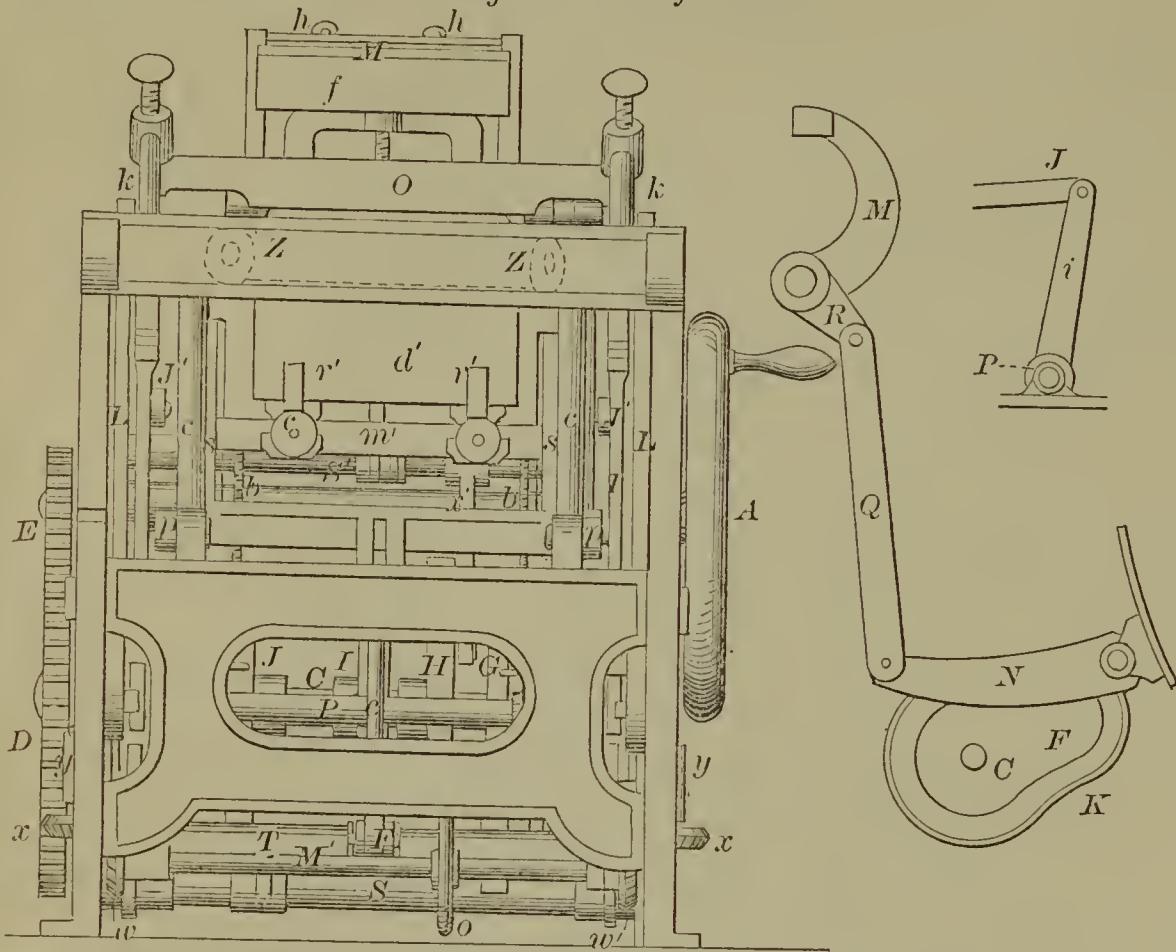

55466—G. Chilson—Cooking Stove.

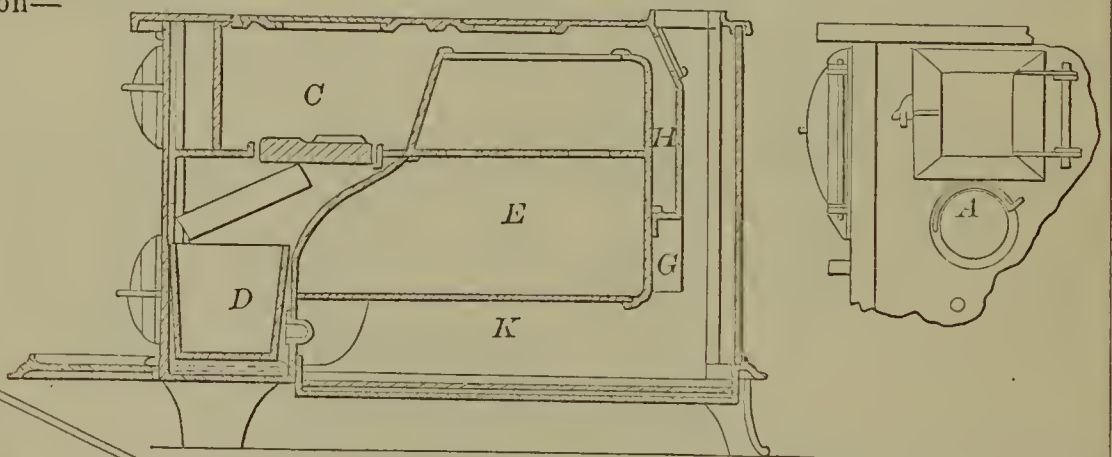

55469—H. H. Cole—Fluting Machine.

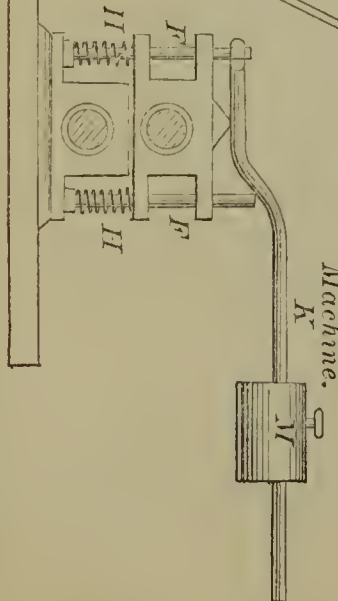

55465—O. B. Buttes—Dental Impression Cup.



55467—M. Clark—Reaping and Mowing Machine.

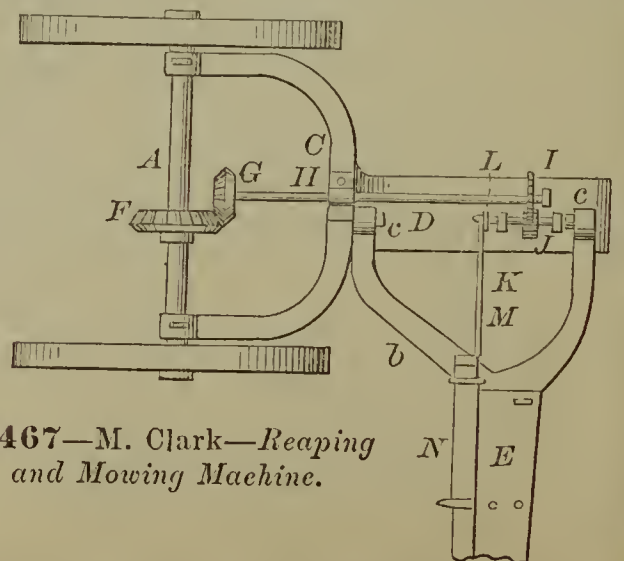

55470—B. D. Cook—*Seeding Machine.*

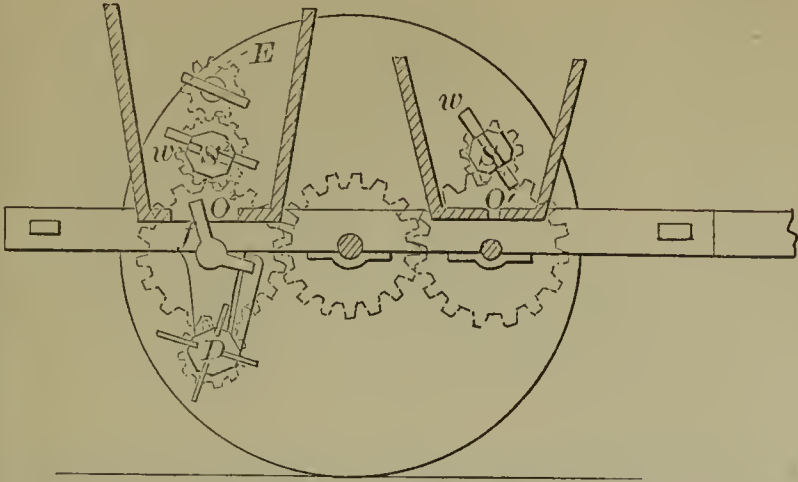

55472—Custer & Rowland—*Plow Cutter.*

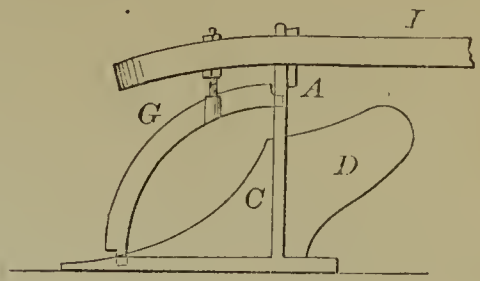

55473—J. G. De Coursey—*Mosquito Net.*

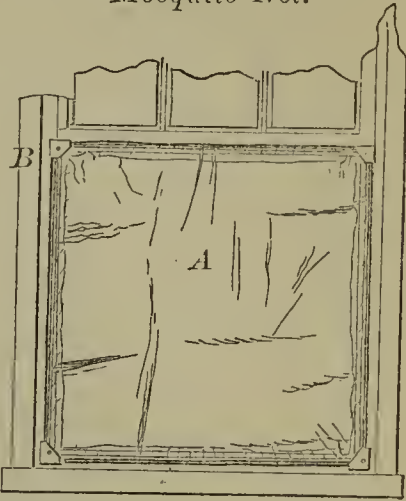

55471—E. H. Cook—*Washing Machine.*

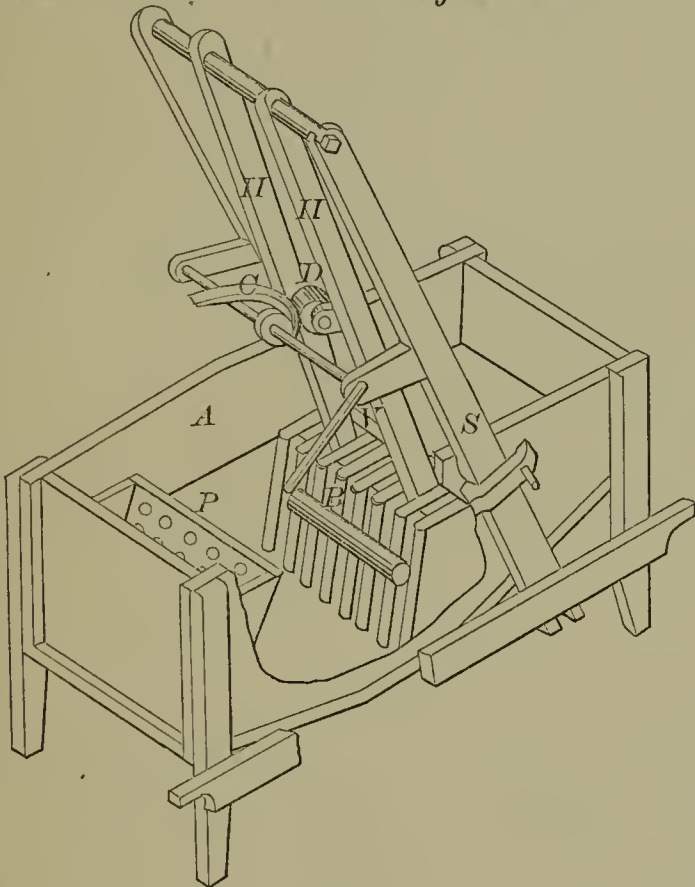

55475—J. W. Elliot—*Sash Fastener.*

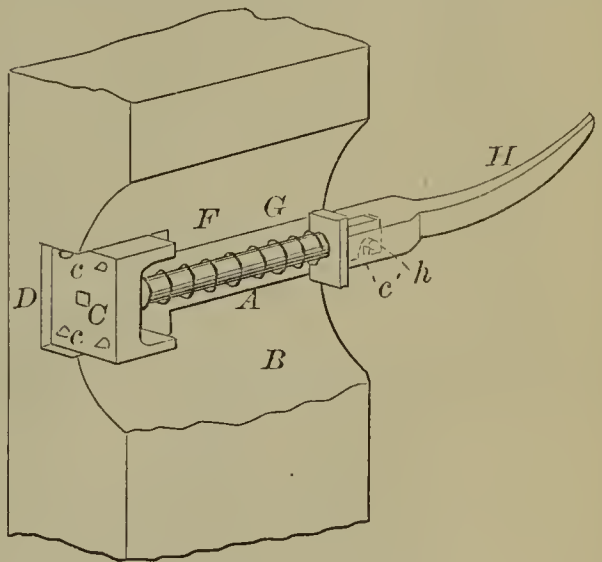

55476—W. Elliott—*Farm Gate.*

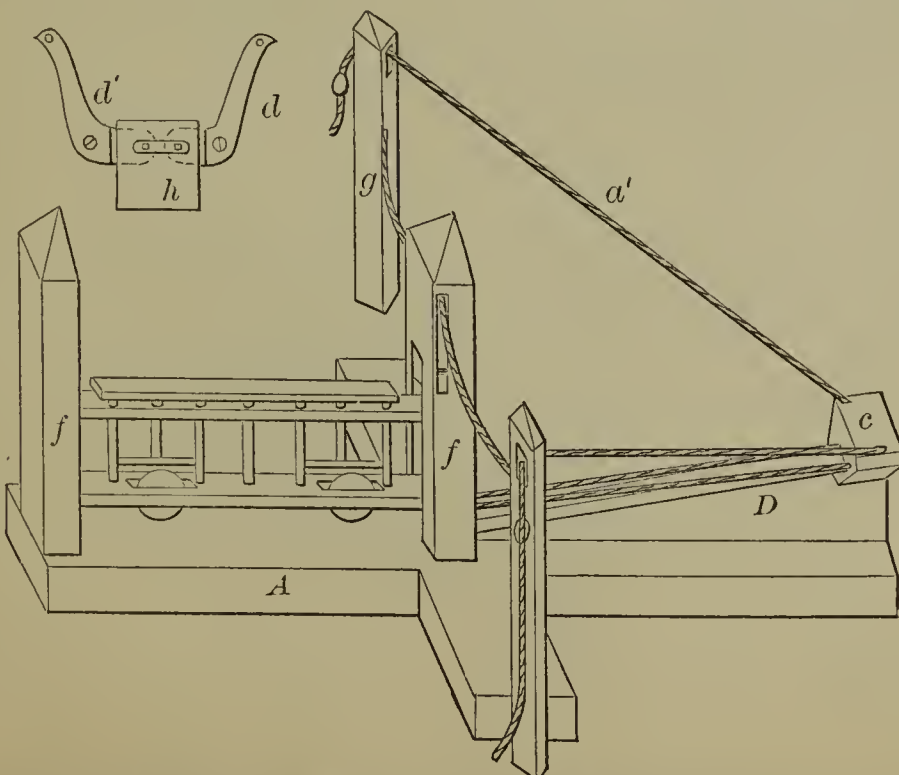

55477—L. S. Enos—*Door Fastening.*

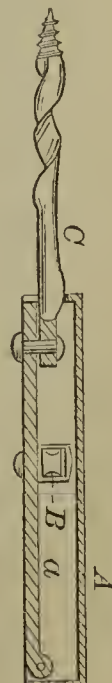

55478—J. B. Fairchild—Animal Trap.

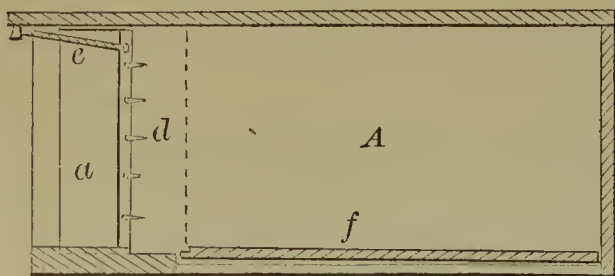

55480—T. W. Fox—Expelling Water from the Holds of Vessels.

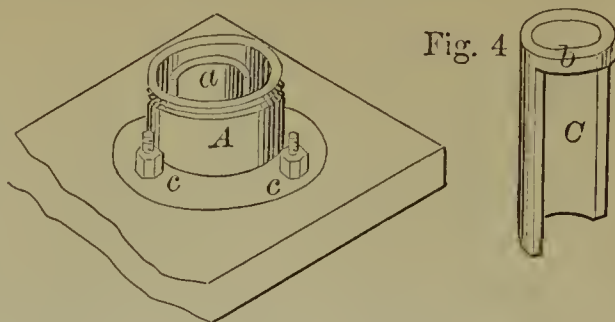

55483—

M. Gates—Pruning Hook.

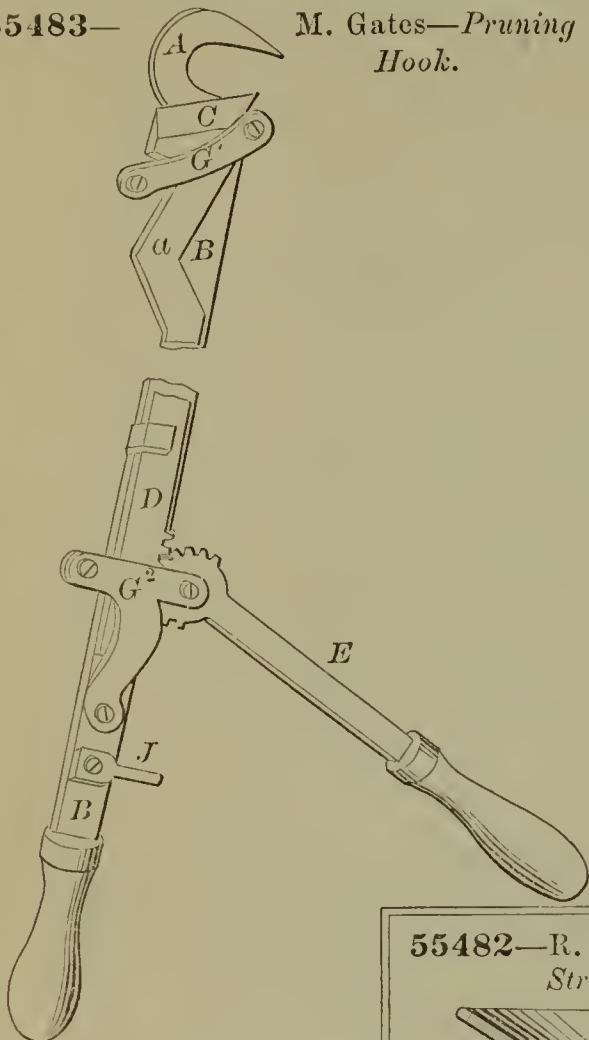

55481—P. Freeman—Gate.

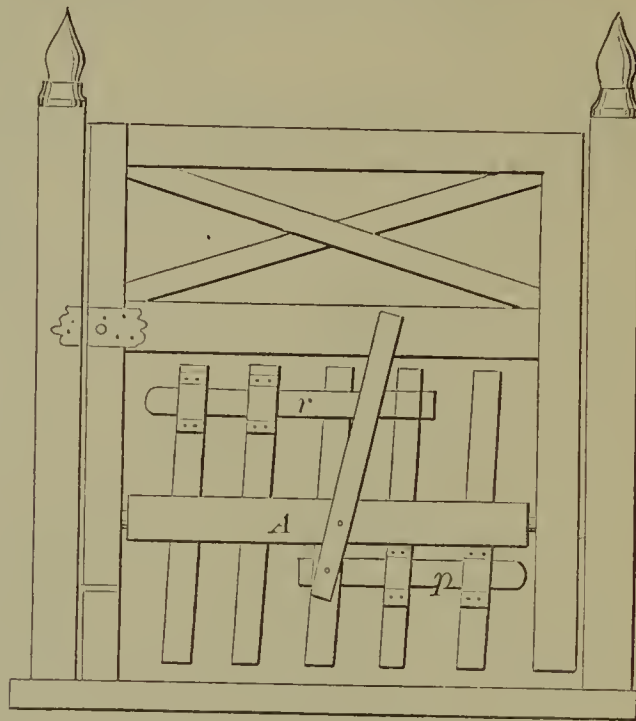

55482—R. B. Fuller—Vase for Strawberries.

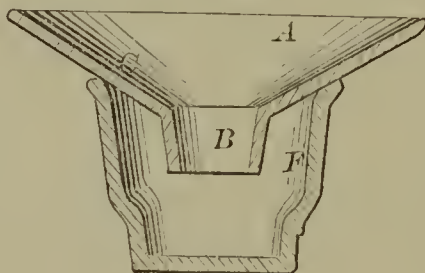

55479—J. M. Foss—Draft Pipe for Locomotives.

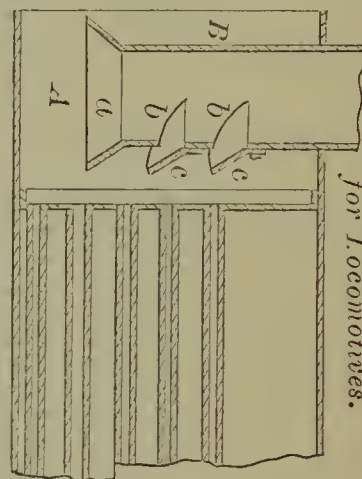

55484—A. J. Gibson—Churn Dasher.

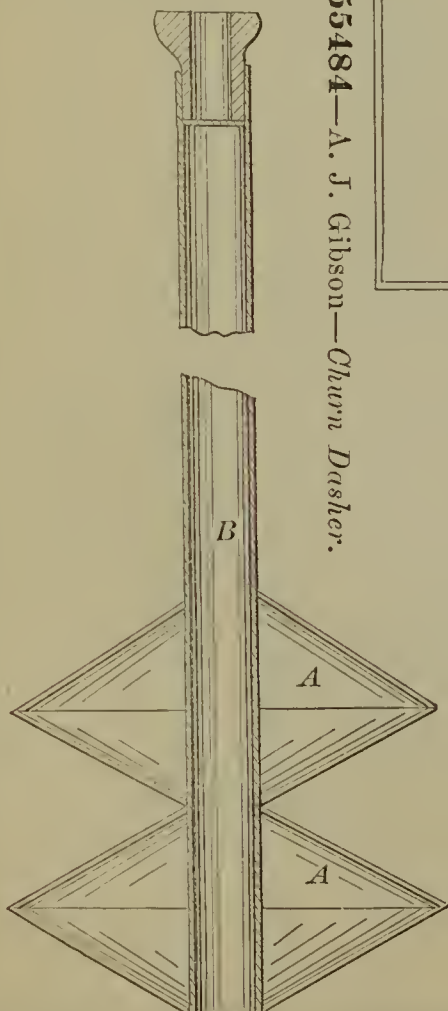

55485—W. Gilman—Corn Sheller.

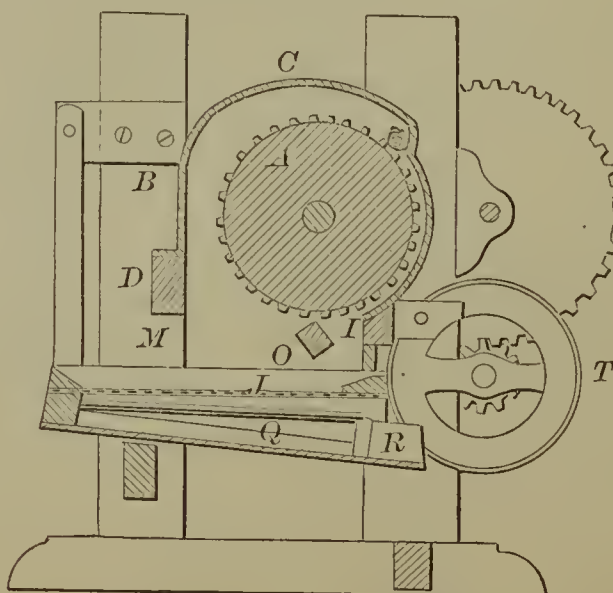



55486—R. Gipson—Clothes Wringer.

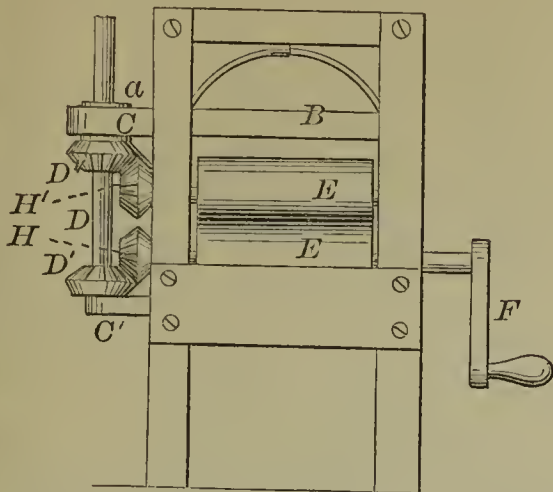

55488—J. Greaves—Rock Drill.

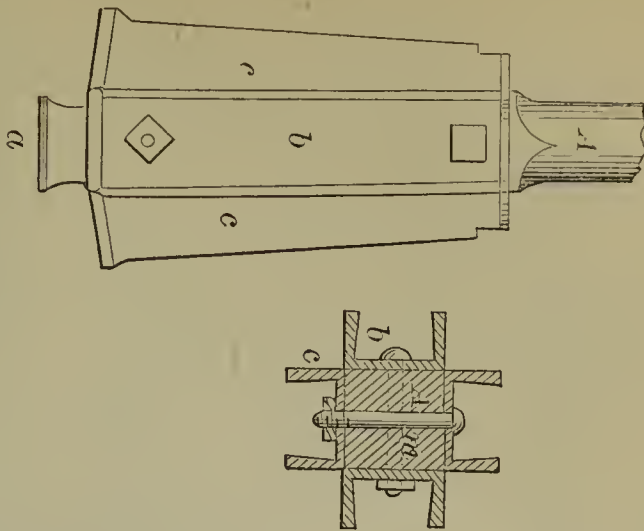

55487—W. F. Goodwin—Harvester Rake.

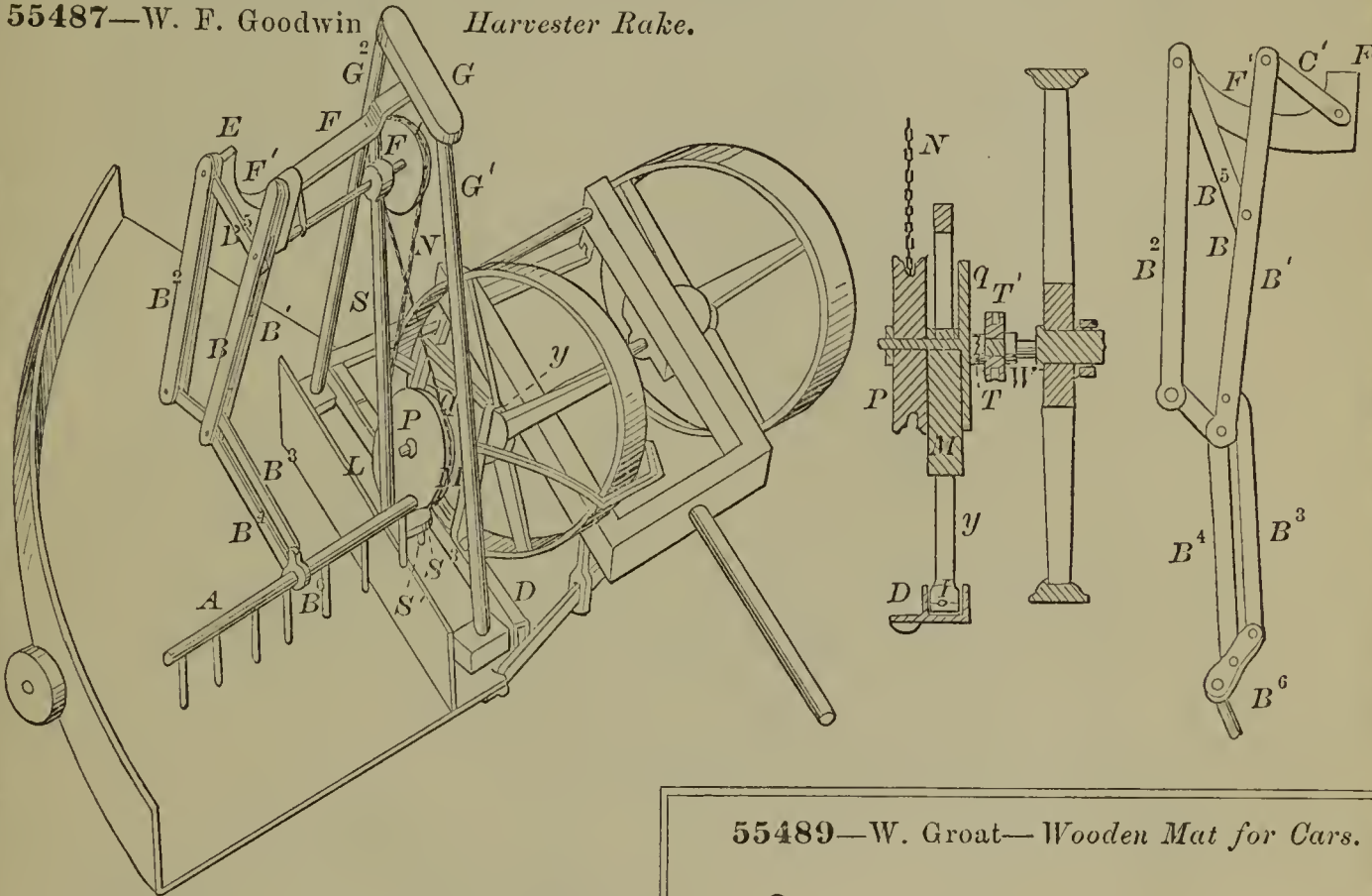

55489—W. Groat—Wooden Mat for Cars.

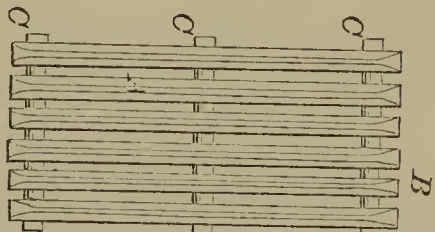

55490—P. S. Haines—Treating Wool for Picking.

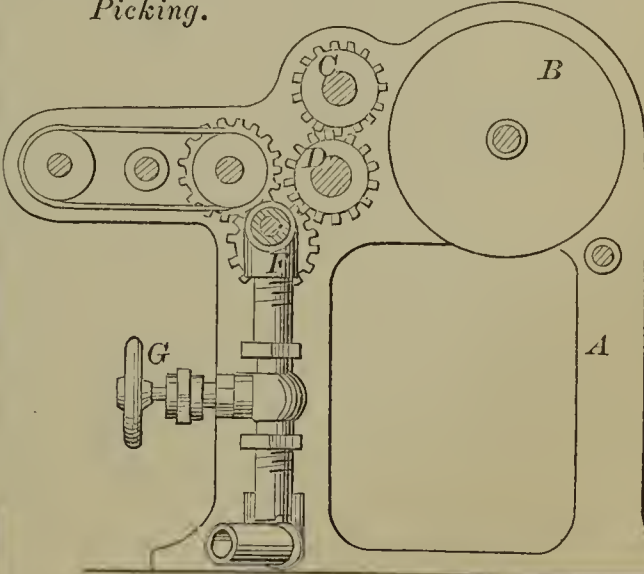

55491—A. W. Hall—Churn.

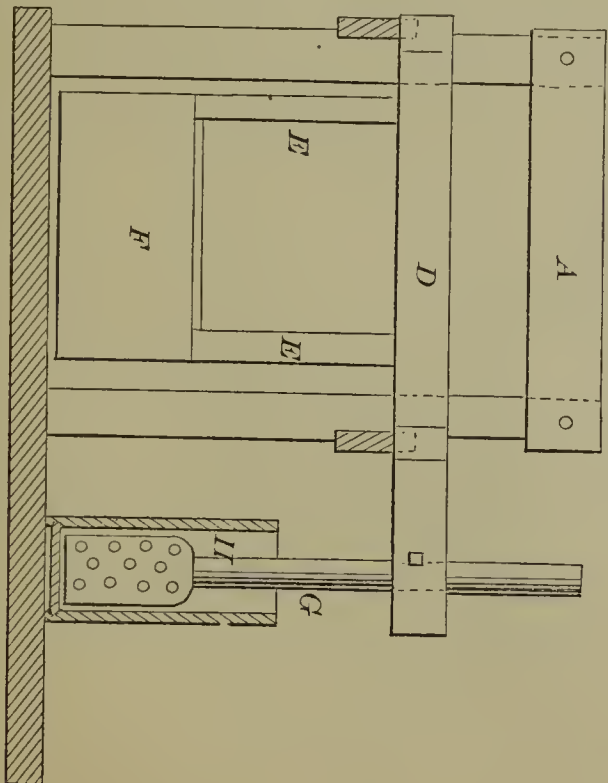

55492—C. Hope—*Revolving Desk.*

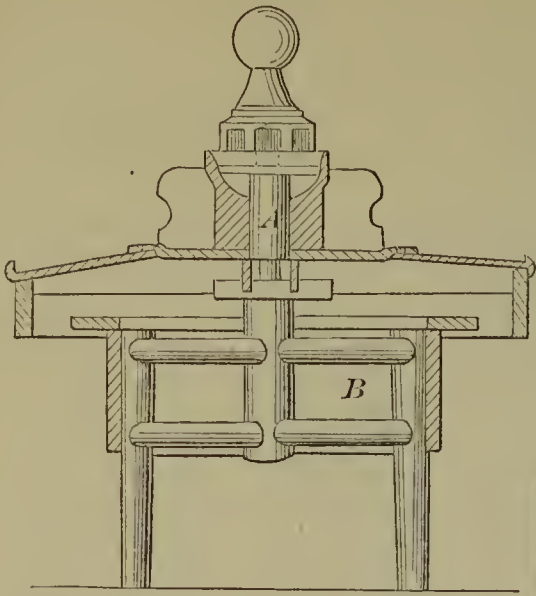

55494—H. Willard—*Transfer Switch.*

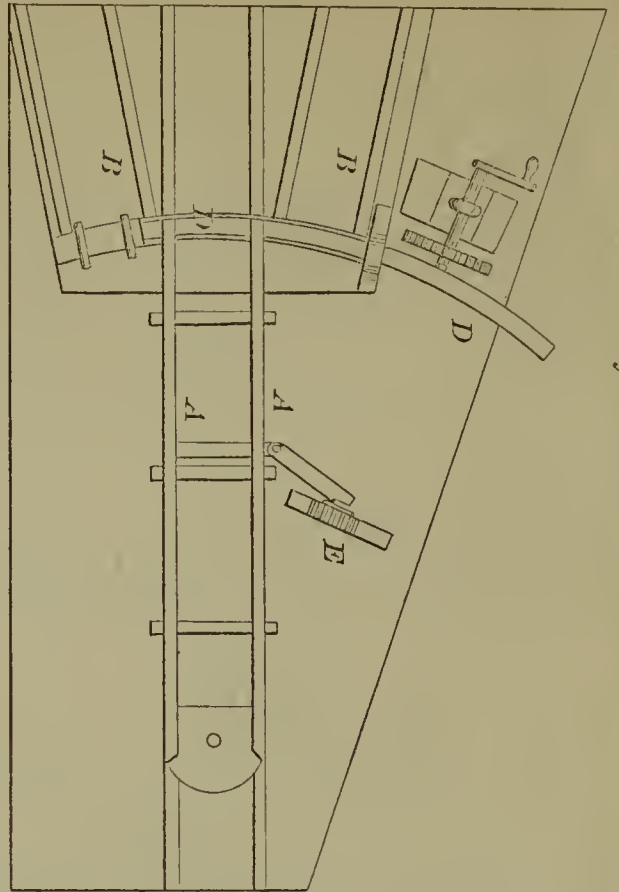

55493—B. Hotchkiss—*Screw Tap.*

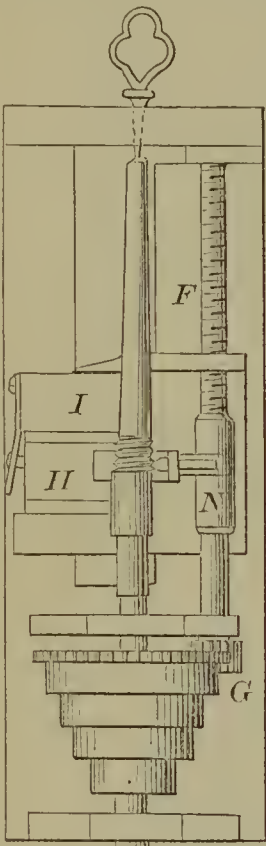

55495—S. Houghton—*Hoop Skirt Wire.*



55497—E. P. Irons—*Saw Mill.*

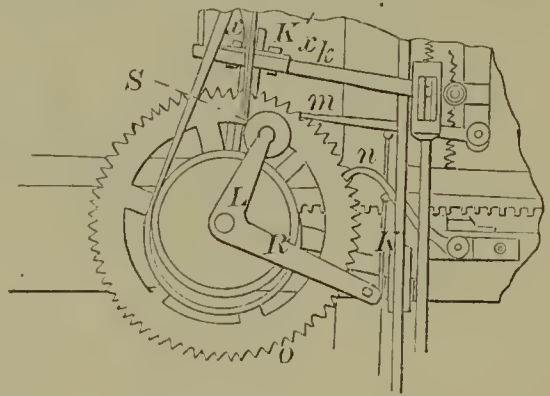

55496—E. Hutchinson—*Invalid Bedstead.*

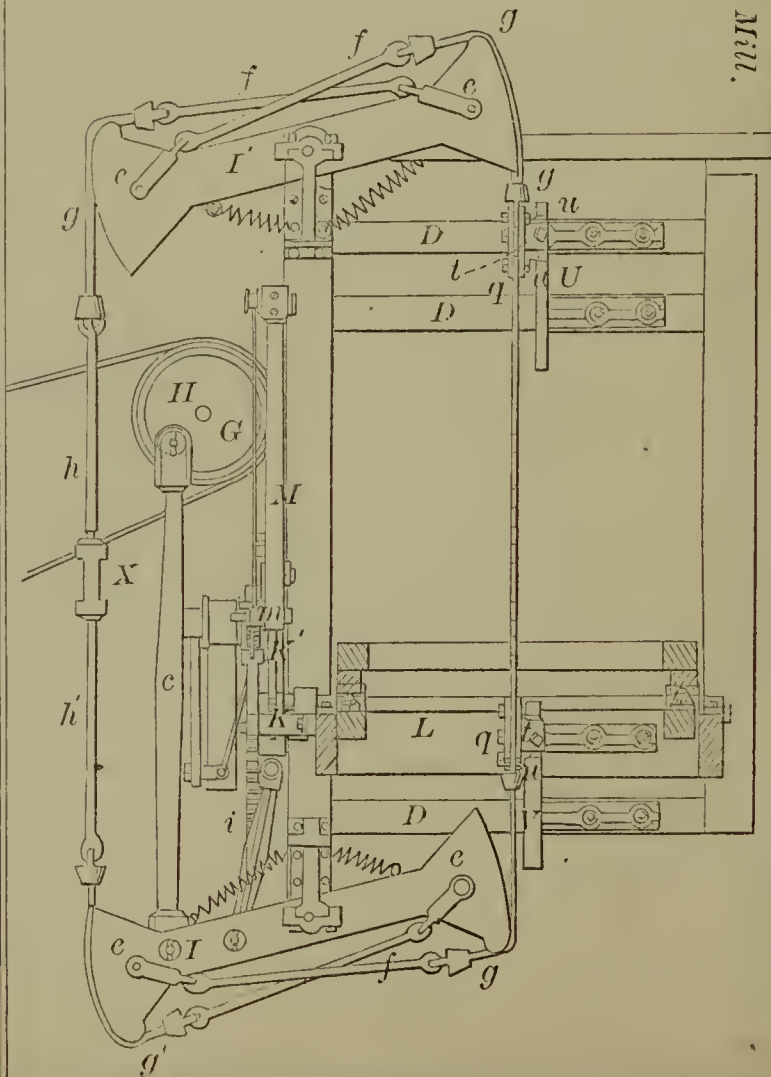
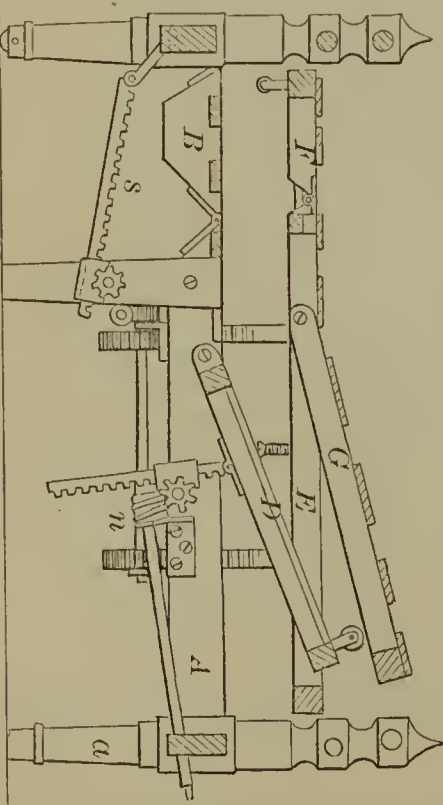

55498—R. Jennings—*For Swaging the Ends of Auger Blanks.*

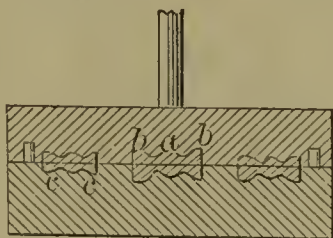

55500—F. G. Johnson—*Knob Lock.*

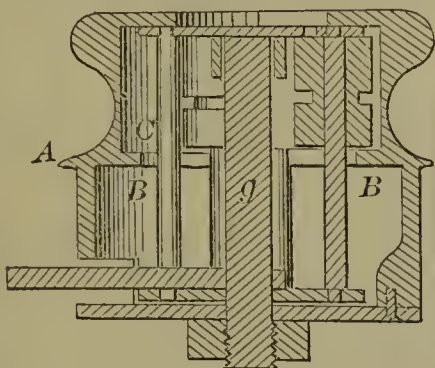

55505—H. Last—*Gate Hinge.*

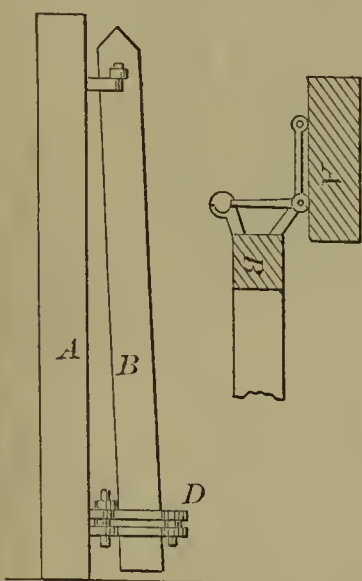

55504—P. W. Lamb—*For Moulding Castings.*

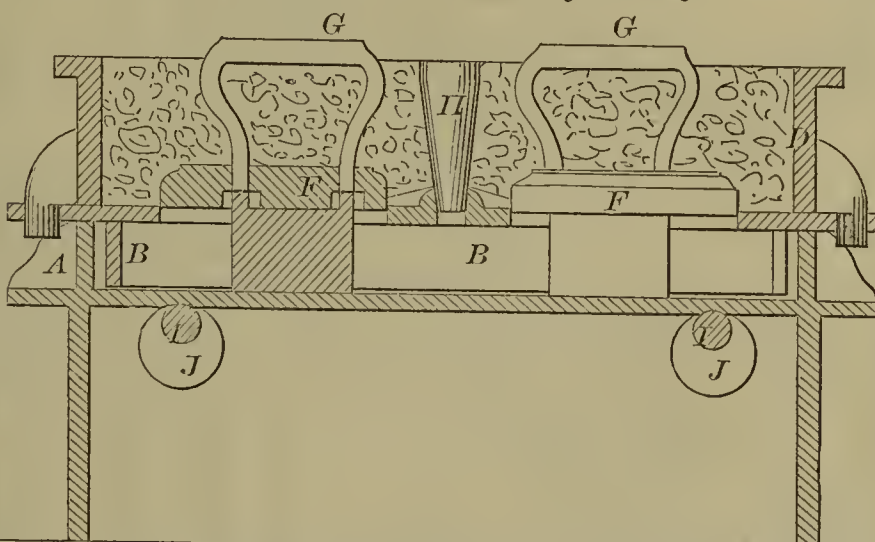

55499—A. Johnson—*Trimming Mitre Joints.*

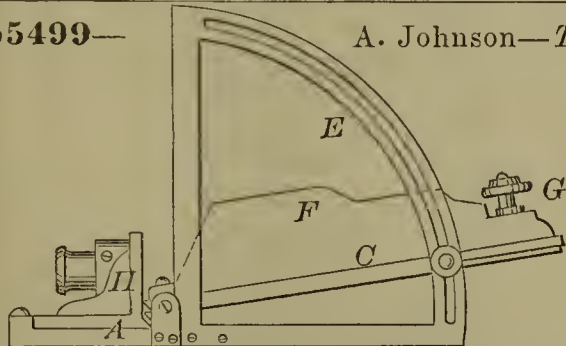

55506—O. B. Latham—*Rope Guard.*

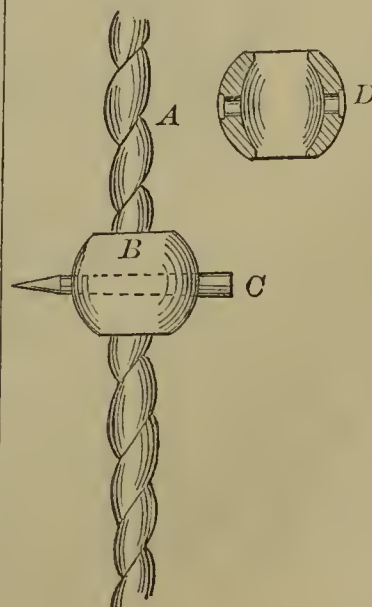

55503—J. S. & E. B. Lake—*Weighing Scale.*

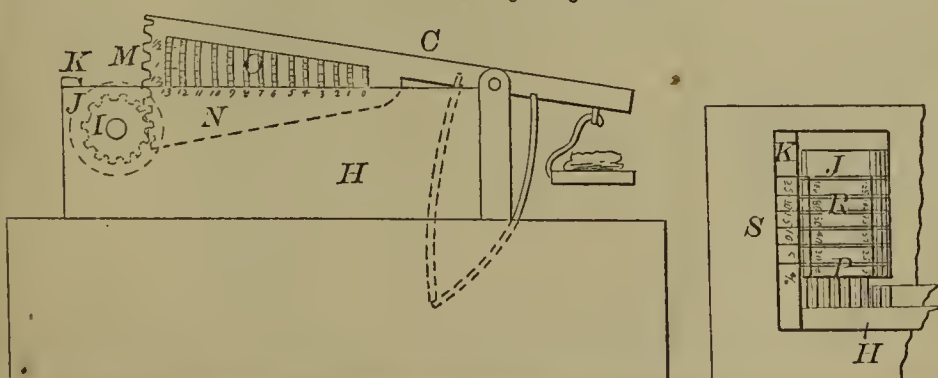

55501—E. Kaylor—*Bolt Heading Machine.*

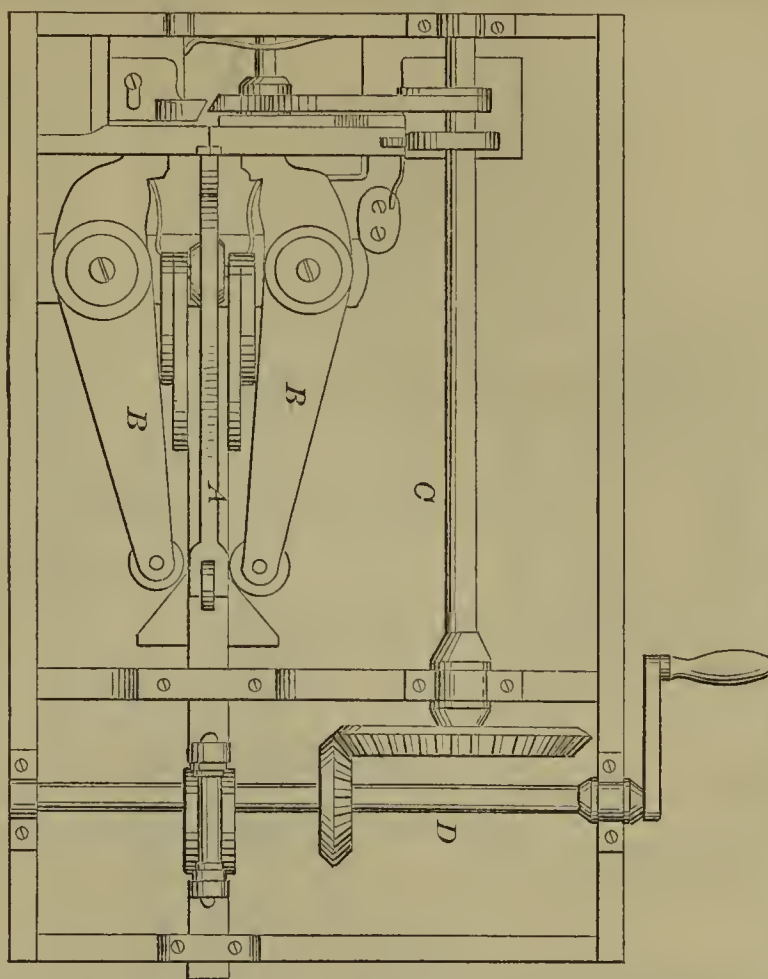

55508—E. C. Leonard—Churn.

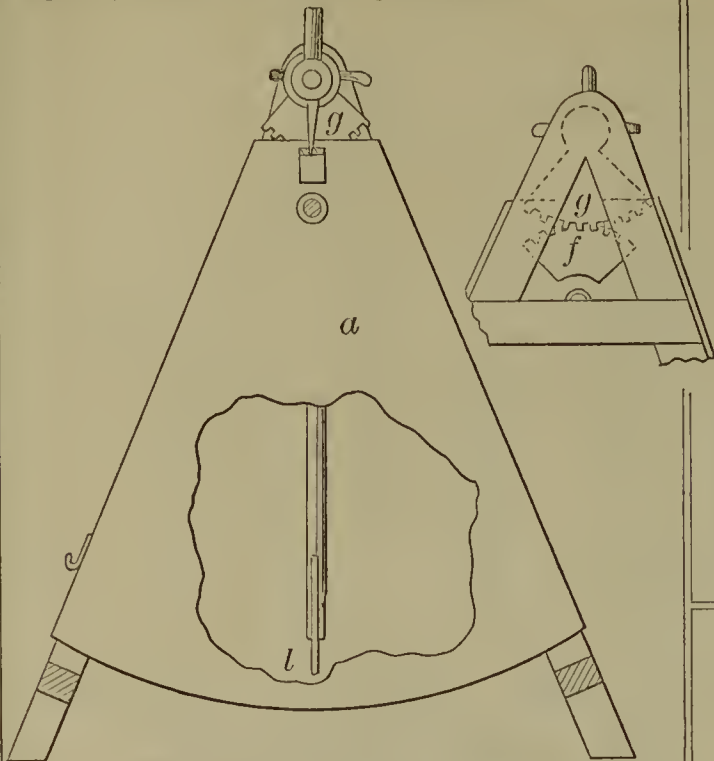

55509—F. Liesche—For Making Coffee.

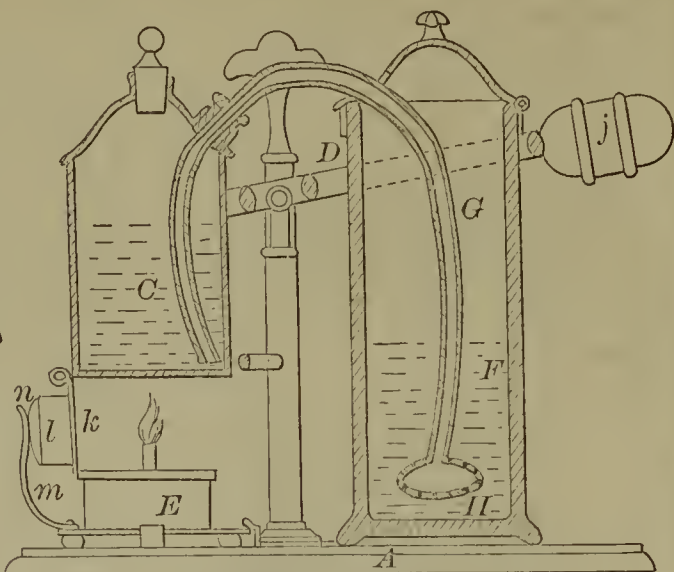

55511—C. Leutz—Speculum.

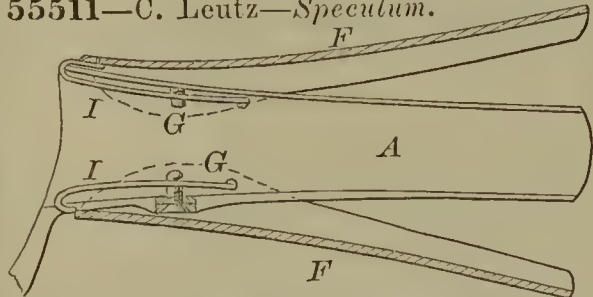

55512—J. Letchworth—Fruit Jar.

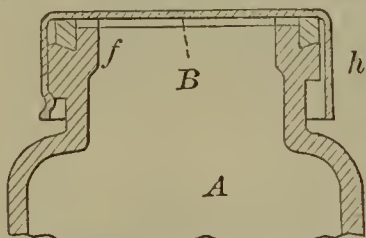

55513—J. Letzkus—Squeezer.

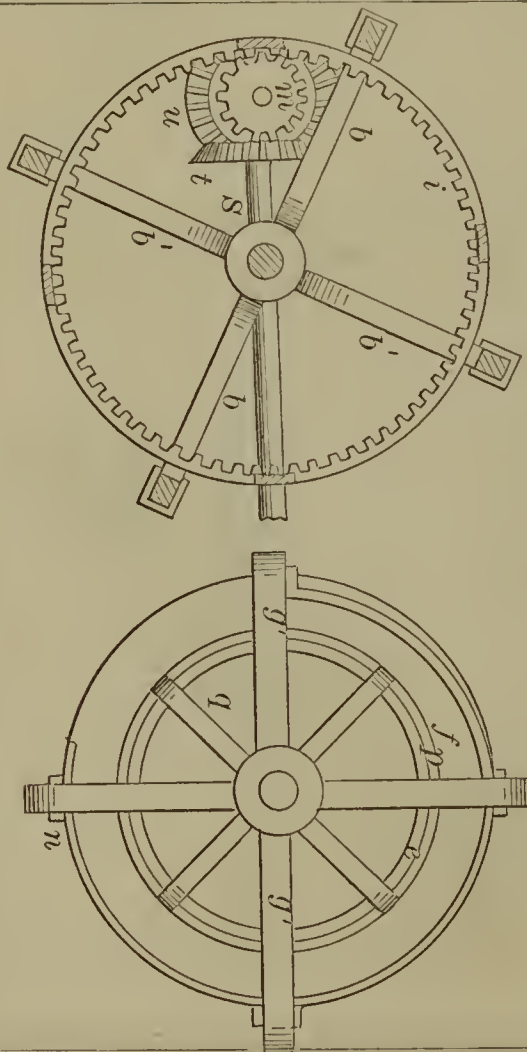

55514—T. Lindsley—Rock Tunneling Machine.

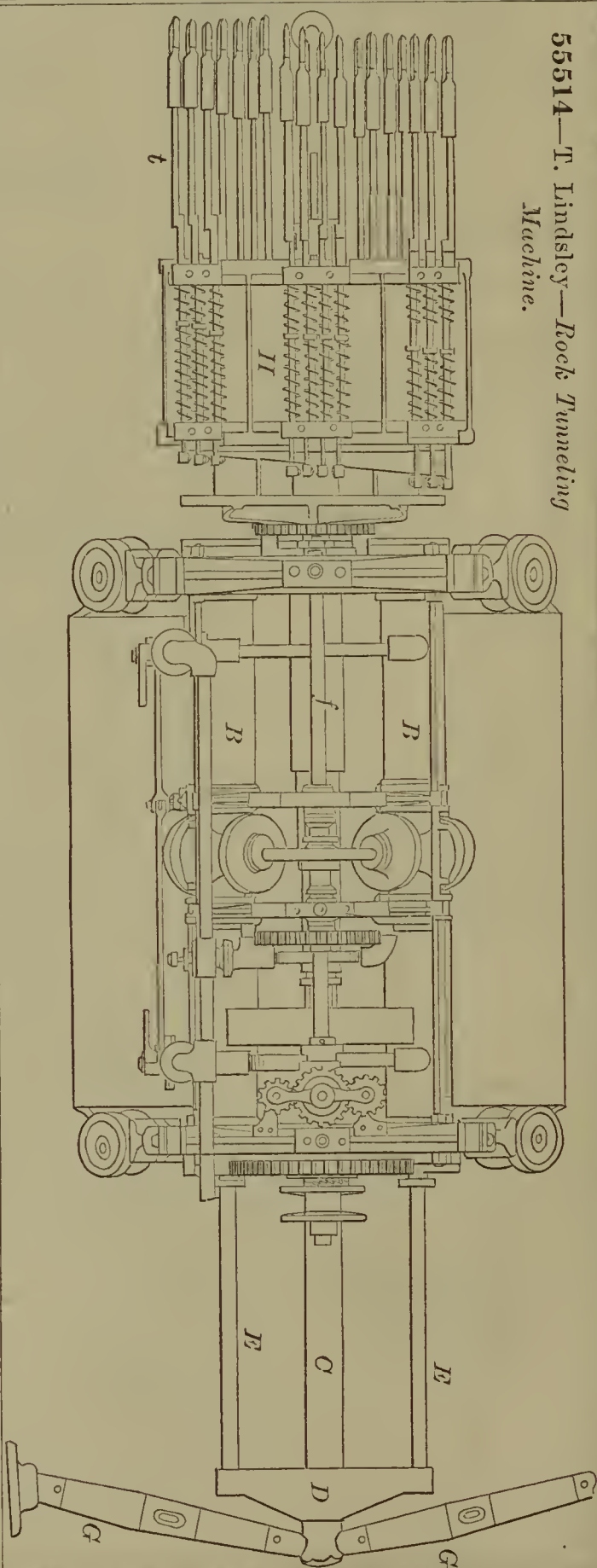

55515—B. McGrath—*Boom Connection for Masts.*

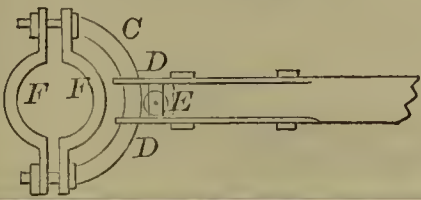

55518—B. F. McKinley—*Balanced Cut-off Valve.*

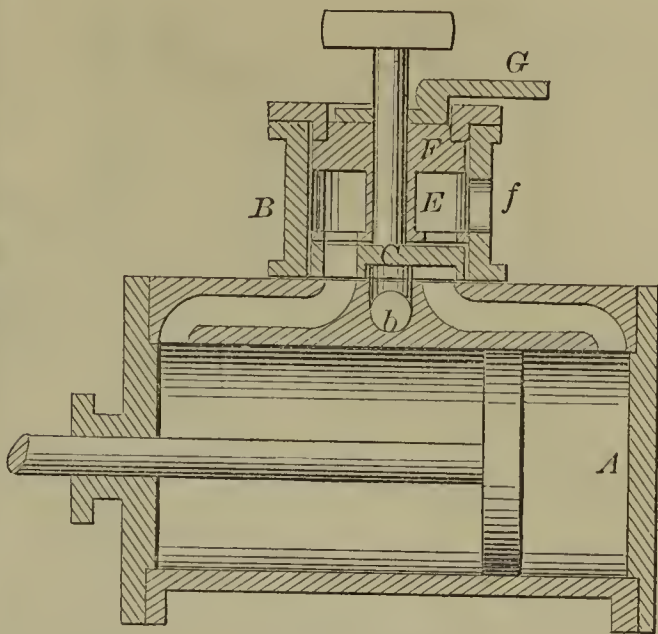

55516—W. L. & T. Winans—*Steam Engine.*

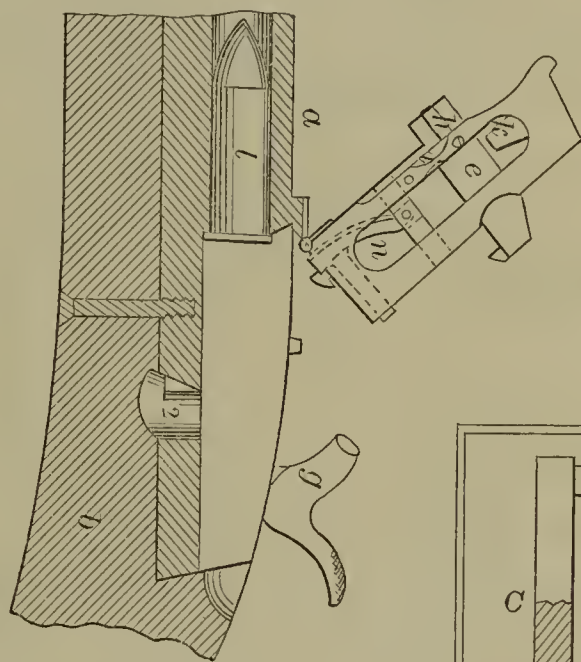
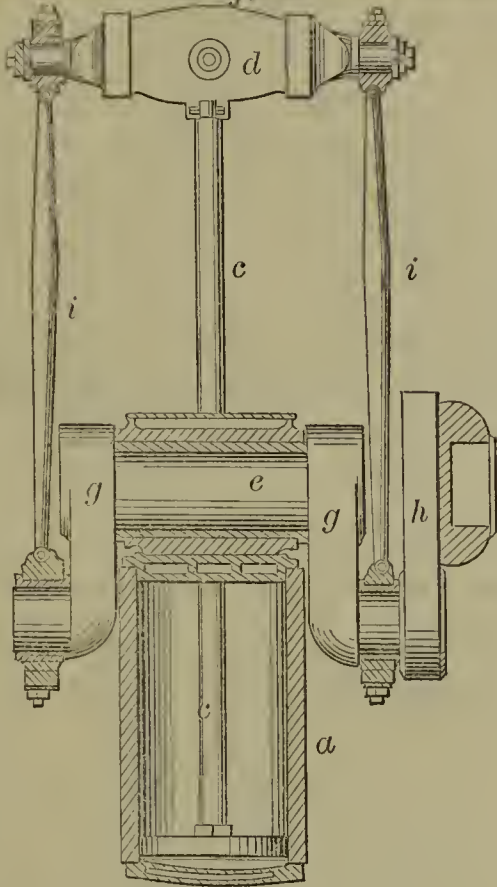

55520—I. M. Milbank—*Breech-Loading Fire Arm.*

55517—D. McKanna—*Hand Corn Planter.*

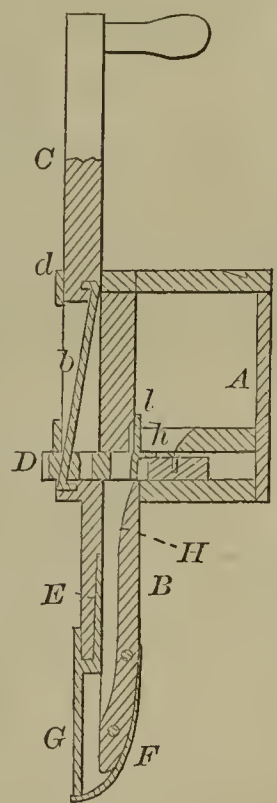

55519—C. Messenger—*Broom Head.*

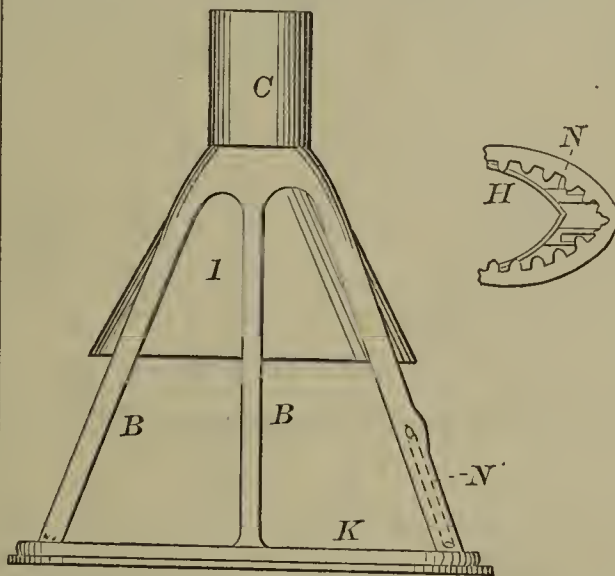

55521—H. Minton, M. D.—*Vaccinator.*

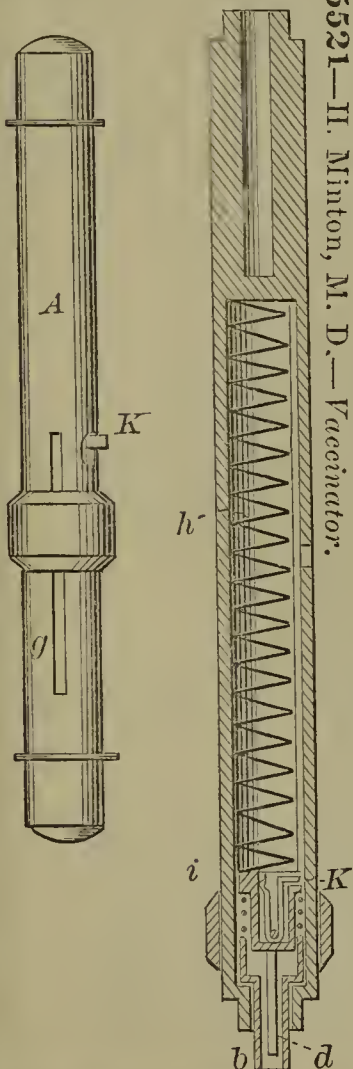

55522—J. J. Moore—*Sleigh Brake.*

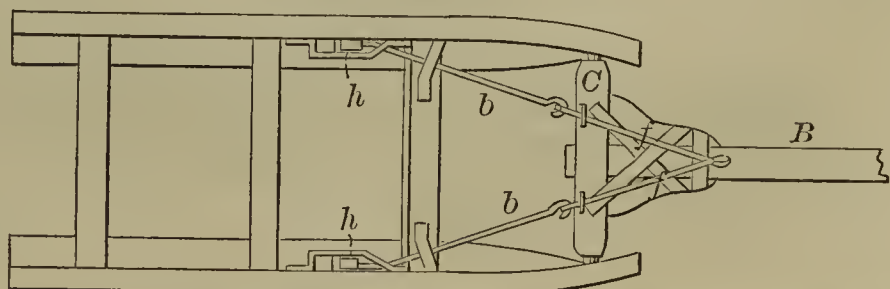

55523—Morawetz & Volkmar—Automatic Heliotrope.

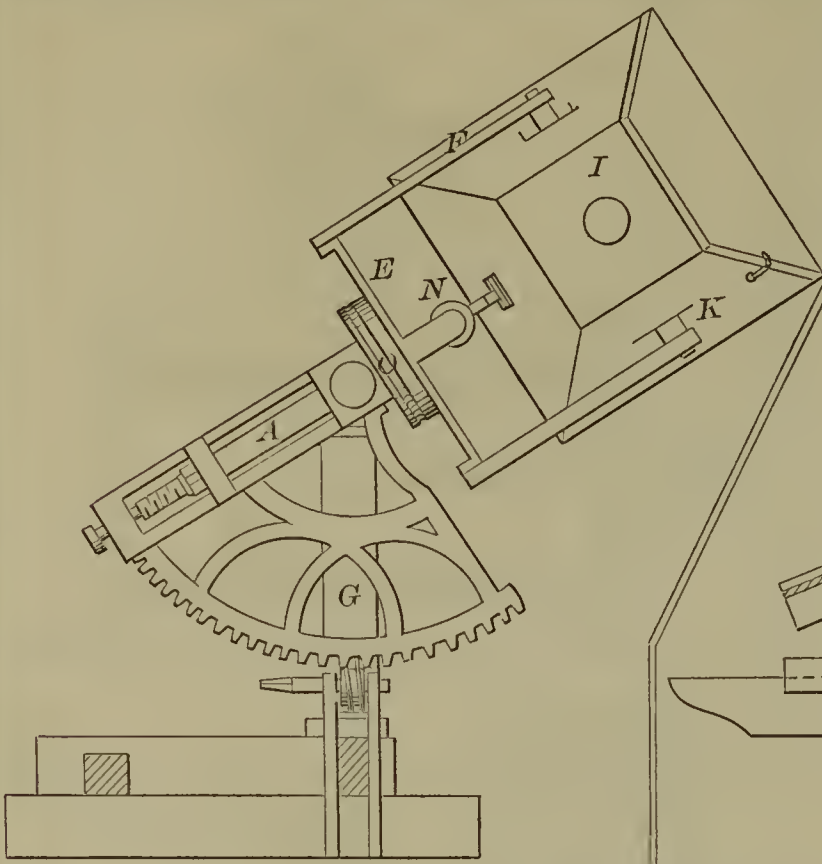

55524—G. L. Morris—Nicking Screw Heads.

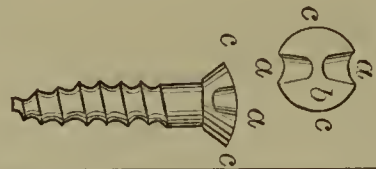

55525—E. Müller—Photographic Apparatus.

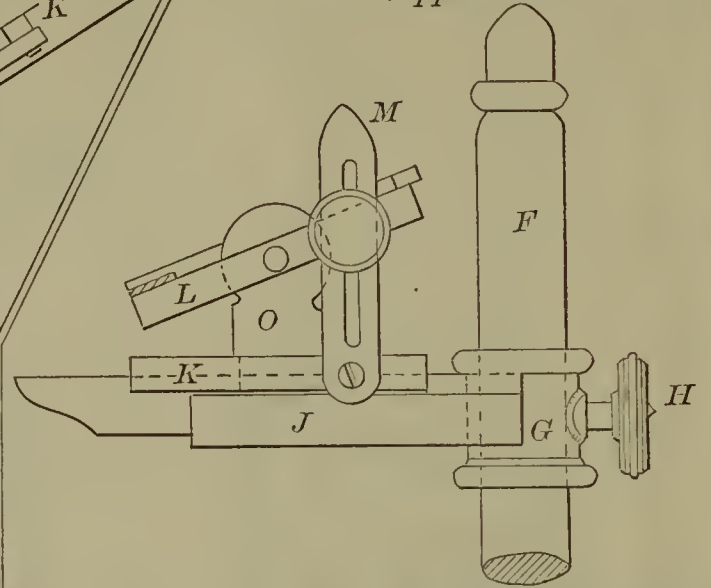

55526—J. Mumma—Fanning Mill.

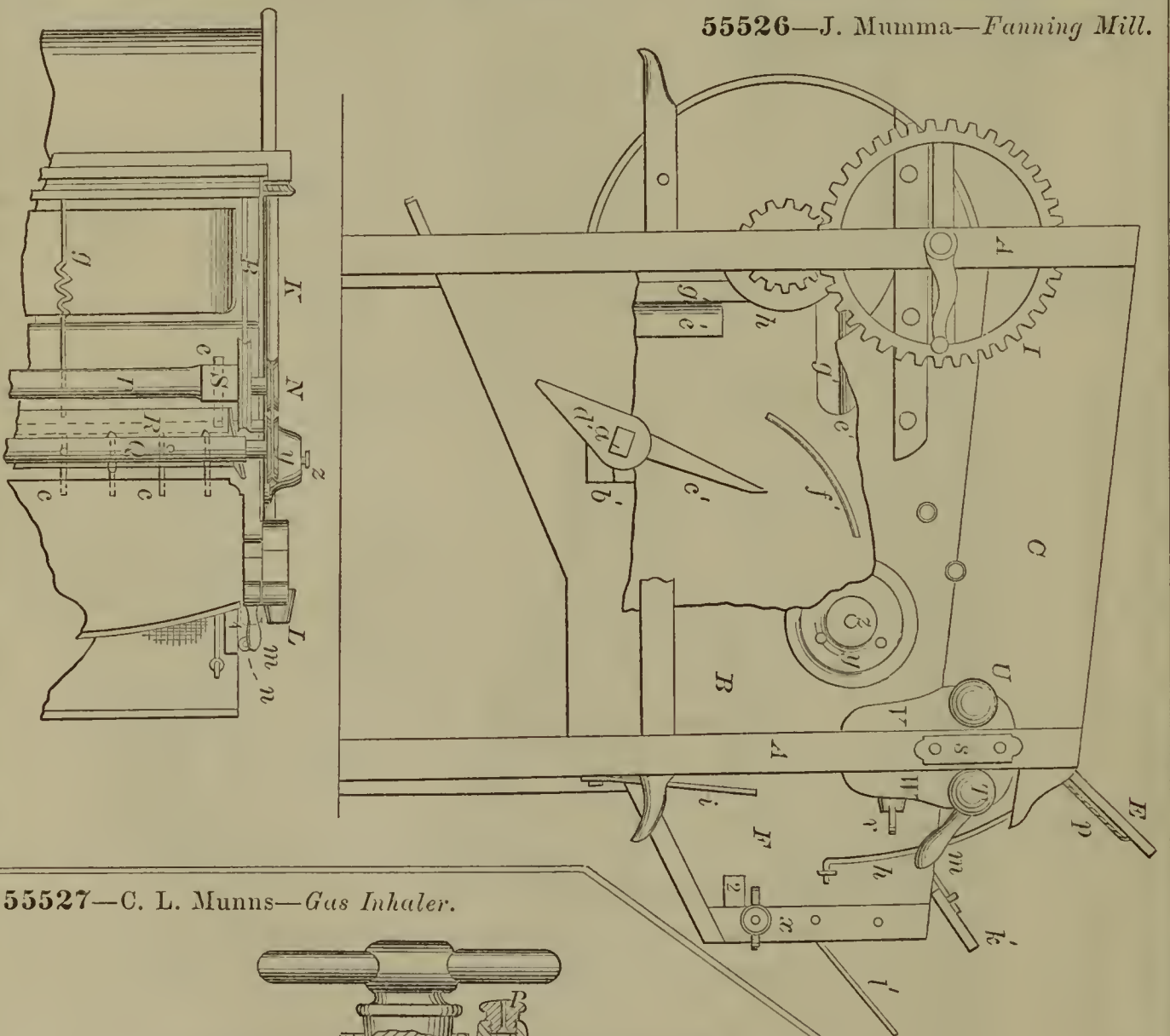

55527—C. L. Munns—Gas Inhaler.

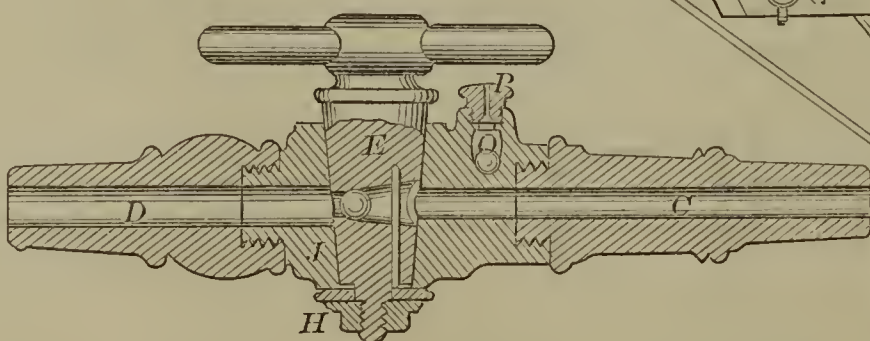

55528—J. K. O'Neil—*Horse Hay Fork.*

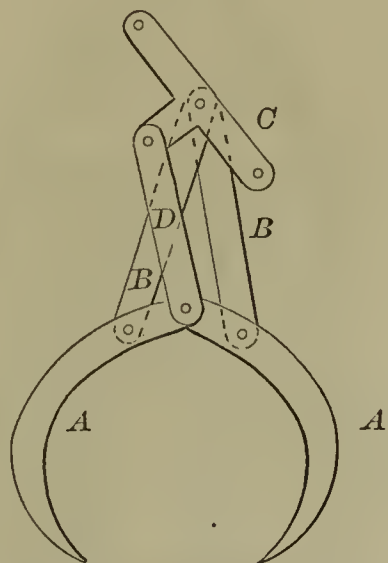

55535—C. F. Rees—*Lard Lamp.*

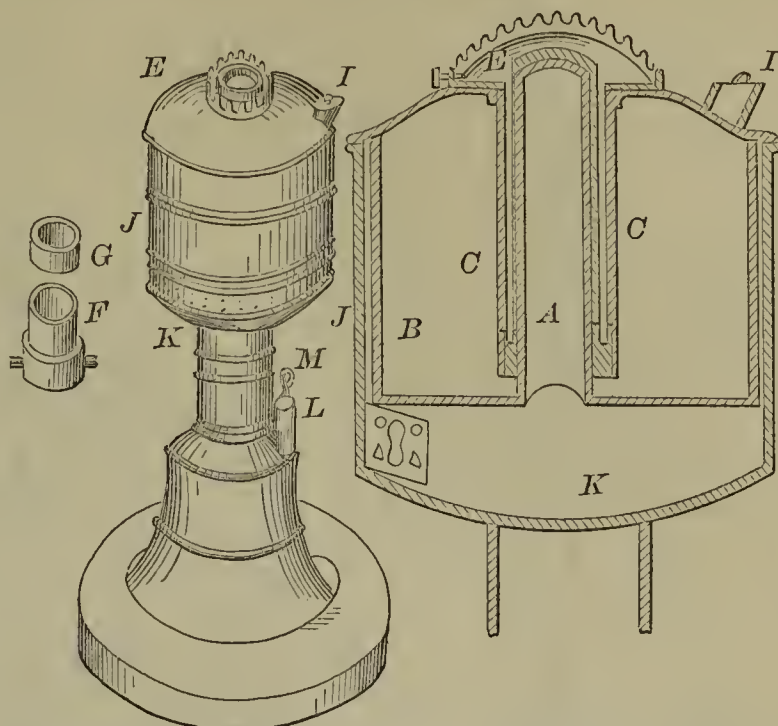

55530—J. K. Park—*Fruit Basket.*

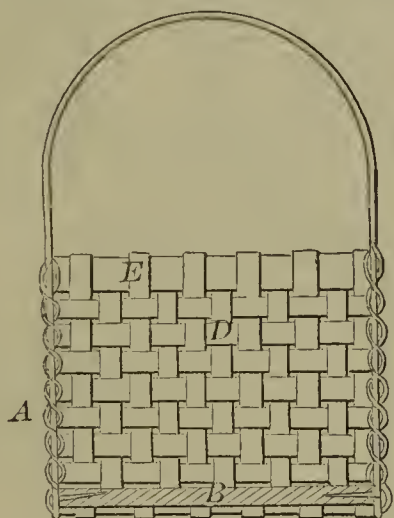

55529—P. Pallissard—*Baby Walker.*

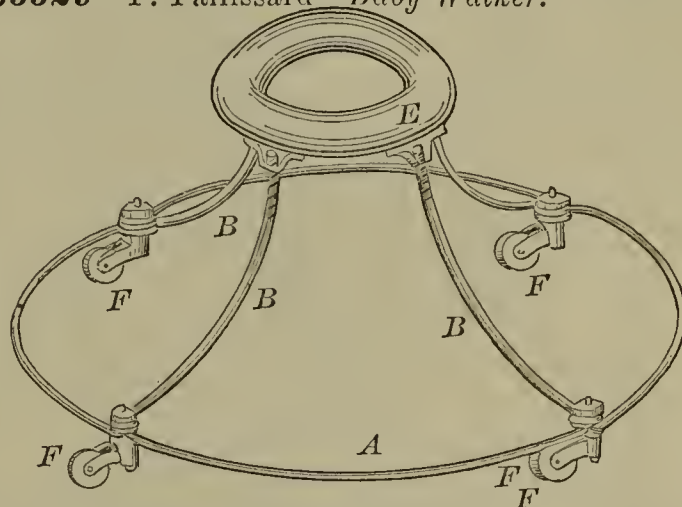

55532—C. F. Pike—*For Cooling Oil, &c.*

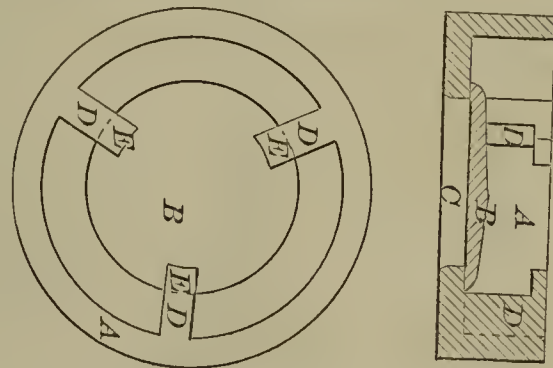
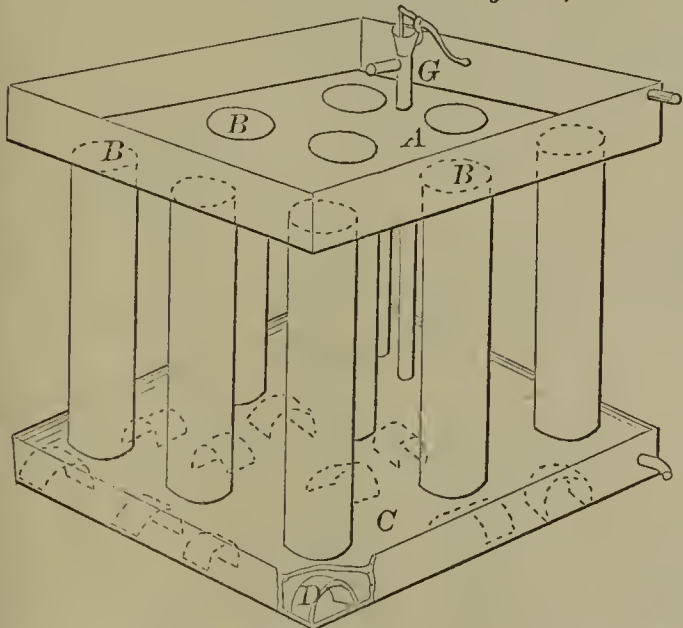

55531—J. Peabody—*Valve.*

55533—I. N. Plotts—*Buckle.*

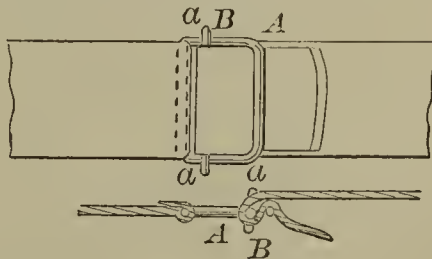

55536—Reynolds & Hilbright—*For Forming Heads on Harness Nails.*

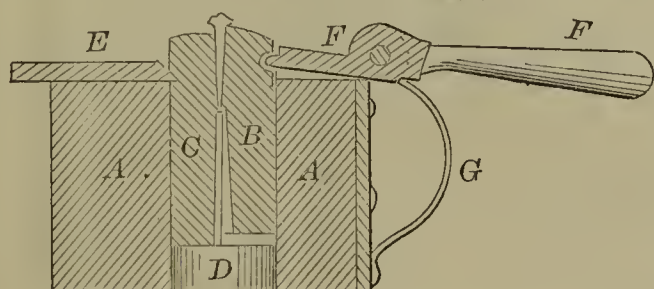

55537—N. Robbins, Jr.—*Car Coupling.*

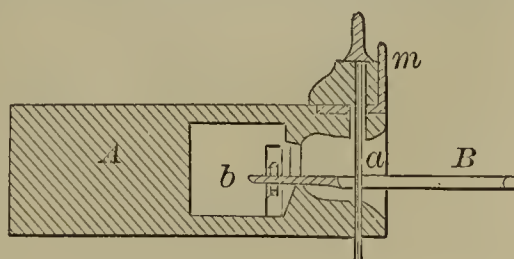

55538—A Roehrig—  
*Hanging Window  
Sash.*

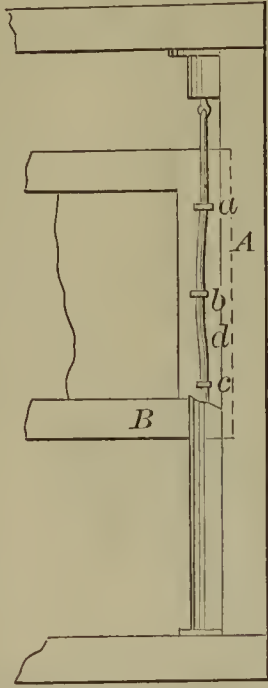

55543—A. J. Sessions—*Bag Frame.*

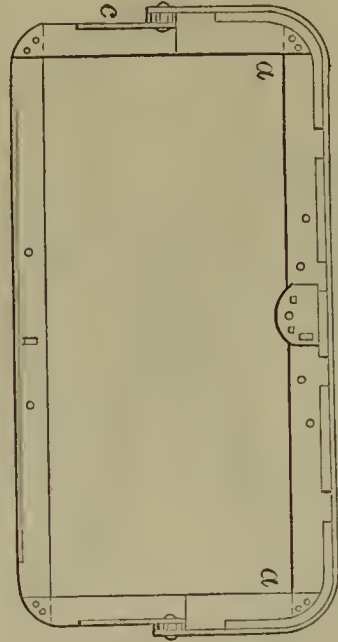

55539—Rogers & Black—*Steam  
Generator.*

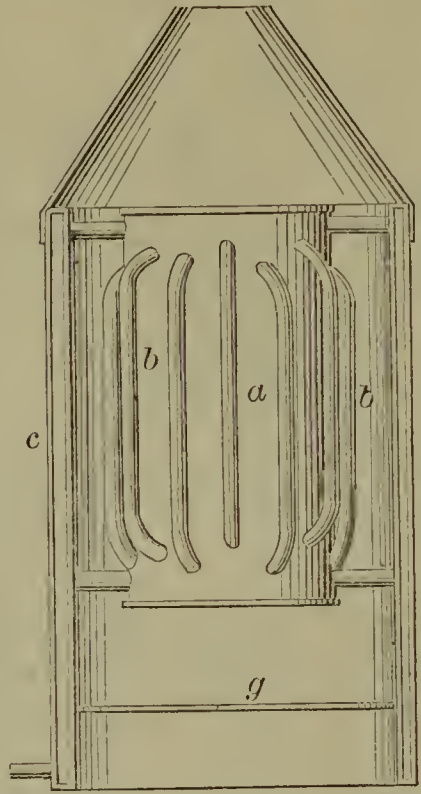

55541—C. H. Rudd—*Telegraphic Repeater.*

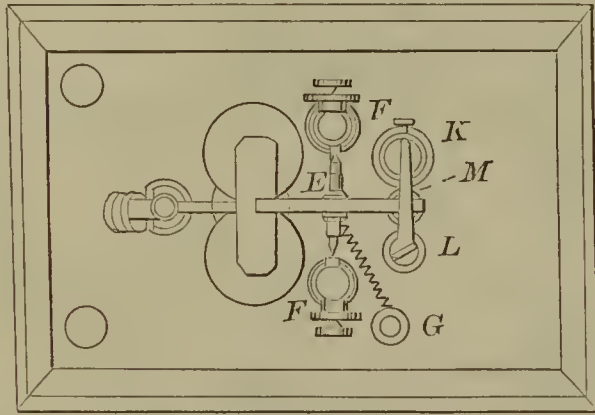

55542—H. V. Scattergood—*Cotton Gin.*

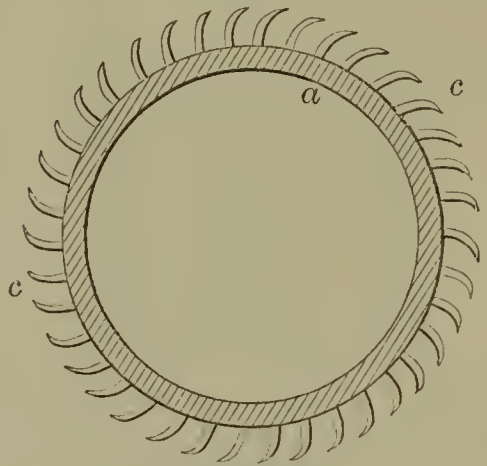

55546—W. H. Smith—*Lamp Burner.*

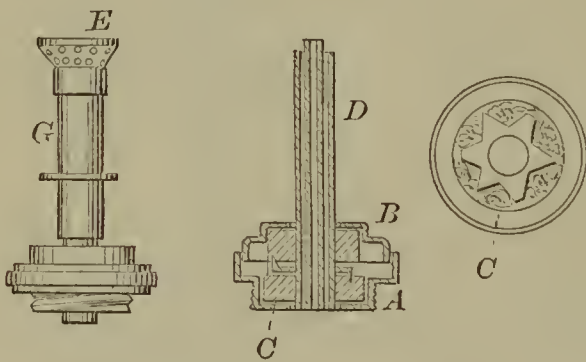

55547—Spencer & Meyer—*Water Meter.*

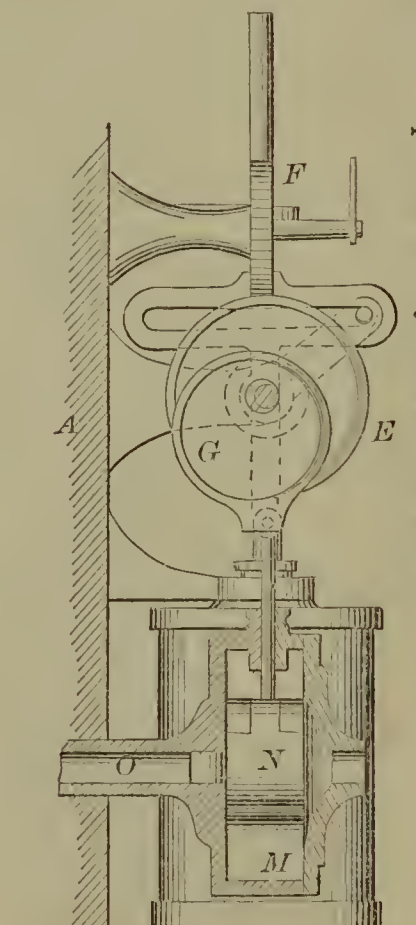

55544—Sholl & Collins—  
*Alarm Tunnel.*

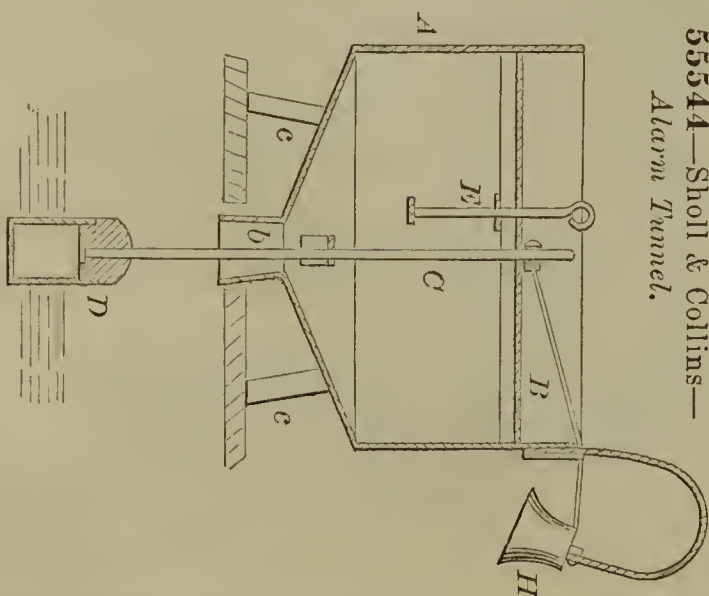



55548—A. W. Sprague—Generating Gas for Inhalation.

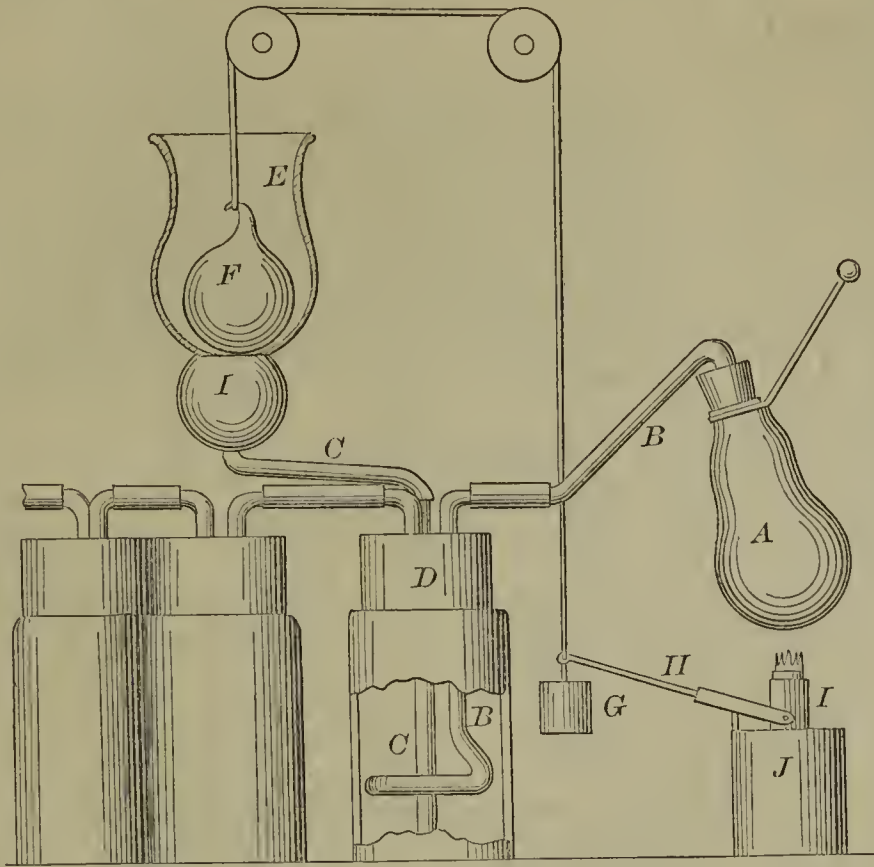

55550—I. H. Stone—Hose Protector.

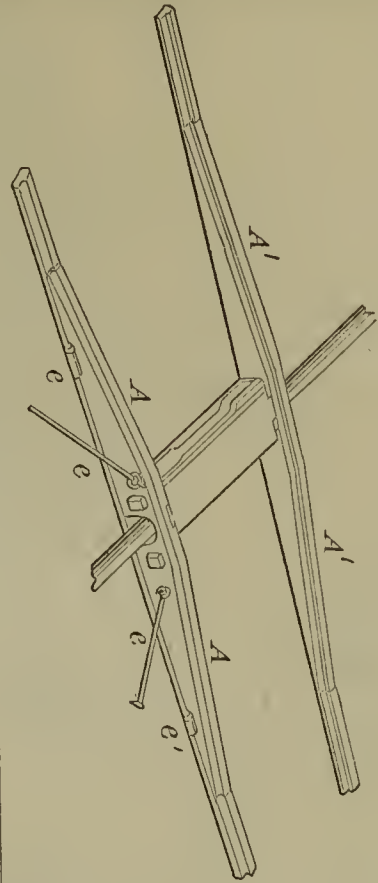

55553—M. Sweet—Curry Comb.

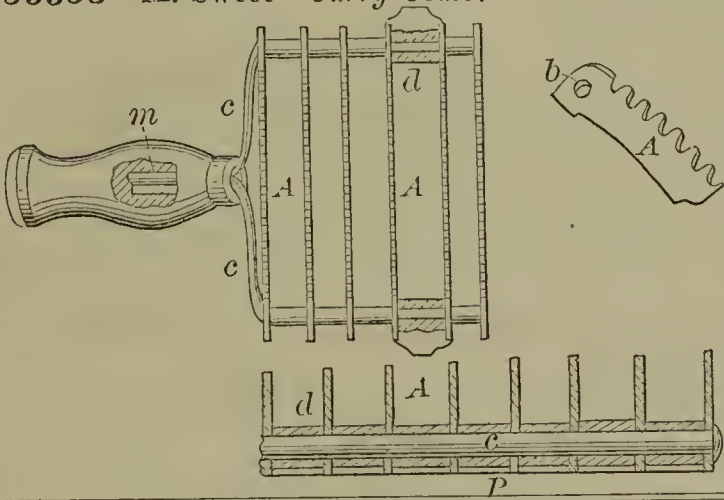

55551—O. O. Storle—Harvester Rake.

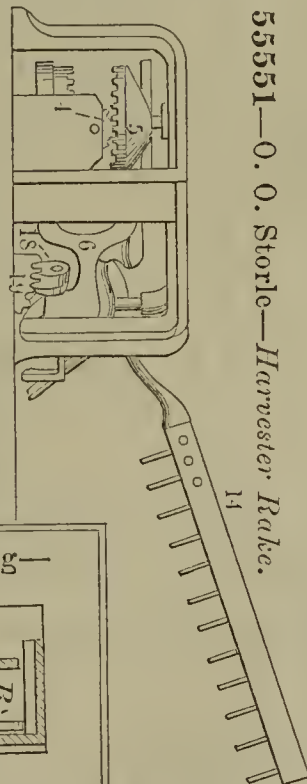

55554—J. C. Thomas—Planking Clamp.

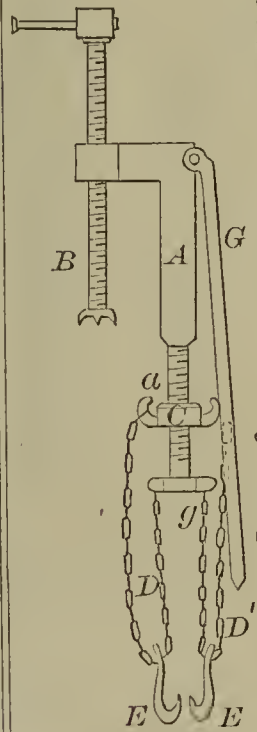

55549—Stachelin & Young—Lock.

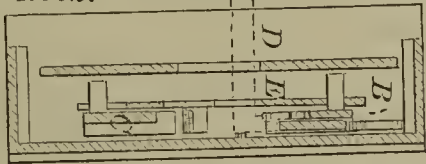

55555—C. Timmerman—Air Tight Burial Case.

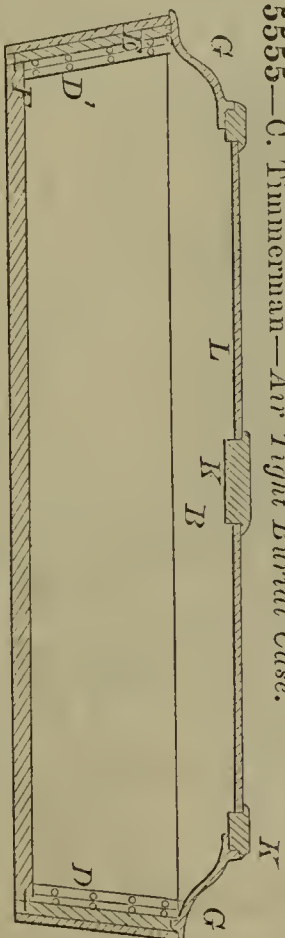

55552—T. I. Sturtevant—Cartridge for Breech-Loading Fire Arm.

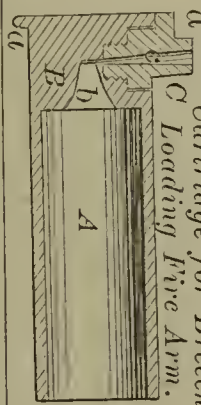

55556—F. Traxler—Dog Chain.

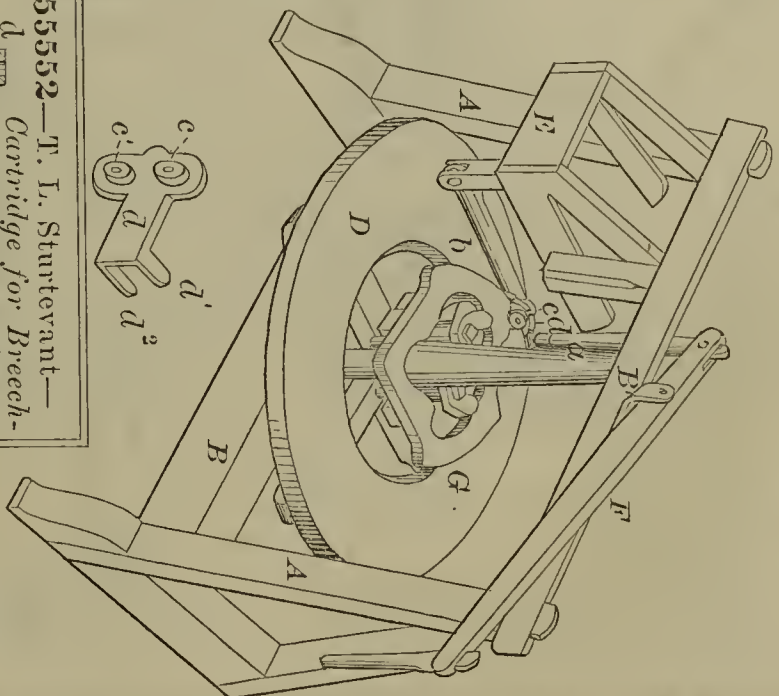

55557—J. P. Tucker—*Coal Elevator.*

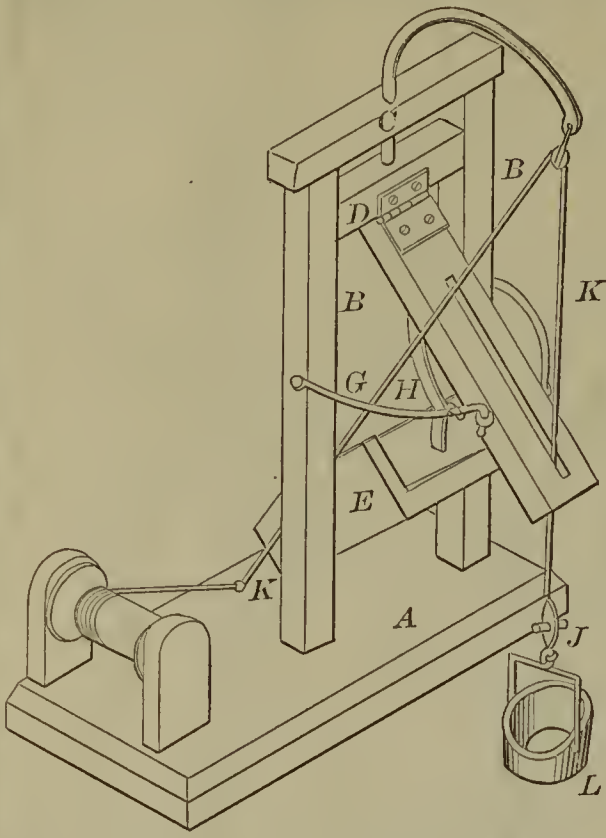

55561—W. Walker—*Picture Holder.*

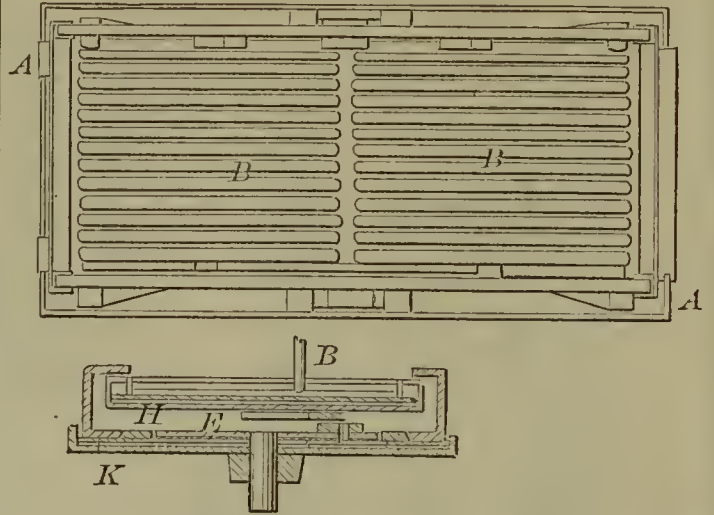

55558—A. Turnbull—*House Bell.*

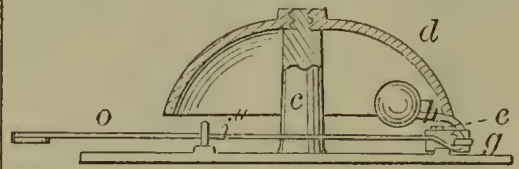

55560—Van Patten & Anthony—*For Welding Links into Chains.*

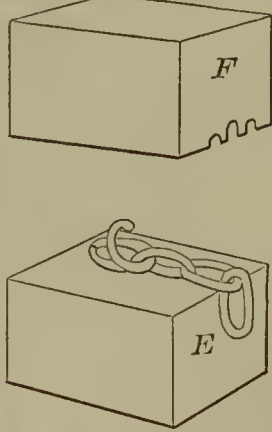

55559—J. B. Van Densen—*Steering Apparatus.*

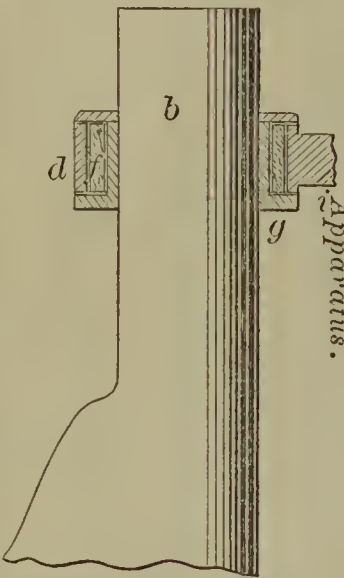

55563—R. L. Webb—*Snap Hook.*

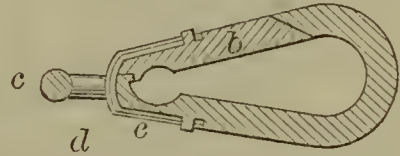

55564—E. Webster—*Hot Air Furnace.*

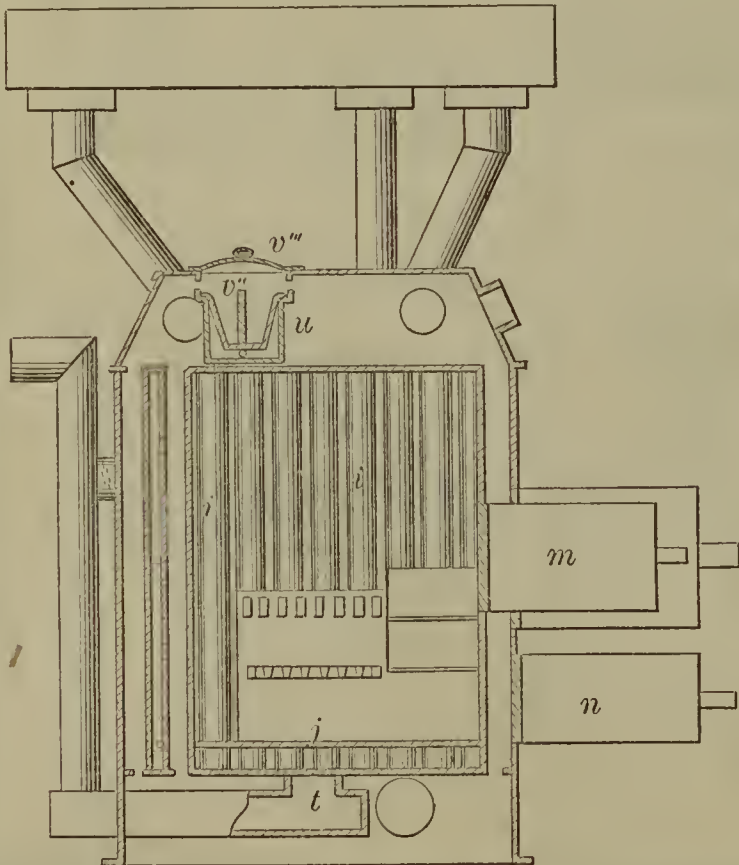

55562—T. V. Waymoth—*For Gunning and Printing Envelopes.*

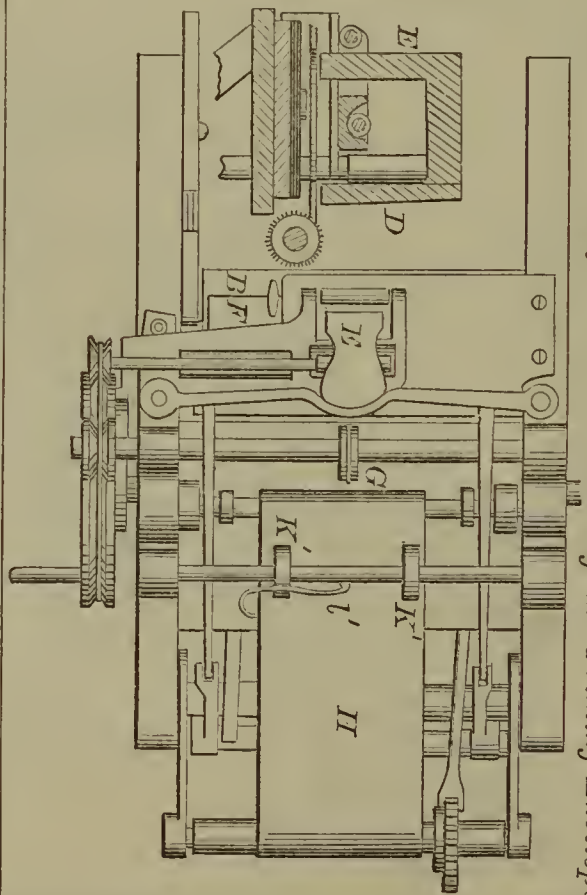

55565—E. Weissenberg—  
For Moulding Peat.

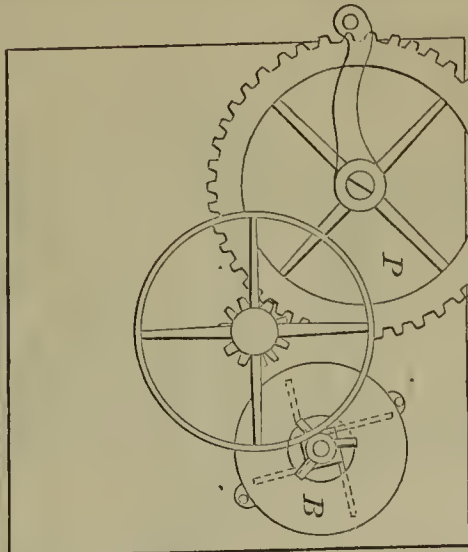
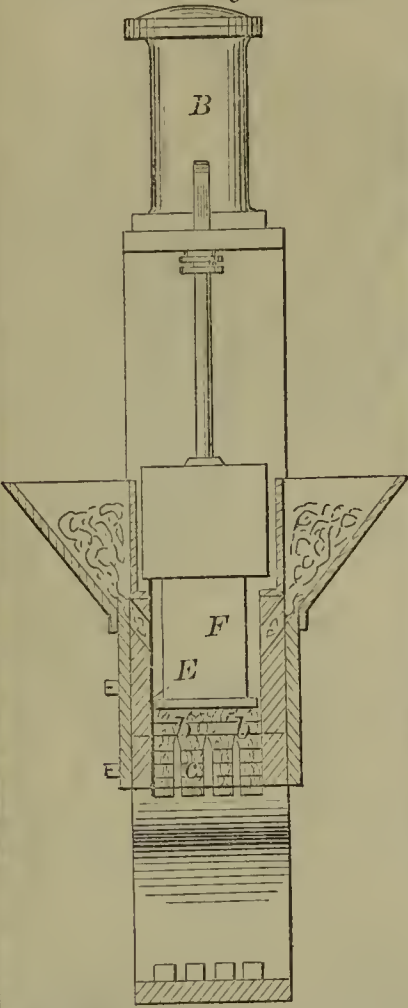

55566—A. Westcott—Churn.

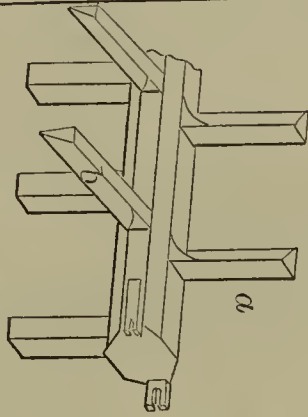

55567—J. N. Wilkins—  
Sewing Machine Caster.

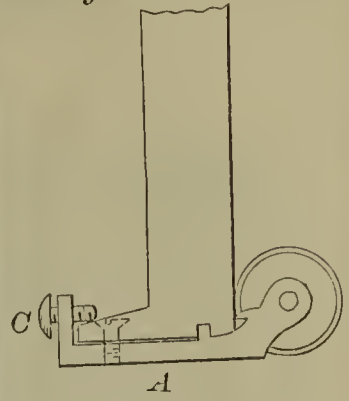

55569—T. & J. W. Wise—Sheep Shears.

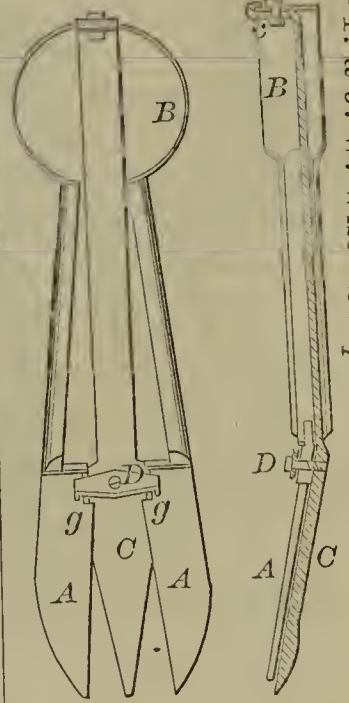

55568—Wing & Myers—Wardrobe and Bedstead.

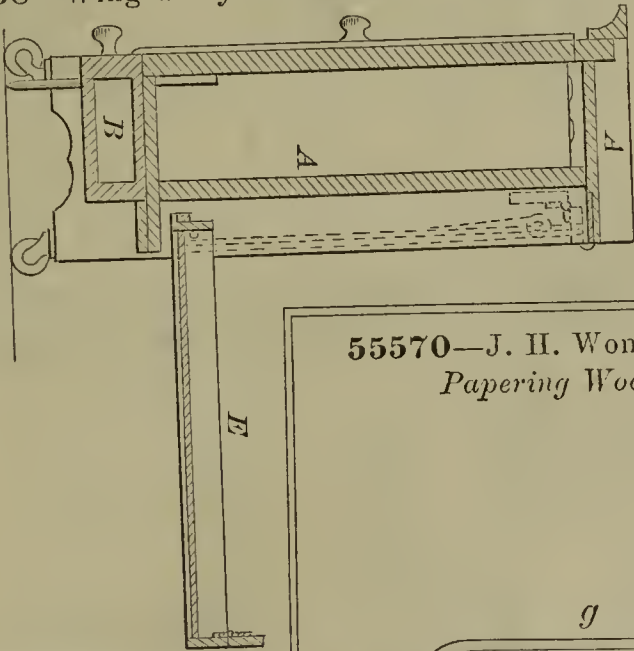

55571—M. M. Young—  
Screw Cutter.

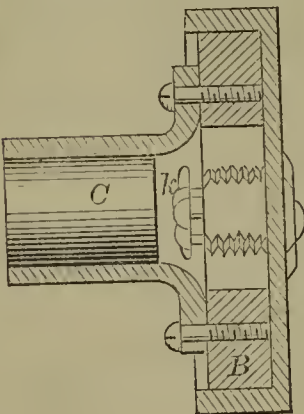

55570—J. H. Wonderly—For Sand  
Papering Wood Work.

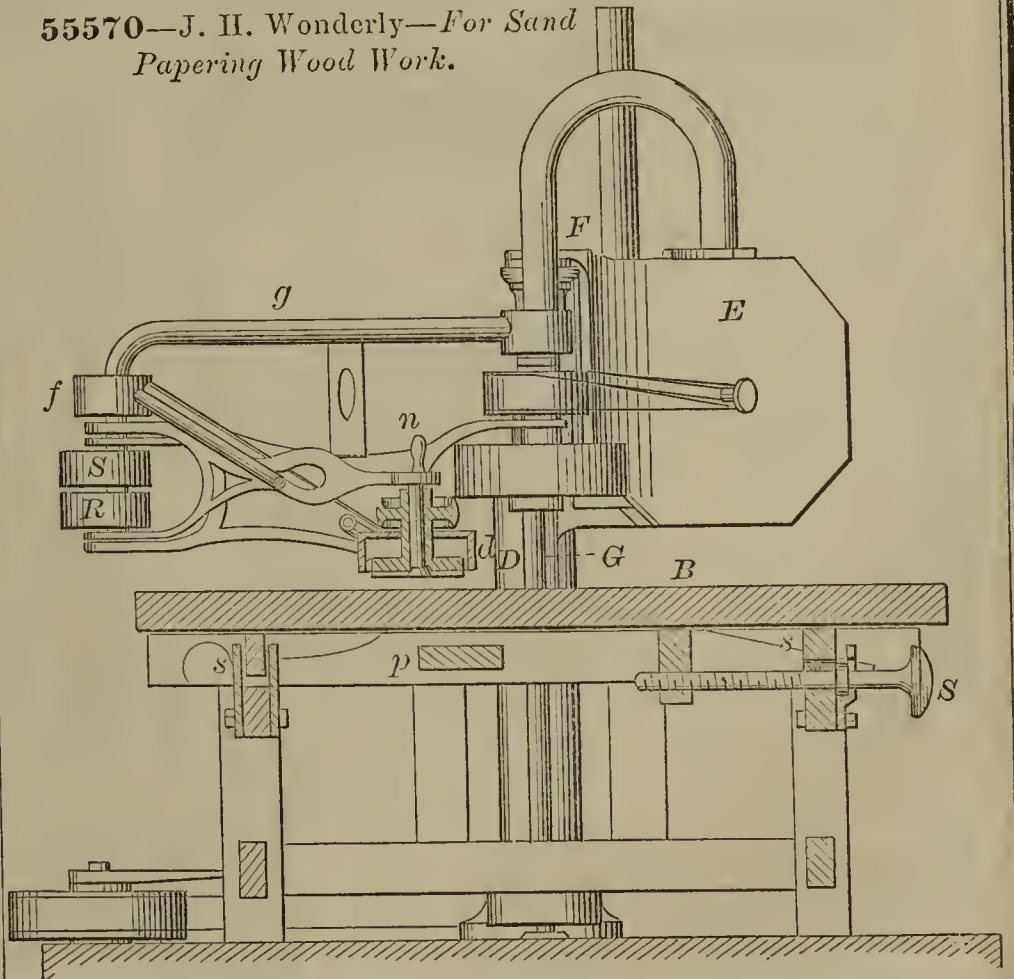

55572—G. P. Zindgraf—Paint Mill.

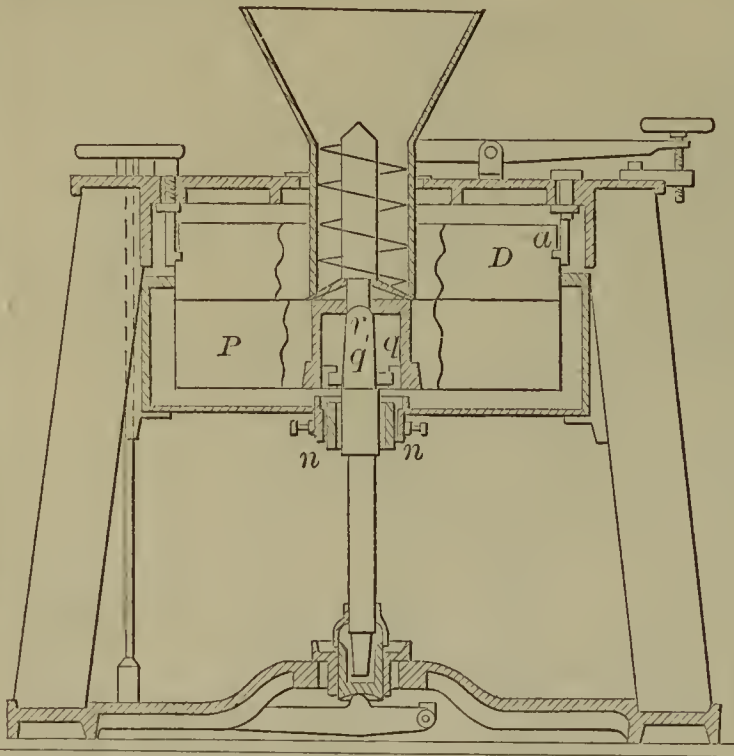

55574—C. B. Bristol—Spring Bed Bottom.

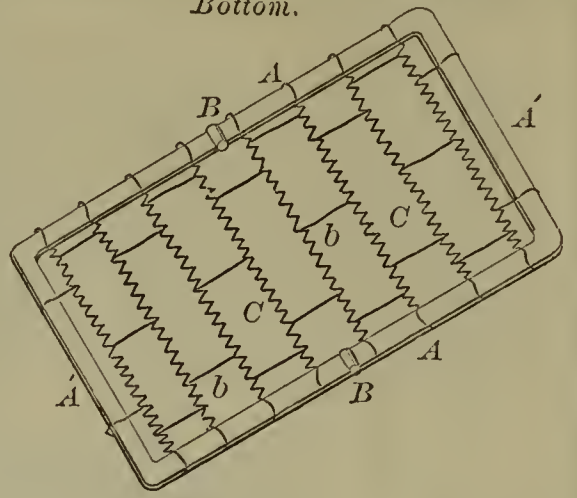

55573—M. Baumgarten—Valve for Organs, &c.

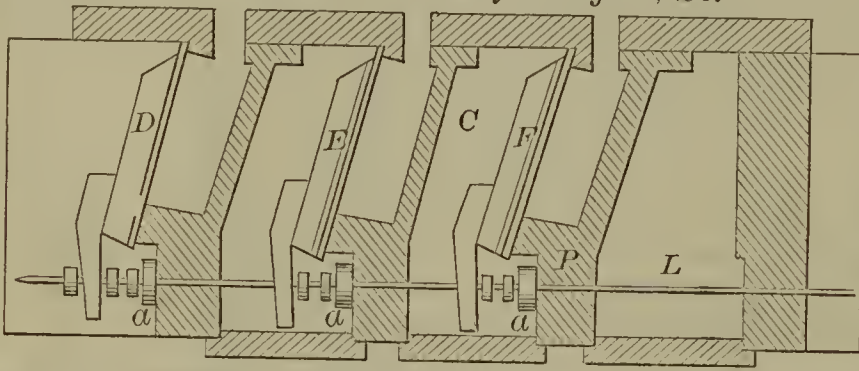

55575—F. Brown—Oscillating Engine.

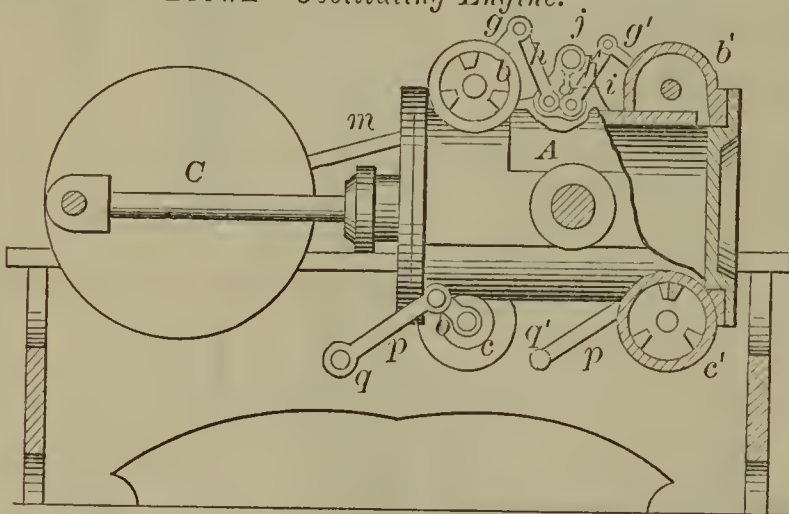

55579—C. Dowd—Canvas Stretcher.

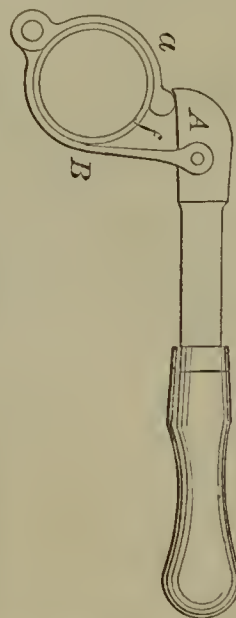
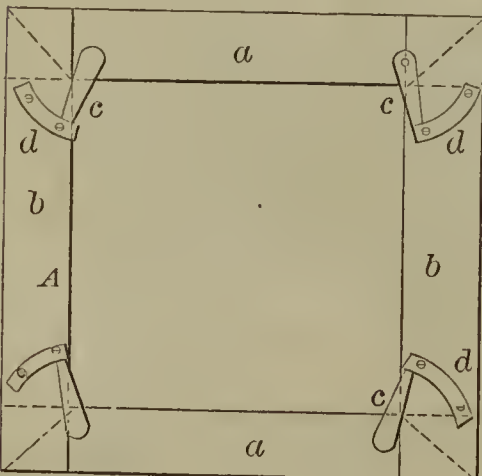

55578—D. W. Coggeshall—Pipe Wrench.

55577—H. M. Clark—Blind Fastener.

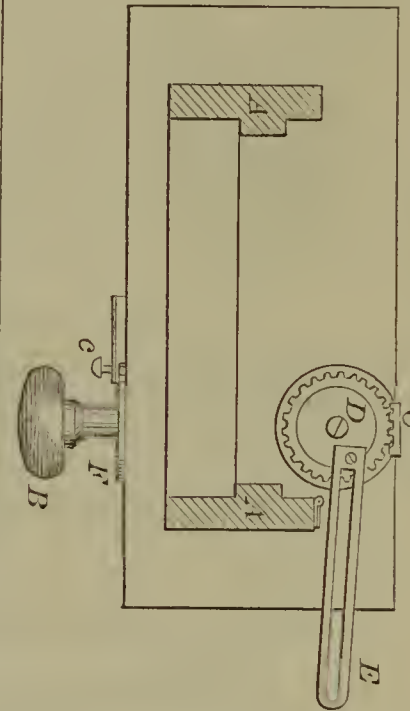

55576—D. Bull—Mitre Box.

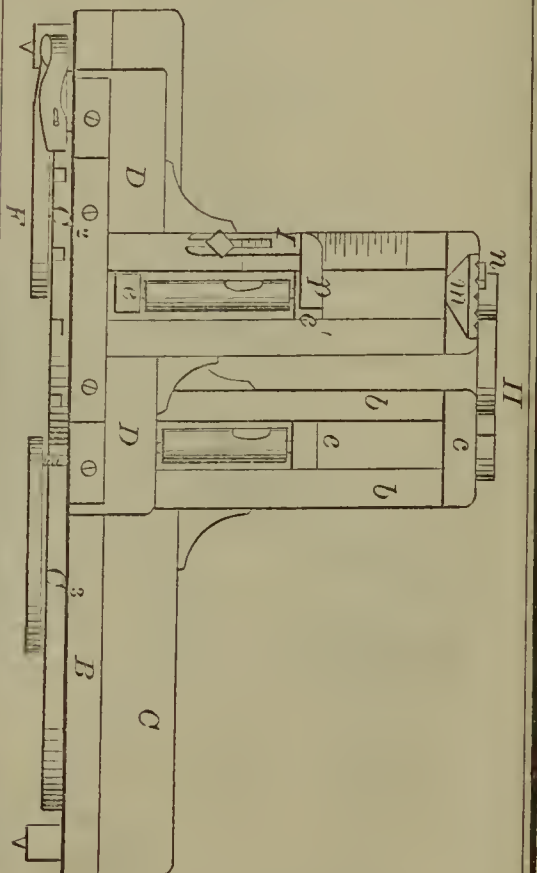

55580—O. E. Brown—Braiding Machine.



55581—J. Focer—Fruit Jar.

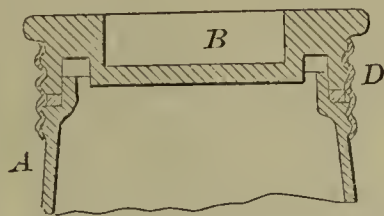

55583—Gregg & Green—Brick Machine.

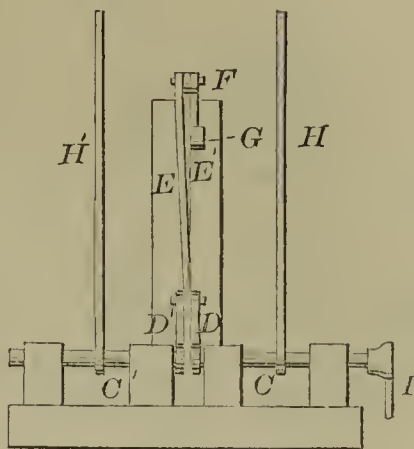

55582—P. A. Gladwin—Lock Key.

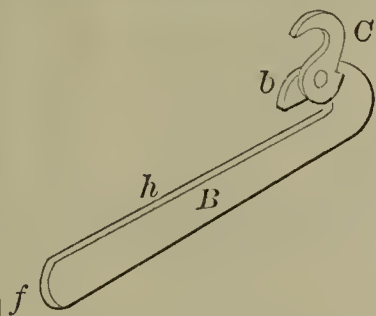

55584—A. S. Hadaway—Ice Creeper.

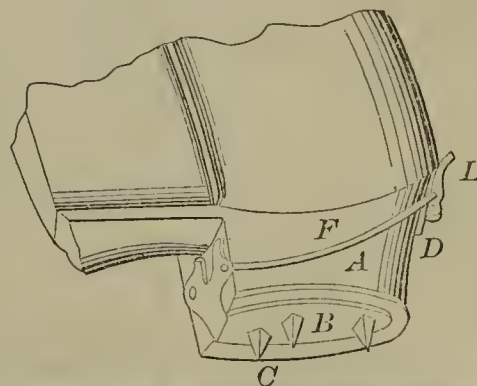

55585—F. H. Lauterbach—Preserve Jar.

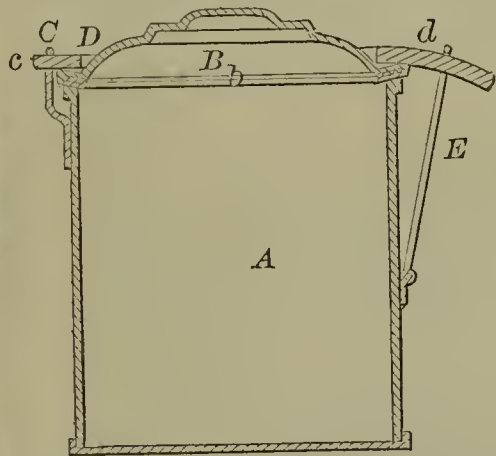

55587—E. Mingay—Ash Sifting Device.

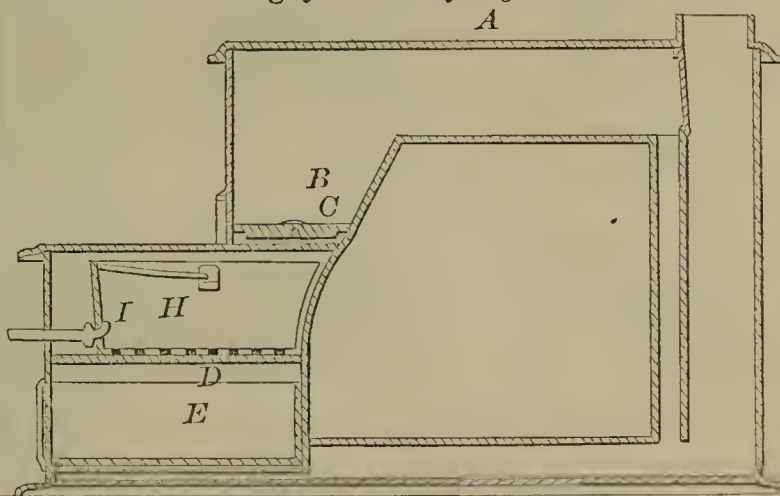

55589—T. Pimer—Bottle Stopper.

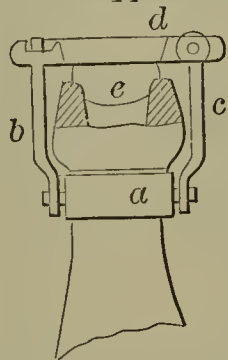

55586—J. McClay—Driving Piles.

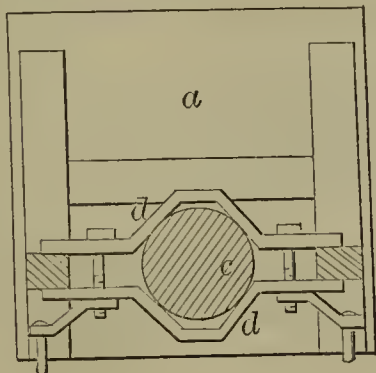

55590—R. E. Sisson—Photographic Bath.

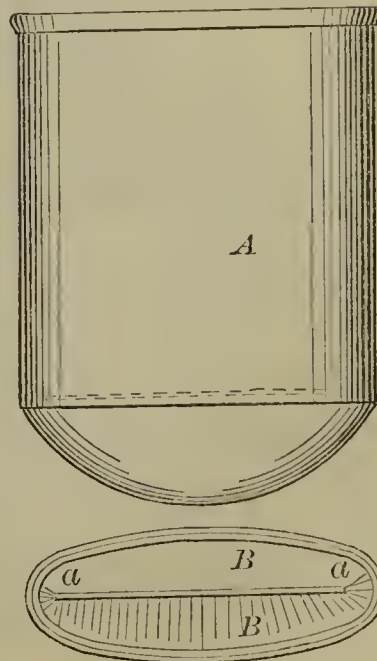

55588—W. G. Oliver—Safety Stop Gun Lock.

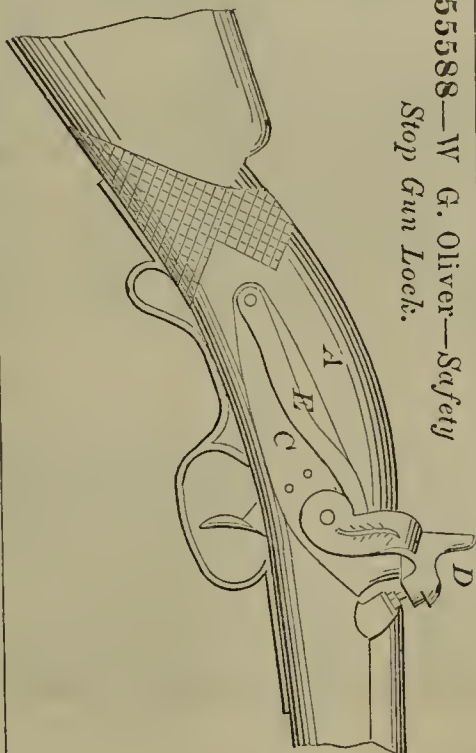

55591—F. O. & W. W. Tucker—  
*Toy Top.*

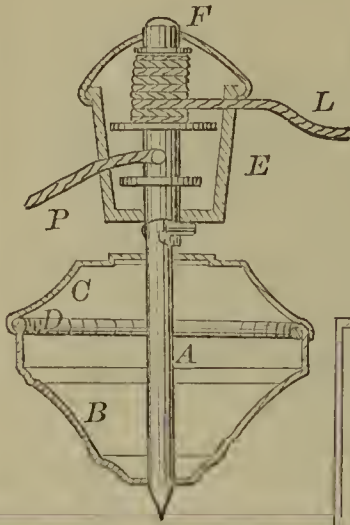

55596—E. Allen—*Heating and Soldering Gun Barrels.*

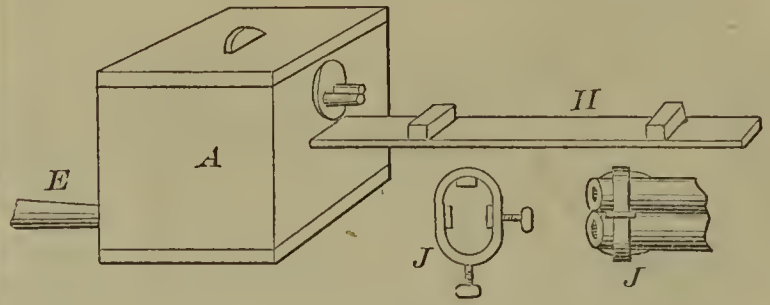

55595—J. P. Abbott—*Eaves Trough.*

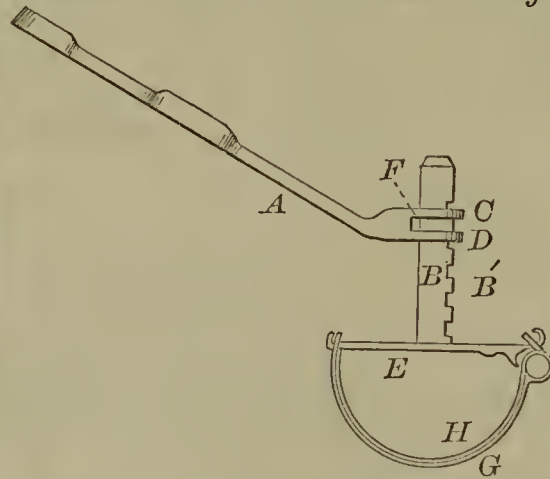

55597—H. E. Anthony—  
*Bolt Heading Machine.*

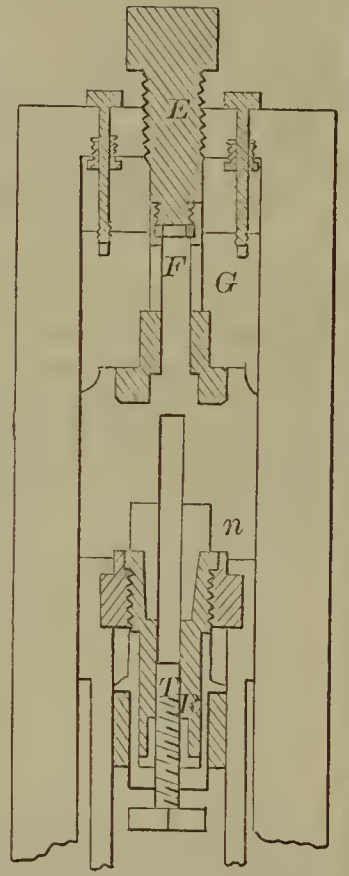

55593—P. Dinzey—  
*Anchor.*

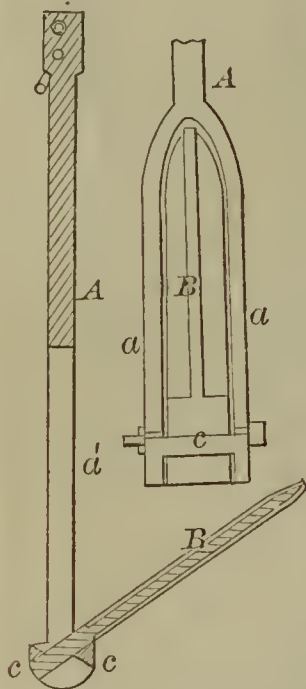

55598—J. Ashcroft—*Covering Steam Boilers.*

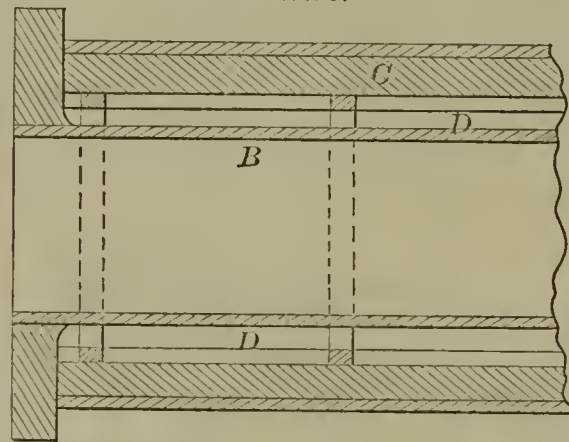

55594—E. D. Averell—*Electro-Magnetic Attachment to Ruling Machines.*

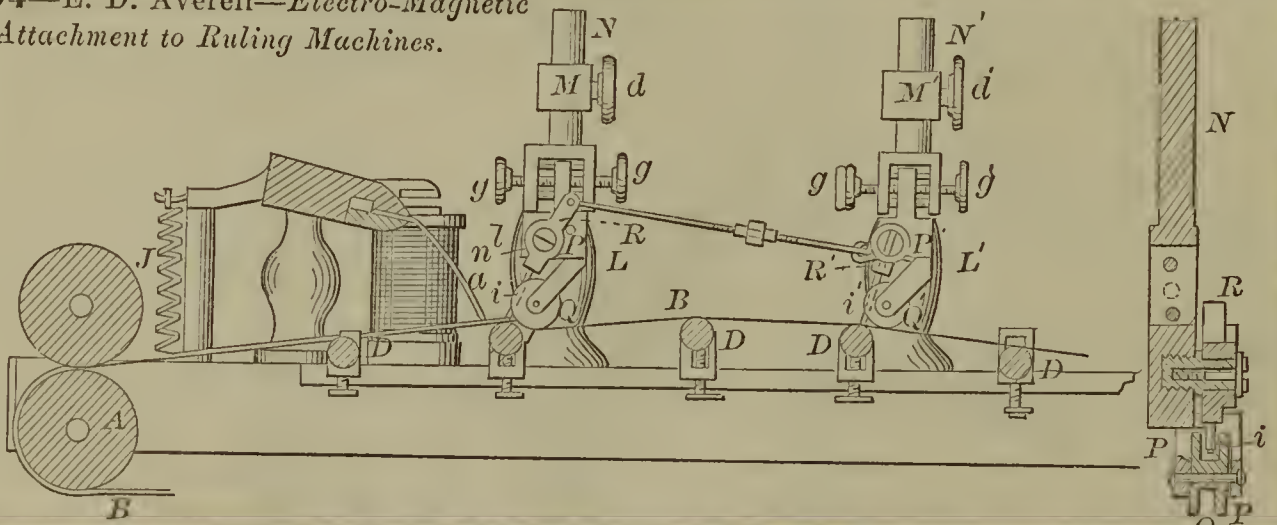

55599—L. Bailey—*Spoke Shave.*

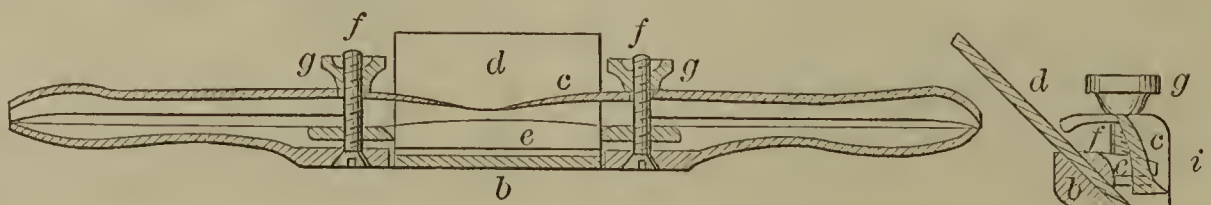

55600—H. M. Baker—Manufacture of Carbonate of Soda, &c.

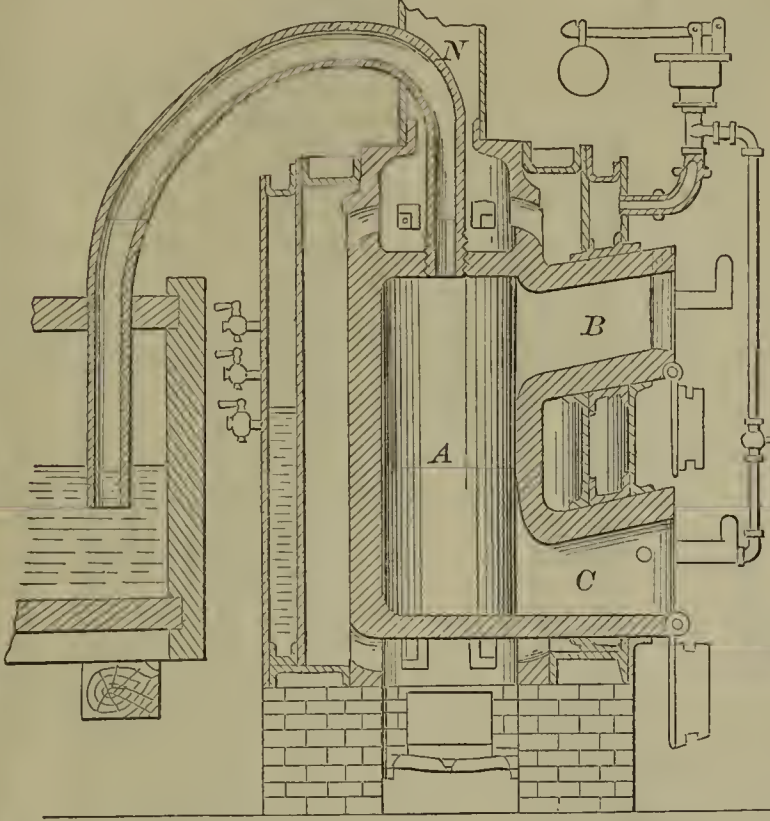

55607—W. W. Blair—Cotton Cultivator.

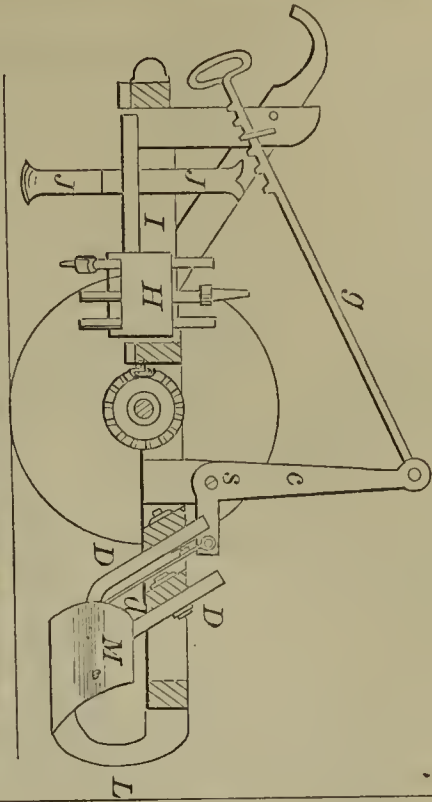

55602—H. J. Batchelder—Horse Shoe Machine.

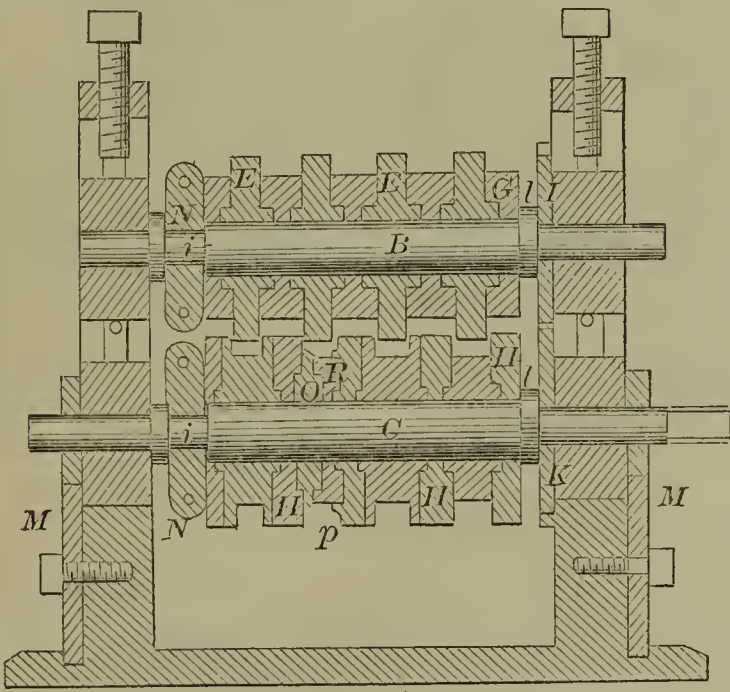

55605—A. Bingham—Chair Seat.



55601—C. W. Baldwin—Hot Air Engine.

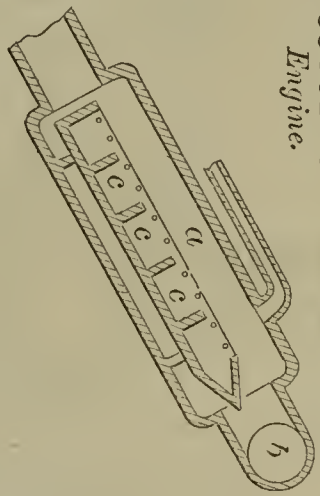

55603—H. K. Bates—Grate Bar.

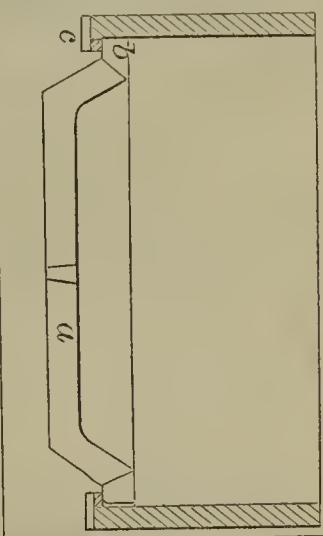

55606—J. F. Birchard—Slide for Extension Tables.

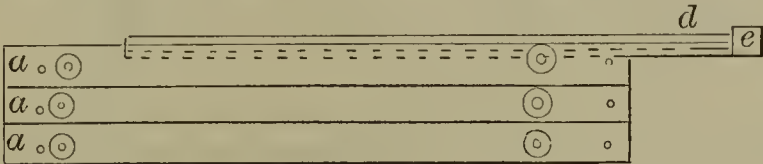

55609—L. W. Broadwell—Ordnance.

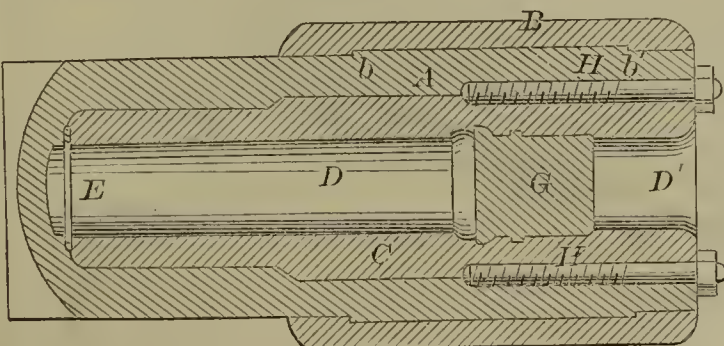

55608—E. Blakeslee—Corset and Skirt Supporter.

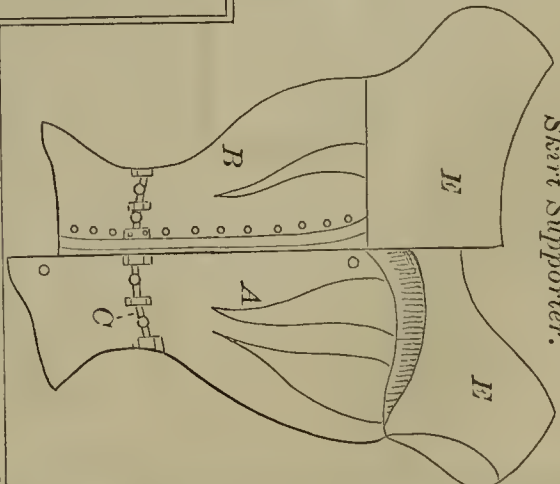

55610—H. Bucknall—Washing Machine.

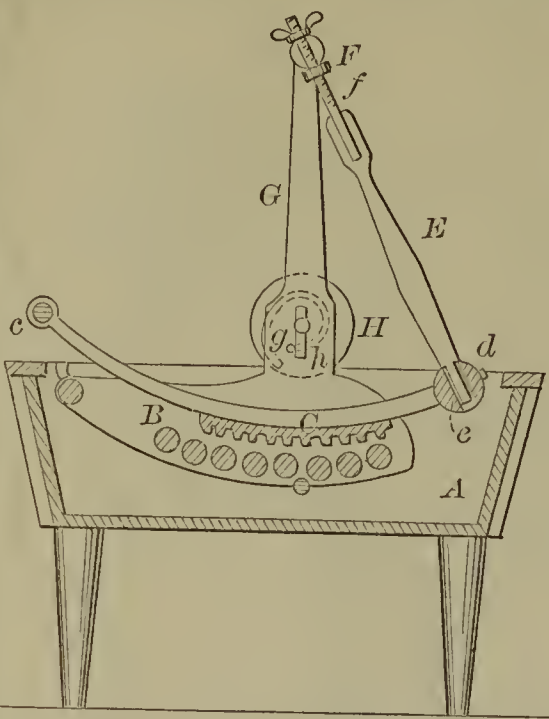

55615—R. Burton—Steam Plug Valve.

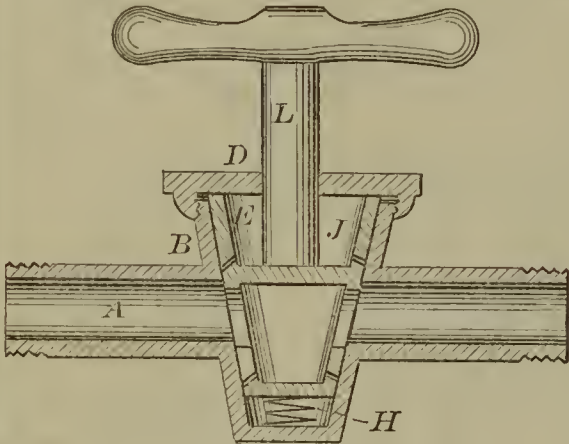

55611—J. Bullock—Sep Bucket Hoop.

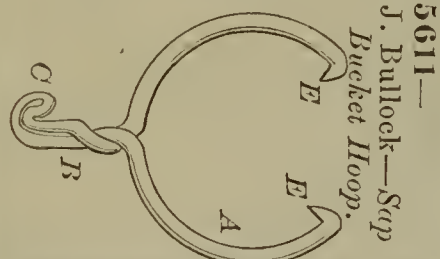

55612—J. A. Burchard—Combined Hoe and Corn Planter.

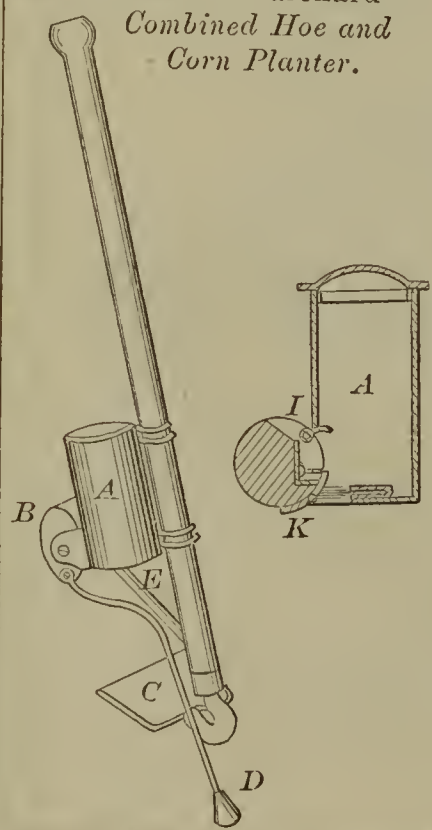

55616—I. D. Bush—Lock.

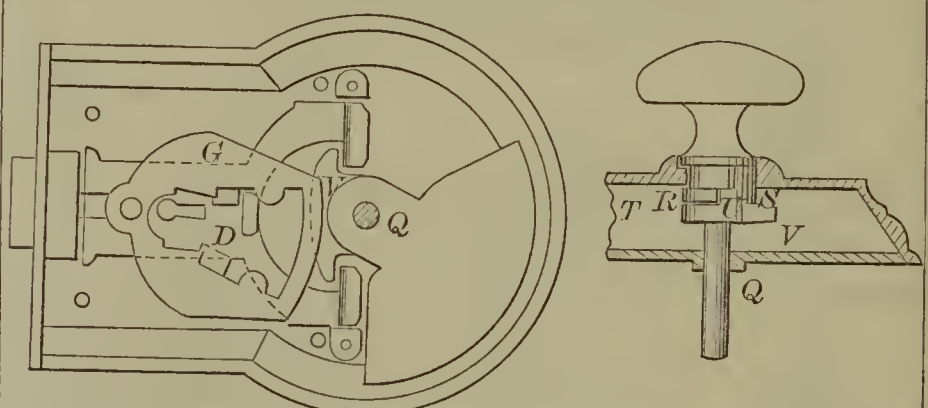

55617—E. A. Bushnell—For Sharpening Horse Shoe Culks.

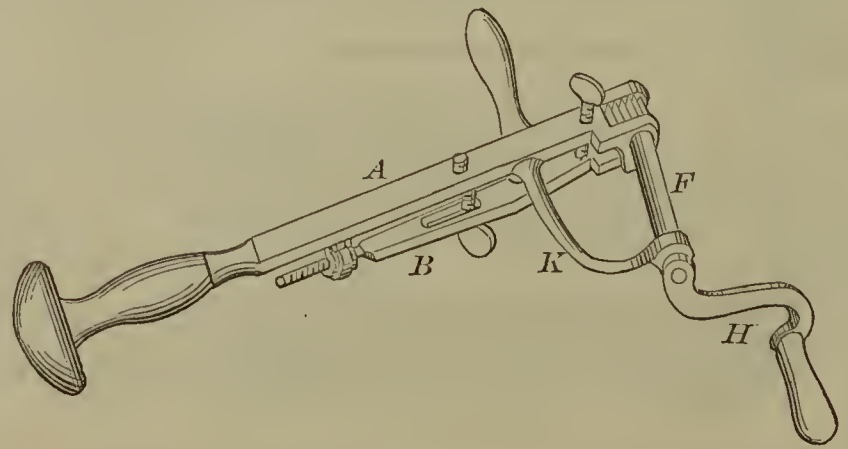

55613—J. Burke—Breech-Loading Fire Arm.

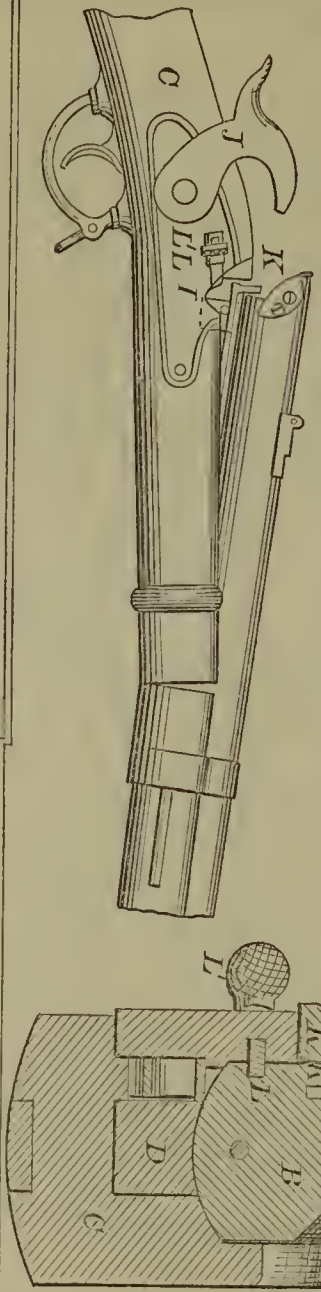

55614—Burt & Dunn—For Cutting Corn from the Cob.

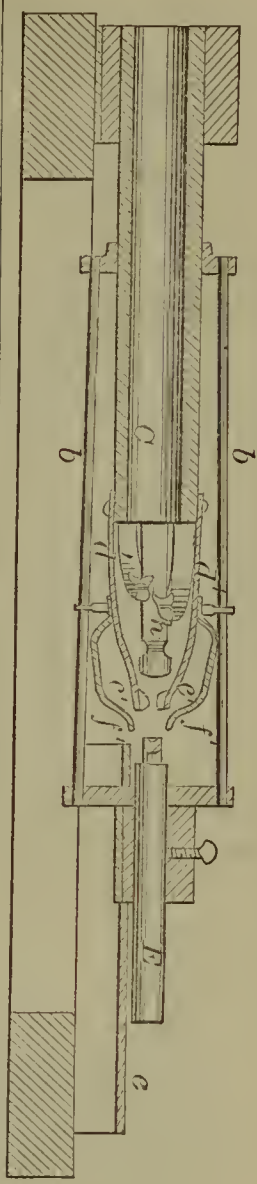



55618—D. P. Butler—*Lifting Bar.*

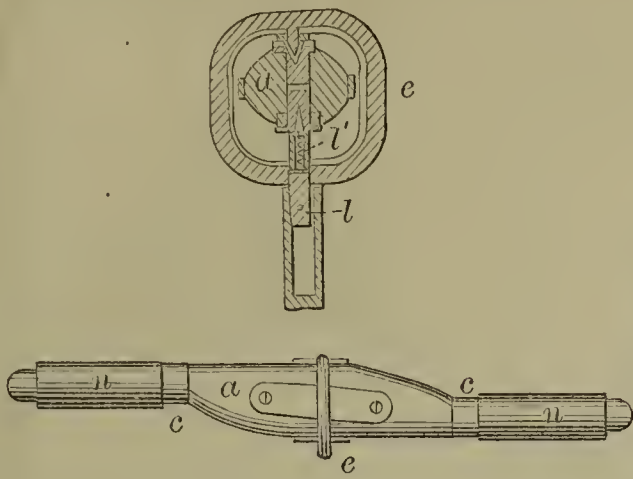

55621—Carton & Ralph—*Milk Pail.*

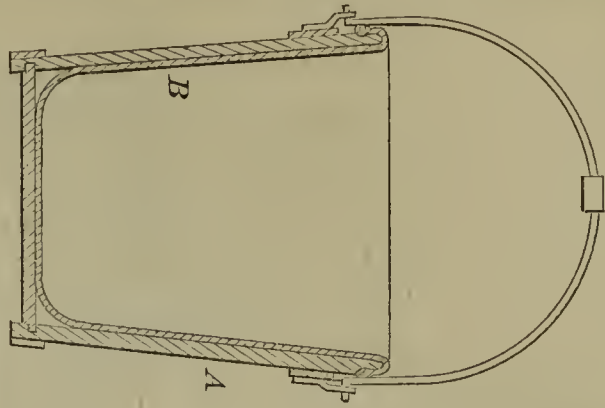

55619—J. Campbell—*Cigar Pressing Machine.*

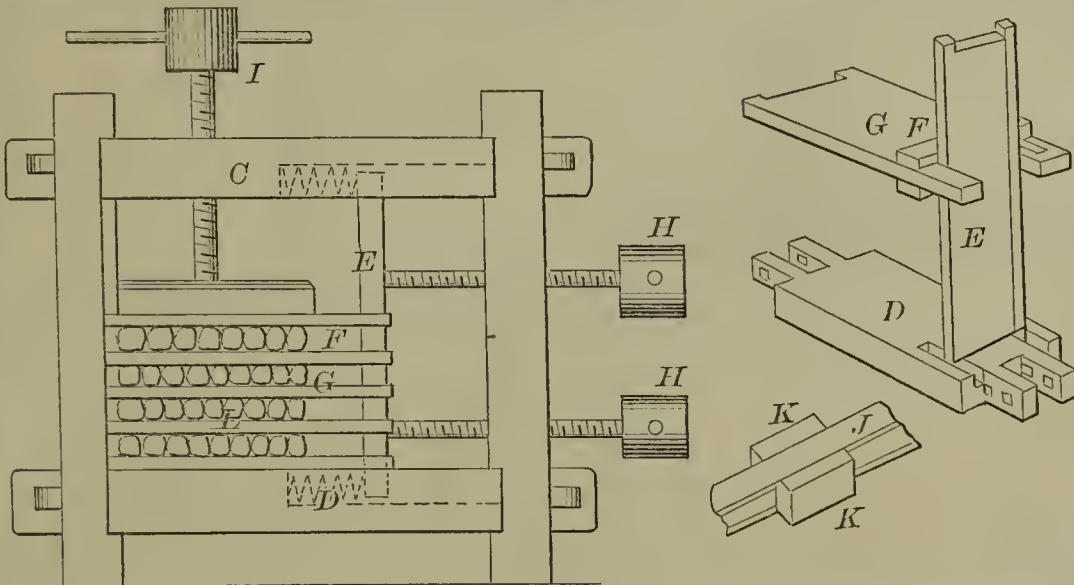

55623—R. Collier—*Pruning Instrument.*



55624—D. Conborn—*Portable Door Fastening.*

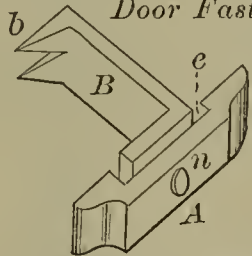

55620—G. J. Capewell—*Spring Lancet.*

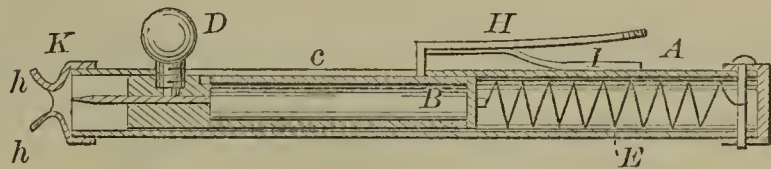

55625—M. G. Crane—*Egg Beater.*

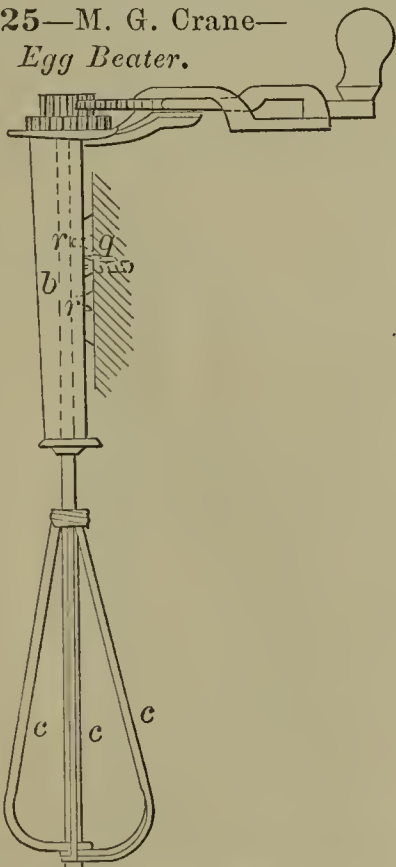

55622—Case & Pratt—*Atmospheric Churn Dasher.*

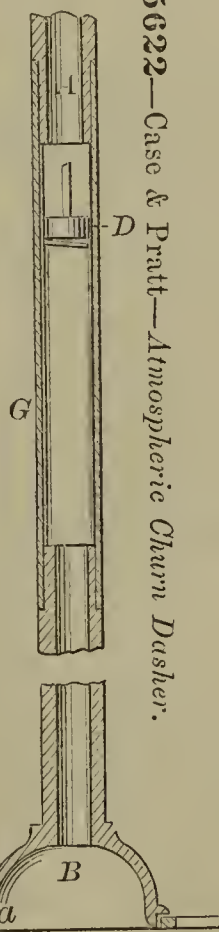

55626—J. H. Davis—*Deep Well Pump.*

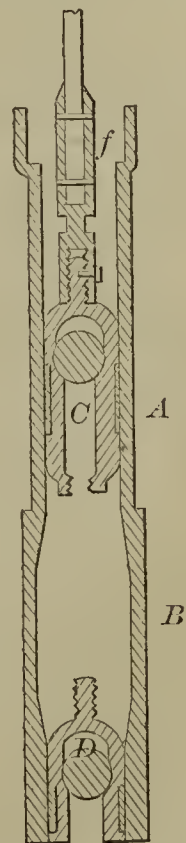

55627—S. F. Day—*Sounder Magnet.*

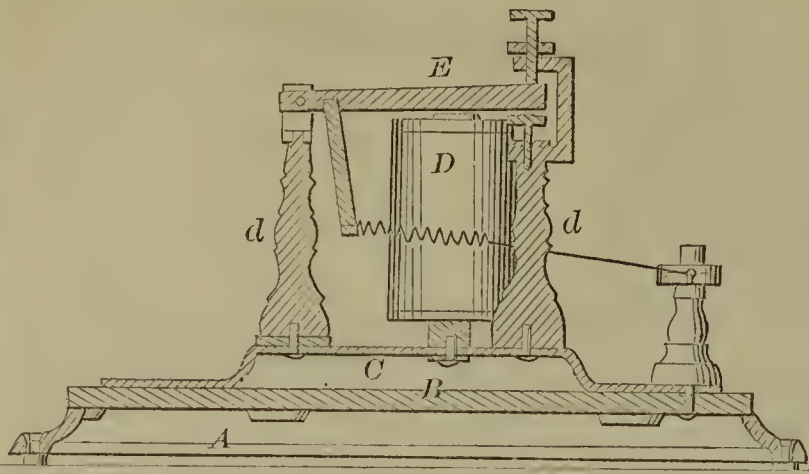

55629—H. J. Deissner—*Making Syrup from Corn.*

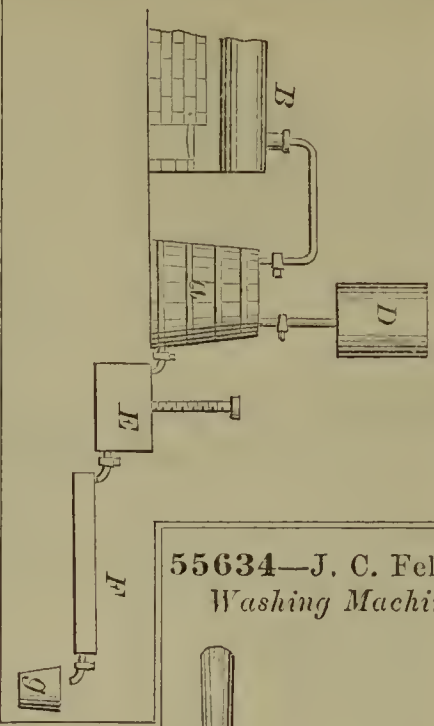

55628—L. P. Decker—*Ferry Bridge Gate.*

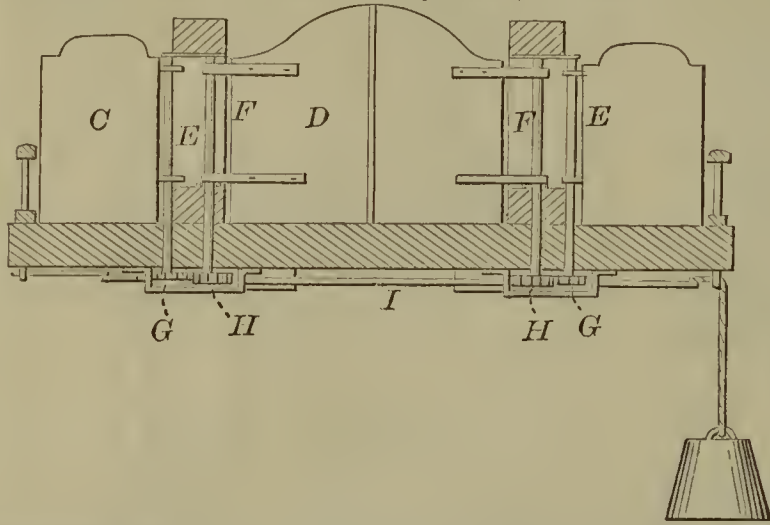

55634—J. C. Fellows—*Washing Machine.*

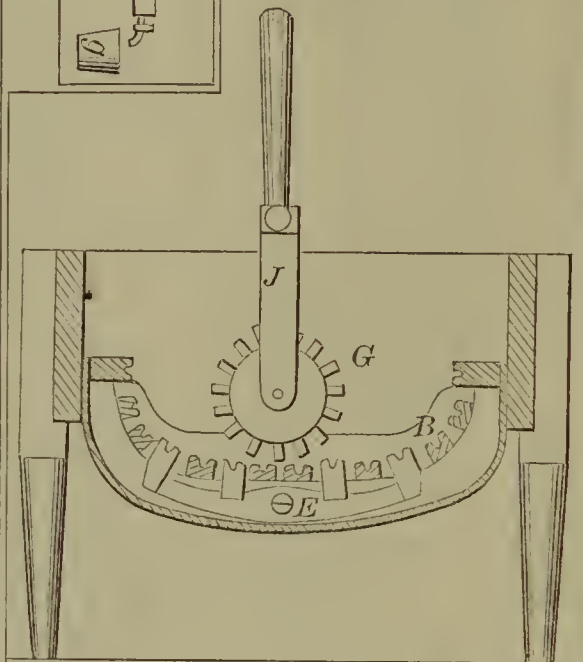

55632—Edmond & Wirt—*Table Fork.*



55631—T. B. Doolittle—*Fruit Box.*

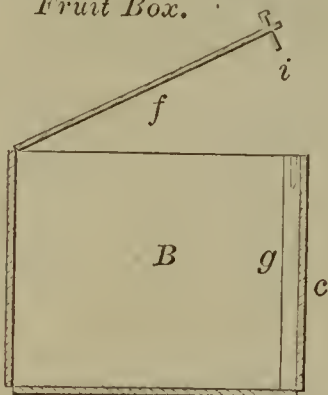

55630—P. Dennis—*Shovel Plow.*

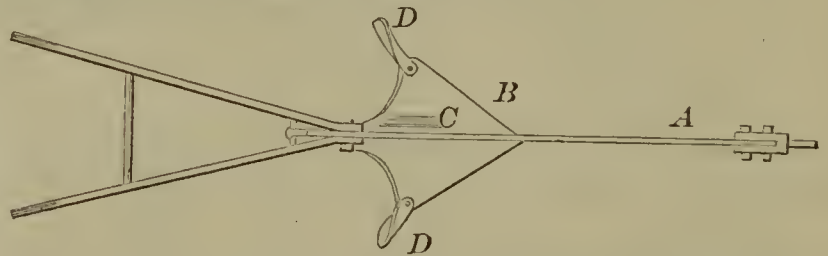

55633—Elkins & Green—*Automatic Gate.*

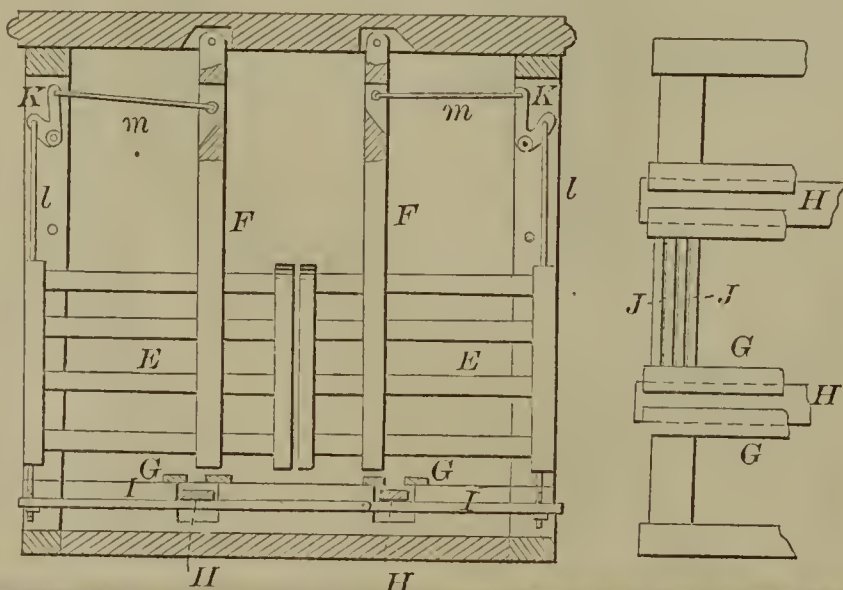

55635—E. A. Field—*Fishing Net.*

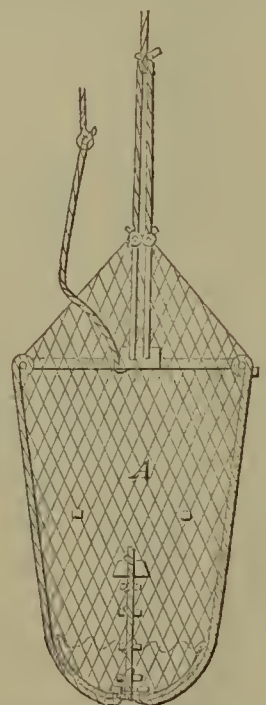

55636—D. D. Foley—  
*Portable Letter Box.*

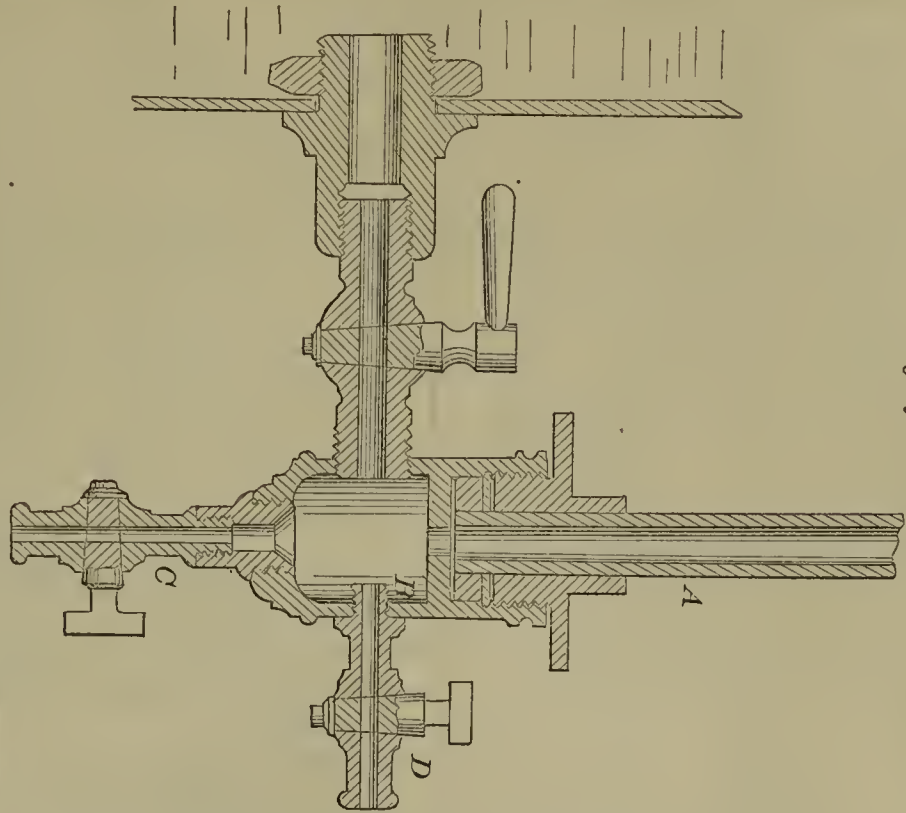
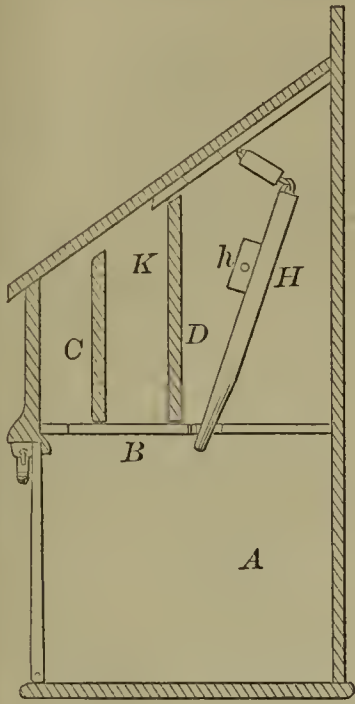

55638—C. L. Frink—*Gauge for Boilers.*

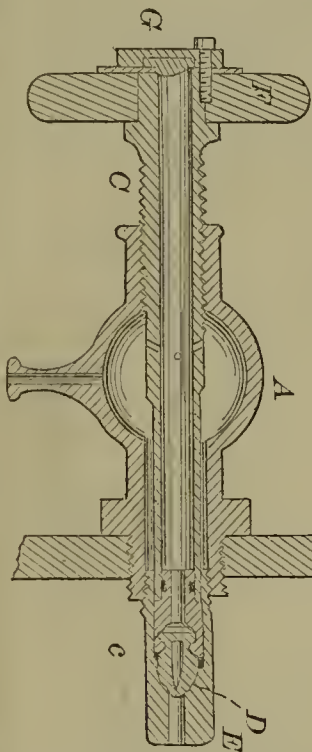

55640—C. L. Frink—*Gauge Cock.*

55639—C. L. Frink—*Safety Valve for Boilers.*

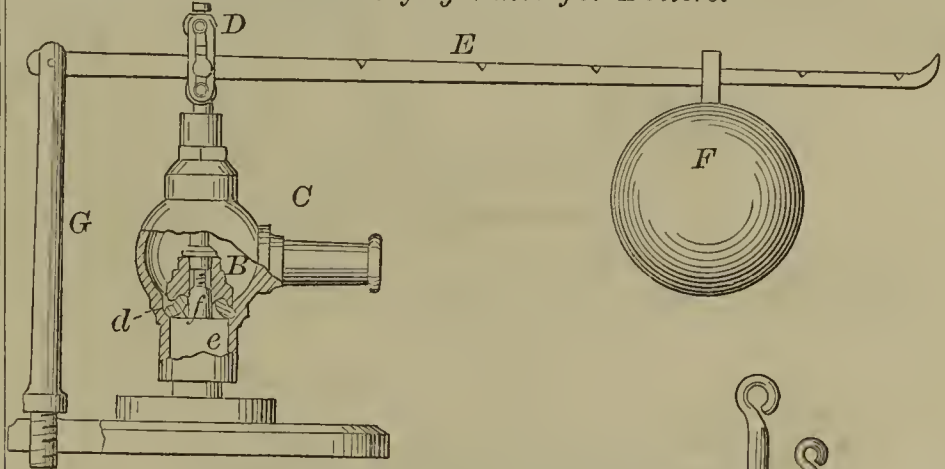

55637—W. Frederick—  
*Boot and Shoe Stretcher.*

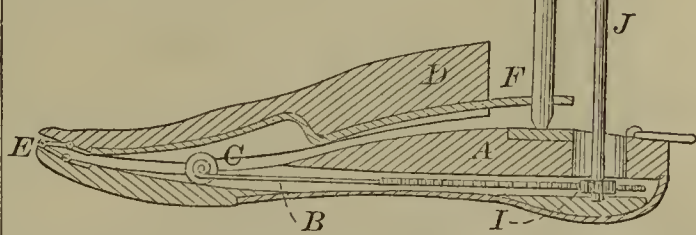

55641—S. Gardiner, Jr.—*Lighting Gas by Electricity.*



55642—S. Gardiner, Jr.—*Turning Gas Cocks by Electro-Magnetism.*

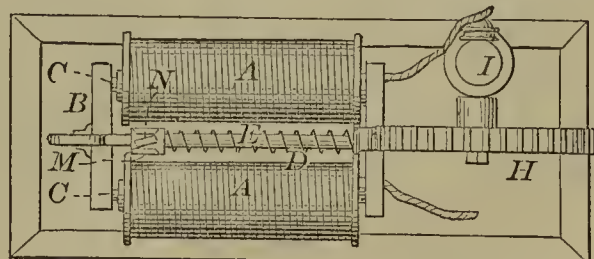
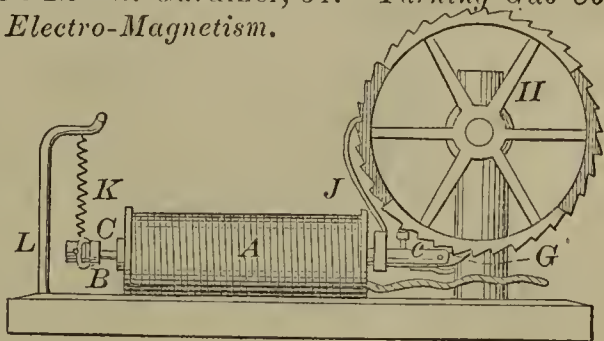

55643—O. S. Garretson—  
*Butt for Blinds.*

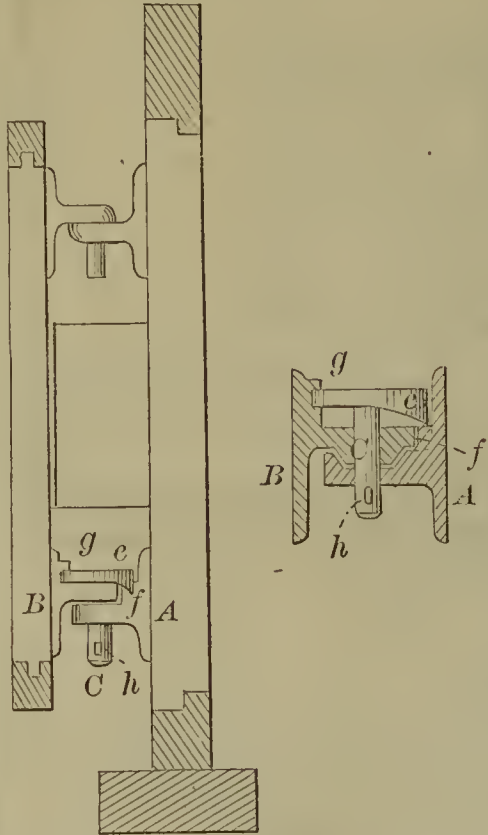

55644—O. S. Garretson—*Shutter Hinge.*

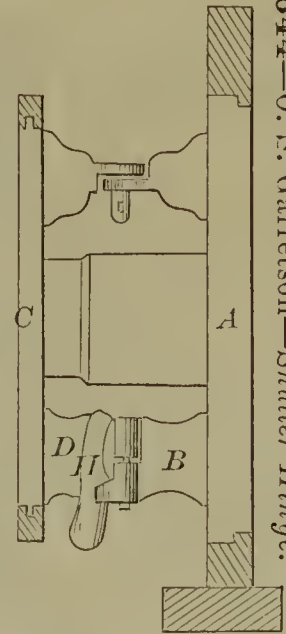

55647—J. S. & H. F. Gray—*For Hanging Mirrors.*

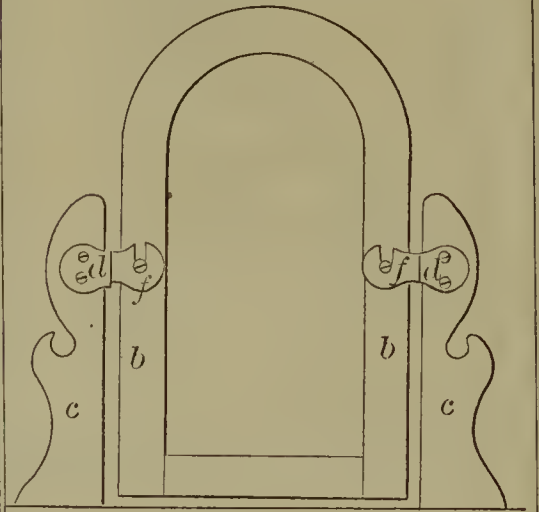

55648—A. Hagny—*Snap Hook.*

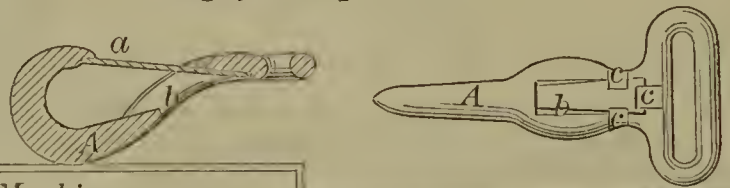

55646—A. B. Glover—*Bolt Heading Machine.*

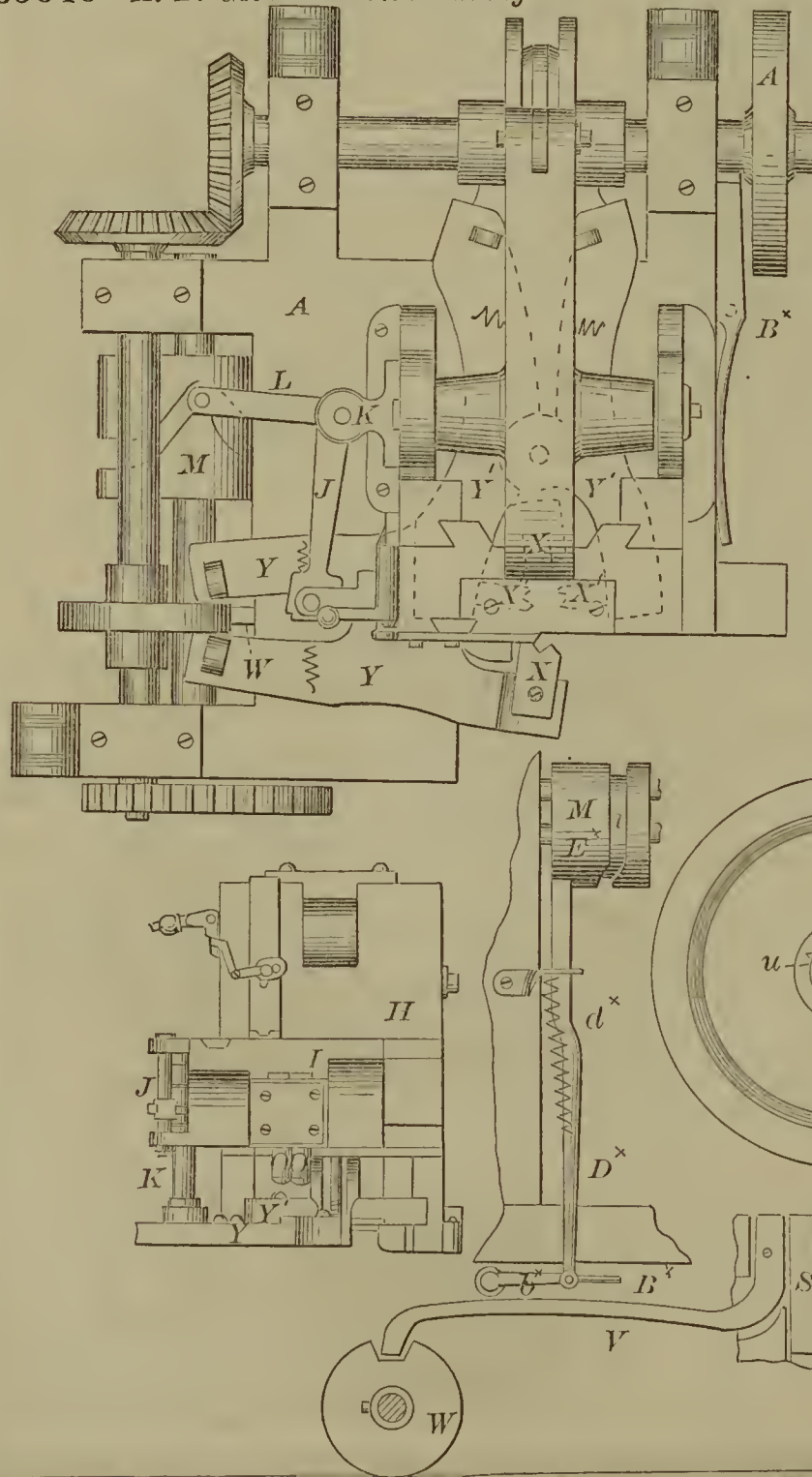

55645—D. Gilson—*Artificial Leg.*

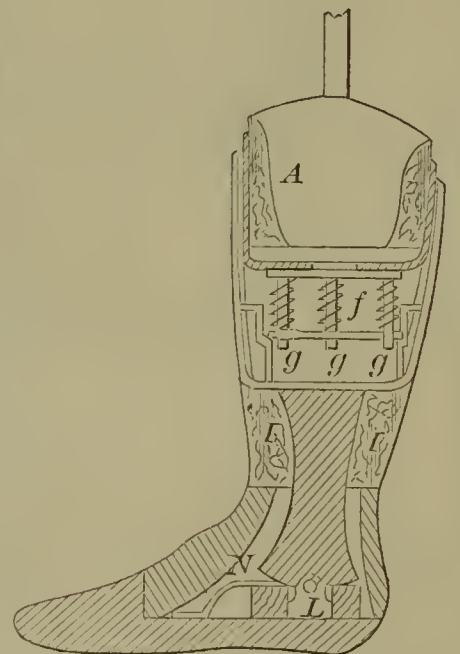

55649—L. C. Hains—*Cheese Vat.*

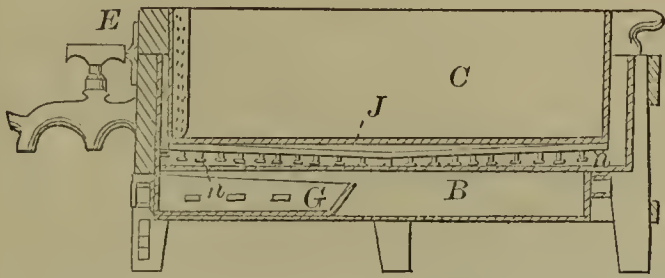

55654—E. & D. Hinchley—*Mowing Machine.*

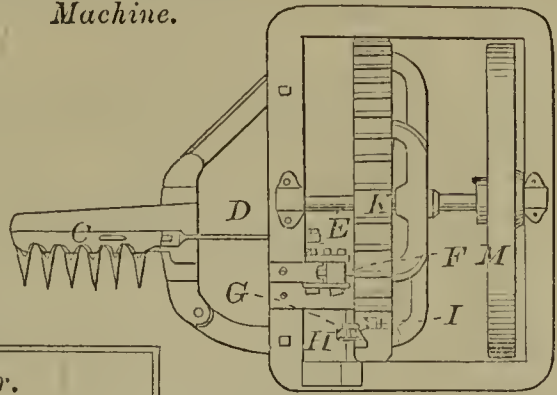

55657—L. J. Holcomb—*Potato Planter.*

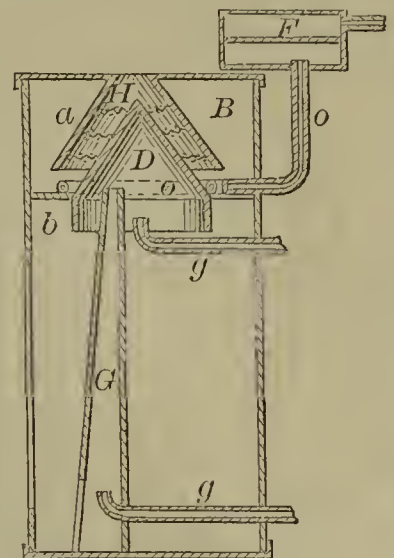
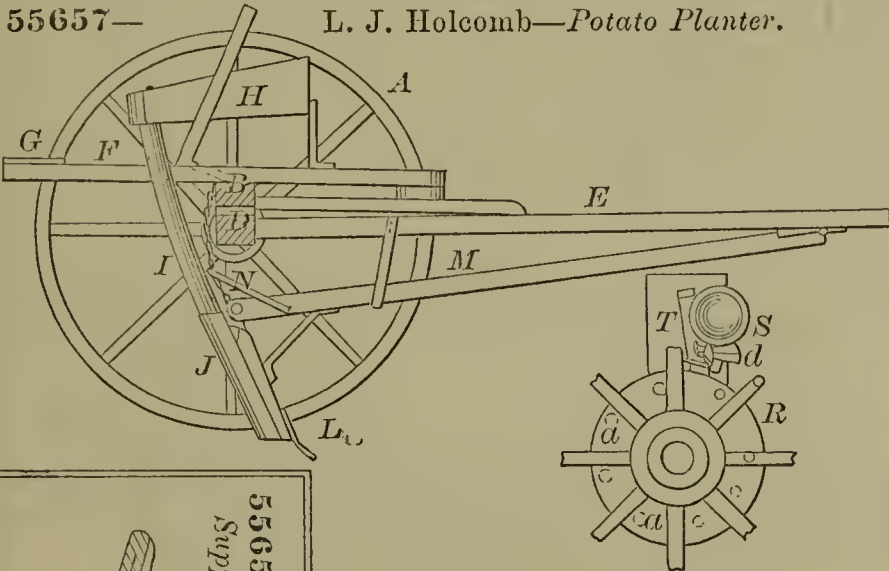

55652—D. G. Haskins—*Gas Stove.*

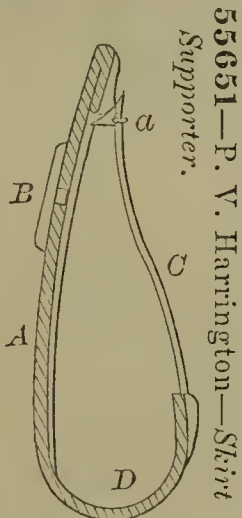

55651—P. V. Harrington—*Skirt Supporter.*

55650—A. Hamill—*Railway Chair.*

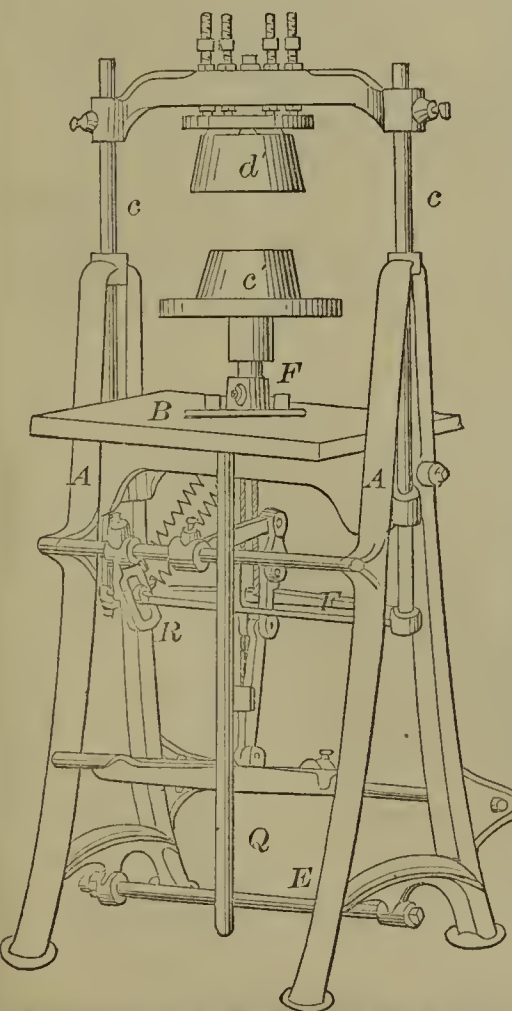
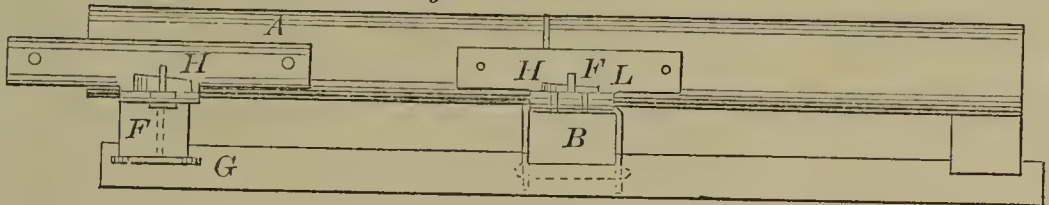

55658—G. C. Howard—*For Pressing and Moulding Materials.*

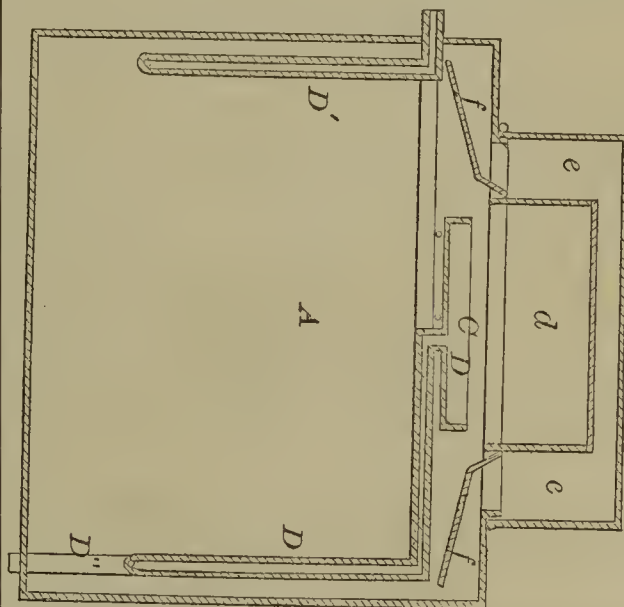

55655—A. A. Hinkley—*Refrigerator.*

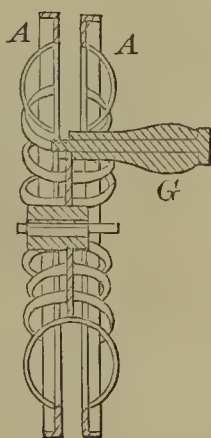

55653—A. Hatch—*Fishing Reel.*

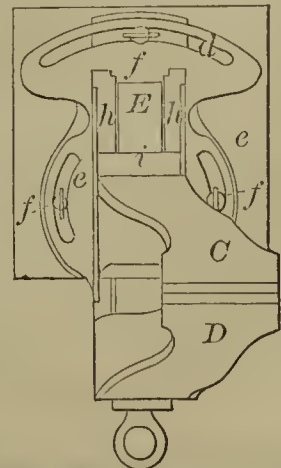

55656—J. S. Hoar—*Bench Vise.*

55659—H. C. Hunt—  
Window Sash Supporter.

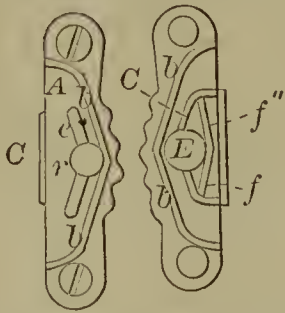

55660—J. B. Hunter—Gang Plow.

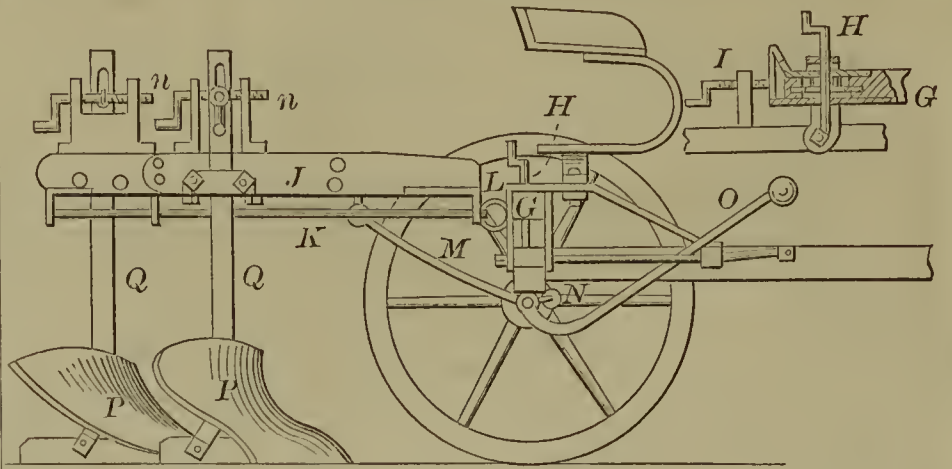

55665—W. Johnson—  
Furniture Caster.

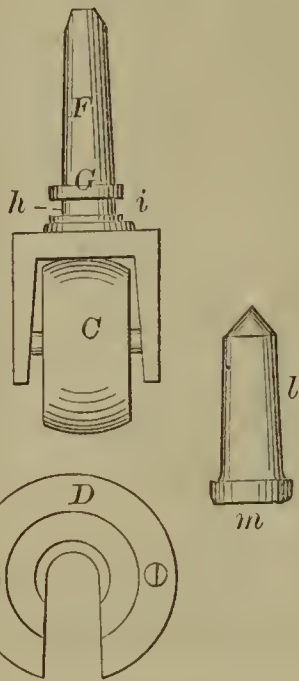

55663—F. W. Jenkins—Railway Car.

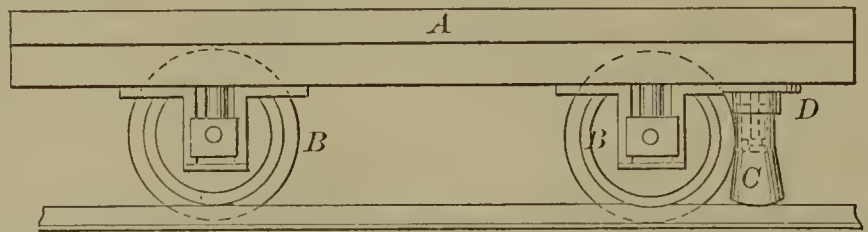

55666—Jones & Kitson—Spinning  
Top.

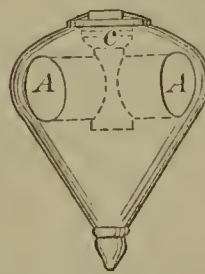

55664—Jewett & Everson—For Facing  
Boot and Shoe Buttons.

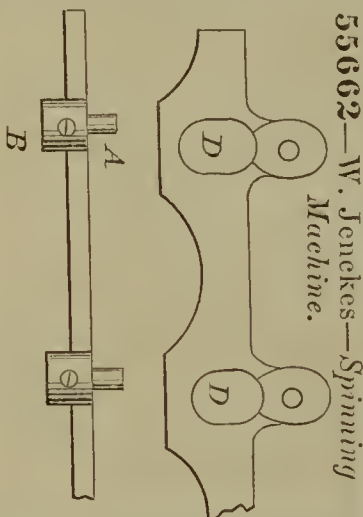
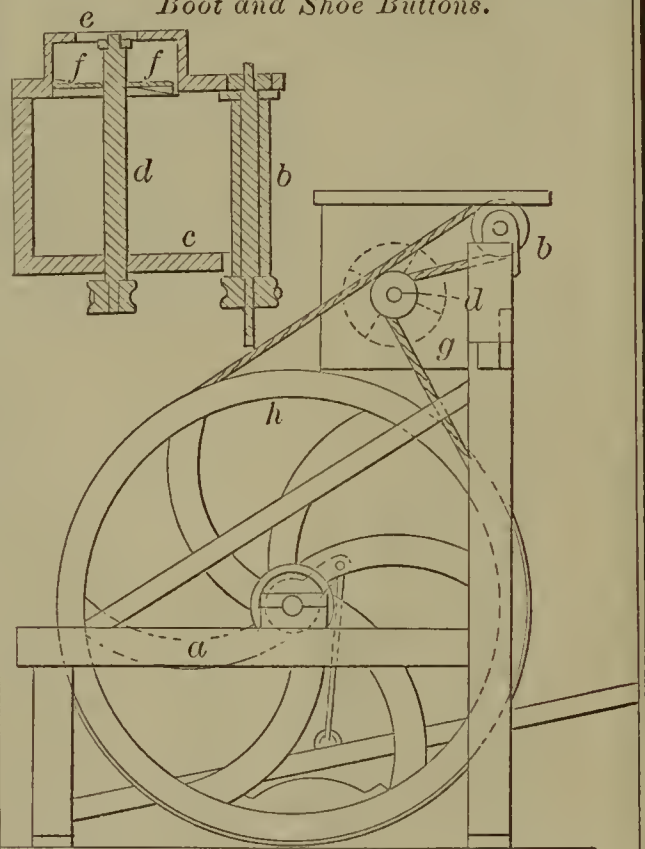

55662—W. Jenkes—Spinning  
Machine.

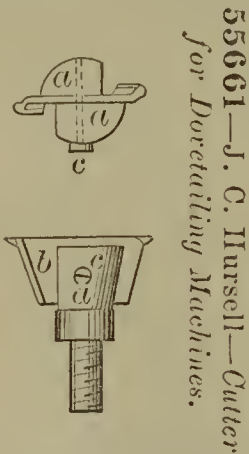

55661—J. C. Hursell—Cutter  
for Doretiling Machines.

55667—F. Jones—Manufacture of Bricks.

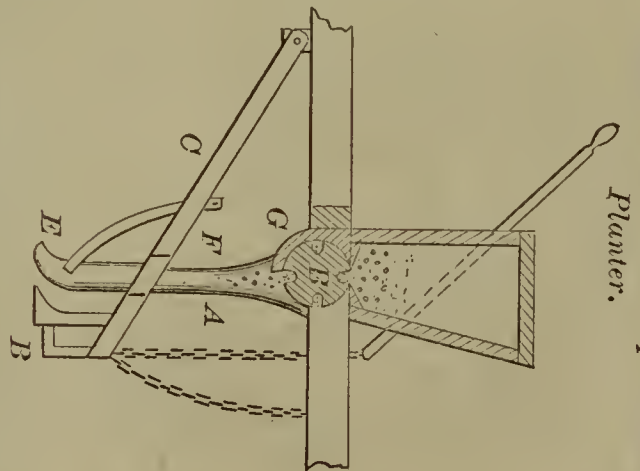
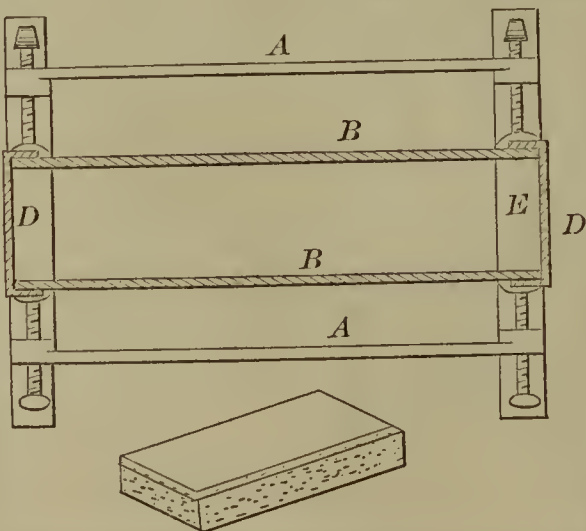

55668—W. H. Karicope—Corn  
Planter.

55669—C. B. Keys—Spark Arrester.

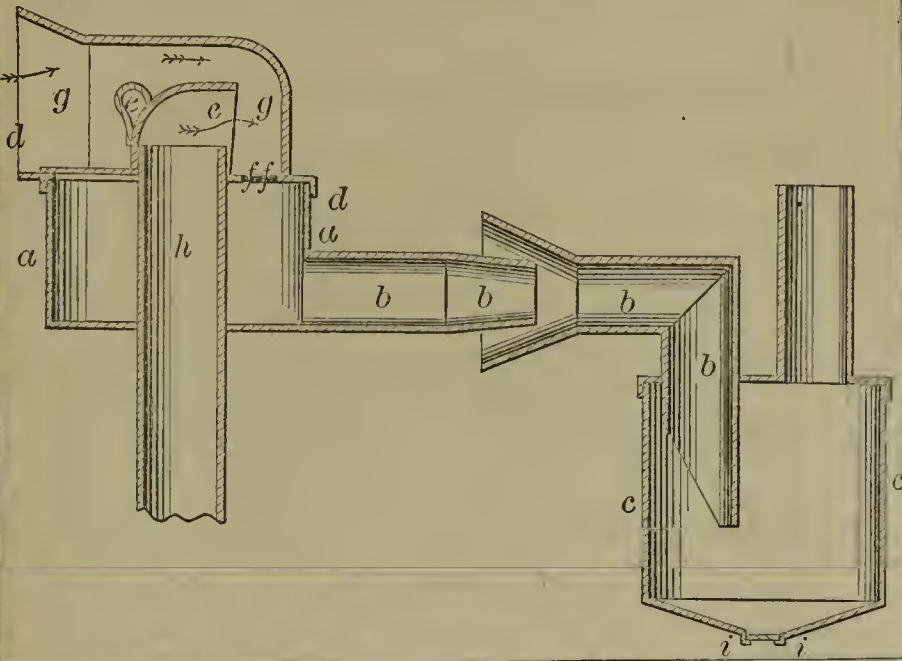

55670—W. H. Kilburn—Car Brake.

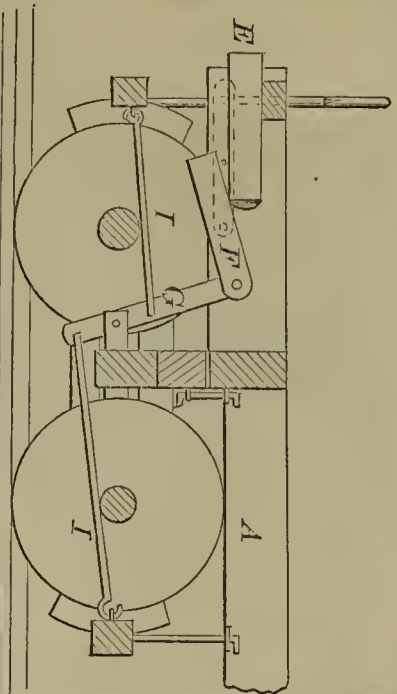

55673—D Knowlton—Winch Capstan.

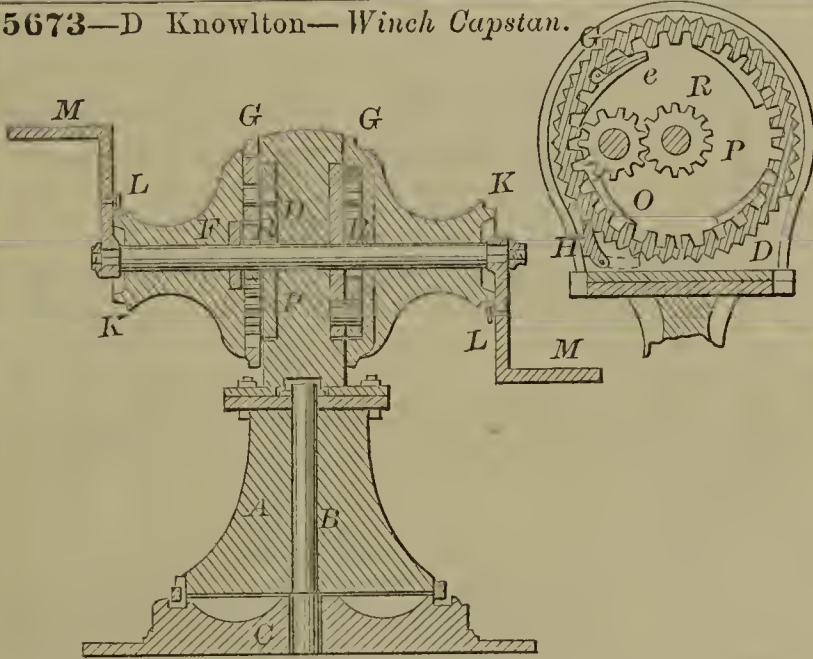

55671—J. Kimball—Boots and Shoes.

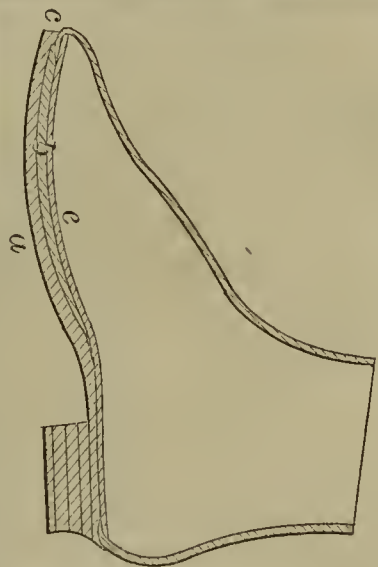

55674—A. Kloman—Upsetting Press.

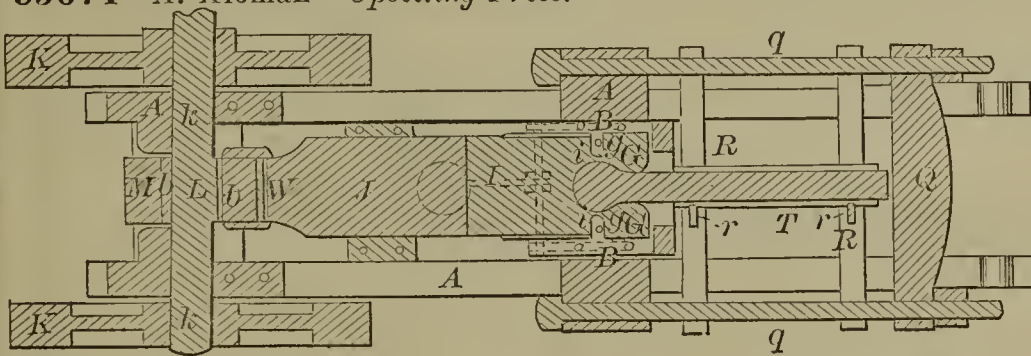

55675—Knudsen & Lassoe—Portable Boat.

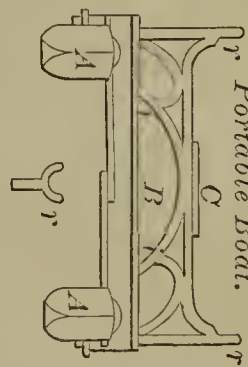

55672—J. King—Horse Rake.

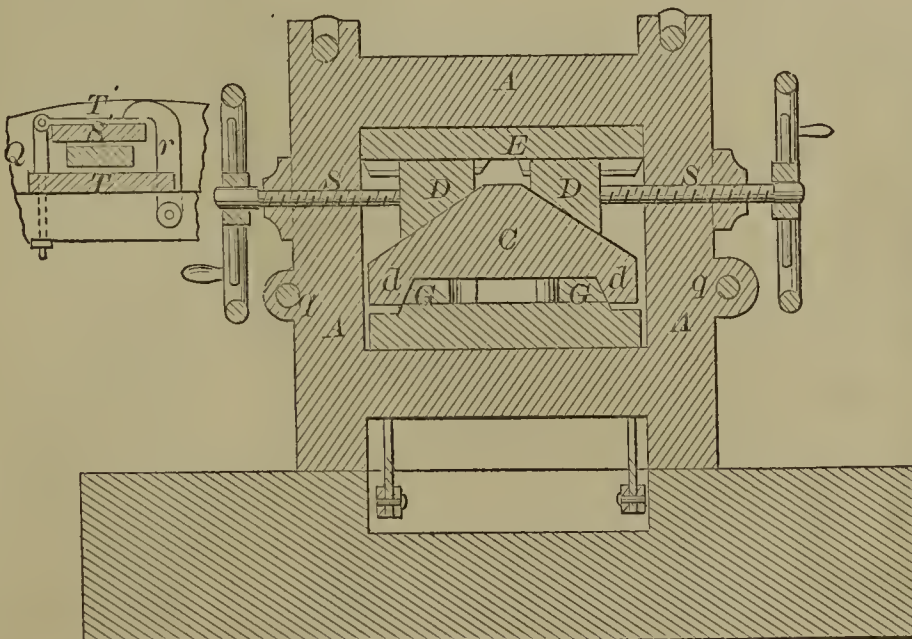
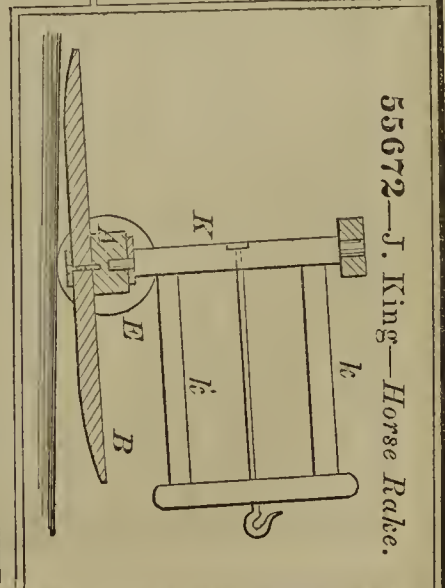

55676—T. T. S. Laidley—*Priming Metallic Cartridges.*

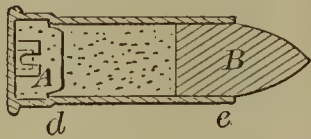

55677—W. L. Lance—*Sewing Table.*

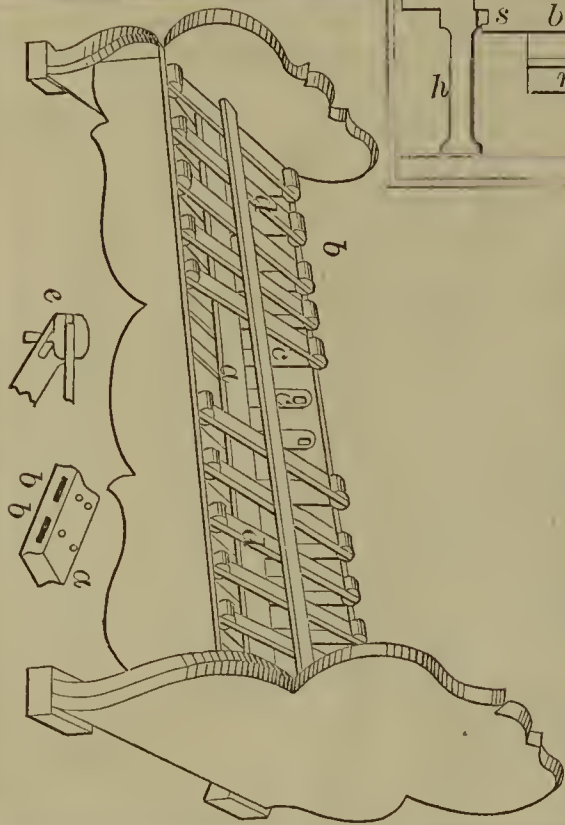
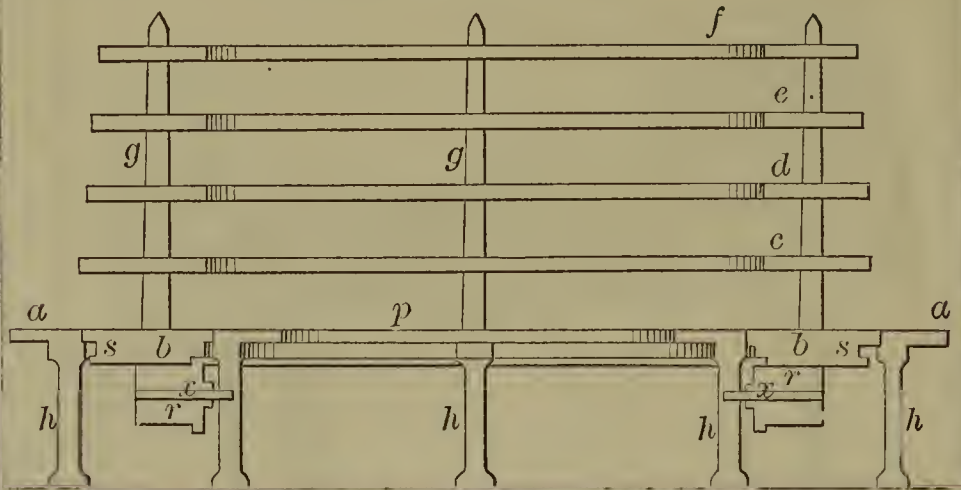

55680—R. Lapham—*Spring Bedstead.*

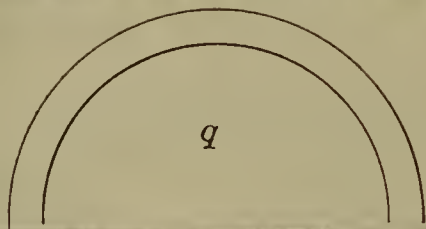

55678—Lauphear & Blair—*Bed Bottom.*

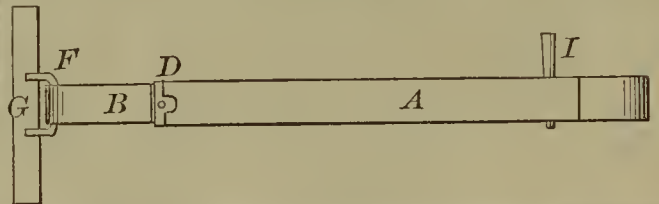

55681—C. W. Le Count—*Adjustable Mandrel.*

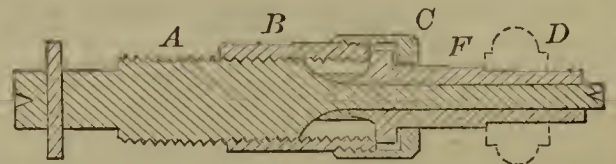

55683—J. E. Lindsley—*Weather Strip.*

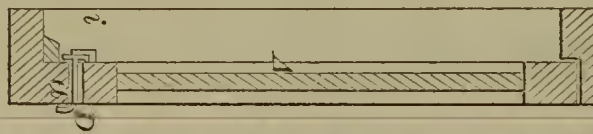

55682—C. A. Lecch—*Photographic Apparatus.*

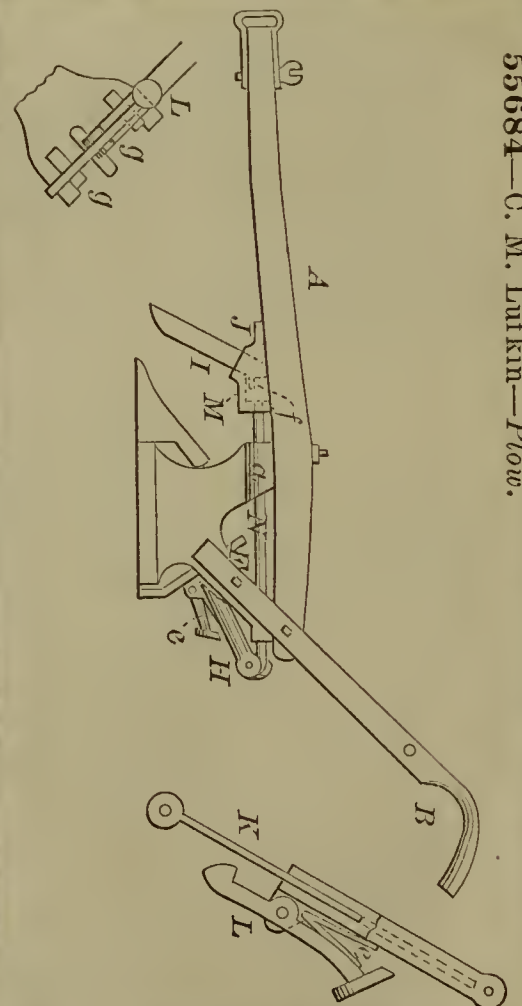
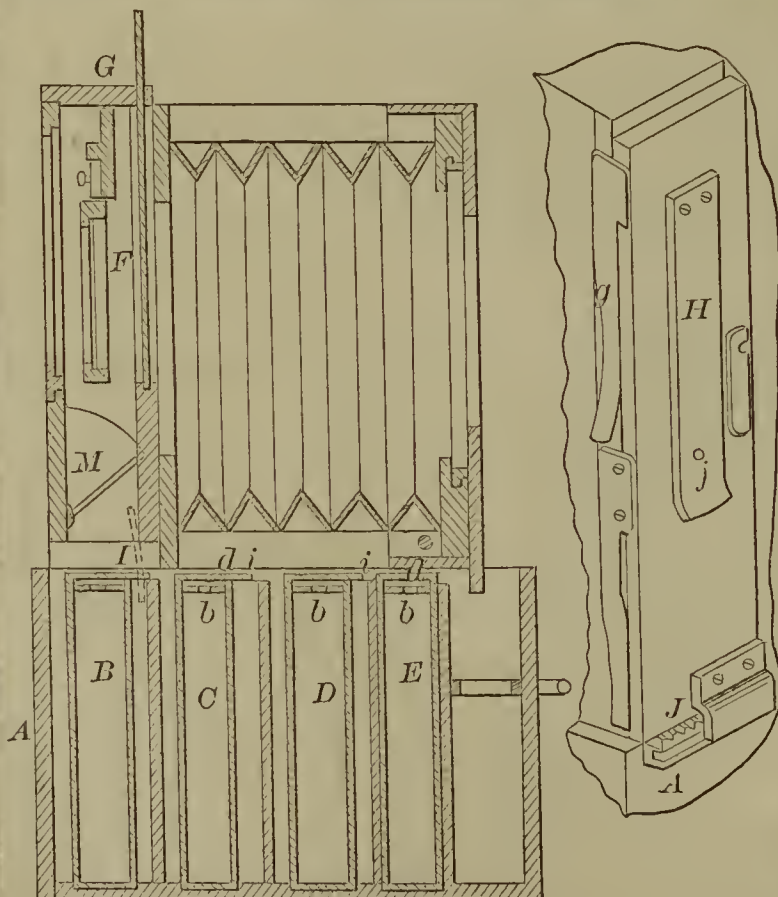

55684—C. M. Lufkin—*Plow.*



55685—T. H. Mahler—Water Wheel.

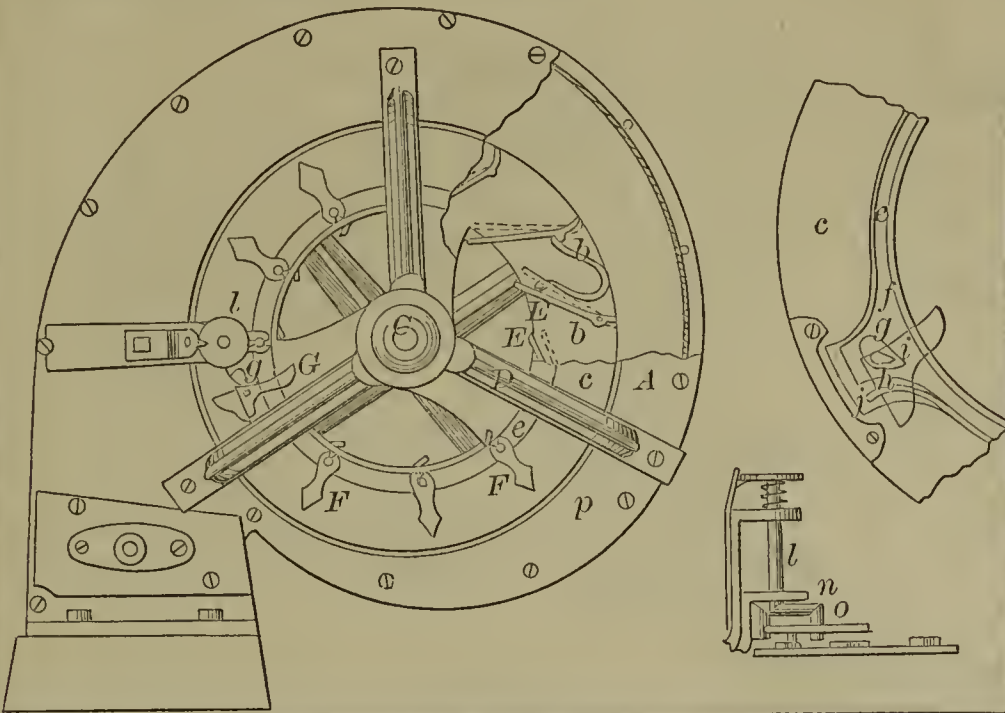

55686—T. T. Markland—Street Lamp.

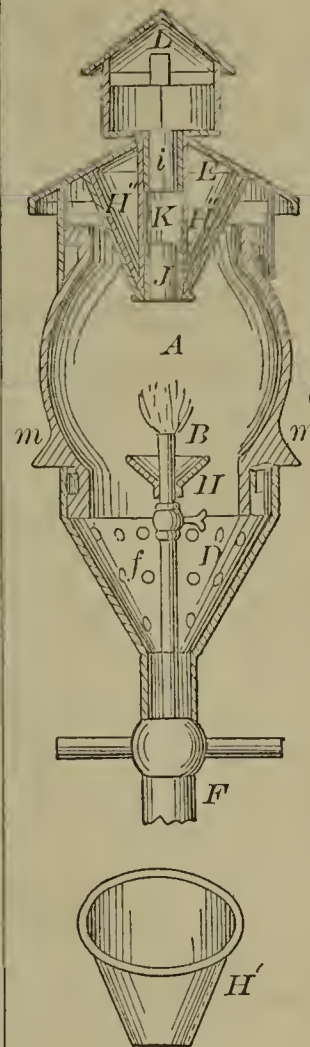

55688—J. McCloskey—Button Hole Sewing Machine.

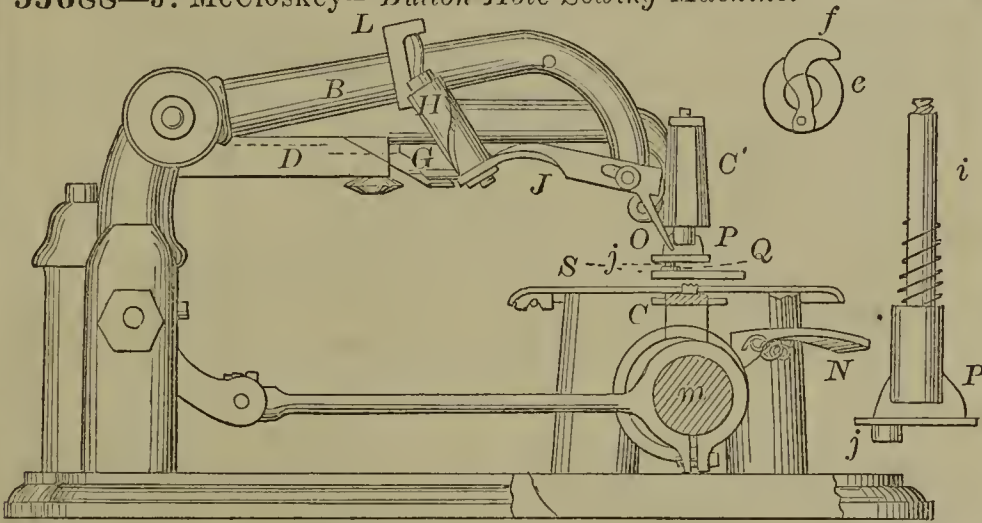

55689—A. McDonald—Trunk.

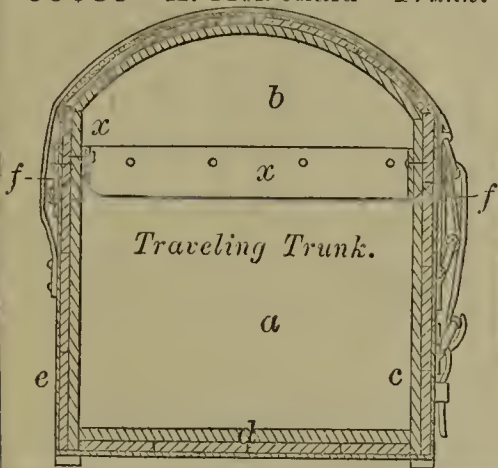

55690—S. S. Meily—Buggy Top.

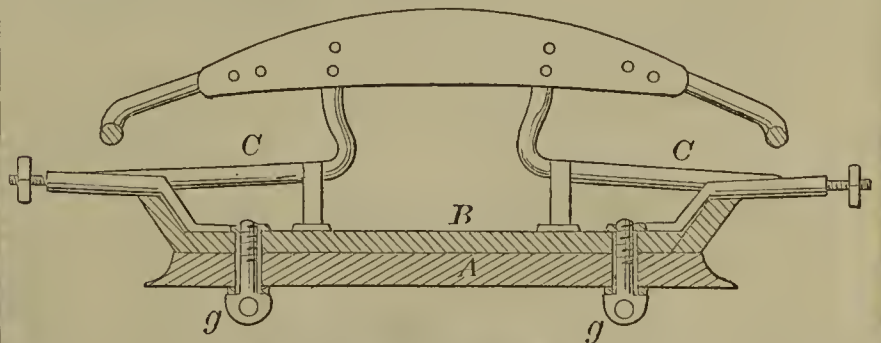

55691—R. S. Morrison—Grain Weighing Apparatus.

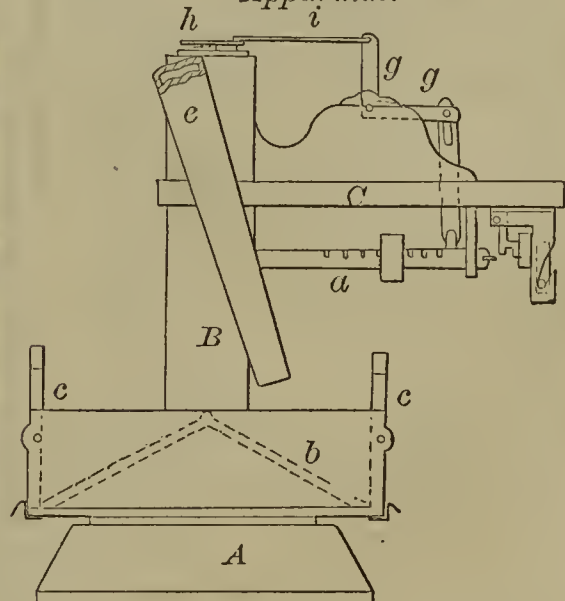

55687—W. W. Martin—Bending Flanges upon Boiler Heads.

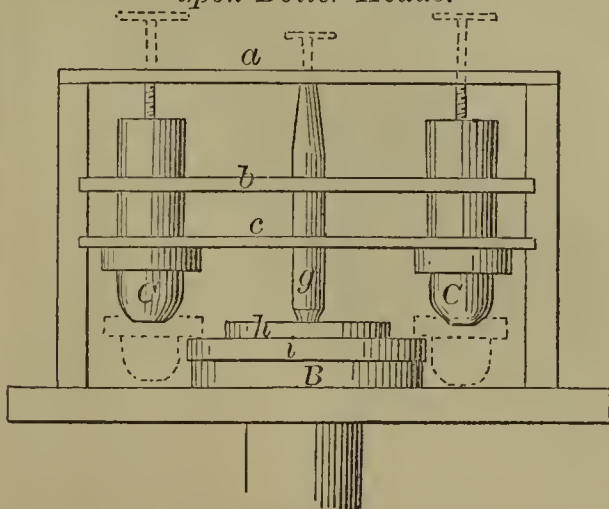

55692—F. B. Morse—*Rub Iron for Carriages.*

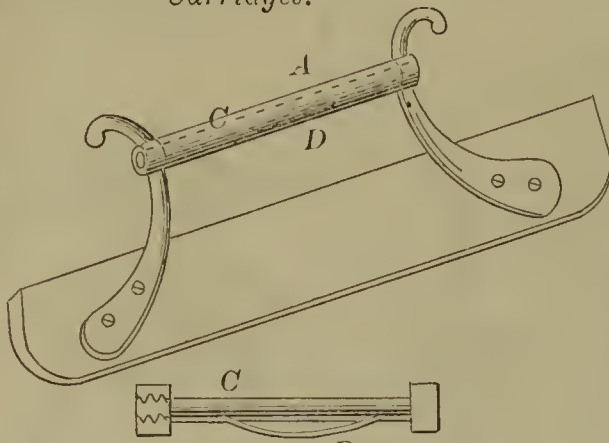

55693—G. Mott—*Well Drilling Machine.*

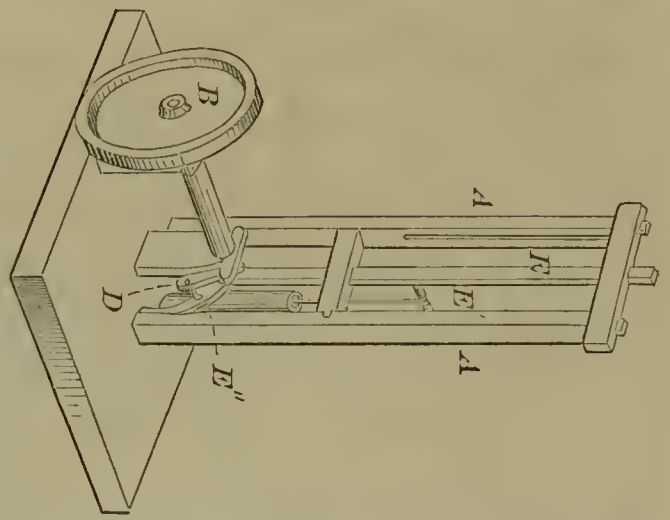

55696—Nevergold & Stackhouse—*Drill and Tongs.*

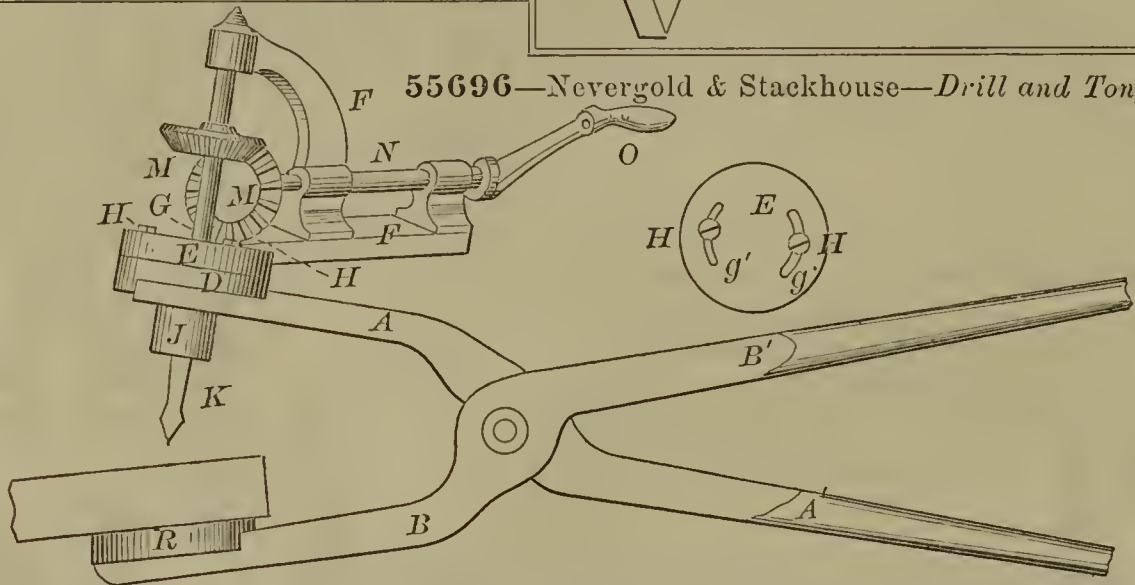

55698—O. Pacalin—*Boots and Shoes.*

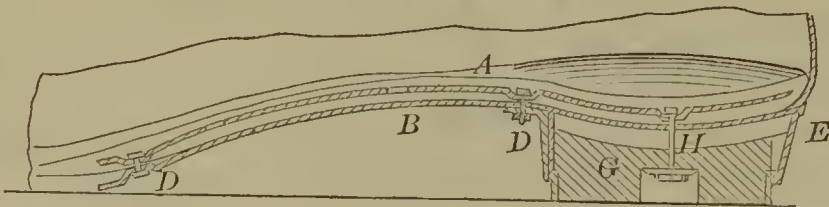

55699—C. D. Page—*Lime Kiln.*

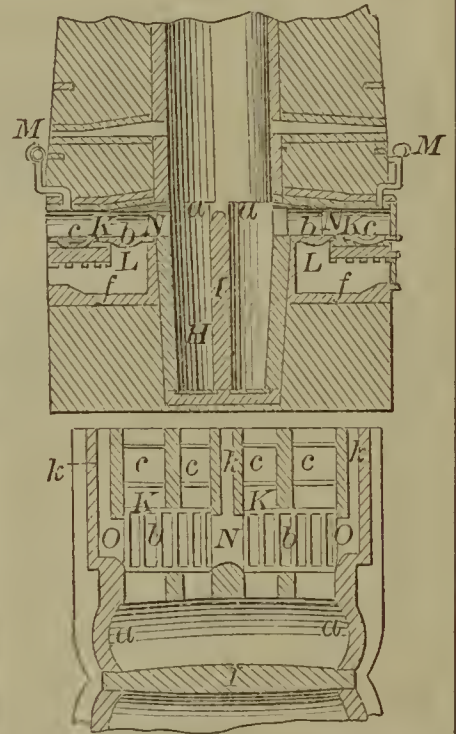

55700—C. C. Parsons—*Stop Cock.*

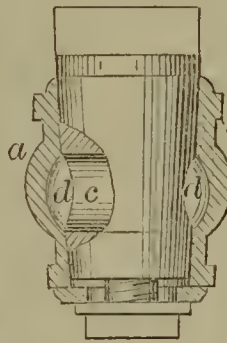

55695—C. Murdock—*Stave Machine.*

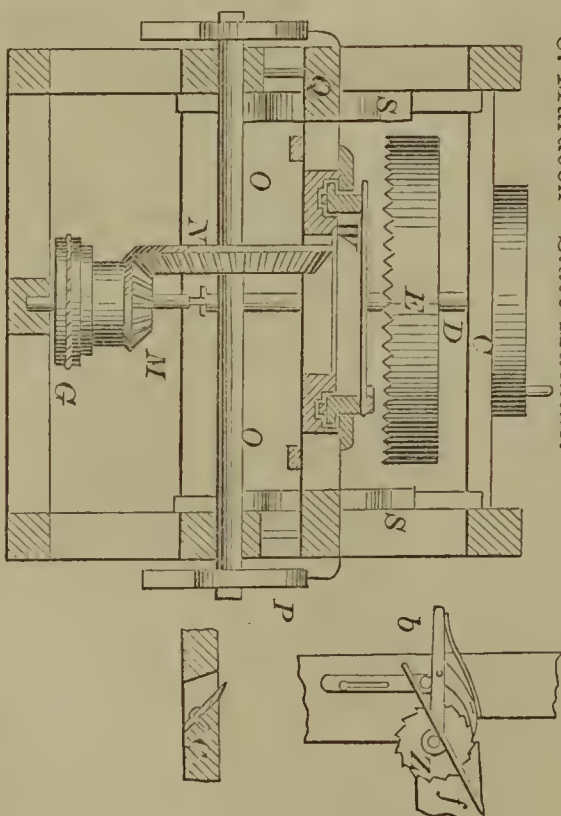

55701—J. Perkins—*Cotton Seed Huller.*

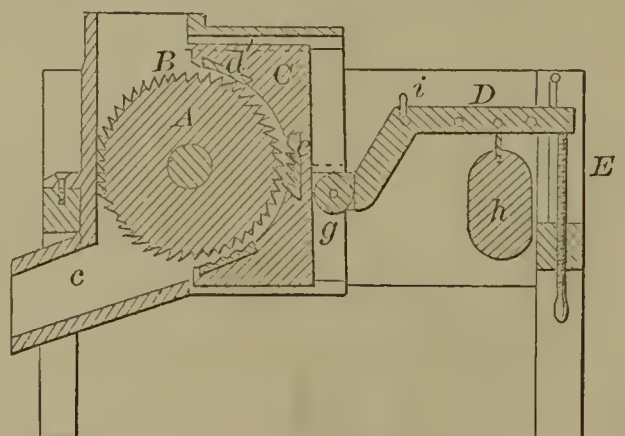

55702—C. L. Pierce—*Shingle Machine.*

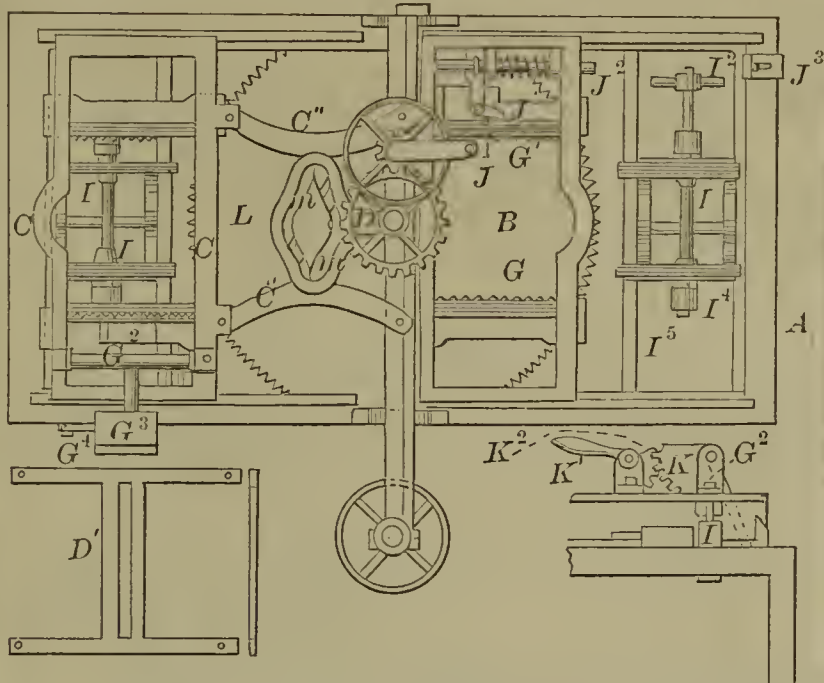

55707—A. Putnam—*Grain Drill.*

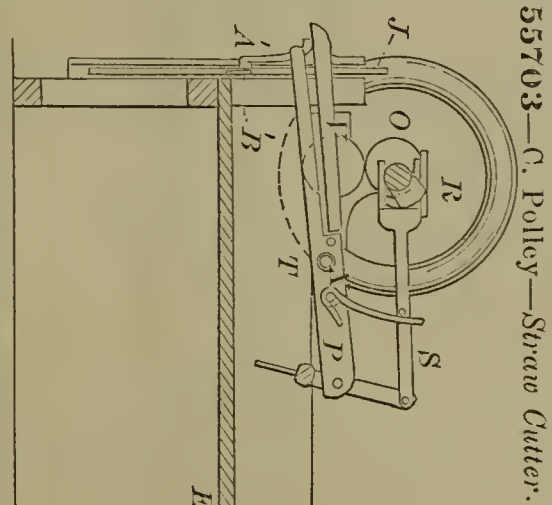
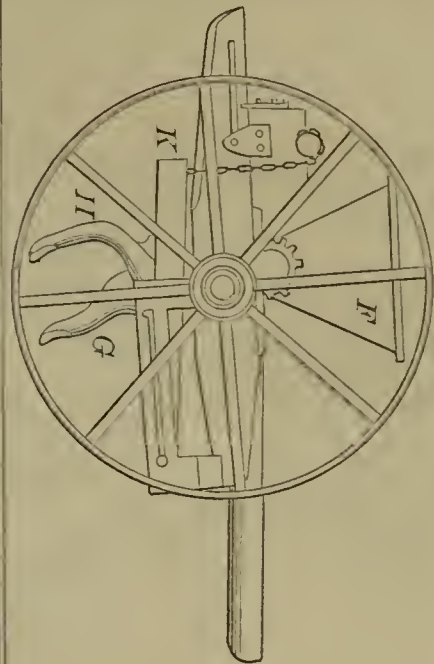

55703—C. Polley—*Straw Cutter.*

55705—T. W. Porter—*Sleigh.*

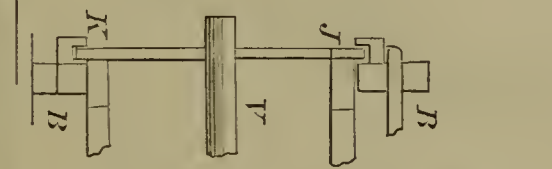
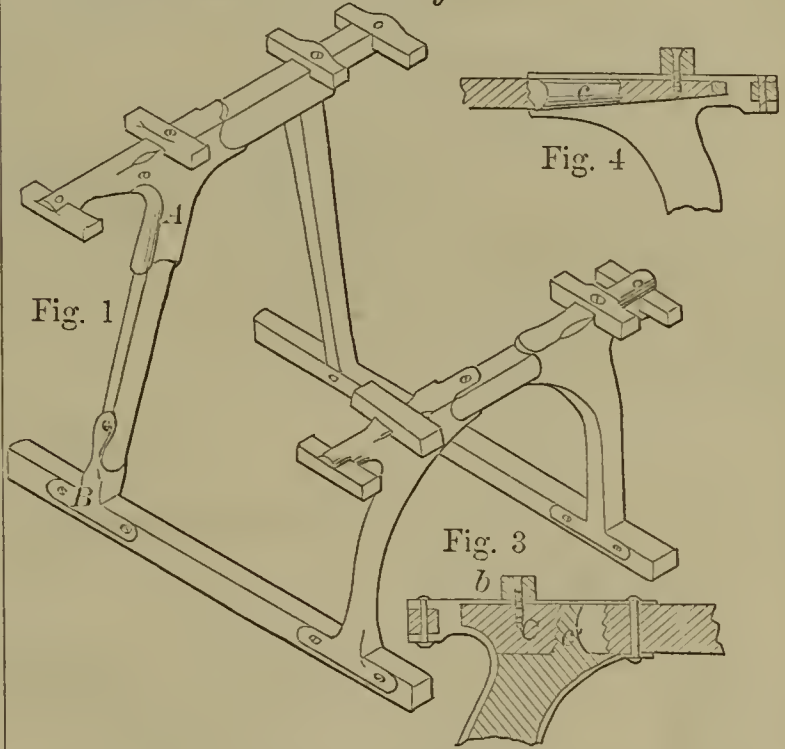

55704—A. Pond—*Tack Hammer.*

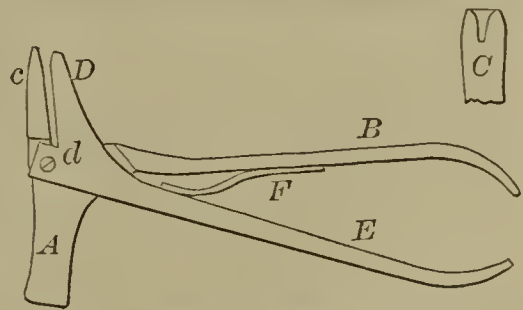

55708—J. J. Ralya—*Stave Machine.*

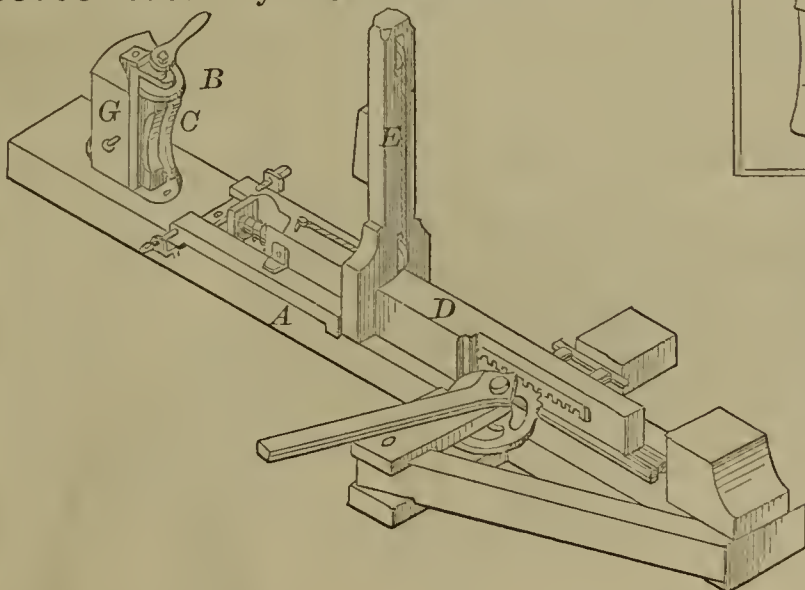

55709—C. Reese—*Fruit Box.*

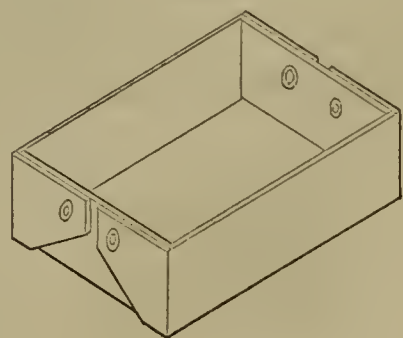

55710—J. Reese—Reducing Metallic Oxides.

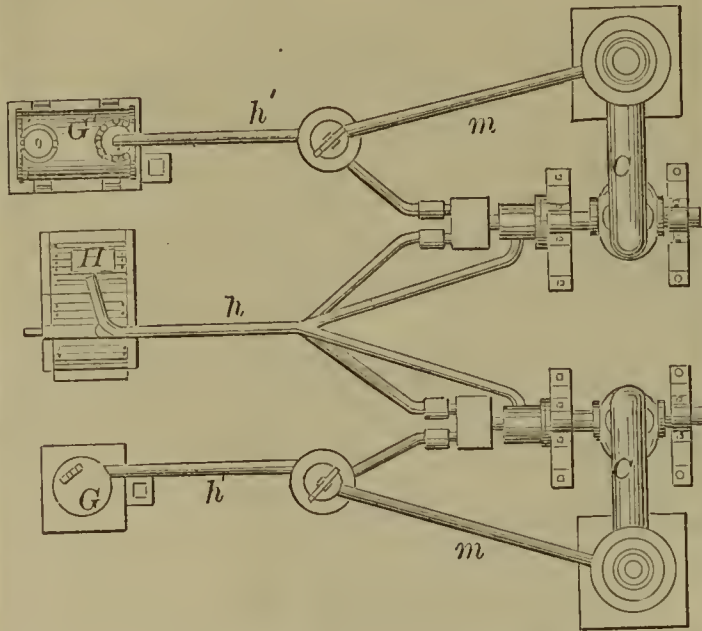

55714—J. Robinson—Butter Worker.

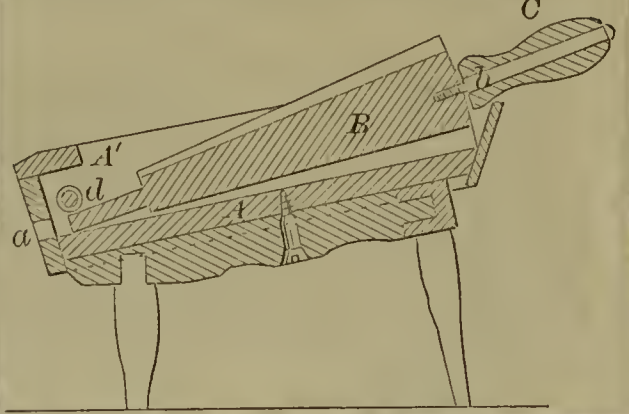

55712—J. Register—Hydrant.

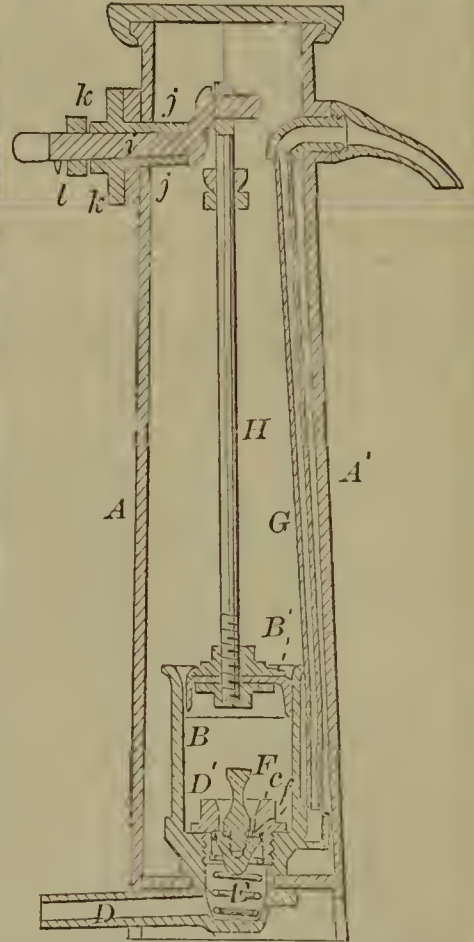

55713—W. D. Rinchart—Mould for Casting Pulleys.

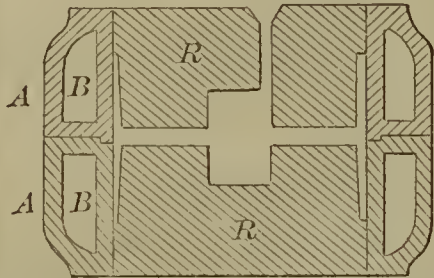

55717—L. W. Russell—Buckle.

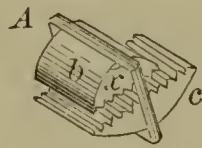

55716—Rudolph & Braun—Gun Lock.

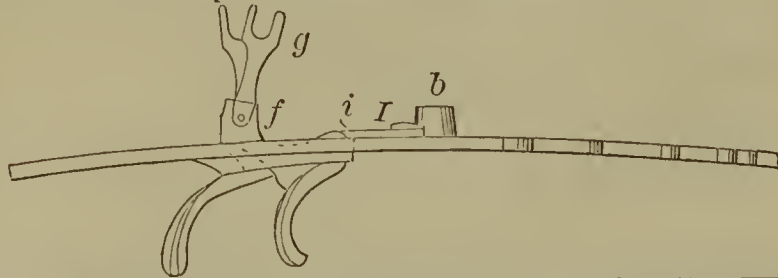

55718—G. W. Sanders—Dough Kneader.

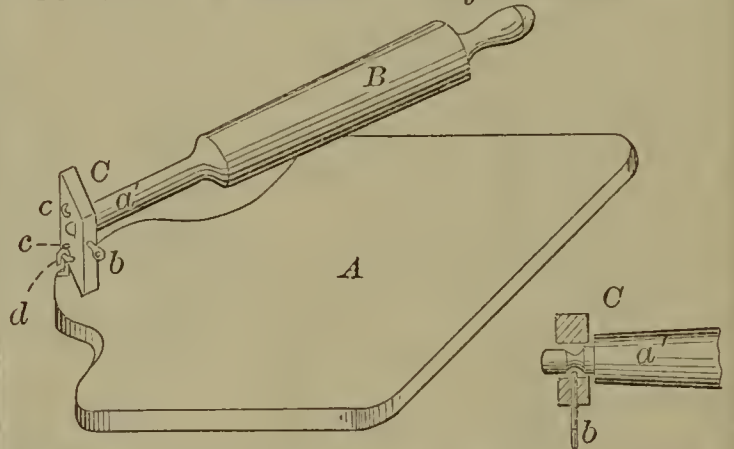

55711—J. Register—Hydrant.

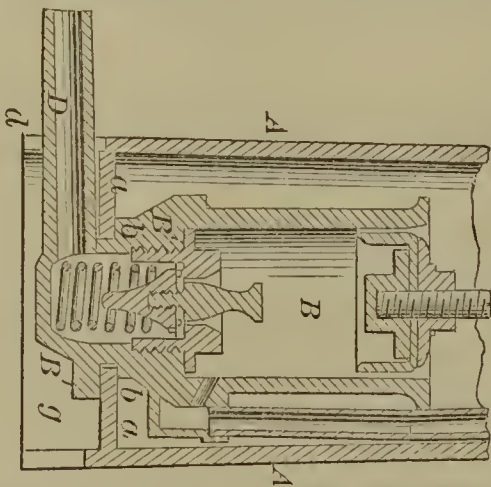

55719—A. Sayer—Fire Arm.

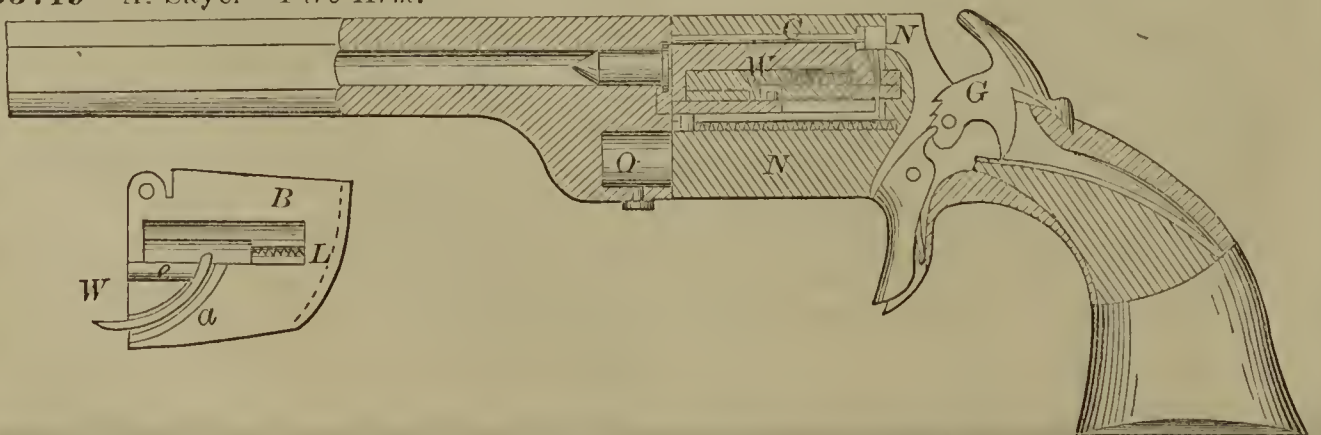

55720—P. G. H. Schaeffer—  
*Tea and Coffee Pot.*



55722—T. A. Searle—*Nail Plate Feeder.*

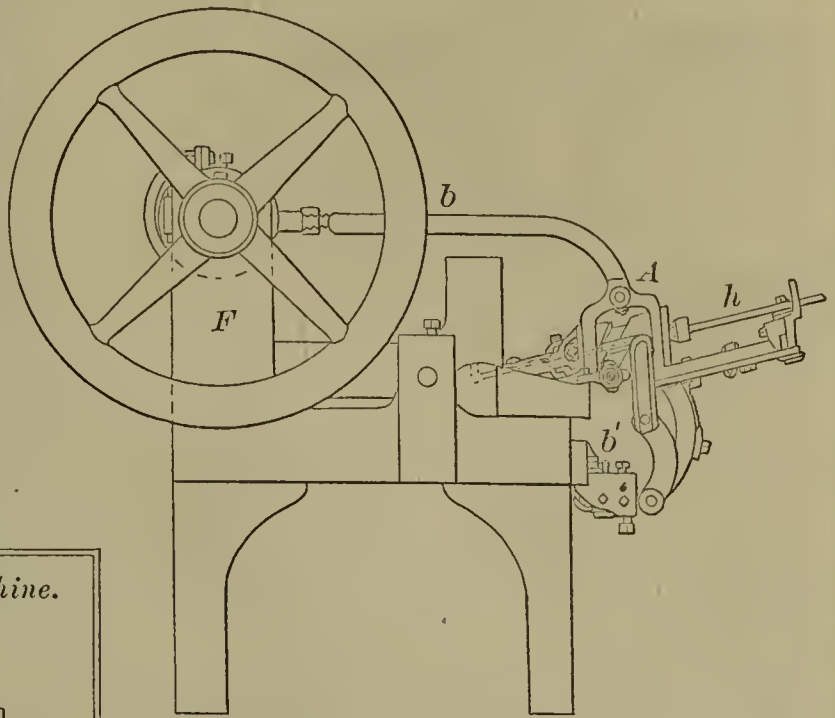

55723—W. Sellers—*Planing Machine.*

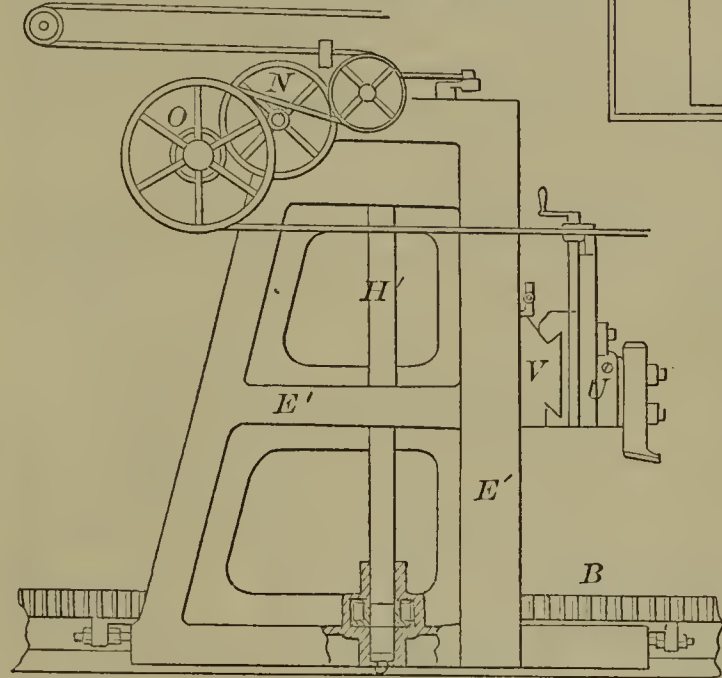

55721—P. Schouler—*Billiard  
Table.*

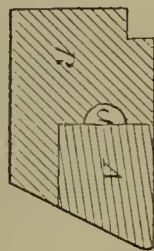

55726—F. J. Simeon—*Feed Bag.*

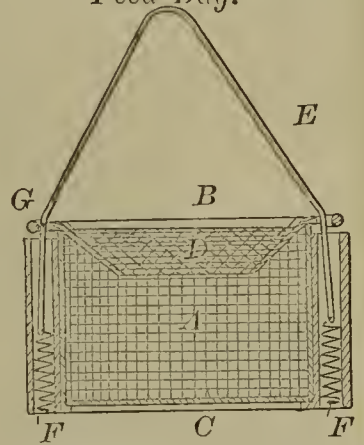

55724—J. A. Sherman—*Truss.*

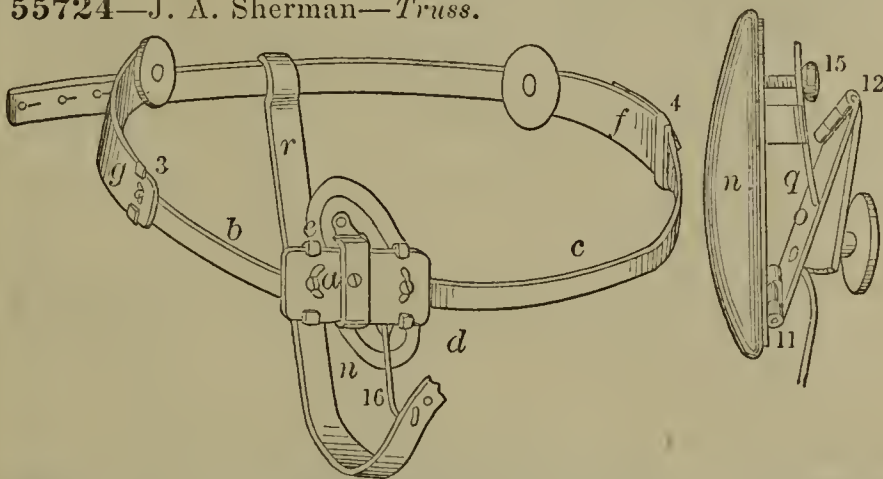

55727—H. C. Small—*Cattle Tie.*

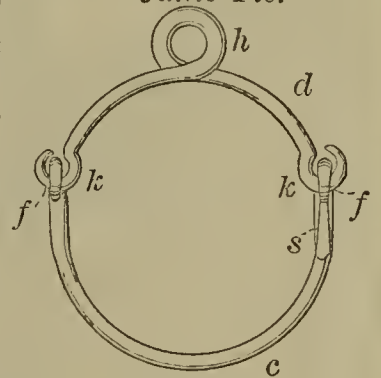

55725—L. Shultz—*Fanning Mill.*

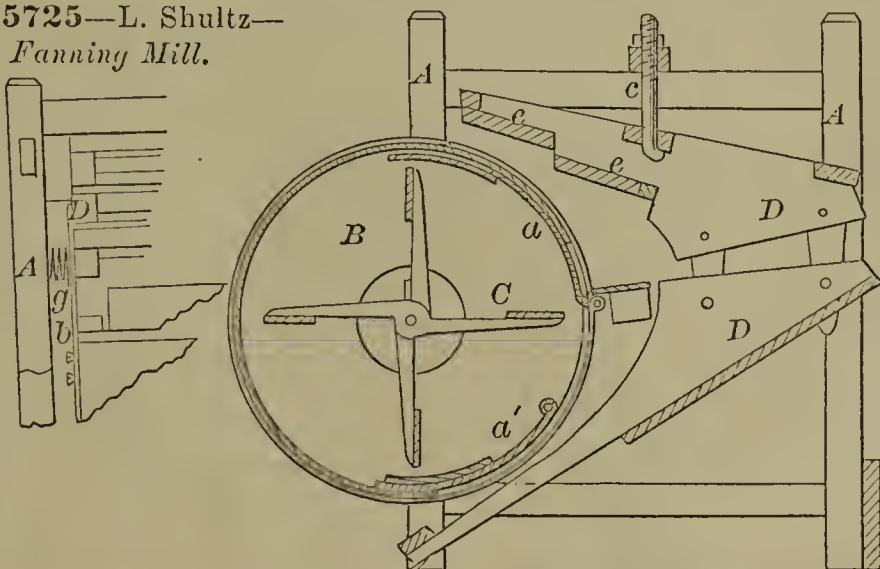

55728—S. Smith—*Heating Stone.*



55729—W. G. Smith—*Spittoon for Cars.*

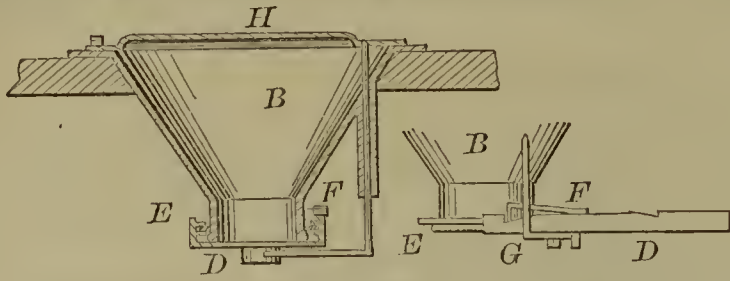

55733—I. Stealy—*Pessary.*



55731—E. Sprague—*Valve Gear for Steam Engines.*

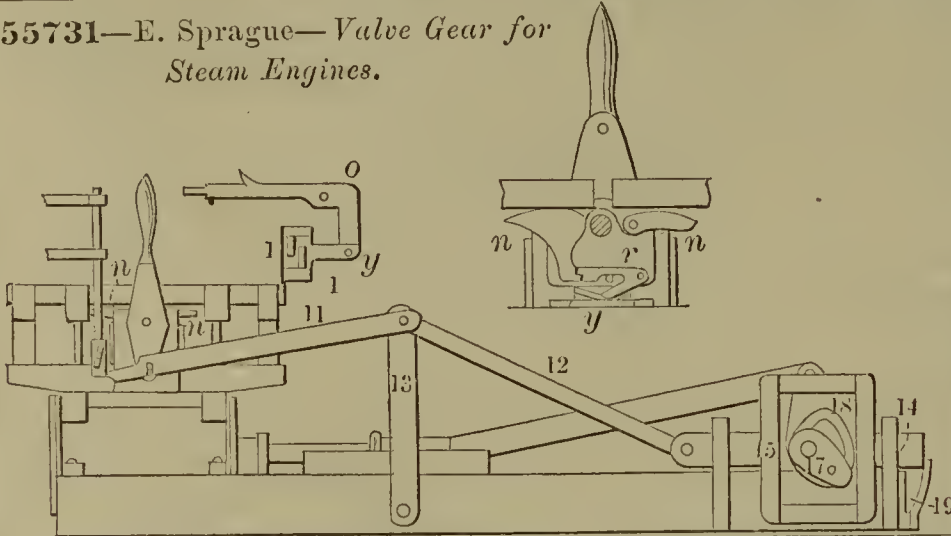

55732—Springer & Bartram—*Indicator for Steam Generators.*

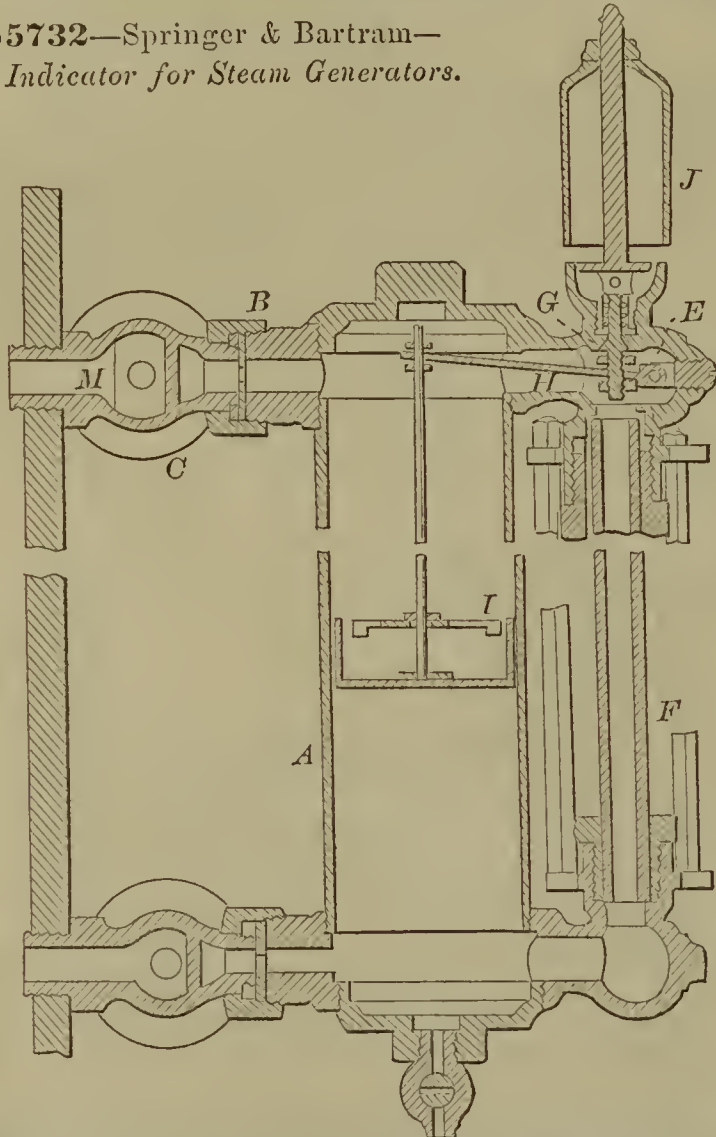

55734—A. B. Stillings—*Knitting Machine.*

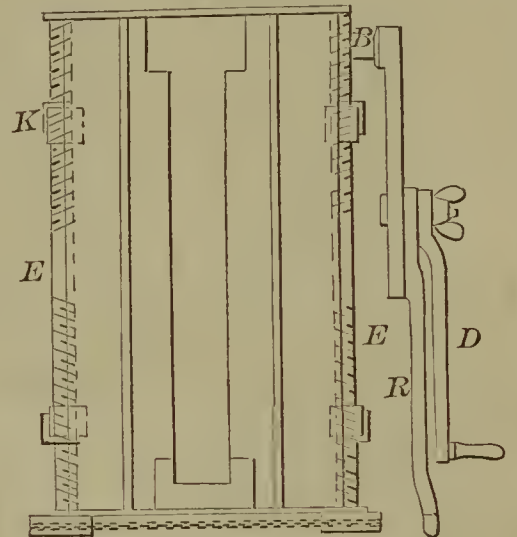

55735—A. Stow—*Device for Upsetting Tire.*

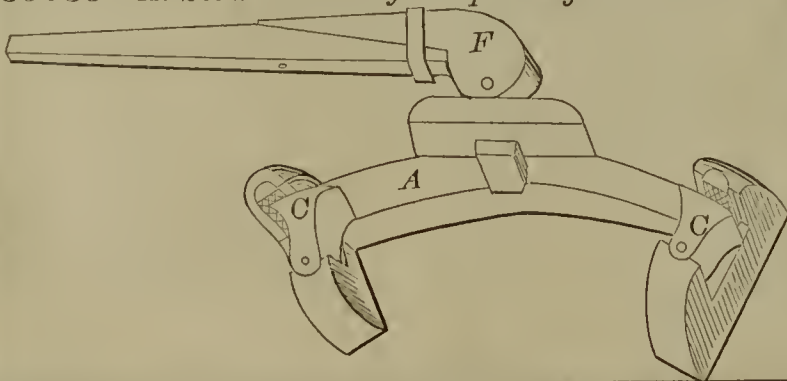

55736—W. J. Stowell—*Railroad Switch.*

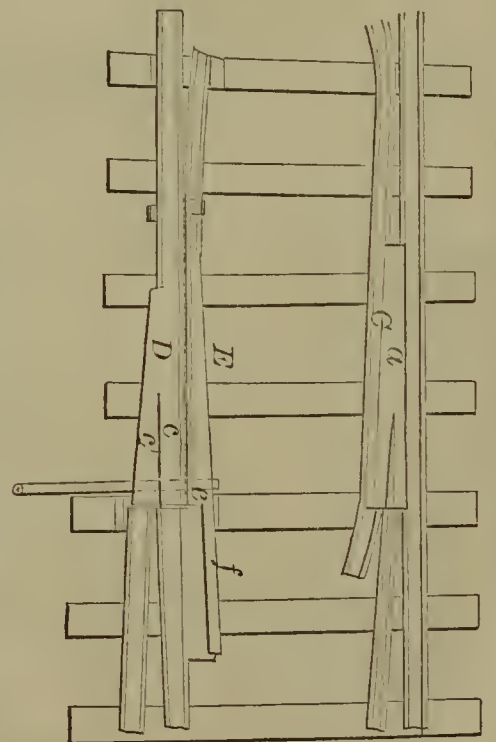

55738—Z. Swope—Sawing Machine.

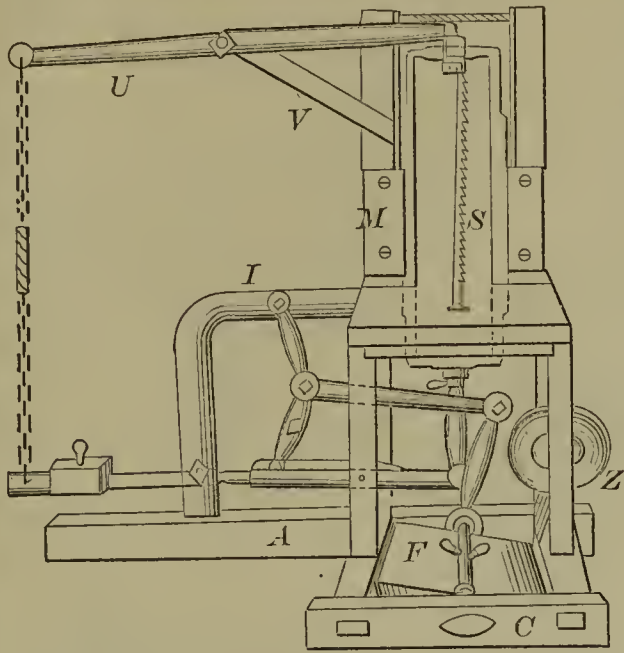

55740—W. B. S. Taylor—Manufacture of Tubing.

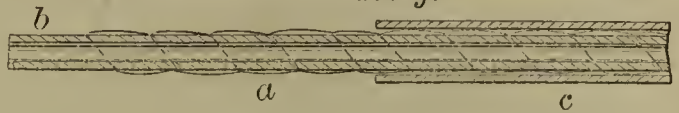

55741—J. B. Terry—Apparatus for Carburetting Air.

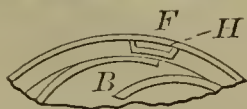
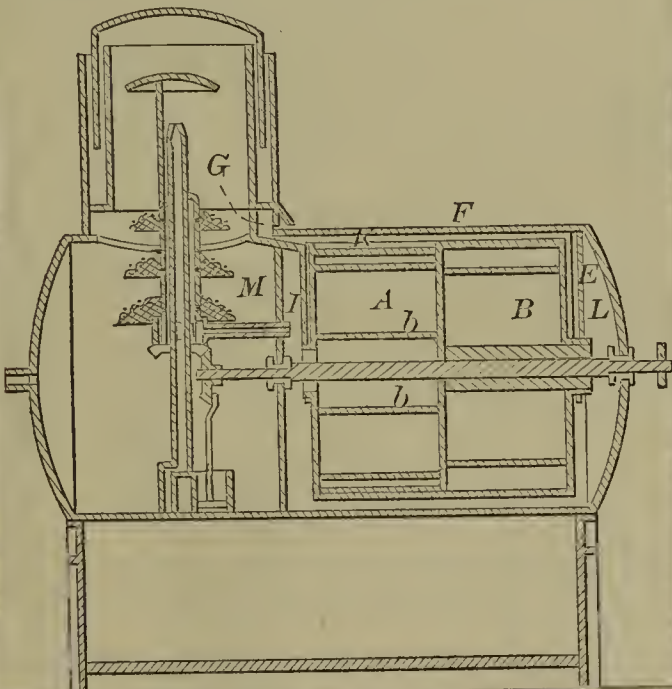

55744—F. W. Tilton—Clothes Pole.

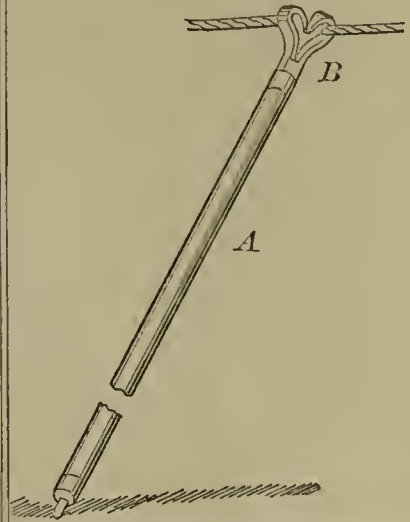

55739—G. C. Taft—Screw Wrench.

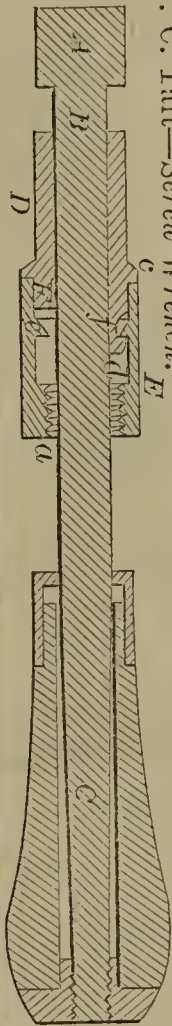

55746—J. Trageser—Apparatus for Cooling and Condensing Beer, Alcohol, &c.

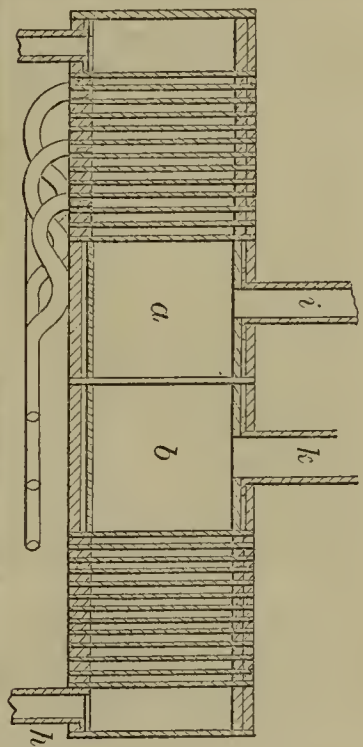

55747—Trageser & Schreiber—Coil for Brewers' Boilers.

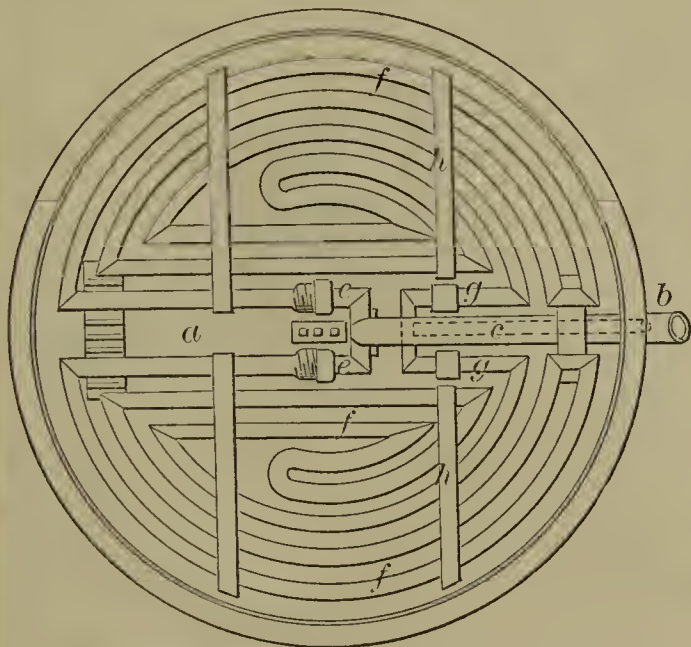

55742—Thomas & Mast—Grain Drill.

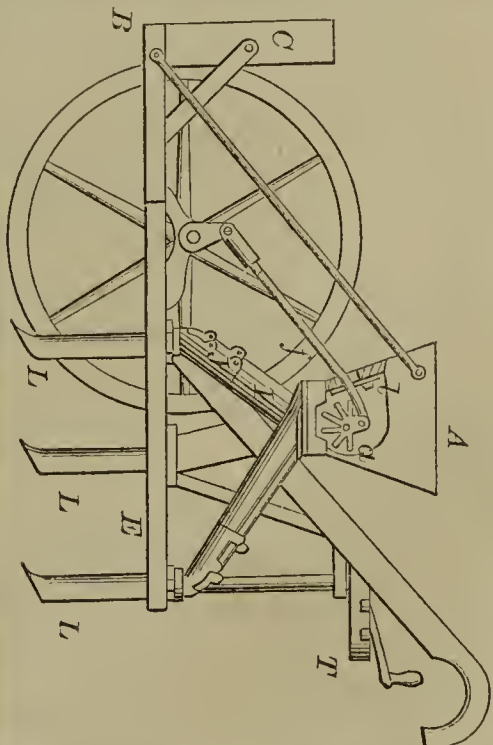

55748—B. Van Vrauken—Clay and Peat Press.

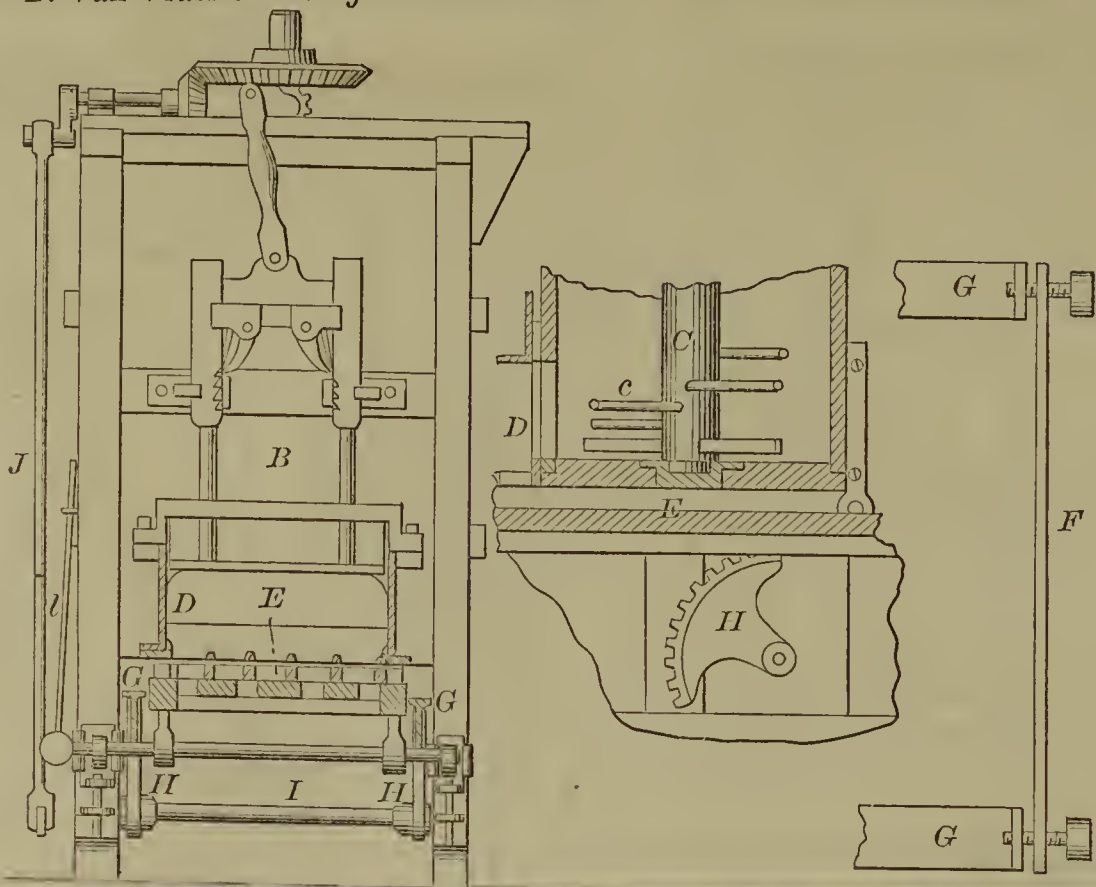

55749—W. T. Vose—Lathe Rest for Turning Balls.

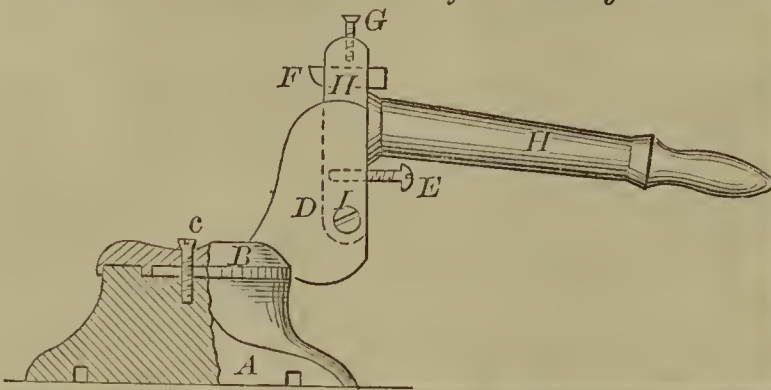

55751—G. W. Walker—Stove Damper.

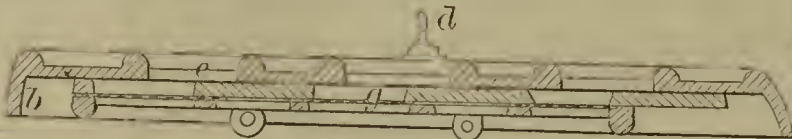

55753—N. F. Whiting—Button Hole for Paper Collars.

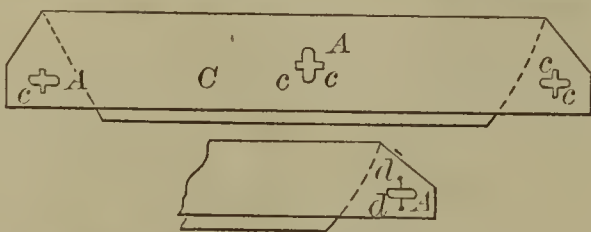

55754—H. Wickham, Jr.—Burglar Alarm.

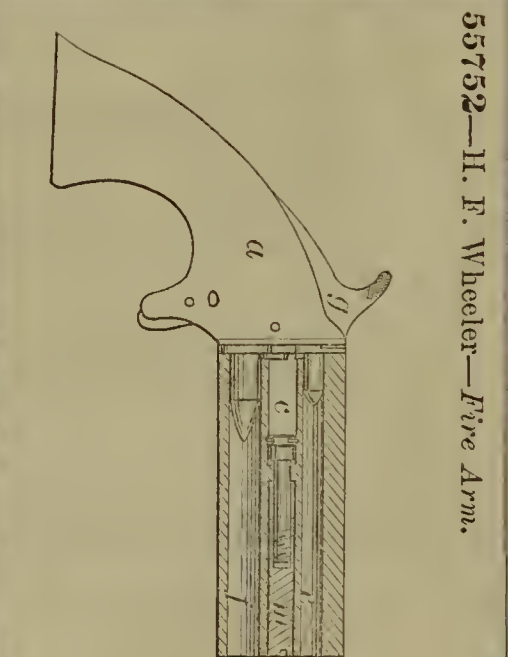
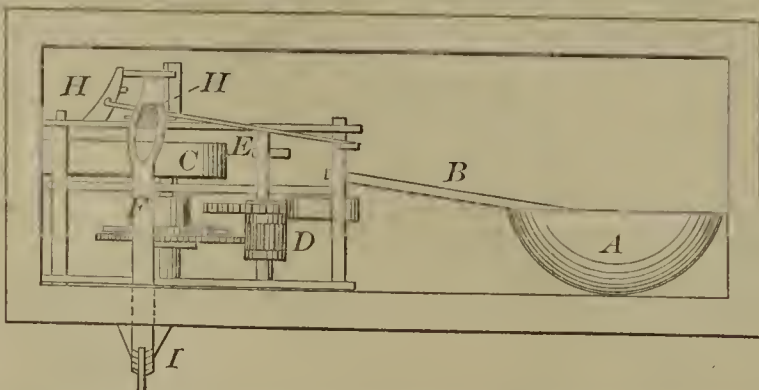

55752—H. F. Wheeler—Fire Arm.

55750—A. Wadsworth—Watch.

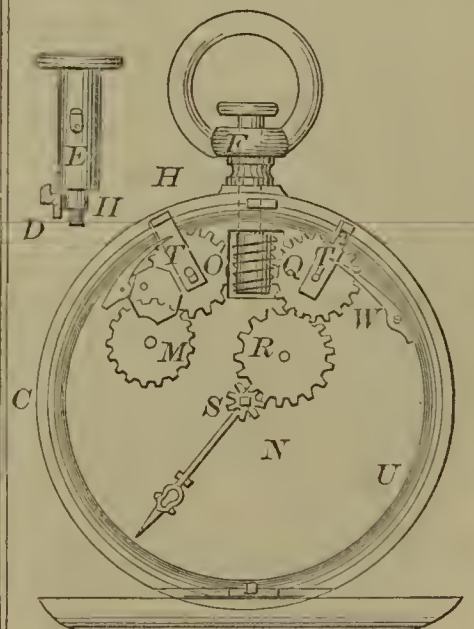



55755—J. L. Wiggin—Nail Plate Feeder.

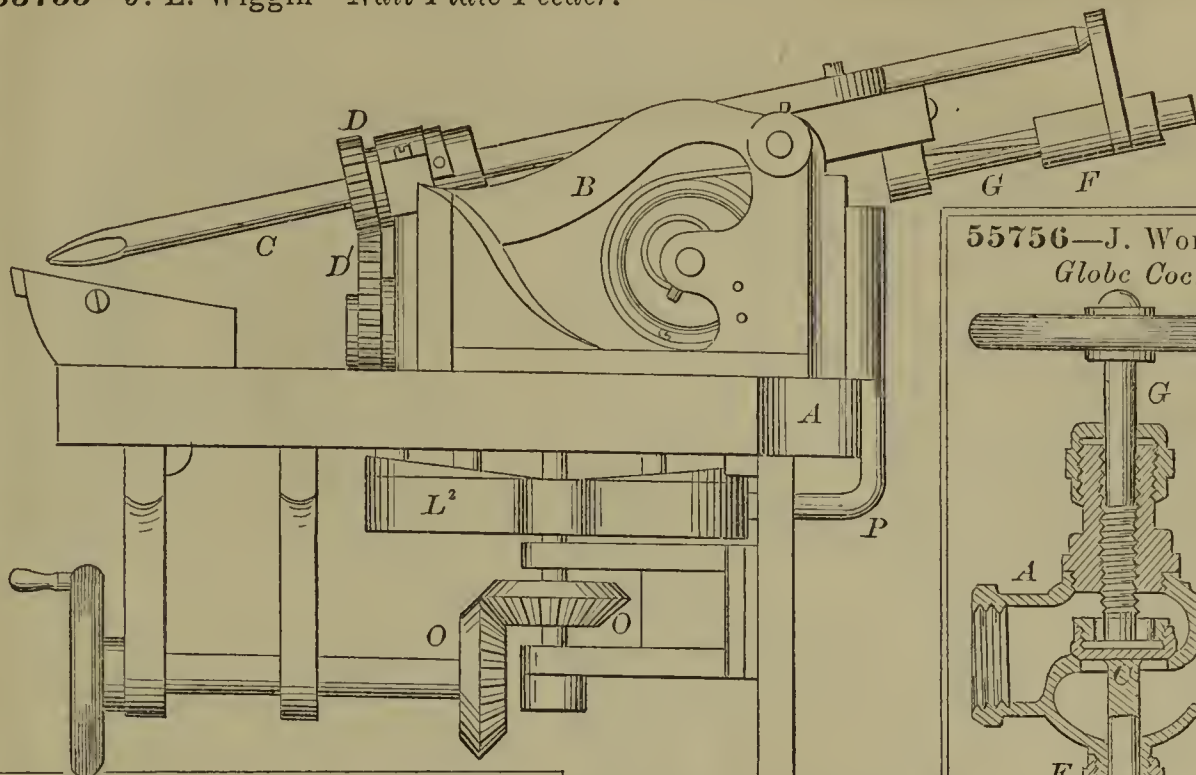

55756—J. Worcester—Globe Cock.

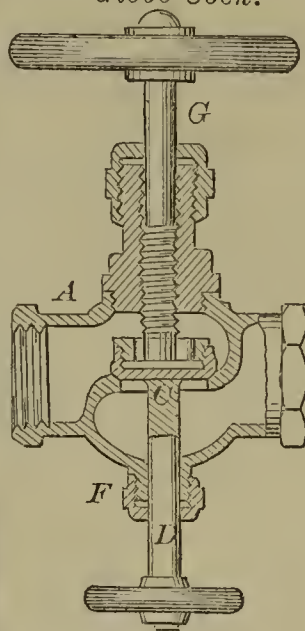

55757—M. Zabel—Fastening Ventilators in Place.

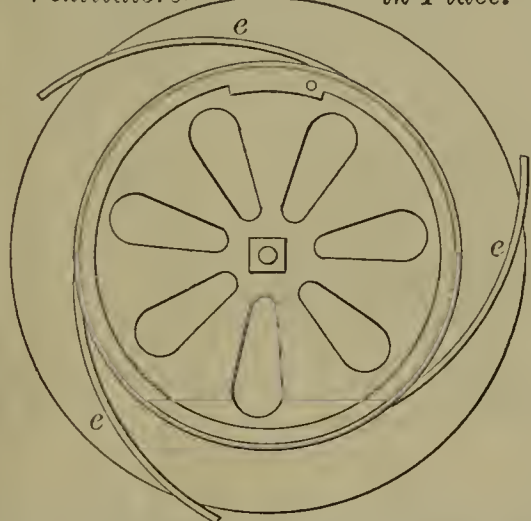

55759—J. W. Barber—Tobacco Press.

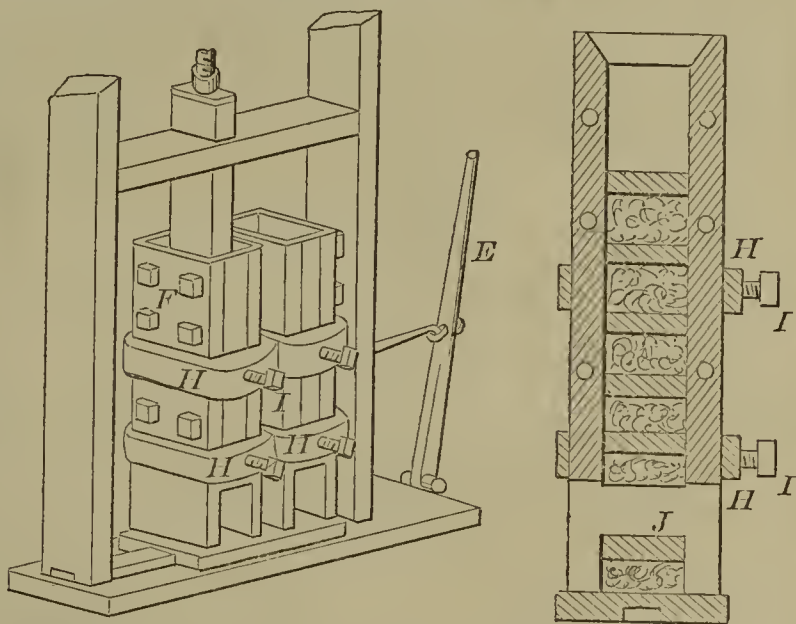

55758—W. Zimmerman—Harvester.

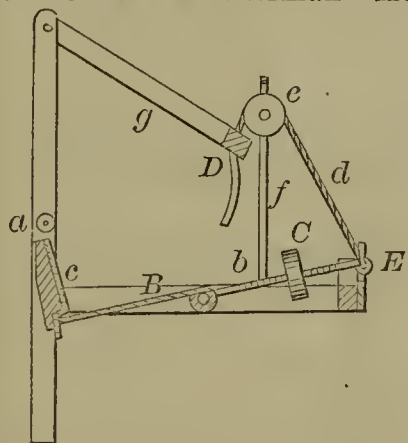

55760—P. Bradford—Sausage Stuffer.

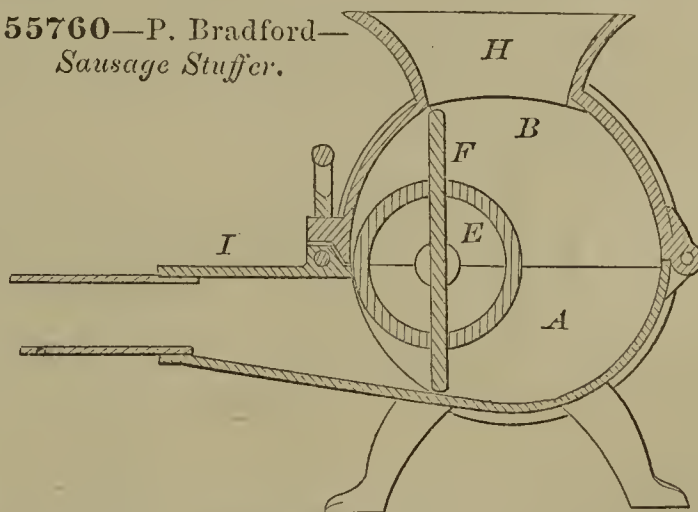

55762—L. W. Broadwell—Ordnance.

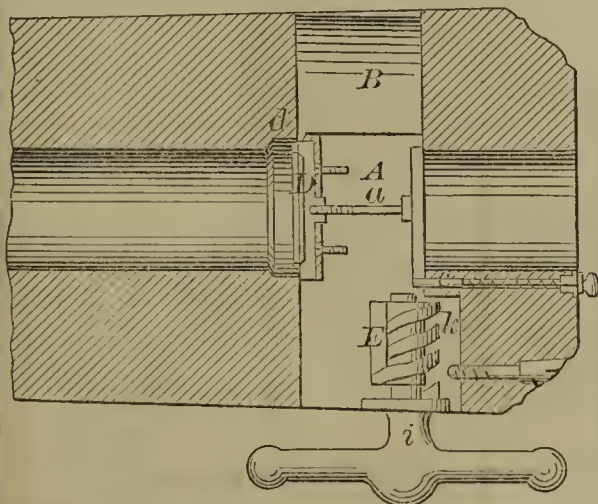

55761—L. W. Broadwell—Packing Projectiles for Rifled Ordnance.

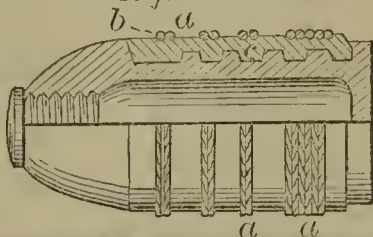

55763—F. C. Coppage—Harvester.

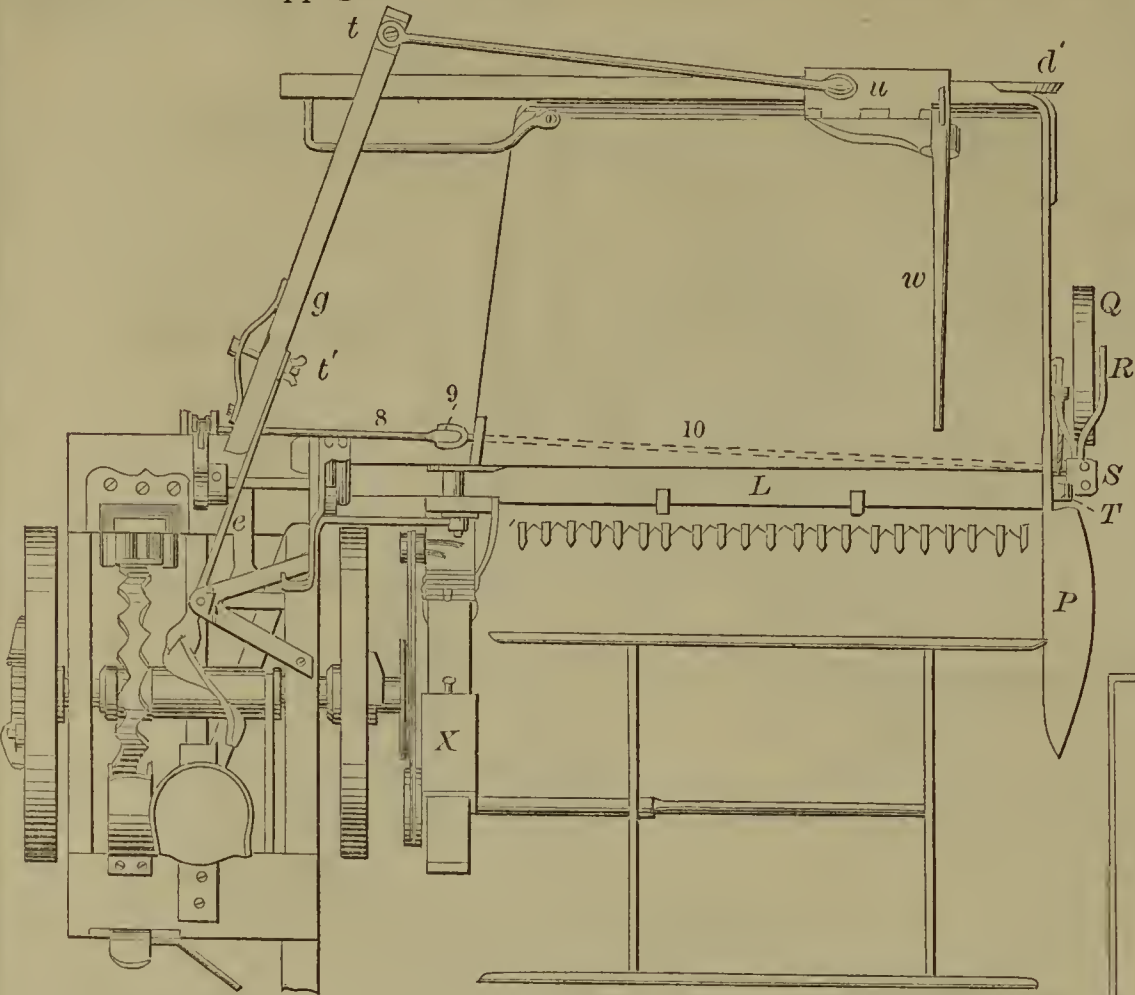

55764—A. C. Estabrook—Brush.



55767—J. Gardner—Capping Wood Screws.

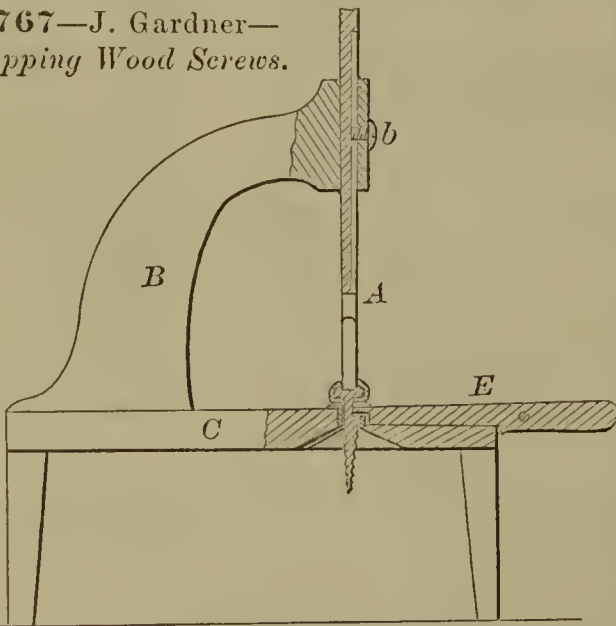

55766—F. W. Flagg—Toy.

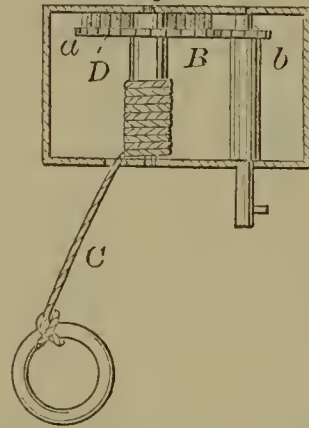

55765—F. J. Fischer—Hay Knife.

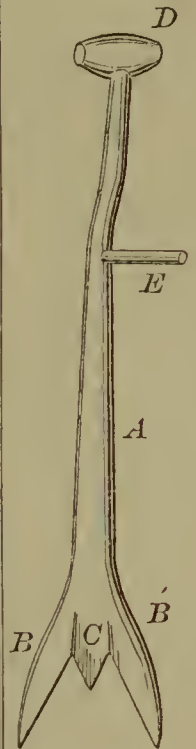

55770—W. H. Holland—Paddle Wheel.

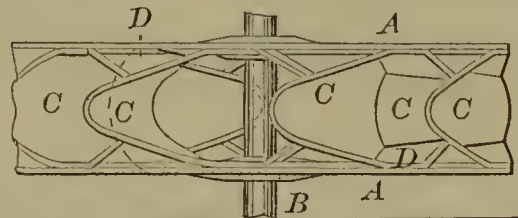

55769—G. W. Golay—Broom Head.

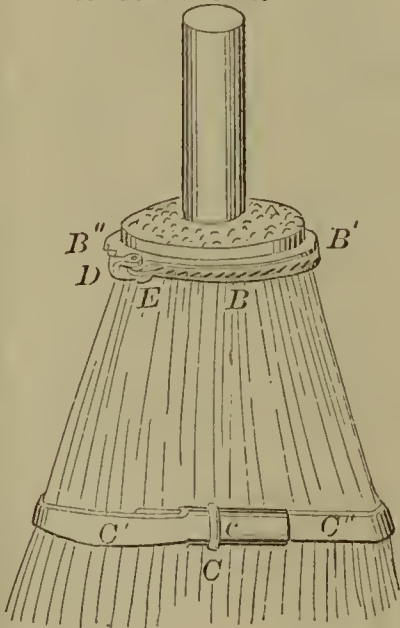

55768—T. S. Gilbert—Hoop Skirt.

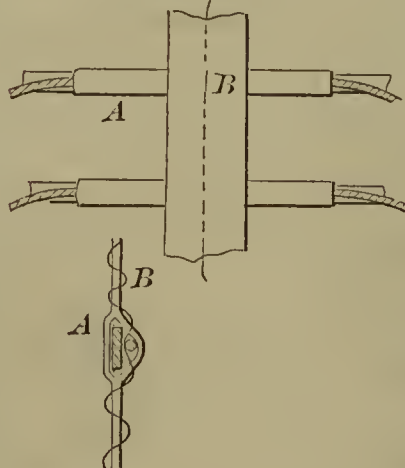

55771—D. Howarth—Lamp.

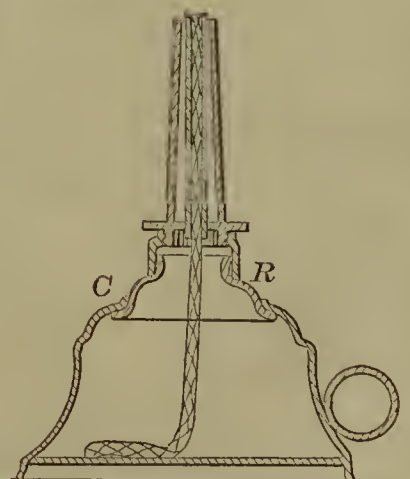

55774—J. Kirk—*Registering Apparatus.*

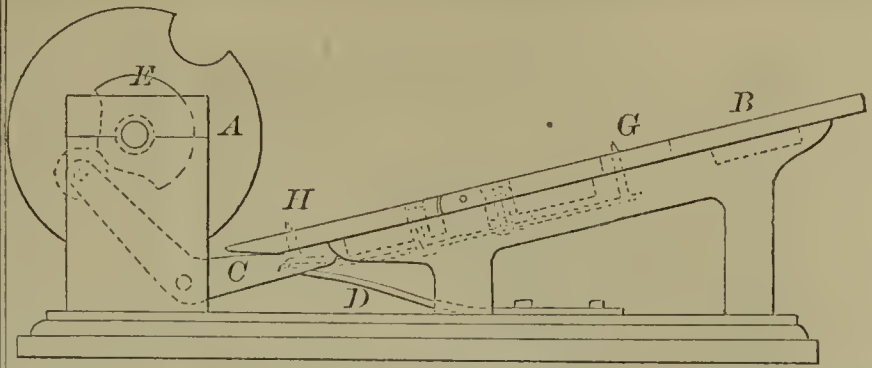

55772—C. R. James—*Operating Hammers and Stamps.*

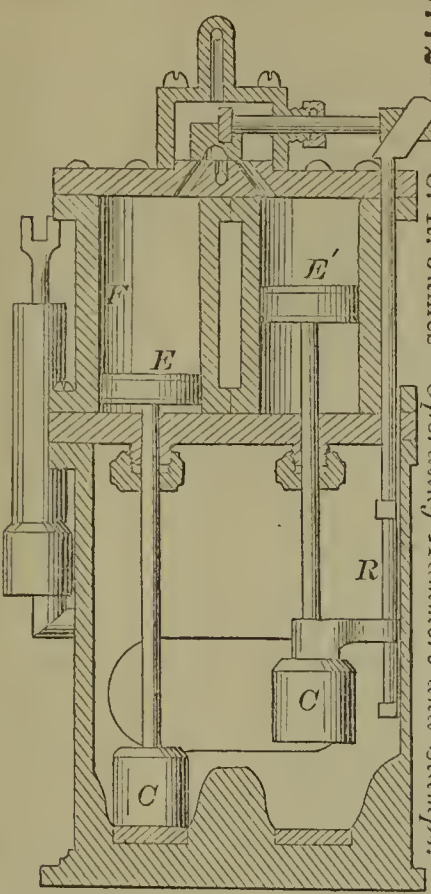

55776—W. & D. McCaine—*Tree Protector.*

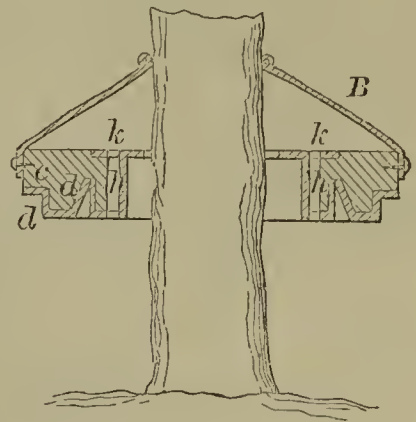

55775—F. Klee—*Instrument for Irritating the Skin.*

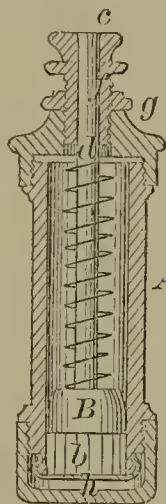

55773—Kinkel & Hubbe—*Propeller.*

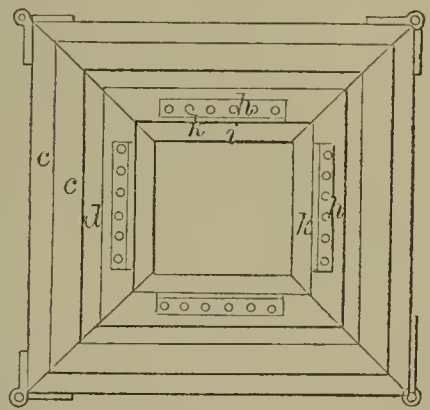
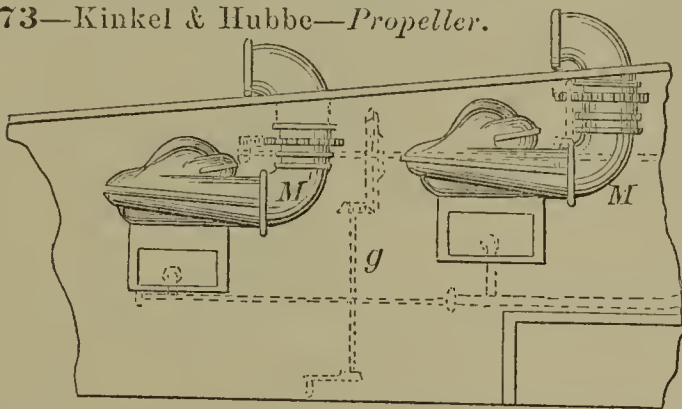

55779—C. Nelson—*Beater Press.*

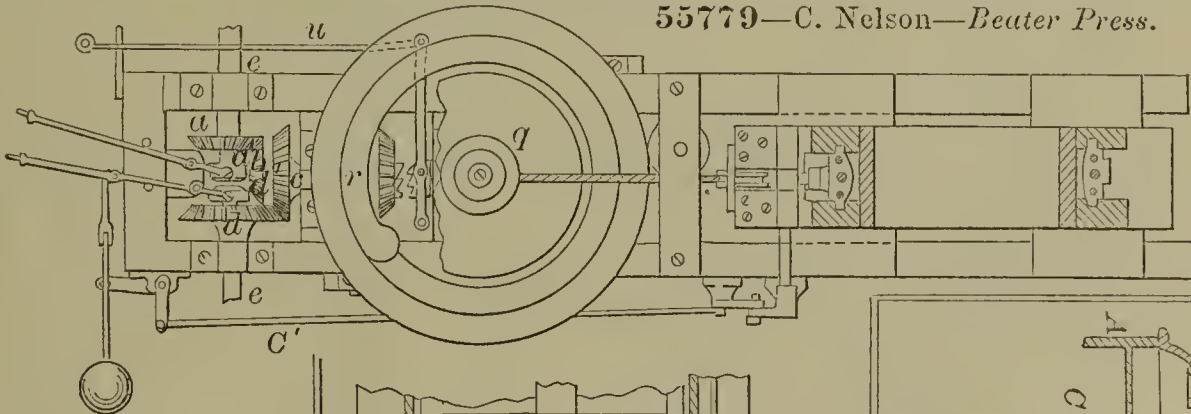

55778—A. C. Messenger—*Apparatus for Carbonating Air.*

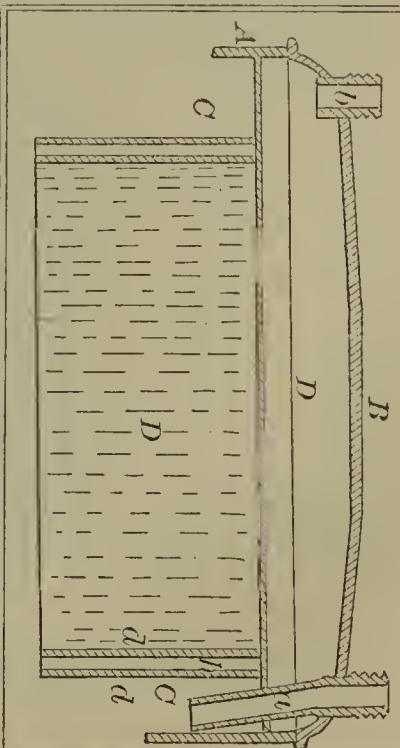

55780—D. G. Norris—Harvester.

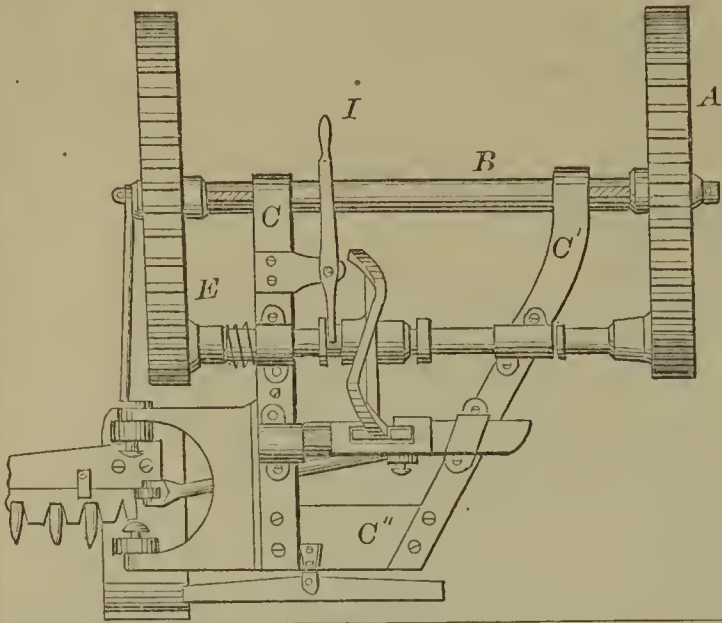

55782—Pixley & Robertson—Hydrant.

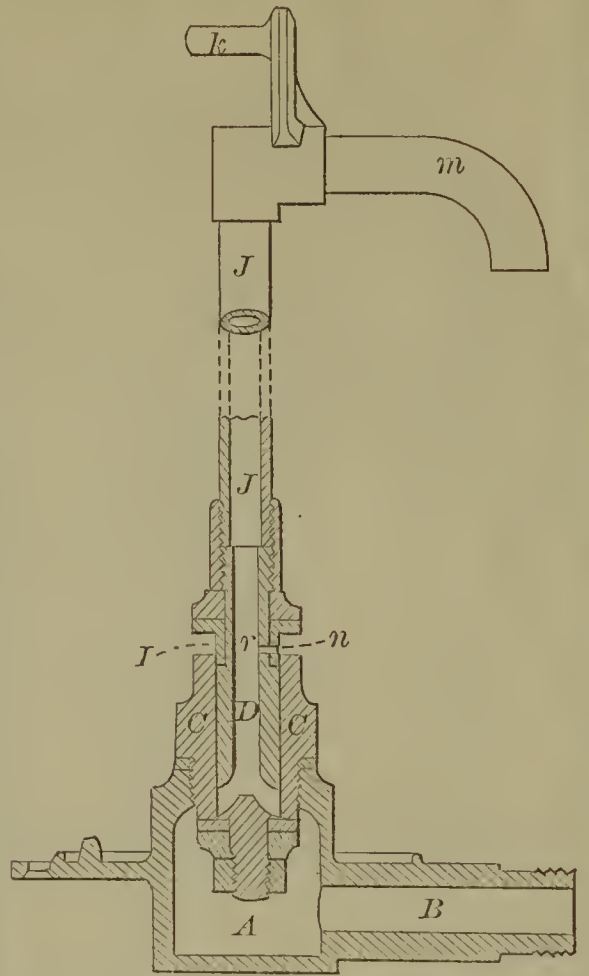

55785—M. M. Rounds—Steam Generator.

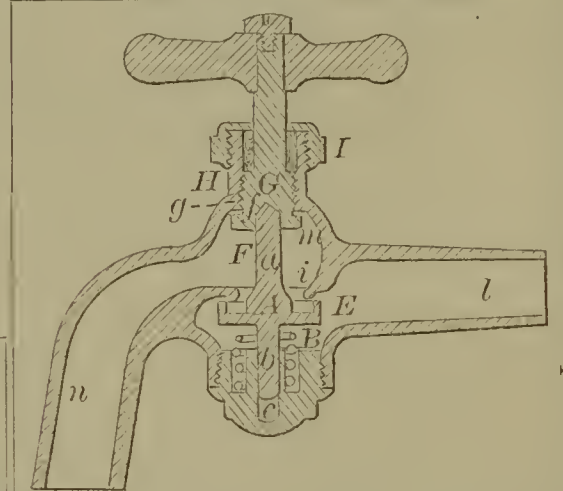
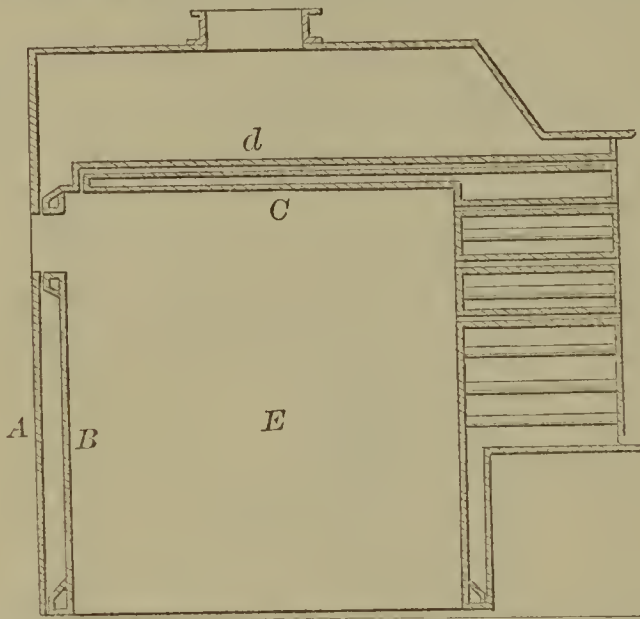

55784—E. Roach—Stop Cock.

55783—A. A. Randall—Finishing Nail and Screw Heads.

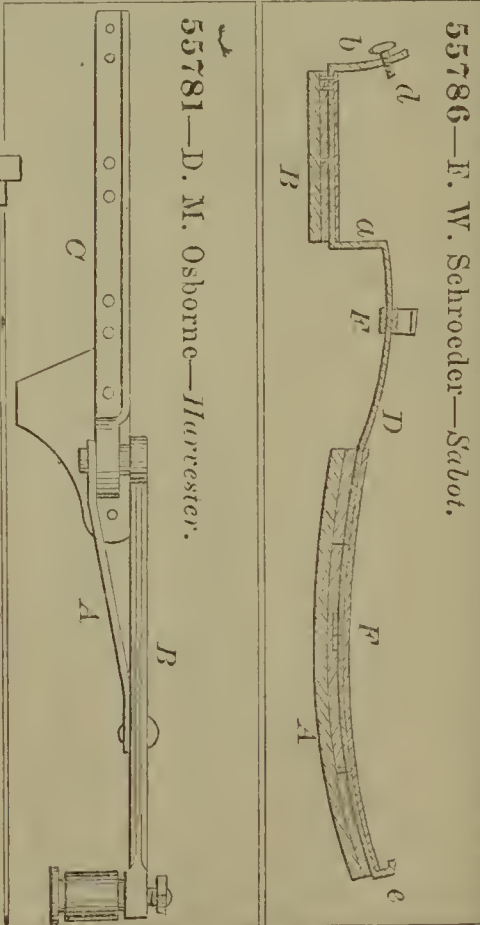
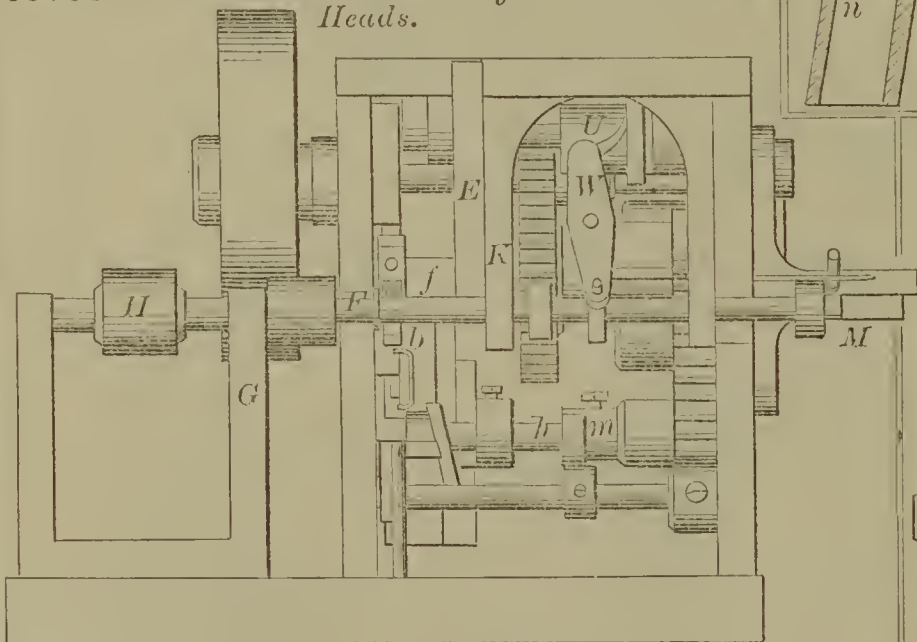

55781—D. M. Osborne—Harvester.

55786—F. W. Schroeder—Scythe.

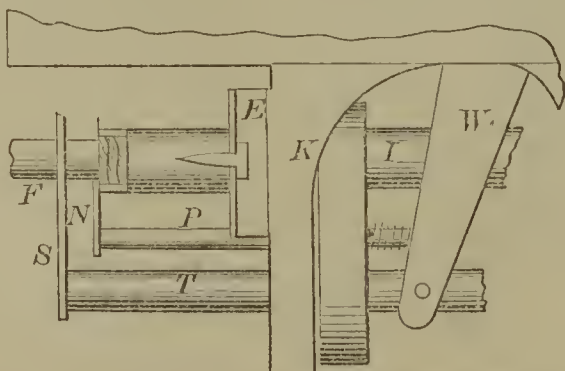

55788—R. C. Swann—Smut Machine.



55790—J. H. Tobey—Swaging Machine.

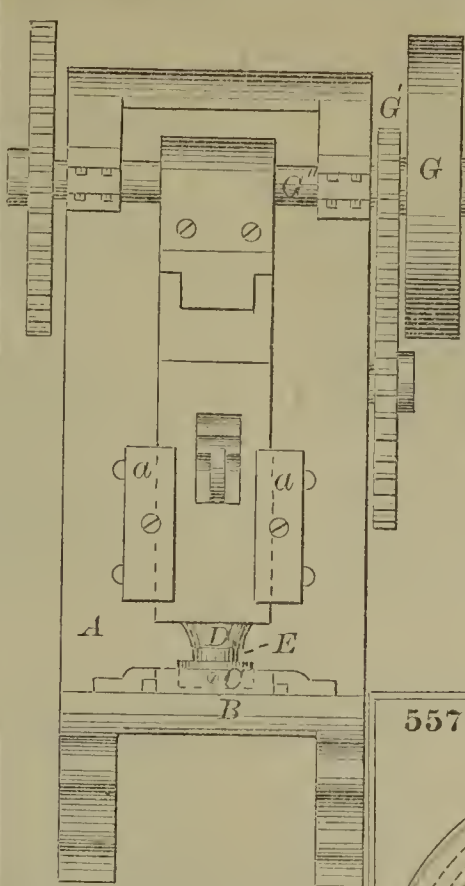

55787—Sporford & Hersey—Cotton Gin.

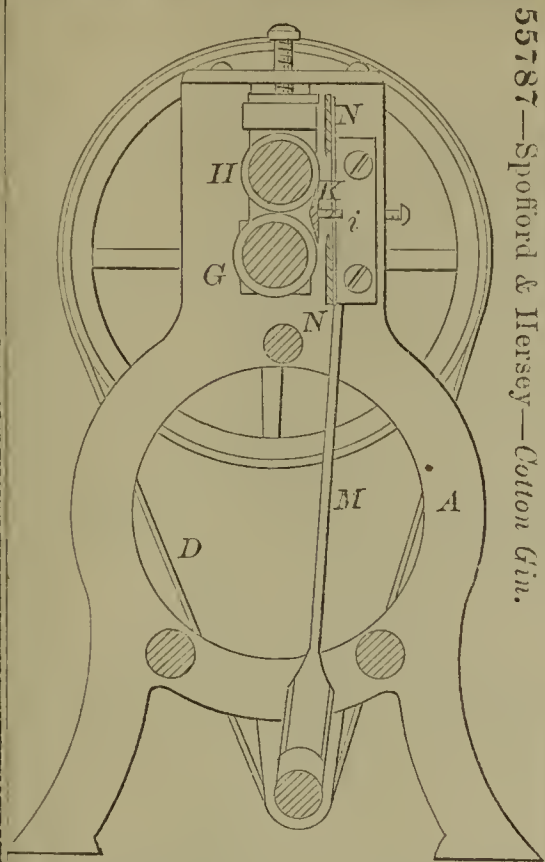

55792—J. Aubin—Grinding Mill.

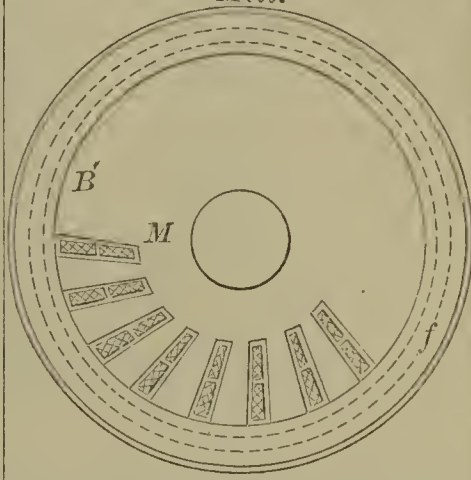

55789—H. Thompson—Rigging Stopper.

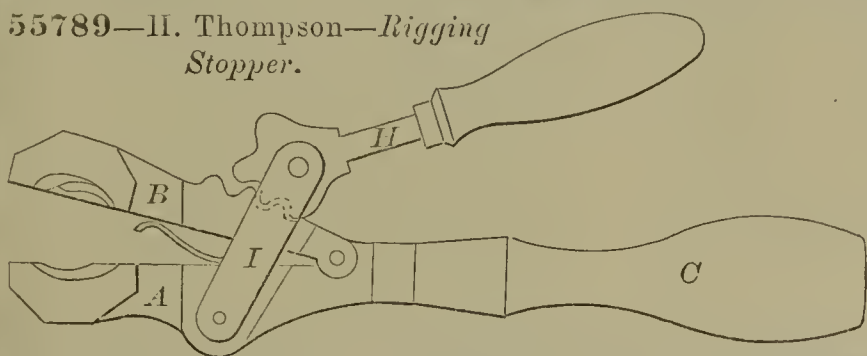

55794—Eveard & Boyer—For Making Hinges.

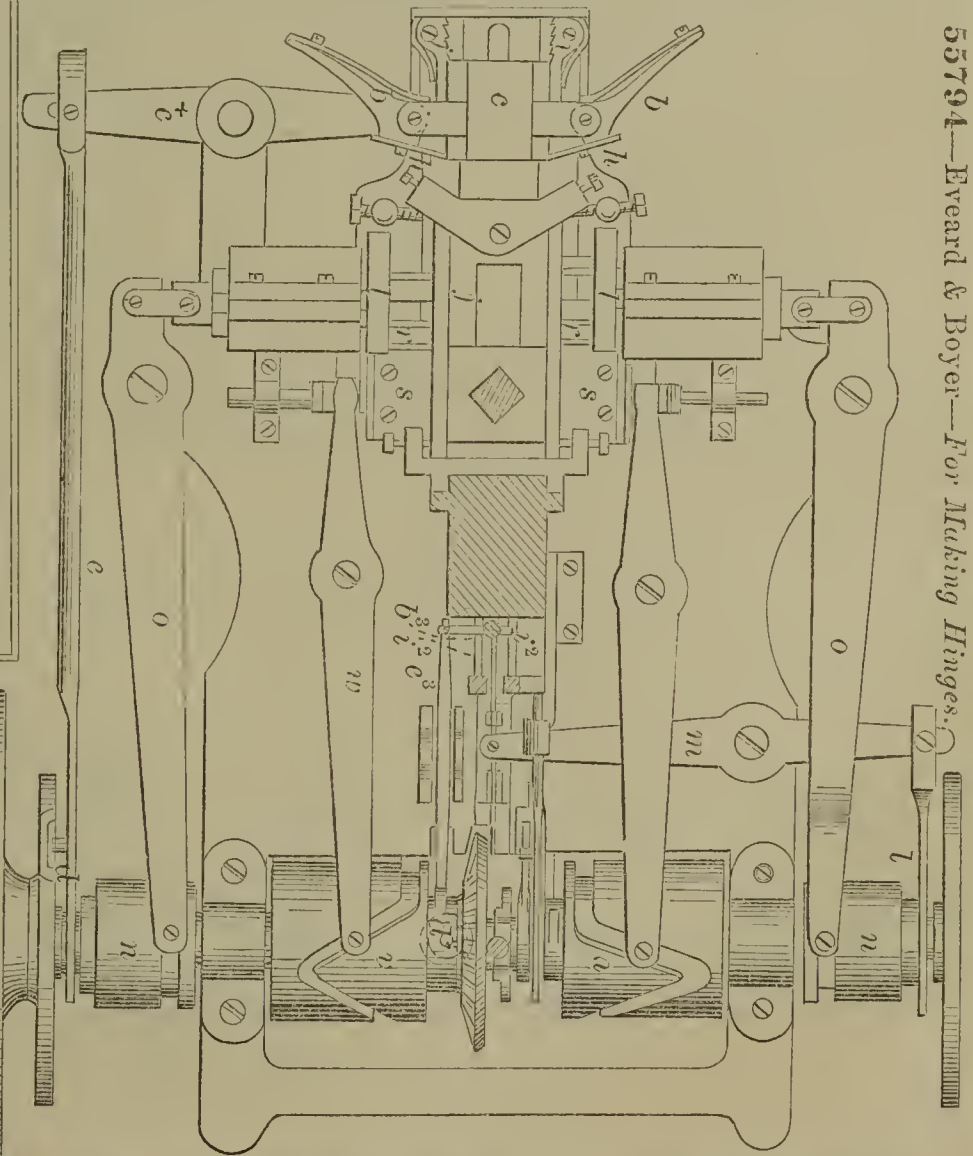

55791—I. F. Van Duzer—Milk Can.

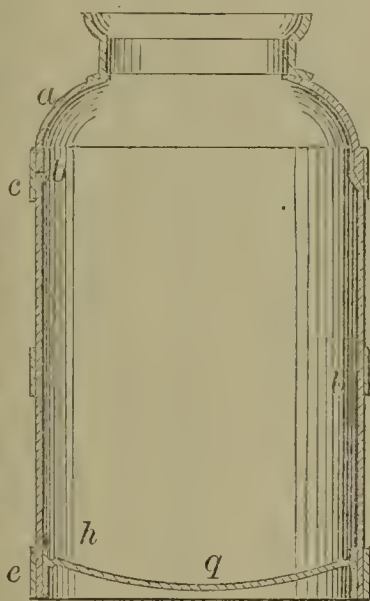

55793—A. Boissonneau—Artificial Eye.



55794—Continued.

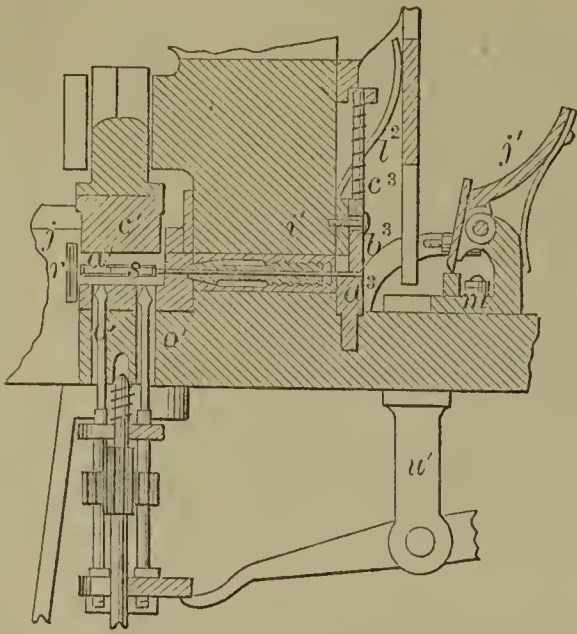

55796—S. H. Haycock—Projectile.

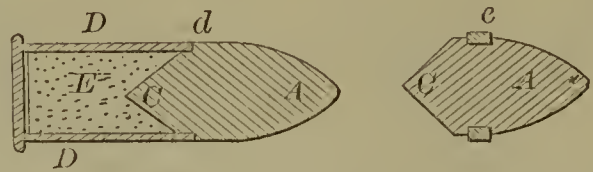

55798—I. Lewine—Button Attachment.

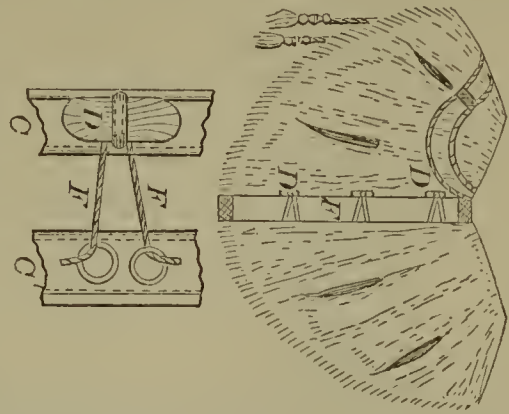

55799—J. Adams—Cutting Boots.

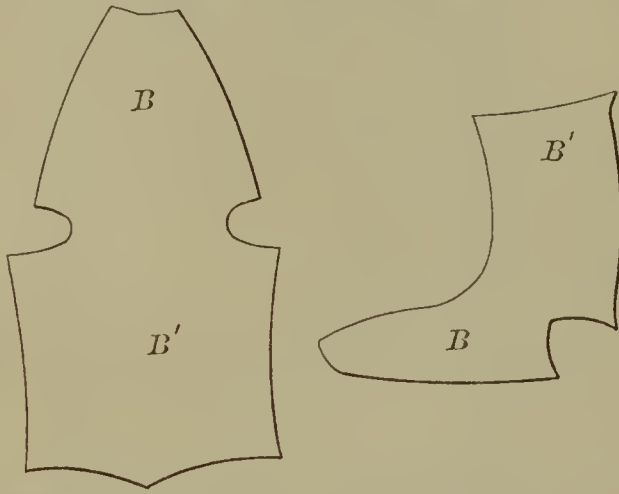

55797—S. G. Elliott—Photometer.

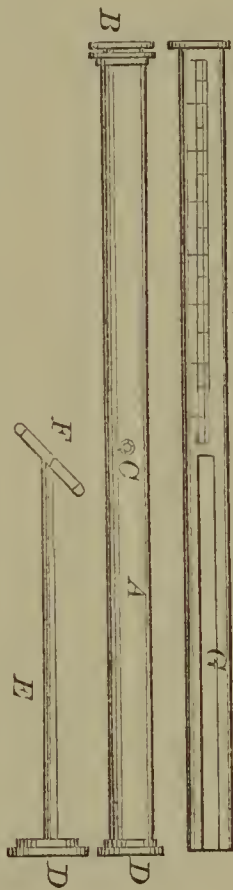

55801—A. Arnold—To Prevent Boiler Explosions.

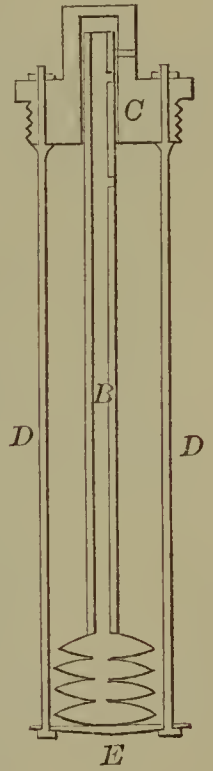

55800—W. M. Arnall—Grain Separator and Cleaner.

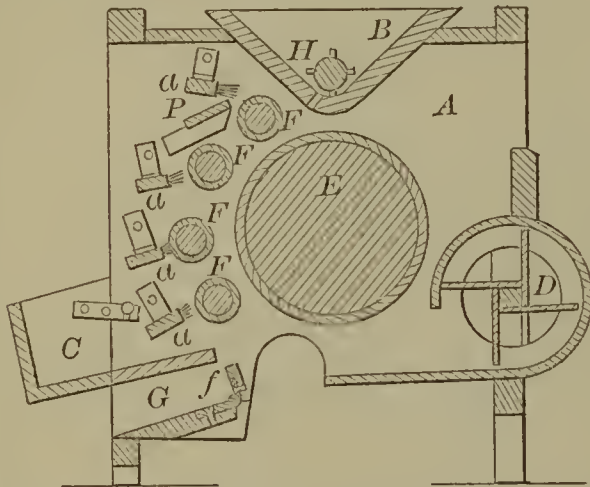

55802—F. Ashley—Egg Beater.

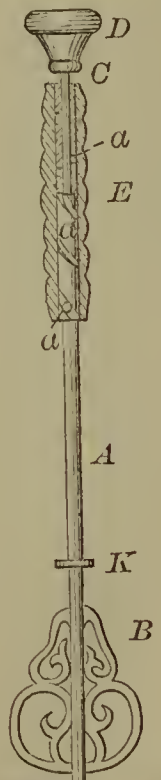

55803—S. W. Ayres—Water Wheel.

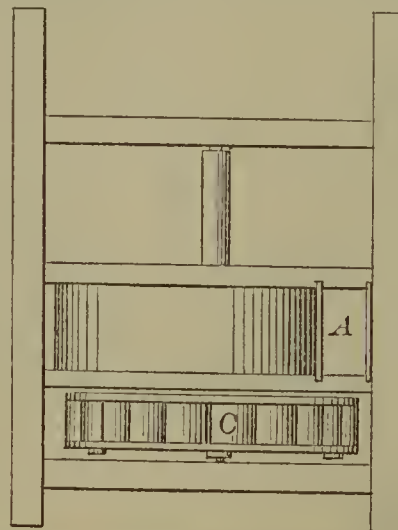
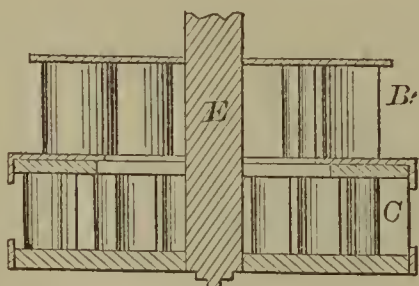

55804—Bailey & Burdick—Horse Rake.

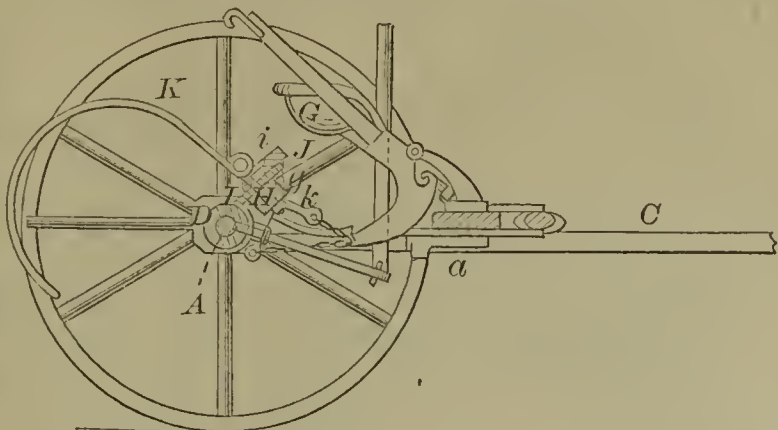

55806—J. H. Beidler—Lamp.

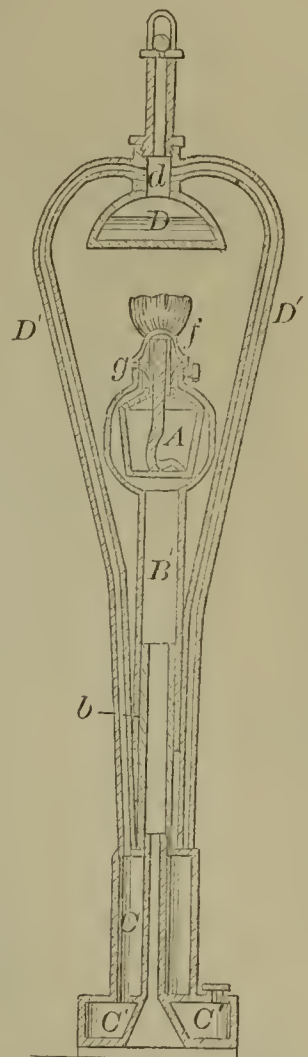

55808—J. Bentz—For Framing Matches.

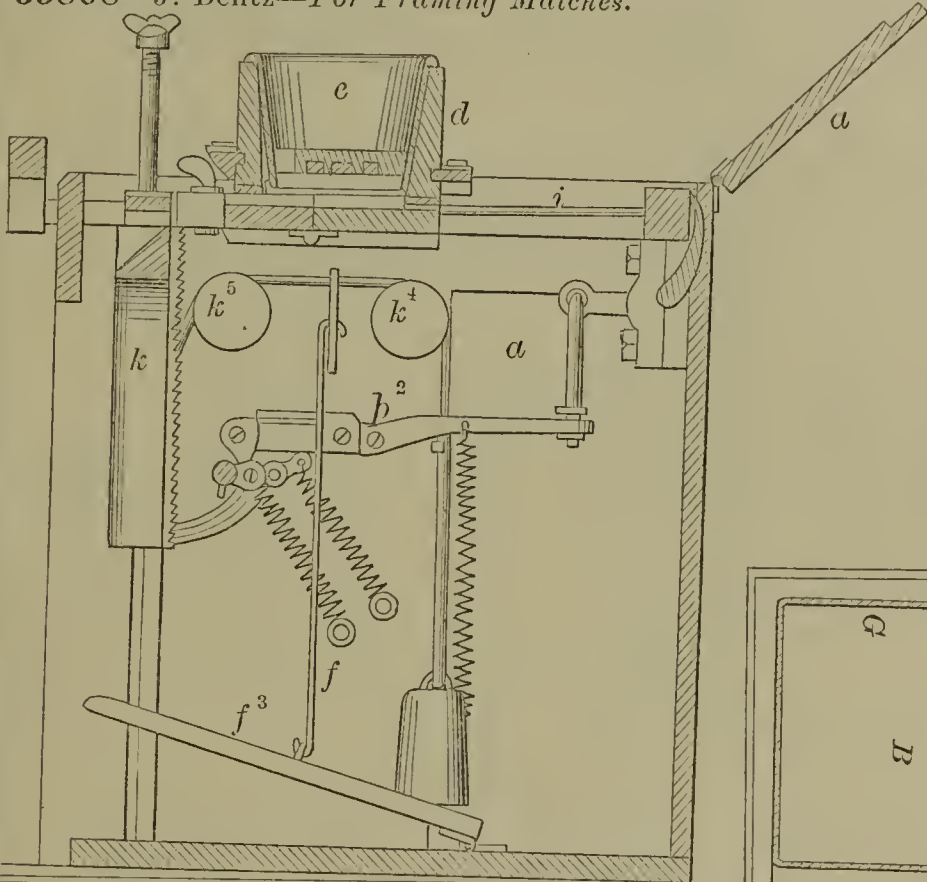

55807—W. A. Bemis—Grater and Egg Beater.

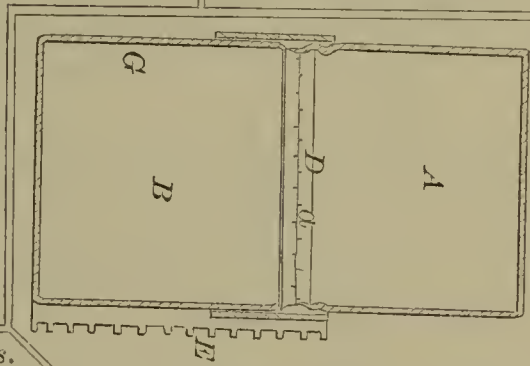

55805—W. W. Beach, M. D.—Roofs of Buildings.

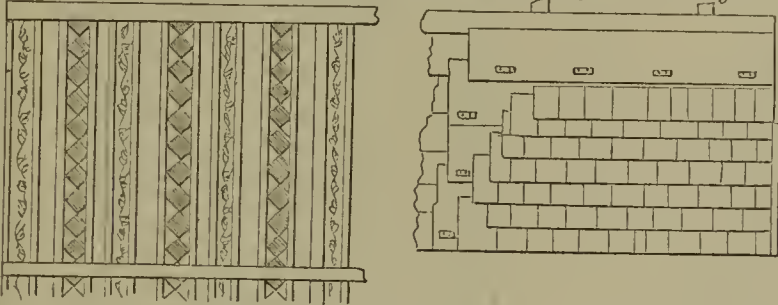

55809—J. W. Blodgett—Stump Extractor.

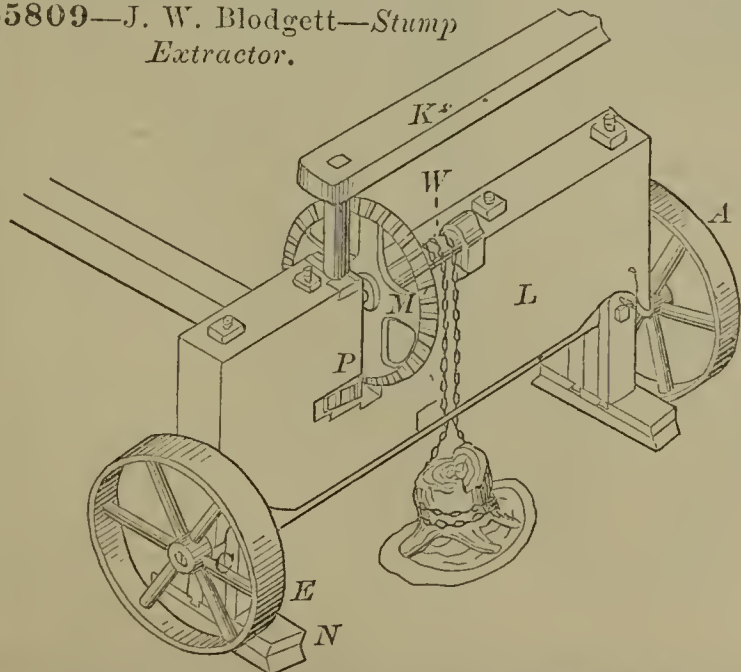

55810—J. M. Brosius—For Utilizing Steam.

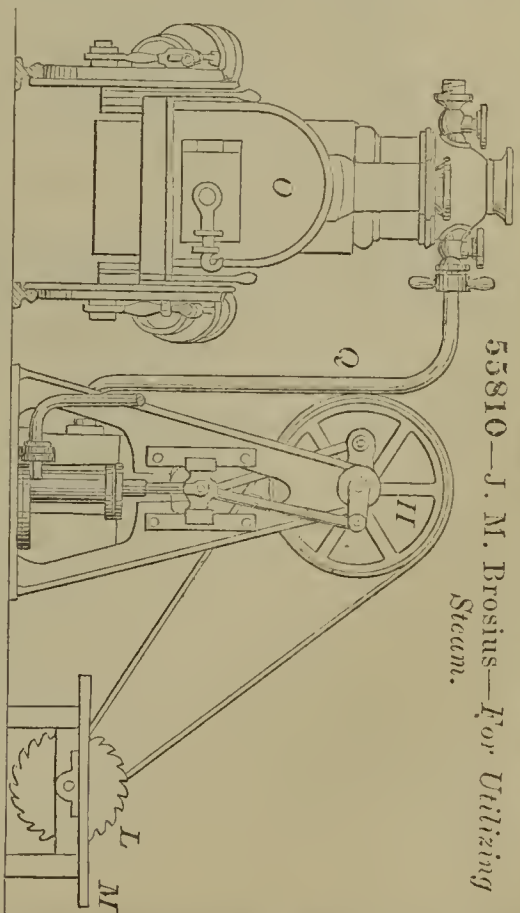

55811—F. H. Brown—Cotton Seed Planter.

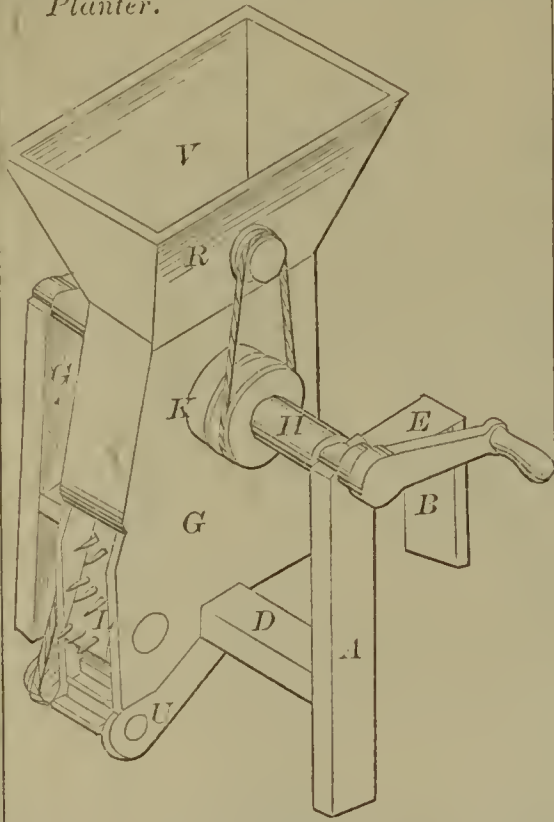

55815—C. H. Bush—Brush for Boiler Flues.

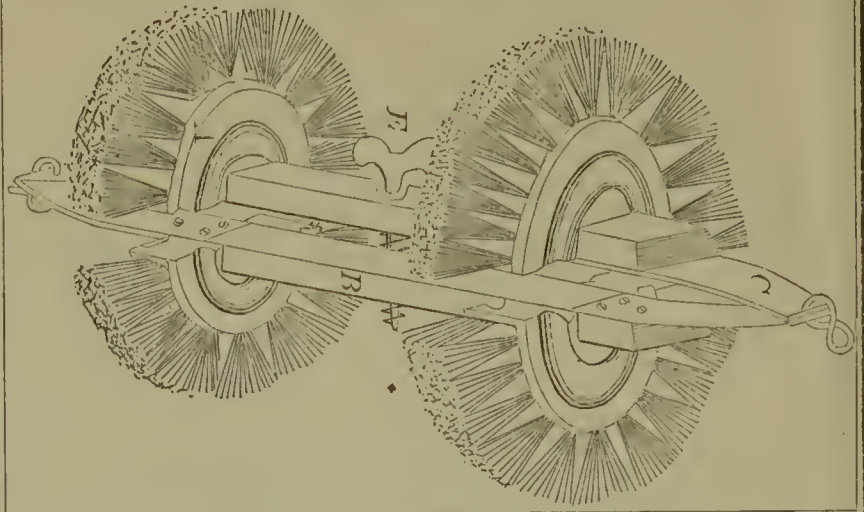

55816—W. H. Butler—Water Elevator.

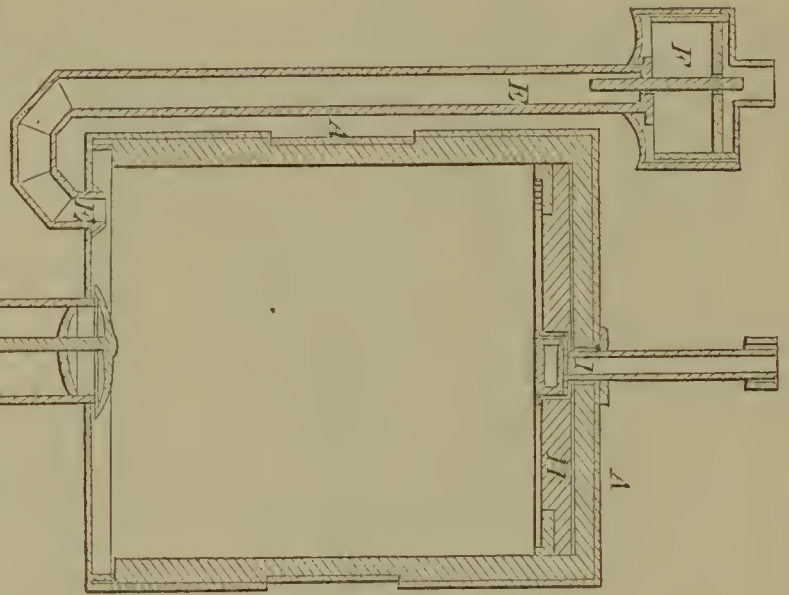

55814—H. & S. W. Budd—Lock.

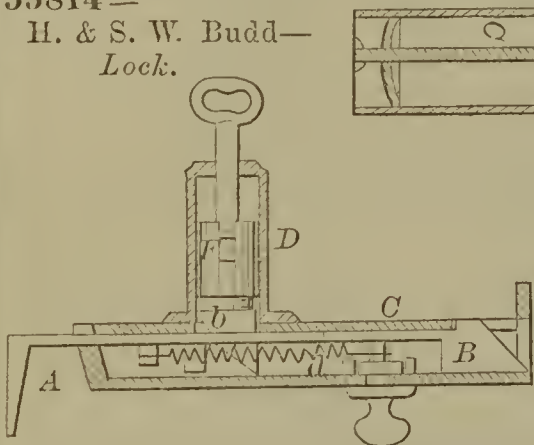

55812—D. Bruce—Constructing Vacuum Vessels.

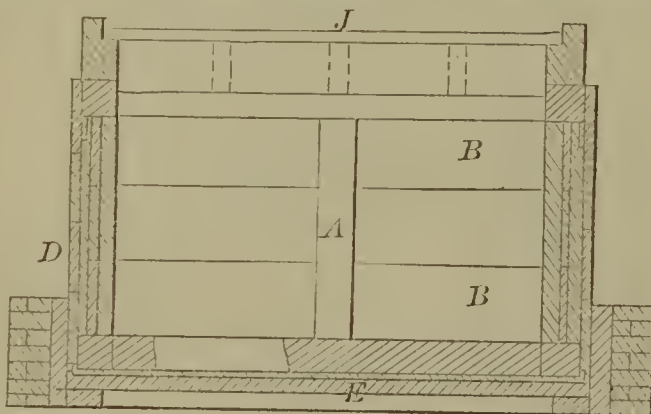

55817—E. P. H. Capron—Ladder.

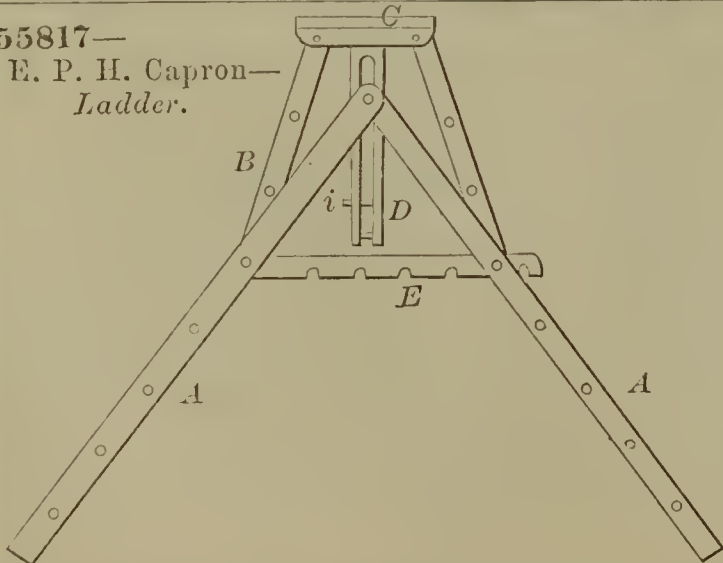

55813—J. T. Bruen—Hammer for Bending Couplings.

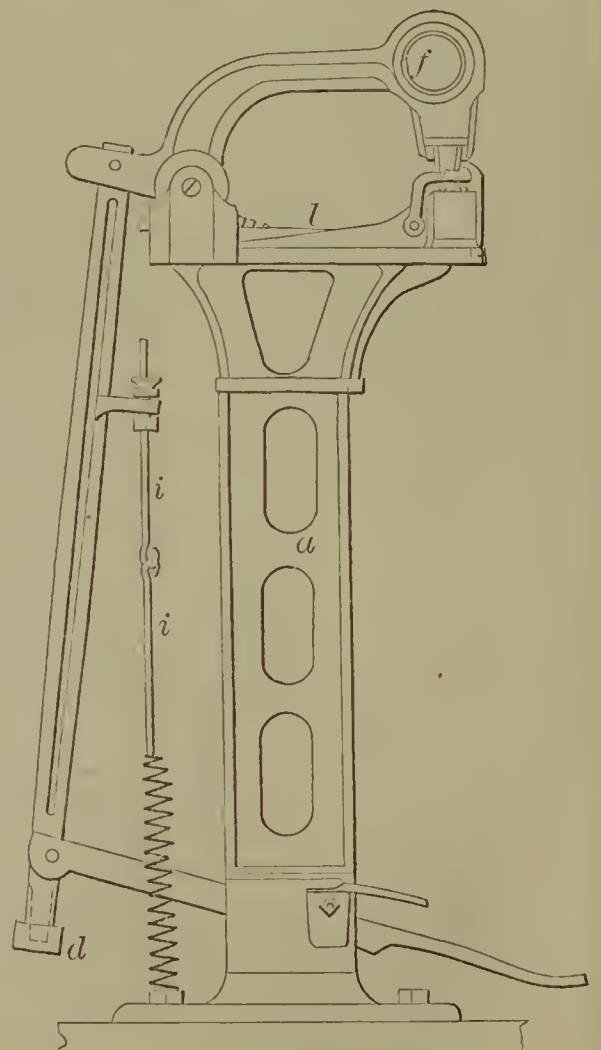



55819—F. Chalfant—Water Indicator for Steam Generators.

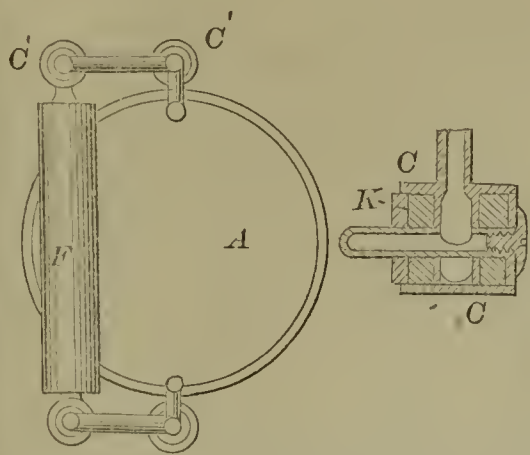

55820—J. R. Champlin—Cream Freezer.

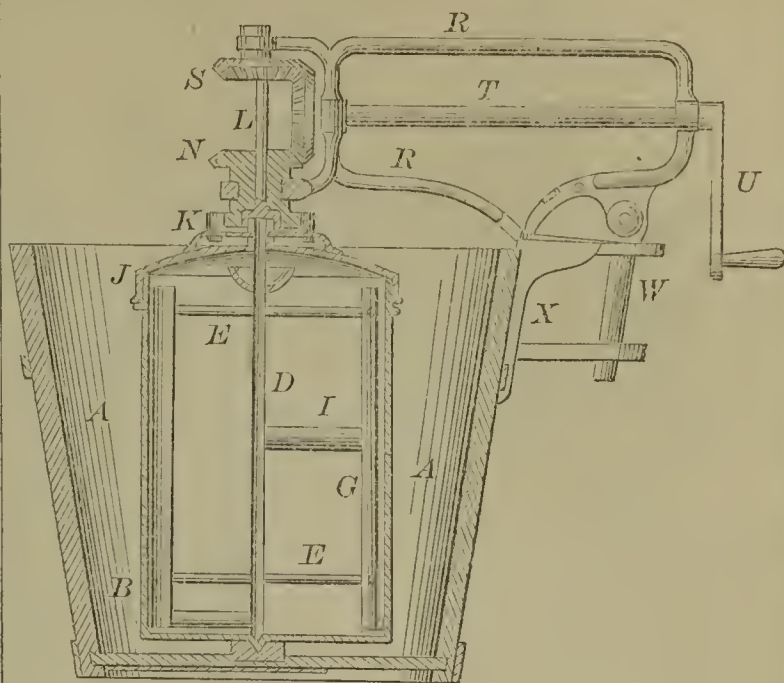

55821—R. Cochran—Pump.

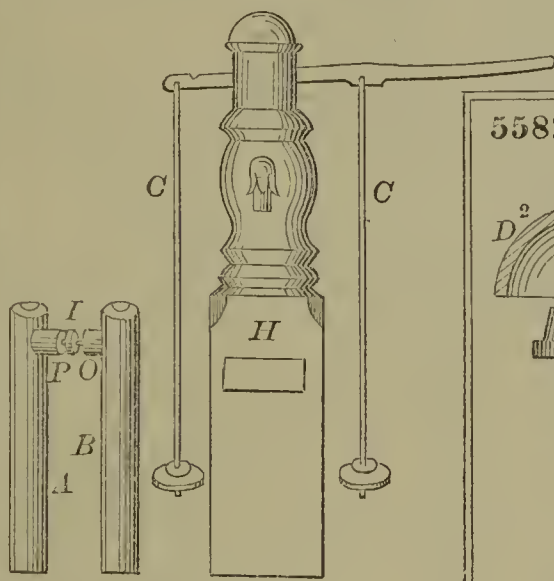

55823—E. H. Crane—Door Bell and Burglar Alarm.

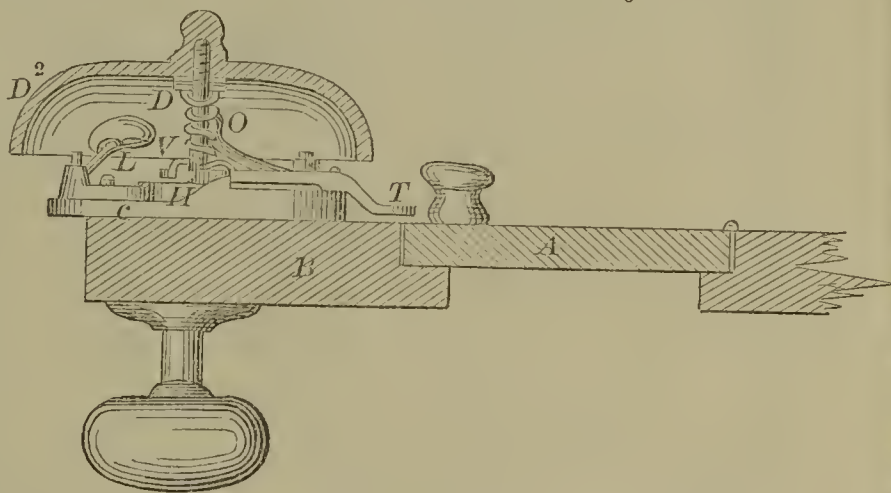

55824—T. C. Craven—Horse Hay Fork.

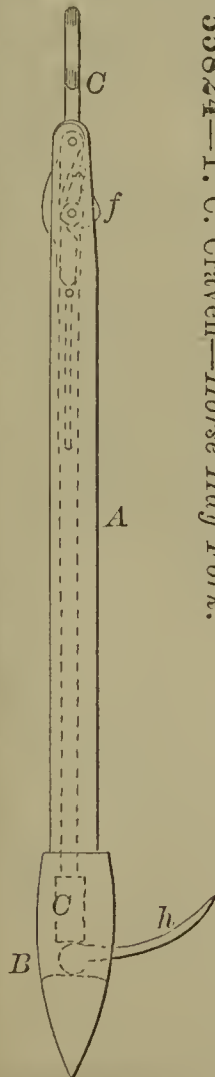

55822—R. Cornelius—Pump.

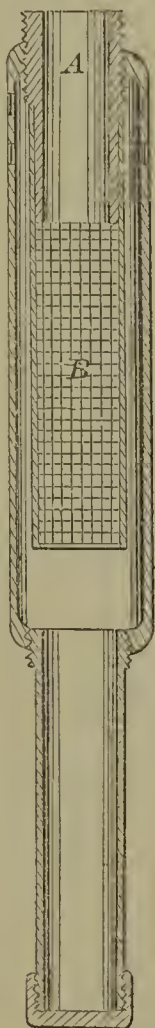

55825—F. J. Crissey—Churn.

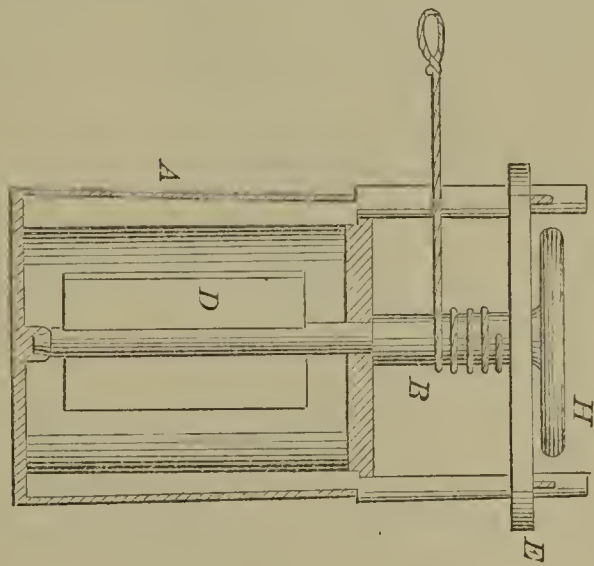

55826—J. Custer—Cultivator.

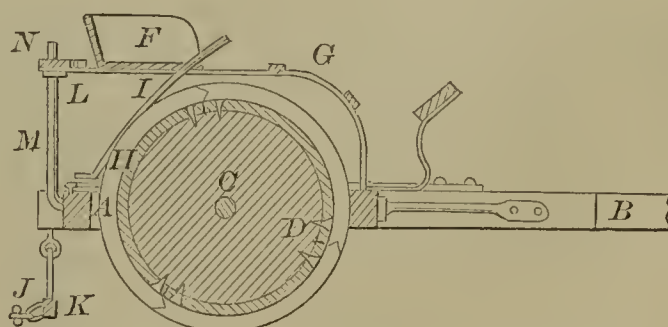

55833—T. Dickinson—Machine for Planing Mouldings.

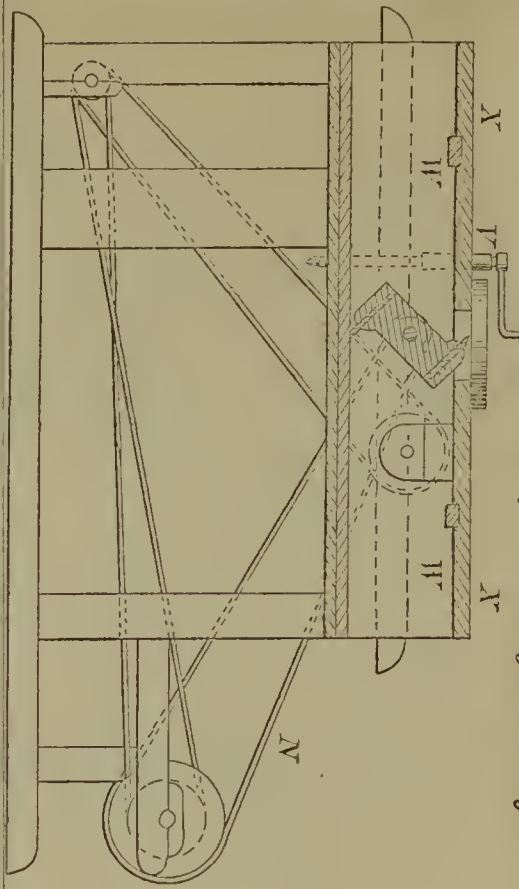

55827—S. Custer—Marine Compass.

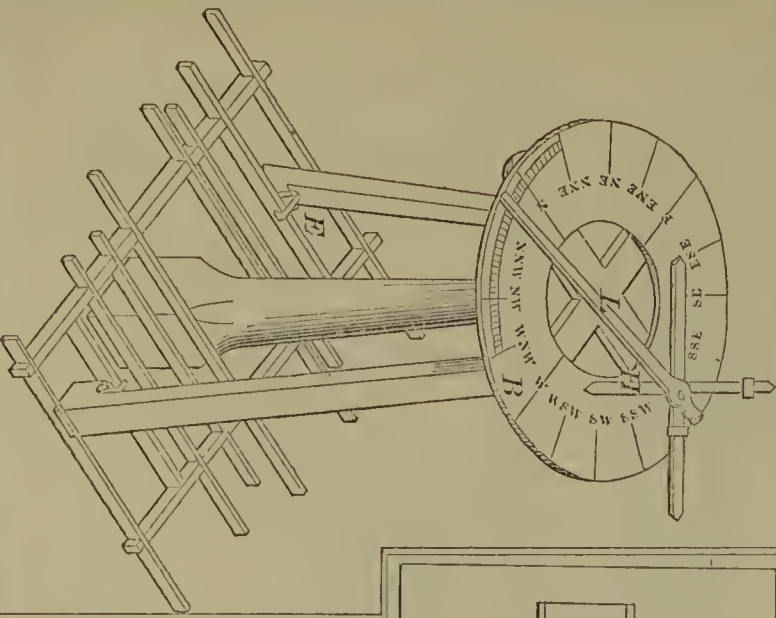

55831—Densmore & Yost—Car for Transporting Petroleum.

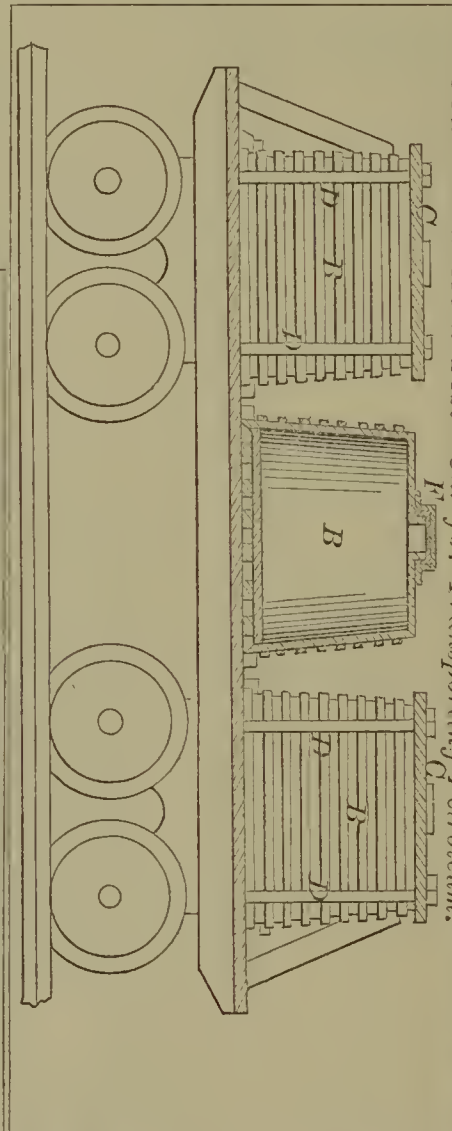

55830—Densmore & Yost—Petroleum Car.

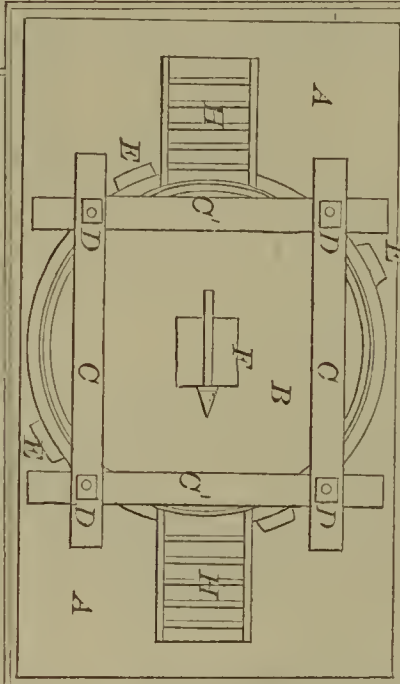

55834—J. W. Dixon—Machine for Making Paper Pulp for Bleaching, &c.

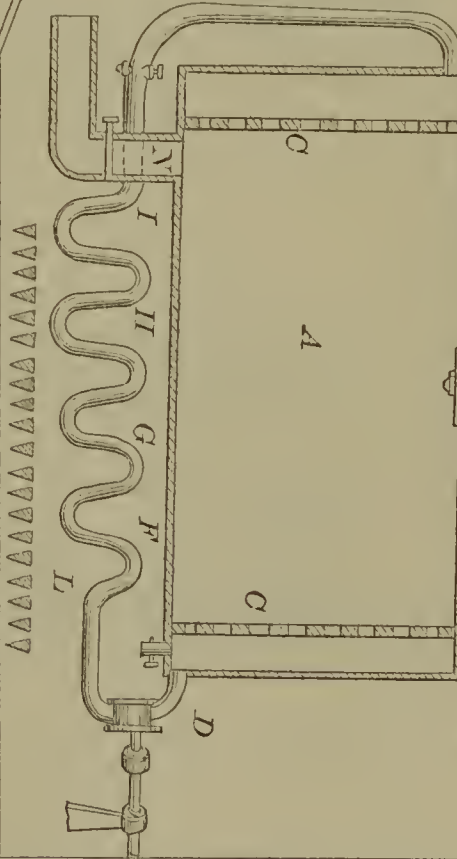

55829—D. Dennett—Hay Rack.

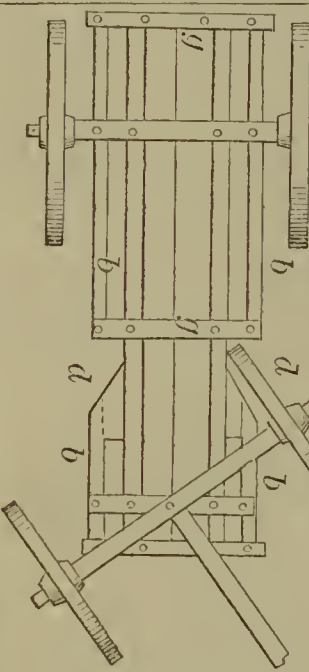

55832—Densmore & Yost—Petroleum Car.



55828—J. Dempster—Roller Feed for Carding and Picking Machines.

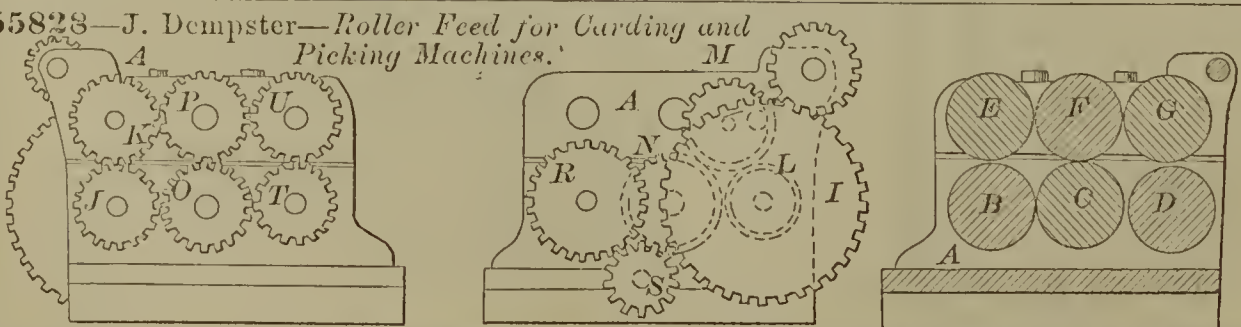

55835—J. W. Dixon—*Making Paper Pulp from Wood, Straw, &c*

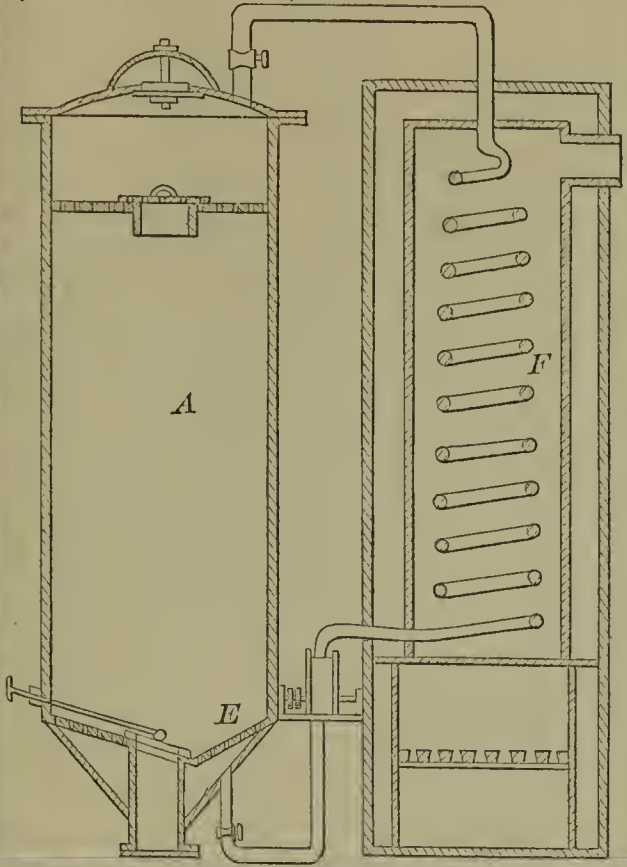

55837—J. A. Dodge—*Harvester.*

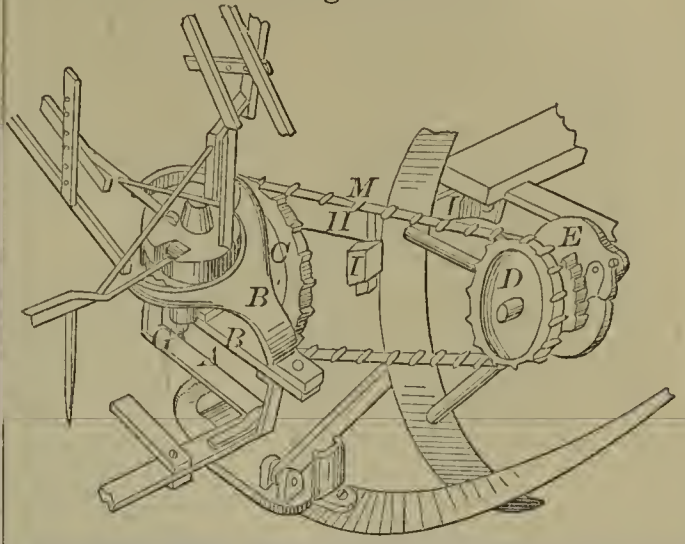

55838—A. Drummond—*Pocket Book Protector.*

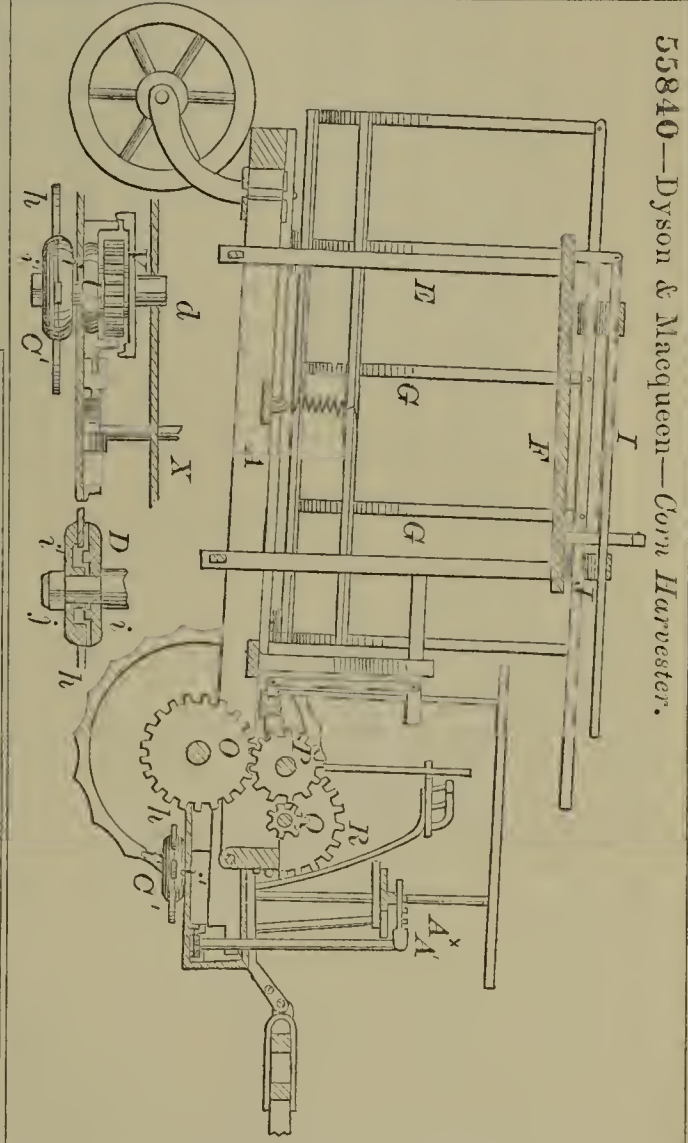
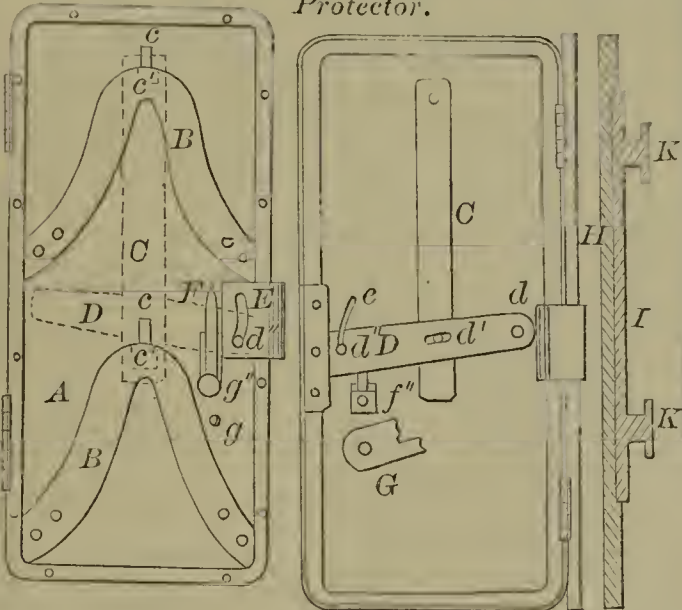

55840—Dyson & Macqueen—*Corn Harvester.*

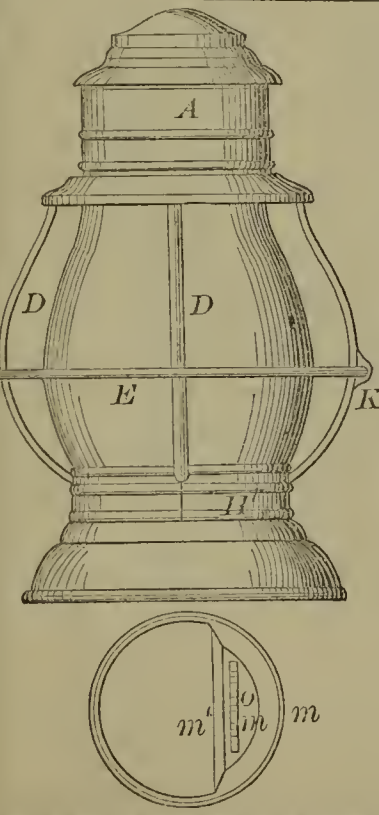

55839—A. M. Duburn—*Lantern.*

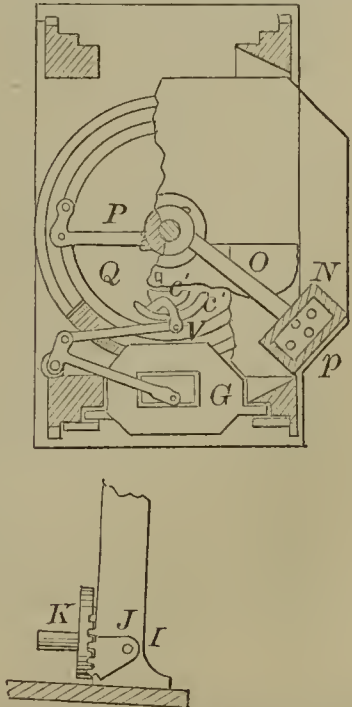
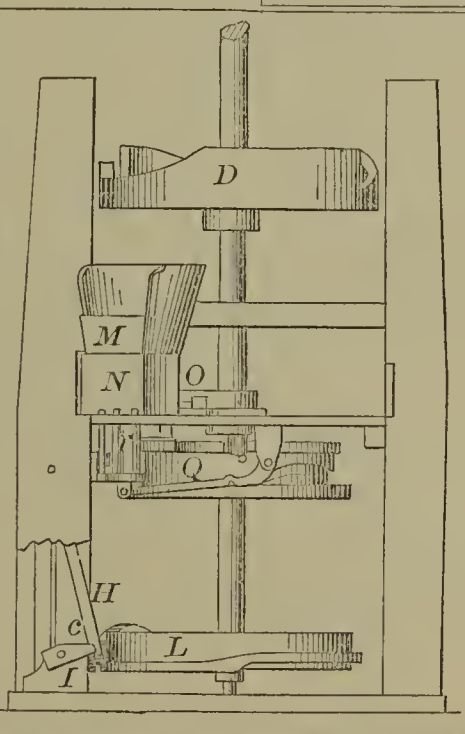

55841—J. S. Elliott—*Brick Machine.*

55844—Fox & Herthel—Draw Bridge.

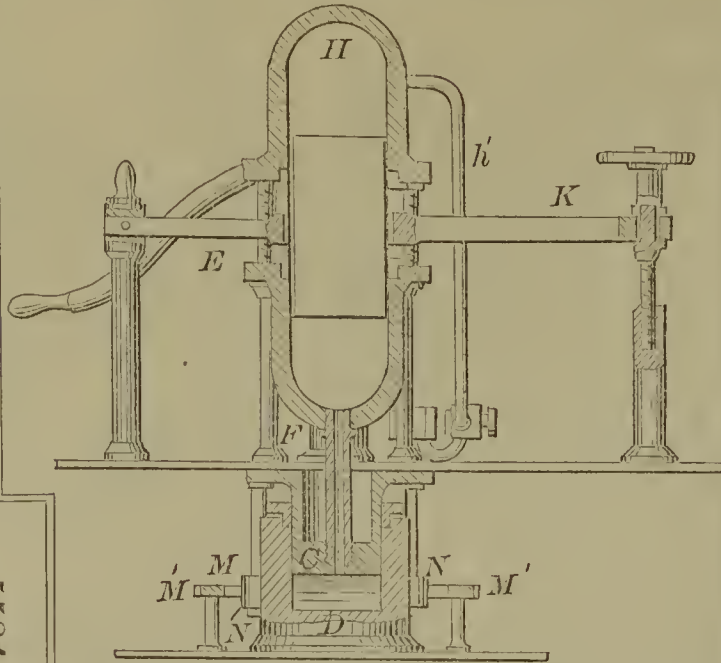

55845—J. M. Francis—Making Tin Fruit Cans.

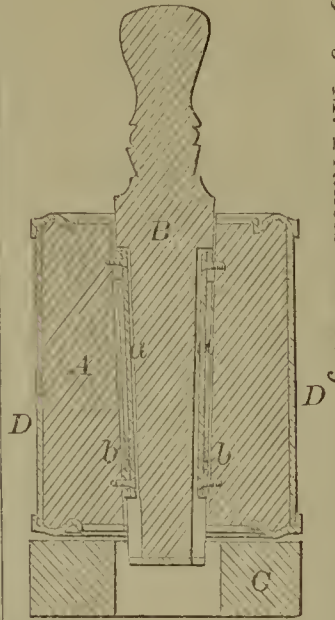

55842—Essex & Johnson—Dress Elevator.

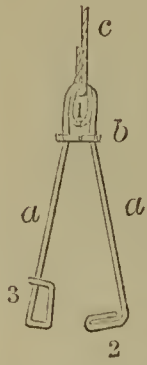

55848—R. R. Gaskill—Roller and Corn Stalk Cutter.

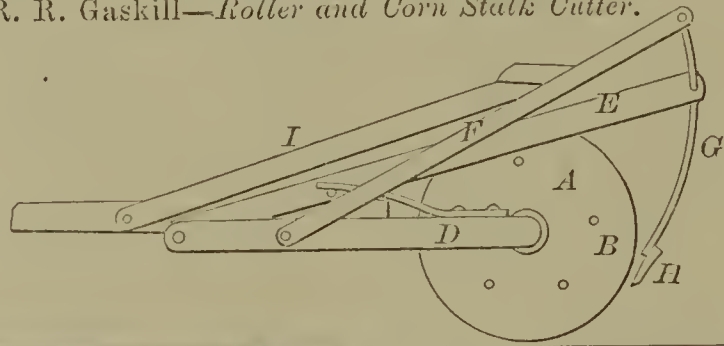

55843—S. S. Evans—Broom Head.



55846—G. Fyfe—Table Leaf Support.

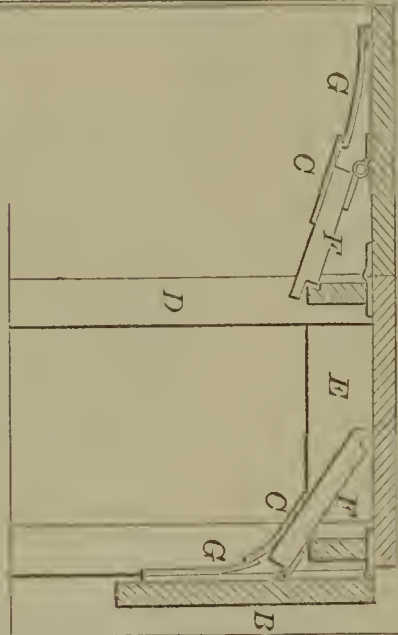

55849—W. Gibson—Baby Jumper.

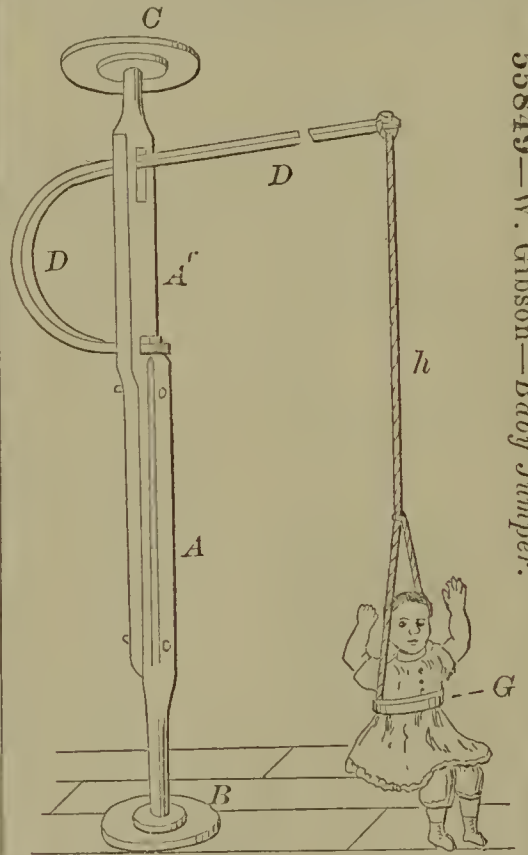

55850—W. Gilbert—Hand Corn Planter.

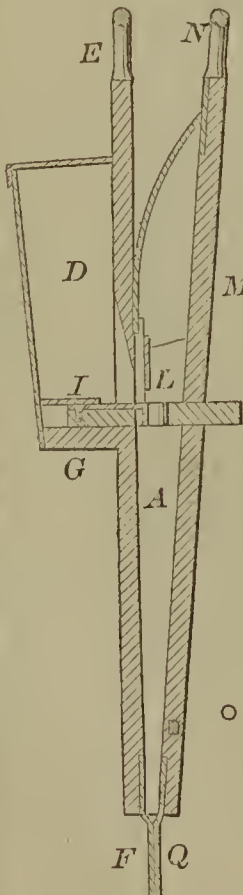

55847—A. Galleth—Feeding Wheel for Sewing Machines.

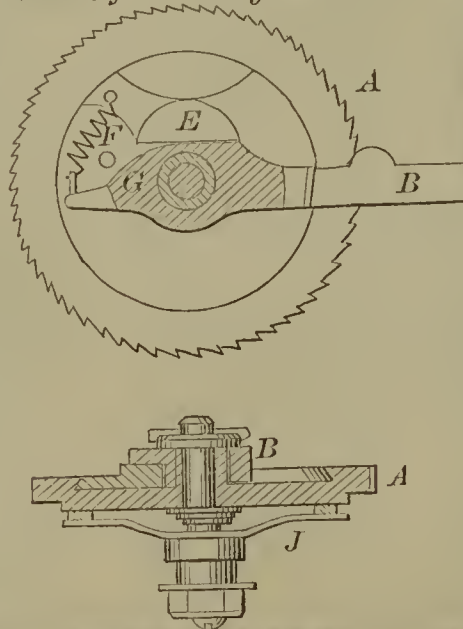

55851—I. C. Gleason—Fruit Basket.

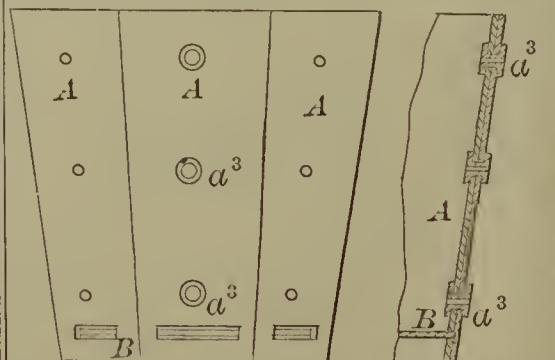

55852—C. Goodyear, Jr.—  
*Lacing for Boots and Shoes.*

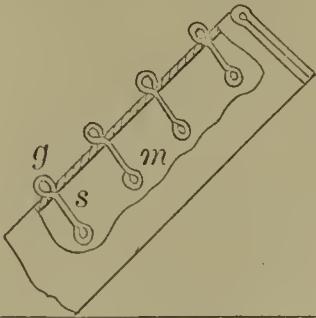

55853—C. Goodyear, Jr.—  
*Lacing for Boots and Shoes.*

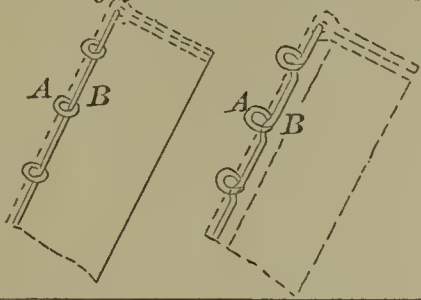

55854—Gunning & Meyer—  
*Buckle.*

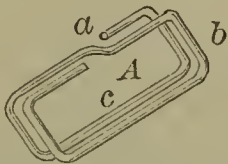

55856—M. Haneline—*Broom Head.*

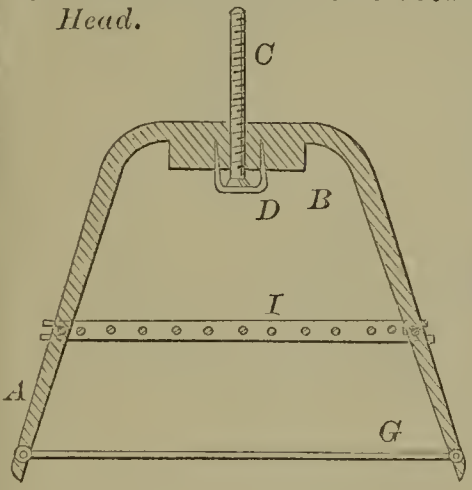

55857—W. H. Hart—*Butter Worker.*

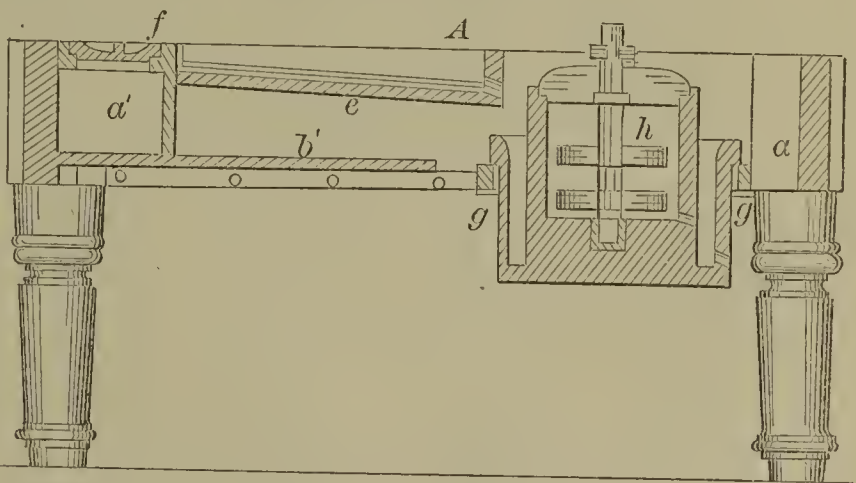

55855—C. H. Hall—*Distilling Petroleum.*

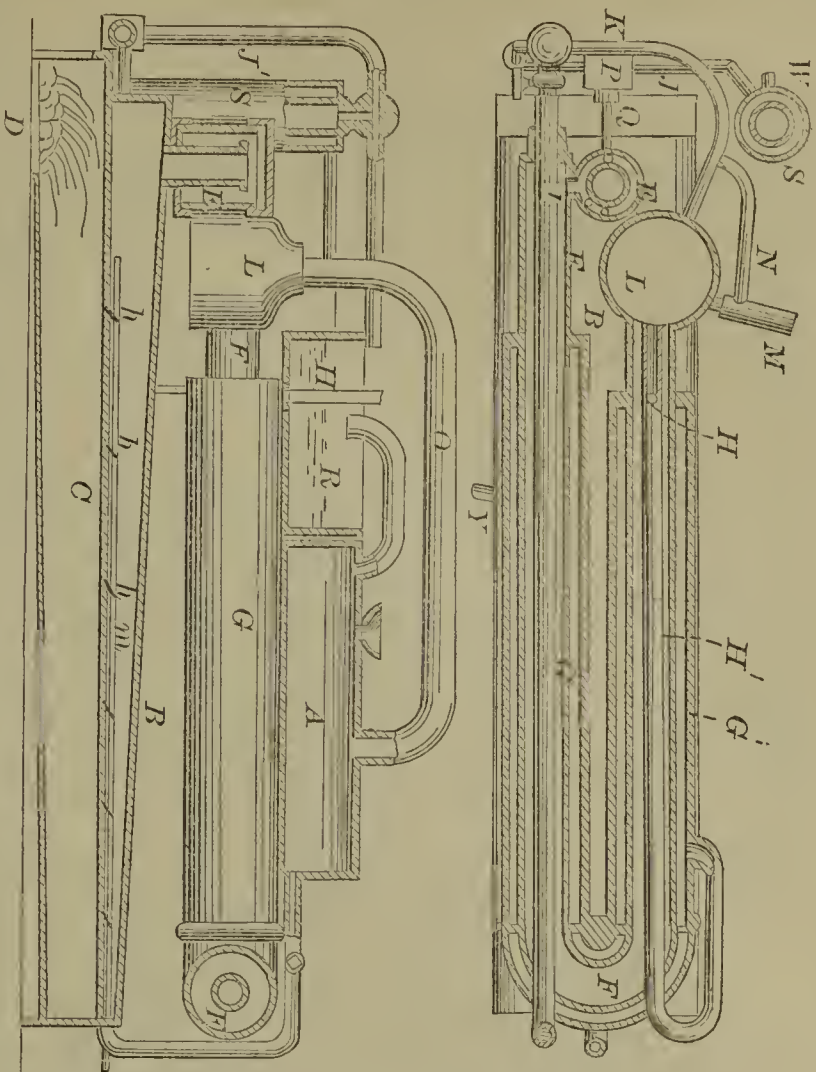

55860—A. D. Hoffman—*For Cutting Fly Nets.*

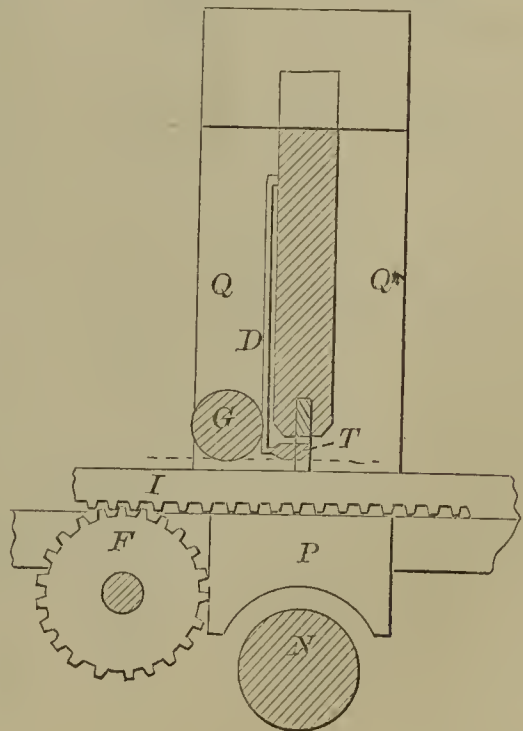

55858—G. Hawkes—*Manufacture of Boots and Shoes.*

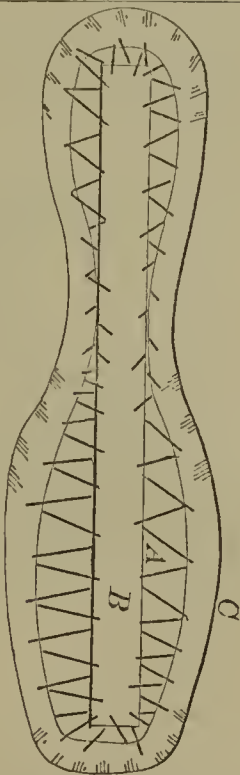

55859—J. G. Hitchcock—*Neck Tie Fastening.*

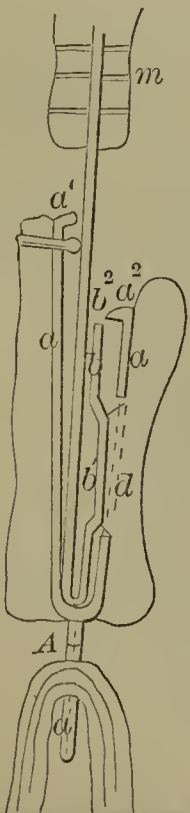

55861—E. Holmes—Tobacco Cutting Machine.

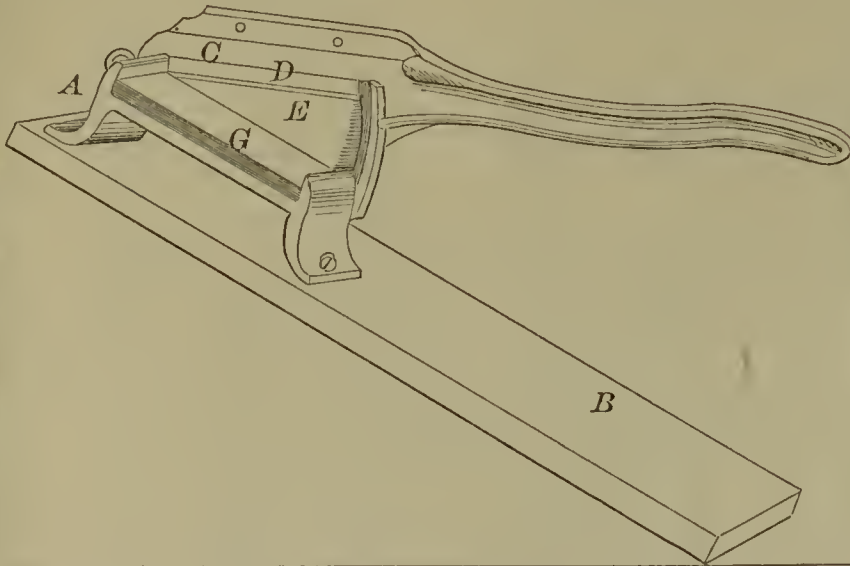

55864—J. A. & H. A. House—Button Hole Sewing Machine.

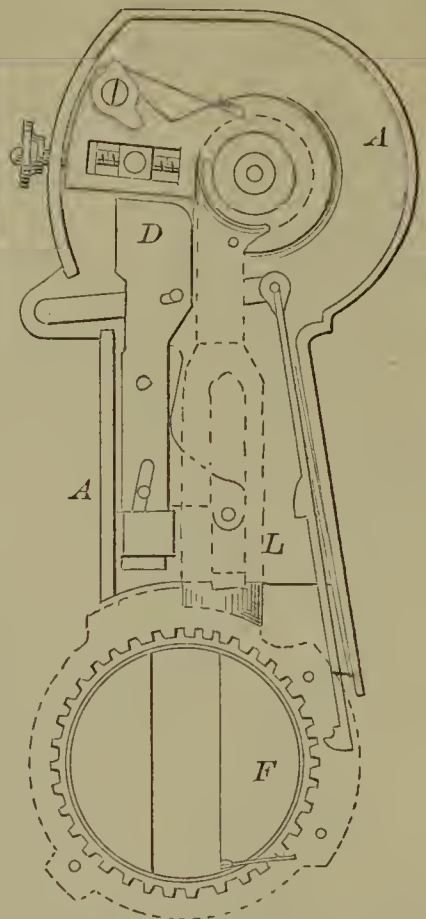

55862—B. F. Horn—Lamp Cleaner.

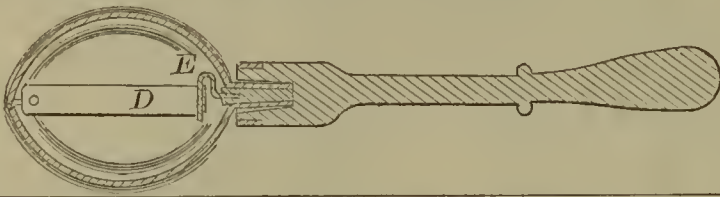

55863—J. A. & H. A. House—Button Hole Sewing Machine.

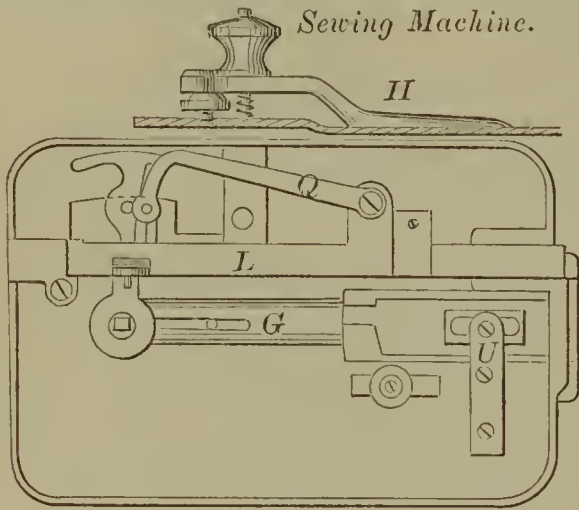

55866—J. A. & H. A. House—Sewing Machine Clamp.

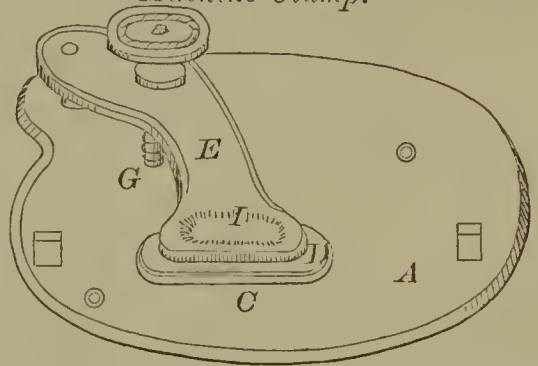

55867—M. V. B. Howe—Knife and Scissors Sharpener.



55865—J. A. & H. A. House—Button Hole Sewing Machine.

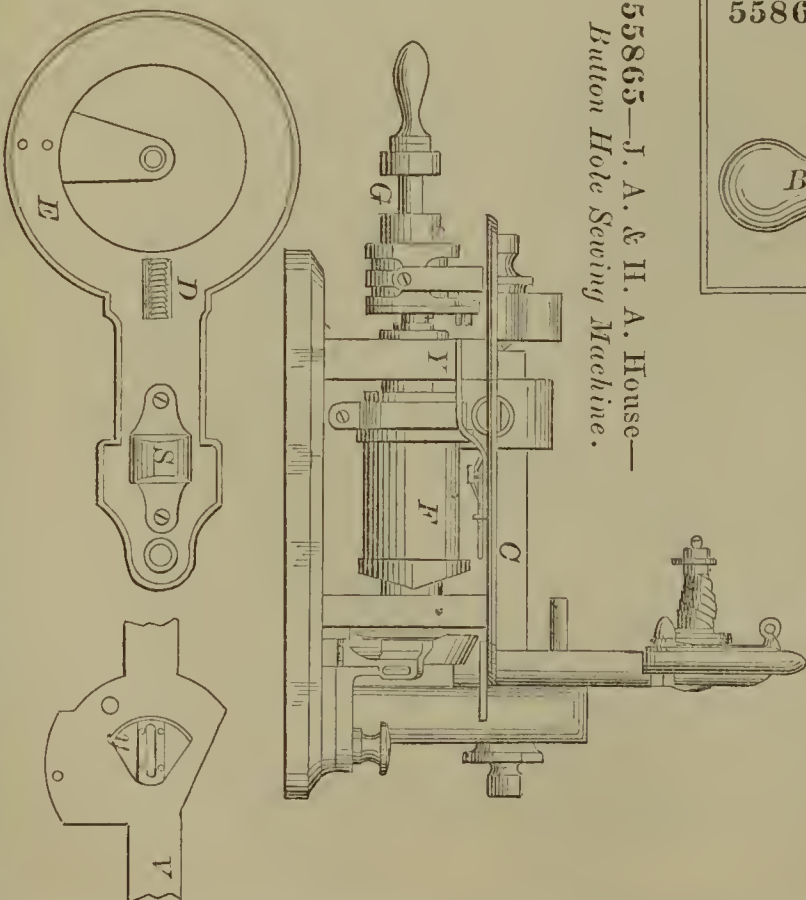

55868—N. W. Hubbard—Truss.

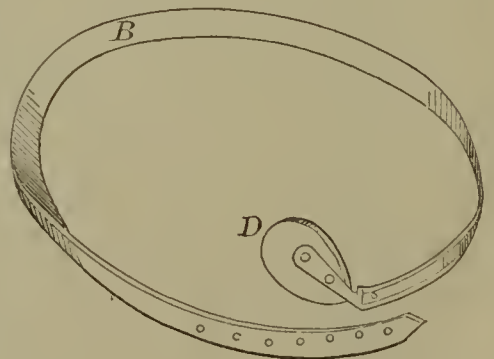

55869—S. Huffman—For Making Patterns.

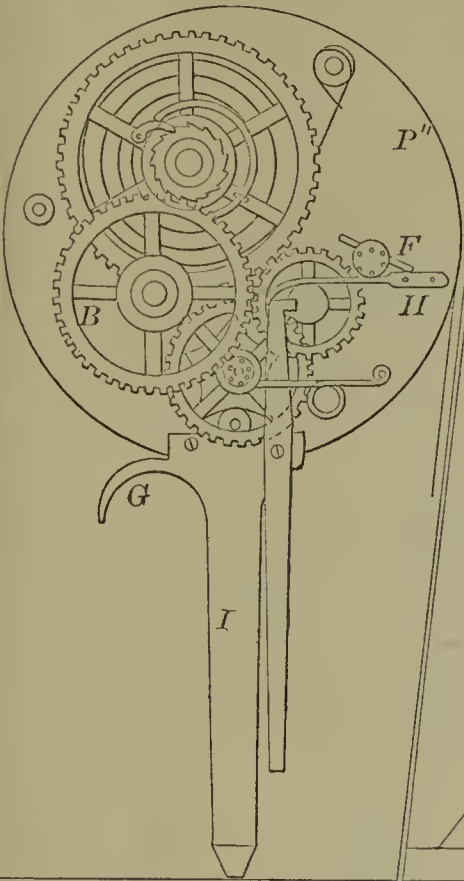

55873—A. Irion—Washing Machine.

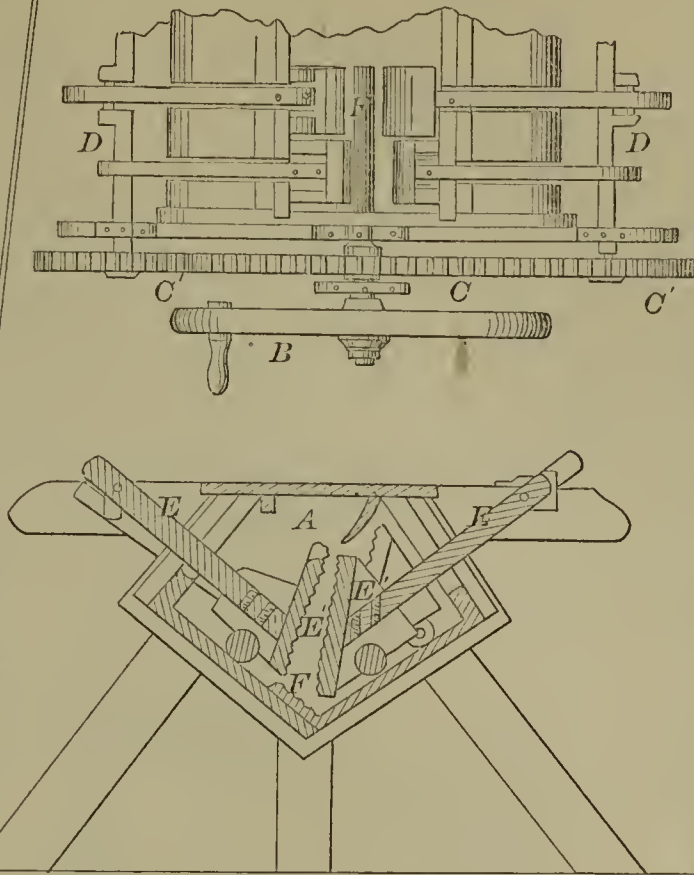

55870—H. Hughes—Car Coupling.



55874—T. E. King—Fence.

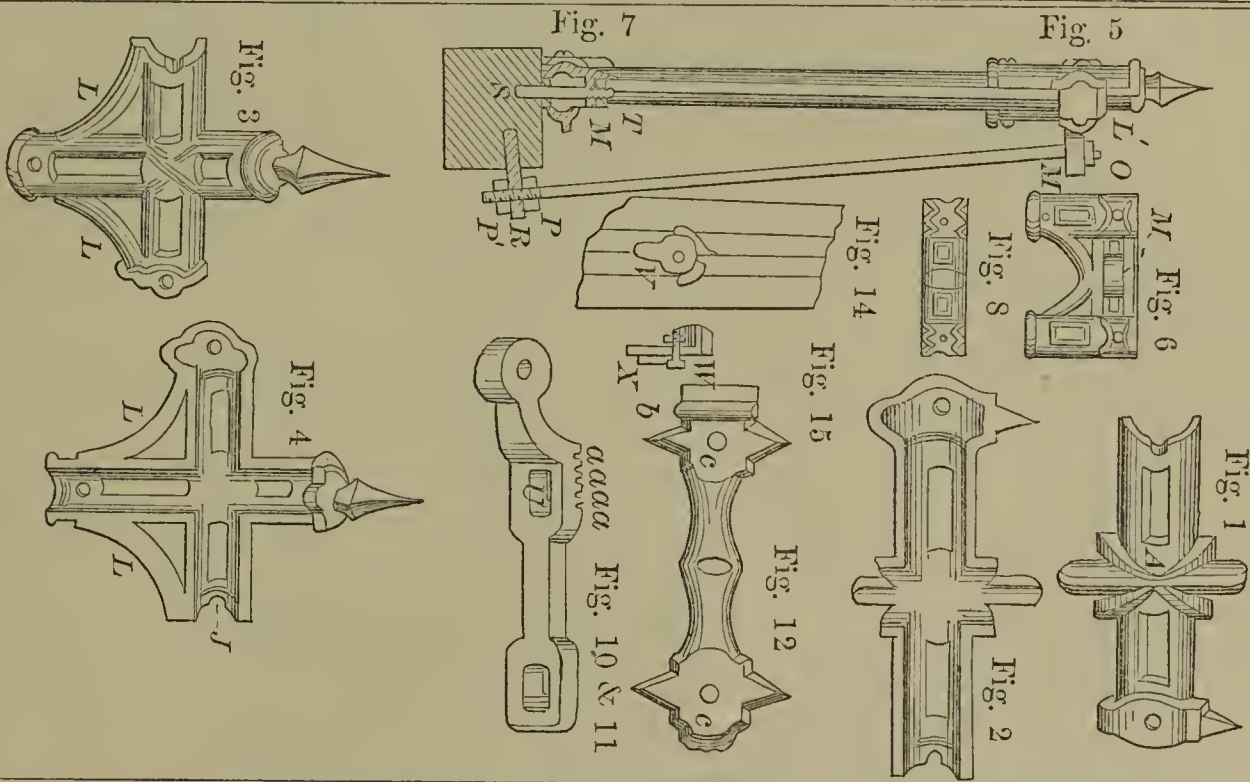

55872—J. Hutchison—Grinding Mill.

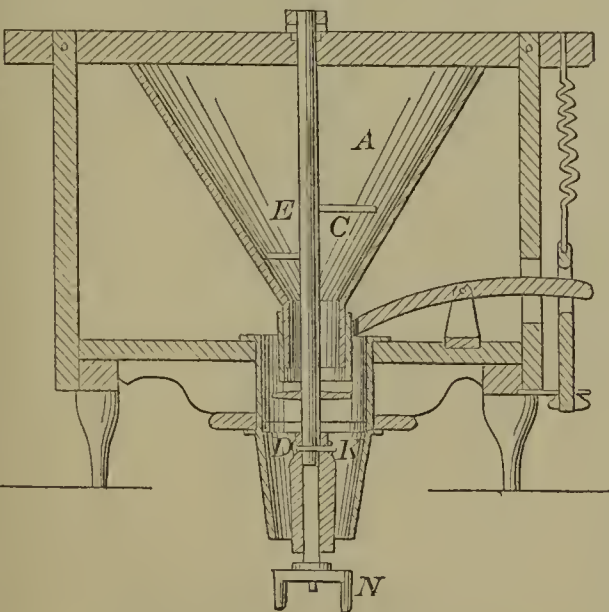

55875—L. Kratzer—Water Wheel.

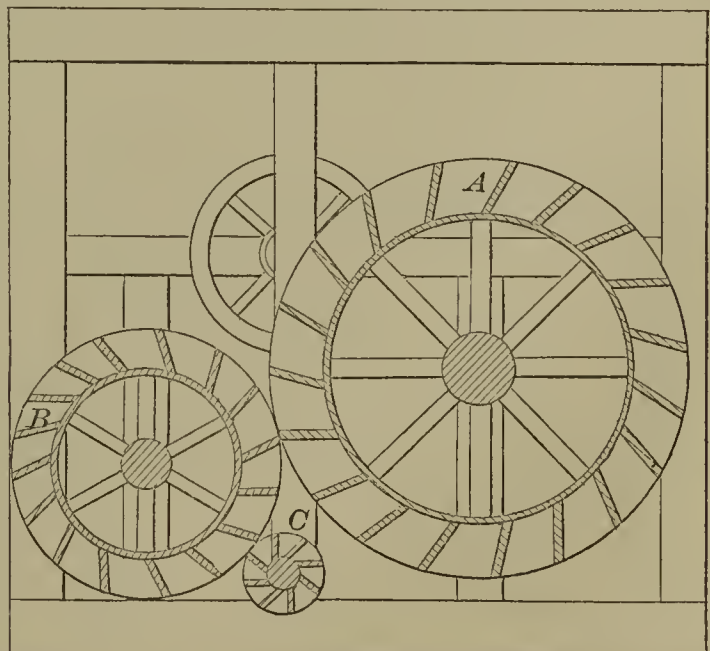

55876—J. Lee—Farm Gate.

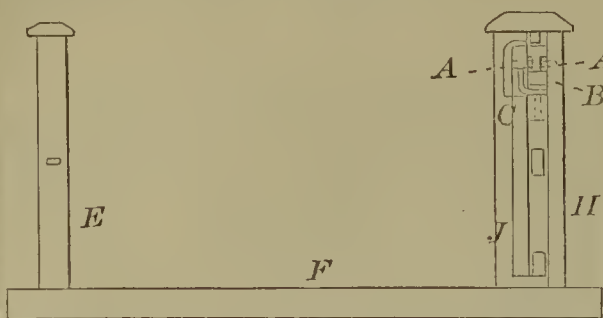

55877—E. J. Leyburn—Harvester Rake.

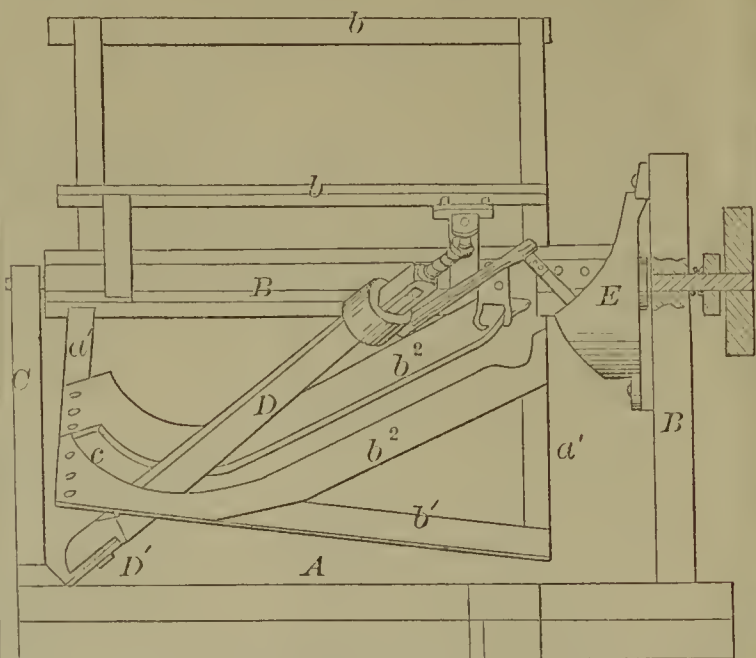

55878—O. J. Livermore—Can Opener.

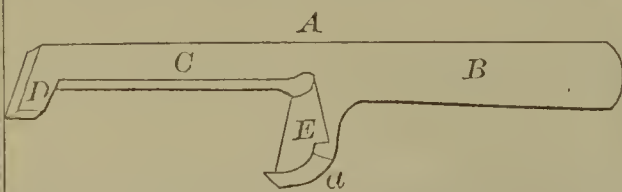

55883—S. H. Mitchell—Fence.

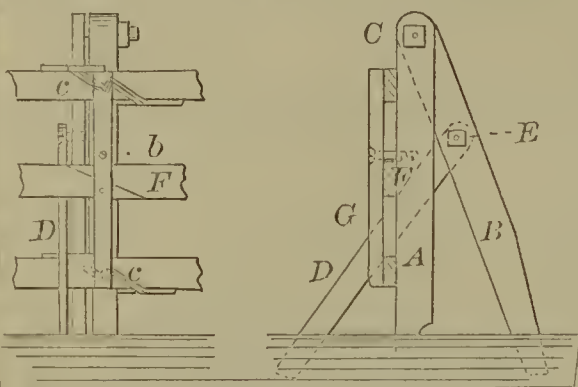

55884—D. Morris—Well Boring Apparatus.

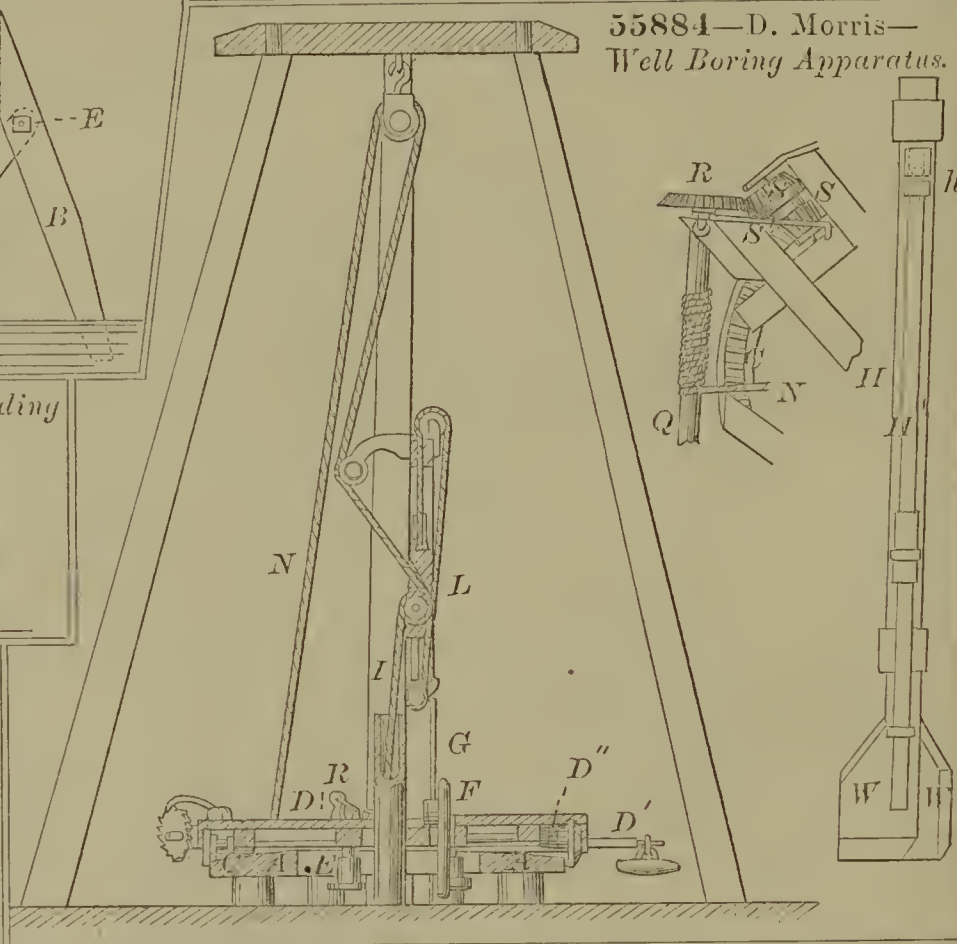

55881—J. McDonald—Carding Machine.



55885—J. Musser—Flour Packer.

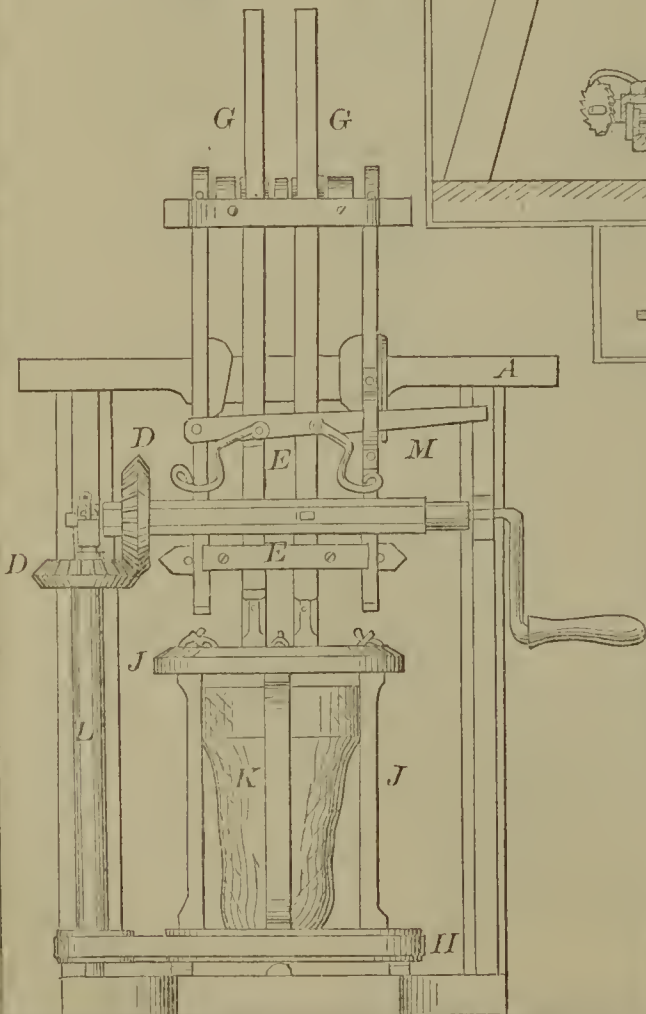

55879—Locke & Heuser—Label.



55882—Mecker & Cortright—Gate for Forebay.

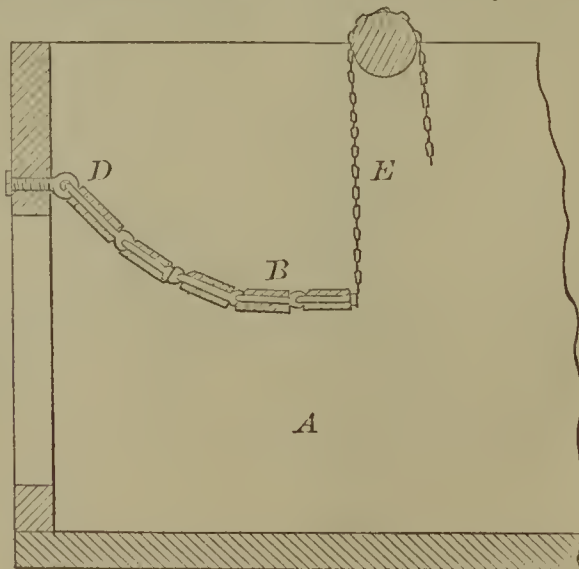



55886—G. Nebeker—Agitating and Heating Apparatus.

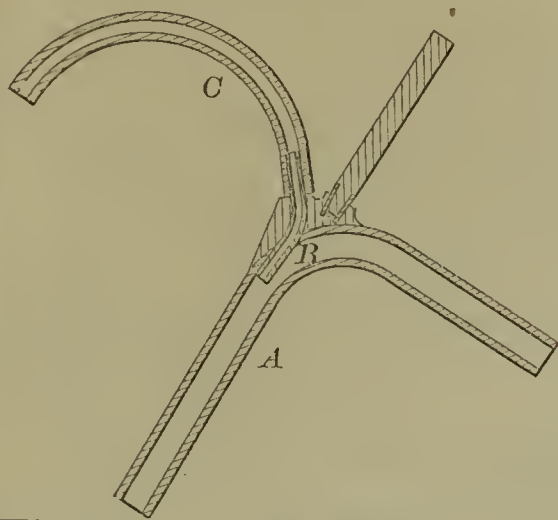

55888—F. Nishwitz—Sugar Mould Tip.

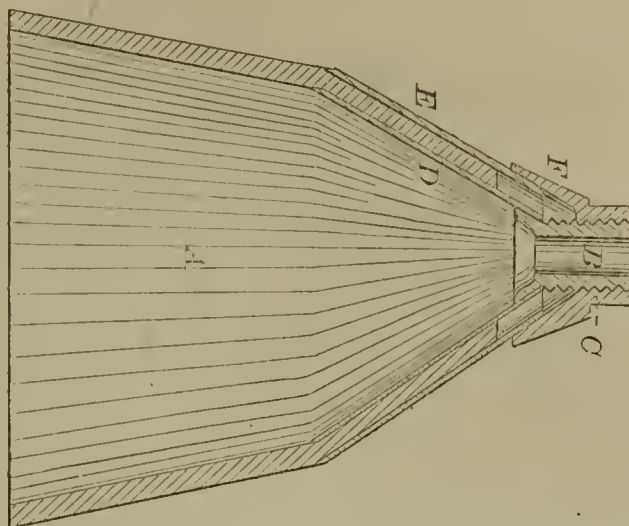

55887—F. Nishwitz—Sugar Mould.

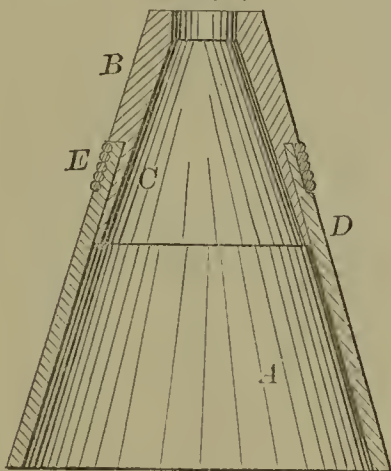

55891—R. Norwood—Roofing.

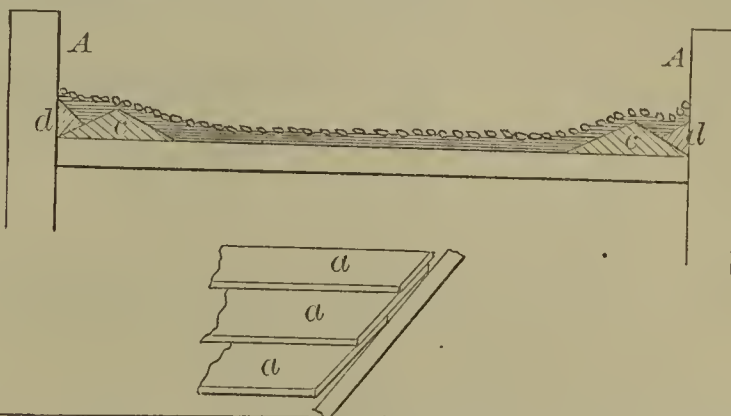

55892—A. S. Ogden—Carbon Battery Connection.

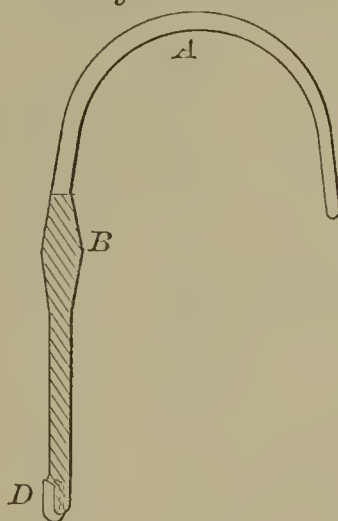

55895—E. F. & C. T. Packer—Drill Coupling.



55890—E. D. Norton—Mill Sieve.

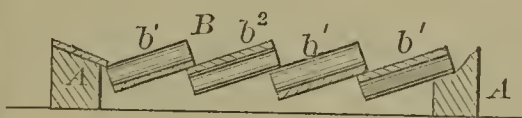

55893—J. Old—Hydrant.

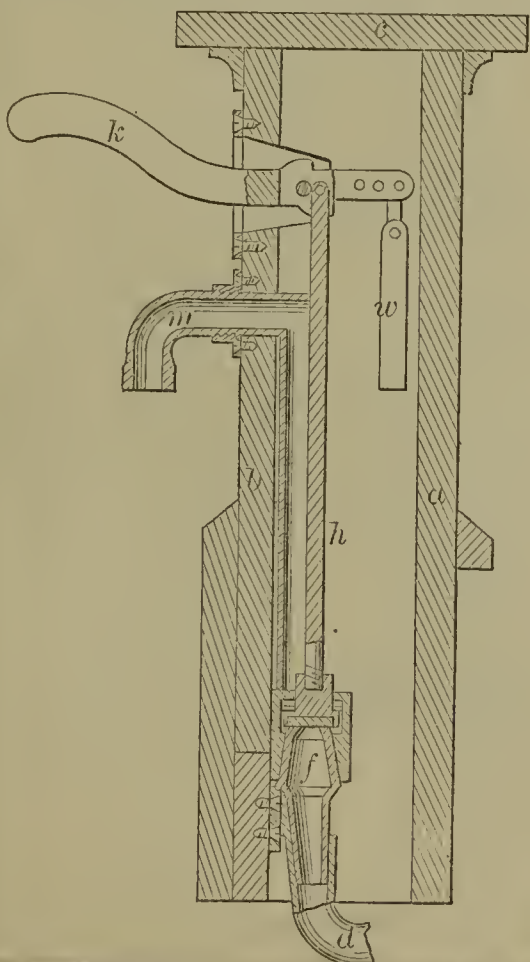

55894—J. Old—Lifter for Stove Covers.

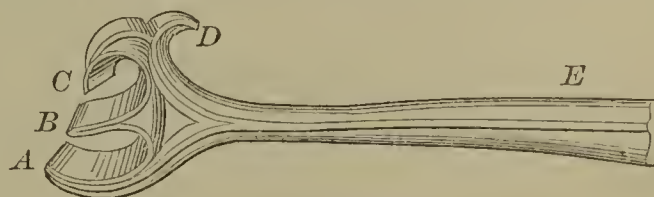

55896—L. Page—Sheep Rack and Holder.

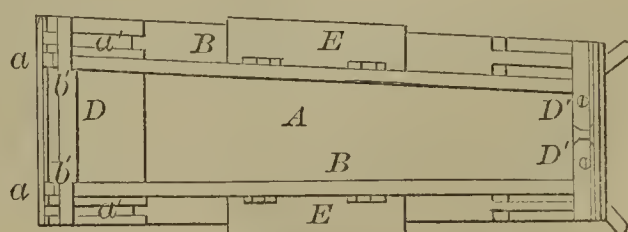

55897—O. B. Parker—Book Holder.

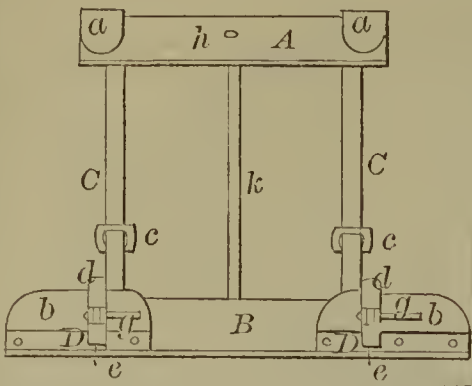

55899—B. P. Pendexter—Corn Sheller and Bean Thresher.

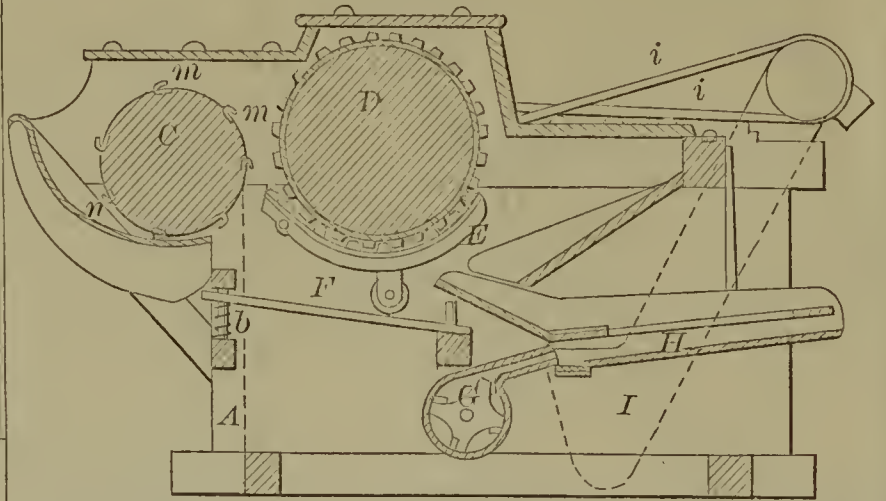

55900—B. Pickering—Water Closet.

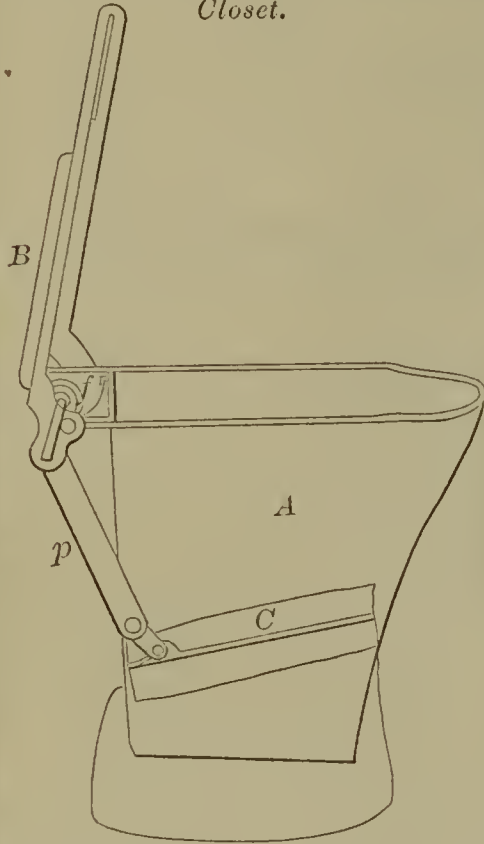

55901—J. L. Plimpton—Skate.

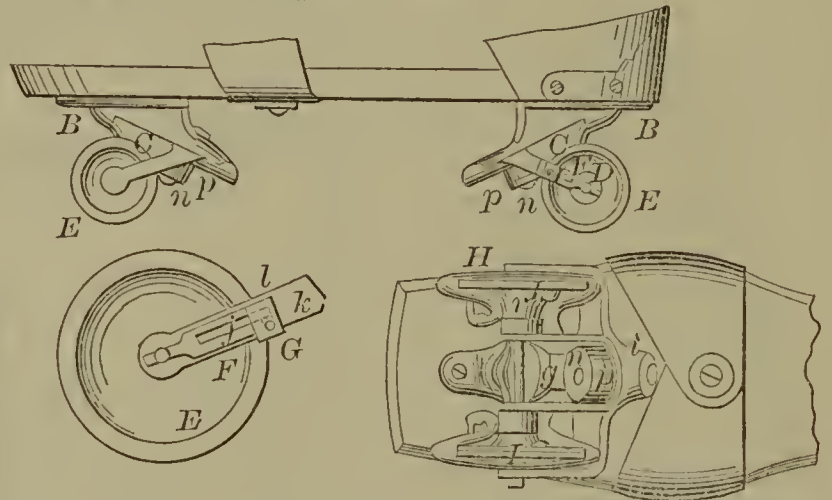

55903—J. Radley—Locomotive Lamp.

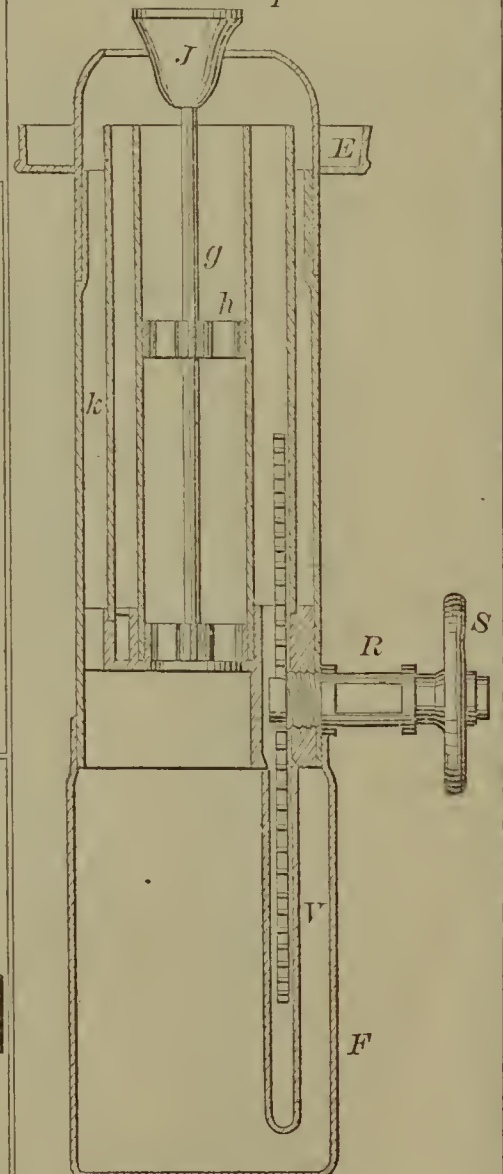

55902—I. T. Price—Horse Hay Fork.

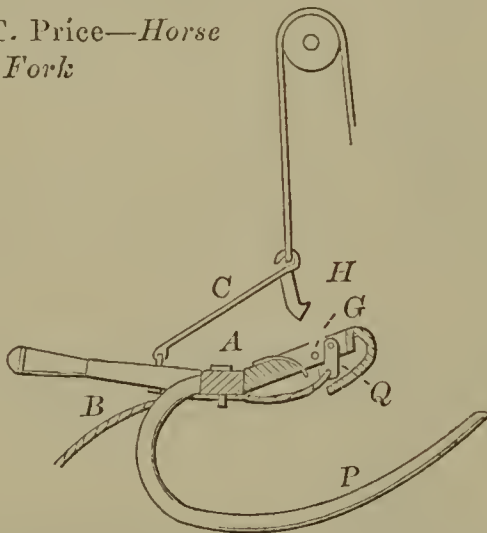

55904—J. Radley—Engine Head Light.

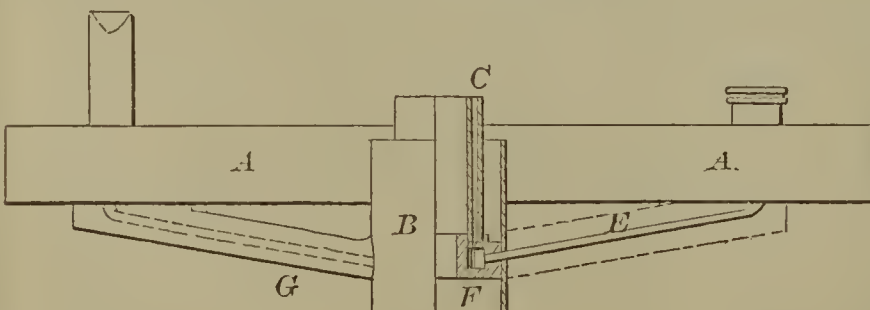

55905—A. Rank—Mowing Machine.

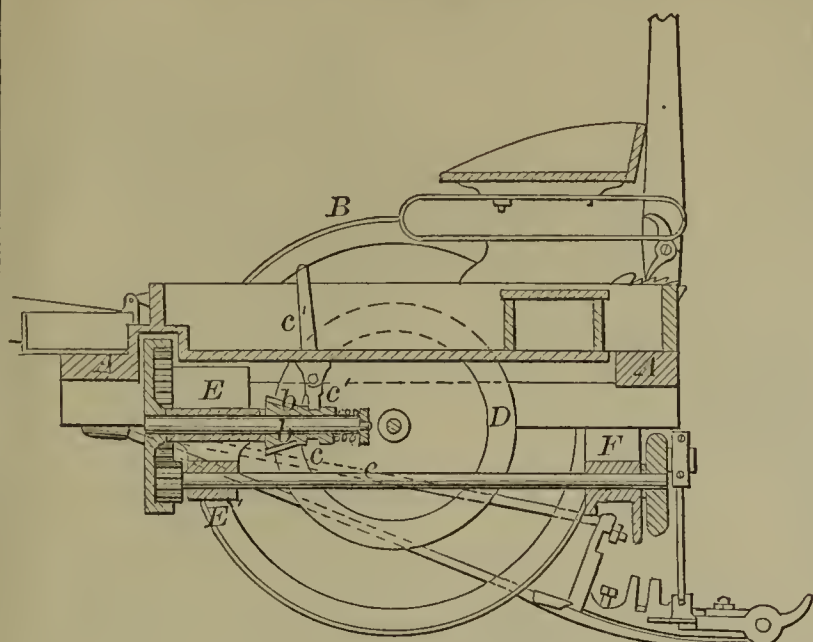

55907—H. Read—Window Shade.

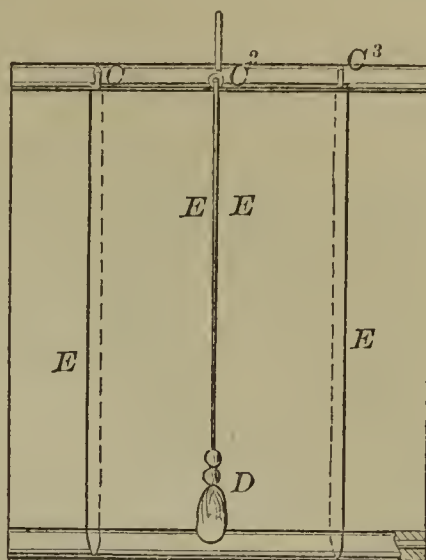

55906—Raymond & Miller—Fence Gate.

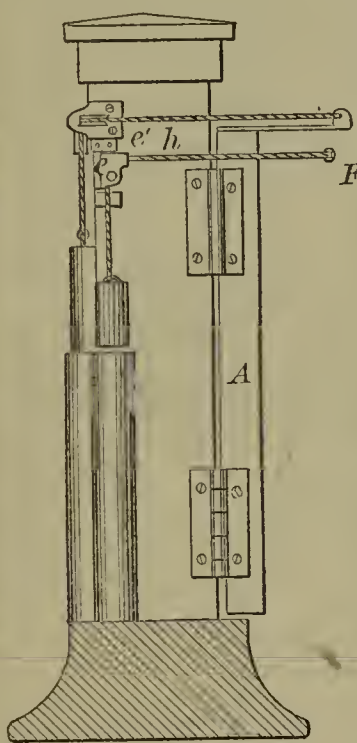

55908—W. E. Rich—Corn Planter.

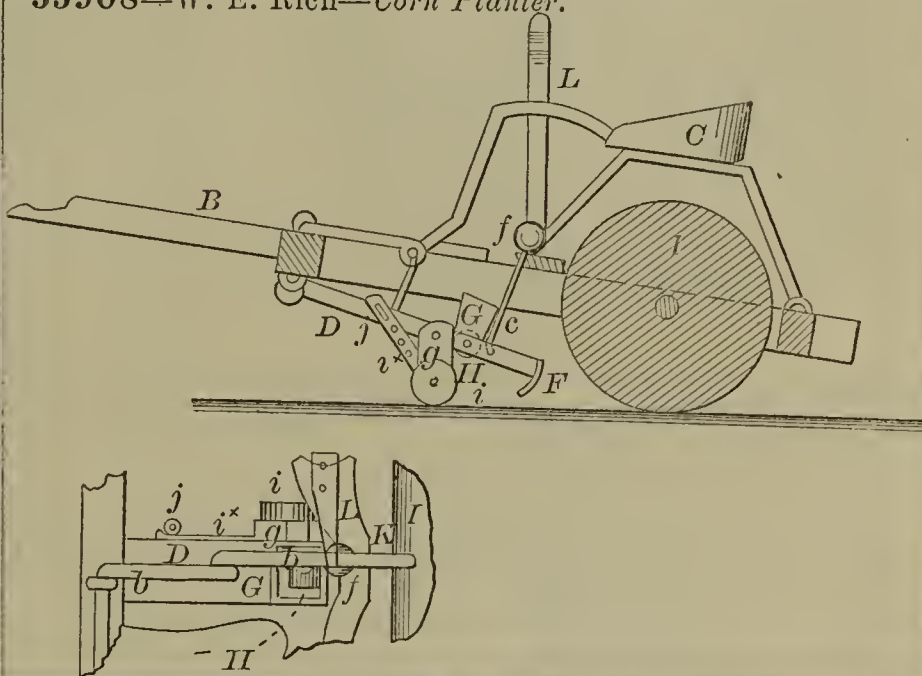

55909—H. S. Richardson—Gas Lighting Machine.

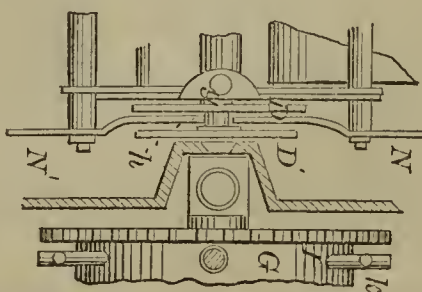
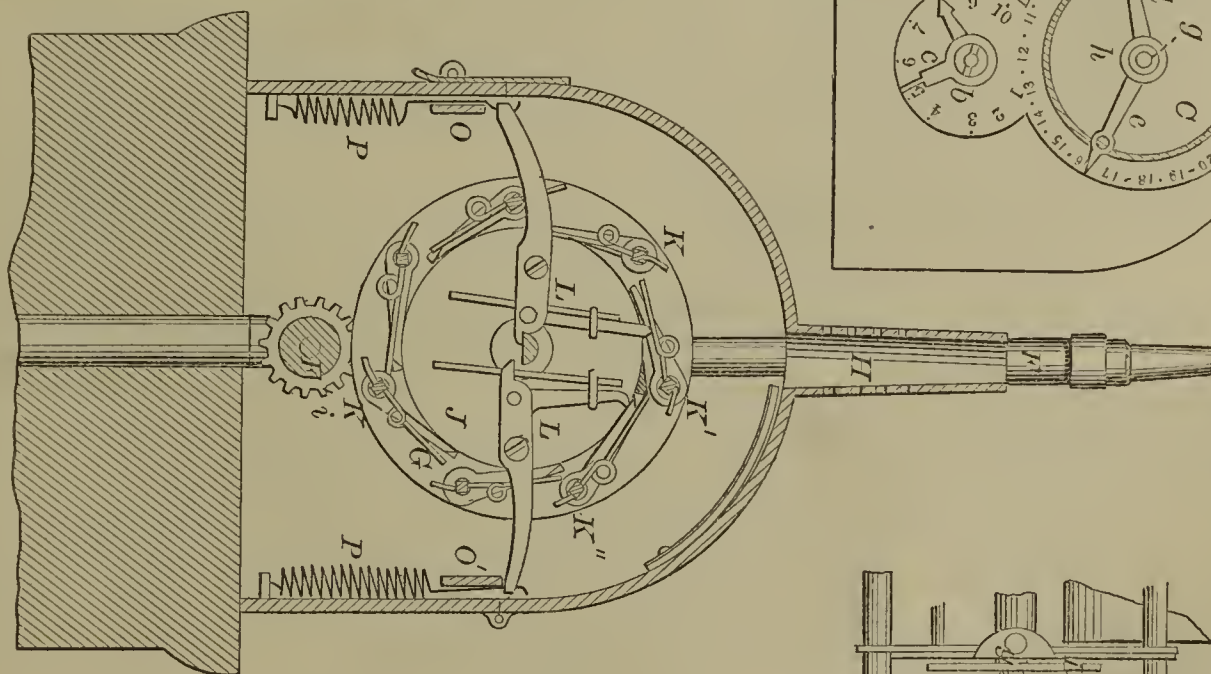

55910—E. P. Russell—Reaping Machine.

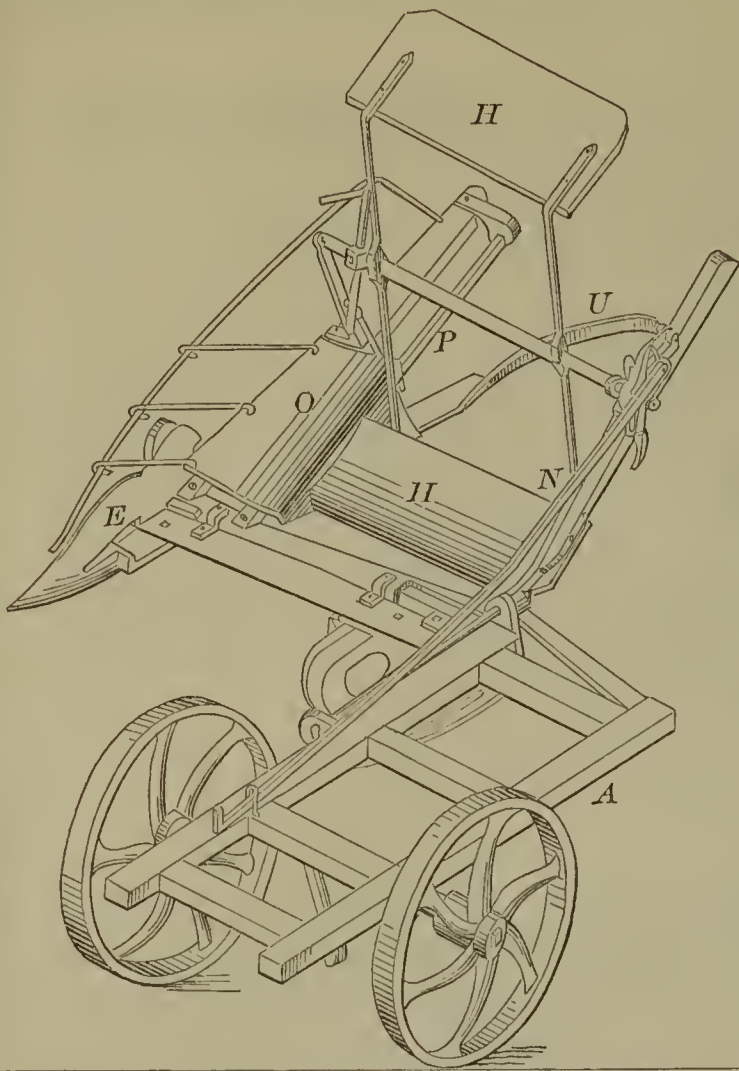

55913—C. H. Sawyer—Railway Switch.

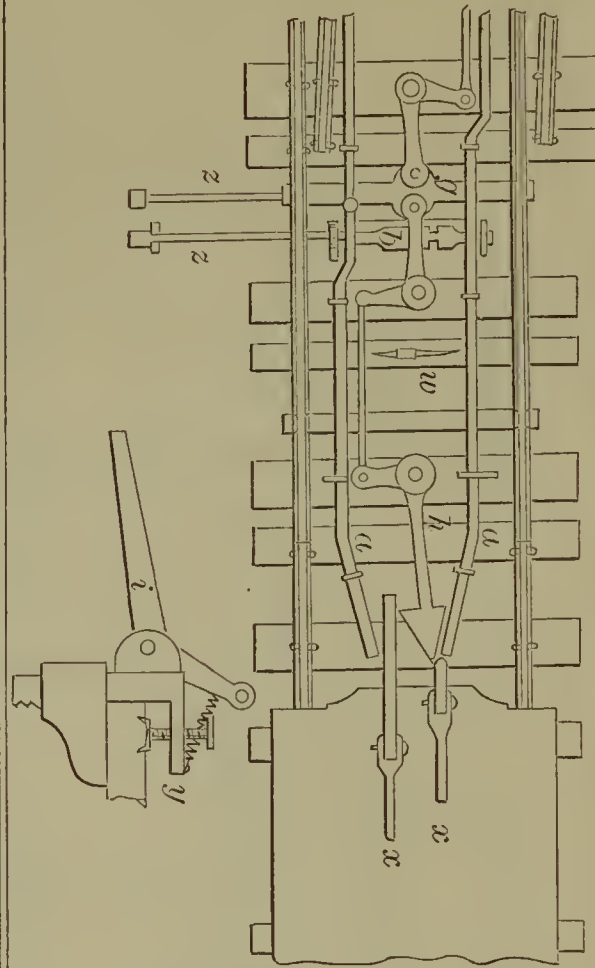

55912—Sargent & Rider—Horse Shoe Nail Machine.

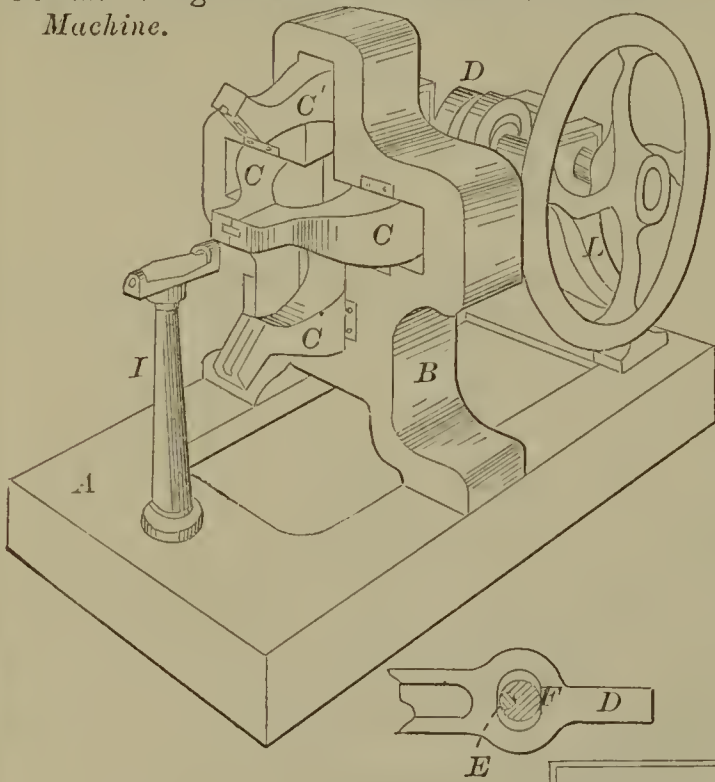

55915—J. Schneider—For Producing Extract of Hops.

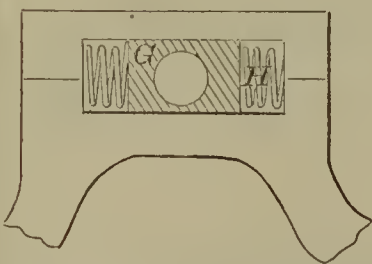
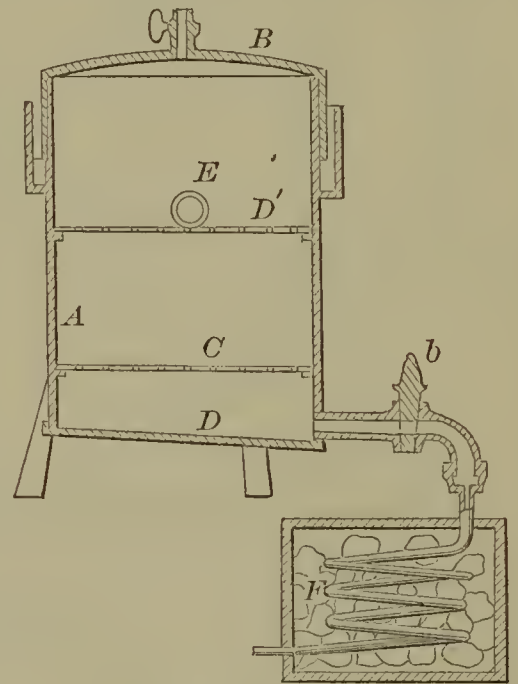

55914—J. H. Schenek—Automatic Gate.

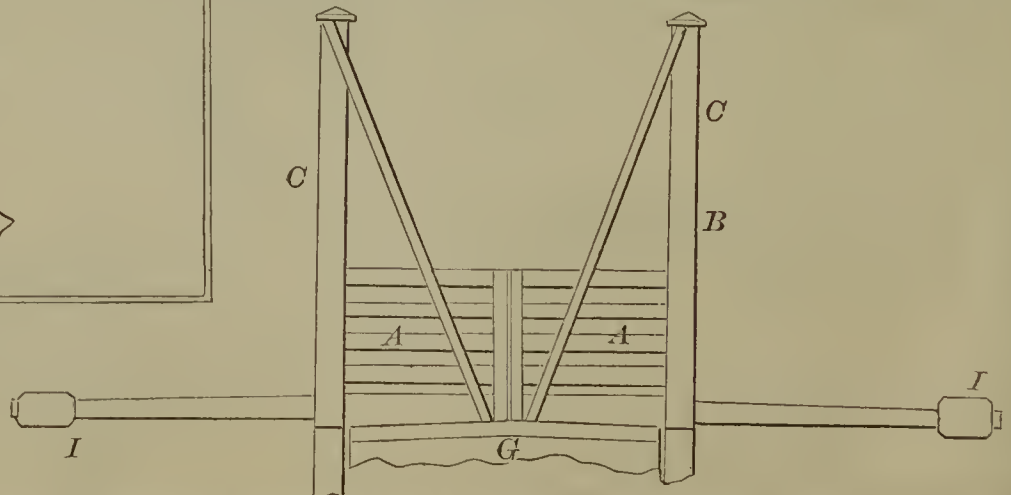

55917—F. J. Seymour—Picture Nail.

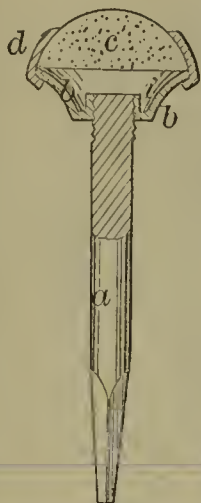

55921—J. D. Smith—Gang Plow.

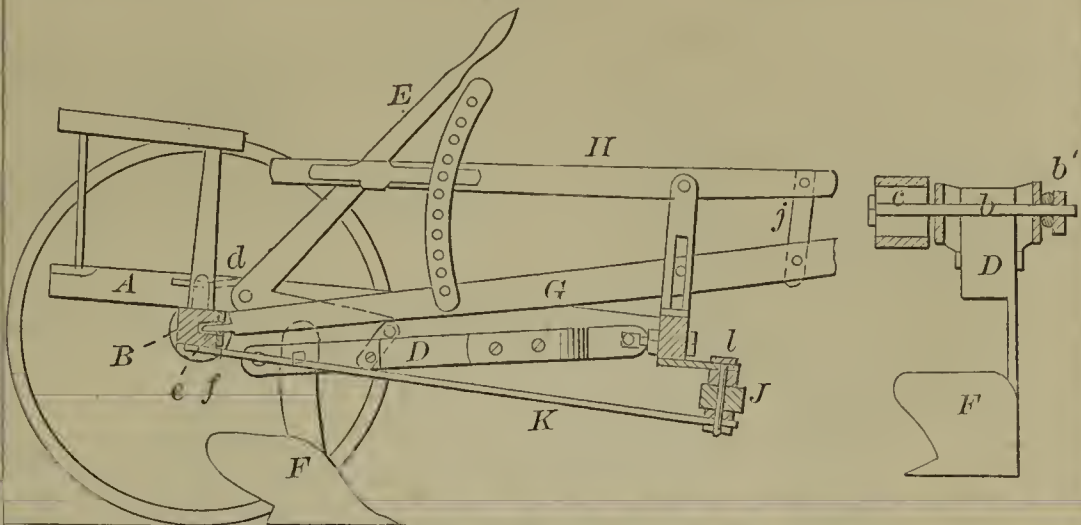

55918—F. Shaller—Drilling Machine.

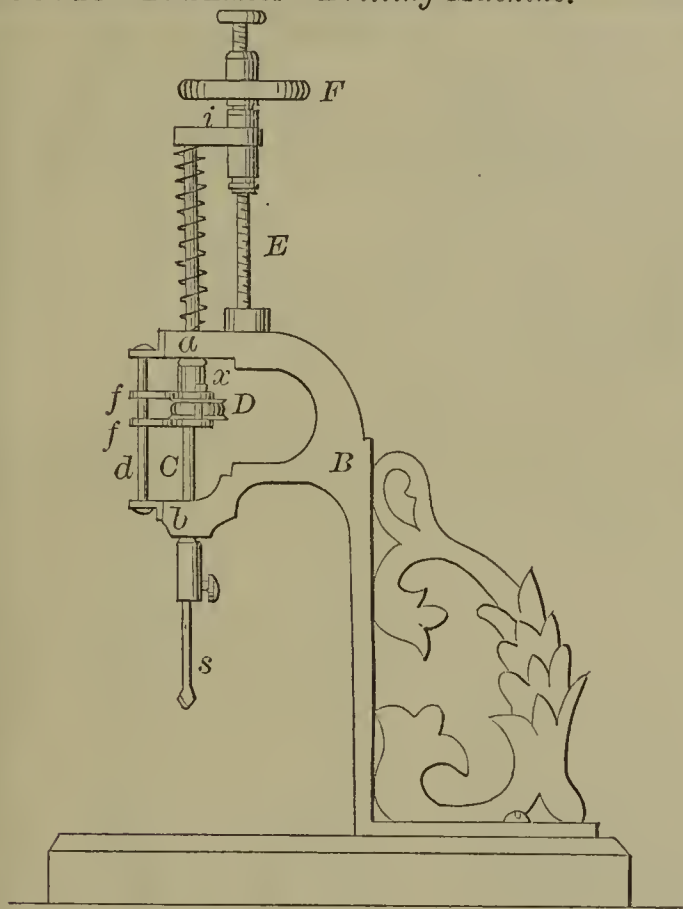

55919—P. P. Simmons—For Cutting Window Shade Slats.

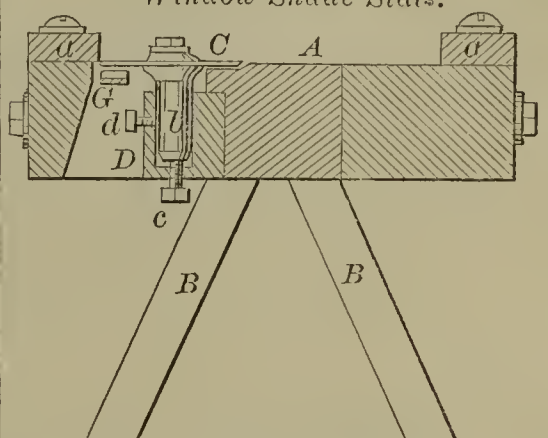

55920—J. J. Slevin—Garbage Box.

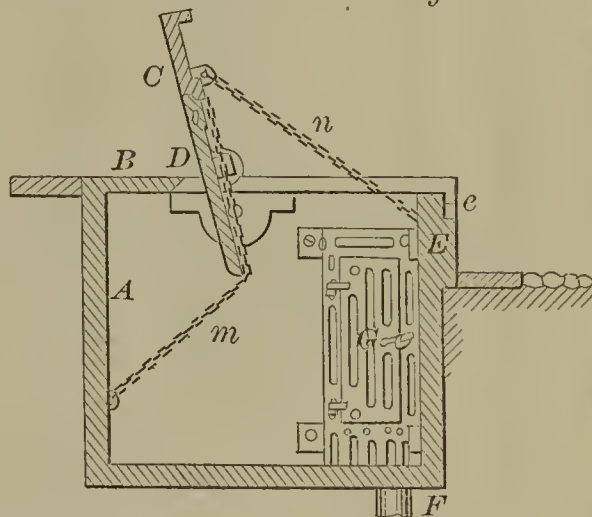

55922—Smith & Hooper—Top Sail Reefing Rig.

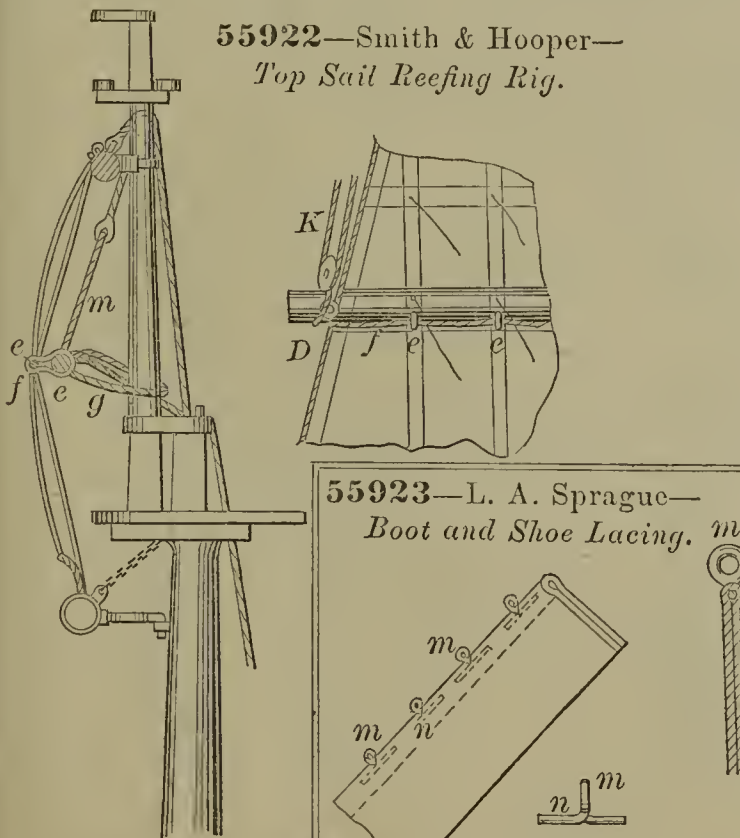

55923—L. A. Sprague—Boot and Shoe Lacing.

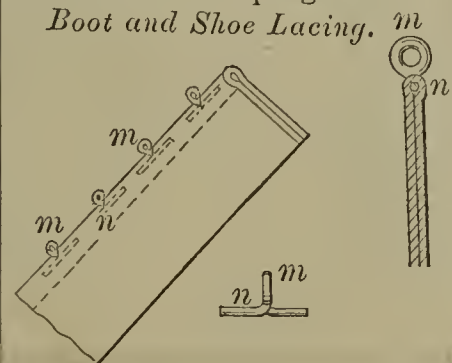

55924—D. I. Stagg—Book Holder.

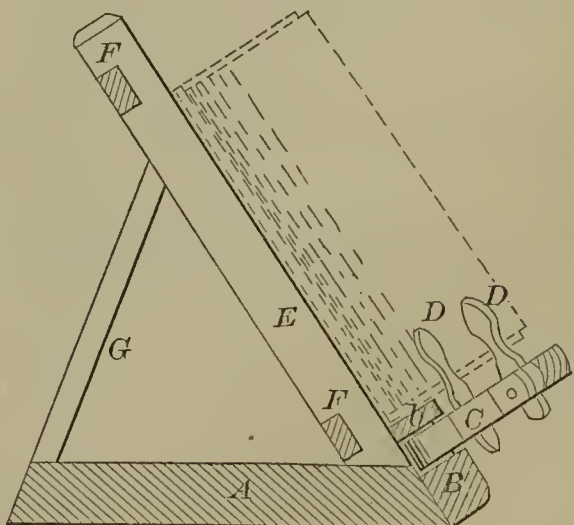

55925—D. I. Stagg—*Stand, Desk, and Book Holder.*

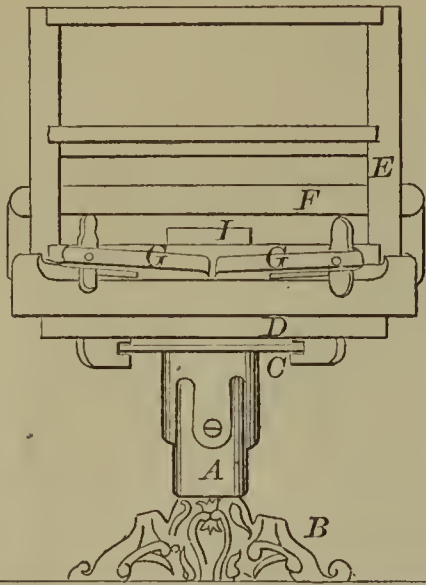

55928—H. H. Staples—*Washing Machine.*

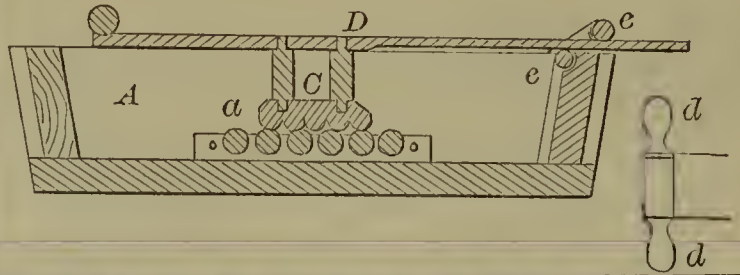

55930—H. Stimmel—*Horse Rake.*

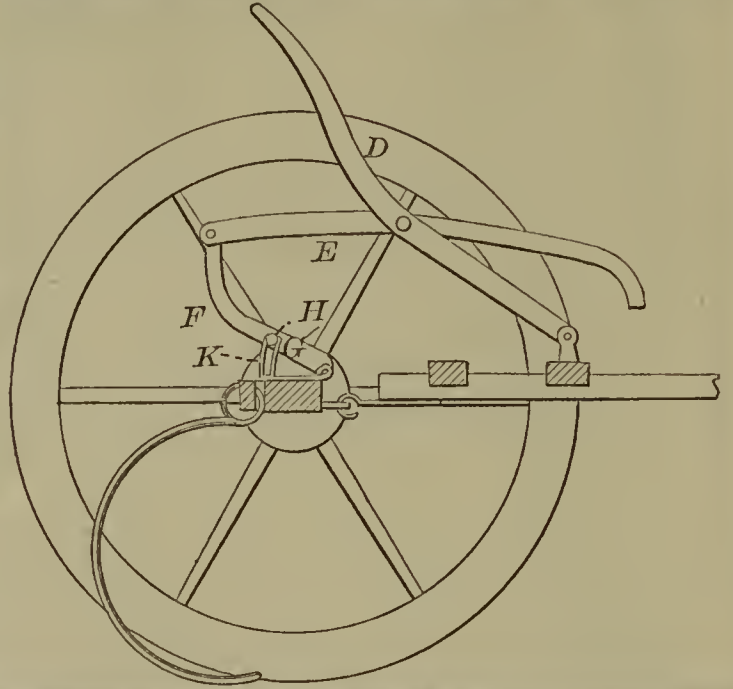

55926—J. K. Staman—*Portable Fence.*

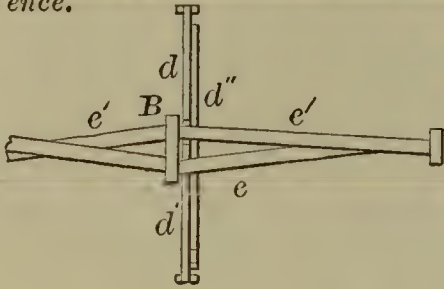

55927—M. Stannard—*Sewing Machine Needle.*



55931—H. Strater, Jr.—*Stop Coek.*

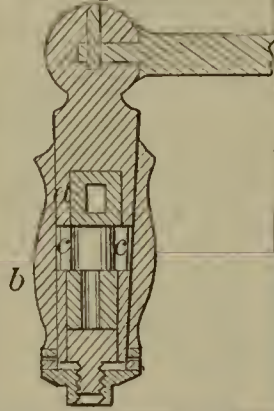

55933—D. S. Thompson—*Buckle.*

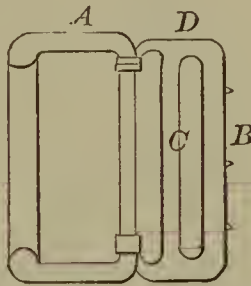

55932—G. C. Taft—*Wrench.*

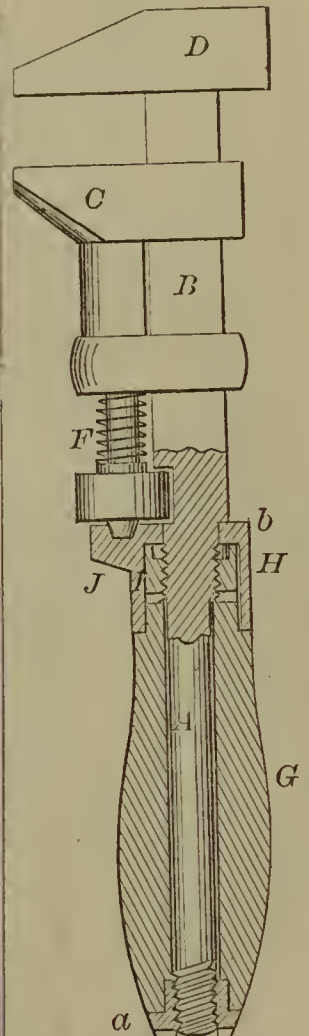

55929—D. Steck—*Fish Way.*

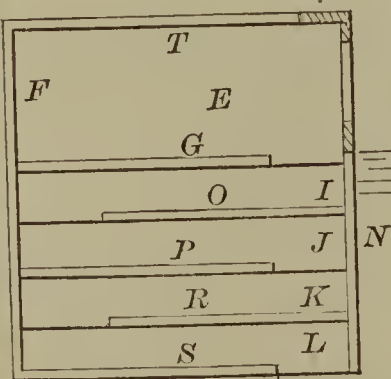

55934—Tillou & Shumway—*Churn.*

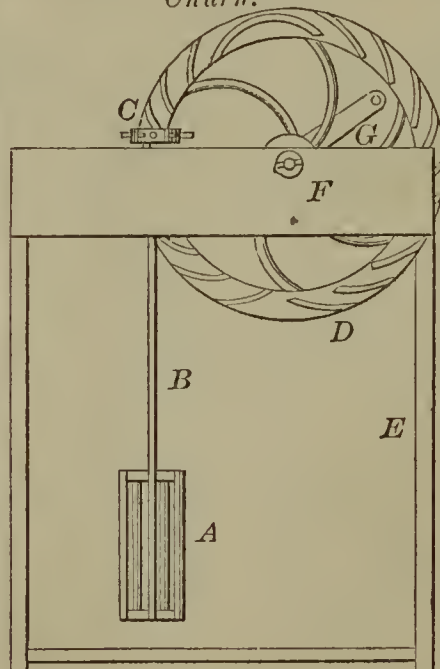

55935—E. W. Twing—Carpet Stretcher.

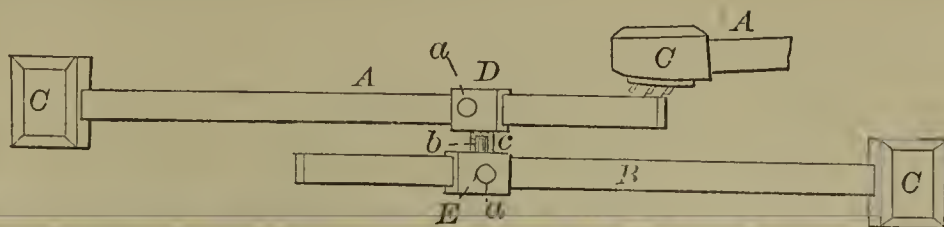

55939—H. G. Whitaker—Stove Pipe Drum.

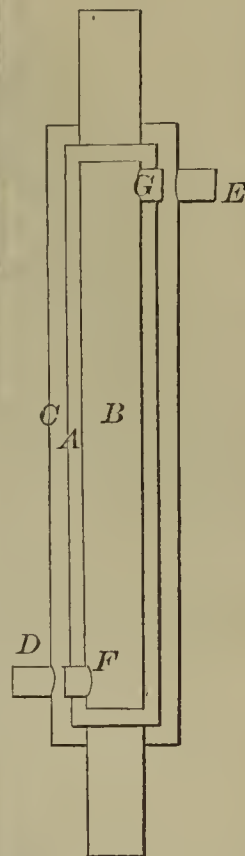

55936—J. Wasson—Broom Head.

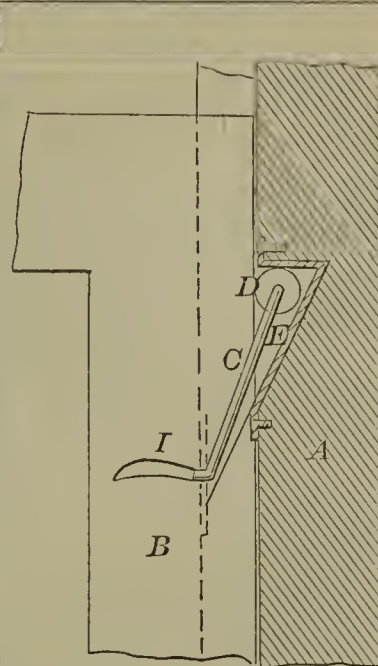
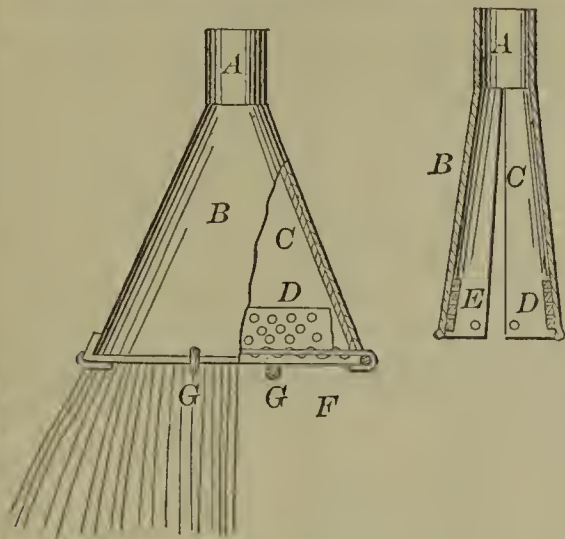

55940—M. V. B. White—Sash Supporter.

55938—J. E. Weaver—For Oiling Journals.

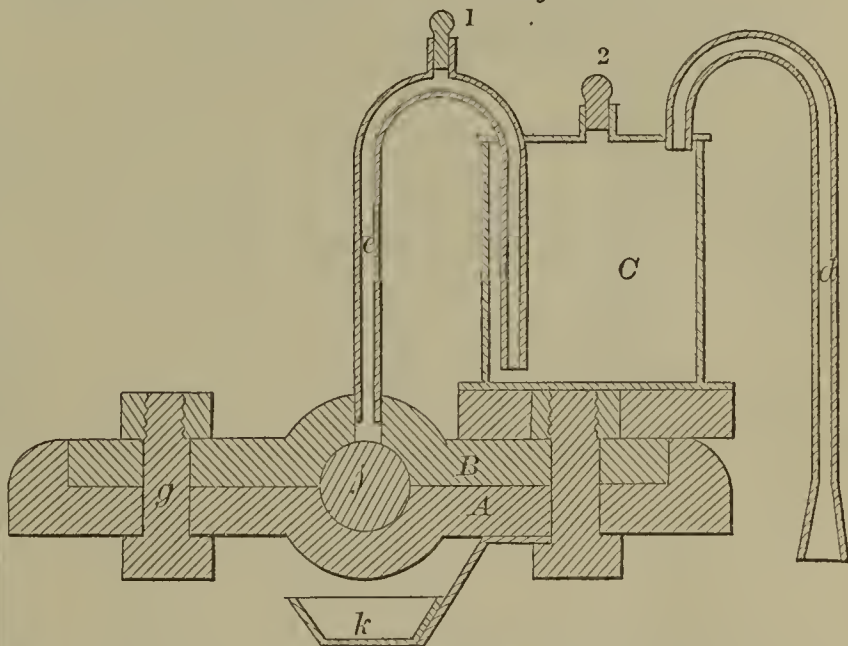

55937—W. H. Watson—Tobacco Press.

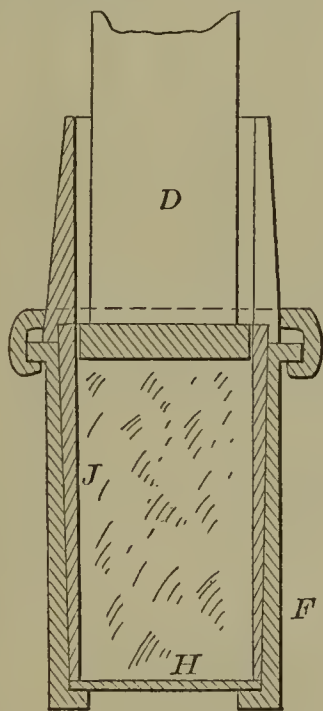

55941—A. H. Whitney—Measuring Funnel.

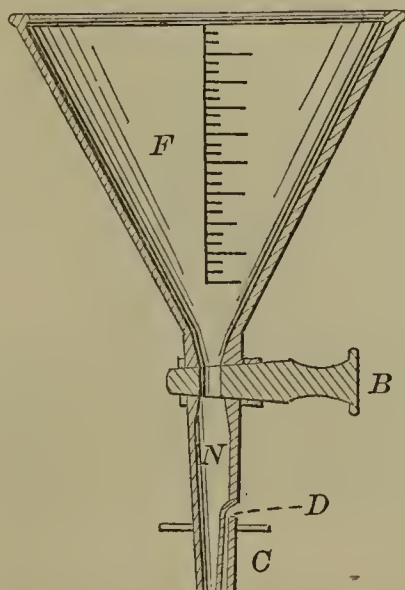

55942—J. J. Wilkins—Harness Hook

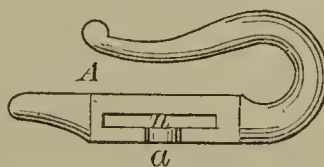

55943—J. A. Williamson—Railroad Switch.

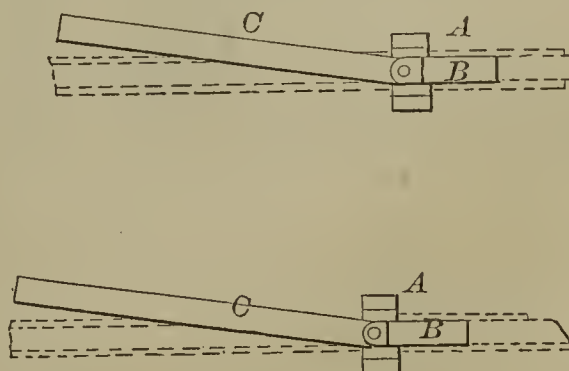

55944—S. R. Wilmot—Die for Raising Articles of Metal.

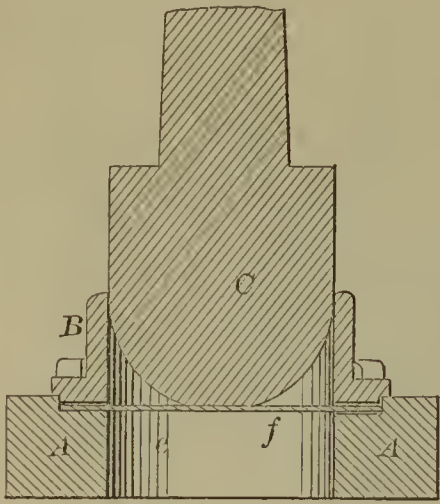

55945—B. F. Young—Boring Machine.

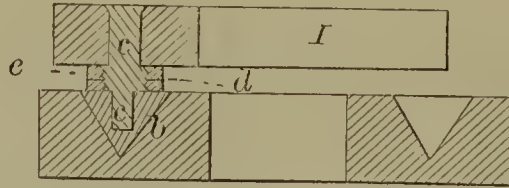

55946—J. H. Zinn—Weighing Cars.

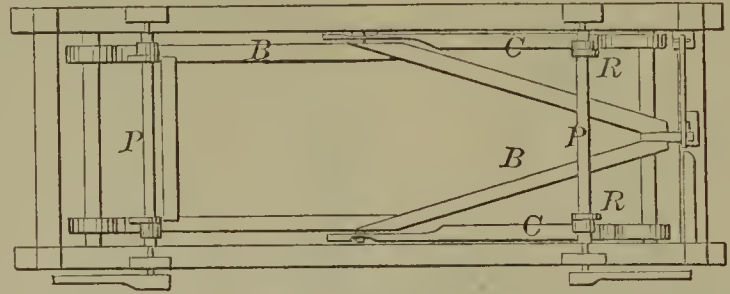

55947—R. Anderson—Coffee Hulling Machine.

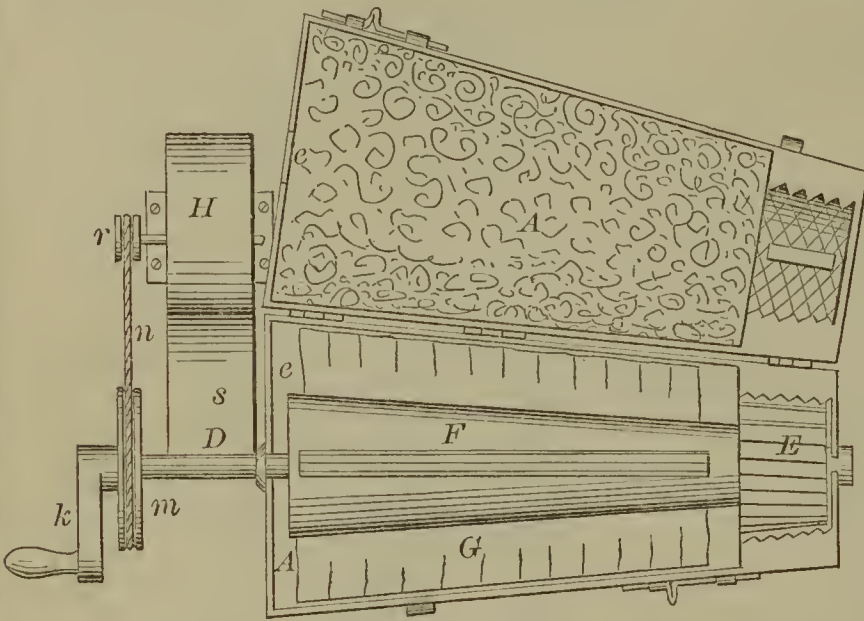

55948—J. D. M. Armbrust—Broom Head.

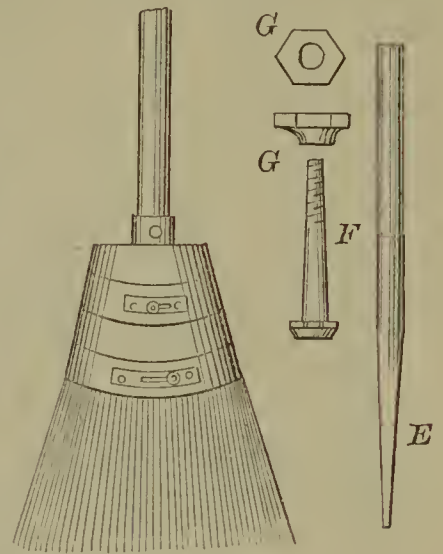

55949—F. H. Brown—For Carbureting Air.

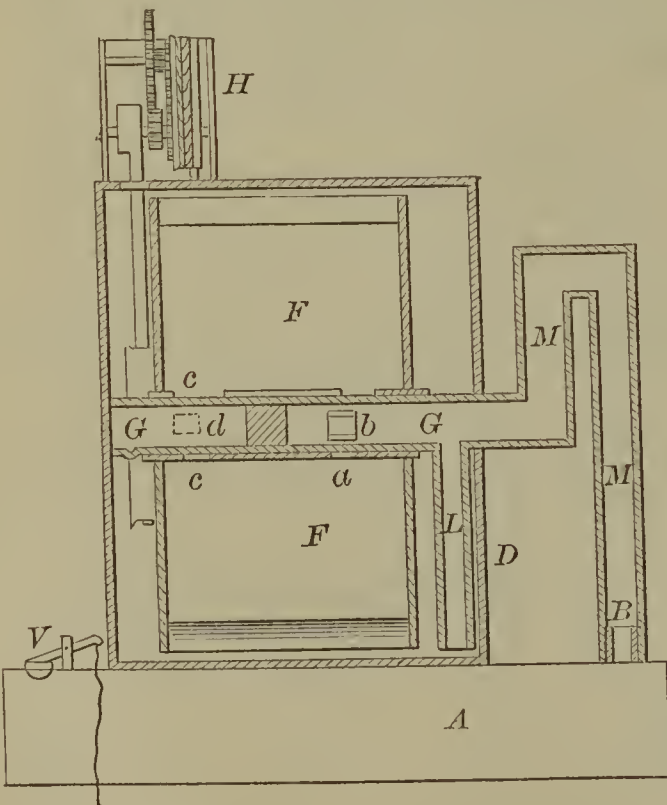

55950—F. H. Brown—For Carbureting Air.

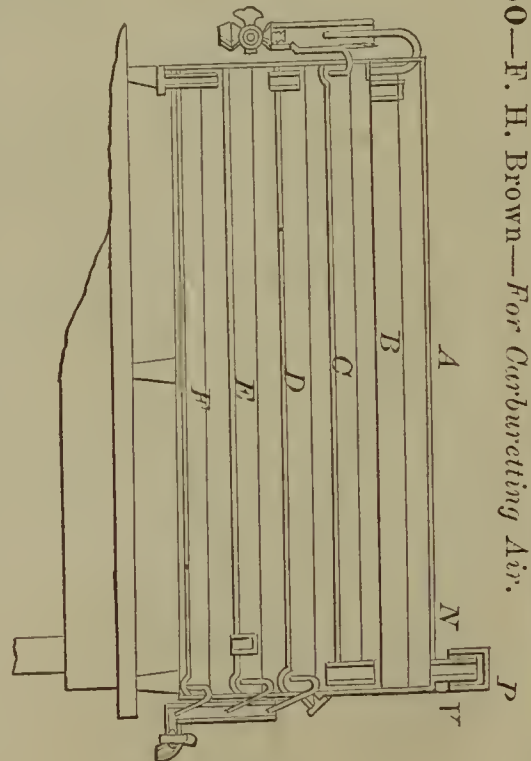



55952—J. Green—*Grain Separator.*

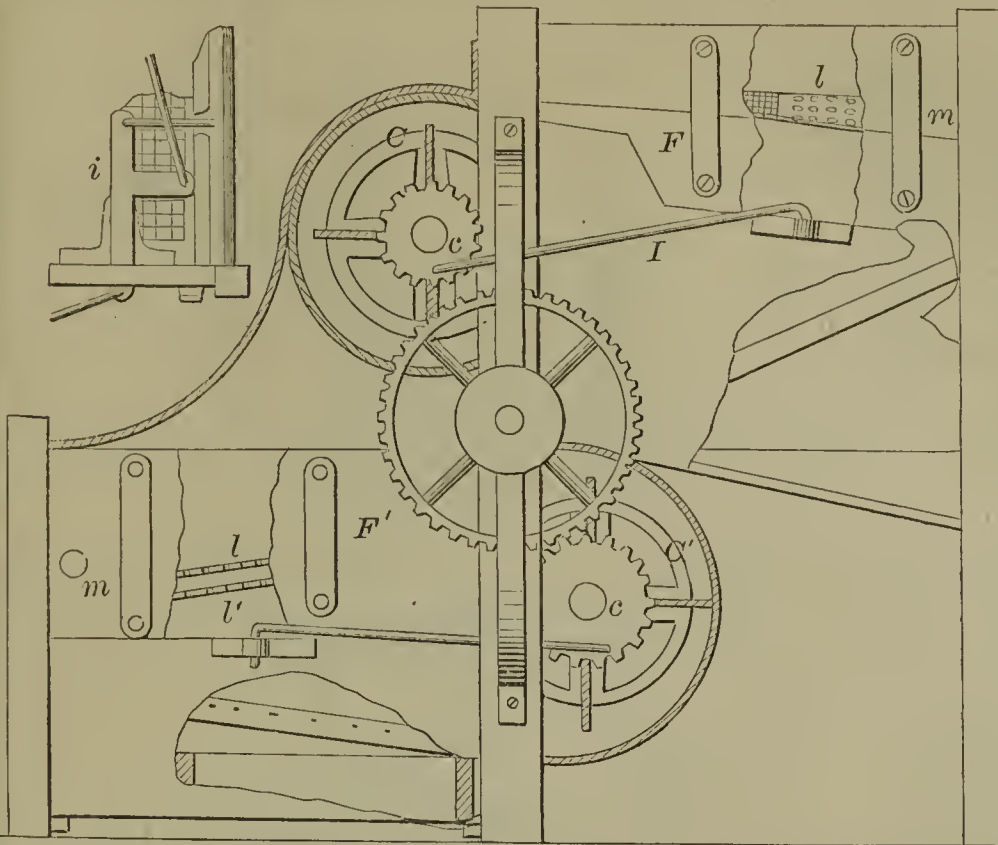

55954—J. C. Hyde—*Butt Hinge.*

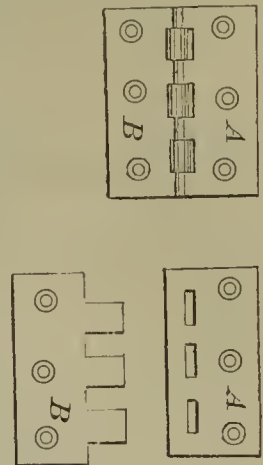

55956—J. L. Kendall—*Clothes Sprinkler.*

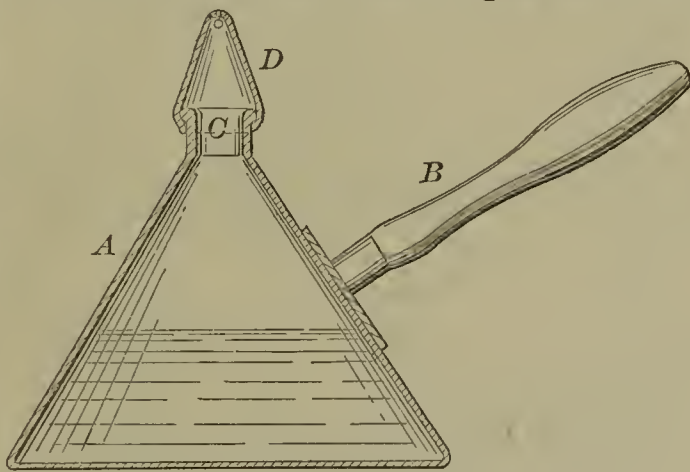

55953—G. H. Hammer—*Fastening for Fruit Cans.*

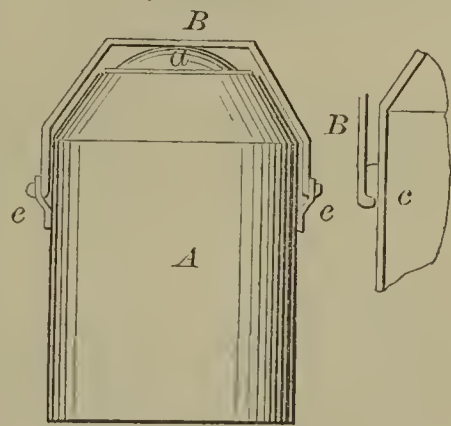

55957—C. D. Kubach—*Fire Alarm.*

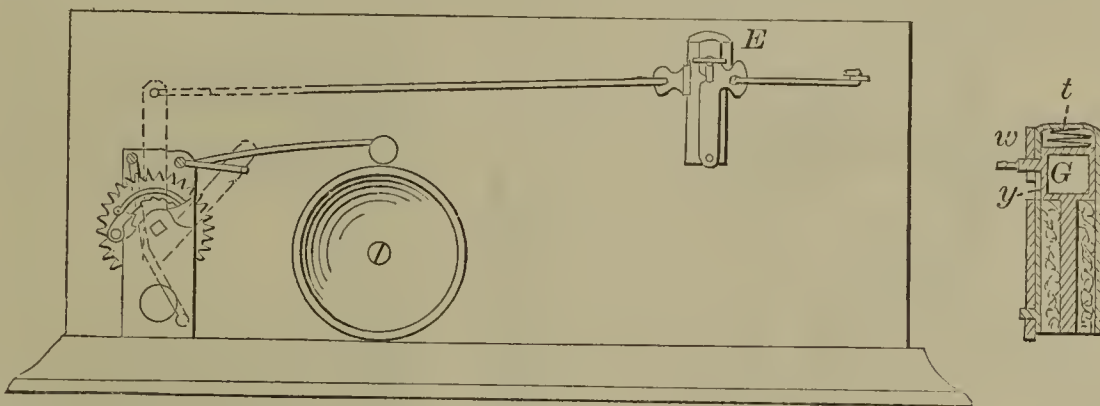

55958—C. S. Nelson—*Setting Stationary Steam Boilers.*

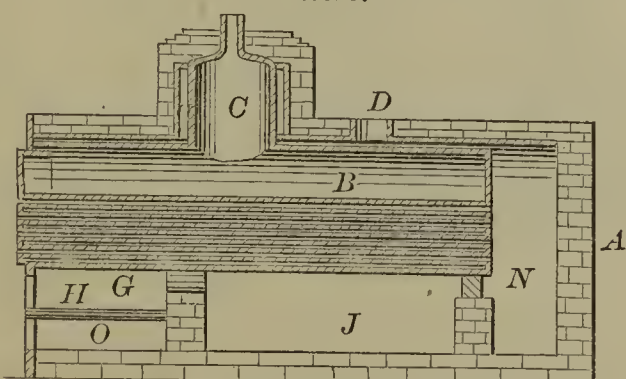

55955—R. S. Jennings—*Metallic Seal Envelope.*

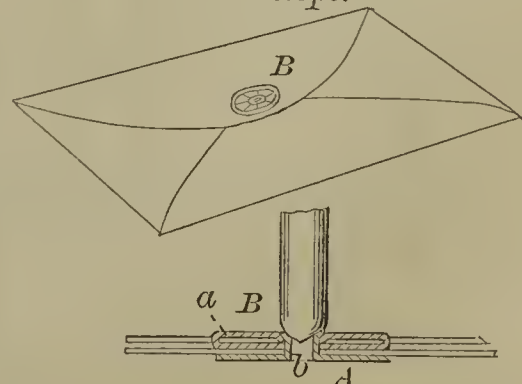

55959—G. W. Patterson—*Picker Arm for Looms.*

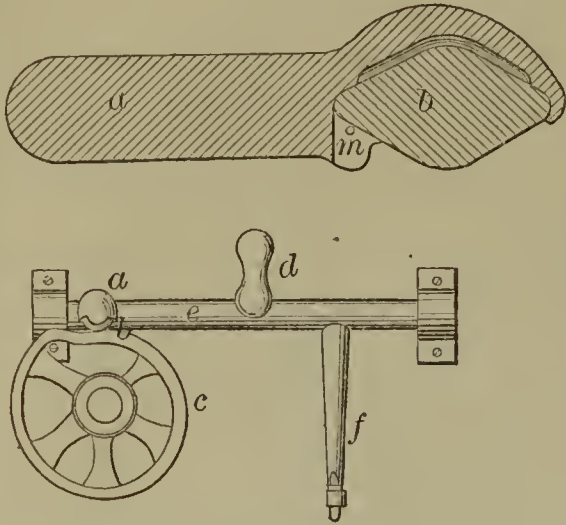

55962—J. R. B. Schwarze—*Liquid Cooler.*

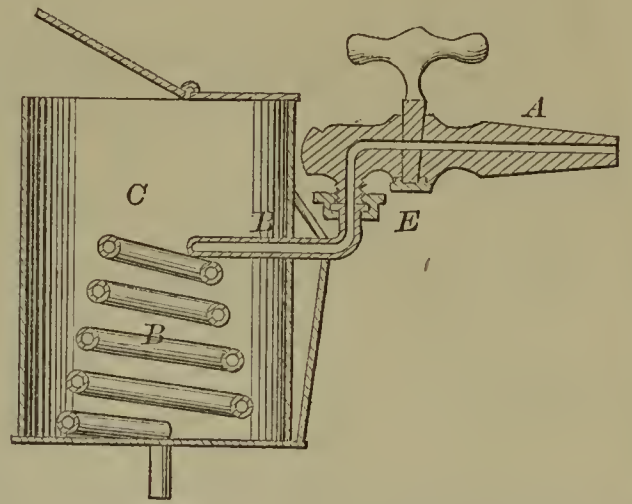

55963—Strong & Ross—*Platform Scale.*

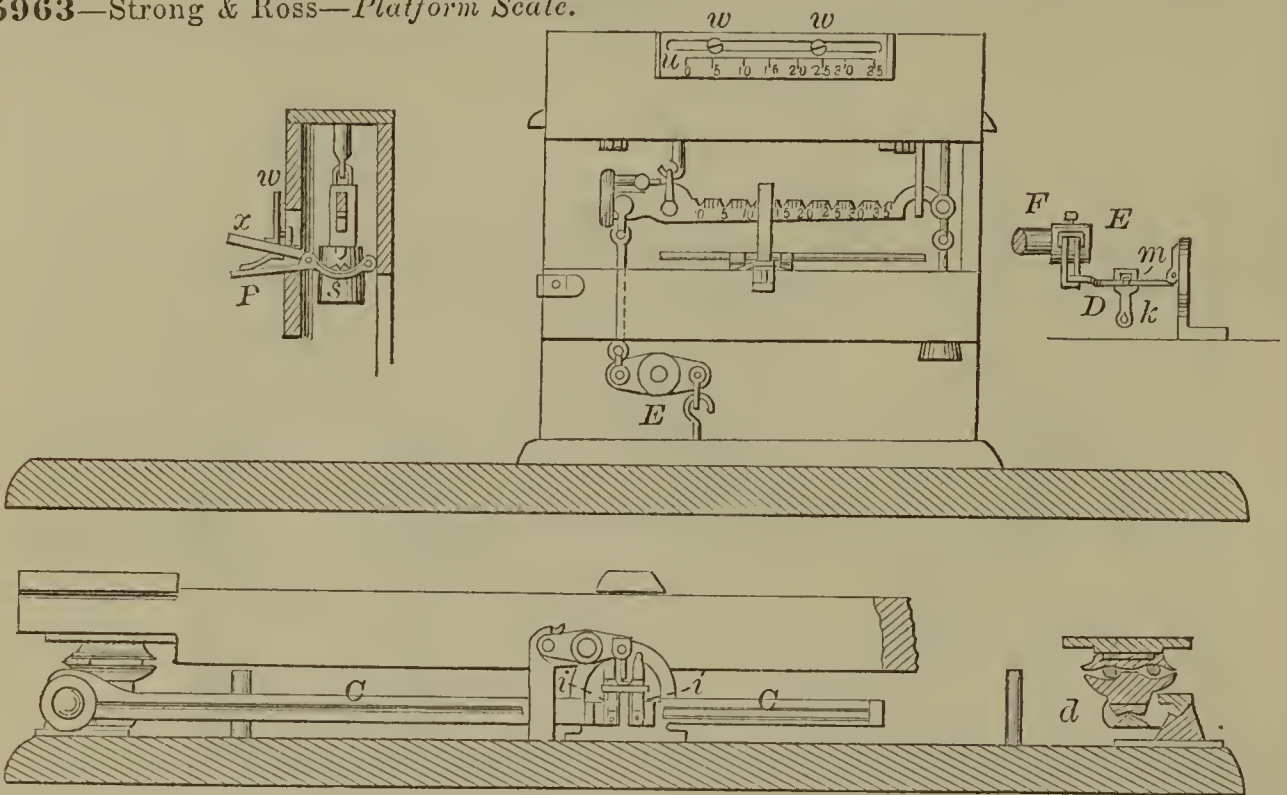

55960—T. W. Pomeroy—*Churn and Ice Cream Freezer.*

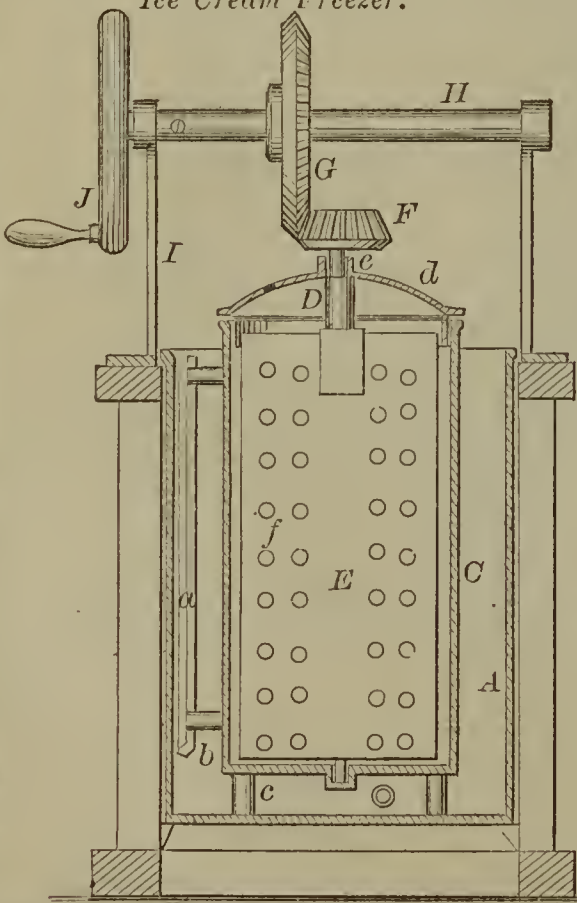

55961—L. C. Rodier—*Mop Head.*

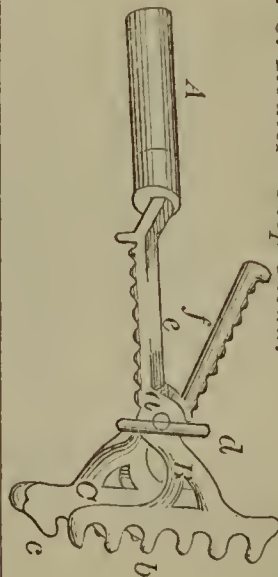

55964—J. Temple—*Car Brake.*

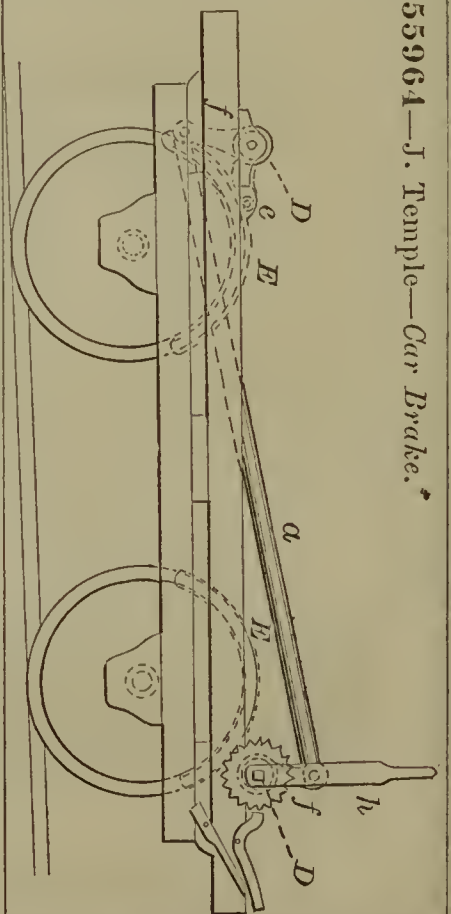

55965—F. Votteler—*Nut Tapping Machine.*

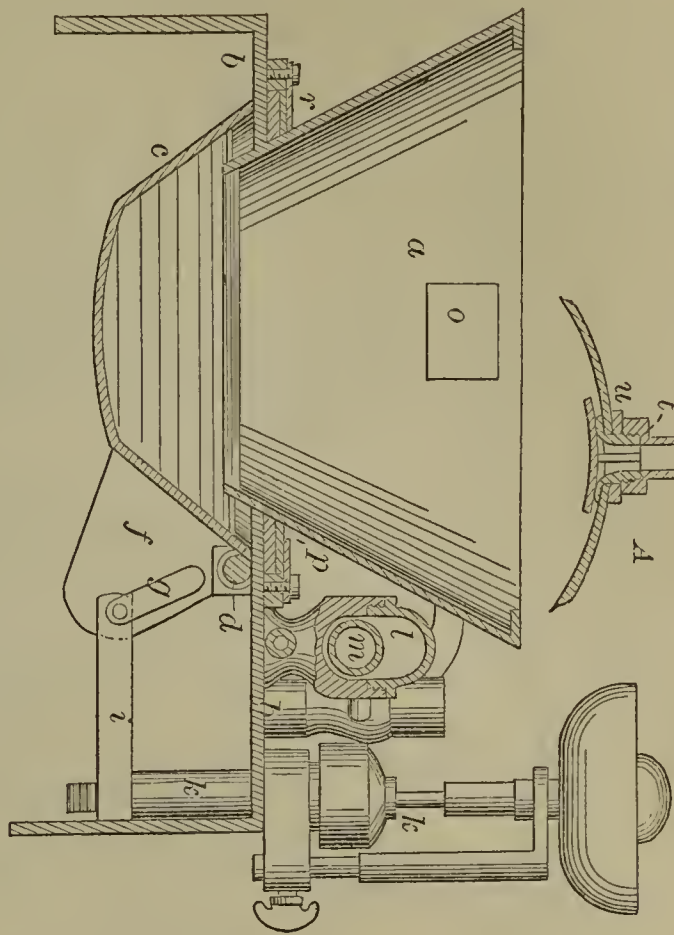
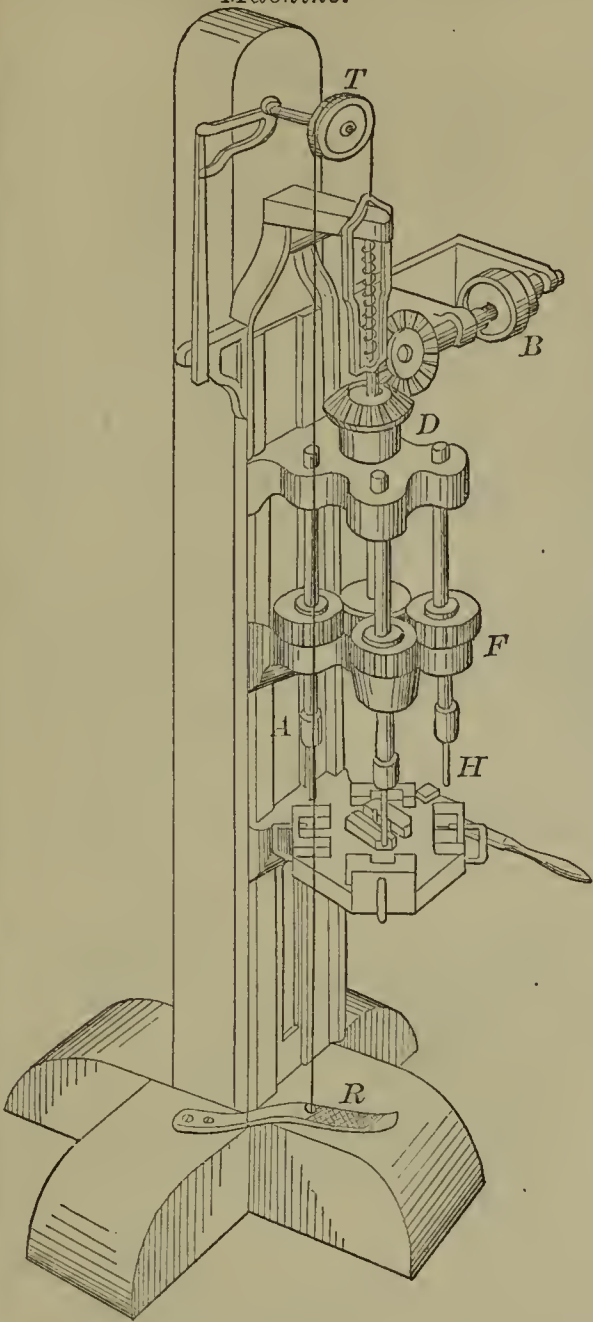

55967—D. Wellington—*Water Closet.*

55968—H. L. Williams—*Knitting Machine.*

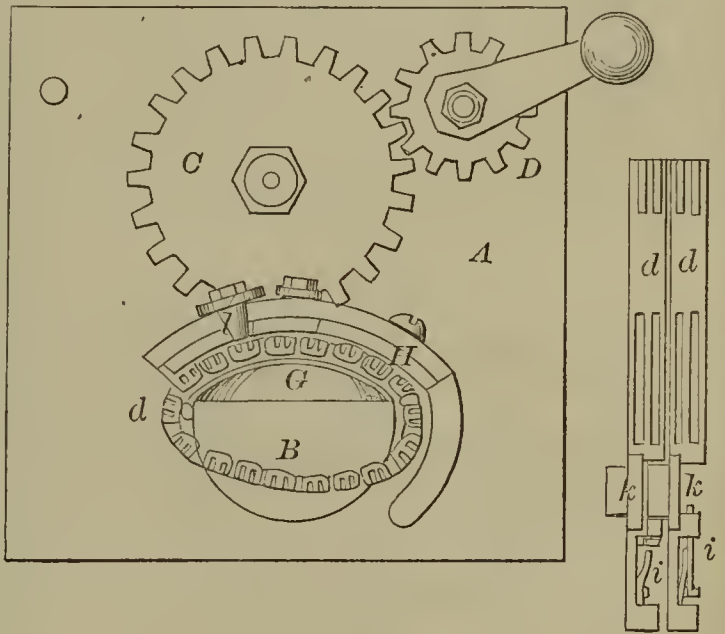

55970—P. Jacovence—*Petroleum Tank.*

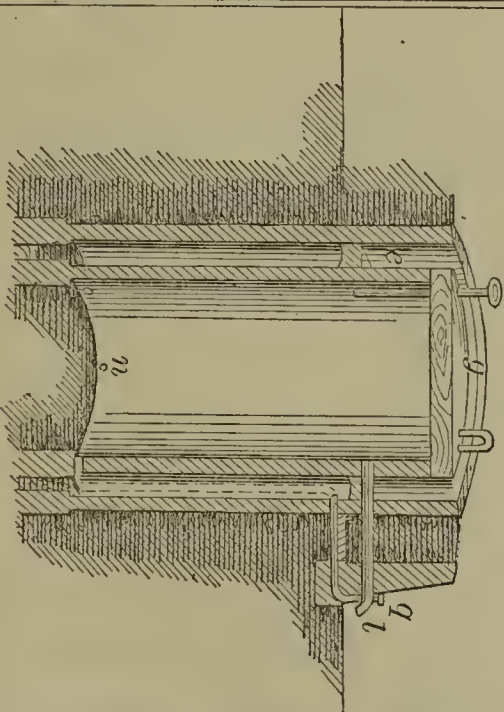

55966—D. T. Warren—*Pencil Case.*

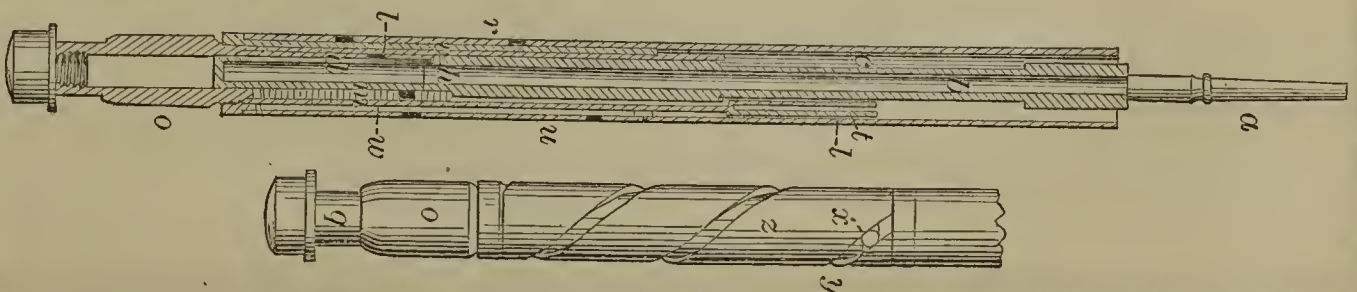

55971—W. Reinlein—Hot Air Engine.

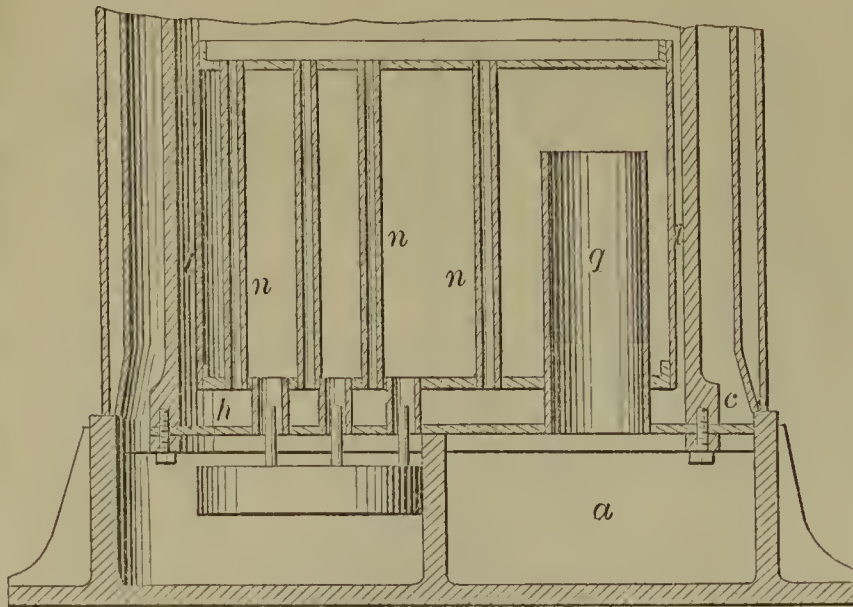

55974—C. Arnold—Paper Cloth Bosom.

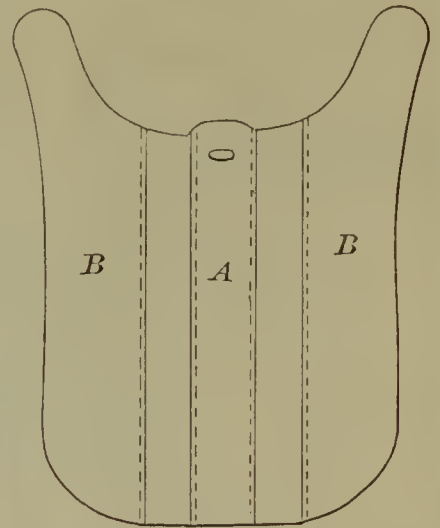

55975—J. Ashton—Oil Can.

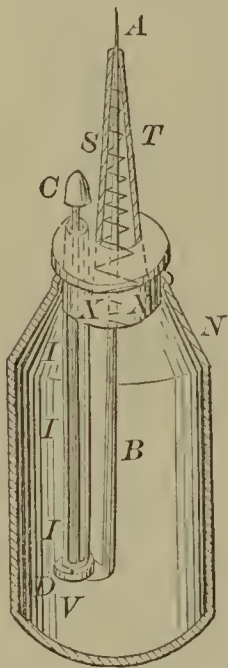

55972—E. Hambyjer—Corset.

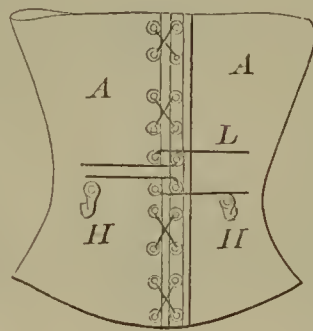

55973—C. E. Abbott—Lamp Extinguisher.

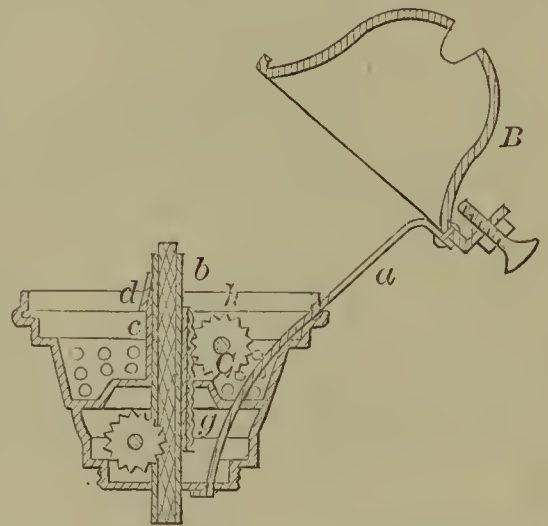

55976—J. Aughe—Drop Hammer.

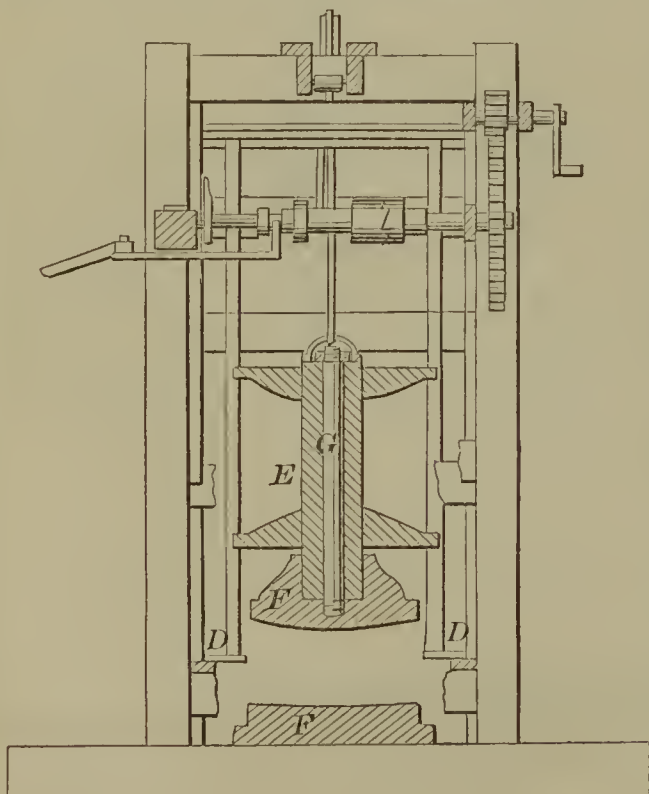

55977—A. S. Babbit—Water Elevator.

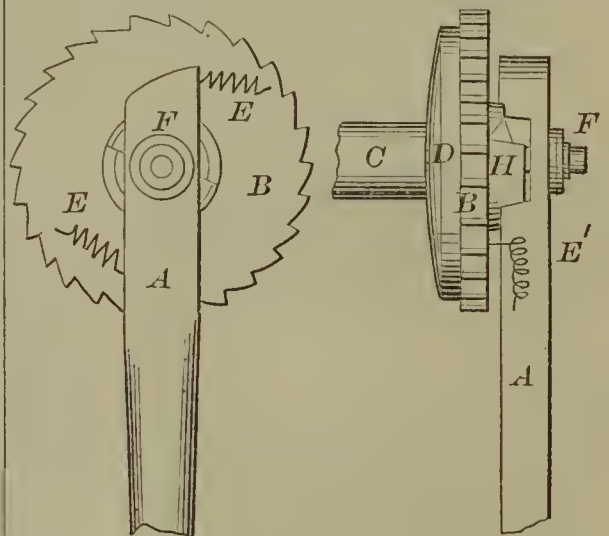

55978—H. O. Baker—Curtain Fixture.

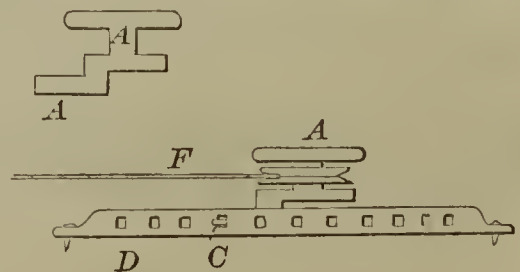

55979—H. Baker—Hay Raker and Loader.

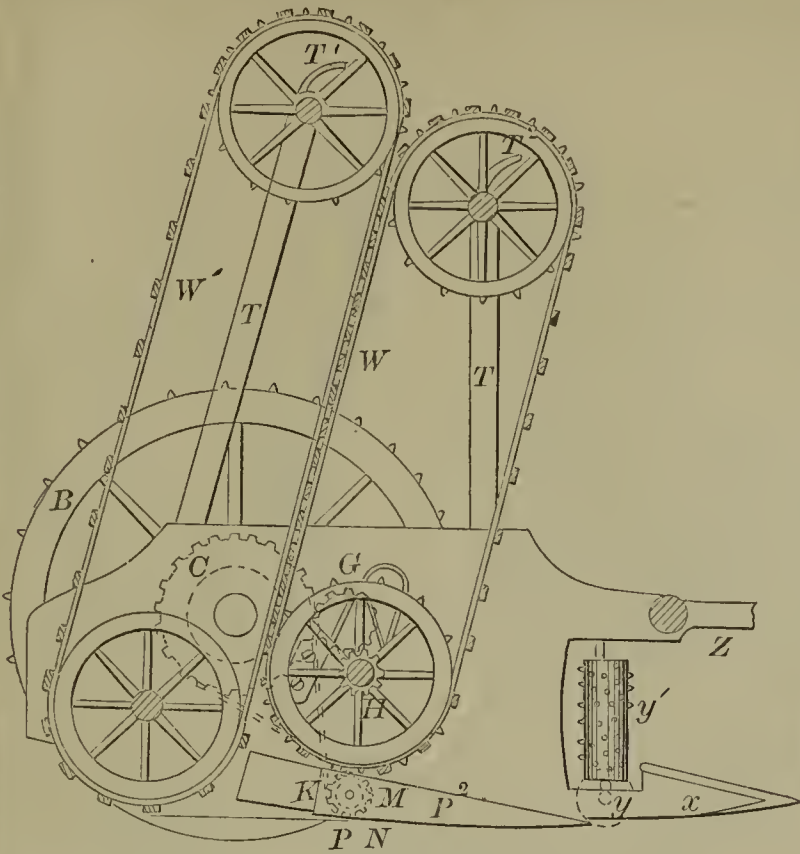

55980—J. C. Barrett—Water Elevator.

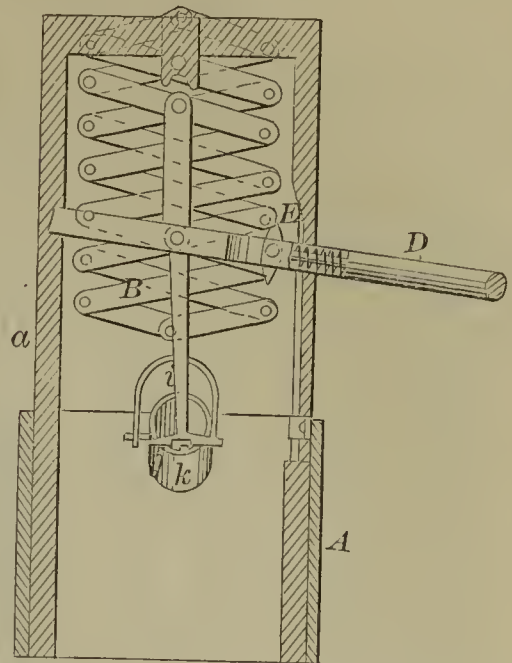

55982—A. Bayley—Wash Stand.

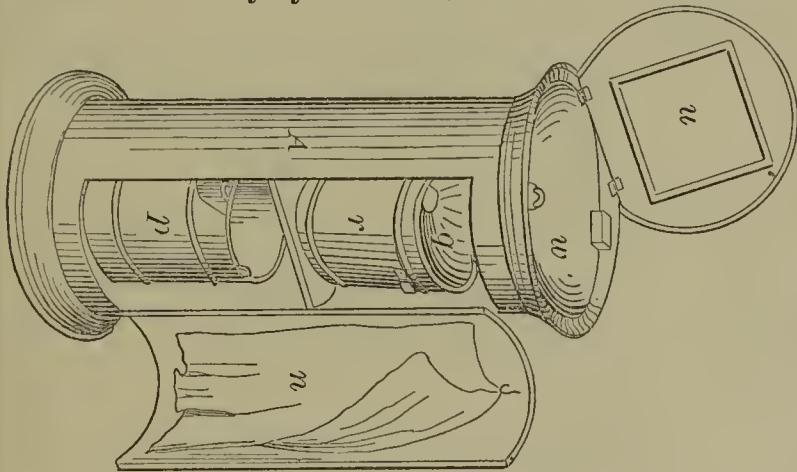

55986—O. D. Beebe—Washing Machine.

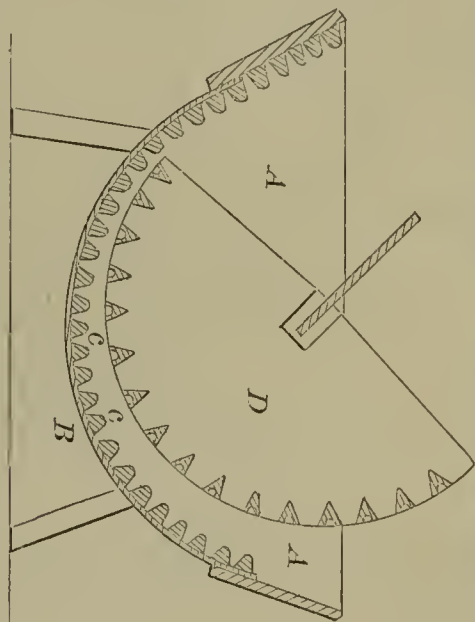

55981—H. De Baun—Sash Fastening.

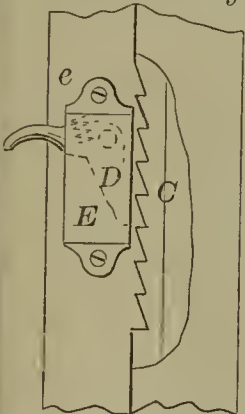

55985—B. M. Beckwith—Carriage Spring.

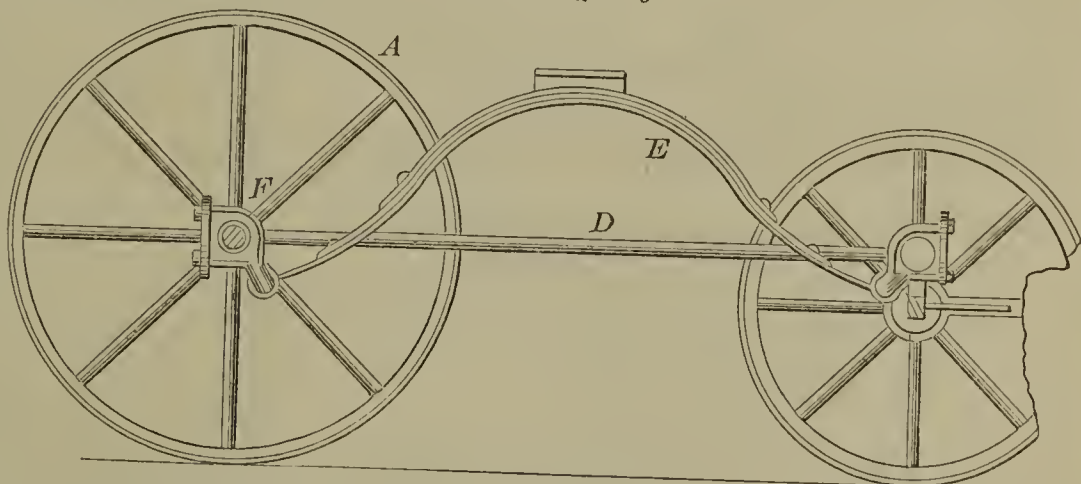

55984—S. Beckett—Plow.

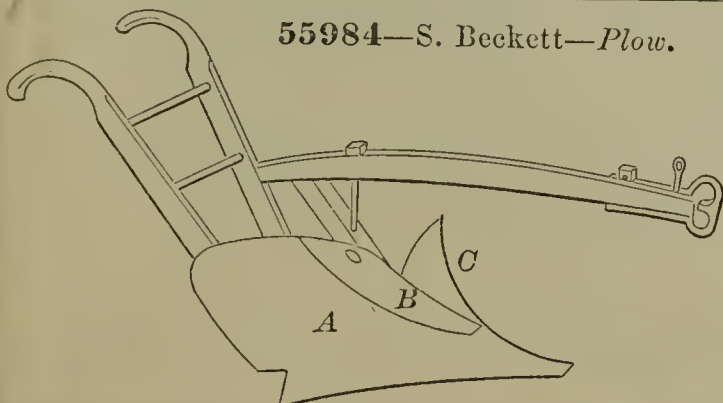

55987—G. W. Beers—Carriage Hinge.

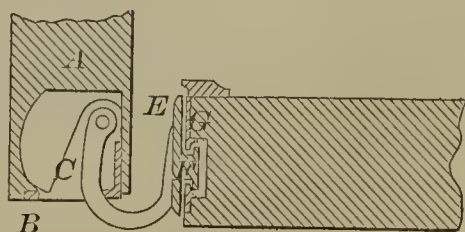

55990—A. Berny—Cradle and Chair.

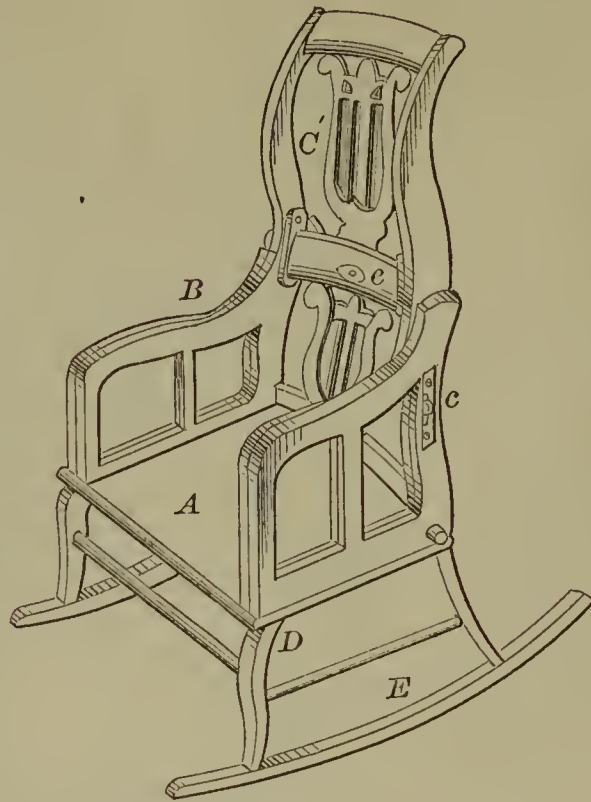

55988—F. Bennett—For Grooving the Mouths of Glass Bottles.

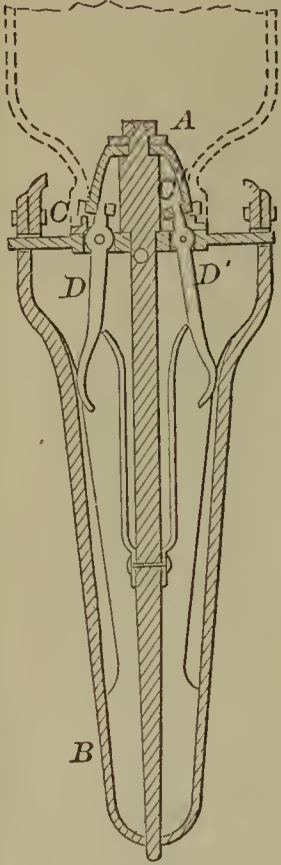

55991—J. T. Bever—Clothes Tong.



55989—W. Bergmann—Car Coupling.

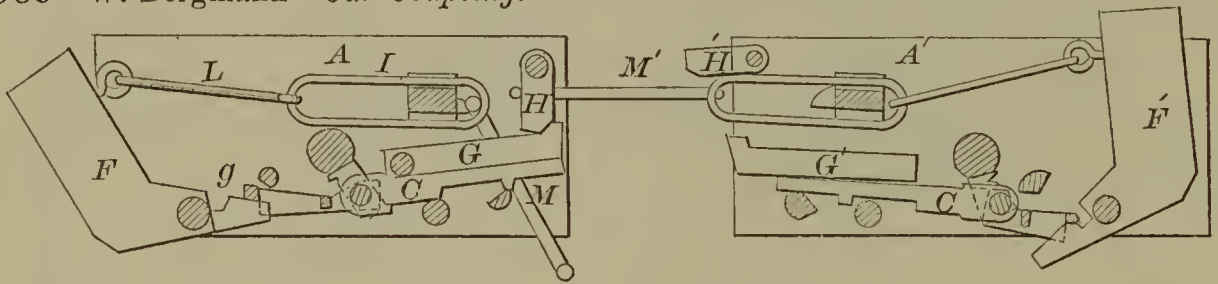

55992—W. R. Bishop—Gib for Cross Heads.

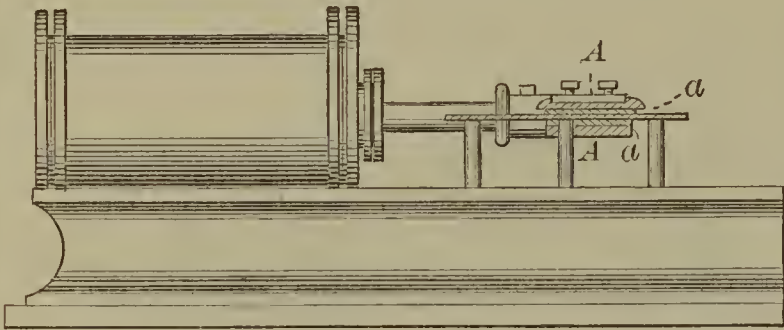

55993—A. M. Black—Cultivator.

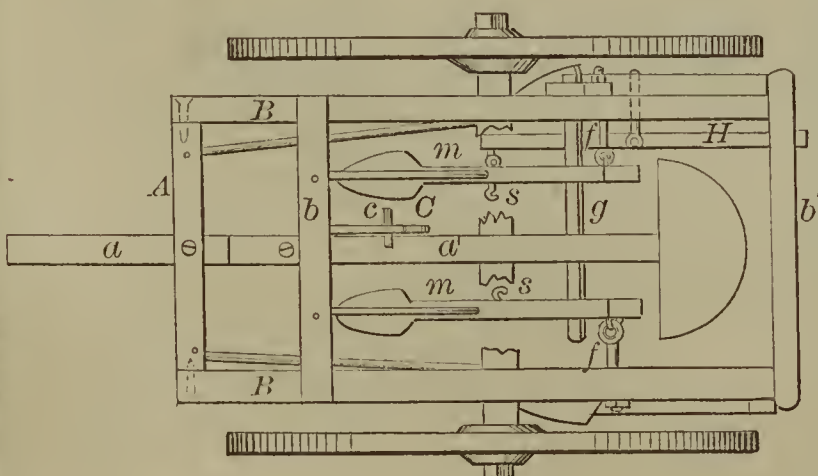

55994—R. C. Boeking—Gas Purifier.

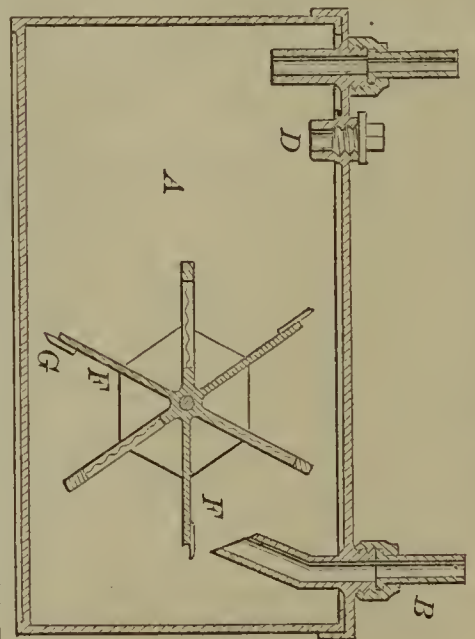

55995—J. T. Bonnell—Quartz Mill.

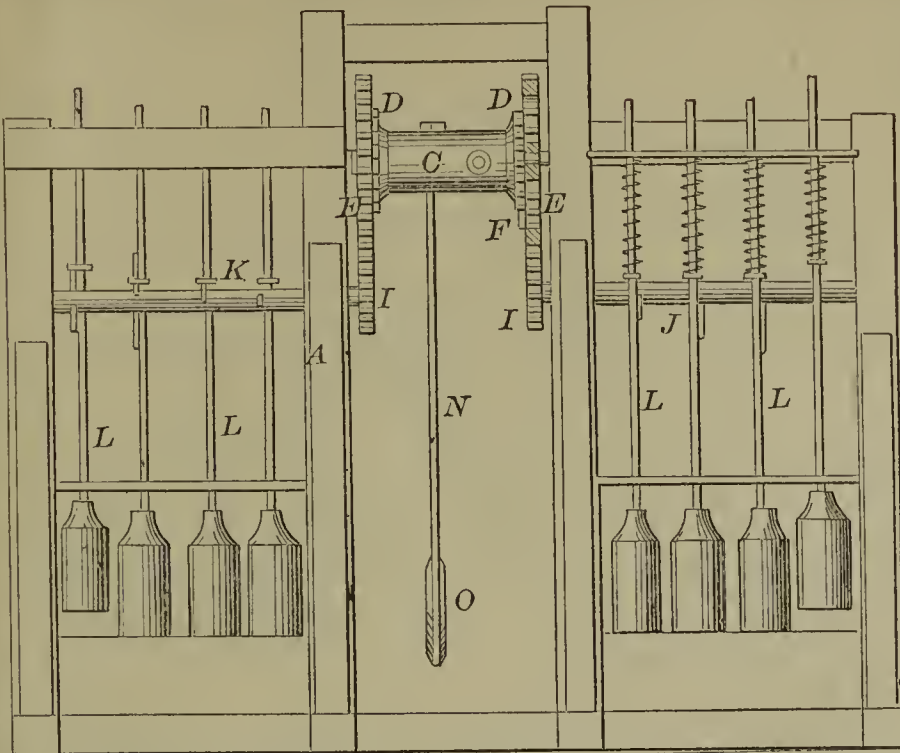

55998—J. Bradt—Beehive.

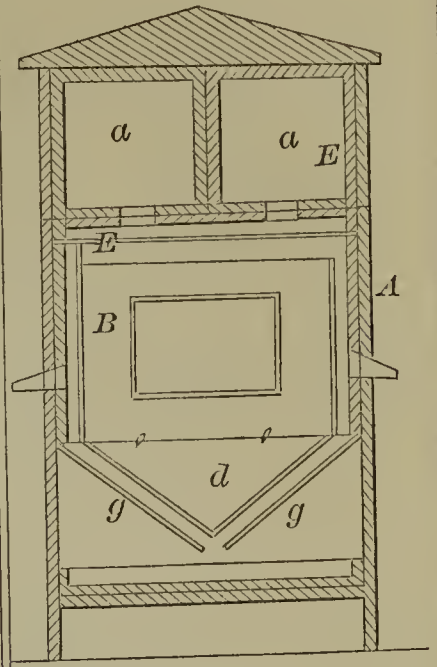

55996—J. Boyers—Churn.

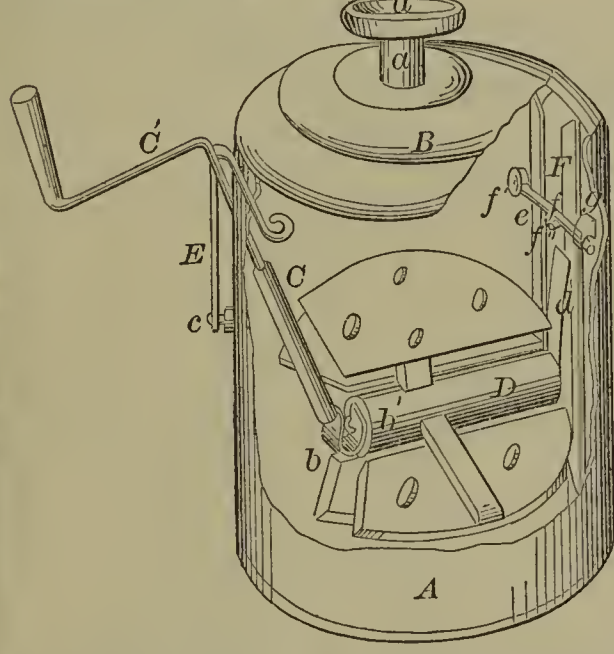

55999—T. E. C. Brimly—Plow.

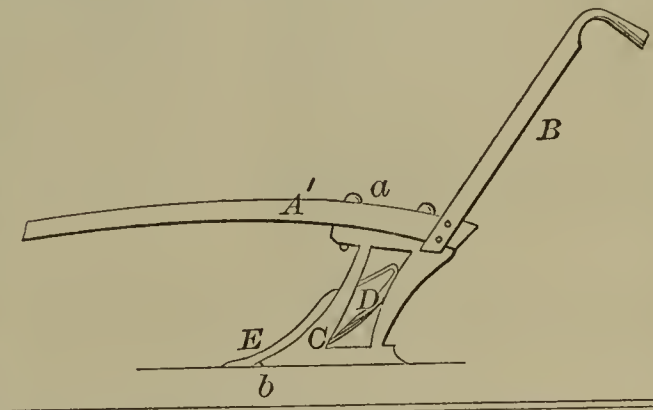

56000—H. Brown—Hay Rake.

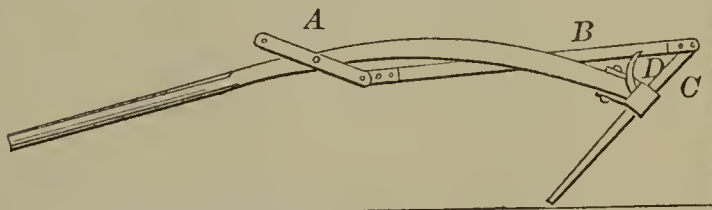

55997—N. A. Boynton—Coal Stove.

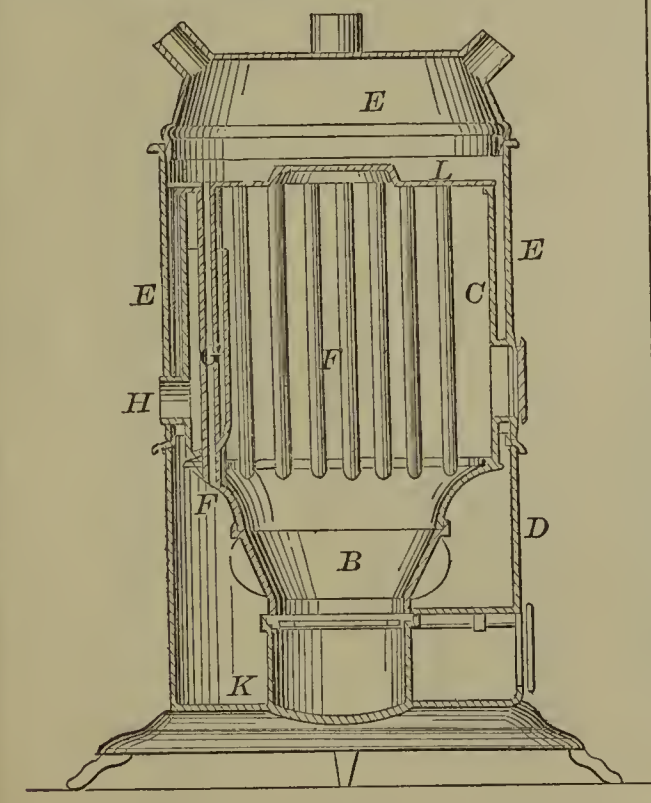

56001—W. Burnham—Washing Machine.

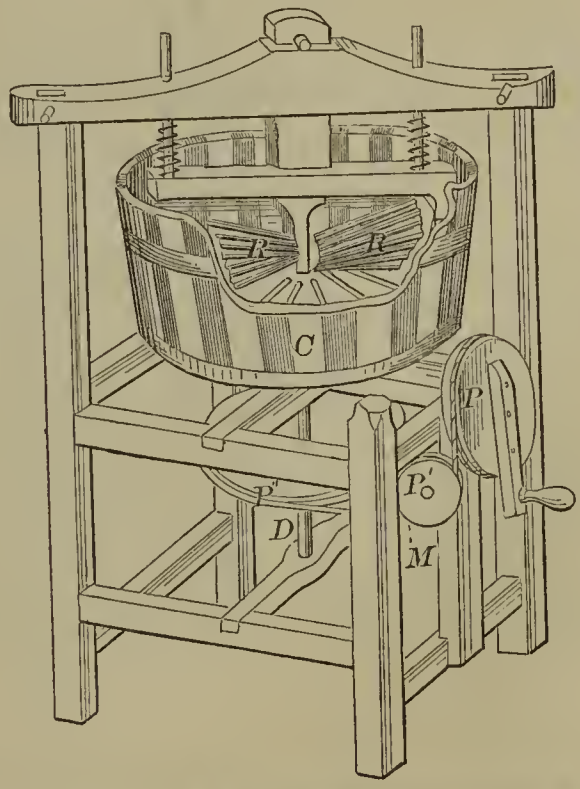

56002—E. Buss—*For Raising Bread.*

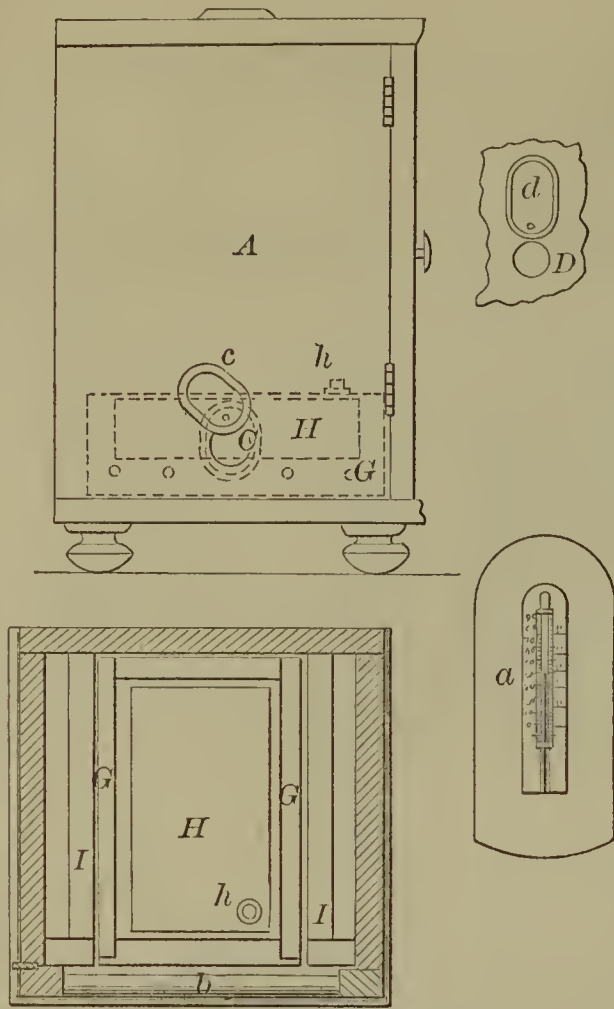

56003—T. Byrne—*Leeway Indicator for Vessels.*

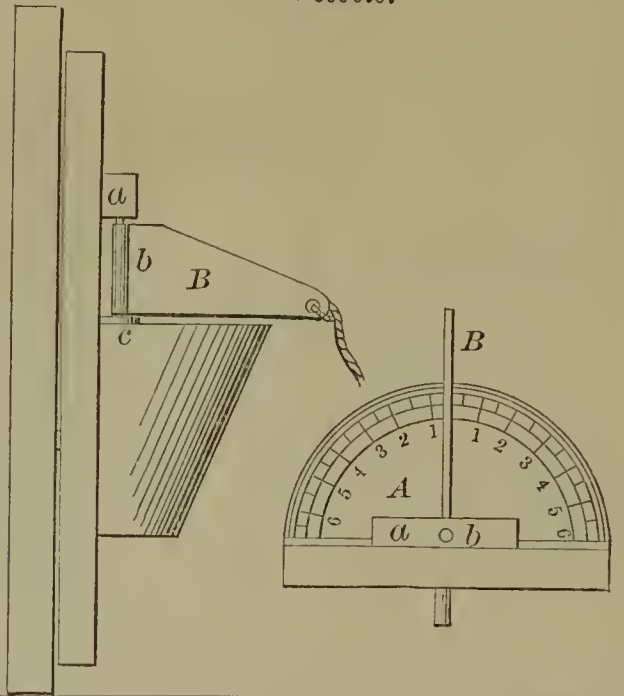

56006—J. A. Chambers—*Fire Escape.*

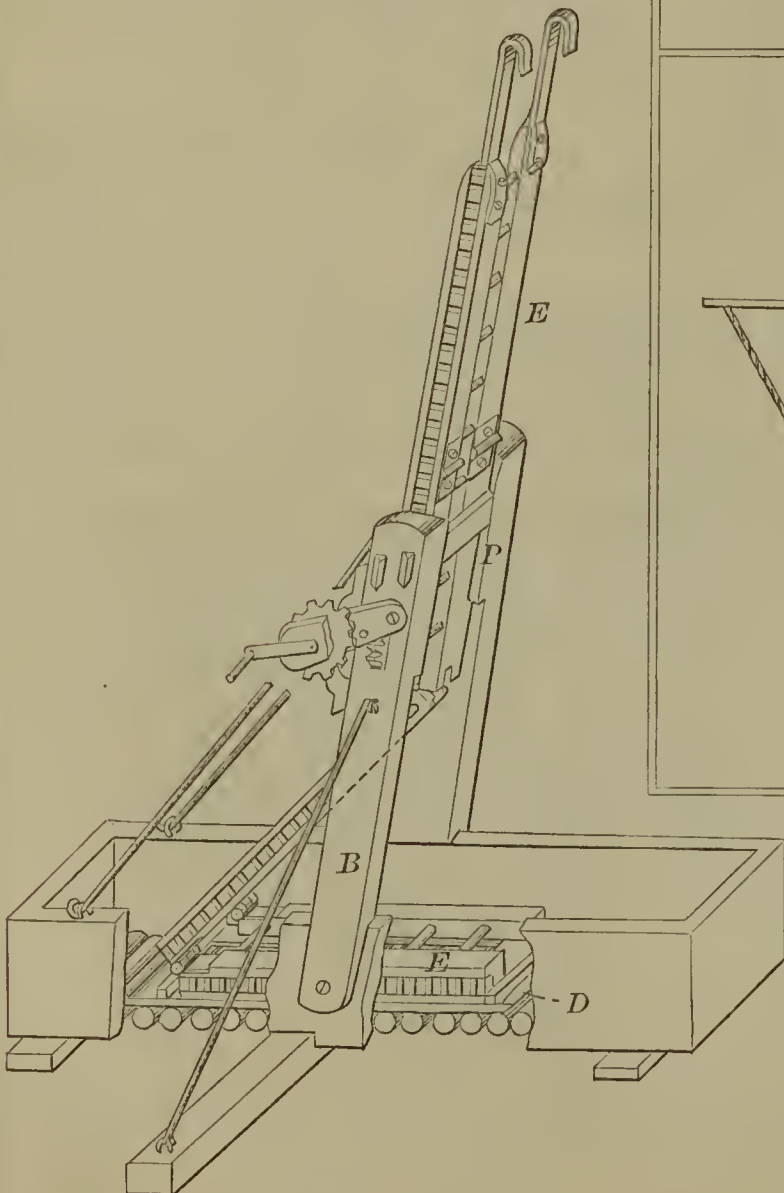

56004—G. J. Capewell—*Oiler.*

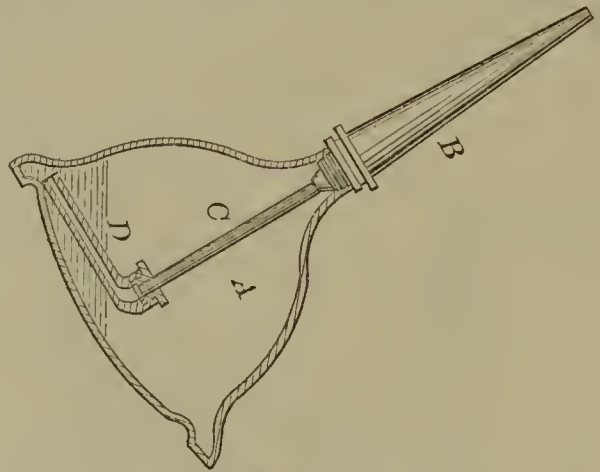

56007—J. M. Clarke—*Pen and Pencil Holder.*

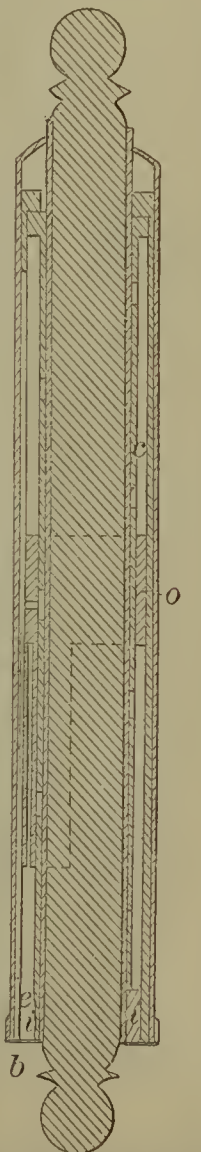

56005—L. R. Cavender—*Table Leaf Support.*

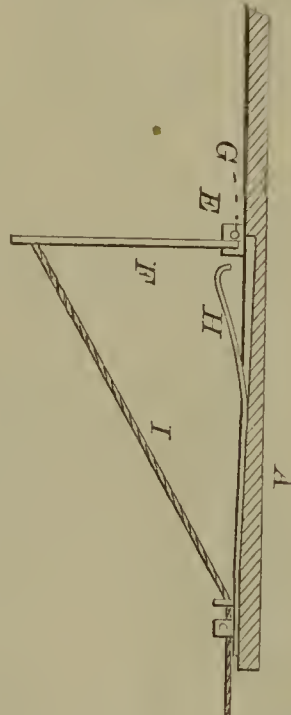

56008—S. Clarke—*Bed Bug Protector.*

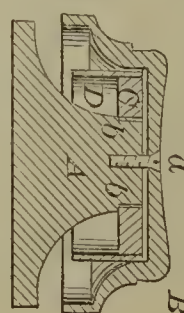



56009—R. Conaroe—Combined Cane Stripper and Knife.

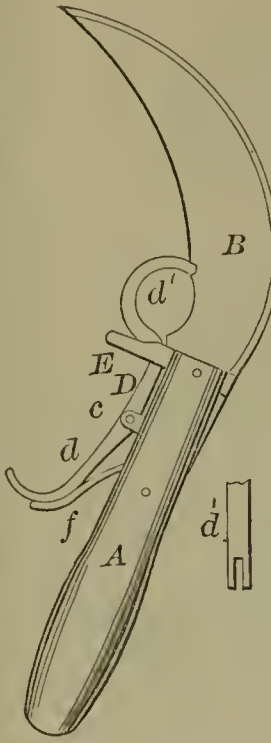

56011—J. H. Connelly—Lamp Shade Supporter.

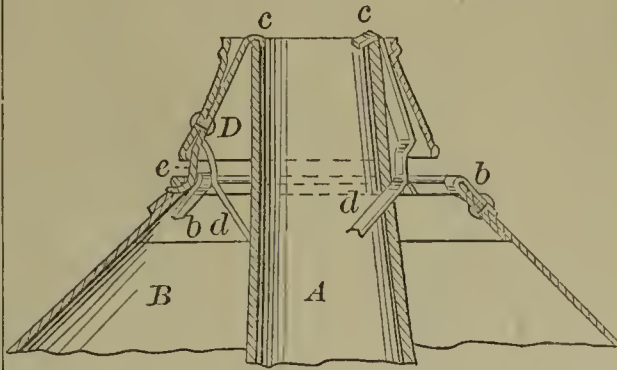

56013—W. W. Cooper—Goniometer.

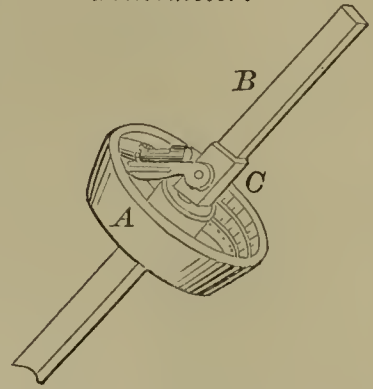

56012—C. W. Conolly—Draft Attachment.

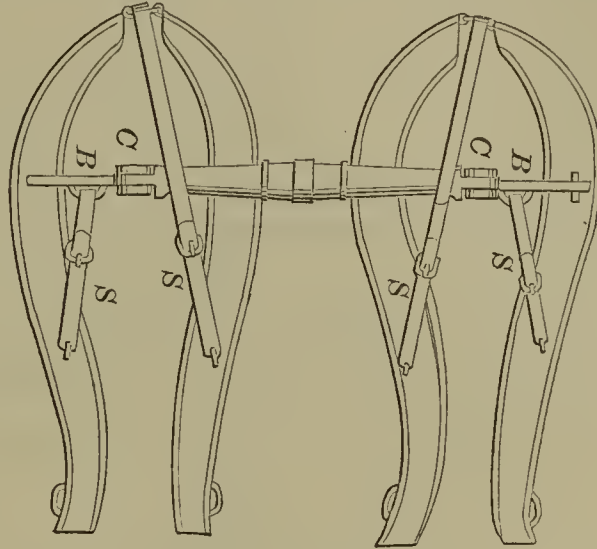

56010—J. H. Connelly—Lamp Chimney and Shade.

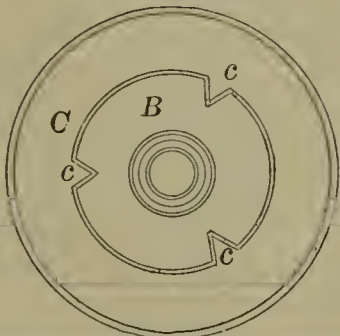
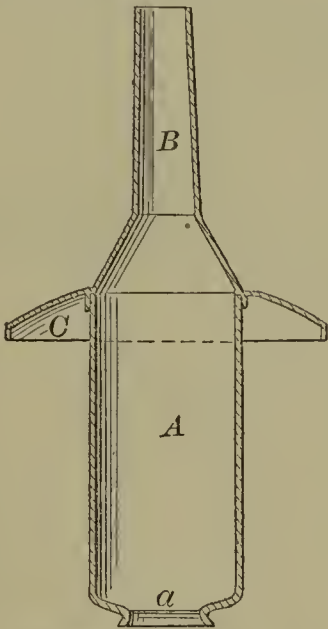

56015—D. M. Cummings—Heating Stove.

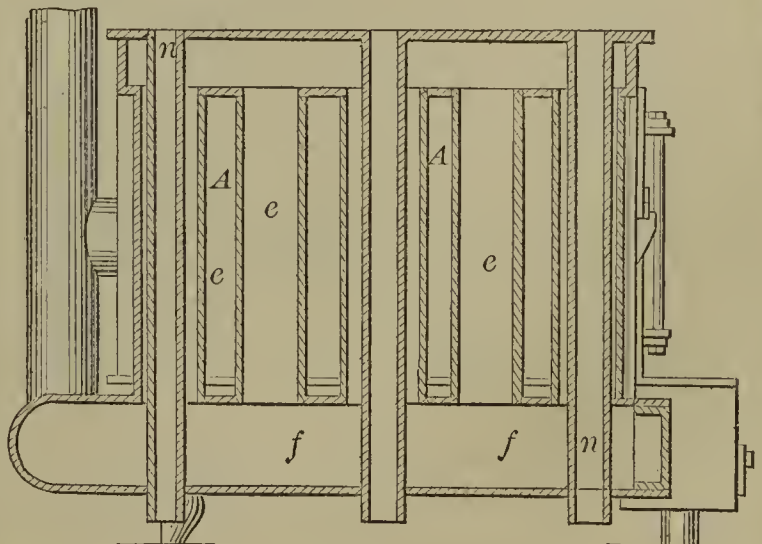
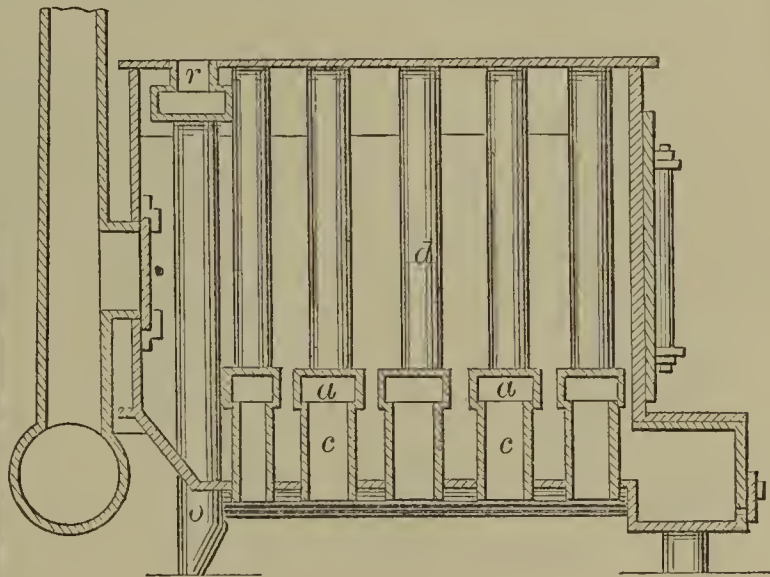

56014—W. W. Covell, Jr.—Safety Watch Pocket.

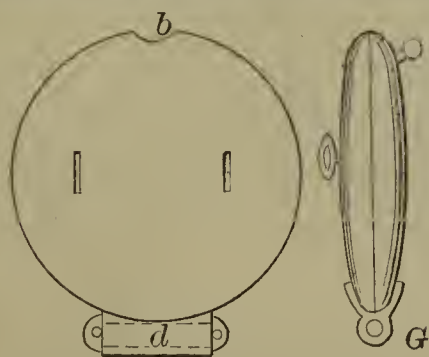

56016—T. D. Day—Hoop Skirt.

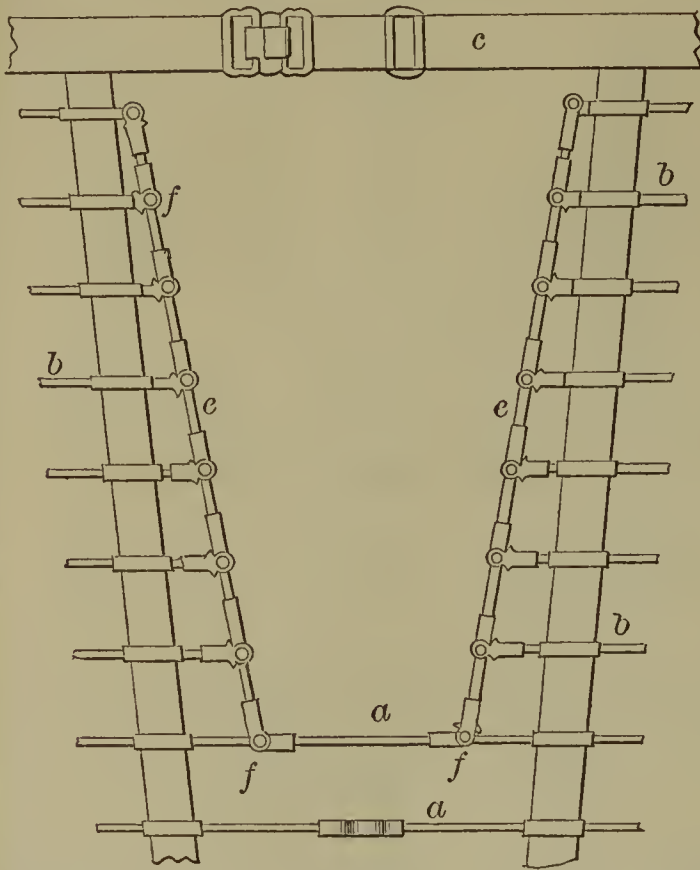

56017—J. Delery—Low Water Detector.

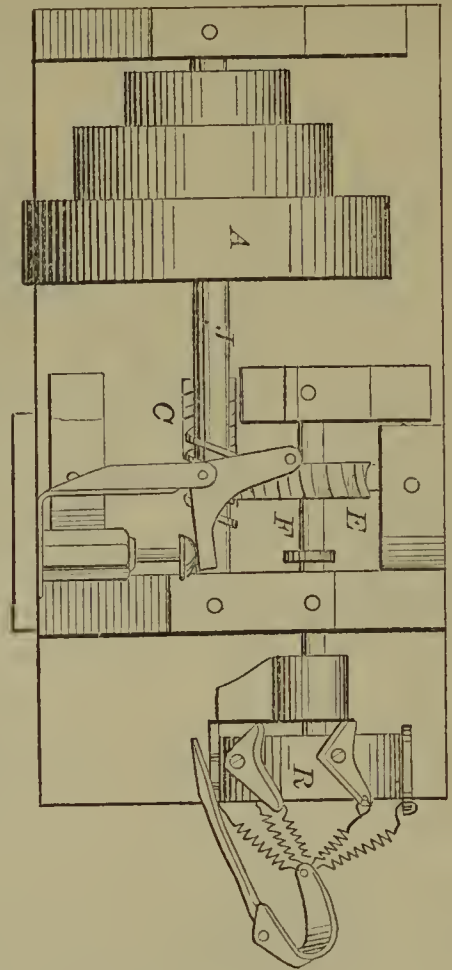

56019—Dixon & Close—Gate.

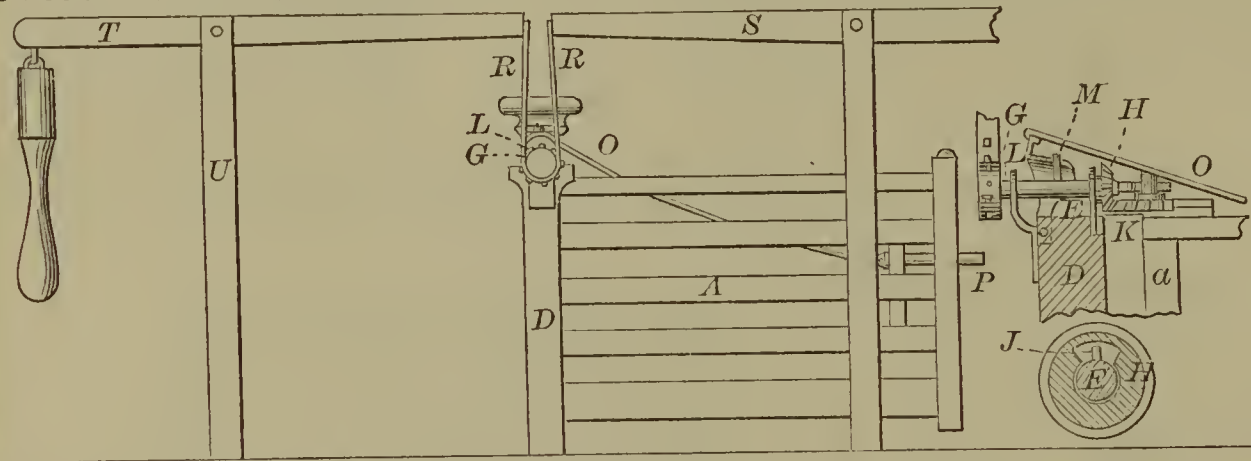

56020—G. L. Dulaney—Sewing Machine.

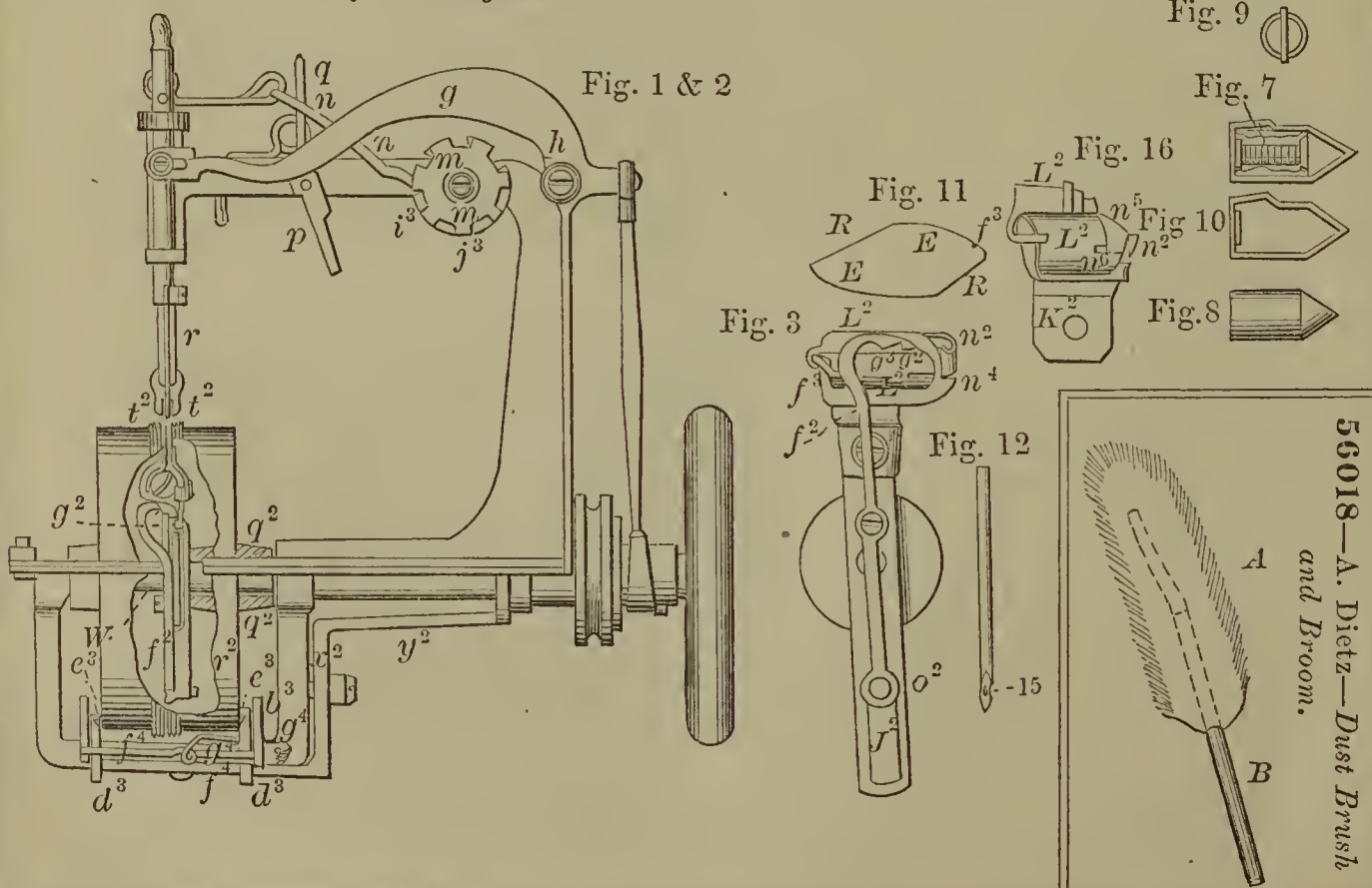

56018—A. Dietz—Dust Brush and Broom.

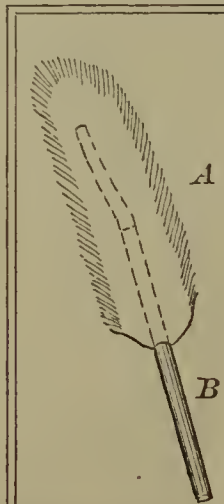

56021—J. B. Eads—Operating Ordnance.

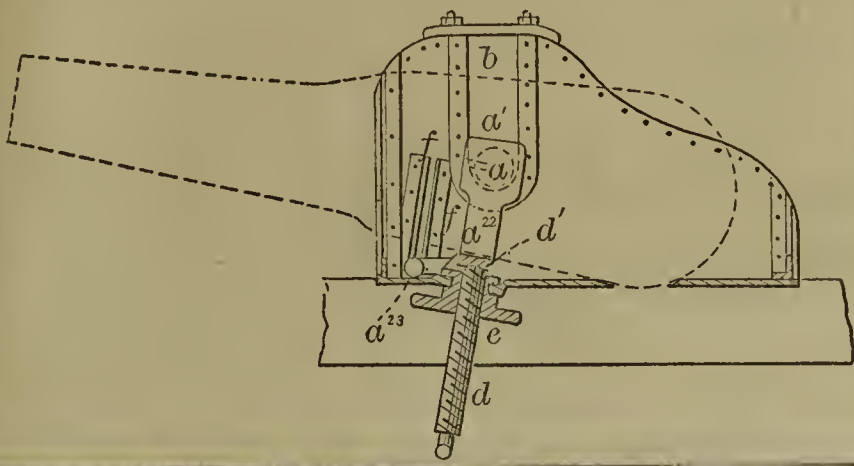

56028—H. L. Folsom—Tether.

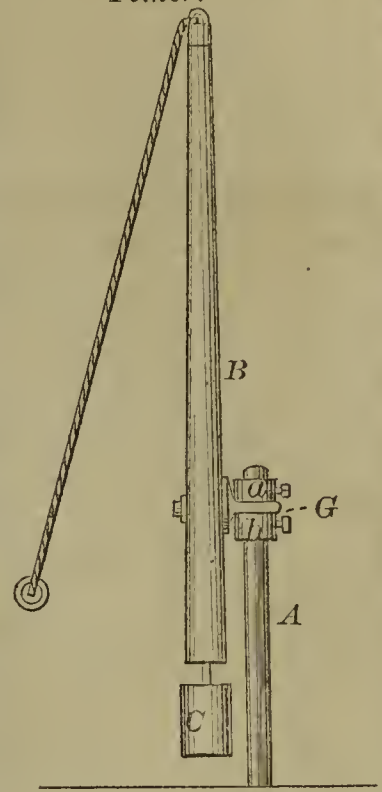

56022—T. E. Ellett—Cultivator.

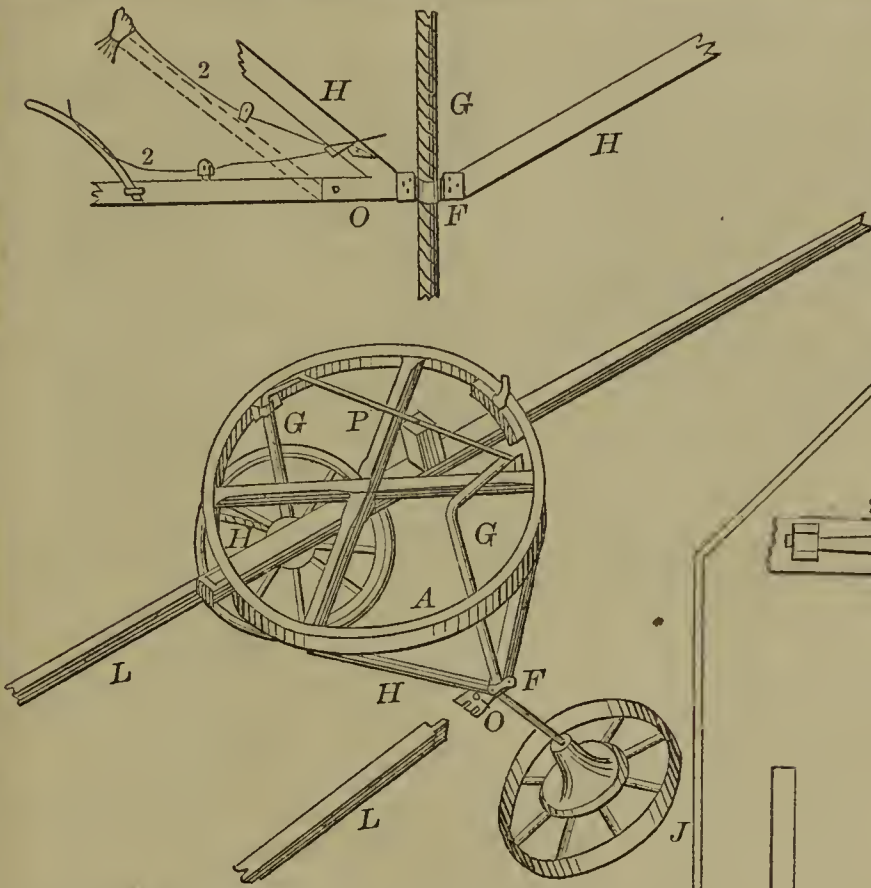

56023—W. H. Elliot—Hay Loader.

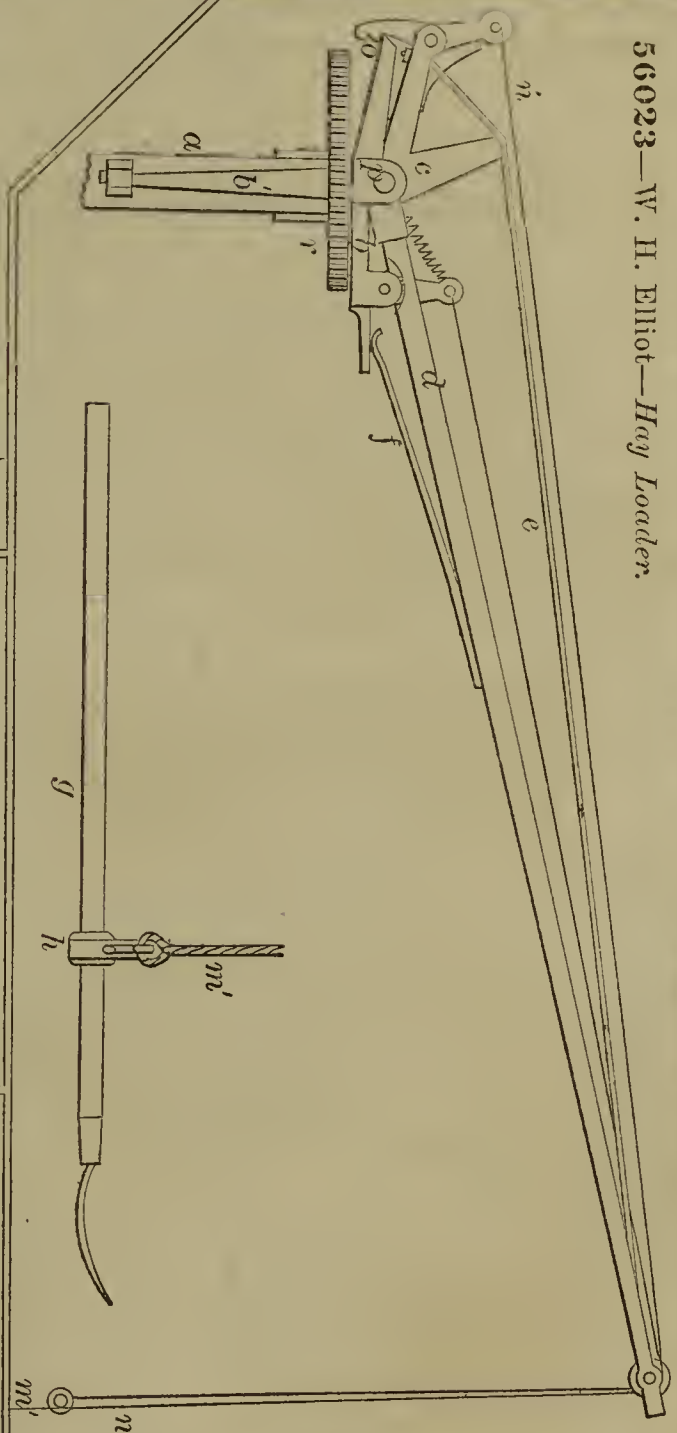

56024—M. S. Every—Sheep Feeding Rack.

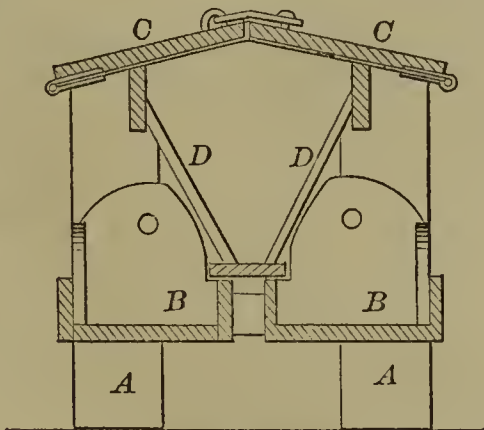

56025—B. Figer—Scrubbing Brush.

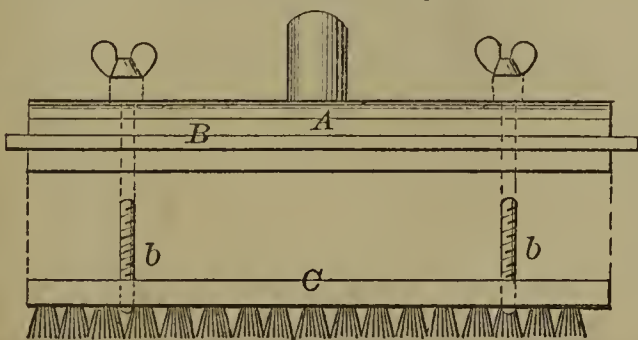

56029—A. M. Force—*Steam Trap.*

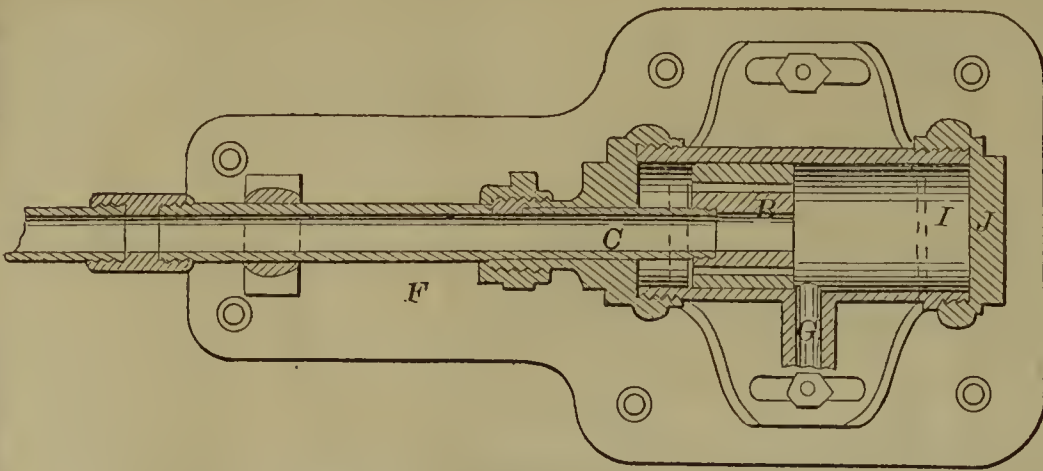

56031—G. S. Foster—*Washing Machine.*

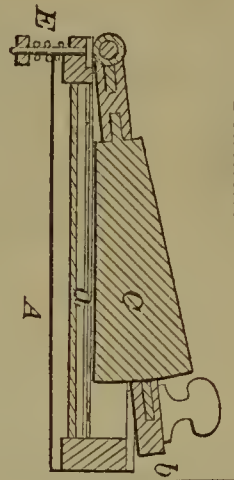

56030—N. B. Forrest—*Car Brake.*

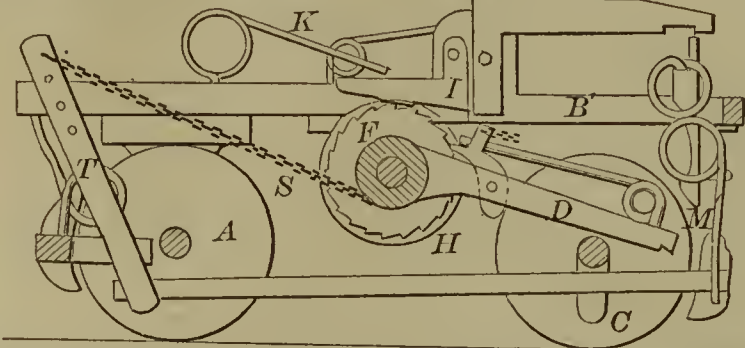

56032—C. French—*Car Spring.*

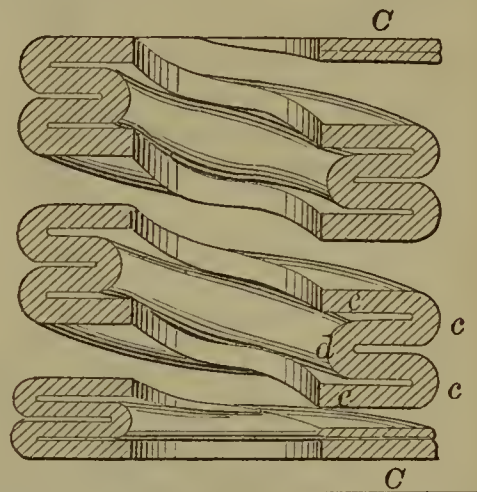

56034—J. S. Getchell—*Ship's Windlass.*

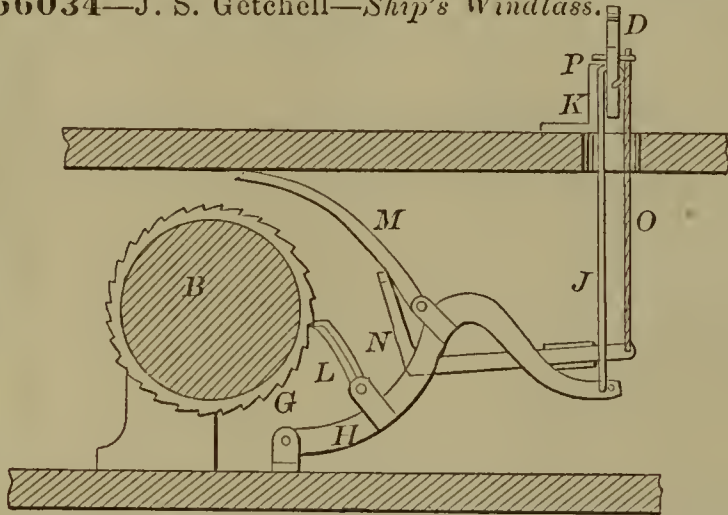

56033—W. Frost—*For Cutting Twist Drills.*

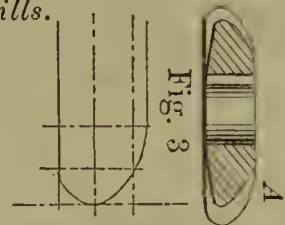

56035—R. P. Gillett—*Scrubbing Brush.*

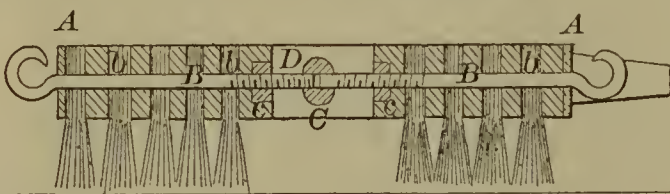

56036—T. Gillmor—*Churn.*

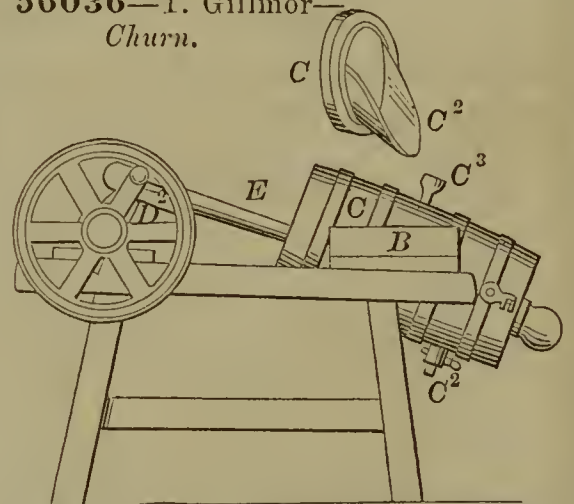

56038—C. L. Goddard—*Wool Burring and Carding Machine.*

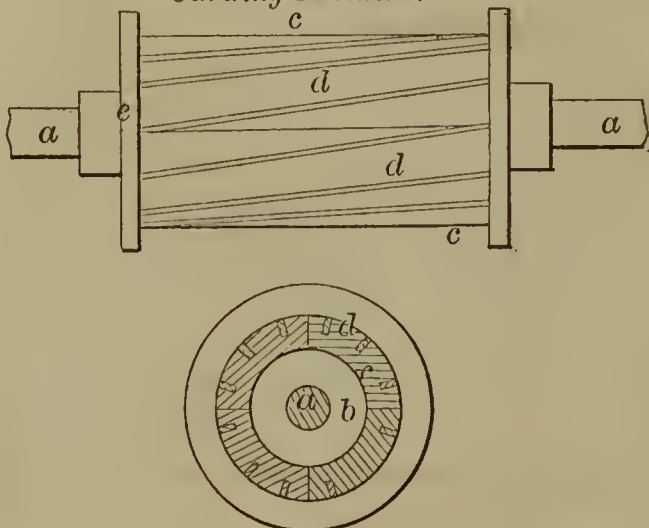

56037—C. L. Goddard—*Wool Burring Machine.*

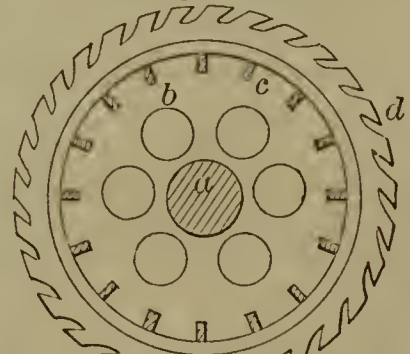

56039—J. H. Graves—Gate.

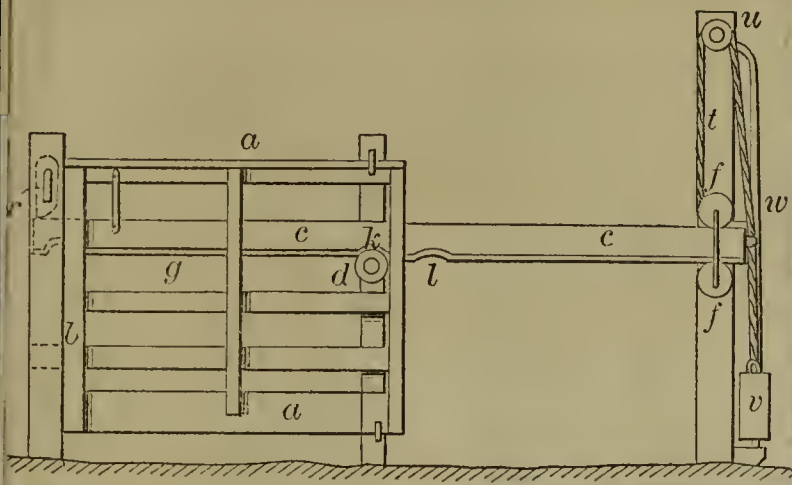

56041—W. A. Greene—Combined Range and Furnace.

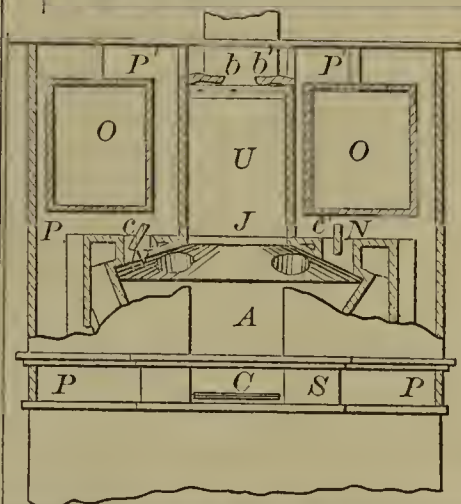
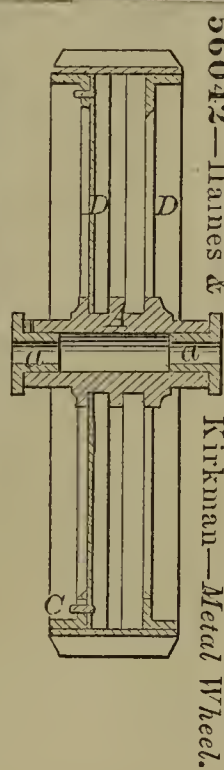
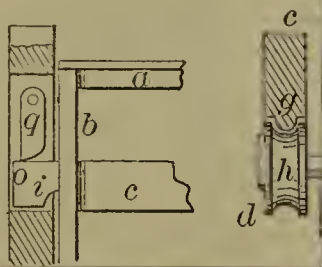
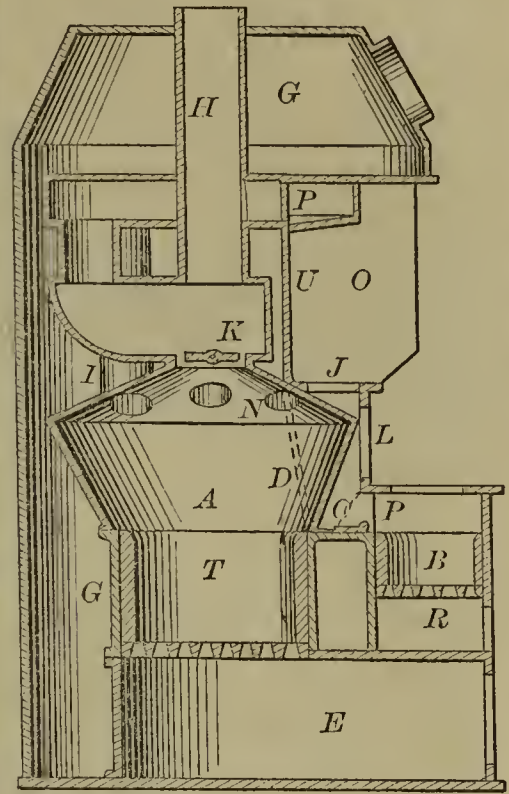

56043—D. Hammond—Bridge.

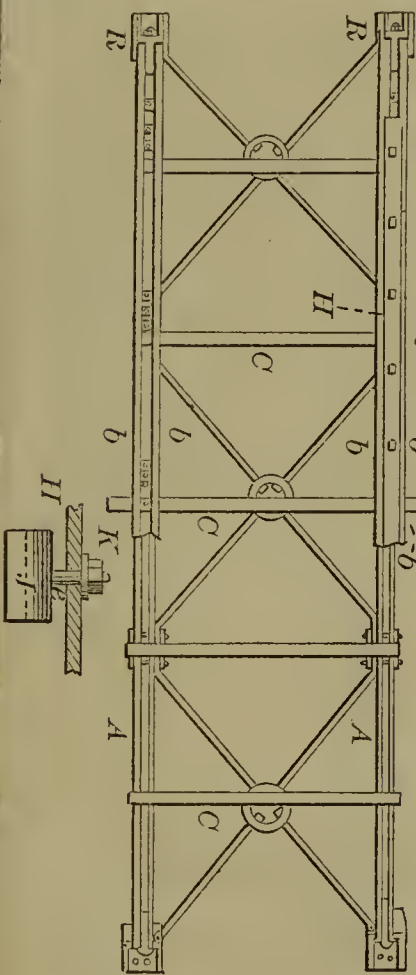

56045—R. F. Hatfield—Steam Engine, Valve, &c

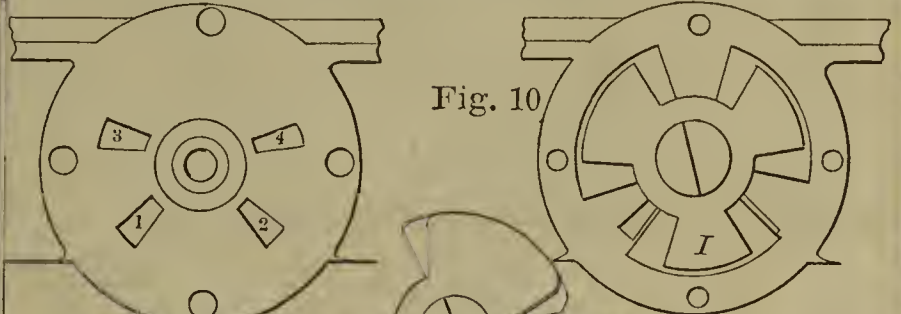

Fig. 9 & 13

Fig. 10

Fig. 14

Fig. 21

Fig. 19

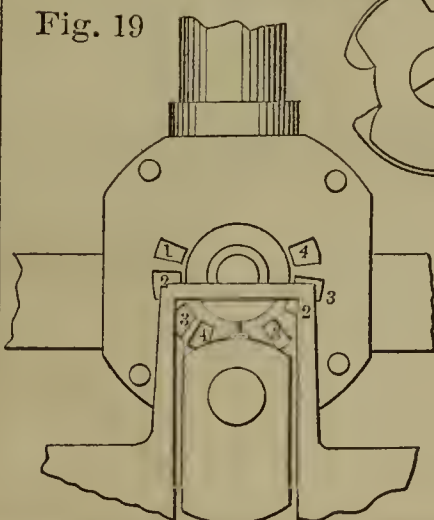
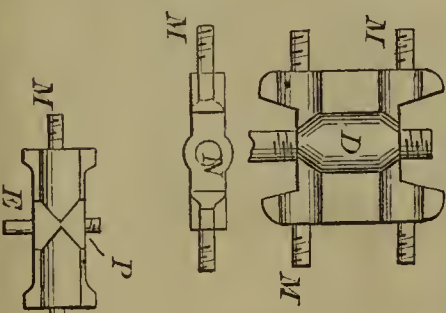
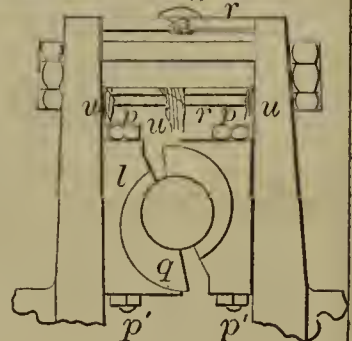
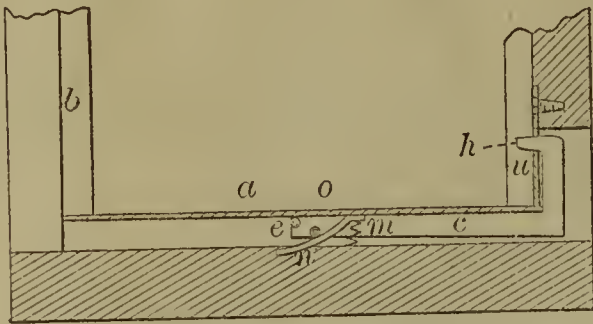

Fig. 24



56046—H. A. Hawkins—Weather Strip.



56047—A. Herdlein—Quartz Stamp Mill.

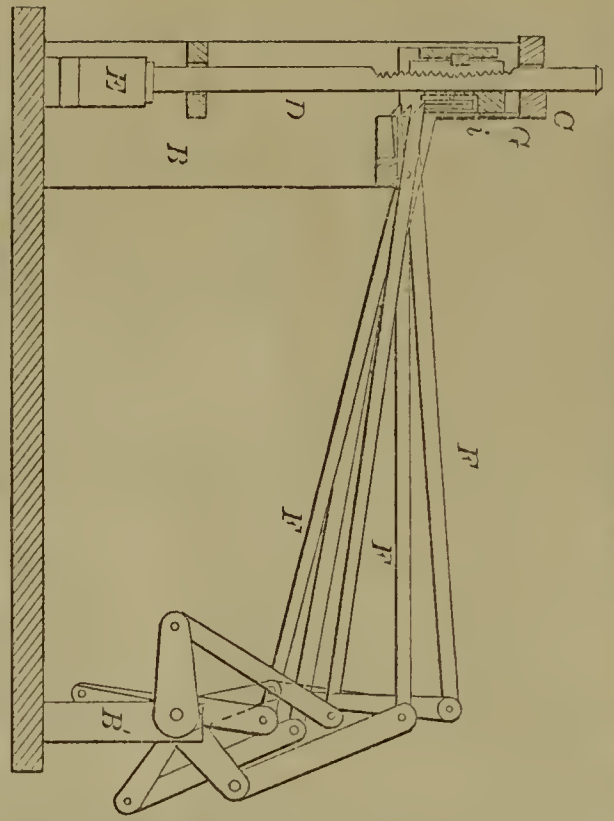

56050—E. Hoyt—Churn.

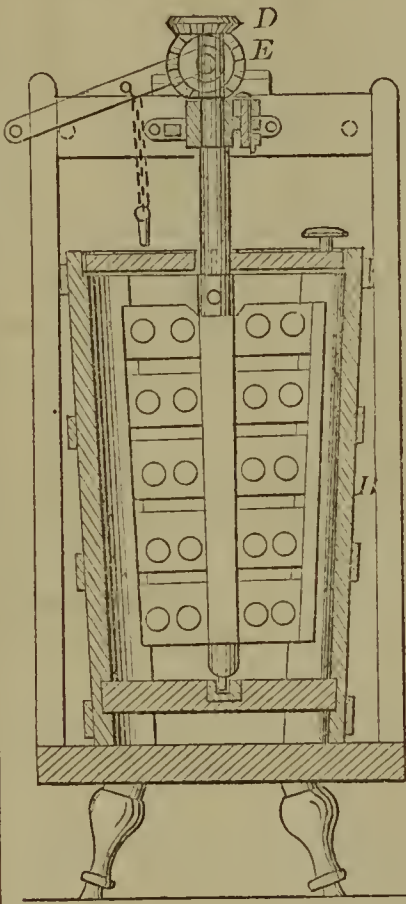

56049—W. Hindhaugh—Safety Pocket.



56048—W. F. Heywood—For Folding Cloth.

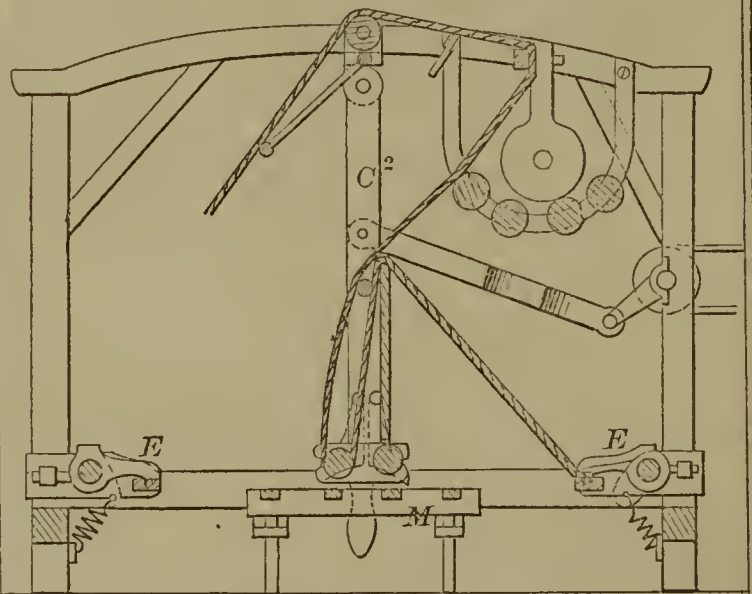

56051—J. S. Hull—Soldering Lamp and Blow Pipe.

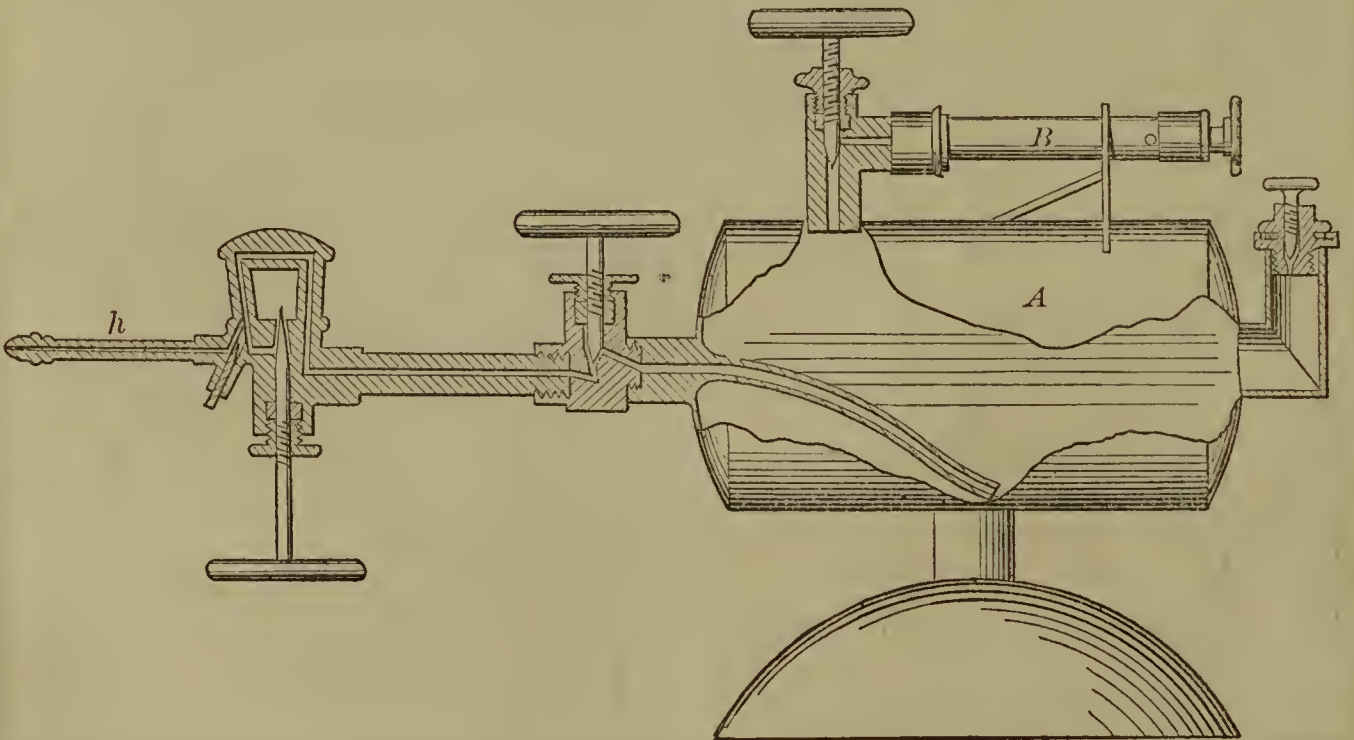

56057—A. Jamson—Vise.

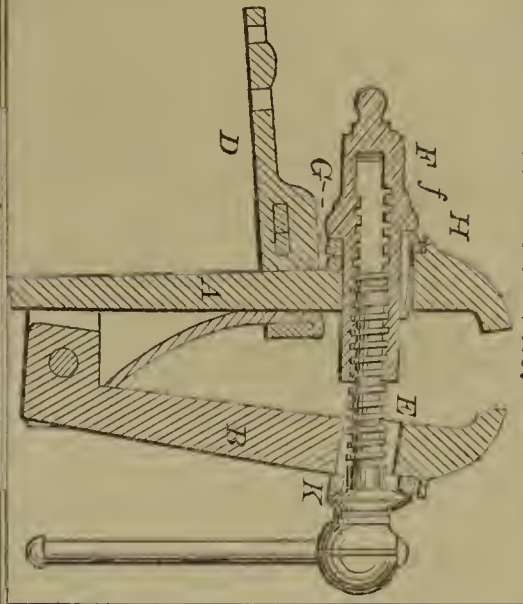

56056—A. Jackson—Milk Rack.

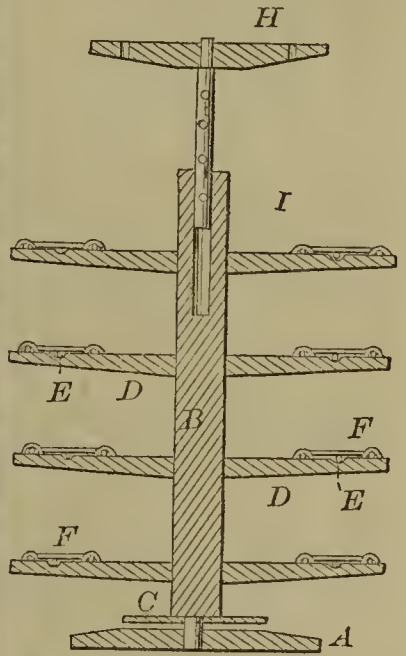

56055—A. Isko—Cigar Press.

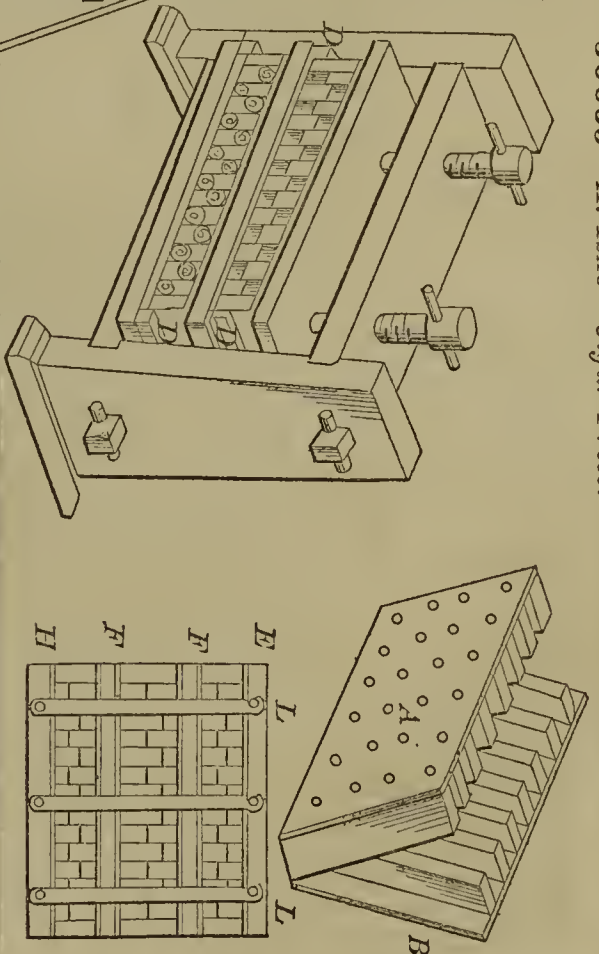

56052—J. S. Hull—Gas Heater for Cooking, &c.

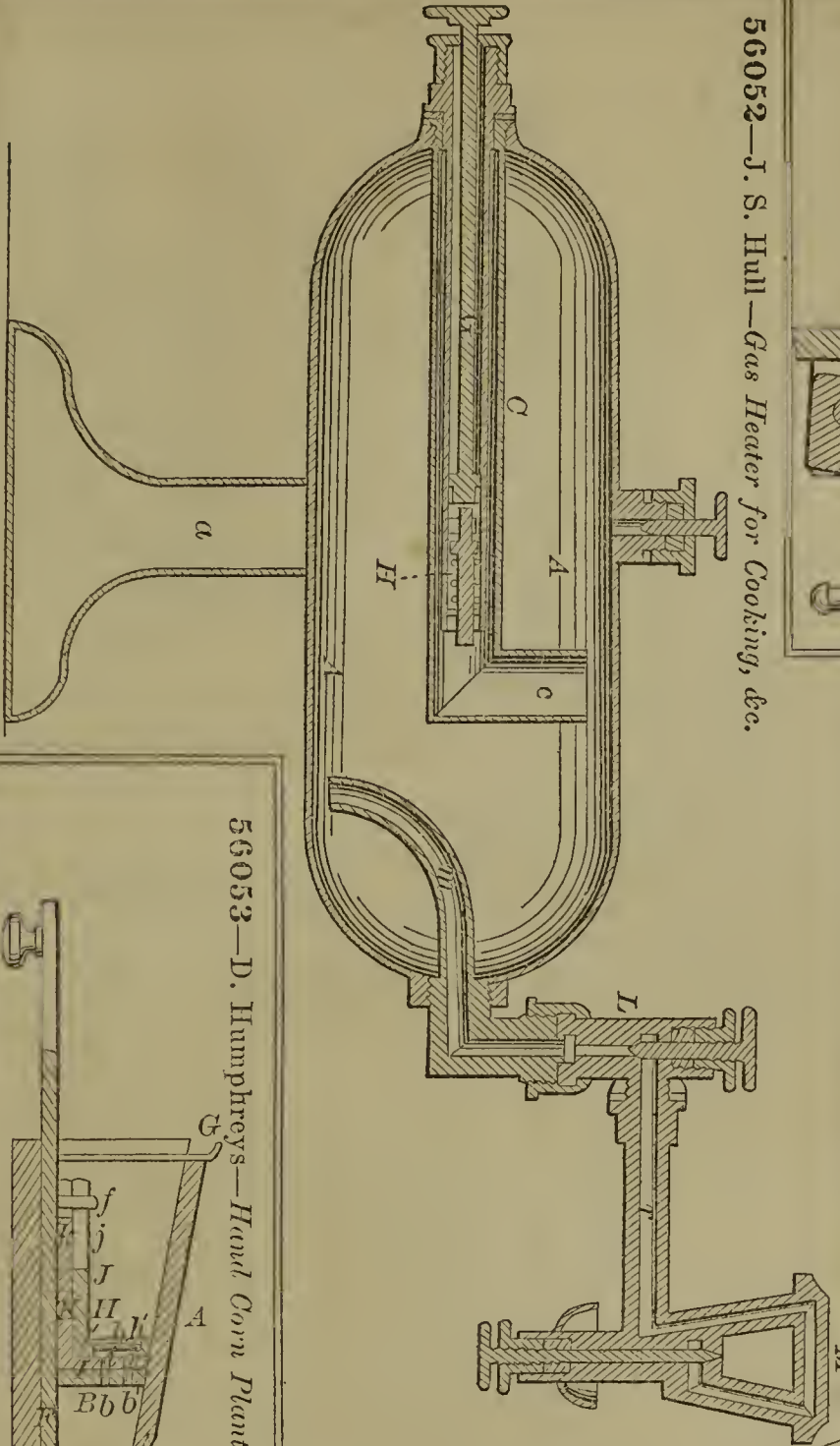

56059—F. G. Johnson—Drill Chuck.



56054—J. L. Husband—Packing for Steam Engines.



56053—D. Humphreys—Hand Corn Planter.

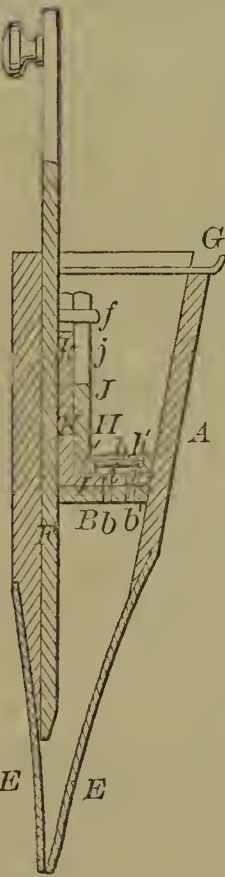

56058—R. Jennings—Tool for Finishing Augers.

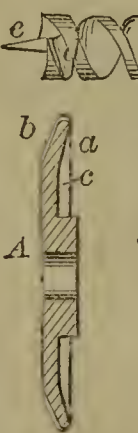

56060—R. V. Jones—*Railroad Switch.*

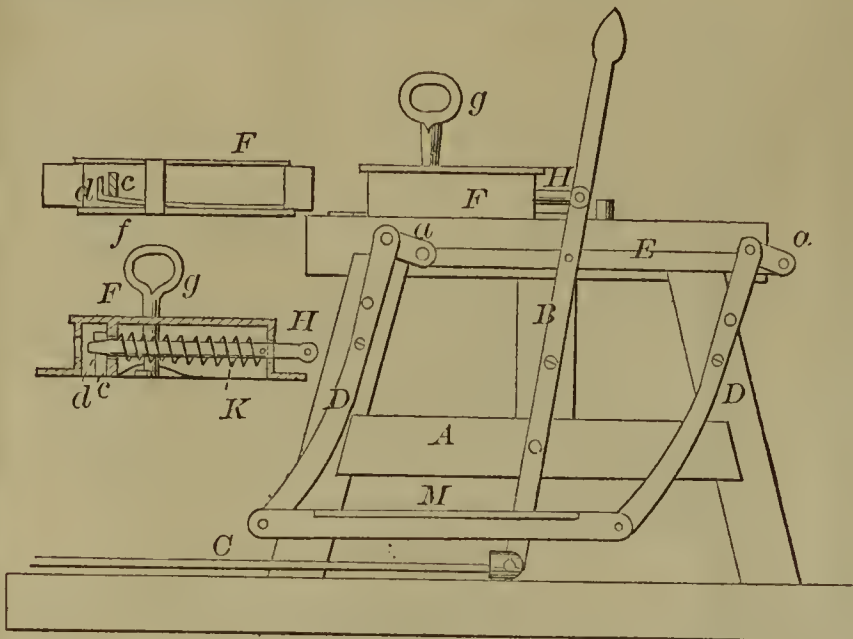

56063—Keep & Dummer—*Sprinkler and Dredger.*

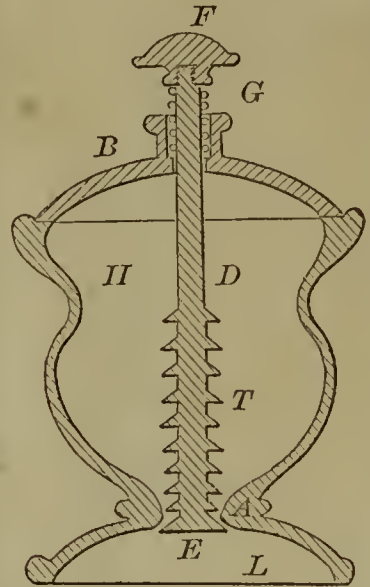

56064—J. S. Kenyon—*Sofa Bedstead.*

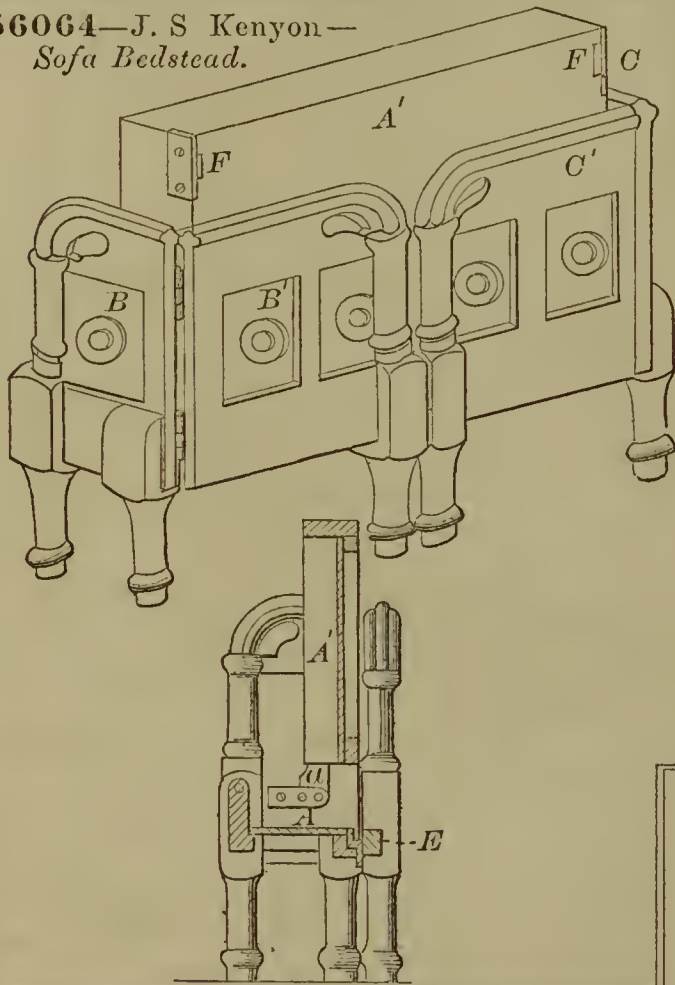

56062—E. Kaylor—*Nut Machine.*

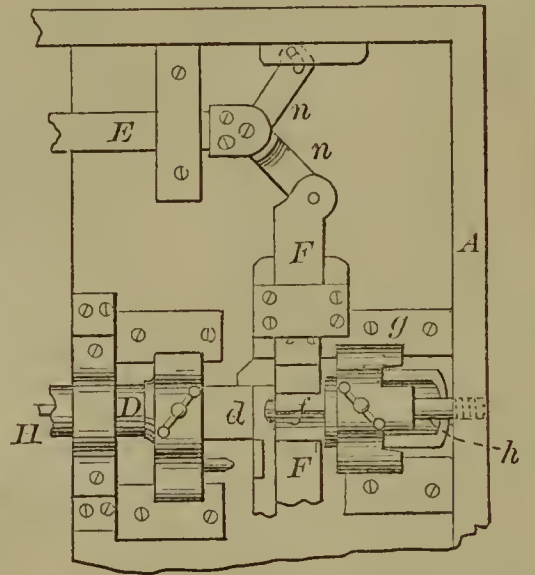

56069—J. B. Logan—*Mail Bag Lock.*

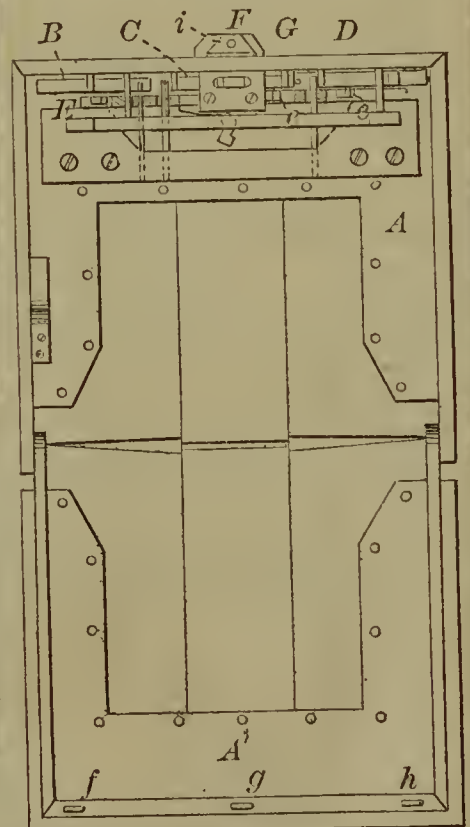

56068—G. H. Lincoln—*Toilet Soap.*



56061—W. Judson—*For Preventing Logs from Roofing.*



56065—P. A. La France—*Horse Shoe.*

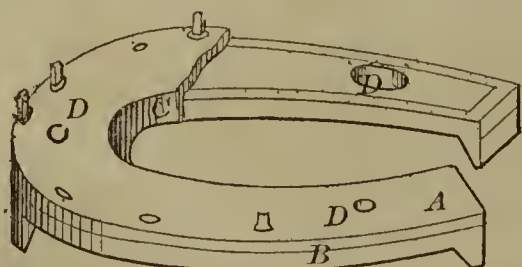

56067—J. H. Lightner—*Broom Head.*





56070—J. Lowe—  
Steam Gauge.

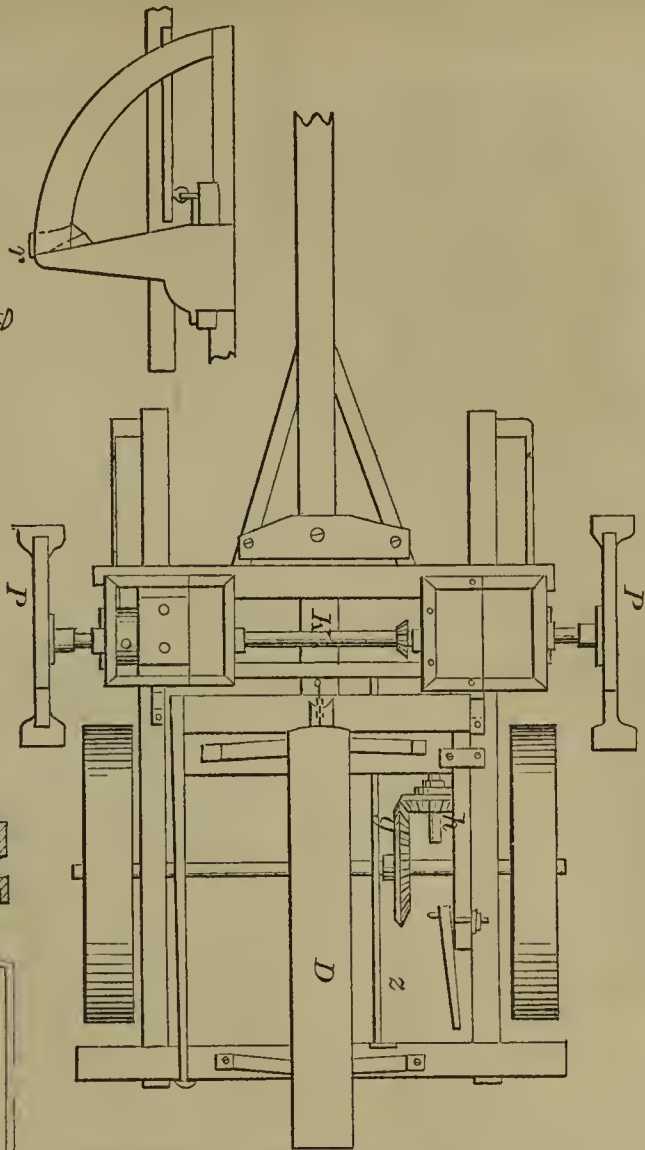
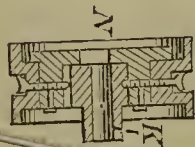
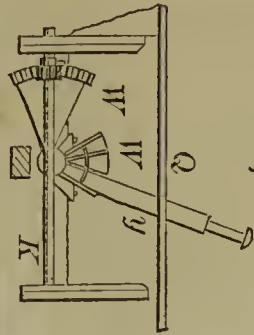
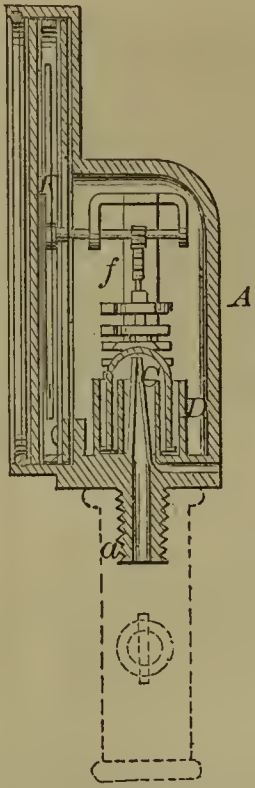

56076—I. W. McGaffey—Seed Planter.

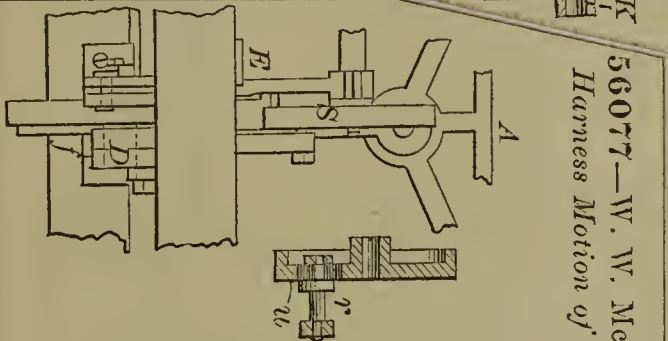

56077—W. W. McGregor—  
Harness Motion of Looms.

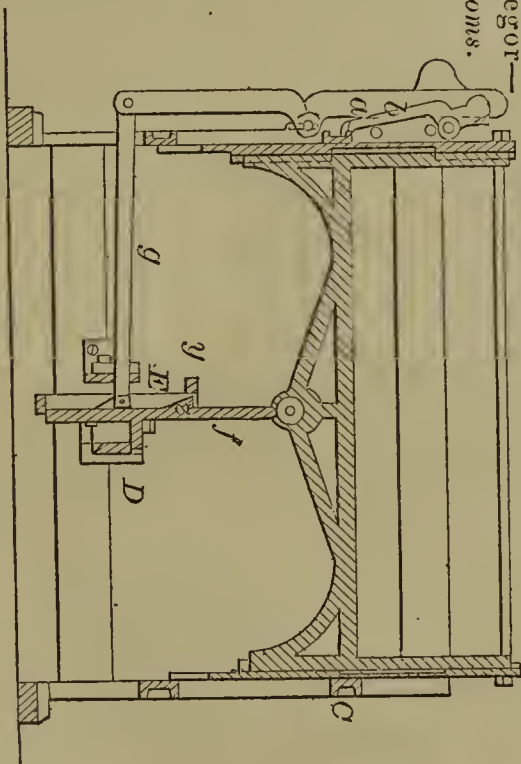

56071—S. Macferran—Door Key Fastener.

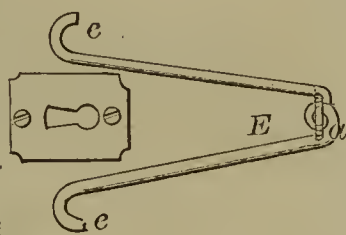
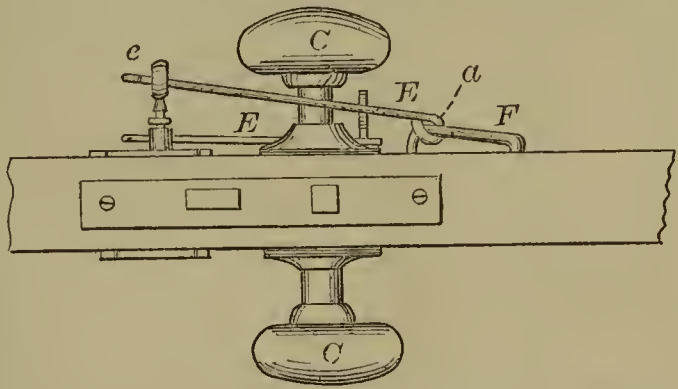

56073—C. S. Martin—  
Wagon Spring.

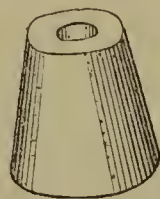

56074—C. S. Martin—Wagon Spring.

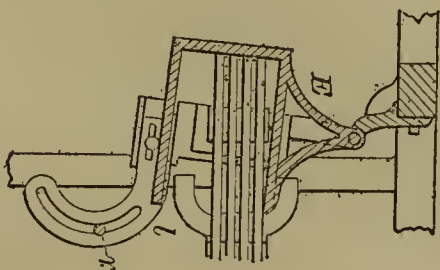
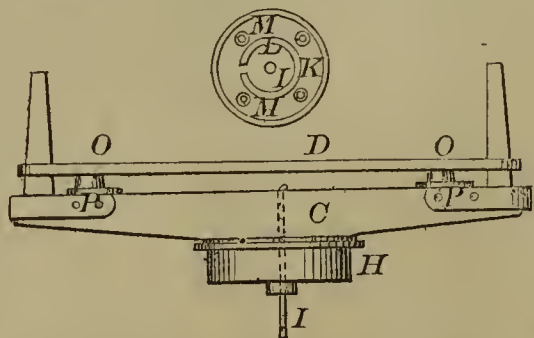

56079—T. W. Mirick—  
Bottle Stopper.

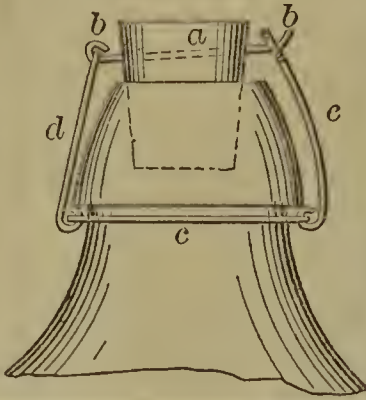

56080—R. E. Monaghan—*Sash*  
Fastening.

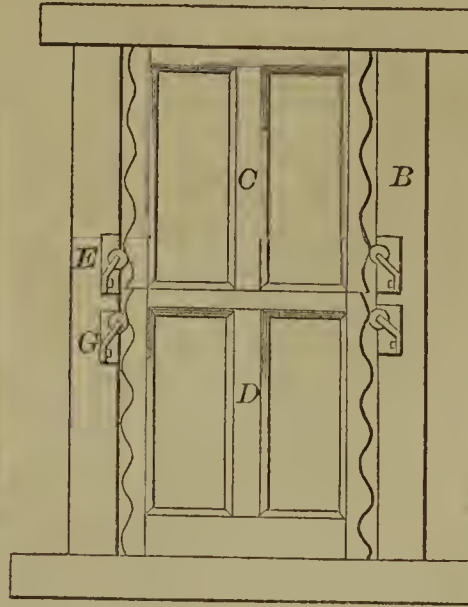

56081—C. Moore, Sr.—  
Woven Bag.

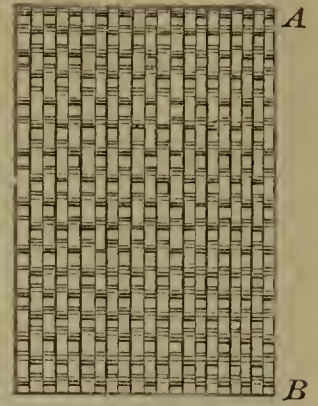

56082—  
H. A. Morse—  
Clothes Sprinkler.

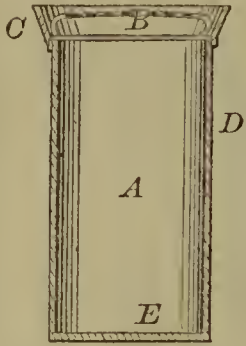

56083—J. M. Muhlig—*Sifter*  
and Strainer.

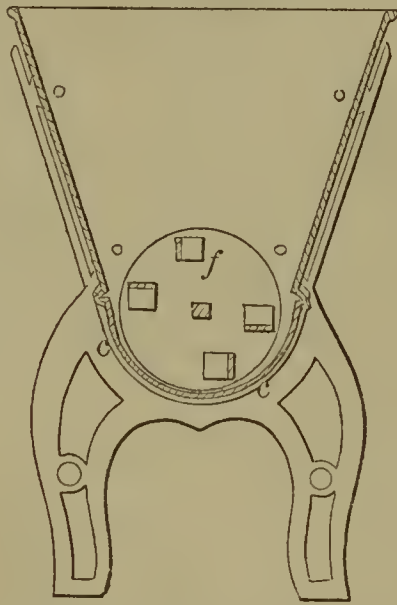

56084—W. R. Nichols—*Car Spring*.

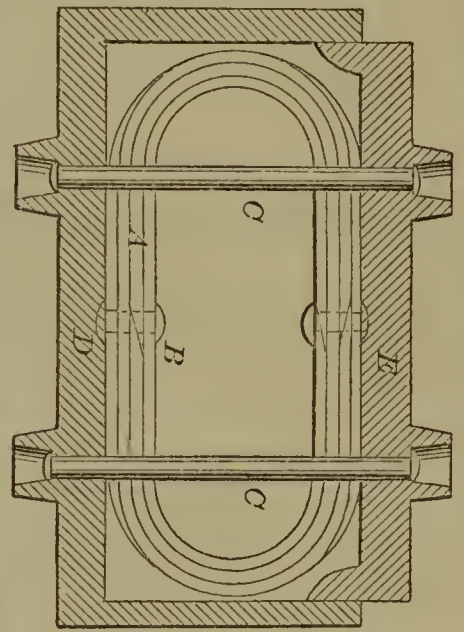

56085—J. A. Niman—*Car Coupling*.

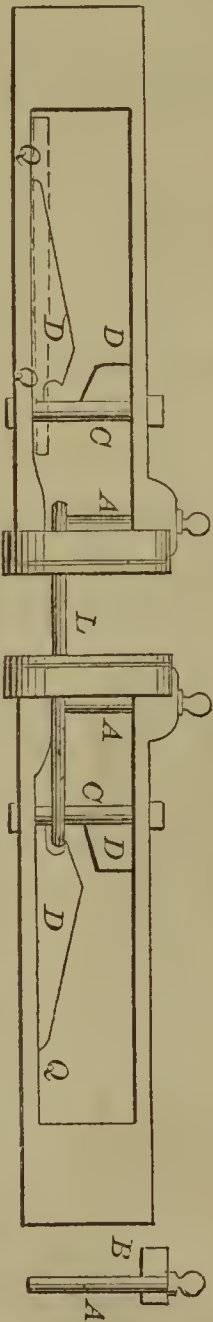

56086—J. W. Norcross—*Row Lock*.

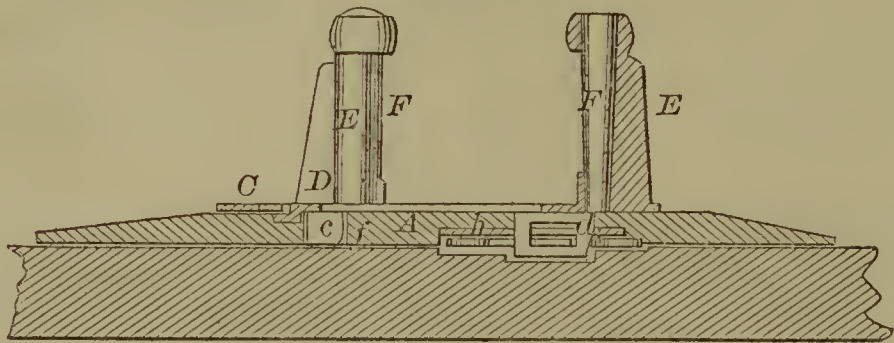

56088—O. D. Padrick—*Harrow*.

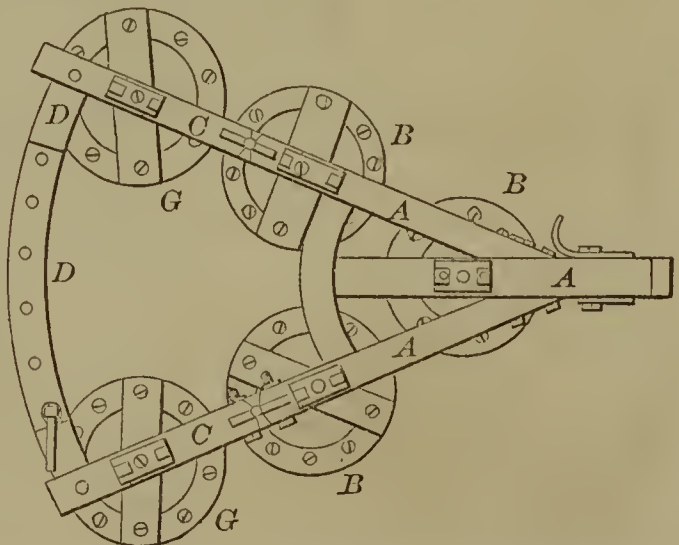

56087—J. W. Norcross—*Tackle Block*.  
Sheave.



56089—R. Palmer—Sheet Metal Water Wheel.

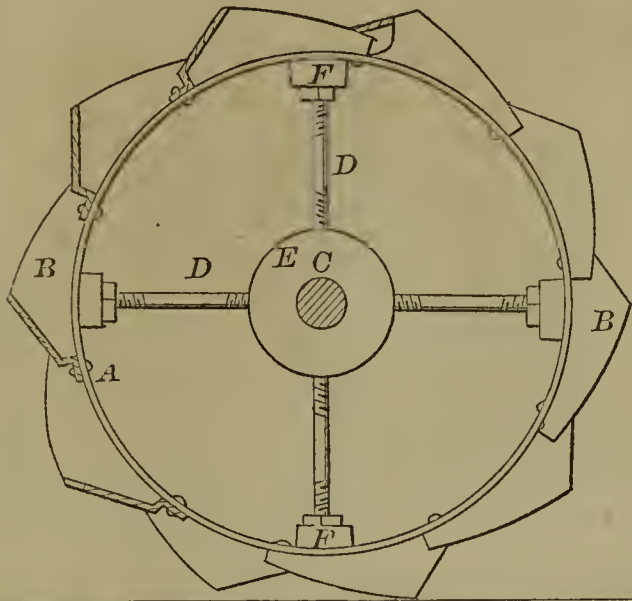

56090—J. Patterson—Tuyere.

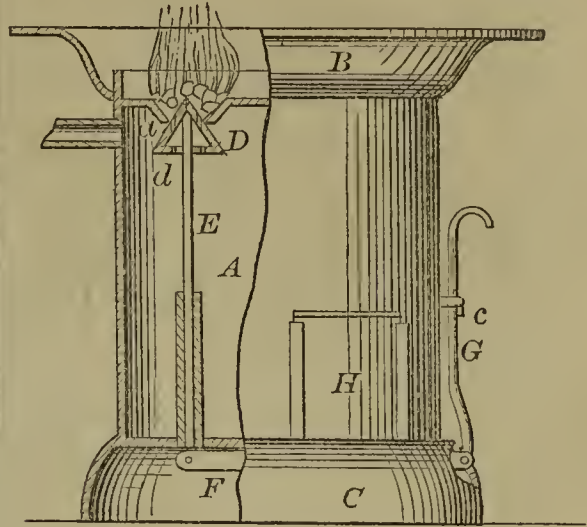

56091—P. Perry—Dough Kneader, Meat Pounder, &c.

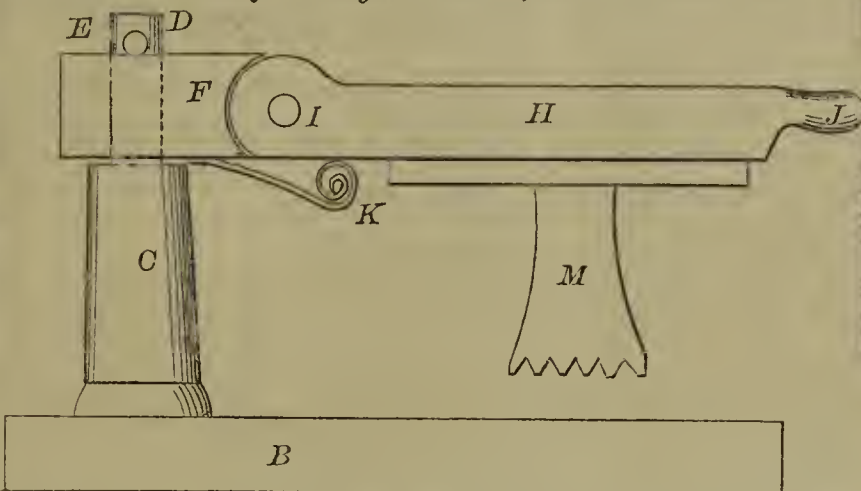

56093—C. Reed—Mowing Machine.

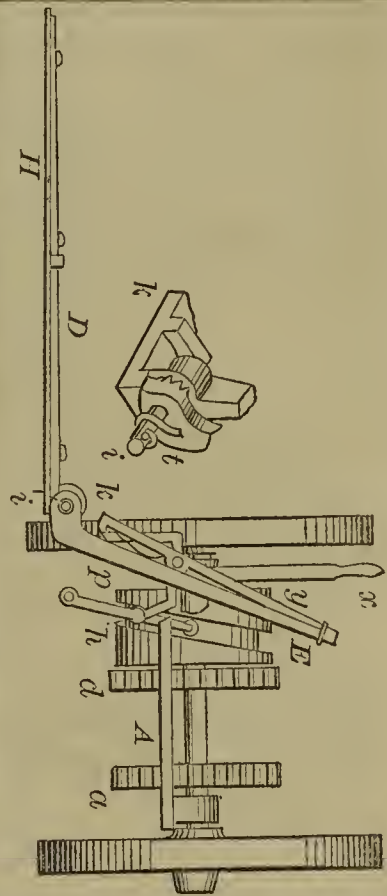

56092—C. N. Pond—Lamp Chimney Cleaner.

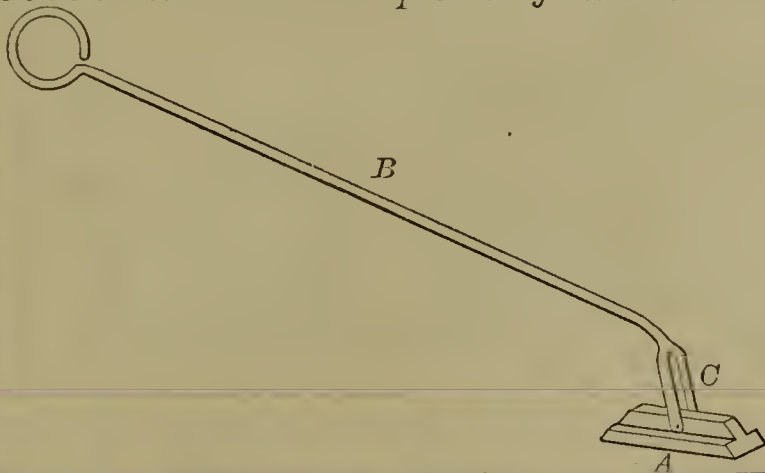

56095—D. Reese—For Tapping Nuts.

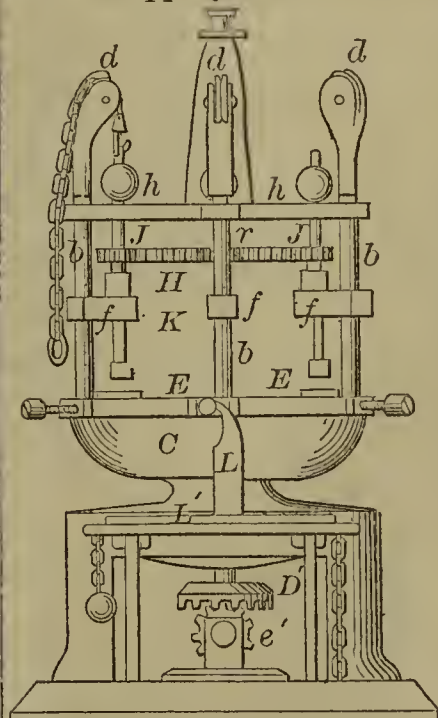

56094—Rees & Tevis—Refrigerator.

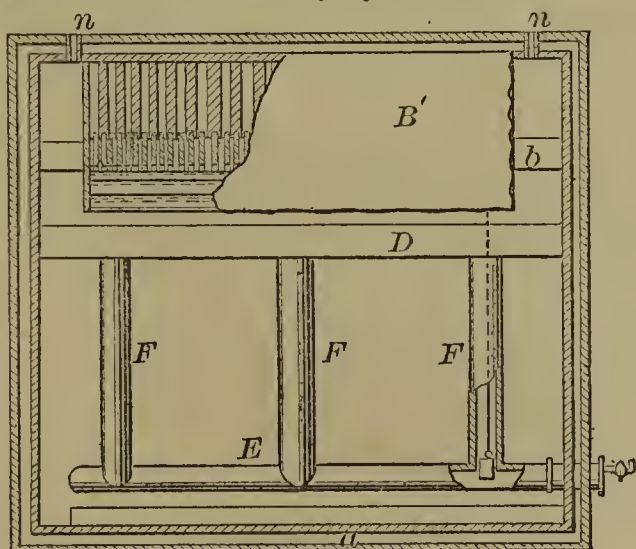

56096—G. A. Riedel—Automatic Boiler Feeder.

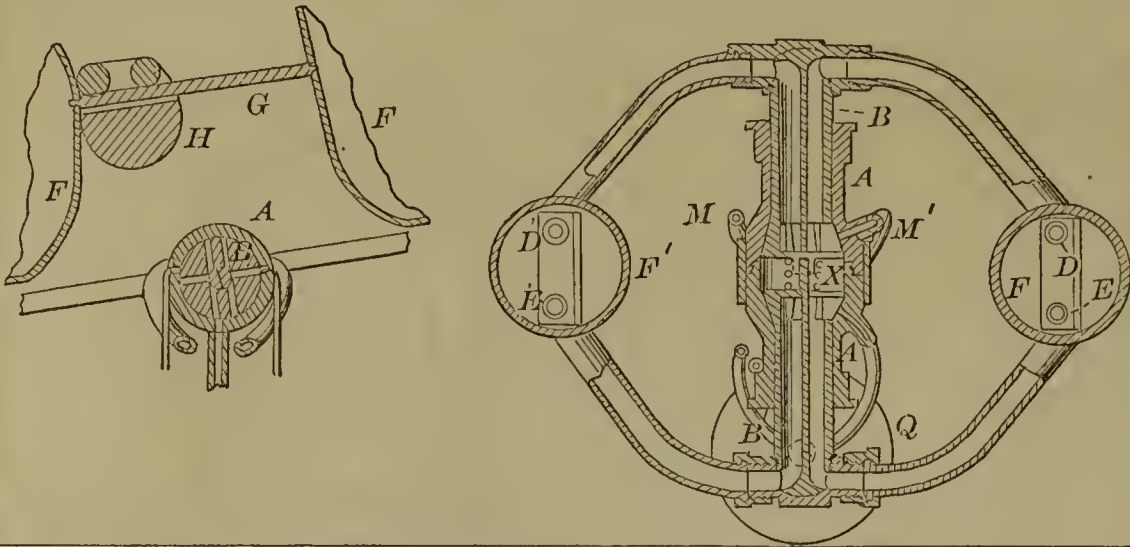

56099—W. W. Robinson—Cutlery.



56097—J. F. Riggs—Evaporator.

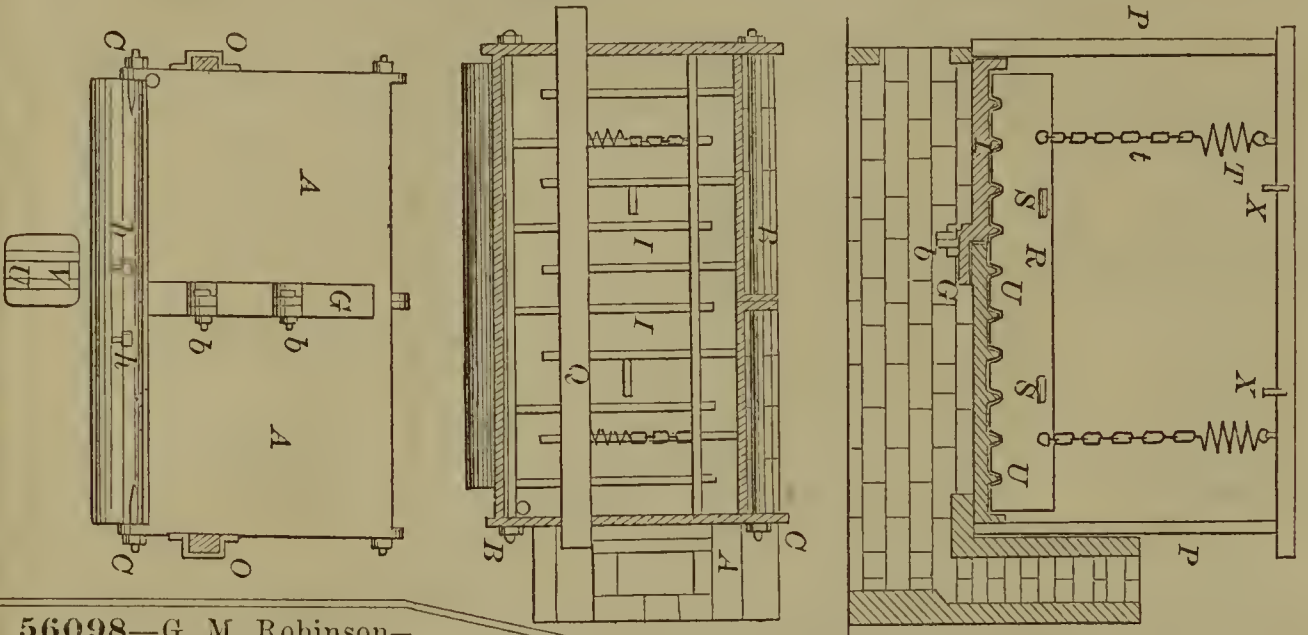

56098—G. M. Robinson—Water Box for Tuyeres.

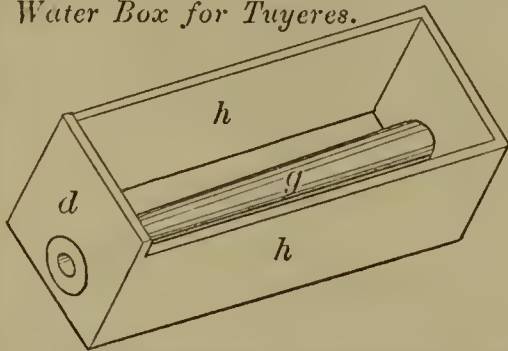

56100—P. Roche—Saw Gummer.

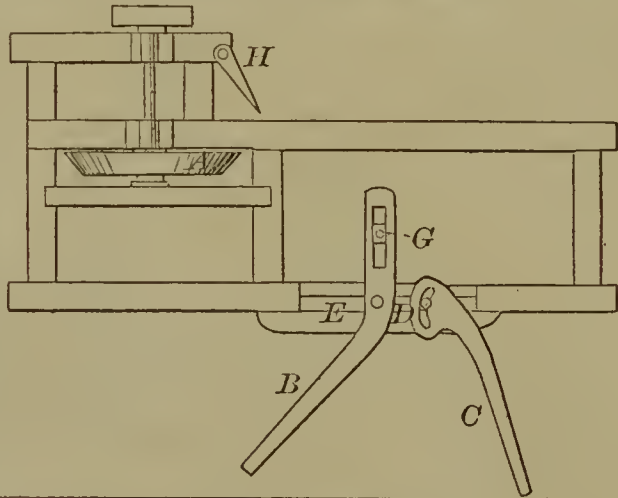

56101—Roebuck & Reece—Pump.

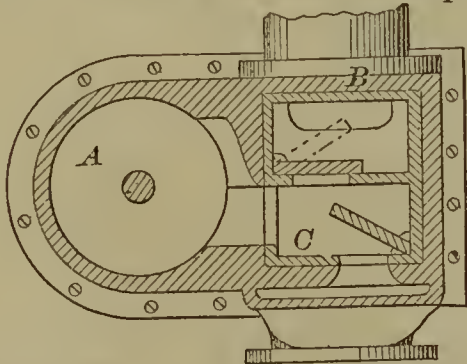

56103—J. L. Rust—Churn.

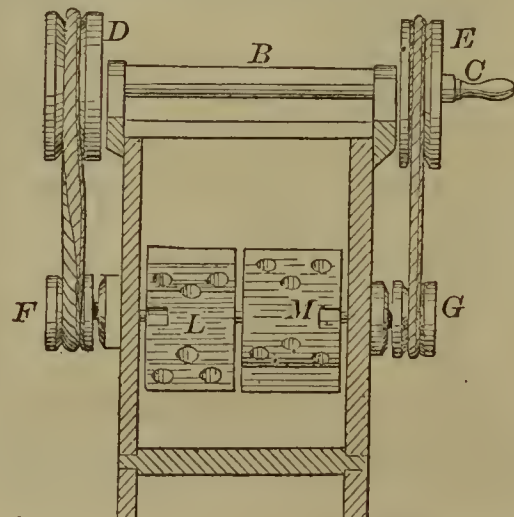

56102—J. S. & I. Rowell—Cultivator.

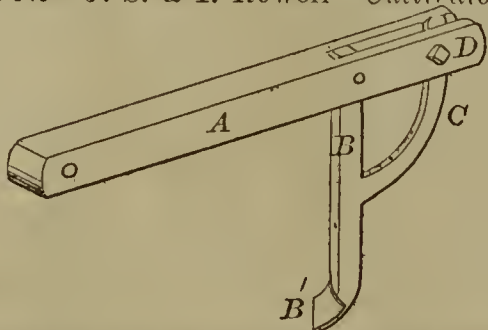

56104—G. Schmidt—*Combined Inkstand, &c.*

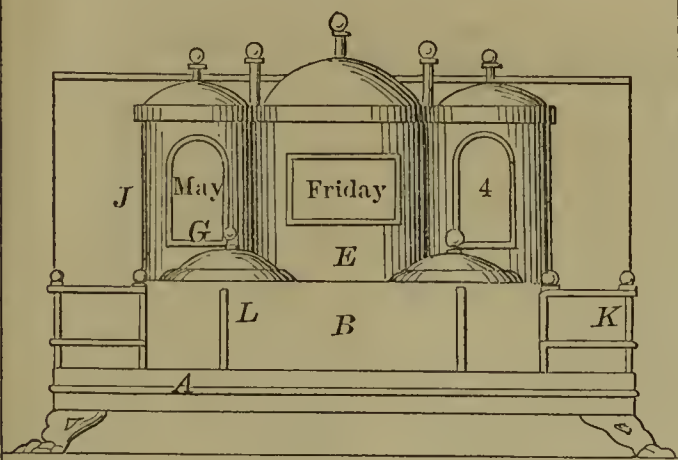

56106—D. Schuyler—*Musical Instrument.*

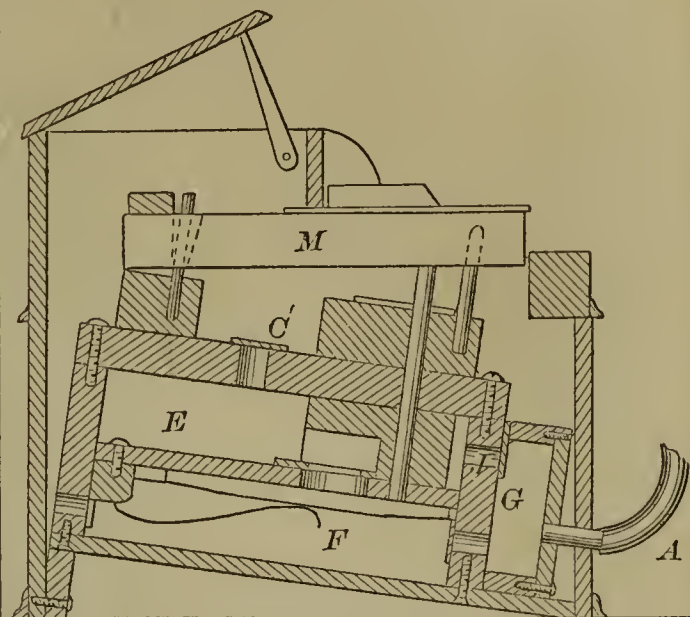

56108—F. Shaw—*Quartz Crusher.*

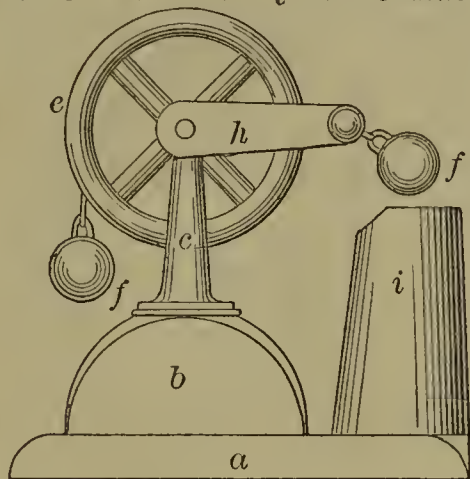

56106—G. E. Shaw—*Carbon Oil Fire Tester.*

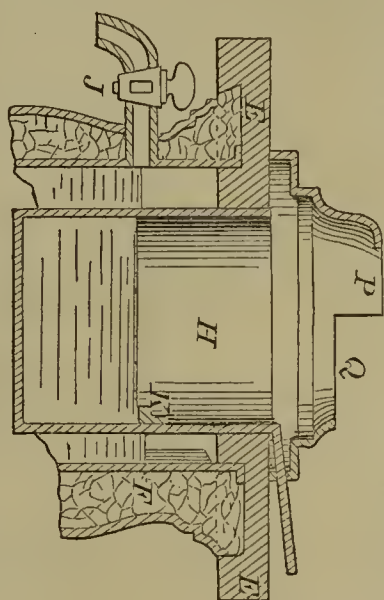

56105—C. Schullian—*Faucet.*

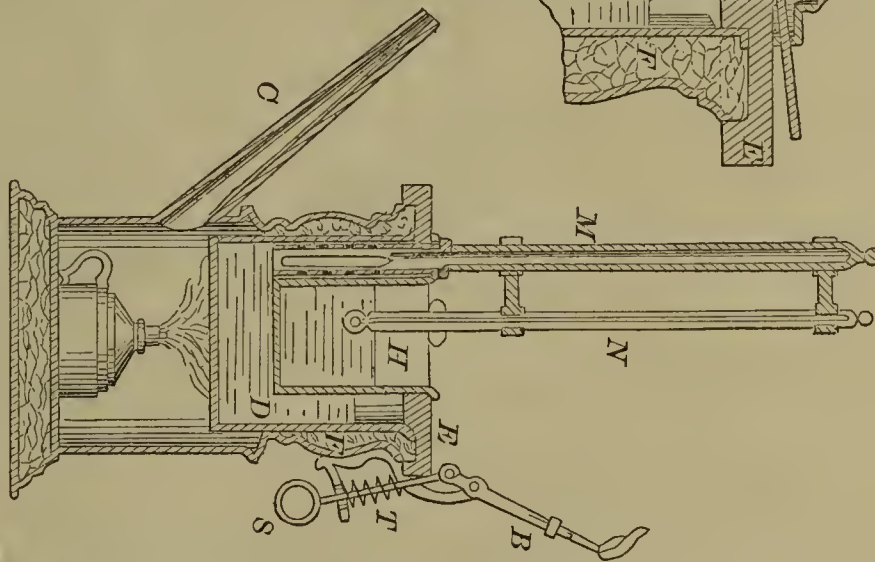
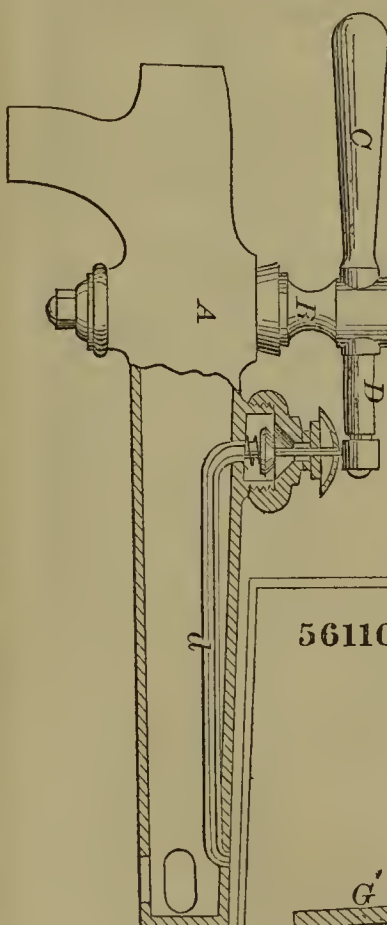

56110—W. S. Shoemaker—*Washing and Wringing Machine.*

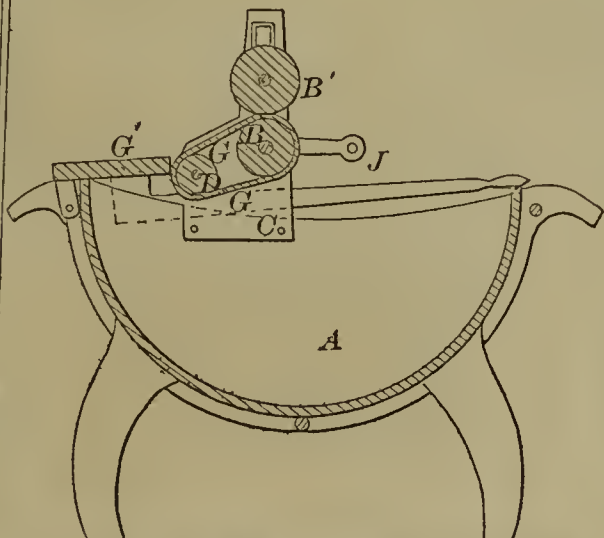

56109—Shedd & Worcester—*Chimney Cup.*

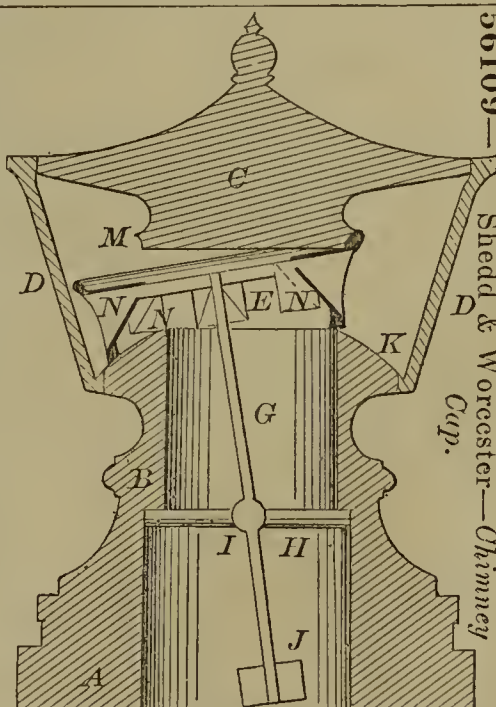

56111—L. Smith—*Lifting Jack.*

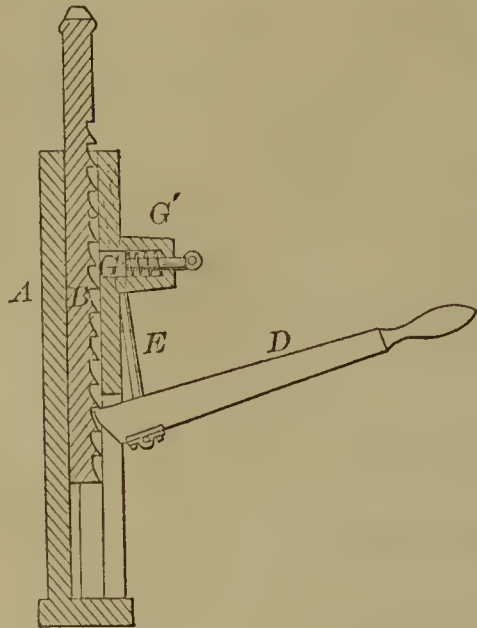

56112—T. D. Smith—*Butter Worker and Mould.*

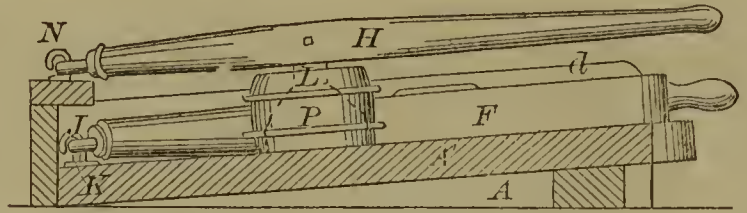

56113—W. G. Smith—*Car Spittoon.*

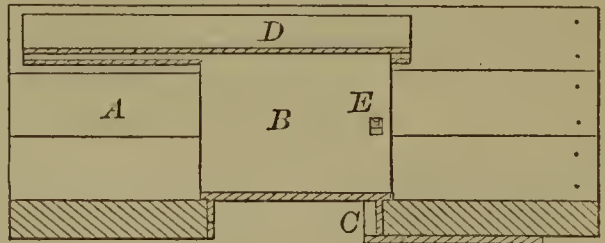

56115—O. W. Stanford—*Churn.*

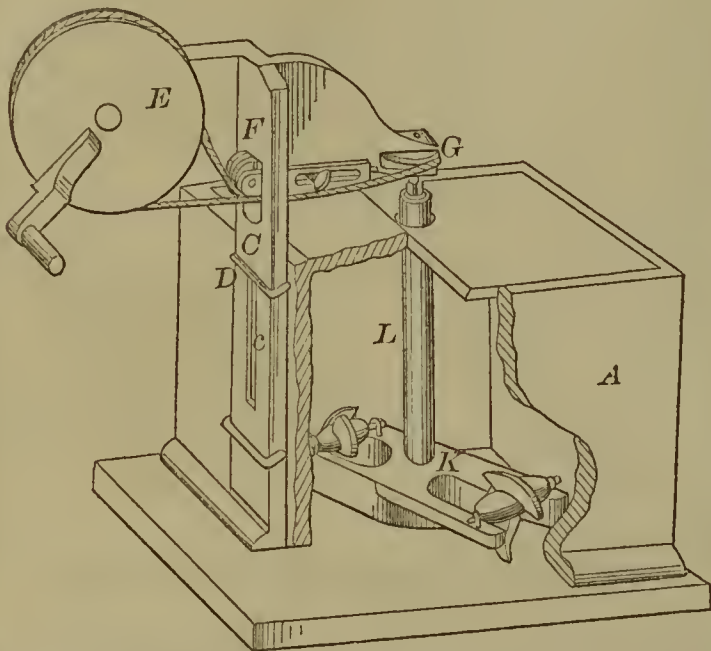

56114—R. Speer—*Nail and Tack.*



56116—L. Stevens—*Treating Gas.*

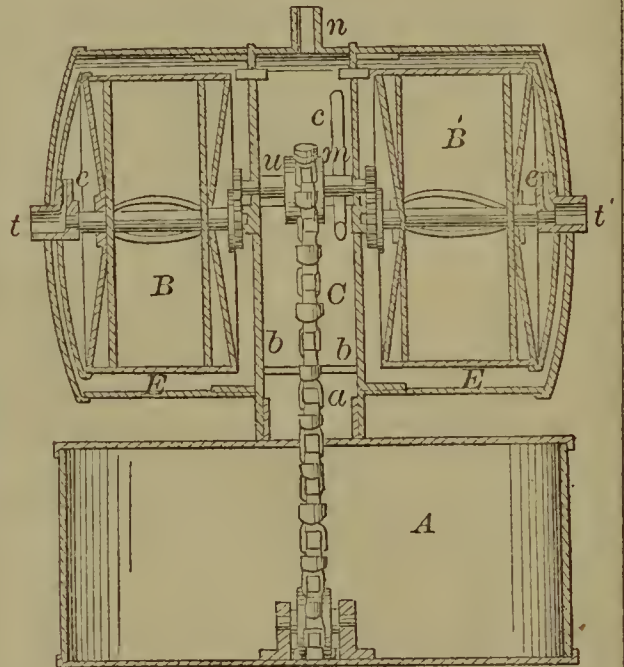

56117—I. H. Stoddard—*Ship's Table.*

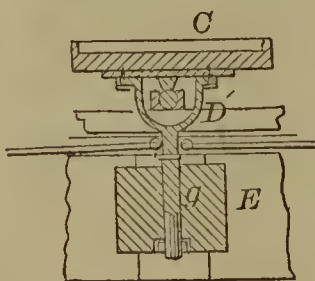
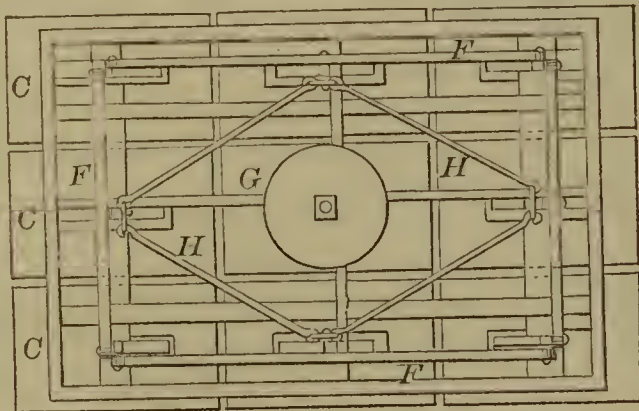

56118—J. M. Story—*For Driving Paddle Wheels.*

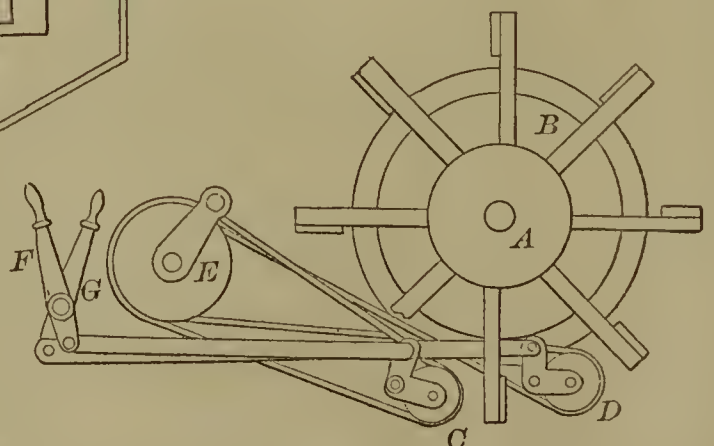

56119—W. D. Stroud—*Broom Head.*

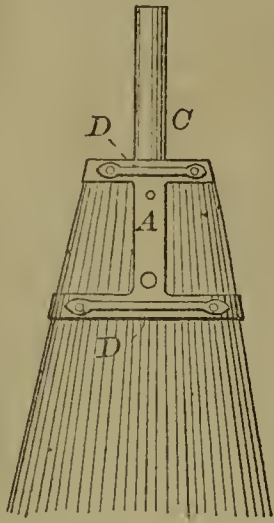

56120—H. H. Stuart—*Hydraulic Engine.*

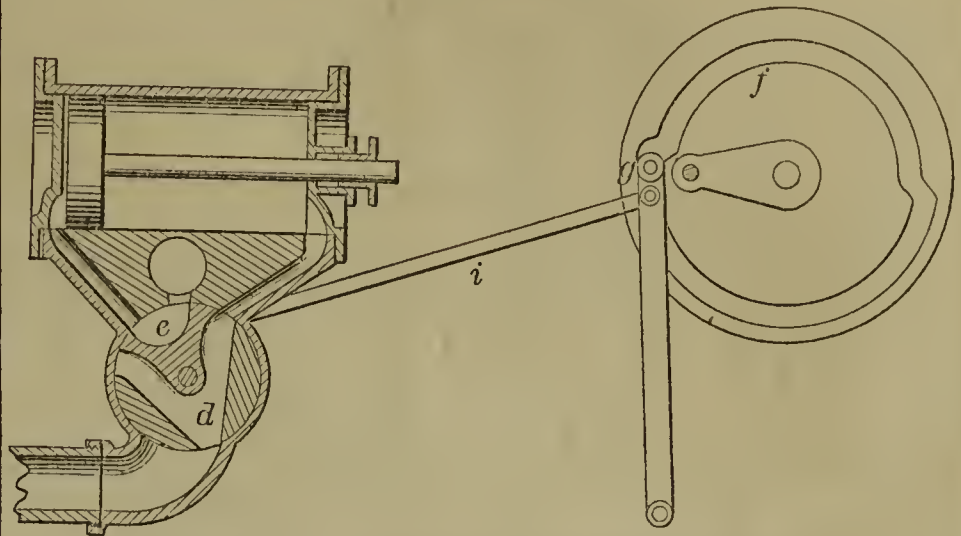

56125—R. B. Tolles—*Eye Piece for Optical Instruments.*

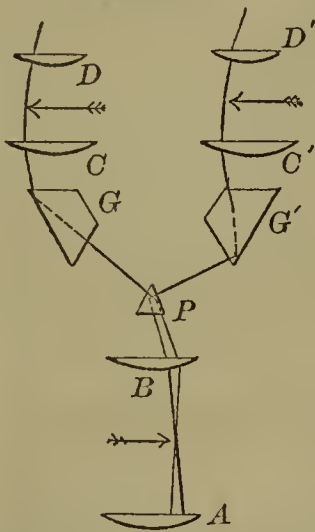

56122—C. W. Taliaferro—*Corn Cultivator.*

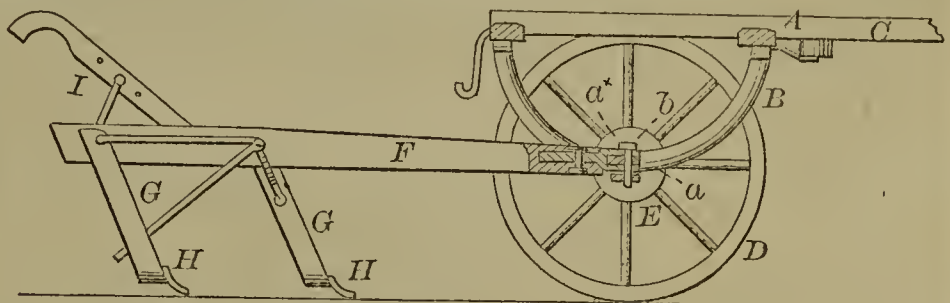

56123—J. W. Thyng—*Printing Press.*

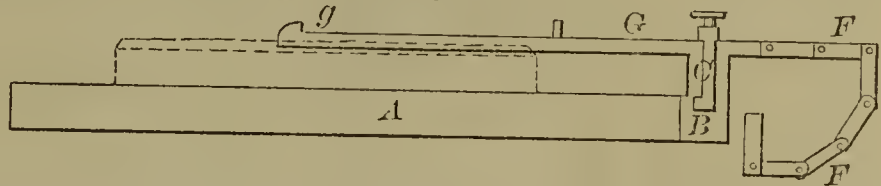

56124—L. Till—*Nut.*

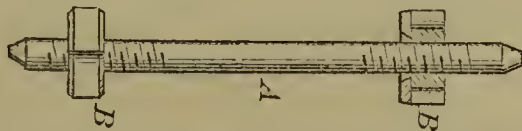

56127—J. Wash—*Beehive.*

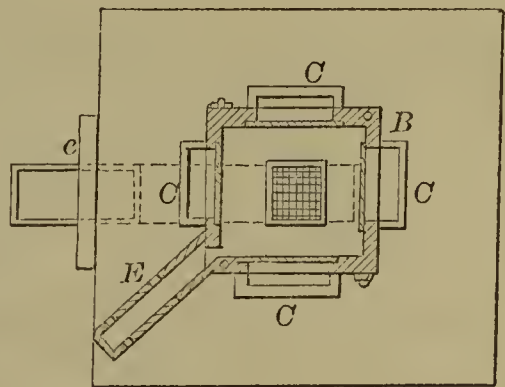

56126—Topping & Gally—*Ratchet Wheel for Lamps.*

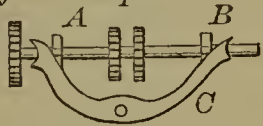

56128—C. L. S. Walker—*Mosquito Bar.*

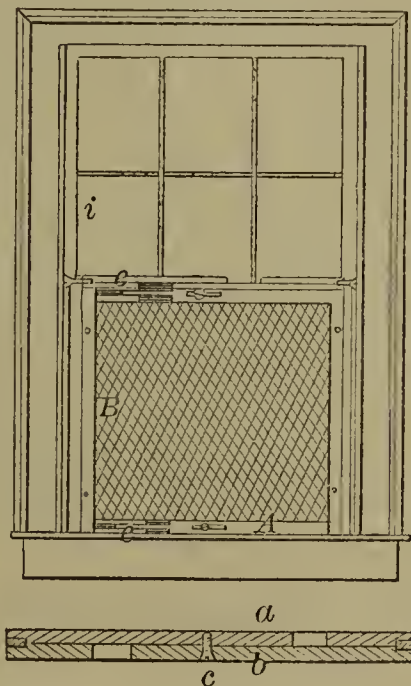

56129—D. M. Weston—*Reciprocating Pump.*

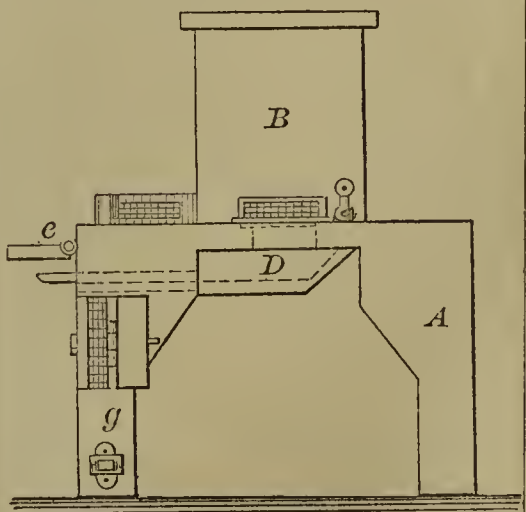
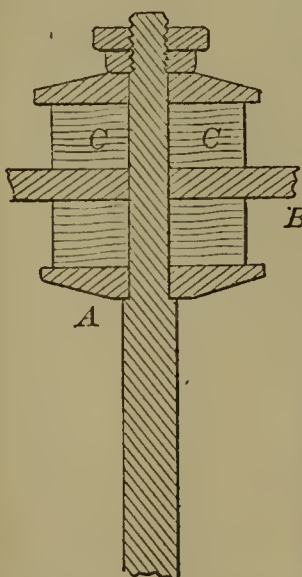

56130—N. P. Wheeler—Method of Condensation.

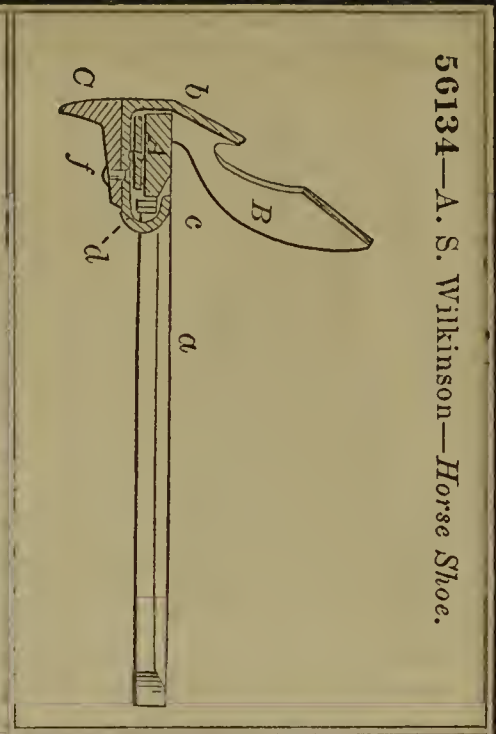
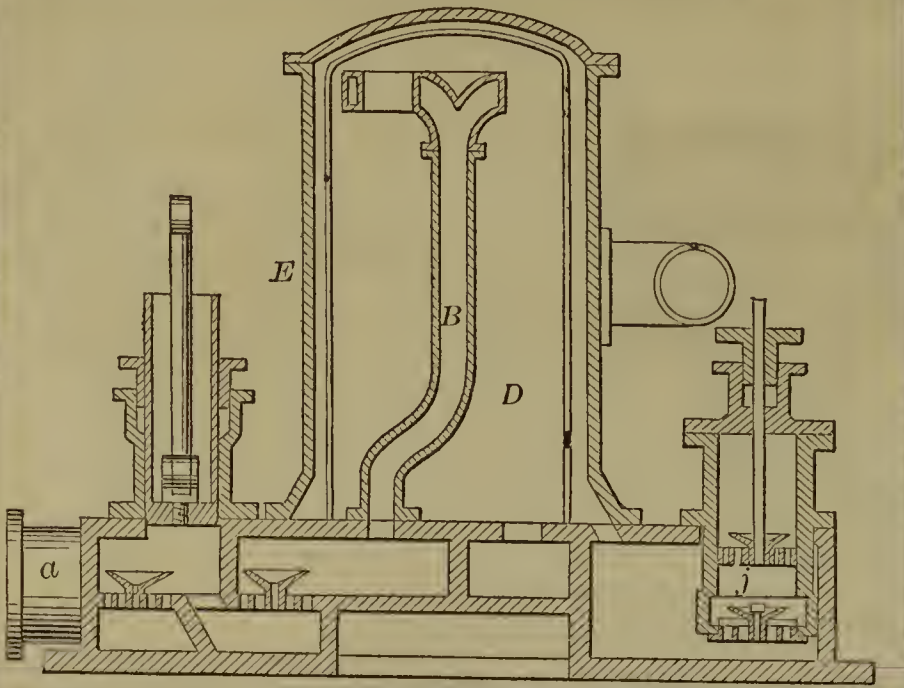

56134—A. S. Wilkinson—Horse Shoe.

56131—L. C. White—Kerosene Burner.

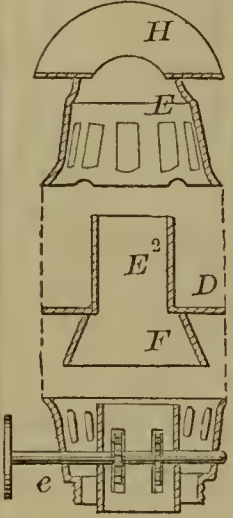

56133—R. Wilde—Spinning Mule.

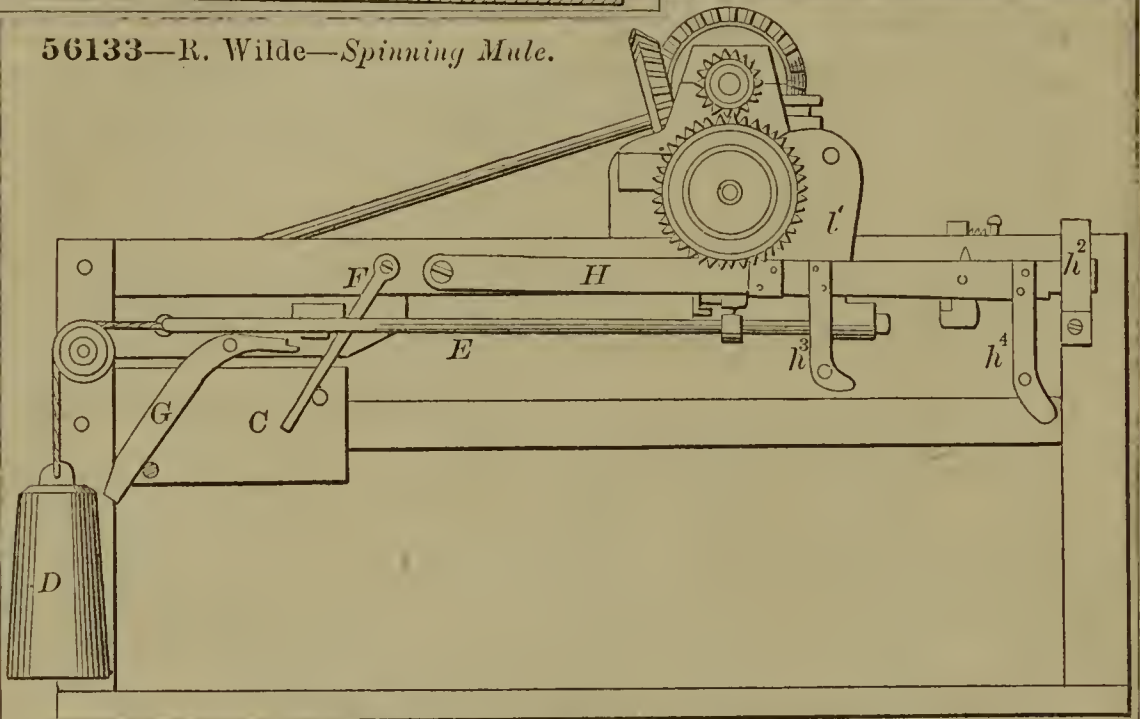

56132—N. B. White—Bed Spring

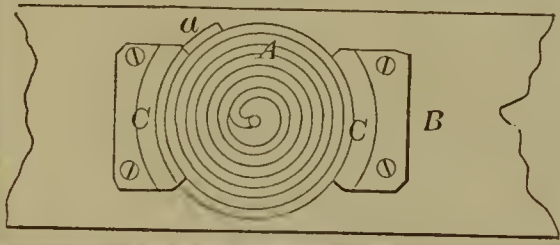

56136—G. D. Woodworth—Grain Cooler.

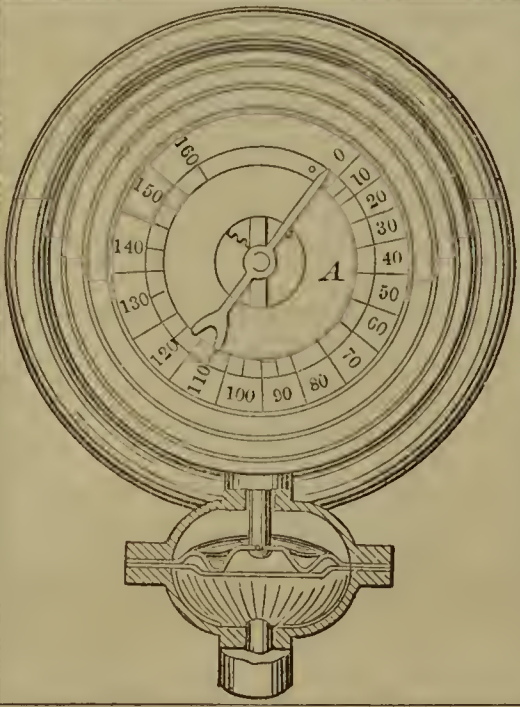
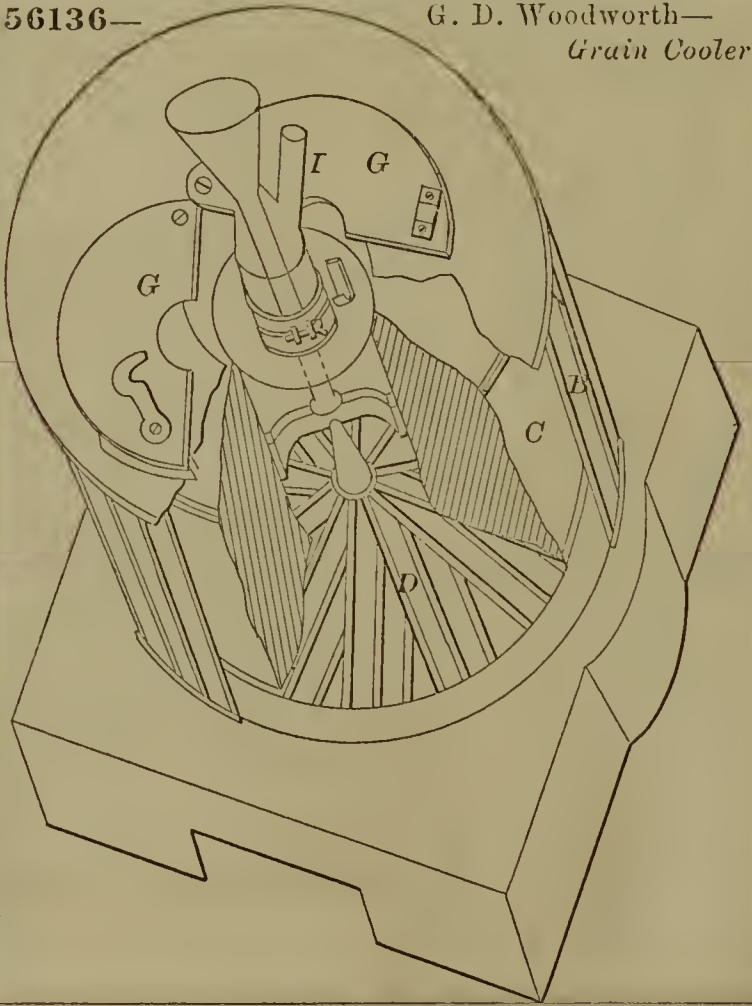

56135—C. A. Wilson—Steam Gauge.



56140—W. Blessing—Preparing Cotton Seed for Planting.

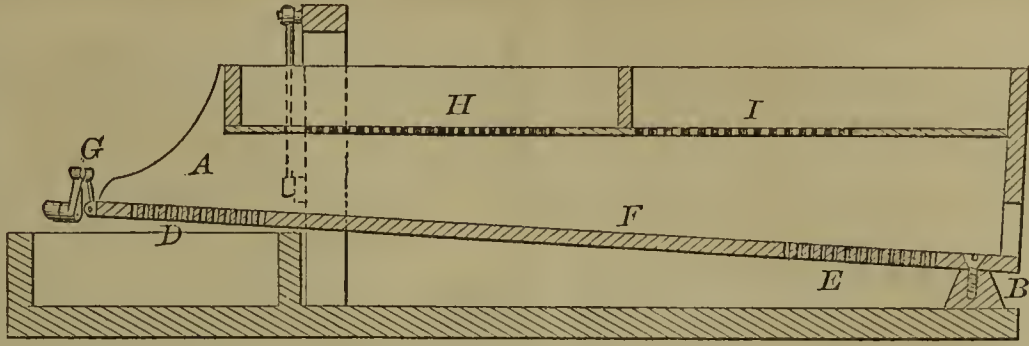

56142—J. E. Emerson—Saw.



56138—T. L. Yates—Sawing Machine.

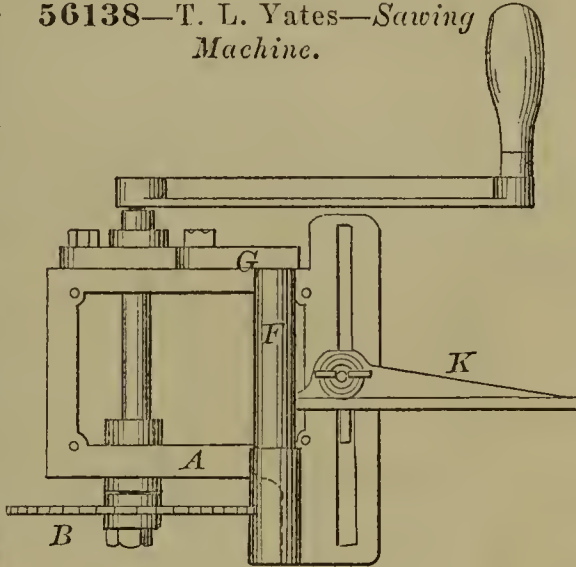

56139—C. H. Bagley—Safety Pocket.

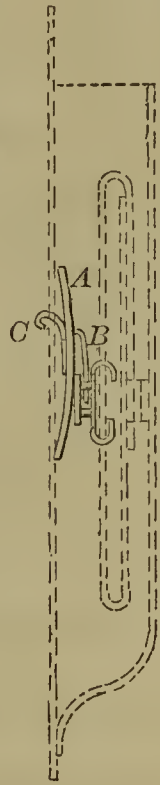

56137—W. G. Wright—Tubular Well.



56144—B. Harrington—Knife for Removing Hair from Hides.



56141—T. Cooper—Turning or Planing Iron.

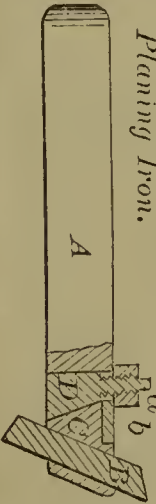

56143—A. J. Griffin—Gas Burning Apparatus.

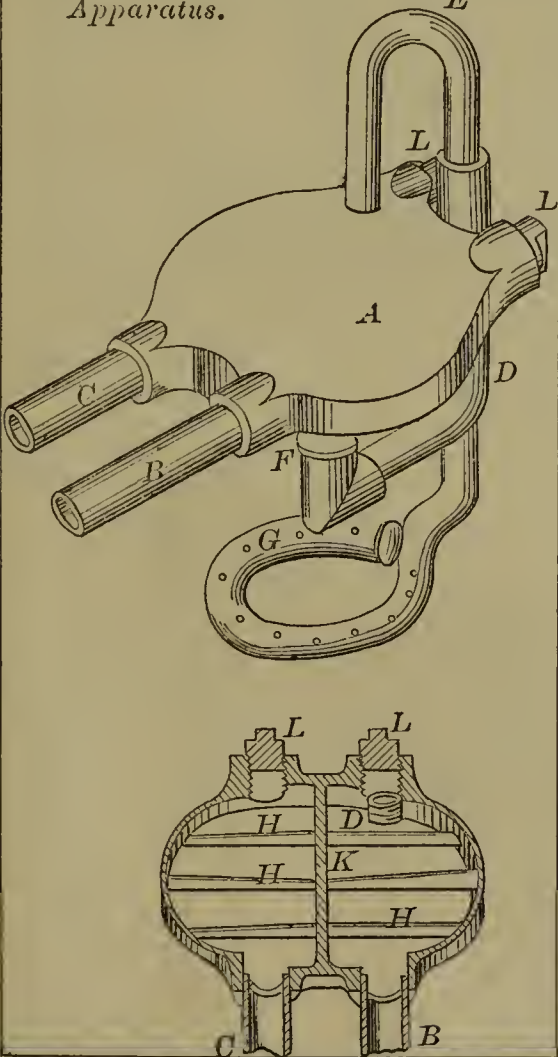

56145—C. Leffingwell—Head Block for Saw Mills.

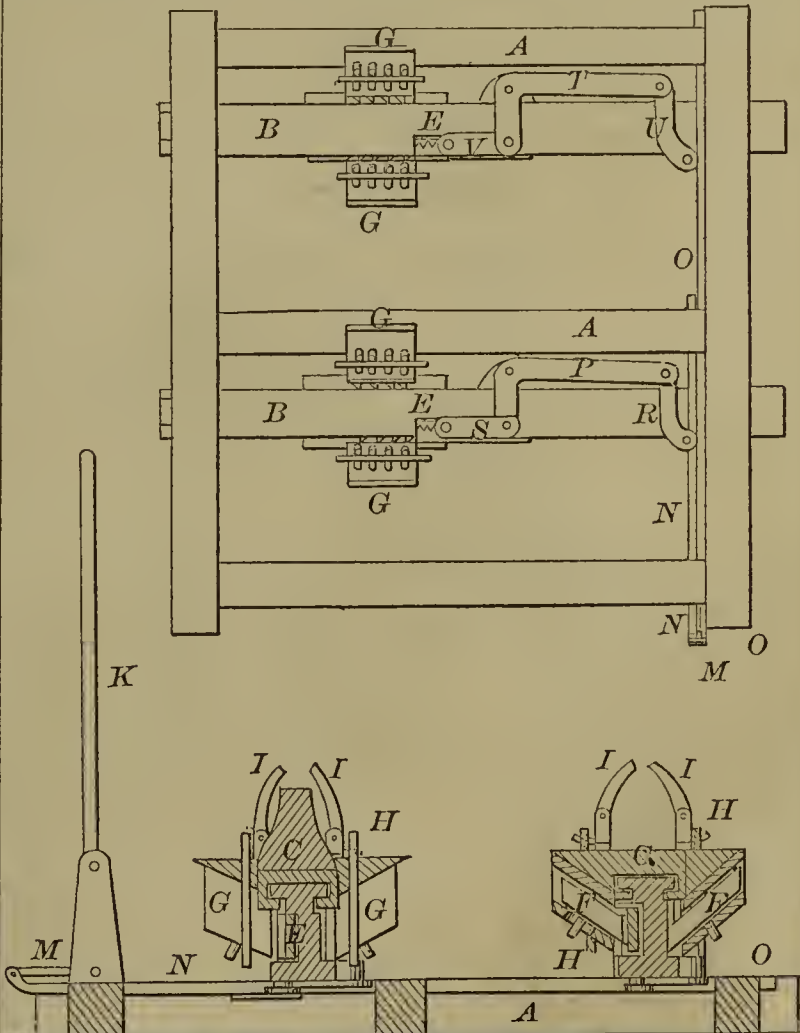

56146—L. W. McFarland—Hoop Skirt Clasp.

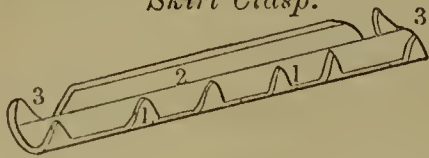

56150—S. B. Pike—Quartz Crusher.

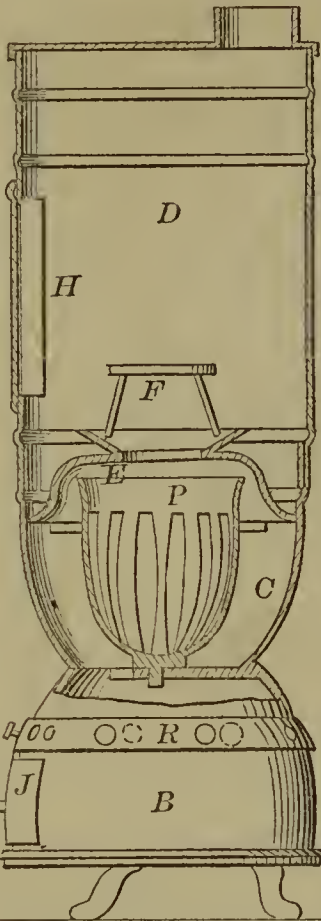
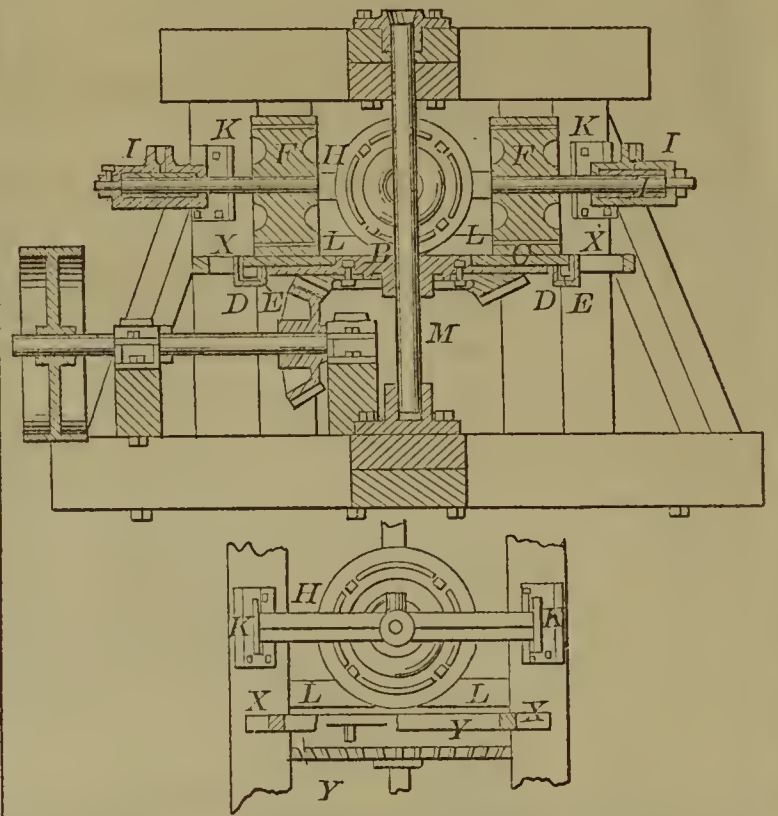

56148—J. W. Paige—Coal Stove.

56153—G. L. Witsil—Churn.

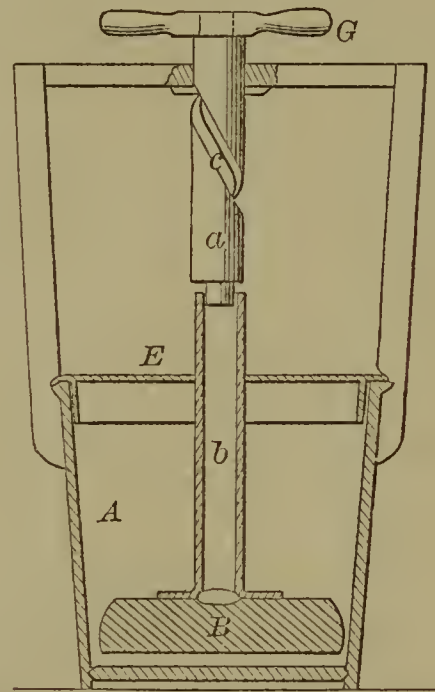

56149—E. Parker—Gear Cutter.

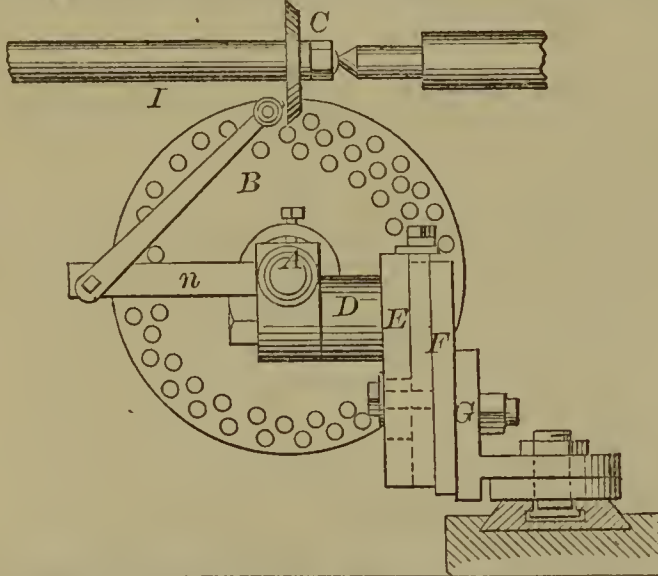

56152—P. L. Weimer—Metal Tube Machine.

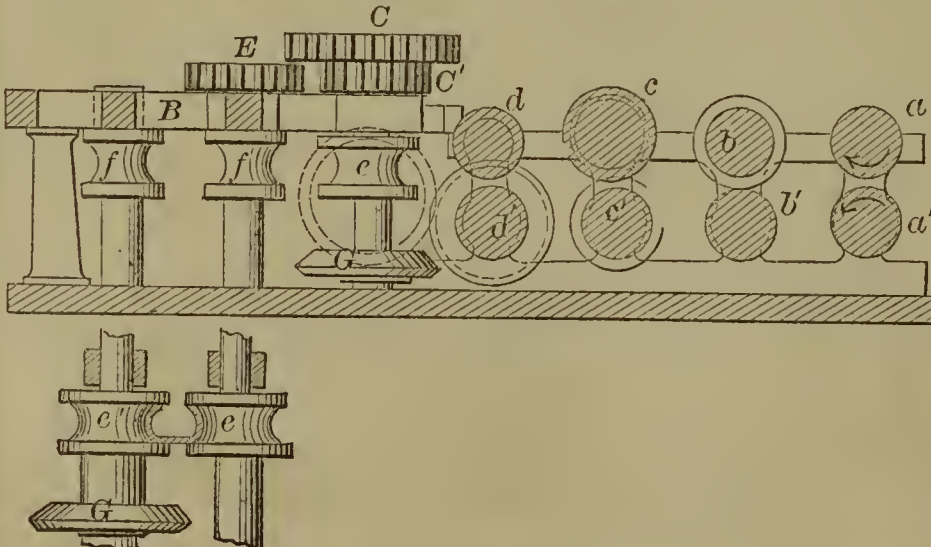

56147—A. M. Olds—Wrench.

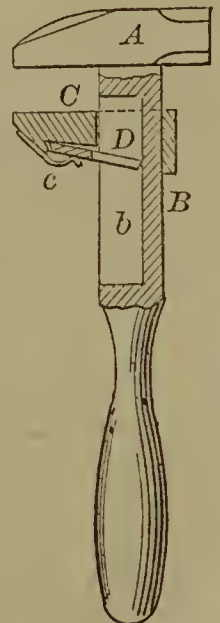

56157—Anderson & Edwards—*Cultivator.*

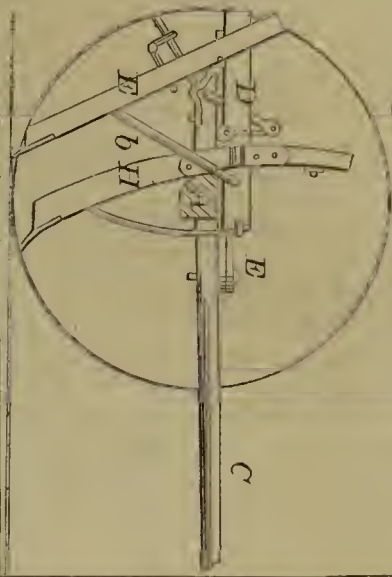

56154—J. Worrall—*Refrigerator.*

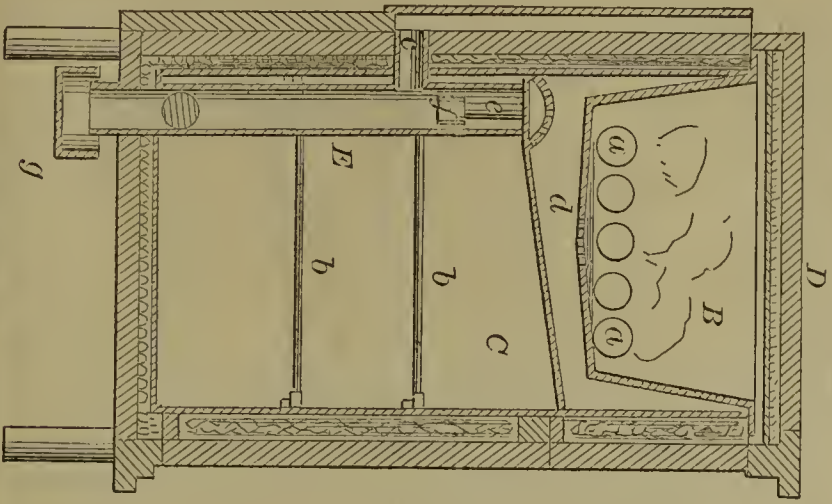

56156—W. Murphy—*Liquid and Spirit Meter.*

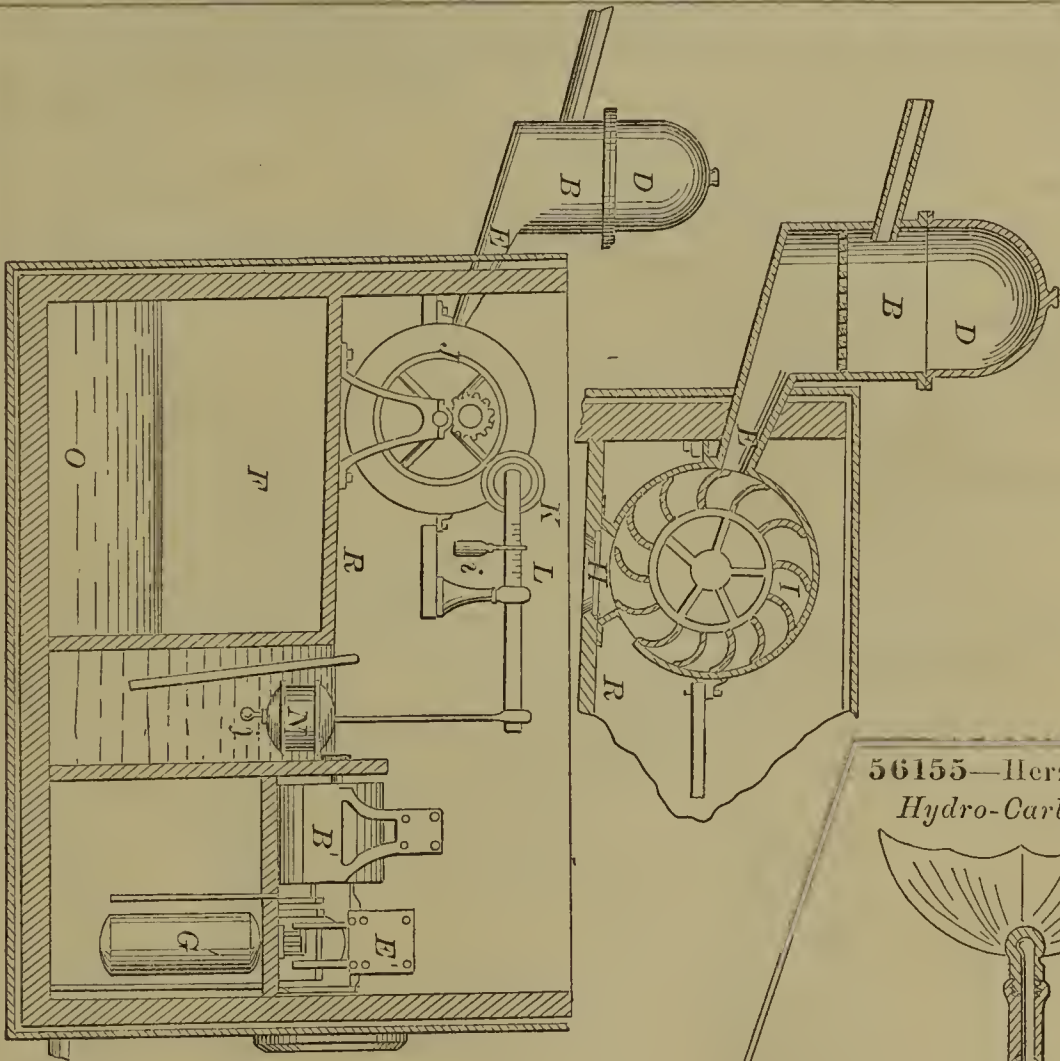

56155—Herzog & Cohn—*Hydro-Carbon Burner.*

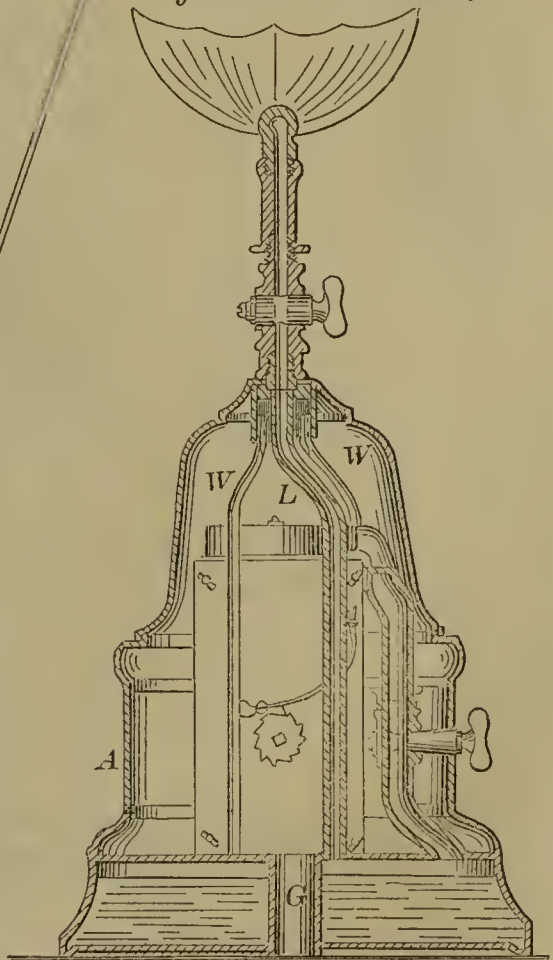

56158—B. Arnold—*Feeding Trough for Stock.*

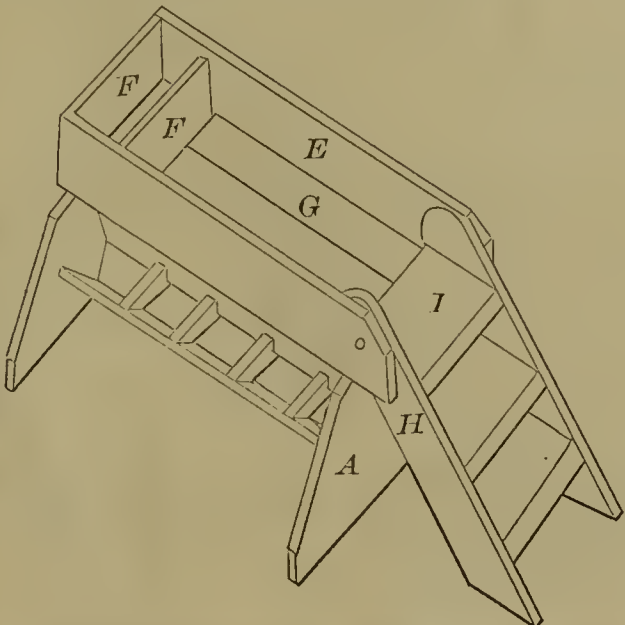

56159—J. Ayers—Harrow.

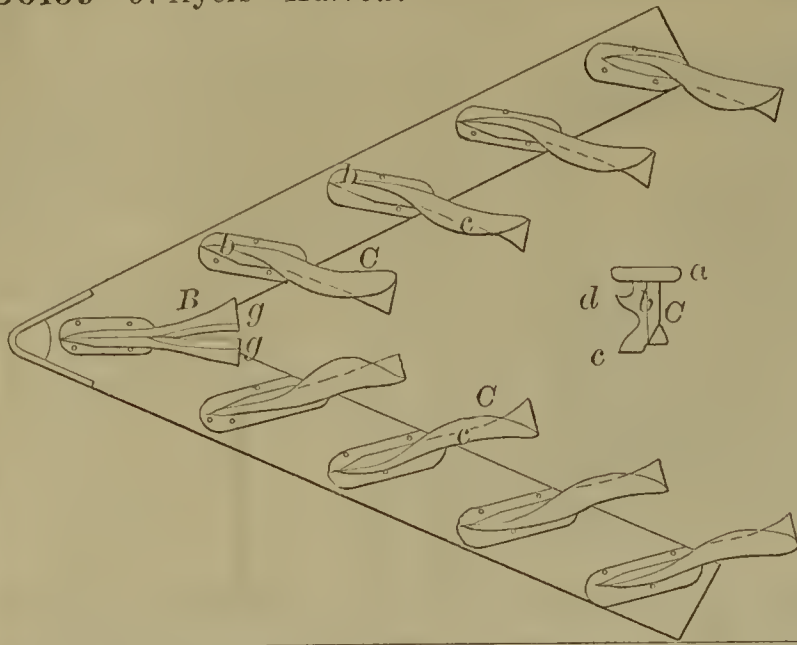

56160 G. E. Baker—Hanging Bells.

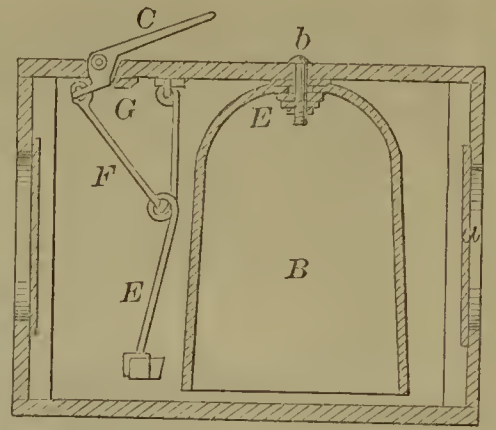

56161—H. H. Baker—Horse Shoe.

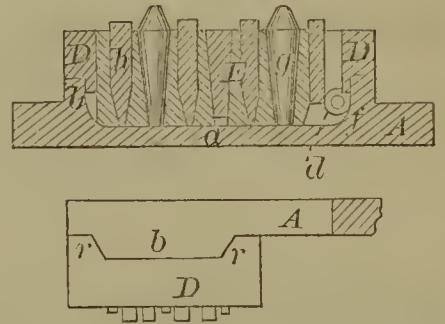

56162—F. G. Bakes—Broom Head.

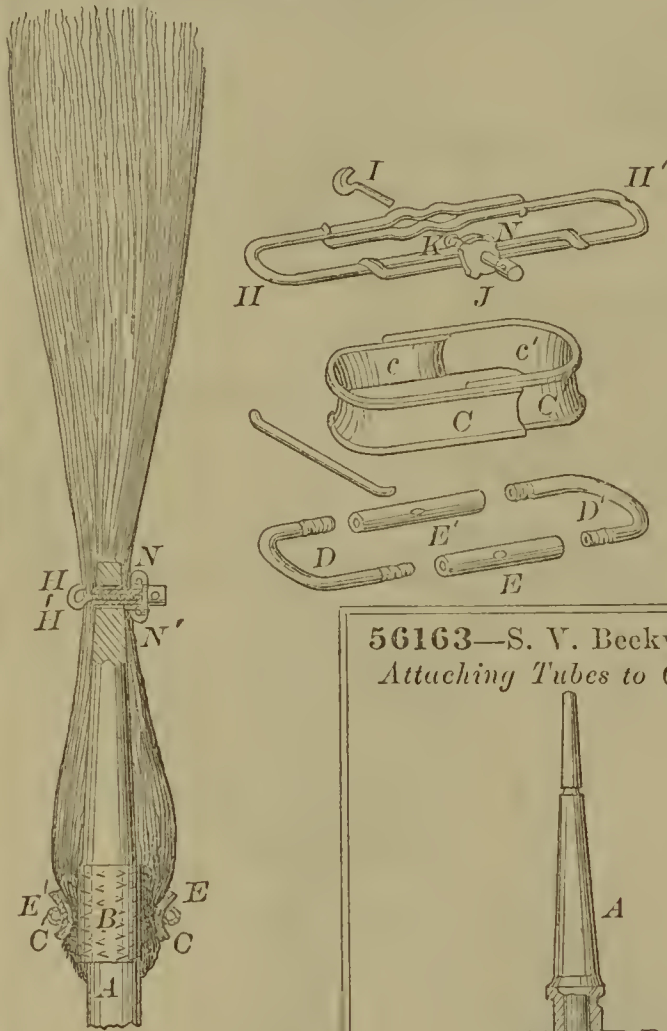

56163—S. V. Beckwith—Attaching Tubes to Oilers.



56165—Bigelow & Murray—Blower.

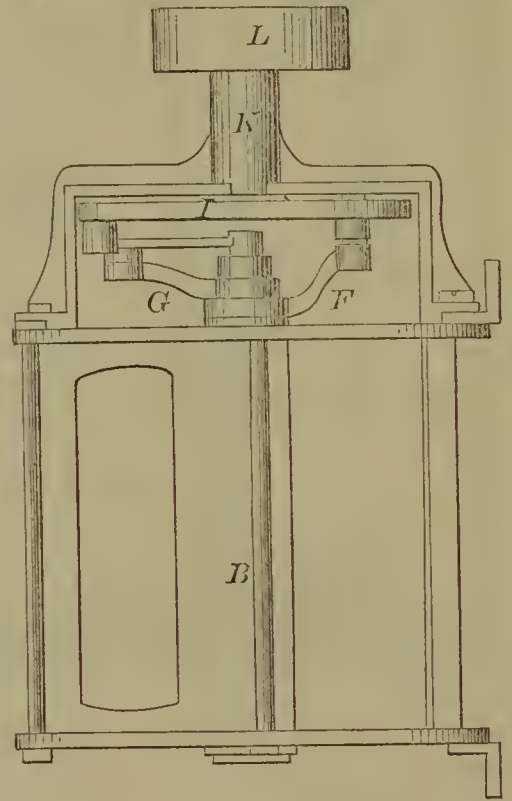

56164—W. N. Berkeley—To Turn Tapering Shafts.

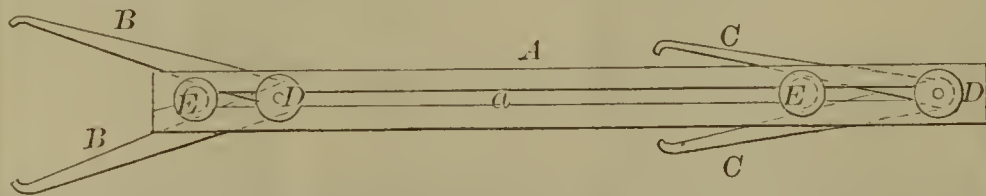

56166—B. Boardman—Tool.

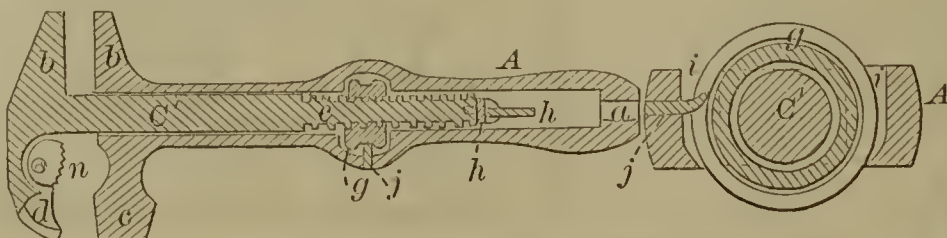

56168—P. Born—Carpet Bag Frame.

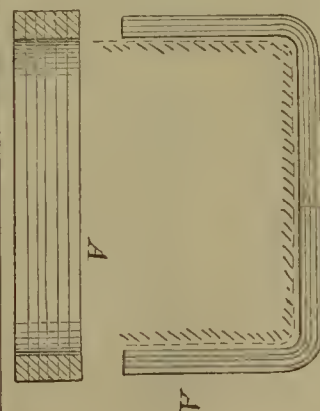

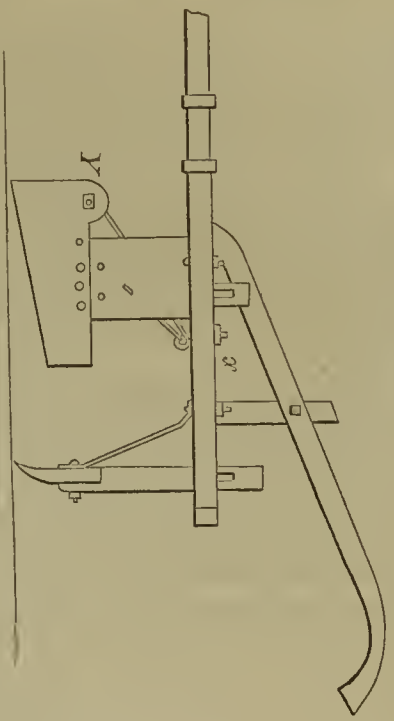

56173—R. Bullock—Cultivator.

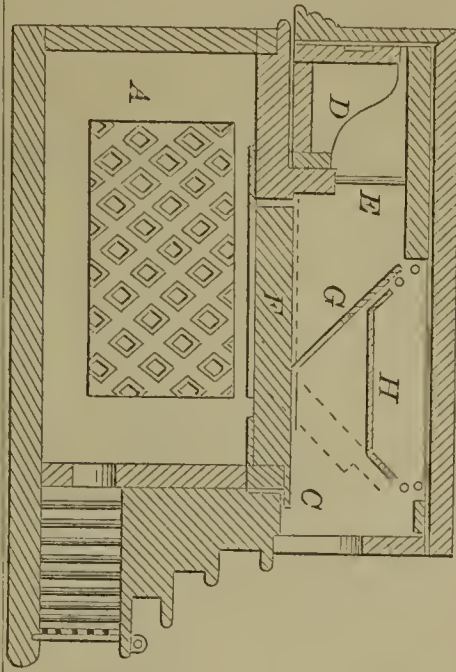

56175—W. H. Campbell—Animal Trap.

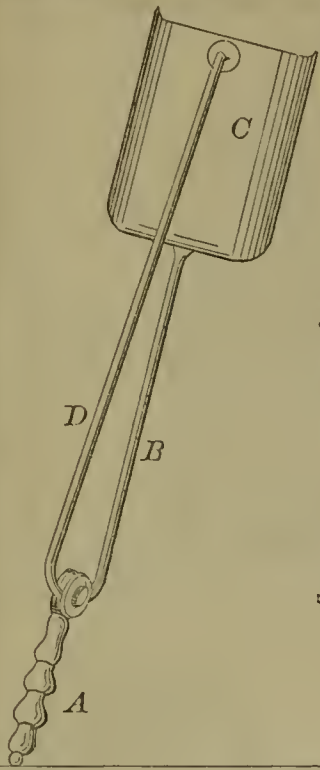

56169—R. D. Brady—Shovel and Tongs.

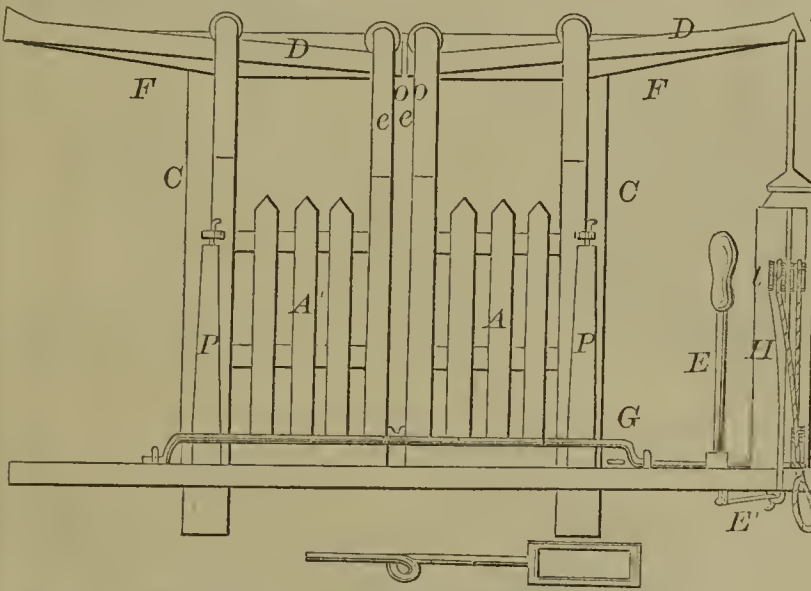

56174—J. P. Cadman—Gate.

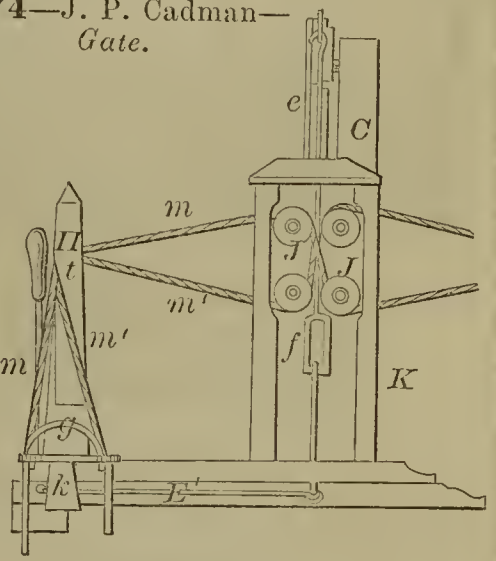

56171—J. Brizee—For Transmitting Motion.

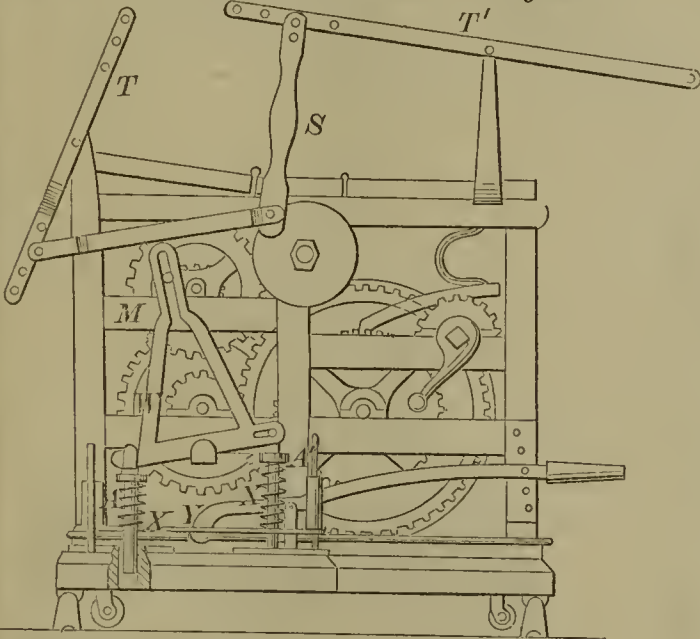

56172—A. P. Brown—Feed Stop for Lathes.

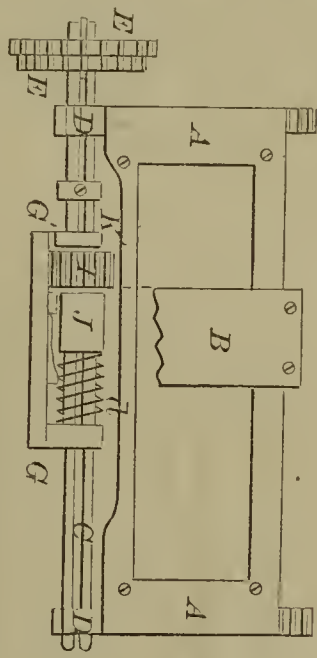

56170—A. C. Briggs—Horse Hay Fork.

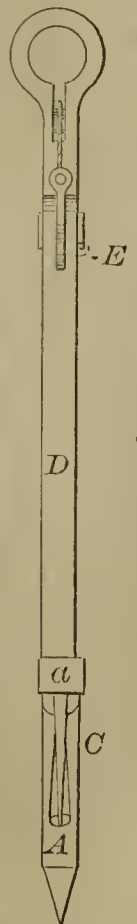

56176—Carlisle & Bowers—Cheese Vat.

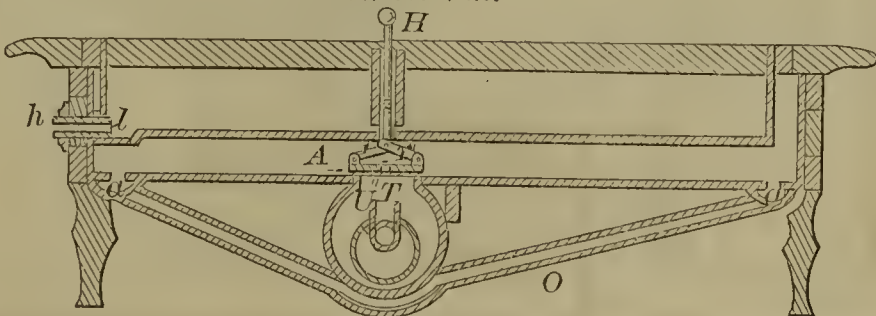

56177—Chase & Tiffany—  
Grain Separator.

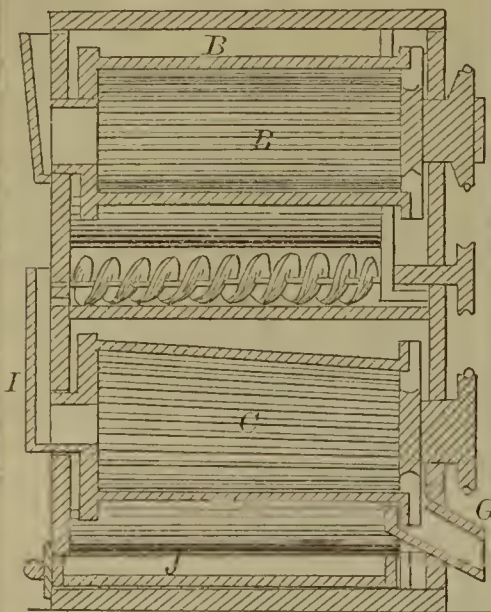

56184—J. E. D. Comstock—For Holding Books.

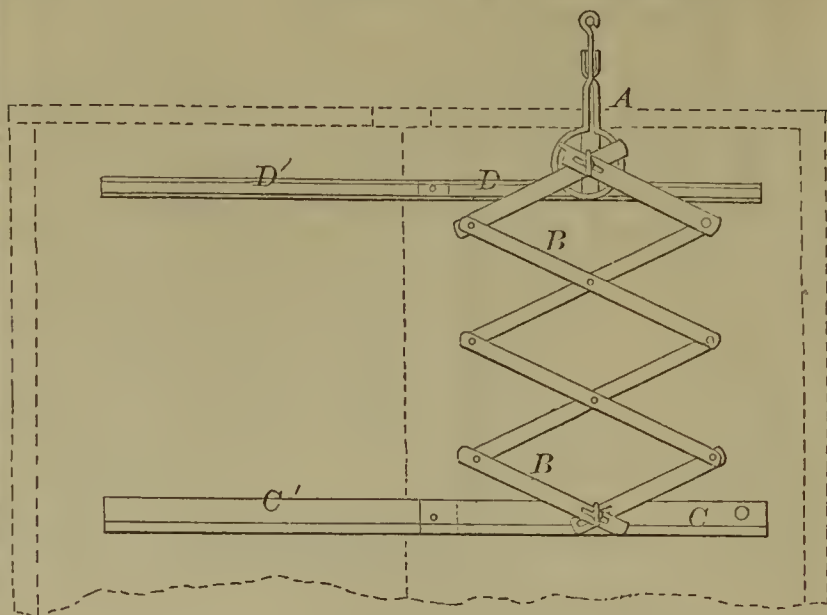

56183—W. Cogswell—Corn Planter.

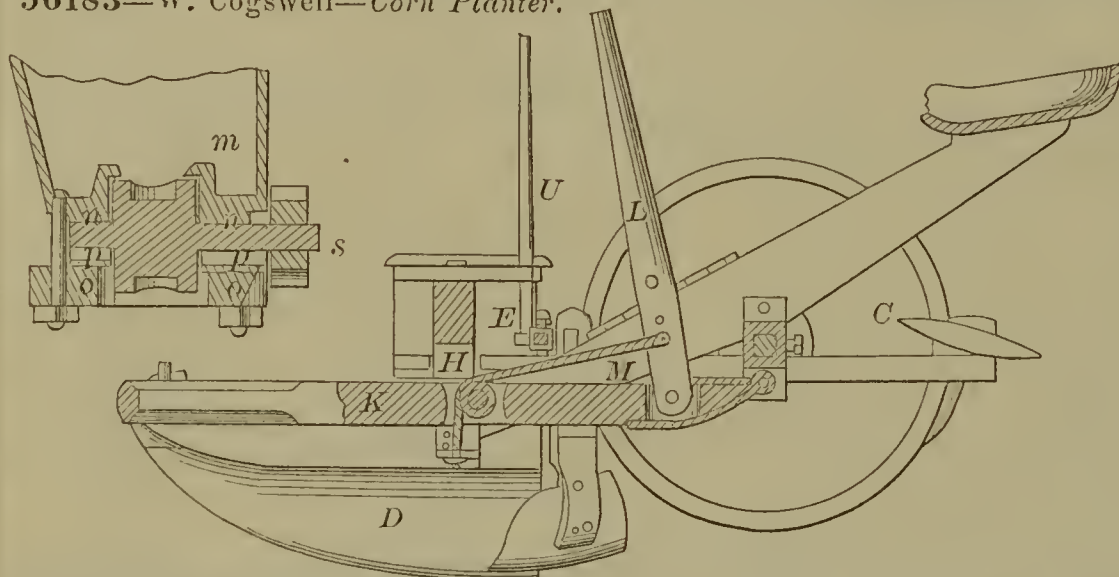

56178—  
O. N. Chase—  
Microscope.

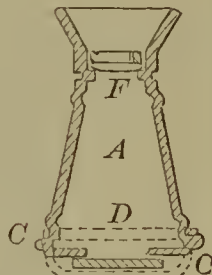

56181—J. N. Clarke—Horse Shoe.

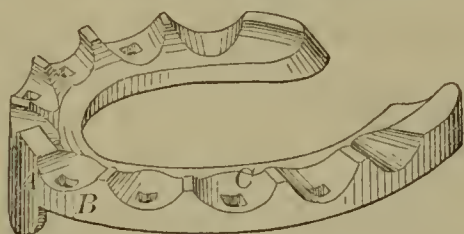

56186—J. Crawley—Governor Stop Valve.

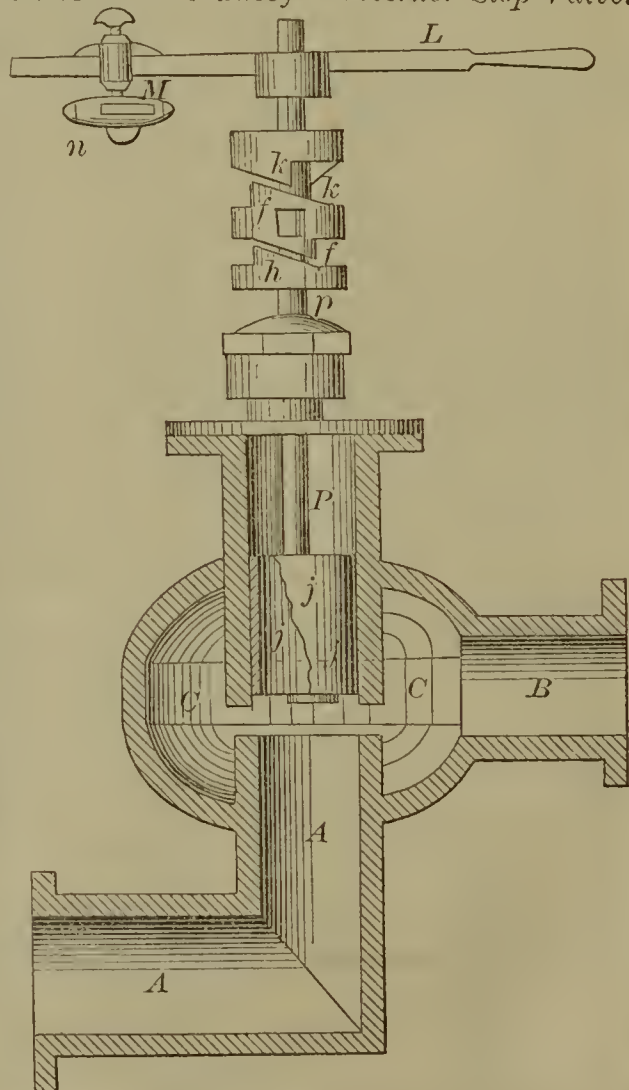

56182—D. Clarke—Coffin.

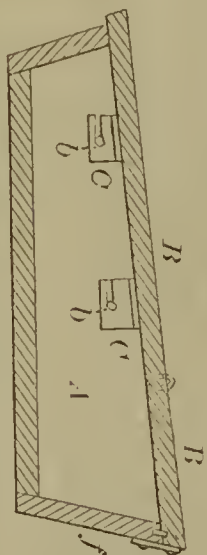

56185—R. Conaroe—Sorghum Mill.



56188—J. Day—For Holding Sheep for Shearing.

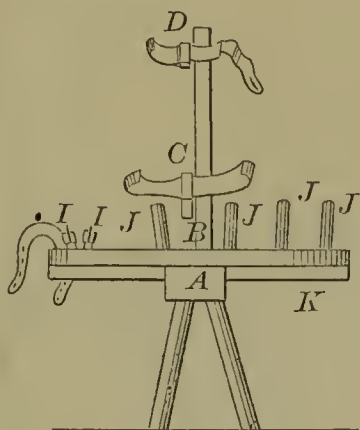

56190—F. F. Dieterichs—Button Hole.

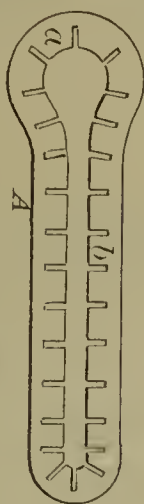

56189—G. Deal—Horse Rake.

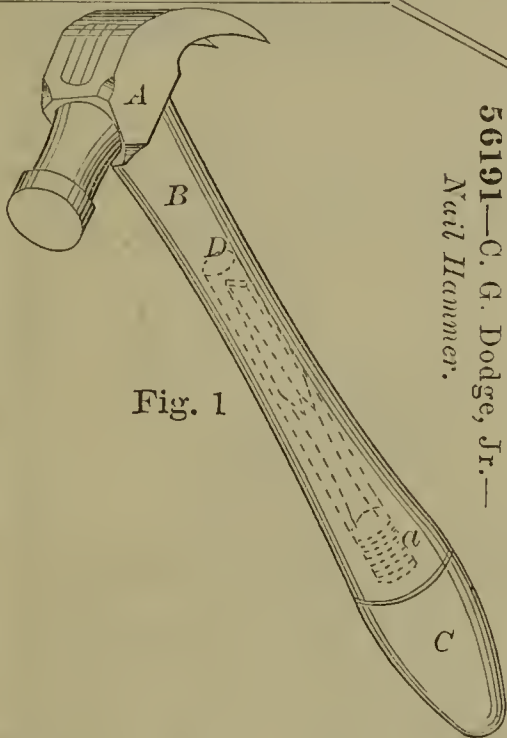
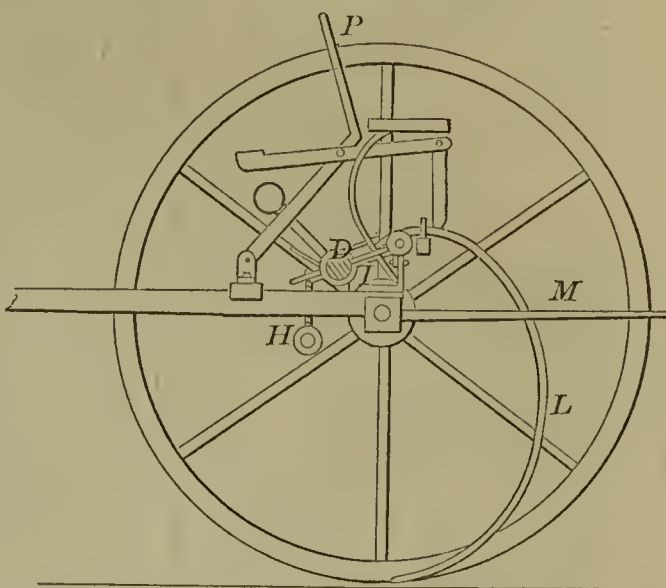
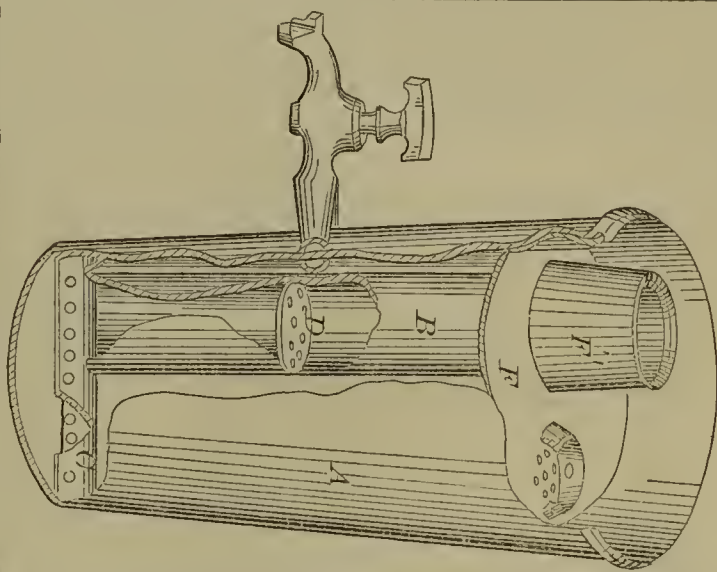

Fig. 1

56191—C. G. Dodge, Jr.—Nail Hammer.



56193—N. Downes—Filter.

56195—S. E. Ellis—Wood Boring Machine.

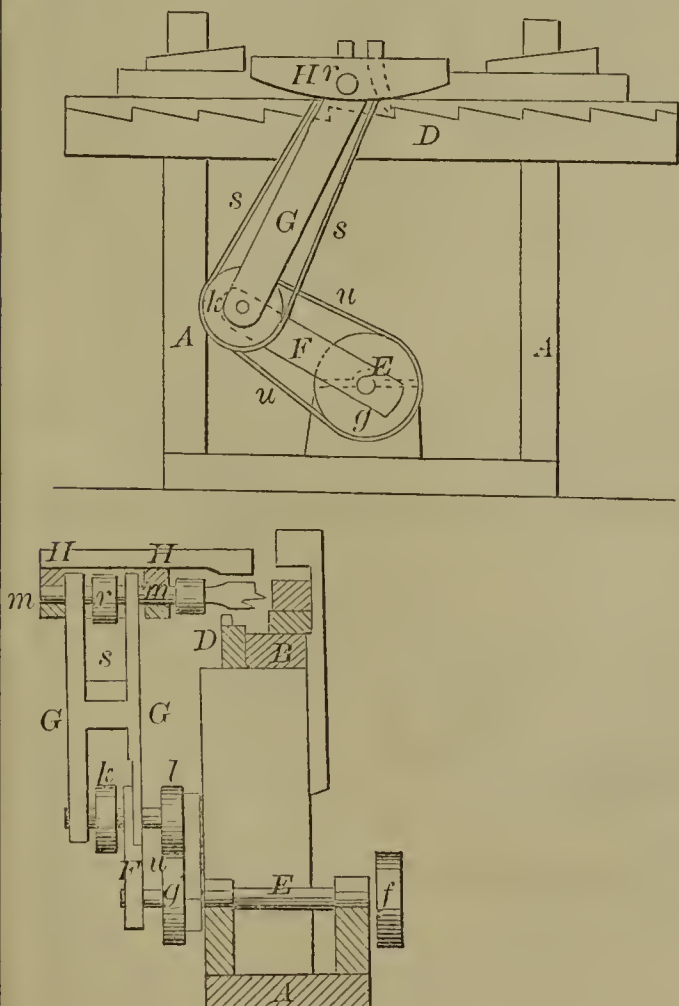

56192—W. M. Doty—Wagon Jack.

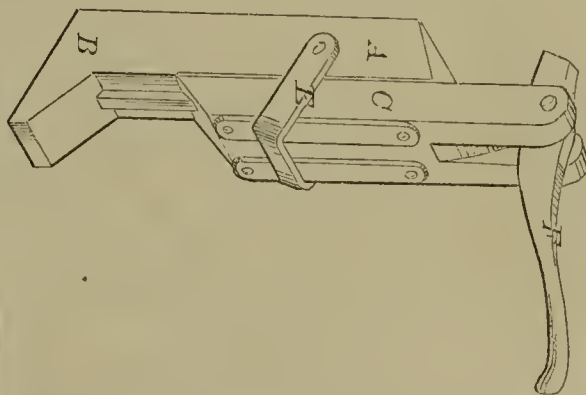

56194—J. F. Dunham—Grain Separator.

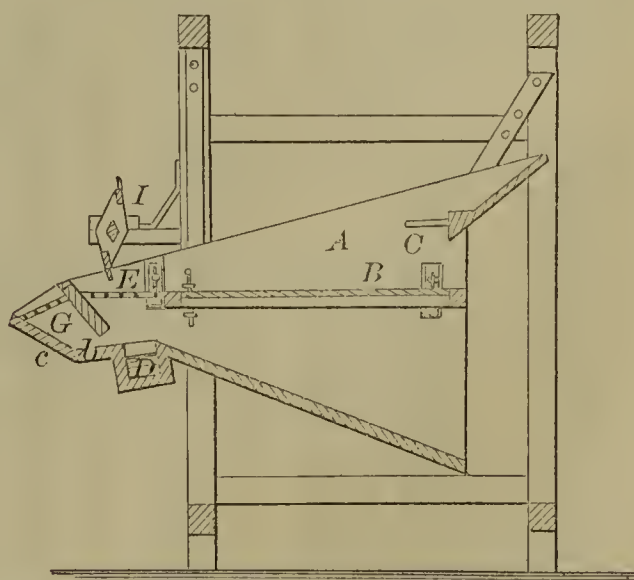

56196—J. A. Eshleman—  
Neck Tie Holder.

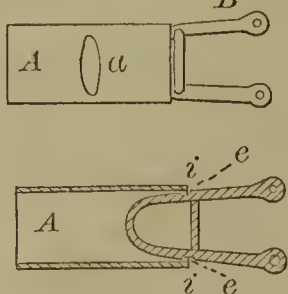

56197—G. W. Ferris—*Refining Spirituous Liquors.*

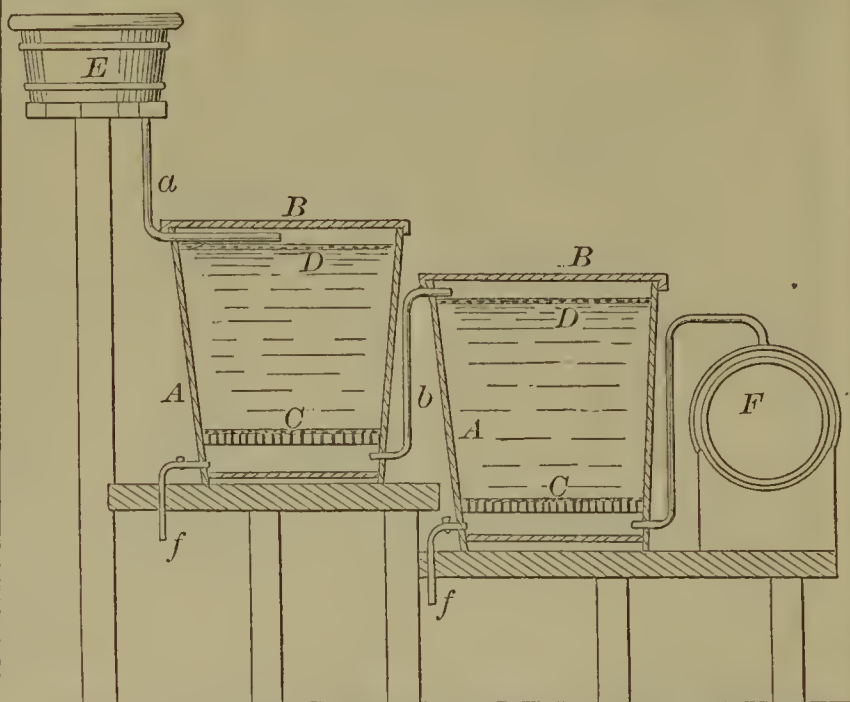

56200—L. W. Fillebrown, Jr.  
*Spring Seat.*

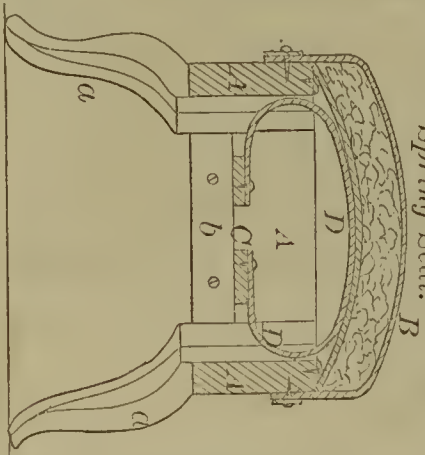

56199—E. Field—*Bellows.*

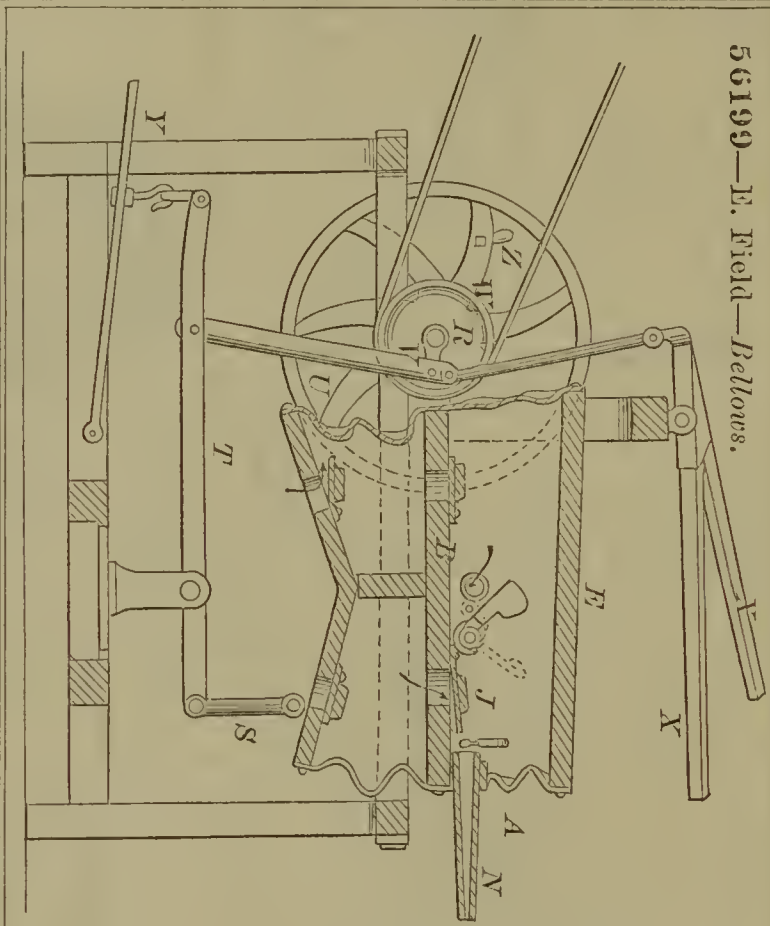

56201—L. F. Frazee—*Life Raft.*

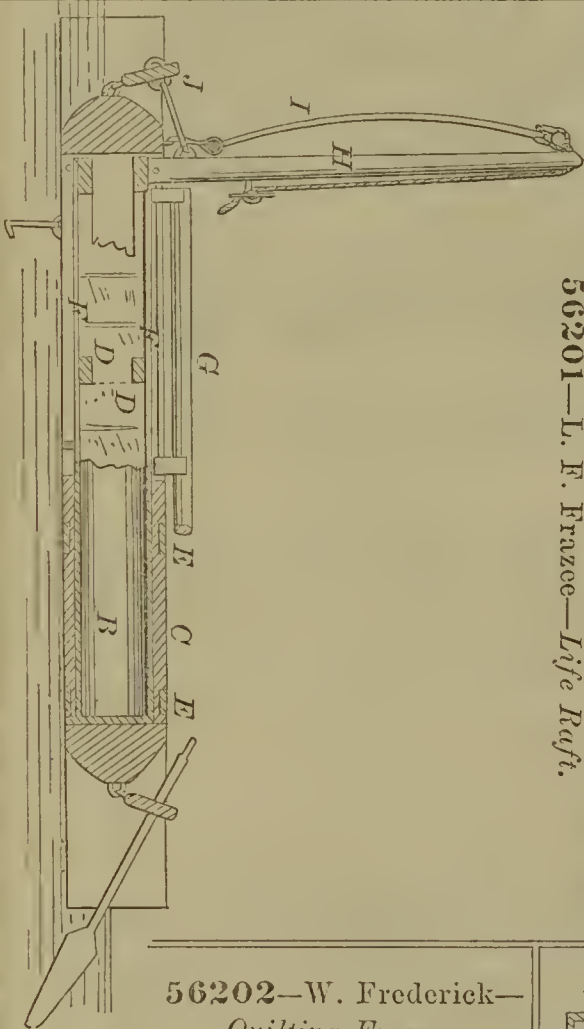

56202—W. Frederick—  
*Quilting Frame.*

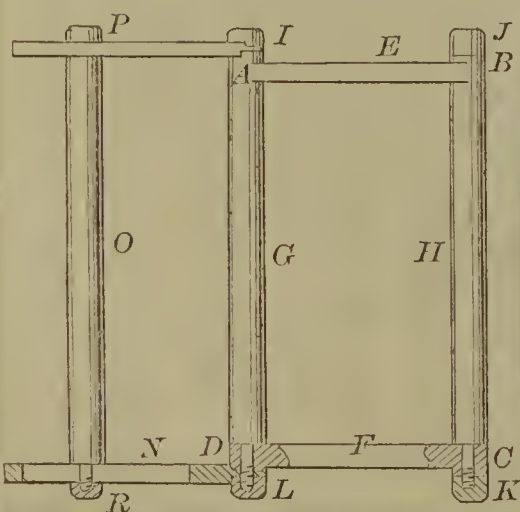

56203—C. Geisse—*Illuminating  
Apparatus.*

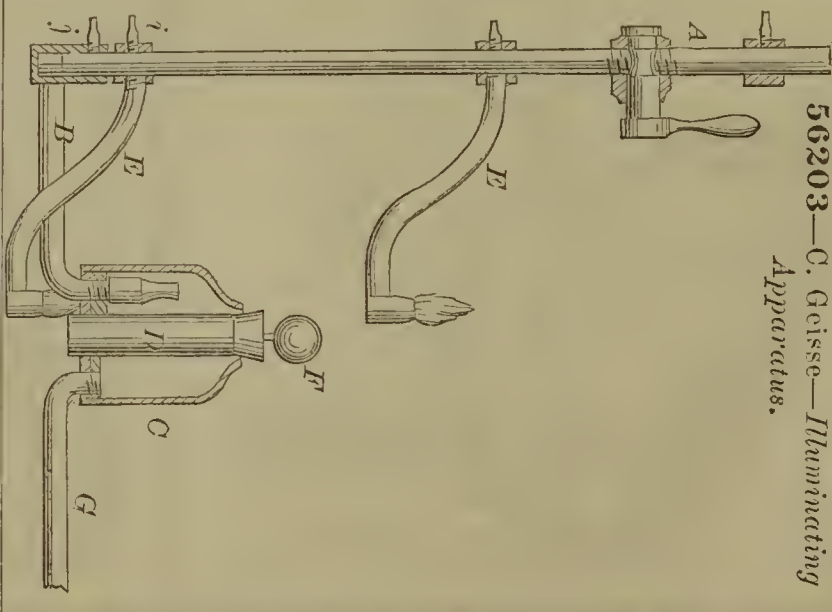



56206—S. D. & S. Gilson—Peat Machine.

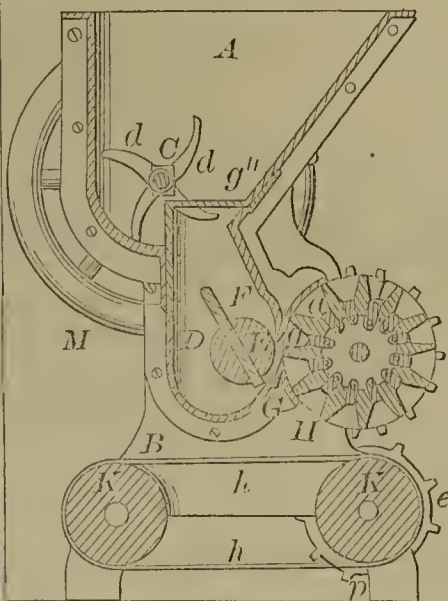

56204—C. Geisse—Gas Heater.

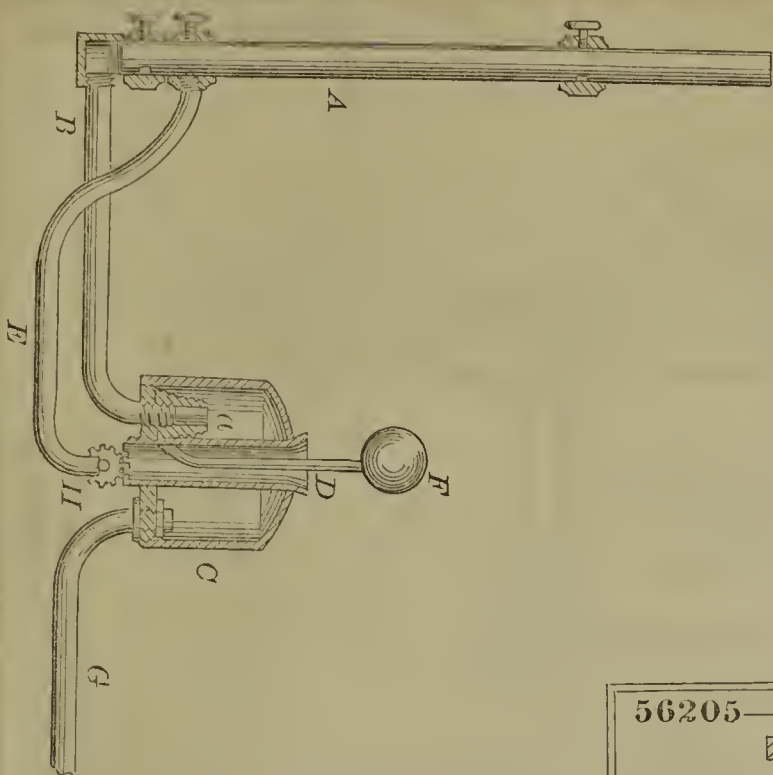

56205—P. M. Gilbert—Sugar Press.

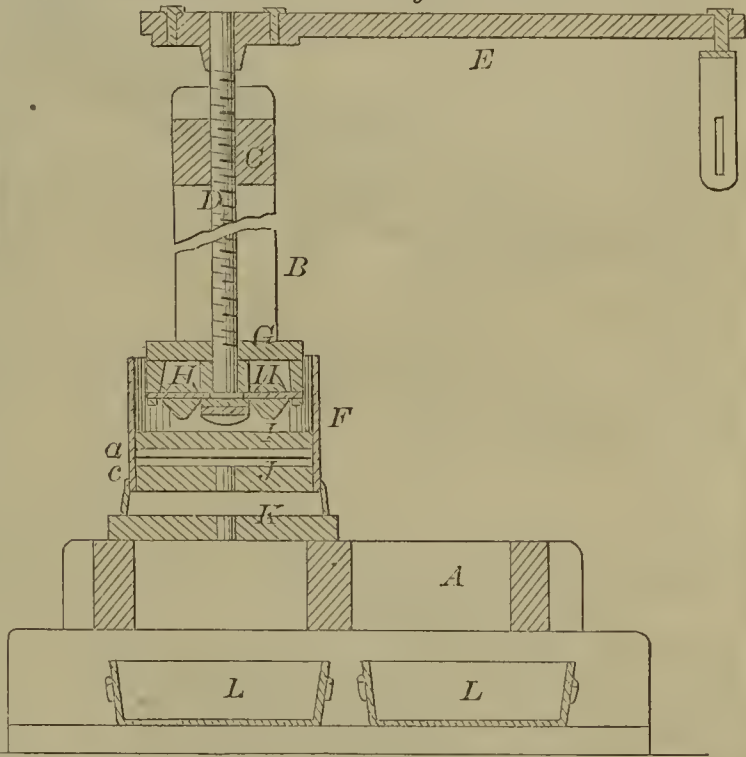

56209—F. C. Gridley—Weather Strip for Doors

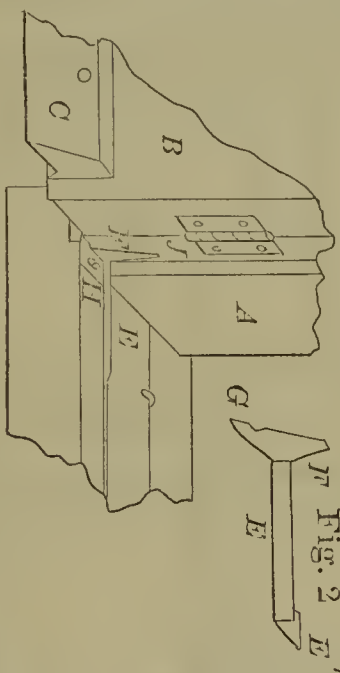

56207—X. W. Gordon—Coupling for Vehicles.

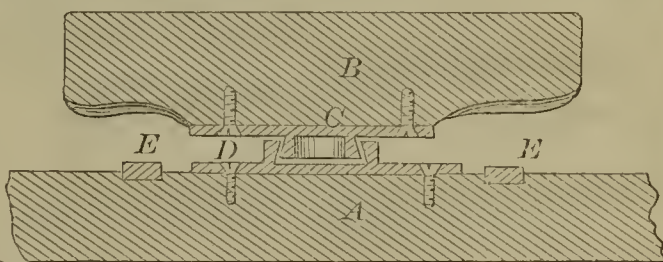

56210—C. A. Griswold—Skirt Supporting Corset.

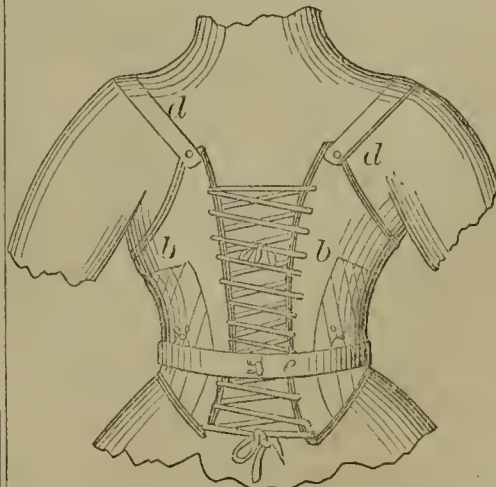

56208—J. Green—Printing Textile Fabrics.

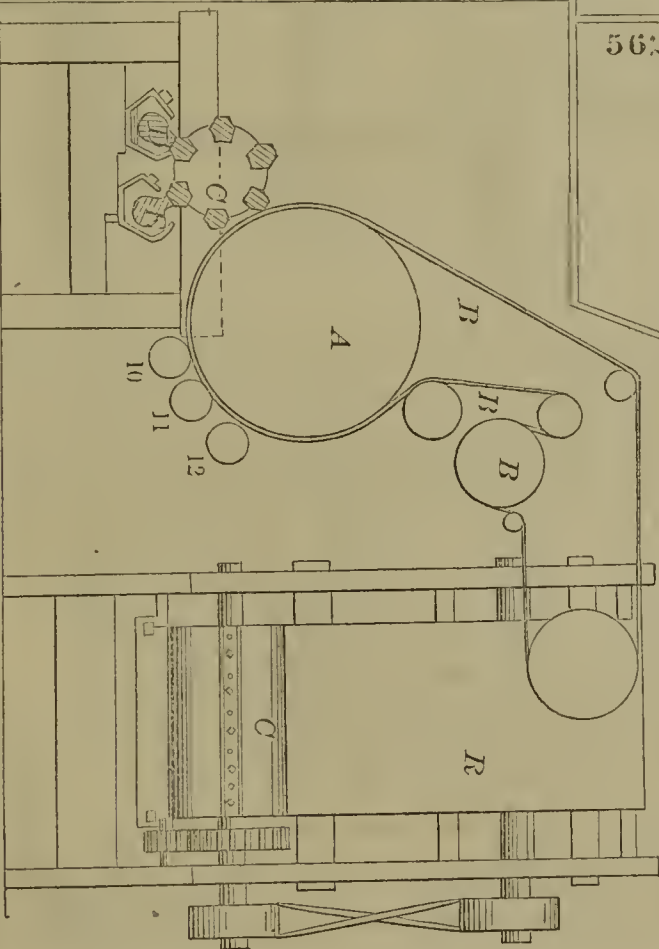

56211—W. A. Guyer—Invalid Bedstead.

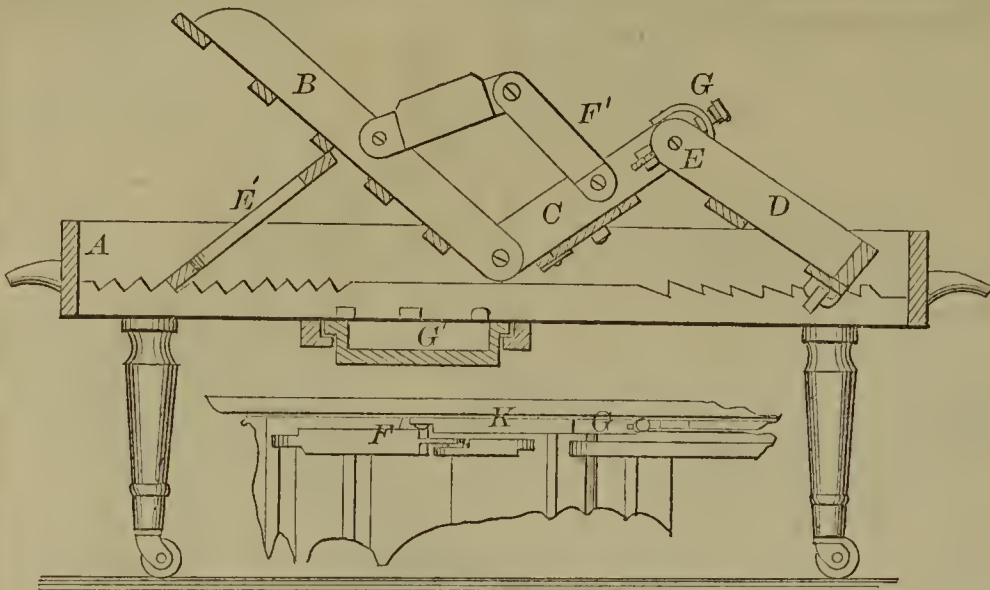

56213—J. C. Haines—Bridle.

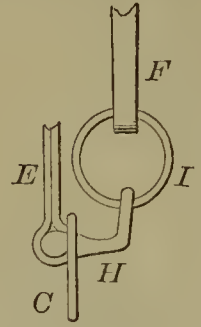

56215—P. H. Hardy—Washing Machine.

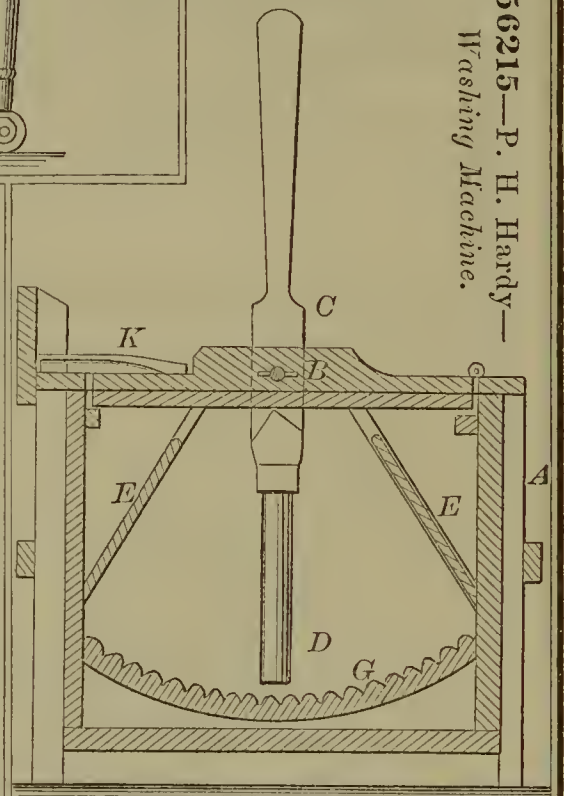

56214—F. Handsehuh—Combined Chair and Fan.

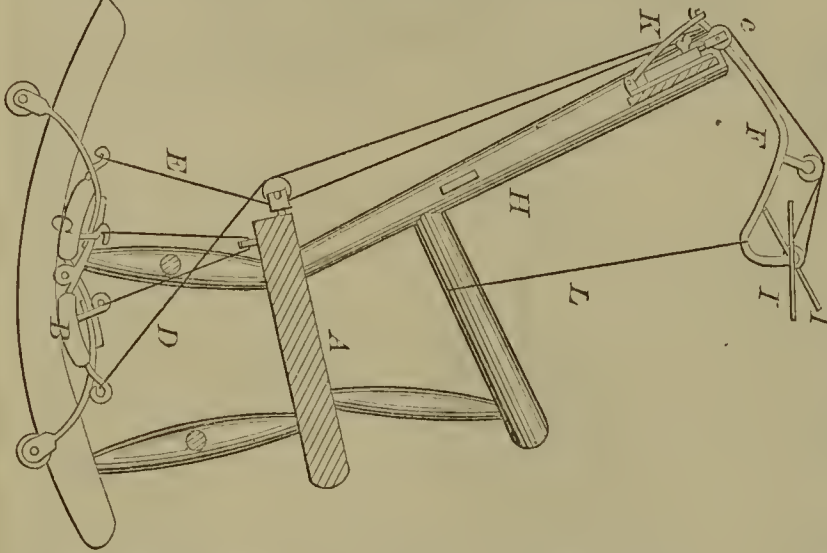

56218—R. Hartley—Pump.

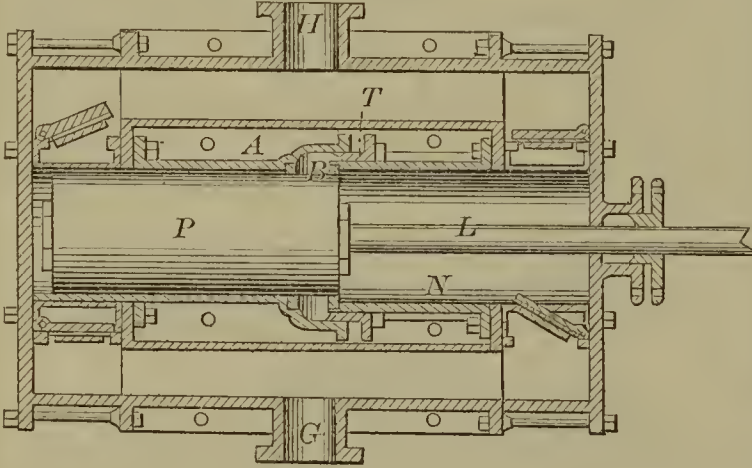

56216—B. S. Harrington—Spring Bed.

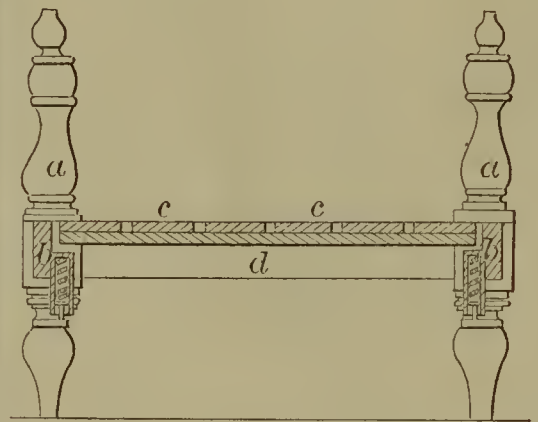

56212—J. Haines—Cheese Cutter.

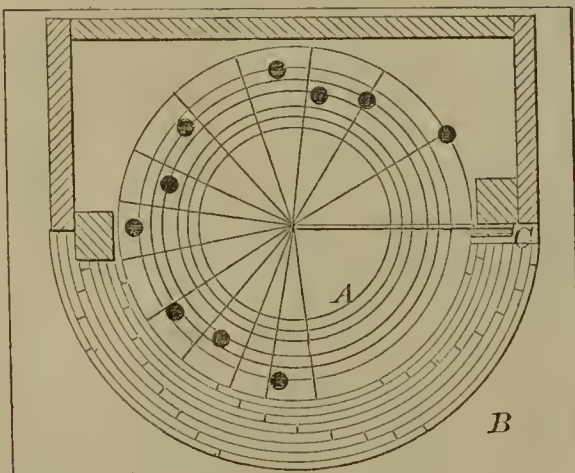

56219—T. Hawkins—Beehive.

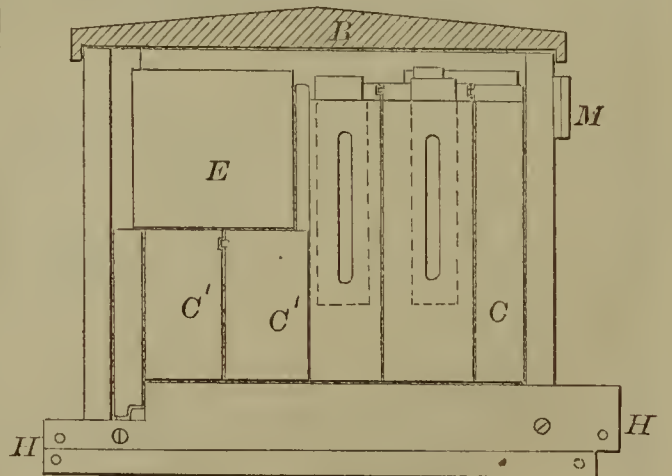

56220—F. Hazard—*For Weaving Wire Rope.*

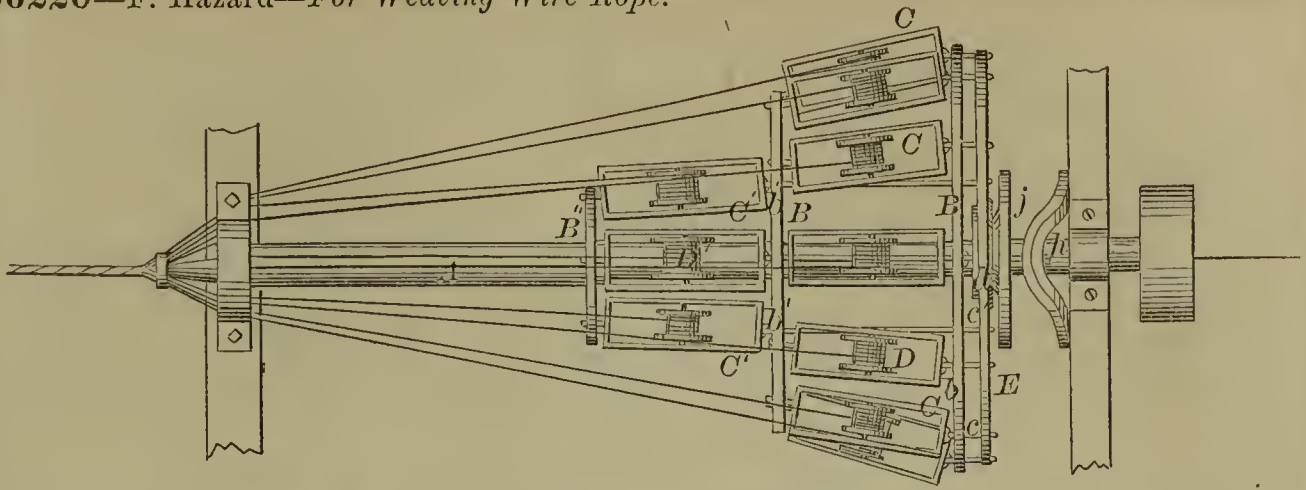

56221—C. W. S. Heaton—*Pantaloons Protector.*



56224—J. A. & H. A. House—*Rotating Hook of Sewing Machines.*

56222—G. L. Heidler—

*Horse Rake.*

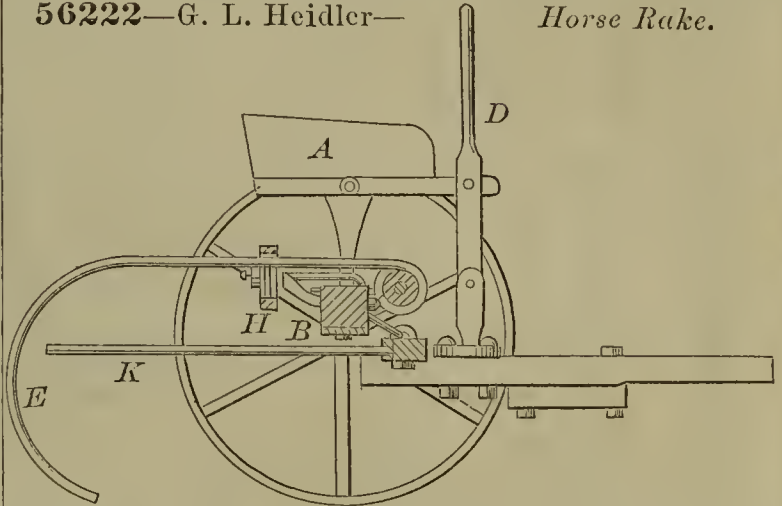

56227—E. O. Jones—*Horse Rake.*

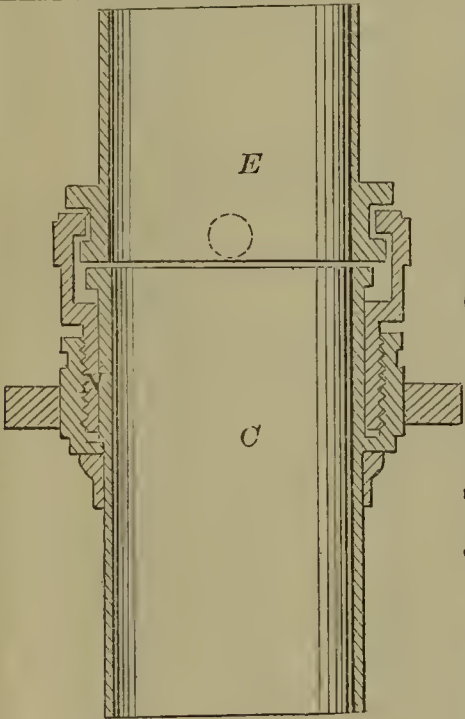
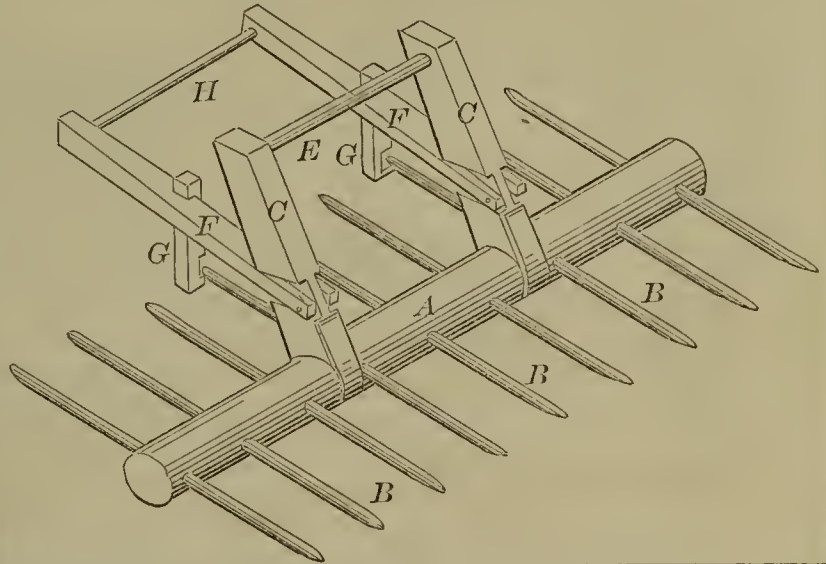

56223—R. Henrage—*Hose Coupling.*

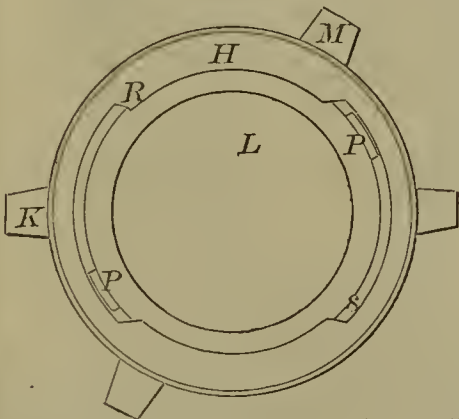

56226—J. Johnson—*Fruit Jar.*

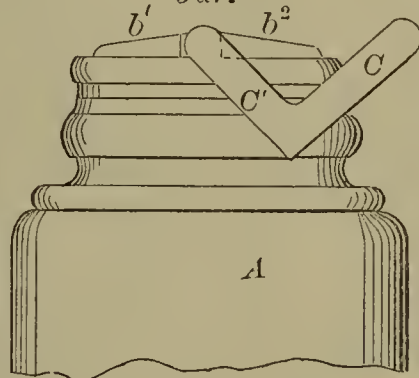

56228—S. F. Jones—*Water Elevator.*

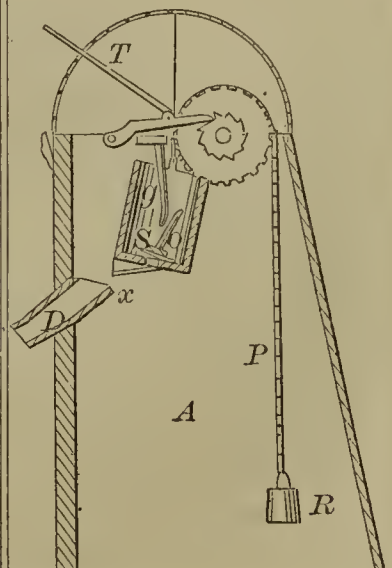

56225—Z. Hunt—*Culinary Sink.*

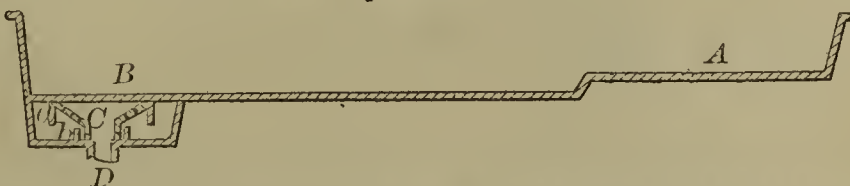

56229—D. Judd—Excavator.

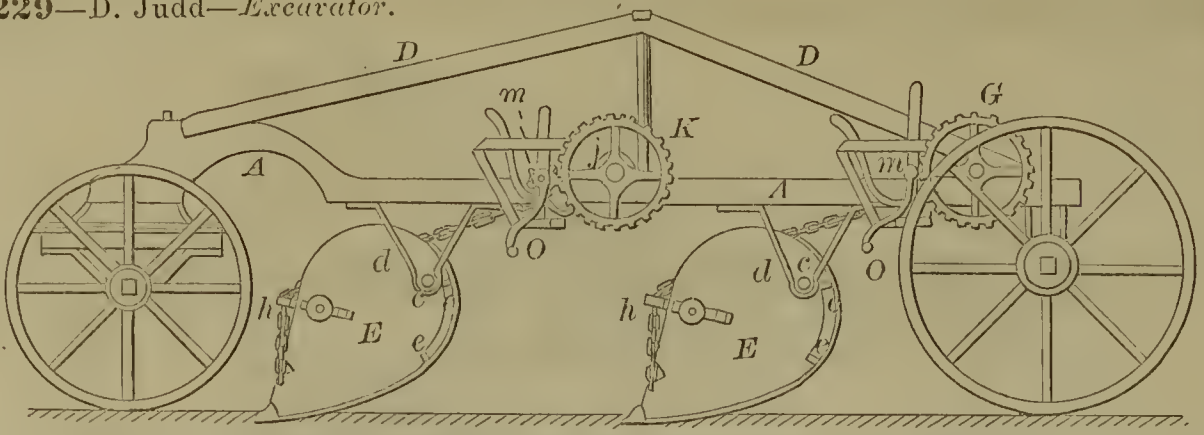

56233—J. King—Oiler.

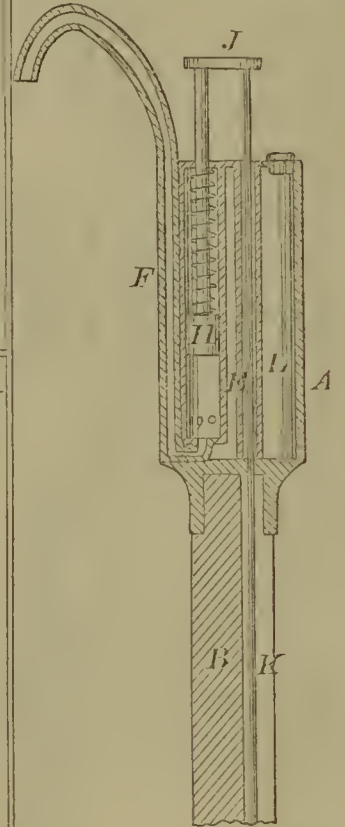

56232—A. C. Kasson—For Cocking.

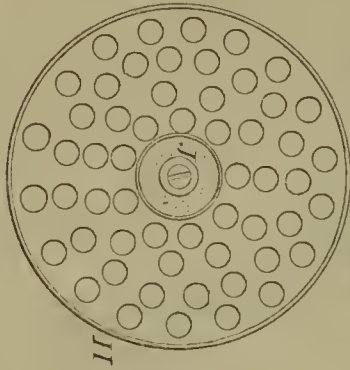
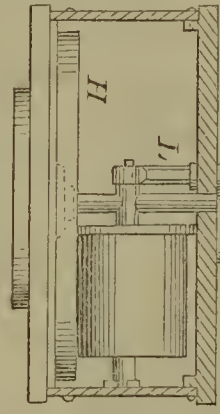

56234—O. B. Latham—Oil Well Tube.

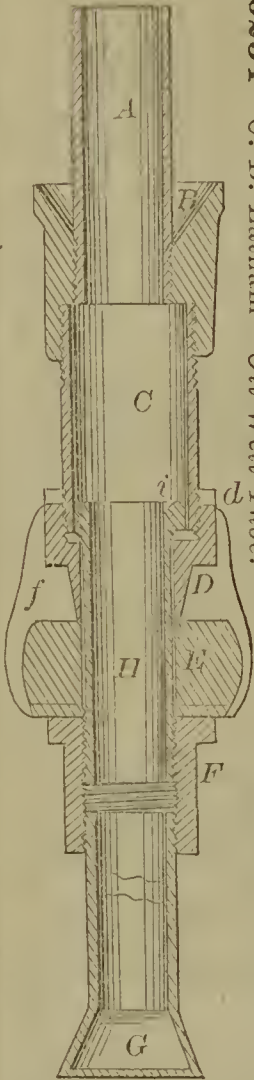

56230—J. J. Justin—Beehive.

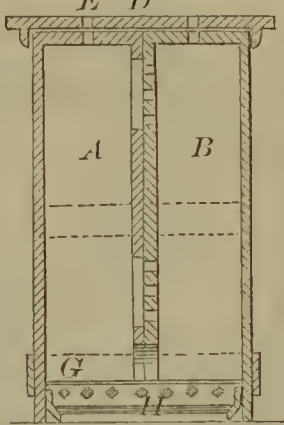

56235—J. Lebeau—Paring Knife.

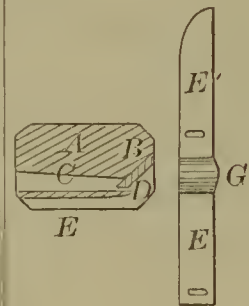

56236—C. M. Lightner—Corn Harvester.

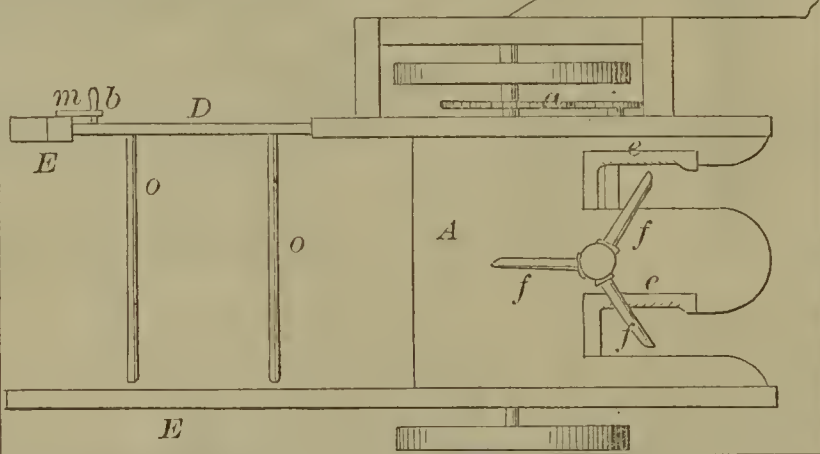

56231—J. E. Karelsen—Diamond Holder.



56237—A. J. & H. Linebarger—Grain Separator.

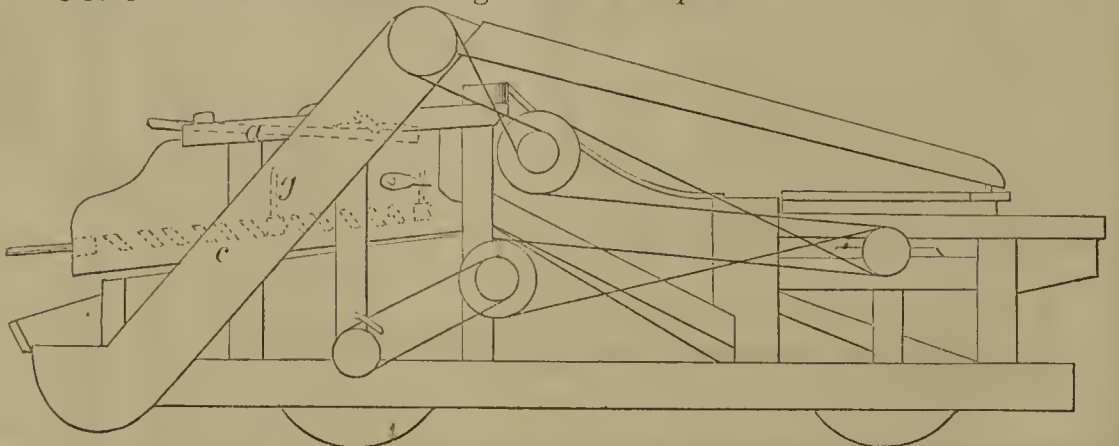

56238—J. Lochridge—Washing Machine.

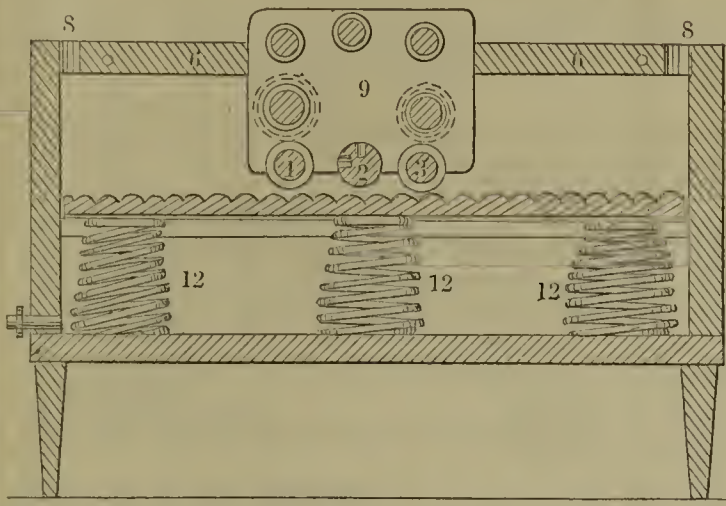

56240—C. Mac Rae—Automatic Gas Cock.



56241—W. Manning—Corn Cake Machine.

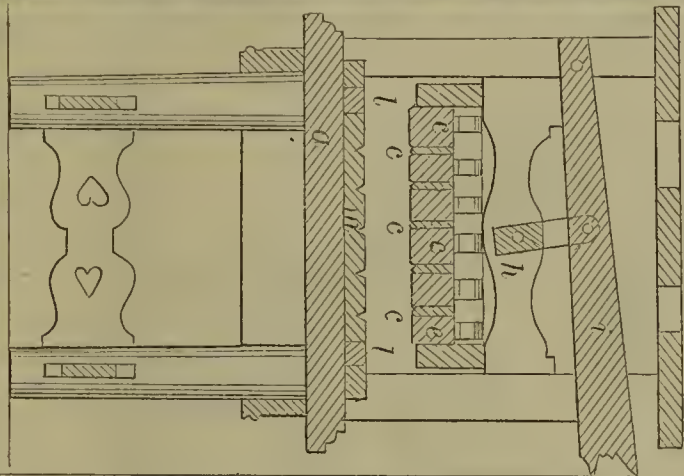

56242—Maxwell & Cope—Steam Engine.

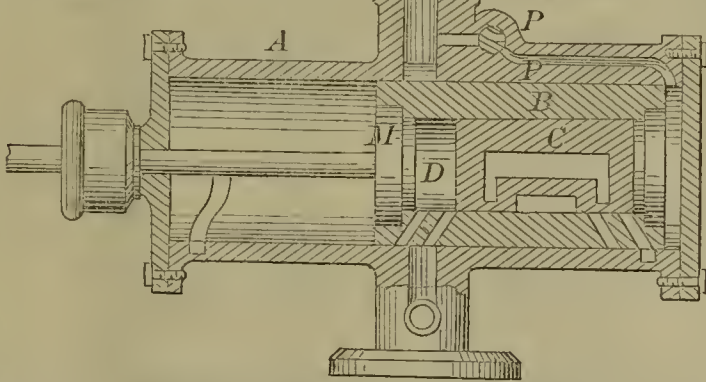

56243—A. McOmber—Artificial Limb.

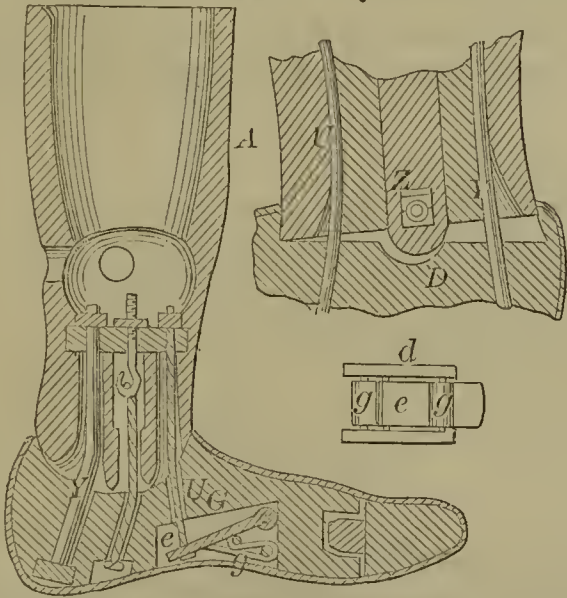

56244—Merriam & Weeden—Embossing Press.

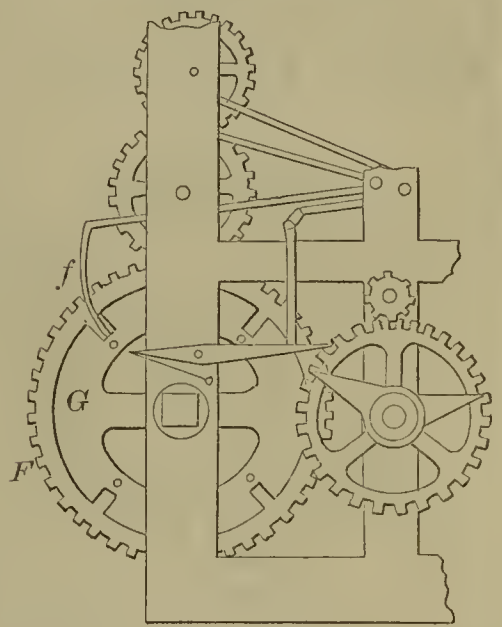
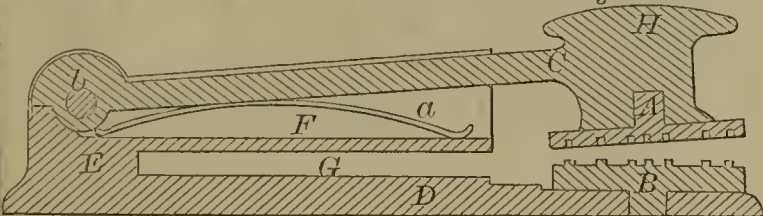

56239—J. W. Lyon—For Drilling Umbrella Tips.

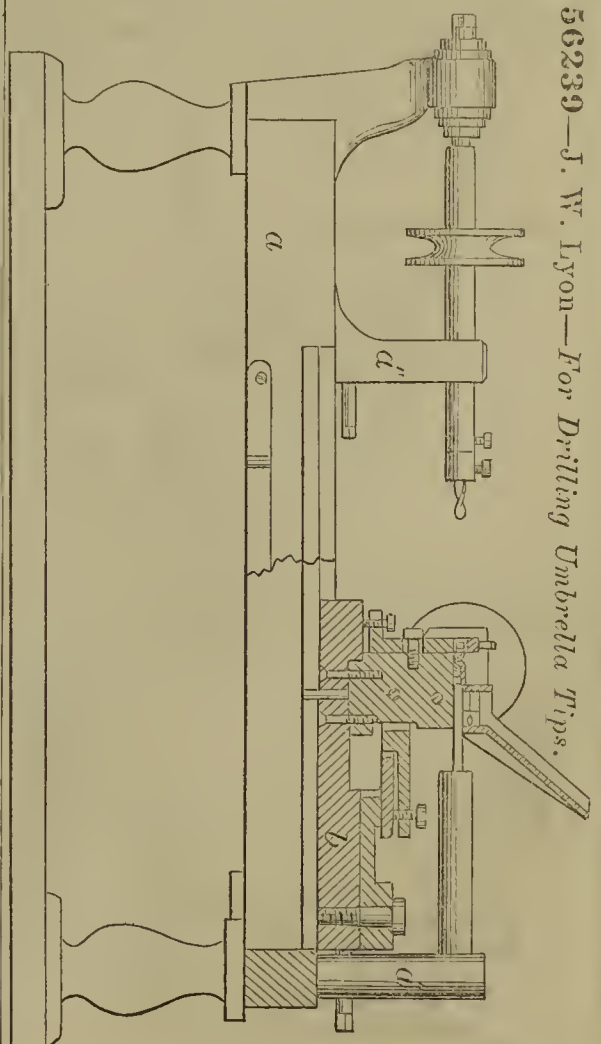

56245—R. S. Merrill—Lamp Burner.

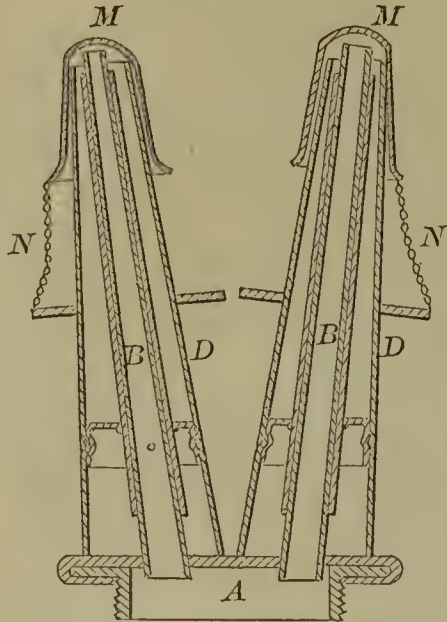

56249—A. Morley—Stock Yard.

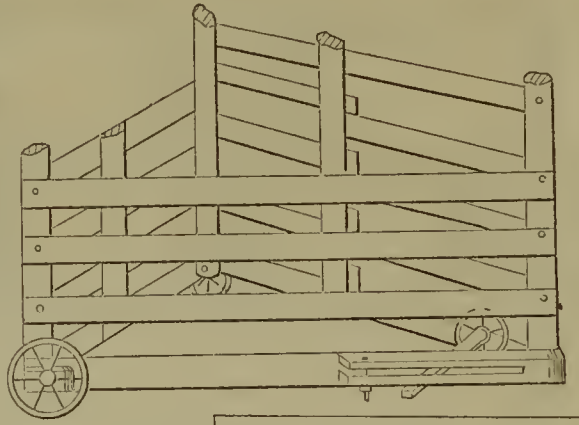

56247—J. Minter—Bolt Heading Machine.

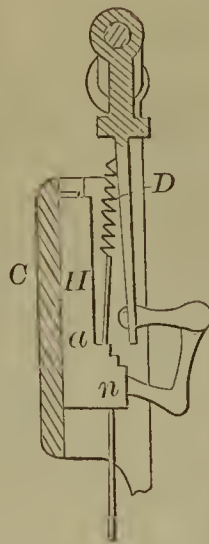

56248—G. A. Mitchell—Safety Pocket.

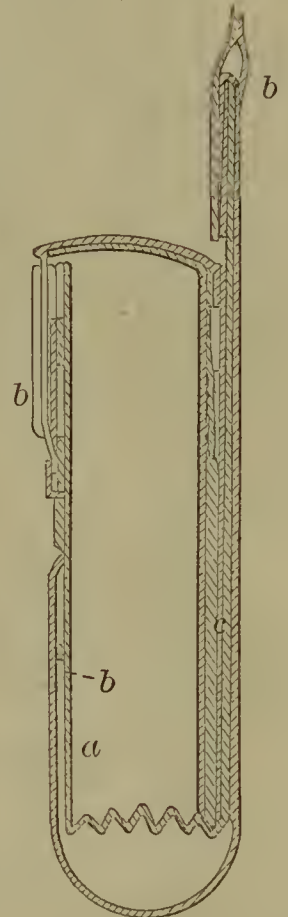

56246—J. W. Miles—Grinding Mill.



56251—L. B. Myers—Pencil Holder.



56252—L. M. Newbury—For Cleaning Boots and Shoes.

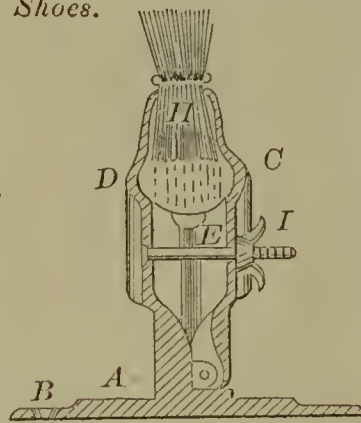

56250—Mund & Hoffman—Lamp Wick Regulator.

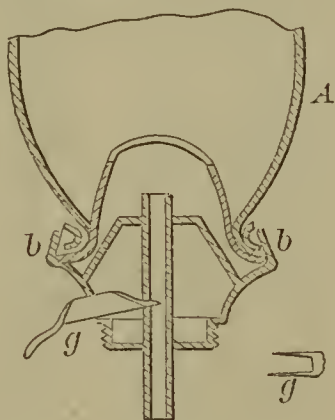

56254—D. Niles—Planing Machine.

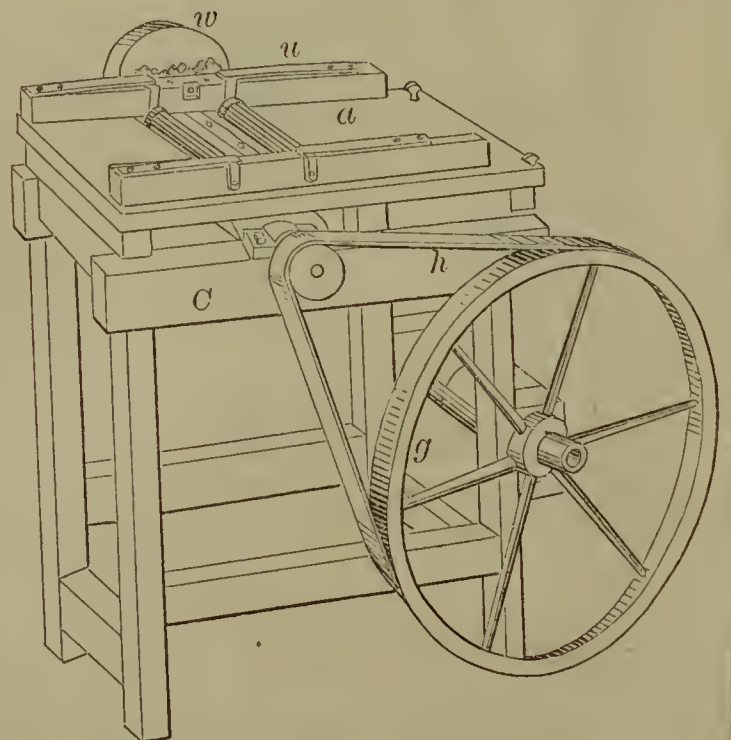

56253—J. W. Newbury—Neck Tie.

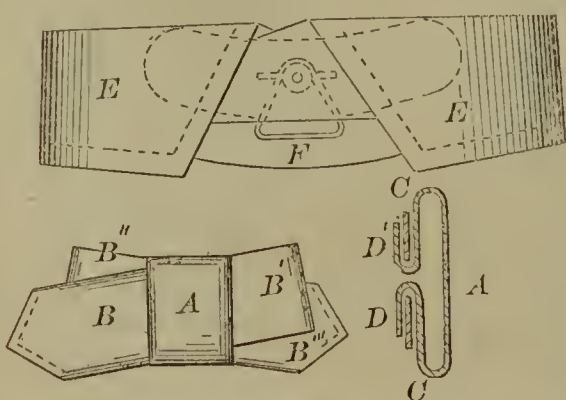

56255—J. Norton, 3d—*Grain Dryer.*

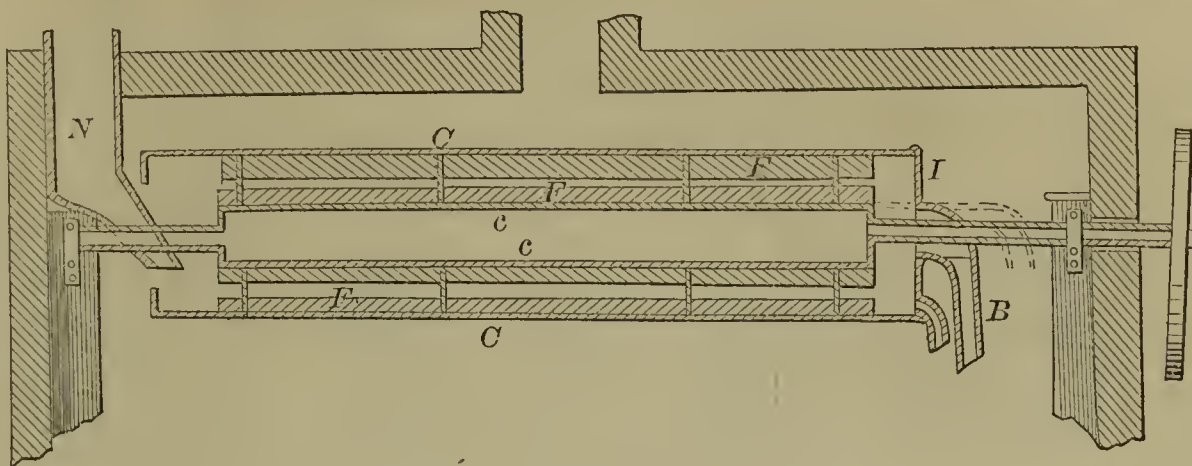

56257—Z. Parkhurst—*Burr Box.*

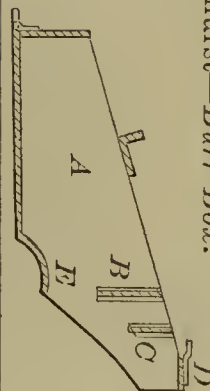

56256—E. A. F. Olmstead—*Railroad Sweeper.*

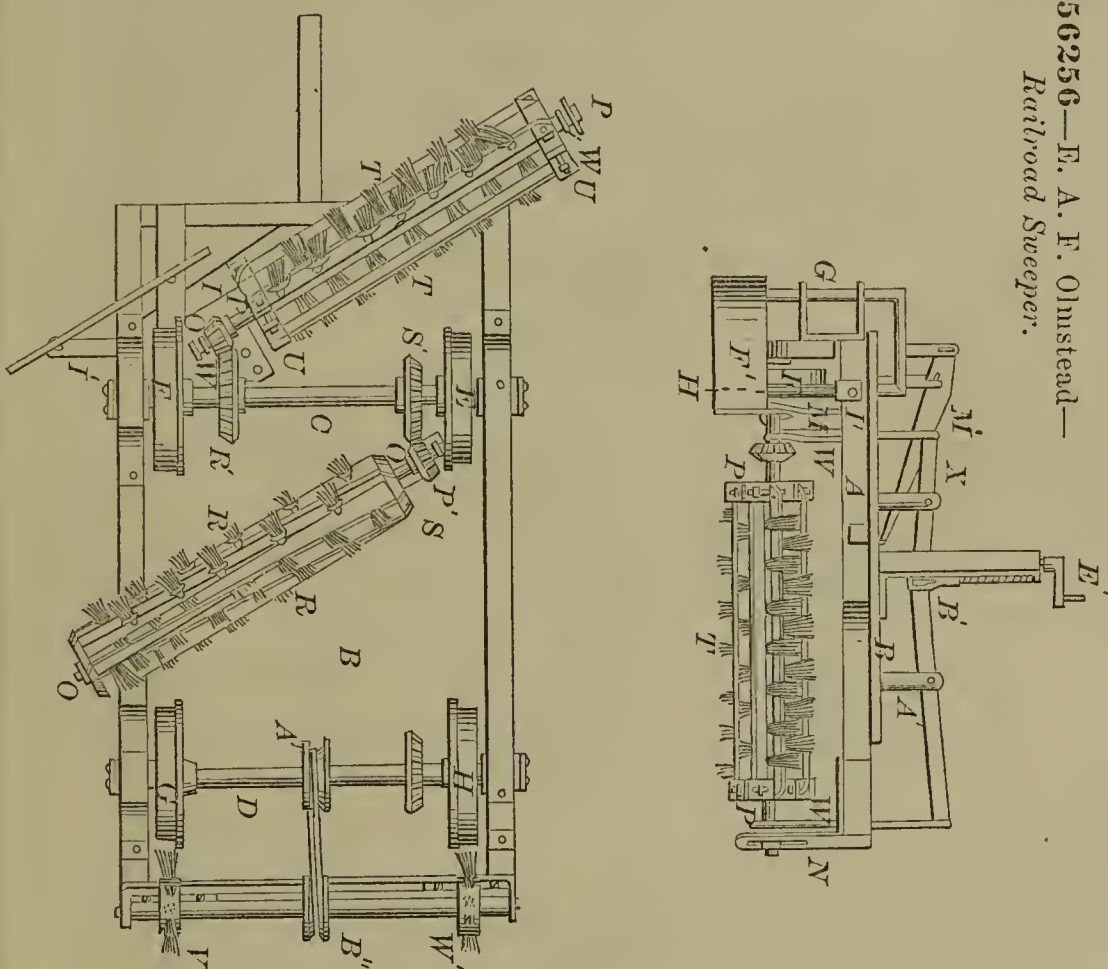

56258—H. Parmelee—*For Twisting and Winding Fibres.*

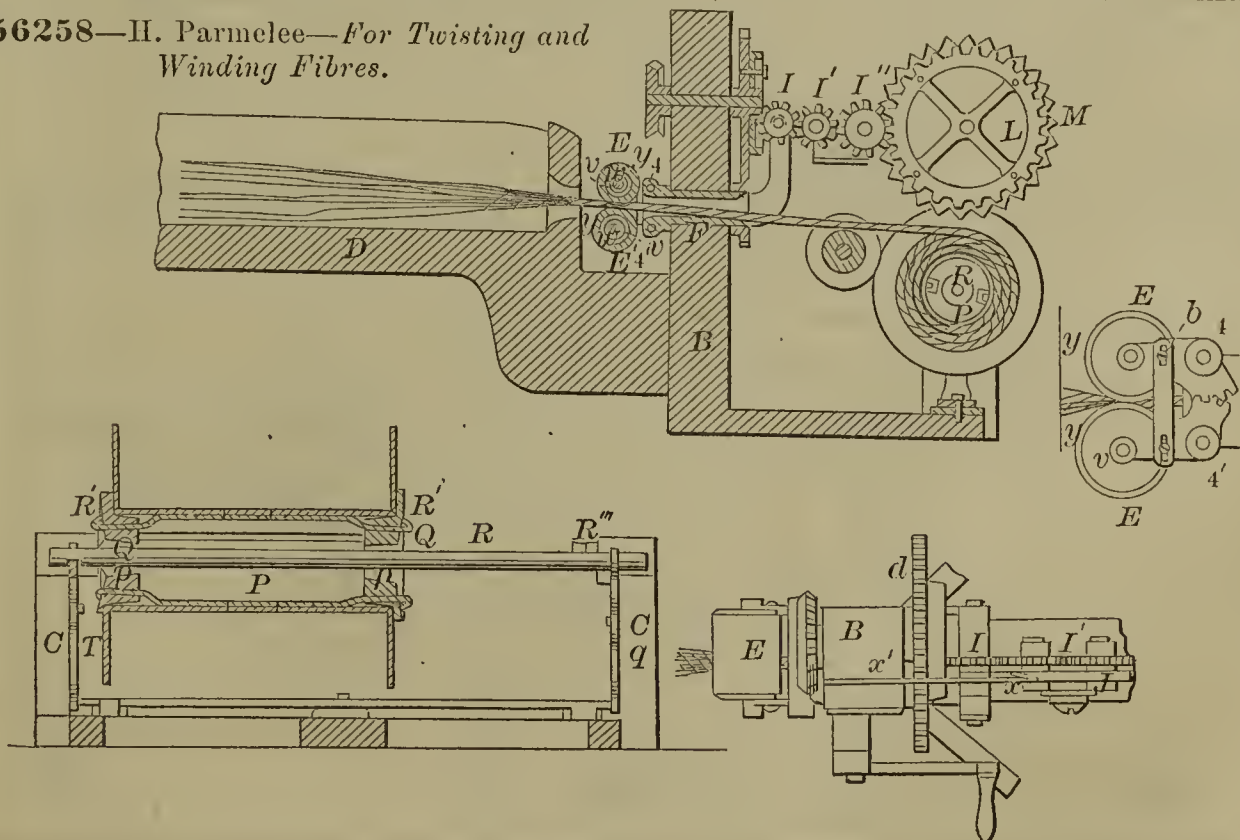

56260—H. M. Peavey—*Potato Digging Machine.*

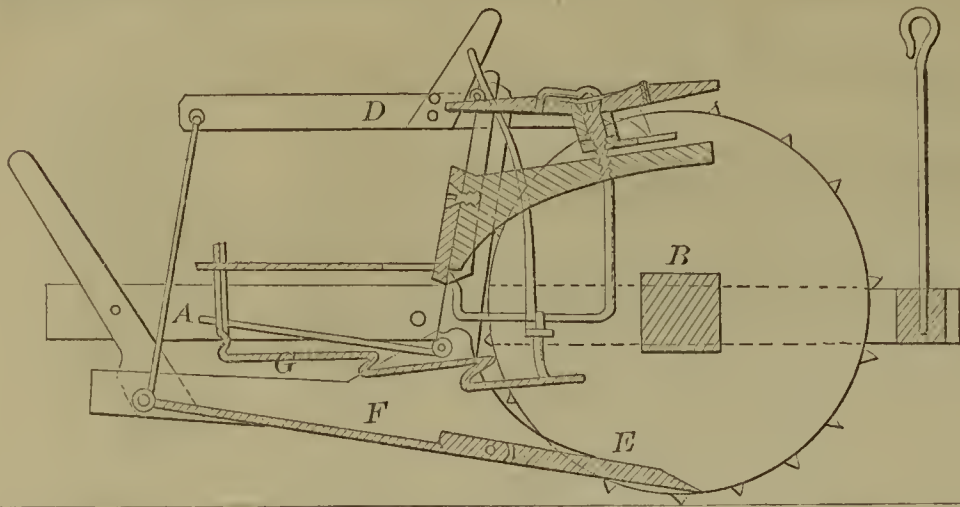

56263—W. Pountney—*Manufacture of Ornel Bottles.*

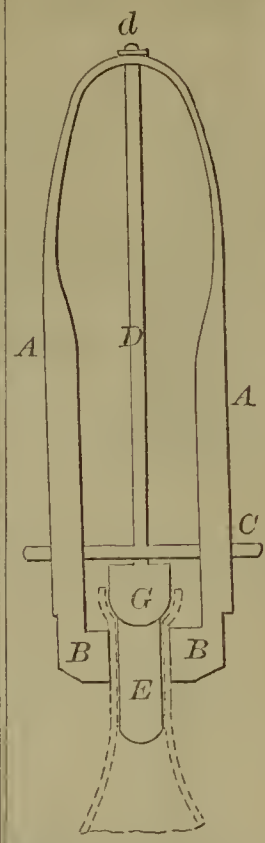

56262—H. H. Potter—*Burglar Alarm.*

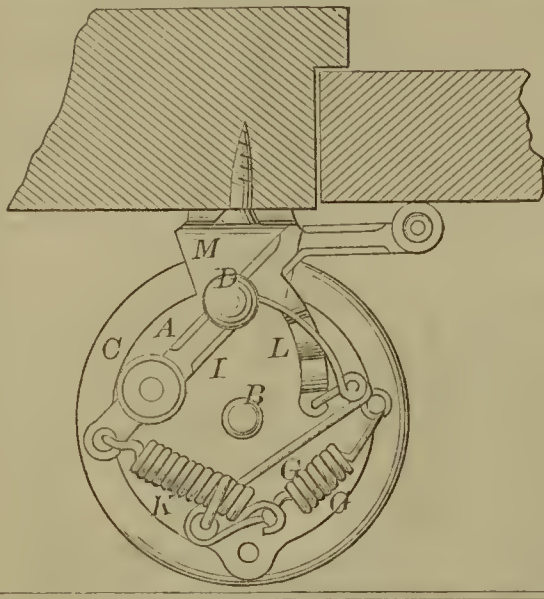

56261—C. M. Platt—*Button.*

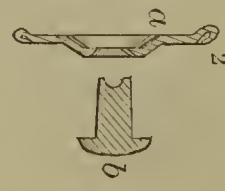

56267—W. F. Redding—*Window Blind.*

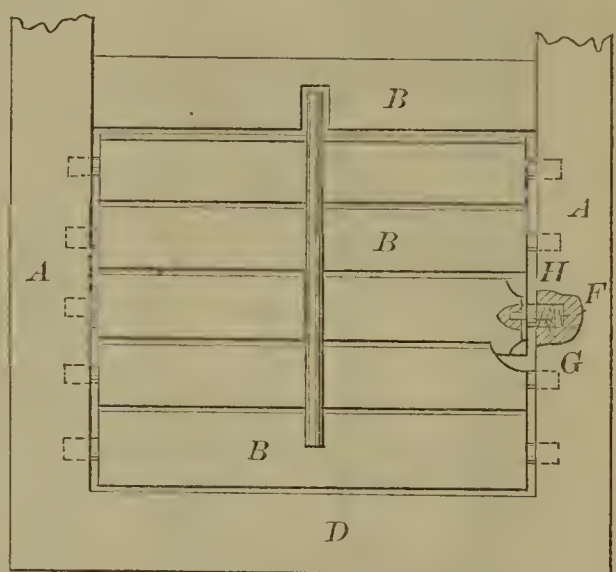

56264—J. B. Pratt—*Knife Sharpener.*

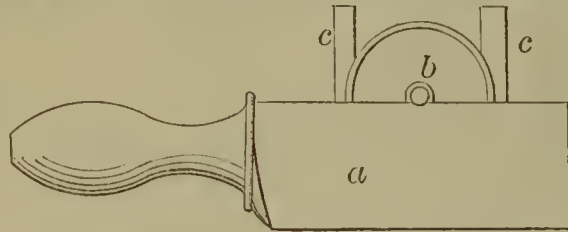

56265—Quinn & Summers—*Snap Hook.*

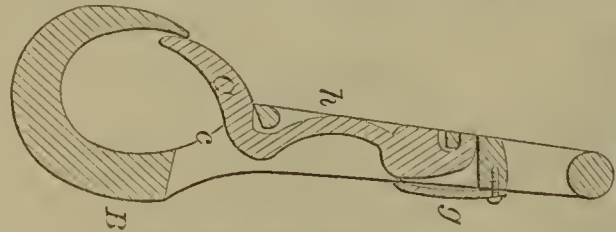

56266—R. I. Rathburn—*Cooking Stove.*

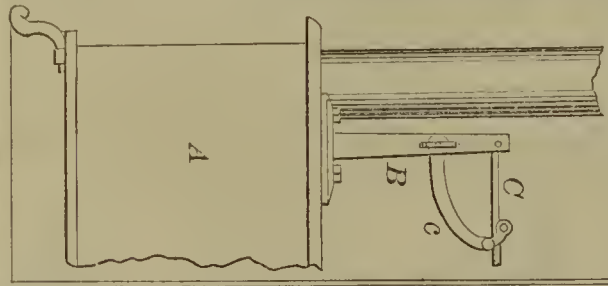

56268—J. C. Rhodes—*Tack Capping Machine.*

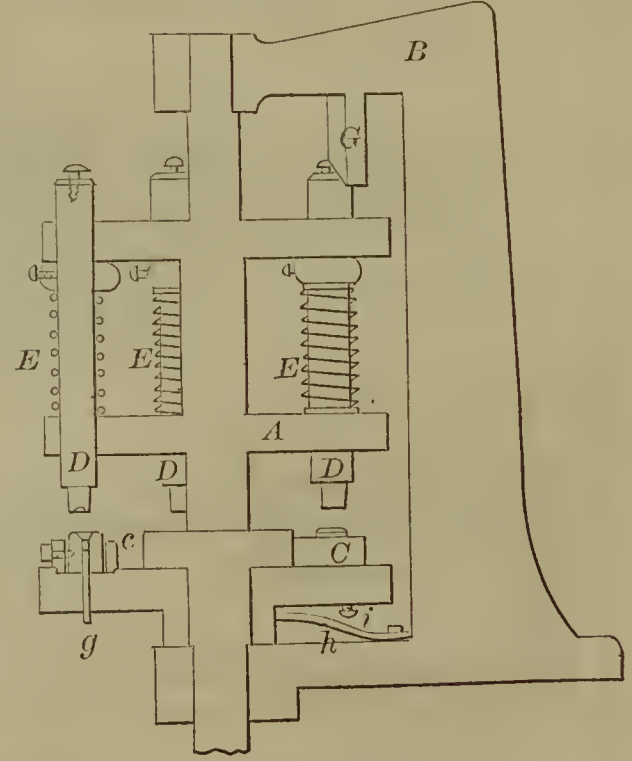

56269—G. T. Ridings—*Tire Machine.*

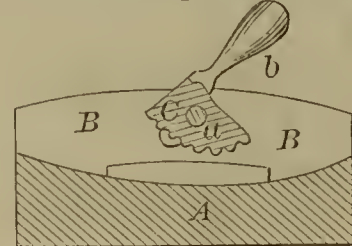



56274—J. L. Russell—Cotton Seed Planter.

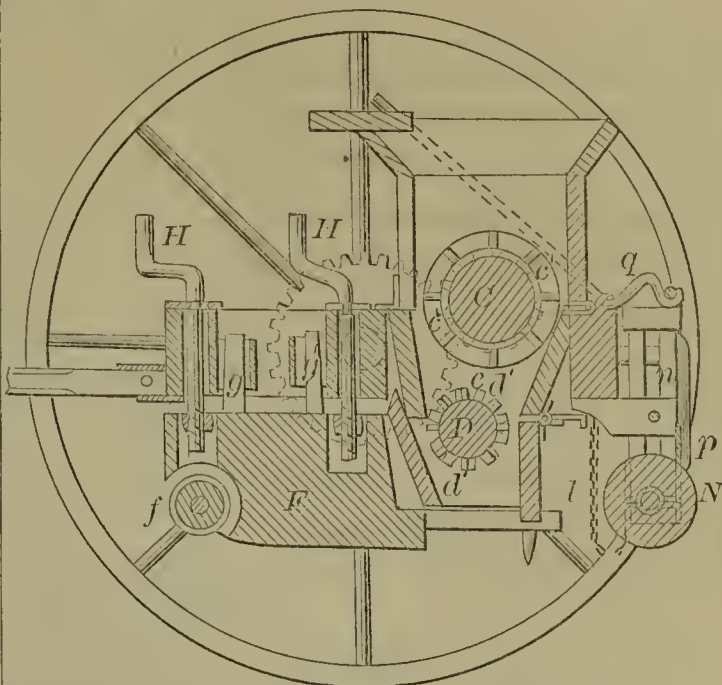

56273—C. Rundell—Hay Stacker.

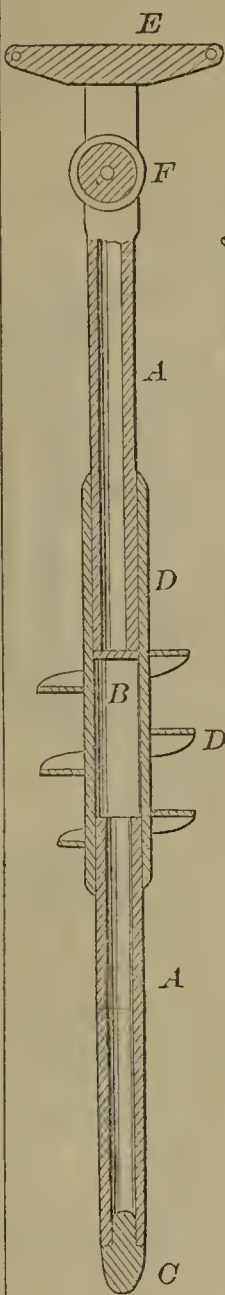

56275—J. Raymond—Water Elevator.

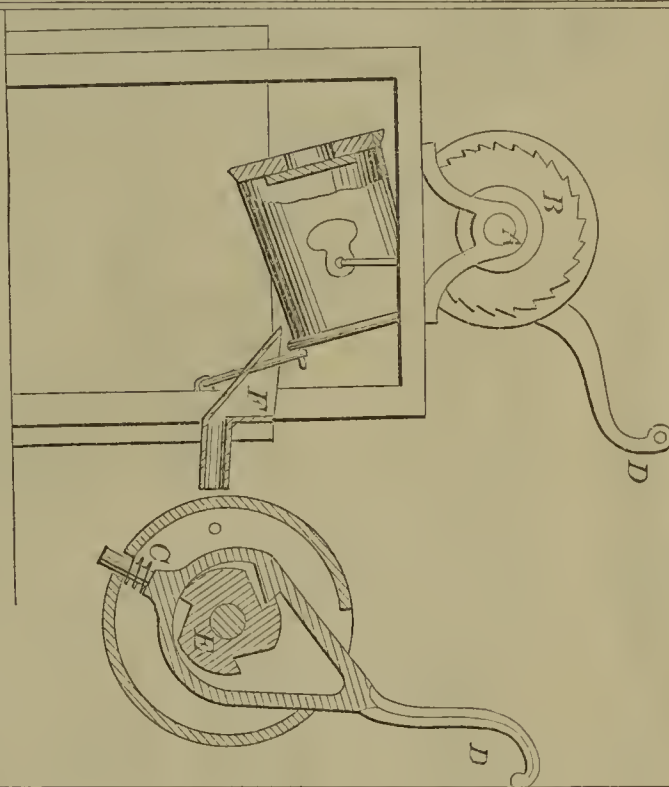

56271—A. Robbins—Railway Frog.

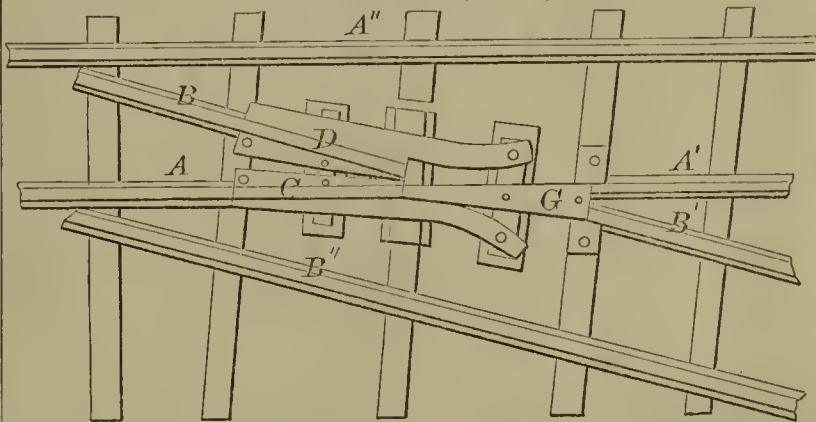

56277—R. Schmidt—Harness Bell.

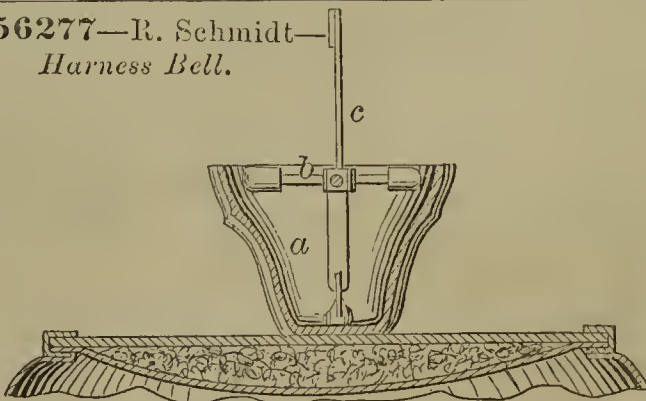

56270—G. T. Ridings—Rotary Tire Heater.

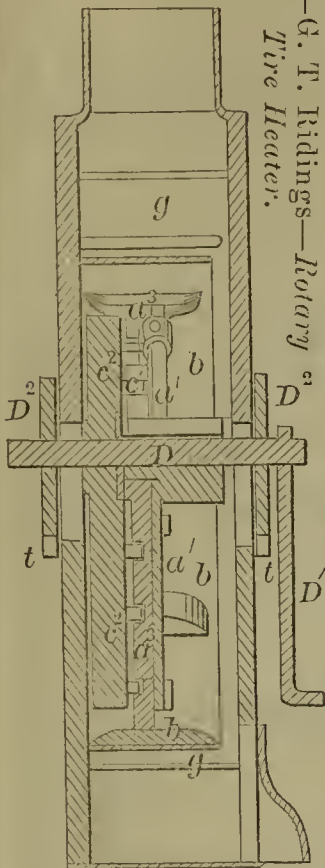

56272—Ross & West—Tobacco Pipe and Cigar Holder.

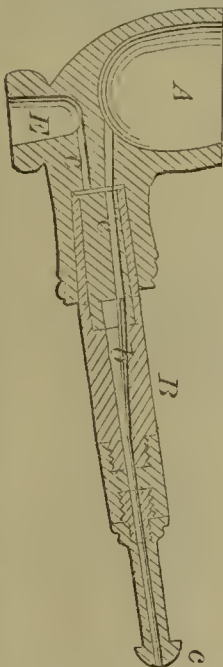

56276—Sangster & Spencer—Distilling Petroleum.

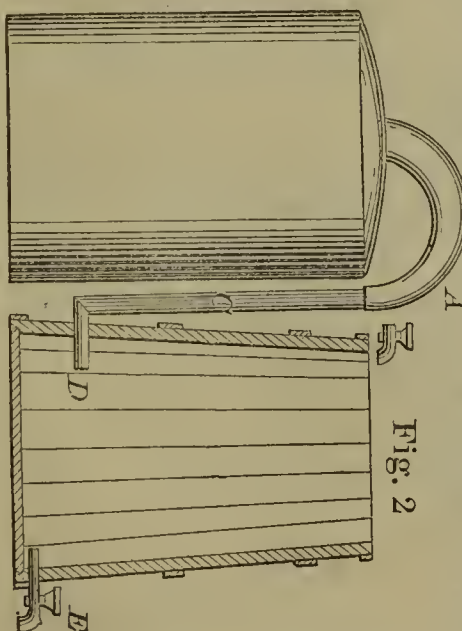

56278—H. G. Seekins—*Bed Bottom.*

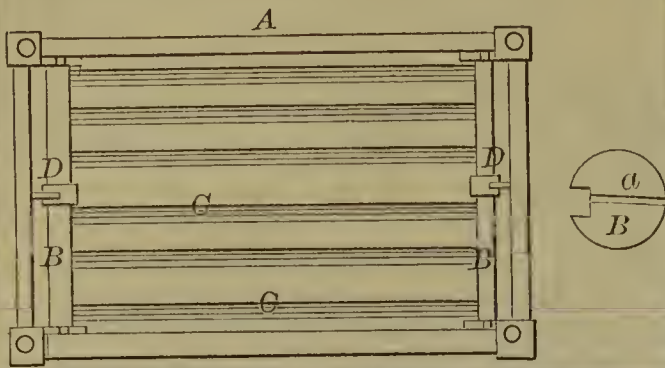

56281—G. W. Simonds—*Securing Axes on Handles.*

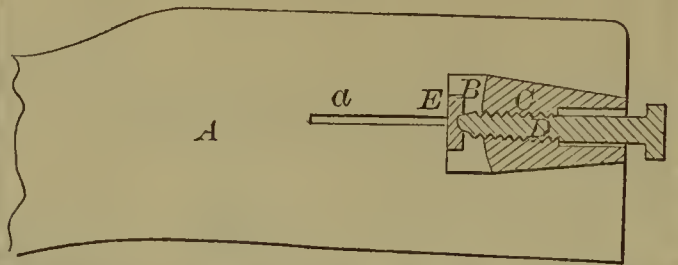

56279—J. W. Shiveley—*Railroad Rail.*

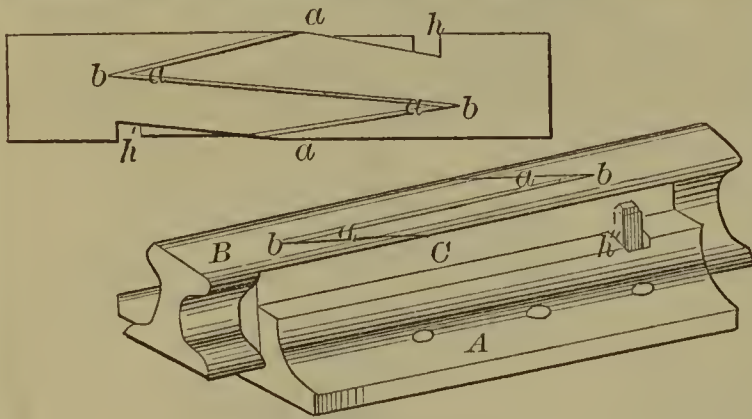

56280—Shinneller & Brislin—*Horse Shoe Machine.*

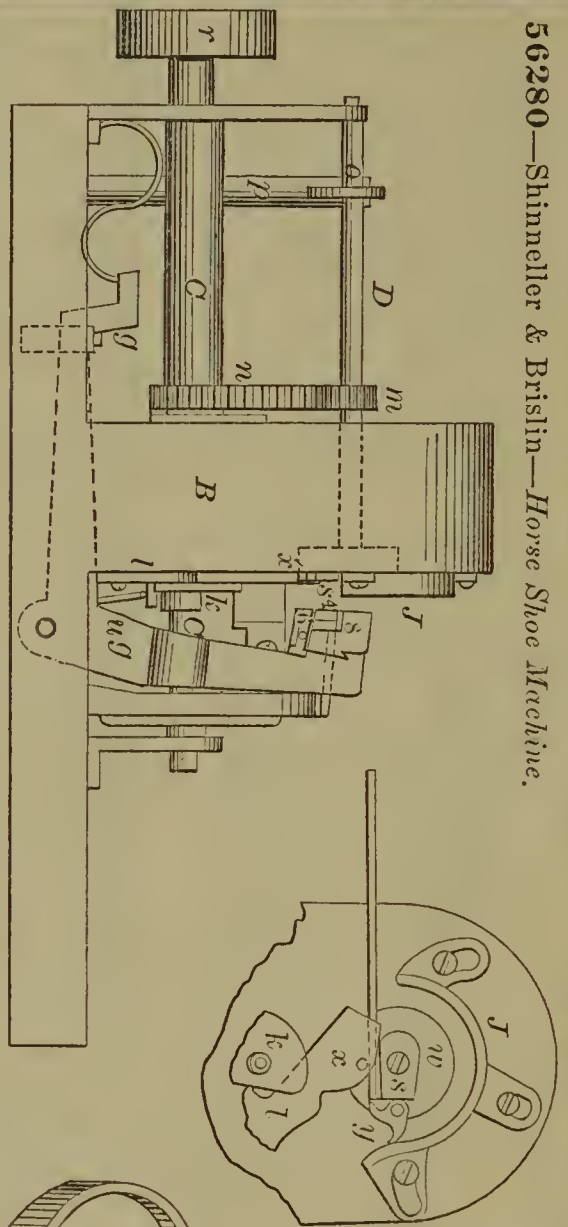

56284—Smith & Tewksbury—*Revolving Hose Nozzle.*

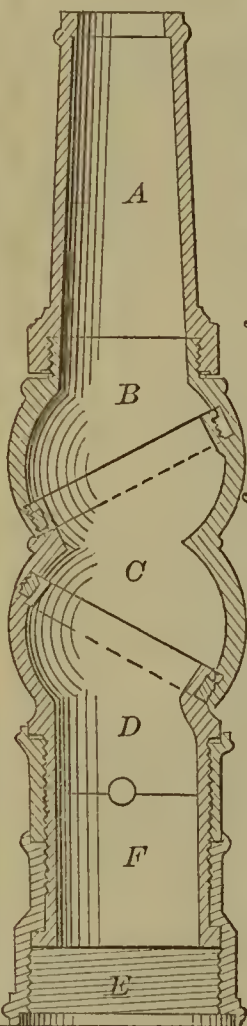

56283—H. C. Smith—*Horse Harness.*

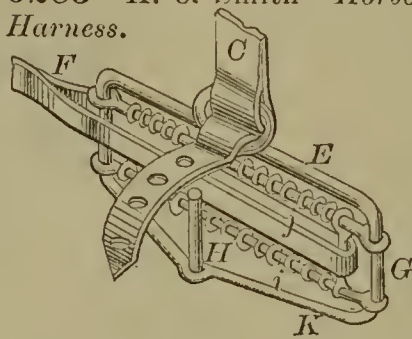

56282—A. P. Smith—*Window Blind.*

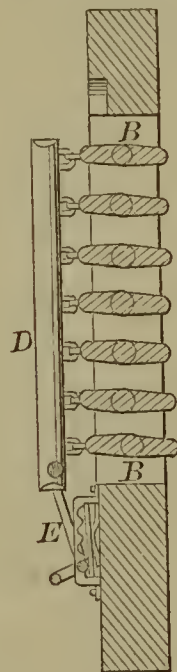

56286—E. M. Sorley—*Cultivator.*

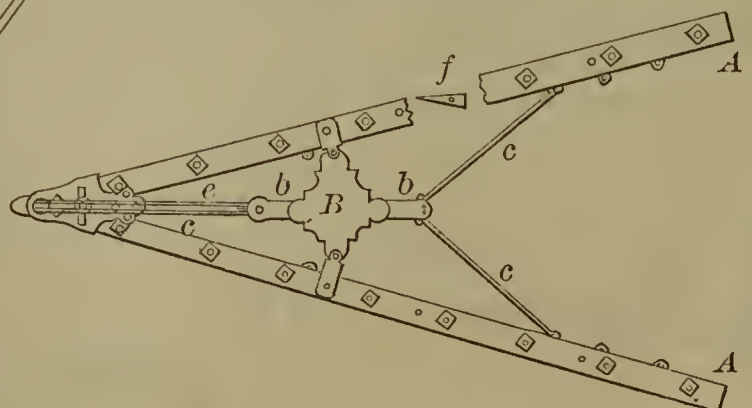

56285—M. Smith—*Street Scraper.*

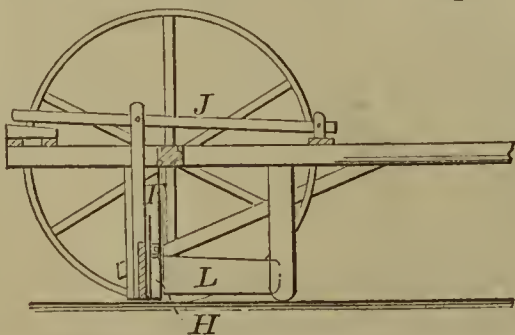

56287—H. D. Sprague—Coffin.

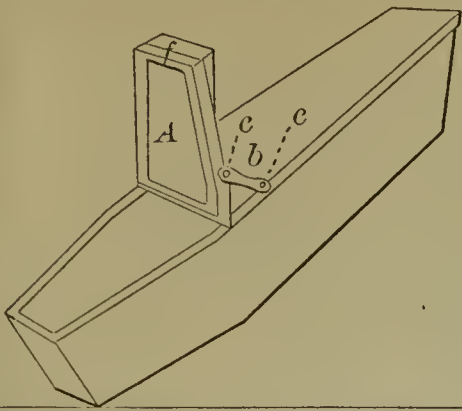

56288—E. Starr—Cultivator.

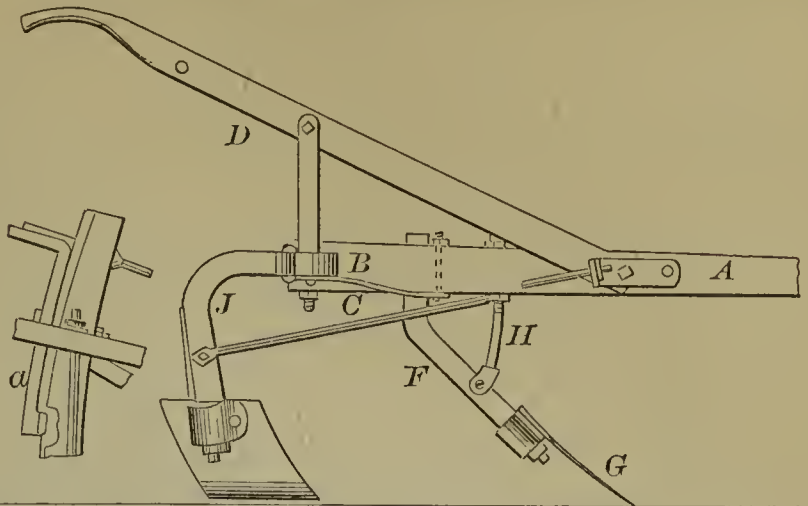

56290—P. L. Suine—Package Case for Plants.

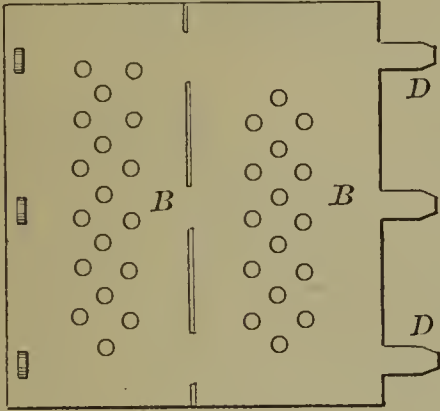

56289—D. C. Stover—Cultivator.

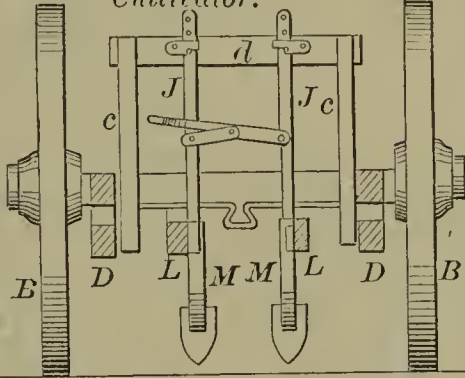

56294—Wakeman & Ballance—Baling Hay

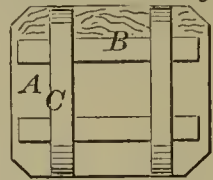

56293—J. Verch—Candle Holder.

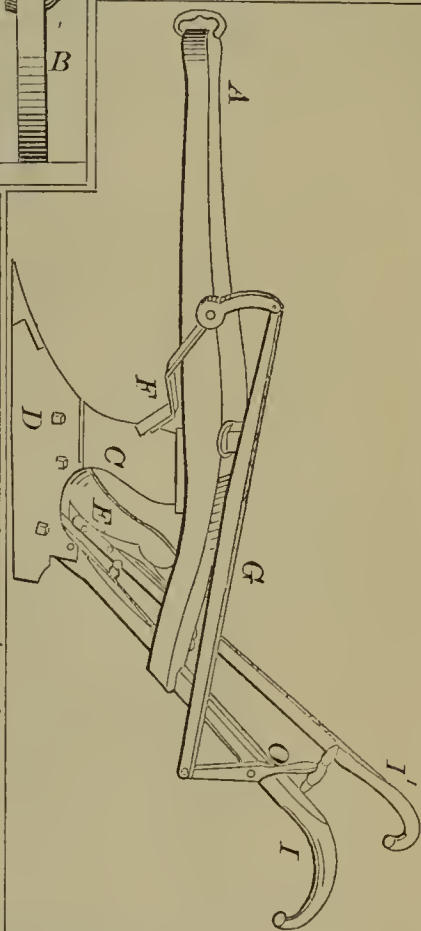
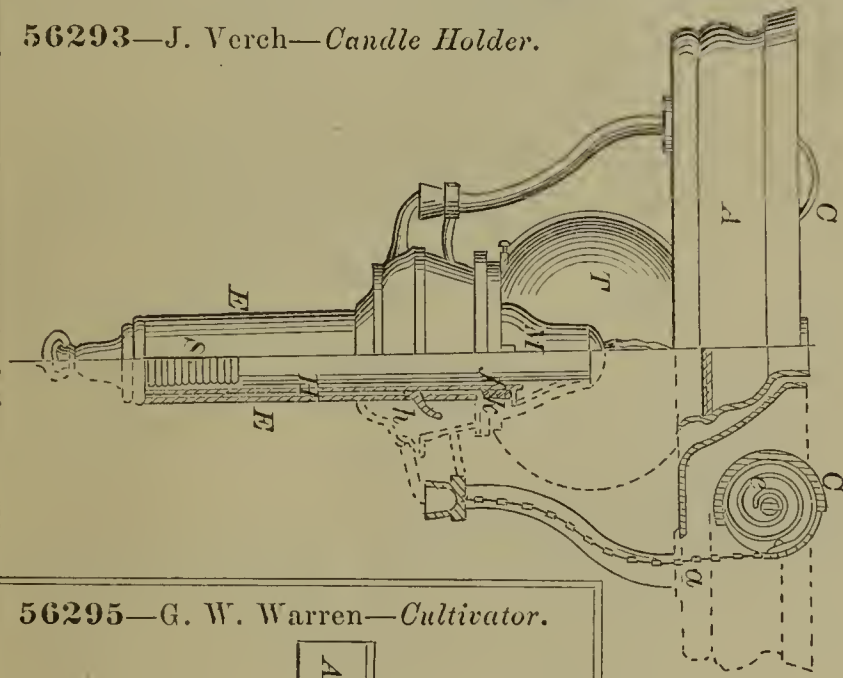

56296—O. F. Warren—Plow Cleaner.

56295—G. W. Warren—Cultivator.

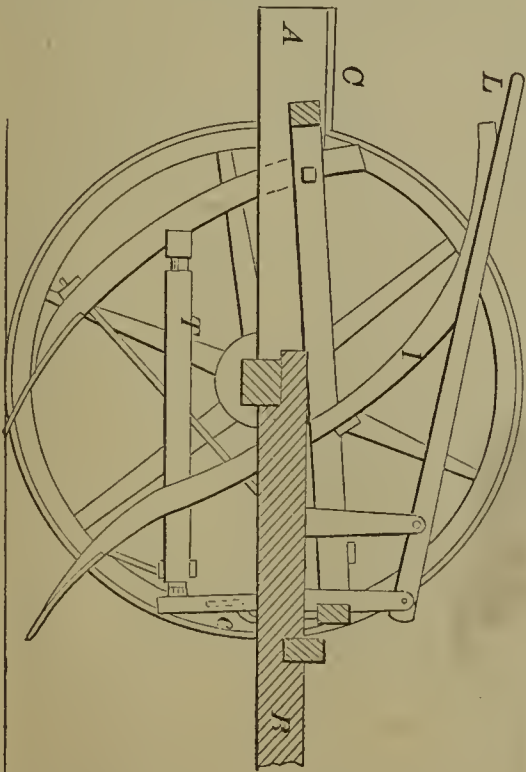

56297—J. C. Wate—Wind Wheel.

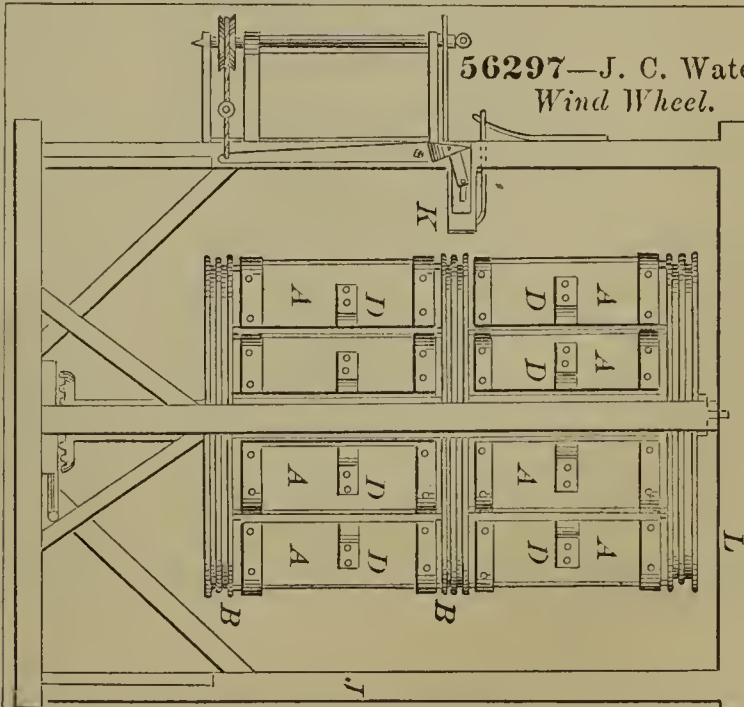

56298—G. Watt—Plow.

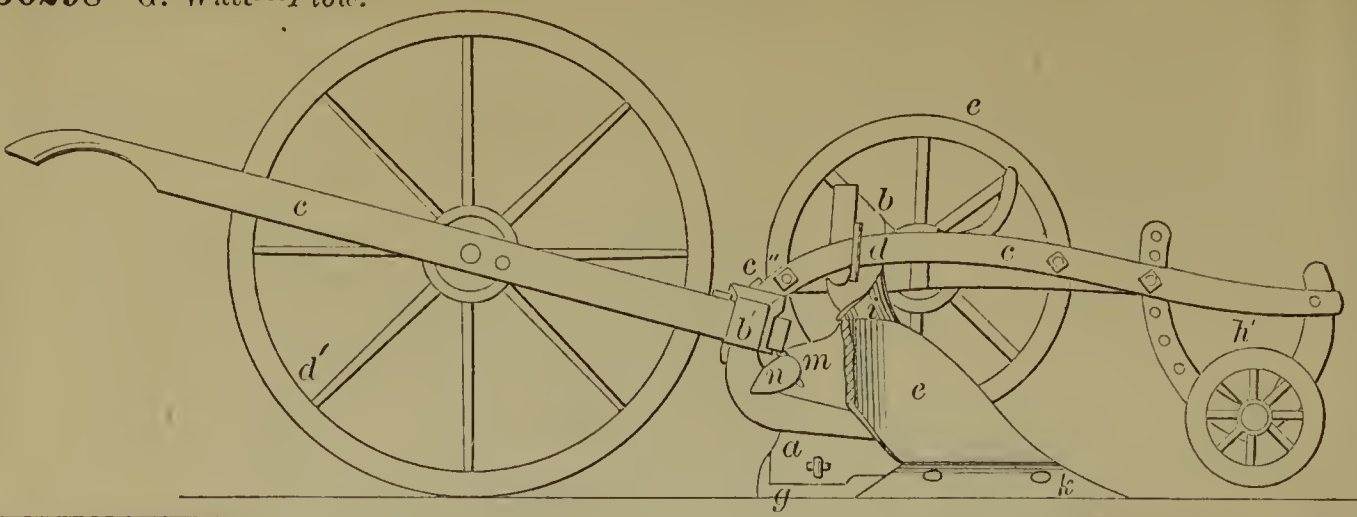

56299—I. S. Weaver—Ditching Machine.

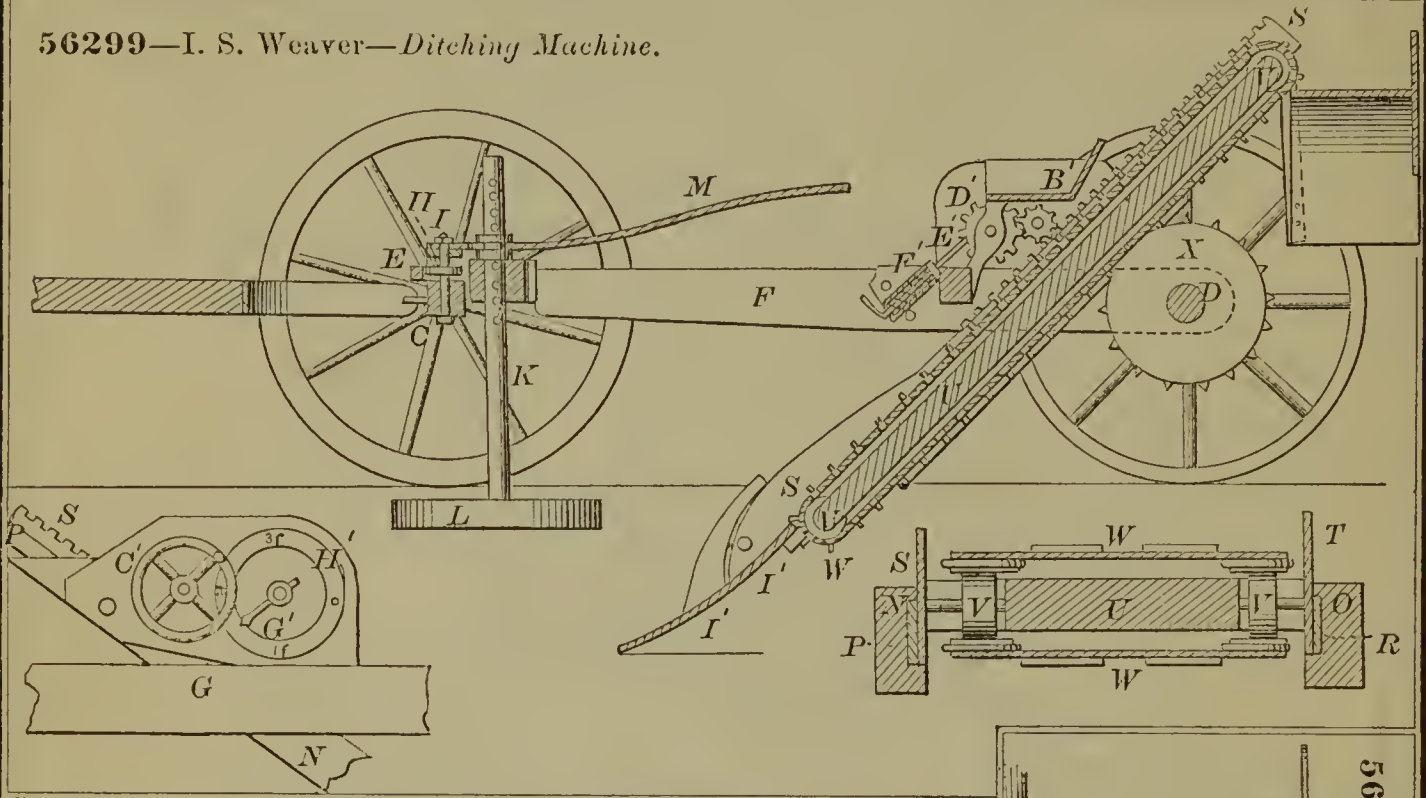

56300—A. A. Webster—Sheep Rack.

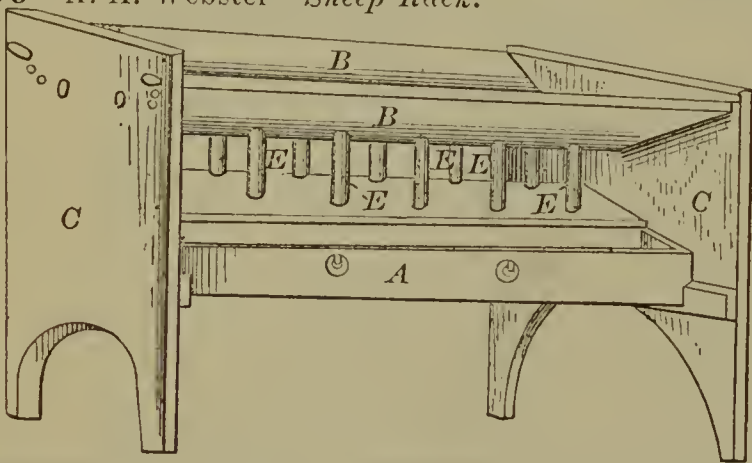

56302—E. Whitehead—Car Brake.

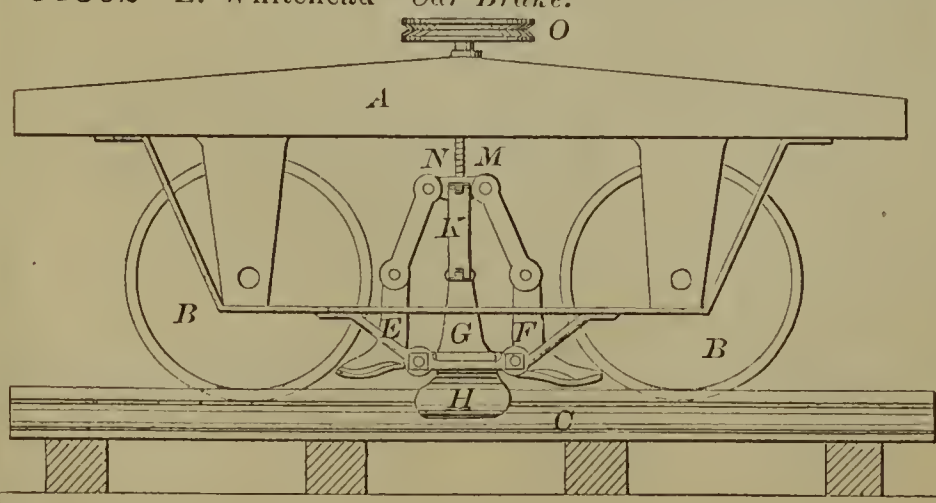

56301—R. T. M. Wells—Railroad Car.

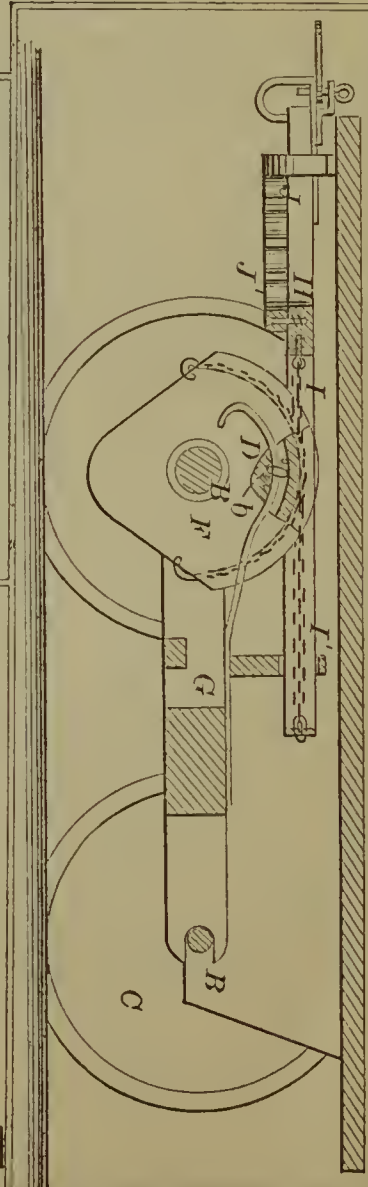

56303—E. Whitehead—*Pavement.*

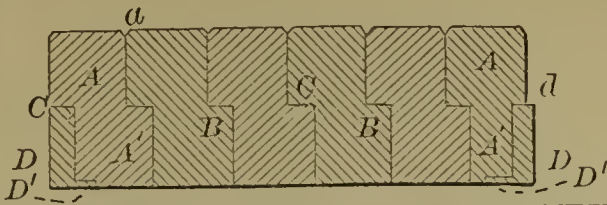

56310—A. S. Wilkinson—*Horse Shoe.*

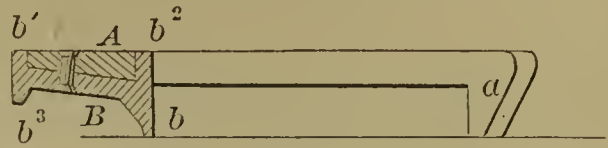

56304—W. N. Whitely, Jr.—*Pitman Head, &c., for Harvesters.*

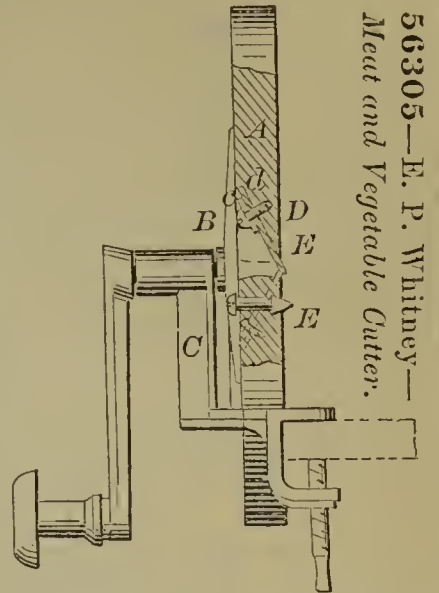
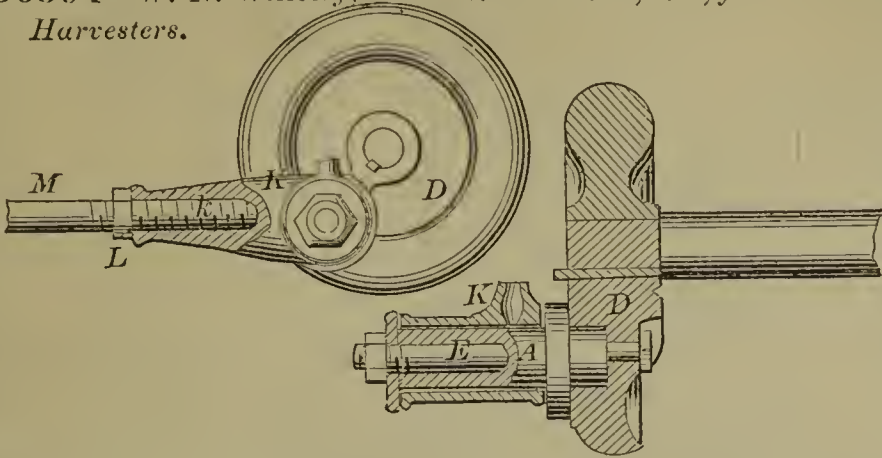

56305—E. P. Whitney—*Meat and Vegetable Cutter.*

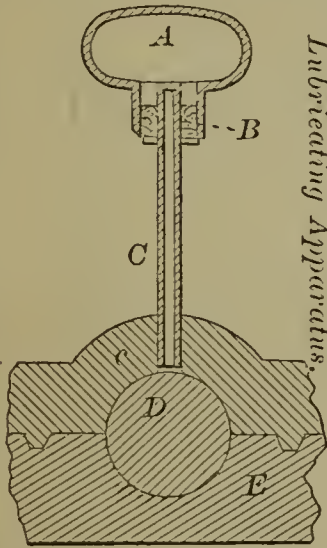

56306—Wiggin & Folsom—*Lubricating Apparatus.*

56307—A. S. Wilkinson—*Horse Shoe.*

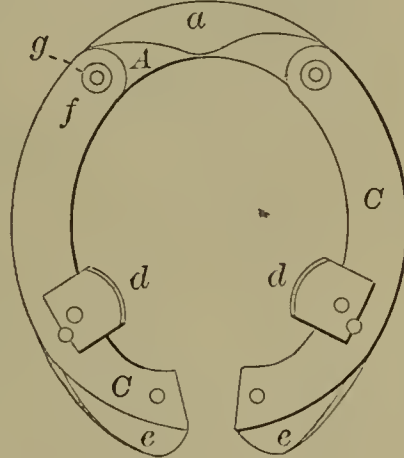

56308—A. S. Wilkinson—*Horse Shoe.*

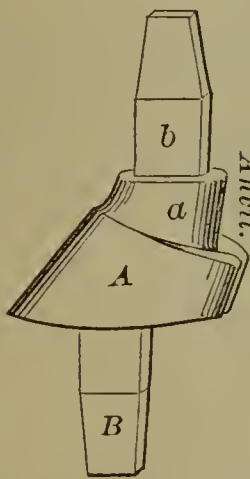
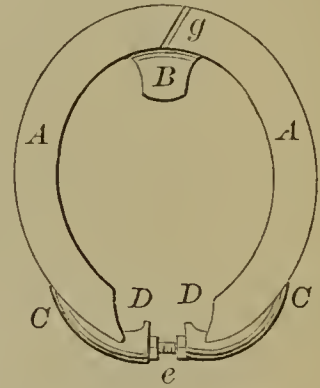

56311—A. S. Wilkinson—*Horse Shoe.*

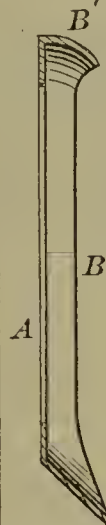

56309—A. S. Wilkinson—*Horse Shoe.*

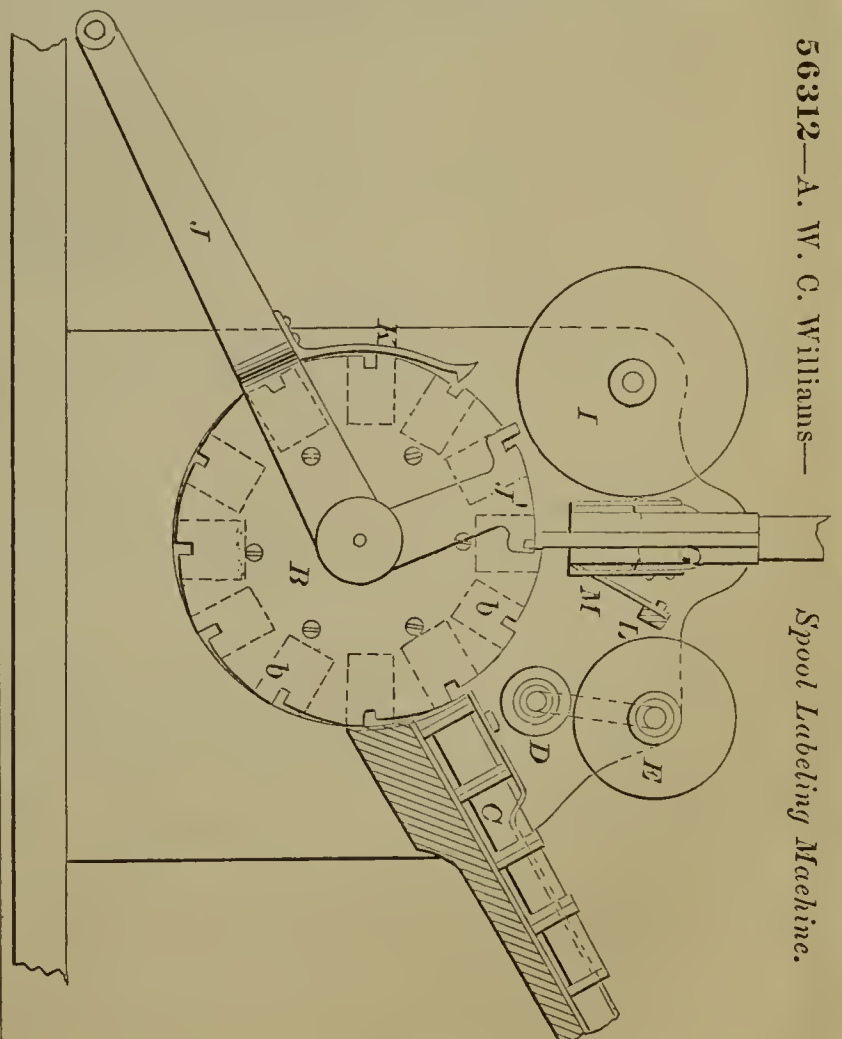

56312—A. W. C. Williams—

*Spool Labeling Machine.*

56313—S. R. Wilmot—*Die for Forming Sheet Metal Vessels.*

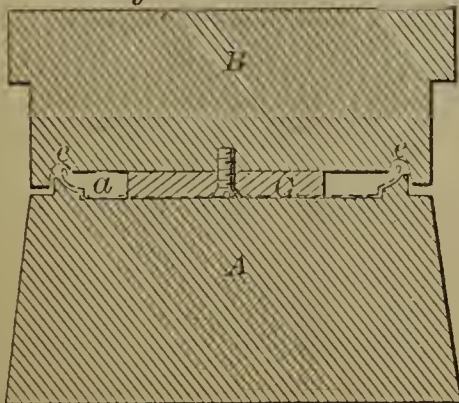

56314—D. S. Wood—Pump Piston.

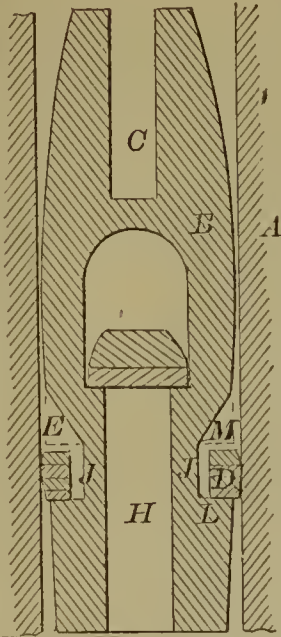

56316—J Woolver—Grain Separator.

Fig. 1

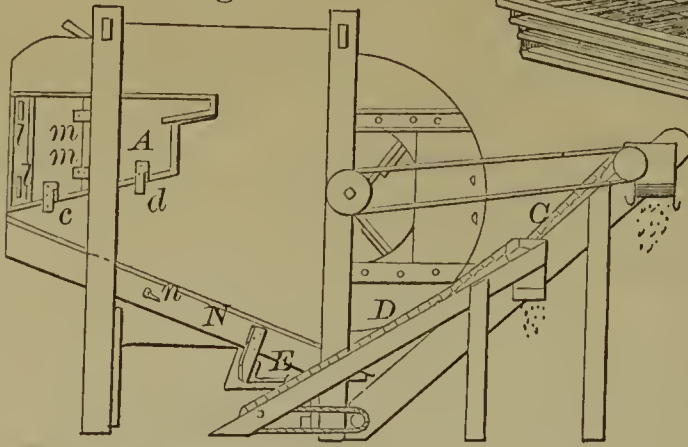

Fig. 9

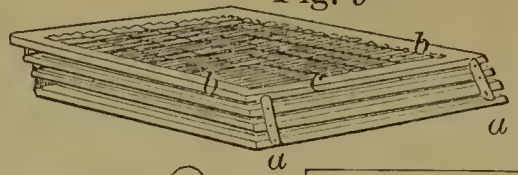
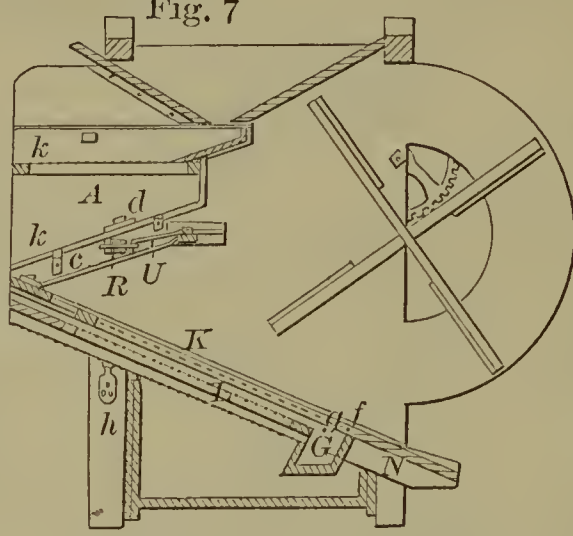

Fig. 10



Fig. 7



56315—Woodward & Smith—Wheel Vehicle.

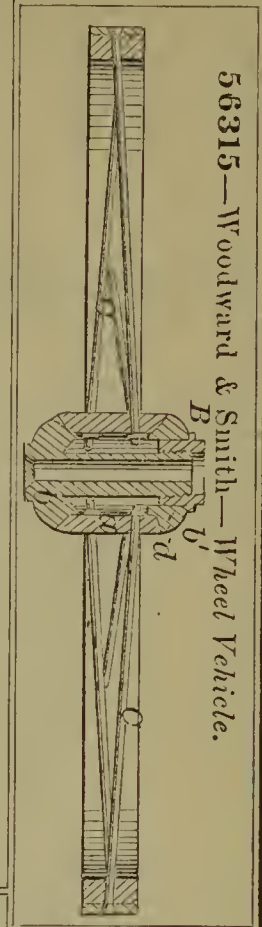

56317—Worcester & Perkins—Flour Sifter.

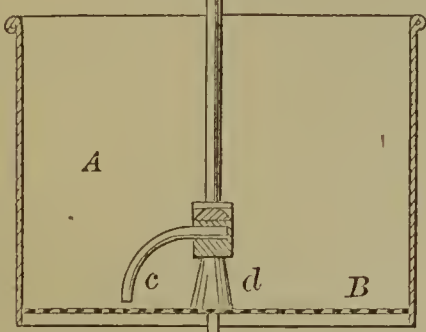

56319—C. F. Zimmermann—Accordeon.

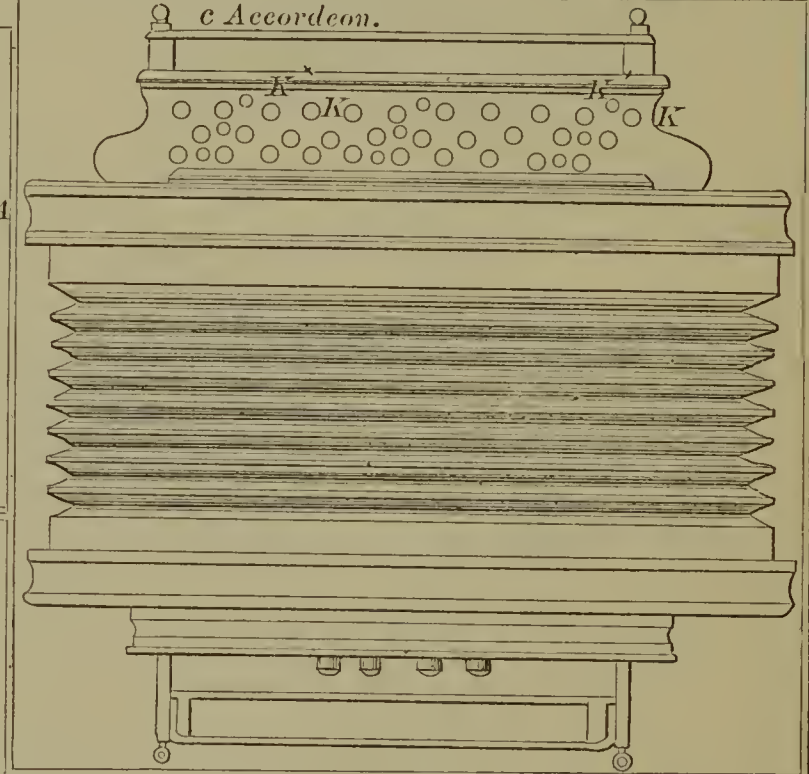

56318—R. M. Yorks—Washing Machine.

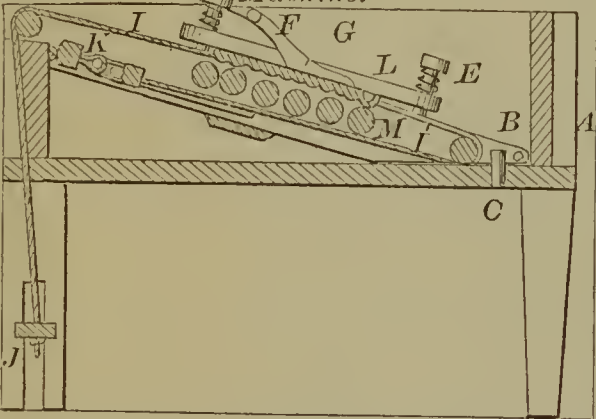

56320—F. C. Coppage—Harvester.

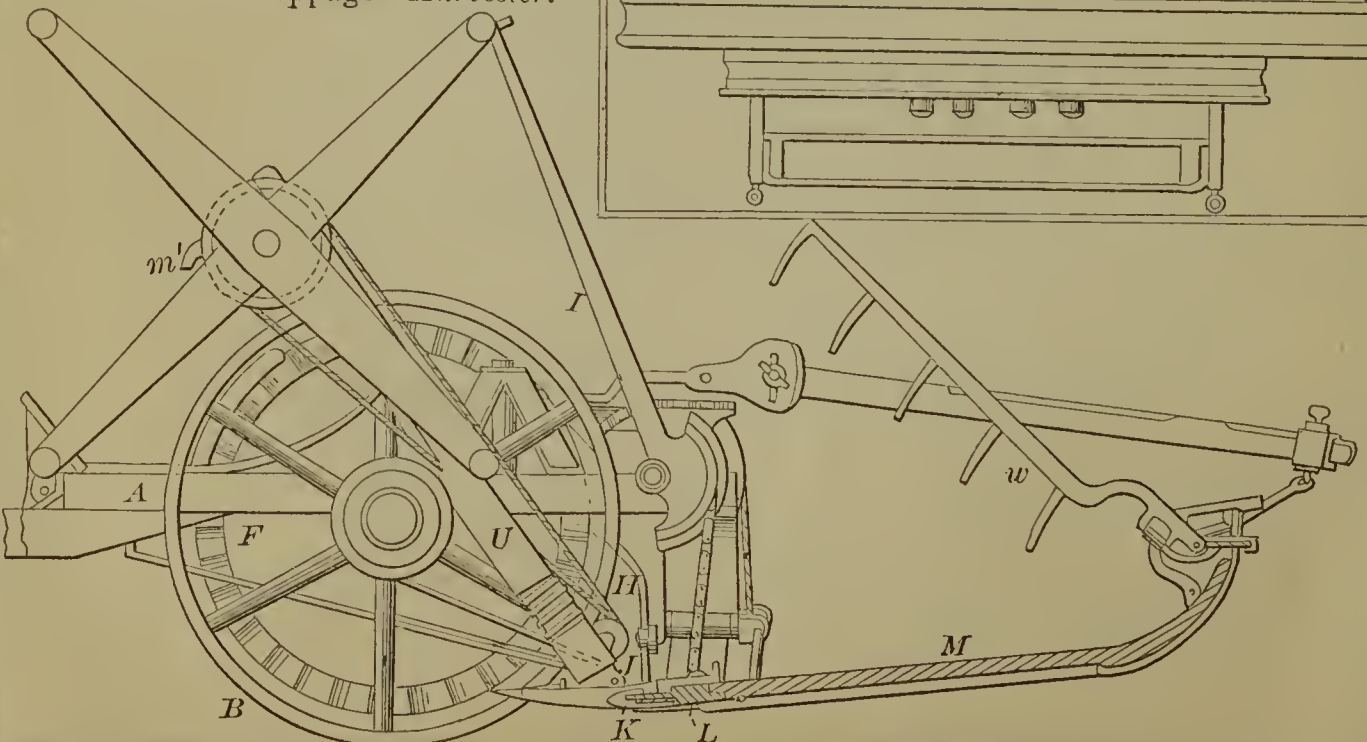

56321—P. W. Gates—  
Stamping Machinery.

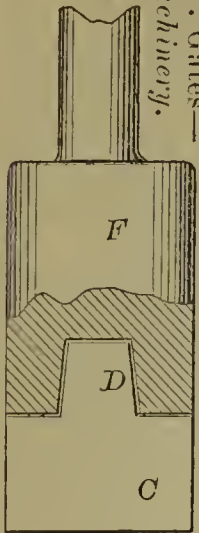

56324—J. B. Mitchell—Hose Coupling.

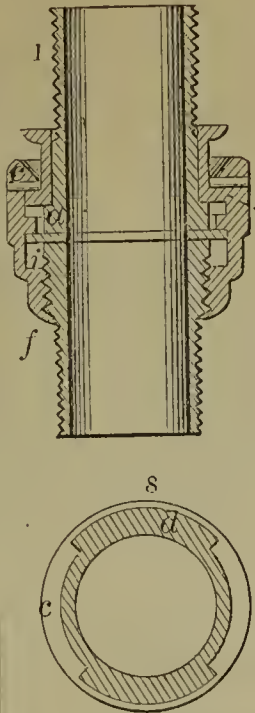

56325—R. Parks—Envelope Machine.

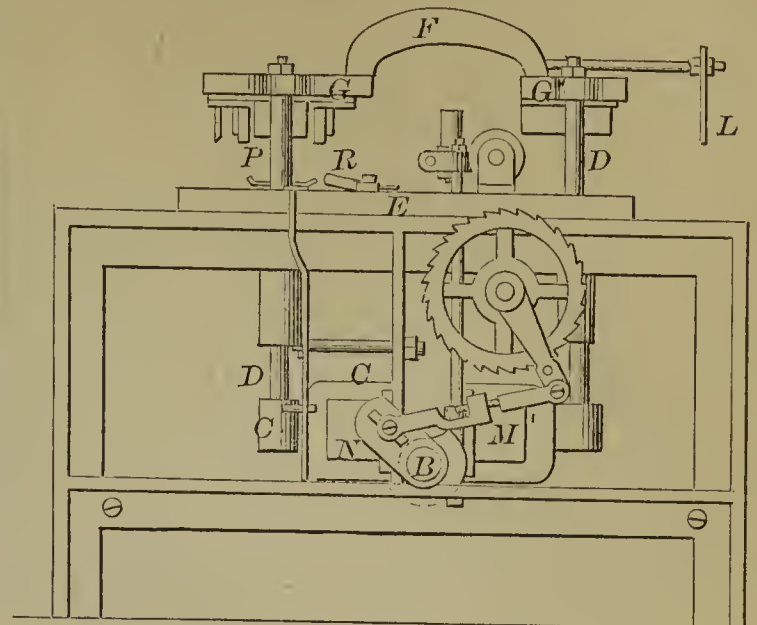

56326—D. Paterson—Flange.

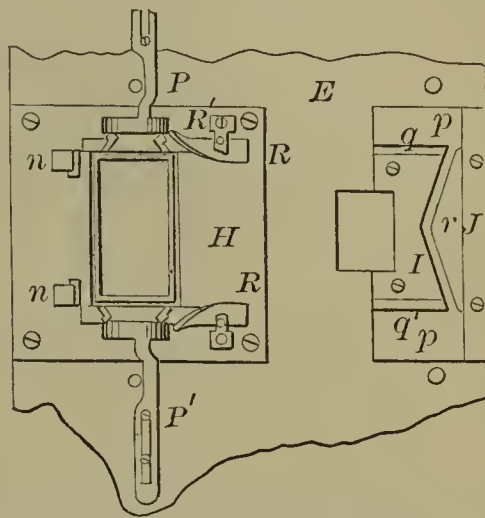
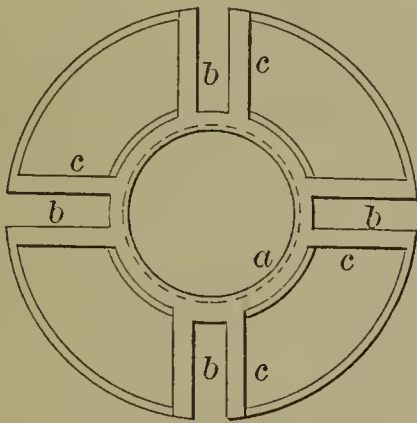

56323—J. B. Gooding—  
Making Calipers.

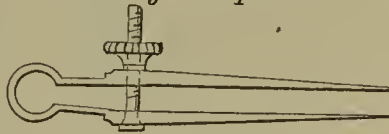

56329—I. Smith—Chuck.

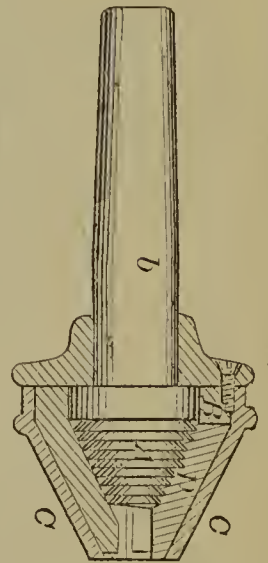

56327—S. Perry—Furrowing Plow.

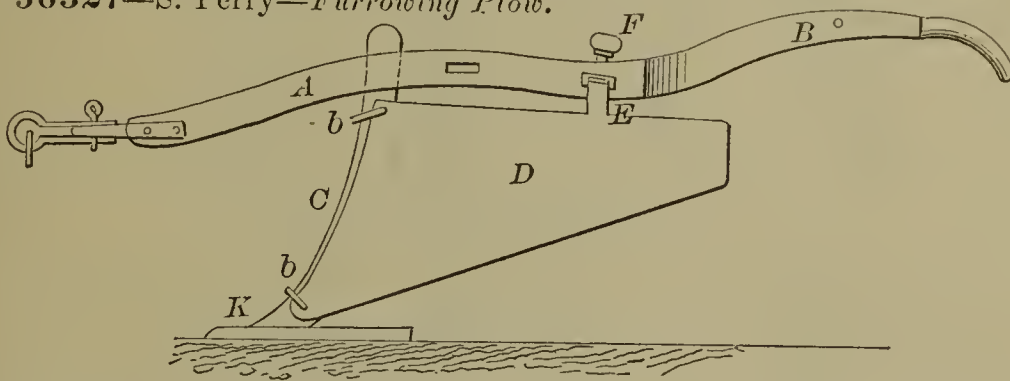

56330—I. Smith—Chuck.

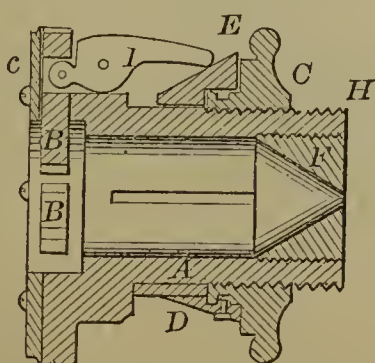

56328—M. C. Remington—Grain Fork.

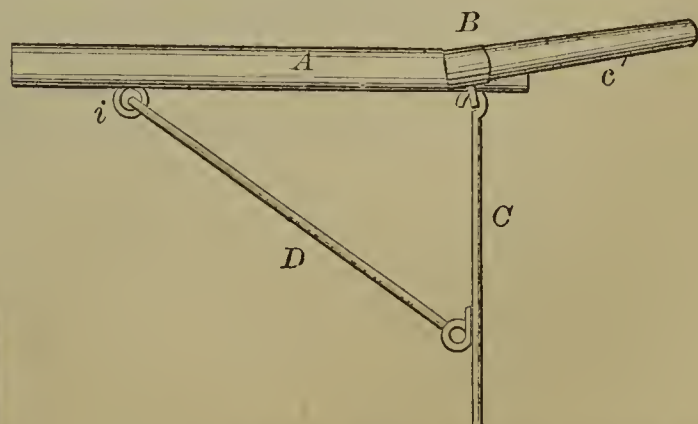

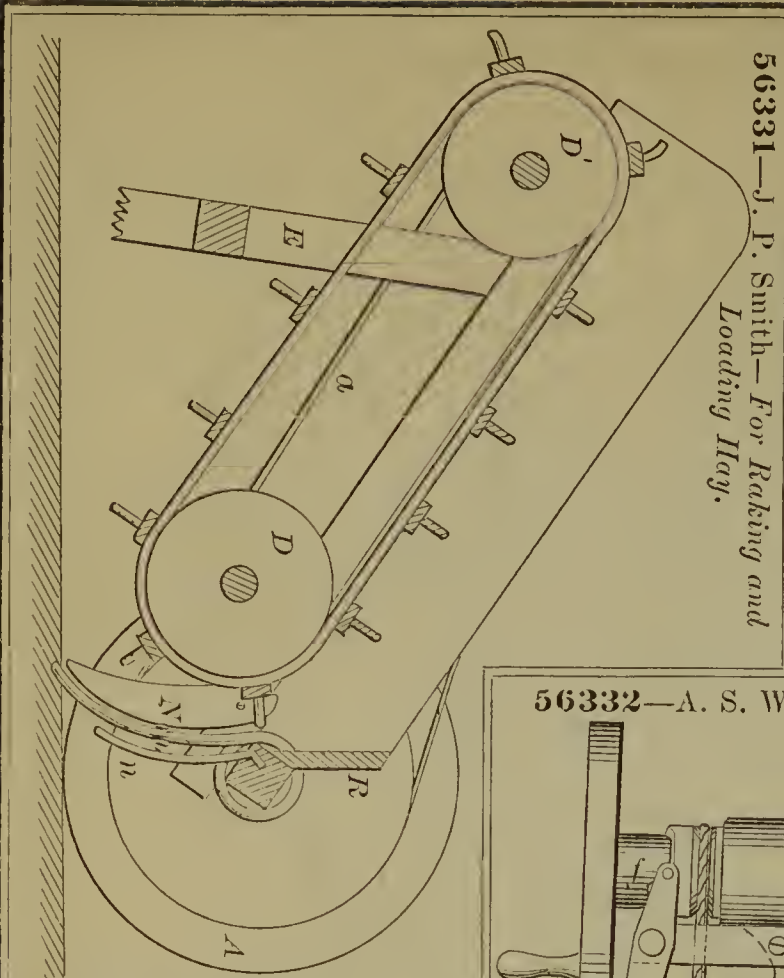

56331—J. P. Smith—For Raking and Loading Hay.

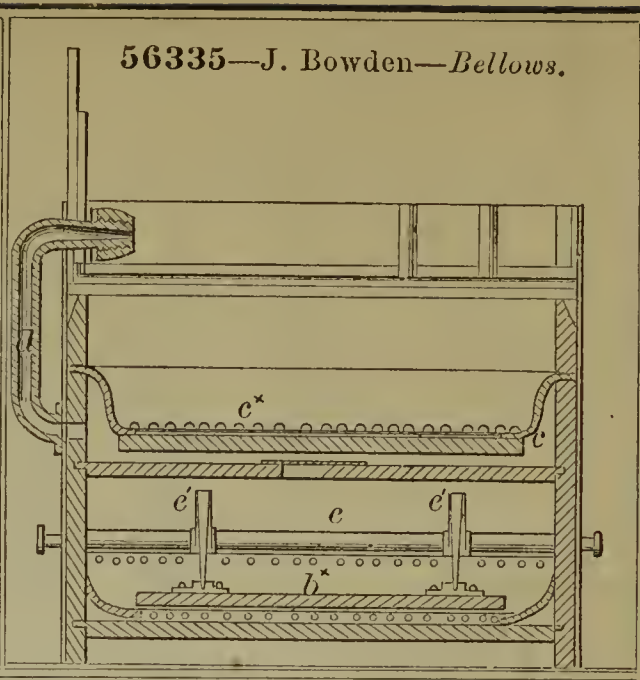

56335—J. Bowden—Bellows.

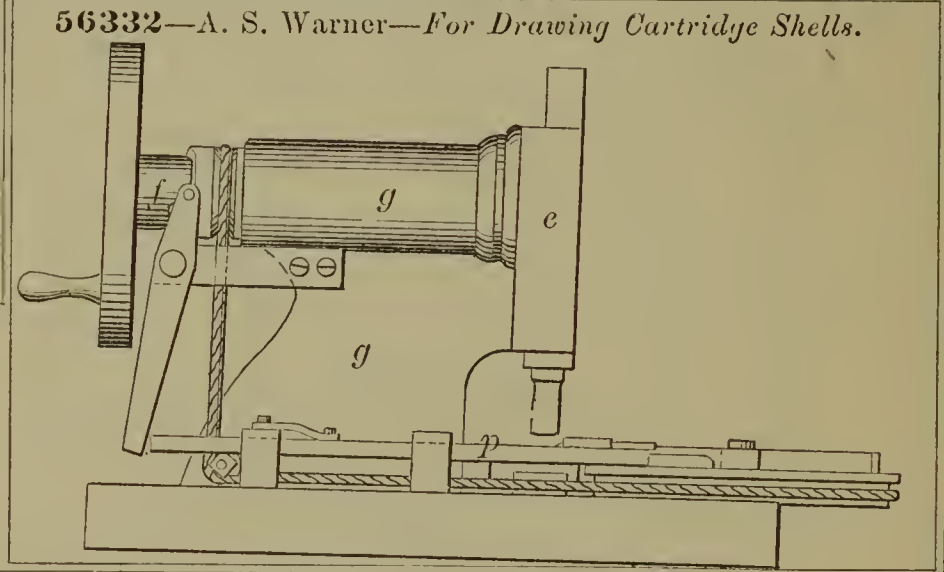

56332—A. S. Warner—For Drawing Cartridge Shells.

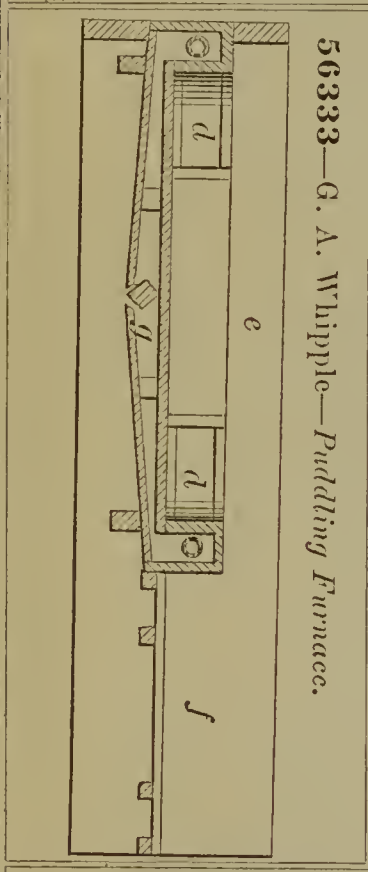

56333—G. A. Whipple—Puddling Furnace.

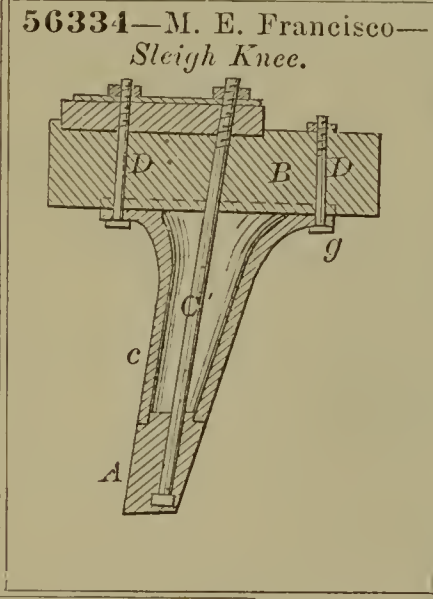

56334—M. E. Francisco—Sleigh Knee.

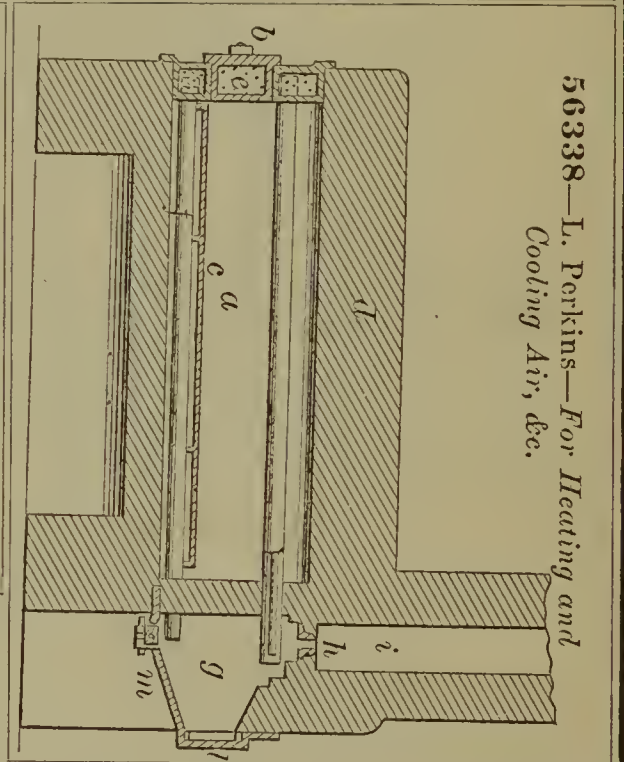

56338—L. Perkins—For Heating and Cooling Air, &c.

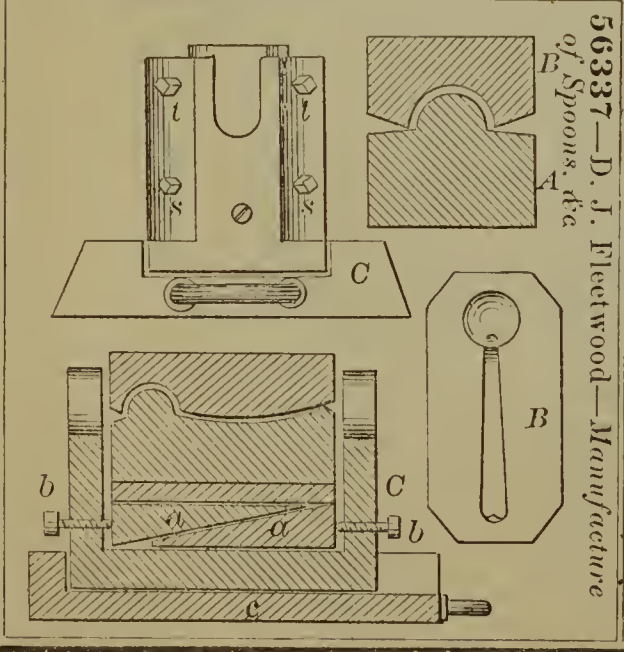

56337—D. J. Fleetwood—Manufacture of Spoons, &c.

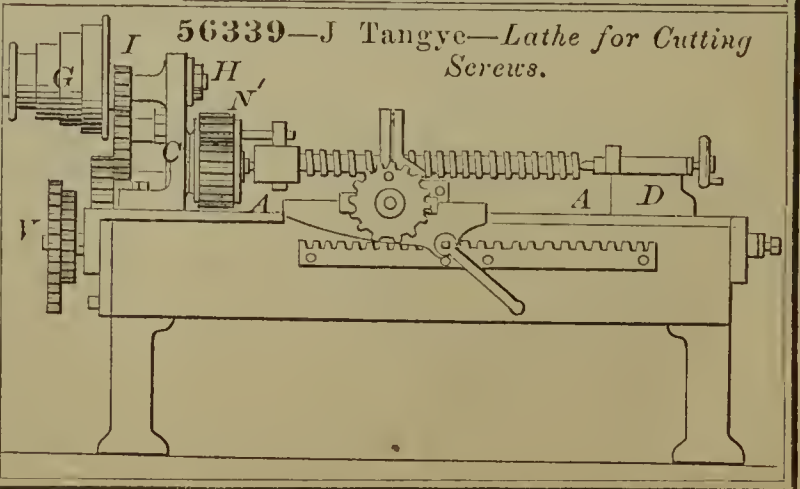

56339—J. Tangye—Lathe for Cutting Screws.



56340—J. Cooper—*Churn.*

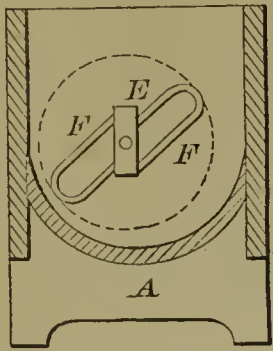

56341—T. V. Phelps—*Skirt Elevator.*



56342—J. G. Baker—*Measuring Faucet.*

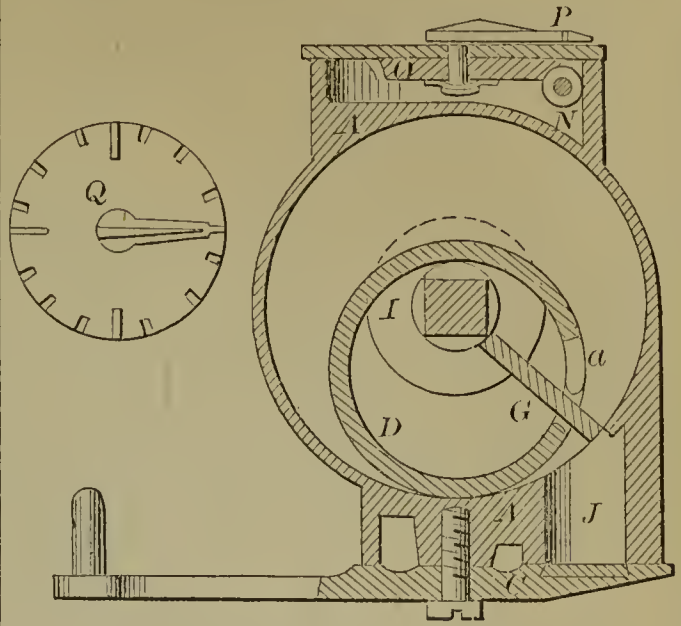

56344—I. Avery—*Cultivator.*

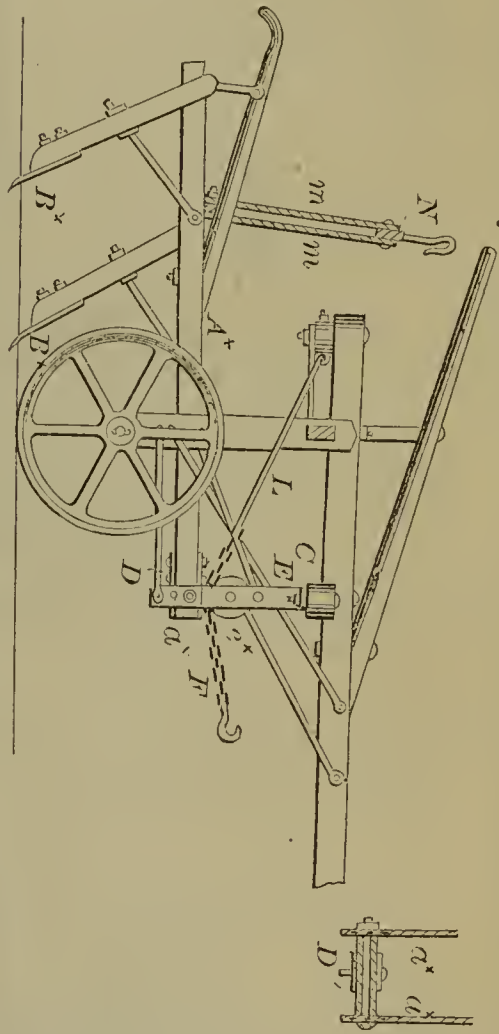

56343—Adair & Tweddle—*Distilling Liquids.*

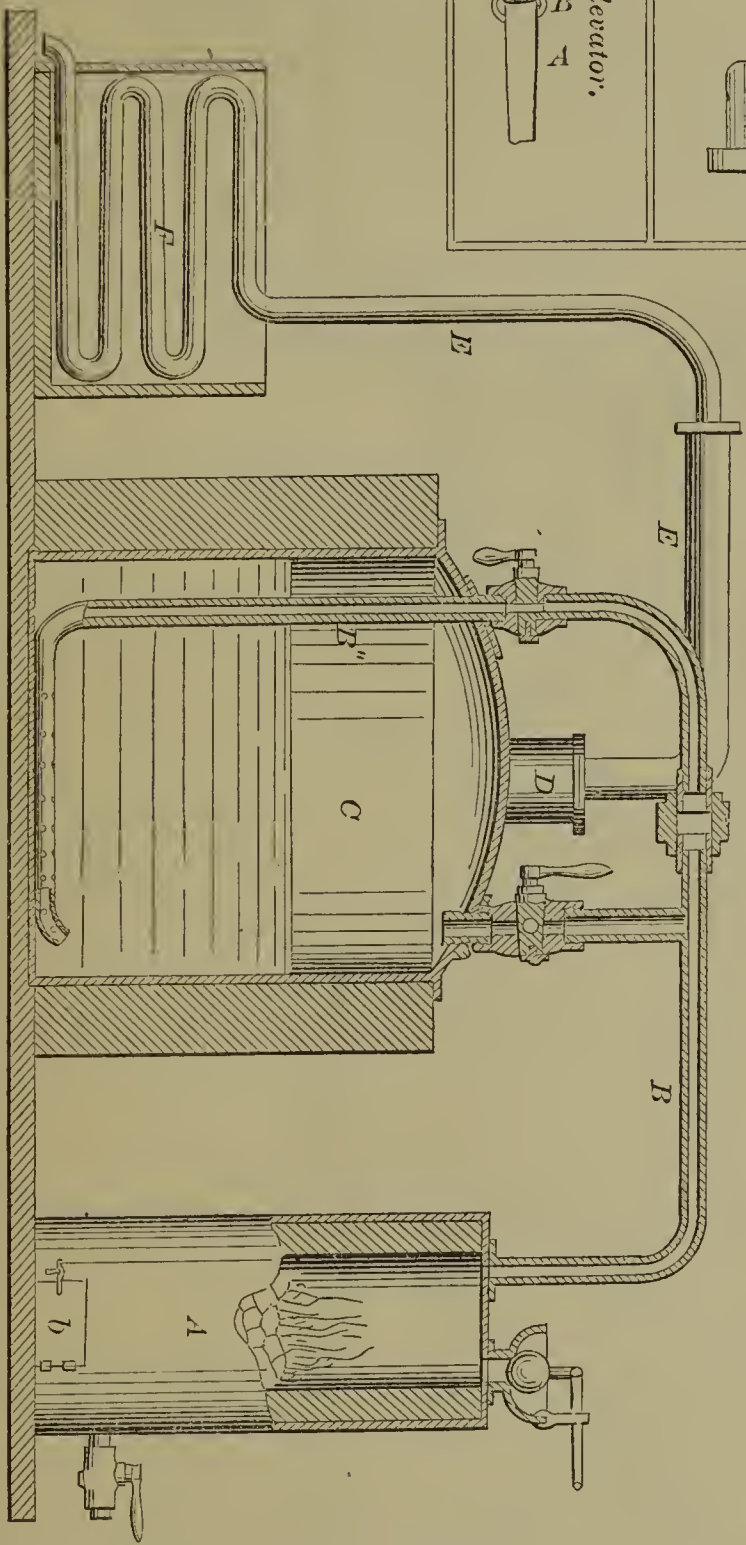

56346—Barton, Rogers & Fisher—*Combined Anvil and Vise.*

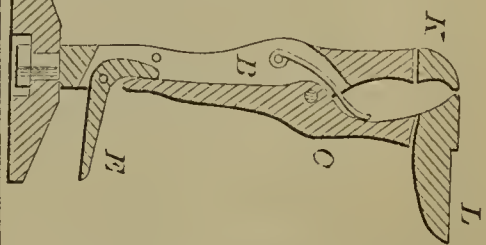

56347—B. Beach—*Sash Fastening.*

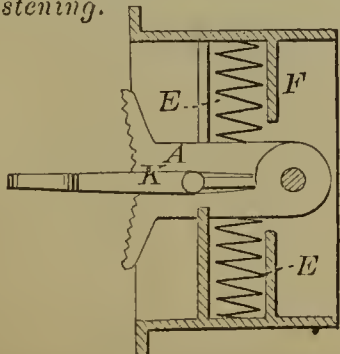

56345—S. H. Barnes—*Corset Spring.*

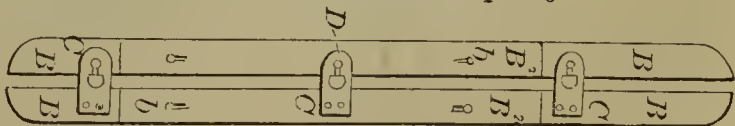

56348—H. H. Beach—Grain Dryer.

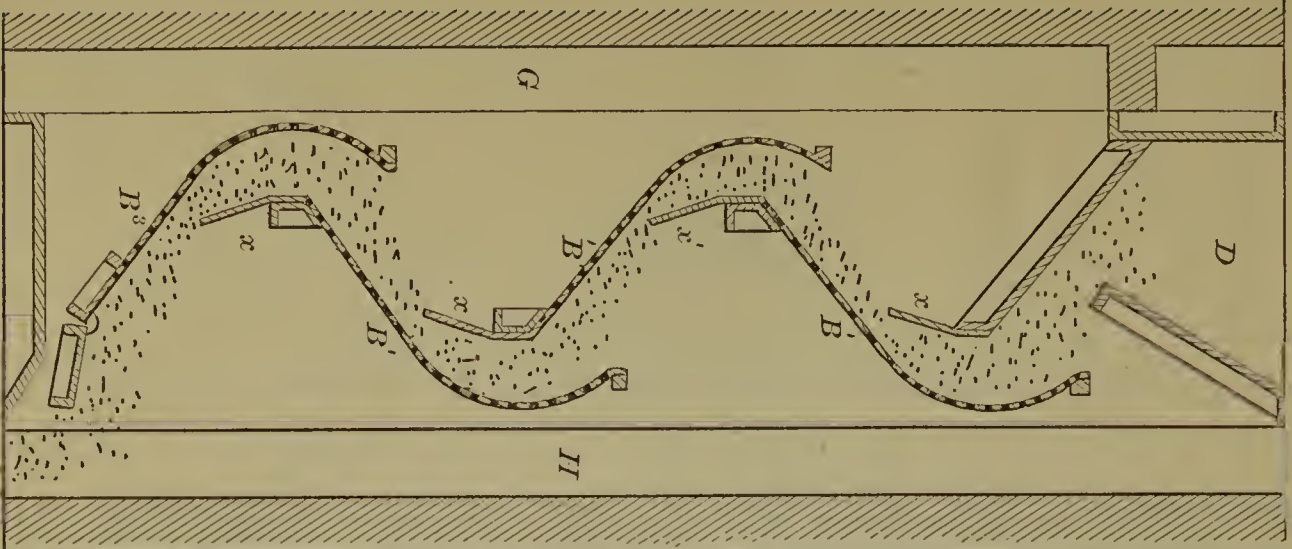

56350—C. Beidler—Plow.

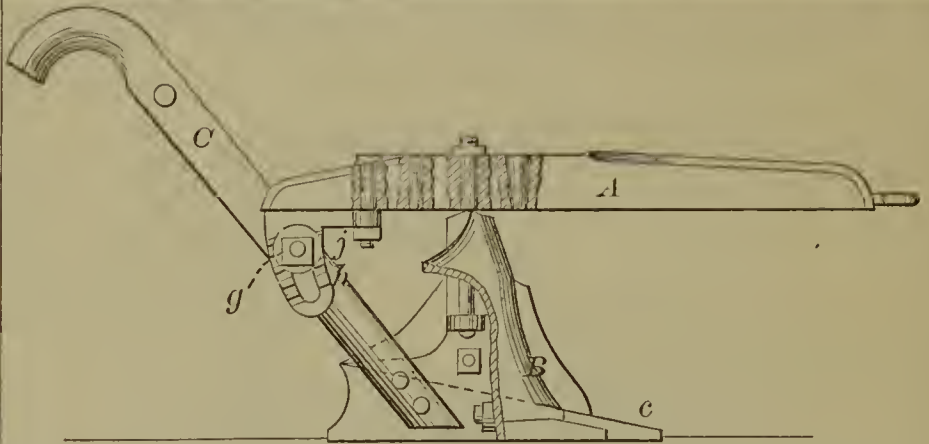

56349—Beard & Fairbanks—Bottle Stopper.

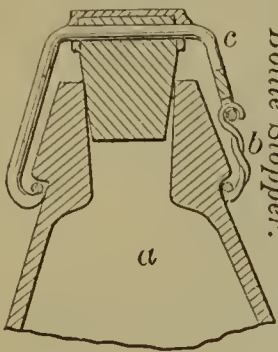

56351—Blomquist & Crook—Marine Car.

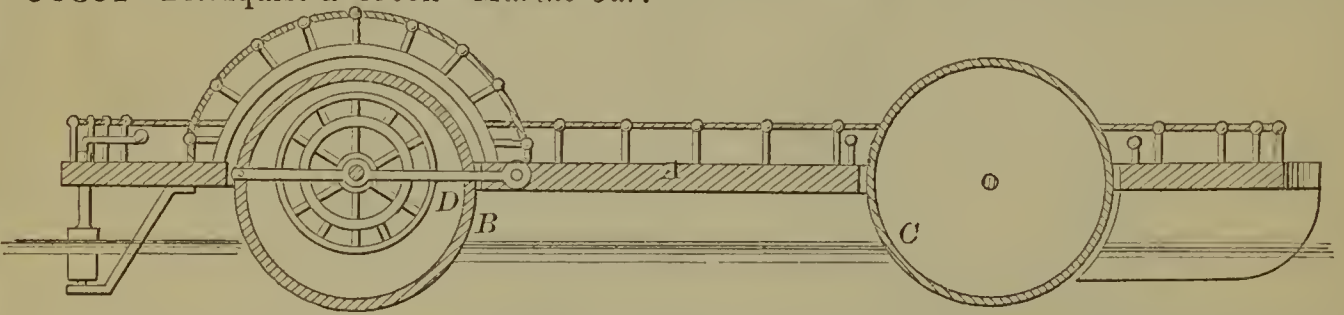

56352—S. R. Boardman—Water Drawer.

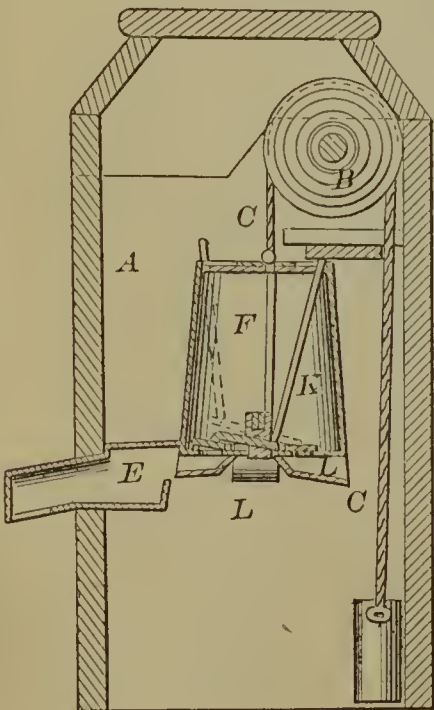

56353—Bogia & Taylor—Plaster.

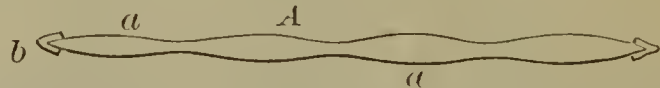

56354—W. Brant—Mechanical Movement.

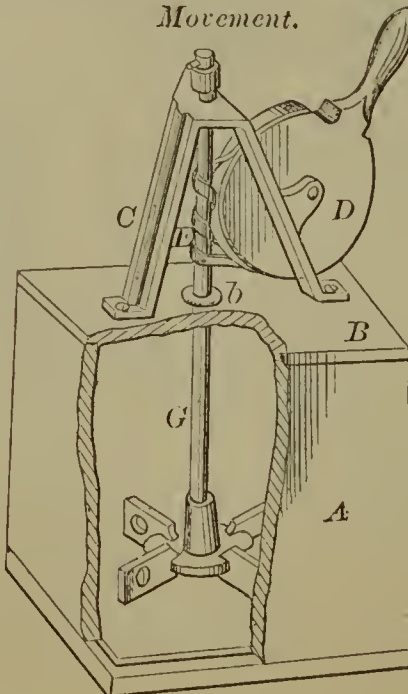

56355—Brewer & Winter—Well Tube.

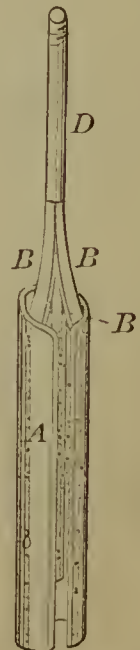

56356—J. Briggs—*Preparing Starch, &c.*

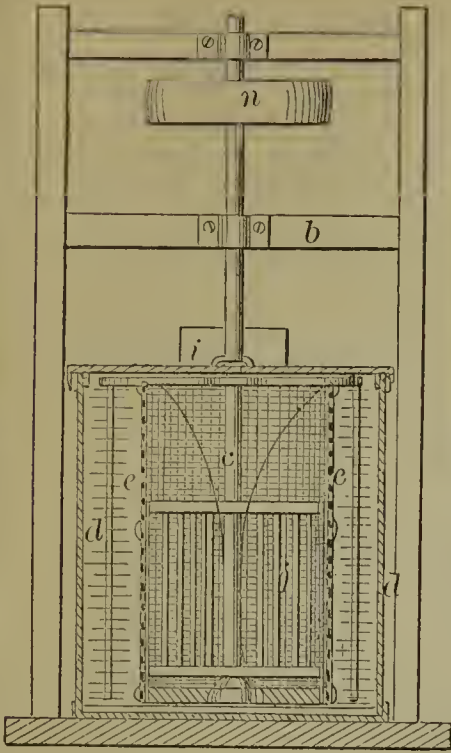

56357—Brown & McGhie—*Beer Faucet.*

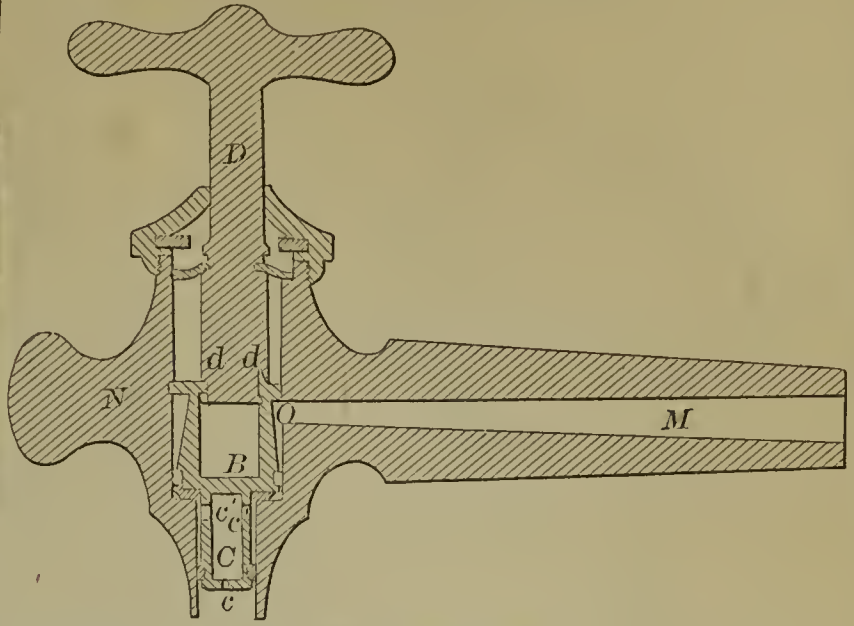

56358—J. H. Brown—*Toy Sled.*

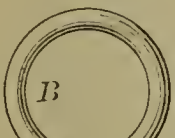
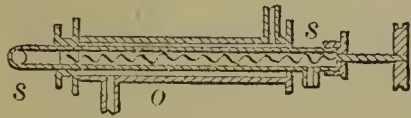
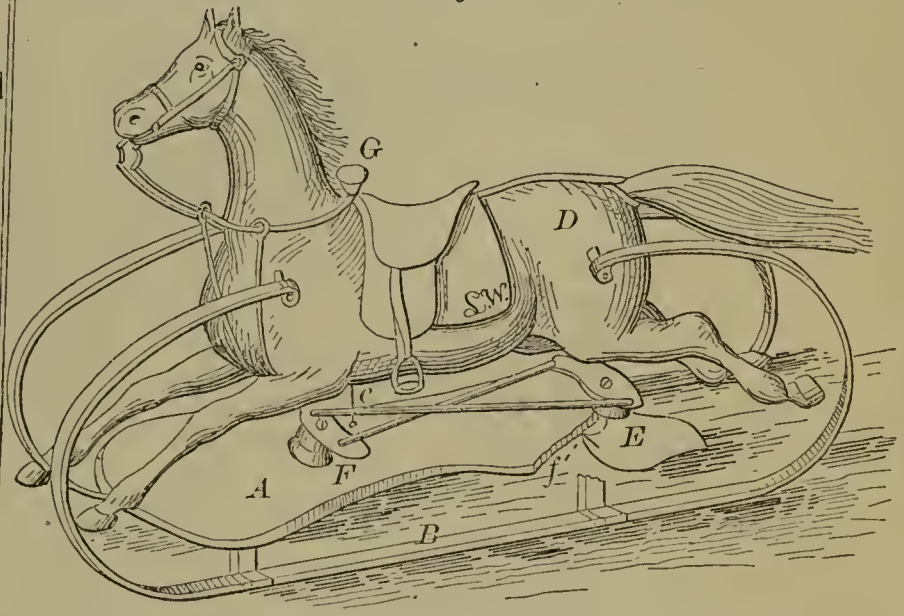

56359—J. S. Brown—*Horse Hay Fork.*

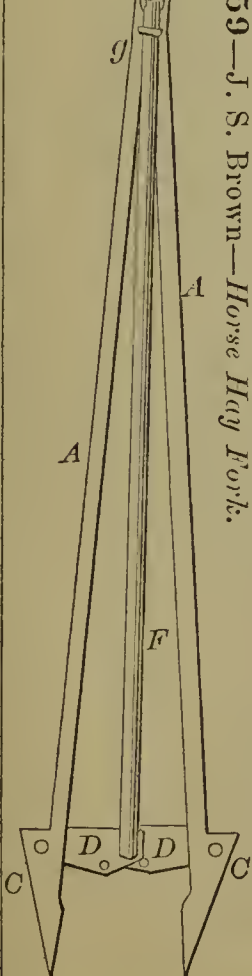

56360—O. C. Brown—*Clothes Dryer.*

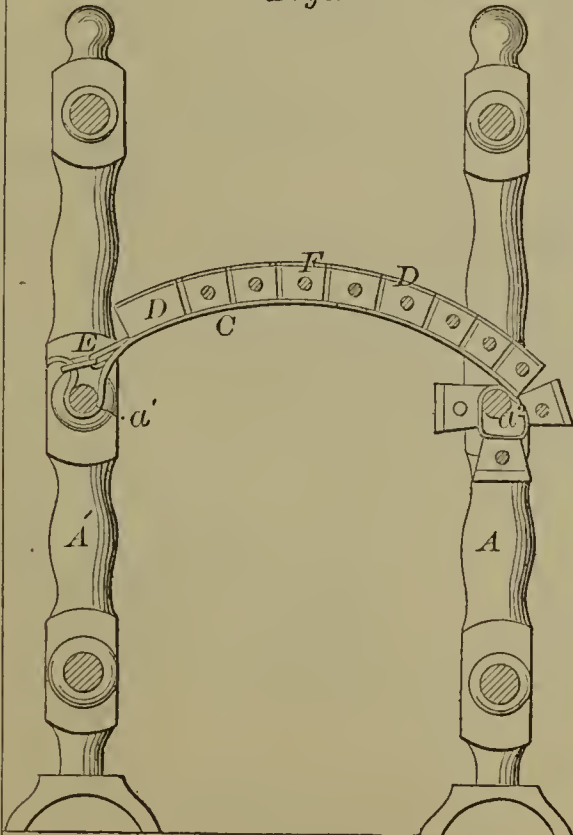

56361—T. W. Brown—*Bracket.*

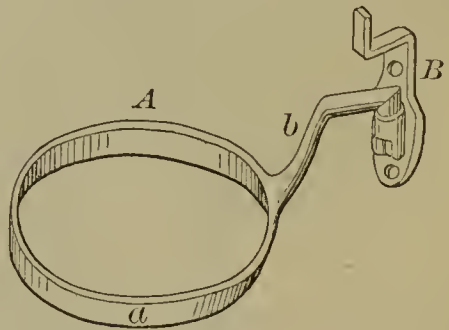

56362—  
H. L. & A. J. Buckwalter—*Horse Power.*

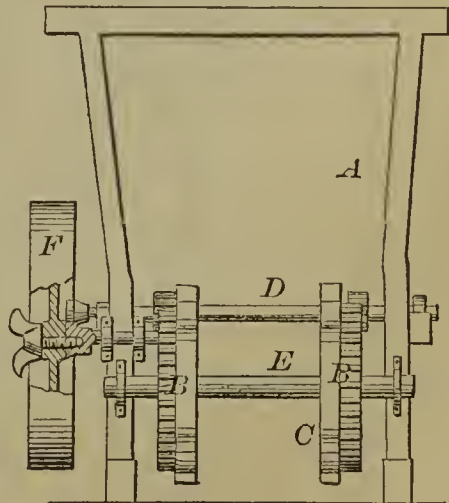

56364—J. Burns—Coffin.

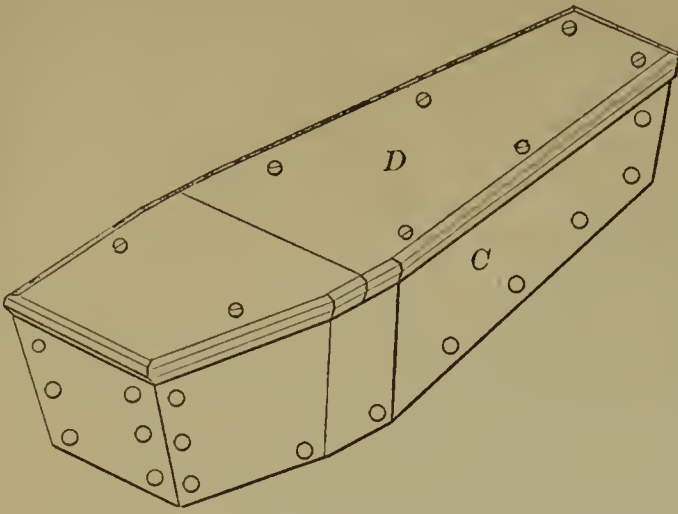

56365—S. G. Cabell—Crimping Machine.

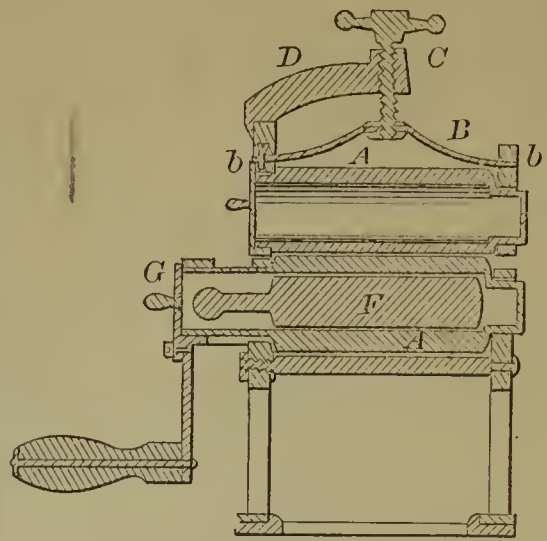

56366—W. F. Caldwell—Potato Digger.

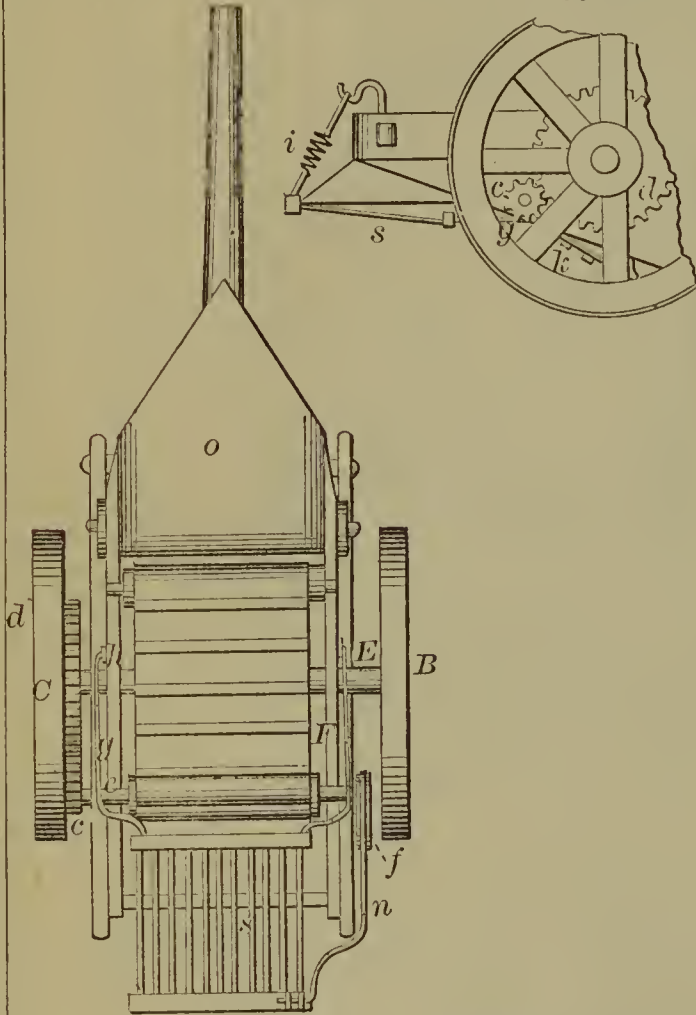

56367—R. Carter—Tea Pot.

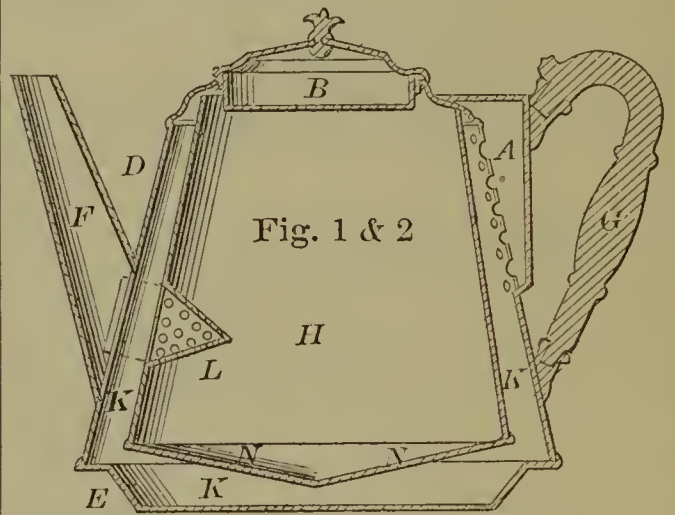

56368—S. P. Chapin—For Opening Cans.

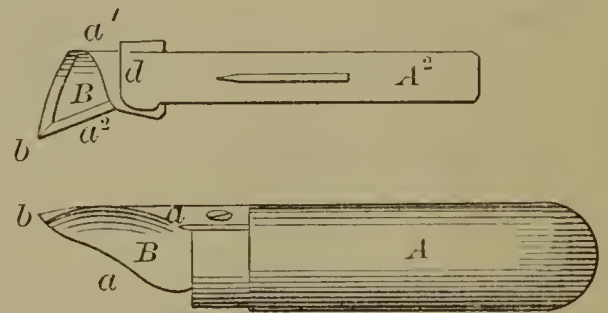

56369—E. G. Chormann—Skate.

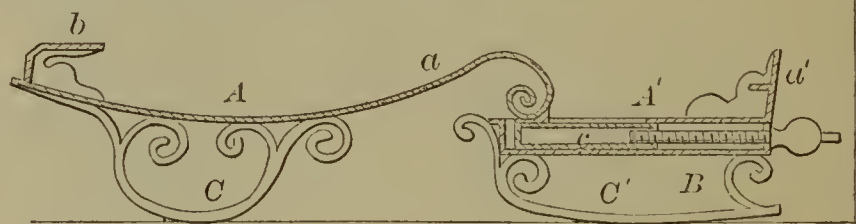
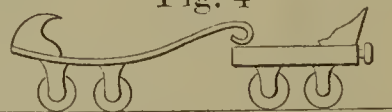
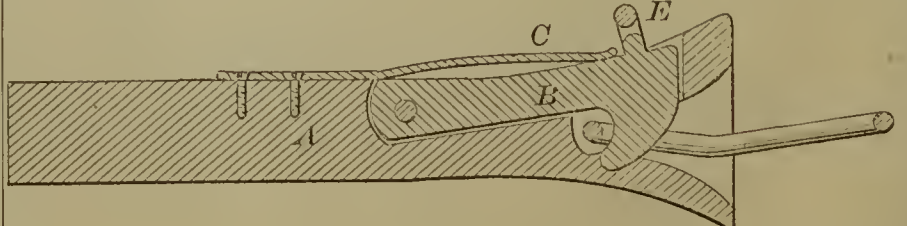

Fig. 4



56371—C. D. Clinton—Car Coupling.



56370—G. Clark, Jr.—Pea Shelling Machine.

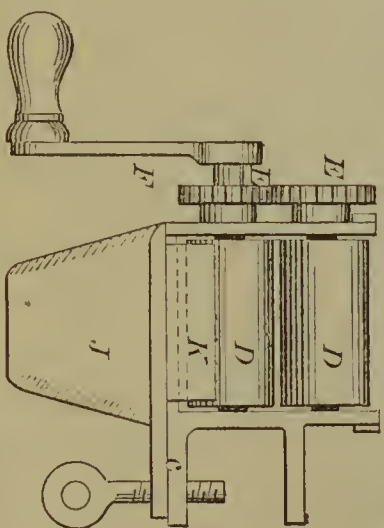

56372—C. Cobb—Cordage Machine.

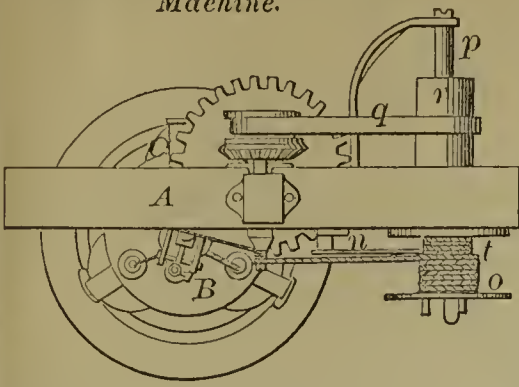

56373—A. Cole—Bed Bottom.

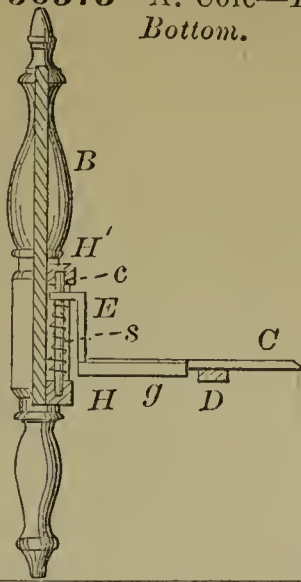

56379—B. F. Cowan—Stove Pipe Damper.

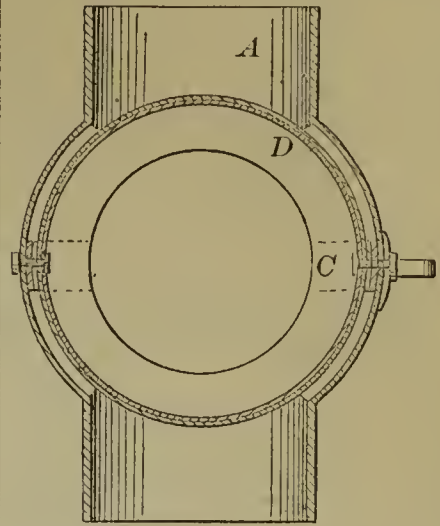

56374—E. G. Connelly—Churn Dasher.

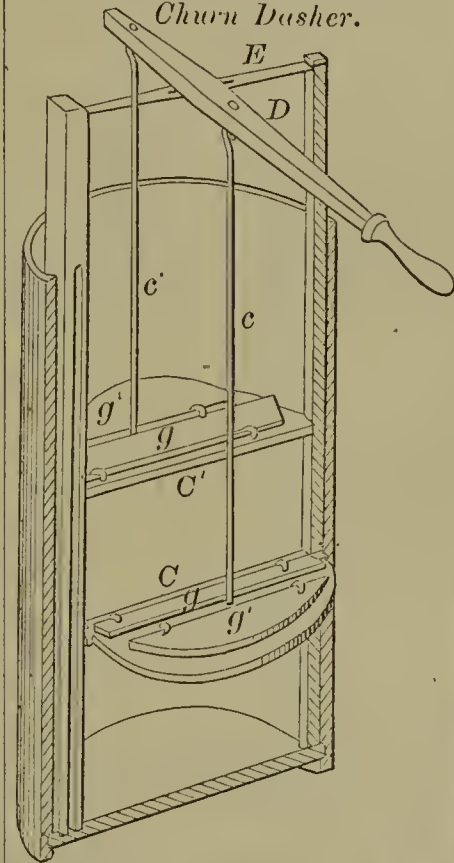

56376—H. Cordes—Invalid Bedstead.

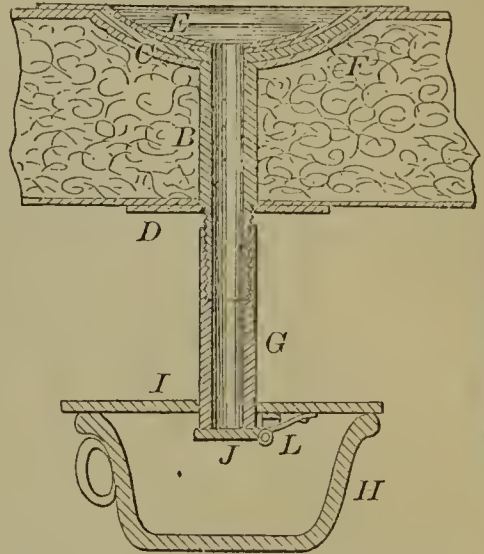

56375—A. J. Cooley—Horse Hay Fork.

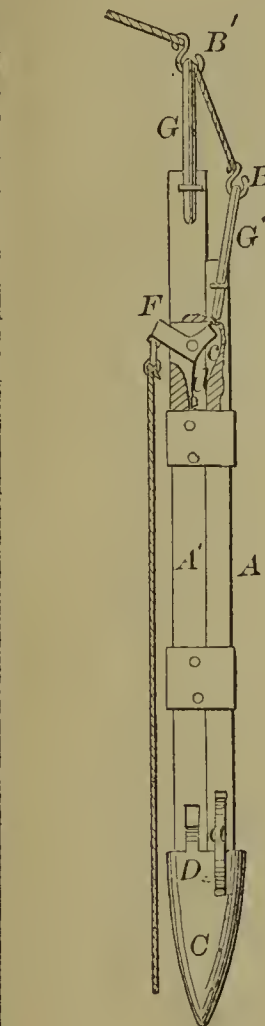

56377—F. T. Cordis—Tool Holder.

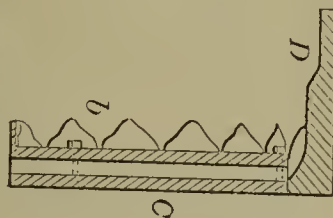

56378—Coults & Roach—For Treating Ores.

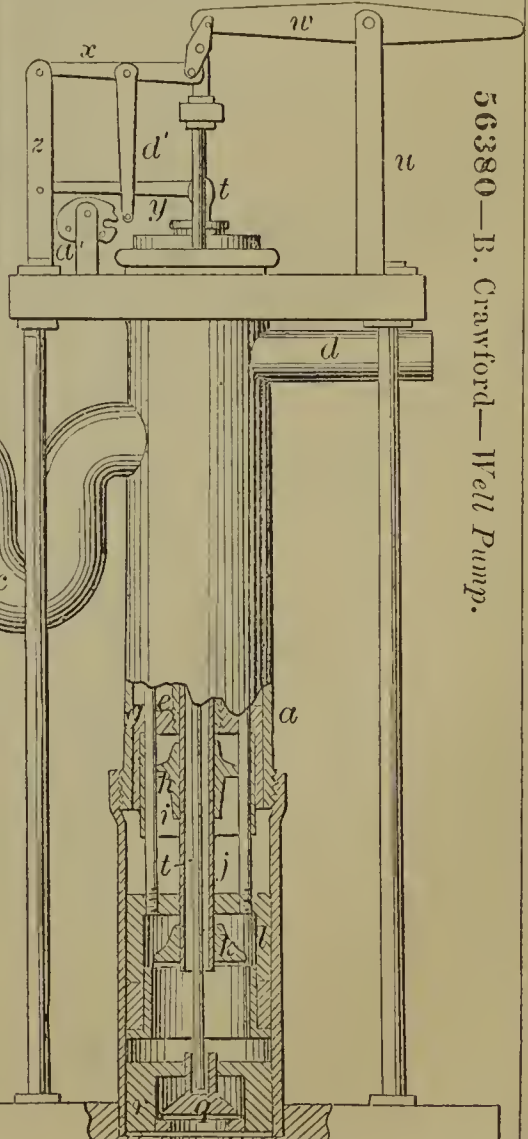
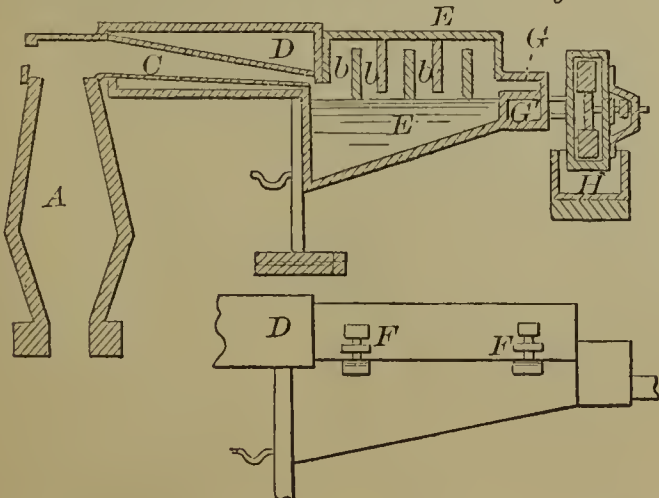

56380—B. Crawford—Well Pump.

56381—  
G Crompton  
Wovey Fabric.

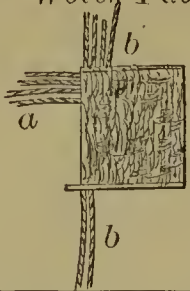

56385—J. B. Douherty—Slide Valve.

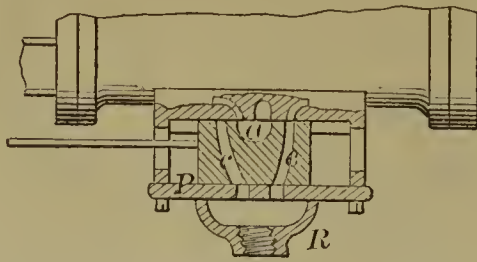

56386—Dorer & Storms—  
Elevator Bucket.

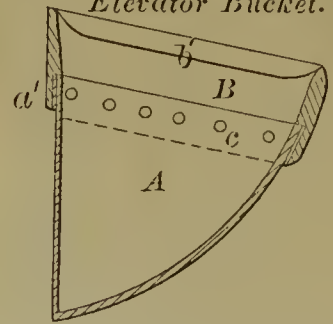

56382—J. Davis—Egg Beater.

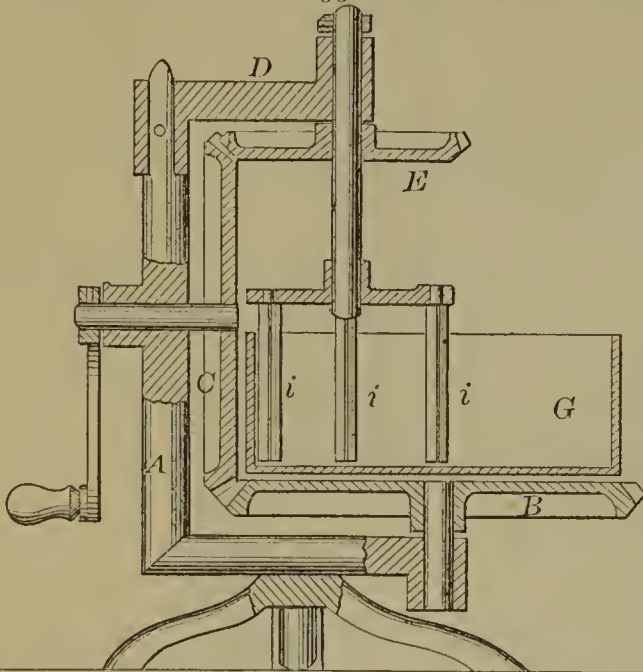

56383—C. Dittenhafer—For Cutting  
Dresses.

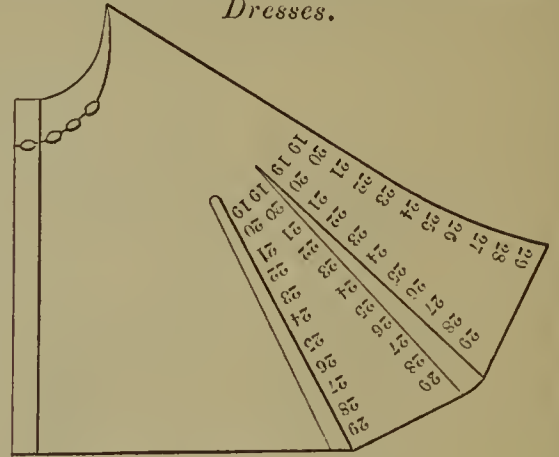

56387—S. S. Durbon—Pump.

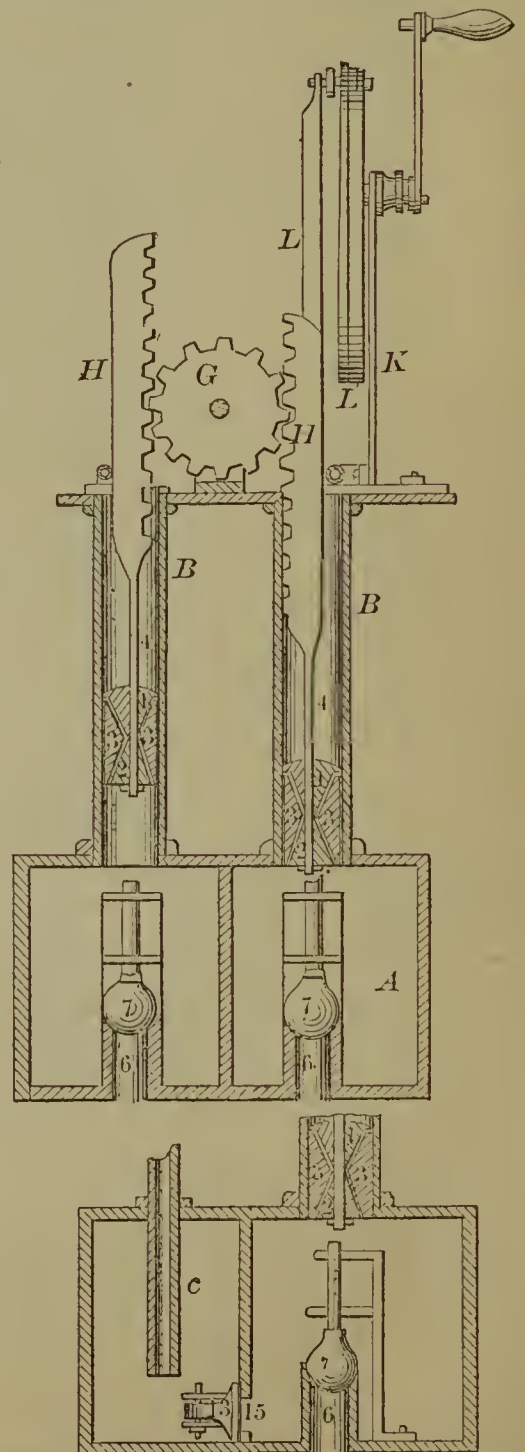

56384—J. B. Douherty—Slide Valve.

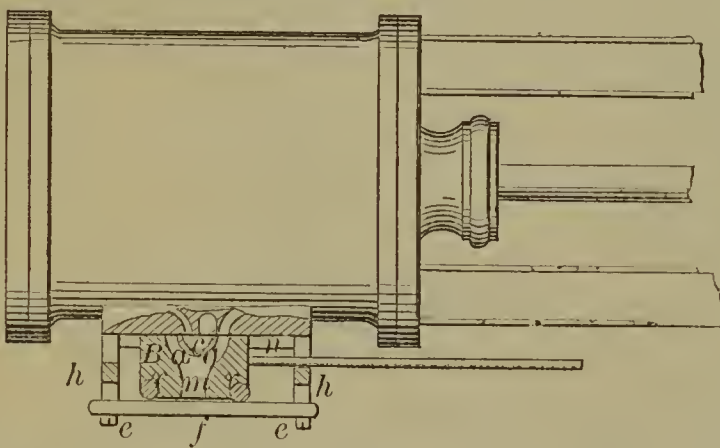

56388—Z. S. Durfee—Flask for Casting.

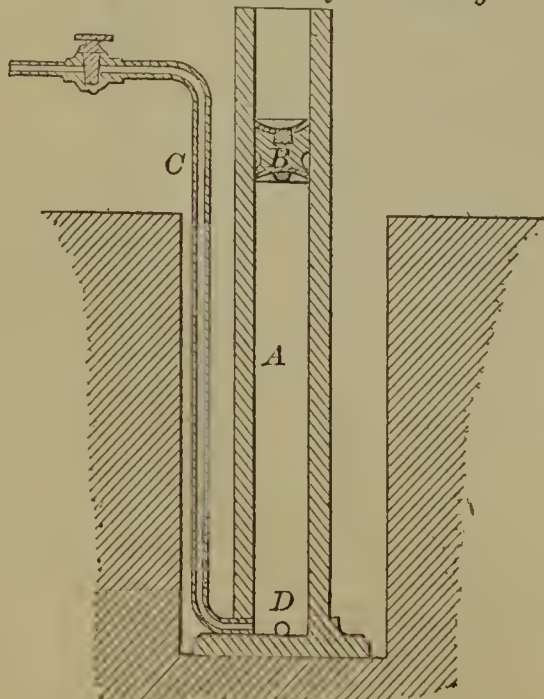

56389—R. Dutton—*Harvesting Machine.*

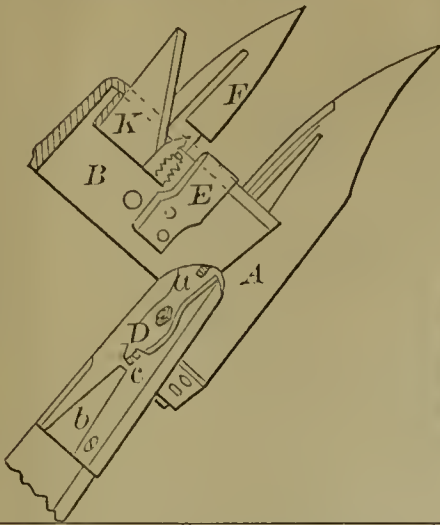

56390—R. F. Ellis—*Fruit Can.*

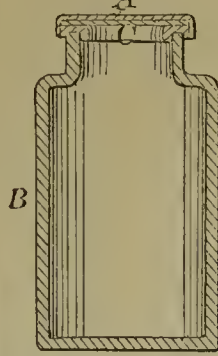

56391—M R. Ethridge—*Boots and Shoes.*

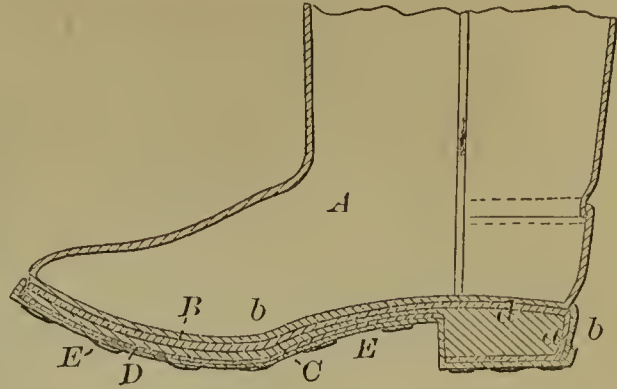

56392—S. F. Emerson—*Gate.*

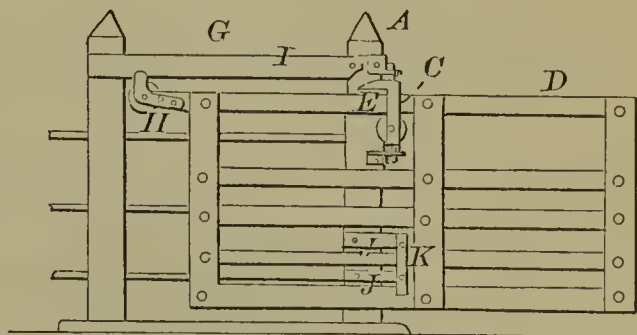

56393—C. A. Ensign—*For Making Corded Binding.*

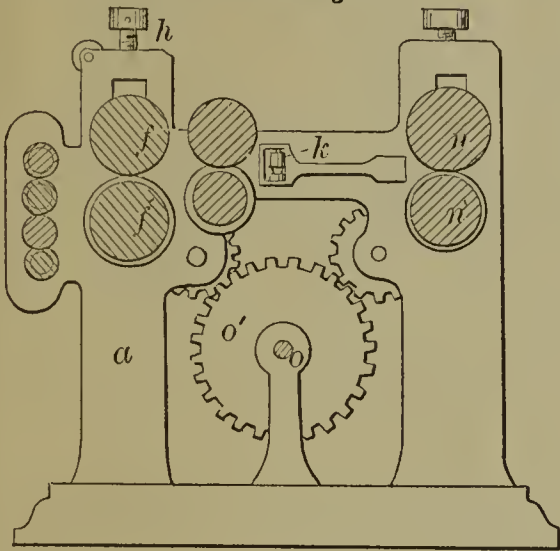

56395—J. H. Field—*Operating Ordnance.*

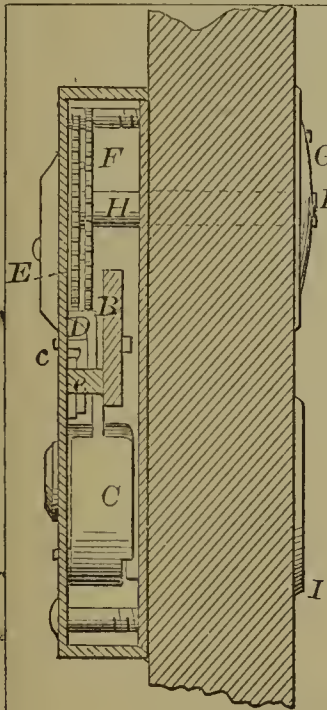
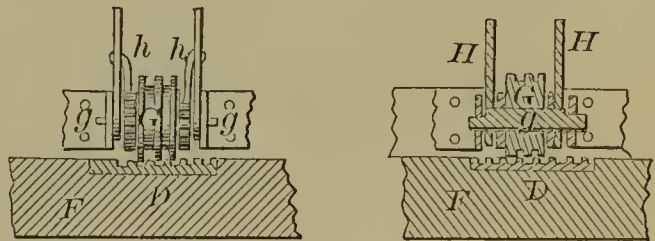

56394—P. S. Feltner—*Lock.*

56396—M. Fletcher—*Steam Generator.*

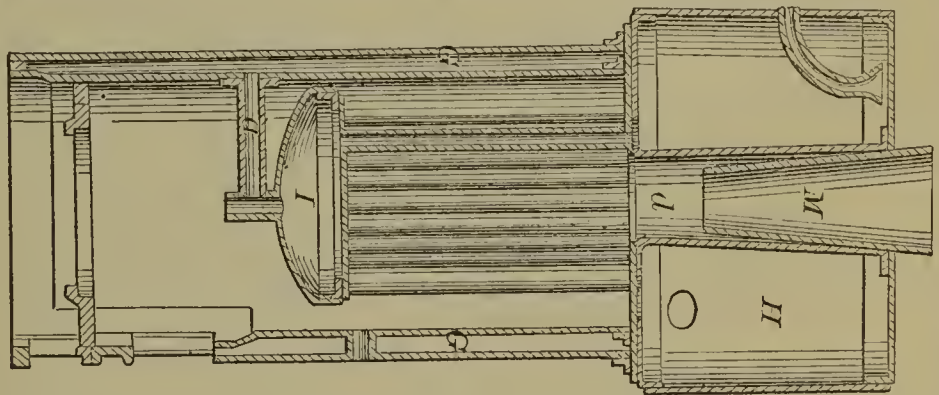

56397—E. T. Ford—*Harvester.*

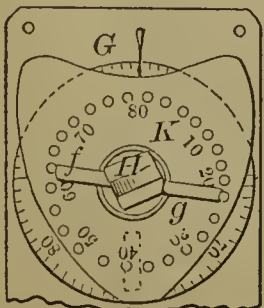
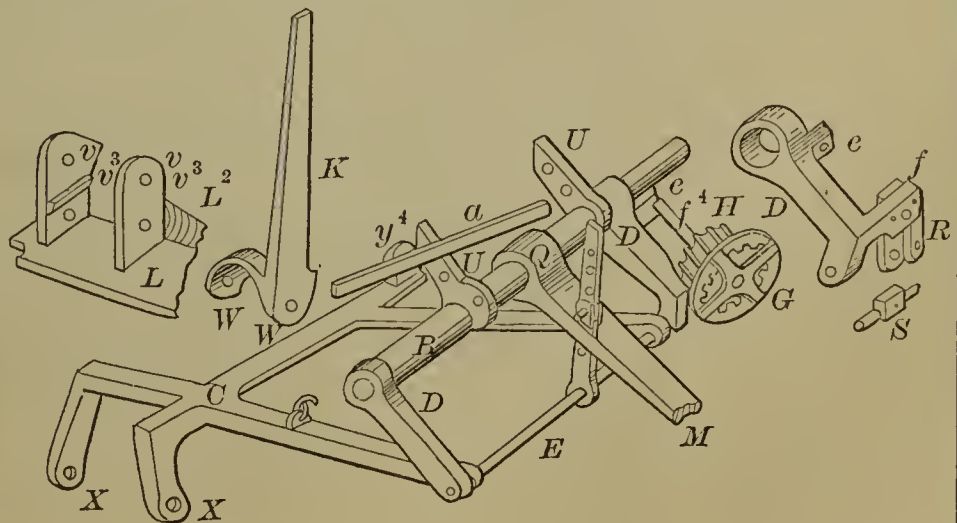

56399—G. P. & G. F. Foster—Fire Arm.

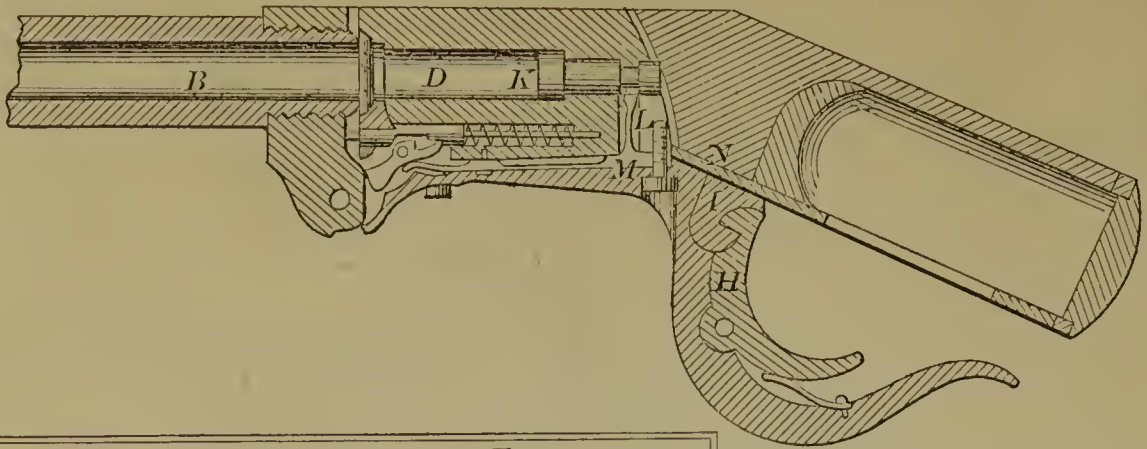

56404—Goodrich & Edwards—Steam Engine.

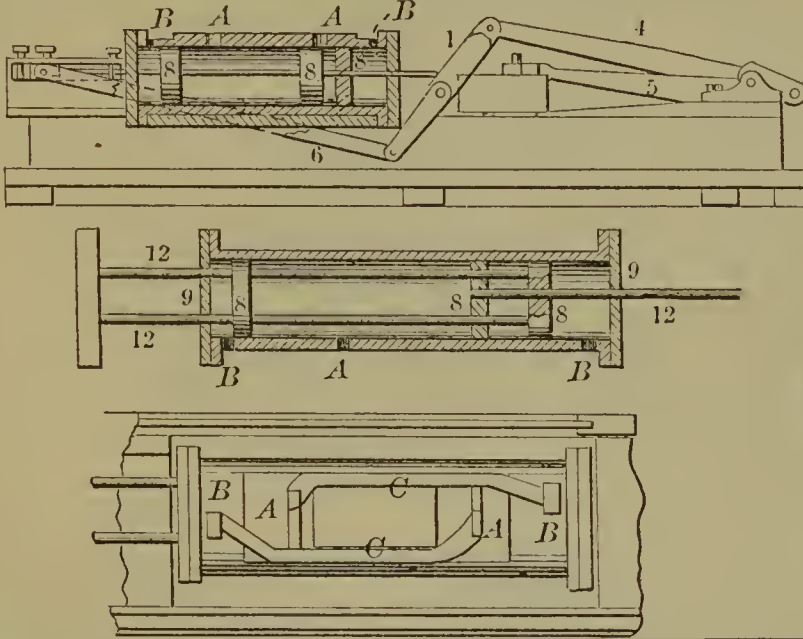

56401—E. C. Gero—Horse Shoe.

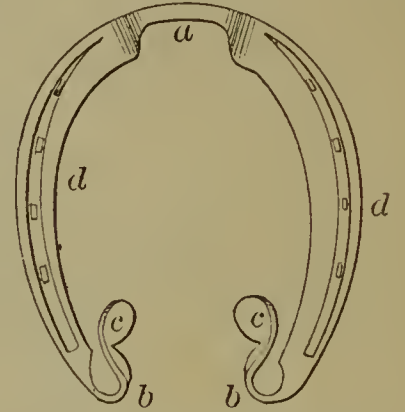

56402—C. F. Gillett—Bag Holder.

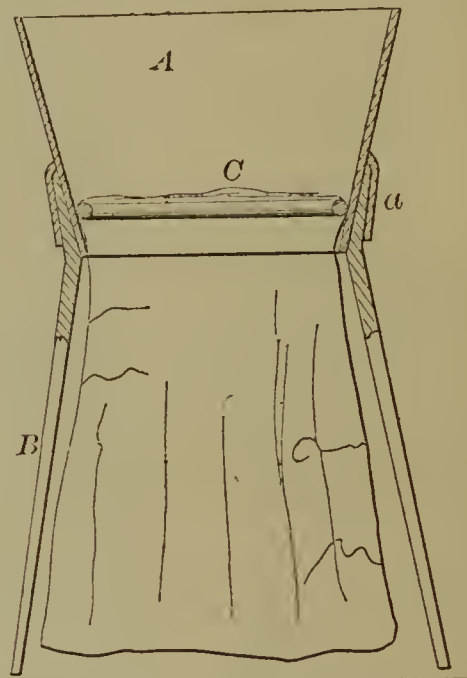

56405—F. Granger—Harrow.

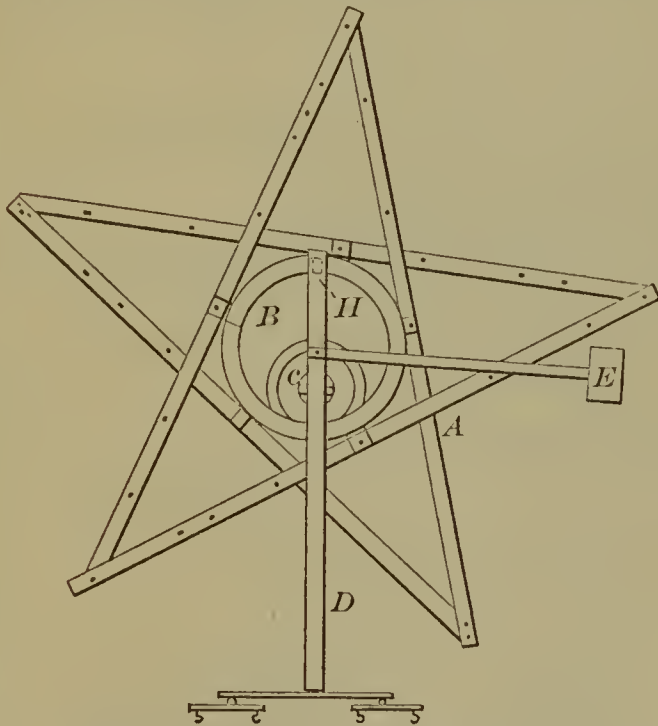

56403—R. S. Gladwin—Grinding Machine.

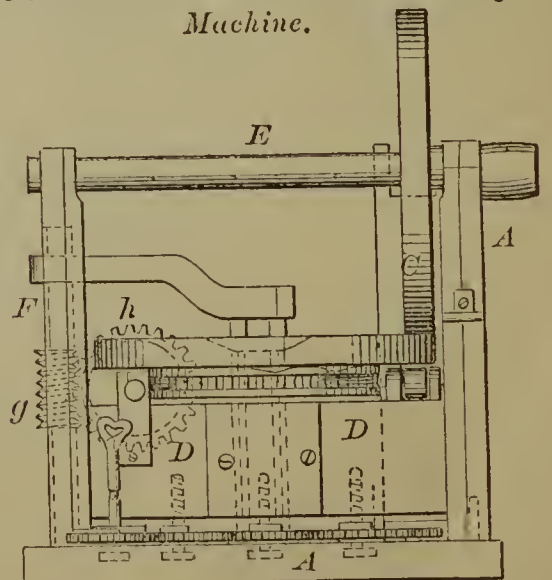

56400—F. H. Furniss—Car Spittoon.

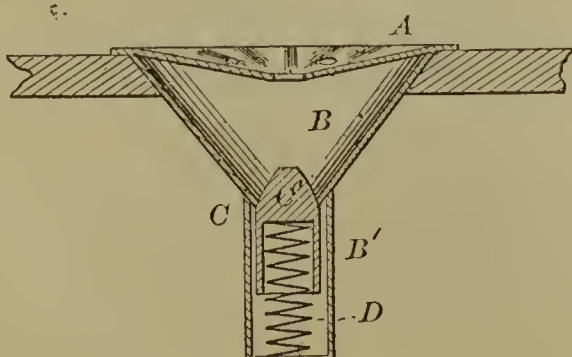



56406—J. Guekian—For Stripping and Cutting Sorghum.

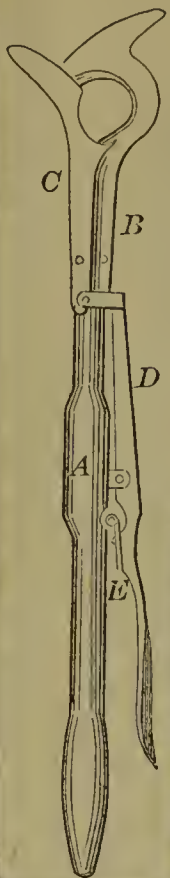

56408—E. R. Hall—Coal Hod.

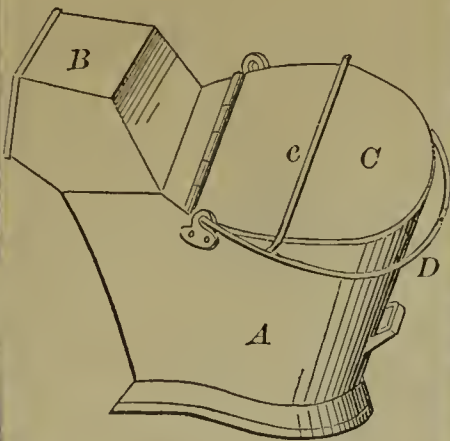

56409—E. Hamilton—Safety Valve.

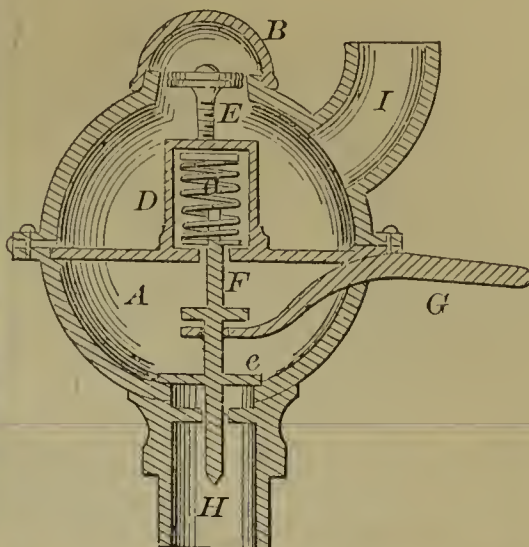

56411—C. T. Harvey—Railroad.

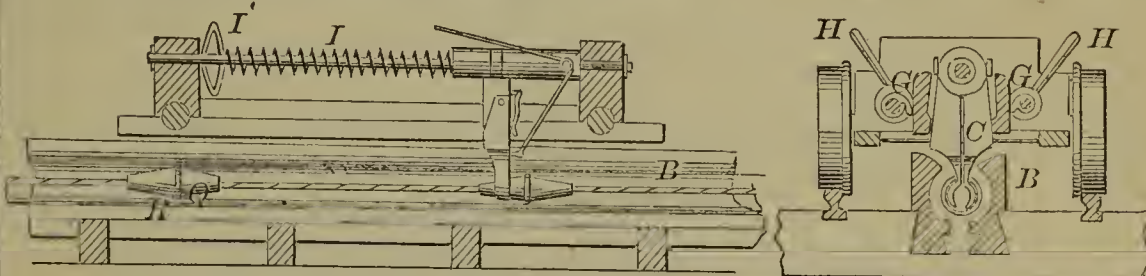

56407—G. Gunther—Bird Cage.

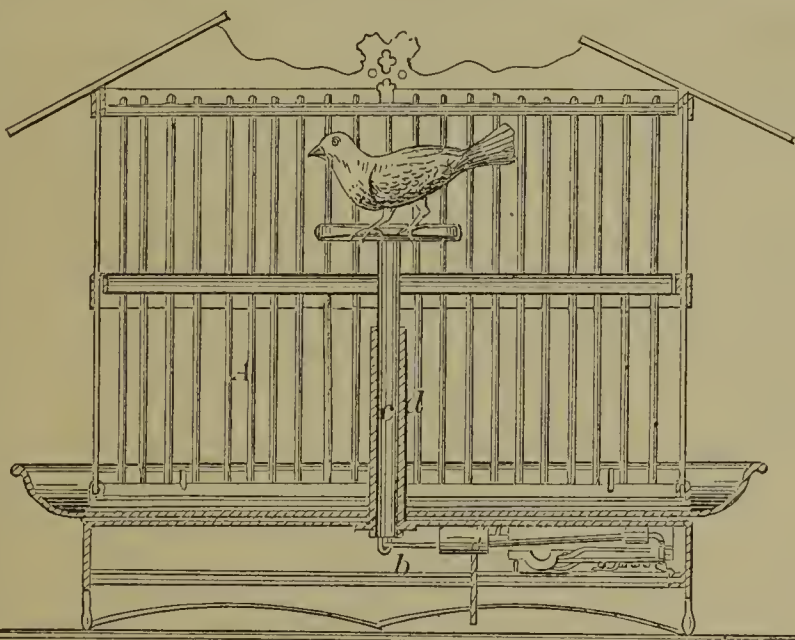

56410—Harrison & Condie—Folding Chair.

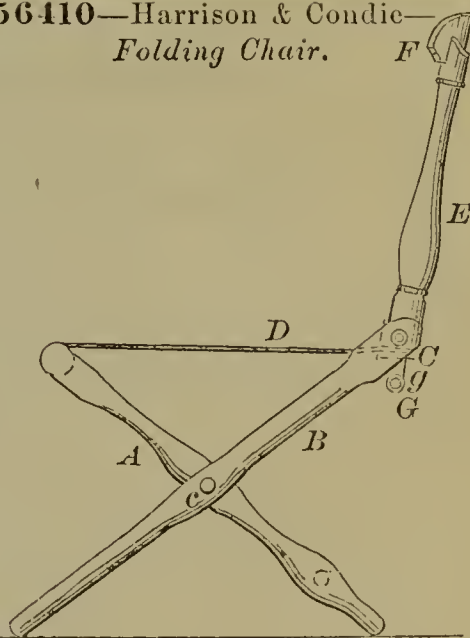

56412—Hawley & Murdock—Gate.

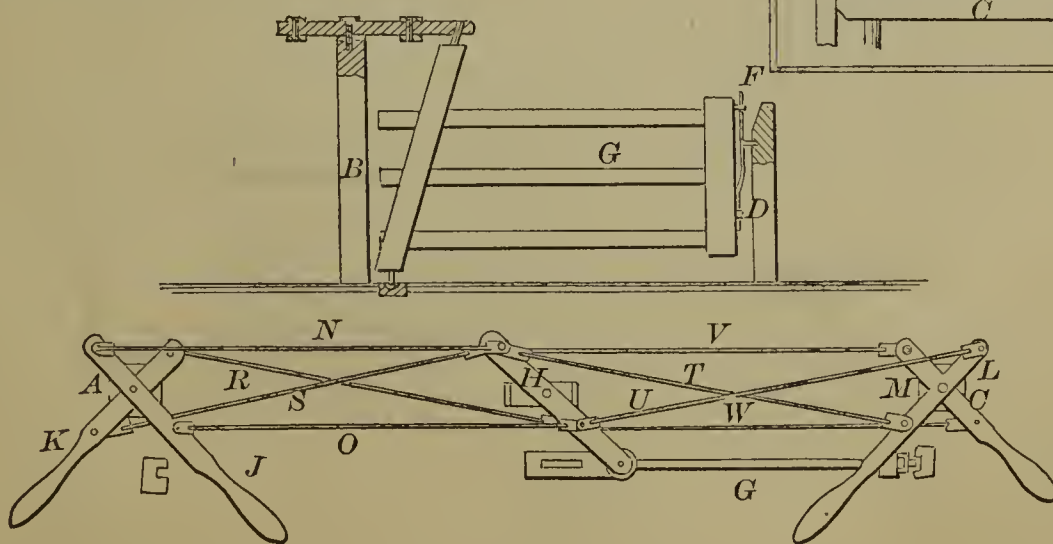

56413—C. Hess—Piano, Couch and Bureau.

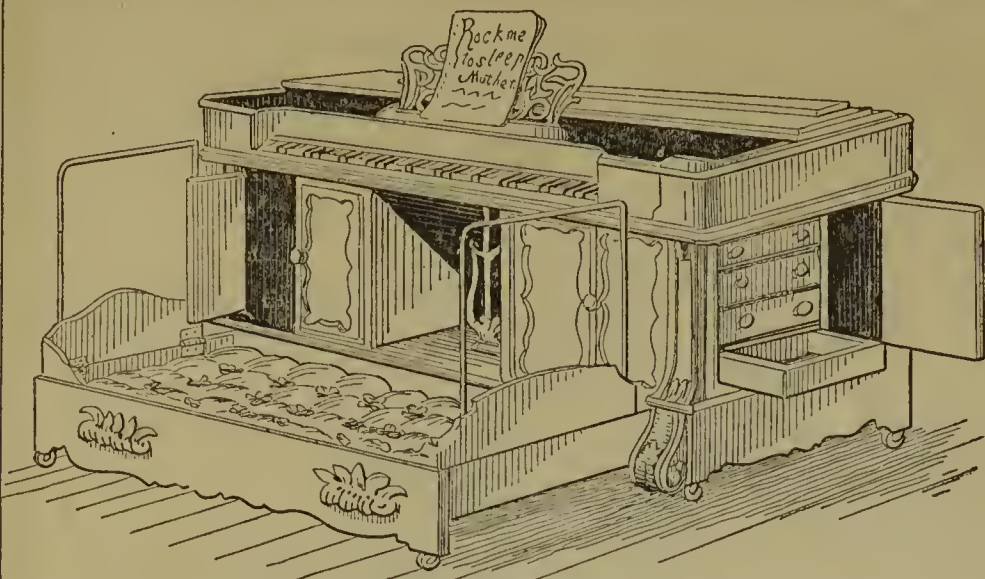

56414—I. W. Hoagland—Pump Piston.

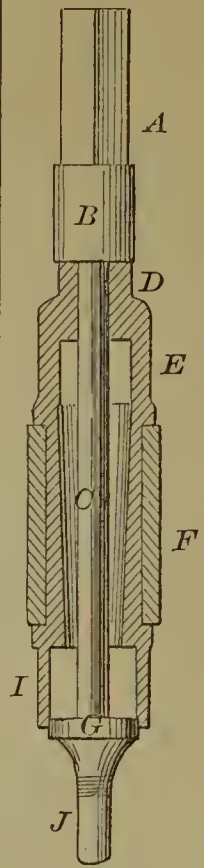

56418—R. B. Huggin—Roller for Clothes Wringers.



56416—W. L. Horne—Steam Water Power Device.

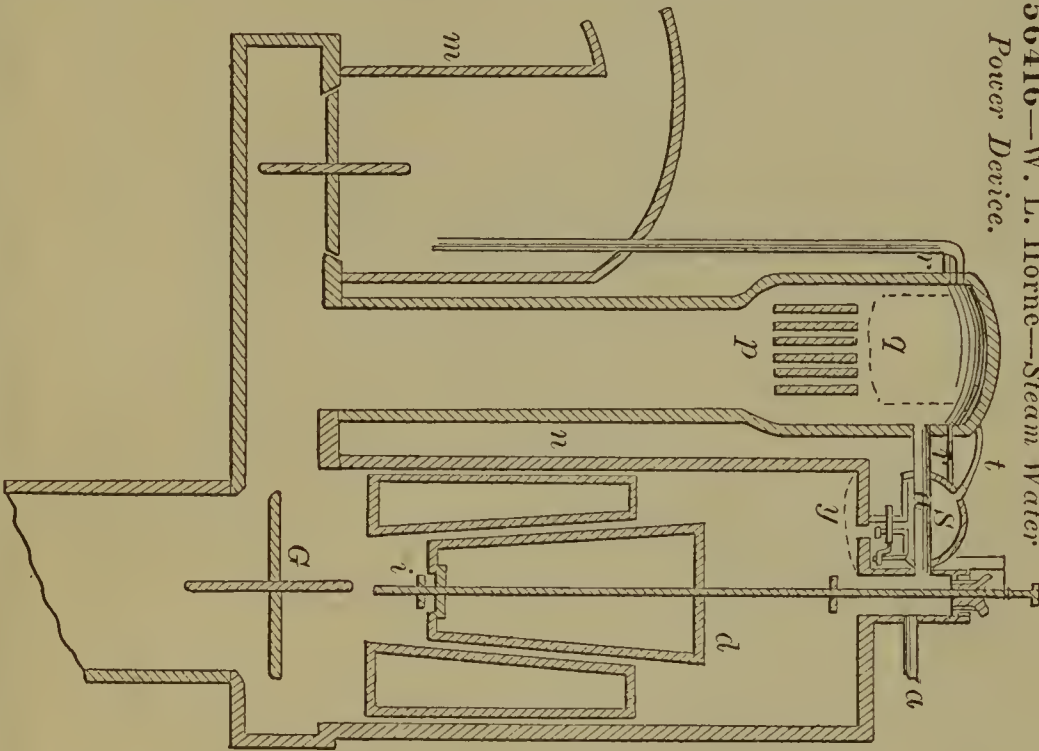

56417—W. L. Horne—Fire Escape.

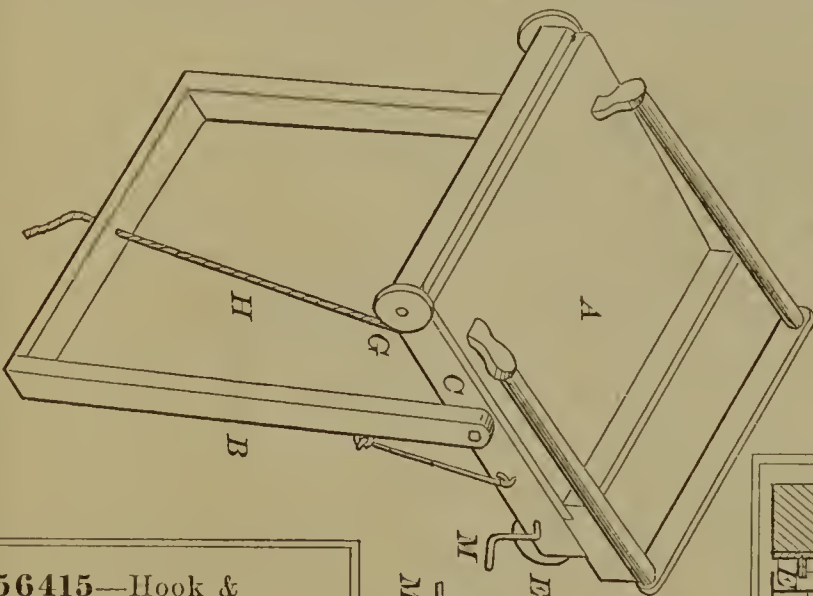

56419—L. Hull—Lathe.



56415—Hook & Adams—Eraser.

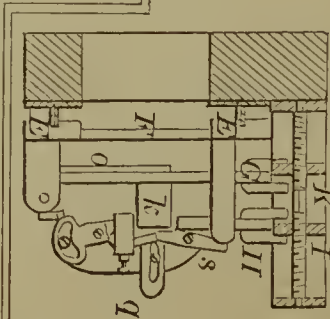
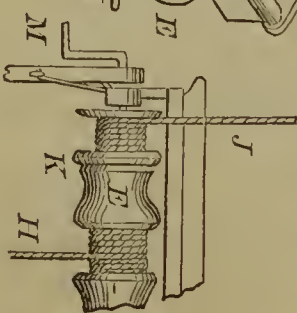
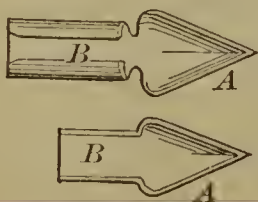

56420—L. Hunton—Piston.

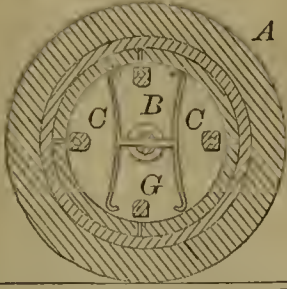

56423—T. C. Law—Stove Hook, &c.

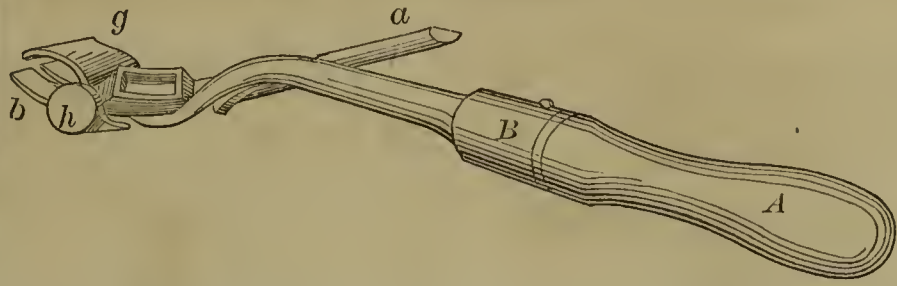

56421—M. E. Hurley—Needle for Caning Chairs.



56424—C. Livingston—Planing Machine Cutter.

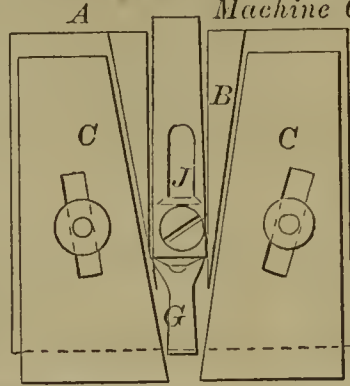

56426—D. R. Mac Lennan—Sawing Machine.

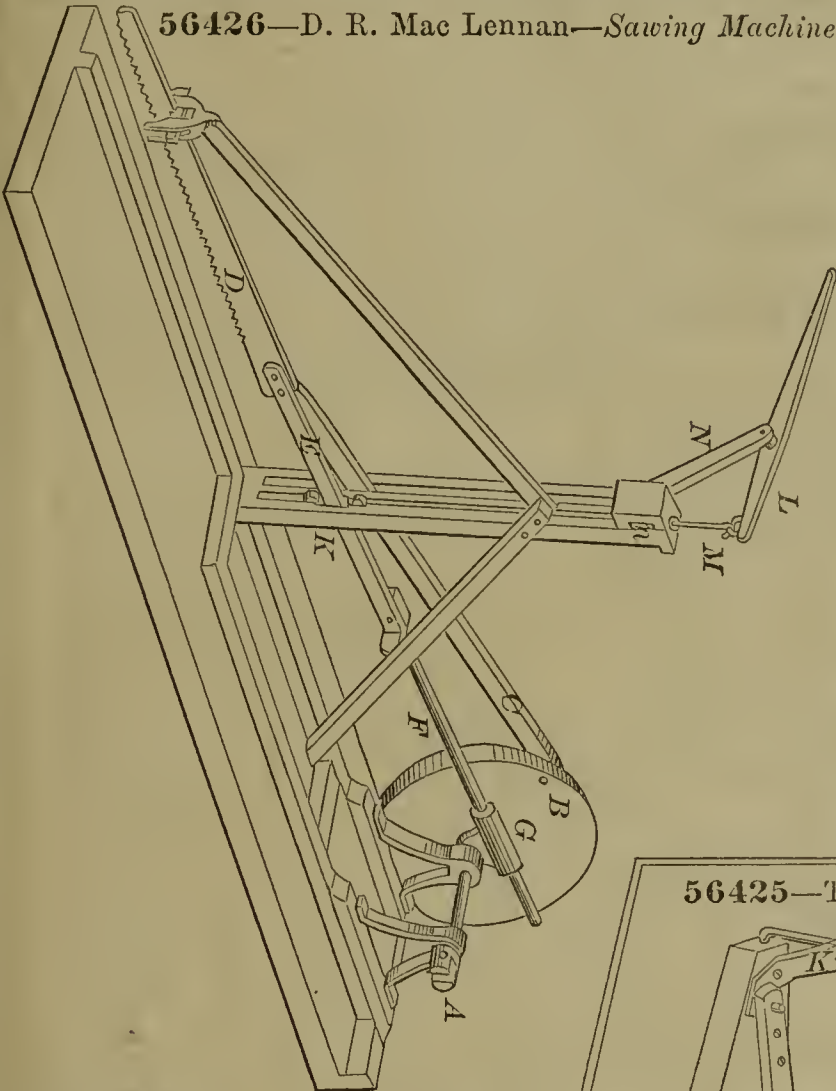

56422—S. L. Latta—Store Shelf.

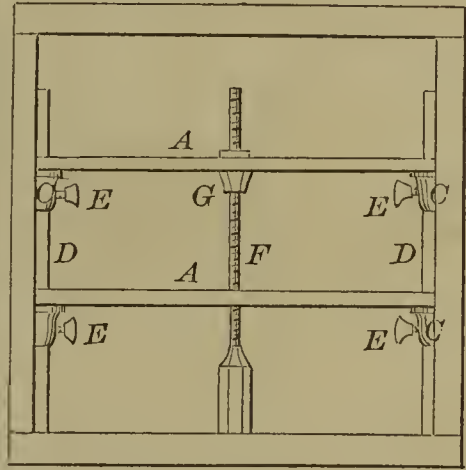

56425—T. E. Lockwood—Churn.

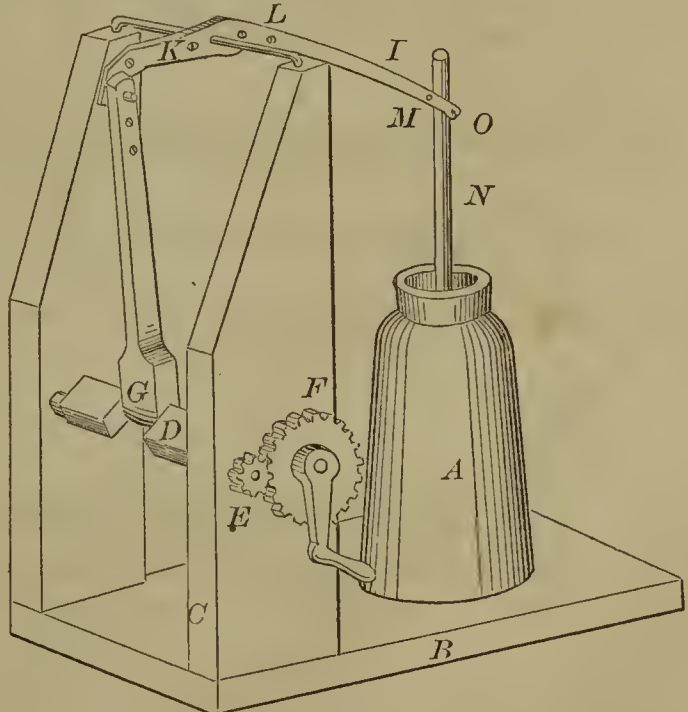

56428—J. Marchant—Straw Cutter.

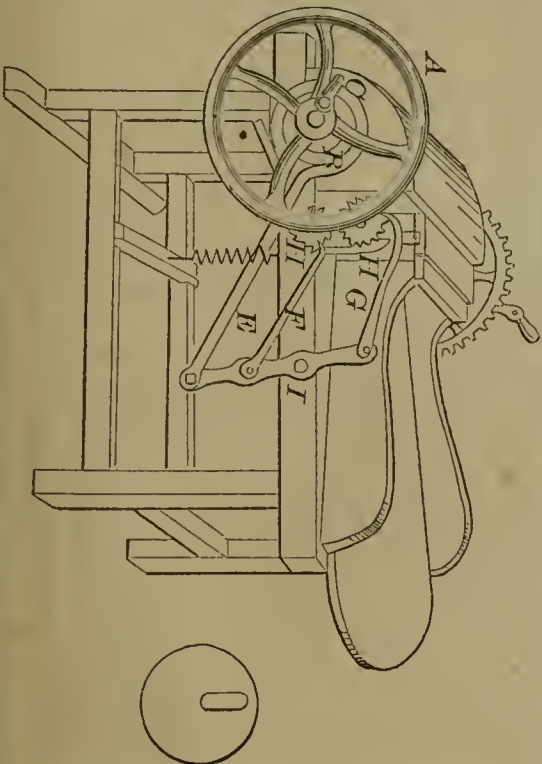

56427—J. F. Maguire—Artificial Hand.

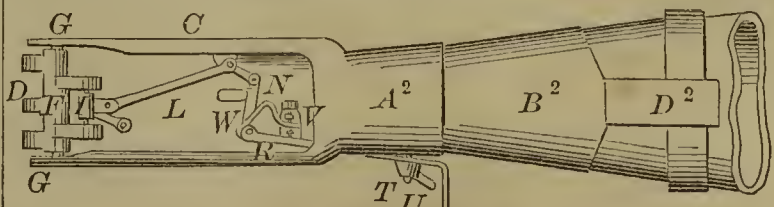

56429—O. F. Mayhew—*Puddling Furnace.*

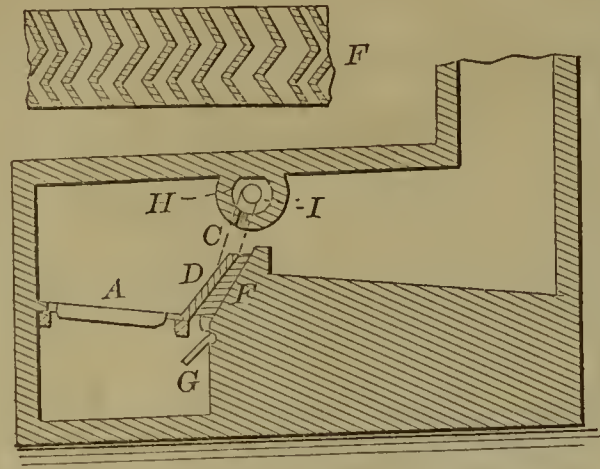

56434—W. B. Moore—*Broom Head.*

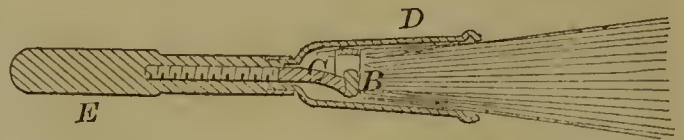

56431—Meyers & Webb—*Extracting Bungs.*

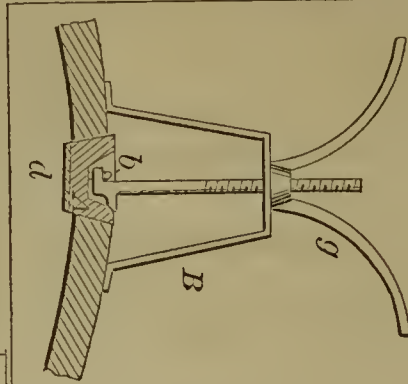

56435—Morrison & Betts—*Well Pump.*

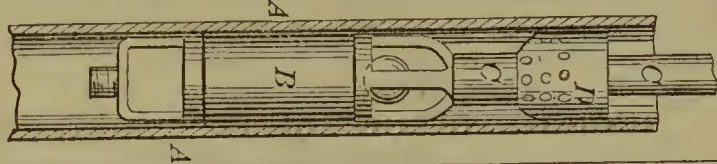

56433—A. Moore—*Quartz Mill.*

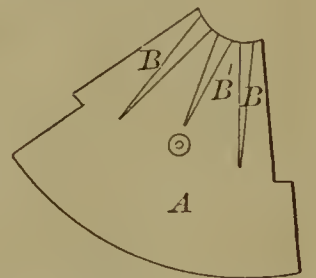

56430—I. W. McGaffey—*Cotton Seed Planting Machine.*

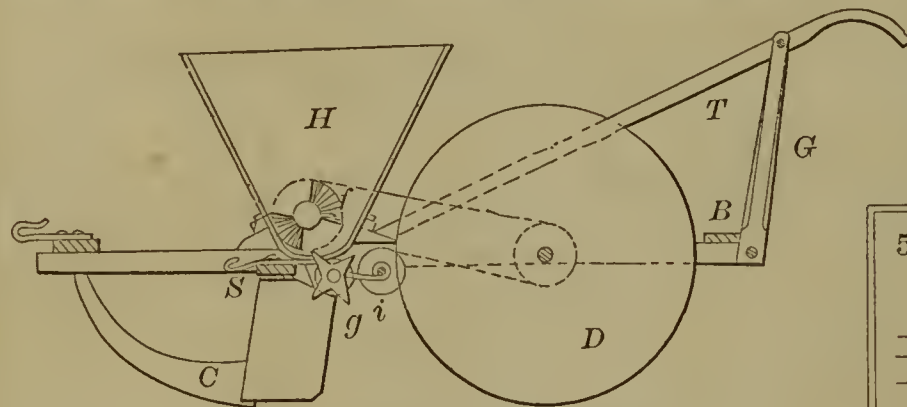

56436—S. E. & G. L. Morse—*Sounding Apparatus.*

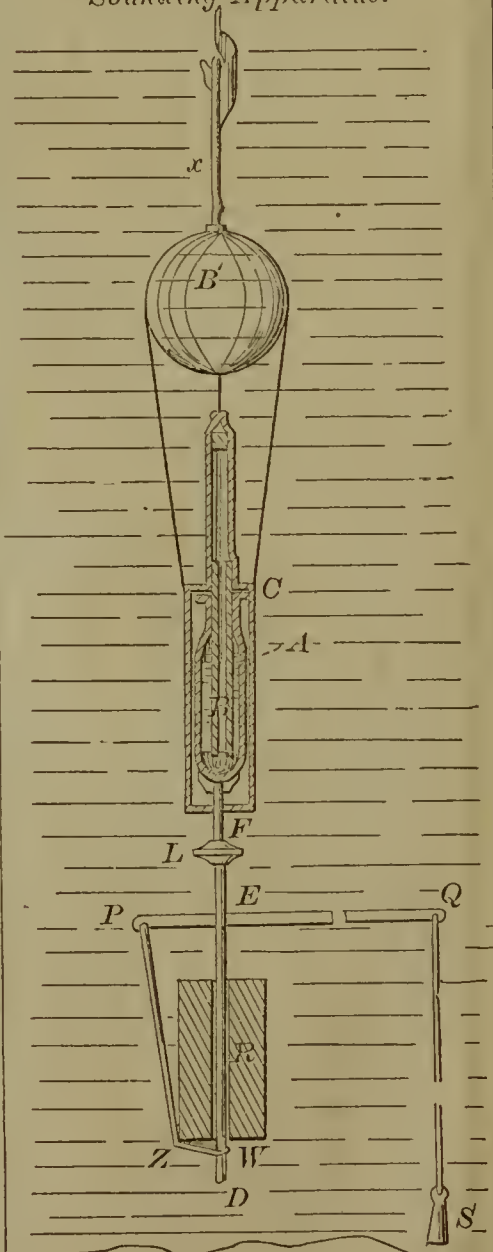

56432—T. S. Mitchell—*Railroad Switch.*

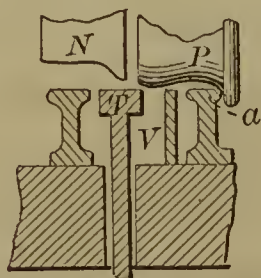
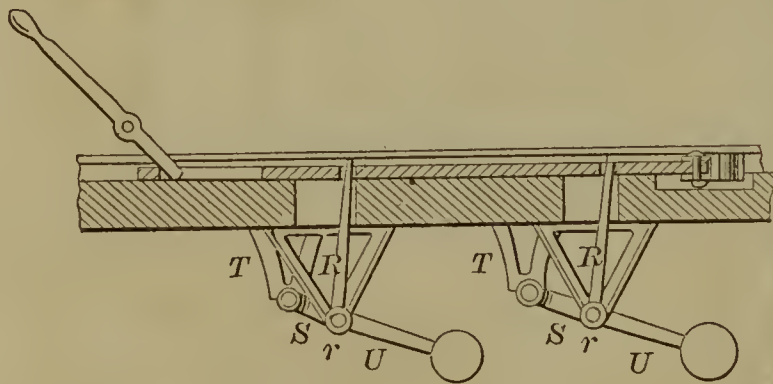
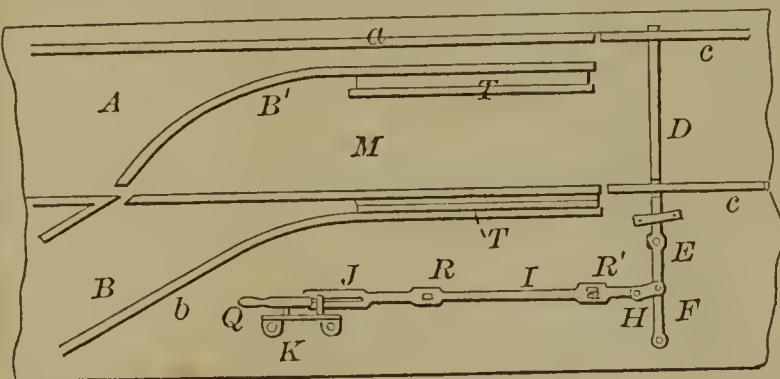

56437—Newbanks & Powel—Scaffold.

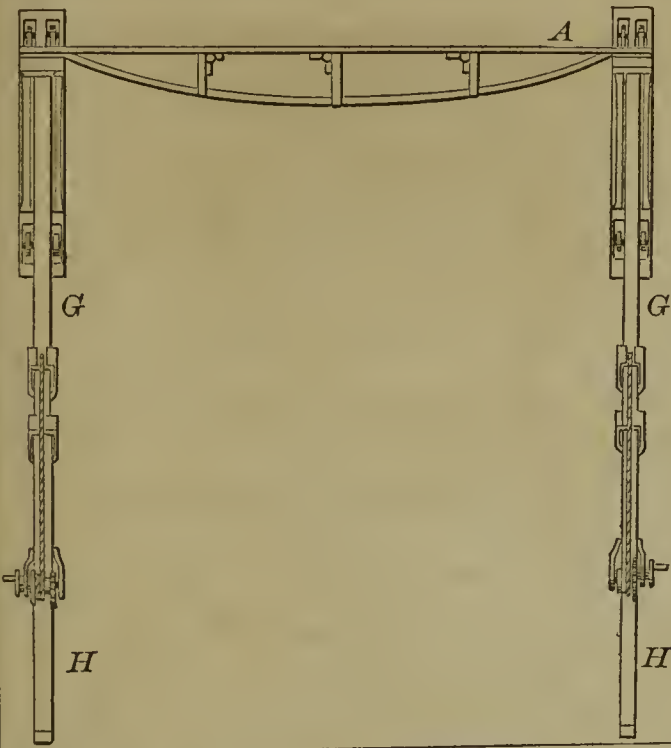

56440—Nishwitz & Hyers—Horse Hay Fork.

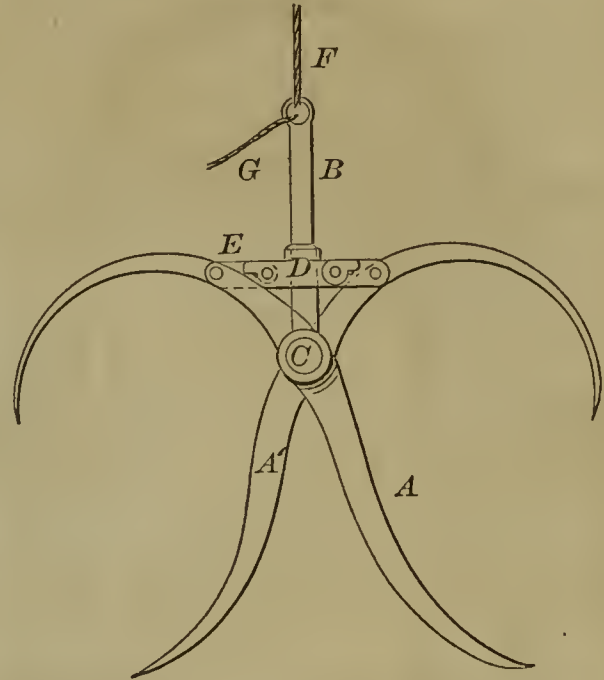

56439—F. Nishwitz—Horse Hay Fork.

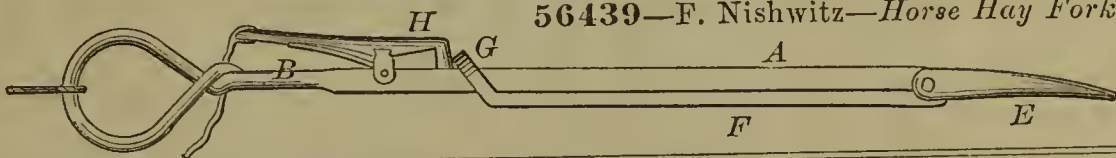

56442—Olin & Hopkins—Washing Machine.

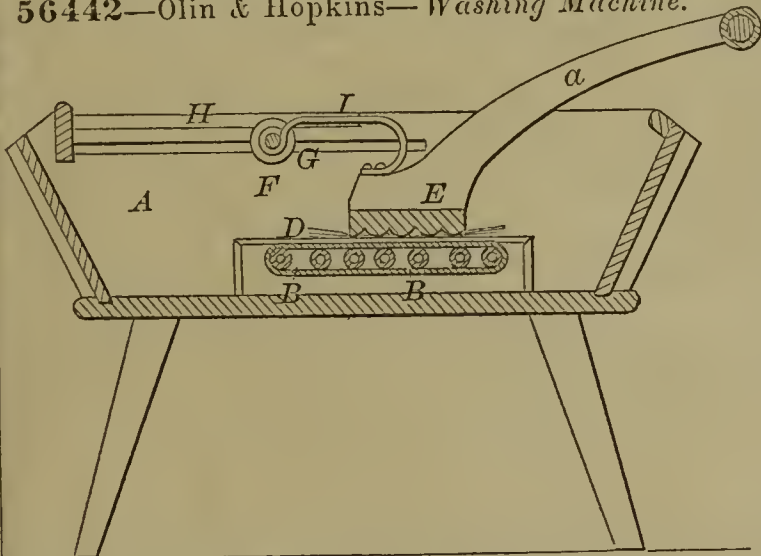

56438—J. L. Newton—Wearing Apparel.

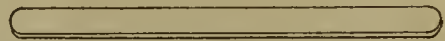

56441—A. W. Olds—Fence.

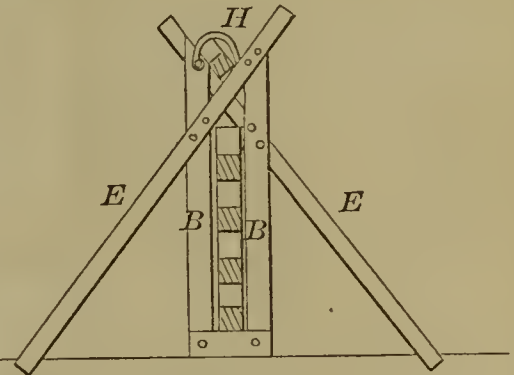

56445—W. Pruett—Tenon Machine.

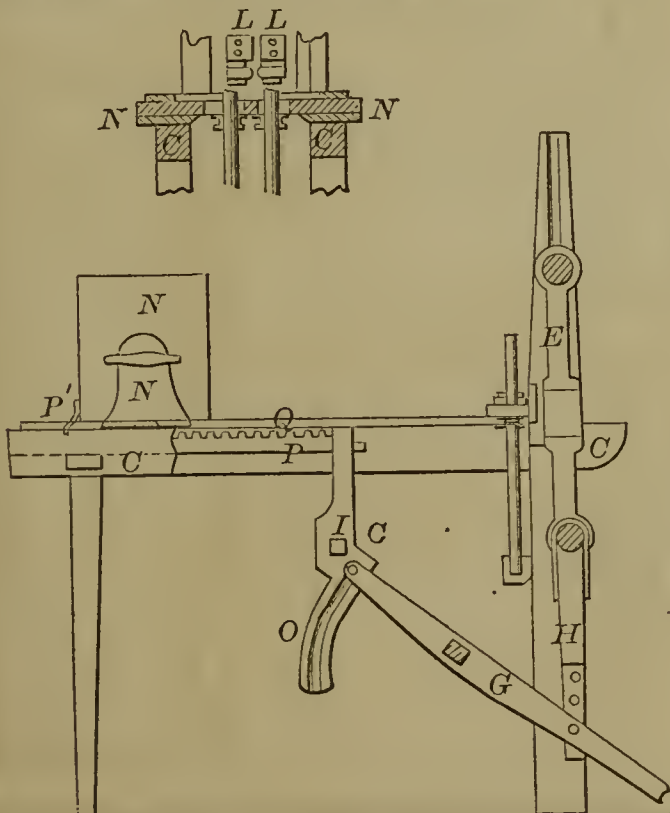

56443—J. Porter—Wool Folding Machine.

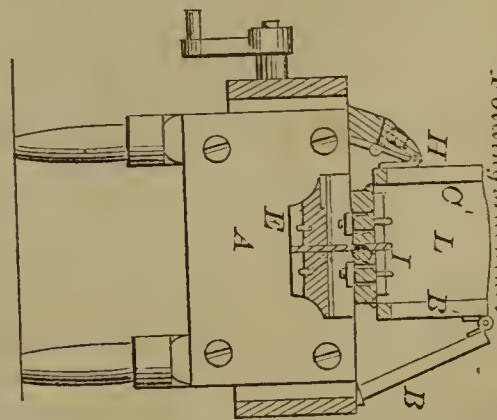

56446—Quinby & Sturdevant—Broom Head.

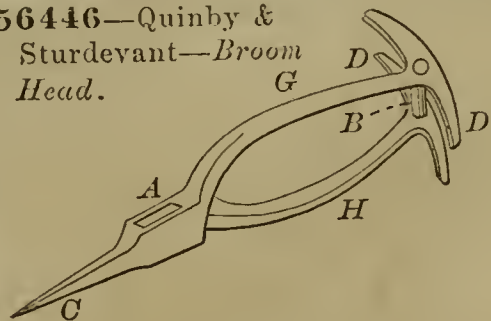

56447—C. L. Rahmer—Hat.

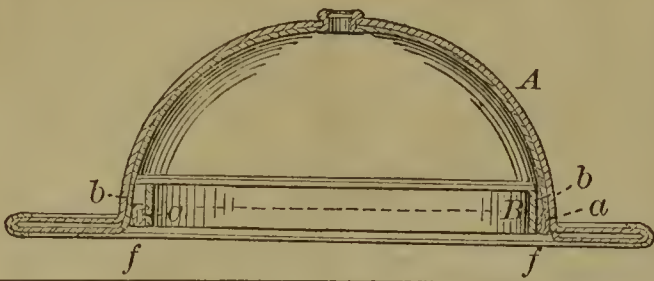

56449—O. Reeves—Clothes Wringer.

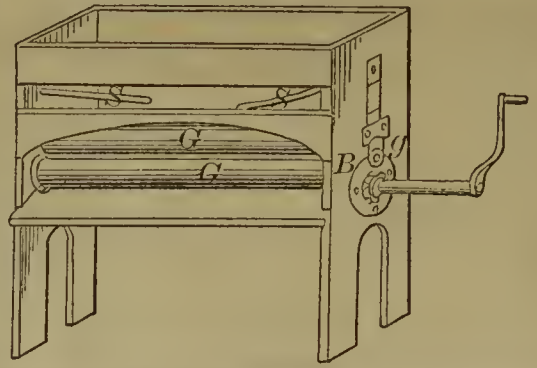

56448—T. L. Reed—Coupling for Gas Fixtures.

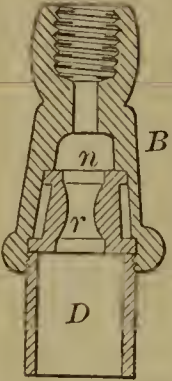

56450—C. W. Saladee—Padlock.

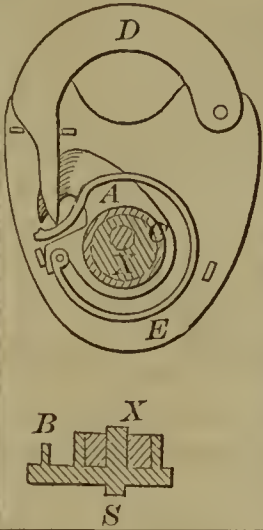

56452—R. S. Sanborn—Safe.

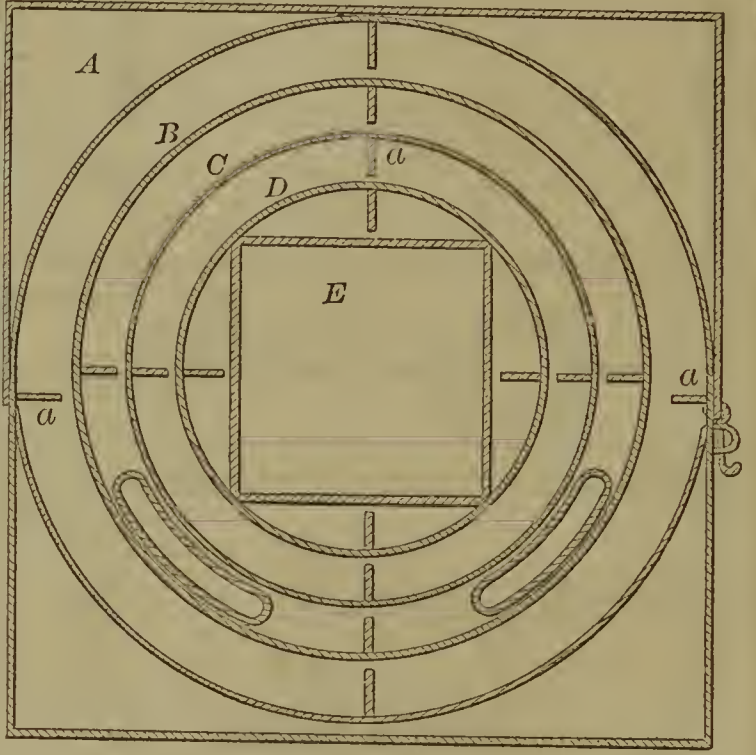

56453—J. Schneider—For Making Lager Beer.

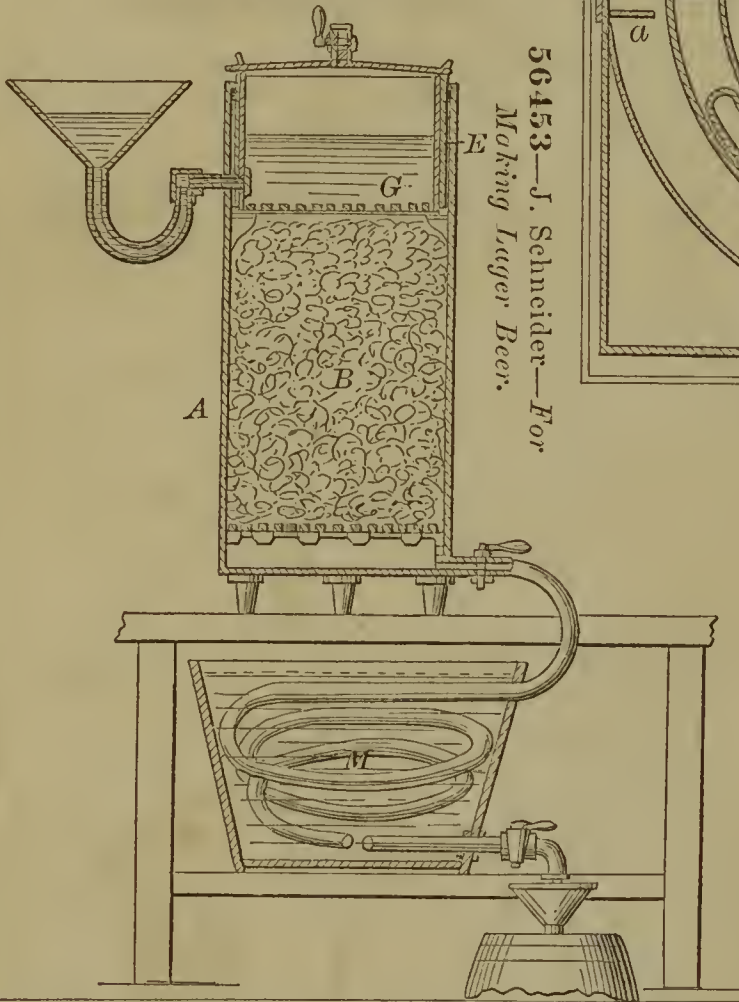

56451—Saladee & Armstrong—Padlock.

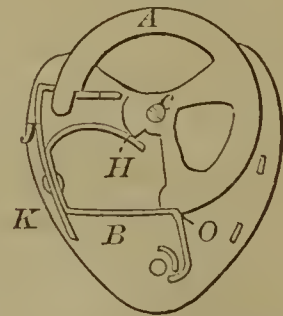

56454—S. C. Schofield—Seeder and Cultivator.

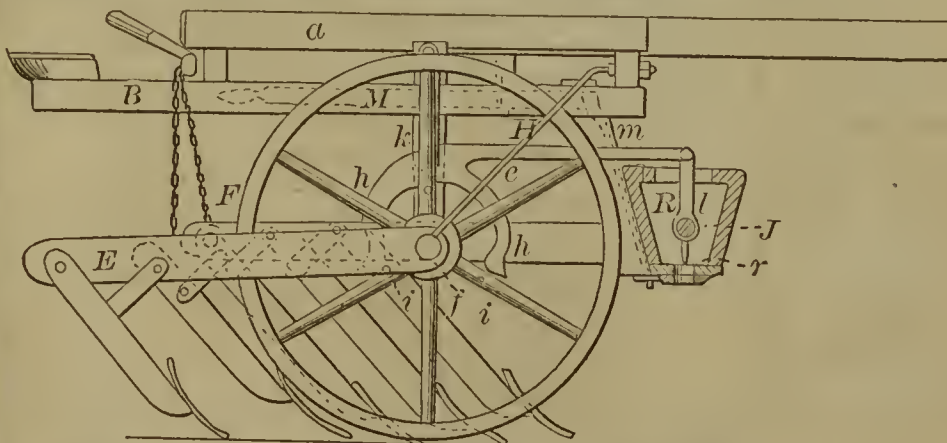

56455—J. Schott—Pen and Eraser.

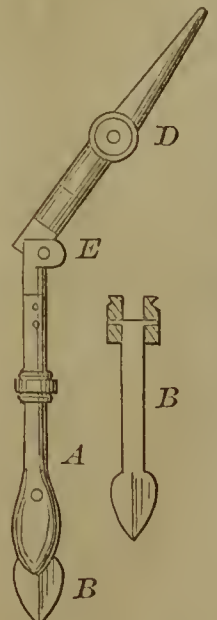

56456—Seelberger & Levy—Baling Press.

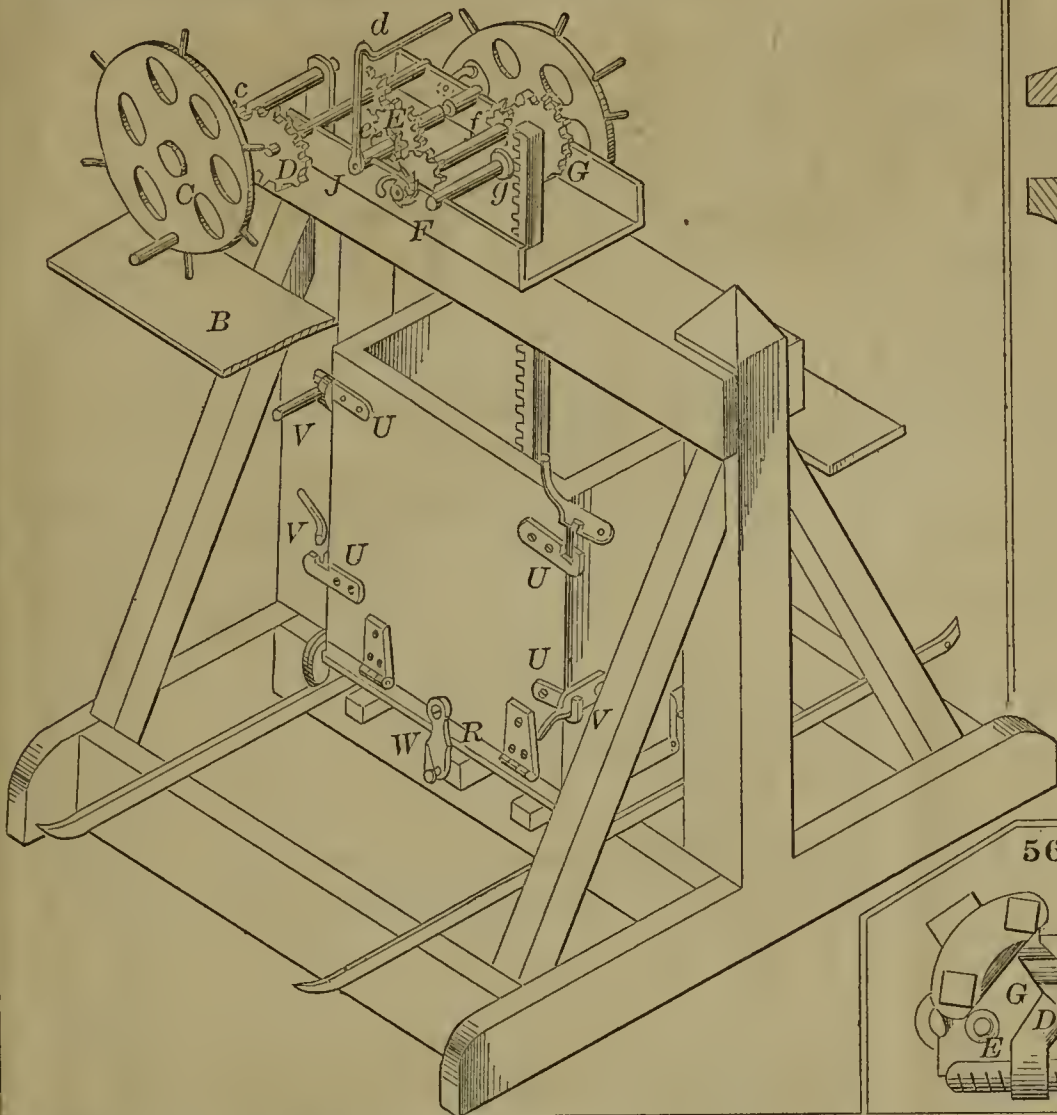

56460—A Stover—Wrench.

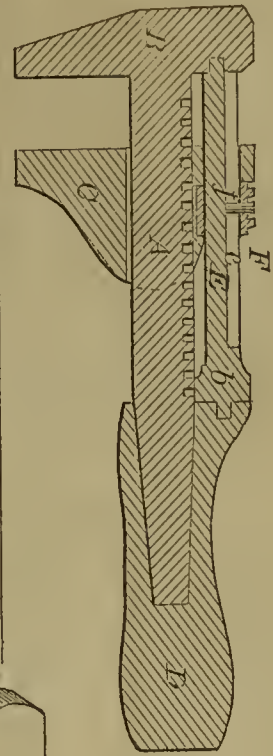

56459—J. H. Smith—Hollow Auger.

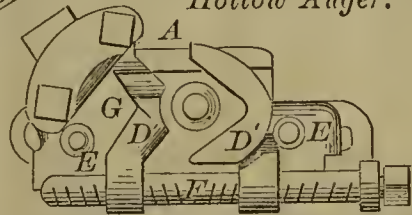

56457—Shepherd & George—Paper Polishing Machine.

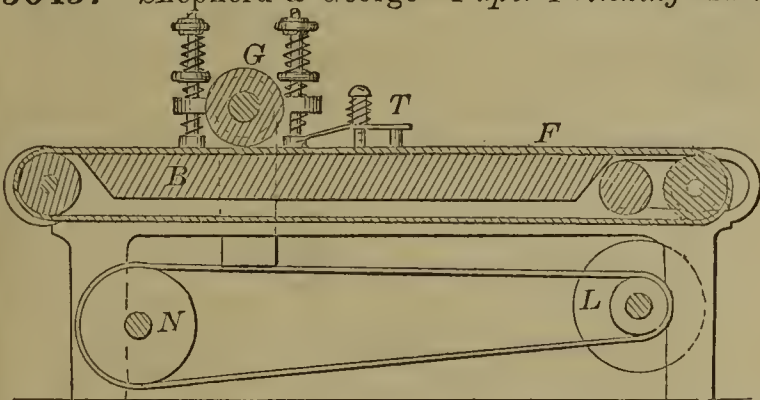

56463—O. C. Phelps—Handcuff.

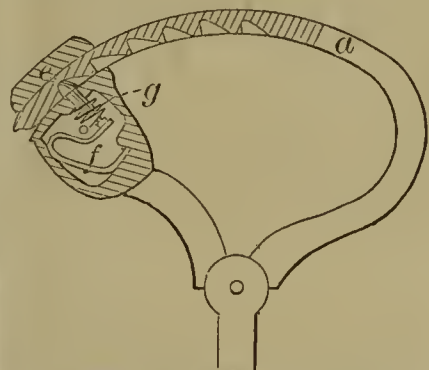

56461—Paine & Caviness—Broom Head.

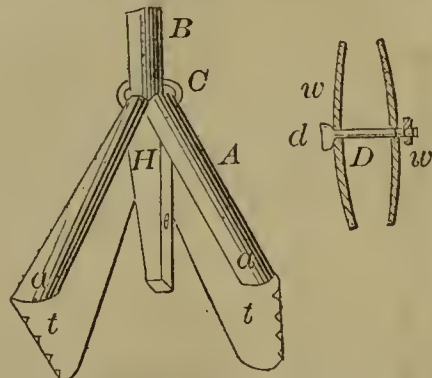

56464—E. W. Taylor—Evaporator.

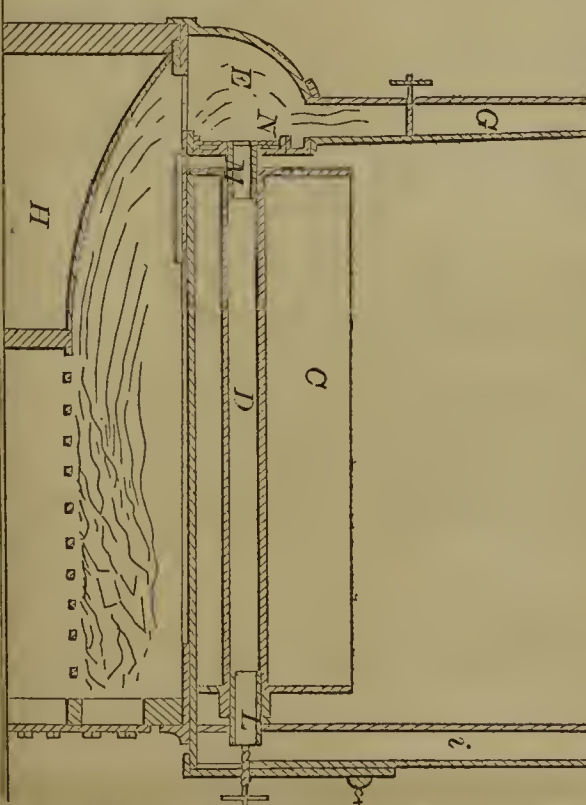

56462—W. Peabody—Harness.

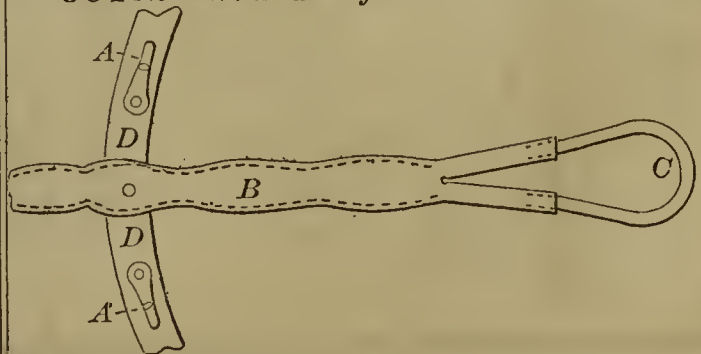

56465—A. L. Thorp—  
*Fence.*

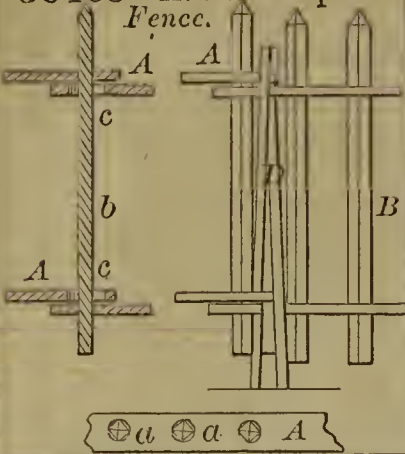

56469—P. Van Bussum—*Washing  
Machine.*

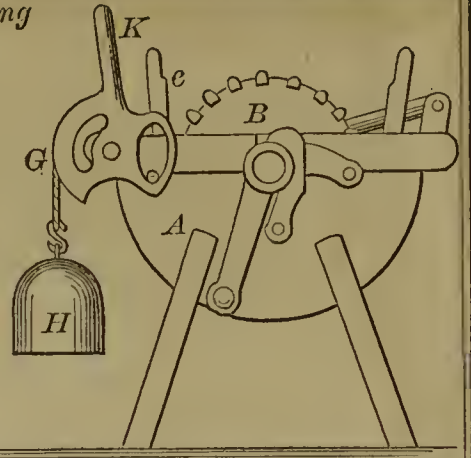
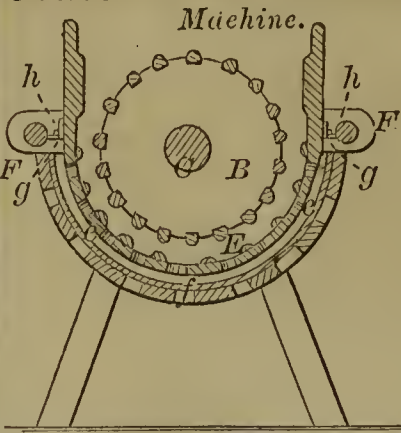

56467—A. W. Todd—*Railroad  
Station Pump.*

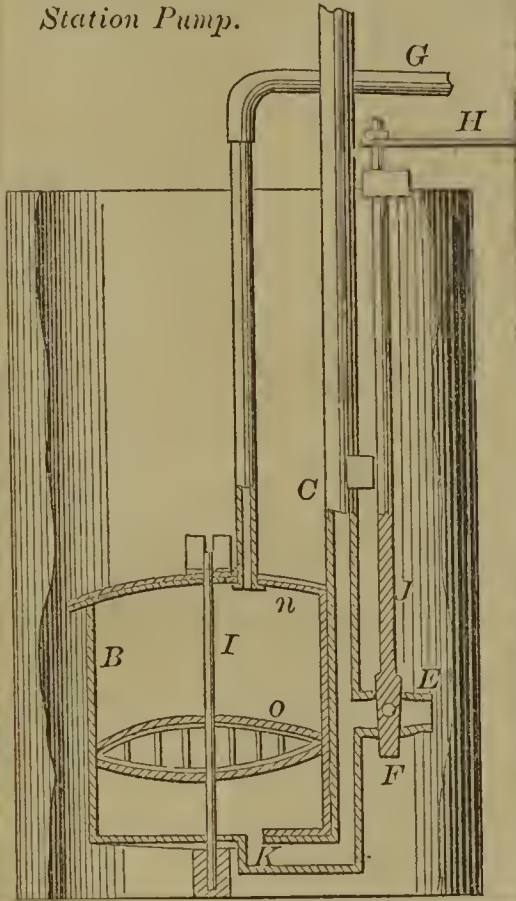

56466—W. Tibbals—*Fire Arm.*

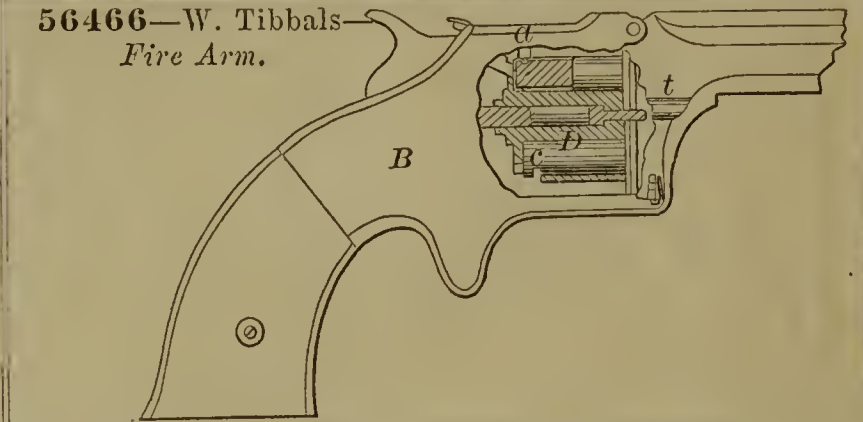

56471—R. M. Webb—*Burglar Alarm.*

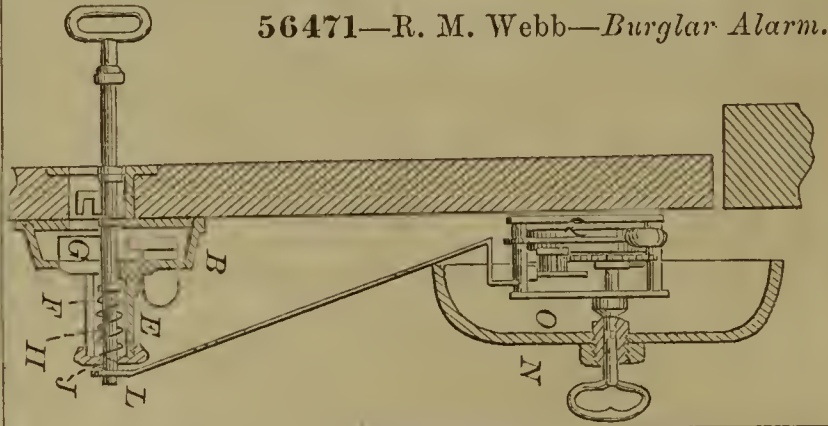

56468—Tully & Reece—*Pump.*

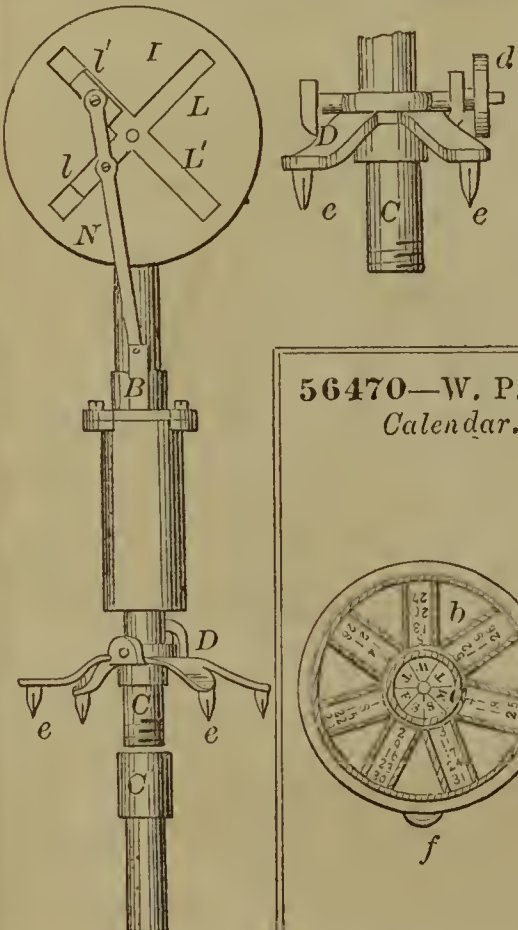

56470—W. P. Ware—*Calendar.*

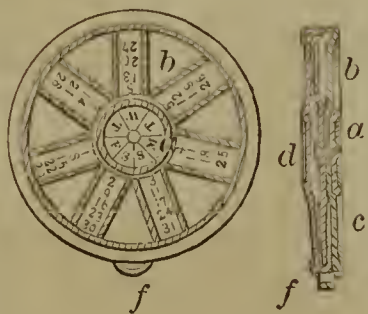

56472—  
O. C. J. Weld—*For Fluting  
Wash Boards.*

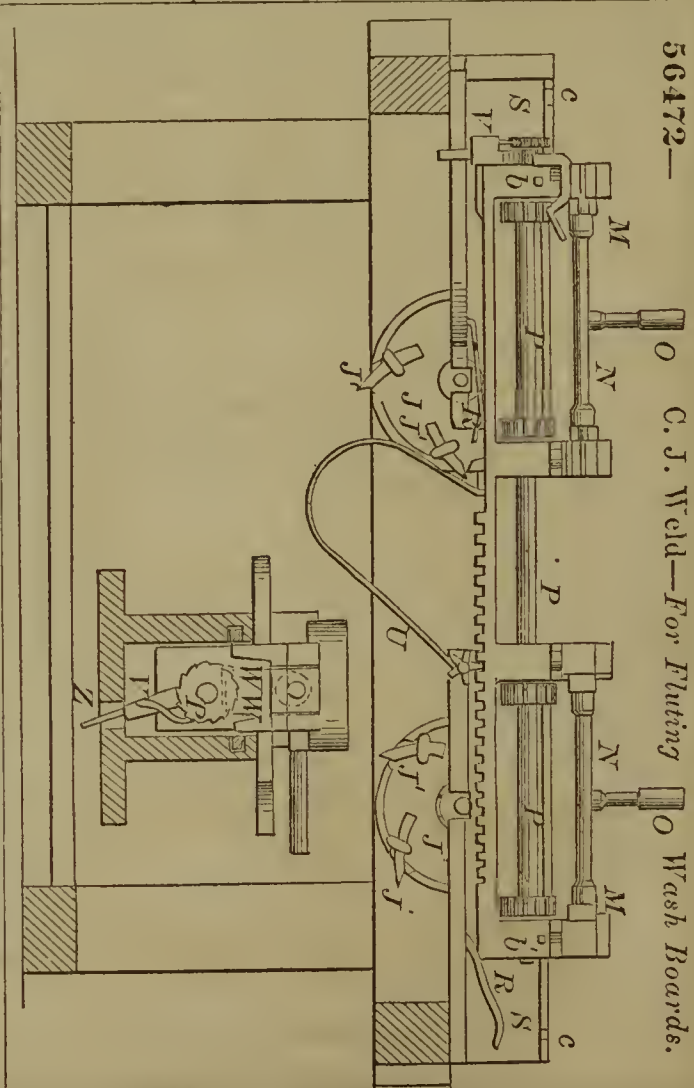



56473—C. C. Webber—*Stove Pipe Drum.*

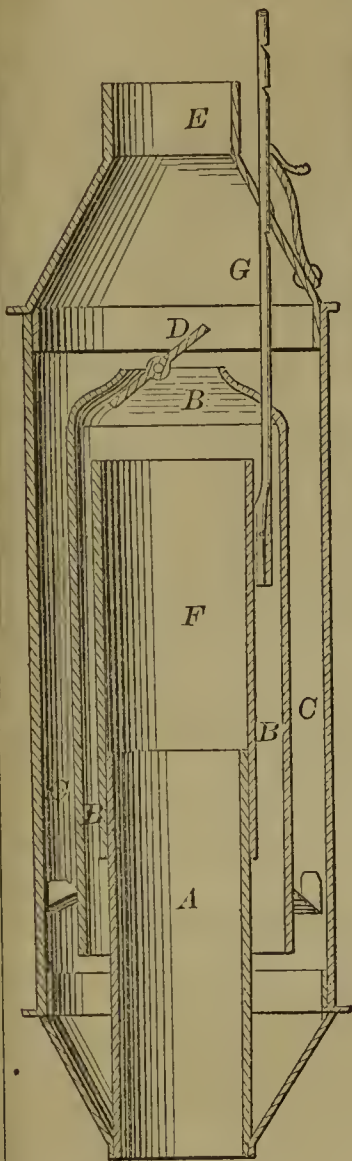

56474—J. Welsh—*Loom.*

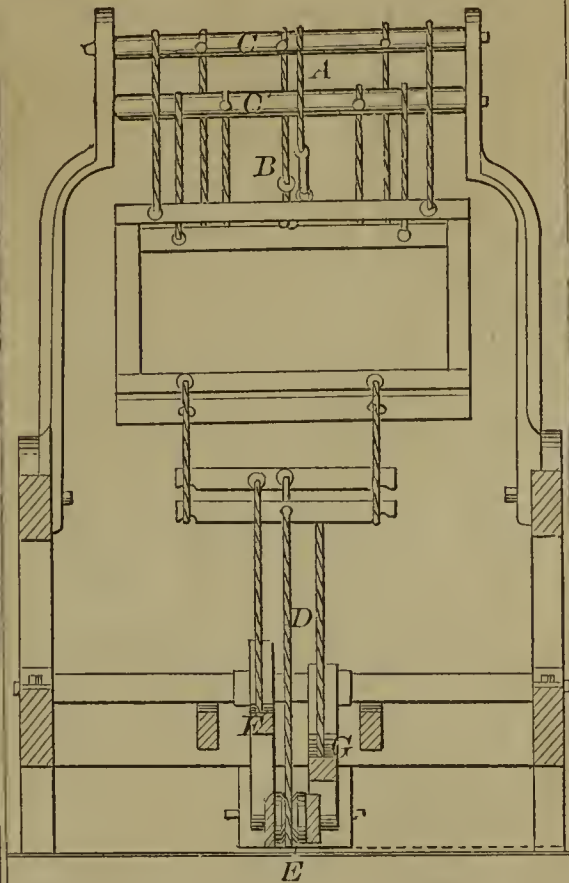

56475—A. S. Wilkinson—*Horse Shoe.*



56476—A. S. Wilkinson—*Horse Shoe.*

Fig. 1

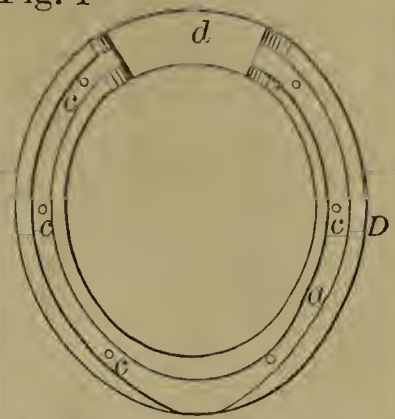
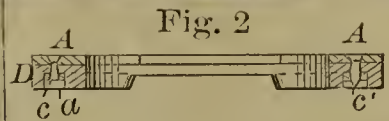
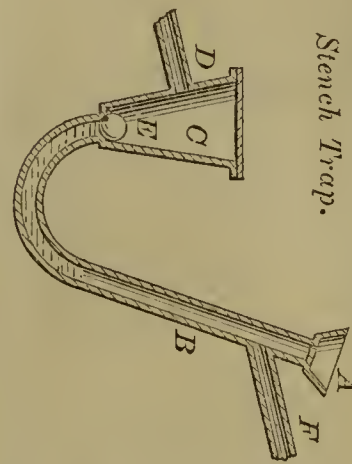

Fig. 2



56478—F. H. Williams—*Stench Trap.*



56477—A. S. Wilkinson—*Horse Shoe.*

Fig. 1

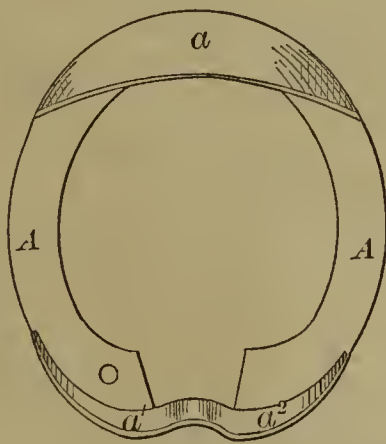
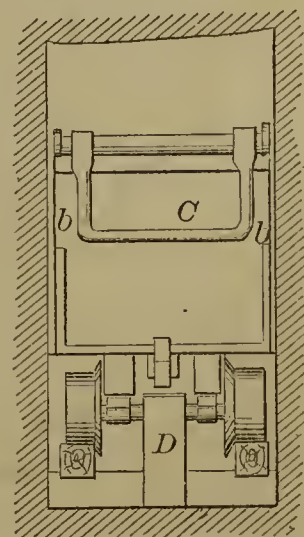
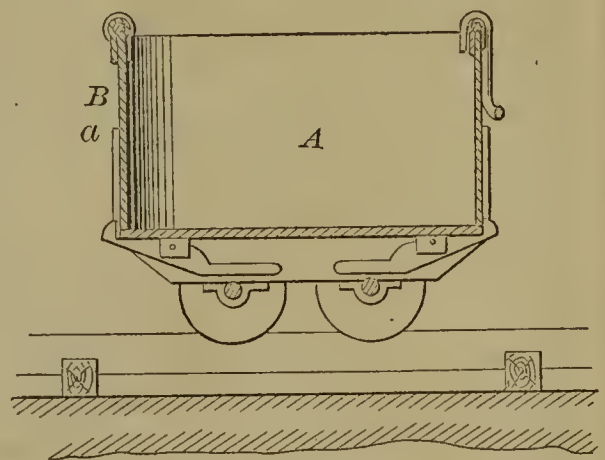

Fig. 2



56480—G. Williams—*Car for Mines.*



56479—F. H. Williams—*Stench Trap.*

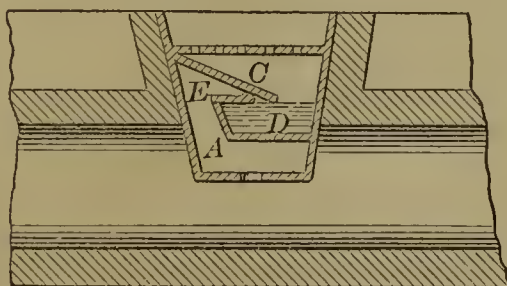

56481—G. Williams—Elevator.

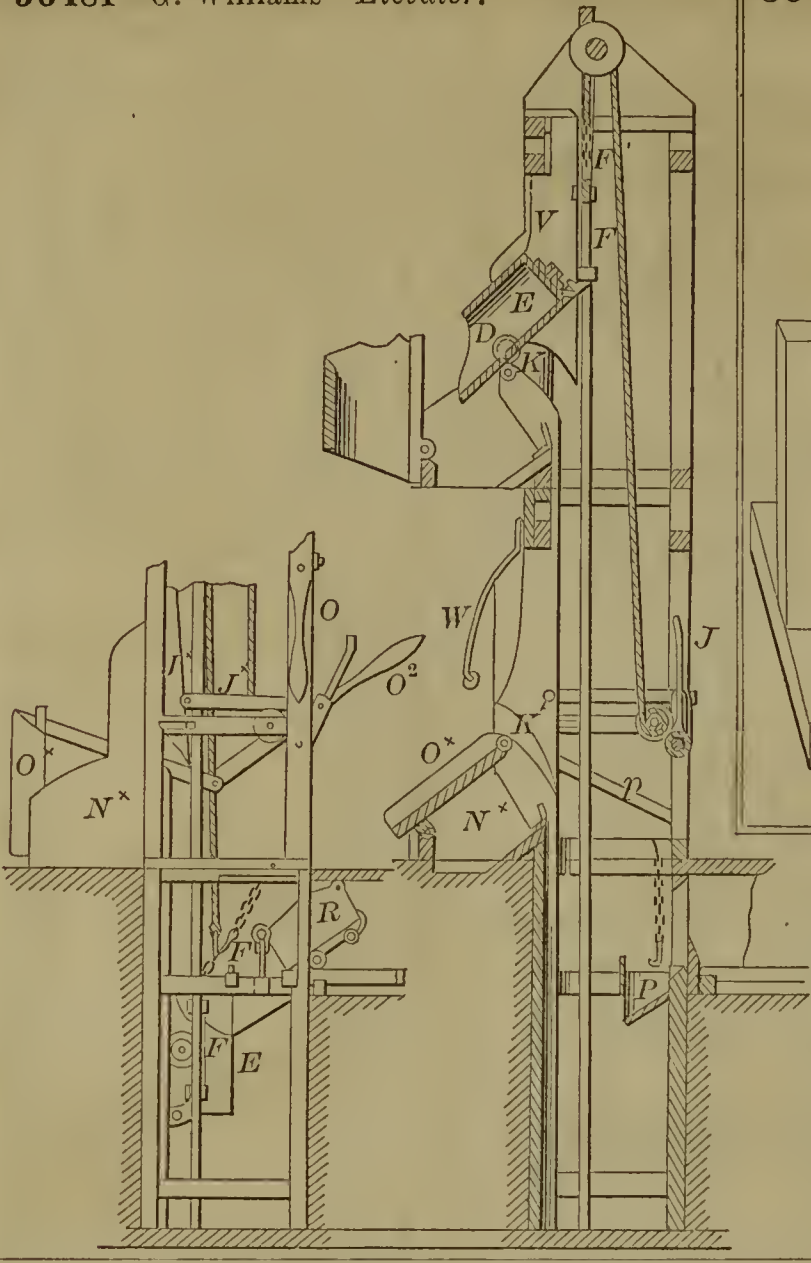

56483—J. O. Woodruff—Applying Liquids to Casks.

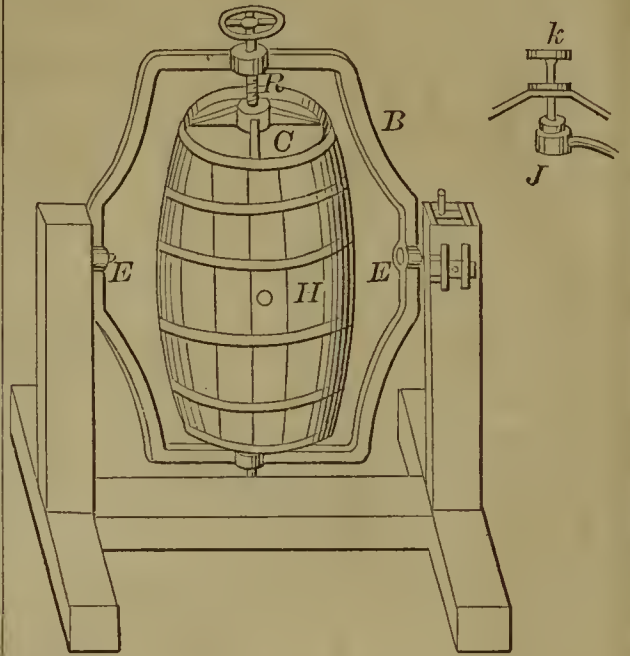

56484—J. Barnes—Bed Bottom.

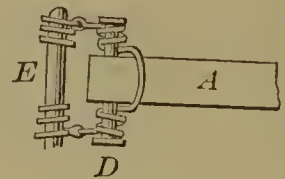

56482—L. H. Wolf—Trunk.

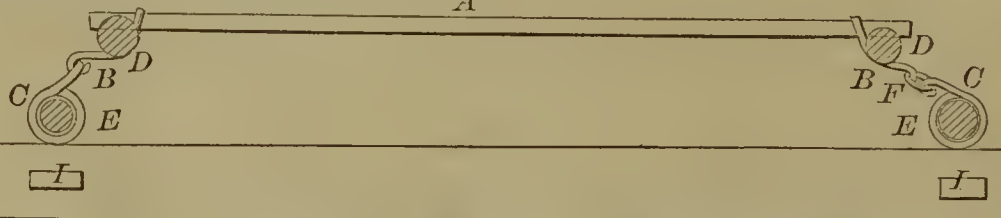
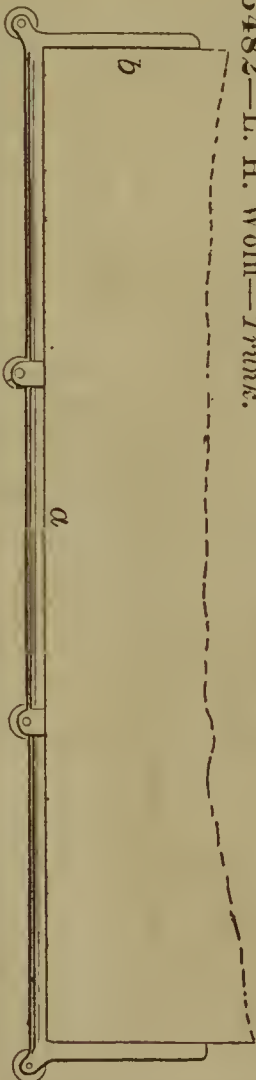

56485—J. A. Bazin—Cordage Machine, &c.

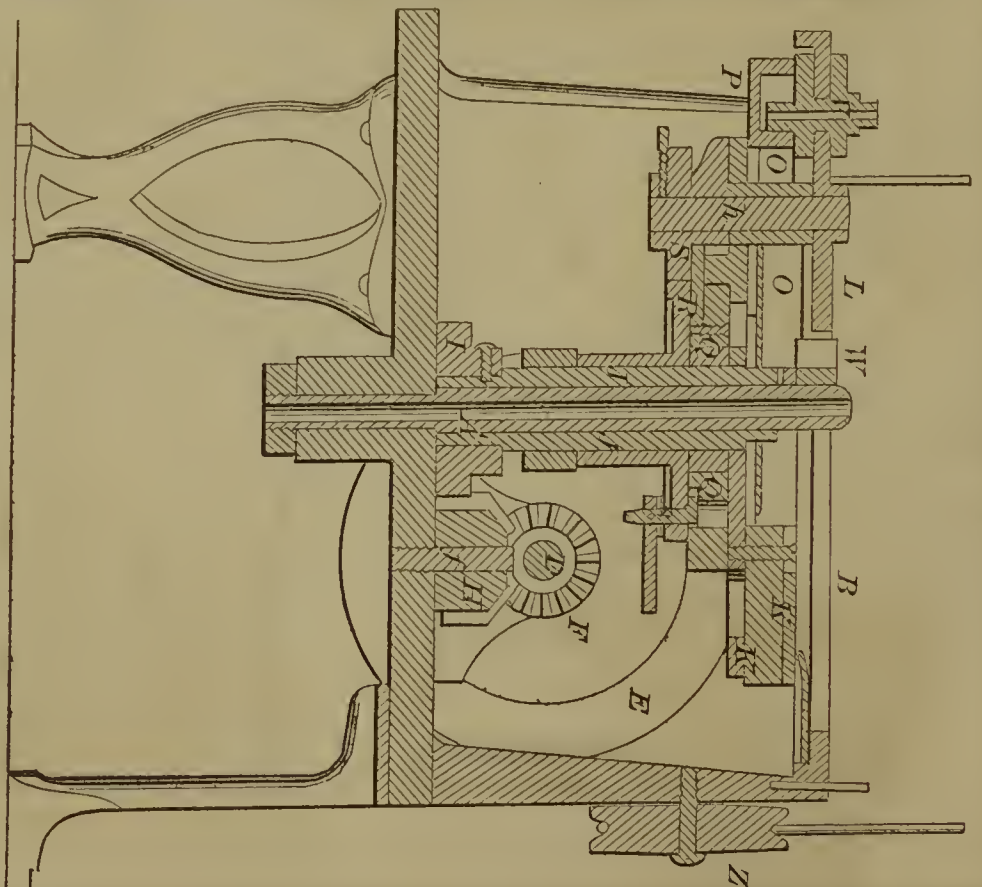

56485—Continued.

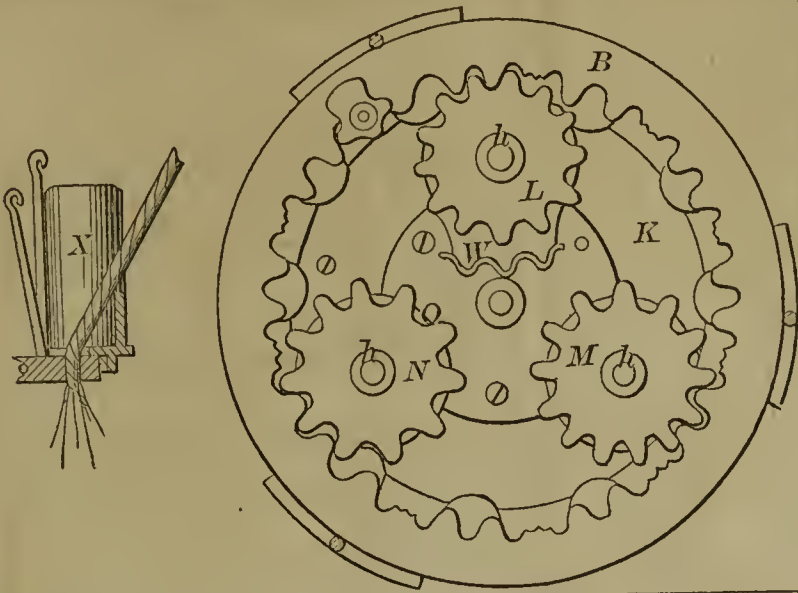

56486—B. Beach—Castor Bottle.

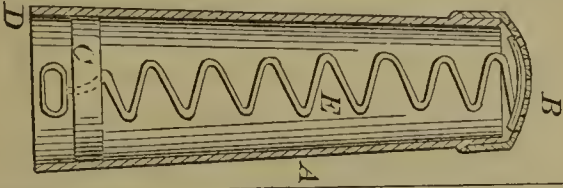

56489—Dodge & Smith—Cartridge Filling Machine.

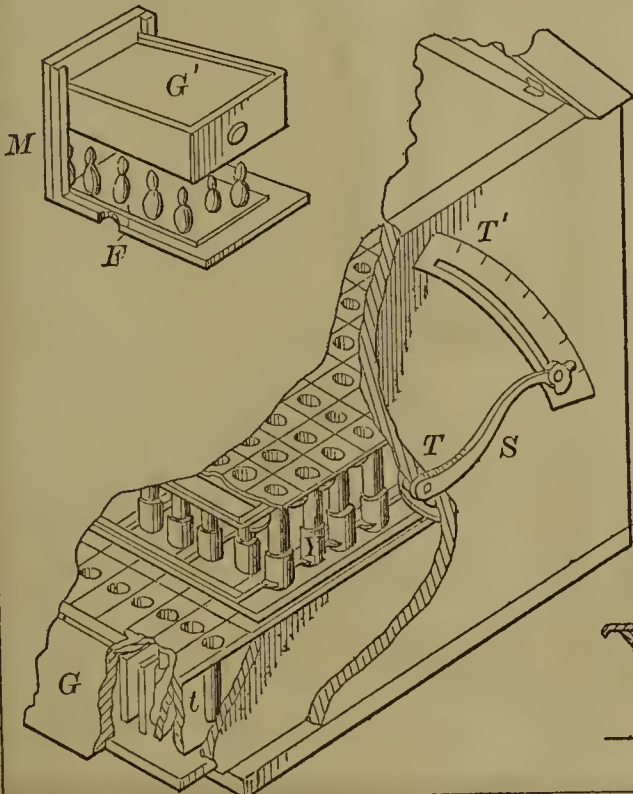
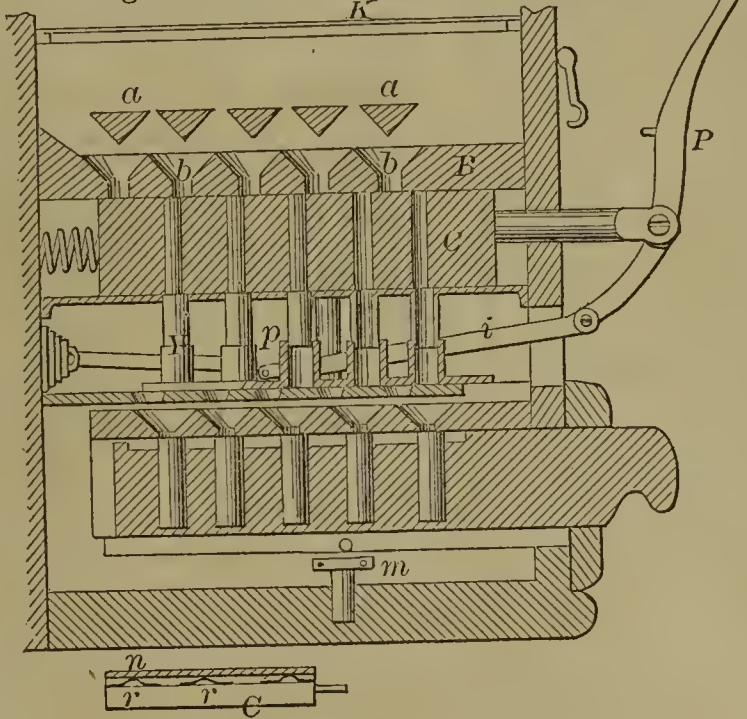

56488—E. Bussey—Cooking Stove.

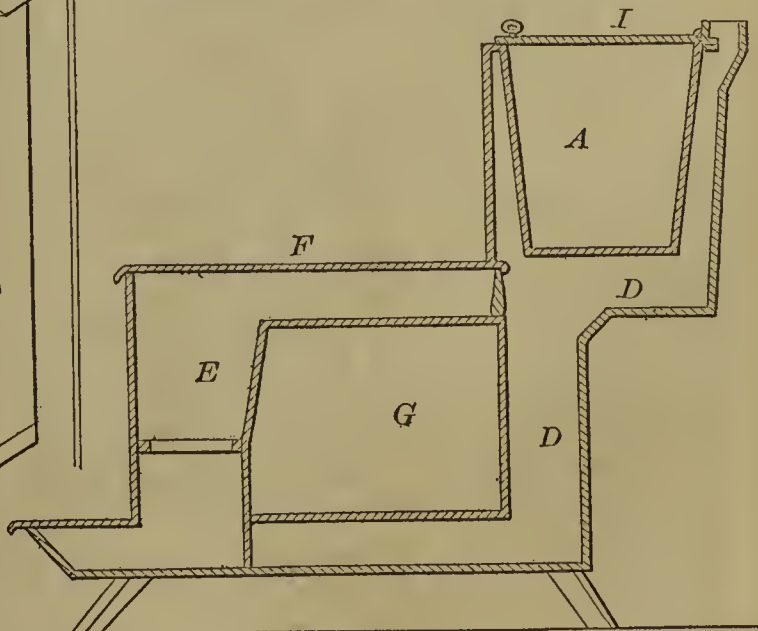

56487—S. W. Bullock—Quartz Mill.

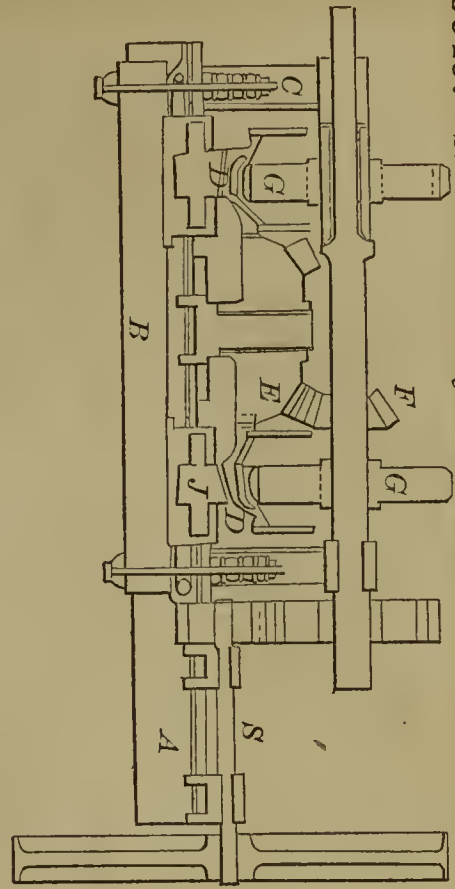

56490—E. Duffee—Screen for Gas Purifiers.

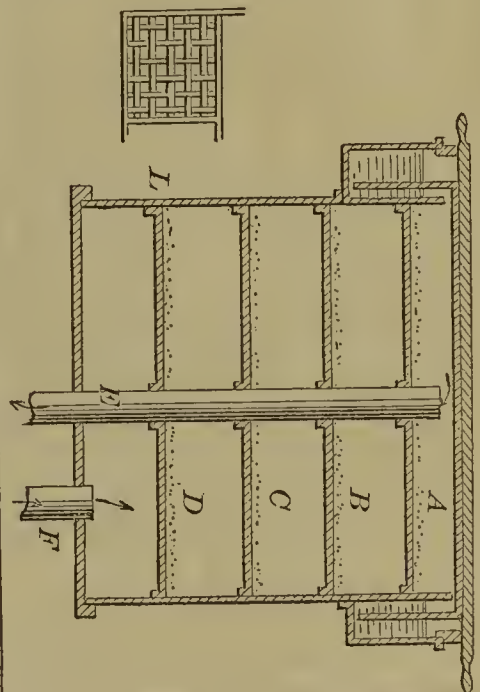

56493—M. Free—*Slat Blind Loom.*

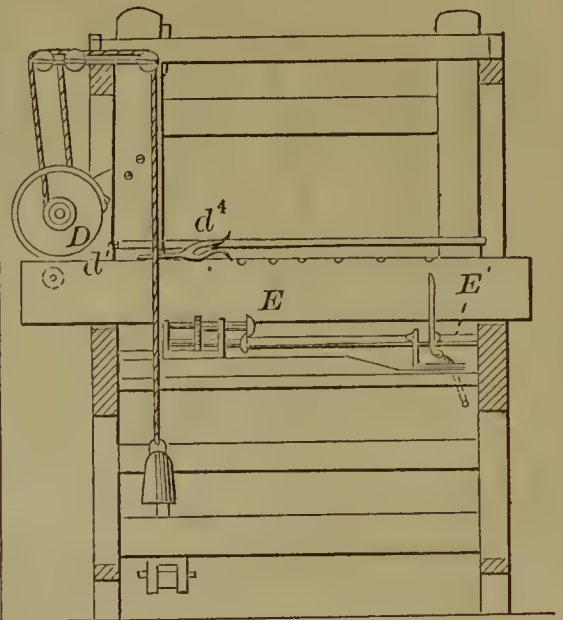

56494—W. J. Gordon—*For Securing the Ends of Strips of Sheet Metal together.*

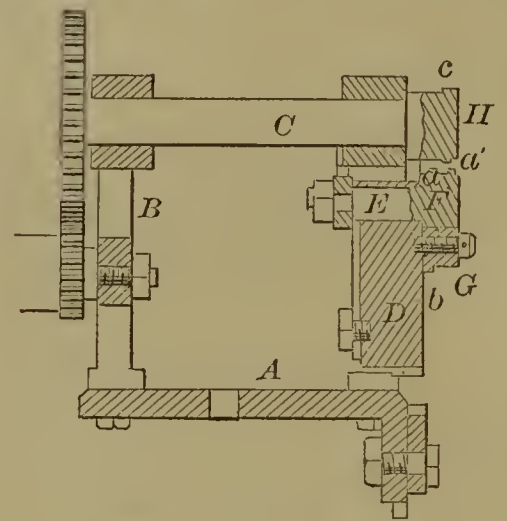

56495—L. F. Grant—*Gear Cutter*

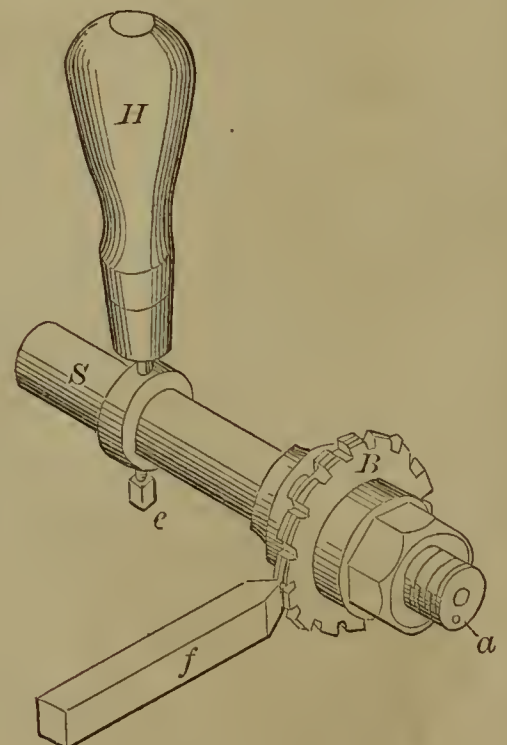

56491—L. B. Edgecomb—*Draw Bridge Signal.*

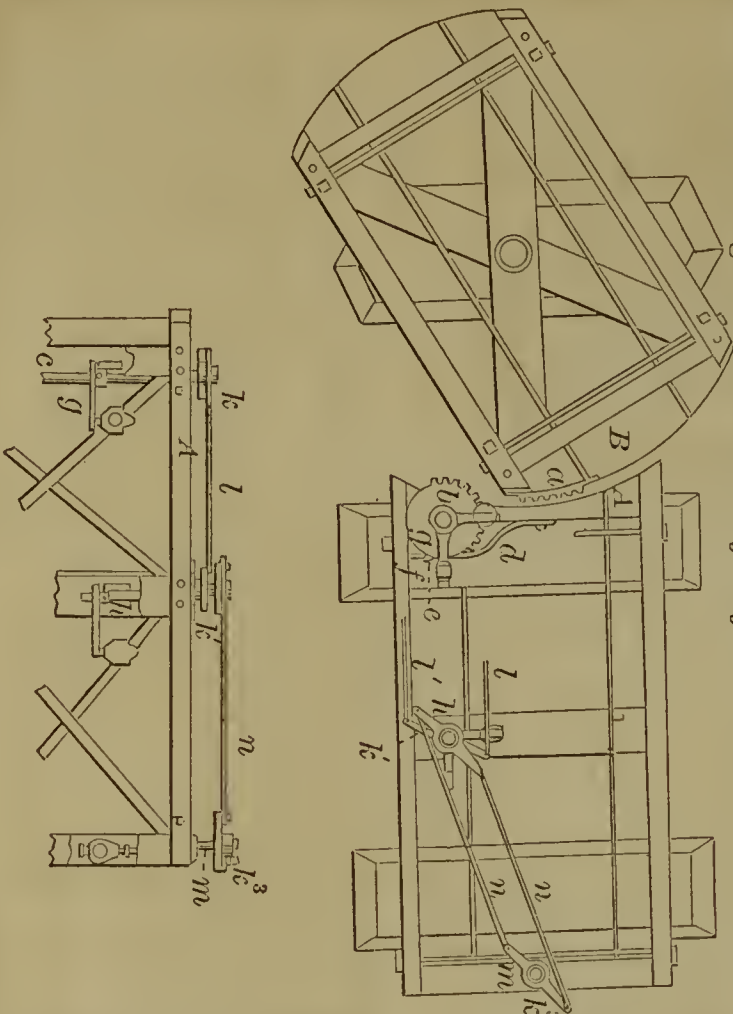

56492—Fowler & French—*Percussion Cap Trimming Machine.*

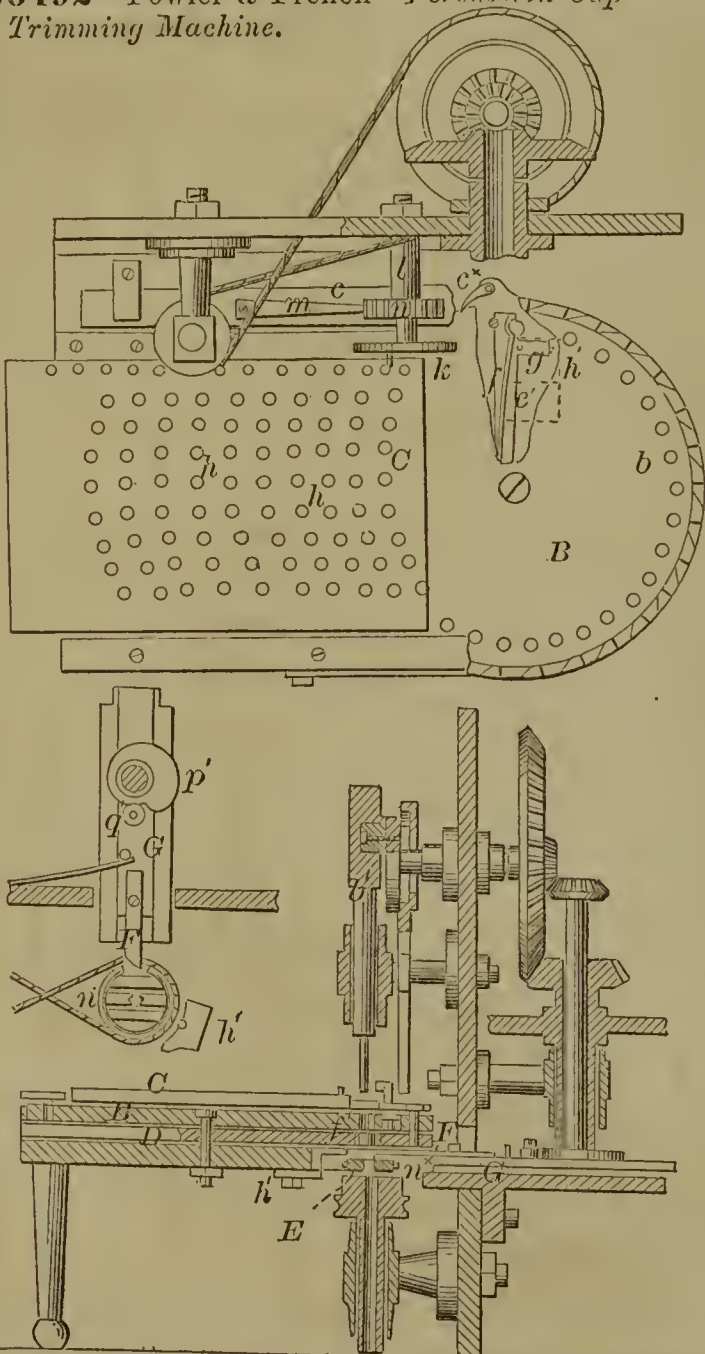

56496—Greacen, Foster & Cooper—For Moulding Materials.

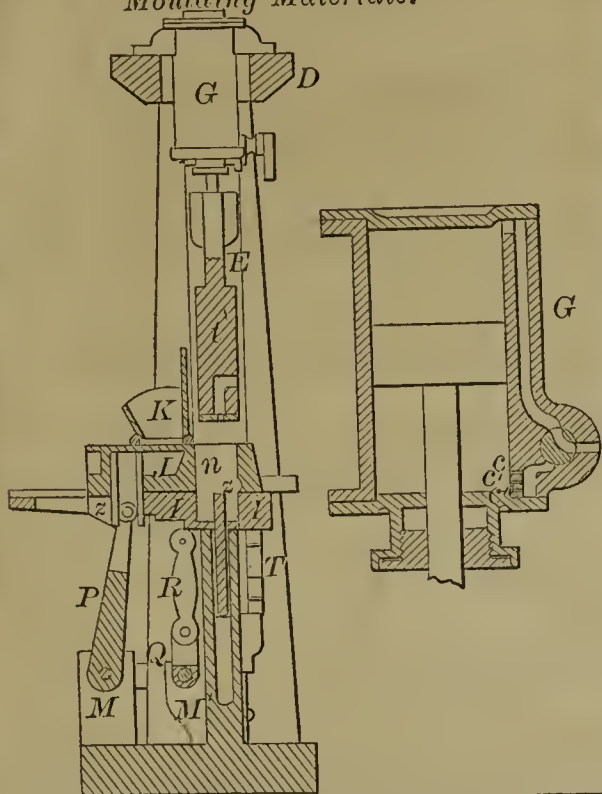

56497—B. J. Hoffacker—Lamp.

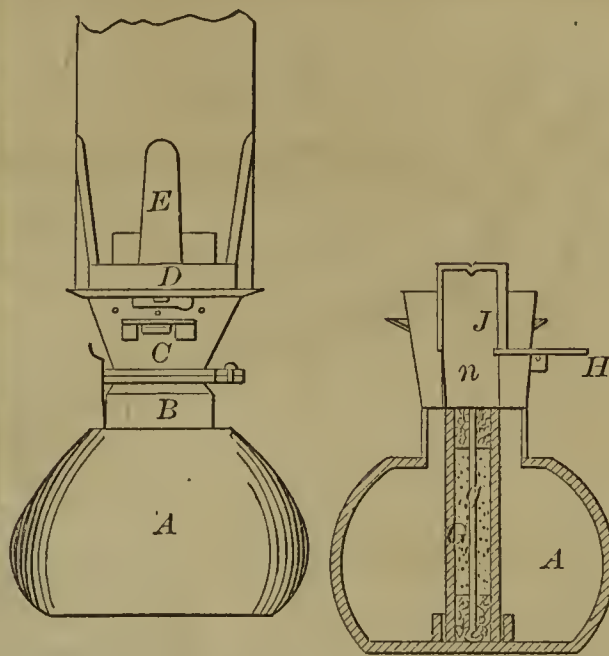

56503—W. M. Wright—Carburetted Gas.

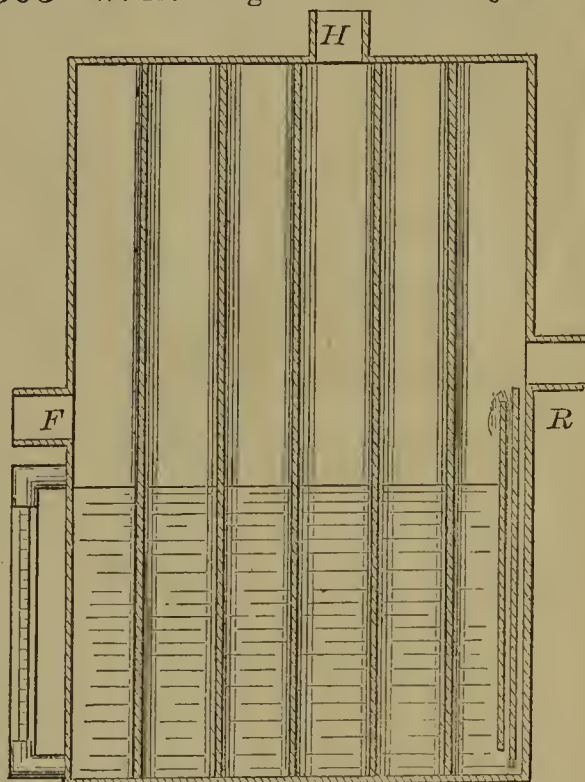

56499—L. Jackson—Trunk.

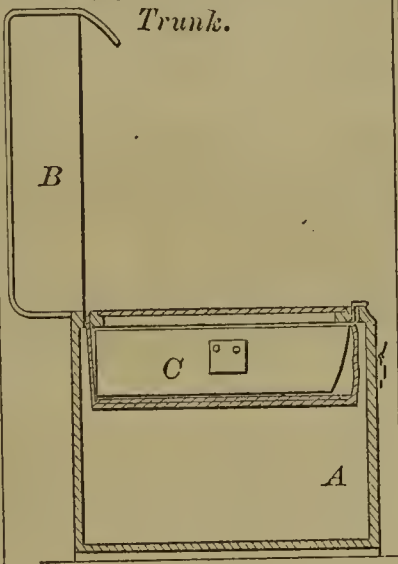

56498—F. Hovey—Caneeling Press.

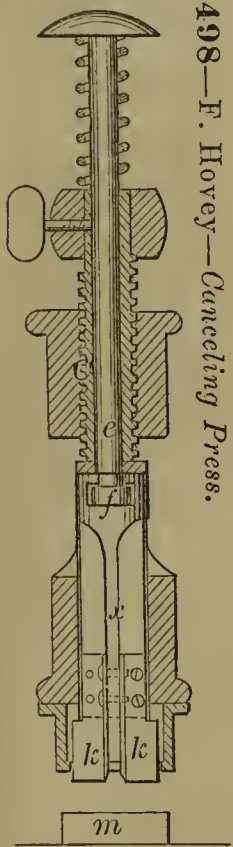

56500—Kimball & Norcott—Valve for Steam Cylinders.

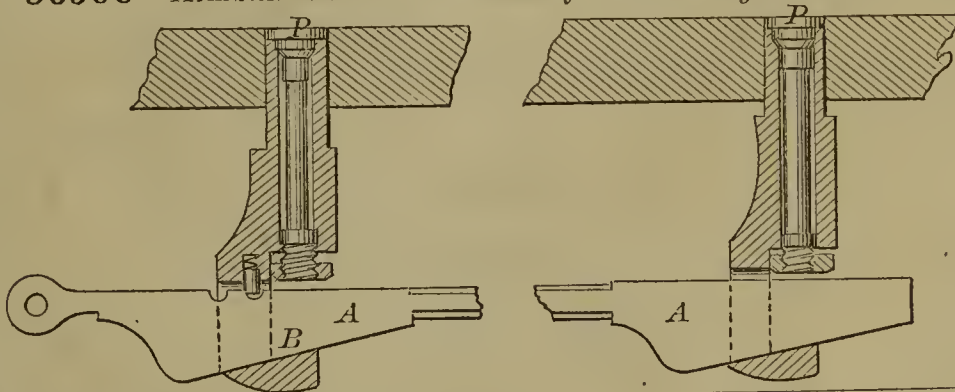

56501—G. B. Lego—Umbrella.

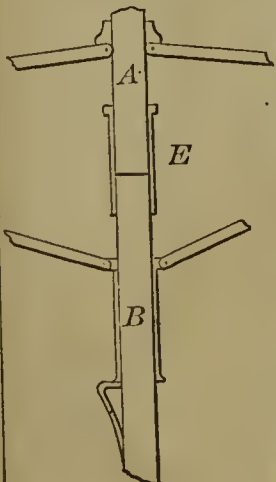

56502—D. B. Tiffany—Boring Wells.

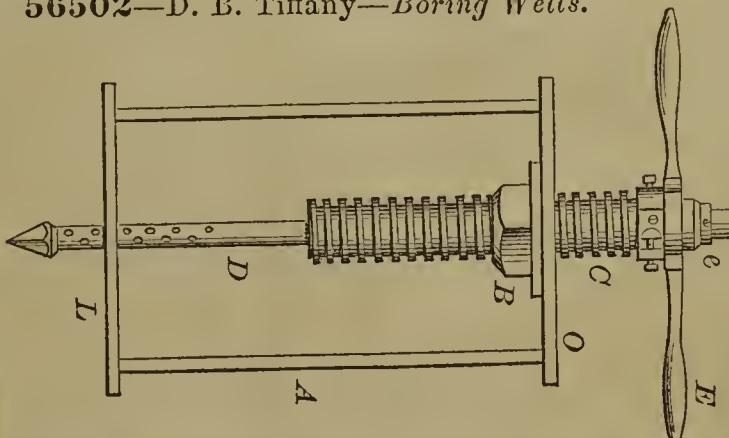

56504—Boulton & Worthington—Manufacturing Tiles, &c.

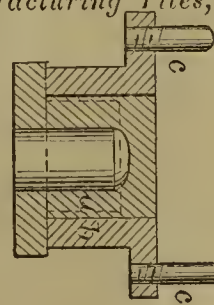

56506—C. W. Jones—Fire Arm.

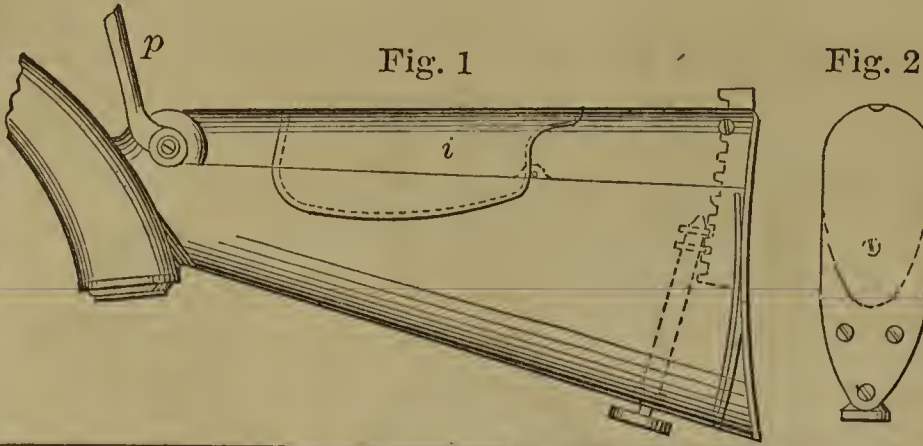

56507—R. Keck—For Steering Mirrors.

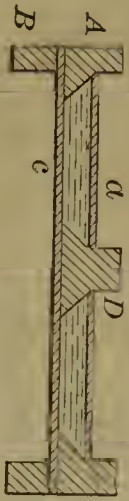

56509—W. Altick—For Pulling up Cotton and Corn Stalks.

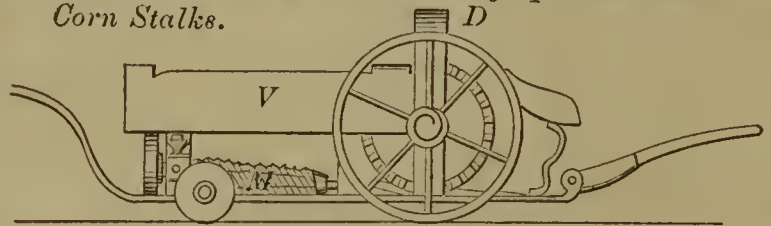

56508—P. C. P. L. Prefontaine—Storing Hydro Carbon.

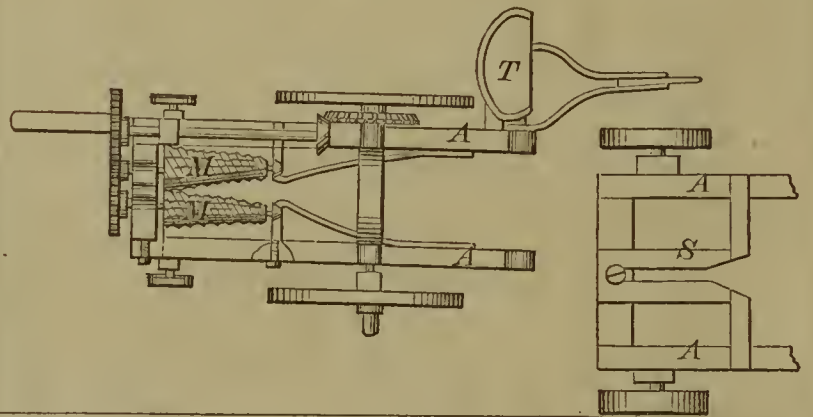
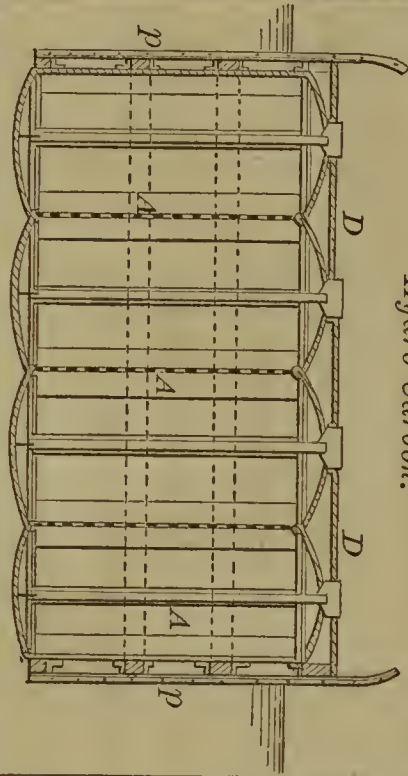

56512—J. E. Atwood—Hoop Skirt.

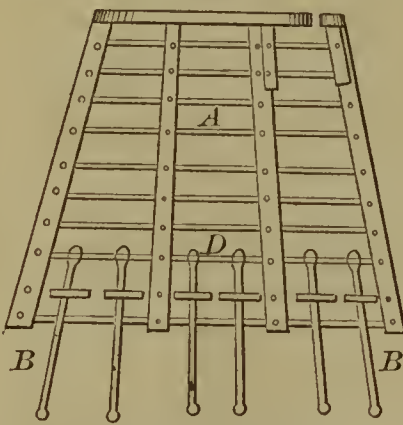

56510—M. Andriot—Carriage Jack.

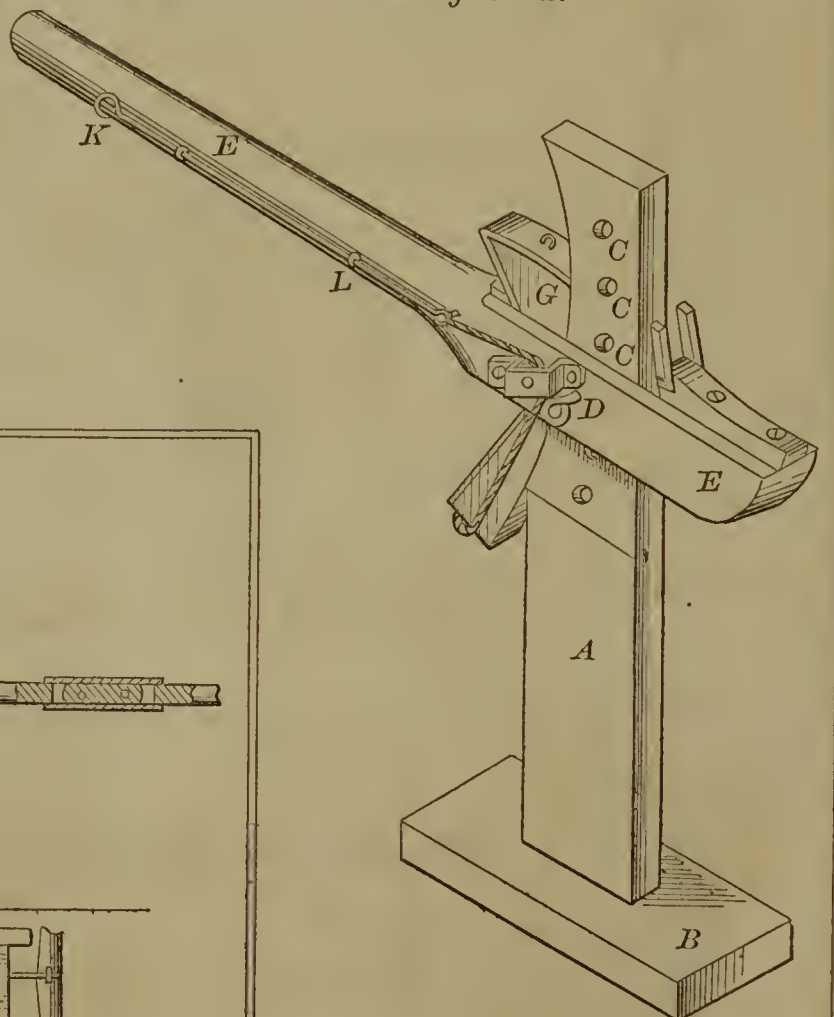

56511—J. N. Arvin—Cultivator.

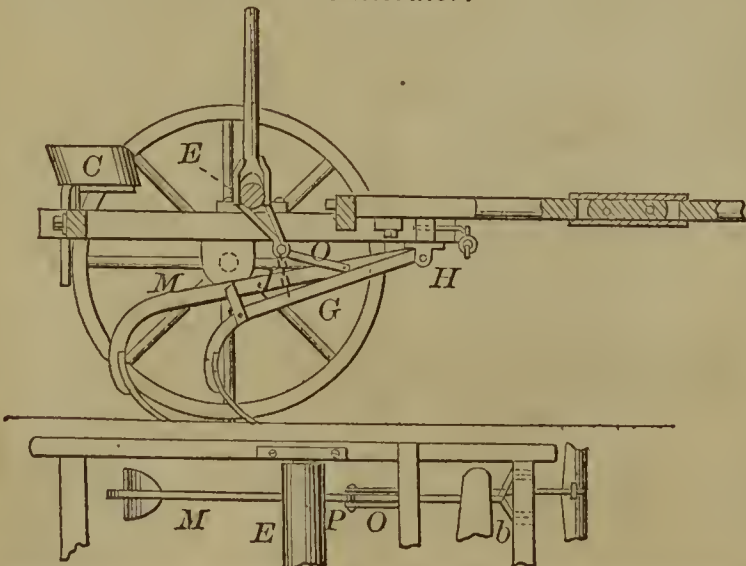

56514—F. A. Balch—Stove Pipe Drum.

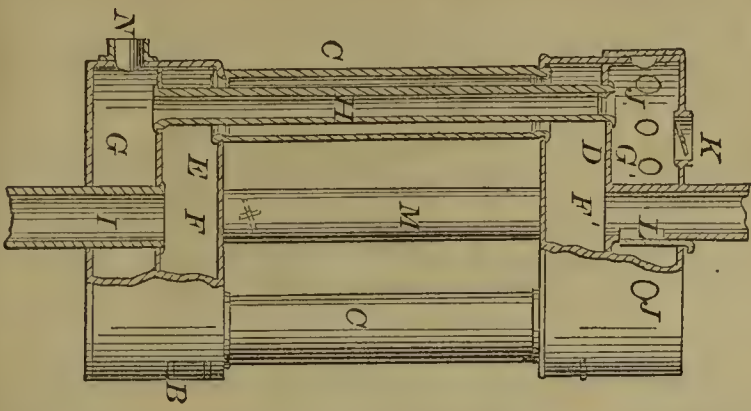

56515  
S. D. Baldwin—  
Sash Supporter.

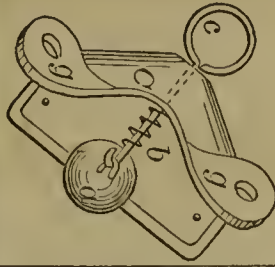

56521—R. D. Brown—Harvester Rake.

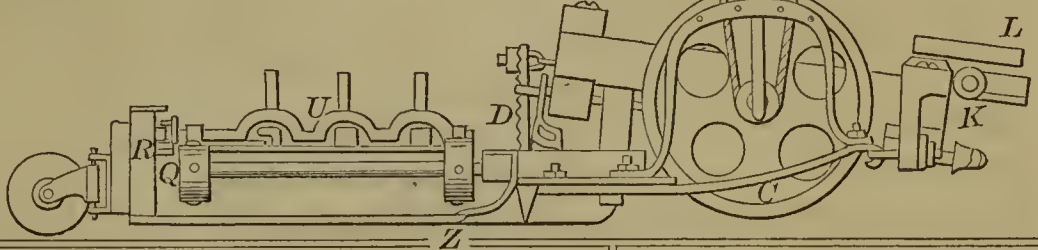

56519—J. Briggs—Clamp for  
Holding Saws.

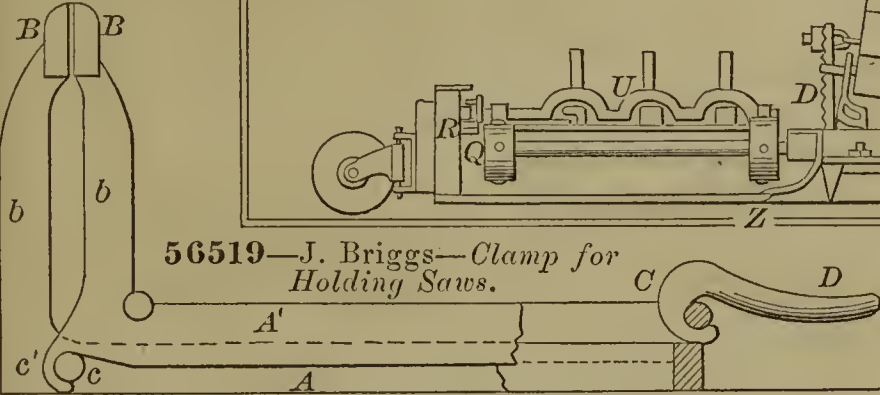

56516—A. Barbarin—  
Bottle Stopper.

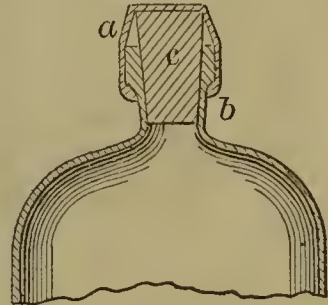

56518—J. Braidwood—Dumping Car.

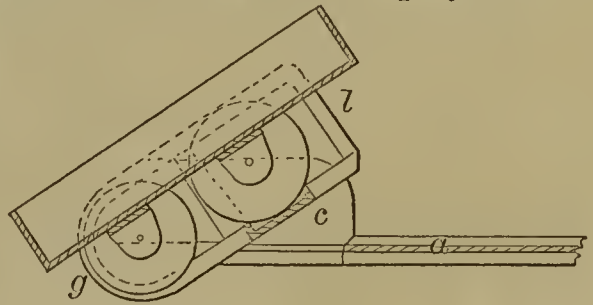

56522—R. Bryson—Reaping Machine.

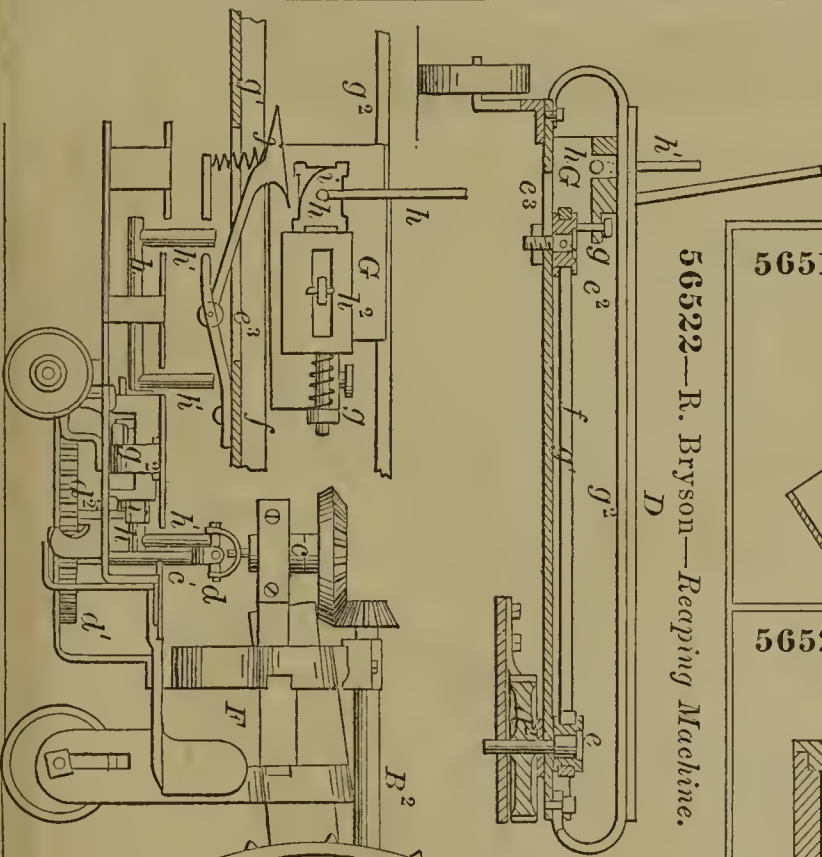

56520—G. N. Brigham—Churn.

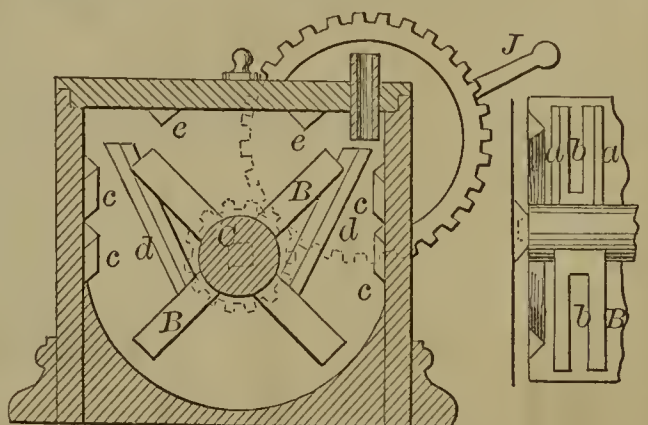

56517—J. N. Baxter—Horse Rake.

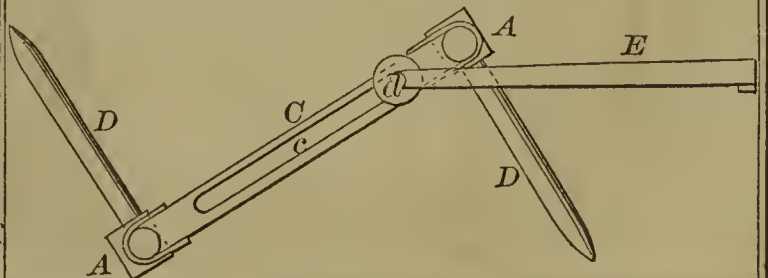

56523—H. Burk—*Clothes Washing Rubber.*

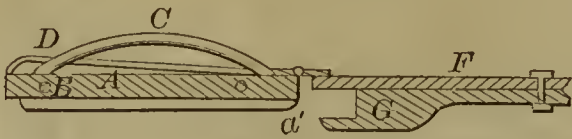

56525—E. Bussey—*Cooking Stove.*

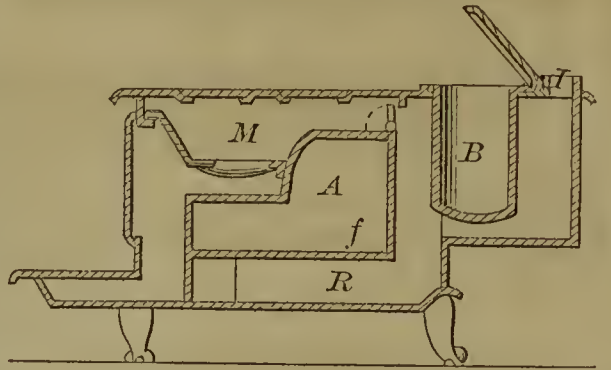

56524—E. F. Burrows—*Garter.*



56527—J. T. Capewell—*Sewing Machine Guide.*

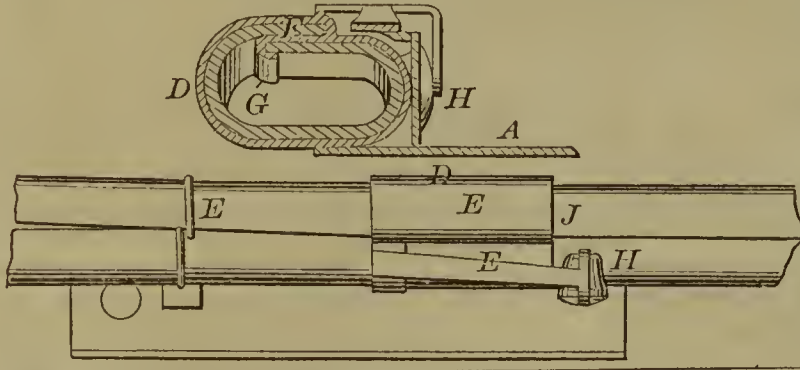

56528—K. S. Chaffee—*For Making Charcoal.*

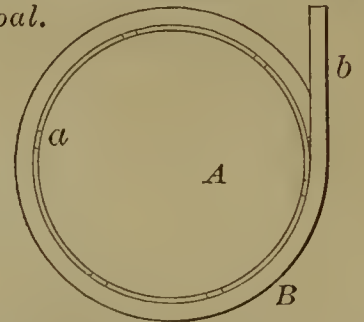

56530—S. Child, Jr.—*Vapor Stove.*

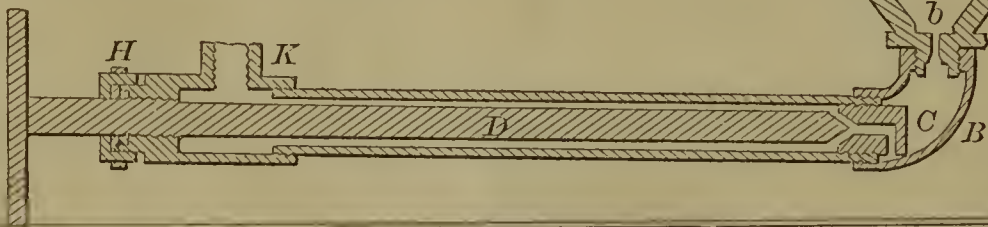

56533—P. M. Devos—*Medical Compound*

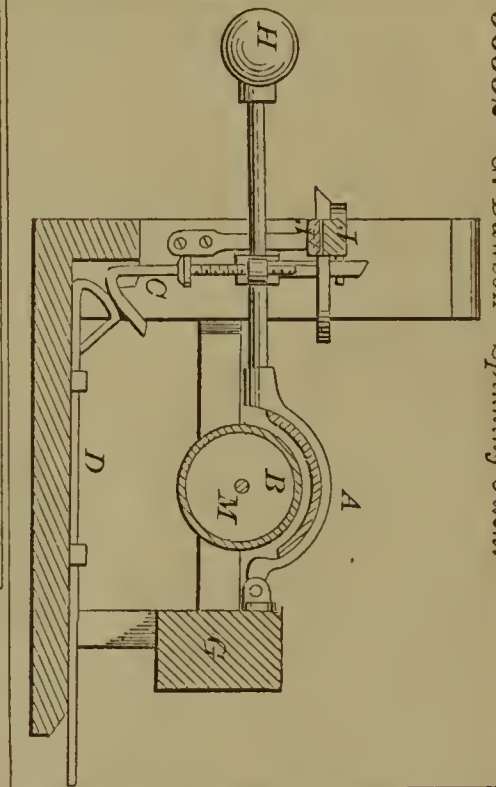
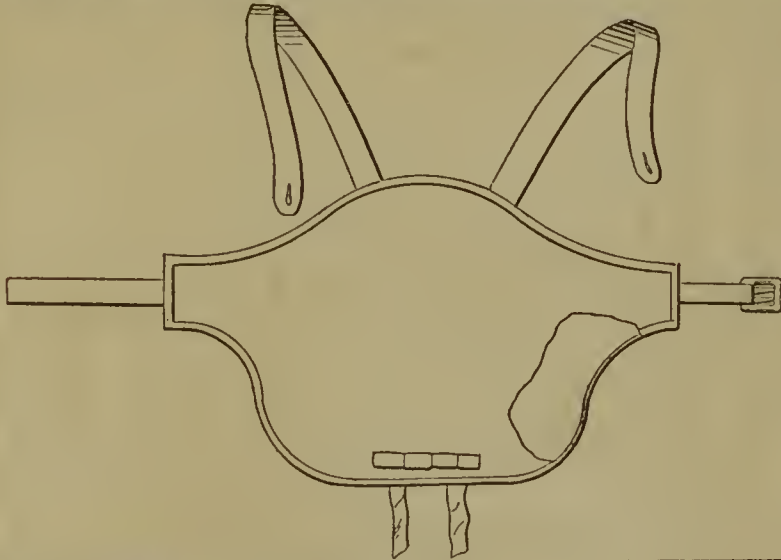

56532—G. Dawson—*Spinning Jack.*

56531—J. K. Cook—*For Soldering Cans.*

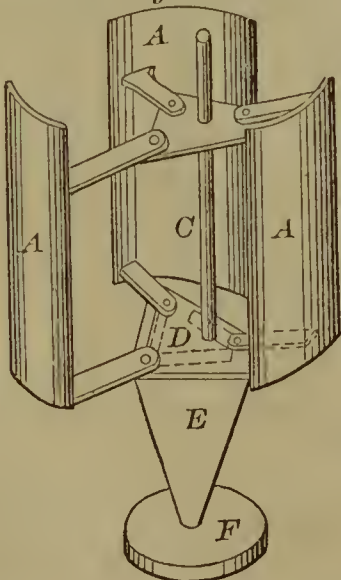

56534—O. Dorsey—*Reaping Machine.*

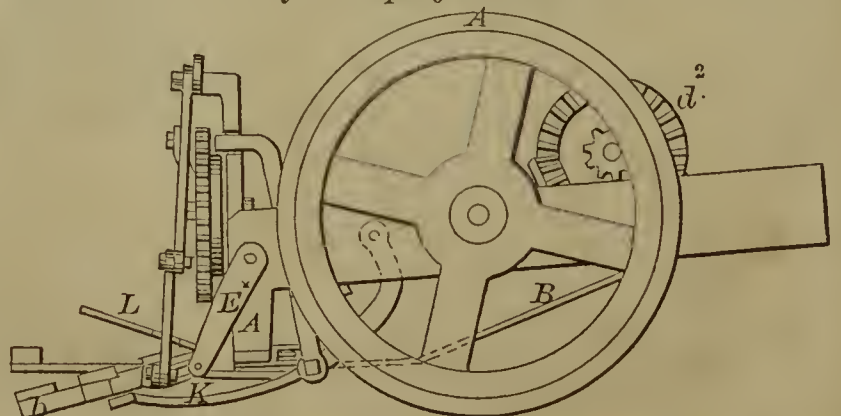



56535—J. H. Doughty—*Blacking Case and Night Chair.*

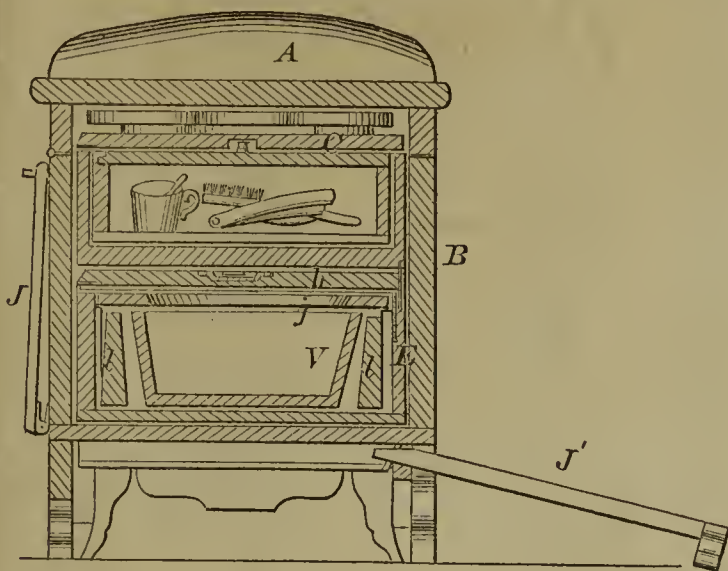

56540—W. A. Ehlman—*Combined Chair and Desk.*

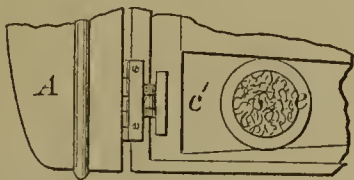
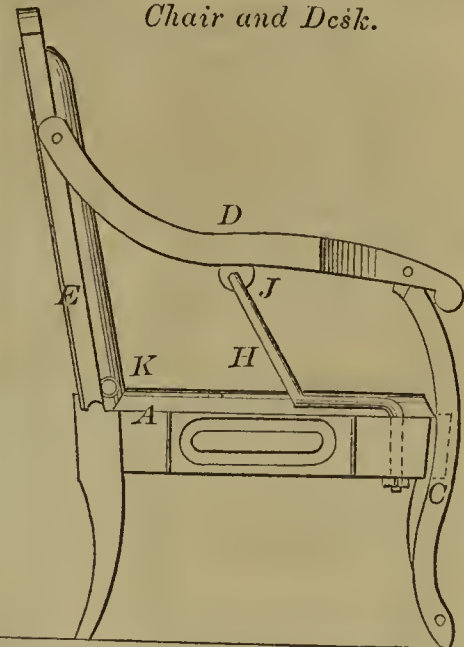

56538—A. Dunn—*Wagon Jack.*

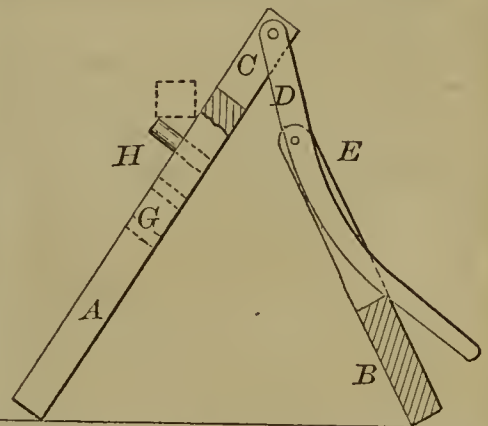

56541—B. F. Elliott—*Grape Trellis.*

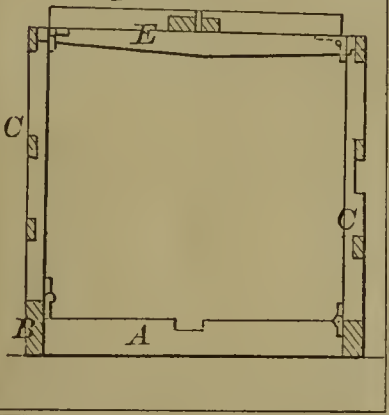

56536—J. Dow—*Signal Tower.*

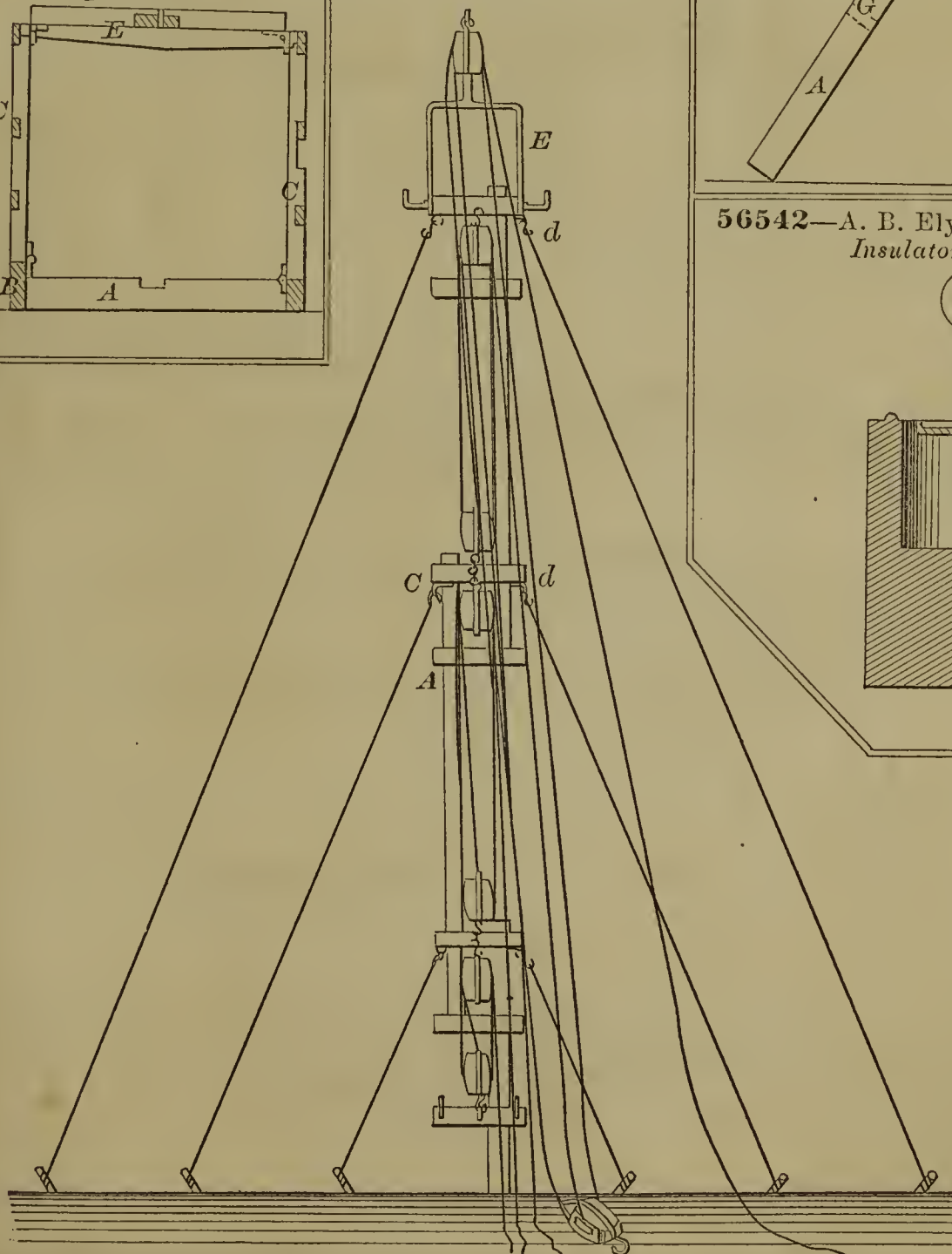

56542—A. B. Ely—*Telegraphic Insulator.*

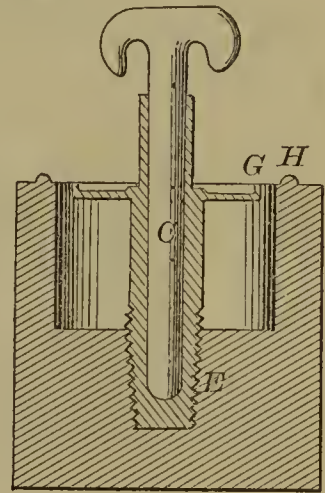

56537—J. Dubree—*Hitching Strap.*



56543—C. Engelskircher—Hand  
Lantern.

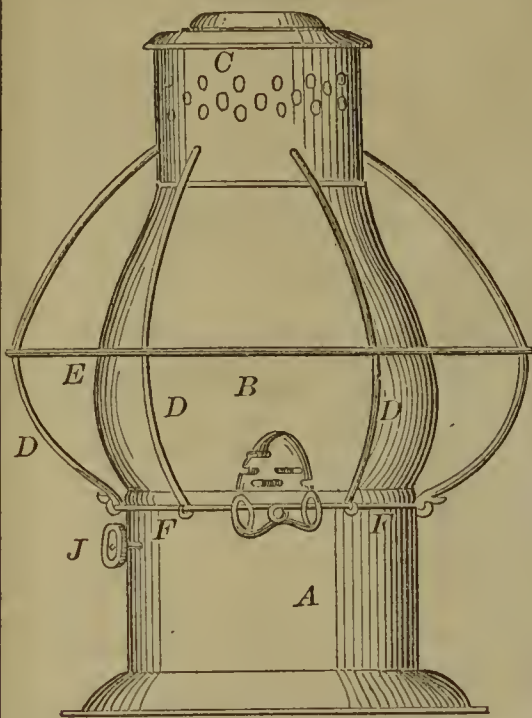

56549—E. Gaussoin—Treating  
Ores with Chlorine.

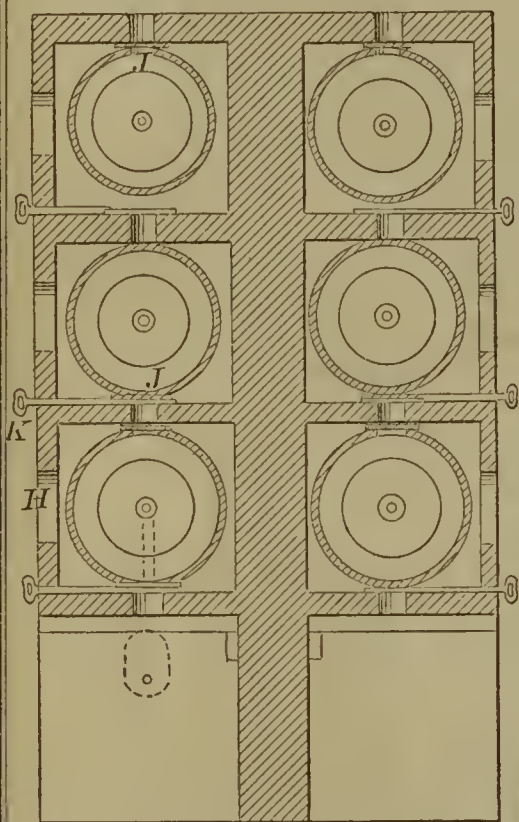

56545—Fisher & Ball—  
Reaping Machine.

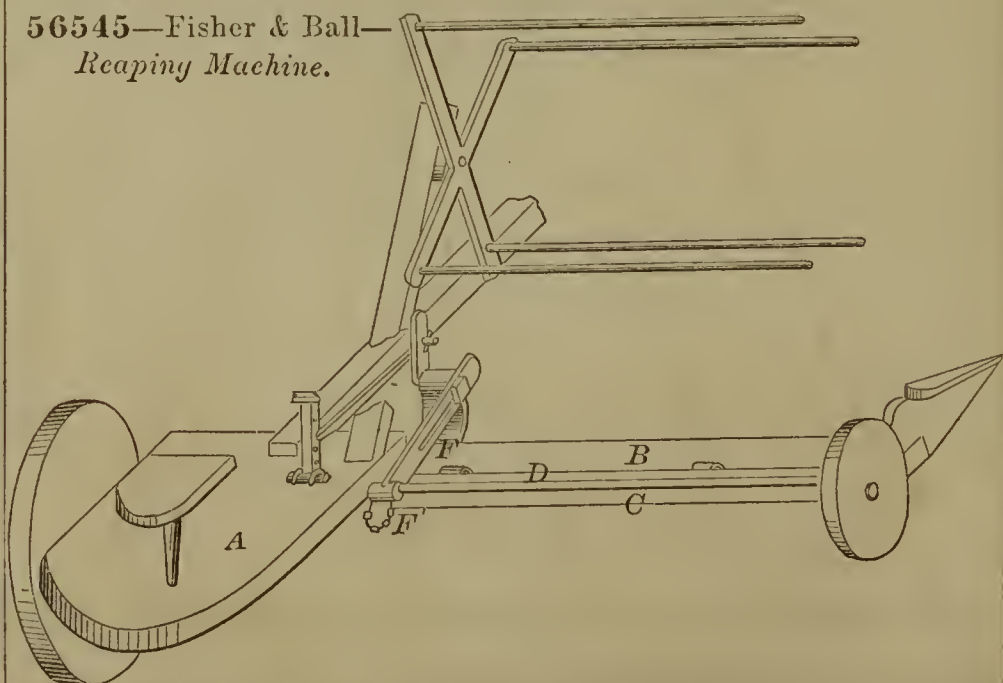
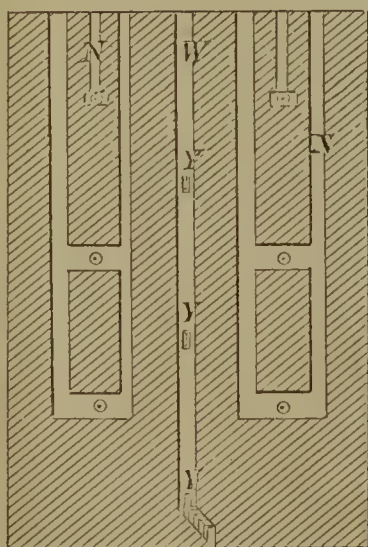

56544—L. W. Fifield—Knitting  
Machine Needle.



56546—J. Foster—Measuring  
Wheel Tyres.

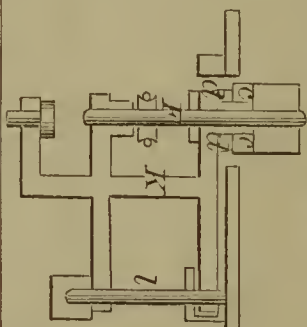
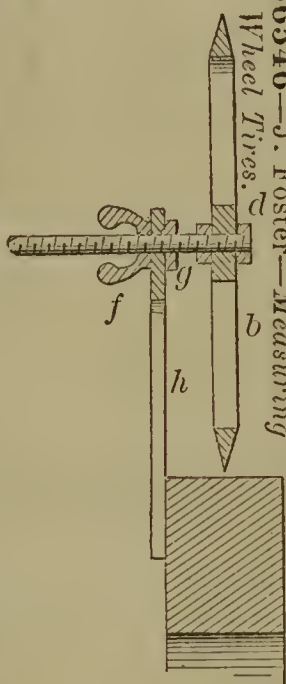

56547—T. T. Fowler—Scale for Weighing Ice.

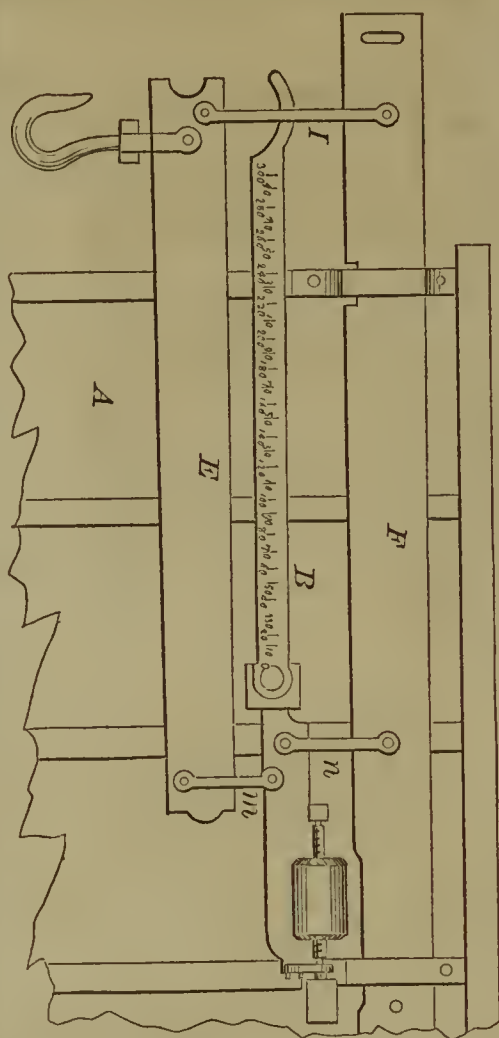

56548—J. Garfield—Planing  
Machine.

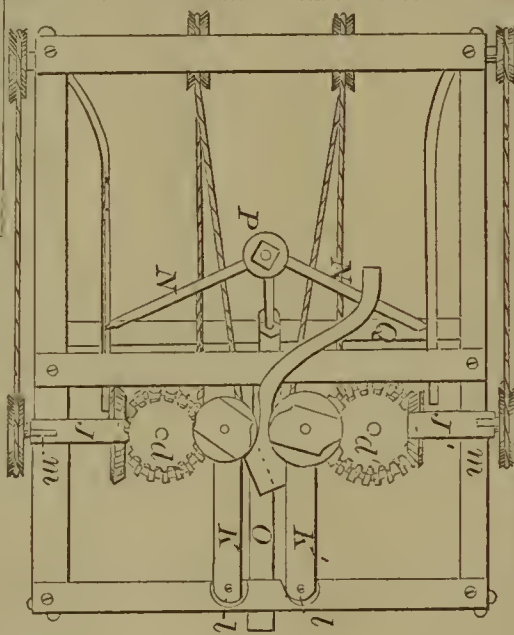

56550—F. Gay—*Farm Gate.*

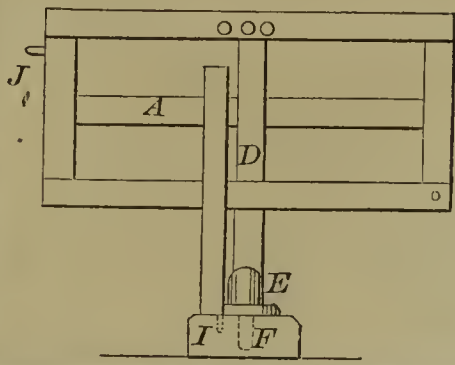

56553—G. Gullmann—*Elevator for Wells.*

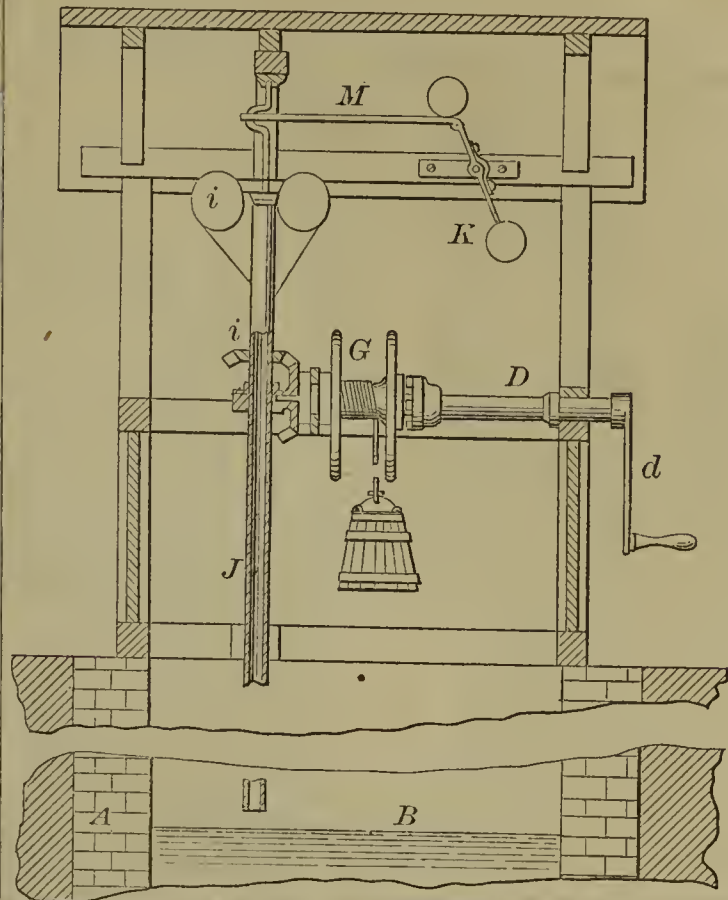

56551—G. Graffham—*Beehive.*

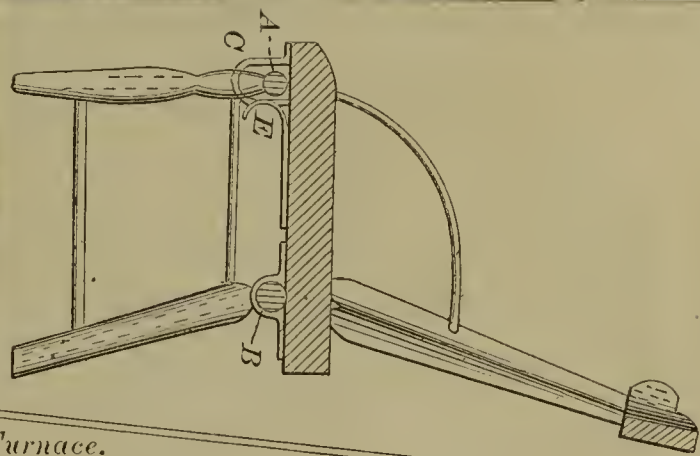
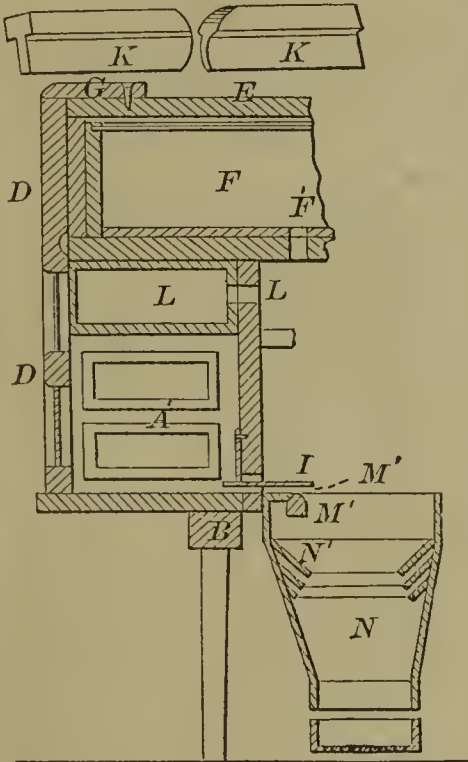

56554—J. Habermehl—*Chair.*

56552—J. R. Grout—*Reverberatory Furnace.*

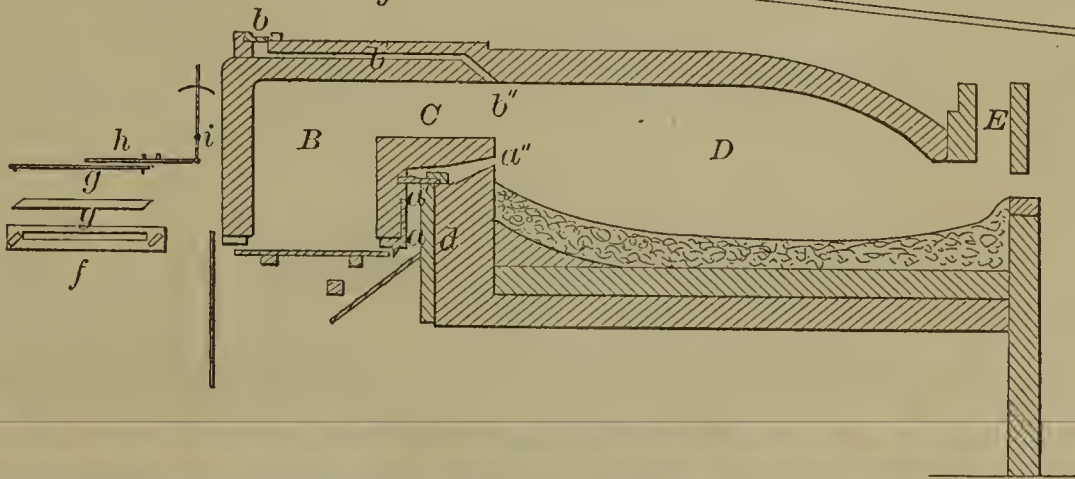

56555—D. Harris—*Horse Hoe.*

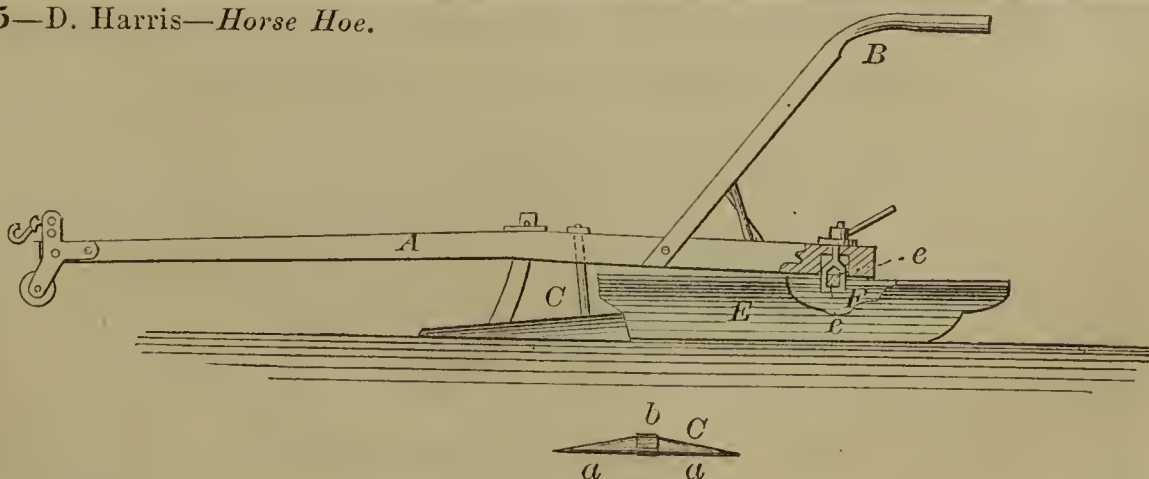

56556—E. B. Harris—Pump.

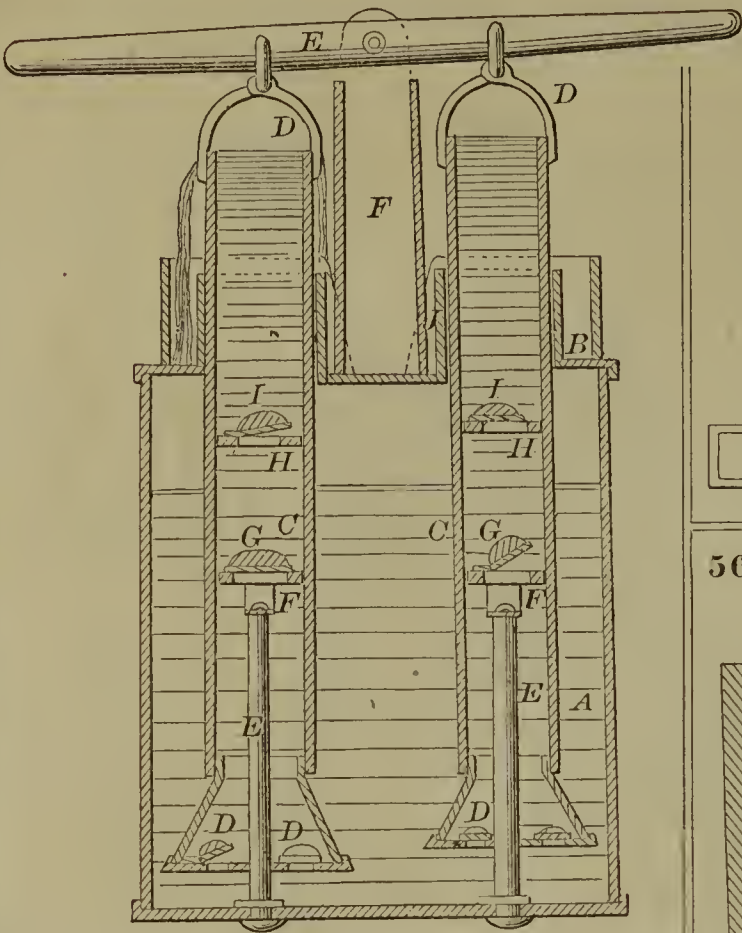

56557—J. Hayden—Ration Feed Box.

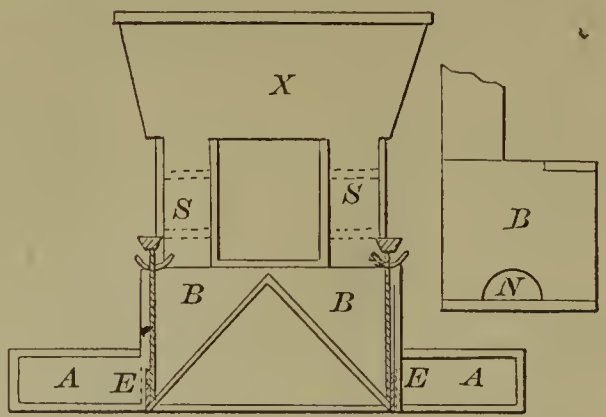

56560—R. S. Holton—Water Wheel.

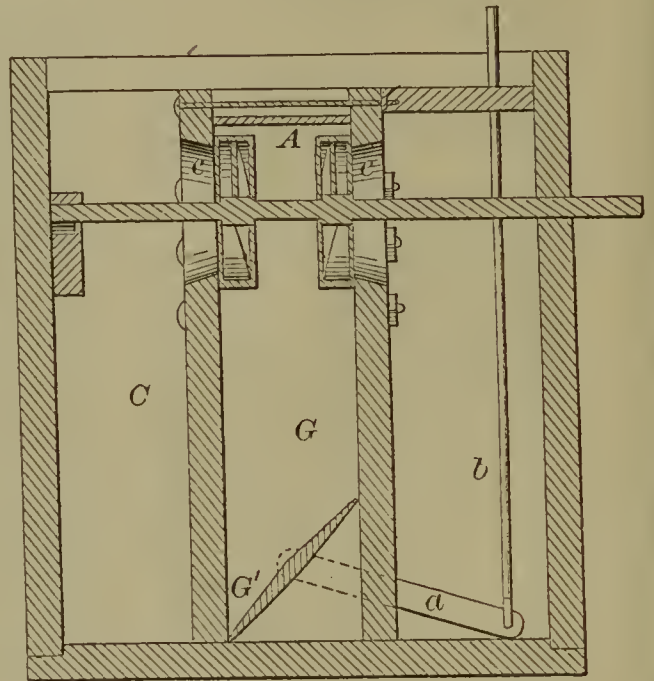

56562—T. L. Hough—Truss.

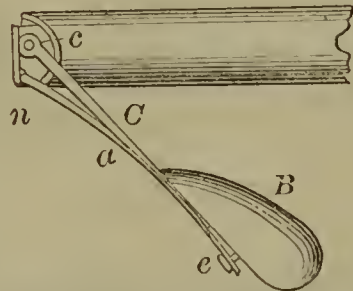

56559—Hendrick & Chataway—Gun Steel.

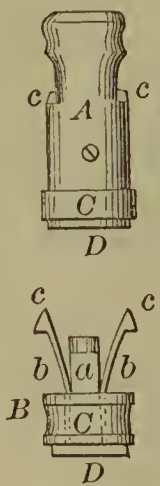

56558—J. W. Hendley—Sand Bellows.

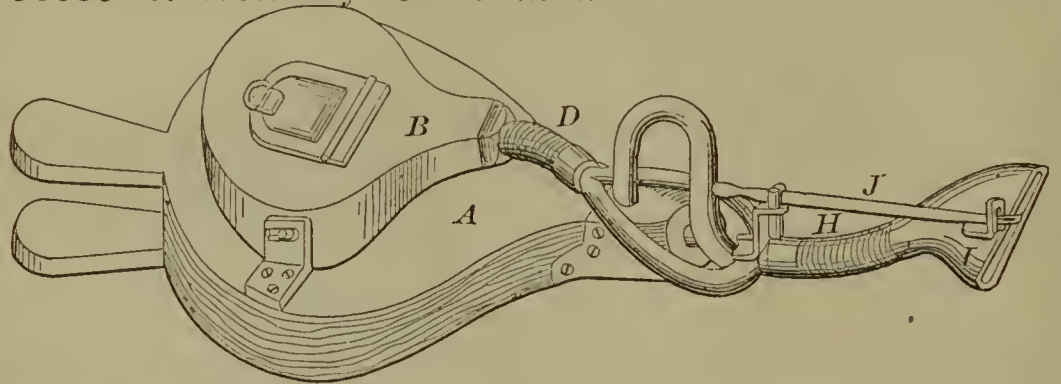

56563—D. Huestis—Pavement.

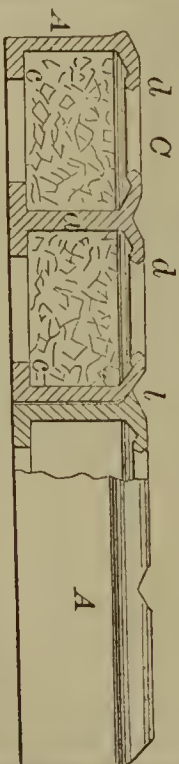

56561—H. Hotchkiss—For Making Metal Tubes.

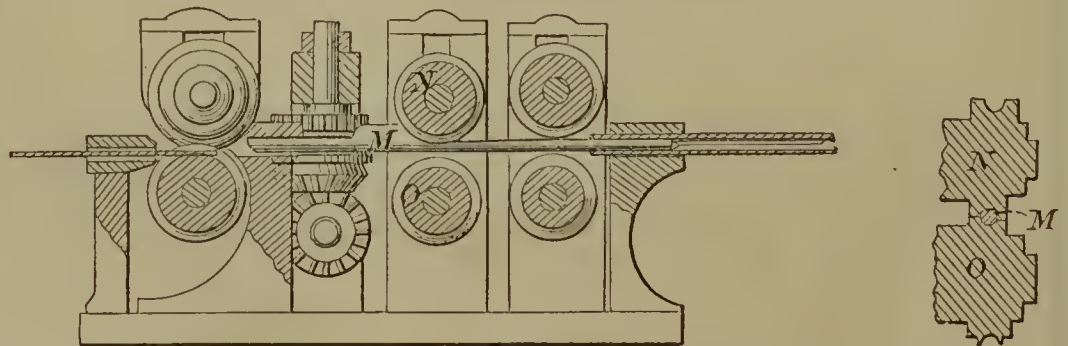

56564—H. B. Hutchins—*Knife Scourer.*

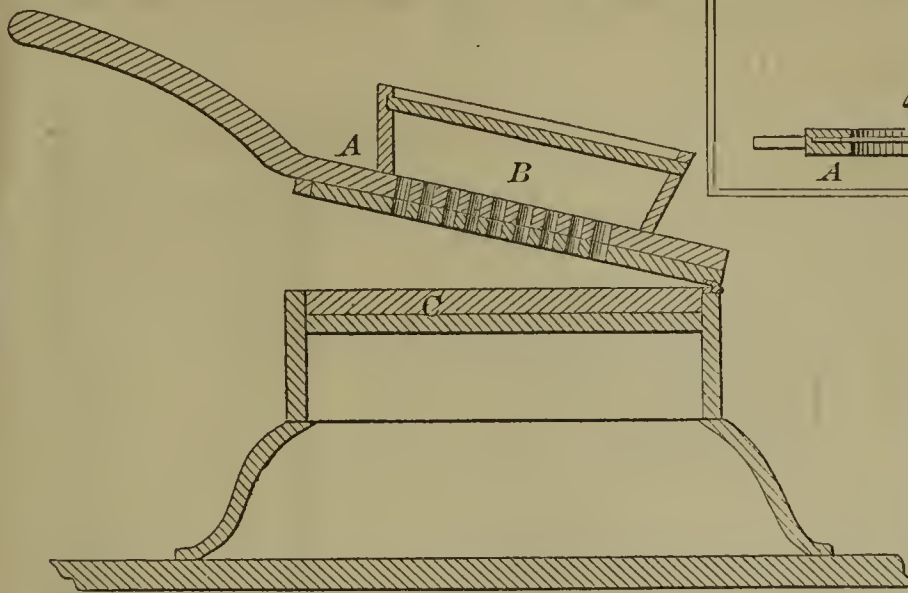

56566—J. A. Jacobs—*Stove Pipe Damper.*

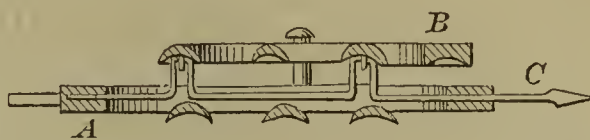

56567—E. N. Jenkins—*Lantern.*

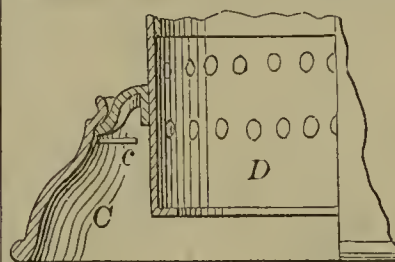
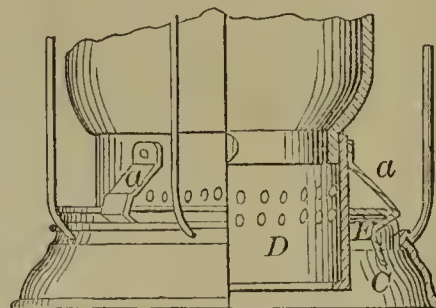

56565—S. T. Hutchins—*Last.*

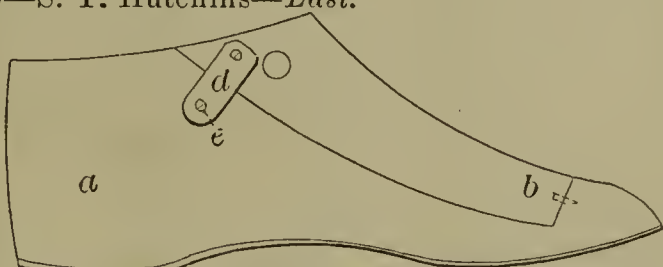

56572—F. J. Kindleberger—*Water Wheel.*

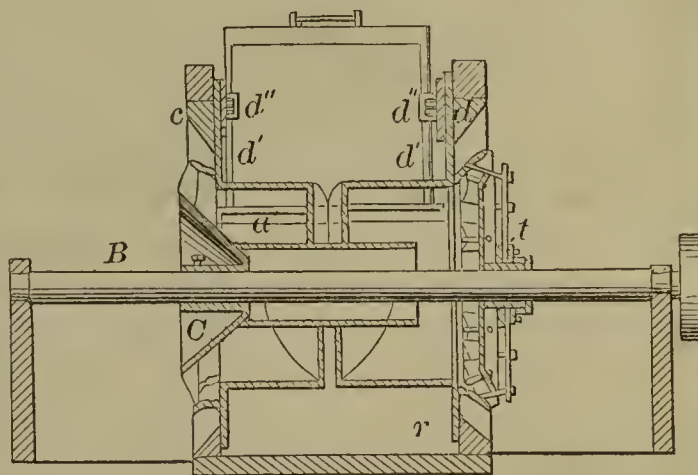

56569—C. H. Keener—*Hat Rack.*

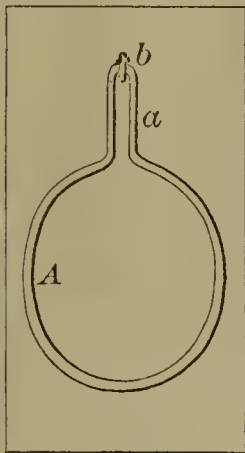

56570—C. A. Kellogg—*Bed Bottom.*

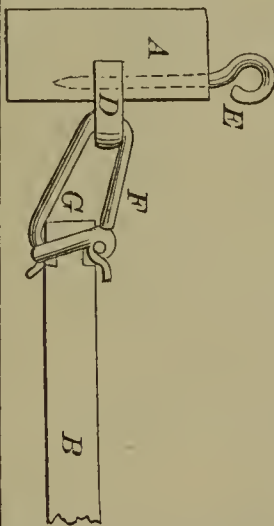

56568—M. W. Jenks—*Water Drawer.*

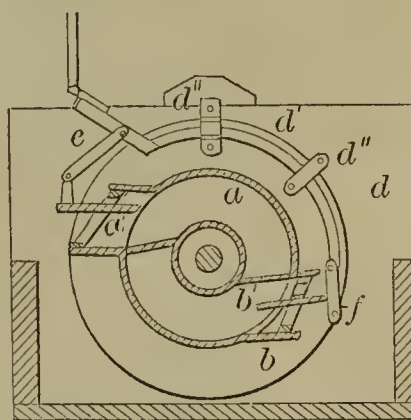
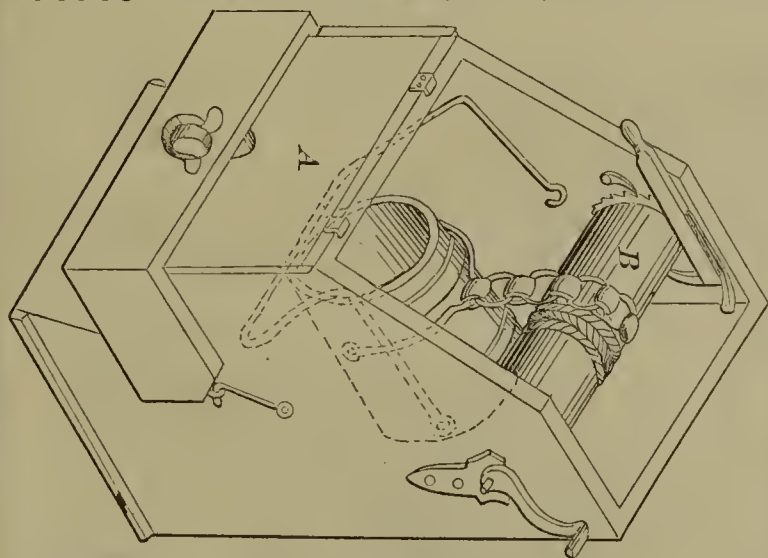

56571—J. B. Kelly—*Turn Table.*

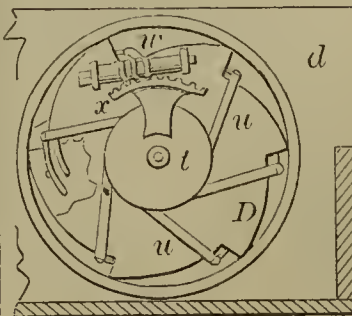
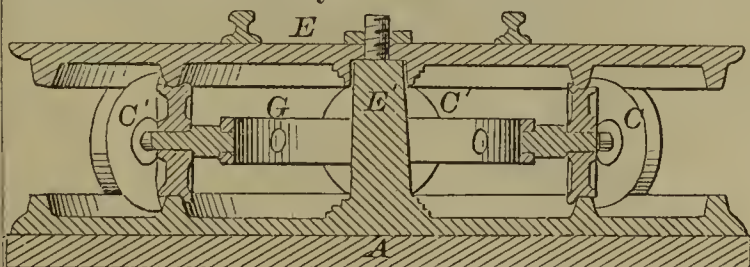

56573—J. Klanke—Robe.



56579—C. L. Lochman—  
Porcelain Printing Frame.

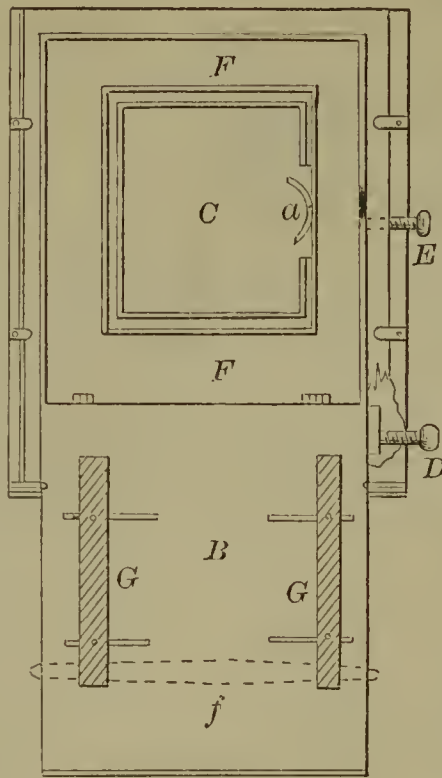

56577—P H Lawrence—  
Rock Drilling Machine.

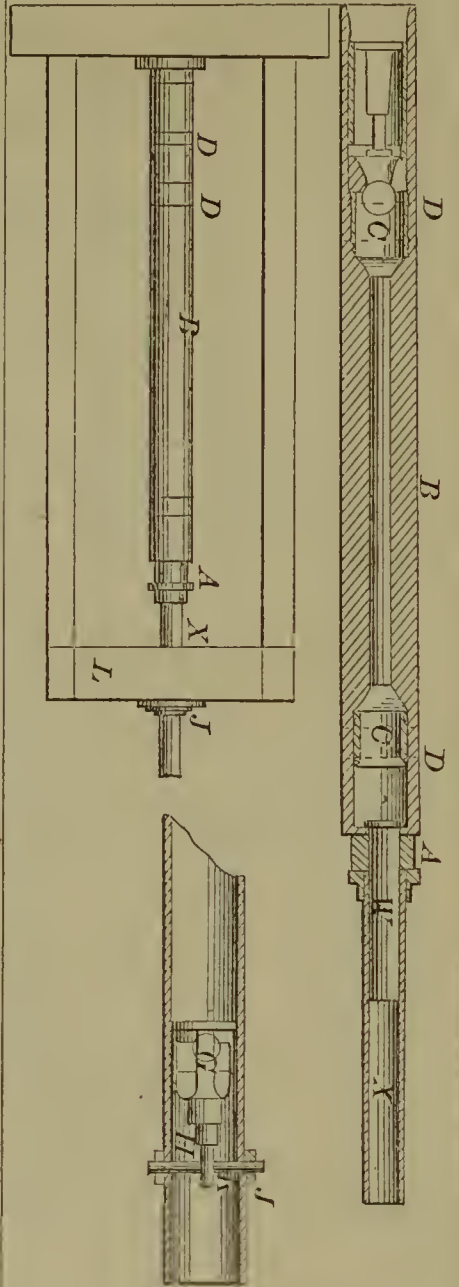

56575—J. G. Konvalinka—  
Watch and Locket Case.

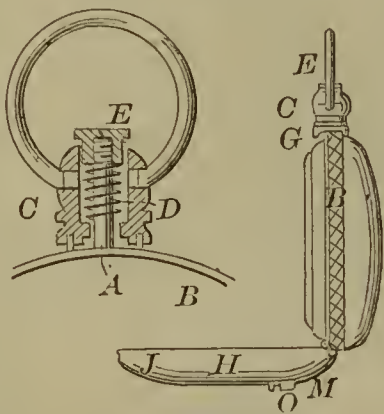

56580—S. D. Locke—  
Grain Binder.

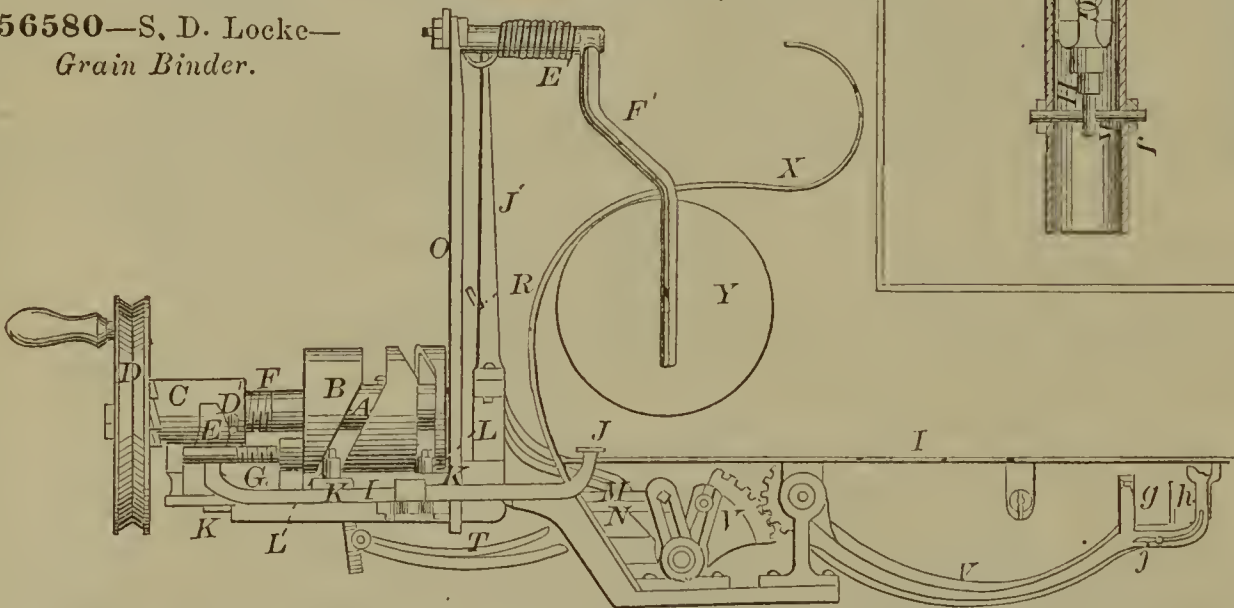

56581—J. Mabbs—Quartz Crusher.

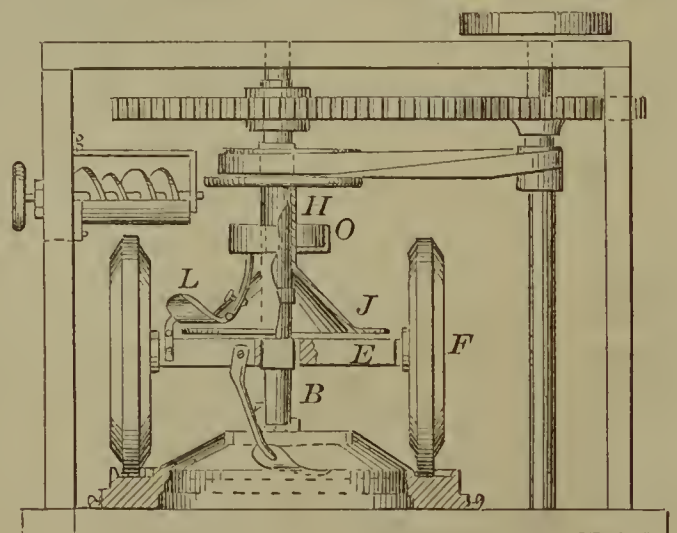

56578—M. Leippe—Cigar Press.

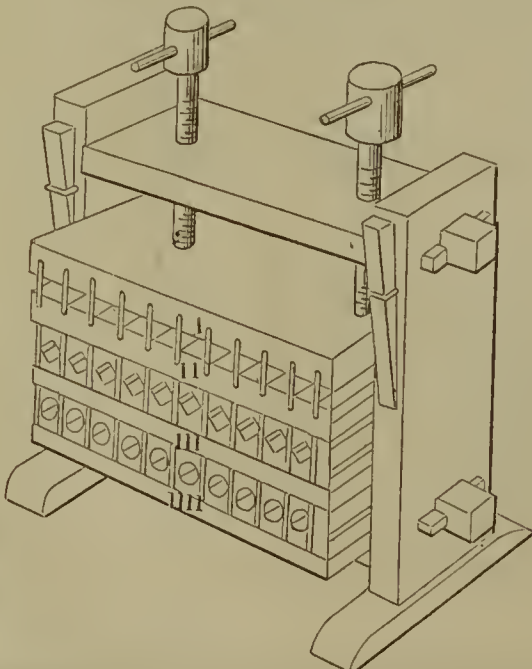

56582—J. F. Maguire—*Tuyere.*

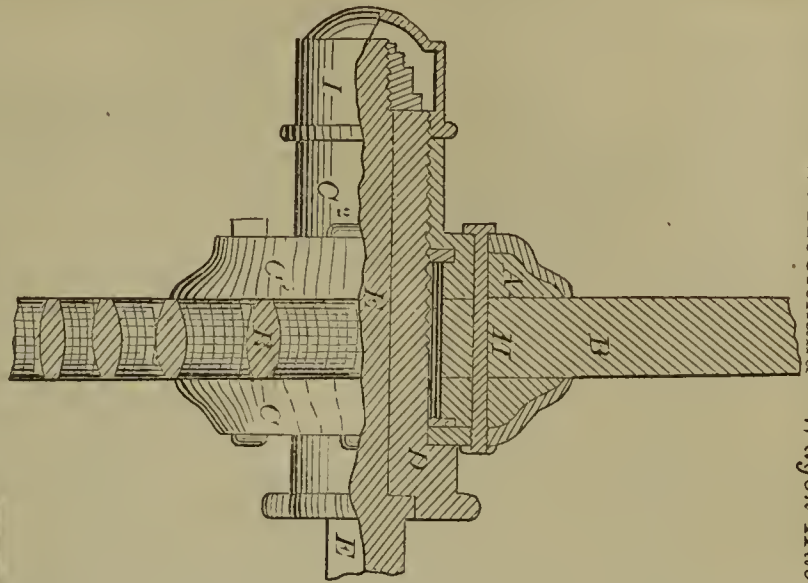
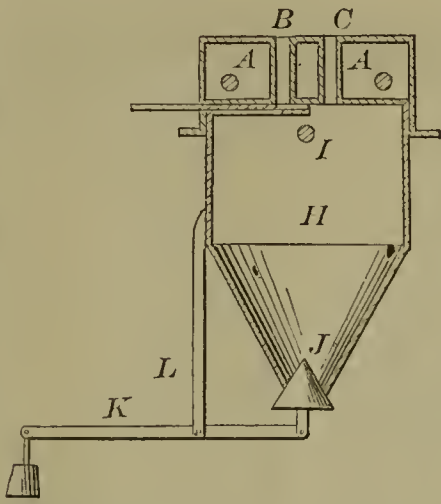

56586—R. W. McClelland—*Wagon Hub.*

56583—M. H. Mansfield—*Clover Threshing and Hulling Machine.*

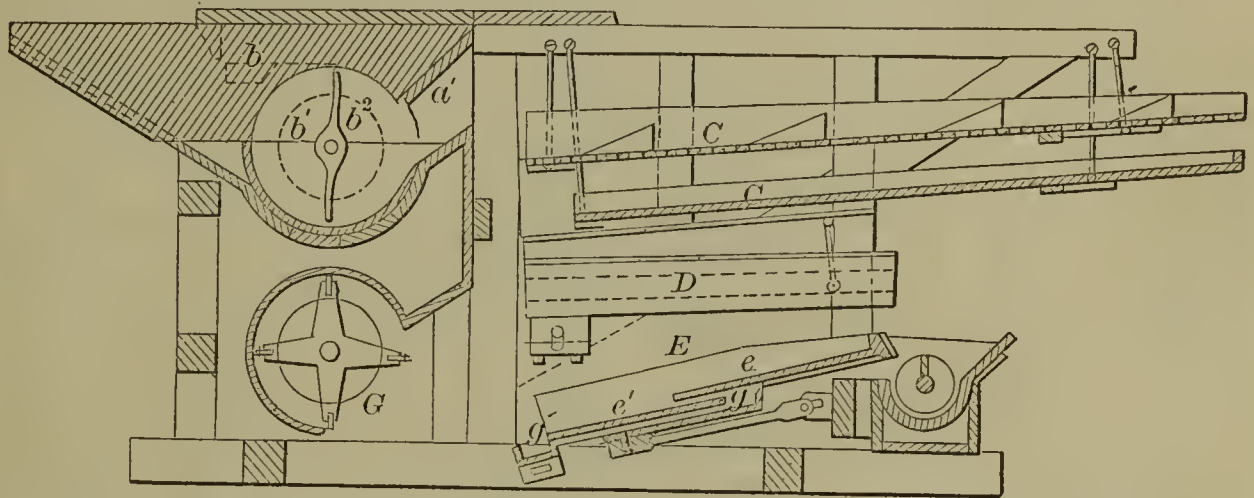

56584—H. A. Martin—*Plow.*

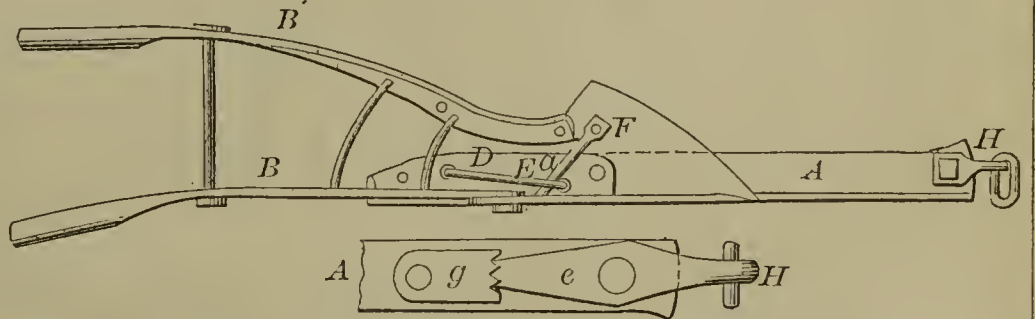
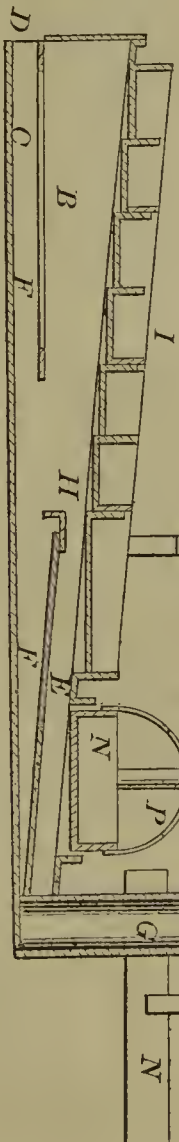

56587—G. W. McGill—*Paper Fastener.*

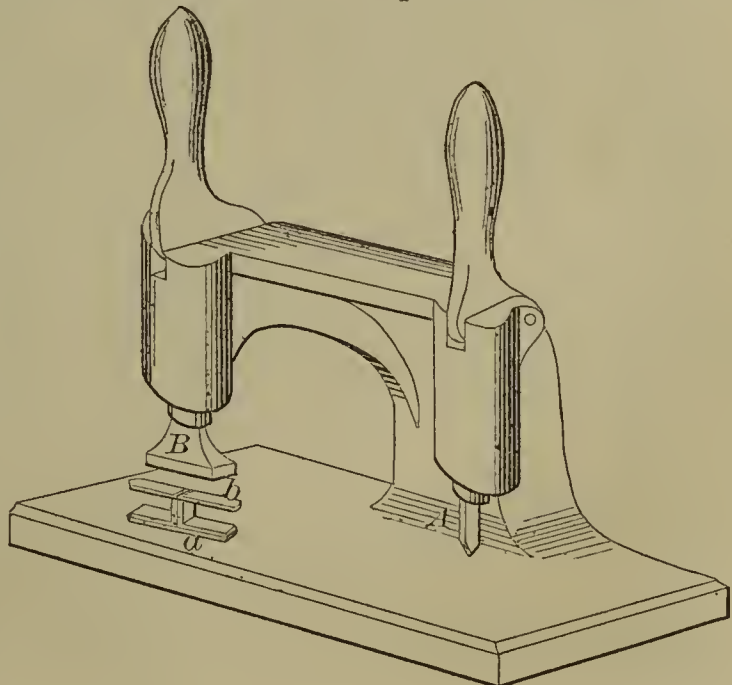

56585—S. B. Mansby—*Evaporator.*

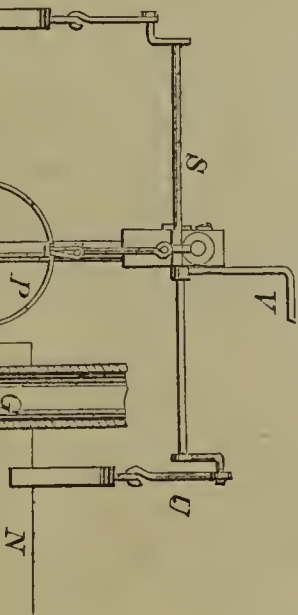

56588—J. A. McGillirrac—*Press.*

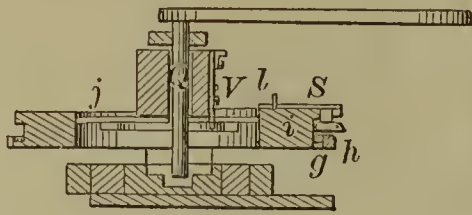

56590—J. McLellen—*Buckle.*

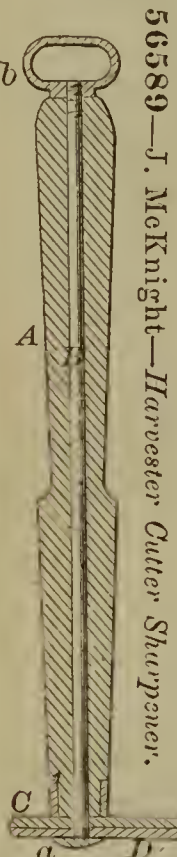
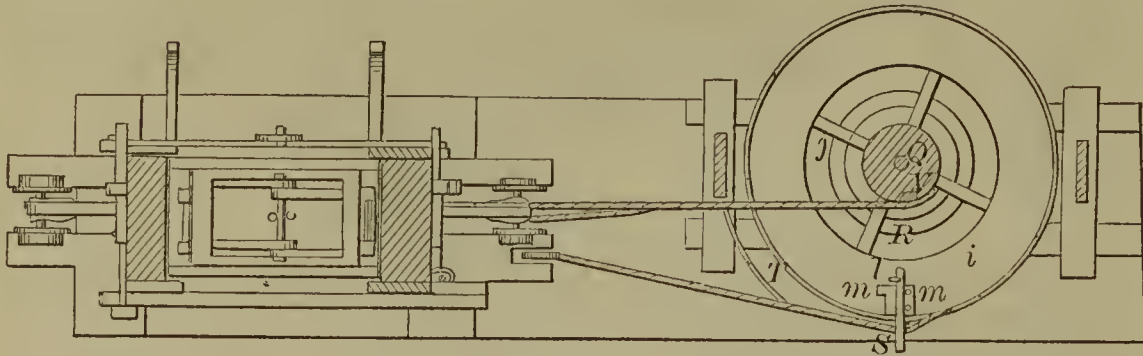
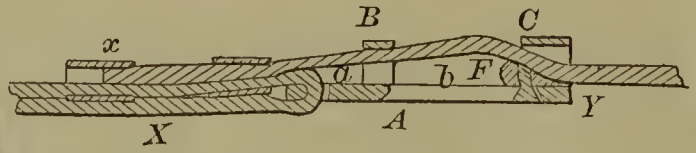

56589—J. McKnight—*Harvester Cutter Sharpener.*

56591—McMillen & Conriek—*Clothes Wringer.*

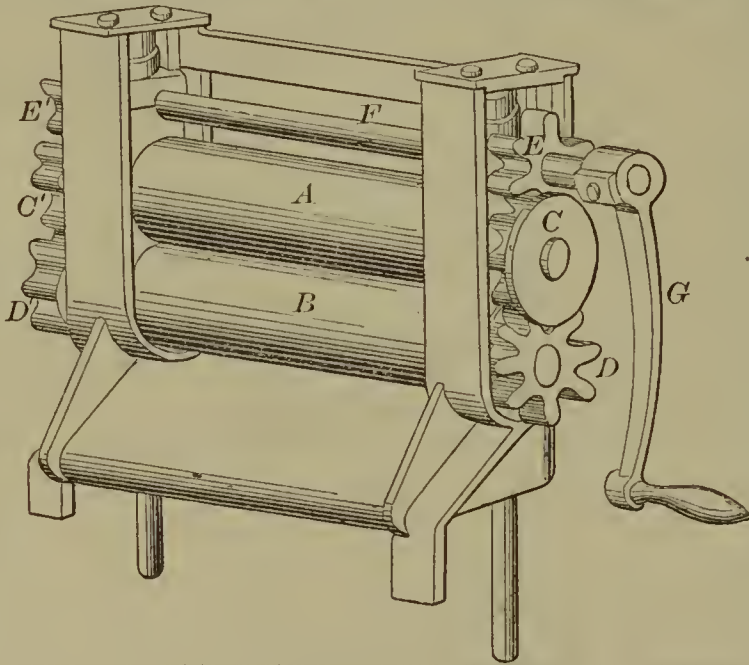

56592—W. M. Merriell—*Sash Fastening.*

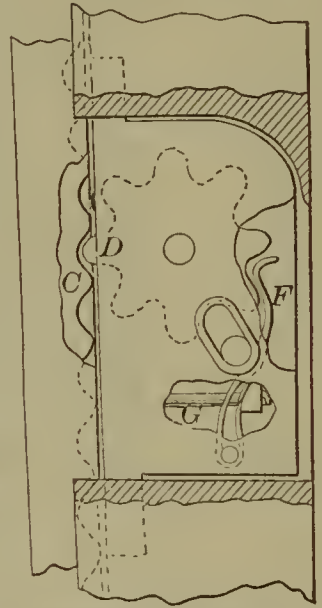

56595—Morris & Eynon—*Granulating Furnace Slag.*

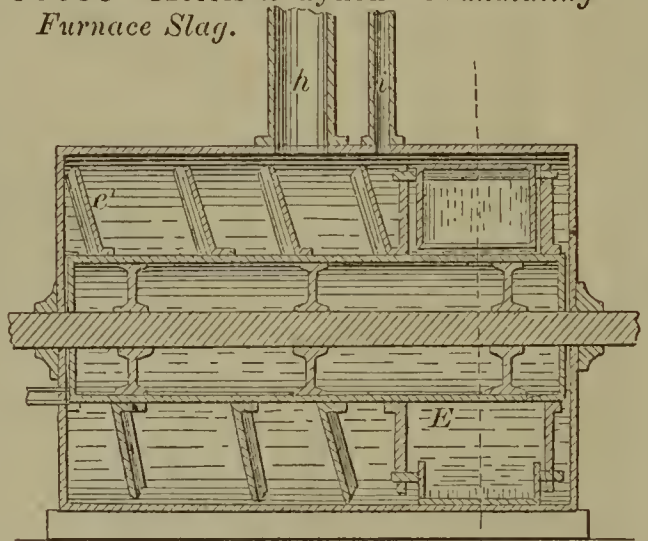

56593—I. L. Miles—*Printing on Bottles.*

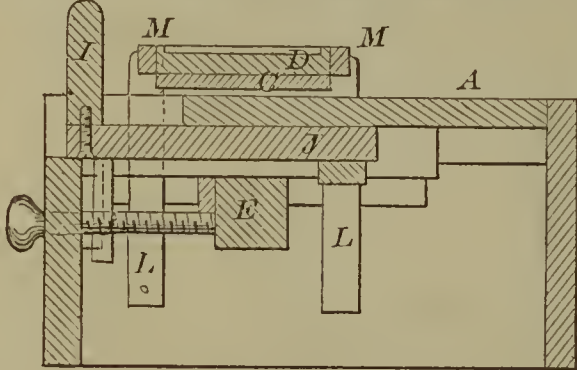

56594—E. Miller—*Railroad Car.*

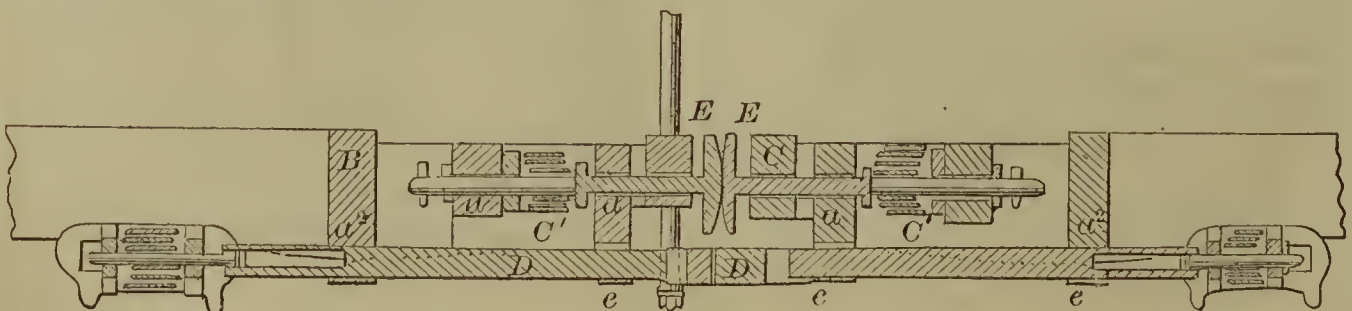



56597—J. M. Naglee—*Syphon.*

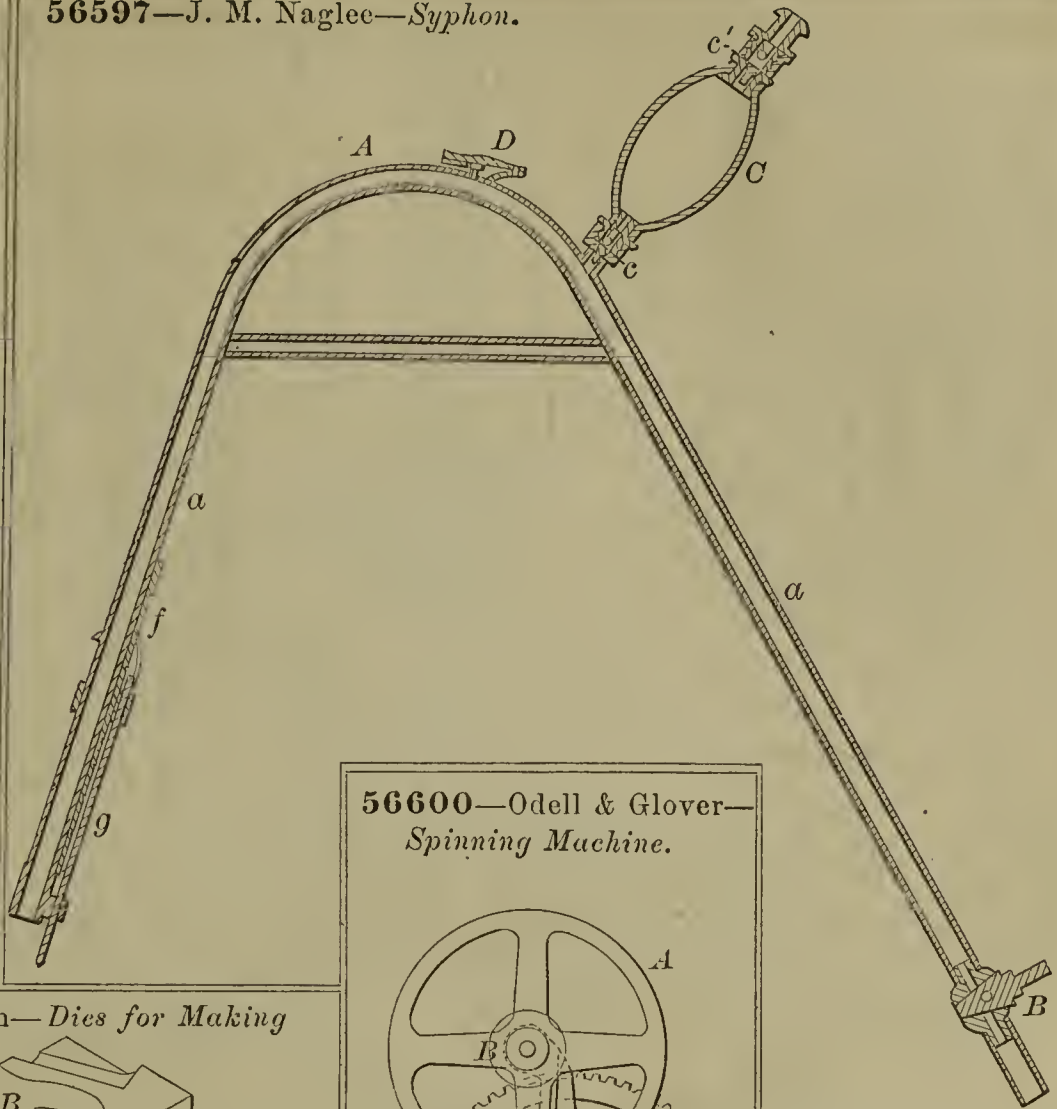

56596—J. M. Naglee—*Extracting Specimen of Liquors.*

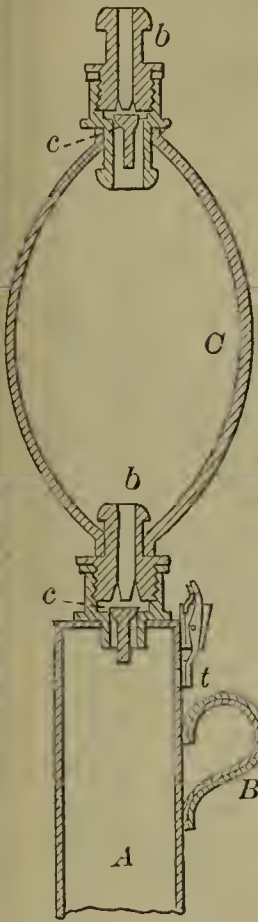

56600—Odell & Glover—*Spinning Machine.*

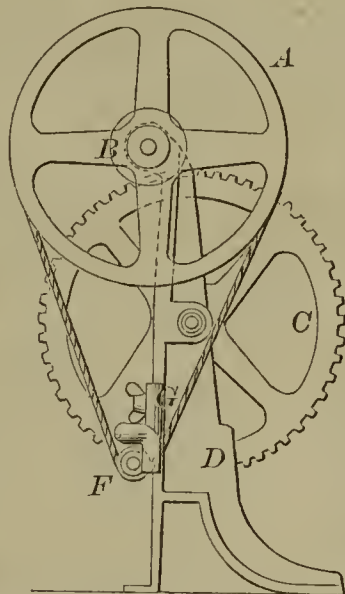

56602—H. W. Pell—*Die for Wrenches.*

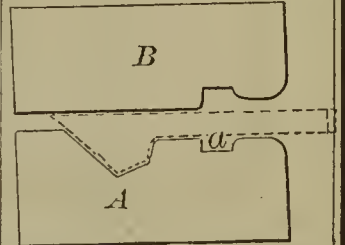

56599—C. Norton—*Dies for Making Eye Bolts.*

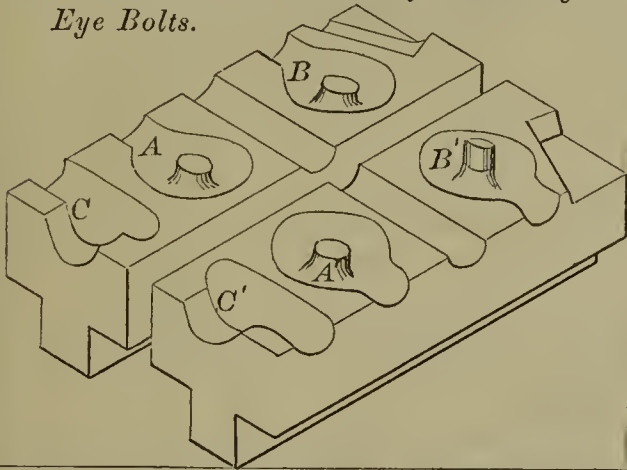

56598—C. Nickerson—*Wind Wheel.*

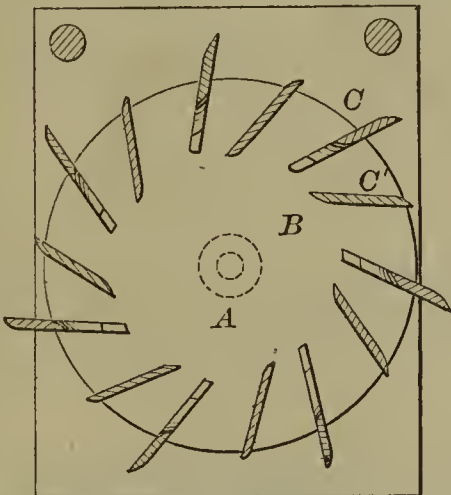

56603—G. G. Percival—*Combined Inkstand and Calendar.*

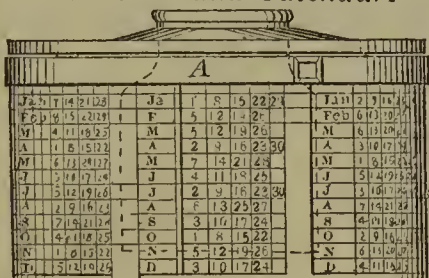

56601—E. C. Otis—*Carriage Axle.*

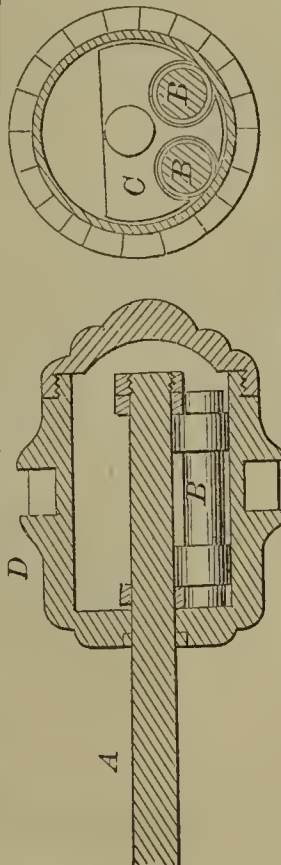

56604—G. Peugeot—*Hand Lantern.*

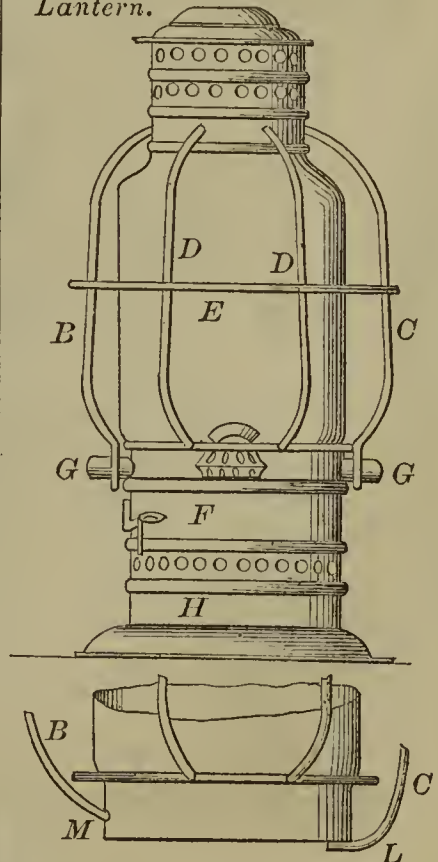

56605—O. Place—Flour Packer.

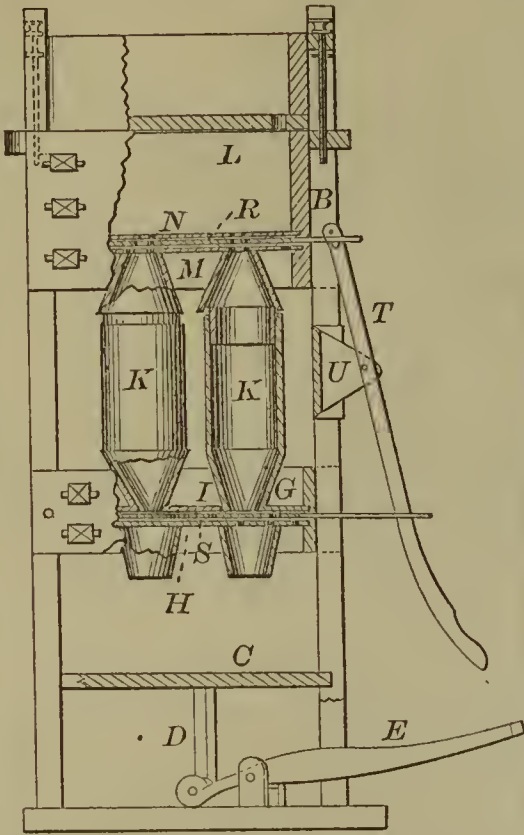

56606—F. R. Pollard—Shackle for Carriage Tongues.

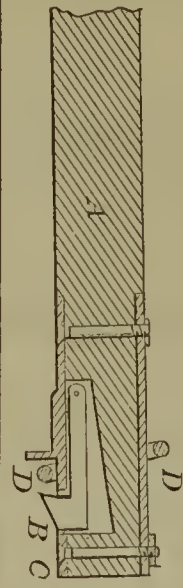

56607—V. T. Priest—Collar for Drill Rods.

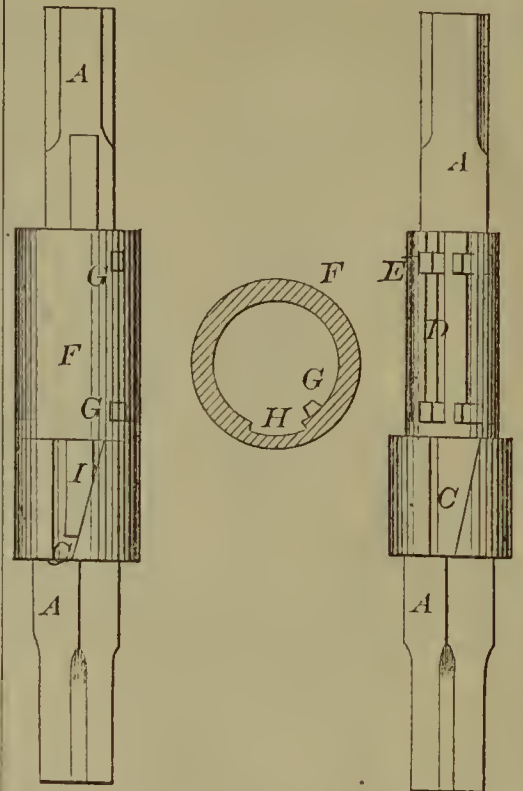

56611—F. Reynolds—Harness Nail.



56609—T. T. Prosser—Boiler.

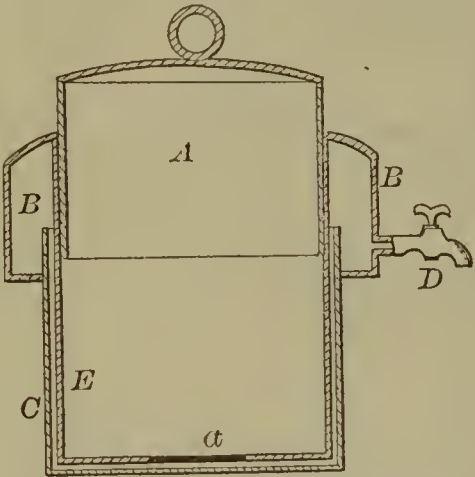

56610—J. Proud—Shirt Collar Attachment.

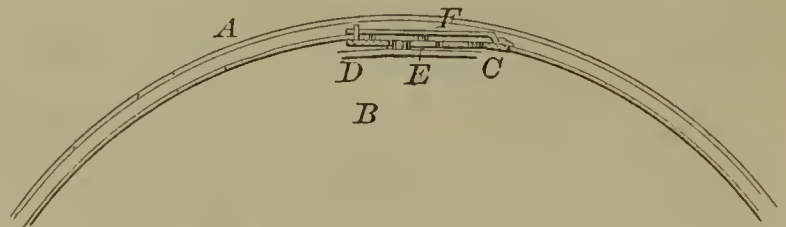

56613—W. T. Rogers—Gang Plow.

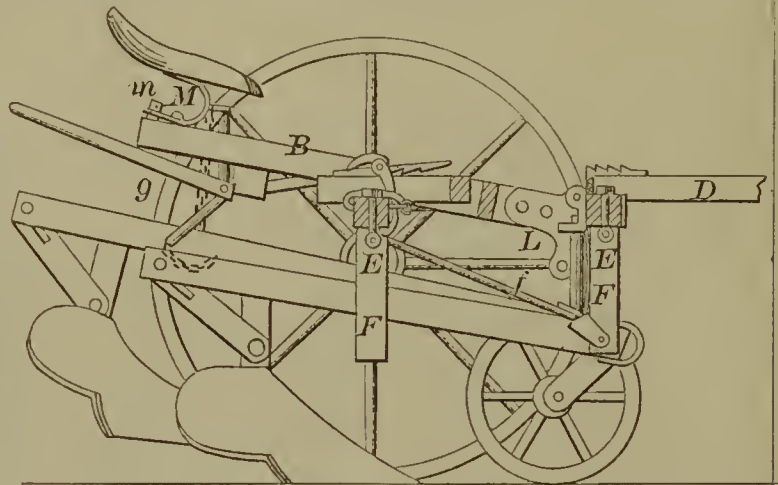

56612—J. W. Roberts—Securing Buttons.

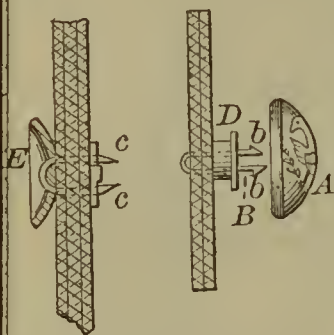

Crosshead for Blowers.

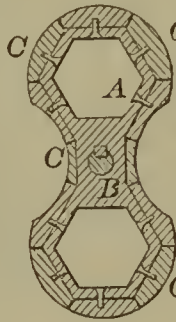

56614—P. H. & F. M. Roots—

56616—C. W. Saladee—Padlock.

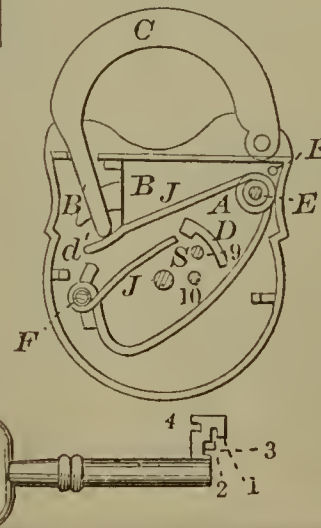

56617—C. W. Saladee—Padlock.

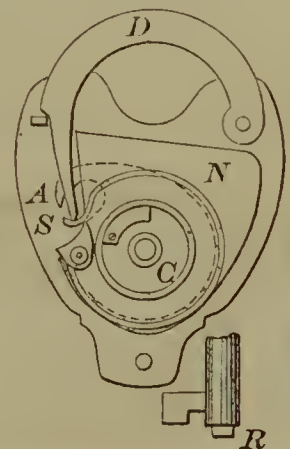

56615—J. J. Russ—Knife and Scissors Sharpener.

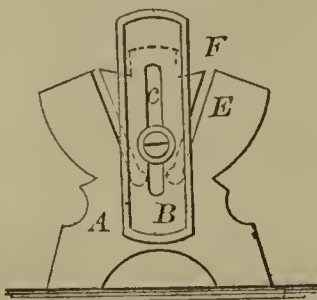

56618—L. Sauter—*Napkin Ring.*

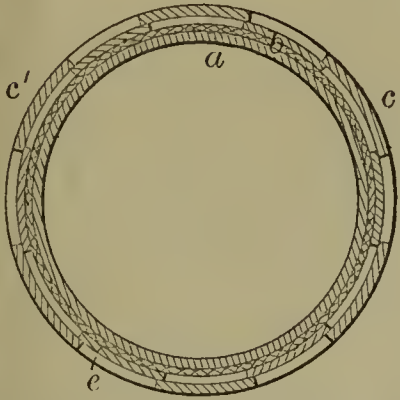

56619—L. G. Sayre—*Check Rein.*

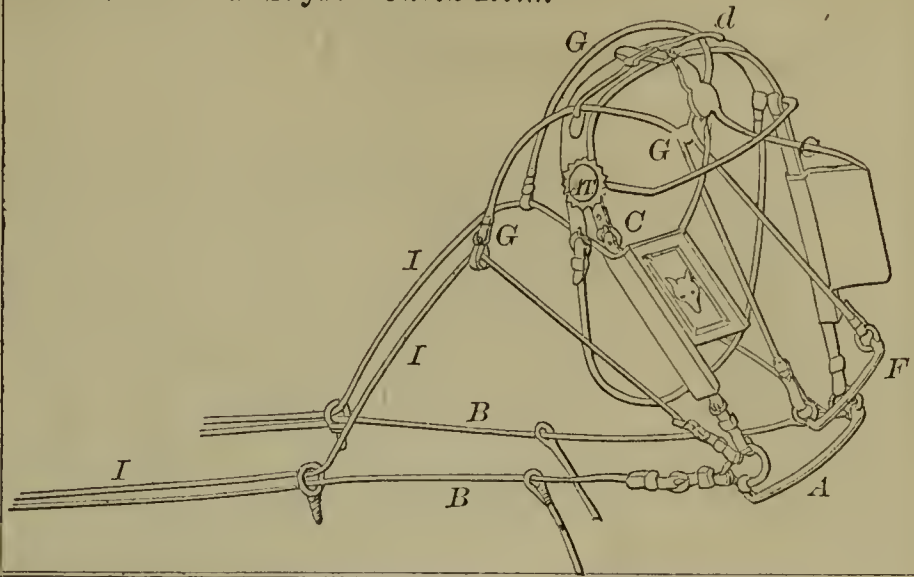

56620—T. P. Shaffner—*Packing Nitro-Glycerine.*

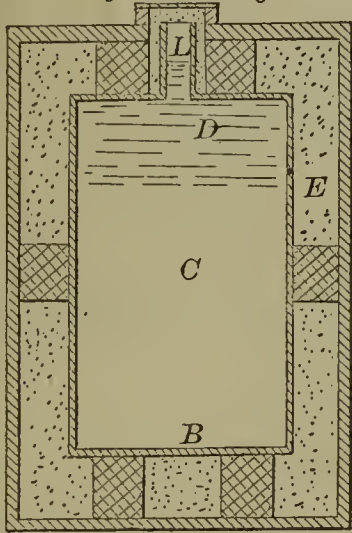

56622—W. A. Shaw—*Die for Manufacturing Lead Pipe.*

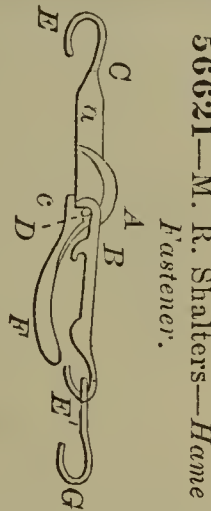
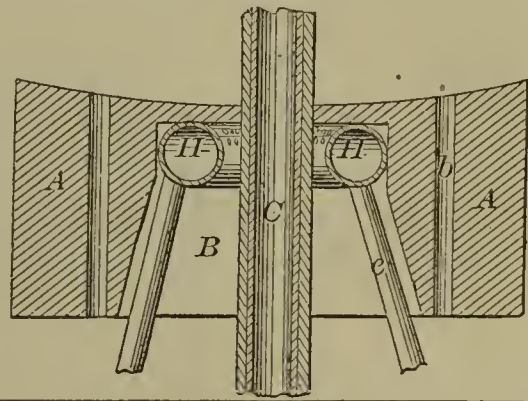

56621—M. R. Shalters—*Horse Fastener.*

56623—C. Shepard—*Well Tube.*

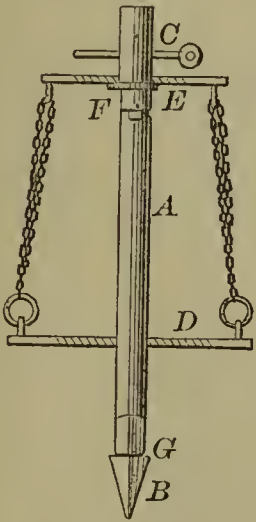

56626—M. B. Stafford—*Peat Machine.*

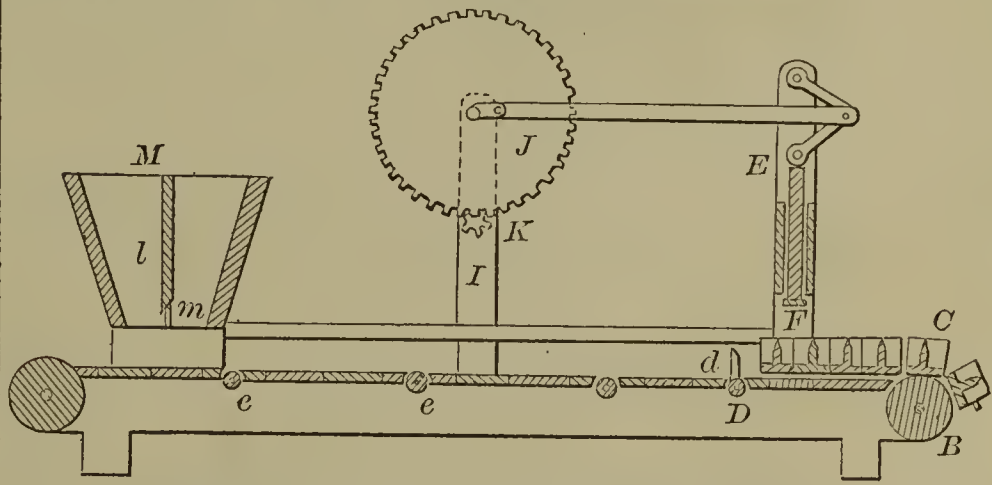

56627—J. A. Stansbury—*Pump.*

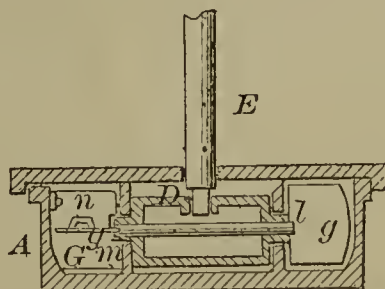
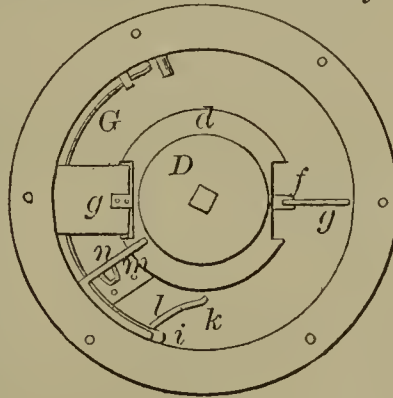

56624—A. R. Sherman—*Lubricating Journal Boxes.*

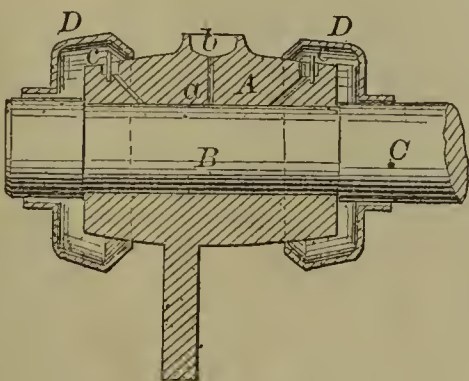

56628—R. S. Stenton—*Wrench.*

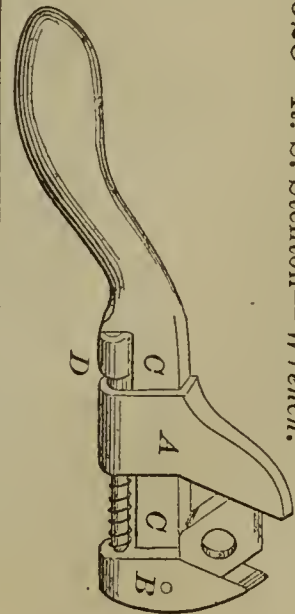

56630—Stewart & Pierce—Curtain Fixture.

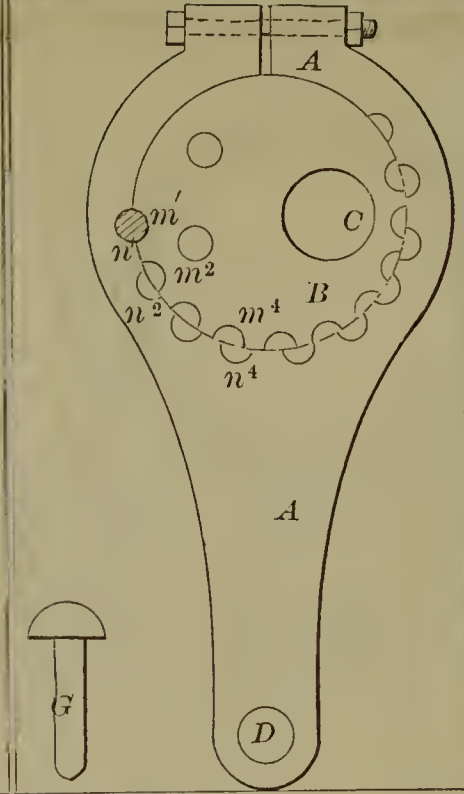
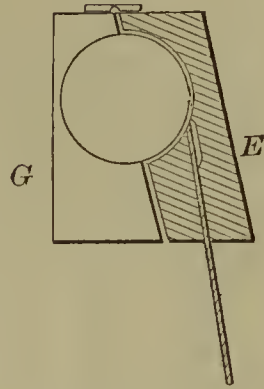
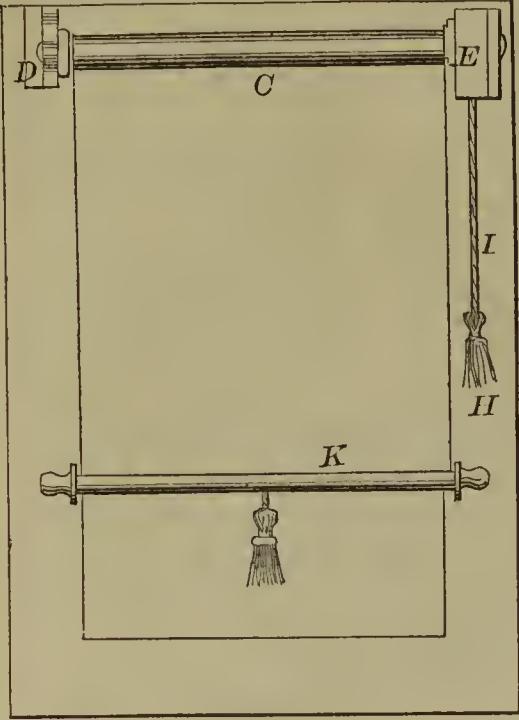

56631—N. C. Stiles—Adjustable Pitman.

56632—

T. B. Stout—Table.

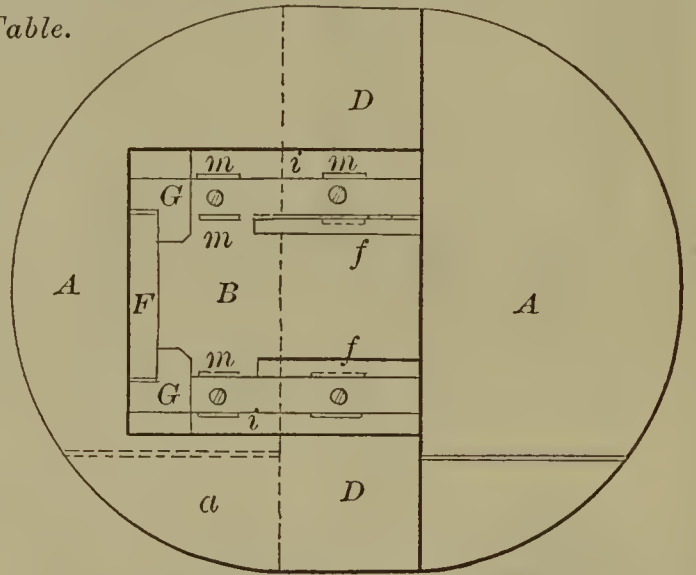
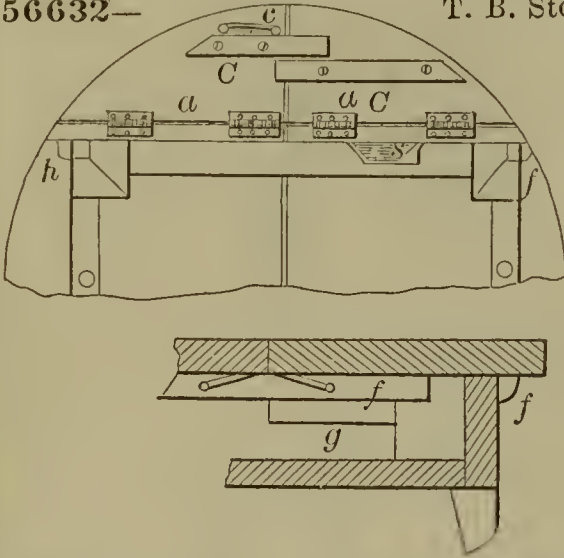

56634—L. Taylor—Water Elevator.

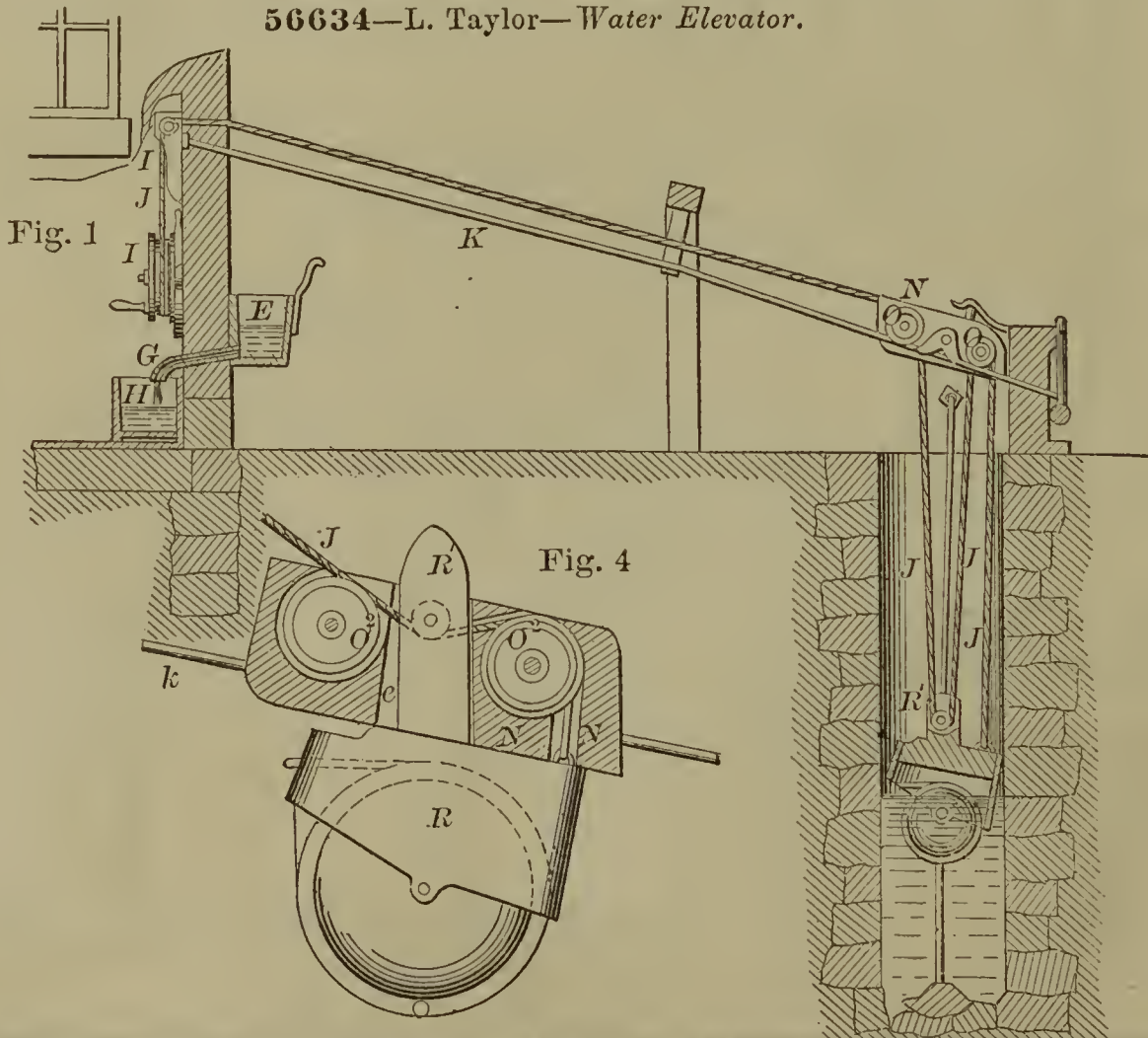

56636—C. F. Testman—Gold Separator.

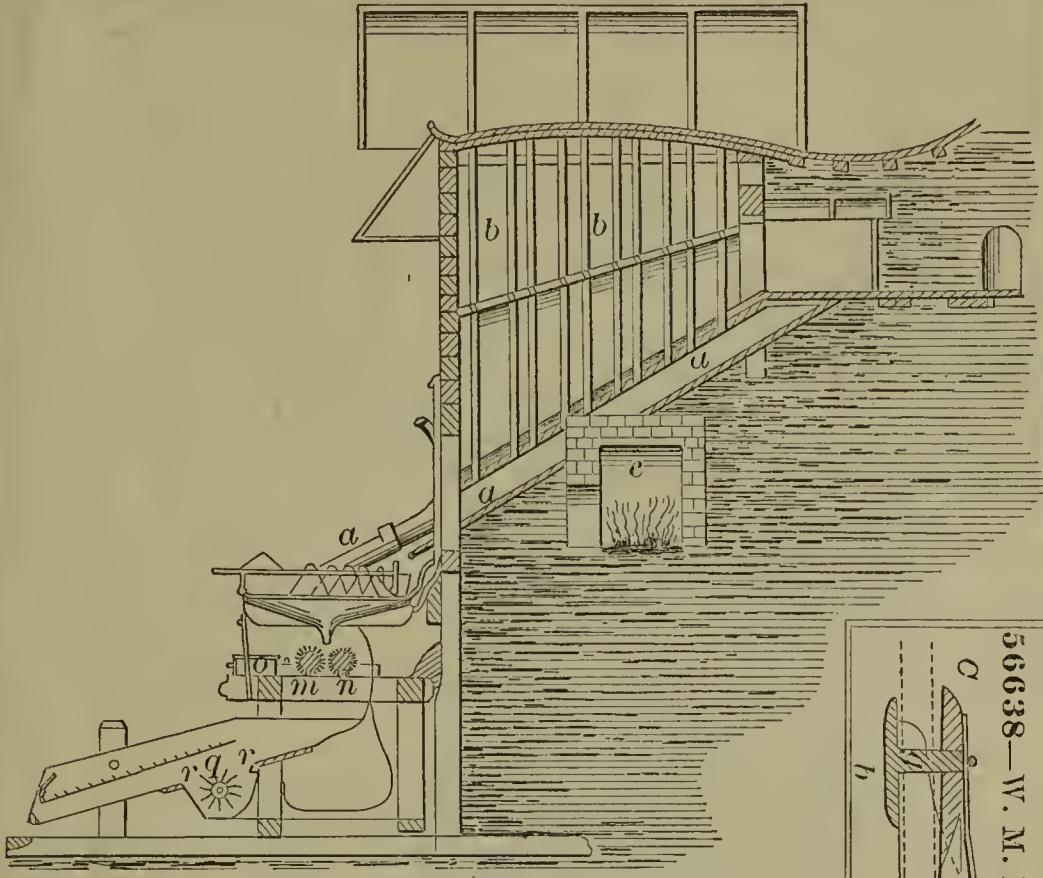

56640—H. Trumbull—Broom Head.

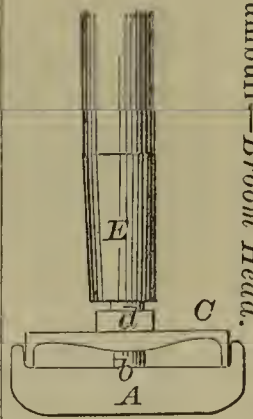

56642—Van Vleck & Nichols—Sash Fastener.

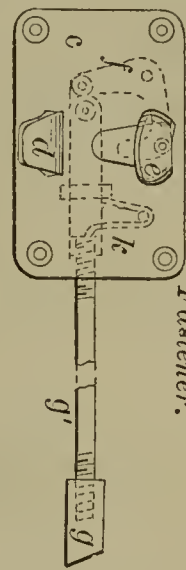

56638—W. M. K. Thornton—Truce Buckle.



56639—C. O. Torrence—Lock for Throttle Valves.

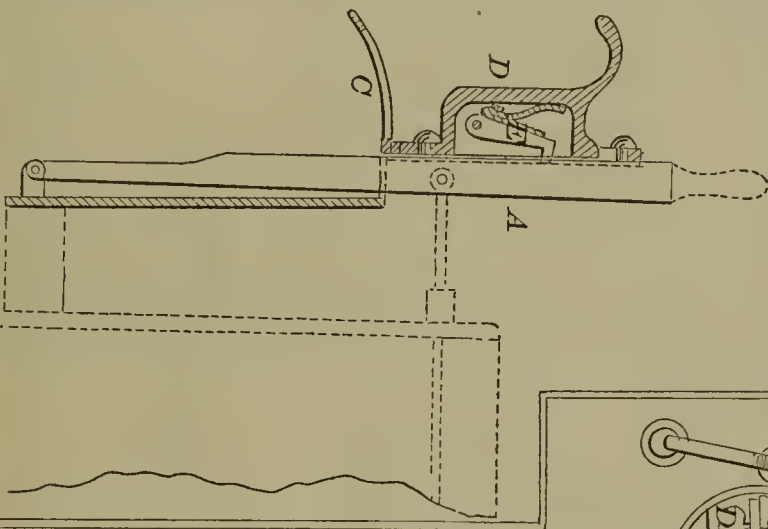

56637—D. M. Thomas—Pump.

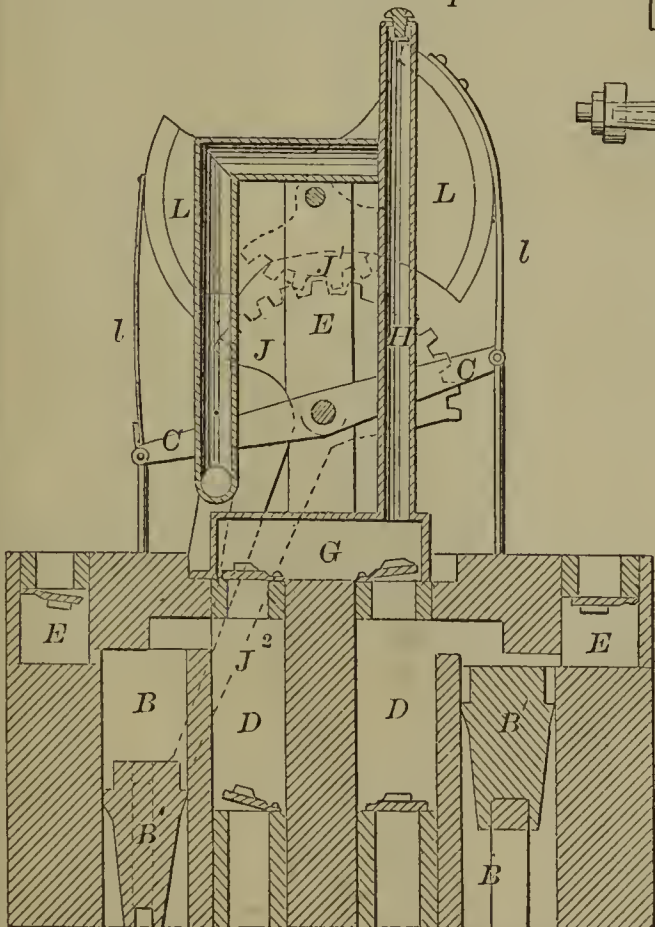

56641—J. C. Tucker—Sewing Machine.

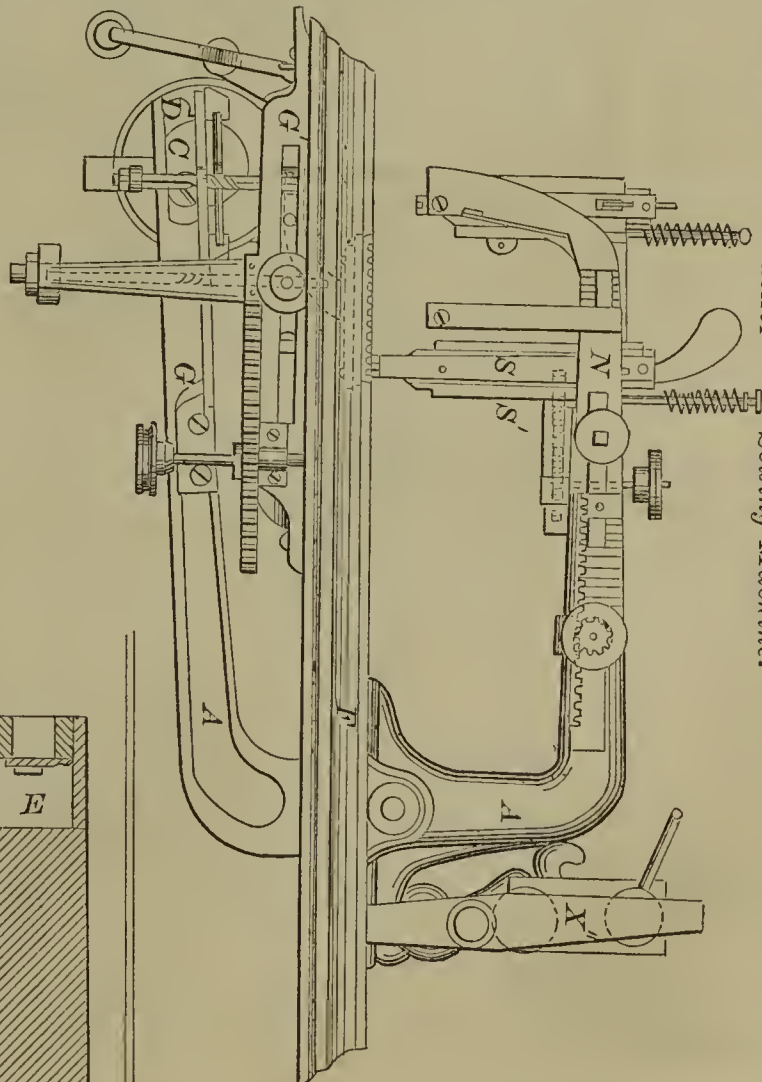

56644—F. W. Vosmer—Washing Machine.

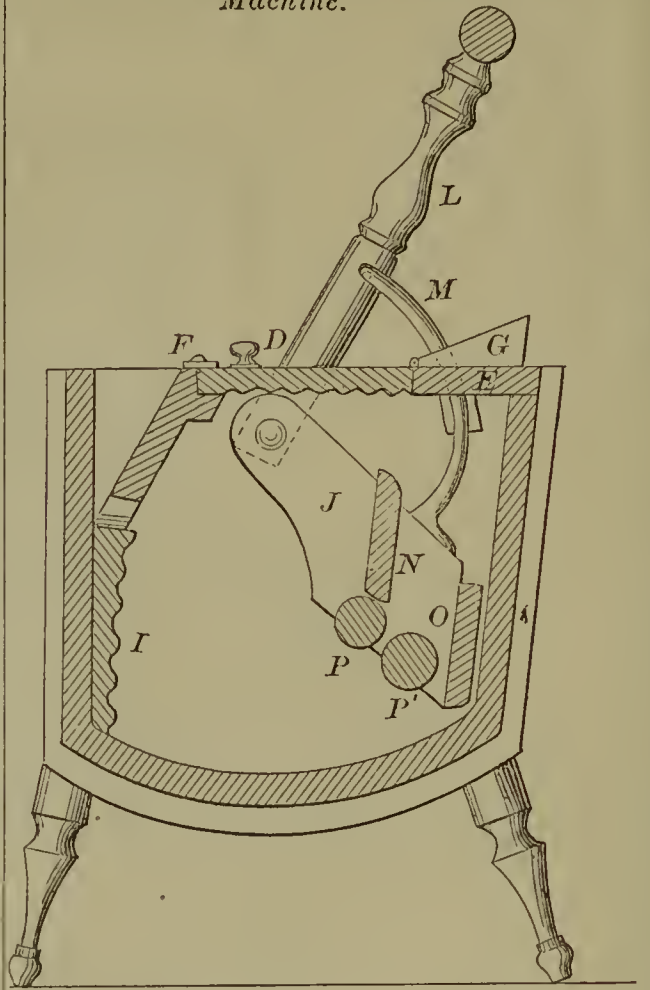

56643—Veerkamp & Leopold—Braiding Machine.

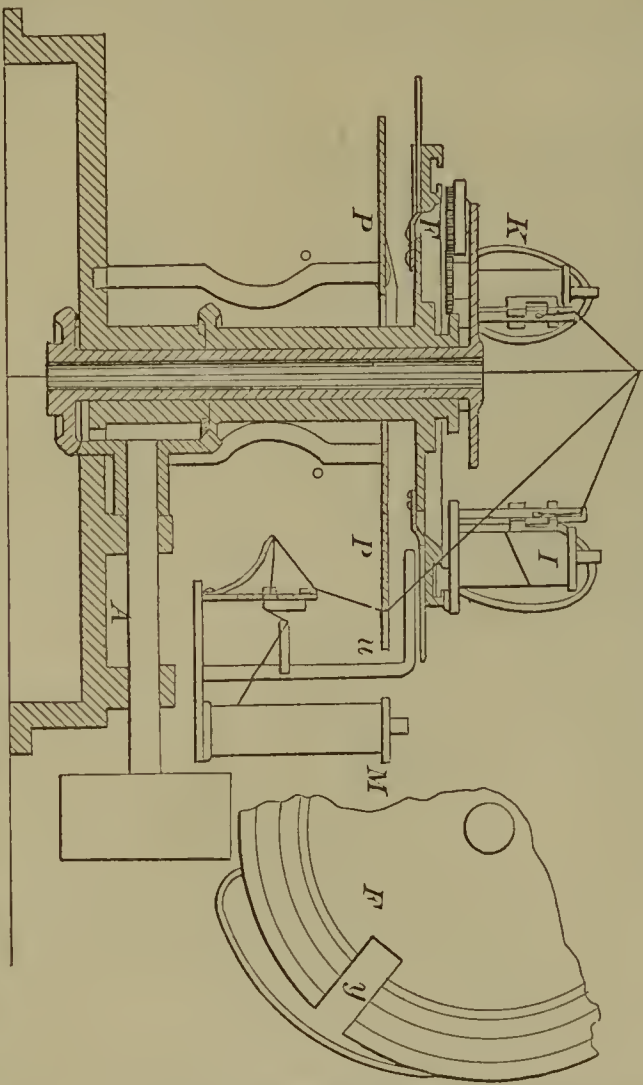

56646—A. Warth—Sewing Machine.

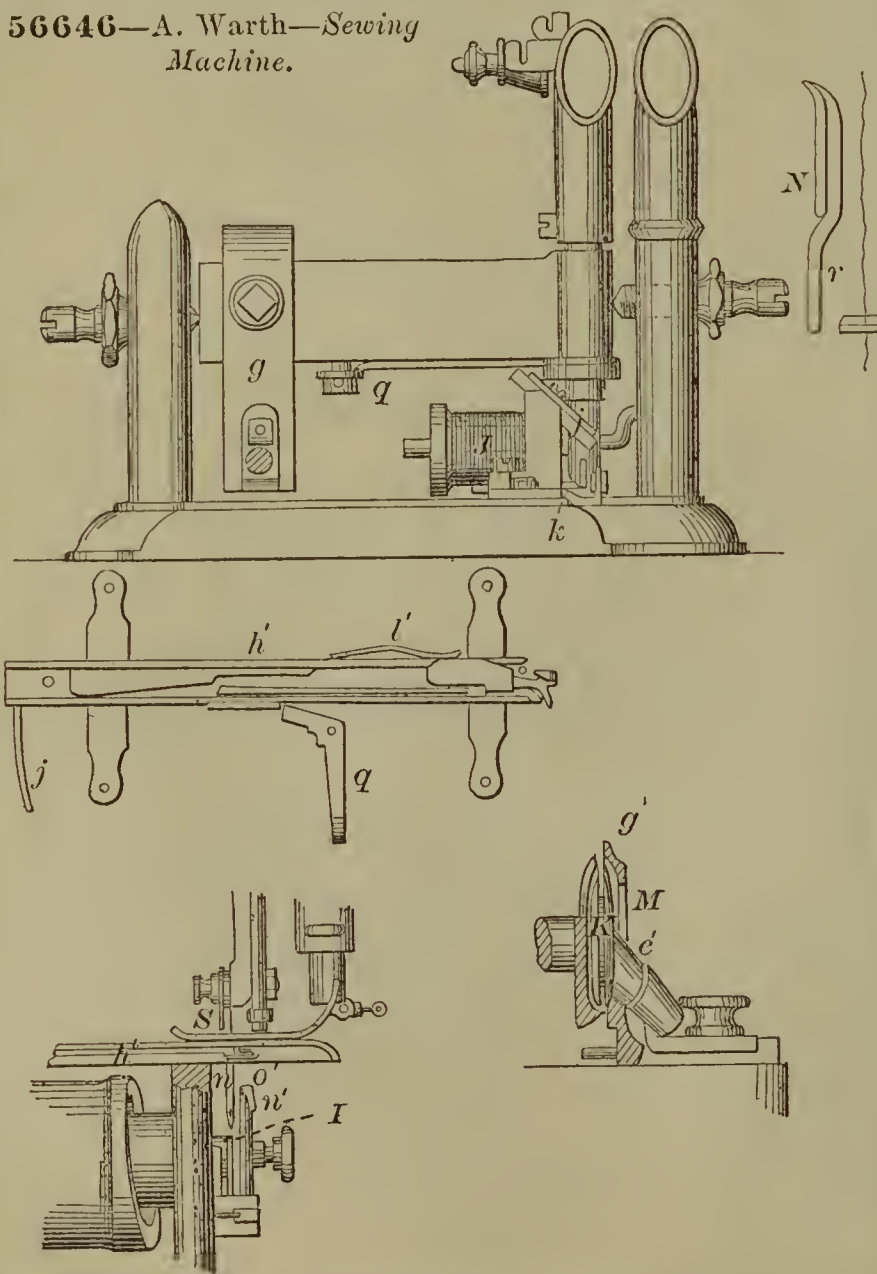

56645—S. Warrington—Pen.

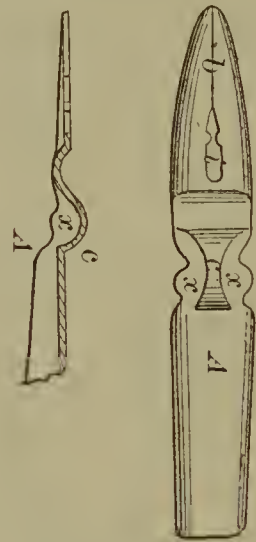

56647—J. H. Webber—Lamp Shade.

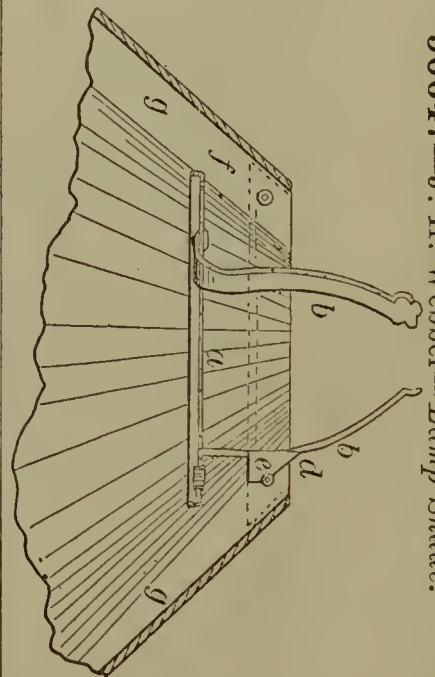

56648—H. White—Shingle Machine.

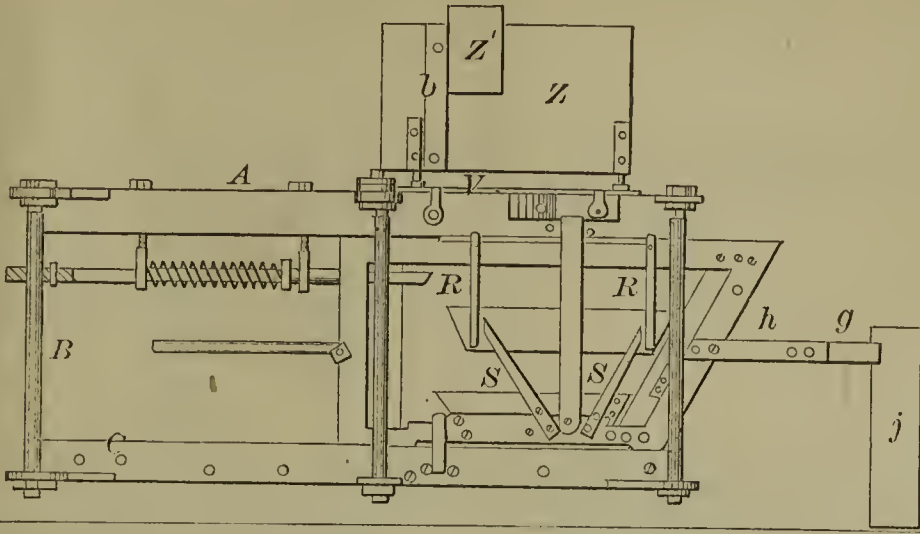

56651—F. A., J. H. & D. G. Williams—  
Cabinet Maker's Scraper.

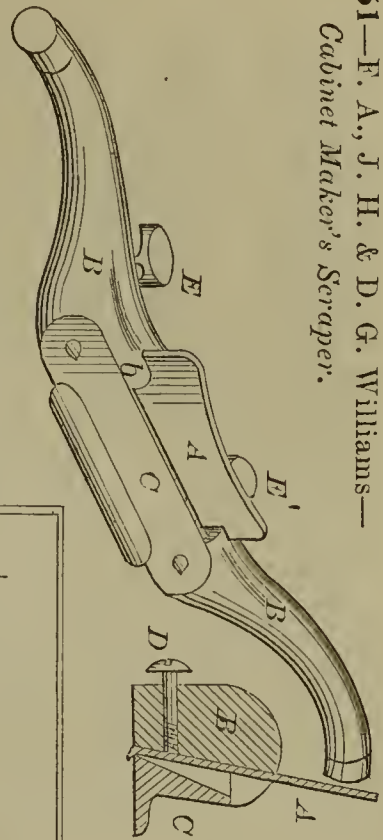

56654—J. N. Wolfe—  
Water Wheel.

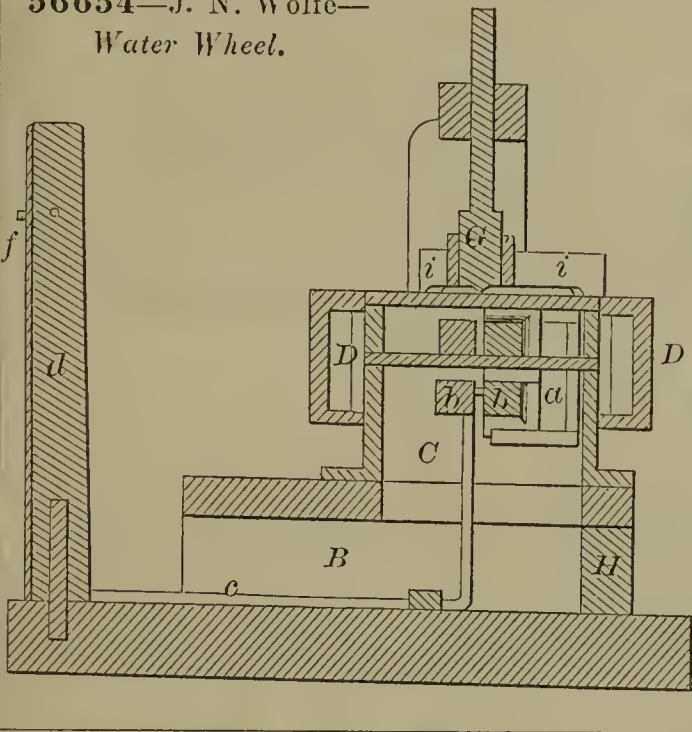

56653—  
H. & J. Wilson—  
Bottle Fastening.

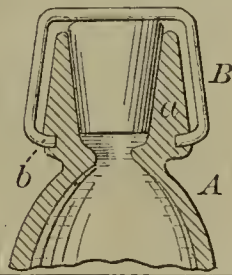

56655—T. Wood—  
Coal Oil Burner.

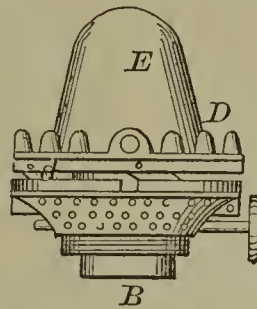

56649—T. White—  
Stove.

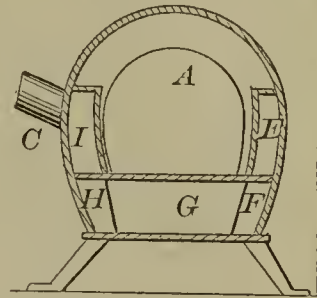

56656—J. A. Woodbury—Planing Machine.

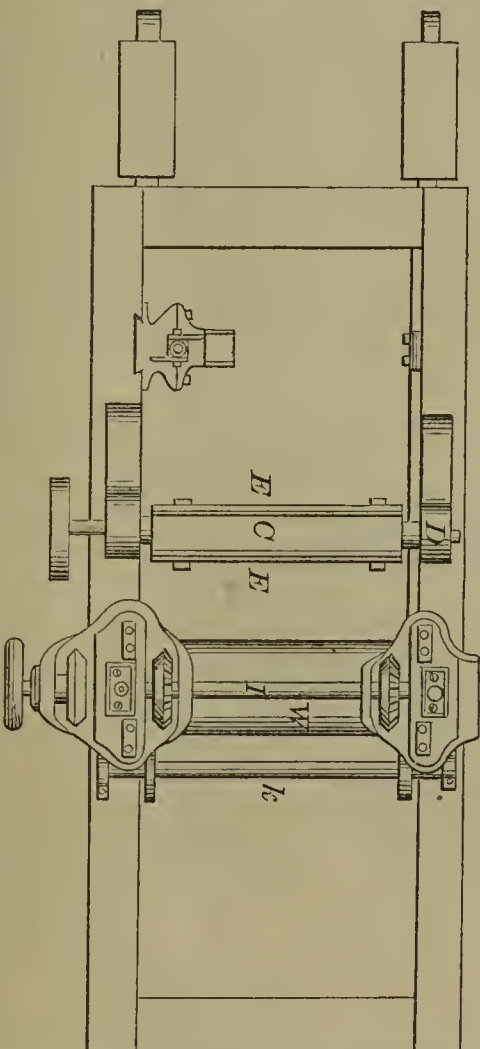

56652—J. H. Williams—  
Potato Digger.

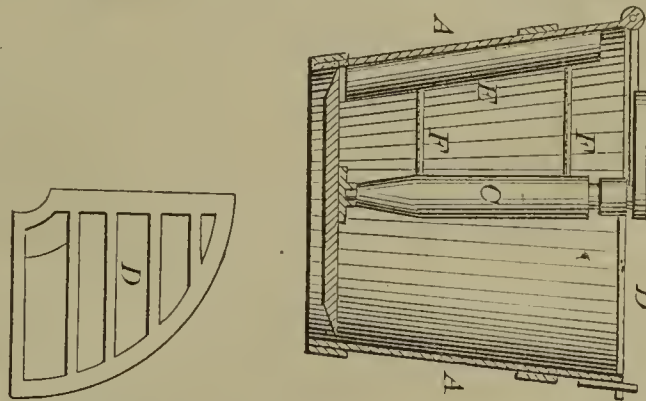

56657—W. E. Worthen—Rotary Valve.

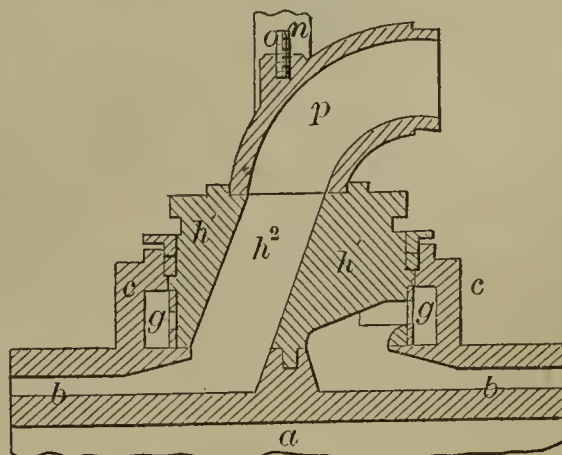

56658—F. Wright—  
Piston Rod Packing.

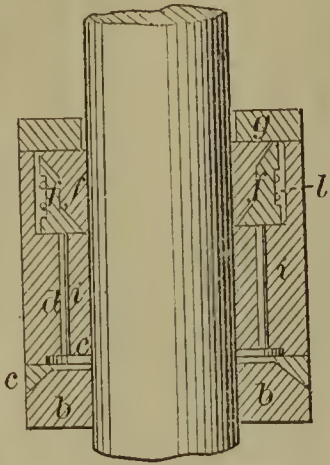

56660—G. H. Young—Marine Car.

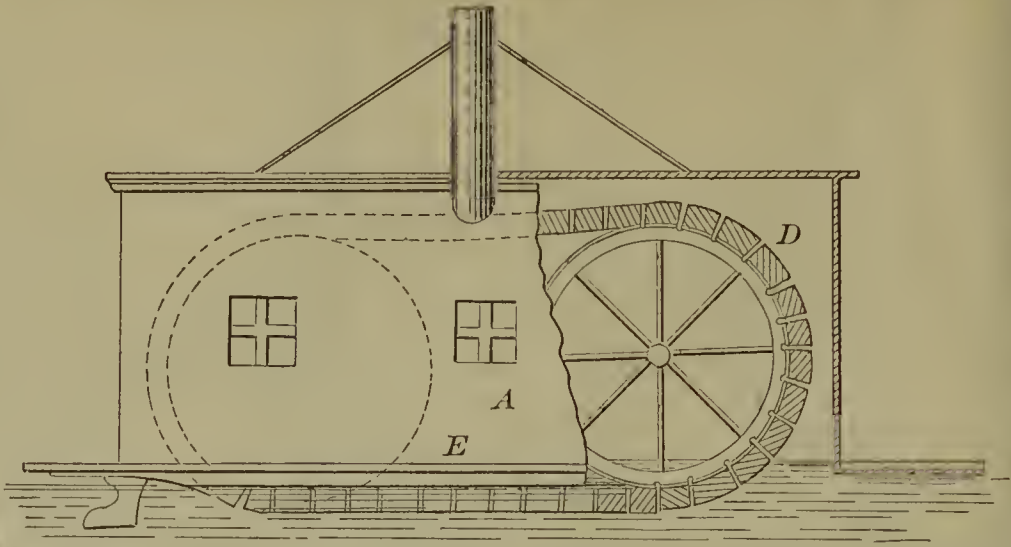

56659—Young & McLean—Grinding Mill.

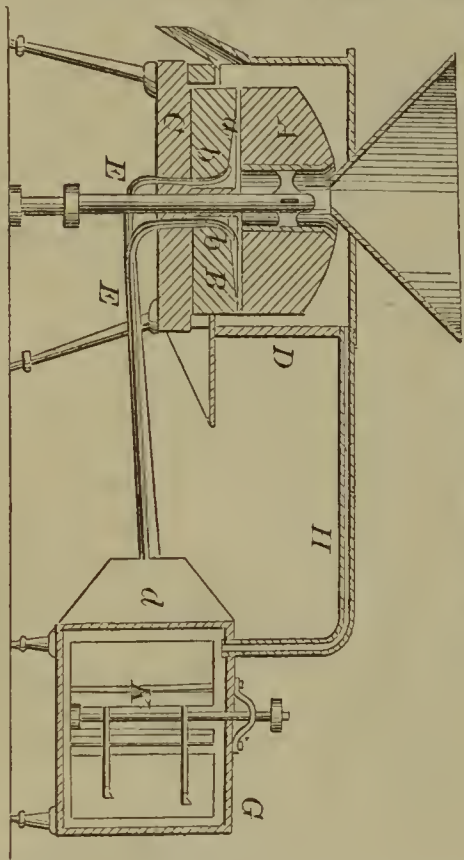

56663—N. Zillier—Screw Plate.

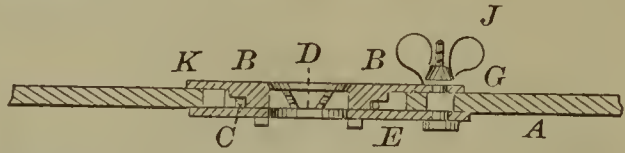

56661—J. Young—Churn.

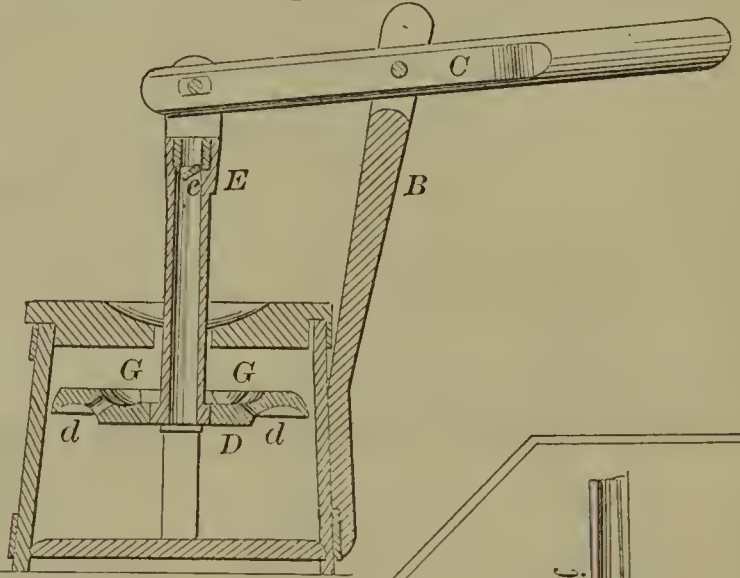

56664—G. Zorger—Wheat Drill.

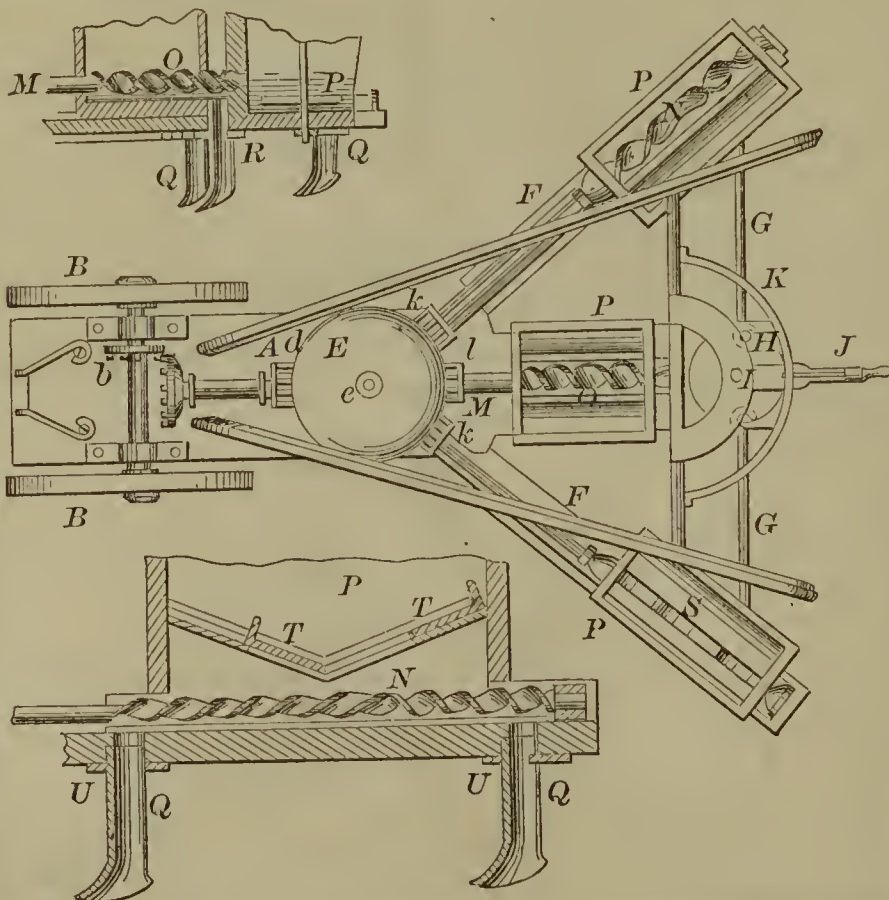

56662—P. Young—Subsley Plow.

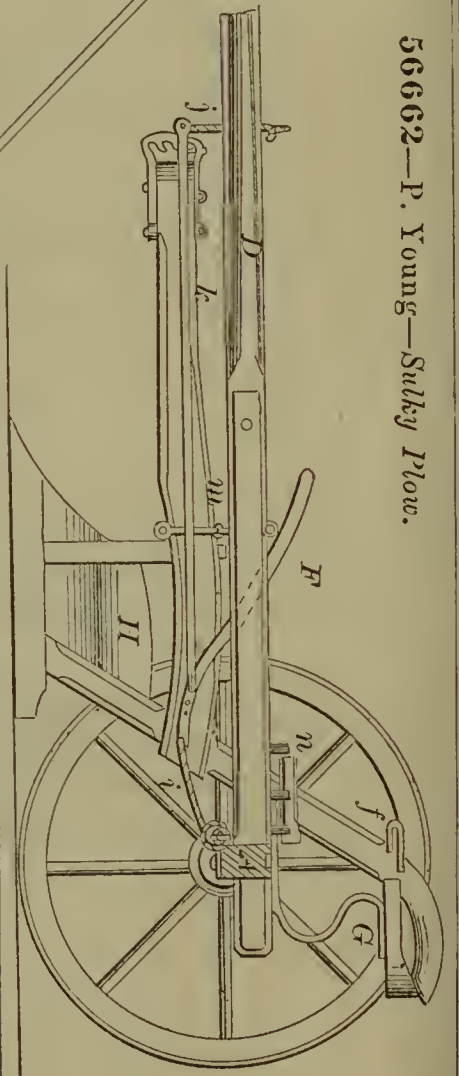



56668—P. C. Clapp—Shears.

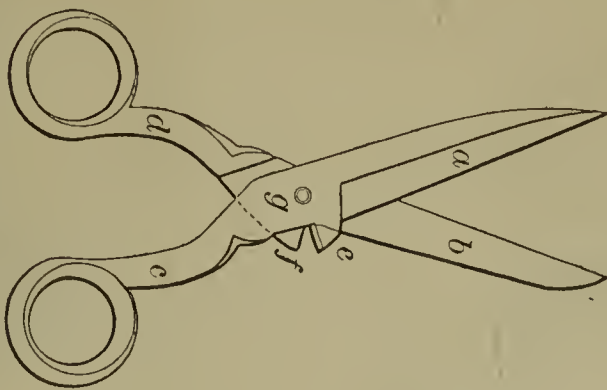

56666—H. Bradbury—Snap Hook.

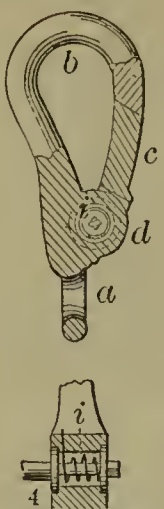

56671—J. W. Douglas—Pump.

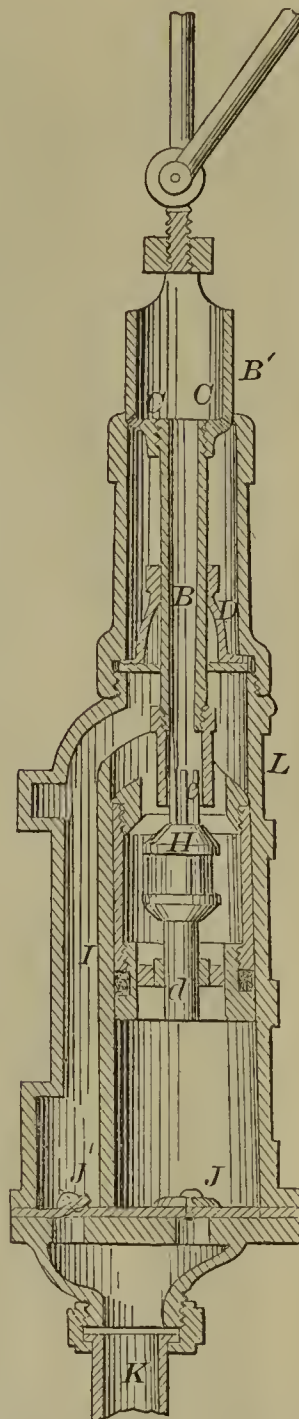

56669—J. A. Conover—

Fire Arm.

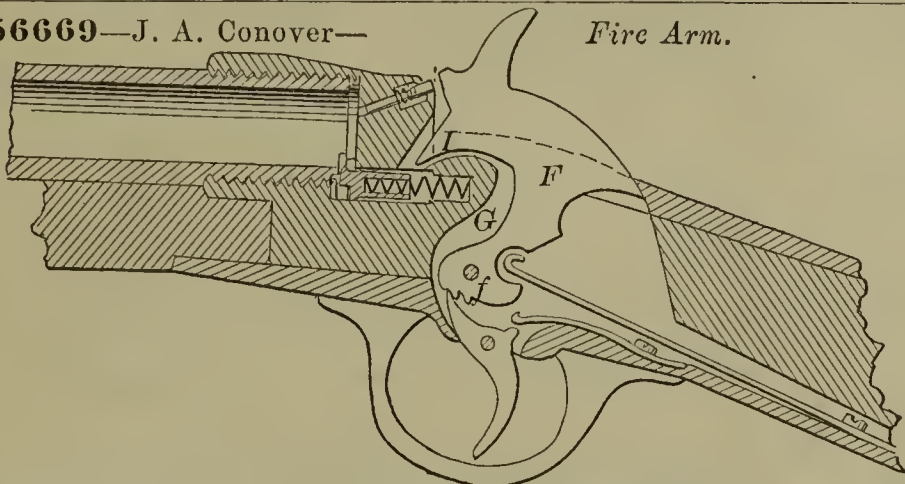

56672—R. Heneage—Smut Mill.

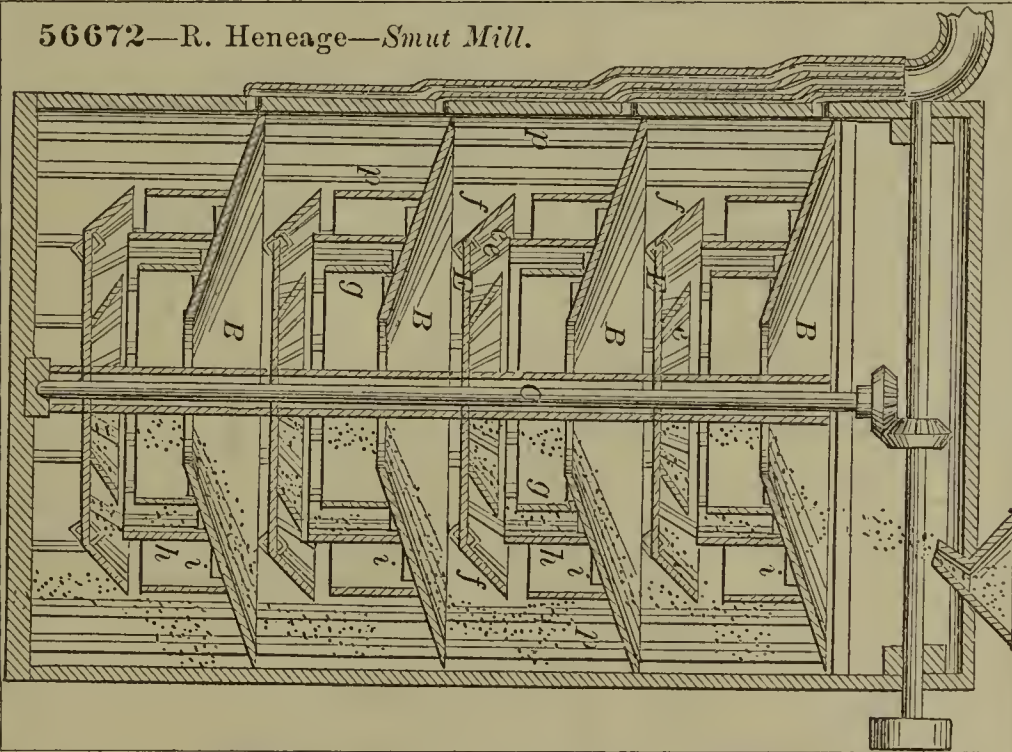

56674—J. M. Merritt—Stencil Numbering Apparatus.

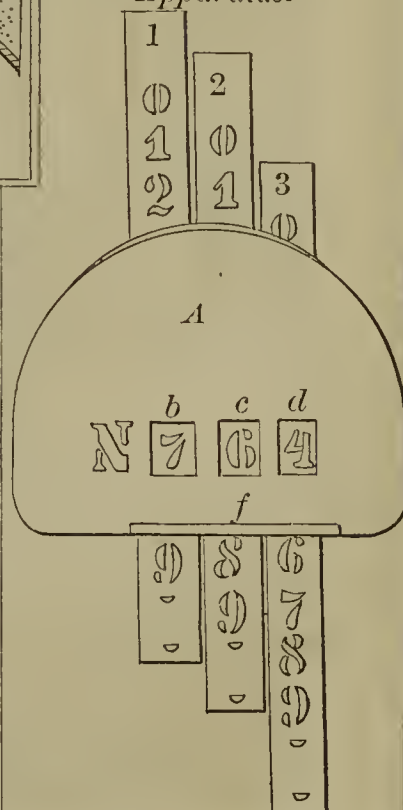

56667—J. F. Champlin—Corn Planter.

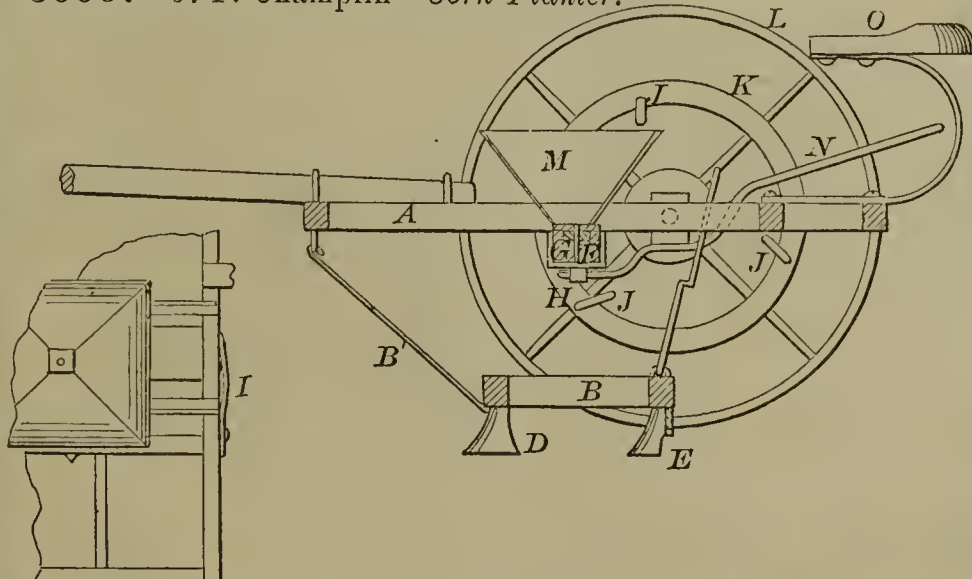

56675—S. R. Parkhurst—*Picking and Cleaning Cotton, &c.*

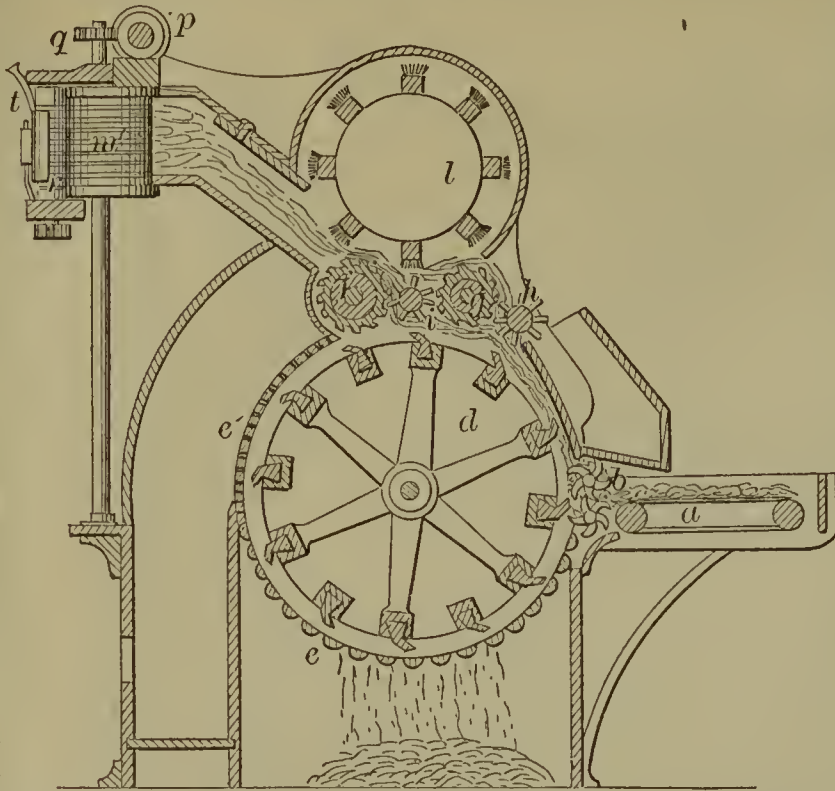

56676—Pease & Lewis—*Clothes Wringer.*

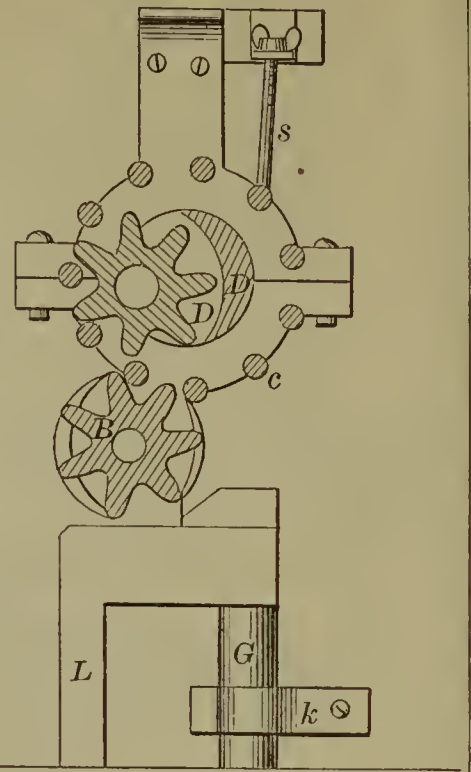

56677—Pennie & Ieland—*Gas Stove.*

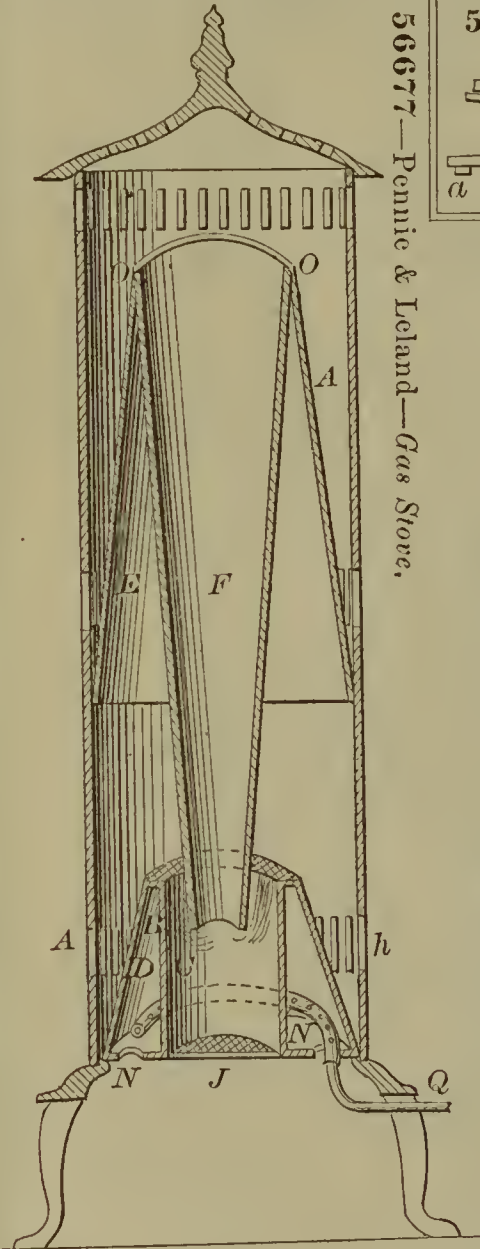

56678—M. Roberts—*Bed Bottom.*

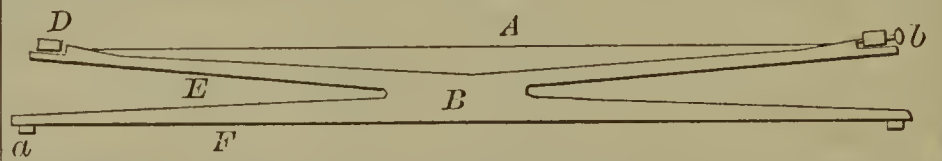

56681—J. Woodburn—*Carriage Wheel.*

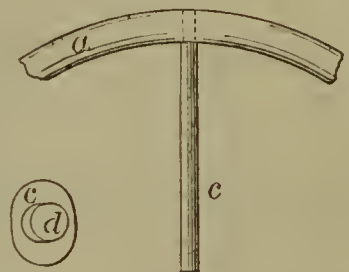

56682—W. F. Wright—*Polishing Enameled Paper.*

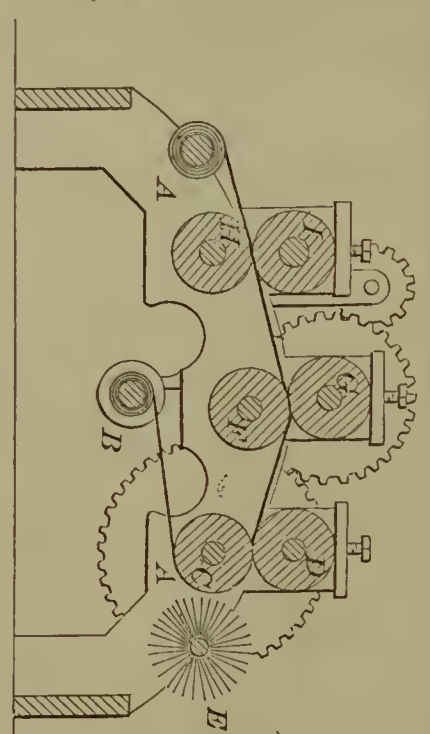

56679—J. F. & G. W. Tapley—*Paper Cutting Machine.*

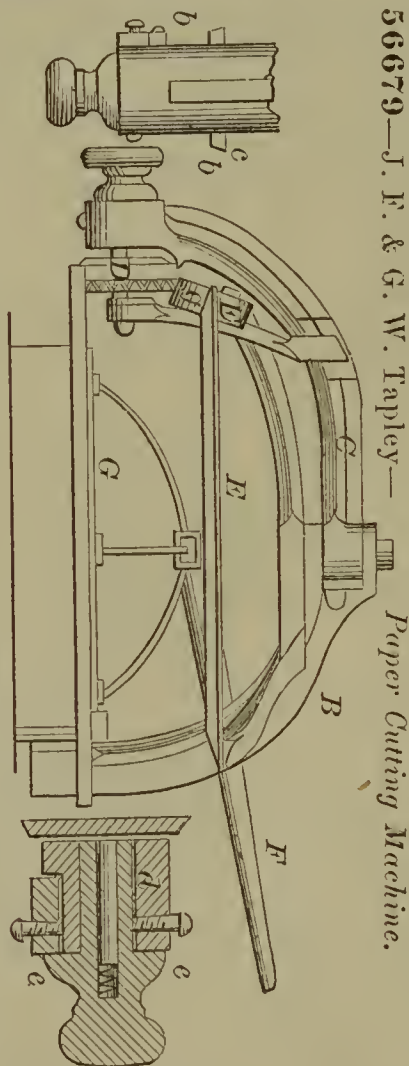

56683—C. Lehmann—*Watch.*

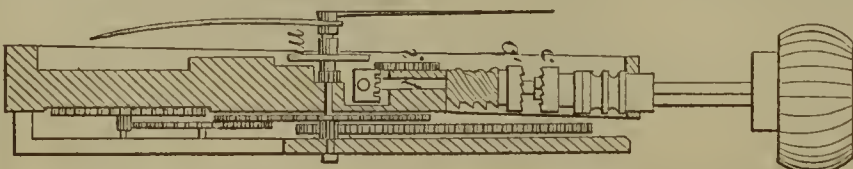

56684—T. C. Craven—Cotton Gin Saw.



56686—E. Bussey—Cooking Stove.

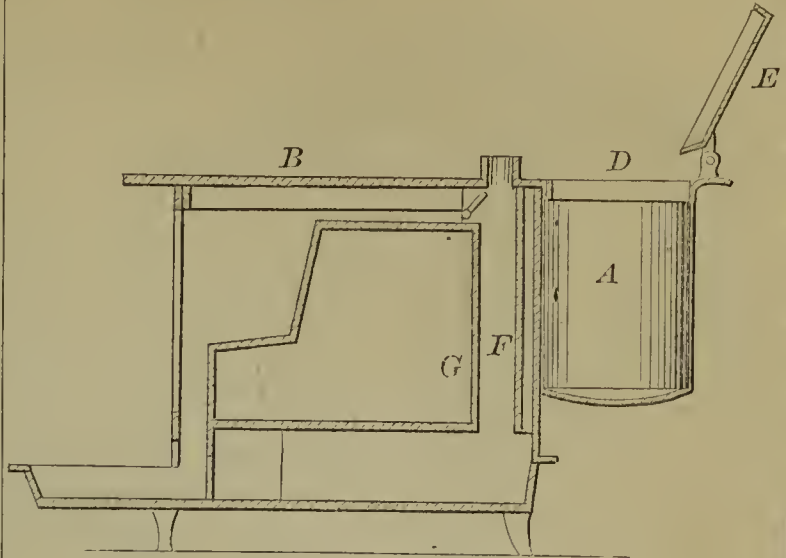

56688—A. Alexander—Washing Machine.

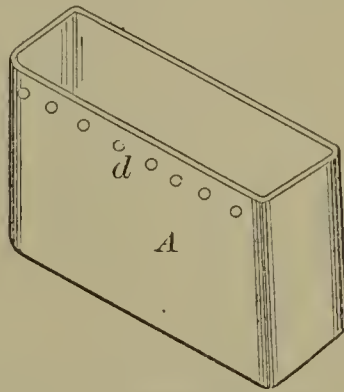
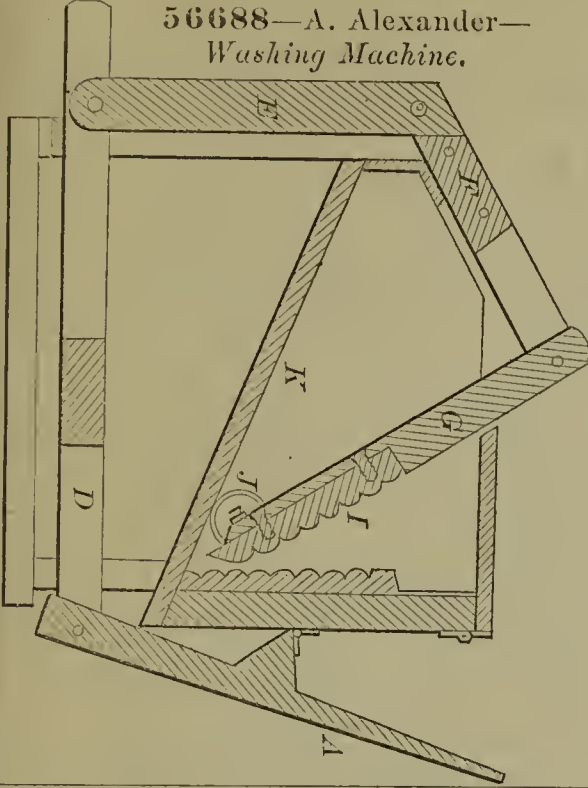

56689—R. J. Algeo—Truce Buckle.

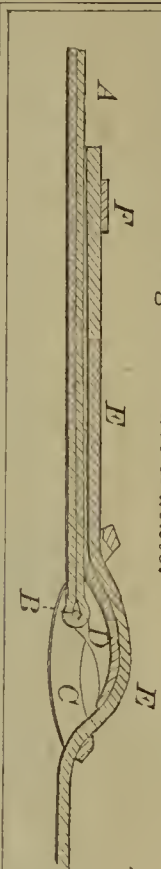

56687—A. Adler—Working Hides.

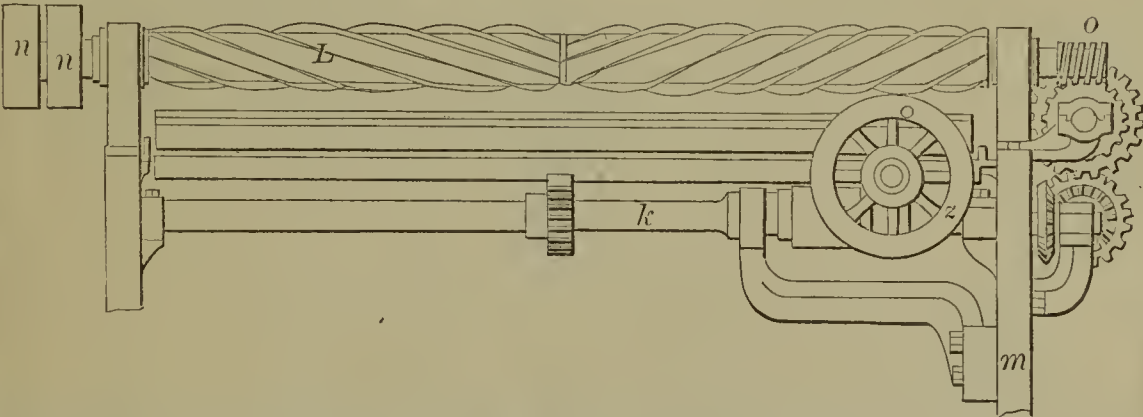

56690—H. A. Amelung—Smoke House.

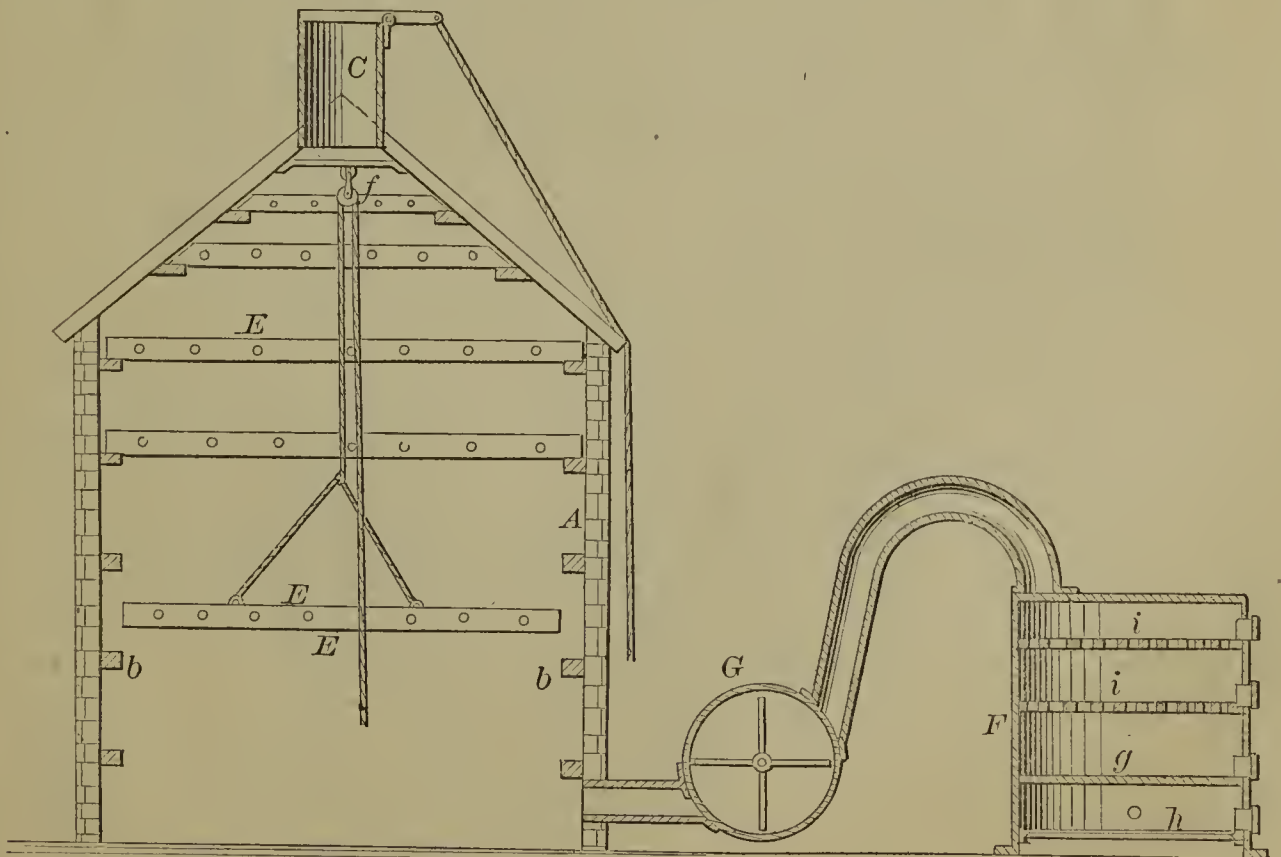

56691—G. Anton—Parasol.

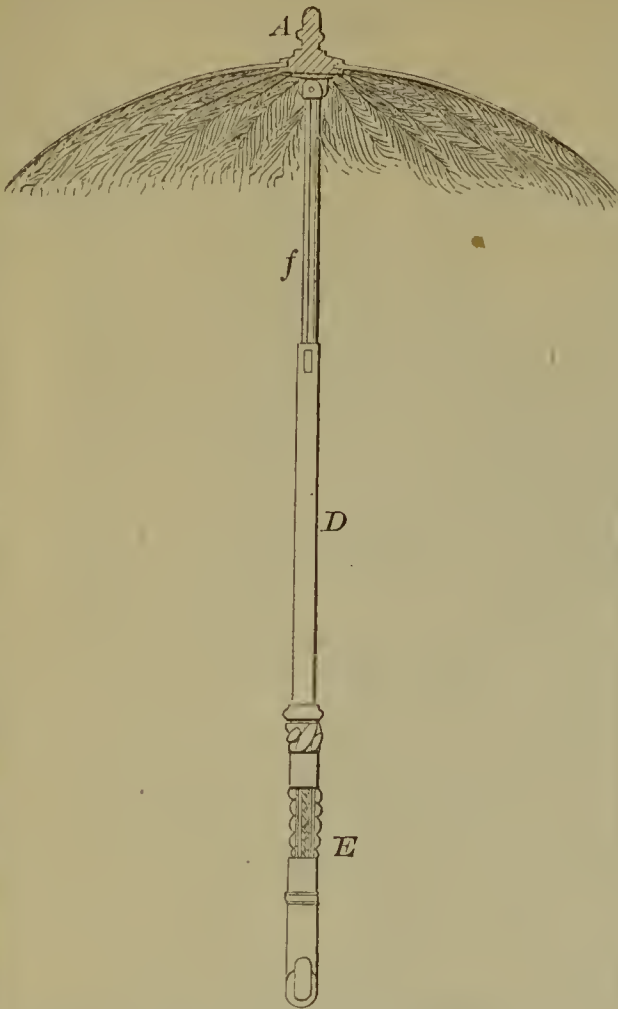

56692—F. Arnold—Flour Sifter.

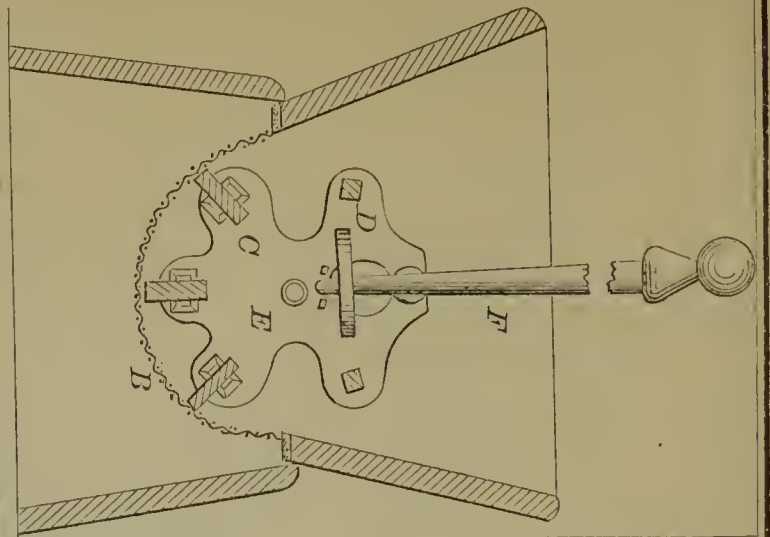

56693—V. Babcock—Gate.

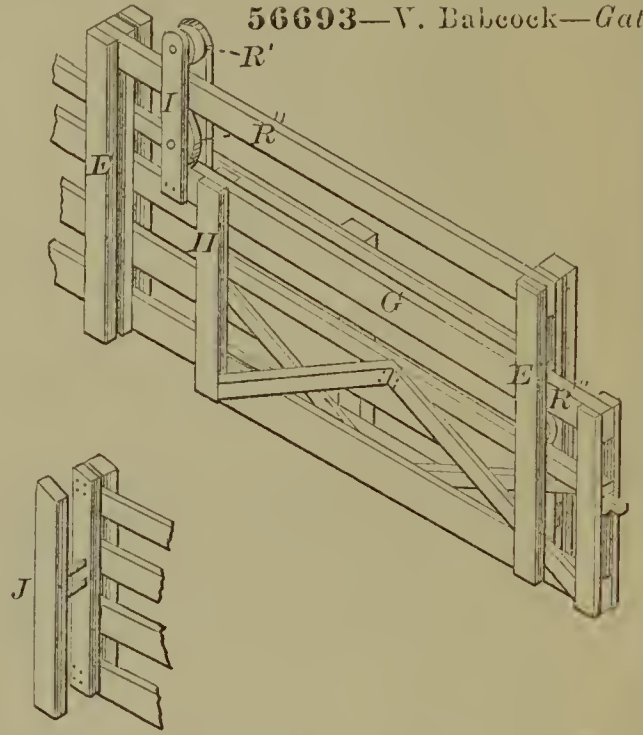

56694—R. C. Blake—Steam Gauge.

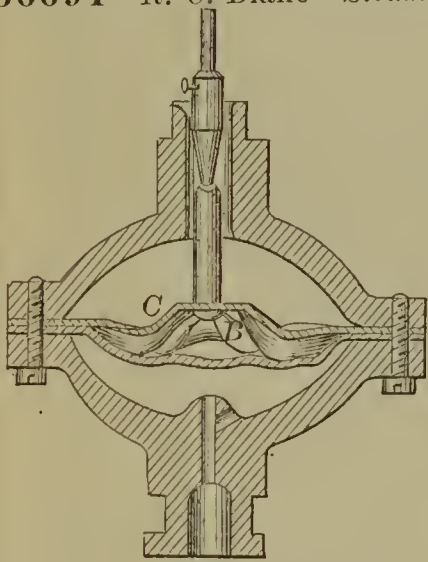

56696—Brown, Ingham & Lomont—Harvester Blade.

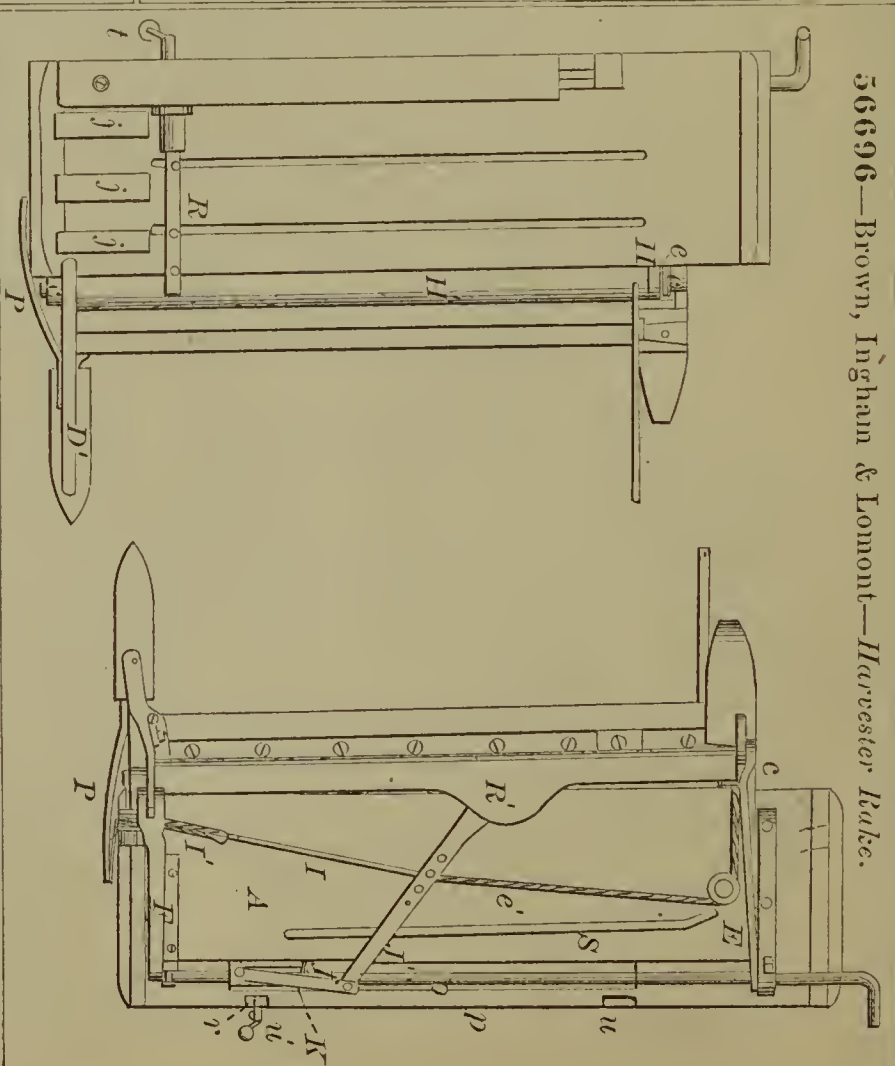

56695—J. Breneman—Portable Fence.

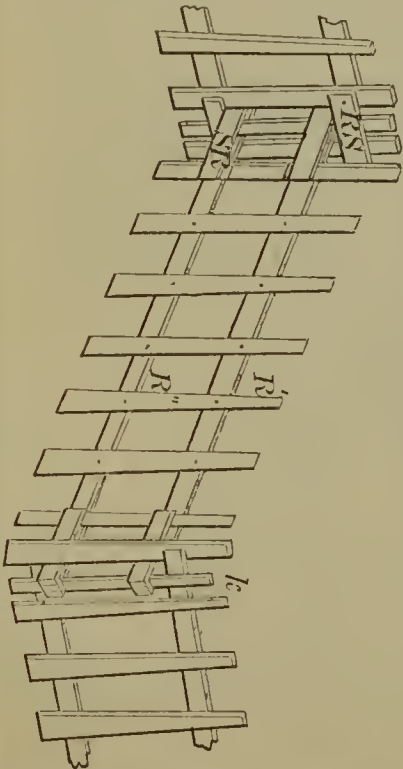

56697—T. Brown—*Re-dying Car Seat Cushions.*

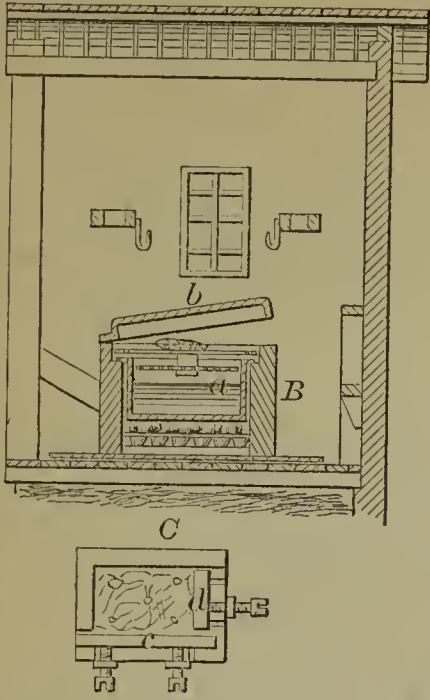

56698—R. Bryson—*Harvester.*

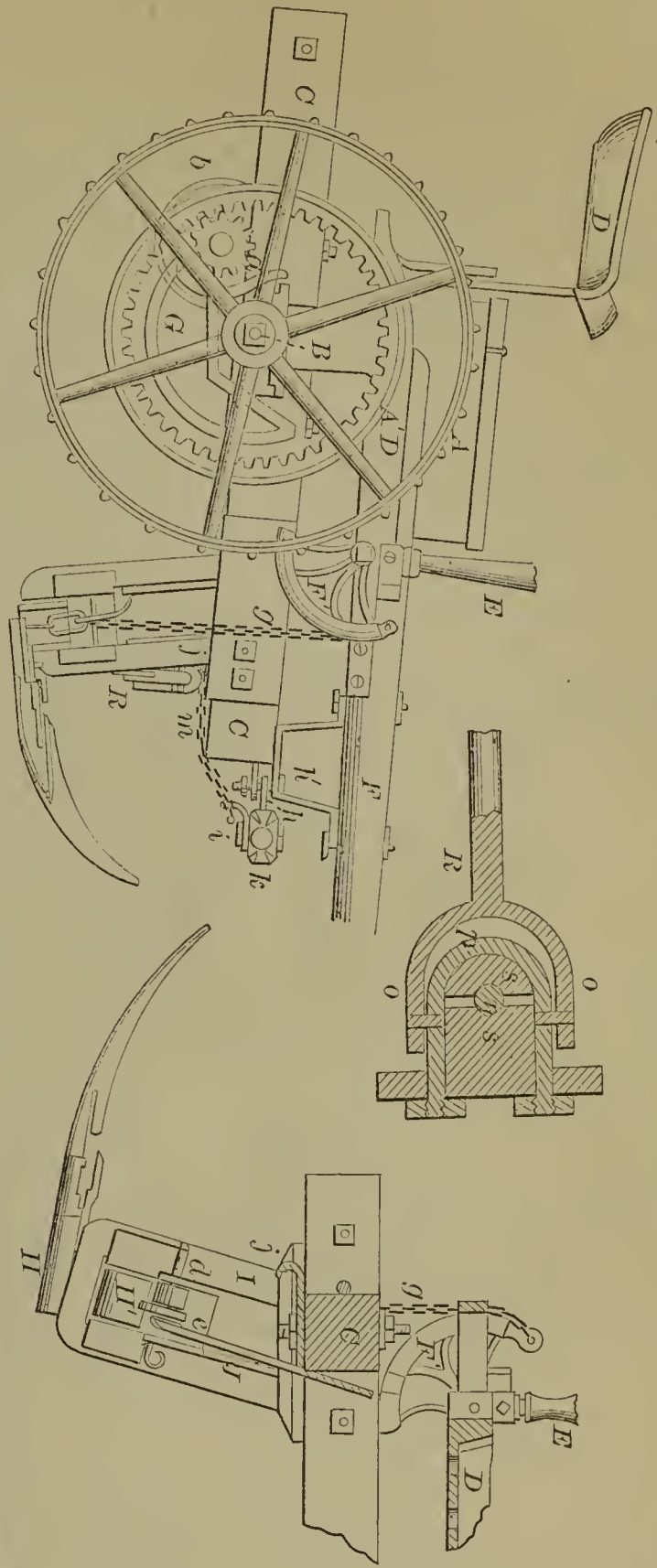

56700—A. Campbell—*Printing Press Spring.*

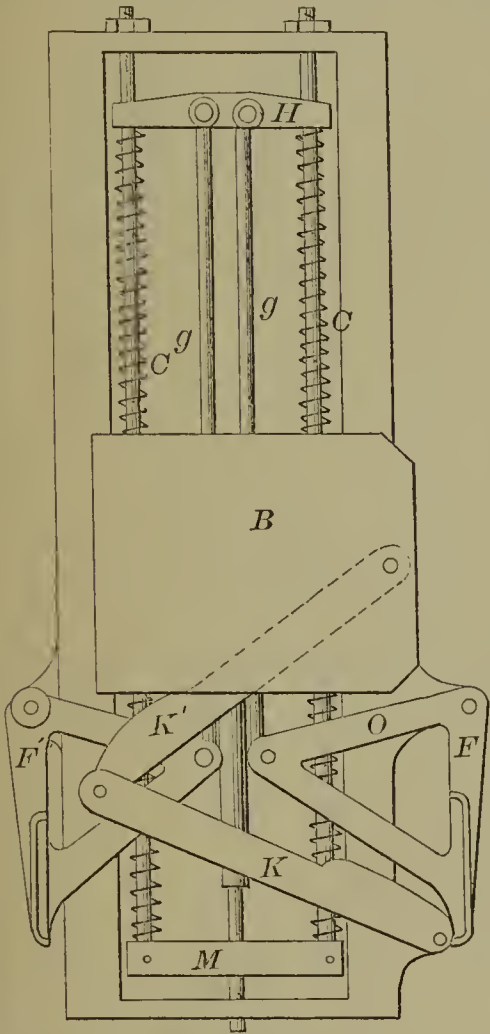

56699—A. S. Cameron—*Piston Packing*

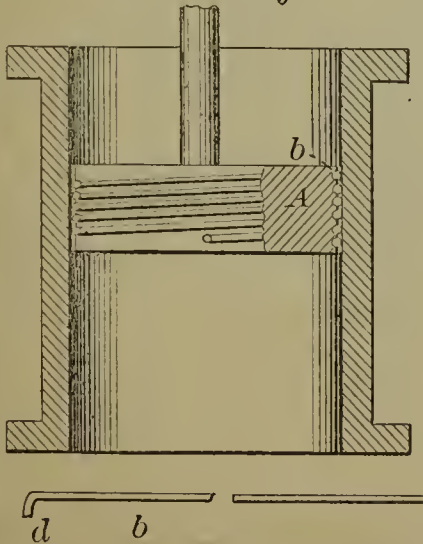

56701—A. Campbell—*Printing Press.*

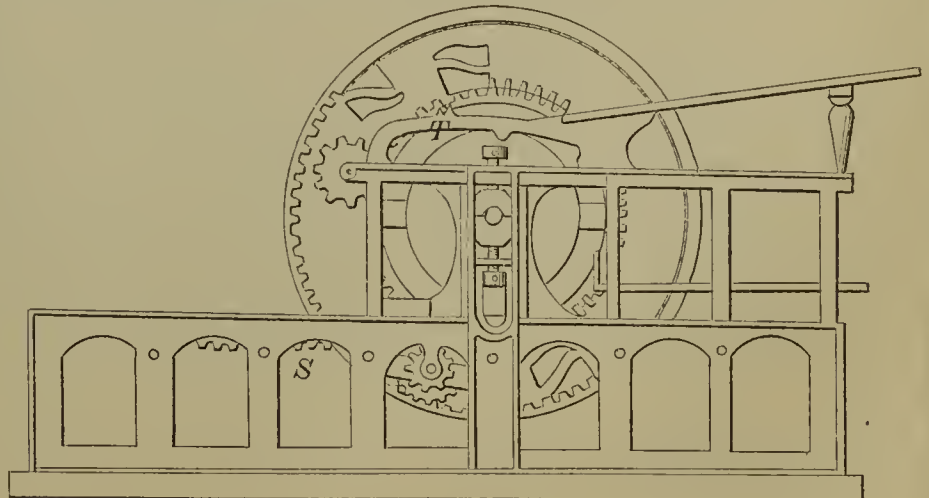

56702—P. F. Campbell—  
*Dry Dock Indicator.*

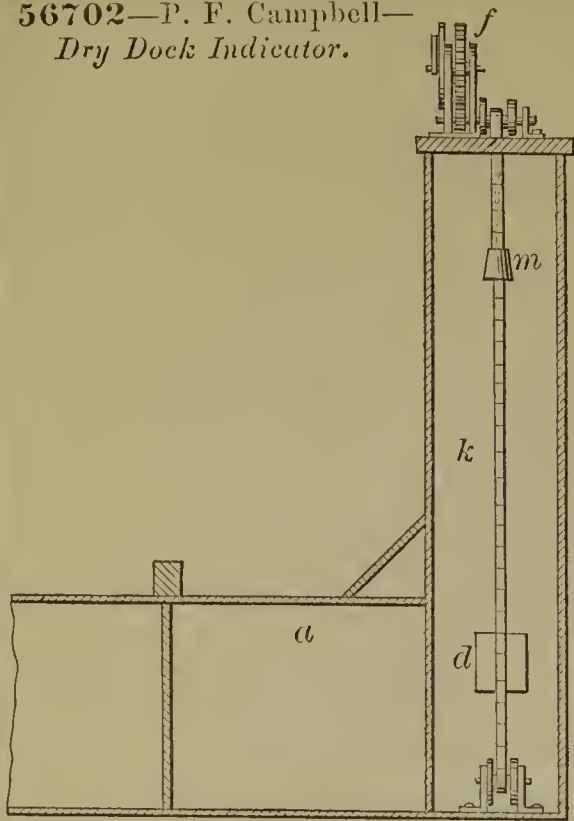

56707—W. Chappell—*Stove Pipe Top.*

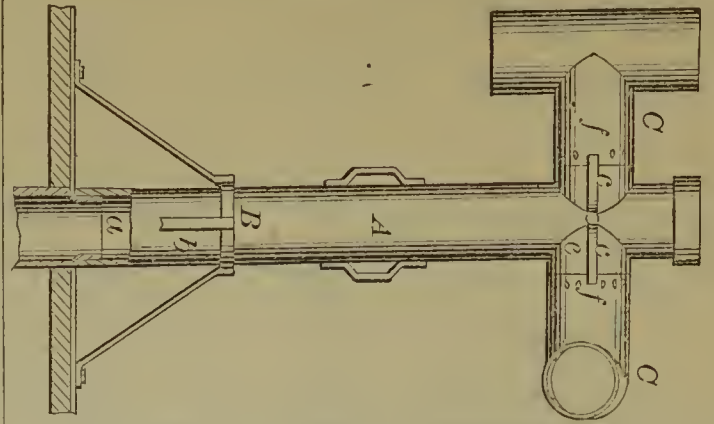

56706—B. Chalfant—*Automatic Boiler Feeder.*

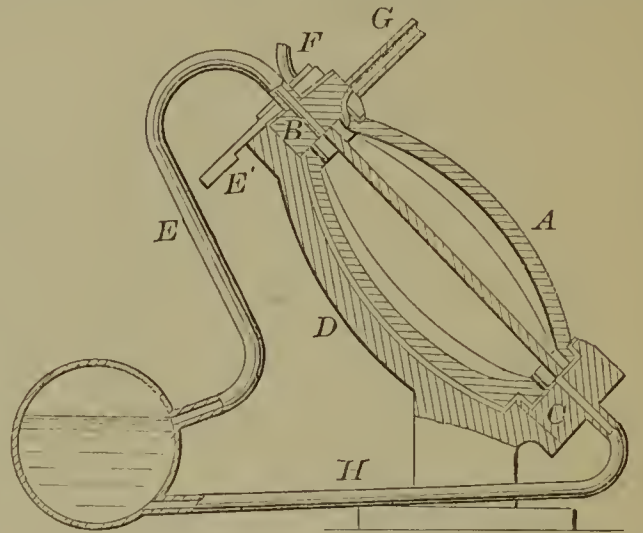

56703—E. P. H. Capron—*Brick Machine.*

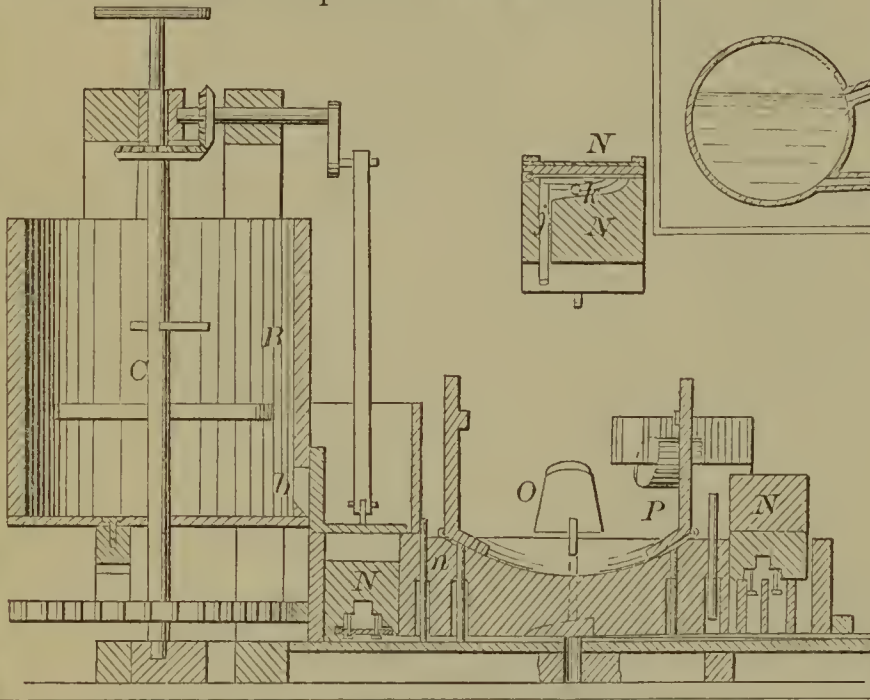

56708—G. Clark—*Grain Dryer.*

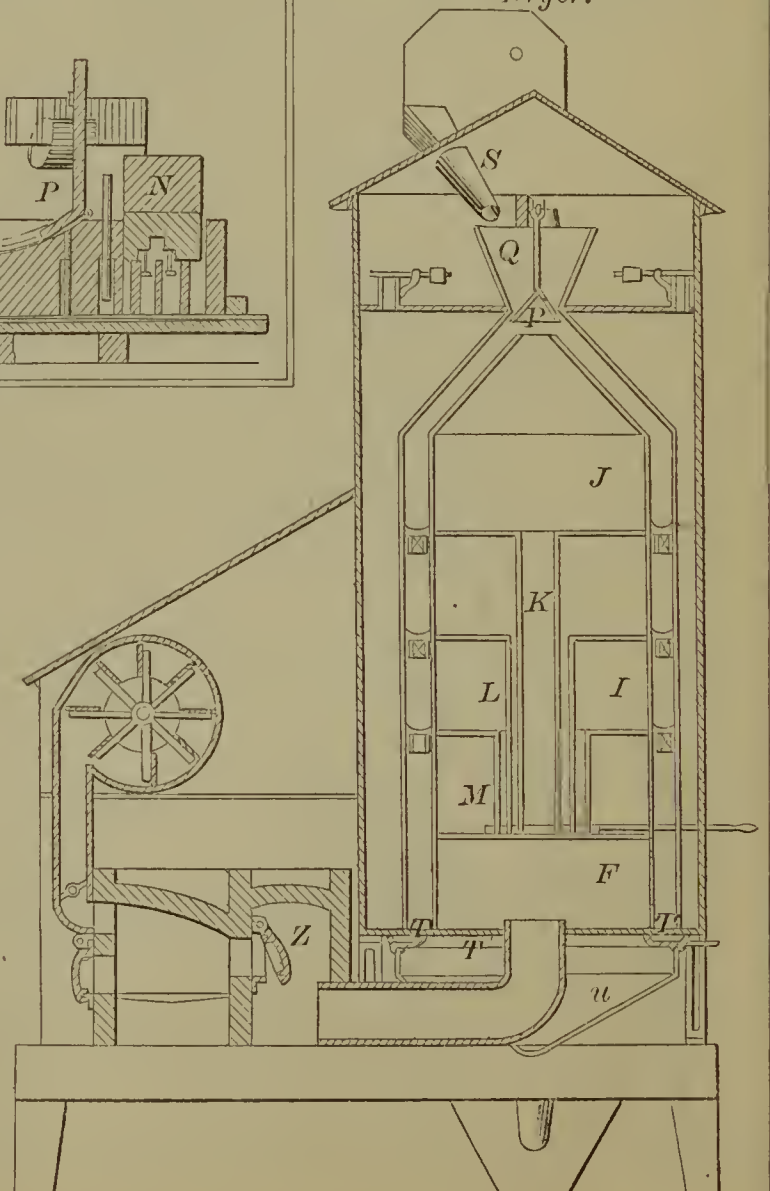

56705—S. Cary—*Boring and Grinding Apparatus.*

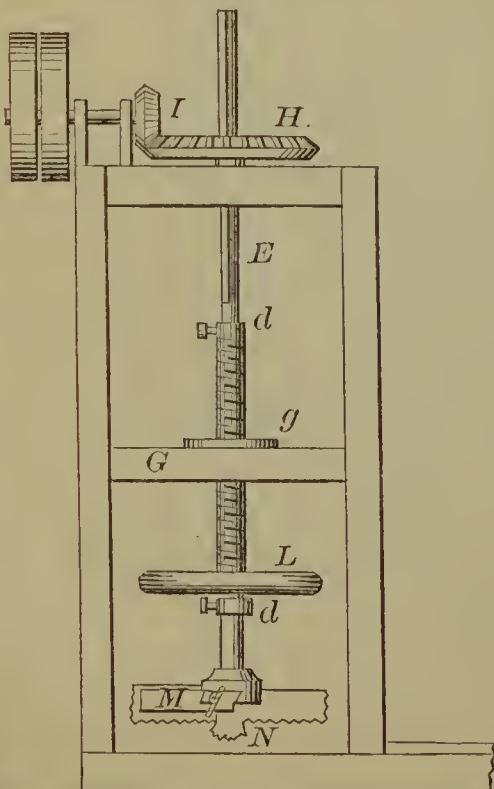

56709—W. P. Clark—Cock for Soda Water Apparatus.

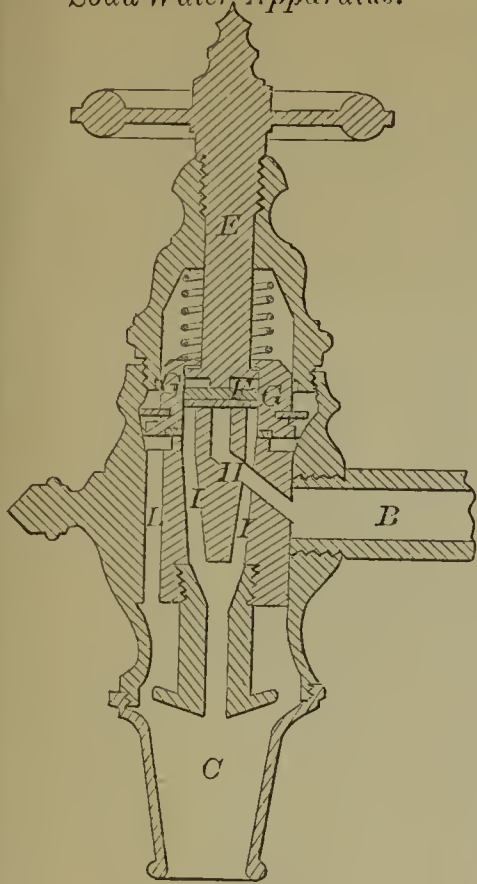

56710—J. W. Clarke—Funnel.

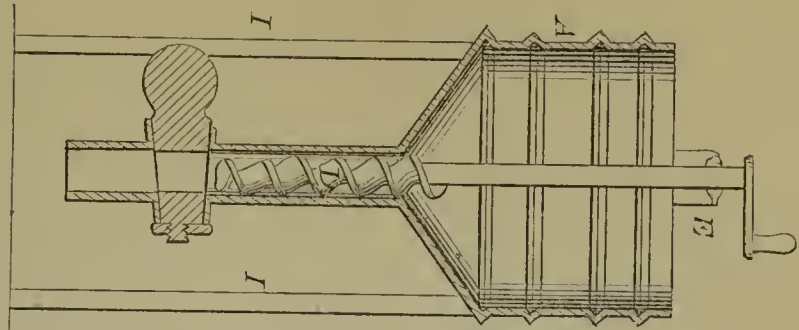

56713—E. T. Colburn—Paddle Wheel.

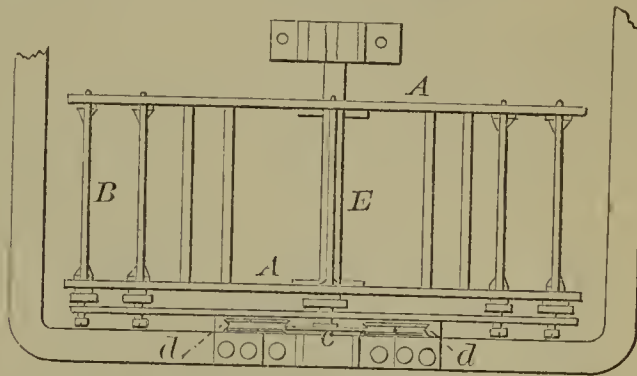

56711—J. W. Clarke—Sulphur Duster.

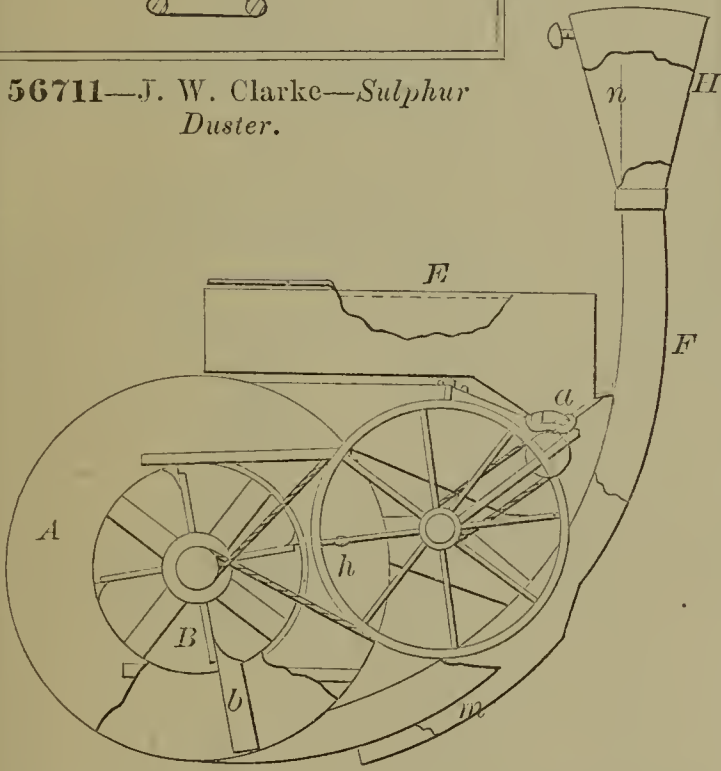

56712—J. W. Cochran—Packing Projectiles.

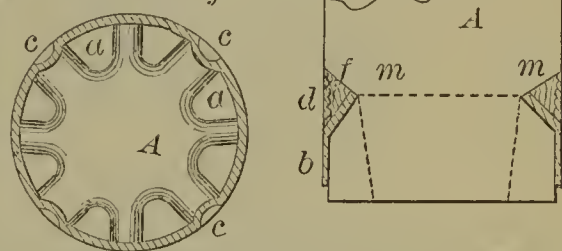

56714—L. T. Conant—Sewing Machine Guide and Binder.

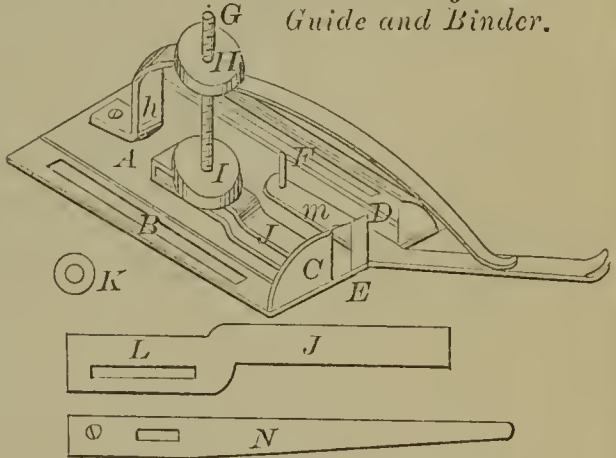

56715—T. P. Conard—Shaving Case.

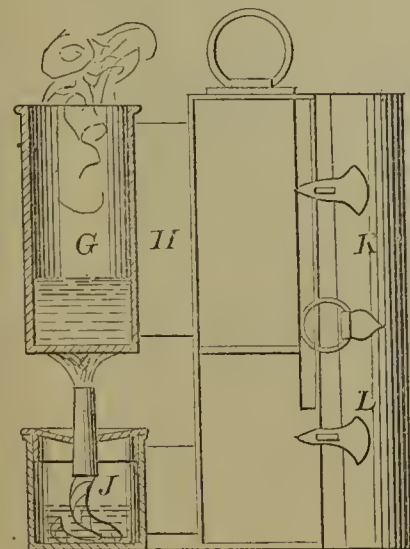

56716—W. F. Converse—Car Spring.

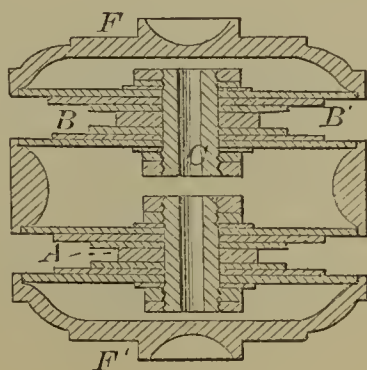

56717—E. P. Cooley—Broom.

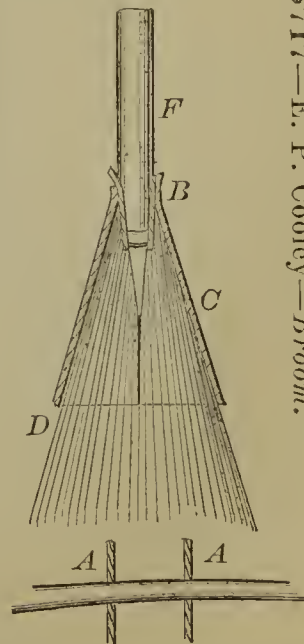

56720—J. J. Cowell—Trunk Brace and Hinge.

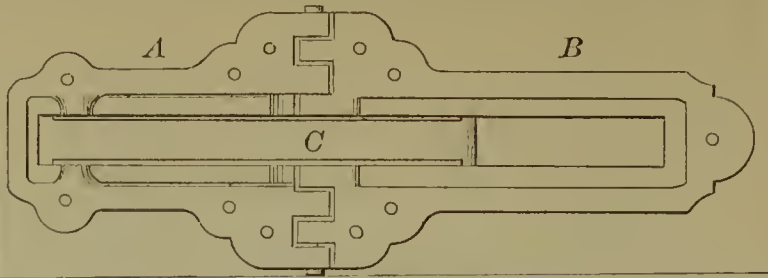

56719—Corbin & Prigh—Water Wheel.

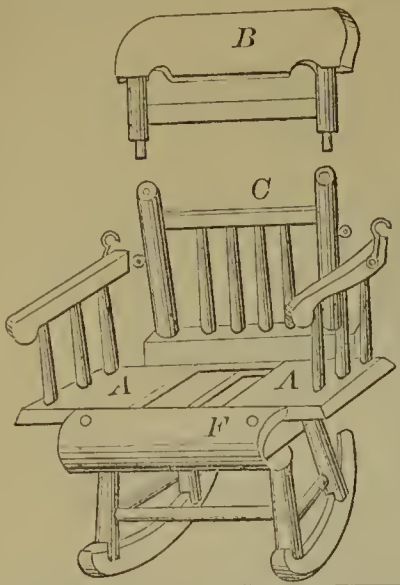
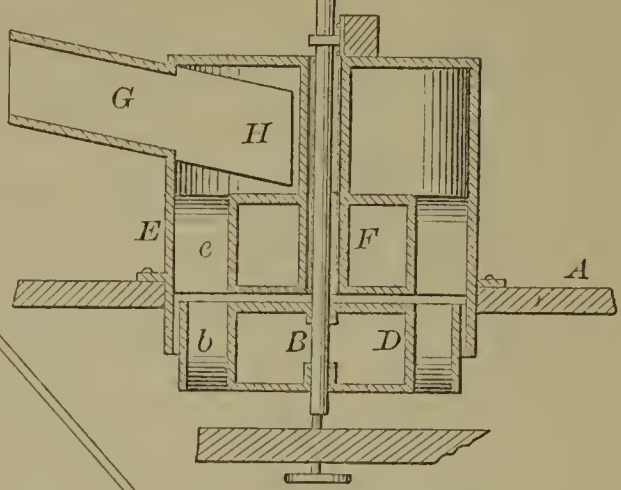

56718—F. E. Coomes—Cradle and Chair.

56721—J. B. Crosby—Raisin Seeder.

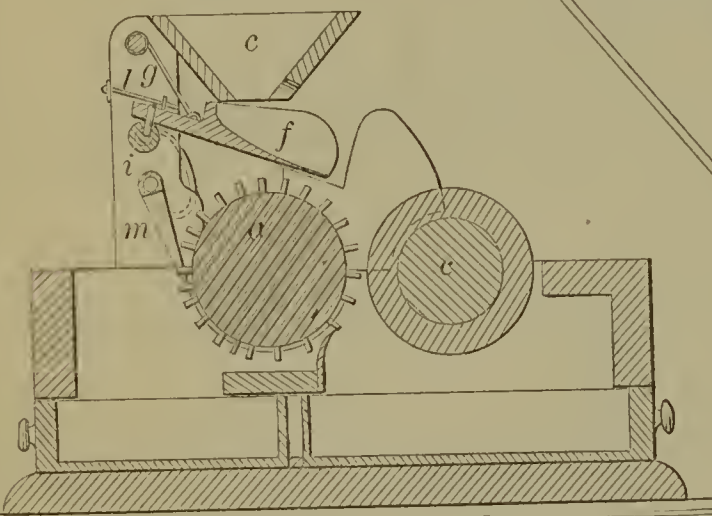

56723—P. A. Dailey—Mirror.

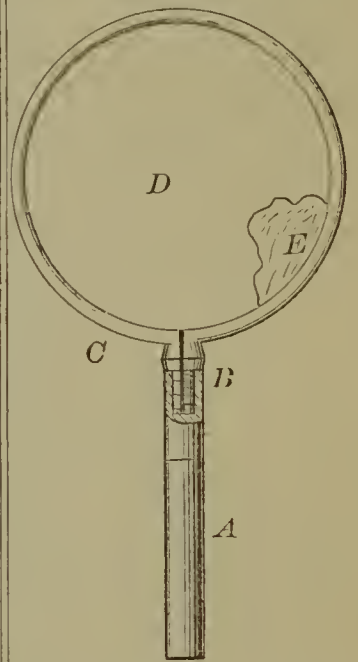

56722—J. G. Cross—Milk and Cheese Rack.

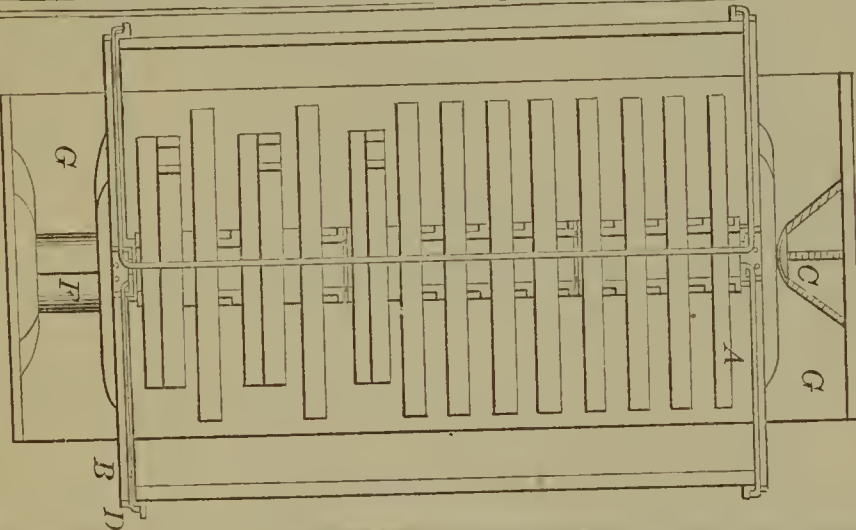

56726—Davis & Hewitt—Railway Chair.

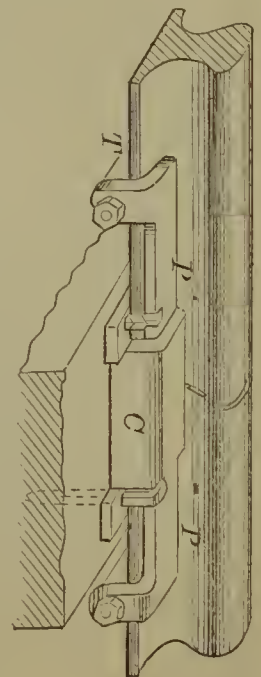

56724—J. N. Davis—Water Closet.

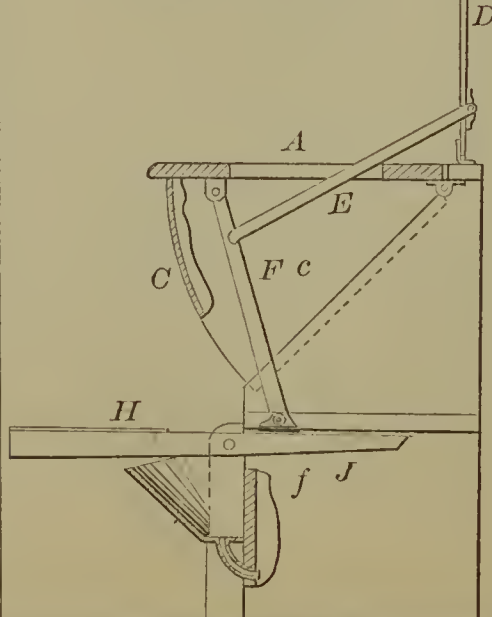

56725—J. Davies—Copper Smelting Furnace.

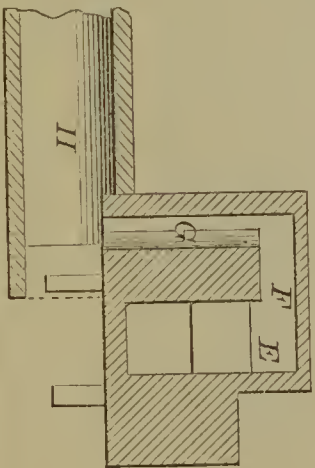



56727—H. G. Dayton—Hot Air Furnace.

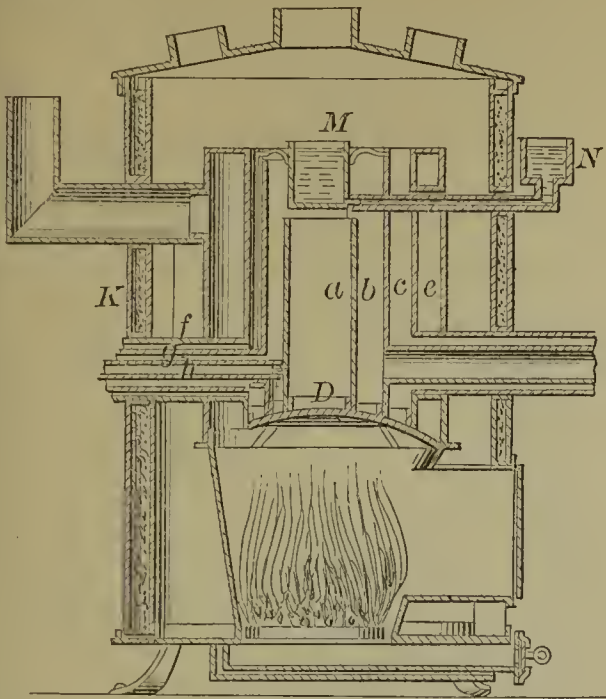

56732—L. Dodge—Bleaching Paper Pulp.

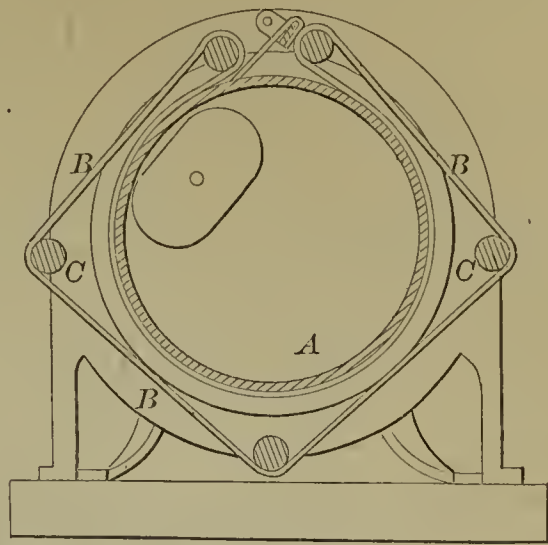

56729—A. Destony—Boot and Shoe Sewing Machine.

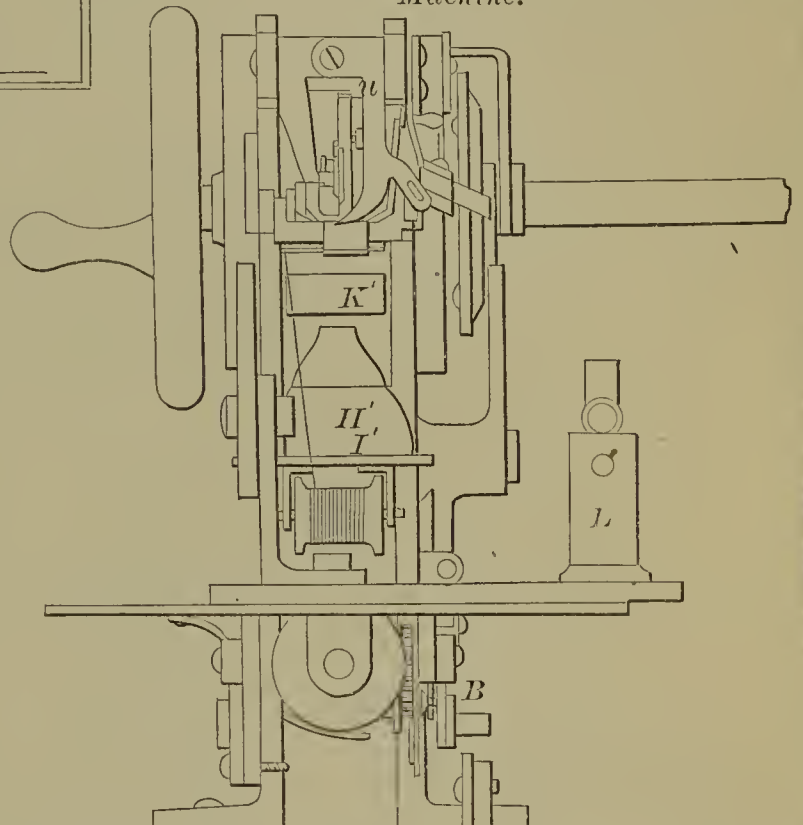

56728—G. Deckman—Churn Dasher.

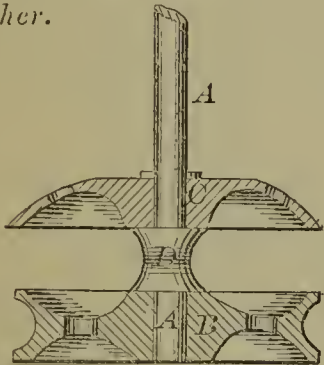

56730—A. L. Dewey—Sewing Machine.

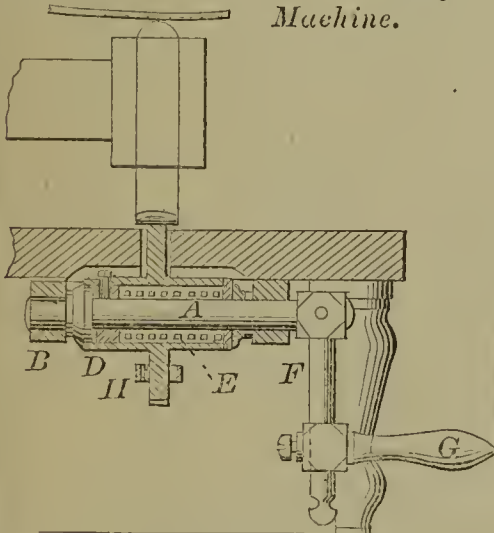

56733—A. L. Drake—Washing Machine.

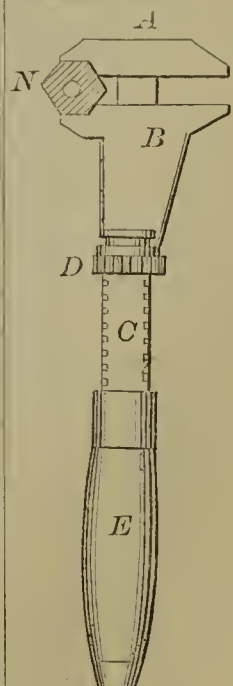
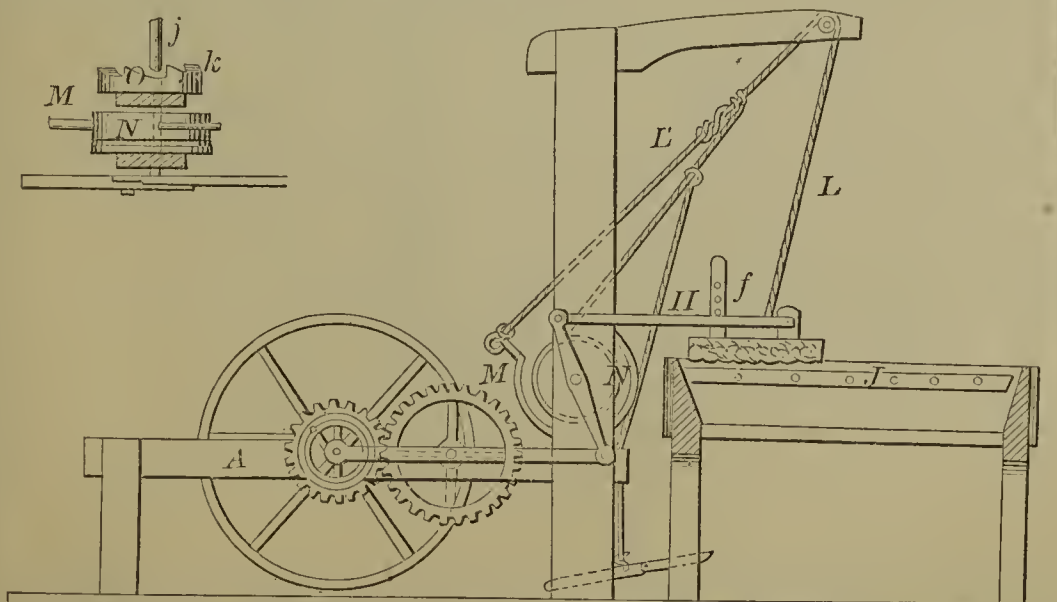

56731—J. F. Dodge—Wrench.

56734—A. A. Dunk—Repairing Files.



56735—Ellis & Albertson—Animal Trap.

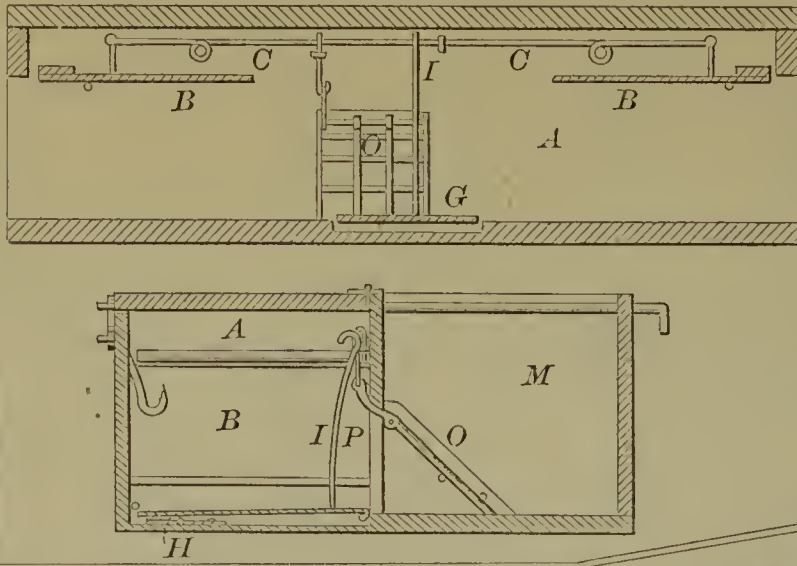

56737—A. A. Evans—Paper Cuff.

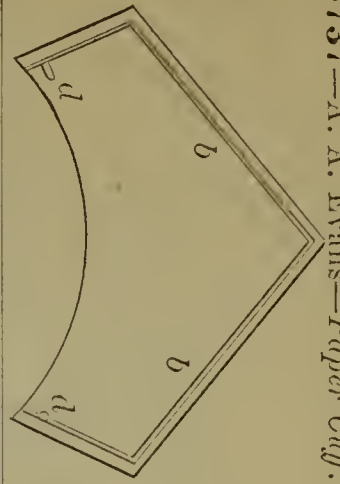

56736—W. A. Ellis—For Forming Plow Handles.

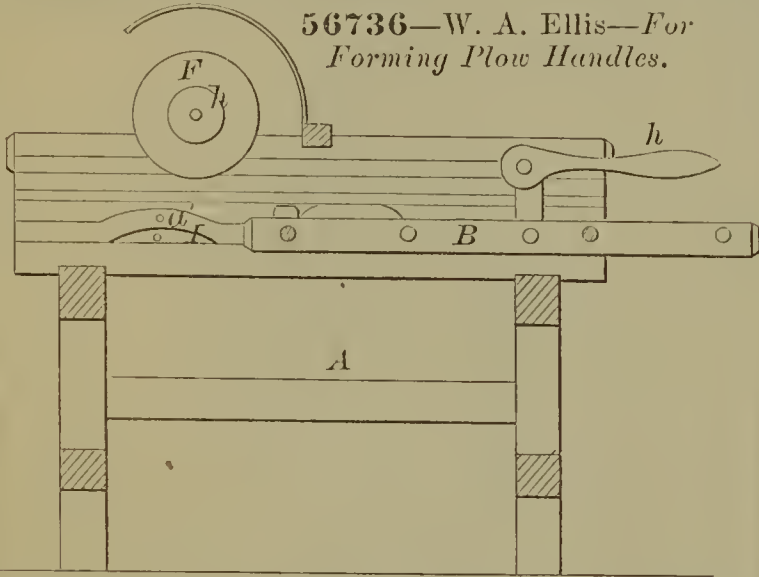

56740—J. Flinn—Bed Bottom.

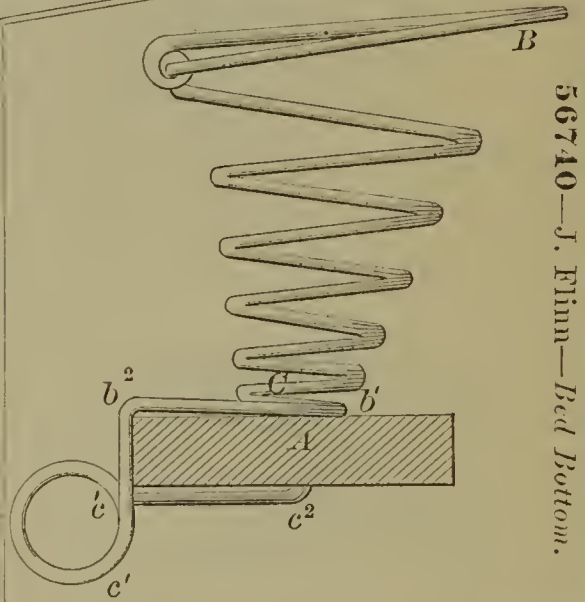

56738—J. K. Ferguson—Steam Condenser.

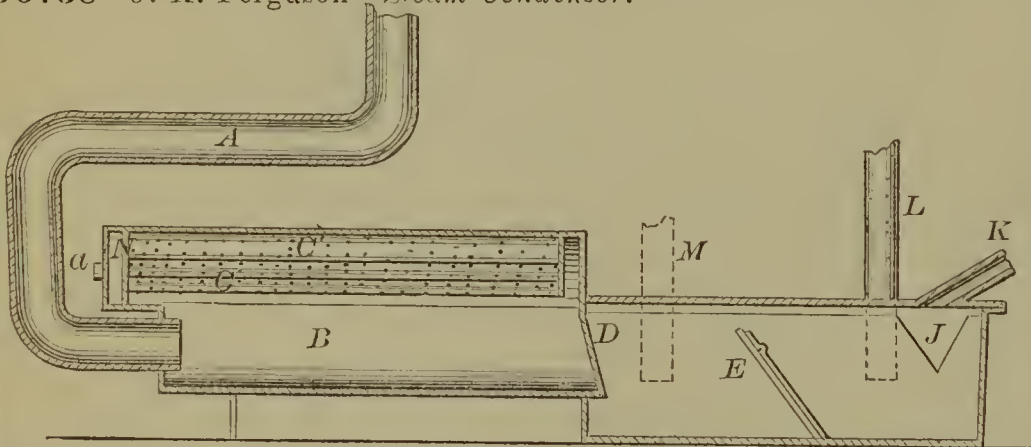

56739—H. Fisher—Horse Hay Fork.

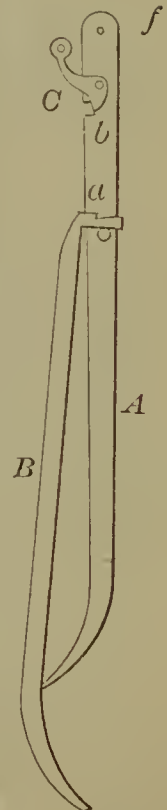

56741—Frazee & Smith—Bed Bottom.

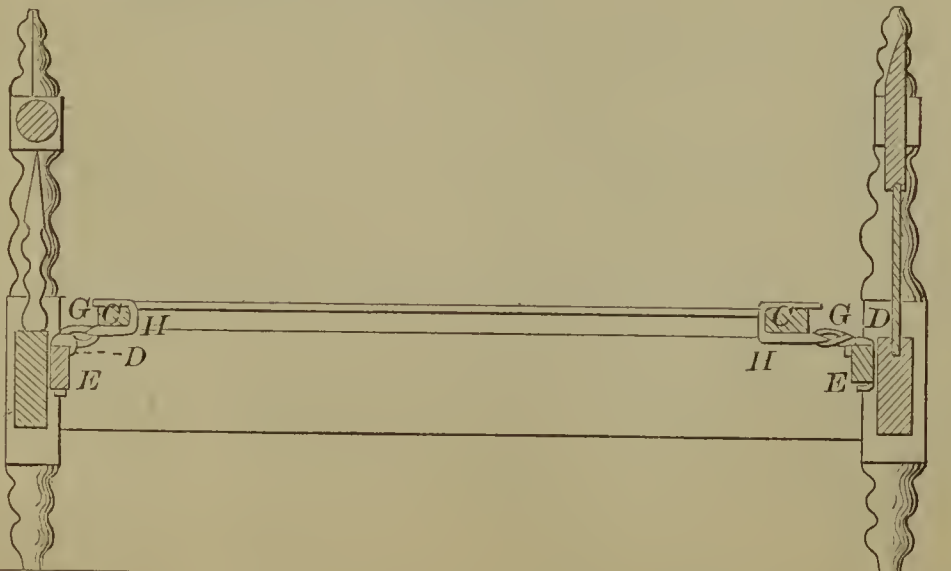

56742—I. H. Garretson—For Making Brick.

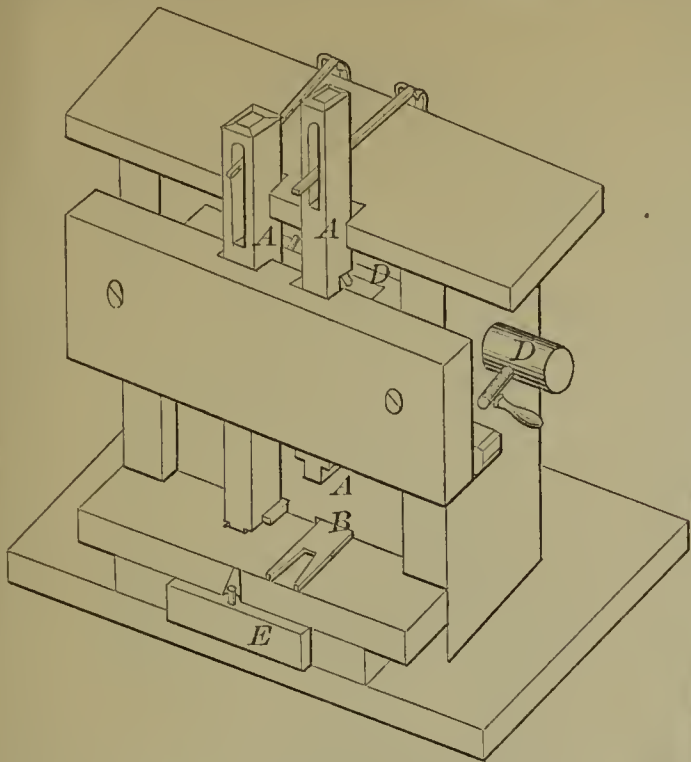

56743—A. Gordon—Straw Cutter.

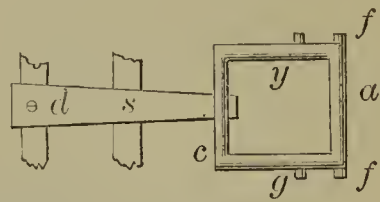
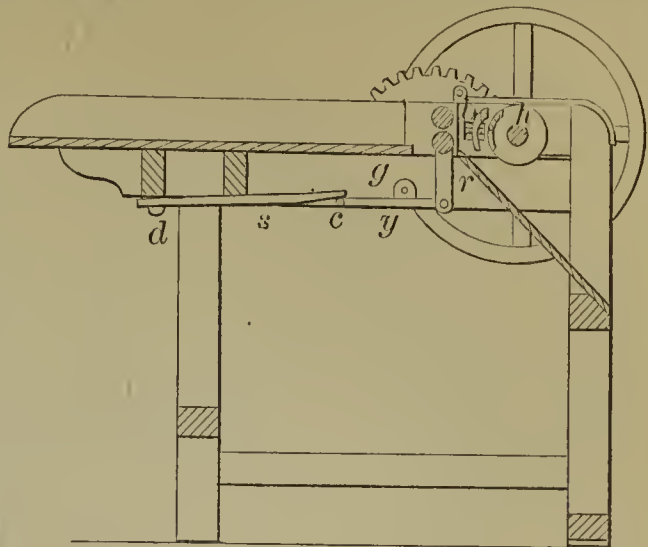

56744—W. Gowen—Washing Machine.

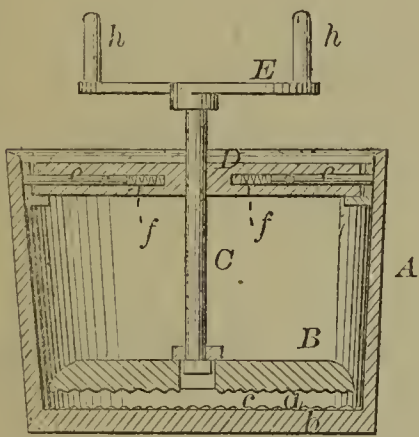

56745—J. Gribben—Die for Making Bolt Heads.

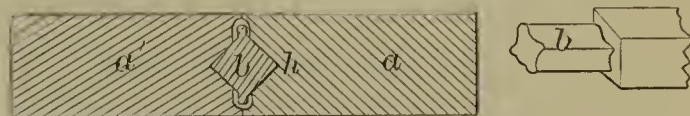

56746—J. R. Grout—Blast Furnace.

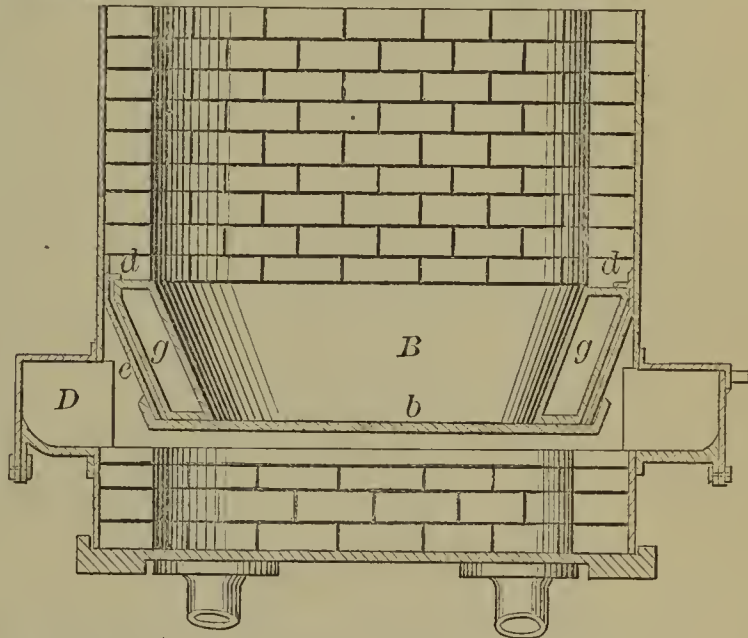

56748—D. G. Haskins—Steam Generator.

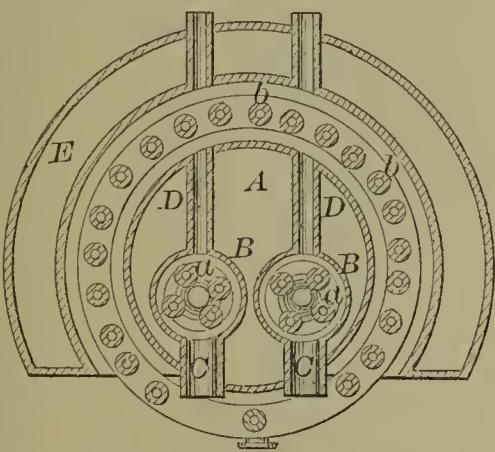

56749—M. H. Hilburn—Sickle Head.

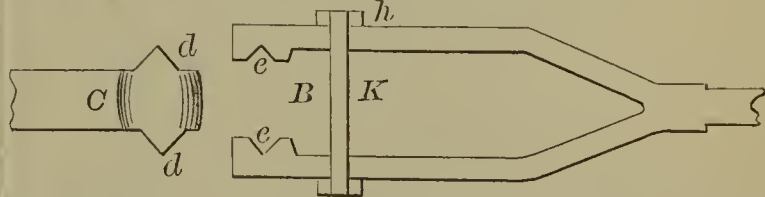

56750—E. Hiss—Paint Brush.

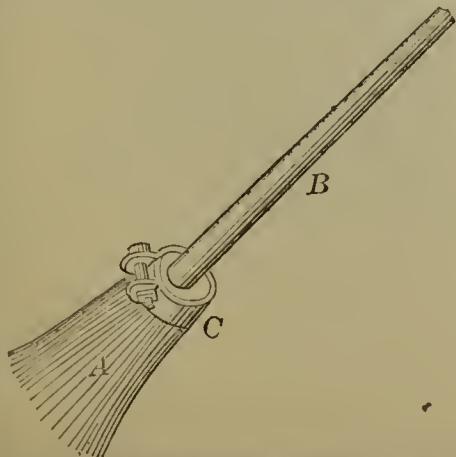

56747—C. L. Hart—Sorghum Stripper and Cutter.

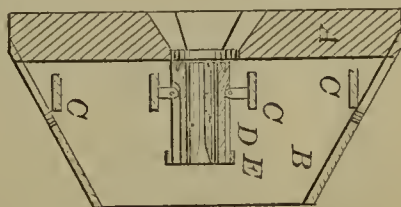

56751—J. F. Hodgson—Roofing.

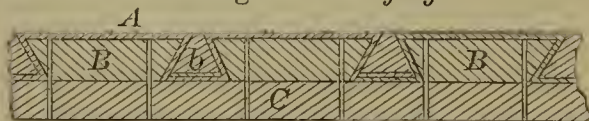

56752—E. Hoyt—Tobacco Pipe.

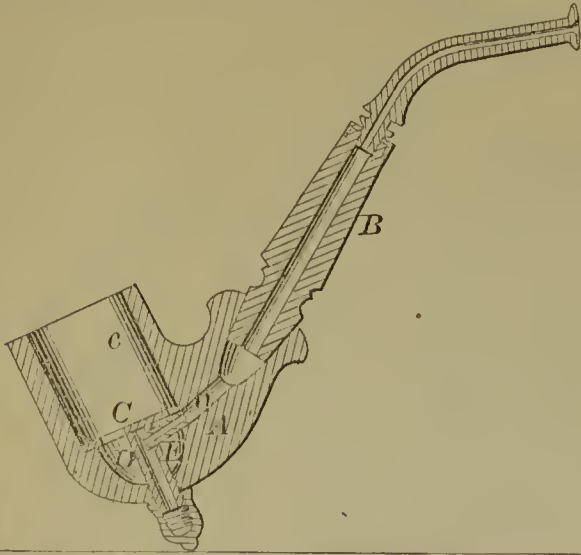

56754—J. M. Hudson—Vessel Rigging.

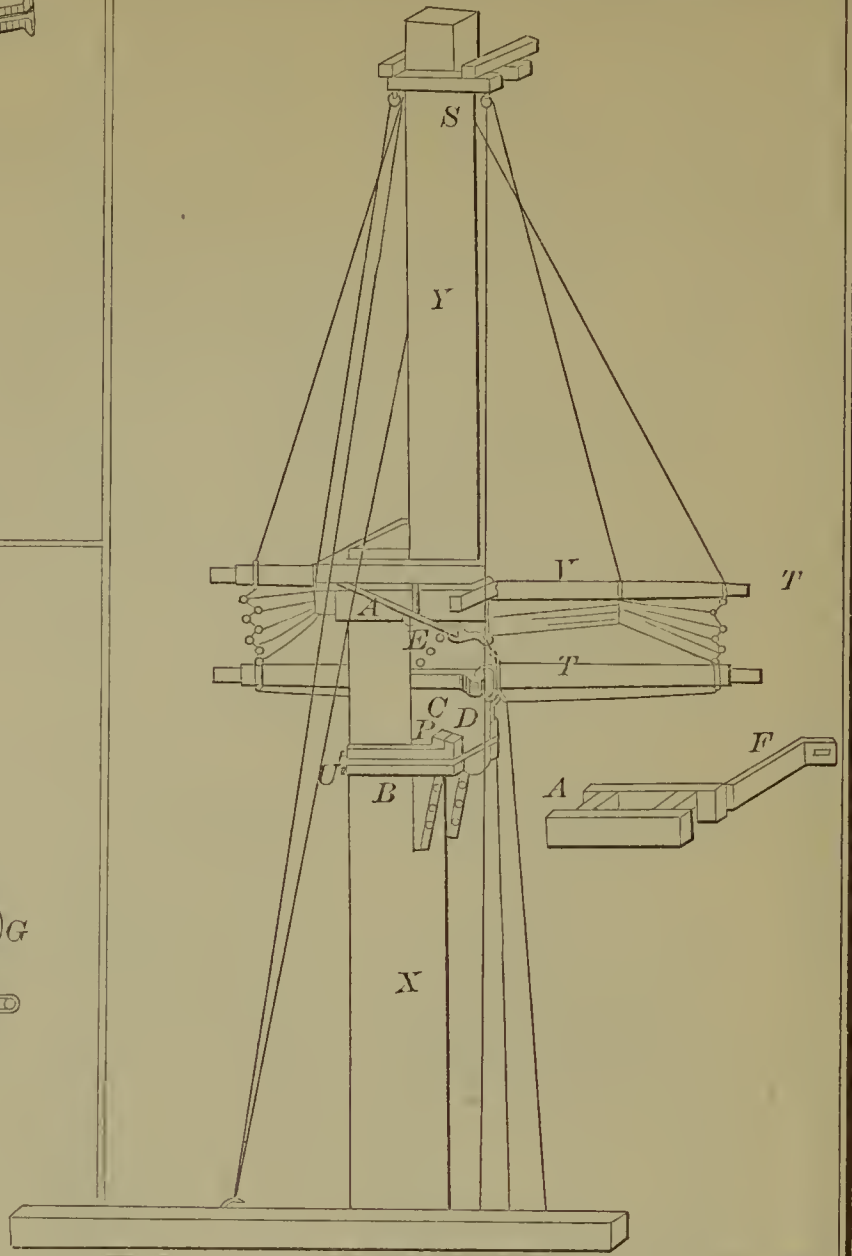

56758—C. Jones—Wool Oiling Machinery.

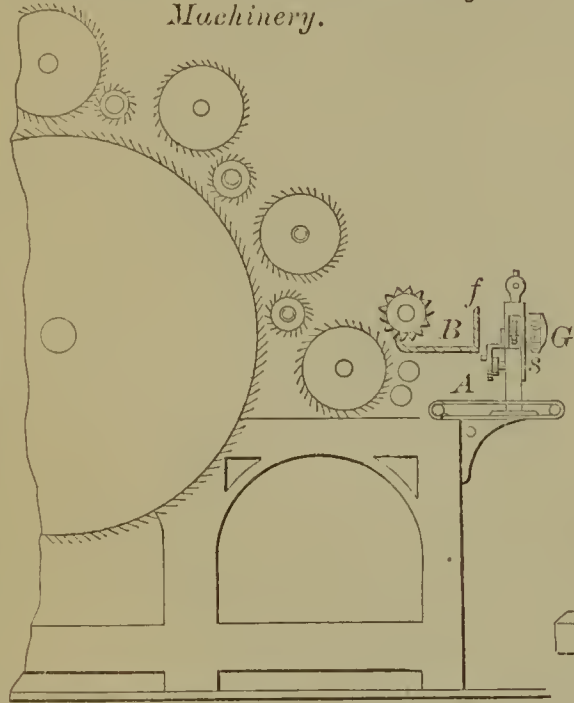

56756—E. H. Jackson—Dumping Car.

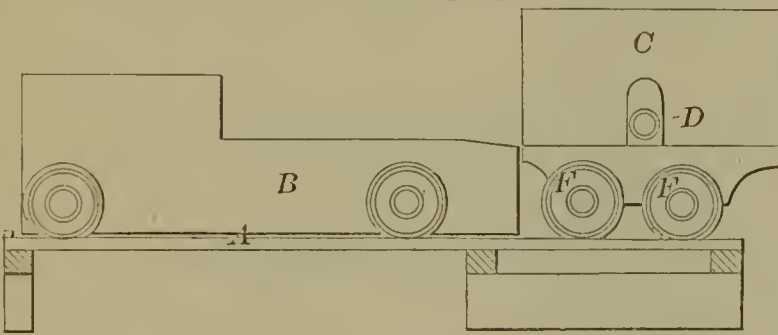

56757—A. L. Jewell—Garden Syringe.

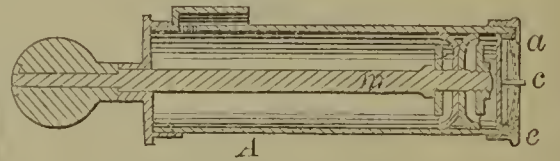

56761—W. & A. G. Kelsey—Washing Machine.

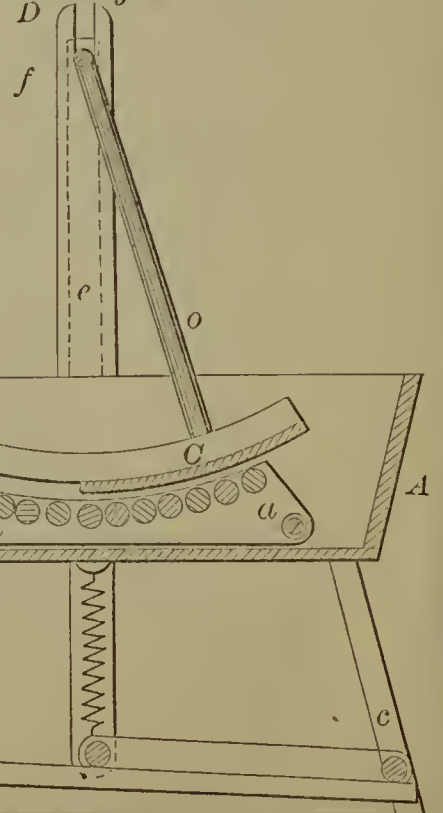

56753—F. M. Hubbard—Carriage Seat.

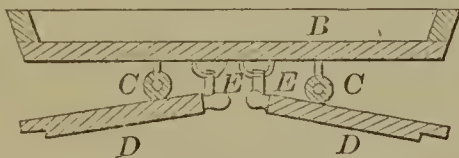

56755—W. Hunt—Fruit Jar.

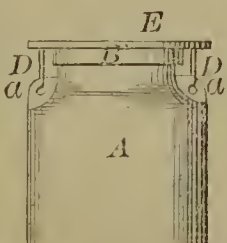

56760—R. V. Jones—Railroad Rail.

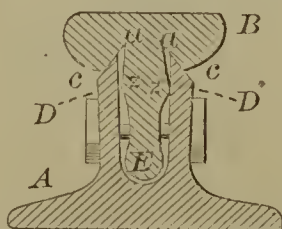

56762—S. M. King—*Bridle Bit.*

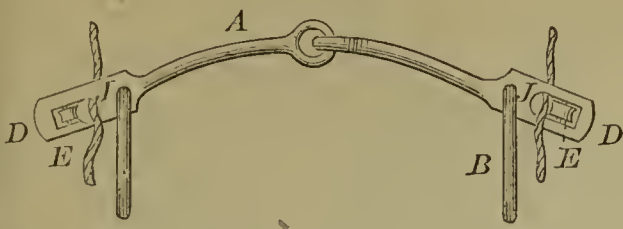

56766—J. W. Larmore—*Field Fence.*

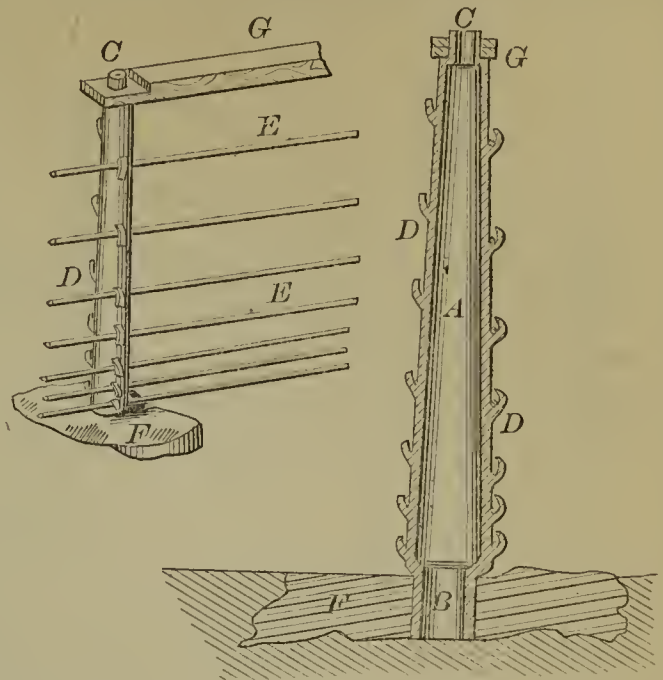

56764—Knauer & Warwick—*Sad Iron.*

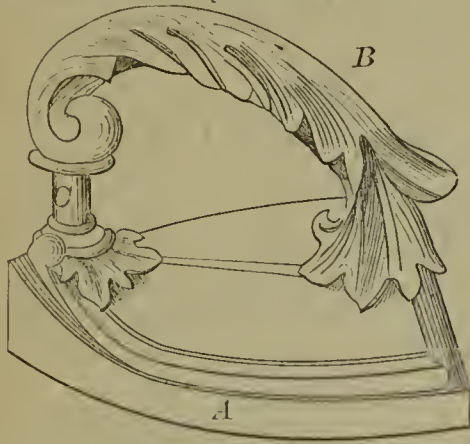

56767—W. Leas—*Belt Coupling.*

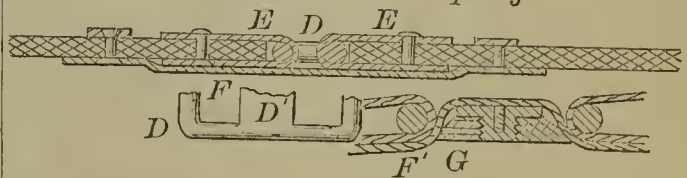

56763—W. P. Kirkland—*Bilge Water Gauge.*

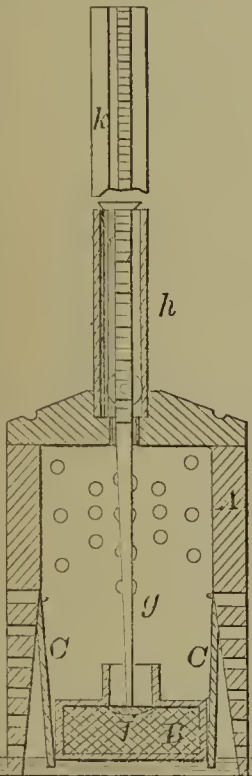

56769—H. Loth—*Table and Stool.*

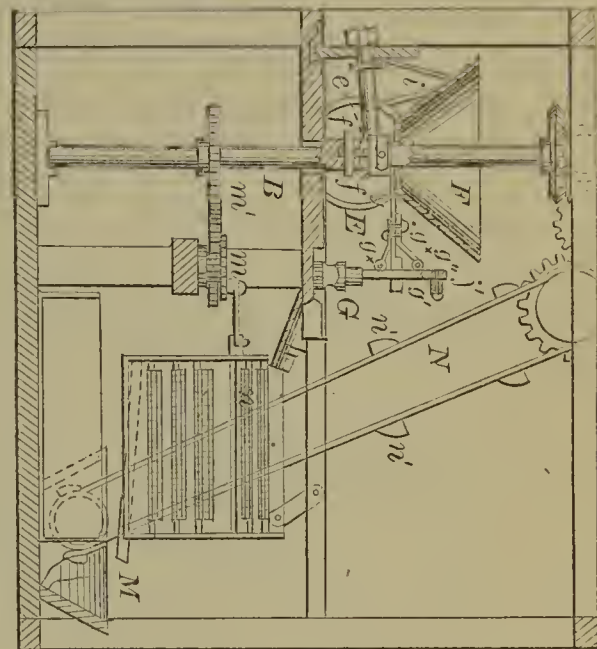
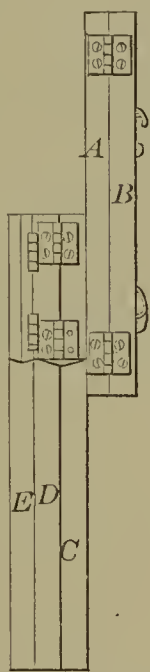

56768—A. Lindsay—*Quartz Crusher.*

56771—A. E. Mason—*Churn.*

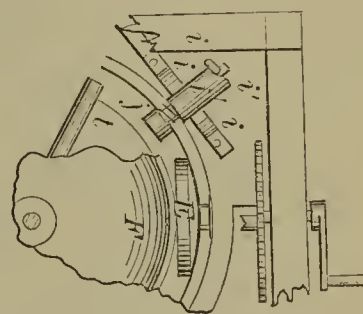
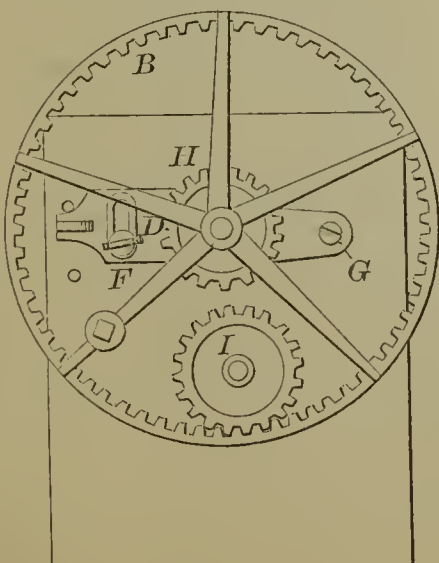

56770—C. E. Lyon—*Lamp Extinguisher and Regulator.*

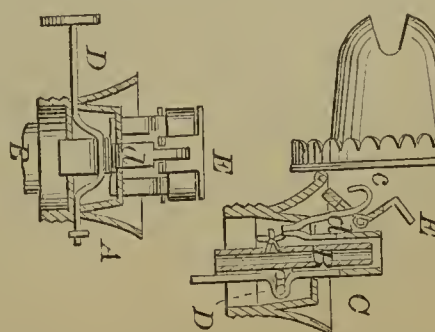

56772—W. B. Mason—Punch, Shears, &c.

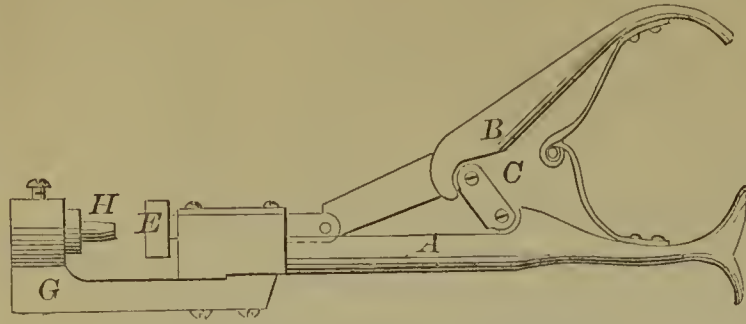

56774—B. F. Miller—Stove Pipe Drum.

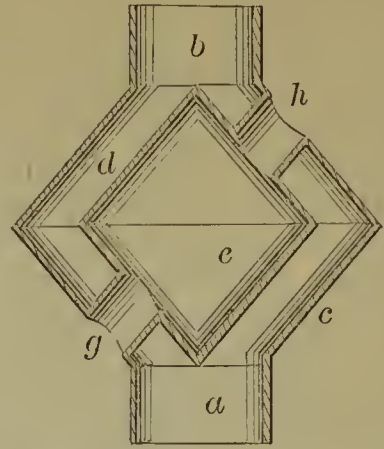

56776—J. A. Minor—Pocket Tablet.  
Fig. 4

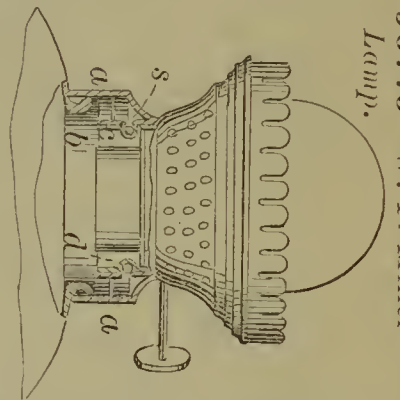
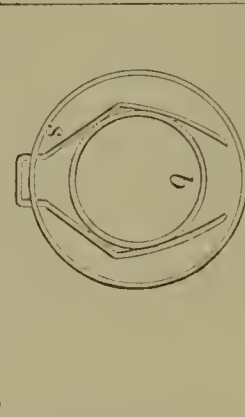
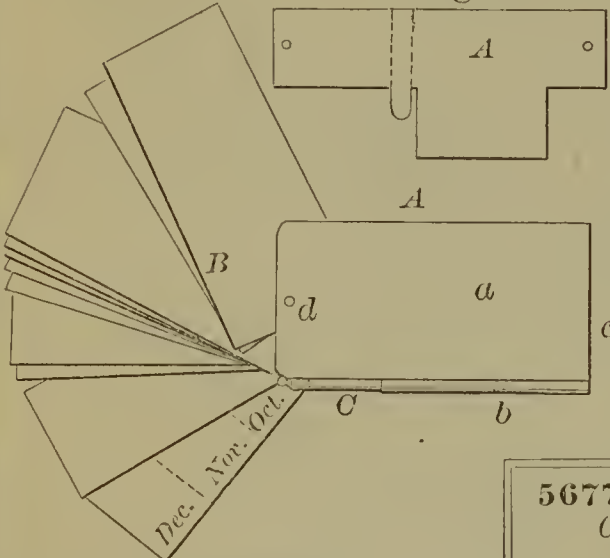

56775—W. P. Miller—Lamp.

56773—A. B. Mercier—Clothes Washer.

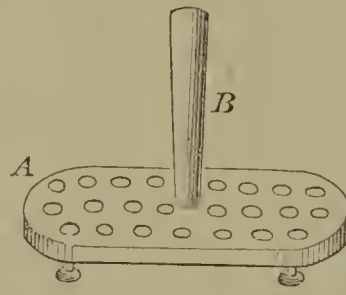

56777—D. A. Mitchell—Bridge.

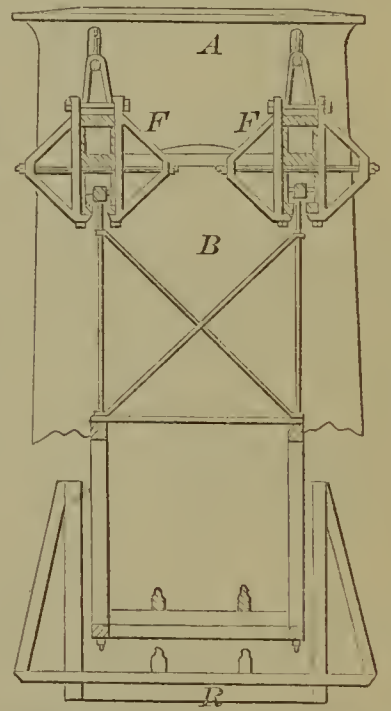

56779—R. Montgomery—Metallic Plate.



56778—T. Mitchell—Steam Generator.

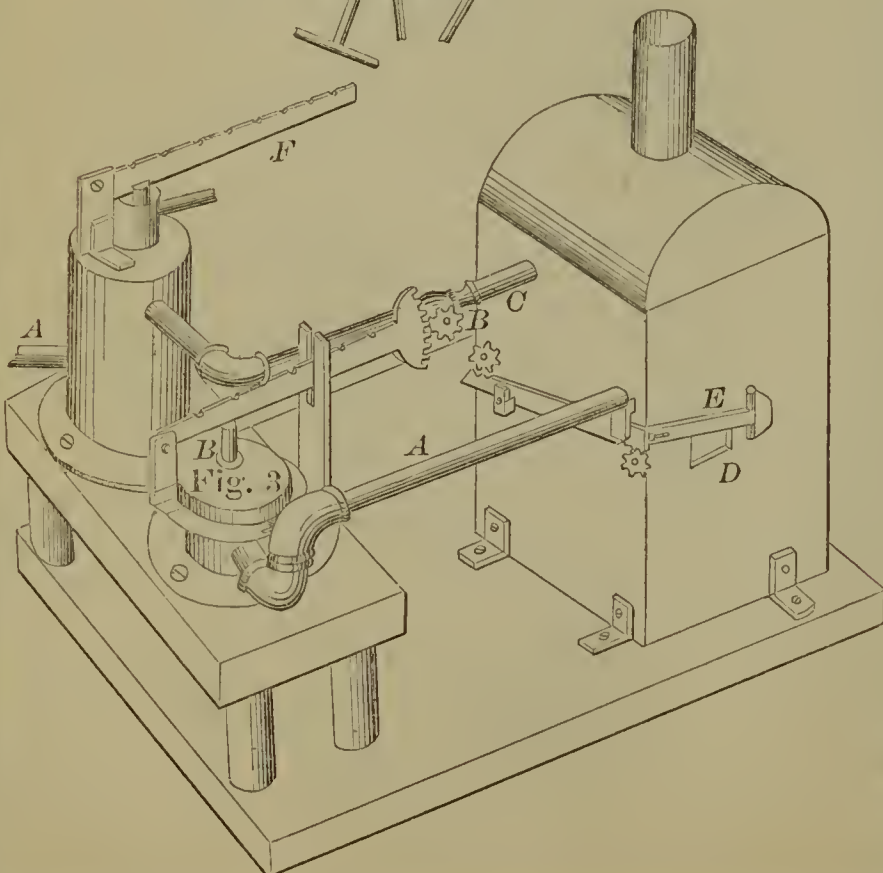
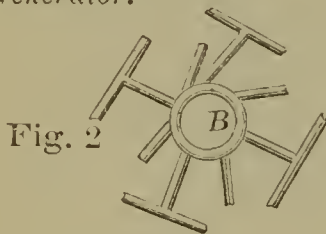

56780—J. O. Moore—For Cooling Milk.

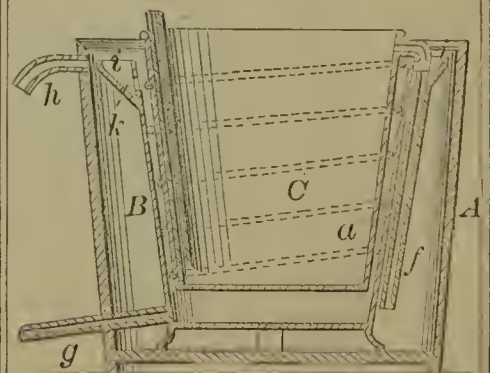

56781—  
W. A. Morse—  
Polishing Box.

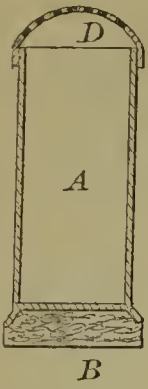

56782—M. D. Mulford, Jr.—  
Beehive.

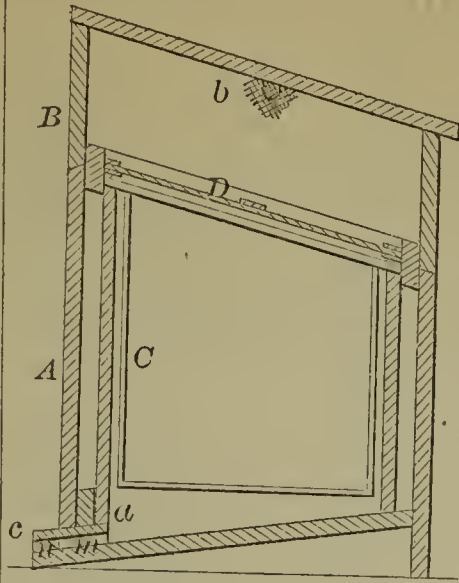

56783—J. Munn—For Heating  
and Melting Roofing Material.

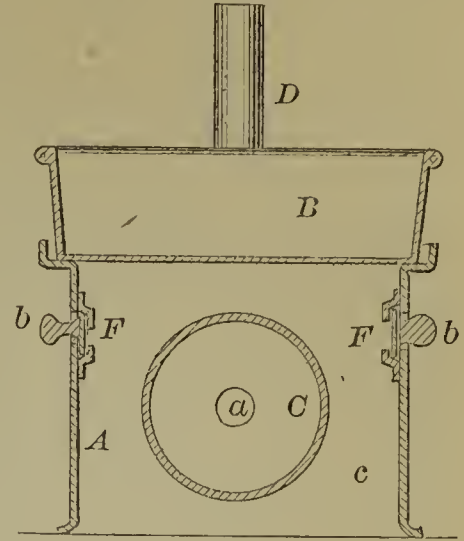

56786—H. Naylor—Sash Fastening.



56788—J. Newman—Wood Bending Machine.

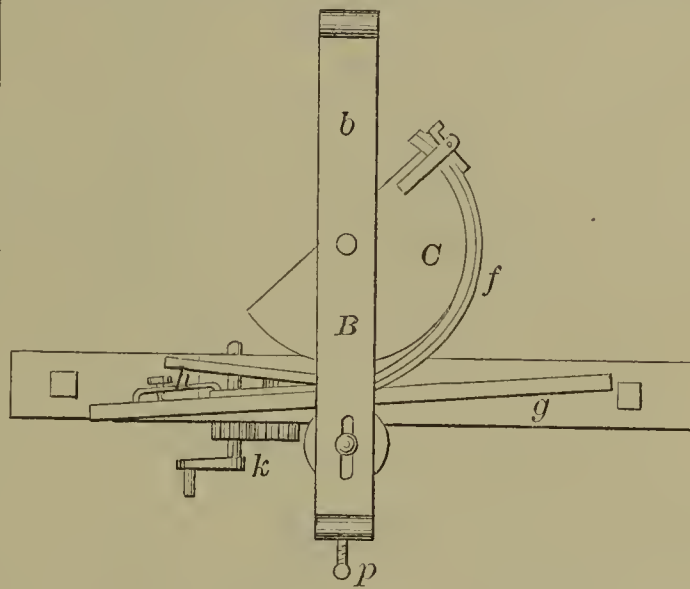

56785—N. Murphy—Buckle.



56784—F. Murgatroyd—  
Condensing Steam.

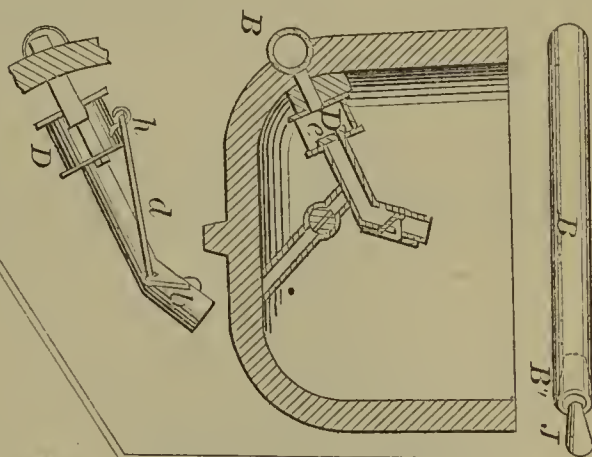

56787—C. Neumann—Hoop Skirt.



56789—W. H. Nutting—Stove Pipe  
Damper.

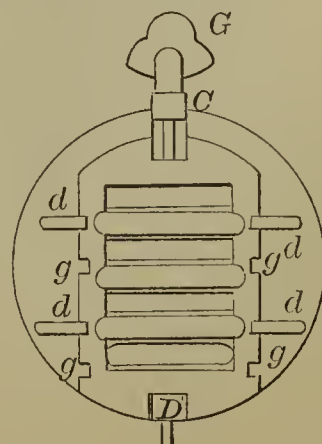

56790—A. A. Oat—Safe Lock.

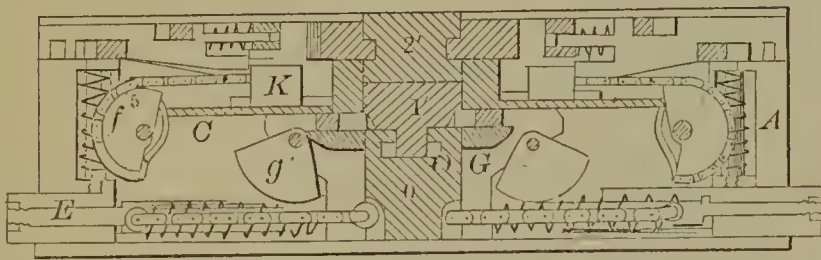
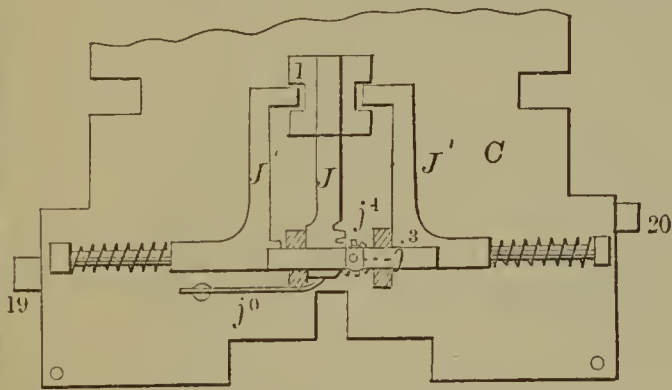
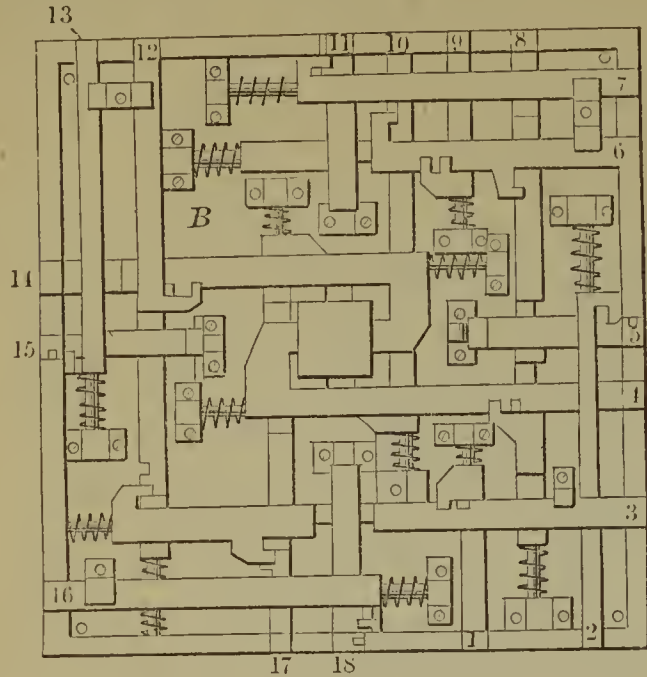

56793—H. Pearce—Quartz Mill.

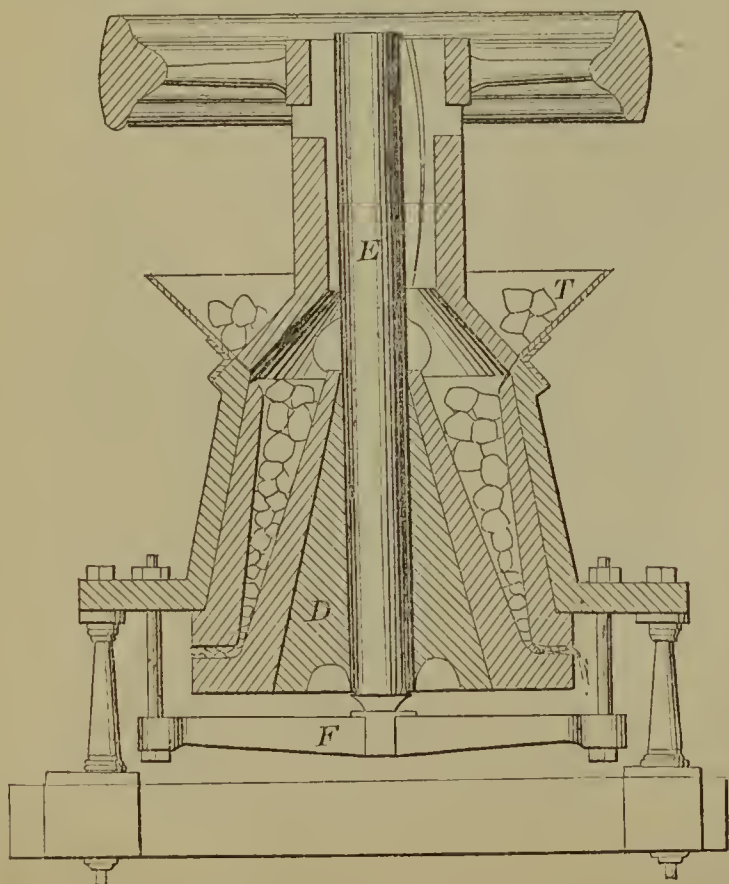

56791—A. W. Overbaugh—Initial Stud.

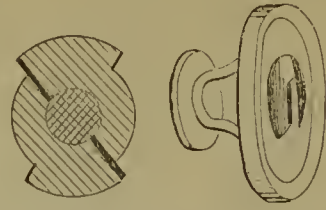

56792—G. T. Palmer—Water Cooler.

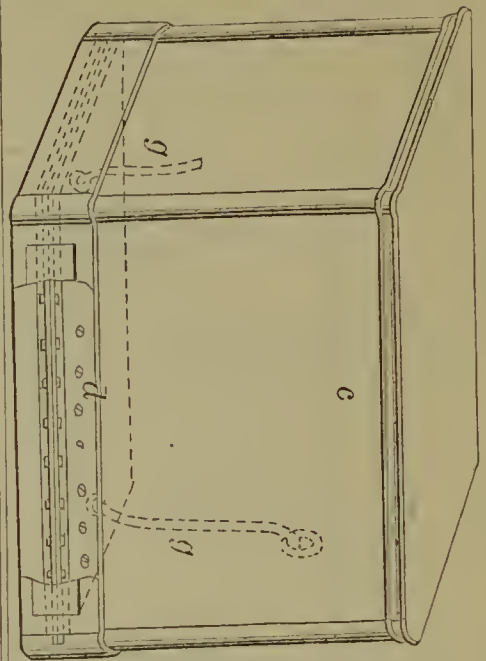

75694—S. M. Perry—Corset.

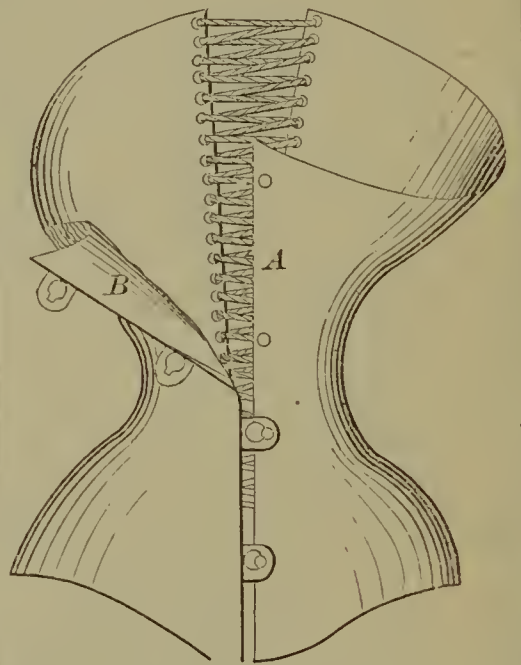

56795—J. W. Petty—Tobacco Pipe.

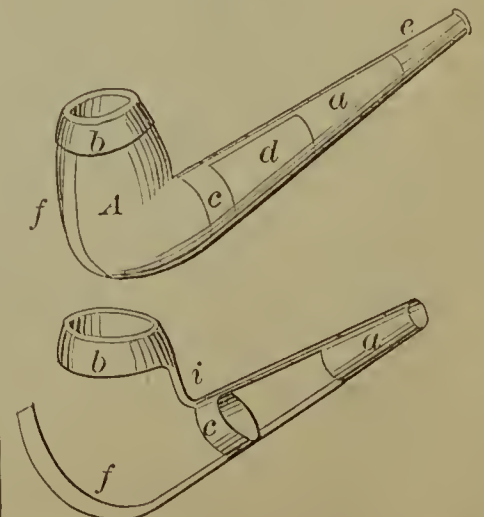



56796—W. Phelan—Steam Generator.

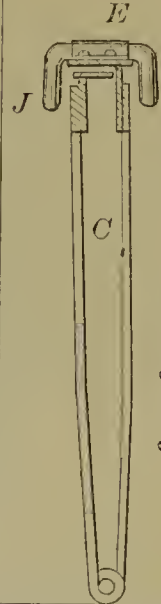
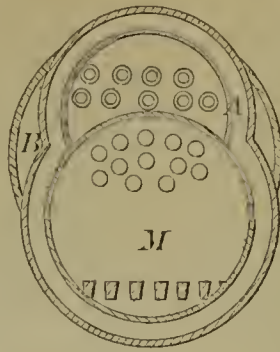
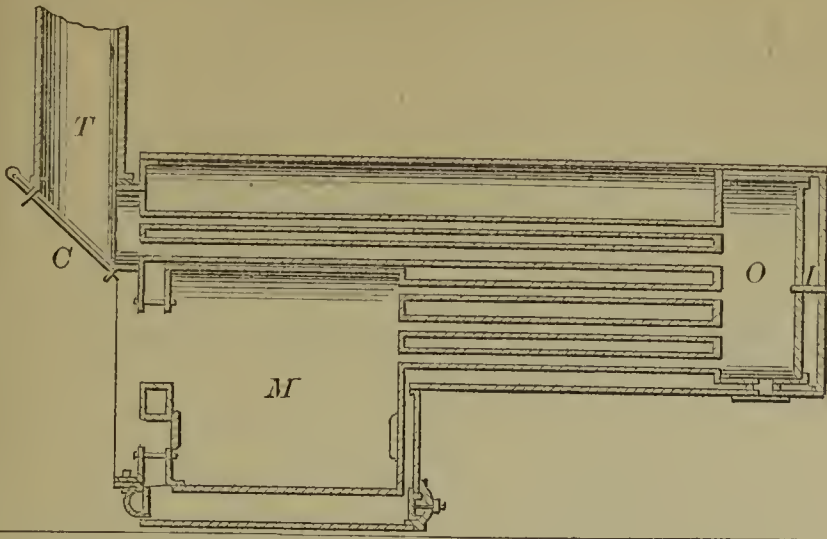

56801—W. Roemer—Traveling Bag.

56802—E. Rouse—Steering Apparatus.

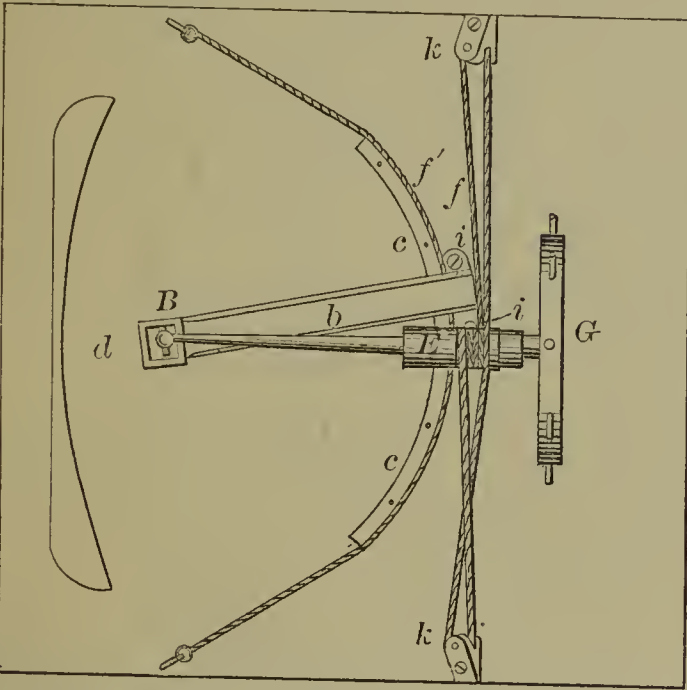

56797—Prentiss & Parsons—For Purifying Whiskey &c.

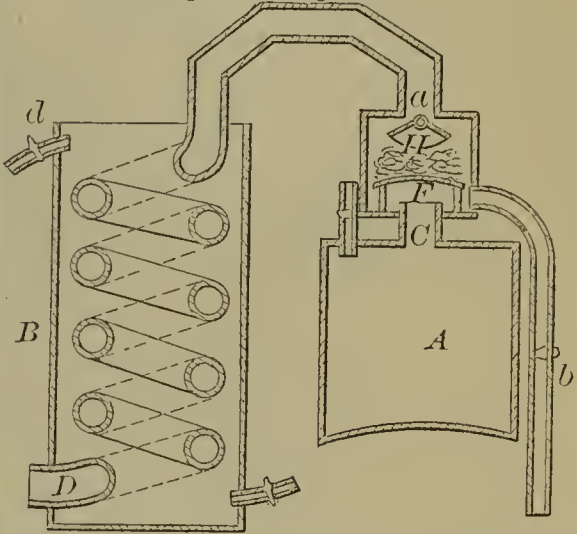

56798—B. Price—Plow.

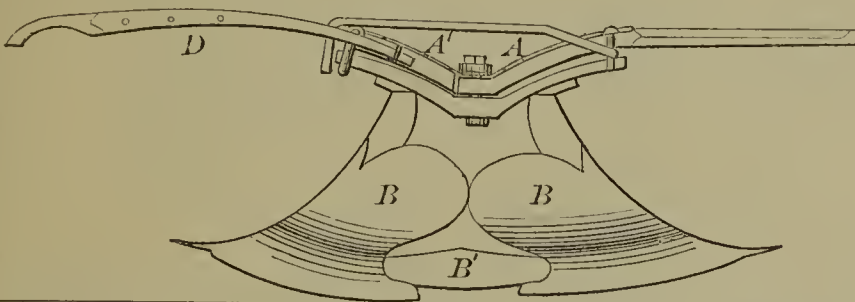

56800—H. C. Richards—Room Protector.

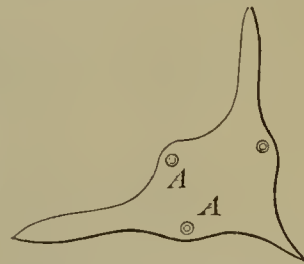

56799—C. Recht—Lamp Shade.

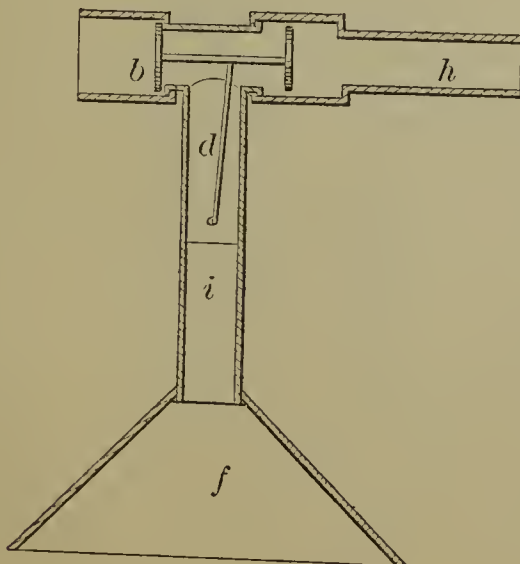

56803—J. Schleisinger—Hoop Skirt.

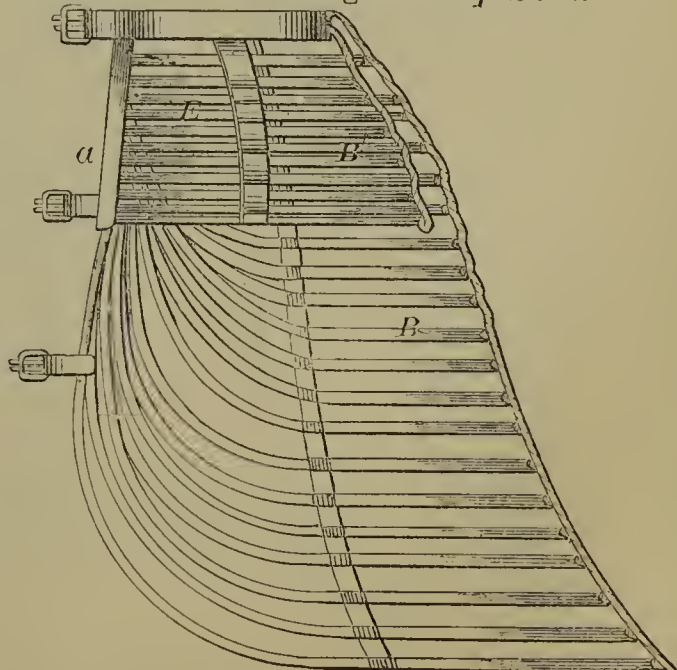

56804—P. F. Schneider—Cartridge Box.

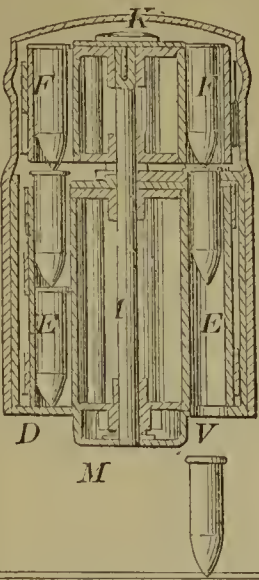

56805—M. Schwalbach—Sewing Machine.

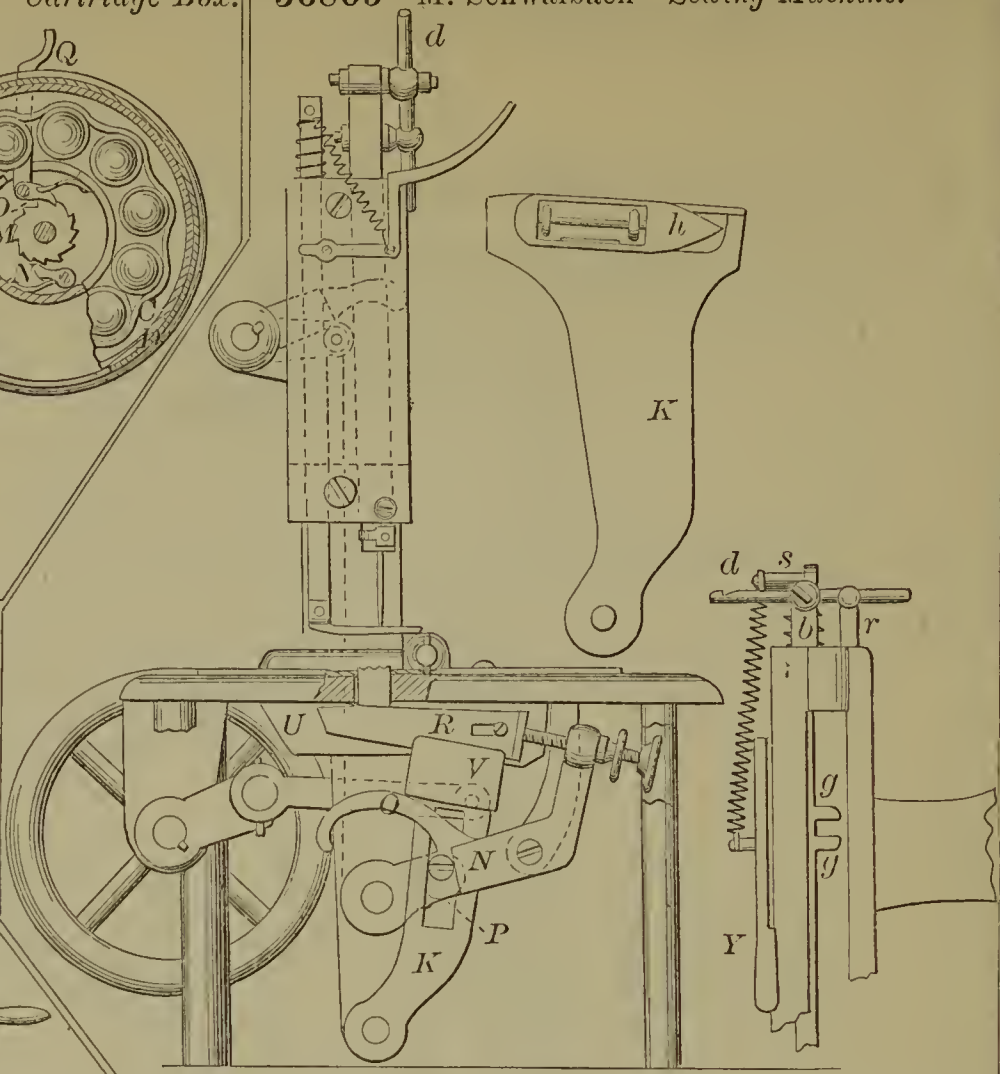

56806—E. S. Scripture—Shoe String Fastener.

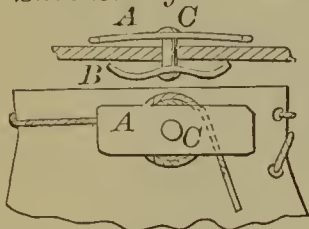

56810—T. R. Sinclair—Car Starter and Brake.

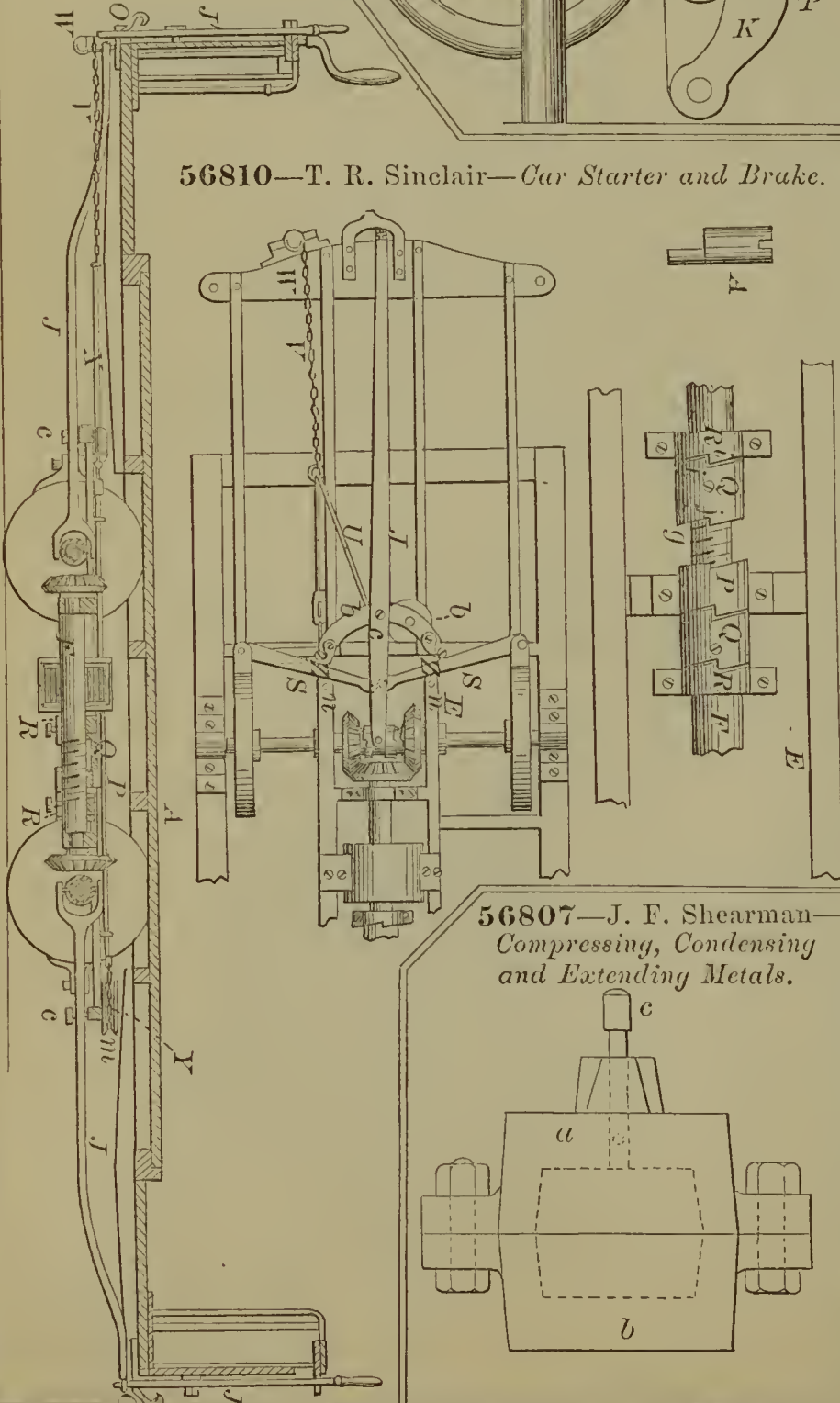

56808—G. A. Sherlock—Lock.

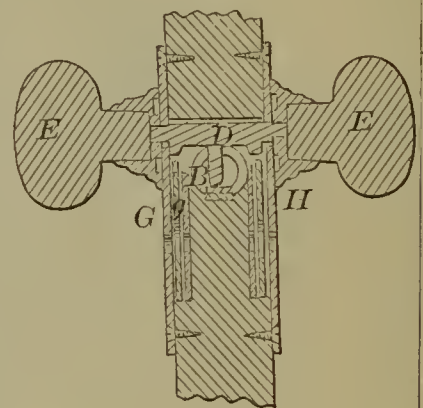

56807—J. F. Shearman—Compressing, Condensing and Extending Metals.

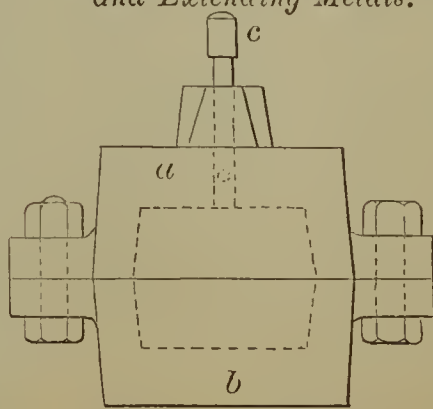

56809—A. & D. Short—Lounger.



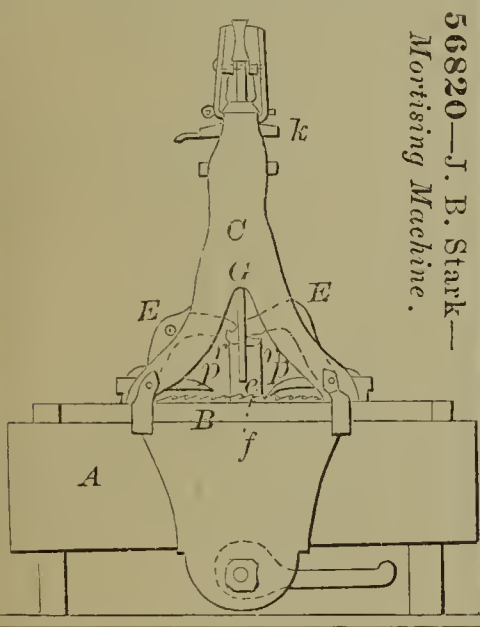
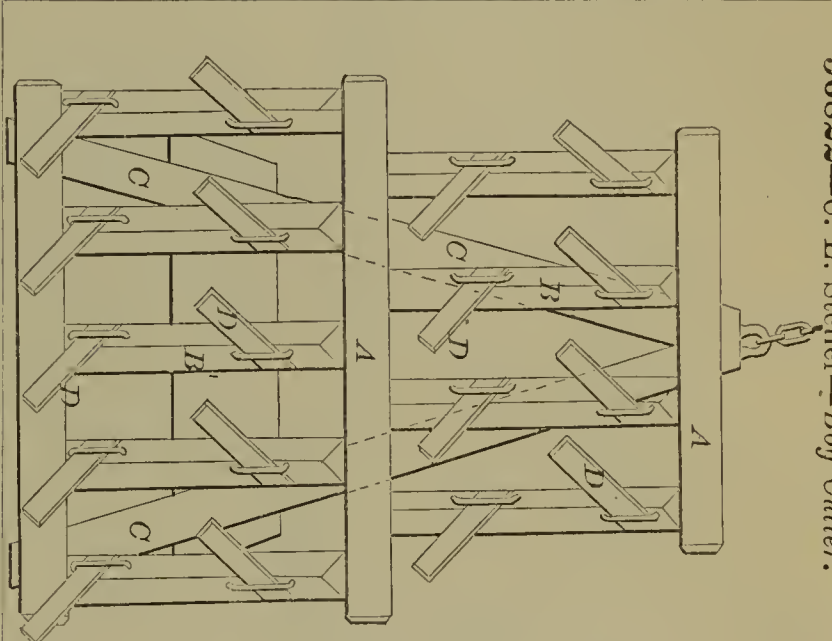
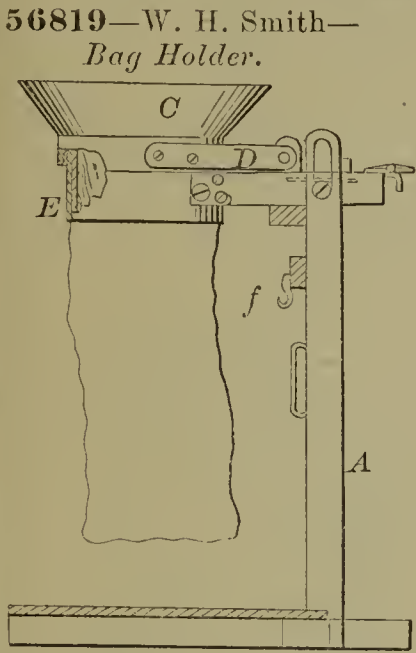
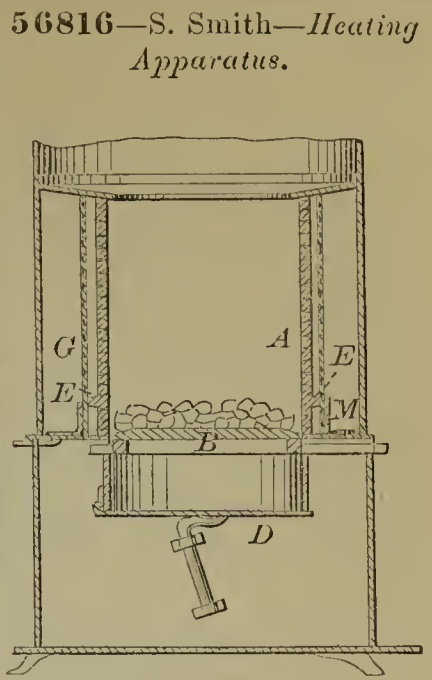
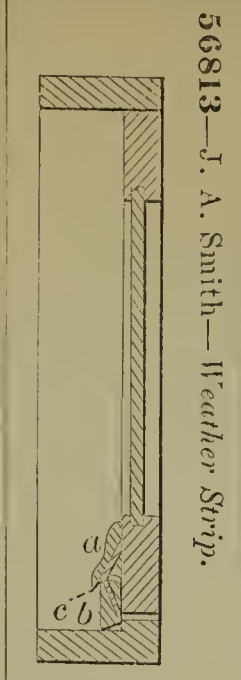
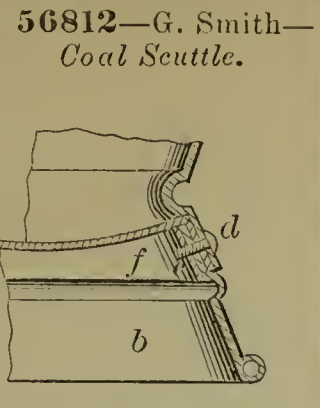
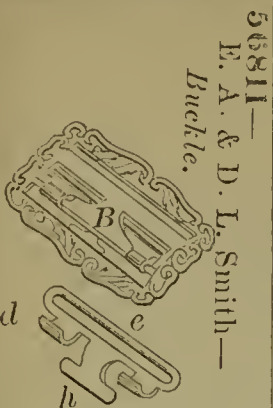

56823—A. Stevens—  
Drying Apparatus.

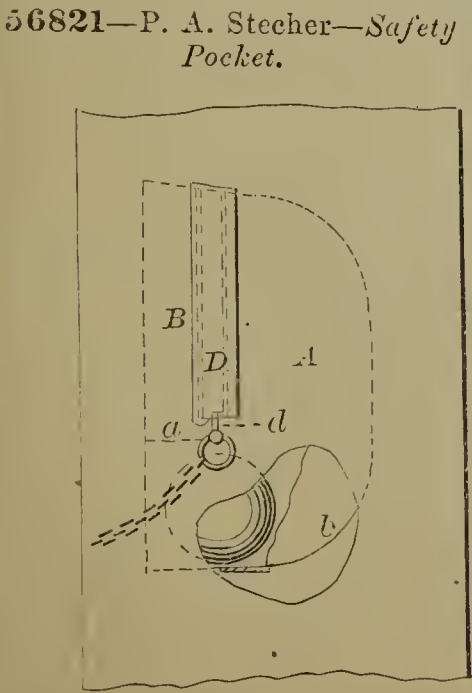
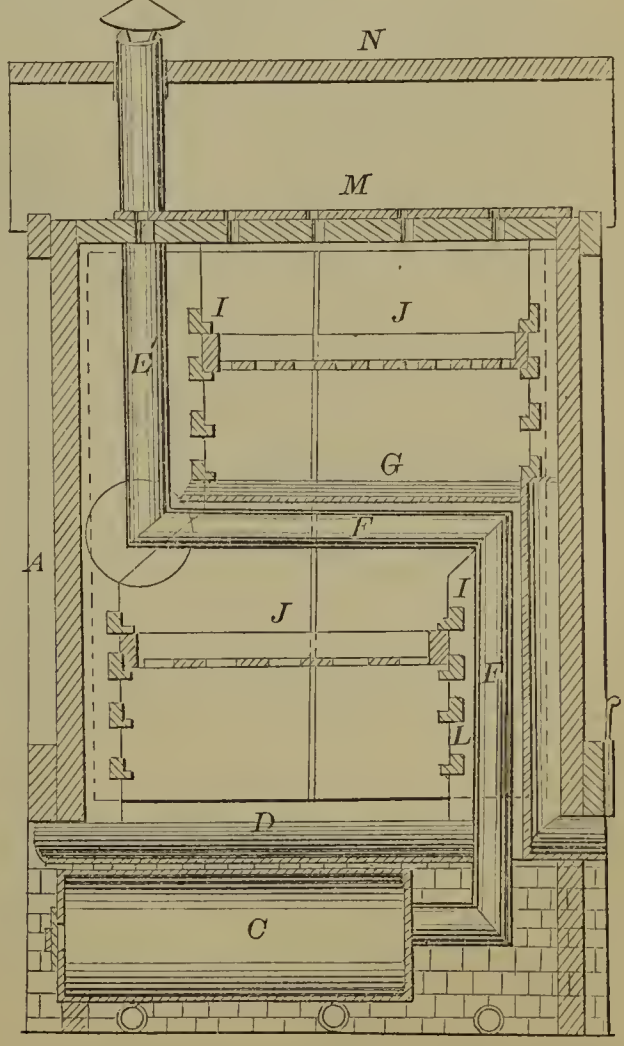

56824—M. Stevens—Cider Mill Press.

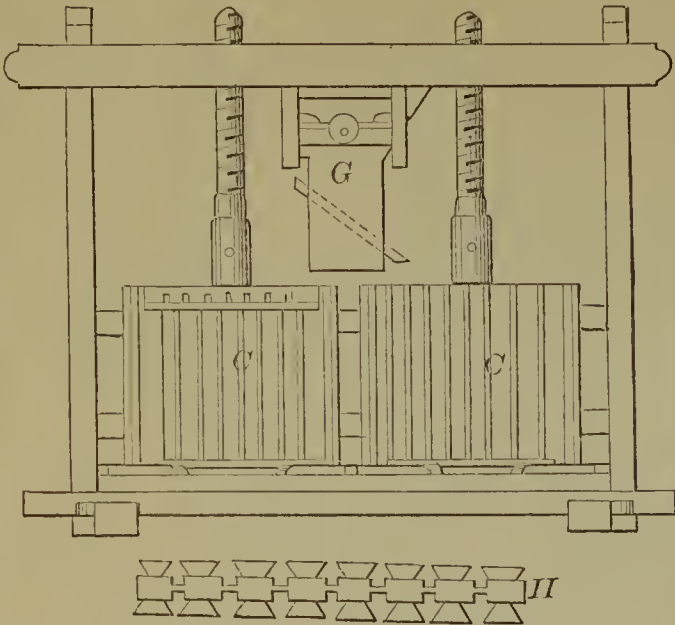

56825—A. C. Stone—For Rolling Metals.

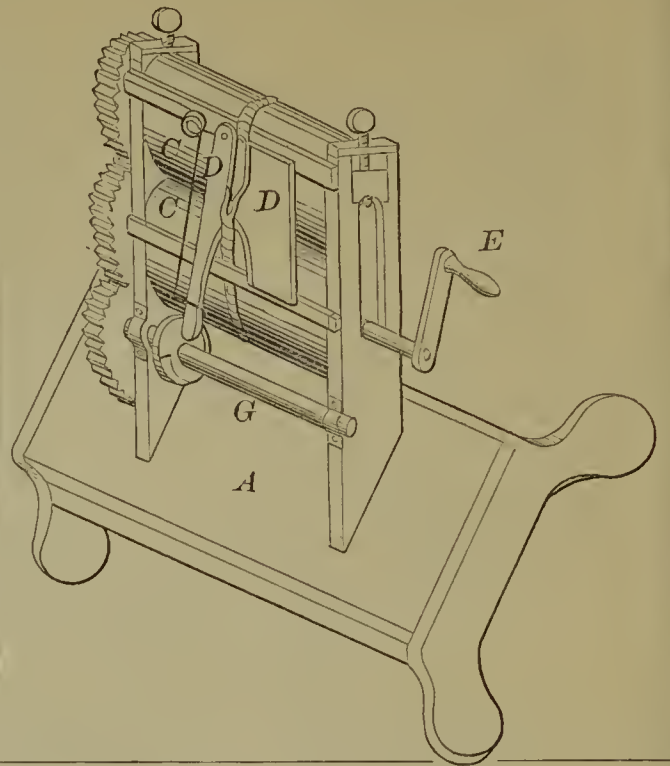

56826—Stone & Blocker—Fence.

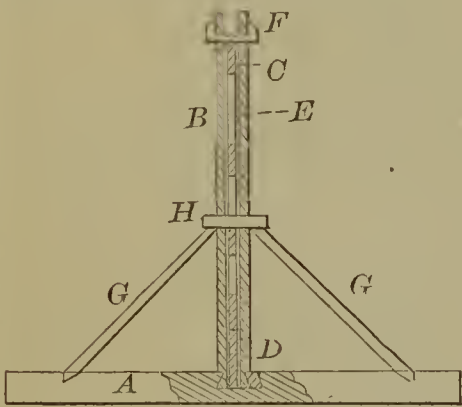

56829—J Sutherland—Self-Acting Mule.

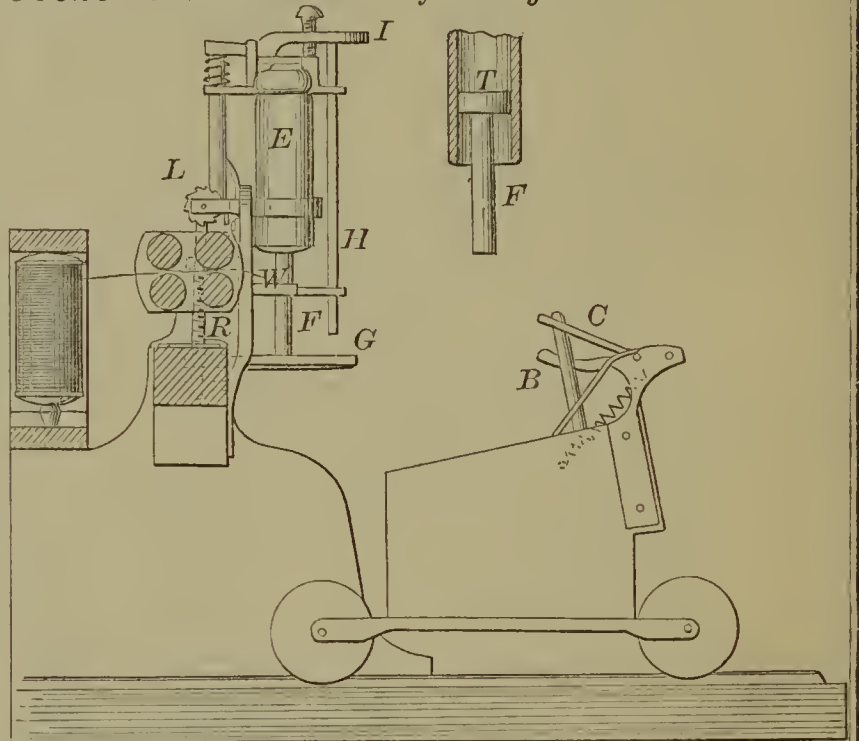

56827—S. S. Stone—Paper Collar.



56828—T. Strobbridge—Lock Keeper.

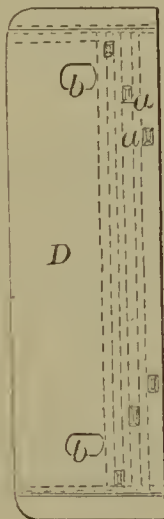

56830—M. A. Taylor—Wash Boiler.

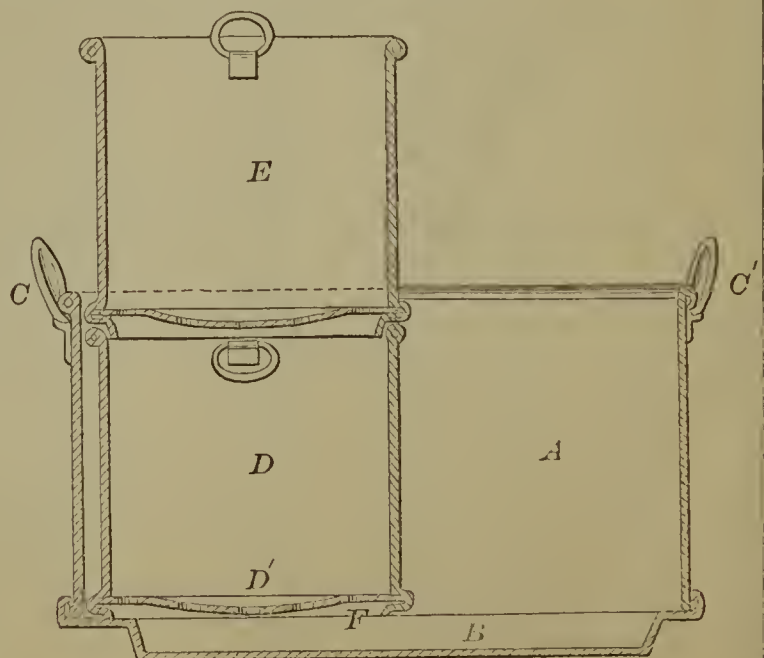

56831—C. W. Thompson—Truss.

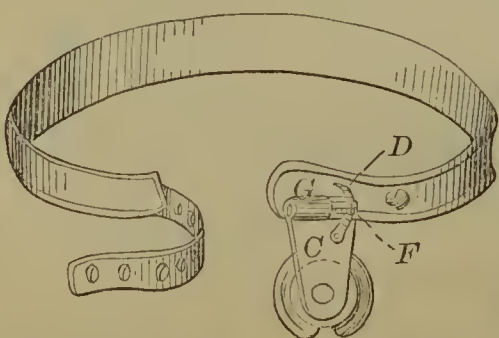

56834—C. A. Todd—Paddle Wheel.

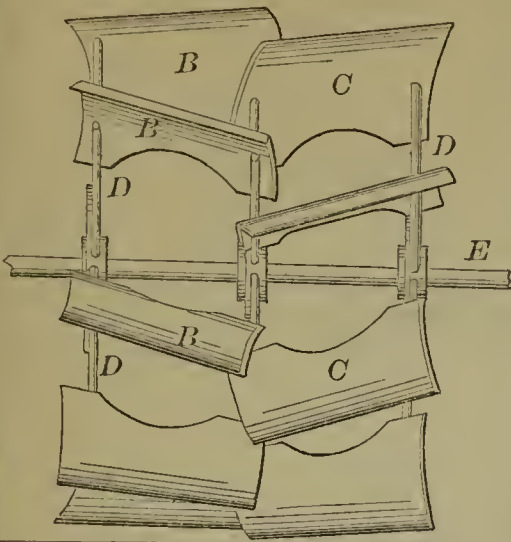

56839—D. R. Warfield—Corn Planter.

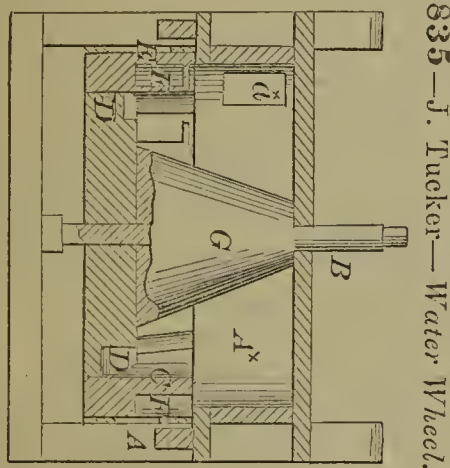
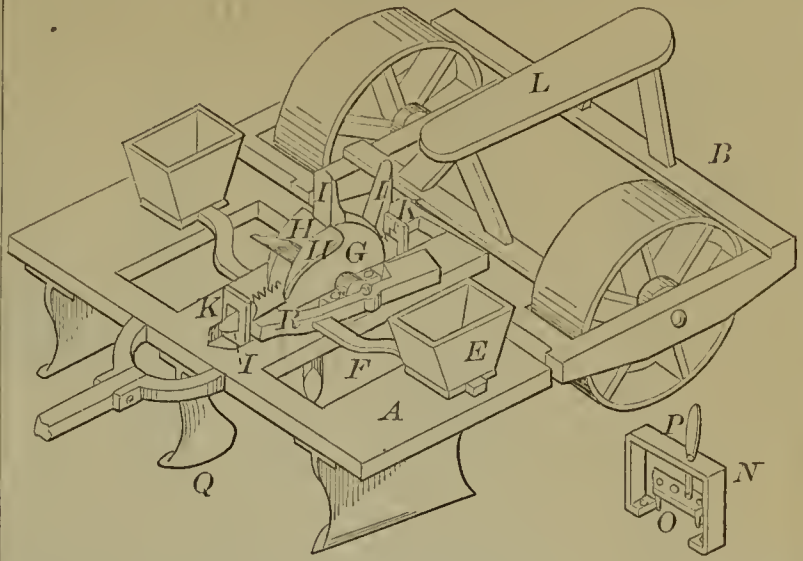

56835—J. Tucker—Water Wheel.

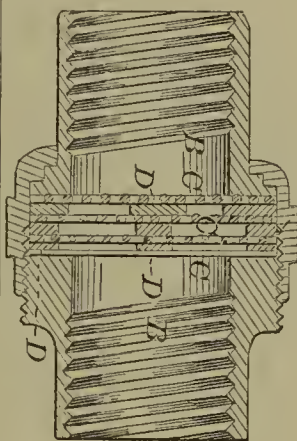

56836—Turrell, Stanton & Ward Gas Pipe Attachment.

56837—W. Van Valkenburgh—Car Coupling.

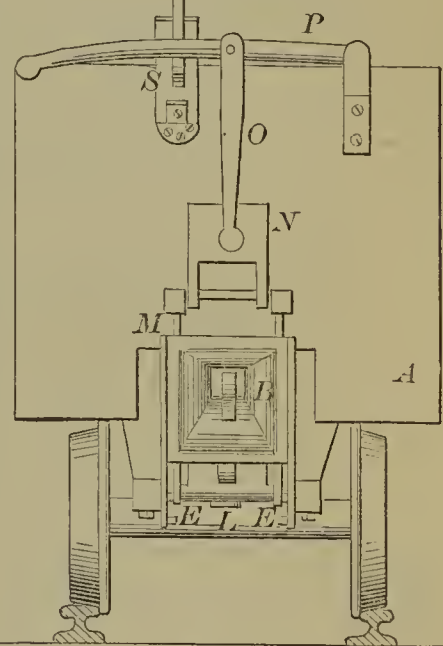

56840—J. Wolfenden—Lathe.

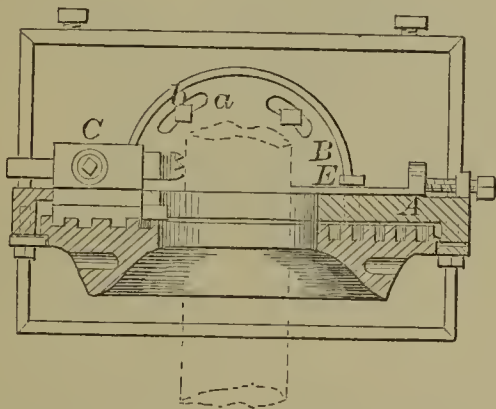

56841—A. H. Woodruff—Slide Valve.

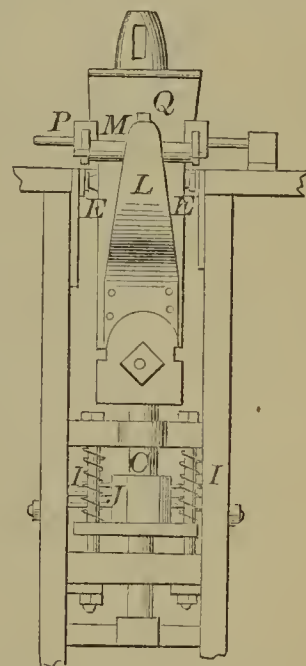
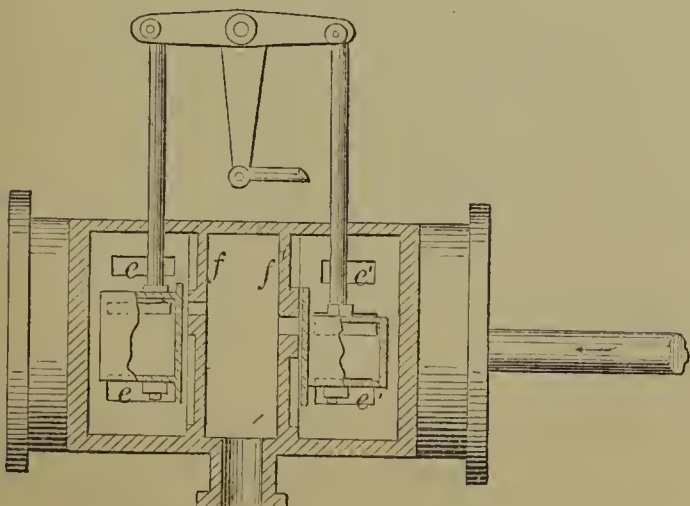

56838—W. G. Ward—Nail Hammer.

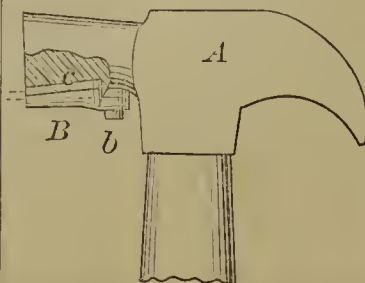

56842—T. D. Worrall—Furnace.

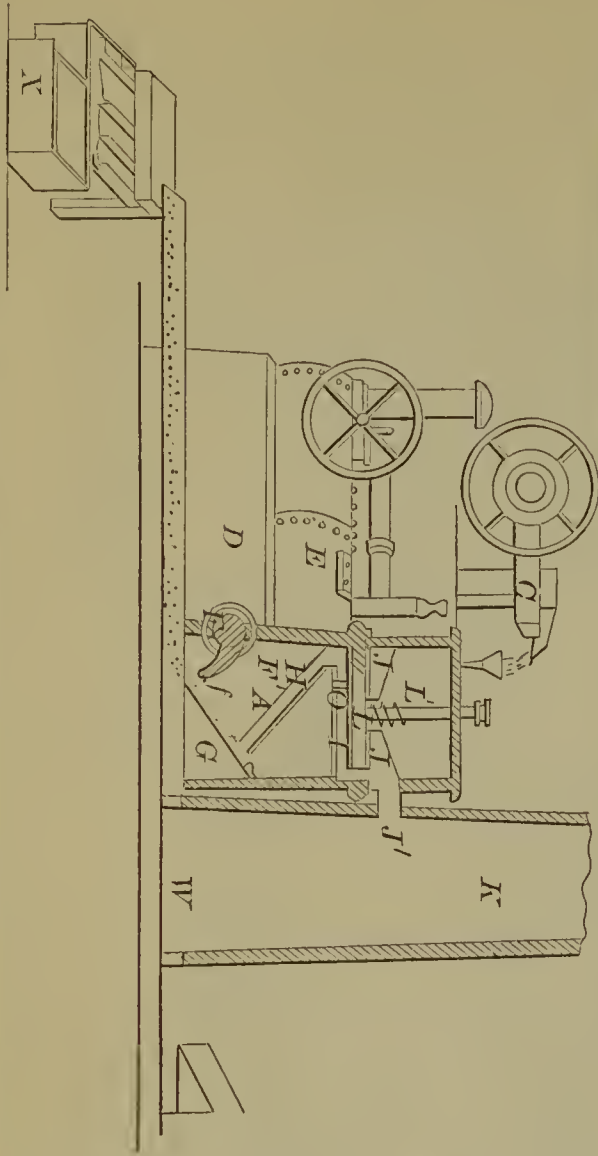

56845—L. B. Alden—Egg Beater.

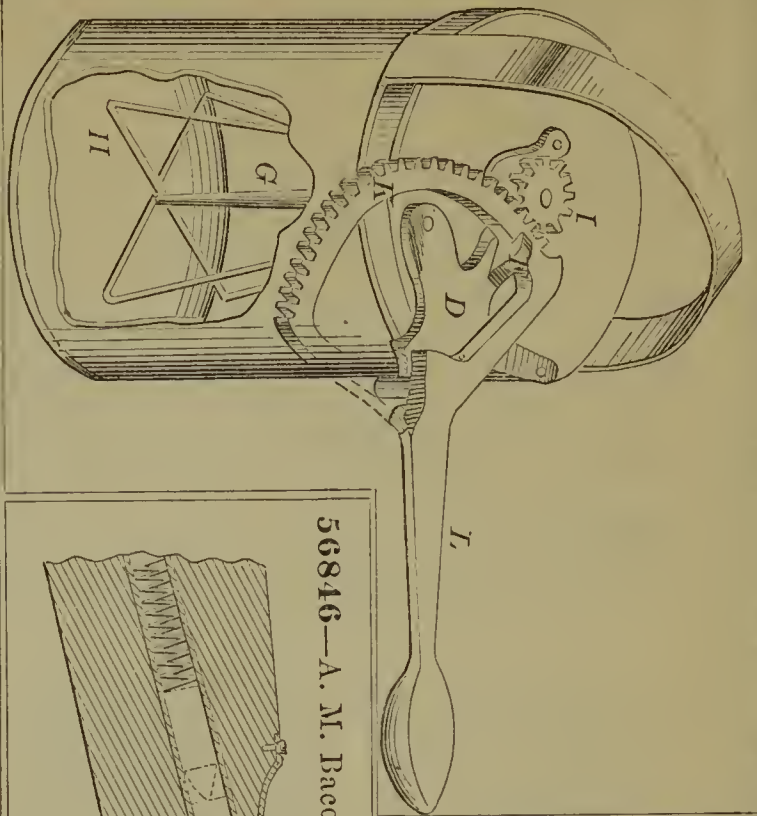

56846—A. M. Bacon—Fire Arm.

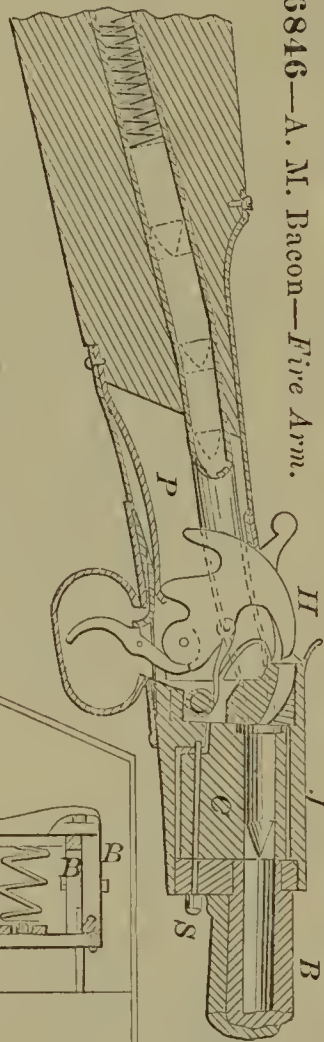

56843—Wren & Barker—Manufacture of Gas.

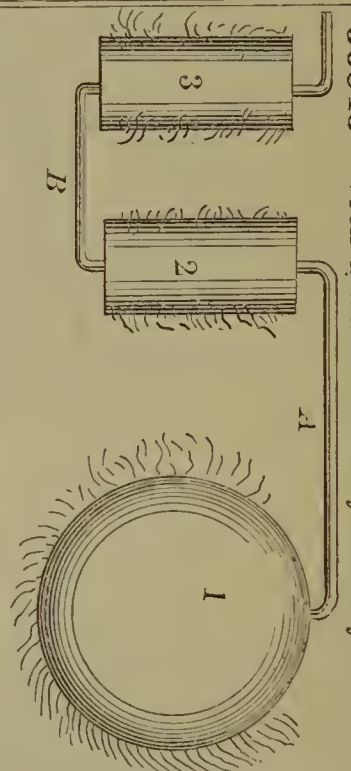

56844—Wilsey & Forbes—Bed Bottom.

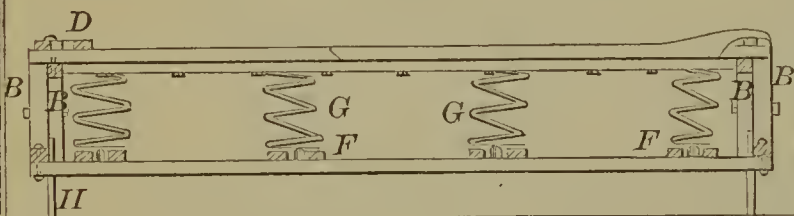

56847—Capron & Winchell—Brick Machine.

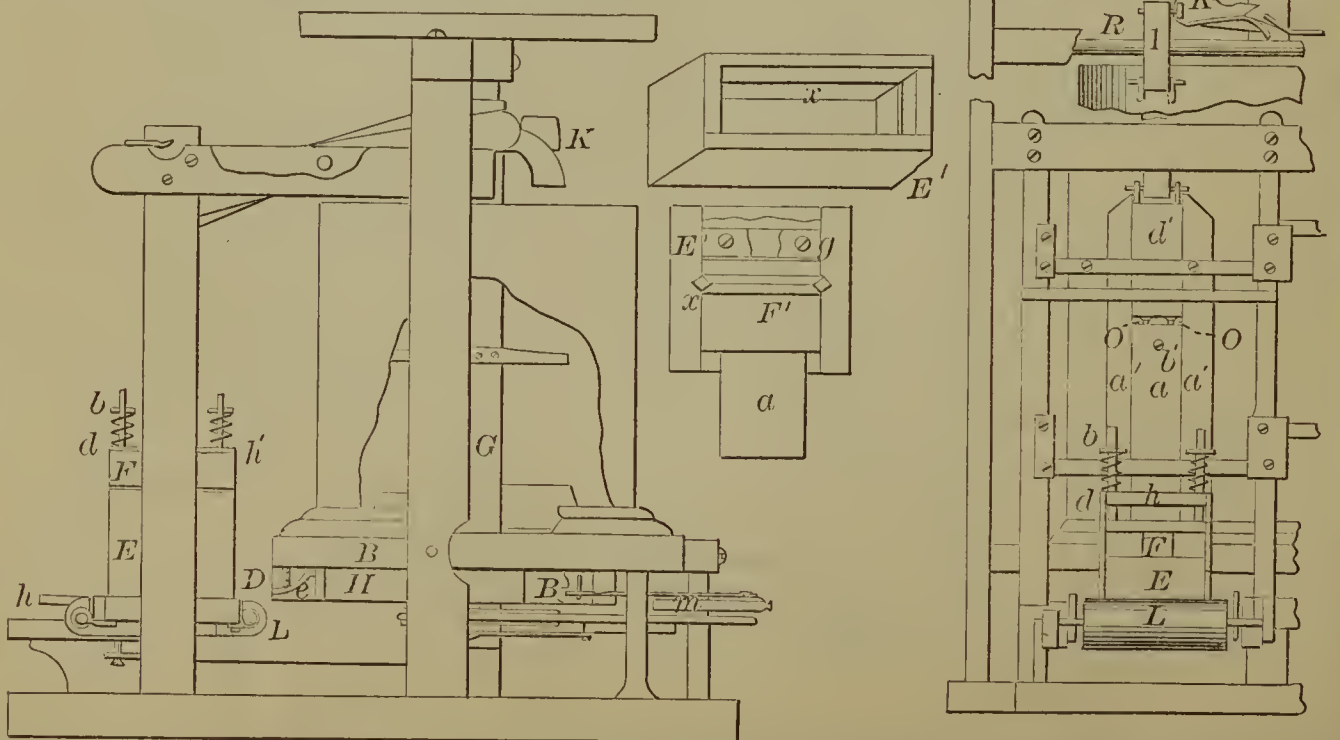

56848—J. D., D. & J. Chase—Water Wheel.

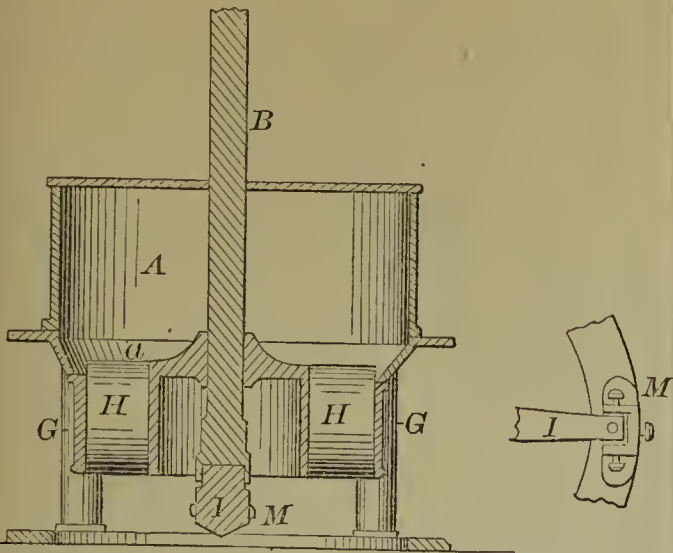

56852—M. P. Euring—For Distilling Petroleum.

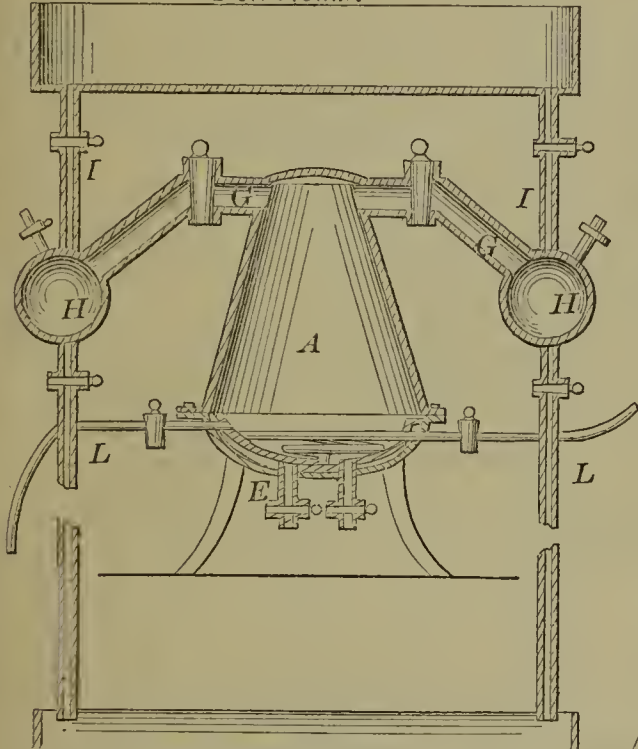

56853—B. Field—Sleeping Car.

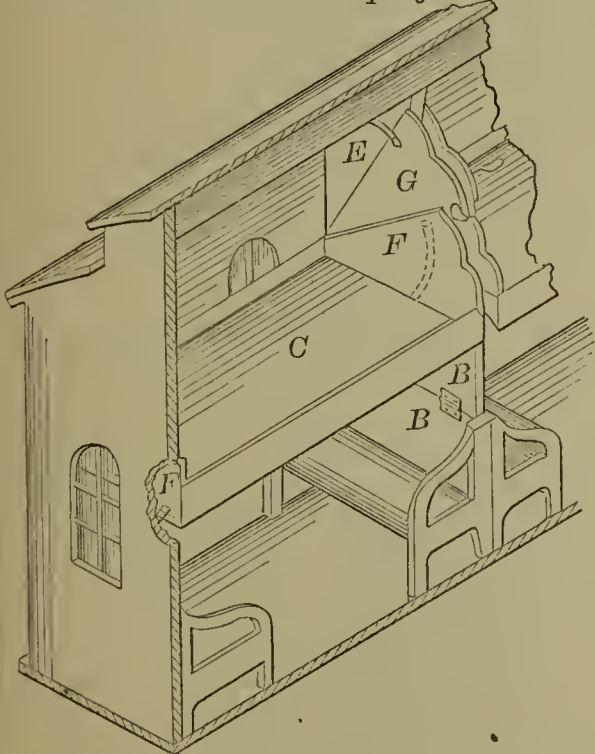

56854—S. Hodgins—Paper Collar Fastening.



56849—D. Daltry—Rod Coupling.

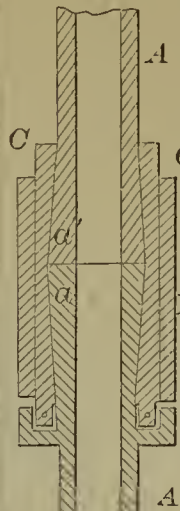

56856—E. C. Little—Steam Pipe and Boiler Covering.

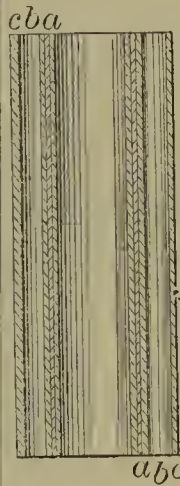

56850—R. Defrees—Rotary Pump.

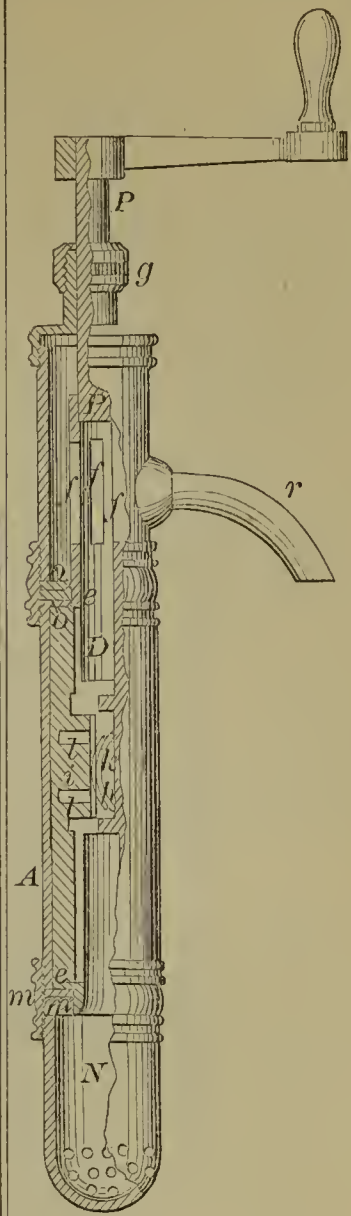

56855—W. Hughes—Life Boat.

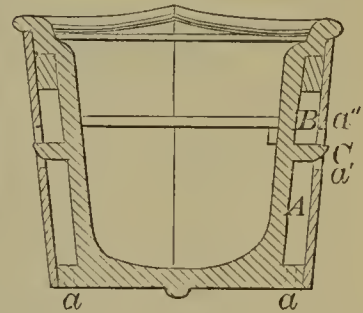

56851—J. B. Drake—Horse Hay Forks.

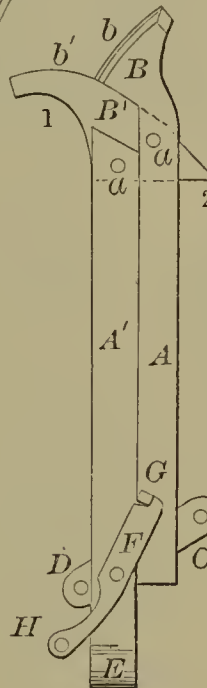

56857—J. R. Martin—Fishing Line.

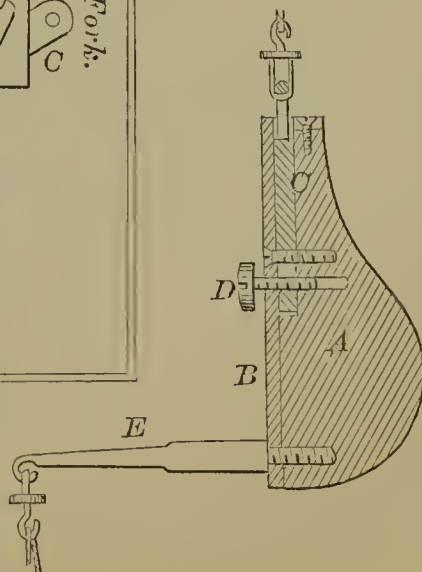

56858—T. C. McKeen—  
For Buoying Vessels.

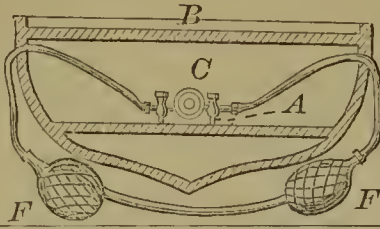

56862—M. Pratt—For  
Smoothing Ivory Key  
Boards.

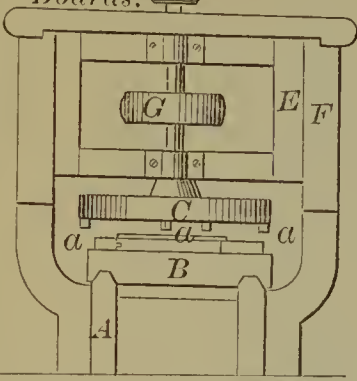

56863—Prentiss &  
Robertson—For Purifying  
Whiskey.

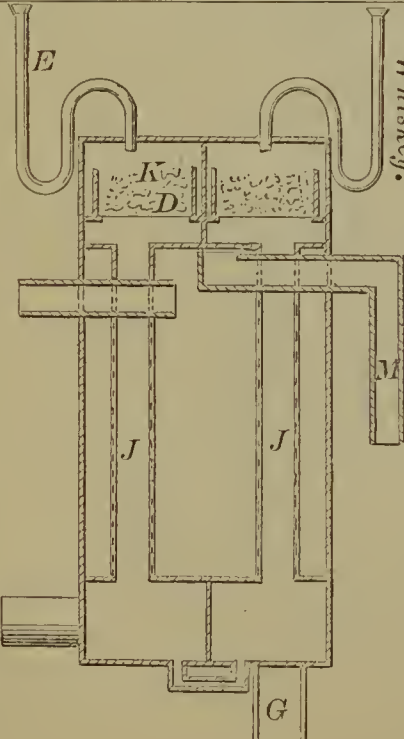
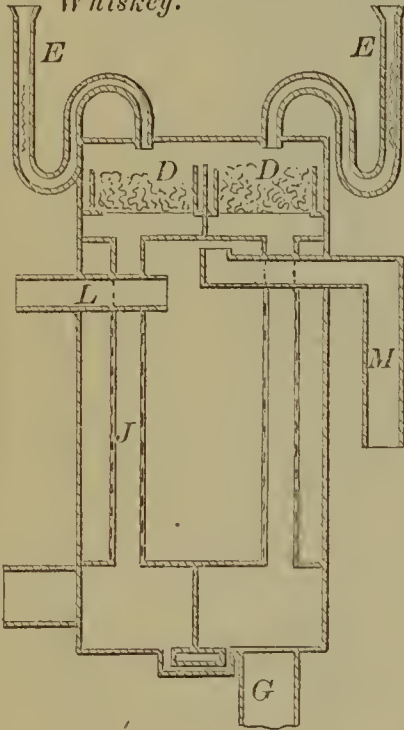

56864—Prentiss & Robertson—For Deodorizing  
Whiskey.

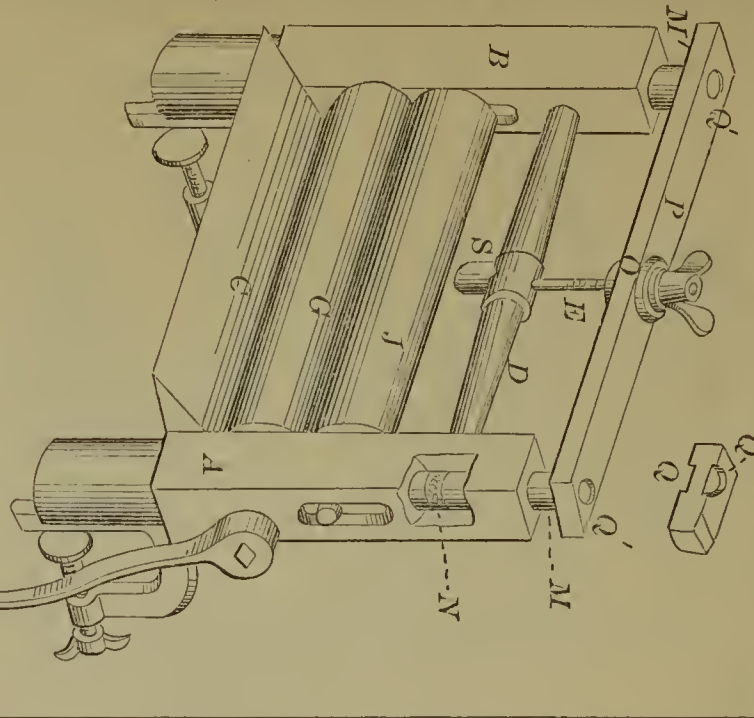

56865—H. Robbins—Clothes Wringer.

56866—

Tickler, Marshall & Marshall—  
Car Coupling.

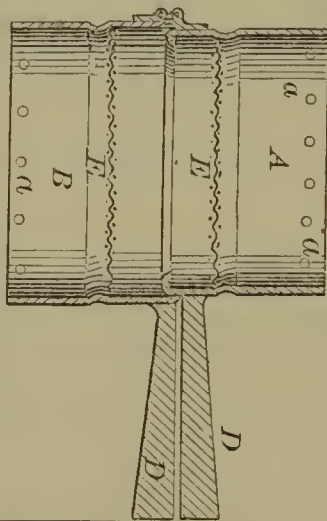
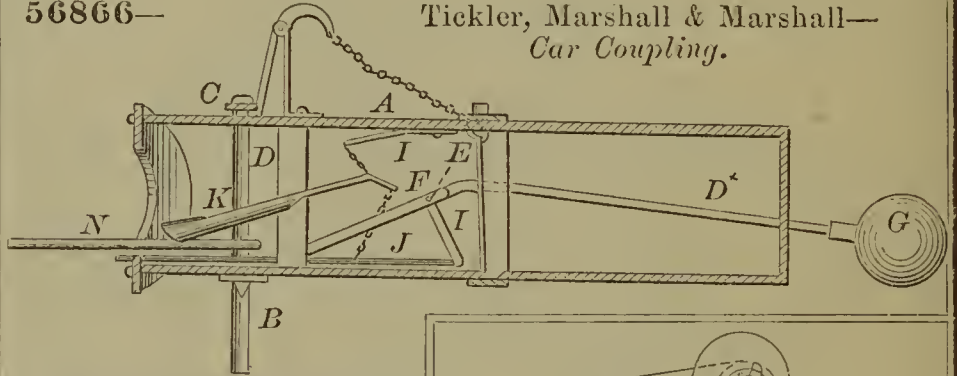

56861—P. Plant—Coffee Roaster.

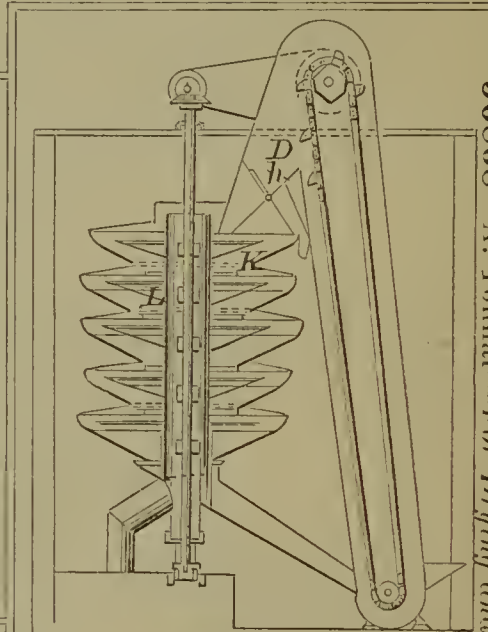

56868—A. Tommar—For Drying and Cleaning Grain.

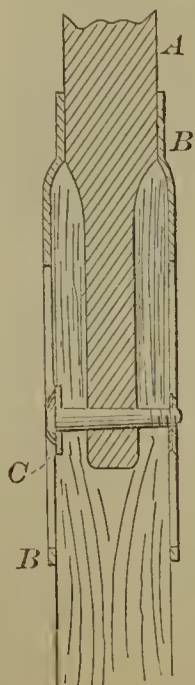

56859—W. A. Middleton—Broom Head.

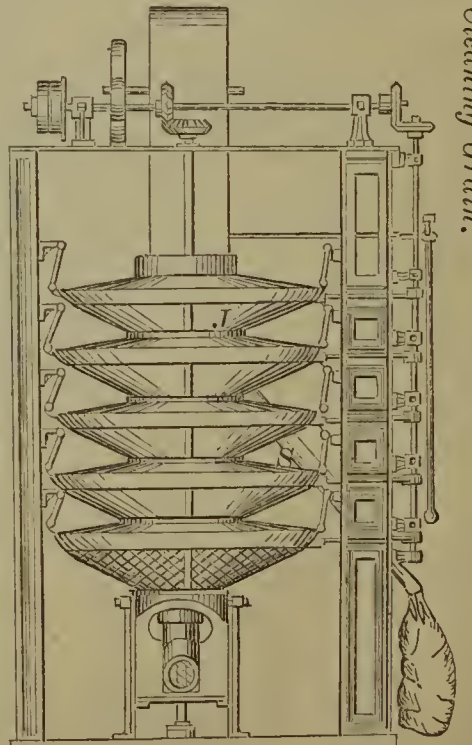



56869—R. Jennings—For Swaging Screw Auger Heads.

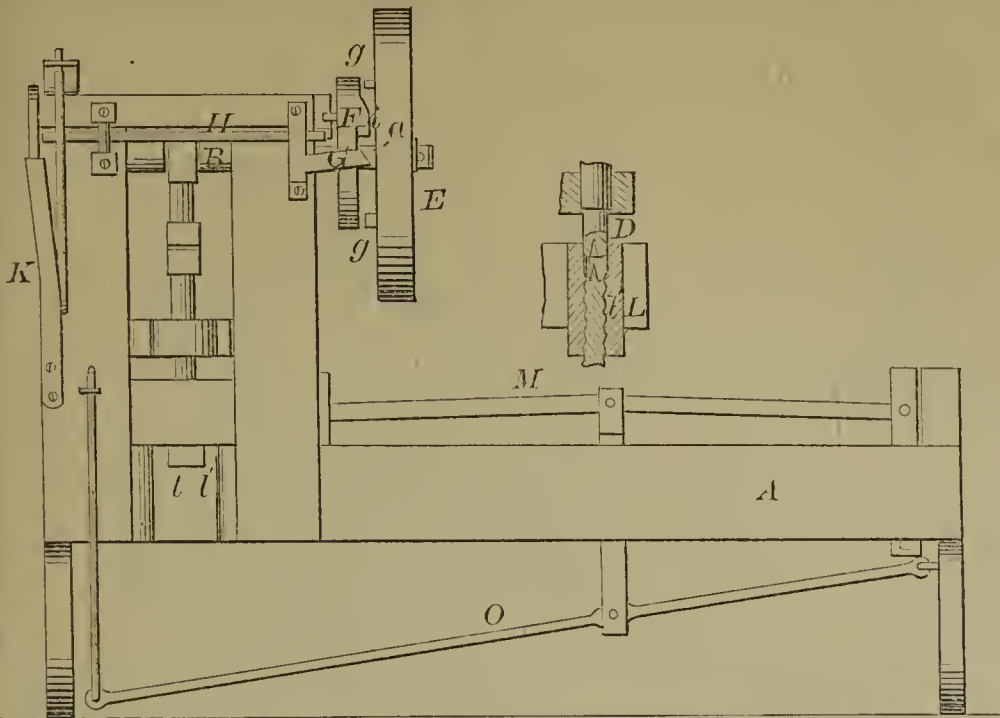

56871—M. J. Atthouse—Pump.

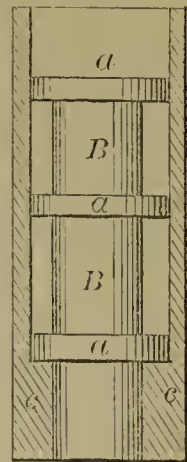

56870—H. J. Alvord—Disinfecting Commode.

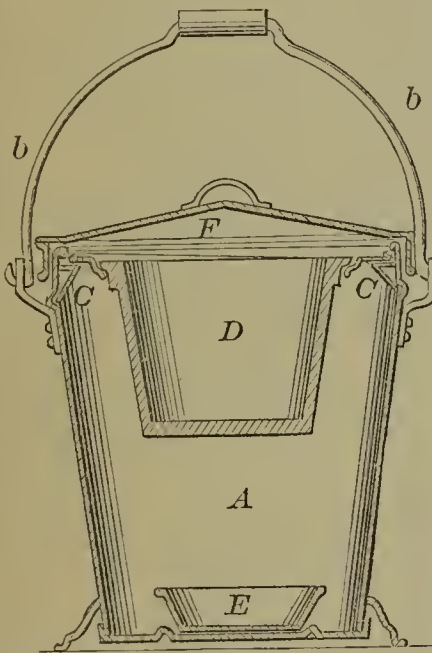

56872—S. D. Arnold—Bridle Bit.

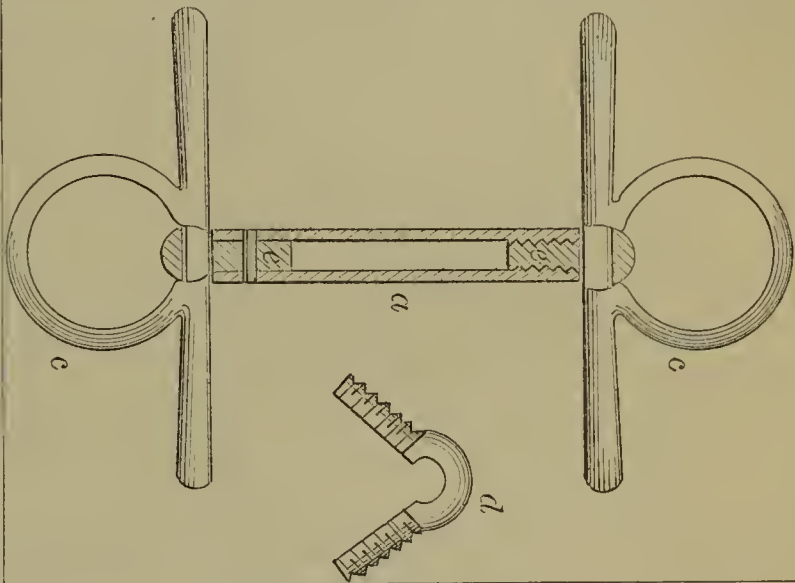

56874—C. L. W. Baker—Coal Scuttle and Sifter.

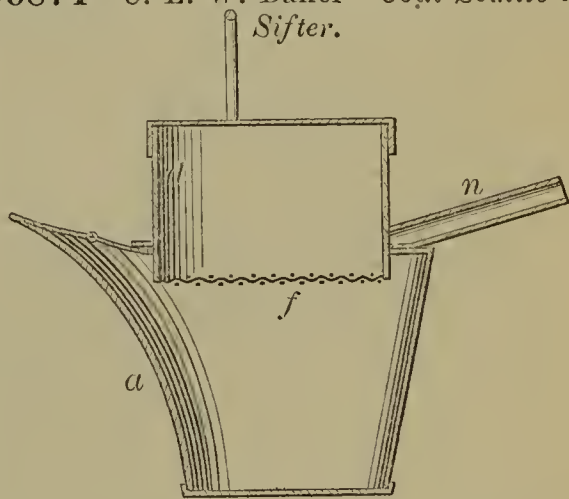

56873—G. H. Babcock—Anchor Stopper.

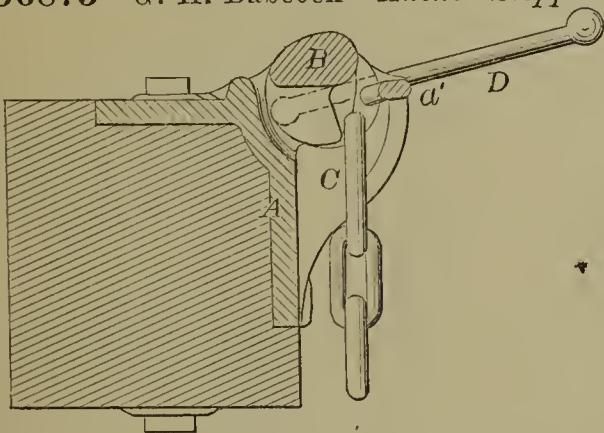

56875—C. A. Bartlett—Side Saddle.

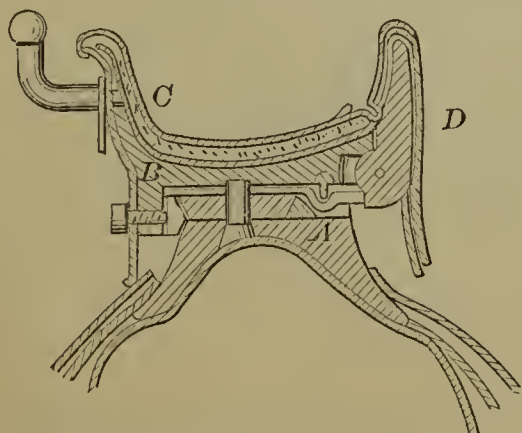

56876—D. W. Bashore—Washstand and Desk.

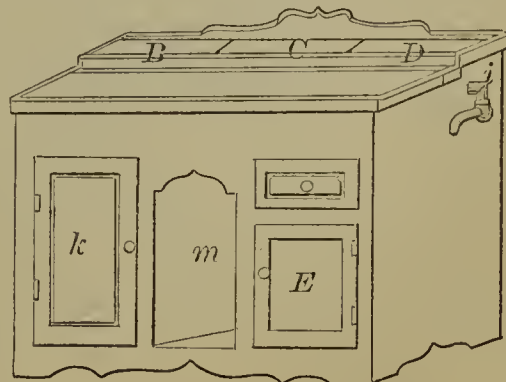

56877—C. Bates—Crushing and Rolling Machine.

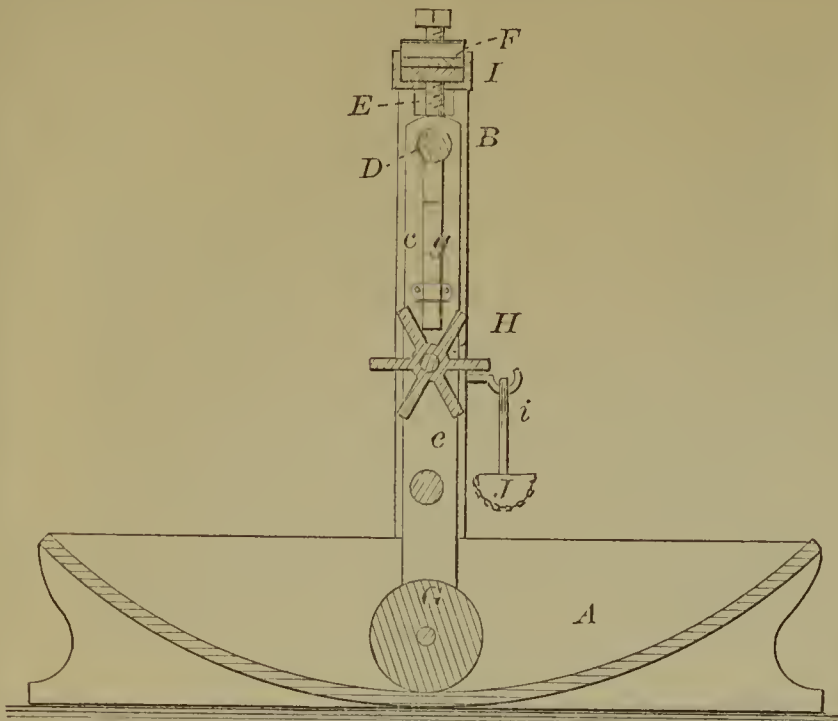

56879—J. Bayliss—Tuyere.

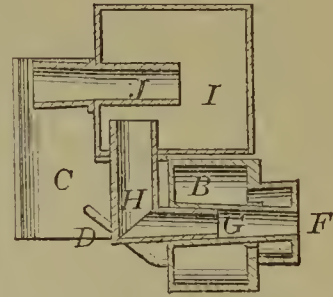
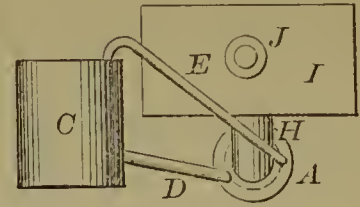

56878—W. Battell—Gang Plow.

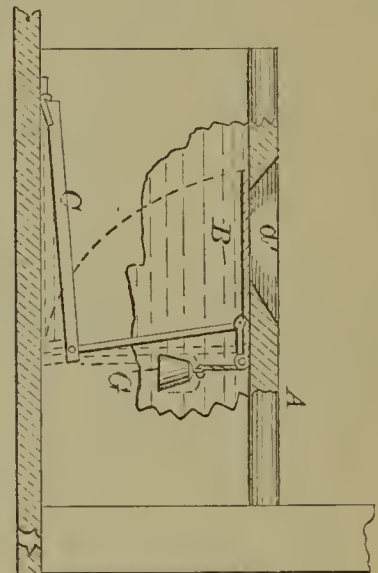
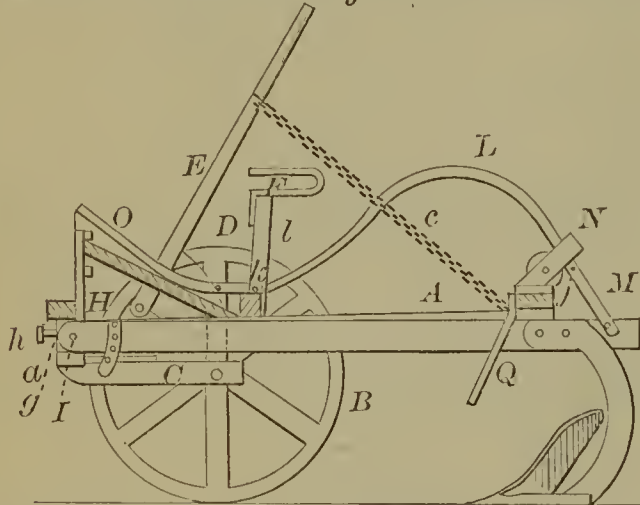

56881—W. Beach—Pry Seat Cover.

56880—C. F. Baylor—Grain Cleaner.

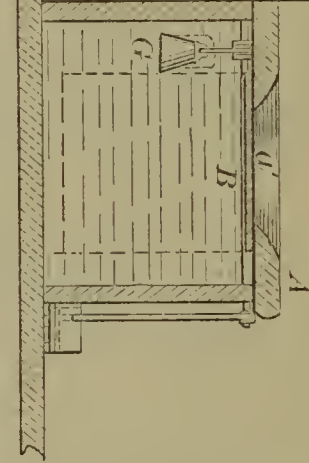
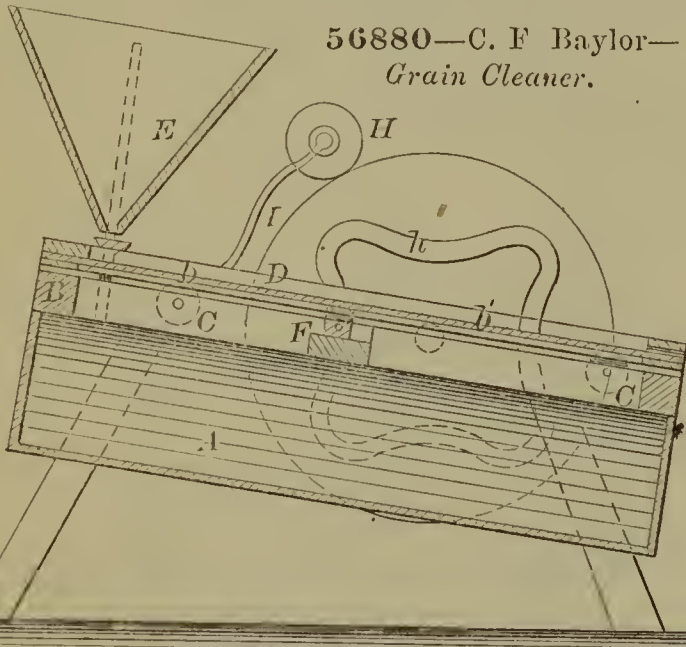

56882—W. L. Beardsley—Last.

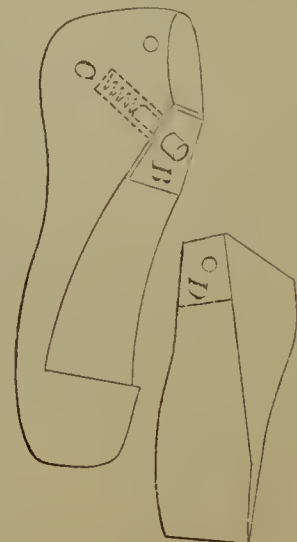

56883—J. Bell—Stave Cutting Machine.

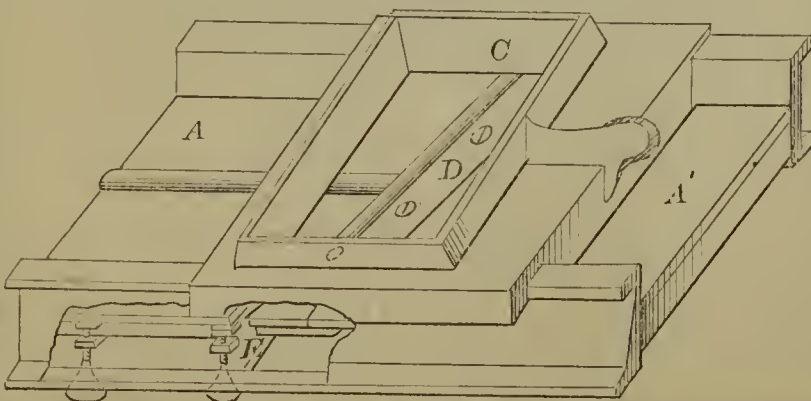

56884—A. C. Betts—For Driving Staples.

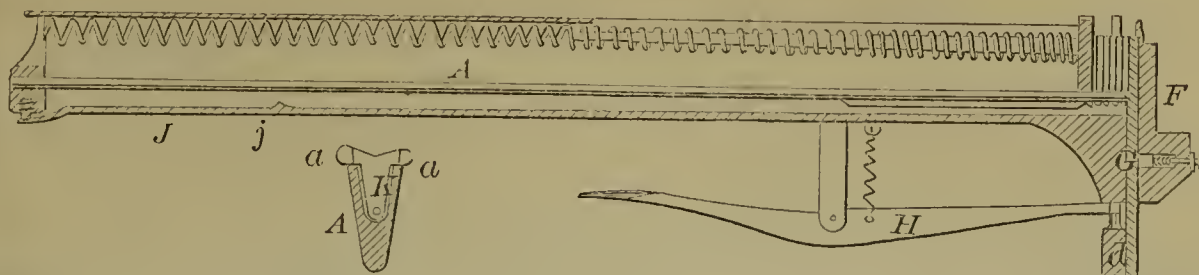

56885—C. E. Billings—Die for Swaging Pistol Frames.

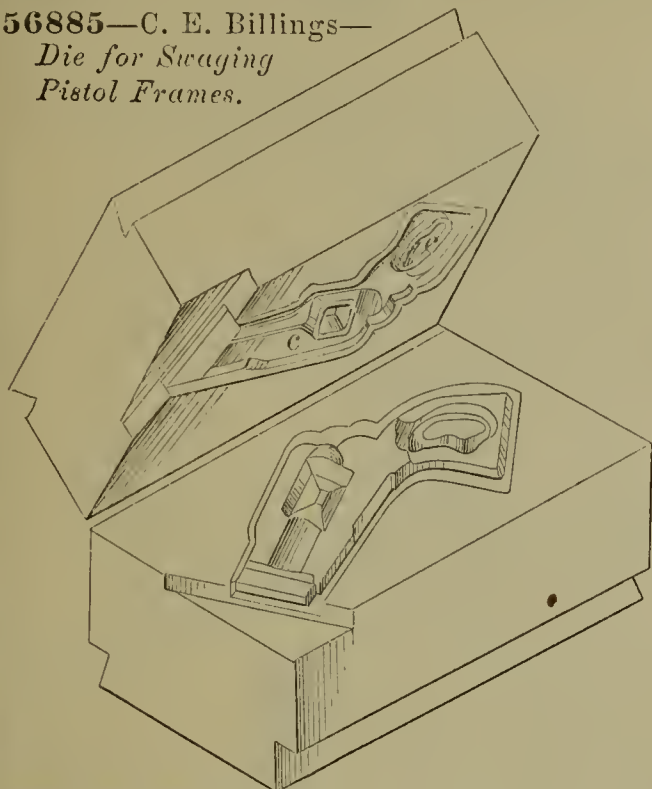

56886—J. Blackie—Electric Telegraph.

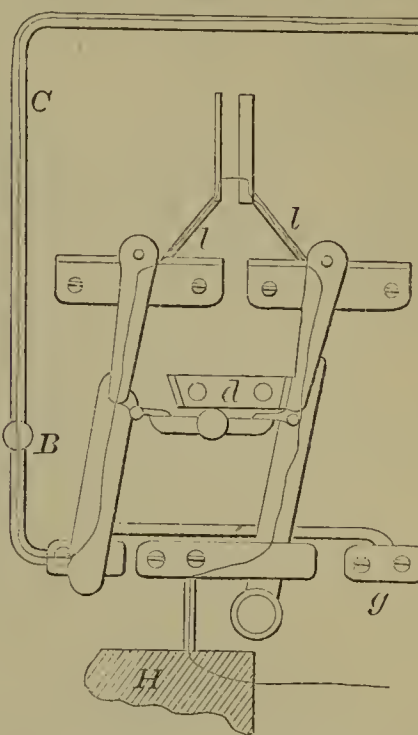

56887—J. C. Blythe—Flour Bolt.

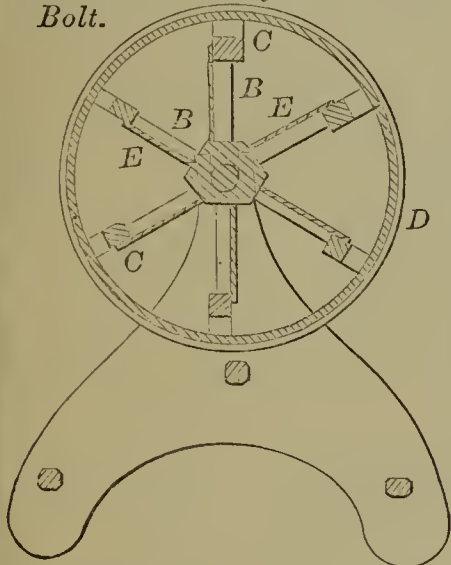

56888—G. Bonnet—Horse Shoe.

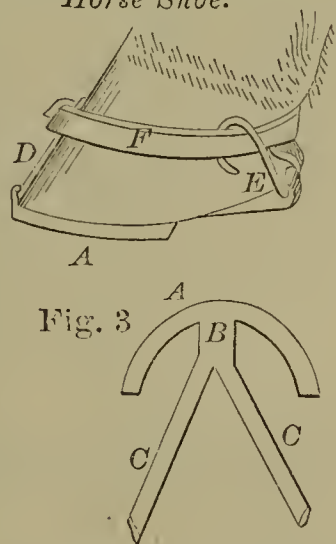

56890—I. Bradley—Five Arm.

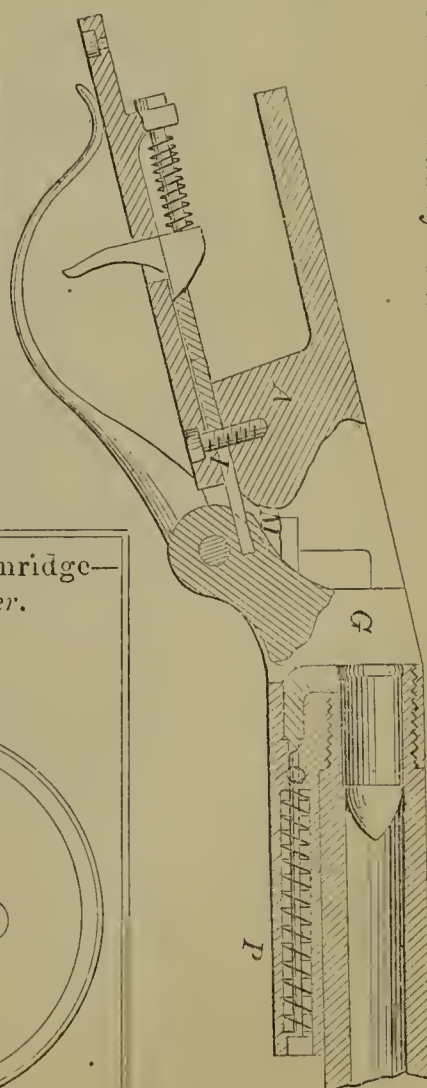

56889—W. Boynton—Tapping Barrels.

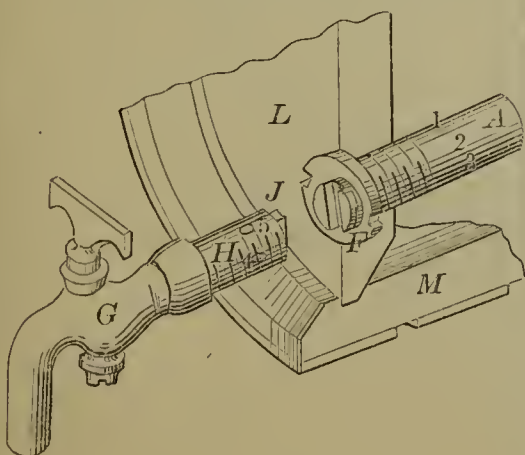

56891—R. M. Breckinridge—Stove Pipe Damper.

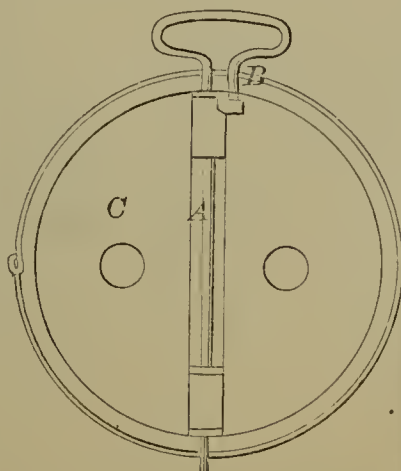



56892—S. O. Brigham—Body Conformator.



56893—R. Brown—Reaping and Mowing Machine.

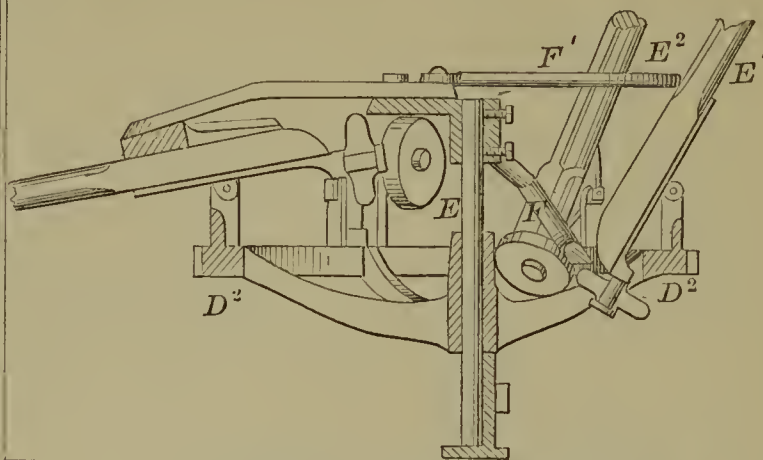
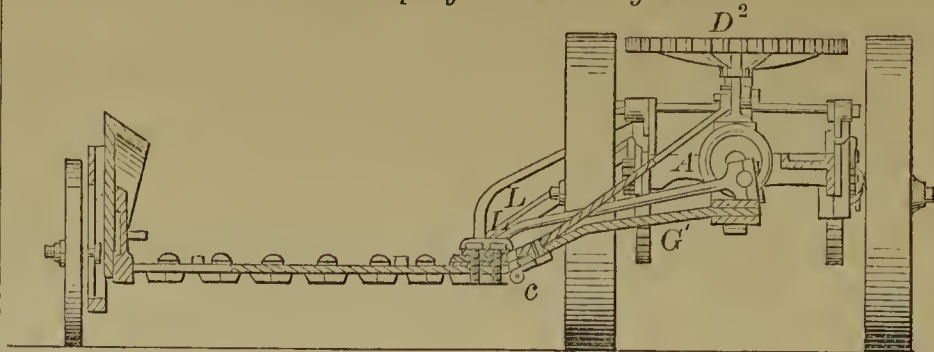

56894—W. H. Brown—Bag Fastener.

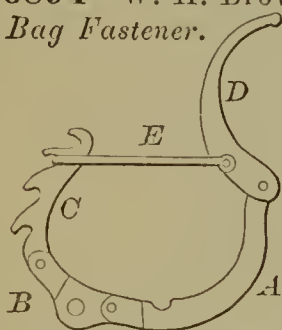

56897—E. B. Butler—For Making Eyelets.

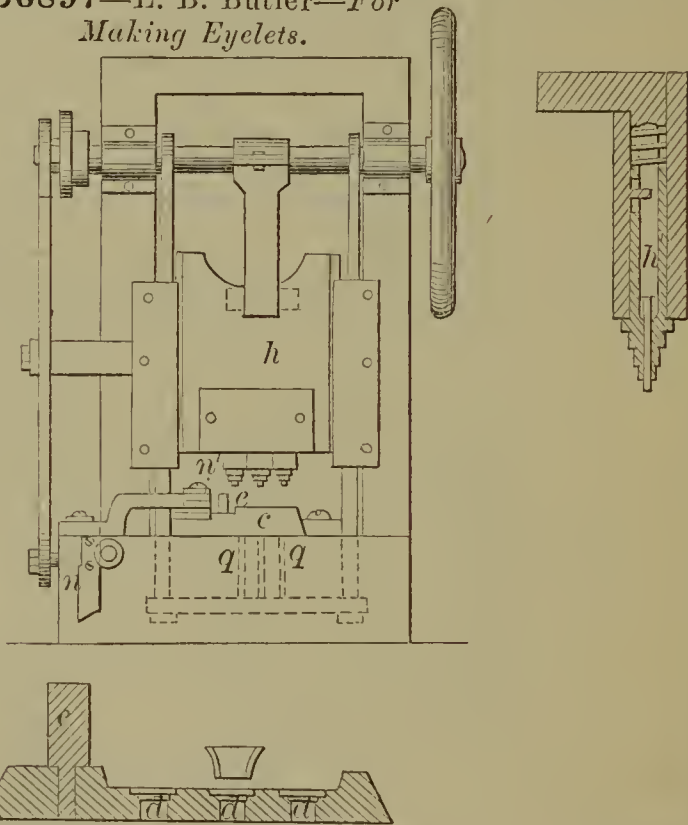

56898—S. G. Cabell—Operating Steam Engines.

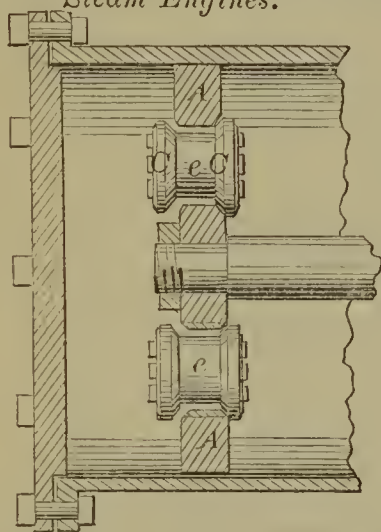

56895—W. H. Brown—Fence.

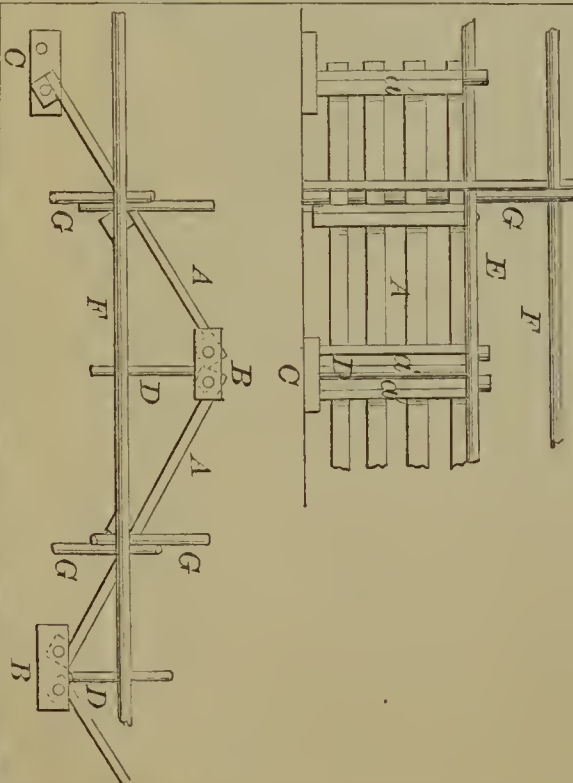

56900—Cantner & Uhlrich—Horse Netting.

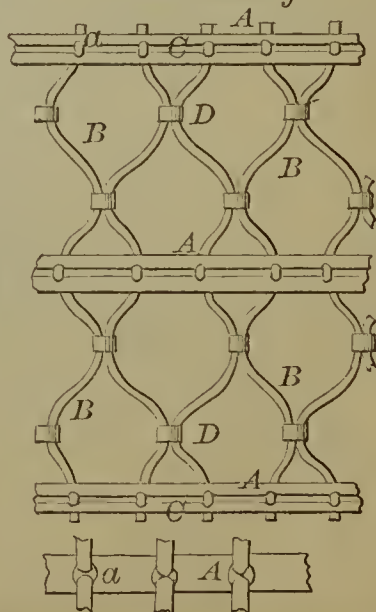

56899—S. G. Cabell—Piston for Steam Engines.

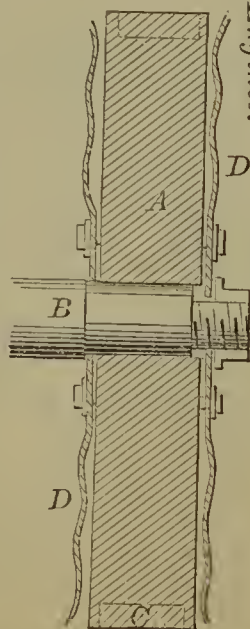

56901—J. Carlin—Wheel.

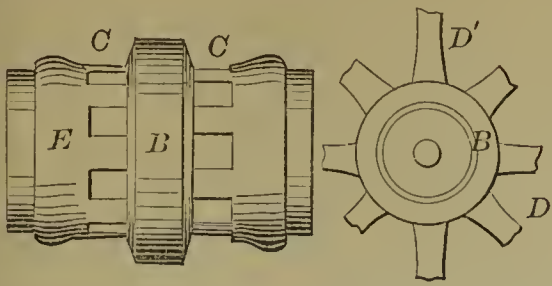

56905—C. W. Copeland—Tube Thimble.

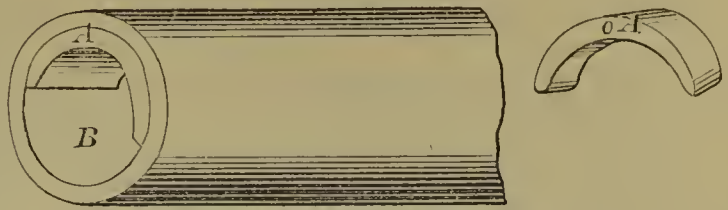

56904—J. S. Clarke—Butter Tongs.

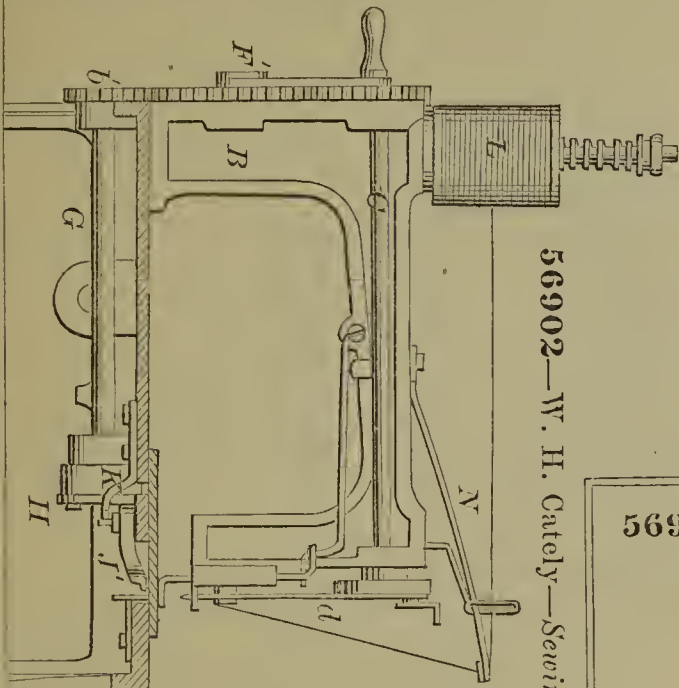
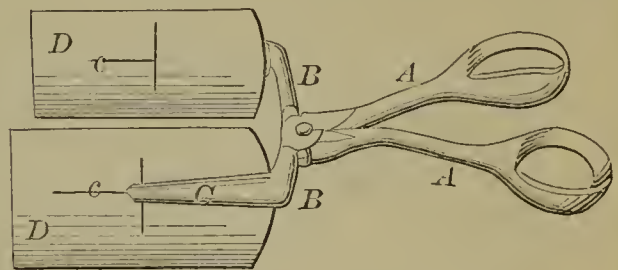

56902—W. H. Cately—Sewing Machine.

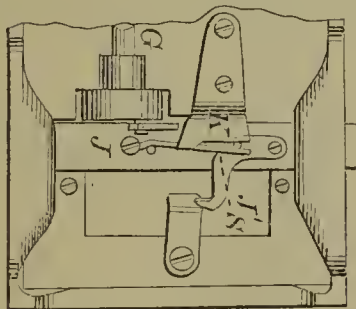

56907—W. E. Davis—Propeller Screw.

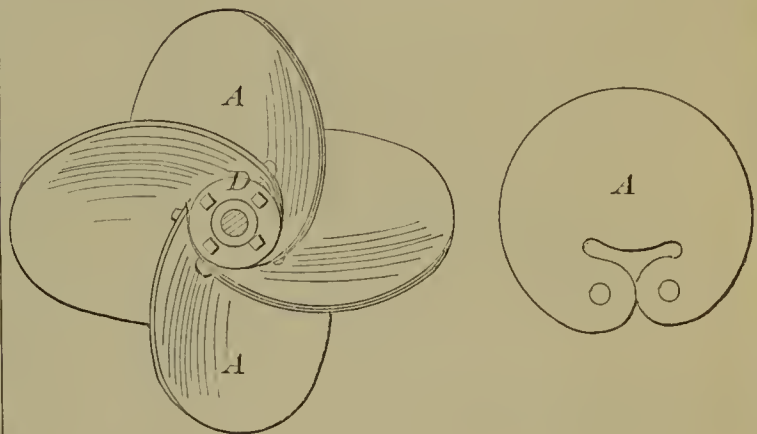

56906—J. Dable—For Unloading Cars.

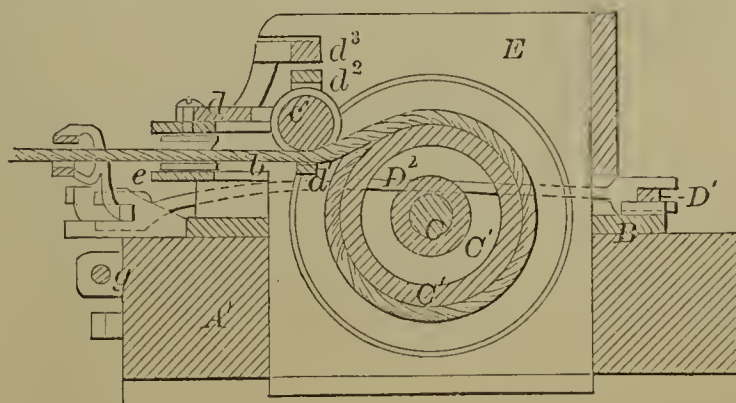
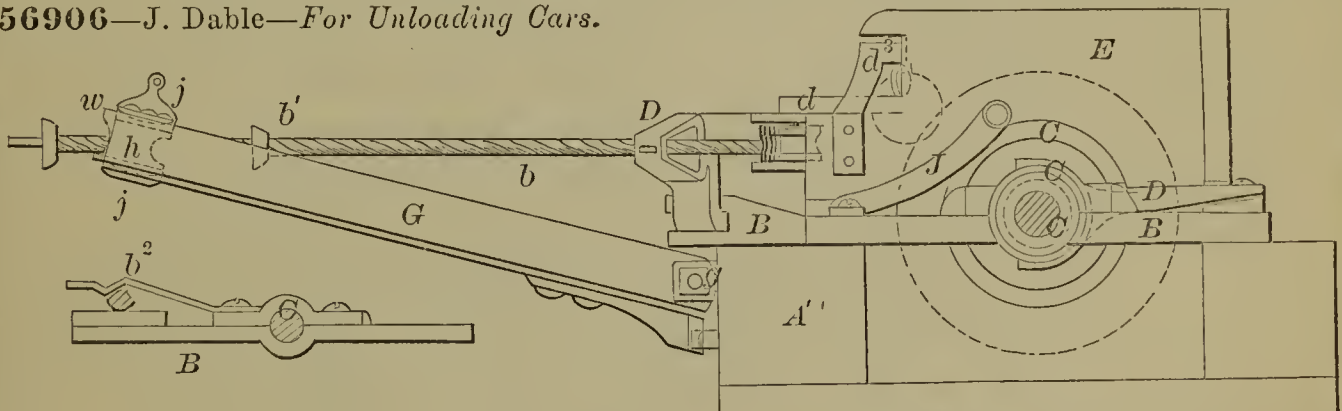

56908—J. Degnon—Governor.

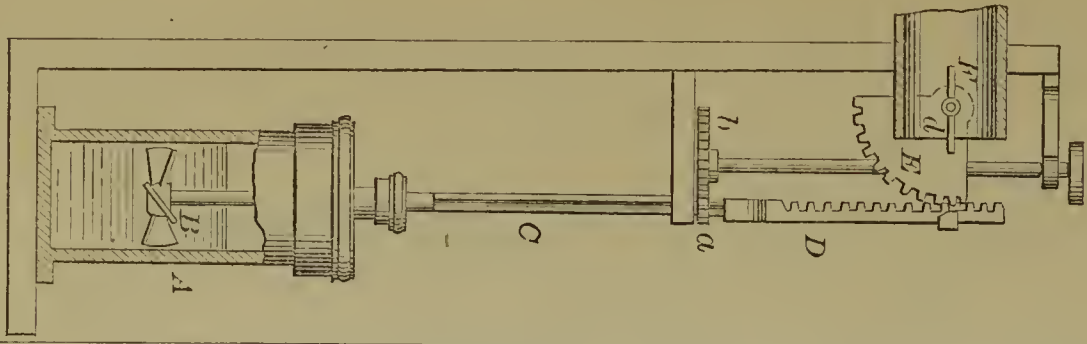

56911—Durant & Grissirn—Washing Machine.

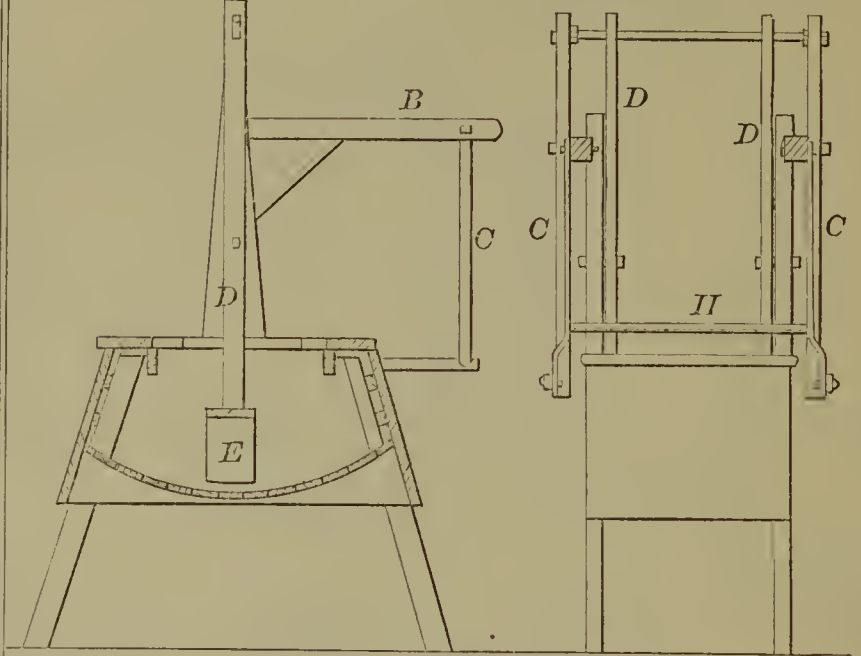

56910—W. M., E. P. & E. Doty—Washing Machine.

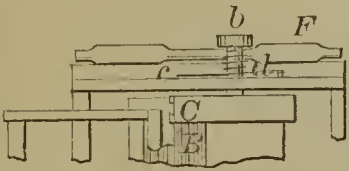
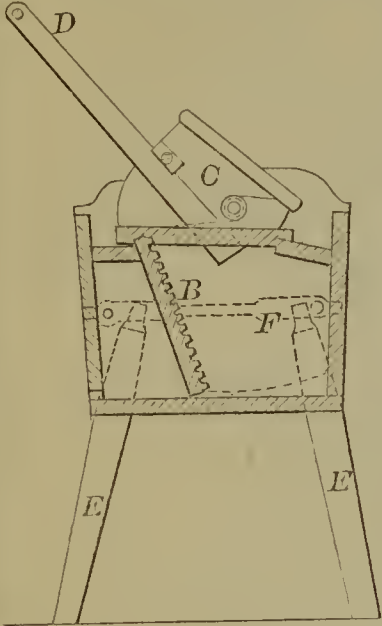

56909—A. L. Dewey—Sewing Machine.

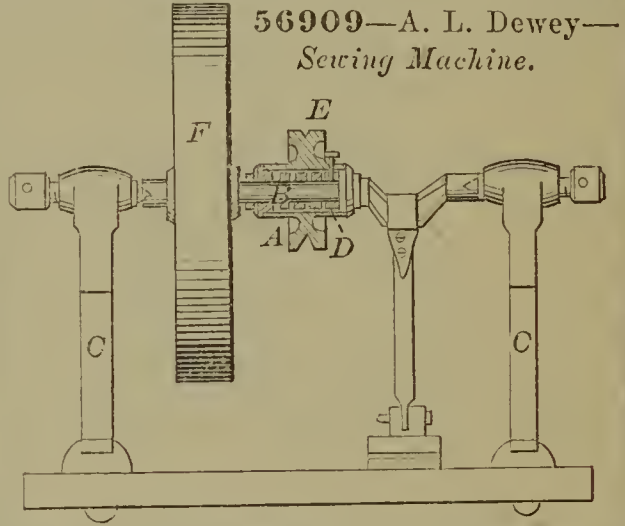

56913—H. Elliott—Power Loom.

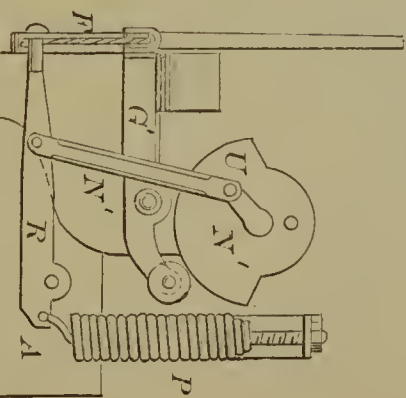
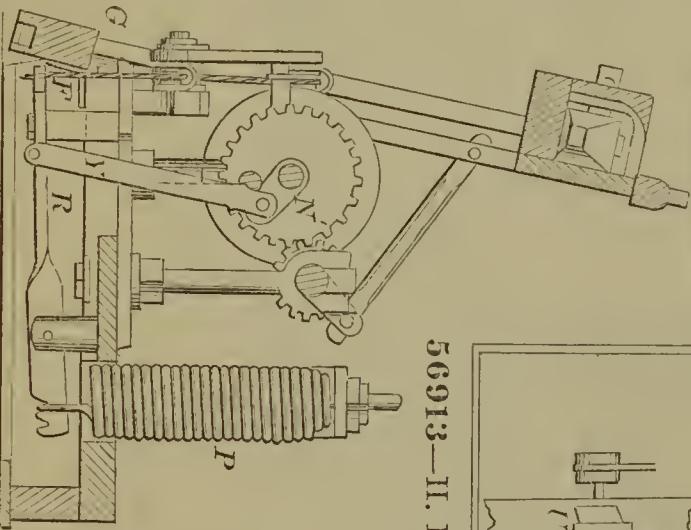

56912—C. K. Ehle—Tearing Mill.

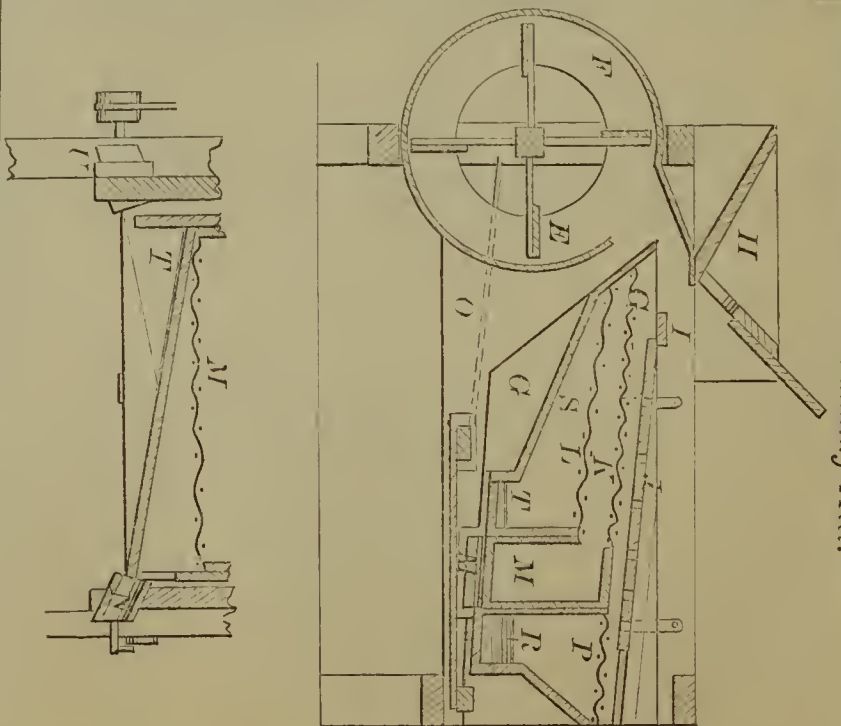

56919—J. Fieldhouse—Furnace.

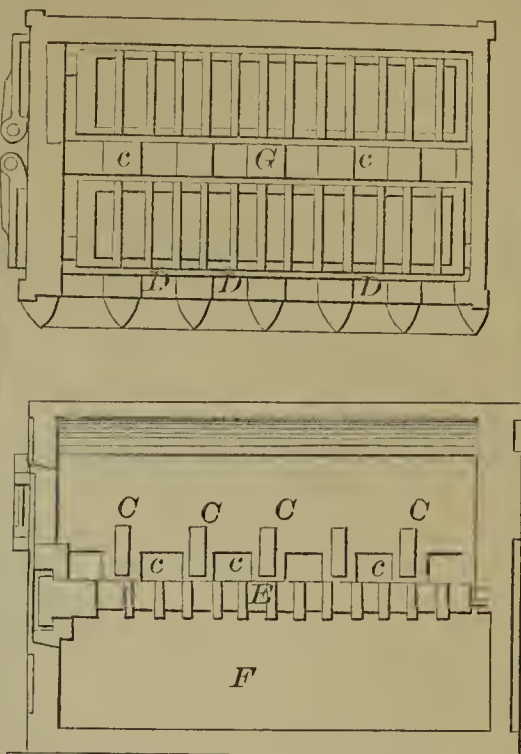

56917—Perl & Larkins—Fishing Apparatus.

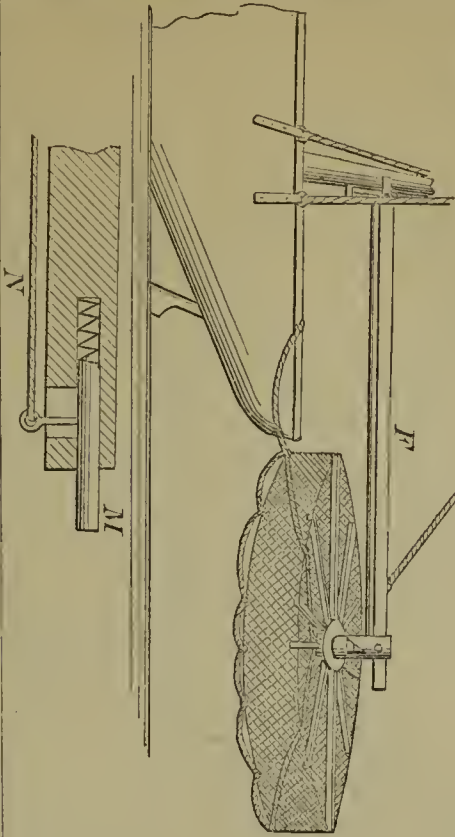

56915—J. Evans—Crane for Mines.

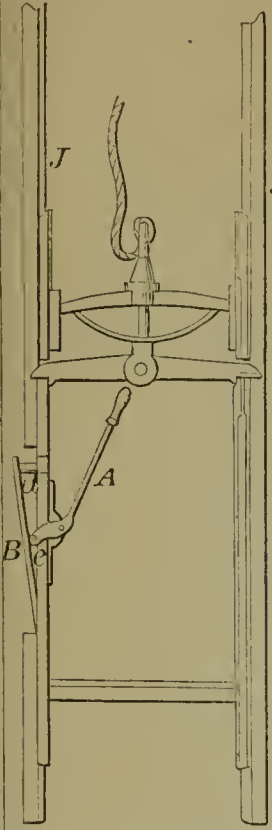

56922—J. Goulding—Spinning Mule and Jack.

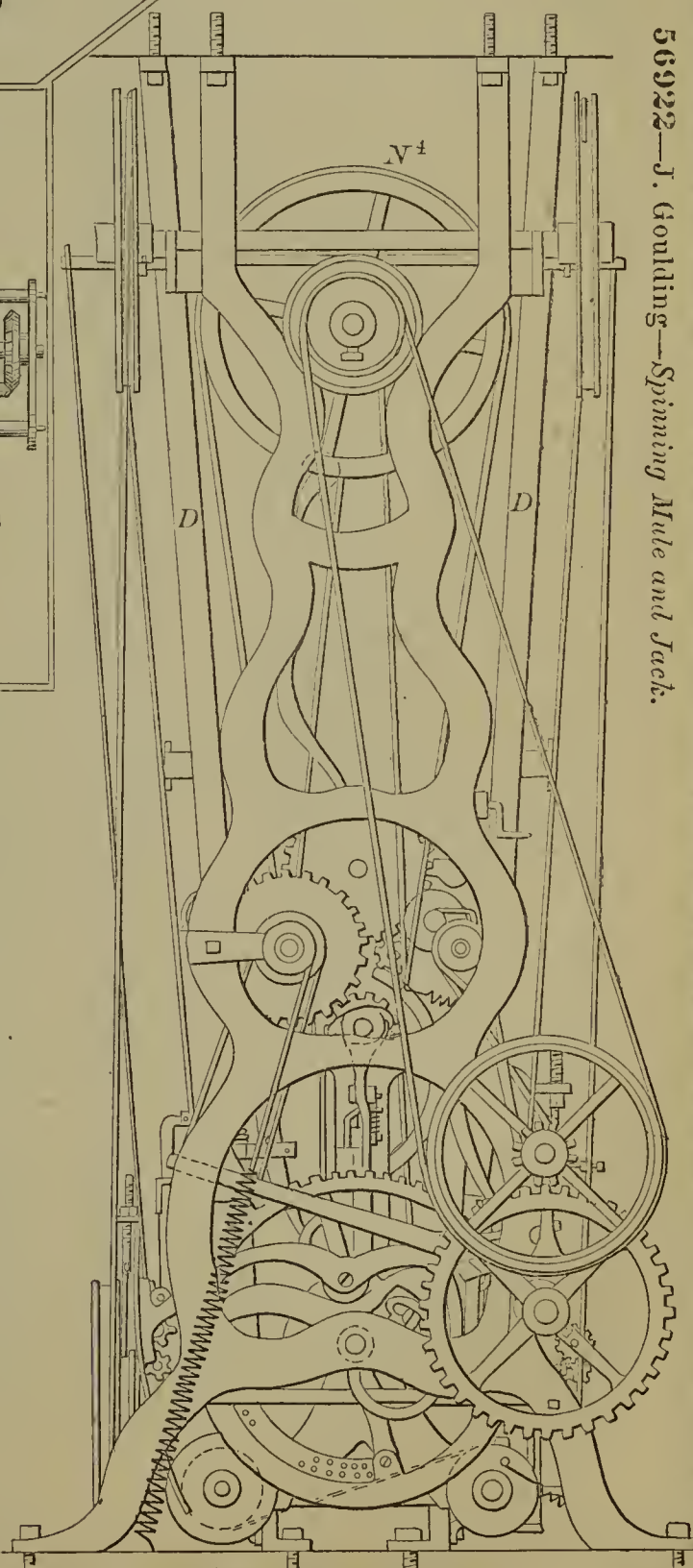

56918—W. S. Ferrier—Churn.

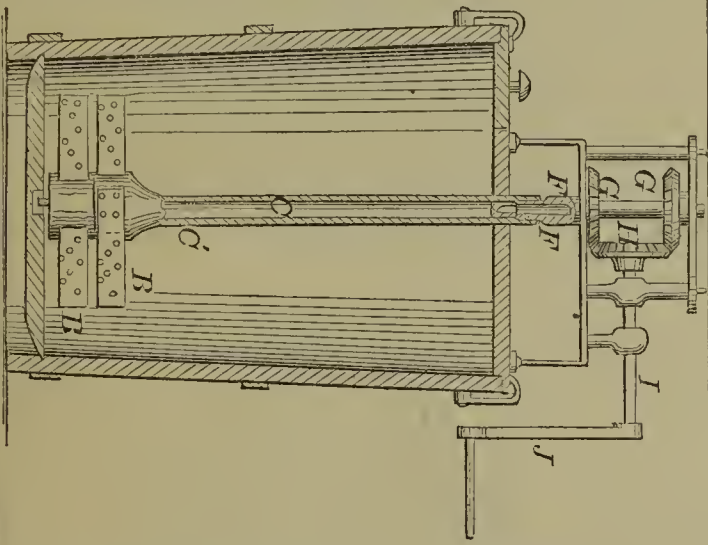

56916—M. W. Everitt—For Tempering Chisels.

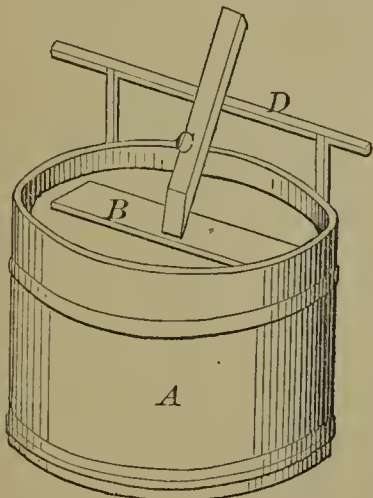

56920—J. T. Foster—Pen Holder.



56921—S. T. Fowler—Boots and Shoes.

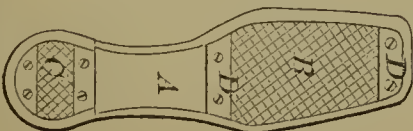

56923—F. N. Frost—*Bridle Bit.*

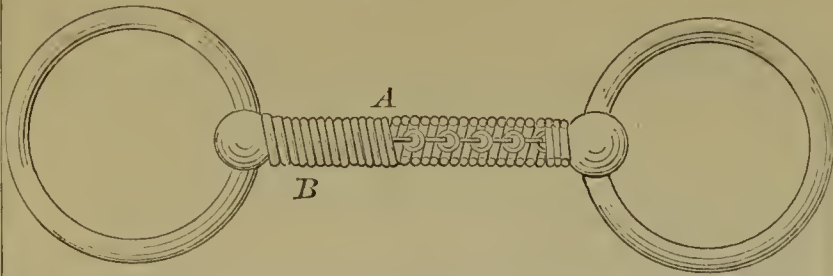

56927—N. B. Gousha—*Hydrant.*

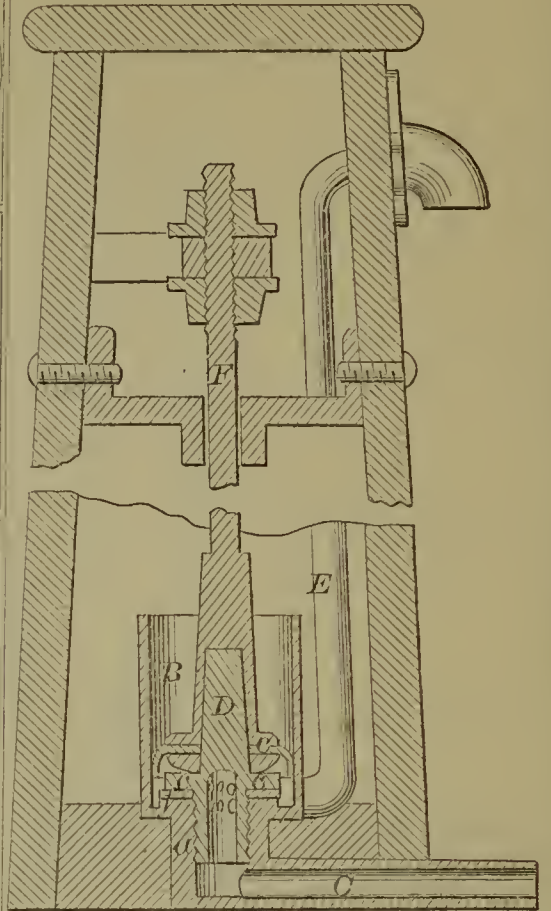

56926—S. L. George—*Clothes Dryer.*

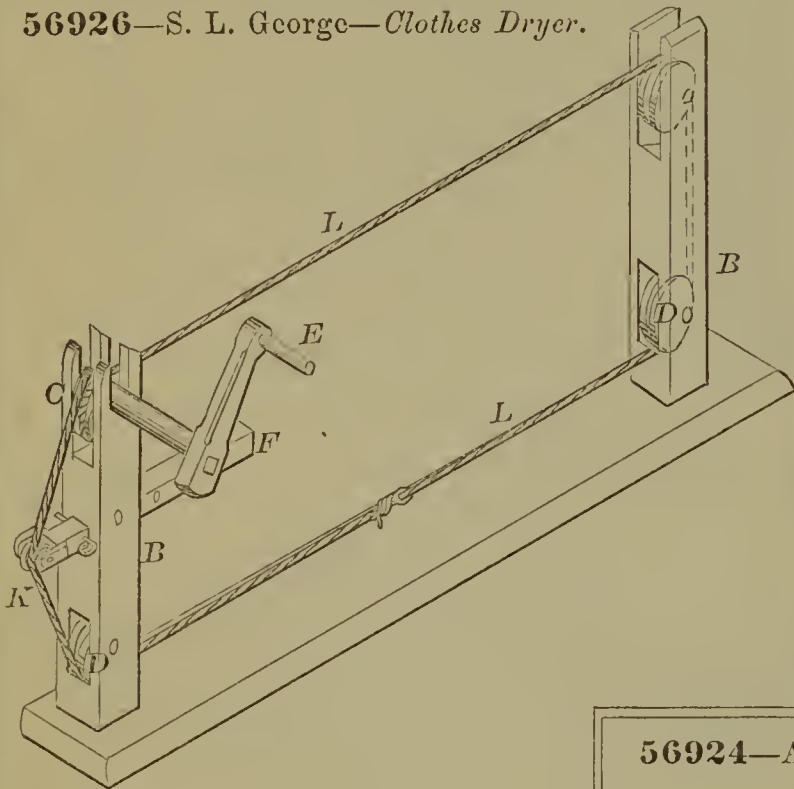

56924—A. Fuller—*Hay Loader.*

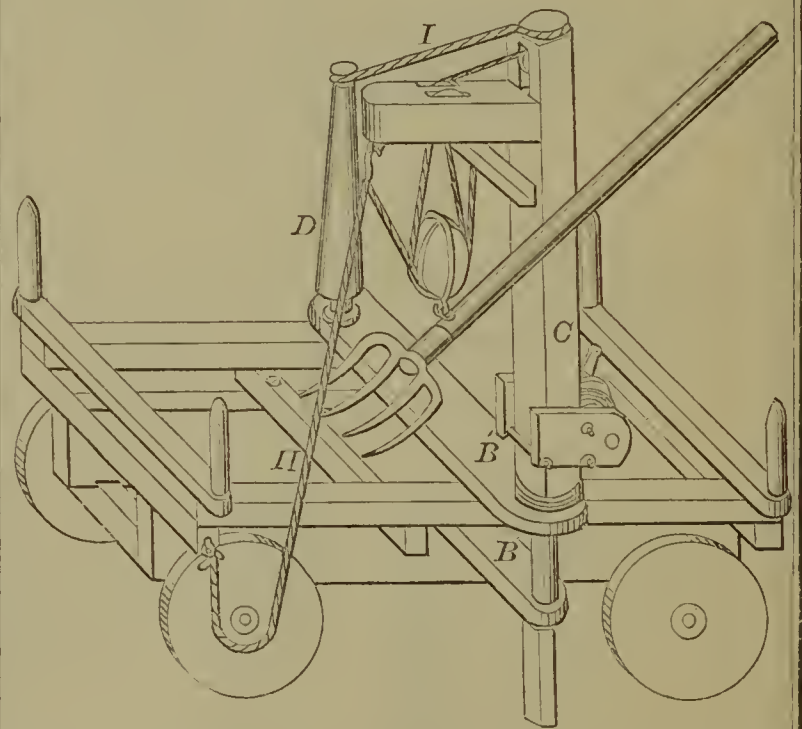

56925—A. P. Garretson—*Loom.*

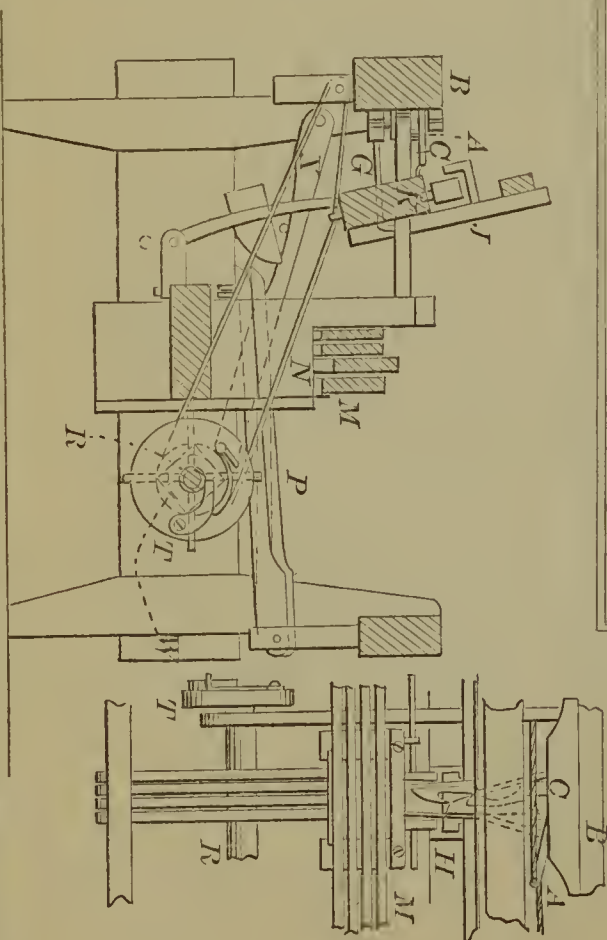

56928—Grier & Boyd—*Scissors.*

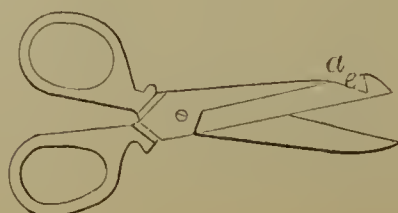



56929—J. A. Griggs—Head Block for Saw Mills.

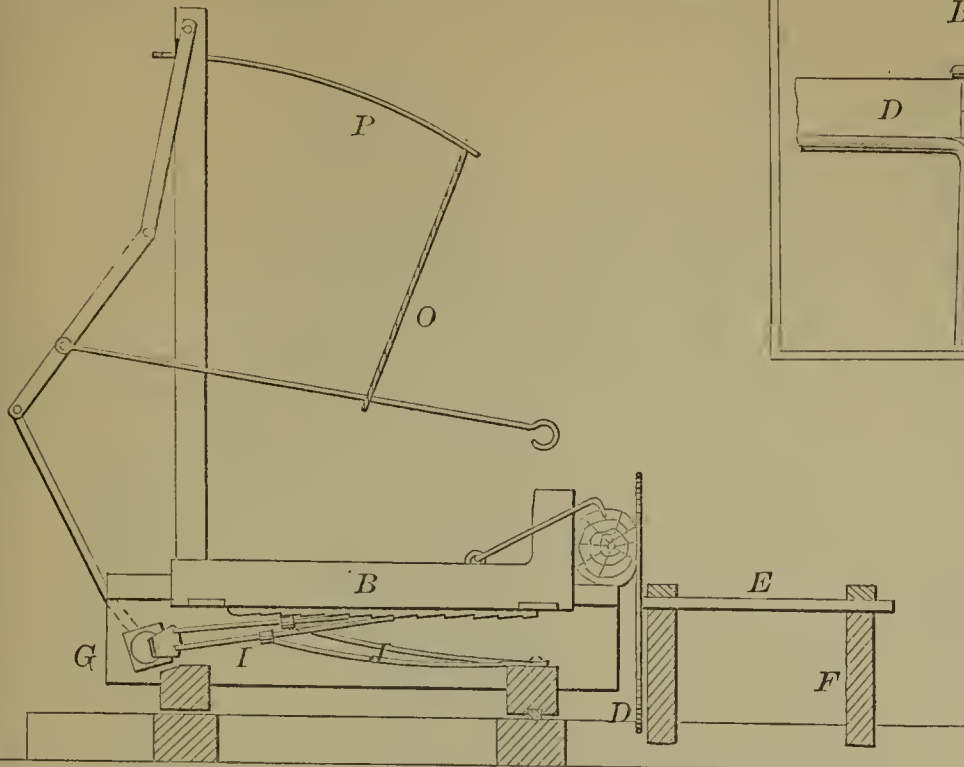

56930—N. Groel—Traveling Bag Frame.

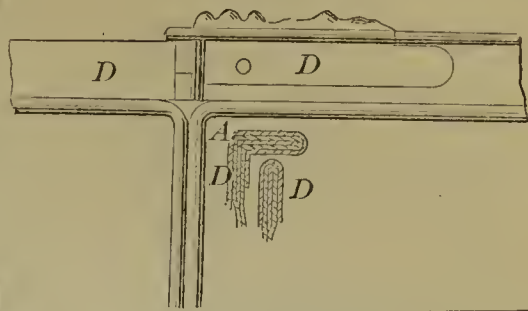

56934—B. I. Harris—Fruit Jar.

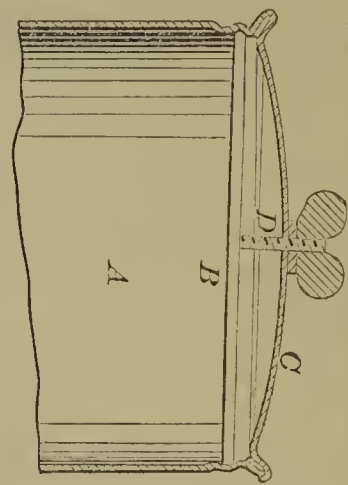

56931—J. Haines—Show Case.

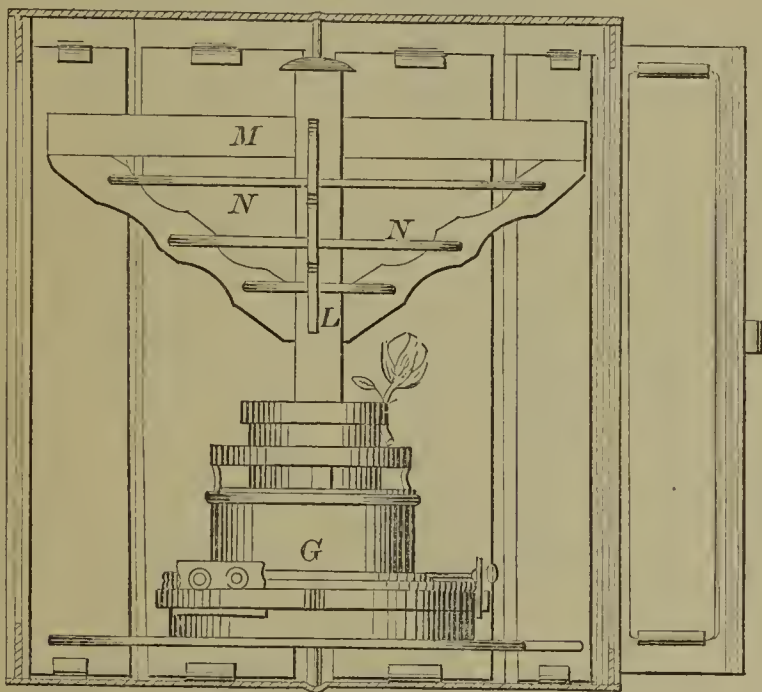

56932—C. H. Hale—Washing Machine.

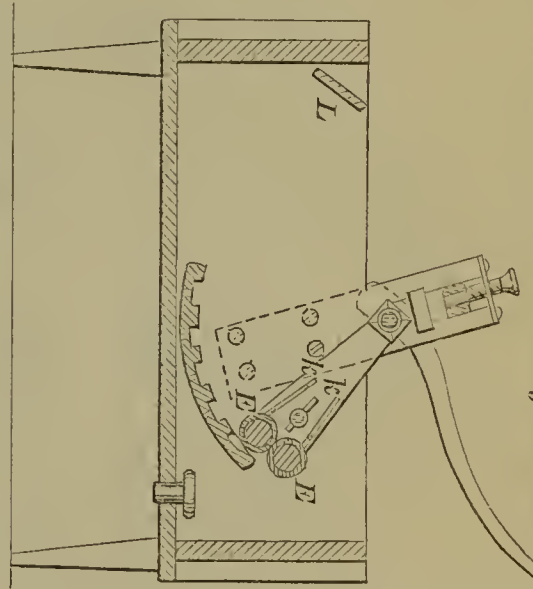

56933—M. P. Hall—Key Fastener.

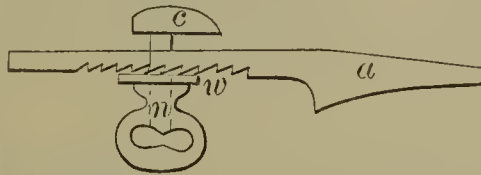

56935—H. Harris—Perpetual Calendar

B		A
Sun.	5 12 19 26	
Mon.	6 13 20 27	
Tues.	7 14 21 28	
Wed.	1 8 15 22 29	
Thur.	2 9 16 23 30	
Fri.	3 10 17 24 31	
Sat.	4 11 18 25	

56936—S. & D. Harris—Horse Hay Fork.

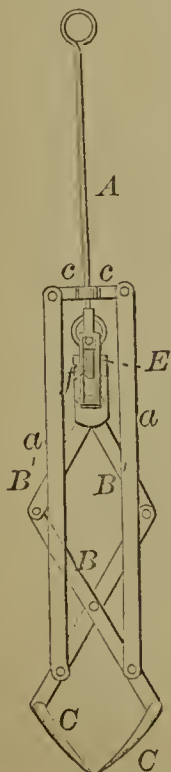

56937—A. B. Hartill—Fishing Line Reel.

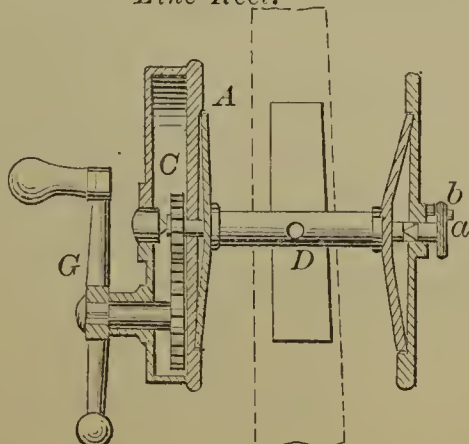

56938—C. H. Helms—Leather Chamfering Machine.

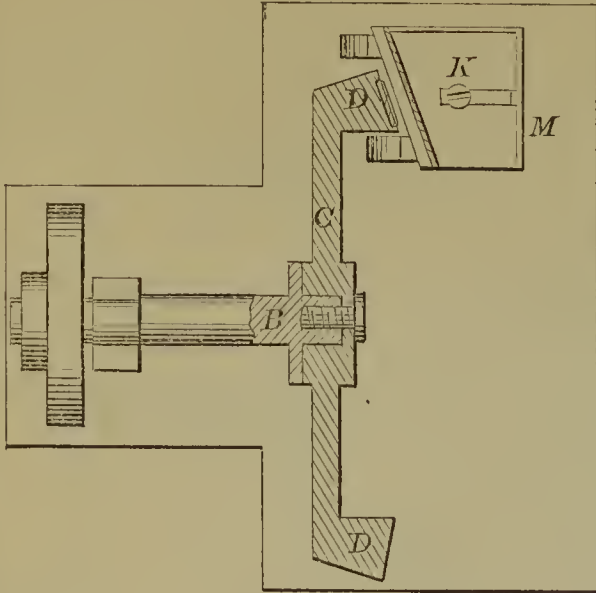

56942—S. Hutchinson—Gang Plow.

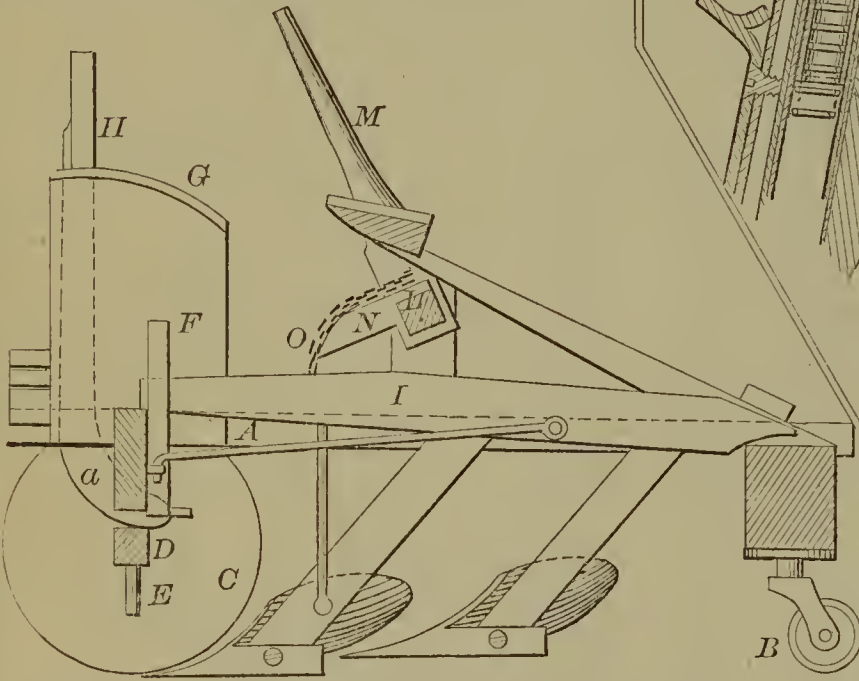

56939—H. W. Hayden—Five Arm.

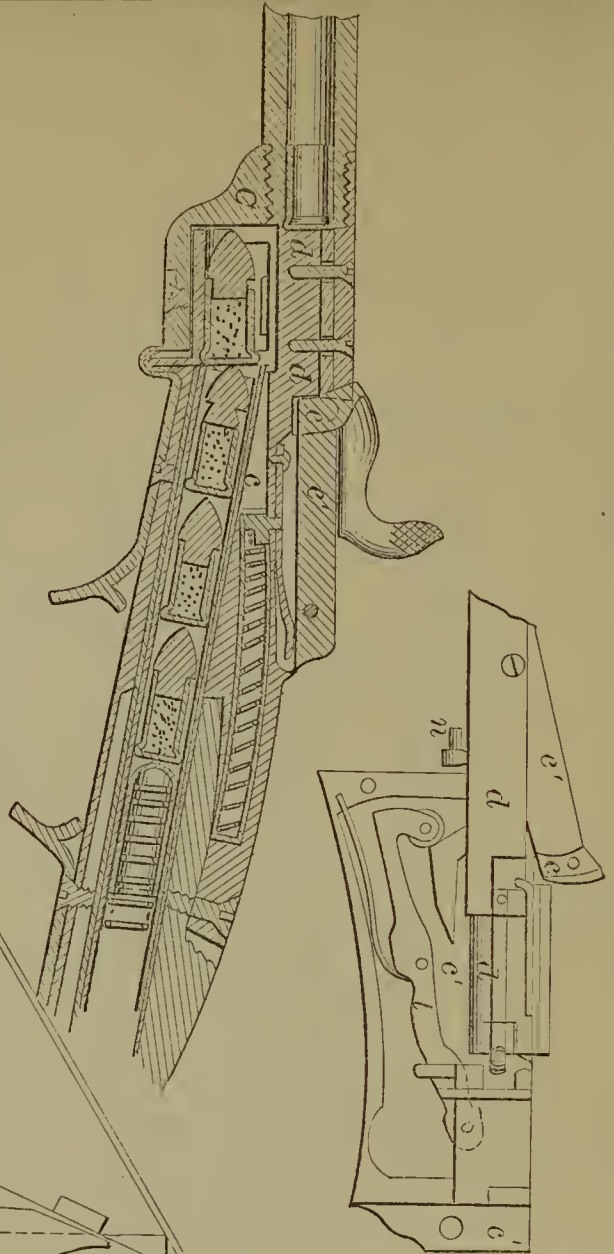

56940—C. W. Hoffmann—Scales.

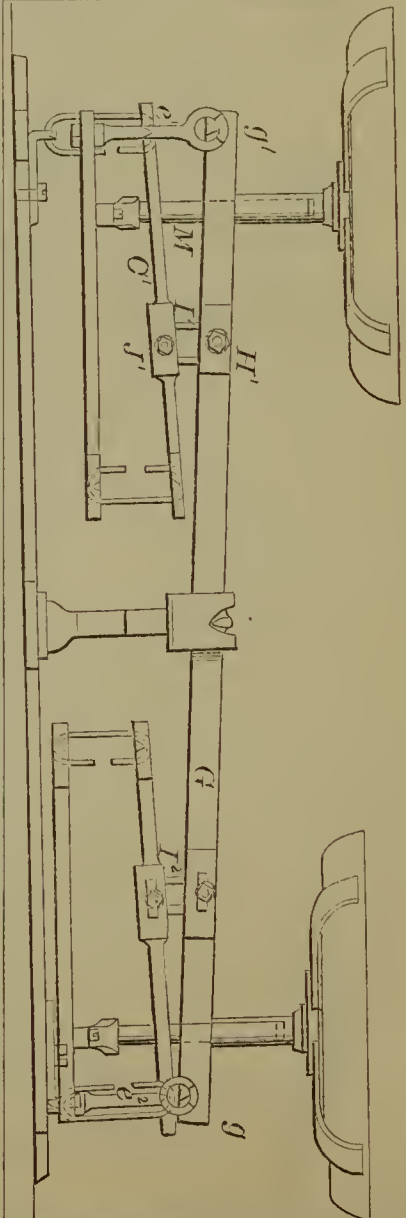

56943—G. N. Jackson—Sliding Slate.

	18	17	16	15	14	13	12	11	10	9	8	7	6	5	4	3	2	1	
A	987	449	925	987	912	317	184	A											
B	905	788	864	425	875	905	337	B											
C	679	435	568	572	617	872	692	C											
D	869	663	410	563	419	312	438	D											
E	153	467	856	216	575	429	418	E											
F	953	205	355	649	876	807	447	F											

X	872	824	824	716	617	897	910	X
Y	444	764	405	425	427	476	511	Y
	18	17	16	15	14	13	12	11
	10	9	8	7	6	5	4	3
	2	1						

56941—M. L. M. Hussey—Filing Documents.

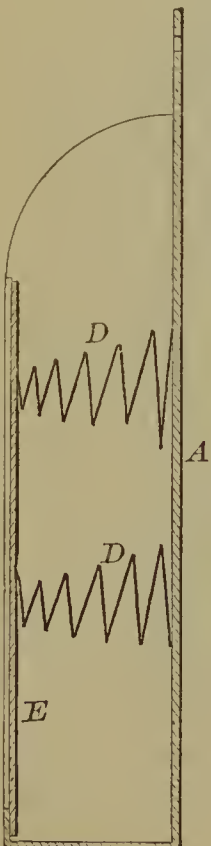

56944—  
W. H. Jacoby—  
Stereoscope.

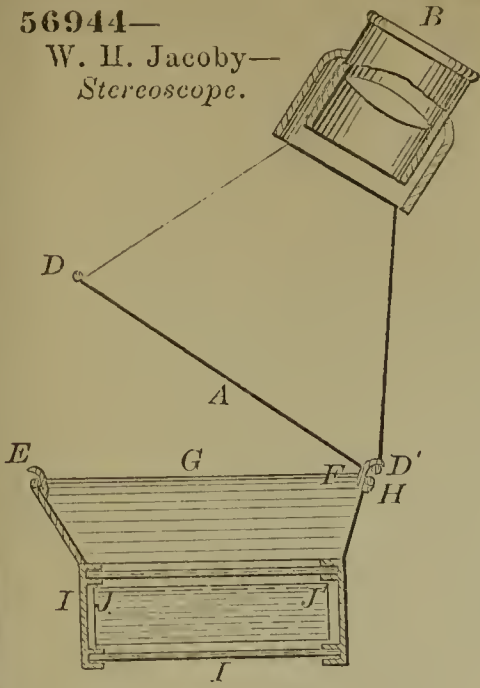

56947—B. H. Jenks—Hoisting  
Apparatus.

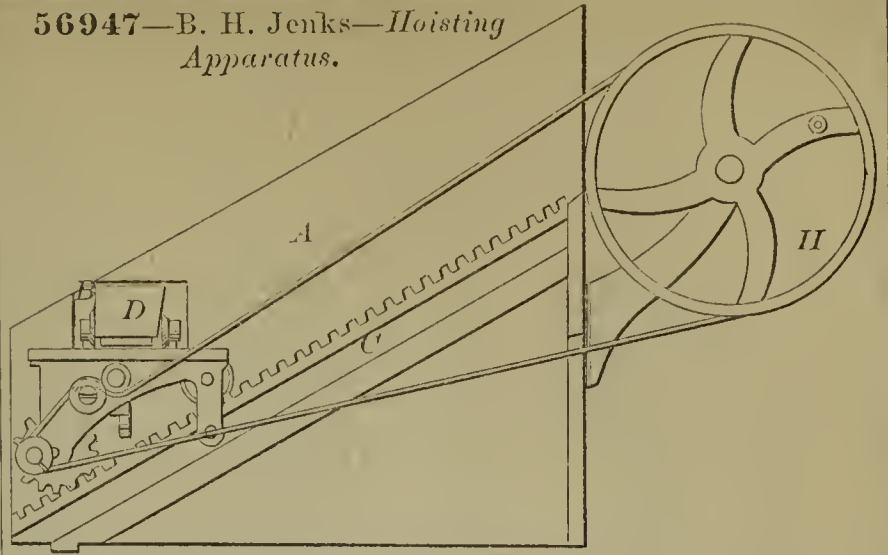

56950—A. Joyner—  
Washing Machine.

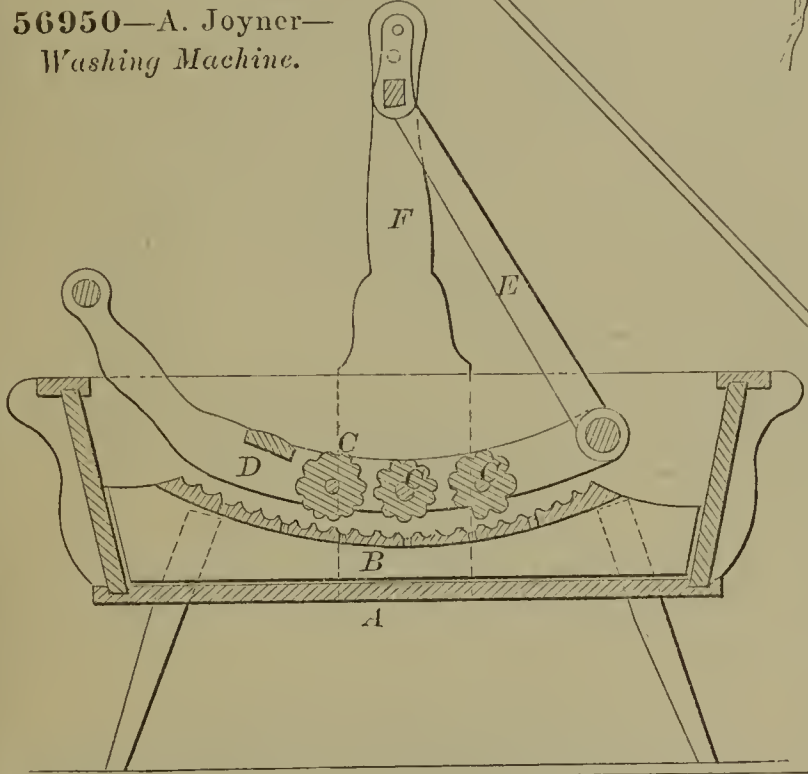

56948—J. Johnson—Dredging  
Machine.

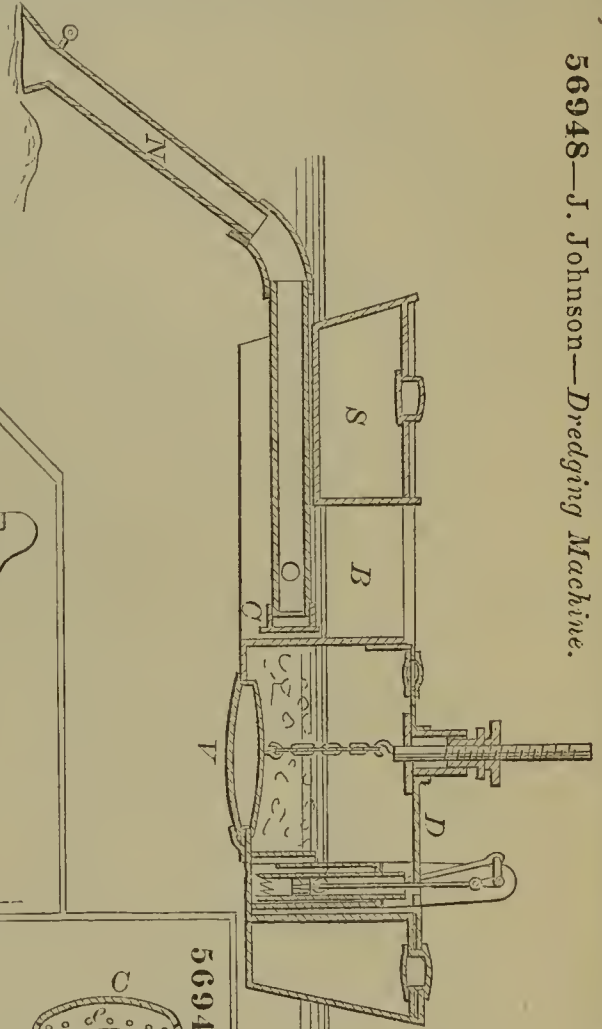

56945—C. H. James—Dentist's  
Vulcanizer.

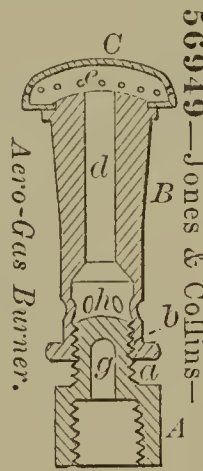
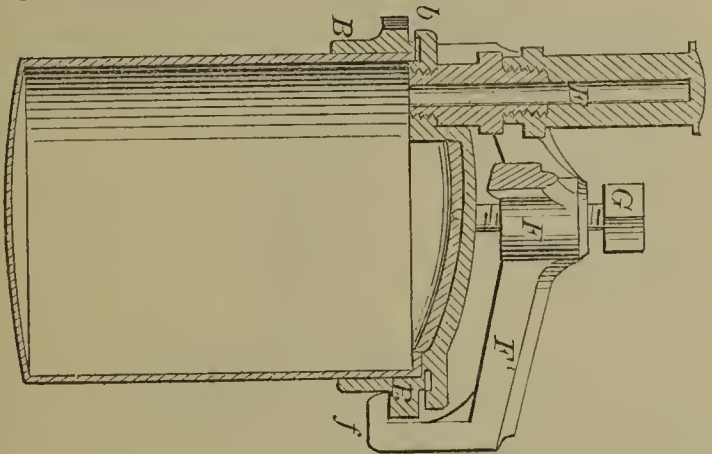

56949—Jones & Collins—  
Aero-Gas Burner.

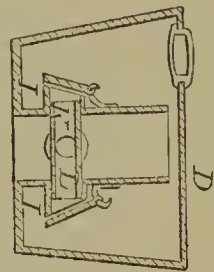

56946—A. Jamison—Steam  
Engine Valve.

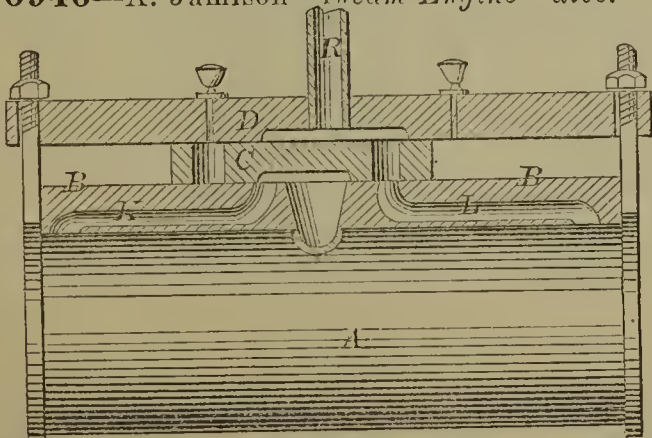

56951—O. S. Judd—Snap  
Hook.

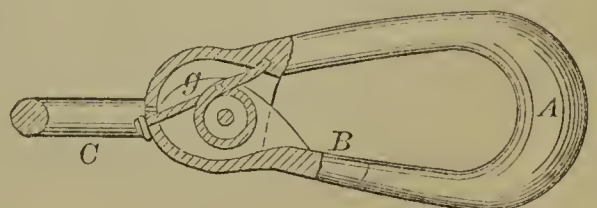

56952—A. Judson—  
Lamp Chimney.

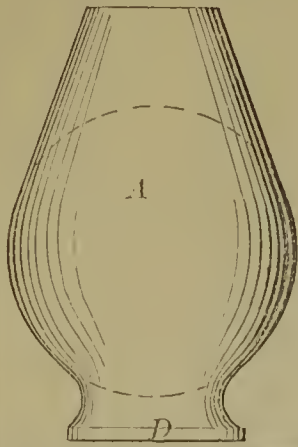

56954—H. B. Kinney—*For Making Forks.*

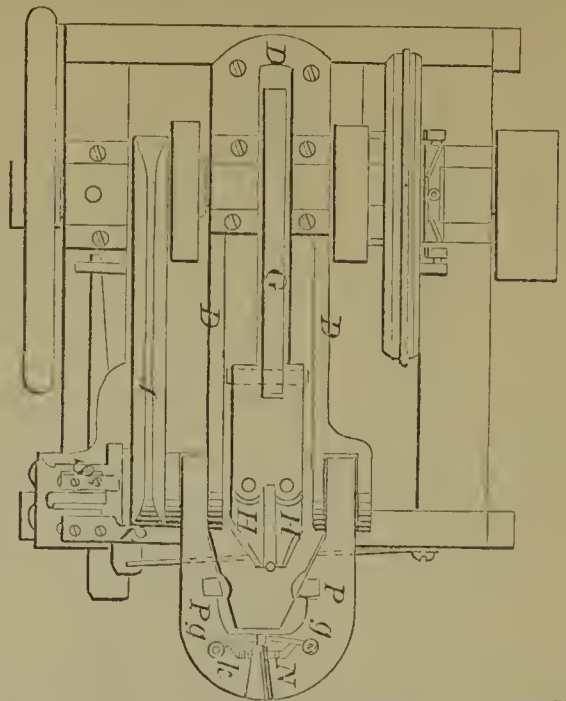

56955—A. F. Kuhlmann—*Washing Machine.*

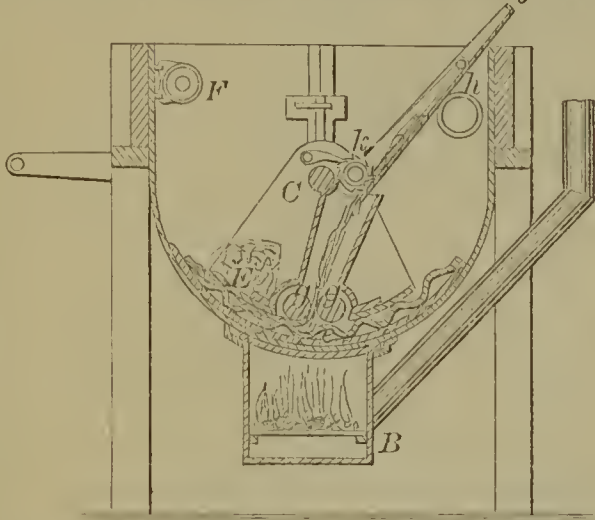

56953—Keene & Snediker—*Broom Head.*

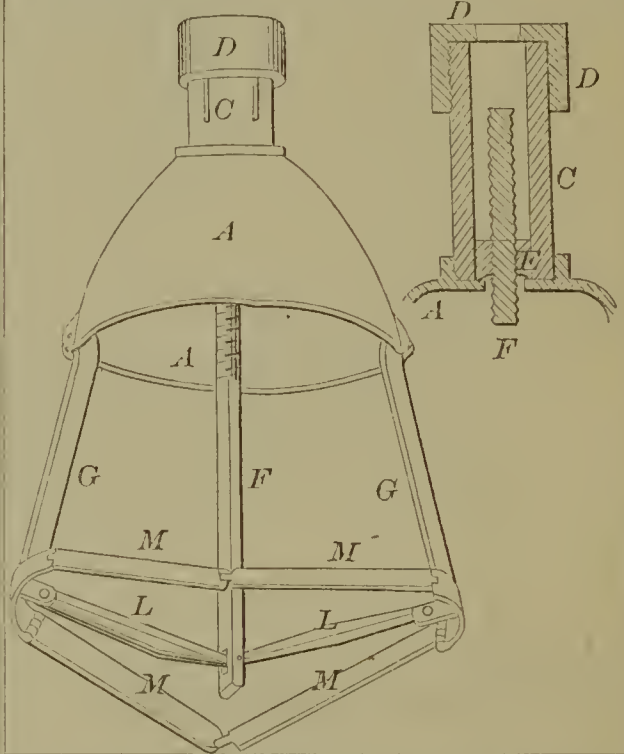

56957—J. S. Lash—*Step Ladder.*

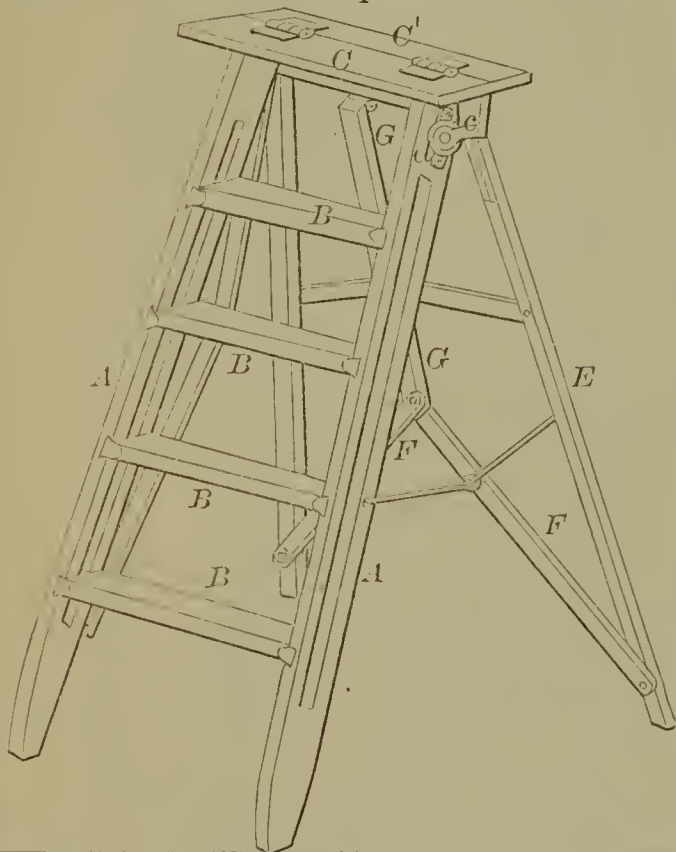

56956—T. S. La France—*Steam Engine Governor.*

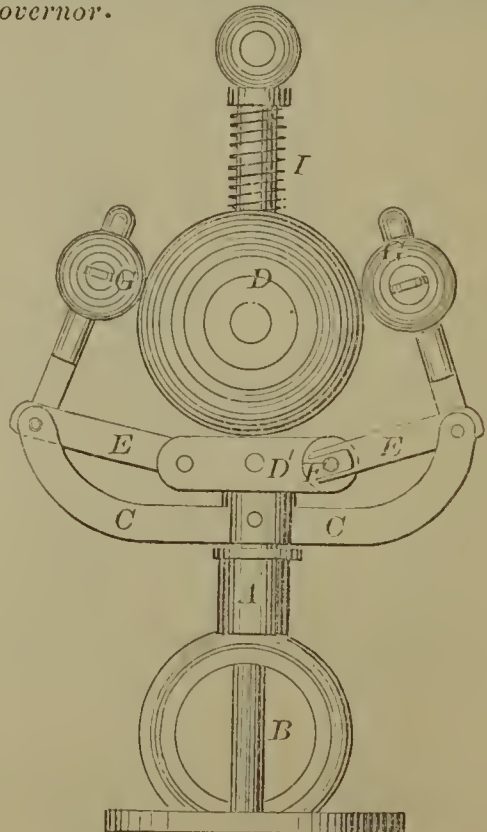

56958—J. W. Latcher—*Centre Chill for Car Wheels.*

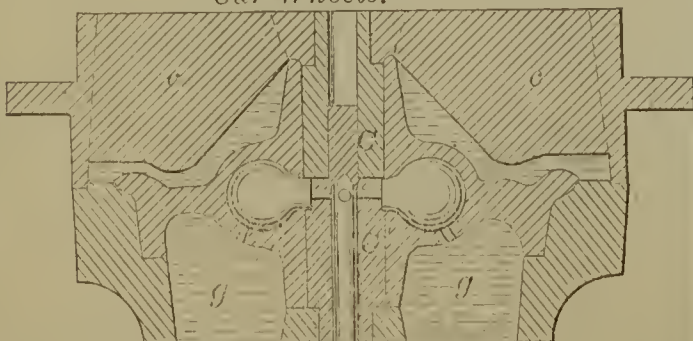

56960—Lugenbell & Barns—Horse Rake.

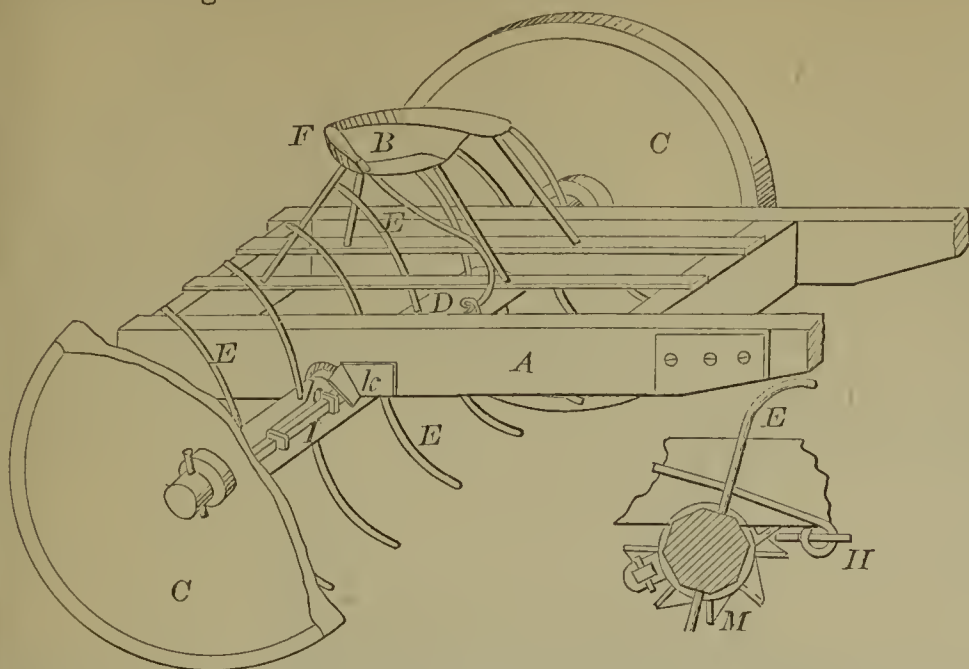

56961—J. H. Luther—Grab for Oil Wells.

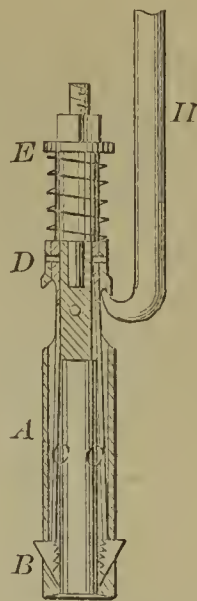

56962—J. Malby—Flood Gate.

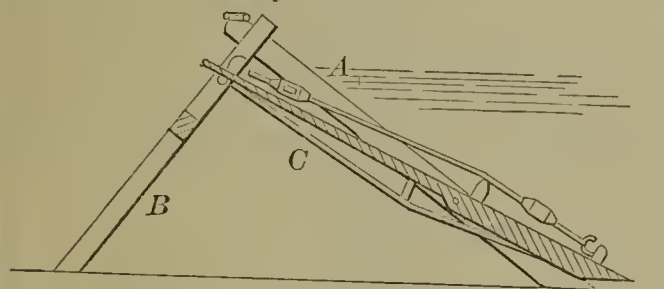

56964—H. B. Masser—Coffee Roaster.

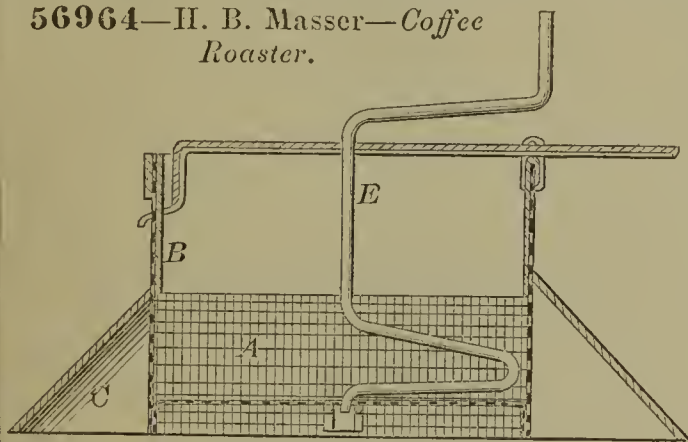

56965—J. D. Matthews—Sawing Machine.

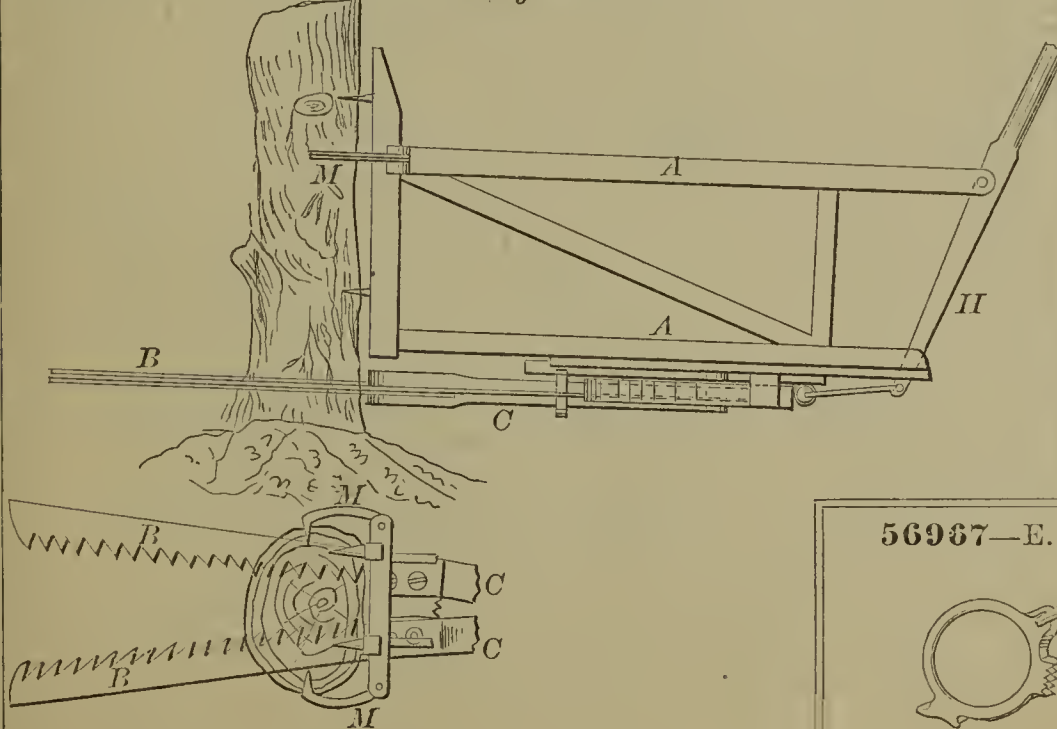

56963—C. S. Martin—Wagon.

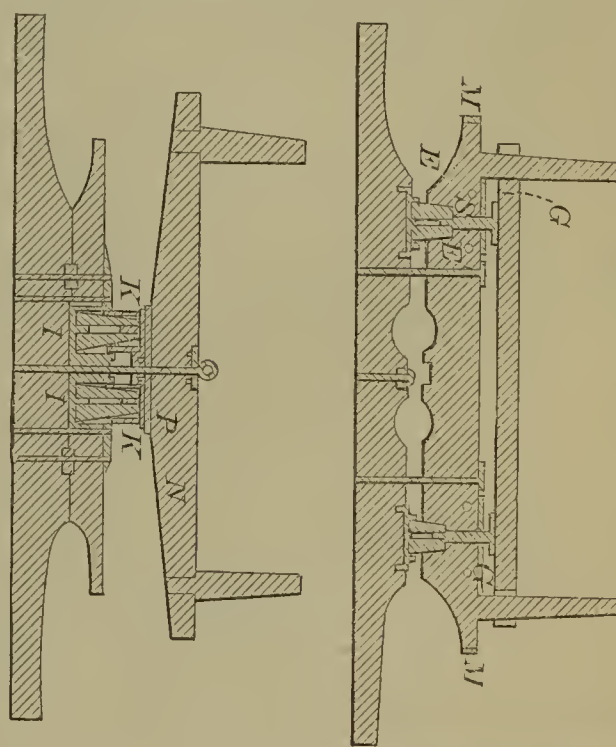

56966—J. Mattix—Belt Coupling.

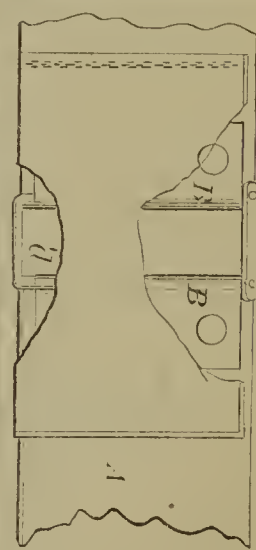

56967—E. Maynard—Eye Glass.



56968—W. McCord—Horse Rake.

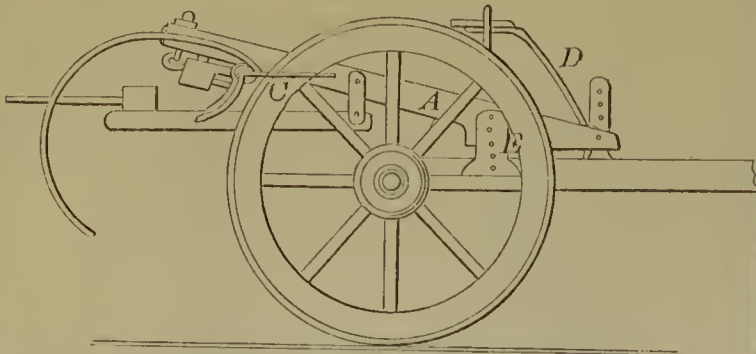

56969—O. C. McCune—Corn Planter.

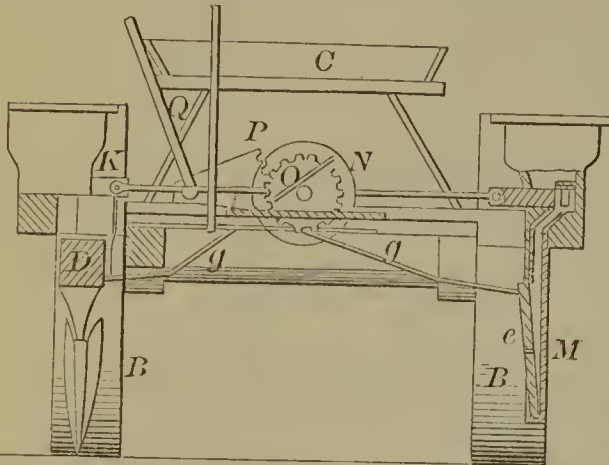

56970—P. McQuaid—For Marking Ground for Planting.

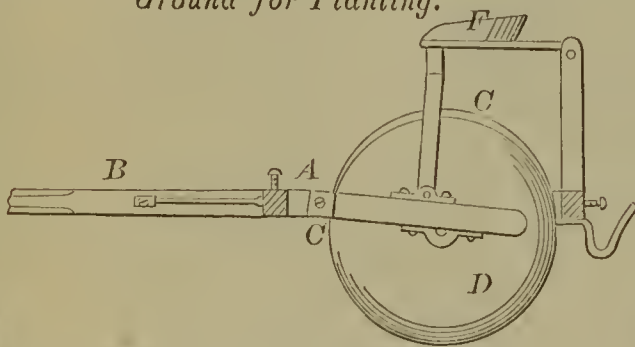

56973—J. Merkel—Paddle Wheel.

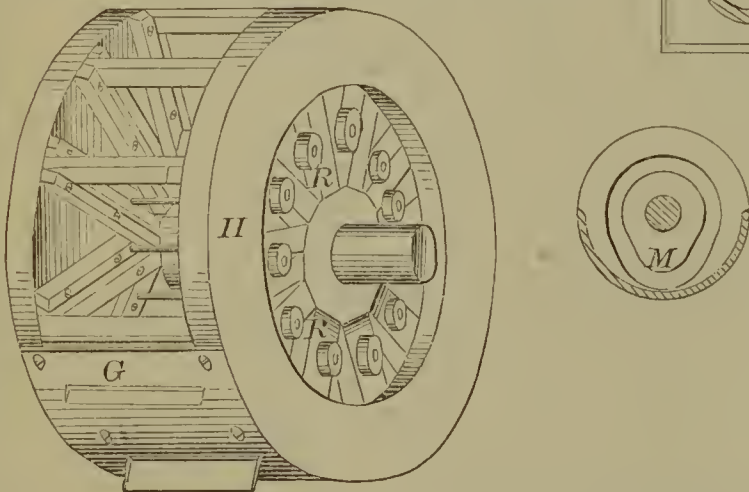

56976—C. Miller—Harness Motion for Looms.

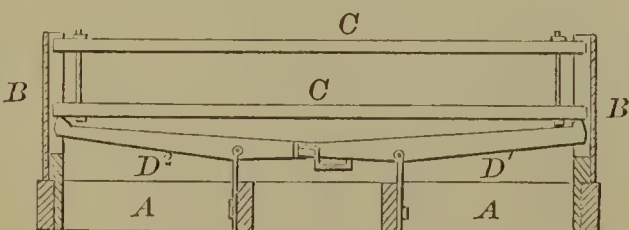

56972—S. Mellinger, Jr.—Fruit Gatherer.

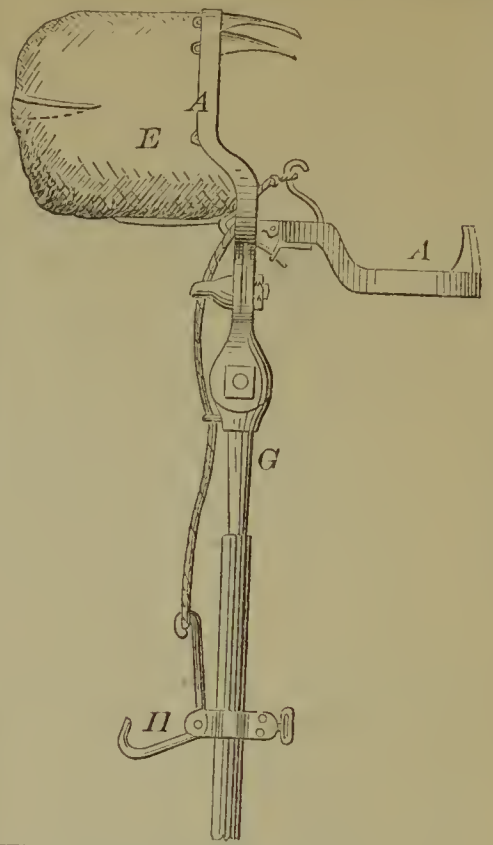

56974—R. S. Merrill—Lamp.

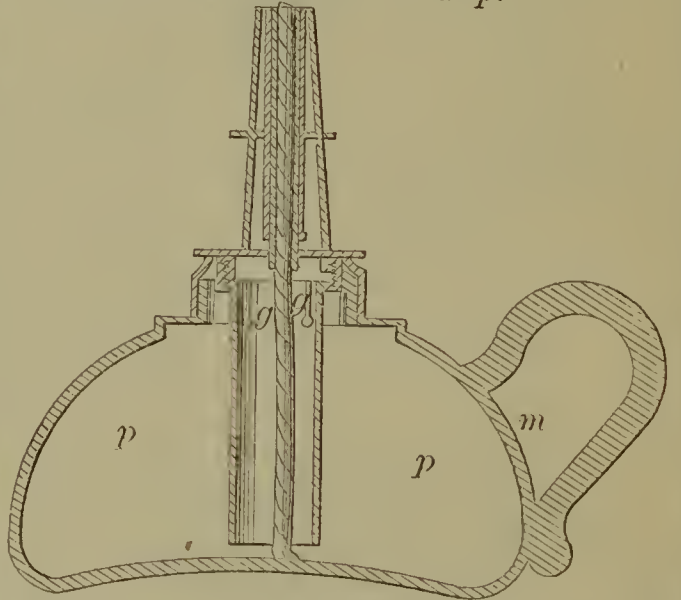

56975—B. F. Miller—Stove Pipe Damper.

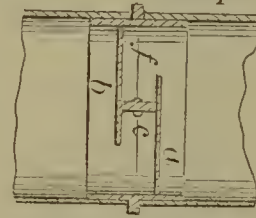

56977—M. V. Miller—Axle Box.

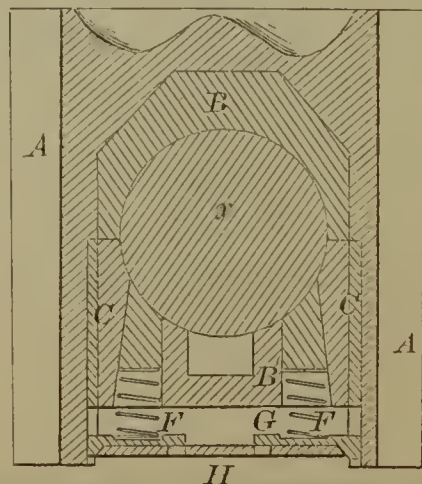

56978—T. H. Miller—*For Cooling Liquors.*

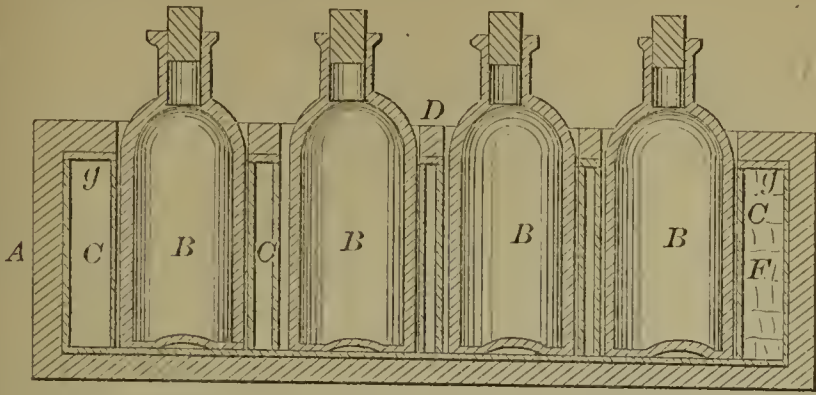

56981—R. W. Morse—*Chuck.*

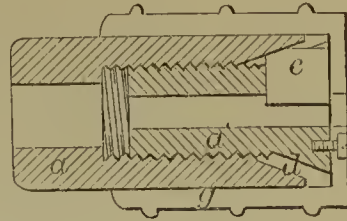

56979—Moody & Hall—*Stove.*

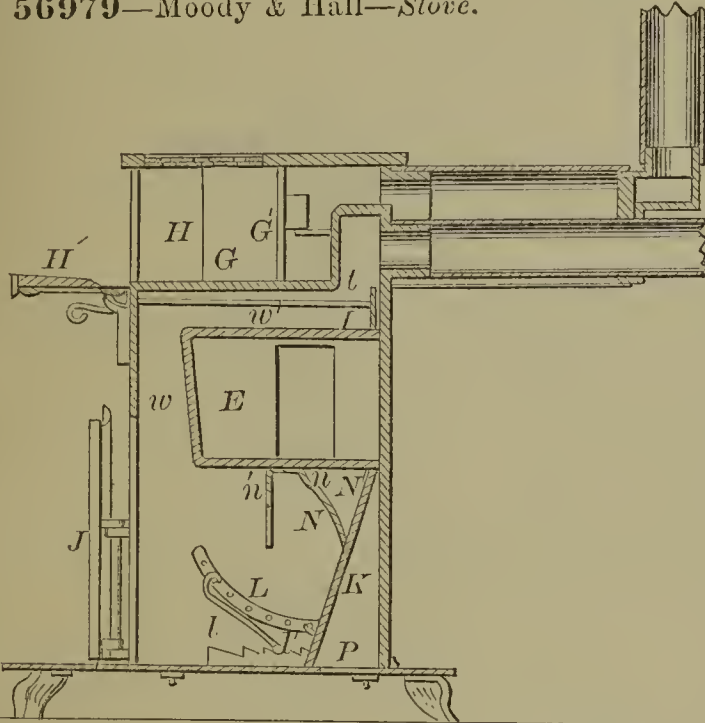

56983—R. H. Nicholas—*Artificial Leg.*

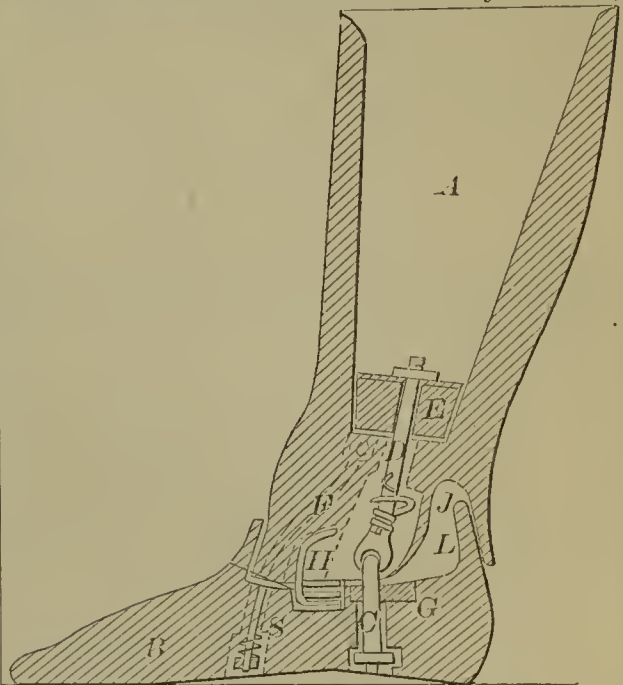

56980—C. N. Morgan—*Wrench.*

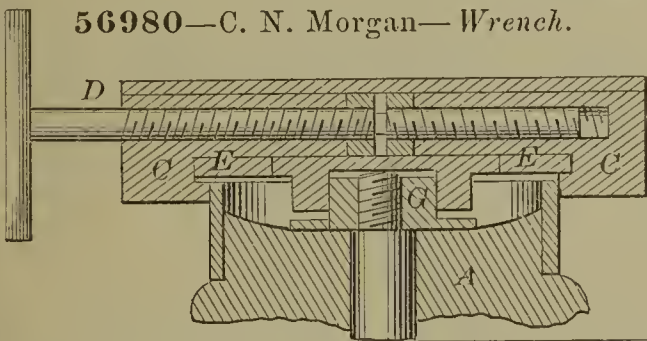

56982—G. R. Nebinger—*Fruit Dryer.*

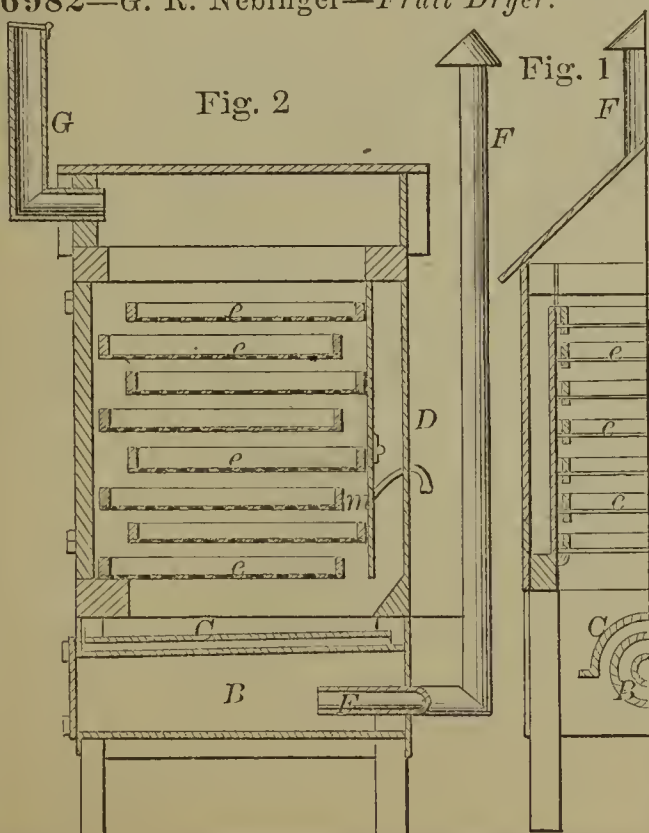

56984—W. H. Nobles—*Dredging Machine.*

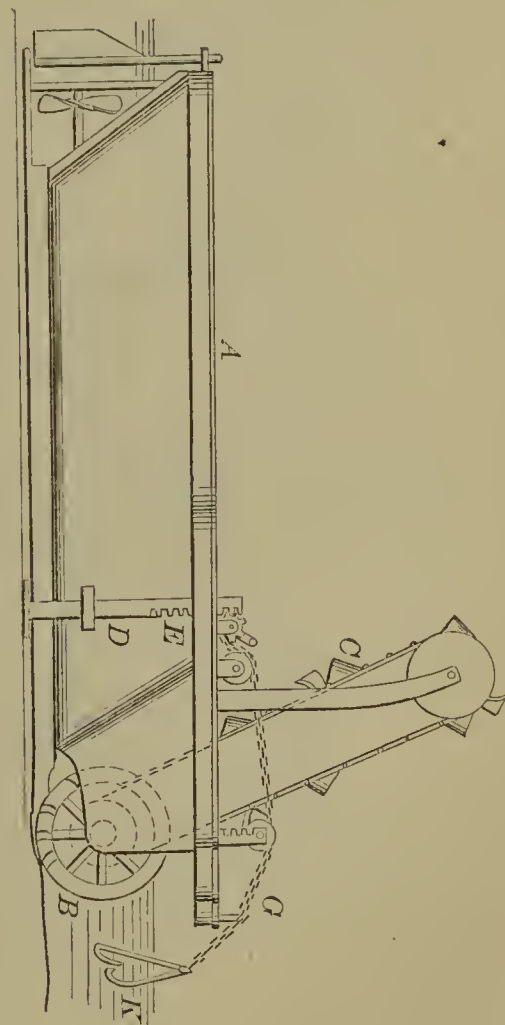

56985—E. Odell—Fence.

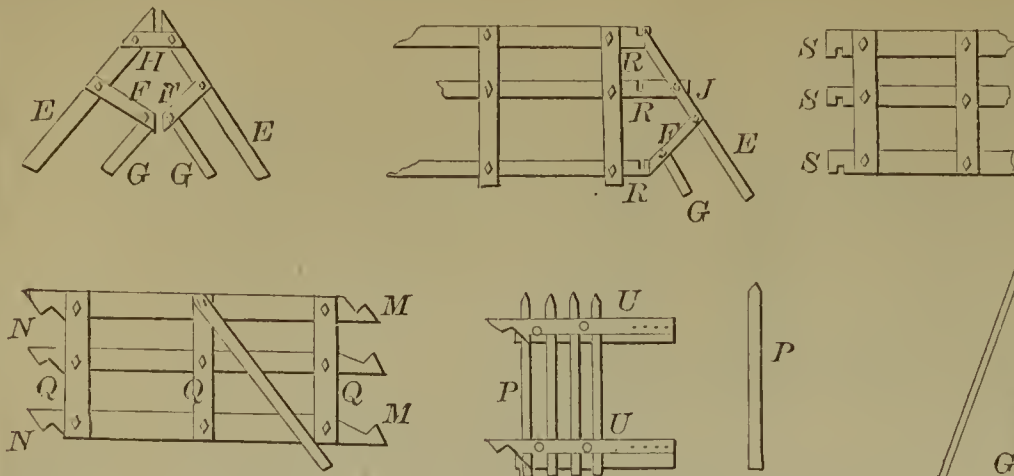

56989—L. Phleger—Obtaining Oil from Wells.

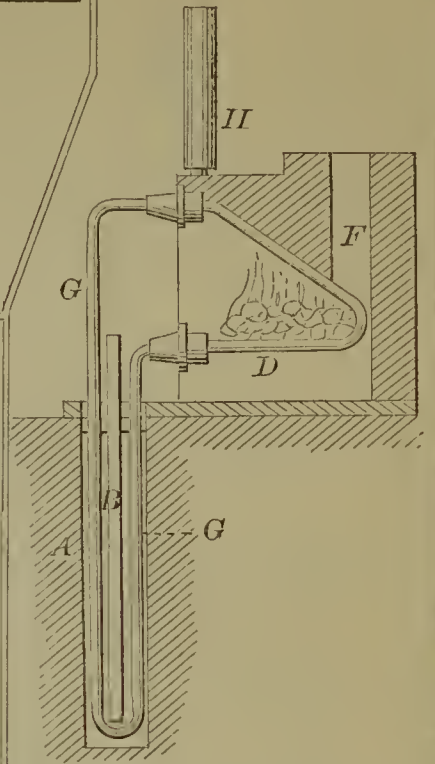

56987—J. G. Page—Automatic Gate.

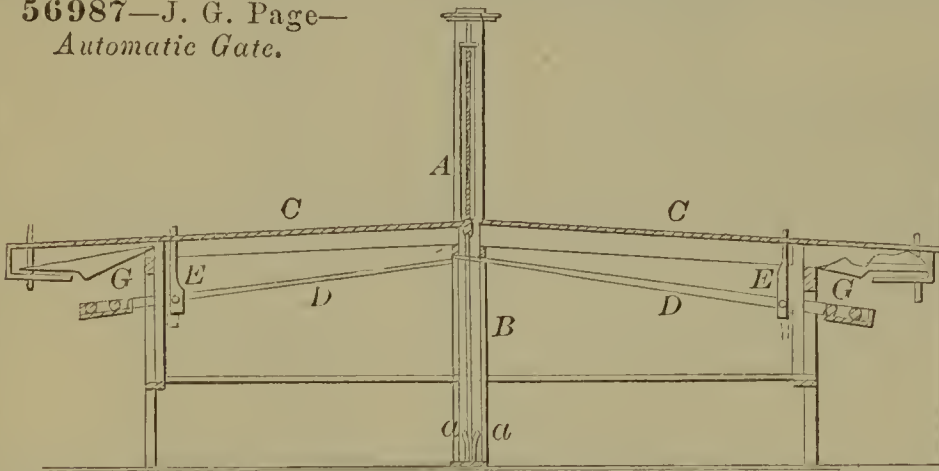

56988—A. F. Park—Electro-Chemical Telegraph.

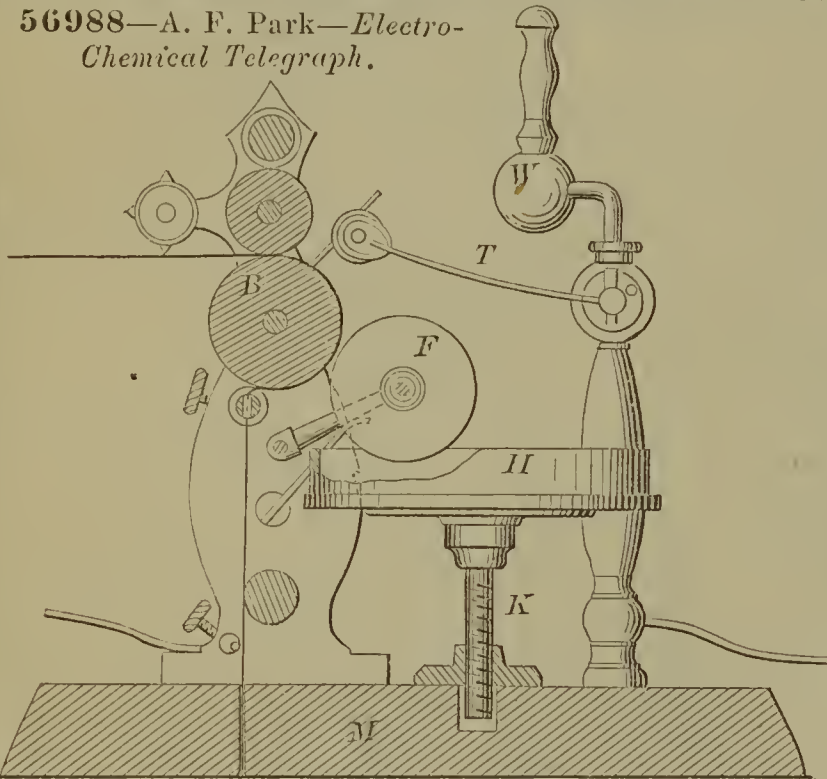

56986—S. Oppenheimer—Table Leg Joint.

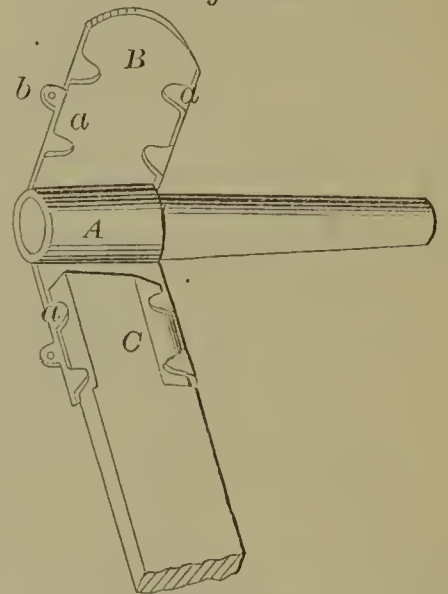

56991—M. Robbins—Molasses Pitcher.

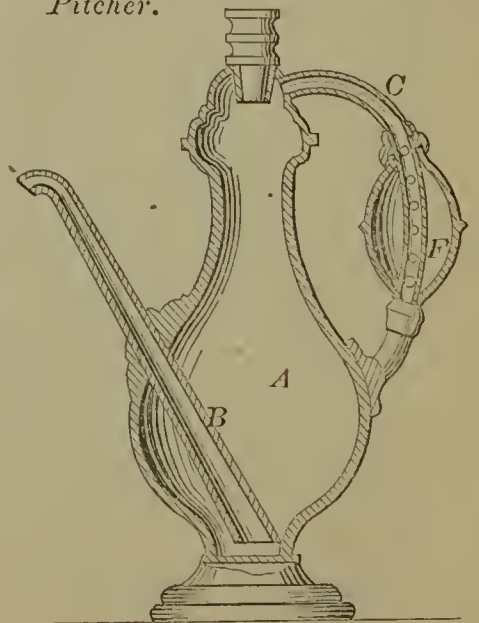

56990—D. B. Piper—Sewing Machine.

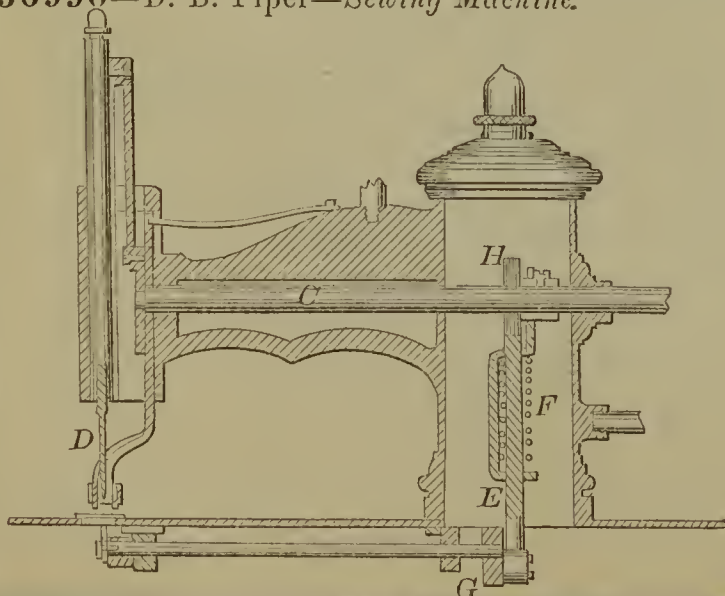



56992—Robinson & Marshall—*Boot Heel.*

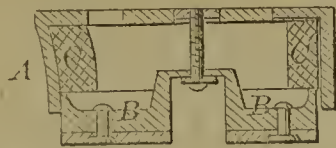

56993—J. B. Root—*Trunk Engine.*

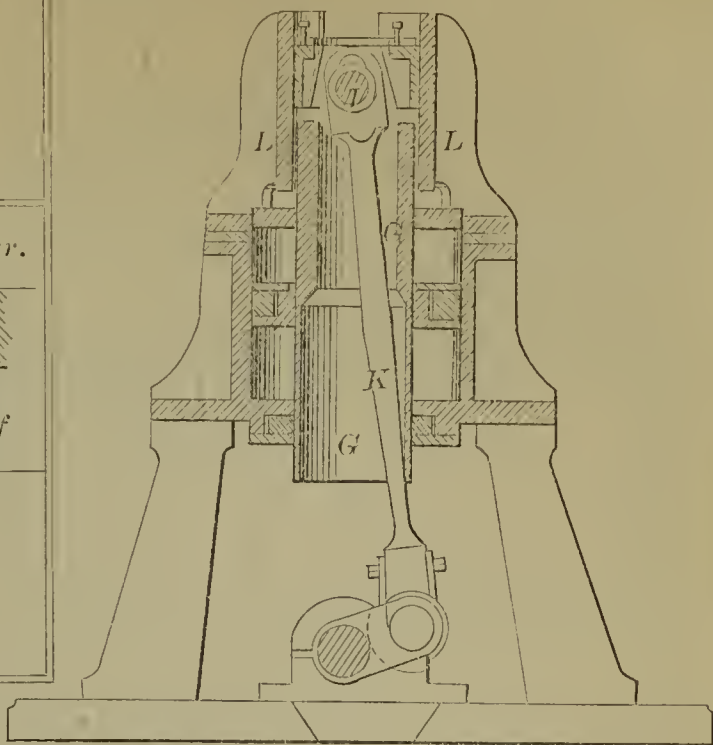

56994—E. A. G. Roulstone—*Mosquito Bar.*

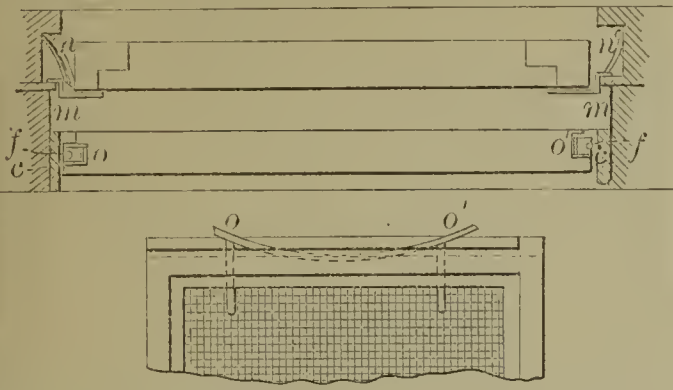

56996—Newton & Favro—*Wrench.*

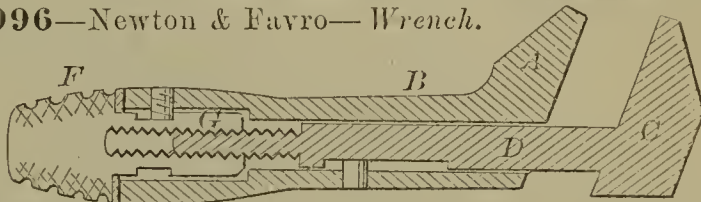

57000—J. B. Sawson—*Fire Box.*

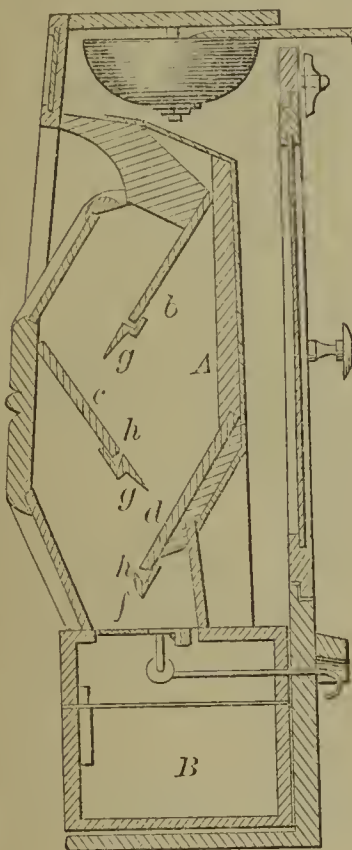

56999—E. O. Scharf—*Lamp, Chimney.*

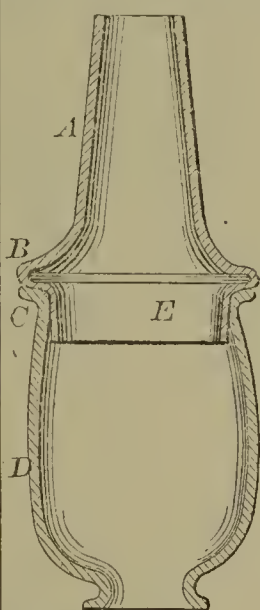

56997—R. Norwood—*Smoking Pipe.*

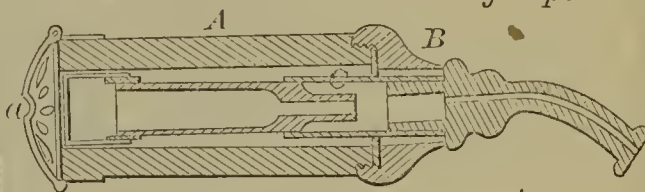

56998—W. Sausser—*Knife.*

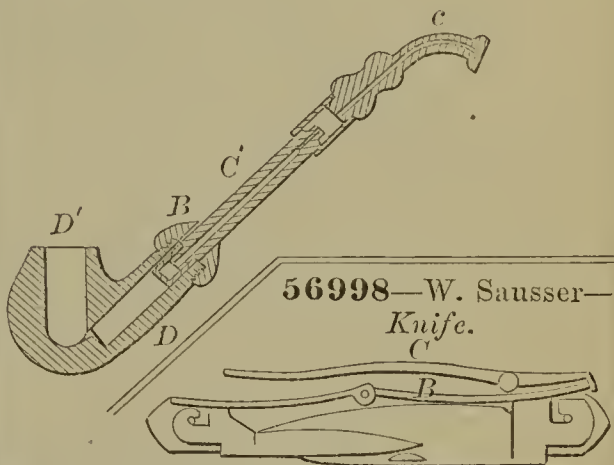

56995—A. P. Routh—*Dough Kneeder.*

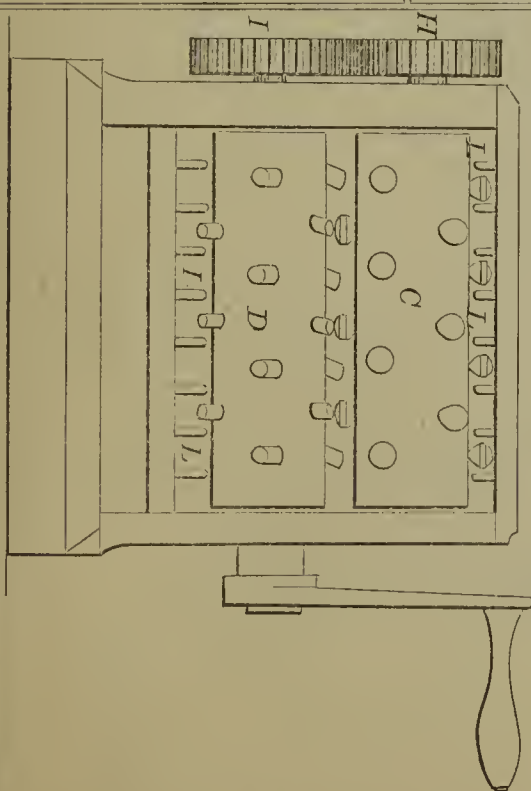

57001—A. & G. Smith—*Smut Machine.*

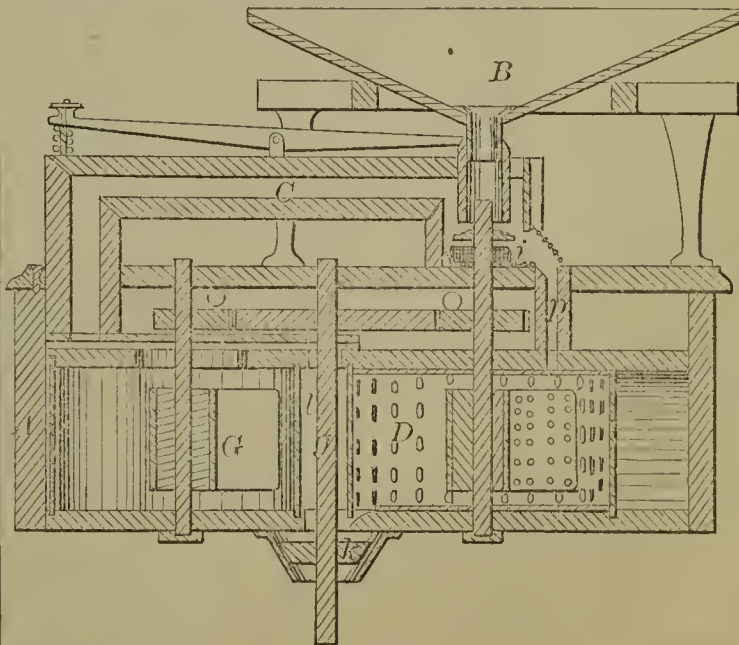

57002—J. B. Smith—Coal Screen.

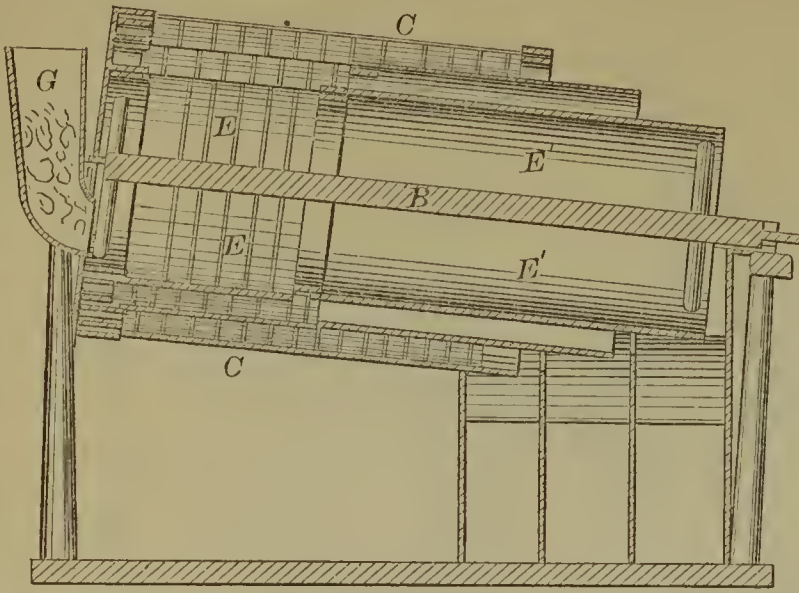

57003—J. G. Smith—Red Bottom.



57007—W. W. Stillman—Cultivator Plow.

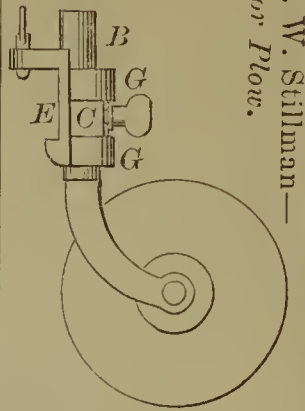

57005—W. W. Sowles—Harvester.

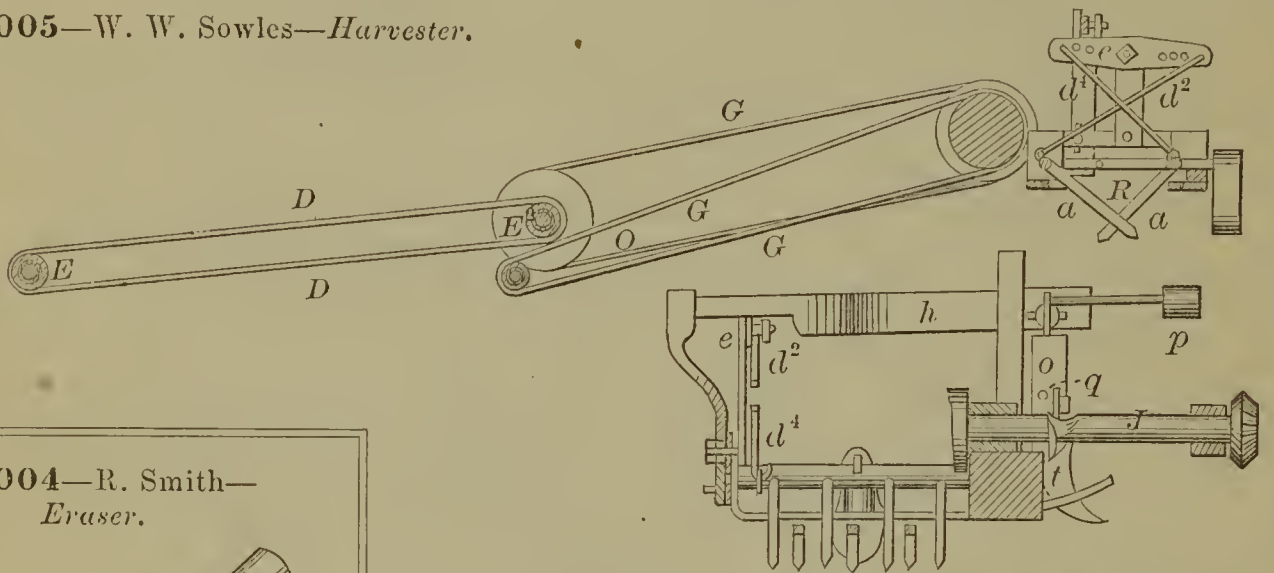

57004—R. Smith—Eraser.



57008—W. H. Stone—Fruit Gatherer.

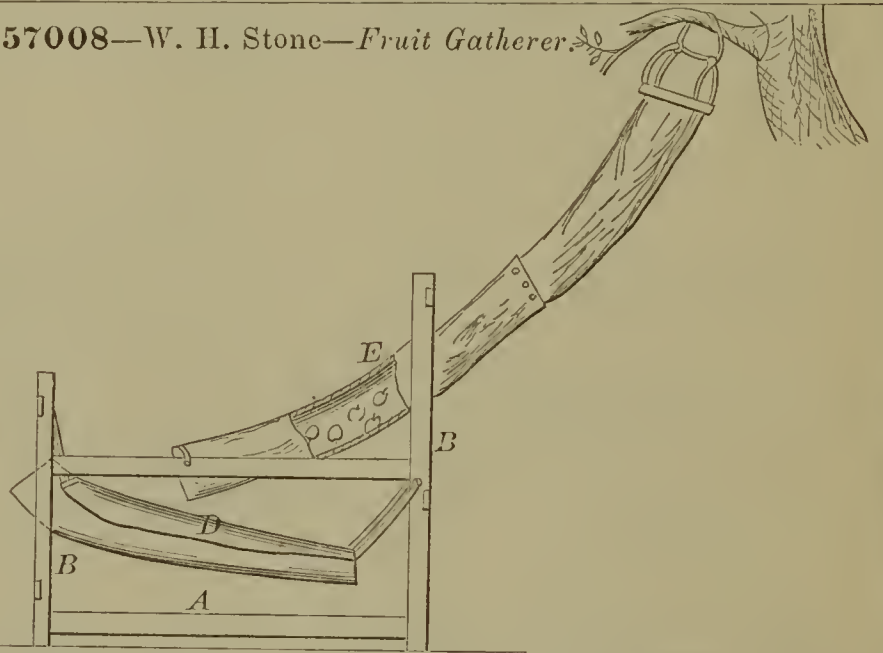

57006—J. N. Stanley—Gas Main.

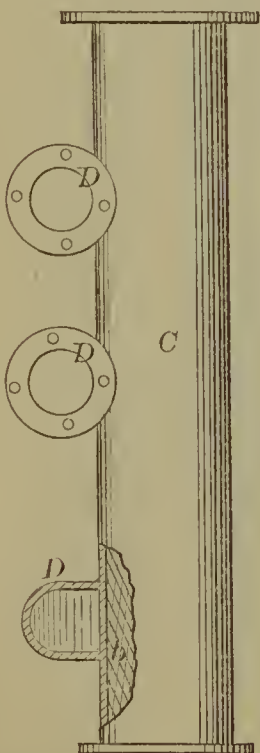

57009—W. M. Storm—For Ripening Liquors.

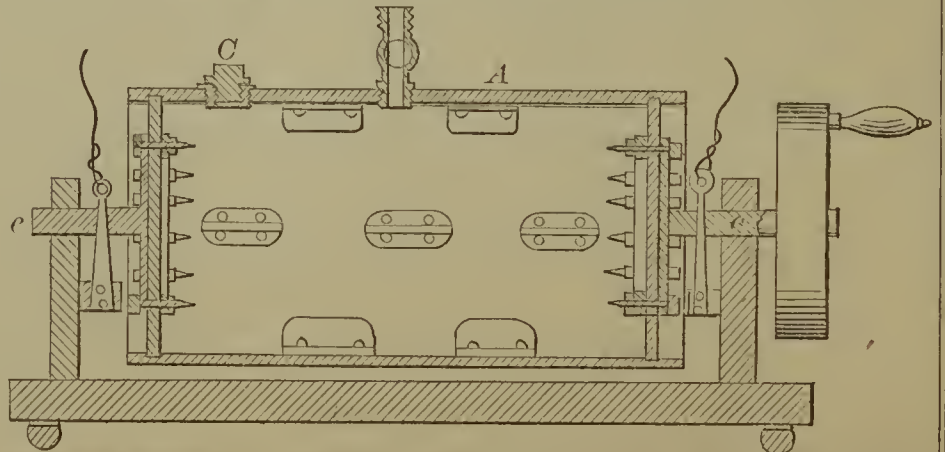

57012—G. H. Tier—*Life Boat.*

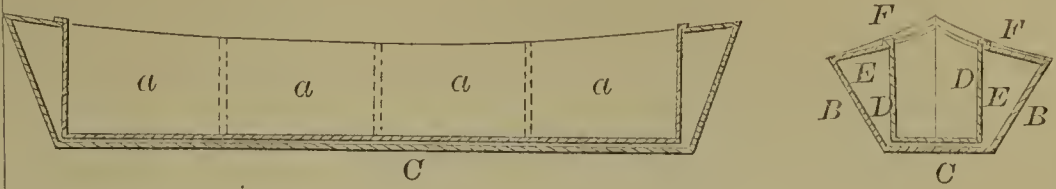

57013—C. H. Tompkins—*Stretcher.*

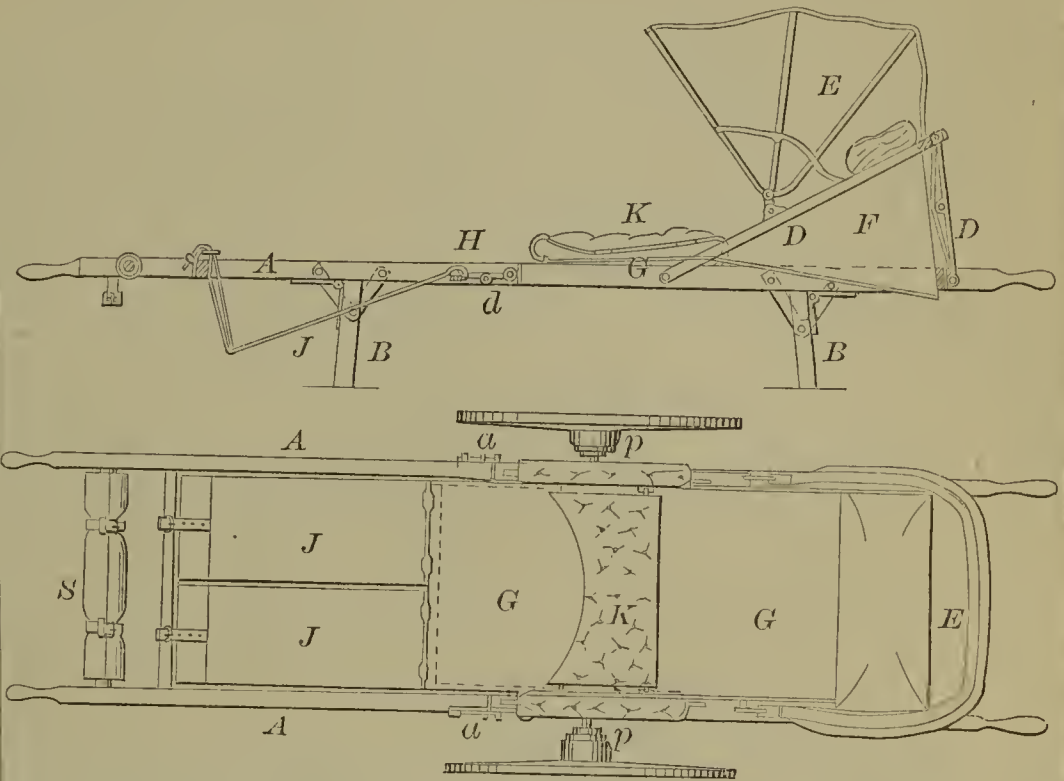

57011—R. A. Thomas—*Drilling Machine.*

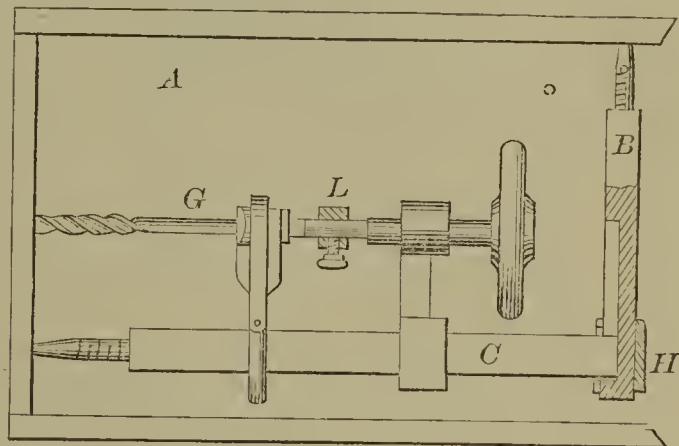

57015—H. H. Trenor—*Car Brake.*

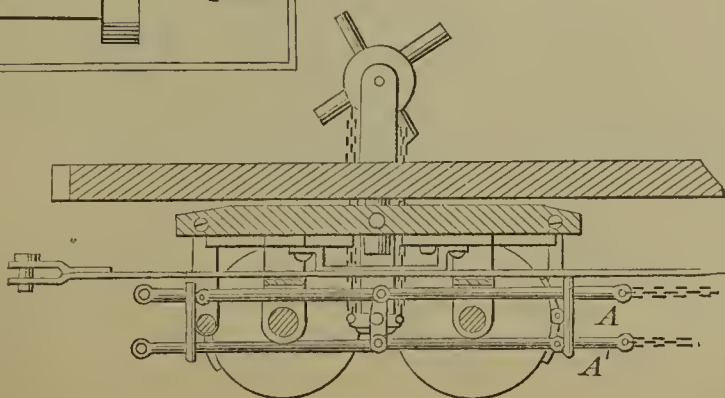

57017—G. Utley—*Candle Stand.*

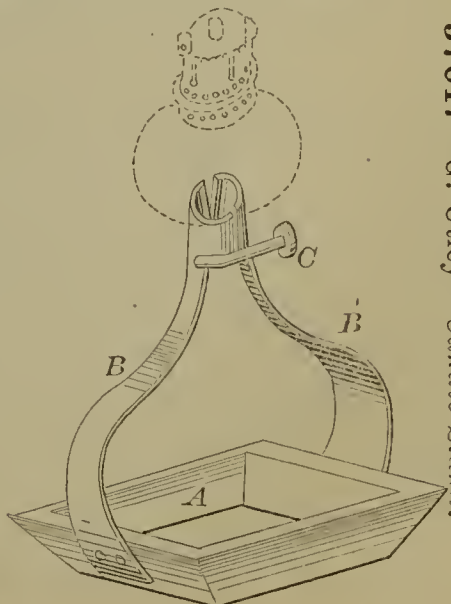

57010—

A. J. Tewksbury—*Sewing Machine Presser Foot.*

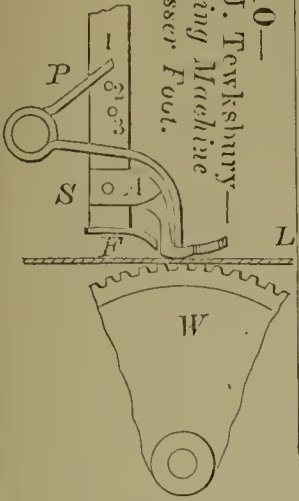

57014—H. H. Trenor—*Car Coupling.*

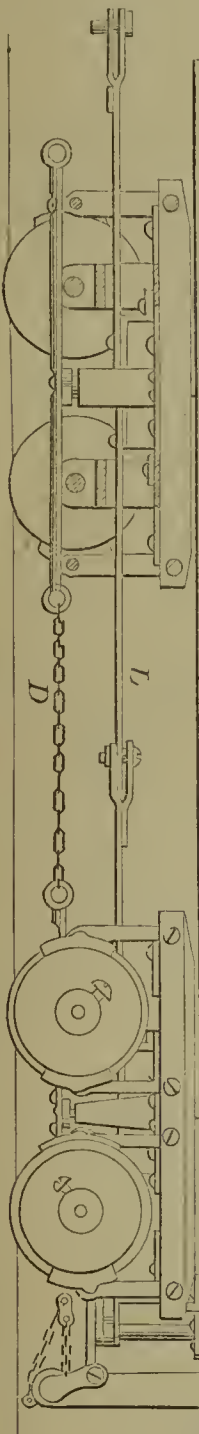

57018—O. Vanorman—For Tenoning Spokes.

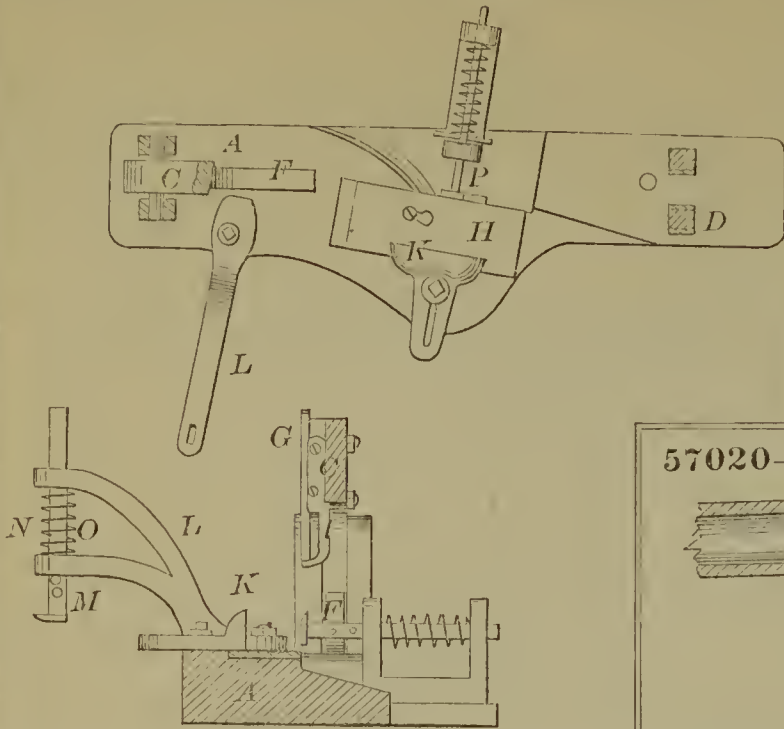

57019—W. F. Warburton—Hat.

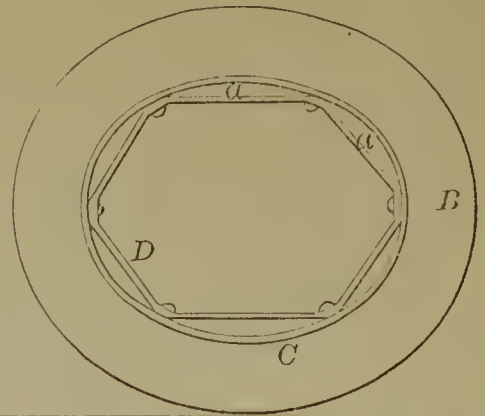

57020—Warner & Redstreak—Gas Apparatus.

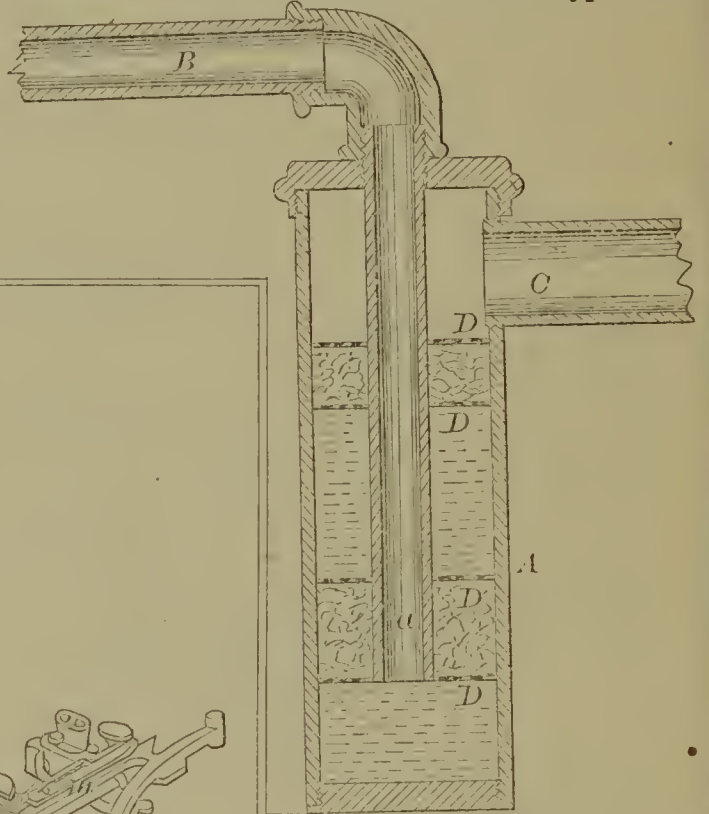

57021—H. Waters—Rolling Apparatus.

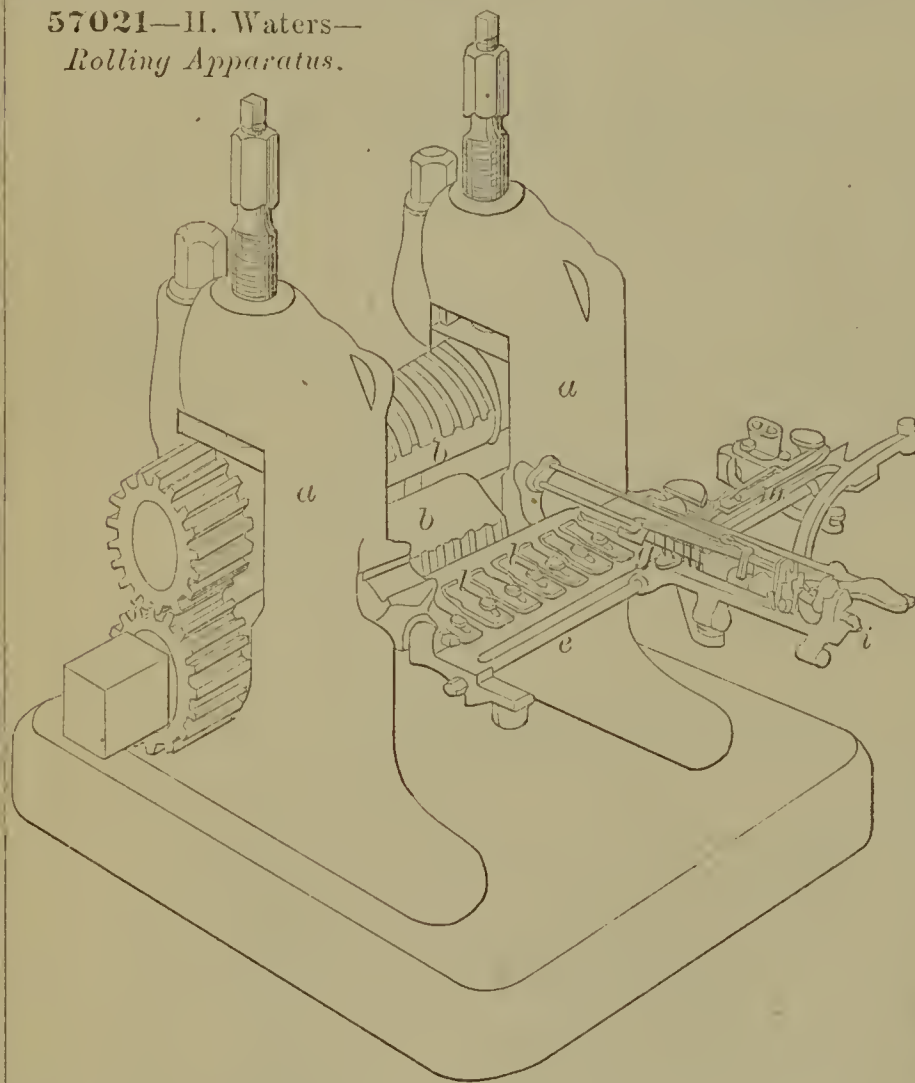

57022—J. Weed—Ventilated Vault.

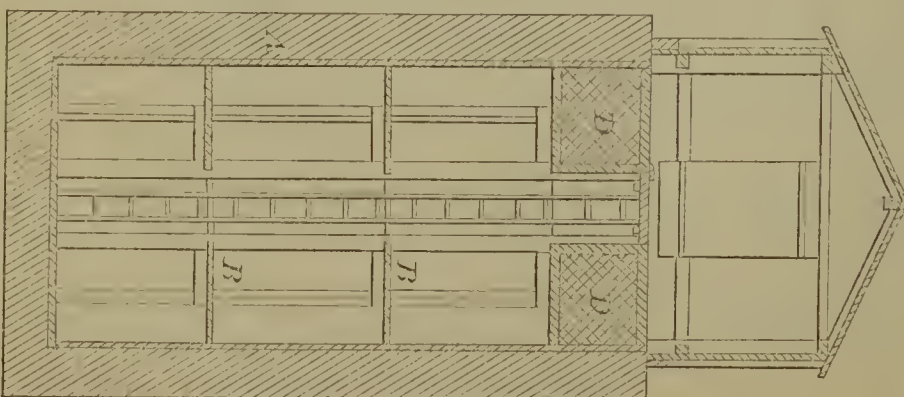

57023—J. M. Wehrly—Harvester Cutter.

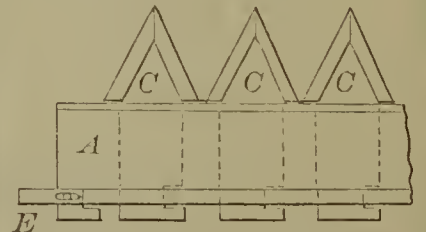

57025—N. T. Whiting—Pitcher.

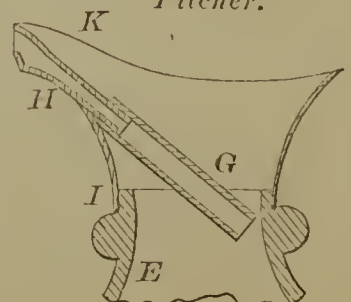

57024—Wheat & Bunge—Fruit Basket.

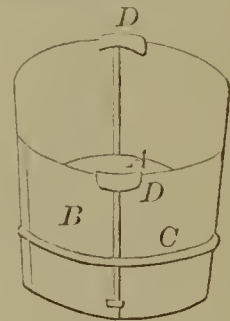

57026—H. Whittingham—Hot Air Furnace.

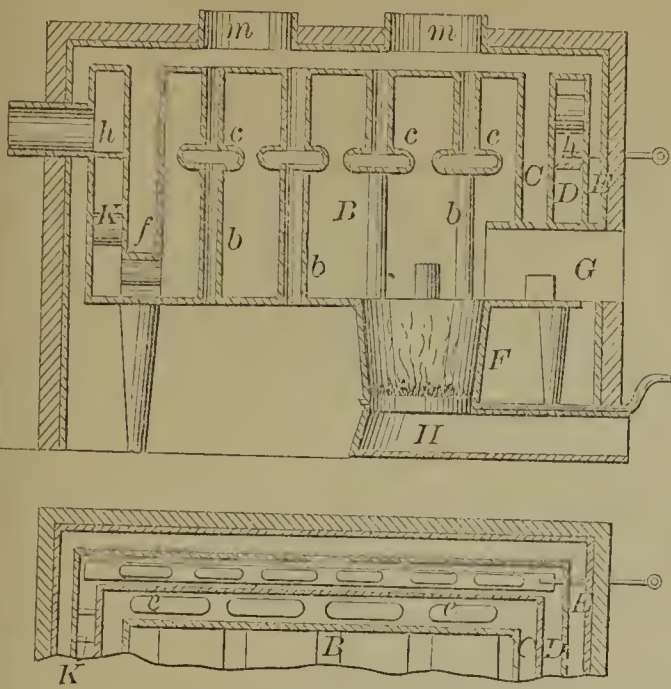

57029—A. S. Wilkinson—Horse Shoe.

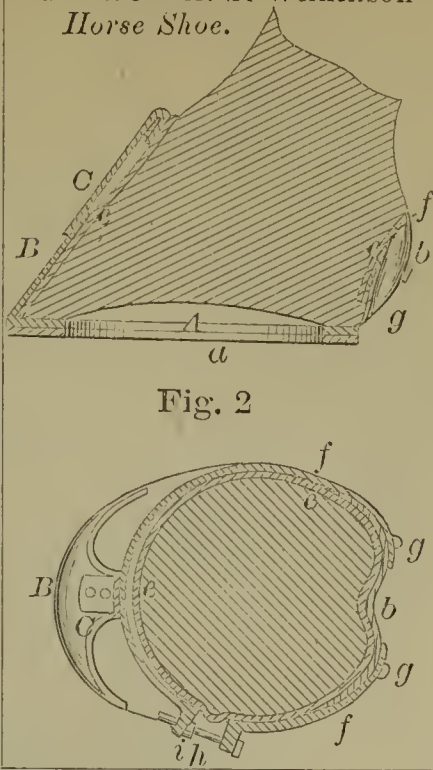

57031—Wilsey & Forbes—Bed Bottom.



57032—E. Wilson—Telegraph Sounder.

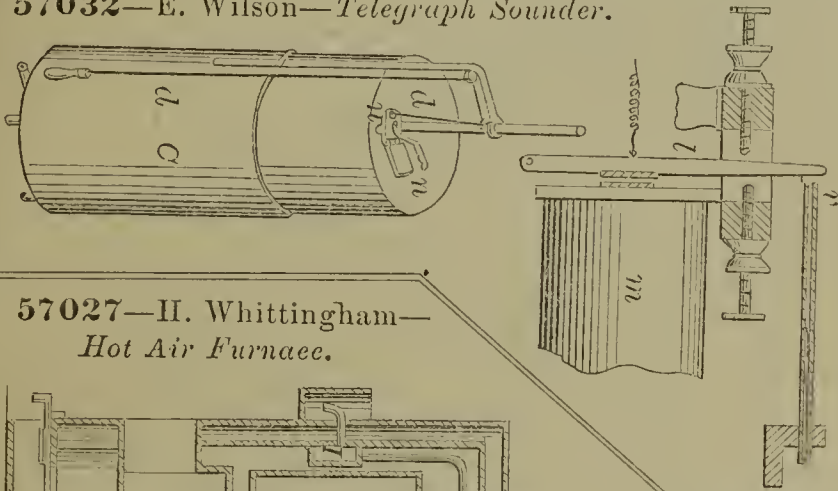

57030—A. S. Wilkinson—Horse Shoe.

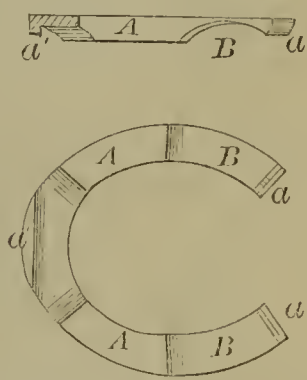

57027—H. Whittingham—Hot Air Furnace.

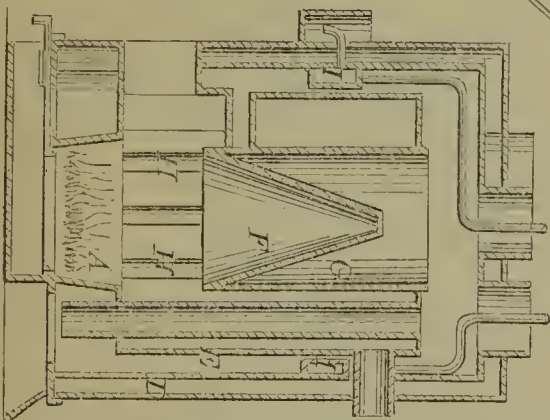

57033—D. Winer—Propelling Apparatus for Vessels.

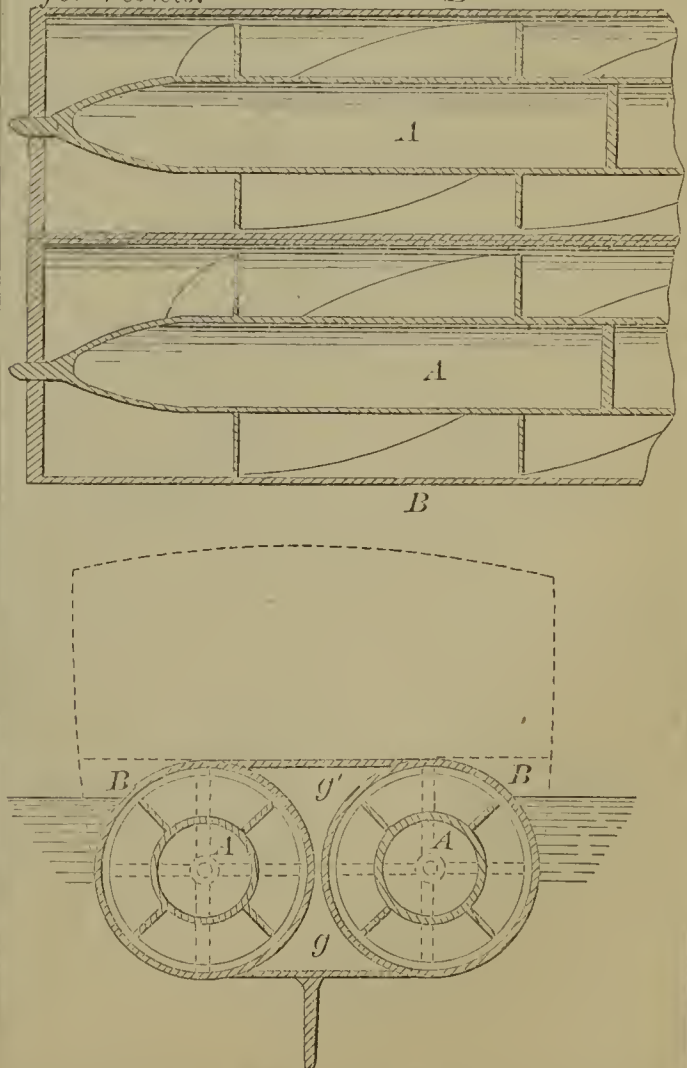

57028—H. Whittingham—Hot Air Furnace.

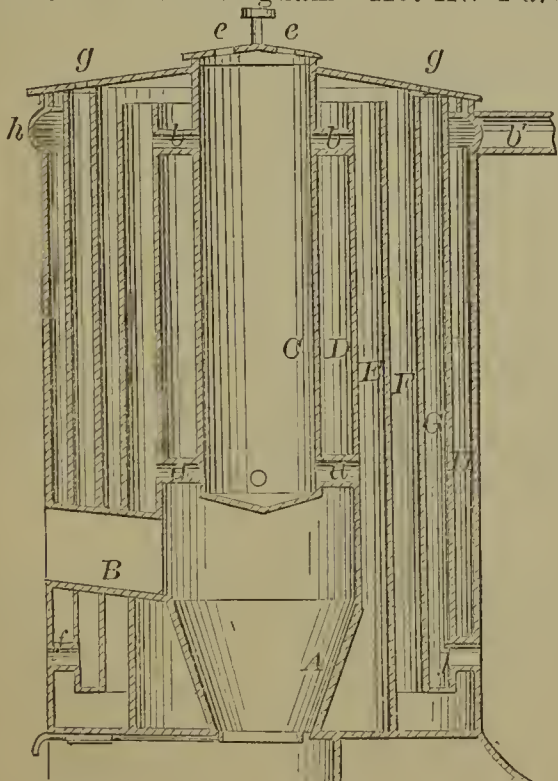

57034—C. Baer—Type-Setting Machine.

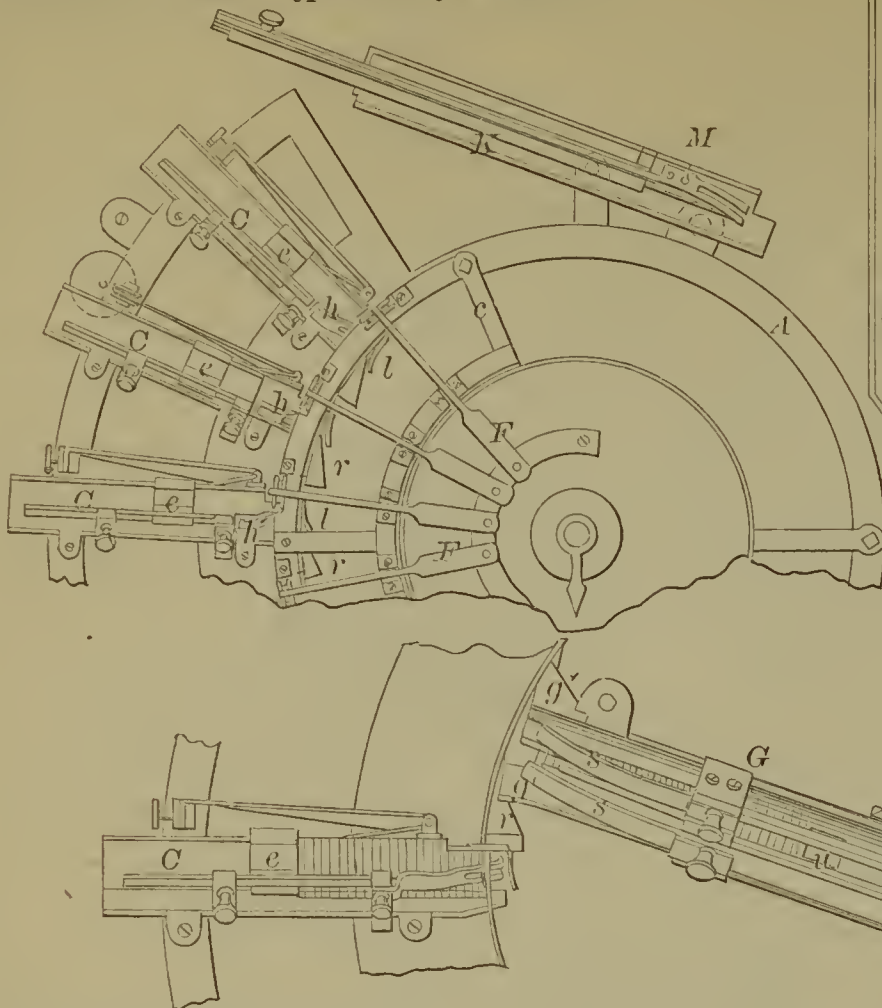

57039—A. D. Chase—Bed Bottom.

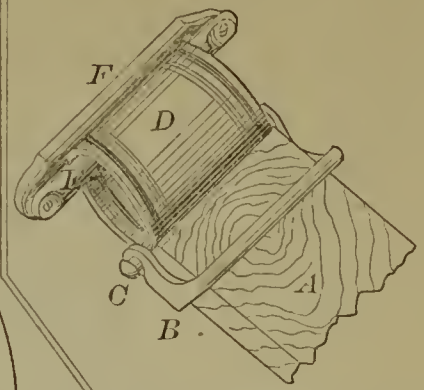

57038—J. Bradley—Excavator.

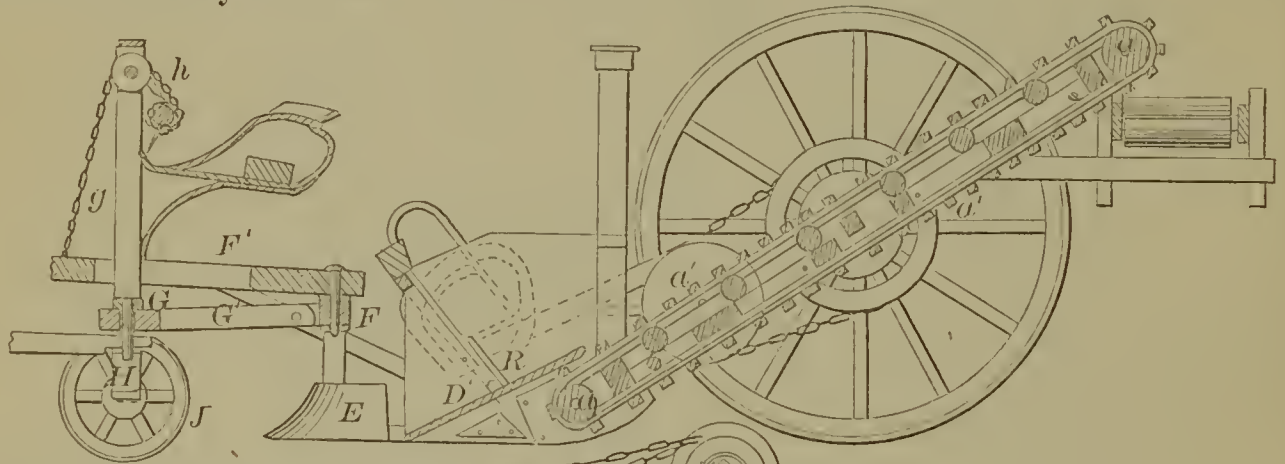

57035—C. Barnes—Steam Jet Pump.

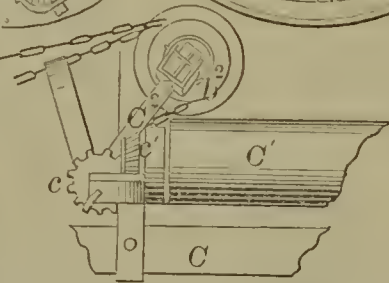
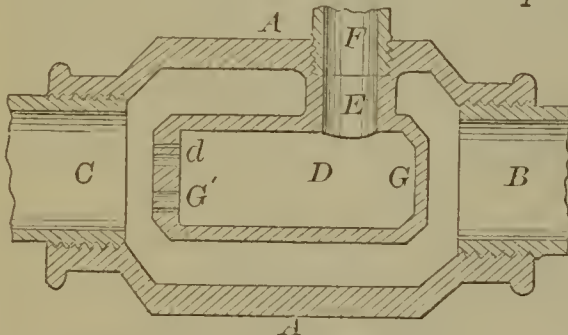

57037—J. F. Borgardus—Packing Rings for Pistons.

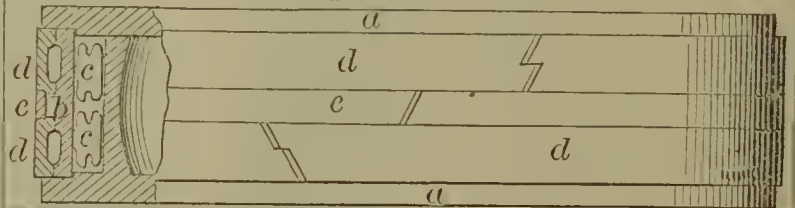

57036—T. Beach—Caster.

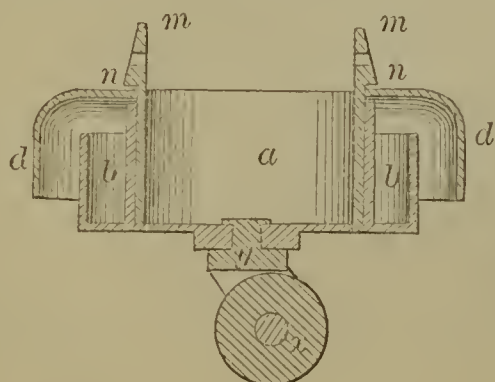

57040—W. B. Dodds—Safe Lock.

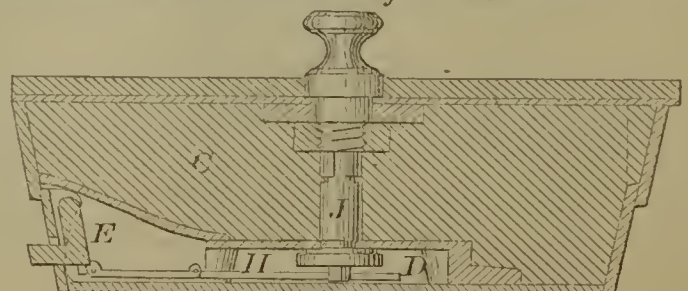

57041—J. M. Ferrell—*Brick Mould.*

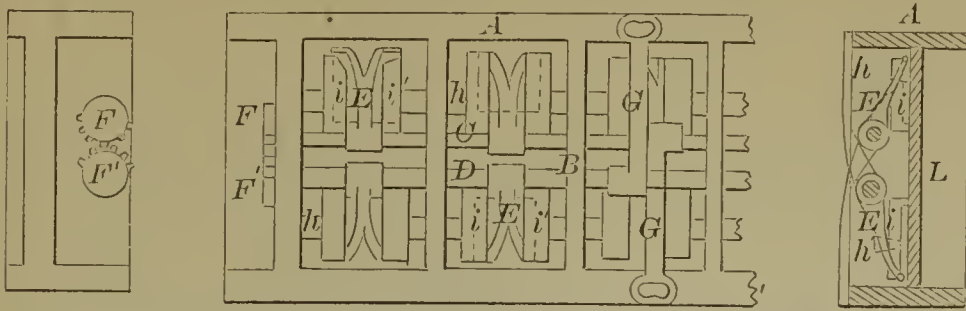

57042—C. P. Geissenhainer—*For Making Nuts and Washers.*

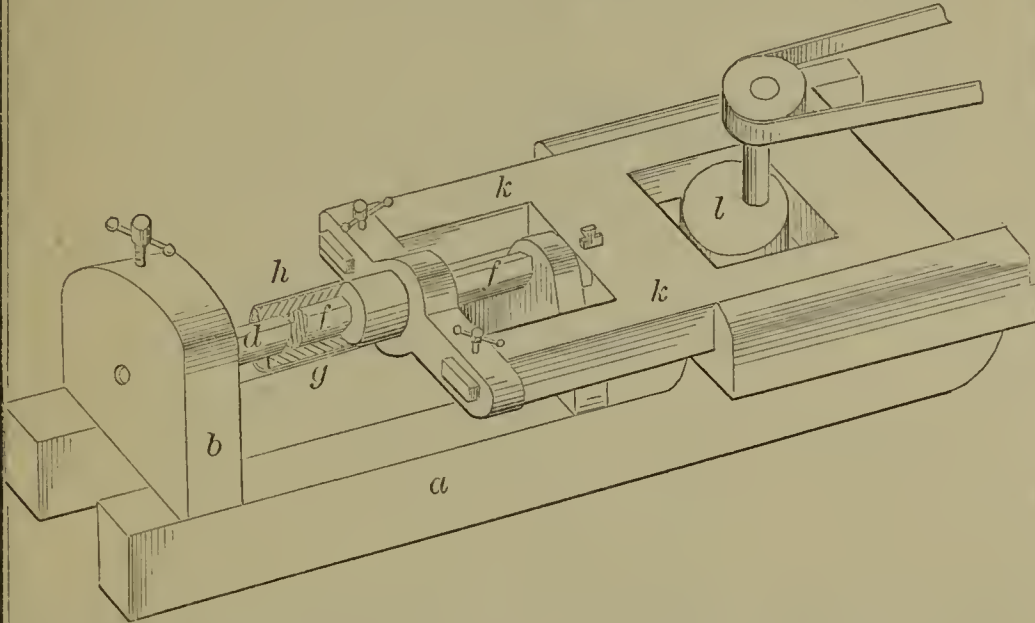

57045—R. Lyon—*Riveting Machine.*

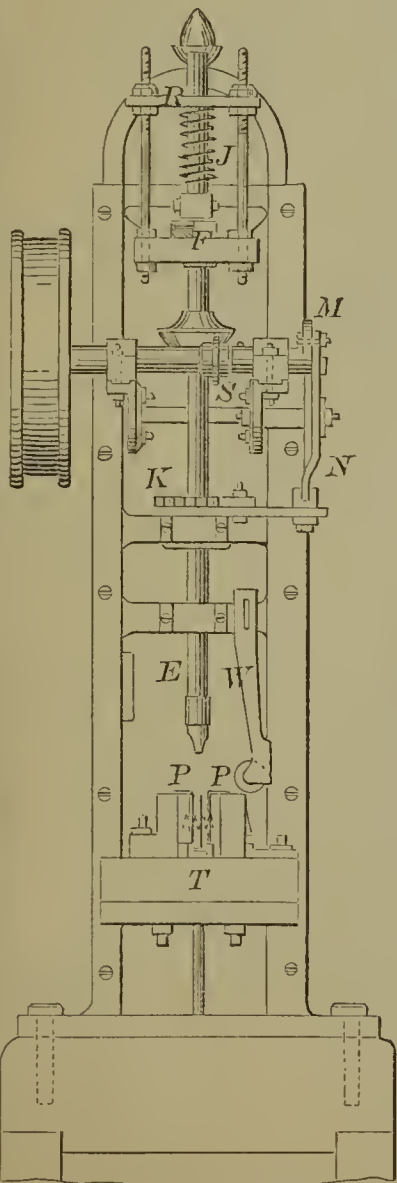

57046—S. W. Putnam—*Sawing Machine.* B

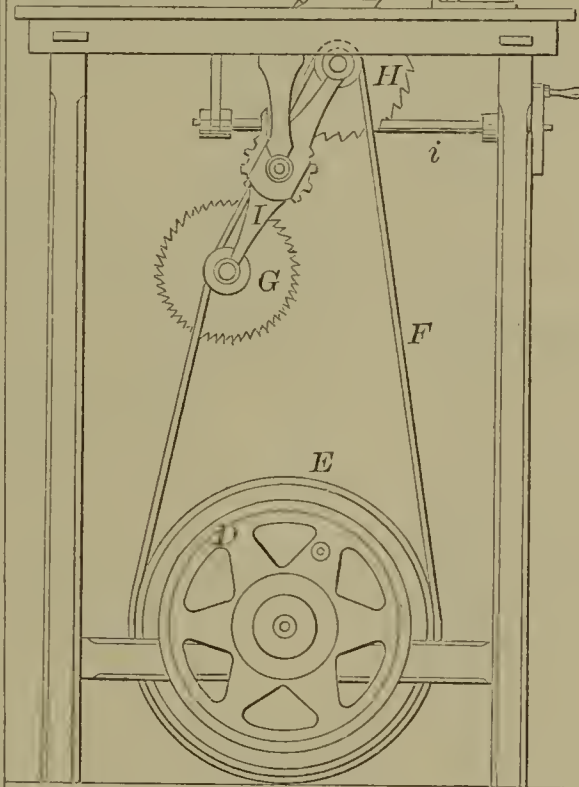

57048—T. Rosenthal—*Neck Tie Supporter.*

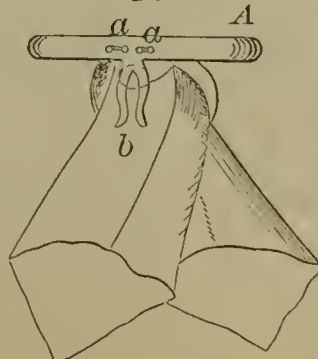

57043—E. L. Keeler—*For Bending Chain Links.*

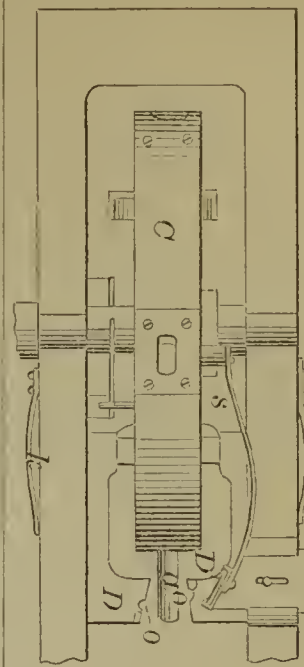

57044—J. Lyle—*Saw Set.*

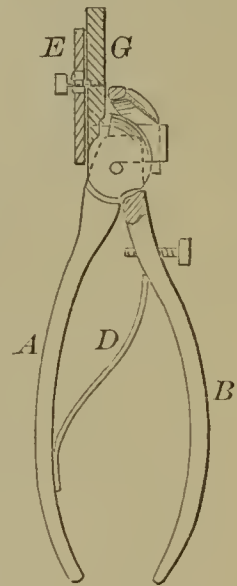

57047—T. K. Reed—*Sewing Machine.*

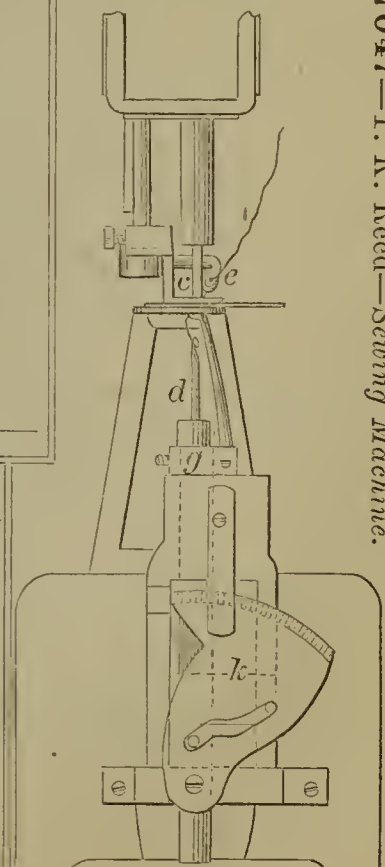

57049—C. H. Sawyer—*Cattle Hitch.*

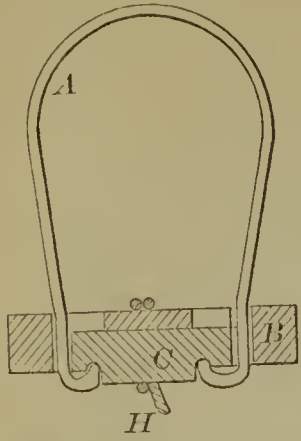

57050—J. Stevens—*Ditching Machine.*

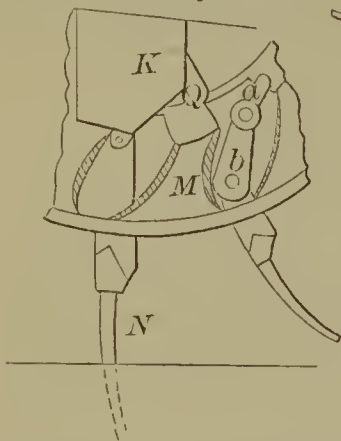
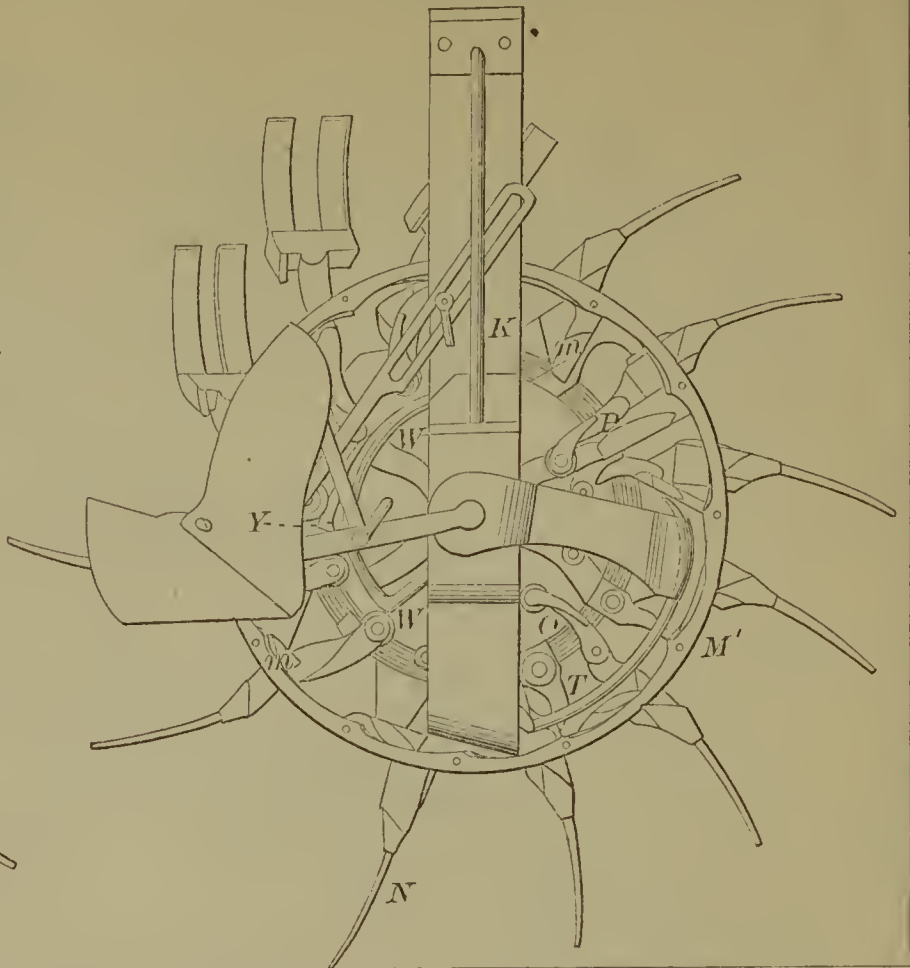

57053—G. M. White—*Curtain Ficture.*

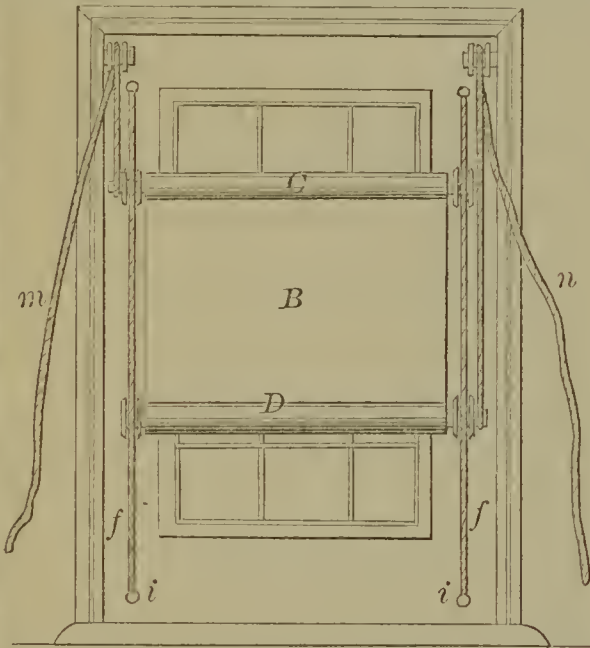

57051—A. C. Wade—*Churn.*

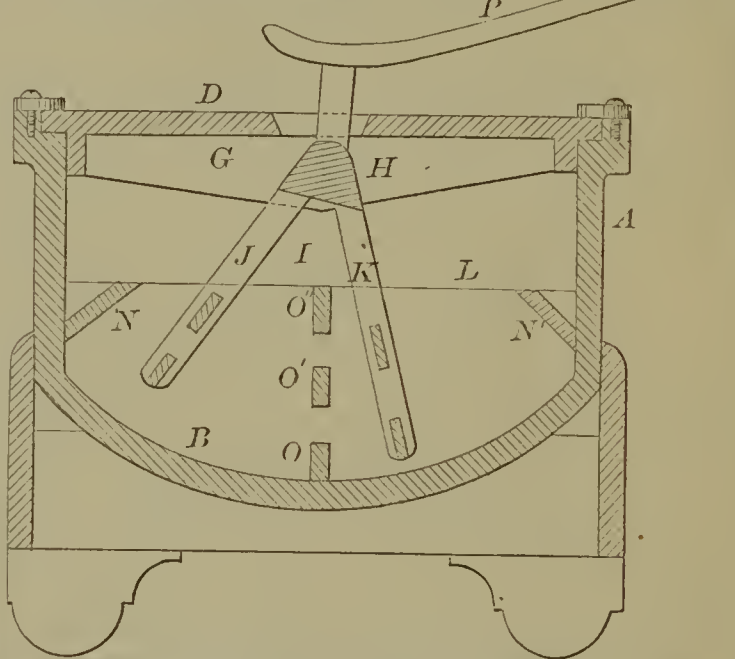

57052—A. C. Wade—*Washing Machine.*

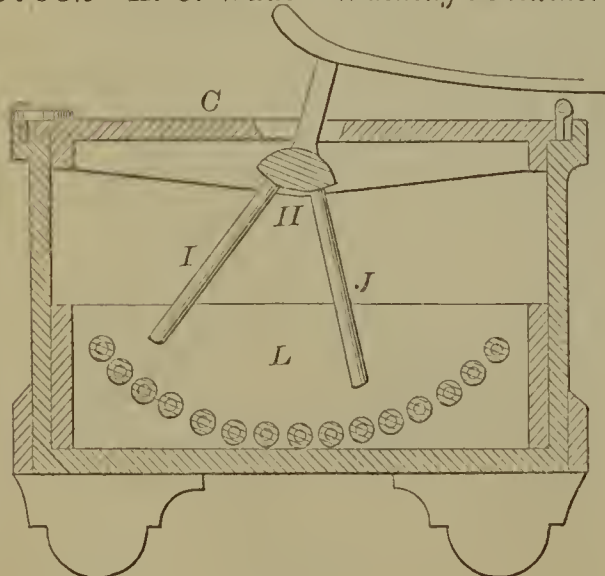

57054—J. C. Wybell—*Turning Lathe.*

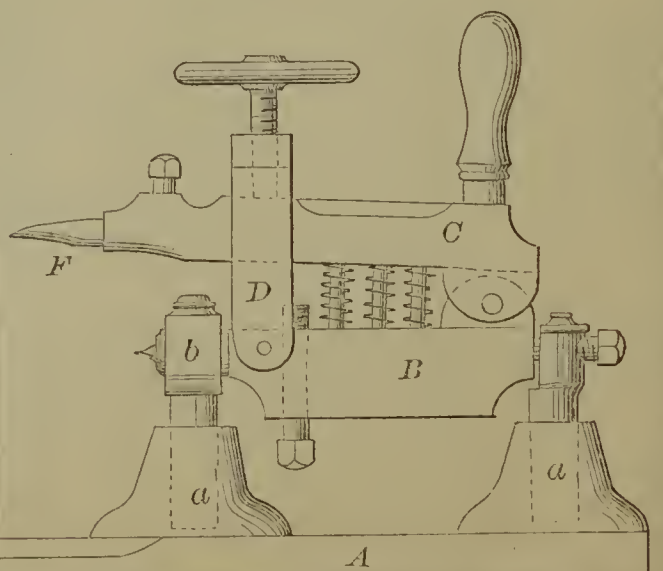



57055—A. T. Atherton—*Sad Iron Heater.*

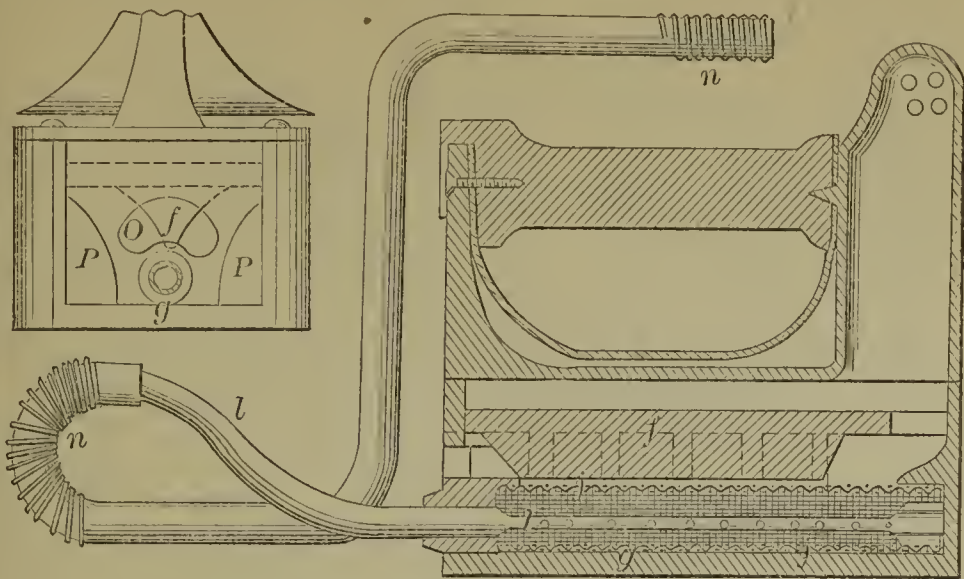

57056—G. W. Bacon—*Block or Plate for Printing Maps.*

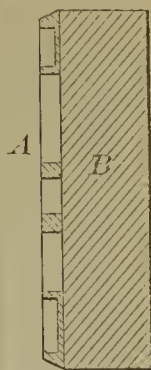

57059—W. Batty—*Uniting Iron and Steel for Railroad Parts.*

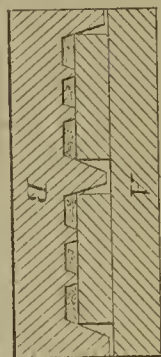

57058—S. Cary—*Boring Apparatus.*

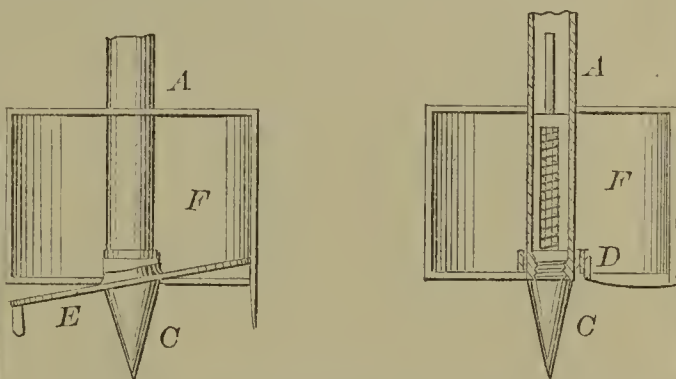

57057—J. Gresham—*Boiler Injector.*

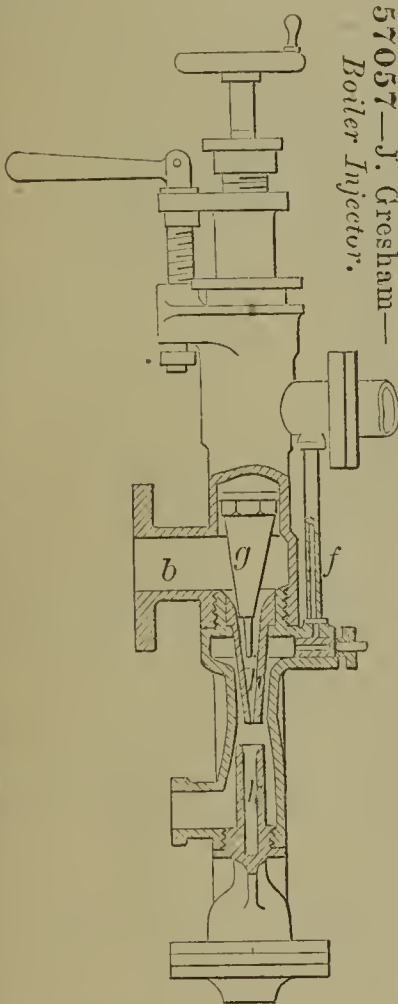

57060—E. Bussey—*Water Reservoir for Cooking Stoves.*

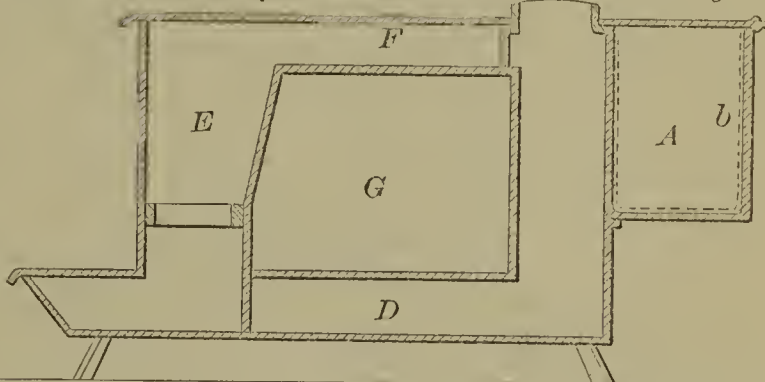

57061—A. S. Acker—*Pitman Box.*

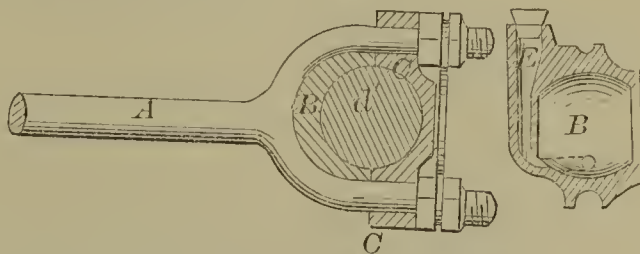

57062—R. B. Angus—*Throttle Valve Mould.*

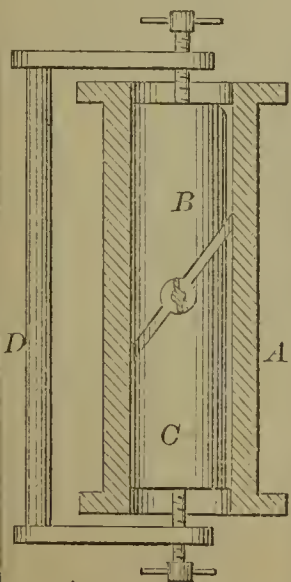

57063—J. S. & T. B. Atterbury—*Smoke Bell.*

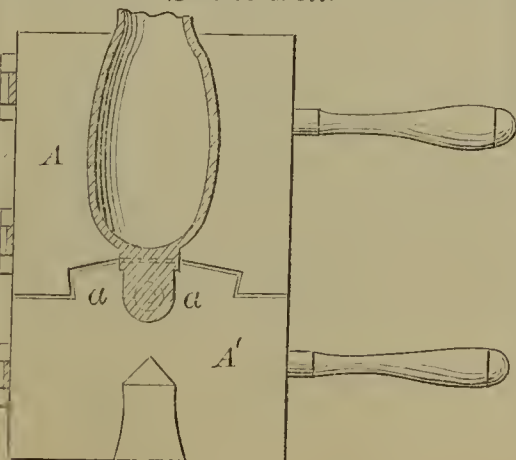

57064—C. H. Bagley—*Lamp.*

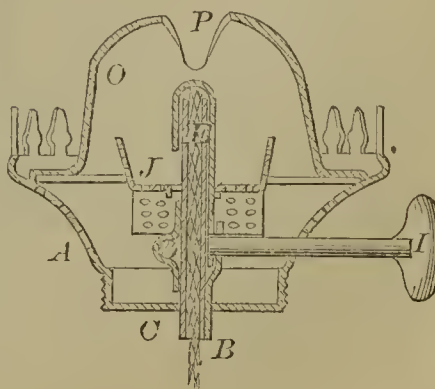

57065—B. A. Bailey—*Spinning Flyer.*

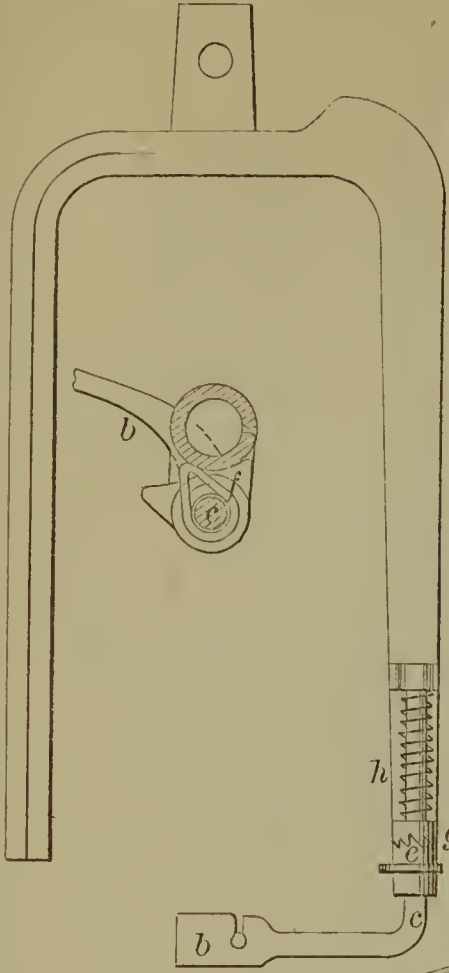

57067—Ball & Houghtelin—*Grubbing Machine.*

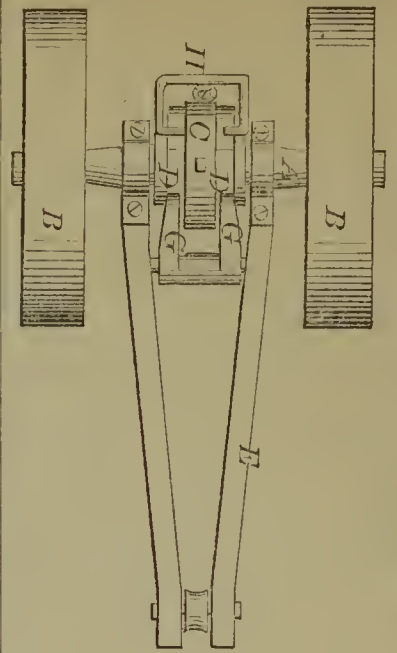

57068—D. C. Baughman—*Hitching Horses to Seeding Machines.*

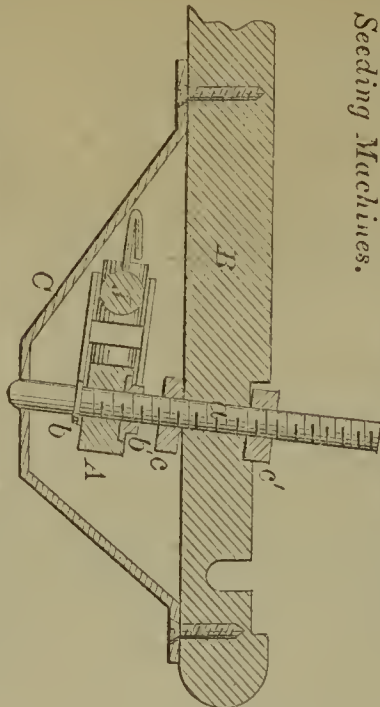

57070—D. Bearly—*Vegetable Cutter.*

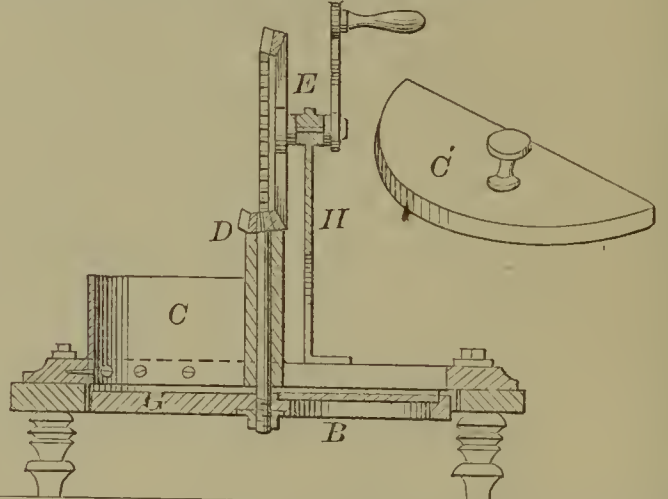

57069—W. Beach—*Maln Shovel.*

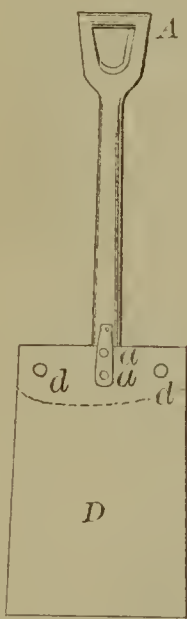

57066—M. G. Baker—*Garden Rake.*

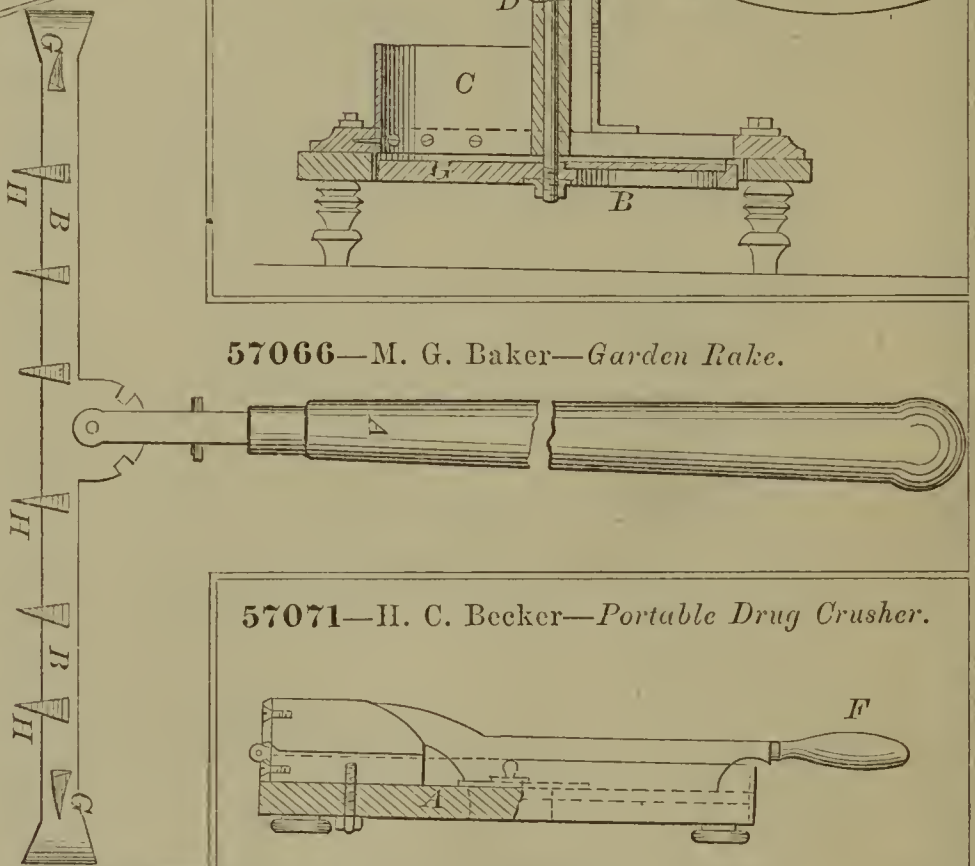

57071—H. C. Becker—*Portable Drug Crusher.*

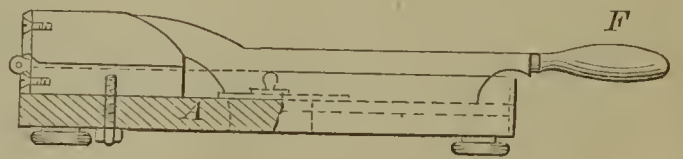

57073—J. S. Bettis—*Farm Fence.*

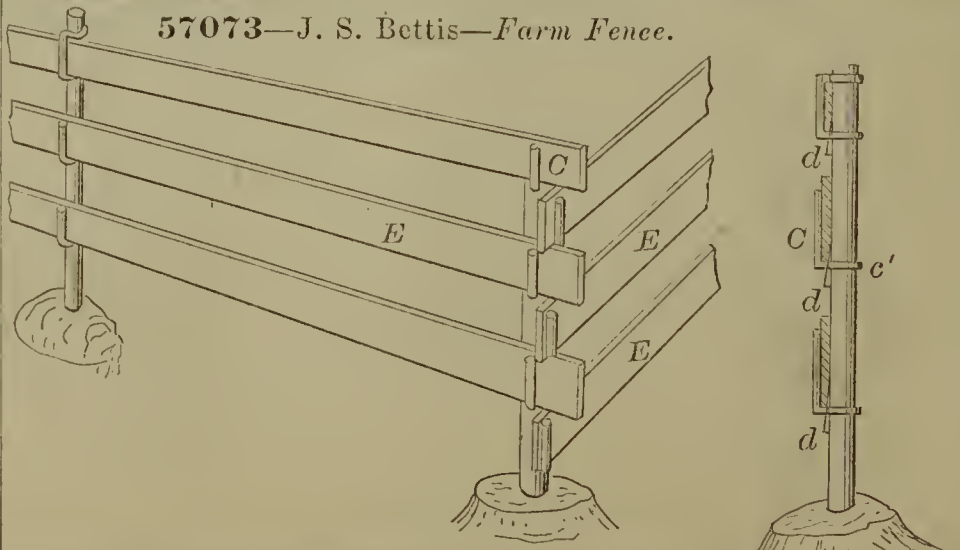

57072—J. A. Bell—*Safety Pocket.*

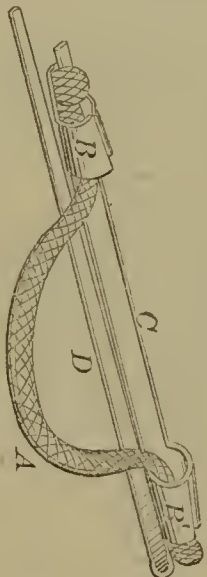

57074—G. W. Bidwell—*Hat Protector.*

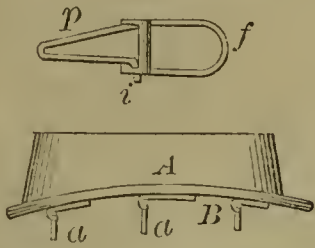

57079—G. B. Brayton—*Oil Injector for Steam Engines.*

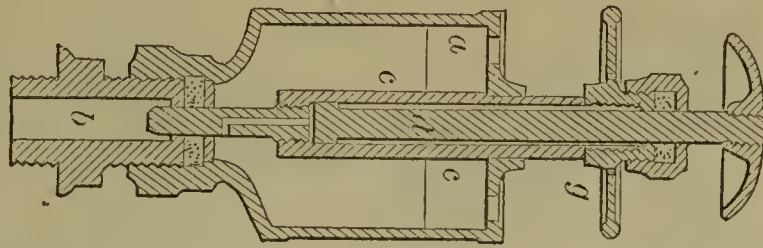

570775—B. Bisbee—*Washing Machine.*

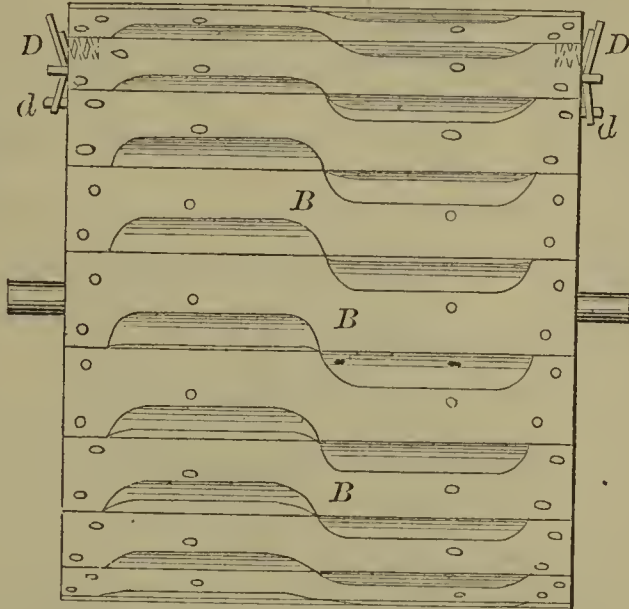
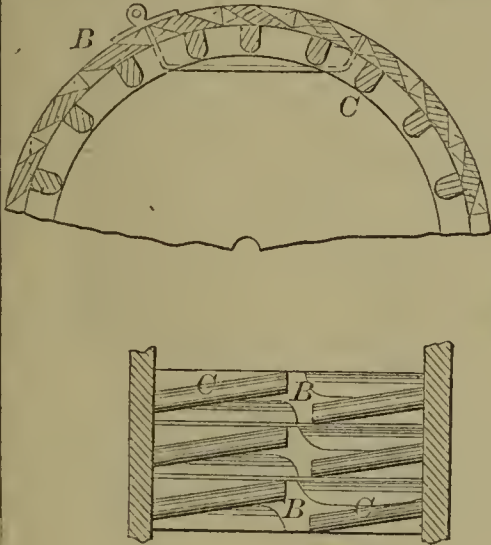

570777—C. Blakeslee—*Hoop Skirt Supporter.*



57078—Blinn & Hewitt—*Flooring Clamp.*

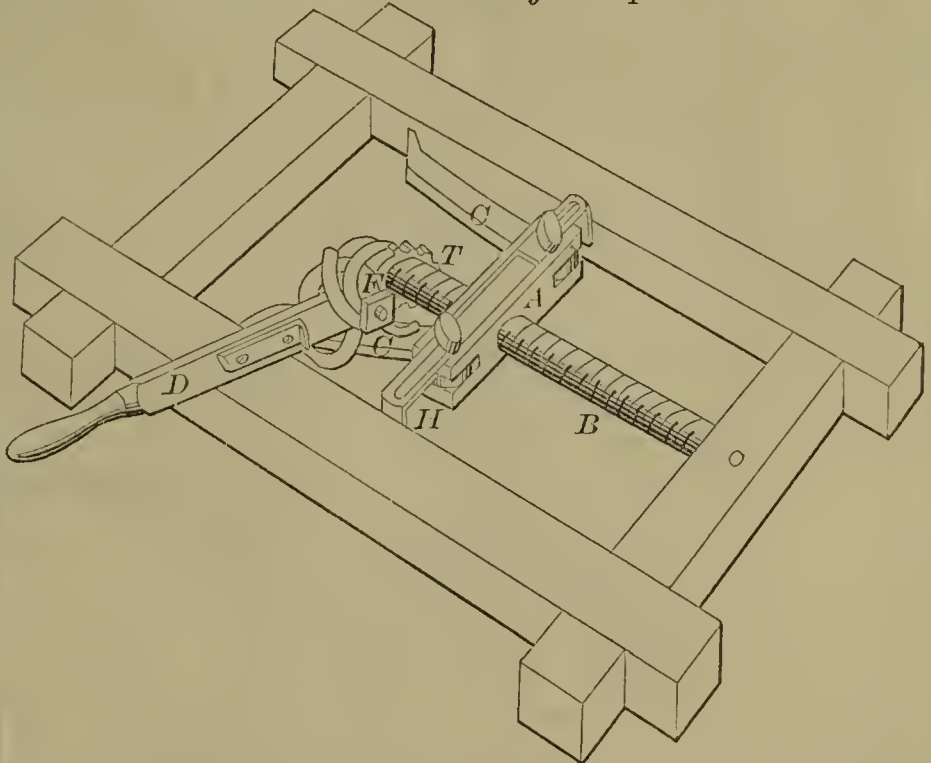

57076—E. S. Blake—*Hat Rack and Seat.*

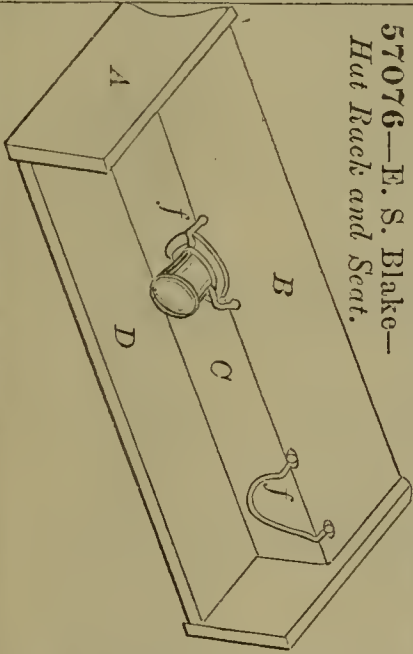

57080—A. Brisbane—*Roofing.*

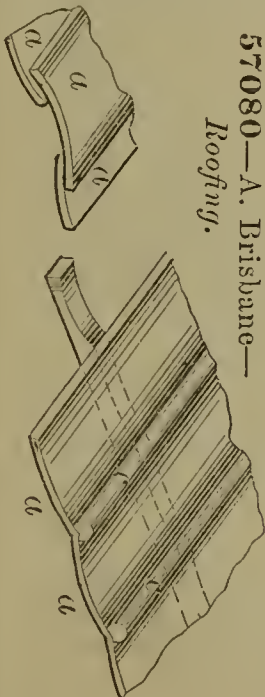

57081—A. H. Burlingame—*Gang Plow.*

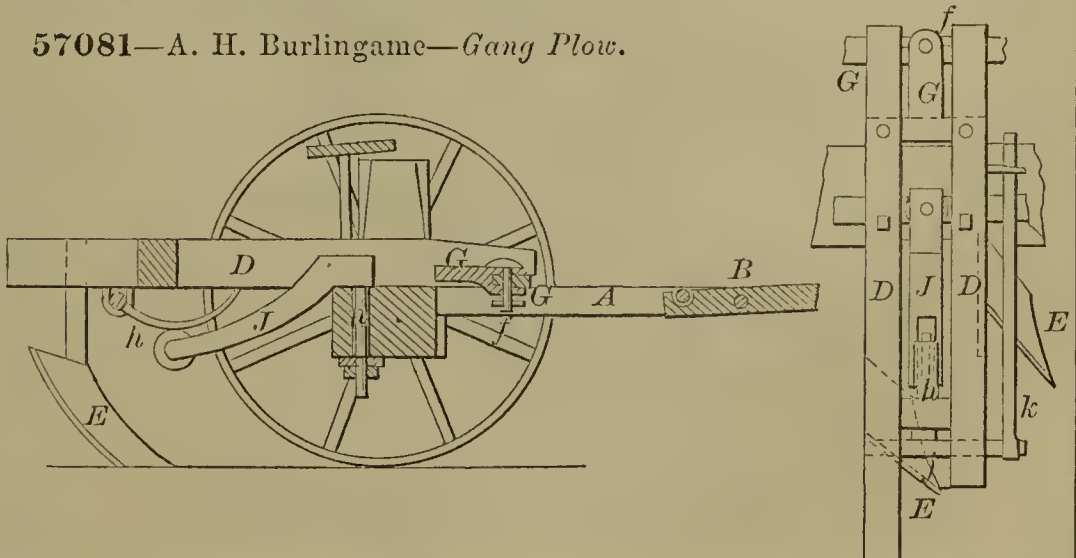

57082—C. Cadwell—Harvester.

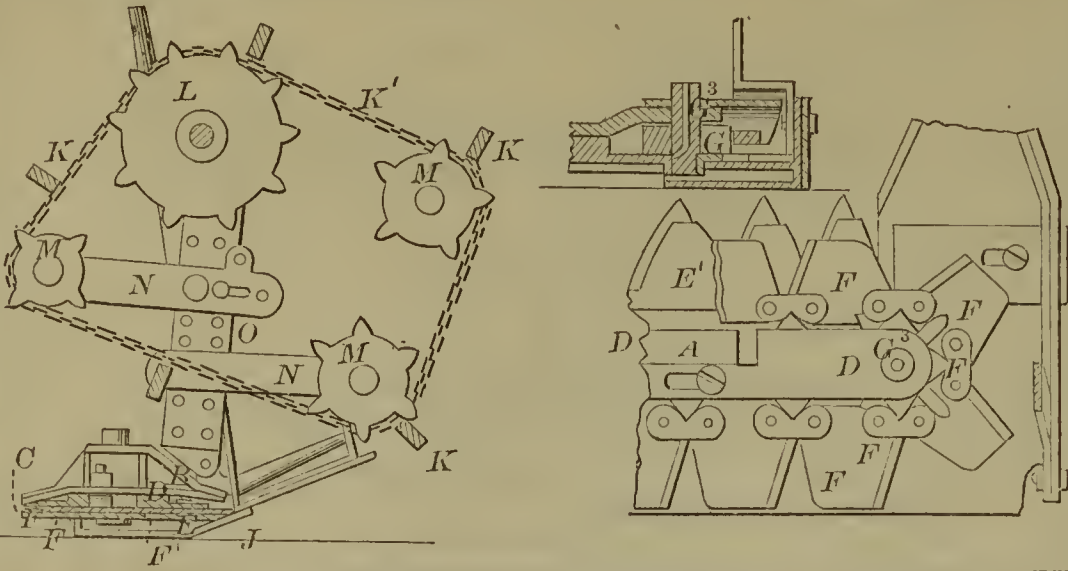

57083—J. W. Campbell—Photographic Printing Frame.

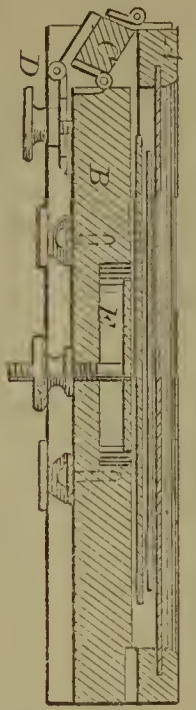

57086—A. Carver—Deep Well Pump.

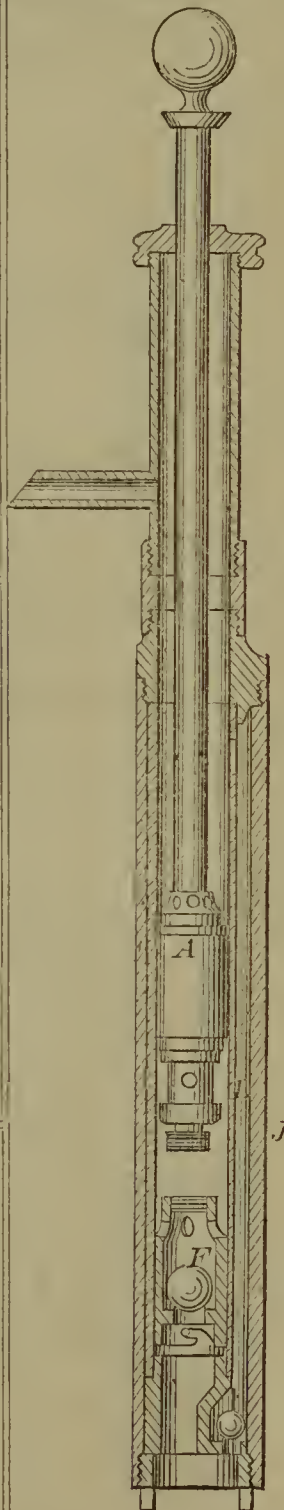

57090—G. E. Clow—Thill Coupling.



57087—W. Clark—Gas Burner Regulator.

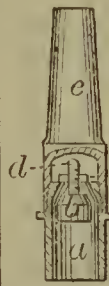

57085—J. W. Carter—Corset Clasp.



57084—J. M. Carpenter—Bridling Machine.

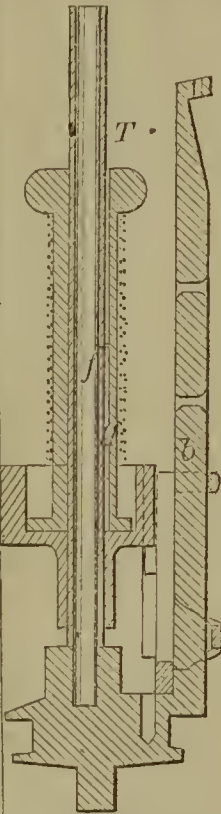

57089—W. R. Close—Water Wheel.

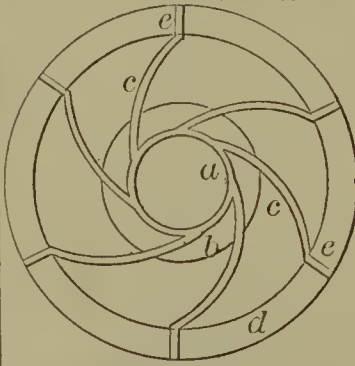

57091—W. R. Coe—For Spreading Plastic Roofing.

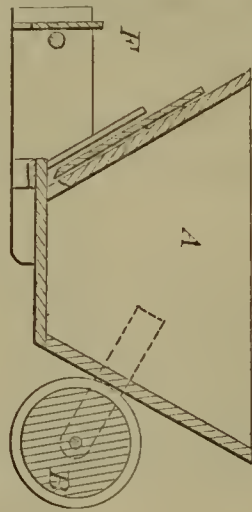

57088—W. Clemson—Saw.

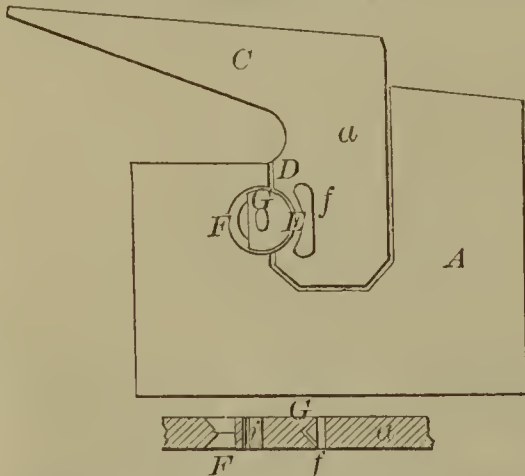

57092—E. Coleman—Wheel Tire.

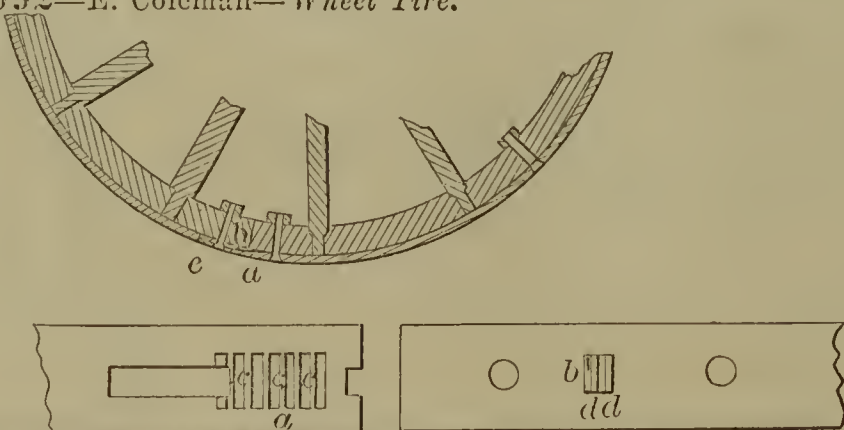

57094—F. Crick—Running Gear of Carriages.

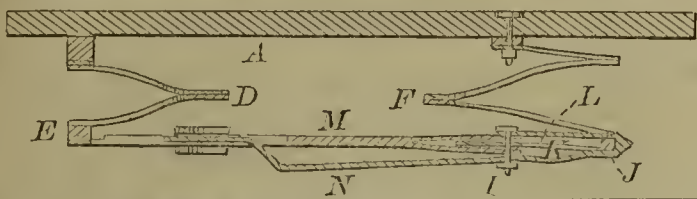

57096—W. R. P. Cross—Curtain Fixture.



57101—Eagle & Smith—Button.

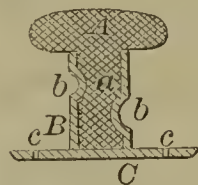

57097—J. Dailey—Liquid Measure.

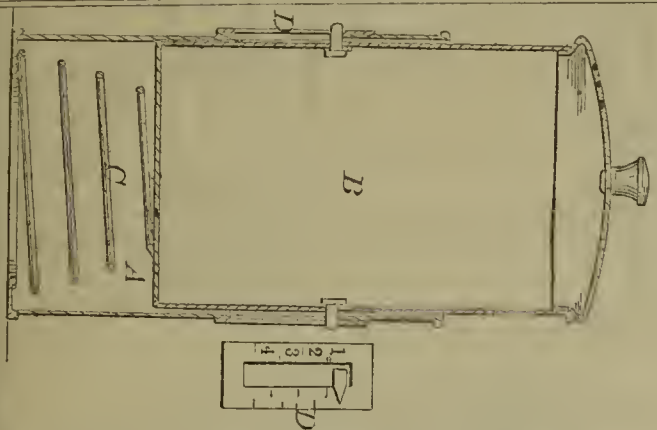

57102—B. F. Early—Shoe Cleaner.

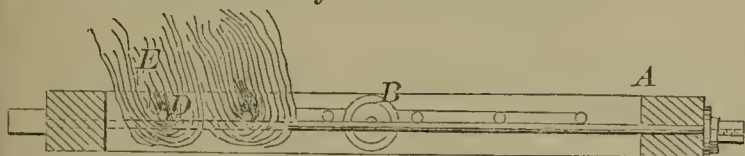

57098—J. Wesley—Trace Buckle.

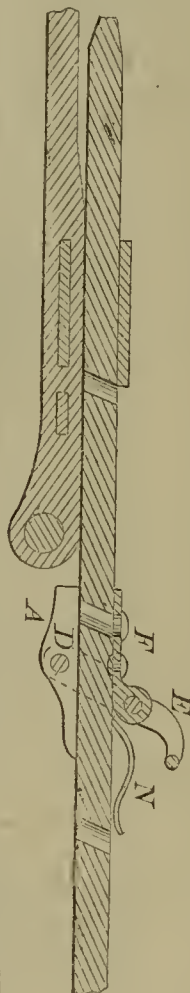

57100—L. Dorman—Carriage Axle and Journal.

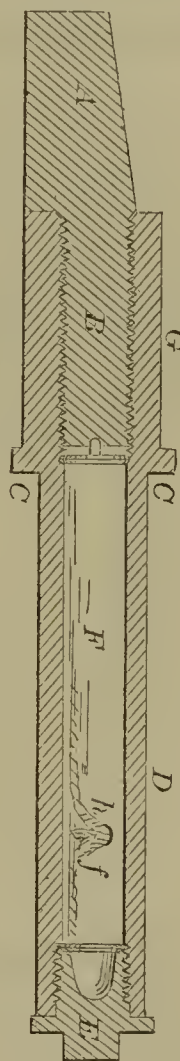

57099—T. Derington—For Turning Wagon Spokes.

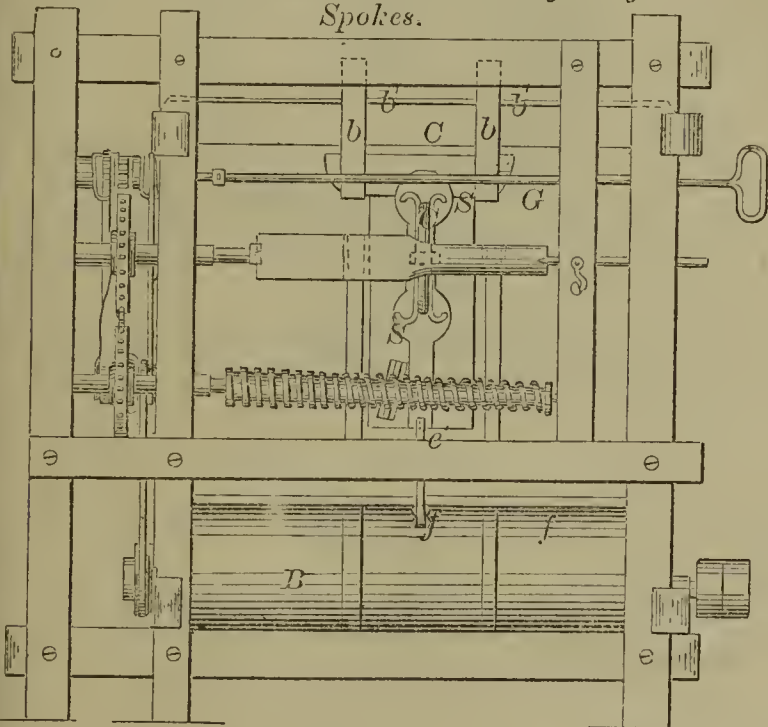

57103—Eckel & Schnyler—For Rendering Tallow, Lard, &c.

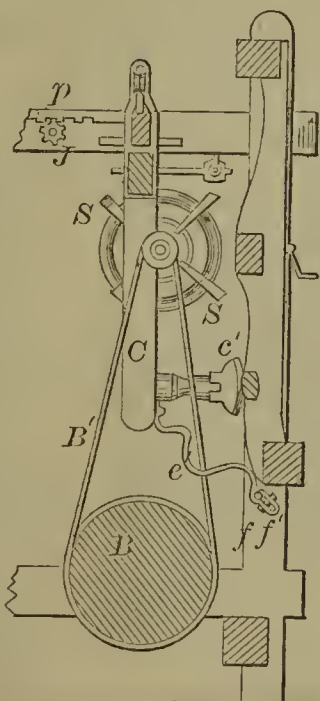
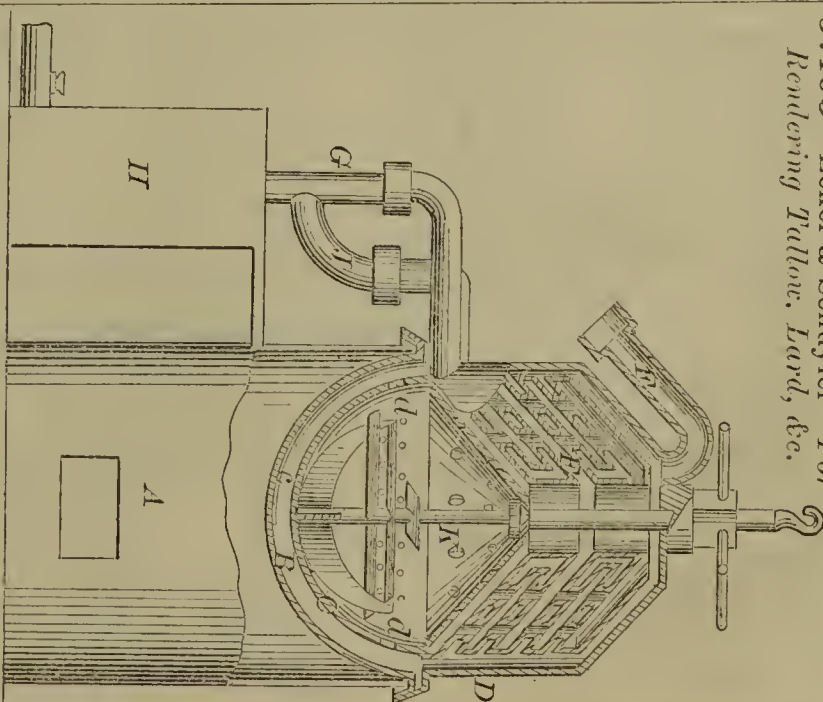

57104—Eckel & Schuyler—For Rendering Tallow, Lard, &c

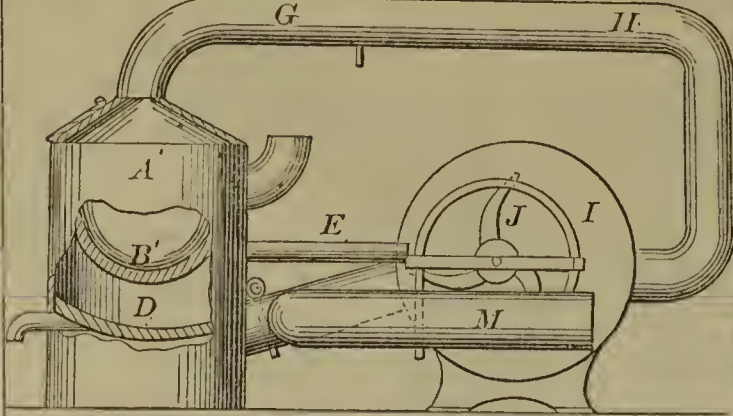

57105—R. H. Emerson—Turf Cutting Machine.

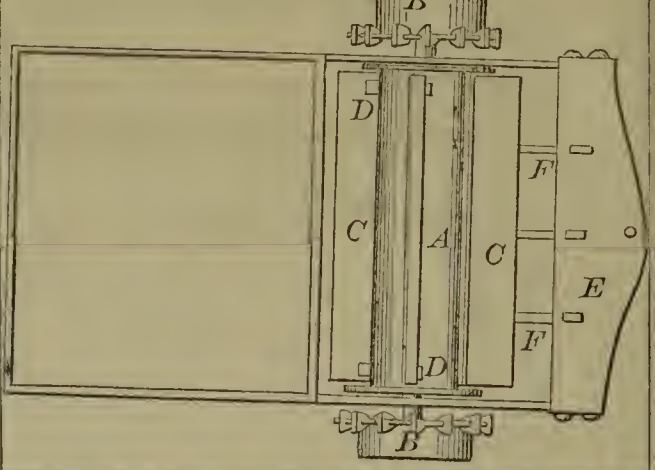

57107—C. Eversol—Screw Driver.

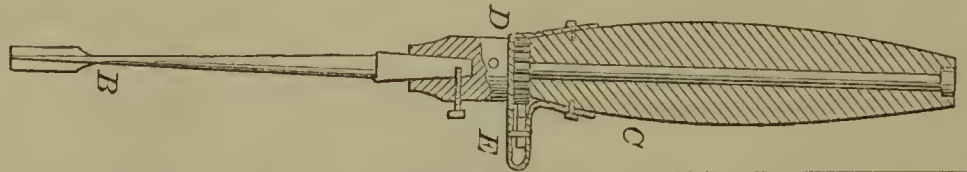

57106—E. Evans—Fruit Picker.

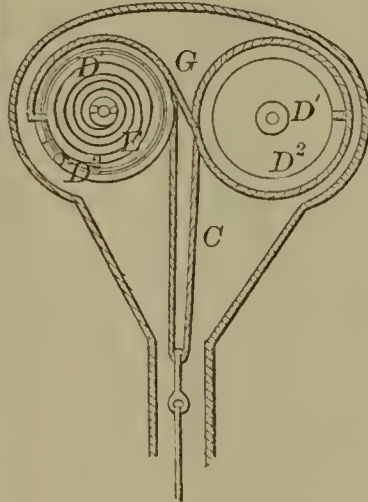
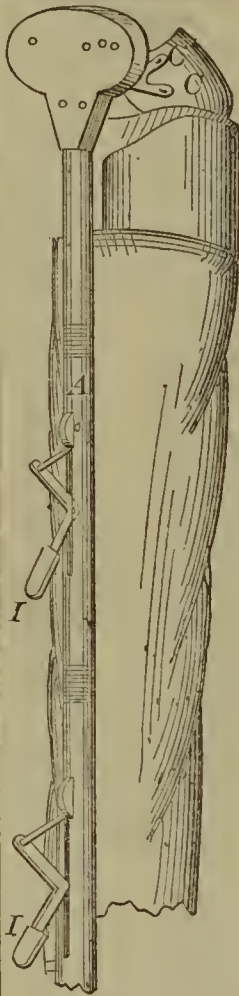

57109—L. Ferguson—Picker for Fibrous Material.

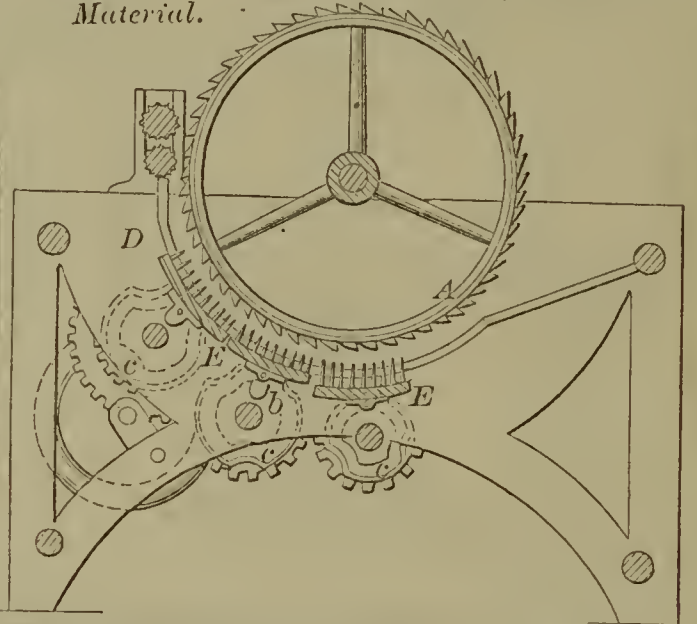

57110—D. Figge—Horse Hay Fork.

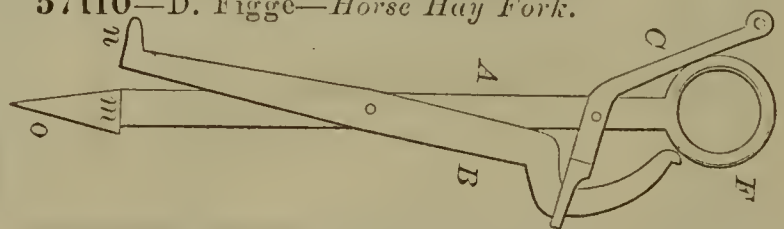

57108—Fairbank & Roods—Valve for the Hulls of Vessels.

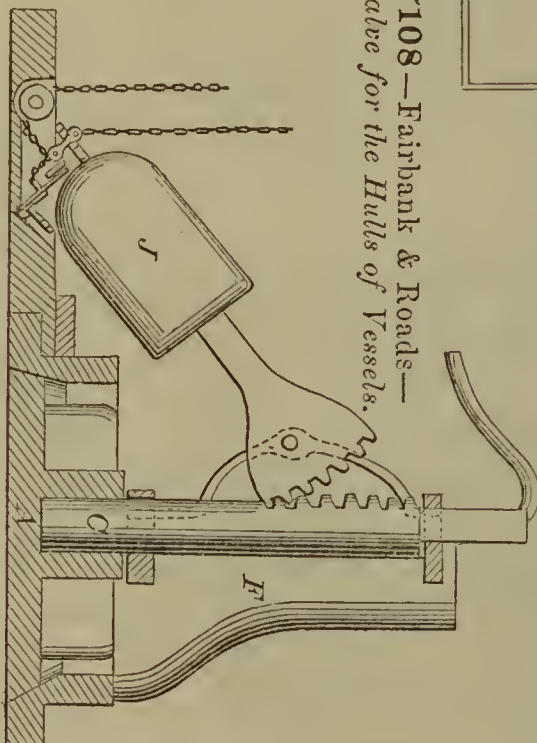

57111—C. Forschner—For Cutting Fat, Lard, &c.

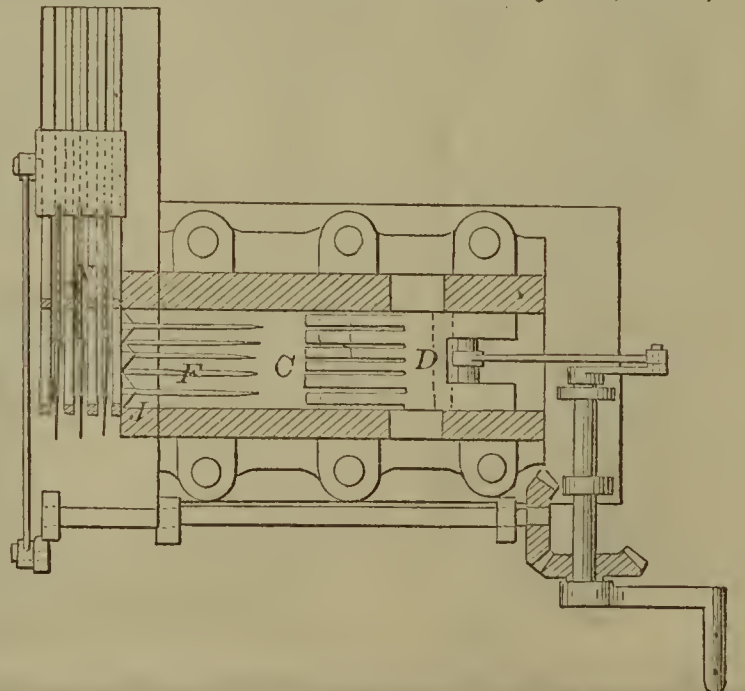

57112—C. Foster—Transmitting Power by Means of Cars upon Rails.

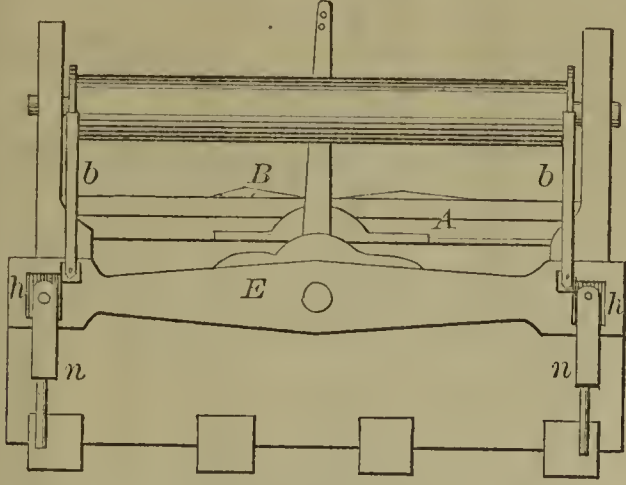

57116—A. Galleth—Sewing Machine.

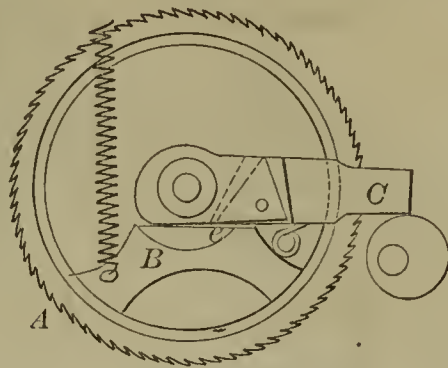

57115—F. F. Fowler—Stack Bottom and Feed Rack.

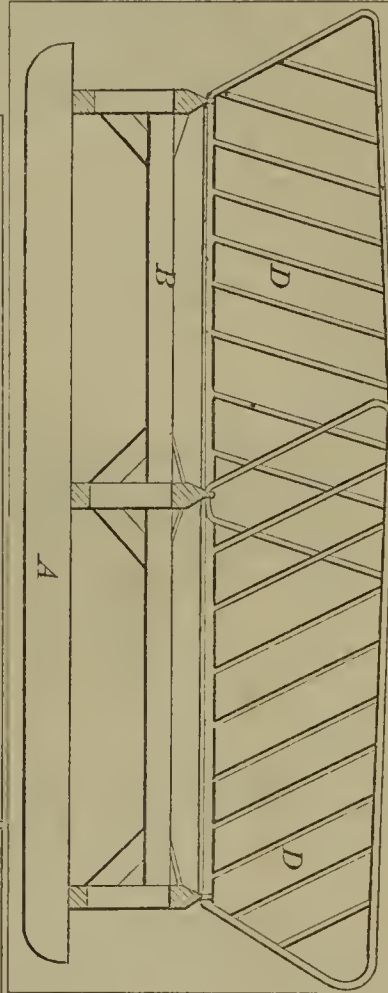

57113—F. F. Fowler—Corn Harvester.

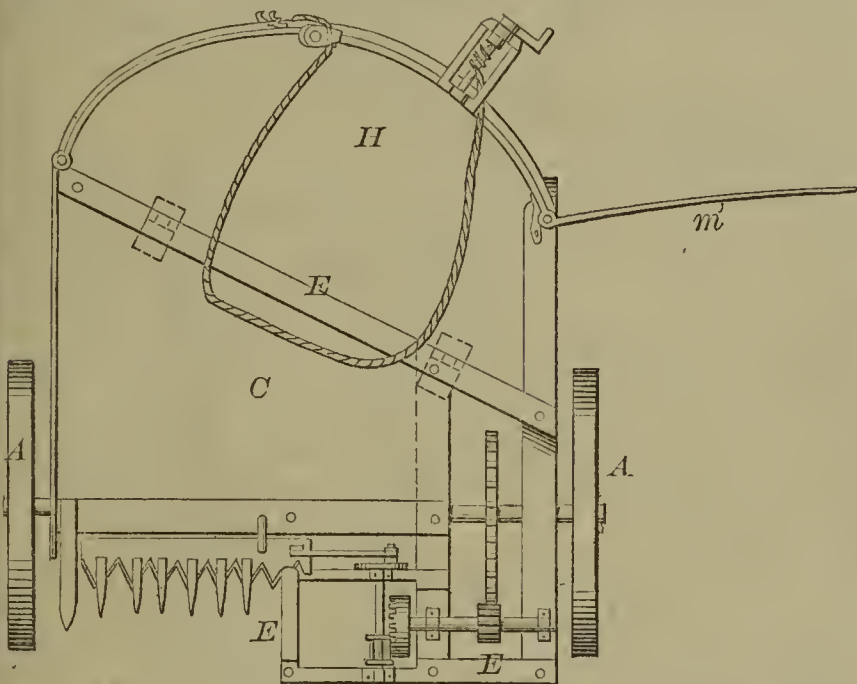

57114—F. F. Fowler—Horse Hay Fork.

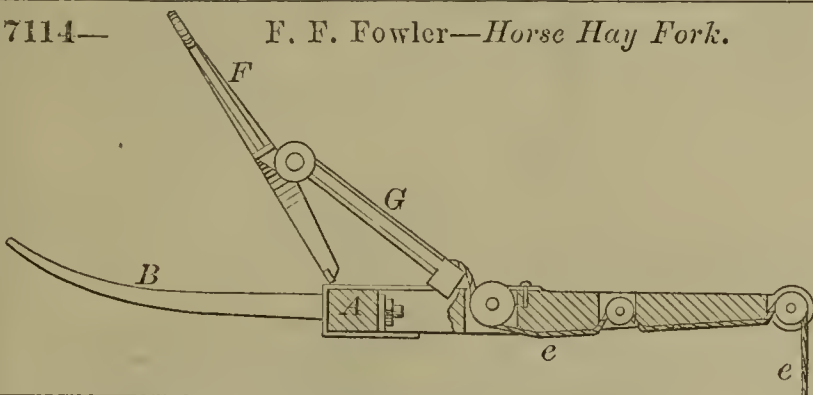

57118—G. M. Gibbens—Water Gauge.

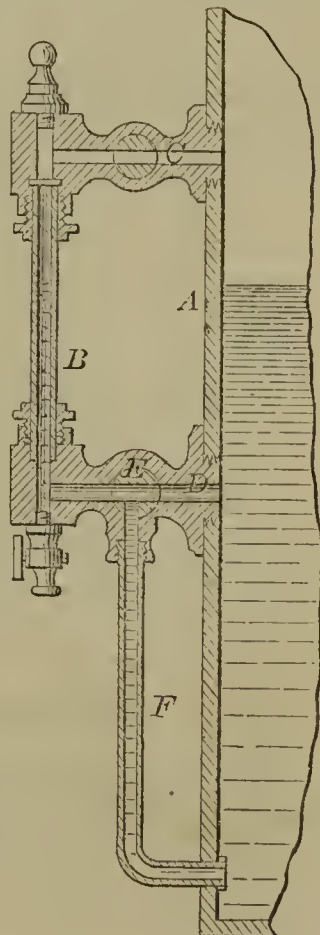

57119—J. Glasson—Hoe.

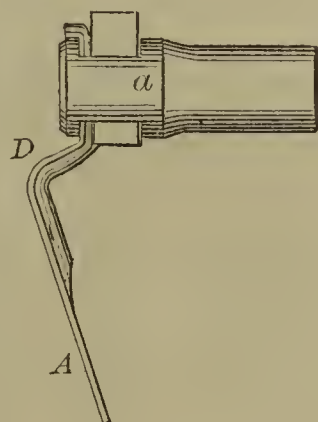

57117—Gallup & Wood—Drying House.

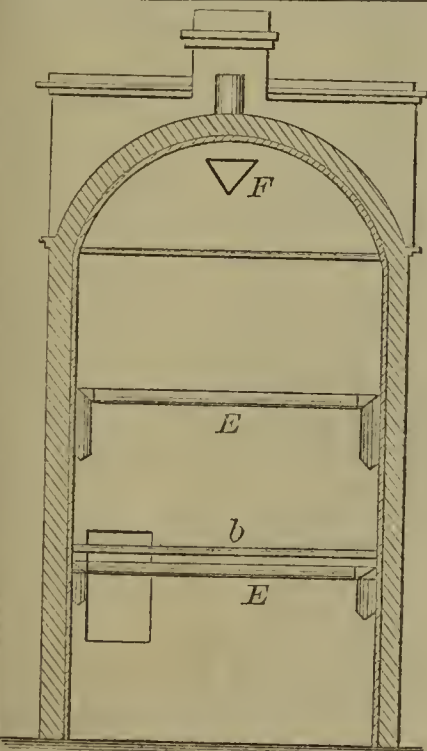

57120—A. Goodyear—For Cutting Barrel Hoops.

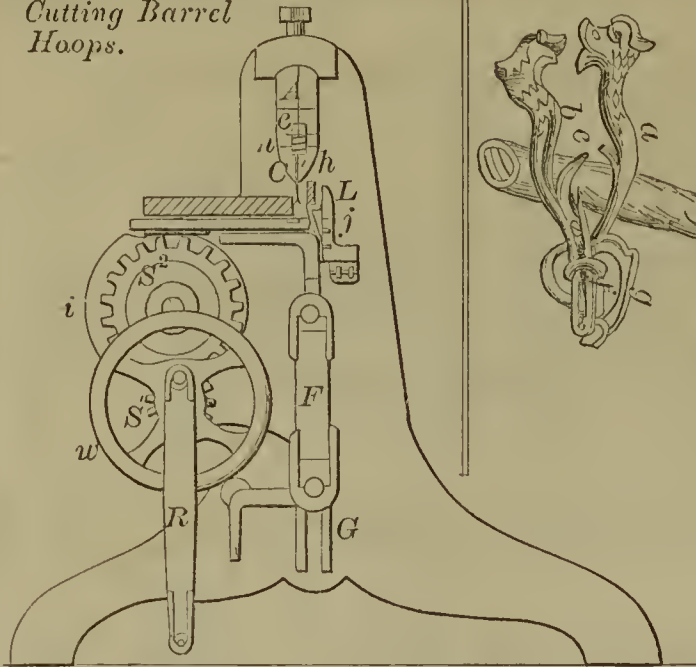

57126—Geschwind & Grether—Cigar Holder and Hat Hook.

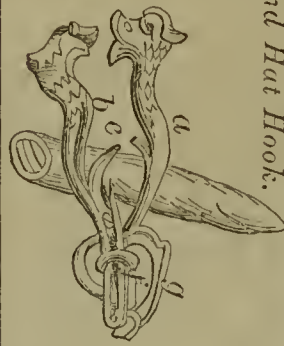

57123—H. D. Green—Illuminating Gas.

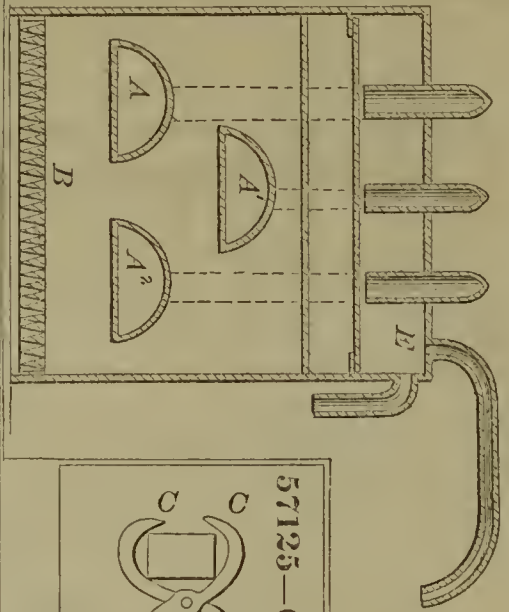

57124—F. S. Gregg—Tup and Die.

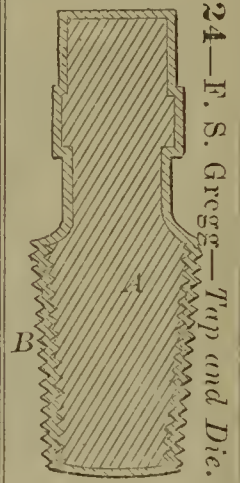

57121—H. Gottfried—Straw Cutter.

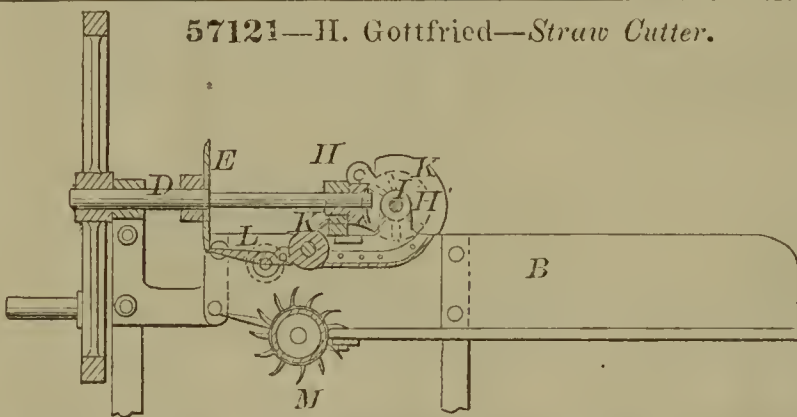

57125—G. W. Gregory—For Raising Weights.



57127 C. Hall—For Adjusting Chain Cables.

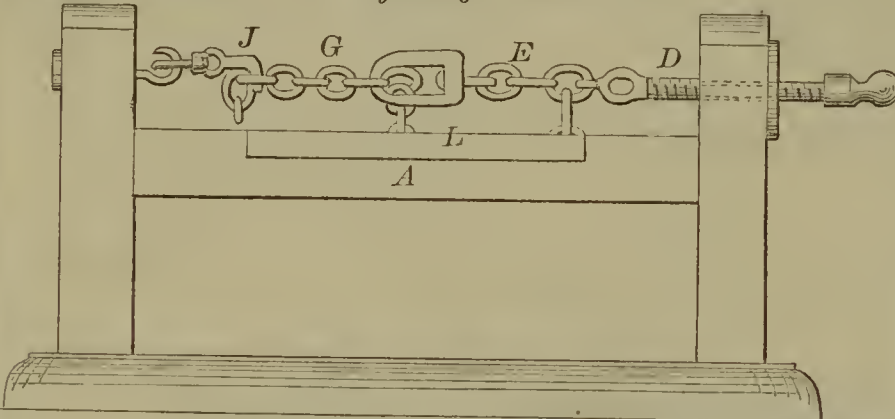

57129—W. H. Hart, Jr.—Neck Tie Supporter.

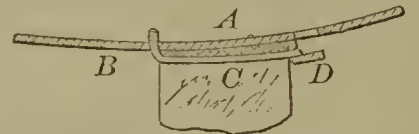

57128—E. Hallett—Brick Machine.

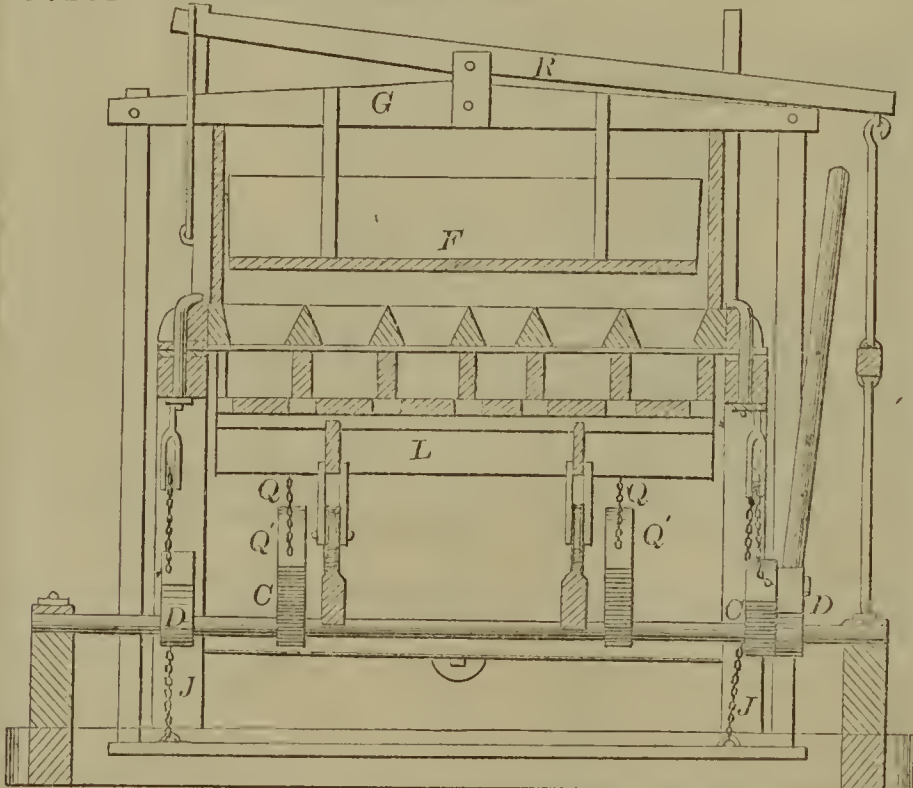

57130—M. P. Hathaway—Harvester.

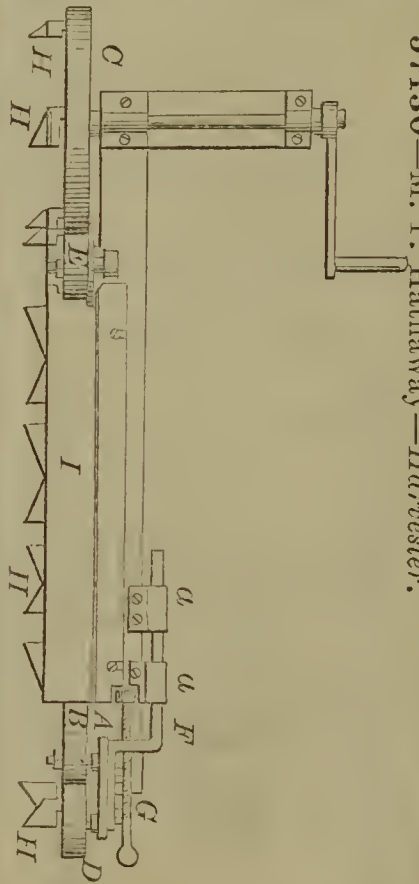



57131—J. H. Heyser—  
Wind Mill.

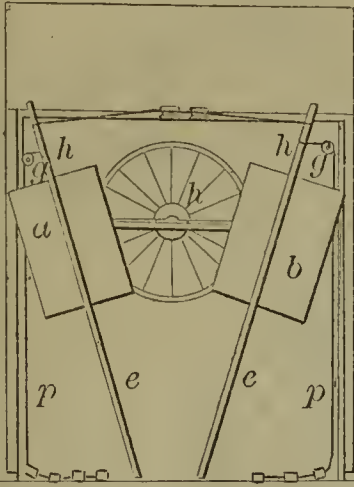

57133—A. Higley—*Car Brake.*

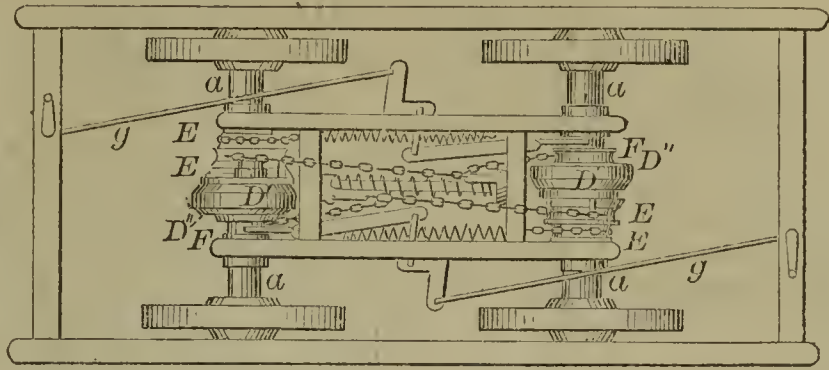

57137—J. Holden—  
Coal Scuttle.

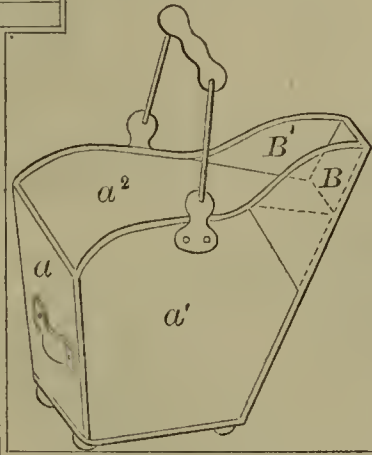

57134—J. Hills—  
Basin Faucet.

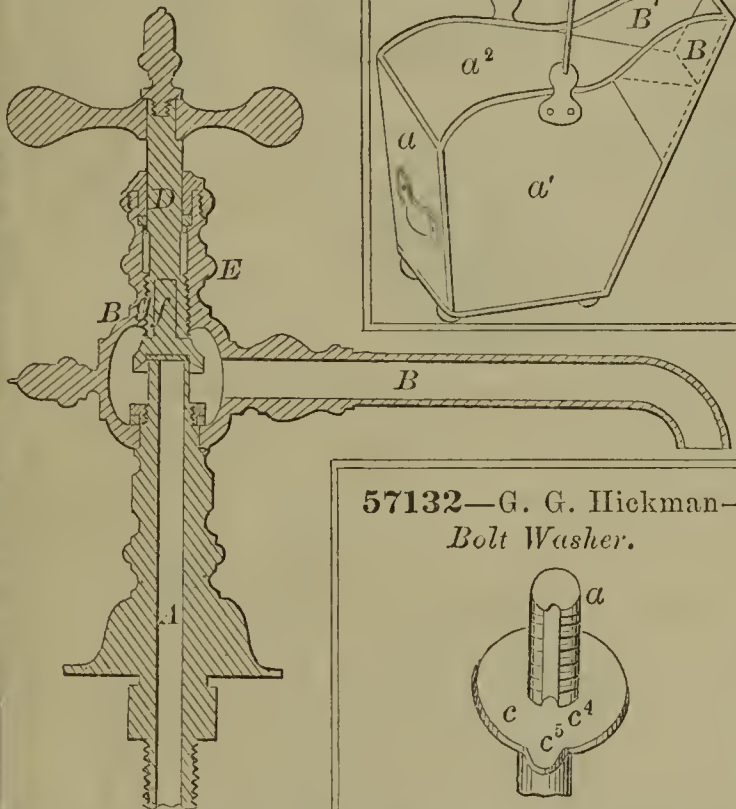

57132—G. G. Hickman—  
Bolt Washer.

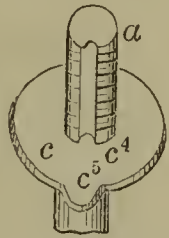

57135—L. Hoffstadt—  
Dentist's Vulcanizing  
Flask.

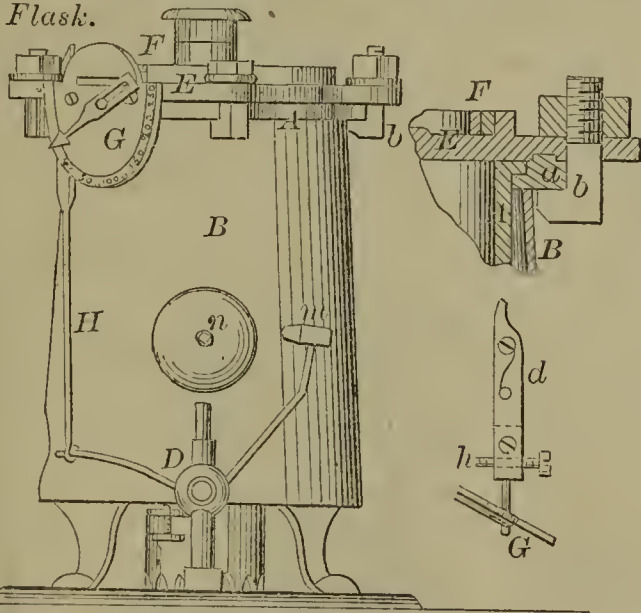

57139—T. Huckans—  
Tobacco and  
Match Box.

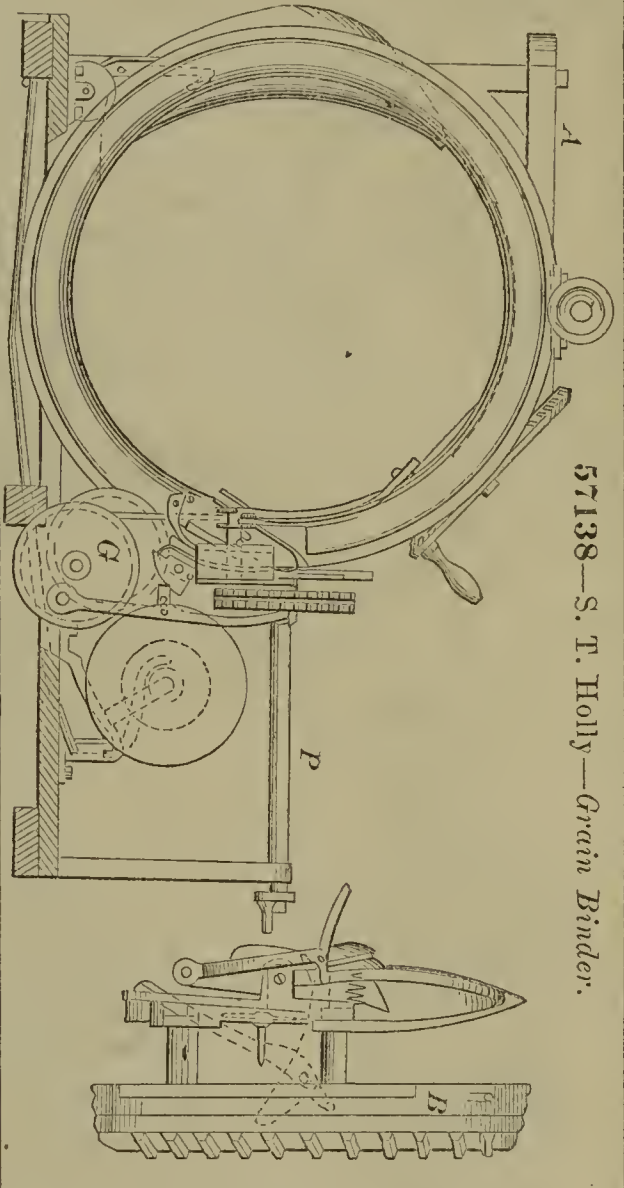
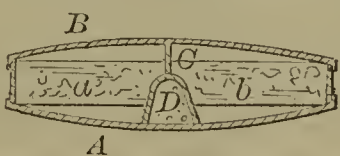

57138—S. T. Holly—  
Grain Binder.

57136—C. B. Holden—  
Punch.

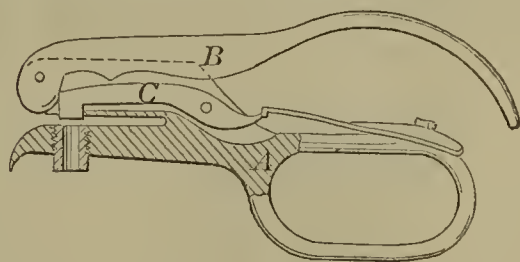

57140—B. J. Hunter—  
Harvester Pitman.

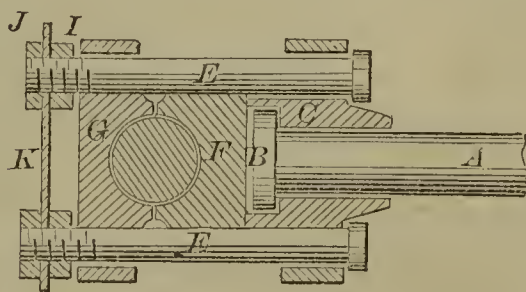

57141—G. Huntington—*Tire Shrinking Machine.*

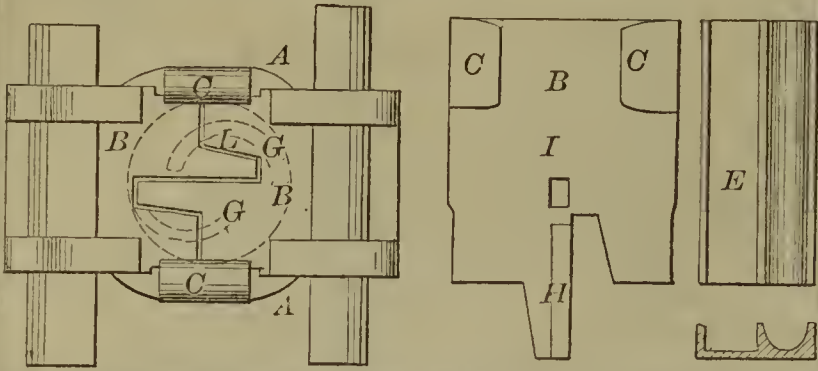

57142—E. F. Hurd—*For Making Axes.*

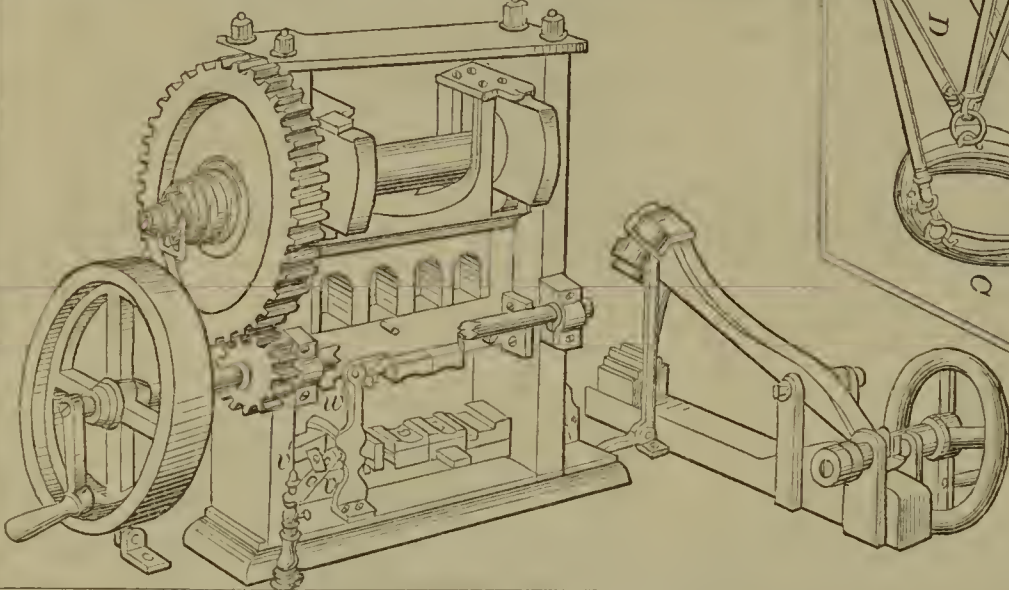

57145—H. Inman—*Lathe for Turning Wagon Hubs.*

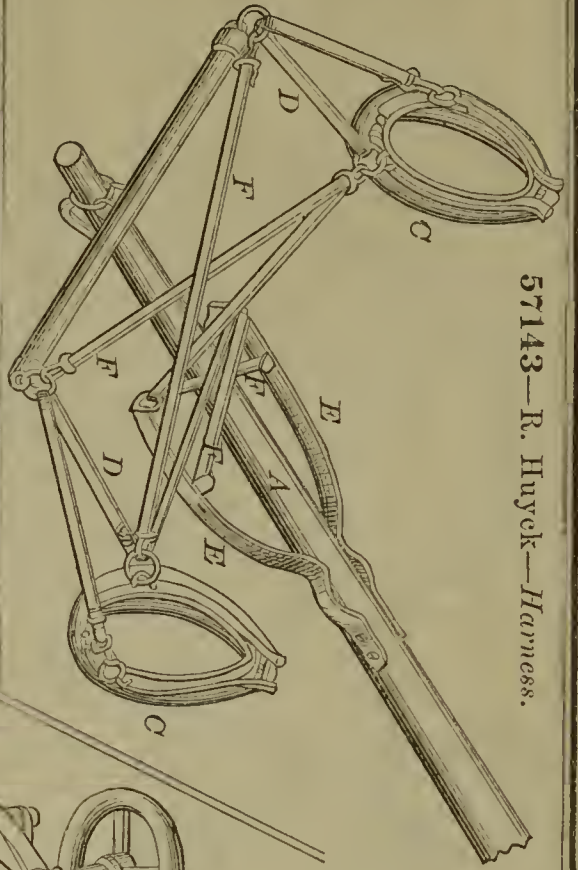
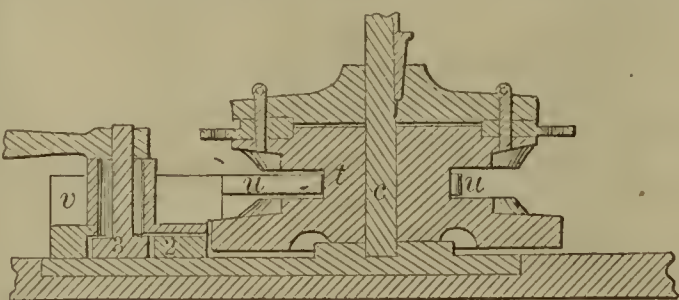
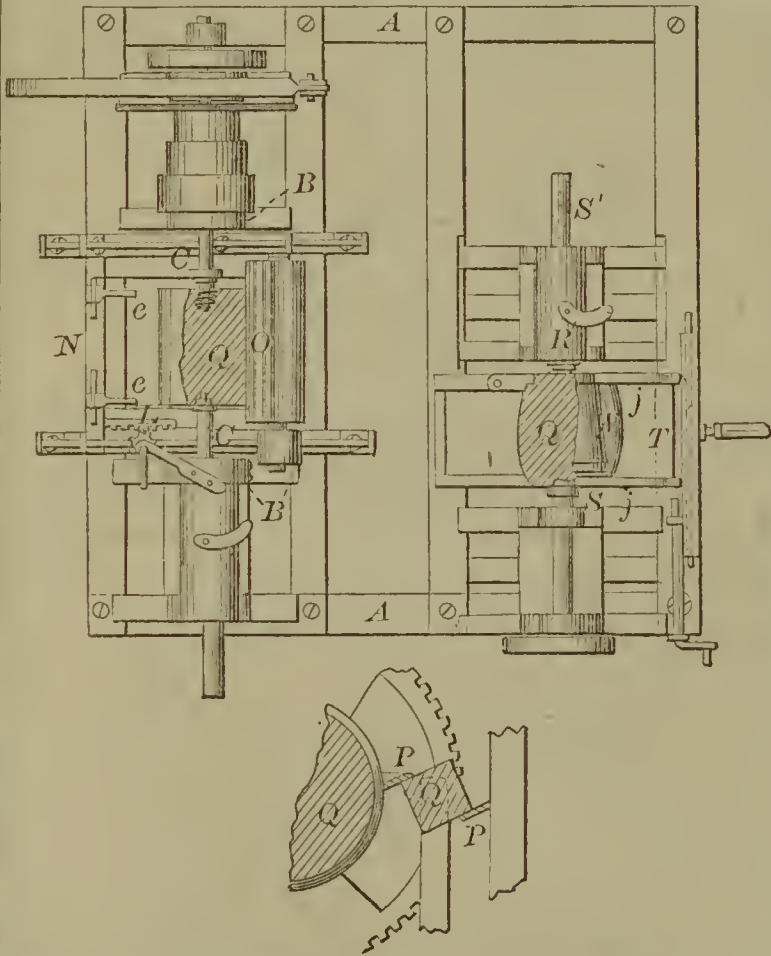

57143—R. Huyck—*Harness.*

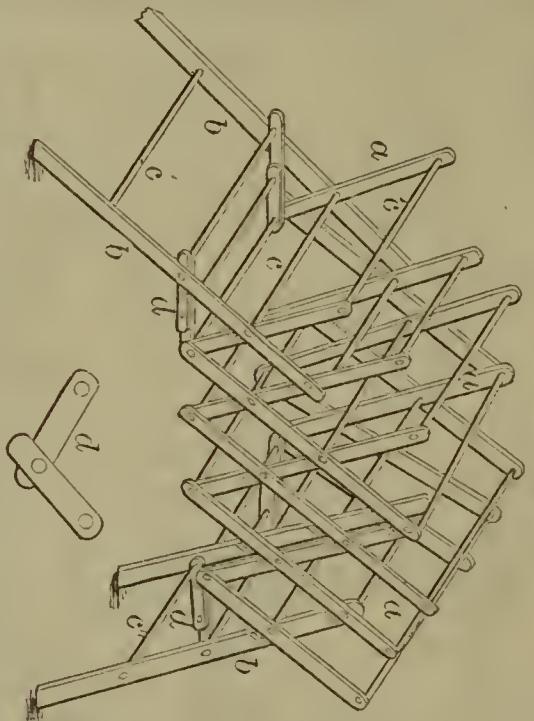

57144—L. T. Ugin—*Clothes Dryer.*

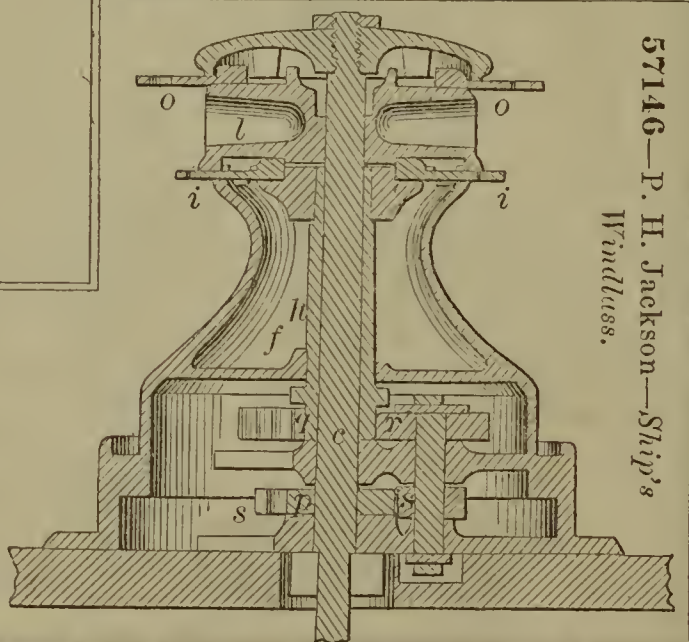

57146—P. H. Jackson—*Ship's Windlass.*

57147—D. Jacoby—*Plow.*

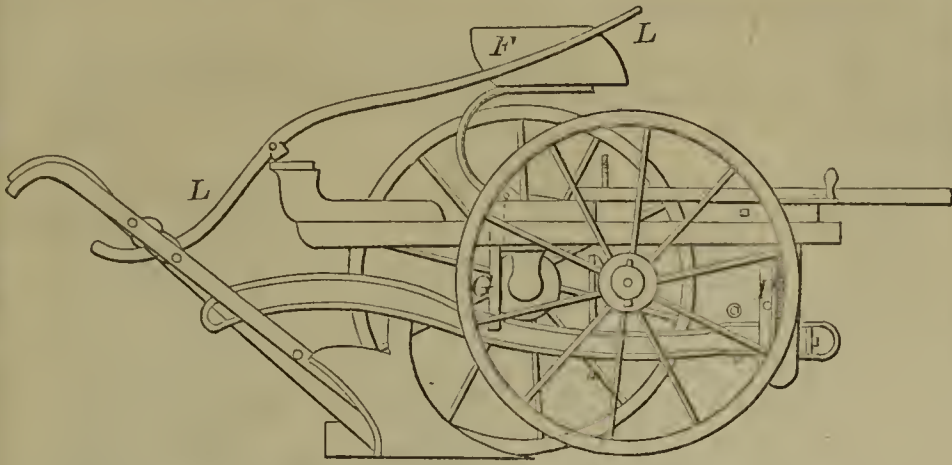

57151—D. Kelly—*Umbrella.*

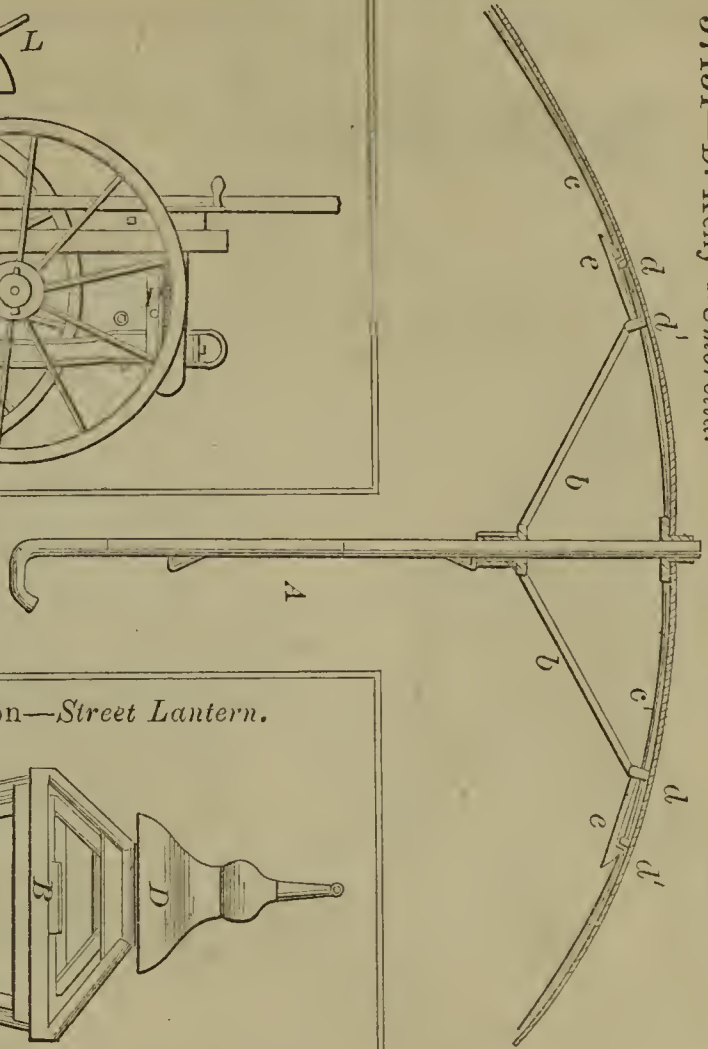

57149—W. J. Johnson—*Lamp Chimney Cleaner.*

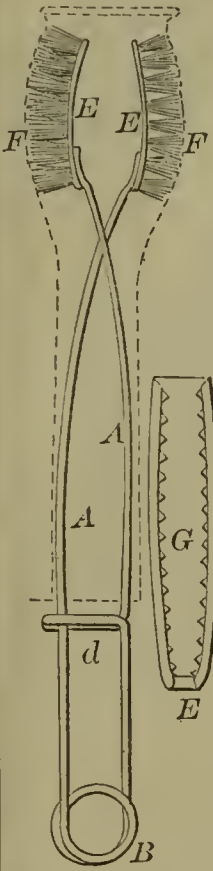

57148—B. A. Johnson—*Street Lantern.*

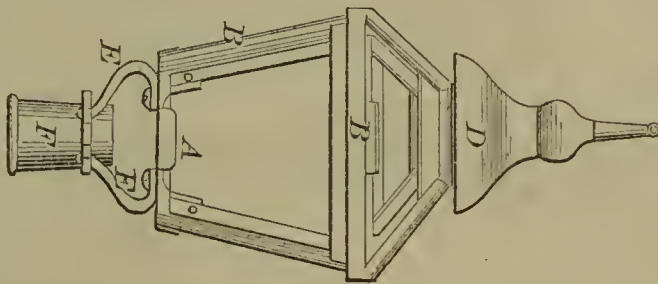

57154—C. Lang—*Imitation Collar.*



57150—H. M. Jones—*Latch Fastening.*

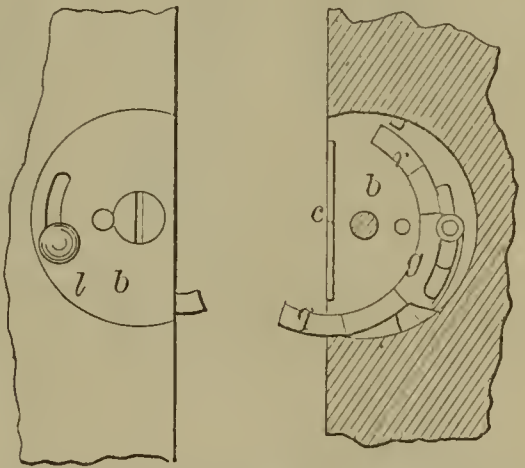

57152—F. Ketcham—*Gate Latch.*

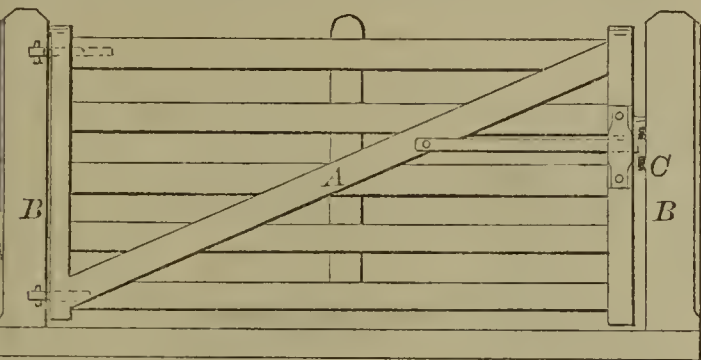

57153—Kline & Schmacker—*Reclining Chair.*

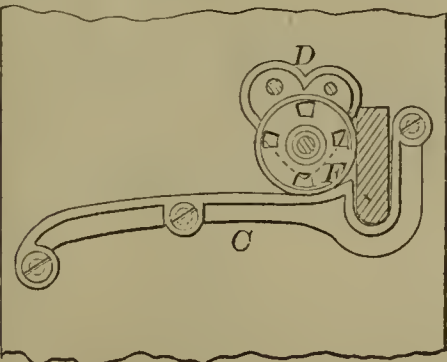
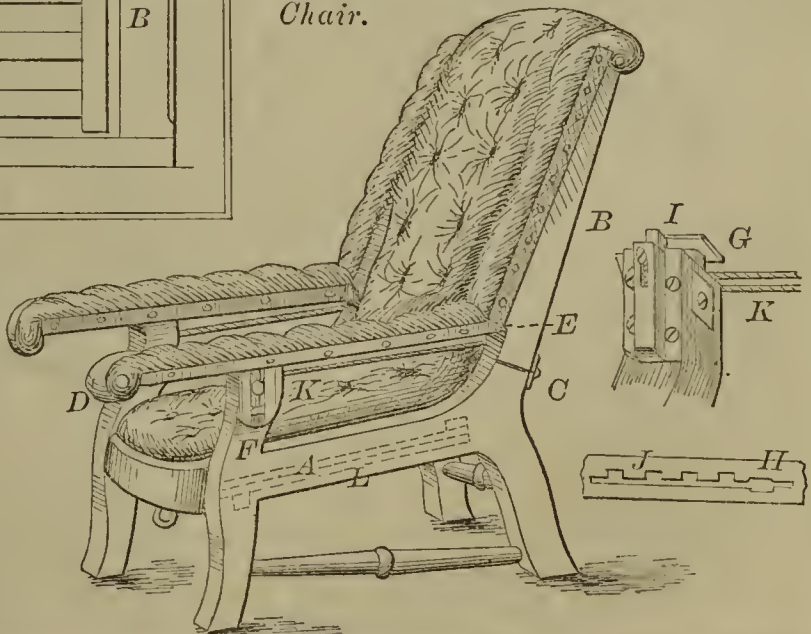

57156—B. B. Lewis—Snap Hook.

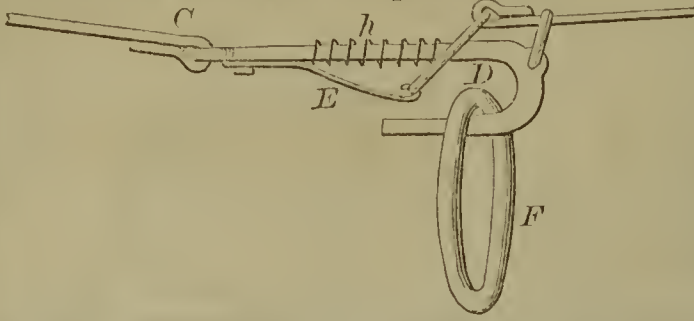

57157—A. Leyden—Sewing Machine.

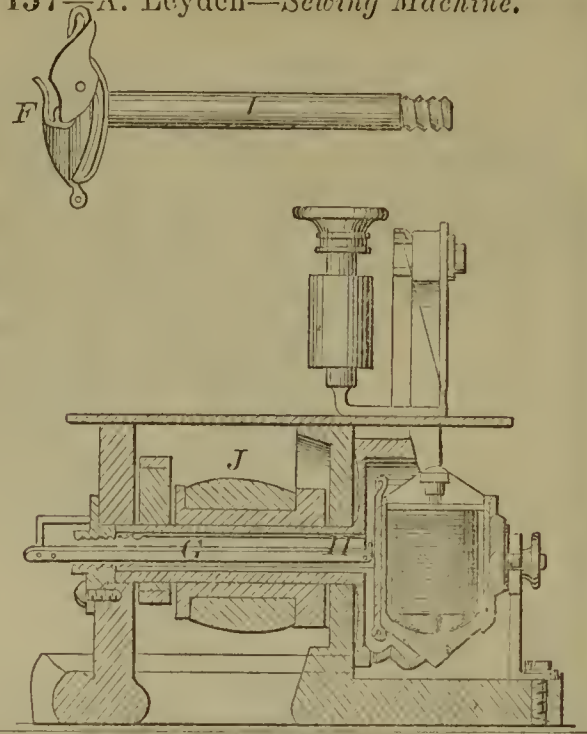

57160—P. Lugenbell—Ditching Machine.

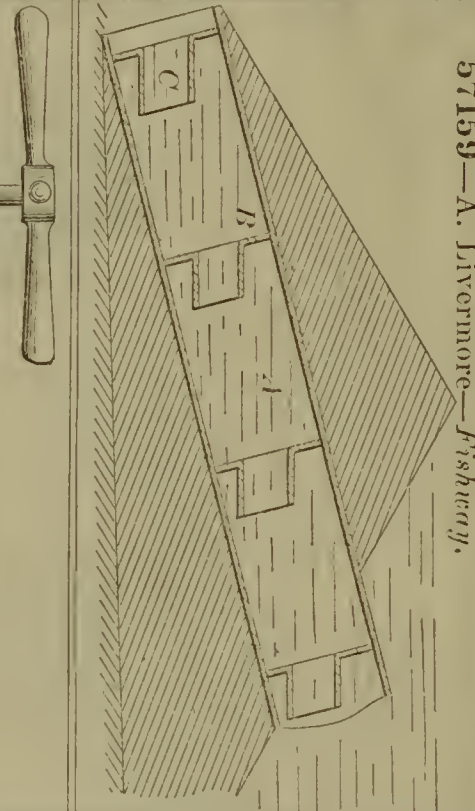
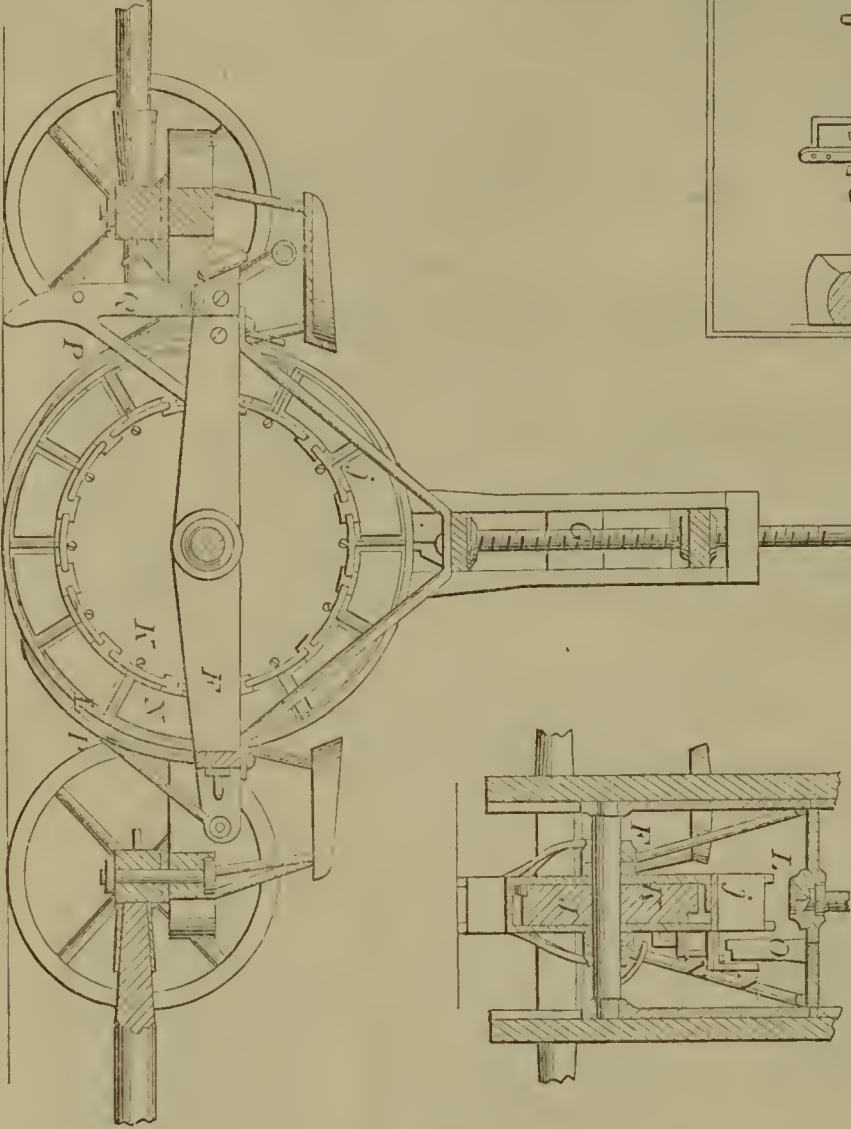

57159—A. Livermore—Fishway.

57158—T. Lippiatt—Rose Engine Lathe.

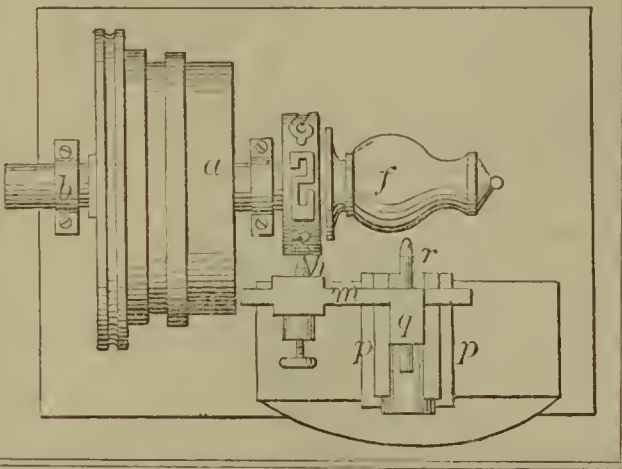

57161—G. F. Lynch—Car Brake.

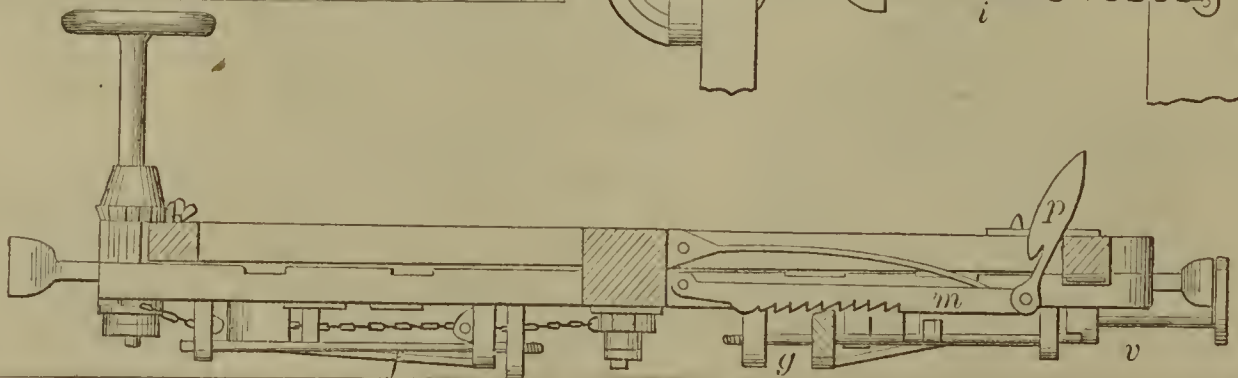
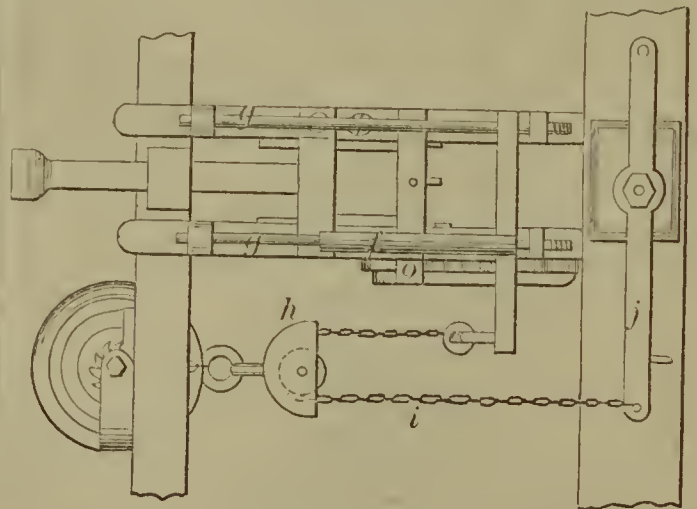

57162—H. Madheim—*Fountain Pen.*

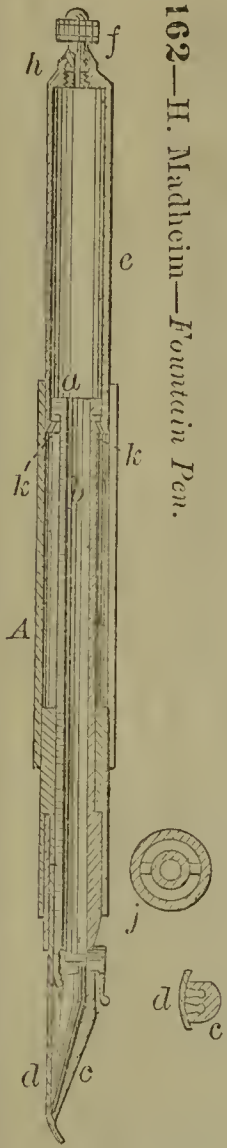

57164—H. L. McAvoy—*For Carburetting Air.*

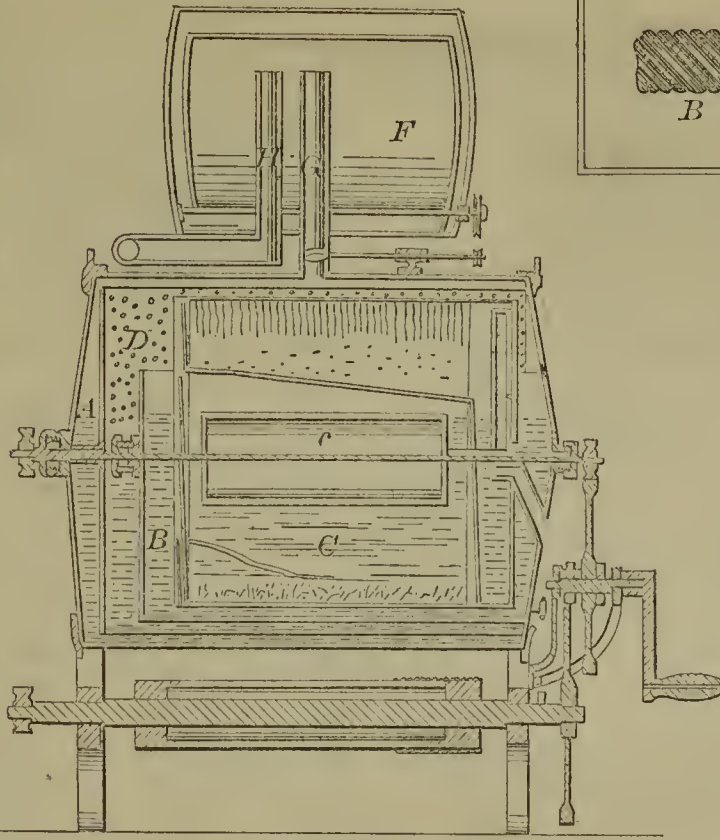

57163—R. Martin—*Piston Rod Packing.*

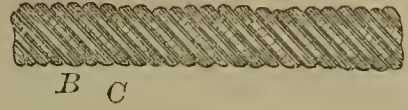

57166—W. McFishback—*Harrow.*

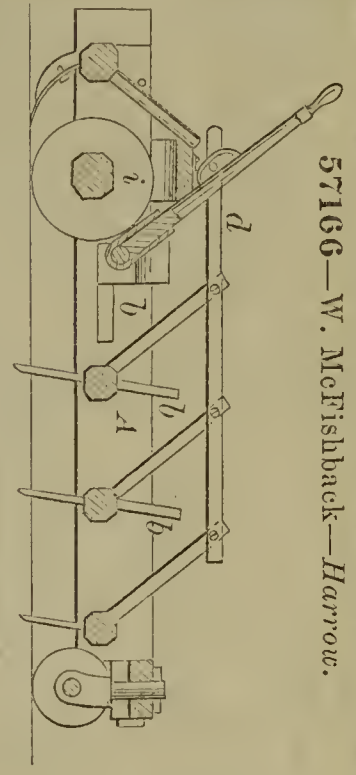

57167—C. F. Moeller—*Lantern.*

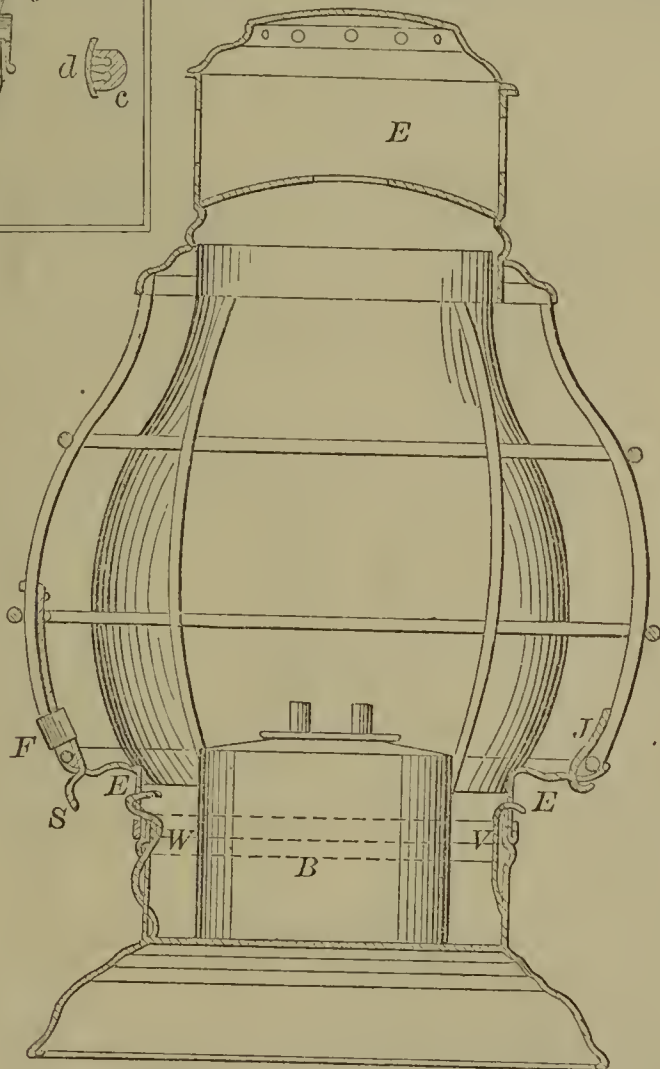

57168—Moller & Shoels—*Shoe Brush.*

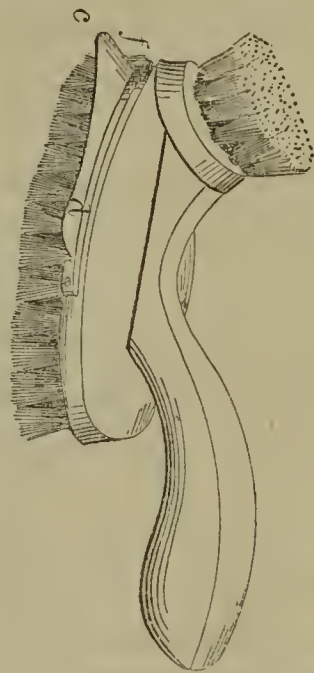

57169—E. L. Morris—*Hoop Skirt.*

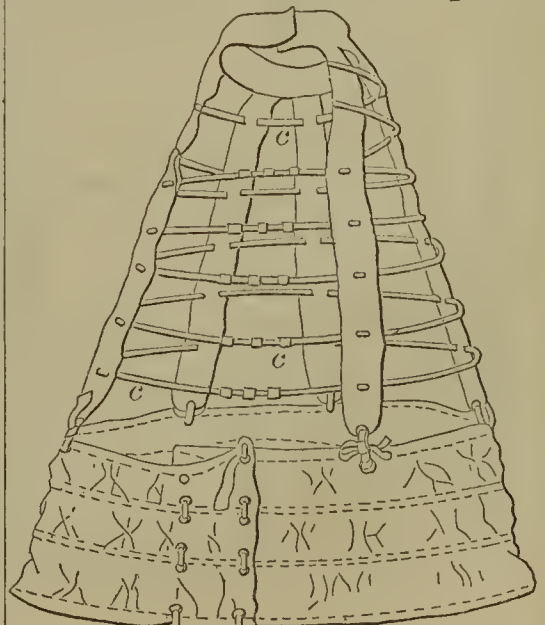

57170—S. A. Mort—*Ironing Board.*

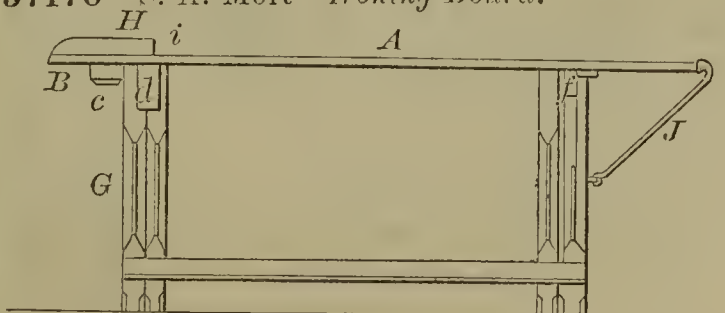

57171—J. Mott—Double Revolving Plow.

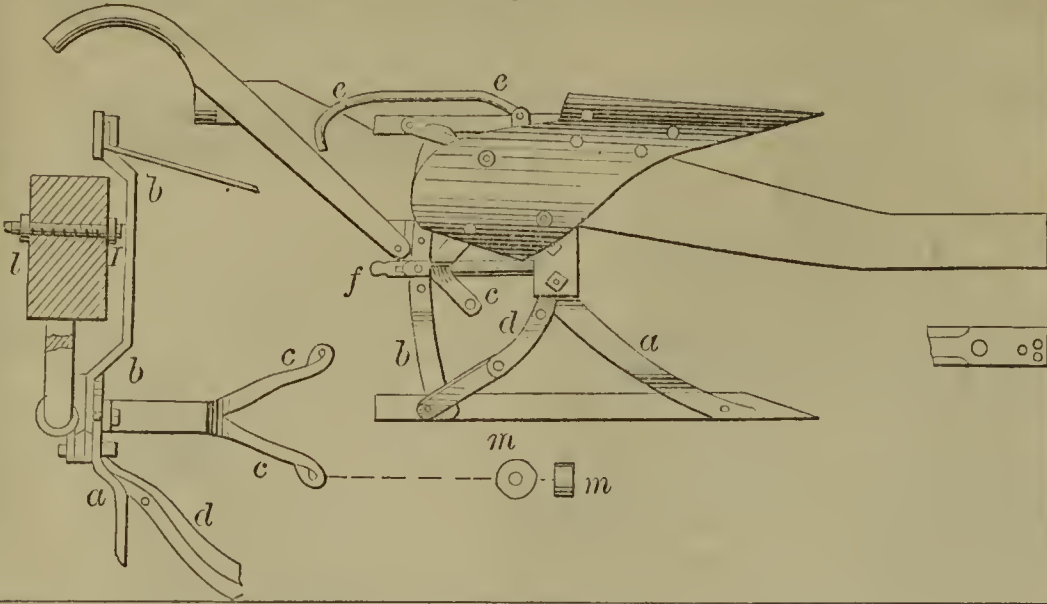

57172—J. H. Mulhall—Preventing the Freezing up of Gas Pipes.

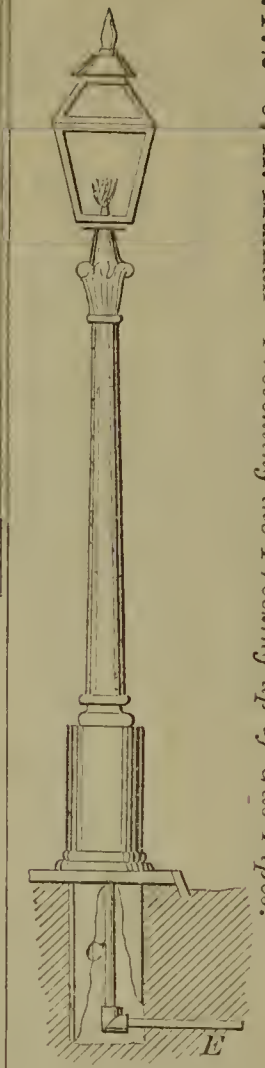

57175—A. Nobel—Explosive Compound.

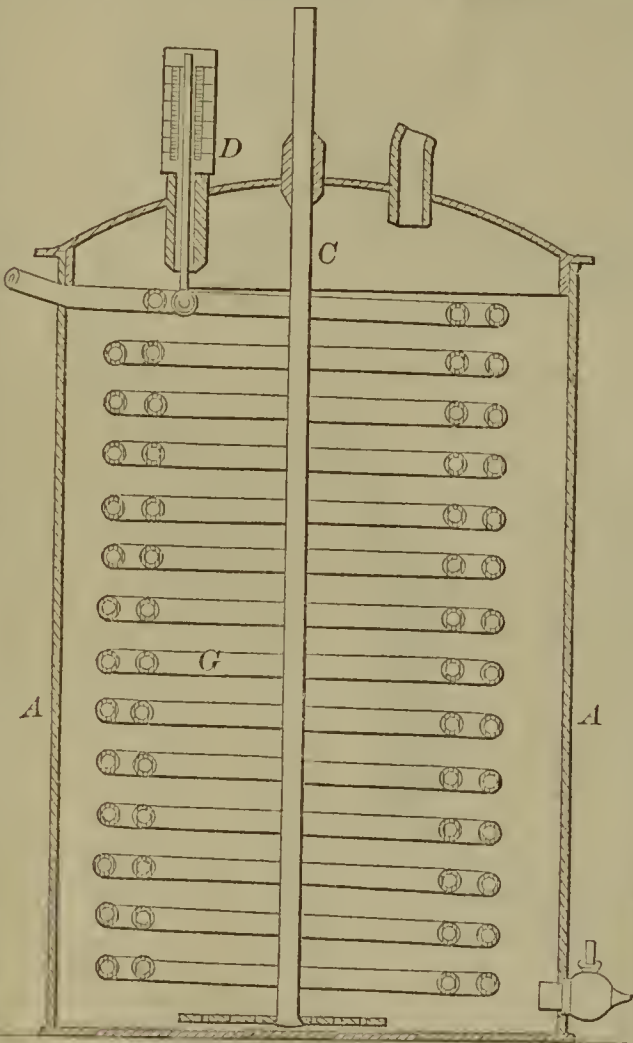

57176—L. F. Noe—Bench Hook.

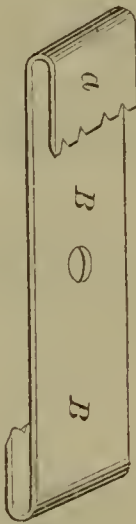

57177—M. Opper—Loom for Weaving Cloth with Swells or Gores.

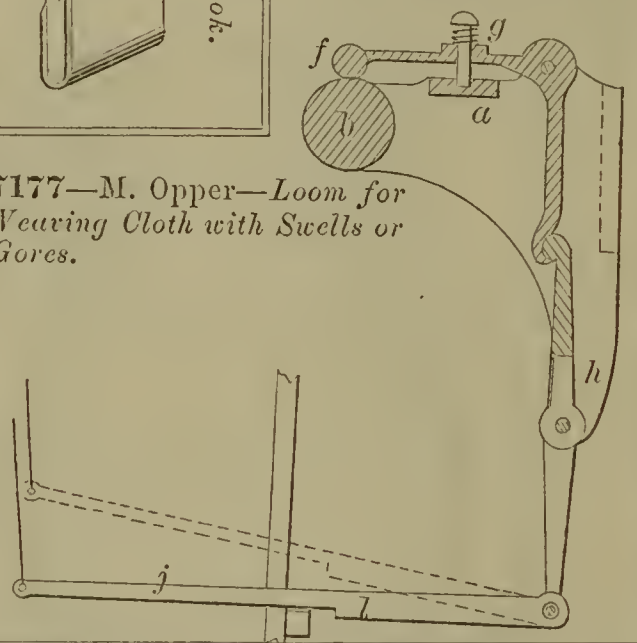

57178—J. B. Page—For Converting Motion.

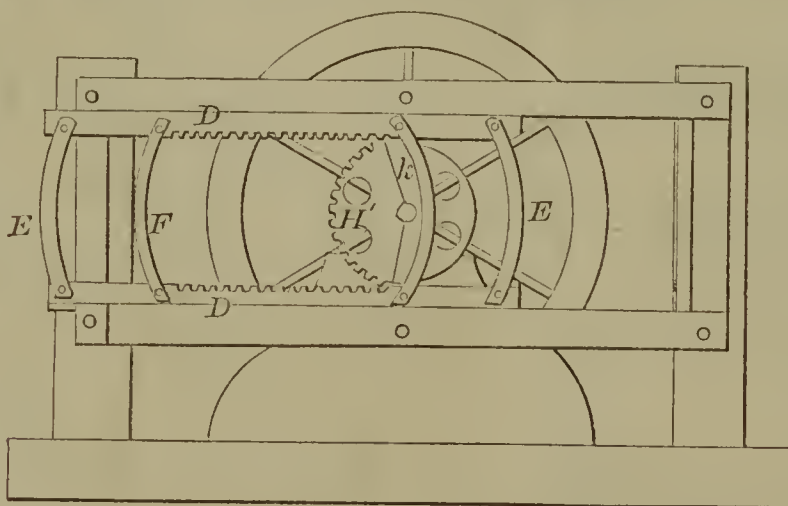

57173—W. H. Myers—Car Roof.



57179—H. W. Painter—Carriage Pole.



57180—J. W. Parsons—Head Block for Saw Mills.

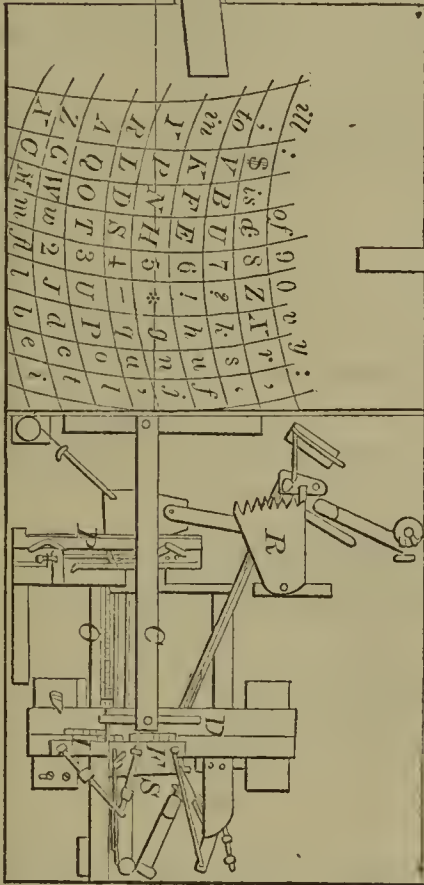
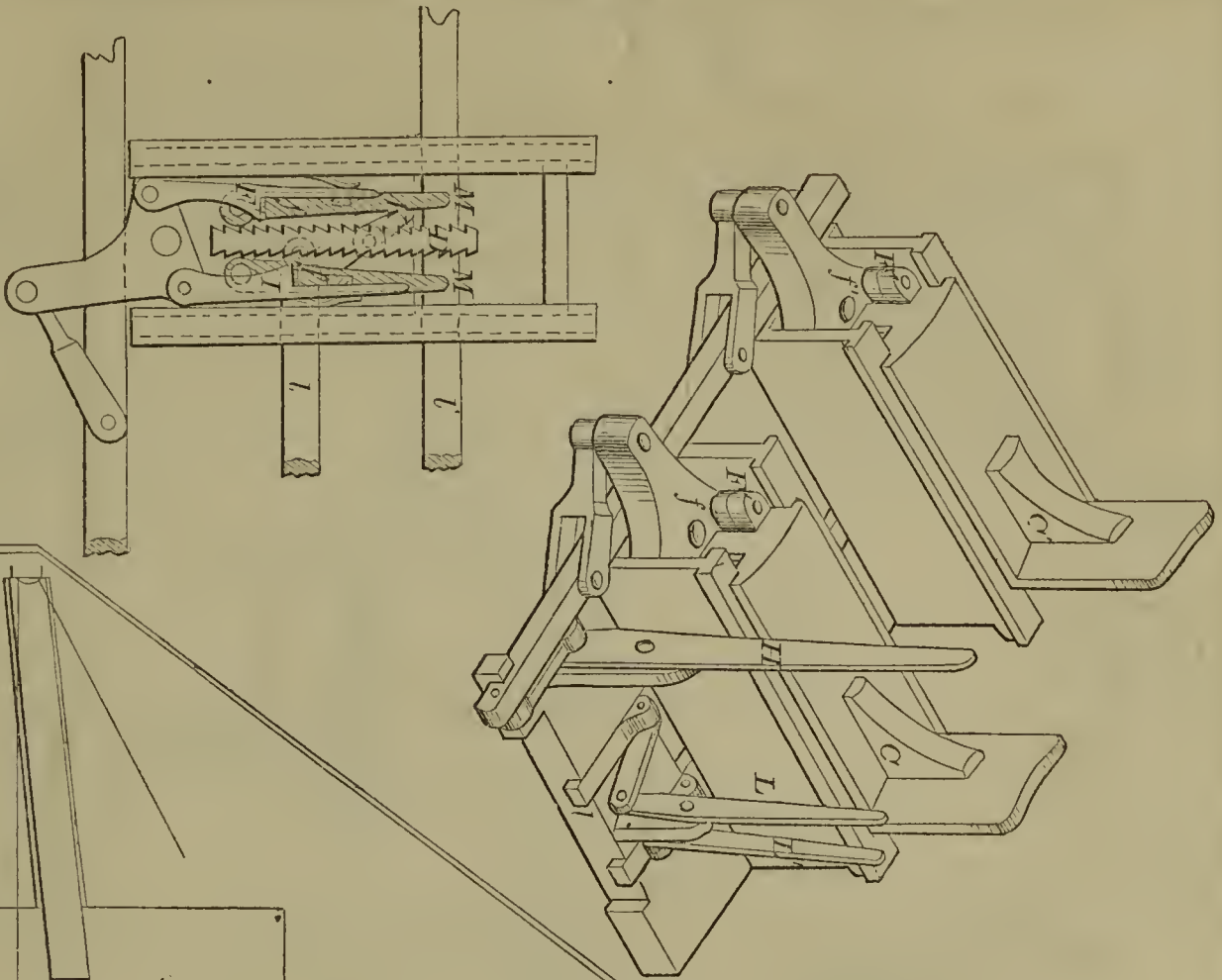

57182—A. Peeler—Writing and Printing Machine.

57181—E. M. Payne—Bed Bottom.

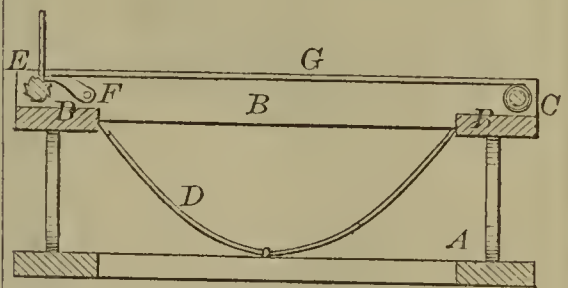

57183—S. Petre—Derrick for Raising Sunken Vessels.

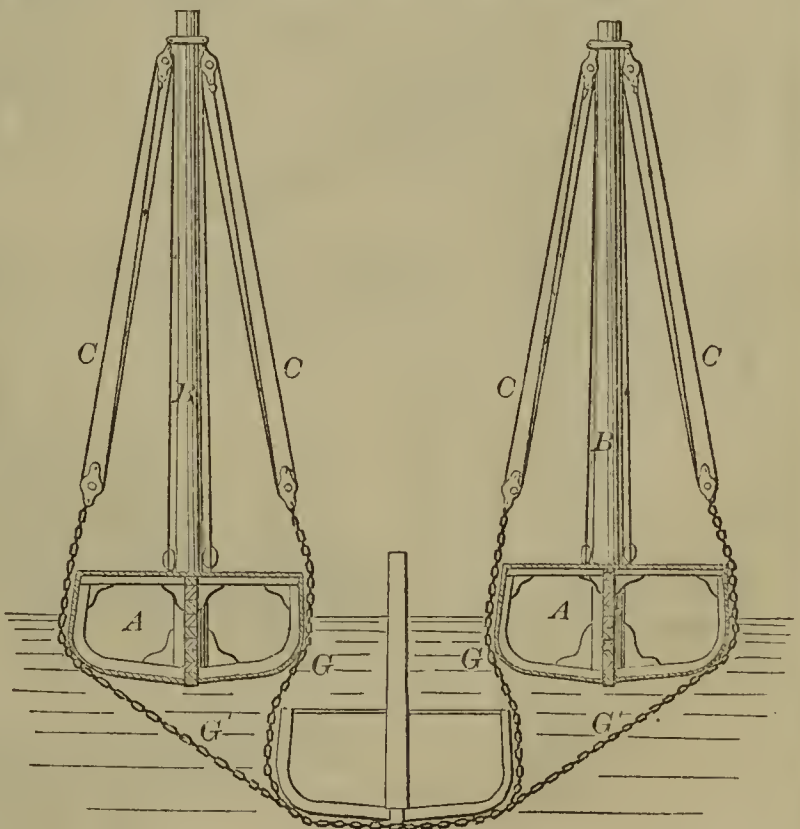

57185—T. J. Price—Combined  
Seeder and Cultivator.

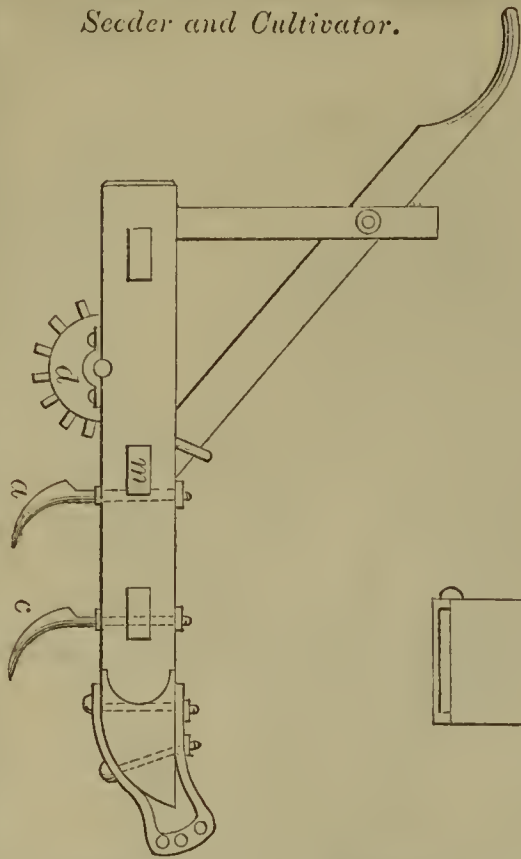

57187—C. R. Rand—Heating Furnace.

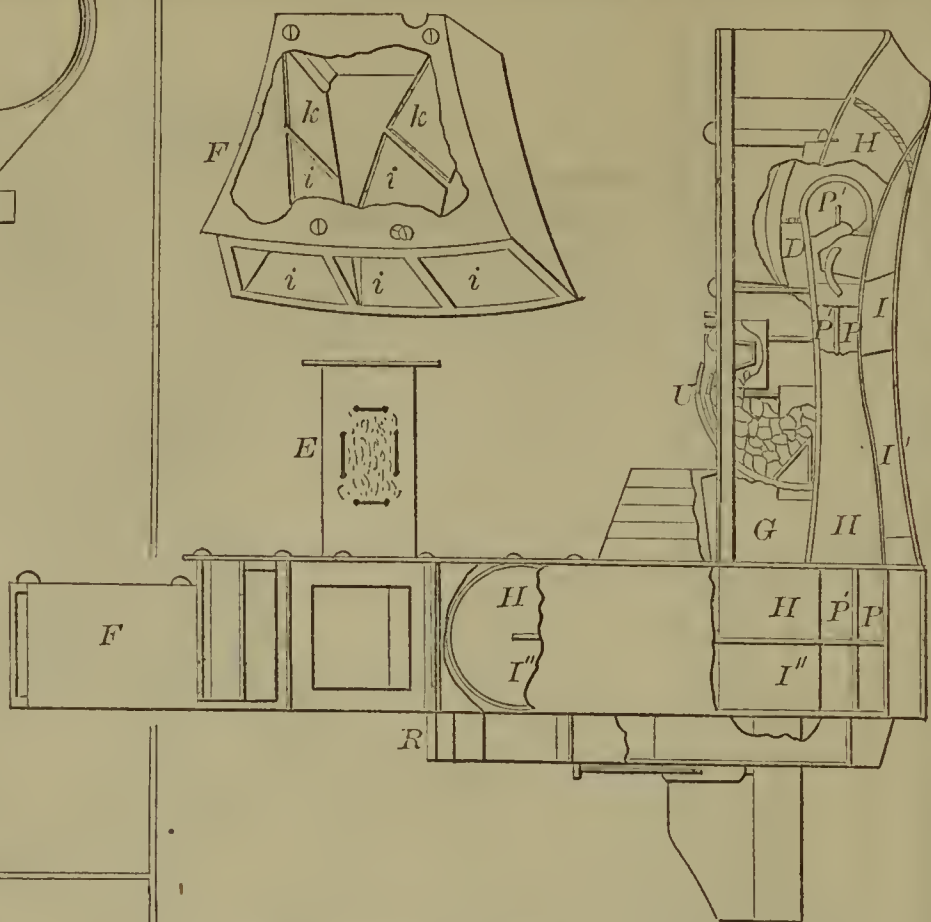

57188—L. C. Rodier—Steam Pump.

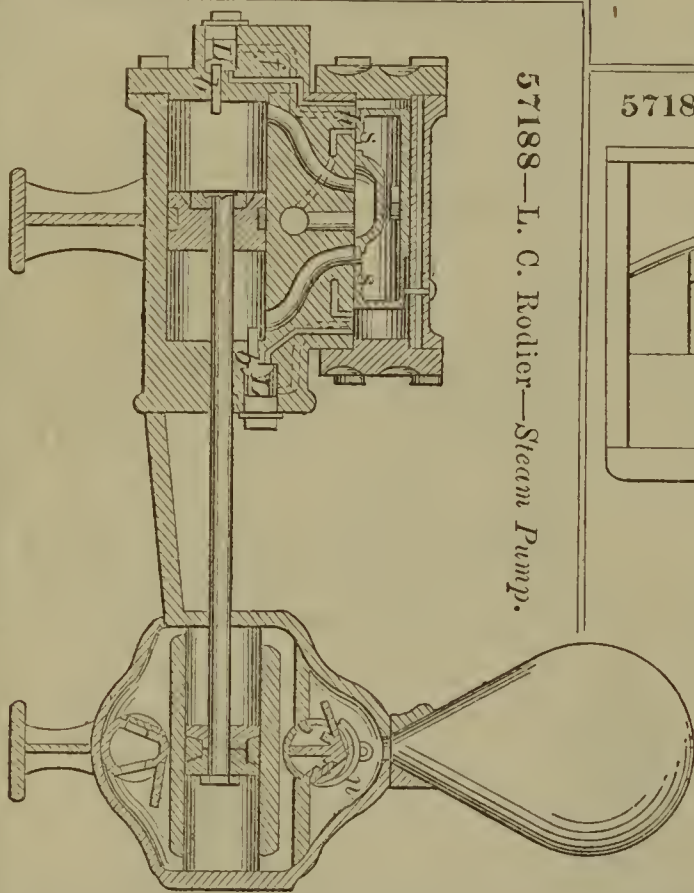

57186—R. Raven—Piano.

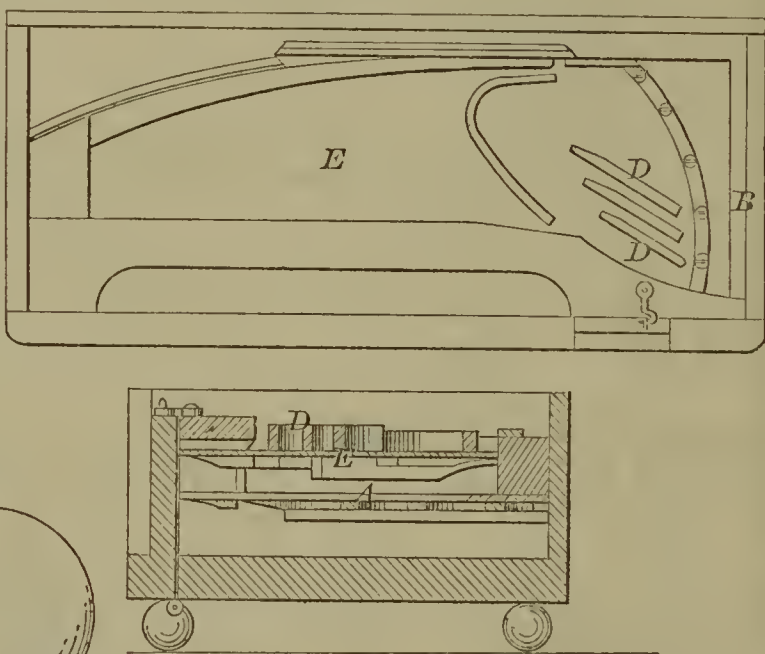

57189—J. B. Root—  
Piston Packing Ring.

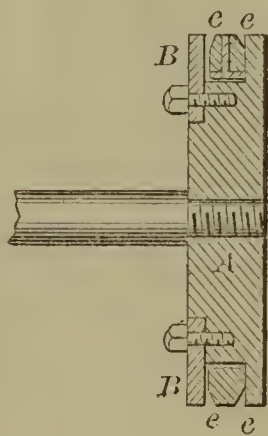

57190—J. B. Root—  
Trunk Engine.

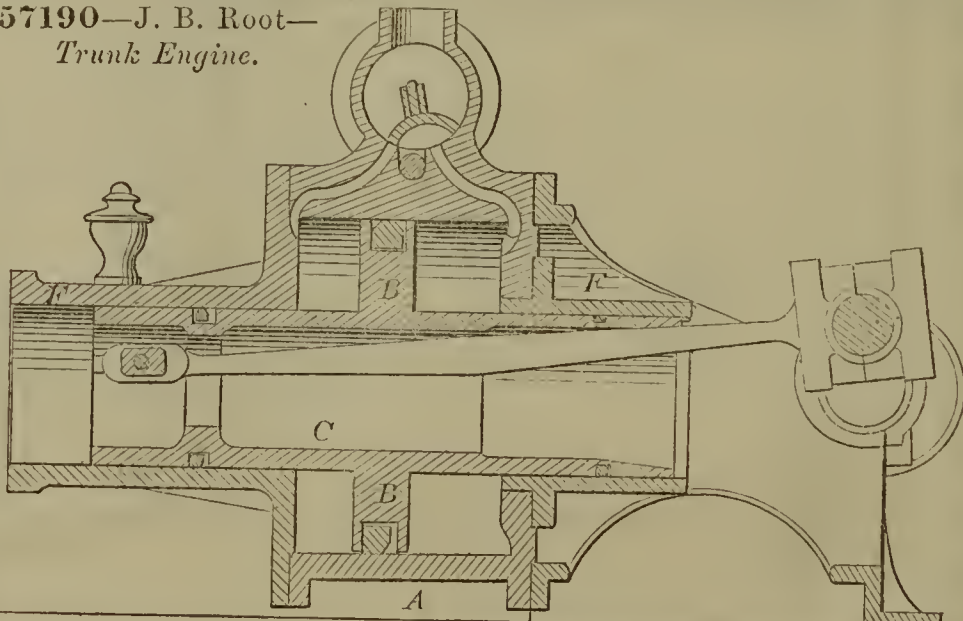



57191—J. J. Russ—Planing Machine.

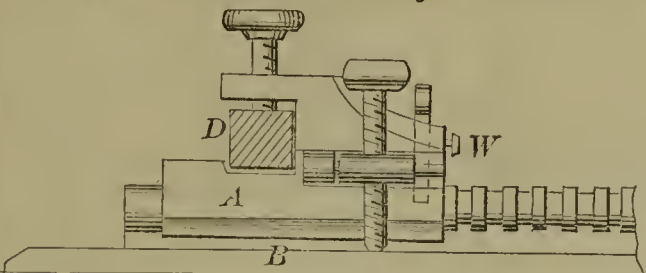

57194—V. B. Ryerson—Desulphurizing Ores.

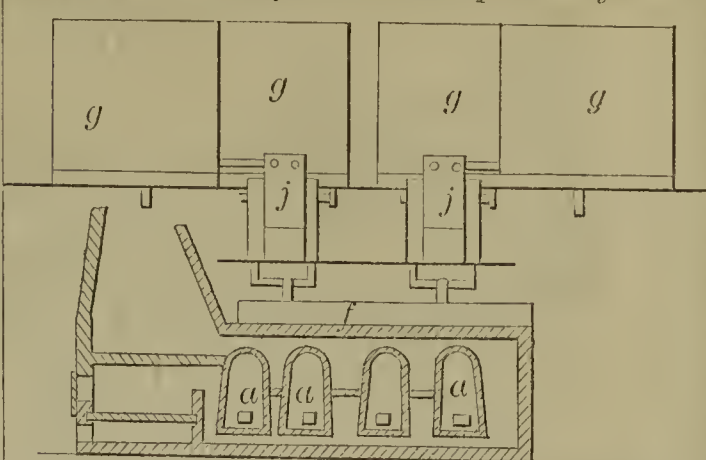

57192—W. A. Russell—Manufacture of Paper.

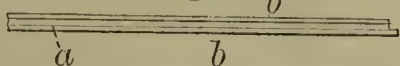

57195—H. Schmidt—Hand Screw Clamp.

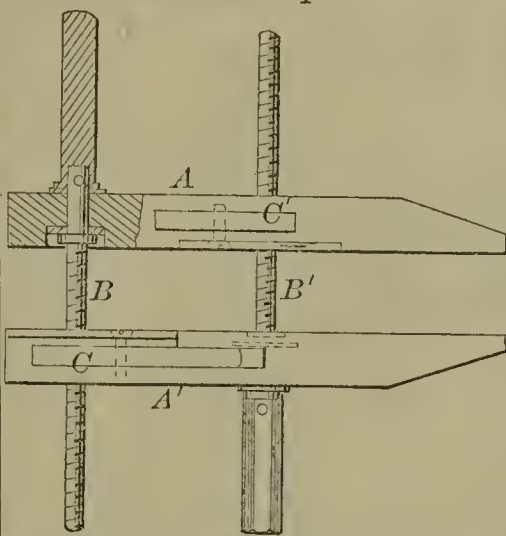

57198—T. Sharp—Car Seat and Couch.

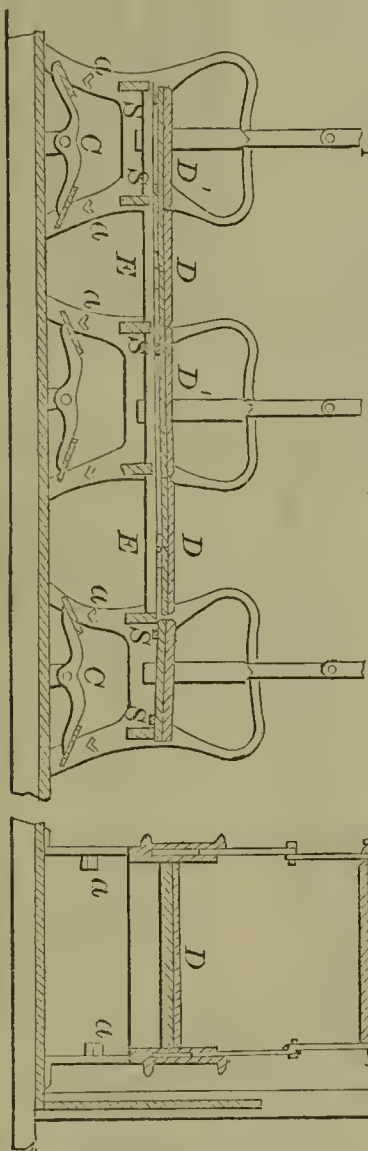

57197—J. Segondy—Sausage Meat Cutter.

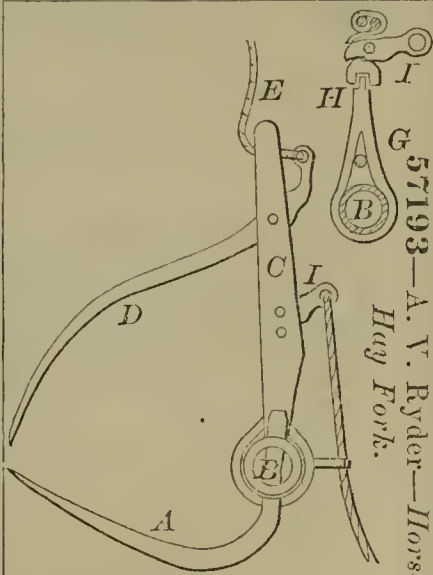
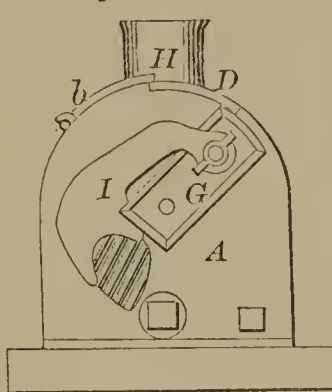

57193—A. V. Ryder—Horse Hay Fork.

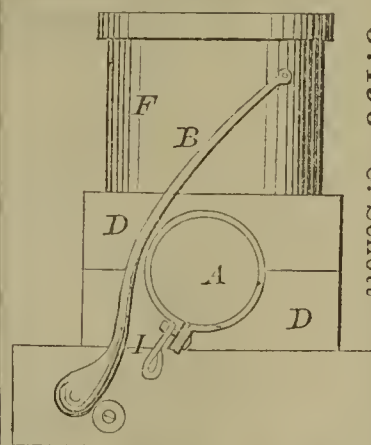

57196—C. Scholt—

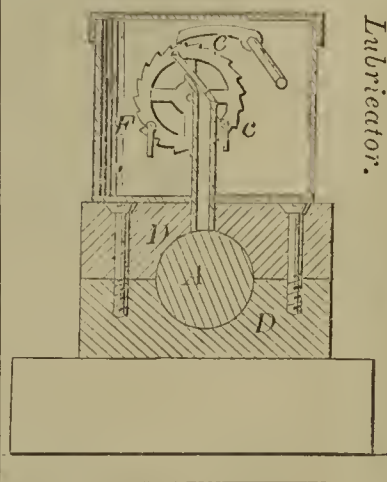

Lubricator.

57199—E. Shorkley—Horse Hay Fork.

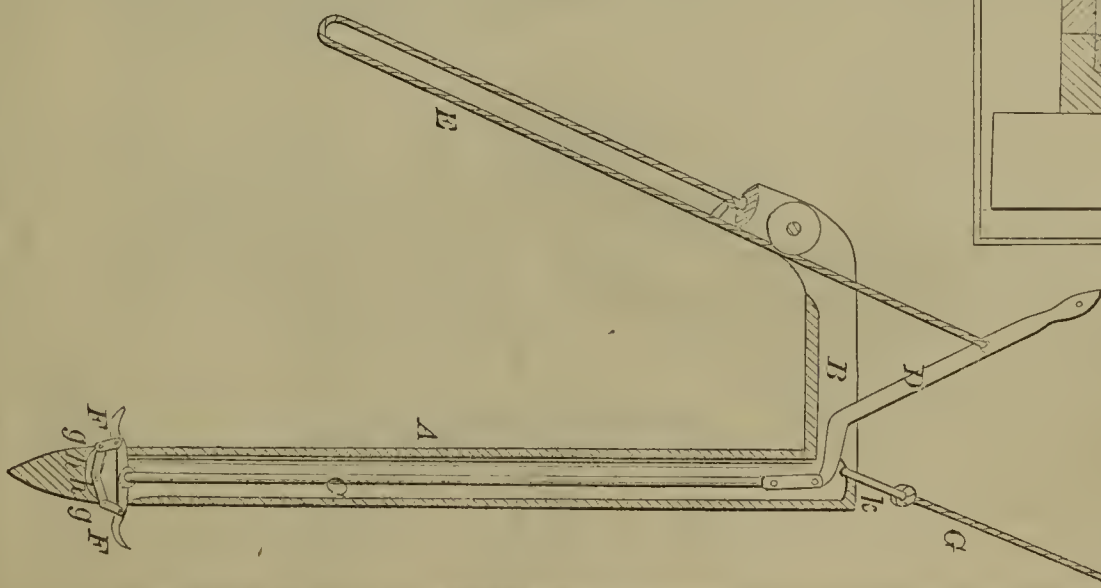

57200—J. B. Skinner—*Plow.*

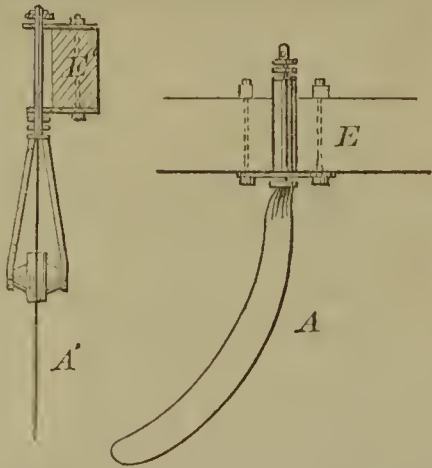

57208—Spooner & Hale—*Car Coupling.*

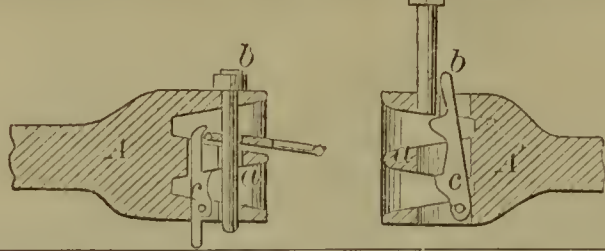

57202—C. D. Smith—*Button Hole.*

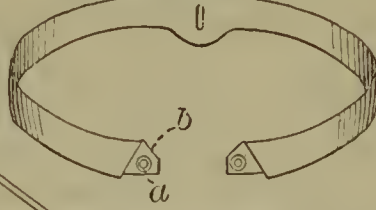

57205—A. Snowden—*Saw Tothing Machine.*

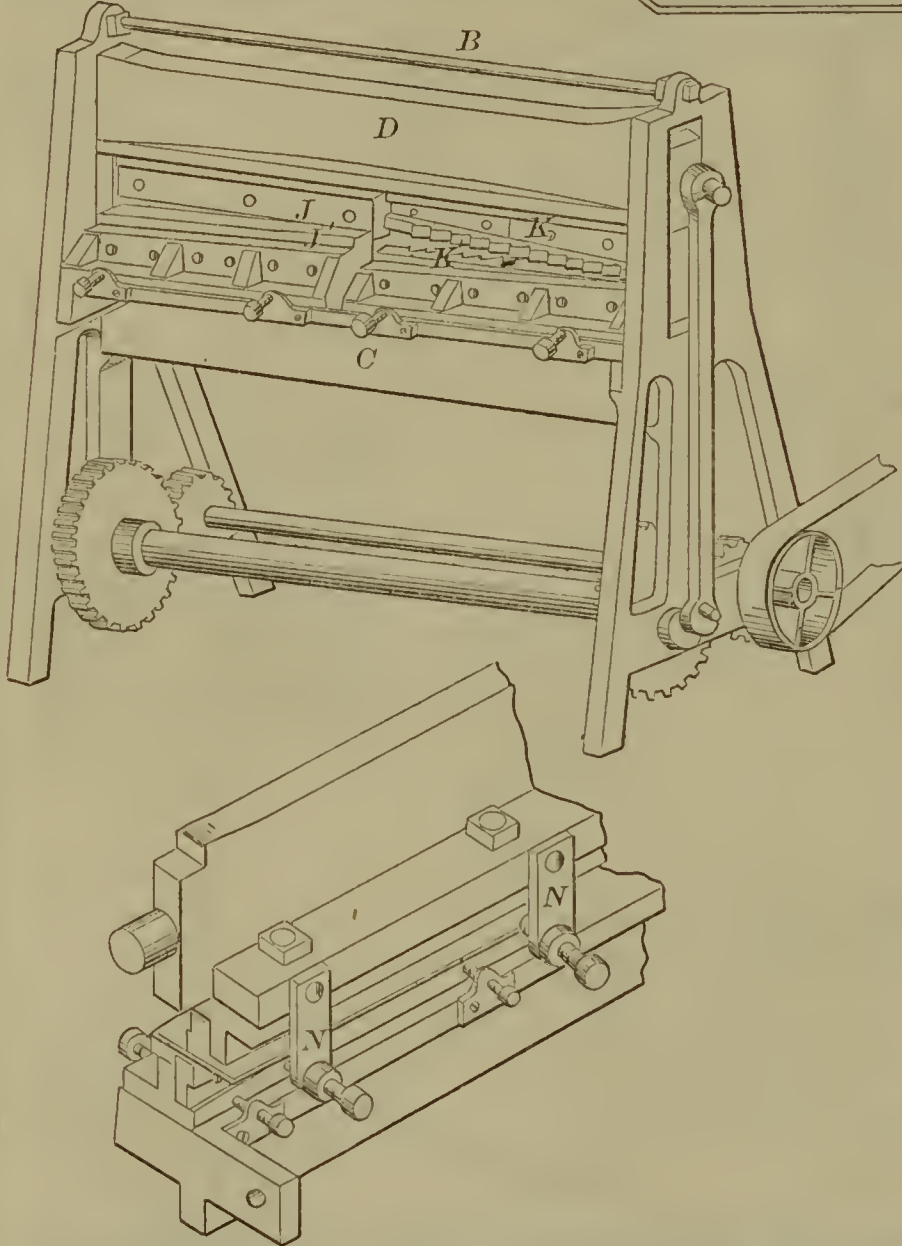

57201—T. J. Sloan—*Braiding Machine.*

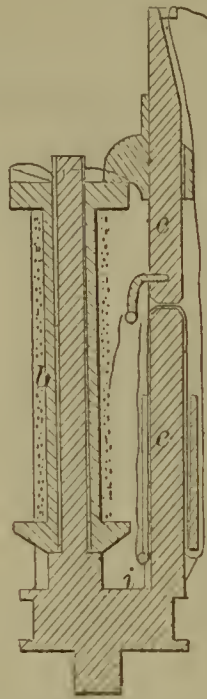

57204—T. F. Snover—*Clothes Dryer.*

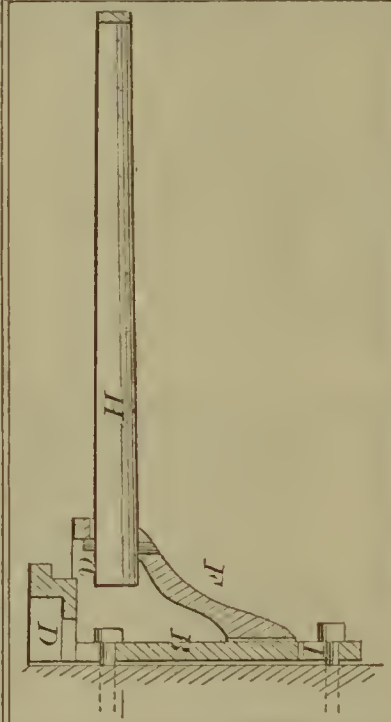

57207—S. L. Spencer—*Potato and Drill Machine.*

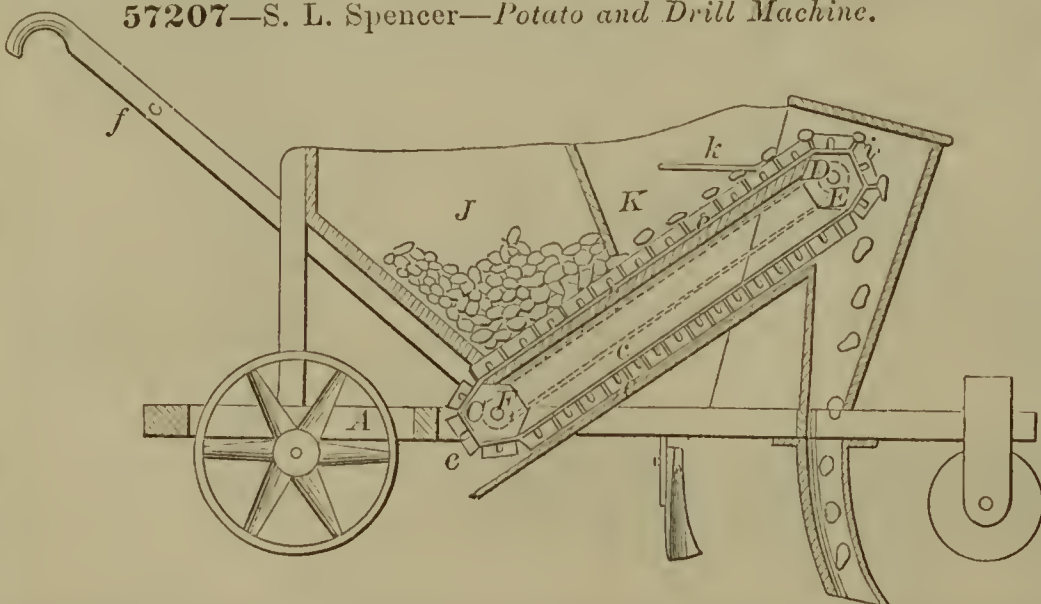

57209—E. L. Staples—*Table.*

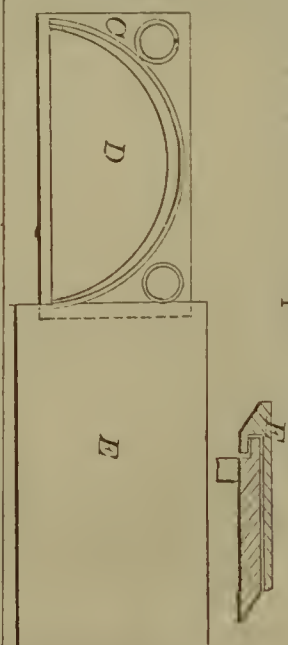

57210—E. T. Starr—*Dentist's Vulcanizing Flask.*

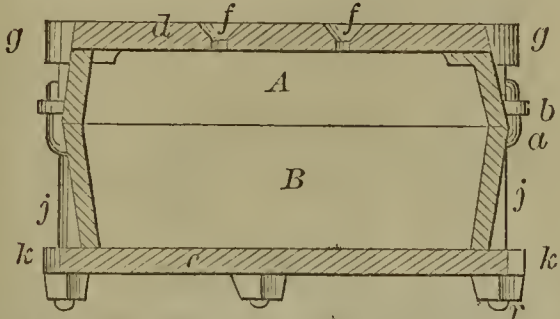

57213—E. Stimson—*Vegetable Grater.*

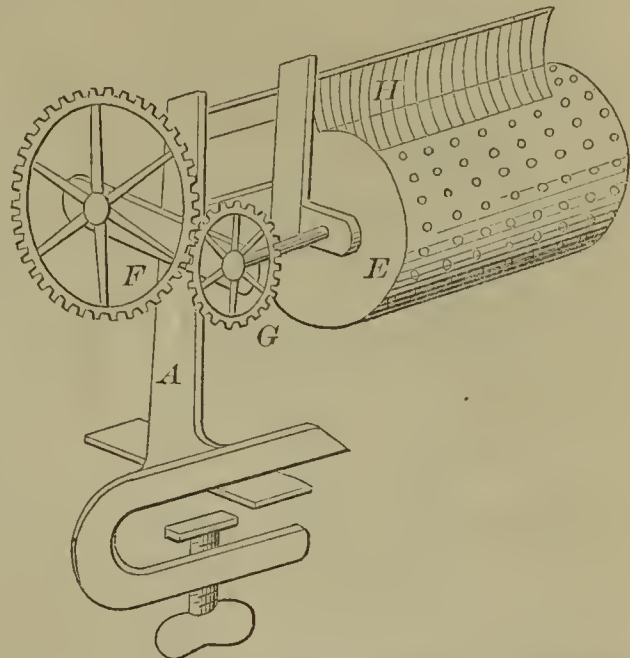

57211—C. L. Stevens—*Elevating Water into Railroad Tanks.*

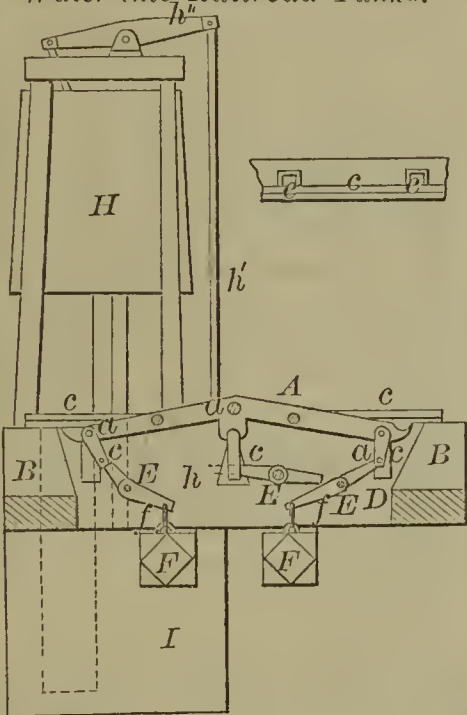

57212—Stilz & Knoepke—*Preserve Can.*

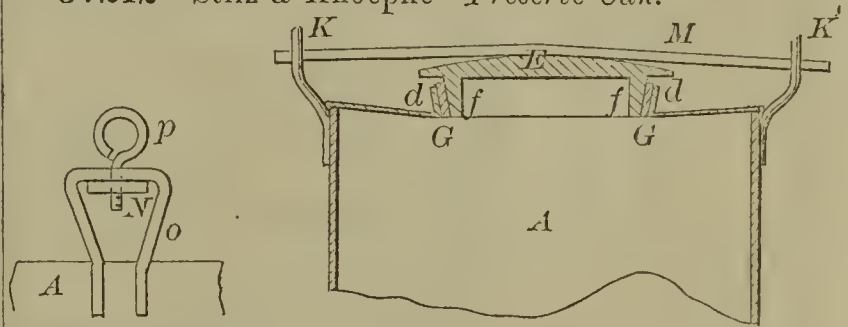

57218—N. S. Thomas—*For Extracting Tanning Matter from Bark.*

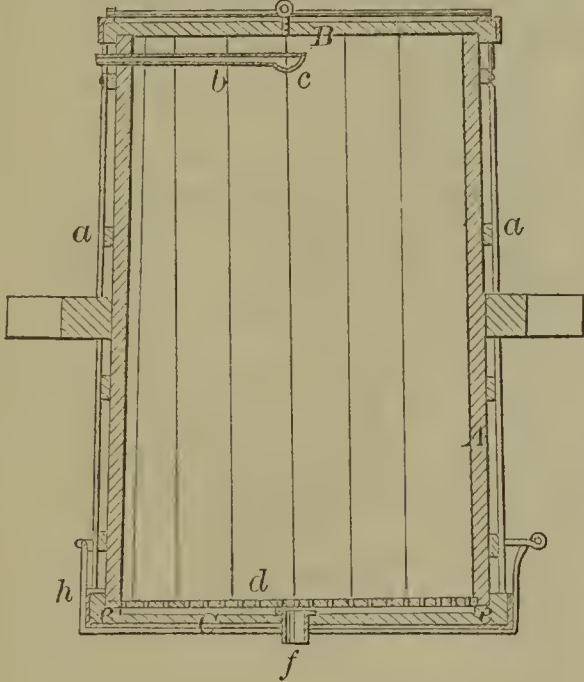

57214—Stockton & Smoot—*Saddle.*

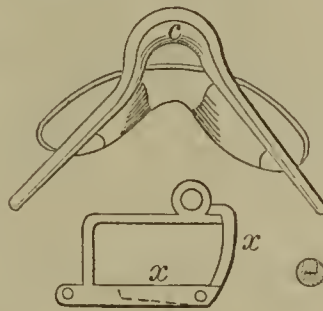

57215—T. Ferrel—*Lard Lamp.*

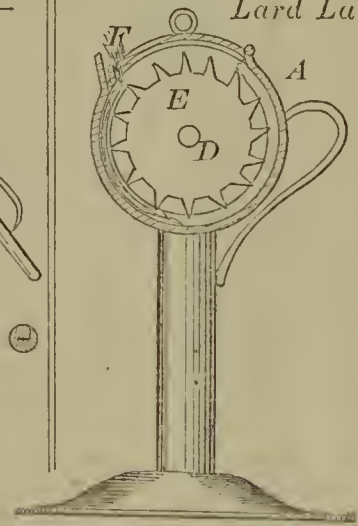

57220—Thorn & Dennis—*Faucet.*

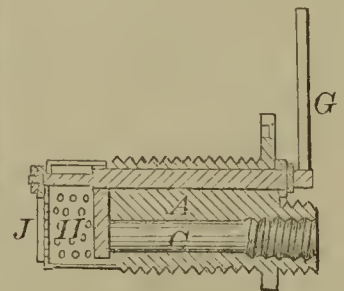

57216—T. Ferrel—*Plow Cleaning Attachment.*

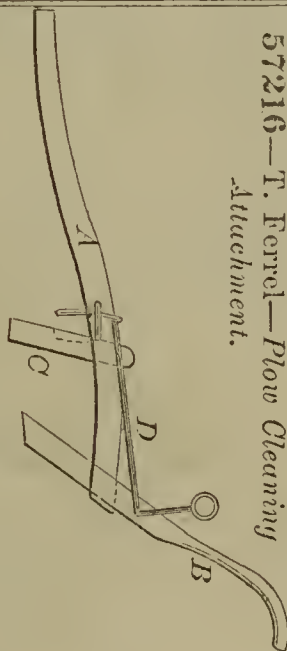

57221—Tschirgi & Kammüller—Beer Cooler.

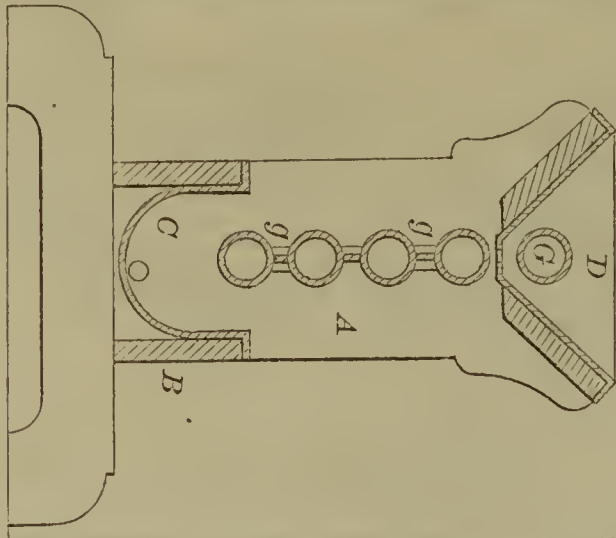

57222—J. W. Tyson—Cultivator.

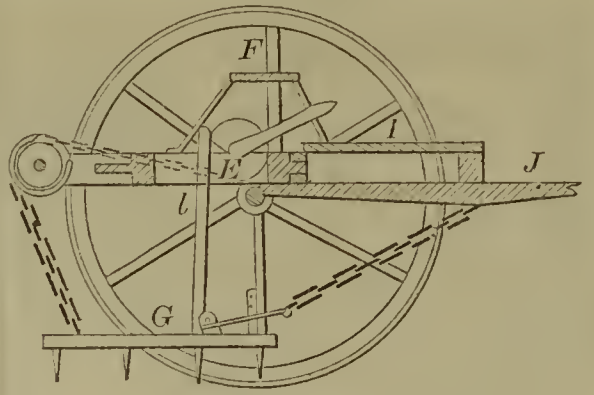

57225—M. Vergues—Piano Forte.

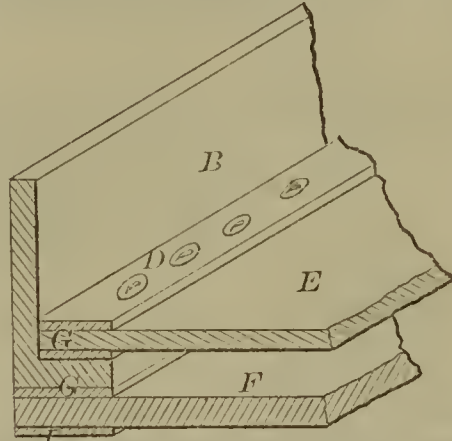

57224—P. O. V. Slyke—Sorghum  
Evaporator.

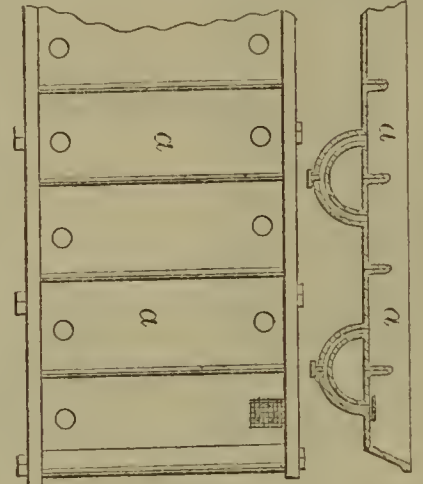

57223—C. V. Dyck—Spring Mattress.



57226—Walker & Hartley—

Hand Loom.

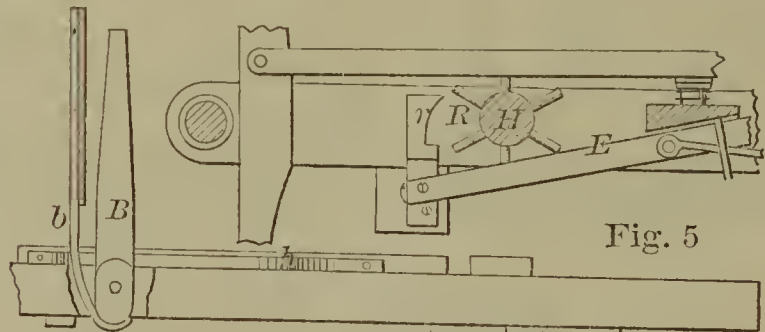
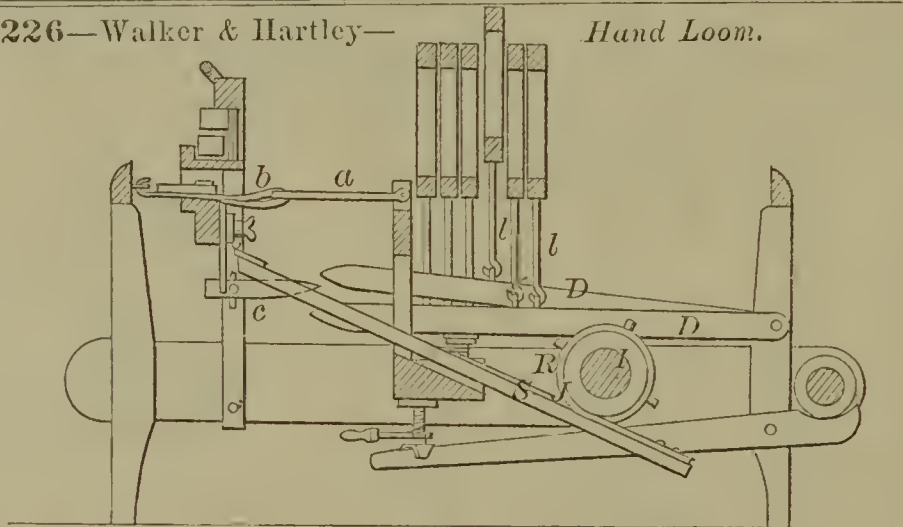
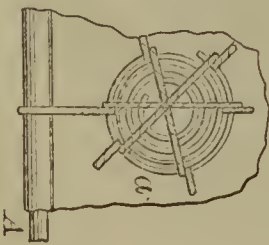
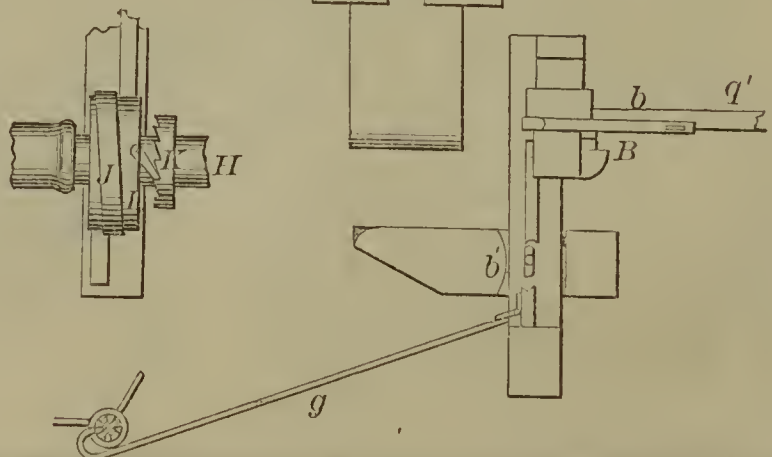
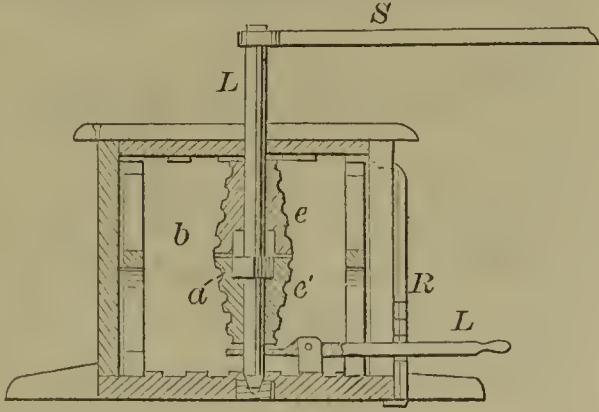

Fig. 5



57227—E. A. Ward—Hay Press.



57228—G. I. Washburn—Steam Engine.

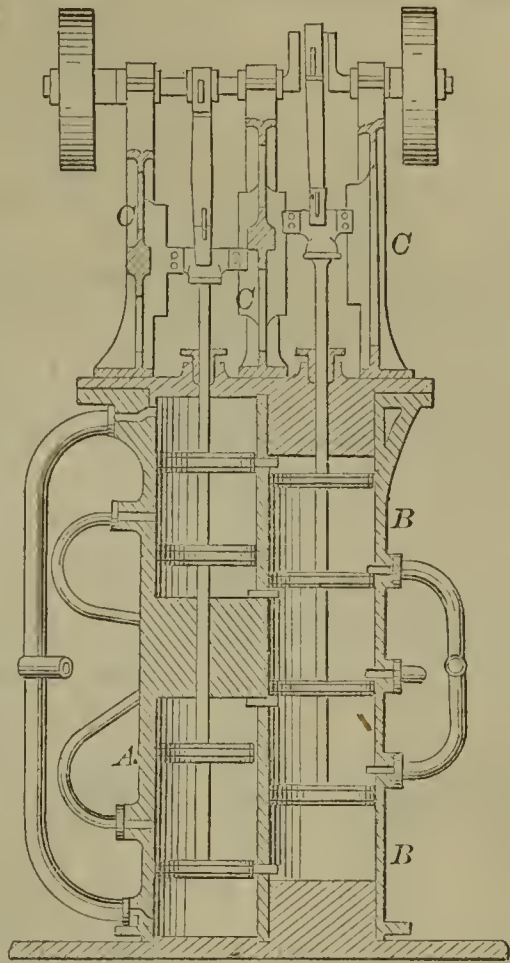

57229—D. P. Webster—Spring Bed Bottom.

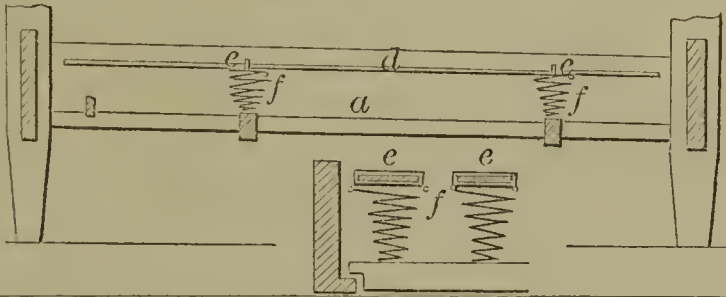

57230—A. Weed—Rasp Cutting Machine.

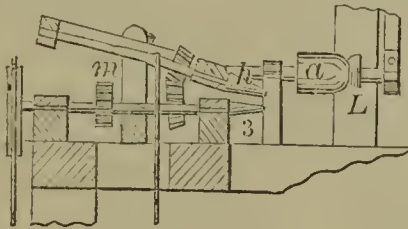
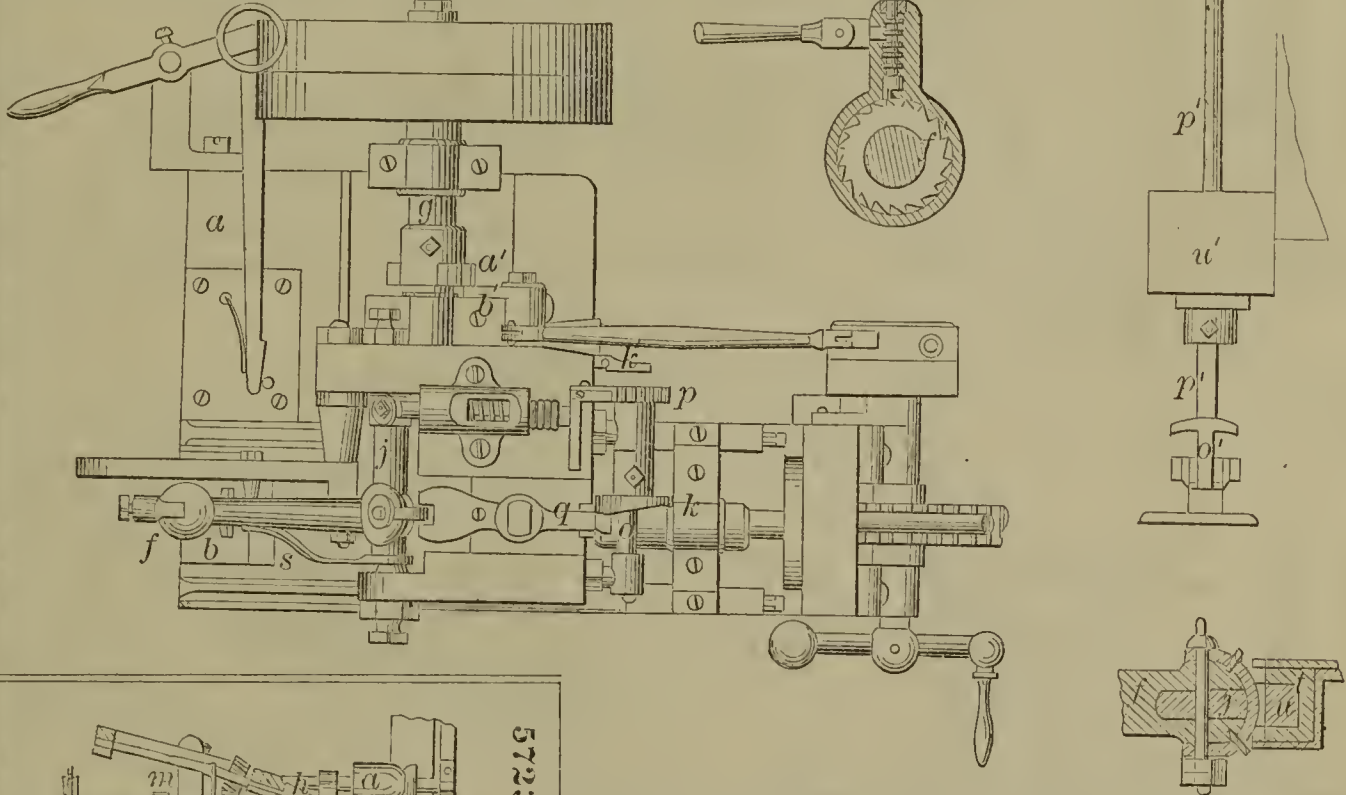

57232—Wheeler & Manley—Hat Pomering Machine.

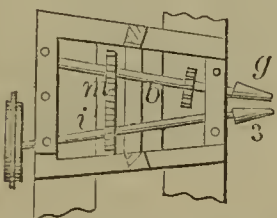

57231—G. E. West—Driving Fence Posts.

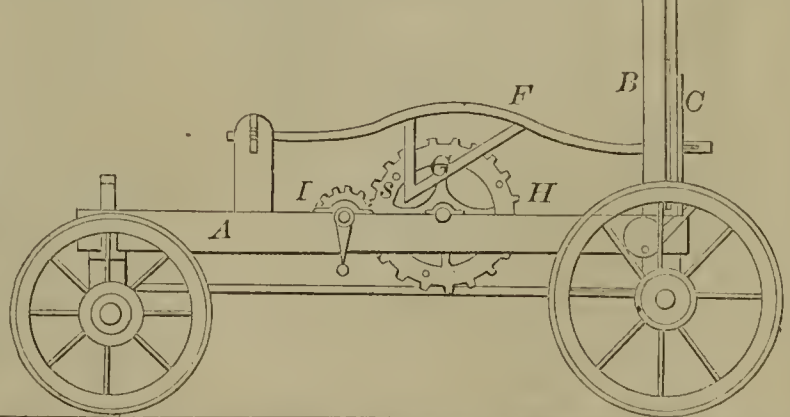

57232—Continued.

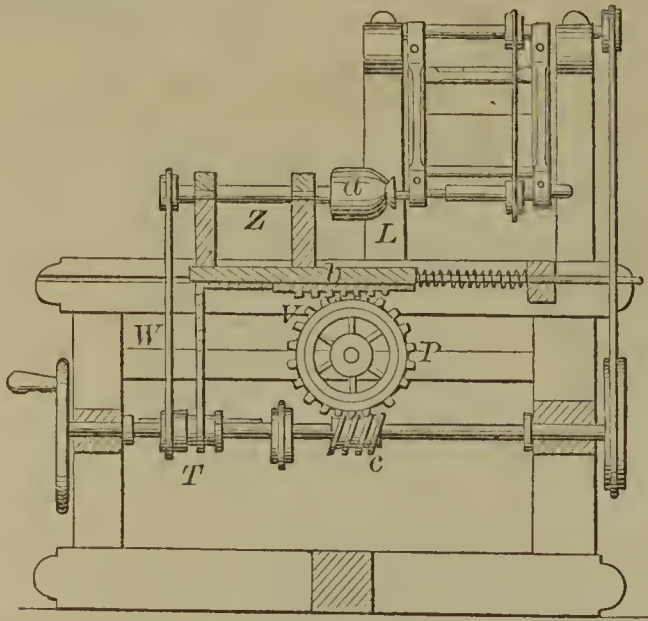

57235—A. S. Wilkinson—Horse Shoe.

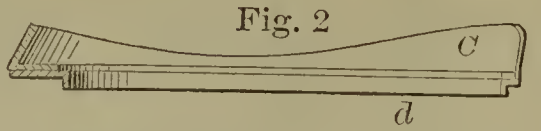
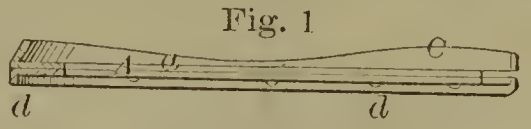

57240—A. Wiswall—Door Spring.

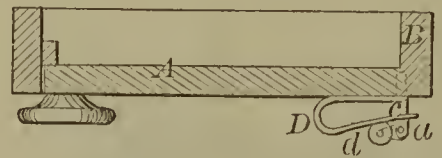

57239—J. D. Winslow—Shutter Fastening.

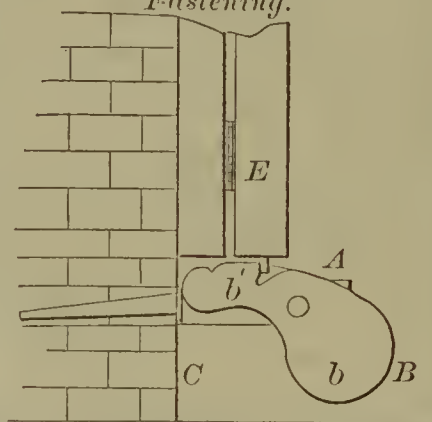

57237—E. Wilkinson, Jr.—For Soldering Eave Troughs.

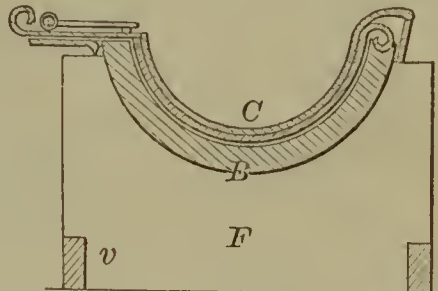

57241—G. M. Wood—Door Bolt.

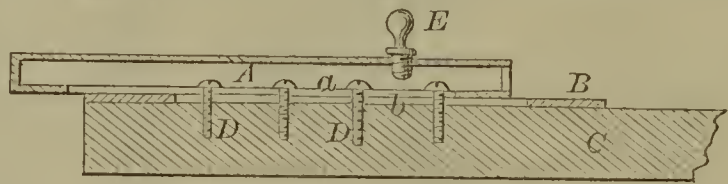

57244—F. W. Bacon—Culinary Steamer for Boilers.

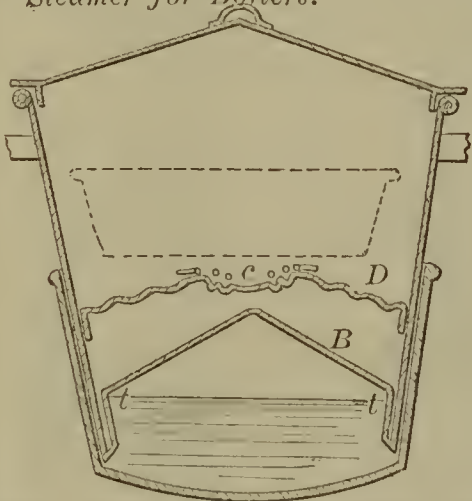

57242—S. Woodbridge—Soil Tilling Machine.

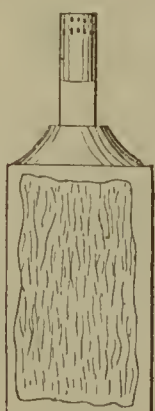
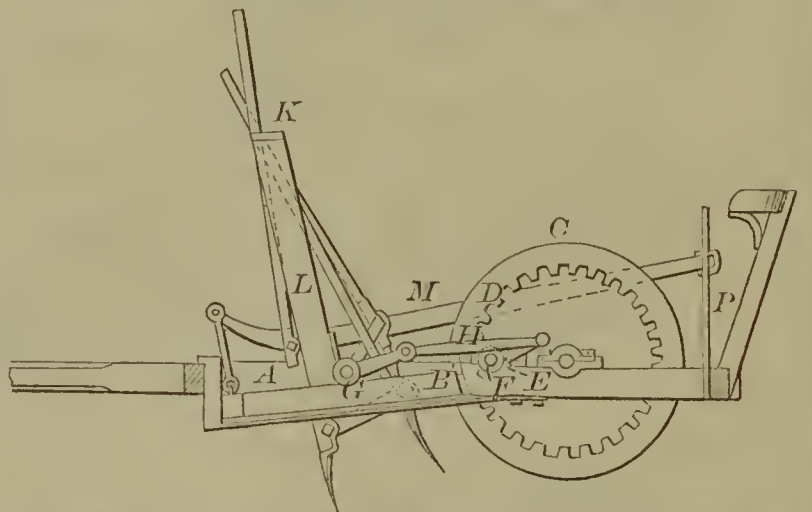

57245—W. Beschke—Using Explosive Liquids for Light and Heat.



57233—White & Bedford—Fabric for Tubing, etc.



57234—A. A. Wilcox—Shoe Nail.

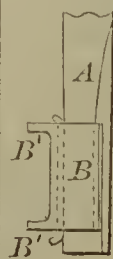

57236—A. S. Wilkinson—Horse Shoe Calk.

57246—H & E. L. Bailey—Urn Cock

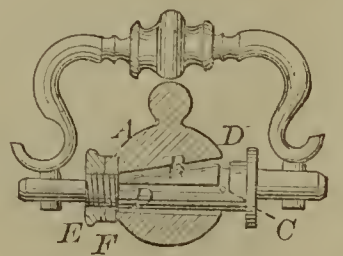

57247—G. Butterfield—*Shoe Lacing Fastening.*

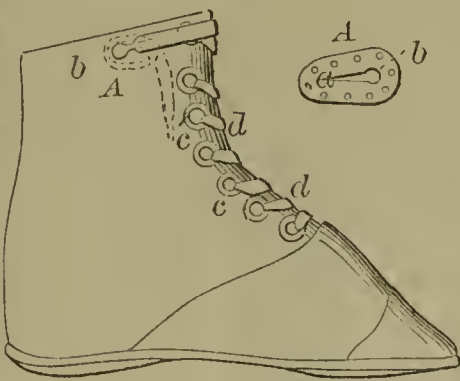

57251—J. Fox—*For Flattening and Punching Umbrella Ribs.*

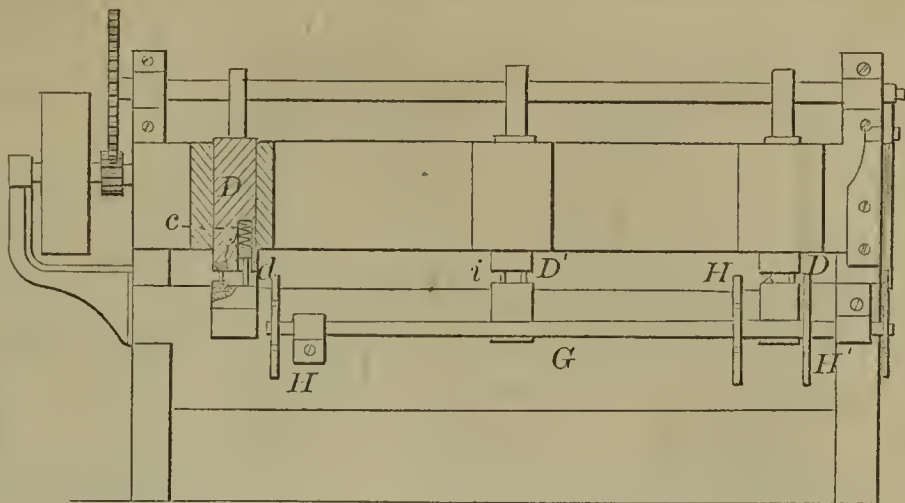

57248—P. B. Curtis—*Whiffletree.*

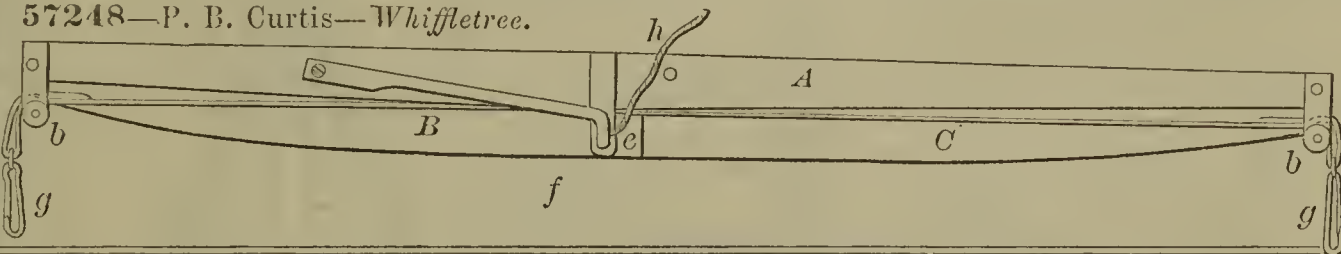

57249—J. Decker—*Slide Bolt.*

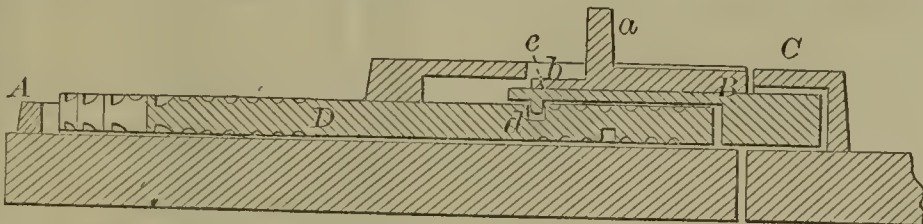

57253—S. A. Grant—*Ladies' Fan.*

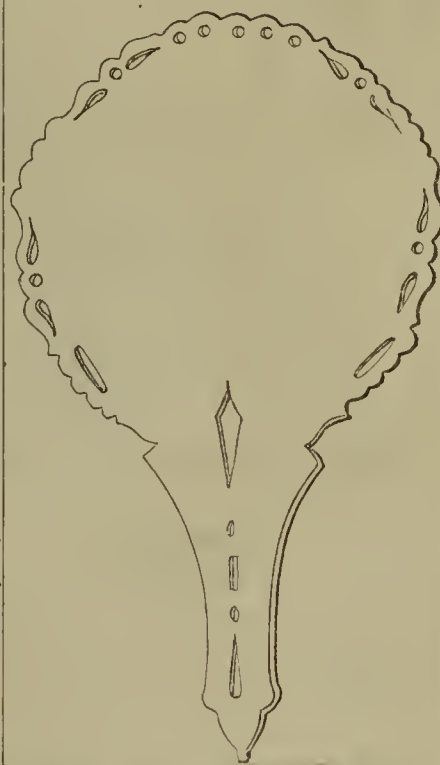

57252—Goty & Guillemin—*Utilizing Timmers' Waste.*

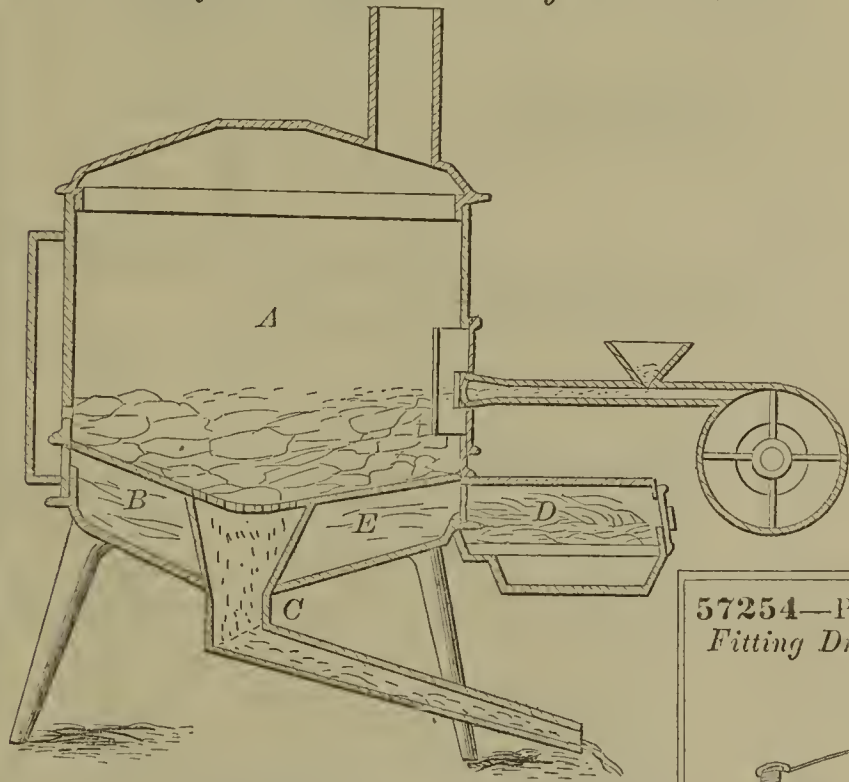

57254—P. A. La Ment—*For Measuring and Fitting Dresses.*

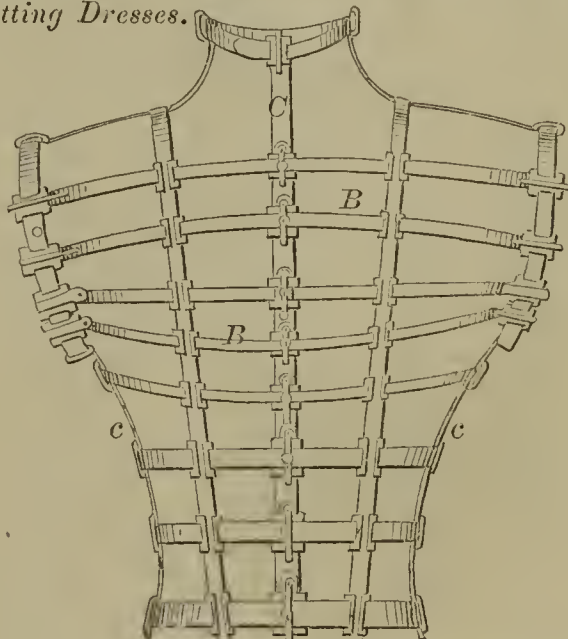

57250—O. V. Flora—*Carpenter's Vise.*

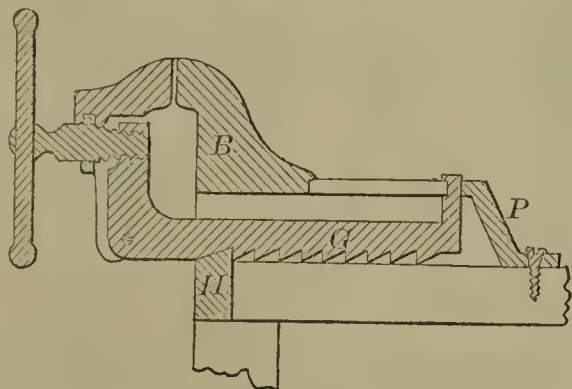

57255—E. Marx—Swinging Chair.

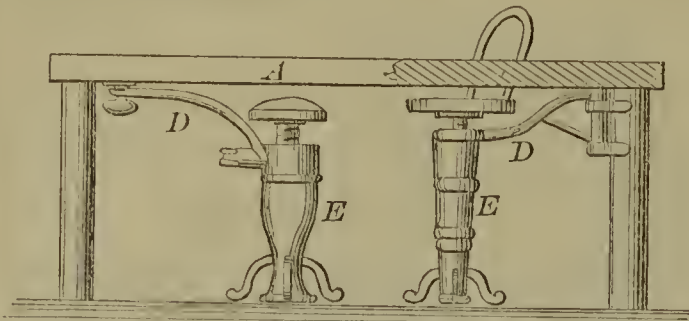

57256—W. W. Meglone—For Removing Efferecing Fluids from Bottles.

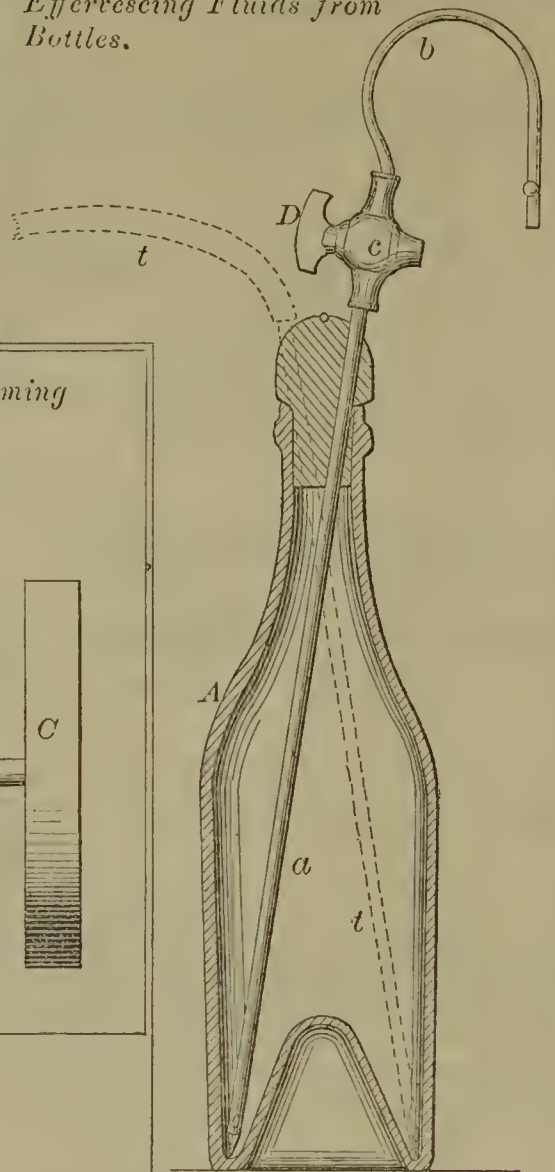

57258—T. J. Powers—For Priming Metallic Cartridges.

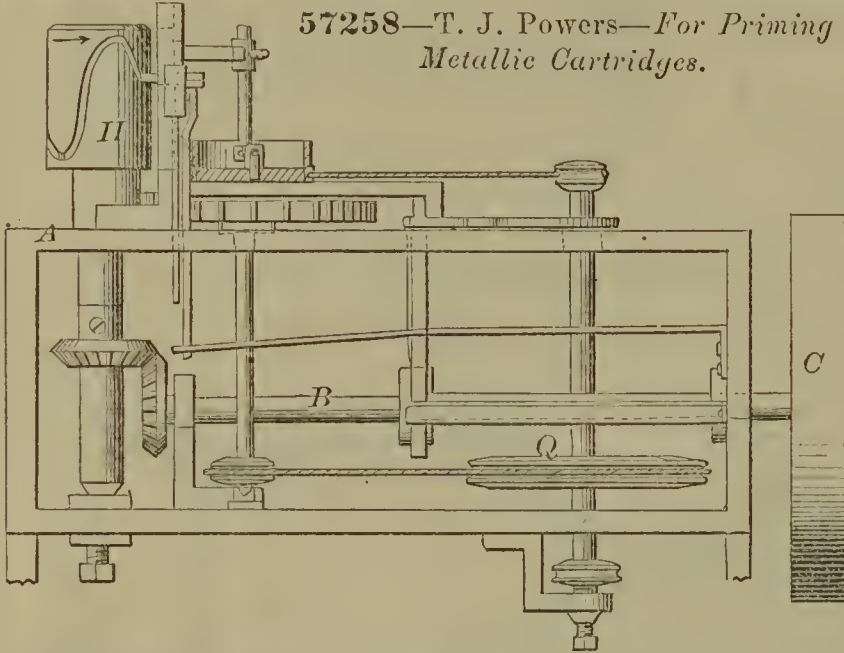

57257—W. Nordhoff—Piano.

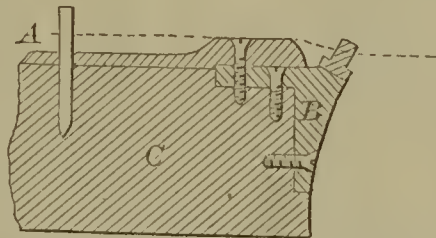

57259—Reed & Pennewell—Corn Planter.

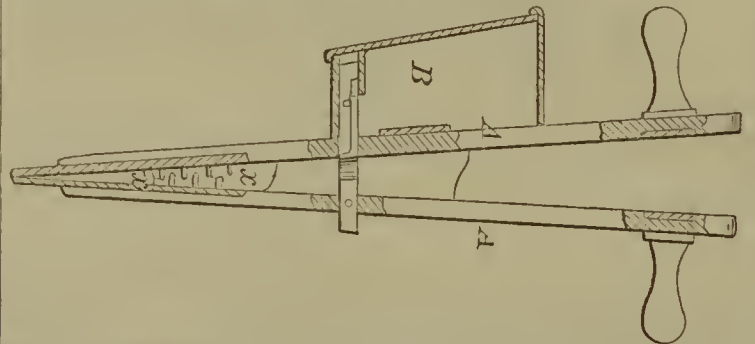

57260—E. A. Robinson—Button.

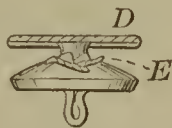

57261—M. S. Sager—Sheet Metal Pan Machine.

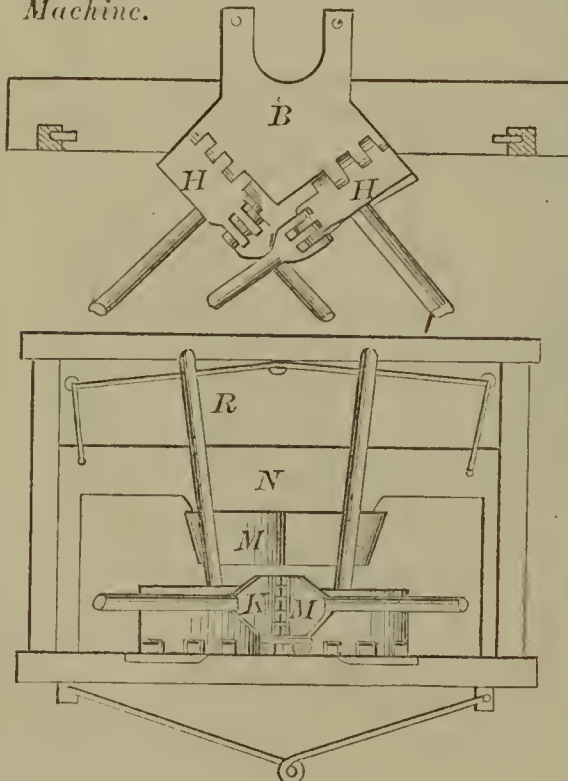

57262—C. & Z. Walsh—Carpet Bag Frame.

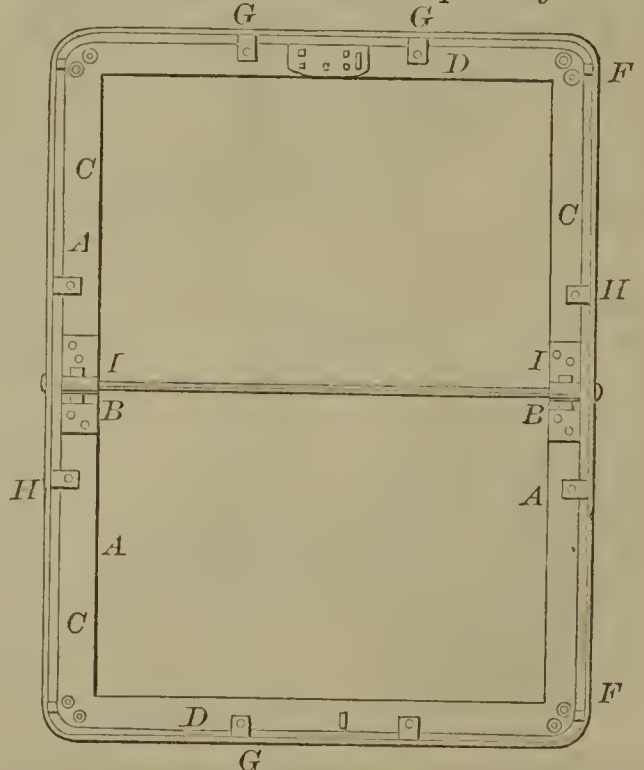



57266—F. A. Lange—Repeating Watch.

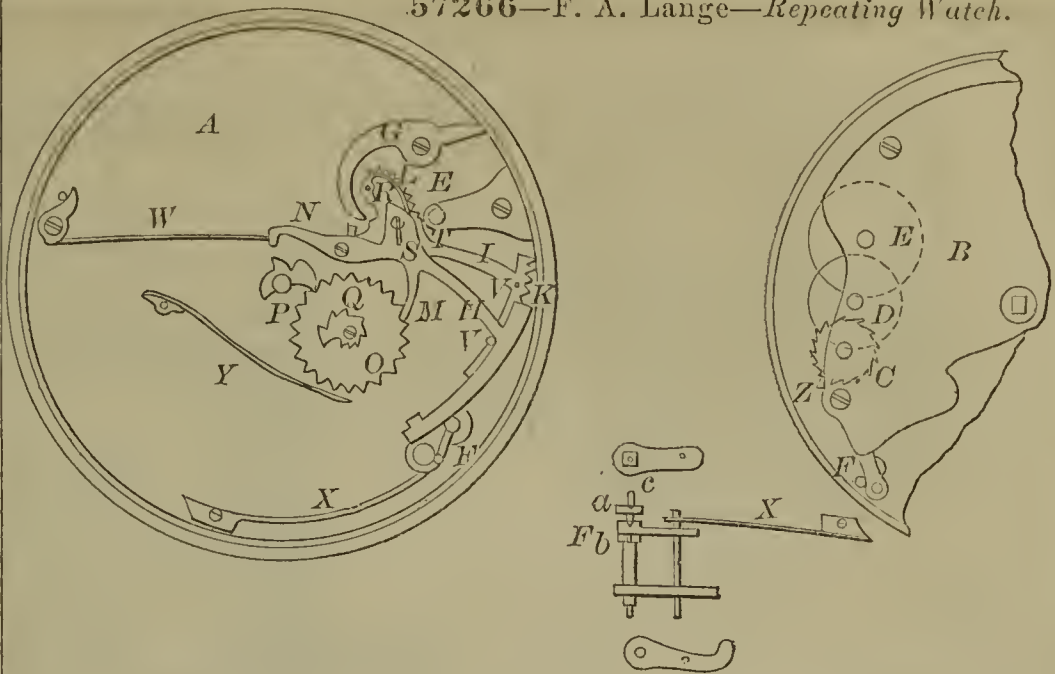

57263—W. Winter—Clothes Line Clamp.

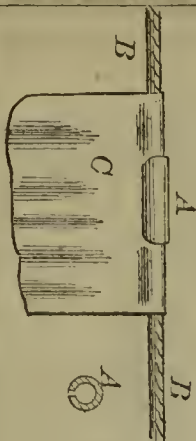

57269—J. H. Selwyn—Breech-Loading Fire Arm.

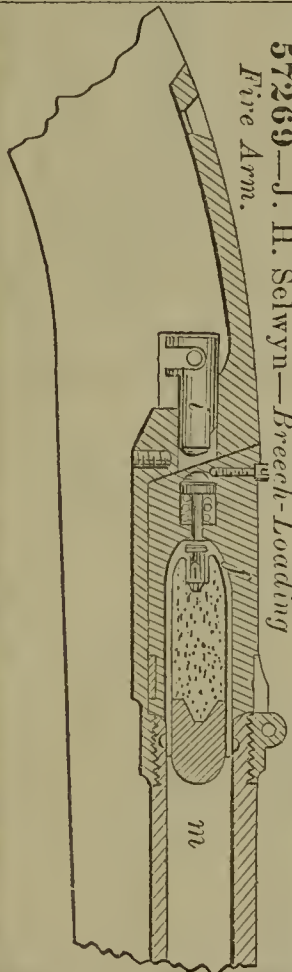

57268—J. T. Scholte—Gas Meter.

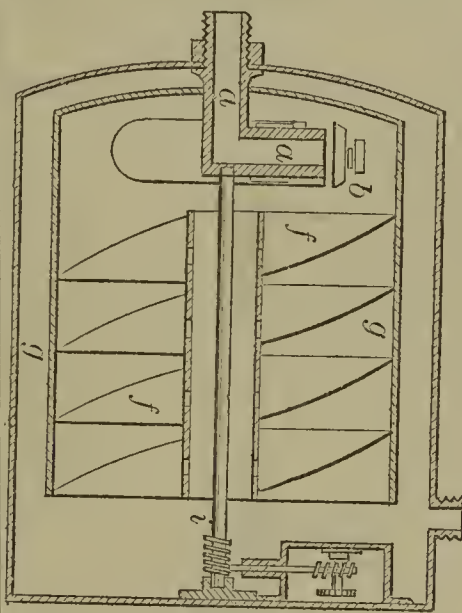

57265—L. P. R. De Massy—Filter Press.

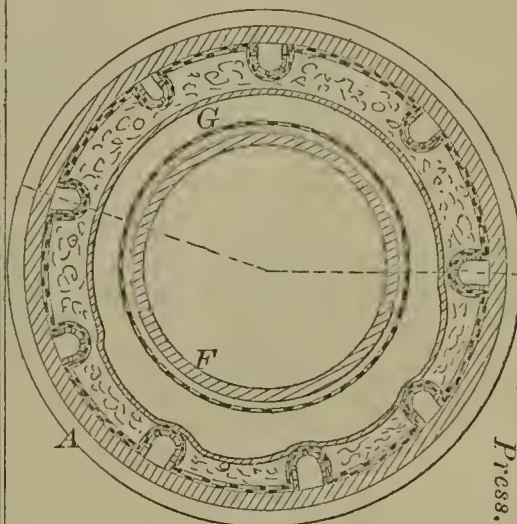

57267—J. Medhurst—For Reefing and Furling Sails.

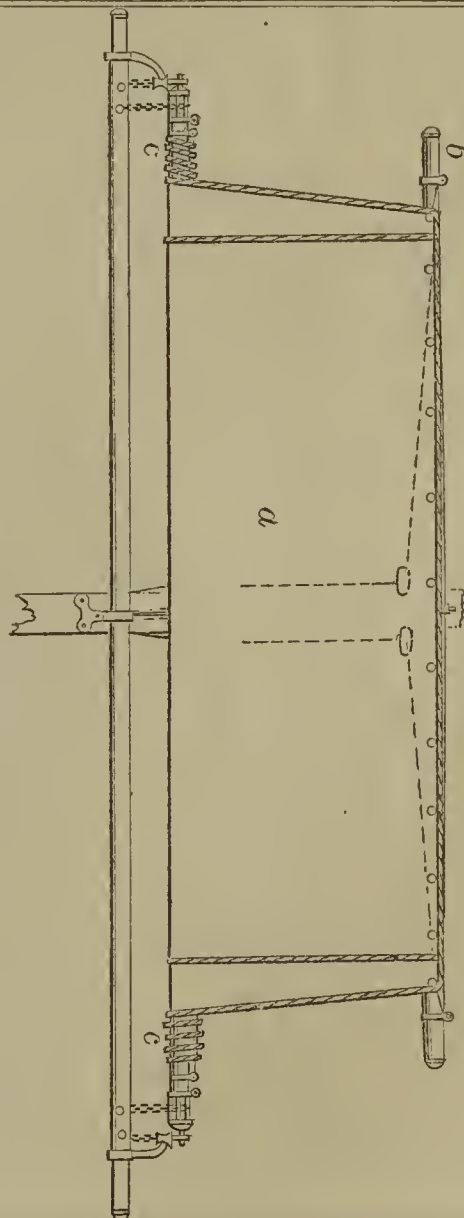

57270—C. F. Uhlig—Harmonium.

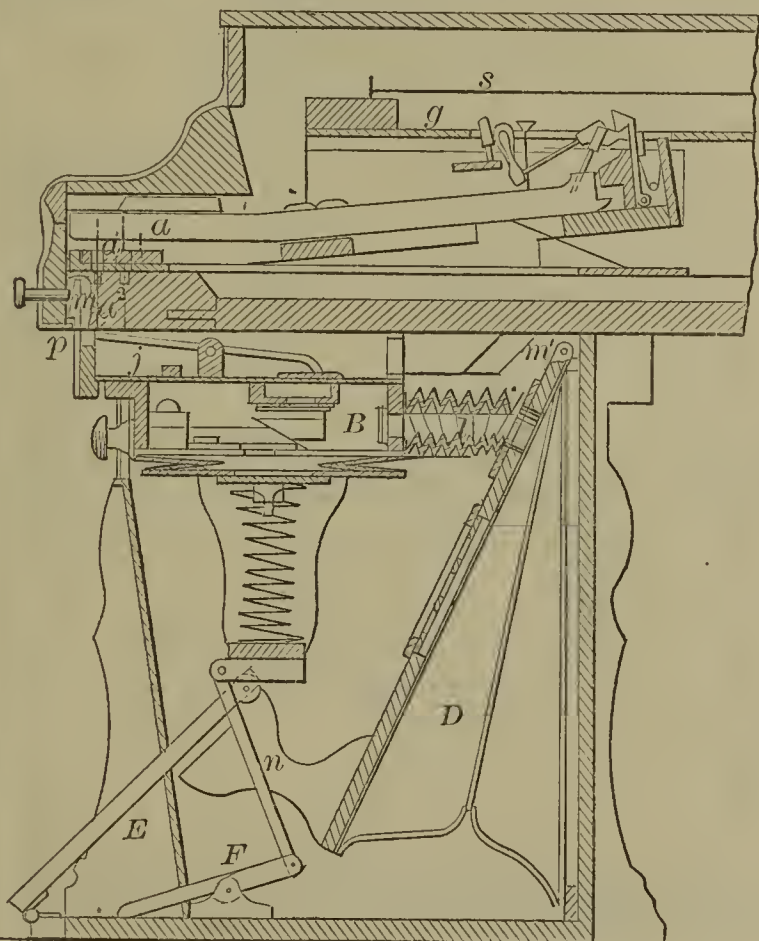

57272—L. W. & S. W. Albee—  
—Beehive.

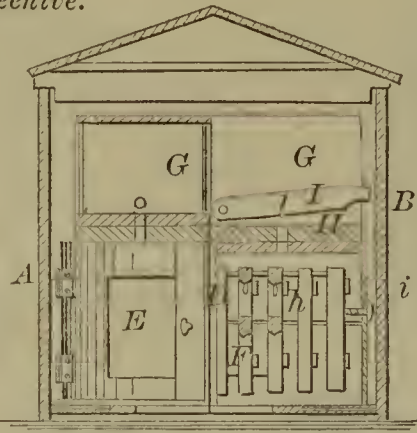

57274—F. Ashley—Letter File.

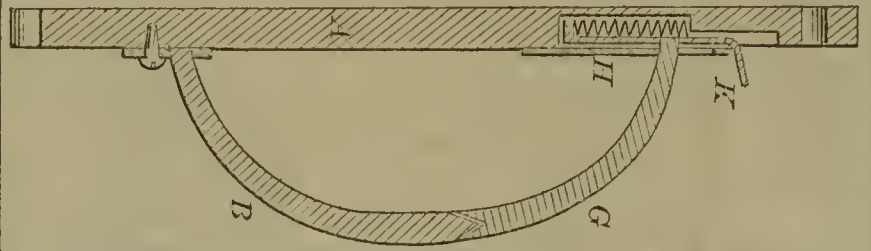

57273—  
S. R. Andres—  
Eraser, &c.



57276—W. W. Batchelder—Vapor  
Burner.

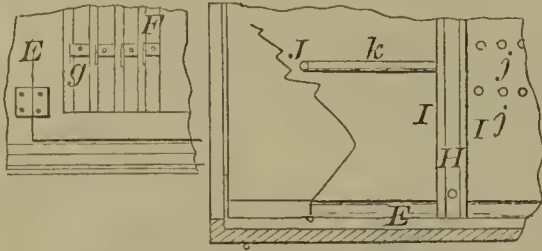
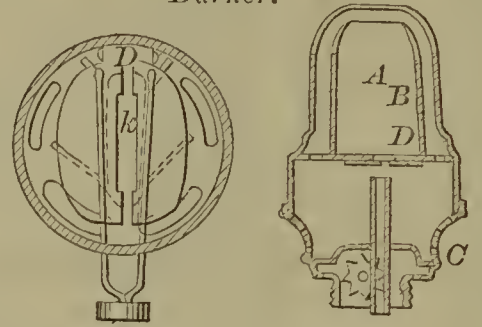

57275—G. Aymard—  
Tobacco Bag.

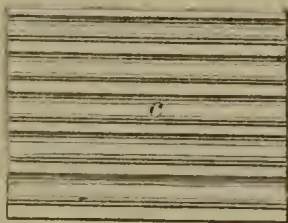

57277—C. Beach—Cider and  
Wine Press.

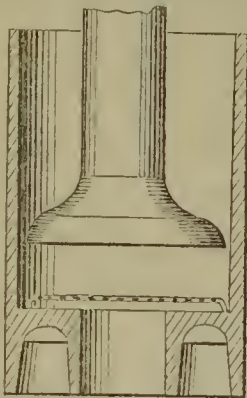
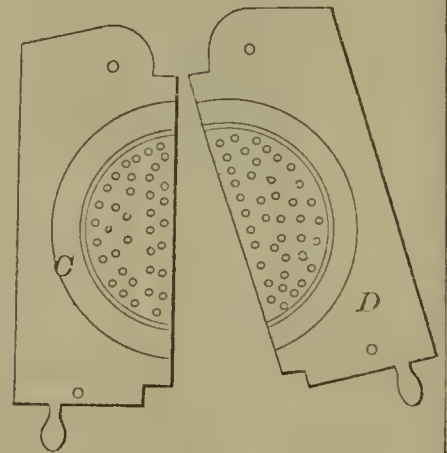
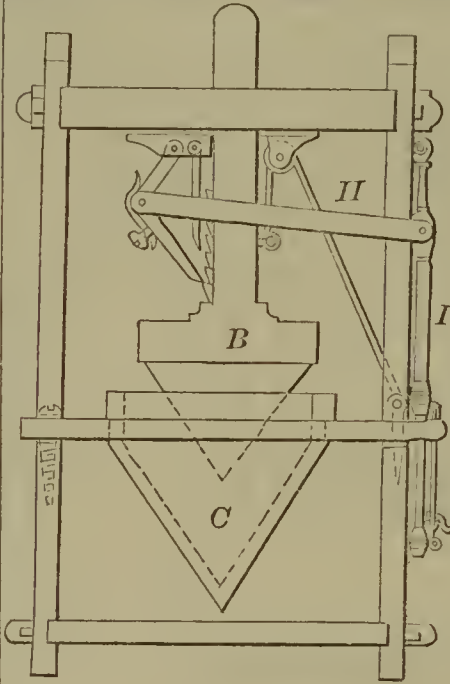

57278—W. W. Beach—  
Skeleton Tumbler.

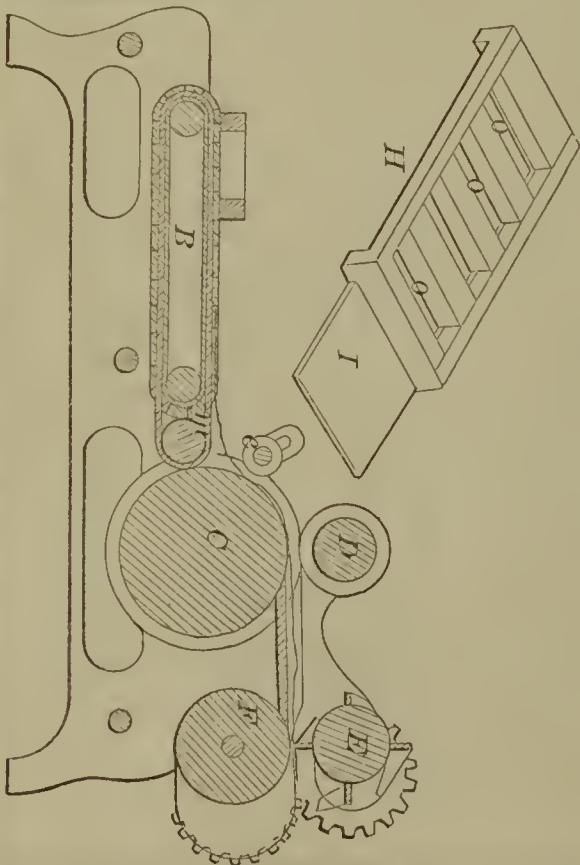

57280—J. Blackie—Tobacco Pressing Machine.

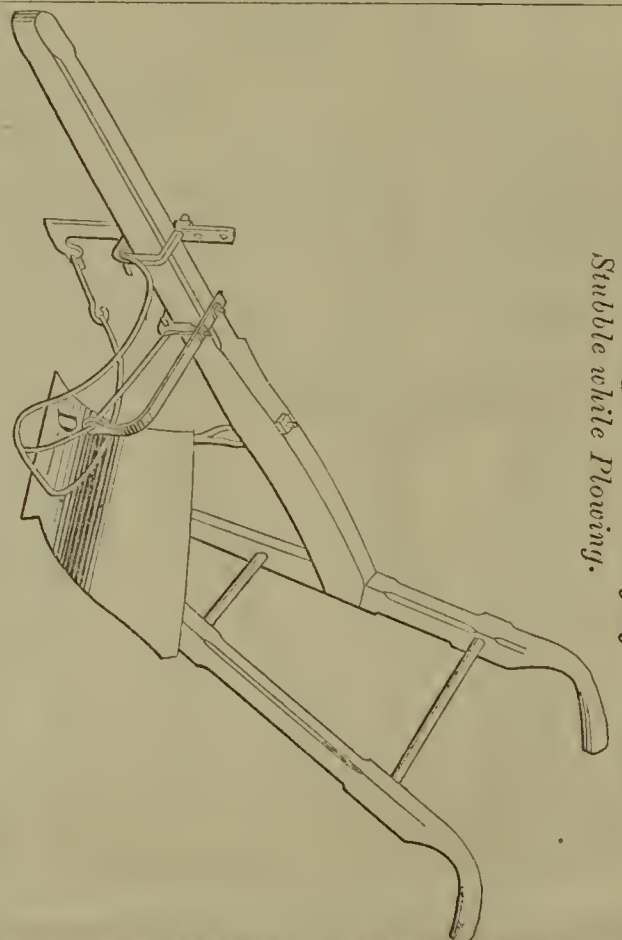

57279—Beer & Wampler—For Burying Weeds and  
Stubble while Plowing.

57281—G. D. Blocher—Cooler.

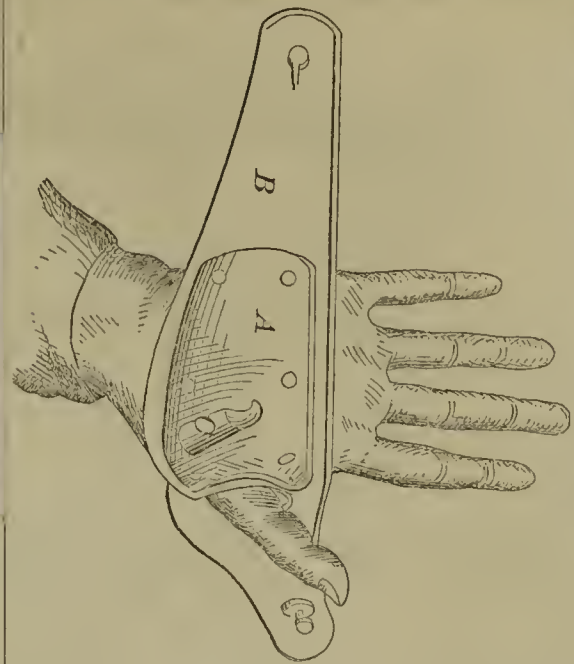
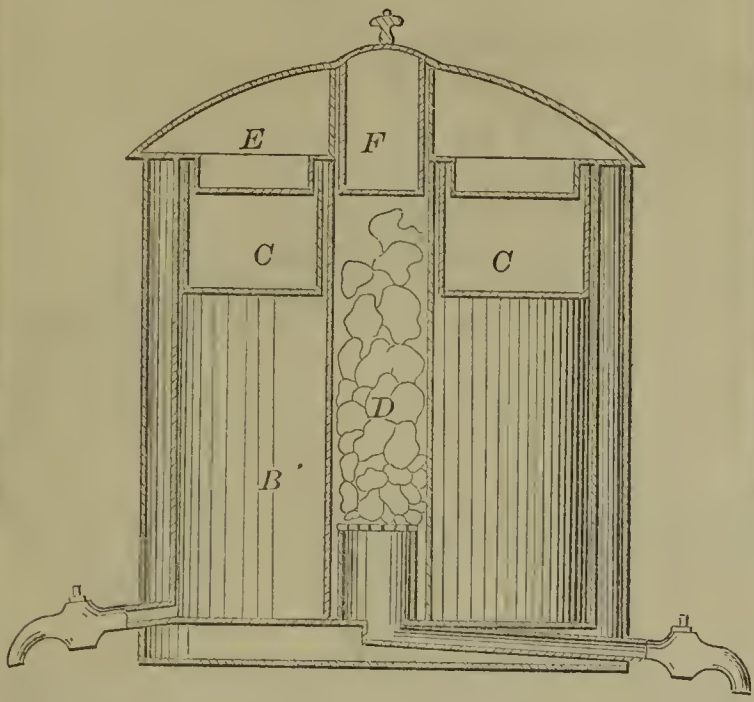

57283—T. J. Brown—Corn Husker.

57284—W. Bryant—For Suppressing Effluvia from Drains.

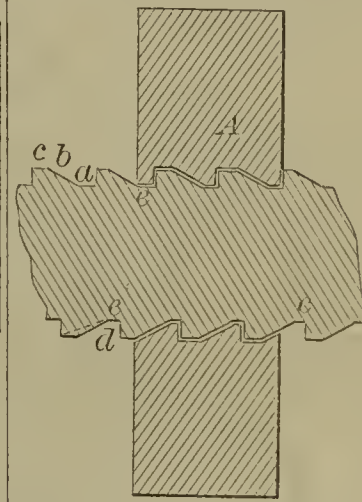
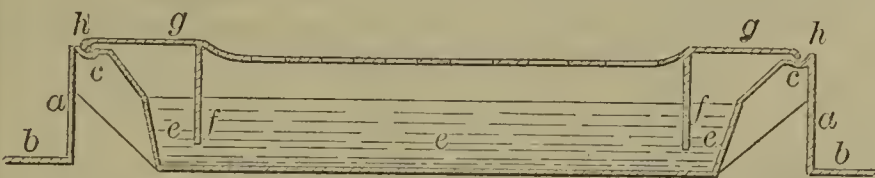

57282—T. Bowers—Wooden Screw.

57285—Burket & Gray—For Treating Petroleum.

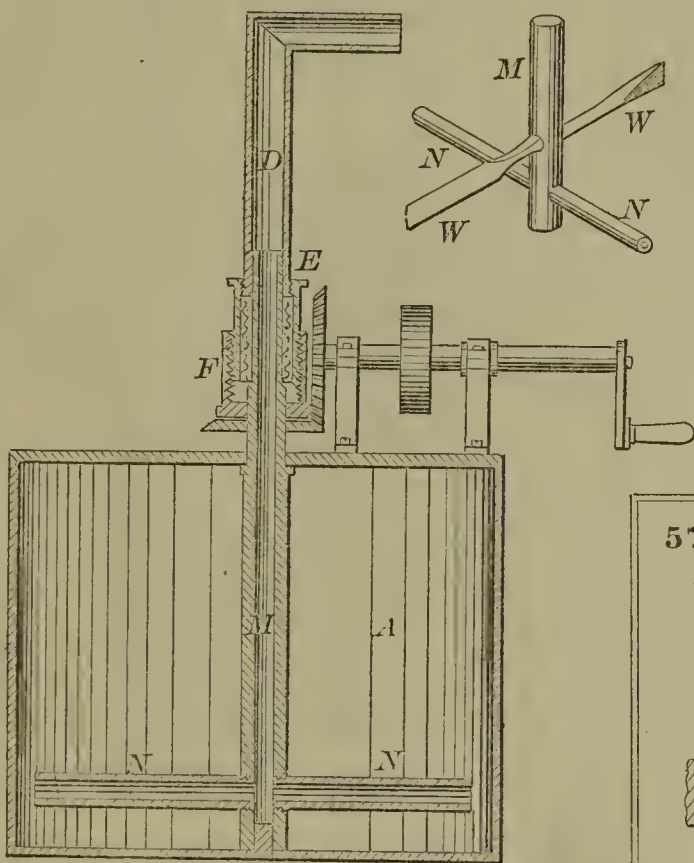

57286—S. Casbeer—Plow Coulter.

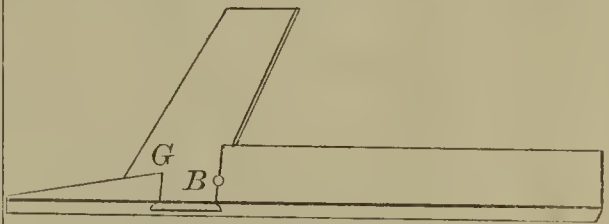

57287—W. Chieken—Sewing Machine.

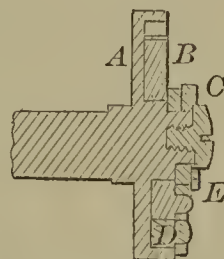

57289—J. J. Christian—Manufacture of Boots.

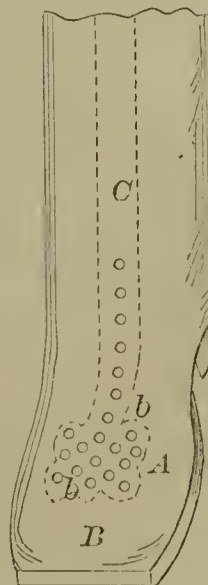

57288—S. Child, Jr.—Vapor Stove.

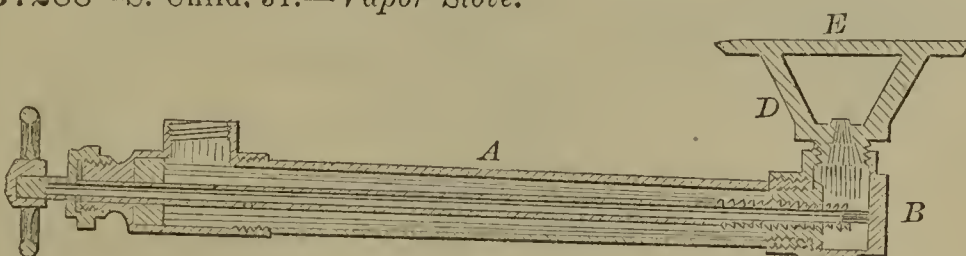

57290—C. S. Clark—*Roof.*

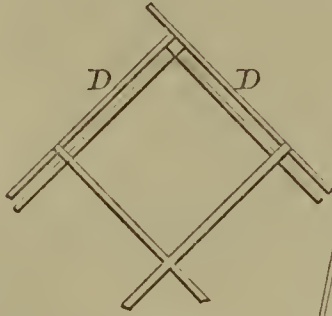
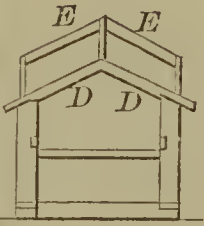
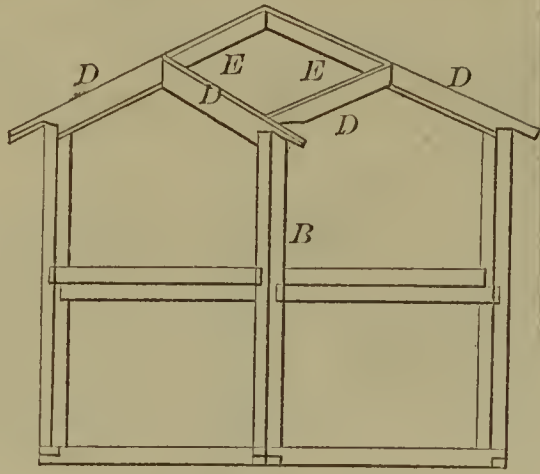

57293—Crosby & Helm—*For Desulphurizing Ores.*

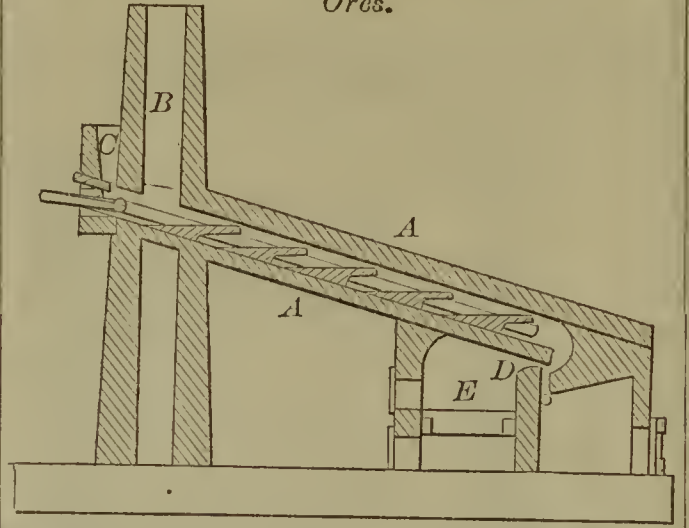

57294—J. W. Dann—*Bending Carriage Thills.*

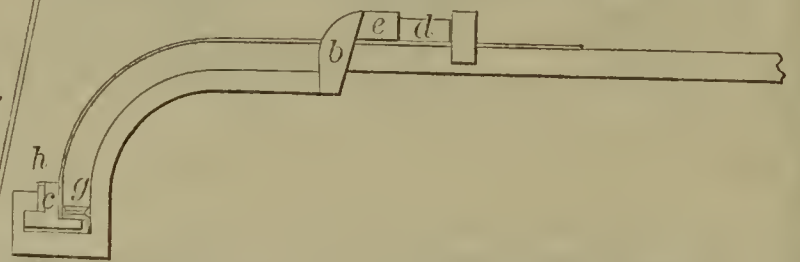

57292—E. H. Craige—*Hanging Pitan, &c.*



57295—E. F. & A. B. Dickerson—*Railroad Switch Lantern.*

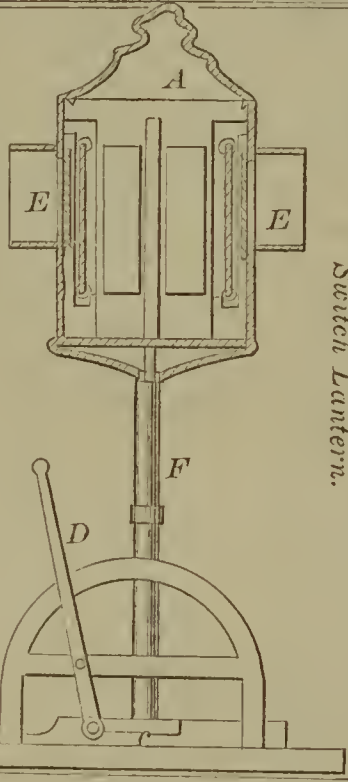

57296—H. Dillaway—*Glass Press.*

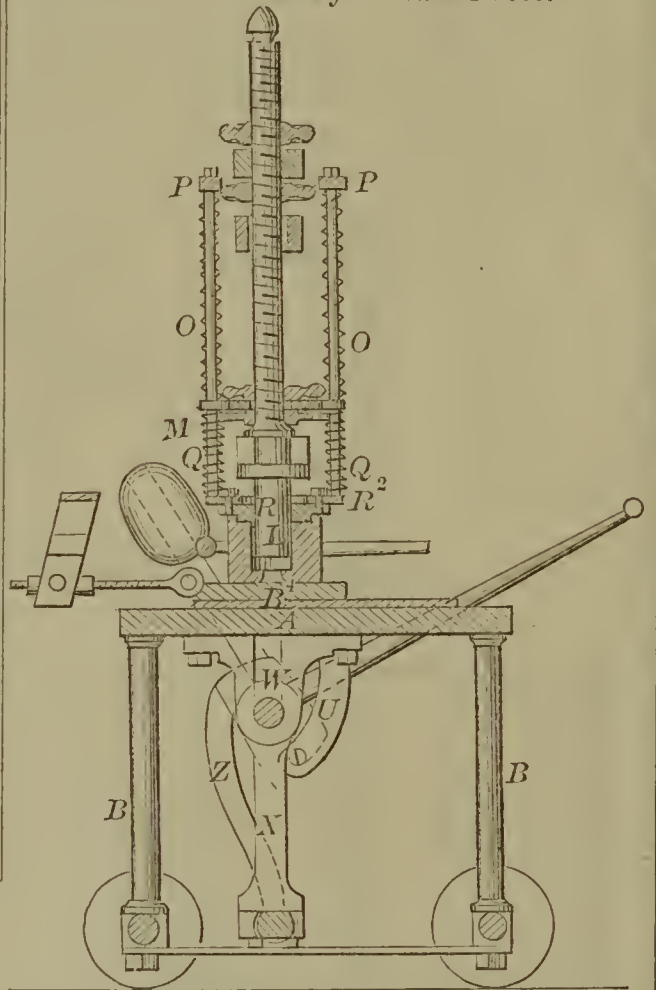

57291—C. A. Codding—*Washing Machine.*

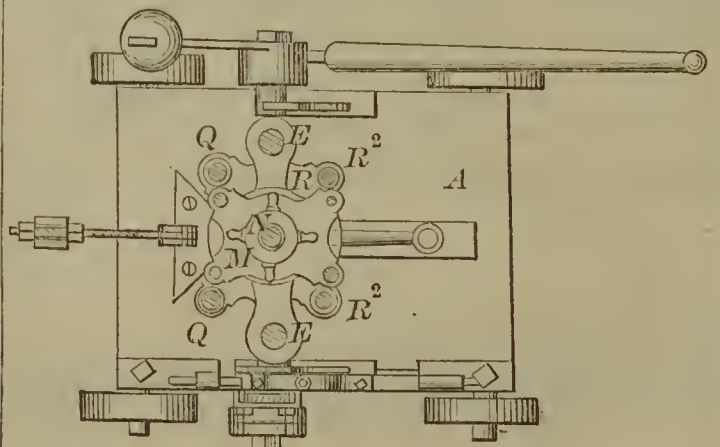
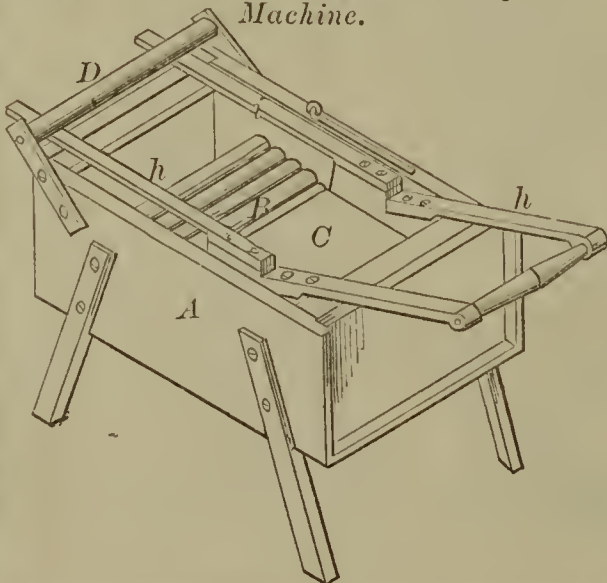

57300—C. Duckworth—Shuttle Binder for Looms.

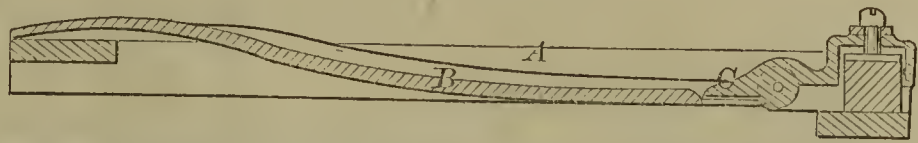

57301—A. S. Eddy—Evaporator.

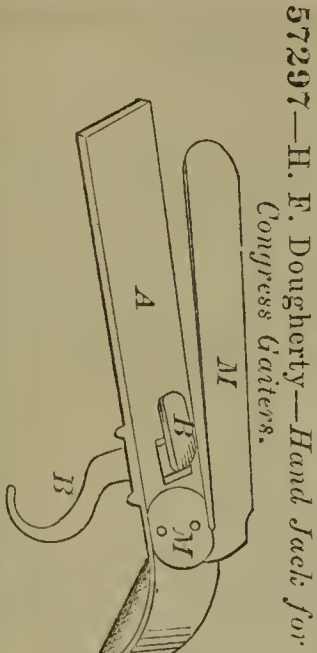
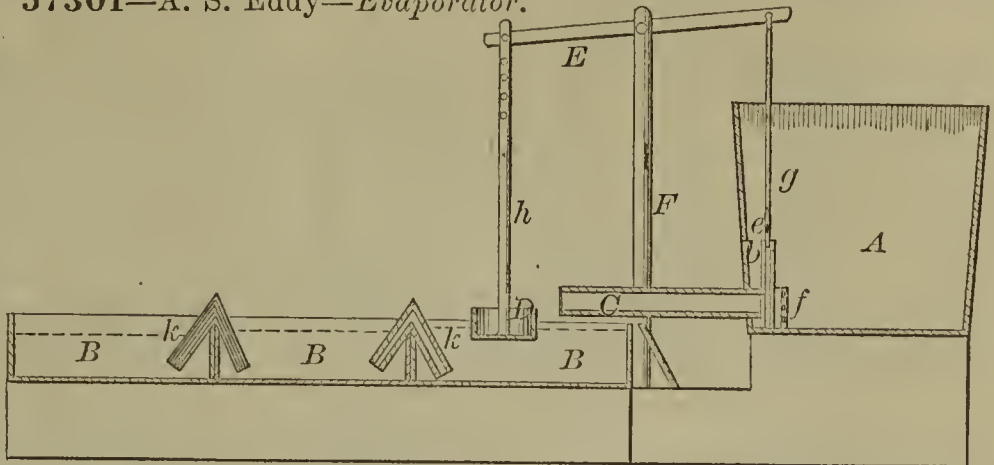

57297—H. F. Dougherty—Hand Jacks for Congress Gaiters.

57299—J. P. Driver—Fountain Lamp.

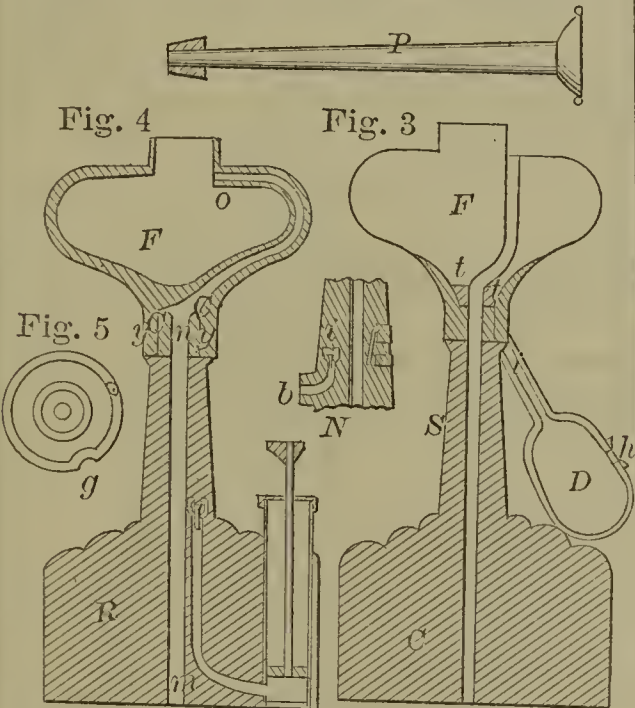

57298—J. Dreisörner—Hydraulic Engine.

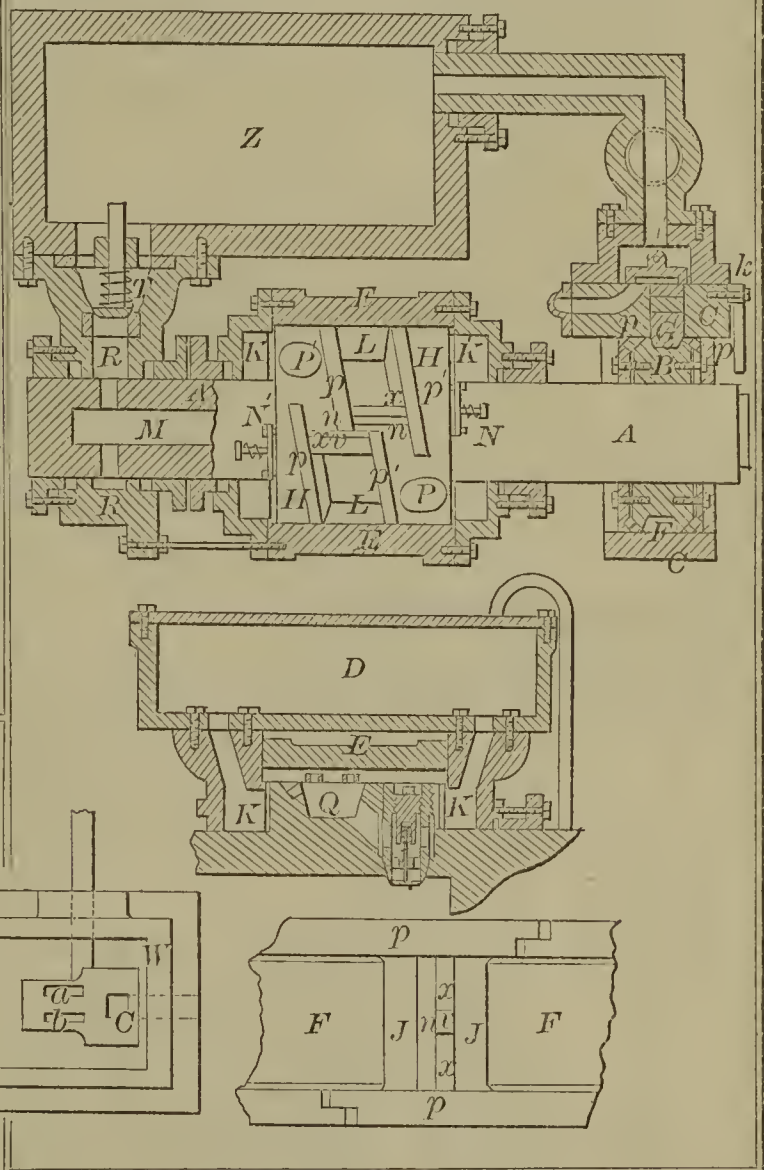

57302—J. Edson—Capstan.

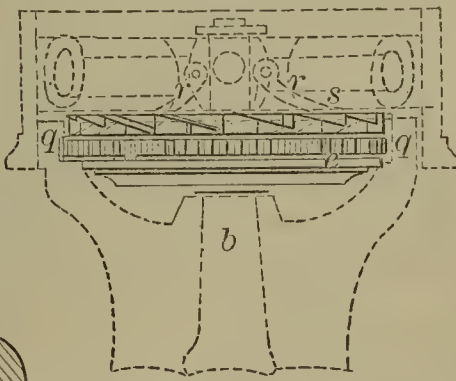
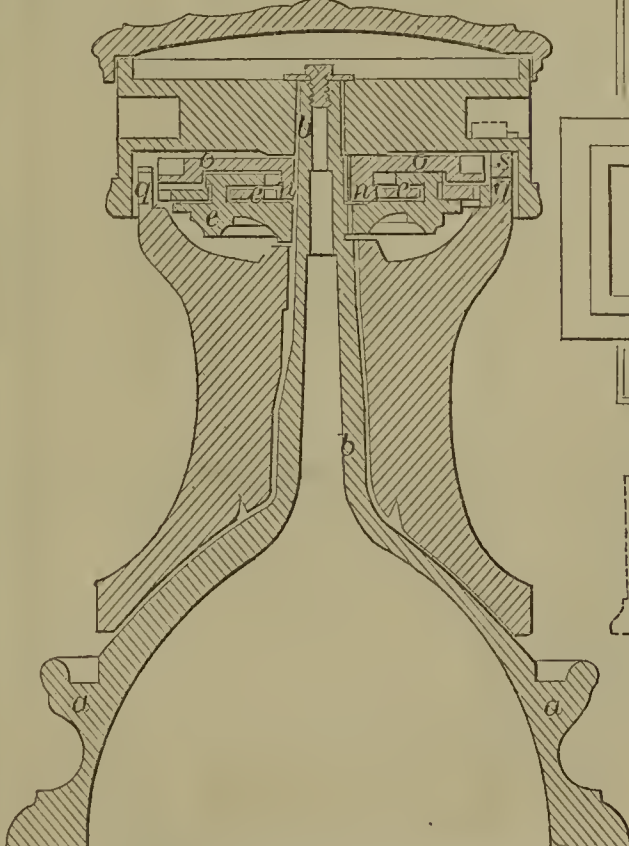

57303—A. H. Emery—Hydraulic Press for Peat, Brick, &c.

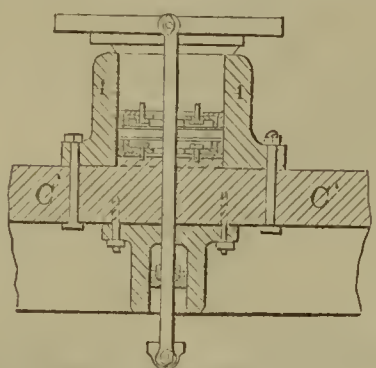
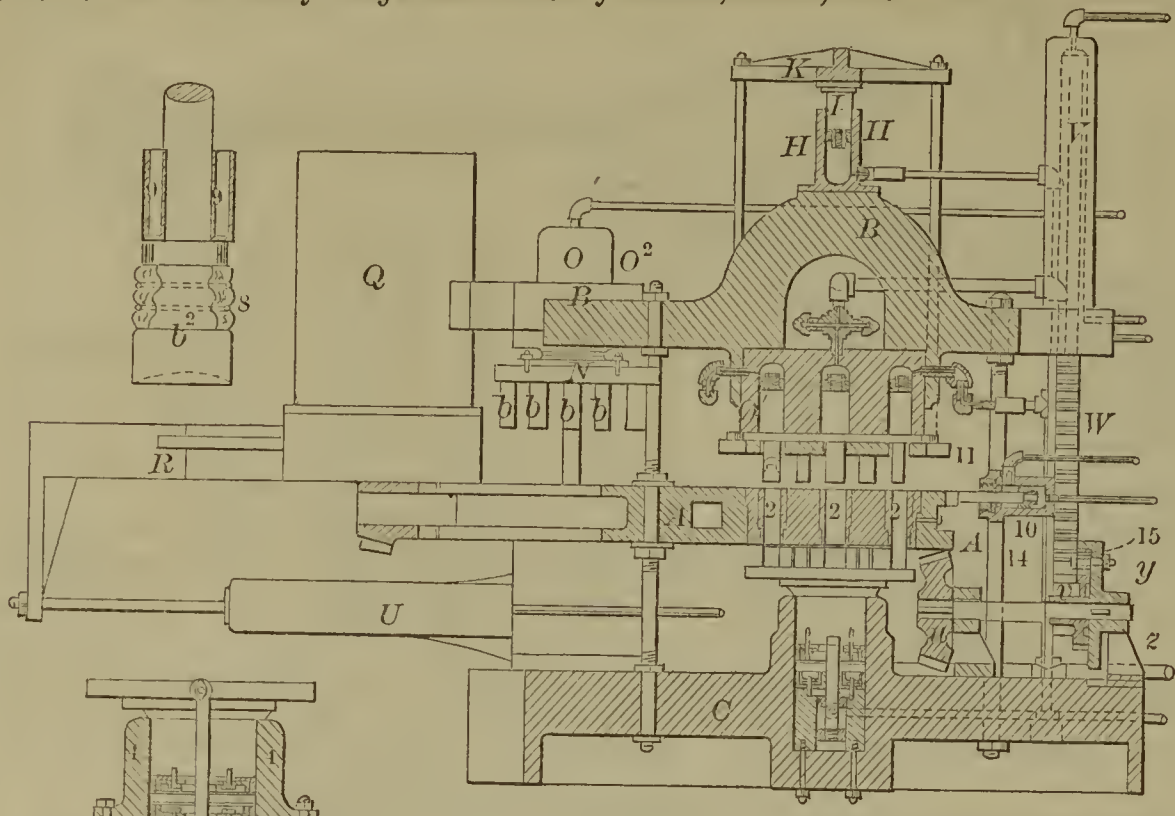

57305—J. J. Fairbanks—For Forming and Cutting Skirt Springs.

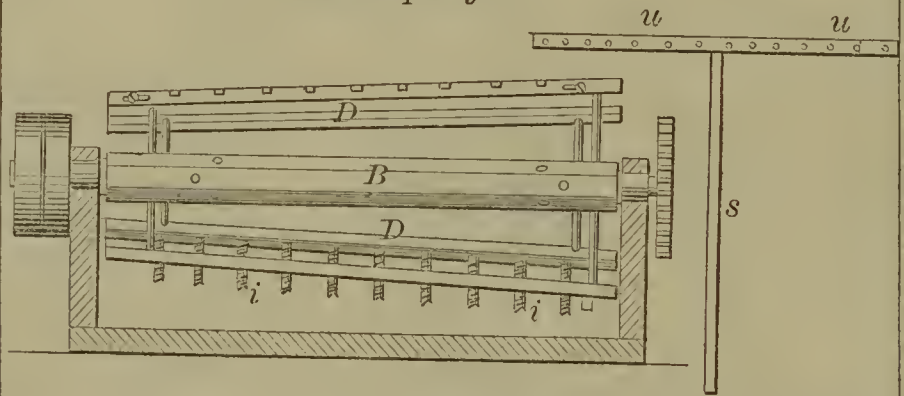

57304—H. B. Esty—Purifying Spruce Gum.

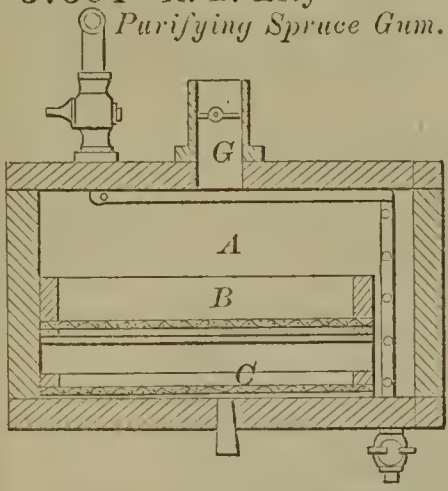

57309—L. H. Foy—Hoop Skirt.

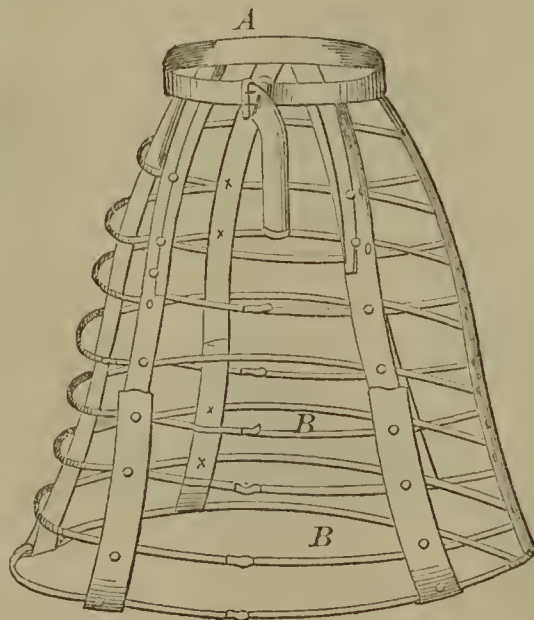

57306—D. Flagg—Water Elevator.

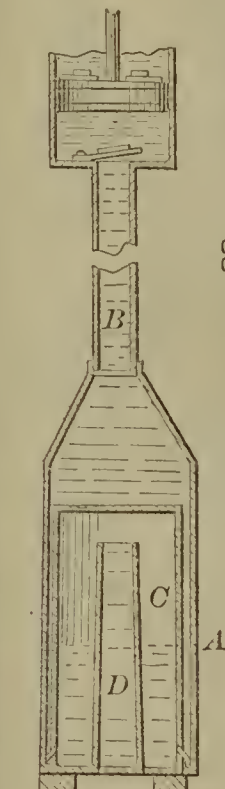

57308—J. C. Ford—Paper Collar Machine.

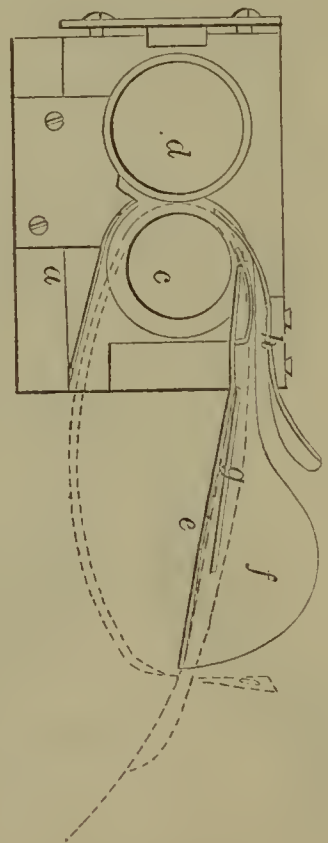

57310—S. D. French—*Watch Escapement.*

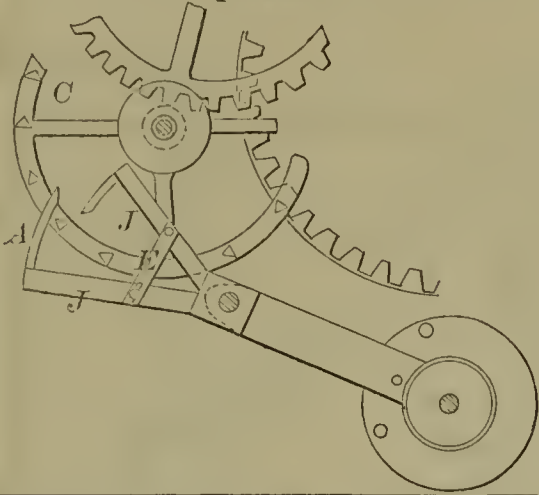

57311—J. B. Grant—*For Distilling Oil.*

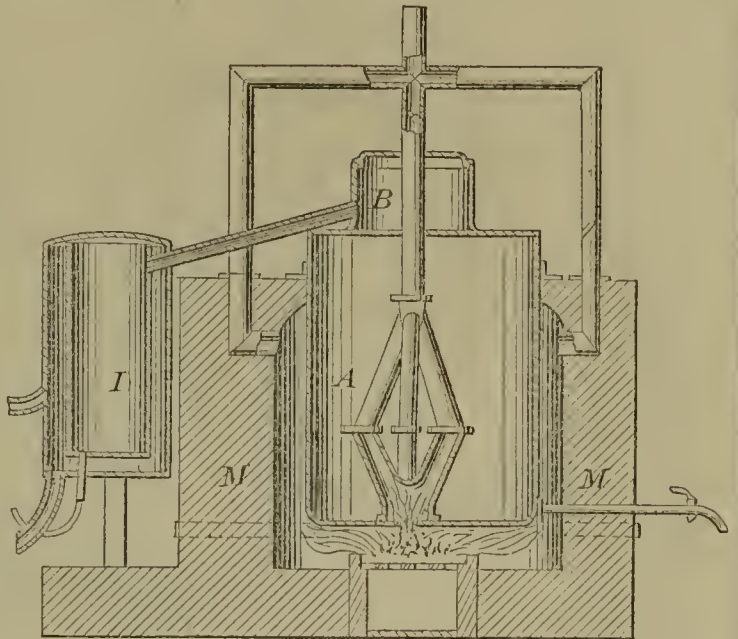

57318—A. A. Hardy—*Umbrella.*

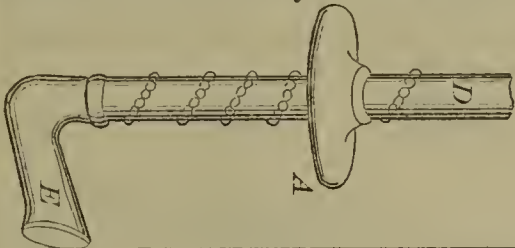

57312—A. B. Greenwalt—*Carriage Spring.*

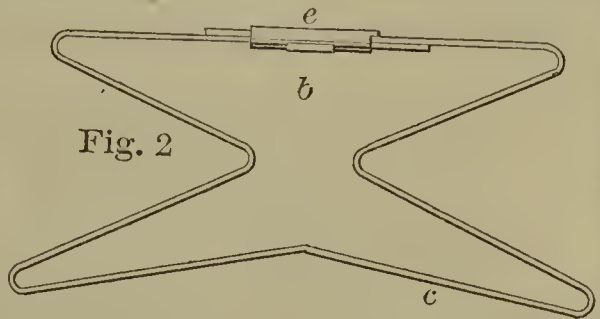

57314—T. Griffin—*Button Hole Patch for Paper Collars.*



57316—Guttridge & Rogers—*Block and Tackle Check.*

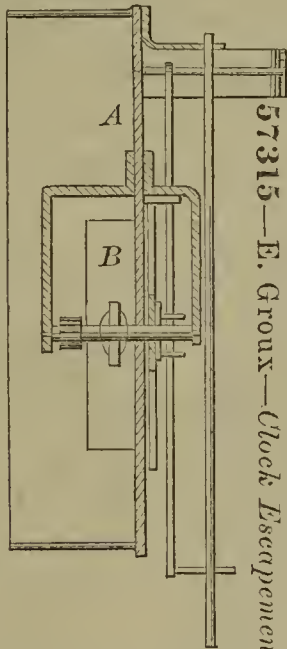
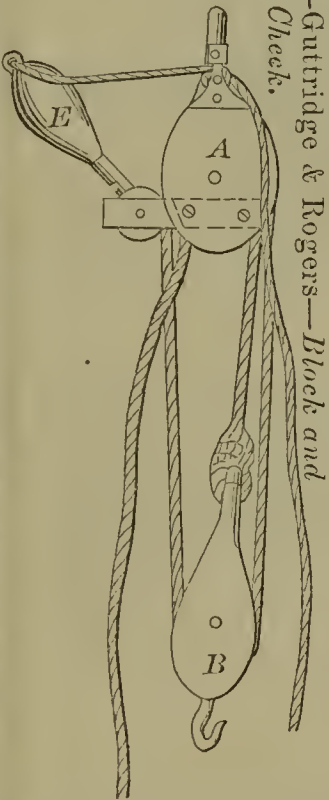

57315—E. Groux—*Clock Escapement.*

57313—J. Gribben—*Die for Bolt Heading Machine.*

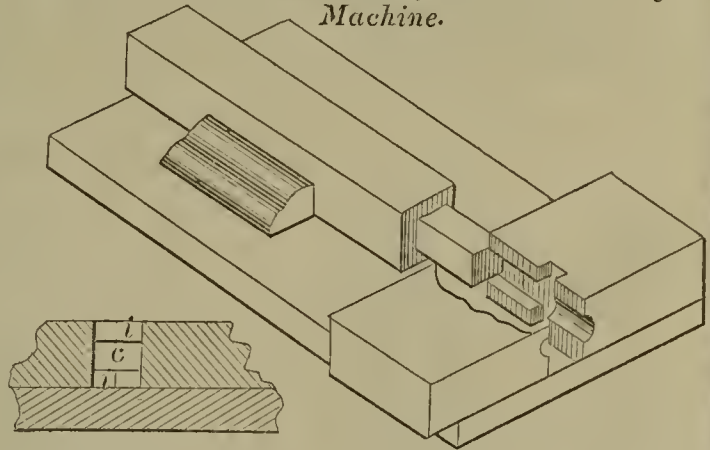

57319—T. Harper—*For Boring Wagon Hubs.*

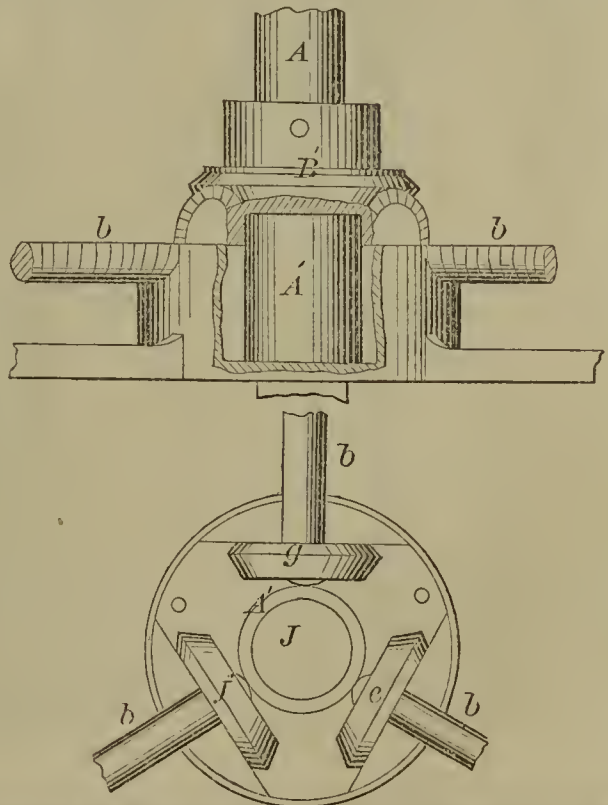

57317—R. Hagen—*Ice and Coal Box.*

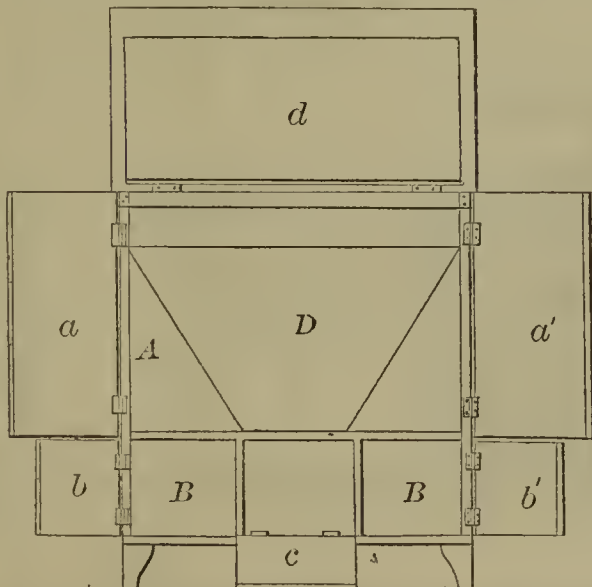

57320—A. Harroun—Broom Head.

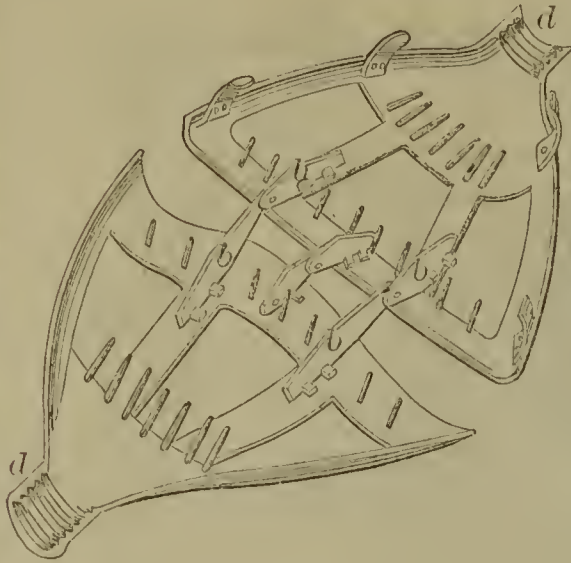

57321—E. Heald—Float Valve.

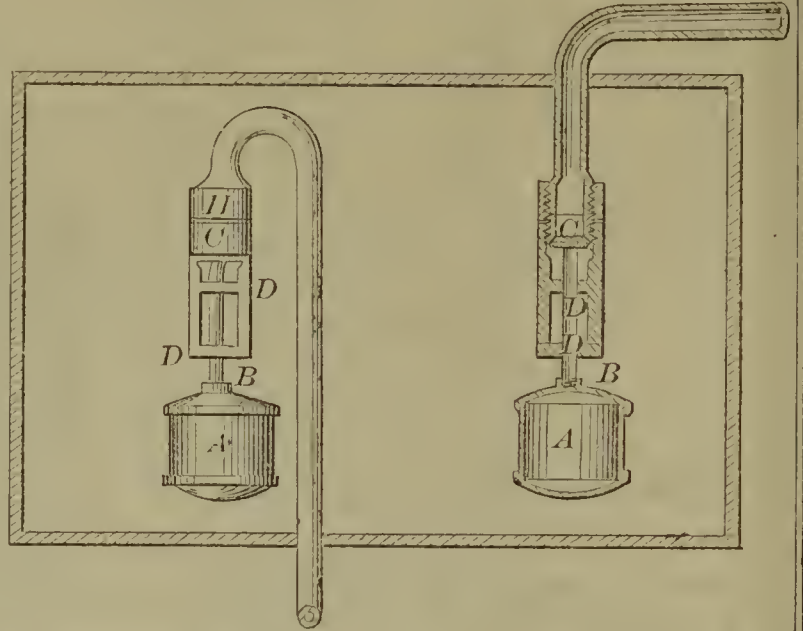

57323—G. Herrick—Wrecking Car.

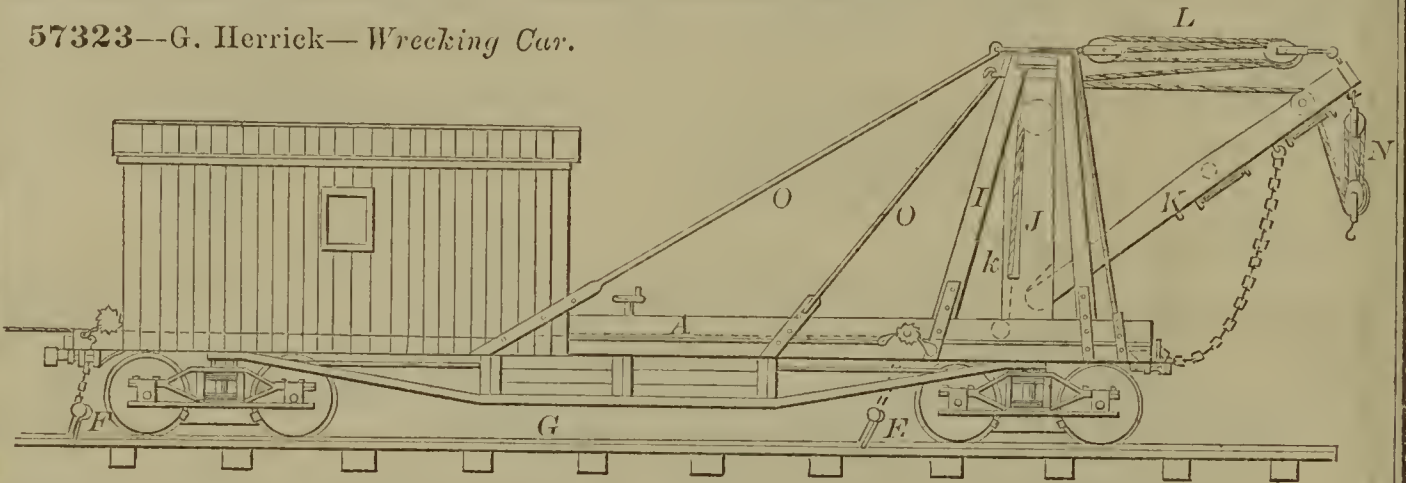

57325—F. A. Howard—Mitering Machine.

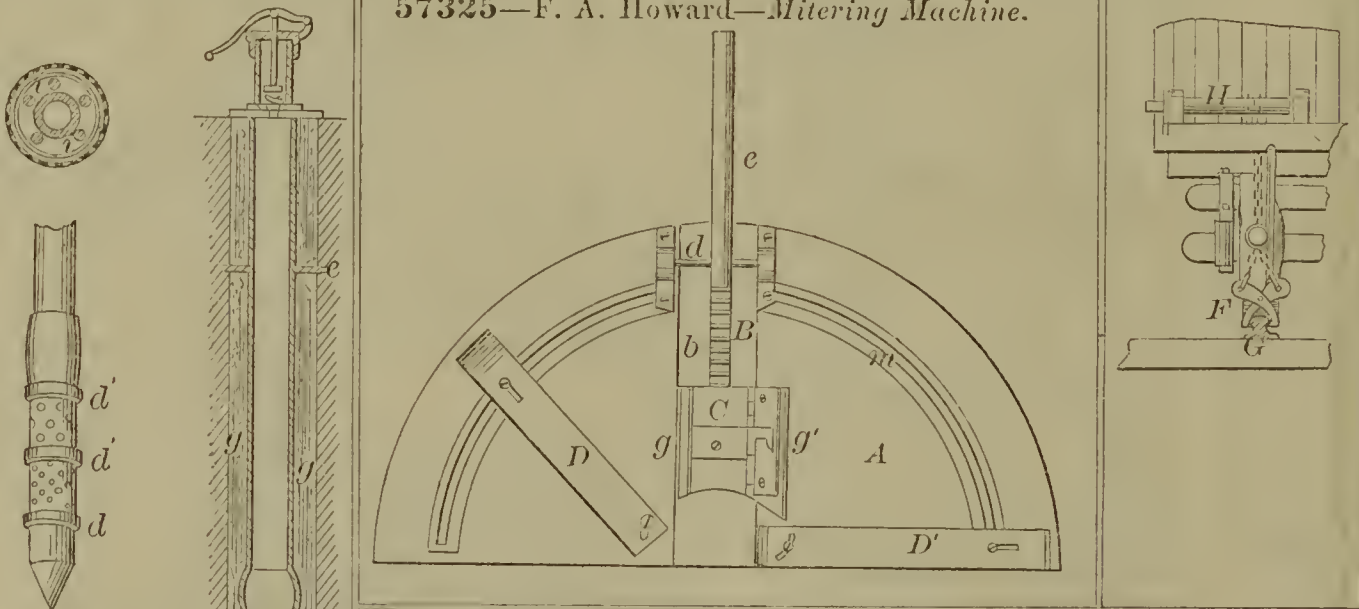

57322—G. G. Heermance—  
Construction of Wells.

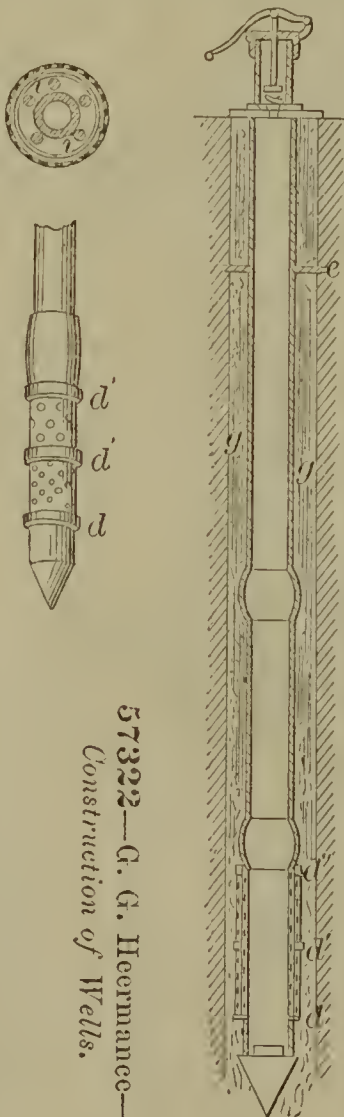

57326—Howe & Mackrell—  
Braiding Machine.

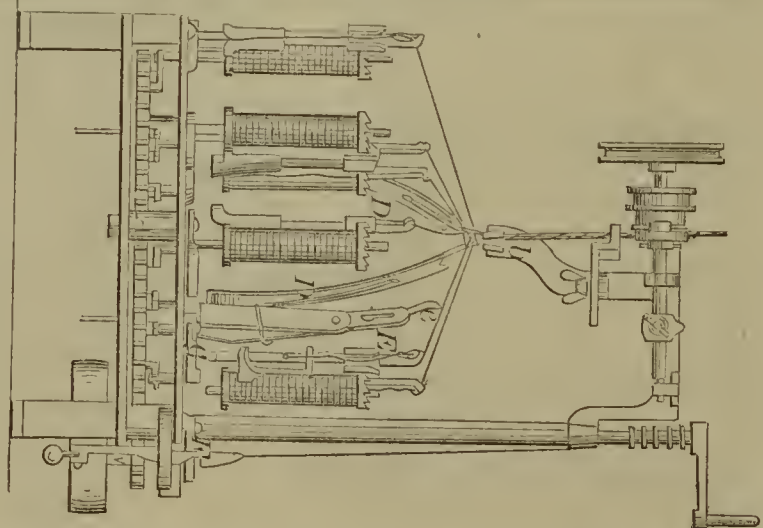



57327—W. H. Isaacs—*Evaporator.*

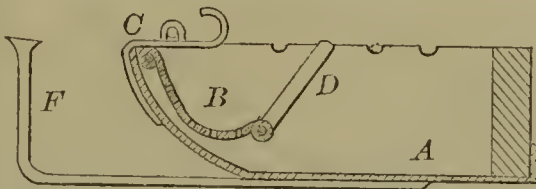

57328—H. S. C. Iwerson—*Head Dress.*



57329—N. Jenkins—*Water Gate.*

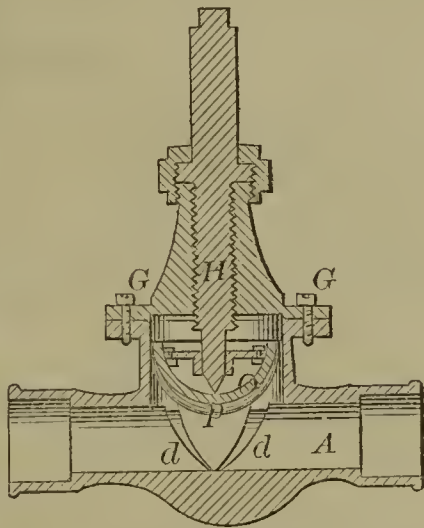

57331—I. H. Johnson—*Hay Press.*

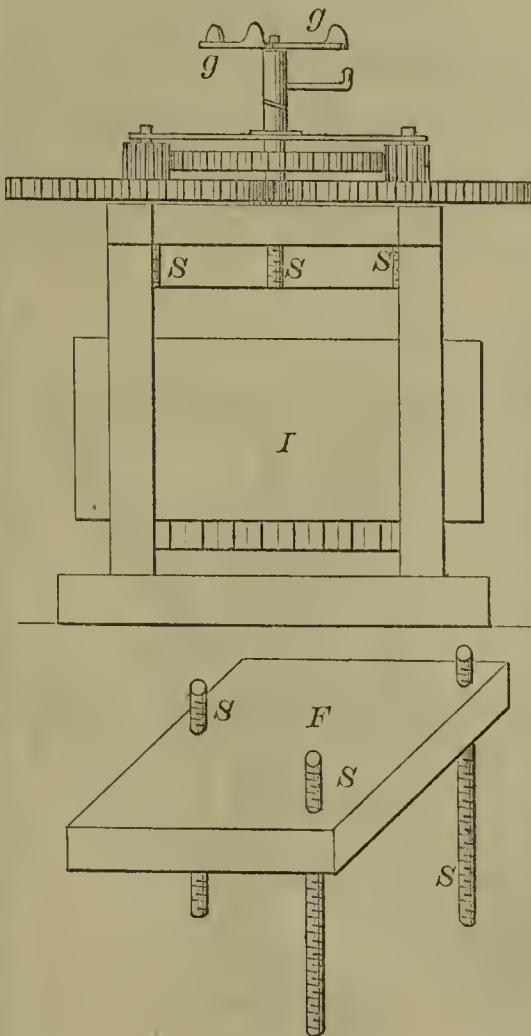

57330—B. H. Jenks—*Cop Winding Machine.*

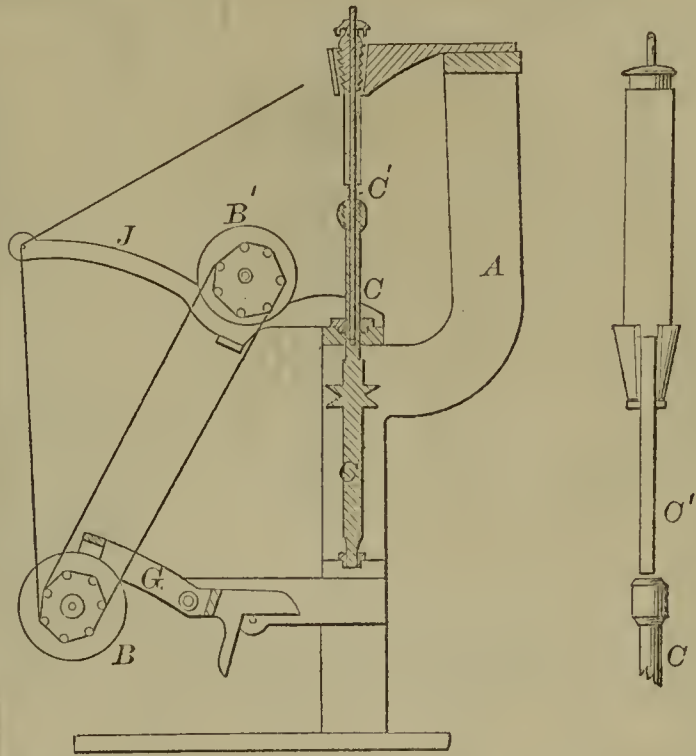

57332—J. Johnson—*Automatic Calculator for Scales.*



57334—G. Keating—*Nibre Box.*

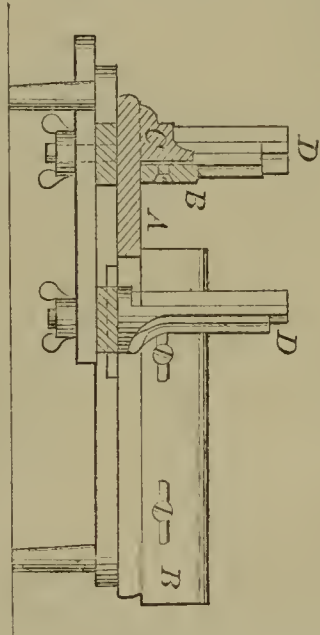

57336—H. Koeller—*Hand Spinning Machine.*

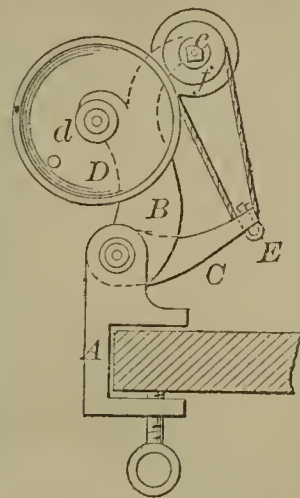

57335—J. Kinzer—*Skate.*

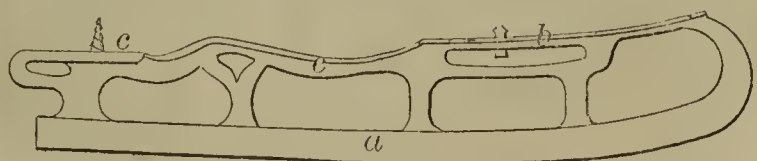

57337—A. J. Laird—  
*Horse Hay Fork.*

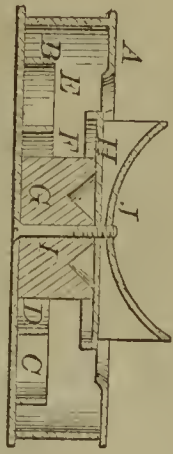
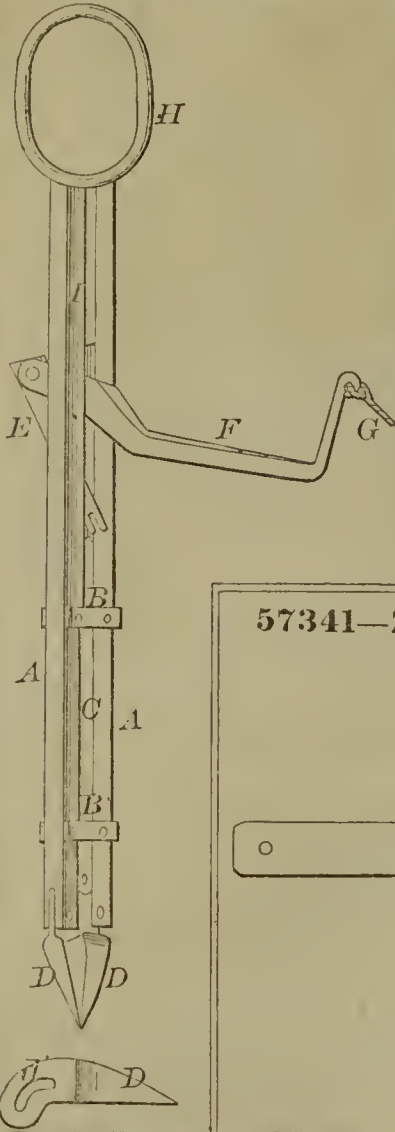

57338—E. B. Lake—*Bed Bug Trap.*

57340—M. M. Latta—*Fracture Bed.*

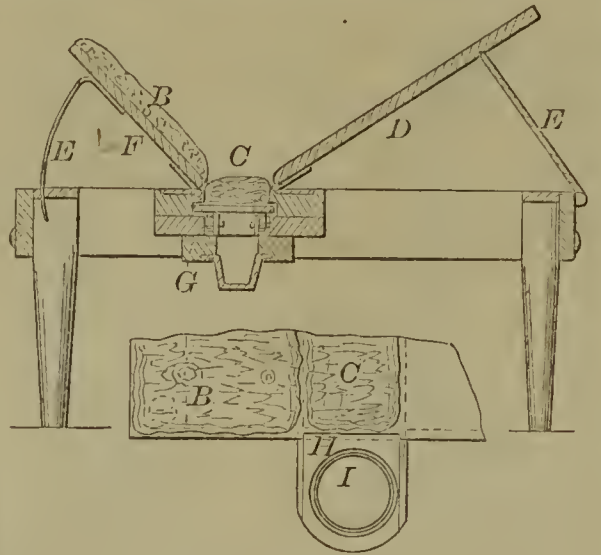

57341—Z. W. Lee—*Plow.*

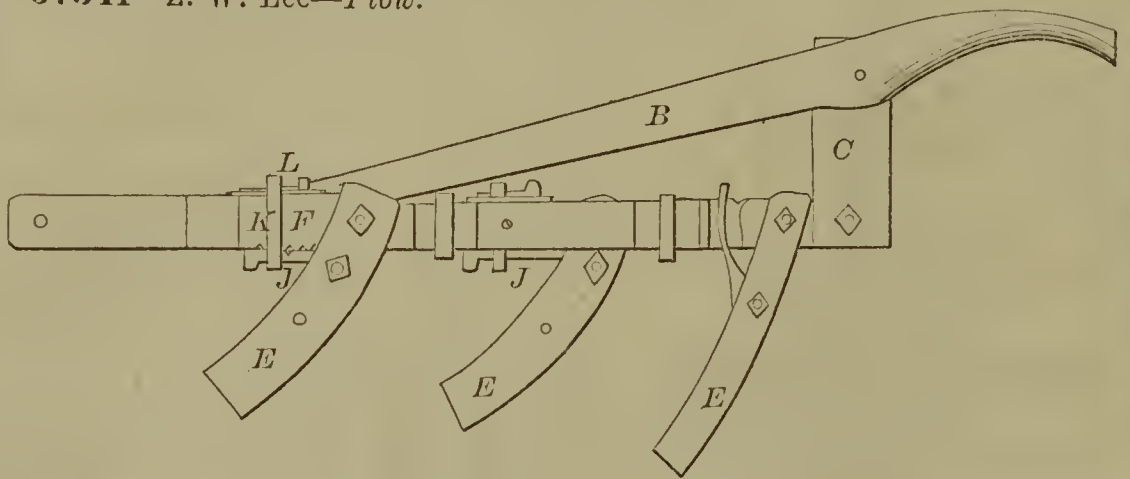

57342—W. Lieber—*Button Hole Cutter.*

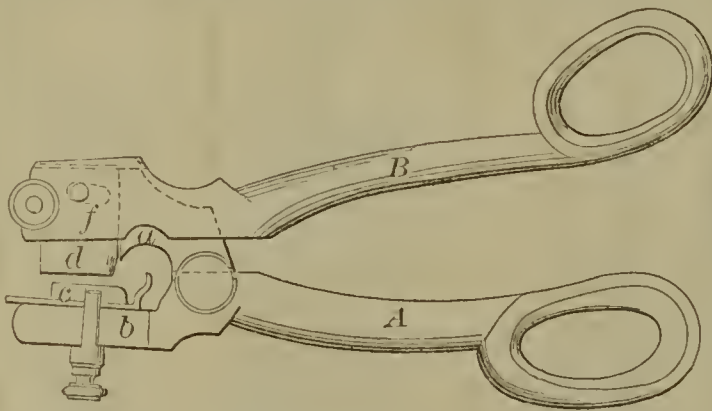

57343—E. F. Leight—*Journal Box.*

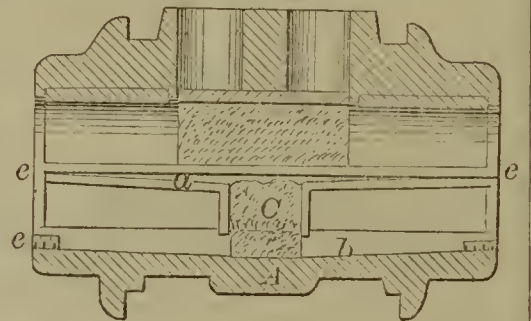

57339—F. J. Latham—*Anchor.*

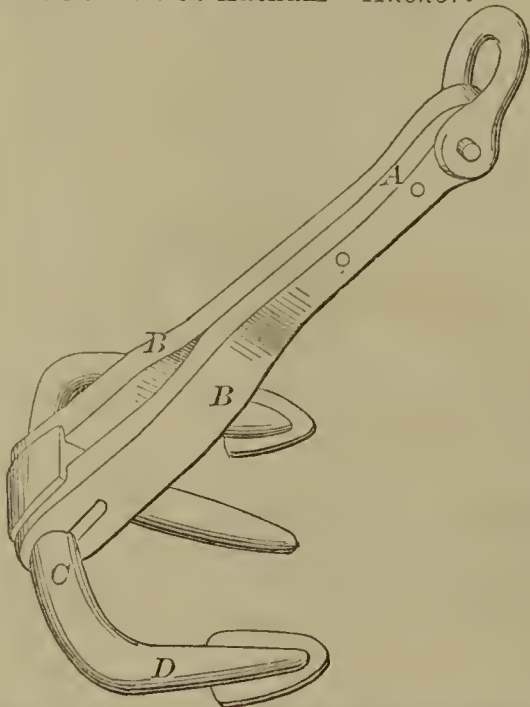

57344—N. P. Lindergreen—*Children's Sled.*



57345—R. B. Linthicum—*Corn Harvester.*

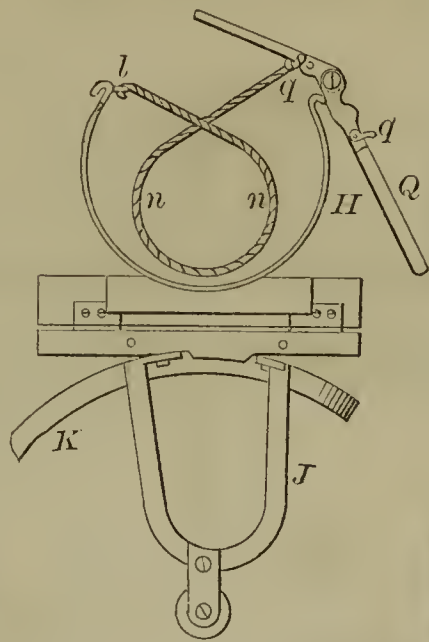
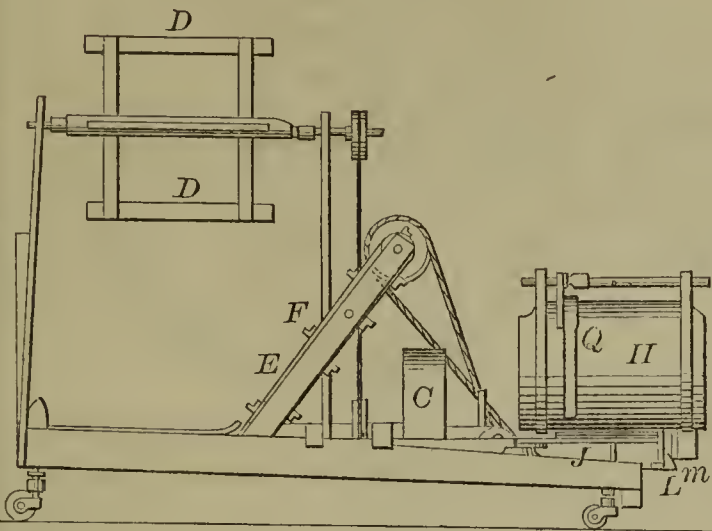

57346—W. Litzenberg—*Horse Shoe.*

57350—A. Marchington—*Stop Motion of Looms.*

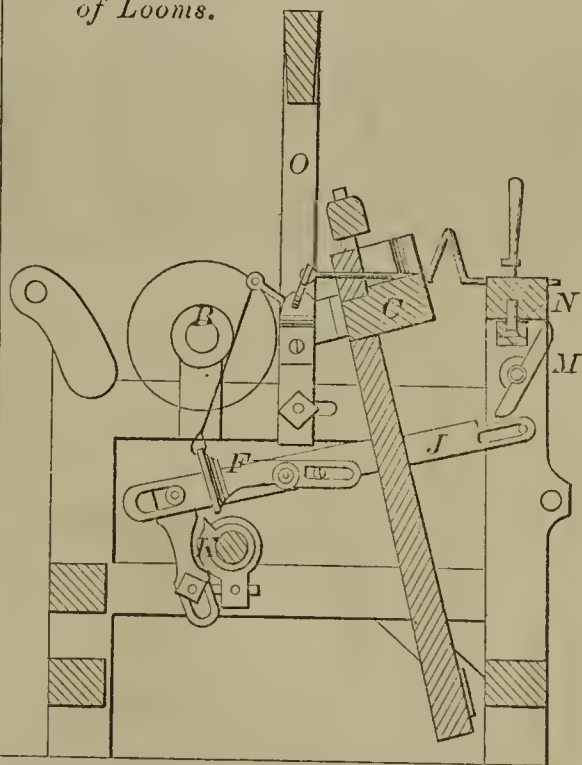

57348—J. R. Madison—*Washing Machine.*

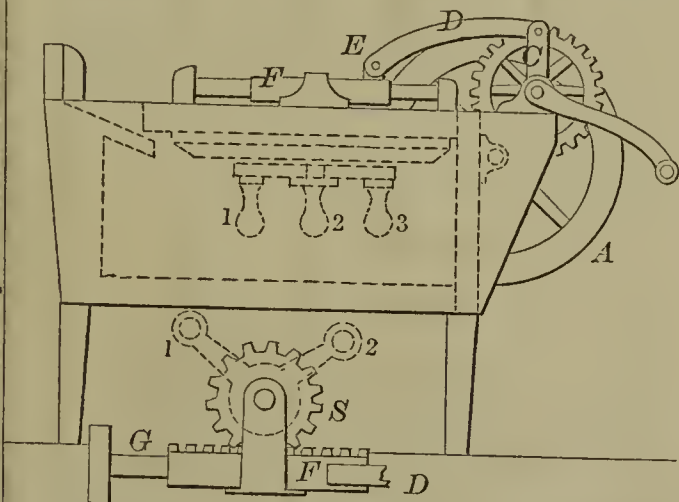

57347—C. L. Lochman—*Funnel.*

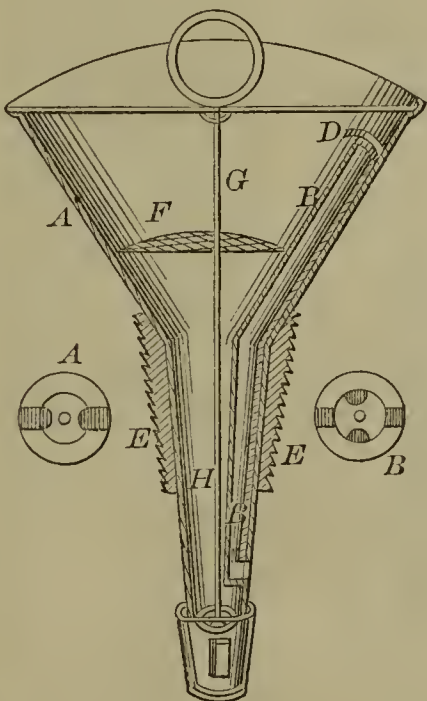

57351—M. M. & F. Martin—*Railroad Car Seat.*

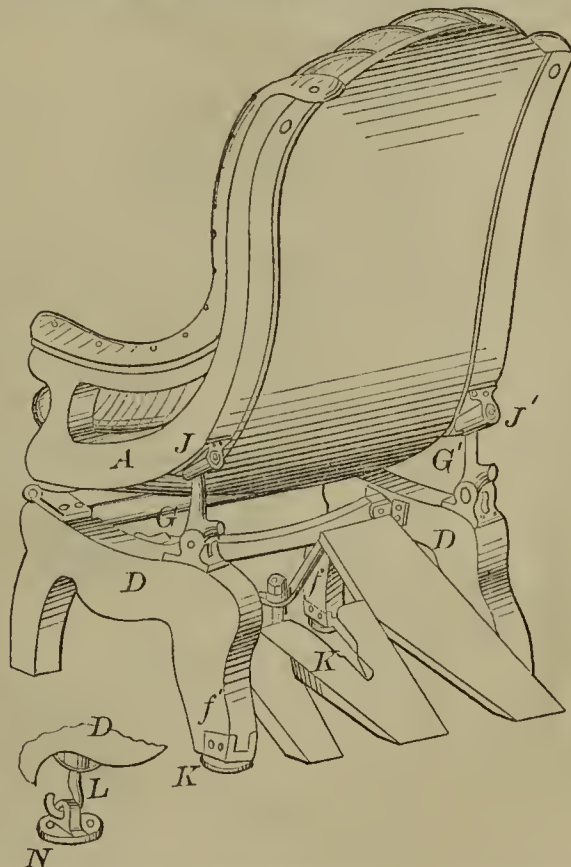

57352—L. G. Mason—Friction Pulley.

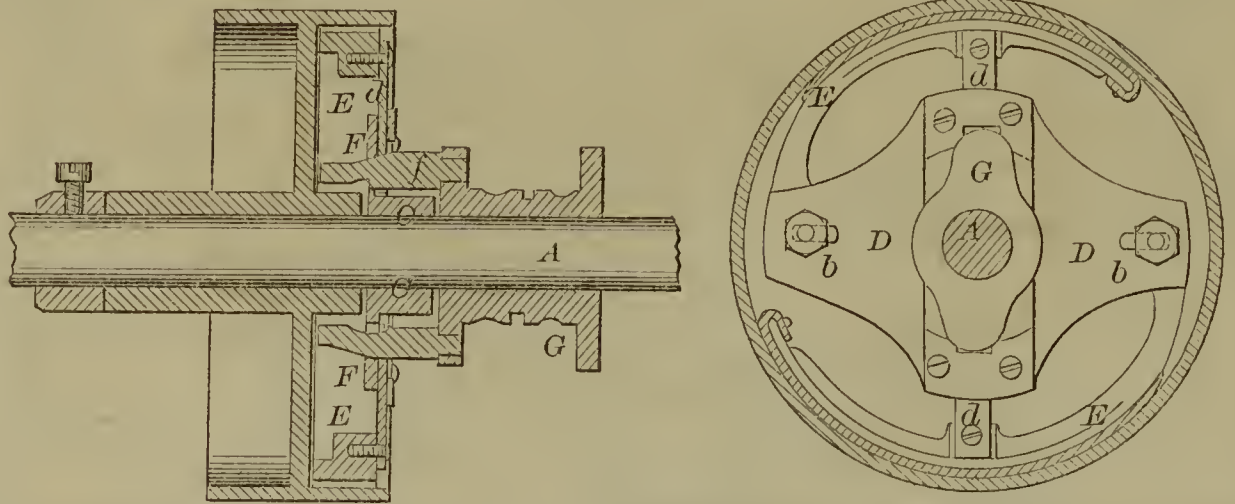

57353—G. B. Massey—Railroad Turn Table.

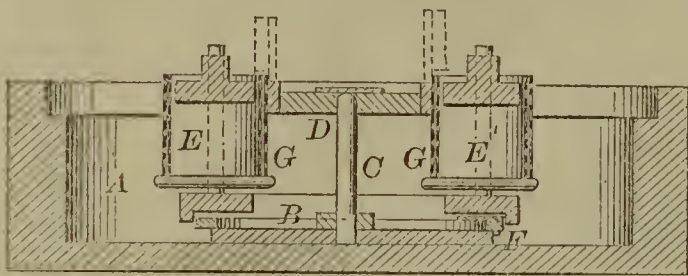

57356—F. Miller—Bottle Stopper.

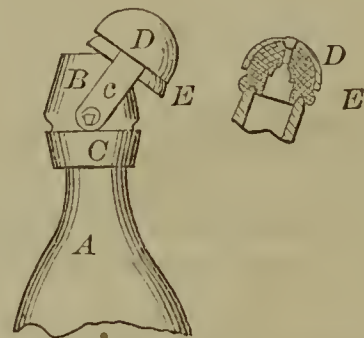

57354—H. S. Maxim—Curling Iron.

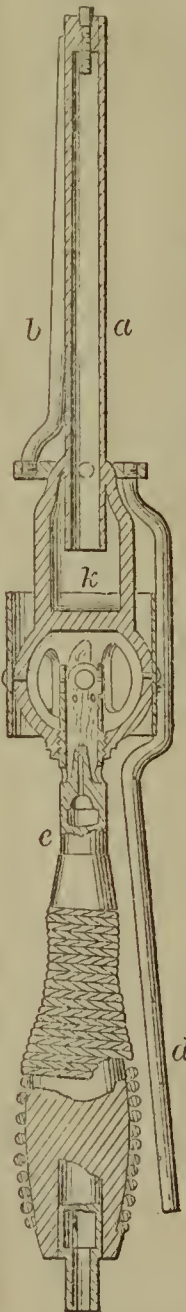

57355—J. McCracken—Rag Engine.

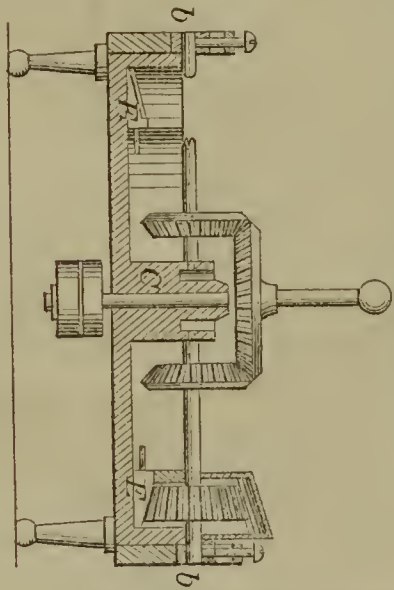

57358—R. Montgomery—Grate Bar.

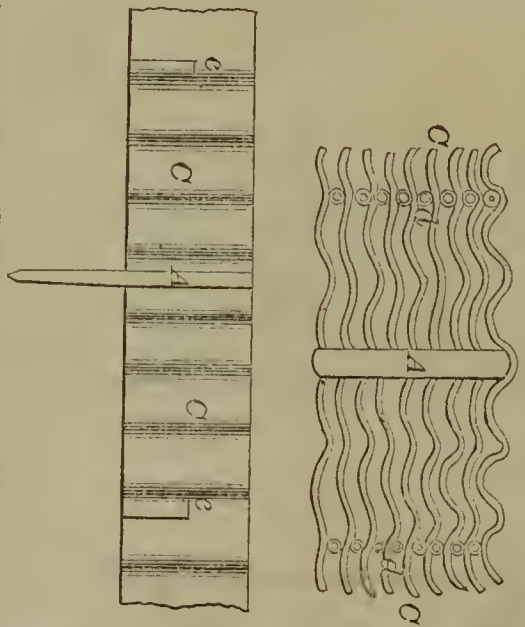

57359—R. Montgomery—Construction of Ships.

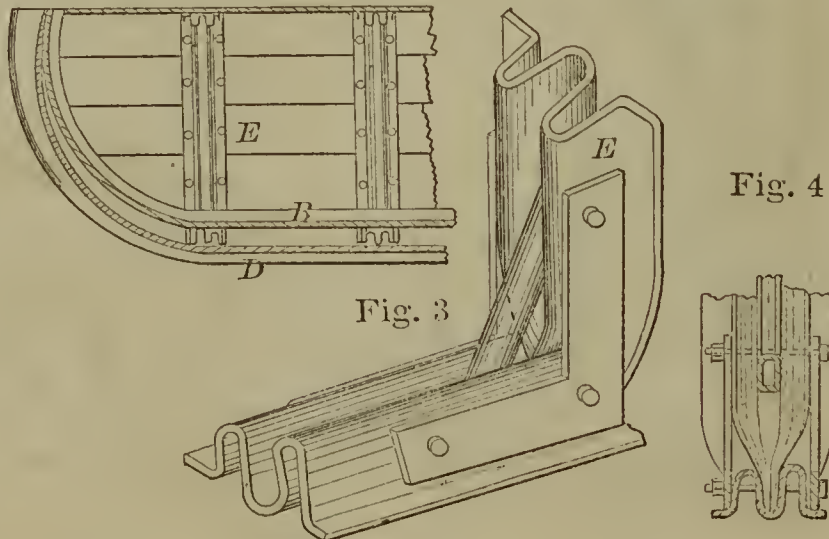

57360—C. G. Moreman—*Corn Harvester.*

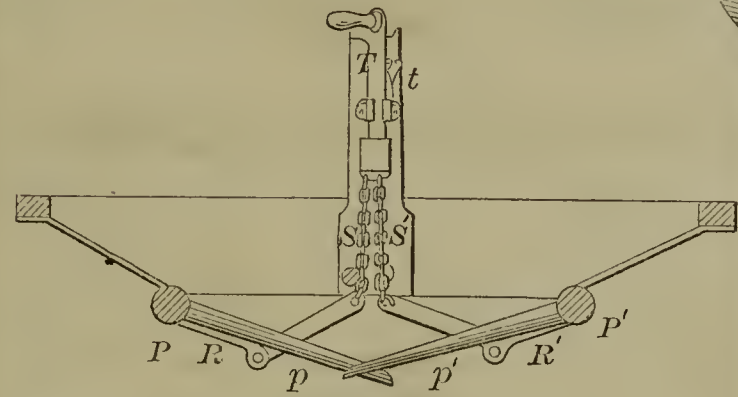
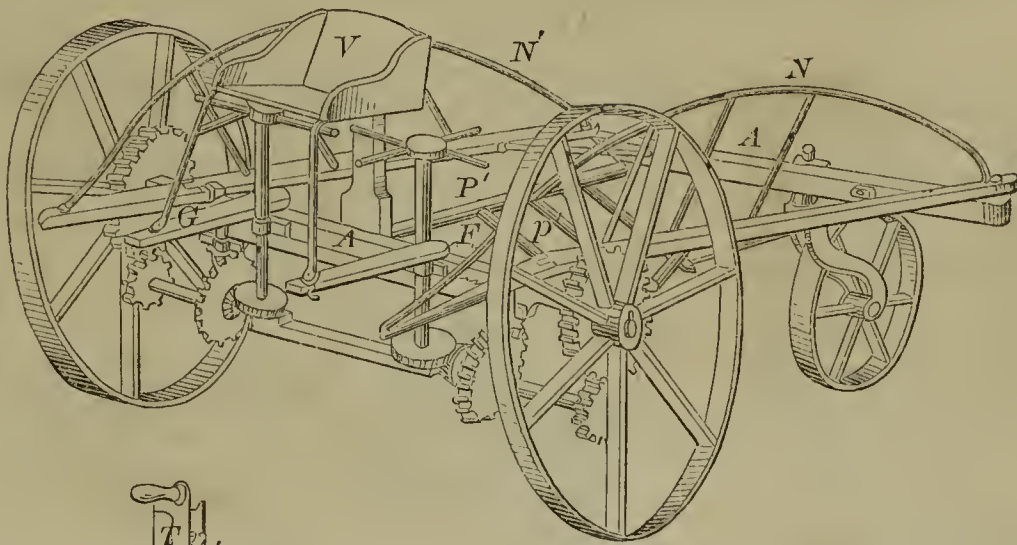

57363—J. H. Mumma—*Straw Cutter.*

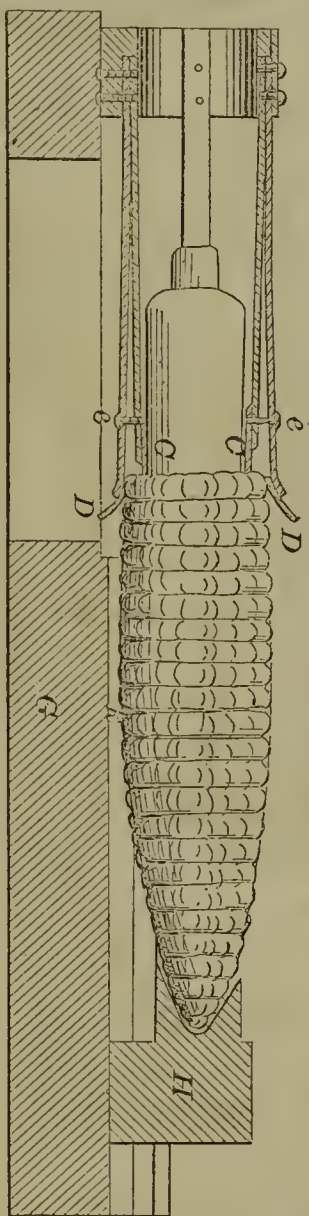
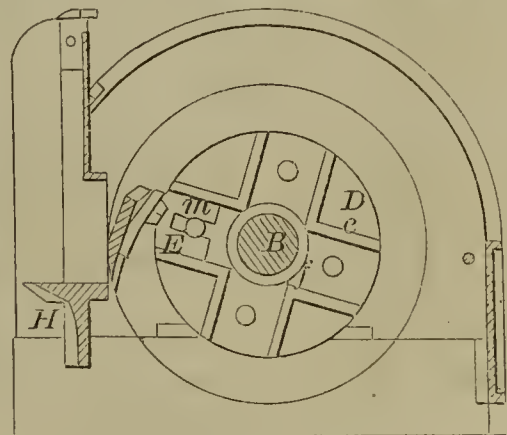

57361—T. A. Morley—*For Cutting Corn from the Cob.*

57362—O. A. Moses—*Blow Pipe.*

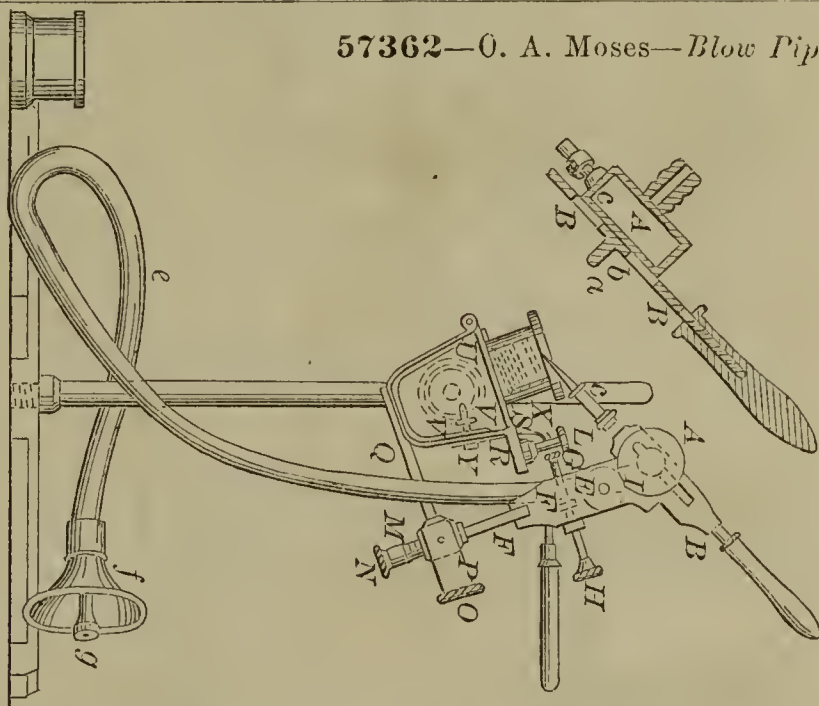

57364—R. Murdoch—*Letter Scale Beam.*

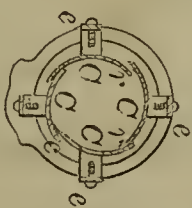
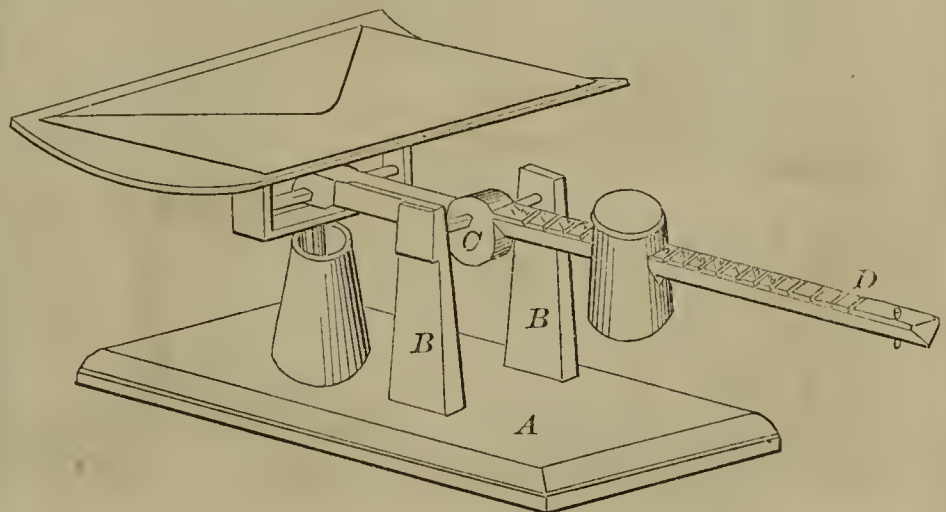

57365—J. Murphy—*Railroad Car Spring.*

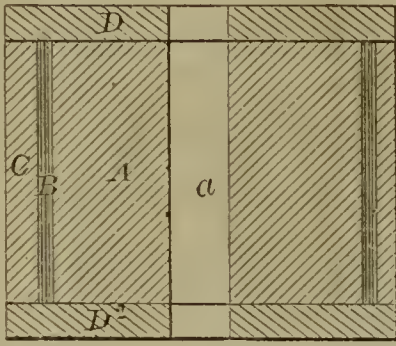

57366—W. Neely—*Fence.*

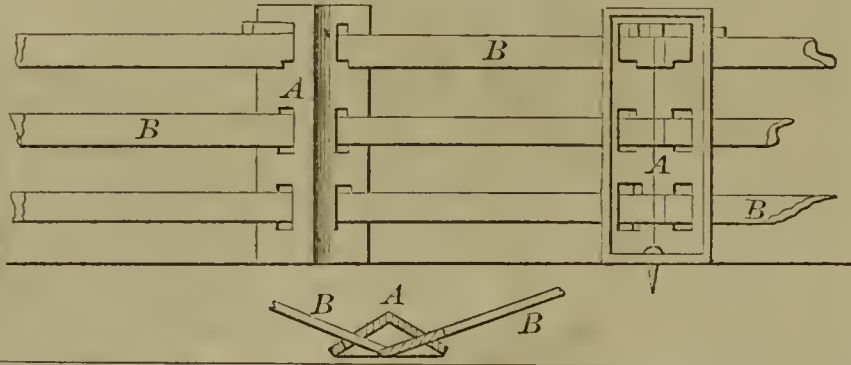

57367—H. Nitzsche—*Cane Handle.*

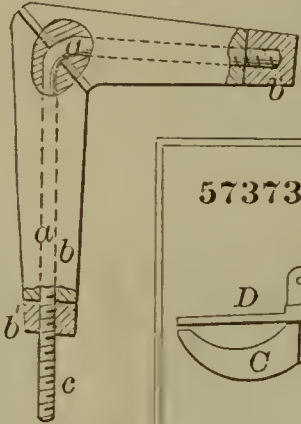

57370—W. P. Patton—*Eraser Holder.*

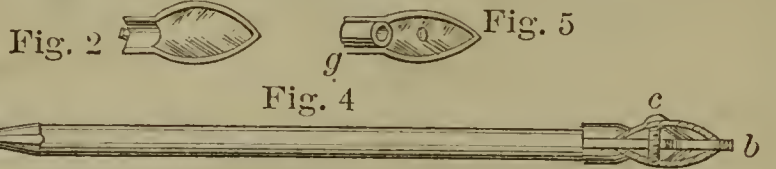

57373—C. H. Porter—*Store Cover Lifter.*

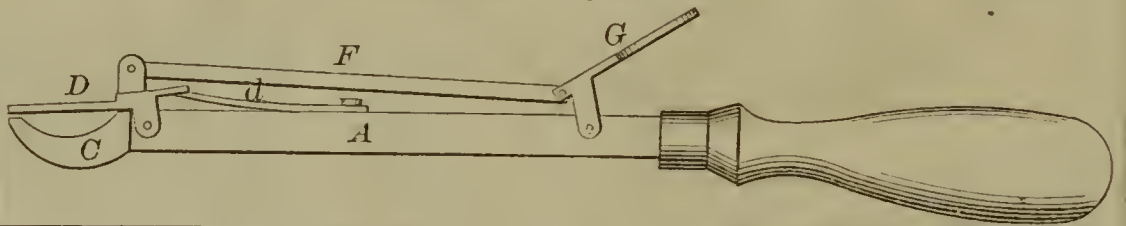

57368—Ogborn & Chapin—*Stove Pipe Damper.*

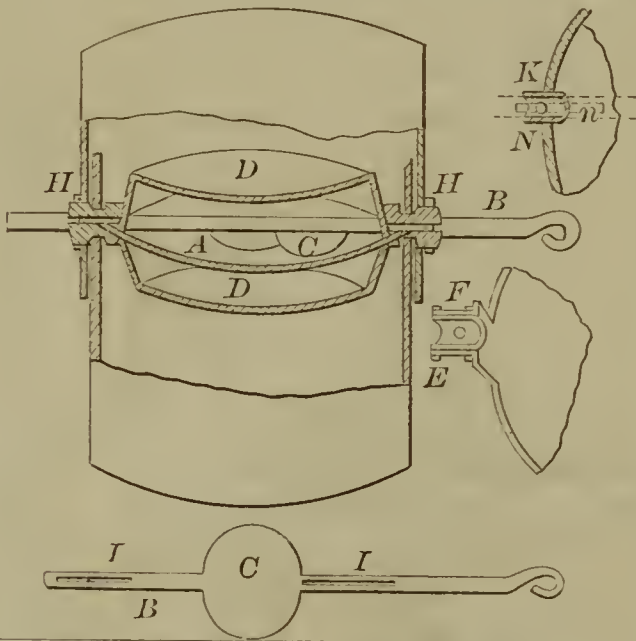

57372—L. A. Phinb—*Tea and Coffee Pot.*

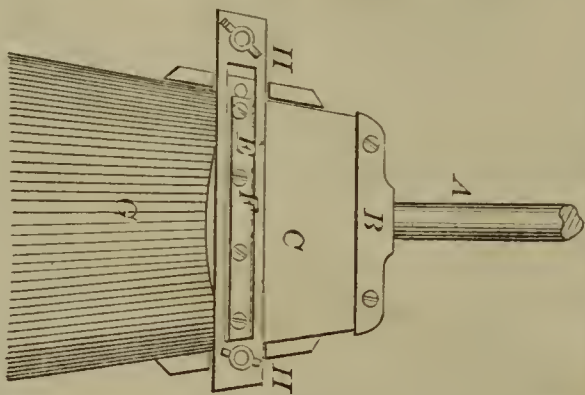
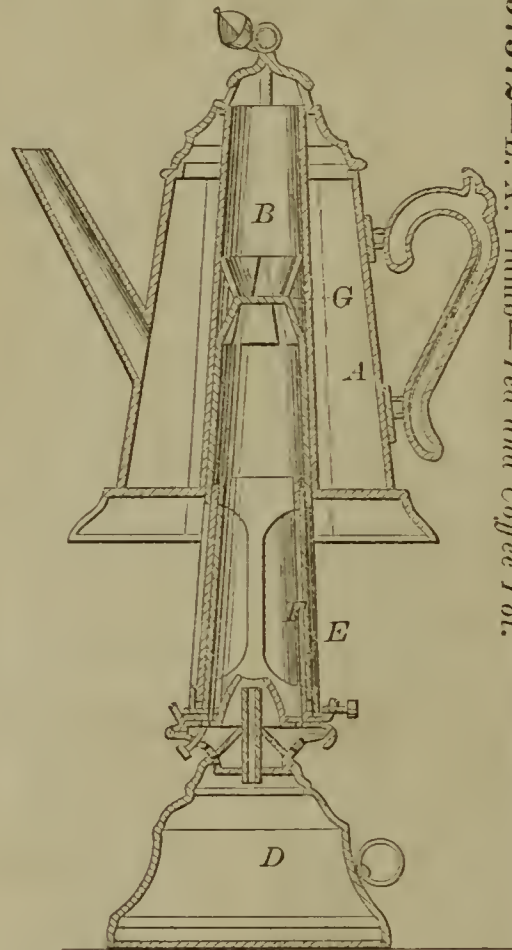

57369—M. W. Owens—*Broom Head and Clamp.*

57374—W. Preiss—*Folding and Plaiting Device for Sewing Machines.*

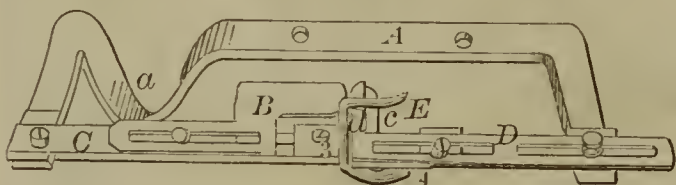

57371—S. Perry—*Ventilating Boot.*

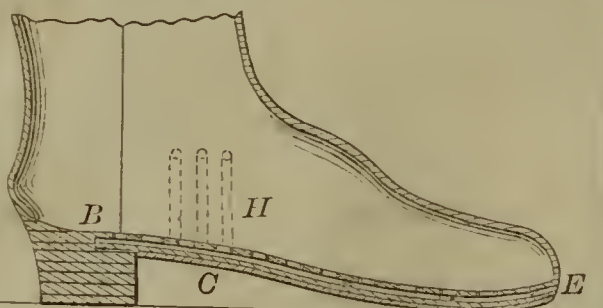

57375—E. T. Prindle—Piston Packing.

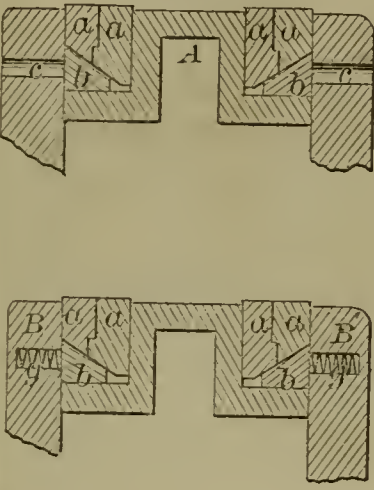

57378—G. T. Reed—Broom and Brush Head.

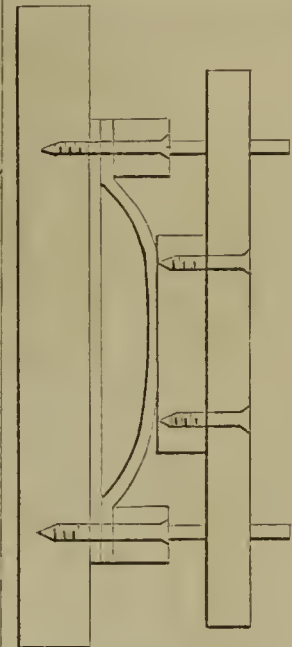
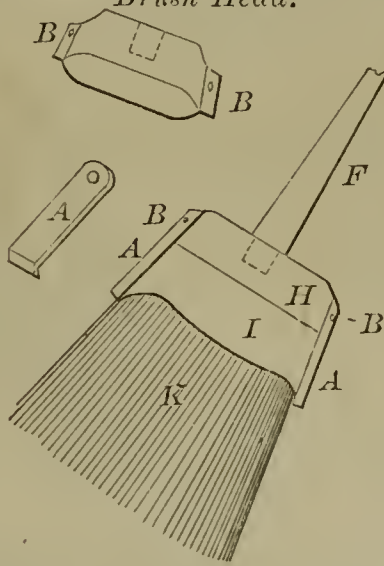

57377—S. G. Randall—Elastic Spring.

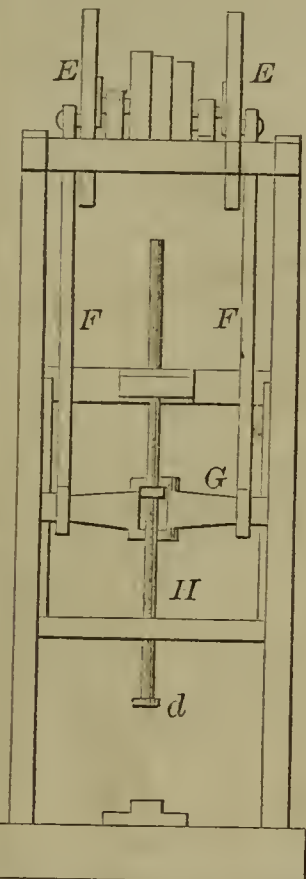

57380—T. C. Robbins—Gold Beating Apparatus.

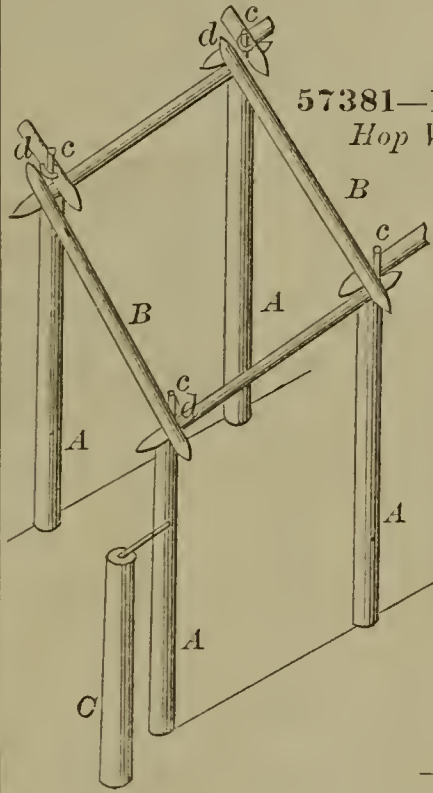

57381—Roberts & Badger—Hop Vine Supporter.

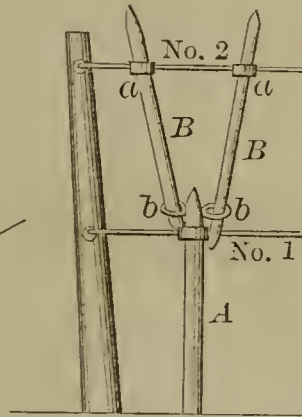

57379—U. Reynolds—Pole Iron Socket for Carriages.

57383—R. & T. Ross—Chuck.

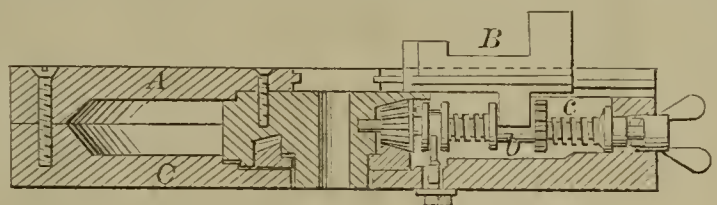

57385—J. B. Rumsey—Car Coupling.

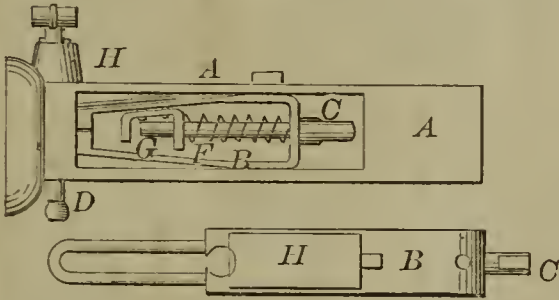

57386—Sangster & Ware—Steam Engine Valve.

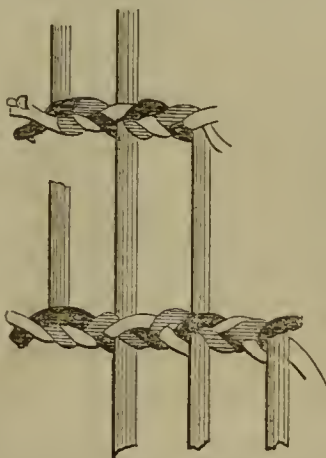
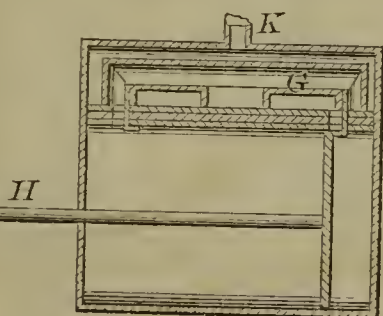

57384—T. Royer—Plug Plug.

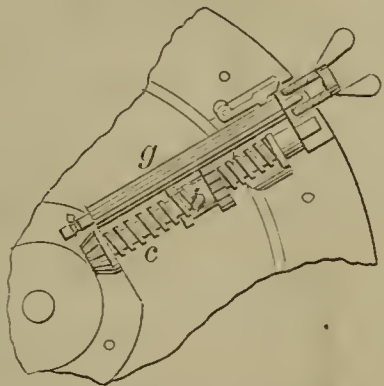

57382—G. W. Rogers—Bottle Stopper.

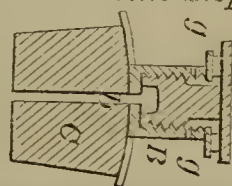

57387—J. F. Sayer—Stave Jointer.

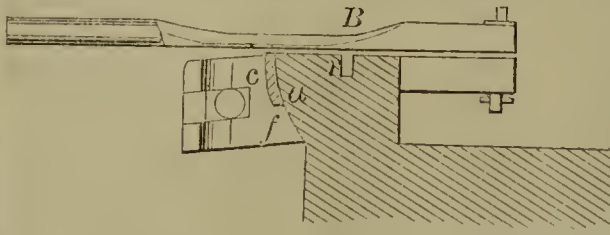

57393—E. F. Sherman—Corn Sheller.

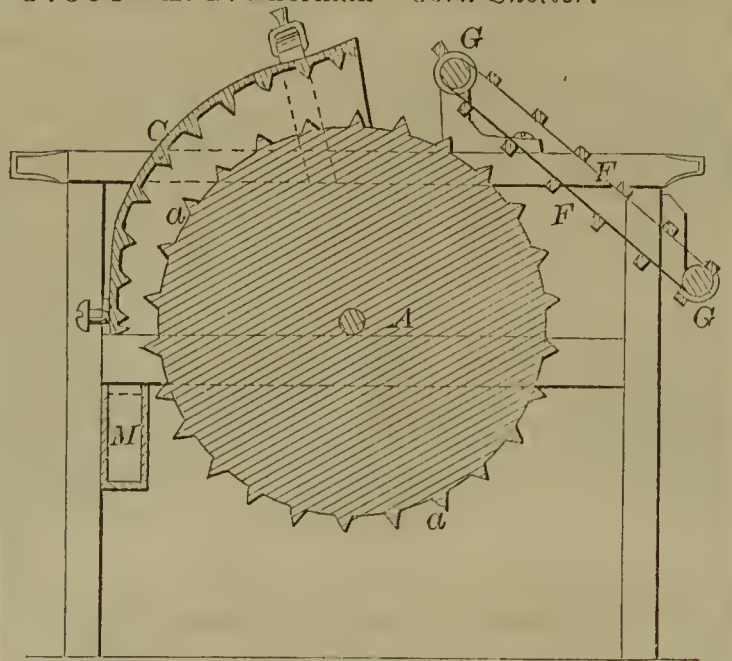

57392—E. Shaw—For Clamping and Stretching Leather.

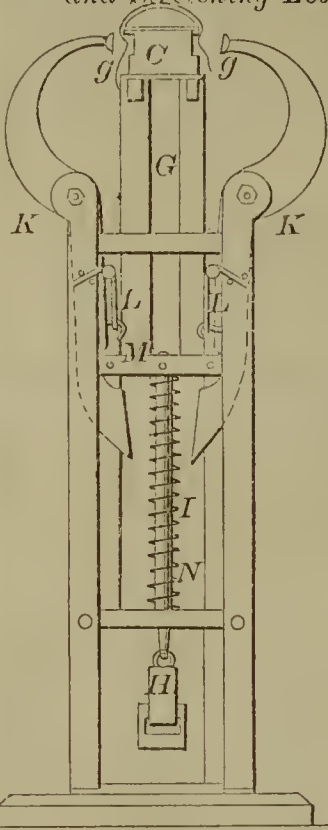

57388—J. S. Seaman—Rolling Iron or Steel.

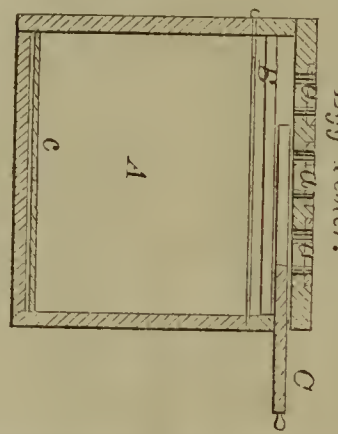
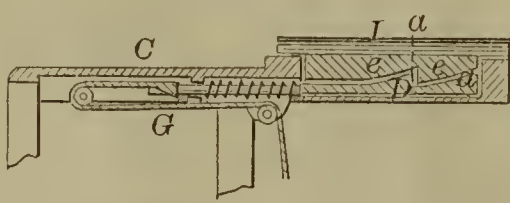
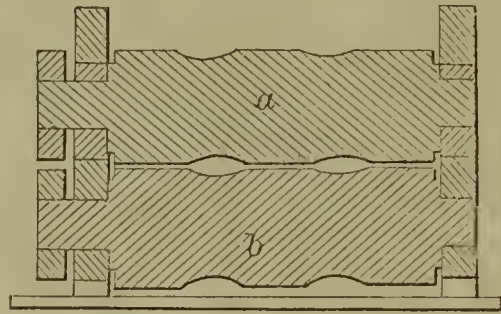

57389—F. B. Sealey—Egg Tester.

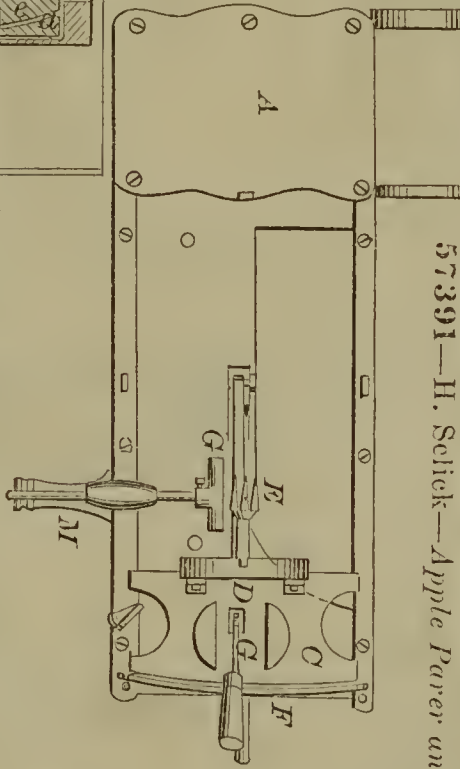

57391—H. Selick—Apple Parer and Corer.

57394—G. B. Simpson—For Reducing Ores.

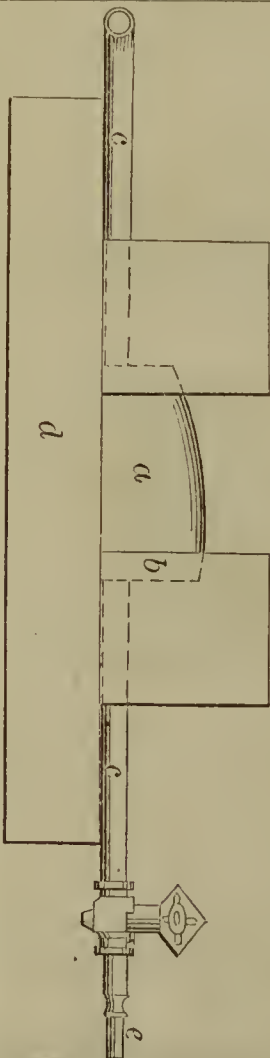

57395—Smith & Chase—Bed Bottom.





57396—G. L. Smith—Grate.

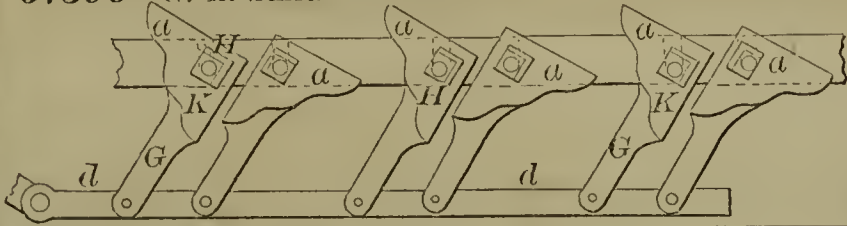

57397—D. B. Snyder—Car Coupling.

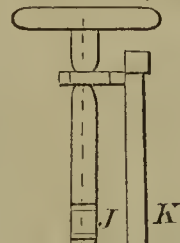

57404—E. Stiles—Safety Car Truck.

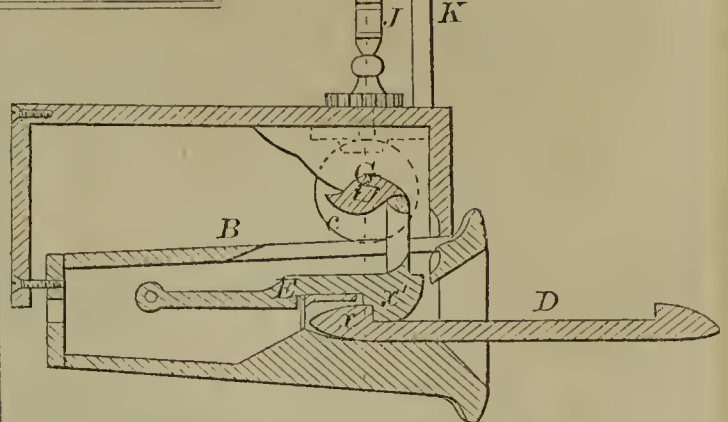
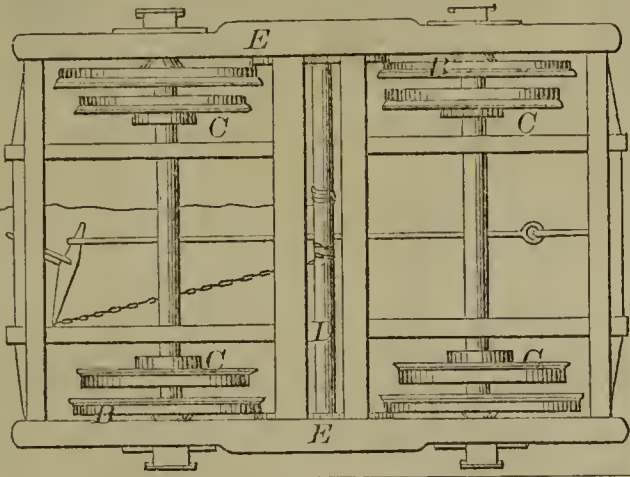

57401—T. H. Spencer—Blacking Box.

57398—G. R. & J. Solomon—Ticket Register.

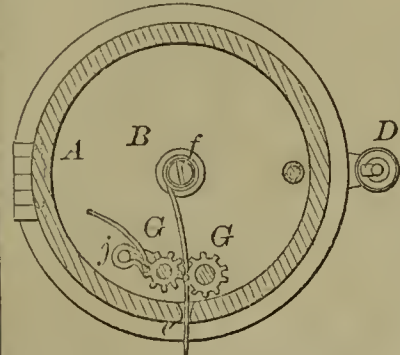
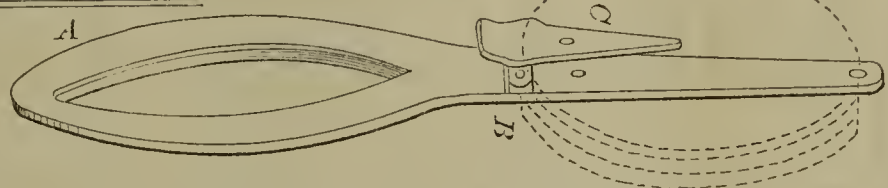

57405—O. Stoddard—Shingle Machine.

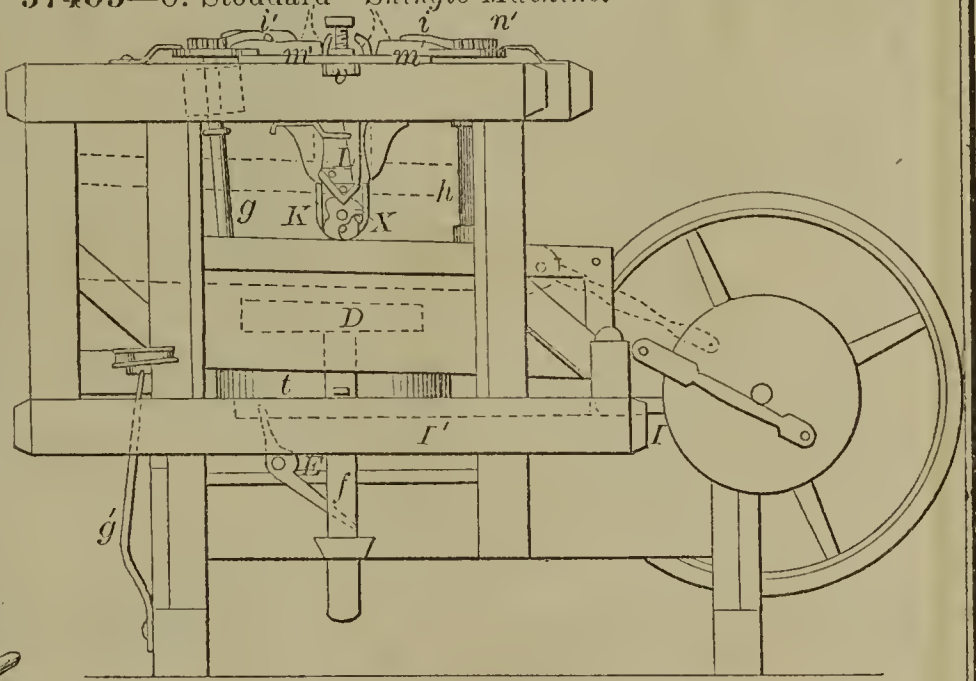

57403—C. A. Sterling—Fluting Machine.

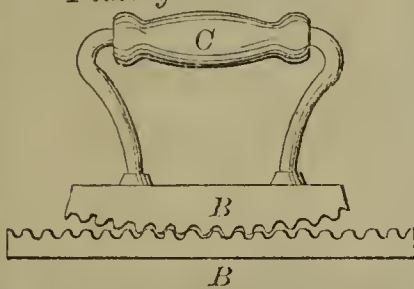

57402—A. F. Stayman—Tobacco Pipe.

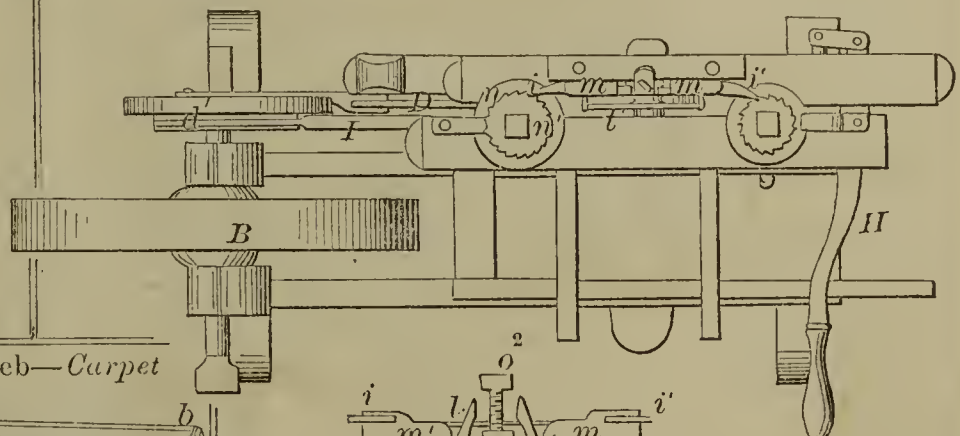
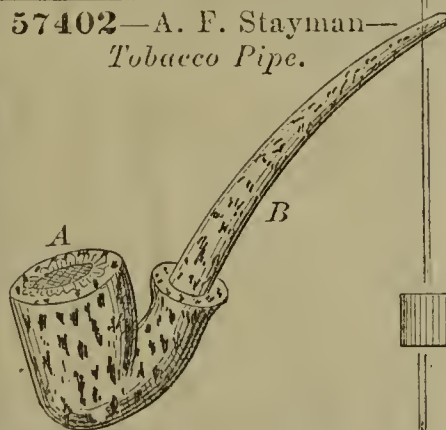

57399—Sonnkalb & Lieb—Carpet Bag Frame.

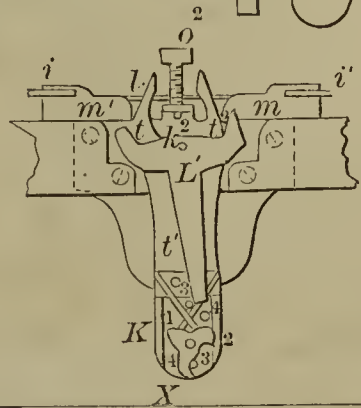
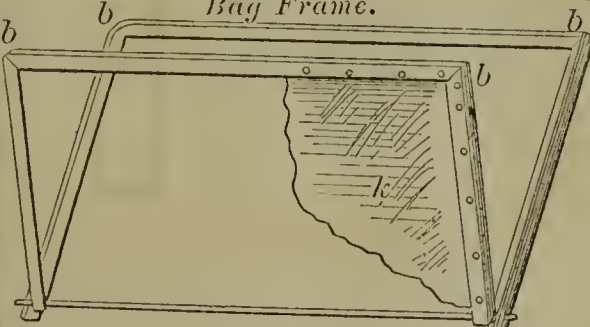

57406—R. H. Taylor—*Hominy Machine.*

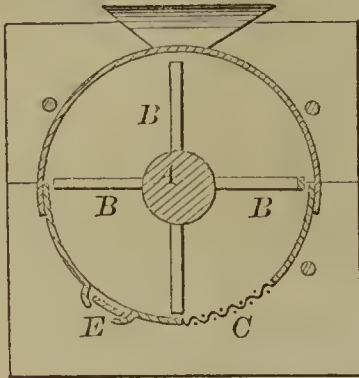

57407—W. H. Taylor—*Weighing Device.*

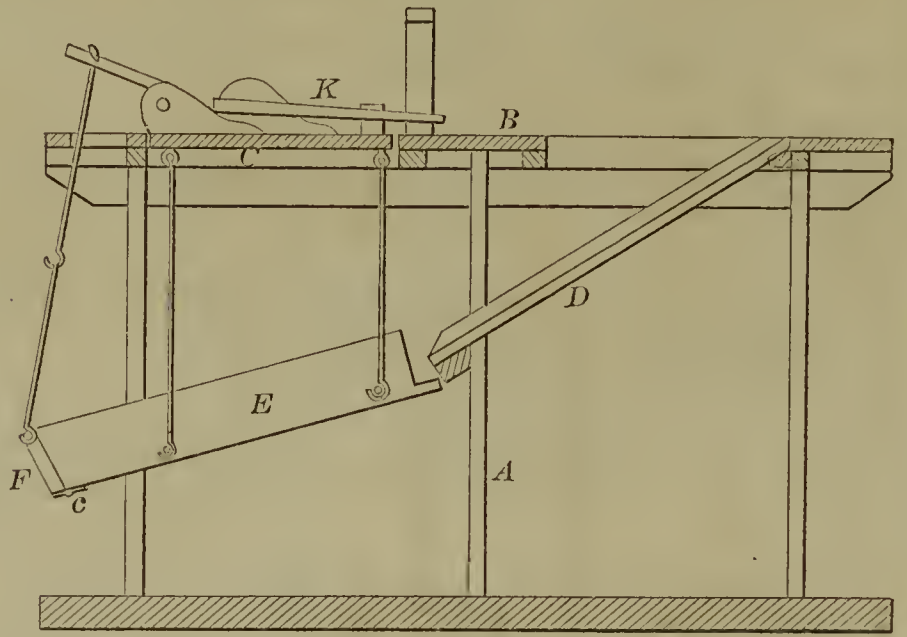

57412—P. H. V. Weyde—*Supplying Air to Air Chambers.*

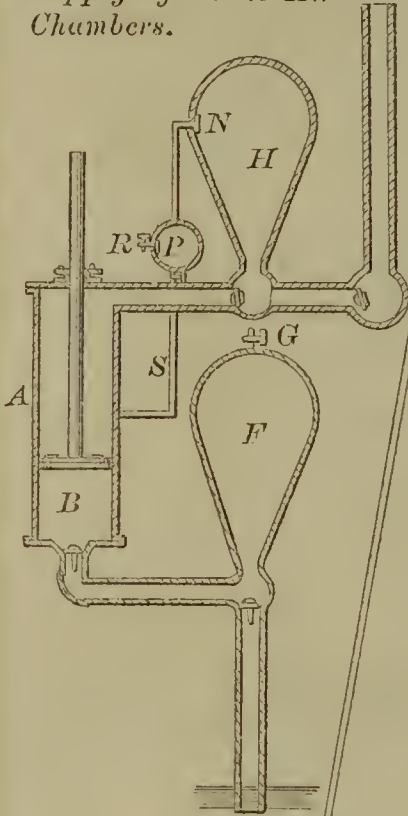

57408—D. Terry—*Fence.*

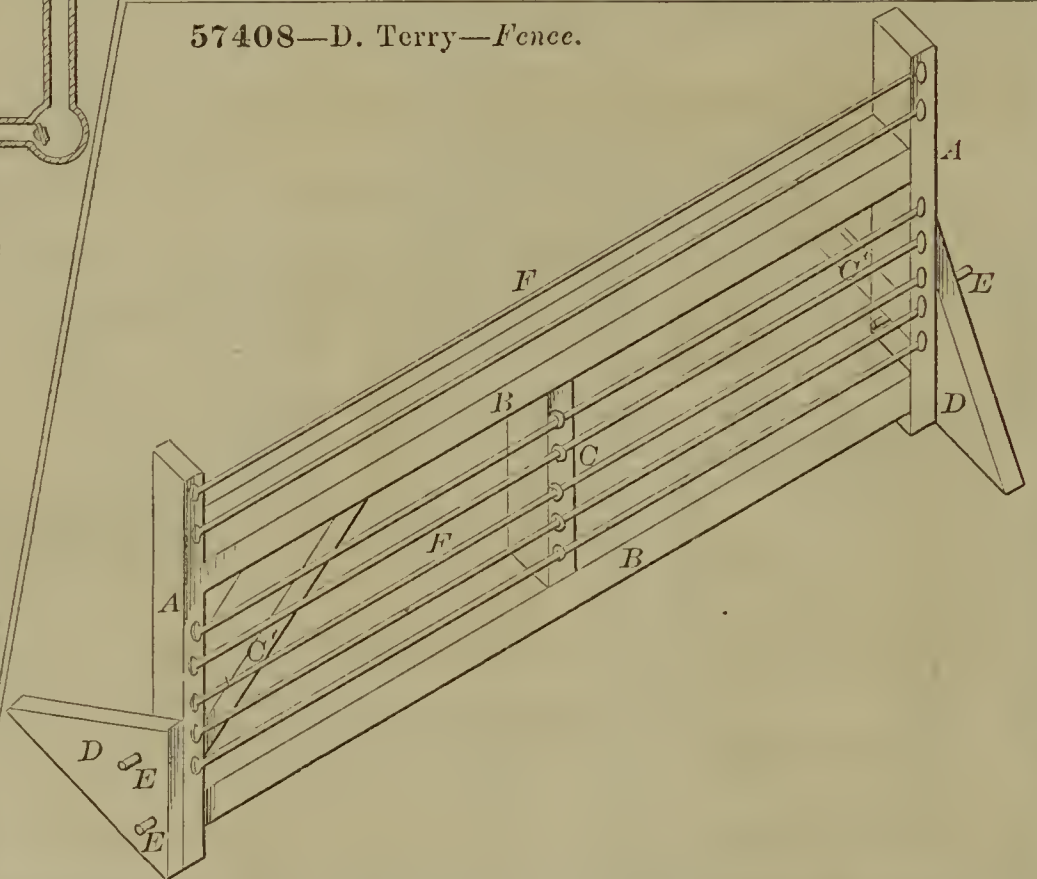

57410—T. Tully—*Tire Shrinking Machine.*

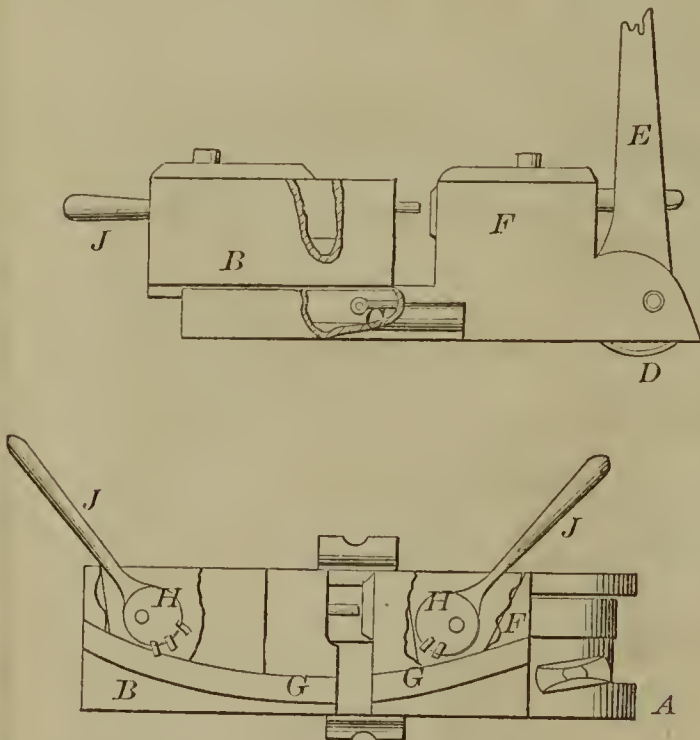

57411—L. B. Tupper—*Grate Bar.*



57413—N. H. Vosburgh—*Neck Yoke.*

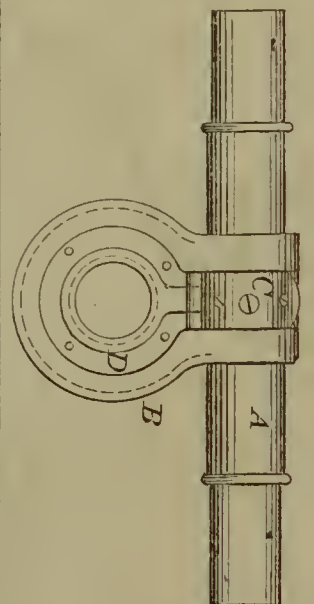

57414—A. J. Walker—*Spice Holder.*

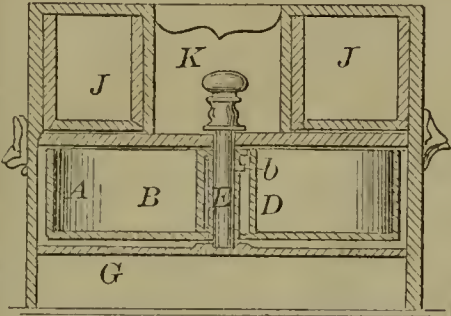

57415—R. L. Walker—*Brick Machine.*

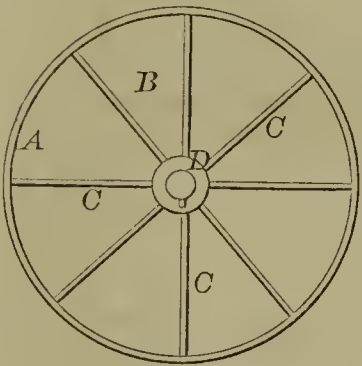
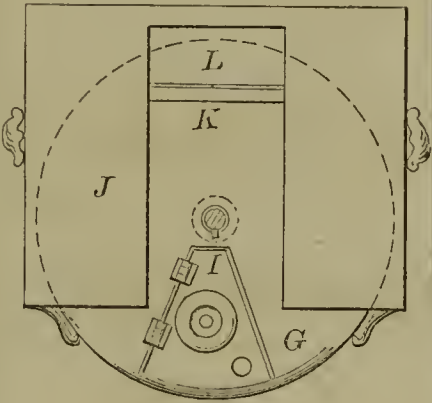
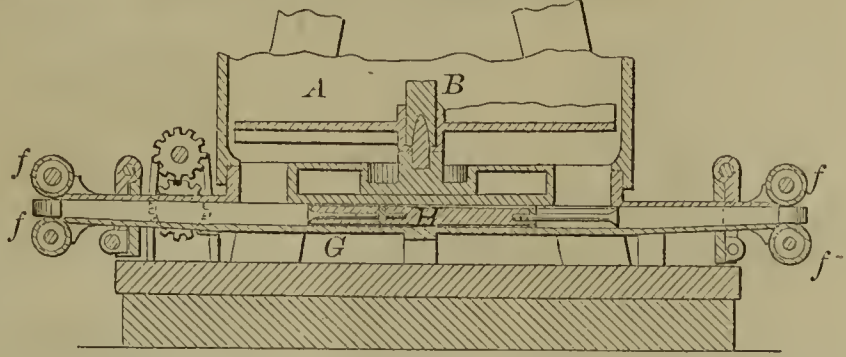

57419—W. N. Whiteley, Jr.—*Harvester.*

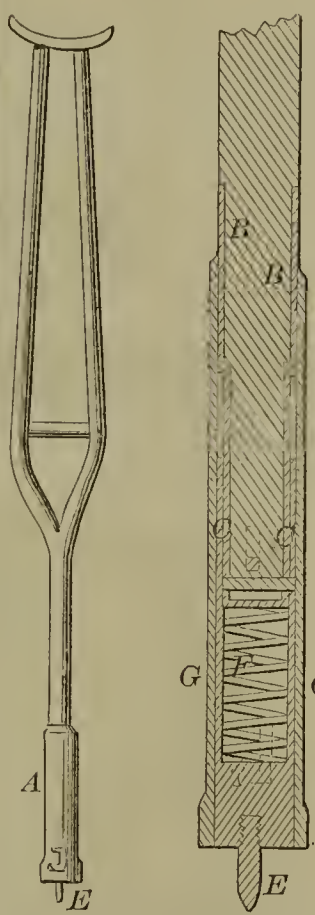
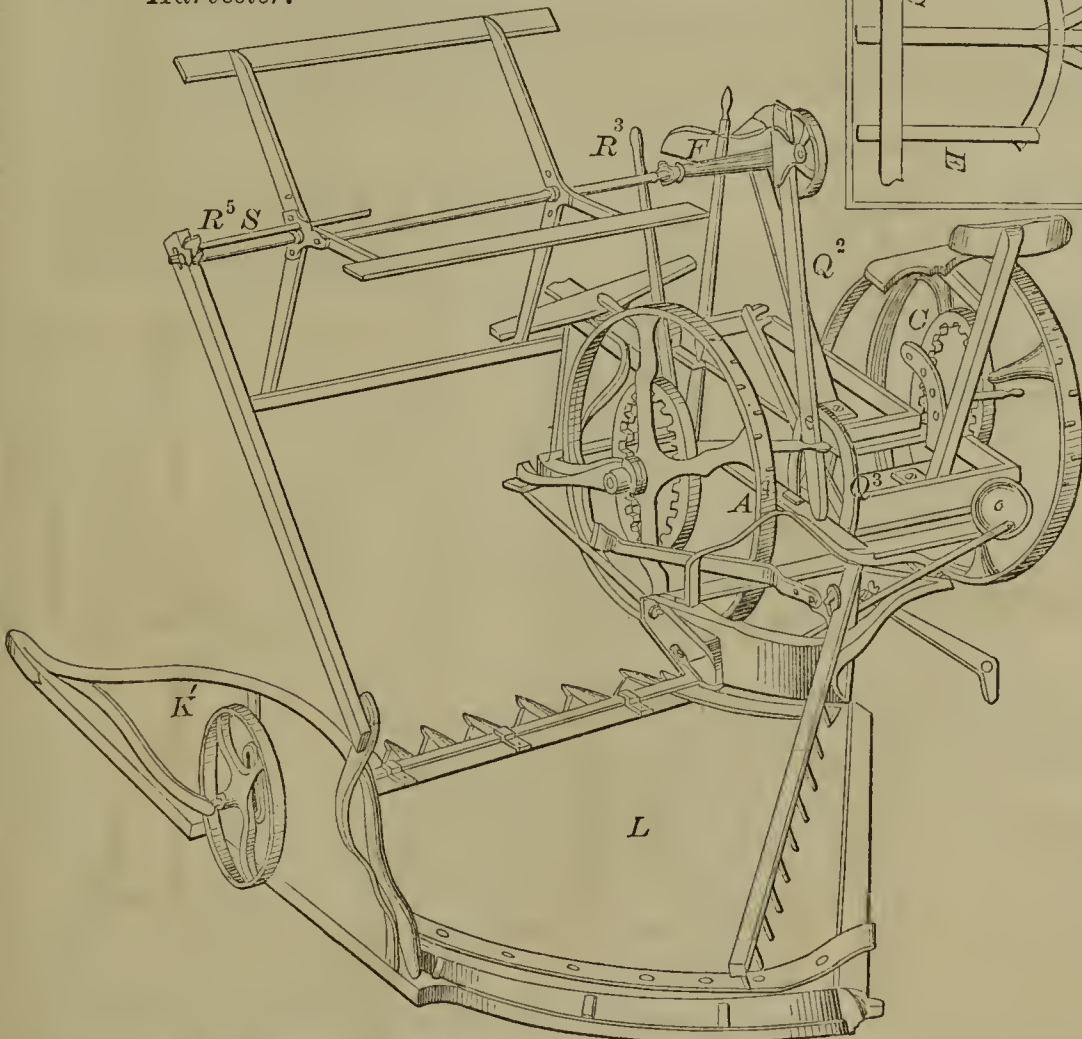

57416—R. W. Ware—*Crotch.*

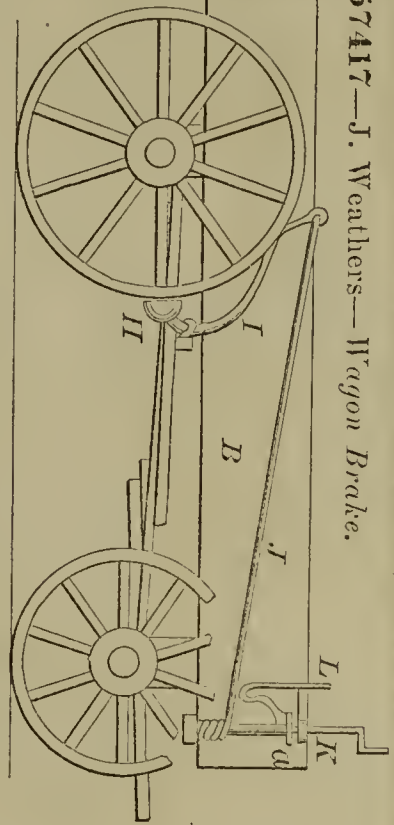

57417—J. Weathers—*Wagon Brake.*

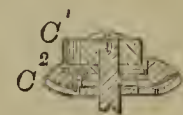
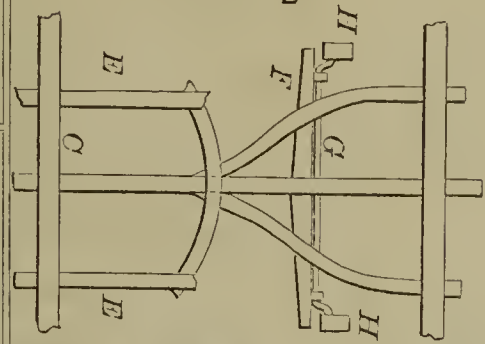

57418—N. J. White—*Steam Engine Oil Cup.*

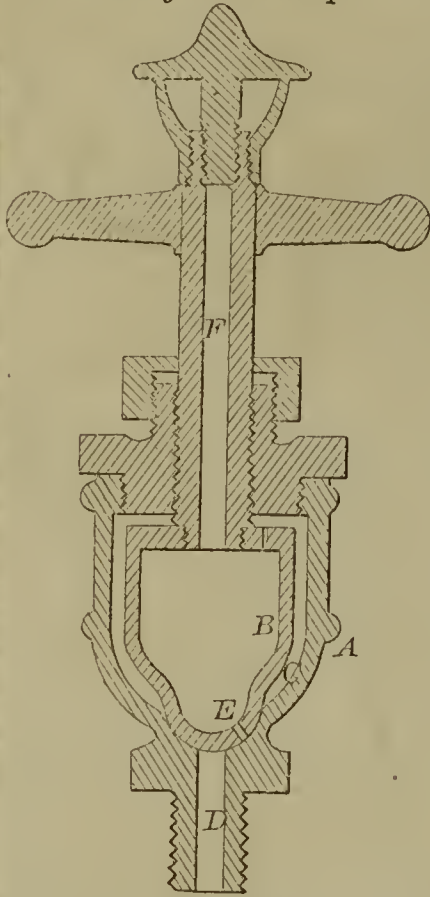

57421—H. Willard—*Hay Raking and Loading Machine.*

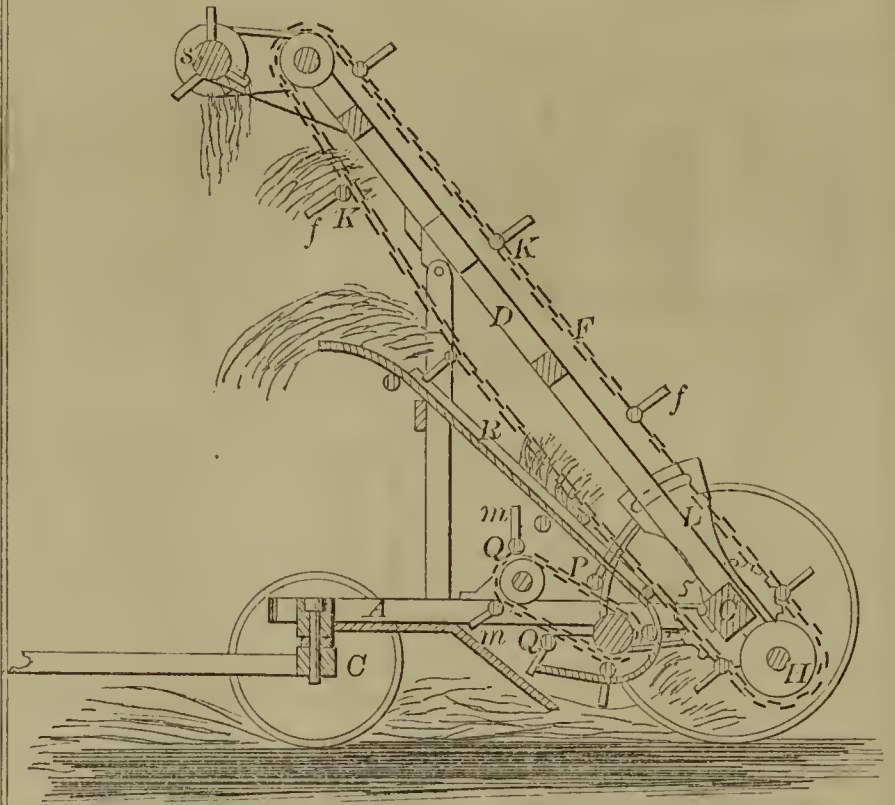

57420—A. S. Wilkinson—*Horse Shoe.*

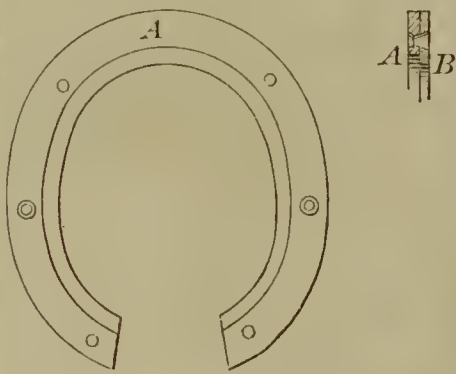

57424—J. B. Wood—*Steam Valve.*

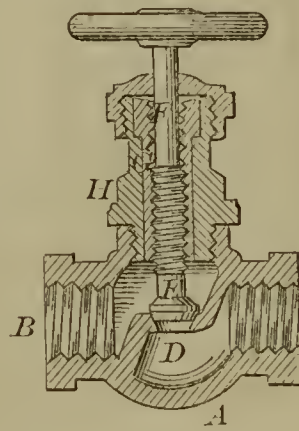

57425—J. S. Wood—*Gas Regulator.*

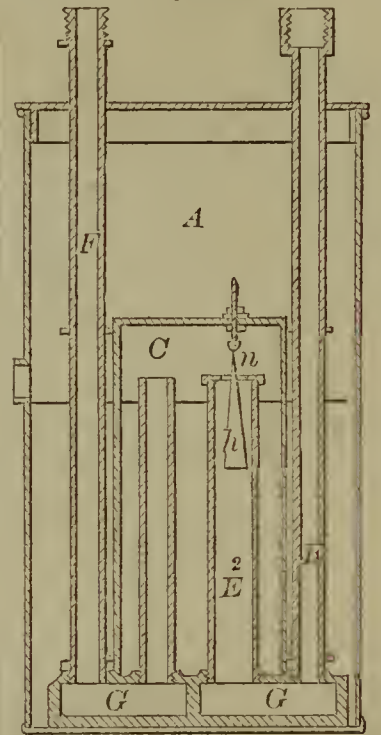

57423—G. M. Wood—*Lock.*

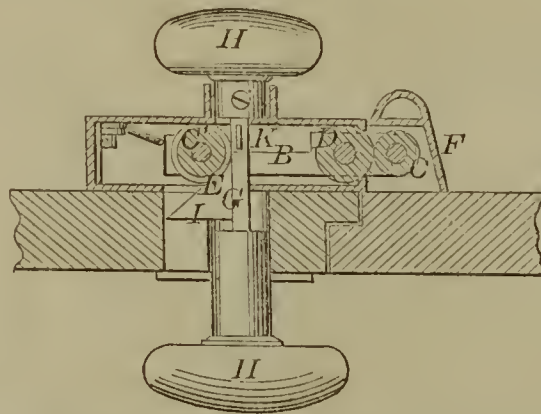

57426—A. Woodard—*Suspenders.*

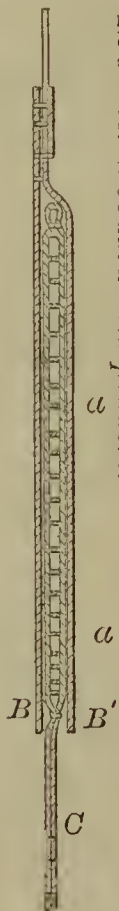

57428—J. E. Wootten—*Winding Apparatus for Inclined Planes.*

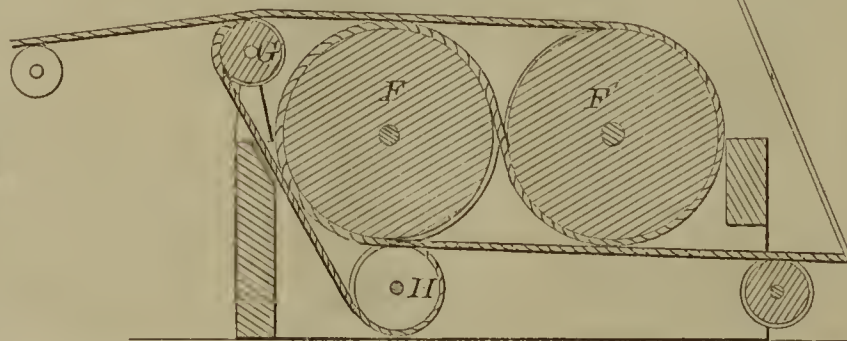

57422—J. Willard—*Tim Can Opener.*

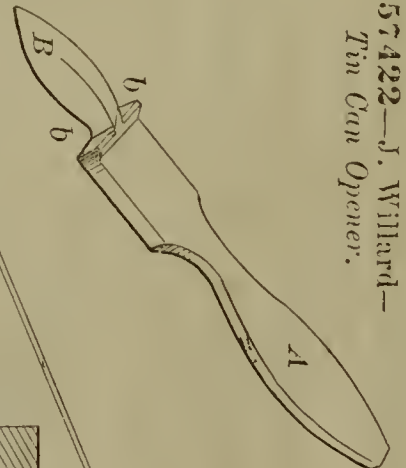

57429—A. J. Works—*Burning Liquid Hydro-Carbon.*

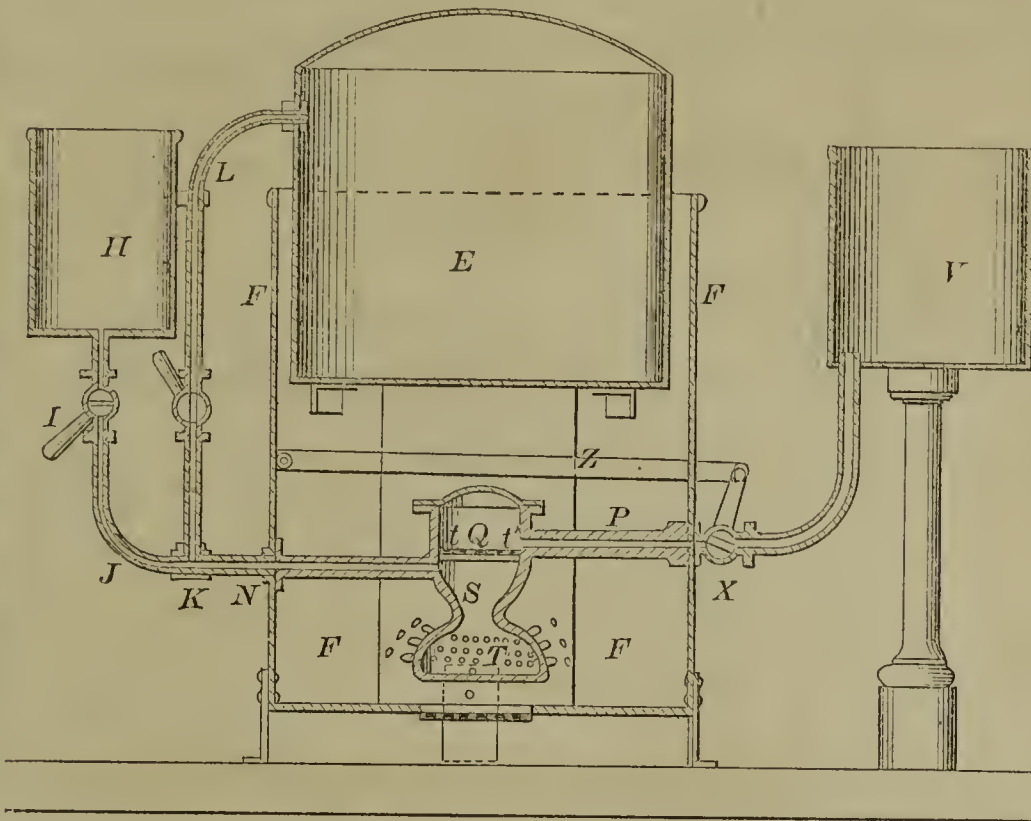

57431—S. D. Yorkes—*Tongs and Poker.*

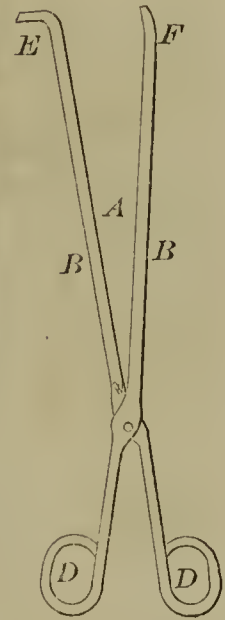

57430—T. D. Worrall—*For Desulphurizing Quartz.*

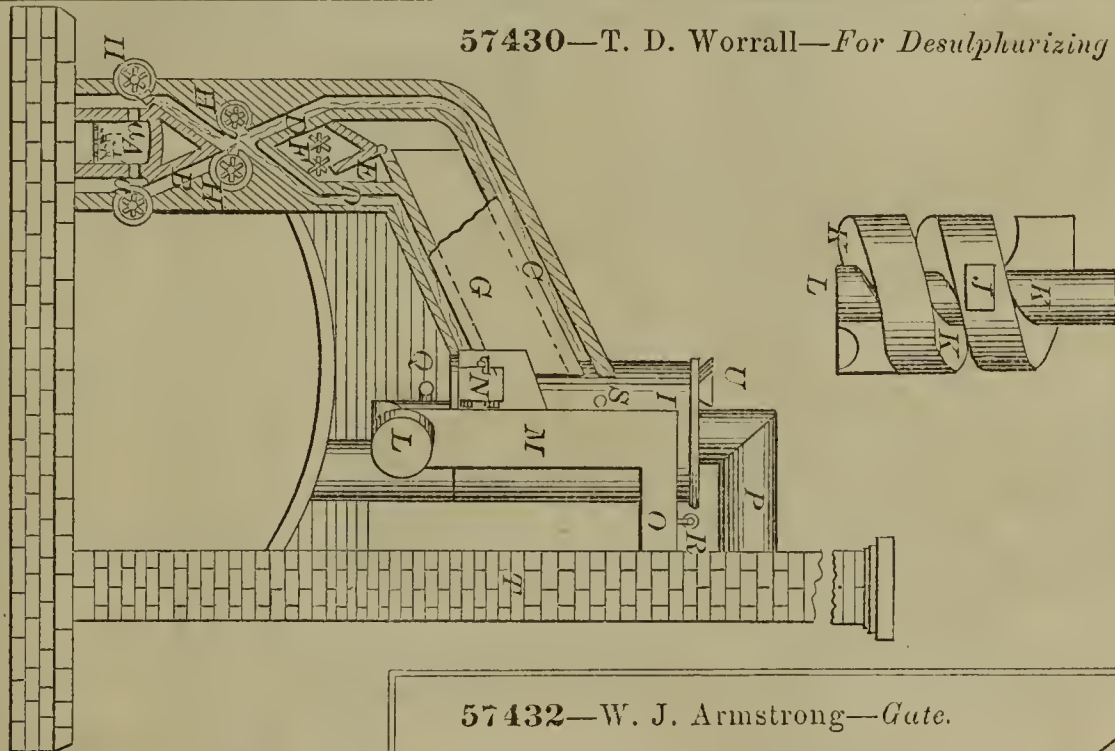

57433—J. Austin—*Horse Shoe.*

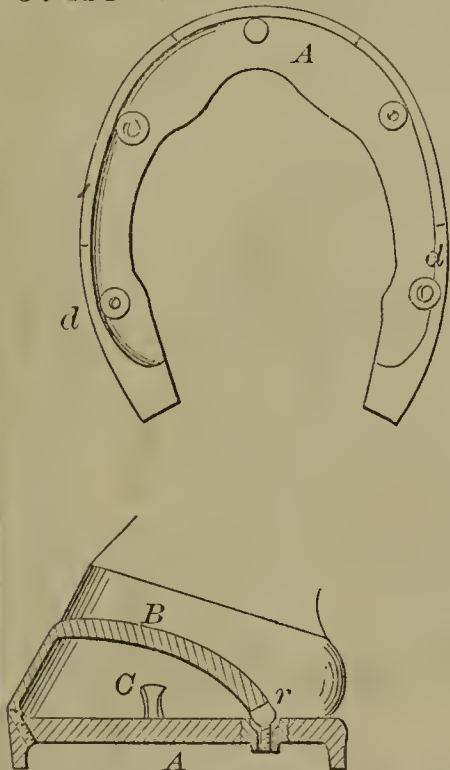

57432—W. J. Armstrong—*Gate.*

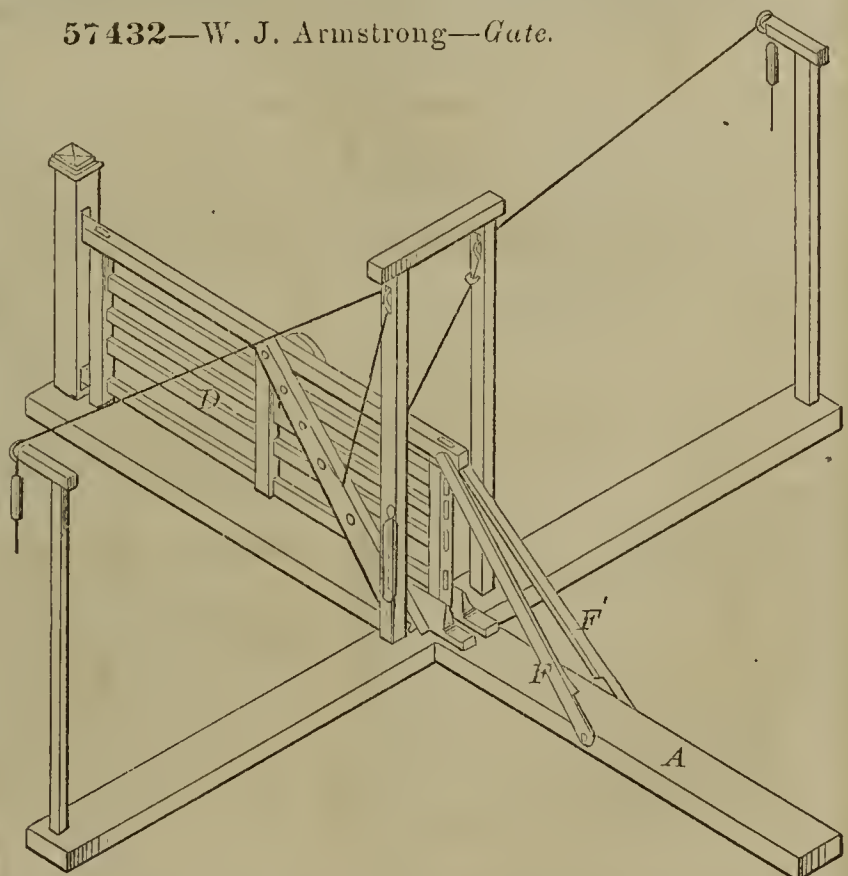

57434—J. J. Bender—*Piano.*

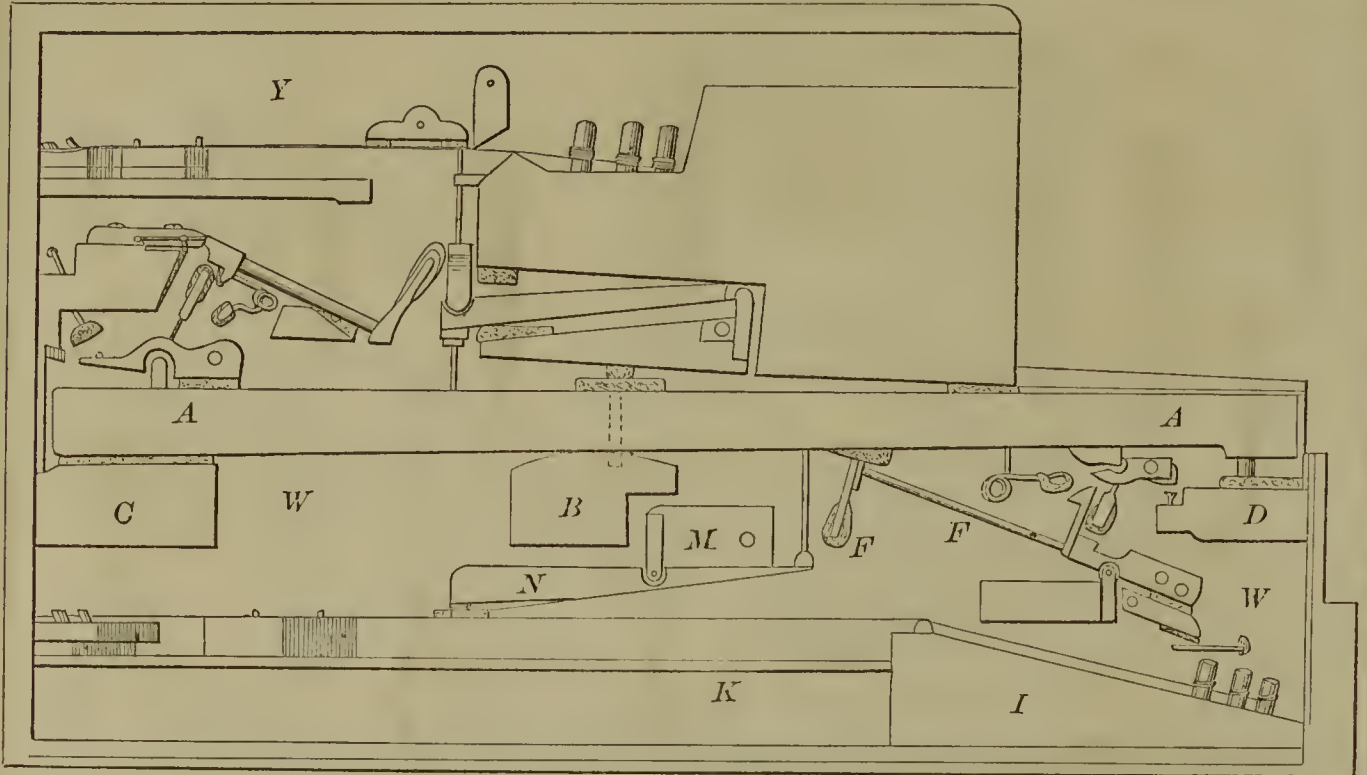

57435—W. Darker—

*Braiding Machine.*

57438—

L. Frühinsfeld—*Traveling Bag Frame.*

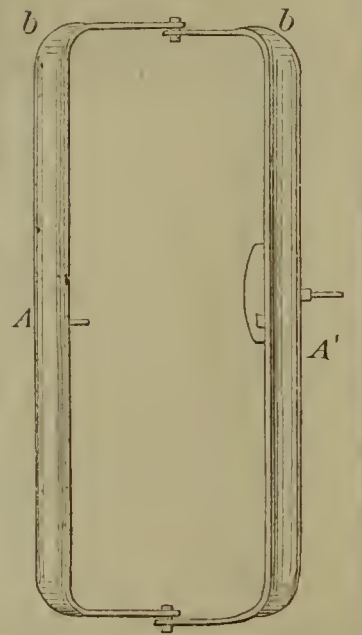
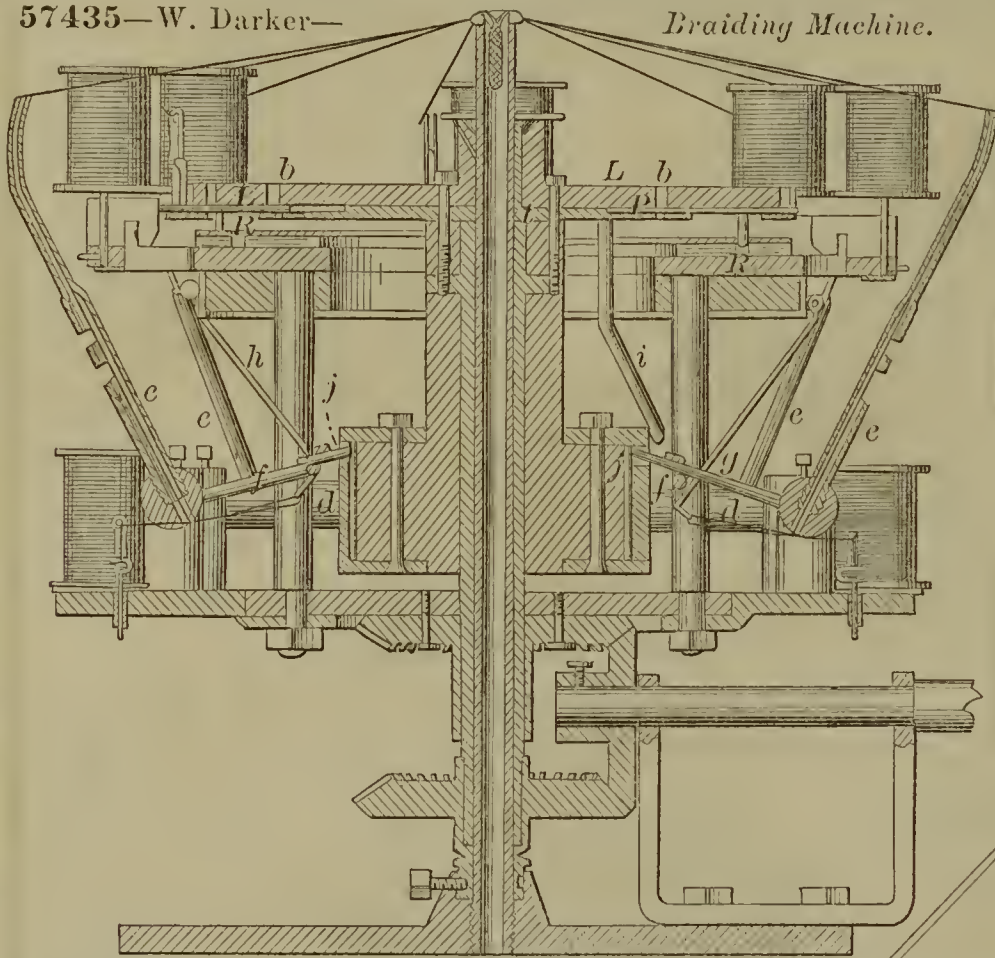

57436—G. P. Darrow—*Plow Clevis.*

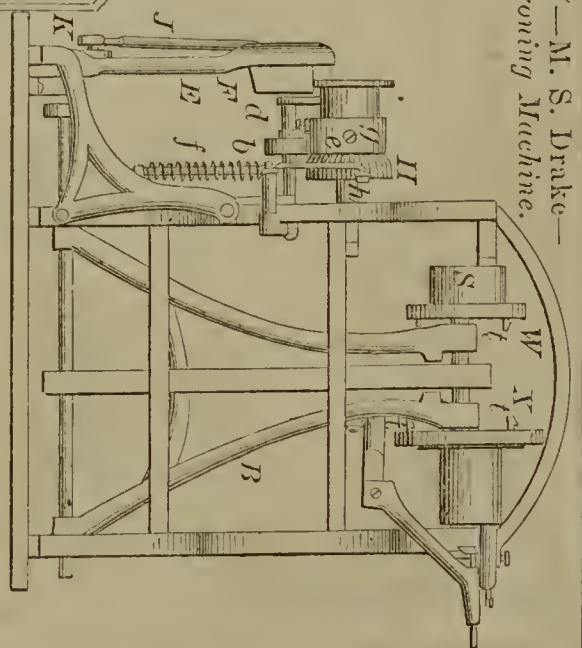
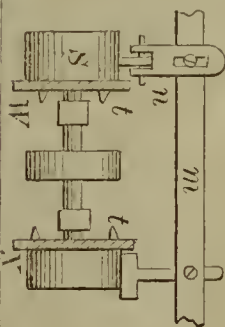
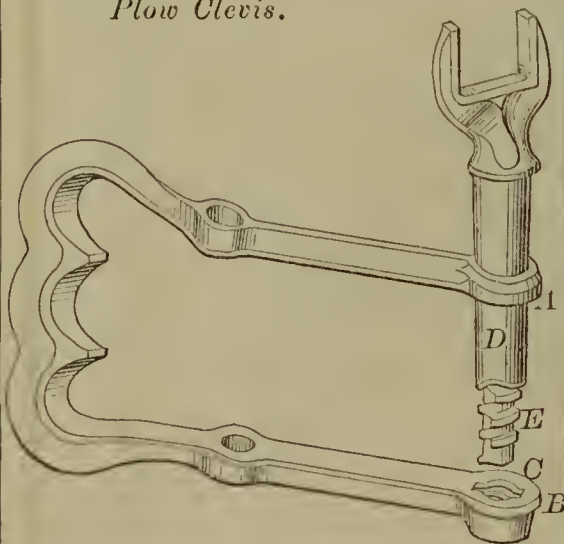

57437—M. S. Drake—*Hat Ironing Machine.*

57439—J. F. Hammond—*Lifting Jack.*

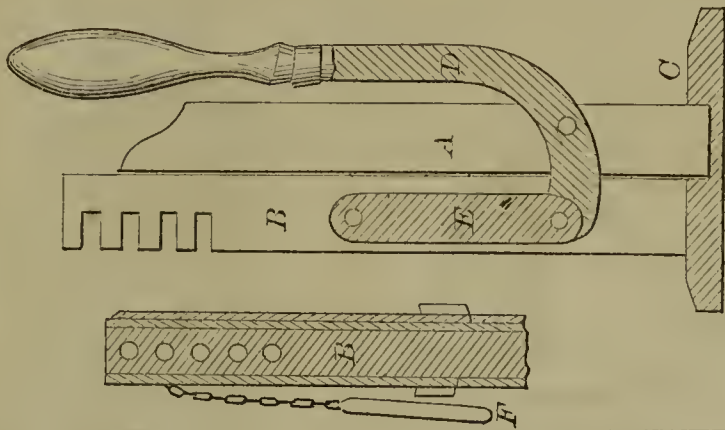

57442—D. McDonald—*For Carburetting Air.*

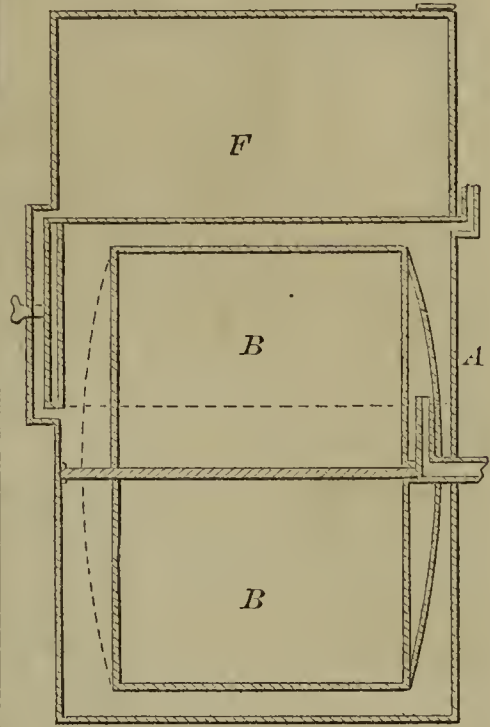

57440—C. M. Hodges—*Scythe.*

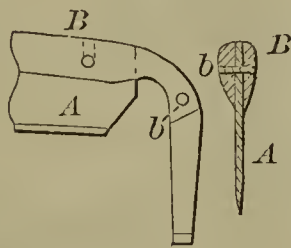

57441—B. Mannon—*Hair Crimper.*

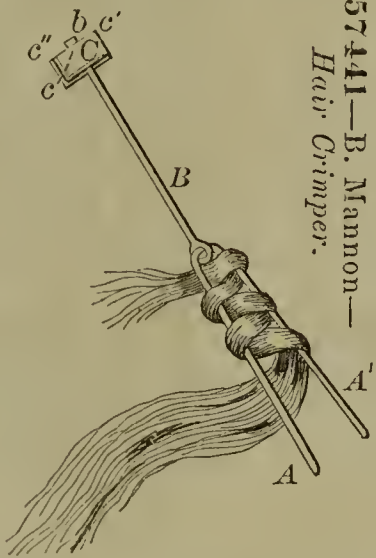

57444—L. Scofield—*Loom.*

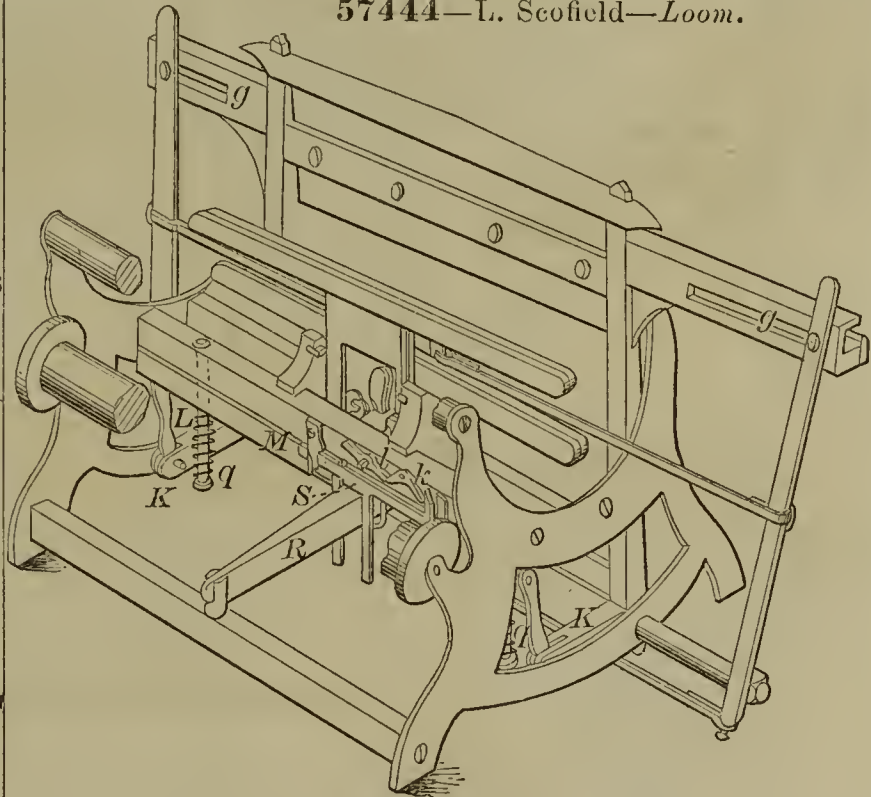

57445—G. Seitzinger—*Grain Gate.*

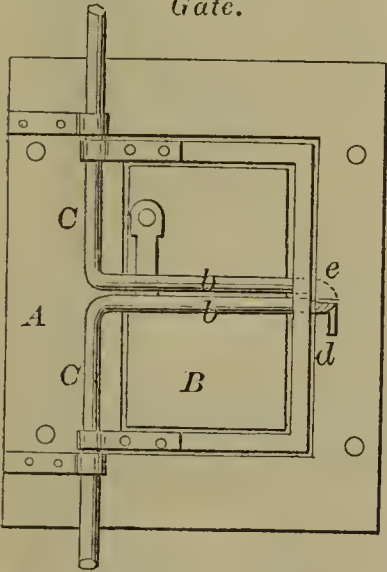

57443—Miller & Reichert—*Billiard Game Keeper.*

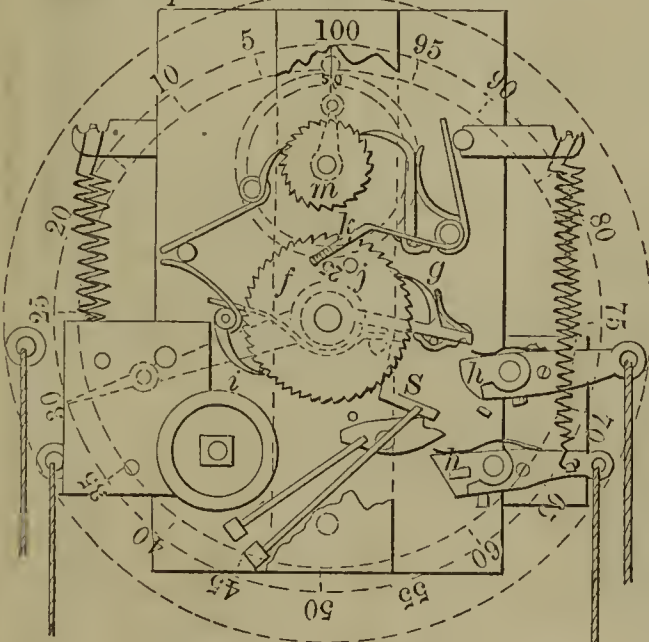

57446—G. Shipman—*Eyeletting Machine.*

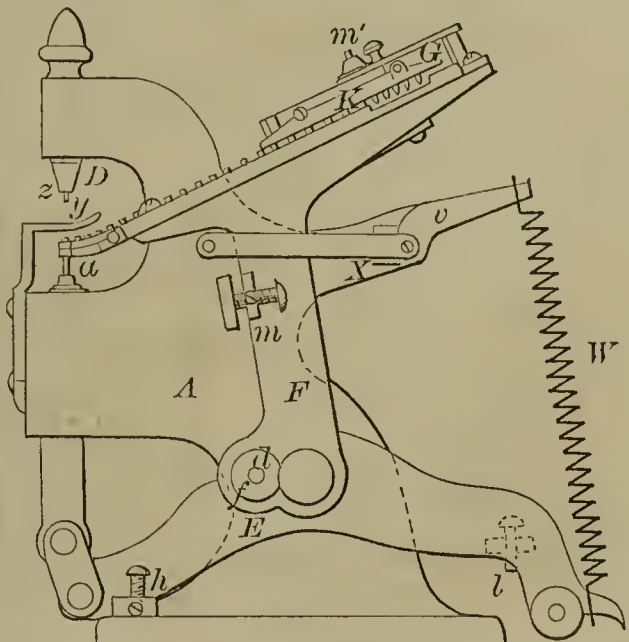

57447—A. C. Stockmar—  
*Hand Vise or Clamp.*

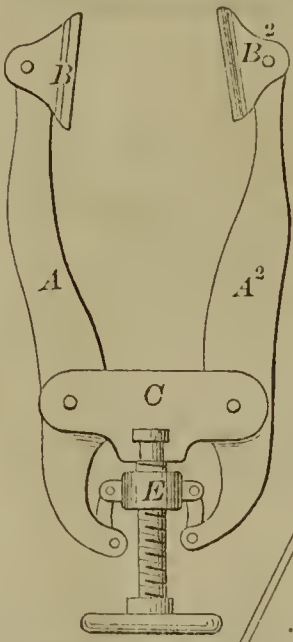

57448—J. H. Vickers—  
*Revolving Fire Arm.*

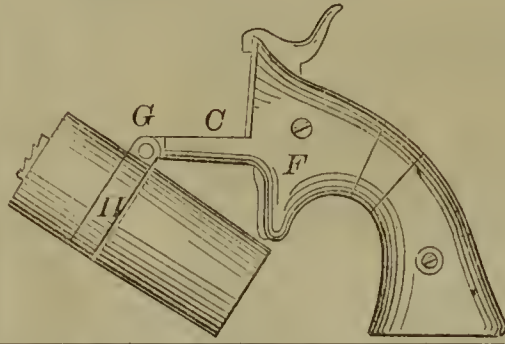

57449—J. M. Ward—  
*Hydrant.*

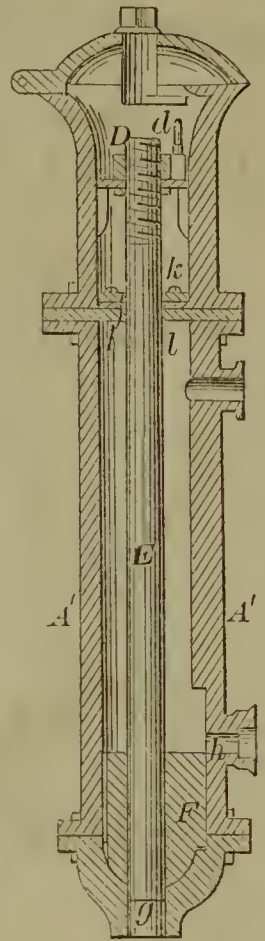

57451—J. M. Clements—*Sewing Machine for Stitching Button Holes.*

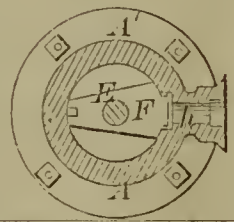
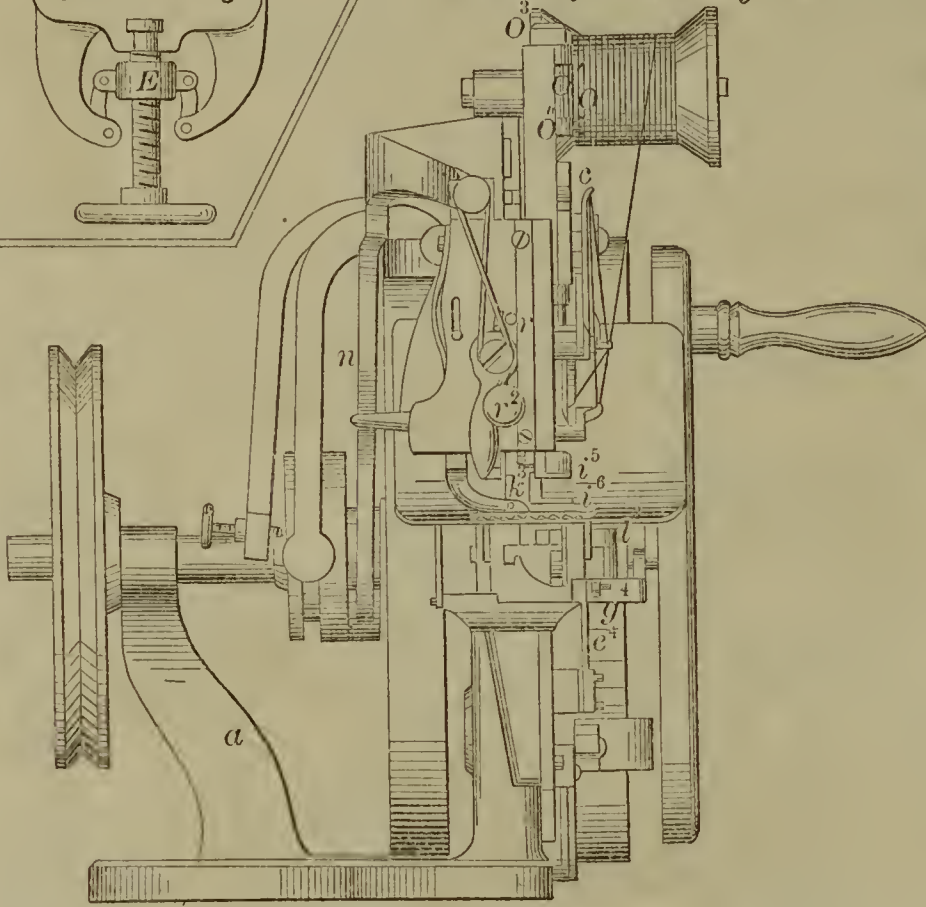

57450—M. Aborb—*Brick for Ceilings.*

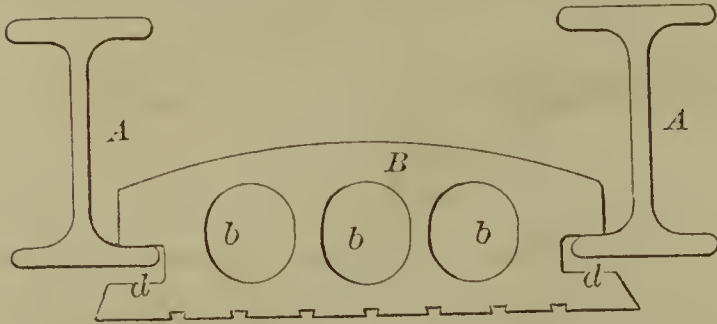

57452—Baker, Holmes & King—*Cream Strainer.*

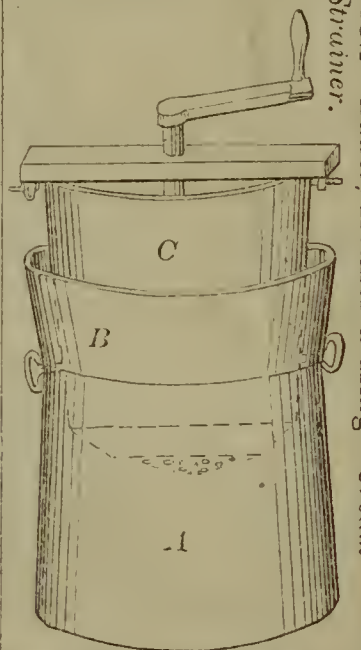

57455—W. Aiken—*Hosiery Ironing Machine.*

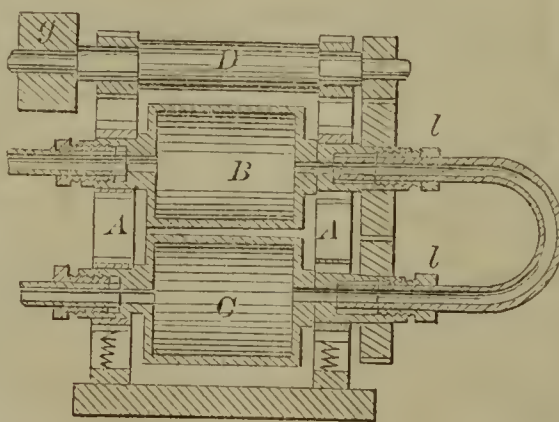

57456—C. H. Alsop—  
*Snap Hook.*

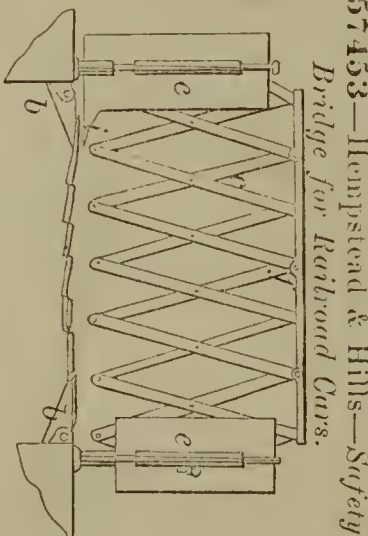
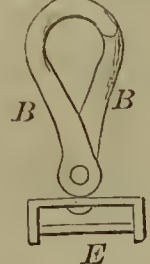

57453—Hempstead & Hills—  
*Safety Bridge for Railroad Cars.*



57457—C. Alvord—*Horse Collar.*

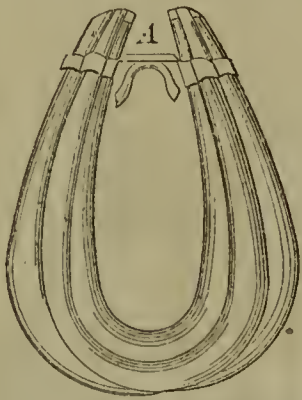

57463—G. A. Beard—*Mould Board for Plows.*

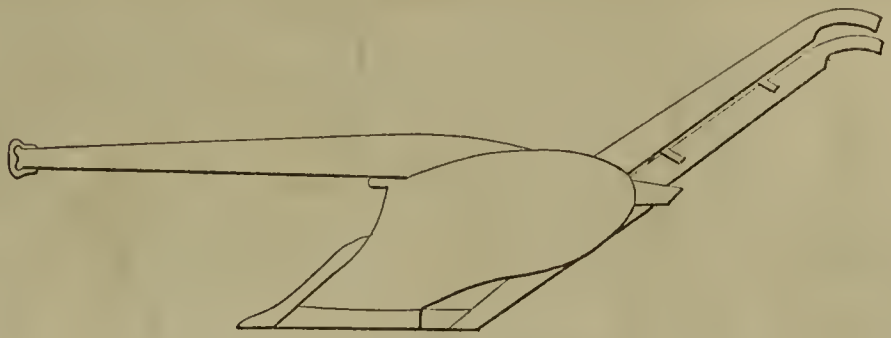

57461—Bartlett & Johnson—*Brick.*

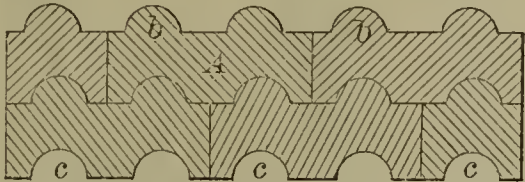

57459—A. Balding—*Evaporator.*

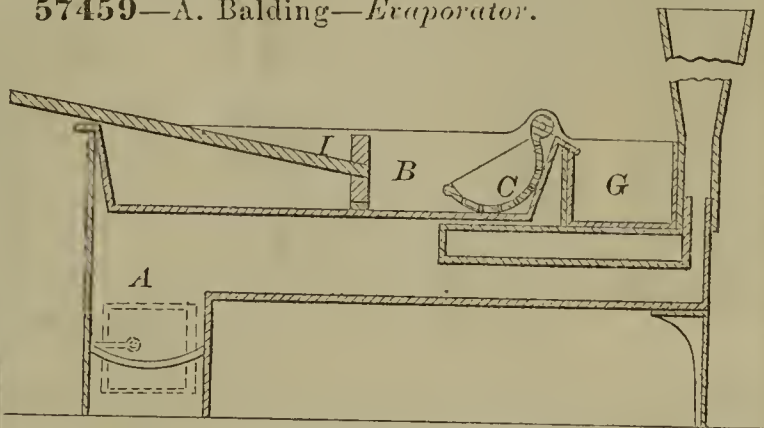

57462—Bartlett & Johnson—*Double Cylindrical Structure.*

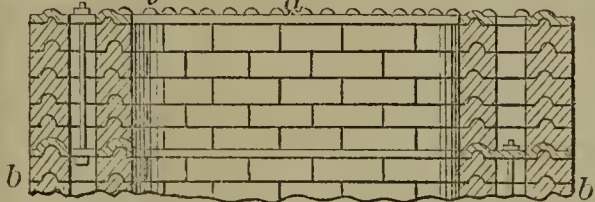

57460—W. B. Barnard—*Lamp Chimney Cleaner.*

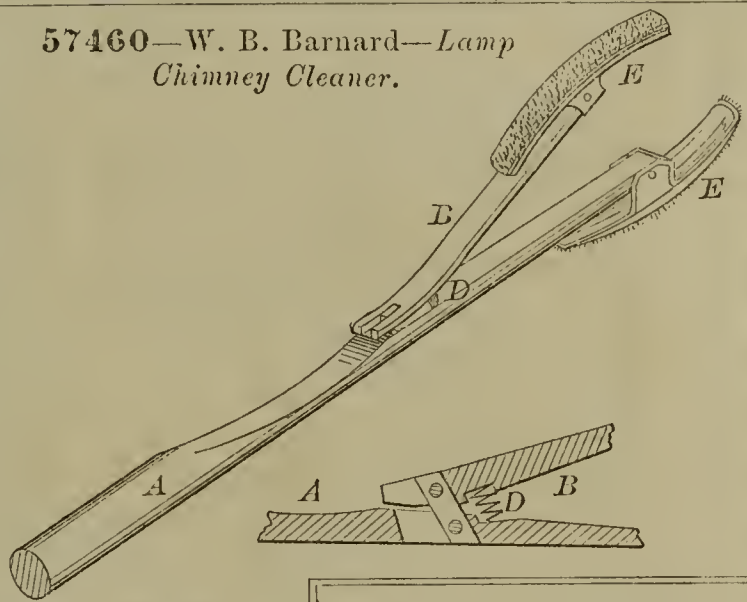

57466—G. W. Bishop—*Ratchet Drill.*

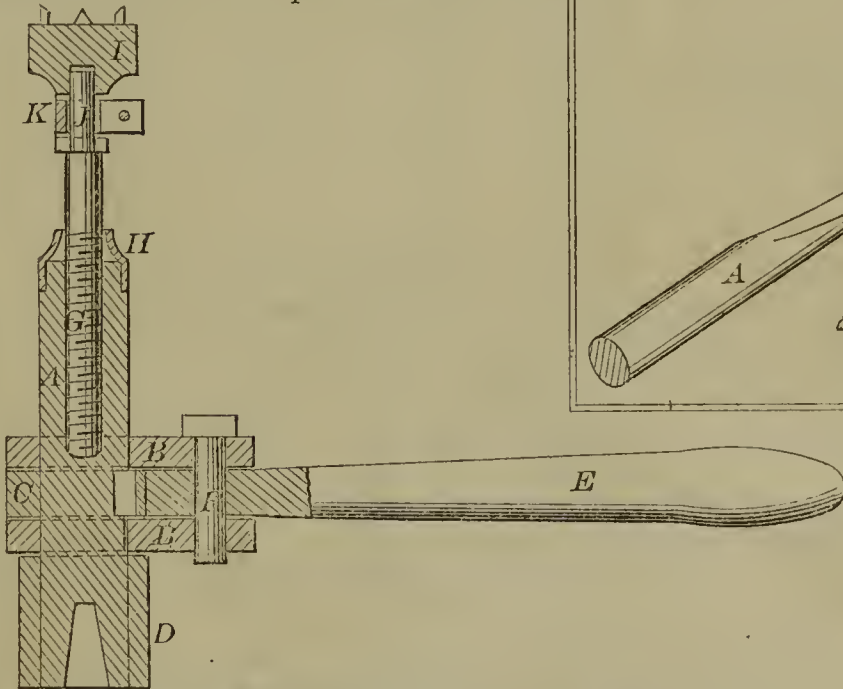

57467—J. L. Booth—*Railroad Rail.*

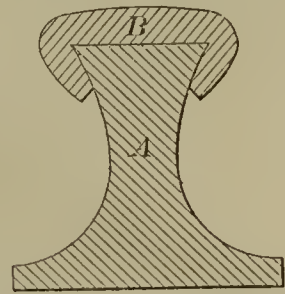

57470—J. A. Caldwell—*Car Ventilator.*

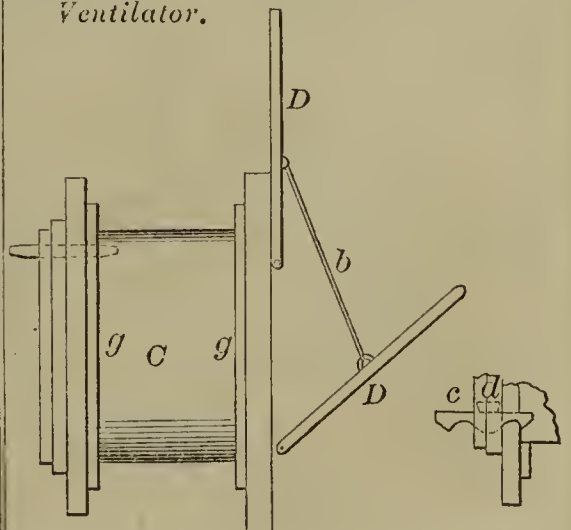

57469—H. Bradford—*For Drying Peat.*

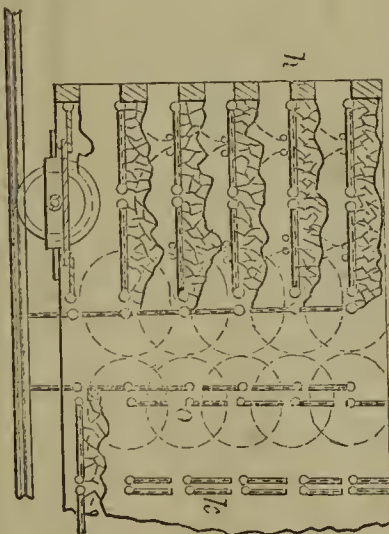

57464—J. H. Beidler—*Post Office Delivery Box.*

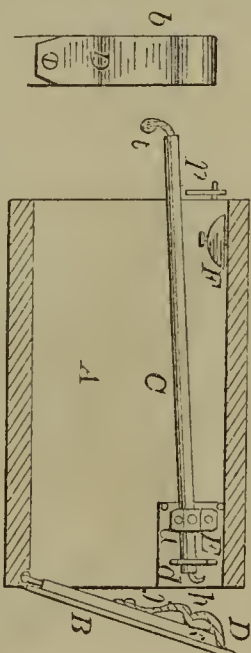

57471—G. J. Caperwell—For Grinding and Polishing Buttons.

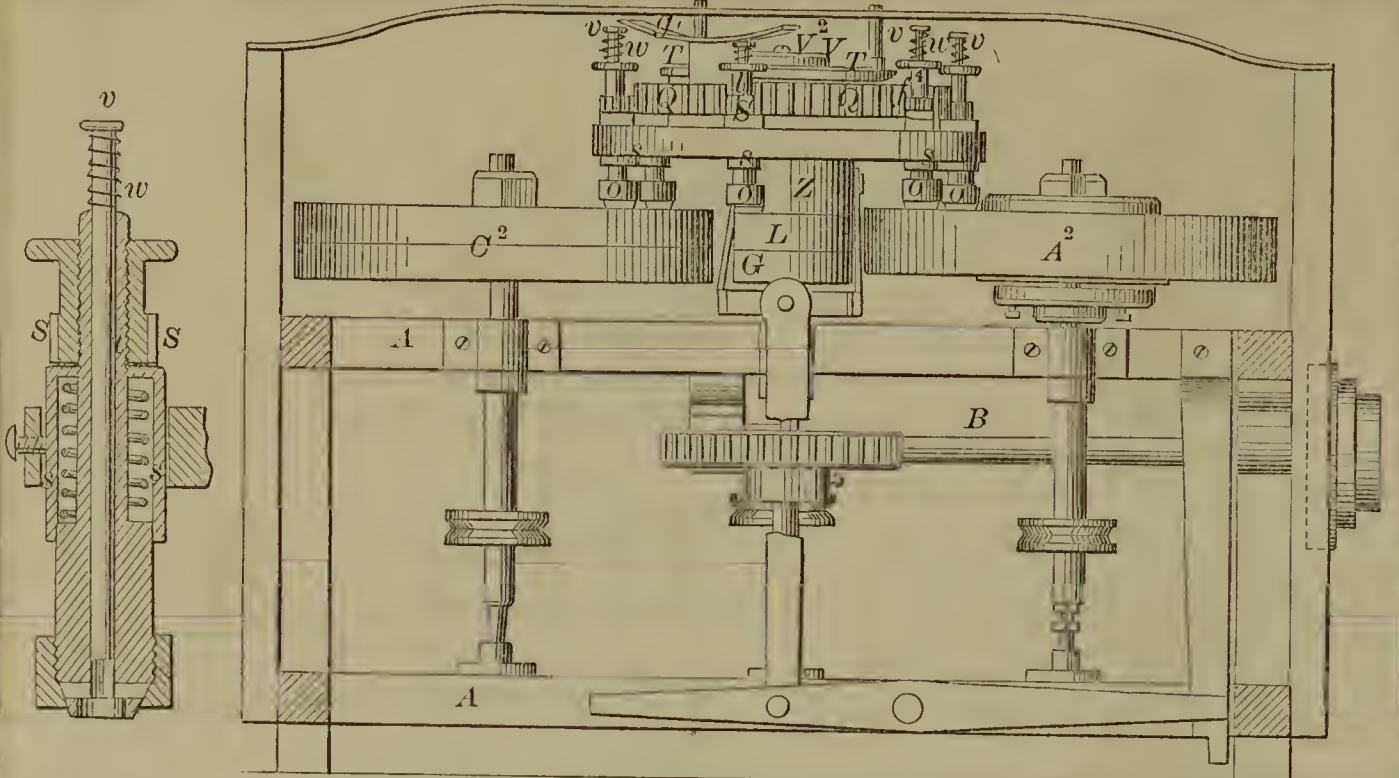

57472—P. Carbach—Melodeon.

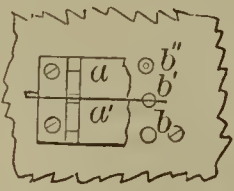
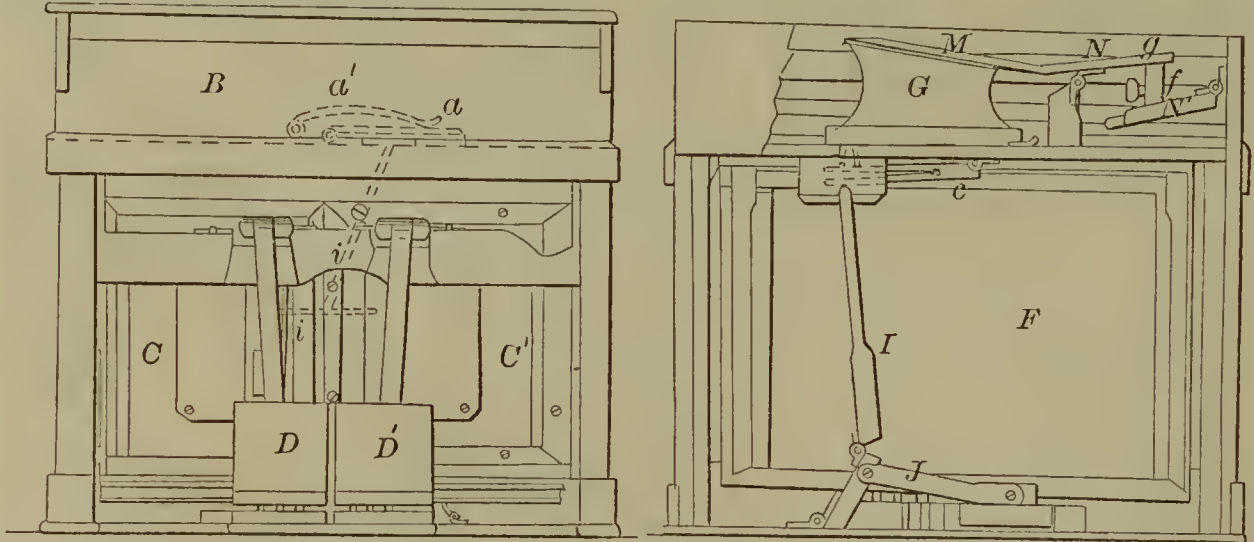

57473—I. T. Carpenter—Fruit Gatherer.

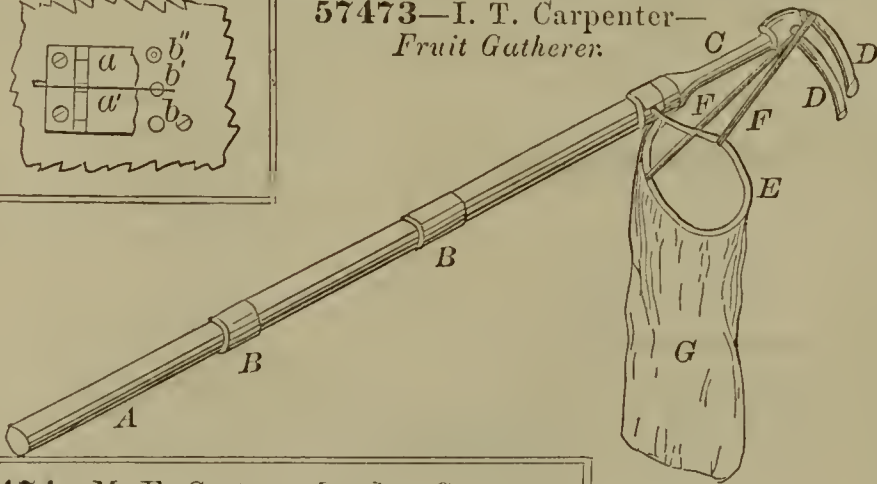

57475—H. W. Caswell—For Shrinking Tires.

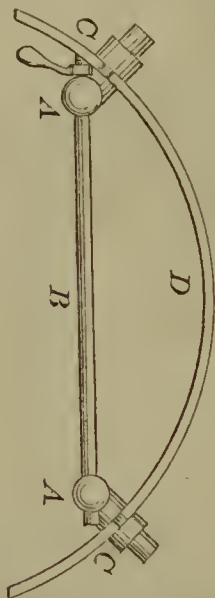

57474—M. E. Carter—Lumber Grooving Machine.

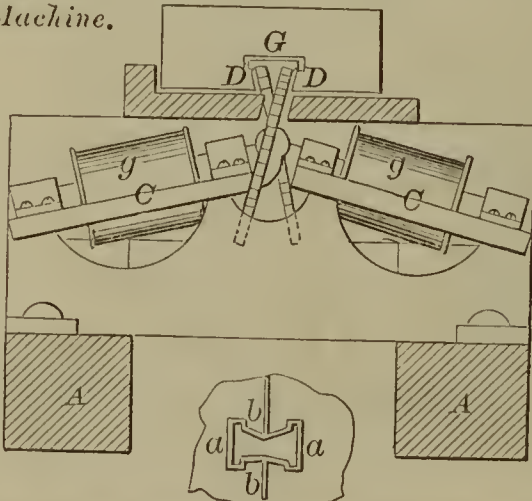

57476—J. H. Chapman—Grapppling Iron.

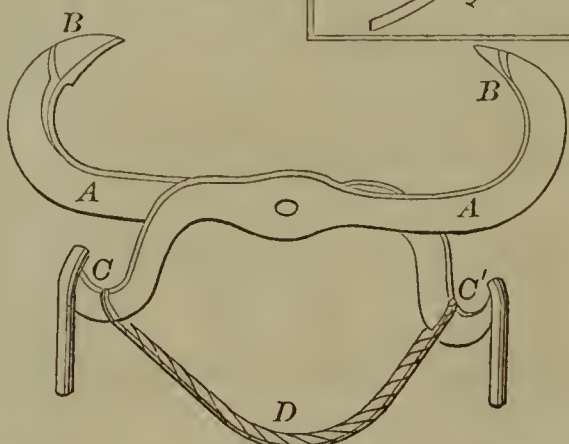

57477—R. Chesnut—Feeding Trough.

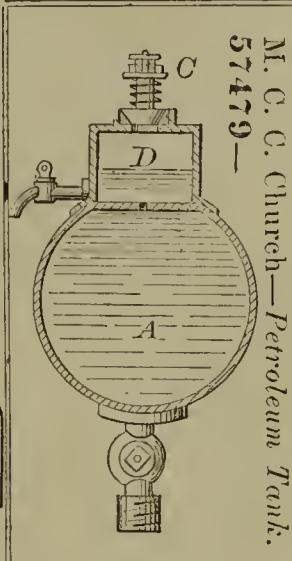
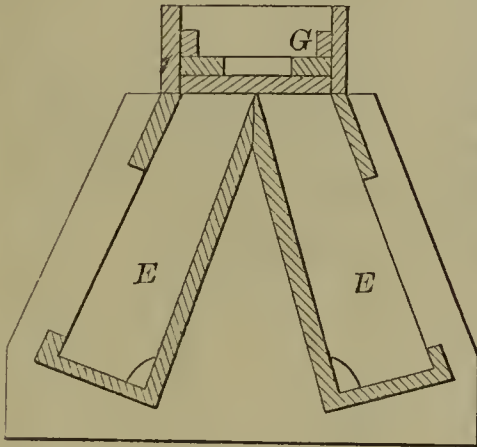
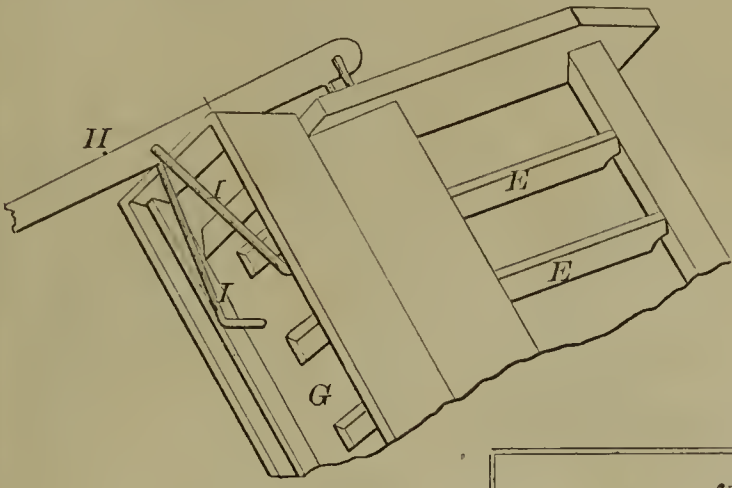

M. C. C. Church—Petroleum Tank.  
57479—

57481—Conver & Bothwick—Heat Radiator.

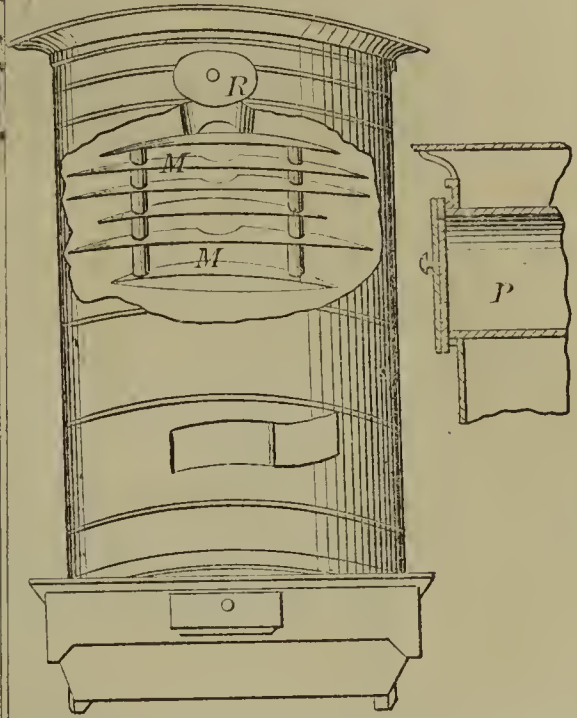

57478—A. M. Clara—Hay Loading Wagon.

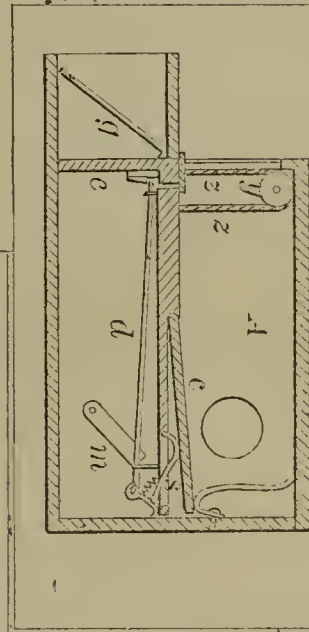
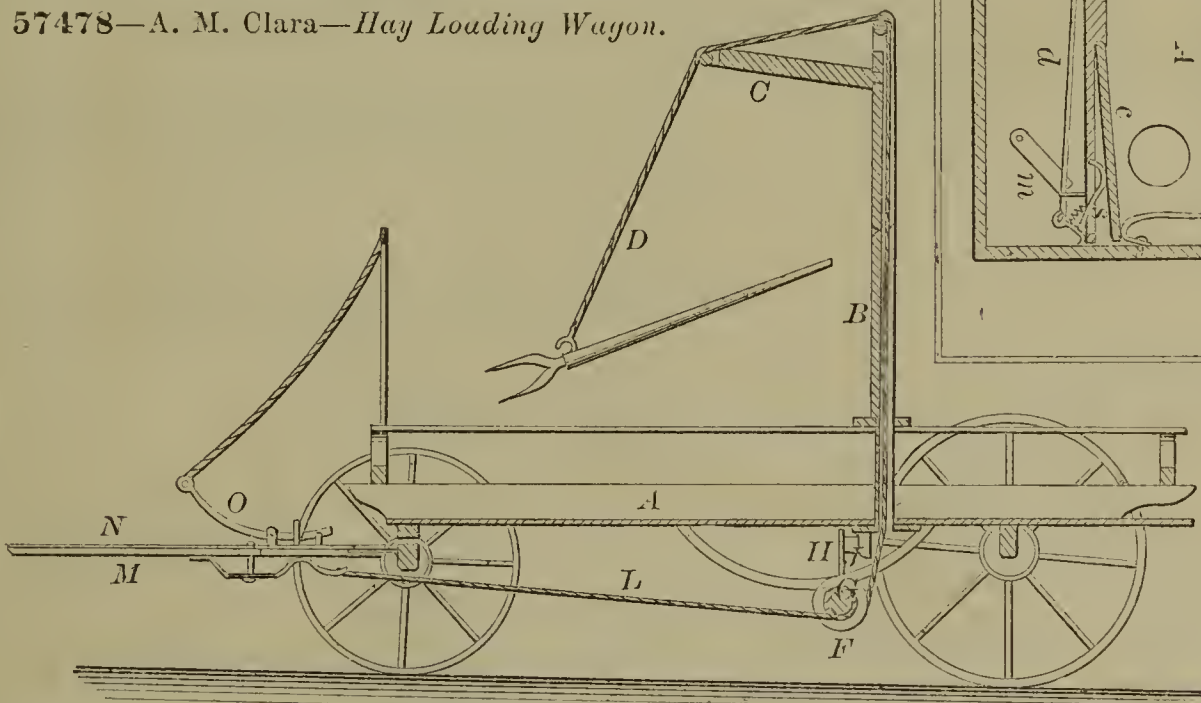

57480—D. Cole—Animal Trap.

57482—Curtis & Roberts—Horse Rake.

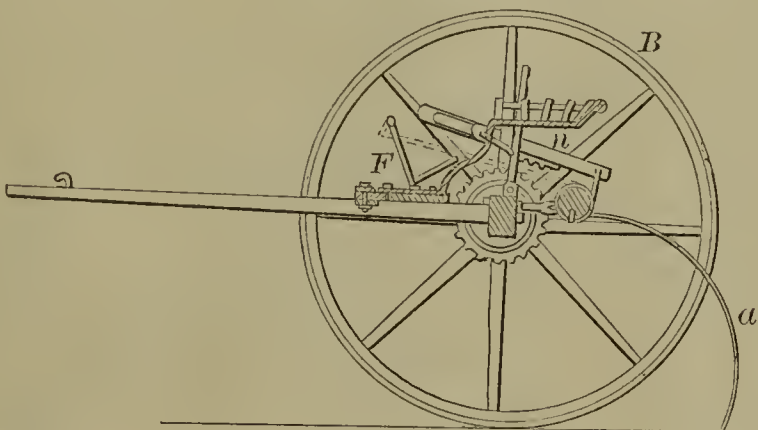

57483—H. W. Curtis—Fanning Mill.

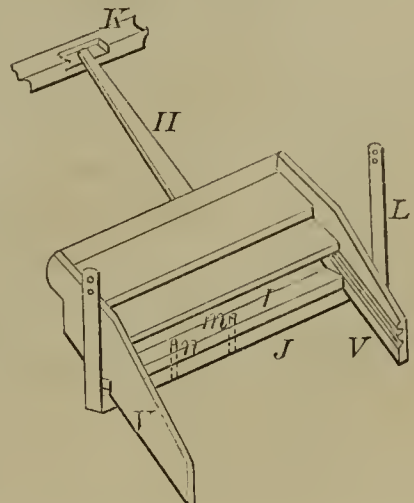

57487—S. R. Dummer—*Hand Truck.*

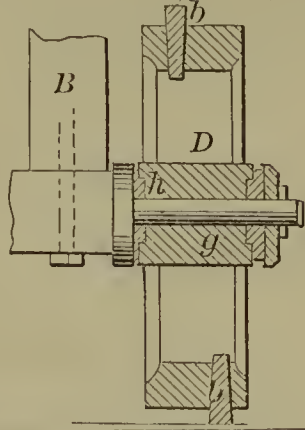
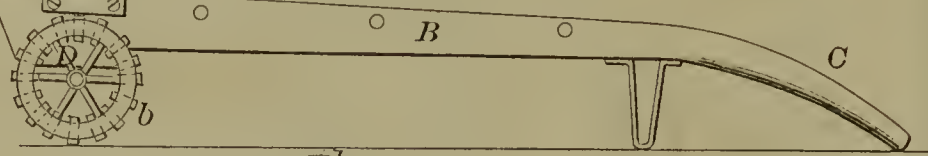

57481—C. Daniel—*Cultivator.*

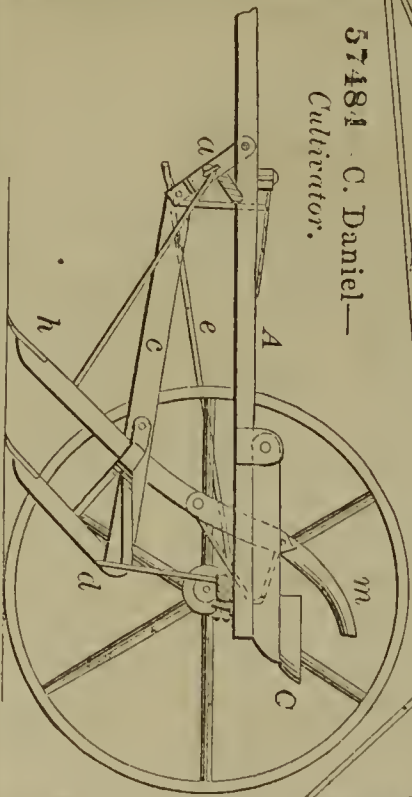

57486—A. Dougherty—*Printing Press.*

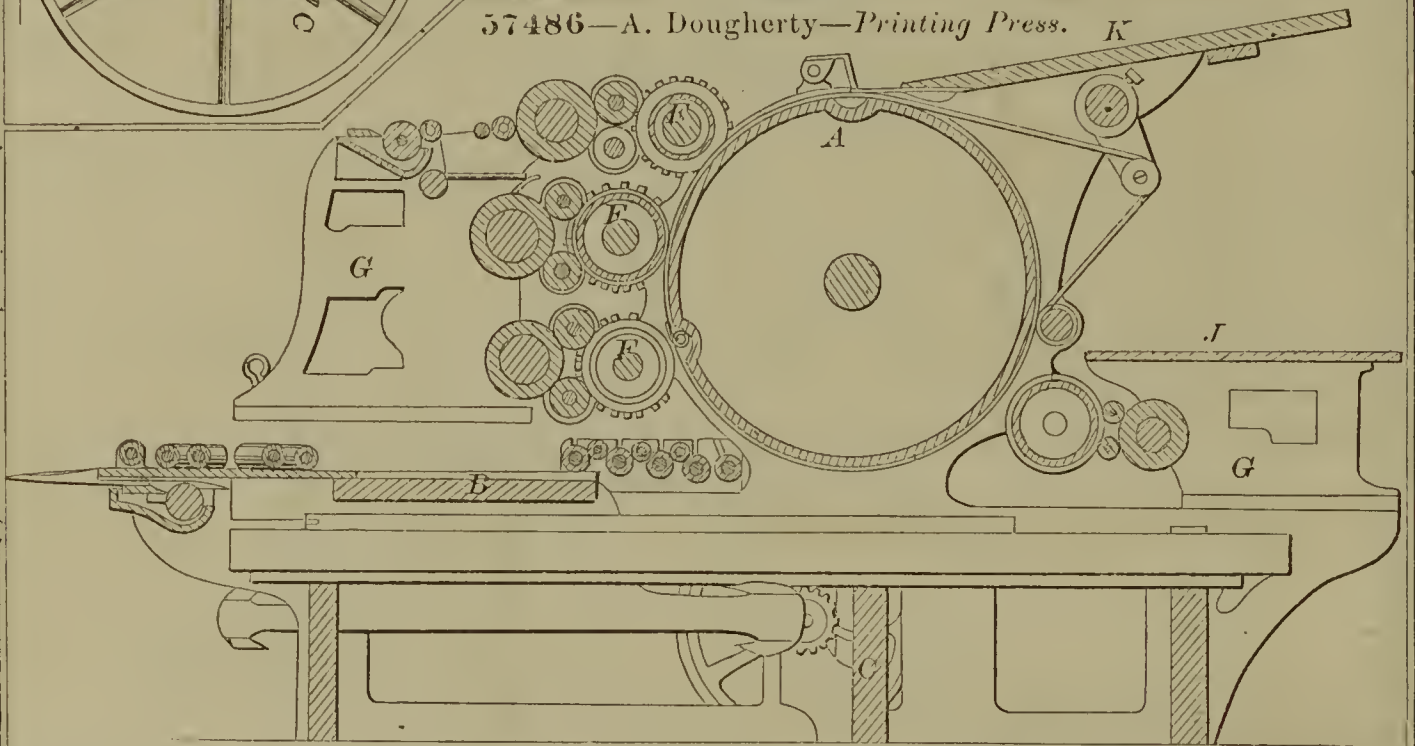

57485—J. C. Dickey—*Clothes Wringer.*

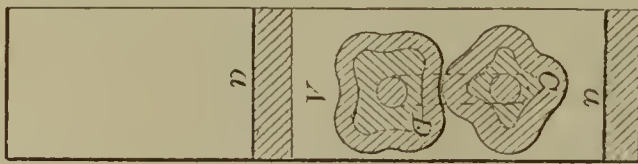

57488—Dunham & J. & A. Webb—*Horse Rake.*

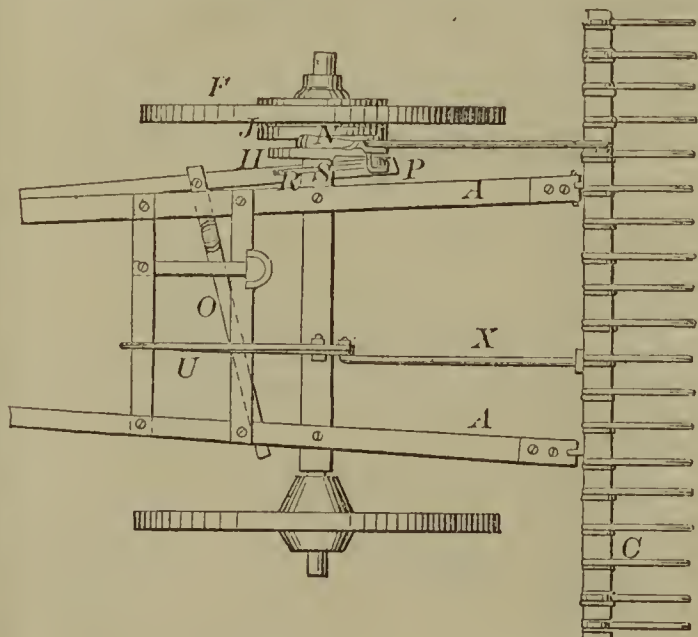

57489—L. Elsberg—*For Preparing Peat.*

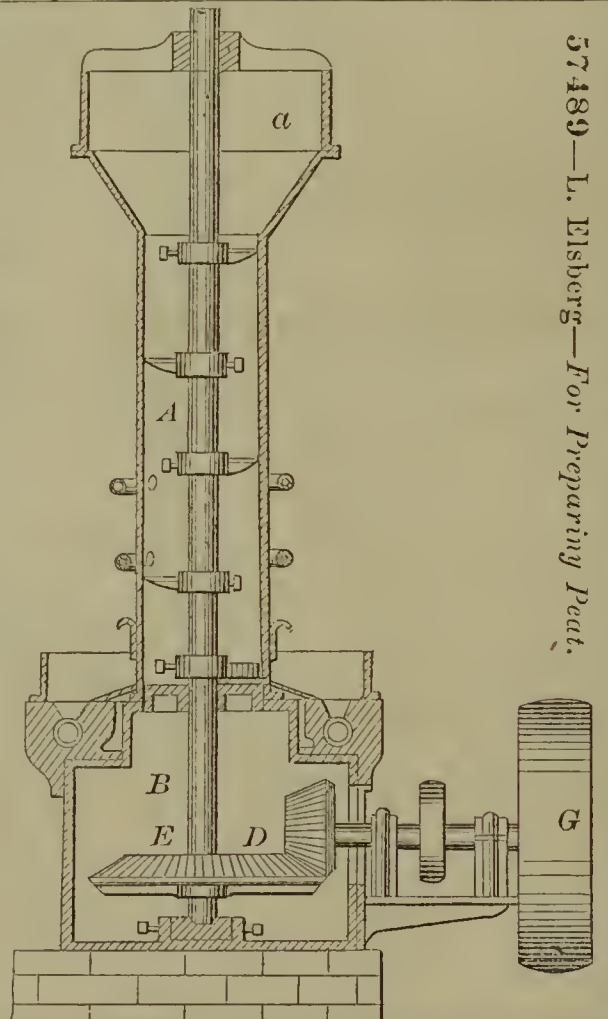

57490—R. Eickemeyer—*Steam Engine Governor.*

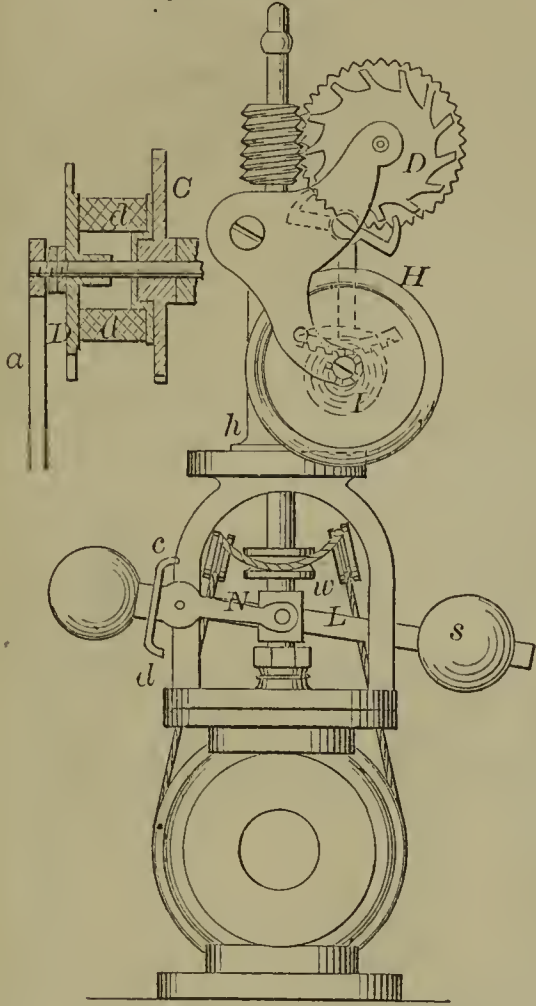

57492—W. R. Evans—*Coal and Ash Sifter.*

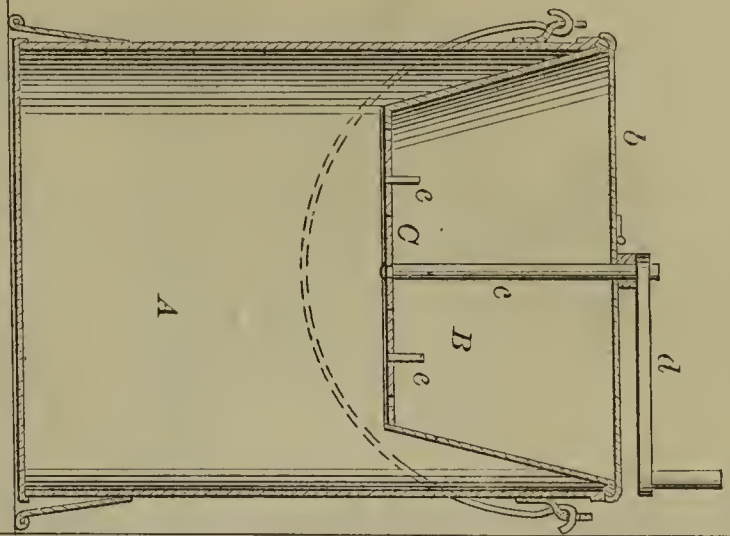

57494—C. W. Fuller—*Funnel Measure.*

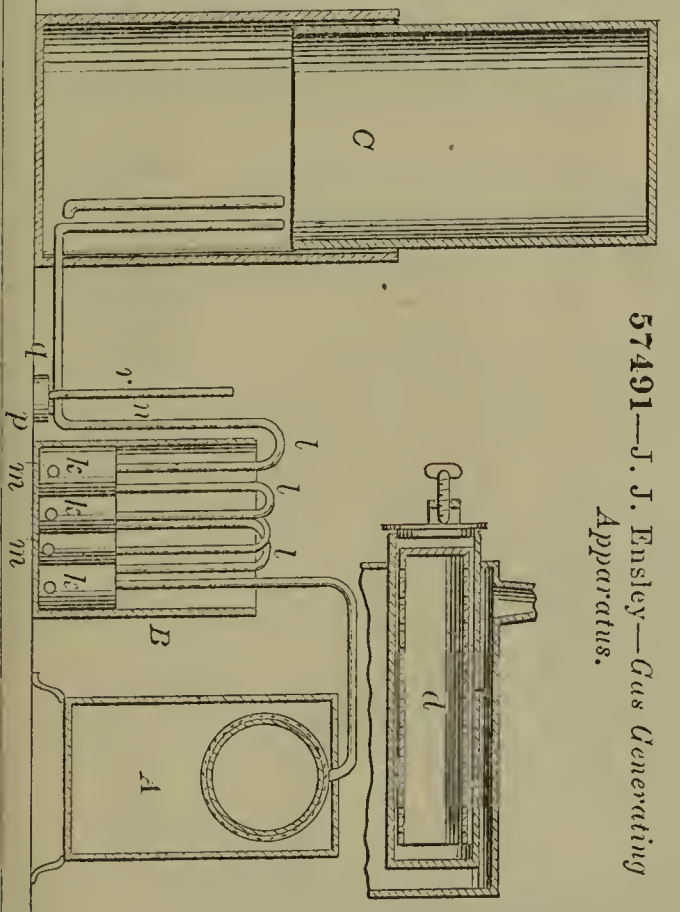
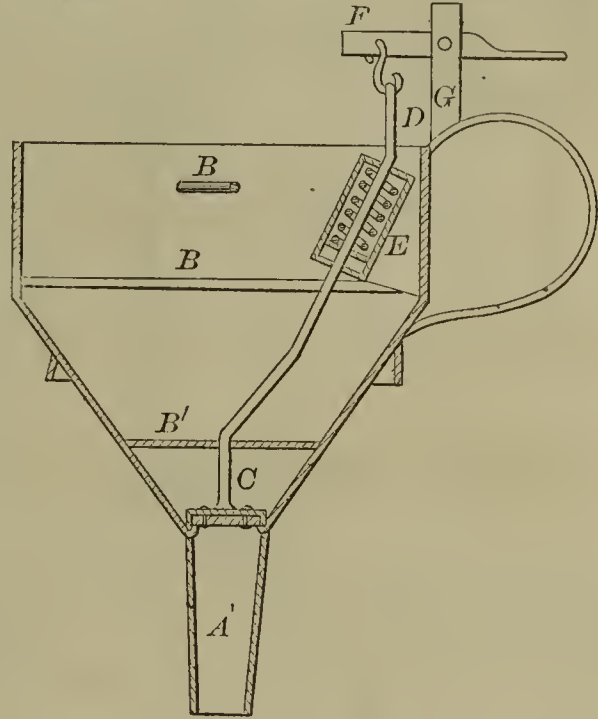

57491—J. J. Ensley—*Gas Generating Apparatus.*

57495—E. A. Giles—*Stem Winding Watch.*

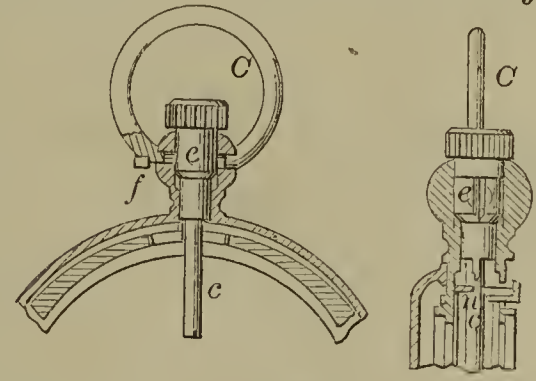

57496—G. P. Goodwin—*Twine Spool Stand.*

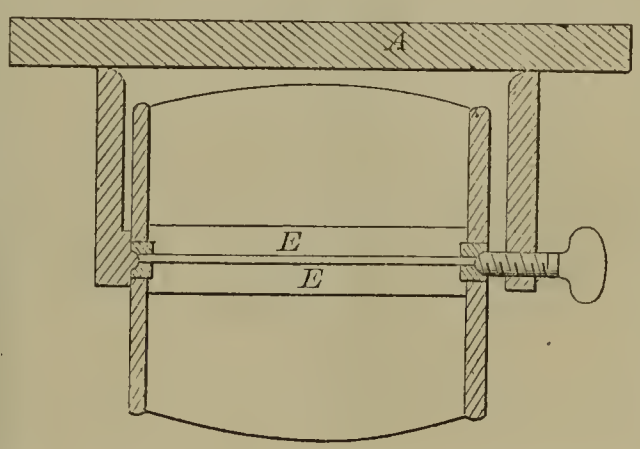

57493—W. Frederick—*Boot and Shoe Edge Parer.*

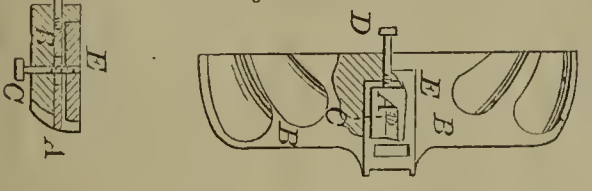

57497—D. A. Gorham—Whiffletree.

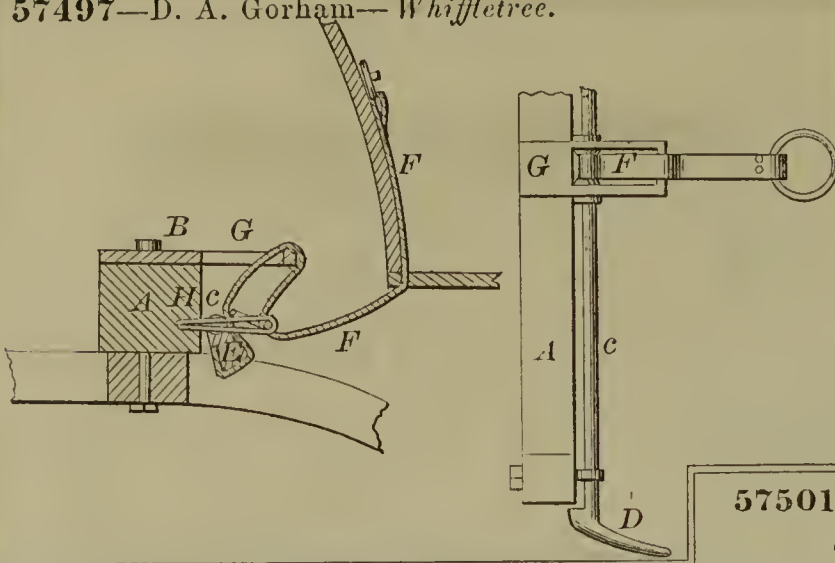

57498—E. B. Graff—Railroad Rail Fastening.

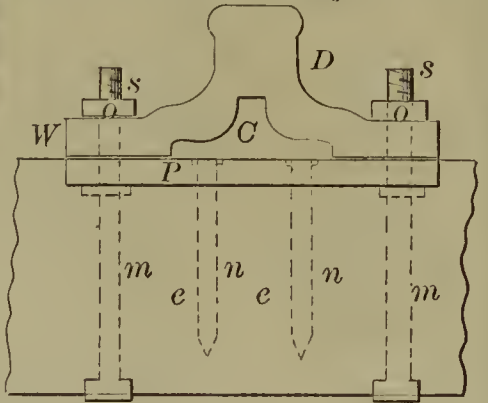

57499—J. P. Gruber—Pump.

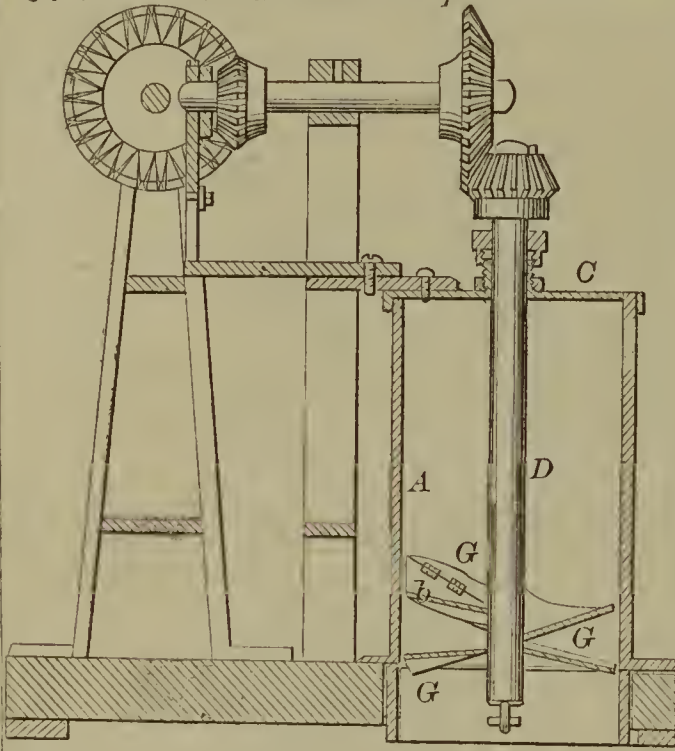

57501—F. Hanson—Turn Table.

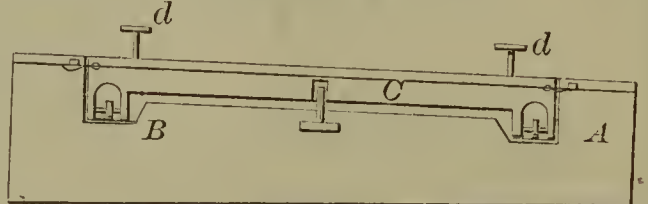

57502—M. E. Hanson—Gas Generator.

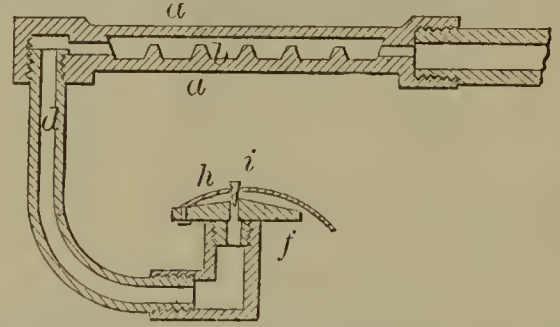

57503—W. W. Harder—Lock.

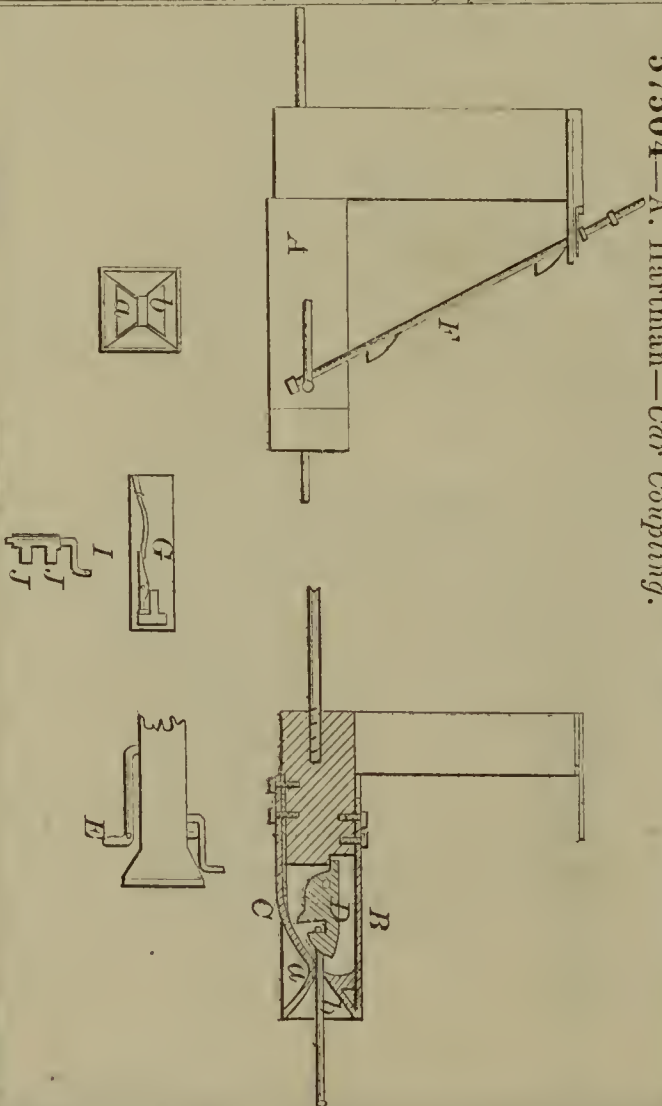
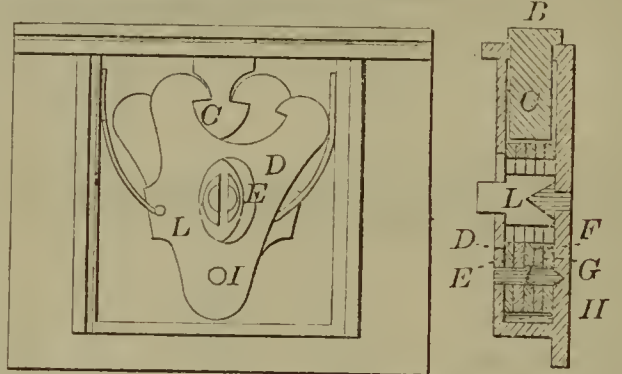

57504—A. Hartman—Car Coupling.

57505—Havens, Johnson & Howe—Uterine Supporter.

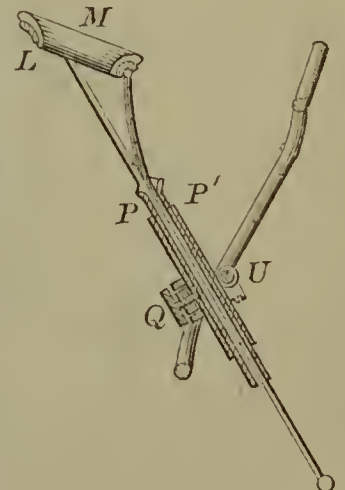

57500—Halsey & Fitzgibbons—Sewing Machine.



57506—H. Herbert—*Pipe Tongs.*

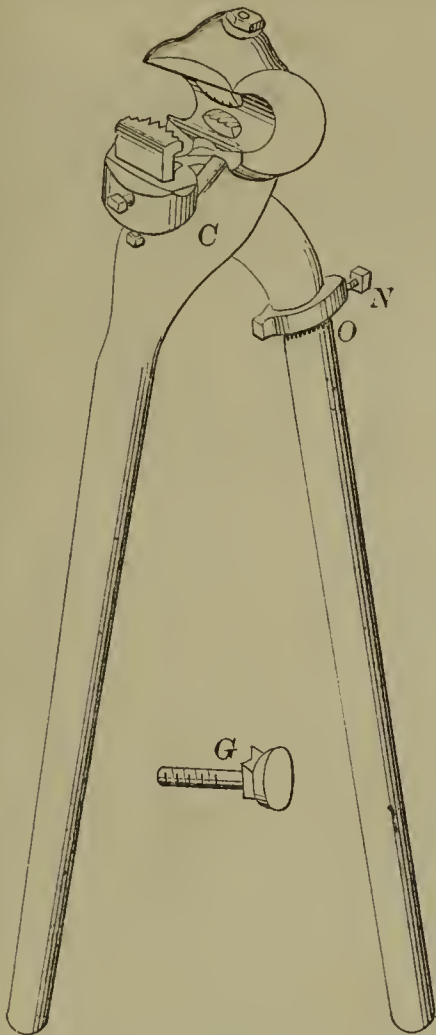

57508—E. R. Hopkins—*Lock.*

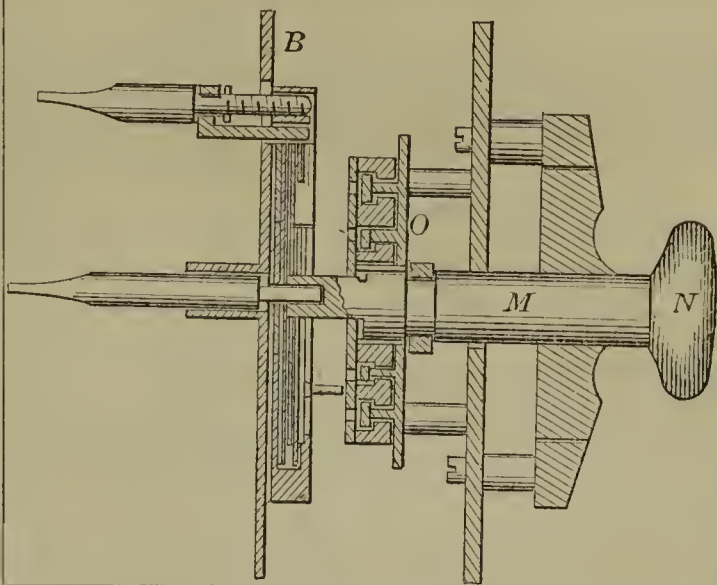

57509—G. W. & E. Hopkins—*Automatic Steam Valve.*

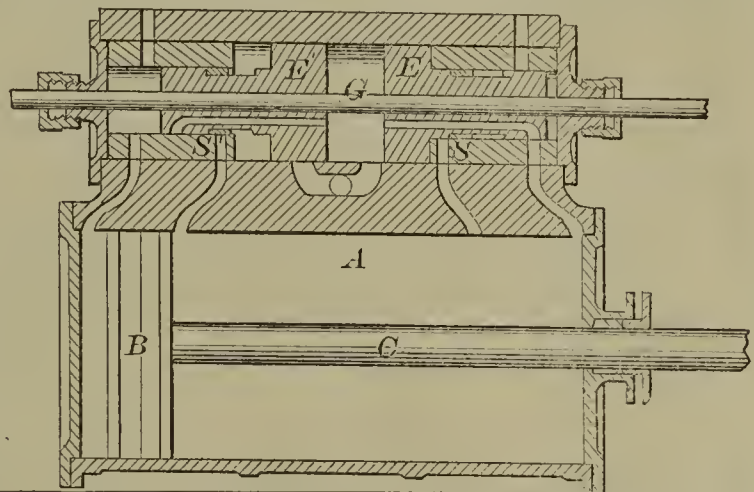

57507—H. Hise—*Tug Buckle.*

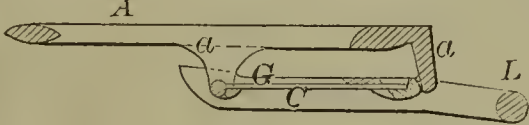

57511—H. B. Horton—*Clock Case.*

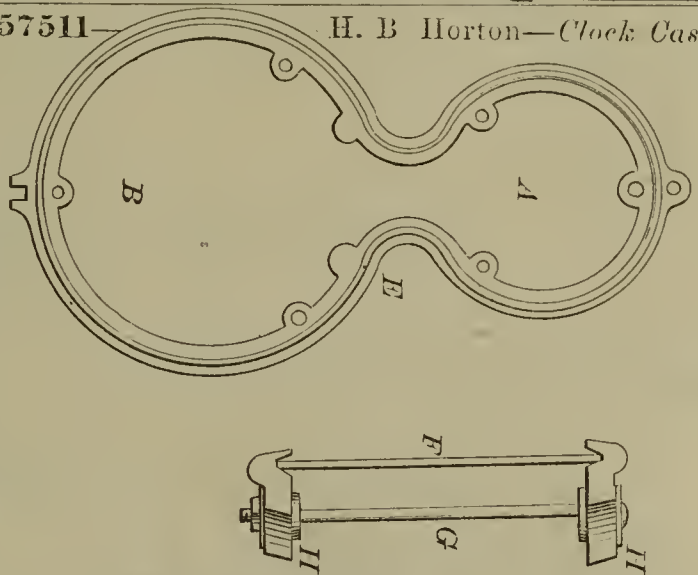

57510—H. B. Horton—*Calendar Clock.*

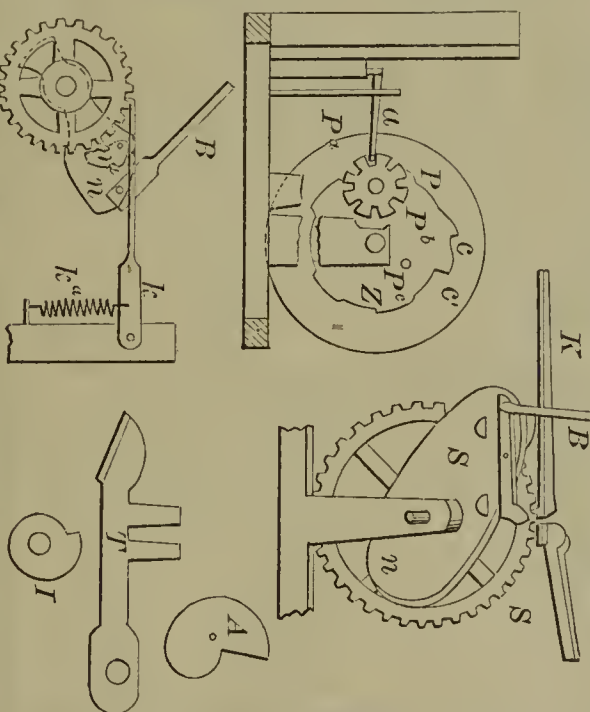

57512—H. Hubbell—*Hydraulic Engine.*

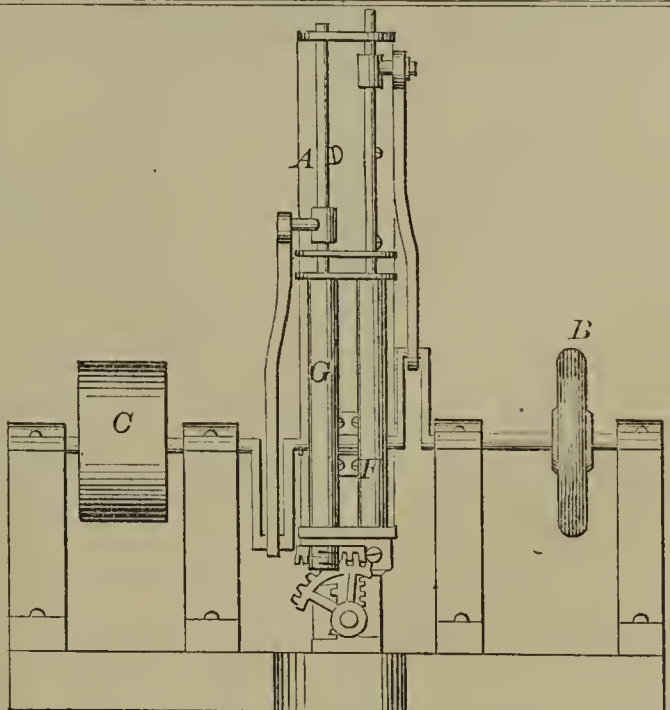

57513—R. C. Hussey—*Cutting Board.*

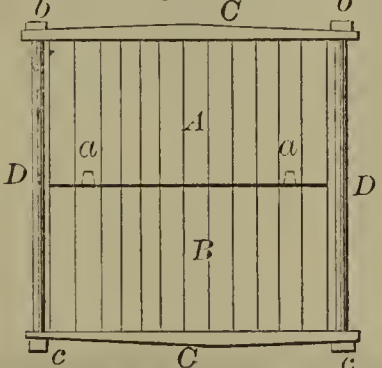

57514—C. F. Ingraham—*Sawing Machine Bobbin.*



57515—G. H. Johnson—Vault Light.

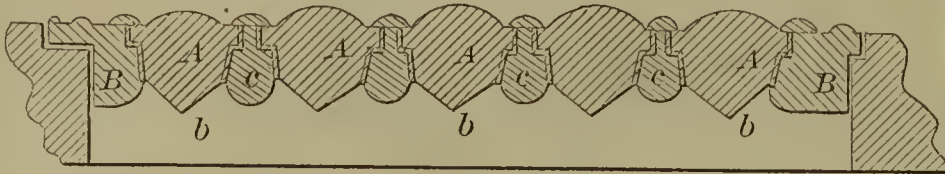

57520—C. Kugler—Horse Rake.

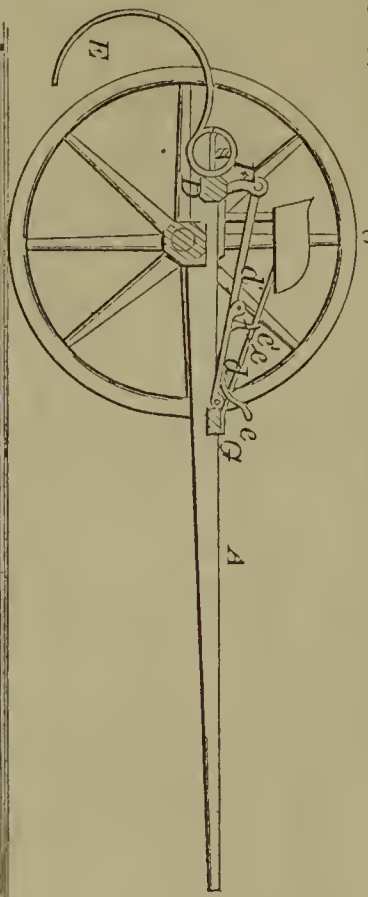

57516—N. Johnson—Pump.

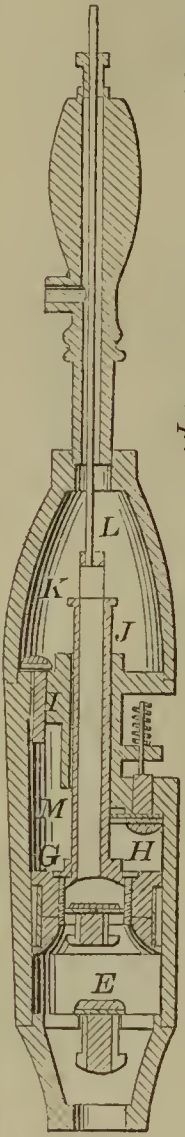

57519—Kammerl & Bollermann—Dress Elevator.

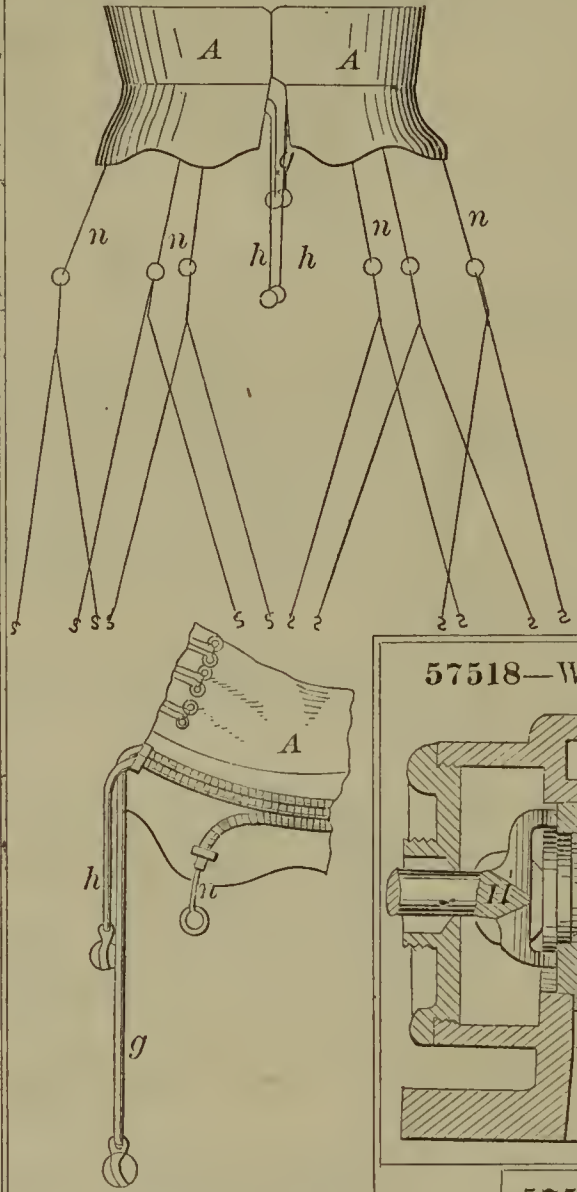

57518—W. A. L. Kirk—Steam Engine Valve.

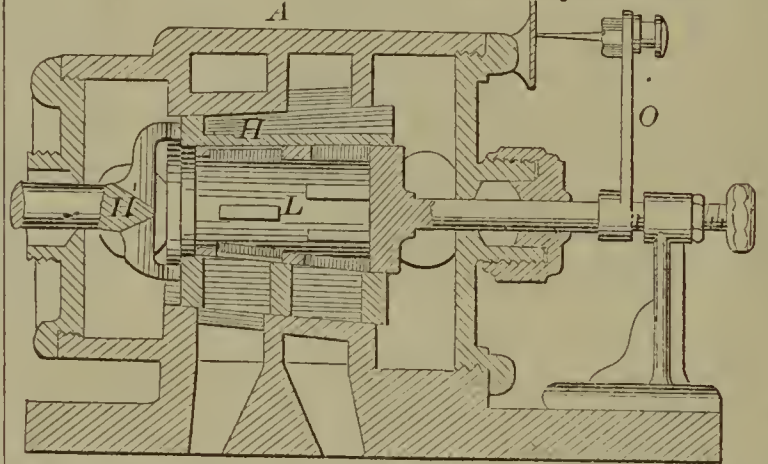

57517—J. O. Joyce—Centrifugal Machine.

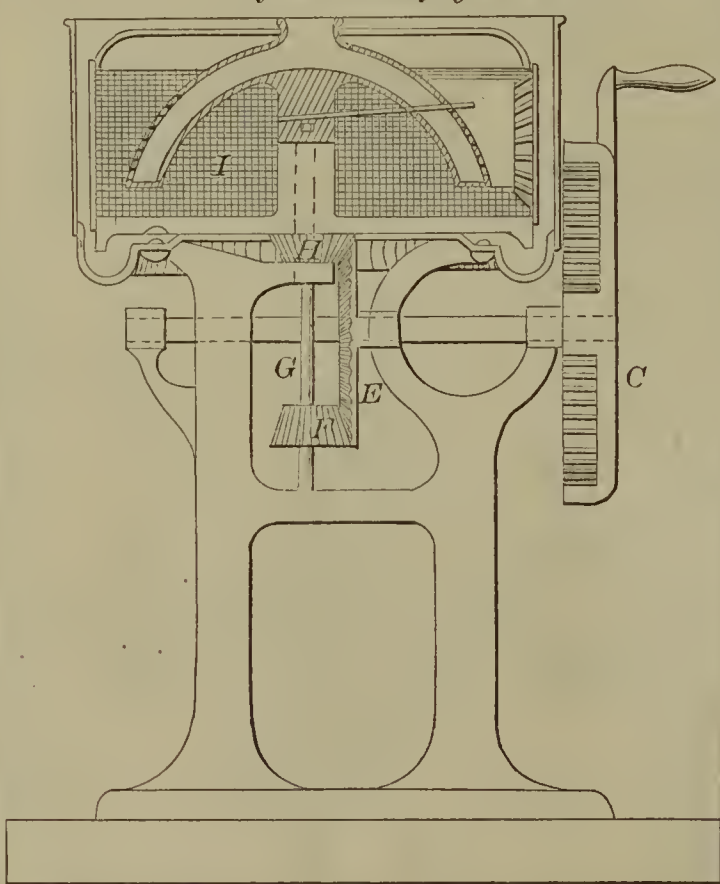

57521—T. D. Larkin—Handle for Cutlery.

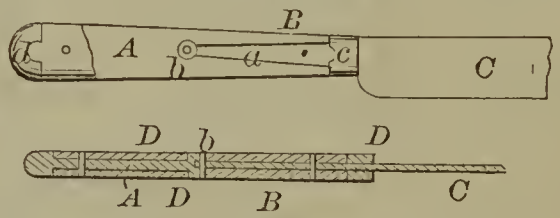

57522—J. D. Leach—For Holding the Heads of Casks.

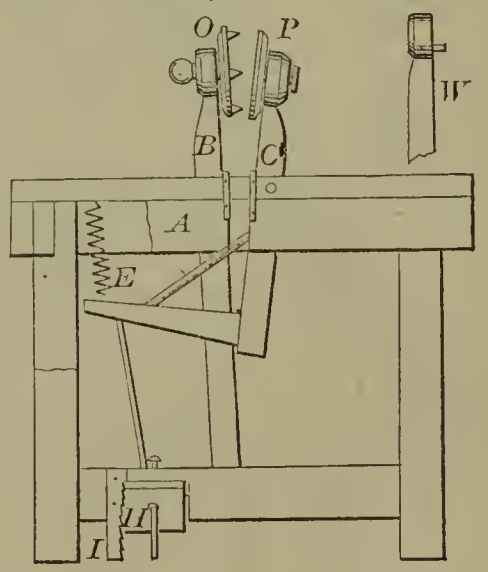



57523—J. & S. W Little—Evaporator.

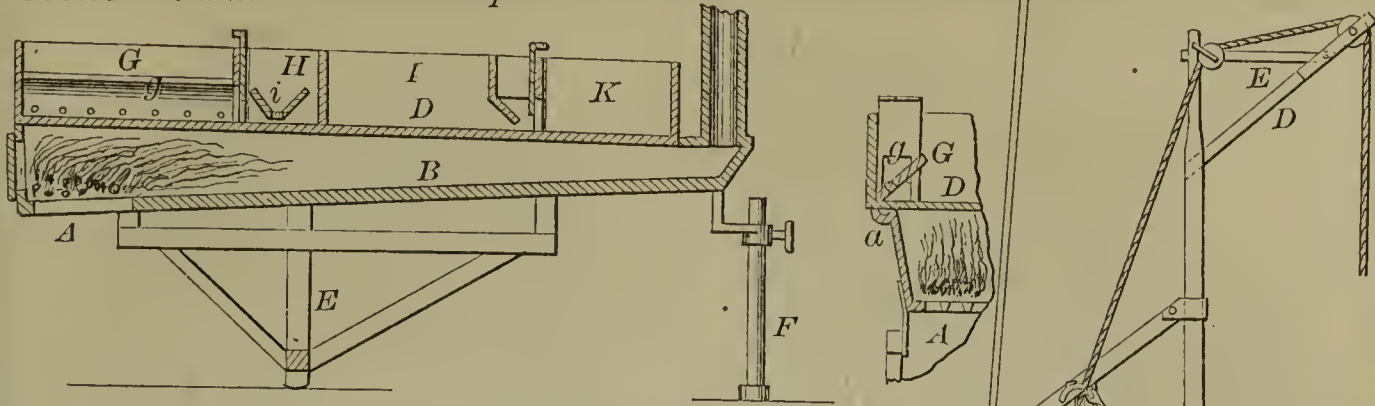

57527—J. K. Lowe—Bronzing Machine.

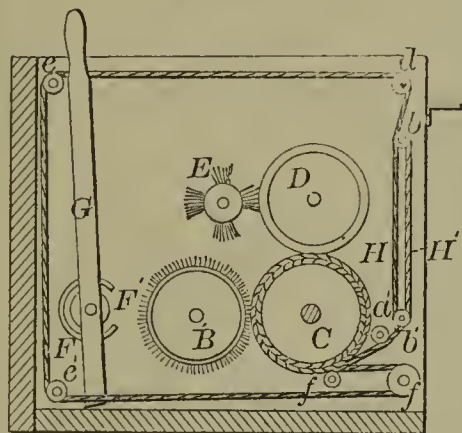

57525—W. Louden—Hay Stacking Device.

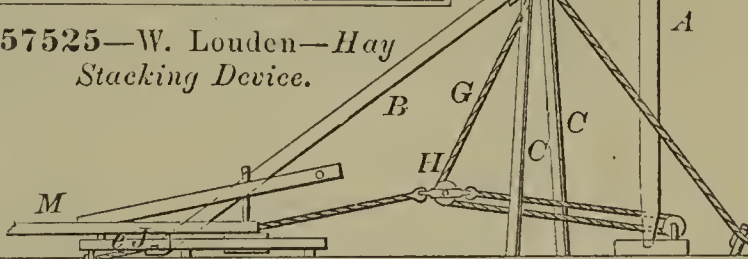

57529—S. C. Maine—Screening and Sifting Apparatus.

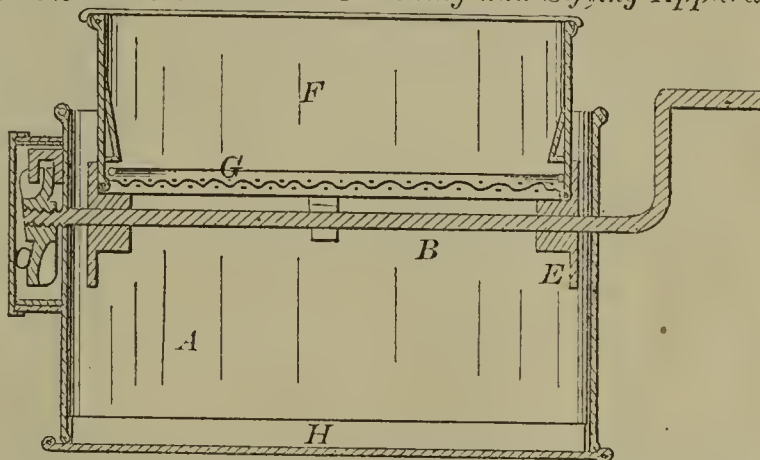

57526—A. & J. London—Water Closet Valve.

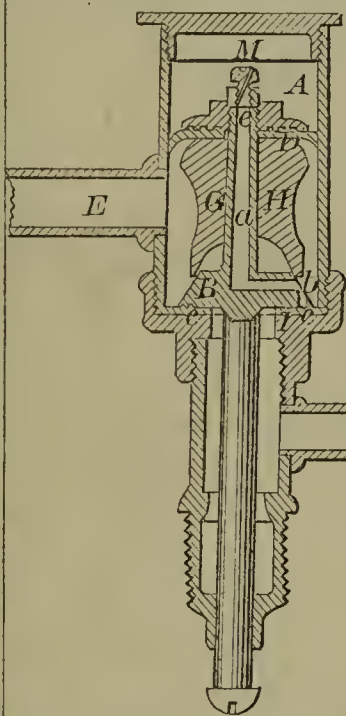

57531—S. G. Mason—Pump Piston.

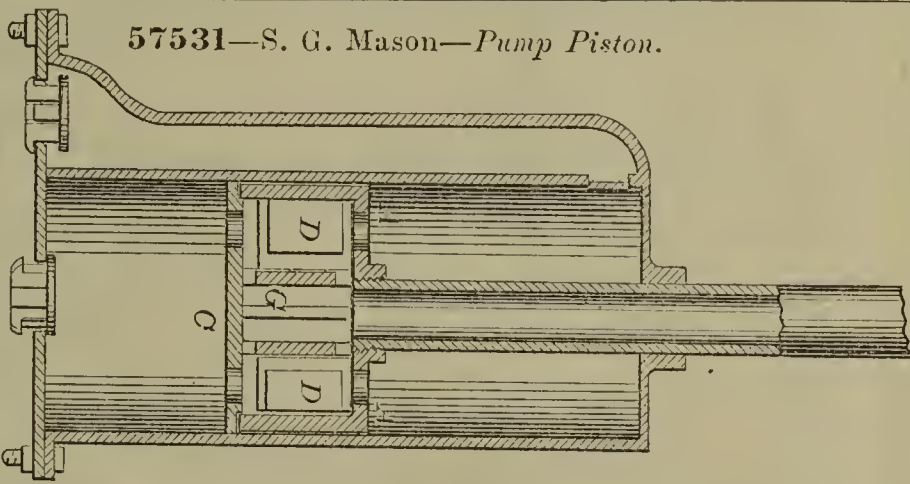

57524—H. O. Lothrop—Applying Screw Mouth Pieces to Cans, &c.

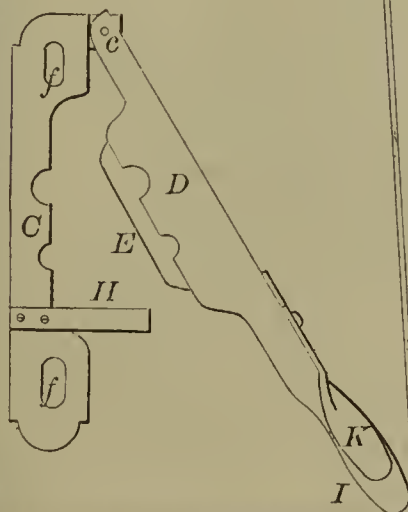

57532—W. McArthur—Carpet Cleaning Machine.

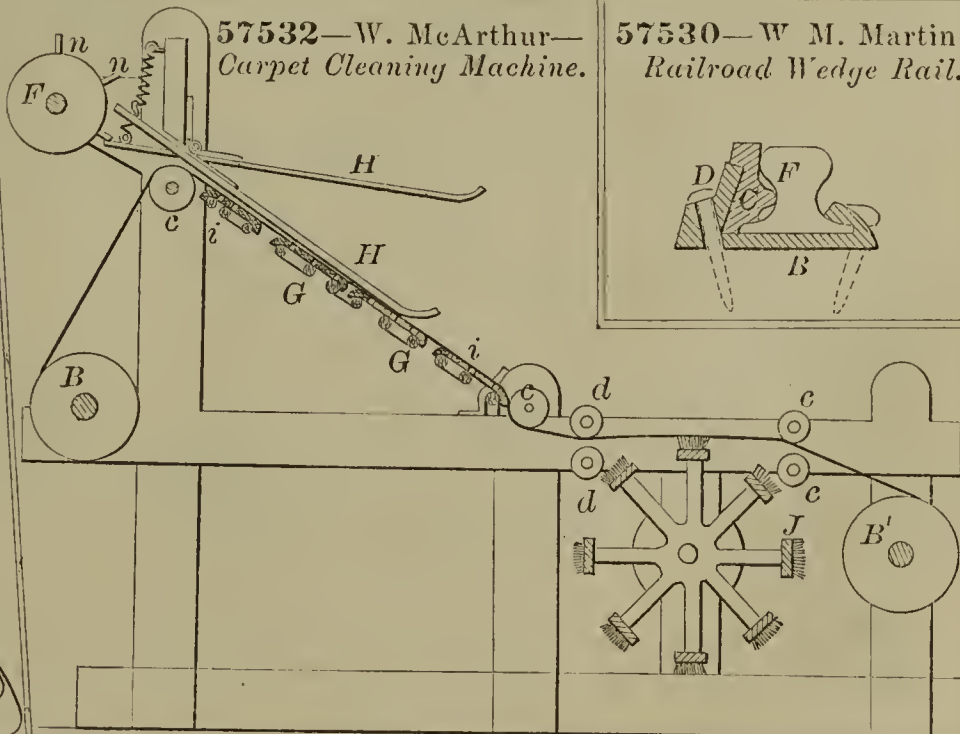

57530—W. M. Martin—Railroad Wedge Rail.

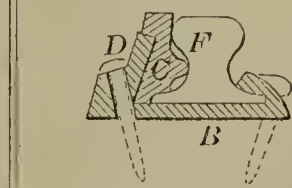

57533—J. McBride—For Cutting Oval Holes in Boiler Heads.

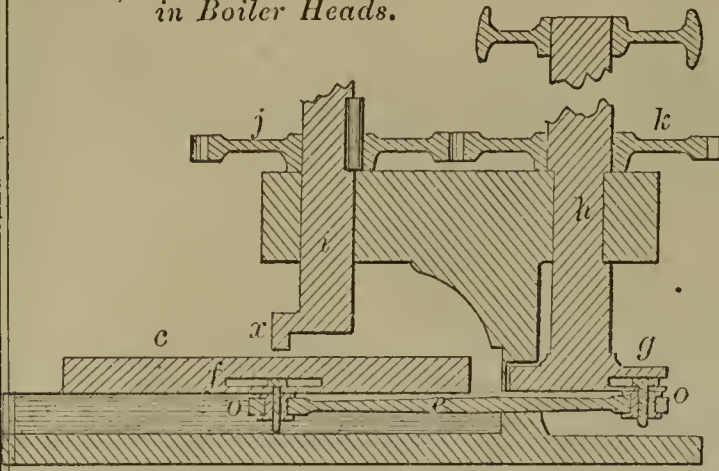

57534—J. McBride—For Cutting Oval Holes in Boiler Heads.

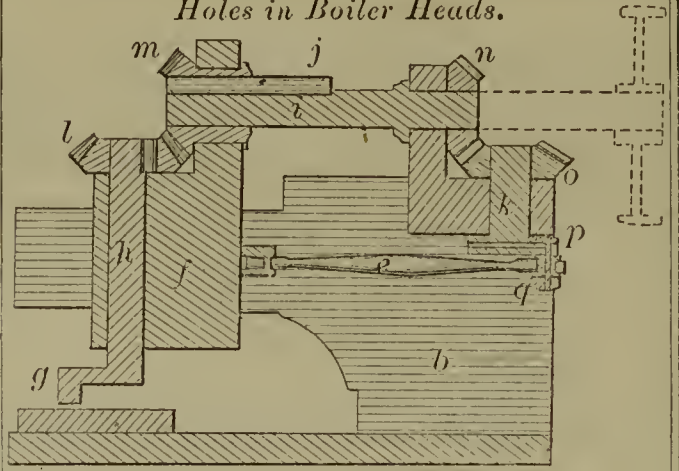

57535—J. McCalvey—Hoisting Machine.

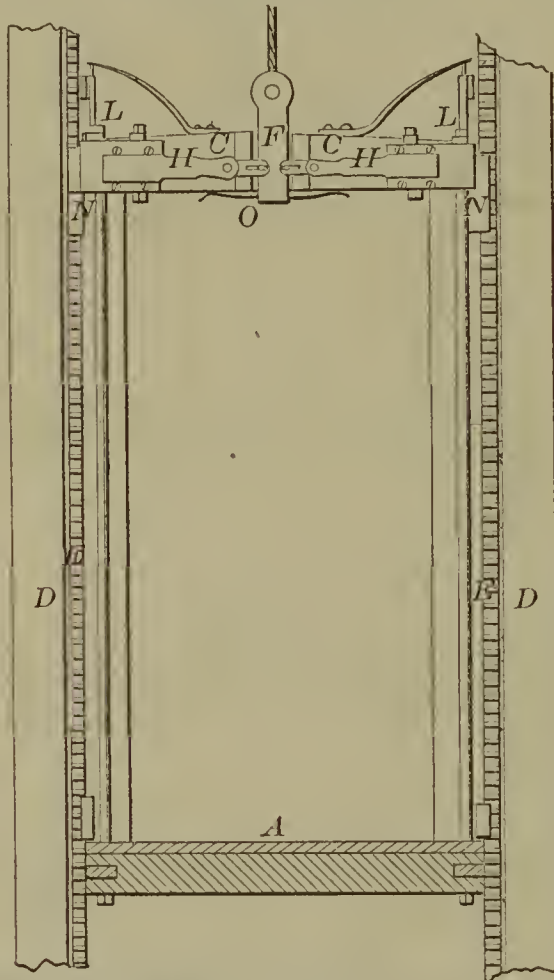
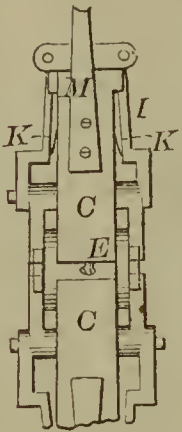

57538—J. S. McGlumphy—Wagon Brake.

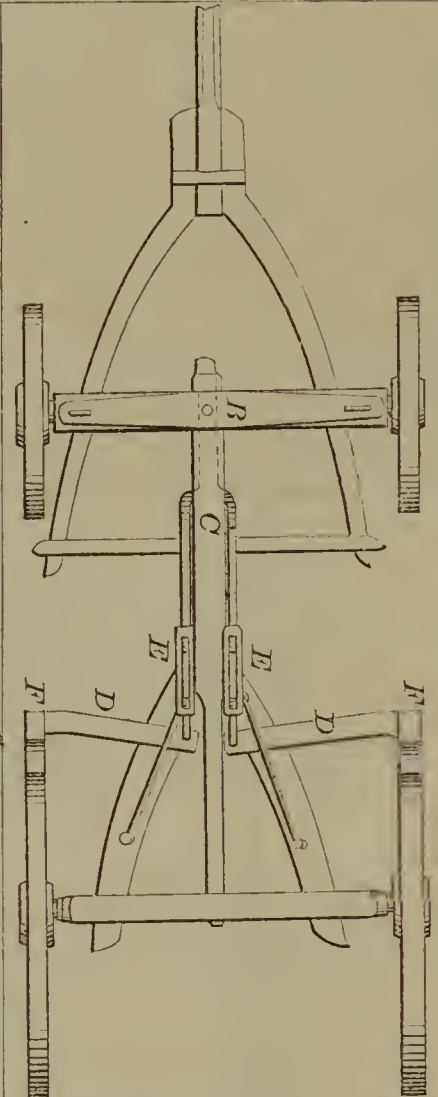

57540—G. Mein—Banjo.



57536—J. McCrum—Drilling Attachment for Turning Lathes.

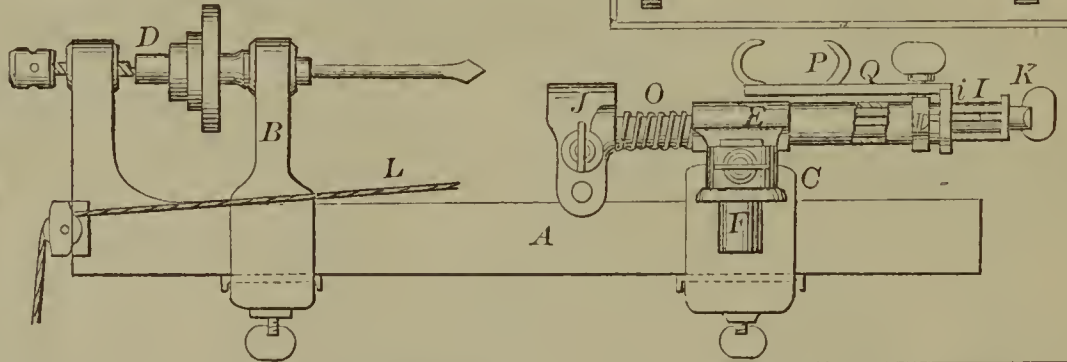

57537—D. McCurdy—Farm Gate.

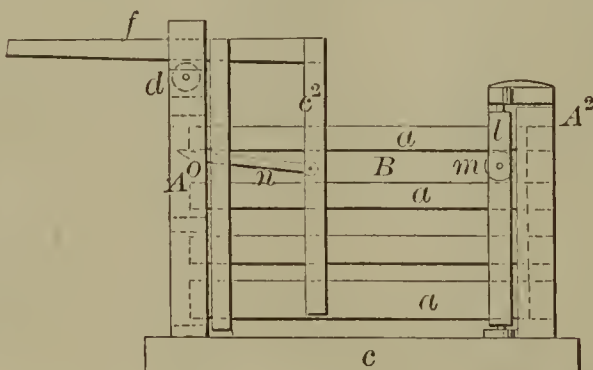

57539—W. McLean—Seal Lock.

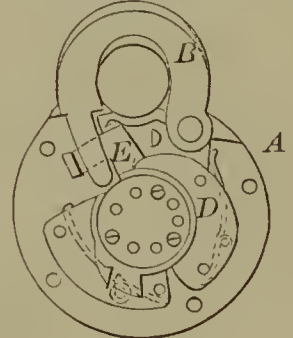

57541—J. H. Melick—*Threshing Machine.*

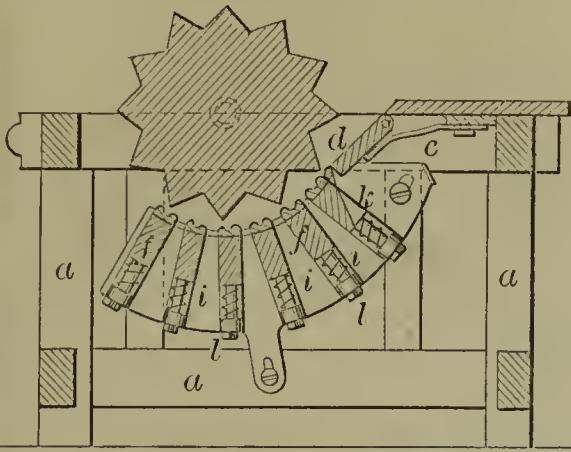

57542—E. Michaels—*For Splitting Bark upon Trees.*

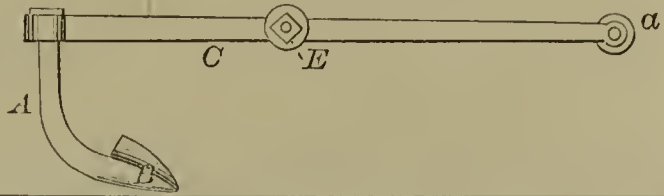

57544—R. S. Miller—*Stove Pipe Damper.*

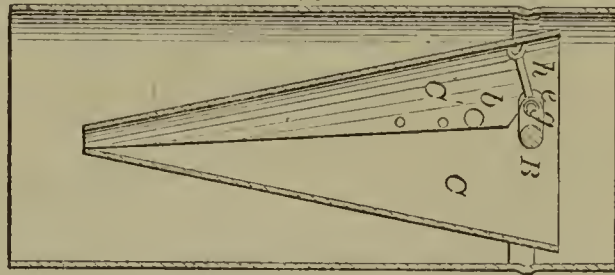

57543—P. Mihan—*For Carburetting Air.*

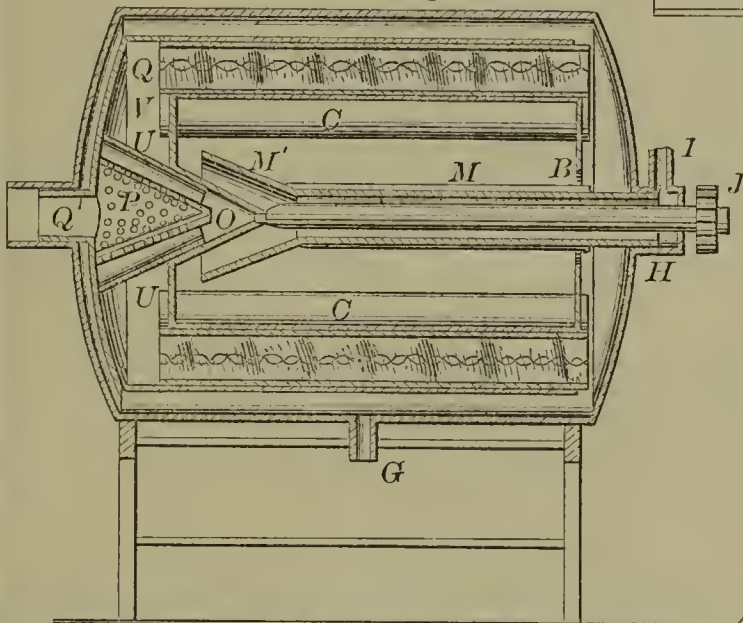

57545—W. K. Miller—*Burial Case.*

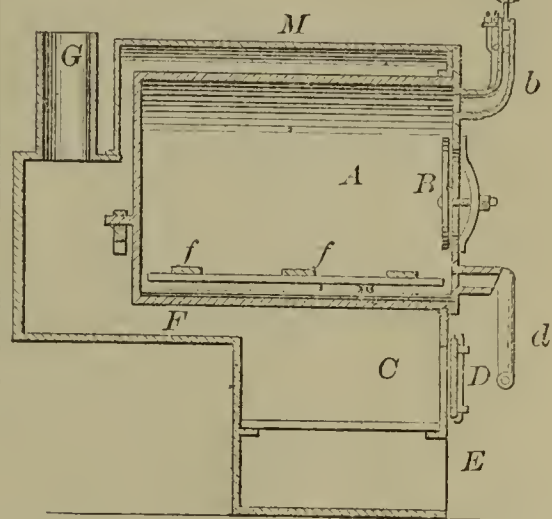

57546—J. E. Moeller—*Water Elevator.*

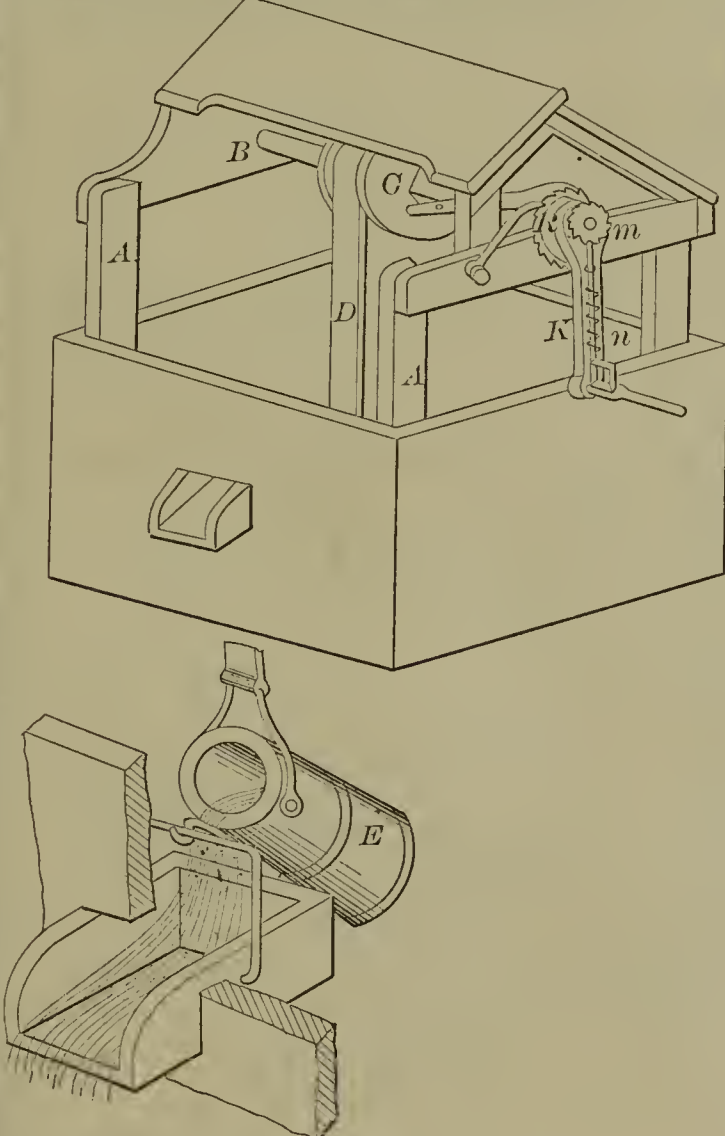

57547—I. & C. M. Morris—*Wrench.*

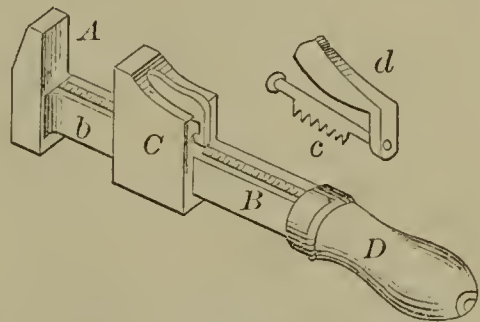

57548—J. J. Morris—*Carriage.*

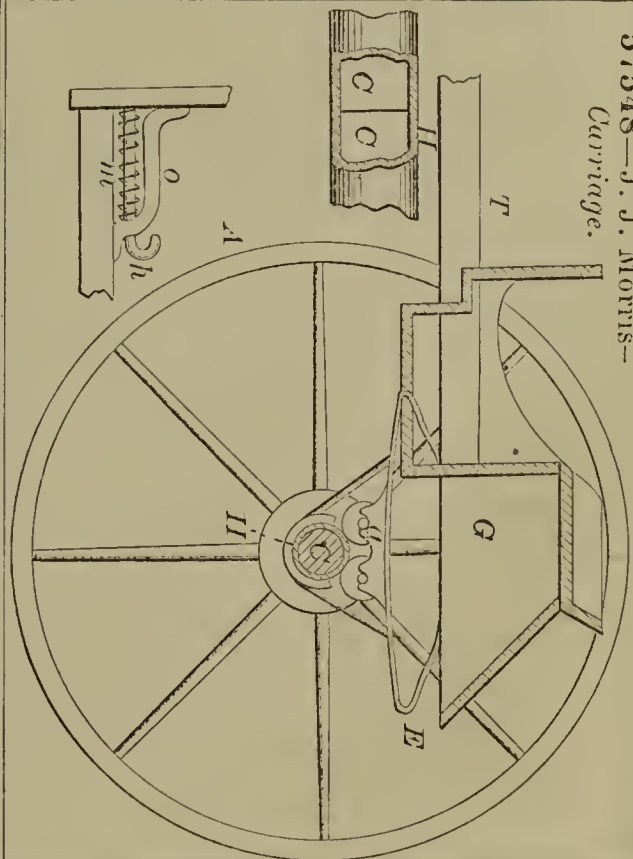

57549—R. Morris—Reaping Machine.

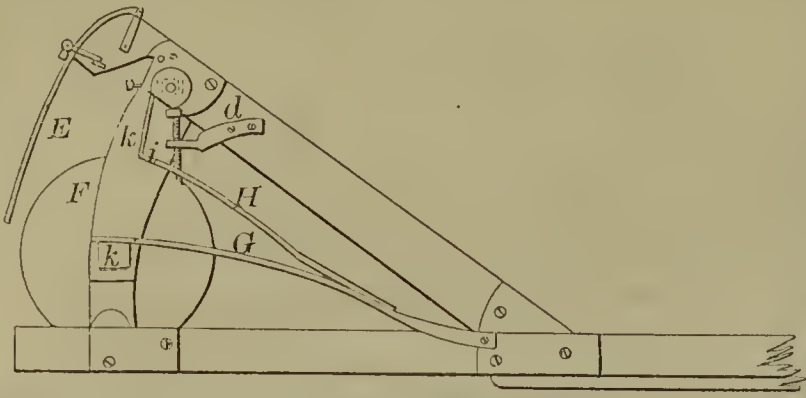

57554—W. S. Nelson—Hat.

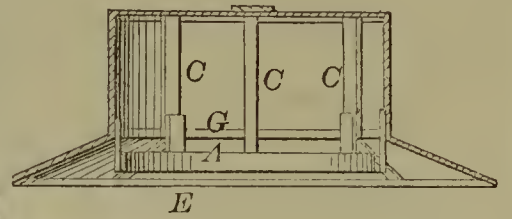

57550—Munger & Jones—Dry Dock.

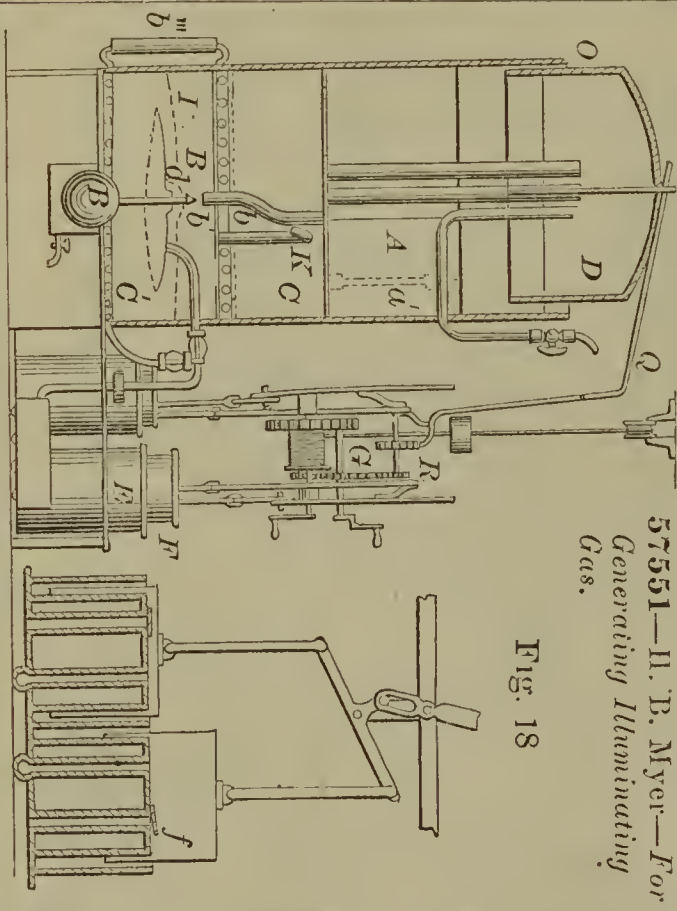
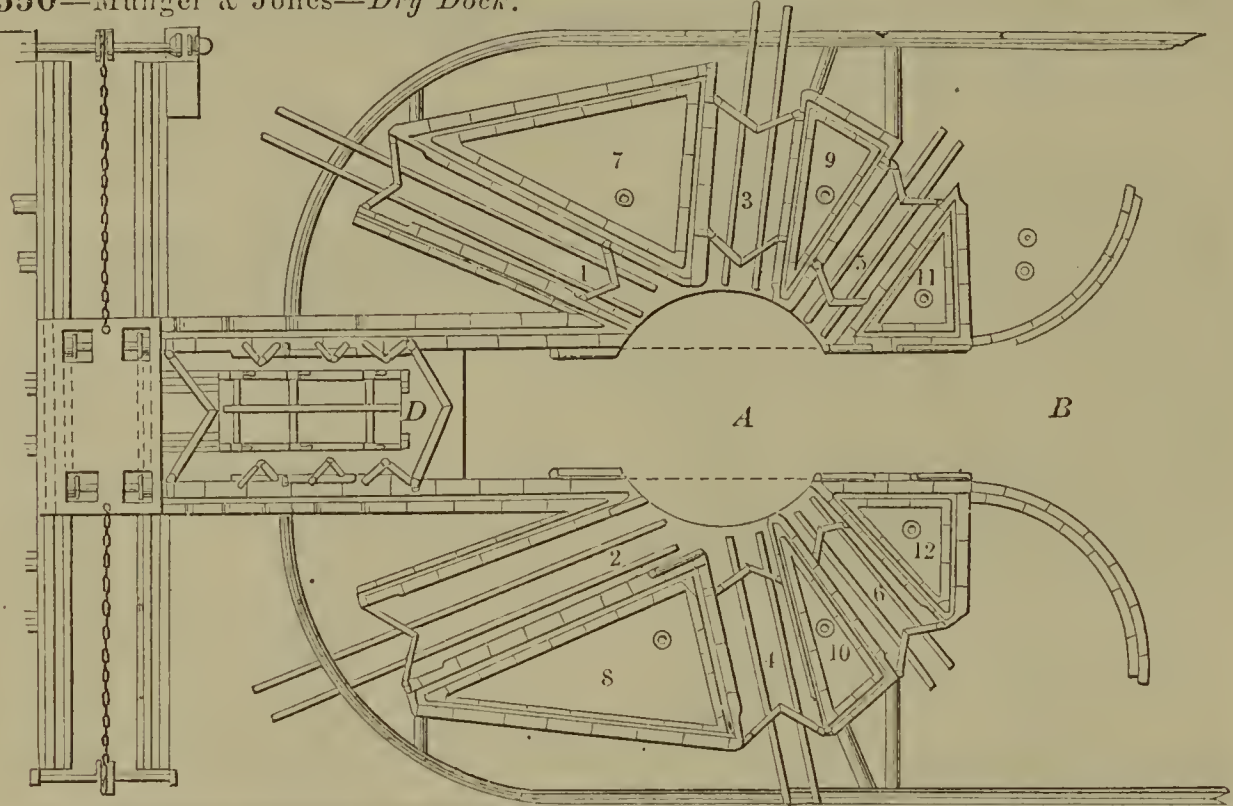
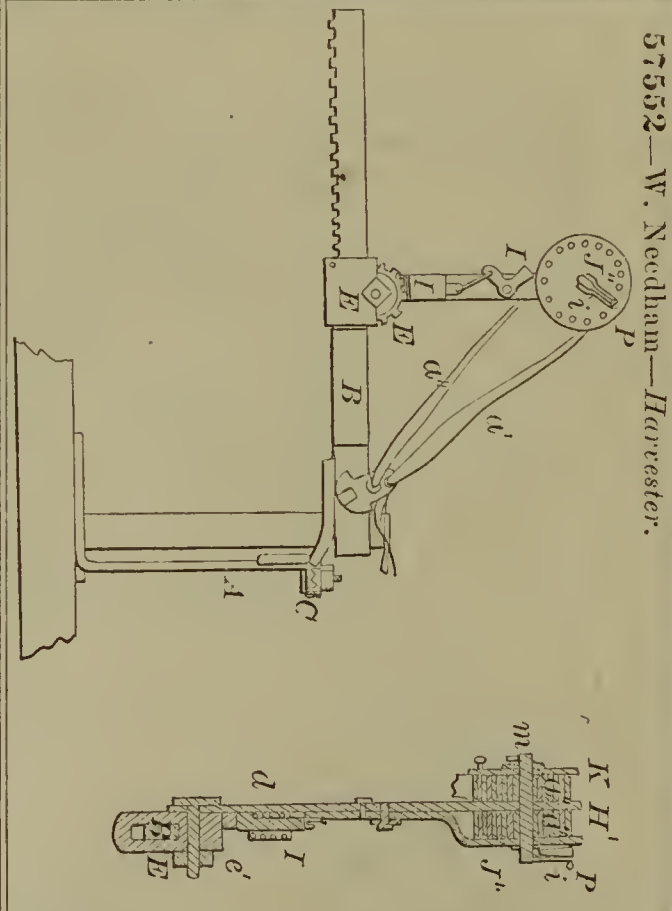
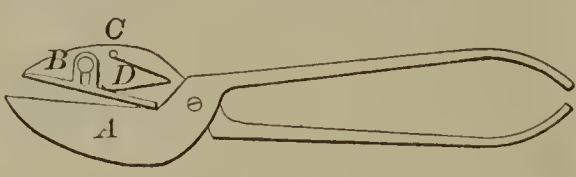

Fig. 18

57551—H. B. Meyer—For Generating Illuminating Gas.

57553—J. Neff, Jr.—Fruit Picker.



57552—W. Needham—Harvester.

57555—N. C. Newell—Covered Button.

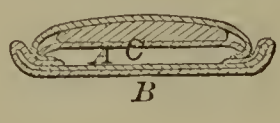

57556—I. H. Newton—Saw Mill.

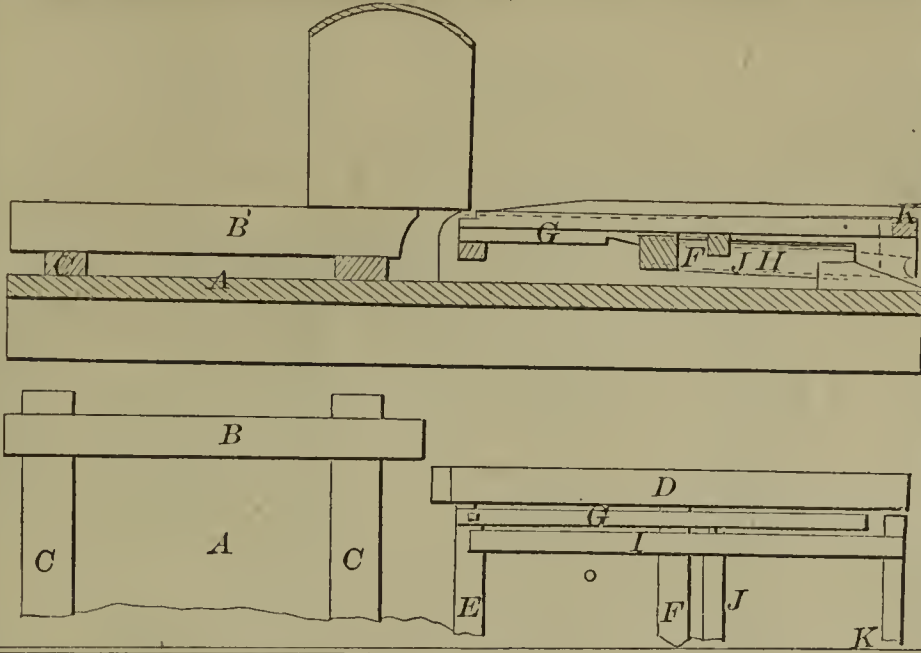

57557—D. H. Nichols—Sorghum Stripper.

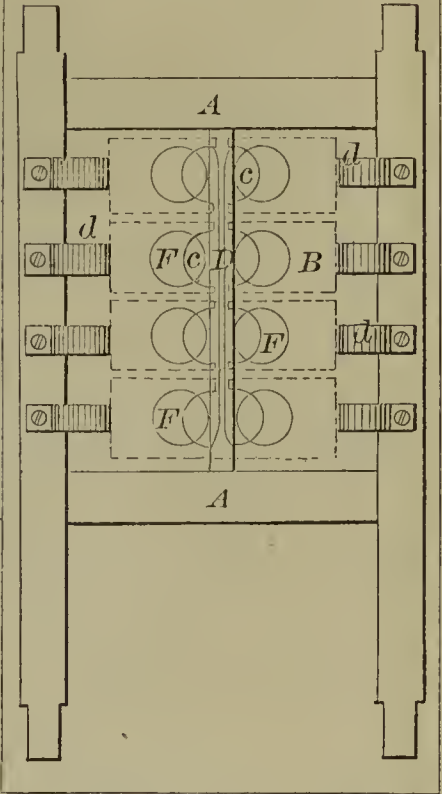

57559—J. C. D. Outwater—Disinfector.

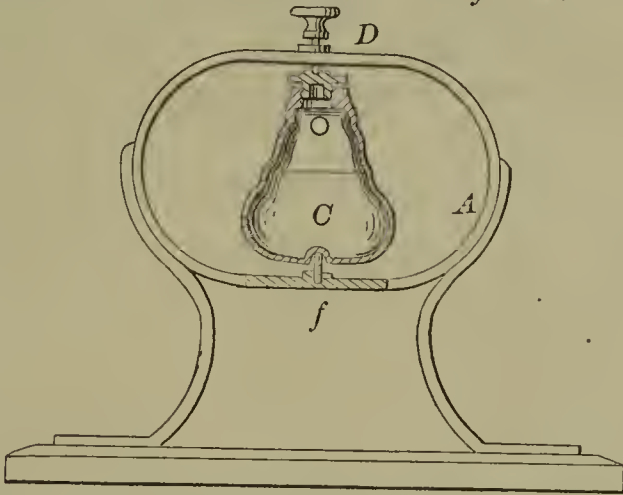

57560—J. D. Patton—Bed Bottom.

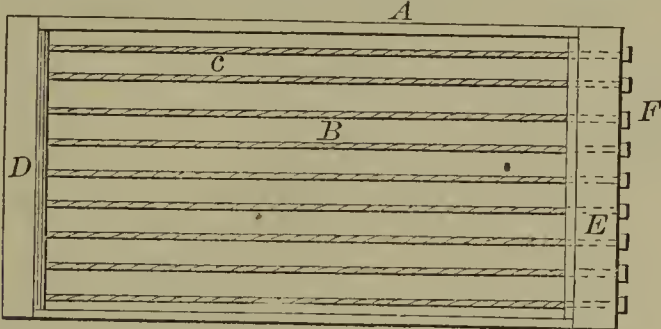

57562—Porter & C. E. & G. F. Jenkins—Cultivator.

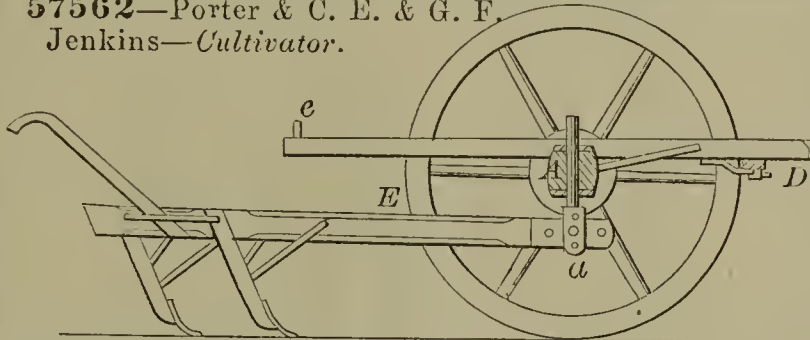

57563—H. S. Potter—Corn Cultivator.

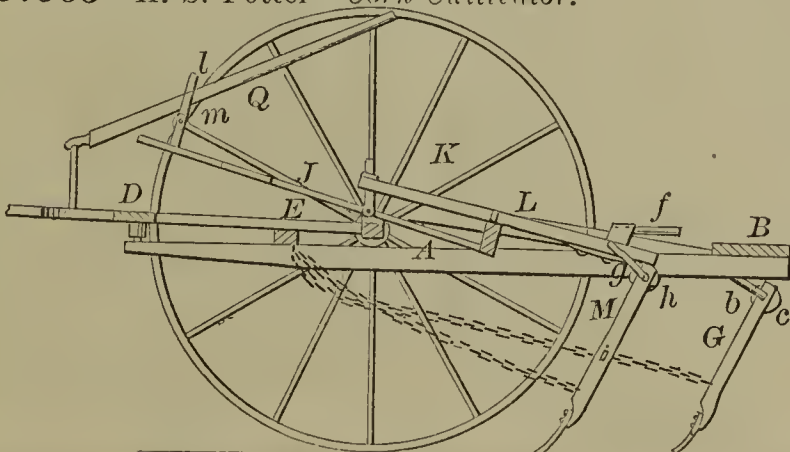

57564—Prosser & Lawson—Knife and Scissors Sharpener.

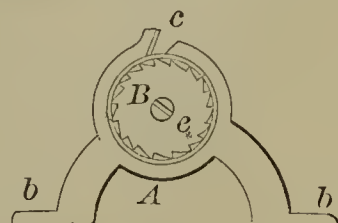

57558—J. W. Otto—Piano.

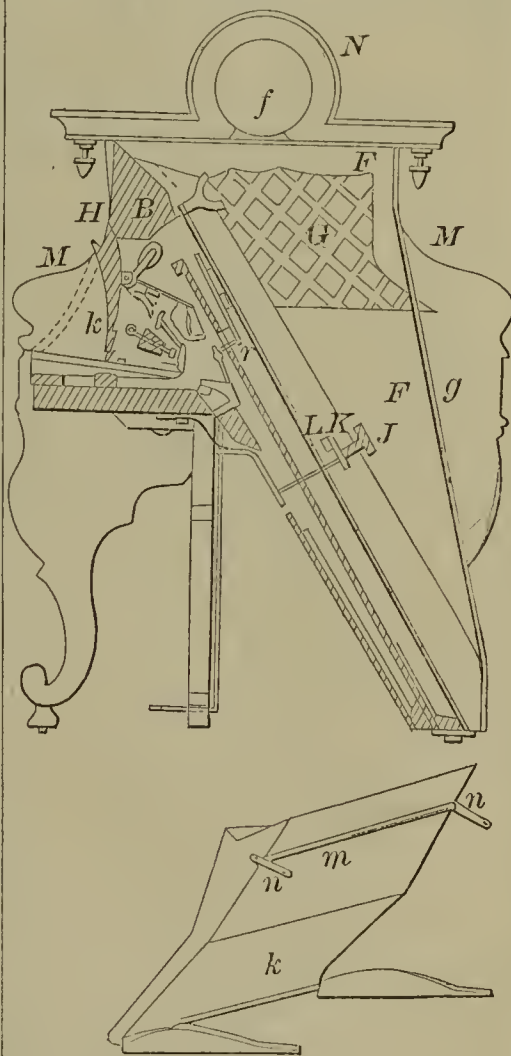

57565—P. Pryibril—Saw Mill.

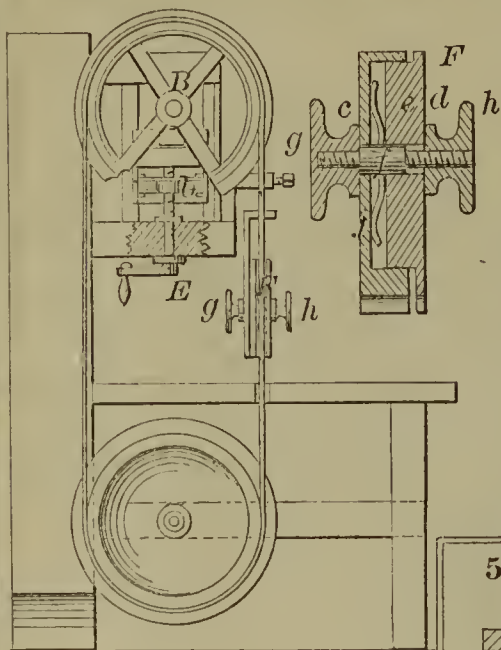

57571—N. B. Reynolds—Tool Grinding Machine.

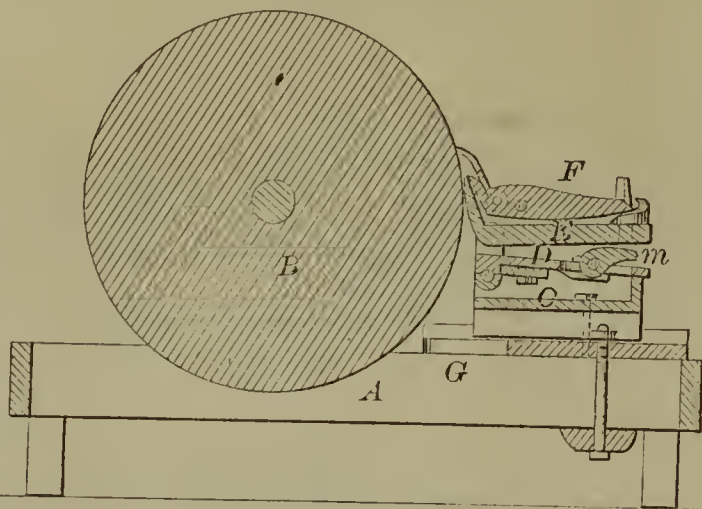

57566—S. S. Quest—Car Coupling.

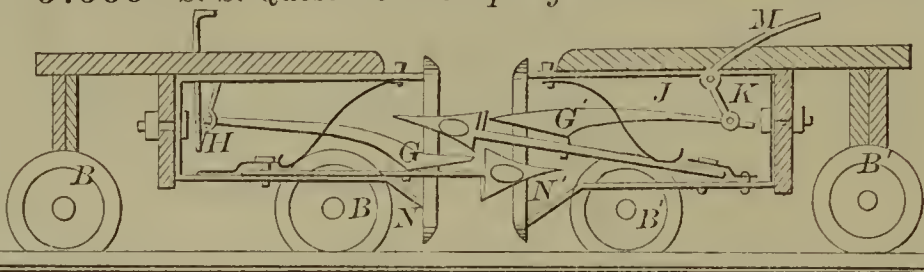

57570—J. Regester—Water Closet Valve.

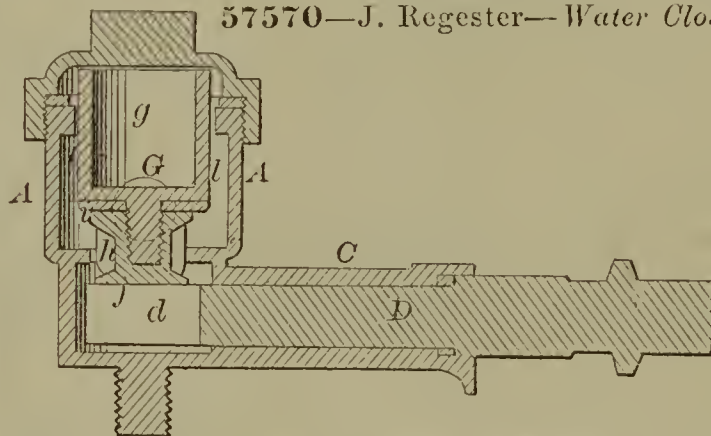

57568—G. Ray—Potato Digger.

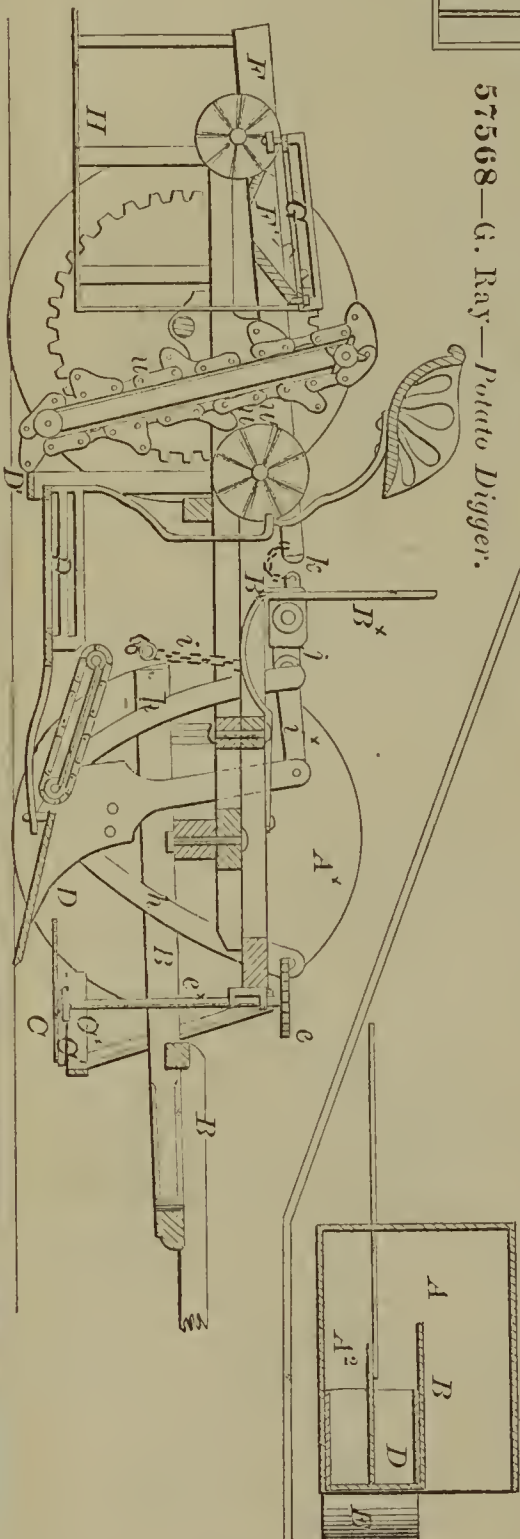

57569—E. Raynole—Canal Boat Propeller.



57572—Ruth & De Long—Store Pipe Drum.

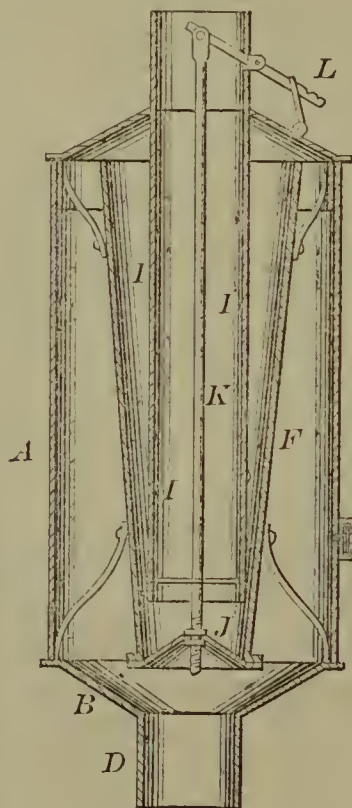

57573—G. H. Sanborn—Churn.

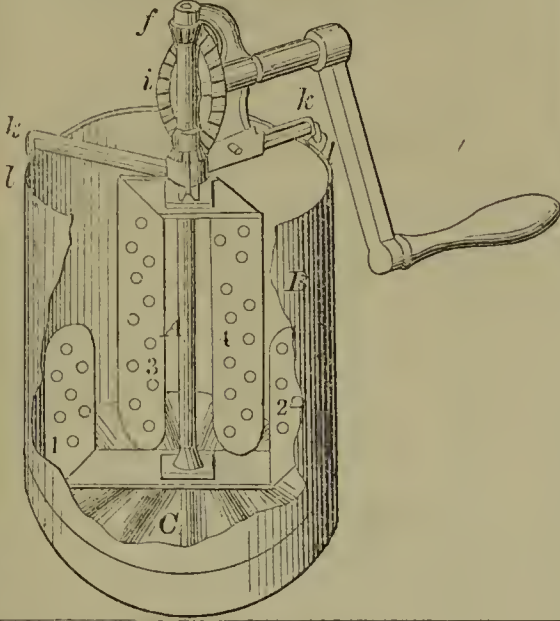

57577—H. S. Saroni—For Steaming Vegetables, &c.

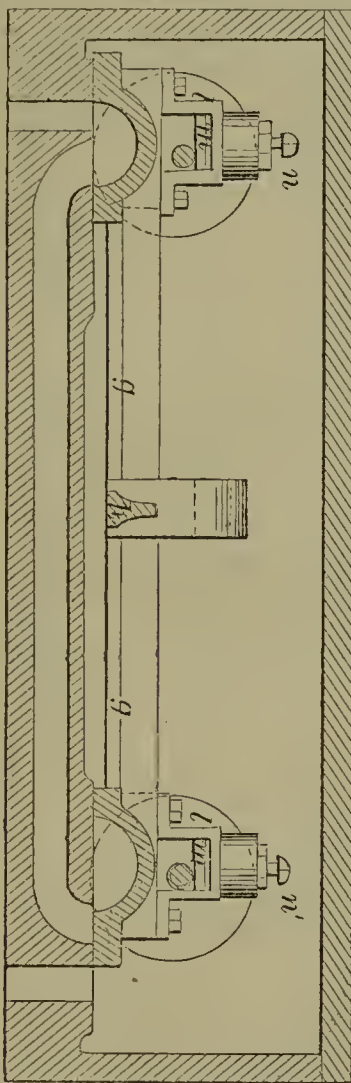
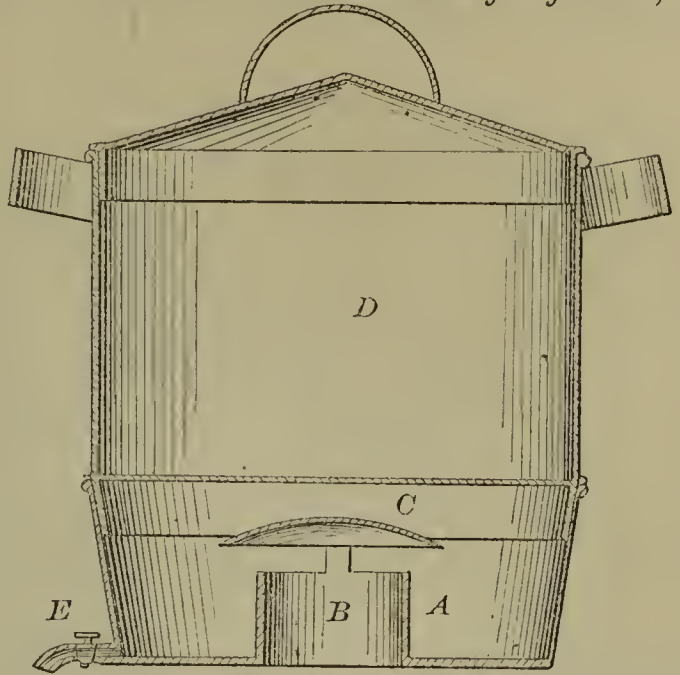

57579—T. Sault—Steam Engine Slide Valve.

57575—H. S. Saroni—Steam Generator.

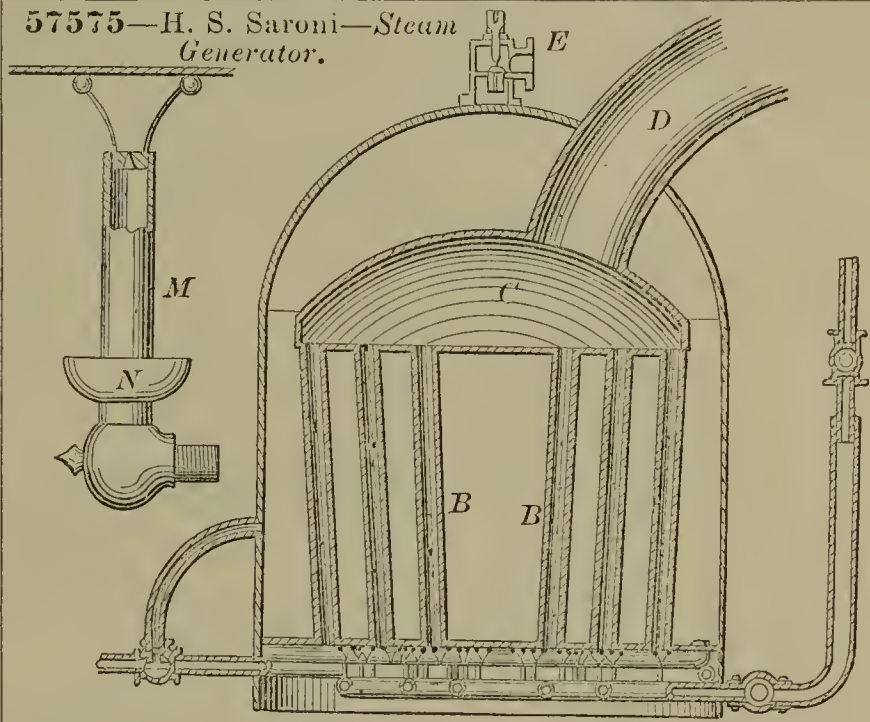

57580—W. Schnebley—Grain Meter.

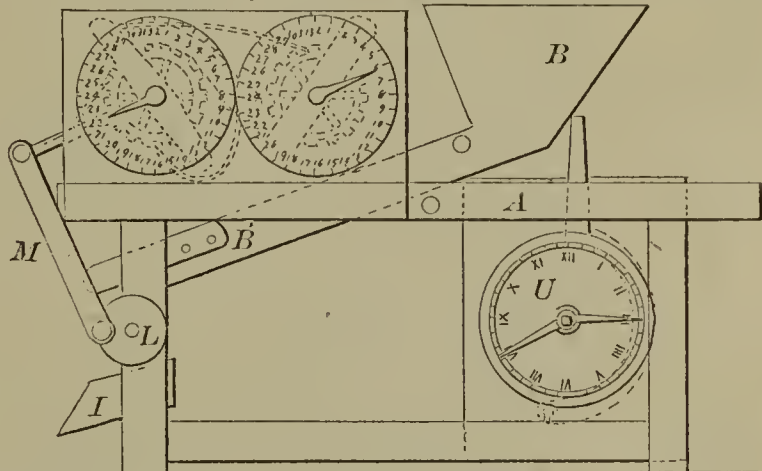

57574—J. Sargent—Lock.

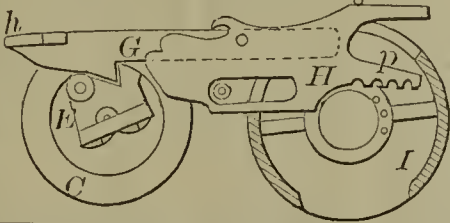

57576—H. S. Saroni—Steam Generator Feed Water Heater.

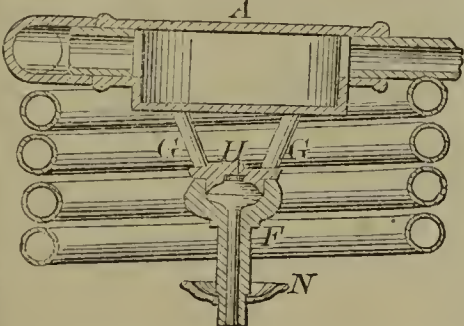

57578—H. S. Saroni—Vapor Burner.

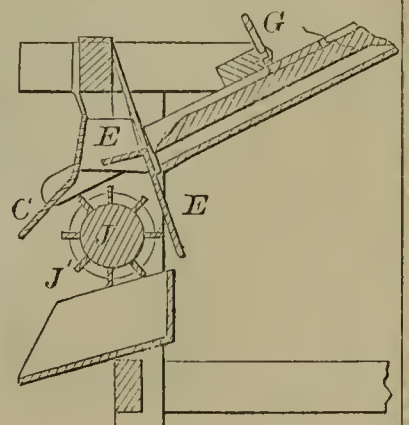
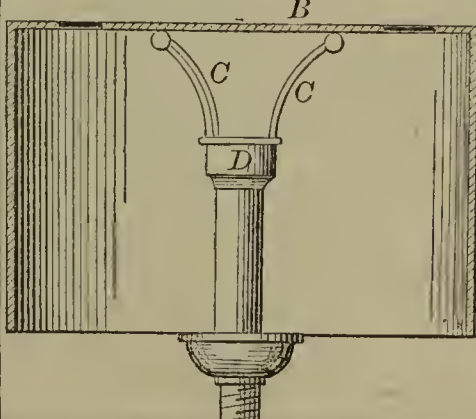

57581—C. Seabaugh—Fence.

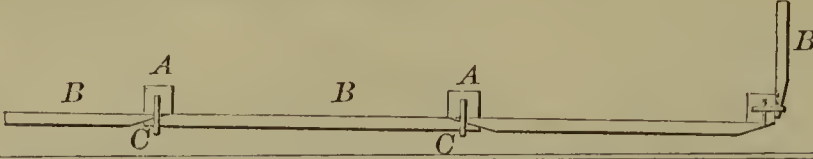

57583—J. F. Seiberling—Harvester.

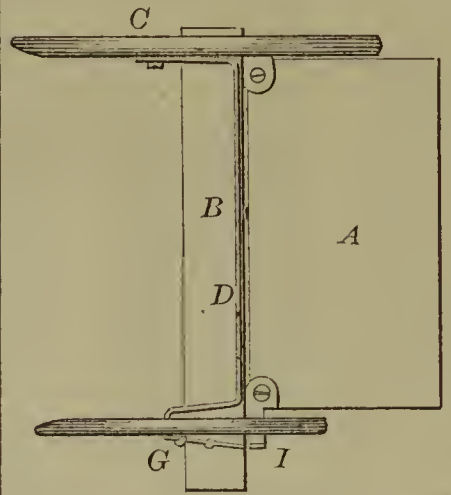

57584—Seymour & Barnard—Button Hole Cutter.

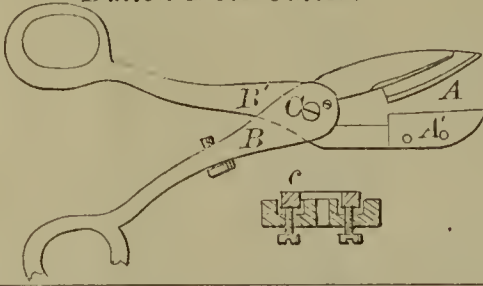

57582—O. W. Seely—Churn.

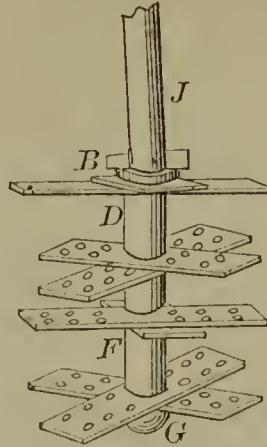

57585—J. Shellenberger—Sewing Machine Shuttle Carrier.

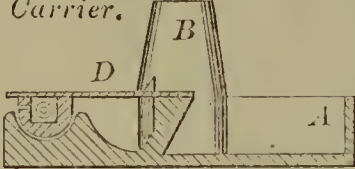

57586—S. Sherman—Stone Sawing Machine.

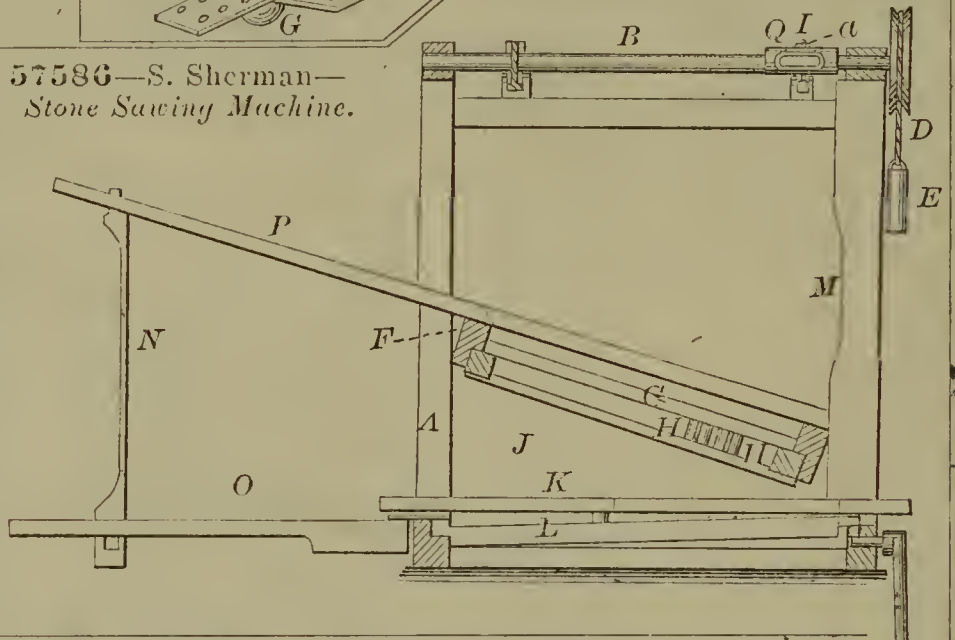

57587—A. G. Smith—Lamp.

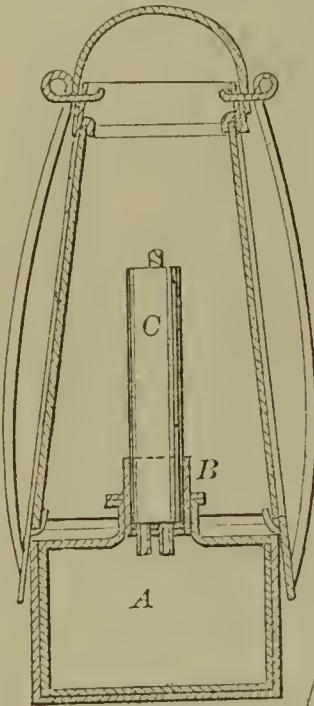

57588—P. Soper—Calipers.

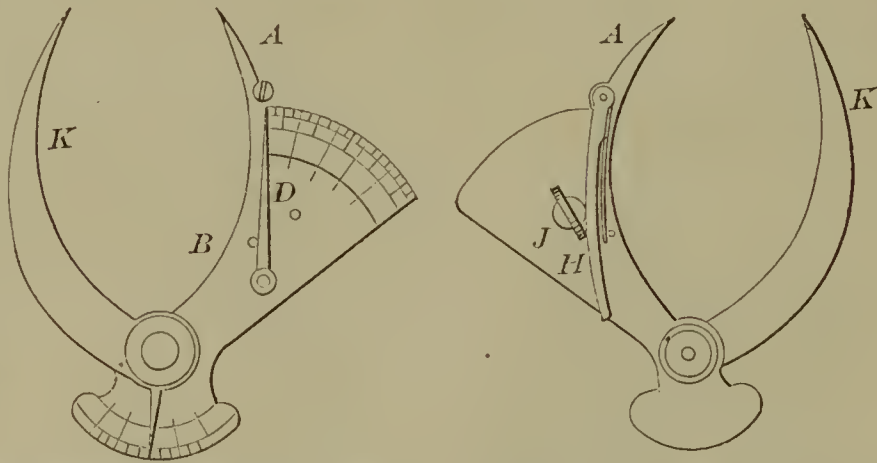

57589—T. E. Sparks—Lamp.

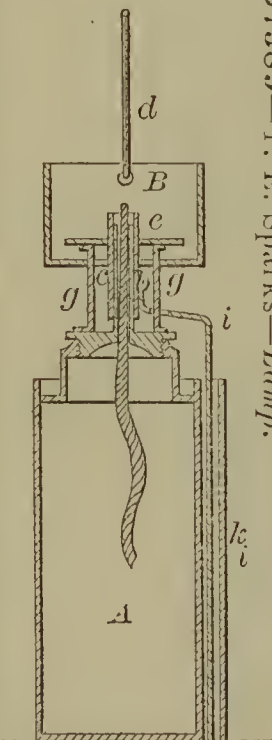

57590—W. & H. Sperry—Hedge Trimmer.

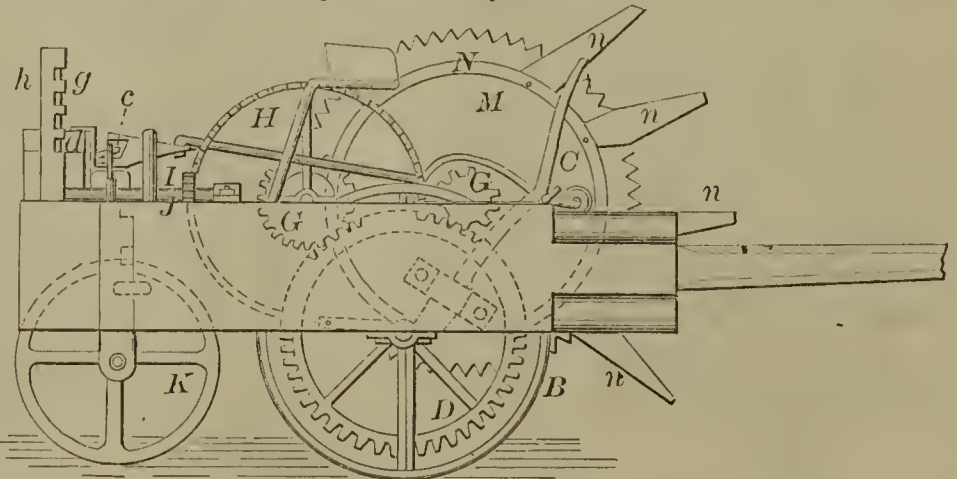



57591—C. E. Staples—Sewing Works Holder and Scissors Sharpener.



57592—Stephens & Green—Yarn Printing Machine.

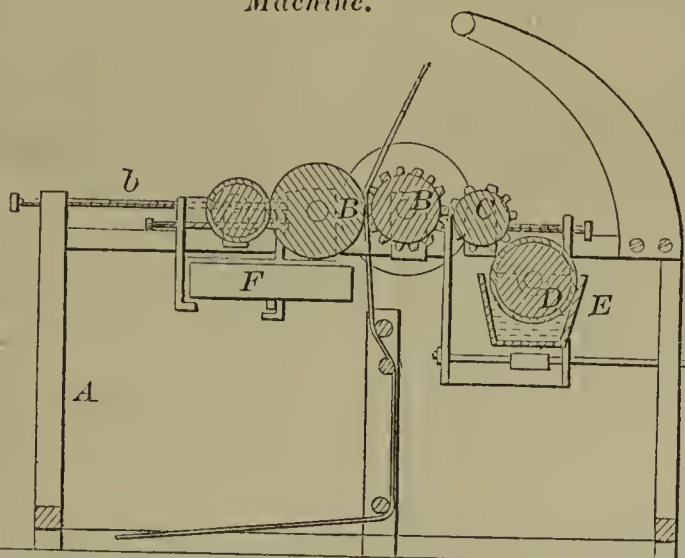

57593—W. W. St. John—Grubbing Machine.

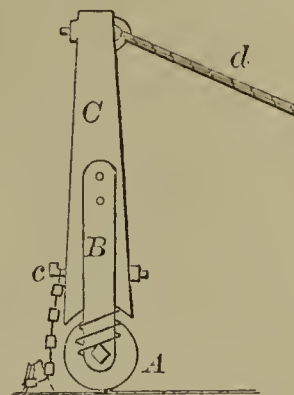

57596—E. C. Strange—Egg Beater and Liquor Mixer.

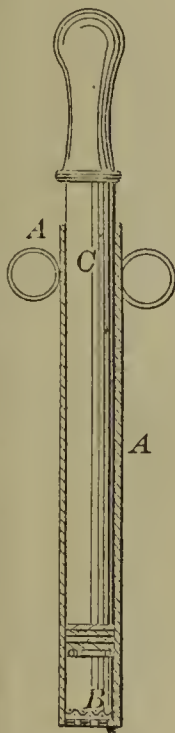

57594—I. Stoffel—Artificial Arm.

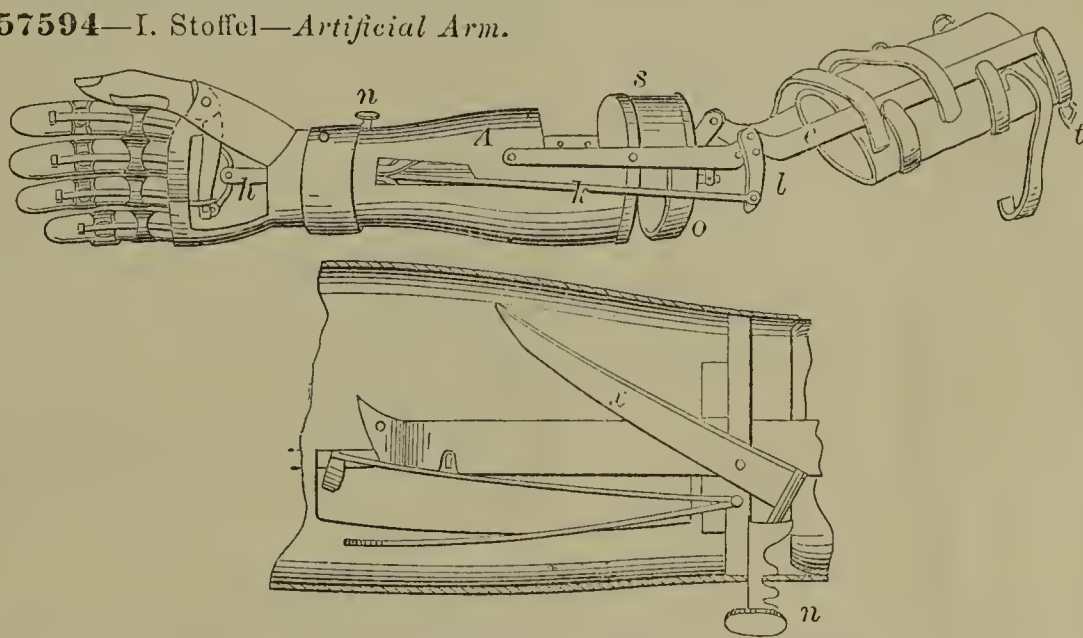

57598—B. Todd—Ladies' Fan.

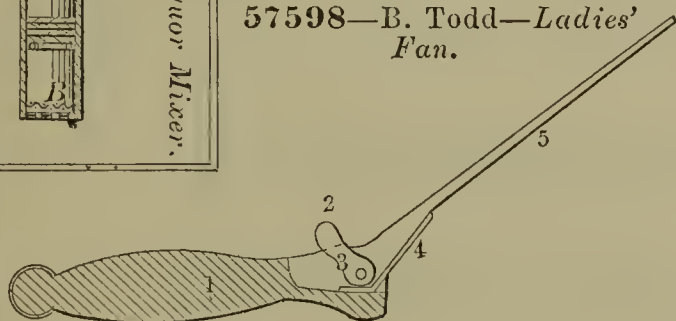

57595—R. E. Strait—Pump.

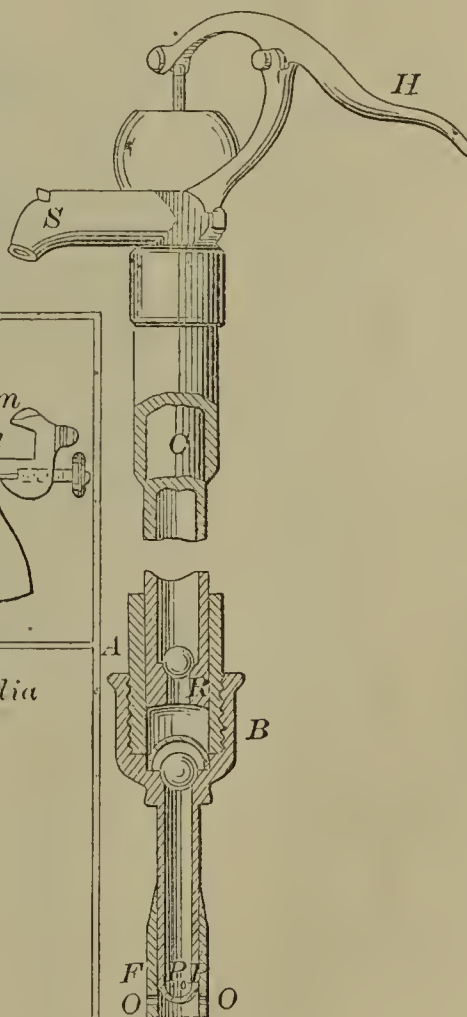

57597—W. A. Sutton—Skate.

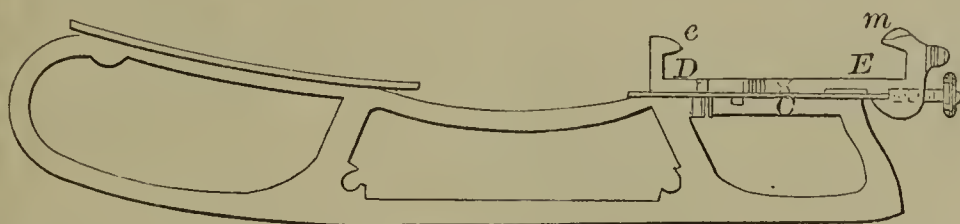

57599—R. Van Horn—Expanding Cheese Hoops.

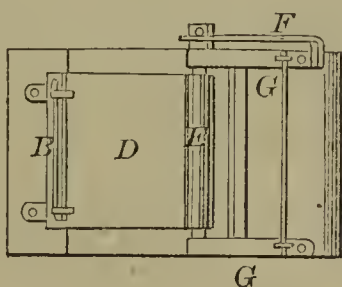

57600—R. Vose—India Rubber Car Spring.

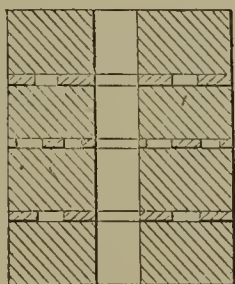

57601—D. T. Ward—Washing Machine.

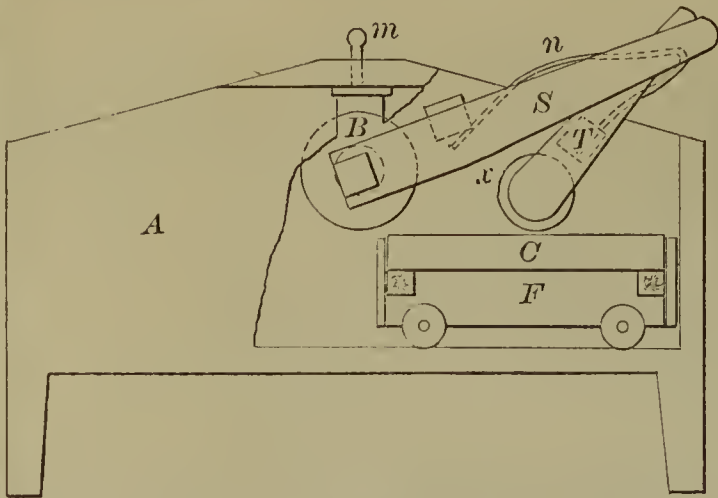

57602—O. Warden—Fluid Lens.

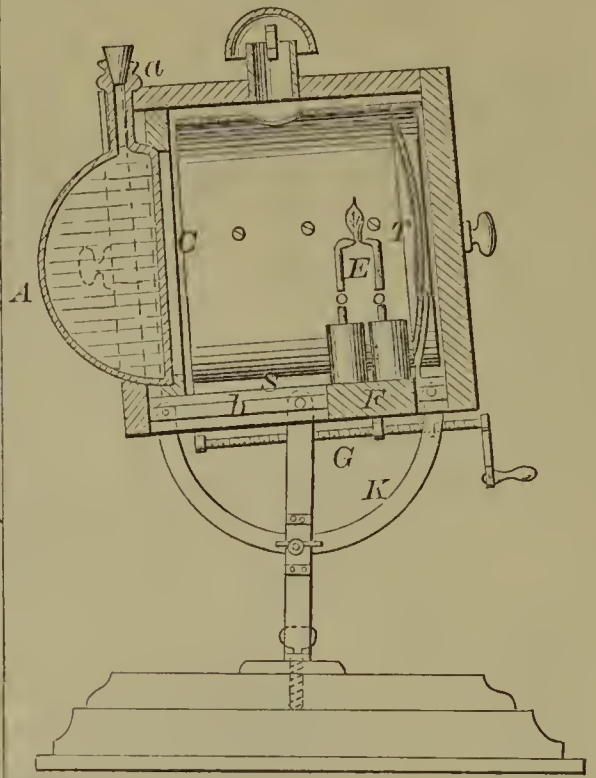

57603—T. Weaver—Whip Socket.

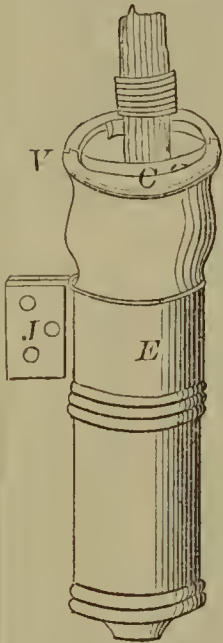

Fig. 2.



Fig. 3.



Fig. 5.



Fig. 6.



Fig. 7.



57606—I. M. West—Churn.

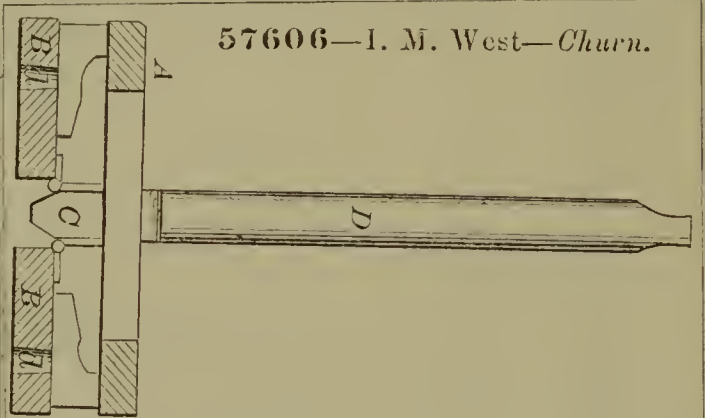

57605—J. A. Welsh—Grain Hulling Machine.

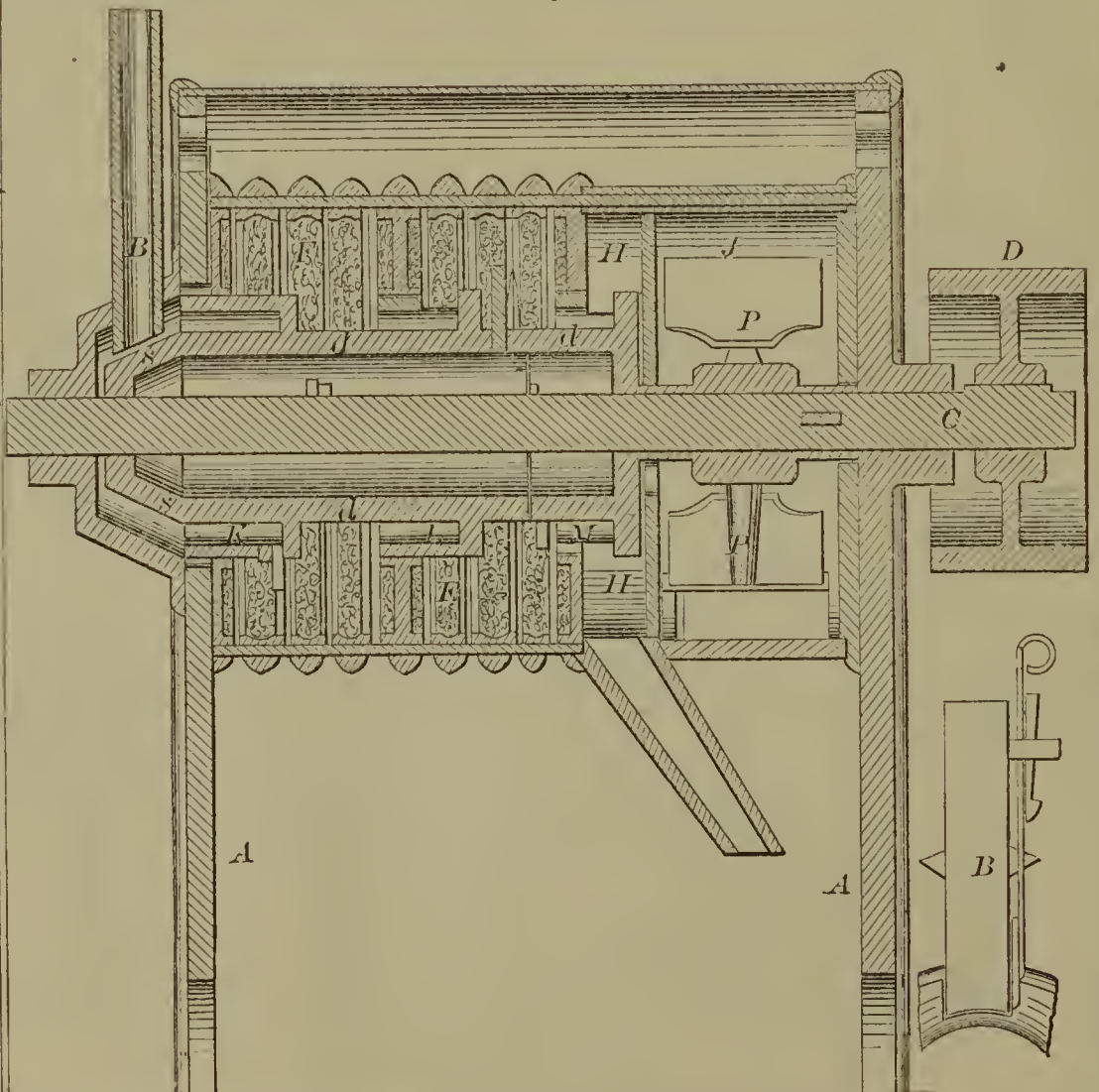

57604—M. D., C. F. & A. Wells—Seed Distributor.

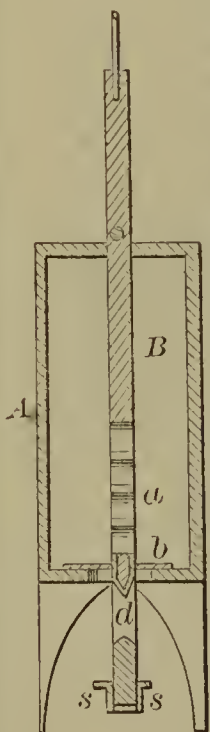

57607—R. White—Fire Arm.

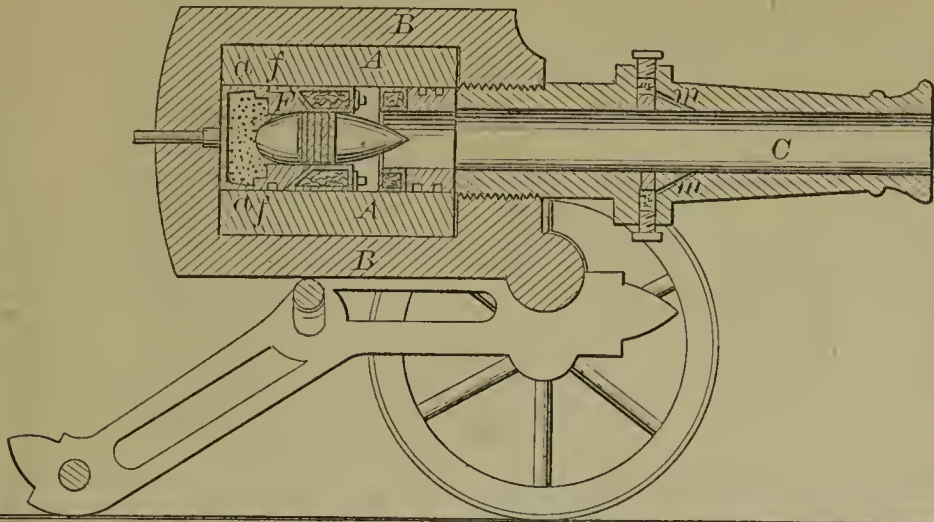

57608—F. Wicks—Horse Power for Elevating Hay, &c.

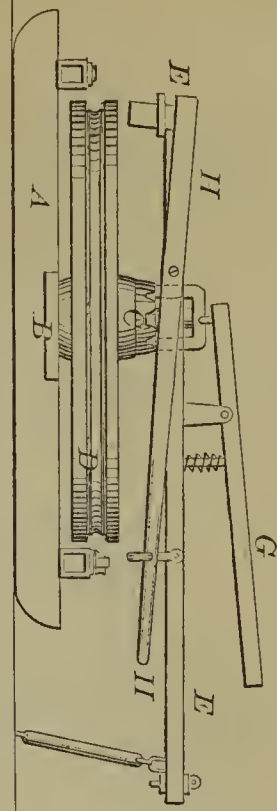

57609—F. Wicks—Horse Hay Fork.

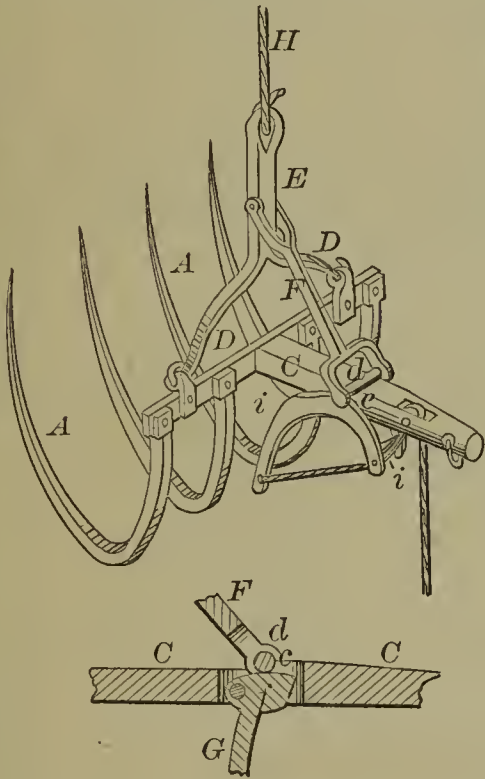

57615—S. Yates—Eaves Trough.

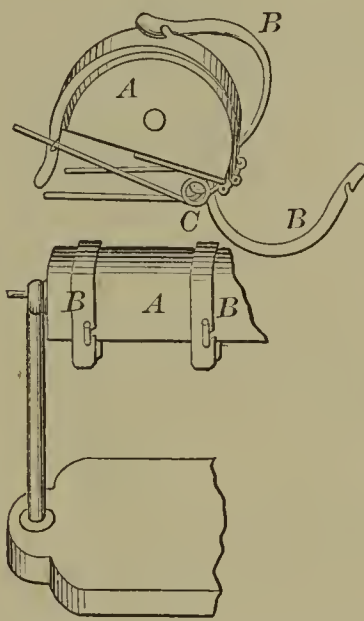

57611—A. S. Wilkinson—Stopping for Horse Feet.

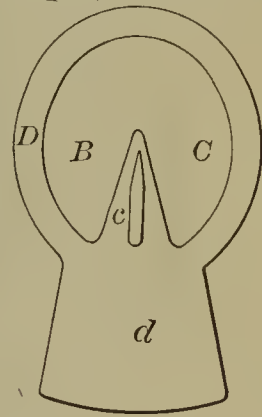

57612—G. L. Wilcox—Sawing Machine.

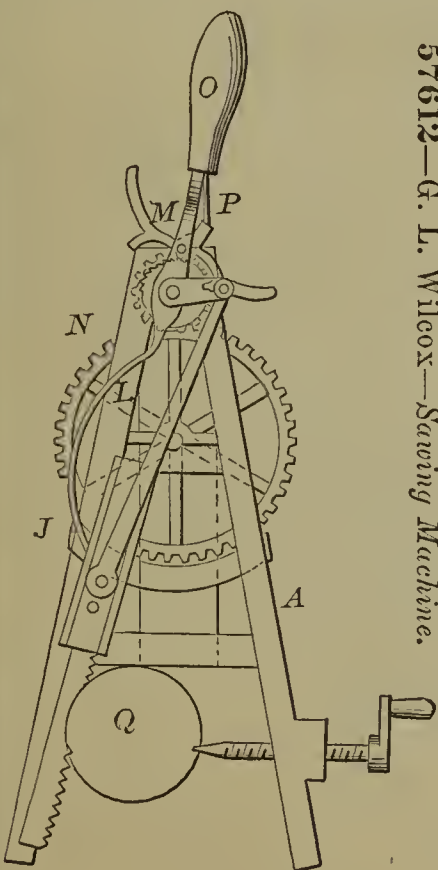

57614—C. Winegar—Excavating Machine.



57610—Wicks & Fowler—Tackle Block for Hay Elevators.

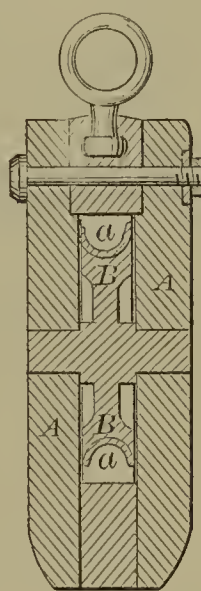

57613—J. Wilson—Steam Trap.

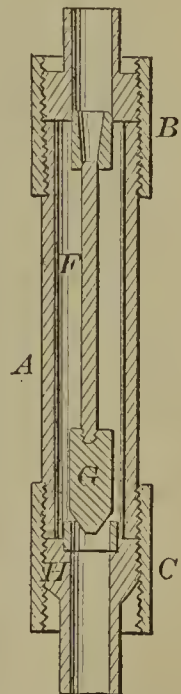

57616—G. T. Allamby—Door Bolt.

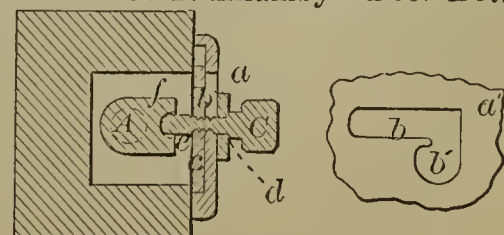

57617—E. Allen—Marking Envelopes. *S'' I u'*

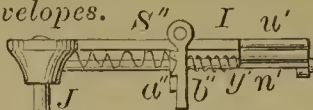
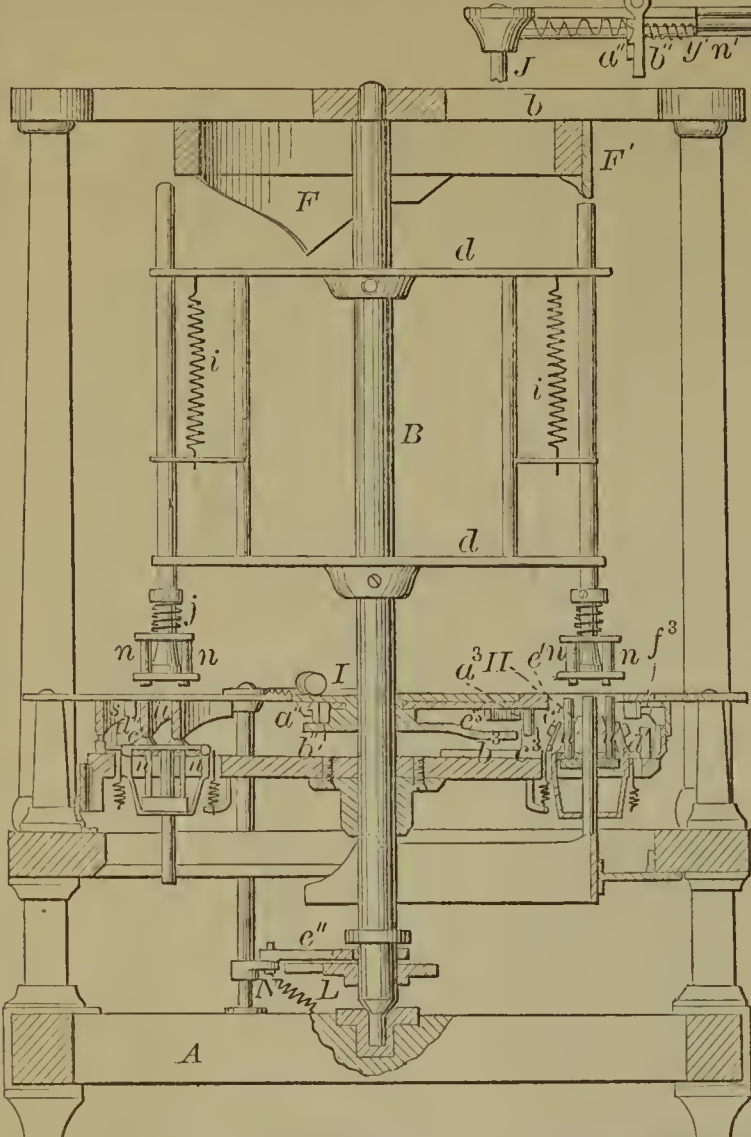

57618—C. W. Baldwin—Car Coupling.

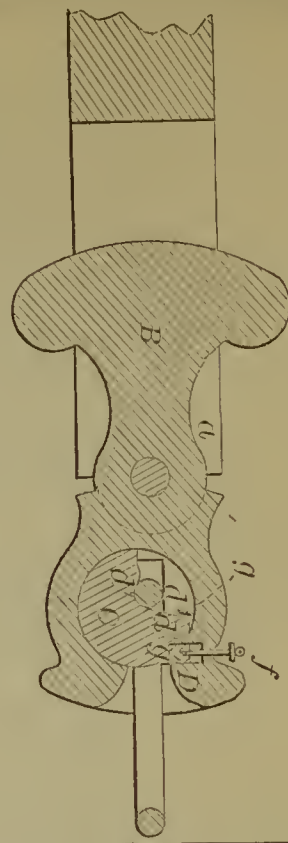

57619—J. Bergen—Cultivator.

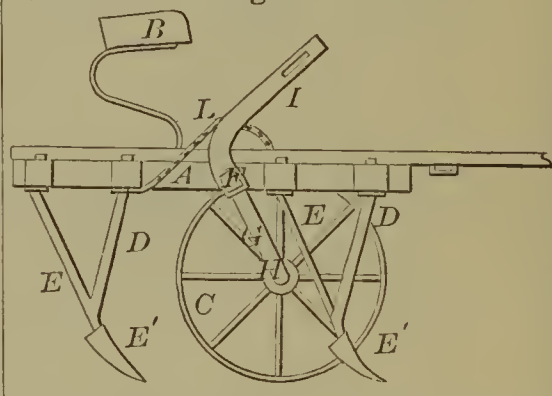

57620—J. F. Bogardus—For Turning Shafts.

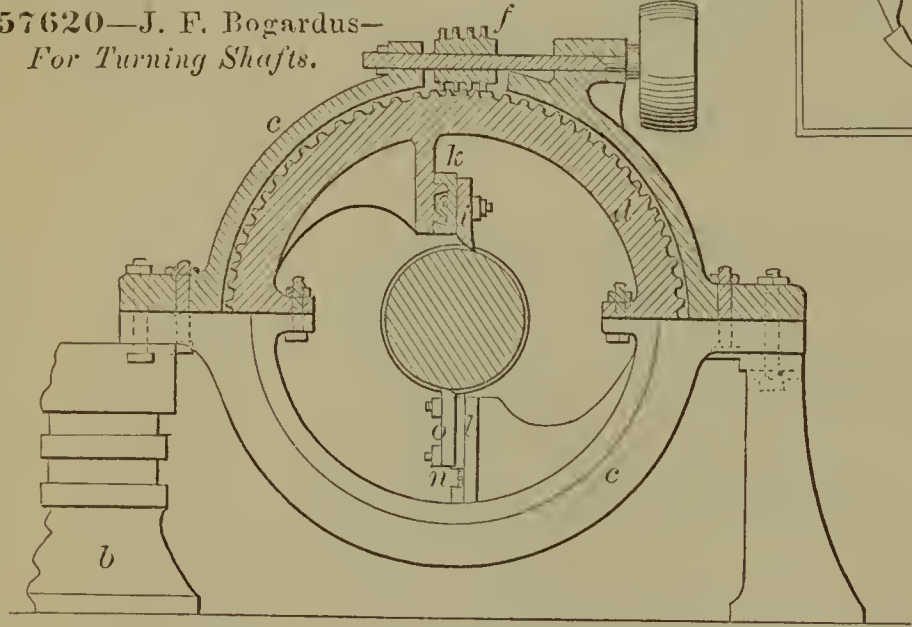

57621—A. Call—Pipe Wrench.

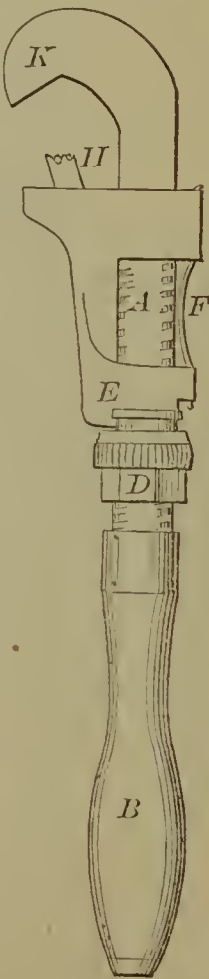

57622—Converse & Hopkins—Revolving Five Arm.

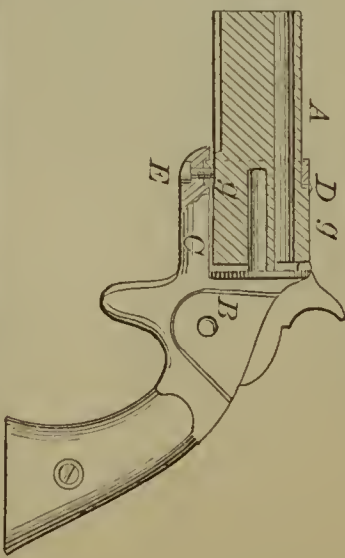

57623—J. W. Conway—Propelling Street Car.

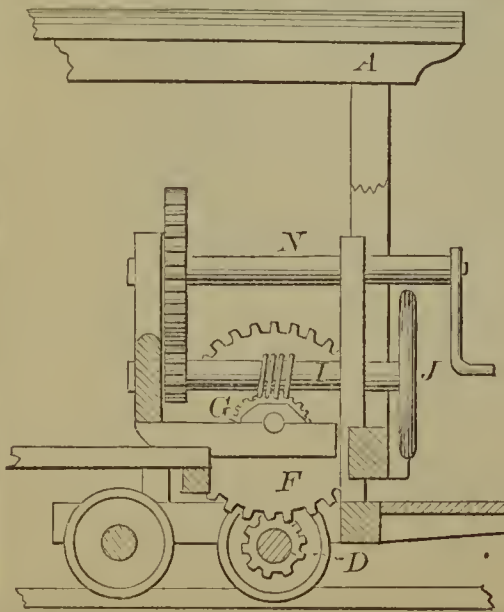

57624—H. H. Covert—Starting Cars.

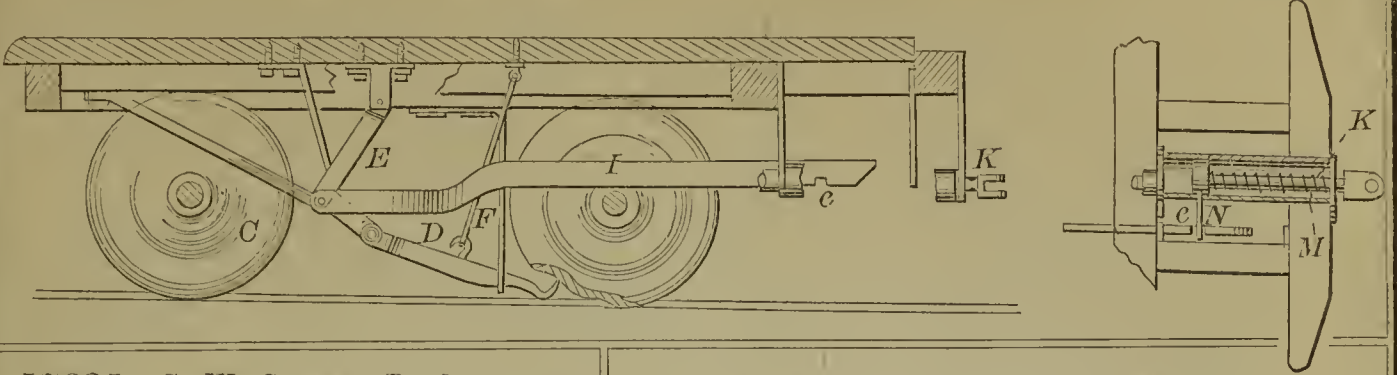

57625—G. W. Crowe—Brake.

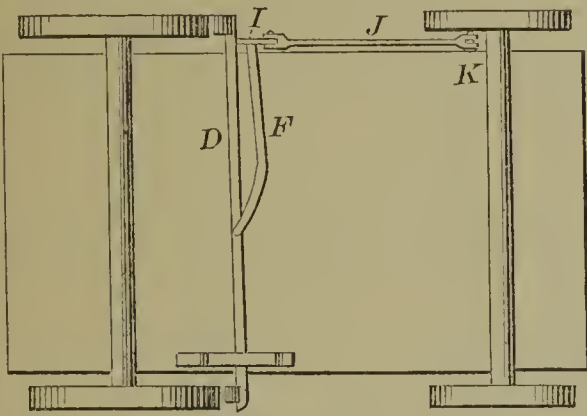

57628—H. J. Ferguson—Brick Machine.

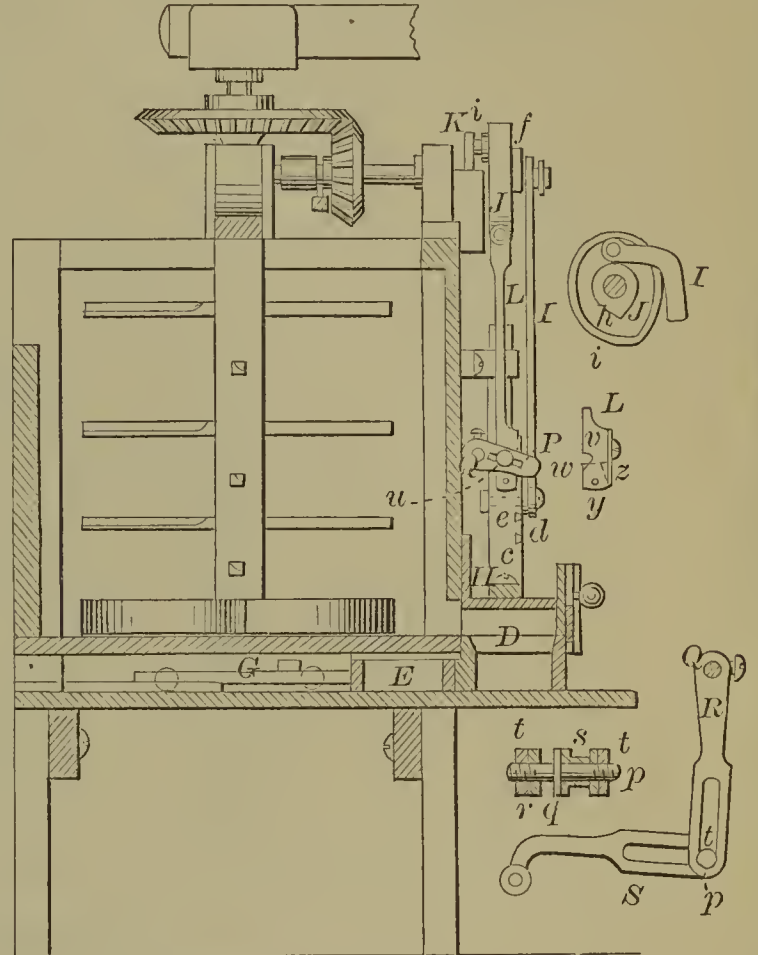

57627—J. E. Emerson—Saw.

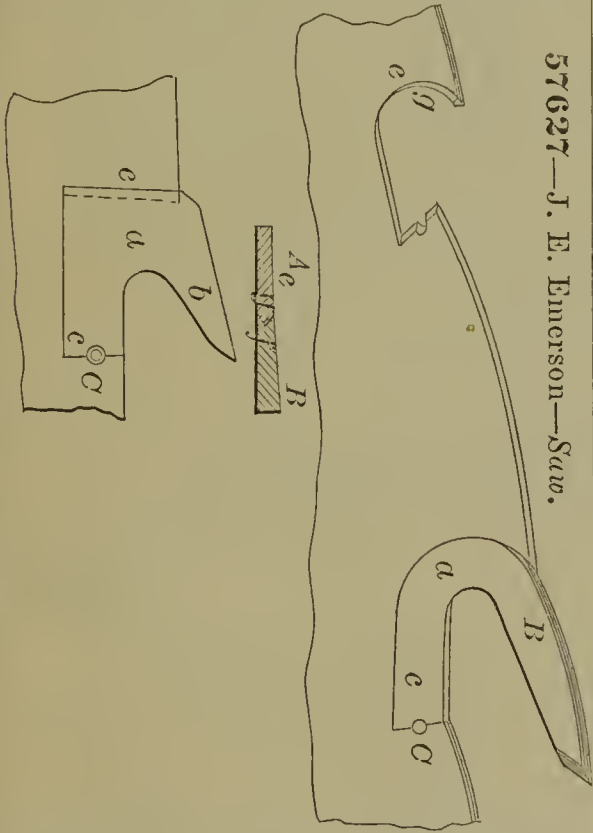

57629—H. Foulkes—Breast Strap Hook.



57630—J. E. Gillespie—Hydraulic Governor.

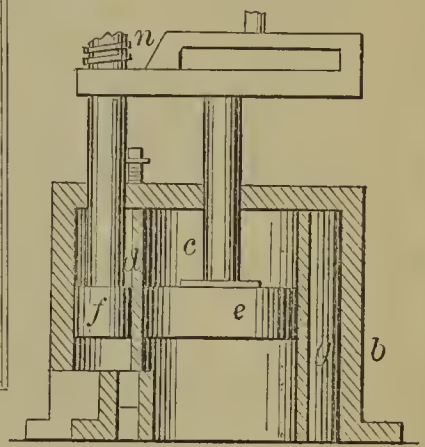
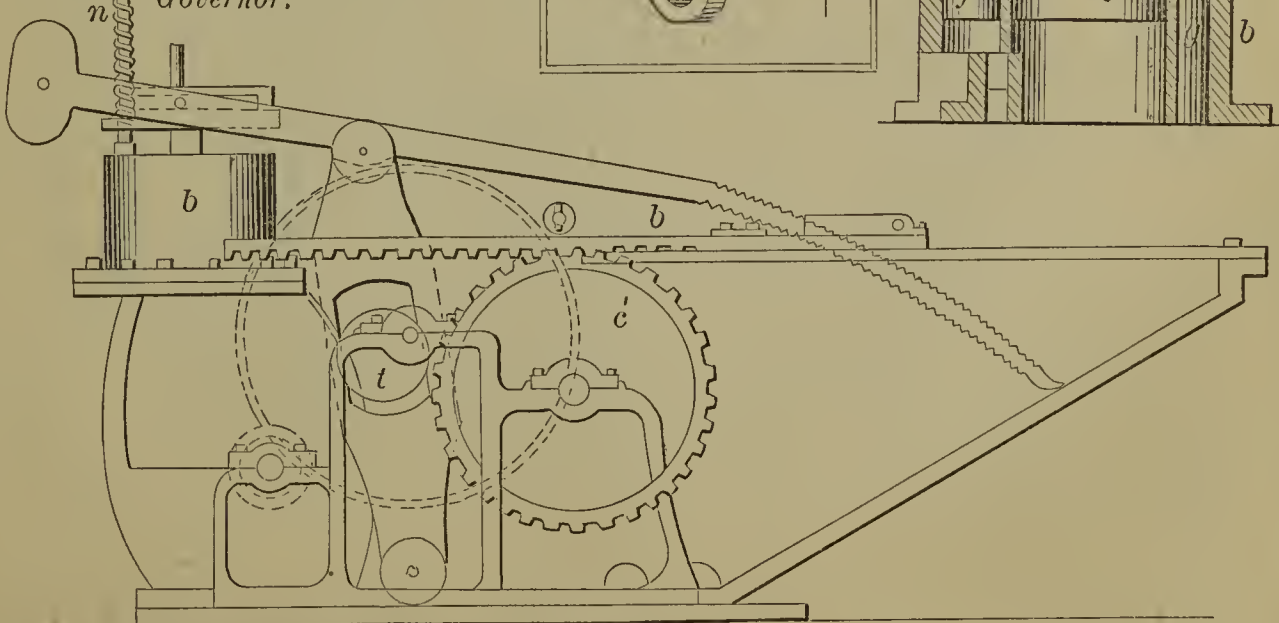

57631—W. F. Goulding—*Bending Horse Shoes.*

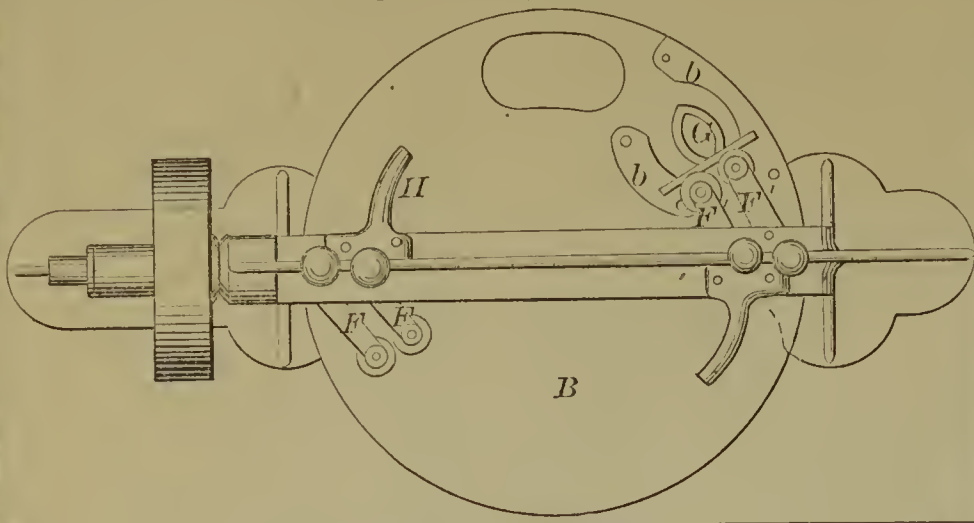

57632—H. C. Griggs—*Buckle.*



57634—Hill & Greene—*Printing Press.*

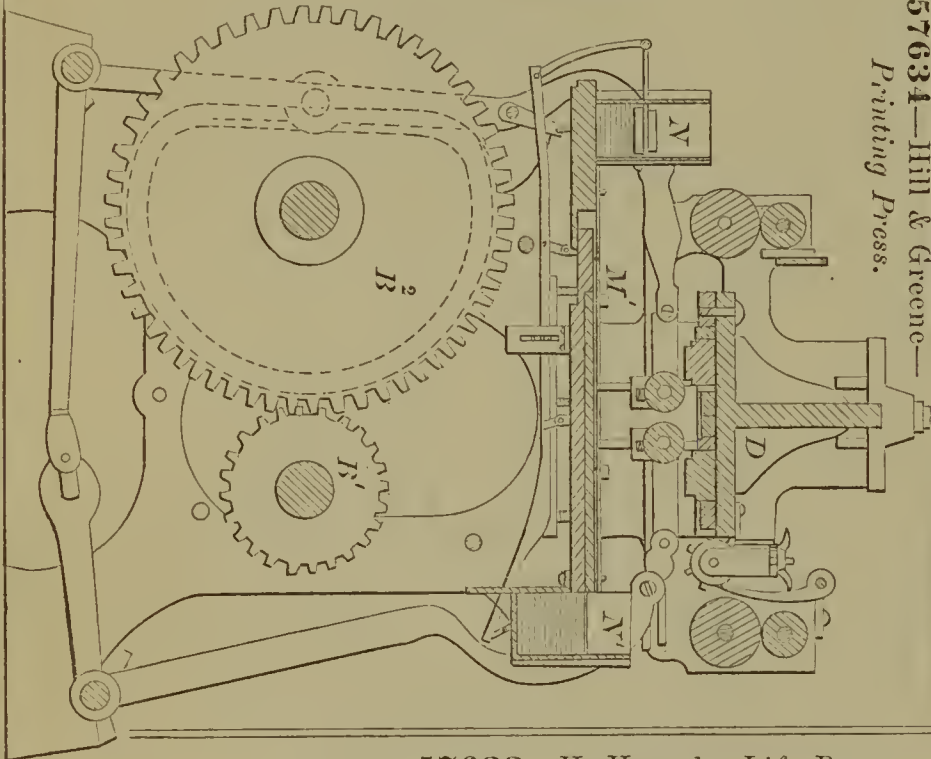

57636—N. King—*Magazine Fire Arm.*

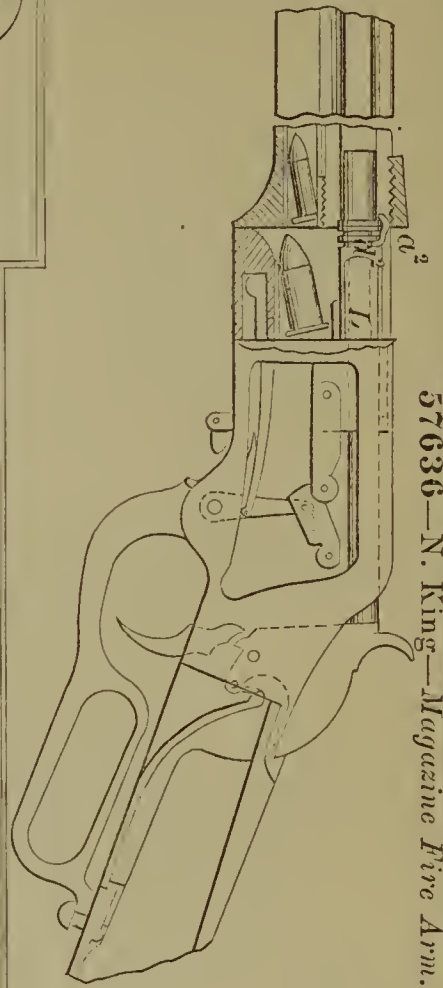

57633—H. Hensel—*Life Boat.*

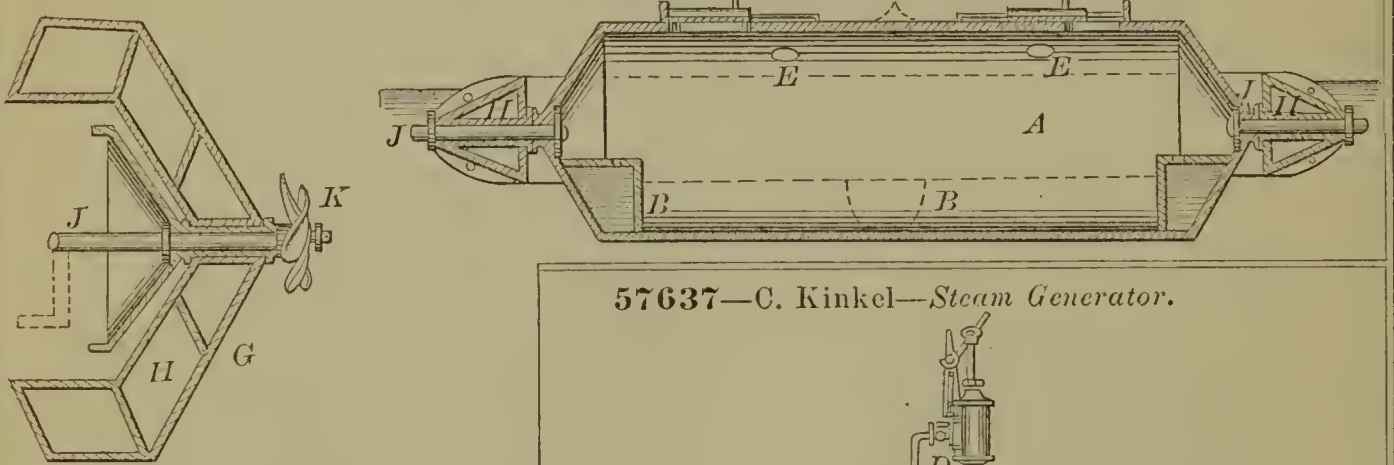

57637—C. Kinkel—*Steam Generator.*

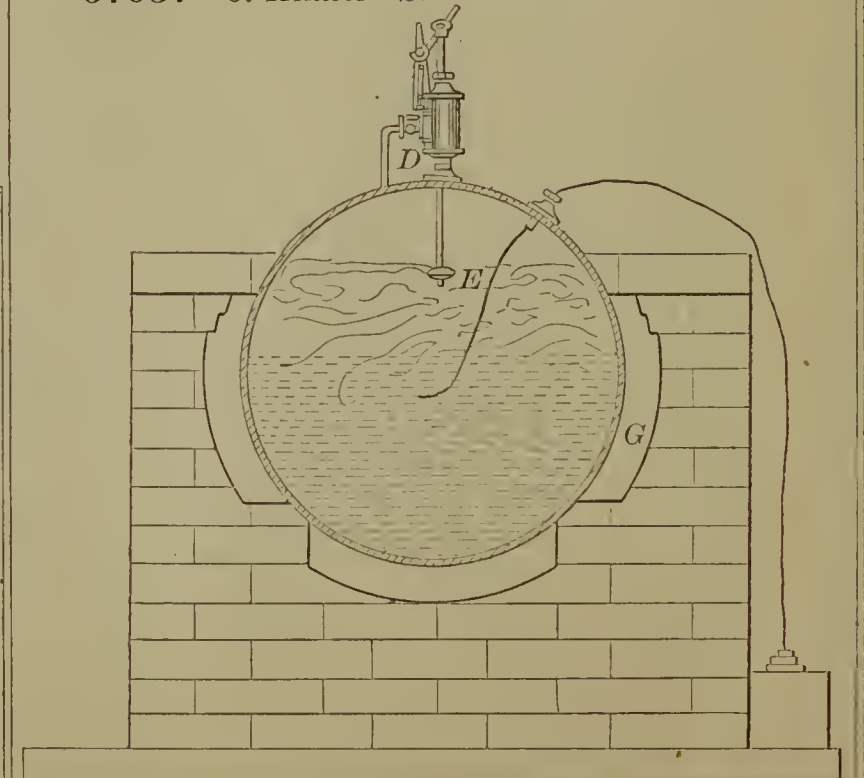

57635—E. B. Juckett—*Pump.*

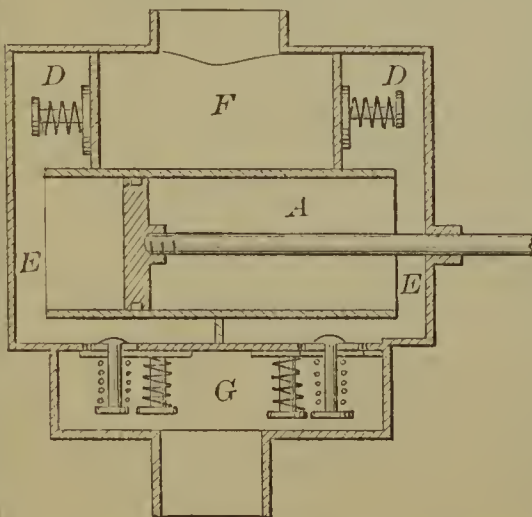

57638—M. Morse—Hat Pressing Machine

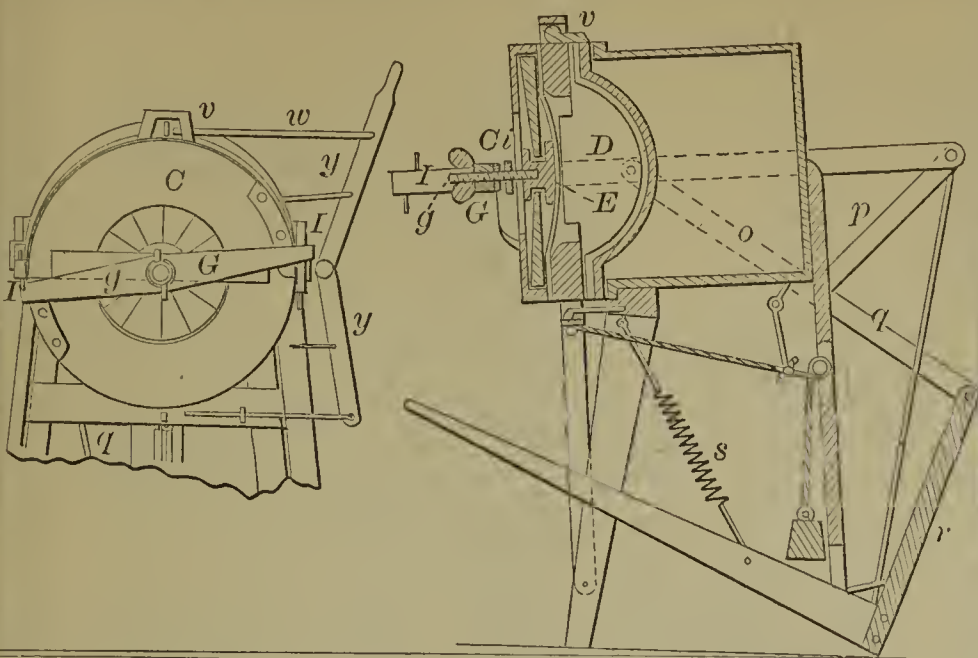

57639—Rowley, Sloane & Woodruff—For Carburetting Air.

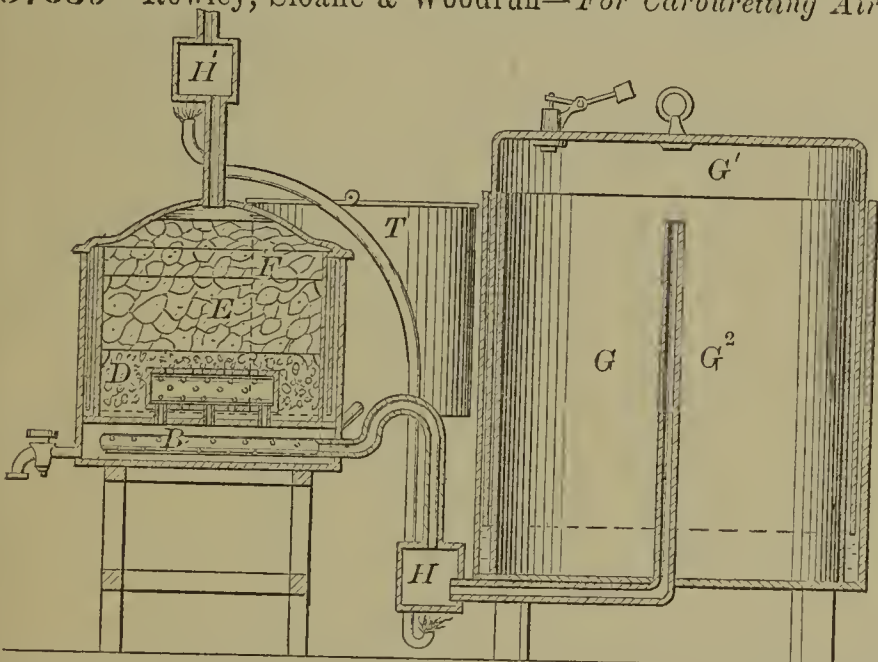

57642—J. Sloan—Ventilated Larder.

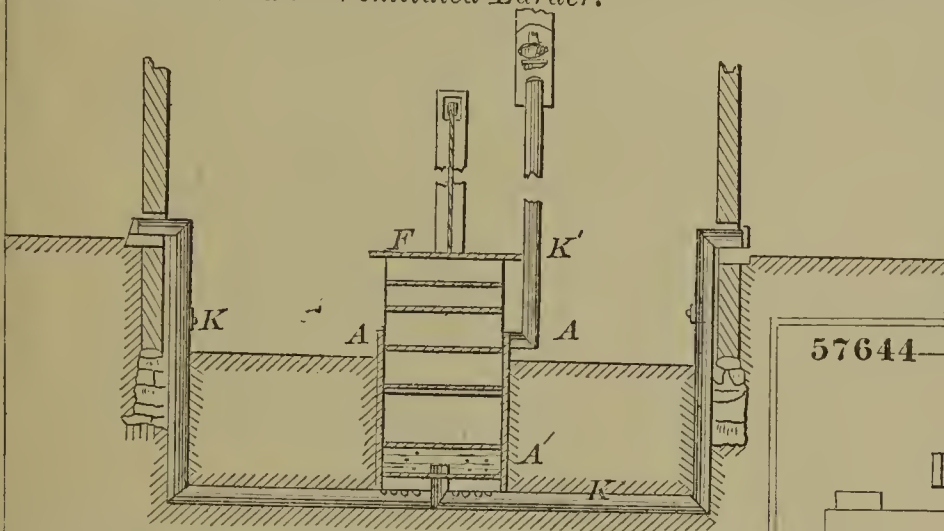

57643—S. A. Smith—Steam Generating.

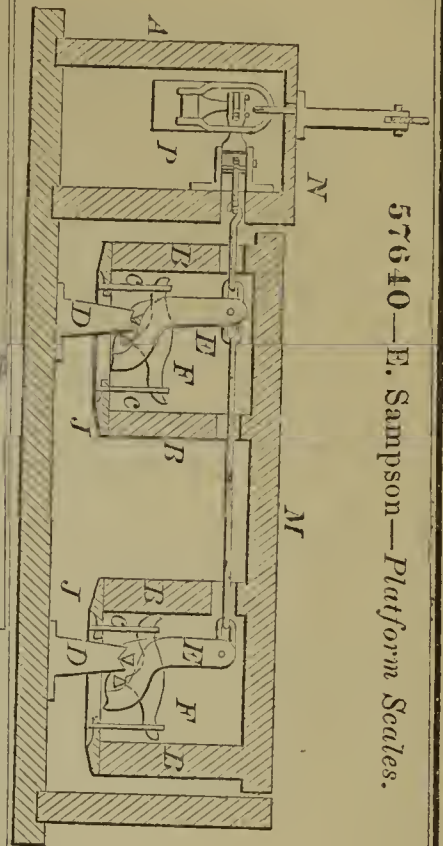
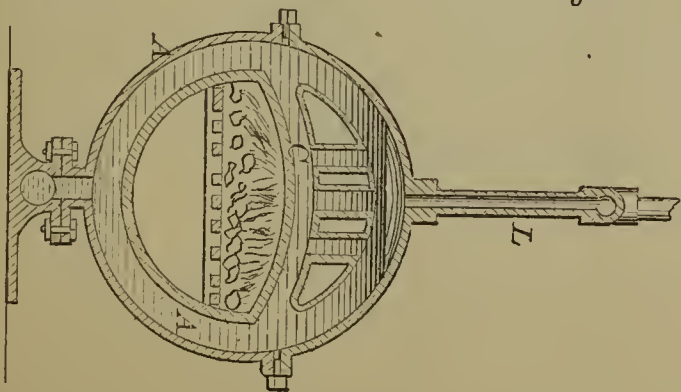

57640—E. Sampson—Platform Scales.

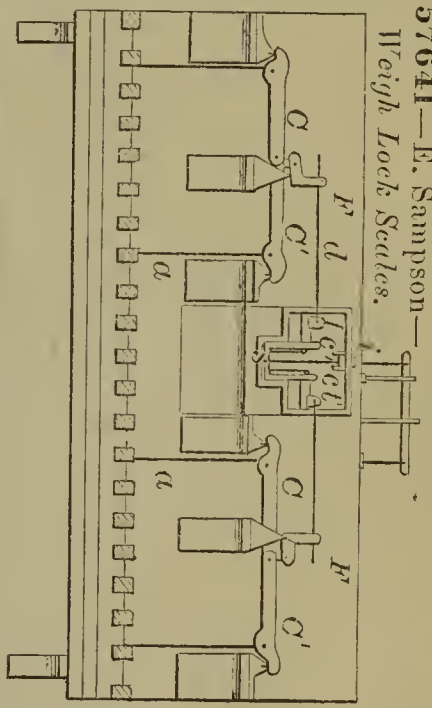

57641—E. Sampson—Weight Lock Scales.

57644—J. B. Tarr—For making Cast Steel Castings.

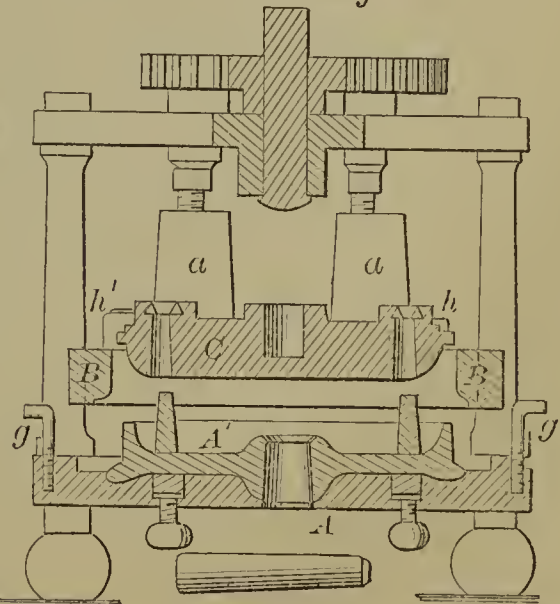

57645—T. W. Terry—*Safety Watch Pocket.*

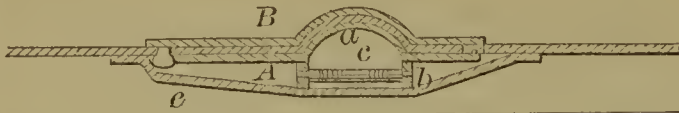

57646—G. L. White—*Temple for Looms.*

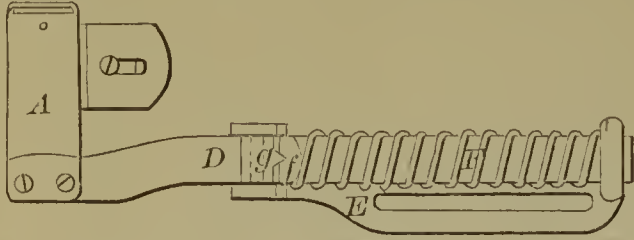

57650—C. F. Hall—*Lumber Wagon.*

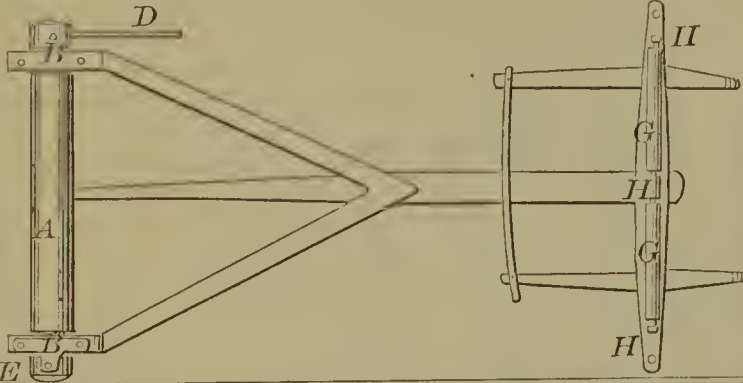

57652—Fowler, Worby & Greig—*Steam Plow.*

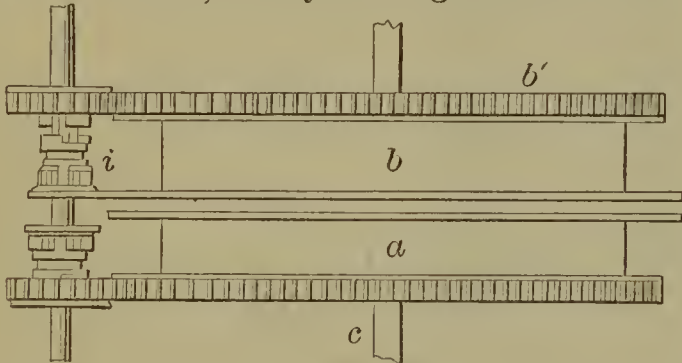

57653—Fowler & Eddison, [Executors of J. Fowler, Jr.,] Greig & Noddings—*Steam Plow.*

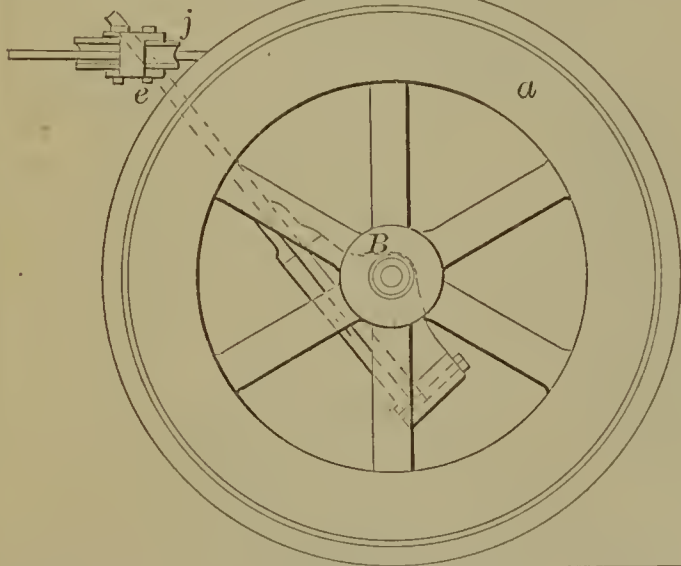

57654—F. Oakley—*Burglar Alarm and Door Fastener.*

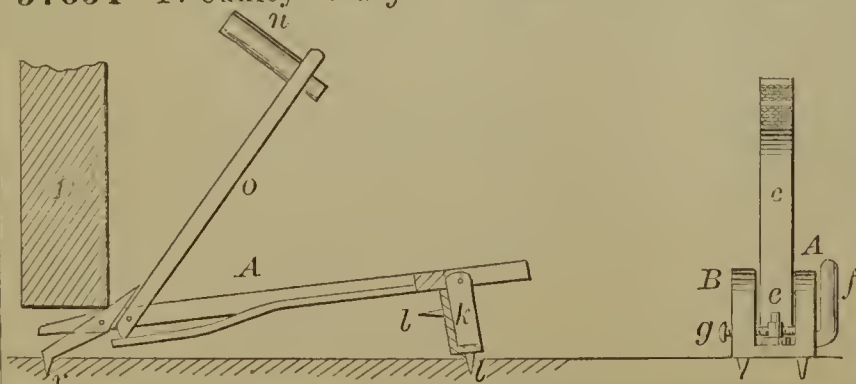

57647—J. W. Wilder—*Operating India Rubber Springs.*

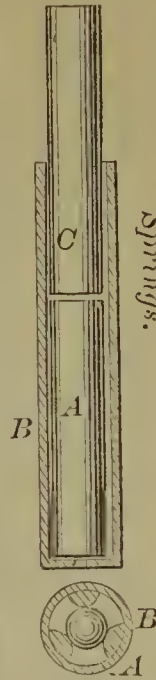

57648—Bower & Qualter—*Steam Engine Piston.*

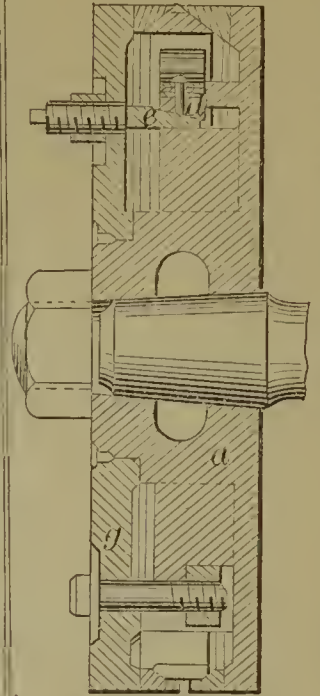

57655—A. R. Reynolds—*Tempering Knife Sections for Harvesters, &c.*

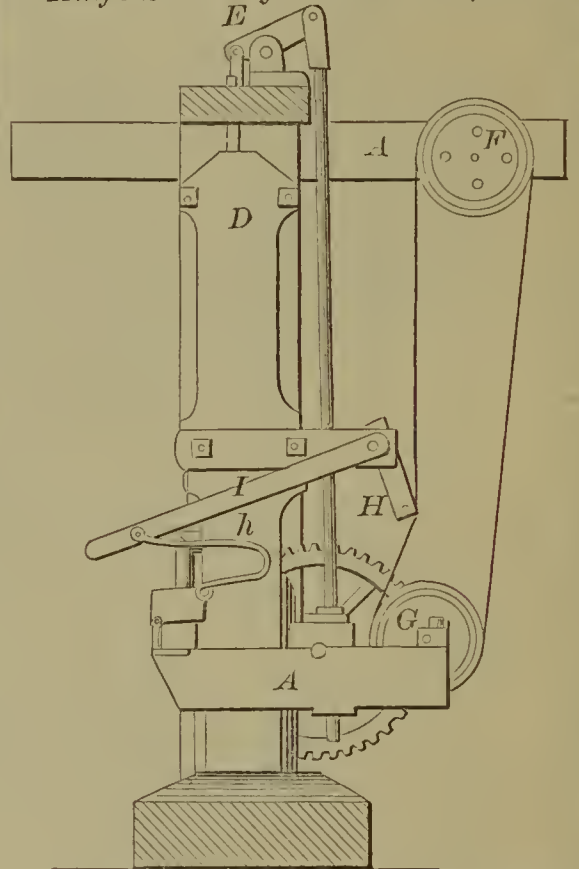

57656—A. Alden—*Handle for Brushes.*

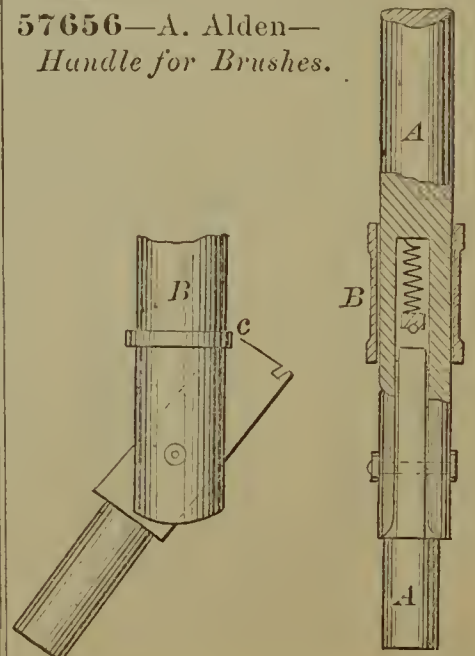



57657—S. F. Allen—*Axle Box.*

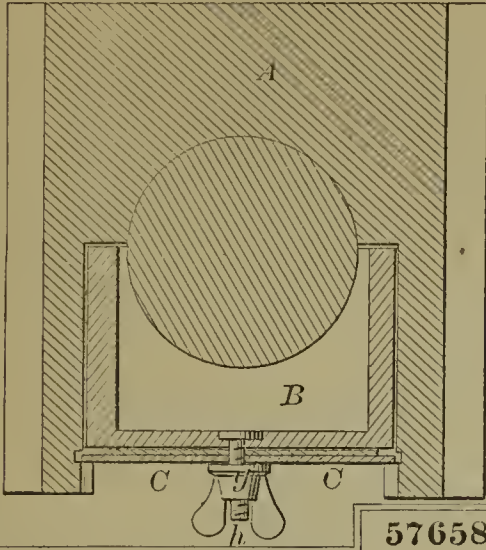

57660—J. H. Barley—*Cultivator.*

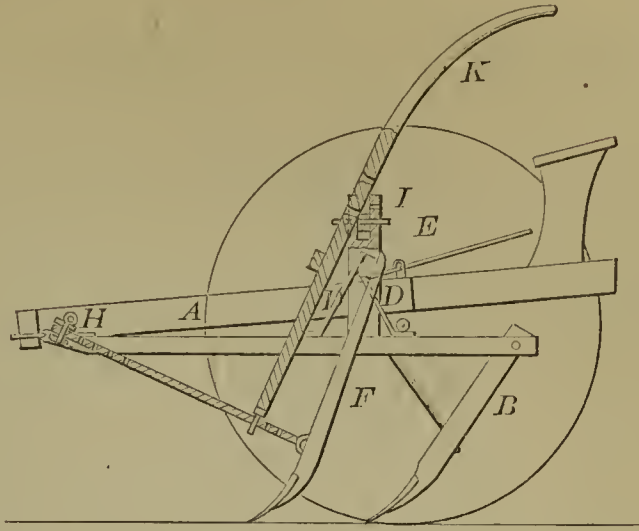

57659—S. W. Baker—*Woven Fabric.*

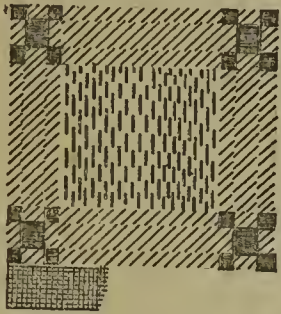

57658—J. Bailor—*Car Coupling.*

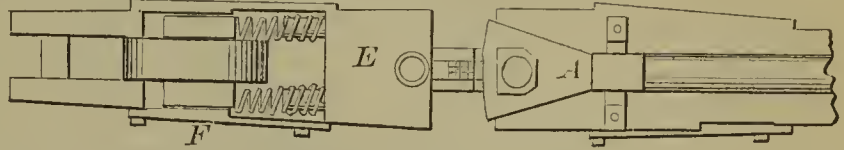

57661—C. J. Bayer—*Railway Switch.*

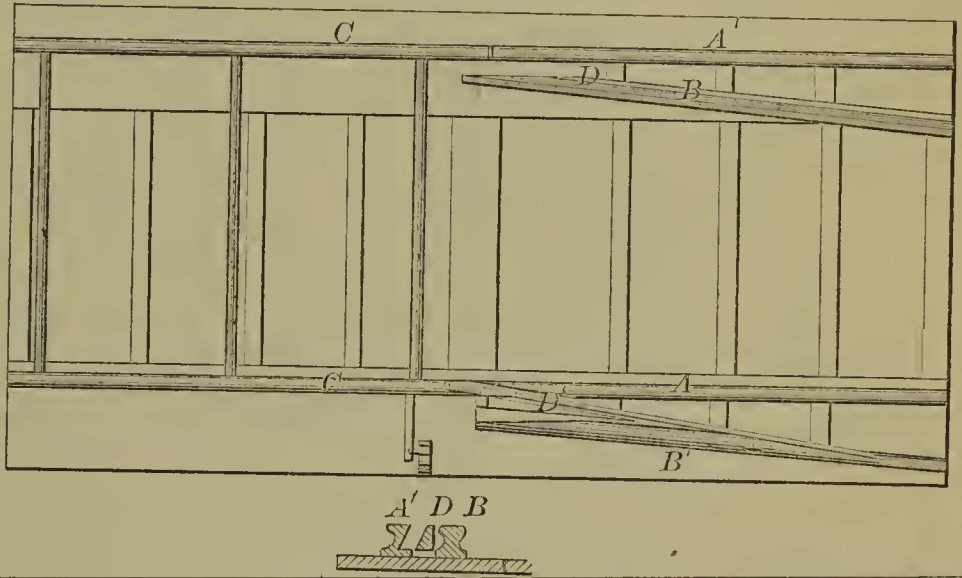

57662—Bench & Klauke—*Knife and Fork.*

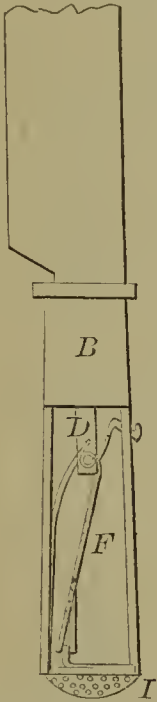

57665—J. C Benzinger—*Catamenial Sack.*

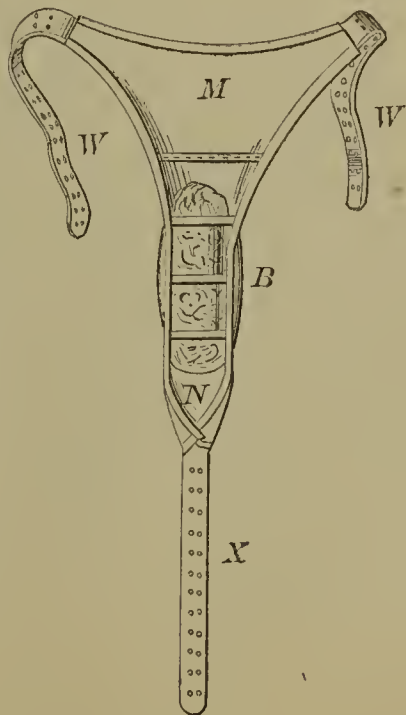

57666—D. Bly—*Artificial Leg.*

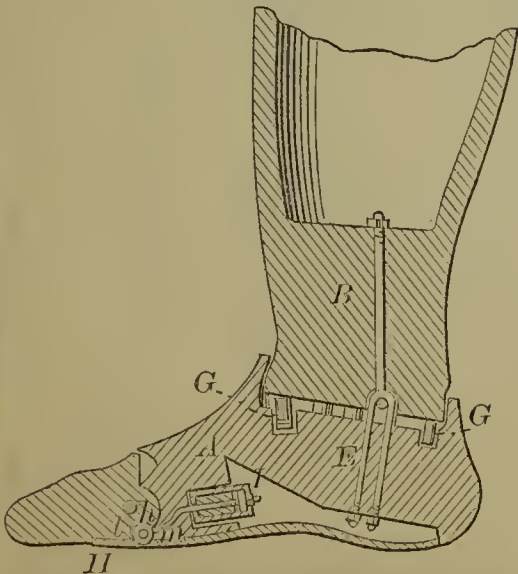

57664—L. H. Bell—*Coupling Joint for Well Boring Shafts.*

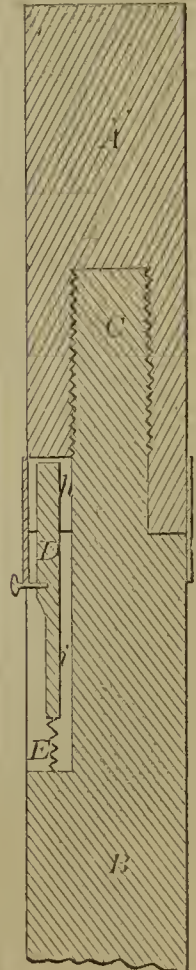

57667—C. Bollinger—Graining Mill.

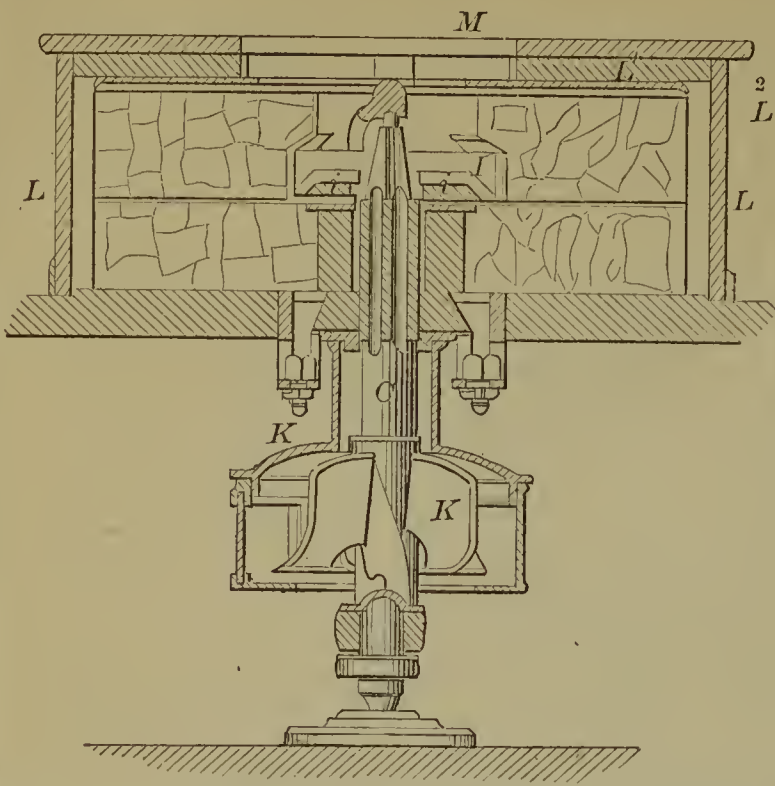

57668—J. W. Boosinger—Cultivator.

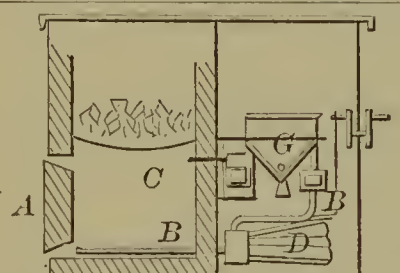
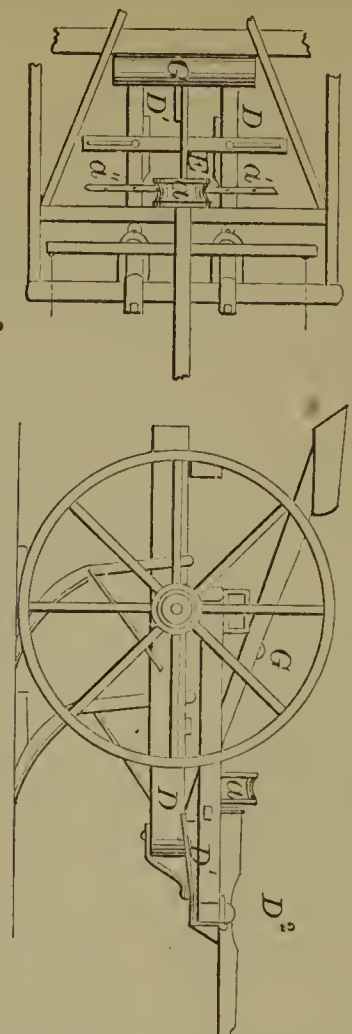

57670—J. A. Boyer—Refrigerator Building.

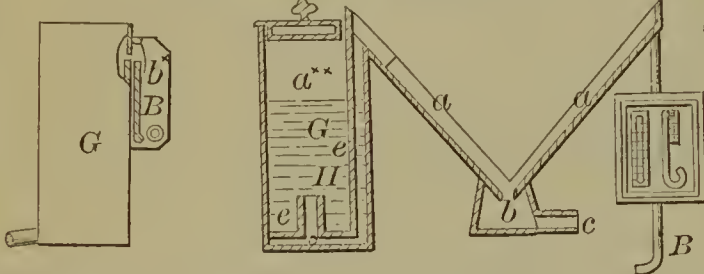

57669—J. K. Boswell—Dry House.

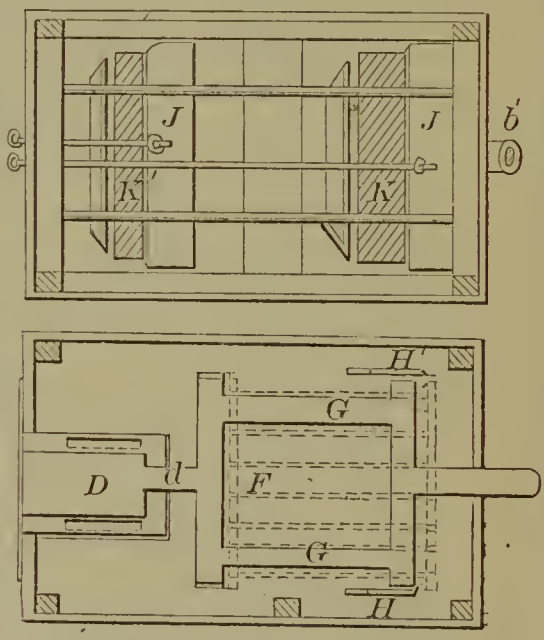

57672—G. S. Carlisle—Portable Fence.

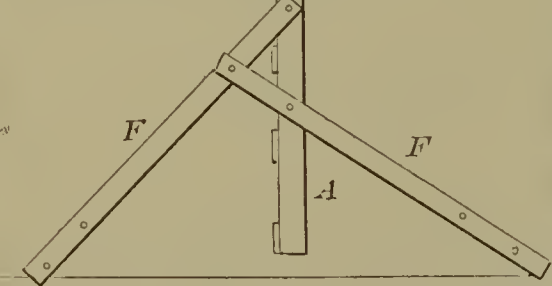

57674—J. Chandler—Well Tube.

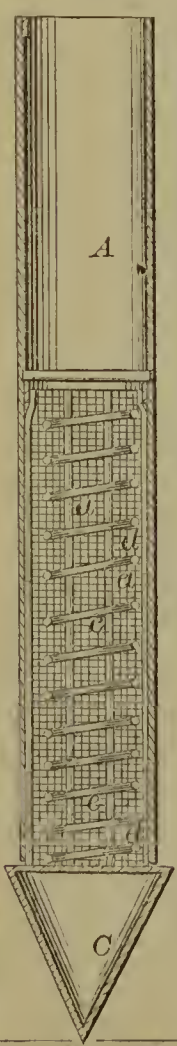

57671—A. M. Brush—Organ Reed.



57673—A. Chace—Electric Telegraph.

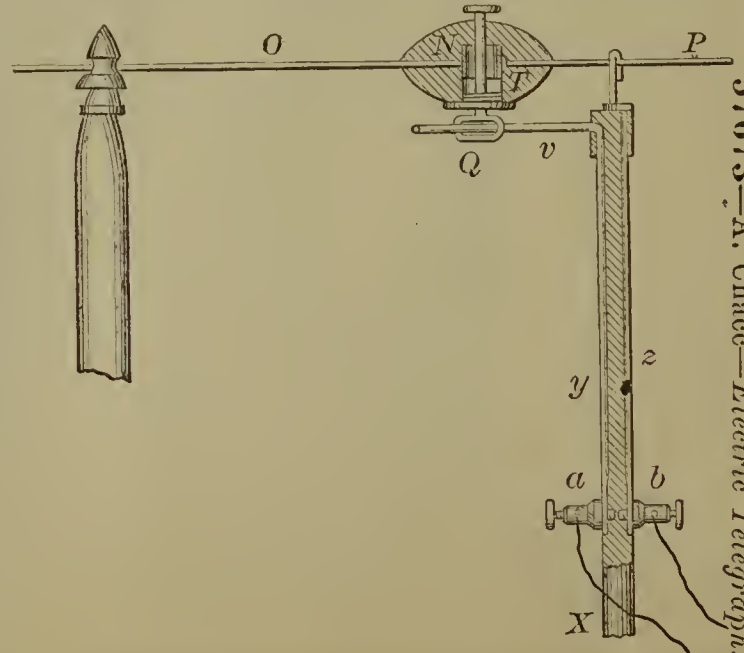

57675—G. L. Chapin—*Venetian Shutters.*

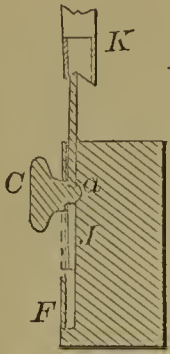

57676—B. Clark—*Corn Planter.*

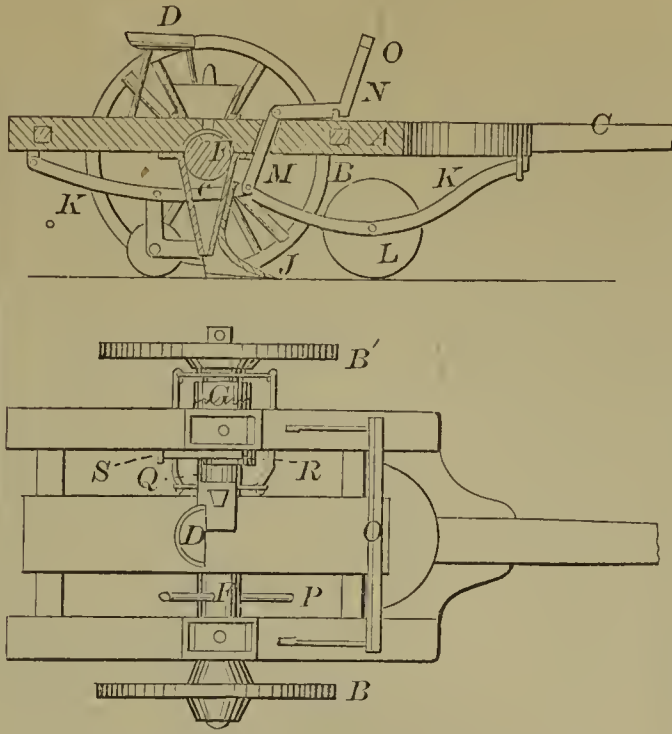

57677—W. Clayton—*Attaching Knives to Handles.*

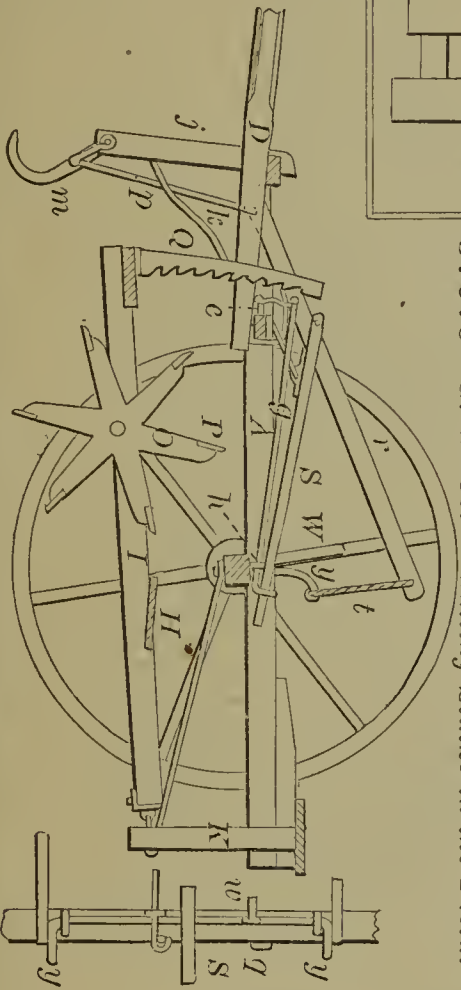
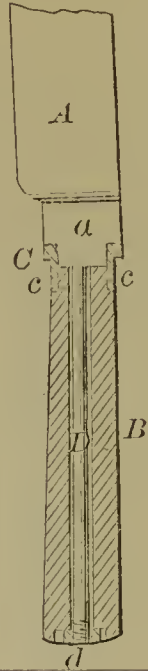

57678—G. W. Cole—*Cutting Stakkes in the Field.*

57679—T. Cole—*Washing Machine.*

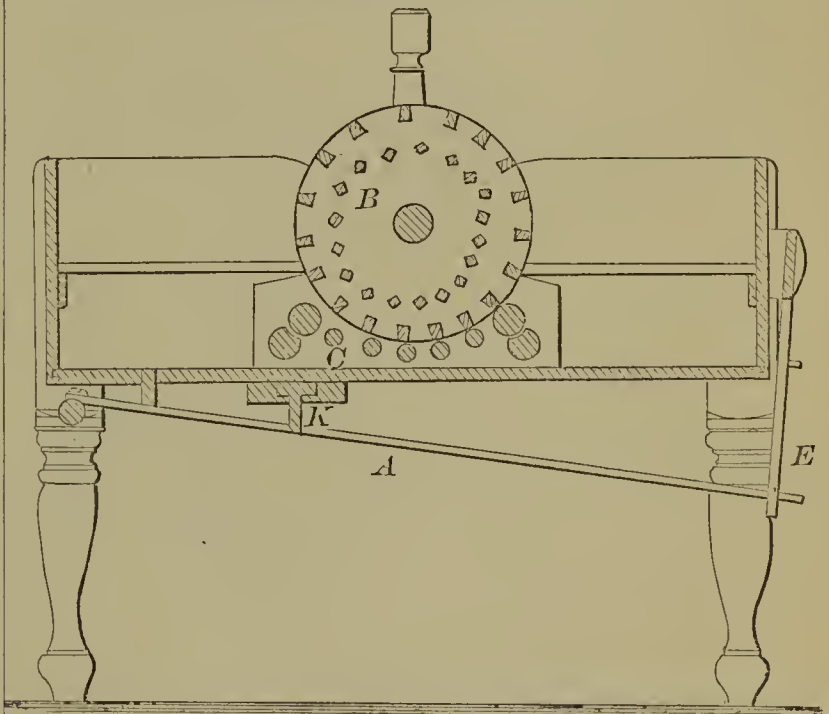

57681—I. C. Connor—*Clothes Dryer.*

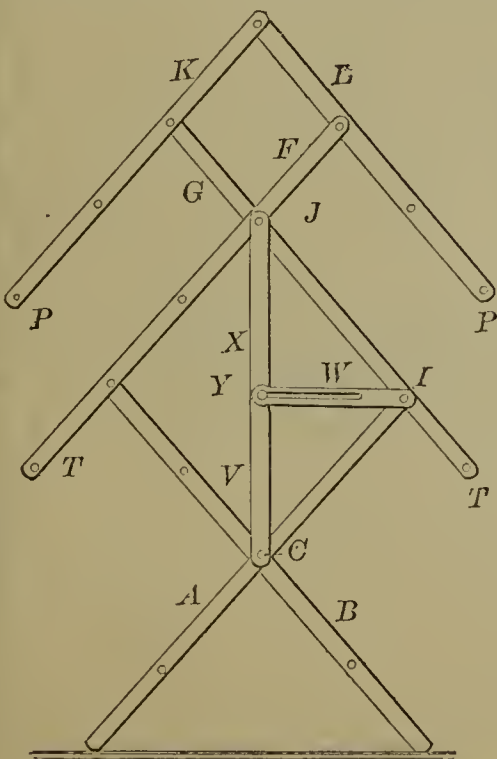

57680—H. B. Comer—*File Cutting Machine.*

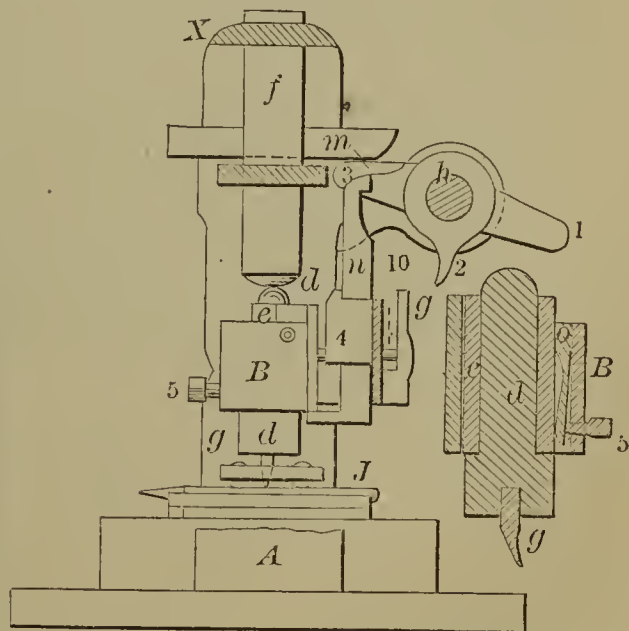

57682—M. P. Coons—Gas Generator.

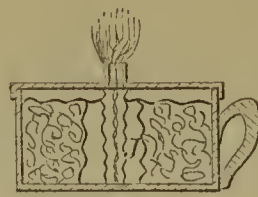
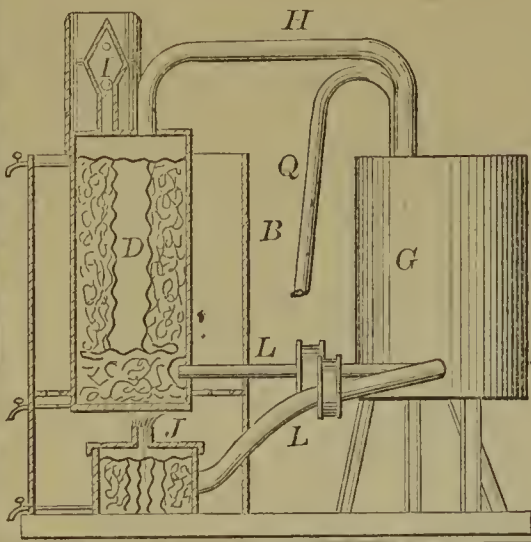
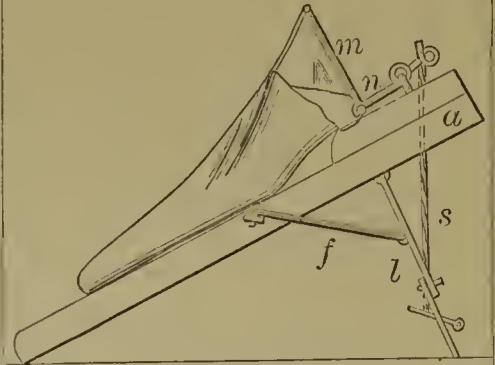
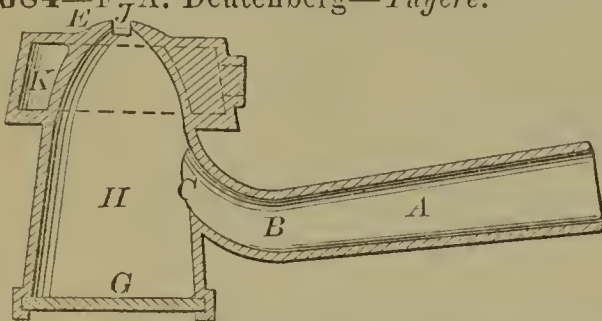

Fig. 4

57683—G. E. Corbin—Bag Holder.



57684—F. A. Deutenberg—Tuyere.



57687—J. Dixon—Galvanic Battery.

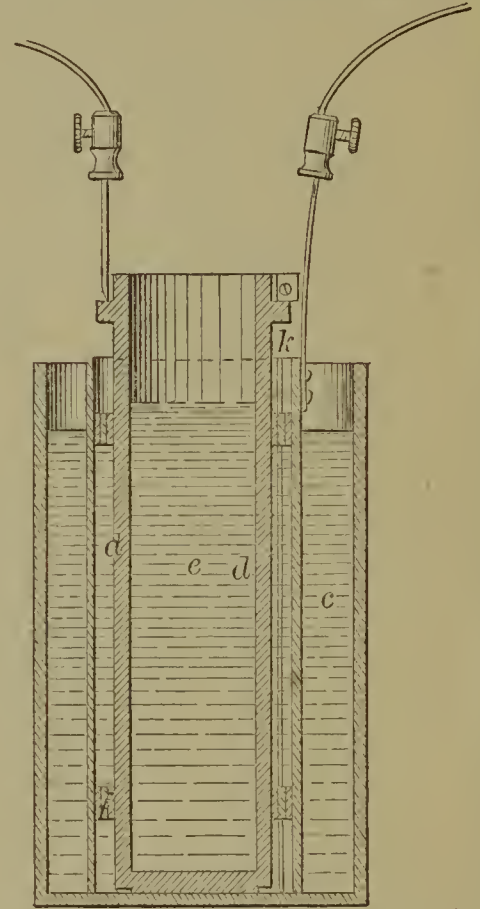

57686—S. R. Devine—For Carburetted Air.

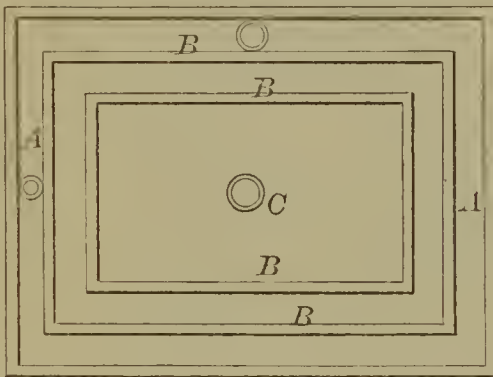

57688—Donaldson, Sheets & Miller—Gang Plow.

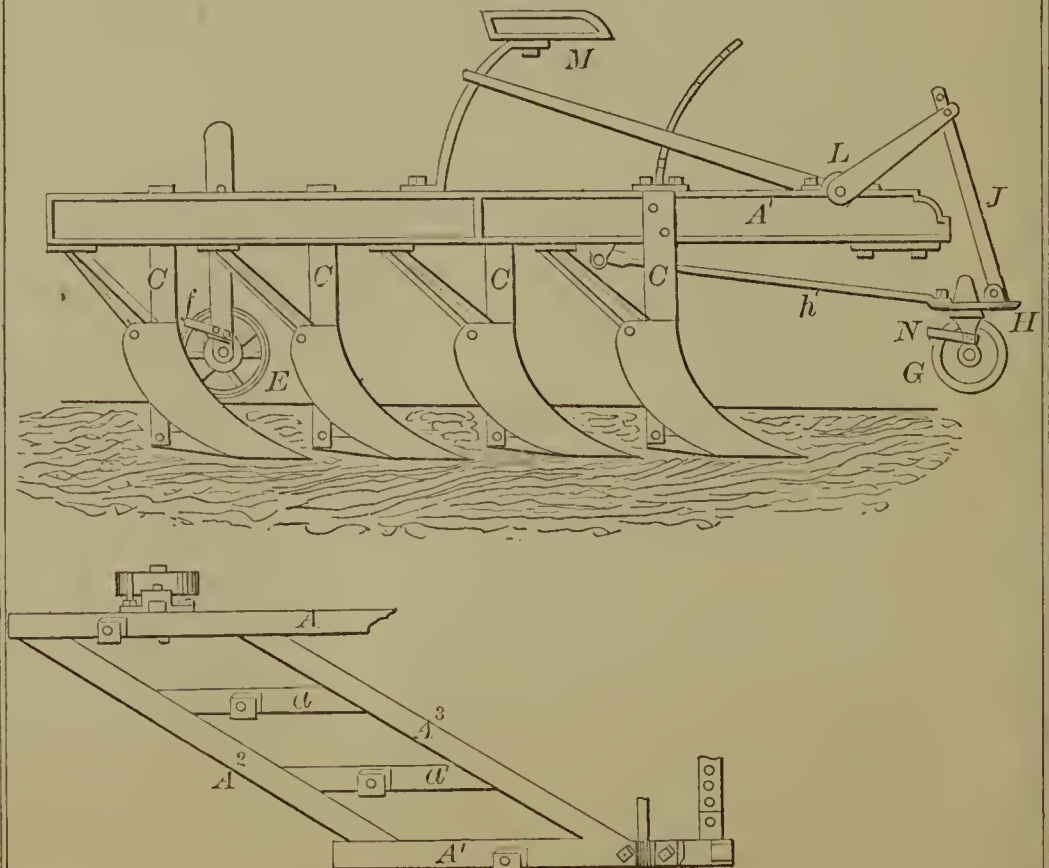

57685—O. R. Dinsmore—Fruit Gatherer.

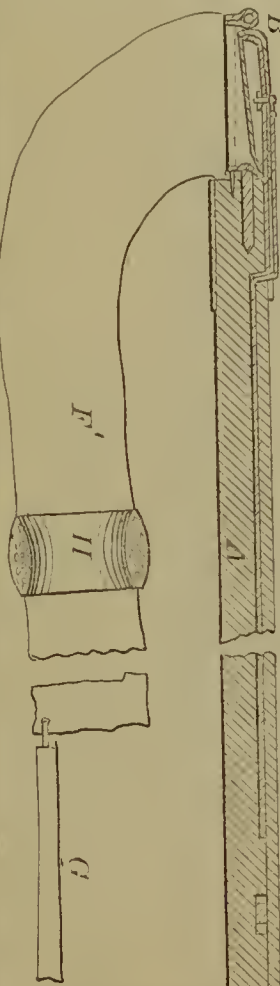

57689—R. A. Douglas—Brick Machine.

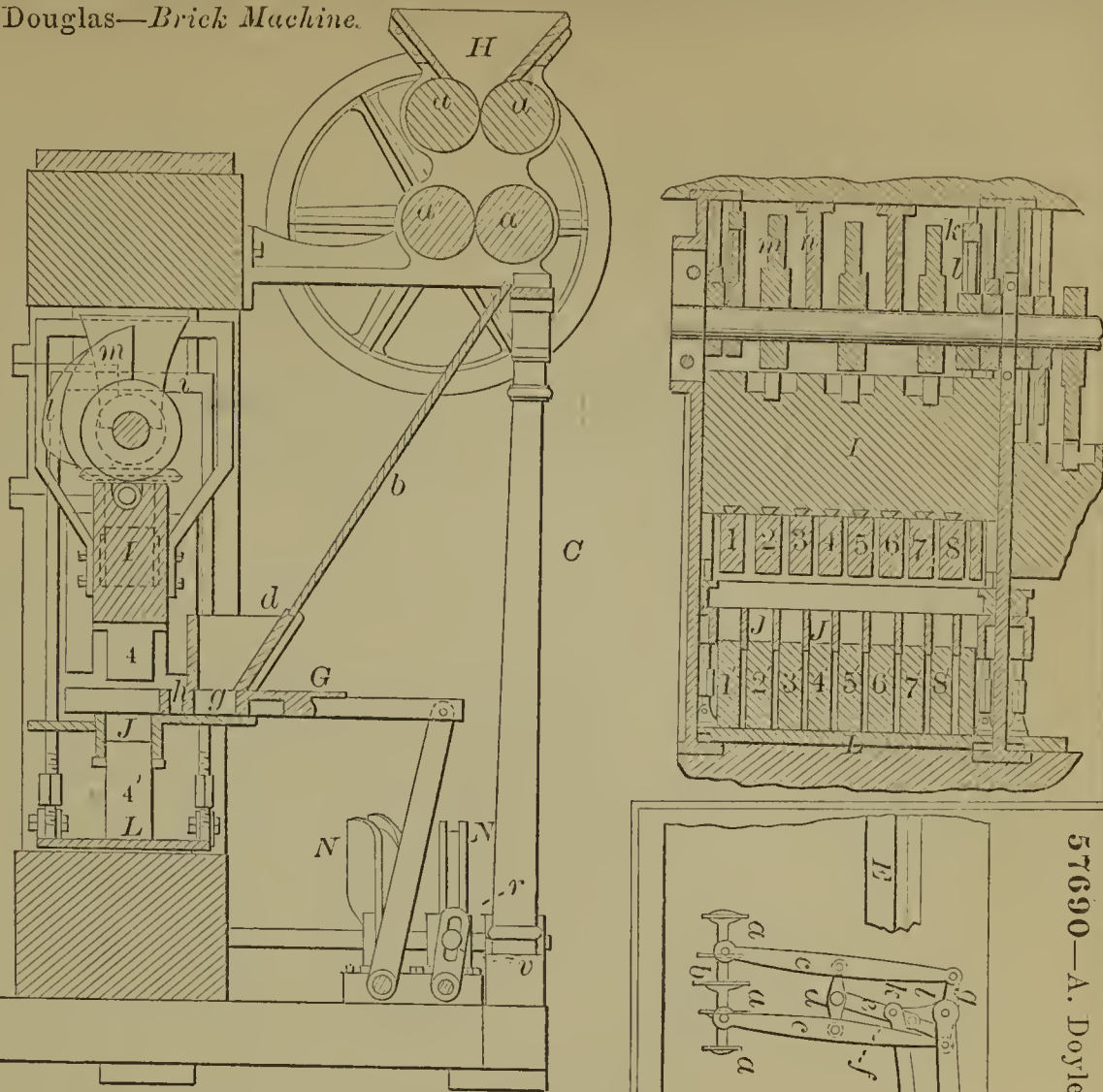

57690—A. Doyle—Steamship Propeller.

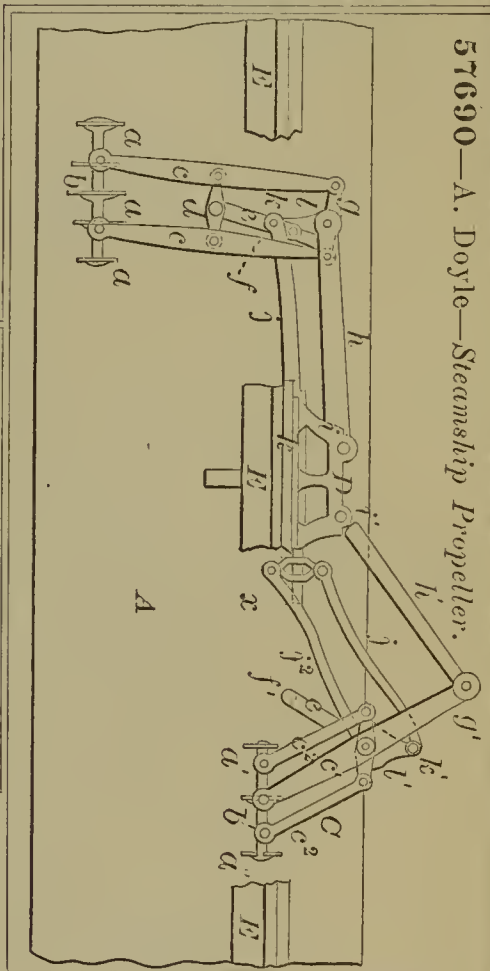

57693—T. C. Entwisle—For Transmitting Motion.

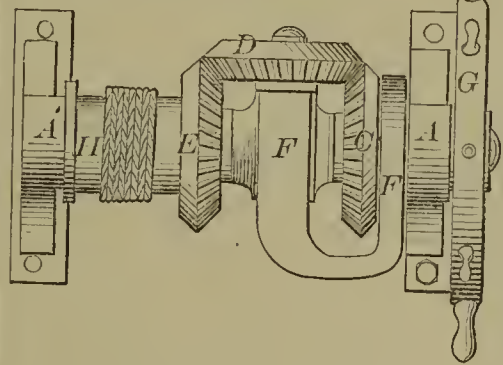

57691—J. S. Drake—Artificial Leg.

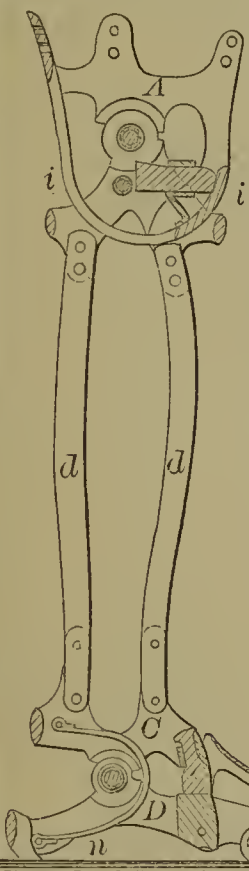

57695—S. H. Everett—Lubricating Brush.

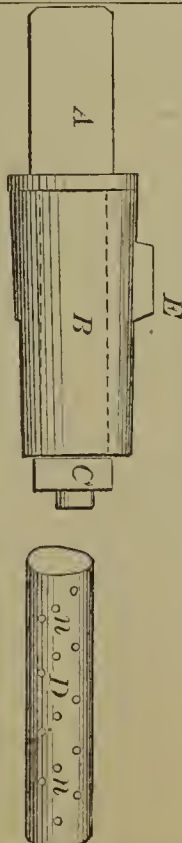

57694—J. A. Eshleman—Neck Tie Supporter.

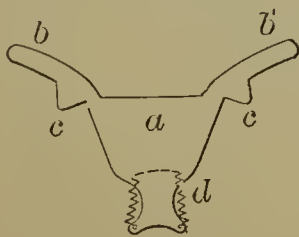

57692—J. B. Fads—Operating Ordnance.

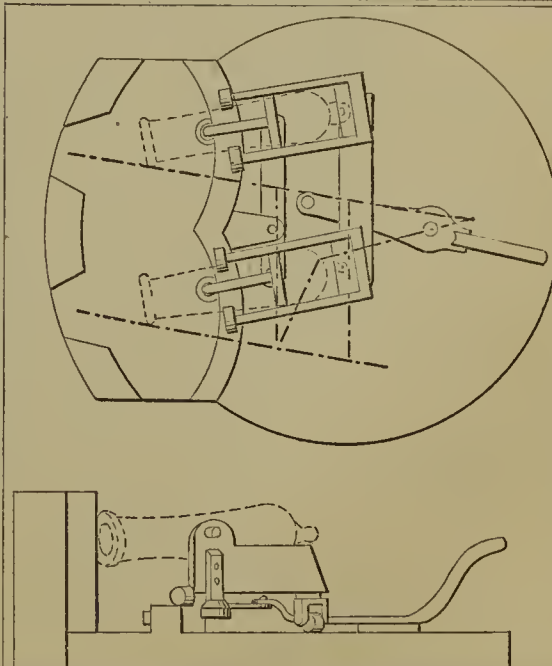

57696—M. Fletcher—*Steam Carriage.*

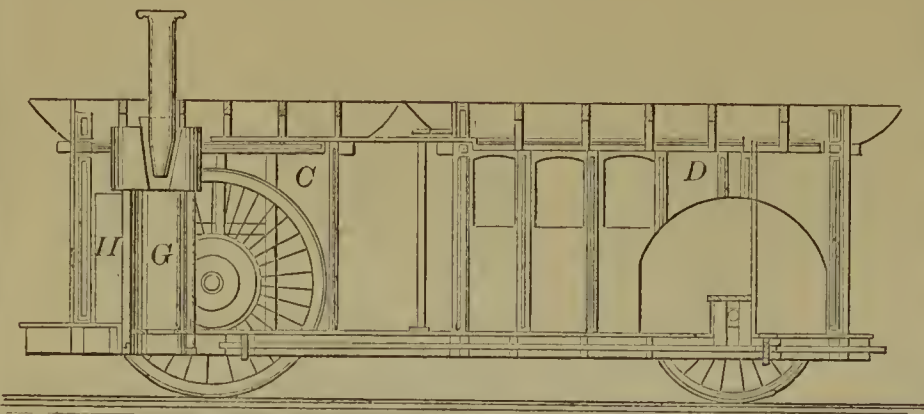

57698—F. Gay—*Farm Gate.*

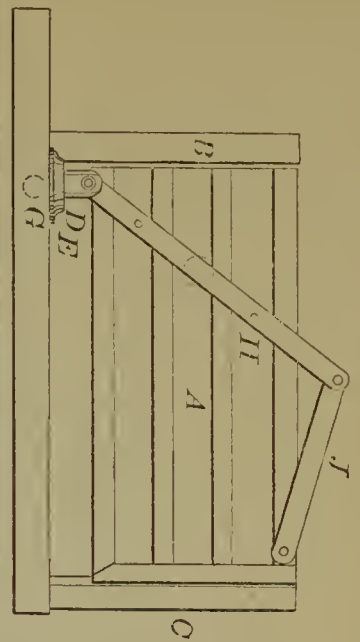

57697—S. Gardiner—*Turning on Gas by Electricity.*

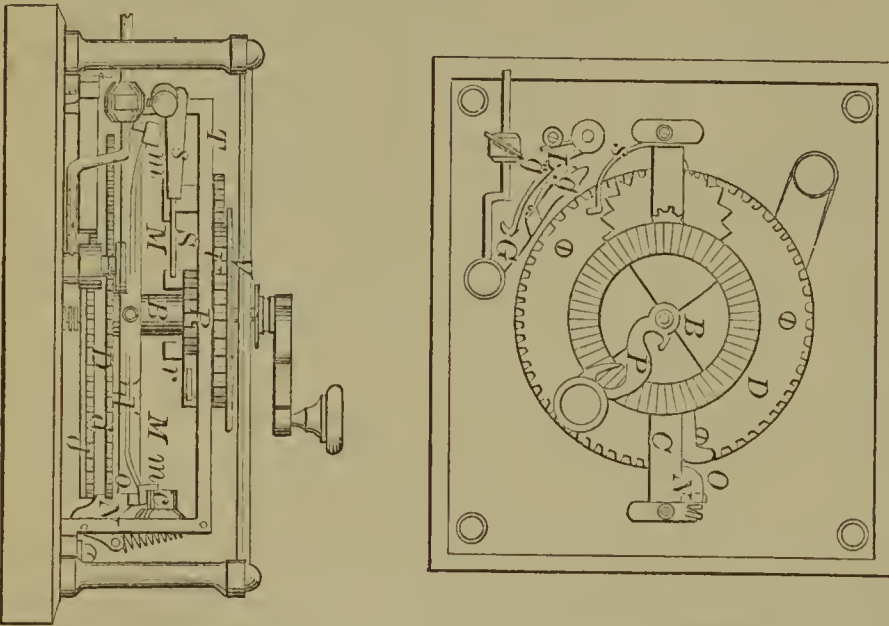

57699—W. Geahr—*Cultivator.*

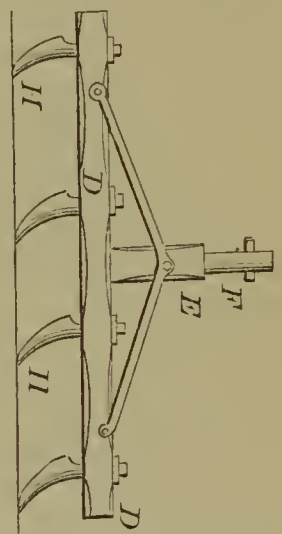

57700—G. T. Gifford—*Cultivator.*

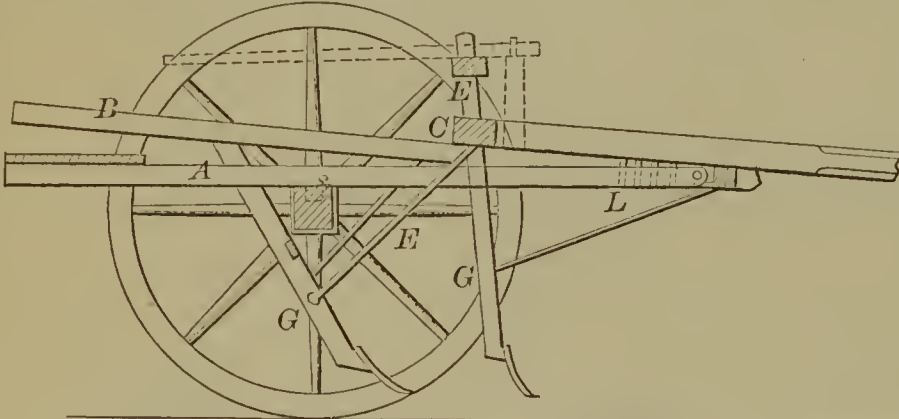

57701—J. L. Gill—*Smelting Furnace.*

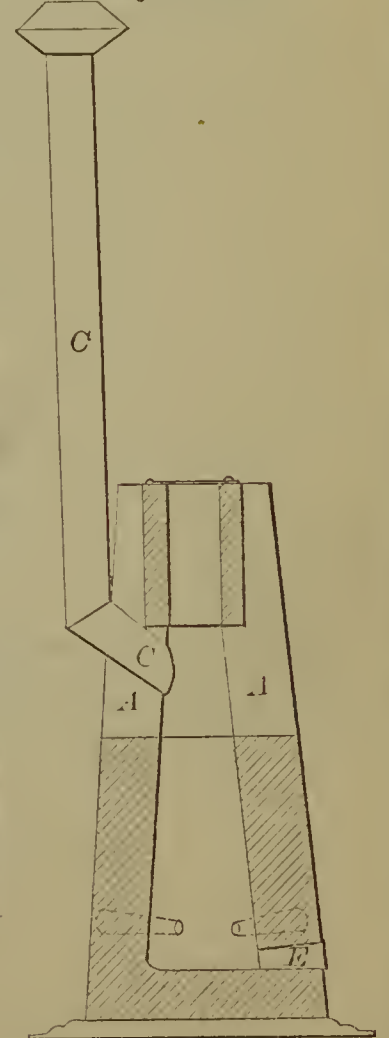

57702—S. Goldstone—*Cup.*

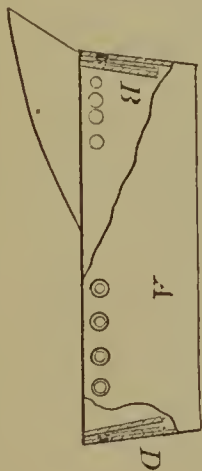

57703—W. T. Grant—*Mop and Scrubber.*

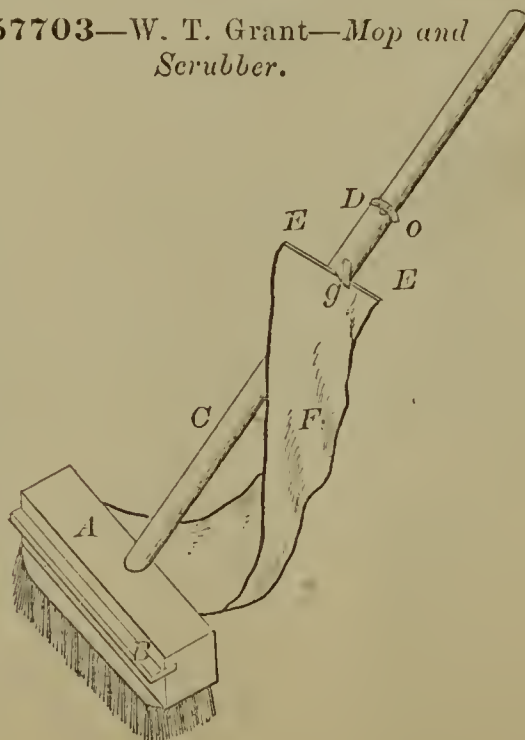

57704—J. T. Guthrie—Lock.

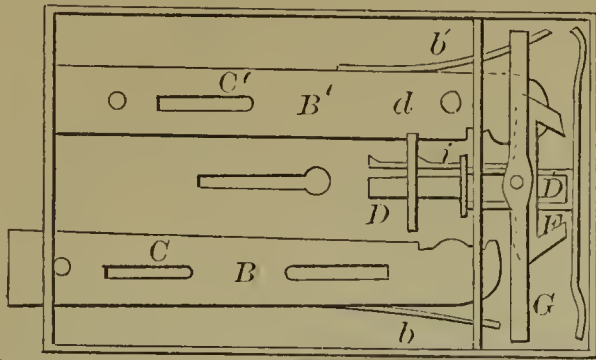

57706—E. R. Hall—Horse Rake.

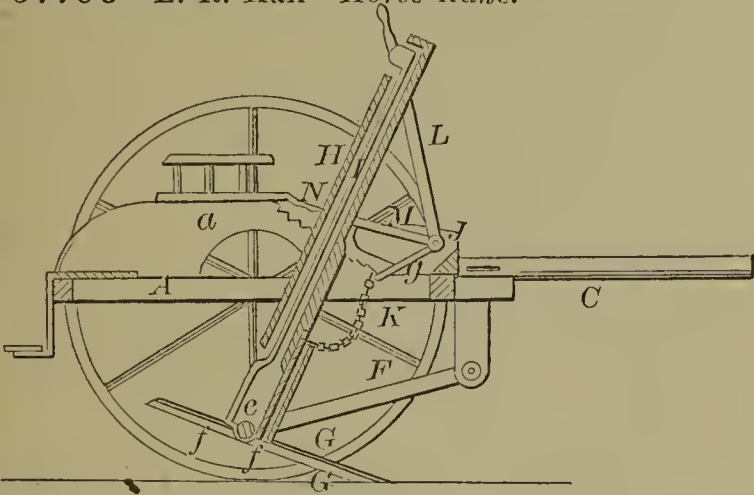

57705—J. Guthrie—Bolt Cutting Shears.

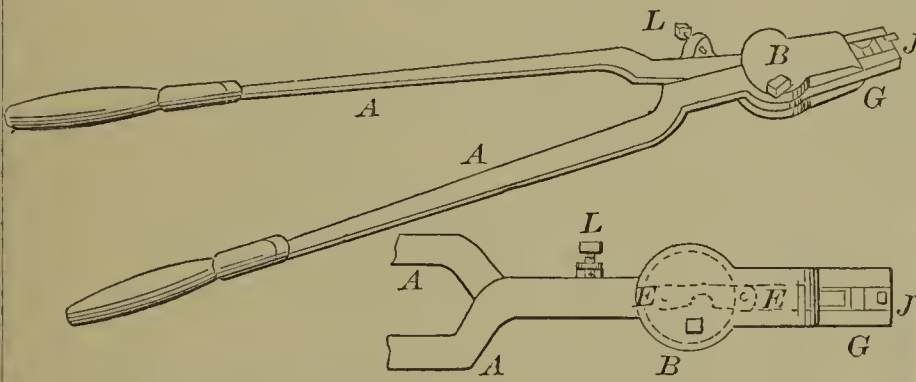

57707—G. W. Hall—Combined Sower and Drill.

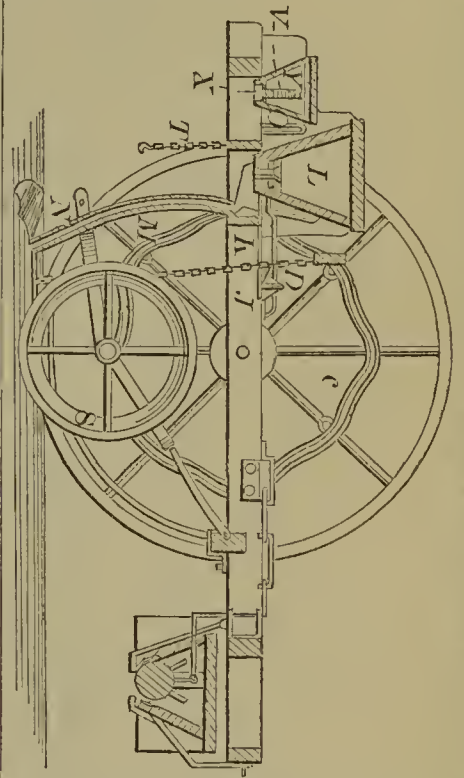

57711—J. Harrison—Illuminated Sign.

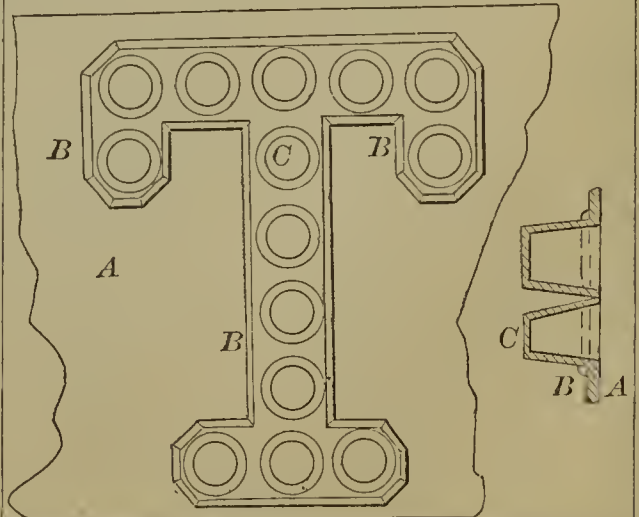

57710—H. Harrier—Grain Binder.

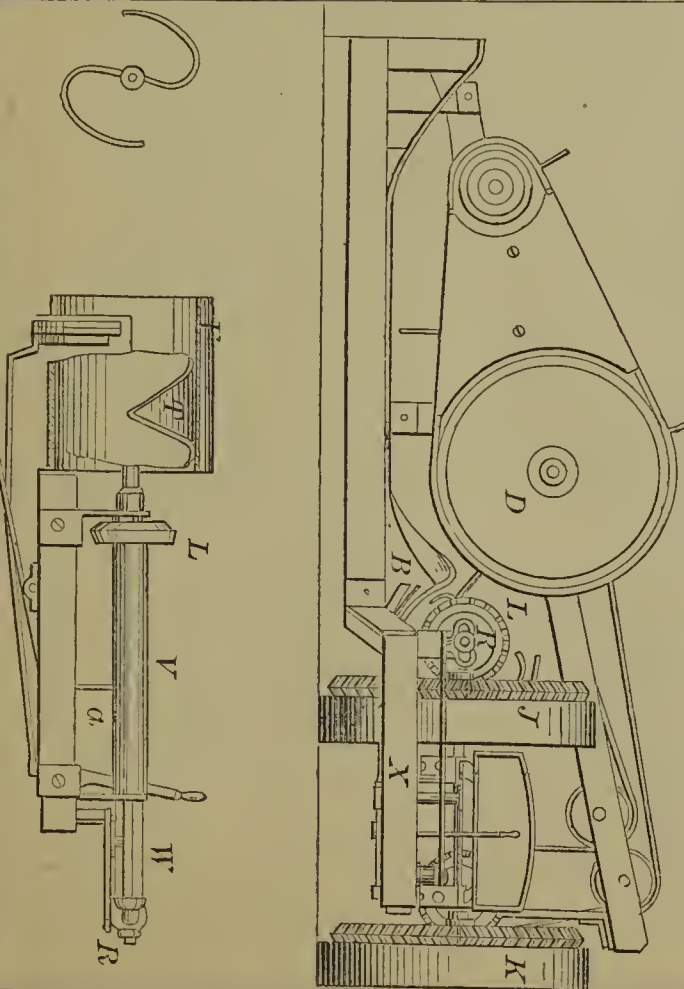

57709—E. Hamburger—Folding Chair.

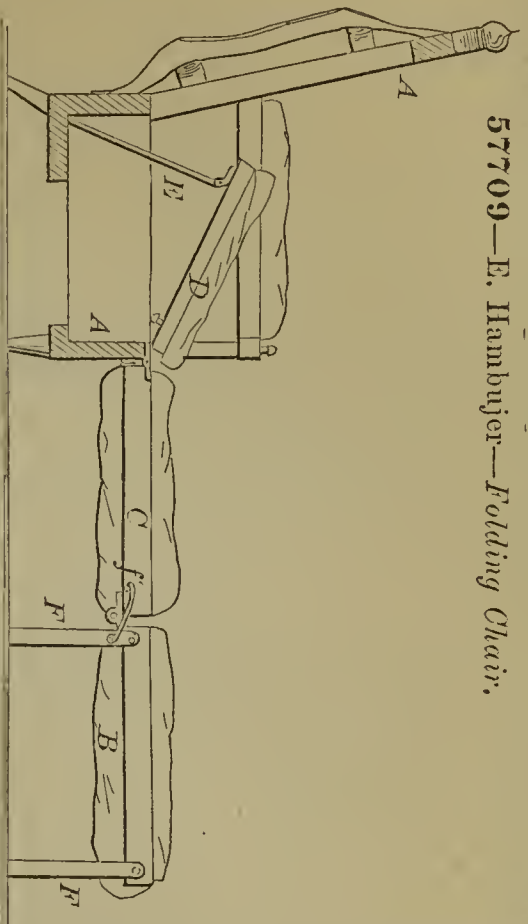

57712—P. W. Hart—Power Loom.

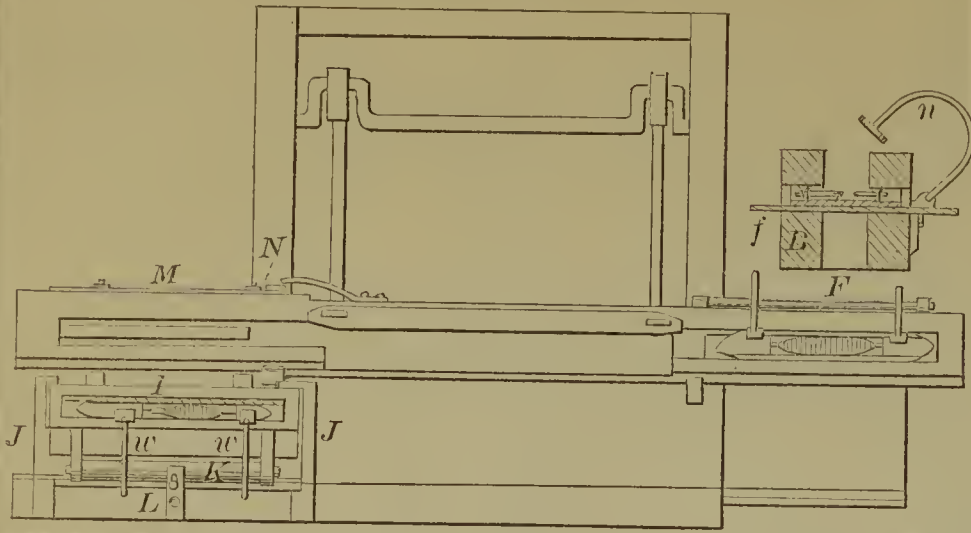

57715—A Hill—Railway Crossing Guard.

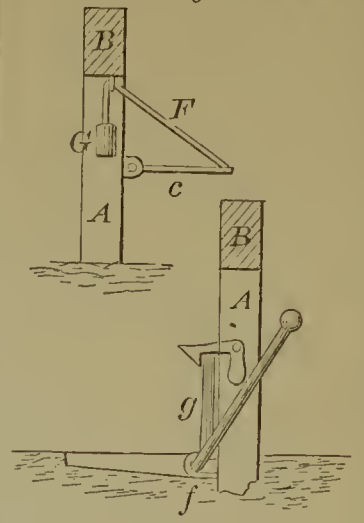

57714—Higley & Columbia—Raking and Binding Attachment to Reapers.

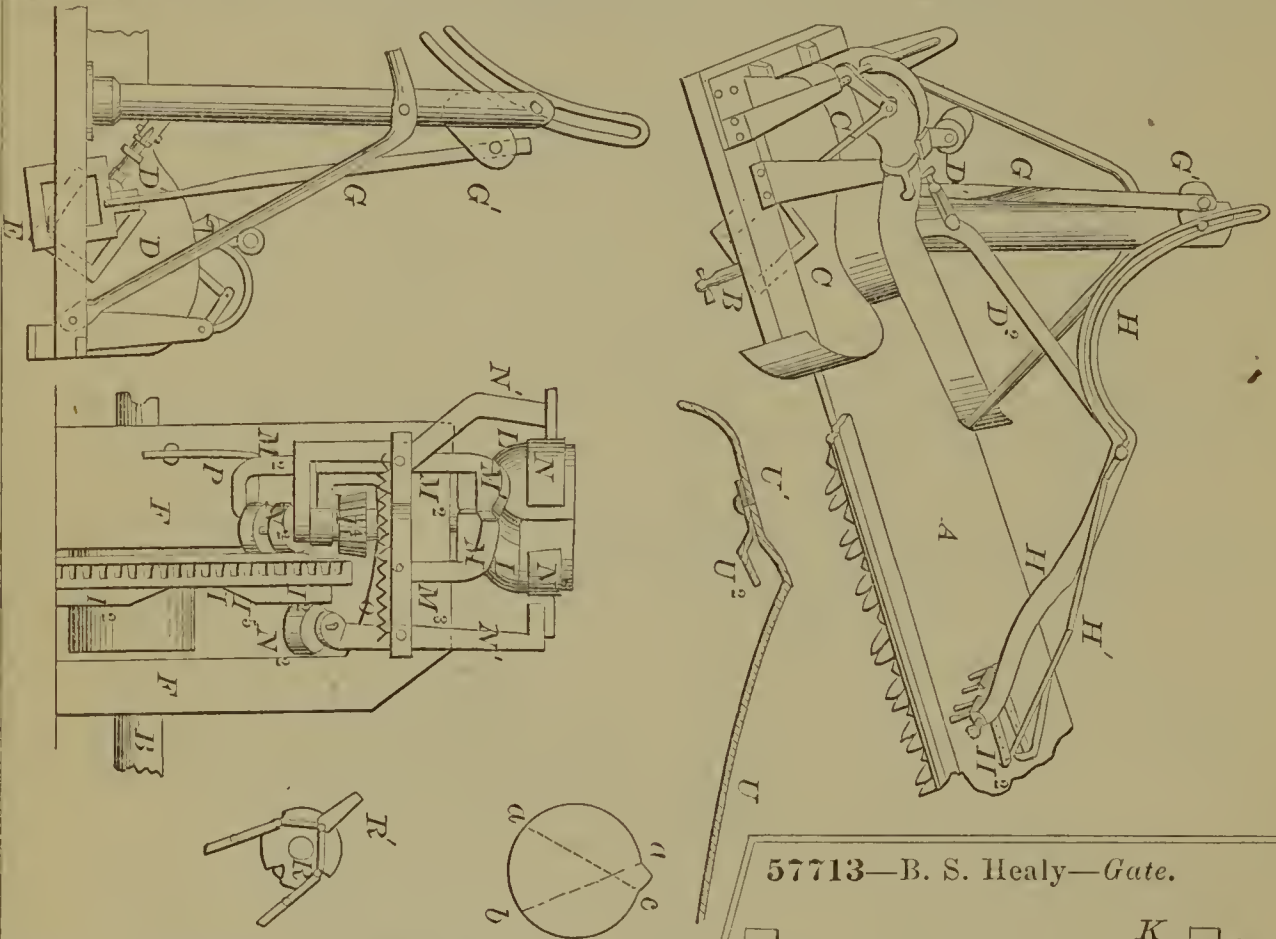

57713—B. S. Healy—Gate.

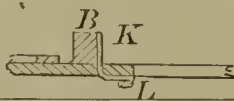
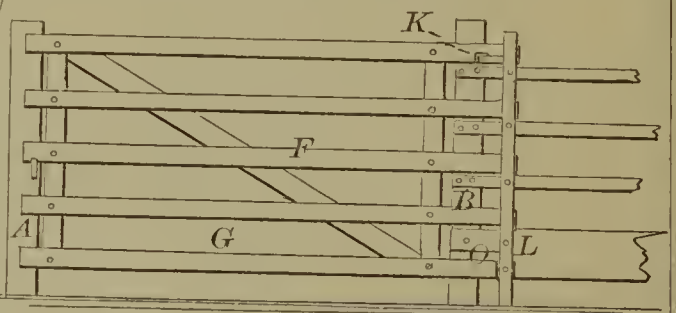

57717—I. N. Hodson—Loom.

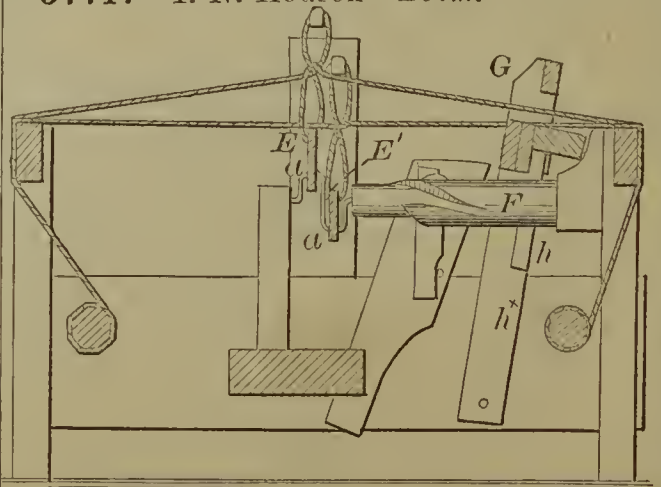

Fig. 1

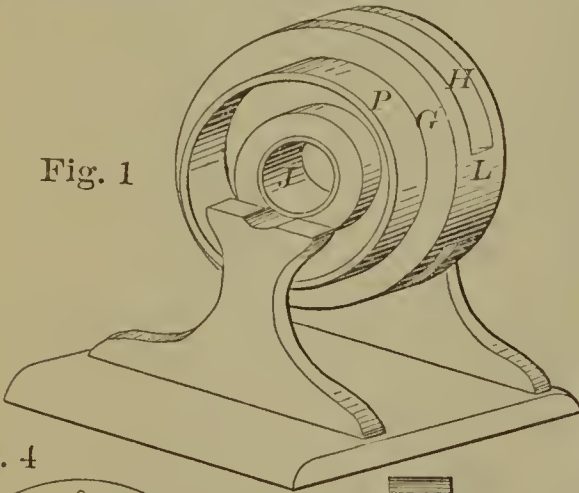

Fig. 4

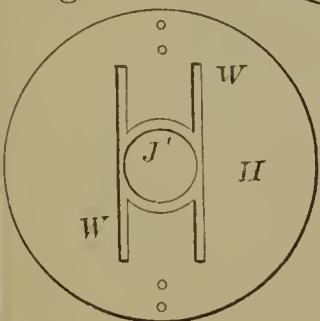
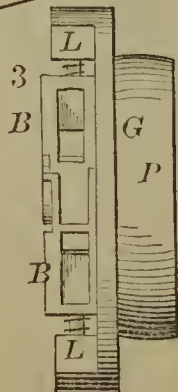

Fig. 3



57716—S. Hinton—Lathe for Turning Scythe Snaths.



57717—Continued.

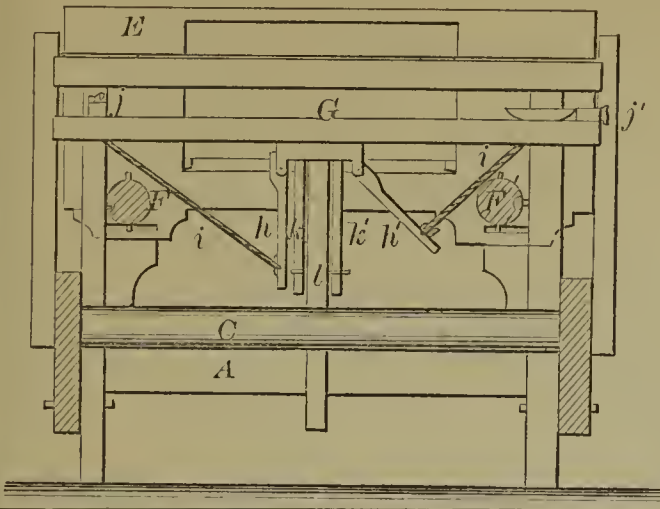

57718—D. Hoit—Wood Boring Machine.

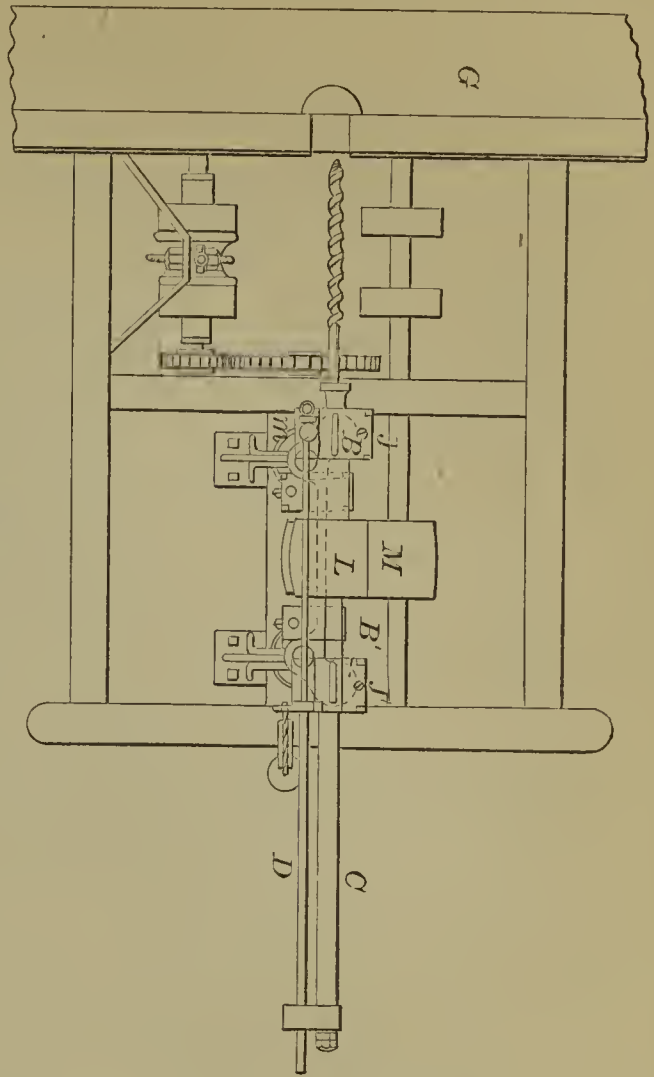

57719—J. Hollinger—Cultivator.

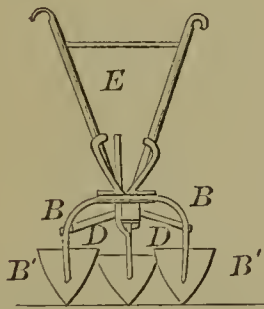
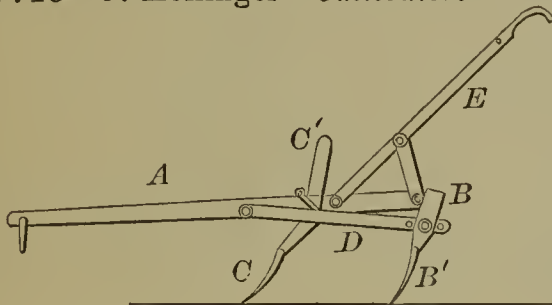

57721—N. P. Holmes—Milk Preserving Apparatus.

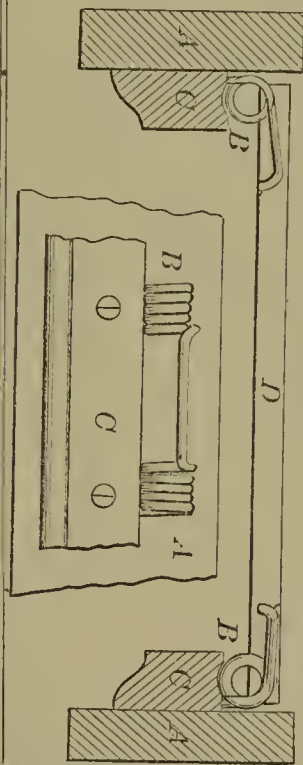
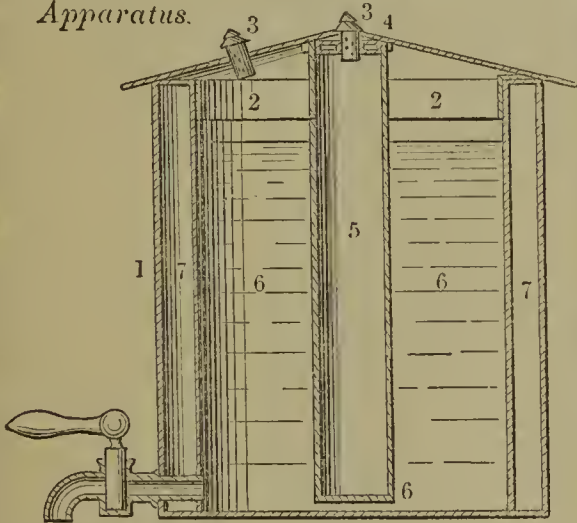

57720—Holloway & Hudelson—Bed Bottom.

57723—Hughes & Lent—Stand and Mirror.

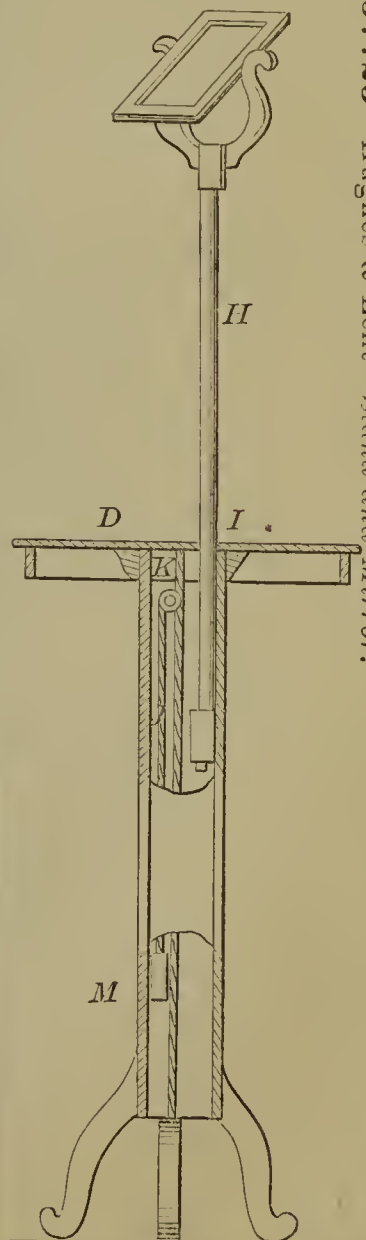

57724—H. A. Hummer—Plow.

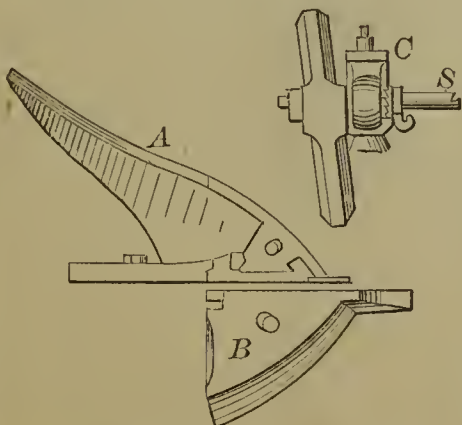

57722—T. L. Hough—Truss.

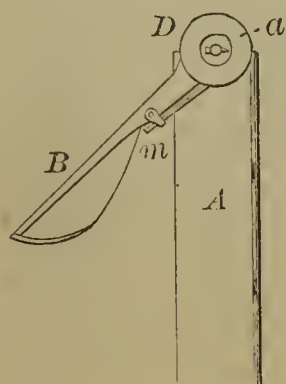

57725—G. H. Hurd—Plate for Artificial Teeth.

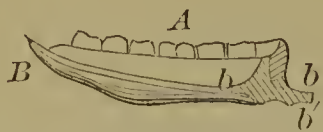

57726—G. H. Hurd—Dental Mould.

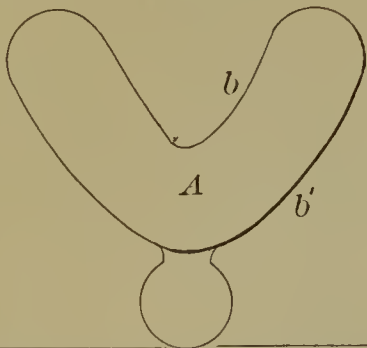

57729—A. K. Johnston—For Carburetting Gas.

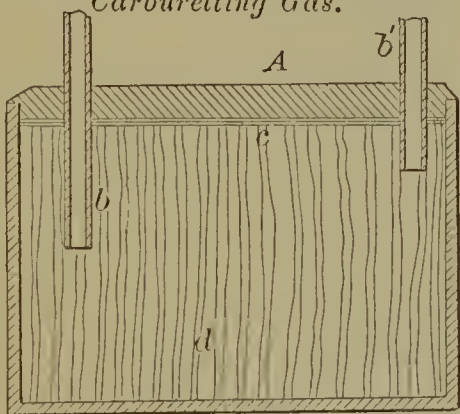

57730—J. D. Kellogg Churn.

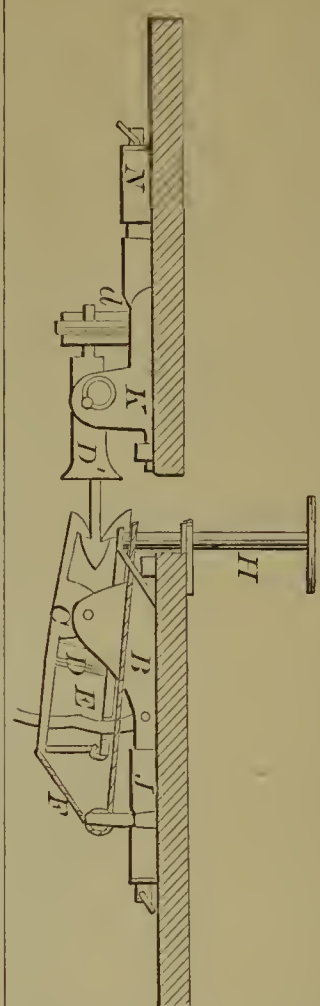
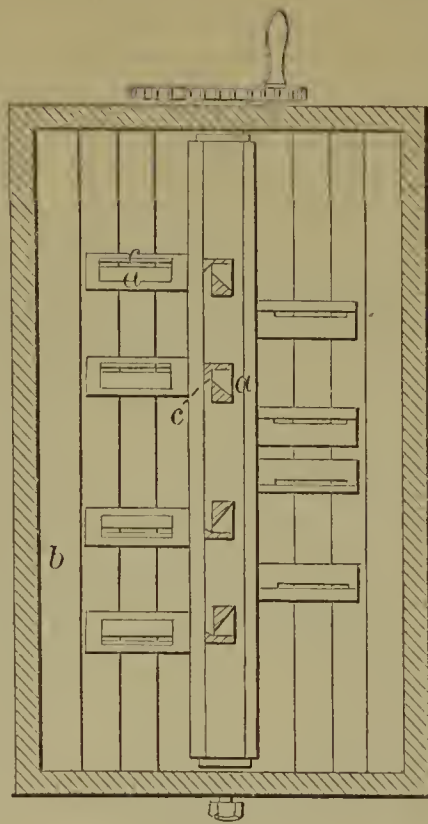

57732—J. Kingsbury—Car Coupling.

57734—A. Ladd—Corn Planter.

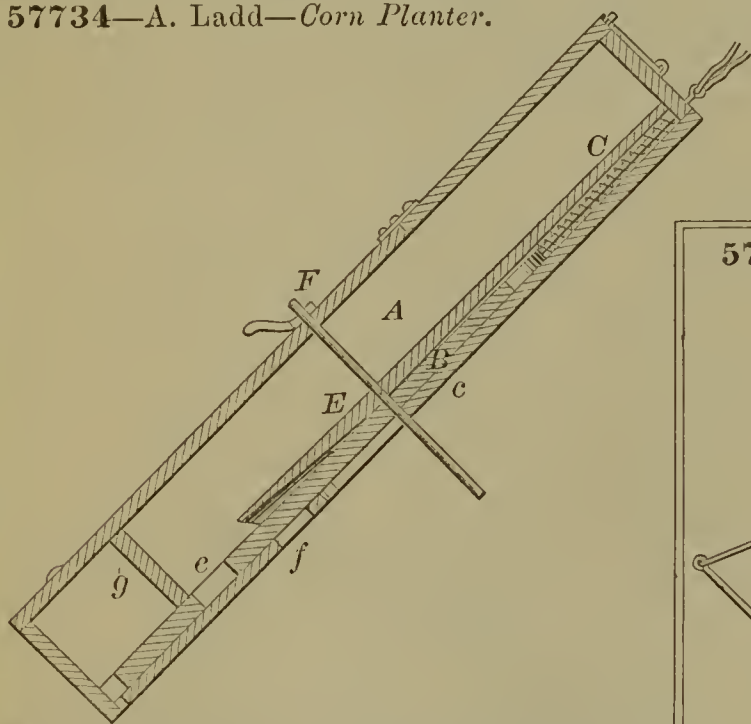

57733—Lacey & Bartlett—Sash Lock.

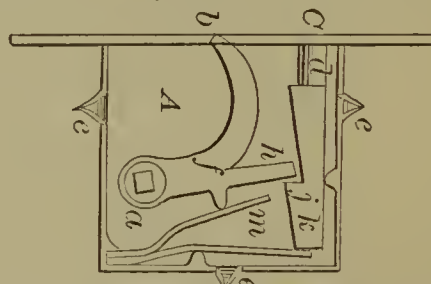

57731—Z. S. Kelsey—Fruit Gatherer.

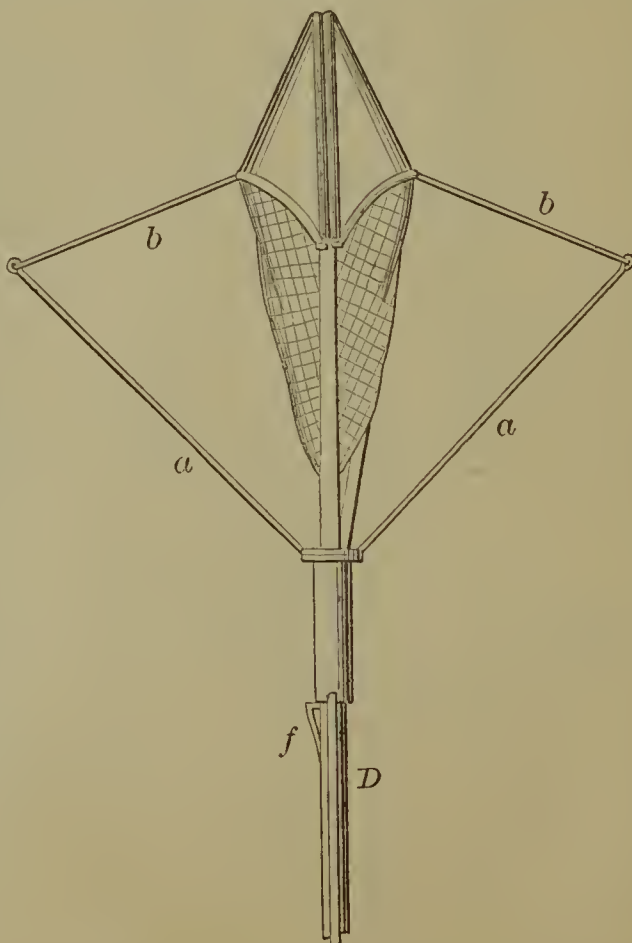

57735—C. Lee—Fence.

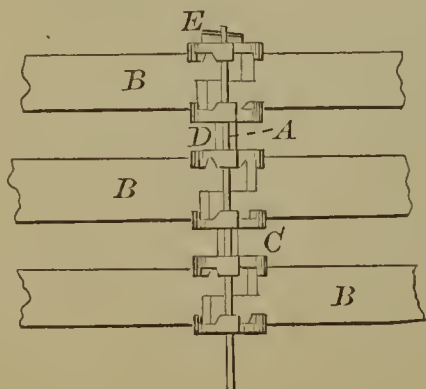

57736—J. Lefeber—*Spoke Tenoning Machine.*

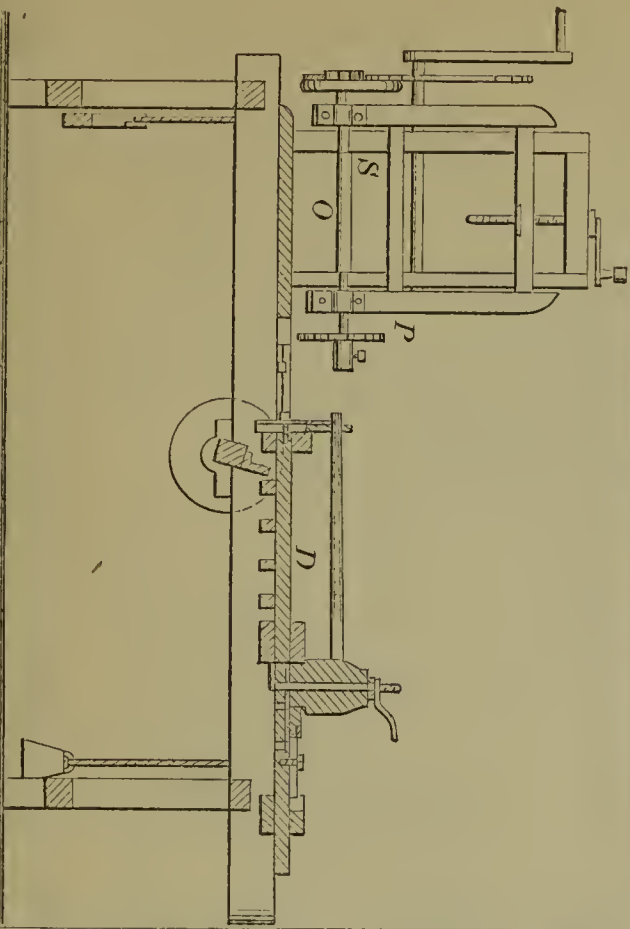

57739—S. D. Locke—*Grain Binder.*

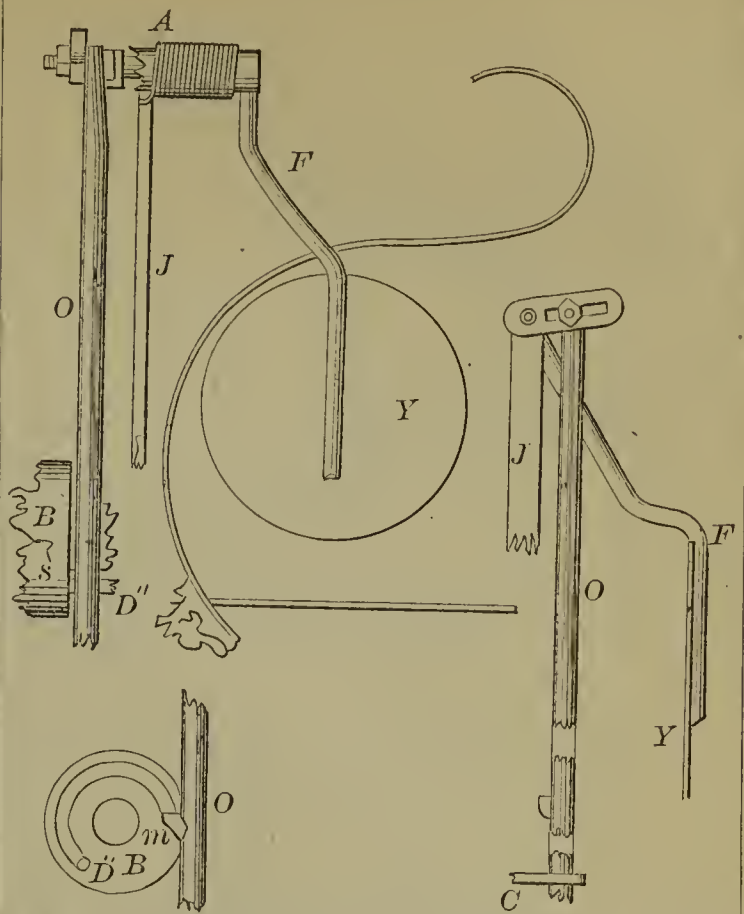

57740—M. J. Lourrentz—*Washing Machine.*

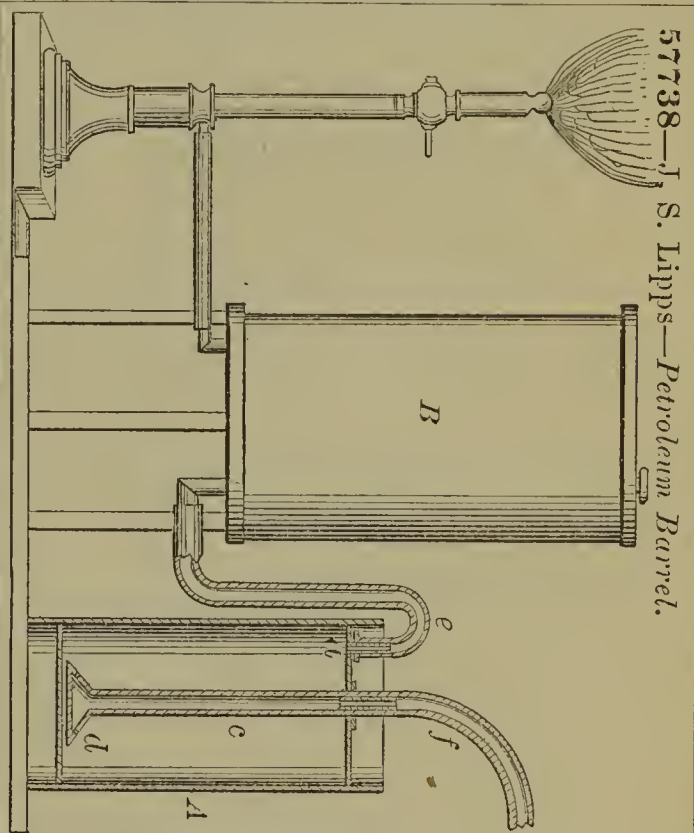
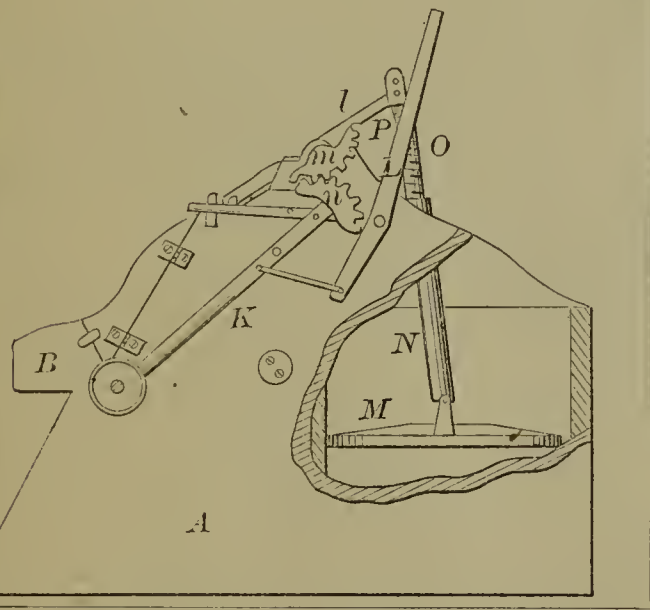
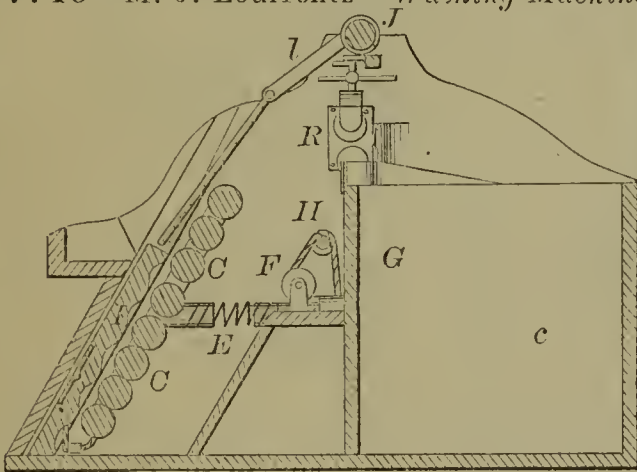

57738—J. S. Lipps—*Petroleum Barrel.*

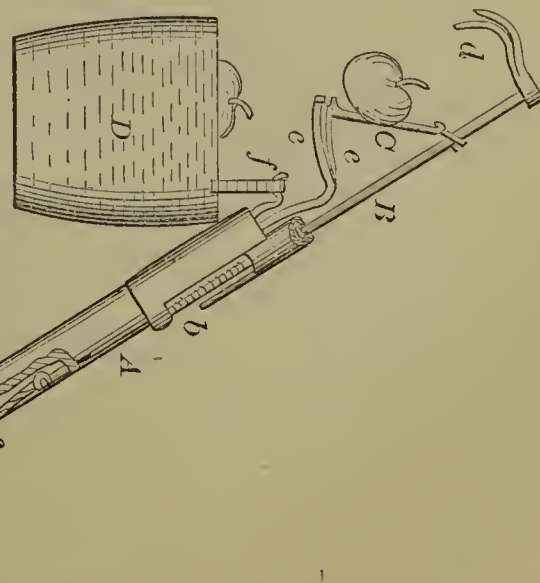

57741—C. M. & W. F. Lunt—*Fruit Picker.*

57742—J. Marquis—Slop Hopper.

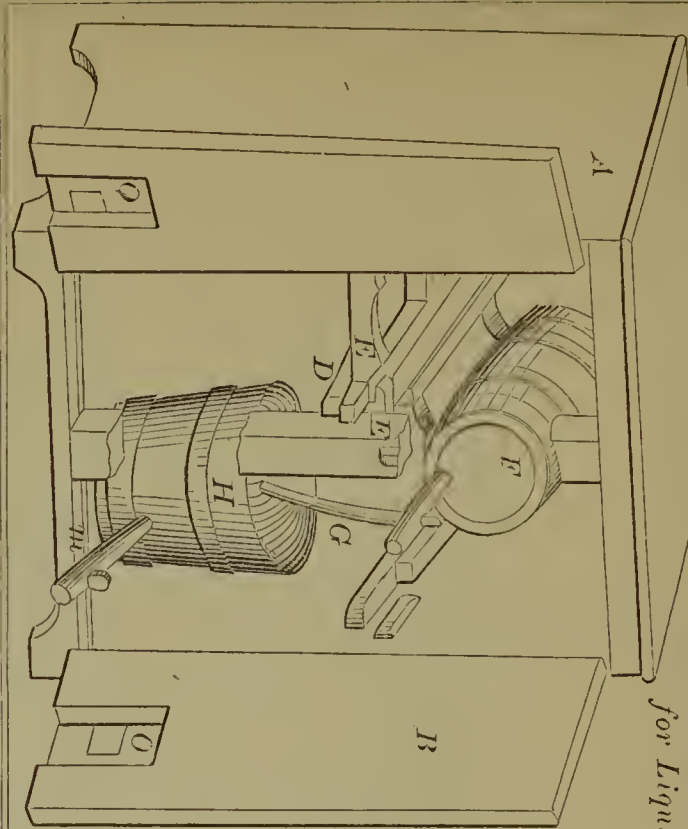
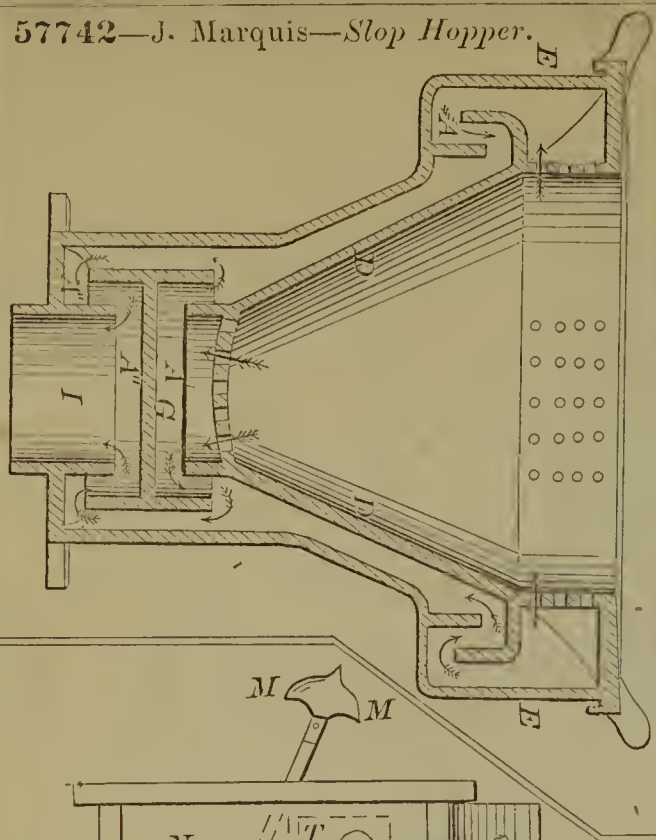

57746—R. W. McClelland—Refrigerator for Liquids.

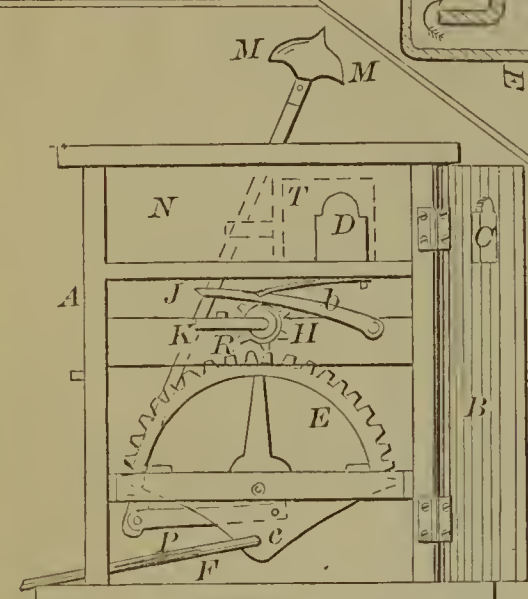

57744—H. Maxell, E. & H. Fessler—Railroad Switch.

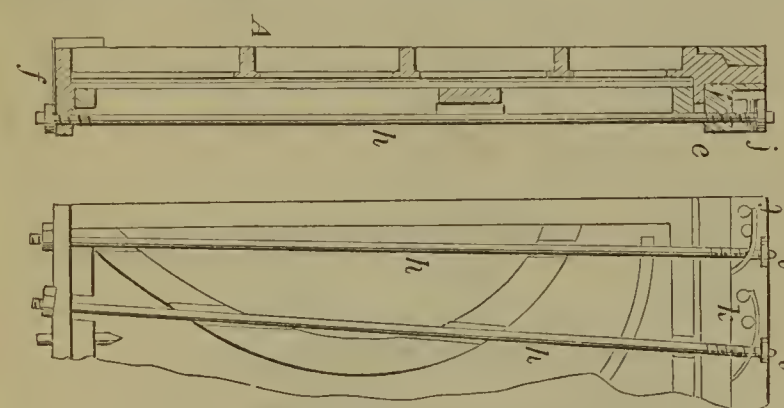
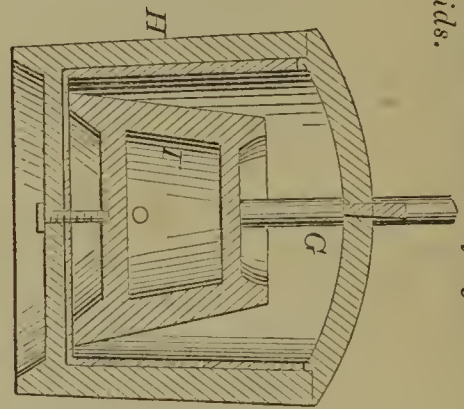

57743—M. Martins—Metal Frame for Pianos.

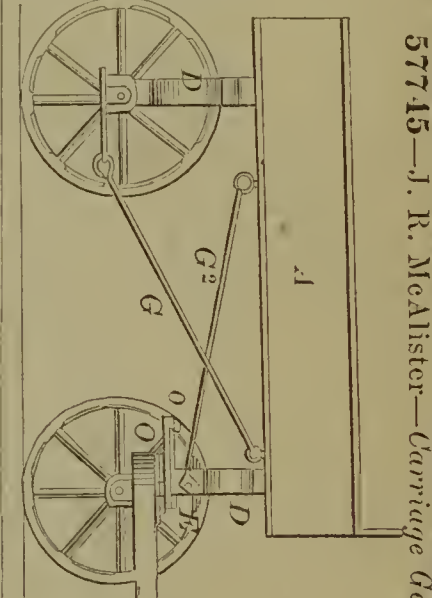

57745—J. R. McAlister—Carriage Gearing.

57747—T. B. McConaughey—Cultivator.

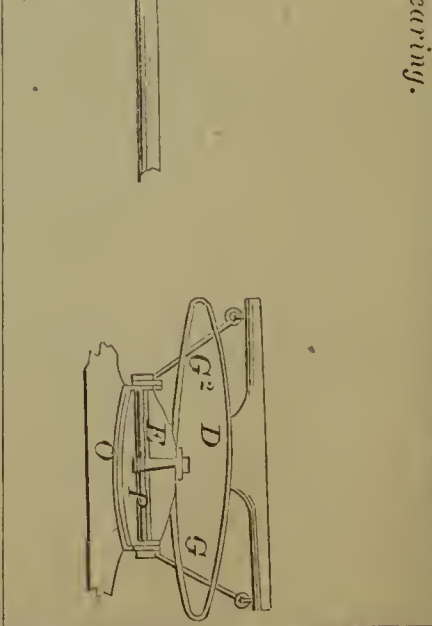
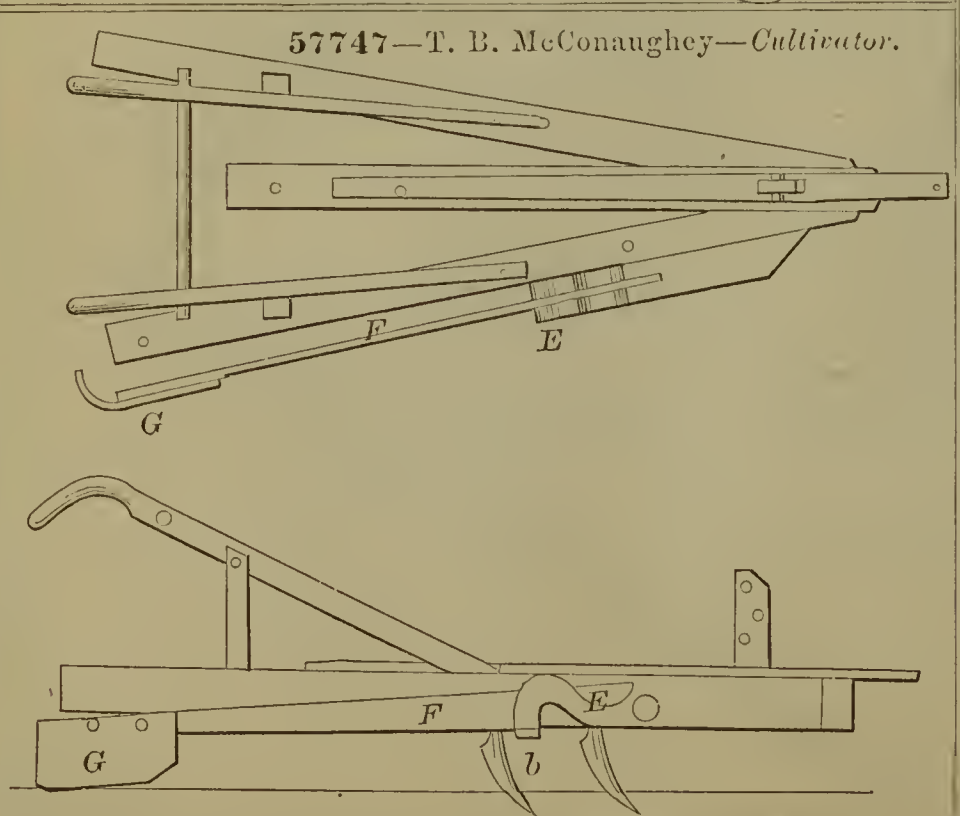

57748—J. McKinley—Plow.

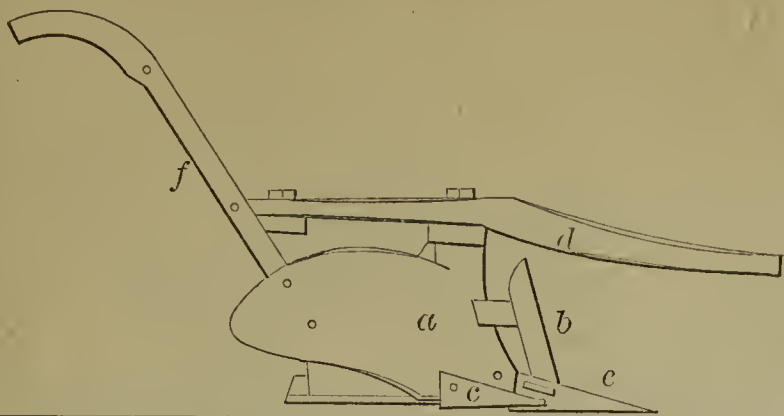

57750—J. H. Mendenhall—Churn.

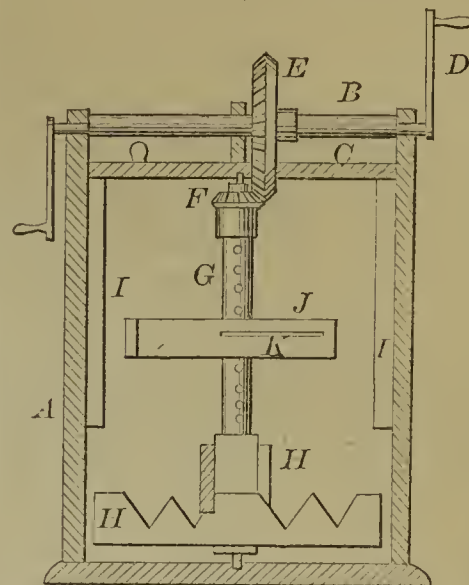

57751—N. L. Milburn—Revolving Ordnance.

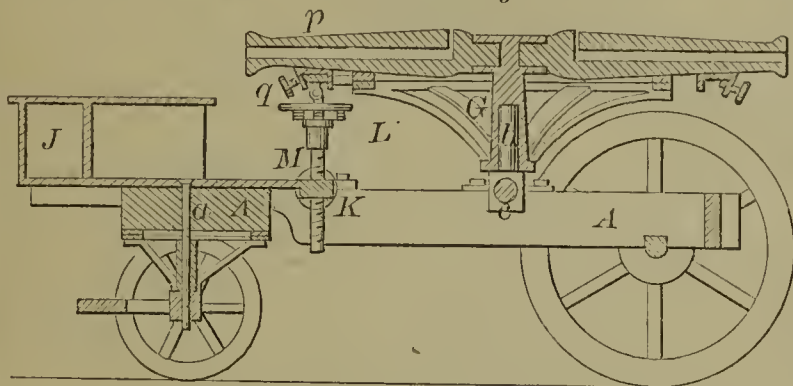

57755—E. Osborne—Tool for Making Wooden Legs.

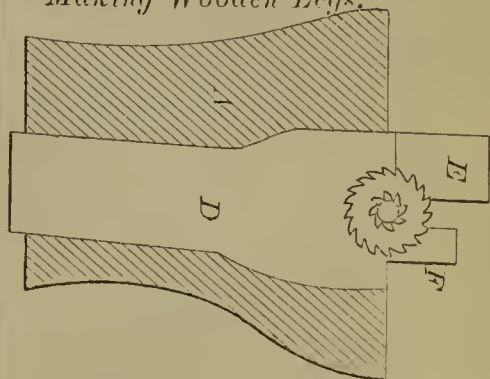

57753—J. G. Morgan—Hoop Shaving Machine.

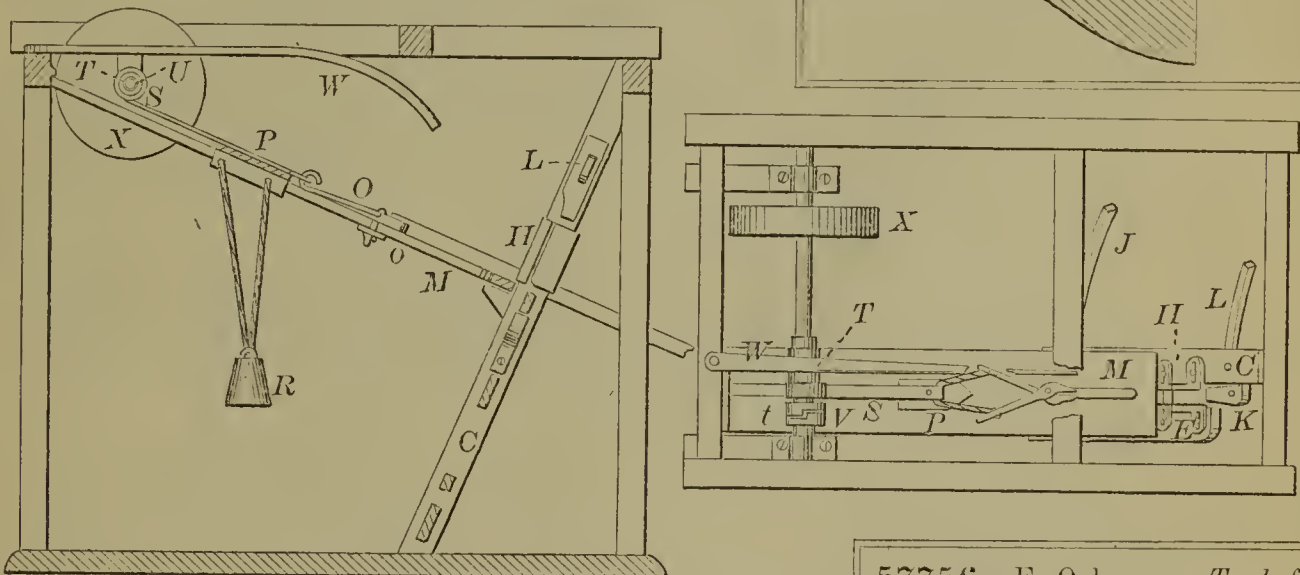

57754—E. & A. H. Nordyke—Grinding Mill.

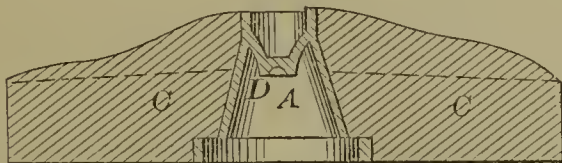

57752—L. B. Moore—Corn Cultivator.

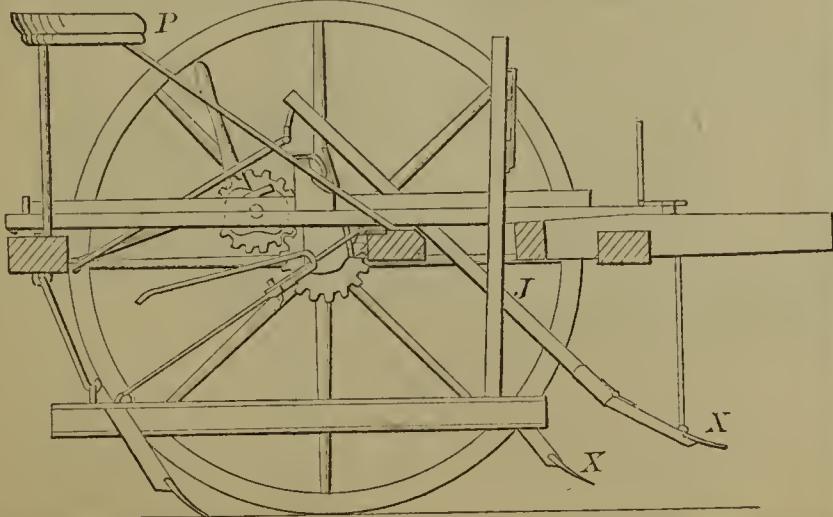

57756—E. Osborne—Tool for Making Wooden Legs.

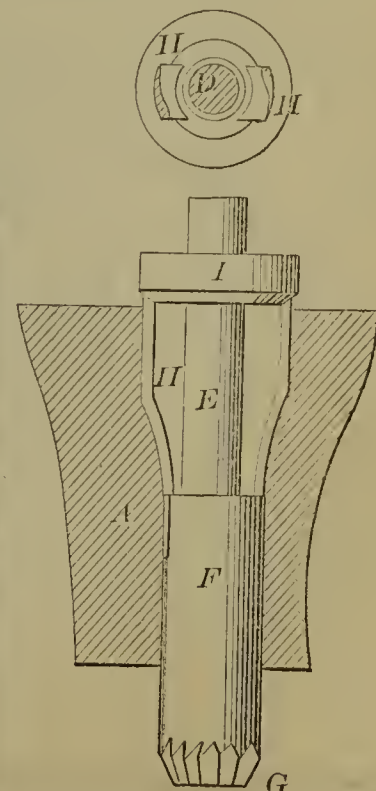

57757—N. Peck—*Earth Scraper.*

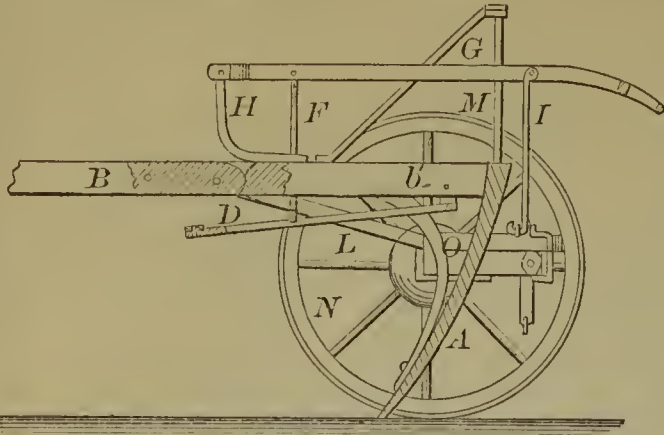

57758—J. Peckham—*Buckle.*



57759—J. Pfeifer—*Coal Shovel Handle.*

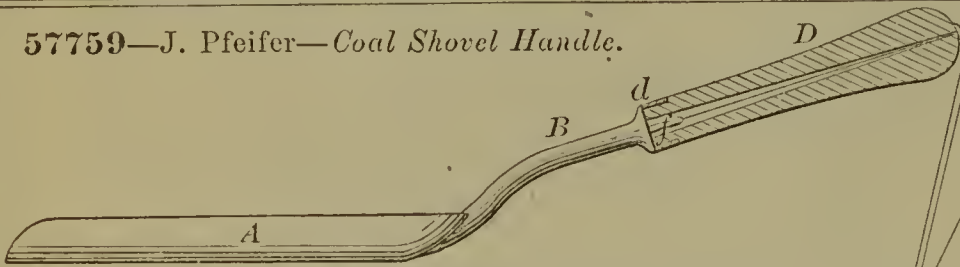

57762—J. K. P. Pine—*Neck Tie.*

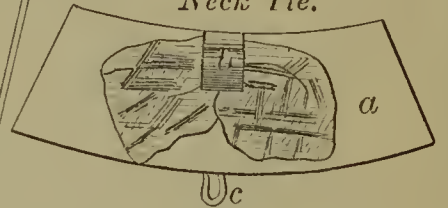

57761—R. G. Pike—*Lighting Gas by Electricity.*

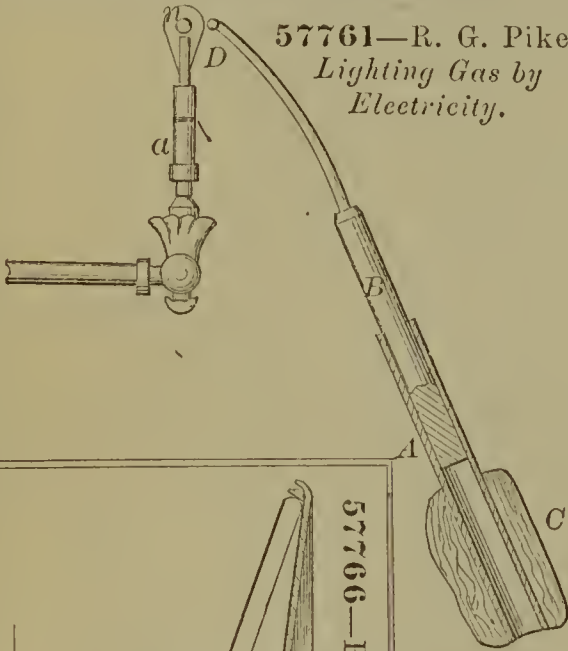

57764—J. H. Pulte—*For Spreading Cement.*

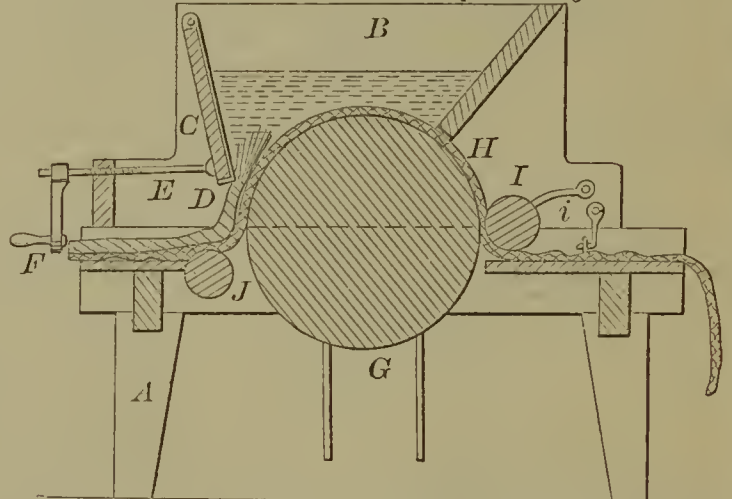

57766—F. I. Rausschert—

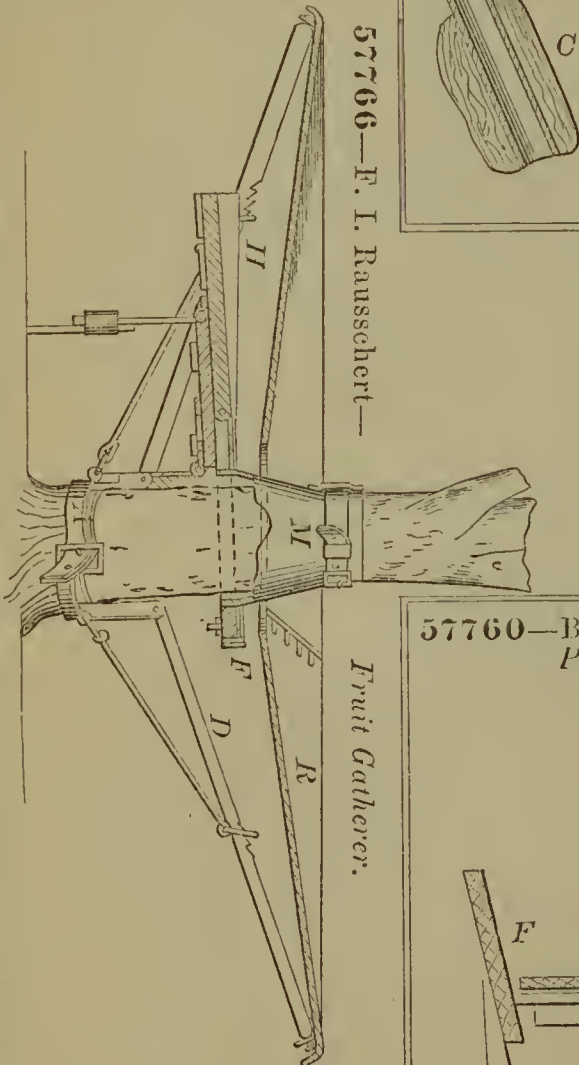

*Fruit Gatherer.*

57765—S. R. Ramsdell—*Carriage Wheel Fender.*

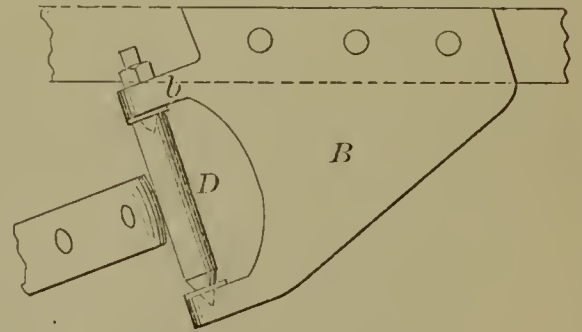

57760—B., E. & B. Pickering—*Pump Piston.*

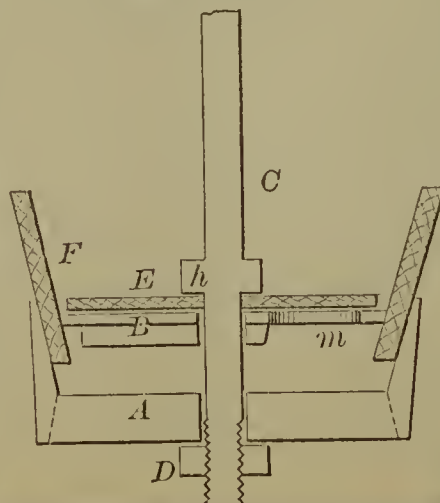

57767—J. H. Reed—*Car Coupling.*

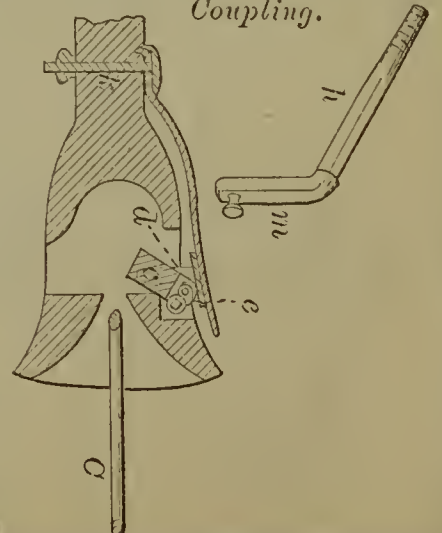

57768—Richardson & Ward—*Lamp Extinguisher.*

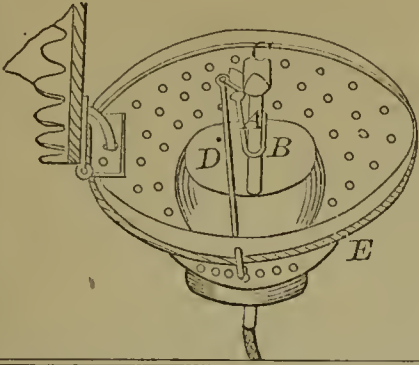

57769—C. Richmond—*Tool.*

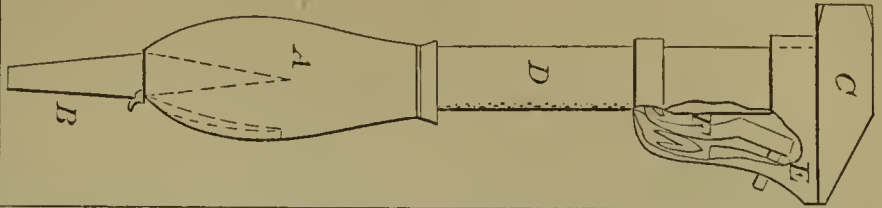

57770—E. R. Rison—*Bed Bottom.*

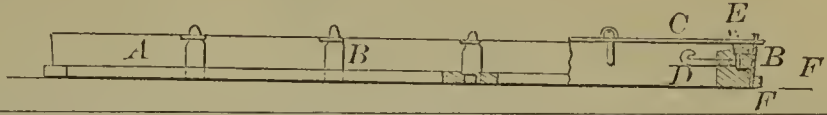

57772—W. H. Robbins—*Hog Trough.*

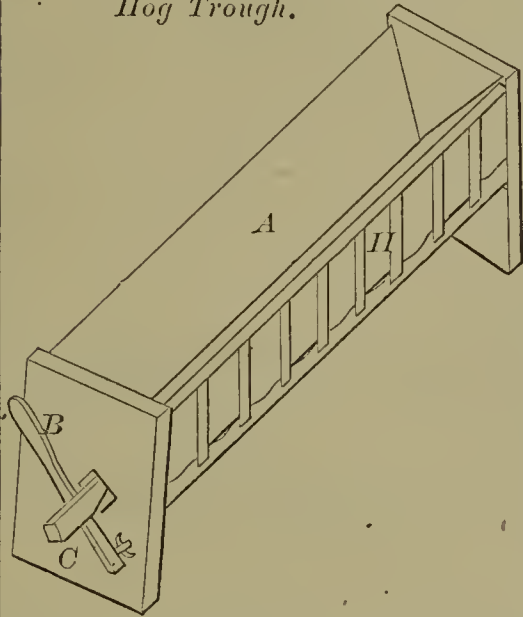

57775—F. Shaller—*Watchmaker's Lathe.*

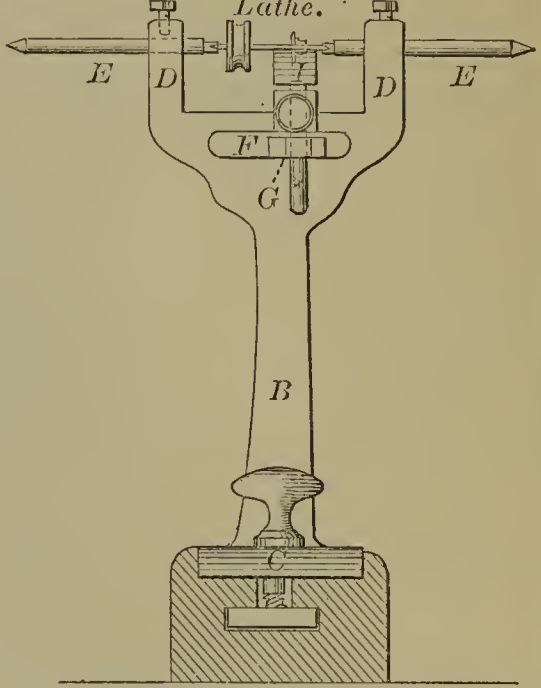

57771—B. Roach—*Shaft Coupling.*

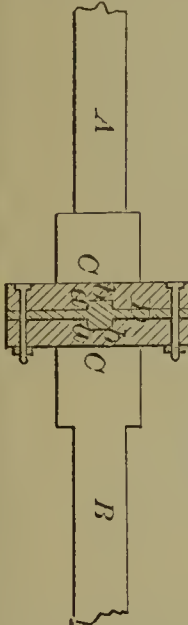

57776—E. Safford—*Card Rack.*

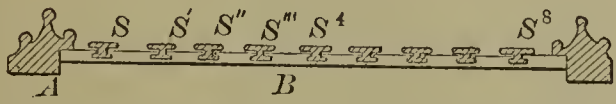
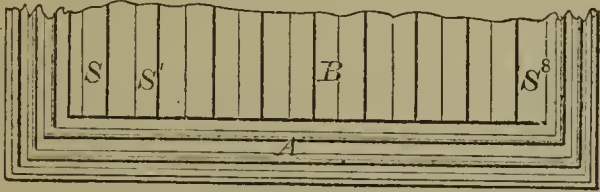

57773—C. D. Roberts—*Ground Roller.*

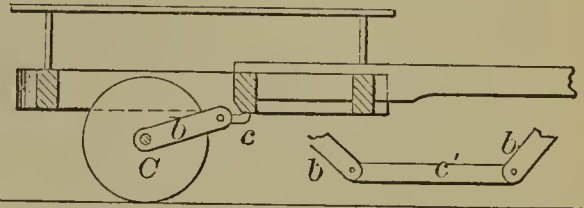

57777—G. S. Salisbury—*Training Grape Vines.*

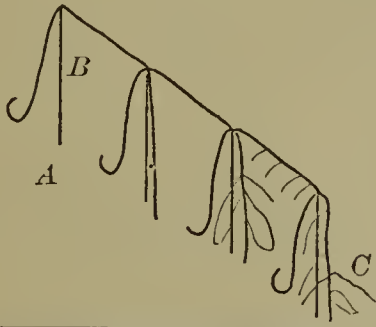

57779—J. L. Shaw—*Railway Crossing.*

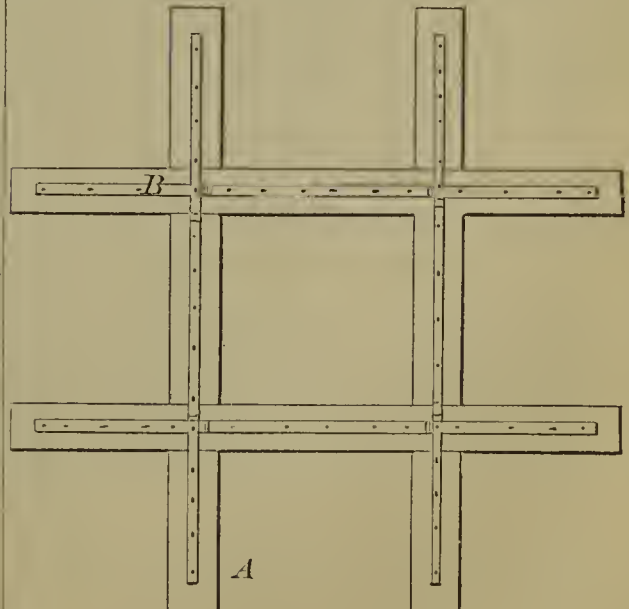

57778—H. H. Senniksen—*Stone Pipe Drum.*

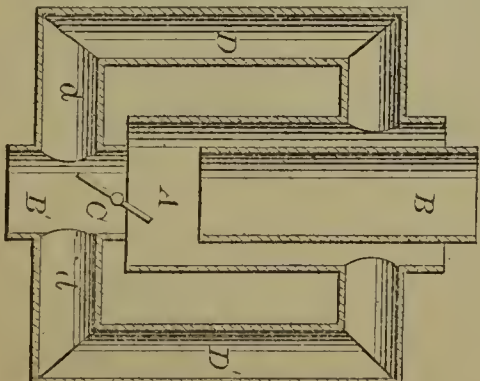

57780—Sheffield & Coburn—Leather Piercing Machine.

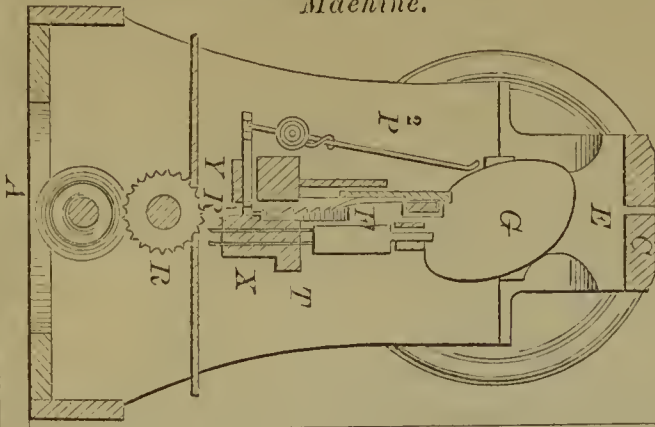

57785—Y. W. Smith—Fruit Gatherer.

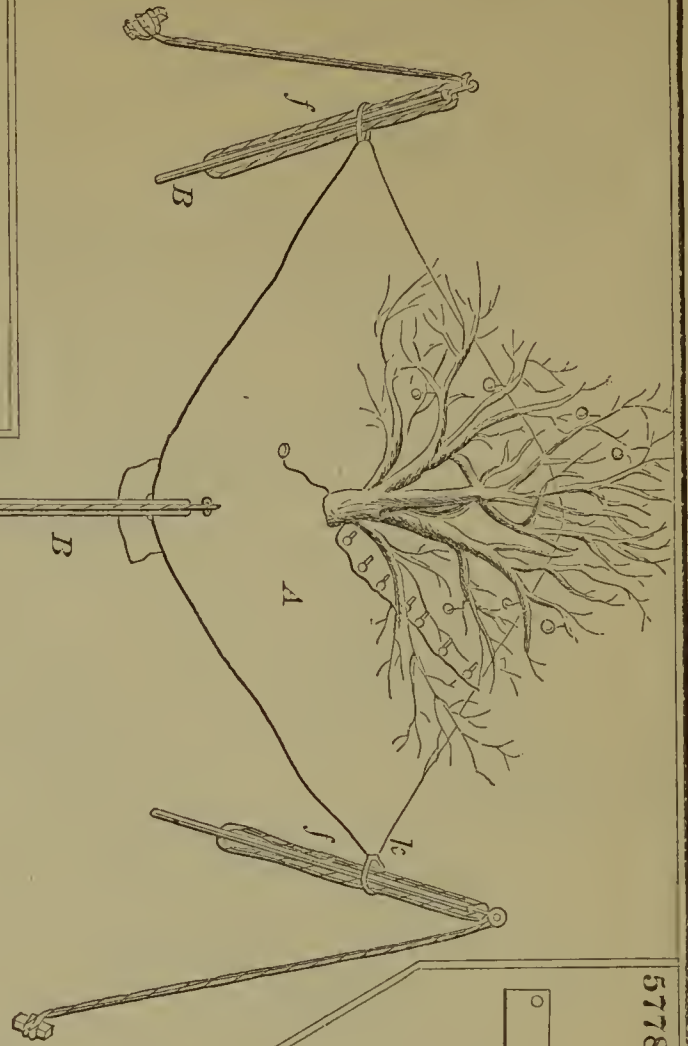

57784—W. S. Smith—For Sinking Hollow Piles.

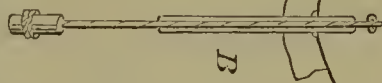
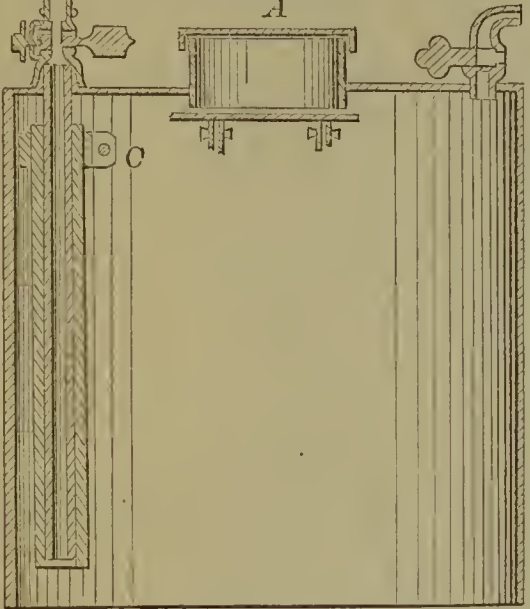

57781—J. W. Sibbet—Die for Bolt Heading Machines.

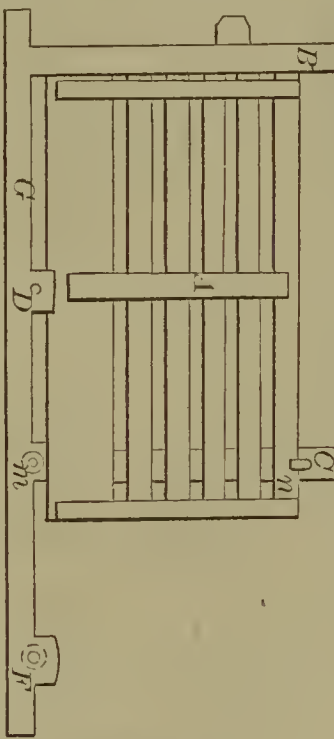
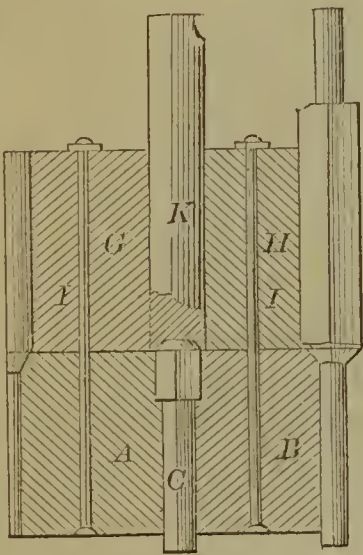

57782—Sigerfoos, Sands & Fry—Gate.

57786—J. Slotter—Tumbler Washer.

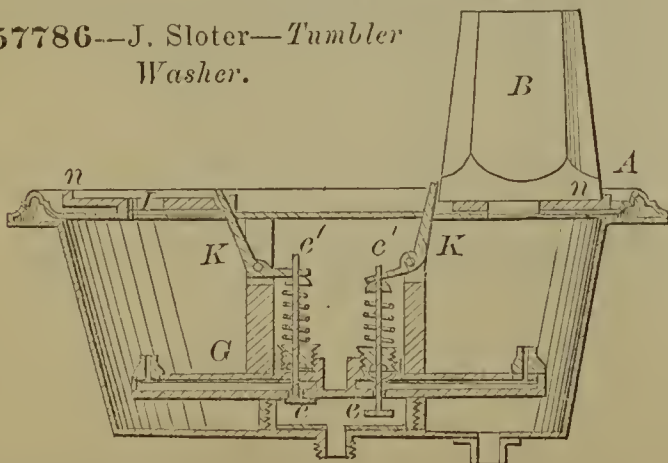

57783—C. G. Smith—For Making Metal Tubes.

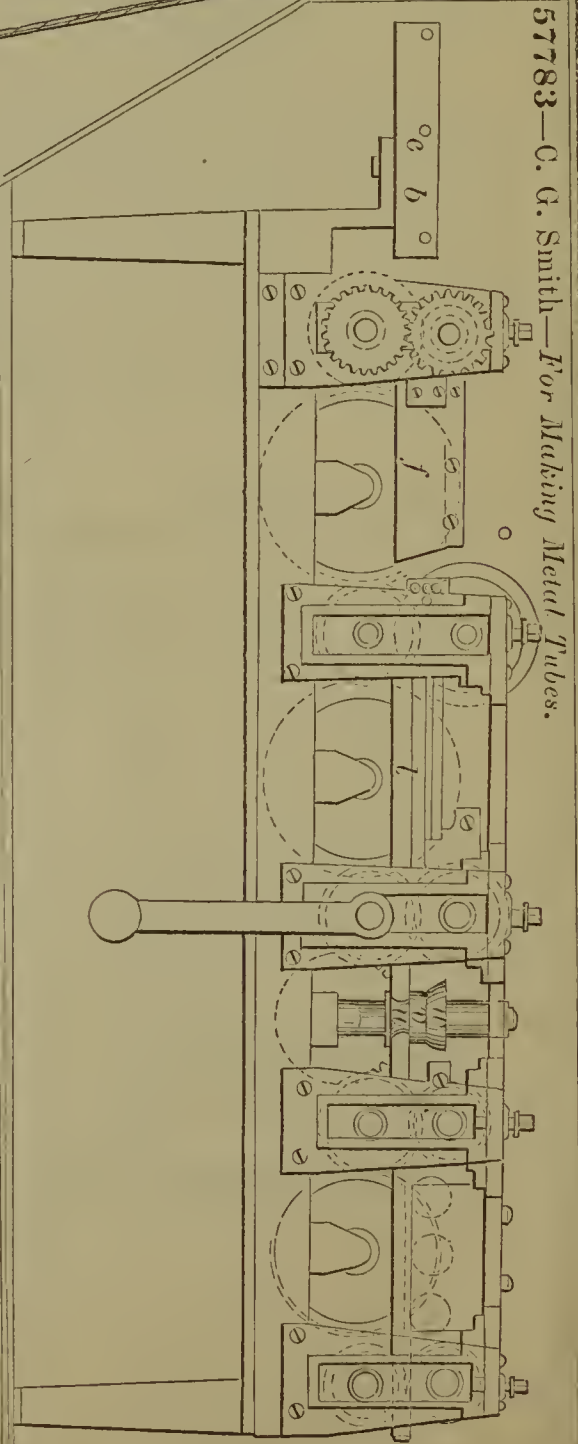



57788—J. F. Spence—For Carburetting Air.

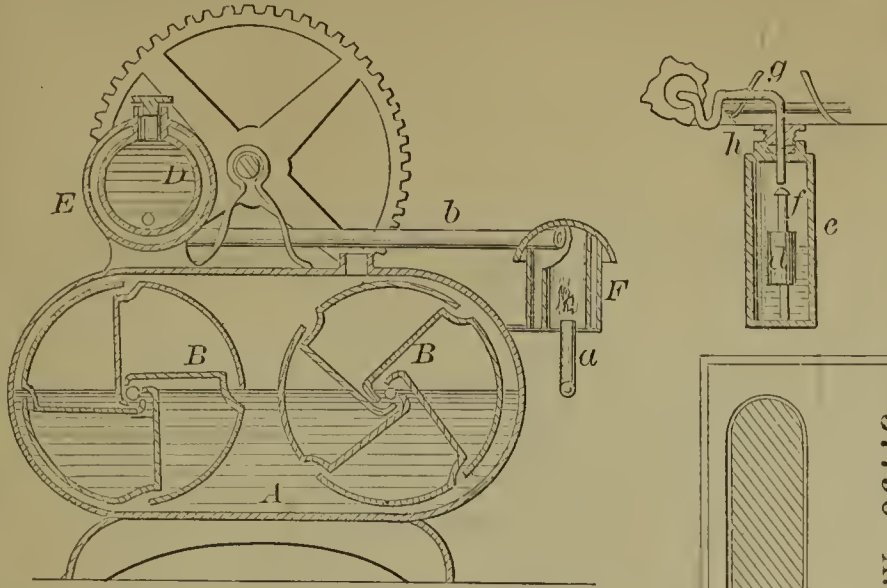

57789—W. S. Spratt—Horse Hay Fork.



57796—G. W. Thompson—Plow.

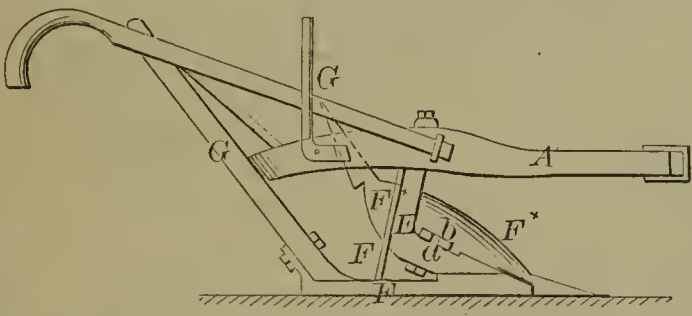

57792—A. F. Stillwell—Cultivator.

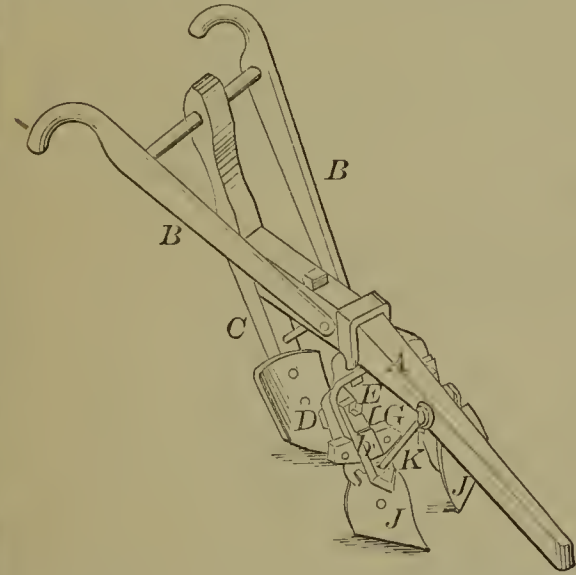

57790—A. G. Squire—Scythe Stone.



57791—M. B. Stafford—Jointed Mould.

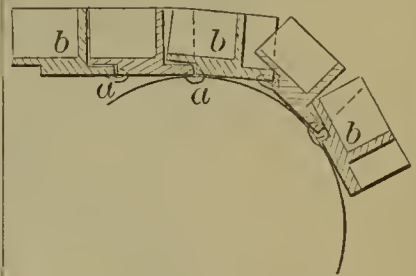

57793—S. W. Stockton—Attaching Artificial Teeth to Bases.



57797—G. F. Underhill—Rock Drilling Machine.

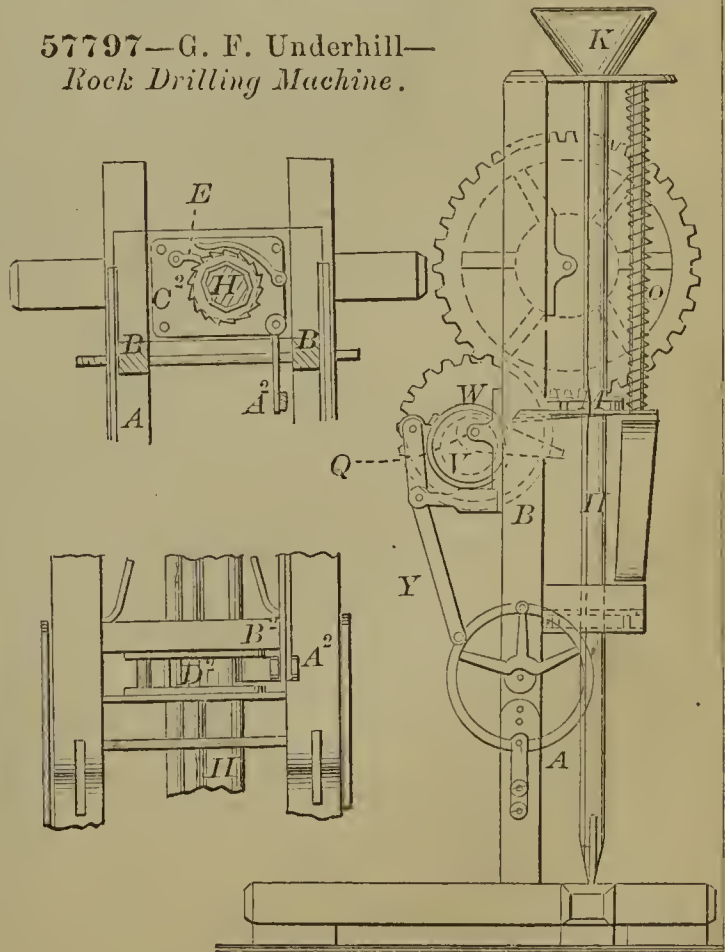

57794—H. C. Stoll—Churn.

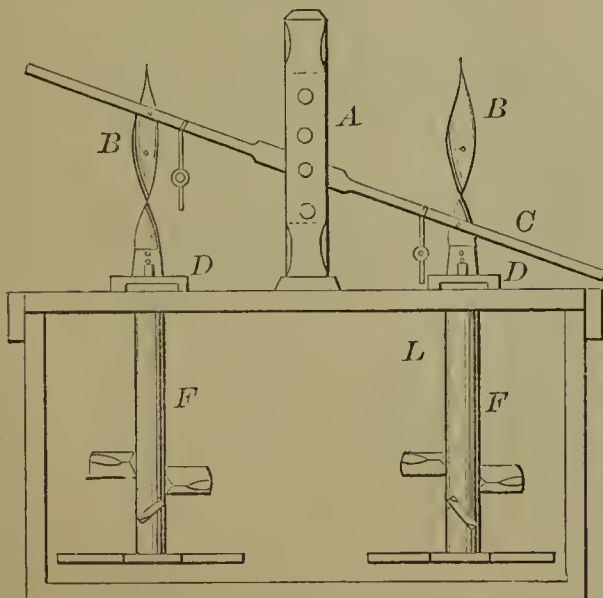

57798—M. Vergnes—*Boat Propelling Apparatus.*

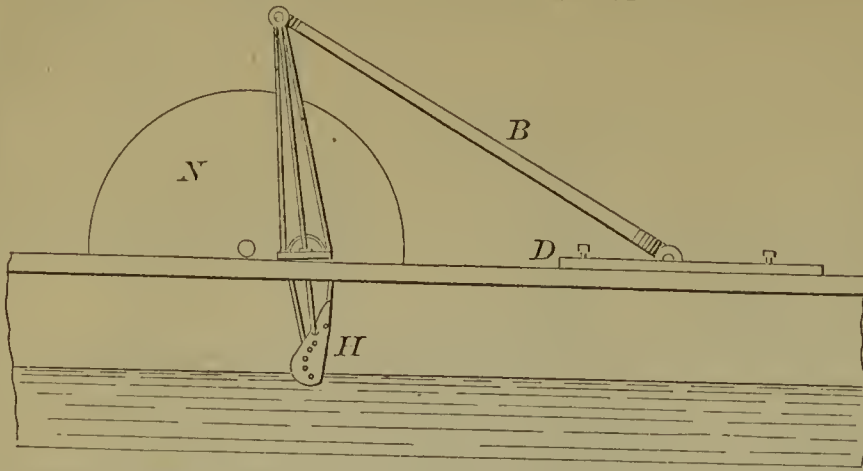

57802—W. J. Wells—*Weeding Hoe.*

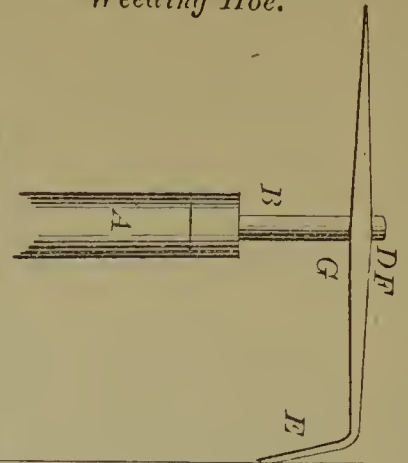

57799—G. I. Washburn—*Steam Engine.*

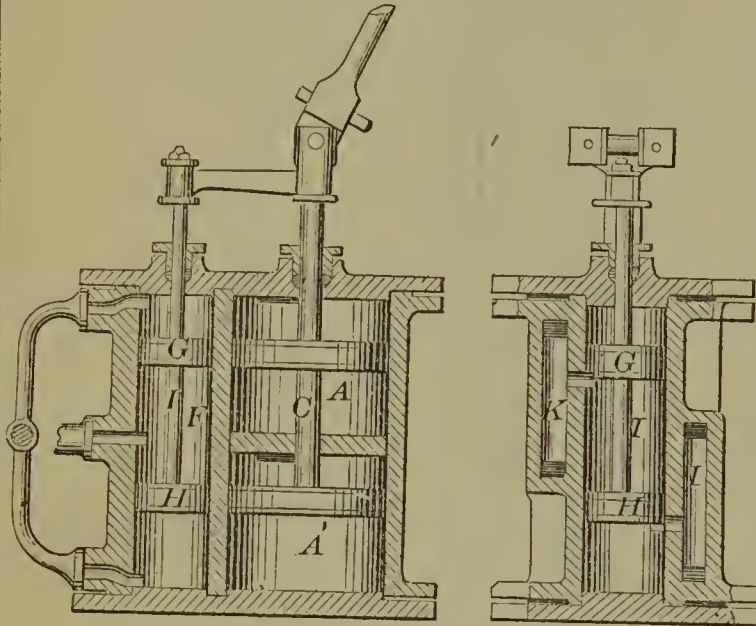

57801—G. Watt—*Whiffletree.*

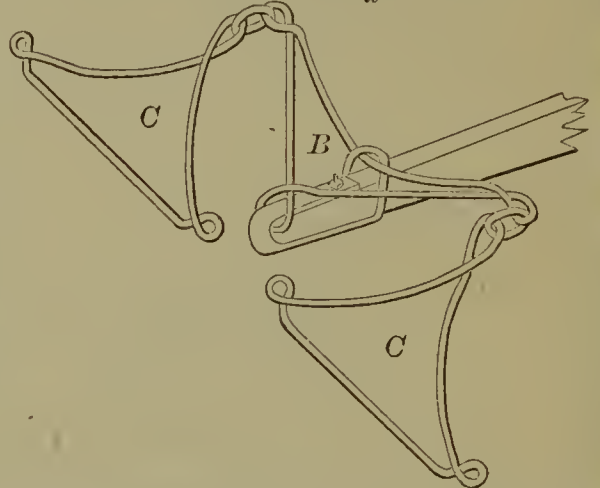

57804—T. H. White—*Knife Sharpener.*

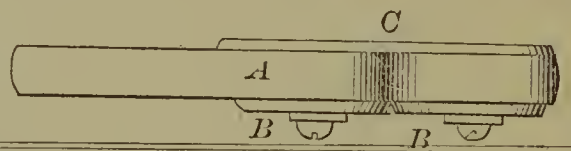

57800—W. H. Watson—*Tobacco Pressing Machine.*

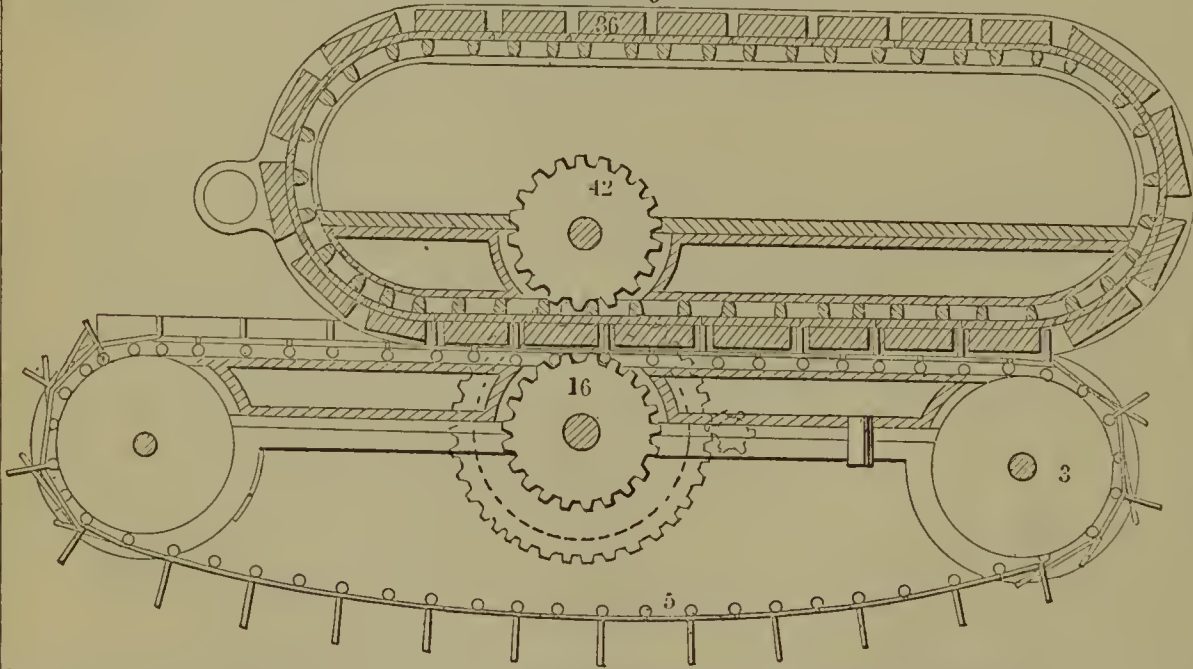

57803—M. Whipple—*Driving Rein Holder.*



57805—W. J. Wilcox—*Cooling Lard.*

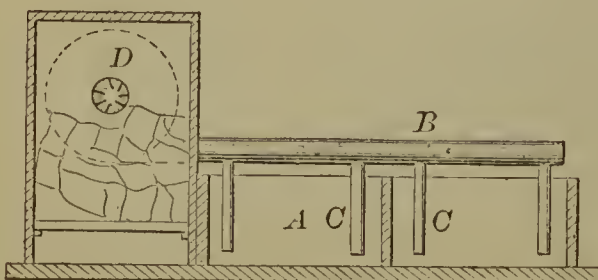

57806—H. F. Willson—*Evener for Wagon Poles, &c.*

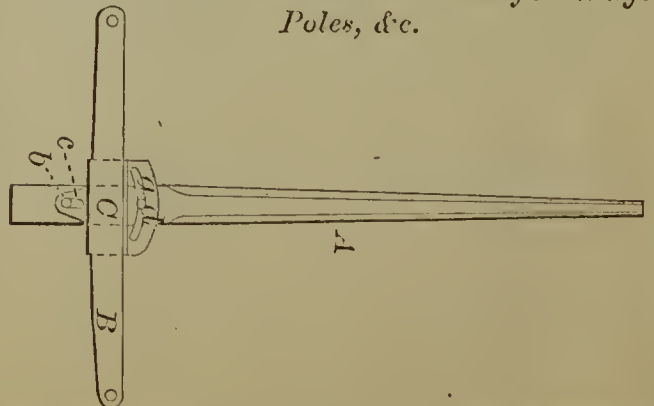

57807—G. W. Wilson—Car Coupling.

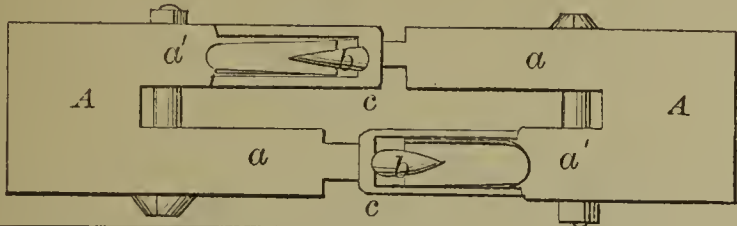
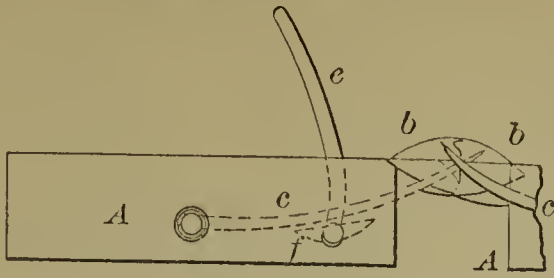

57809—B. L. Wood—Carriage Thill.

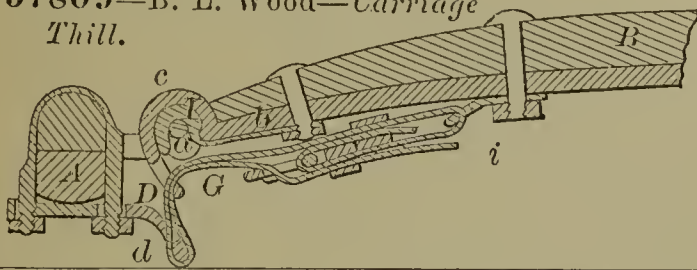

57810—L. E. Woodard—Wagon Brake.

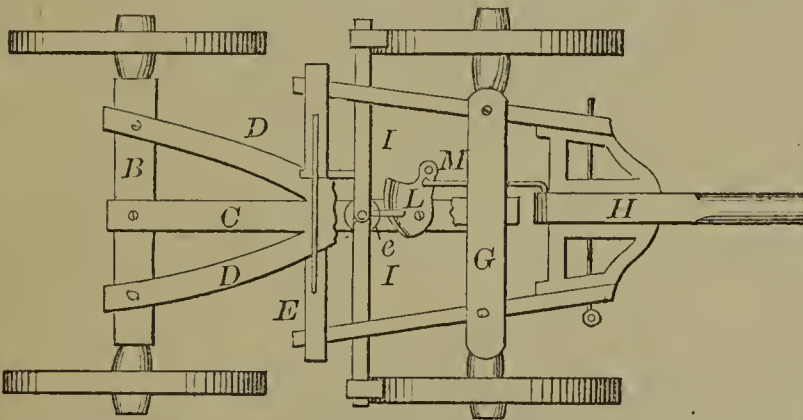

57811—A. Woodworth—Water Elevator.

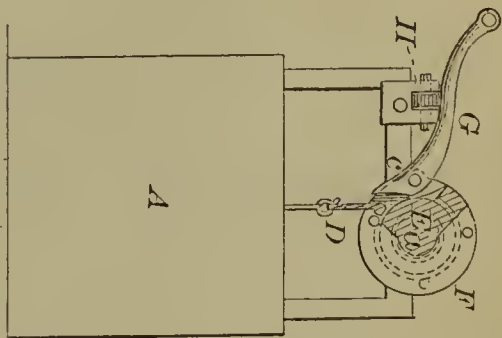

57813—W. Yapp—Eaves Trough.

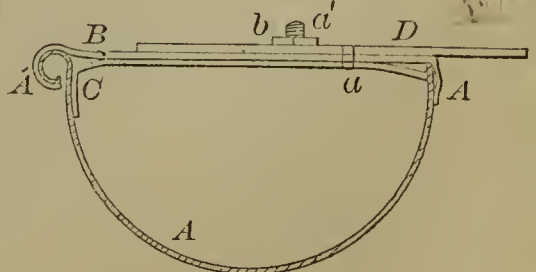

57808—O. F. Winchester—Magazine Fire Arm.

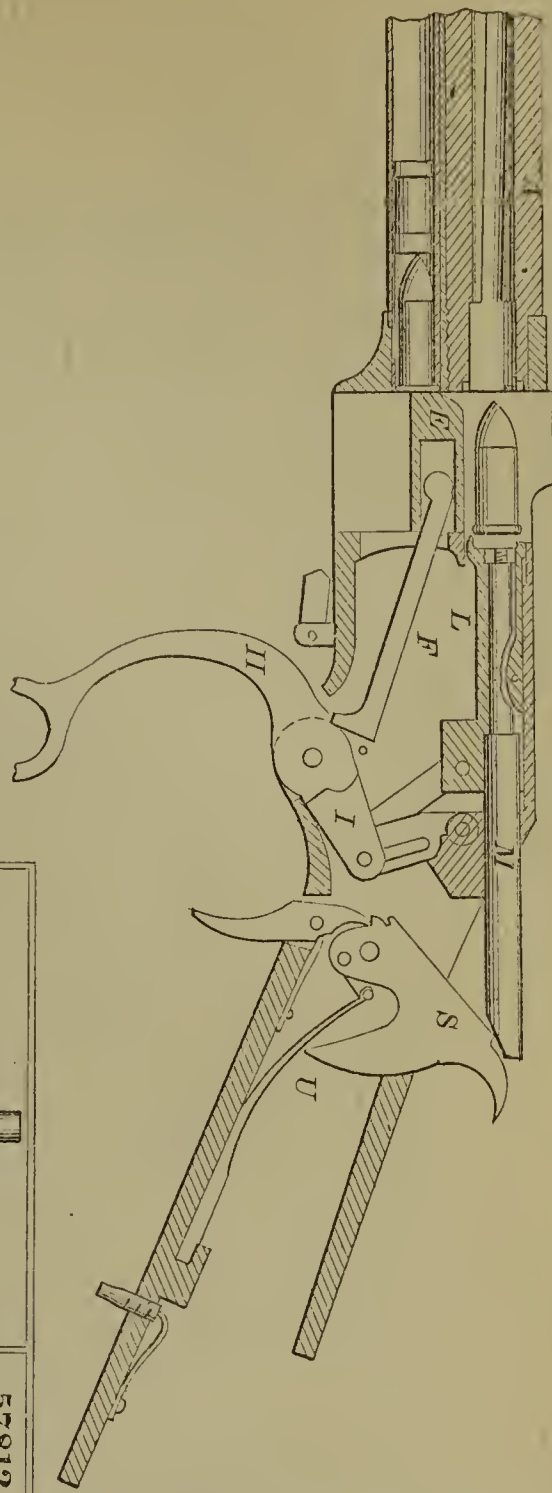

57812—T. D. Worrall—For Carburetted Gas.

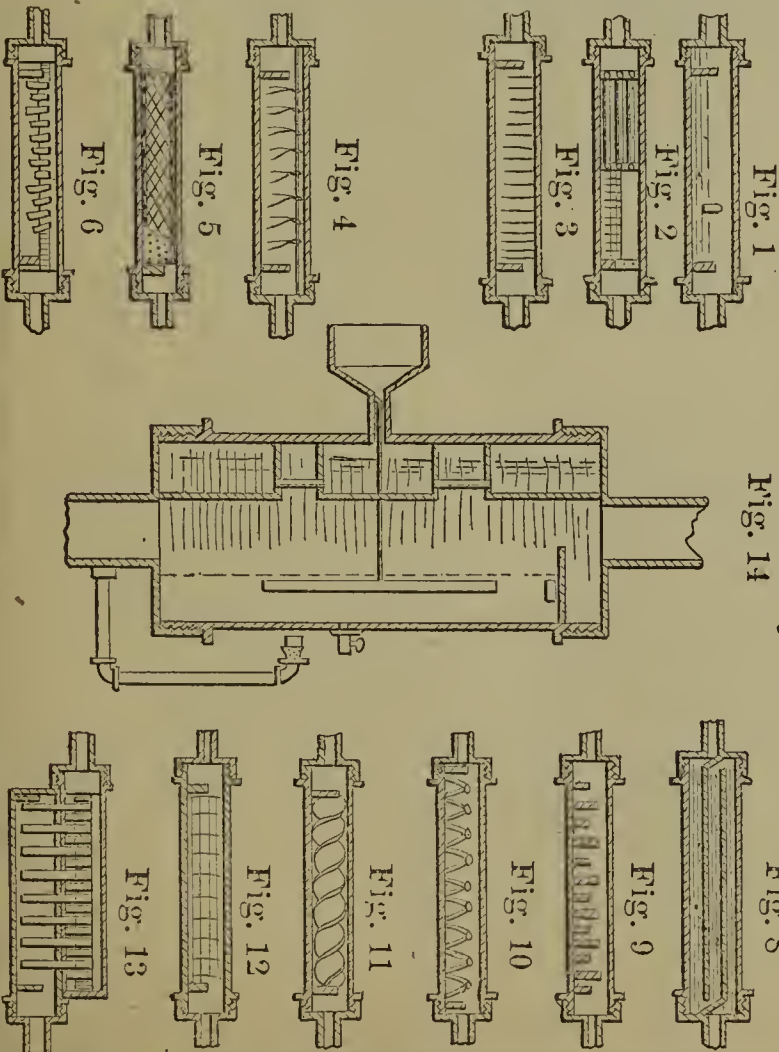

57814—A. Zink—*Lifting Jack.*

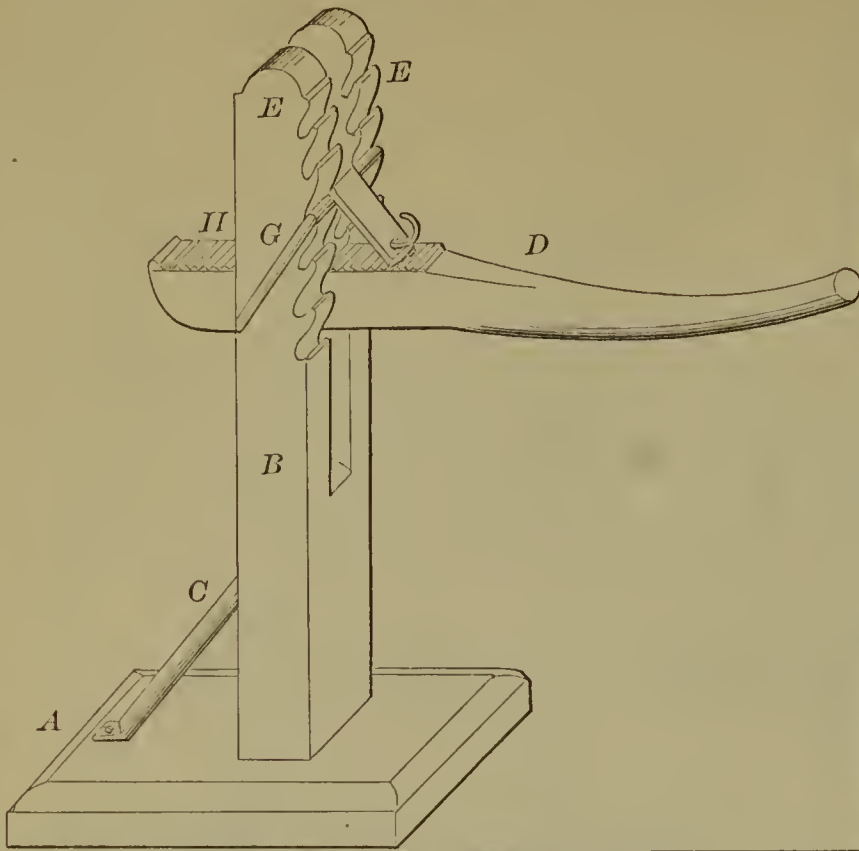

57816—J. W. Draper—*Railway Chair.*

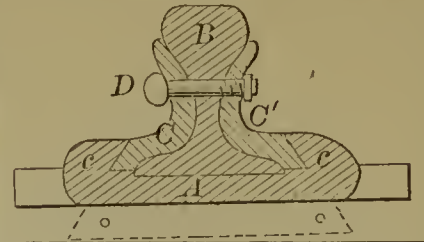

57817—Evans & Seymour—*Pruning Instrument.*

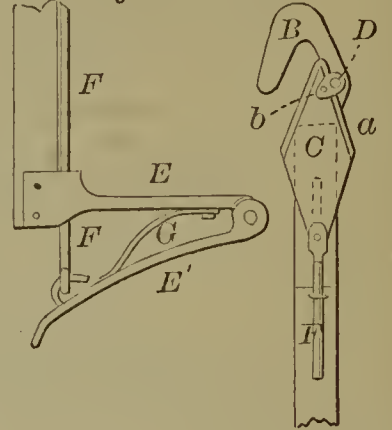

57815—Ballard & Magee—*Ditching Machine.*

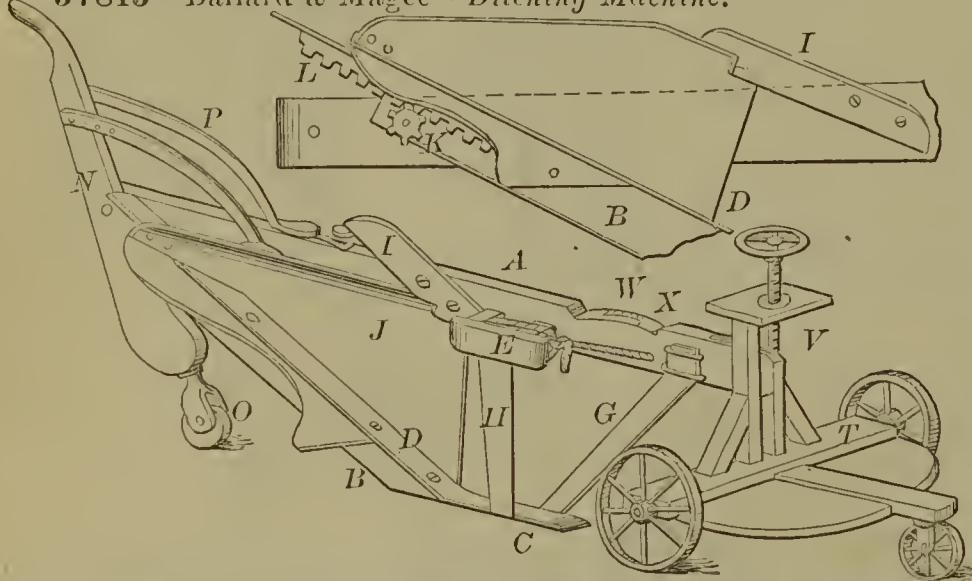

57818—J. Fahney—*Faucet.*

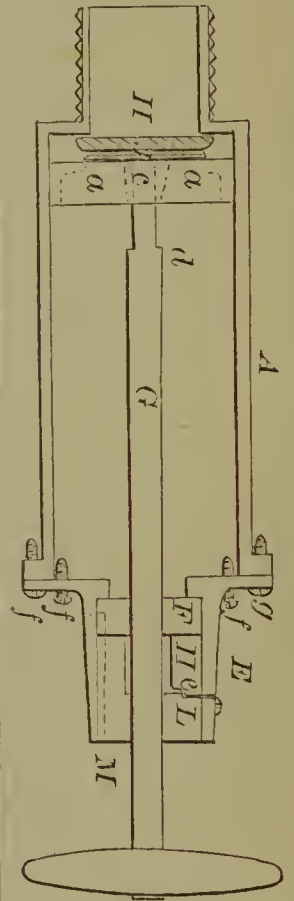

57820—W. A. Horrall—*Whiffletree.*

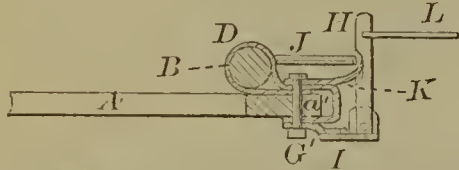

57821—C. M. Hyatt—*Neck Tie and Collar Clasp.*

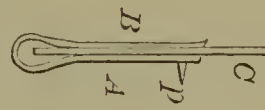

57819—L. H. Goff—*Barrel Lifter.*

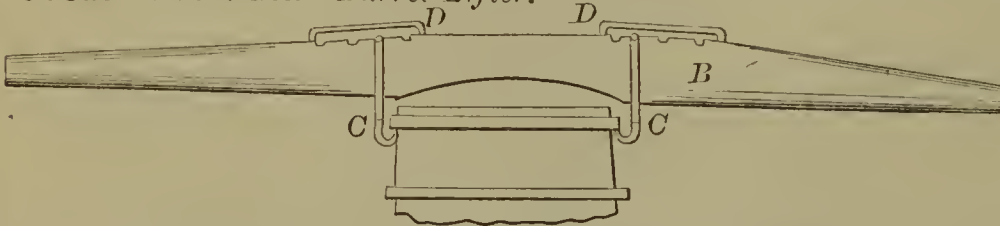

57823—M. B. Mason—*Steam Cylinder Piston.*

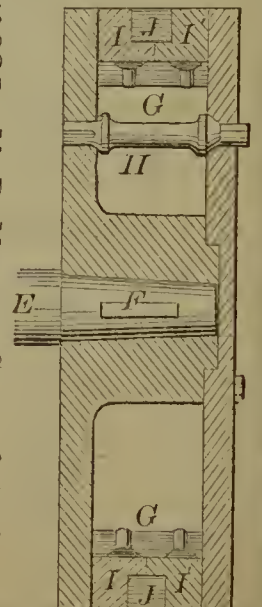

57822—A. King—*Moulding.*

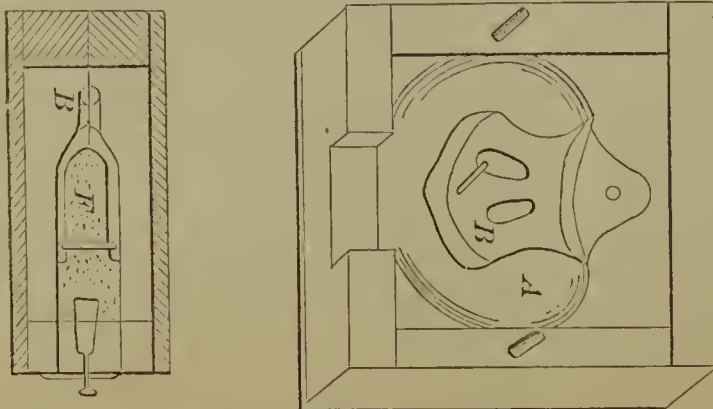

57824—G. Munger—School Desk and Seat.

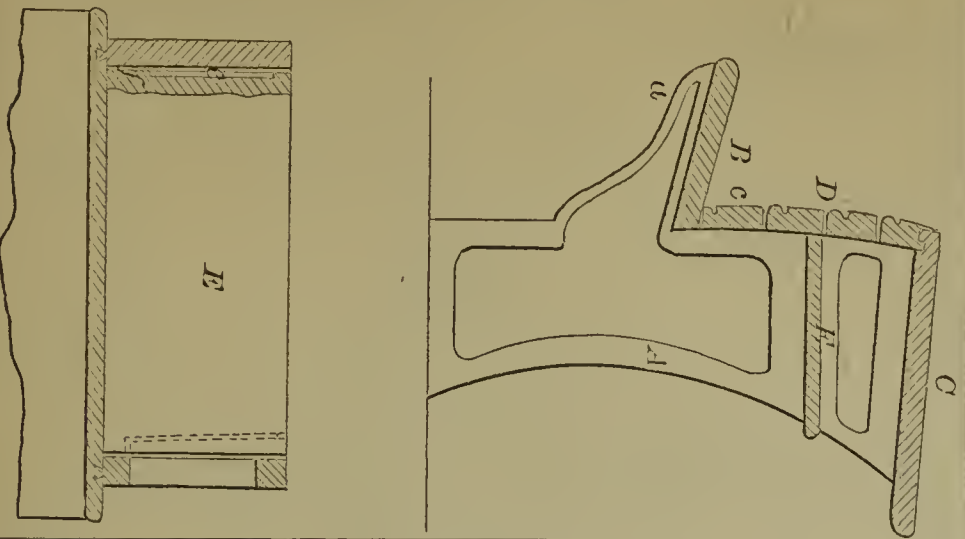

57826—J. N. Peteler—Portable Railroad.

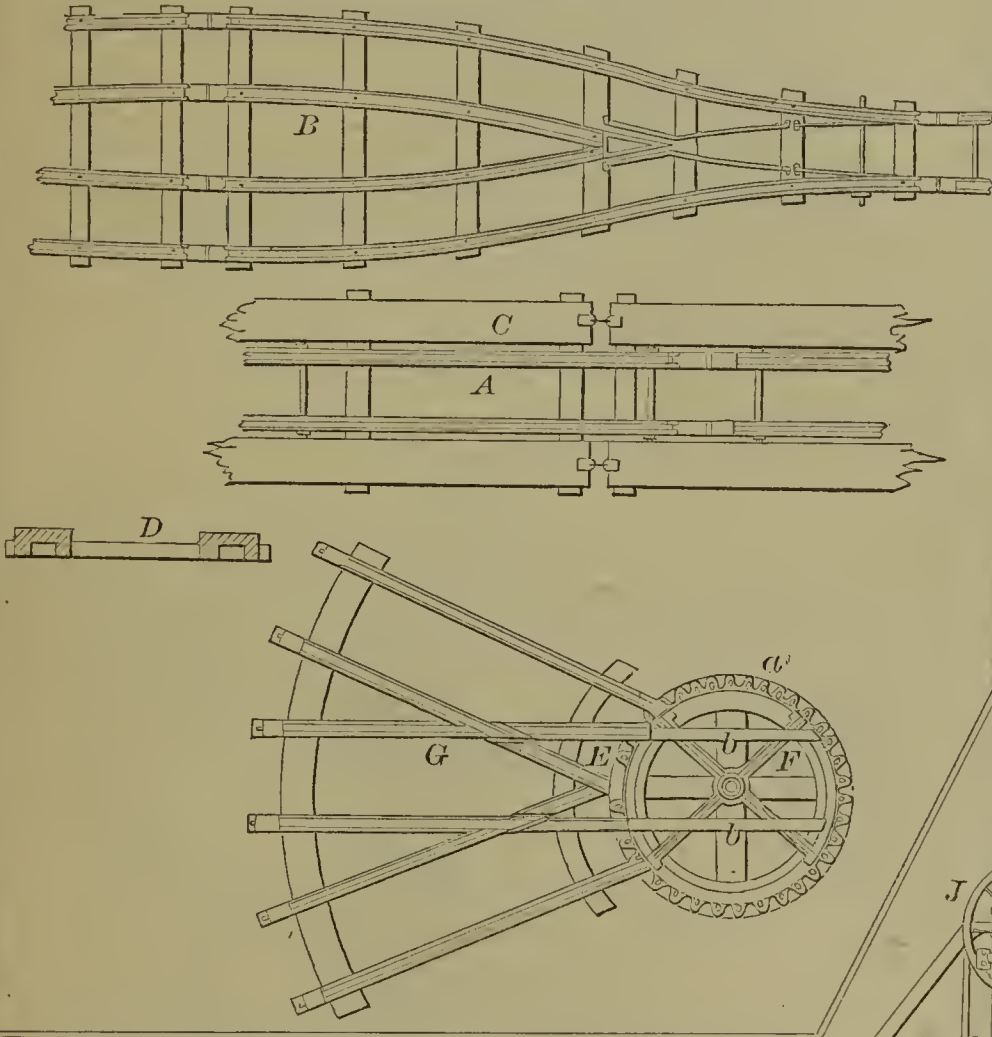

57825—N. A. Patterson—Receiving and Discharging Freight.

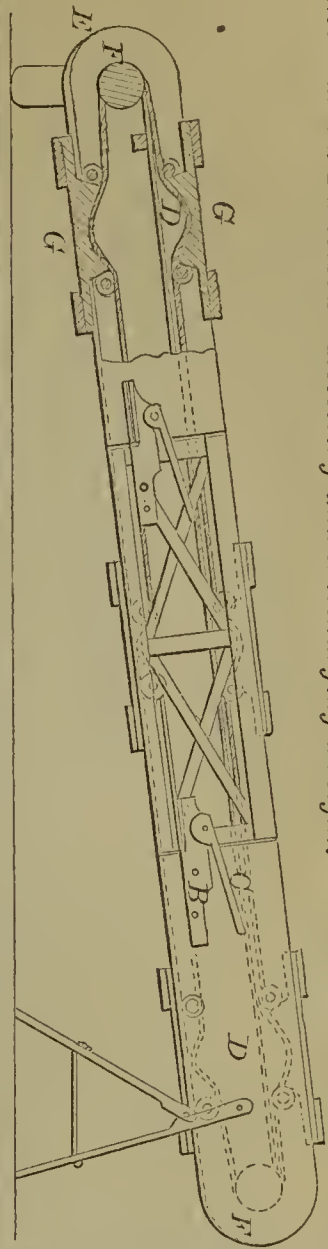

57827—C. Mather—Well Boring Machine.

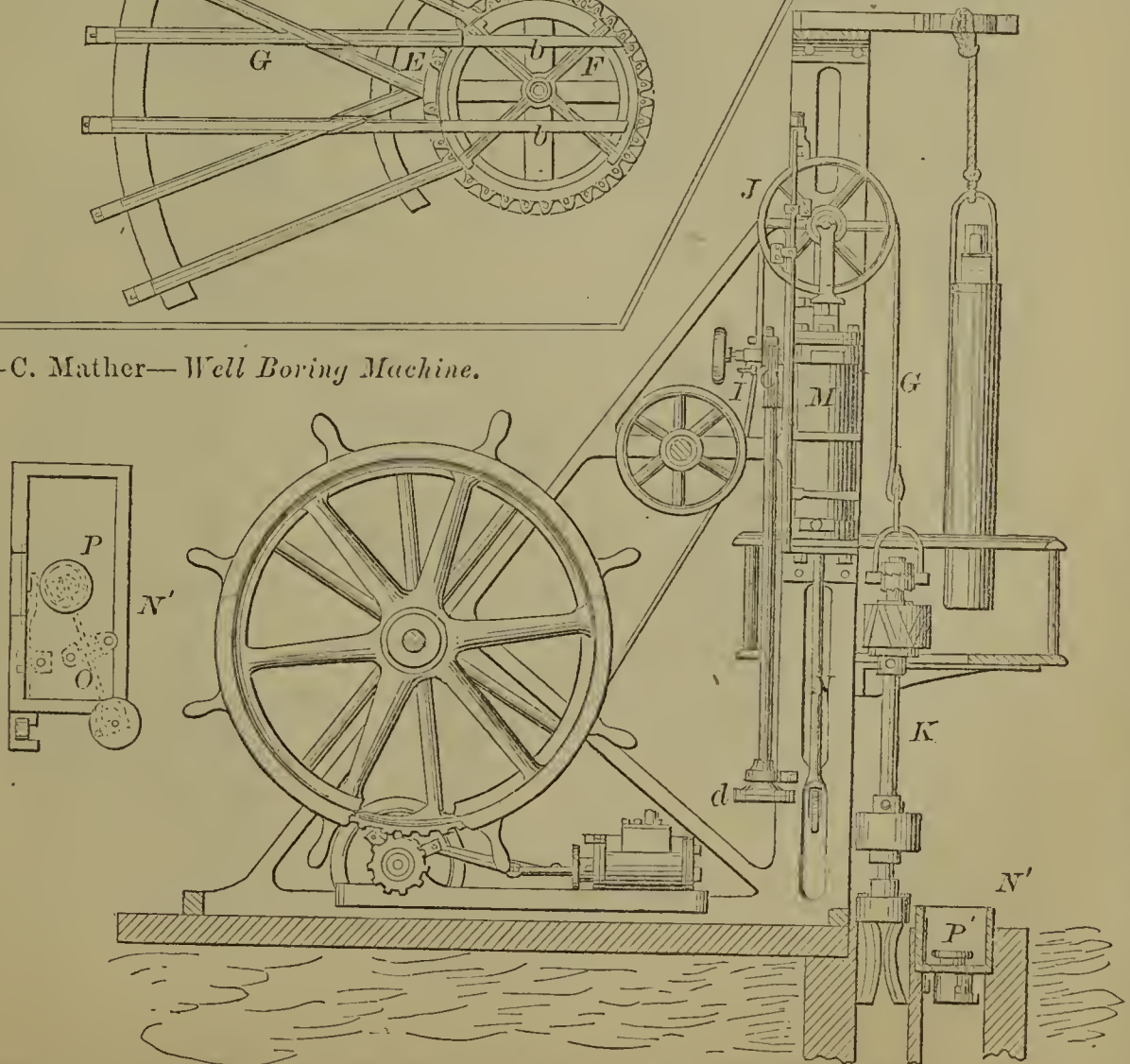

57828—C. Mather—Well Boring Drill.

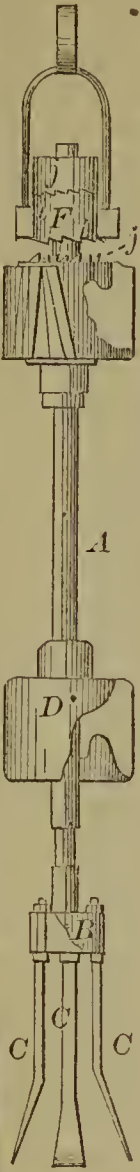

57829—J. A. Fogg—Coffin.

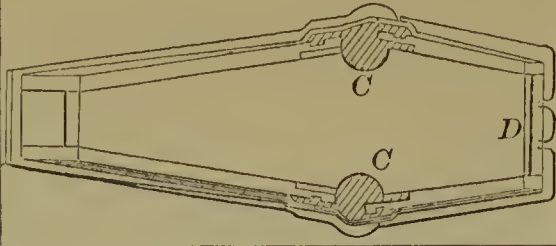

57832—E. Morewood—Coating Sheet Iron with Metals.

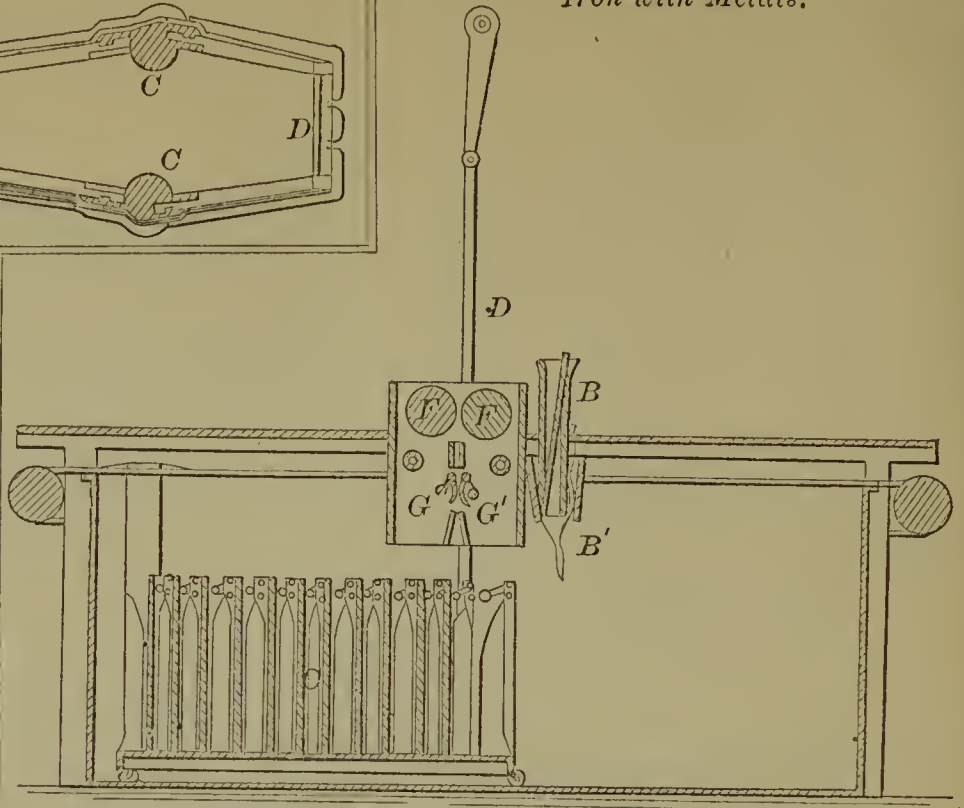

57830—C. Mather—Sand Pump.



57834—W. L. & T. Winans—For Trimming Ships.

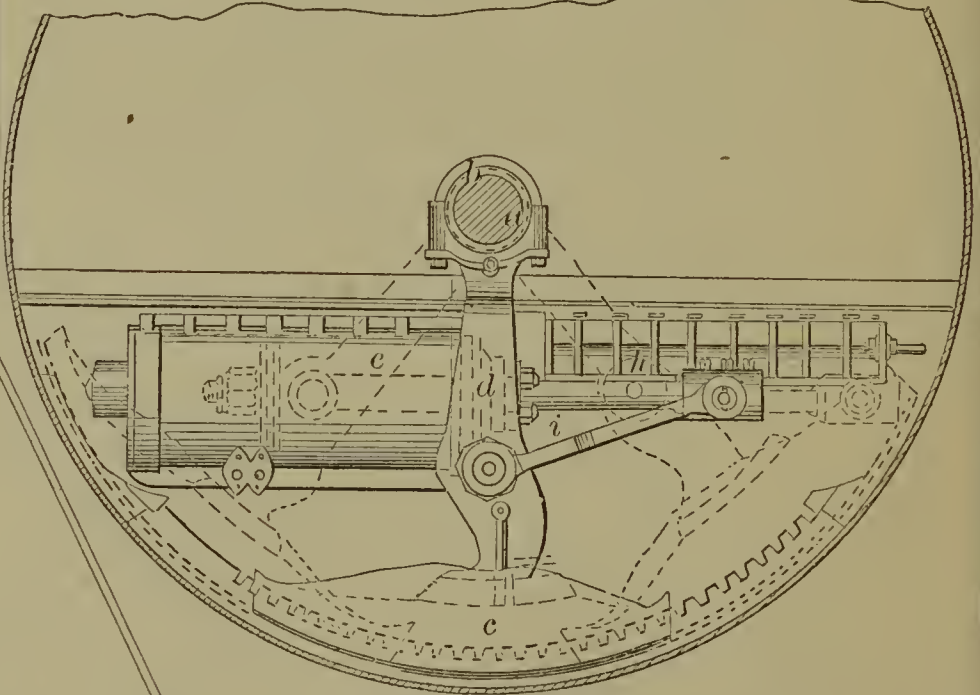

57831—P. F. Millot—Water Wheel.

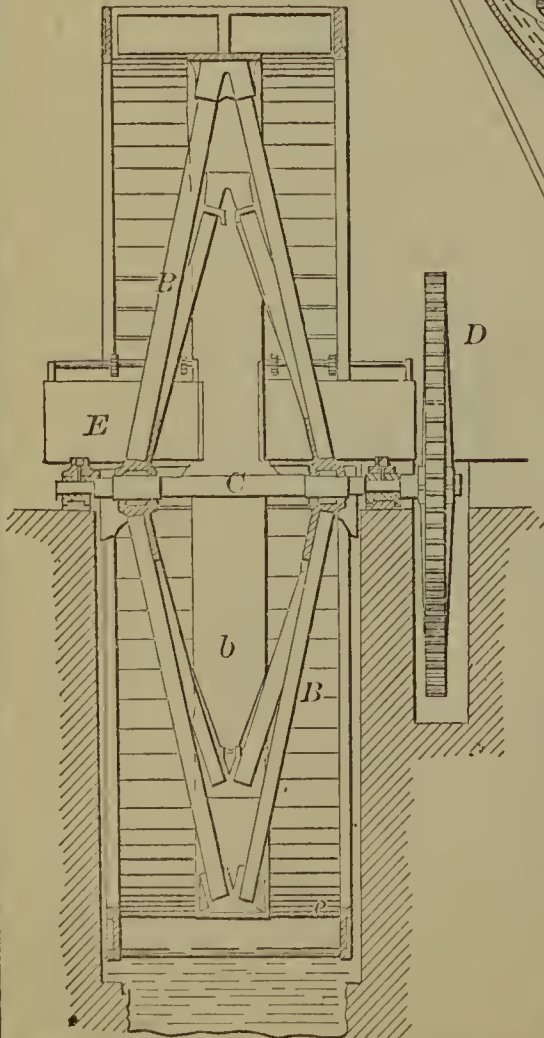

57833—H. Sells—Cider Mill.

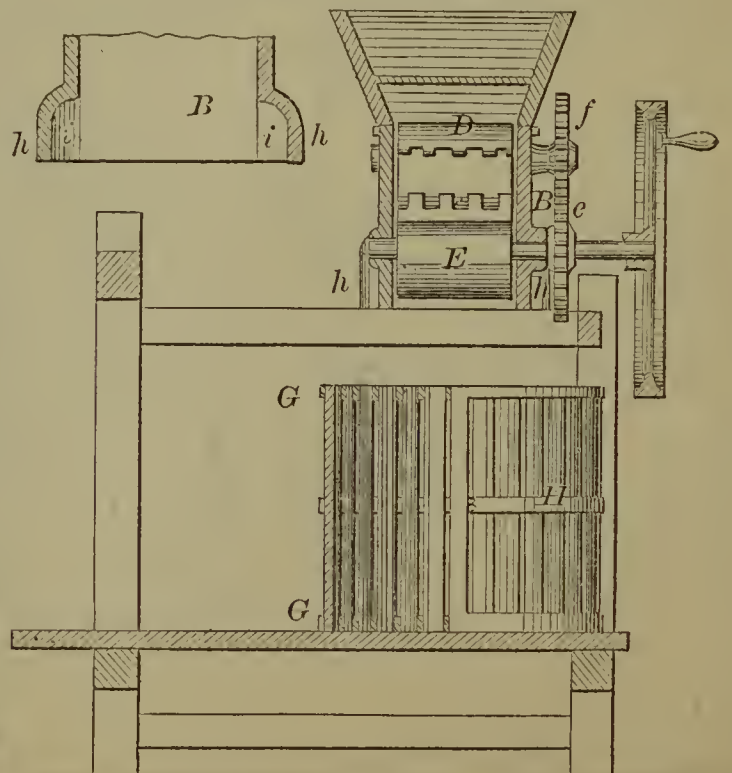

57835—W. L. & T. Winans—Coupling for Propeller Shafts.

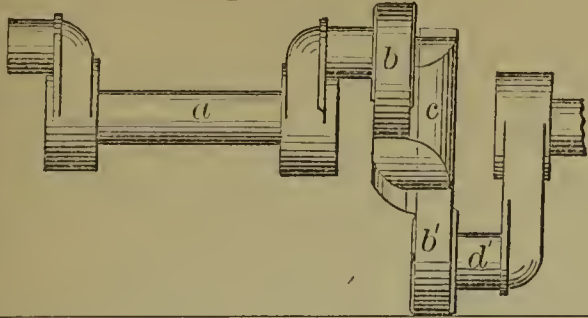

57836—W. L. & T. Winans—Propeller for Spindle Shaped Ships.

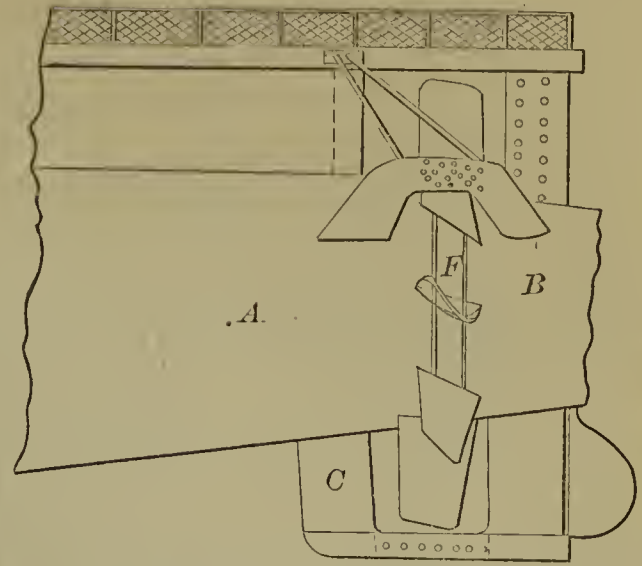

57839—W. H. Allard—Self Operating Flood Gate.

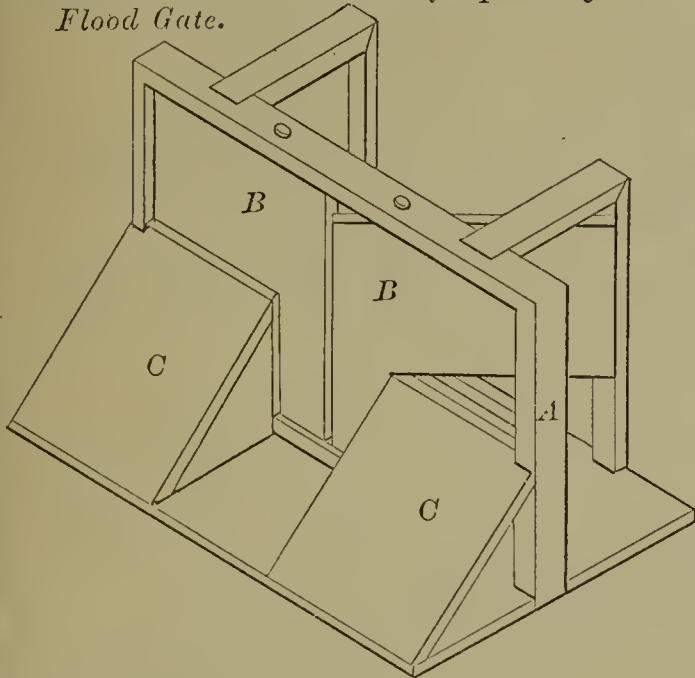

57837—H. M. Carpenter—Cutting Dresses.

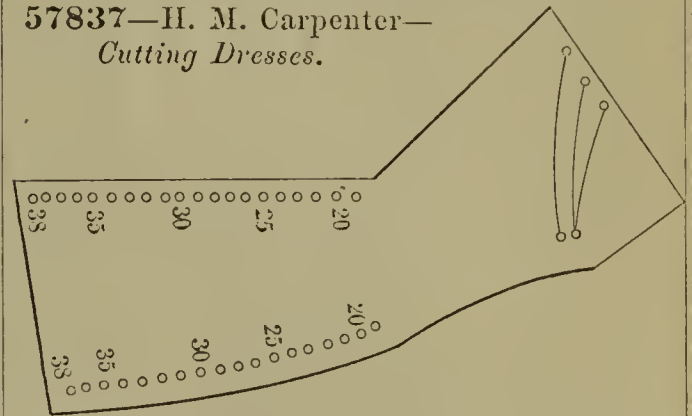

57842—A. Armstrong—Wheat Drill.

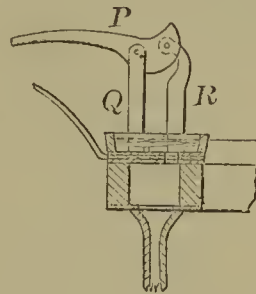
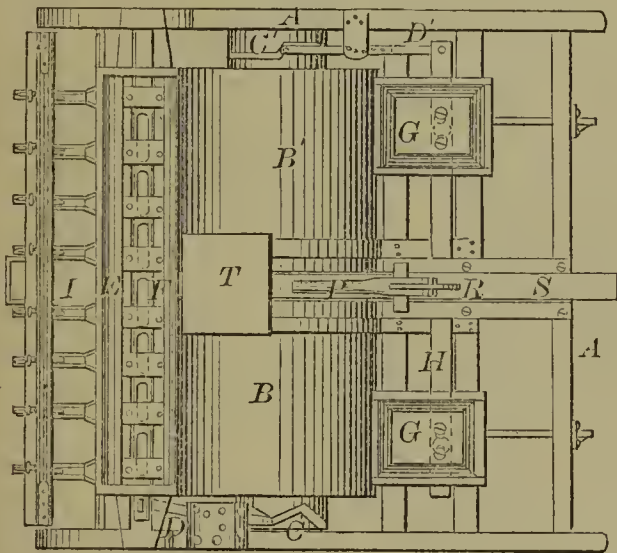

57840—R. N. Allen—Piston for Deep Well Pumps.

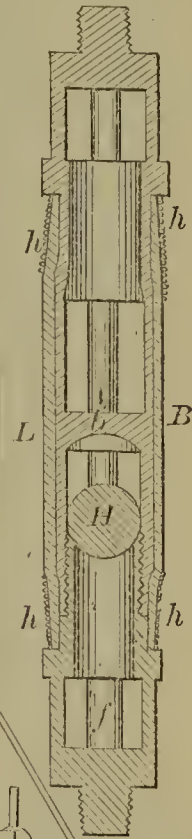

57841—W. J. Andrews—Cultivator.

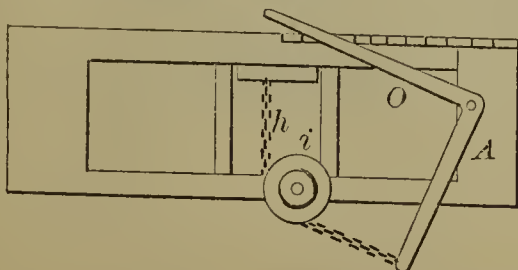
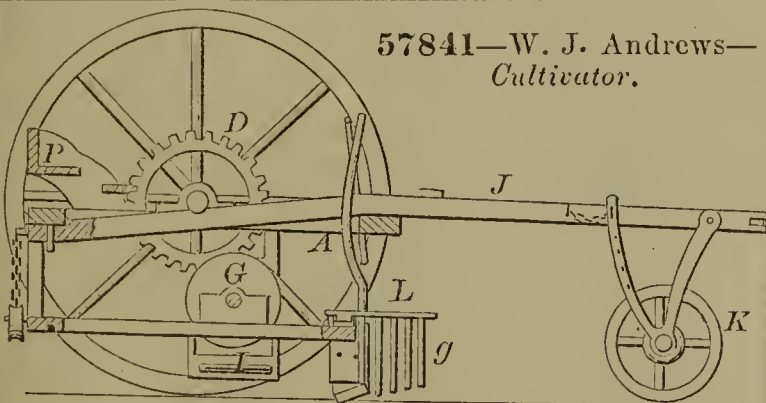

57843—B. Bacon—Striking Works for Clocks.

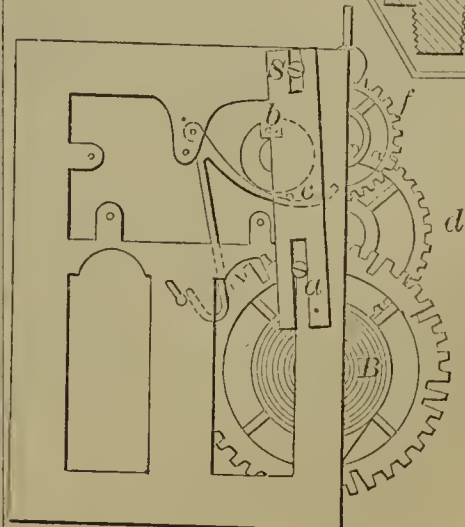

57844—F. A. Balch—Whiffletree.

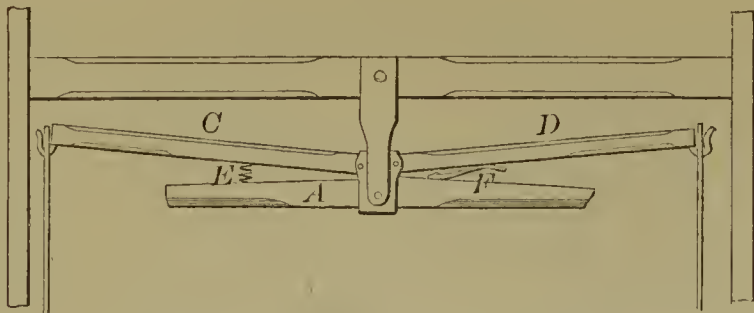

57845—R. Bartley—Weather Strip.

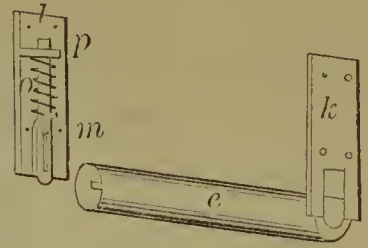

57850—H. Black—Hoisting Apparatus.

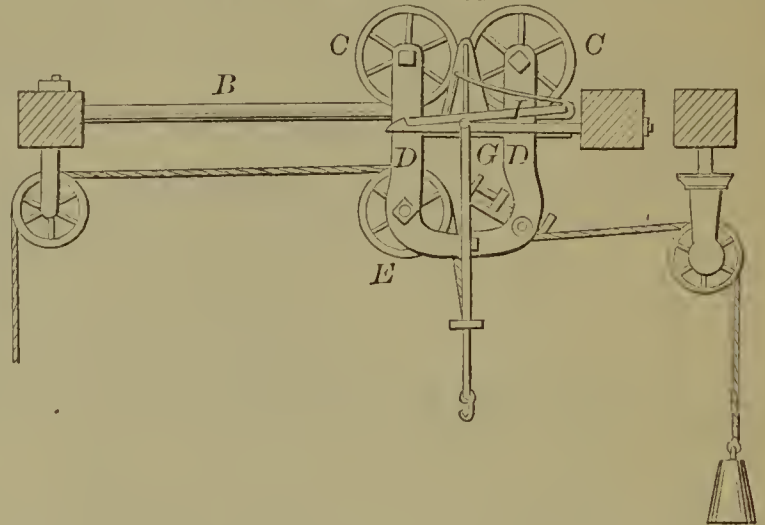

57851—E. Bradley—Harrow.

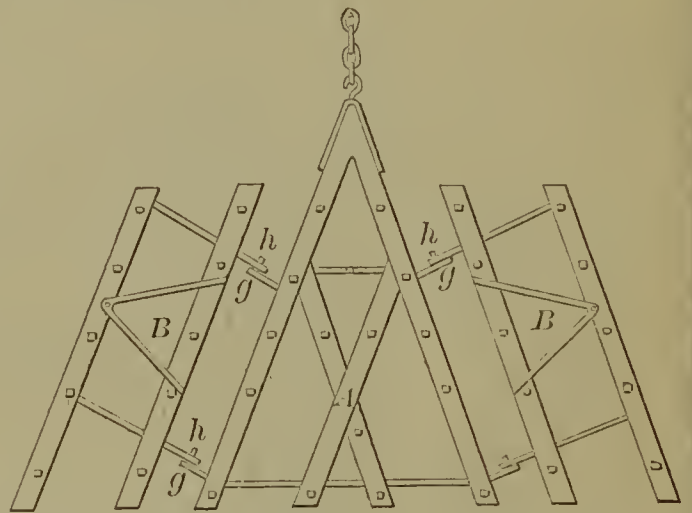

57846—A. L. Bausman—Expanding Scraper for Cleaning Gun Barrels.

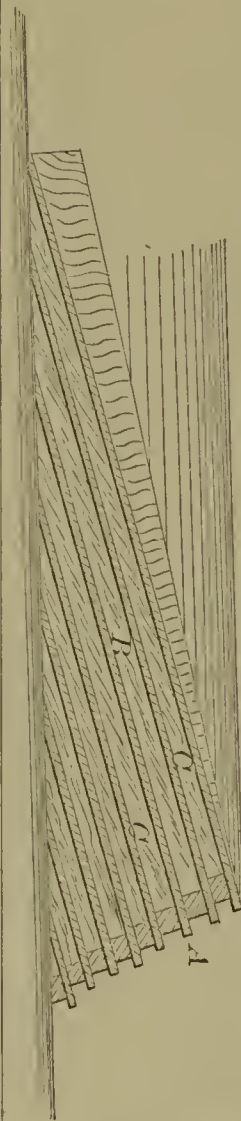

57852—B. Britten—Dam and Level.

57847—F. Beals—Snap Hook.

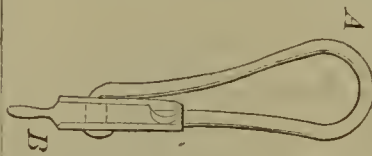

57848—W. M. Beeman—Register for Regulating Time Keepers.

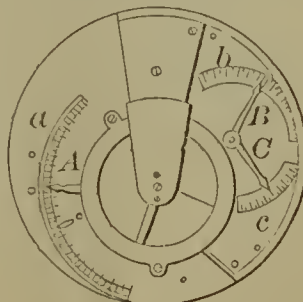

57853—J. B. Brown—Sheep and Cattle Rack.

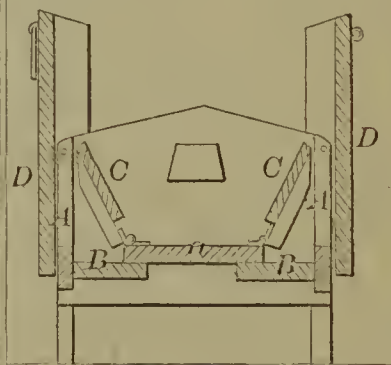

57855—H. B. Buch—Metallic Hub.

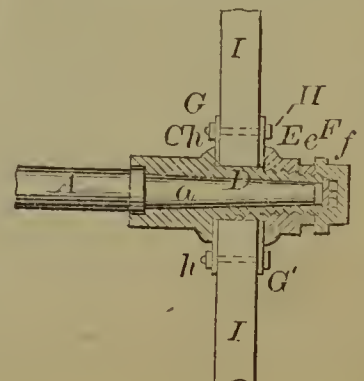

57854—J. J. Brown—Phill Coupling.

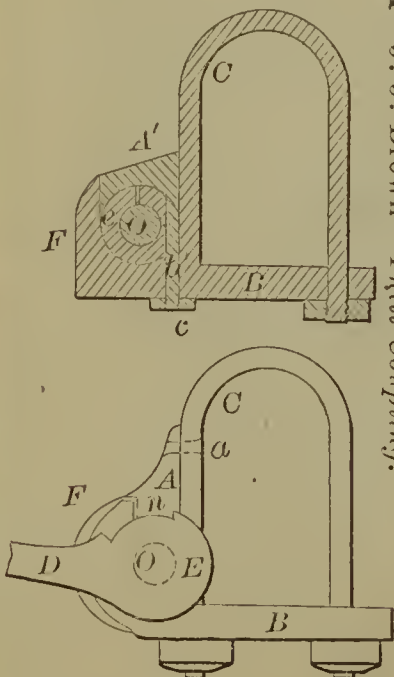



57856—M. H. Bucknall—Cultivator.

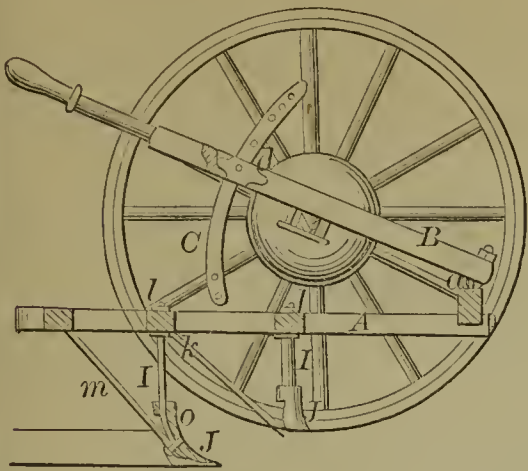

57857—R. B. Burchell—Lock.

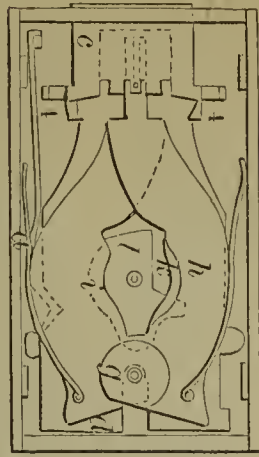

57859—T. Byrne—Dredging Machine.

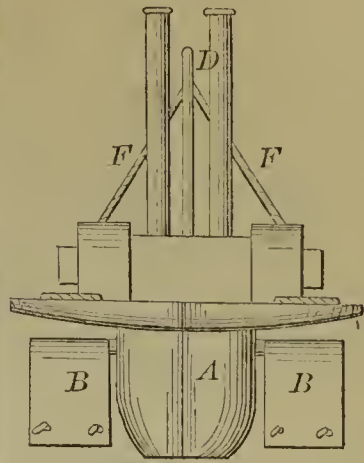

57861—R. W. Carpenter—Musical Instrument.

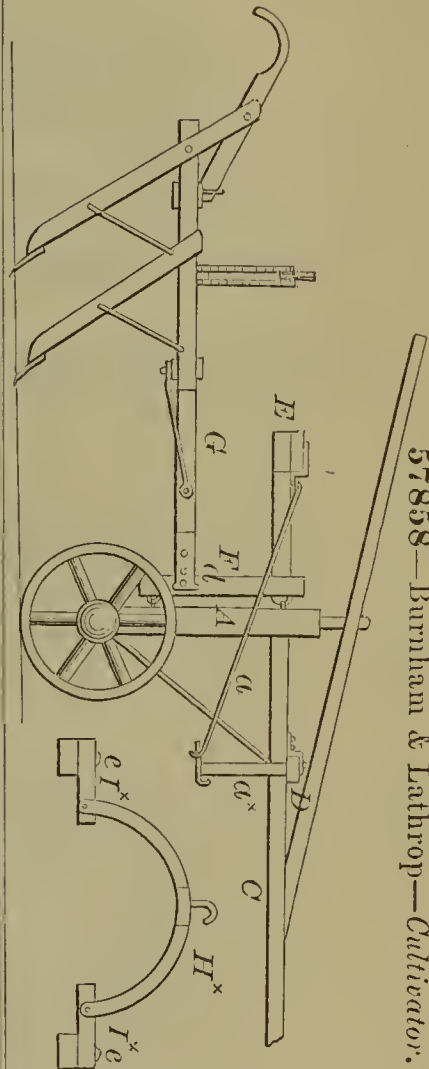
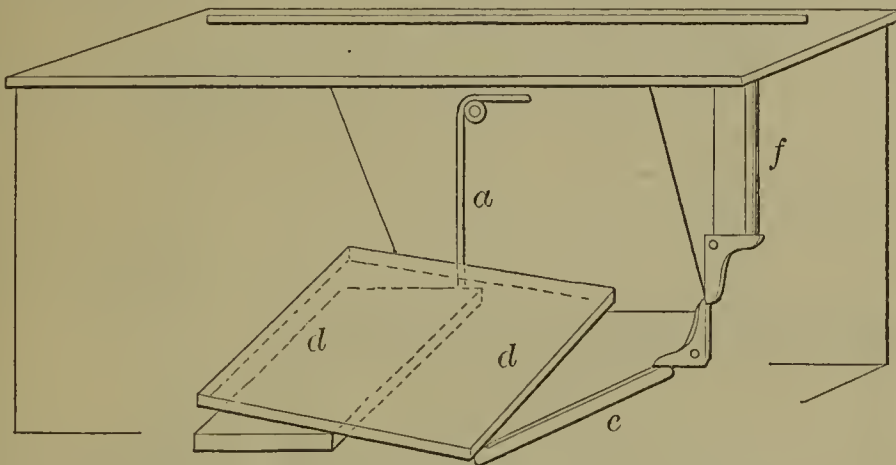

57858—Burnham & Lathrop—Cultivator.

57863—C. H. Carver—Barrel or Cash.

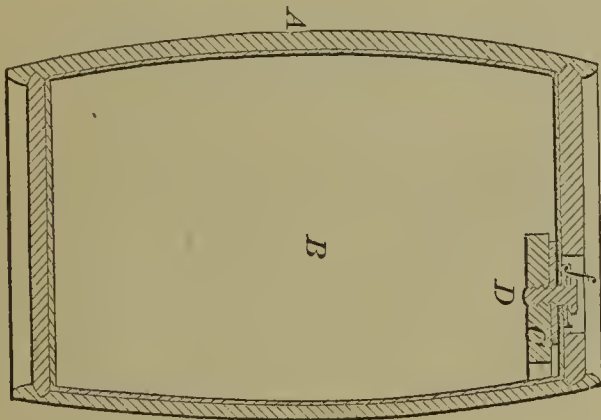

57864—A. Christ—Revolving Fire Arm.

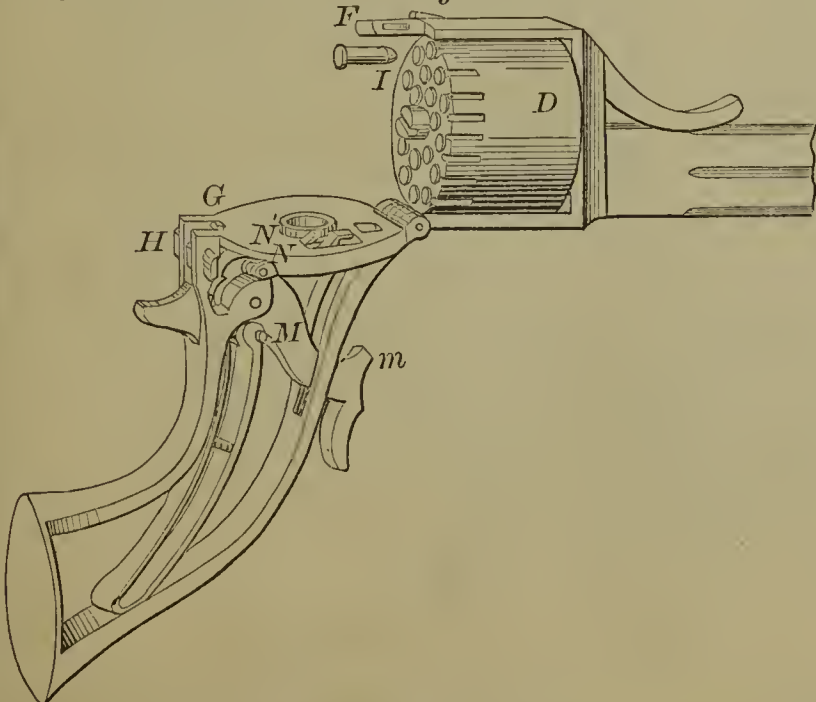

57862—C. C. Carter—Wheat Sowing Machine.

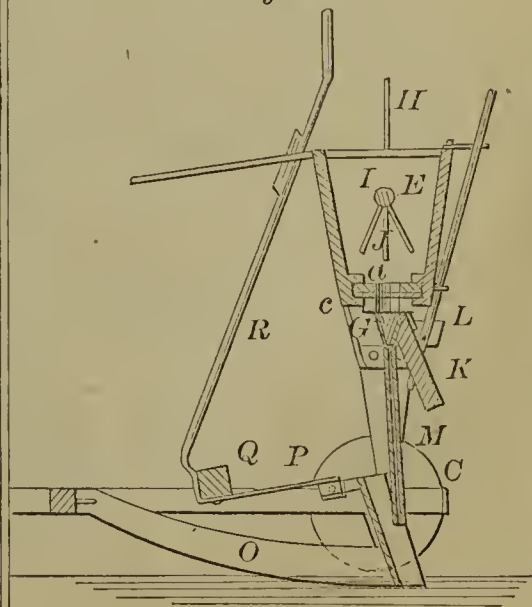

57865—Christian & Morrow—*Knife Cleaner.*

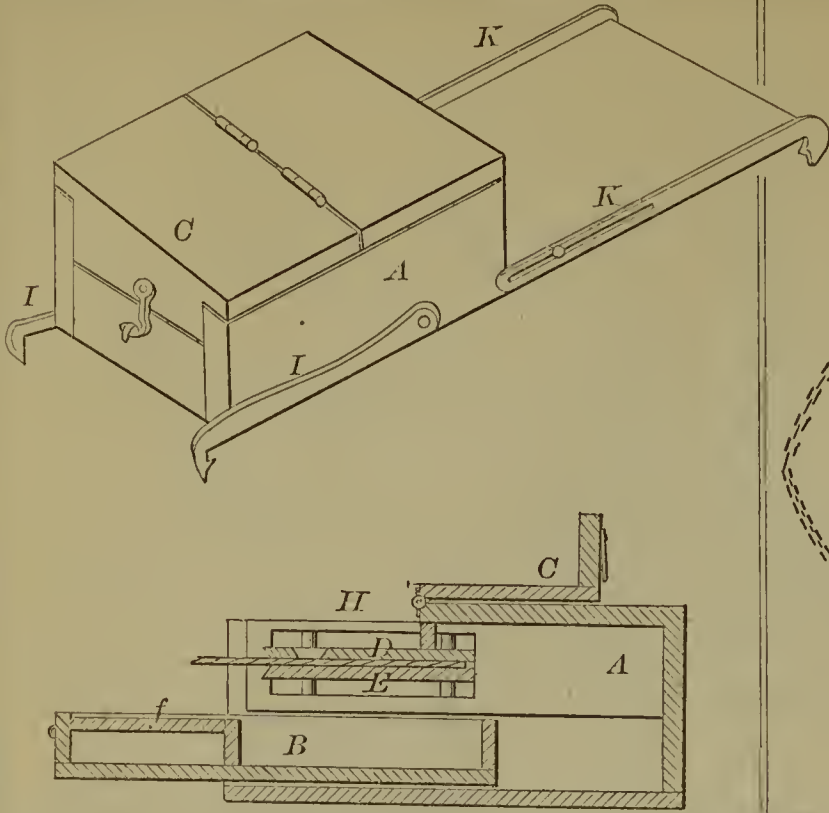

57867—F. Clemens—*Whiffletree.*

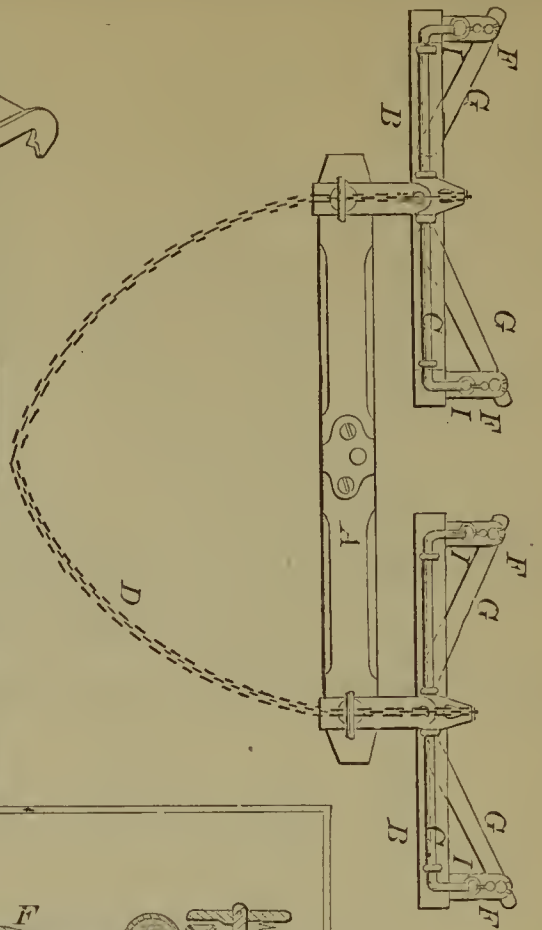

57866—Church & Knight—*Petroleum Tank.*



57870—Crane & Fox—*Compound Projectile.*

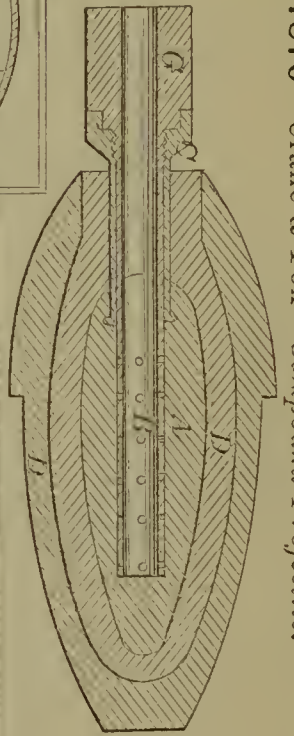

57869—F. Coldwell—*File Stripper.*

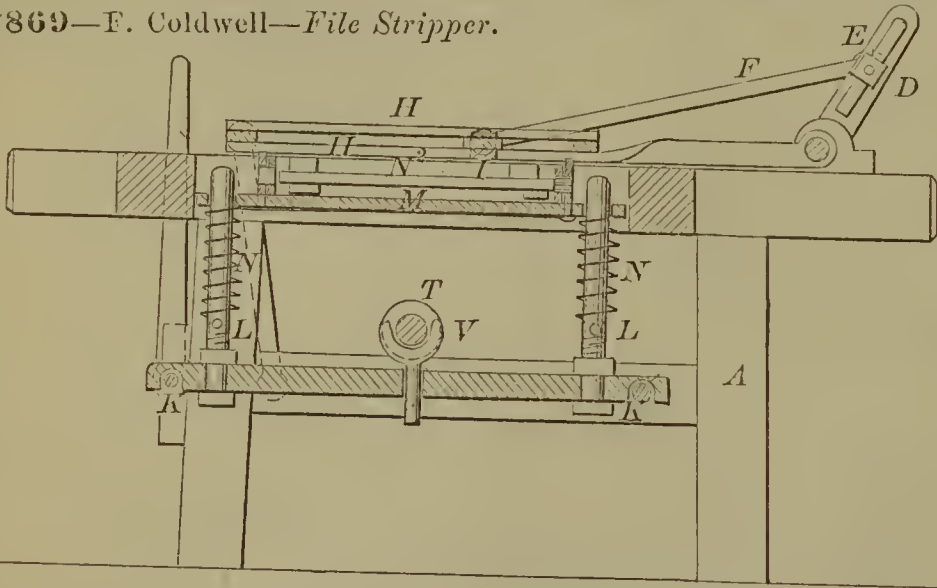

57868—R. L. Cleveland—*Hand Corn Planter.*

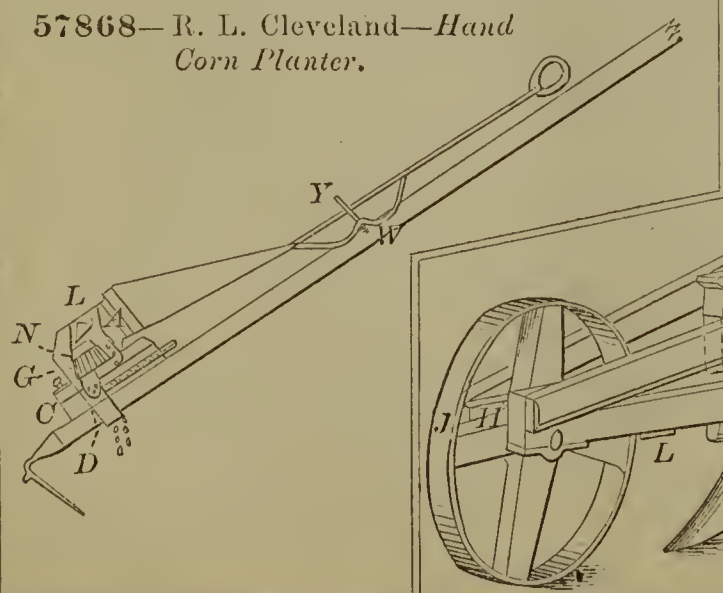

57871—J. M. Crawford—*Garden Plow.*

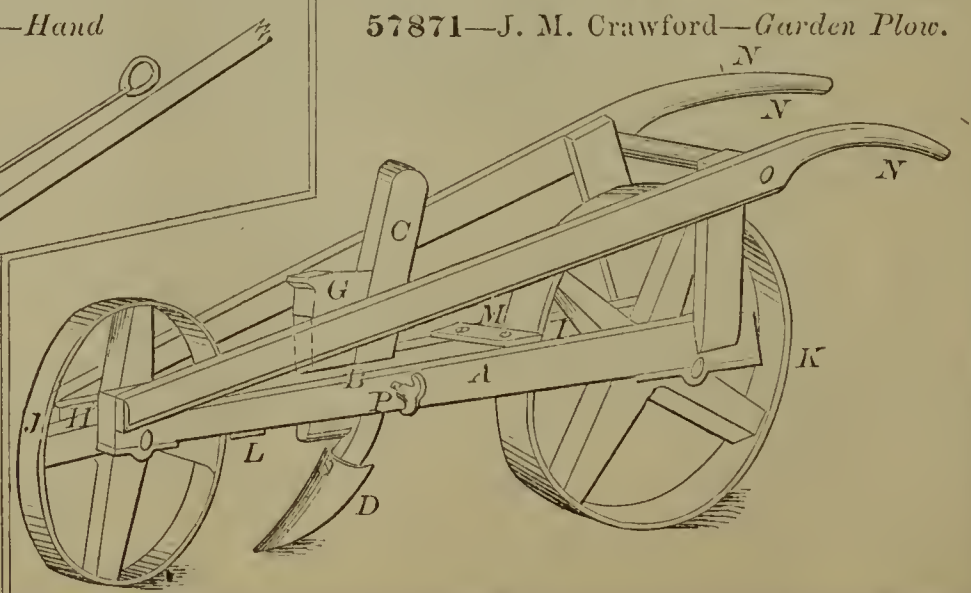

57872—S. Crocker—Fence.

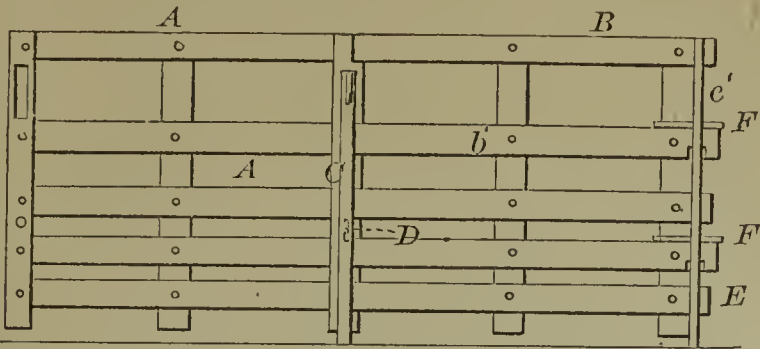

57873—C. O. Crosby—Wire Pointer.

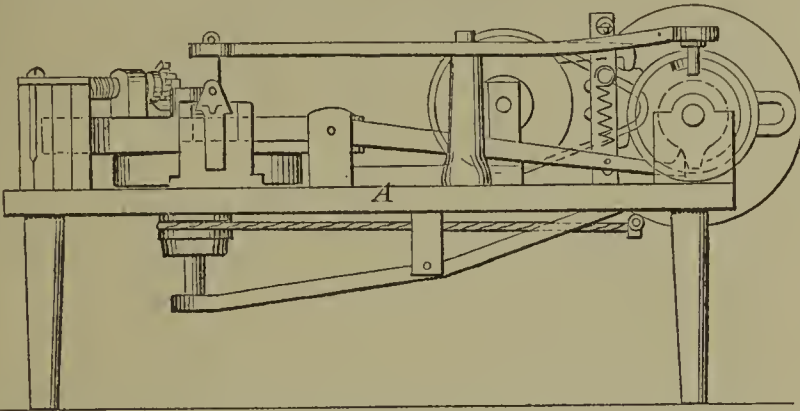

57877—W. A. Devon—Raising and Lowering Boats.

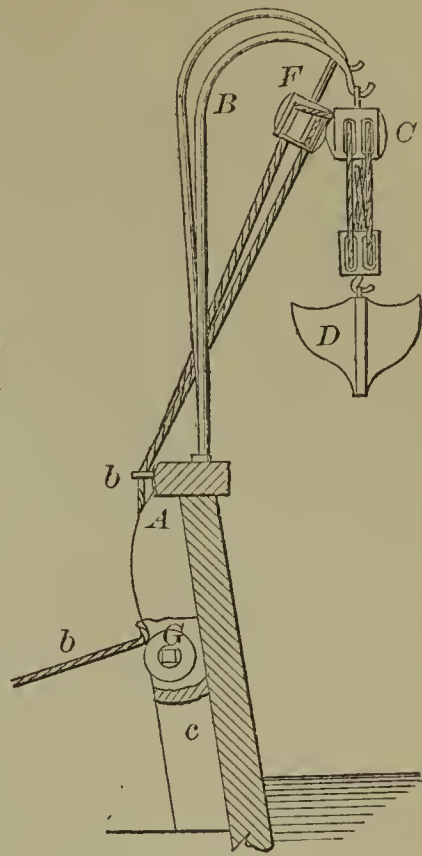

57875—J. & S. Danner—Spring Bed Bottom.

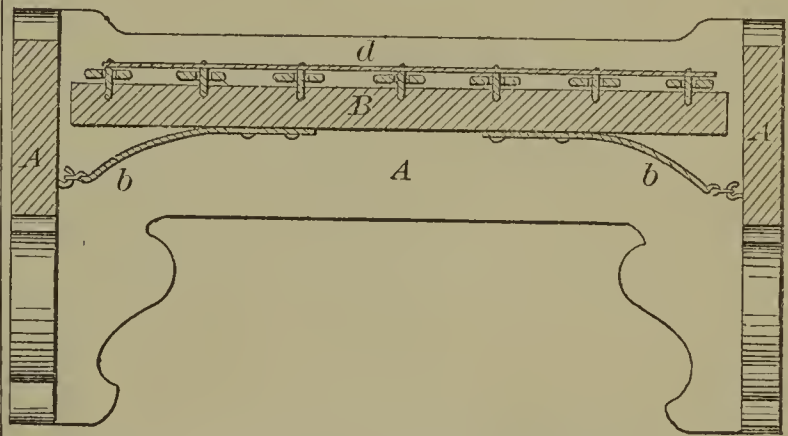

57878—O. P. Dills—Wheel Plow.

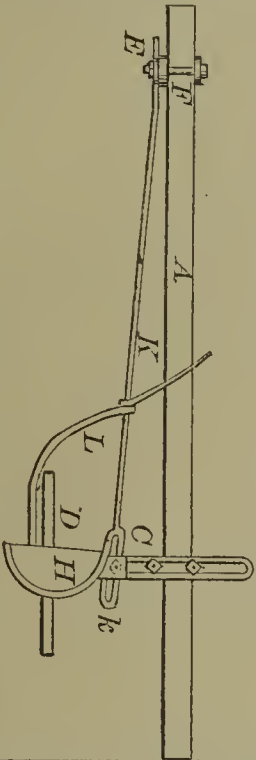

57879—E. Doe—Throttle Valve Lever.

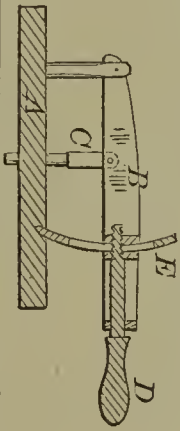

57880—H. W. Dopp—Wick Burner for Heating and Cooking.

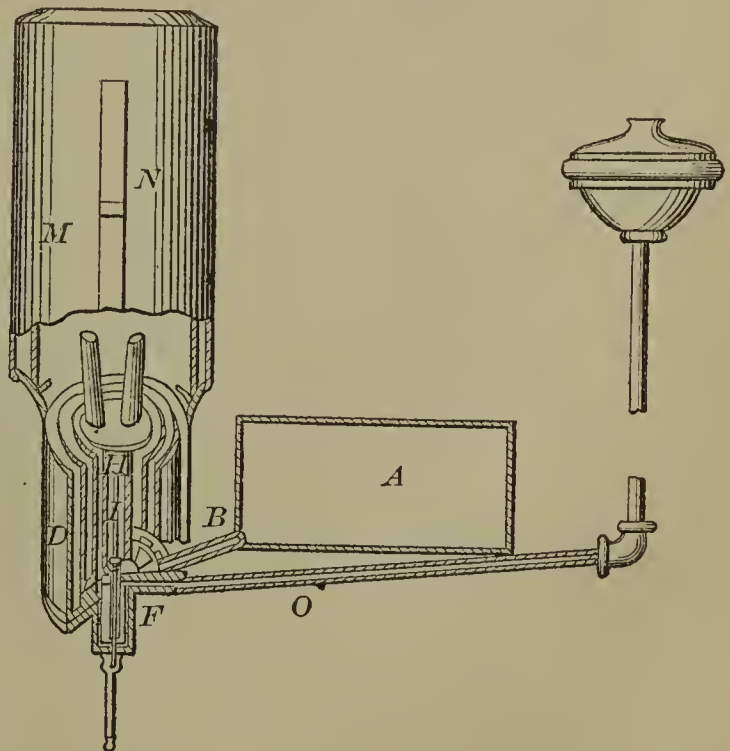

57876—Davis & Leland—Clutch Hook for Slaughtering.

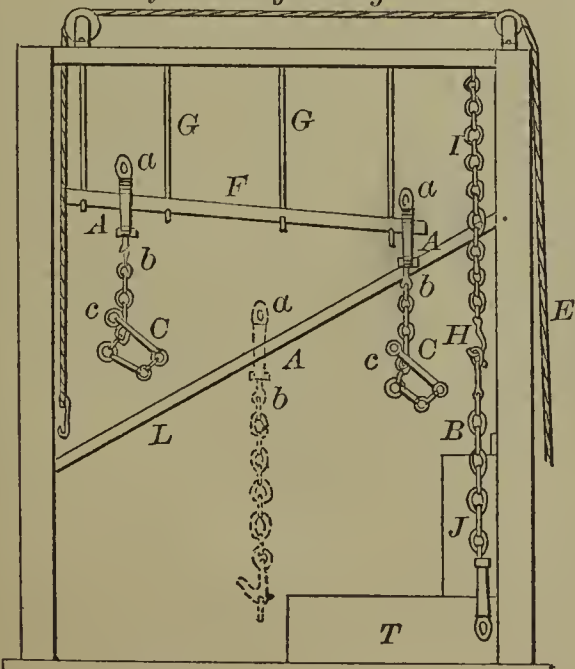

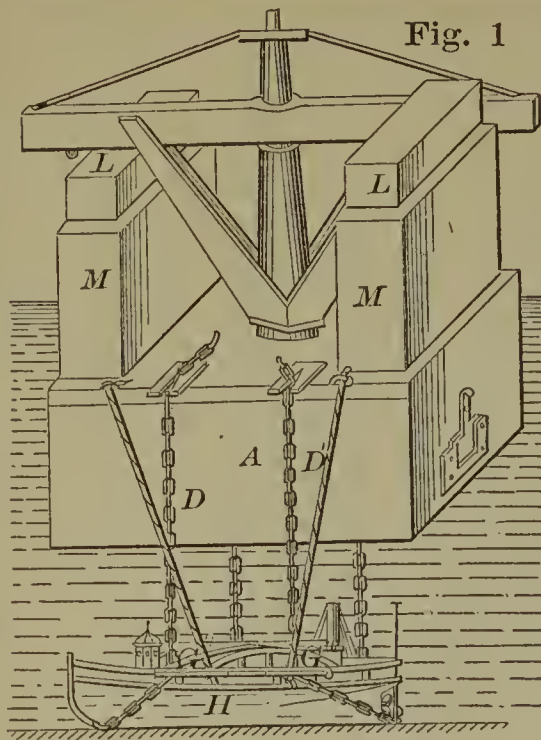
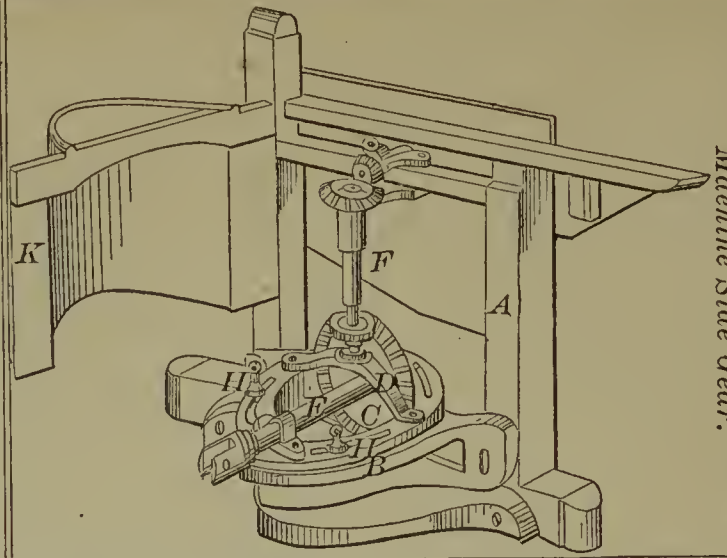

Fig. 1

57881—O. Drouillard—Raising Sunken Vessels.



57882—C. F. Du Vall—Threshing Machine Side Gear.

57887—E. P. Gale—Bow Pin for Ox Yokes.

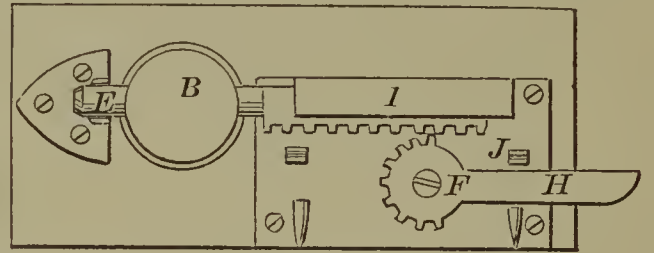
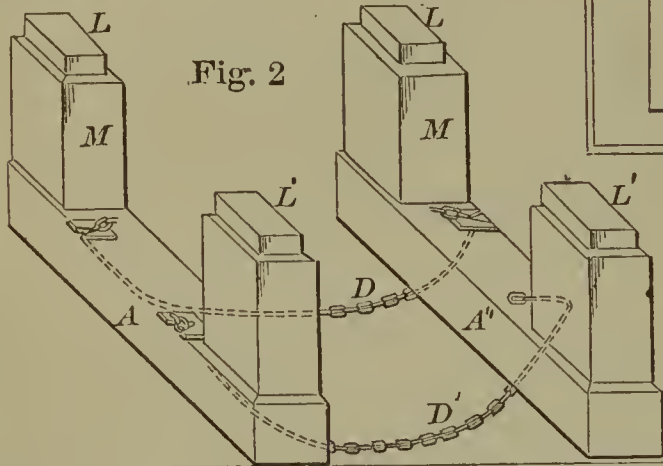
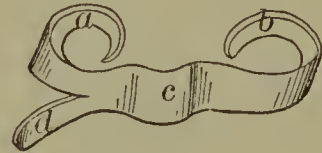

Fig. 2



57888—J. H. Gano—Corn Husker.



57883—A. Eaton—Sugar Cane Mill.

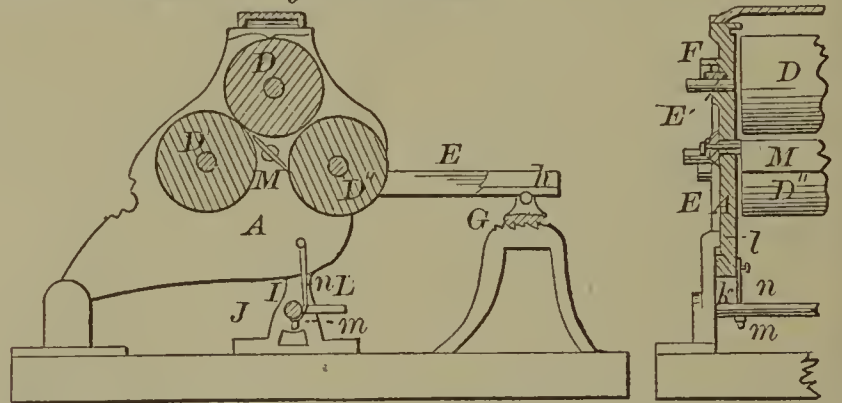

57885—Fisher & Holly—Fruit Dryer.

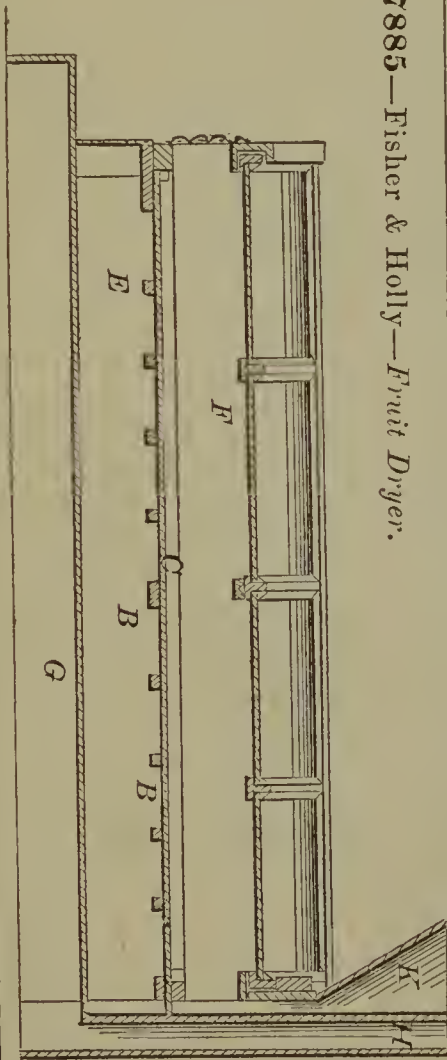

57889—R. R. Gaskill—Sulkey Plow.

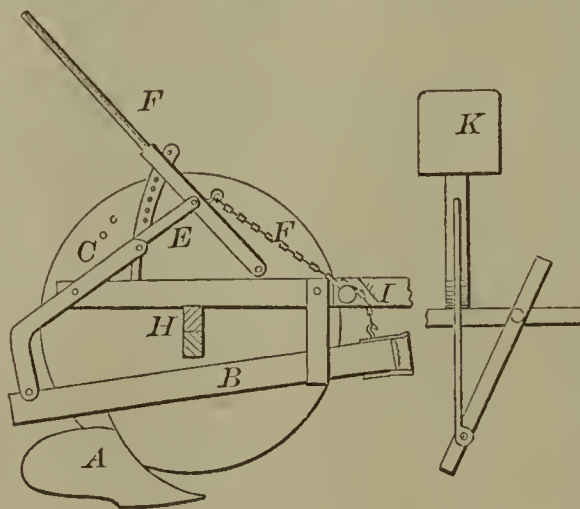

57886—P. Trentz—Carrying Hose.

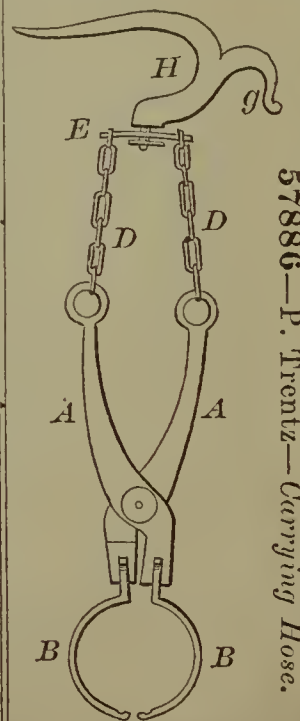

57890—S. D. Gilson—  
Artificial Fuel.

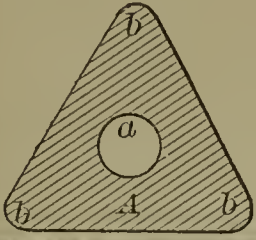

57892—F. Godfrey—Furnace for Calcining Gypsum.

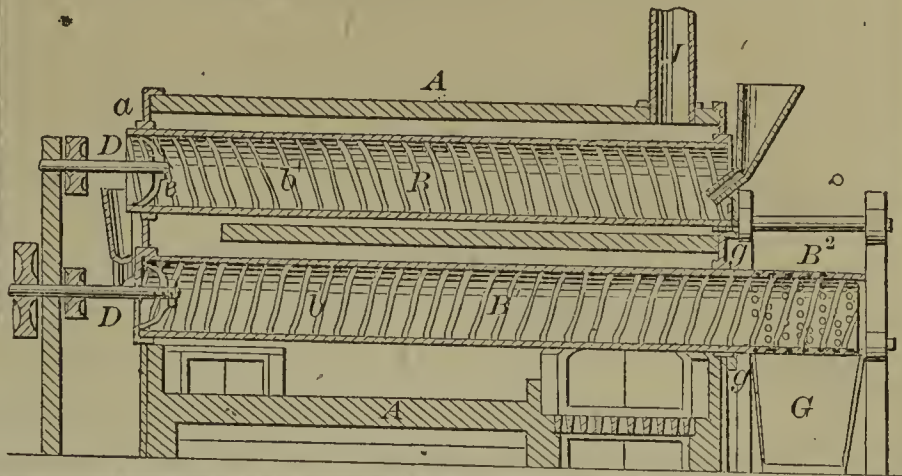

57891—C. Gleason—Yeast  
Cake Dryer.

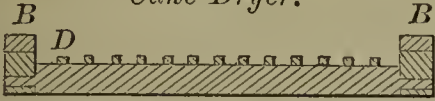

57893—J. M. Goff—Cutting Standing  
Corn Stalks.

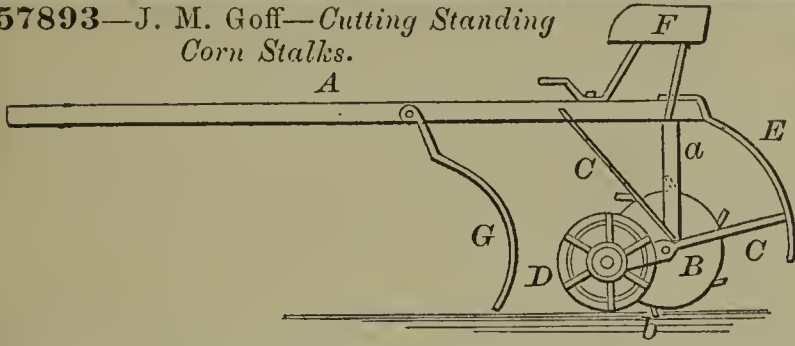

57895—C. Gullmann—  
Carpet Fastener.

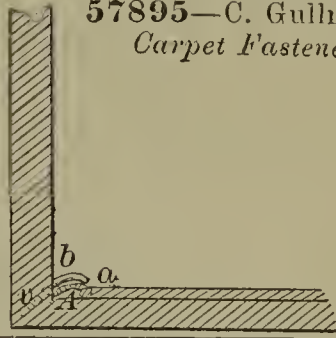

57894—T. Grundmann—Making Vinegar.

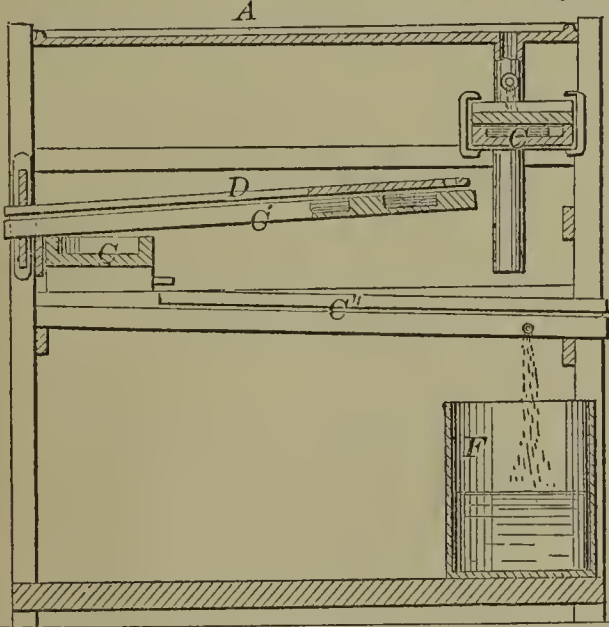

57897—A. S. Hanson—Pump.

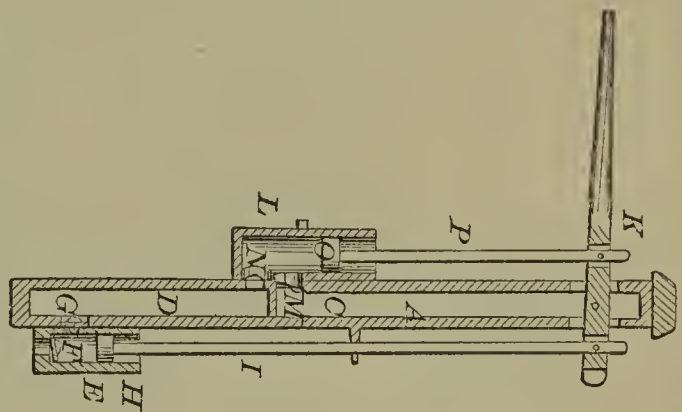

57898—G. Hasecoeter—Loom for Weaving Slatted Window Shades.

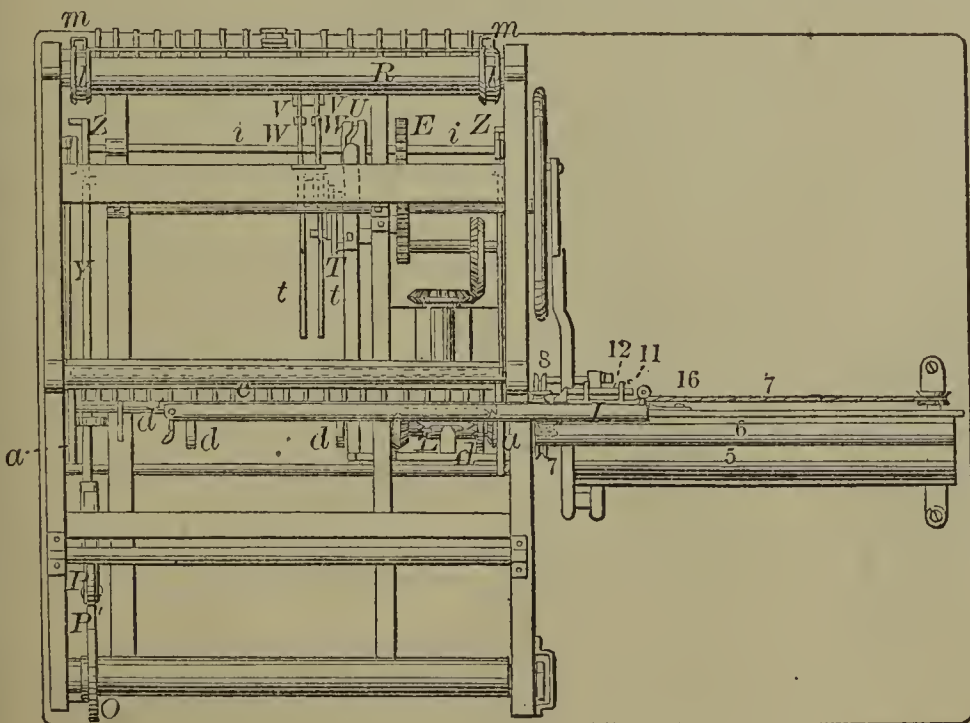

57896—H. Hammond—Spectacle Frame.

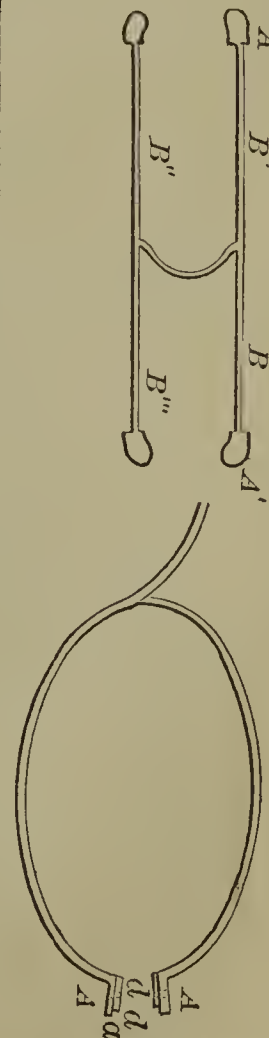

57899—L. W. Heelan—Hame Tug and Buckle.

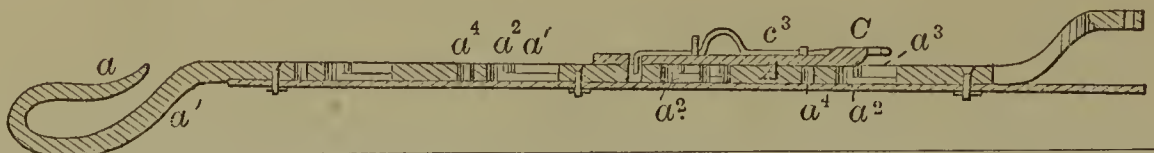

57901—A. Heuston—Paddle Wheel.

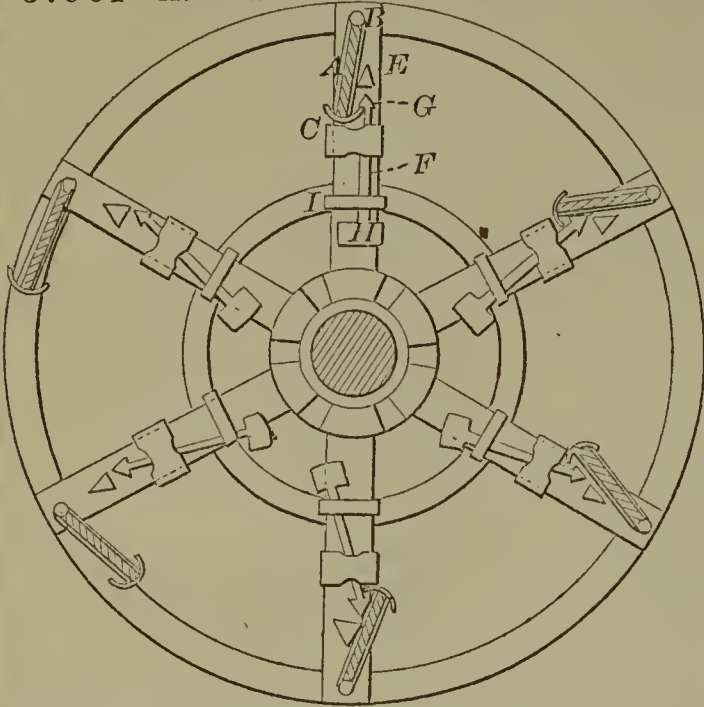

57903—J. G. Holliday—Moulders' Flask.

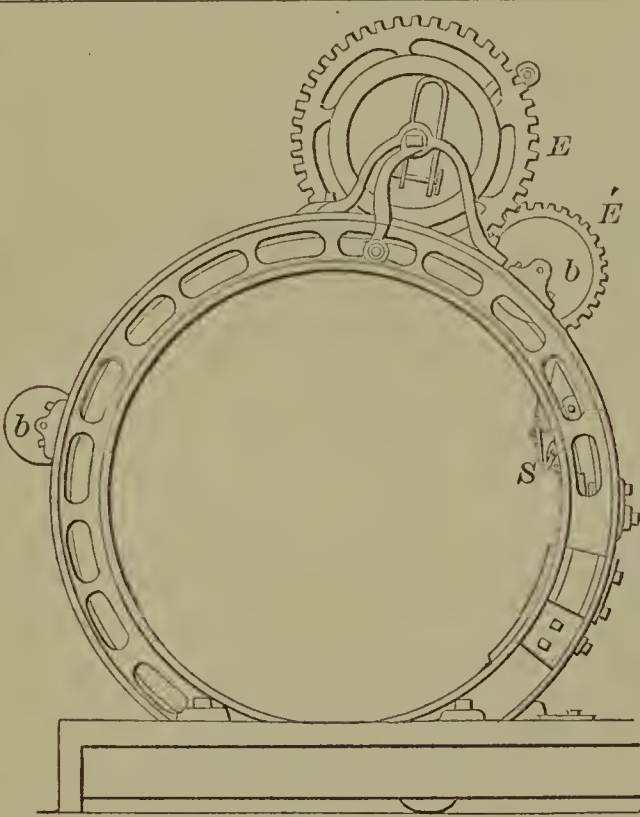
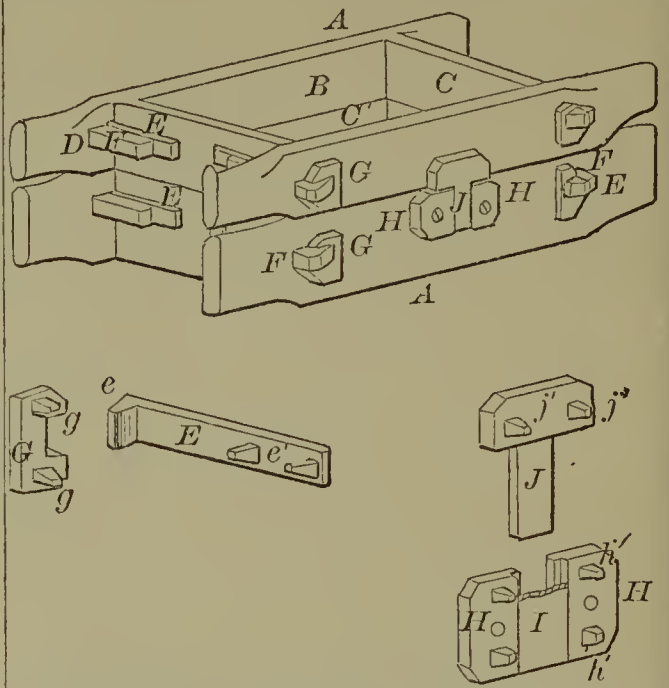

57904—S. T. Holly—Grain Binder.

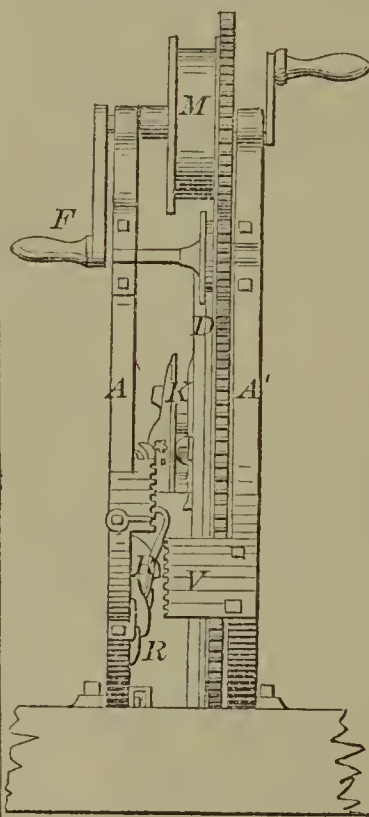

57904—S. T. Holly—Grain Binder.

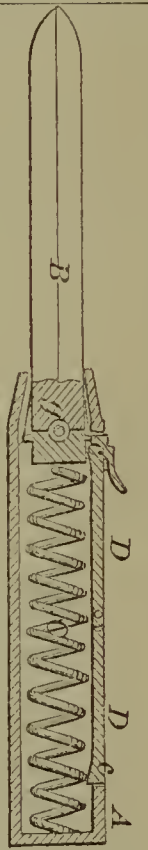

57902—C. Hibbard—Spring Dirk Knife.

57900—J. Herget—Beer Cooler, &c.

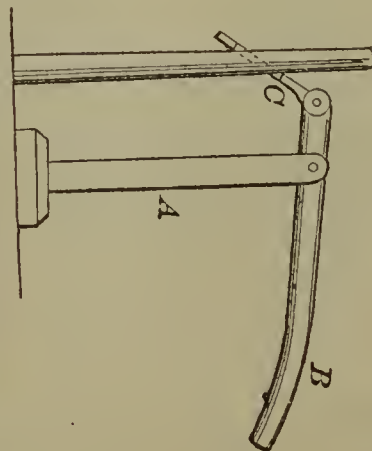
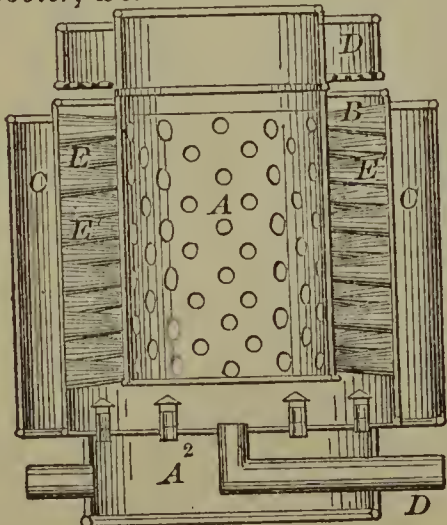

57905—I. Holmes—Pole and Post Puller.

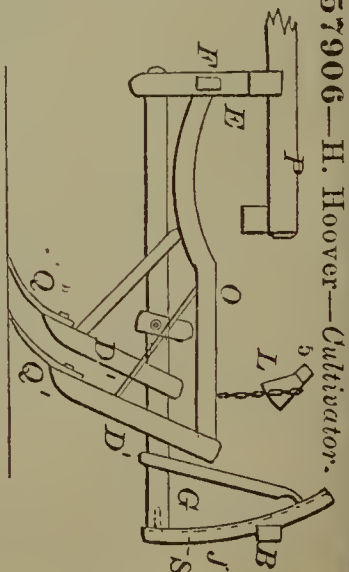

57906—H. Hoover—Cultivator.

57907—S. D. Horton—*Founders' Cleansing Mill.*

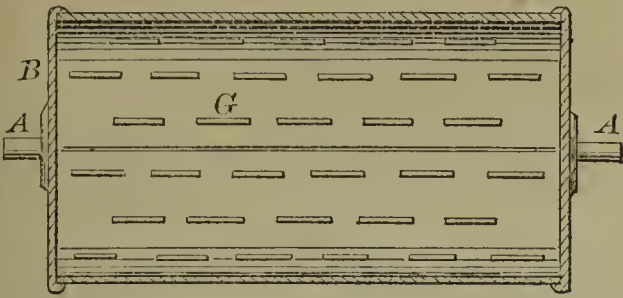

57911—Hurt & Douglass—*Spike Drawer.*

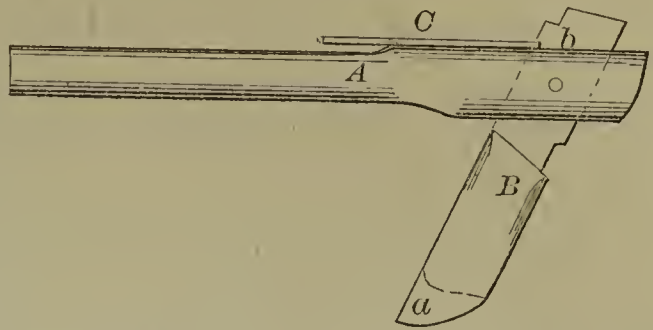

57908—W. Hotine—*Dough Moulder.*

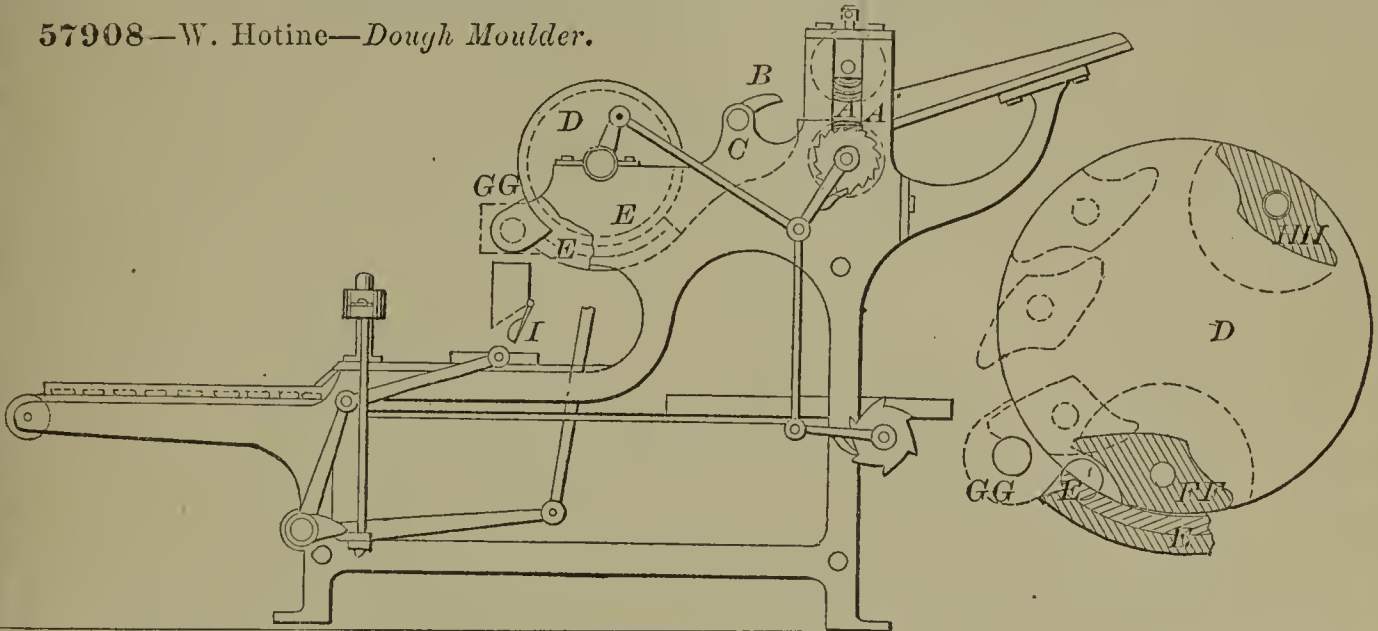

57912—A. De Kuhn—*Piano Sounding Board.*

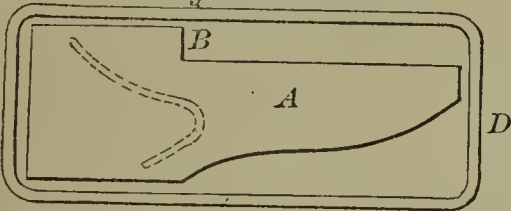

57910—

G. R. Huntley—*Faucet.*

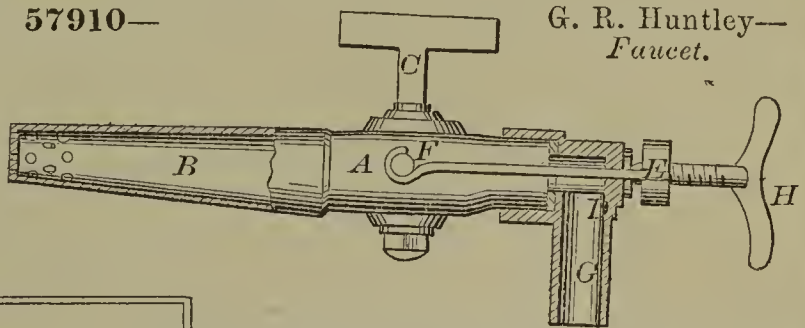

57909—C. B. Hunting—*Plow.*

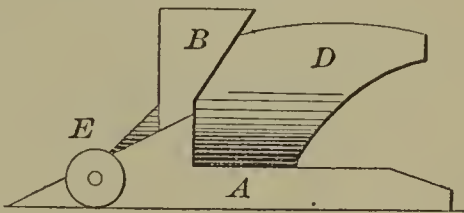

57913—B. Mingsworth—*Churn.*

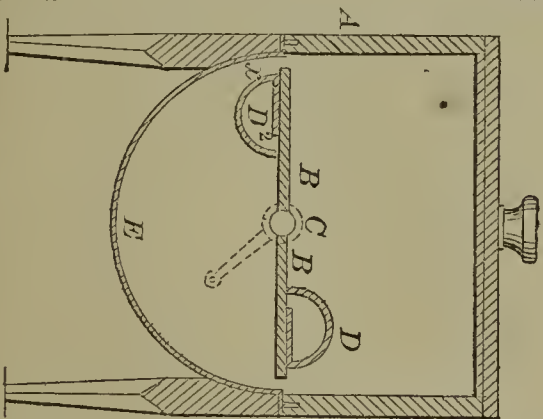

57915—J. H. Irwin—*Retort for Generating Gas.*

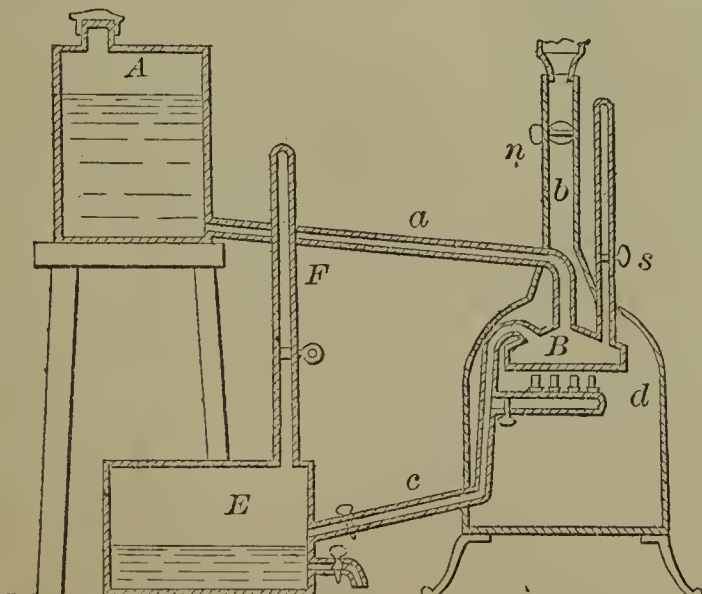

57914—J. H. Irwin—*Lantern.*

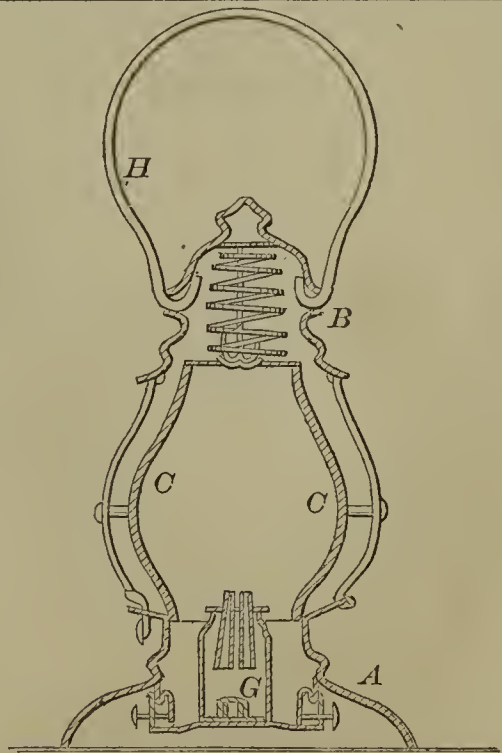

57919—J. Jones—Brick Machine.

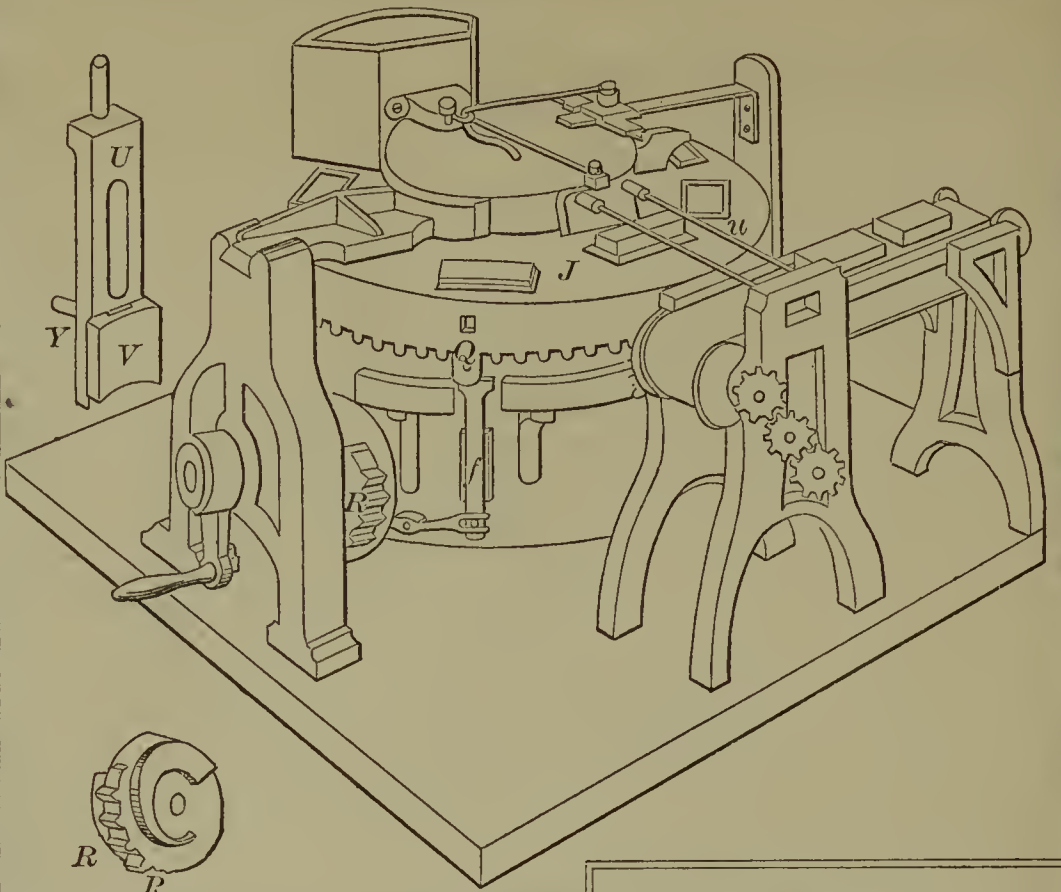

57916—A. W. Jackson—Piston Packing.

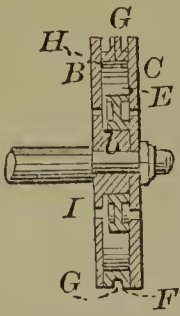

57918—J. S. Jennings—Combined Knife and Fork.

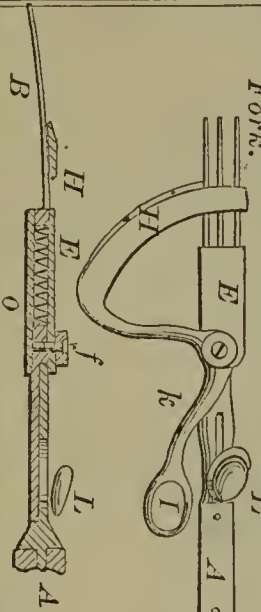

57921—J. F. Keeler—Scale Beam.

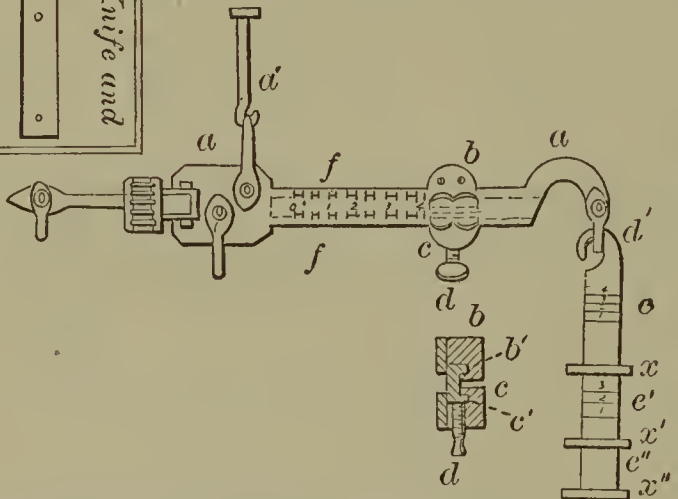

57917—L. R. Jenkins—Belt Guide.

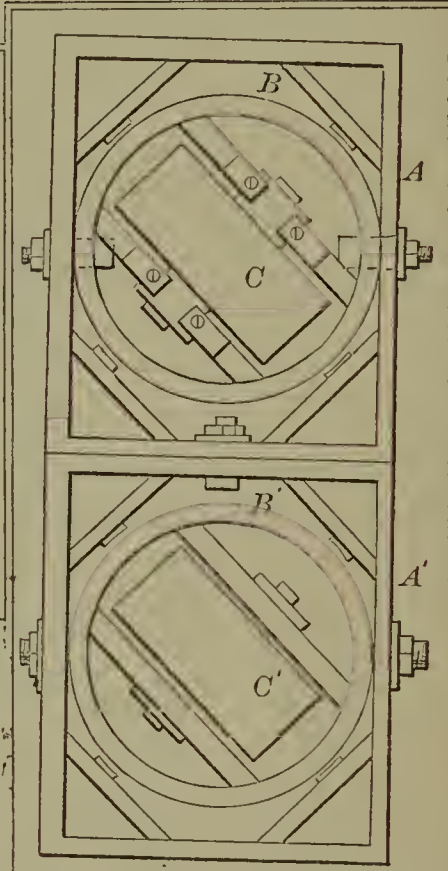

57922—G. H. Kidney—Washing Machine.

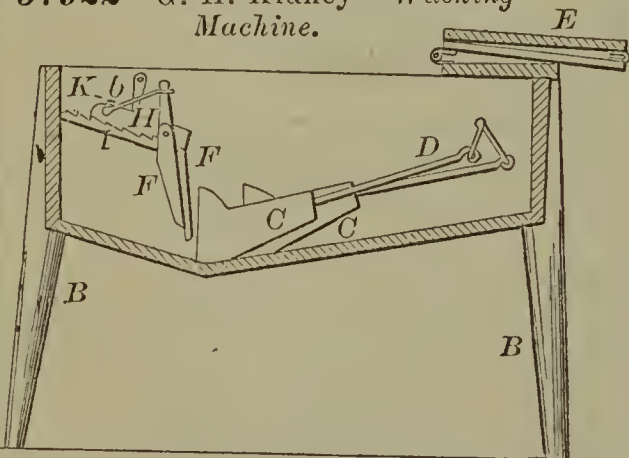

57920—W. Kearney—Water Pipe Valve.

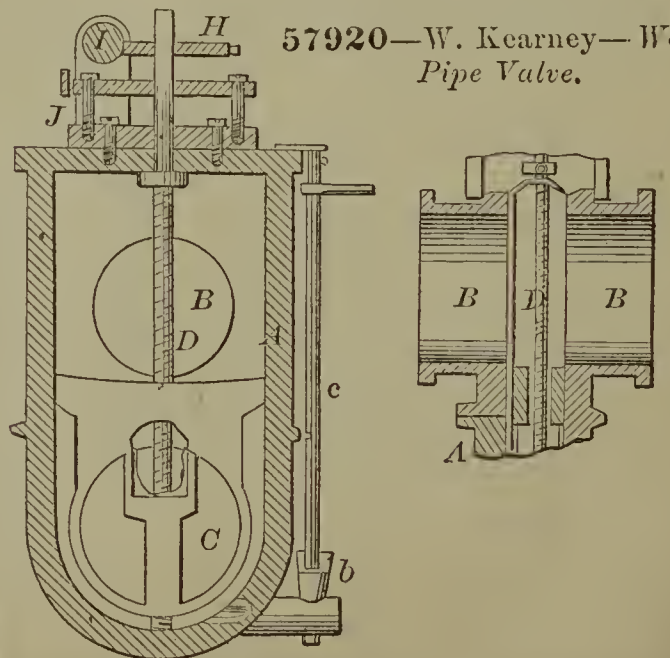

57923—D. Kinzer—Evaporator.

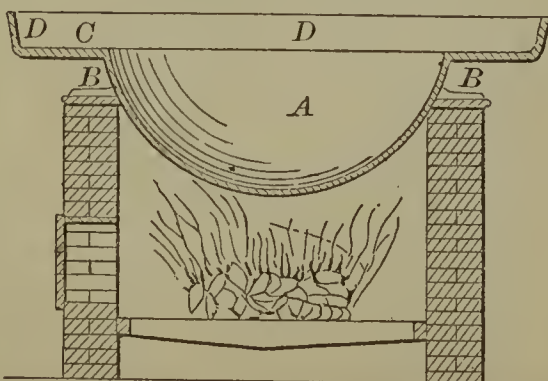



57924—E. N. Kingsley—Beehive.

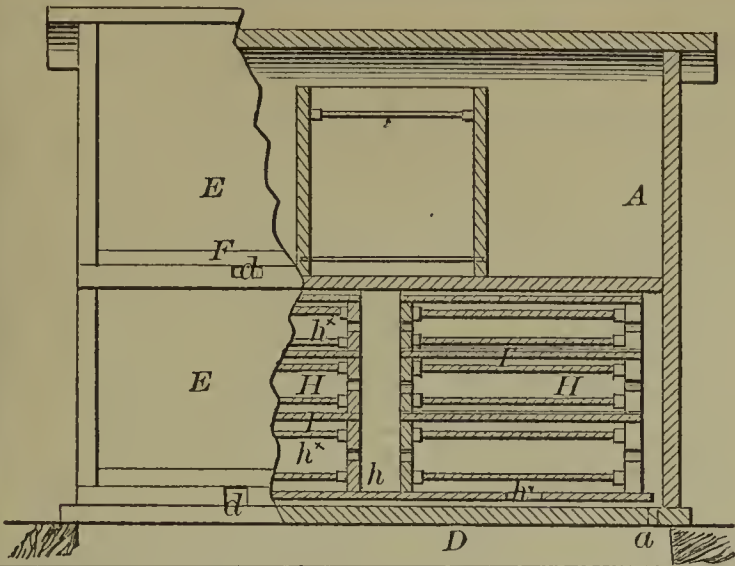

57925—Kunns & Burson—Starting Street Cars.

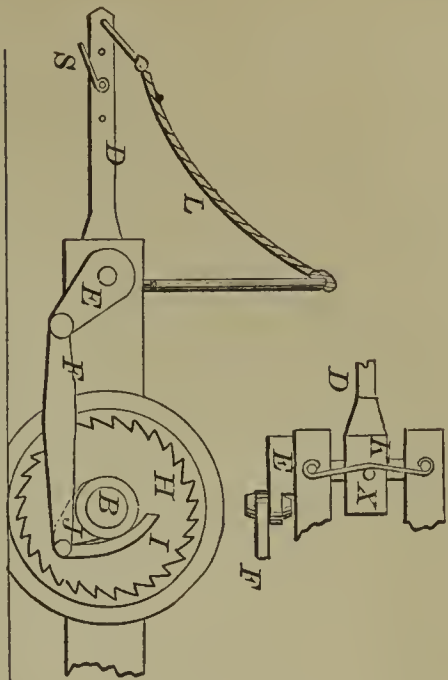

57926—La France & Dinsmore—Railway Car Head Rest.

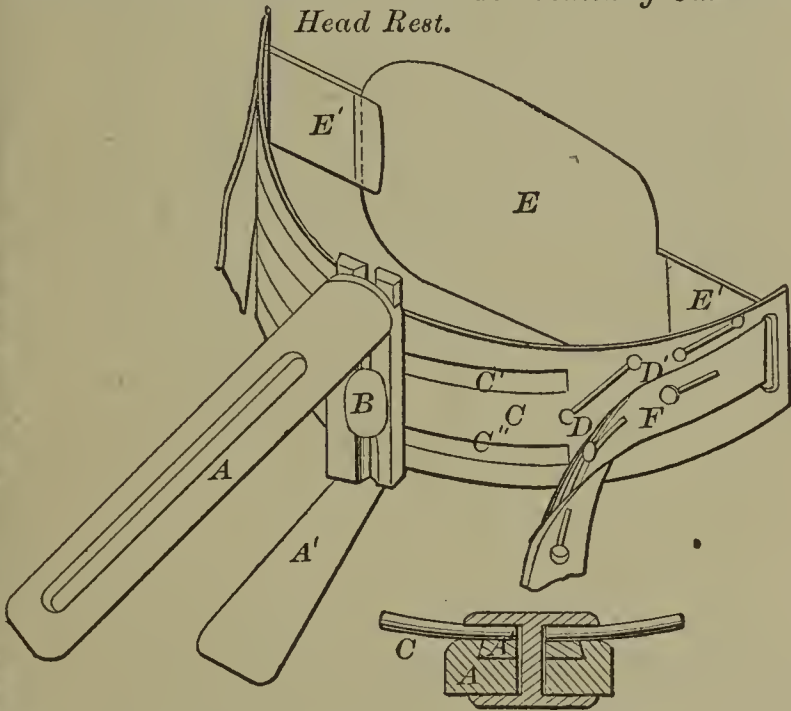

57927—Lauter & Kautz—Extension Table.

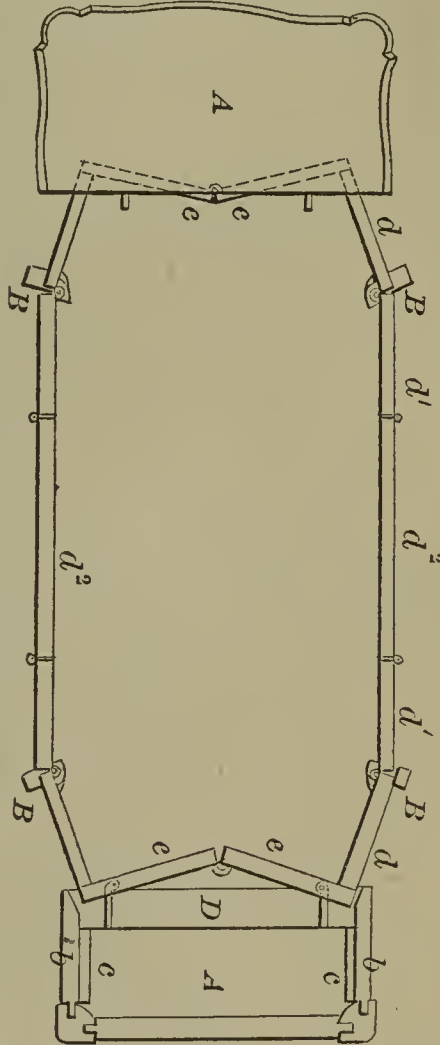

57928—R. W. Lawrence—Dumb Waiter.

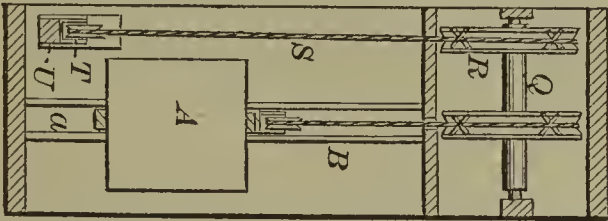

57930—R. Lee—Knob Latch.

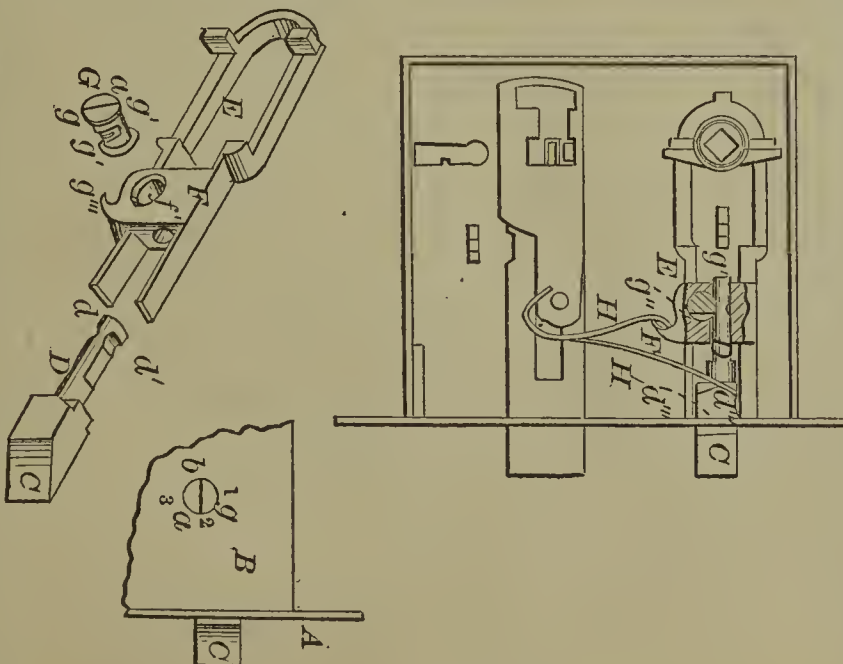

57929—L. L. Lee—Water Gauge Float.

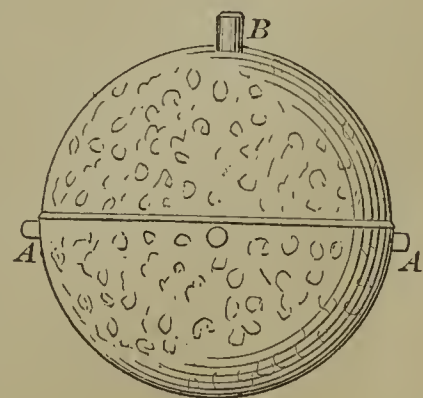

57931—D. Lippy—Car Coupling.

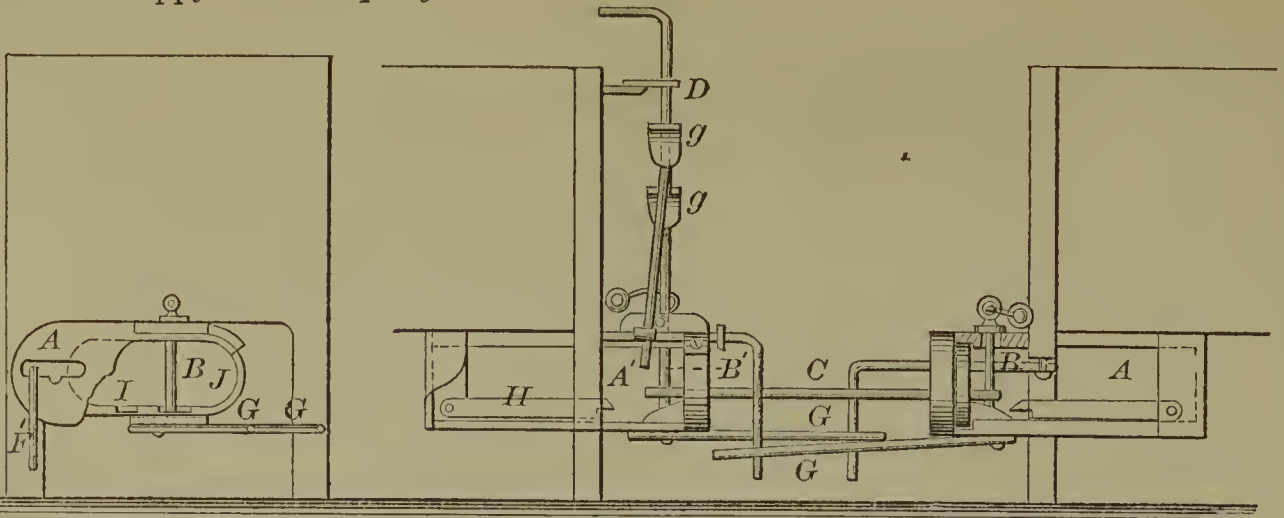

57932—J. F. Llewellyn—Condenser.

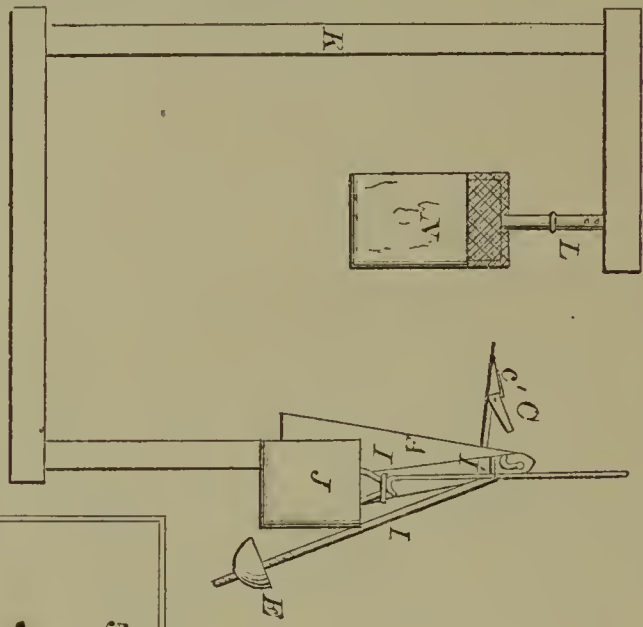
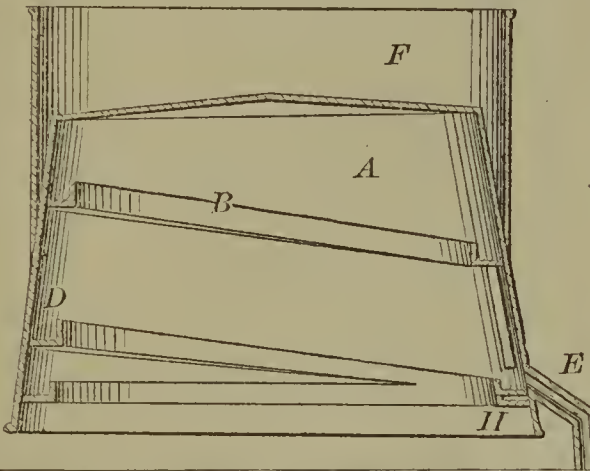

57936—P. N. Maine—Receiving Mail Bags on Cars.

57934—E. Lyman—Gauge for Screw Cutting Tools.

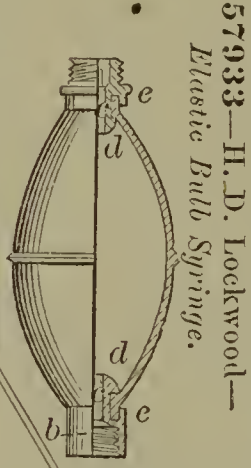
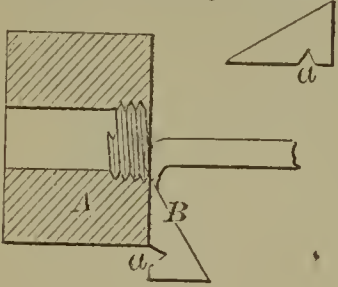

57933—H. D. Lockwood—Elastic Bulb Syringe.

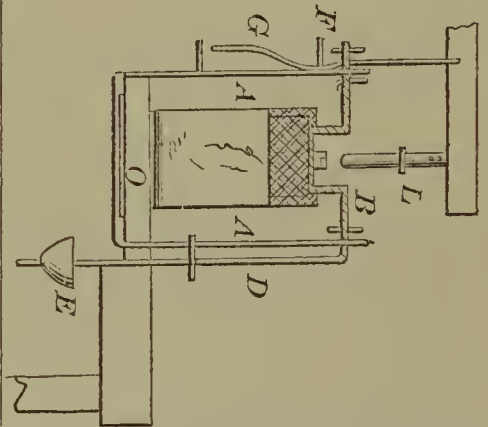

57935—F. A. Mack—Well Tube.

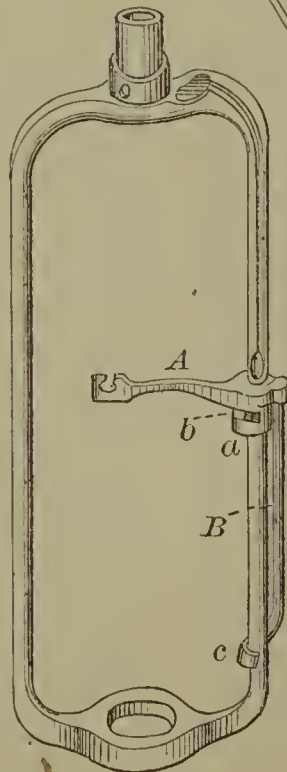

57938—T. Mayor—Rowing Frame Flyer.

57937—D. P. Mathews—Tree Protector.

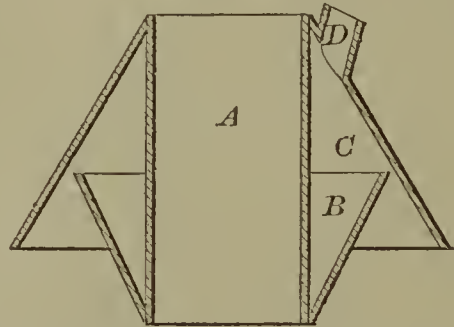

57939—McAfee & Wirt—Ground Drag.

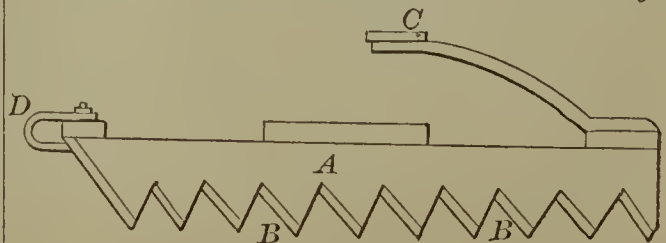

57940—H. L. McAvoy *For Carbureting Air.*

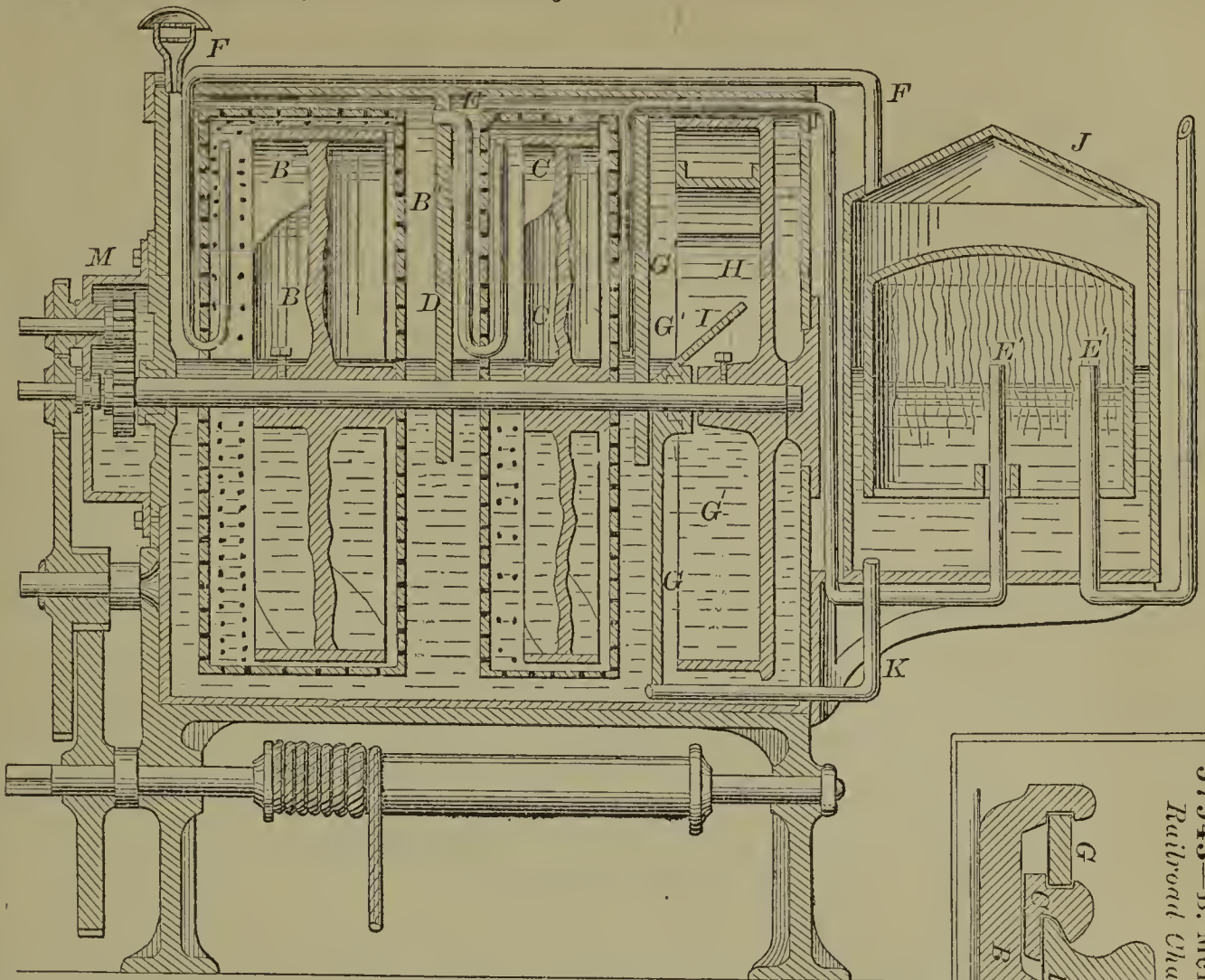

57943—B. McDevitt—*Railroad Chair.*

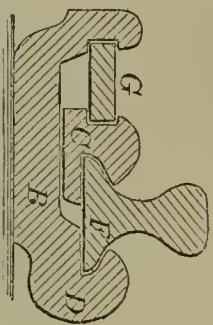

57942—W. R. McCutcheon—*Churn.*

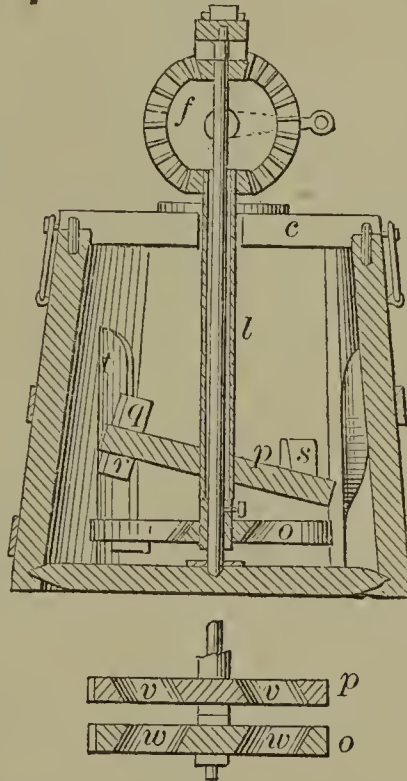

57944—J. McInnes—*Hame Yug.*

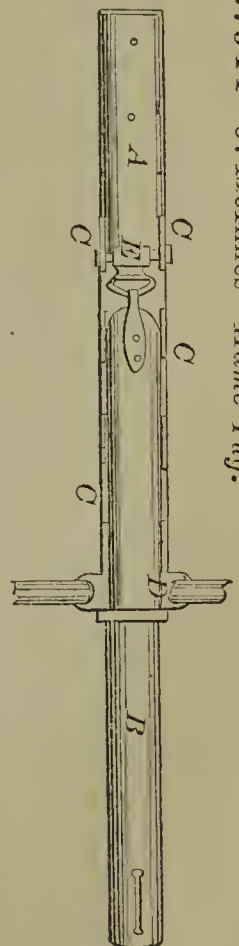

57941—T. B. McConaughey—*Horse Power Governor.*

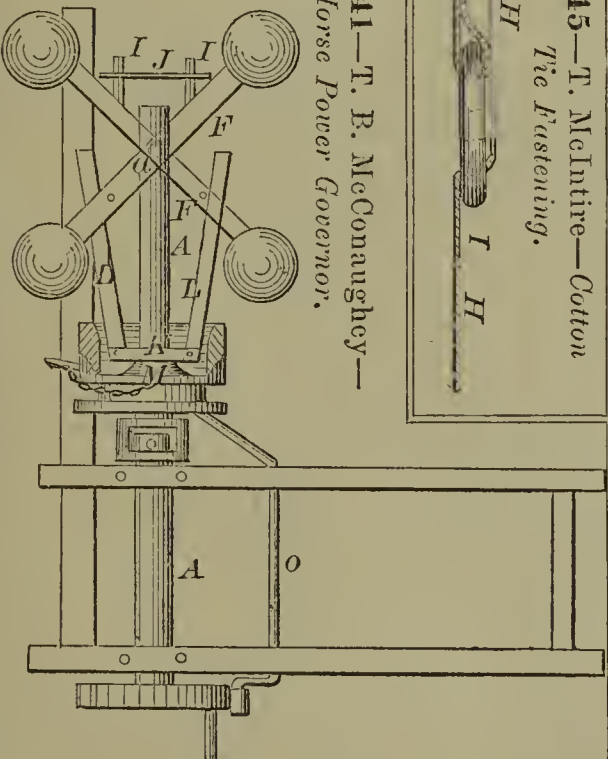

57945—T. McIntire—*Cotton Tie Fastening.*



57946—H. D. Mead—*Farm Gate.*

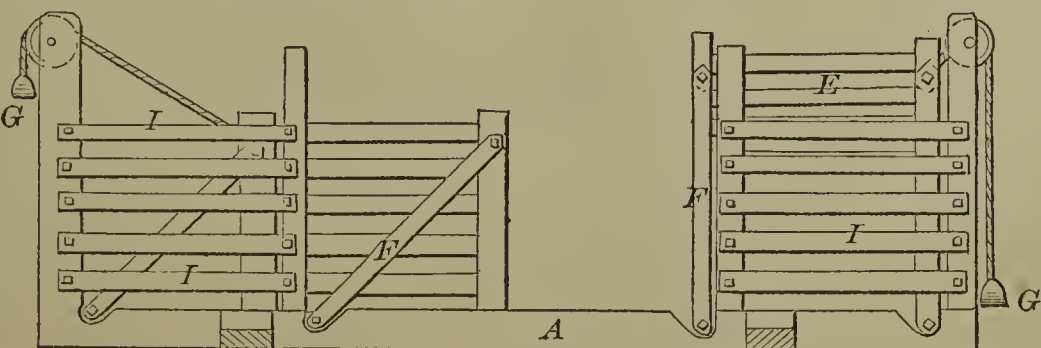

57947—H. B. Meech—Packing  
Straw into Boilers..

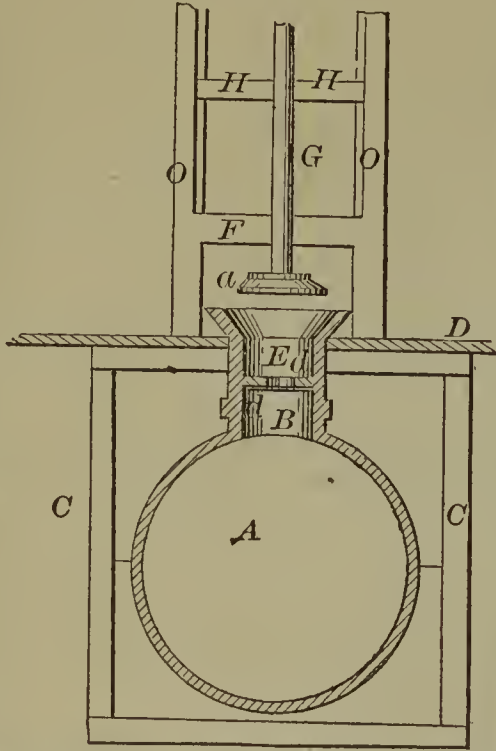

57948 W. P. Miller—Bottle Valve.

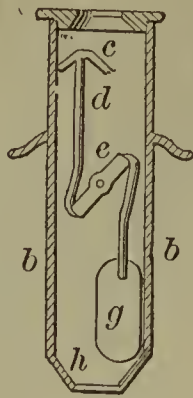

57951—H. L. Naramore—  
Sled Brake.

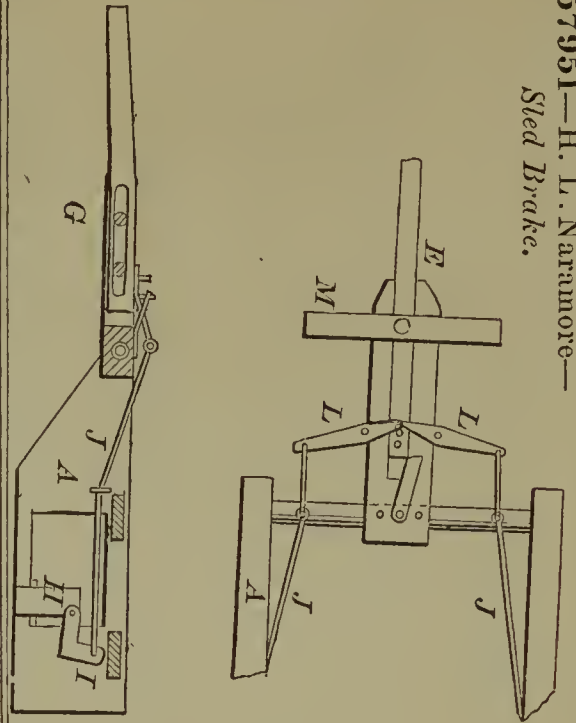

57949—R. Montgomery—Aerial Railroad.

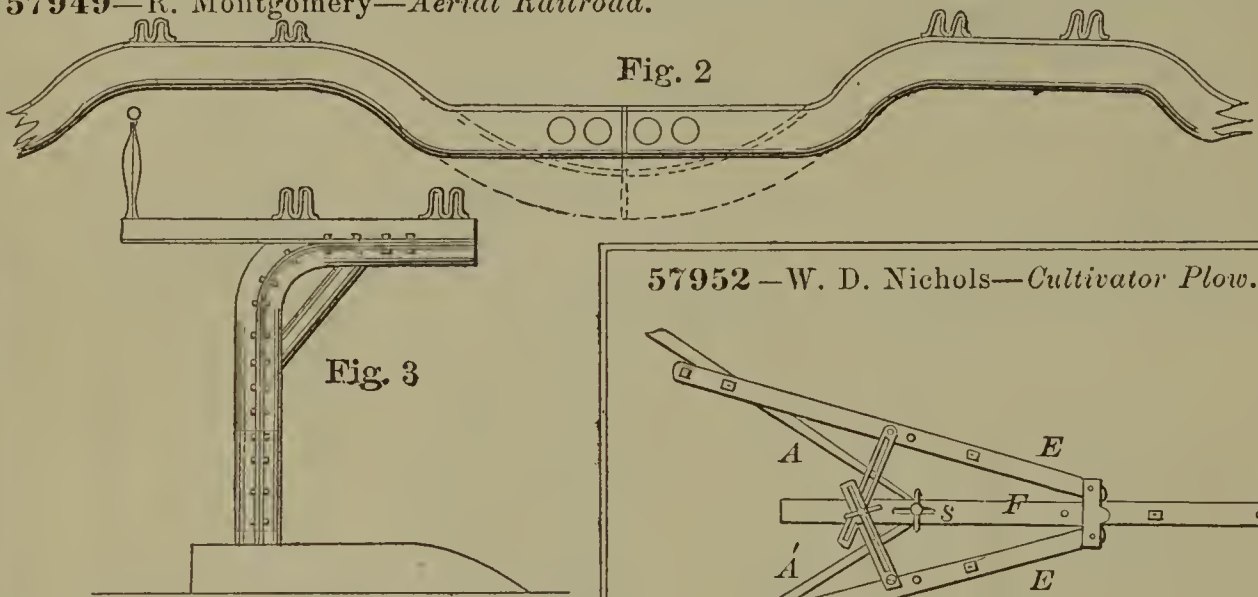

57952—W. D. Nichols—Cultivator Plow.

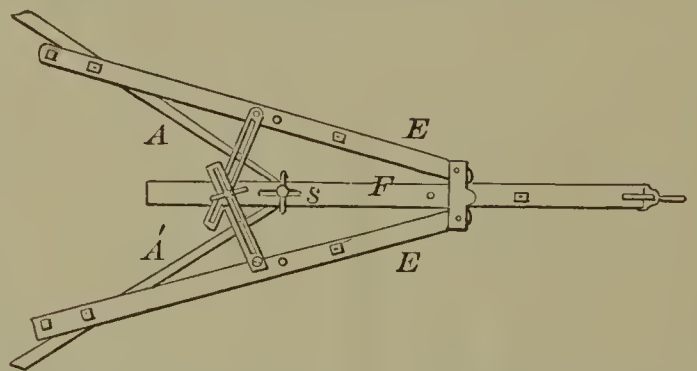

57950—S. A. Moody—Ladies' Dress  
Elevator.

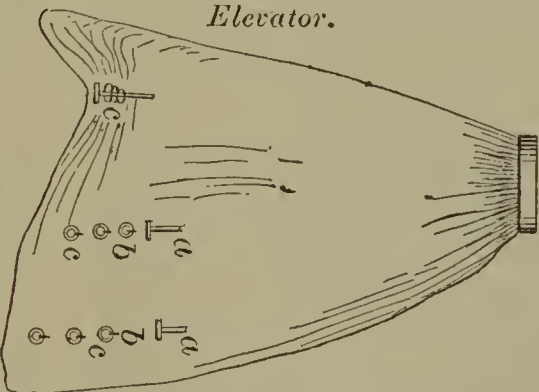

57953—W. Nichols—Steam Engine Governor.

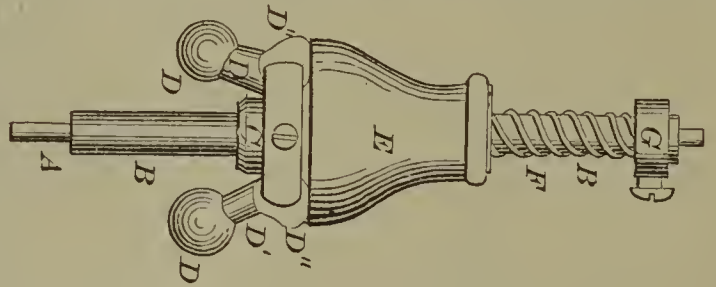

57954—R. C. Nourse—Evaporator.

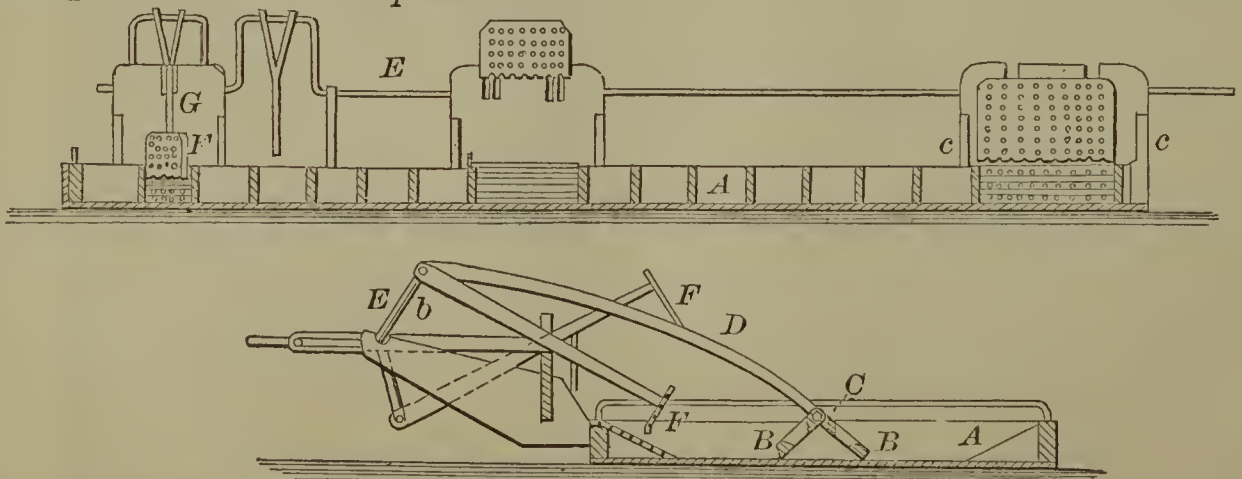

57955—S. B. B. Nowlan—Varnishing Cloth.

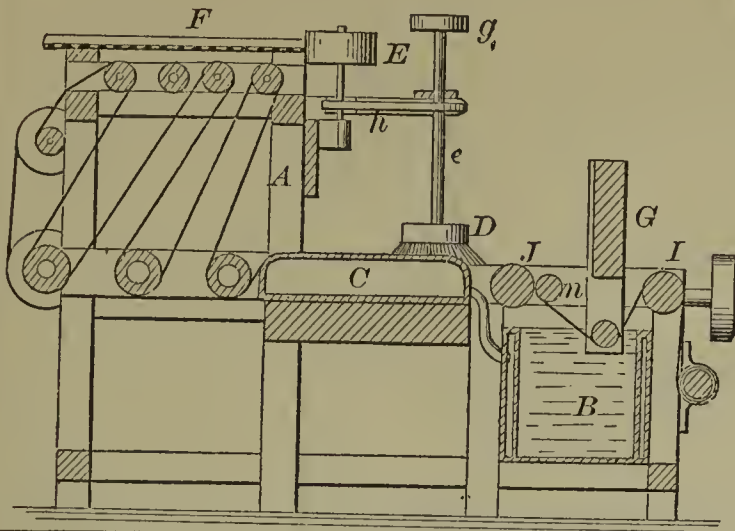

57957—C. Parker—Vise.

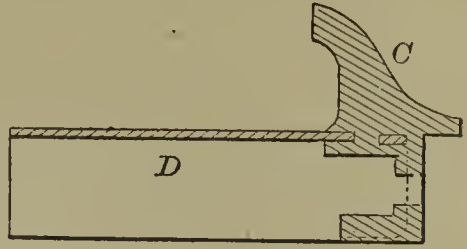

57958—J. E. Pattison—Treating Cane Juice.

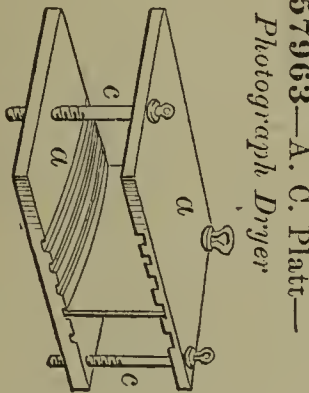
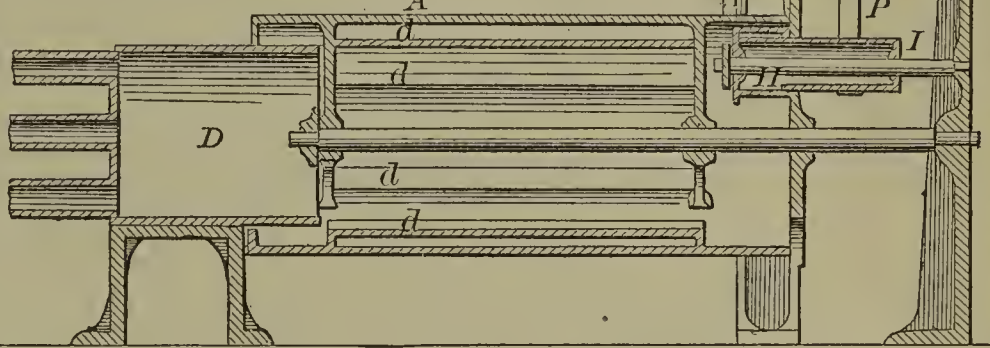

57963—A. C. Platt—  
Photograph Dryer

57961—A. Pierce—Combined  
Harrow and Marker.

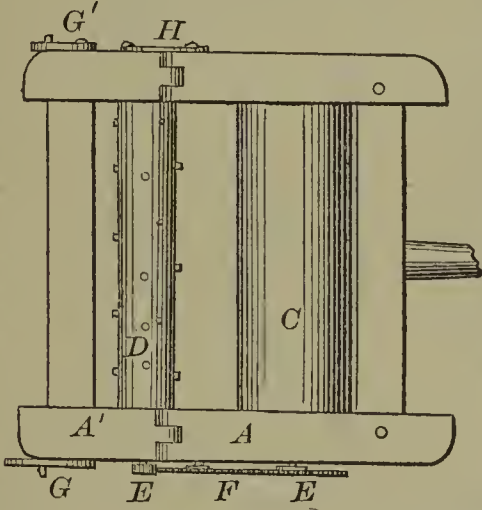

57959—F. Peabody—Sled.

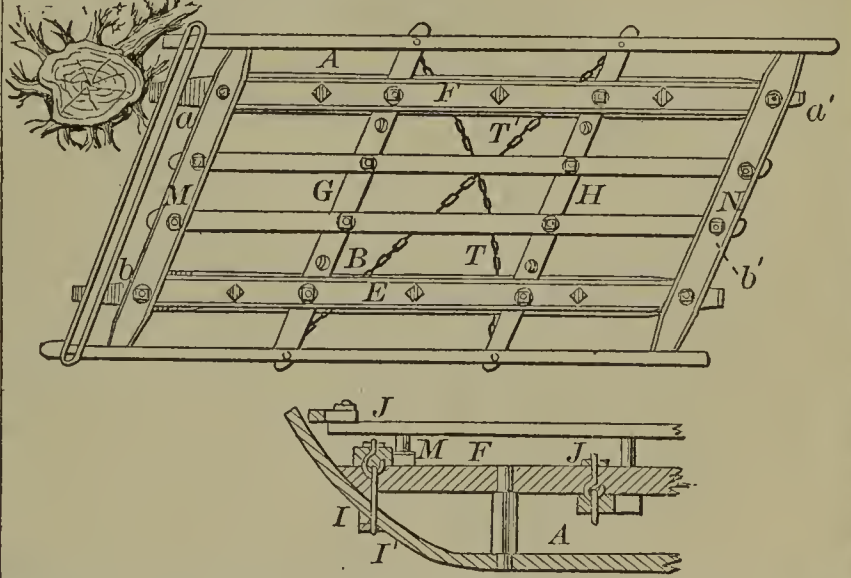

57964—B. F. Porter—Table Stand for Food.

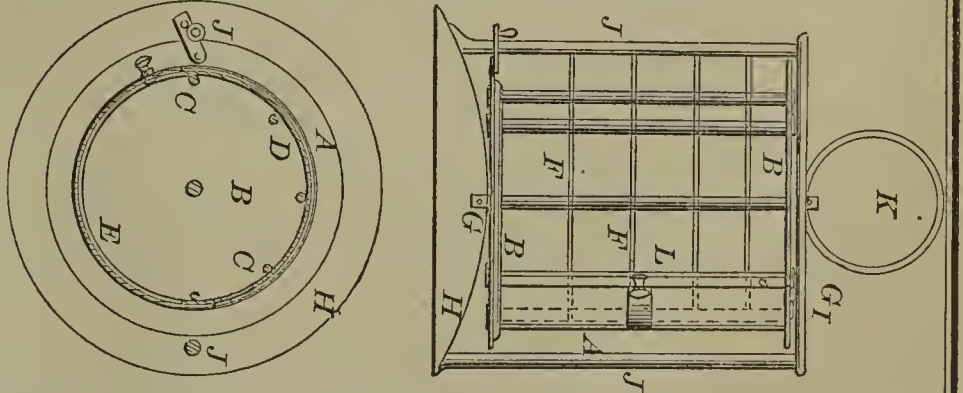

57962—A. Pierce—Car Coupling.

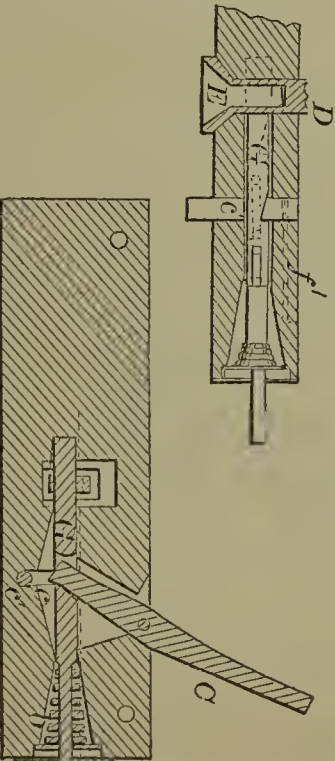

57965—D. A. Porter—  
Combined Sheep Rack and  
Shed.

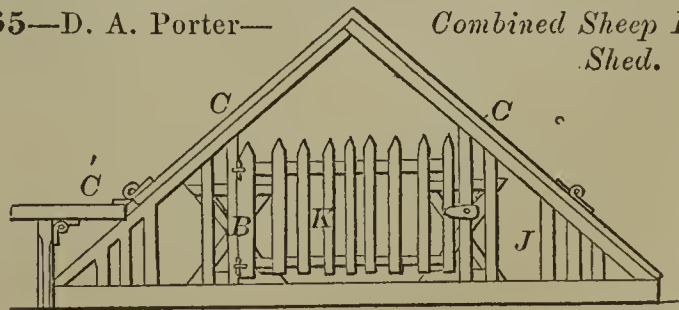

57966—T. T. Prosser—Screw.



57968—T. Rams—Plow.

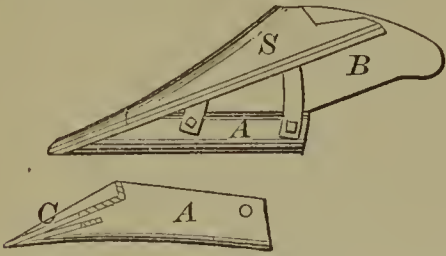

57970—J. Reid—Mariner's Compass Scale.

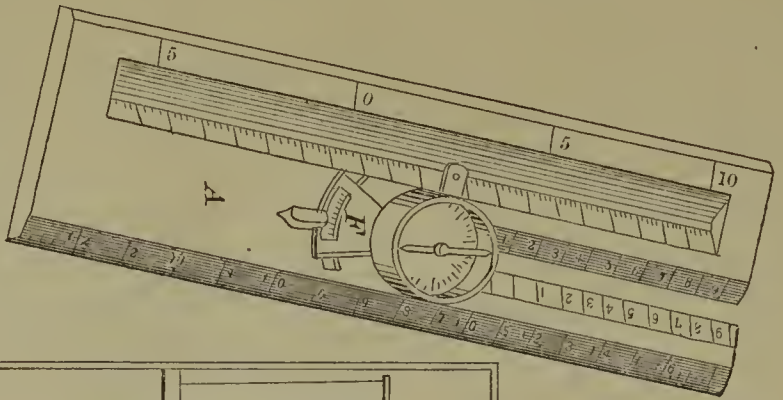

57969—J. Reese—Reducing Metallic Oxides.

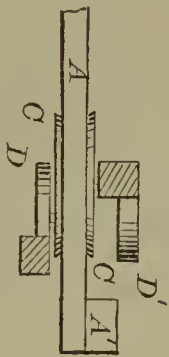
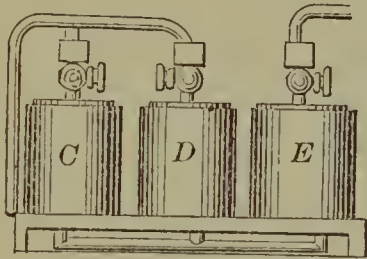
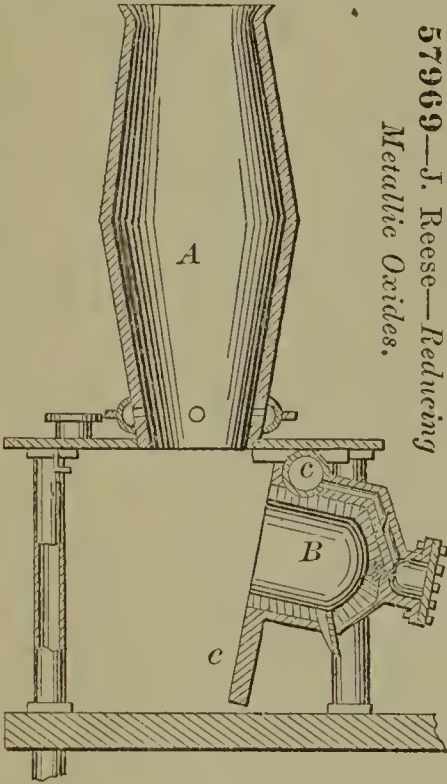

57967—S. Puffer—Gate.

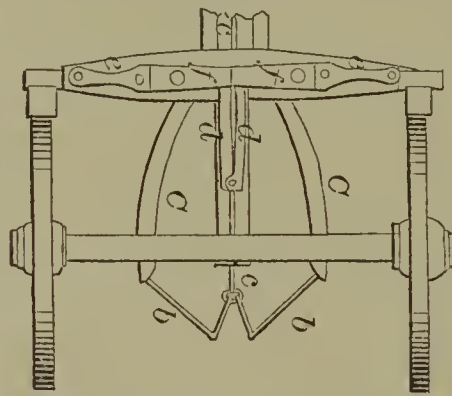
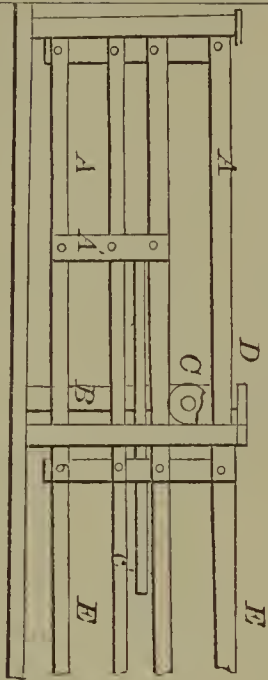

57972—T. J. Rokey—Self-Acting Wagon Brake.

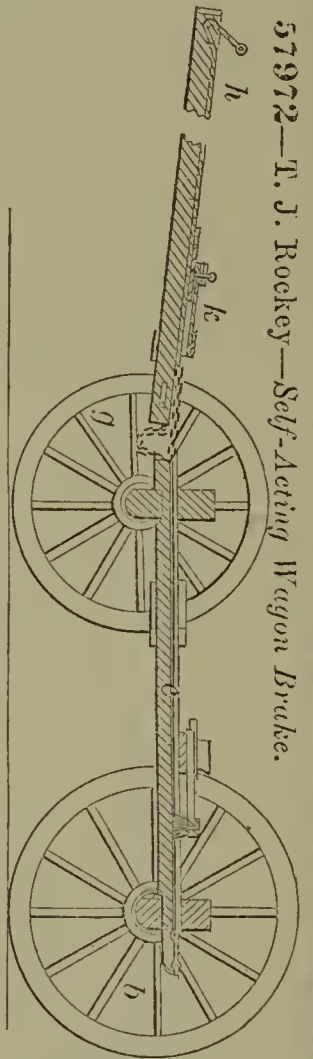

57973—G. A. Roland—Wind Wheel.

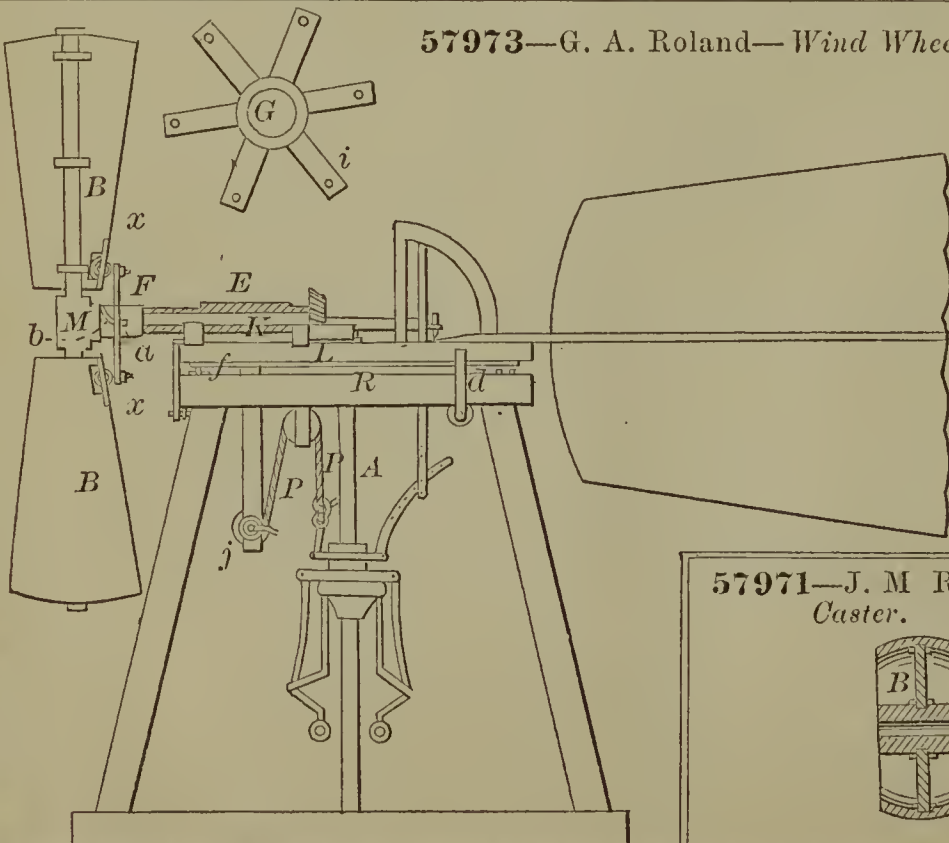

57971—J. M. Riley—Caster.



57974—T. Rose—Separating Sand from Water in Wells.

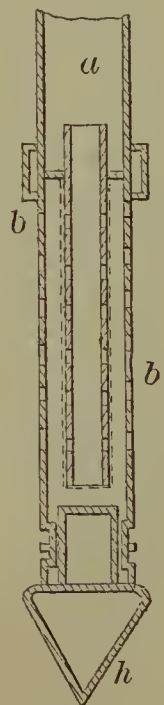

57975—D. Sager—Wagon Brake.

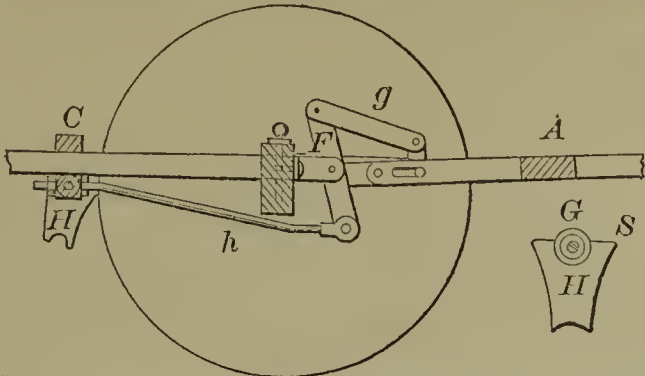

57978—F. Schenck—Gun Lock.

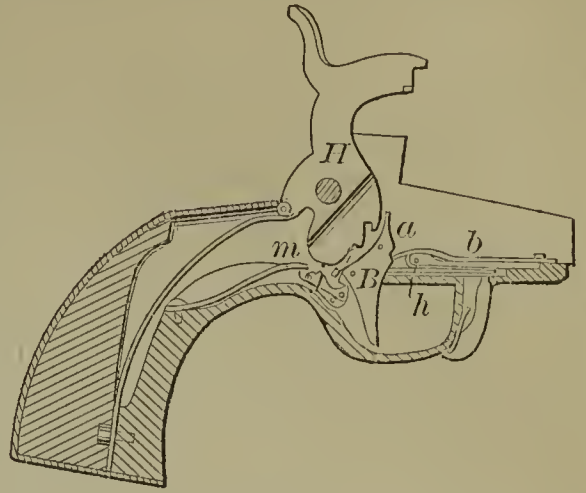

57977—R. S. Sanborn—Clothes Pin.

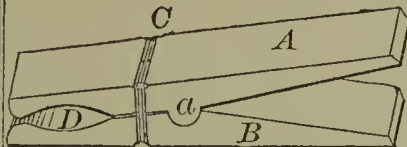

57976—B. F. Sanborn—Belt Lacing Cutter.

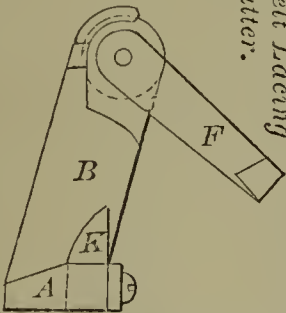

57980—J. Shaw—Forming Lock Joints in Sheet Metal.

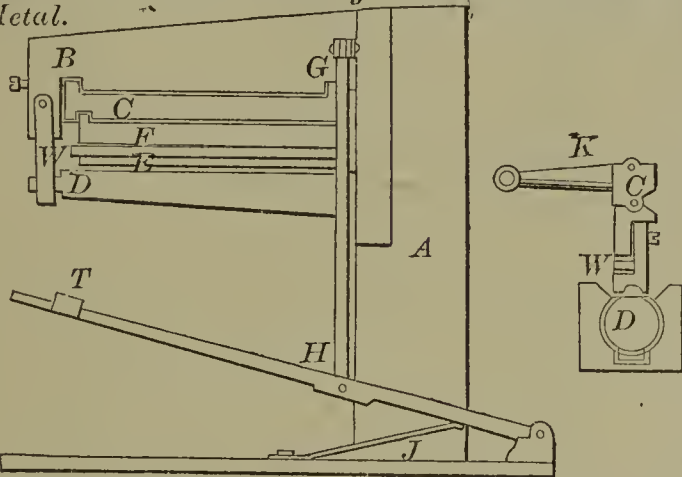

57979—D. W. Shares—Sorghum Stripper.

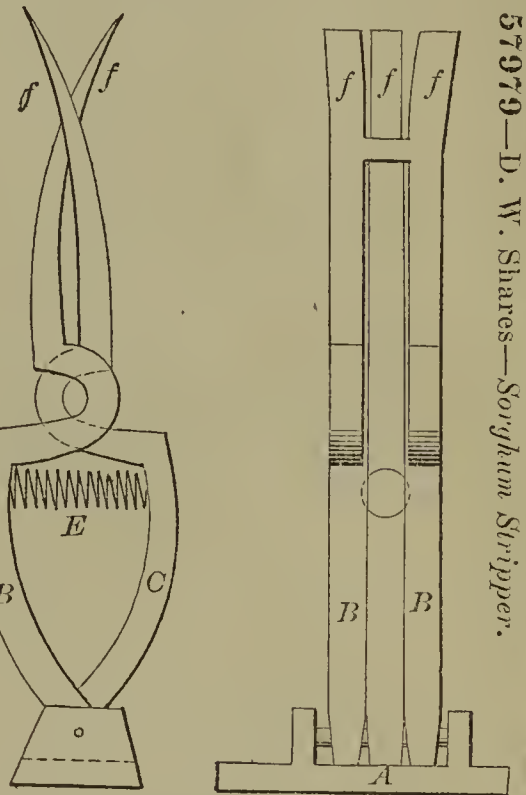

57981—Shaw, Morly & Cushman—Telegraphic Fire Alarm.

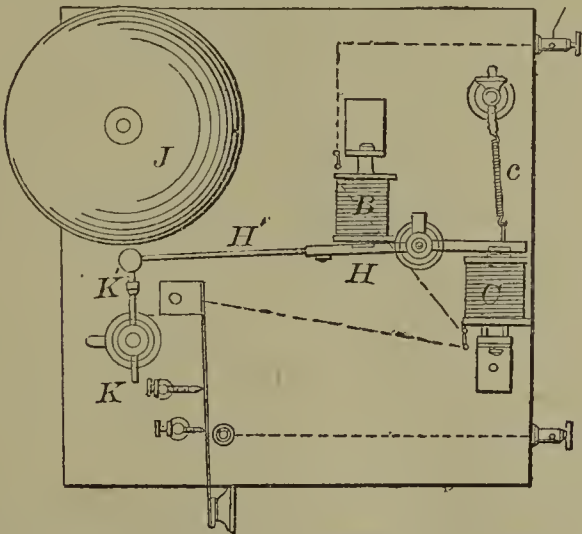

57984—Simpson, Oman & Foreman—Turning Lathe.

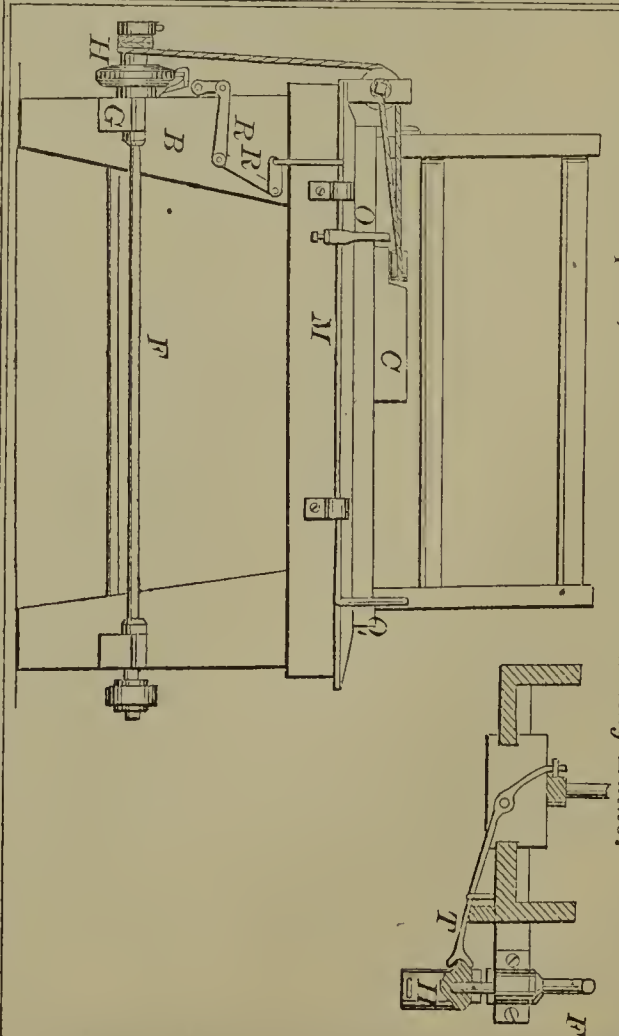

57983—T. P. Sibley—Combined Sheep Shed and Rack.

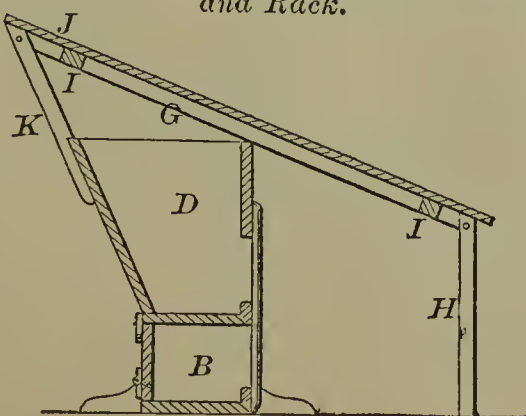

57985---E. & D. Skeels---  
*Sheep Rack.*

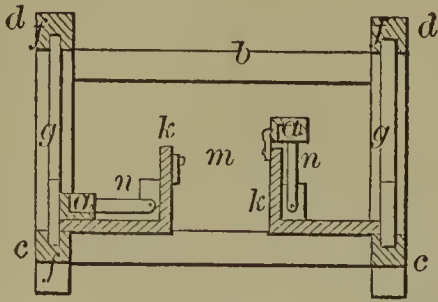

57988---W. P. Smith---*Lantern.*

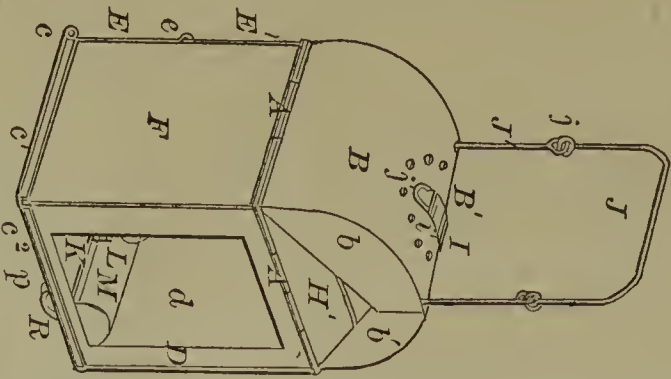

57986---T. Slight---*Baggage Car Door Lock.*

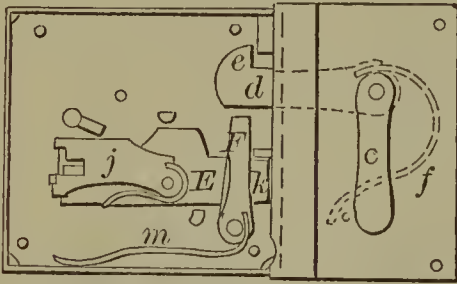

57989---S. E. Southland---  
*Covered Tub for Butter and Lard.*

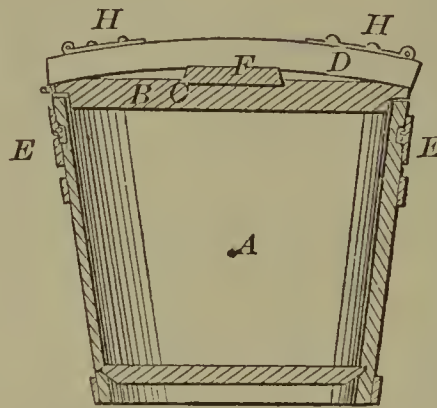

57987---A. E. Smith---*Wagon Axle Box.*

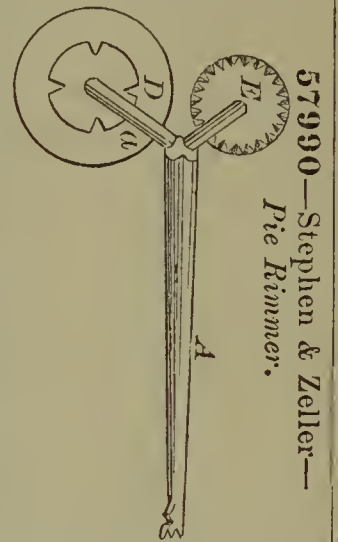
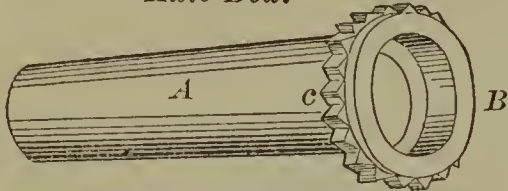

57990---Stephen & Zeller---  
*Pie Rinmer.*

57991---A. W. Stoker---*Plow.*

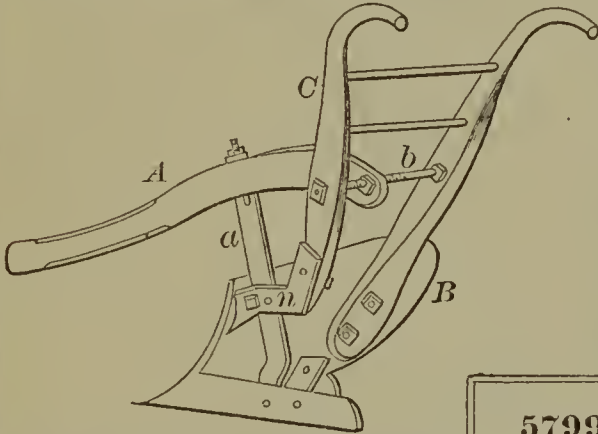

57993---S. Stucky---*Steam Generator Safety Valve.*

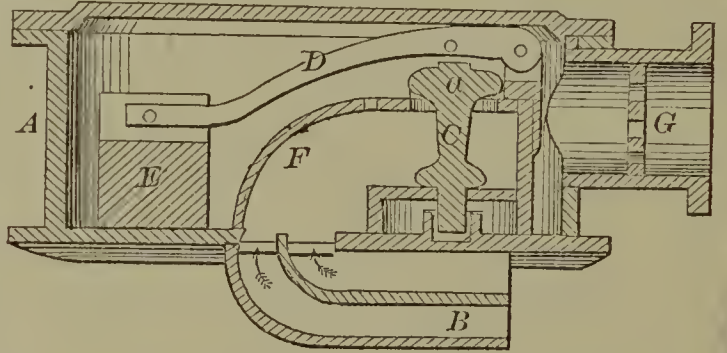

57994---S. M. Swartz---*Combined Corn Planter and Plow.*

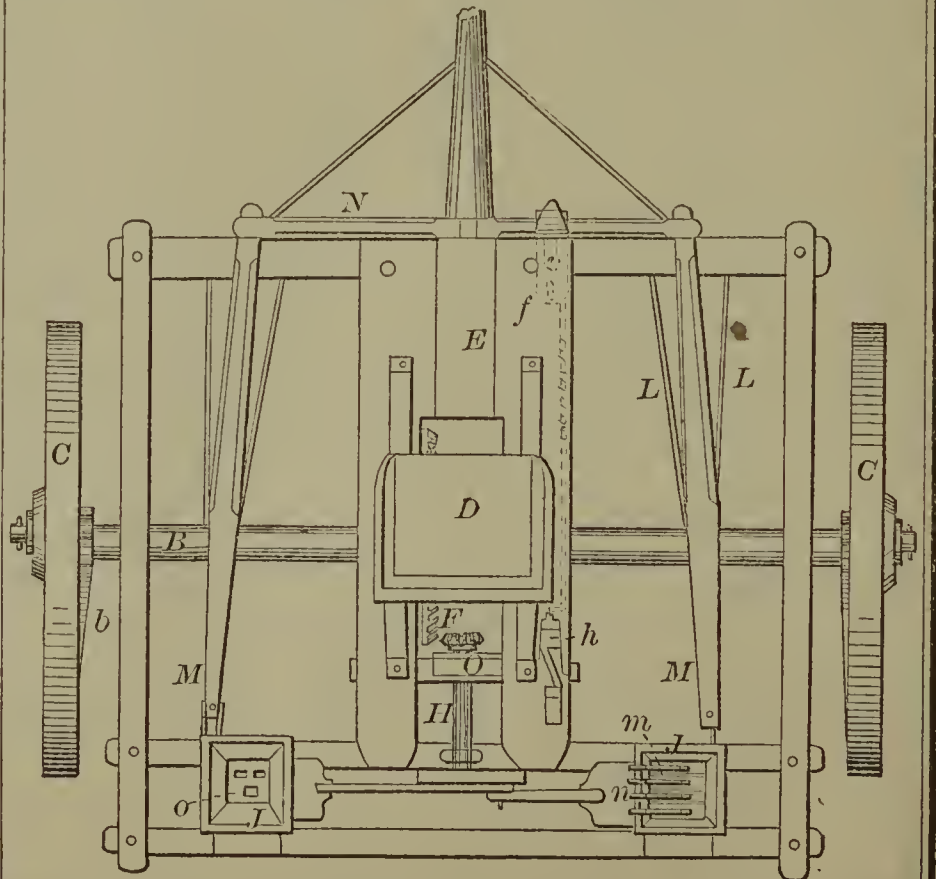

57992---S. Stout---*Sulkey Plow.*

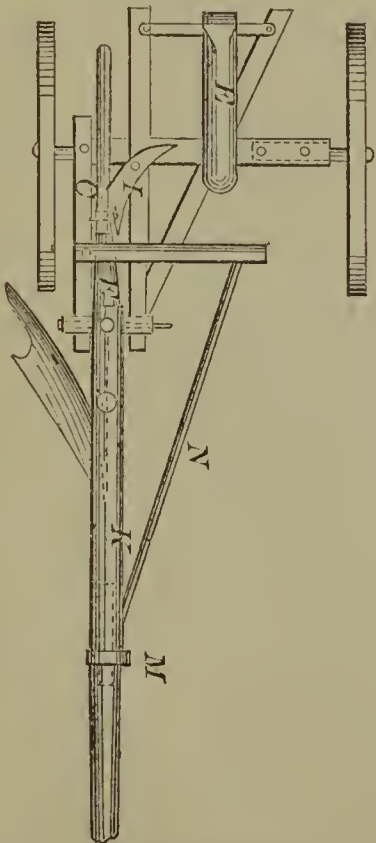



57995—J. B. Sweetland—Horse Power.

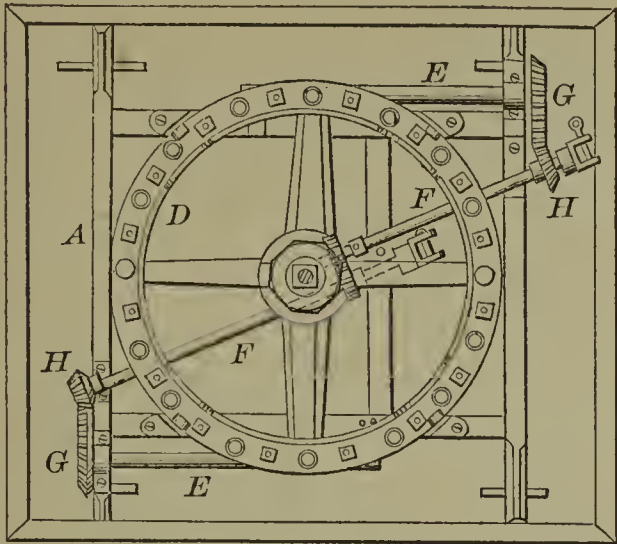

58000—G. H. Tift—Meat Mangler.

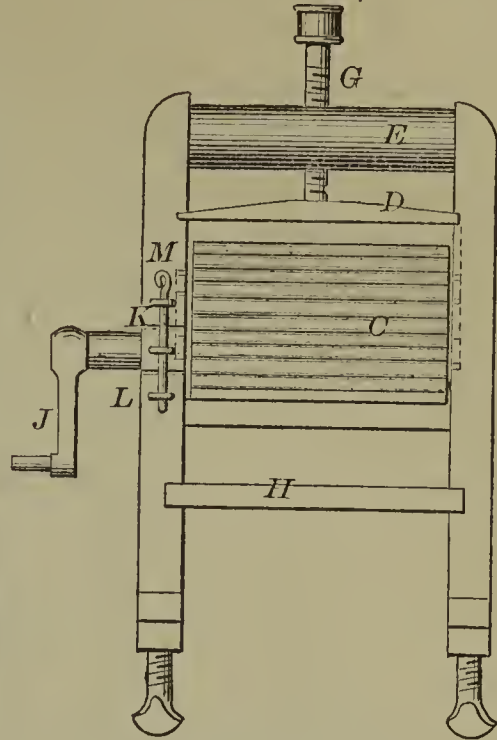

57996—C. W. Sykes—Marine Balloon.

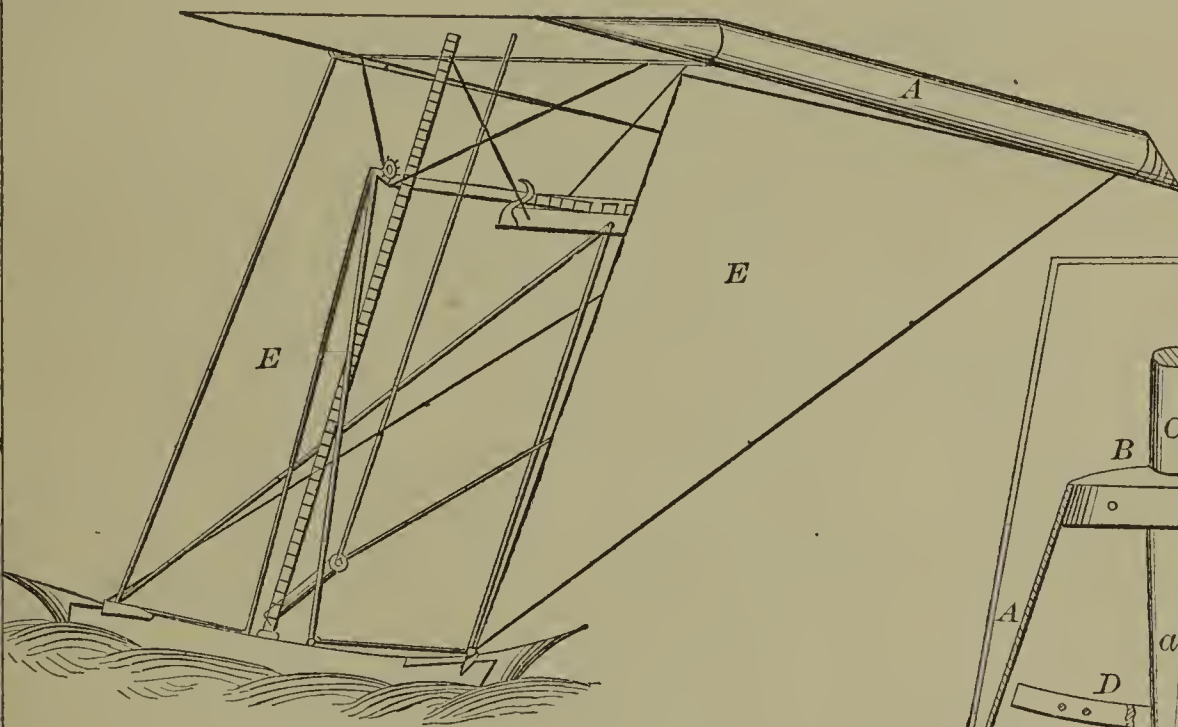

57998—Taylor & Lafferty—  
Broom Head.

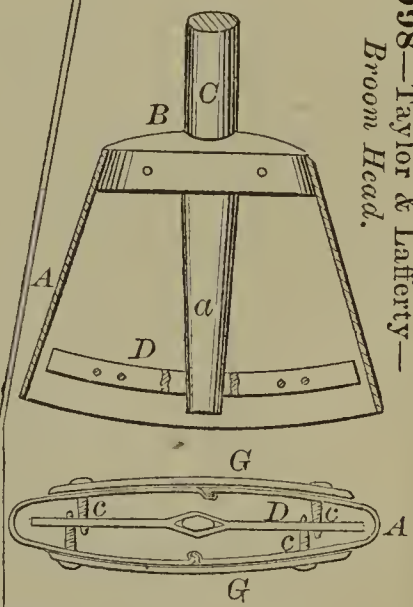

57997—G. Taylor—Malt Kiln Floor

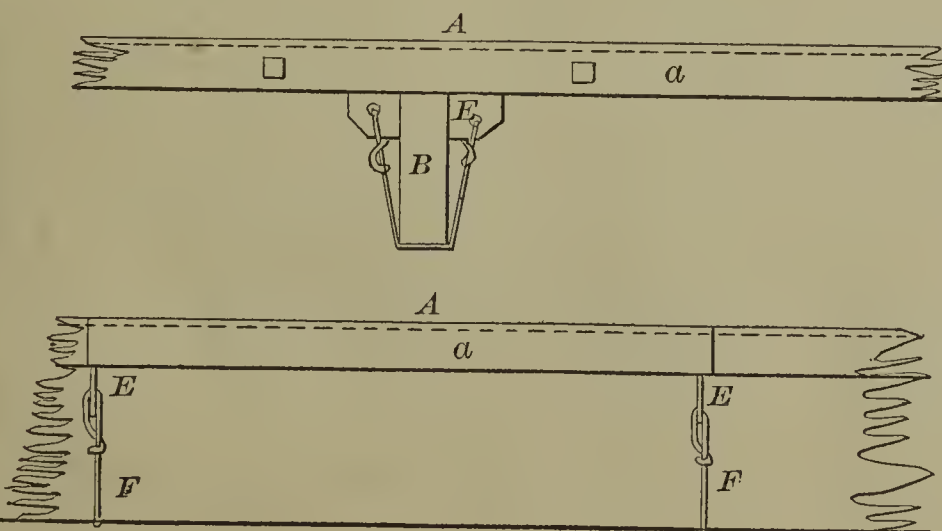

58001—A. R. Tully—Wagon Top.

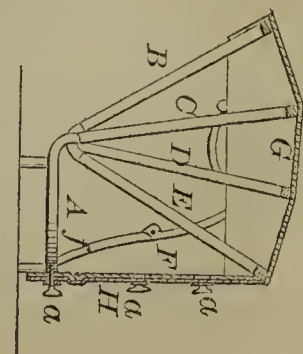

58002—W. C. Turnbull—*Gas Purifier.*

58004—H. Underwood—*Lap Joint for Belting.*

58007—W. G. Ward—*Clothes Pin.*

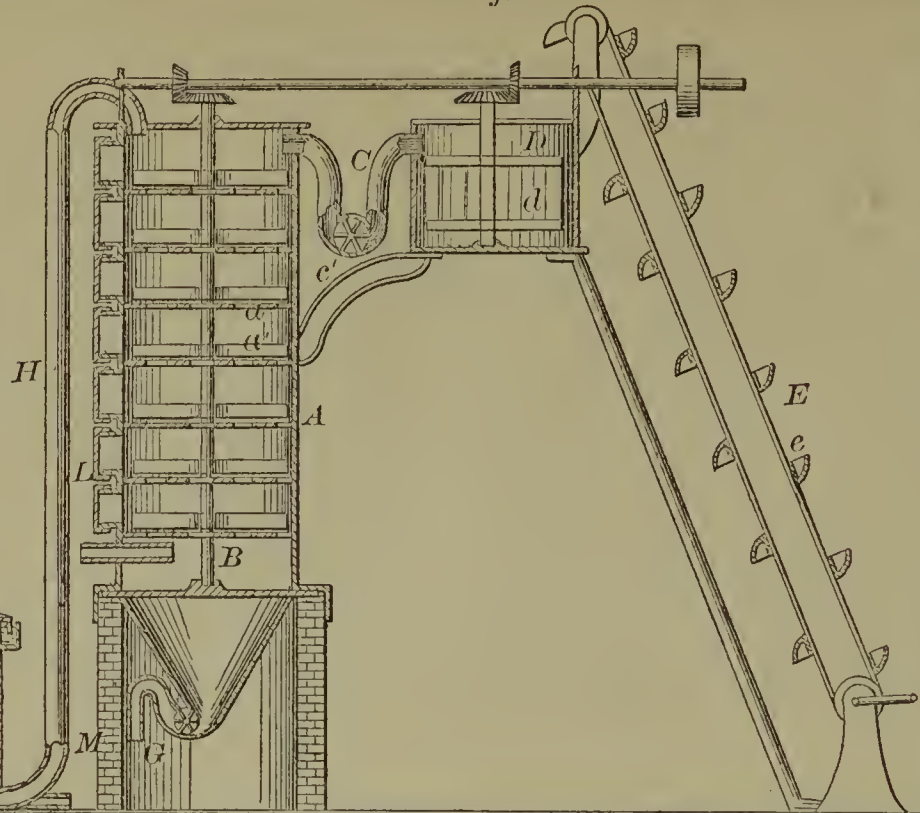
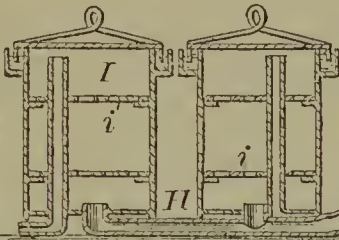

58005—P. H. V. Weyde—*Distilling Petroleum and other Liquids.*

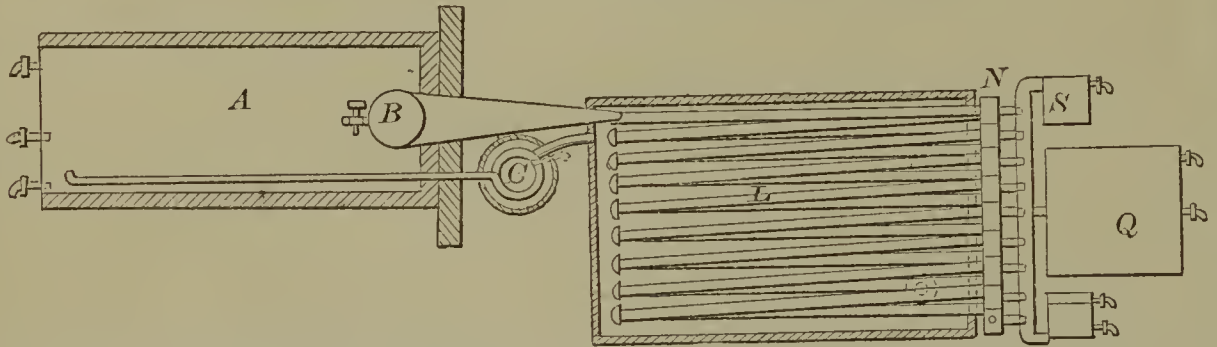

58006—H. S. Vrooman—*Mechanical Toy.*

58003—W. Tuttle, Jr.—*Fence.*

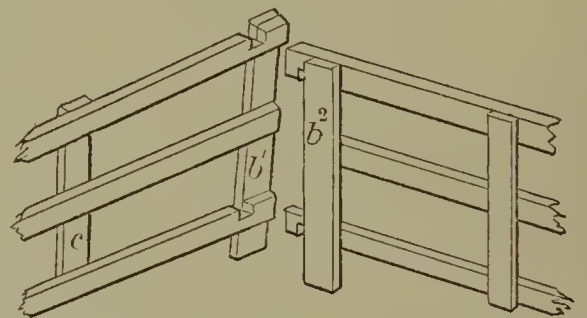
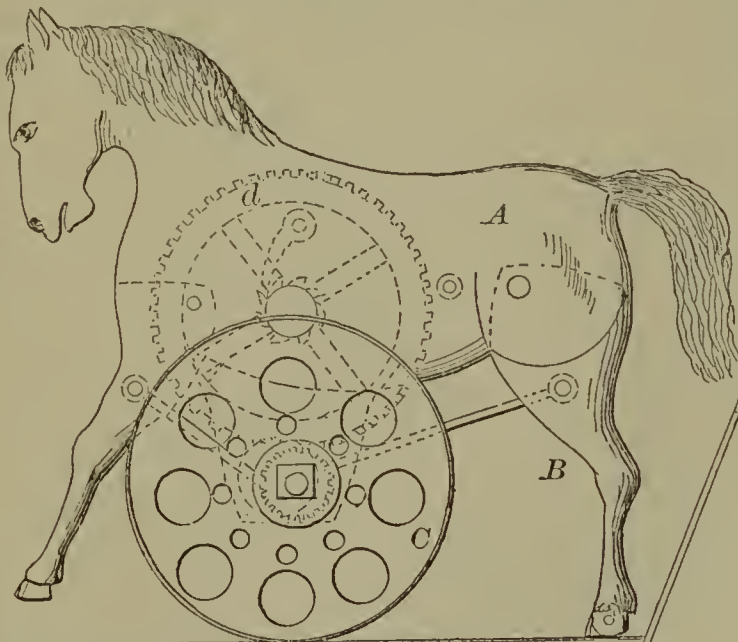

58008—J. S. Warren—*Water Wheel.*

58009—J. C. Wharton—*Condenser.*

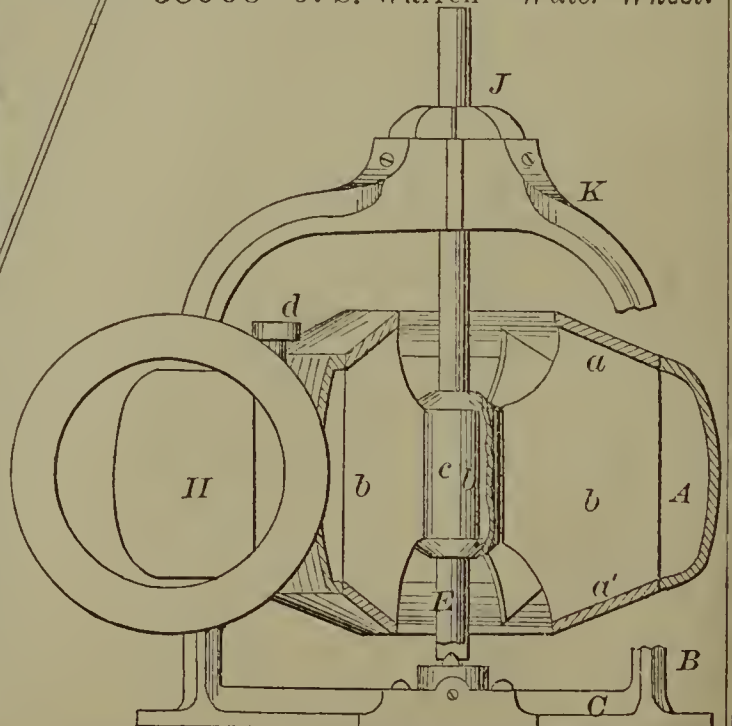
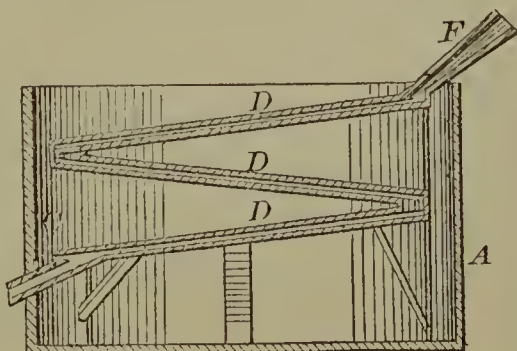

58010—Whelpley & Storer—Amalgamator.

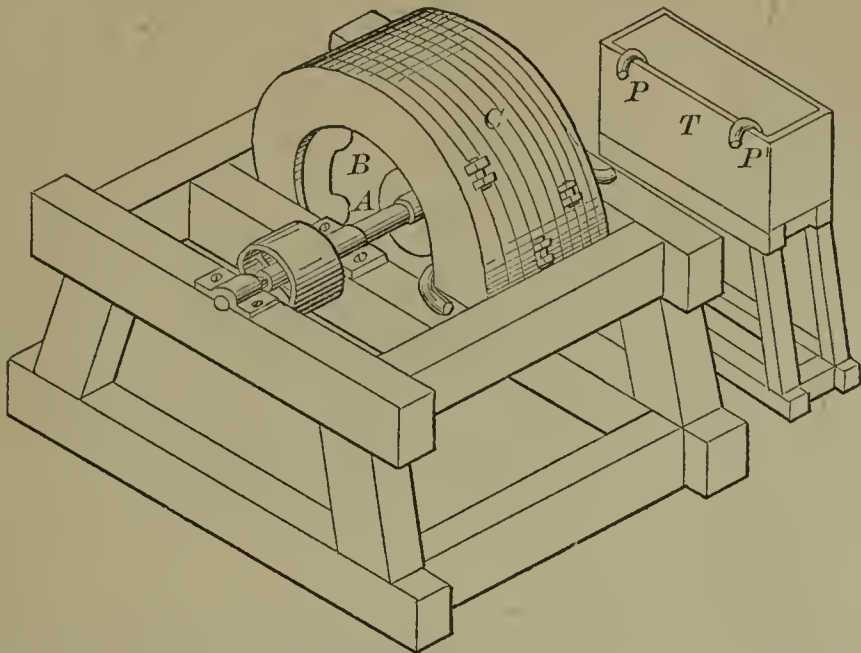

58013—J. Whiteside—Fence.

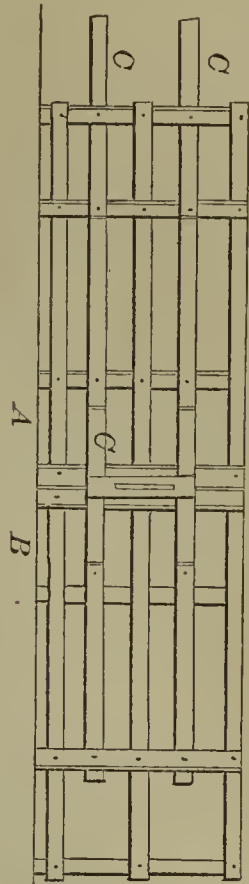

58011—Whelpley & Storer—Cleaning Particles of Metals.

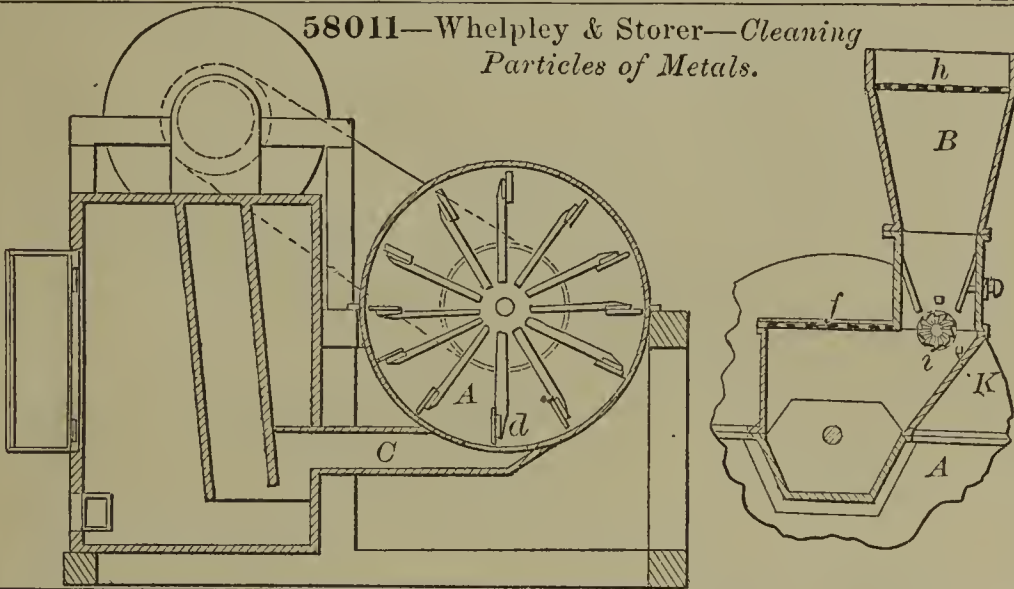

58016—L. J. Woodruff—Carriage Seat.

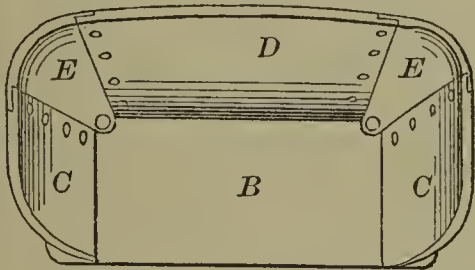

58017—C. S. Bell—Steam Generator.

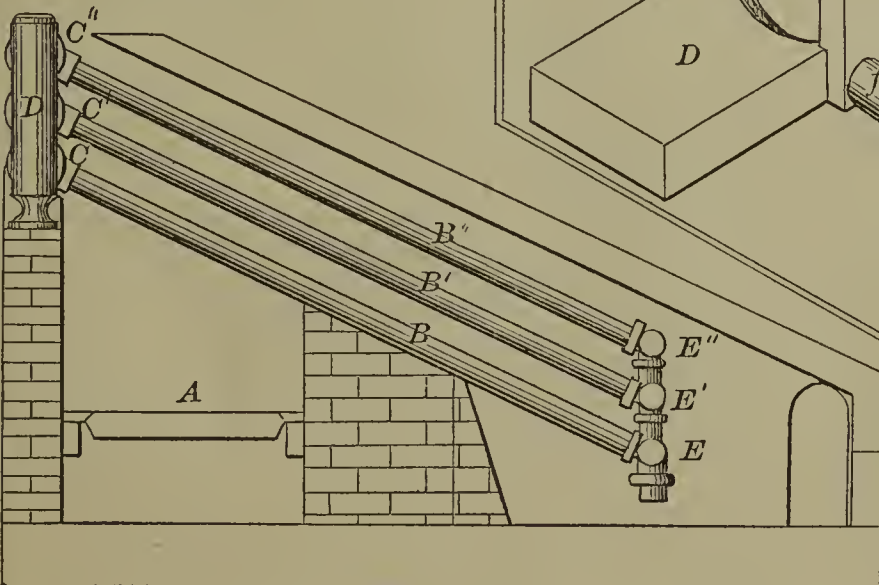

58015—Wilson & Fairbanks—Hand Spinner.

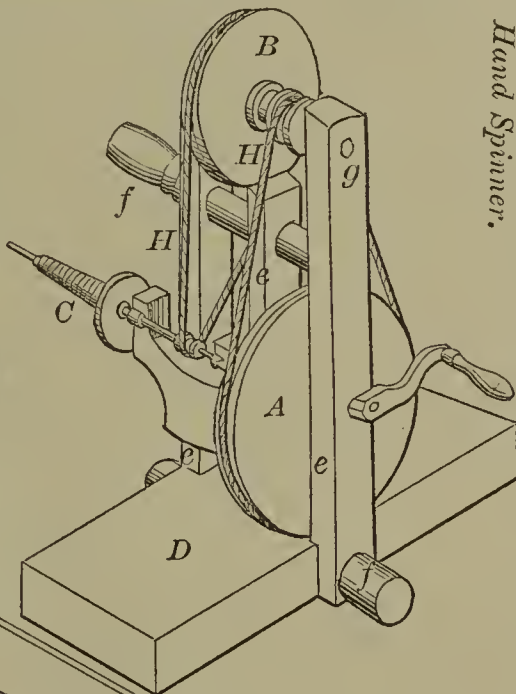

58014—T. T. Wier—Wagon Brake.

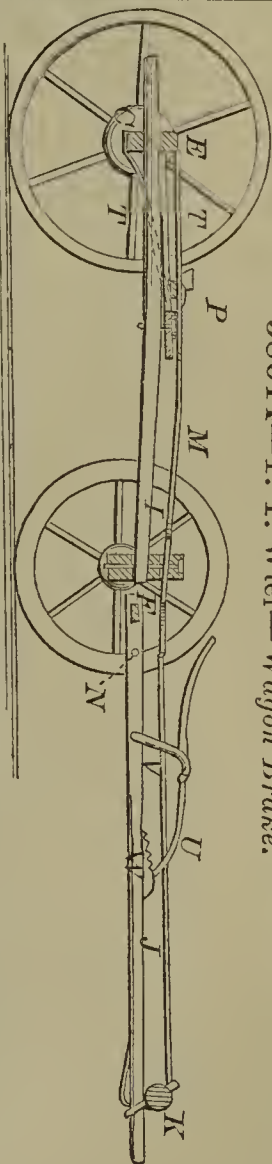

58018—T. B. Bunting—Bale Fastening.

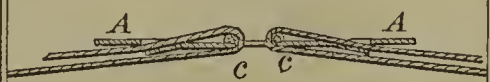

58021—Ewing & Everst—*Distilling Petroleum, &c.*

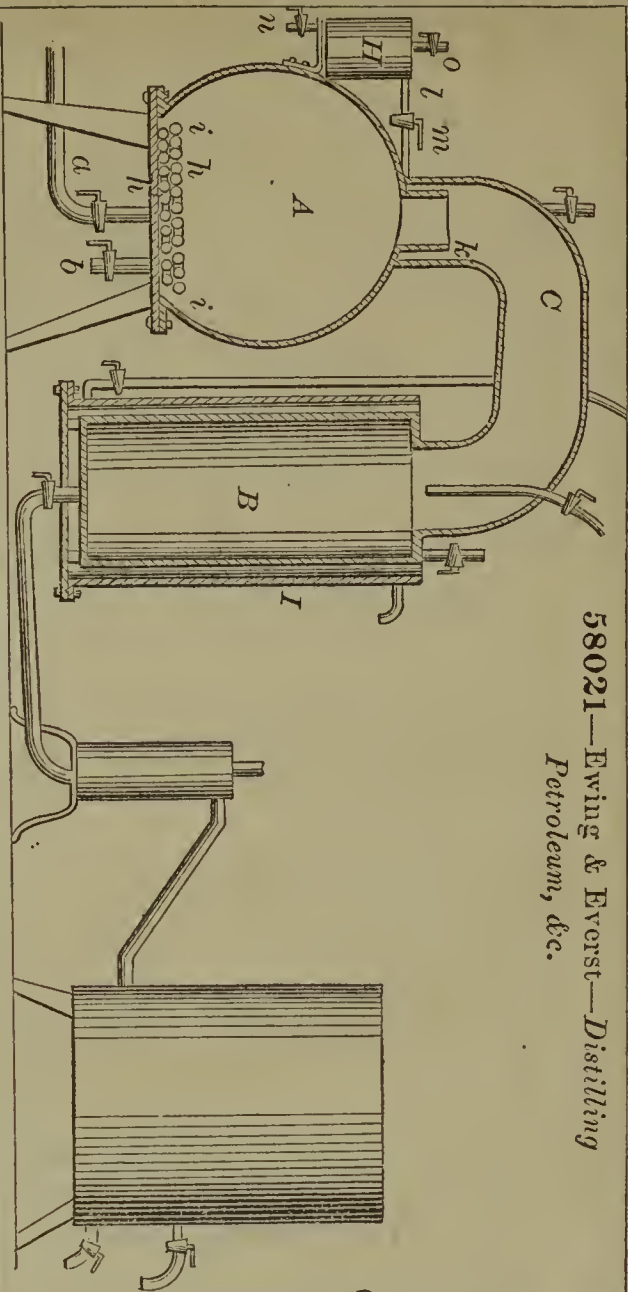

58022—S. C. Goodsell—*Flute.*



58019—G. B. Curtis—*Water Elevator.*

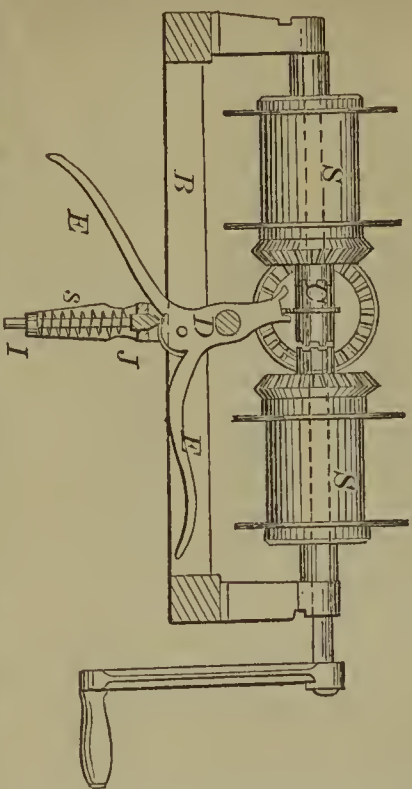

58020—M. P. Ewing—*Lubricating Material.*

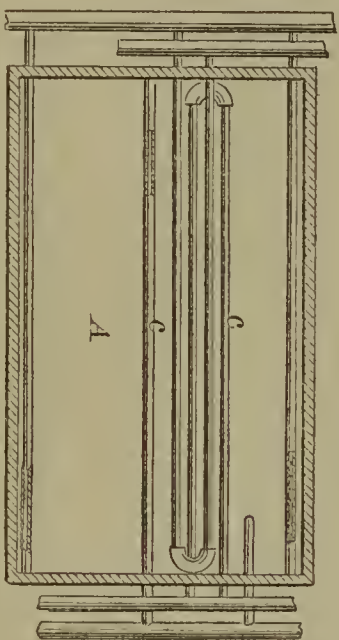

58023—B. A. Grant—*Hand Spinner.*

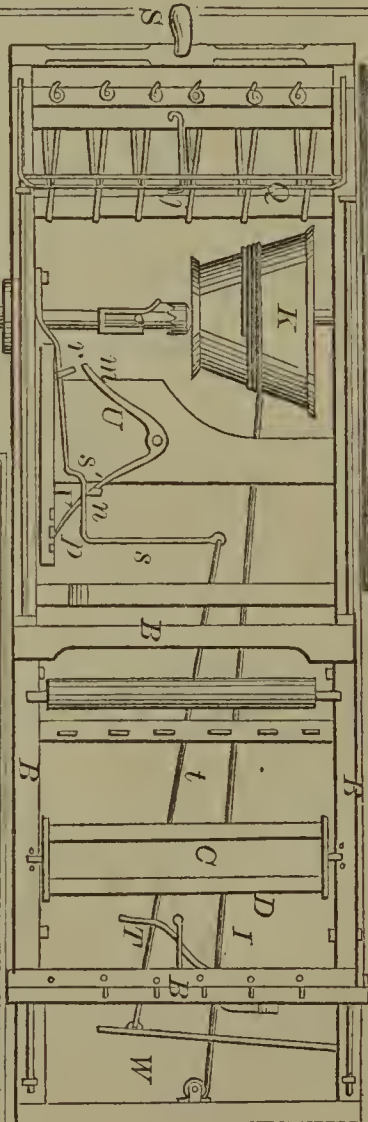

58024—J. B. Kershaw—*Loom.*

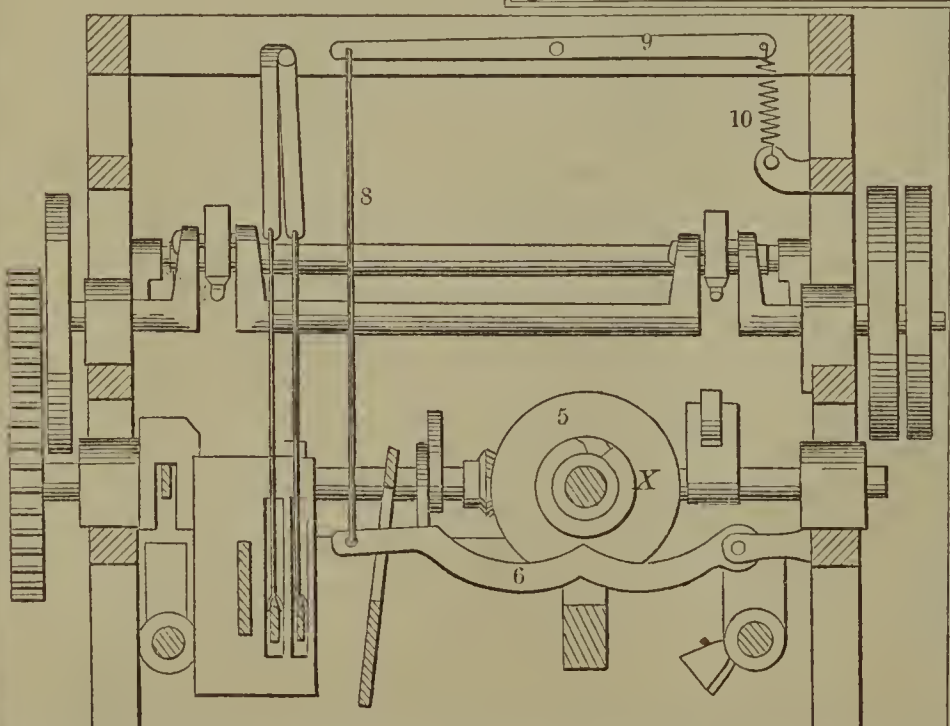

58025—W. T. Nicholson—File.



58026—G. S. Reynolds—Reaper and Mower.

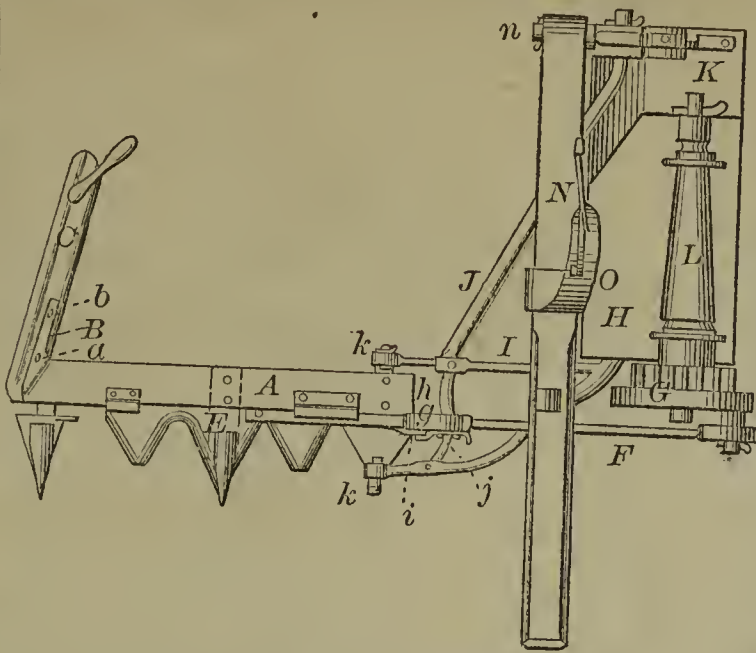

58028—Rust & Buzzeo—Rubber Thread Cutter.

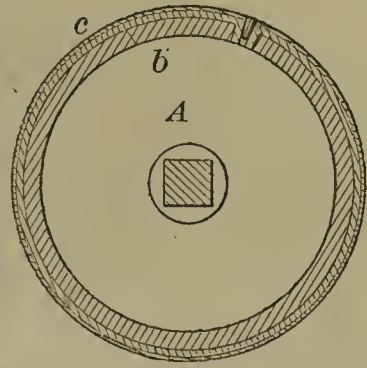

58030—R. Walker—Carriage Wheel.

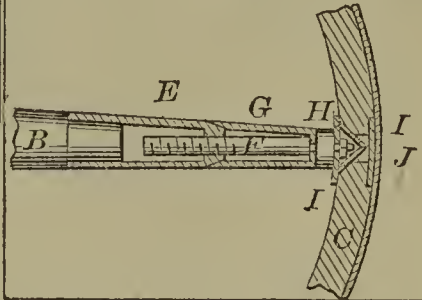

58027—H. Robbins—Wringer Roller.

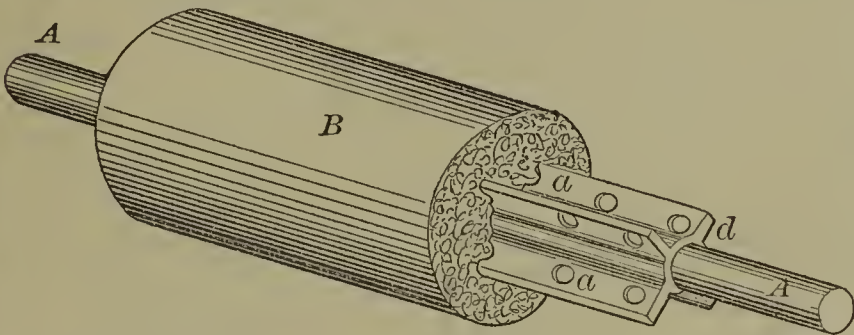

58029—E. J. Steele—Window Shade Fastening.

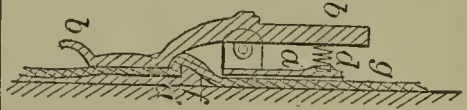

58031—Whysall & Porritt—Tempering Springs.

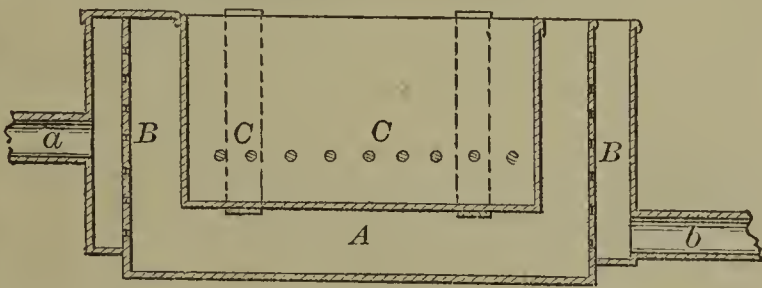

58035—G. Köttgen—Seamless Pocket.

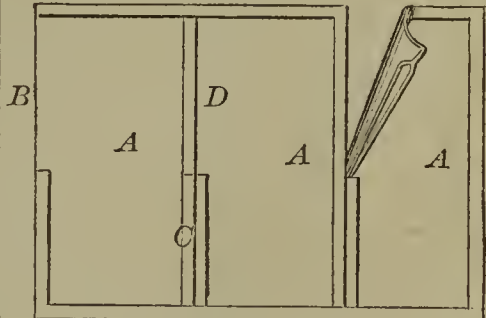

58032—G. Woods—Musical Instrument.

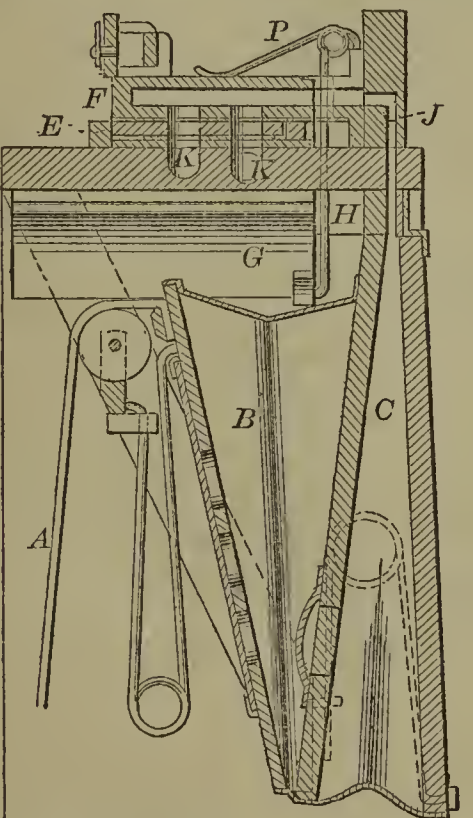

58033—E. B. Wright—Soda Fountain.

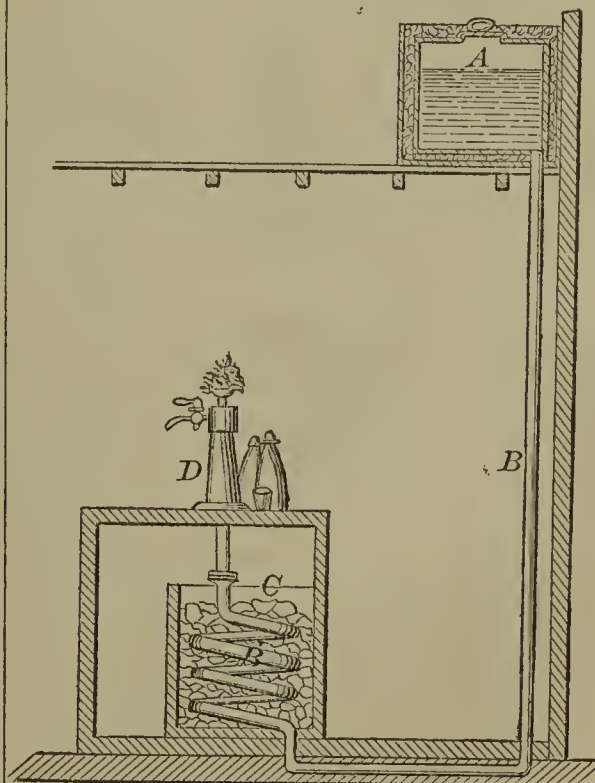

58036—Sabathe & Jourdan—Impregnating Substances with Preservative Material.

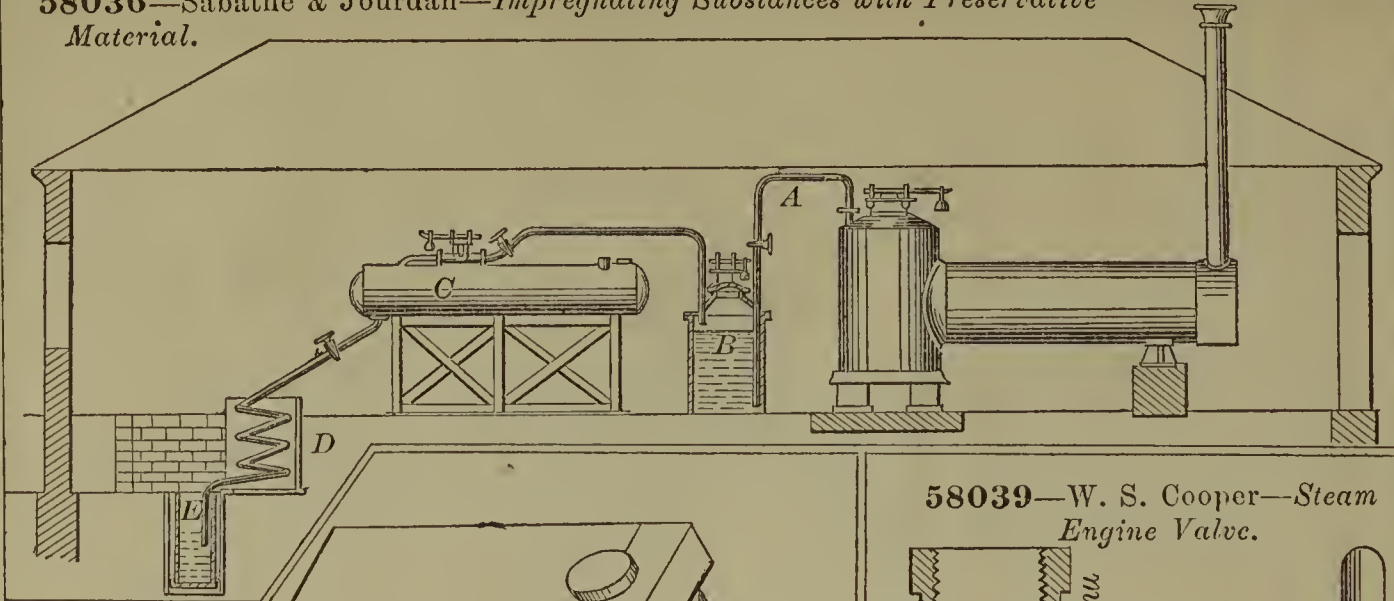

58039—W. S. Cooper—Steam Engine Valve.

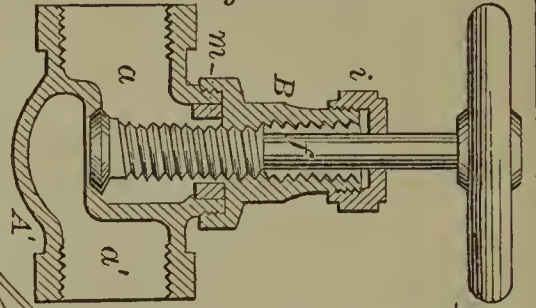

58042—J. O. Altie—Globe Steam Valve.

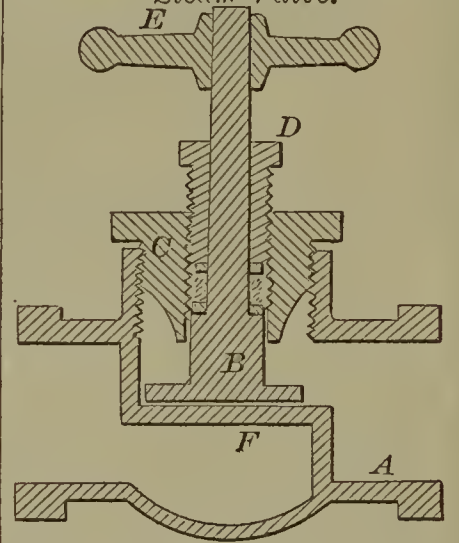

58041—H. Adkins—Car Coupling.

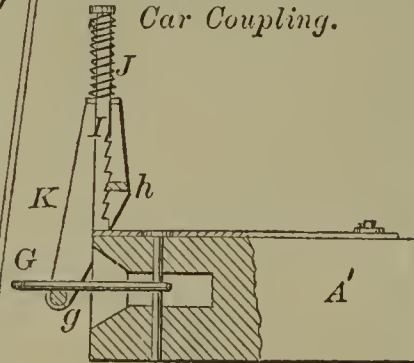

58040—D. F. Adams—Making Bolts.

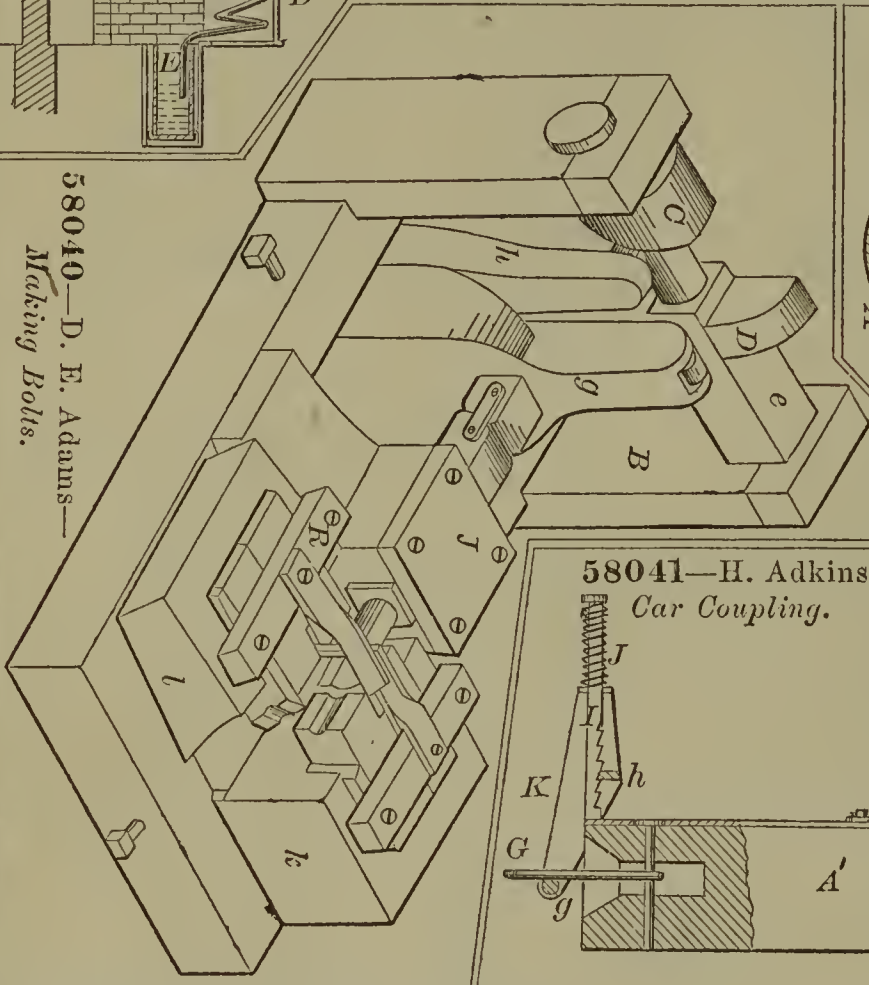

58038—W. L. & T. Winans—Steam Generator.

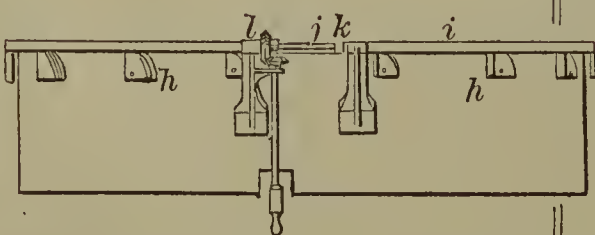
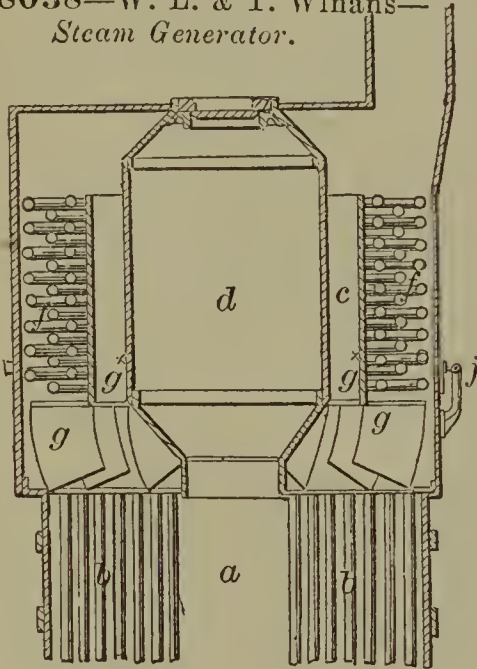

58043—S. A. Andrews—Alarm Clock.

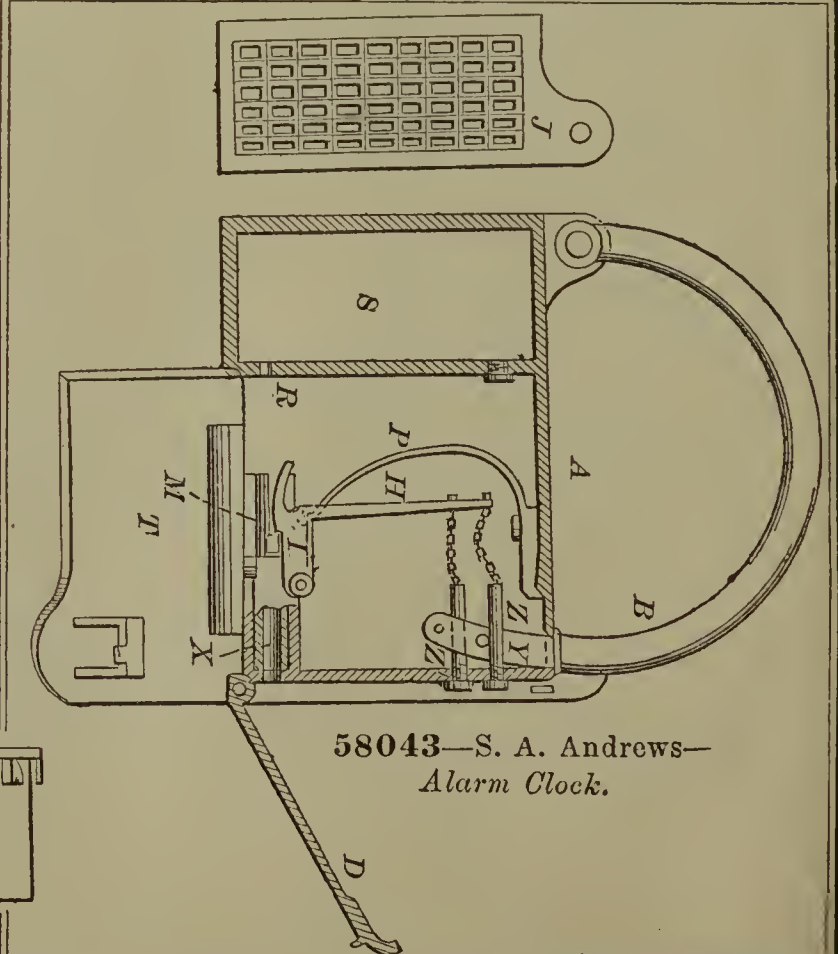

58044—E. Arloth—*Making Vinegar.*

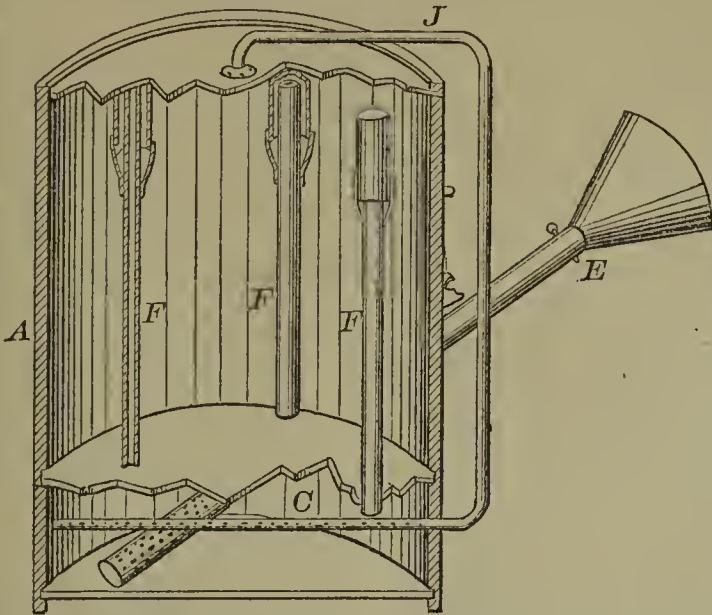

58047—J. A. Balzart—*Churn.*

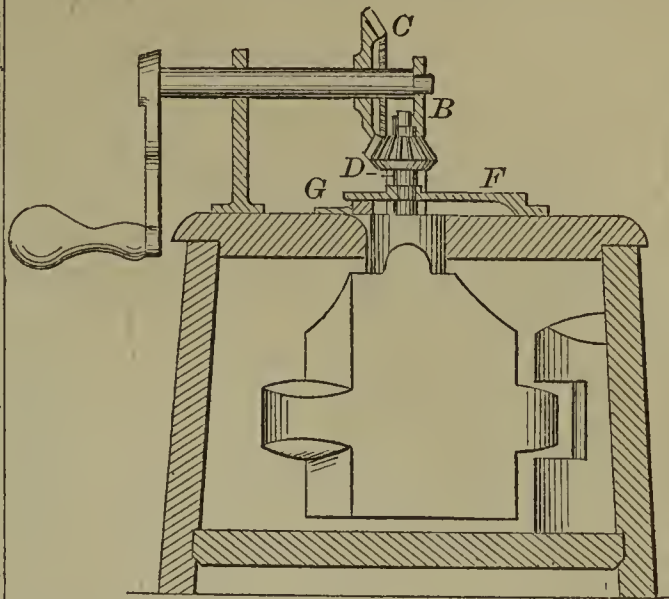

58045—A. Armstrong—*Combined Seed Drill and Cultivator.*

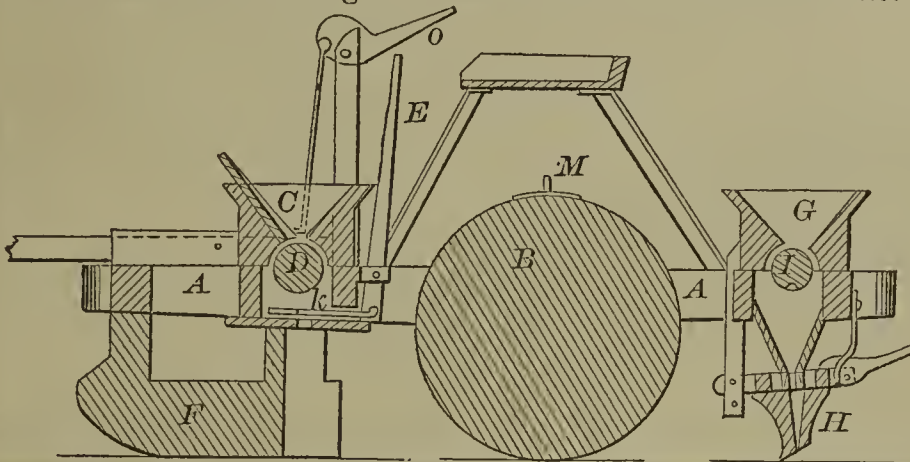

58046—J. E. Atwood—*Spinning Frame Spindle.*

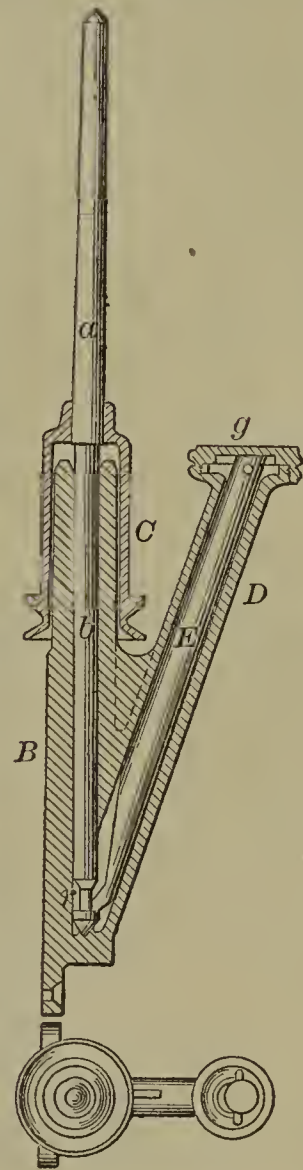

58049—W. N. Barr—*Cane Stripper.*

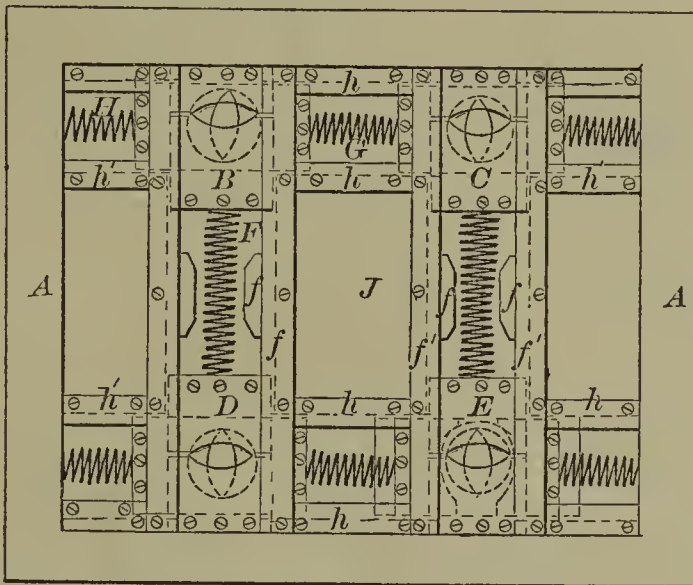

58048—B. Barney—*Grain Cleaner.*

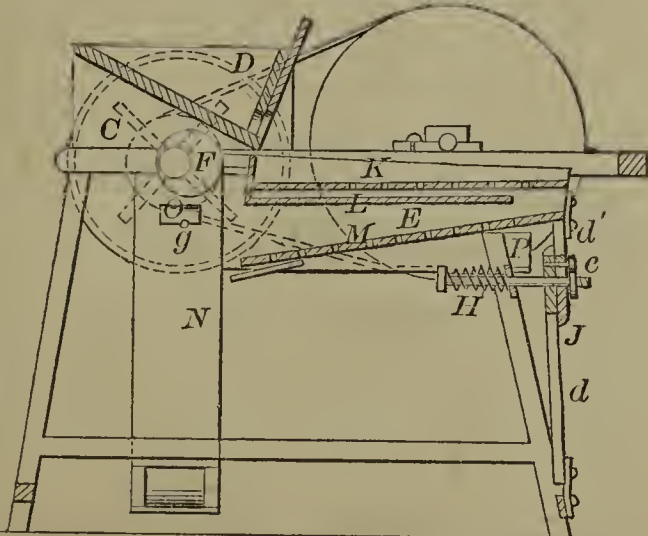

58050—C. F. Baylor—*Grain Screen.*

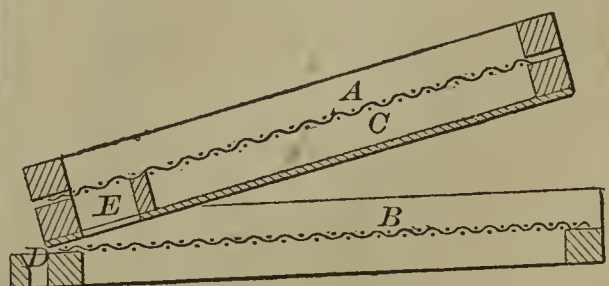

58051—E. B. Bingham—Paper Making Machine.

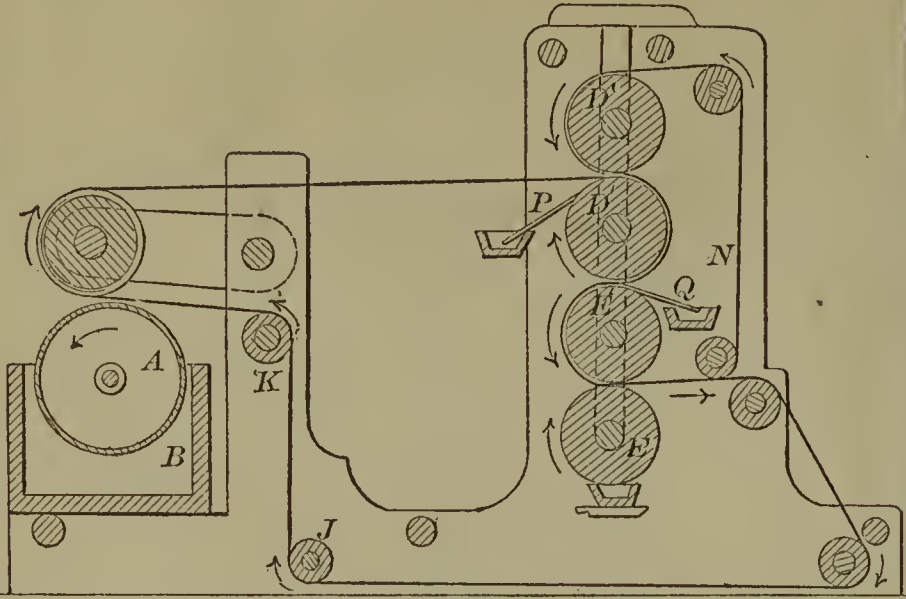

58052—J. S. Bodge—Grain Separator.

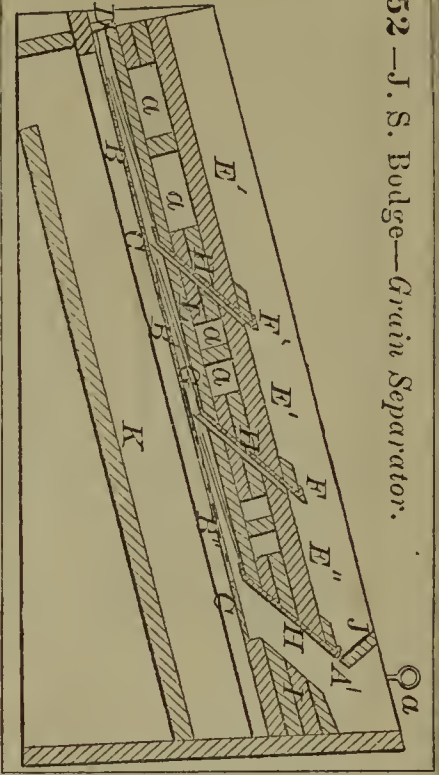

58055—J. F. Boynton—For Gas Machines and Carburetors.

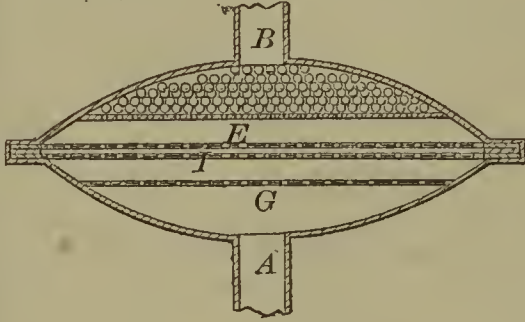

58053—P. J. Boris—Skirt Elevator.

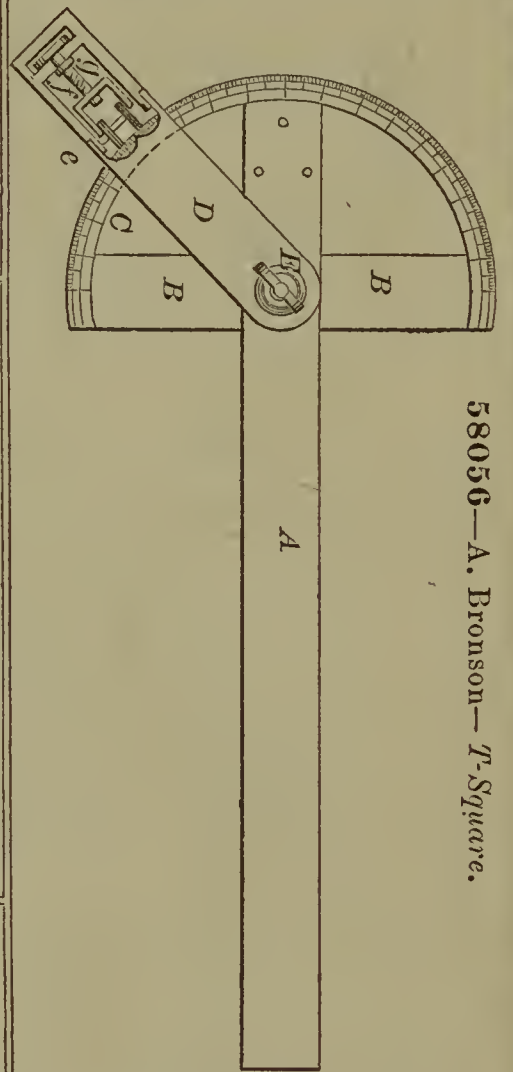
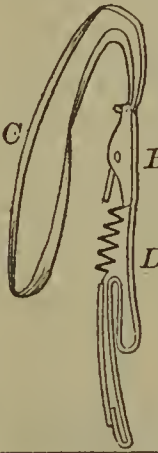

58056—A. Bronson—T-Square.

58057—B. Brownell—Hot Air Furnace.

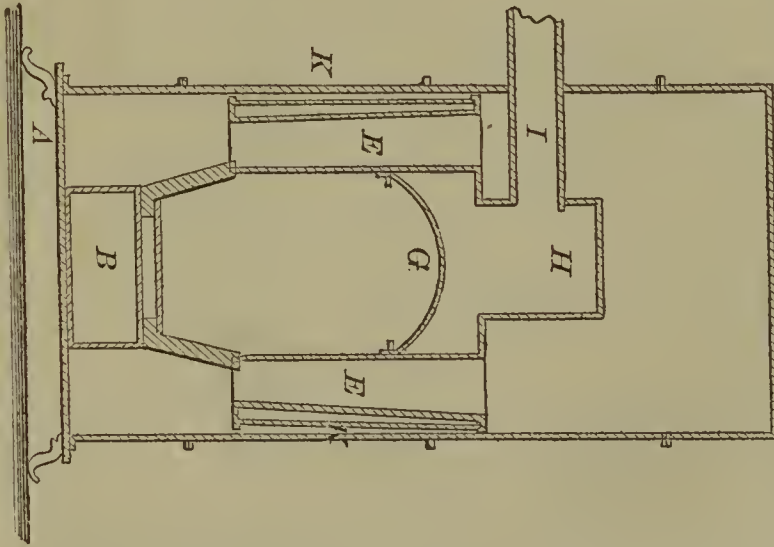

58058—J. E. Buerk—Alarm Clock.

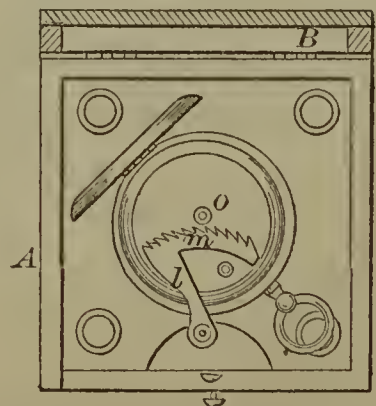
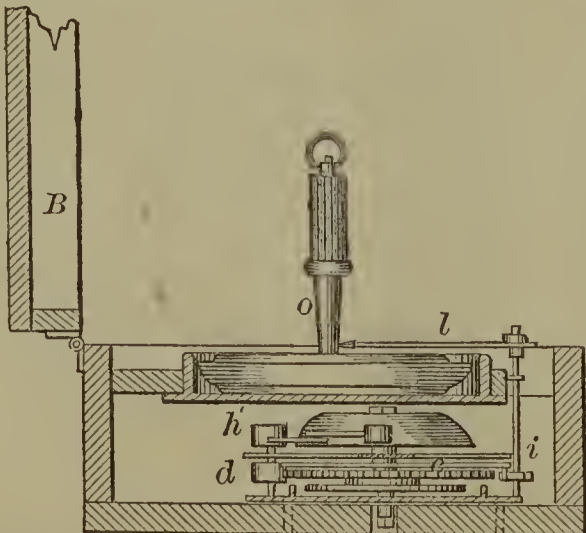



58059—W. & D. C. Burson—Churn.

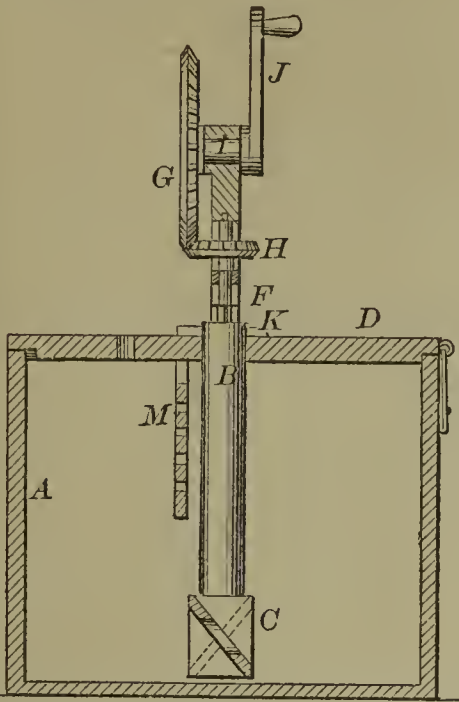

58060—W. F. Caldwell—Planter

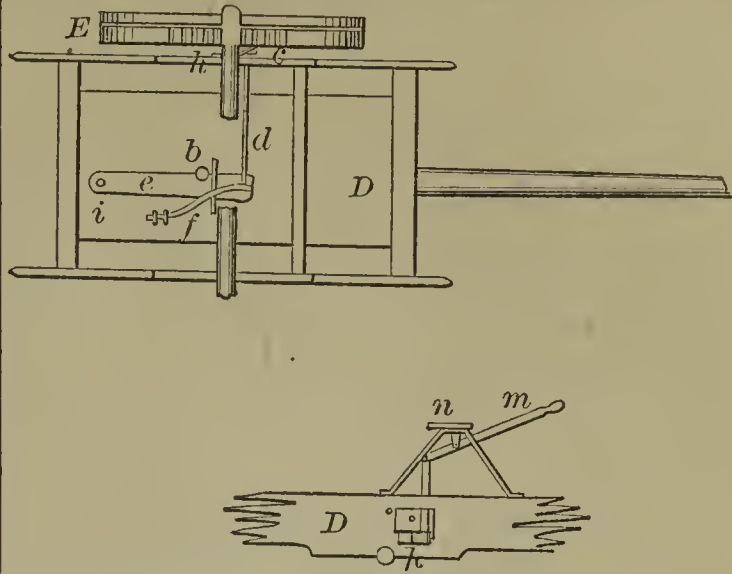

58061—J. Chambers—Cooking Stove.

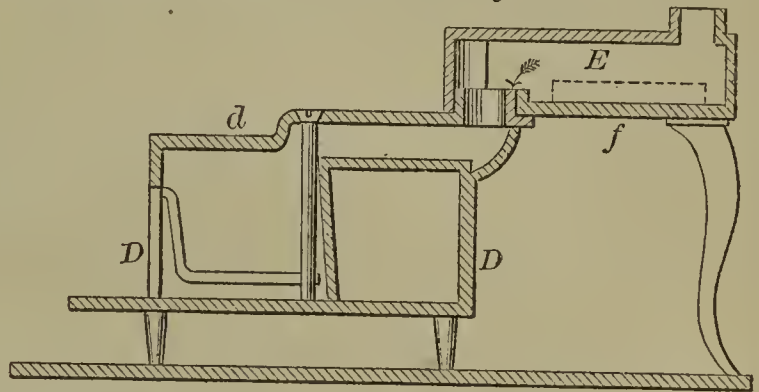

58063—D. P. Chesbrough—Waste Water Receptacle.

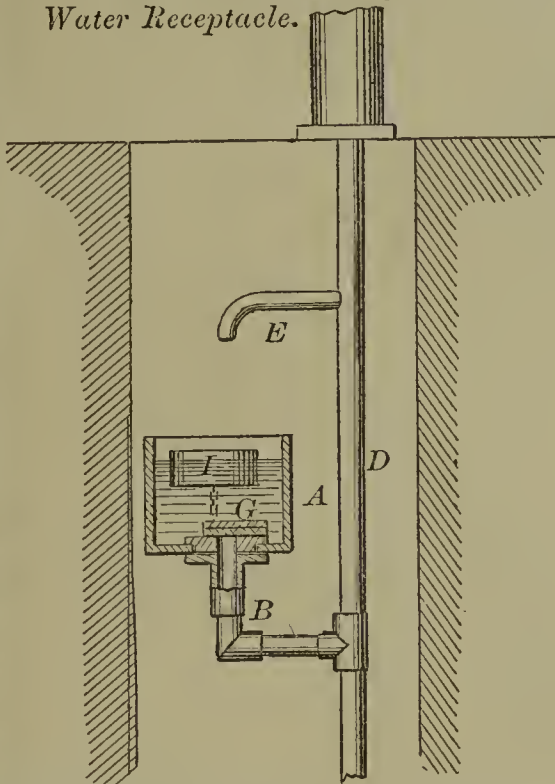

58062—J. T. Chambers—Safety Pocket.

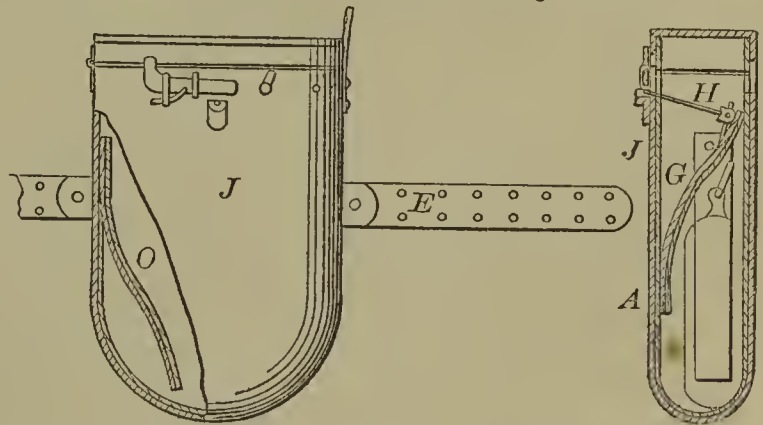

58064—W. J. Christy—Fire Arm.

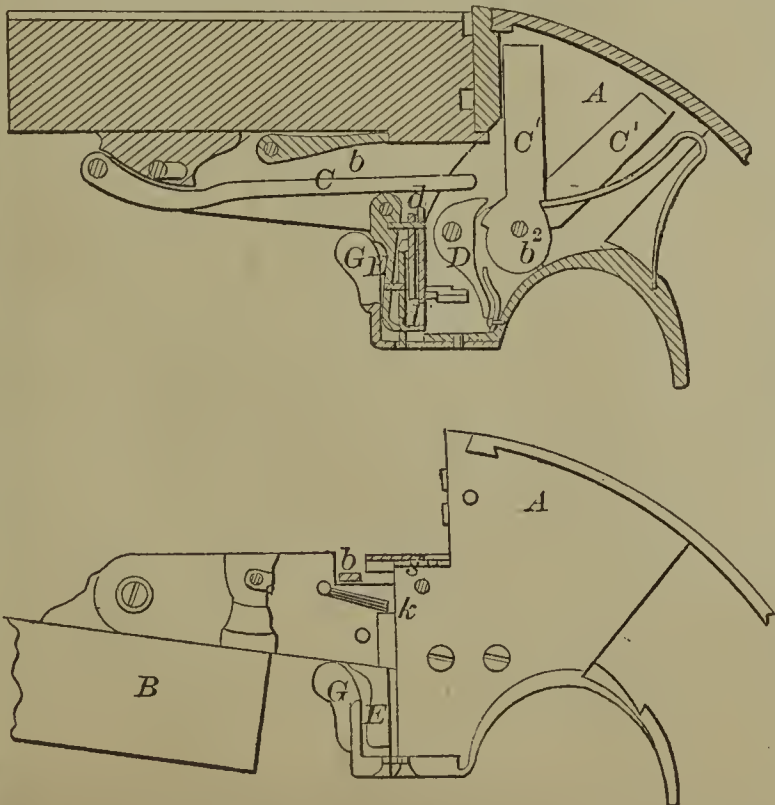

58065—M. C. Clark—Sheep Rack.

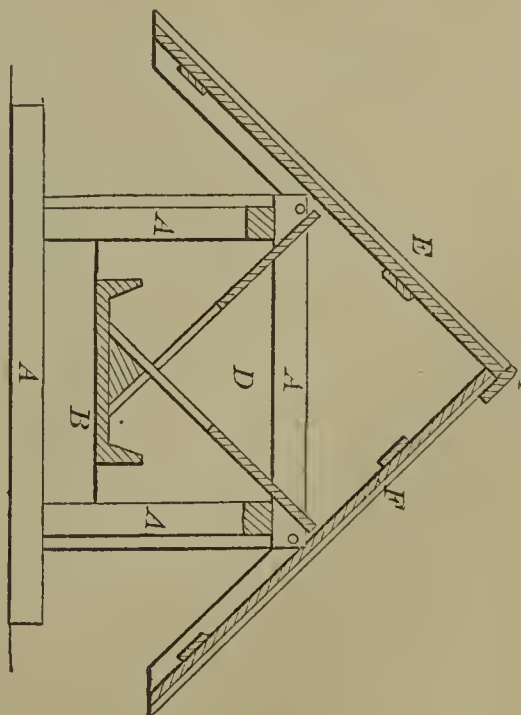

58066—H. Clarkson—*Sad Iron Handle.*

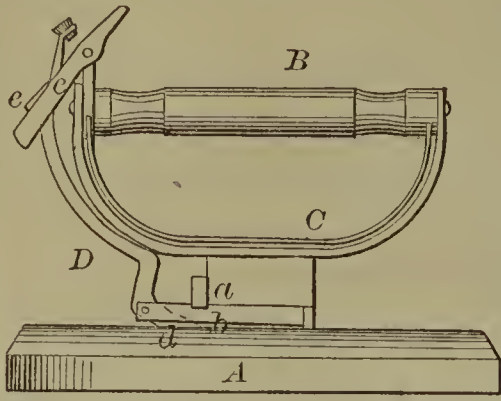

58069—Z. E. Coffin—*Capstan Windlass.*

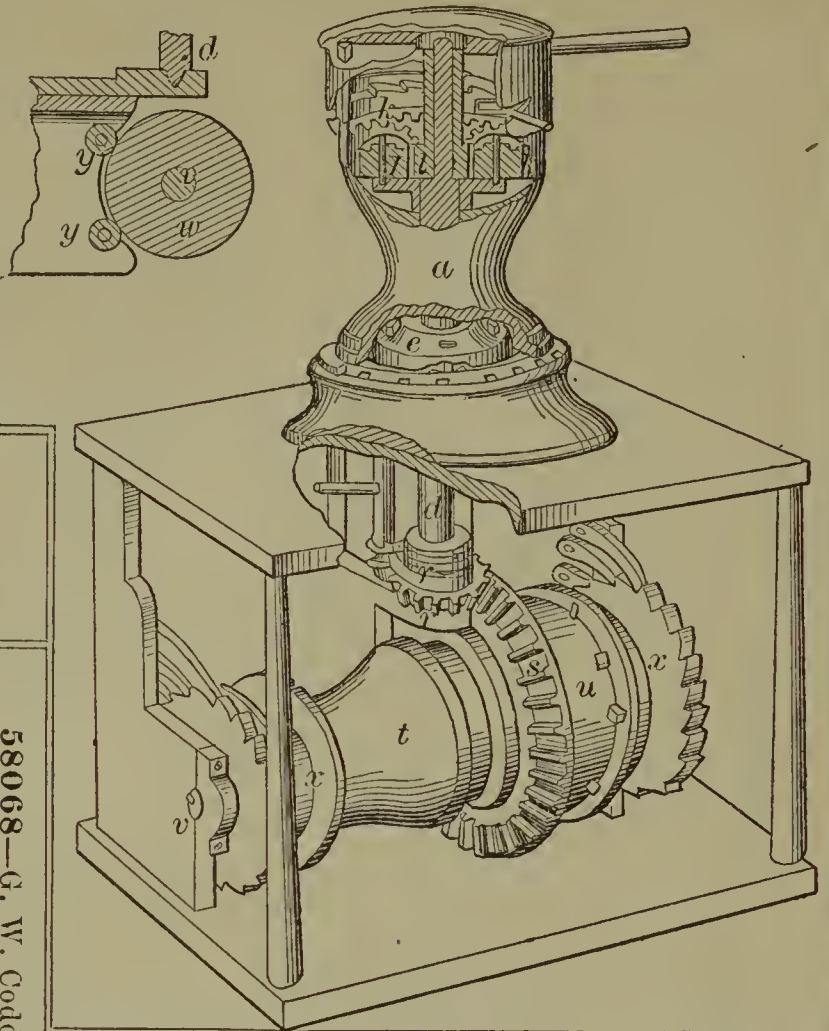

58067—F. Closs—*Boot Heel.*

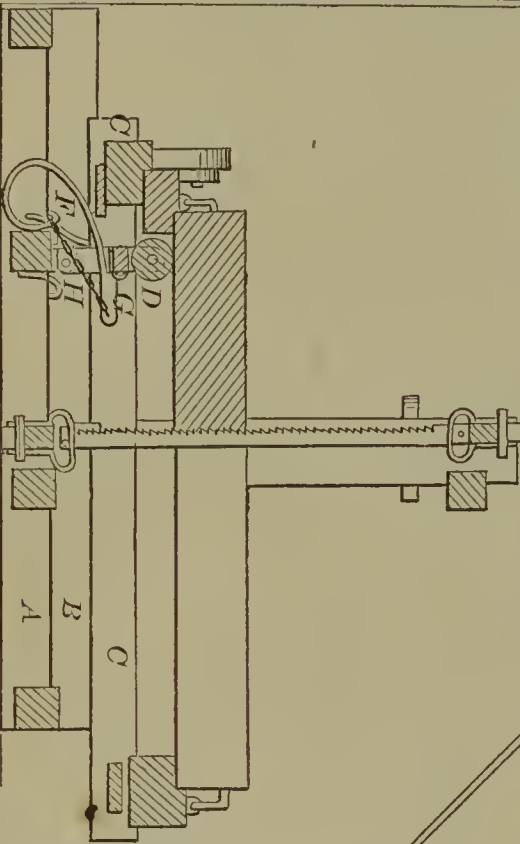
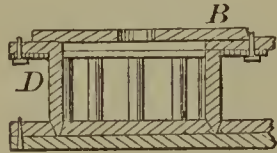

58068—G. W. Coddington—*Saw Mill.*

58071—L. M. B. Coleman—*Wagon Shackle.*

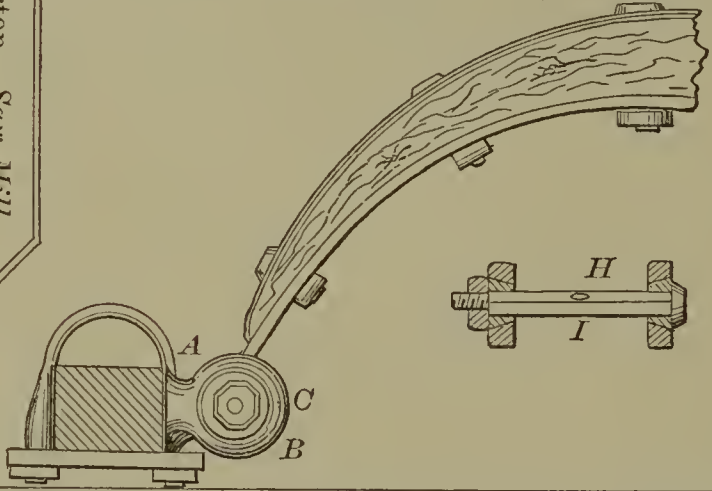

58070—E. T. Colburn—*Sad Iron.*

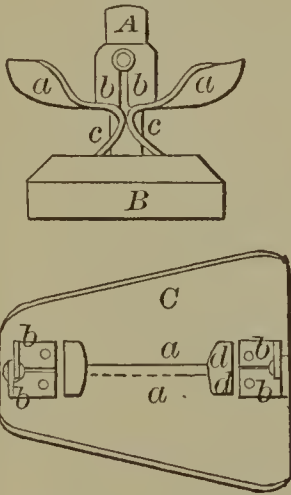

58072—M. M. Coppuck—*Tobacco Pipe.*

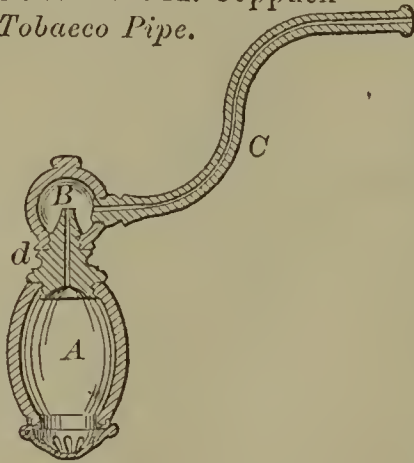

58073—N. C. Decker—*Horse Rake.*

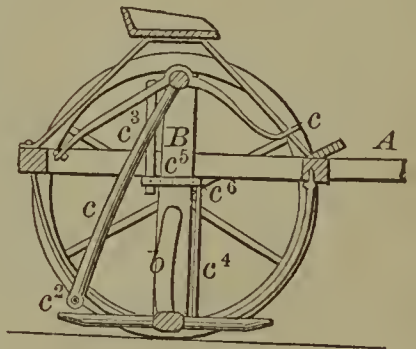

58074—W. Dennison—*Steam Engine Valve Gear.*

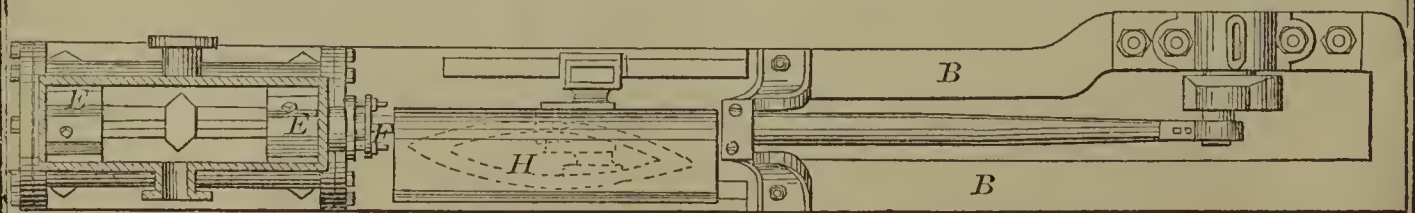

58075—J. Dillier—*Horse Rake.*

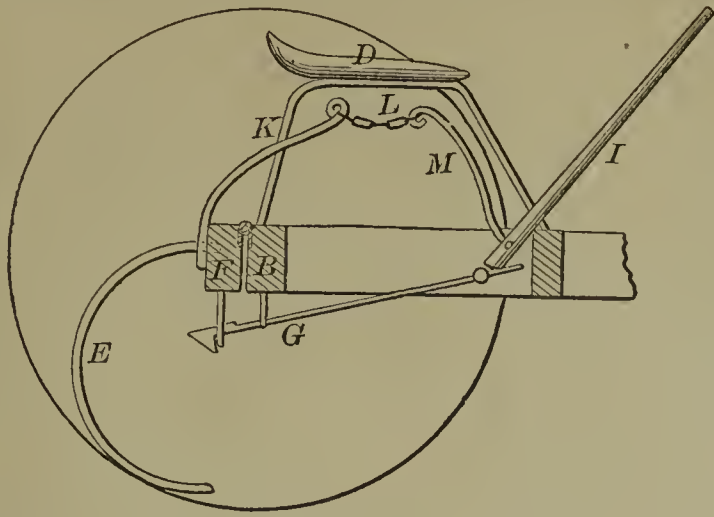

58076—J. K. Dirner—*Key Seat Cutter.*

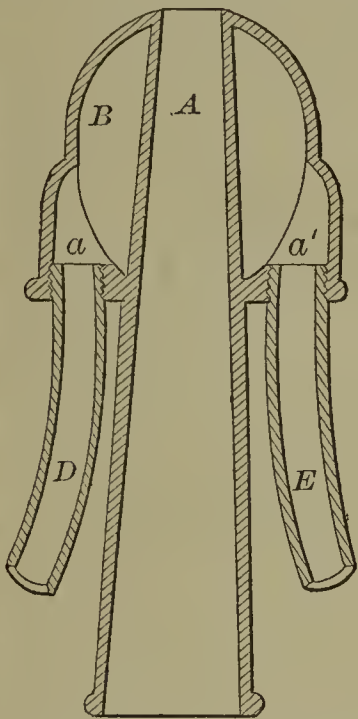
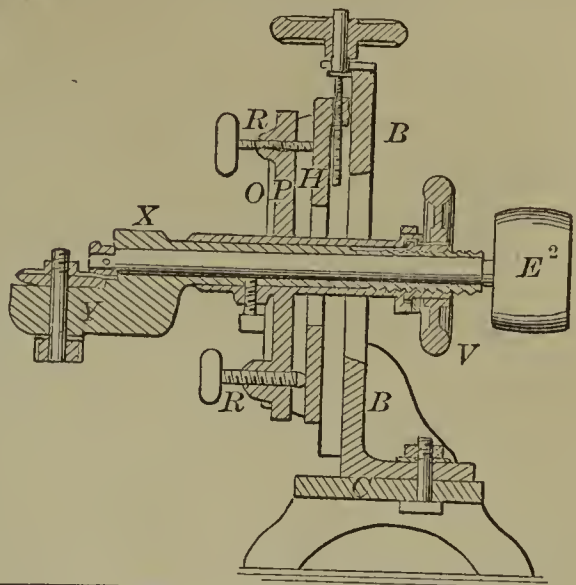

58077—L. A. Dole—*Tugere.*

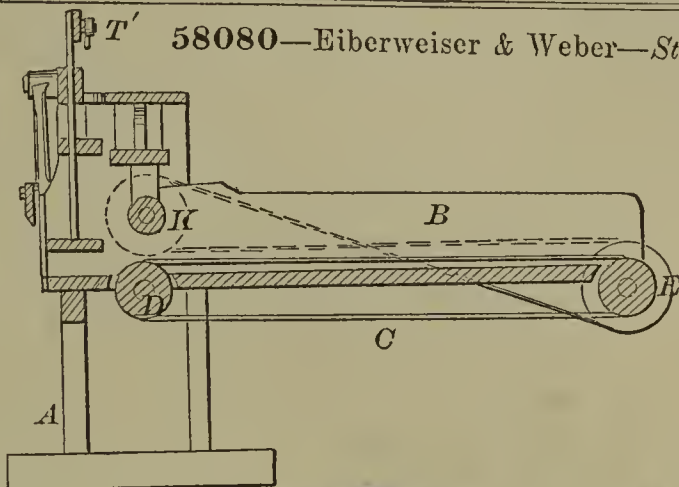

58080—Eiberweiser & Weber—*Straw Cutter.*

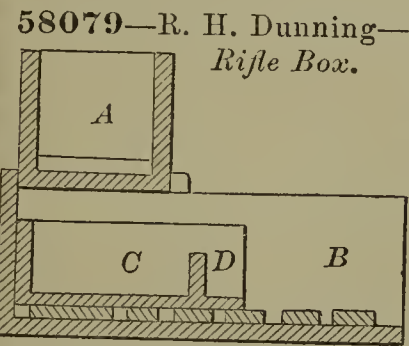

58079—R. H. Dunning—*Rifle Box.*

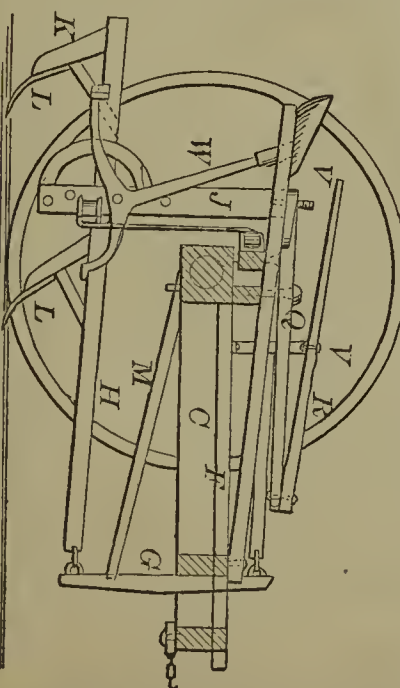
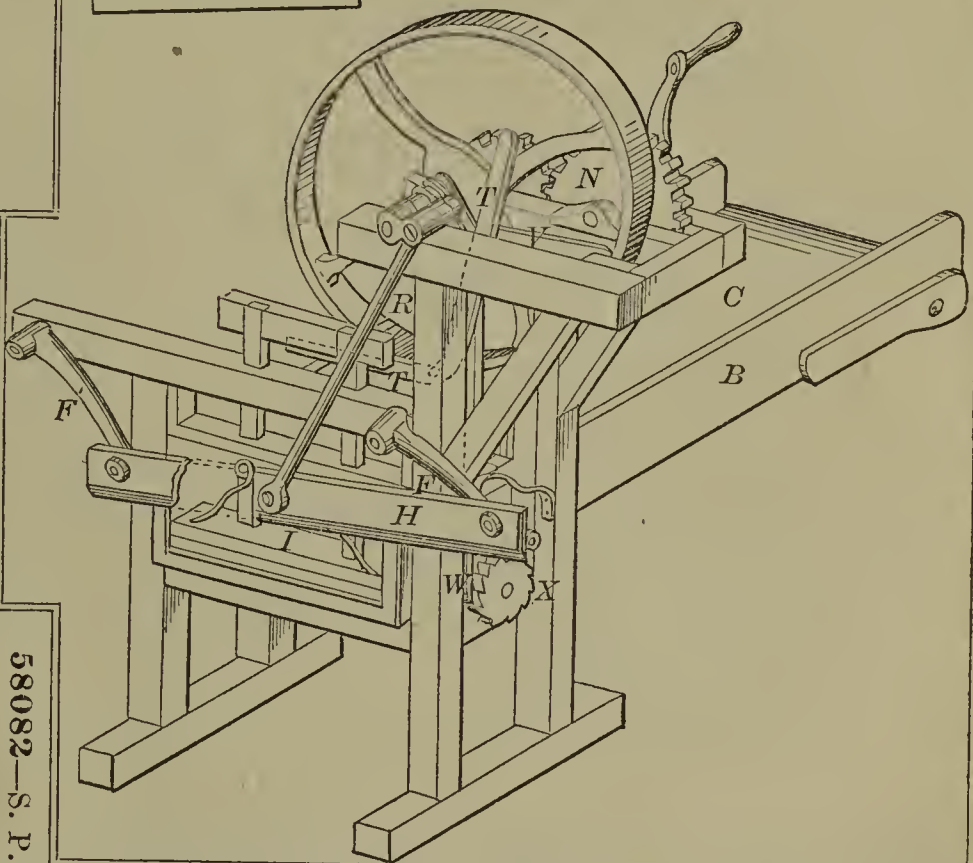

58082—S. P. Etter—*Cultivator.*

58078—C. W. Dunlap—*Ice Breaker.*

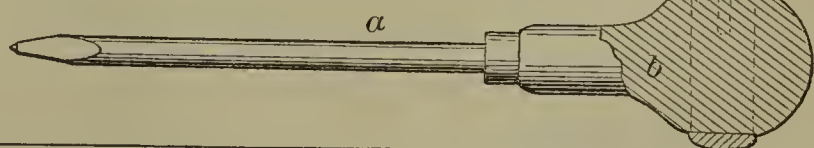

58081—C. Elveena—*Protecting Animals from the Sun.*

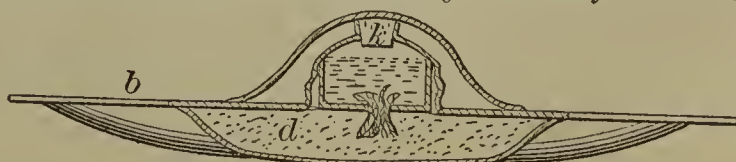

58083—J. Fehrenbatch—*Hand Propeller for Small Boats.*

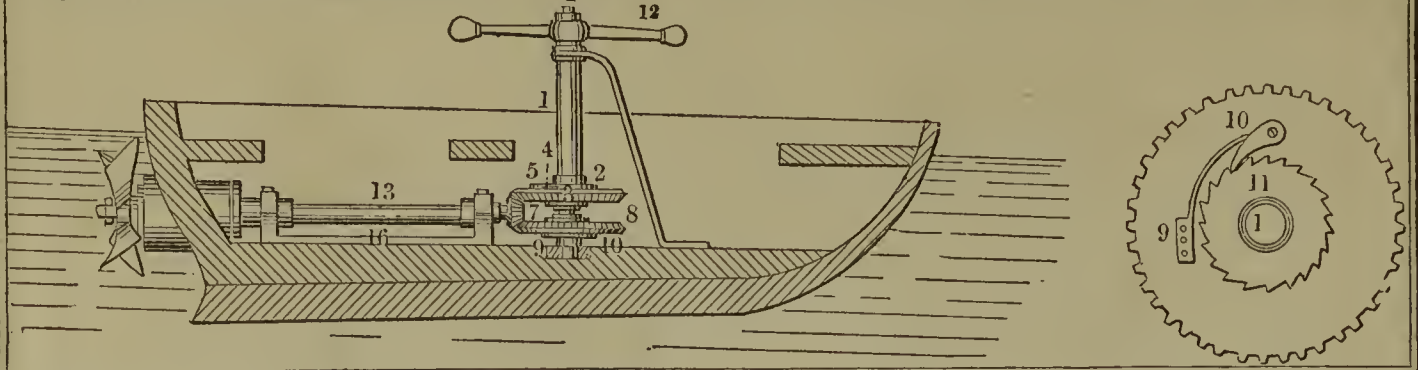

58084—M. Fleisher—*Skate.*

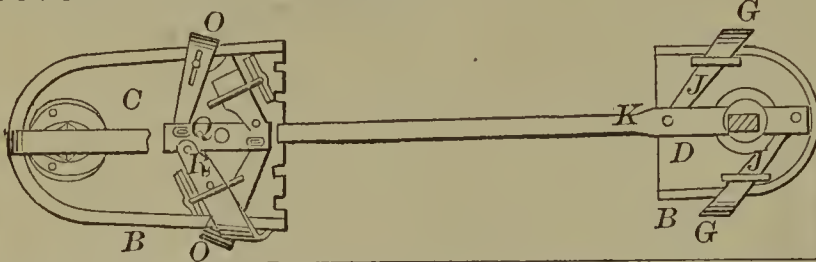

58085—A. F. Fletcher—*Pump.*

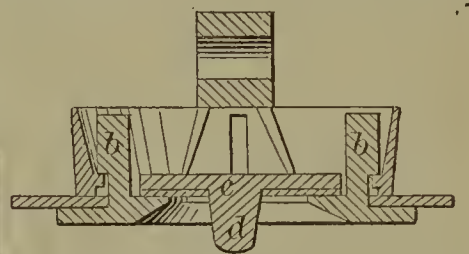

58088—Foreman & Mathowson—*Amalgamating Gold with Mercury.*

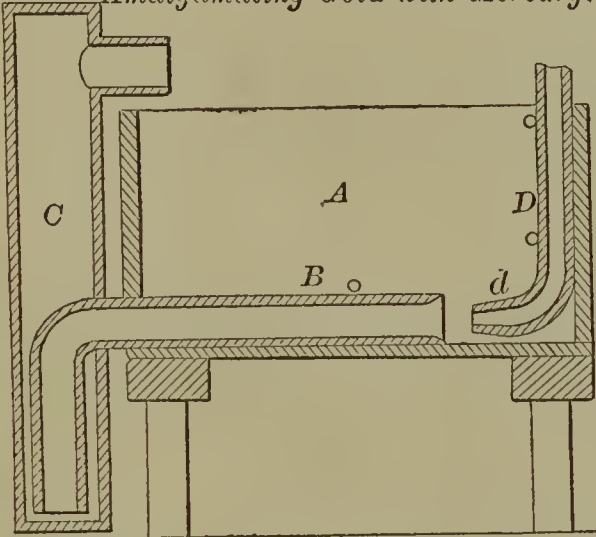

58087—H. R. Foote—*Generating and Burning Vapor of Hydro Carbon Oil.*

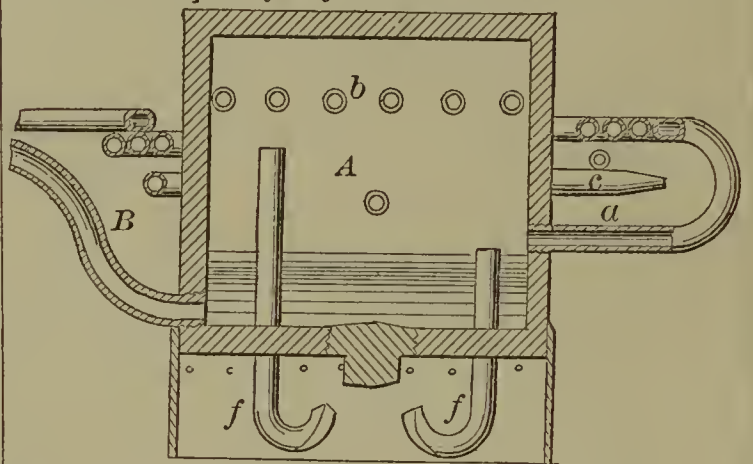

58089—J. Fowler—*Ore or Quartz Crusher.*

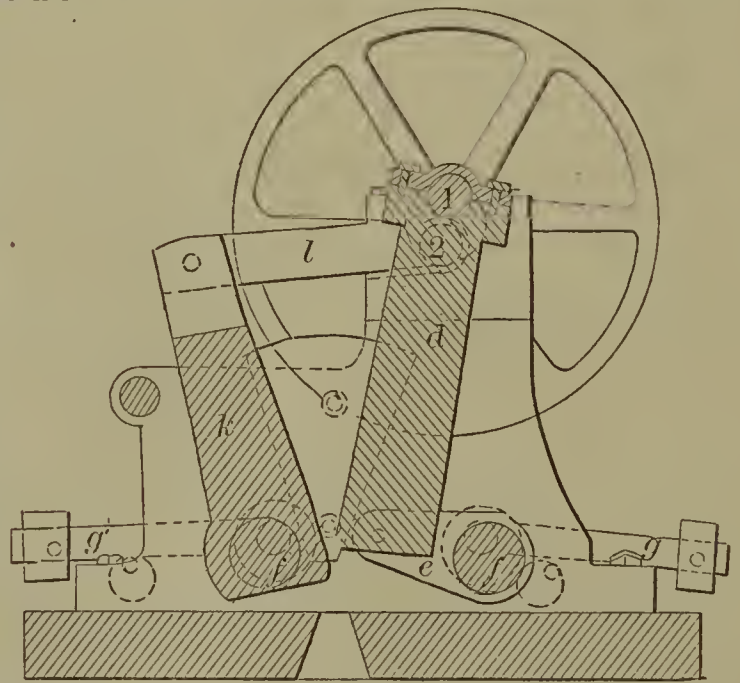

58086—M. Fletcher—*Rotary Steam Engine.*

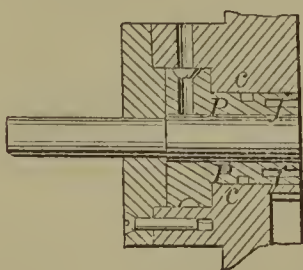

58090—R. G. Fowler—*Car Coupling.*

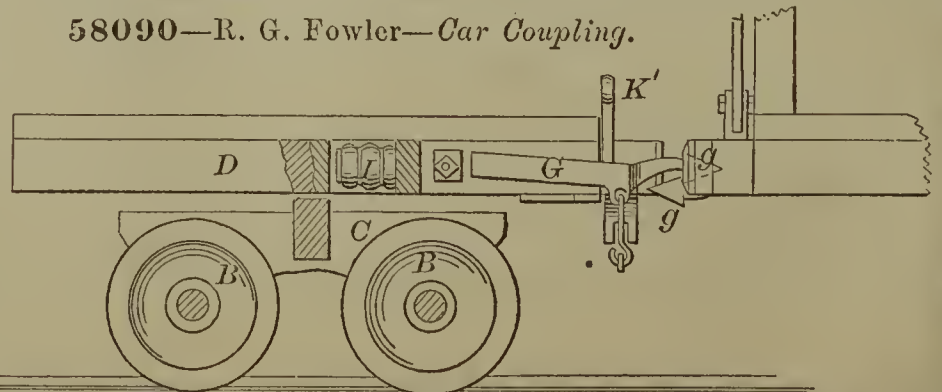

58091—L. Fox—Mail Bag Clasp.

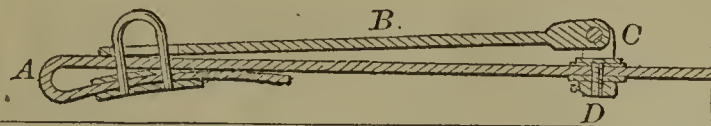

58097—T. Hall—Lamp Burner.

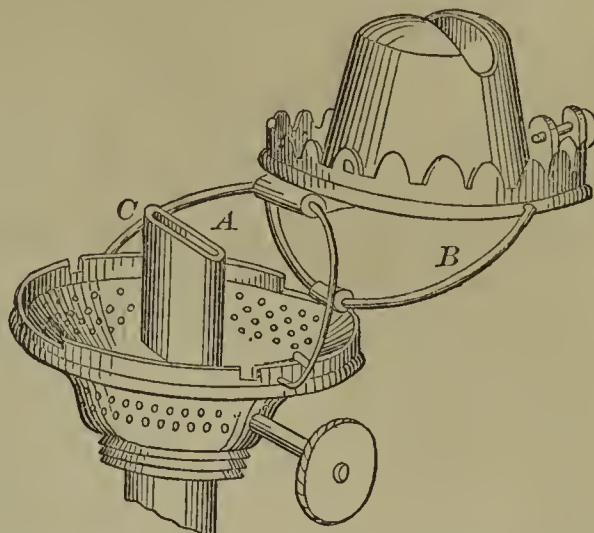

58093—J. Freret—Water Elevator.

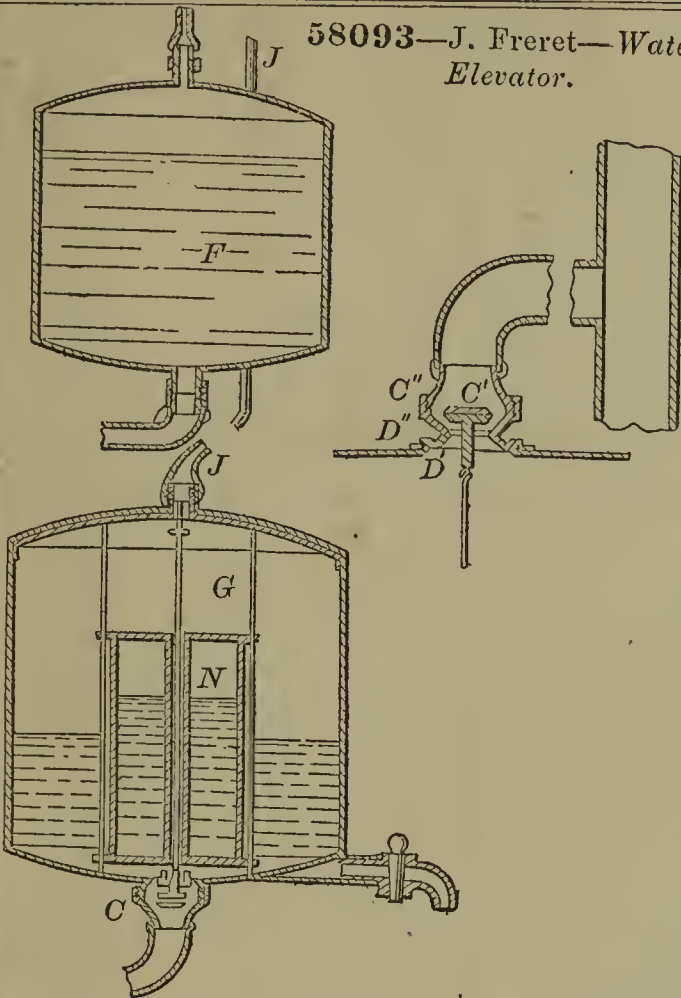

58096—Hall & Hubner—Bolt Heading Machine.

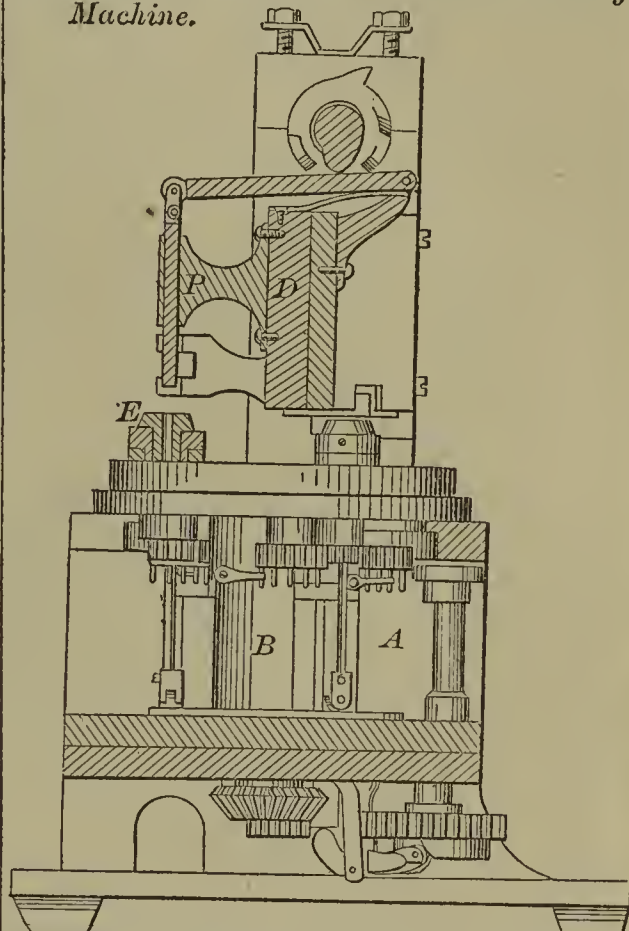

58094—J. H. Gilbert—Bridge.

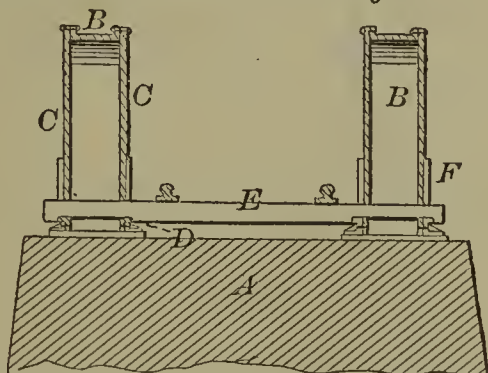

58092—J. French—Inserting Fusible Plugs in Steam Generators.

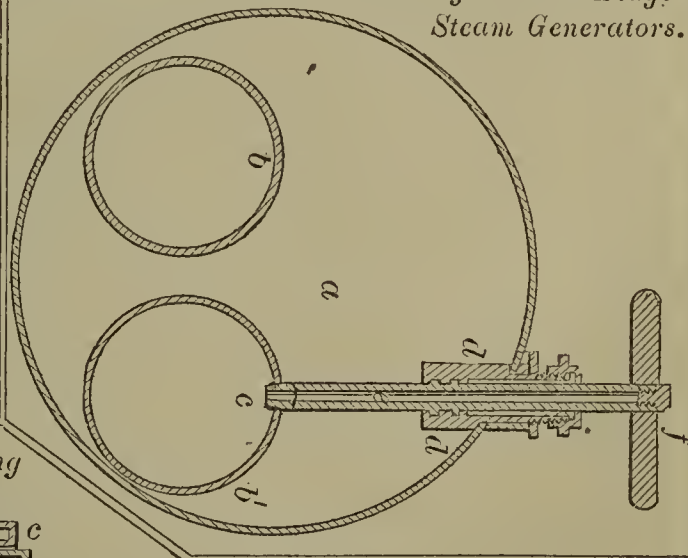

58095—H. Gortner—Separating Gum from Cane Juice.

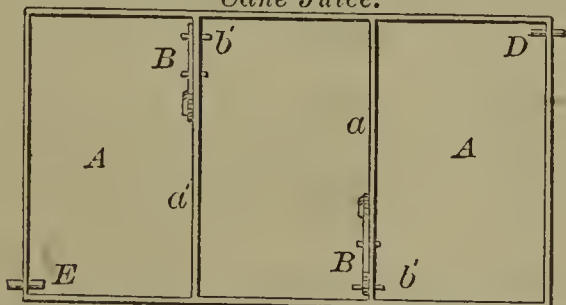

58098—J. Hanford—Granulating and Drying Sugar.

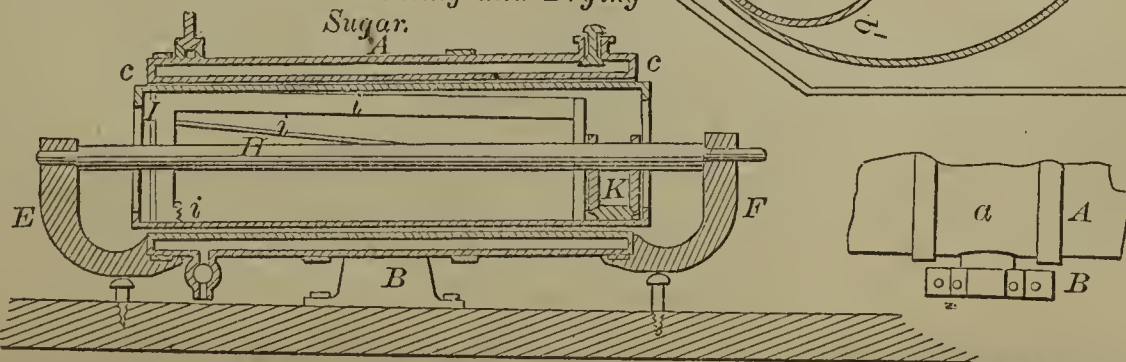

58100—J. A. Hitchings—Desulphurizing Ore.

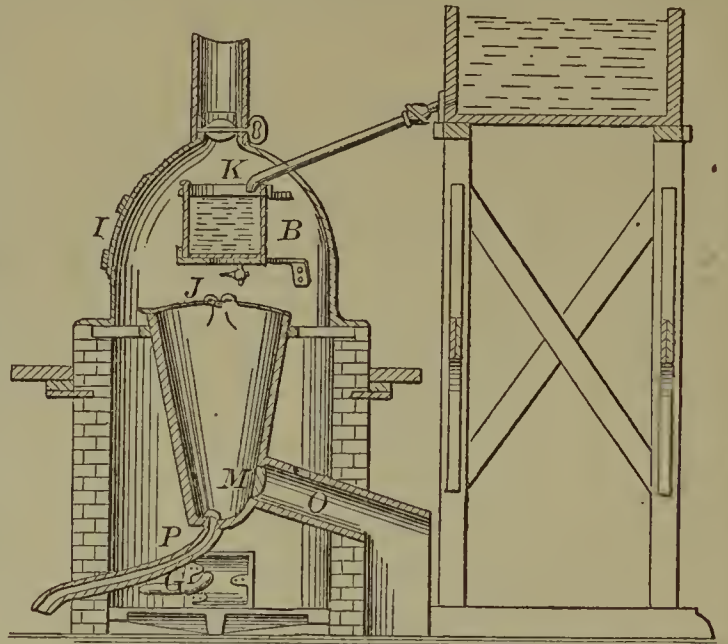

58102—H. W. Holly—Pencil Holder.

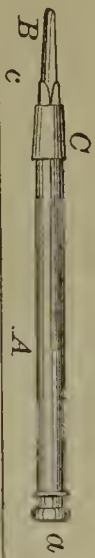

58099—Hasecoeter & Stephens—Feed Water Heater.

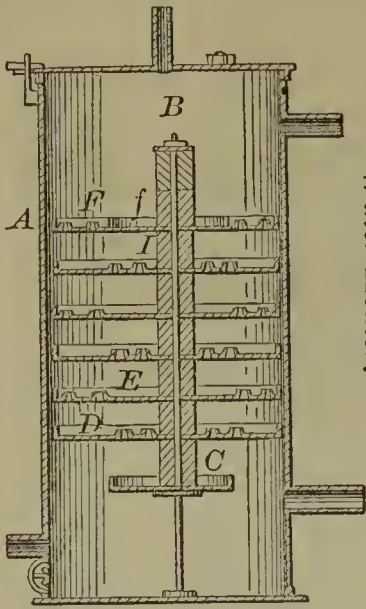

58101—C. B. Hoard—Spinner.

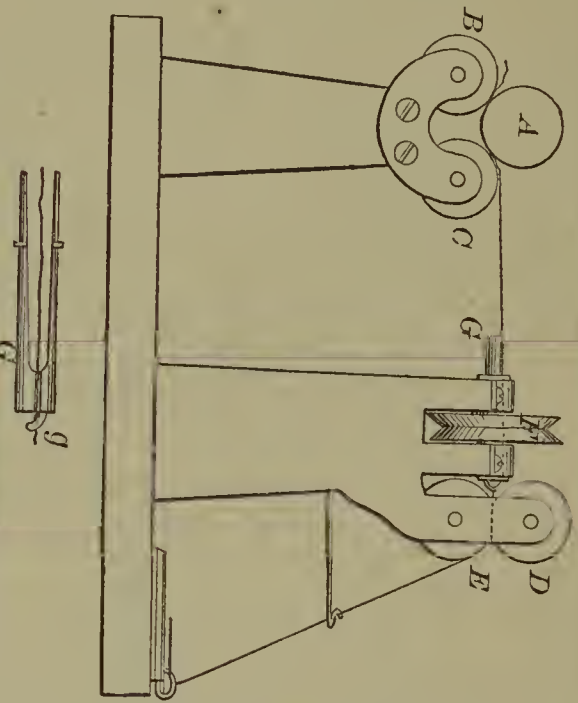

58104—W. W. Hubbard—Making Nuts.

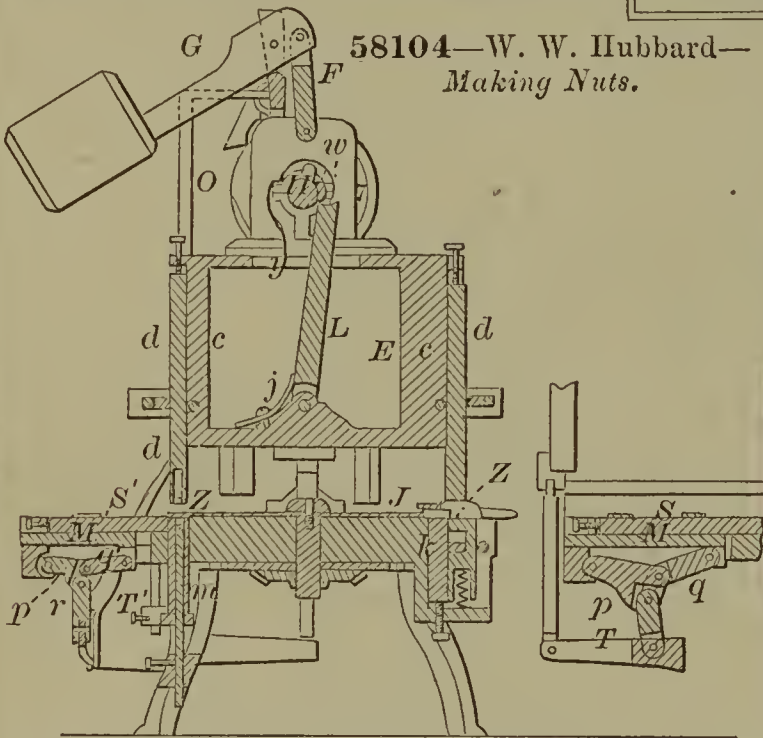

58103—G. L. Howland—Hoisting Apparatus.

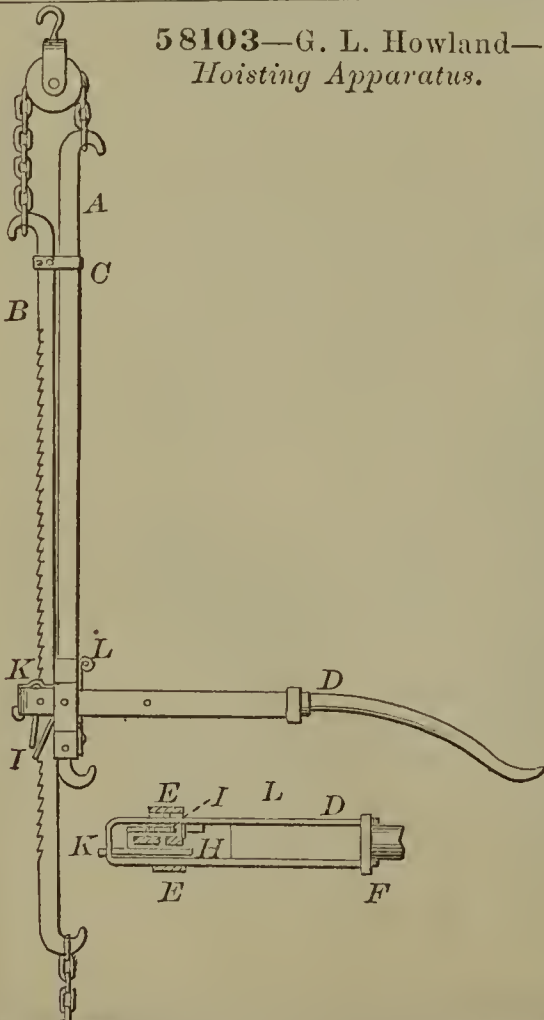

58105—J. Kidder—Magneto-Electric Apparatus.

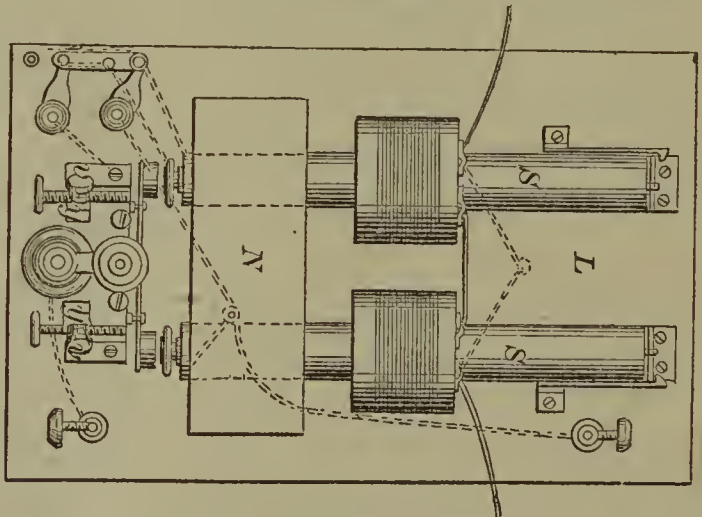

58107—P. Laffin—Oiler.

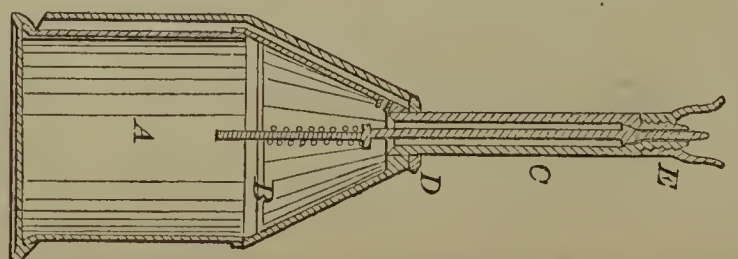

58108—A. Landis—Wood Hauling Rack.

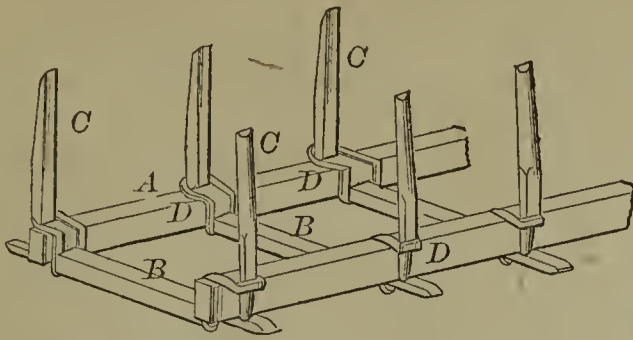

58109—H. M. Le Duc—Anti-Friction Journal Box.

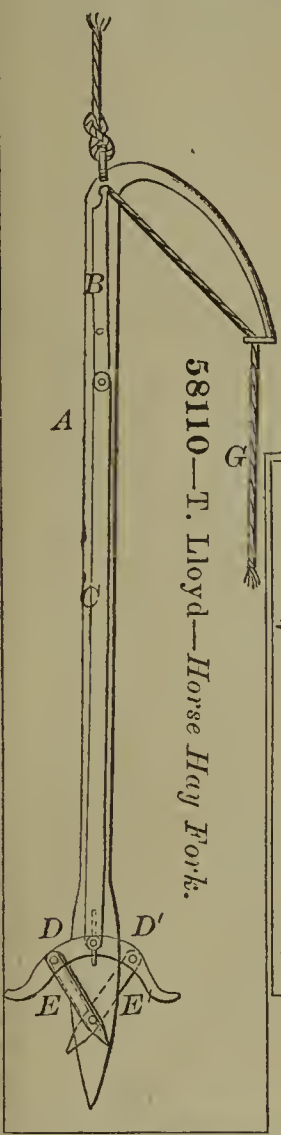
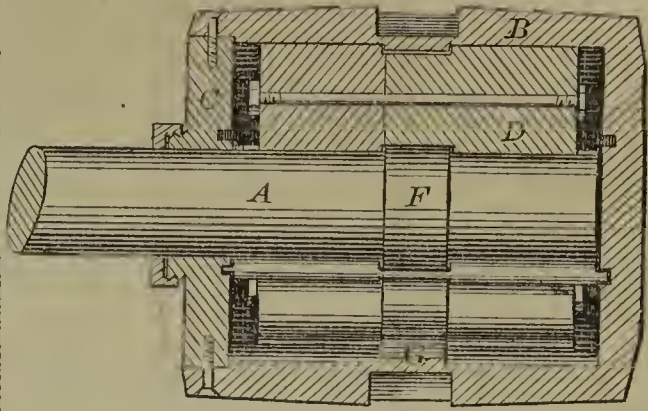

58110—T. Lloyd—Horse Hay Fork.

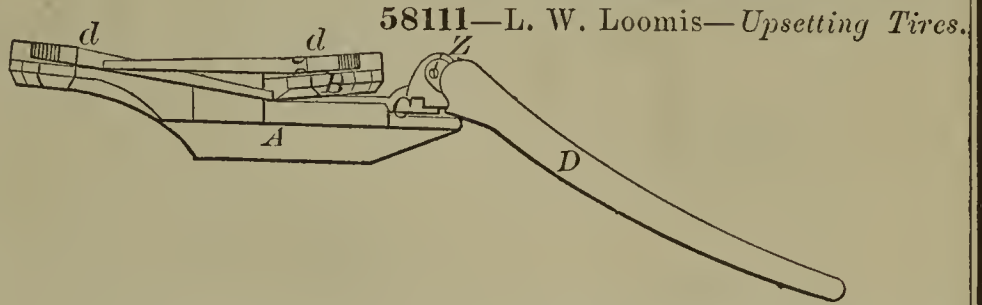

58111—L. W. Loomis—Upsetting Tires.

58113—O. Lugo—Distilling Petroleum, &c.

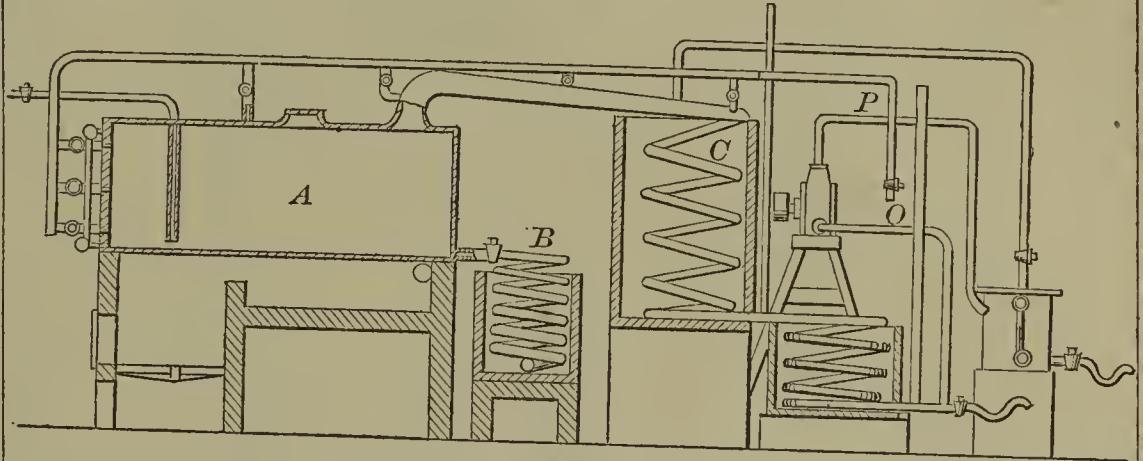

58115—Cambridge & Martin—Car Brake.

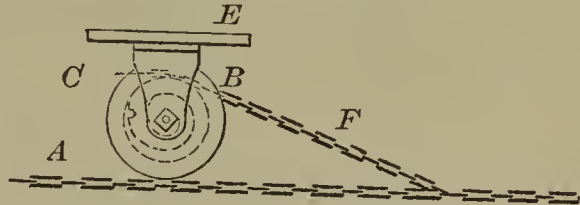

58114—W. Magrowitz—Spirit Meter.

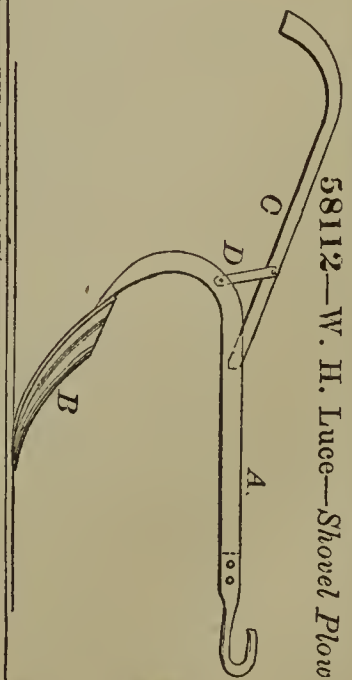
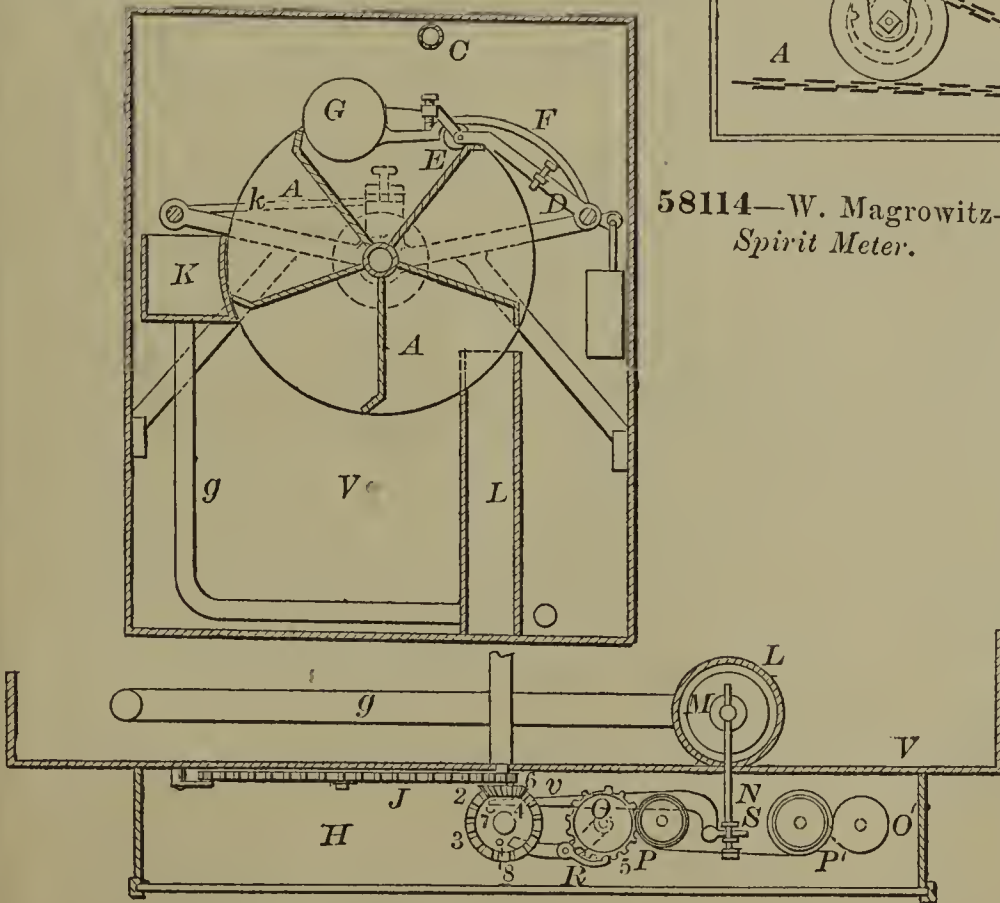

58112—W. H. Luce—Shovel Plow.

58118—J McFarland—Blow Pipe.

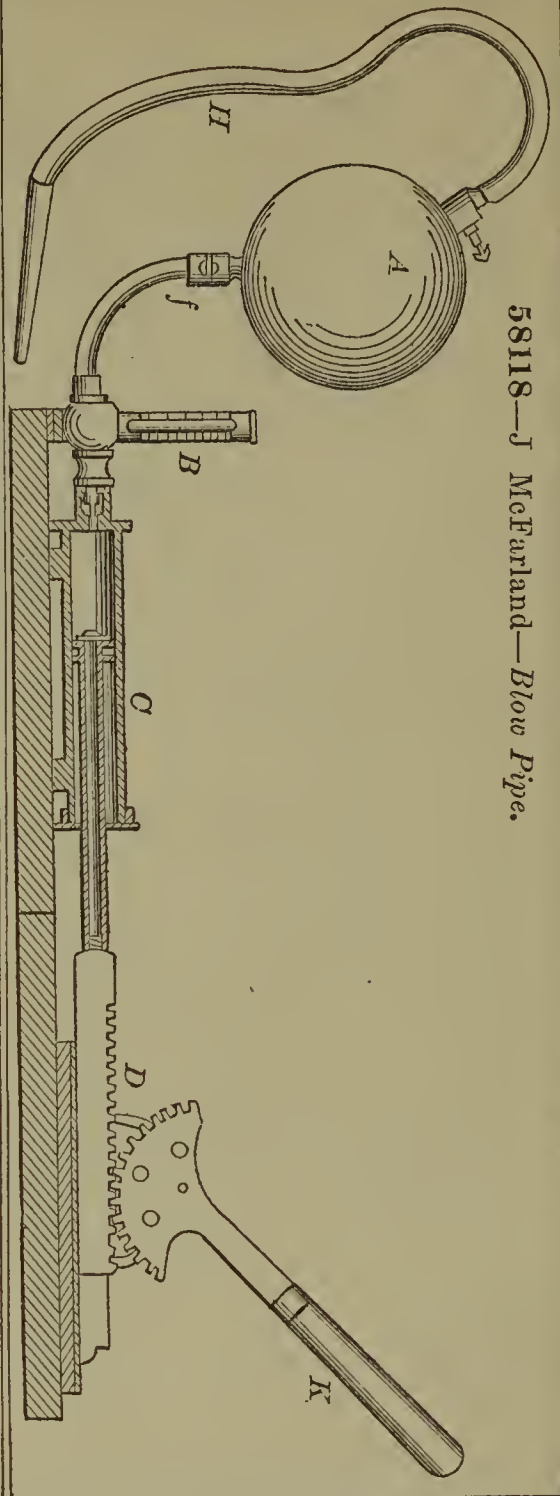

58117—W McCoy—Holding Rolled Work while being Stitched.

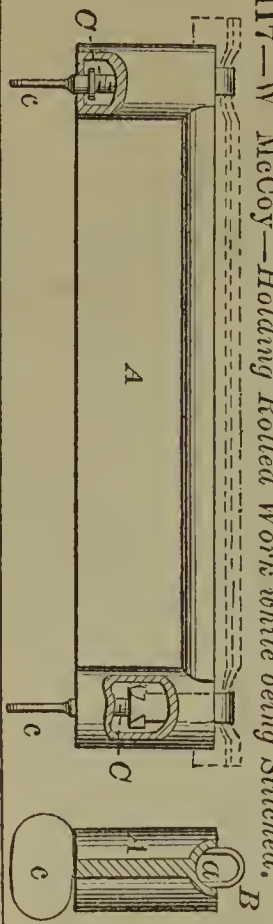

58120—J. Metzendorf—Safety Pocket Attachment.

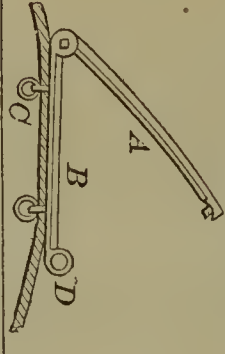

58116—E. P. McCarthy—Ore or Quartz Crusher.

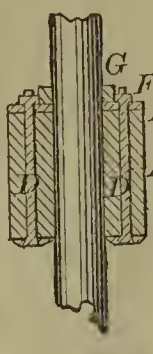

58122—F. Meyrose—Lantern.

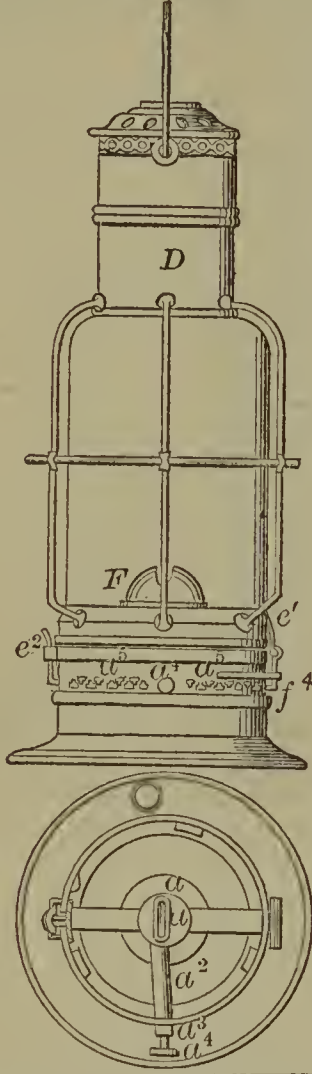

58121—J. Meyer—Saddle.

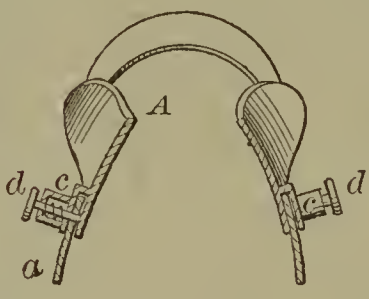

58123—S. Miller—Edge Plane.



58124—R. B. Nevens—Snow Plow.

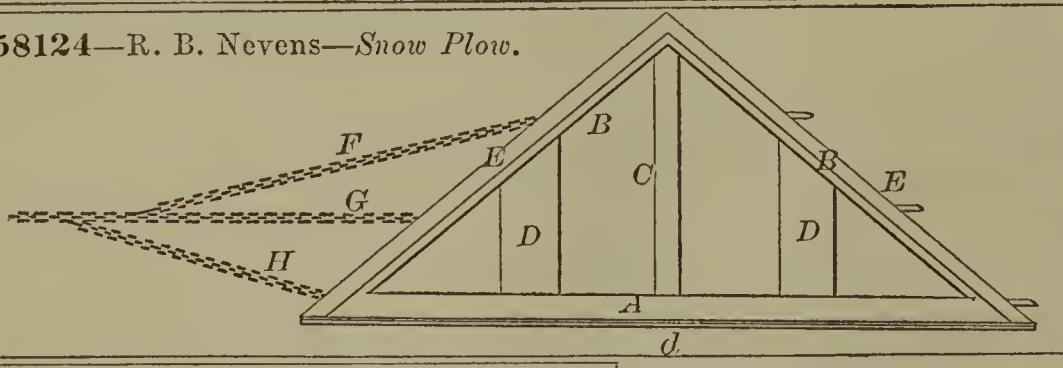

58119—F. W. McMeekin—Plow.

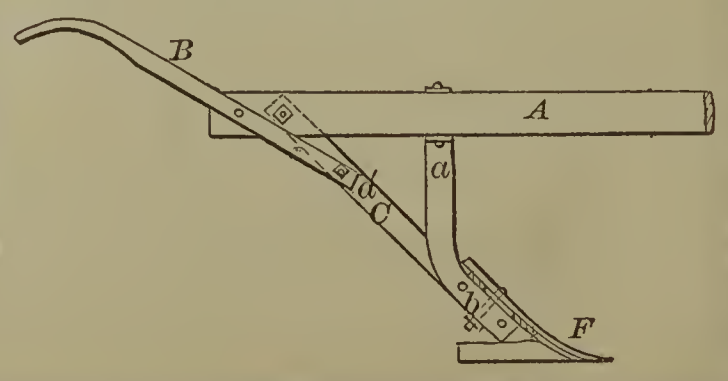

58125—D. J. Noble—Corn Cultivator.

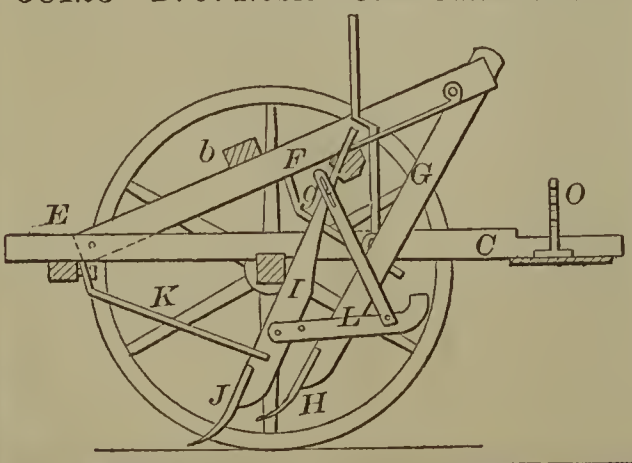



58126—E. Nougaret—*Hat Pouncer.*

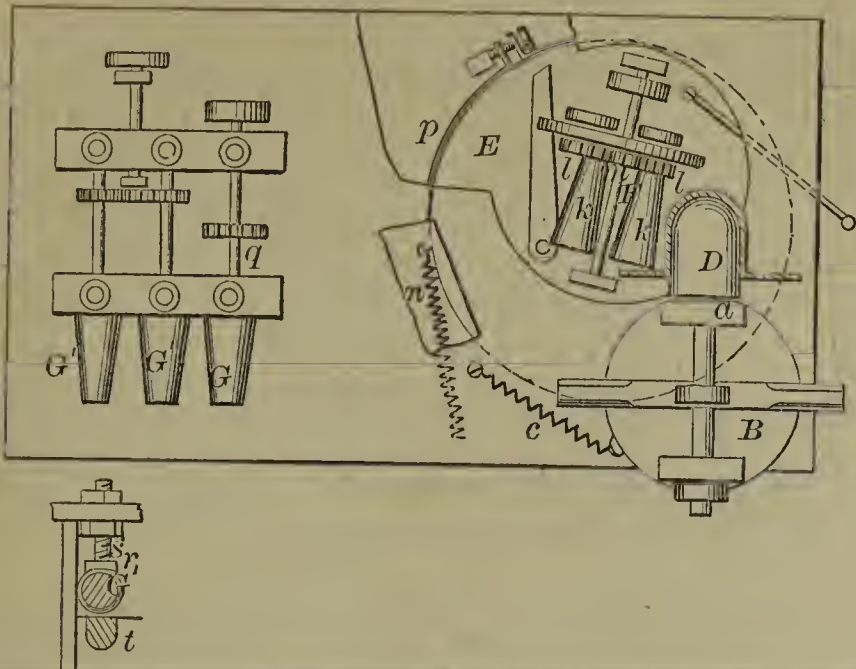

58127—J. C. Parker—*Locomotive.*

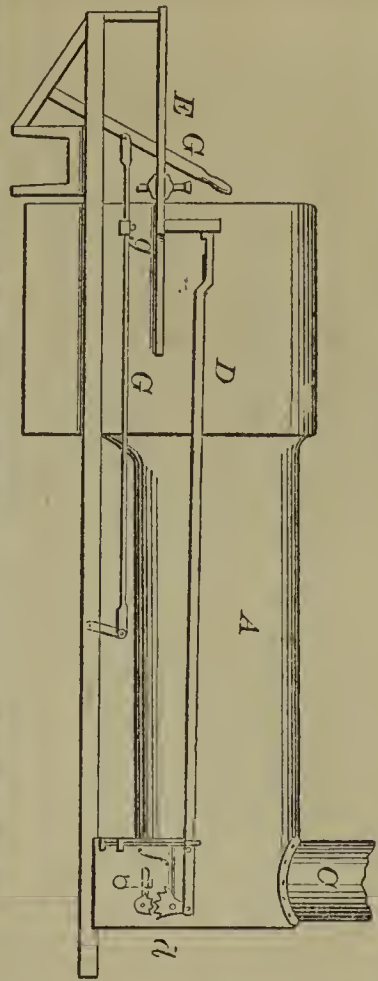

58129—S. Pettibone—*Straw Cutter.*

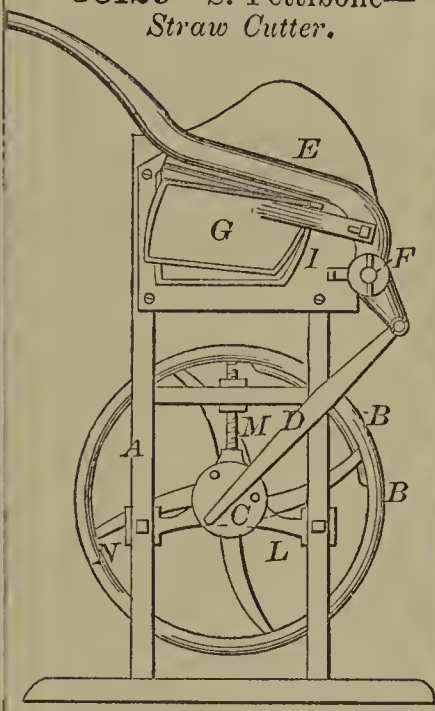

58130—P. Philippi—*Gate Fastening.*



58131—C. F. Pidgin—*Shirt Bosom.*

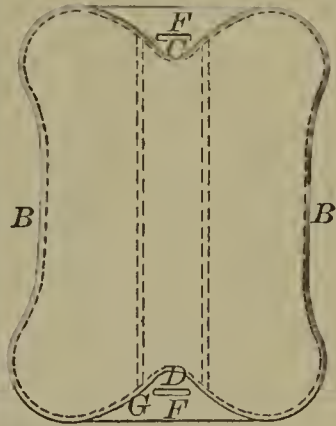

58132—C. L. Pierce—*Ash Sifter.*

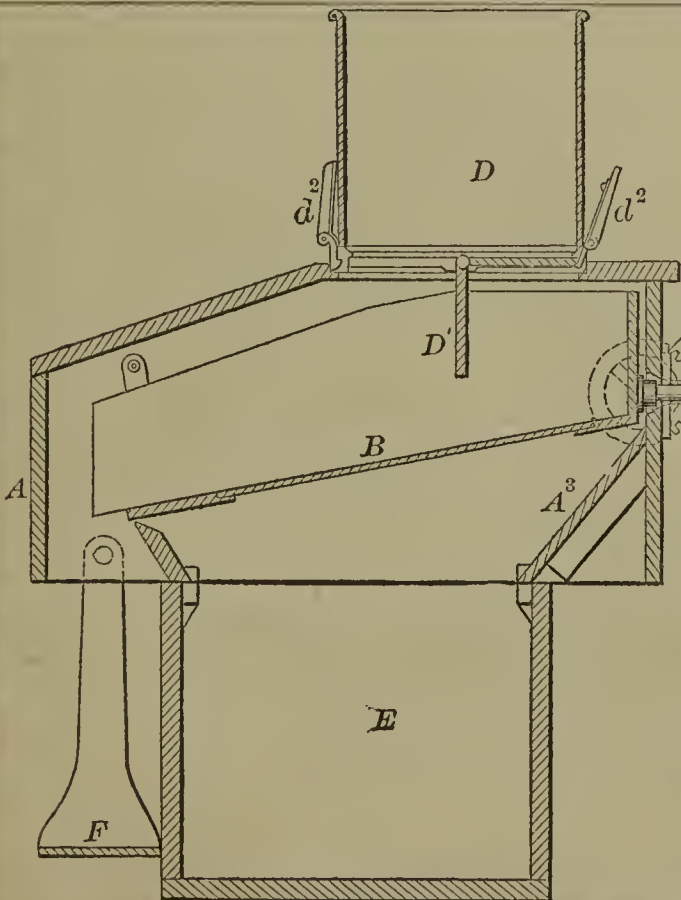

58128—G. C. Pattison—*Anchor.*

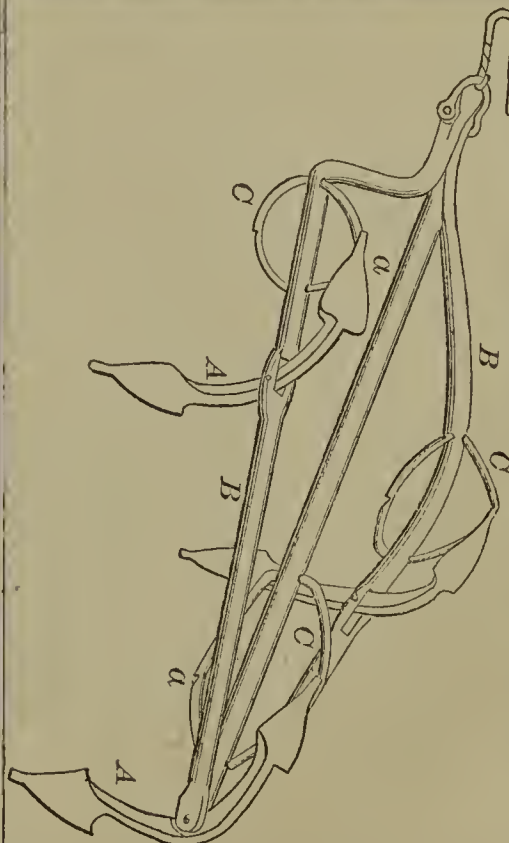

58133—C. Poor—Dental Mallet.

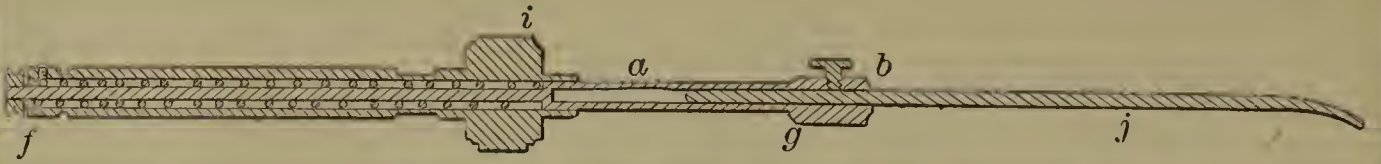

58134—T. T. Prosser—Making Screws.

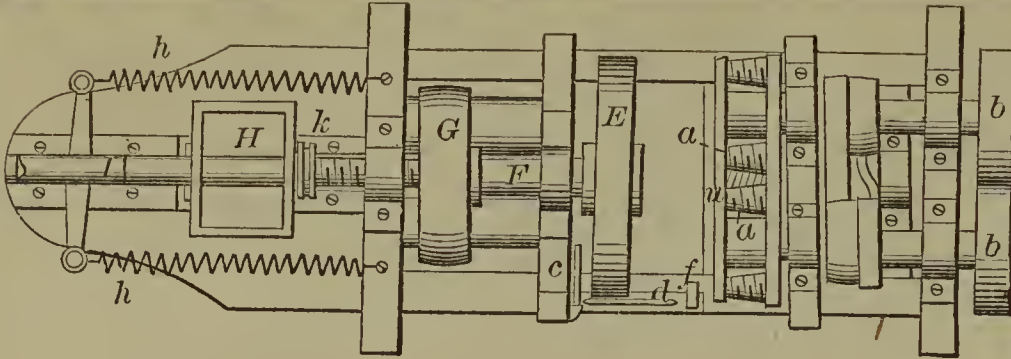

58137—S. G. Reynolds—Making Nails.

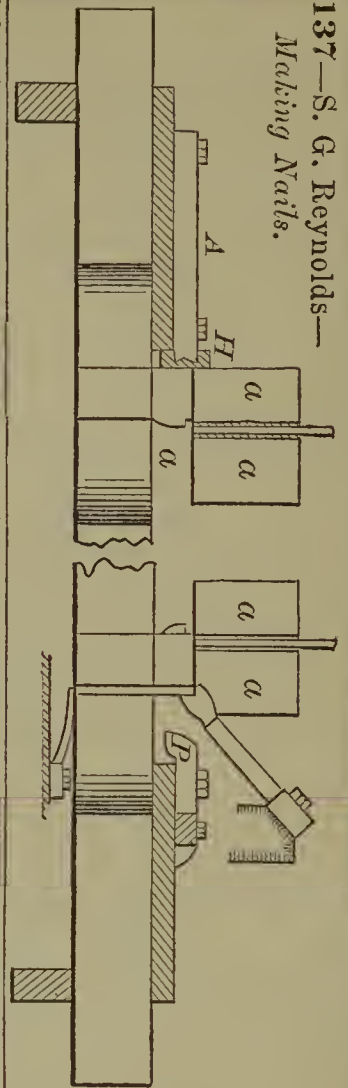

58138—E. B. Robinson—Flat Iron.

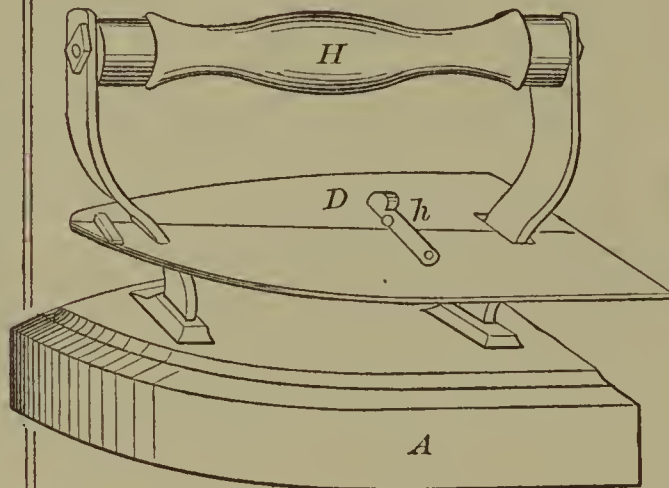

58136—J. W. Reid—Car Brake.



58135—A. Putnam—Corn Planter.

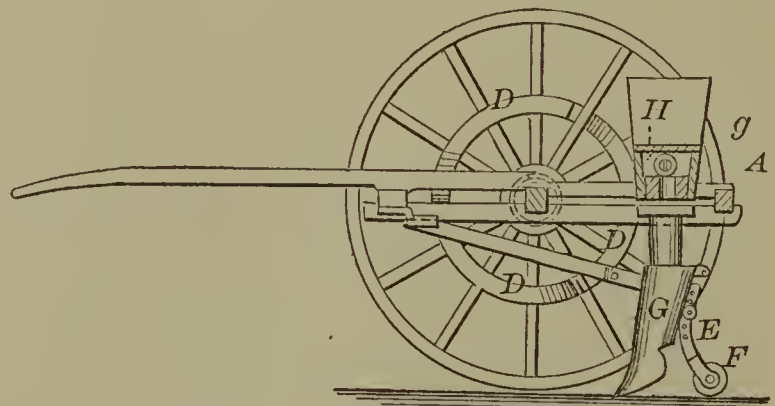

58139—D. P. Rood—Surcingle.

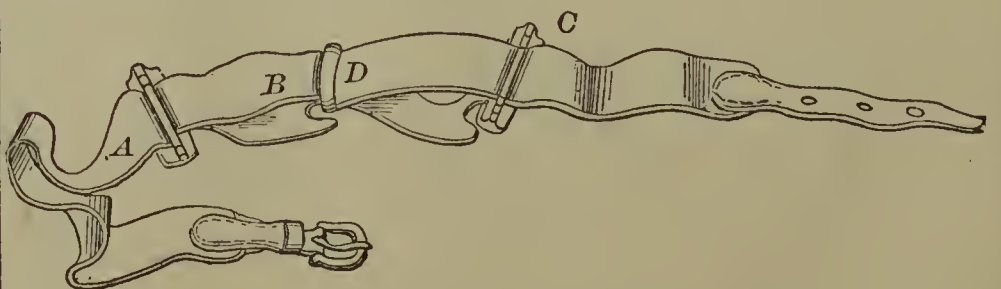

58140—D. C. Rosier—*Bean Harvester.*

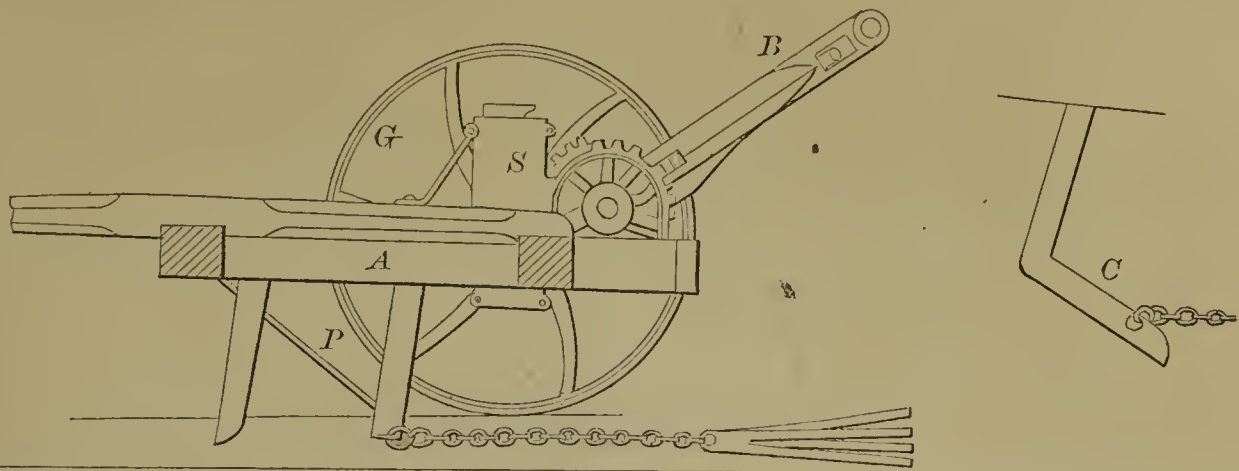

58143—S. Secrist—*Corn Harvester.*

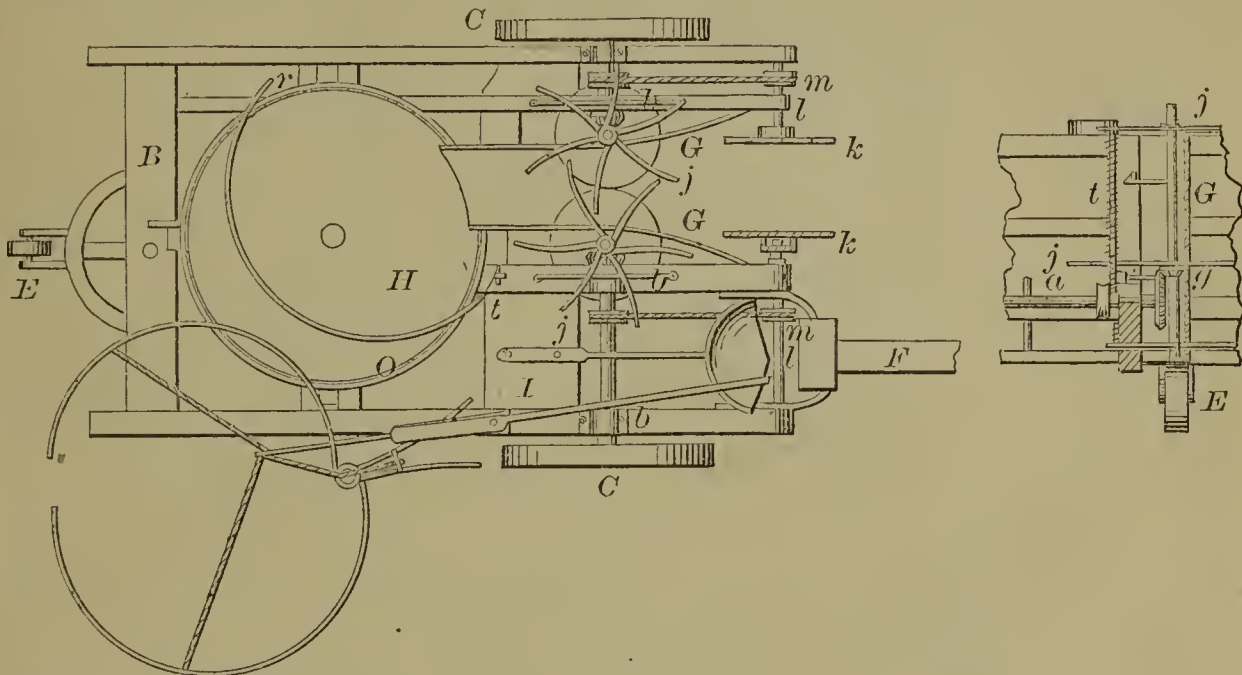

58142—W. R. Satterly—*Fall Block Hook.*

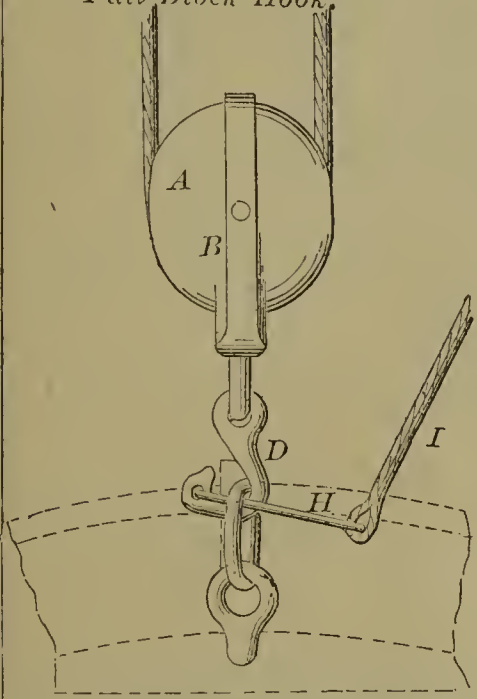

58141—A. V. Ryder—*Trunk.*

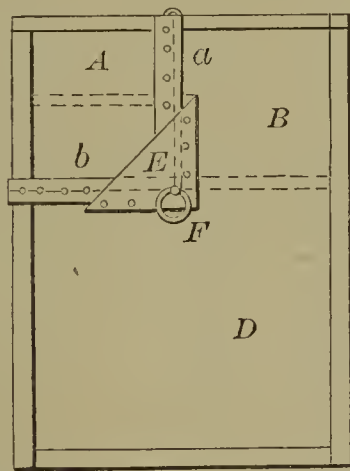

58144—H. Sidle—*Washing Machine.*

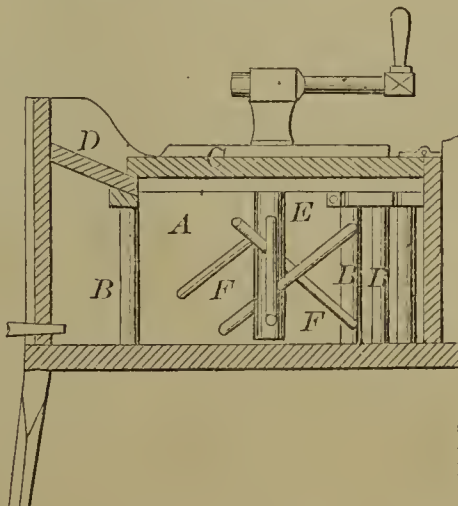

58145—Sinnott & McIntyre—*Tuyere.*

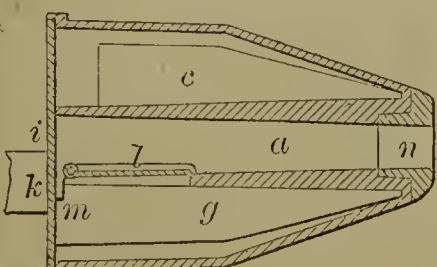

58146—F. H. Smith—*Brick Kiln.*

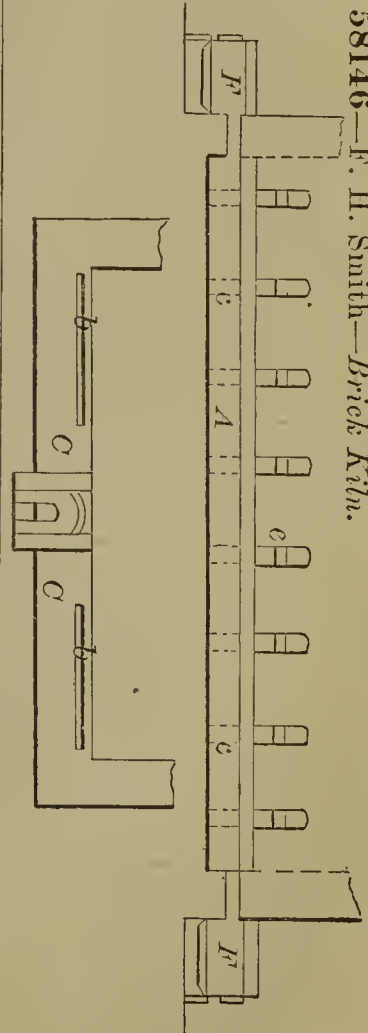

58147—A. Stark—Cultivator.

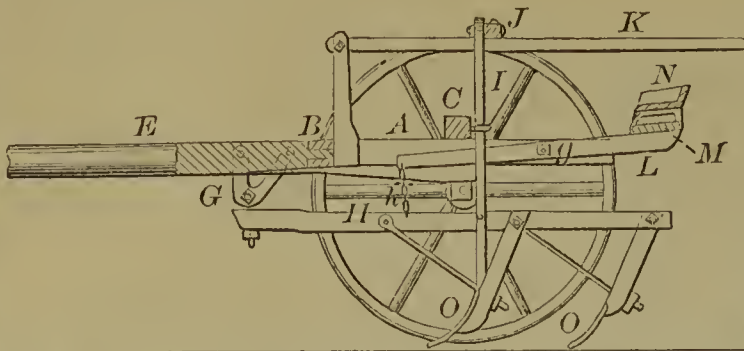

58152—R. H. Thorn—Chuck.

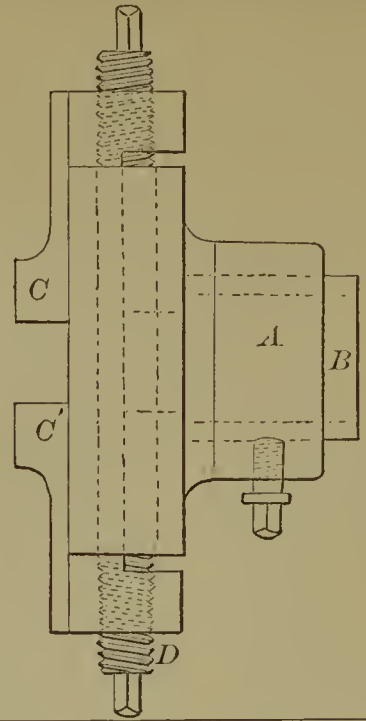

58149—S. G. Sturges—Amalgamator.

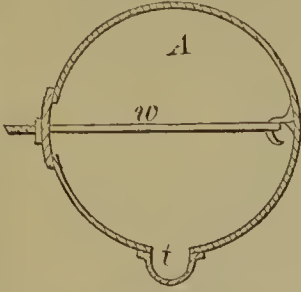

58151—A. Sweetland—Saw Filing Machine.

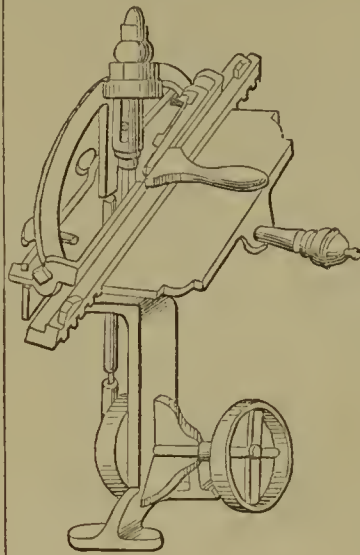

58156—Vose & Toshach—Coiling Springs.

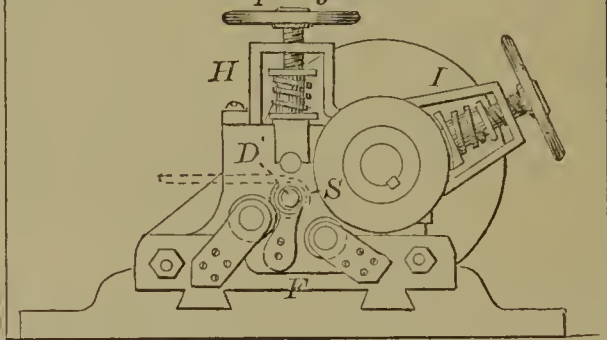

58150—J. W. Summers—Deep Well Pump.



58155—W. V. Anden—Making Railroad Chairs.

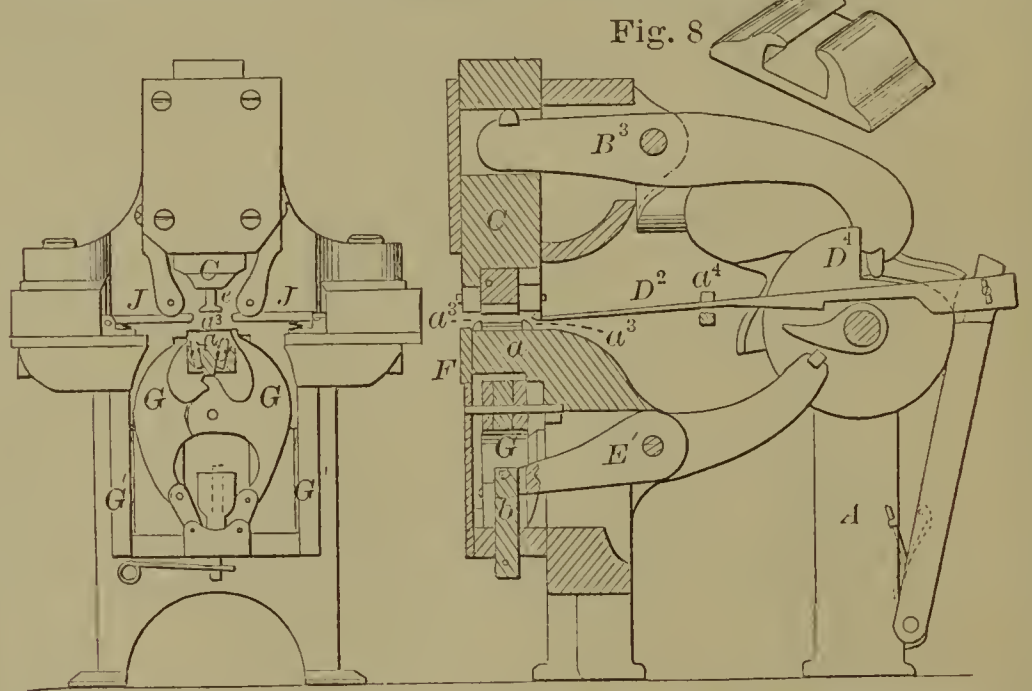

58153—S. H. Timmons—Bottle Stopper.

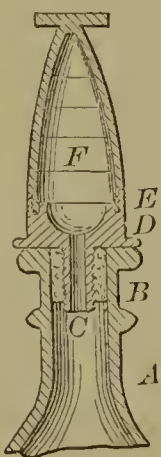

58154—J. E. Todd—Artist's Stretcher.

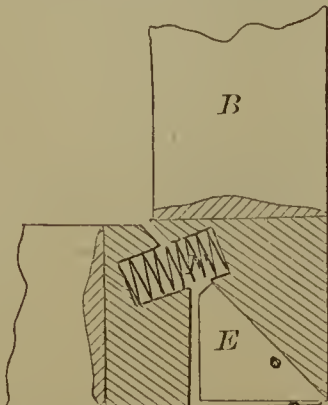

58157—J. E. Weaver—Oil Can and Oiler.

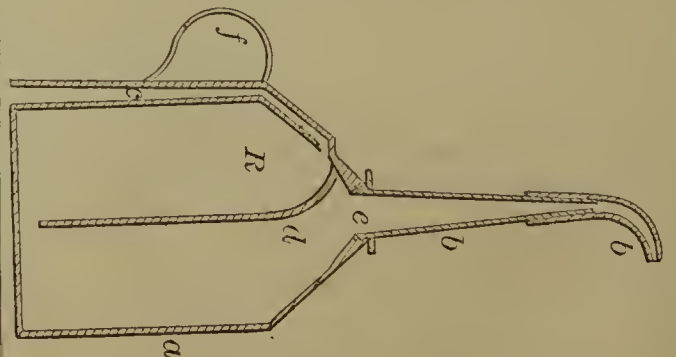

58158—D. N. Webster—Hay Rack.

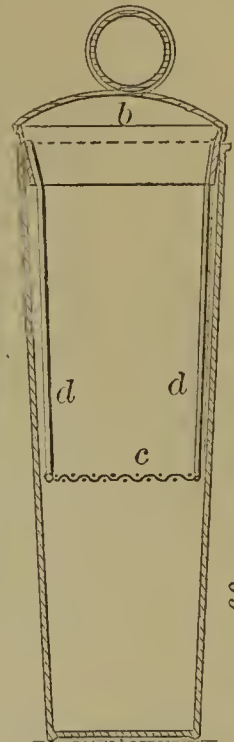
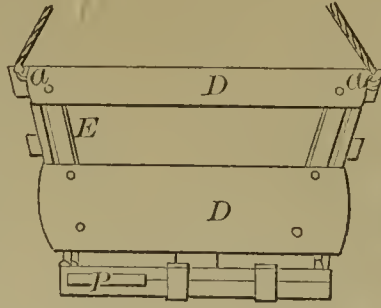
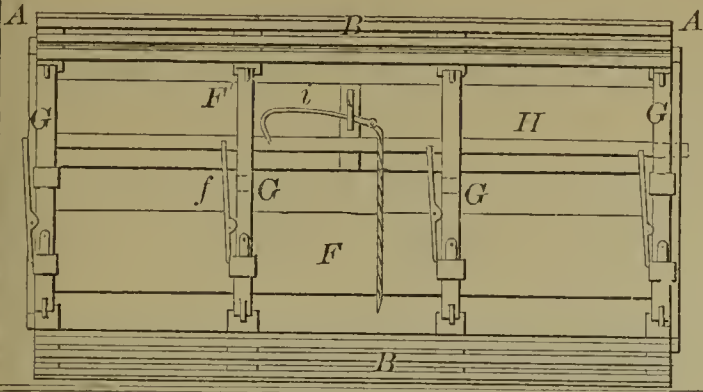

58165—C. M. Drennan—Egg Beater.

58161—J. F. Winchell—Gate.

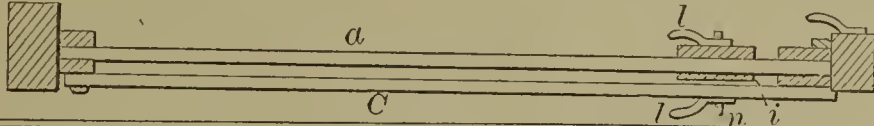

58162—F. M. Wood—Wiring Sheet Metal Pans.

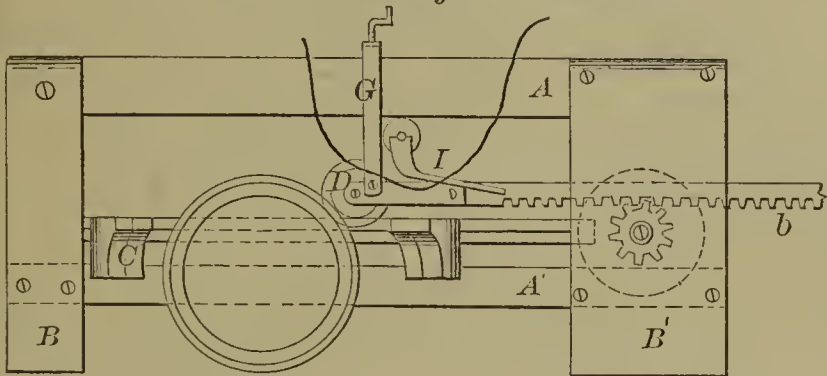

58160—J. T. Williams—Toy.



58164—E. P. Chase—Steam Generator.

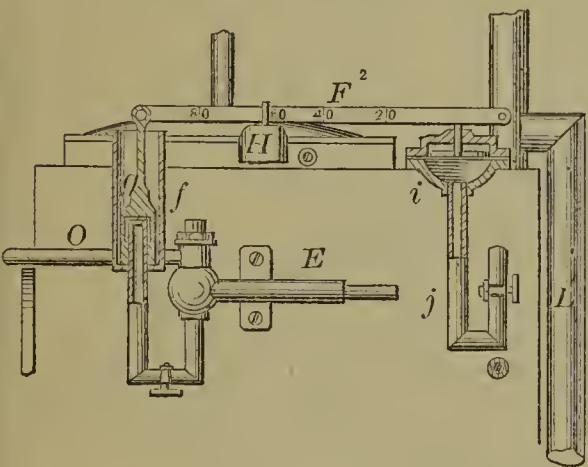

58159—A. A. Wilder—Ventilating Pipe for Stoves and Heaters.

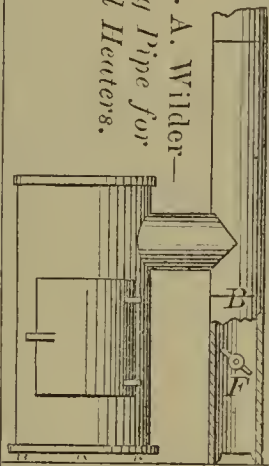

58166—A. J. Edgett—Corn Planter and Broadcast Seeder.

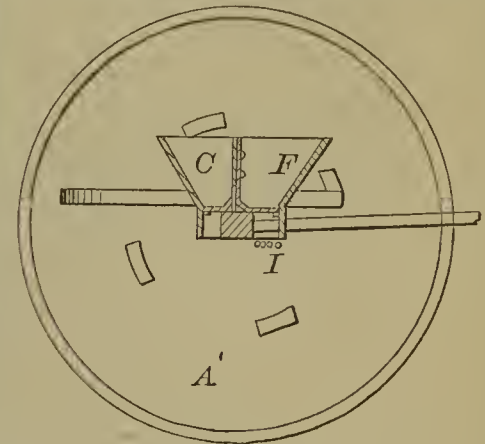

58167—H. B. Gregg—Floor Planking Clamp.

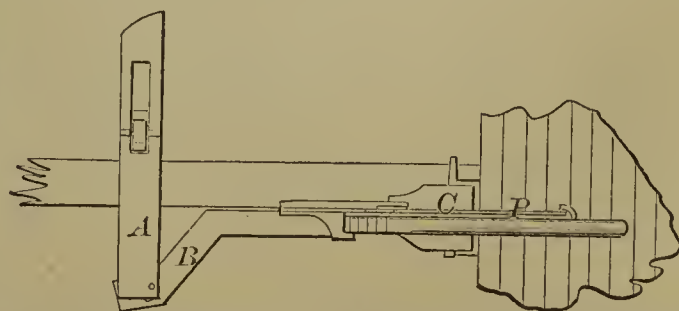
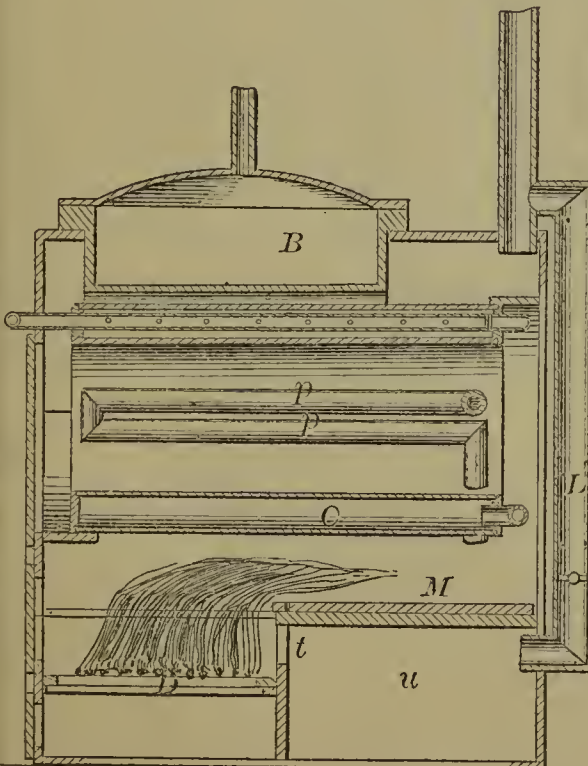
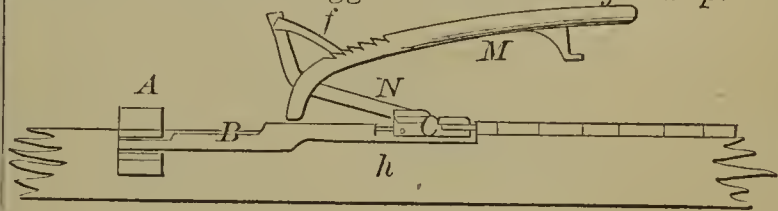

58168—I. W. Hamlet—Neck Tie.

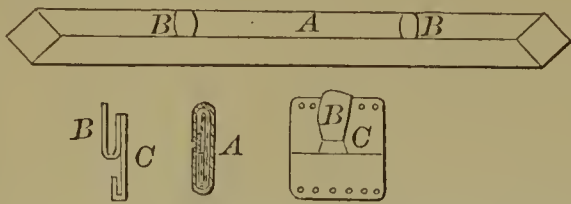

58170—T. J. Jones—Pump Attachment.

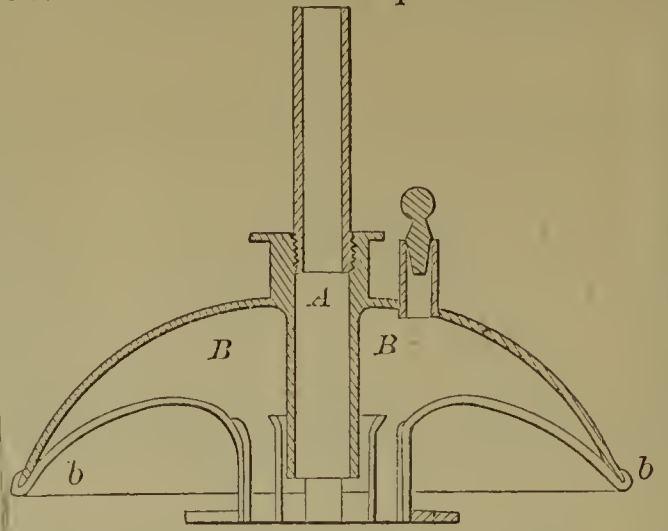

58173—E. C. Little—Moulders' Flask.

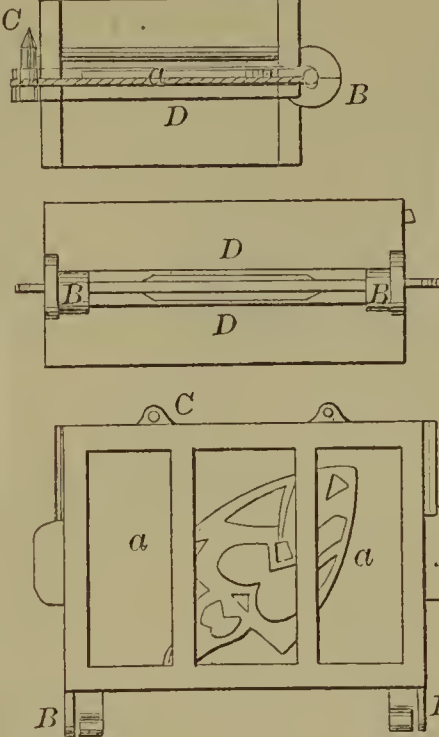

58174—J. Mulchahey—Bottle Stopper.

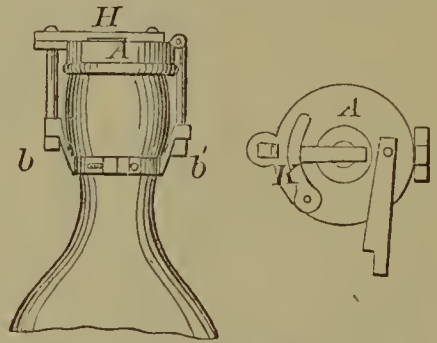

58172—D. B. Lacy—Weight.

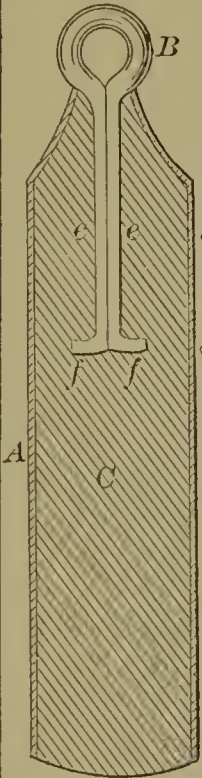

58175—R. Nutty—Drilling Machine.

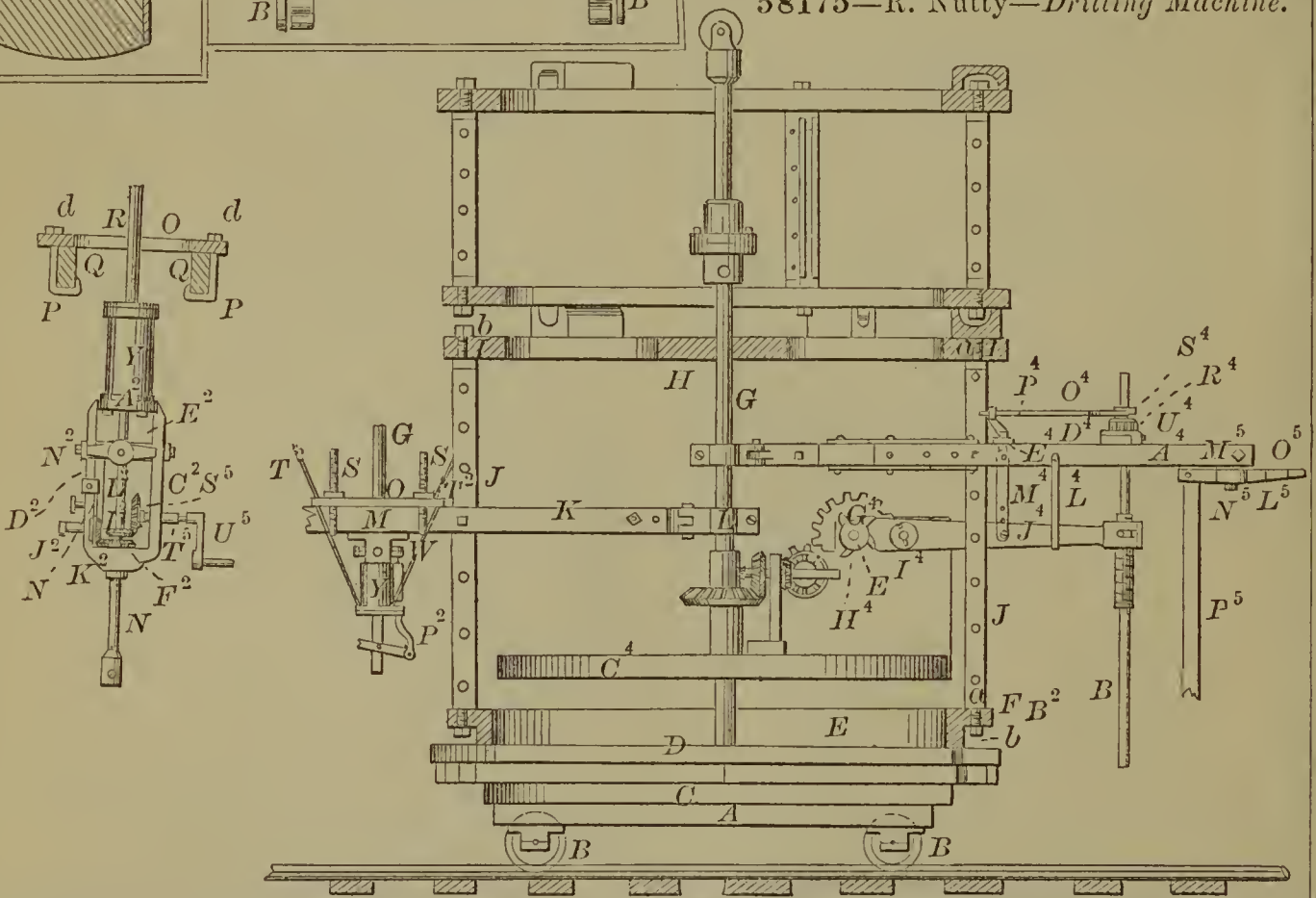

58177—J. A. Quick—Plow.

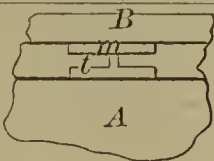
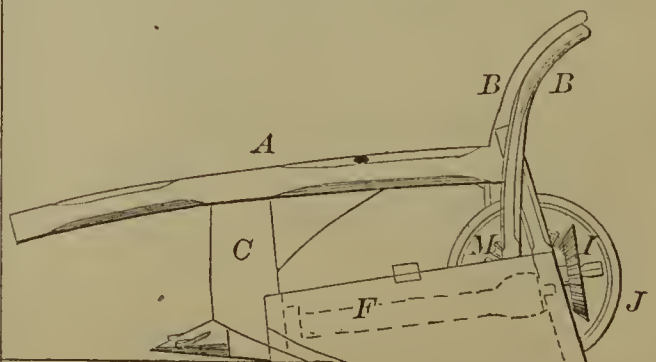

58176—W. A. & T. F. Powers—Piston Packing.

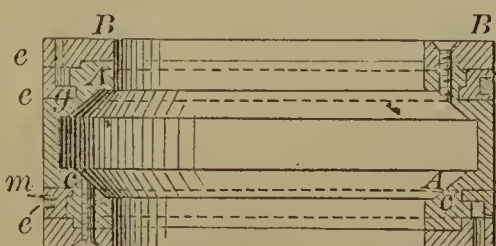

58178—T. K. Reed—*Shoe Shanking.*

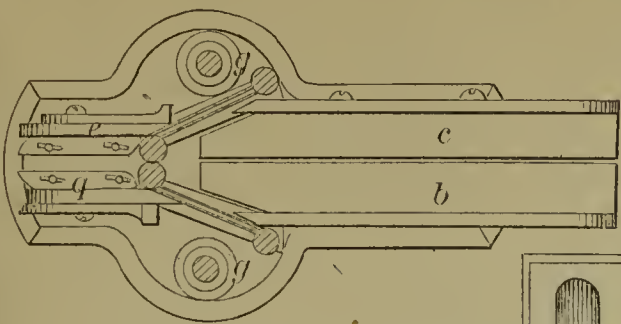

58179—T. Savill—*Low Water Detector for Steam Generators.*

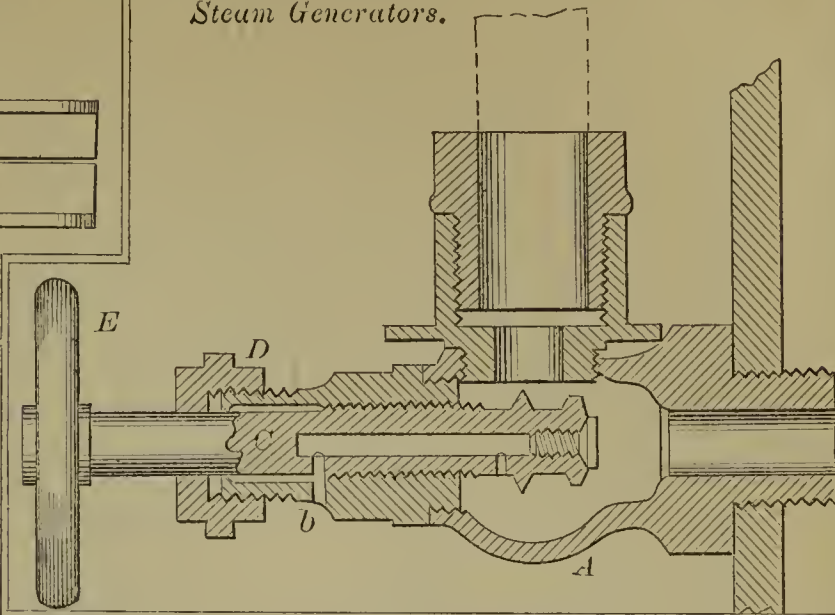

58181—S. M. Tyler—*Sewing Machine.*

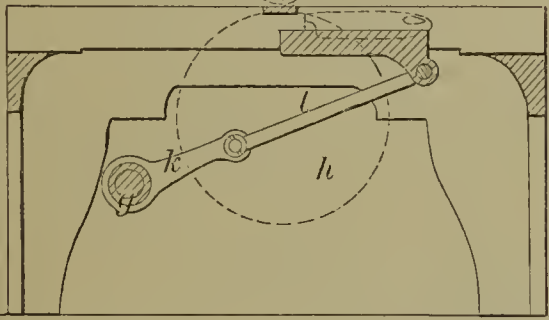
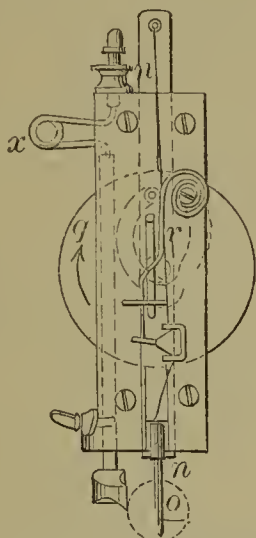

58185—J. F. Winchell—*Fruit Jar.*

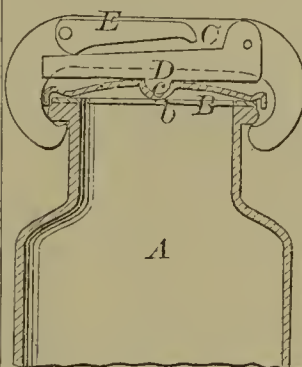

58184—T. Whittemore—*Railway Chair.*

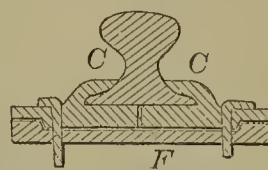

58182—S. M. Tyler—*Sewing Machine Shuttle.*

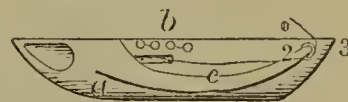

58187—Ackland, Mitchell & Mustapha—*Cotton Gin.*

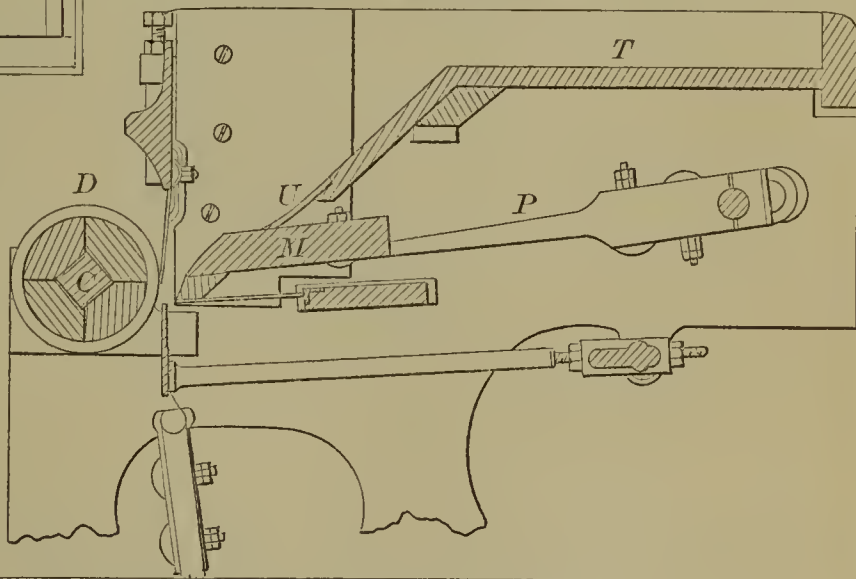

58183—D. Whitlock—*Cutting Paper Corners.*

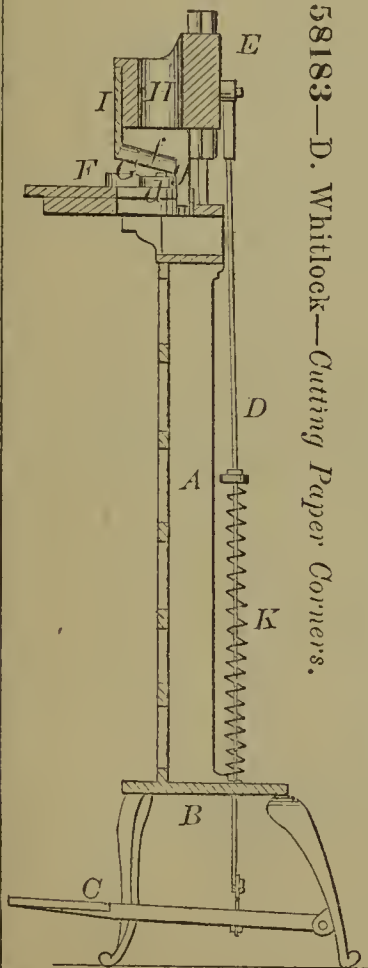

58188—A. Anderson—*Cultivator.*

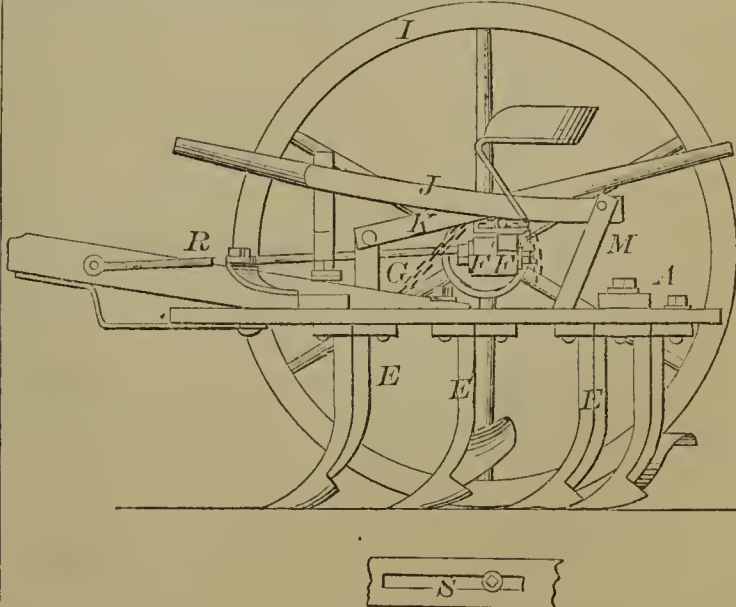

58186—E. Bourquard—*Teeth Cutter.*

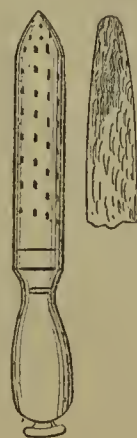

58191—S. Grenell—Rotating Harrow.

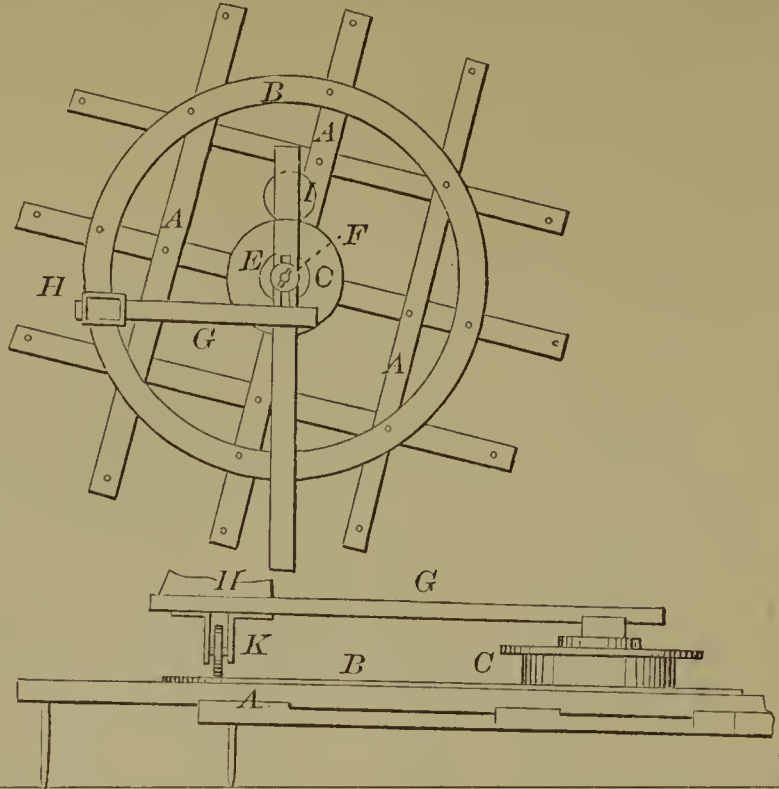

58193—B. Rowell—Fence.

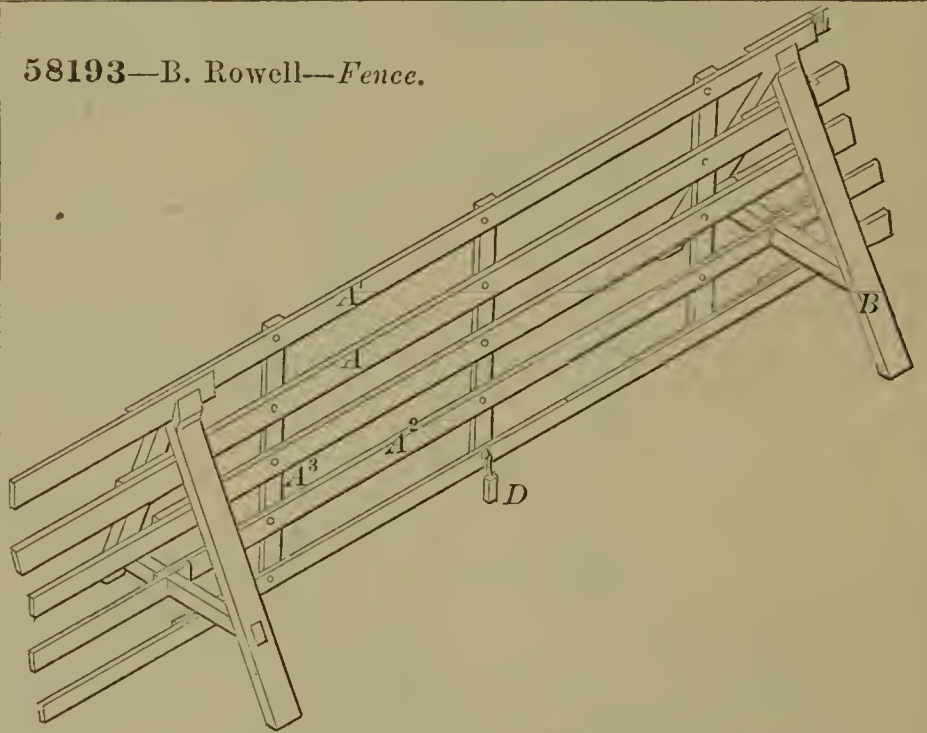

58190—A. H. Emery—Peat Slicer and Dryer.

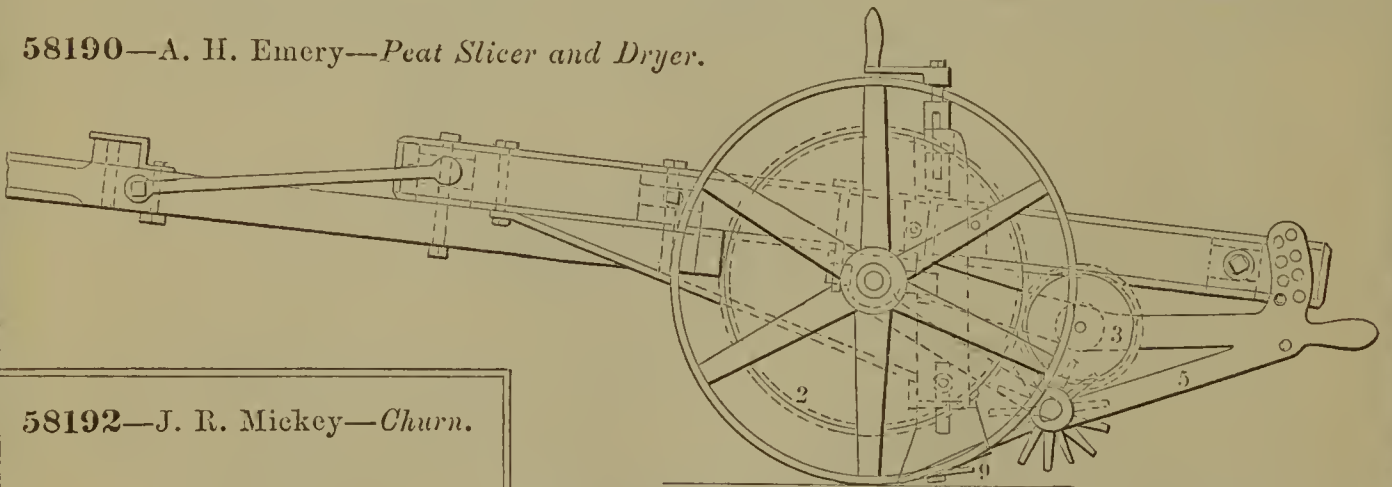

58192—J. R. Mickey—Churn.

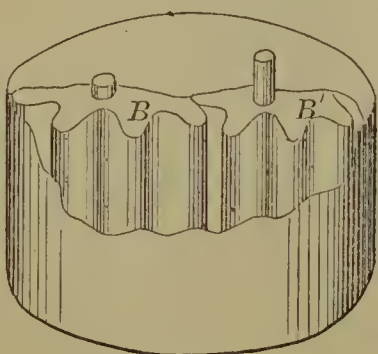

58194—E. Abbott—Milk Can.

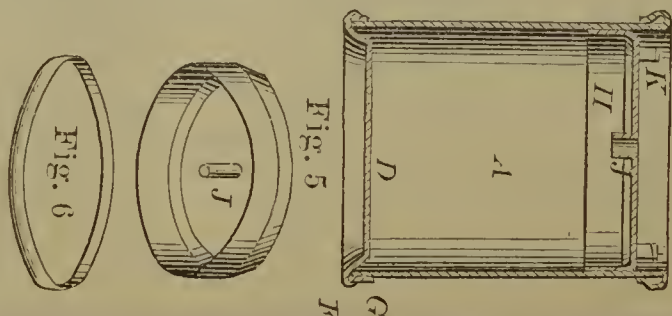

58189—T. Walker—Vessel's Speed Indicator.

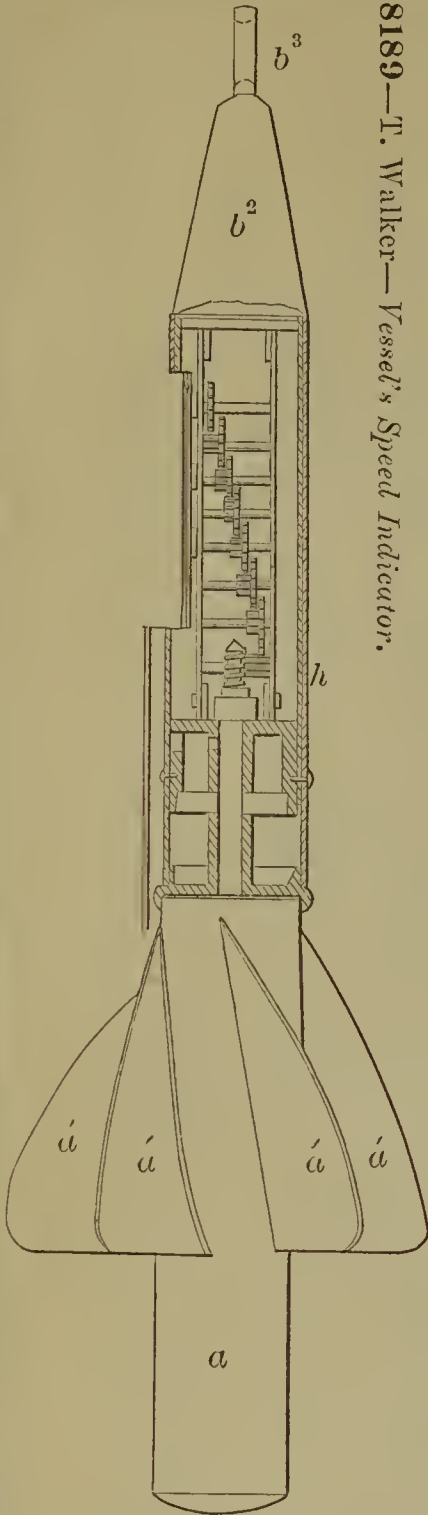



58195—J. Albert—Trace Button and Loop.

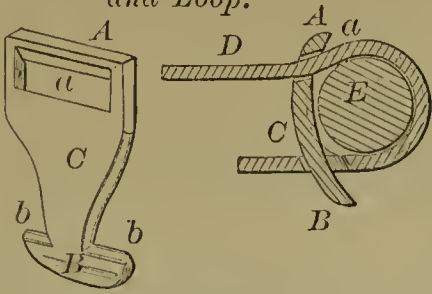

58197—S. Andrews—Distilling Oil.

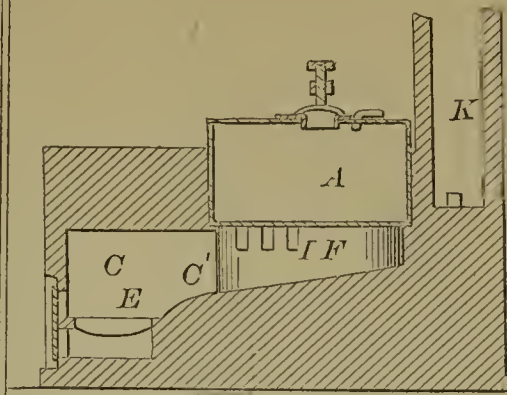

58196—E. G. Allen—Railway Frog.



58198—M. Andriot—Carriage Jack.

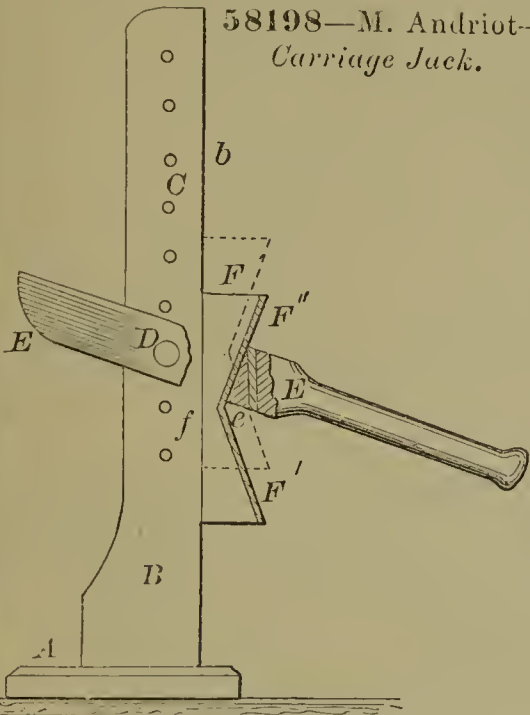

58200—C. B. Baker—Brick Machine.

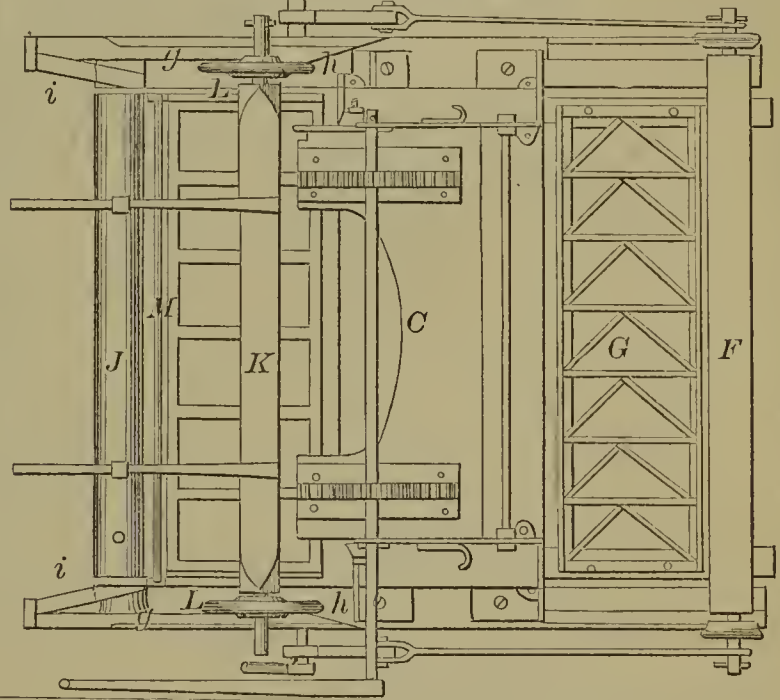

58199—G. H. Babcock—Darning Last.

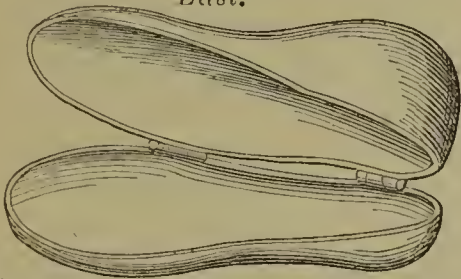

58201—R. J. Barr—Trap for Removing Water.

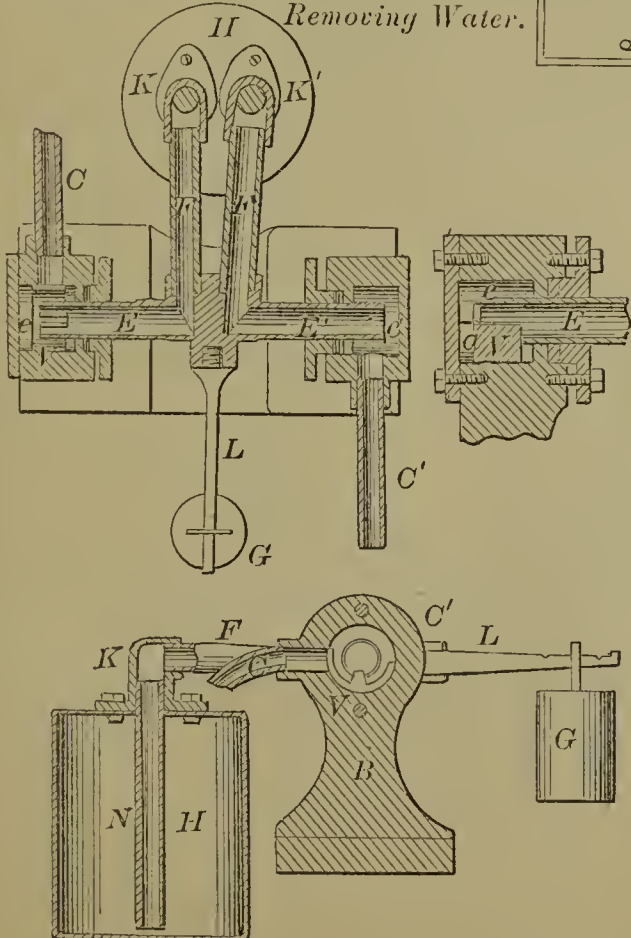

58202—T. B. Belfield—Steam Radiator.

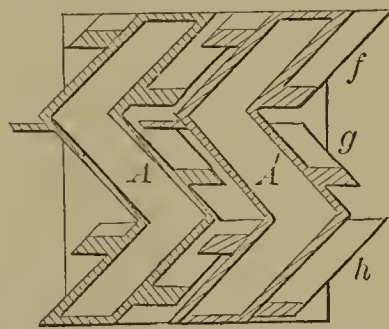

58204—C. P. Benoit—Piston Rod Packing.

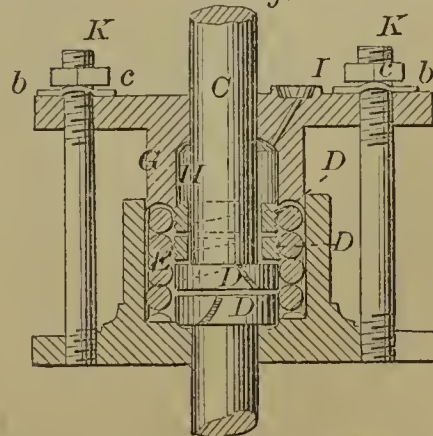

58205—E. Bigelow—Syrup Stand and Soda Fountain.

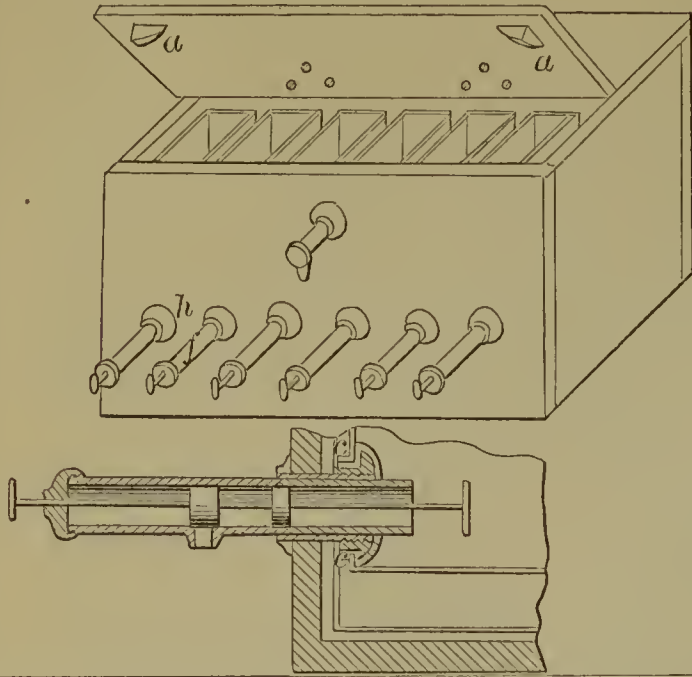

58208—Blackmer & Carpenter—Water Wheel.

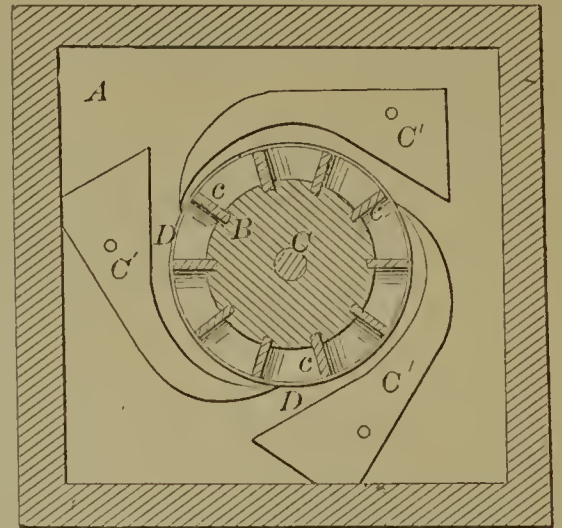

58206—A. C. Baldwin—Rotary Steam Engine.

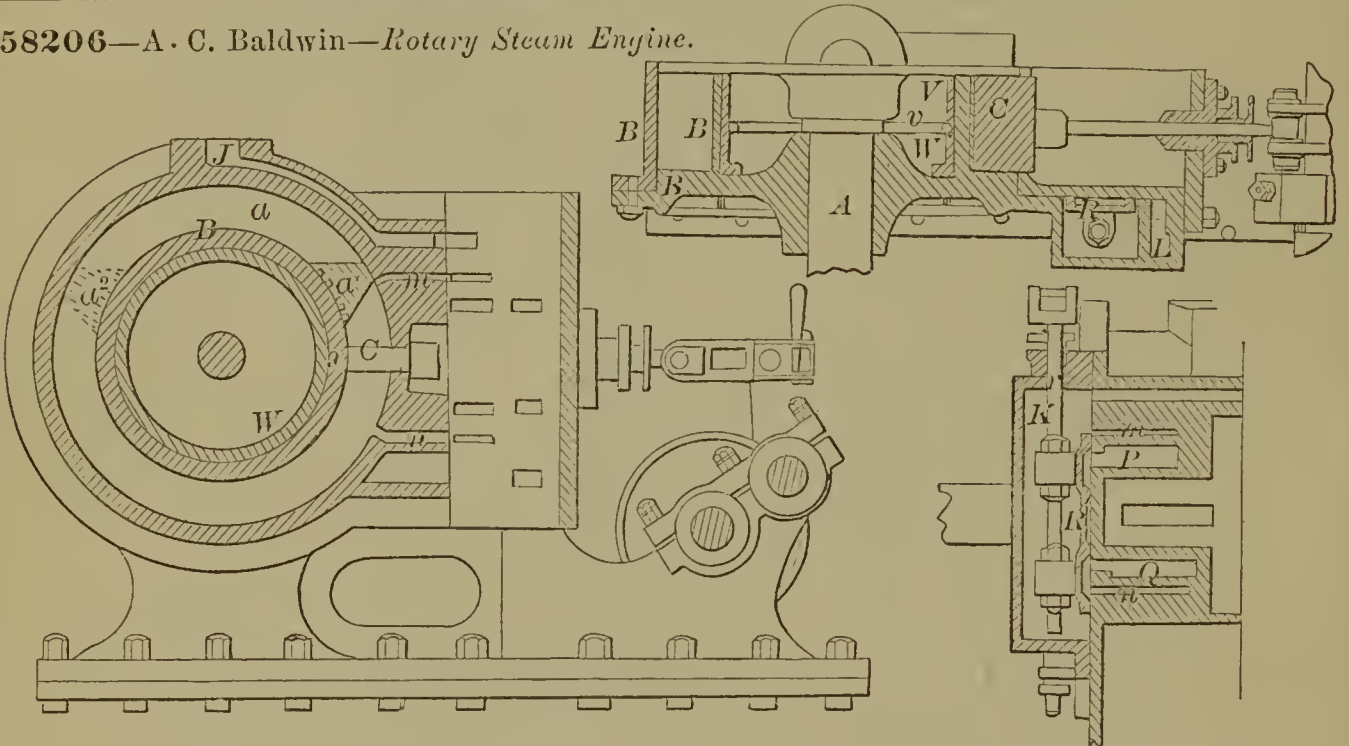

58207—J. Bing—Car Brake Shoe.

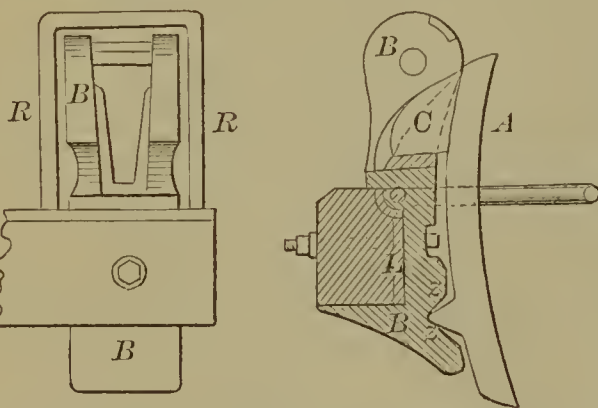

58209—J. F. Boynton—For Carburetting Gas.

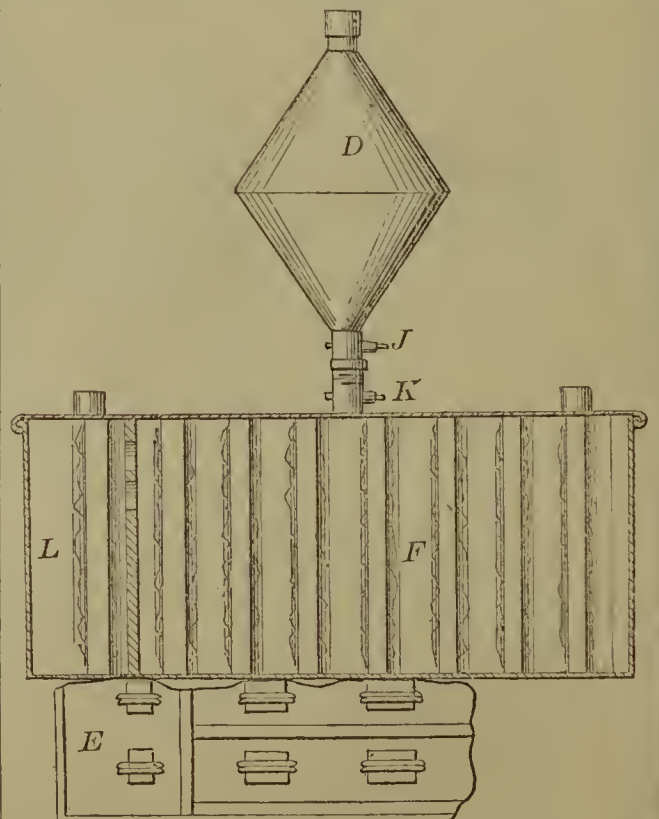

58210—Browning & Hard—Sewing Machine Hemming Guide.

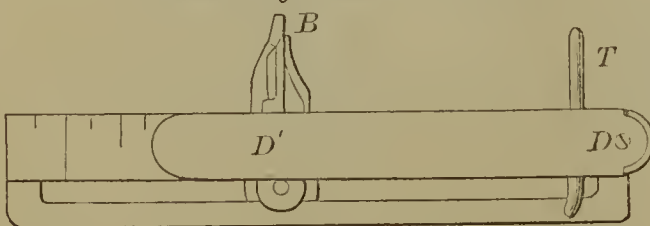

58214—J. M. Carr—Seeding Machine, &c.

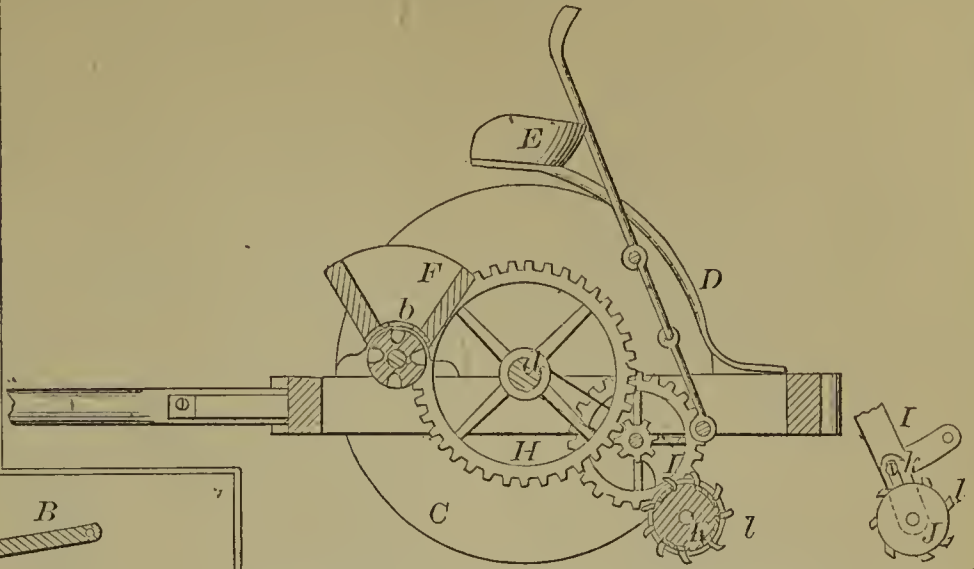

58211—L. A. Burnham—  
Fishing Line Sinkers.

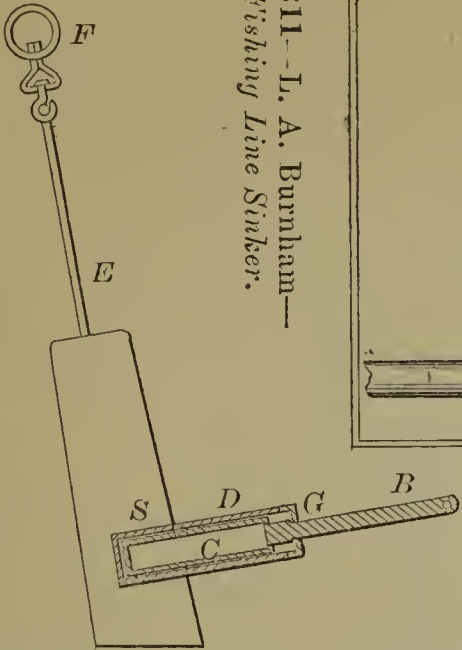

58215—E. Chesterman—Wringer and Washing Machine.

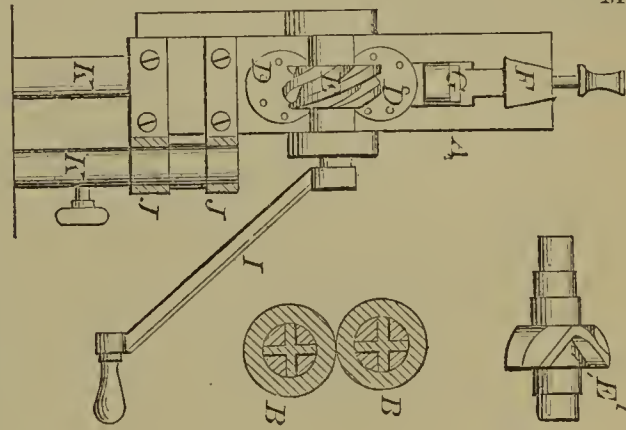

58212—W. A. Butler—Lantern Reflector.

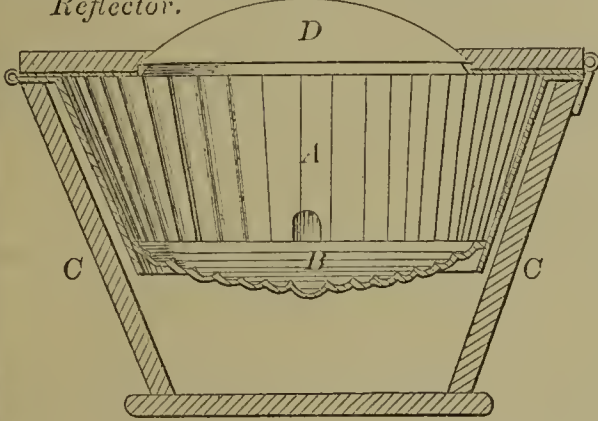

58218—B. Clough—Gate.

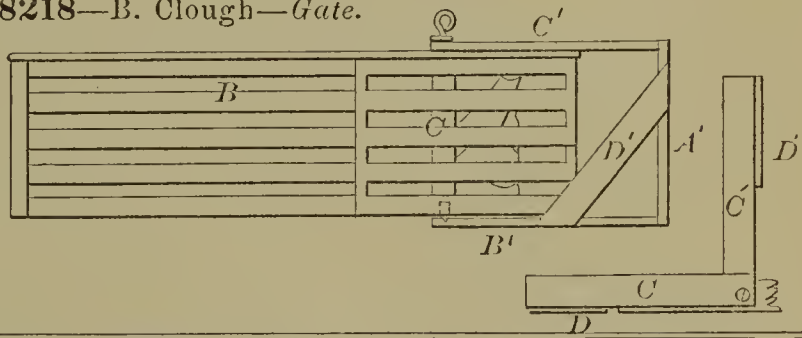

58219—W. S. Coffman—  
Broadcast Seeding Machine.

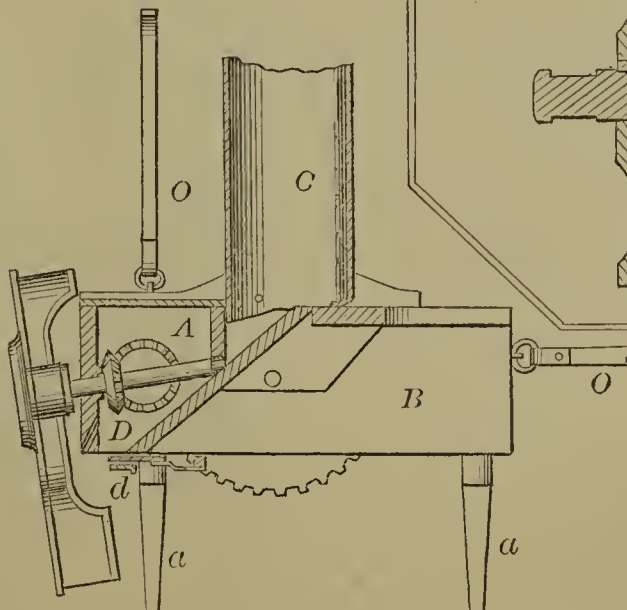

58216—S. B. Childs—Running Gear of Railway Cars.

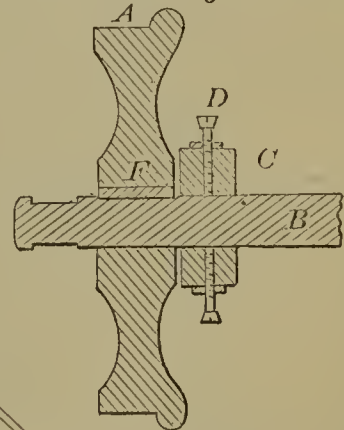

58217—Clark & Splitdorf—  
Insulating Wires of Helices.

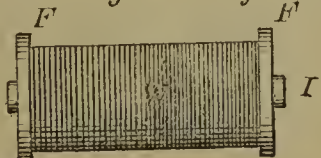

58213—G. J. Capewell—Lamp Burner.

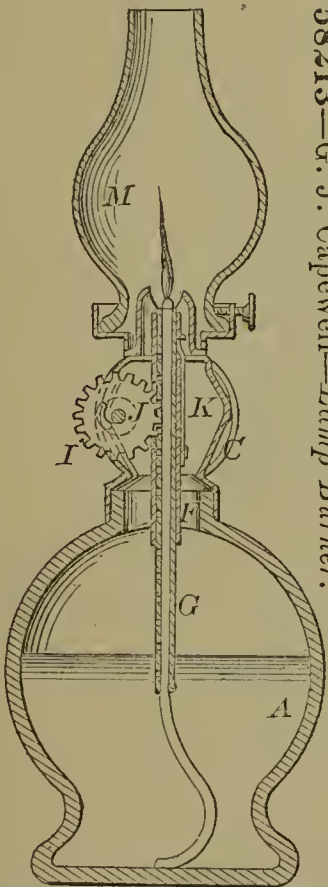

58220—T. Cole—Sorghum Evaporator.

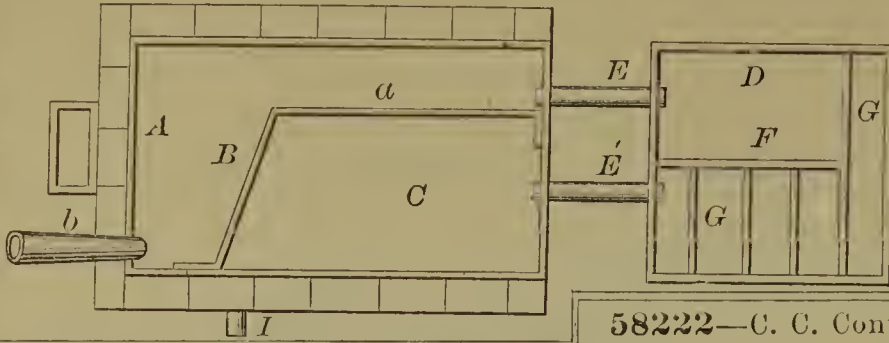

58223—L. M. Crane—Paper Collar.

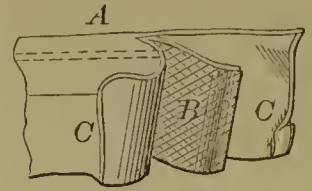

58221—J. H. Connelly—Making Gas.

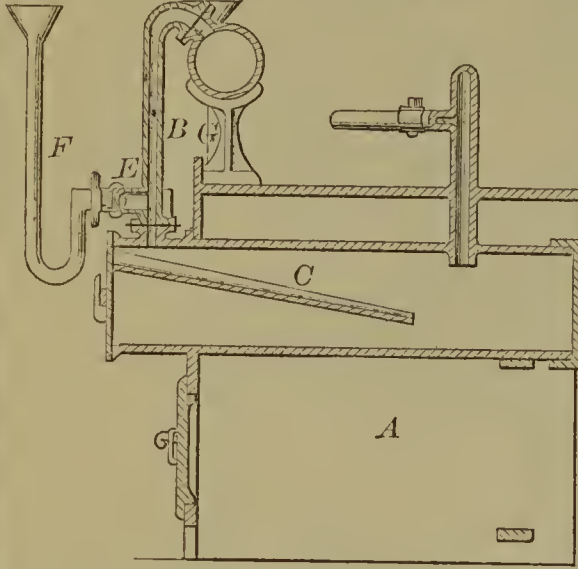

58222—C. C. Converse—Baling Press.

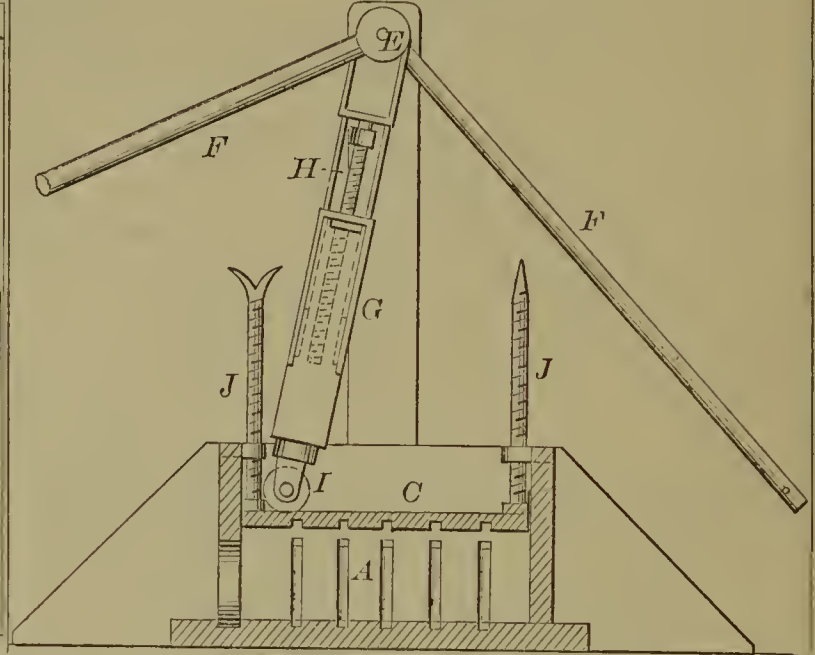

58224—A. D. Groeker—Kettle Bail.

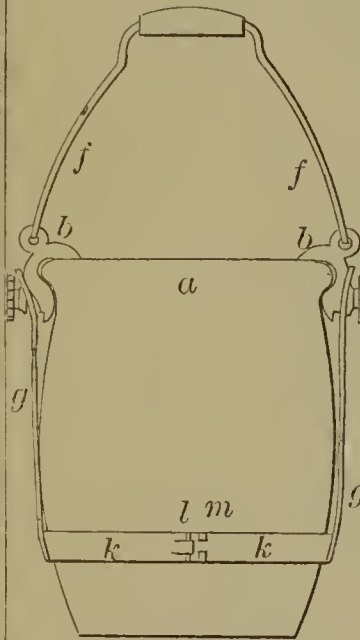

58225—D. Cumming, Jr.—Slate Frame.

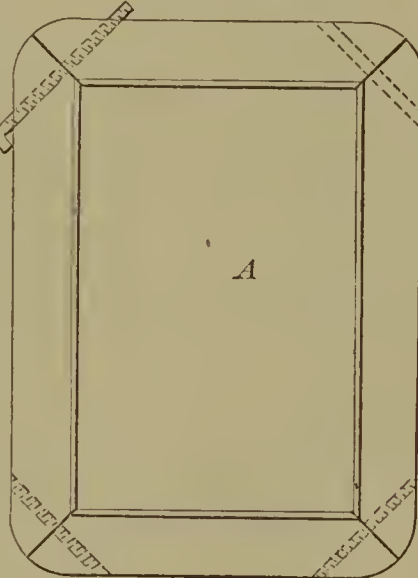

58226—L. Cutting—Spinning Machine Stop Motion.

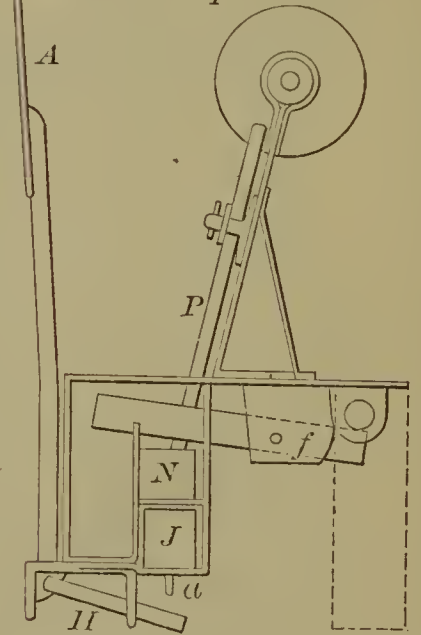

58227—W. Damerel—Umbrella.

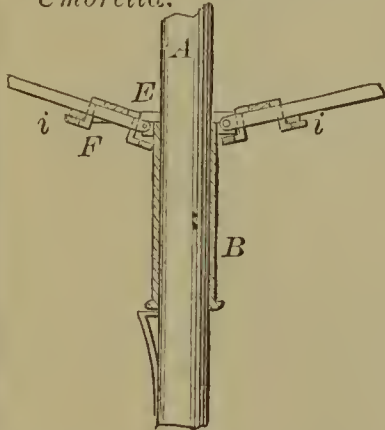

58228—F. Danzenbaker—Churn.

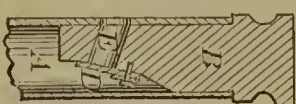

58229—M. D. Dickinson—Assorting Potatoes, Coal, &c.

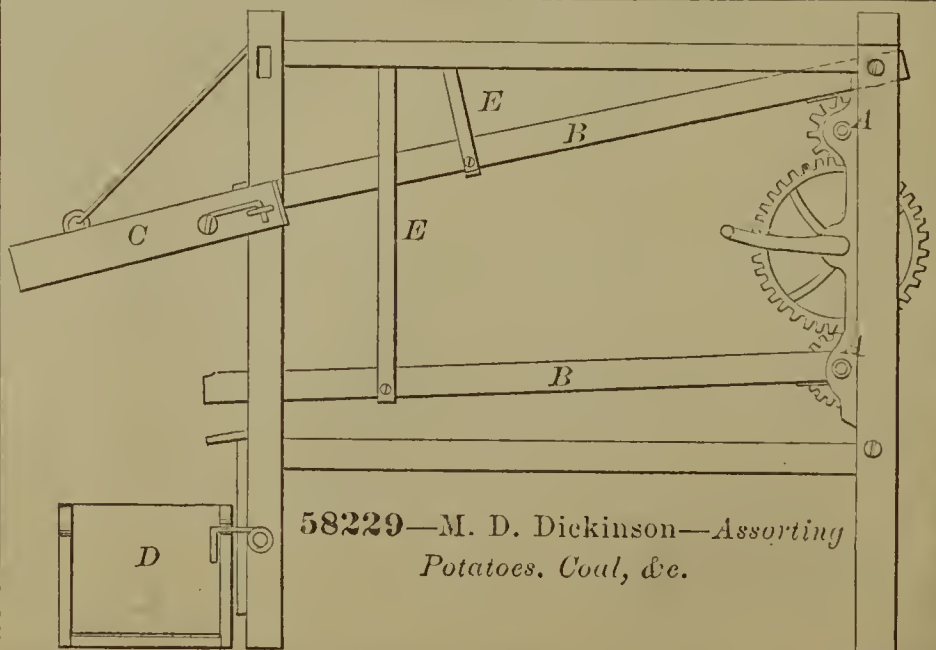

58230—B. Douglas—*Boot Jack and Blacking Case.*

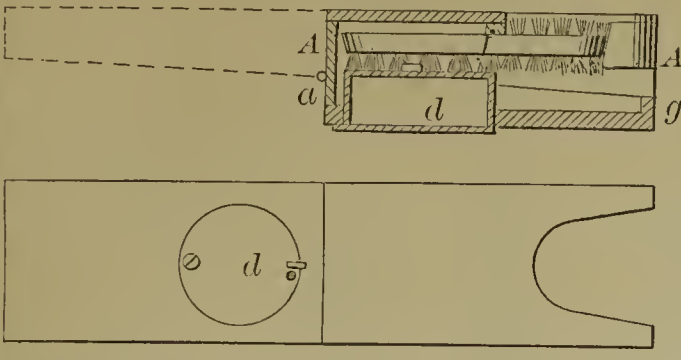

58235—L. C. English—*Stump Extractor.*

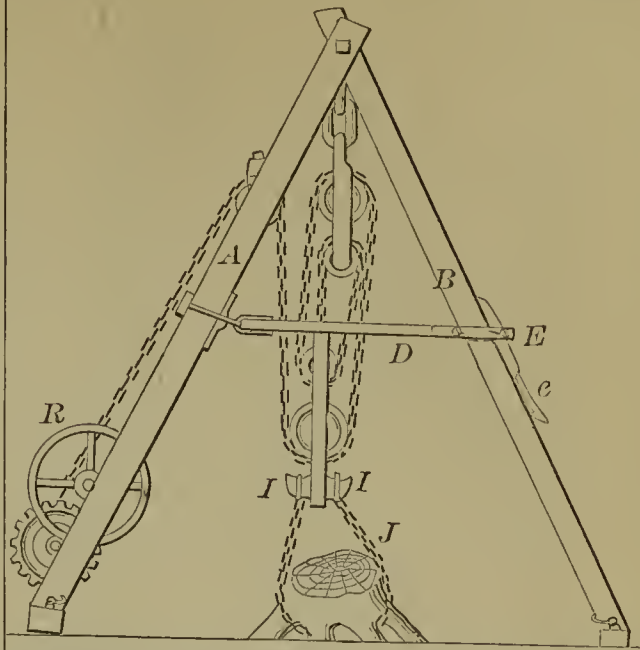

58233—N. J. Eldred—*Stove Pipe Damper.*

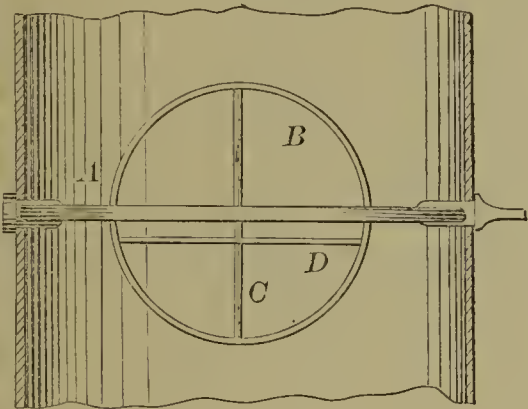

58231—J. B. Duane—*Reclining Chair.*

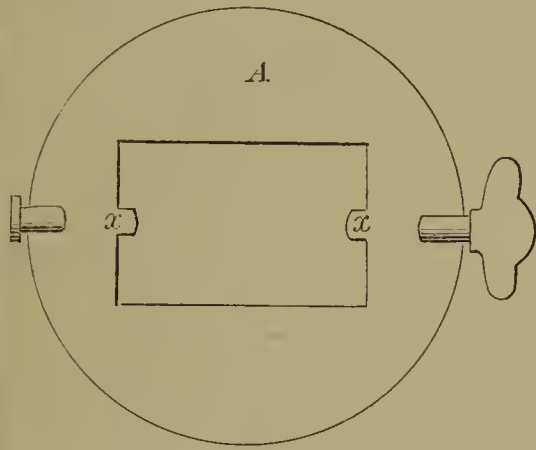
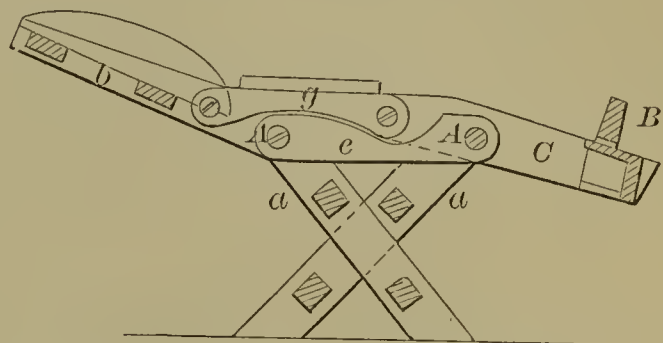

58237—D. Fasig—*Straw and Hay Knife.*

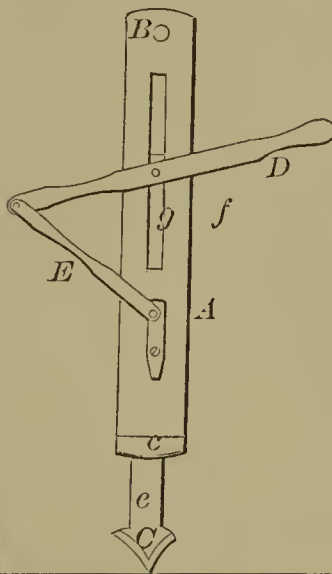

58236—Farguhar & Doan—*Evaporator.*

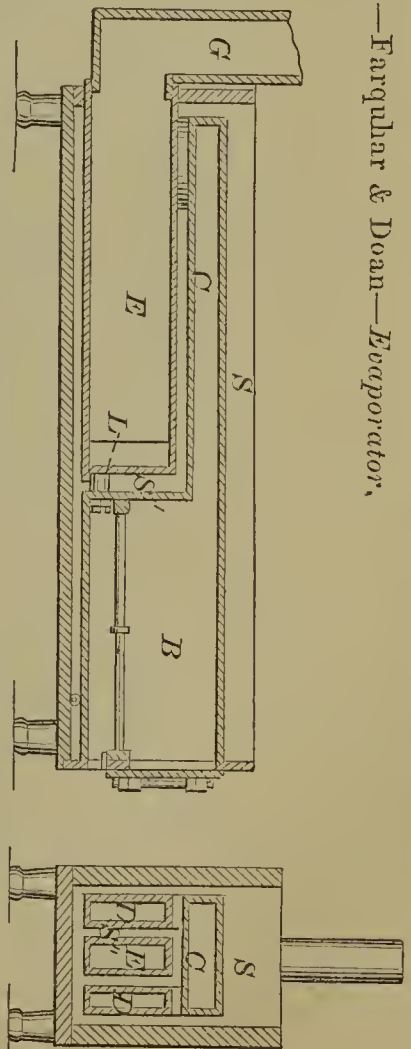

58234—O. Ellsworth—*Bit Stock.*

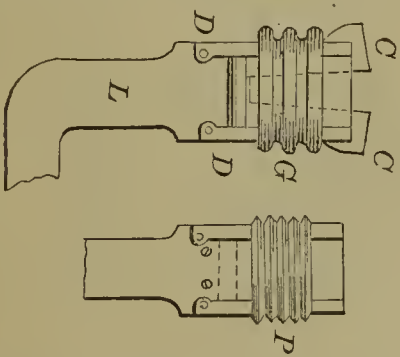

58238—B. Fish—*Tuyere.*

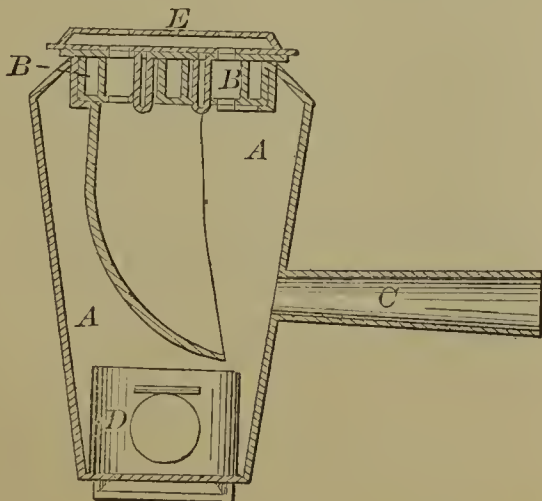

58239—C. Fisher—For Promoting Combustion in Furnaces.

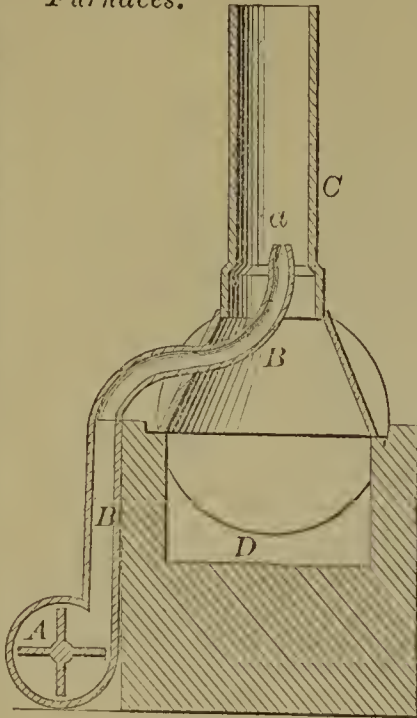

58241—J. Frankle—Measuring Distances.

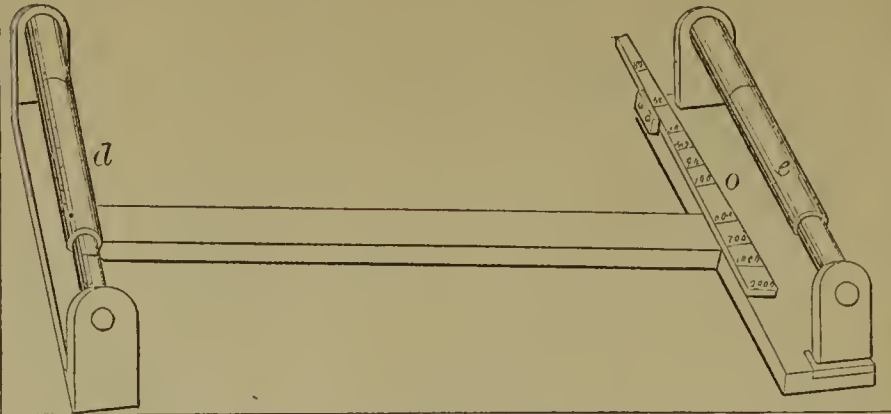

58245—H. W. Fuller—Sewing Machine.

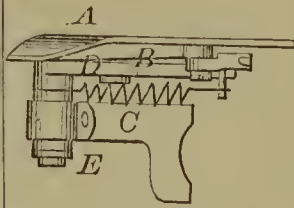

58240—F. Fitzgerald—Vault Cover.

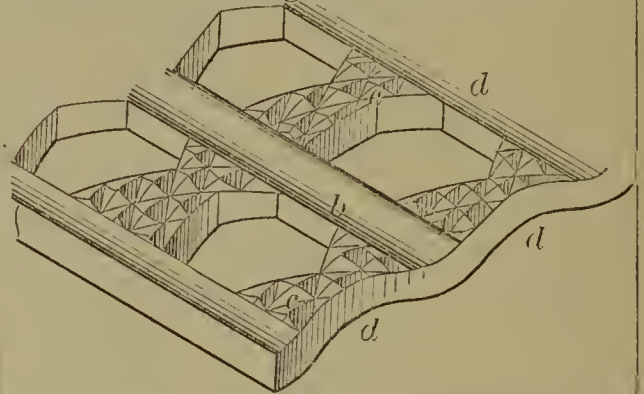

58243—W. J. Freeman—Seeder and Cultivator.

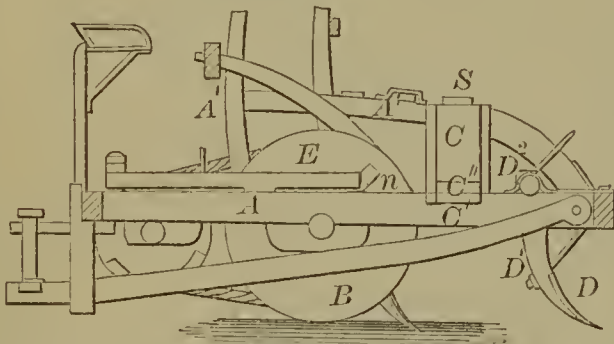

58247—C. H. Guard—Attaching Hubs to Acles.

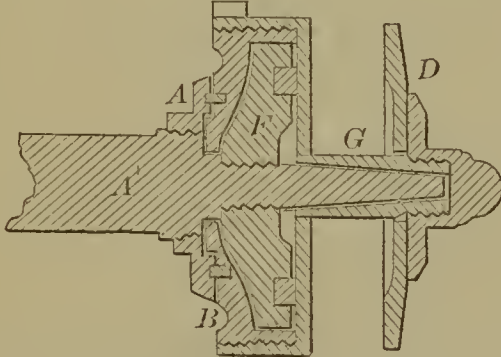

58242—J. D. Fenny—Knife and Fork.



58244—A. French—Lantern.

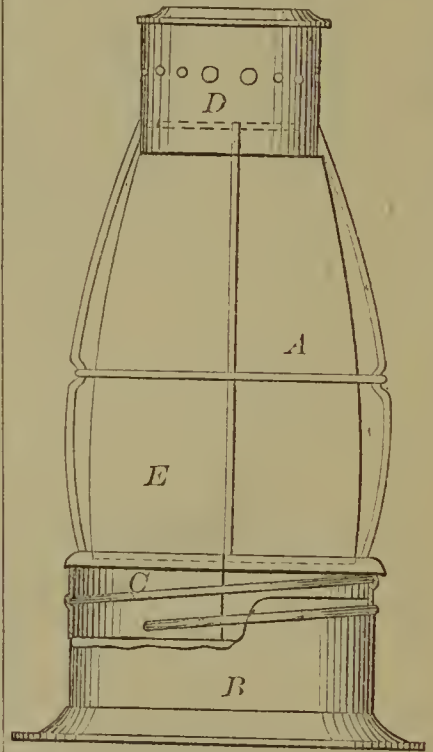

58248—J. Haines—Fuel Damper.

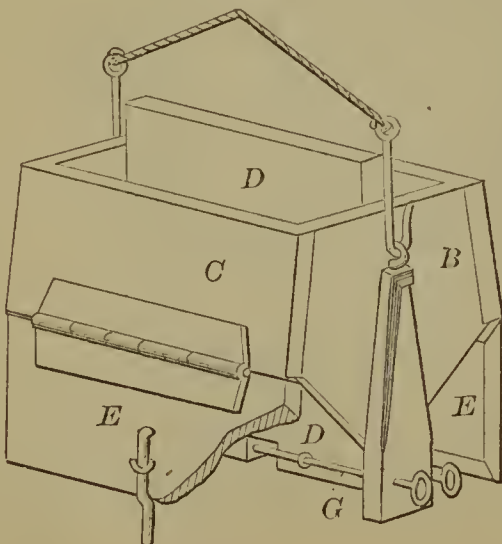

58246—W. Gilbert—Roofing

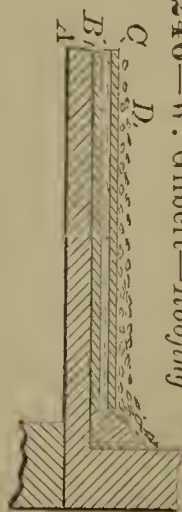

58250—N. Harper—Fan.

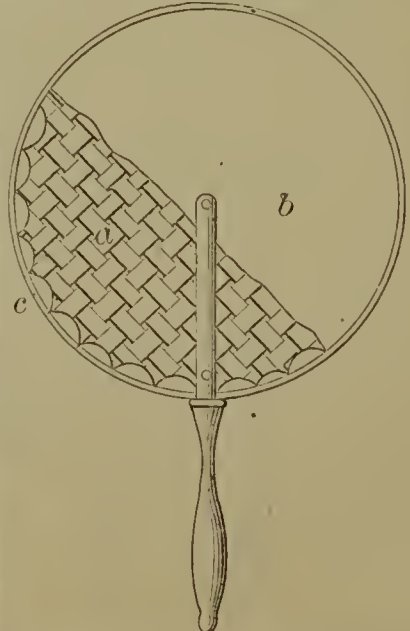

58251—B. I. Harris—*Stove Pipe Damper.*

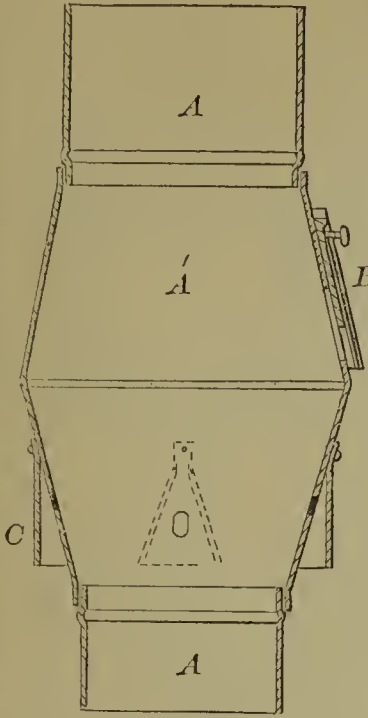

58254—R. Heneage—*Grain Dryer.*

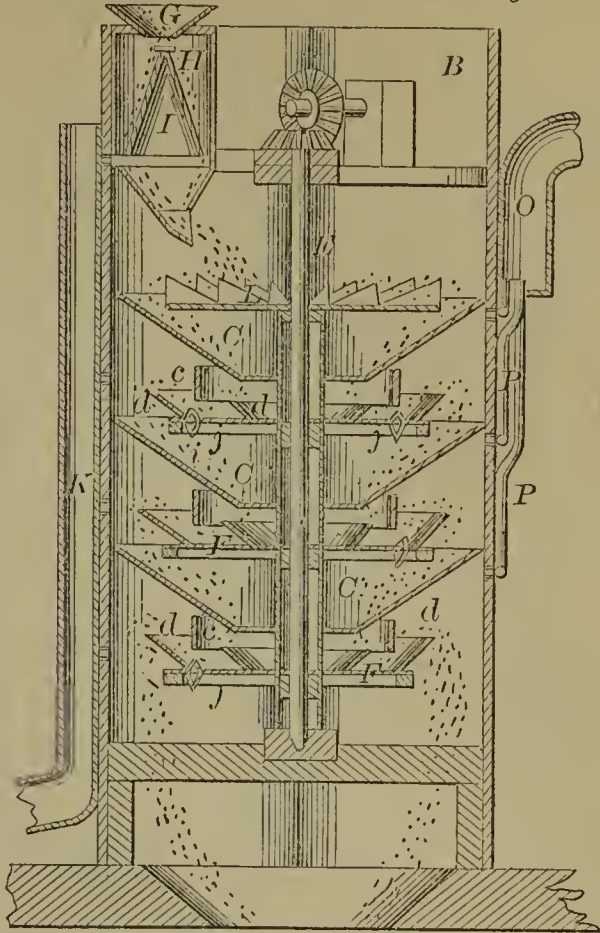

58257—C. M. Hooker—*Dentists' Tooth Plugger.*

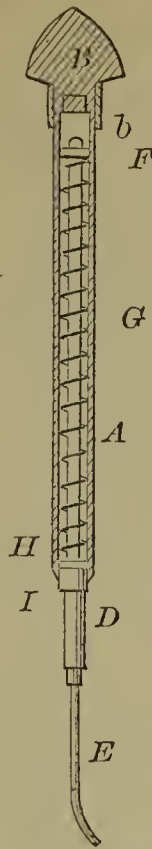

58253—T. S. Hathaway—*Match Safe.*

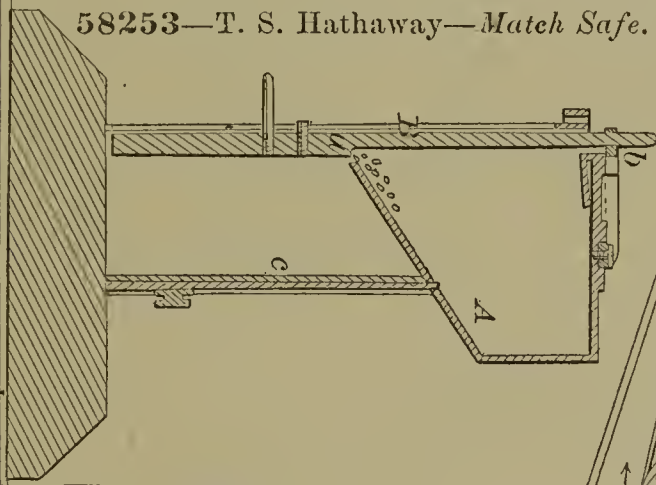

58256—G. Holland—*Stretching Silk, &c.*

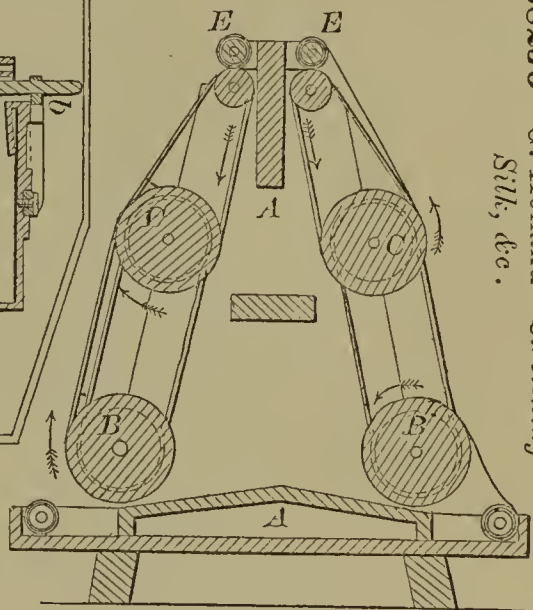

58255—T. A. Hoffmann—*Respirator.*

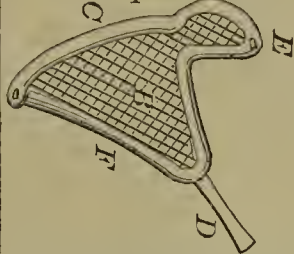

58258—H. Howard—*Steam Radiator.*

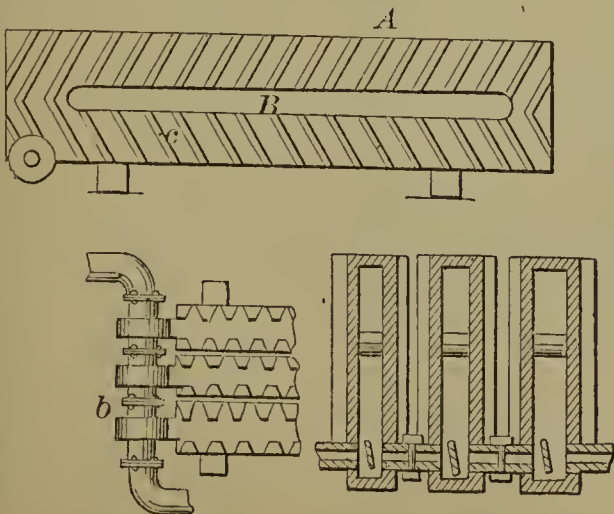

58259—Hubbell & Sherman—*Hay Elevator.*

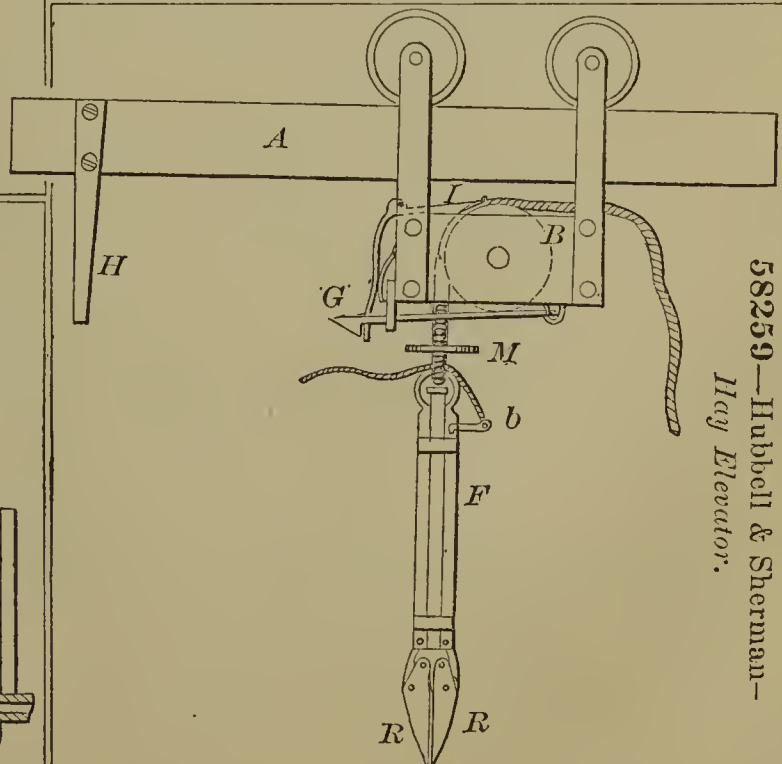

58252—S. Harrison—*Grate Bar.*

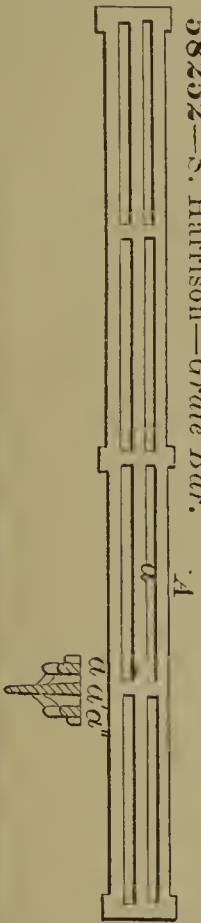

58260—J. S. Hull—*Petroleum Cooking and Heating Apparatus.*

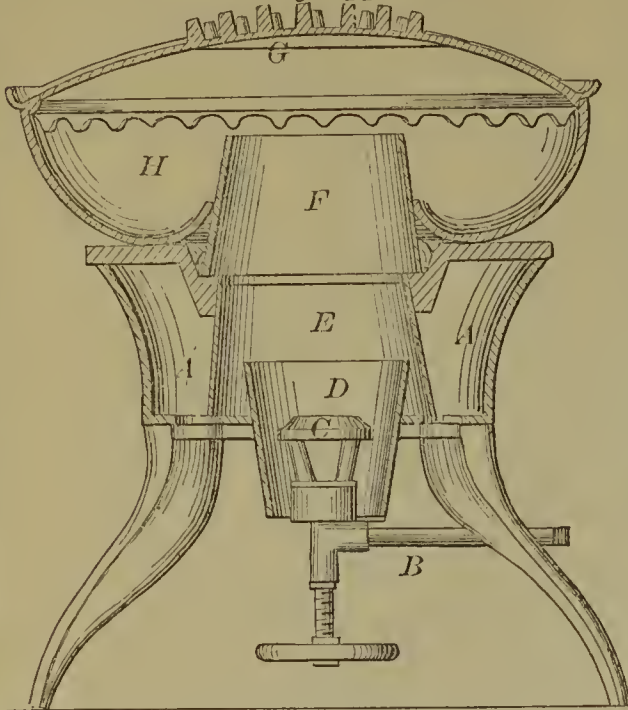

58261—J. S. Hull—*Vapor Lamp Burner.*

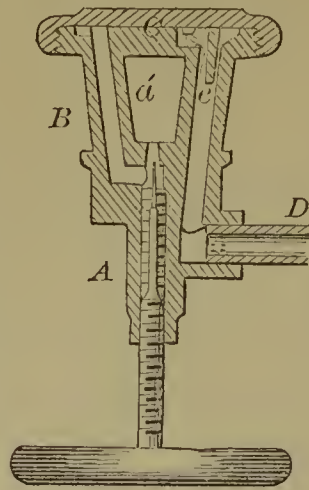

58262—J. W. Hyde—*Measuring Scale for Coffins.*

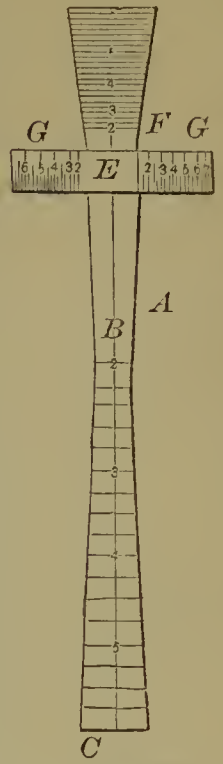

58263—J. Johnson—*Manger.*

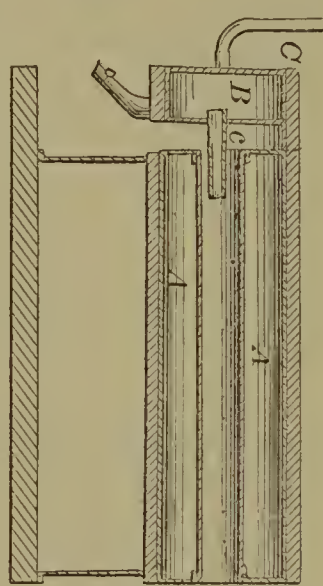
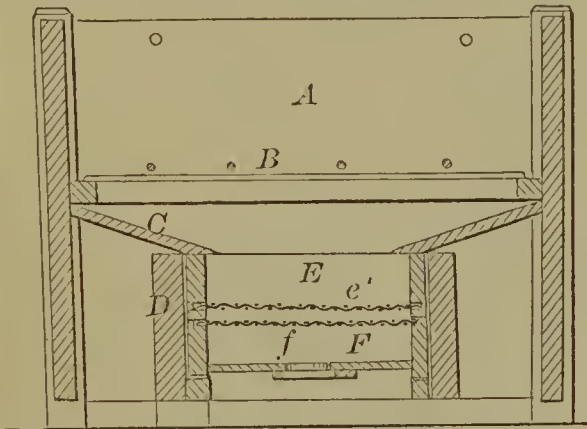

58264—J. H. Johnson—*Steam Blower.*

58265—L. Heller—*Lamp Chimney Cleaner.*

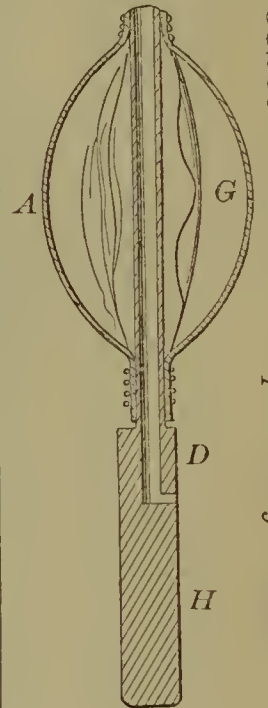

58266—Z. King—*Bridge.*

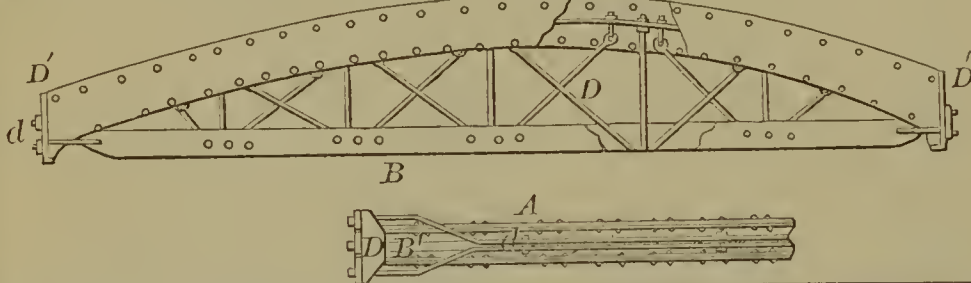

58267—I. Lamplugh—*Shearing Apparatus.*

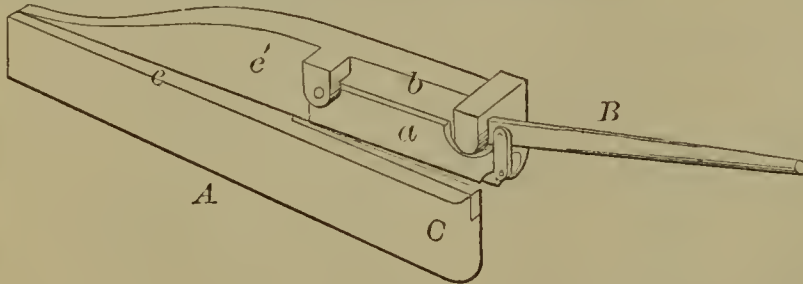

58270—A. A. Marks—*Card Holder.*

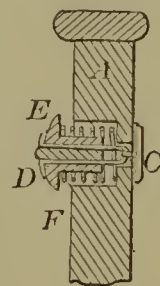

58269—J. B. H. Leonard—*Knife and Fork.*



58268—R. A. Leeds—*Gate Fastening.*

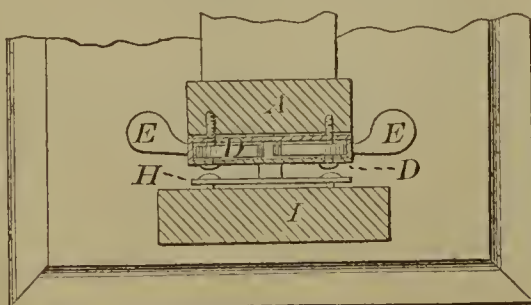

58271—D. Masten—*Level.*

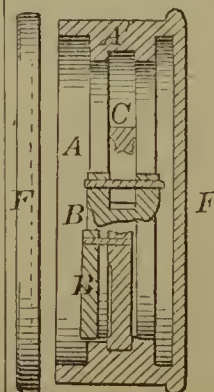



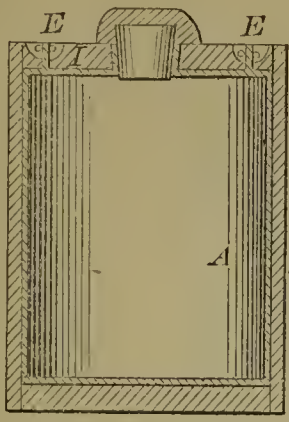

58272—J. W. Masury—Packing Vessels for Petroleum.

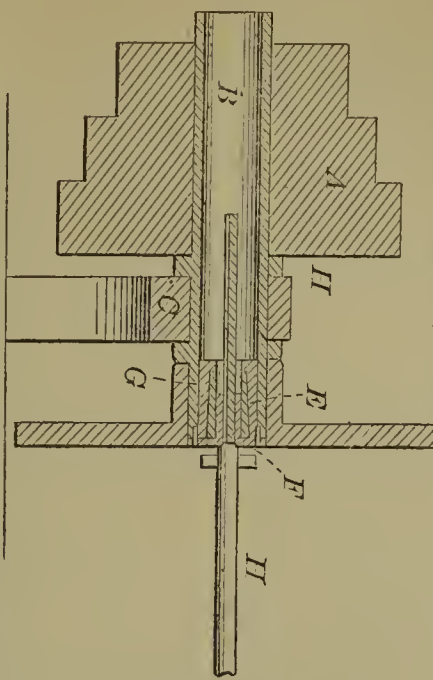
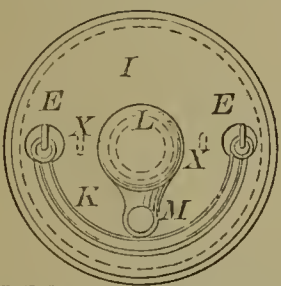

58273—C. E. McBeth—Boring Attachment to Lathes.

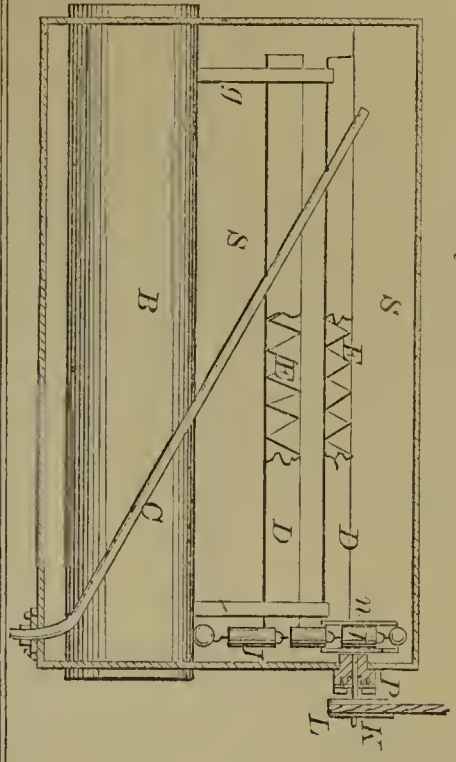

58275—J. McMurtry—Steam Generator.

58274—J. McDonald—Grain Drill.

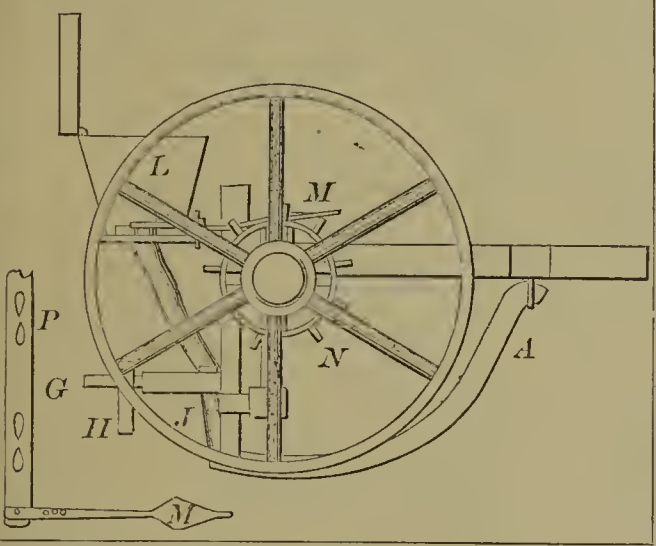

58276—G. W. Merchant—Beehive.

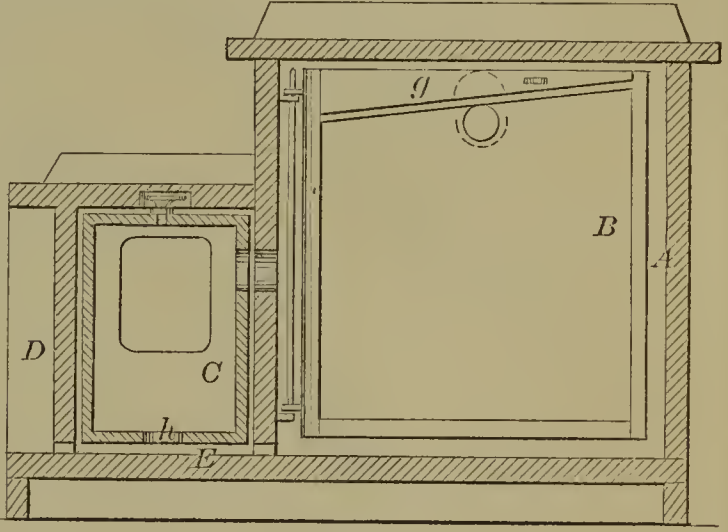

58277—Metz & Rohrer—Corn Planter.

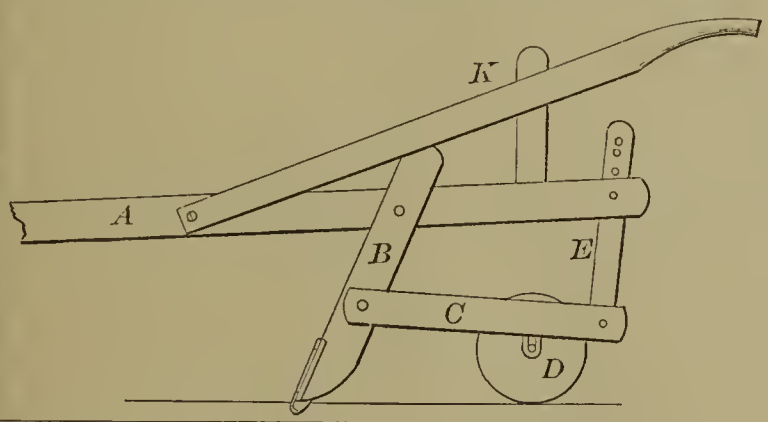

58280—A. Naramor—Wagon Hay Rack.

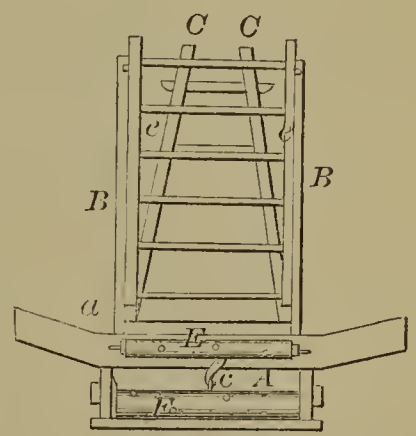

58278—E. M. & J. E. Mix—Padlock.

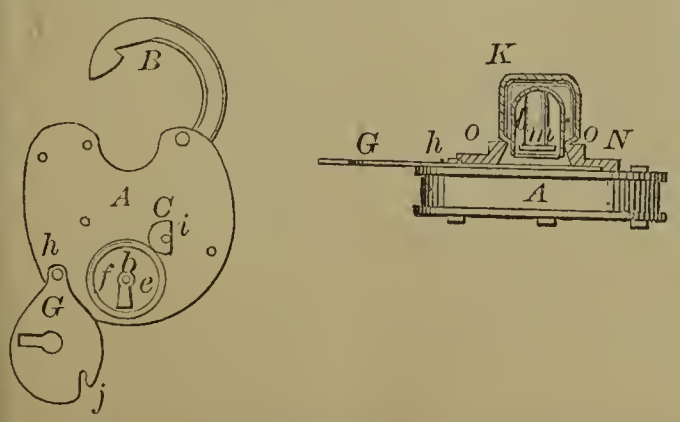

58279—J. U. Mueller—Stove Handle.

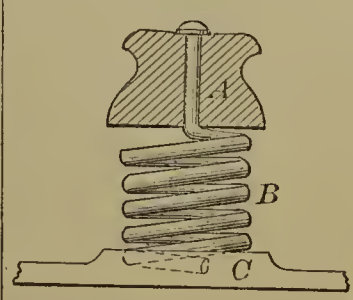

58281—M. V. Olry—Bottle Cap.

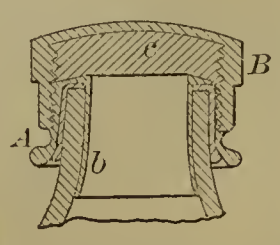

58282—H. S. Palmer—Hay Raker and Loader.

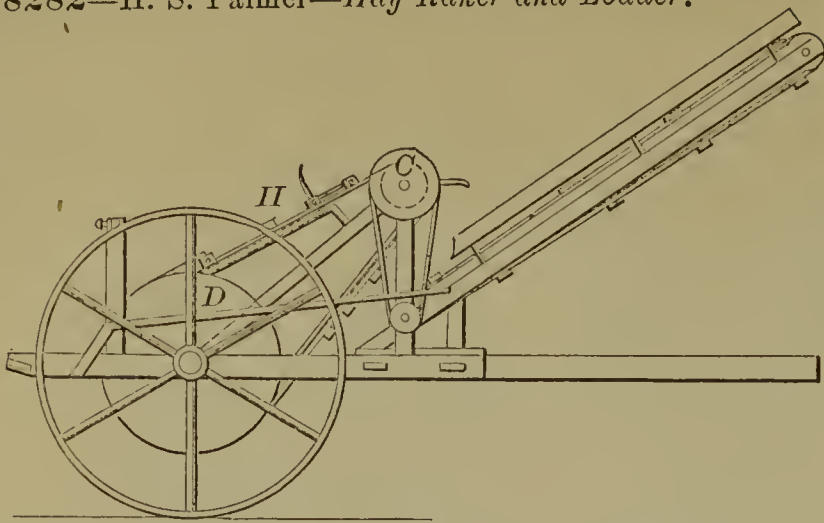

58283—I. E. Palmer—Mosquito Canopy Frame.

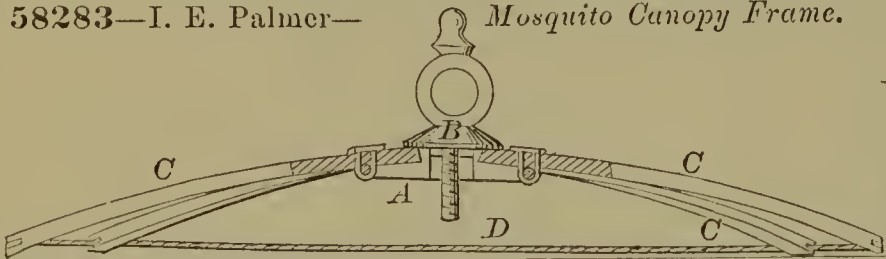

58284—E. Perin—Roller and Seed Planter.

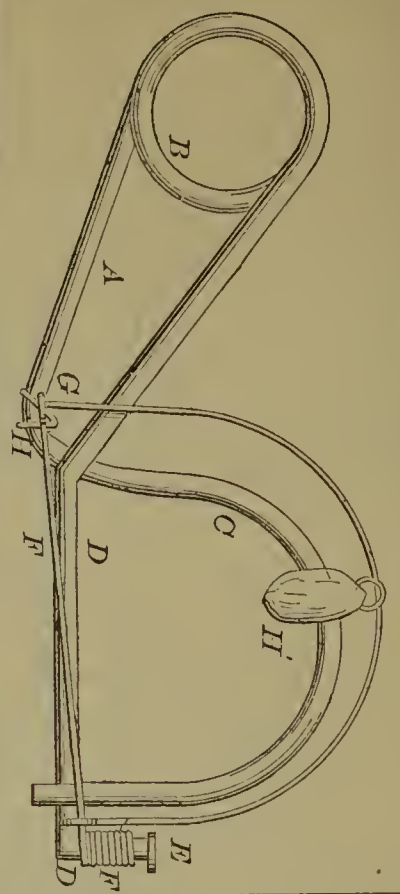
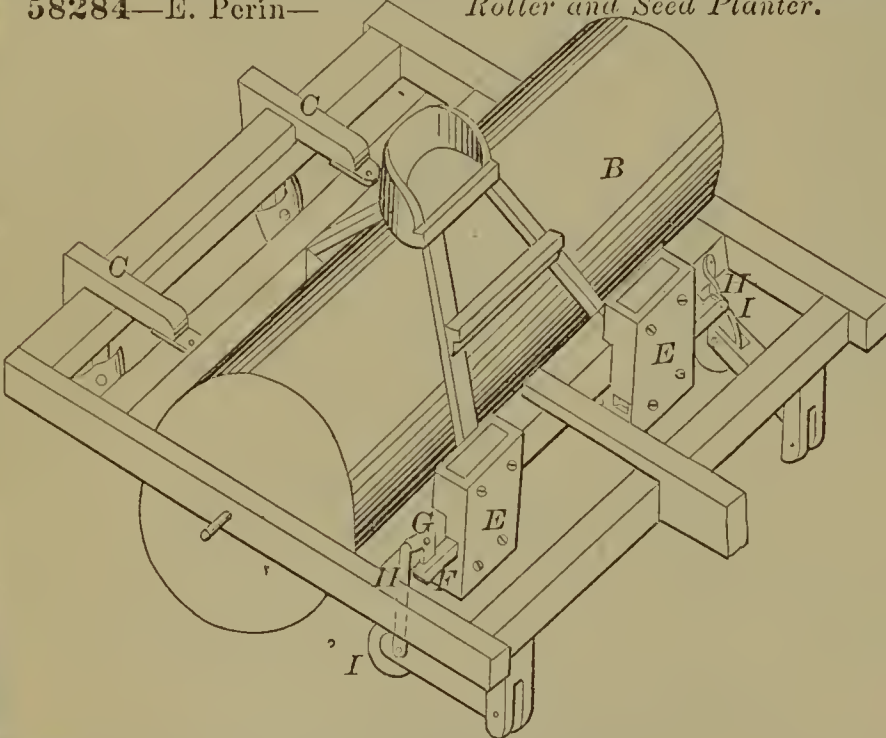

58286—D. N. Phelps—Animal Trap.

58287—M. Pollak—Watch Chain Hook.

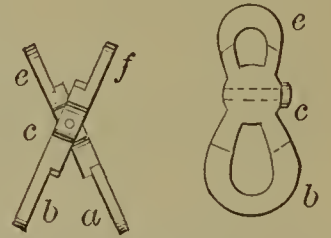

85288—I. T. Price—Churn.

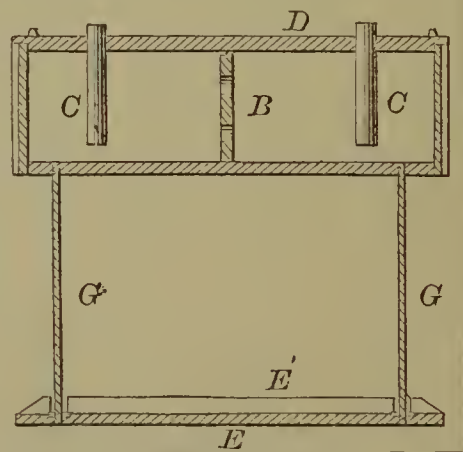

58289—Quinby & Lobdell—Rotary Digger.

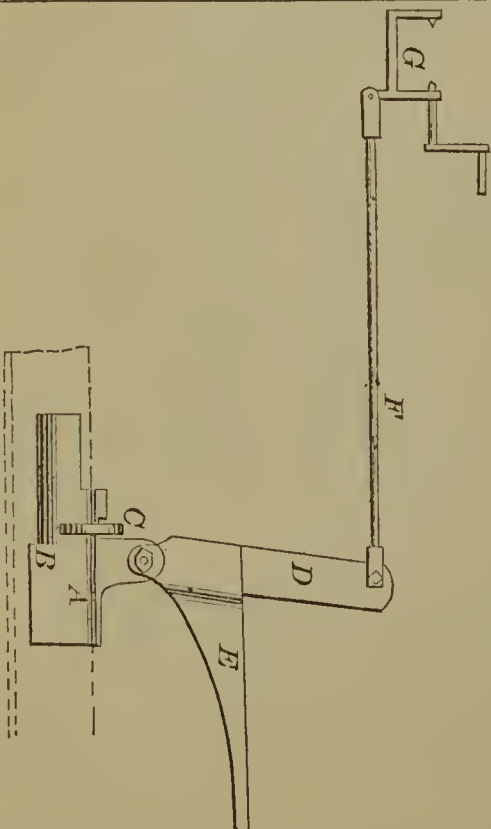
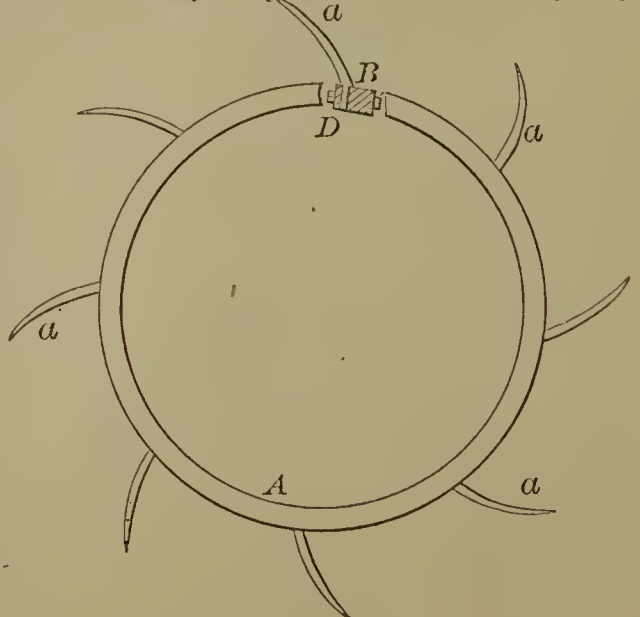

85285—J. W. Pettengill—Moving Cars on the Tracks.

85290—D. R. Reed—*Sheep Holder.*

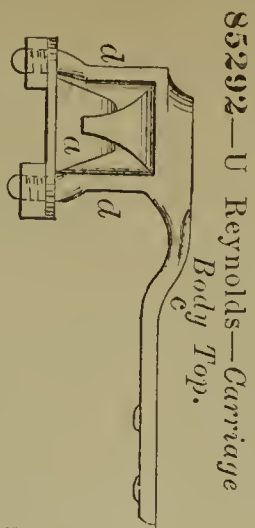
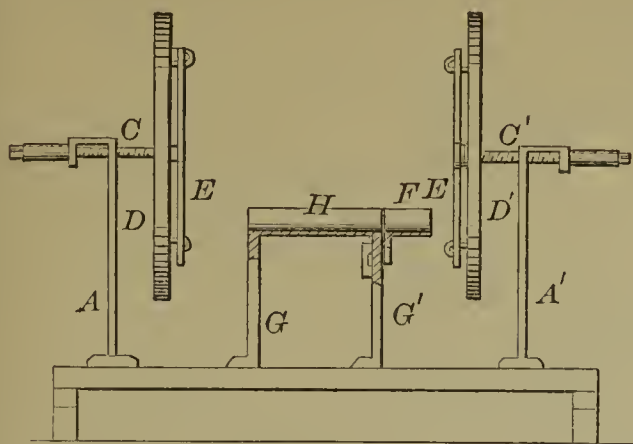

85292—U Reynolds—*Carriage Body Top.*

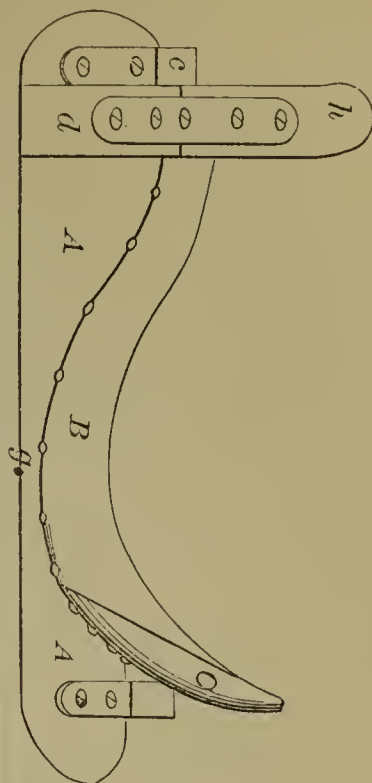

58293—Rhodes & Hazlewood—*Ladies' Saddle Tree.*

58291—F. Rehorn—*Sad Iron Handle.*

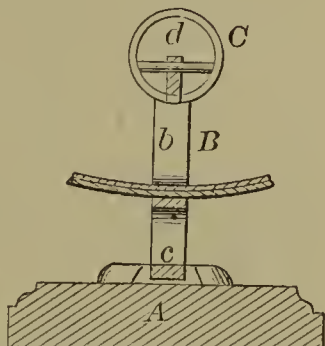
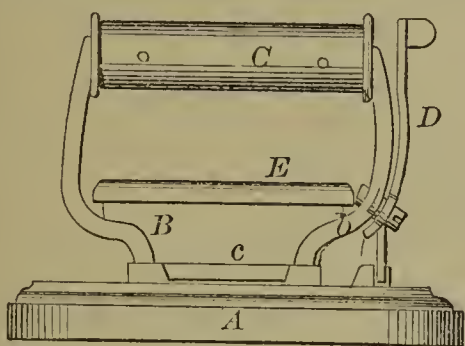

85294—G. W. Richardson—*Steam Safety Valve.*

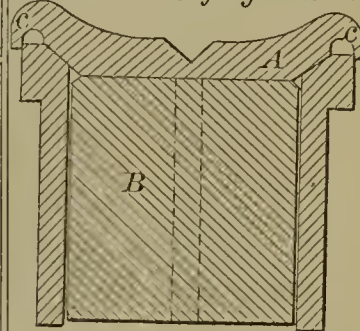

58295—J. S. Rickel—*Corn Planter.*

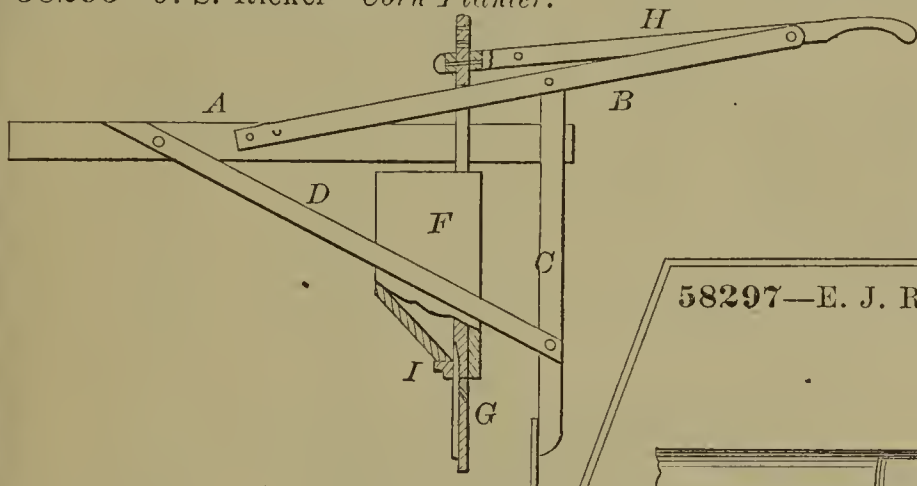

58297—E. J. Robinson—*Saw.*

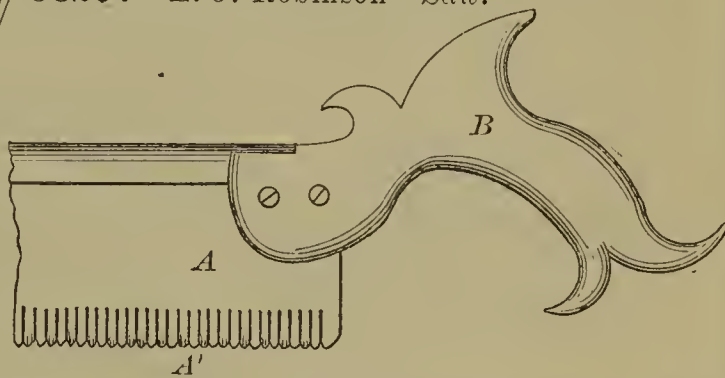

58299—J. B. Root—*Boring and Pumping Apparatus for Oil Wells.*

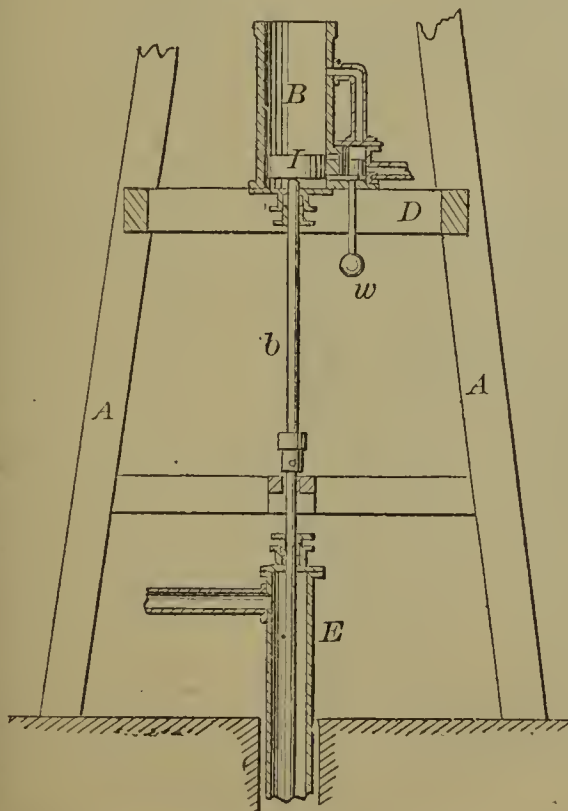

85296—A. Rix—*Candleslick.*

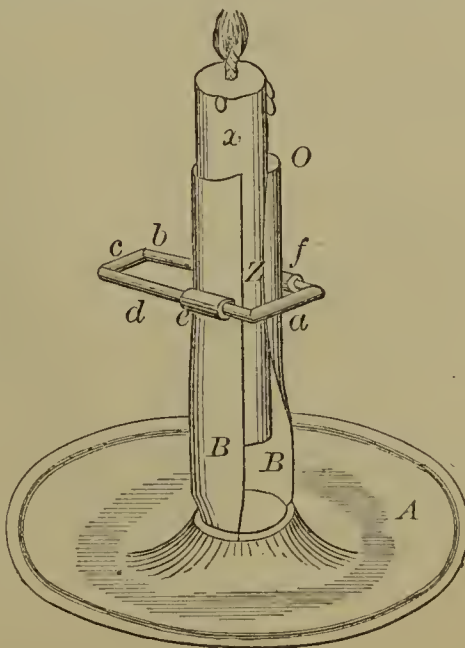

85298—E. S. Robinson—*Car Wheel.*

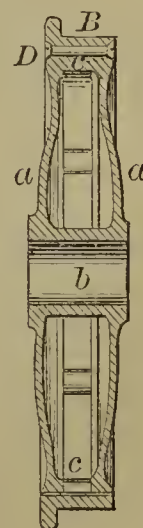

58300—S. H. Rose—Fence.

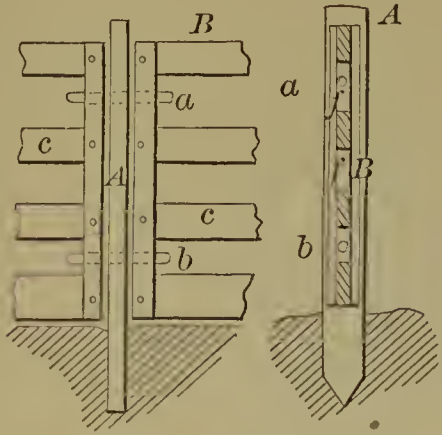

58304—Saladec & Veach—Mechanical Movement.

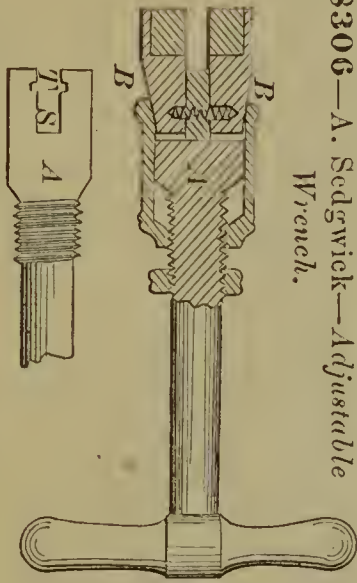
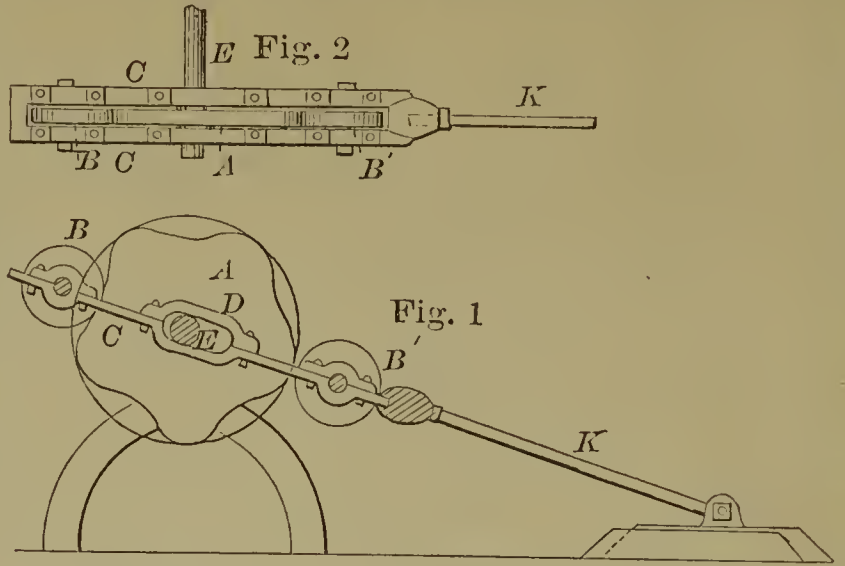

58306—A. Sedgwick—Adjustable Wrench.

58301—P. A. Royce—Mechanical Medicator.

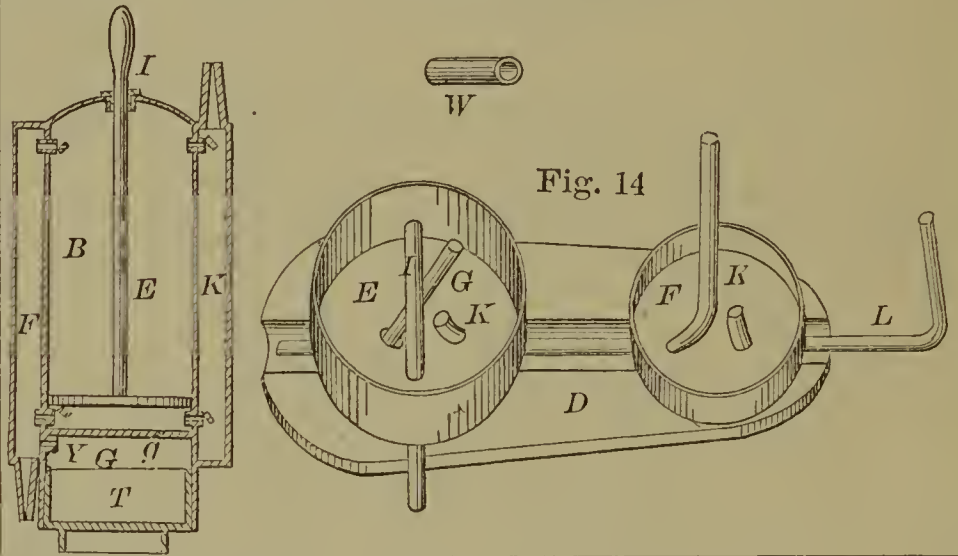

58305—G. T. Savary—Pea Sheller.

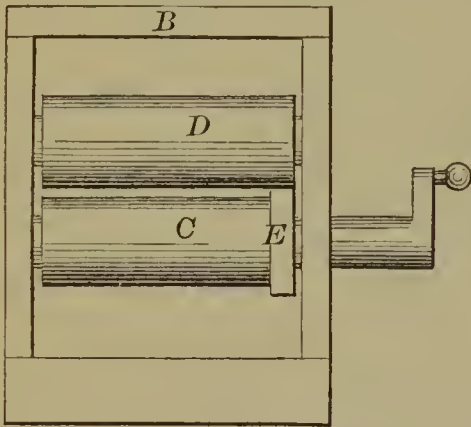

58307—D. Sexton—Rotary Valve.

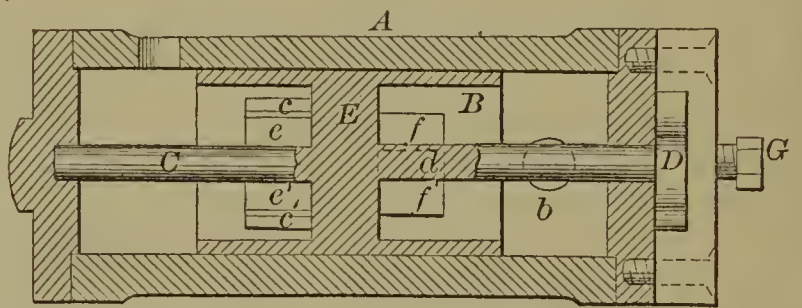

58308—J. W. Shankland—Fence.

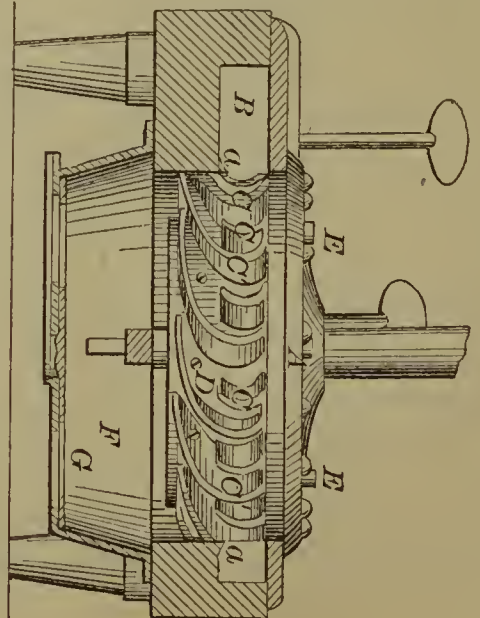
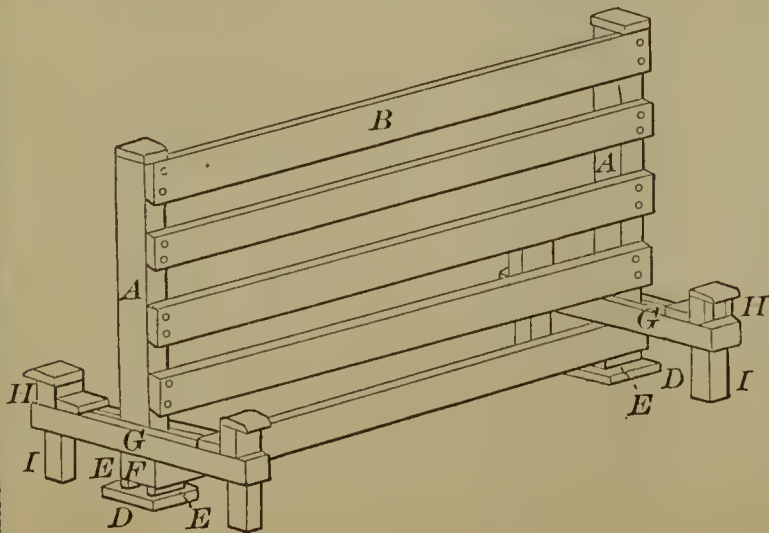

58309—S. Sherman—Water Wheel.

58310—A. M. Smith—*Button.*



58311—W. M. Smith—*Measuring Stopple for Canisters.*

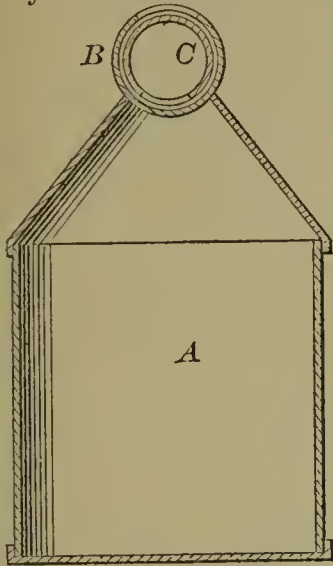

58312—L. Soehmann—*Pepper Caster.*

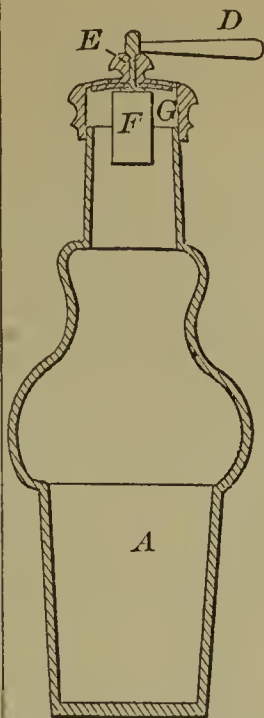

58315—C. S. Stearns—*Leather Cutter.*

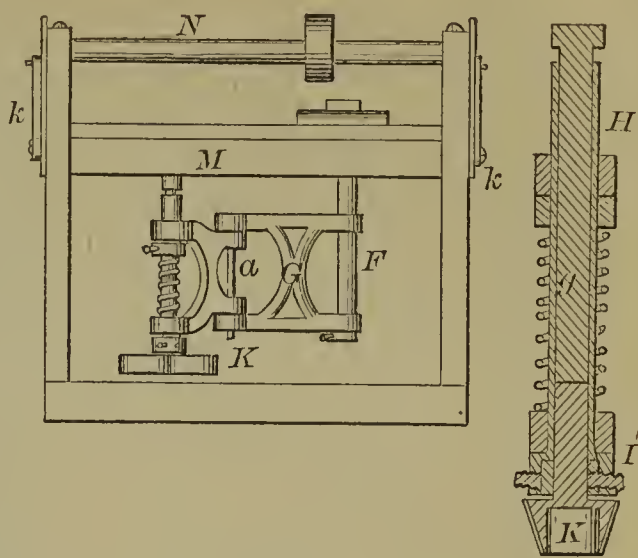

58318—Summers & Dement—*Plow.*

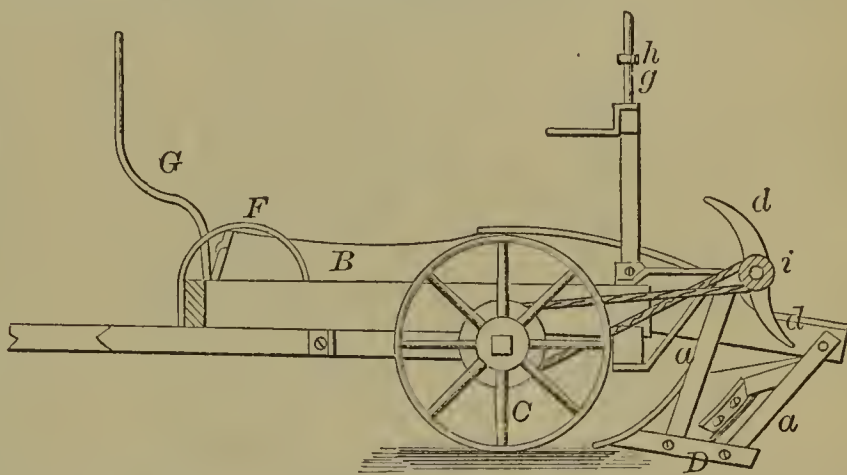

58316—E. I. Stearns—*Syphon.*

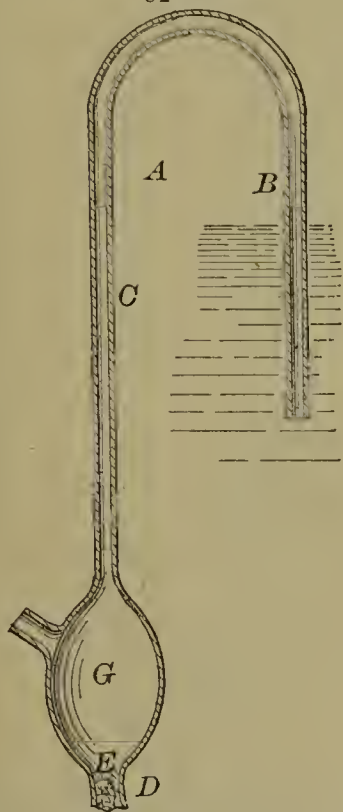

58314—C. L. Spencer—*Needle Threader.*

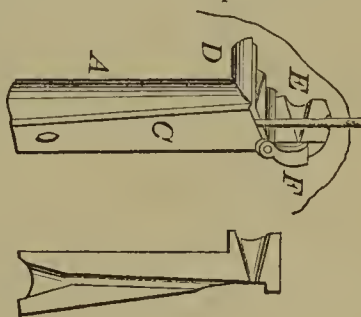

58313—W. B. Soumeilian—*Billiard Table Leg Attachment.*

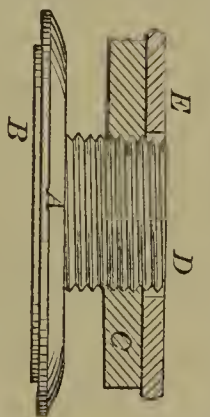

58317—J. W. Stiles—*Raising Water by Steam.*

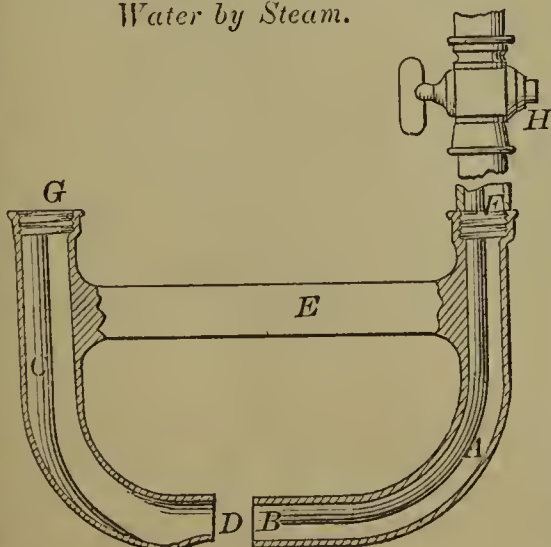

58319—A. Thompson—*Rotary Cultivator.*

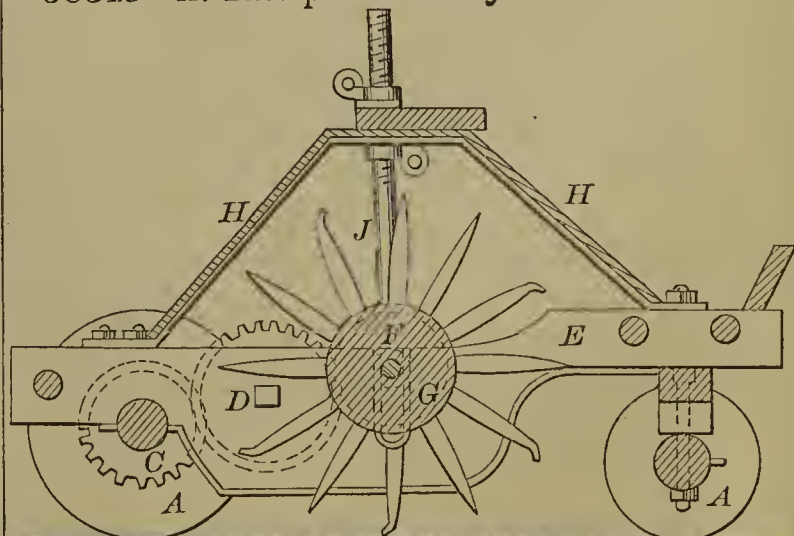

58320—D. J. Tittle—*Corn Harvester.*

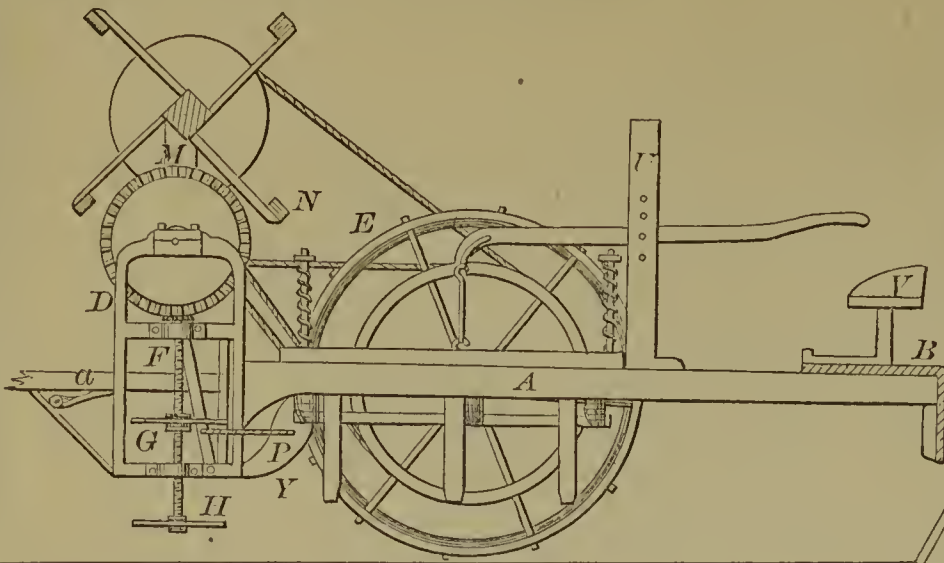

58322—W. S. Van Hoeseon—*Sash Supporter.*

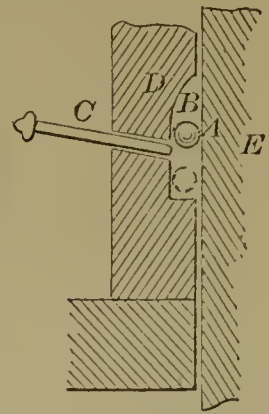

58321—N. Treadwell—*Supplying Gas on Steamboats.*

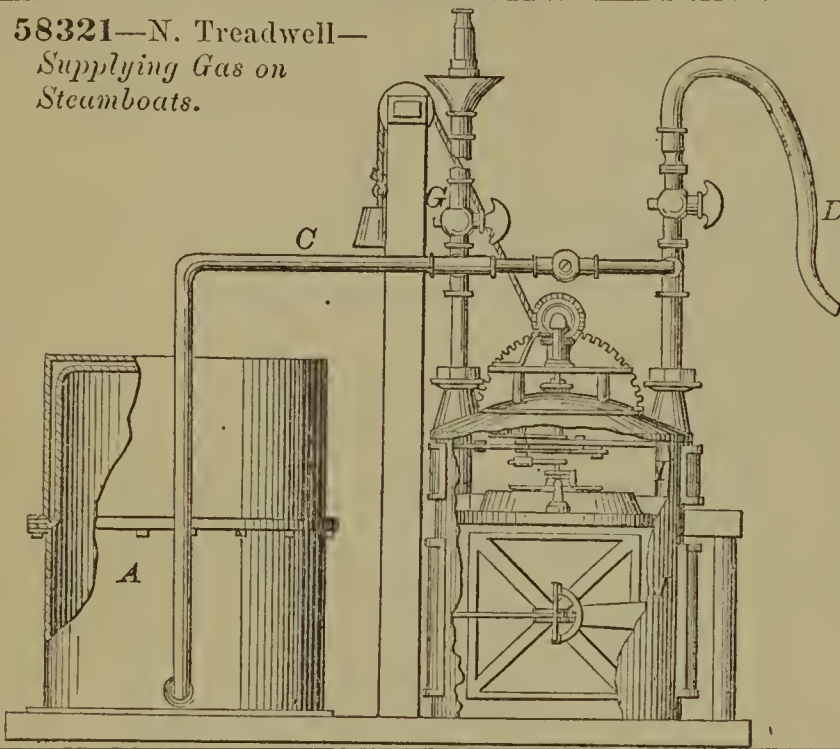

58323—W. Veber, Jr.—*Plow.*

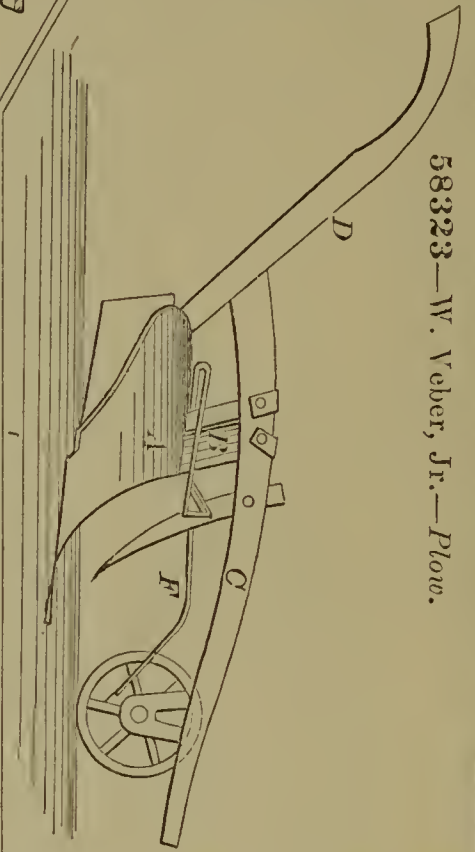

58324—W. P. Wage—*Sad Iron Heater.*

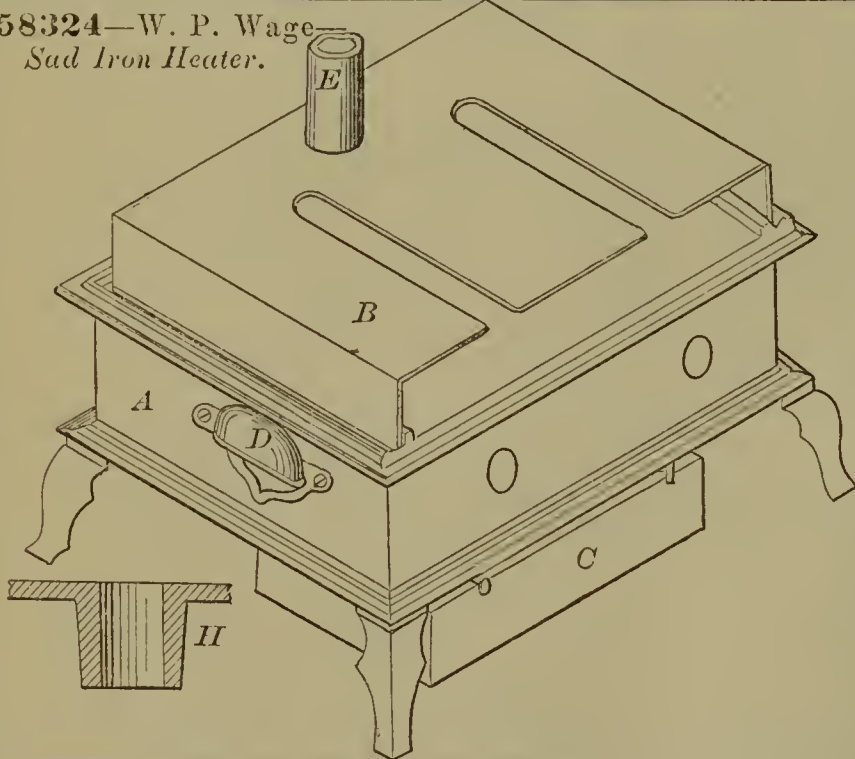

58325—G. A. Warner—*Flour Packer.*

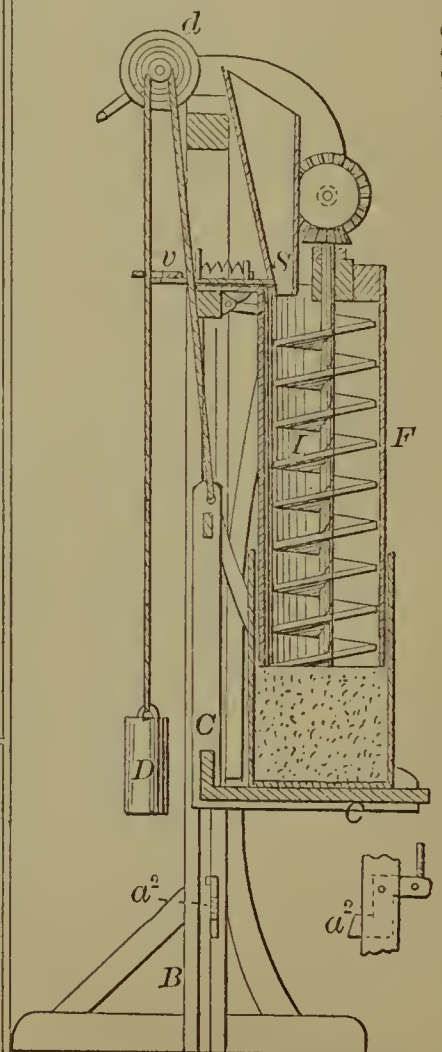

58326—G. F. Waters—*Pruning Instrument.*

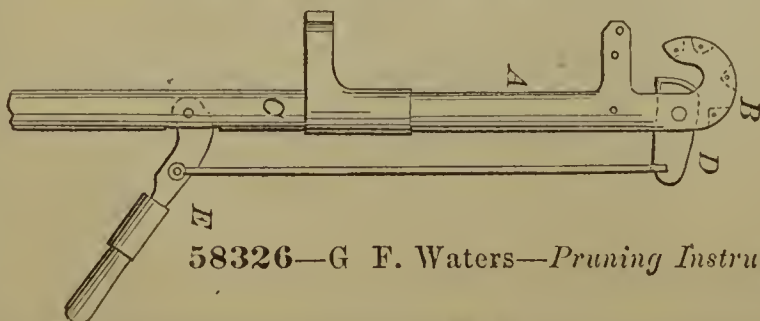

58327--T. V. Waymoth--Envelope Machine.

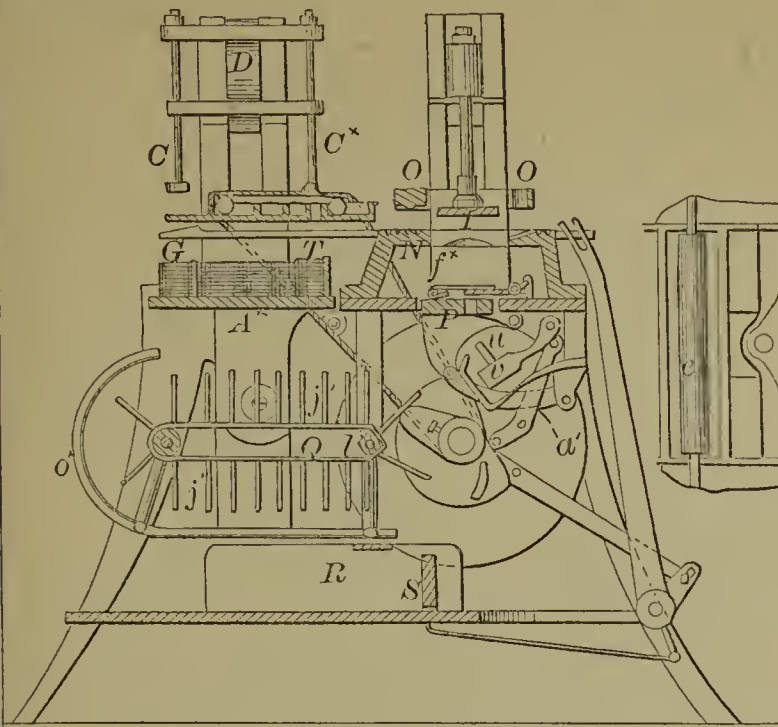

58328--W. H. White--Hat.

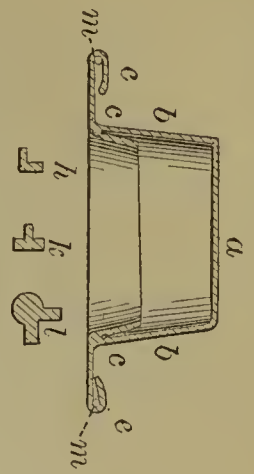

58329--W. H. White--Hat.

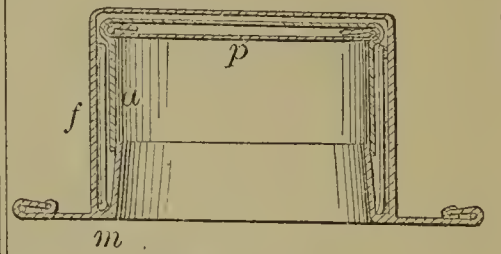

58331--J. E. Youngman--Evaporator.

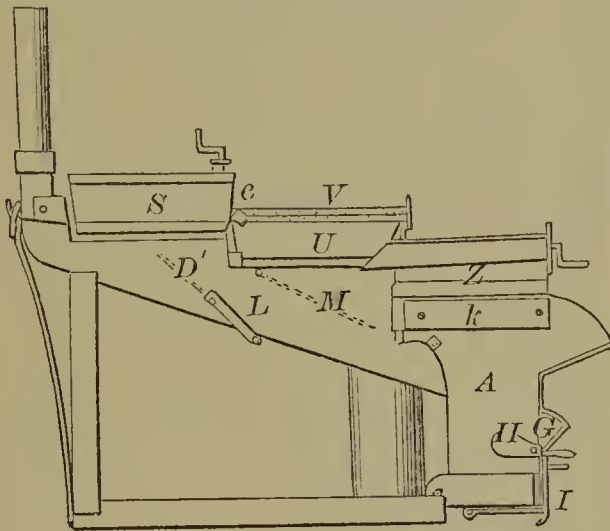

58332--A. W. Browne--Button.

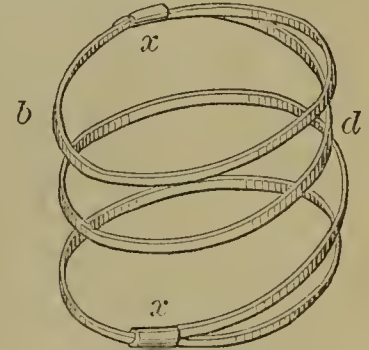
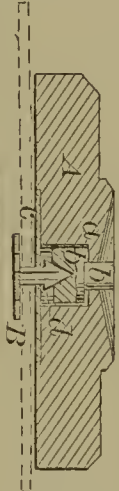

58330--J. L. Winslow--Shaft Coupling.

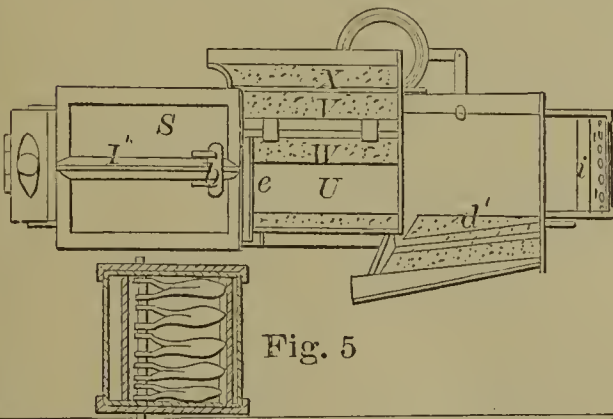
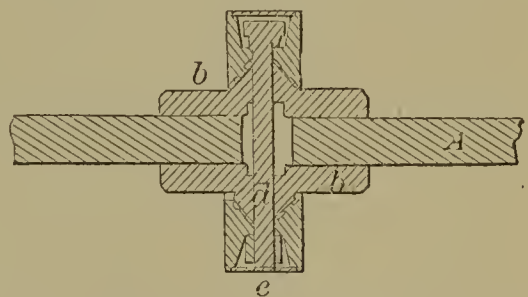
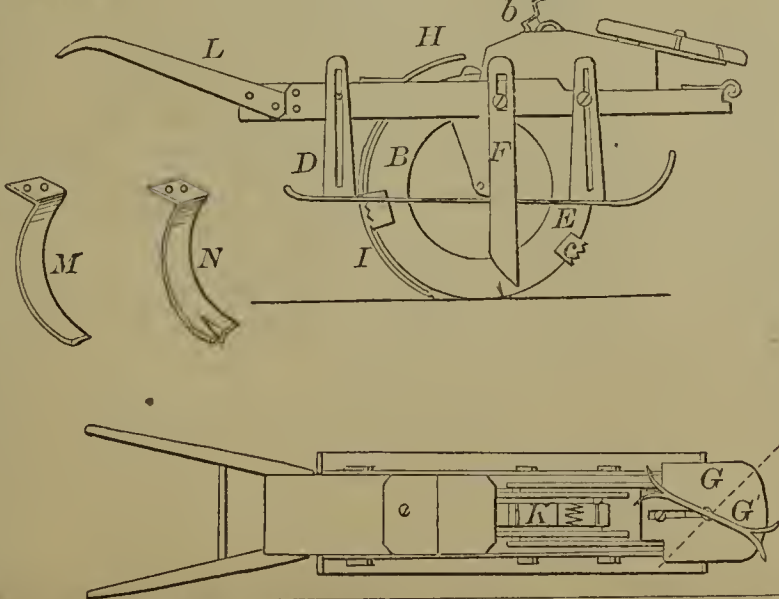
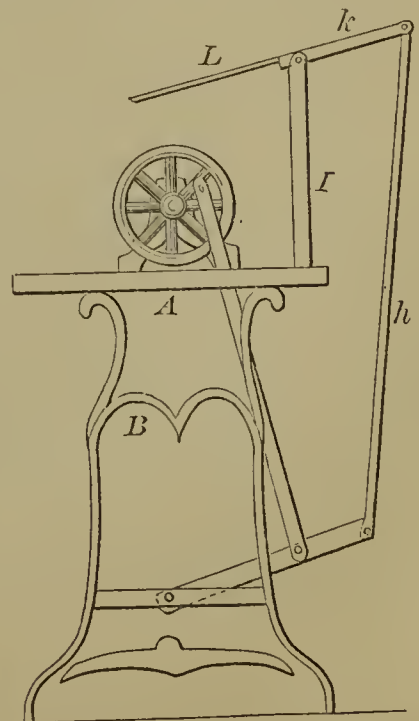

Fig. 5

58334--W. H. Burridge--Potato Digger.



58333--S. Burr--Sewing Machine Foot Attachment.



58335—S. F. Charles—*Amalgamator*,

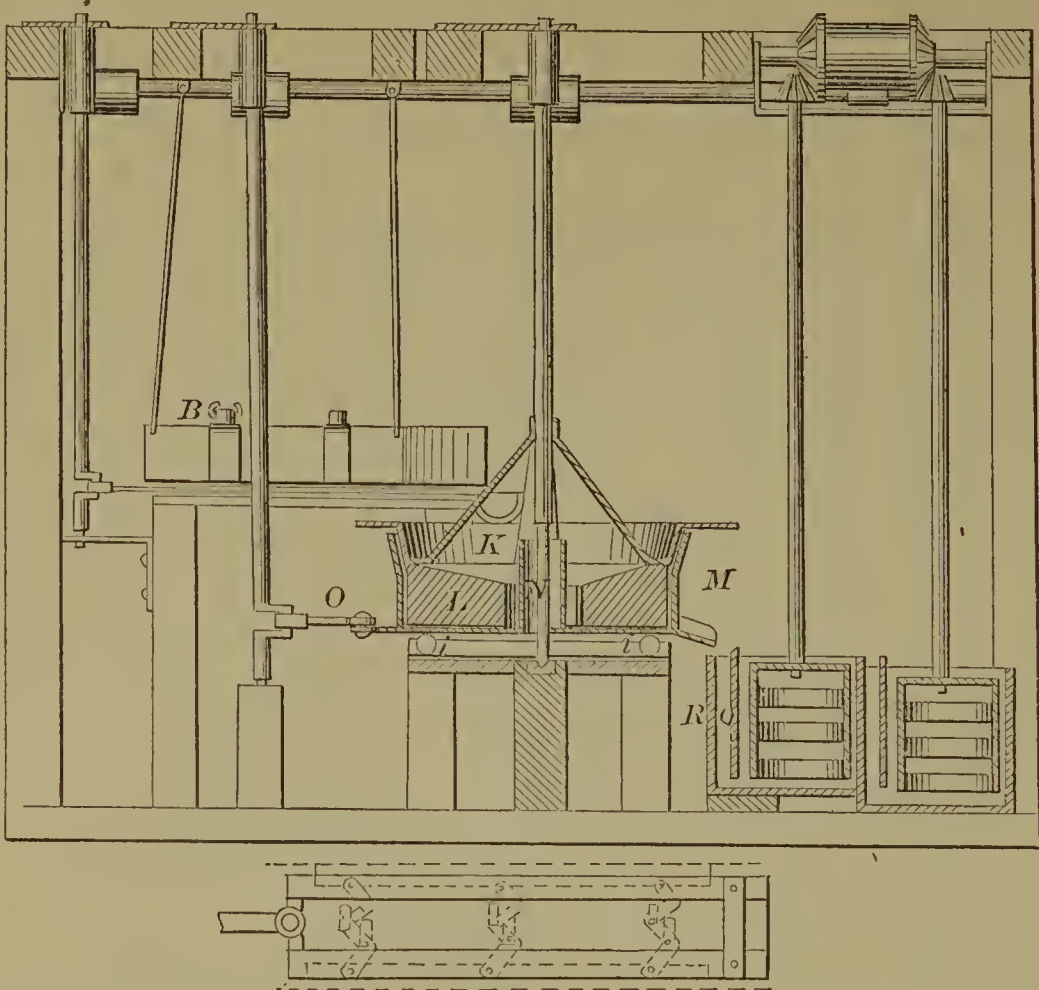

58336—D. M. Church—*Ladies' Skirt*.

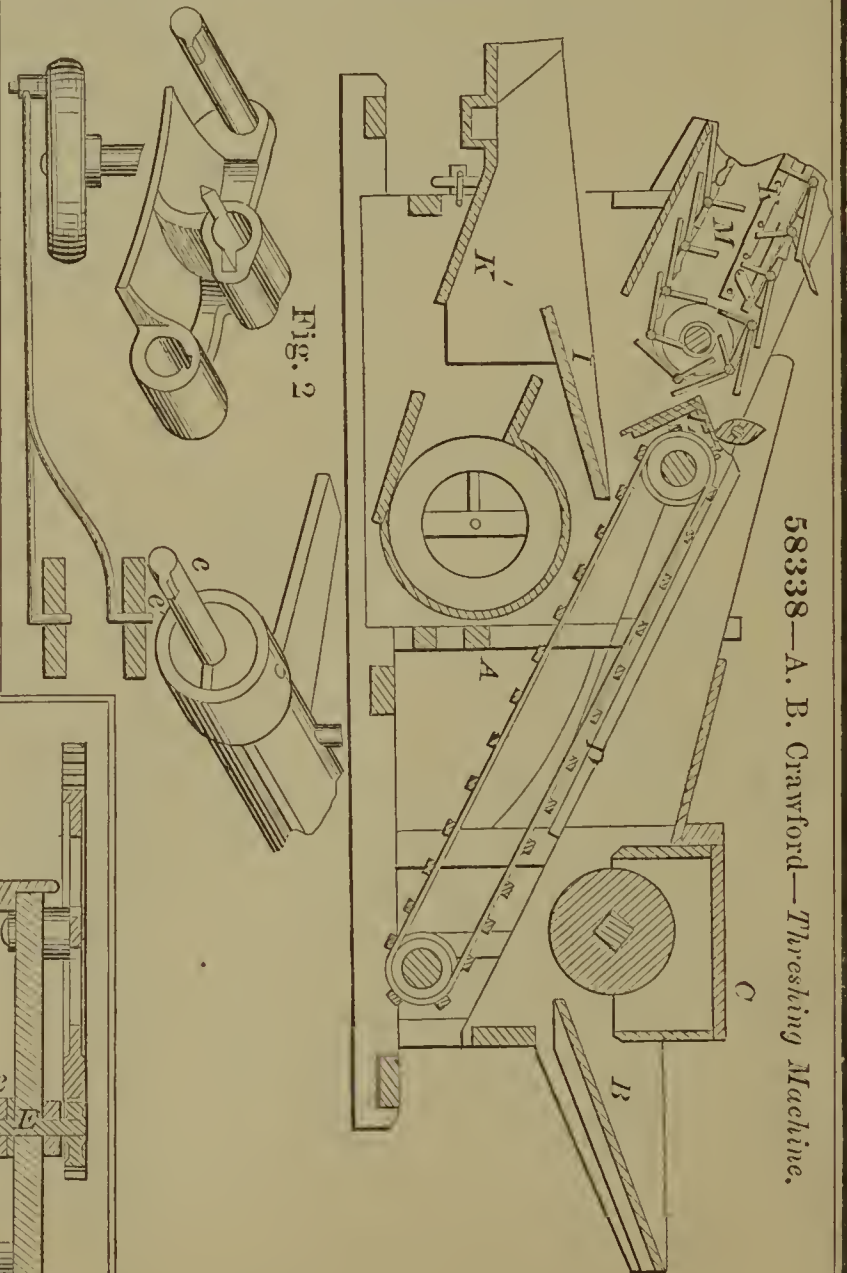
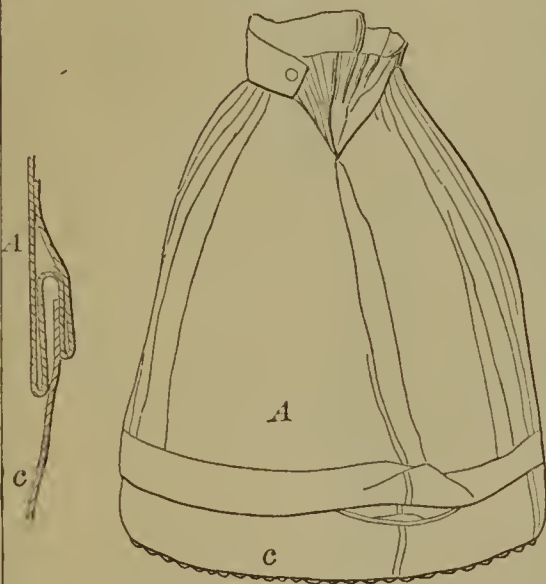

58338—A. B. Crawford—*Threshing Machine*.

58337—H. Cleft—*Churn*.

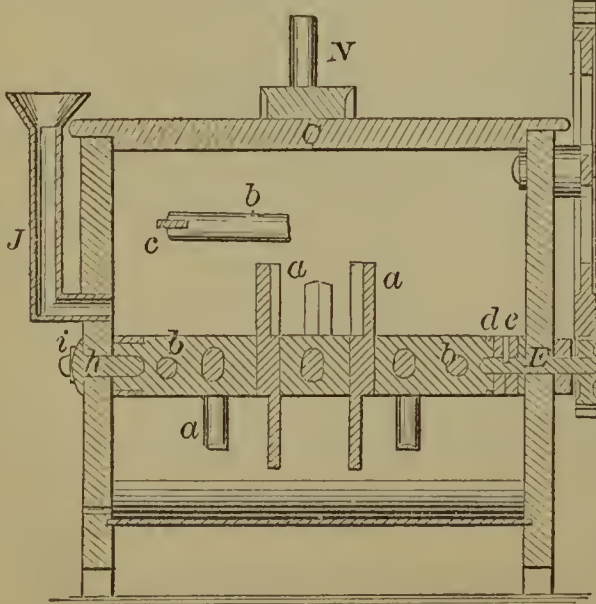



58339—J. C. Eggleston—  
*Lubricating Apparatus.*

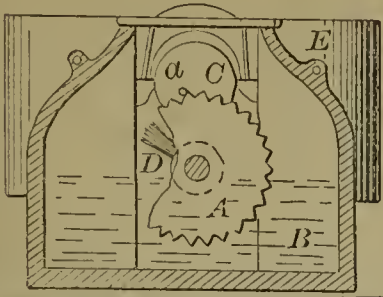

58341—Goodsell & Frisbie—*Cotton and Hay Press.*

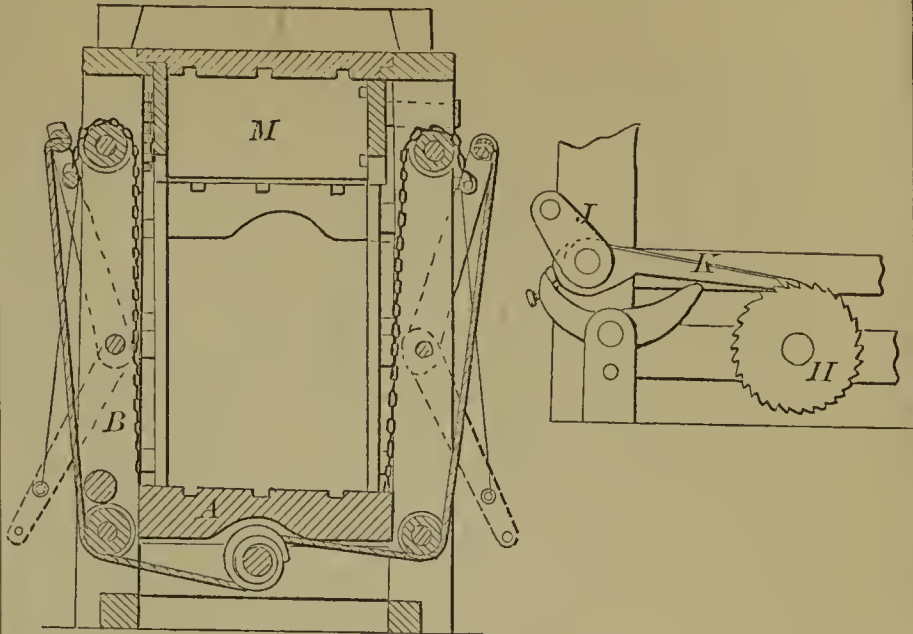

58342—R. H. Gray—*Lifting and Pressing Screw.*

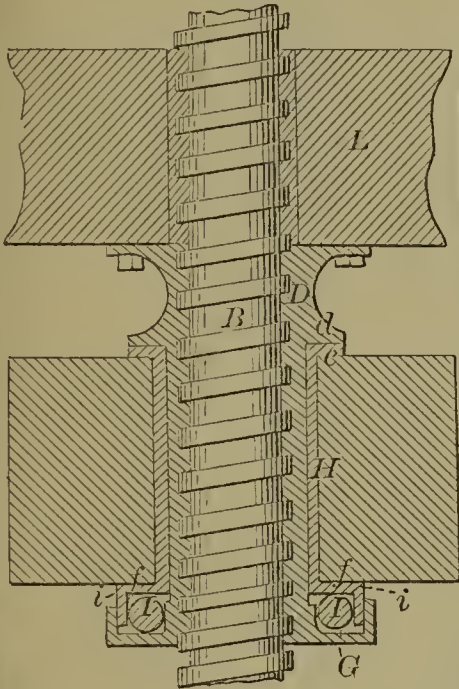

58343—D. B. Hall—*Recumbent Chair.*

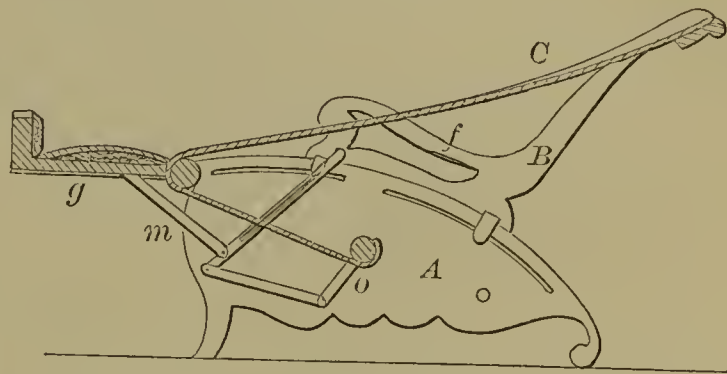

58340—D. Frisbie—*Hoisting Apparatus.*

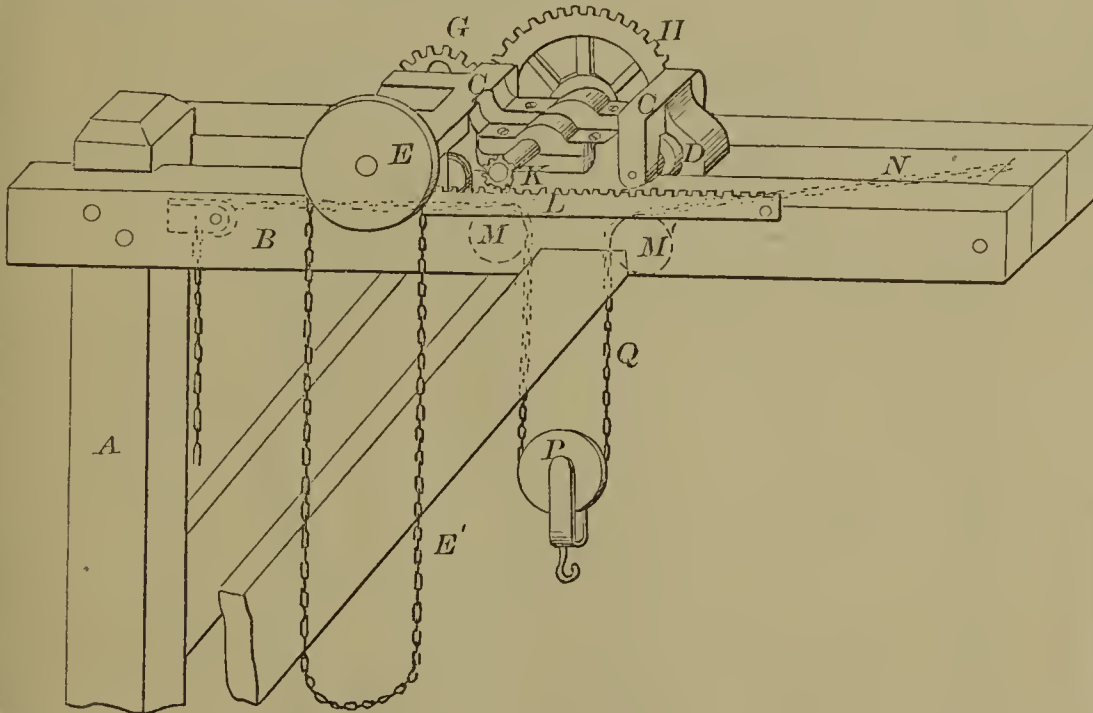

85345—M. Hawkins—*Shaft Coupling.*

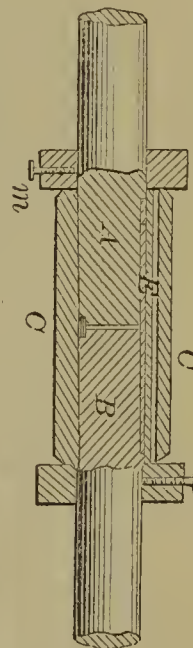

58344—W. H. Halsey—*India Rubber Neck Tie.*

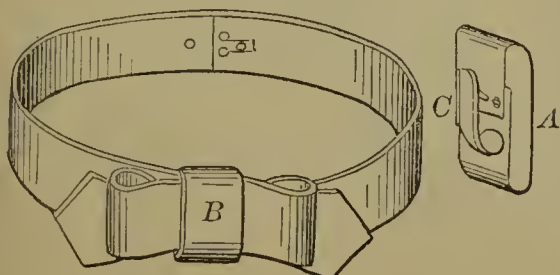

58346—Hotchkiss & Shattuck—*Forge Furnace.*

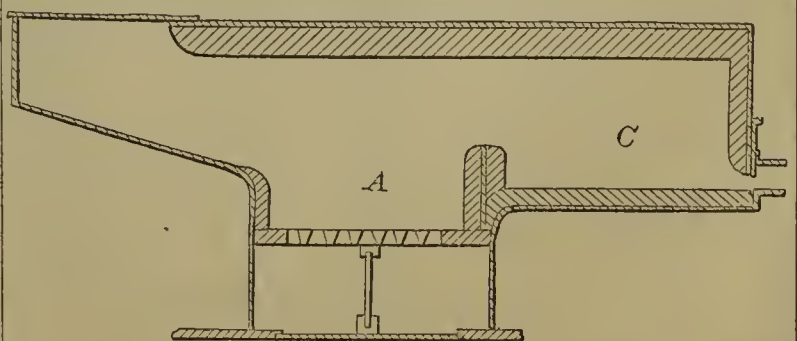

58349—Manlove & Green—Corn Harvester.

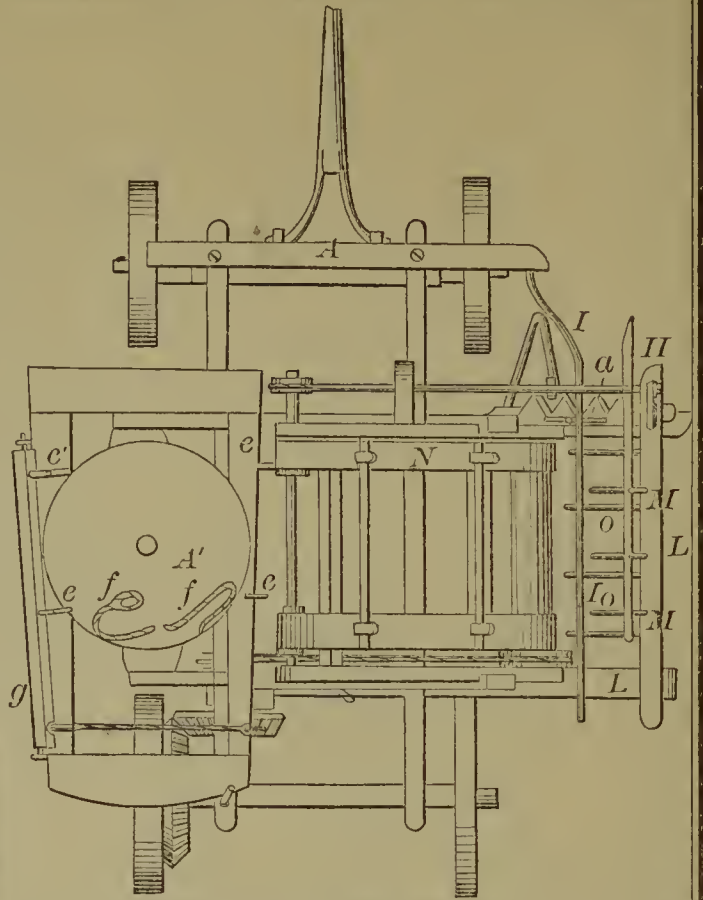

58346—Continued.

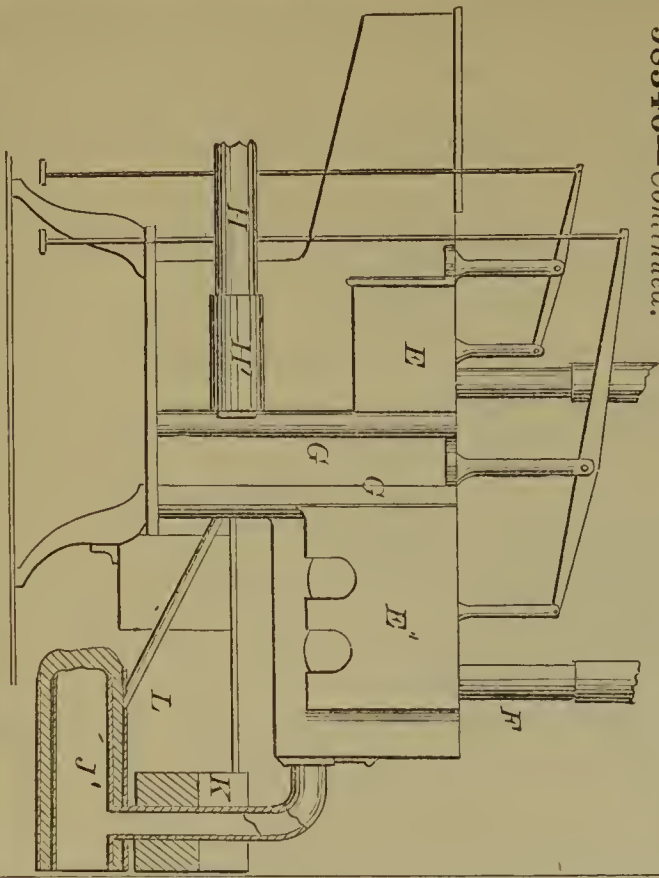

58348—Manlove & Green—Corn Harvester.

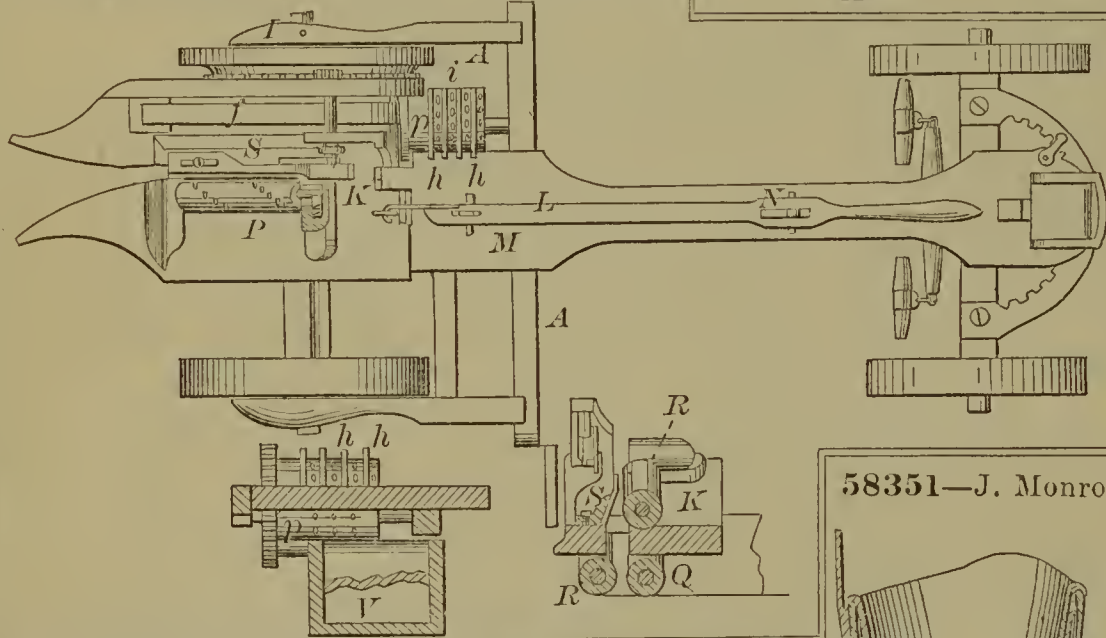

58350—A. McManus—Snap Hook.



58351—J. Monroe—Artificial Limb.

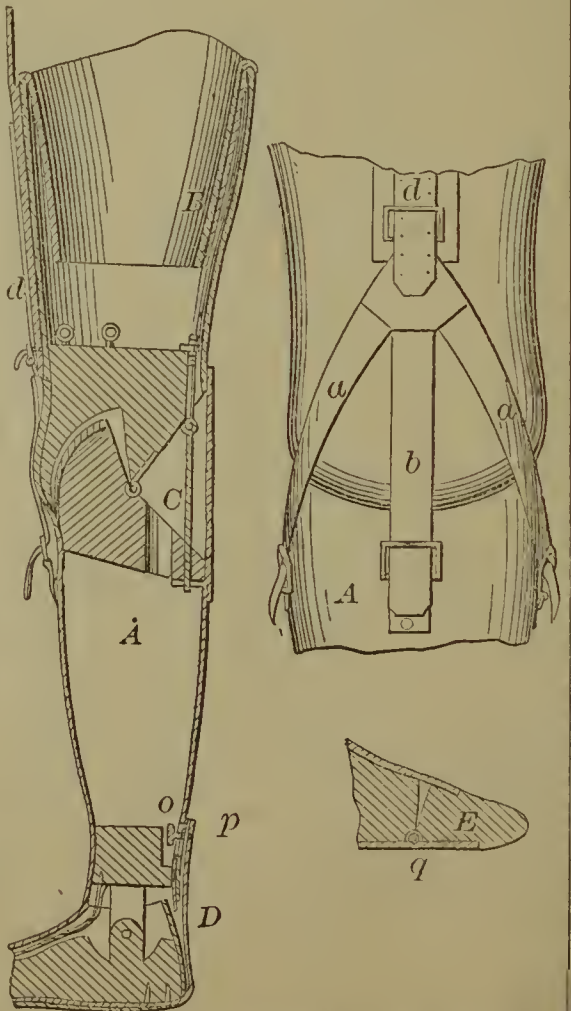

58347—S. J. Kelso—Cyphering Machine.

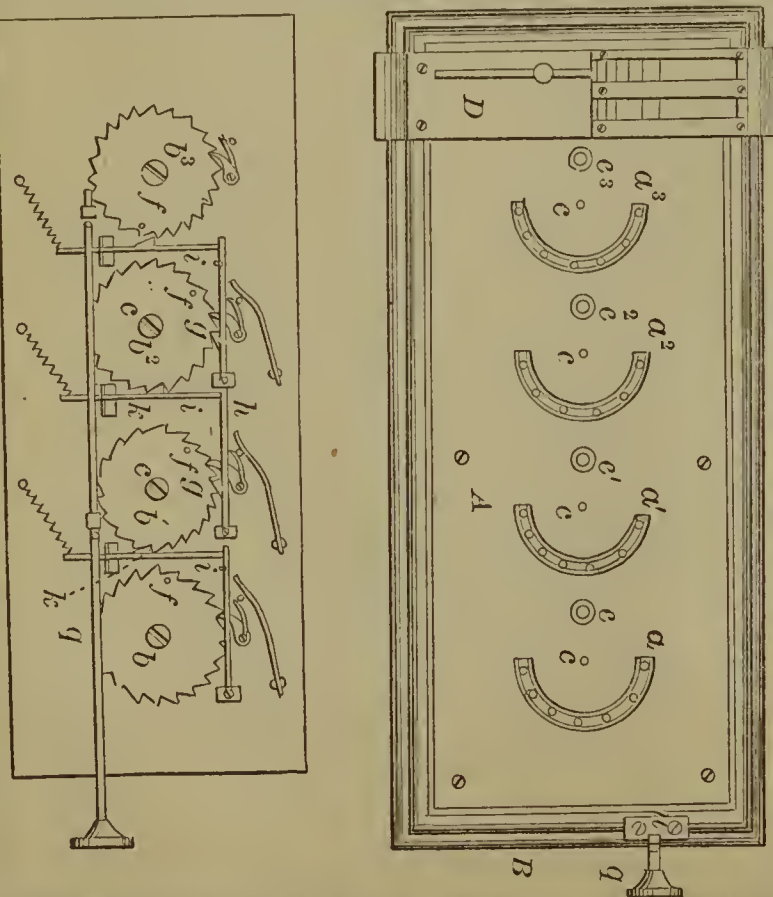

58352—Roos & White—*Pad Hook.*

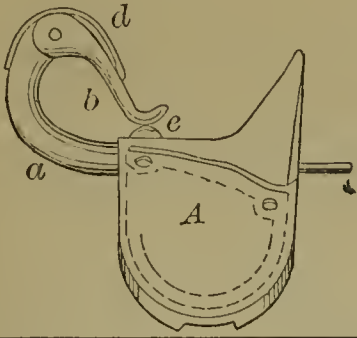

58353—H. L. Taylor—*Shifting Cutter Thills.*

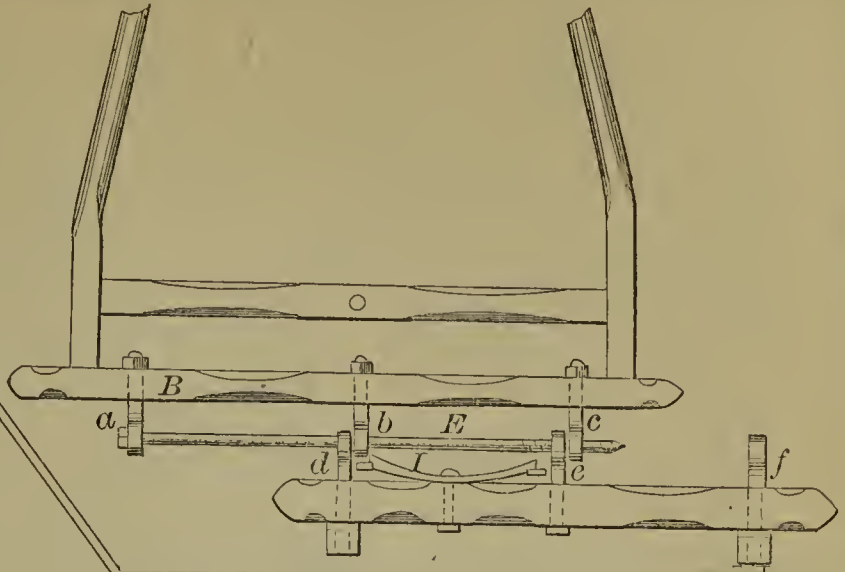

58356—E. Candler—*Faucet.*

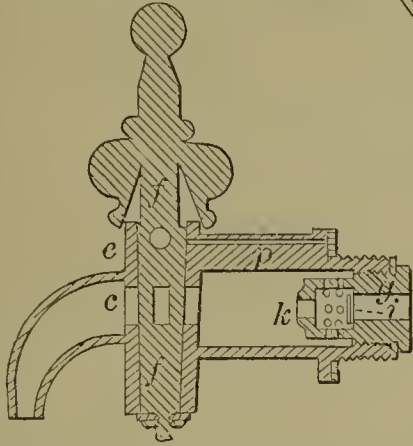

58355—C. M. Werner—*Horse Shoe.*

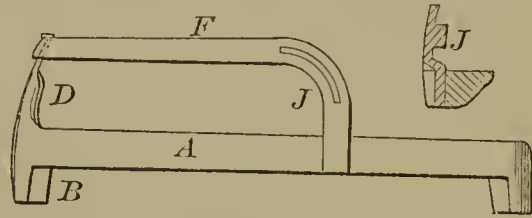

58357—F. A. Lamontague—*Card Case.*

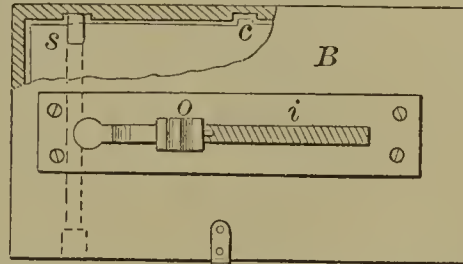
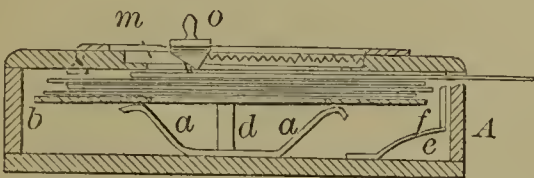

58354—M. Vergnes—*Steam Engine Lubricating Cup.*

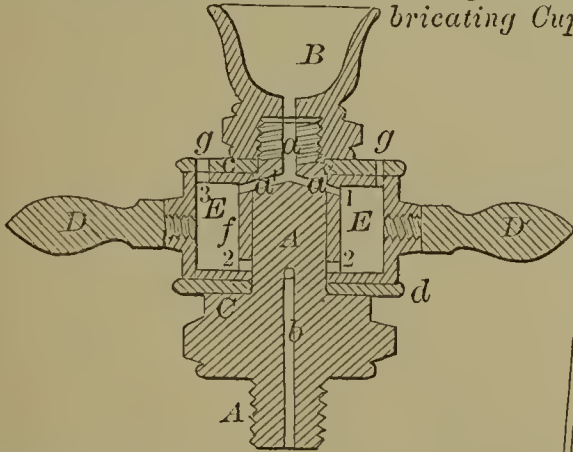

58359—Petrie & Teal—*Wool Washing Machine Lifting Cylinder.*

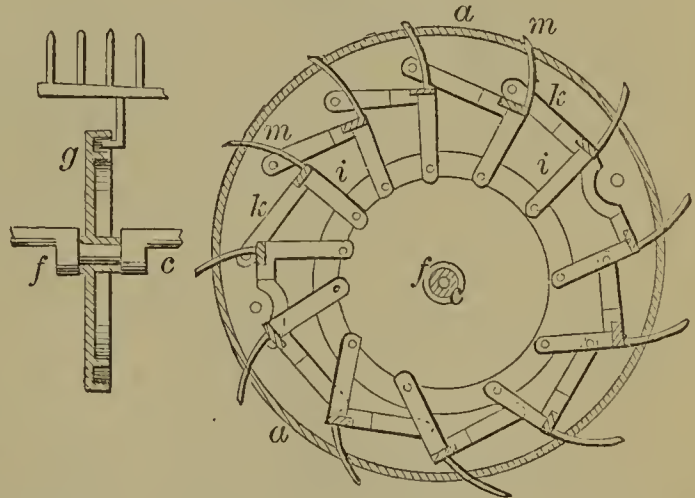

58361—G. Stobwasser—*Lamp.*

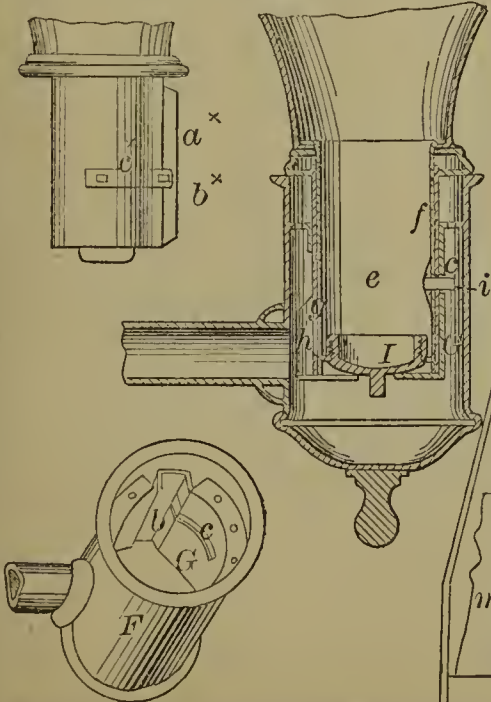

58360—L. Drescher—*Pump.*

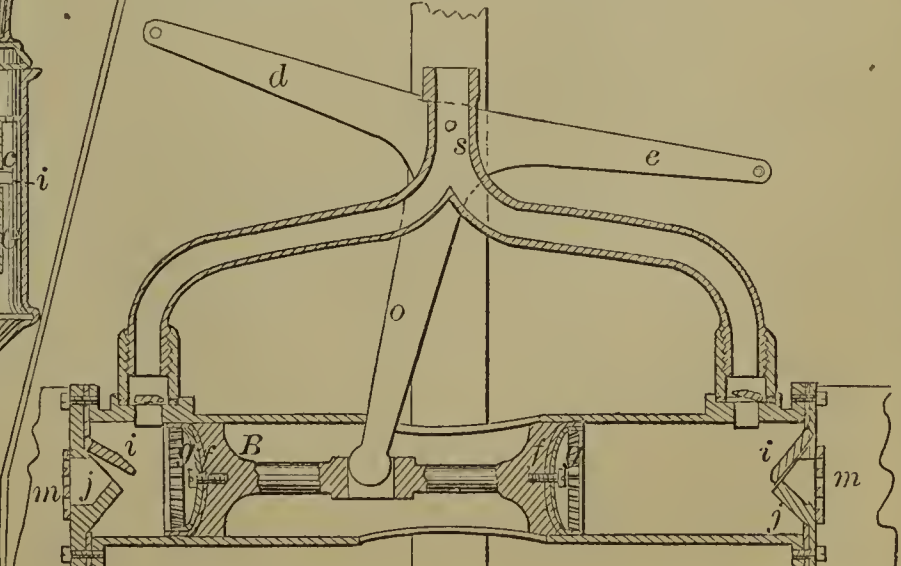

58362—J. Absterdam—*Steam Engine Condenser.*

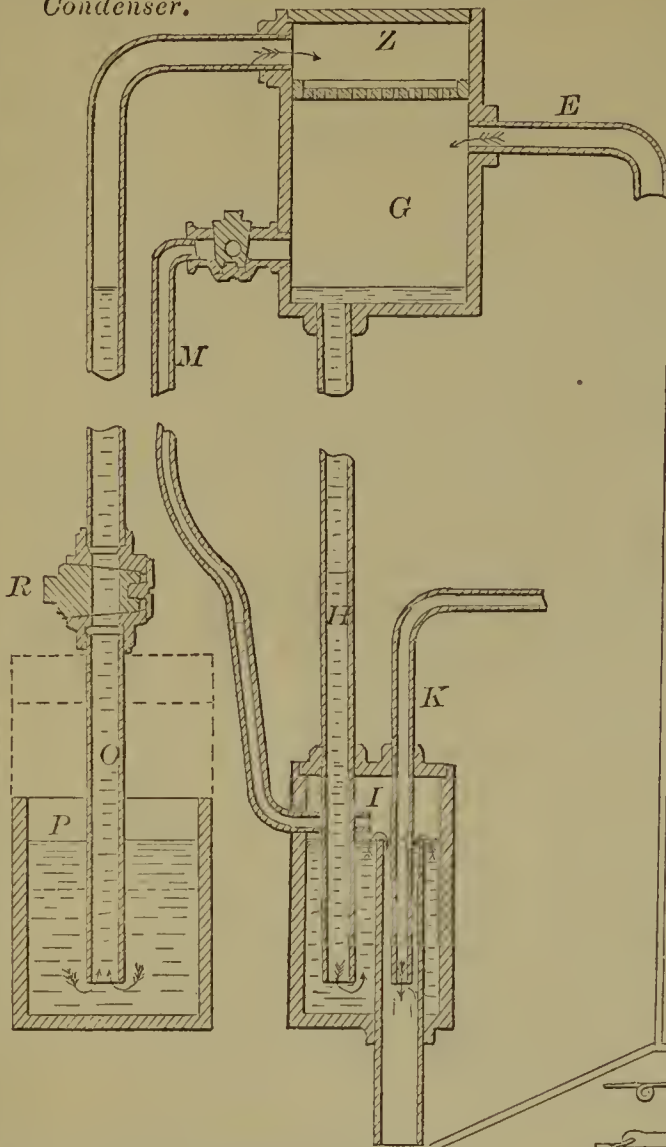

58363—J. Adair—*Spring Pen Rack.*

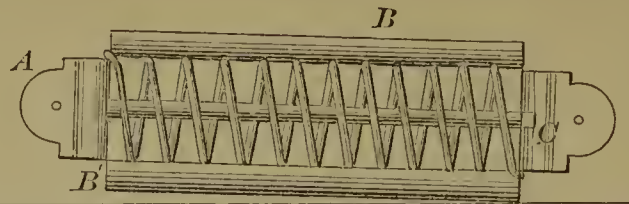

58364—R. Adams—*Shoe Fastener.*

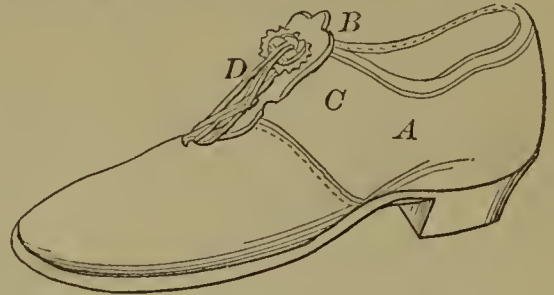

58367—F. W. Arvine—*Skate.*

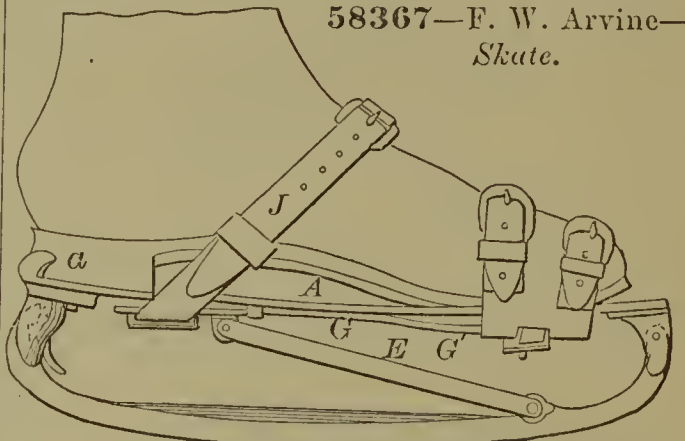

58366—J. F. Andrews—*Sewing Machine.*

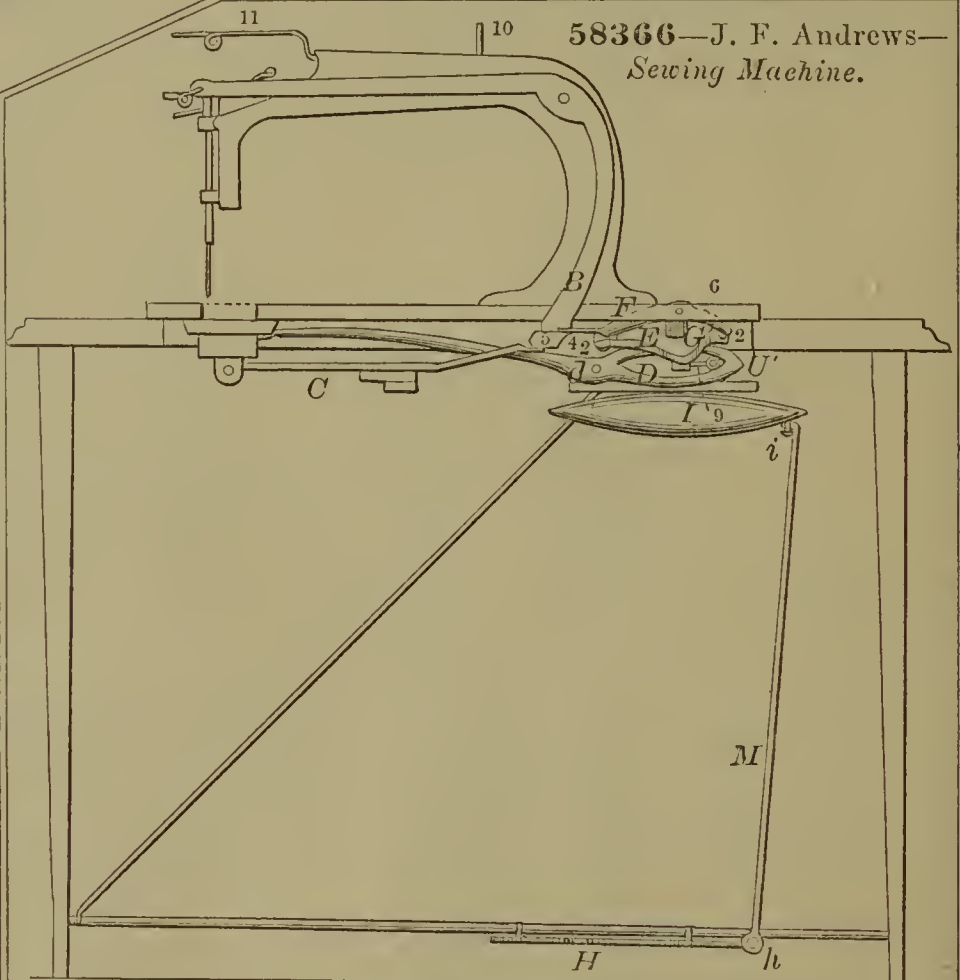

58365—C. L. Alexander—*Paper Fastener.*



58368—E. R. Austin—*Water Elevator.*

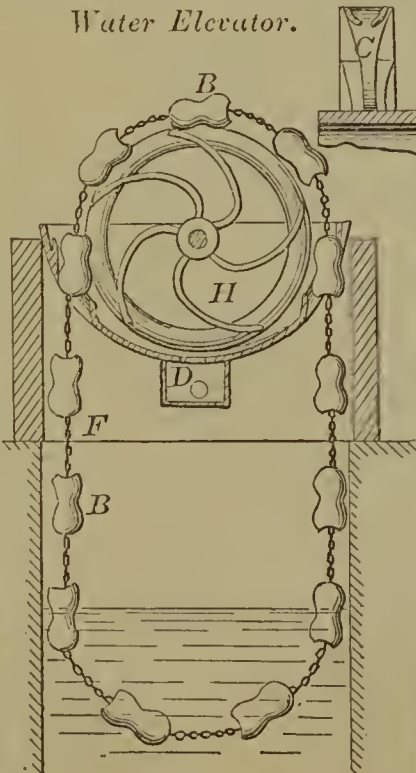

58369—J. S. Benedict—*Fence Gate.*

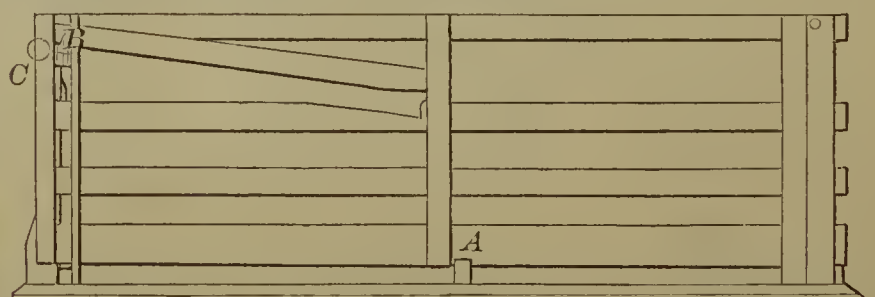

58372—F. H. Brown—Cotton Seed Planter.

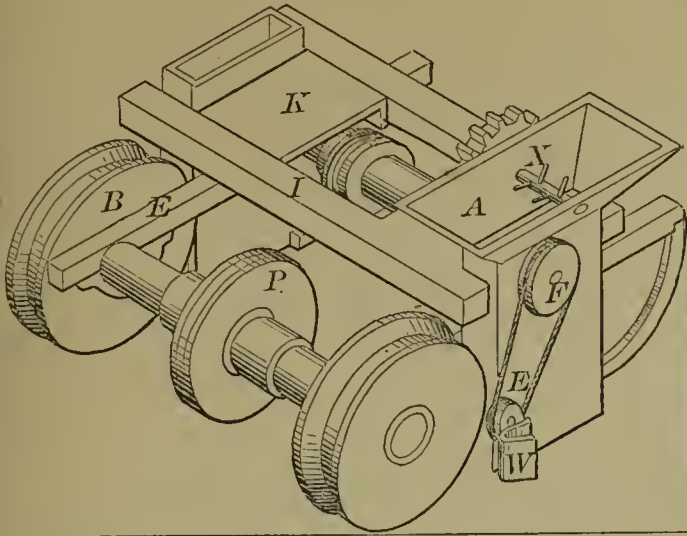

58373—J. T. Budd—Hot Air Furnace.

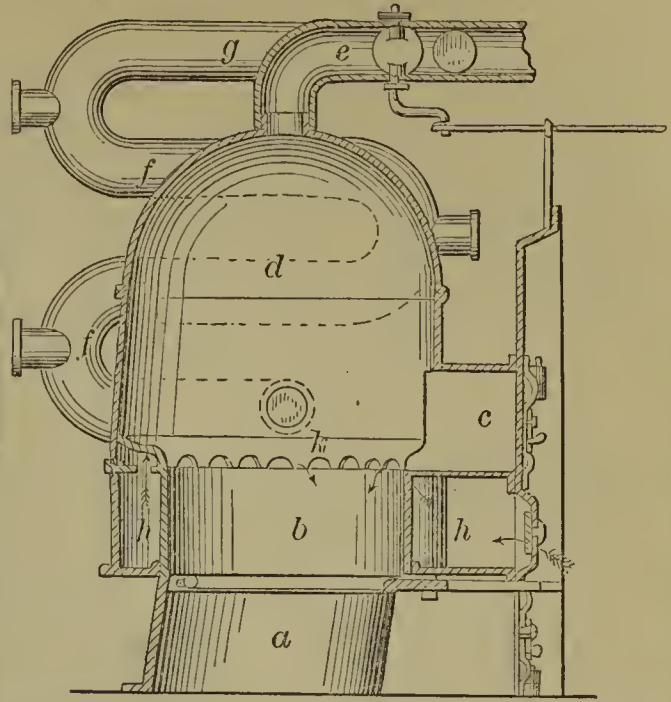

58375—J. W. Cahill—Soda Fountain.

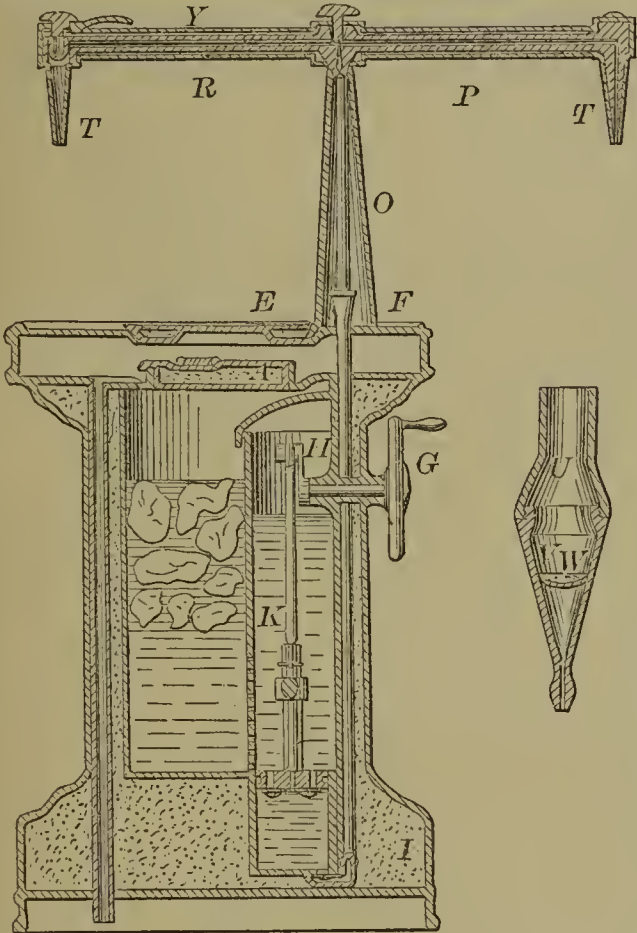

58378—H. W. Chamberlain—Cord and Line Reel.

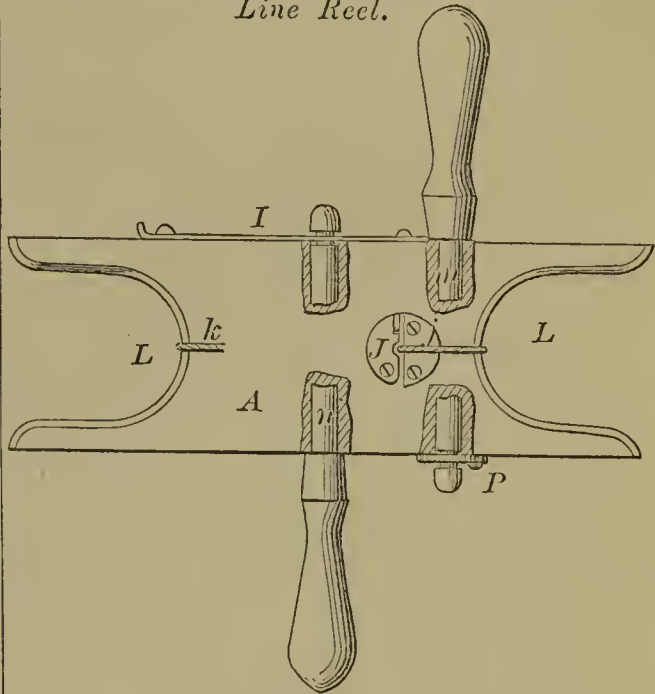

58374—J. Carlin—Preserving Flour, Grain, &c.

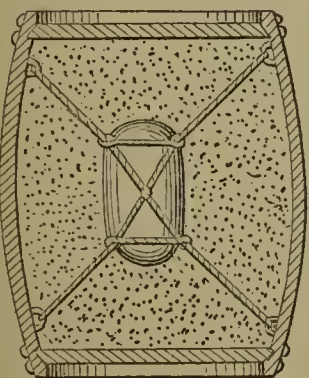

58376—D. C. Cary—Sewing Machine Ruffling Attachment.

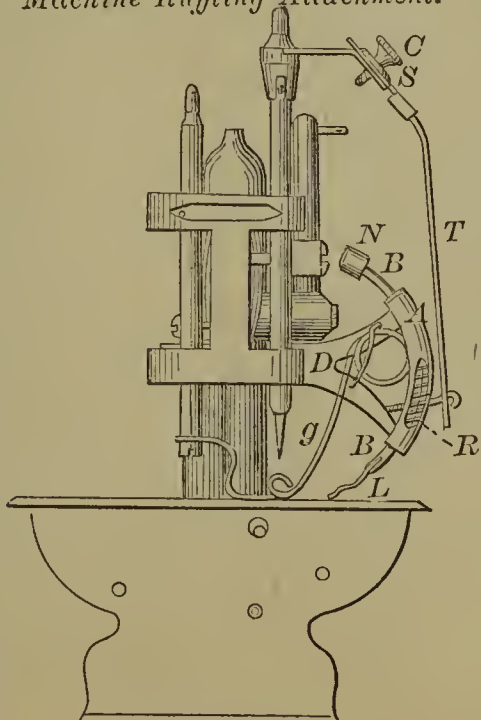

58380—E. Children—Cultivator.

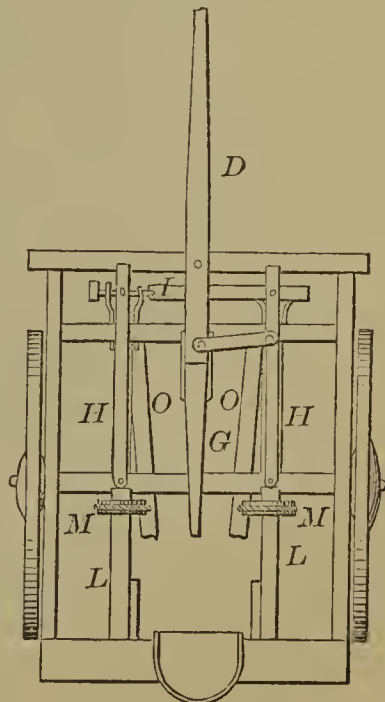

58381—J. G. Clark—Cotton Seed Planter.

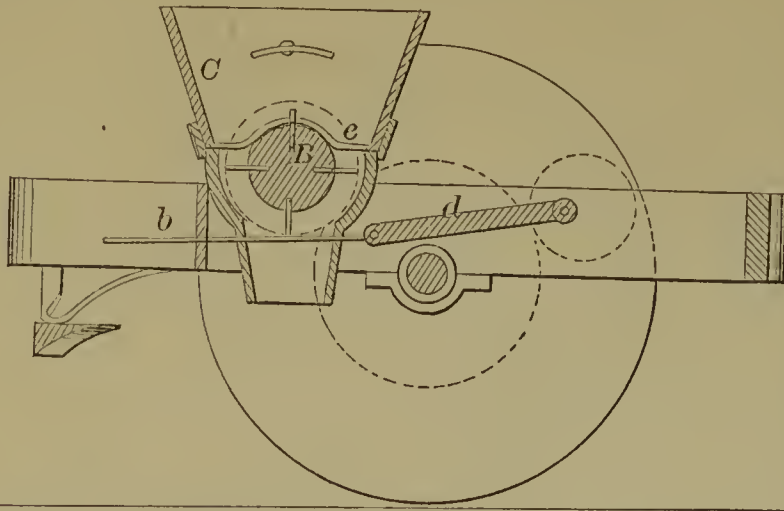

58382—Comer & Denton—Lightning Rod.

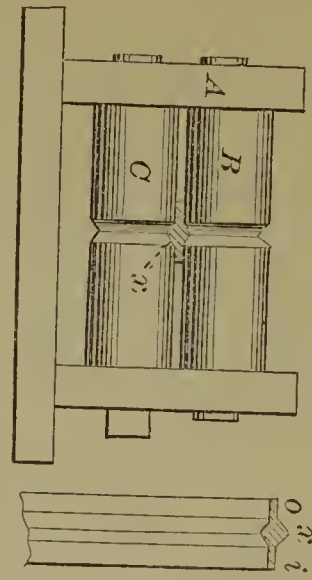

58383—J. Cook—Cultivator.

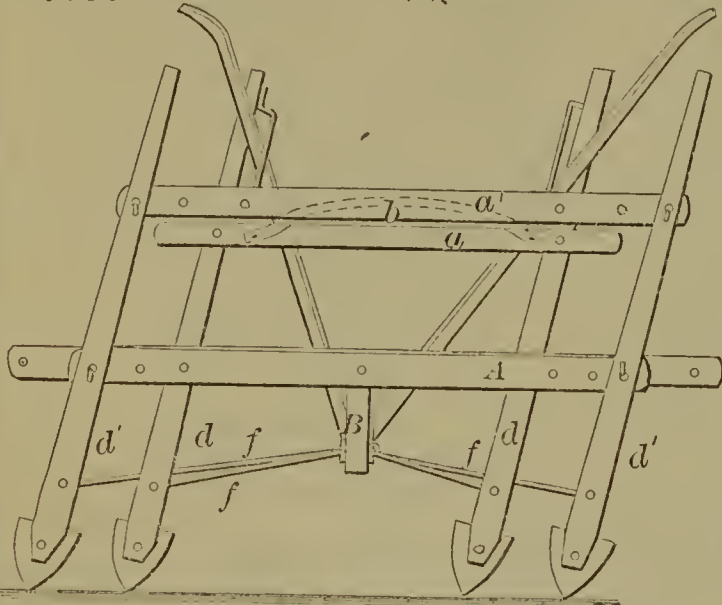

58385—J. Croco—Potato Drill.

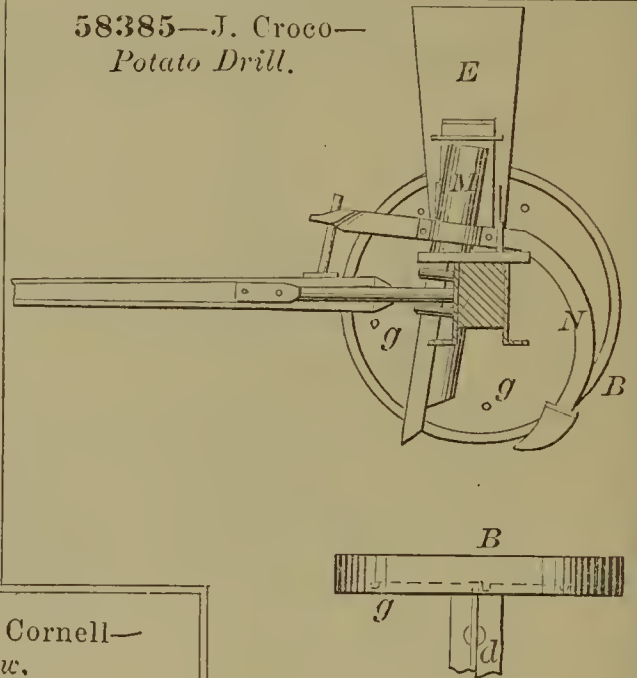

58384—T. J. Cornell—Gang Plow.

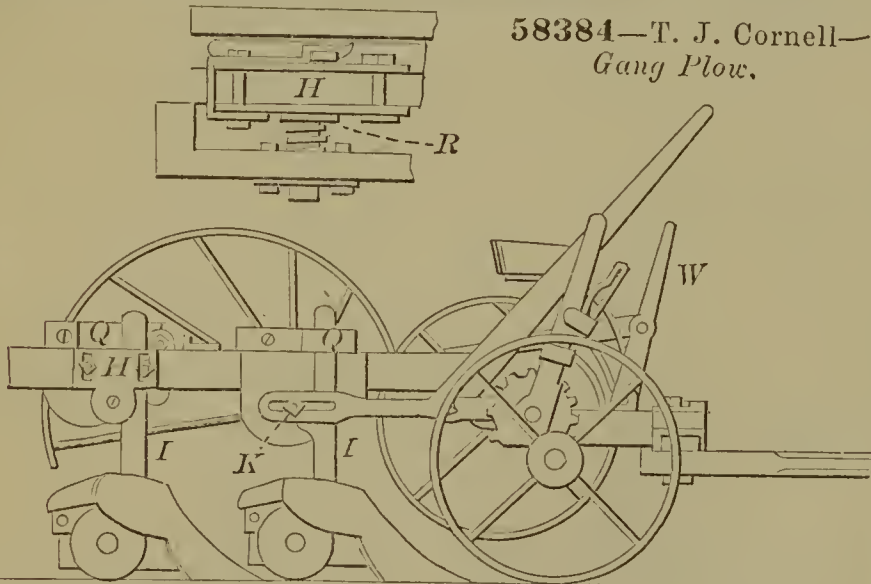

58386—H. N. Dalton—Gang Plow.

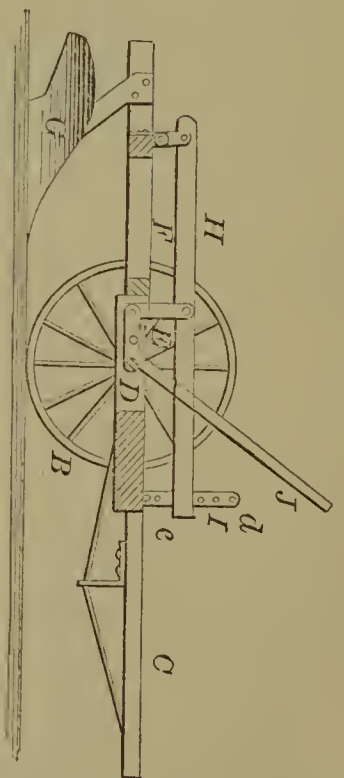

58387—R. E. Deane—Carving Table.

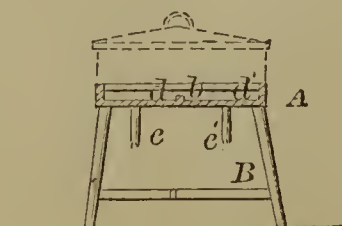
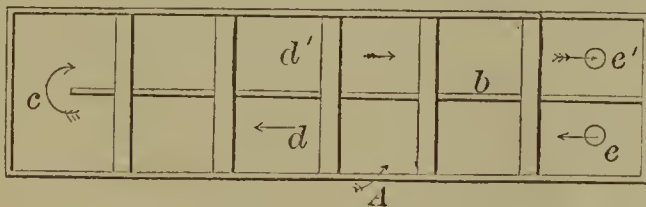

58388—C. M. Dedrick—For Removing the Wire from Soda Water Bottles.

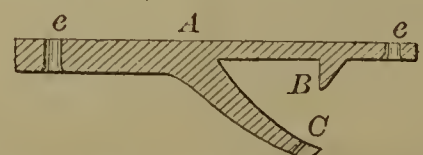

58389—G. W. Doolittle—Cultivator.

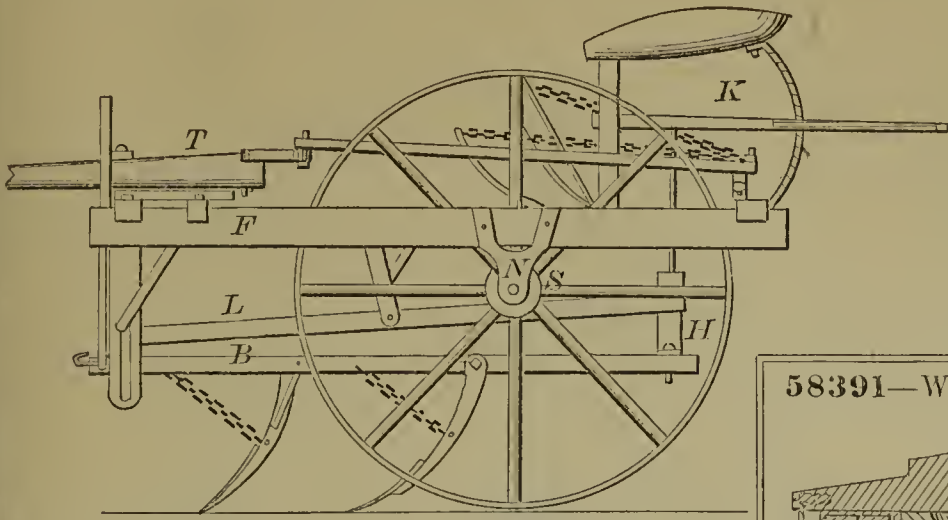

58393—E. Duffee—Screen for Dry Gas Purifiers.

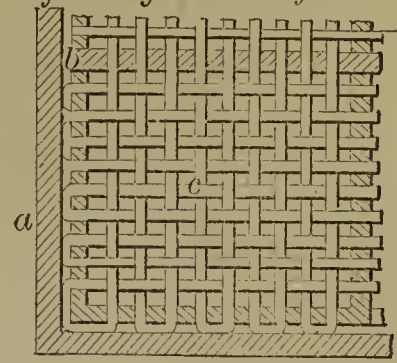

58390—H. Doolittle—Potato Digging Fork.

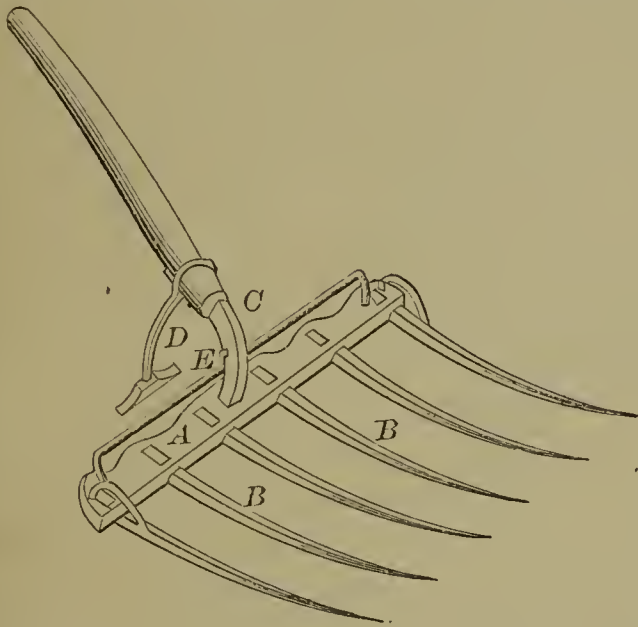

58391—W. E. Doubleday—Hat.

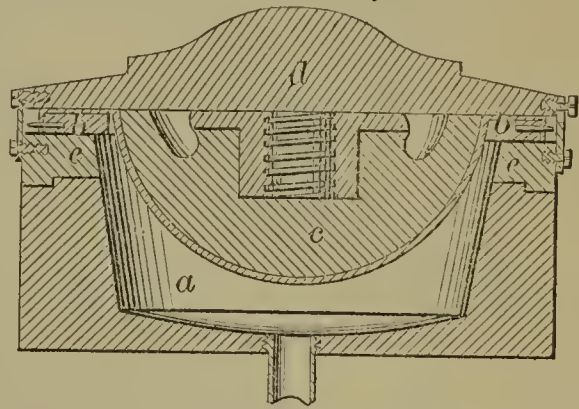

58394—F. B. Duffy—Bed Bottom.

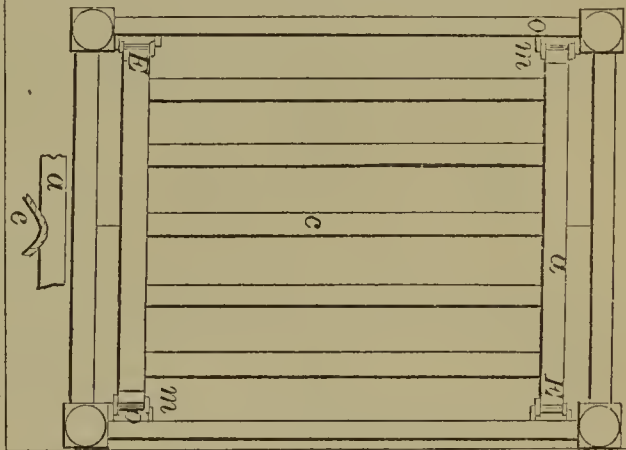

58392—A. M. Duburn—Lantern.

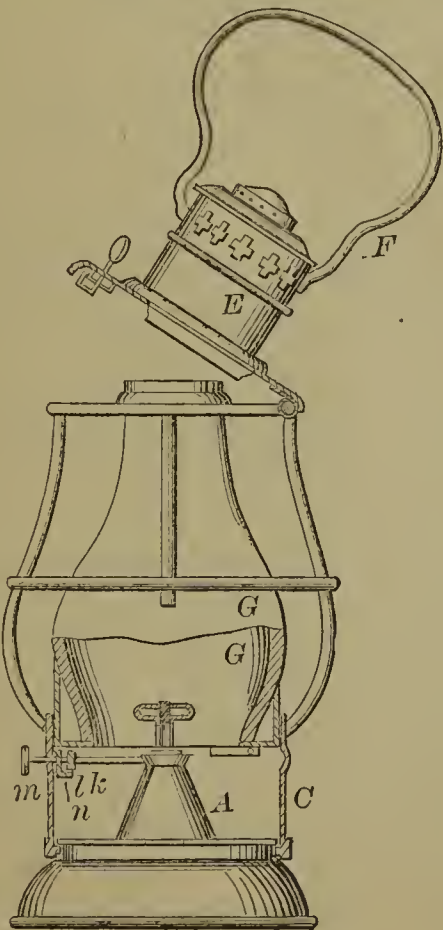

58395—Edgell & J. W. & E. A. Alexander—Plow.

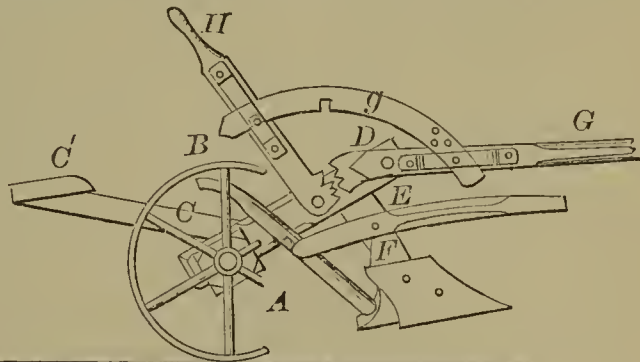

58396—W. Edson—Coffee Pot.

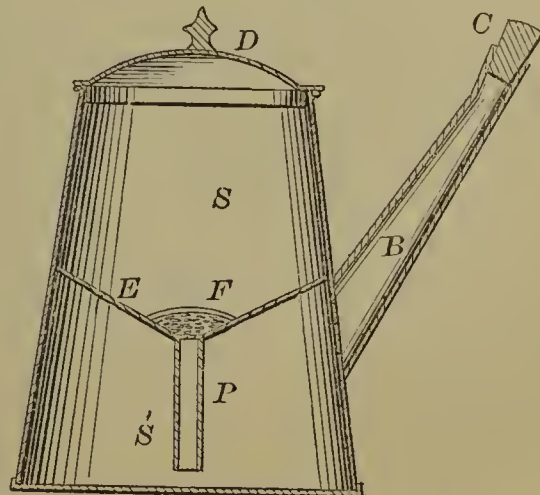

58397—P. A. Ensign—Air Engine and Motor.

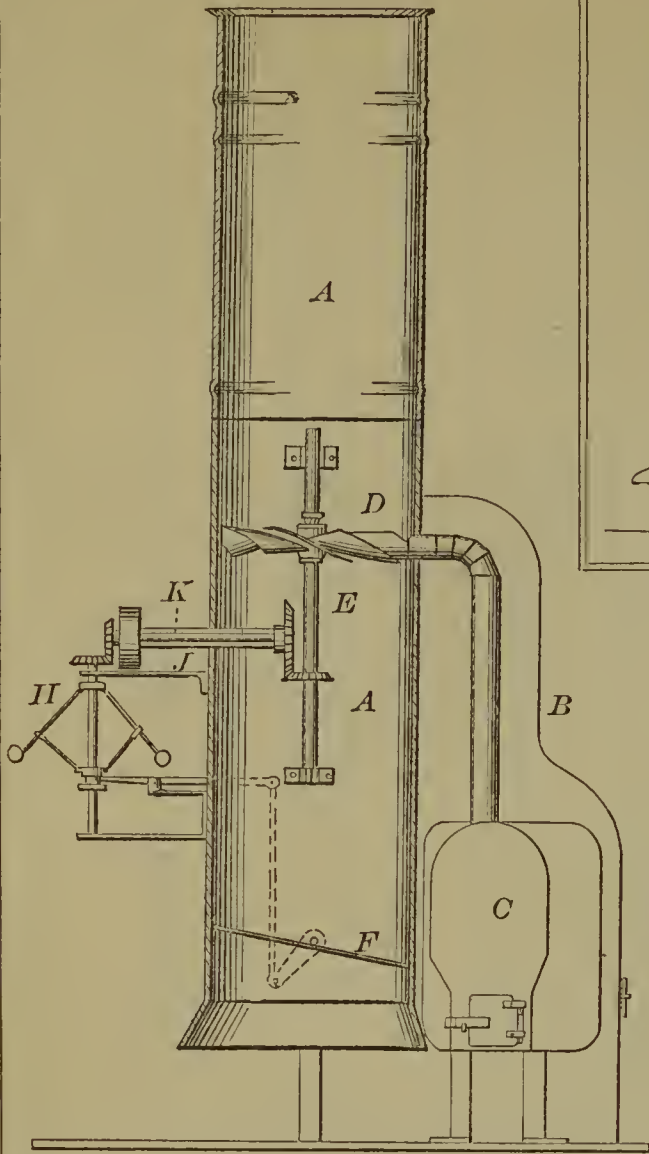

58398—L. Erving—Oven for Gas Cook Stoves.

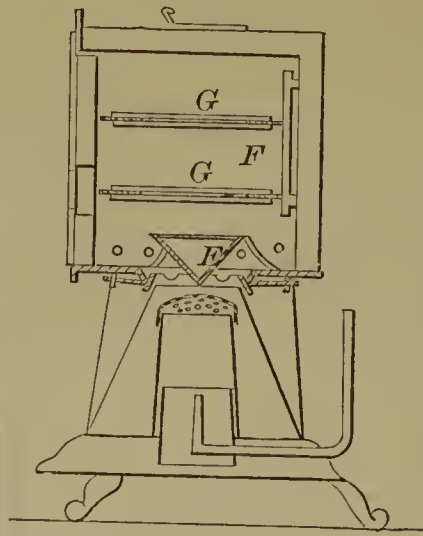

58399—F. Etzold—Sewing Machine Shuttle.

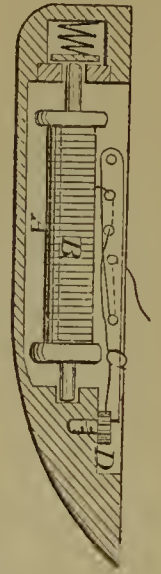

58401—A. J. Frisbie—Hay and Grain Protector.

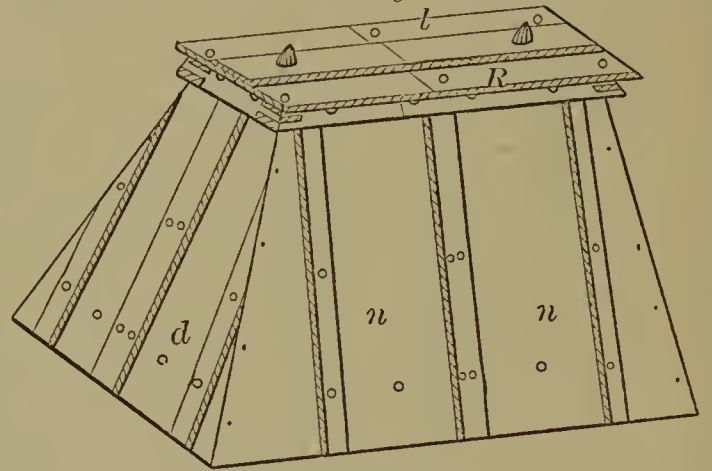

58400—D. S. Forney—Privy.

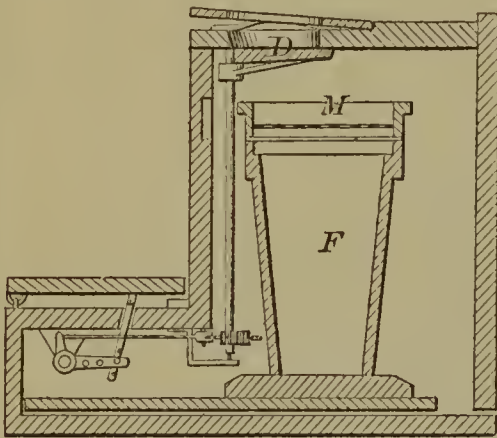

58402—M. Fryer—Oar Swivel.

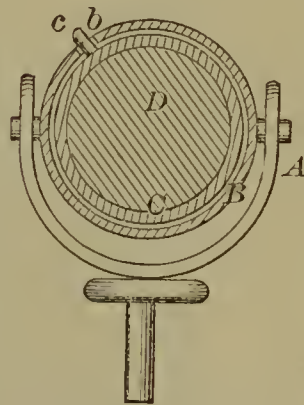

58403—R. J. P. Goodwin—Surgical Splint.

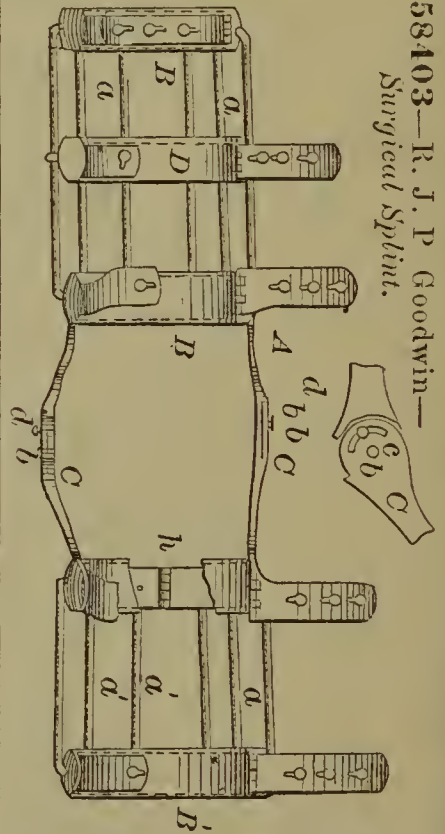

58404—W. C. Goodwin—Fish Hook.

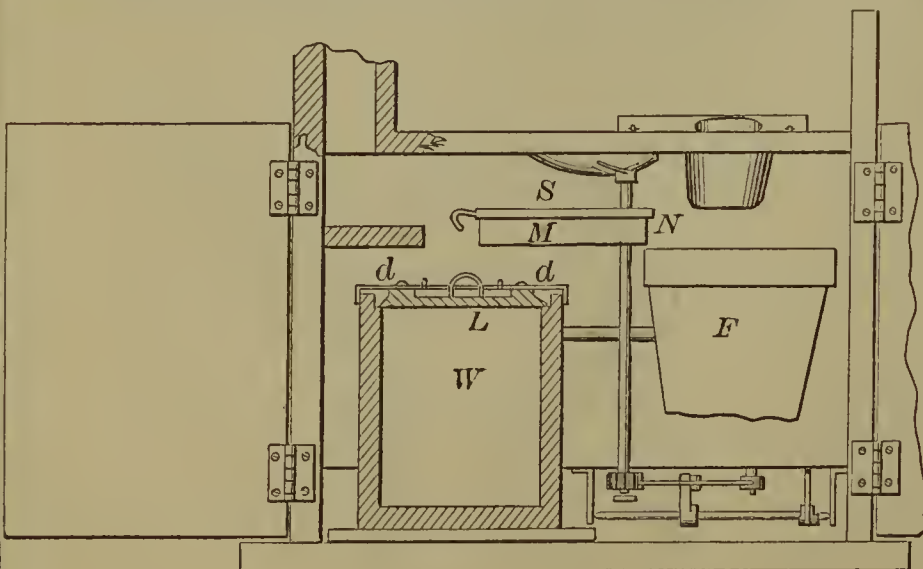



58405—J. C. Gould—Door and Gate Spring.

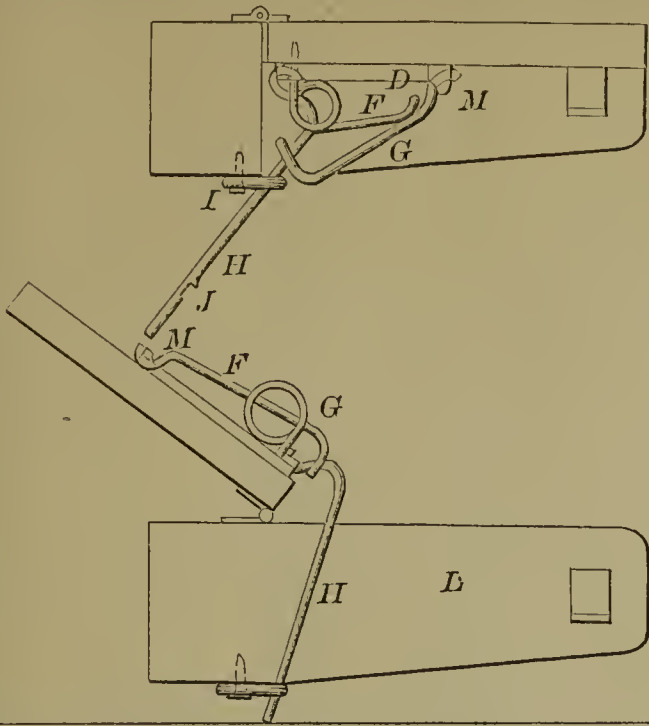

58406—C. Grün—Ladies' Skirt Elevator.

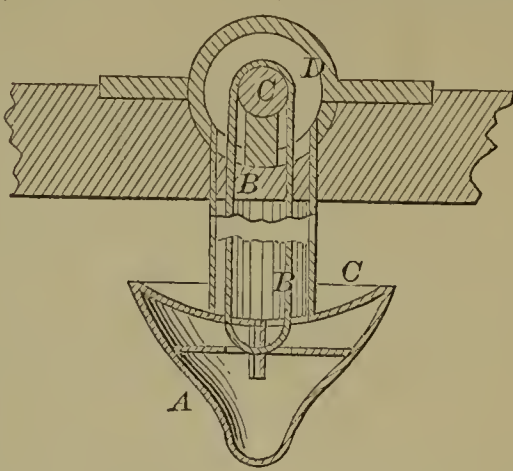
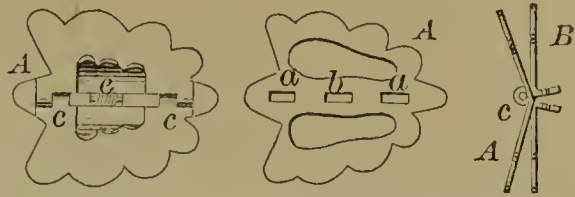

58409—W. Hamilton—Lubricating Apparatus.

58408—D. Hagerty—Melting and Moulding Tinners' Solder.

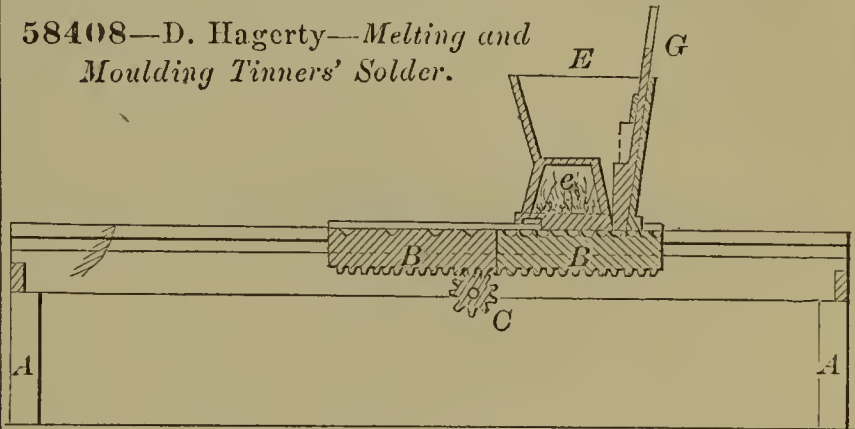

58412—J. Hayward—Horse Hay Rake.

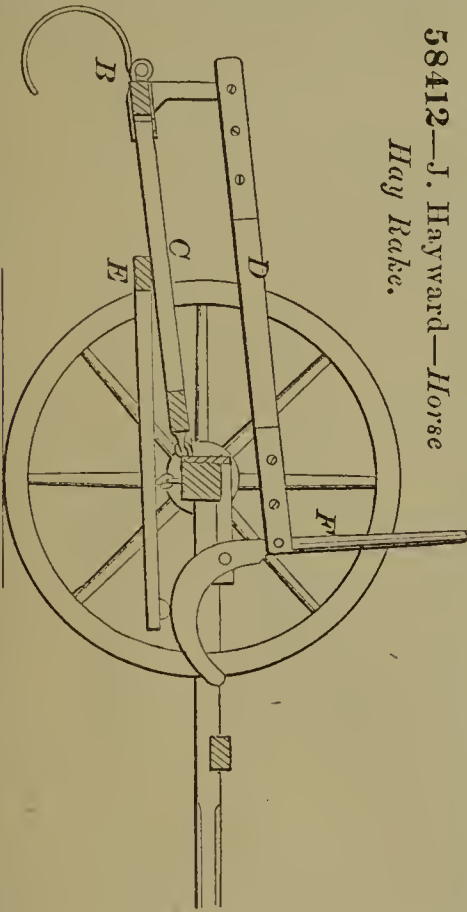

58411—S. R. Hathorn—Snow and Ice Guard for Roofs.

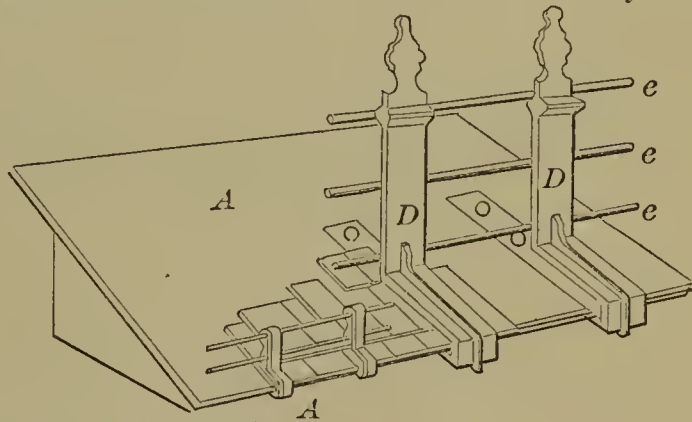

58407—C. Guidet—Belgian Pavement.



58413—E. Heath—Ditching Machine.

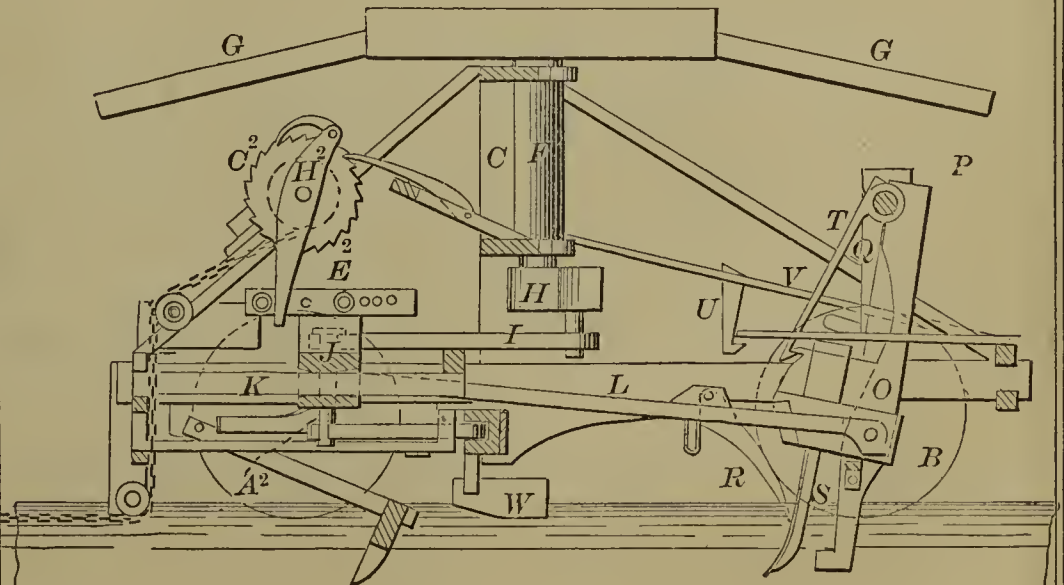

58410—T. R. Hartell—Ornamenting and Lettering Glass.



58414—H. M. Heineman—  
Neck Tie Fastening.

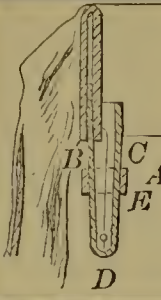

58415—J. Henry—Churn.

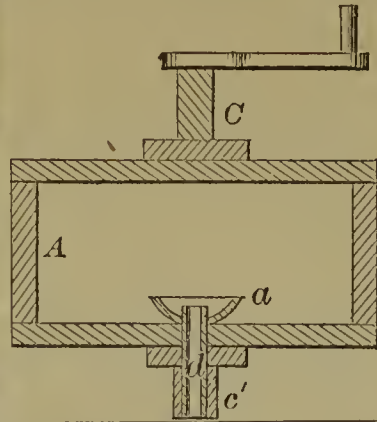

58416—A. Hermann—Discharging Bilge  
Water.

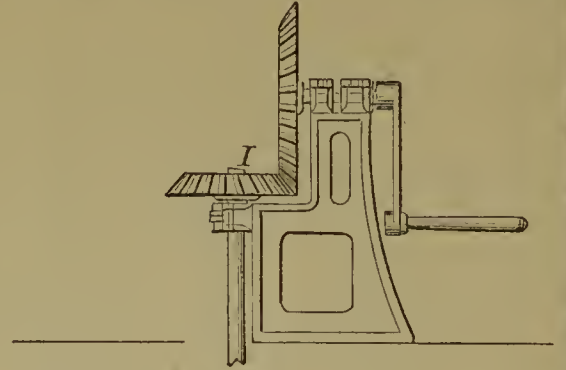

58417—T. N. Hickox—Mucilage Bottle Cap.



58418—C. Holtz—Car Coupling.

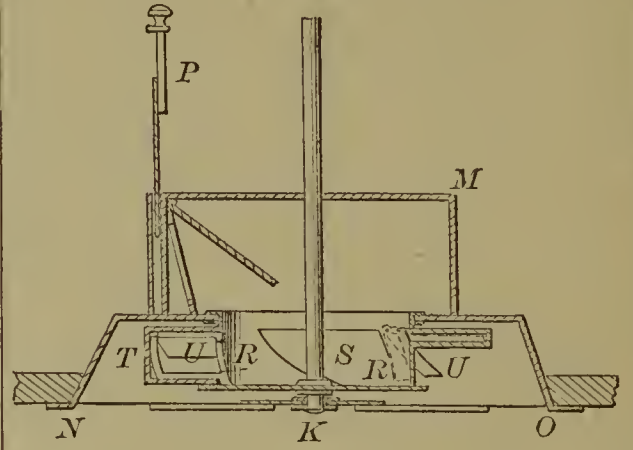
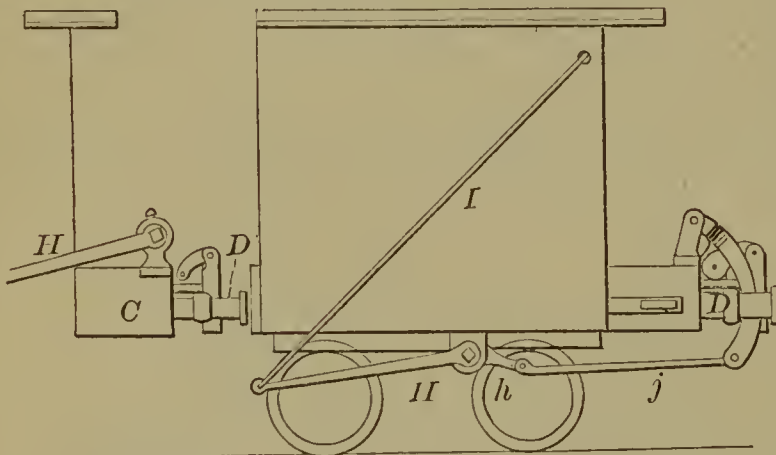
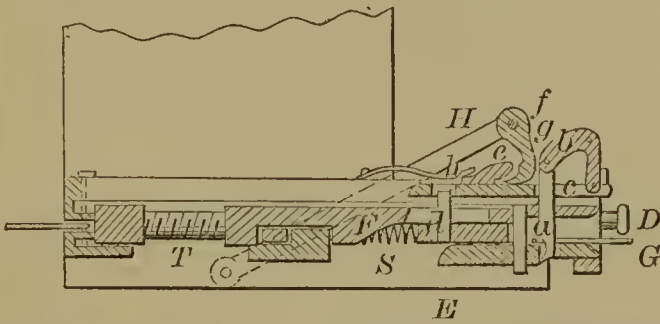

58420—H. A. Hoyt—Stamp  
Moistener.

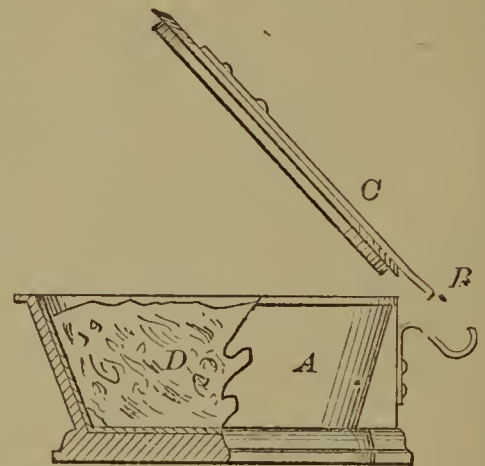

58419—C. W. Howard—Clothes Line  
Clamp.

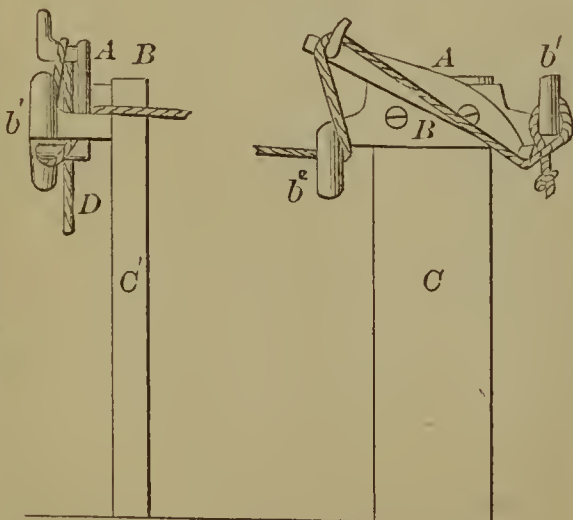

58422—E. S. Hutchinson—Automatic Feed for  
Carburettor.

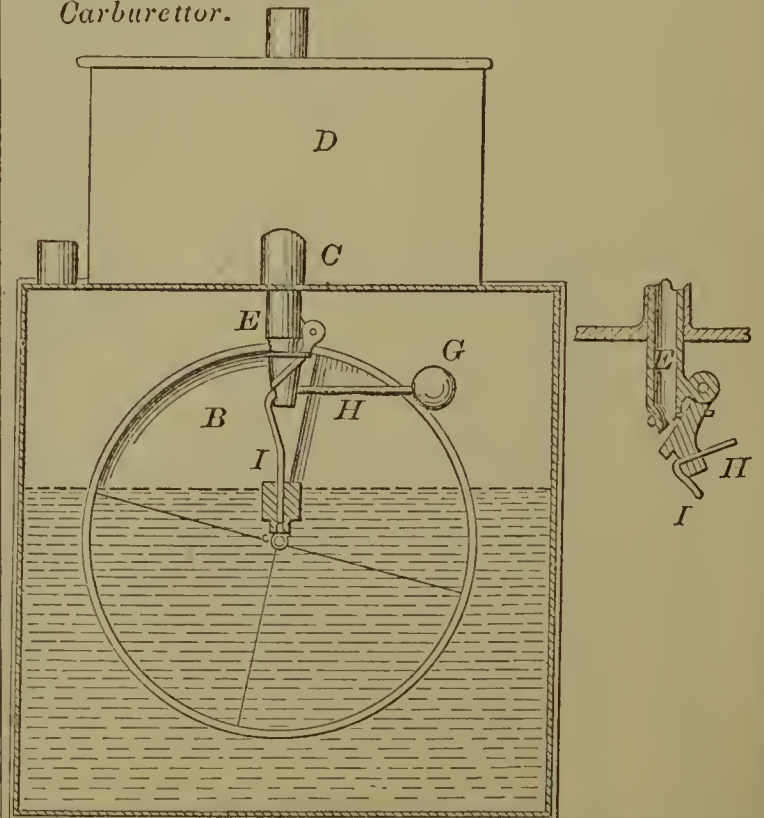

58424—E. N. Jenkins—  
Said Iron Heater.

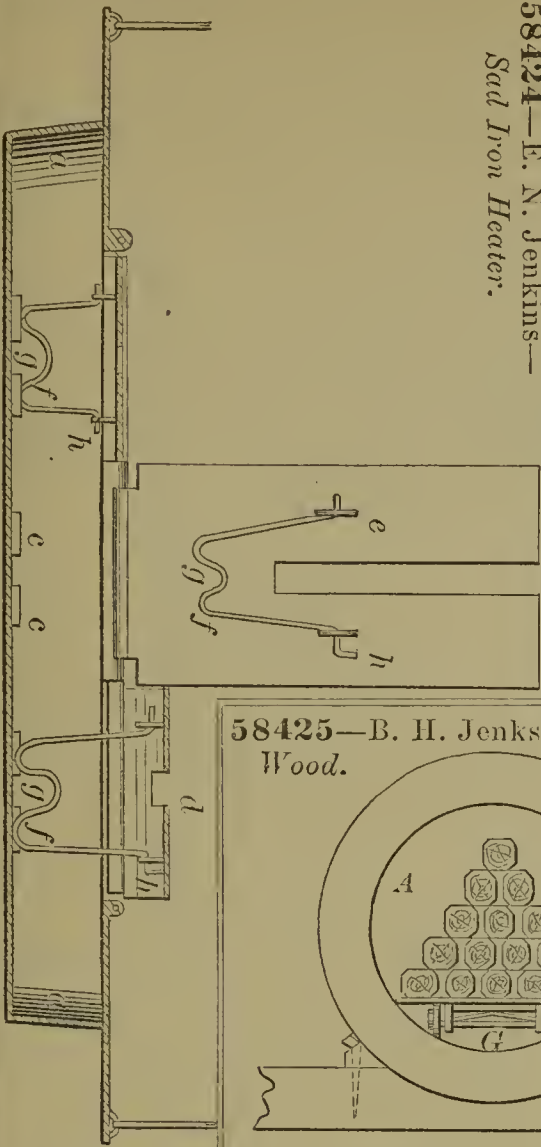

58426—J. Johnson—Oyster Rake.

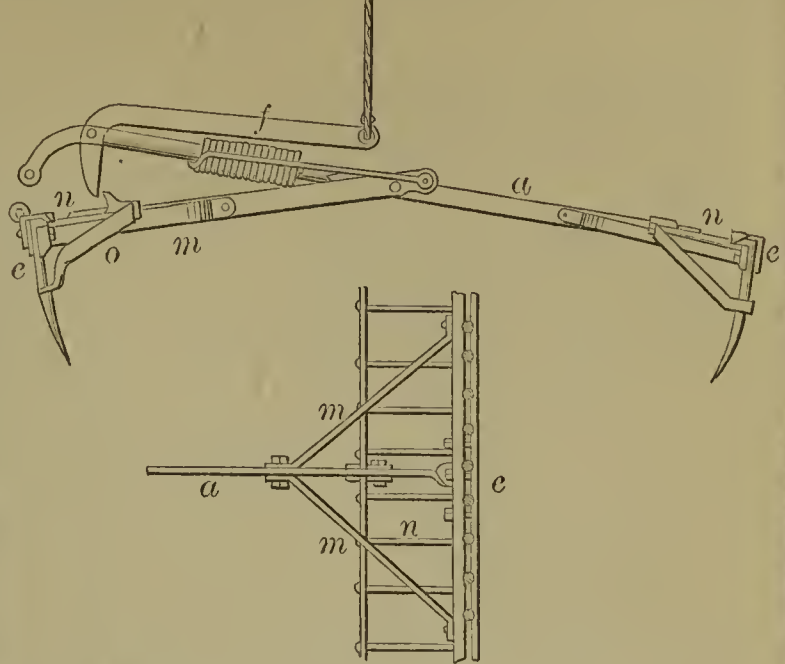

58425—B. H. Jenks—Seasoning  
Wood.

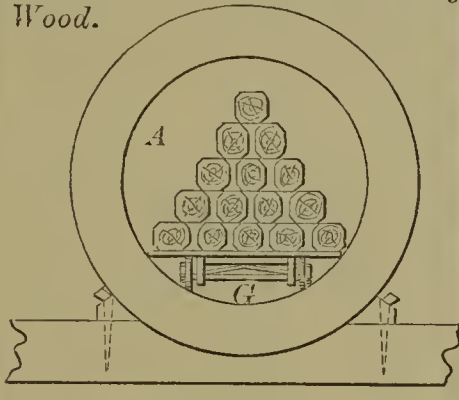

58427—T. Johnson—  
Watch.

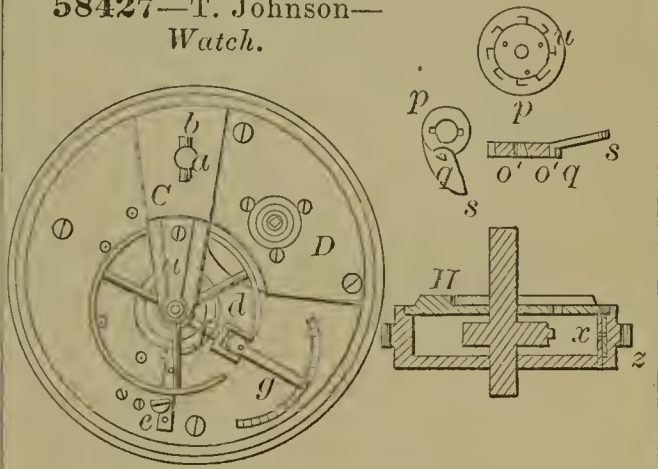

85431—I. Kennedy—Plow.

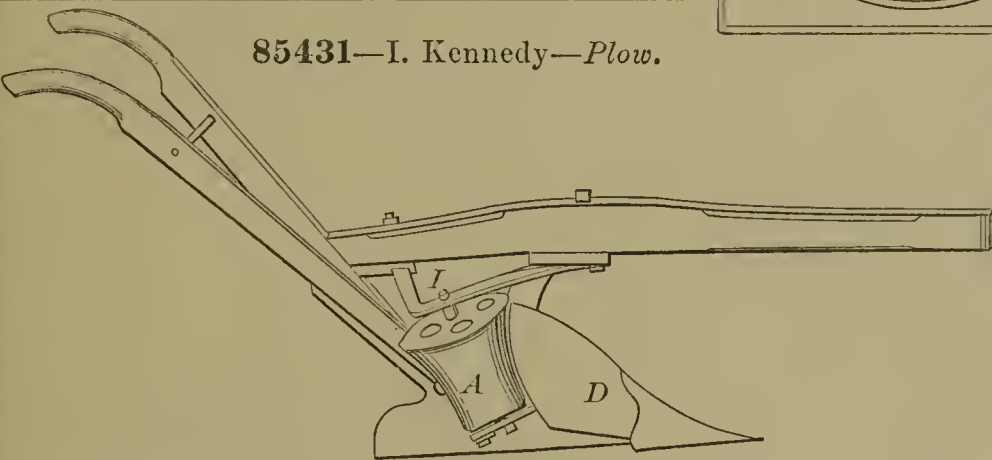

58430—G. R. Kelsey—  
Belt Buckle.

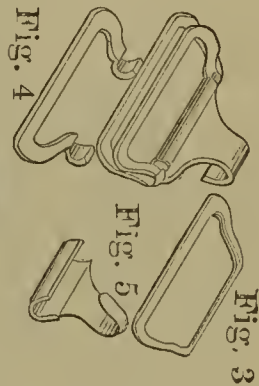

58432—G. Kieherer—Fence.

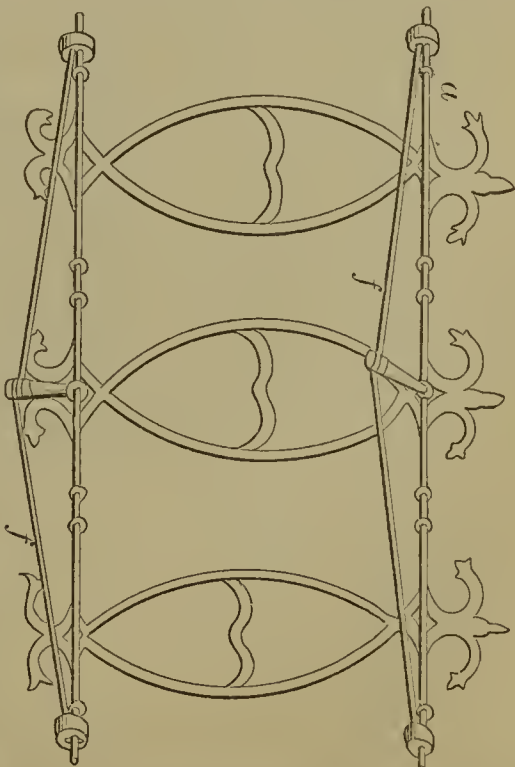

58428—J. M. Keop—Card Rack.

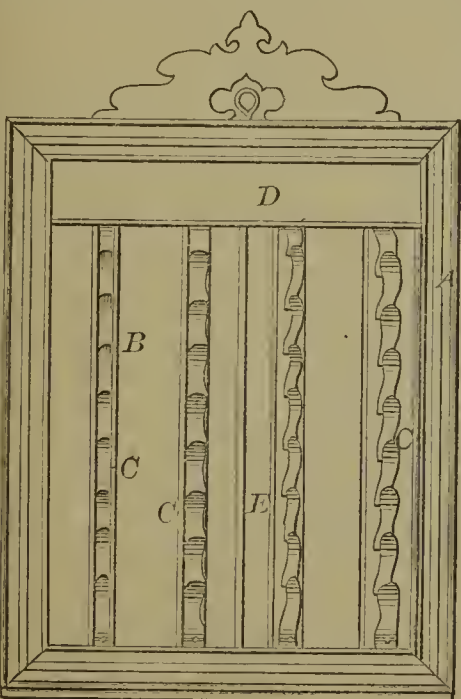

85429—Kellogg & Hill—Billiard Register.

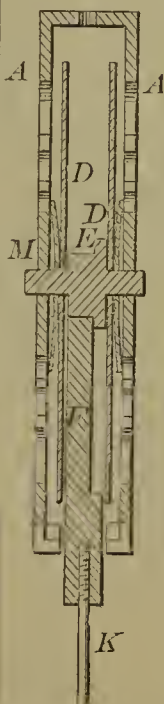

58434—T. Kohn—For Twisting and Reeling Silk.

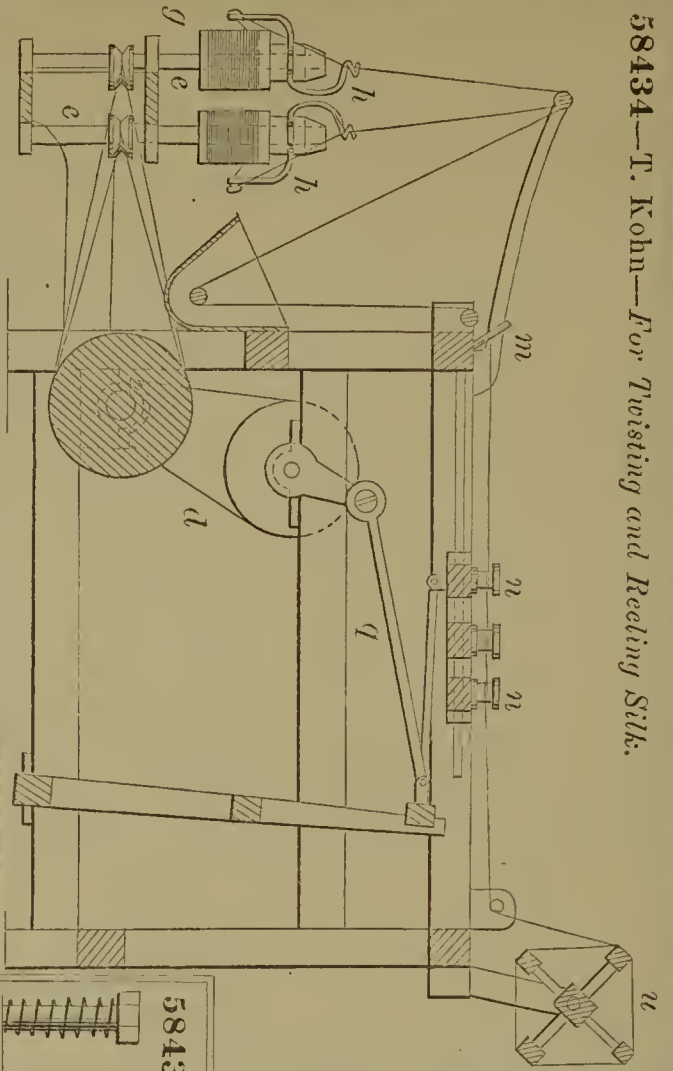

58433—J. F. Kirkwood—Let-off and Take-up for Looms.

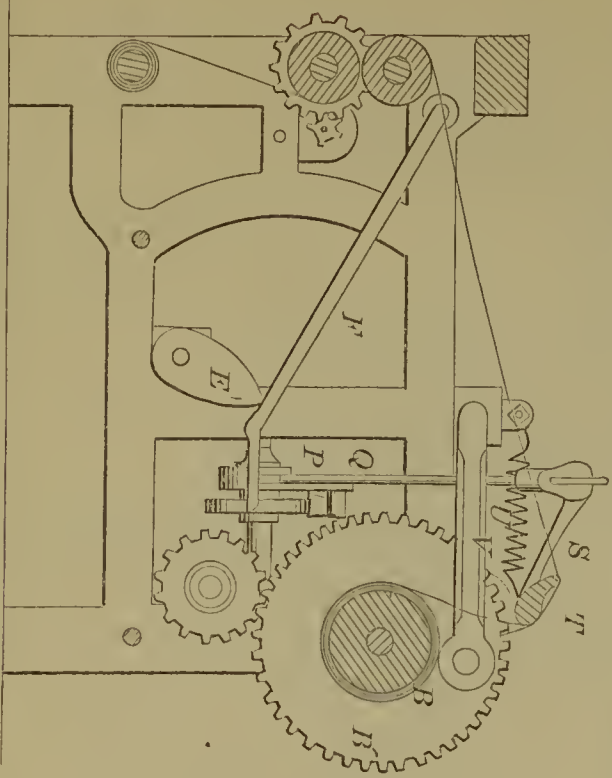

58436—J. Lefebvre—Hollow Auger.

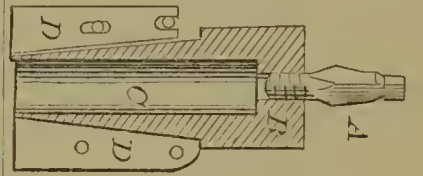

58437—J. Lemman—Bedstead Fastening.

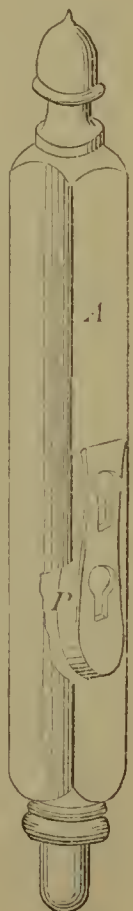

58435—E. G. Lamson—Drilling and Quarrying Stone, &c.

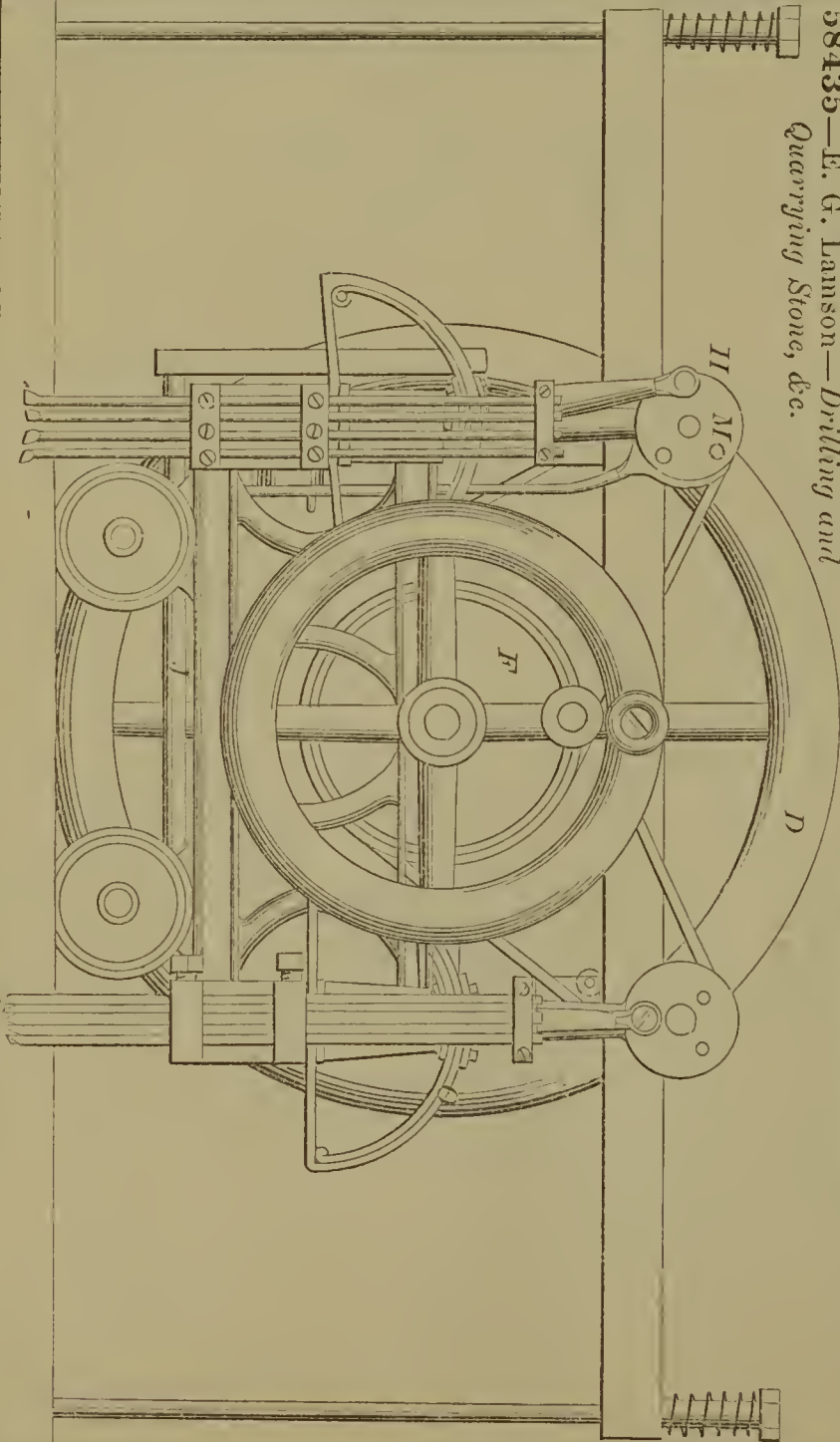

58438—H. L. Lowman—*Combined Pick and Axe.*

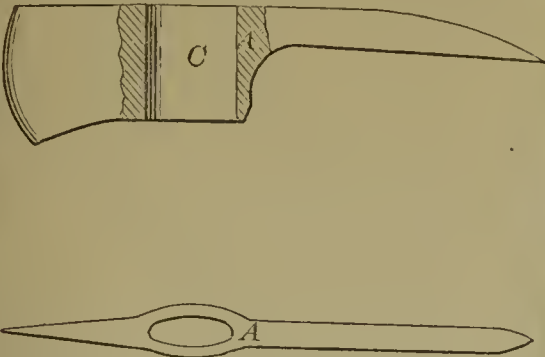

58441—F. A. Makepeace—*Window Blind Fastening.*

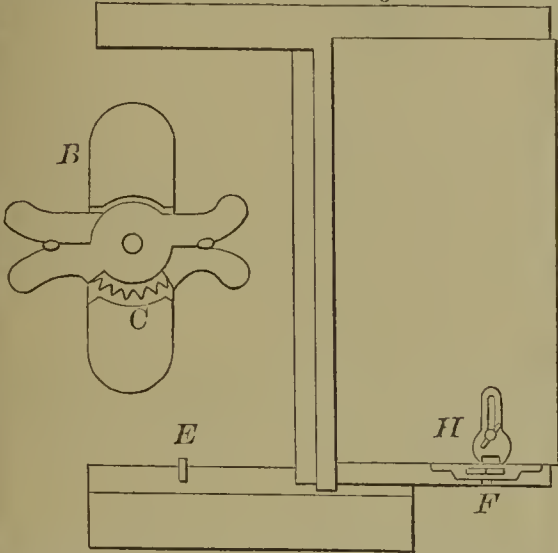

58442—Maltby & Brown—*Stove Cover Lifter, &c.*

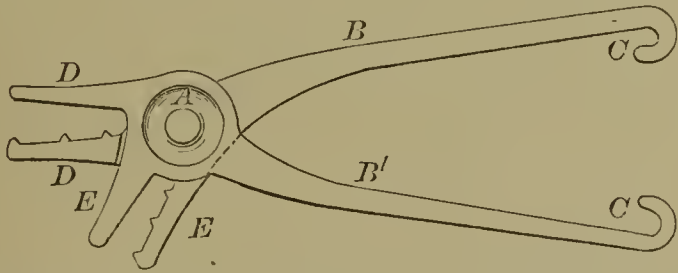

58444—R. McChesney—*Breech-Loading Fire Arm.*

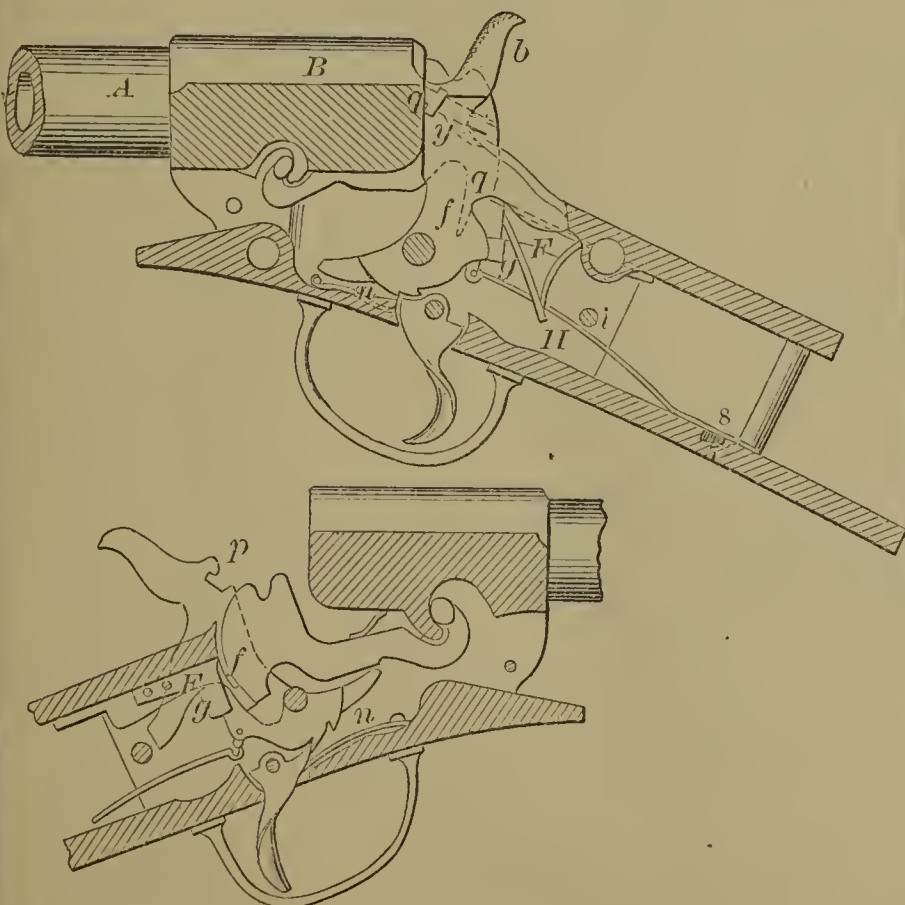

58440—A. Mabon—*Slate.*

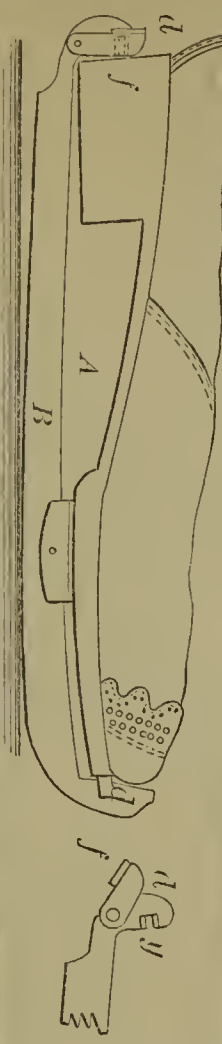

58439—Lyon & Doll—*Induction Coil for Electro-Magnets.*

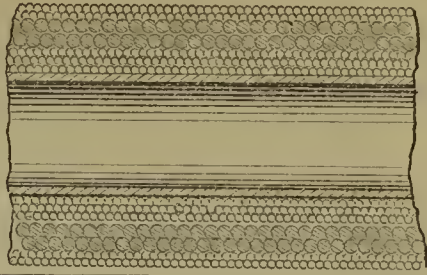

58443—J. E. McBeth—*Safety Gun Lock.*

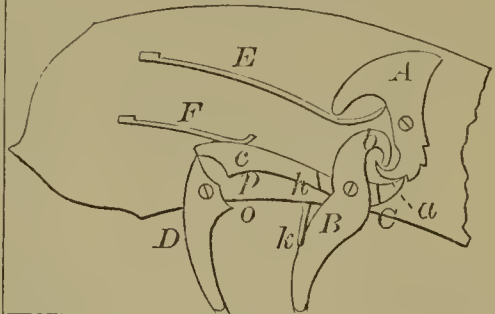

58445—J. McMurtry—*Cotton Bale Tie.*

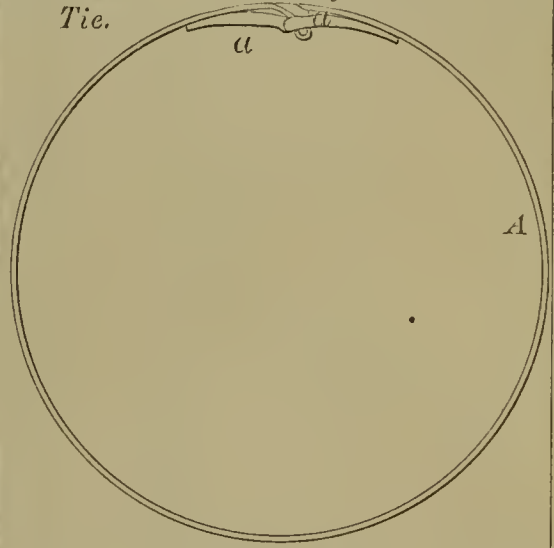

58446—D. F. Mellen—*For Gripping Screw Blanks.*

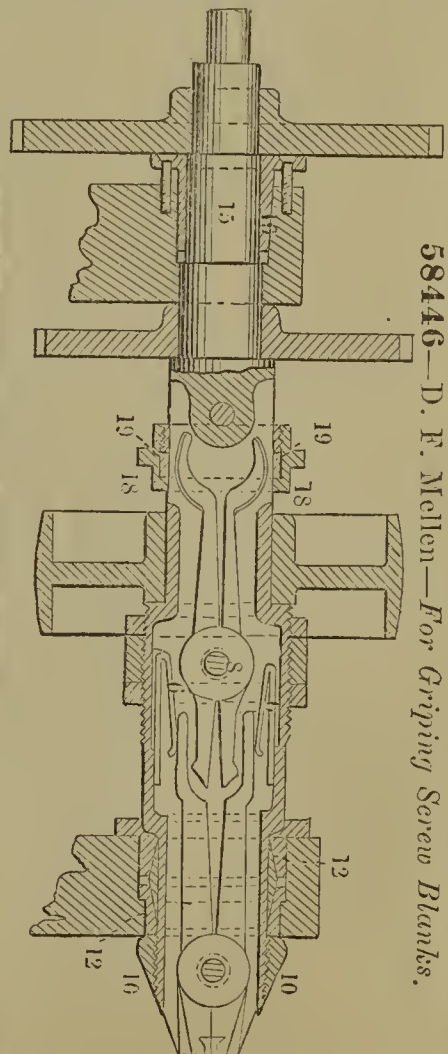



58447—E. Mellon—Attaching Tires to Locomotive Wheels.

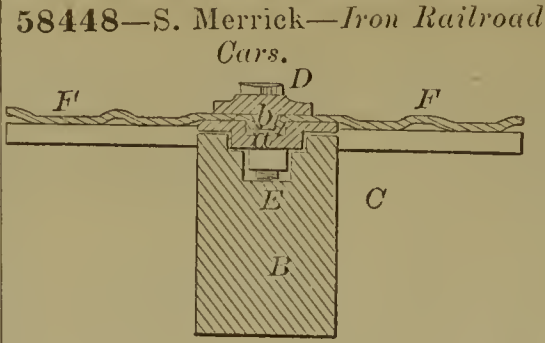

58448—S. Merrick—Iron Railroad Cars.

58456—D. R. Miller—Planing and Sawing Machine Dust and Shaving Conveyor.

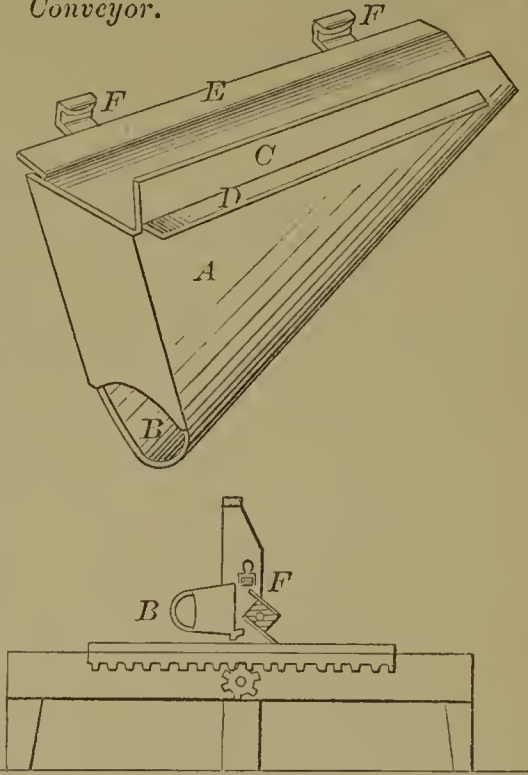

58451—J. Merrill—Cask, Barrel, and Keg.

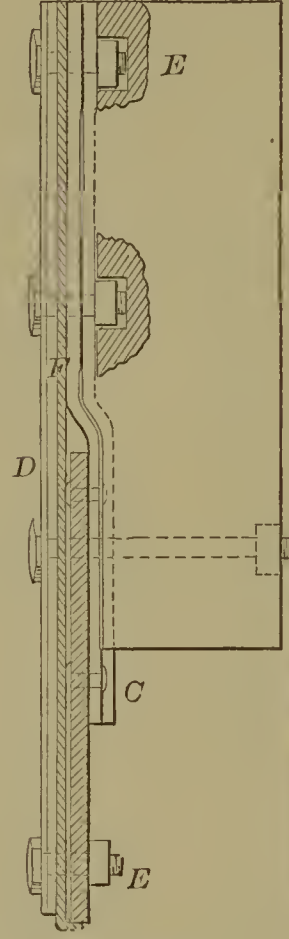
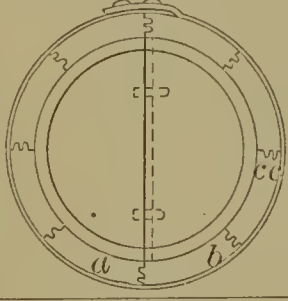

58449—J. Merrill—Cask Barrel &c.

58450—J. Merrill—Cask, Barrel, &c.

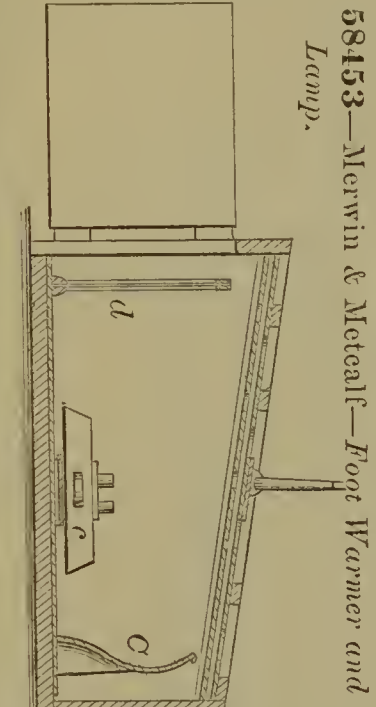
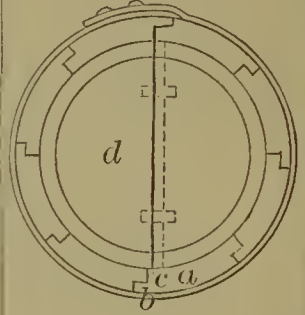
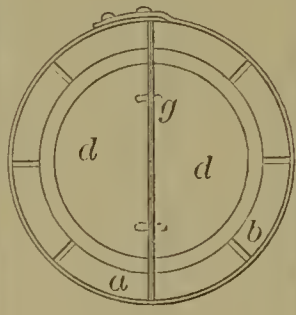

58453—Merwin & Metcalf—Foot Warmer and Lamp.

58455—W. A. Miles—Spice Box.

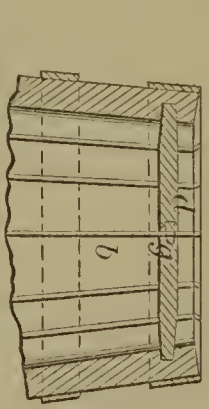
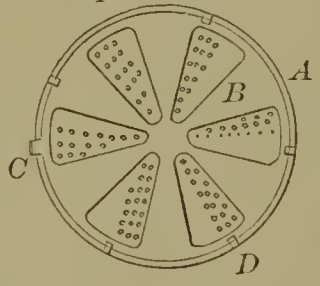

58452—J. Merrill—Barrel and Keg.

58457—B. Morahan—Sand Pump.

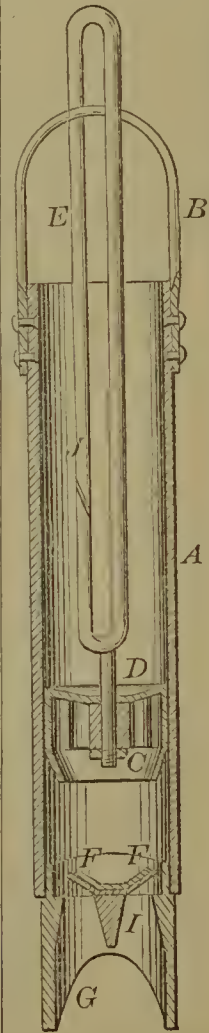

58460—Mull & Reed—Spider.

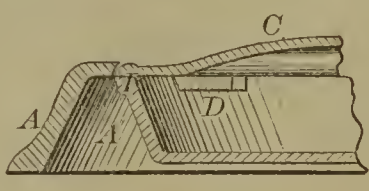

58459—C. Mulchahey—Lamp.

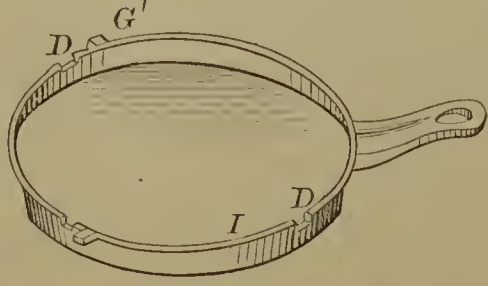
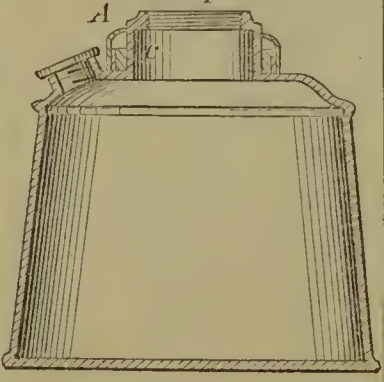

58461—H. Munroe—Window Blind Fastening.

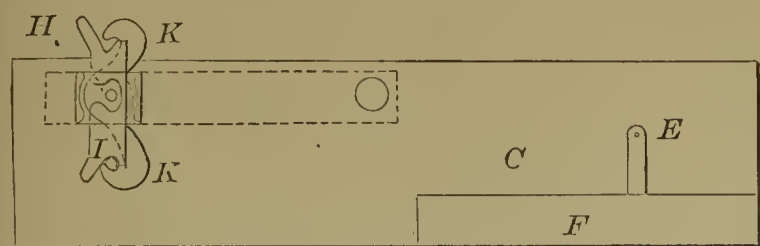

58462—G. W. Nellis—Folding Table.

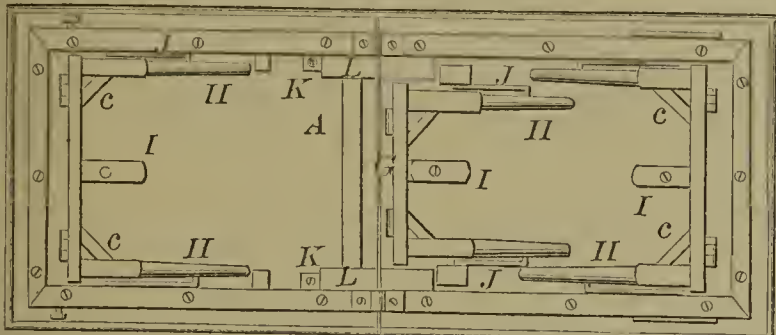

58464—B. Oldfield—Loom for Weaving Narrow Wares.

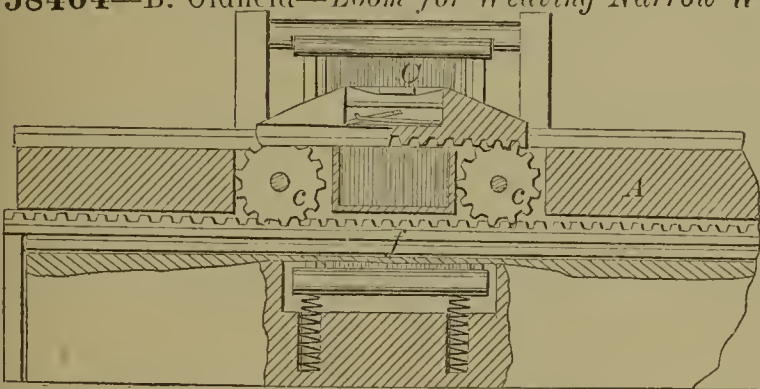

58467—W. S. Paddock—Fastening for Trunks, Boxes, &c.

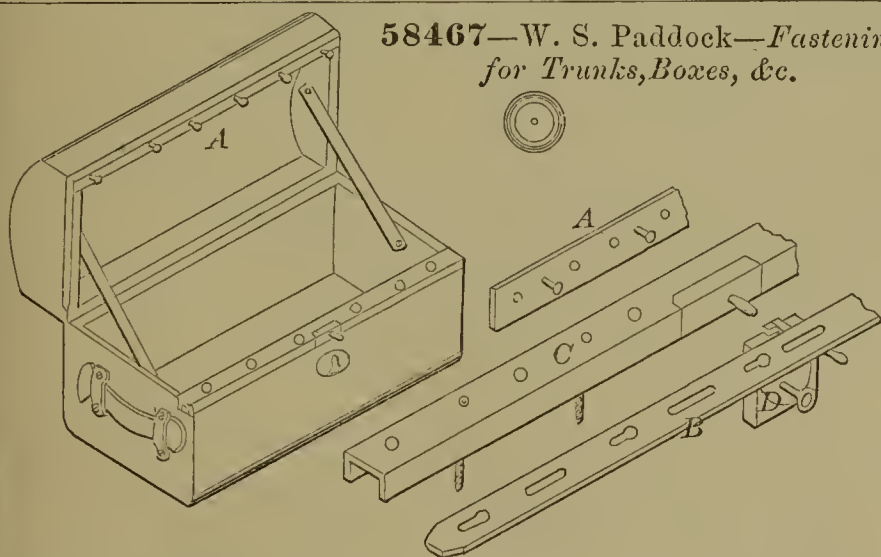

58470—J. J. & E. D. Parker—For Making Dies for Braid and Embroidery.

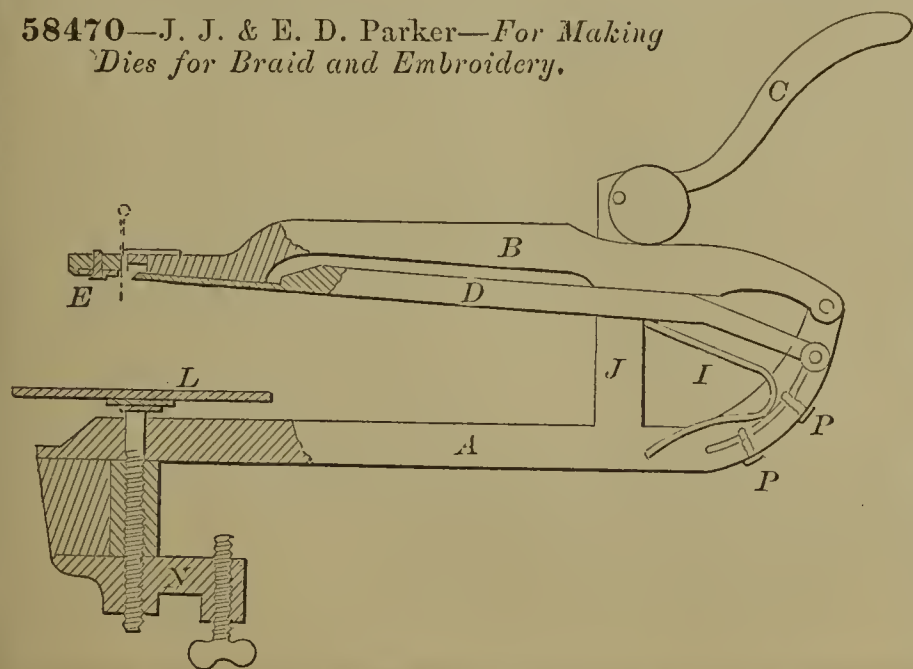

58463—E. B. Nourse—Alphabet Frame.

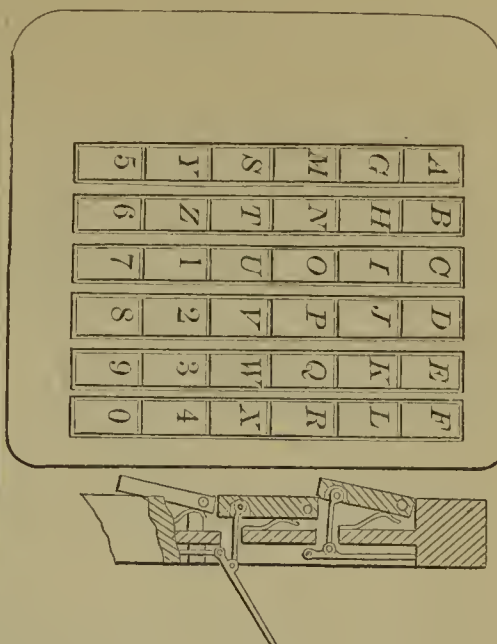

58465—J. H. J. O'Neill—Carriage Shackle.



58469—J. J. Parker—Well Packing.

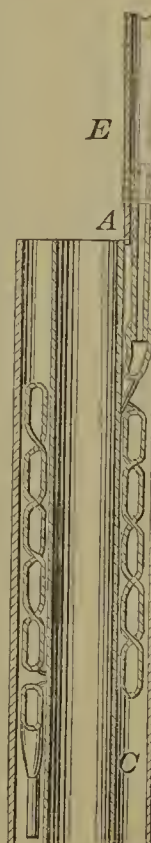

58468—J. J. Parker—Deep Well Tube Packing.



58471—A. Patterson—  
For Carburetting Air, &c.

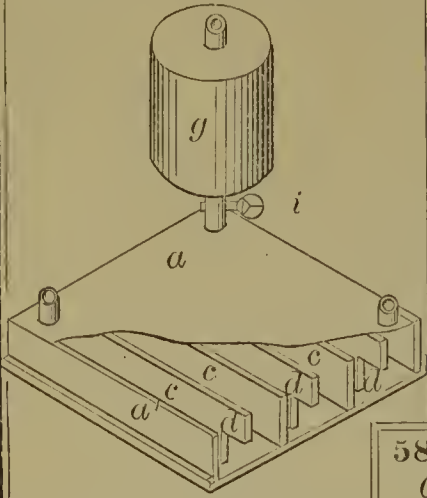

58472—P. & H. A. Perdeu—Syrup Filter.

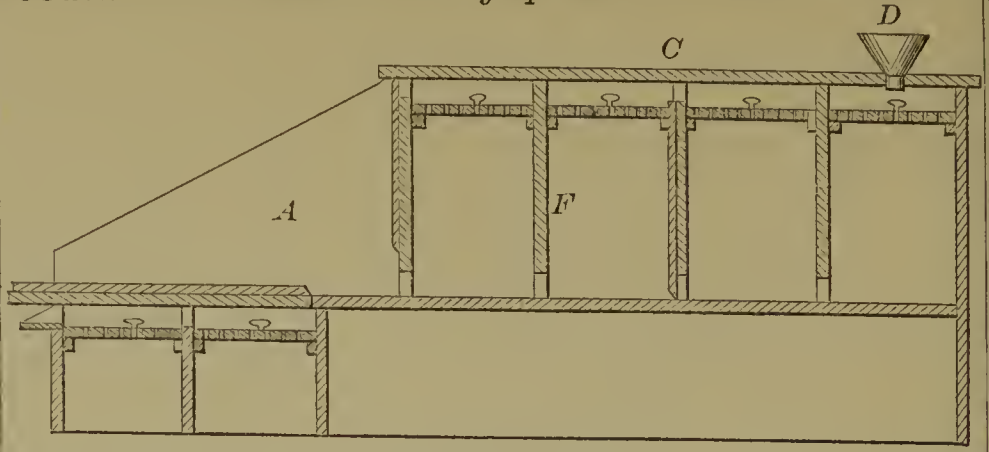

58473—H. & A. Phelps—For  
Cutting and Stamping Soap.

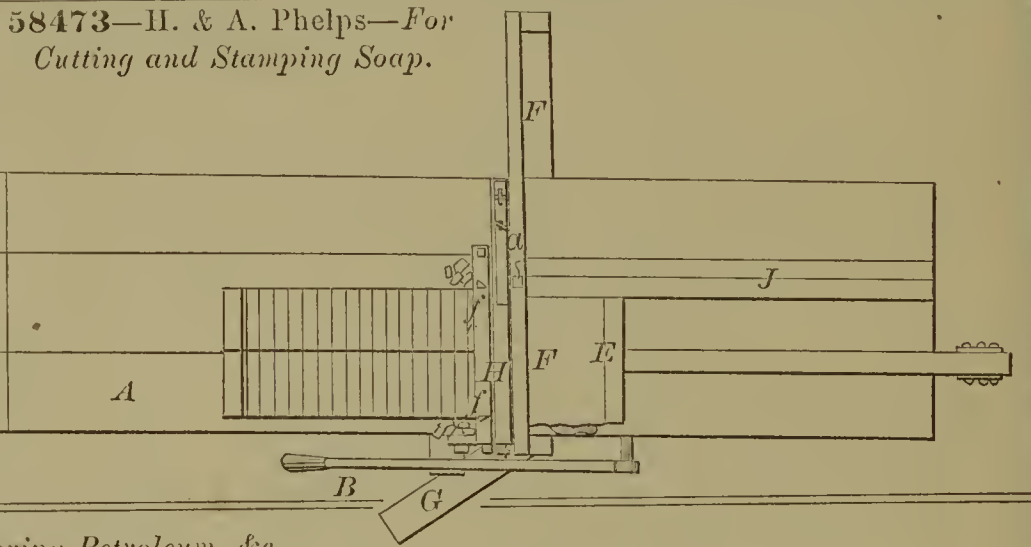

58474—C. W. Pierce—  
Grate Bar.

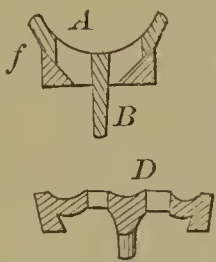

58475—E. Quinn—Storing Petroleum, &c.

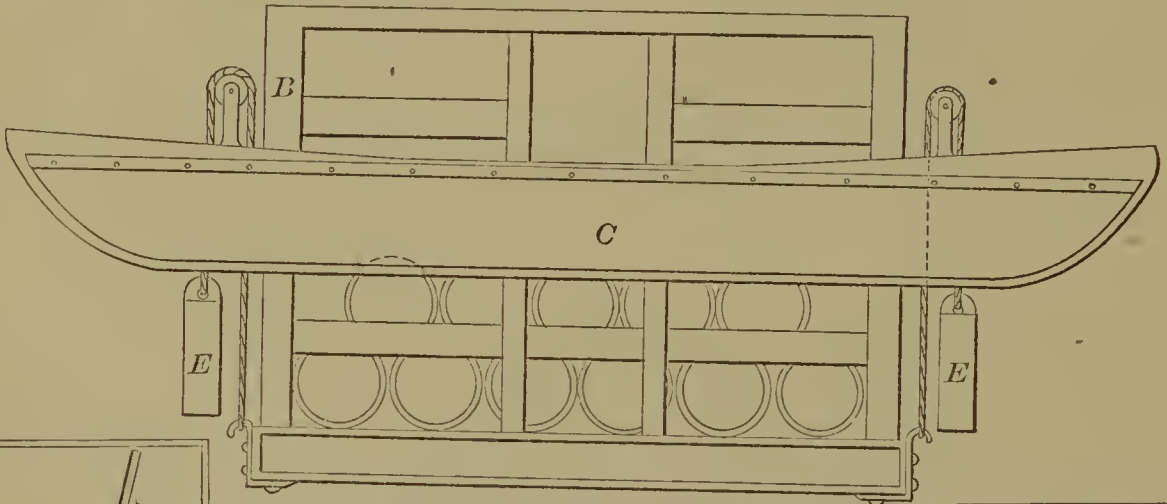

58477—W. Resor—Heating Stove.

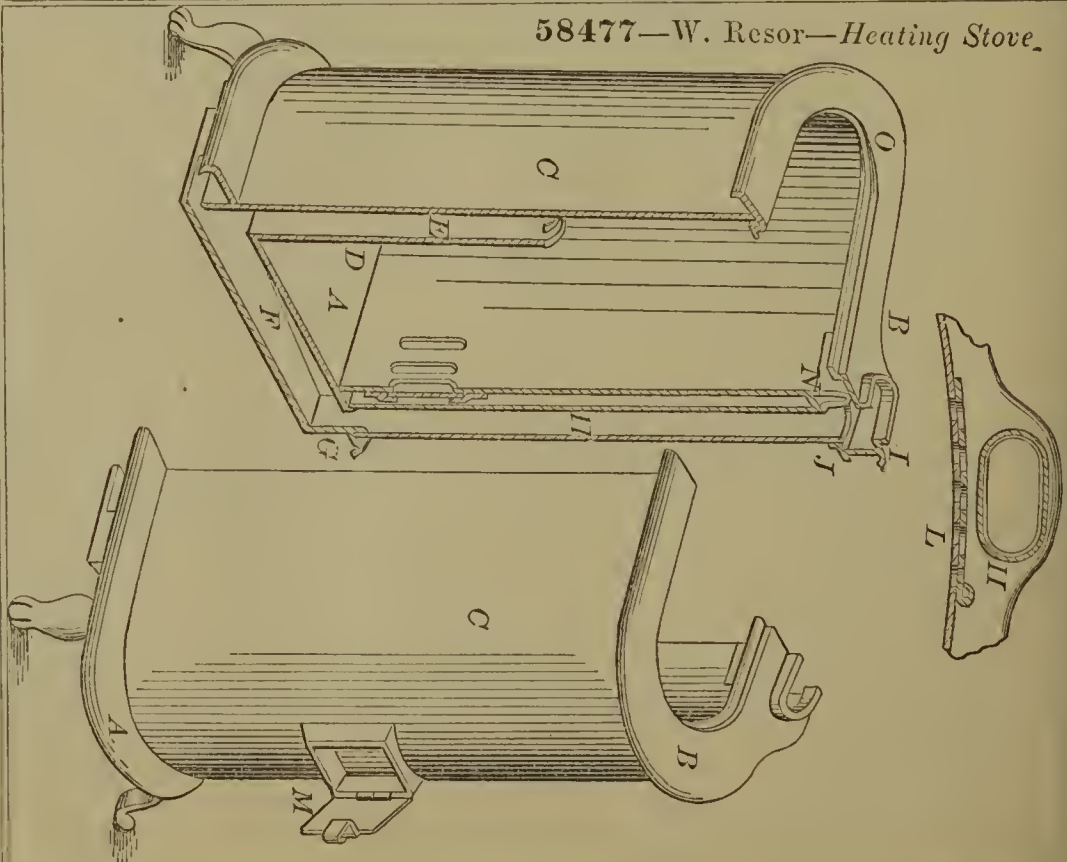

58476—J. K. Reimer—Cultivator.

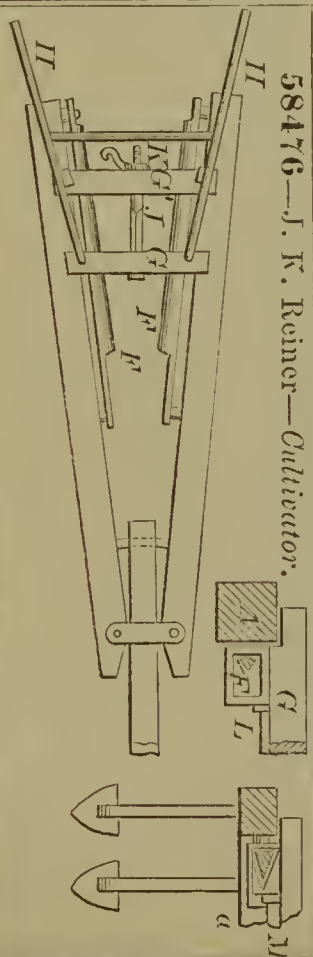



58478—G. H. Reynolds—*Steam Engine.*

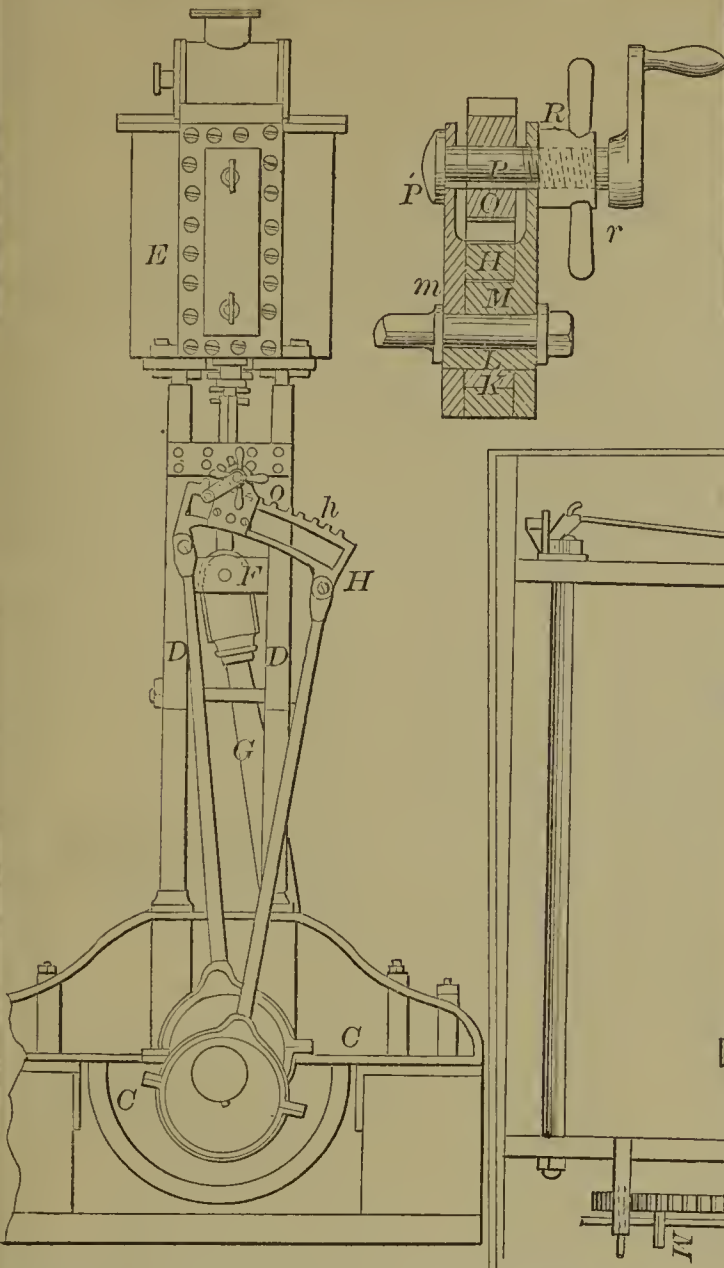

58481—K. Riedel—*Lamp.*

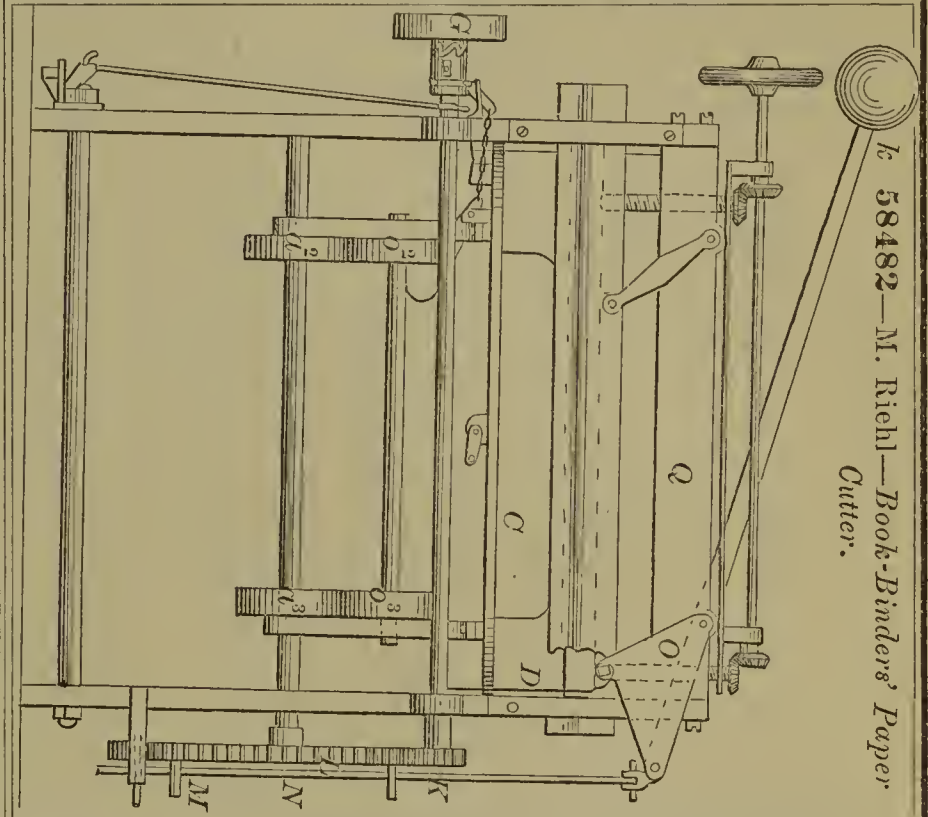
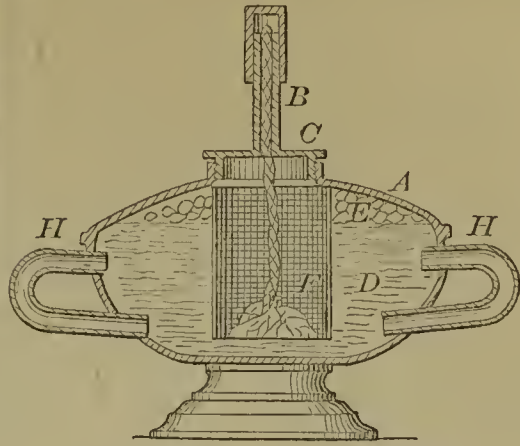

58482—M. Riehl—*Book-Binders' Paper Cutter.*

58479—S. H. Rhoades—*Driving Pump.*

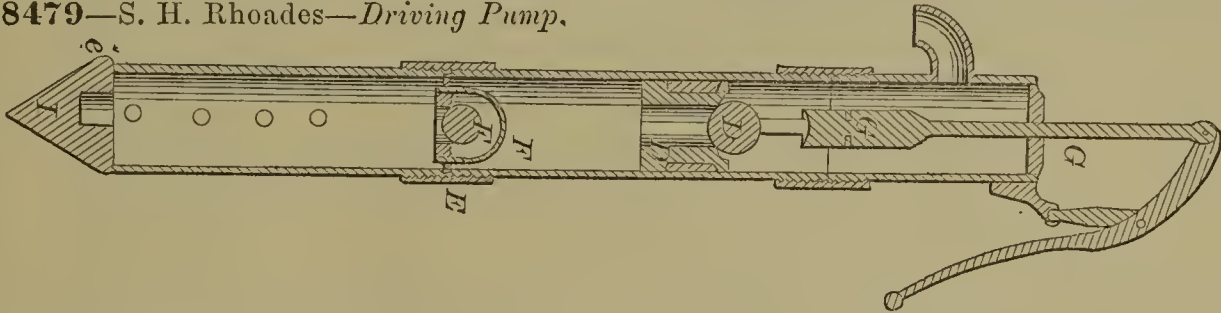

58480—E. Richmond—*Whip Rack.*

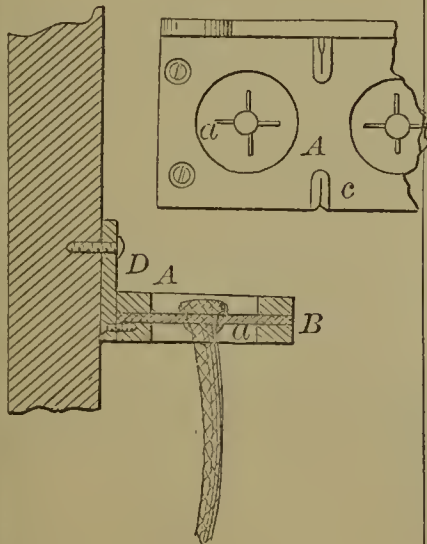

58483—Rogers & Rinehart—*For Making Spikes.*

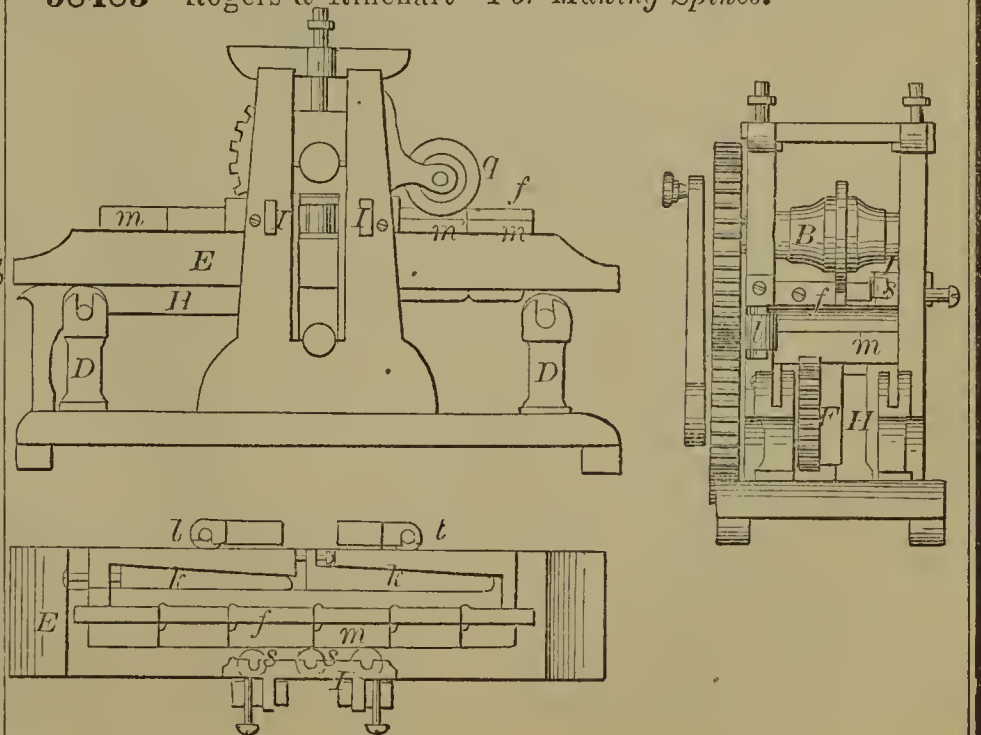

58485—J. Roy—For Forging Horse Shoe Nails.

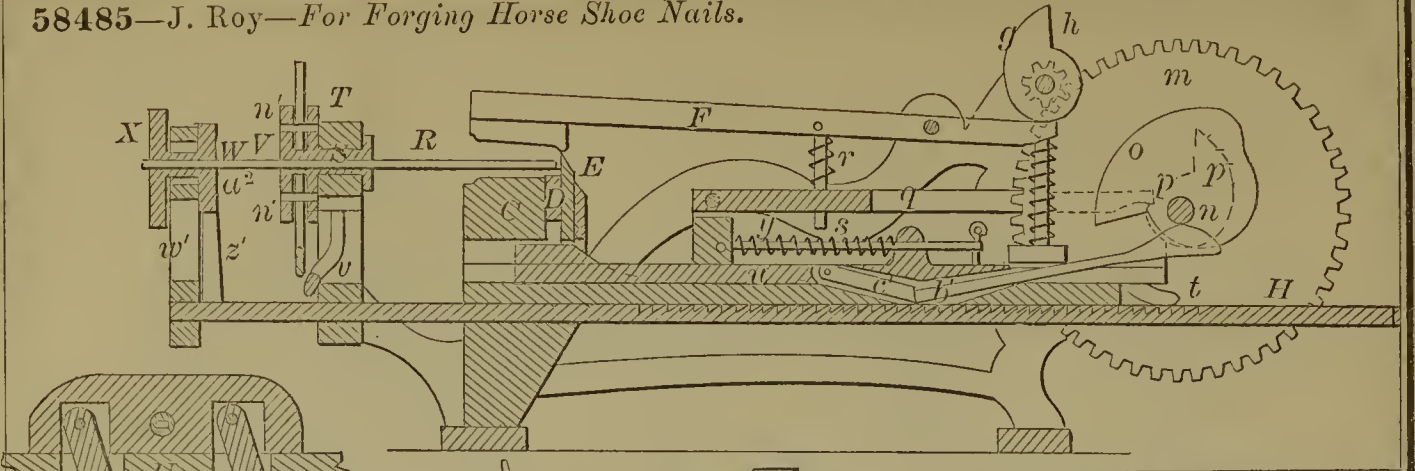

58486—N. Safford—  
Hand Planter.

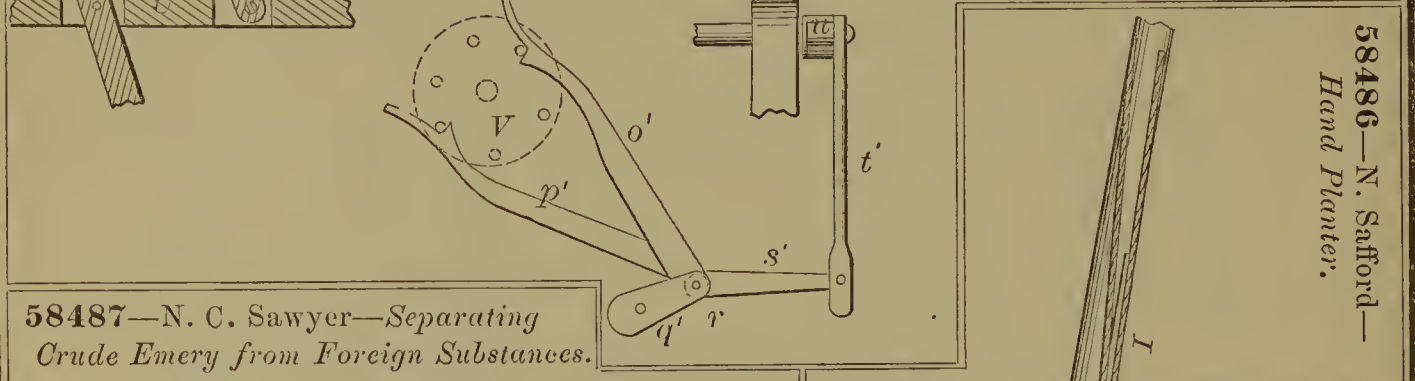

58487—N. C. Sawyer—Separating  
Crude Emery from Foreign Substances.

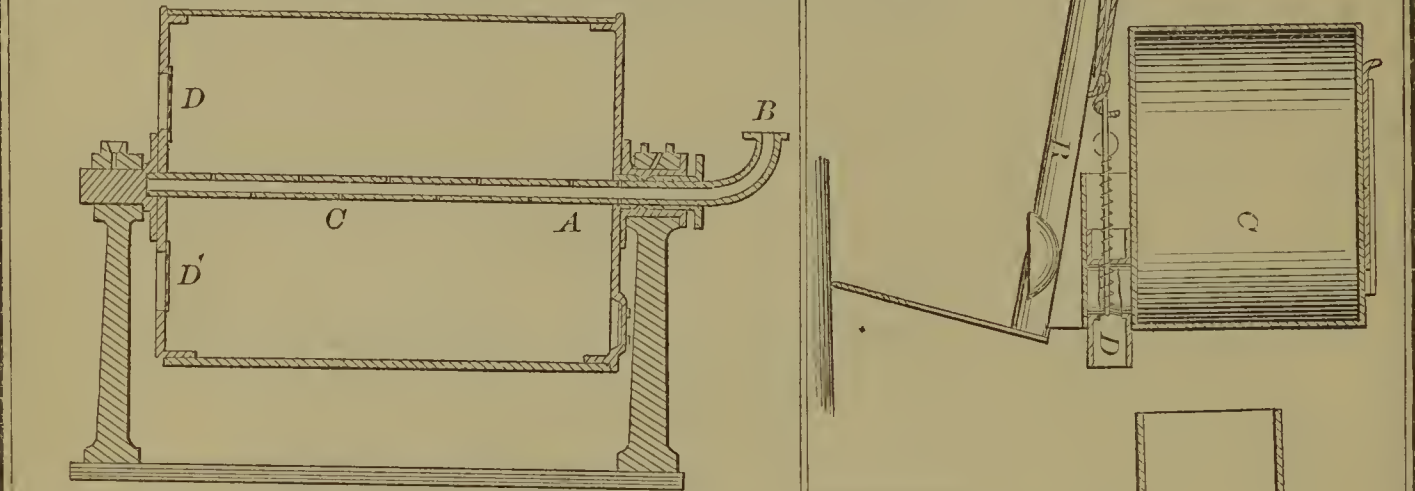

58488—J. P. Schmucker—Wood Bending Machine.

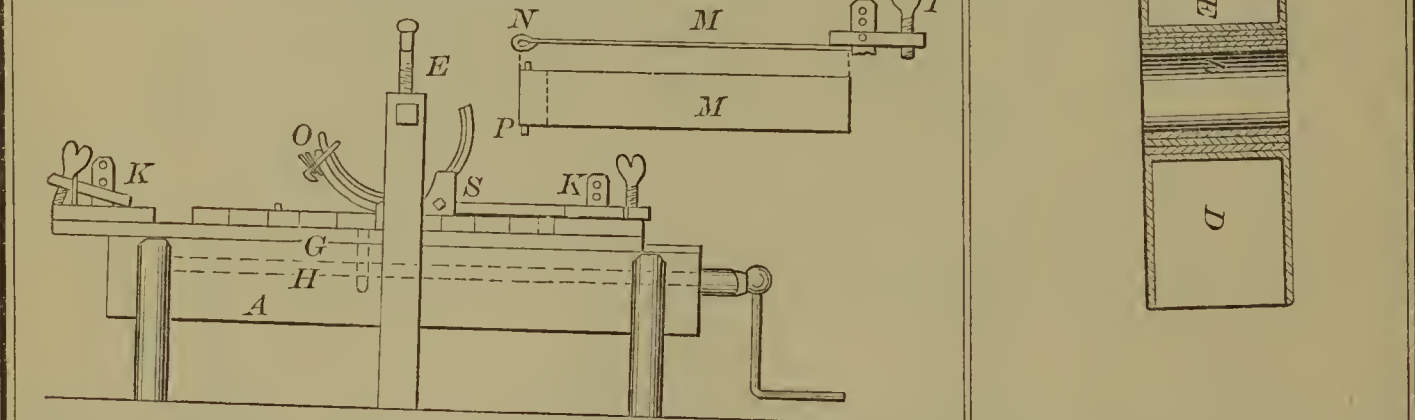

58489—R. Shaler—Bakers' Oven Turn  
A Table.

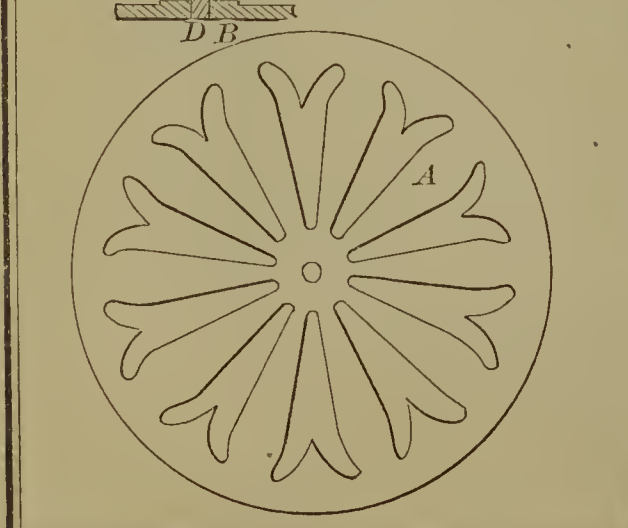

58490—A. G. & P. M. Shults—Money  
Drawer.

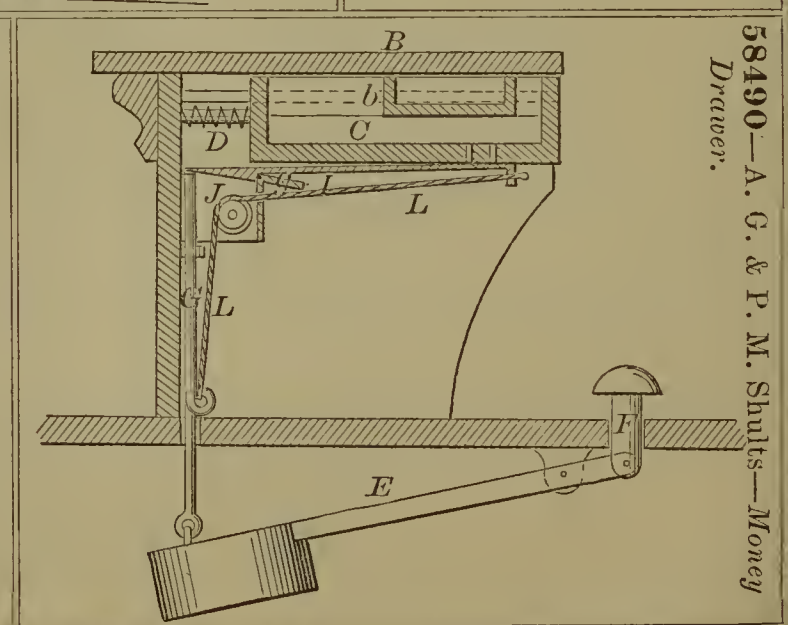

58491—T. Silver—*Steam Engine Governor.*

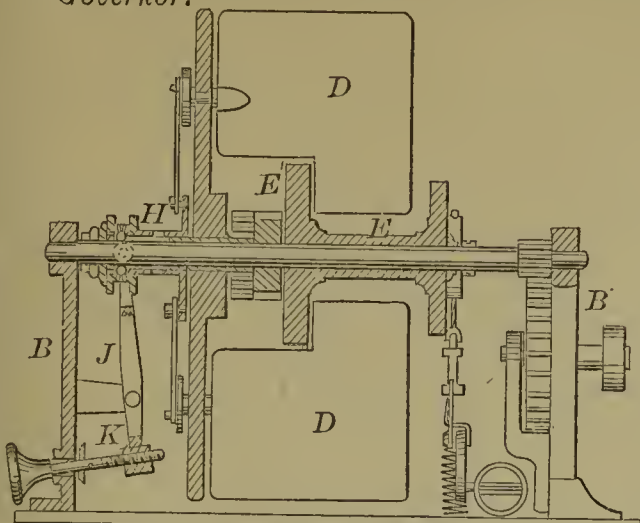

58498—Stanley & Goodrich—*Angular Saw Gauge.*

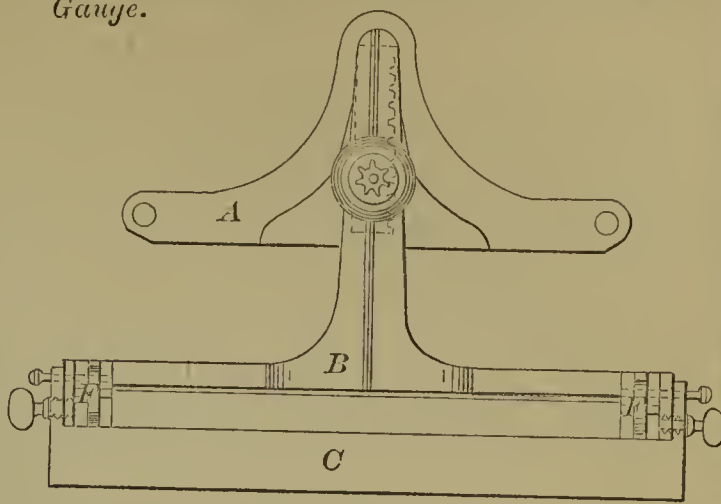

58492—A. T. Smith—*Railroad Draw Bridge Signal.*

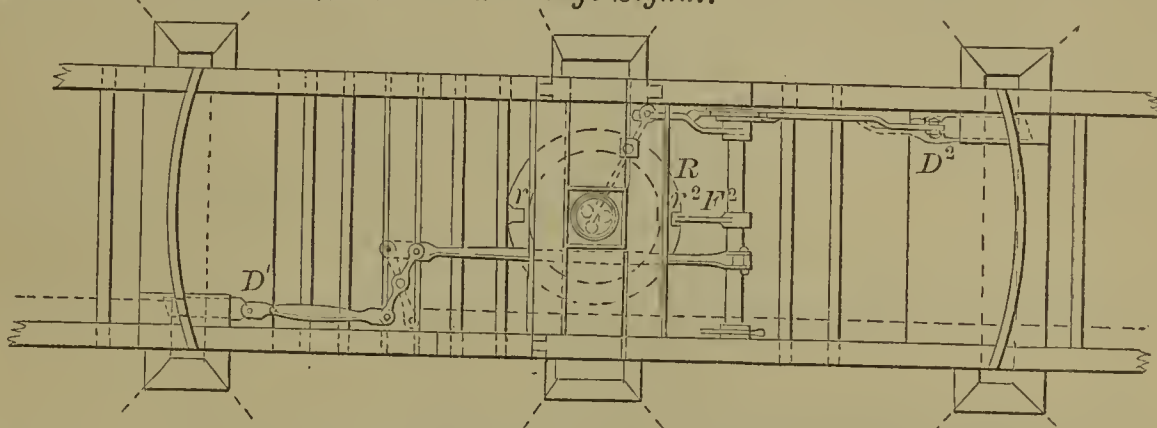

58494—S. Smith—*Grate Bar.*

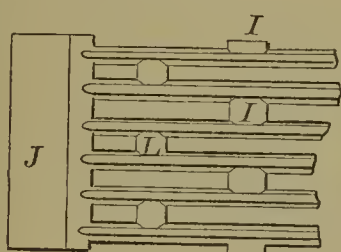

58493—S. Smith—*Cooking Stove.*

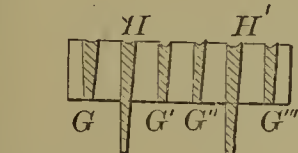
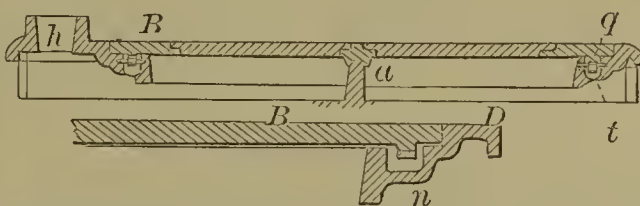

58500—C. Steen—*Plow.*

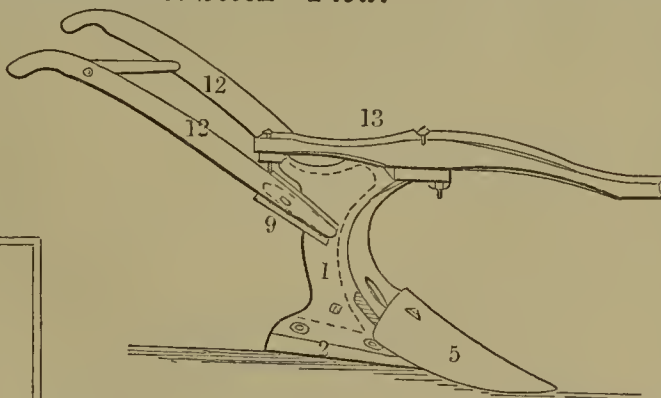

58495—E. Sneider—*Horse Shoe.*

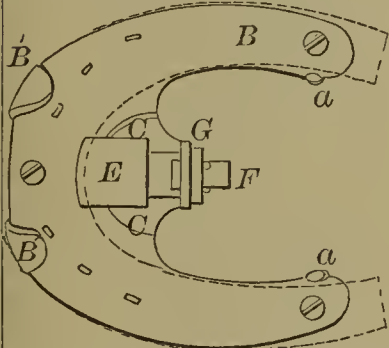

58502—A. Stewart—*Fruit Can Top.*

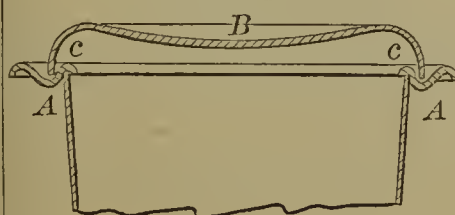

58496—T. S. Speakman—*Safety Valve in Water Backs for Ranges.*

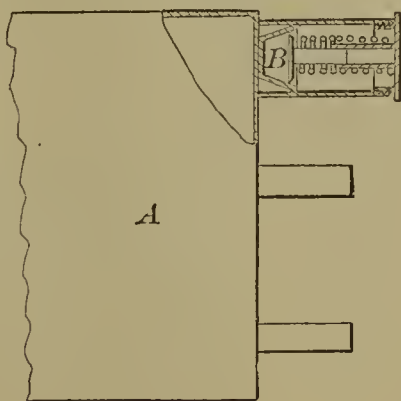

58501—F. Stefane—*Setting Stones in Jewelry.*

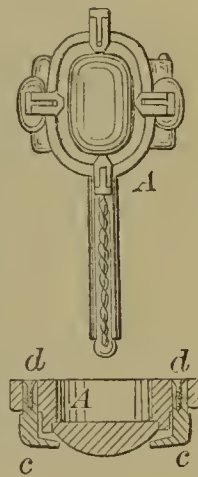

58503—Stierle & Baer—*Steam Engine Globe Valve.*

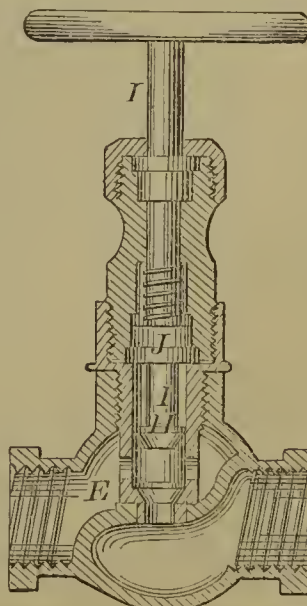

58504—W. H. Strahan—Grindstone Tool.

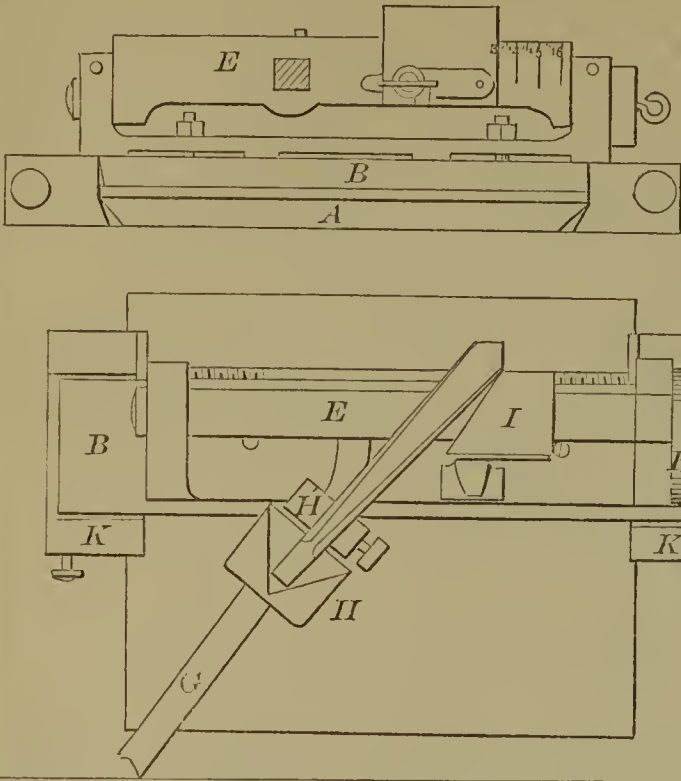

58507—J. A. Taplin—For Cutting Wood.

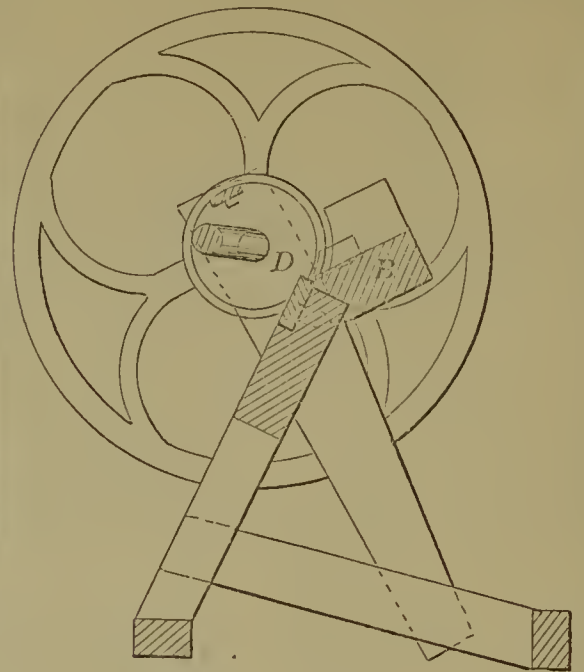

58506—Tait & Avis—Steam Generator.

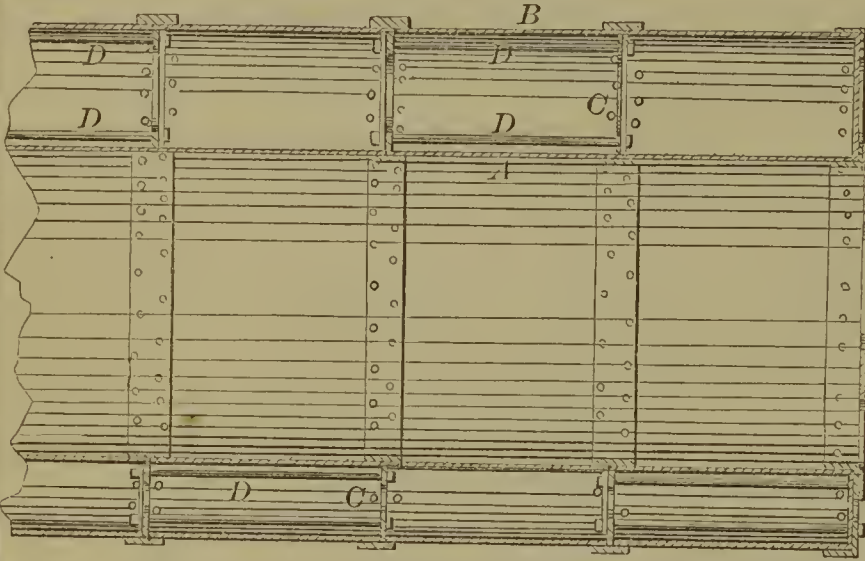

58508—J. S. P. Taylor—Lap Shiver.

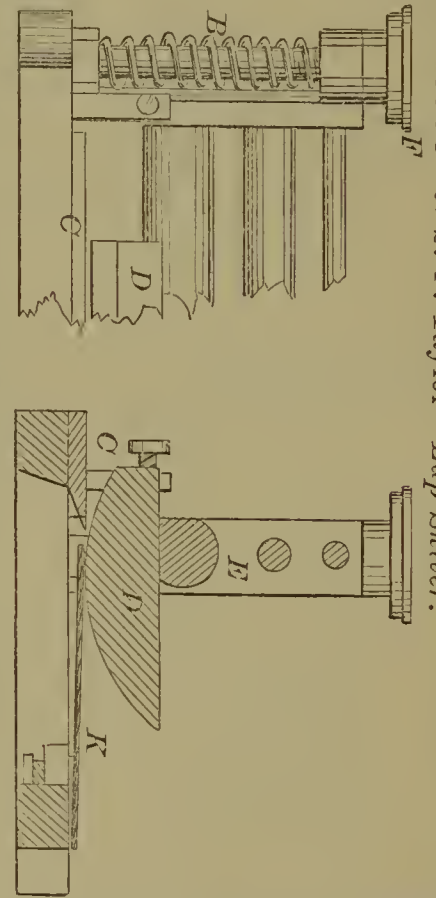

58505—J. Taggart—Skirt Supporter.

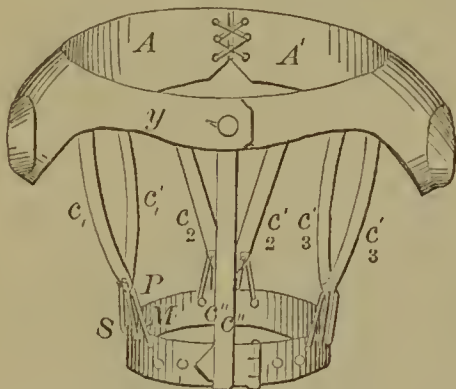

58510—J. P. Thompson—Baby Jumper.

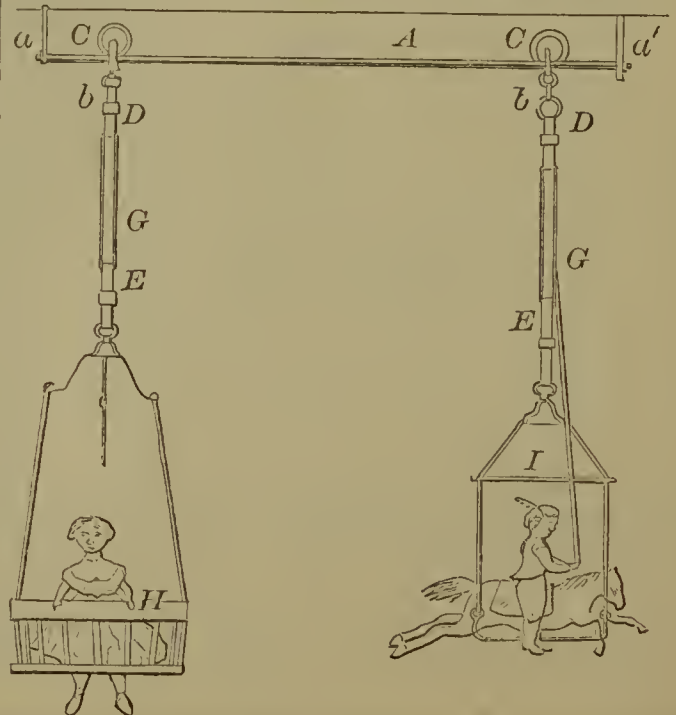

58509—J. Theat—Tuyere.

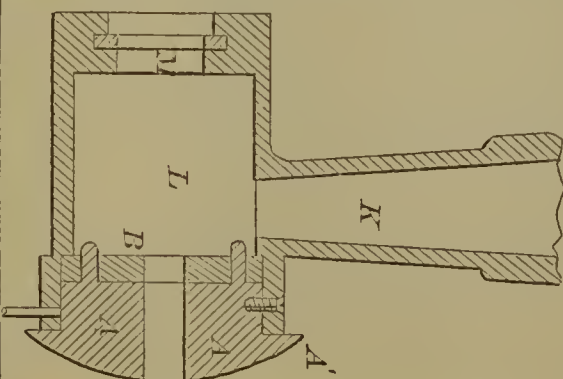

58511—J. Tilton—Preserving and Curing Meat.

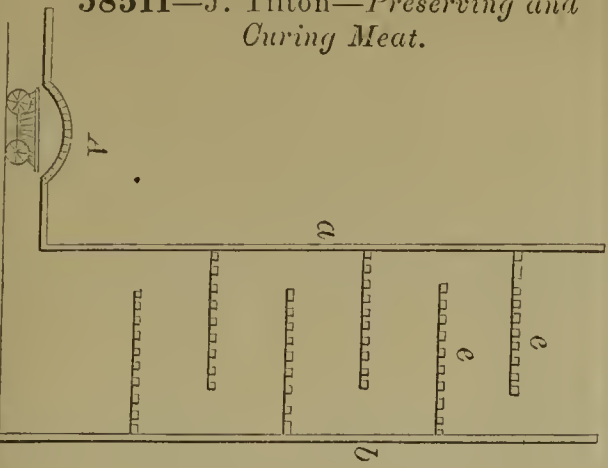

58512—P. H. V. Weyde—Petroleum Double Still.

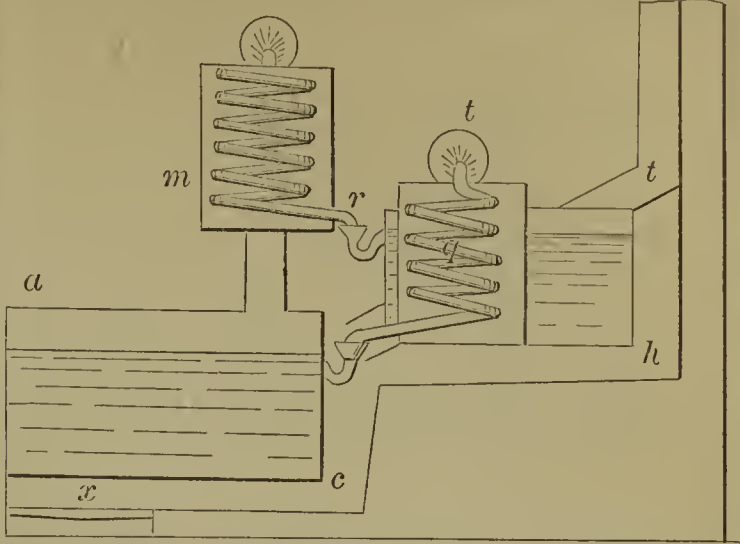

58517—Wertman & Reinbold—For Gathering Clover P Seed.

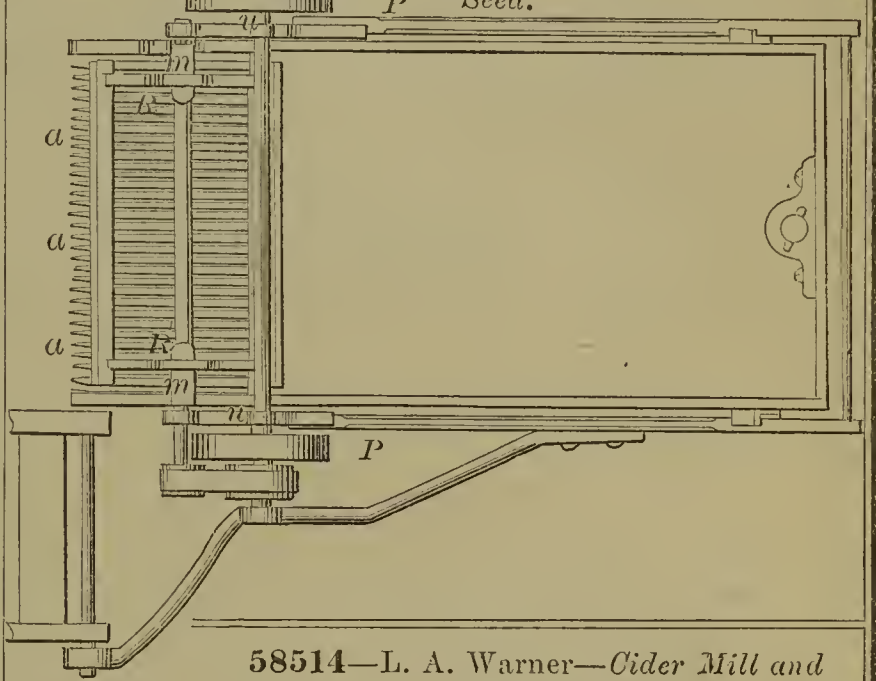

58513—W. W. Jr. & M. J. Walsh—Hat Finishing Press.

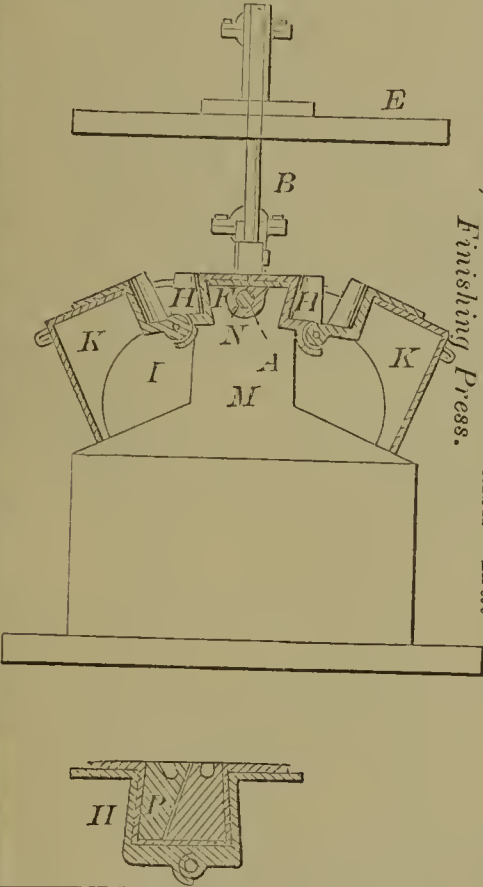

58514—L. A. Warner—Cider Mill and Fruit Press.

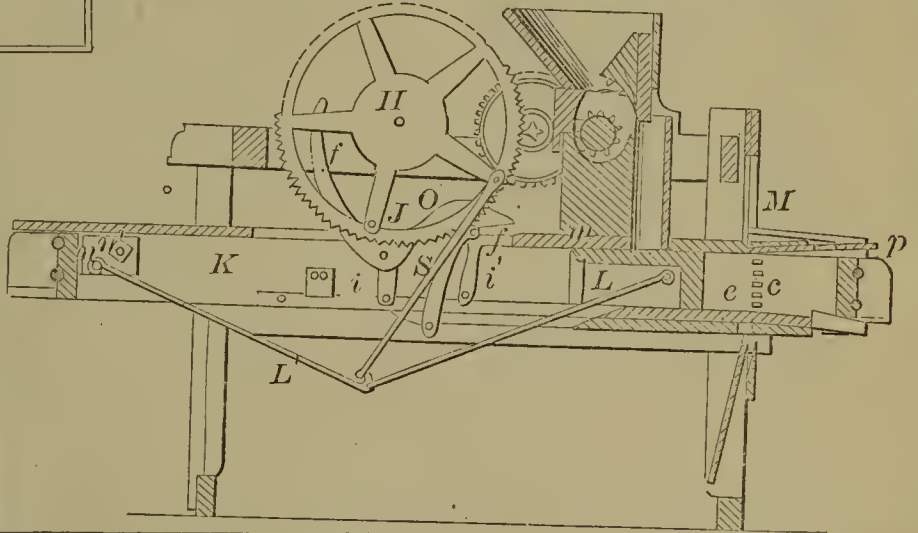

58515—J. L. Weyer—Washing Machine.

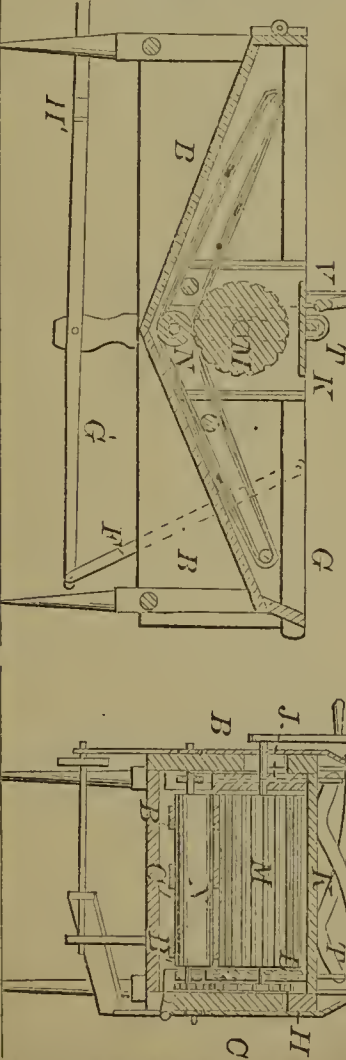

58518—W. Westlake—Coffee Pot.

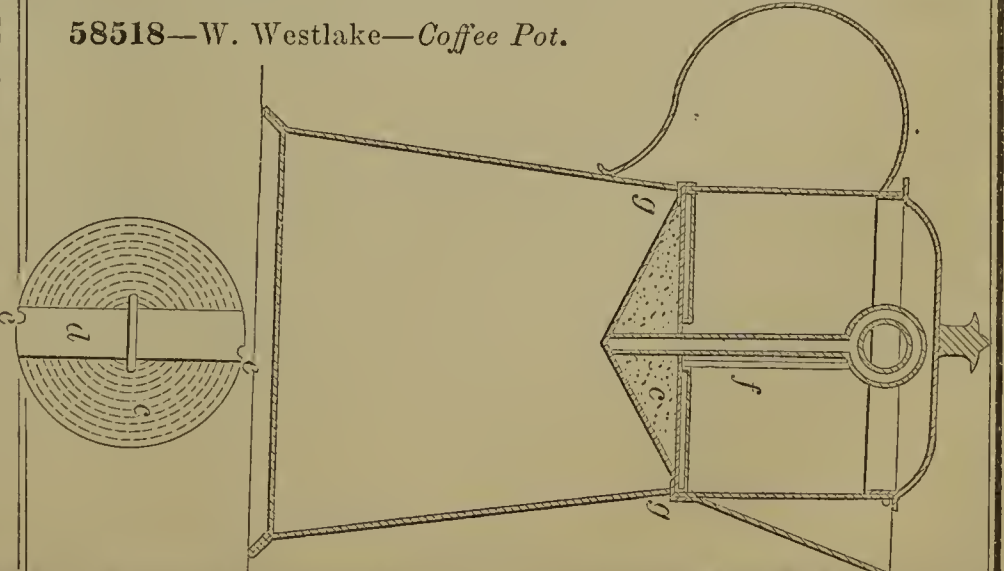

58522—A. Whitlock—Oven.

58519—C. H. Weston—Bench Hook.

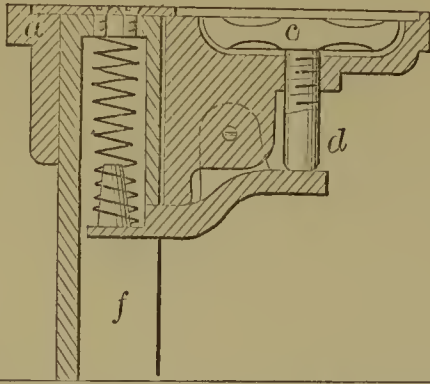

58521—A. Whittemore—For Making Split Spikes.

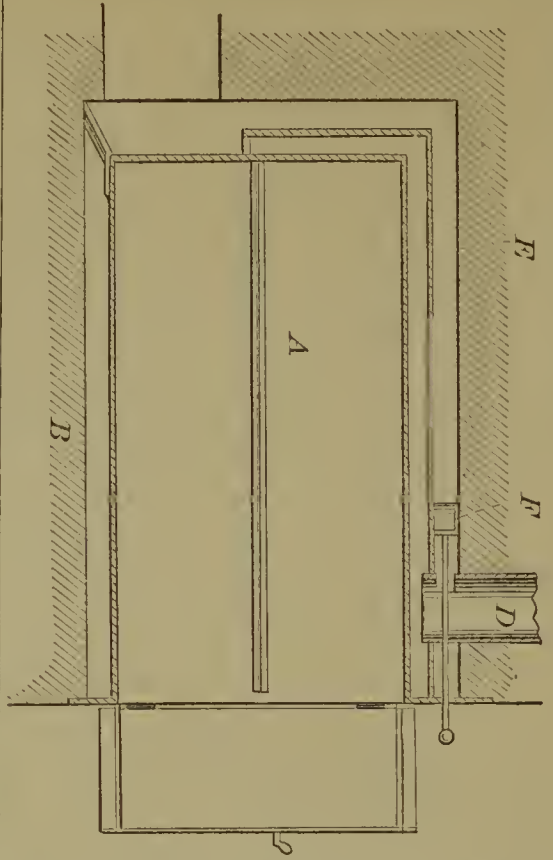
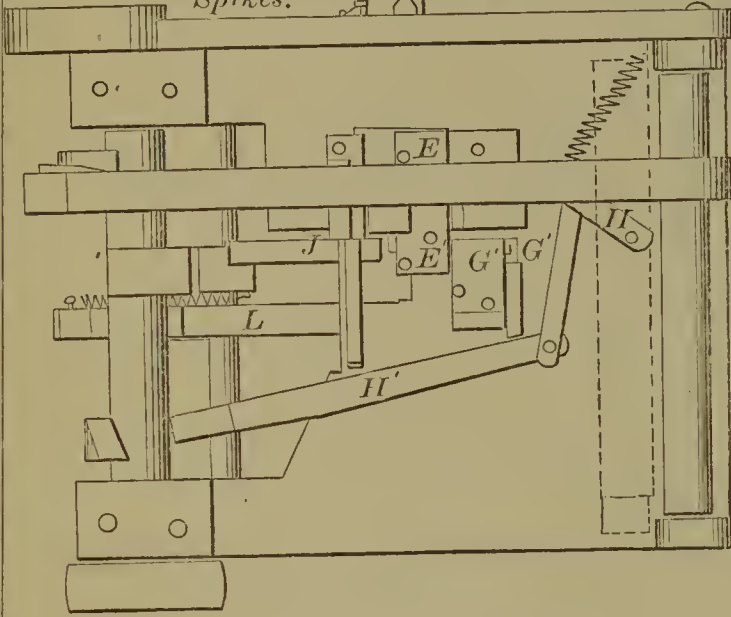

58520—A. Whittemore—For Making Horse Shoe Nails.

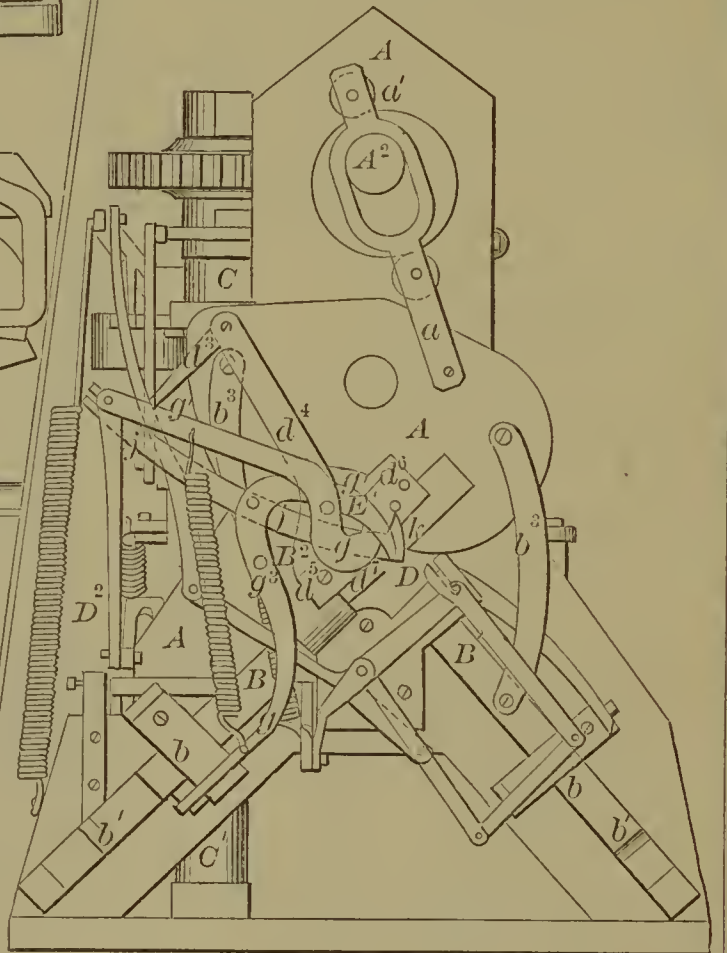
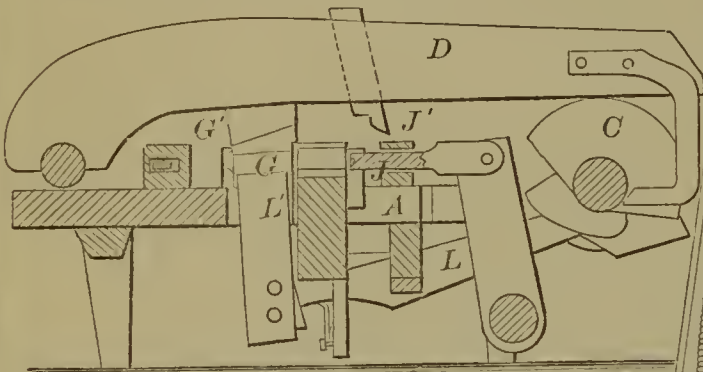

58523—J. A. Wiedsheim—Furniture Caster.

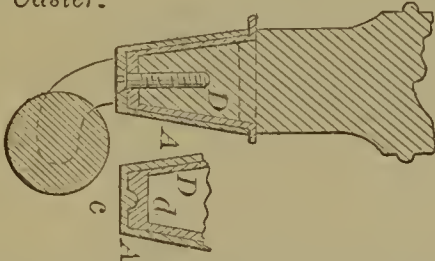

58524—S. W. Wilcox—Lamp Burner.

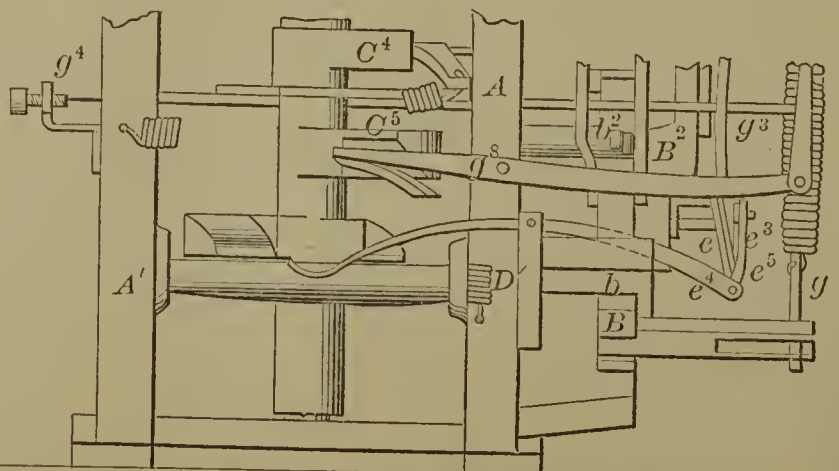
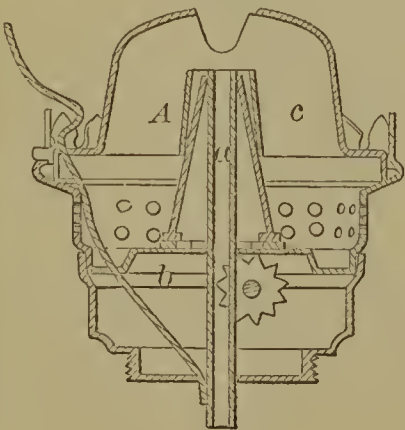

58525—D. Williamson—Breech-Loading Fire Arm.

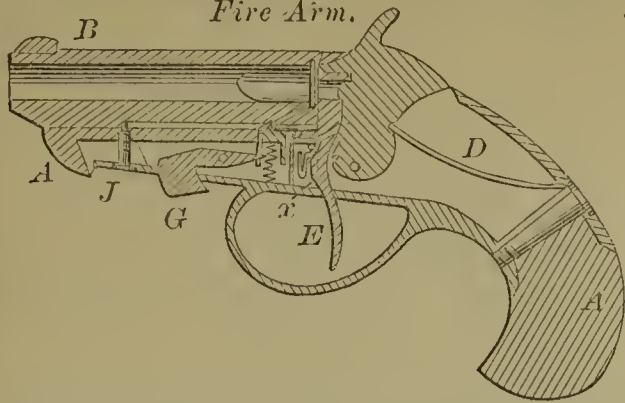

58530—H. T. Woodman—Filter and Cooler.

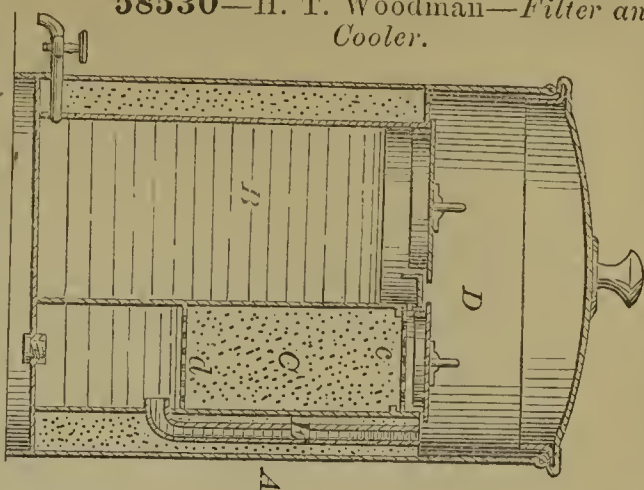

58528—Winter & Newton—For Preparing Peat for Fuel.

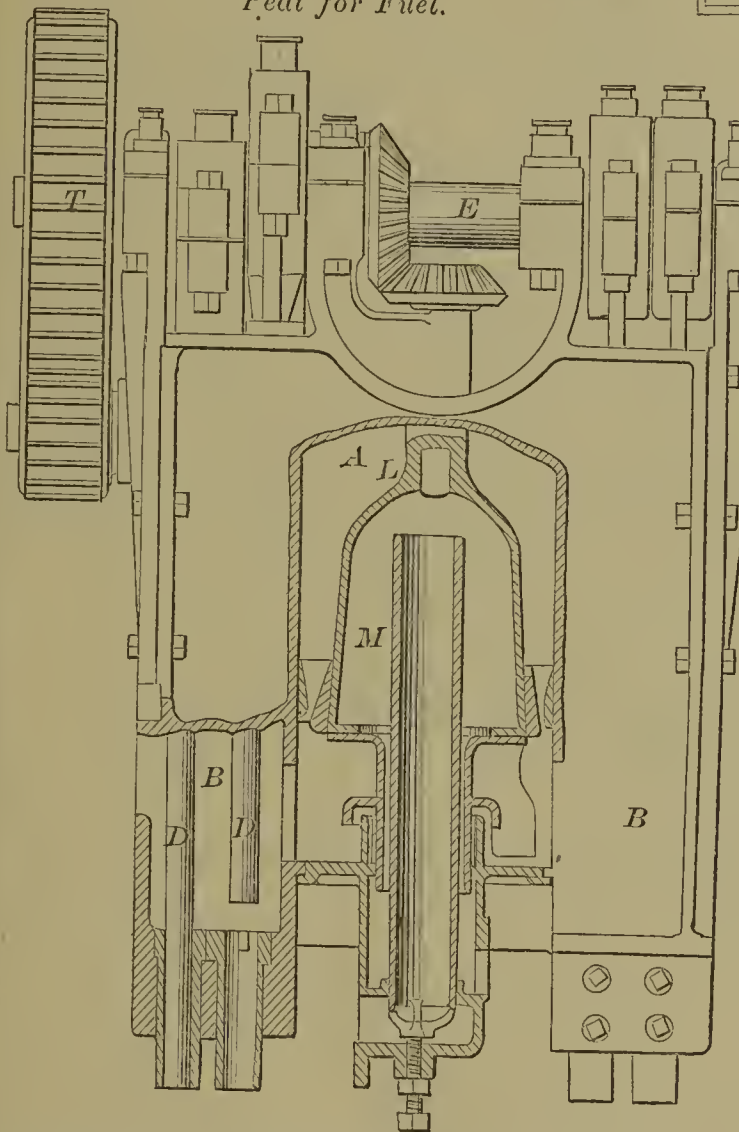

58527—S. R. Wilmot—Hoop Skirt Clasp.

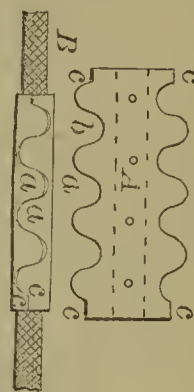

58529—J. D. Woodbury—Sheep Rack.

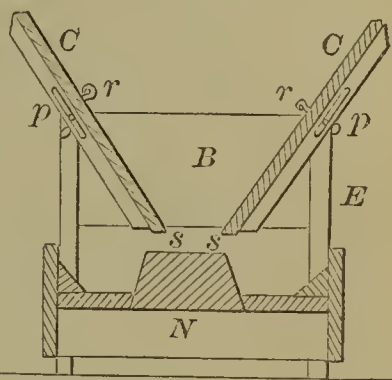

58531—C. E. Wright—Cherry Stoner.

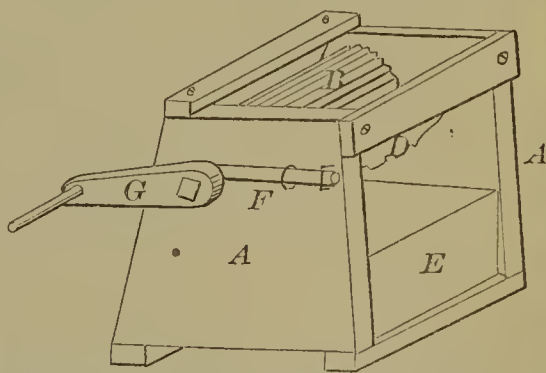

58526—J. I. Williams—Baling Press.

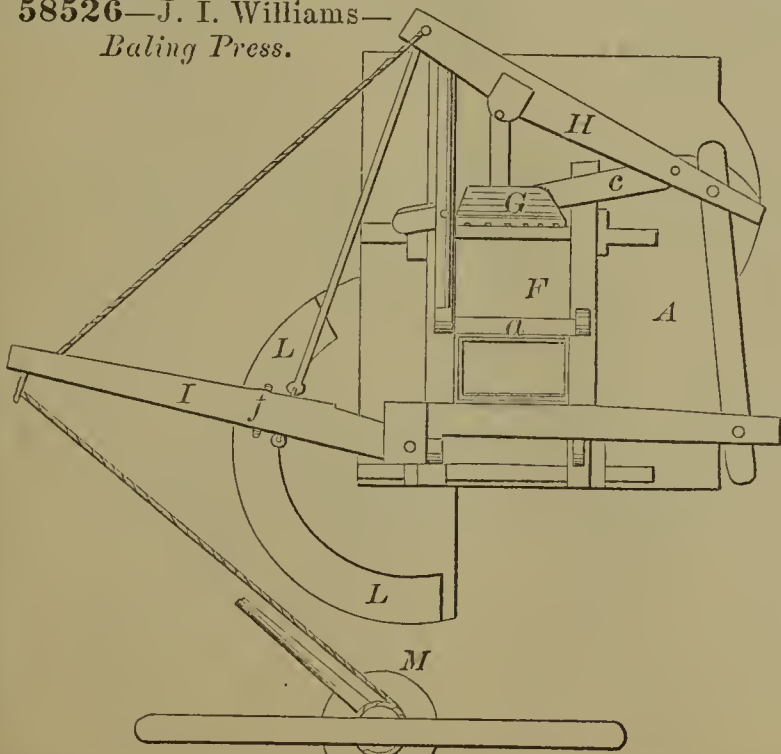

58533—G. W. Zeigler—Attaching Cultivator Teeth to Frames.

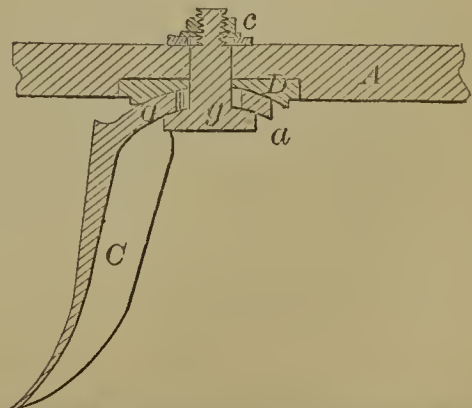

58534—C. Zimmerman—*Plow.*

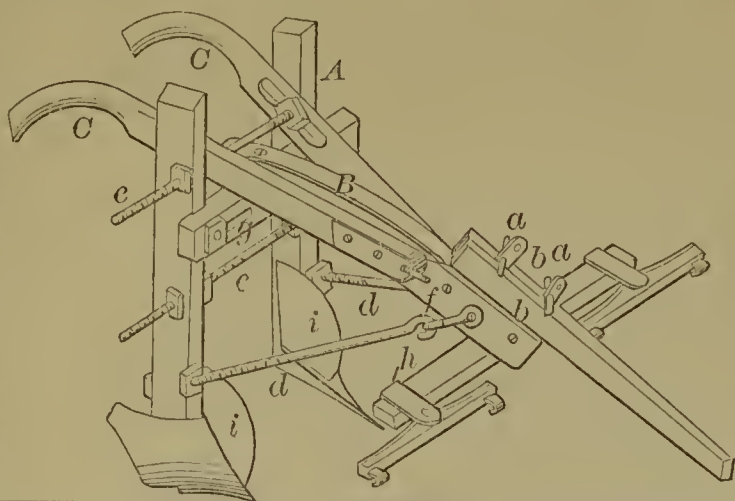

58536—J. E. Auld—*Match Safe.*

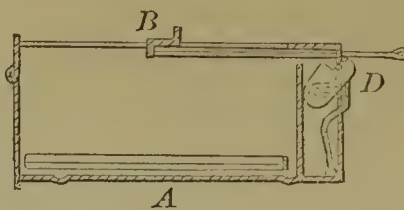

58540—T. B. De Forrest—*Hoop Skirt Clasp.*



58538—J. Campbell—*Cigar Press.*

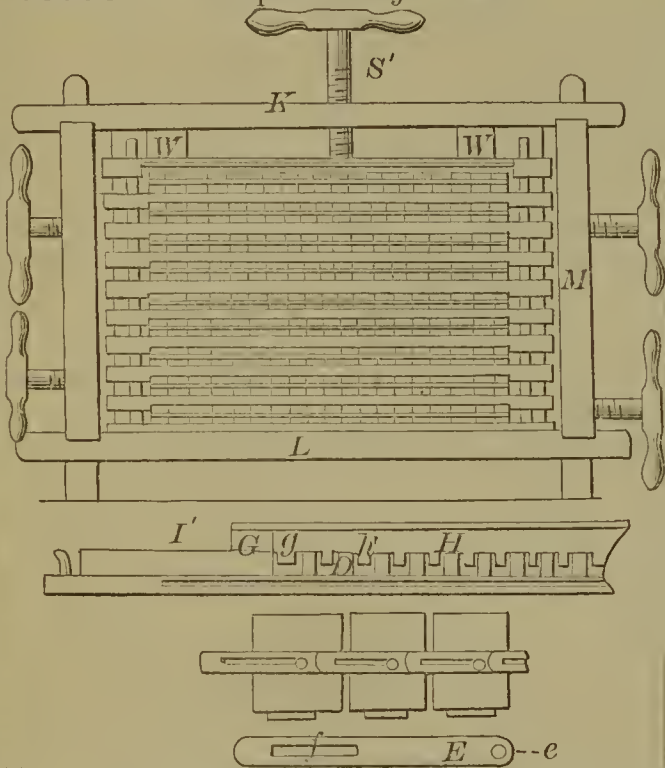

58539—I. S. Croll—*Quartz Crusher.*

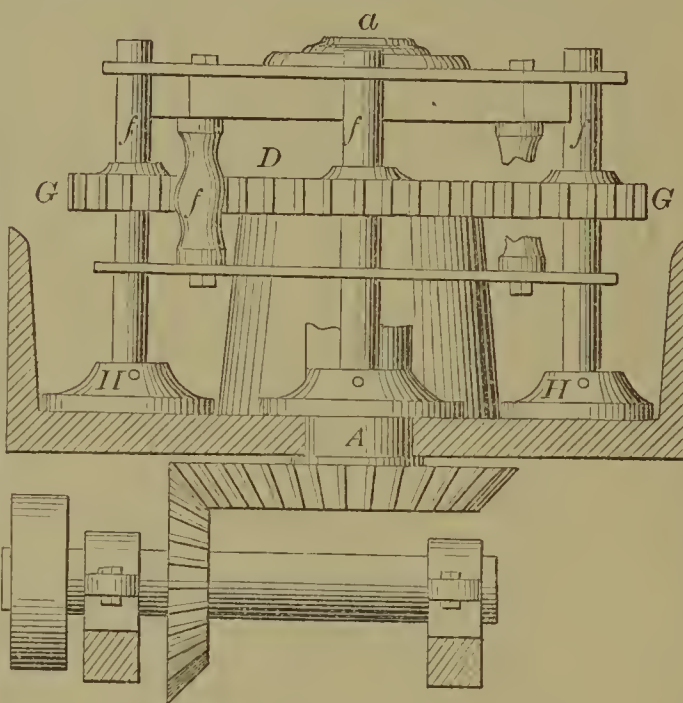

58535—W. W. Armington—*Clothes Pole.*



58541—P. C. Ellsworth—*Hay Elevator.*

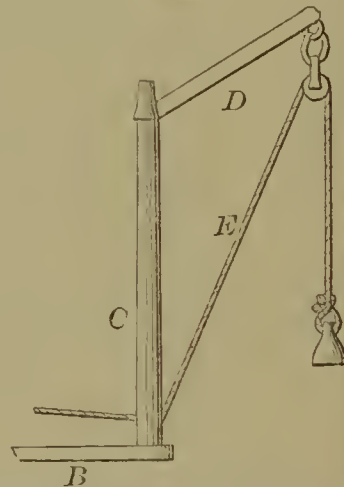
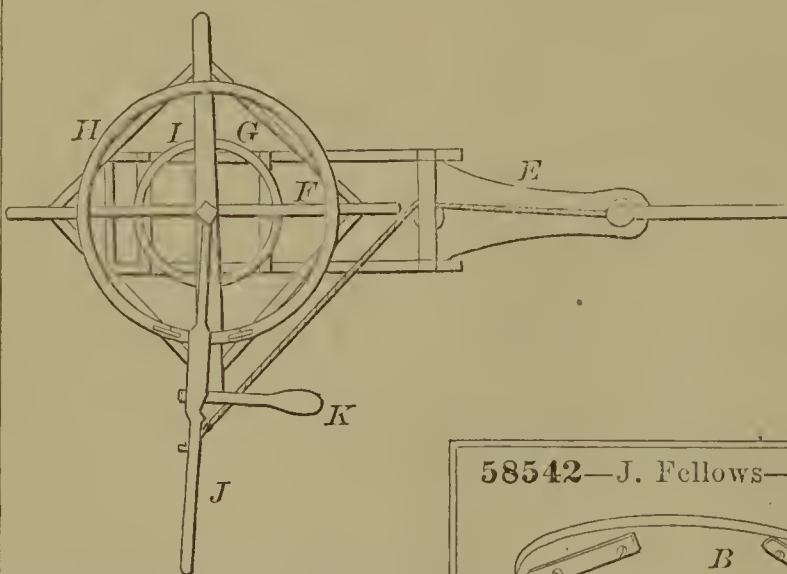

58542—J. Fellows—*Shifting Rail for Carriage Seats.*

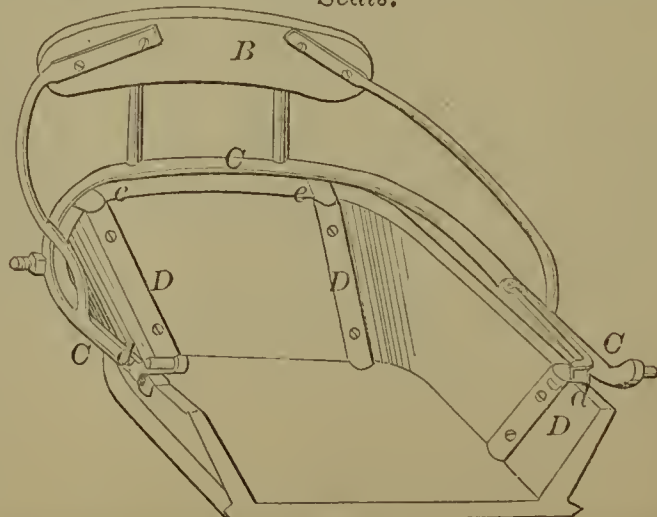

58537—W. Belcher—*Cigar Light.*

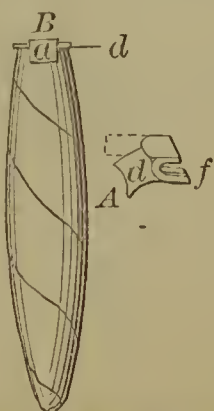



58543—E. J. Fraser—Rotary Spading Machine.

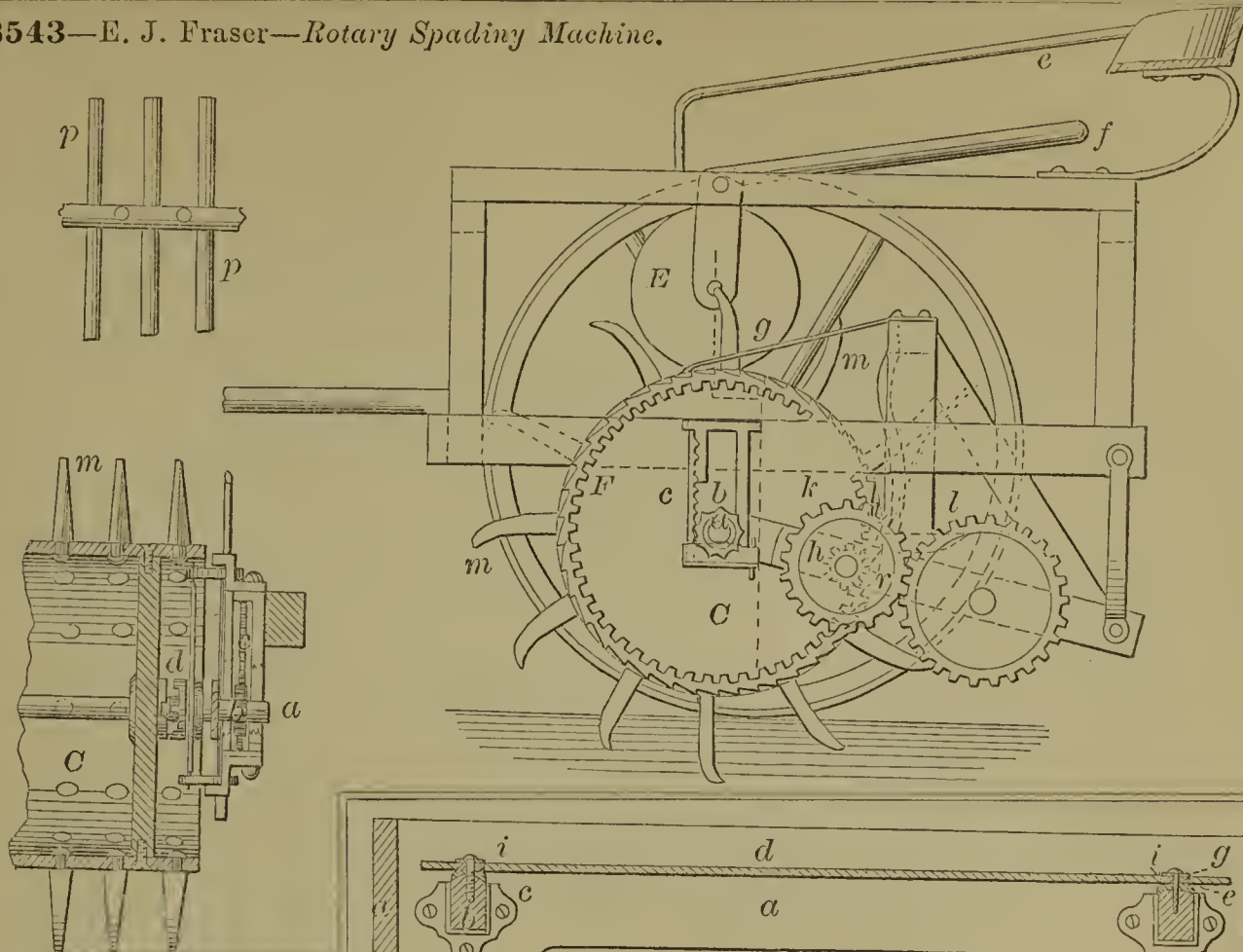

58546—W. T. Howard—Boiler Gauge Cock.

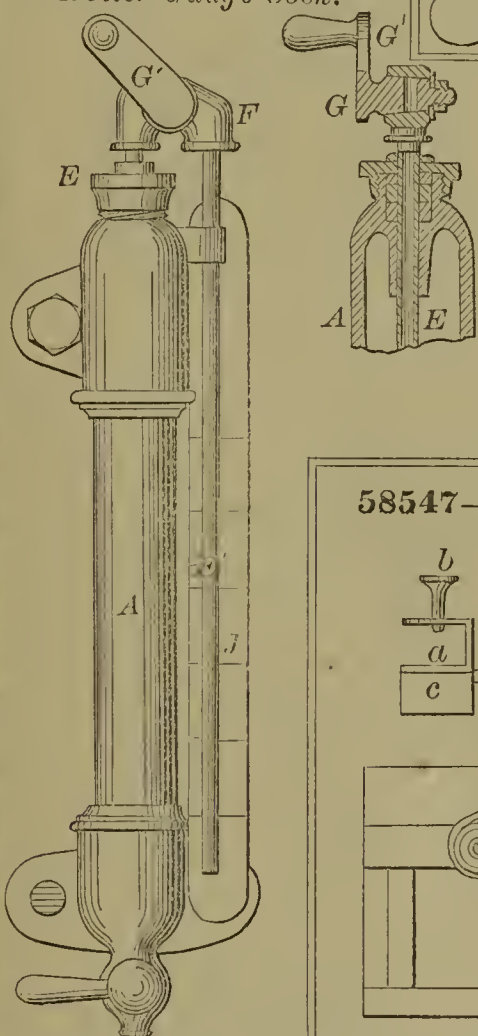

58545—R. L. Hall—Bed Bottom.

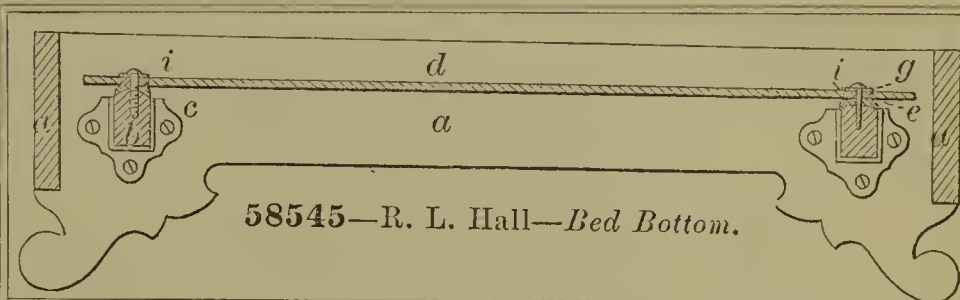

58544—I. T. Green—Hat Pressing Machine.

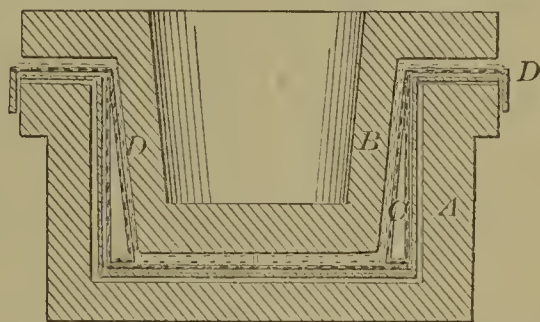

58547—Hull & Anderson—Horse Power Brake.

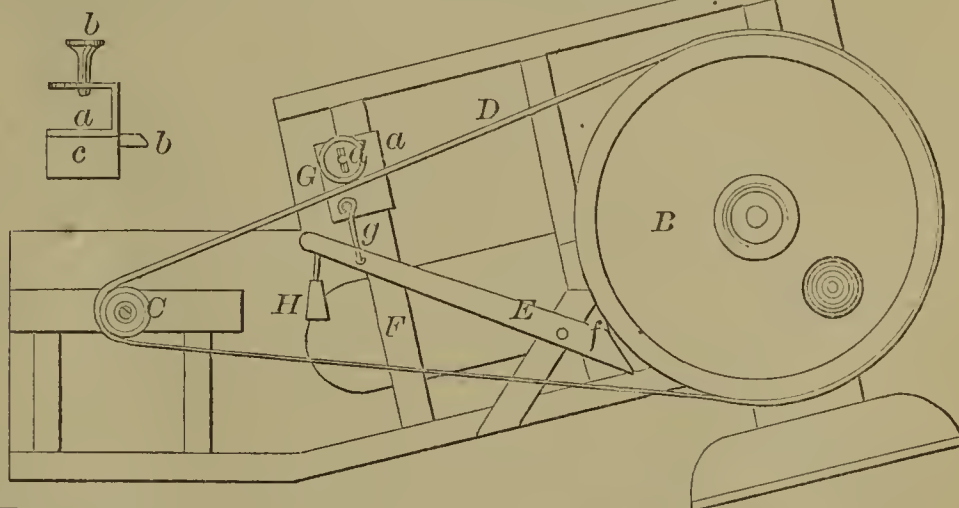

58548—J. G. Kast—Trunk Lock.

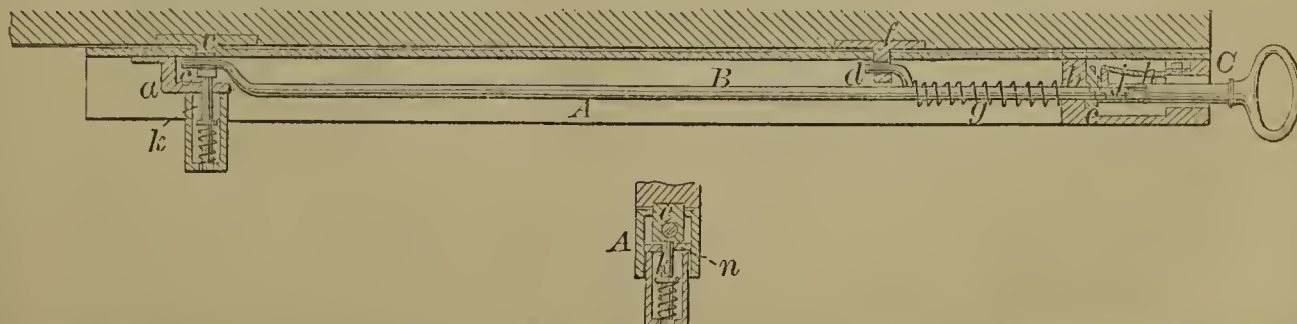

58549—E. R. Kerr—Coal Dumping Apparatus.

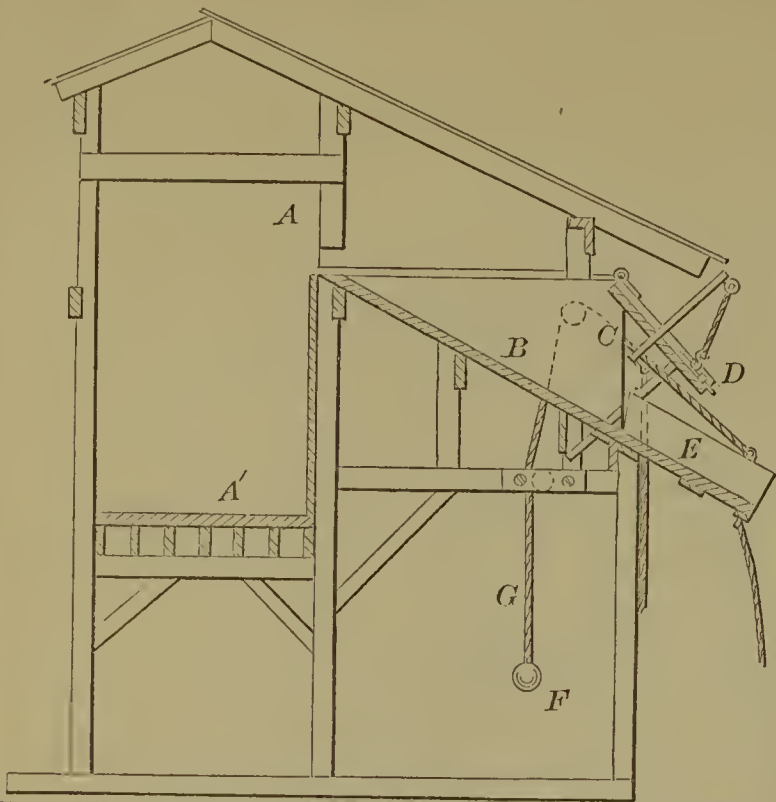

58552—H. Mc Clure—Furnace and Boiler.

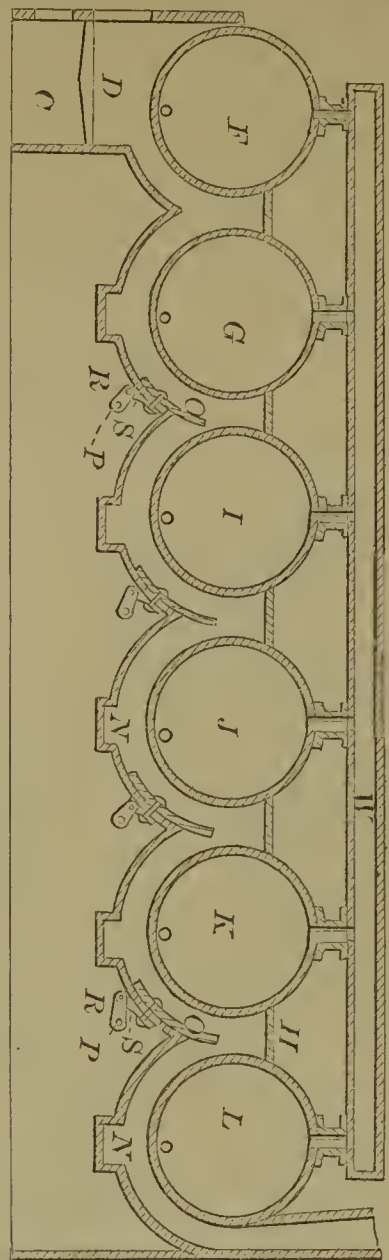

58550—C. E. Langmaid—Cast-off of Waxed Thread Sewing Machines.

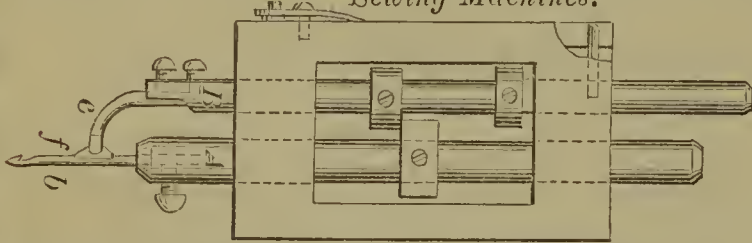

58551—J. Long—Grain Screen.

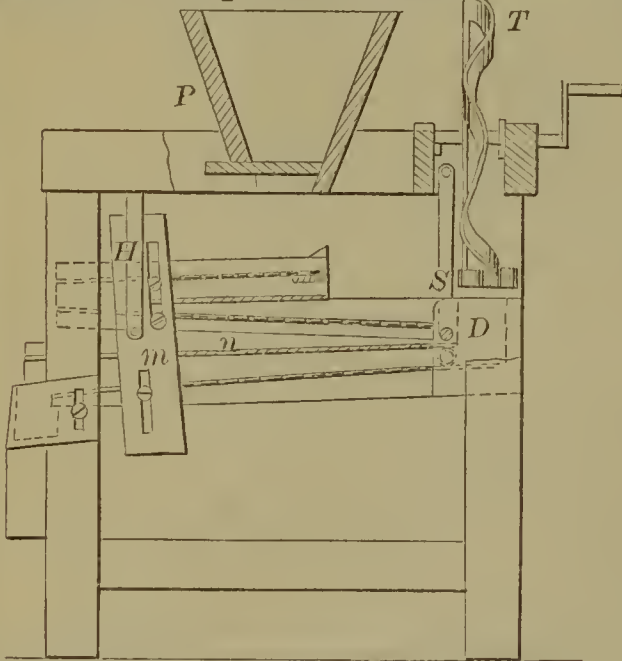

58553—A. Millochau—Manufacture of Illuminating Gas.

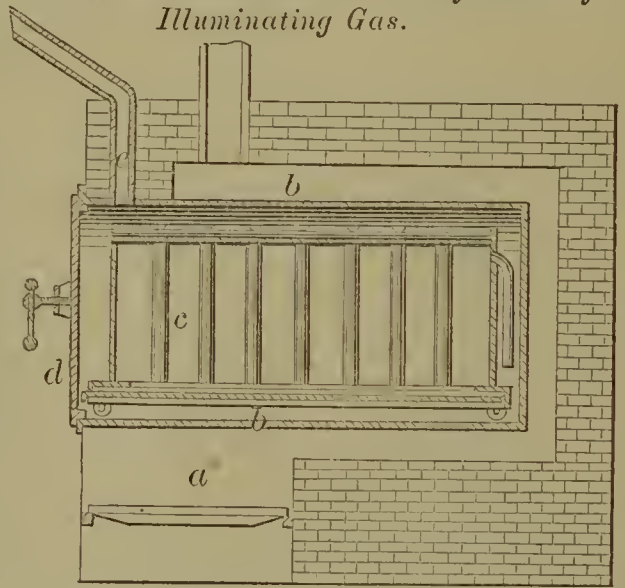

58554—J. Osterhondt—Opening Tin Cans.

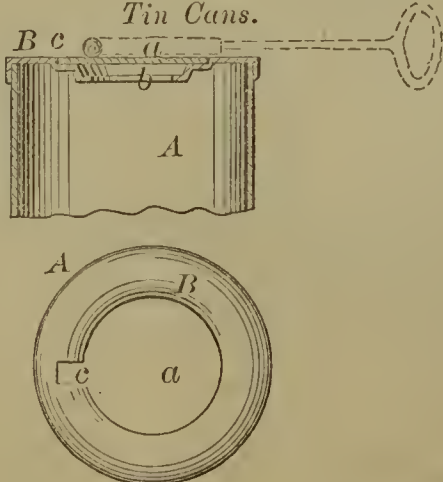

58555—G. M. Richardson—For Pressing Bonnets.

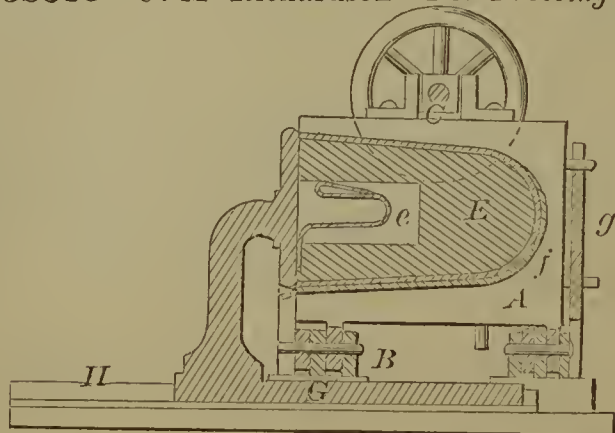

58556—W. H. Salisbury—*Wool Oiling Machinery.*

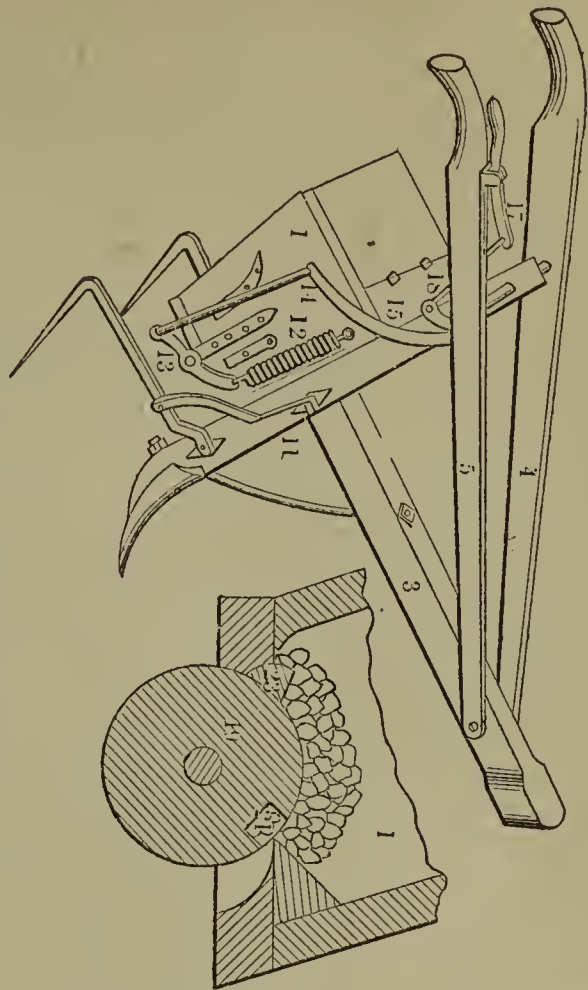
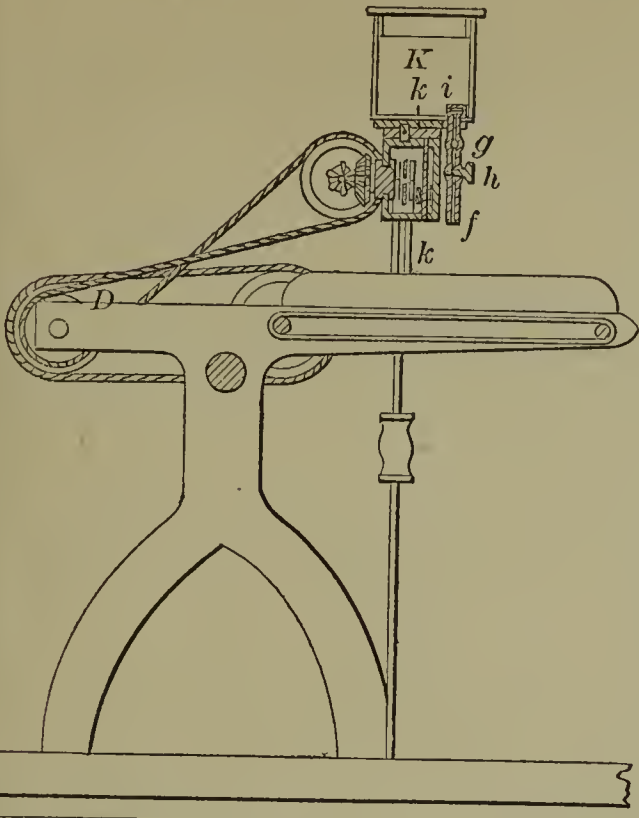

58557—T. T. Shawcross—*Corn Planter.*

58558—C. D. Smith—*Eraser and Pencil Sharpener.*

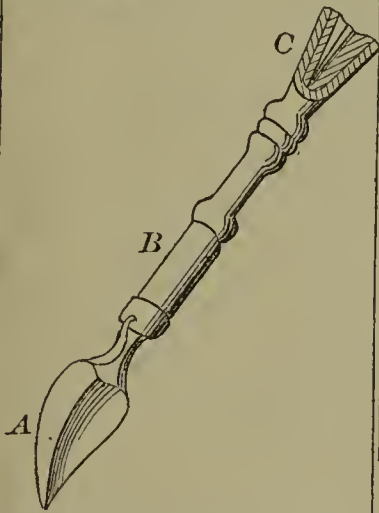

58560—A. Walker—*Potato Digger.*

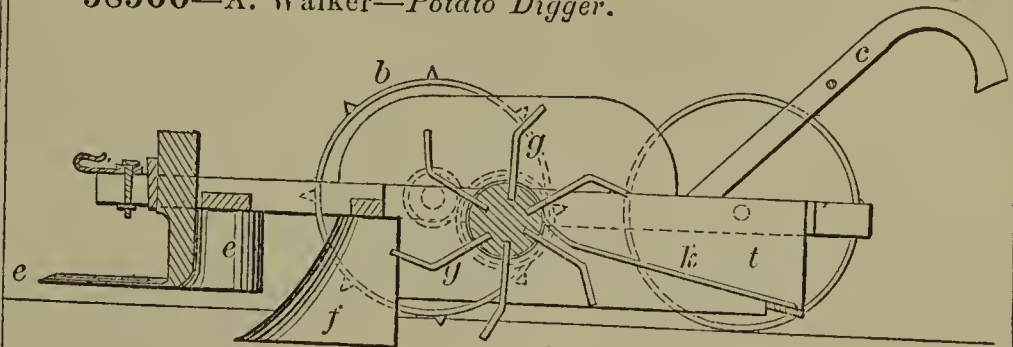

58563—G. Keeble—*For Cutting Continuous Sheets of Paper.*

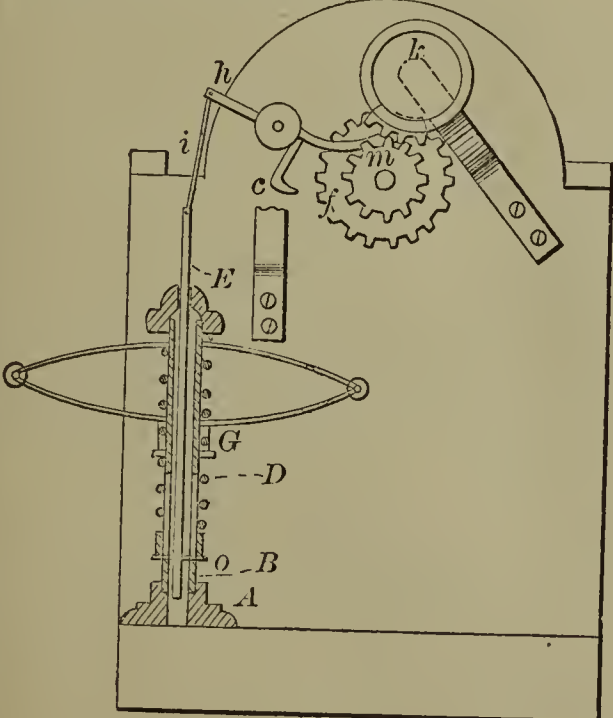

58561—G. V. Woods—*Neck Tie, Collar, and Bosom.*

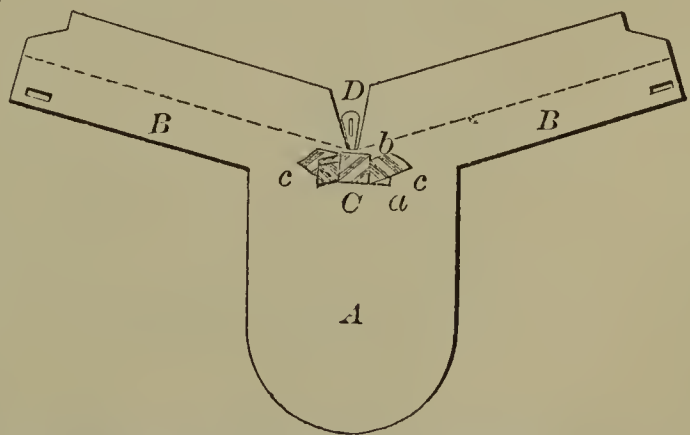

58559—L. Stevens—*For Carburetting Air.*

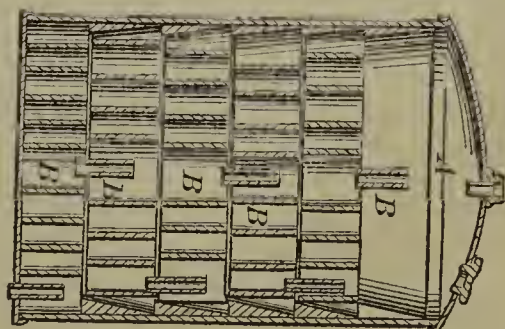

58564—R. W. Tompson—  
Steam Generator.

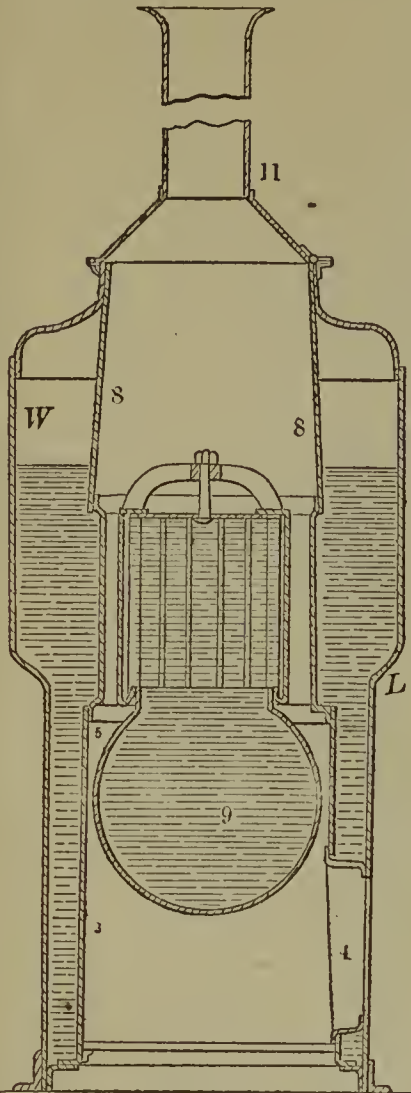

58565—S. Winkley—*Railway.*

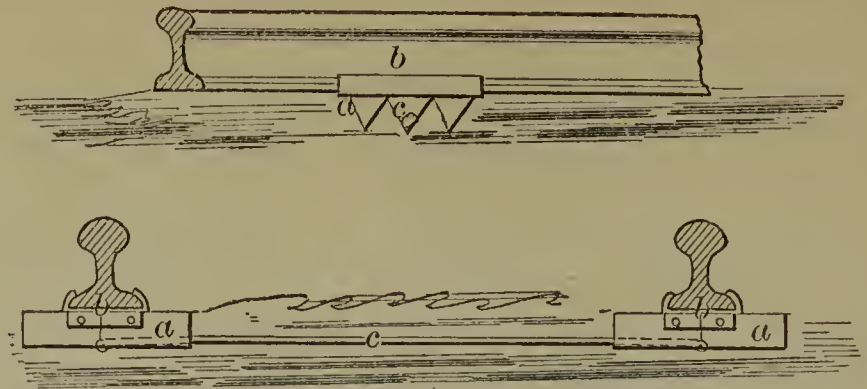

59569—E. Andrews—*Securing  
Cross Cut Saws to their  
Handles.*

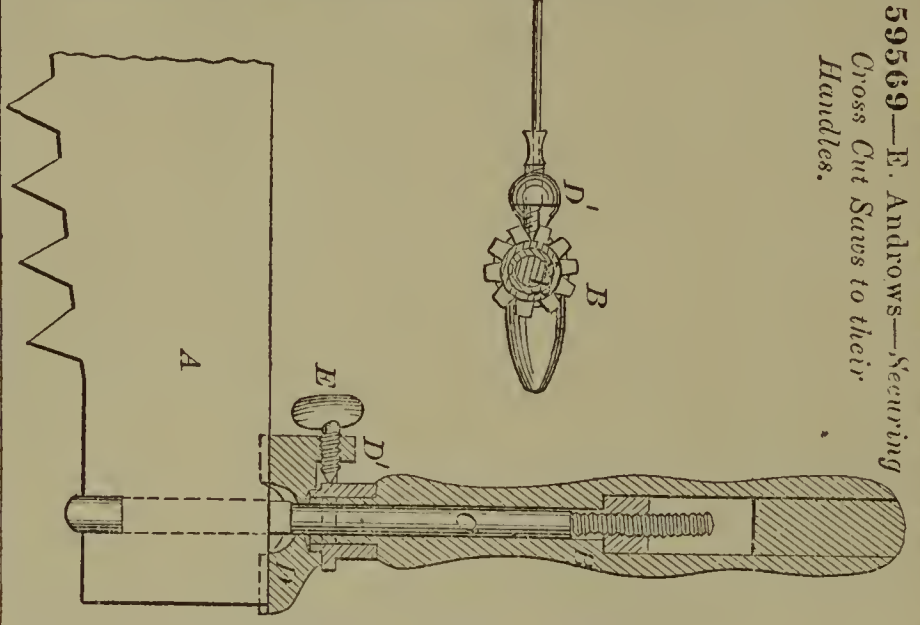

58566—P. M. Ackerman—*Gate.*

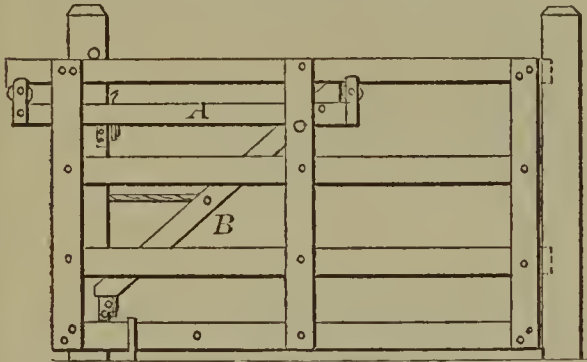

58570—F. Arnold—*Vegetable Cutter.*

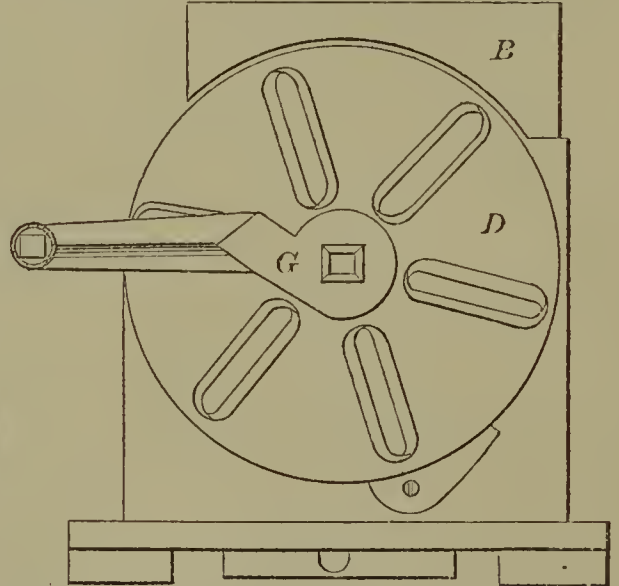

58568—R. Allison—*Boring Machine.*

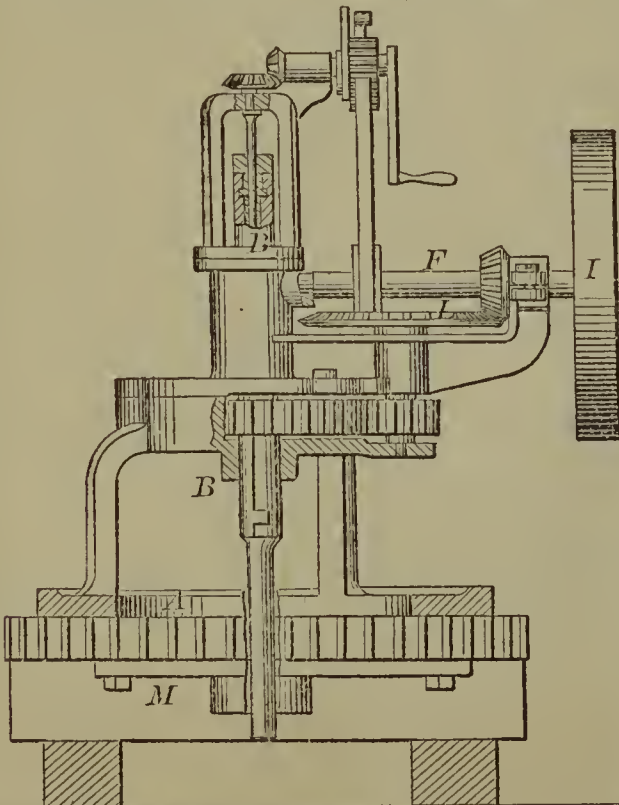

58571—W. Arrouquier—*Staging.*

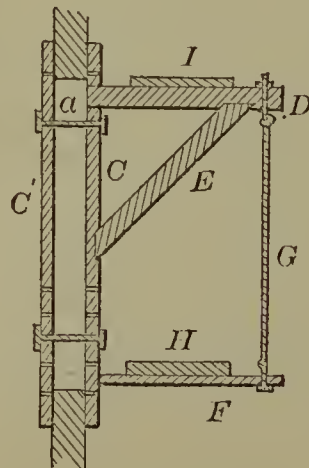

58572—E. Dwight—*Pen Holder.*

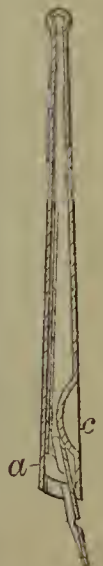

58573—H. H. Baker—*Horse Shoe.*

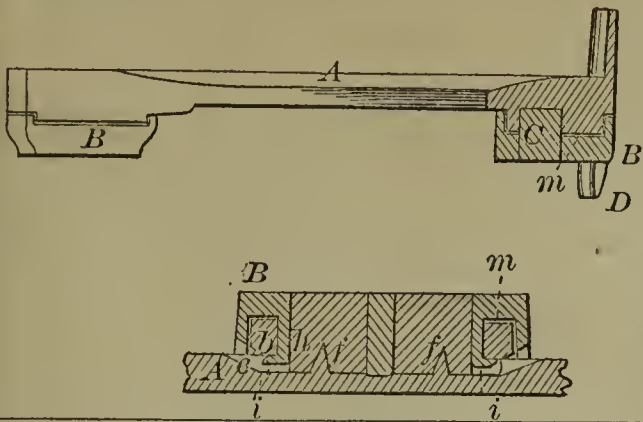

58576—H. Barton—*House Bell.*

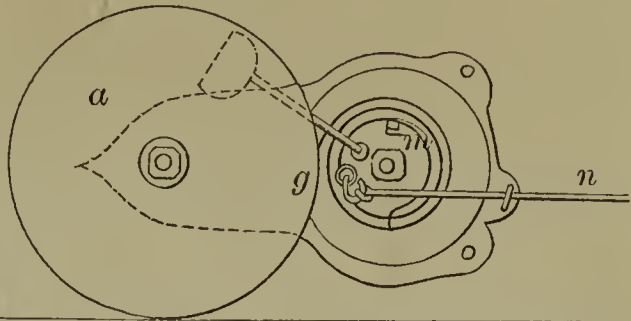

58574—A. Barbarin—*Metallic Band Fastening.*

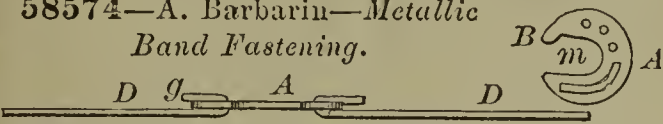

58575—H. Barton—*Dumping Wagon.*

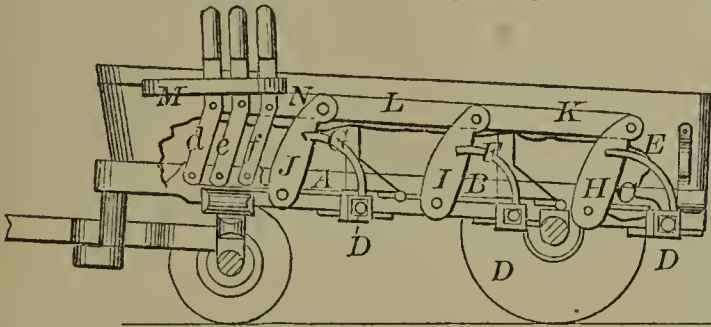

58580—I. A. Bevin—*Gong Bell.*

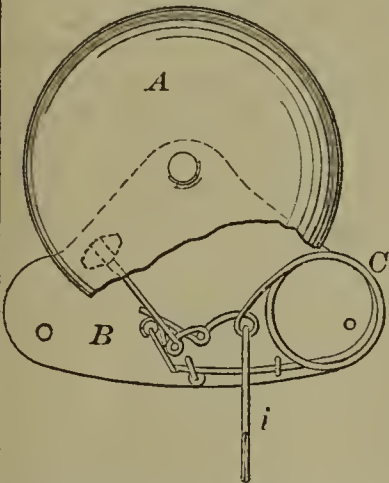

58578—T. Beale—*Cultivator.*

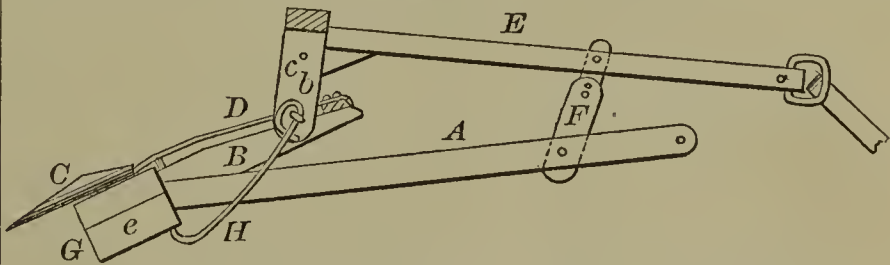

58581—J. C. Boyd—*Shovel Plow.*

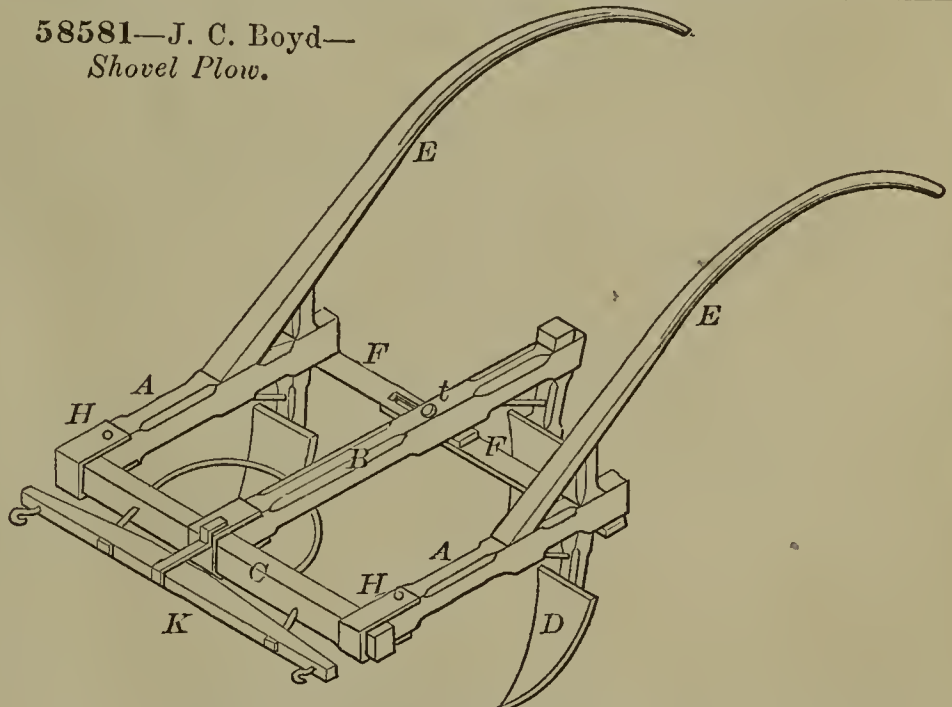

58582—N. A. Boynton—*Base Burning Stove.*

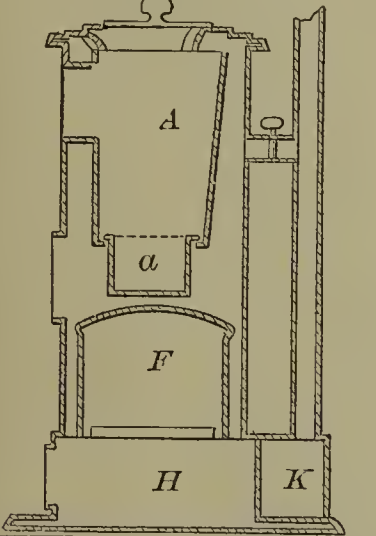

58579—J. Benson—*Sand Pump.*

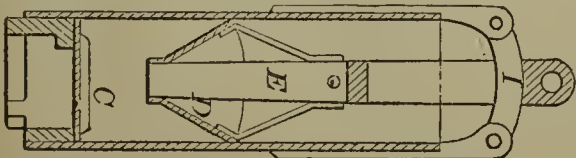

58583—E. Bredt—*Galloon Trimming.*

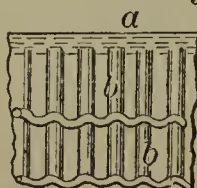

58584—E. Bredt—*Galloon Trimming.*

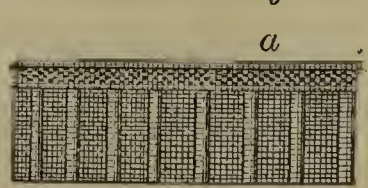

58577—Bassett, Bearse & Wilber—*For Making Nails and Tacks.*

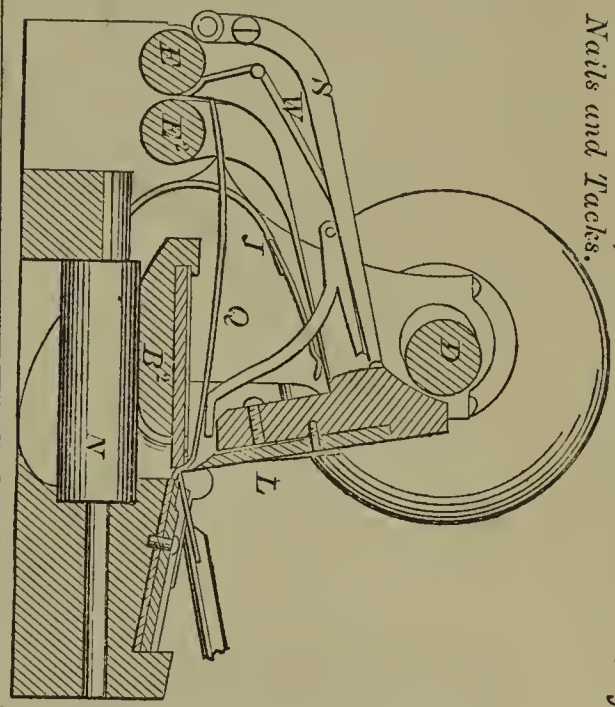

58585—Bristol & Alverson—Beehive.

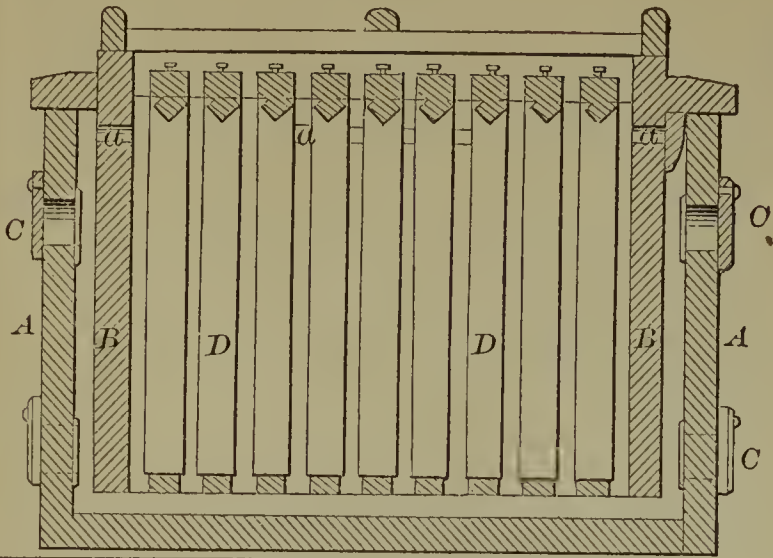

58587—C. F. Brown—Safety Valve Tender.

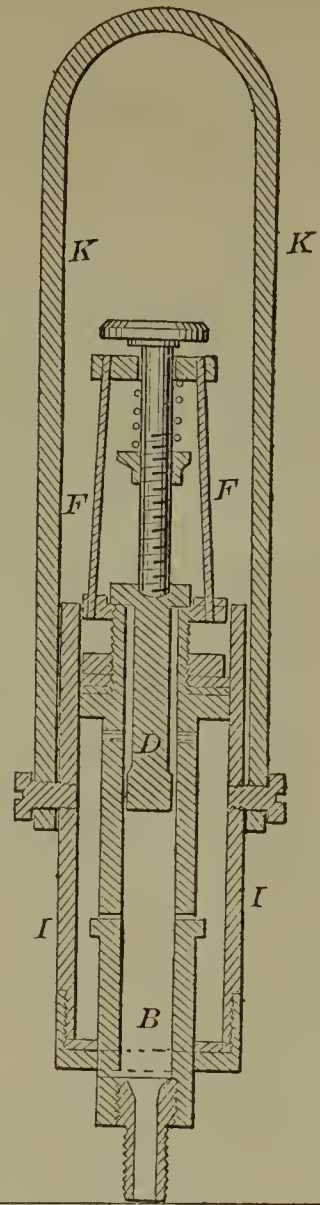

58589—W. Breitenstein—Power Loom.

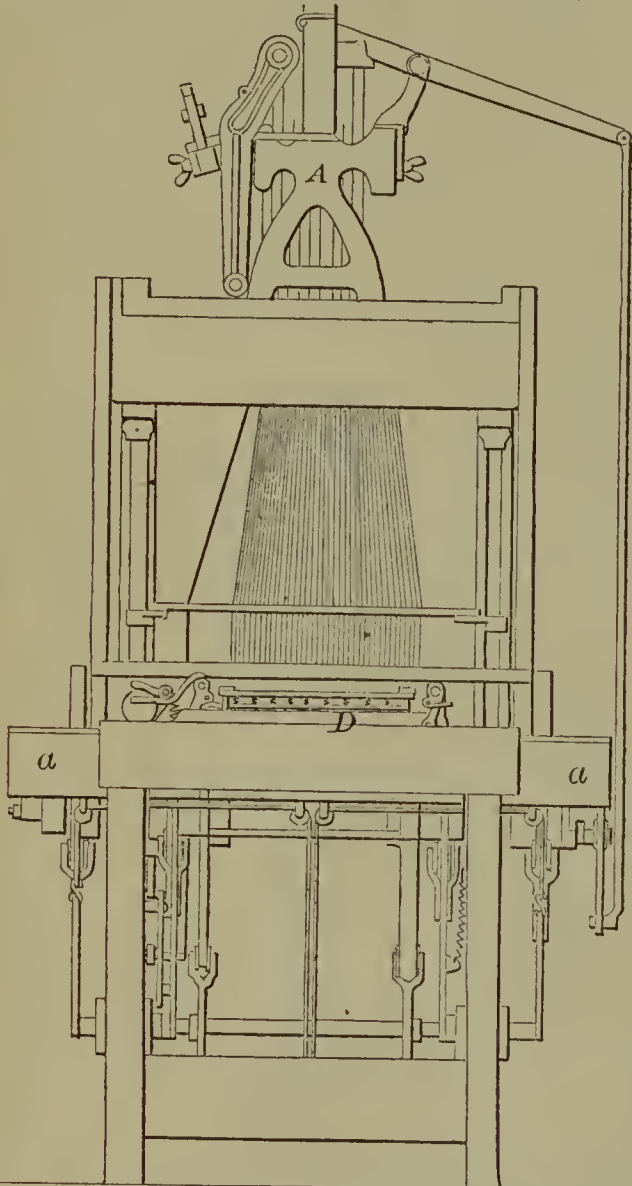

58588—C. P. Brown—Seed Planter.

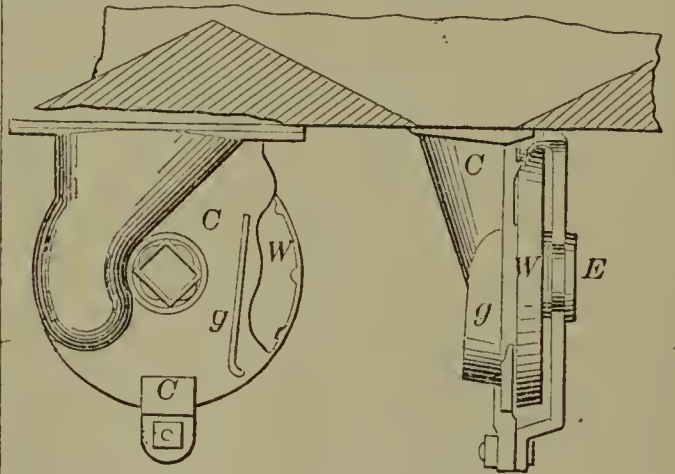

58586—N. Brockway—Sawing Machine.

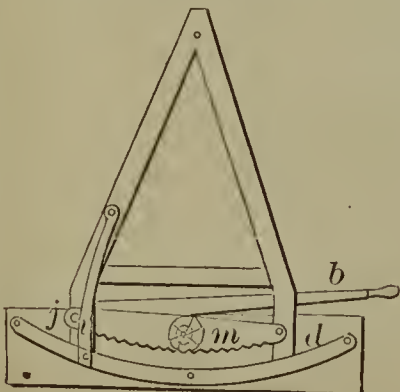

58590—J. P. Brown—Bedstead.

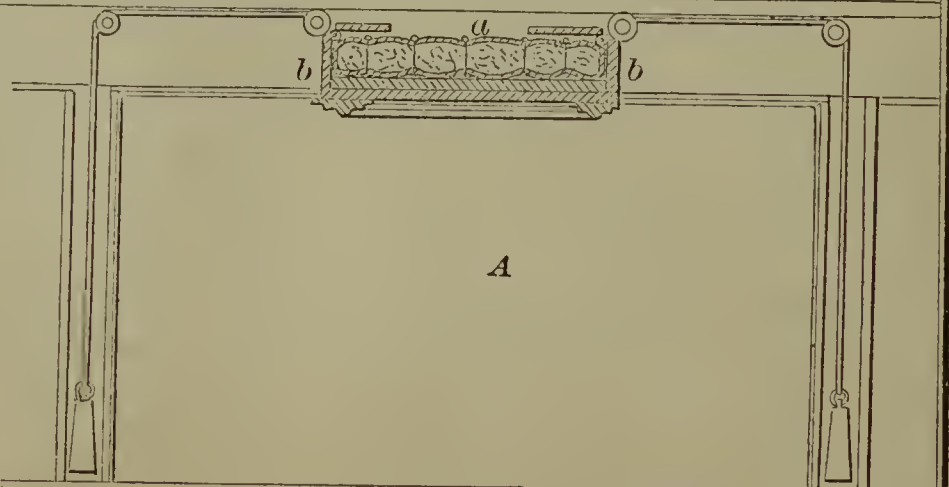

58592—H. L. & J. A. Buckwalter—Measuring Faucet.

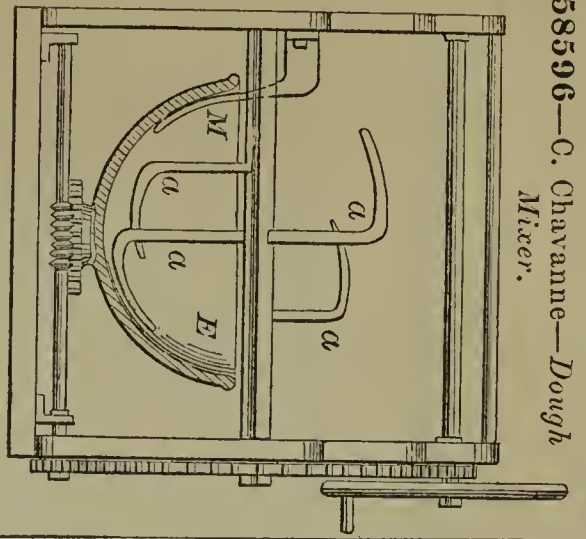
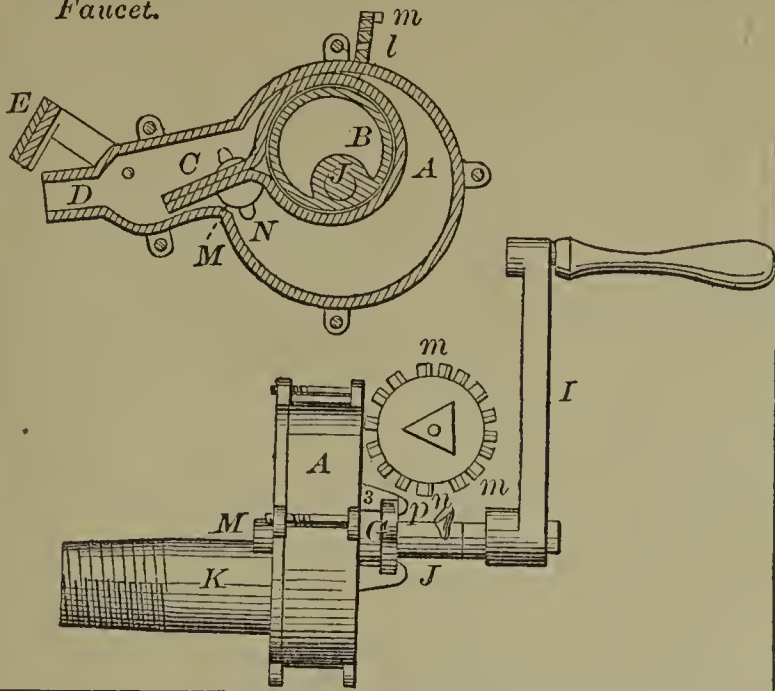

58596—C. Chavanne—Dough Mixer.

58593—A. J. Burke—Tally Box for Measuring Grain.

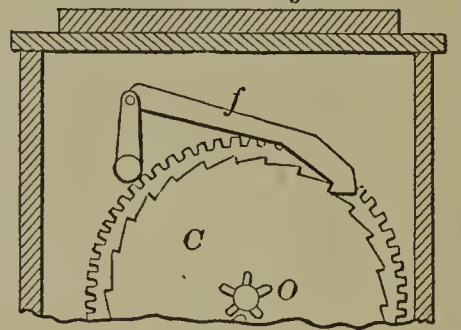

58597—J. Clarridge—Double Shovel Plow.

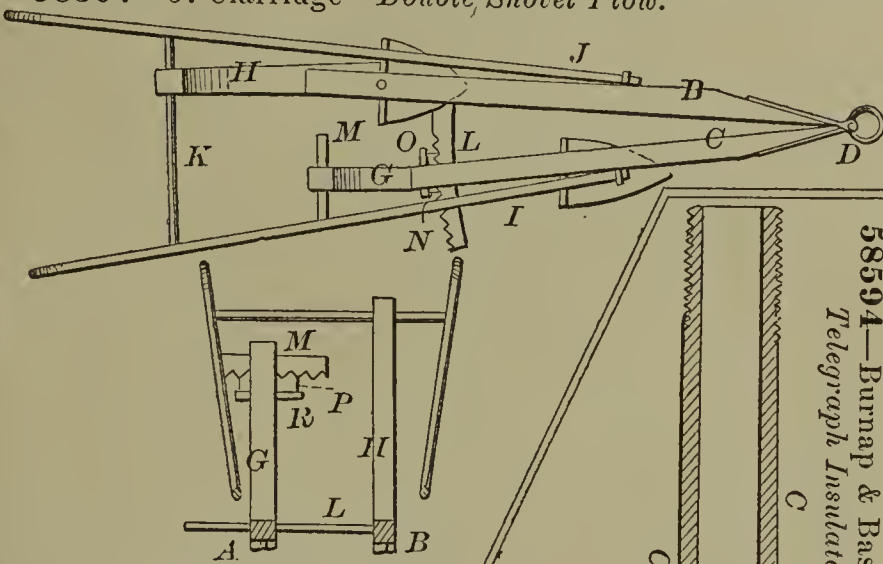

58594—Burnap & Bassington—Telegraph Insulator.

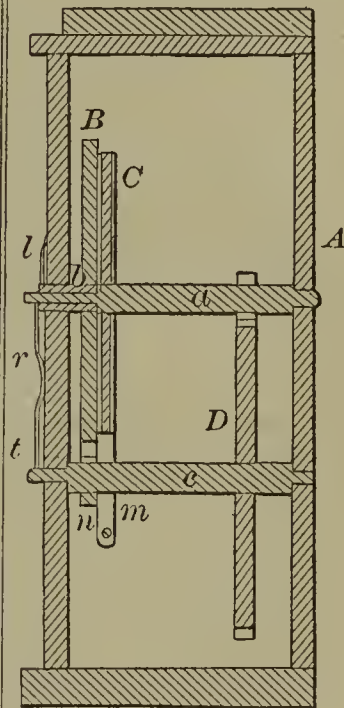
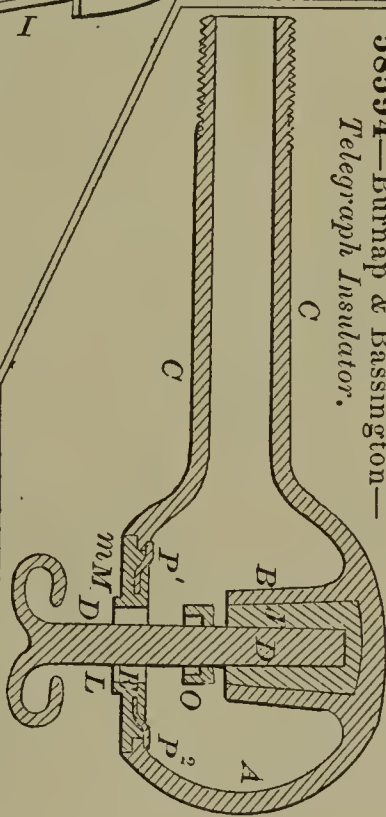

58595—C. Camp—Elevator Bucket.

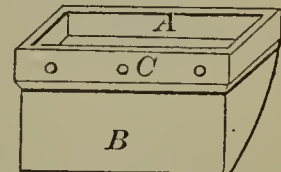

58599—T. J. Close—For Making Mouldings.

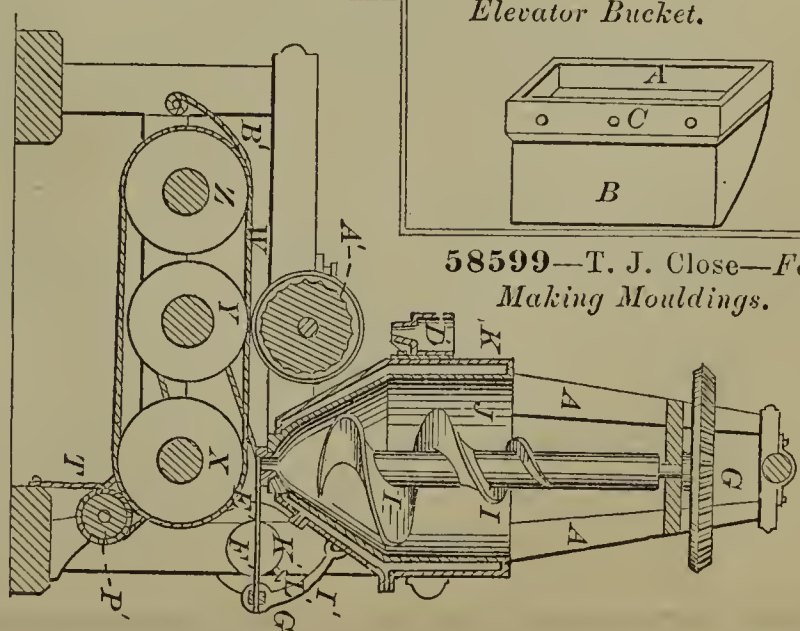

58598—J. Clarridge—Single Row Corn Planter.

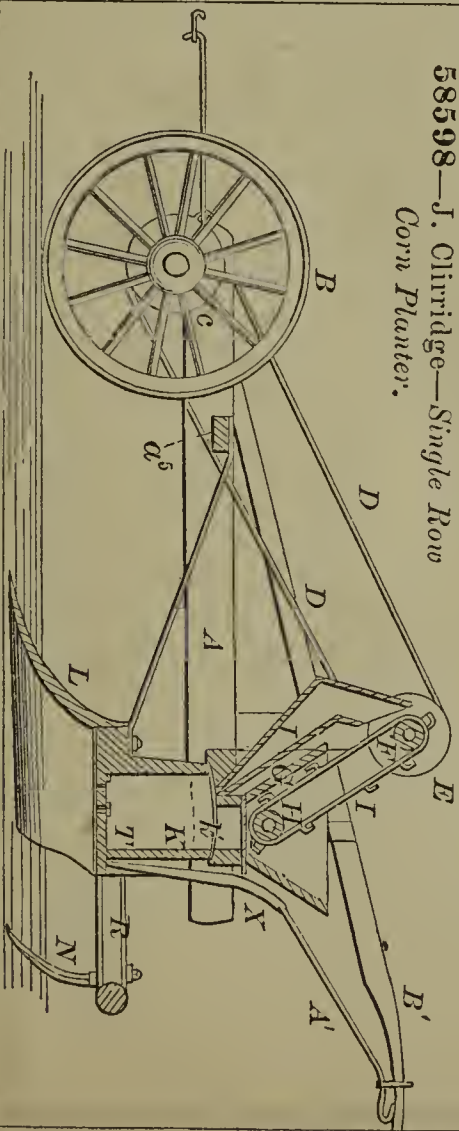

58600—T. M. Coffin—Faucet.

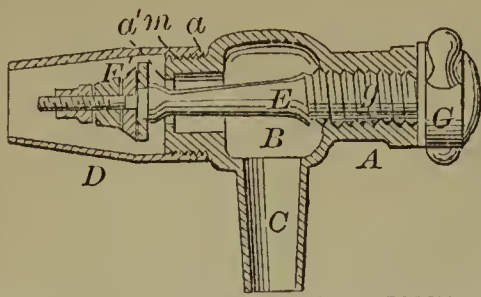

58601—M. & D Cole—For Raking and Loading Hay.

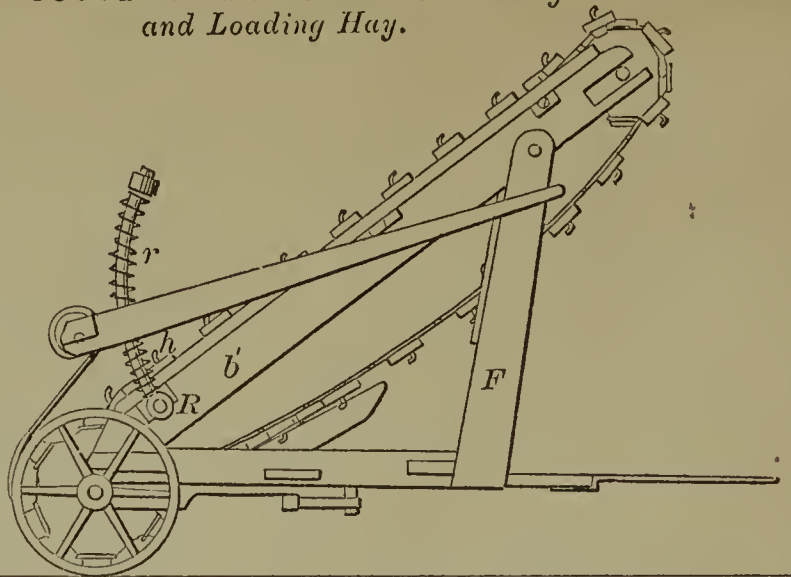

58603—Collins & Holland—Paddle Wheel.

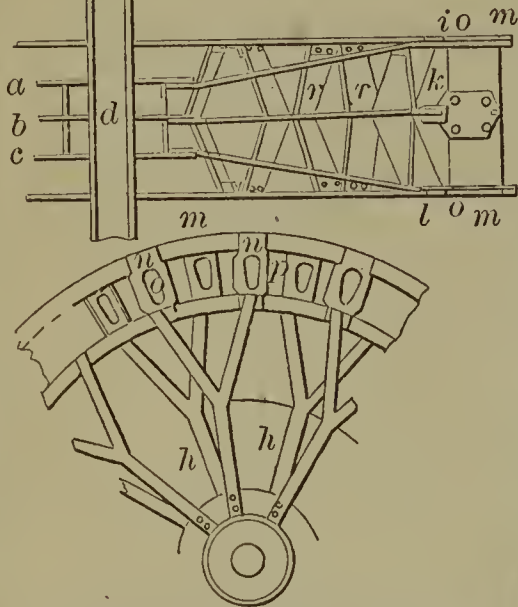

58602—M. H. Collins—Rotary Steam Engine.

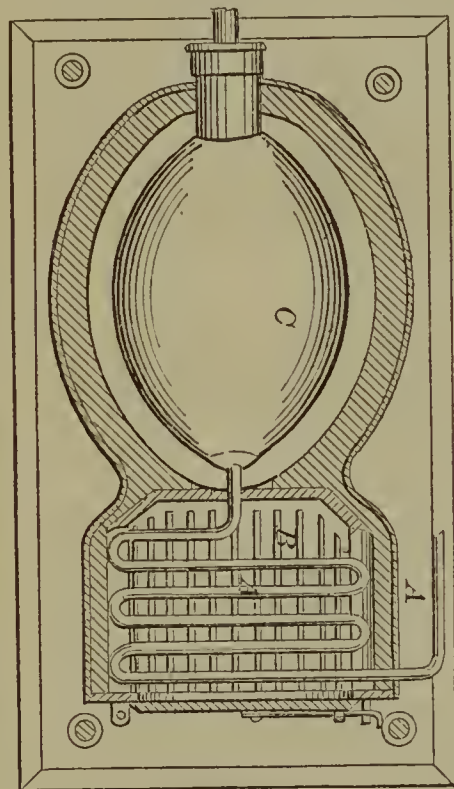
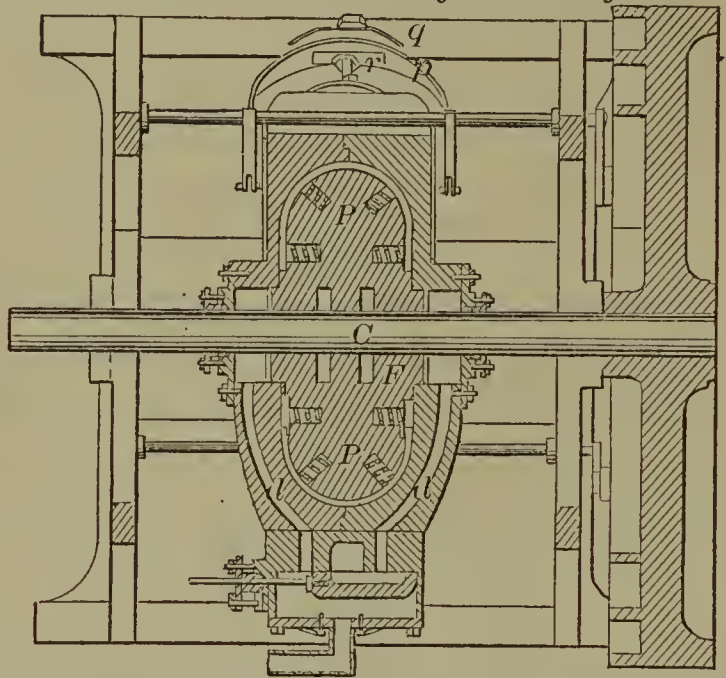

58604—W. Conant—Steam Generator.

58605—J. J. Conley—Lathe for Turning Shafting.

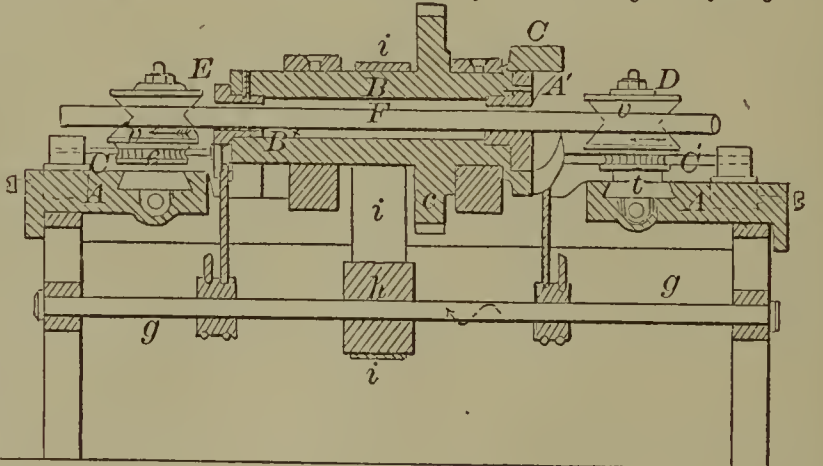

58606—J. B. Coolidge—Gas Burner.

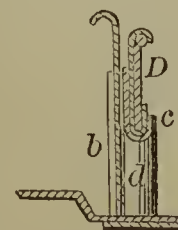
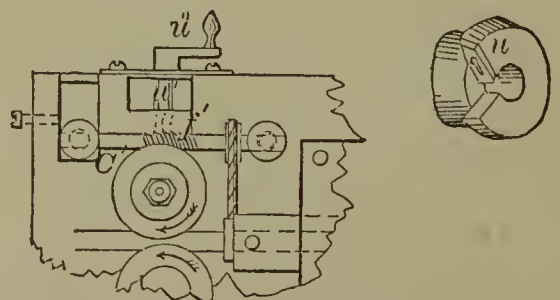

58607—J. Cooper—Evaporator.

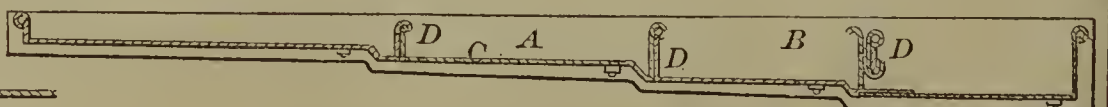



58608—W. Coughlan—Soda Fountain.

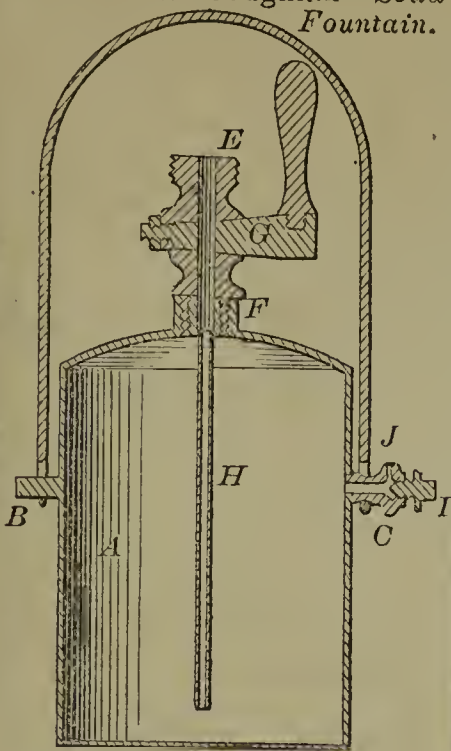

58609—H. Dale—Loom.

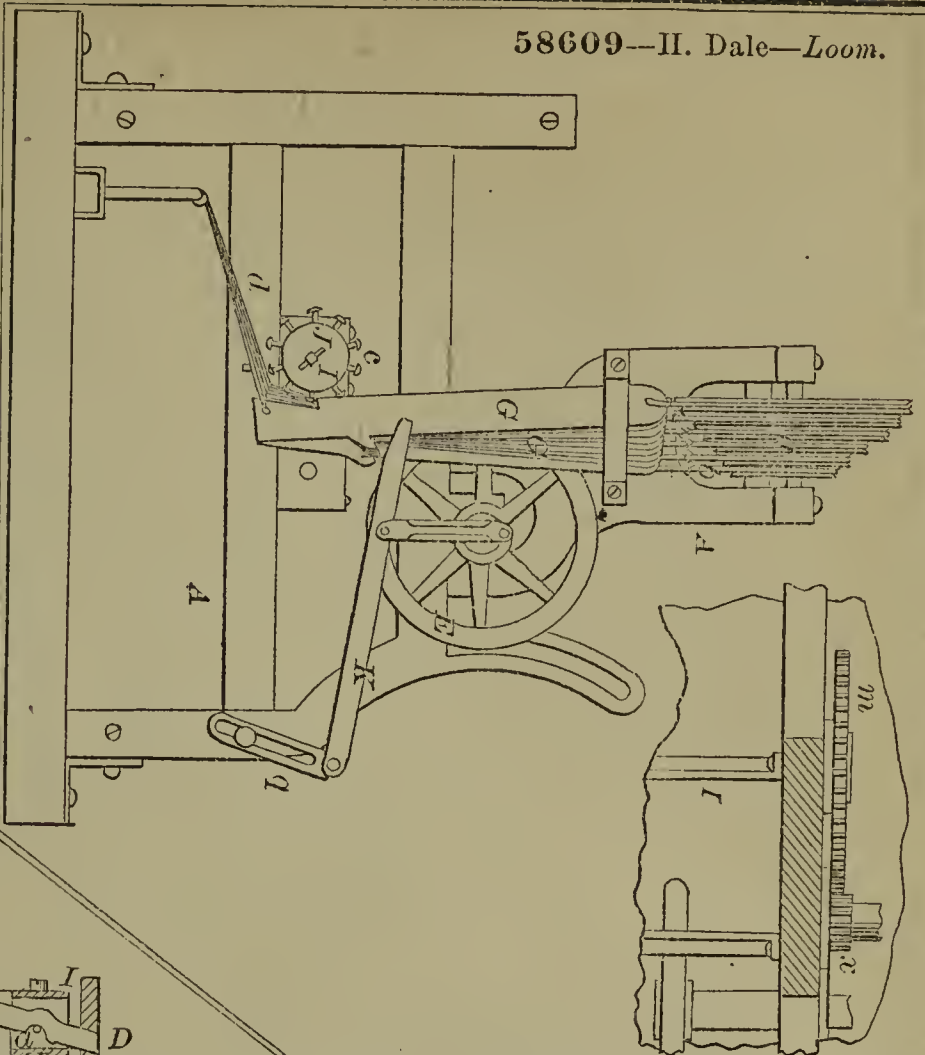

58610—J. Dalton—Knitting Machine.

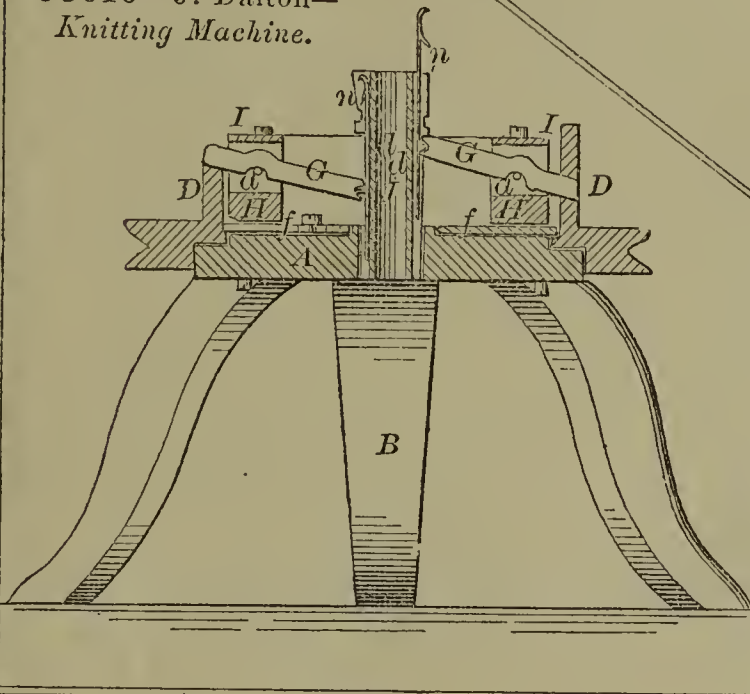

58611—A. M. Damon—Warp Dressing Frame.

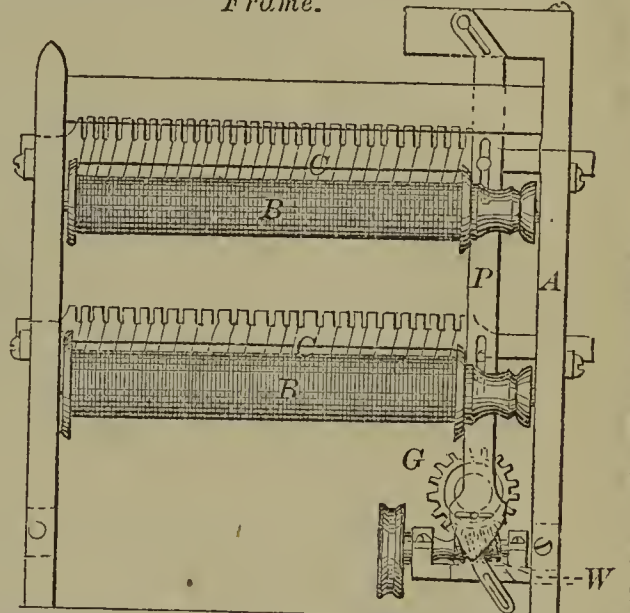

58614—J. A. Davis—Needle Feed of Sewing Machines.

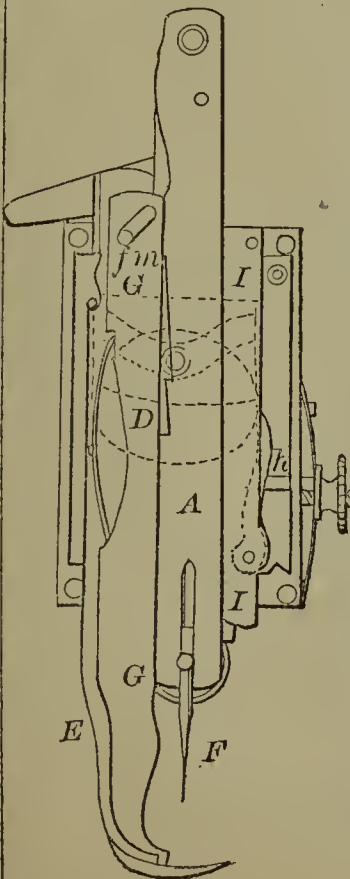

58612—F. S. Davenport—Gang Plow.

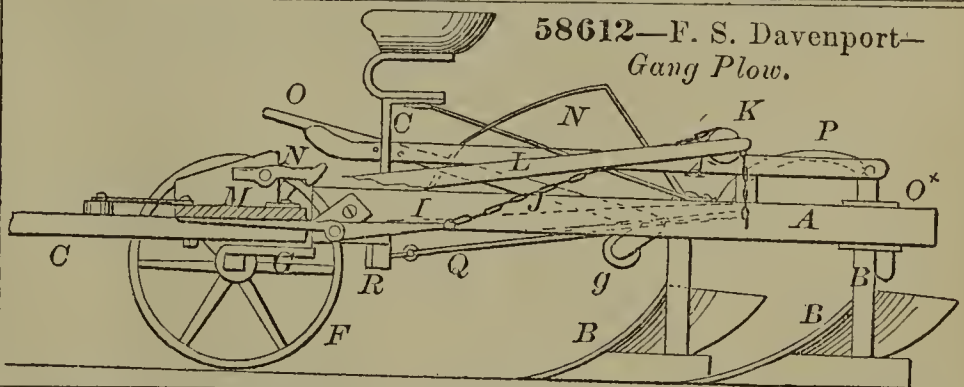

58613—J. Davis—Roller and Harrow.

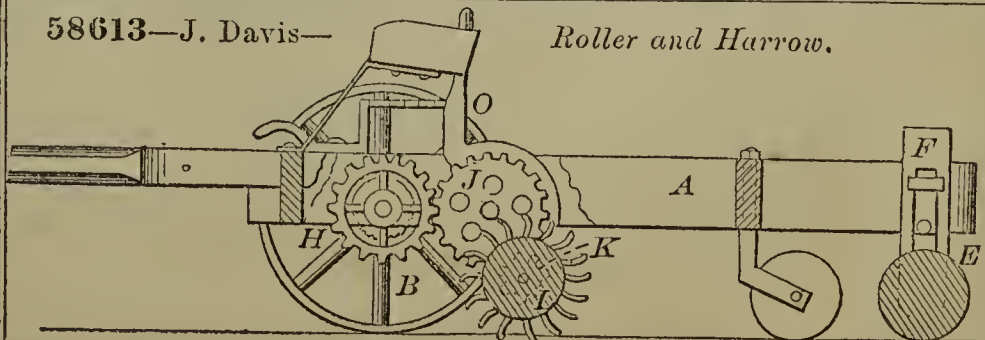

58616—C. M. Day—*Hand Wood Saw.*

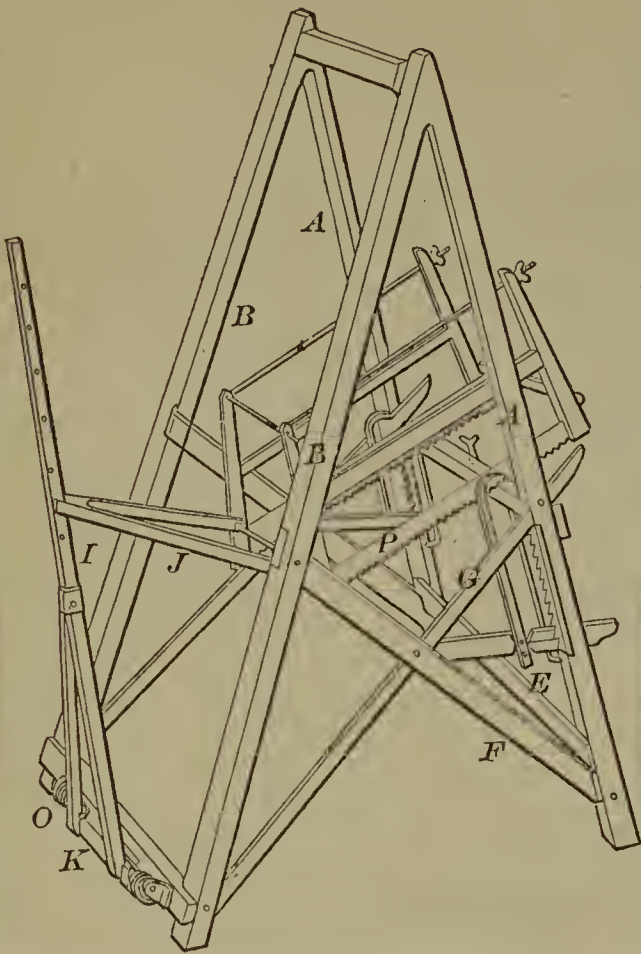

58618—J. B. Dougherty—*Shingle Machine.*

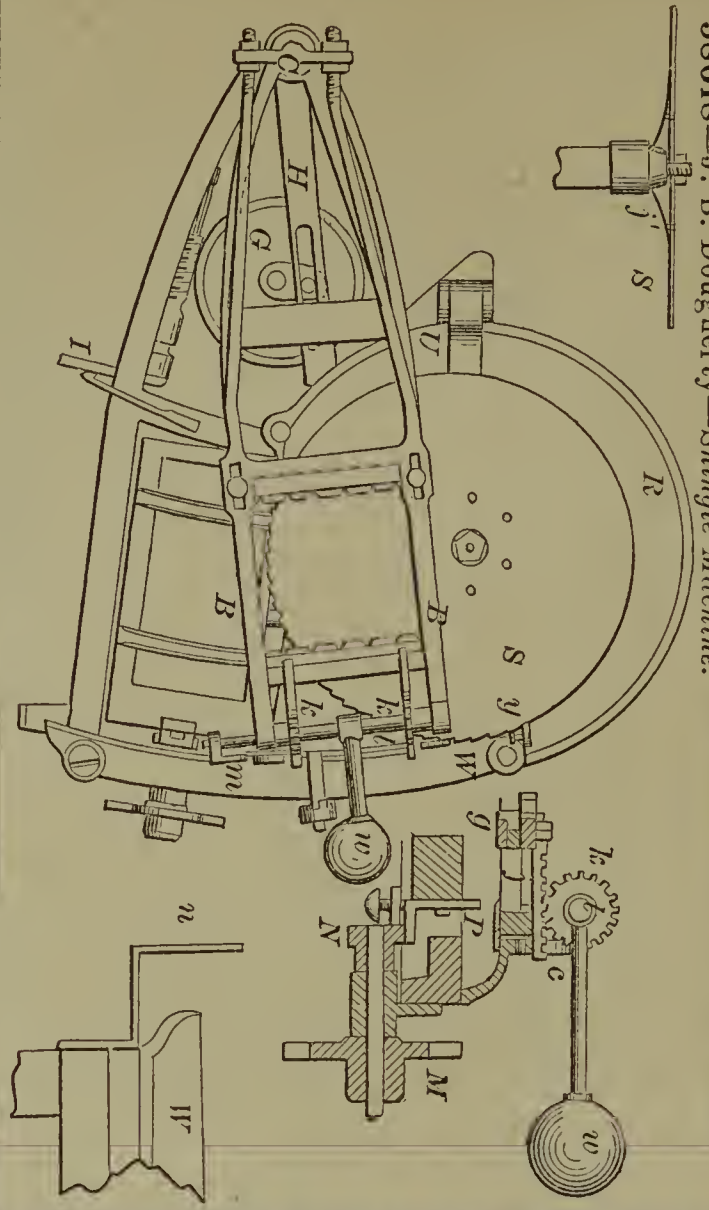

58619—R. C. Dunham—*Buckle and Ring.*

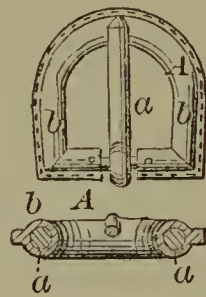

58617—J. Dick, Jr.—*Harvester.*

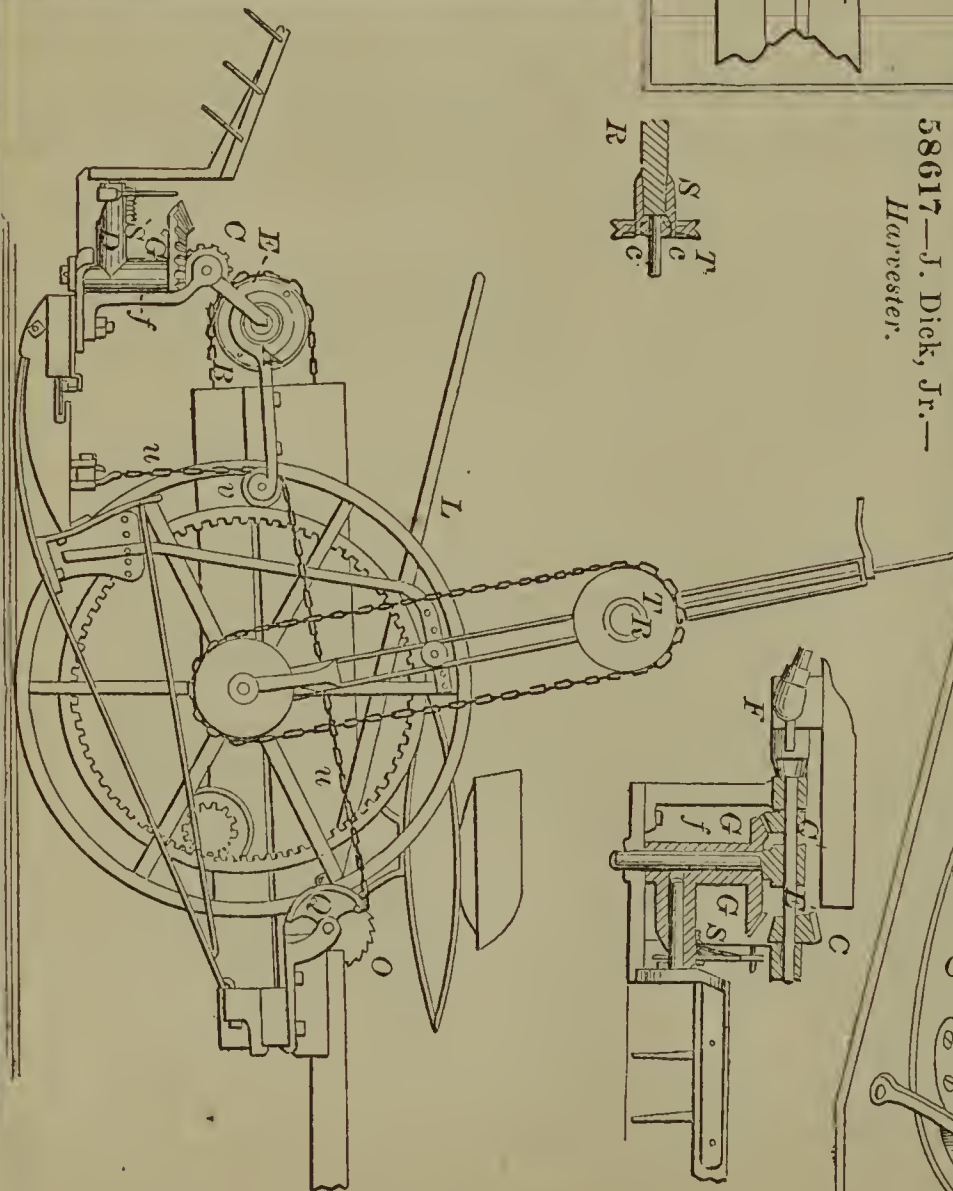

58620—C. R. Durfee—*Horse Collar.*

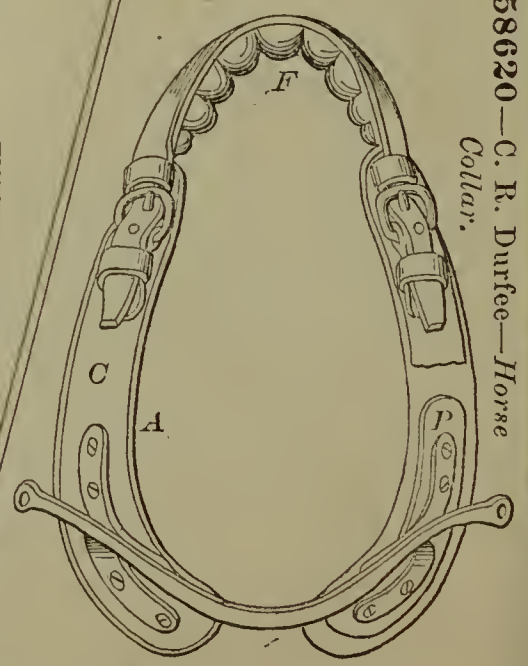

58621—Z. Eastman—*Railway.*

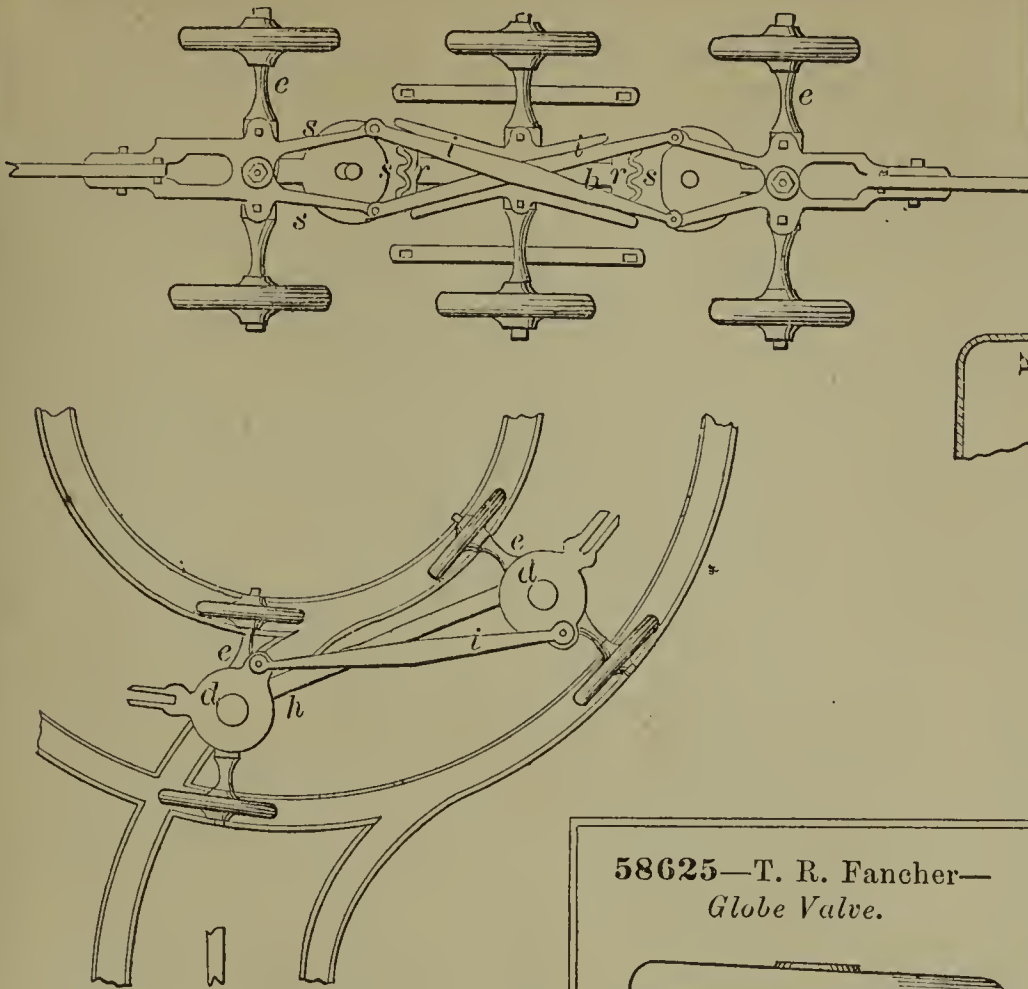

58622—R. Fickemeyer—*Sewing Sweat Linings into Hats.*

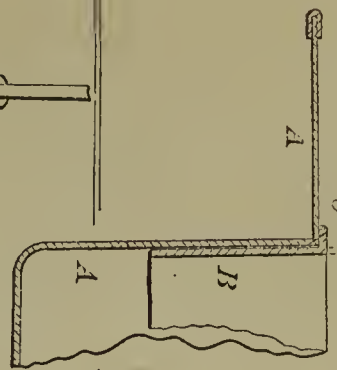

58626—R. A. Fish—*Spike Puller.*

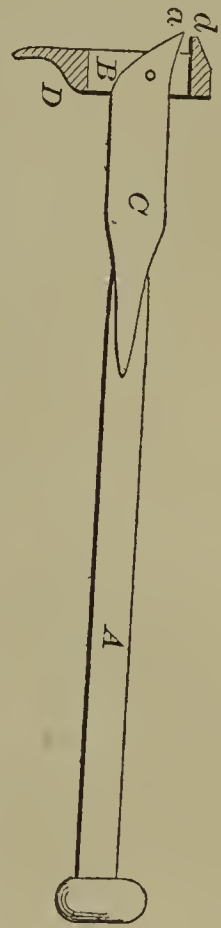

58625—T. R. Fancher—*Globe Valve.*

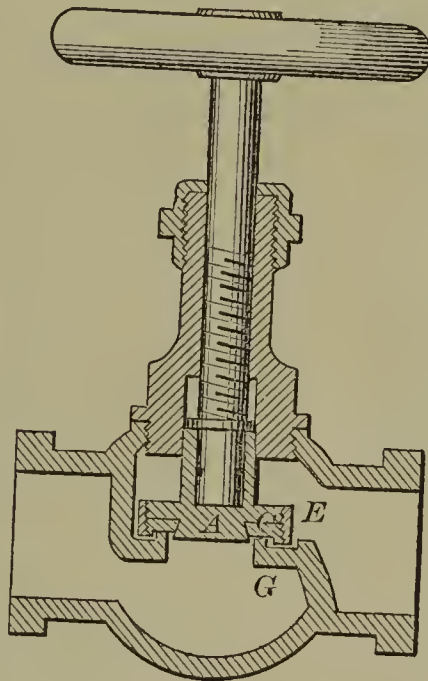

58623—L. Elliott, Jr.—*India Rubber and Leather Sole.*

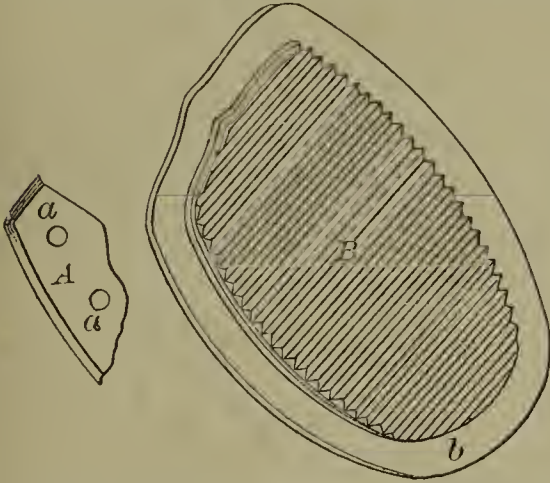

58624—A. E. Ellis—*Beehive.*

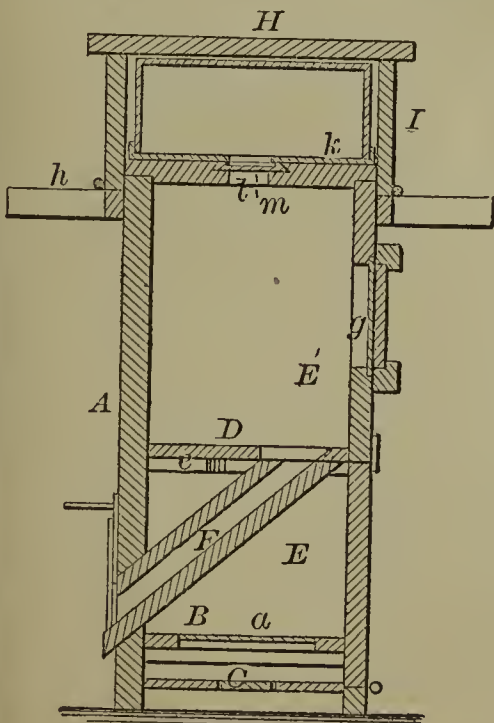

58627—Flagg & Storer—*Canvas Stretcher.*

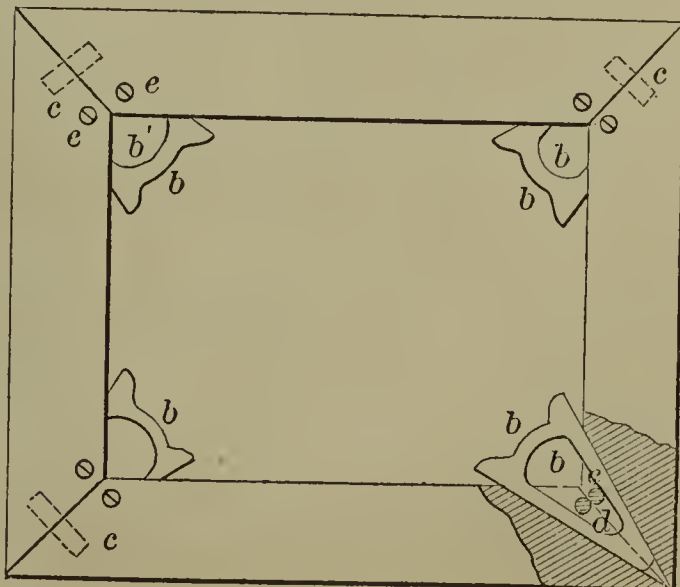

58628—J. W. Forsyth—Churn.

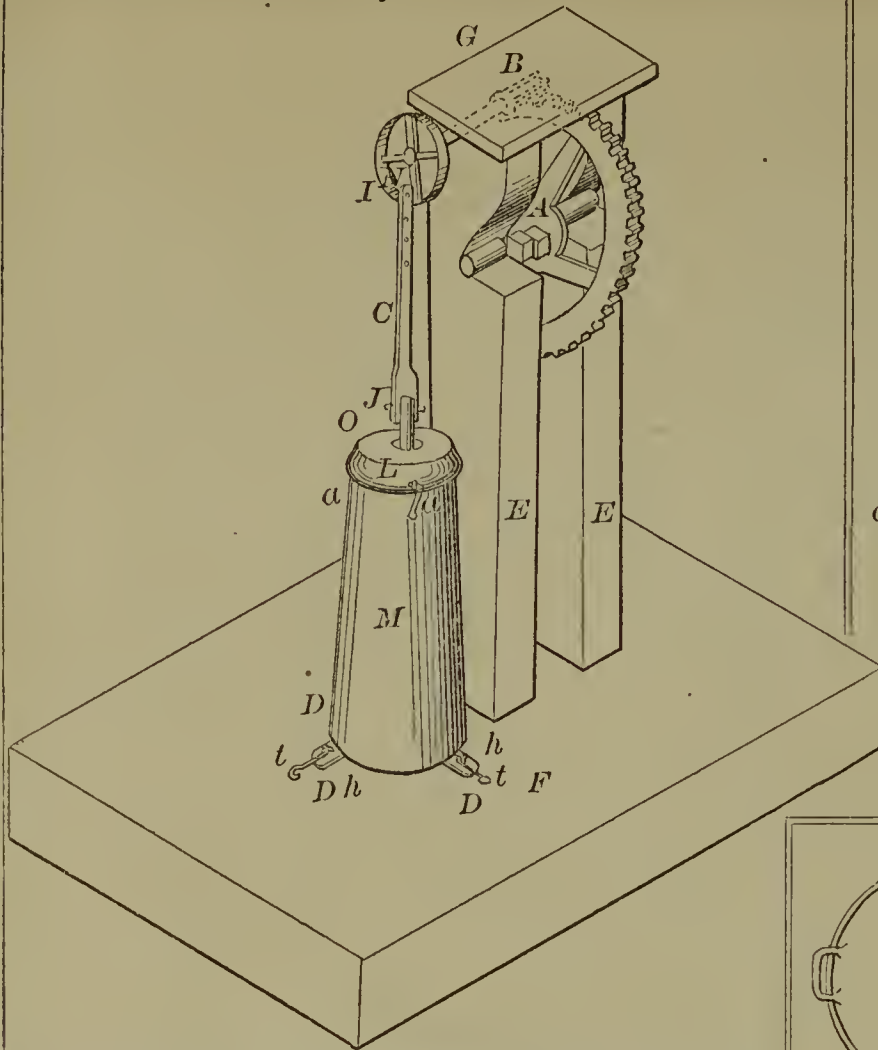

58632—C. L. Gilpatric—Nutmeg Grater.

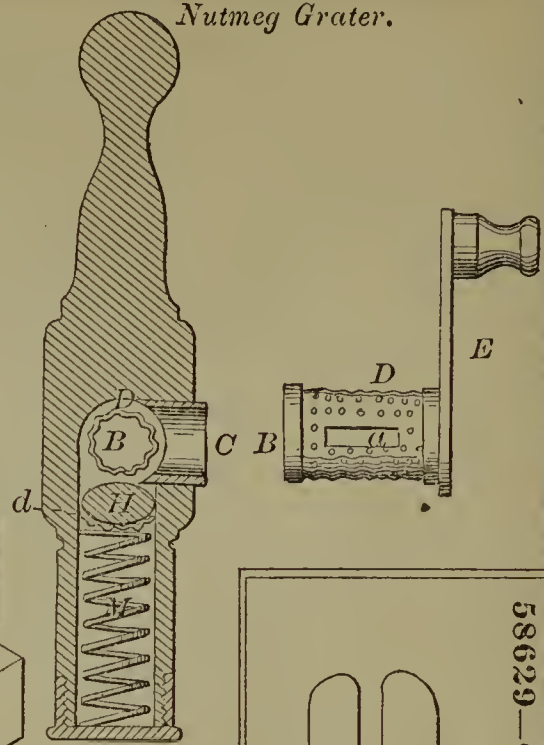

58629—C. H. Frost—Sud Iron Heater.

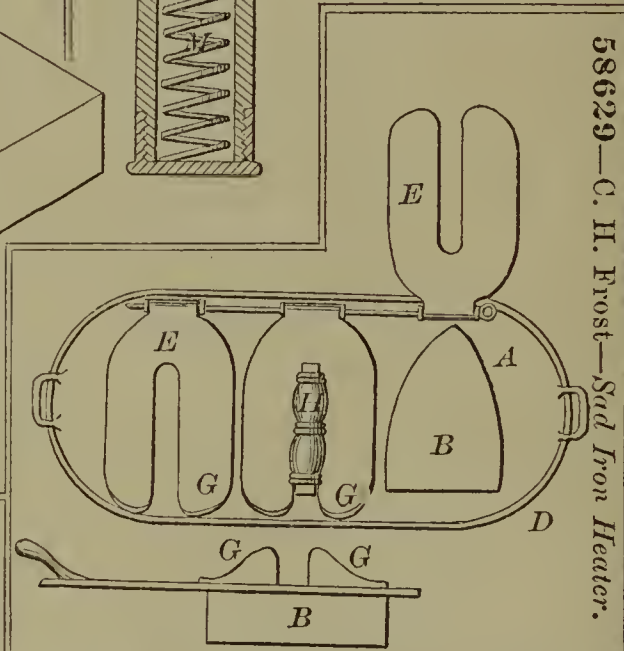

58634—M. J. Goodwin—Railway Track Clearer.

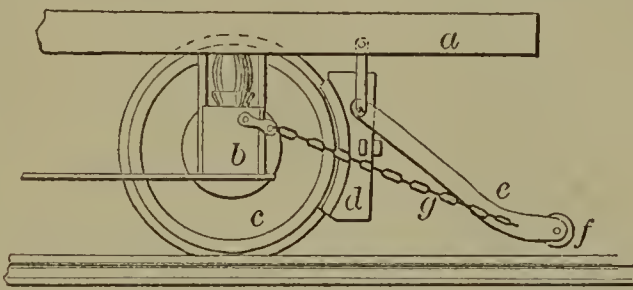

58630—F. Frye—Winnowing Machine.

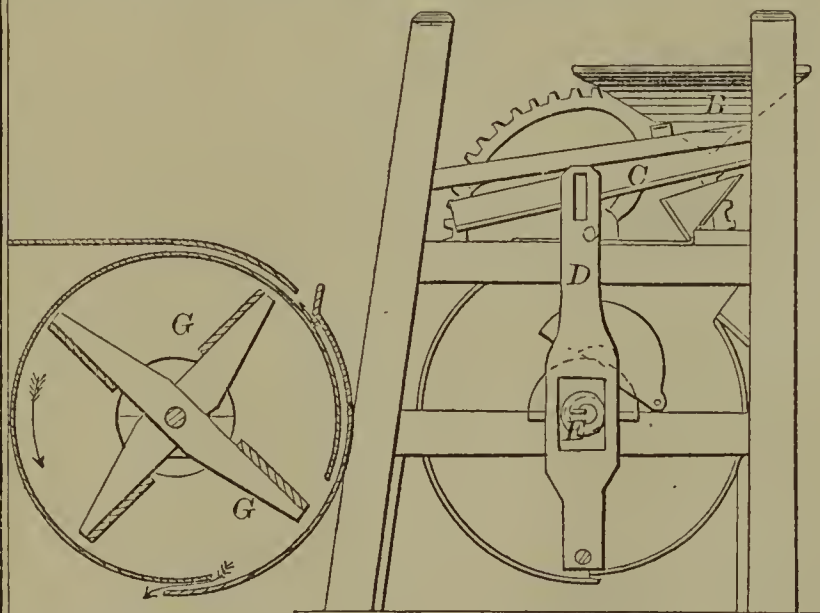

58631—W. H. Gates—Dental Drill.

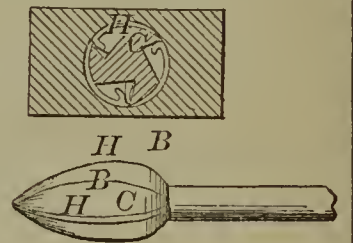

58636—S. J. Gouchee—Shovel.

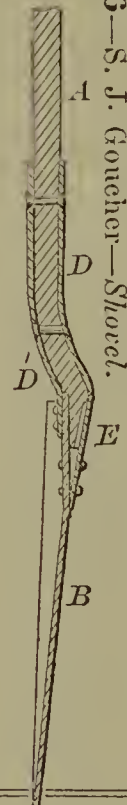

58633—W. D. Gold—Wrench.

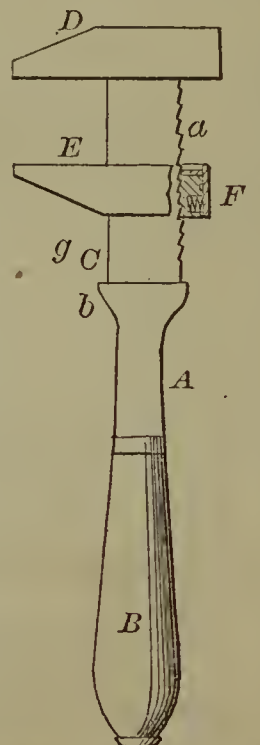

58635—A. Gordon—Horse Hay Fork.

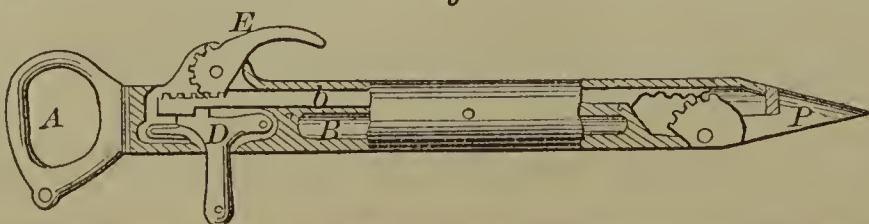

58637—S. L. Gould—Nail Machine.

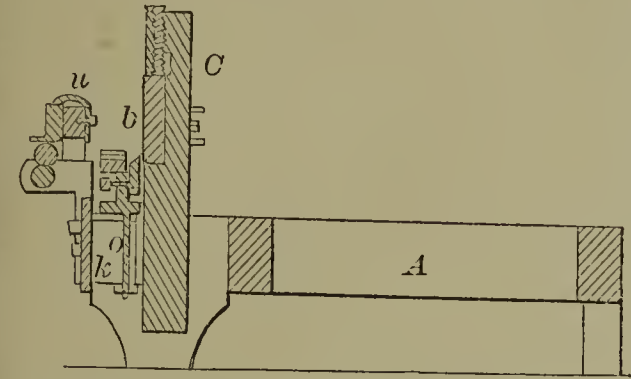
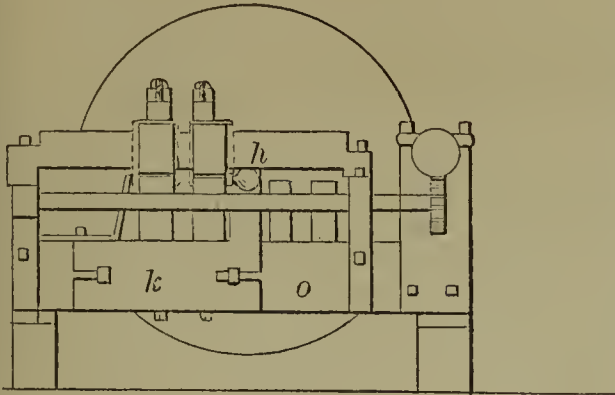

58638—D. Graves—Cooking Stove.

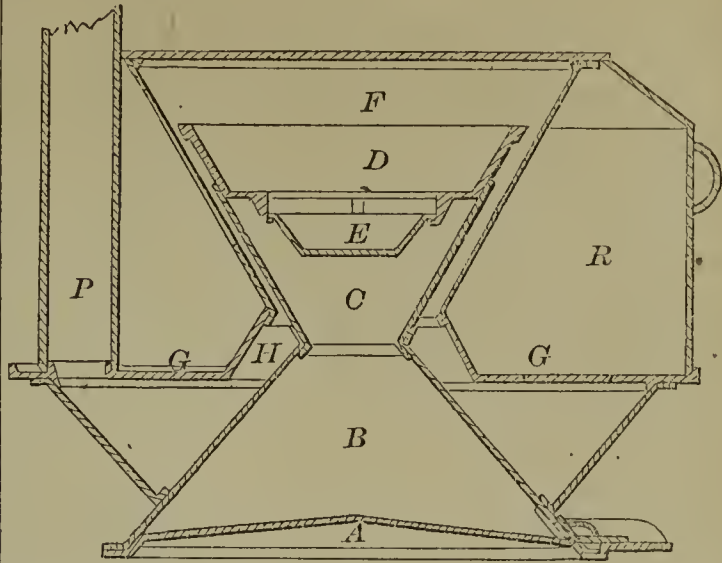

58641—J. H. Hayward—Ladies' Paper Skirt.

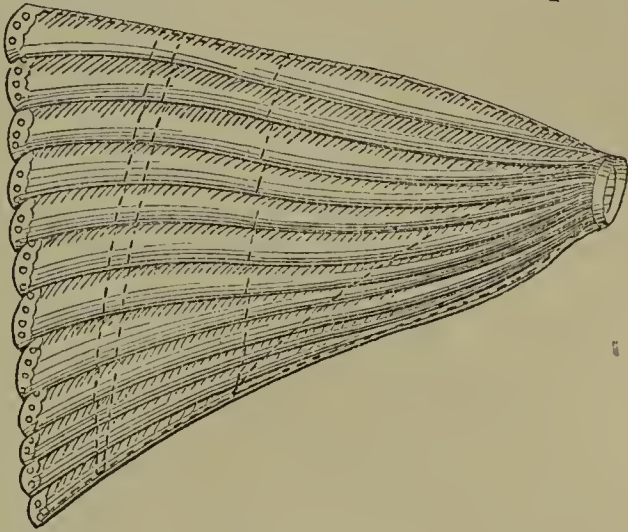

58642—G. M. Heim—Washing Machine.

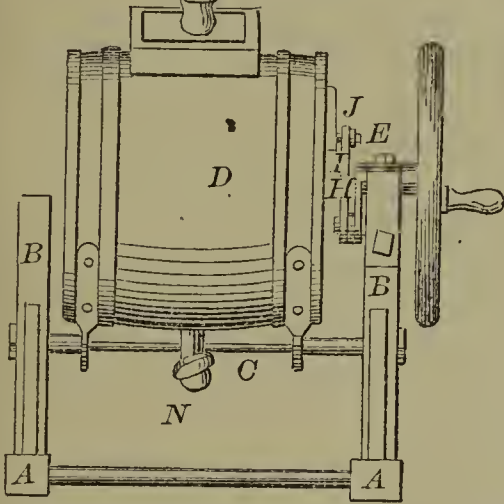

58639—G. Hagenmeyer—Miners' Fuze Lock.

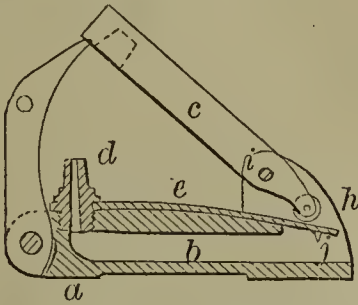

58645—C. Huie—Horse Shoe Punch.

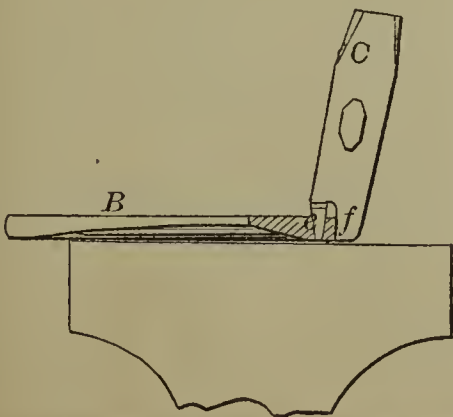

58640—F. K. Hain—Axle Box Cover.

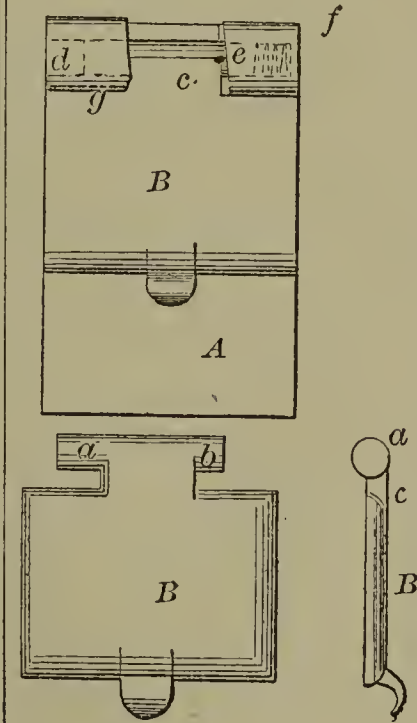

58647—A. Huston—Hub.



58646—E. S. Hunt—Rocket.

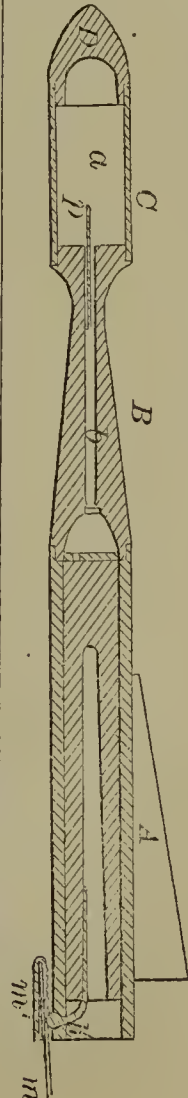

58648—T. C. Joy—Oil Tank.

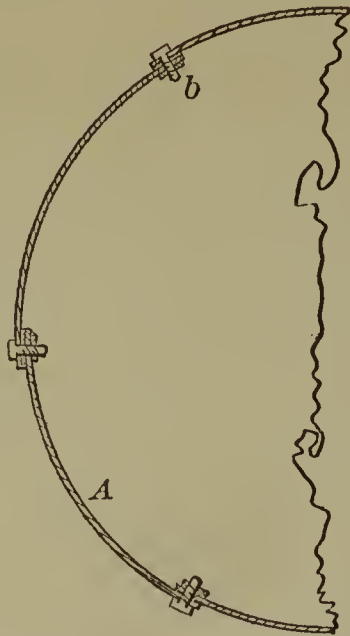

58650—G. L. King—Driving Pipe for Oil Wells.

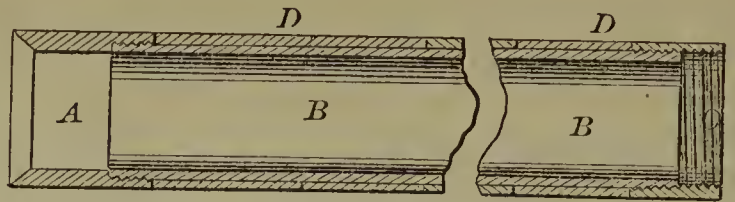

58649—A. B. King—Feed Cutter and Box.

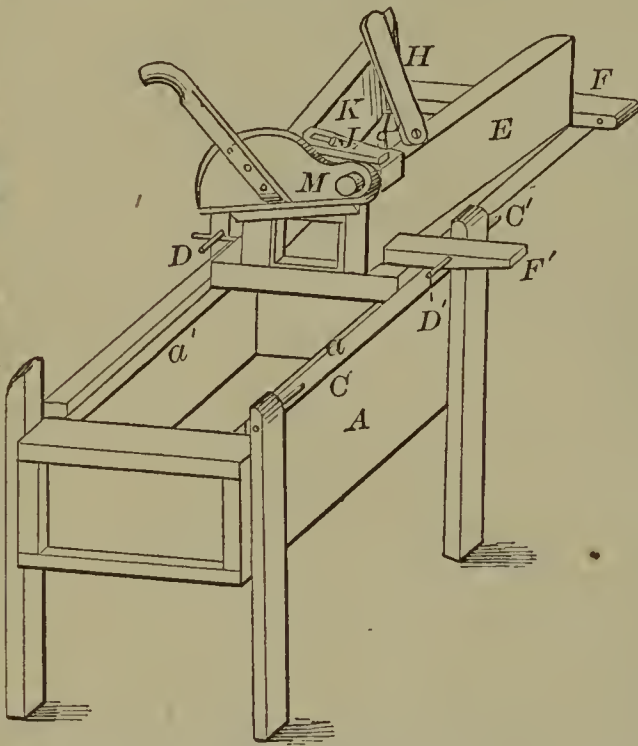

58653—C. A. Lindner—Carpet Stretcher.

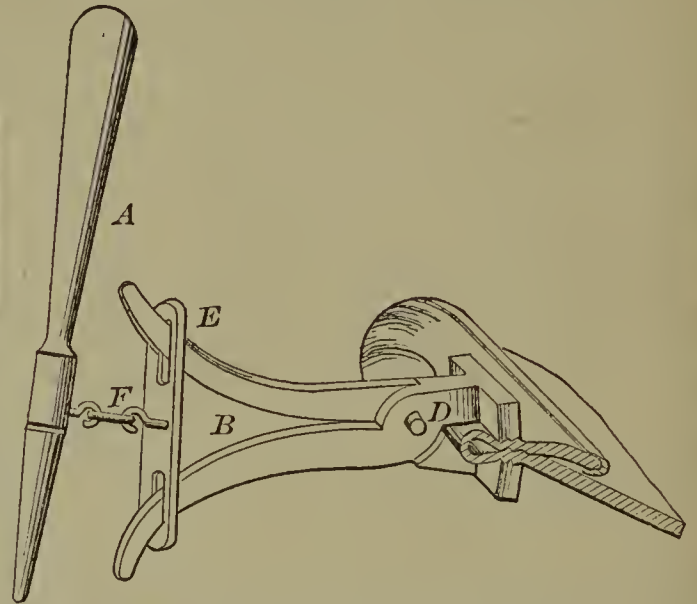

58656—H. S. Lucas—Blasting Cartridge.



58651—J. Levy—Skirt Hoop.

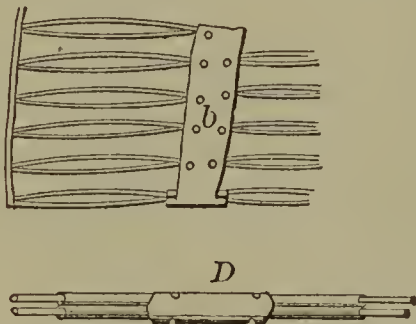

58654—F. Lindner—For Making Button Holes.

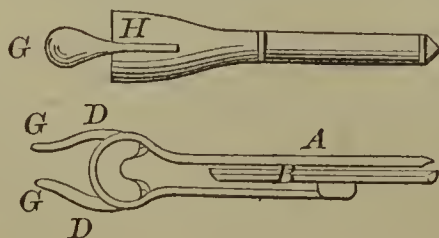

58657—H. H. Mansfield—Metallic Fastening for Buckles.

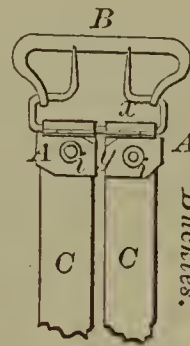

58655—J. W. & S. A. Livingston—Sash Supporter and Fastener.

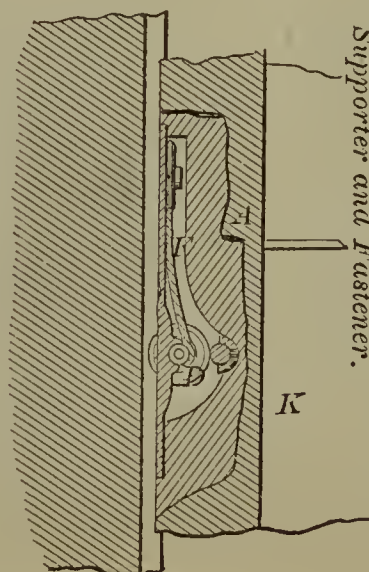

58658—J. McClure—Hollow Auger.

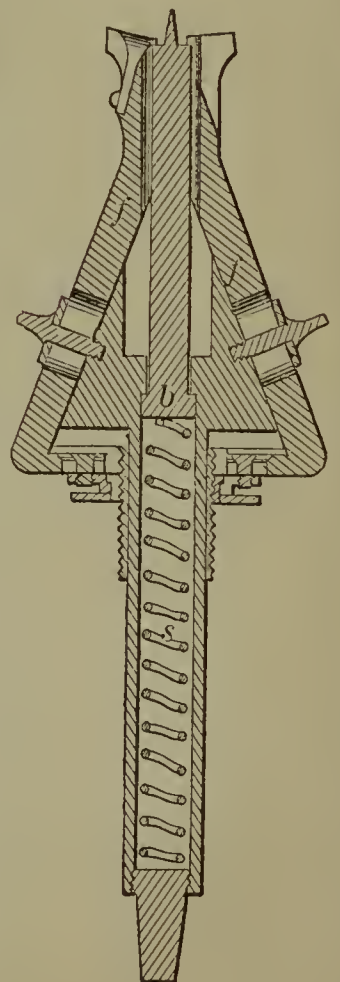

58659—C. McCrea—Pruning Knife.

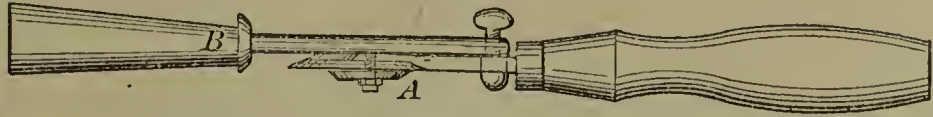

58666—H. W. Moore—Annealing Furnace.

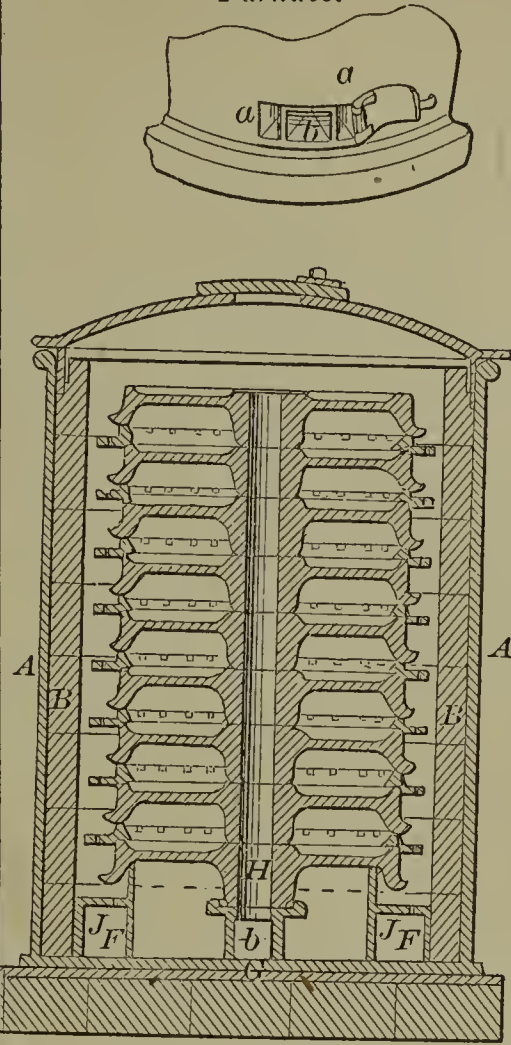

58664—W. P. Miller—Saw.

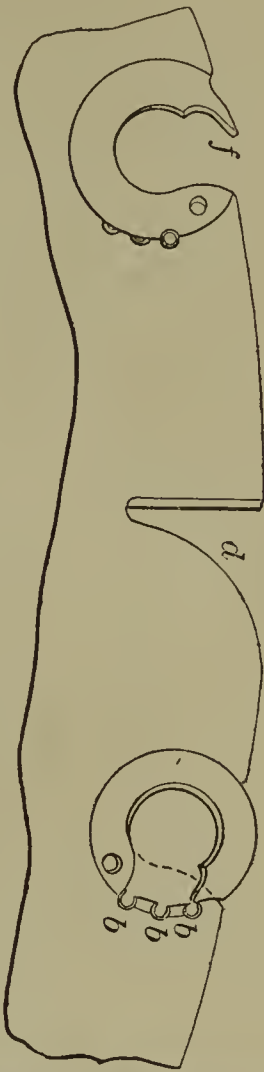

58661—S. S. Merriam—Submarine and Torpedo Boat.

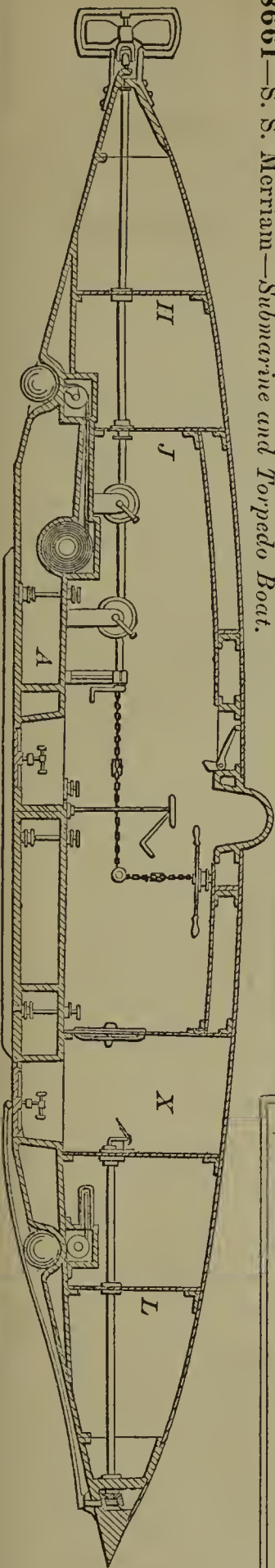

58663—J. S. Miller—Attaching Thills or Tongues to Vehicles.

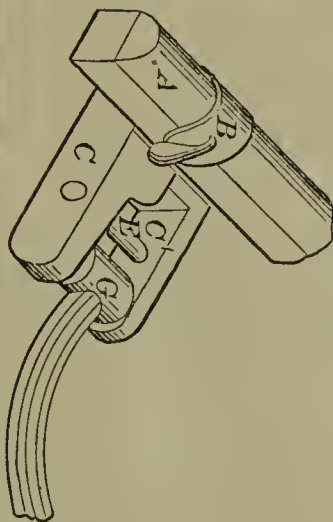

58662—E. Middleton—Fire and Burglar Alarm.

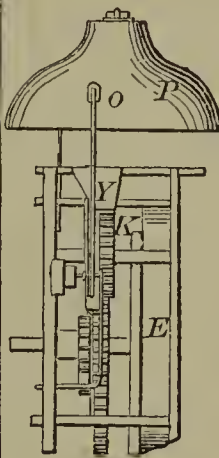

58665—G. I. Mix—Spoon.



58667—G. G. W. Morgan—Paper Fastener. Fig. 2

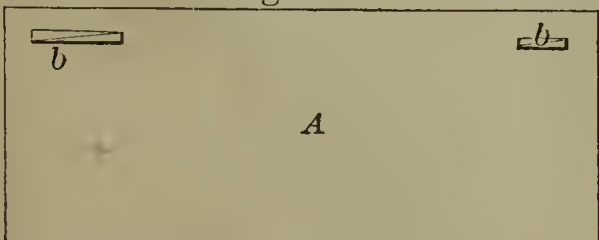
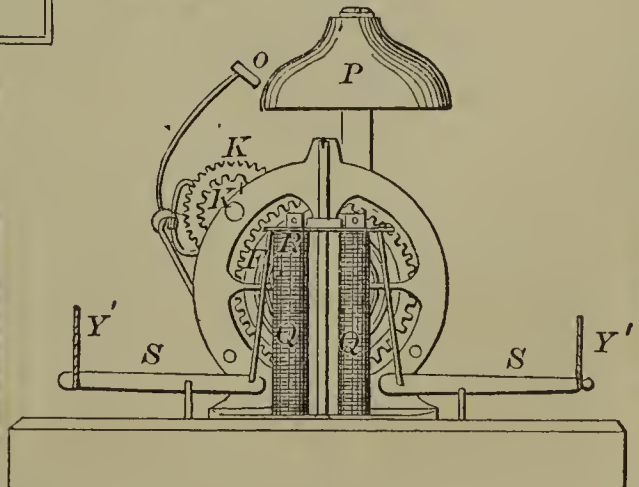

Fig. 2



Fig. 5



58668—W. H. Morrison—Window Curtain.

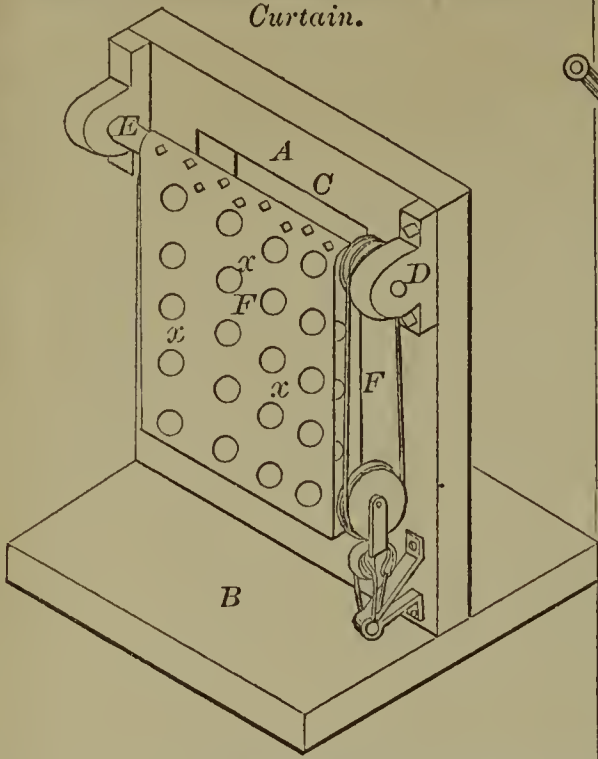

58669—H. Nash—Clothes Wringer.

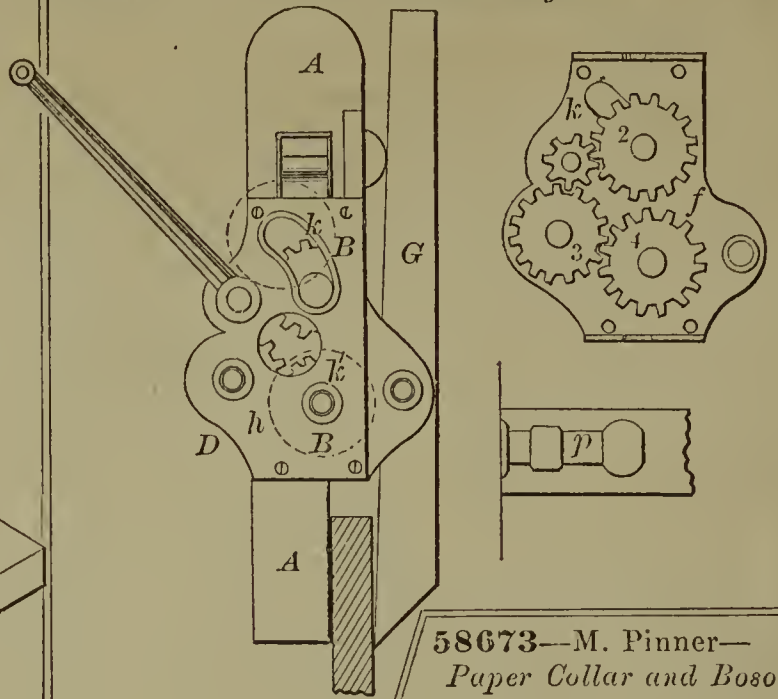

58673—M. Pinner—Paper Collar and Bosom.

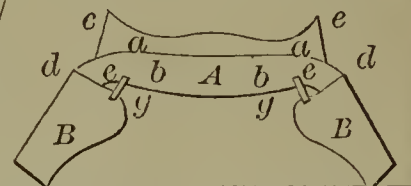

58672—J. T. Parker—Well Borer.

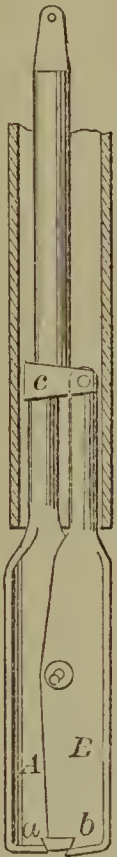

58671—S. Page—Evaporator.

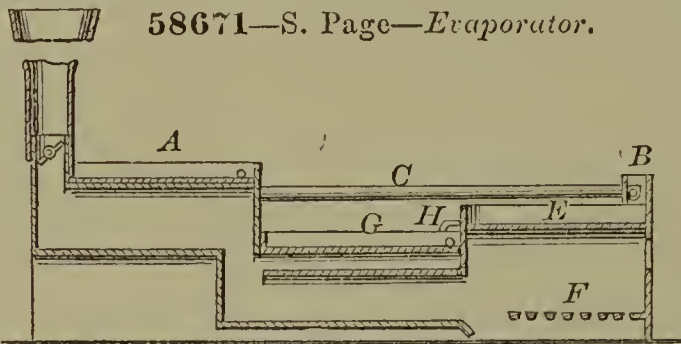

58674—G. A. Reynolds—Fruit Jar.

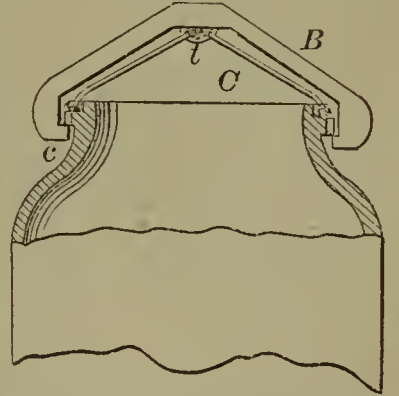

58675—W. M. Rice—Heel Iron.

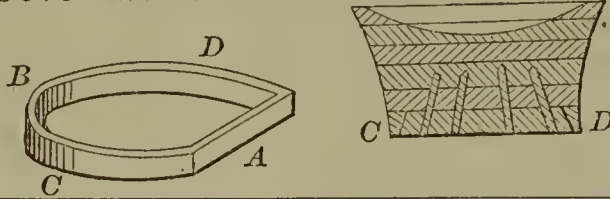

58676—Riter & Farquhar—For Punching Sheets of Metal.

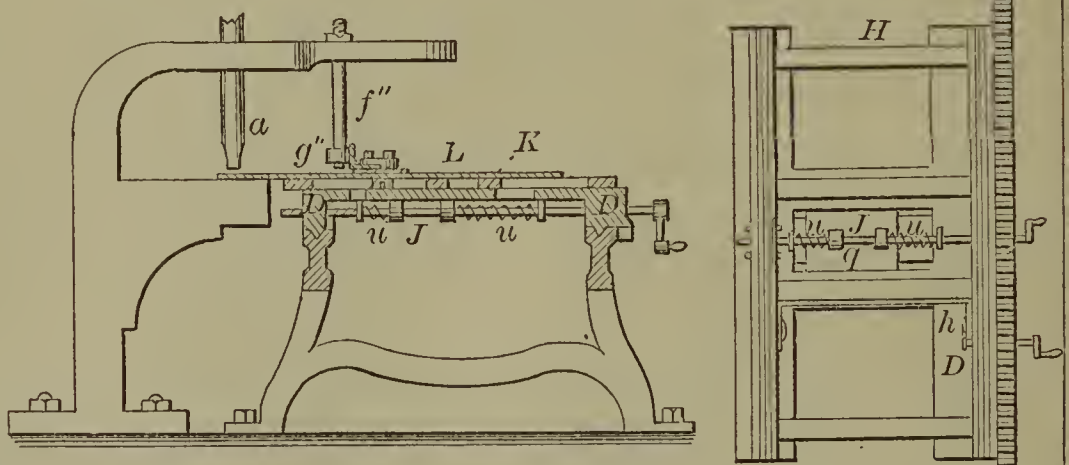

58670—S. D. Ogburn—Hemming Guide.

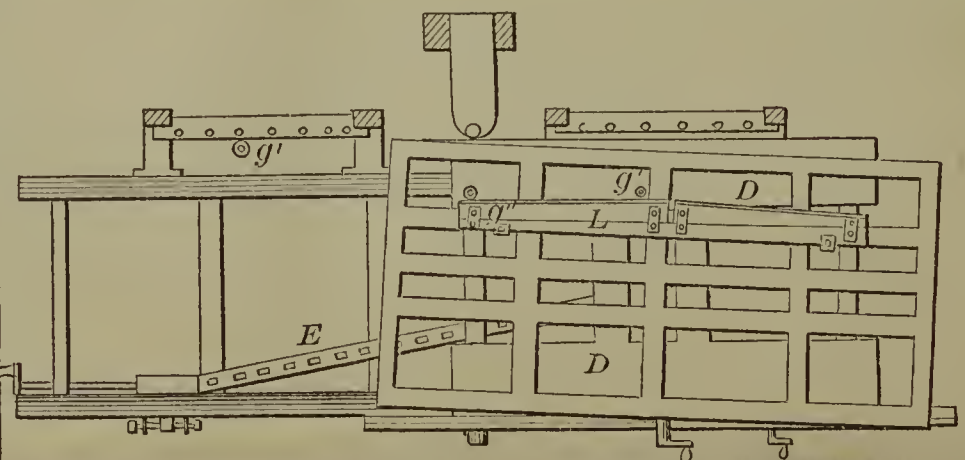
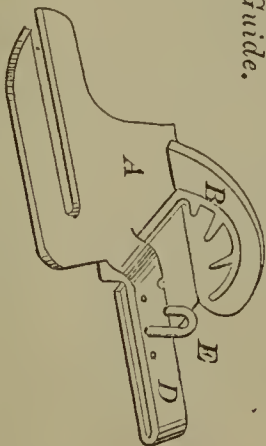



58677—A. H. Rowand—Car Spring.

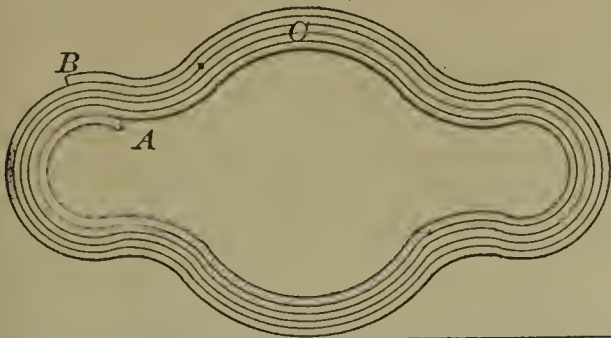

58679—R. S. Sanborn—Bed Bottom.

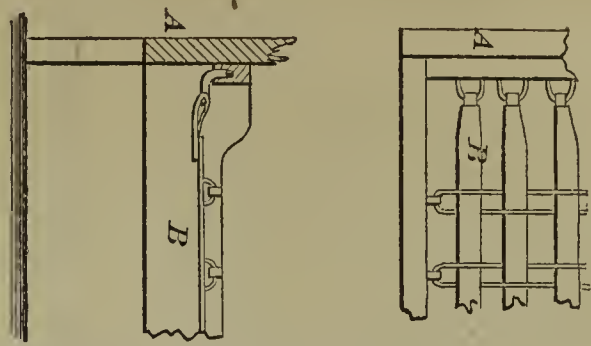

58678—E. Rowing—Steam Generator.

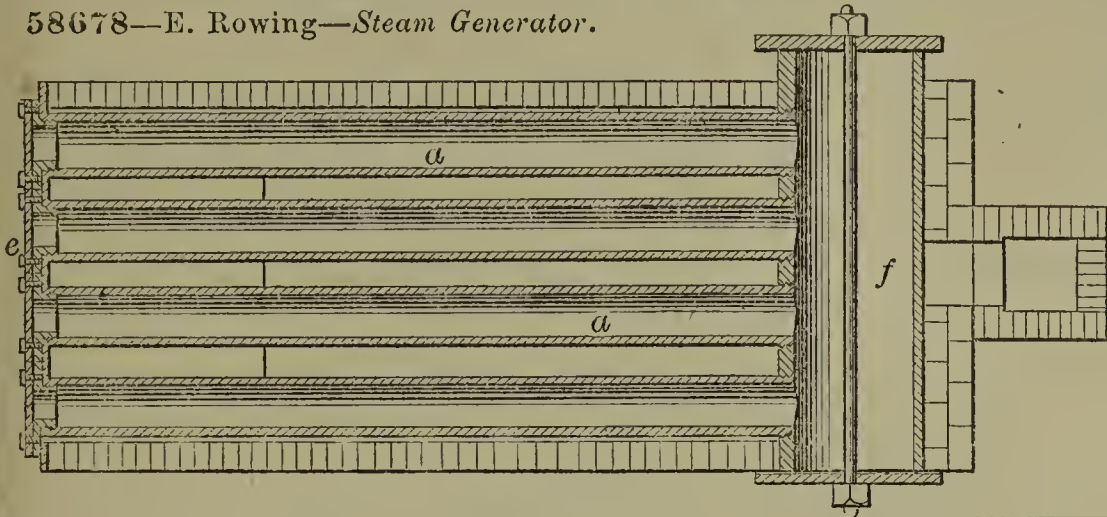

58681—S. H. Schenck—For Splitting and Skiving Leather.

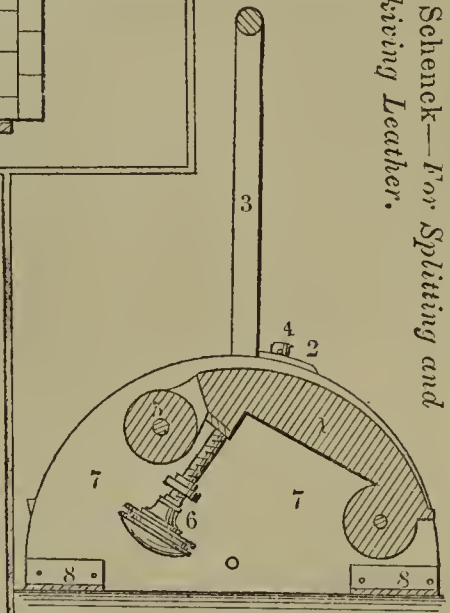

58680—L. B. Sawyer—Observatory.

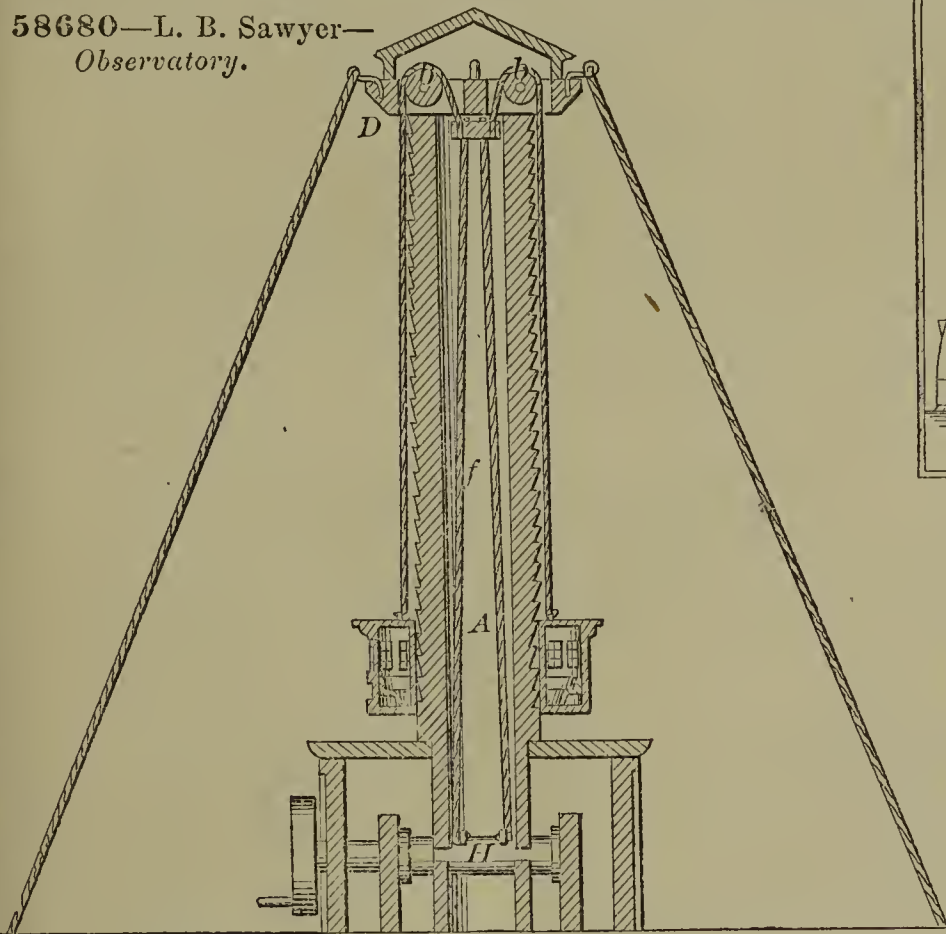

58683—Schwemmer & Mueller—Fly Fan.

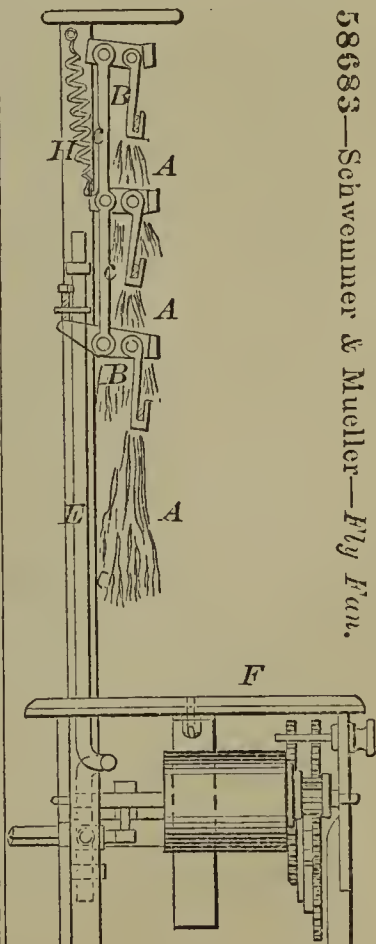

58682—C. C. Schmitt—Chair.

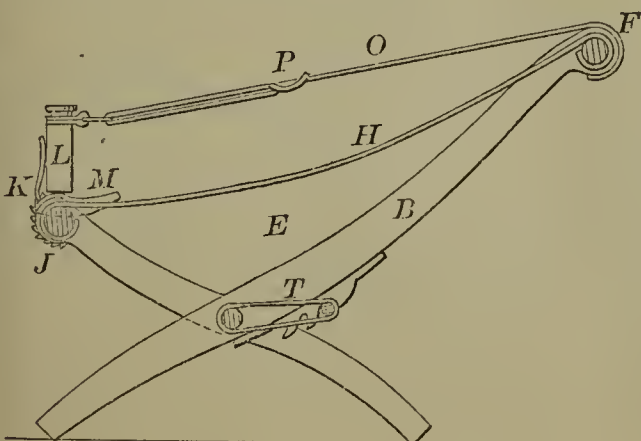

58684—A. G. Shaver—Eraser and Burnisher.



58685—S. Sherman—Steam Generator.

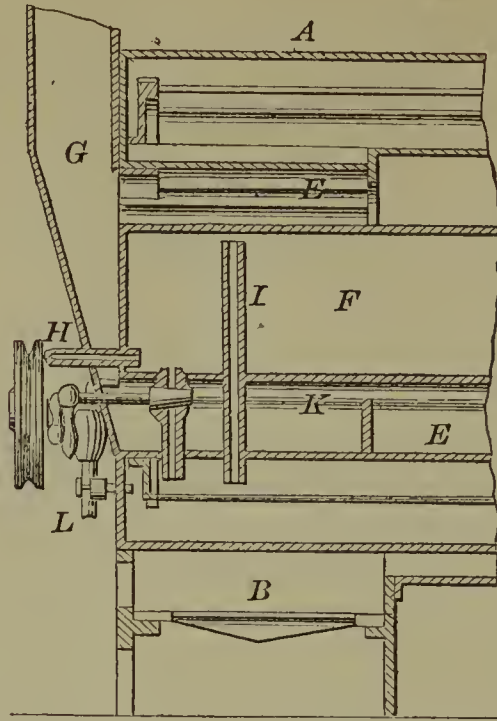
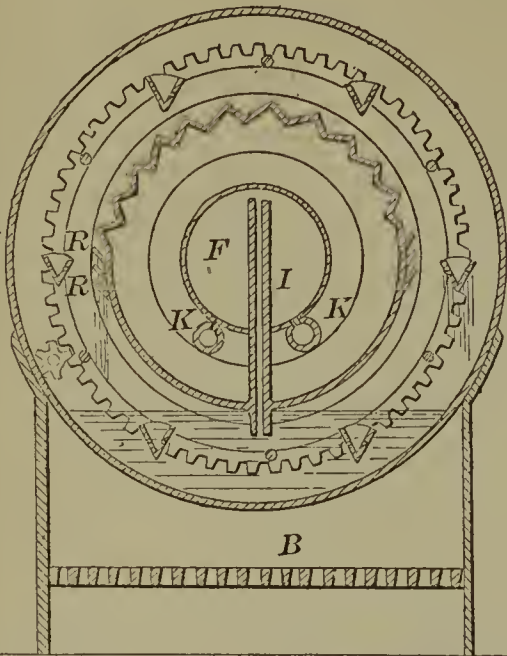

58687—D. M. Smith—Paper Holder.

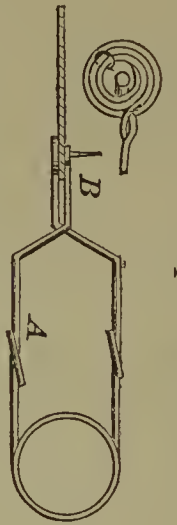

Fig. 1

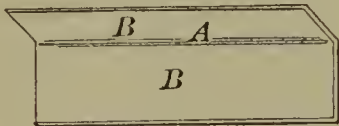
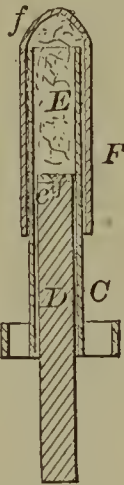
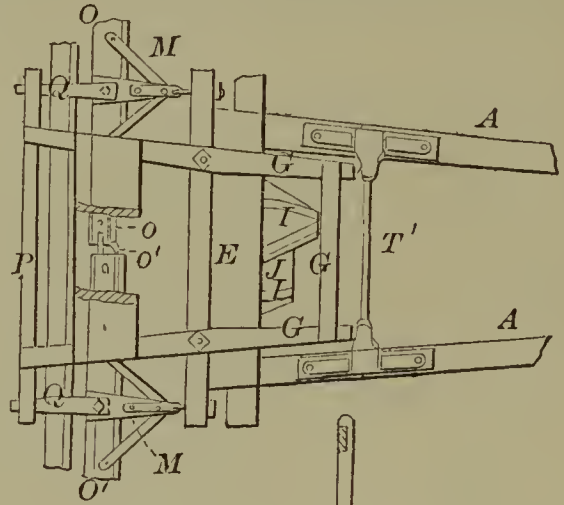

Fig. 2



58686—S. Shuck—Cigarette.

58689—J. A. Spear—Horse Rake.



58688—A. W. Snow—Lock.

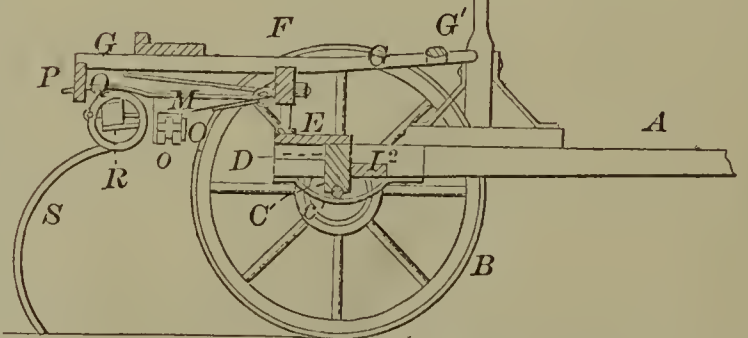
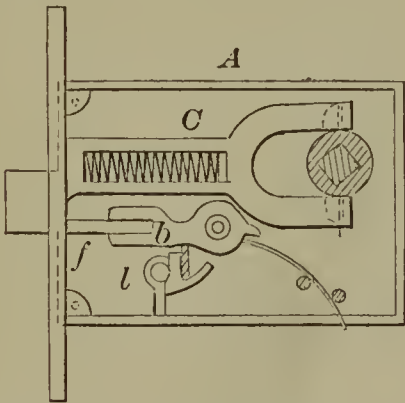

58691—J. M. Stanyan—Dough Mixer.

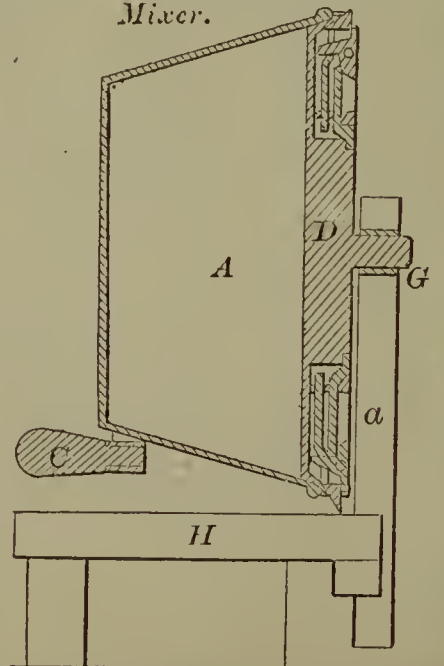

58692—G. N. Stearns—Saw Holding Vise.

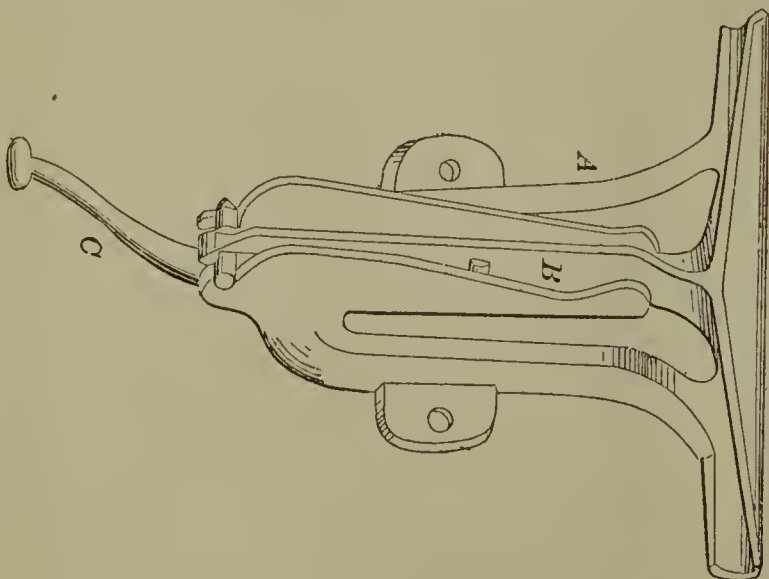

58693—L. O. Stevens—*Corn Cultivator.*

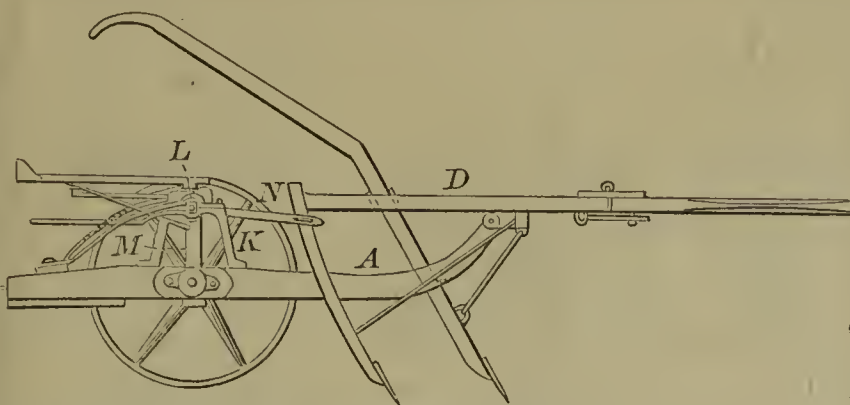

58697—H. A. Tozier—*Beehive.*

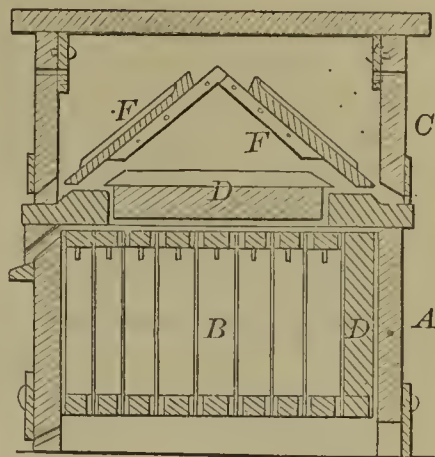

58695—J. A. Strong—*Sheep Shears.*

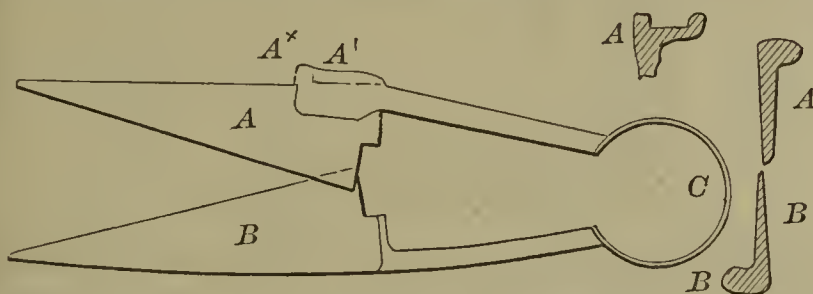

58696—S. Taylor—*Beehive.*

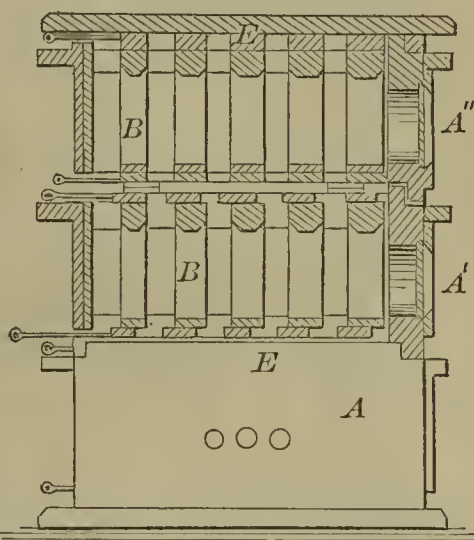

58699—J. H. Wait—*Balance Slide Valve.*

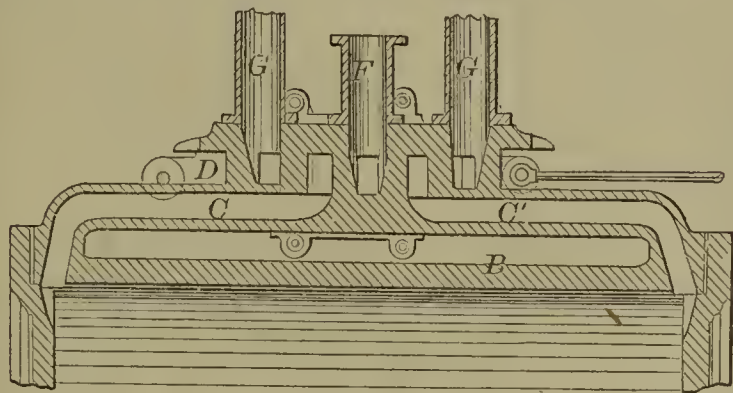

58694—J. Stimpson—*Wringing Machine Clamp.*

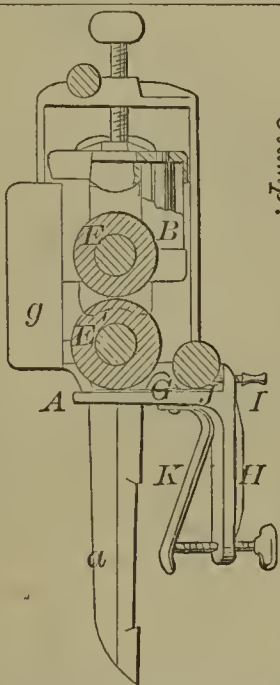

58698—C. W. Wailey—*Cotton Tie.*

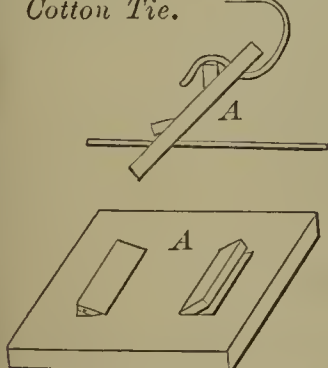

58700—W. H. Warrath—*For Pressing Brick.*

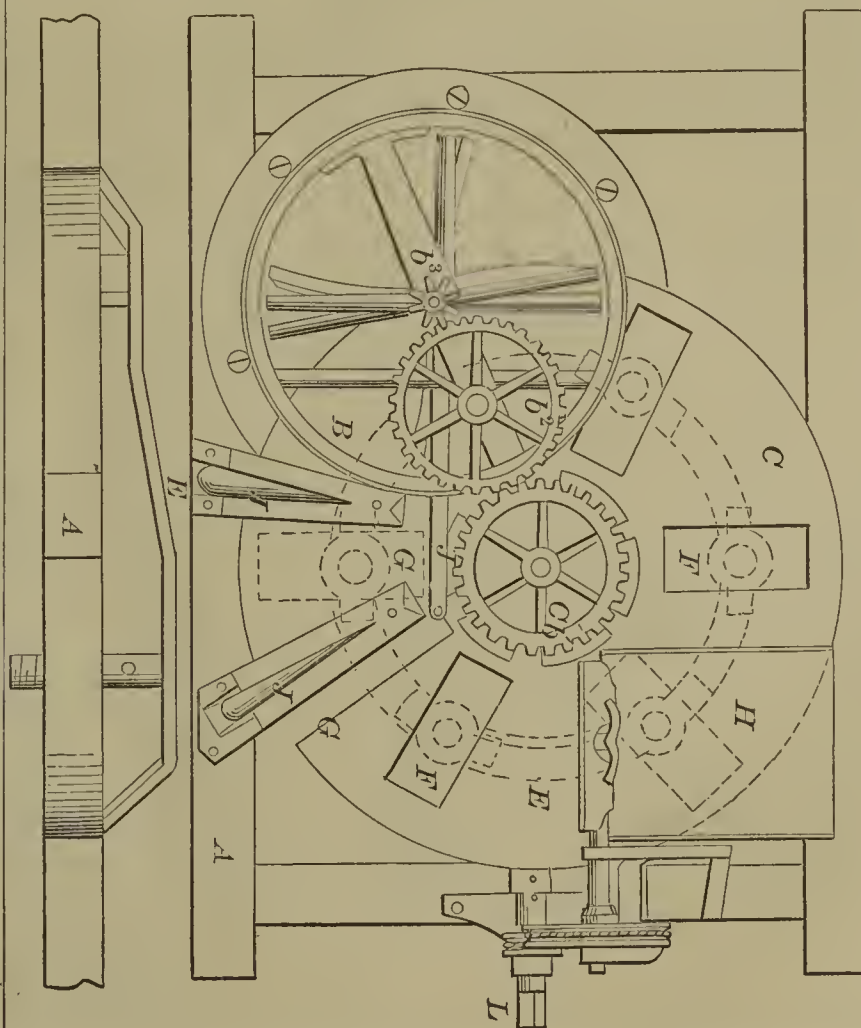

58701—C. P. Walter—  
*Plastering Mould for Cornices.*

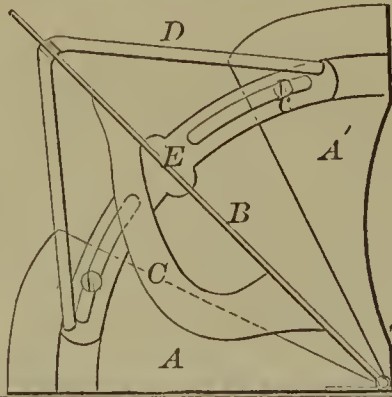

58704—D. E. Whiton—*Chuck.*

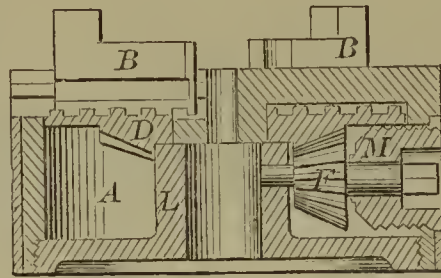

58703—Whitney & Stockin—*Mop Head.*

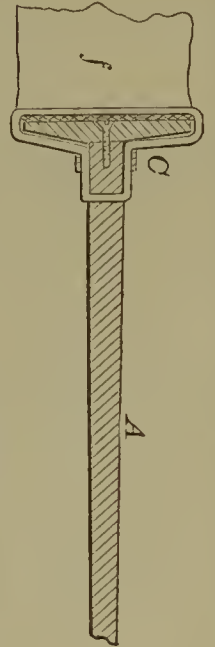

58702—H. Whiting—*Reaping Machine.*

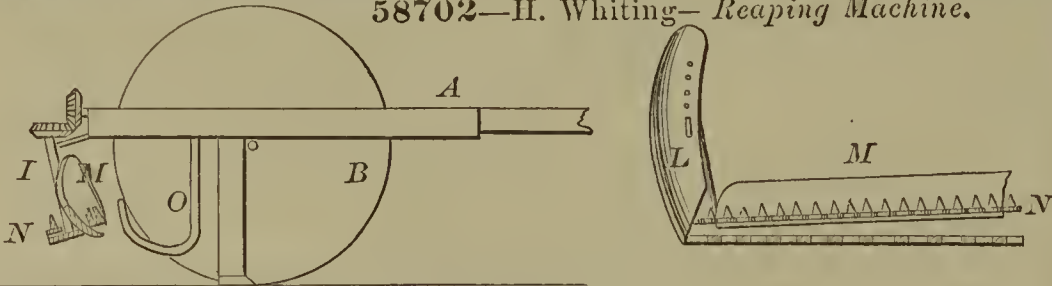

58705—W. Wilson—*Cooking Stove.*

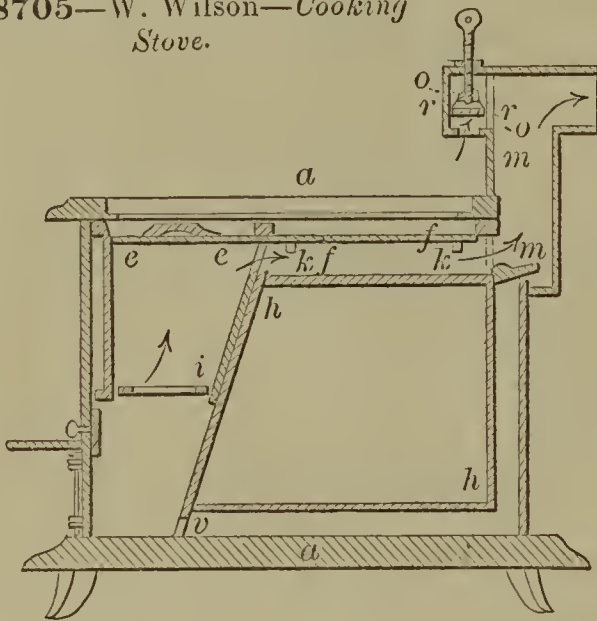

58706—J. F. Winchell—*Corn Harvester.*

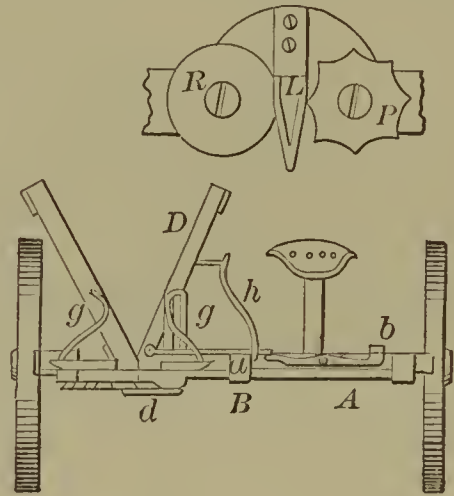

58708—M. Wolf—*Take-up for Narrow Ware Looms.*

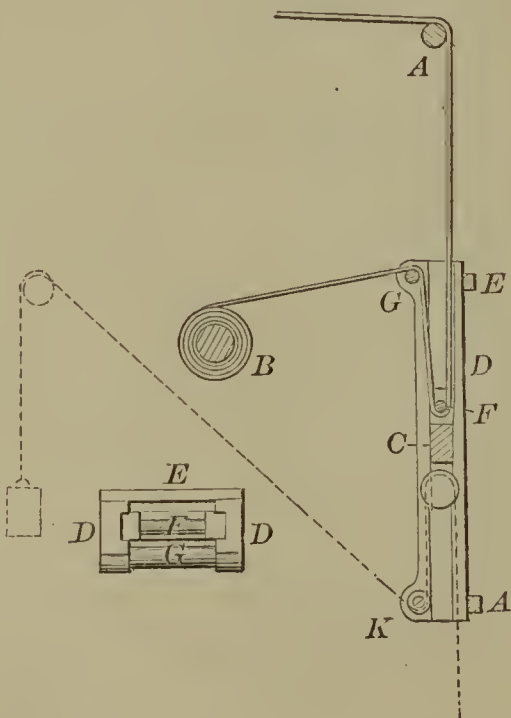

58707—Wirts & Swift—*Grain Separator.*

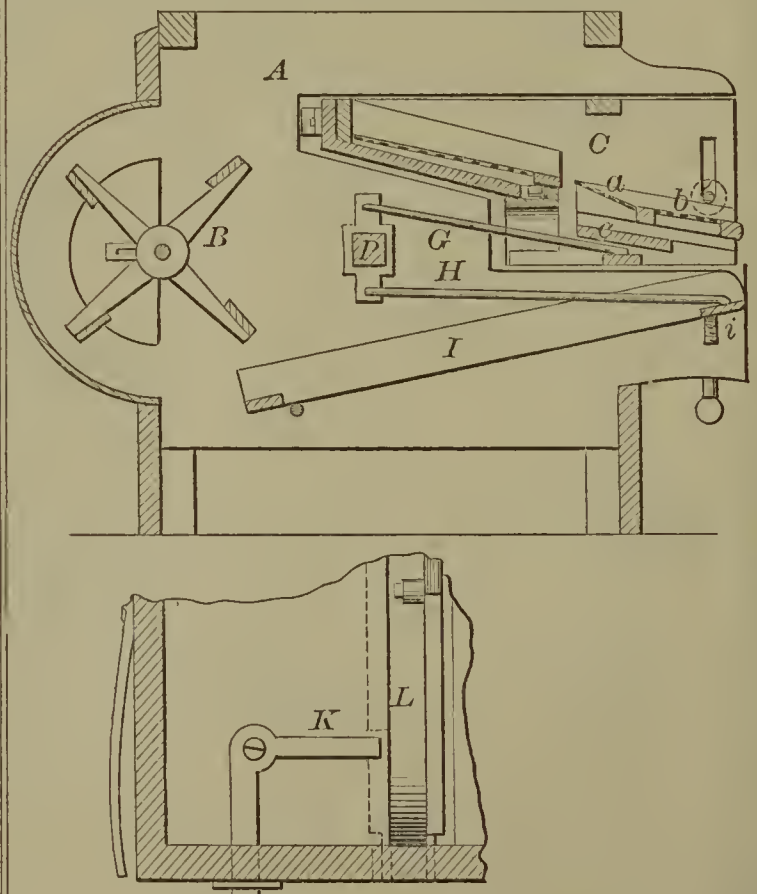

58709—T. D. Worrall—Speculum.

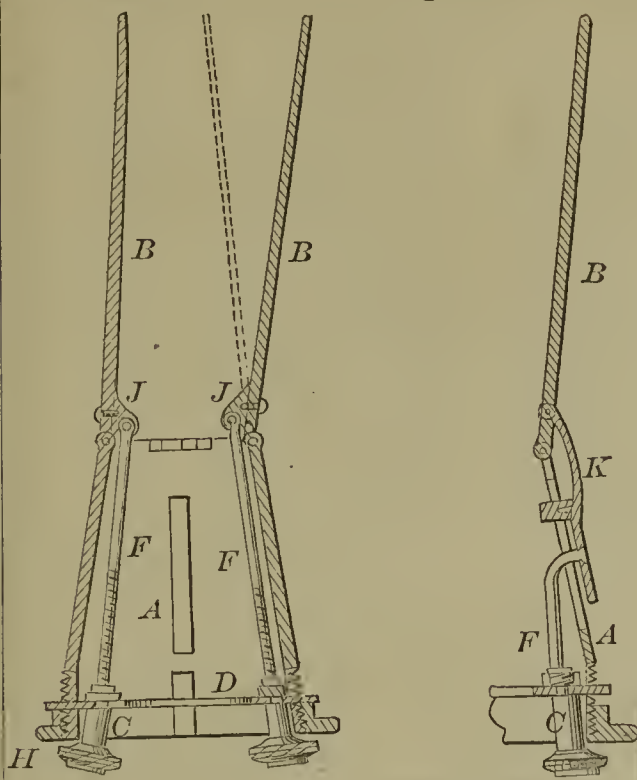

58714—C. L. Campbell—For Fitting Axle Spindles to Skeins of Wagons.

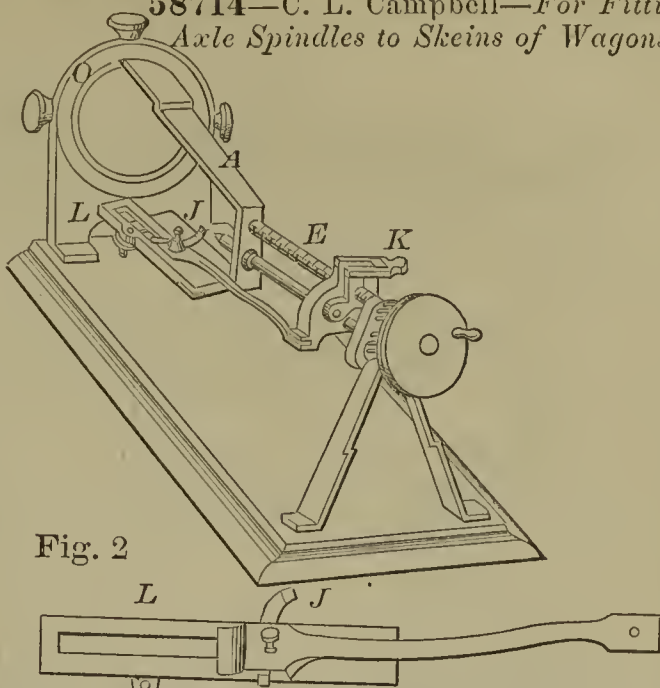
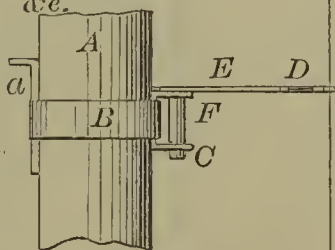
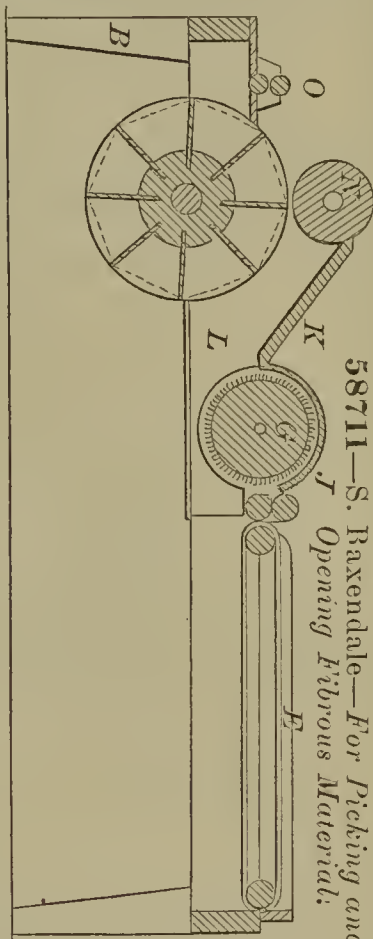
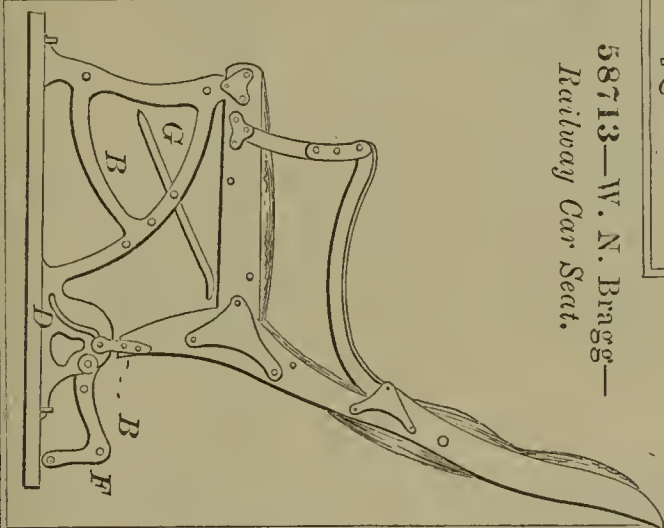

Fig. 2

58712—S. V. Beckwith—Shelf for Stove Pipes, &c.



58713—W. N. Briggs—Railway Car Seat.



58711—S. Baxendale—For Picking and Opening Fibrous Material.

58710—J. K. Andrews—Car Window.



58715—T. F. Christman—Elevator.

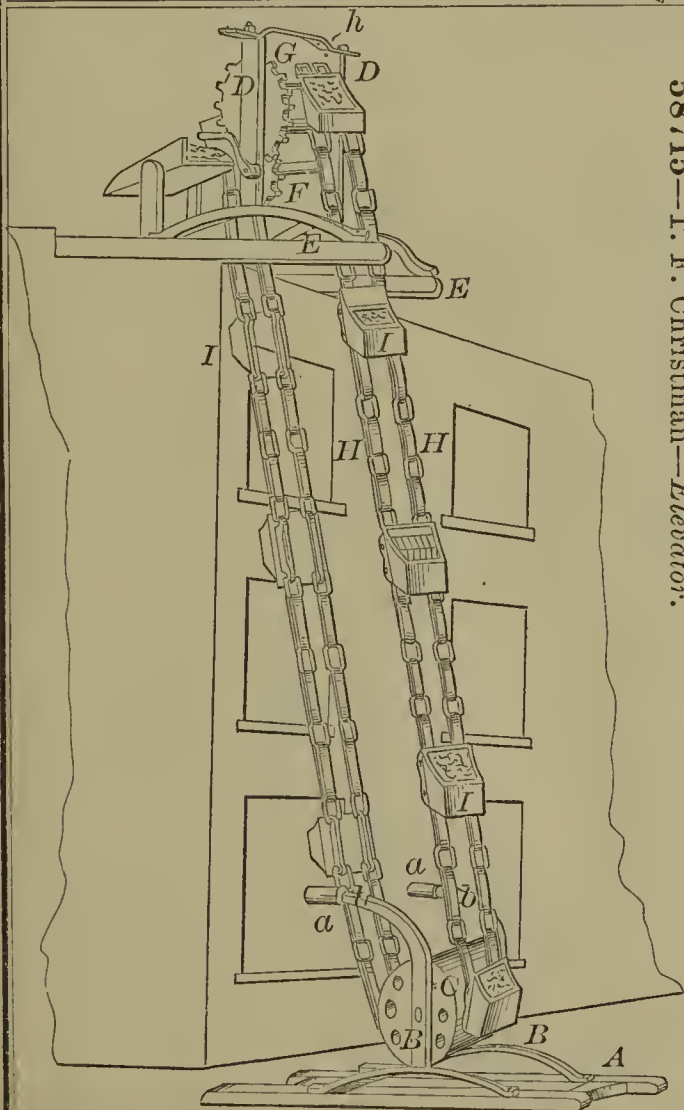

58716—C. P. Crossman—Pen Rack and Bill Holder.

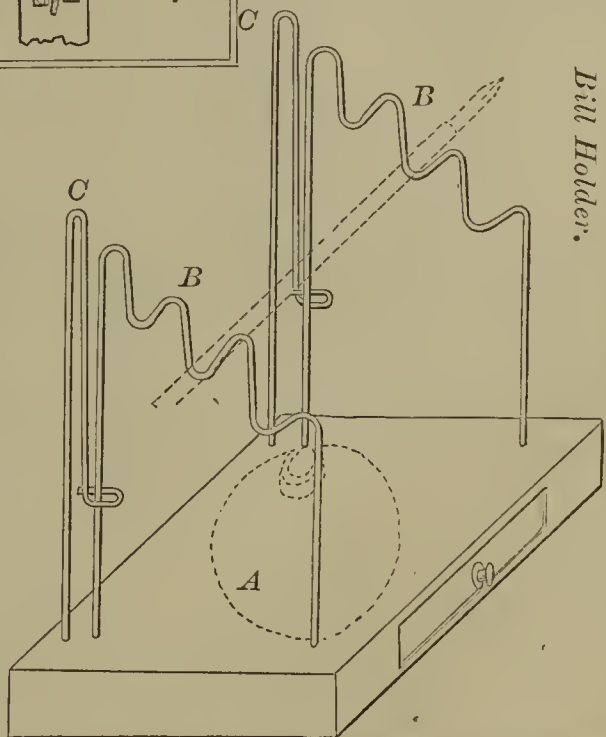

58717—S. Crowell—Connecting and Supporting Stove Pipe.

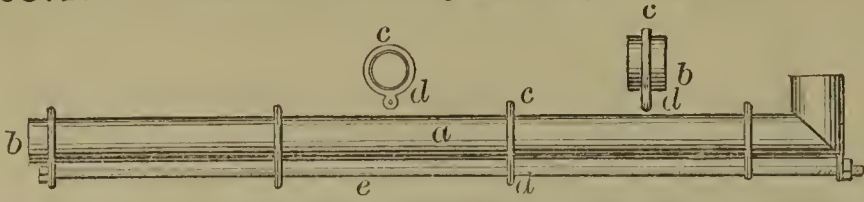

58719—G. F. Deam—Grinding Mill.

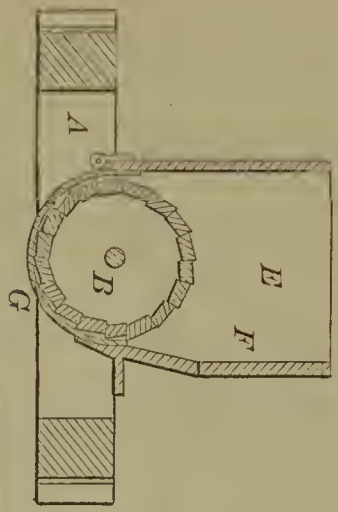

58720—C. Denton—Harvester.

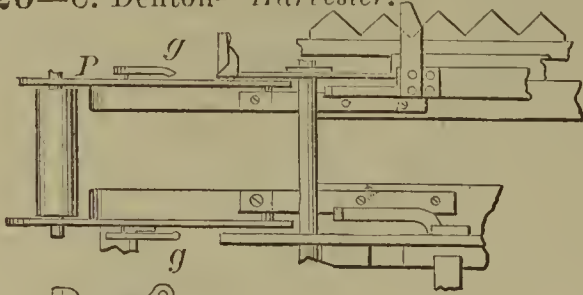

58721—Duck & Whitcomb—Well Pipe and Fixture.

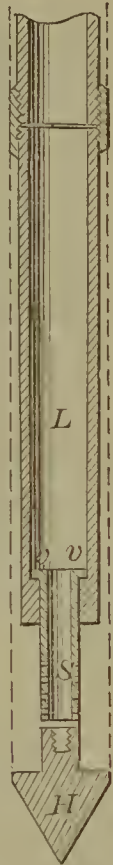

58722—E. S. French—Wood Scraping Machine.

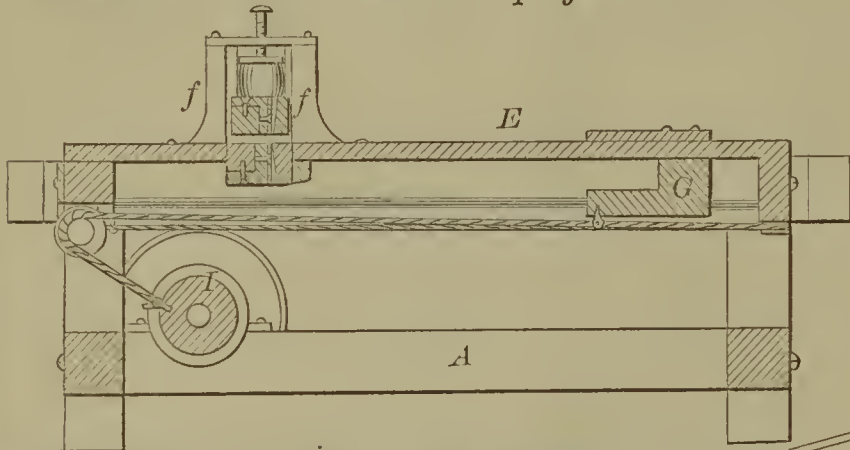

58724—E. R. Holford—Corn Planter.

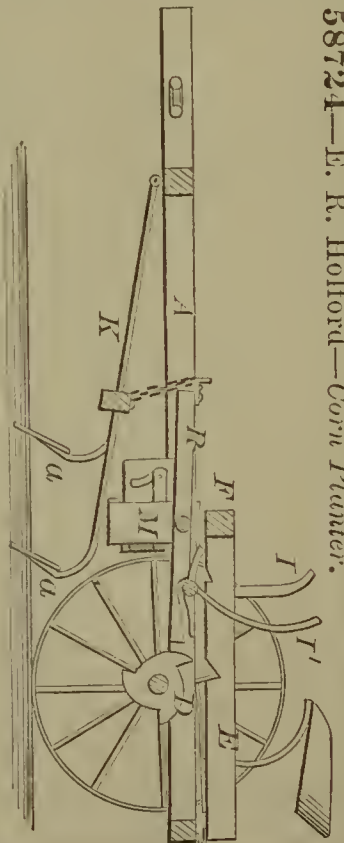

58723—D. C. Guttridge—Car Coupling.

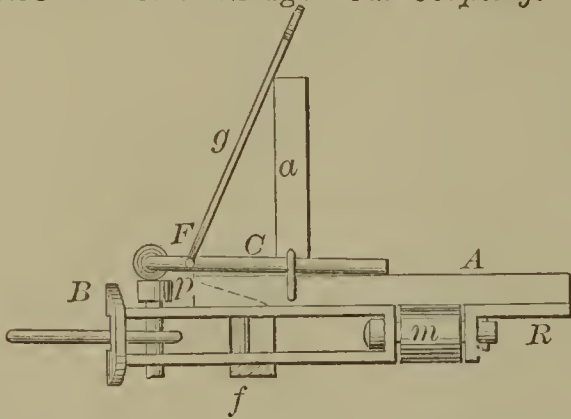

58725—Hopson & Brooks—Buckle.

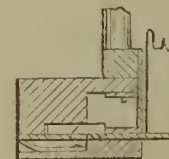
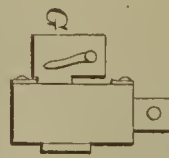
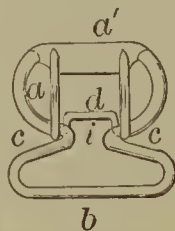

58726—J. Hoyt—Saw Machine.

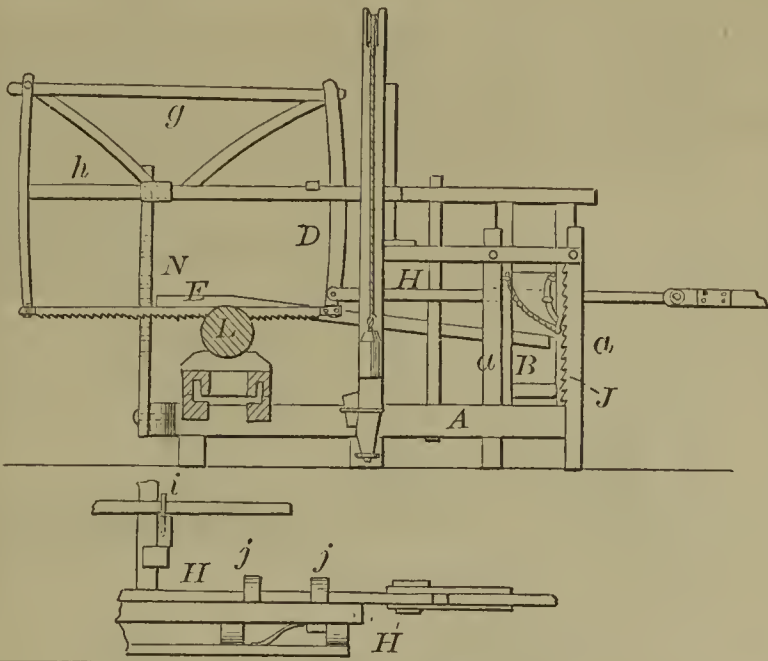

58728—E. M. Lang—Solder Casting Machine.

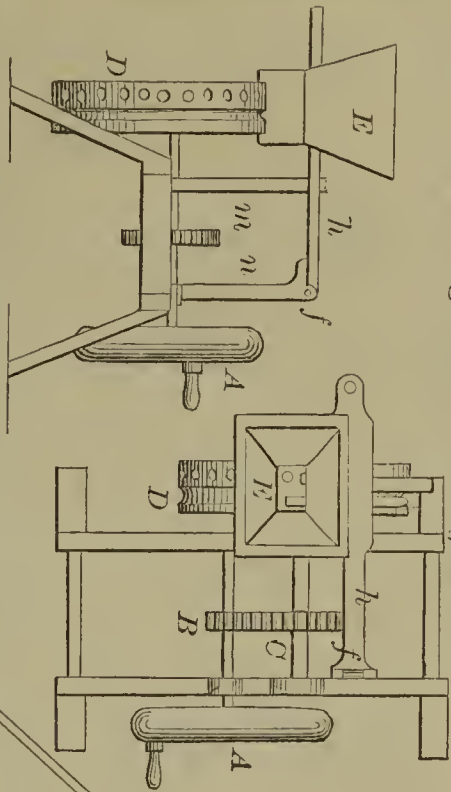

58727—E. S. Hutchinson—Steam Generator.

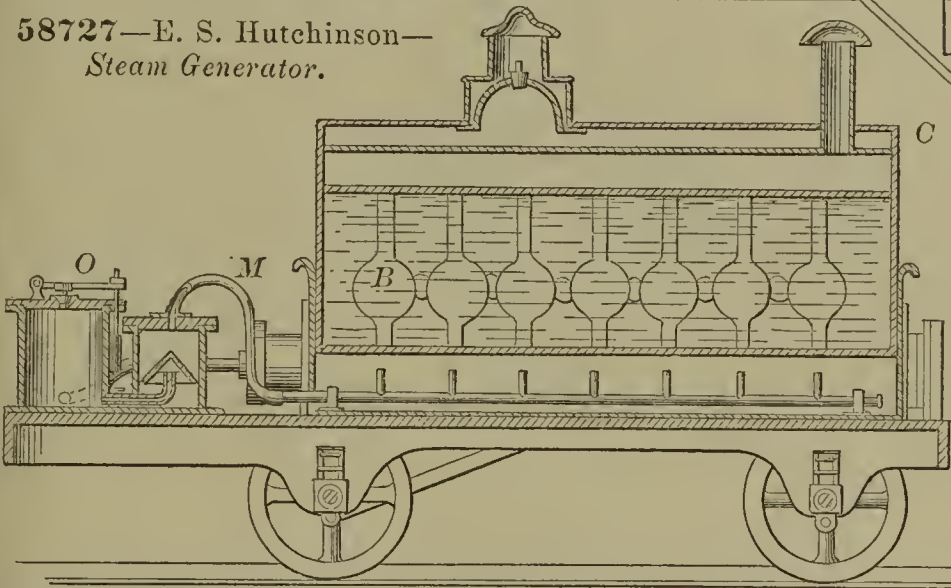

58731—W. McDonald—Gas Meter Register.

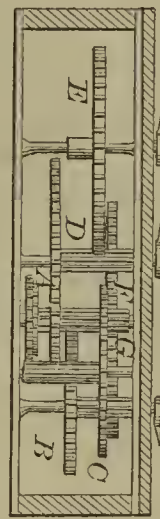

58729—P. H. Lawler—Barrel Machine.

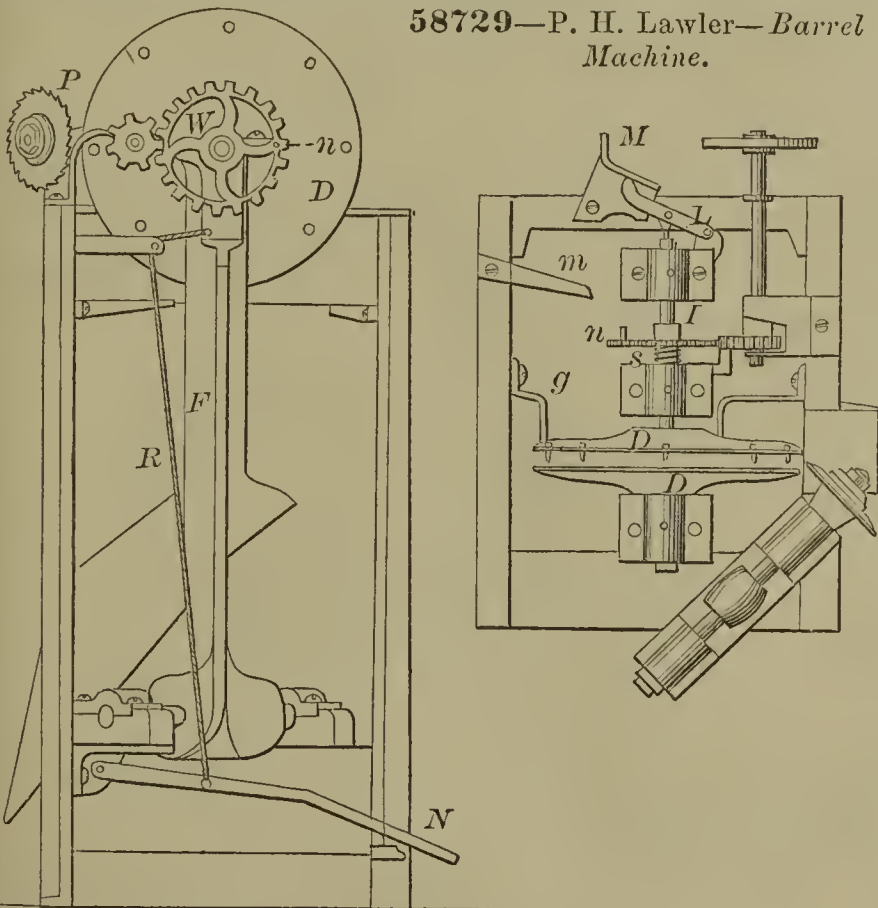

58730—E. J. Manville—Wire Pointing Machine.

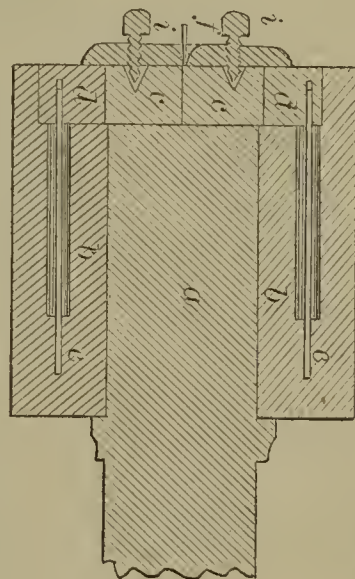

58732—G. R. Metten—Fountain Pen.

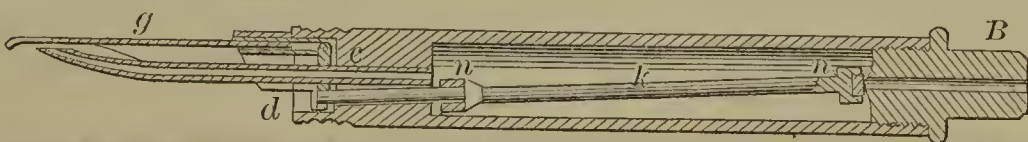

58734—J. G. Rockwell—  
Ladder Hook.

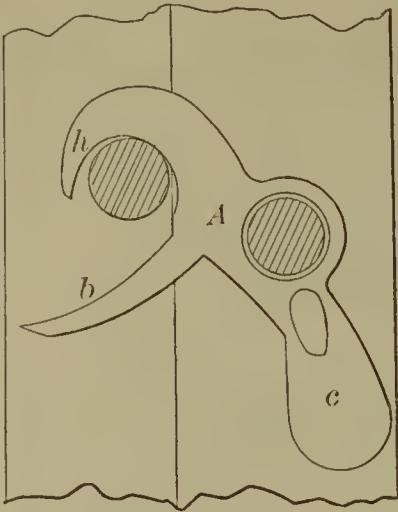

58735—G. Sickels—Water Meter.

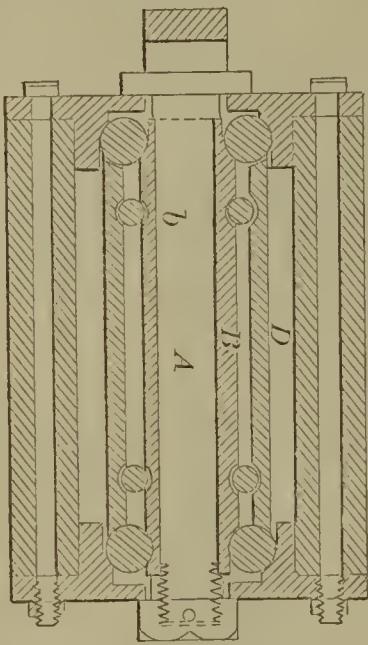
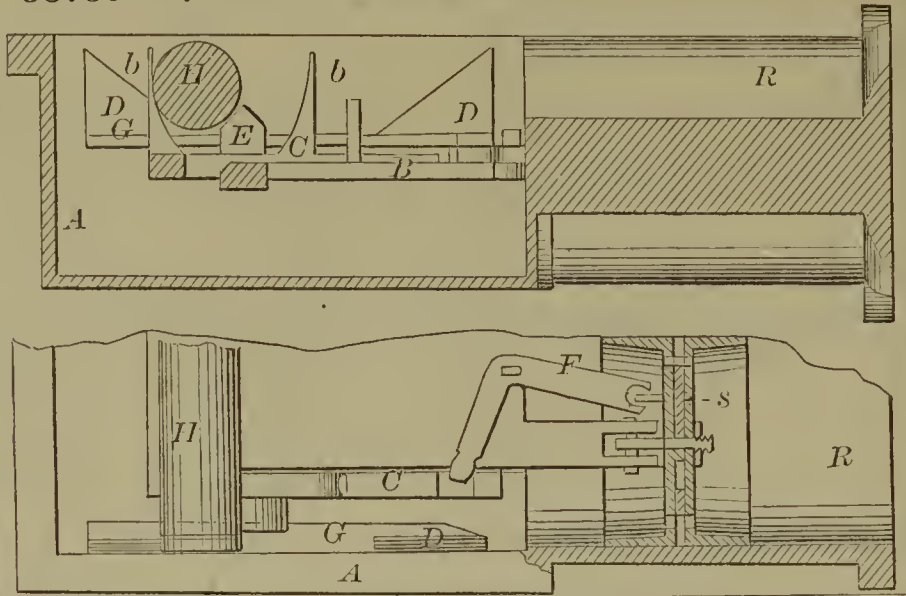

58739—Bailly, Durand, Mesnard & Poirier—  
Anti-Friction Device for Axles.

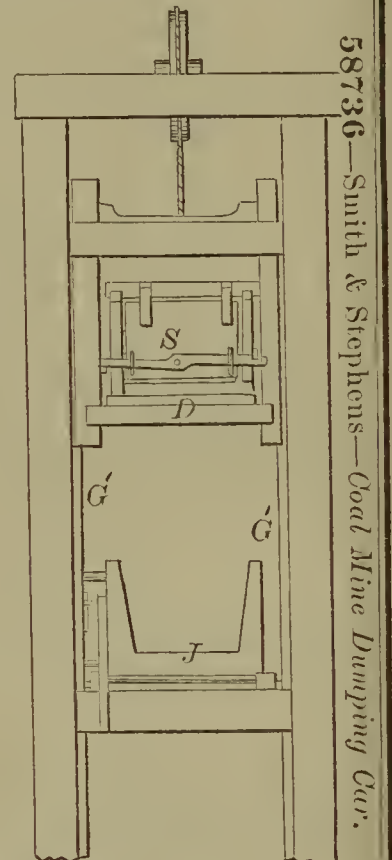
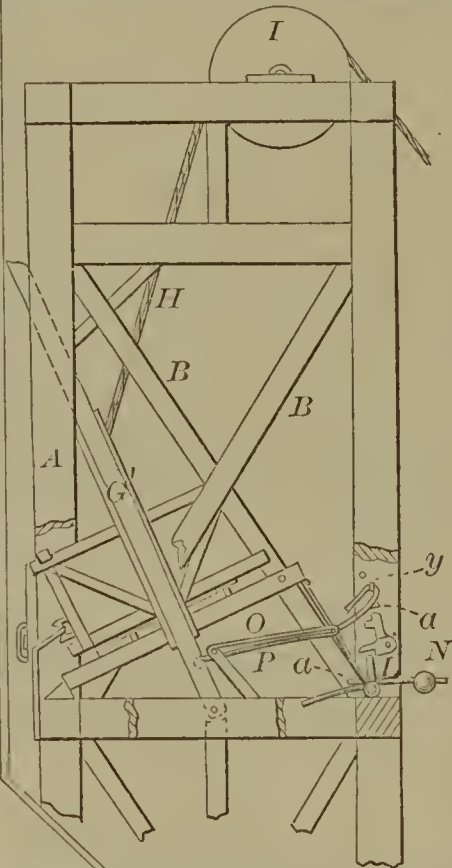

58736—Smith & Stephens—Coal Mine Dumping Car.

58738—C. M. Spencer—  
Magazine Fire Arm.

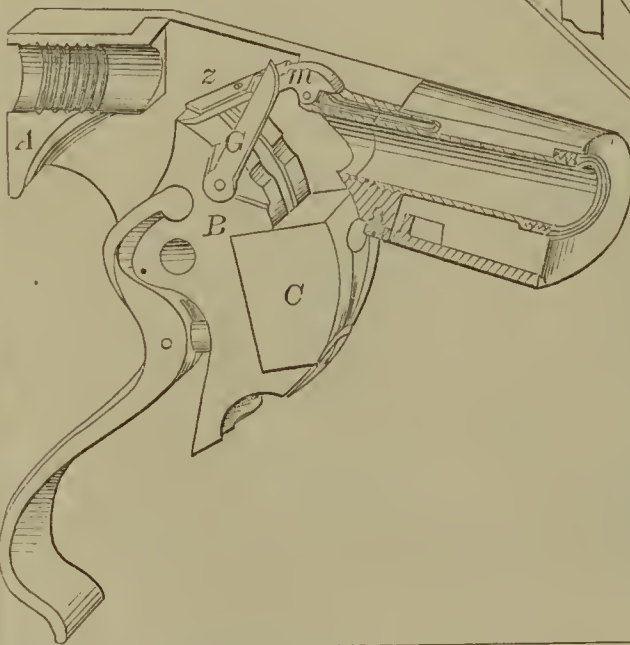

58740—W. Goodman—  
Ship's Windlass.

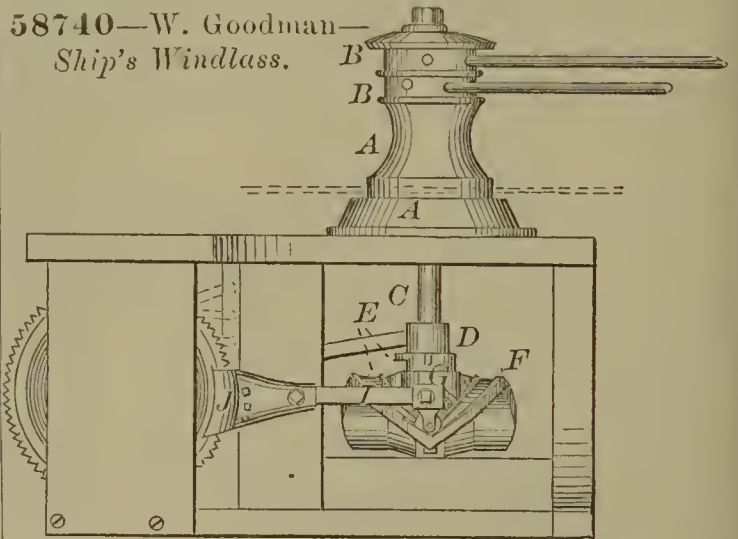

58737—C. M. Spencer—  
Magazine Fire Arm.

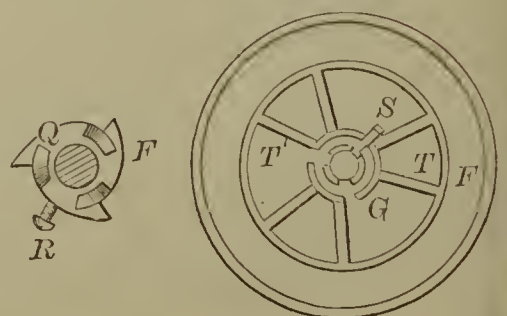
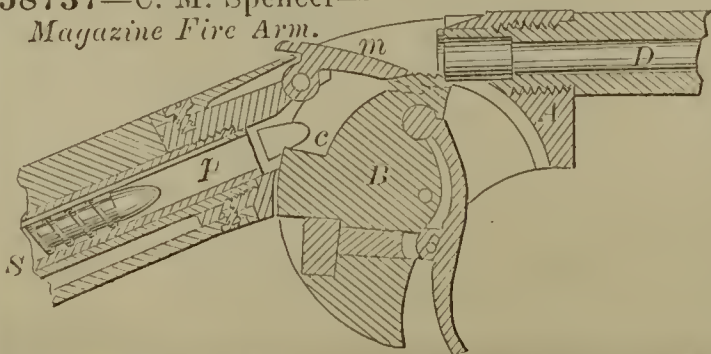



58741—R. C. Mansell—*Car Wheel.*

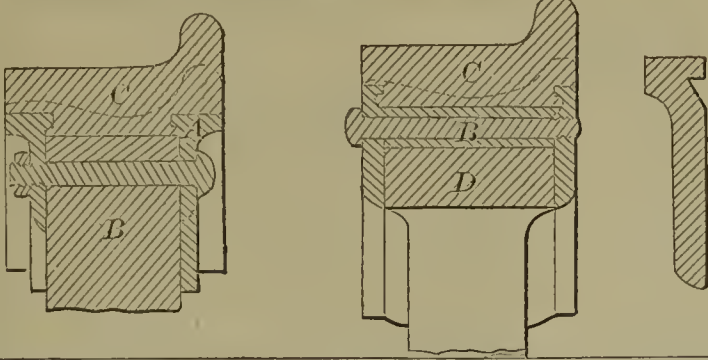

58743—W. L. & T. Winans—*Application of Rudders to Spindle Shaped Hulls.*

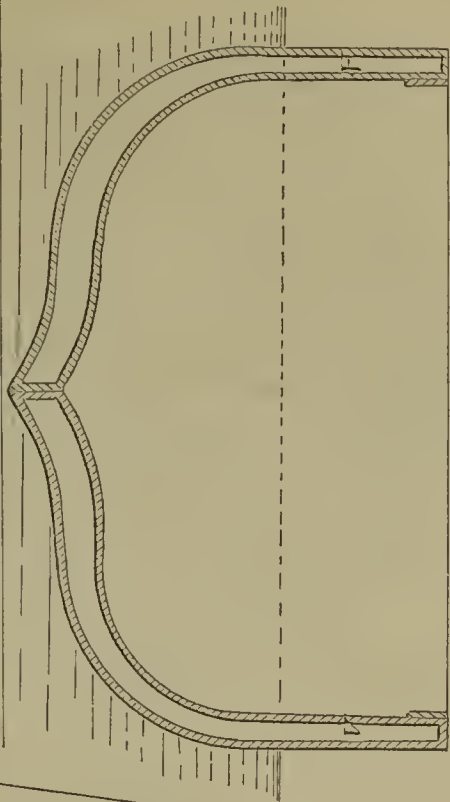
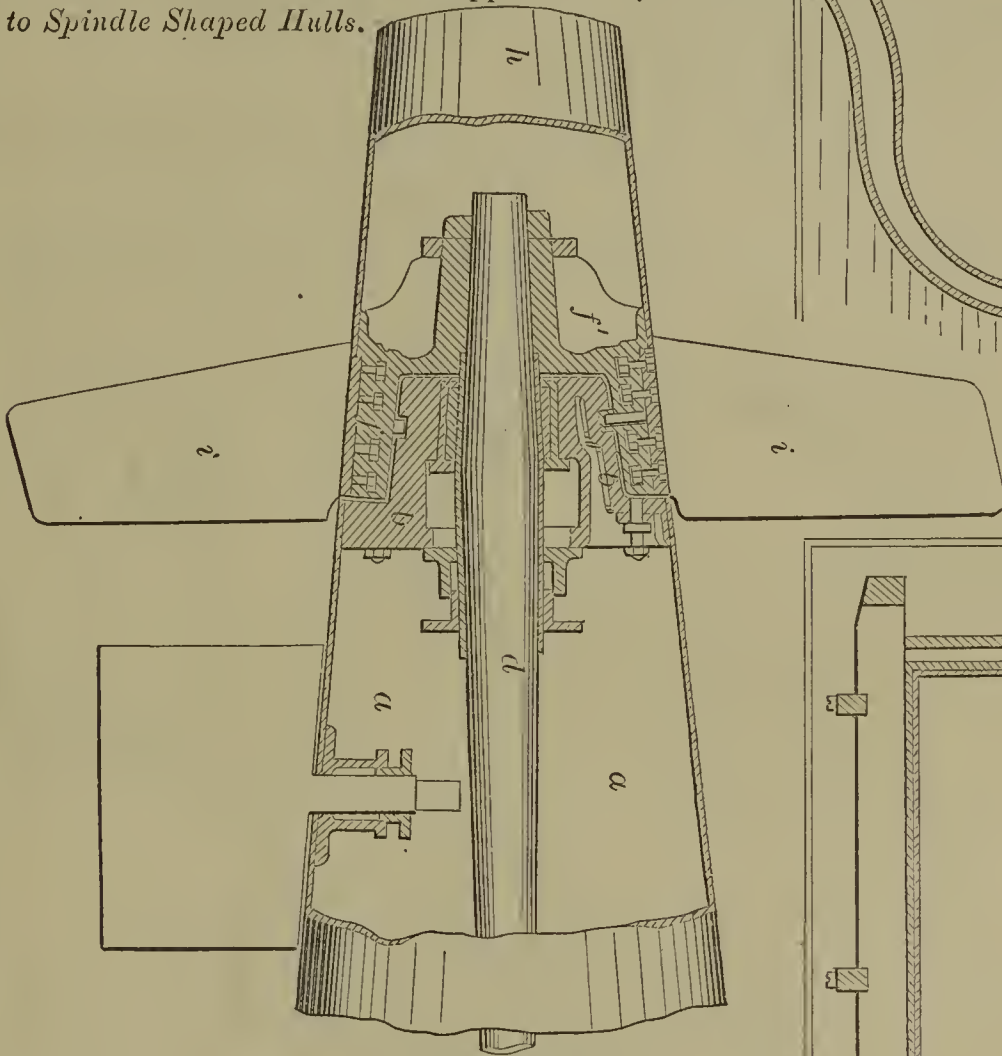

58742—J. Weems—*Ship.*

58745—P. H. Roots—*Rotary Blower.*

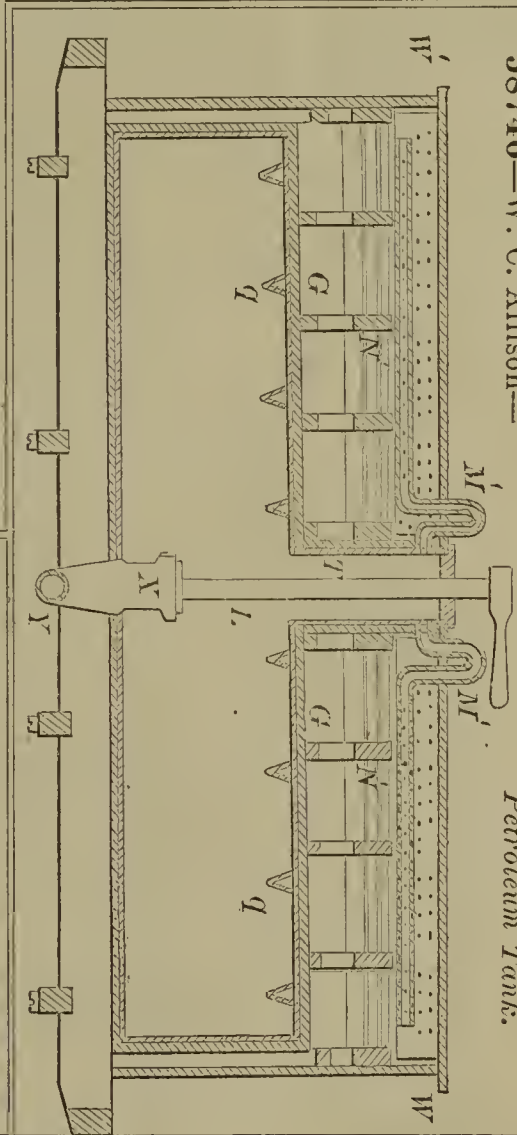
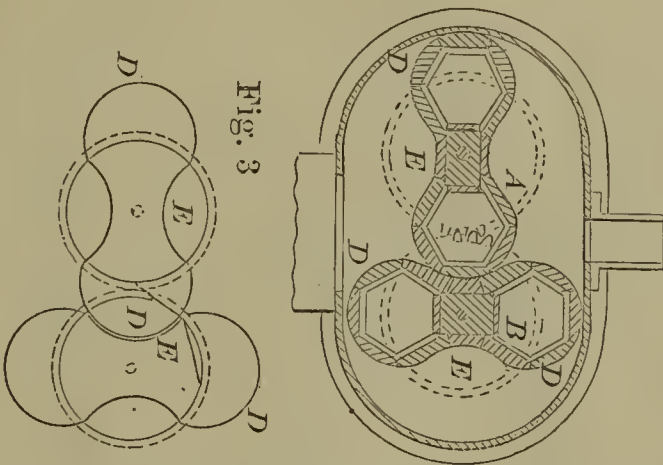

58746—W. C. Allison—

*Petroleum Tank.*

58744—W. L. & T. Winans—*Propeller.*

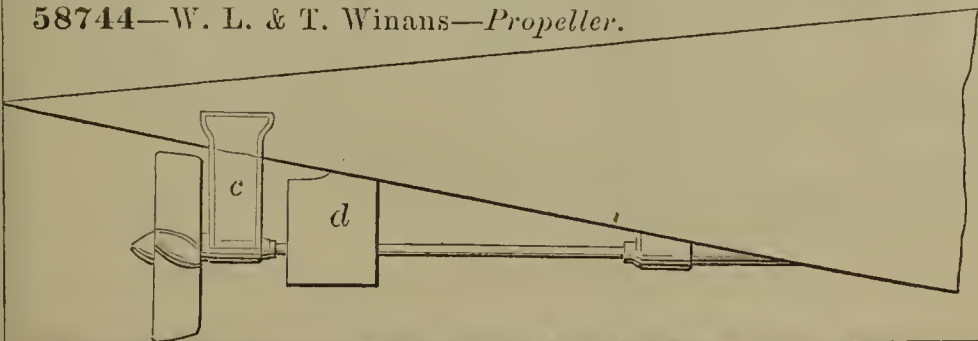

58753—A. Badlam, Sr.—Washing Machine.

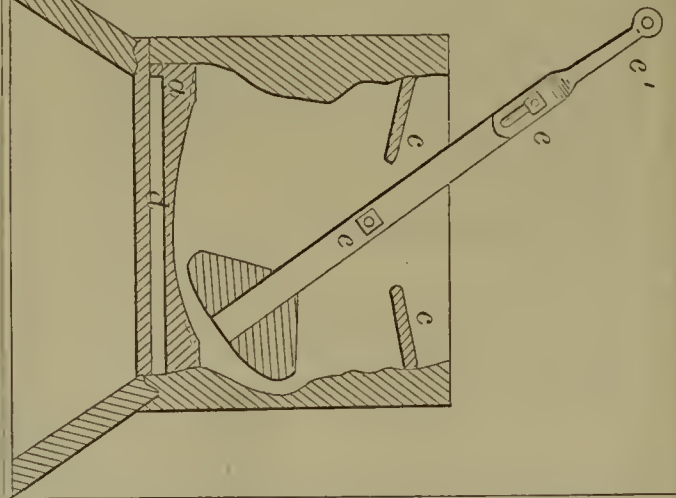

58749—T. G. Arnold—Screen for Gas Purifiers. c



58750—V. G. Arnold—Egg Beater.

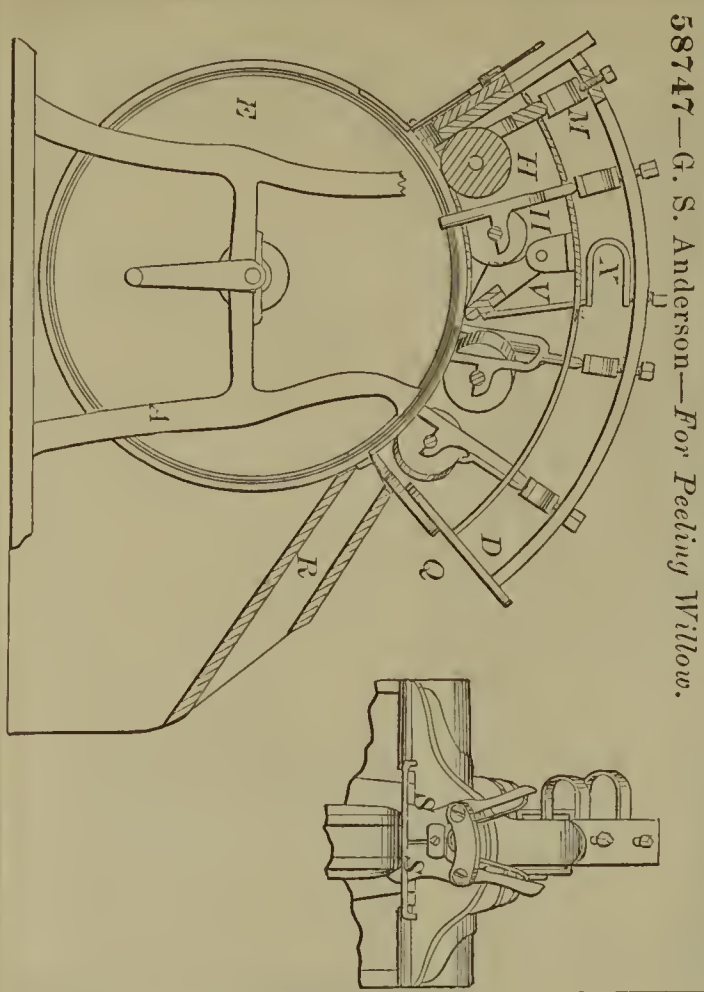
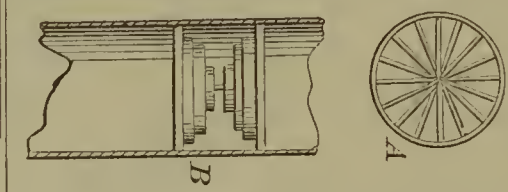

58747—G. S. Anderson—For Peeling Willow.

58748—E. A. & A. C. Apgar—Geographical Map.

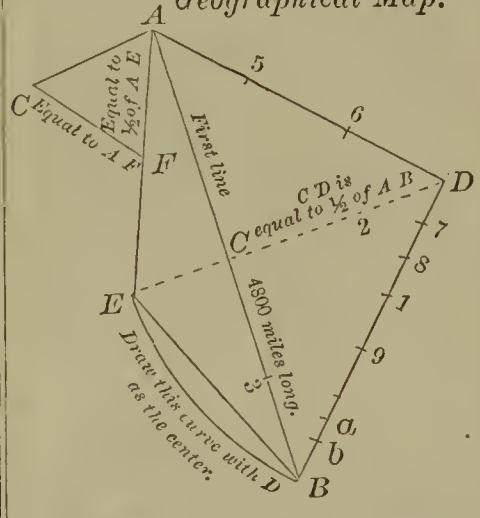

58752—N. E. Badgley—Cotton Seed Planter.

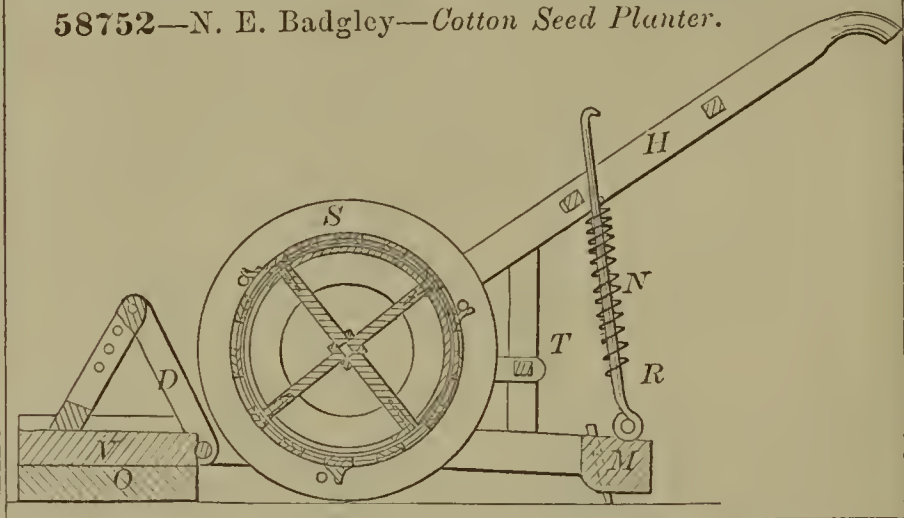

58754—H. Baker—Barrel Machinery.

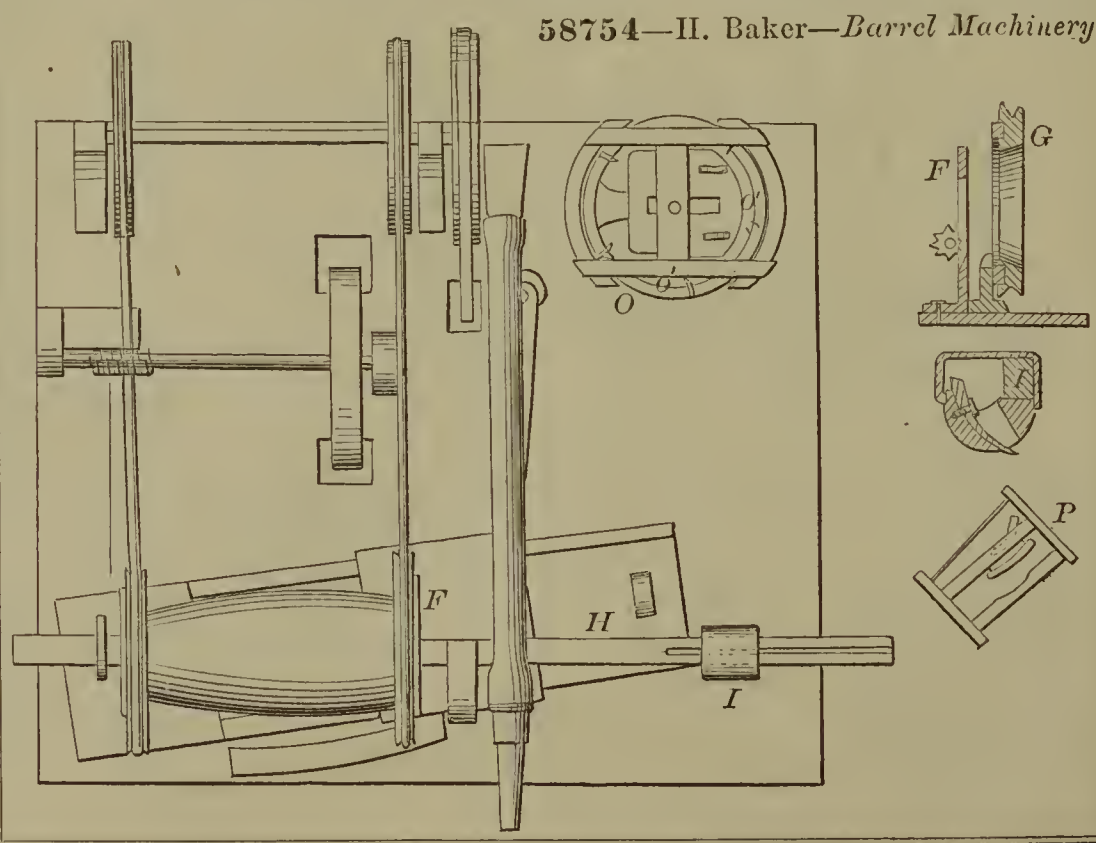

58751—F. Ashley—Carpet Stretcher and Tacks Holder.

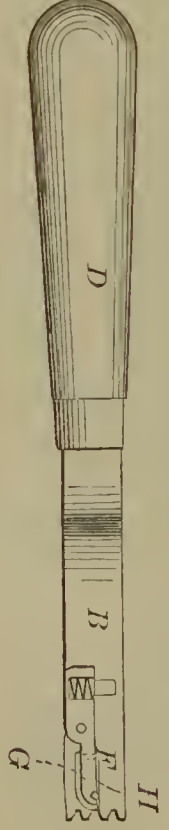

58756—H. Barker—*Washing Machine.*

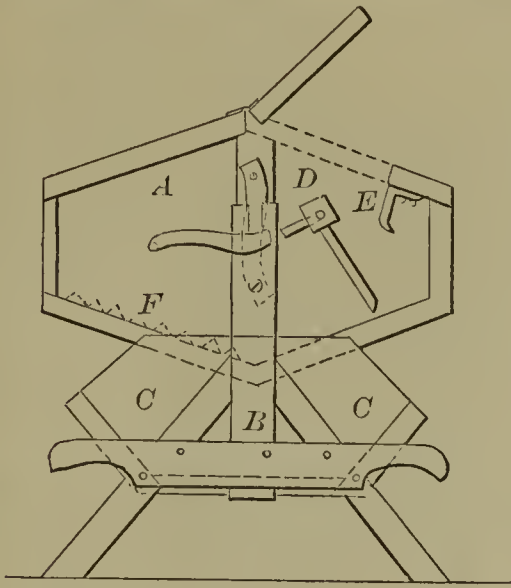

58757—E. Bascom—*Globe.*

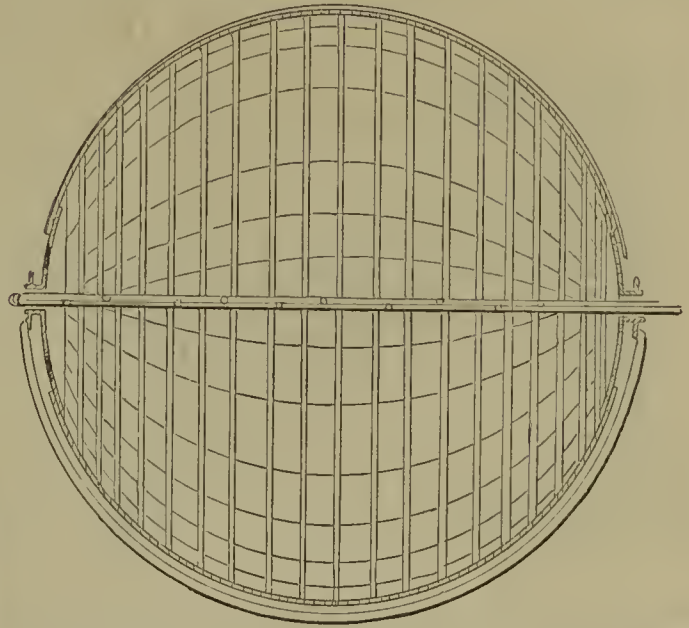

58758—A. Basse—*Wood Turning Lathe.*

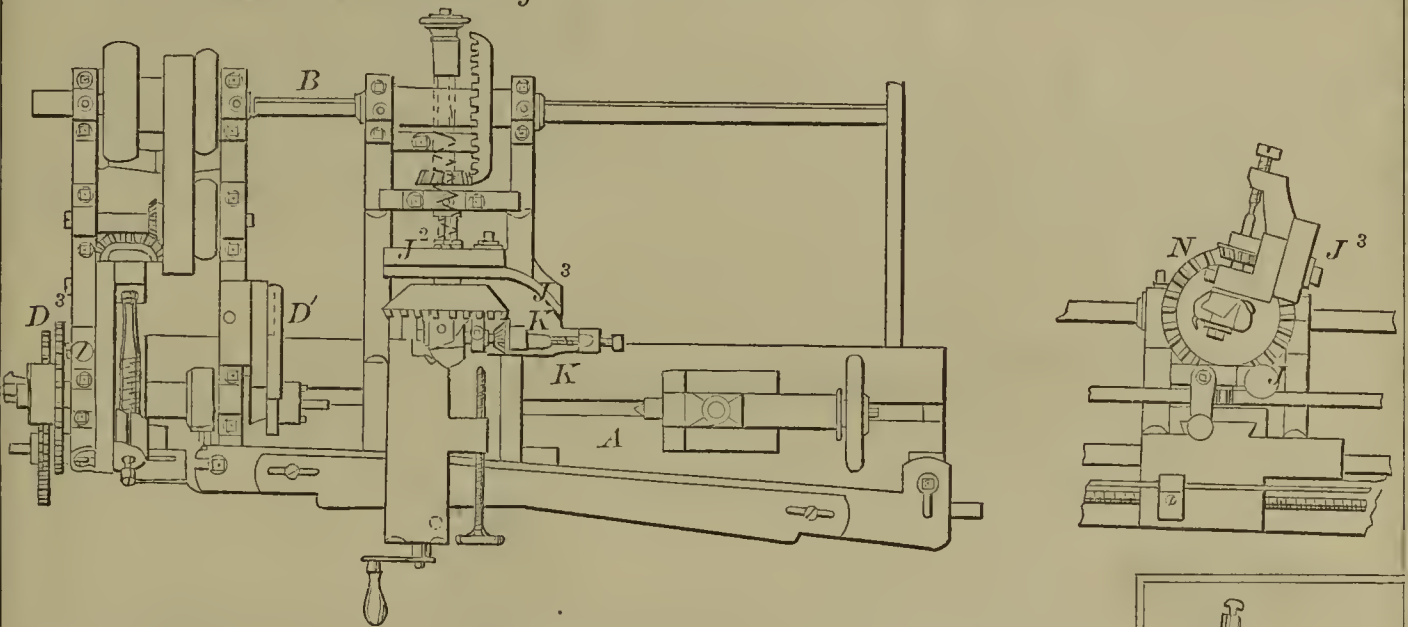

58761—J. M. Bent—*Creasing or Ornamenting Leather.*

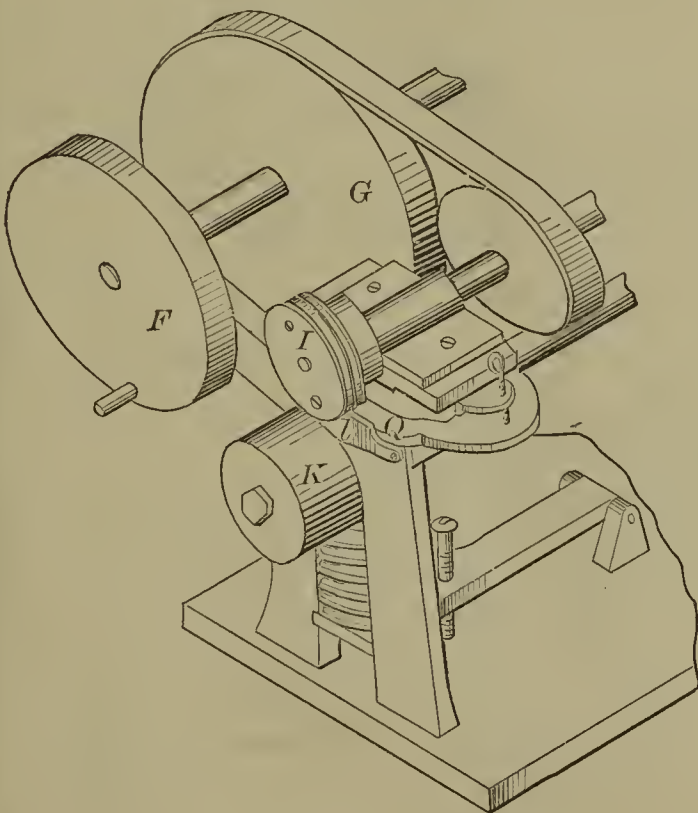

58760—G. N. Beard—*Hoop Lock.*

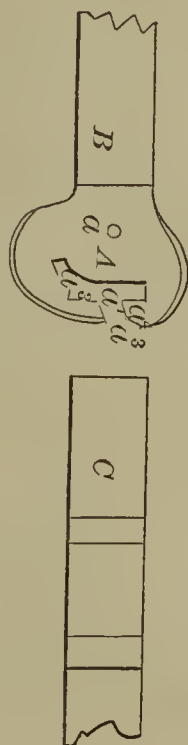

58759—A. Bell—*Whistle.*



58762—J. M. Bent—*Punching Leather.*

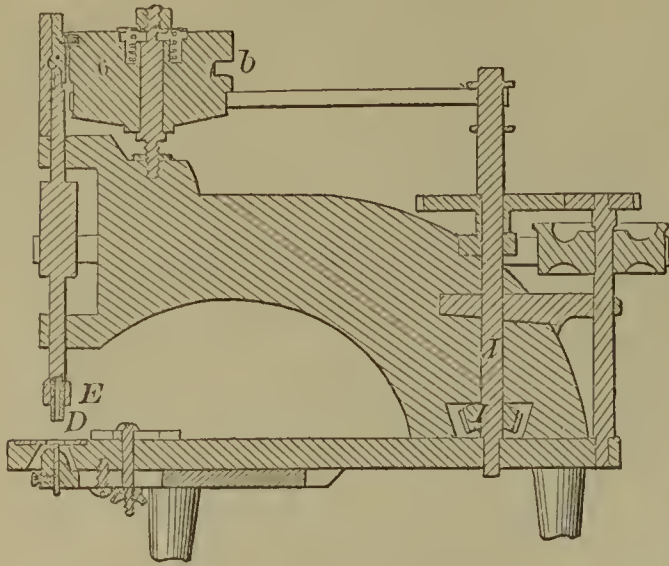

58763—J. Benz—*Piano Sound Board.*

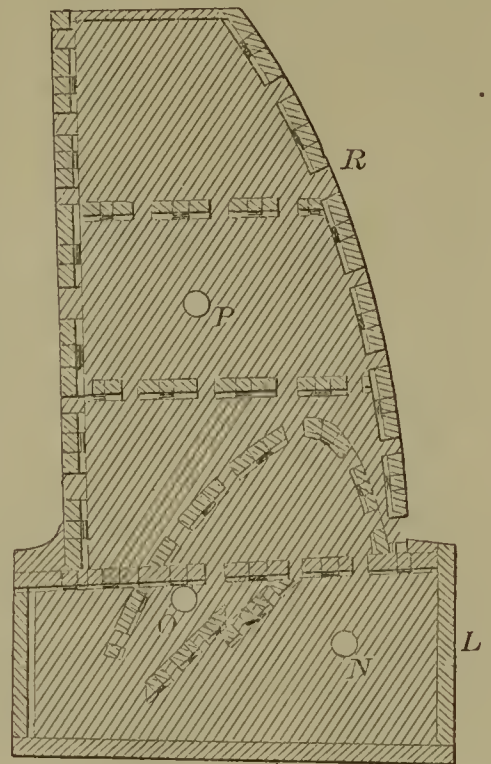

58764—Berg & Blessing—*Gas Burner.*

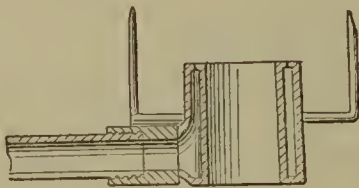

58769—J. H. Bruen—*For Sinking and Tubing Wells.*

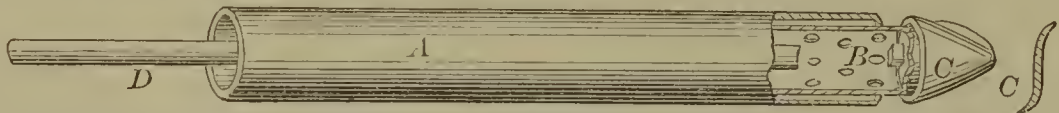

58767—J. Broughton—*Steam Engine Lubricator.*

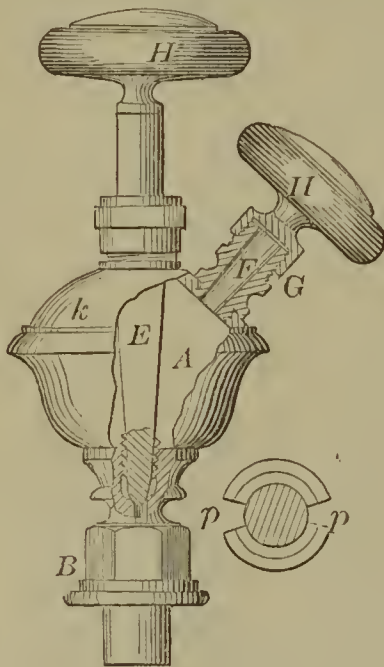

58765—G. W. Bishop—*Friction Clutch Pulley.*

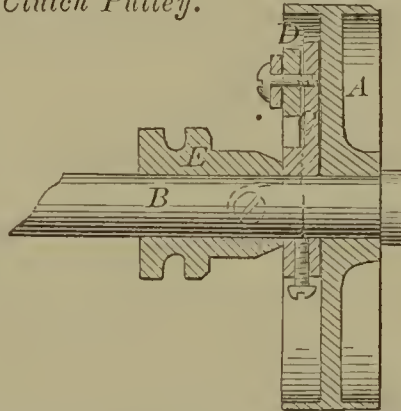

58768—T. W. Brown—*Grindstone Journal Box.*

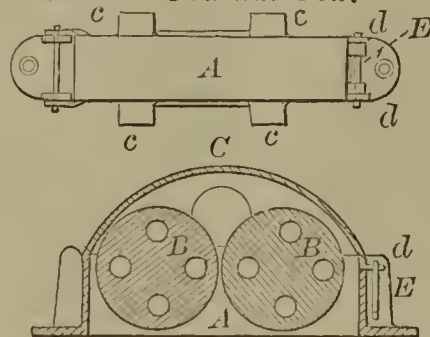

58770—C. H. Butterfield—*Egg Beater.*

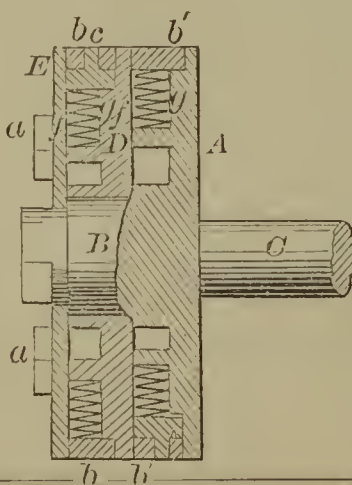
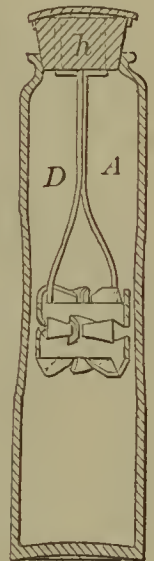

58766—J. Broughton—*Piston Packing.*

58771—F. H. Carney—*Car Seat Indicator.*

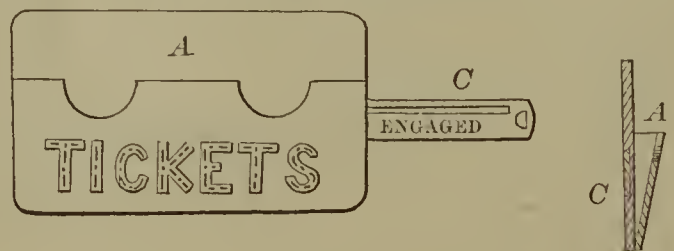

58772—N. Chapman—Coffee Mill.

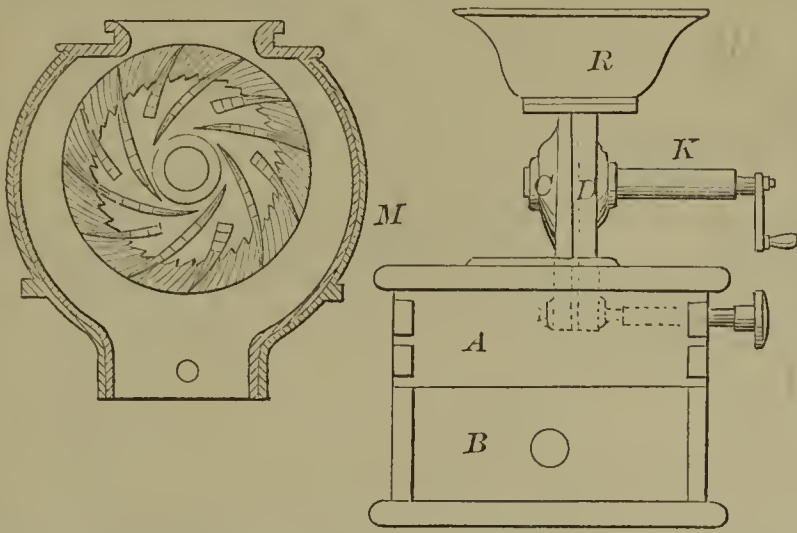

58774—W. Chesley—Globe Valve.

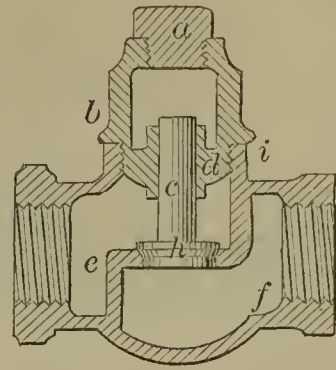

58777—C. P. Colby—Quartz Mill.

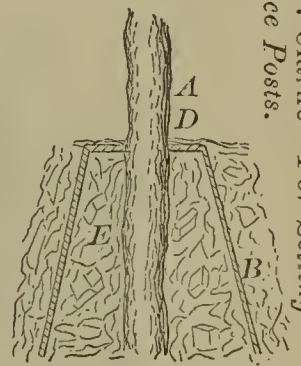
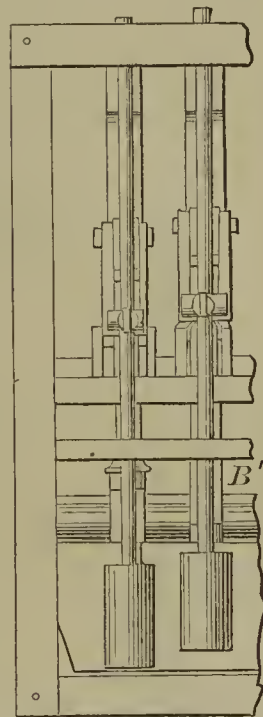
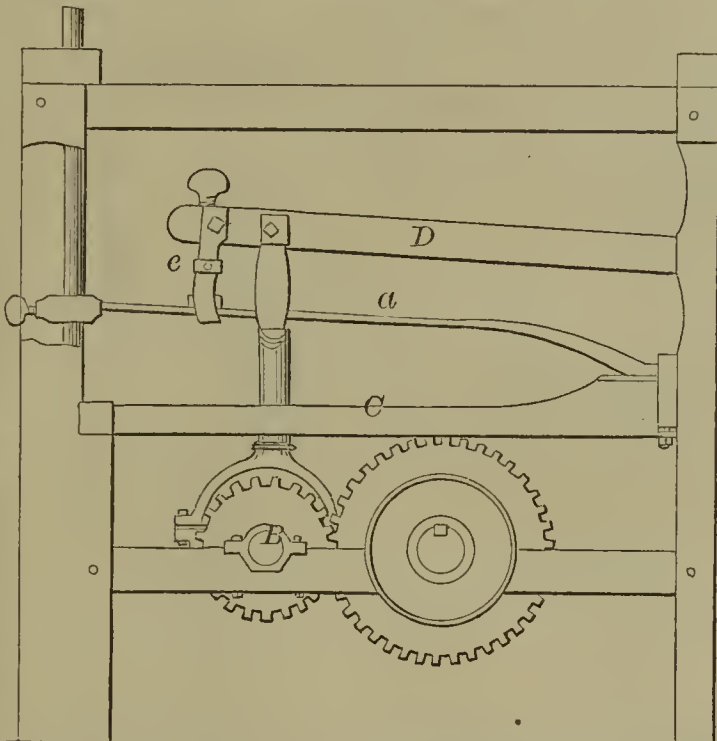

58776—H. W. Clarke—For Setting Fence Posts.

58775—W. Churchill—Steam Engine Governor Valve.

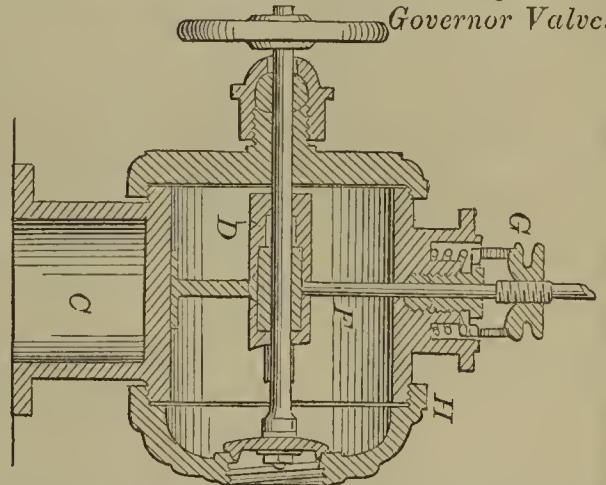

58773—J. E. Cheasebro—Sulky Plow and Harrow.

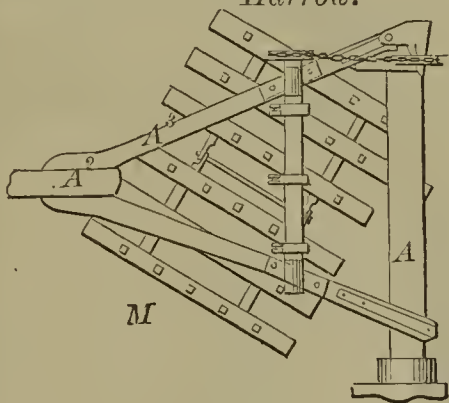

58778—R. Conarroe—Straw Cutter.

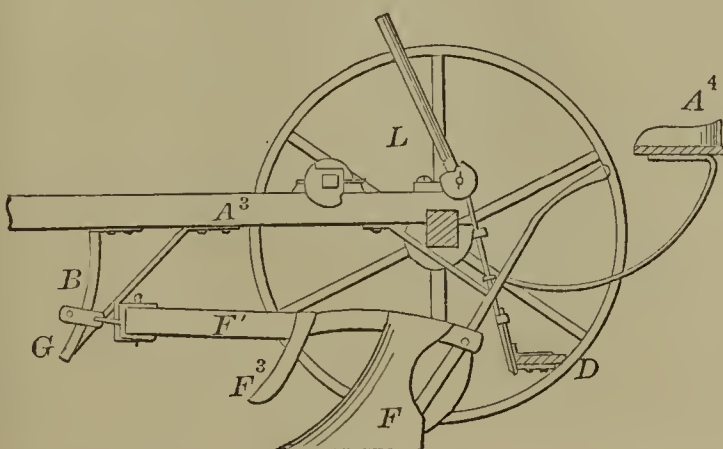
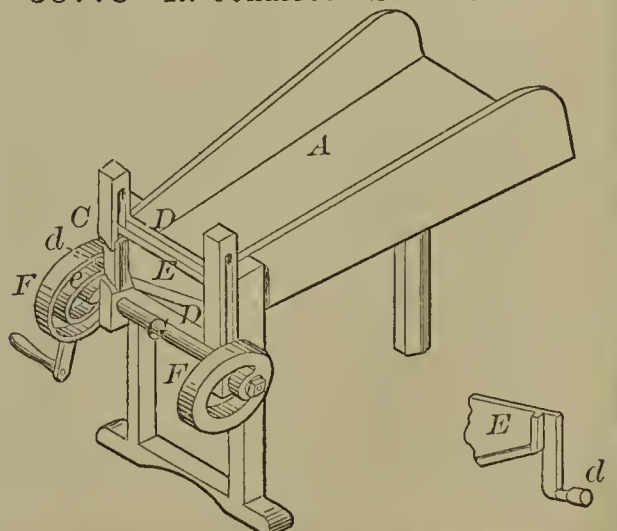

58779—S. Cooley—Wool Press.

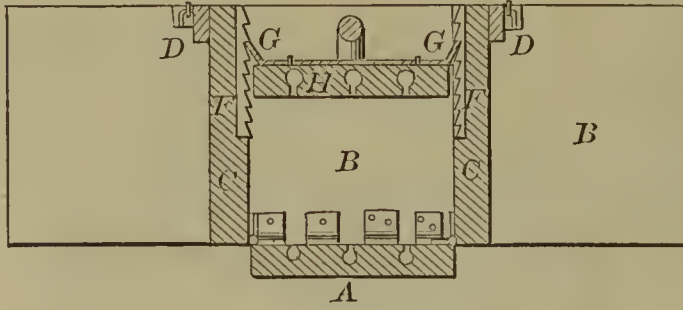

58782—E. N. Cummings—Heating Stove.

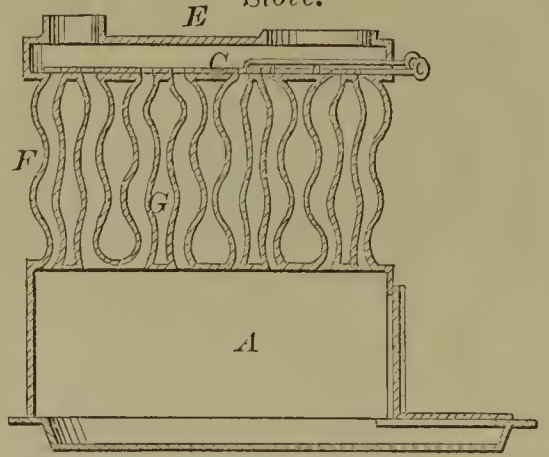

58780—J. Cram—Shaft for Rubber Rollers.

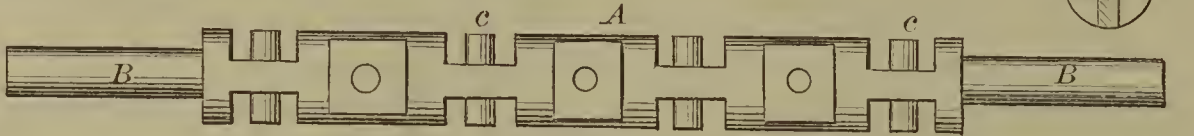

58783—J. M. Currie—Projectile for Ordnance.

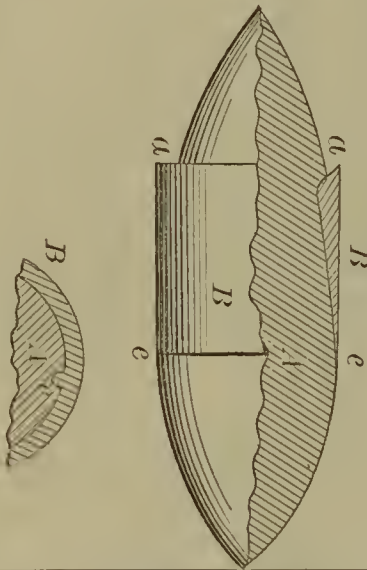

58781—C. Croley—Ladder.

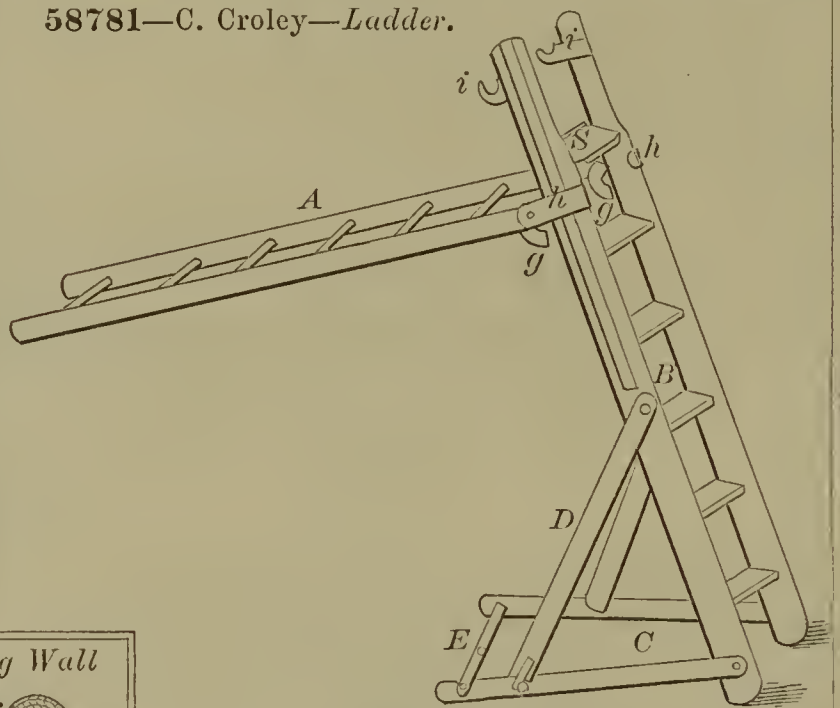

58784—J. W. Davis—For Hanging Wall Paper.

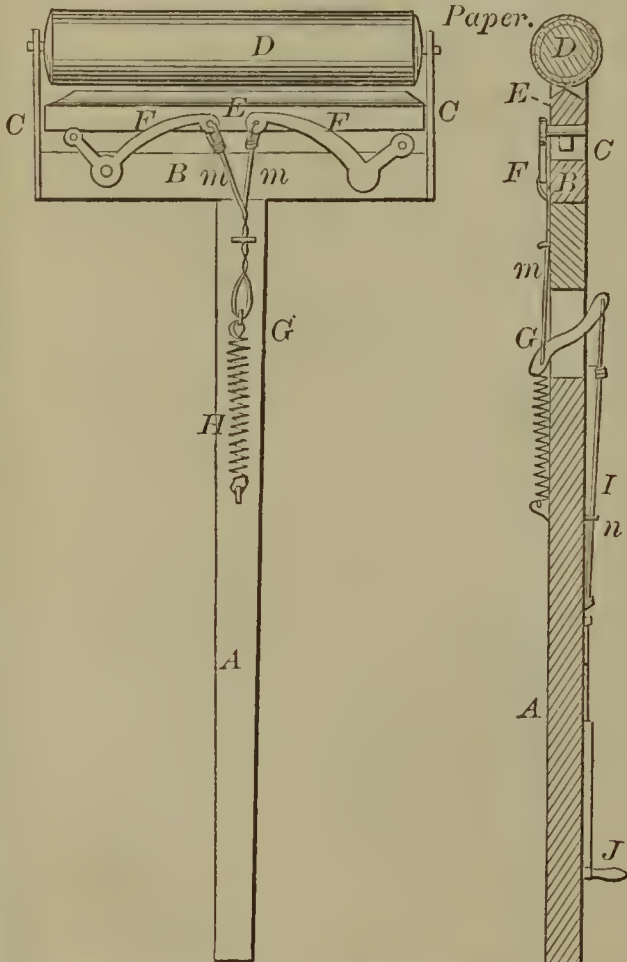

58785—D. A. Dickinson—For Harvesting, Husking and Shelling Corn.

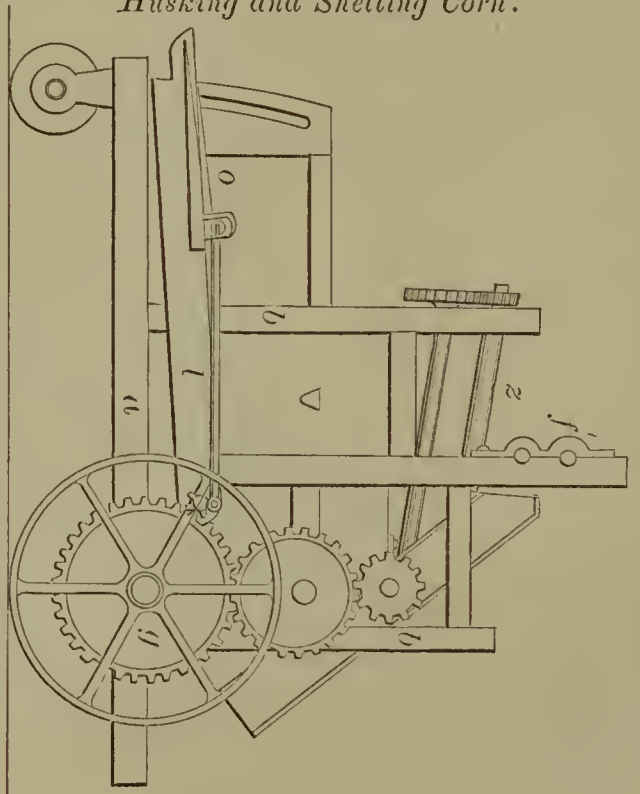

58786—W. Dickinson—Car Wheel.

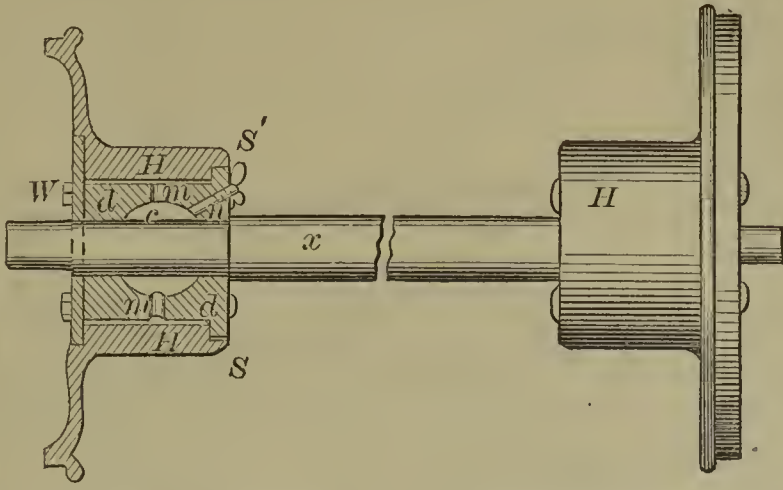

58787—Doane & Burr—Barrel Skid.

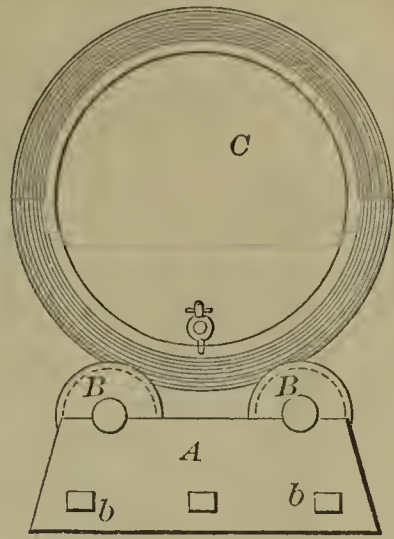

58788—Dodge & Walker—Gang and Subsoil Plow.

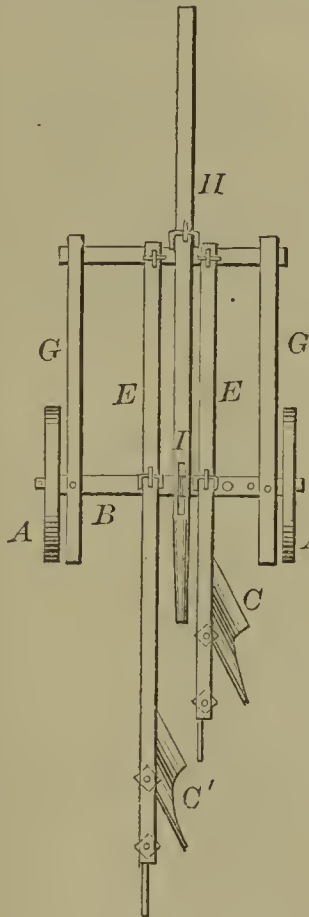

58791—Dupraz, Dumont & Dickason—Steering Apparatus.

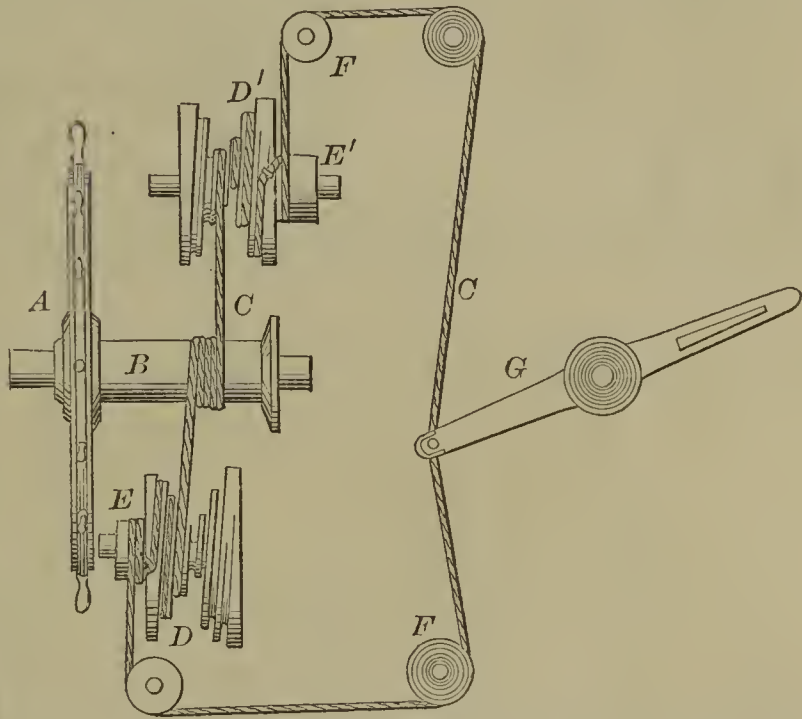

58790—W. C. Dodge—Magazine Fire Arm.

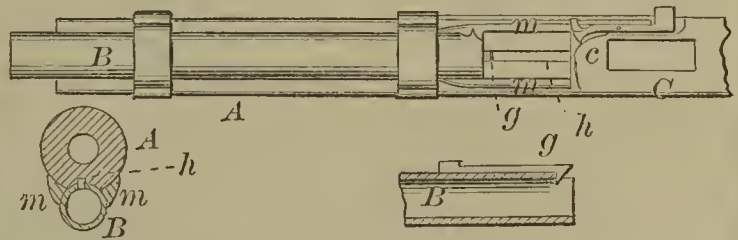

58793—J. Eckert—Water Cooler.

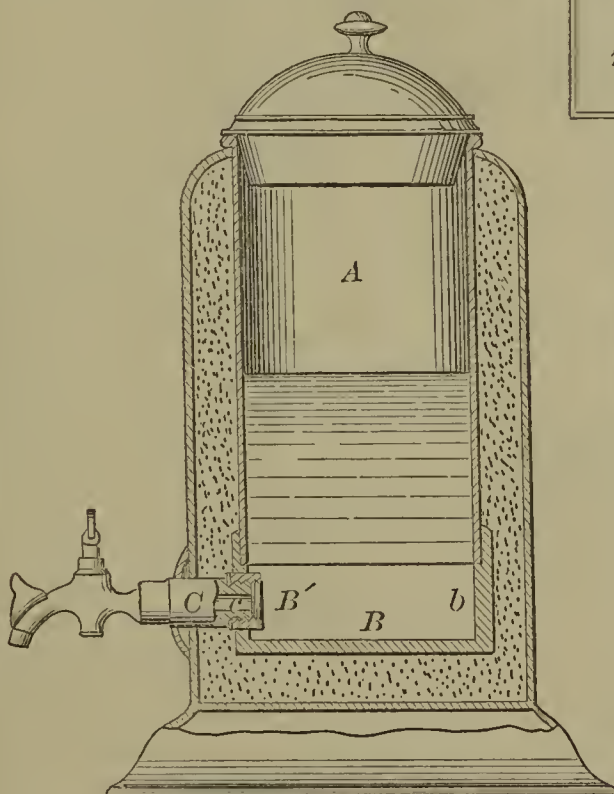

58792—Z. S. Durfee—Hat Box and Valise.

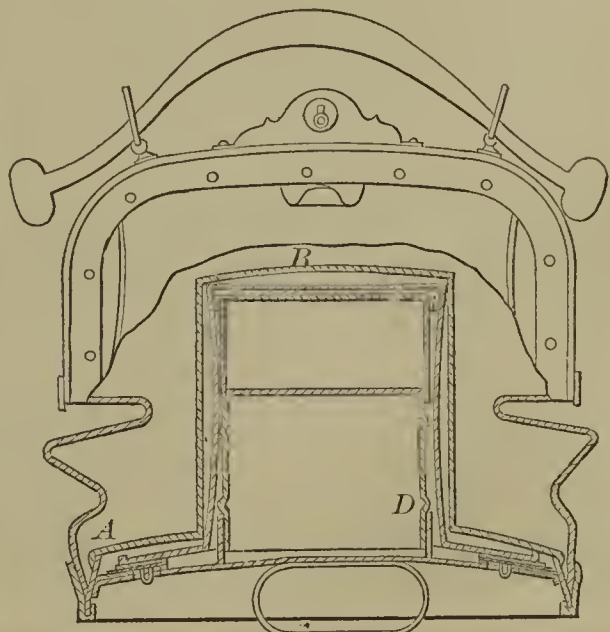

58795—S. F. Estell—Animal Trap.

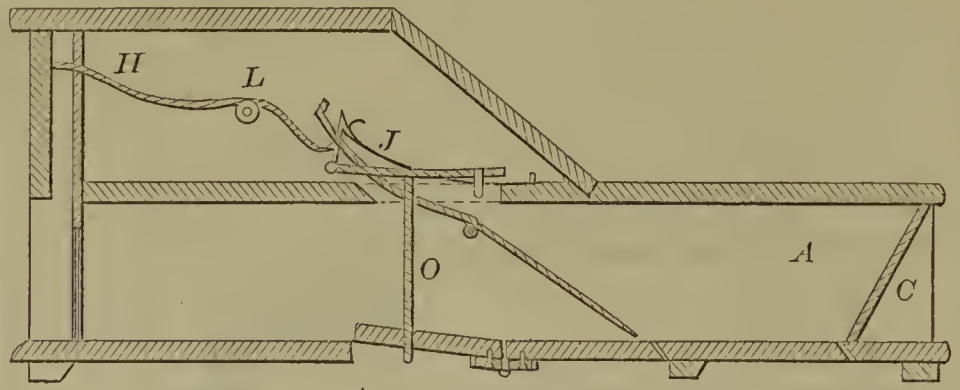

58796—R. P. Estep—Steam Engine Valve.

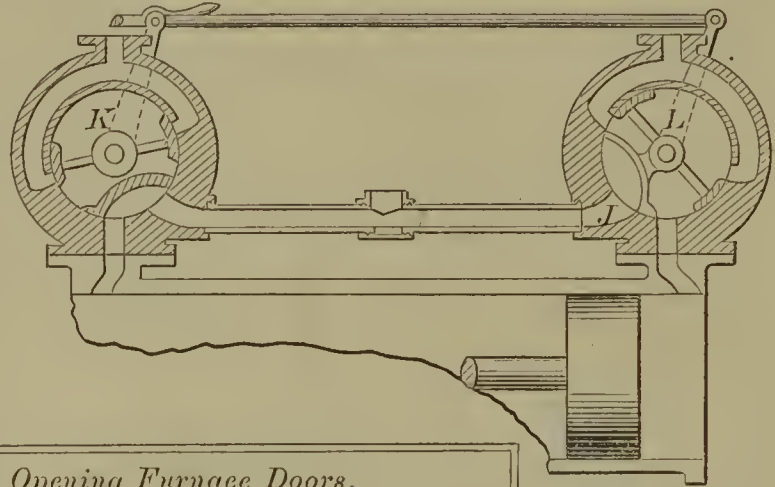

58794—W. C. S. Ellerbe—For Transplanting Plants.

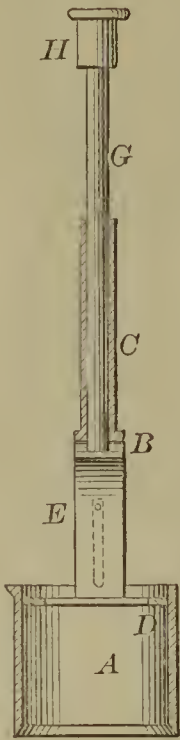

58799—Fessler & Maxell—For Opening Furnace Doors.

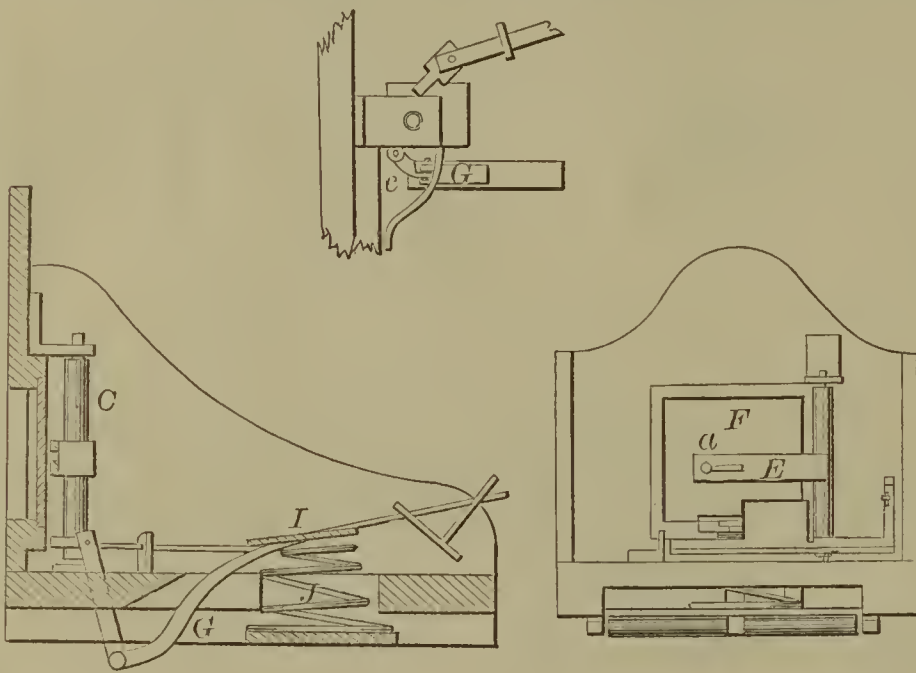

58797—H. C. Fairchild—Wagon Brake.

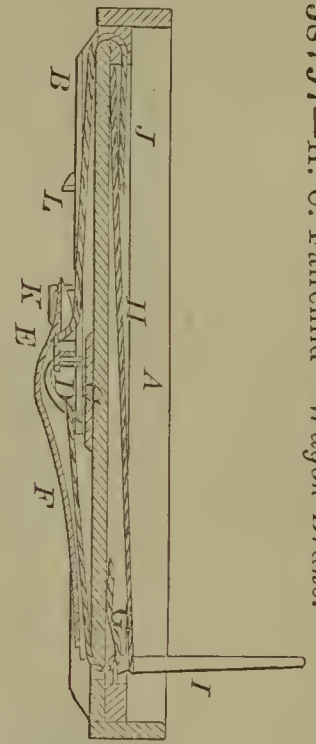

58800—G. A. Fitch—For Priming Cartridges.

Fig. 2

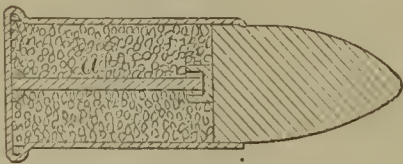

Fig. 3



Fig. 1

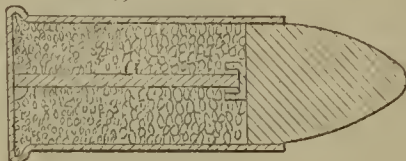
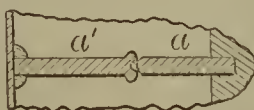
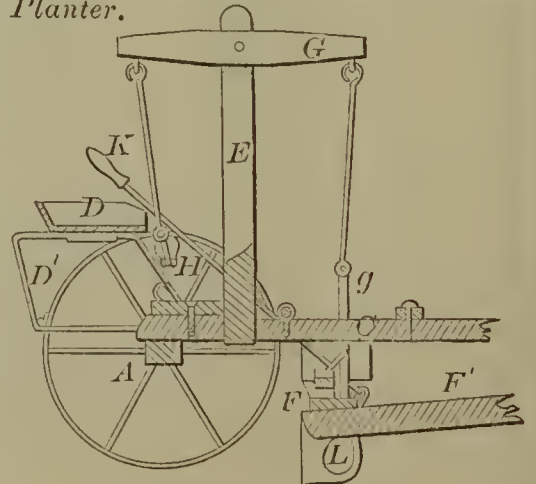

Fig. 4



58798—J. M. Fate—Corn and Cane Planter.





58801—A. F. Fletcher—Pump.

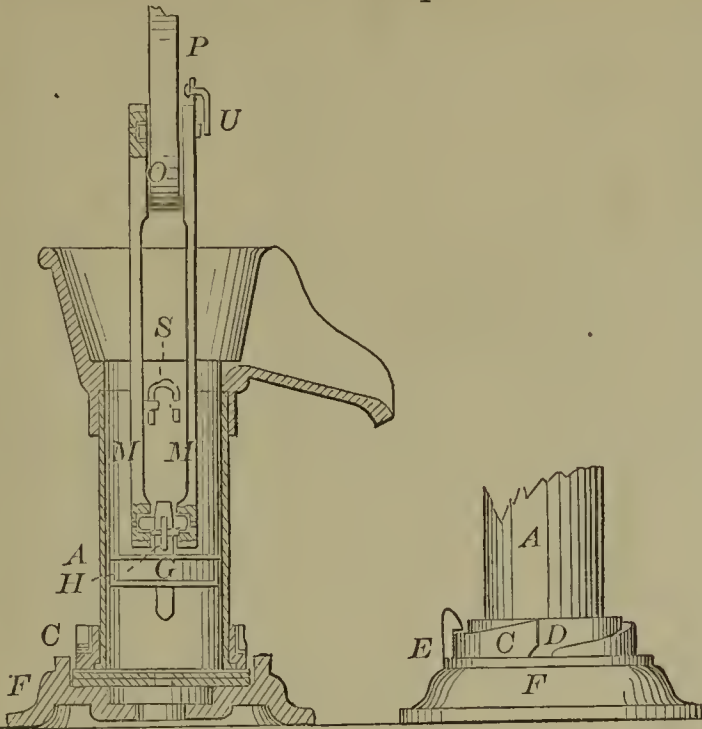

58802—M. Foreman—Steam Generator.

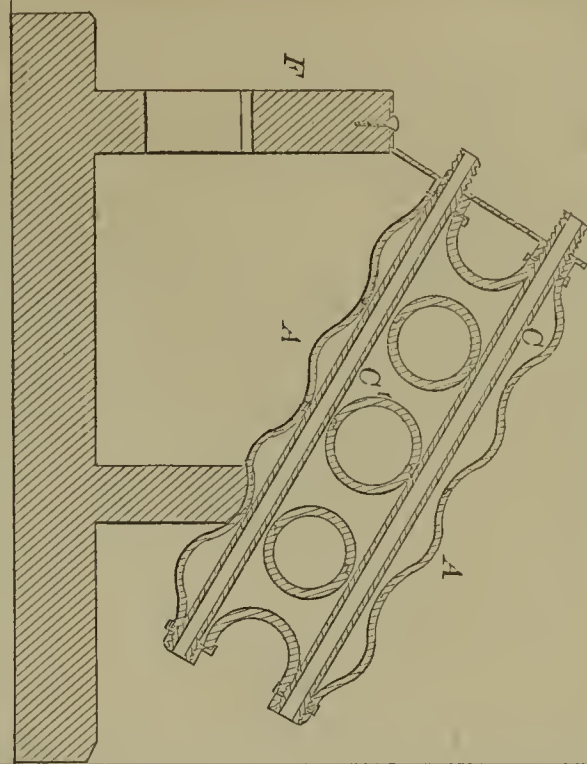

58803—C. Forster—Oil Well Drill.

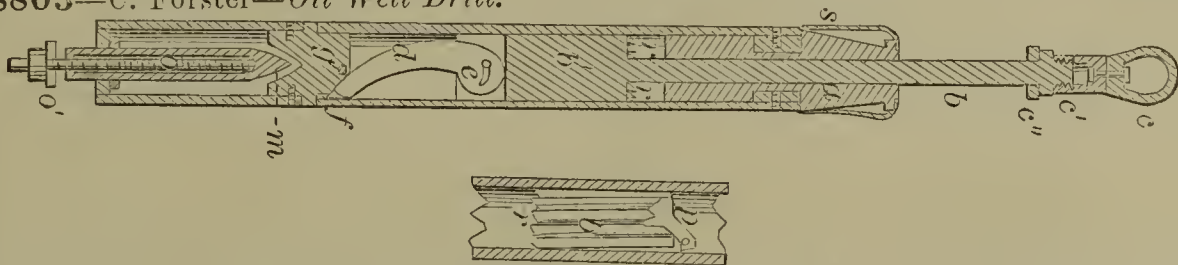

58804—J. W. Foust—Hay Raker and Loader.

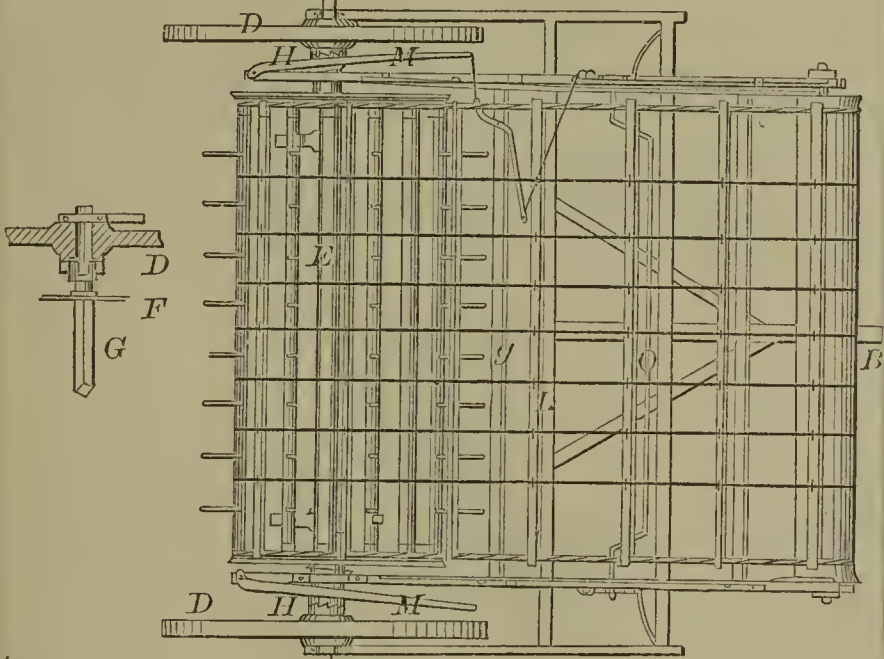

58806—W. B. Frue—Shaking Table.

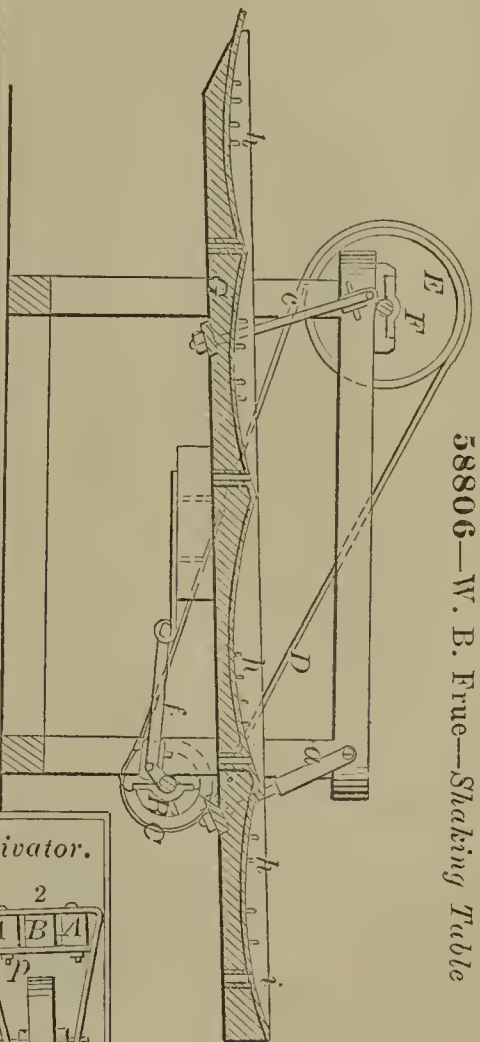

58807—C. Geisse—Gas Heater Boiler.

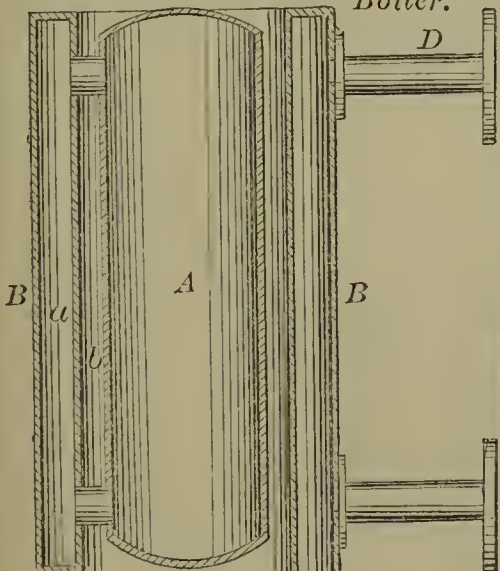

58805—J. Fridy—Cultivator.

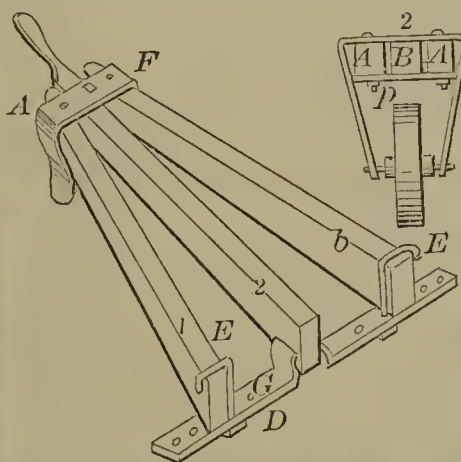

58808—J. E. Gillespie—*Steam Trap.*

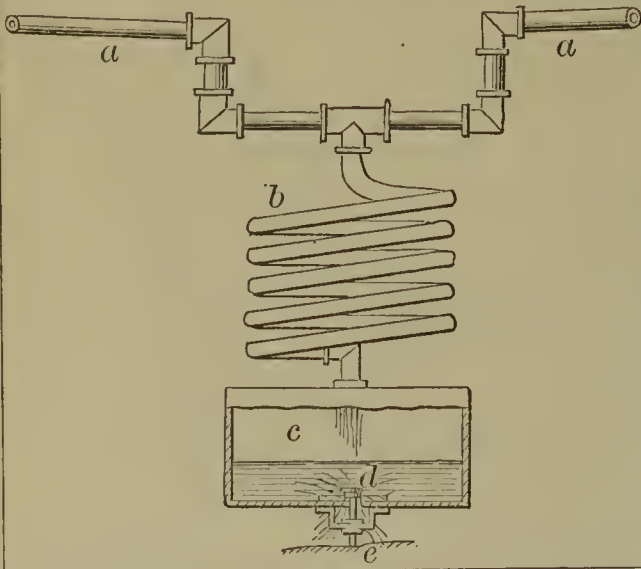

58811—G. D. Greenleaf—*Stove and Drum.*

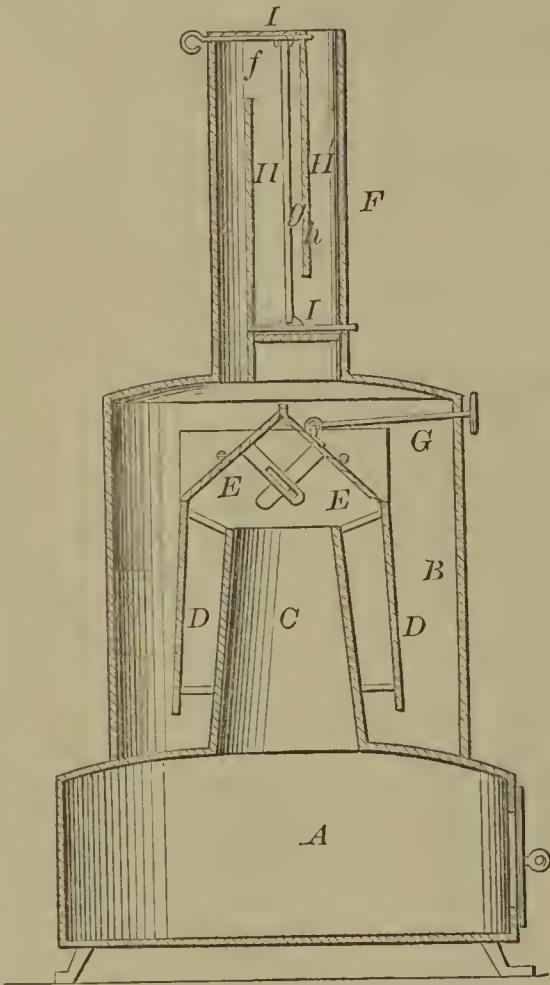

58813—Hall & Ellis—*Distilling Apparatus.*

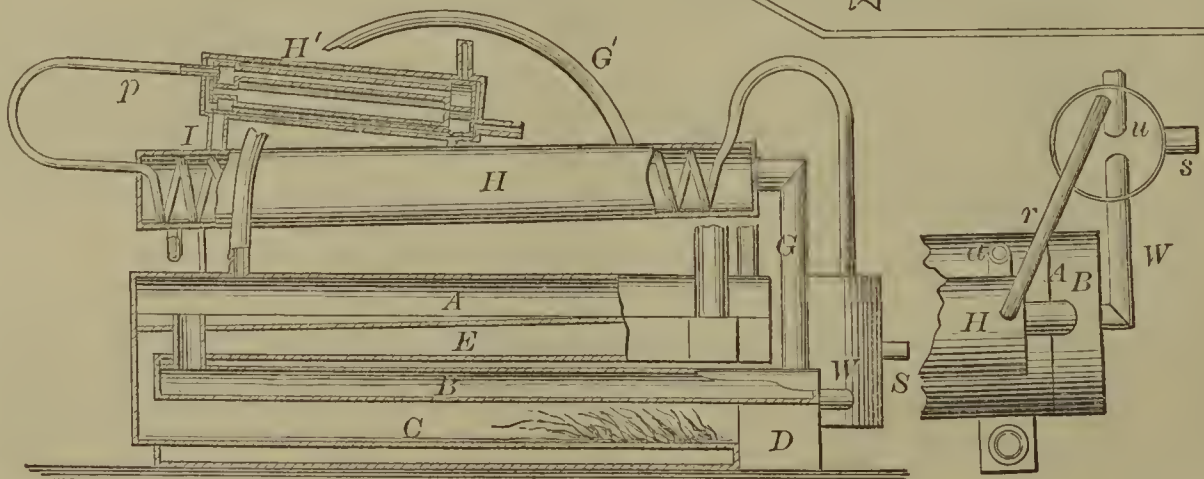

58809—J. & A. W. Gillmore—*For Sinking Well Tubes.*

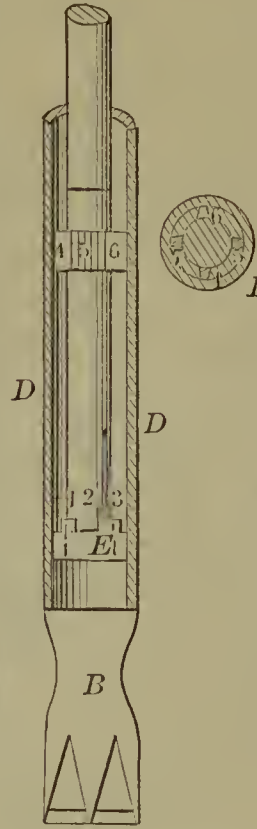

58810—H. Goulding—*For Lowering Boats.*

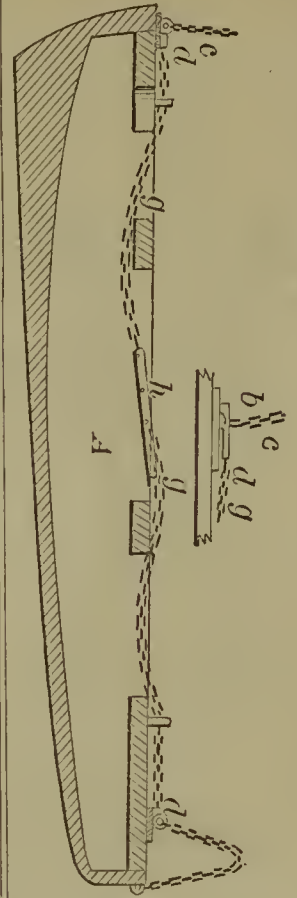

58812—Grissold & Sigwalt—*For Making Paper Collars.*

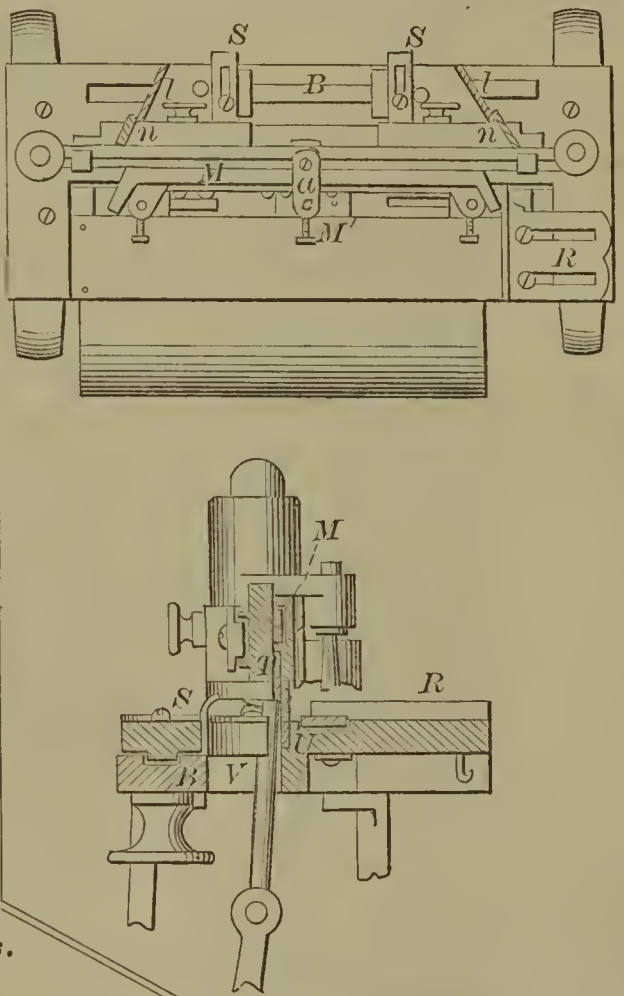

58814—J. A. Hall—Garden Cultivator.

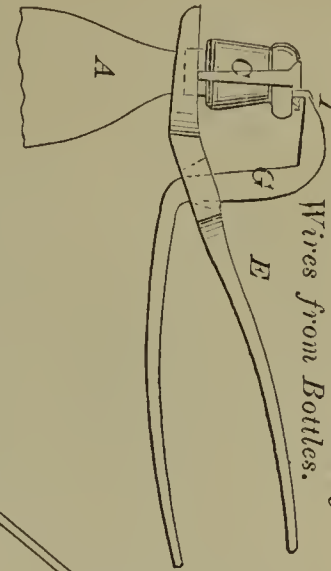
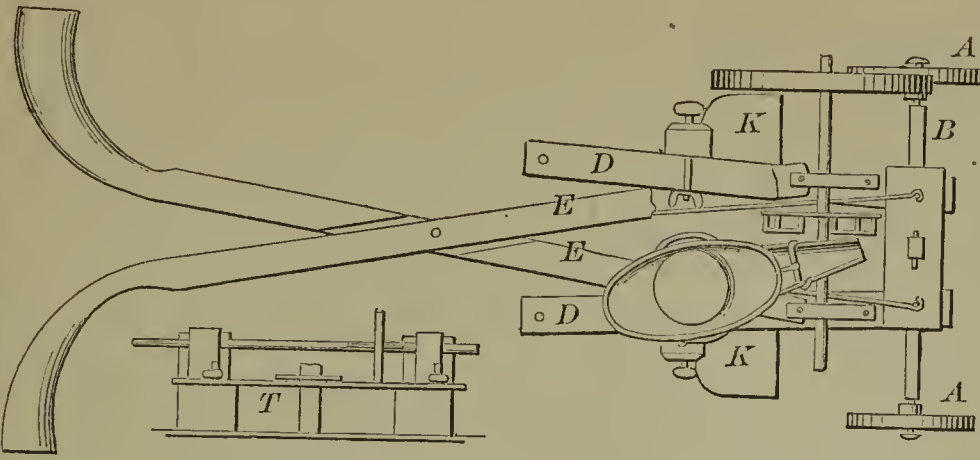

58820—J. S. Hazard—For Removing Wires from Bottles.

58818—A. Hartman—Railroad Switch.

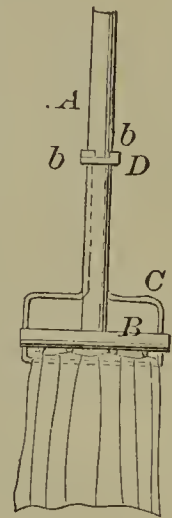
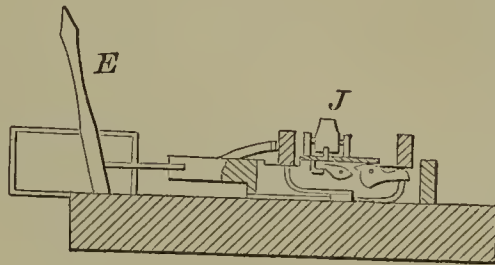
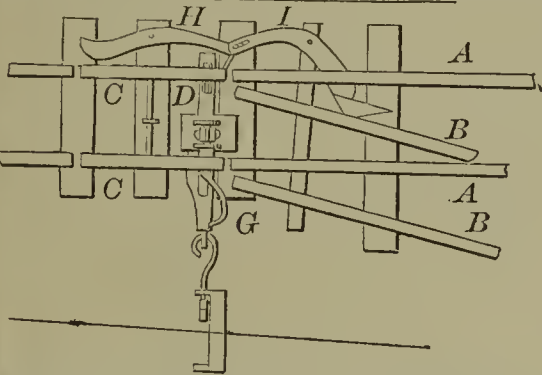

58817—Hardison & Hooper—Mop Head

58815—J. R. Halsey—Ice Boat.

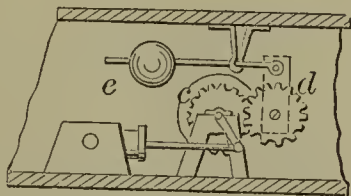
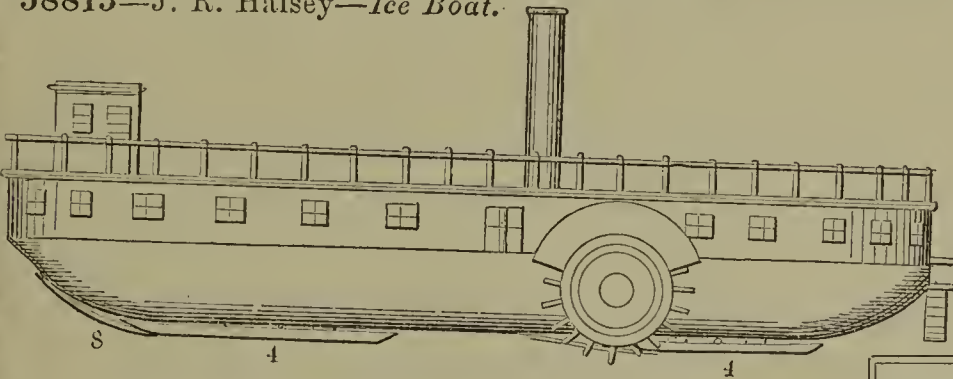

58821—M. Hickey—Cask and Barrel.

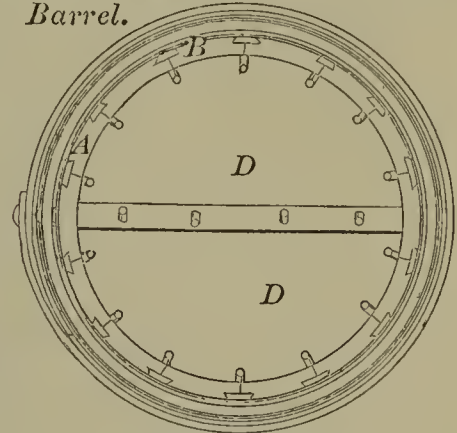

58819—N. Hawkes—Cultivator and Ditcher.

Fig. 1

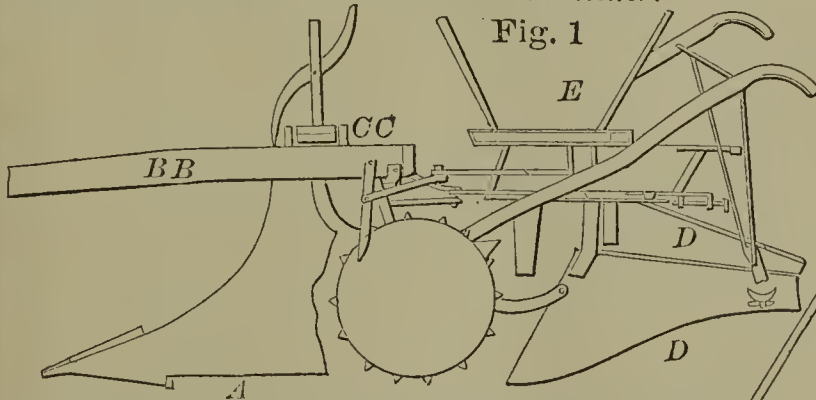

58822—S. P. Hildreth—Dentists' Lamp Stove.

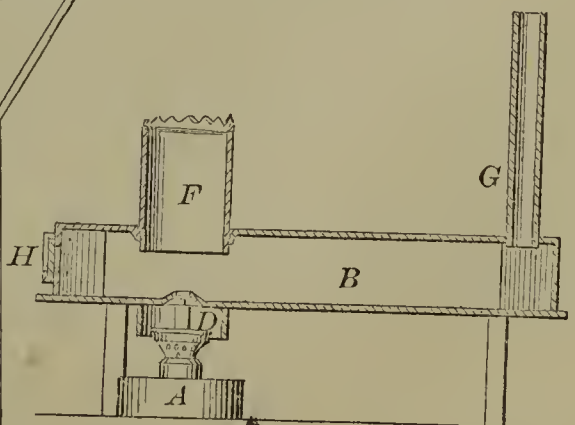

58816—D. J. Happersett—Car Truck.

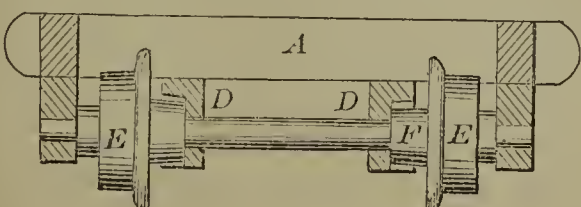

58823—A. Hoepfner—For Making Vinegar.

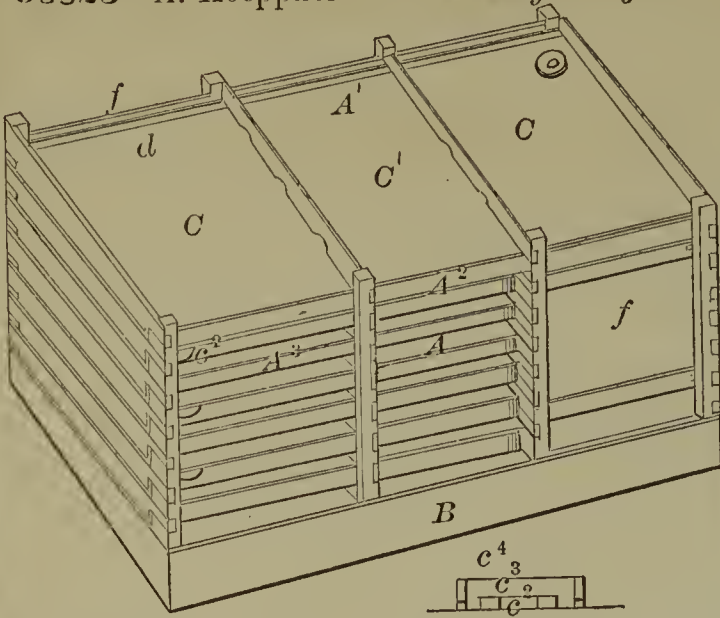

58828—N. Homes—Saw Handle.

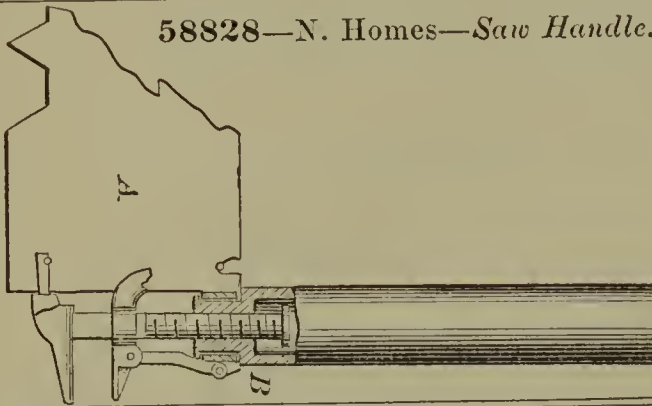

58825—A. B. Hoffman—Dust Pan.

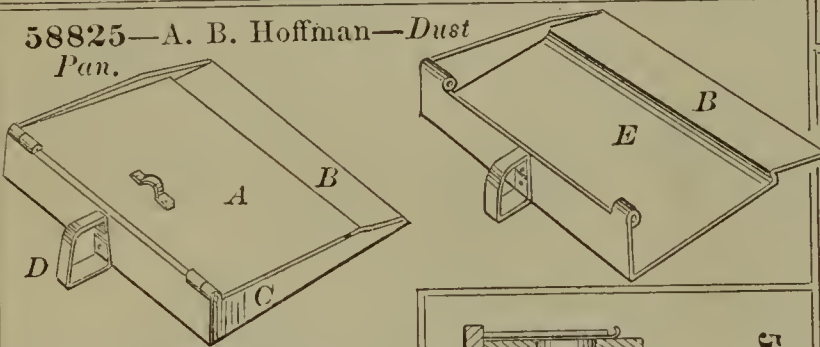

58831—H. Hungerford—Carpet Stretcher.

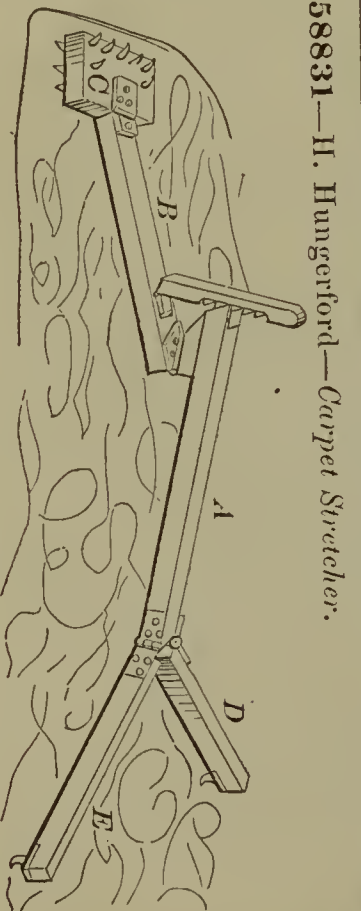

58826—J. W. Hollingsworth—Animal Trap.

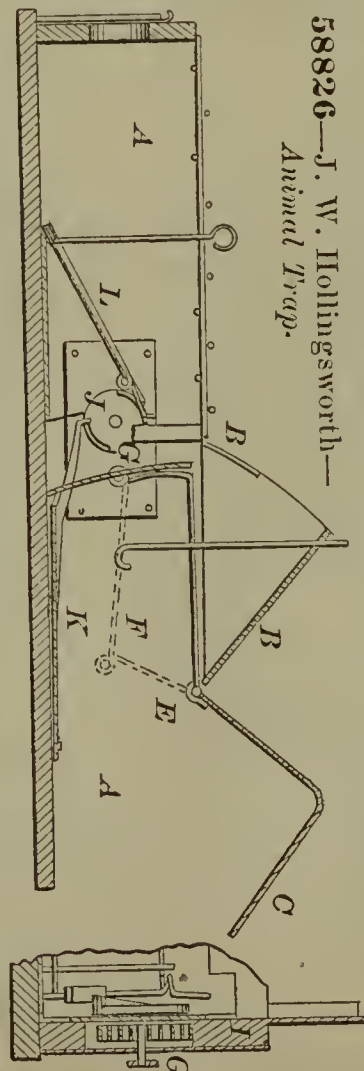

58827—G. W. Holly—For Hanging Doors.

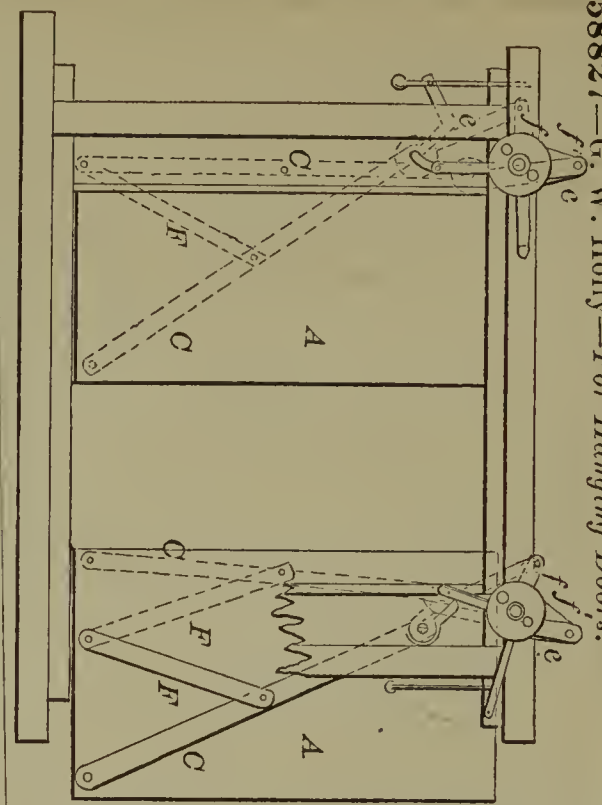

58829—Howard & Manchester—Sponge Cup.



58830—L. Hull—Braiding Machine.

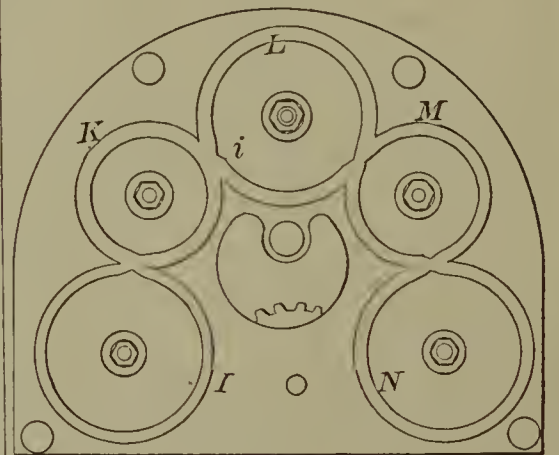

58832—C. S. Huntington—Horse Rake.

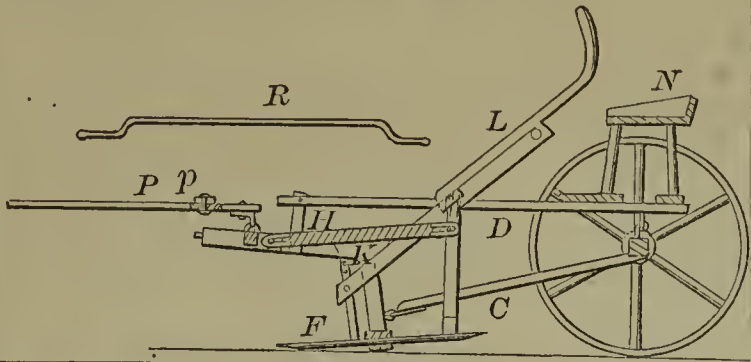

58833—R. N. Isaacs—Fishing Rod.

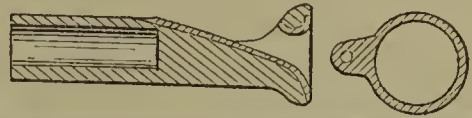

58835—Jincks & Altmeyer—Hearse.

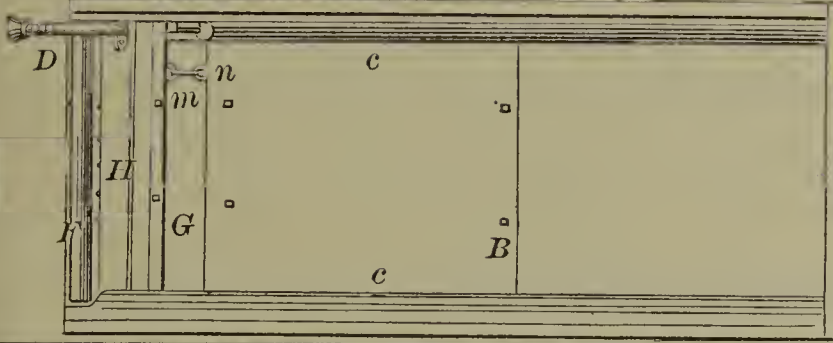

58837—H. Kewley—Stopwater for Oil Well Tubing.

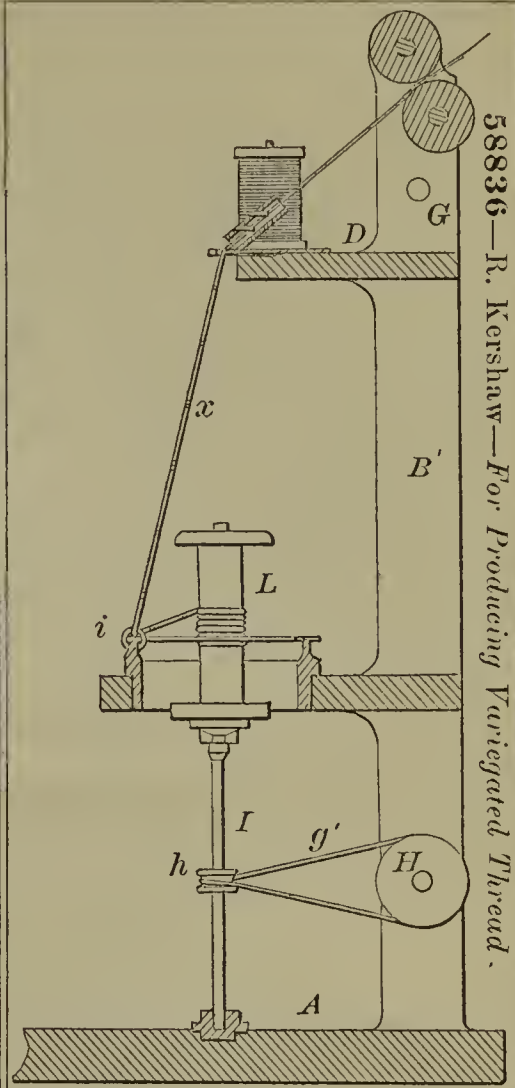
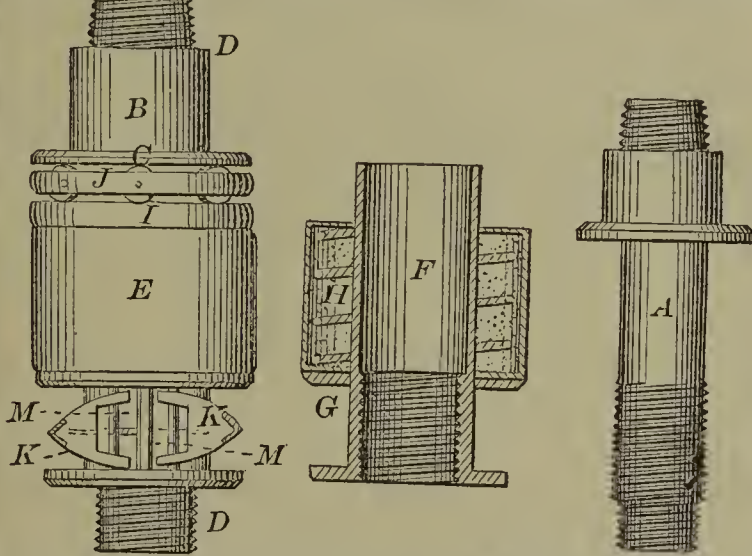

58836—R. Kershaw—For Producing Variegated Thread.

58834—G. Jensen—Ditching Machine.

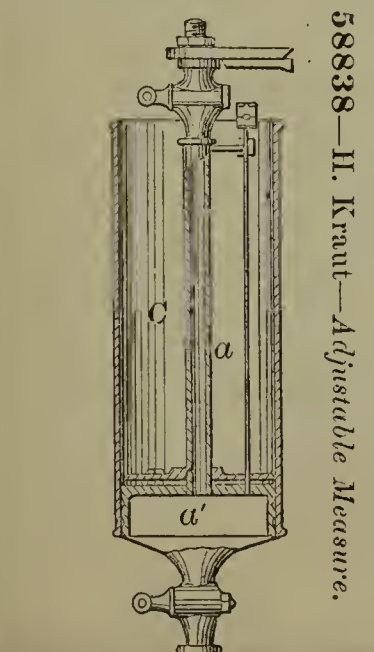
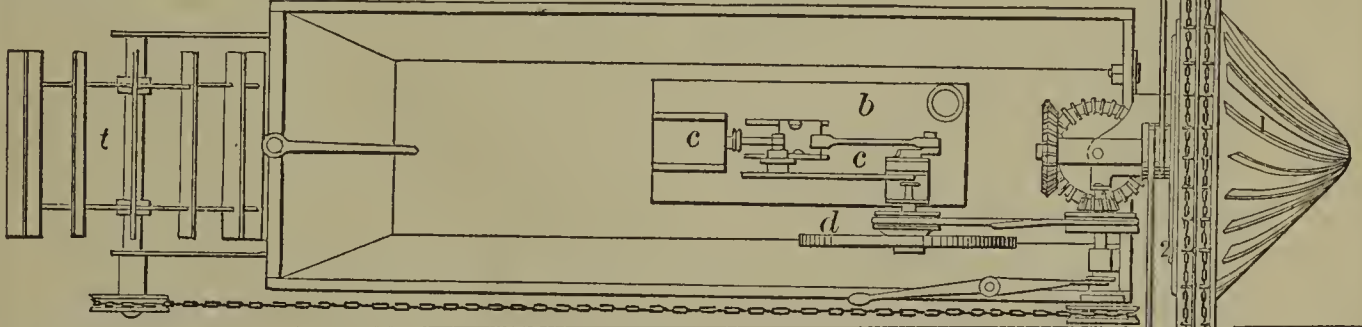

58838—H. Krant—Adjustable Measure.

58839—S. R. Krom—For Separating Metals from Ores.

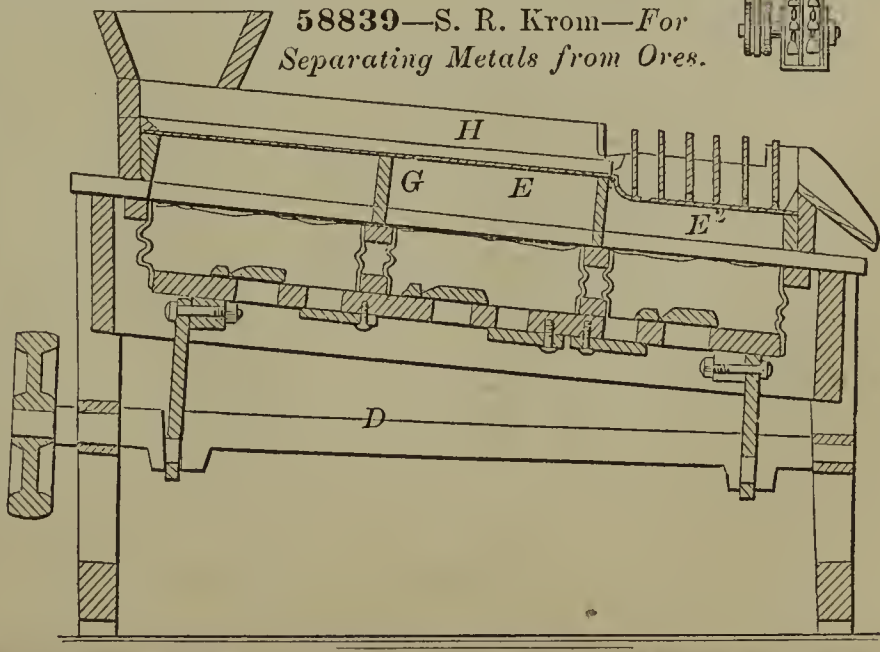

58841—R. G. Lamson—*Hay Rake.*

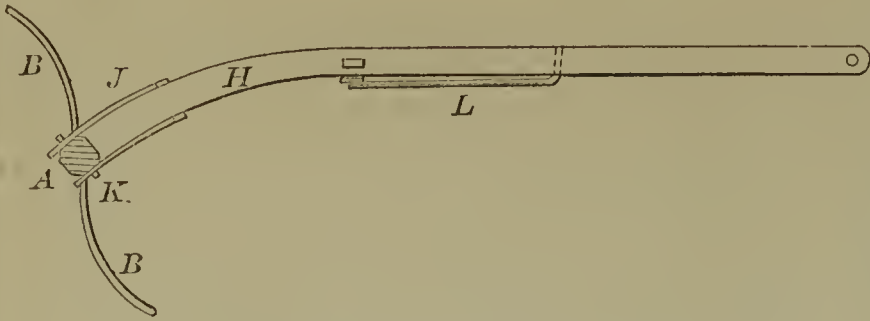

58844—Z. W. Lee—*Cotton Bale Tie.*

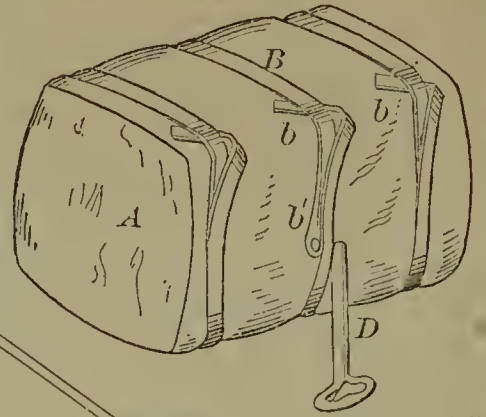

58842—Lane & Bolles—*For Raising Sunken Vessels.*

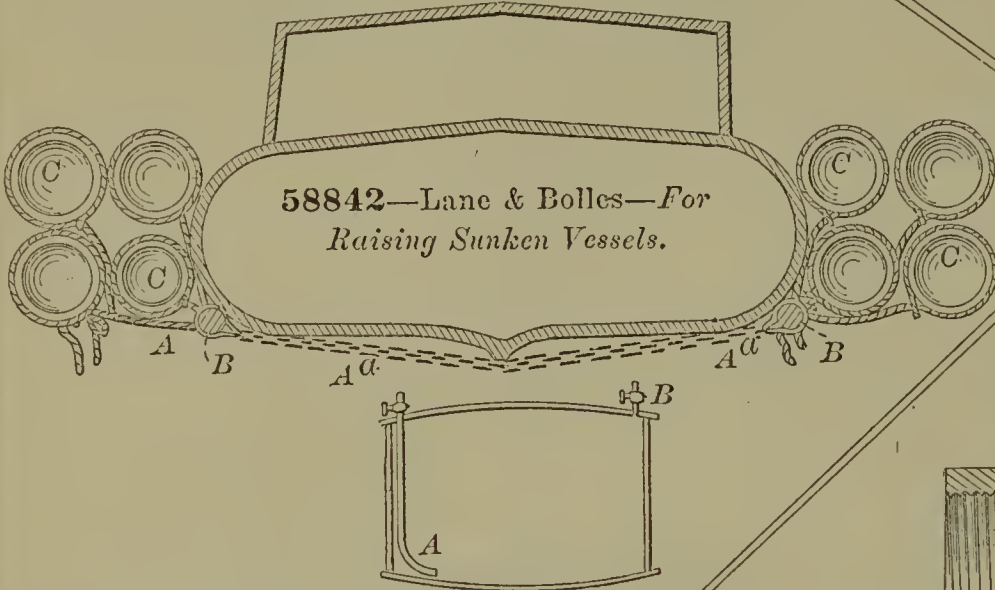

58845—B. E. Lehman—*Stop Cock.*

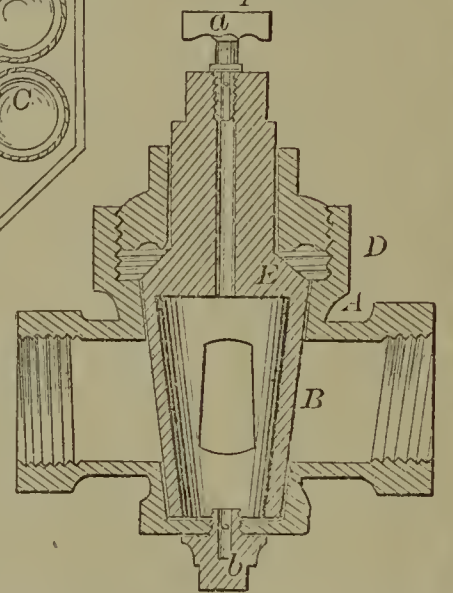

58843—Lawther & Letz—*Water Meter and Motor.*

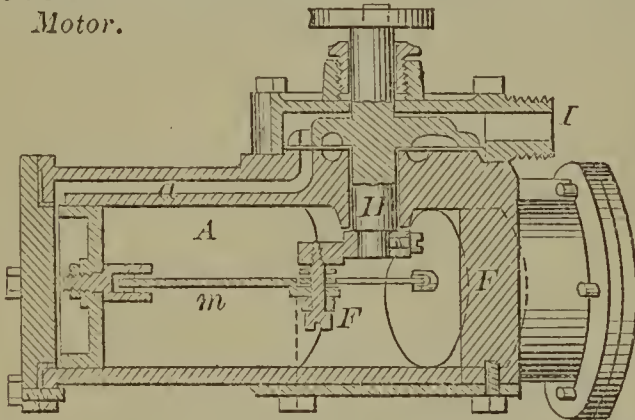

58846—A. Lind—*Water Wheel.*

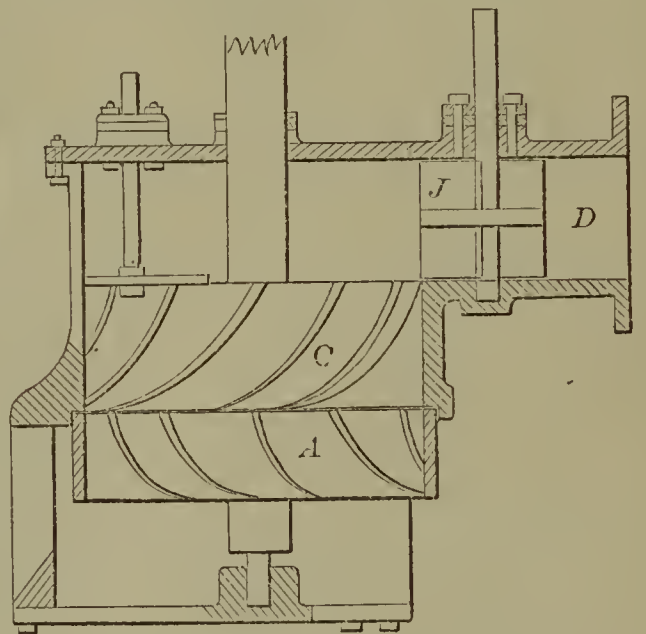

58847—E. A. Locke—*Mark for Casks and Boxes.*

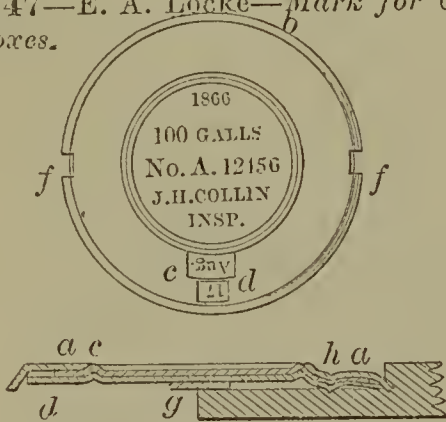

58848—L. E. Lockling—*Fence.*

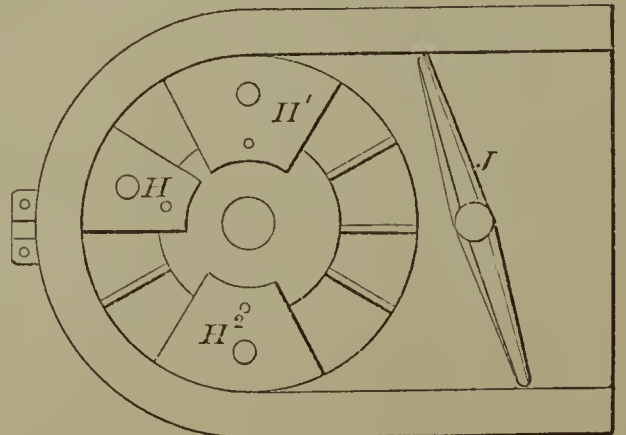
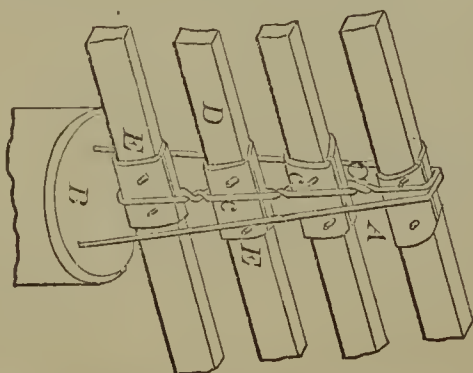

58849—S. M. Longley—  
*Railroad Bar Joint.*

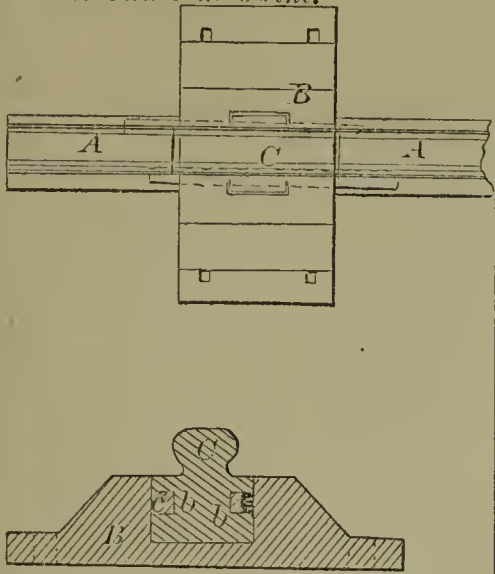

58852—J. W. Maloy—*Marble Polishing Machine.*

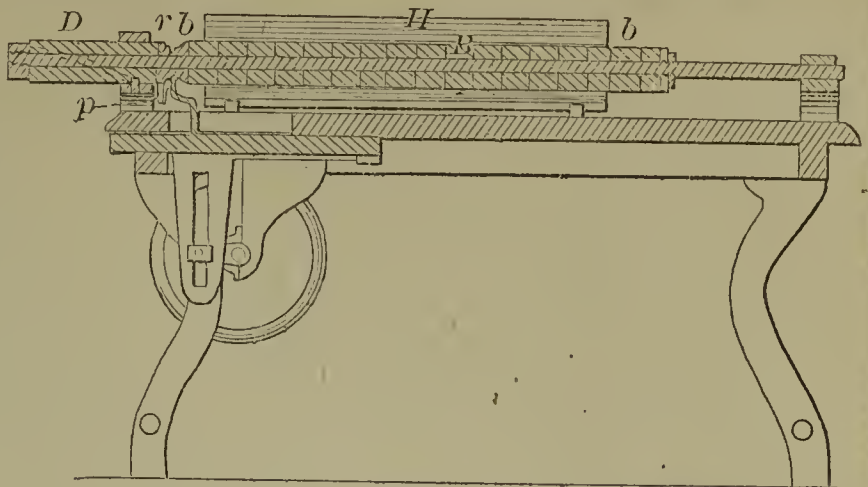

58850—S. H. Loring—*Hose Coupling.*

Fig. 2 Fig. 9 Fig. 8

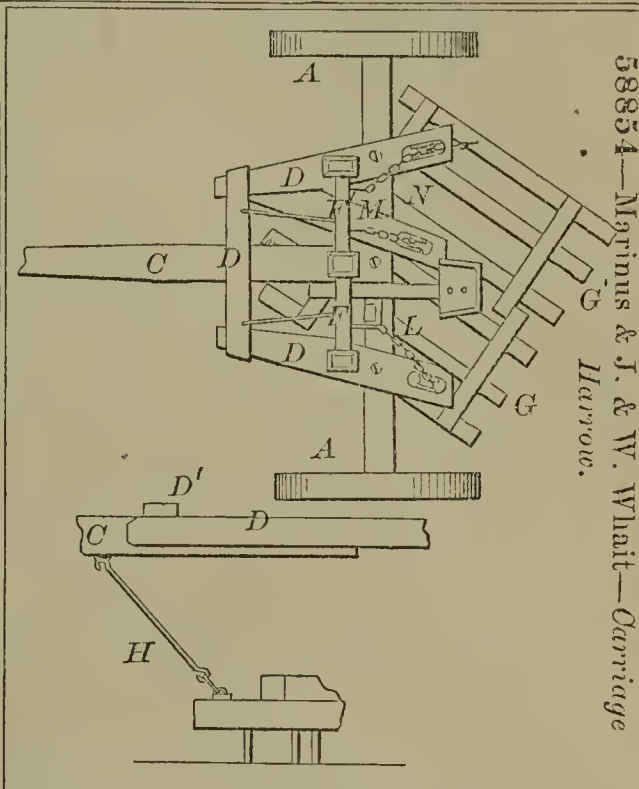
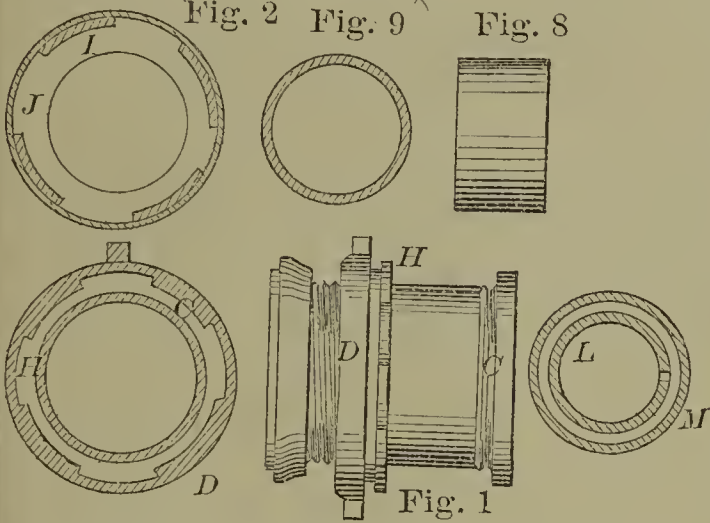

58854—Marinus & J. & W. Whit—*Carriage Harrow.*

58851—G. D. & H. A. Goodrich—  
*Clay Pipe Die.*

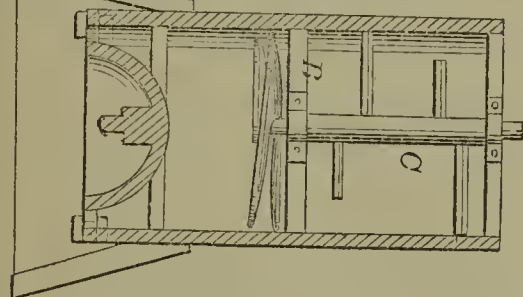

58853—J. W. Maloy—*For Cutting Granite.*

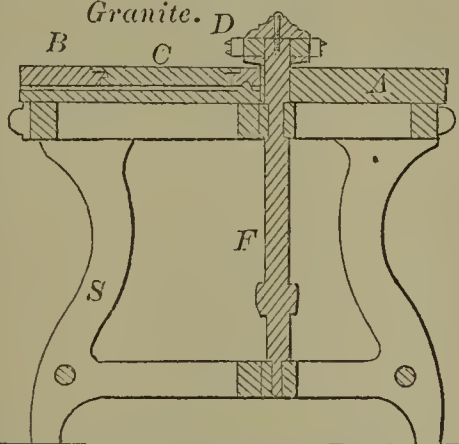

58855—J. S. Marsh—*Plow.*

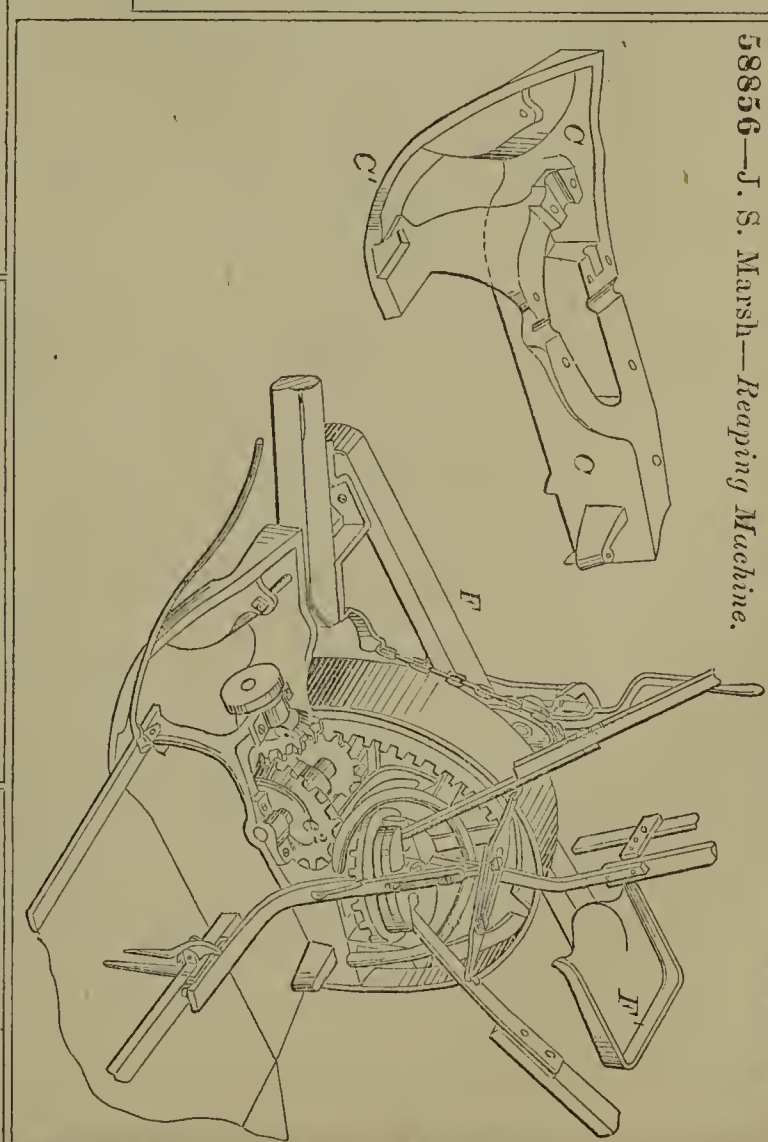
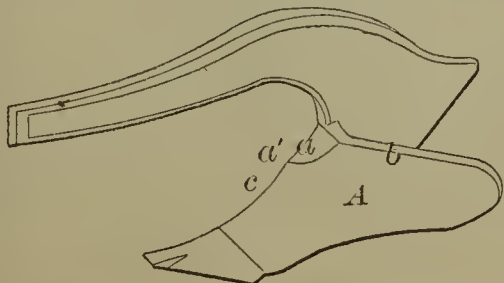

58856—J. S. Marsh—*Reaping Machine.*

58857—J. McClelland—  
*Street Washer.*

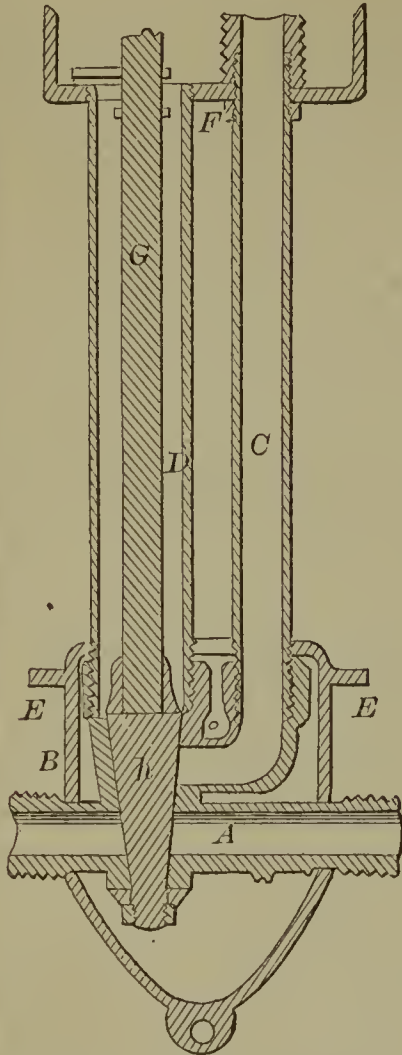

58858—R. McConnell—*Carpenters' Bench.*

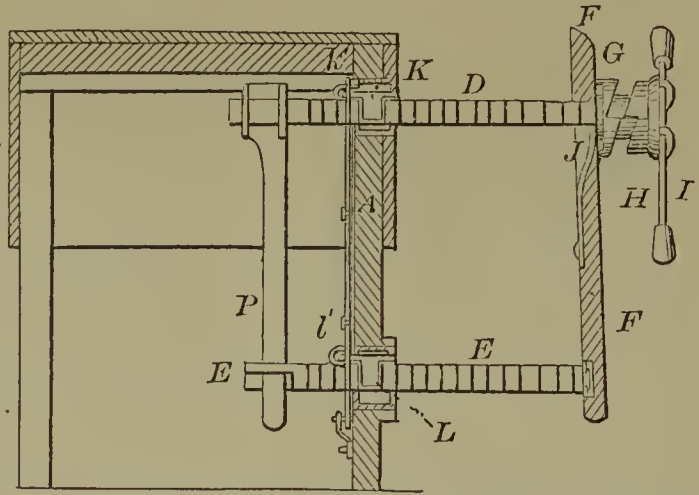

58860—O. C. McCune—  
*Wool Press.*

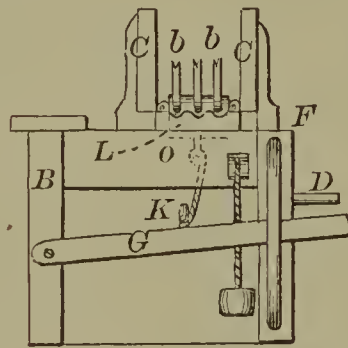

58861—J. McGearry—*For Carbureting  
Air.*

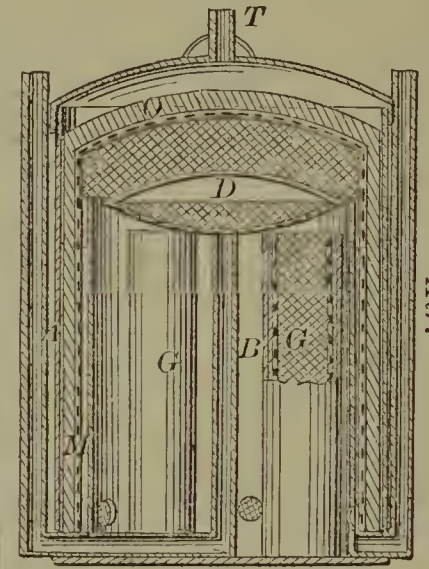

58862—E. McKinney—  
*Coal Oil Stove.*

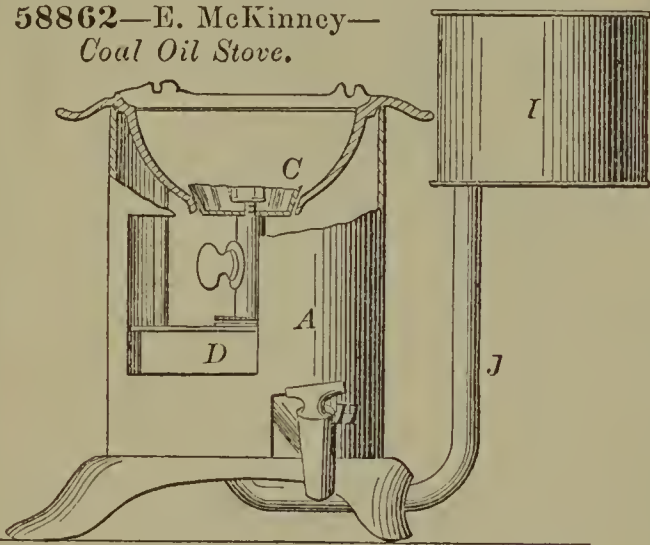

58859—M. J. McCormick—*Vault Light.*

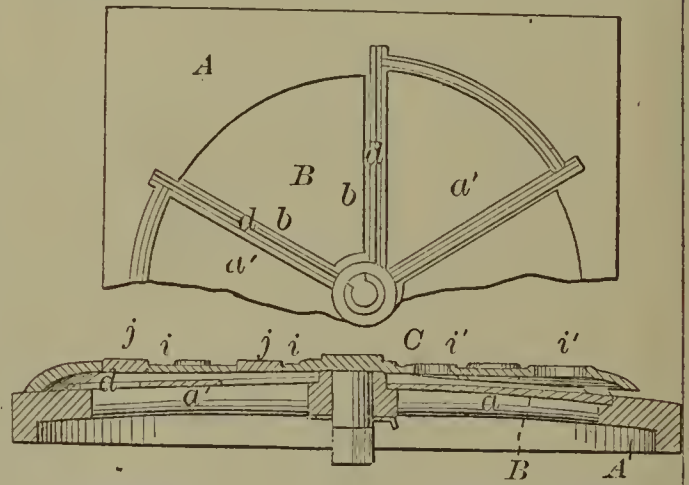

58863—J. H. Mearns—*Furnace.*

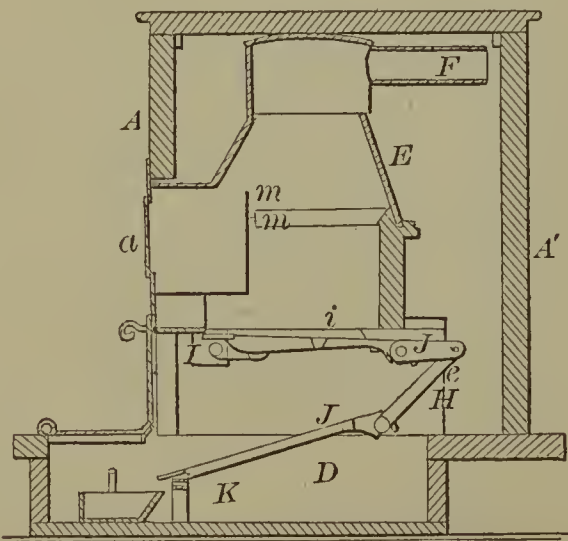

58864—W. R. Meins—*For Supplying  
Liquor to Centrifugal Machines.*

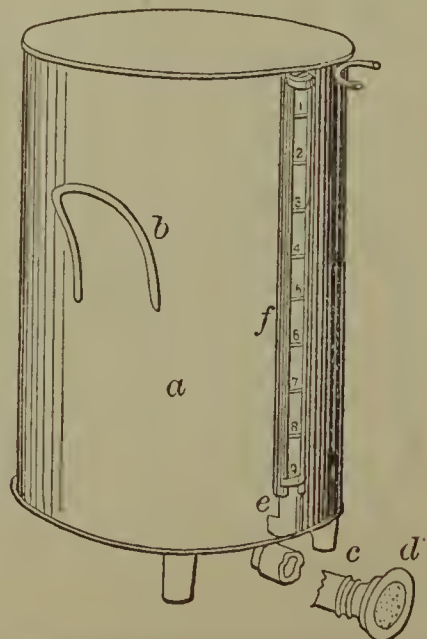



58865—D. Mendenhall—  
*Hand Loom.*

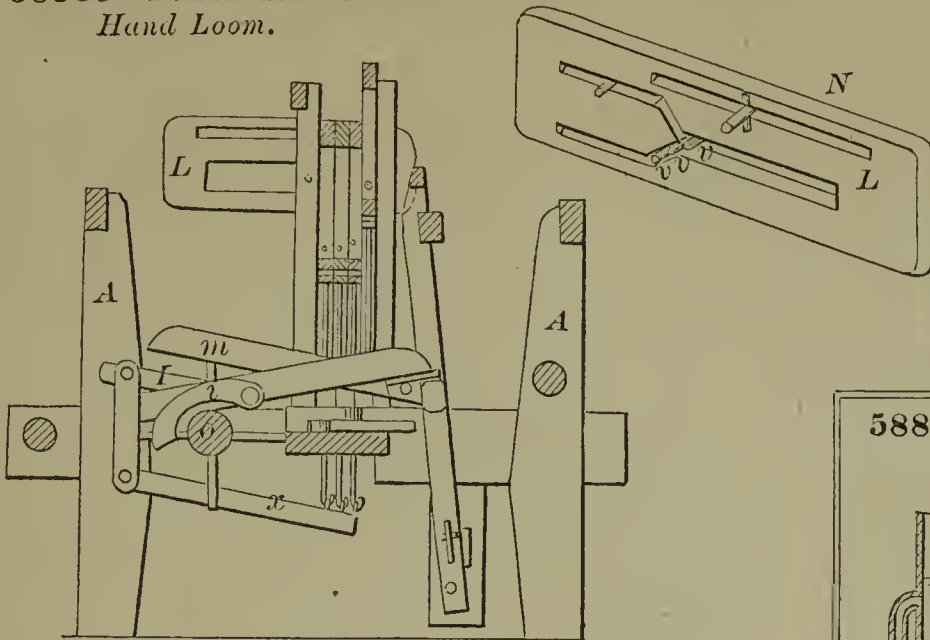

58866—D. Mendenhall—  
*Tree Protector.*

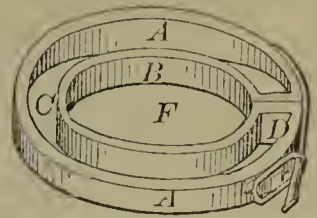

58868—C. F. Mietzsch—*Filter.*

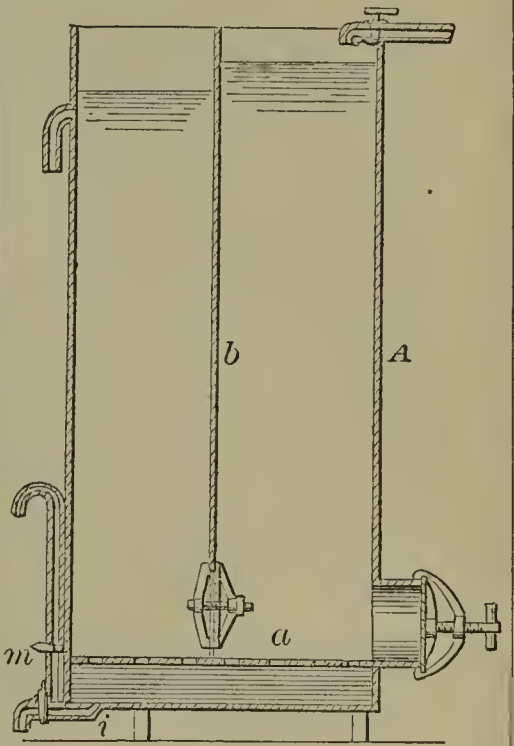

58867—S. F. Merritt—*Eye Glass  
Suspender.*

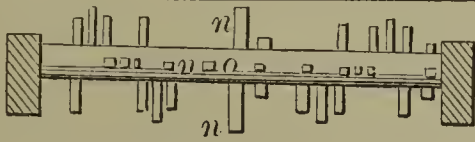
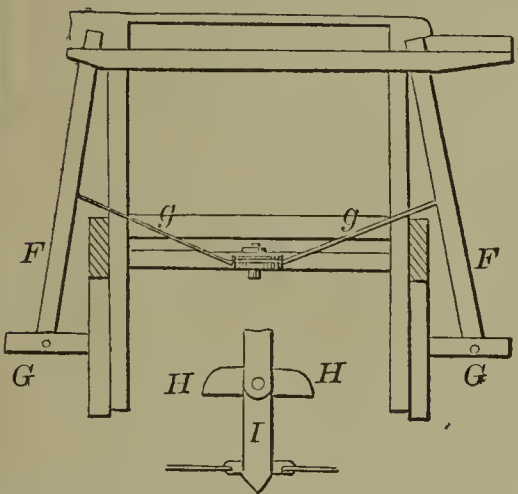

58871—Moon & Doan—*Ditching Machine.*

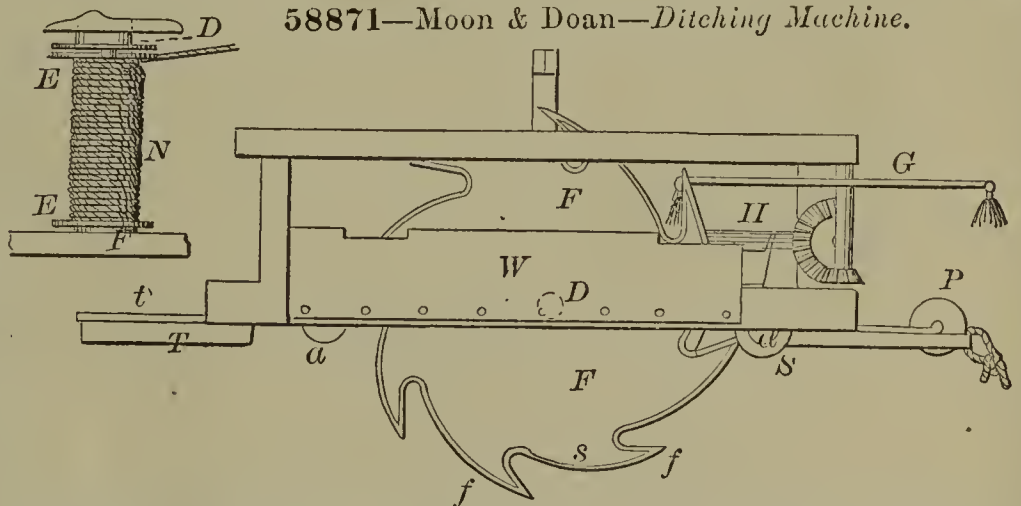

58869—D. T. Miller—*Sorghum Evaporator.*

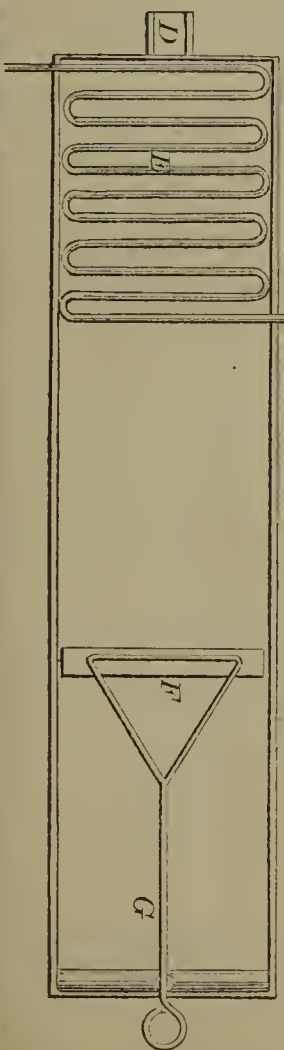

58873—C. Moyer, Jr.—*Wood Bending Machine.*

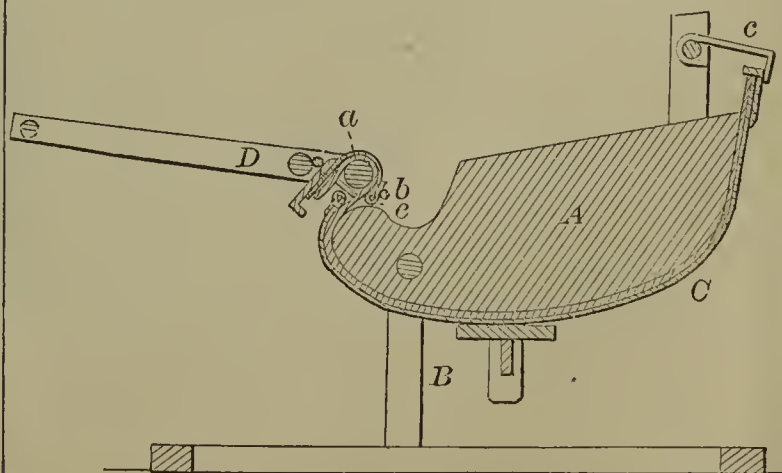

58872—W. Morehouse—*Mop Holder.*

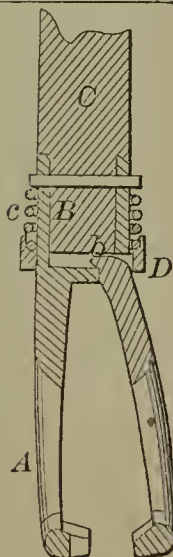

58874—J. Murphy—Clothes Wringer Roller.



58876—C. C. Myers—Corn Planter.

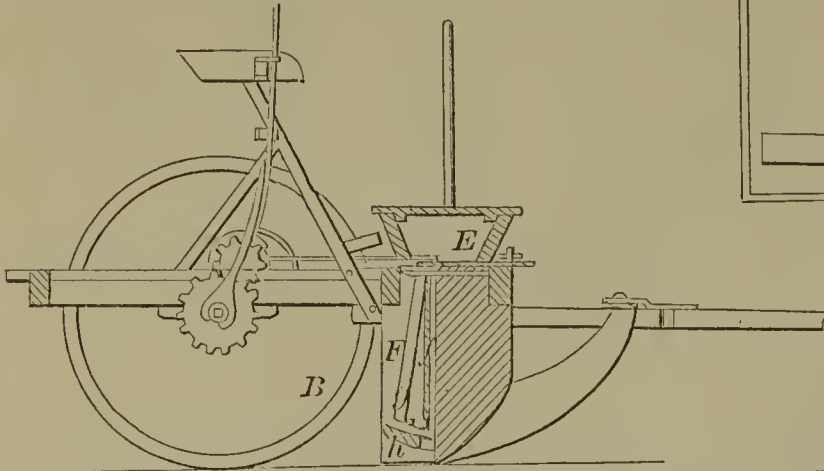

58875—J. Murray—Steam Engine Whistle.

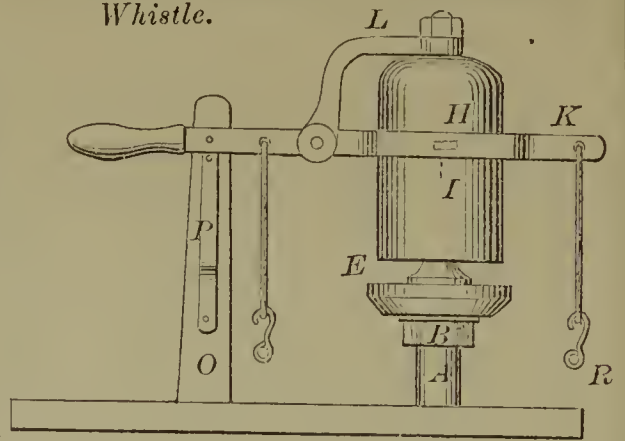

58877—D. Myers—Car Brake.

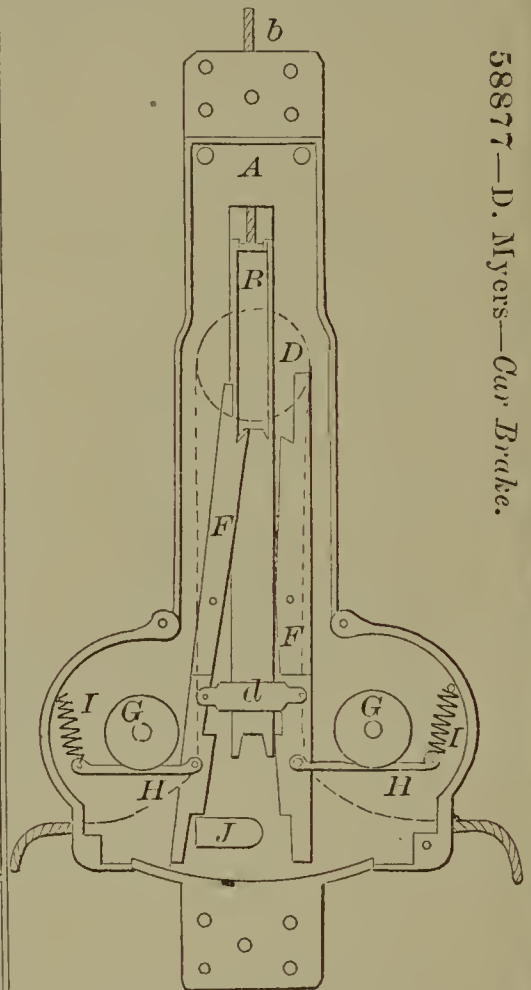

58878—W. Nangel—Morising Machine.

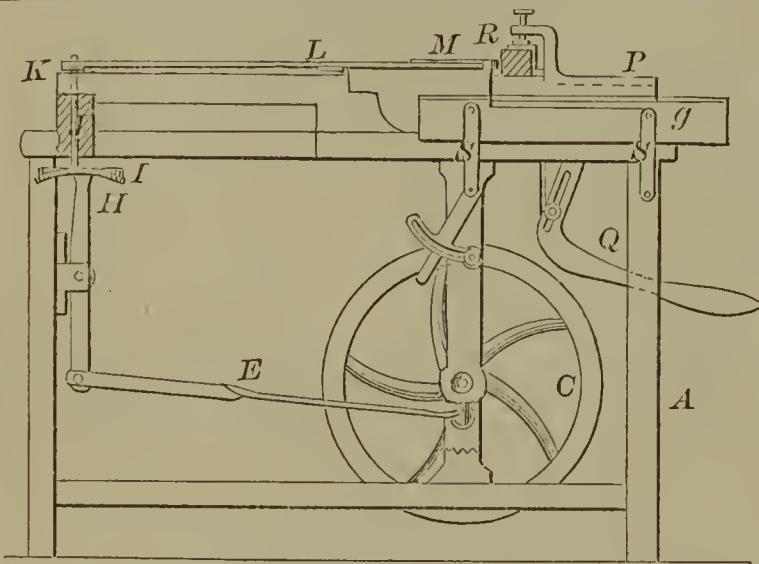

58879—H. Naylor—Furniture Caster.

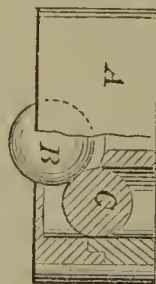

58881—W. H. Pierson—Beehive.

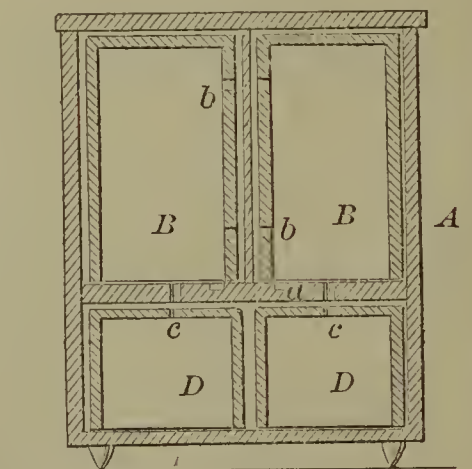

58882—C. Pinder—Egg Beater.

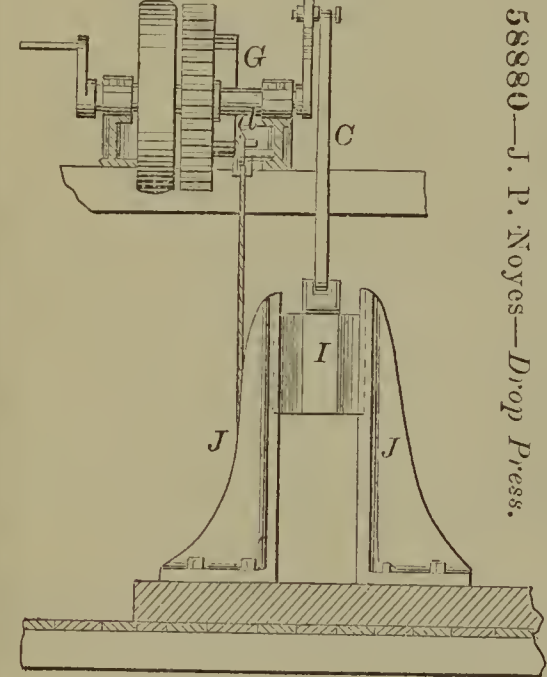
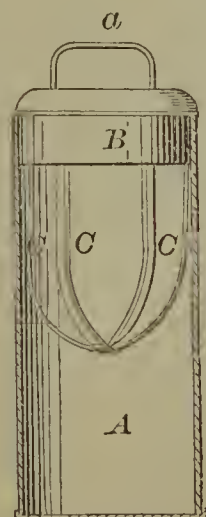

58880—J. P. Noyes—Drop Press.

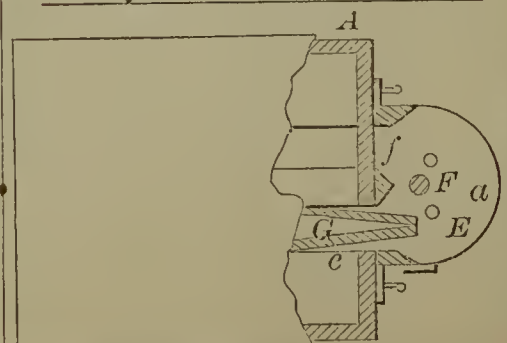
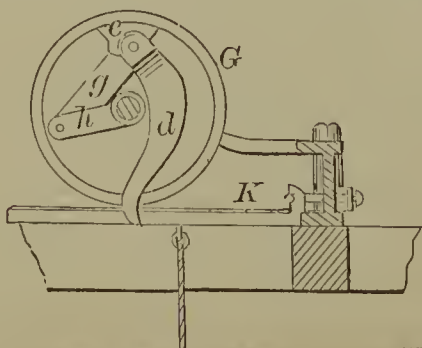

58883—T. D. Powers—*Car Coupling.*

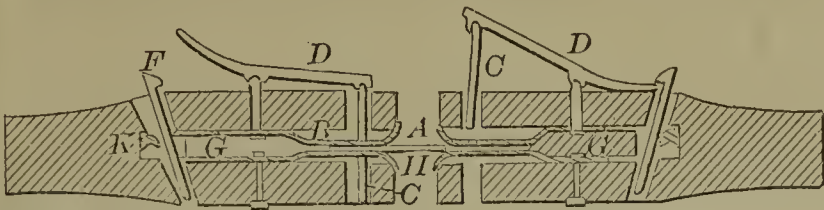

58887—J. O. Reilley—*Spike Making Machine.*

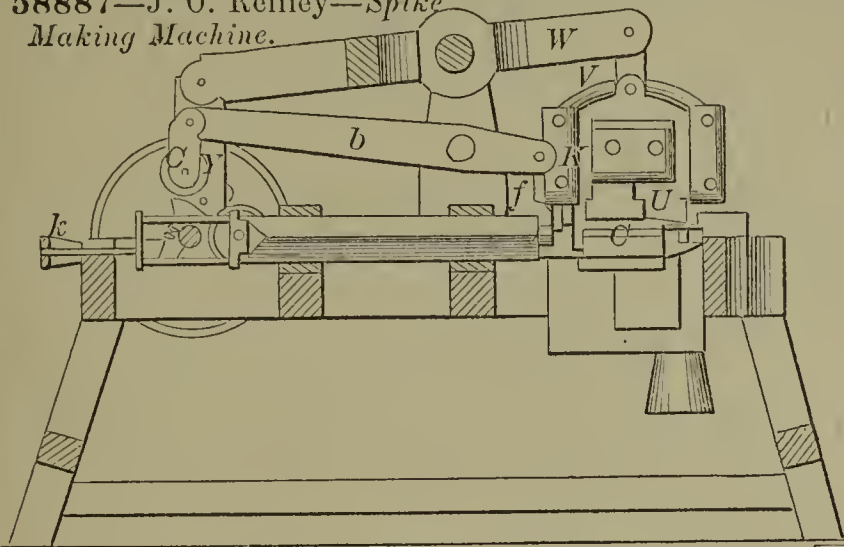

58884—Rains & Adams—*Cart Saddle.*

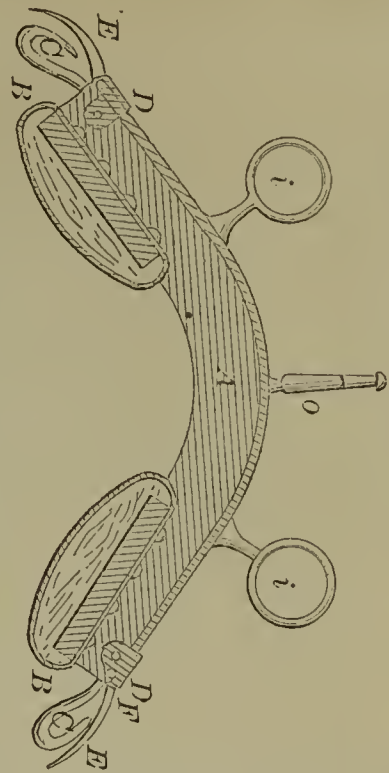

58888—Remington & Stewart—*Water Elevator.*

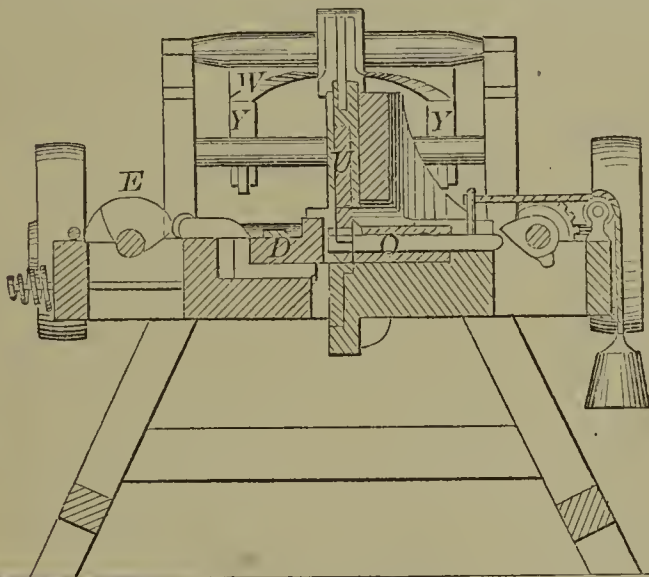
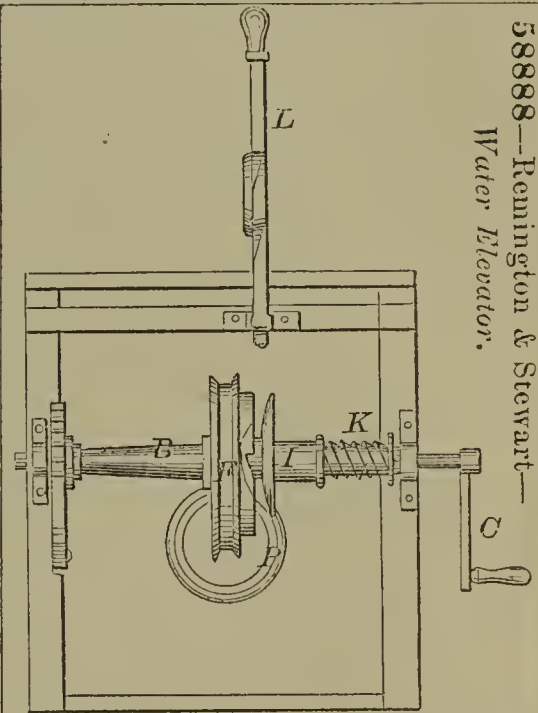

58885—G. W. Raitt—*Carriage Dress Guard.*

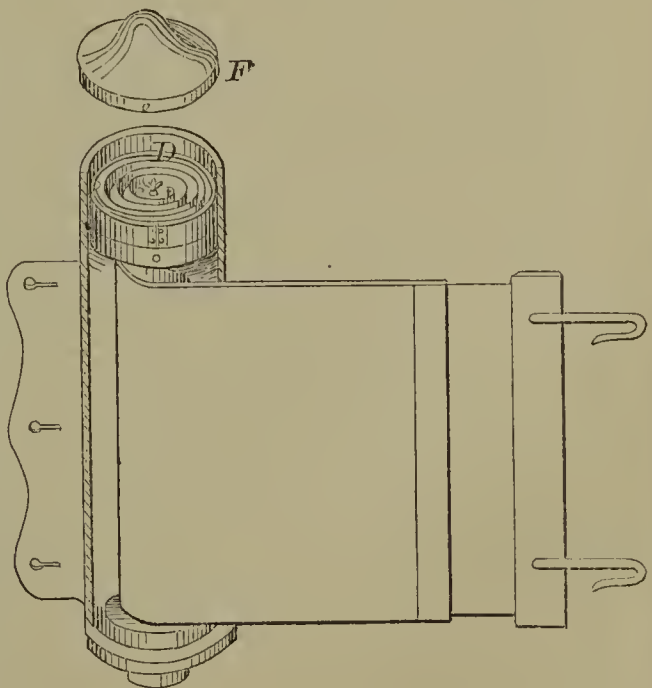

58889—C. Rosenberry—*Cork Extractor.*



58886—Ransey & Miller—*Tool for Cutting Boiler Tubes.*

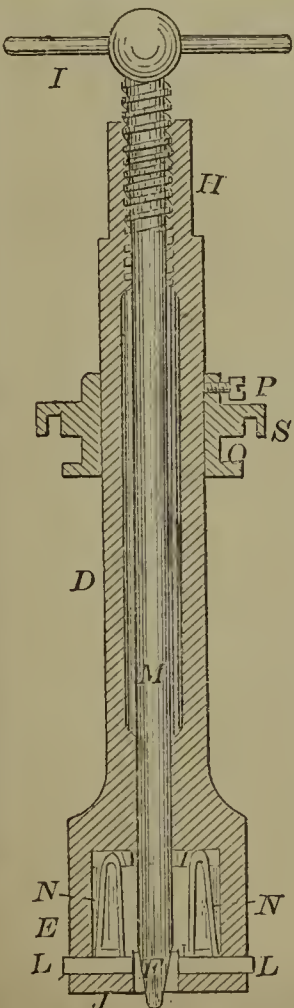

58891—C. F. Ruset—*Revolving Cylinder Engine.*

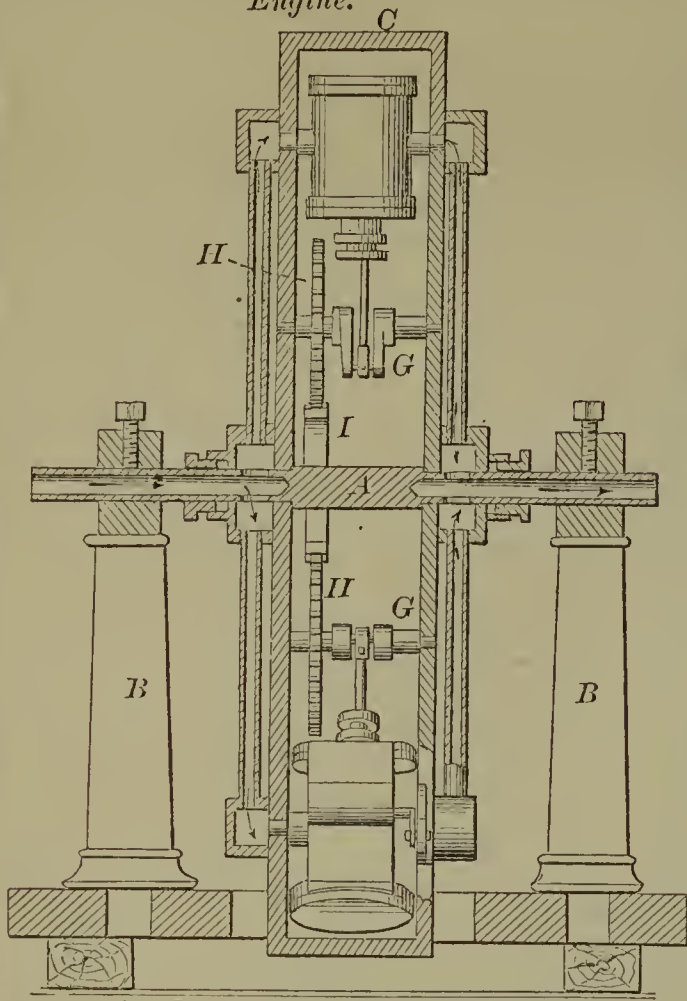

58895—J. J. Sawyer—*Dish Washer.*

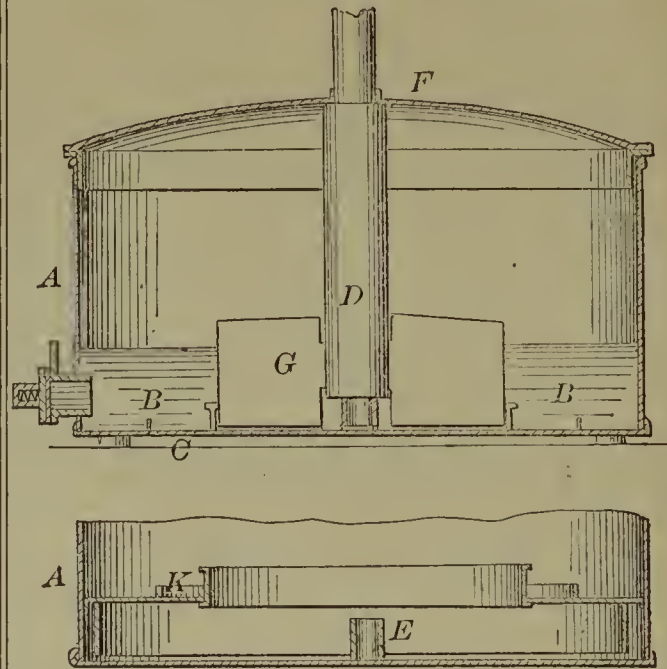

58892—Saladec & Eddy—*Chimney.*

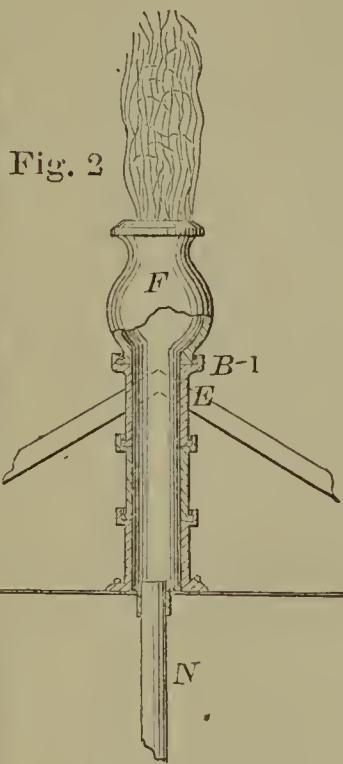
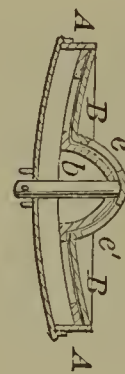
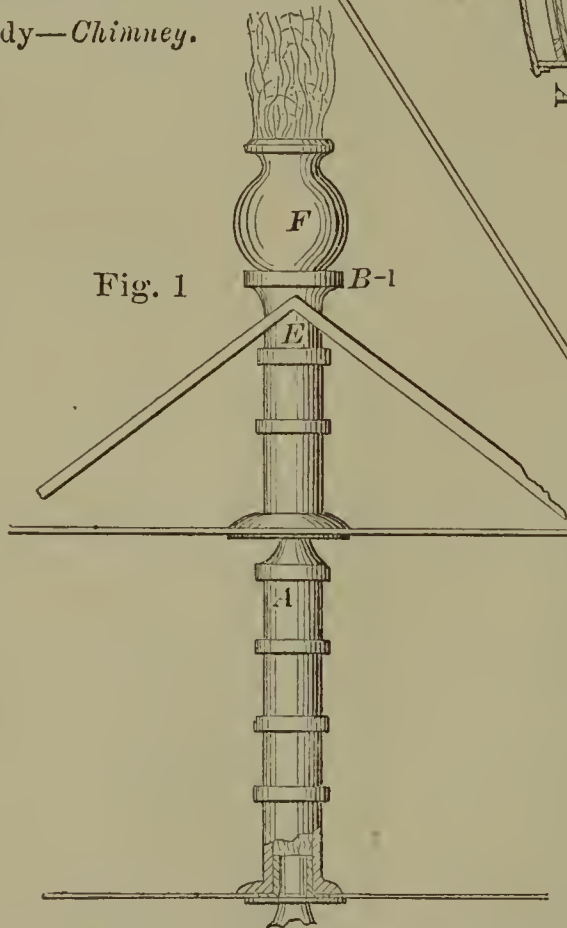
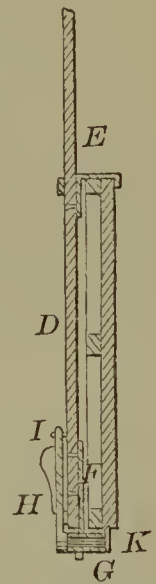

Fig. 1



58894—L. Sauter—*Breastpin.*



58897—A. R. Scott—*Wagon Bow Fastening.*

58893—J. F. Sanford—*Lamp Burner.*

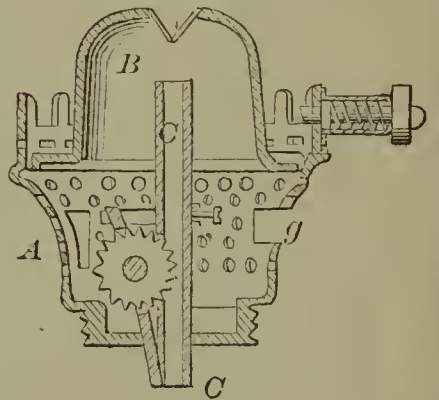

58896—P. Schuler—*Piano Forte.*

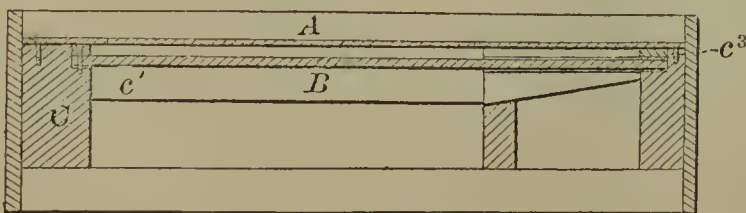

58898—W. Sellers—*Lock.*

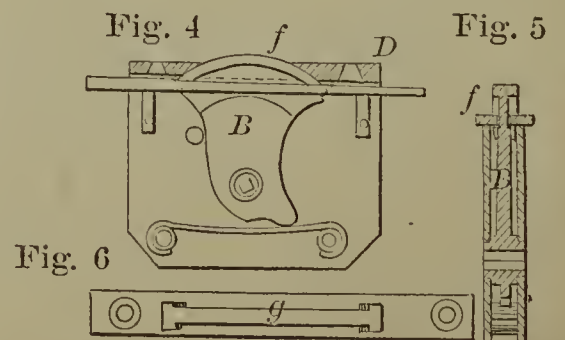

58899—J. T. Severns—*Fruit Box.*

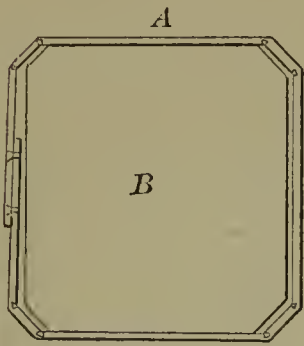

58907—J. F. Spence—*Shade for the Eyes.*



58900—S. Sherman—*Rotary Engine.*

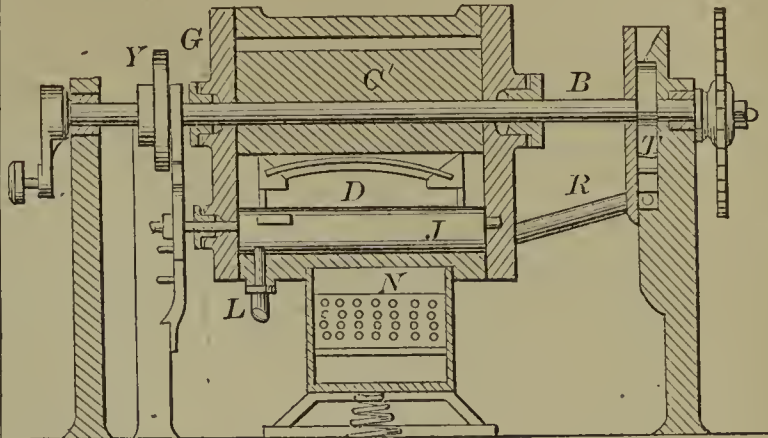

58904—J. Snyder—*Puddling Furnace.*

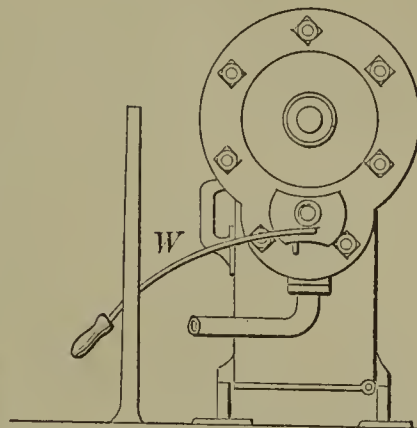
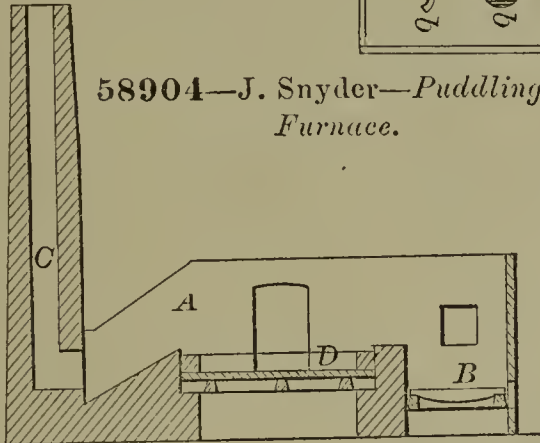

58906—F. Speck—*Water Wheel.*

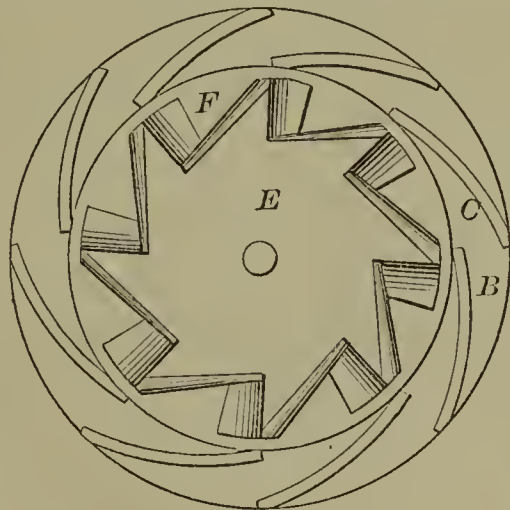

58908—D. I. Stag—*Seat and Desk.*

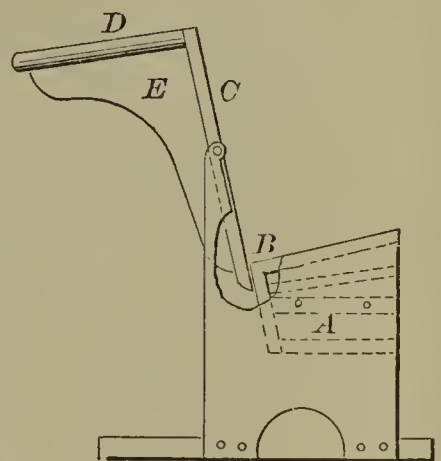

58903—C. T. Smith—*Spinning Machine Bobbin.*

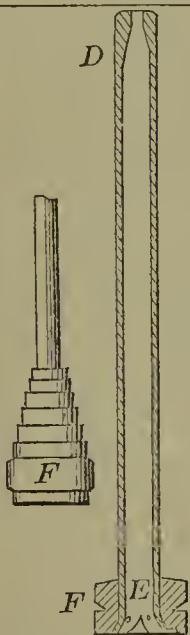

58910—T. Stead—*Railroad Signal.*

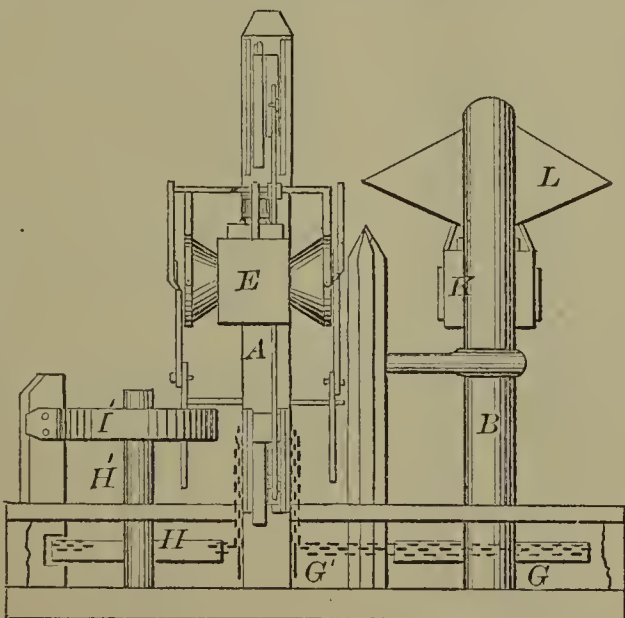

58909—W. F. Starnes—*For Cutting Stalks in the Field.*

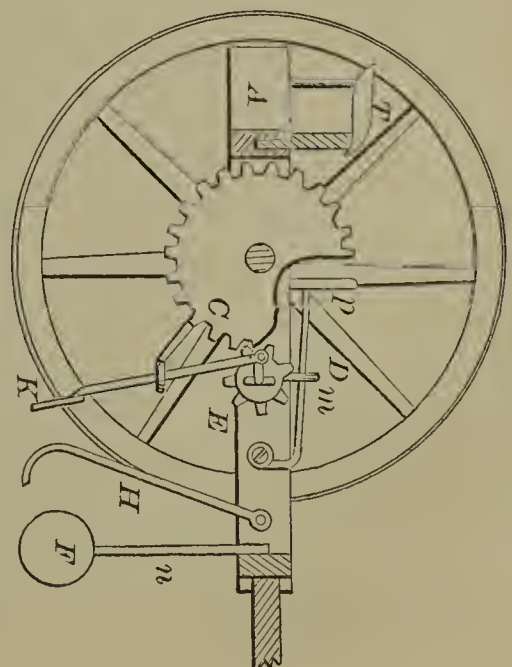

58911—C. St. John—Plow.

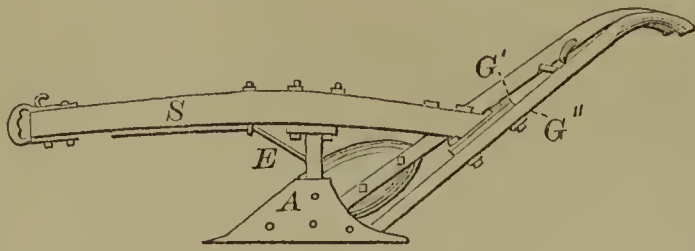

58912—S. Stukeley—For Grinding Cob and Corn.

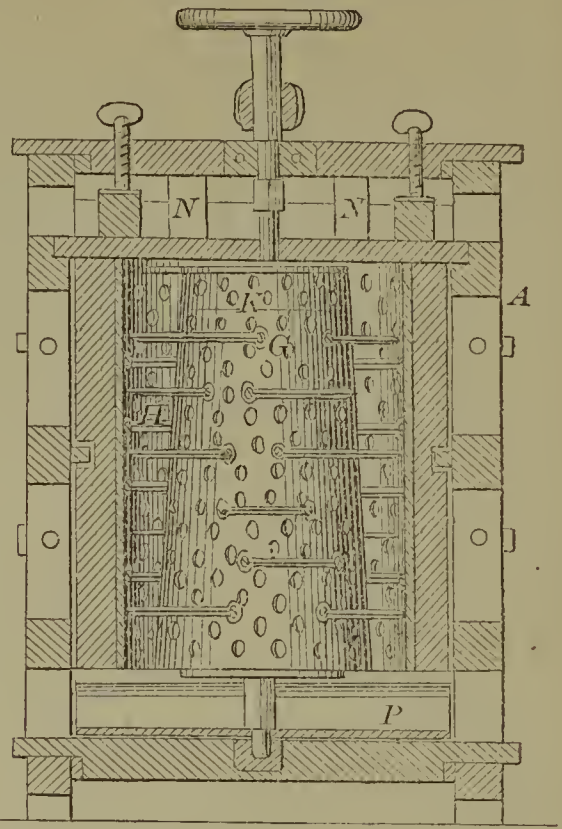

58914—S. H. Tift—Spring Bedstead.

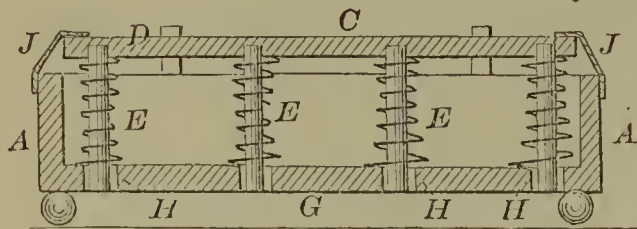

58915—F. J. Tinker—Lamp Chimney Attachment.



58916—J. Tinkey—Door Guard.

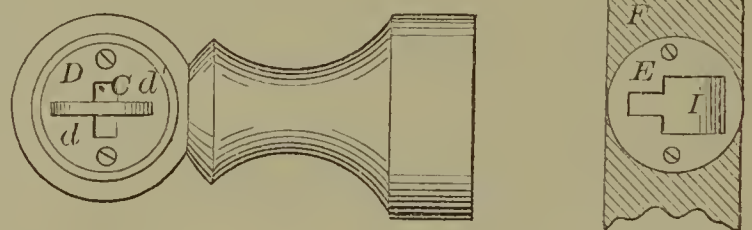

58917—J. Ungerer—Chair.

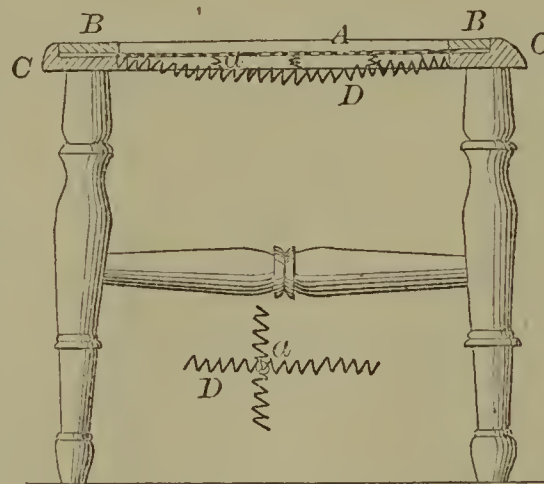

58913—G. Tagliabue—Hydrometer.



58918—I. Van Olinda—Communicating Reciprocating Motion to Pumps, &c.

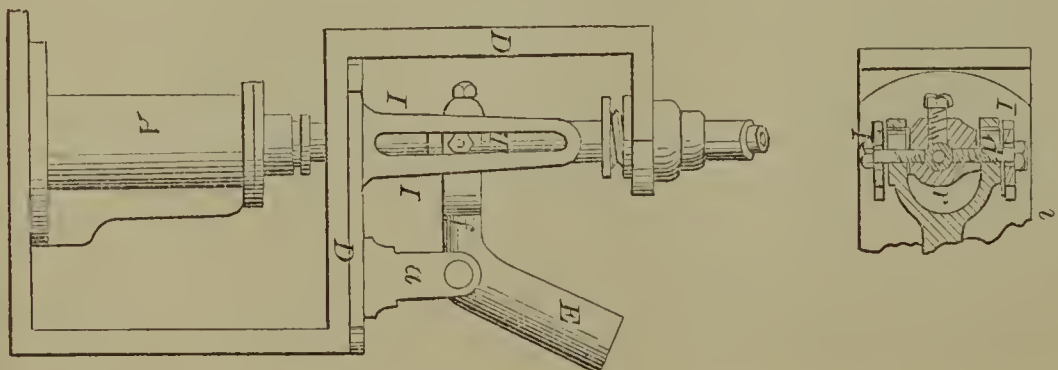

58920—H. N. Walter—Shirt Elevator.

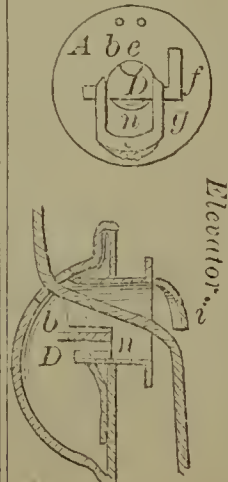

58921—Warner & Bales—Sawing Machine.

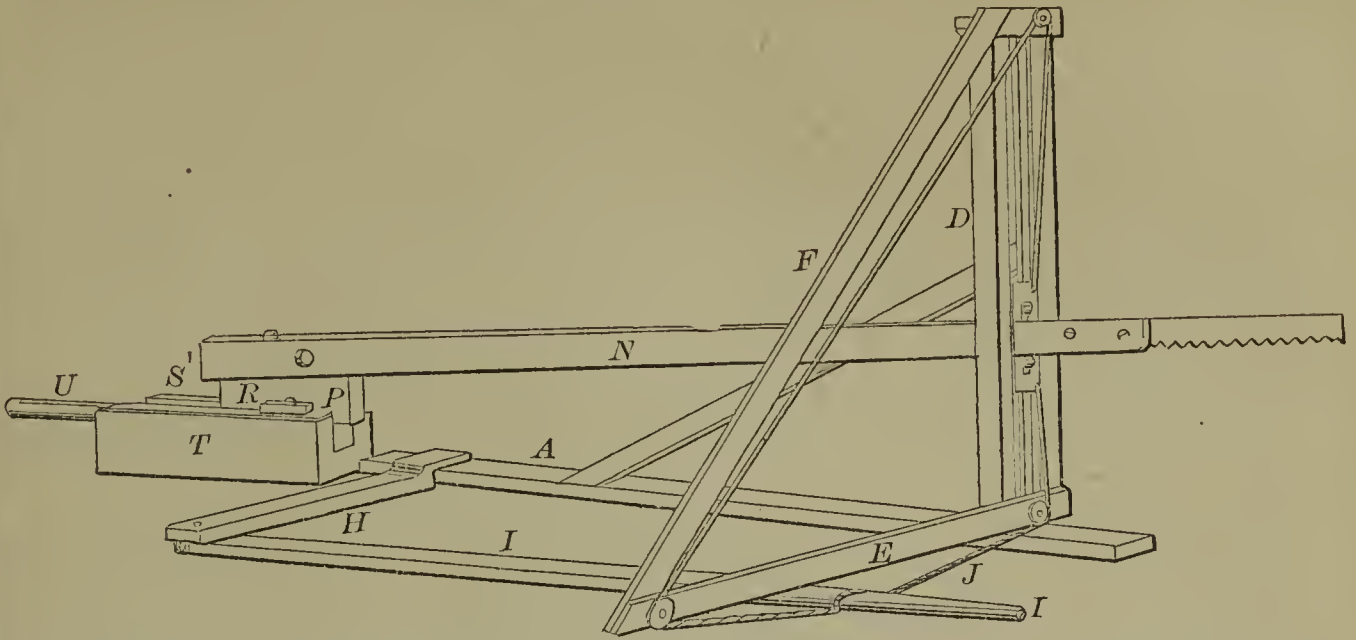

58923—W. H. Warwick—For Furrowing Corn Ground.

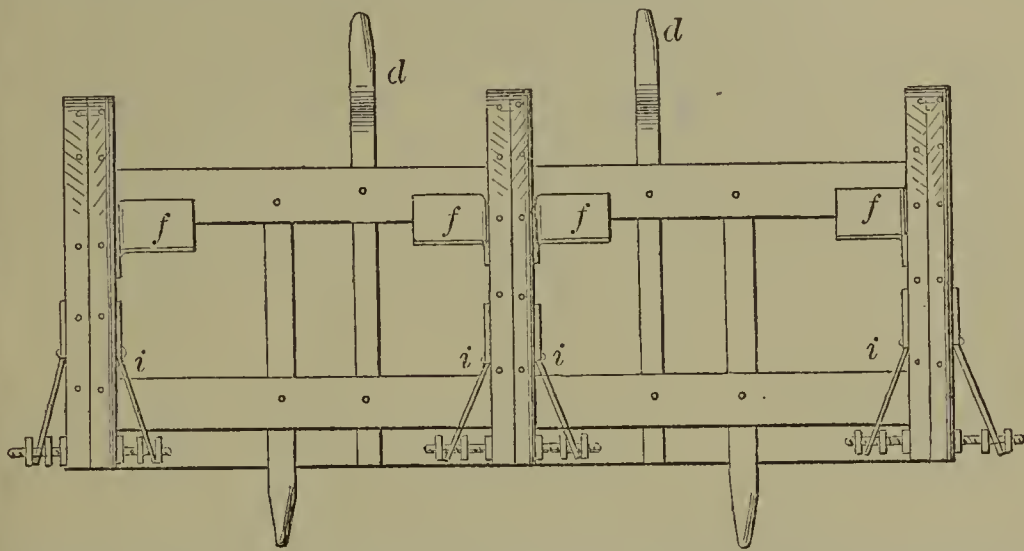

58924—T. L. Webster—Tube Sheet Cutter.

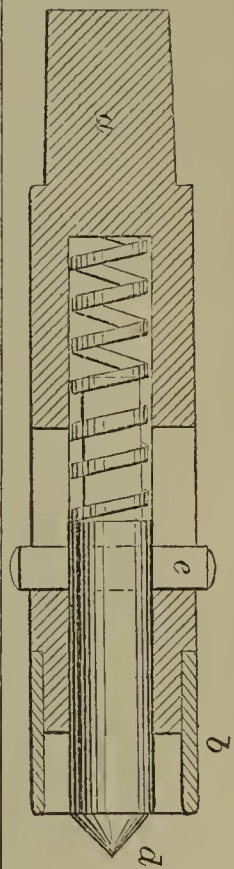

58922—R. Weir—Toy Walking Figure.



58925—A. Warth—Sewing Machine.

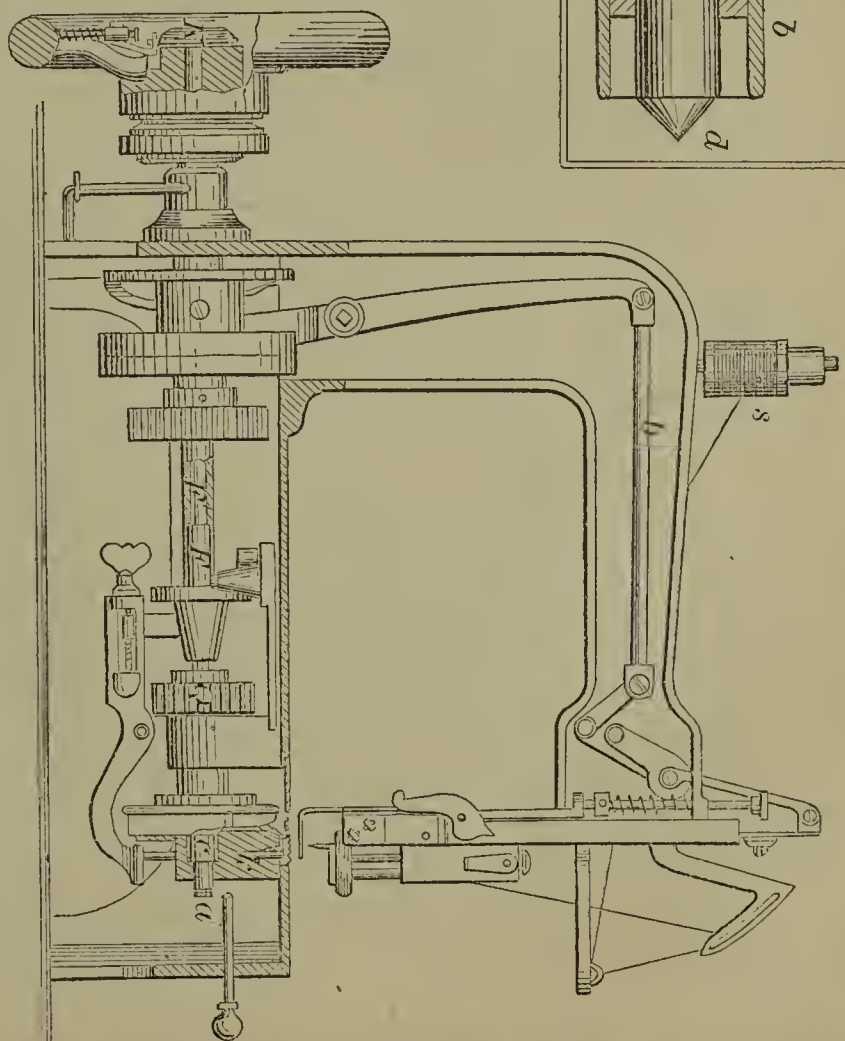

58925—Continued.

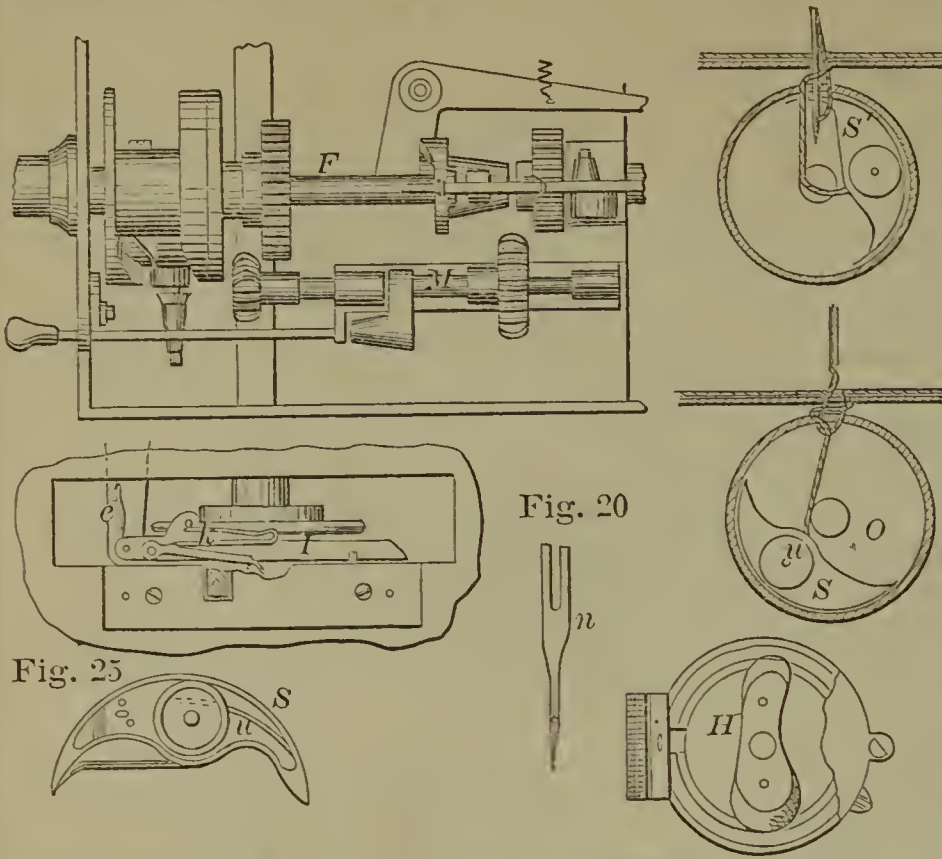

58926—(1. Weissenborn—For Drying Peat.

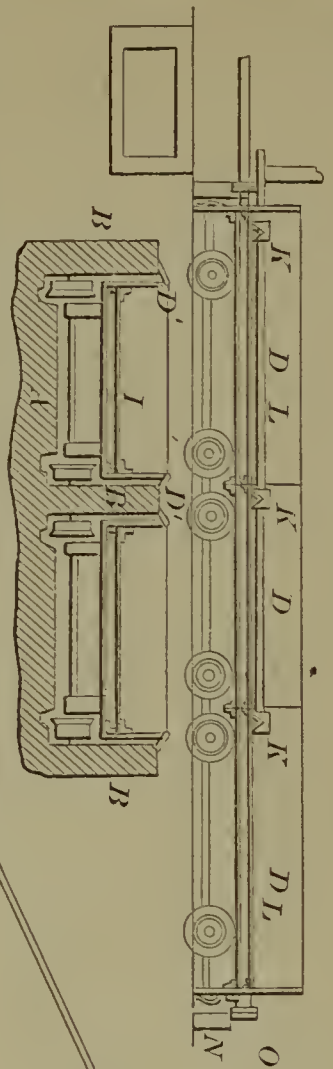

58928—D. J. Whittemore—For Unloading Grain Cars.

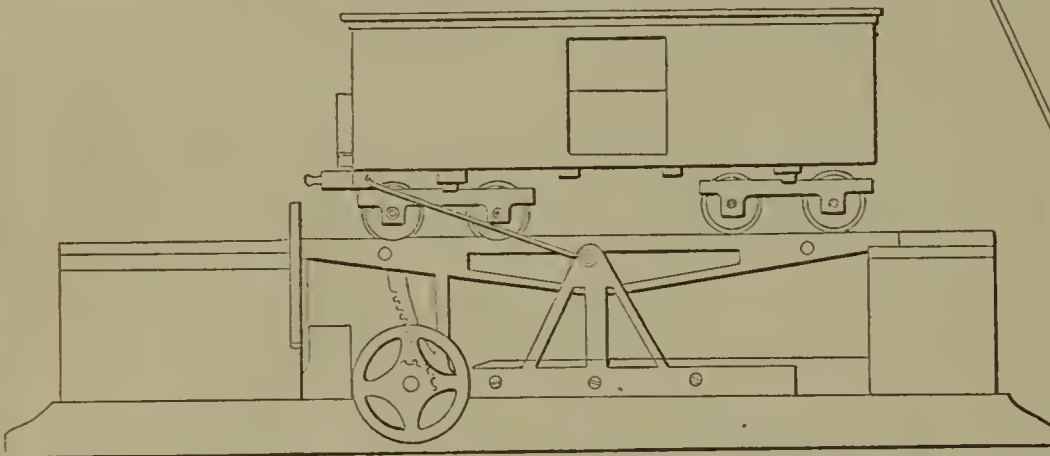

58929—G. M. Wood—Bolt Keeper.

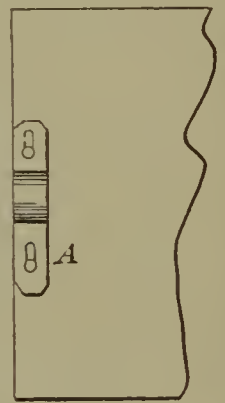

58927—I. P. Wendell—Railroad Car Box.

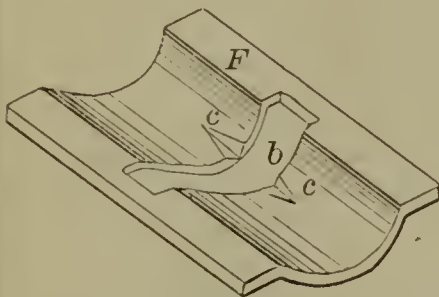

58930—L. E. Woodard—Gate Hinge.

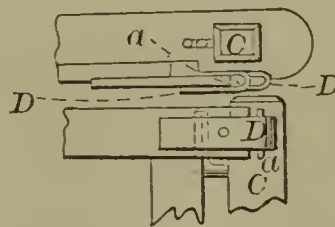

58931—M. A. Woodside—For Washing Ores.

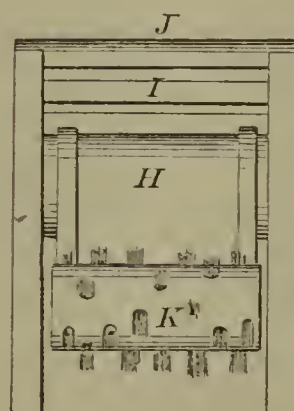

58932—J. E. Wooten—For Quarrying Slate.

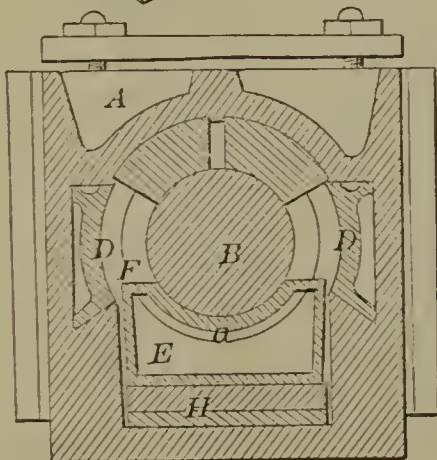
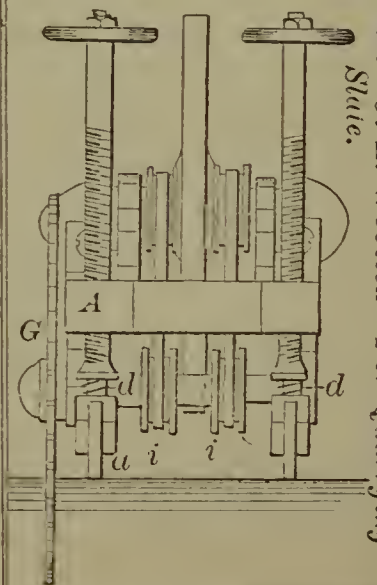



58933—I. Allard—Wood Sawing Machine.

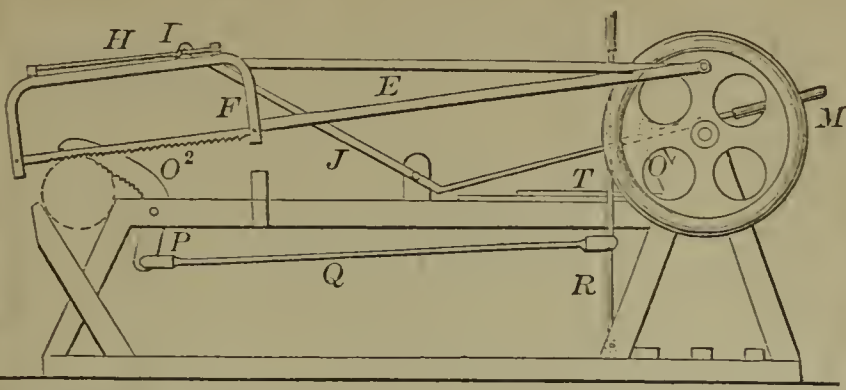

58936—J. C. Barlow—Lid Supporter.

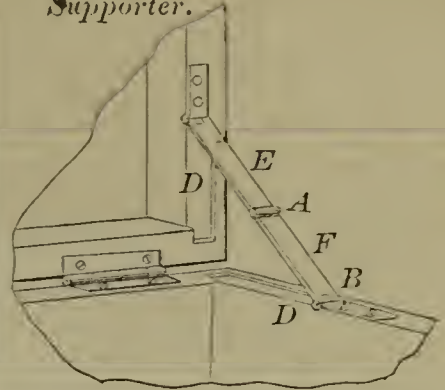

58938—A. M. Connett—Shingle Machine.

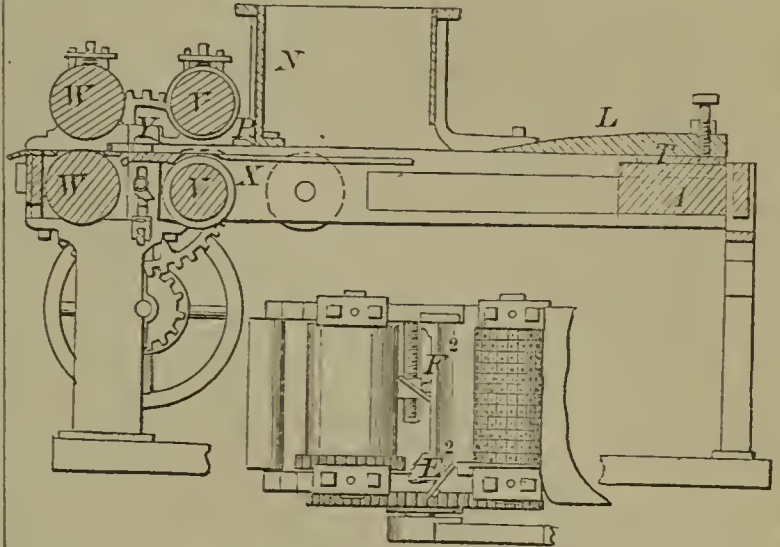

58940—T. Goodrum—School Boys' Bookbinder.

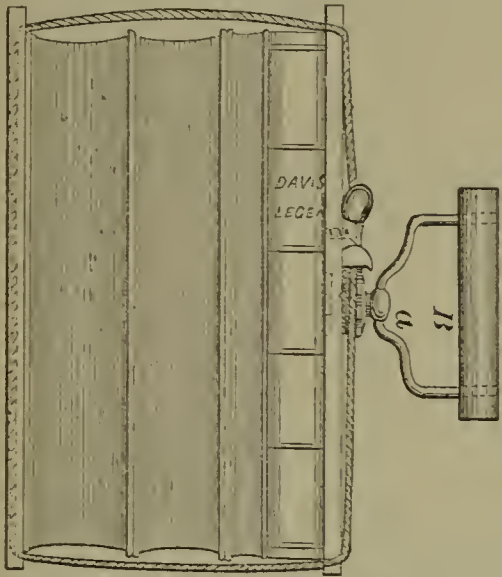

58934—H. Anderson—Steam Generator Safety Valve.

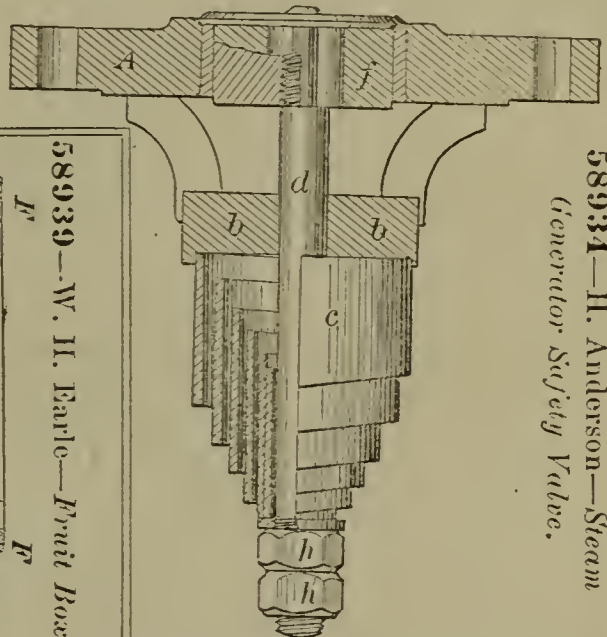

58939—W. H. Earle—Fruit Box.

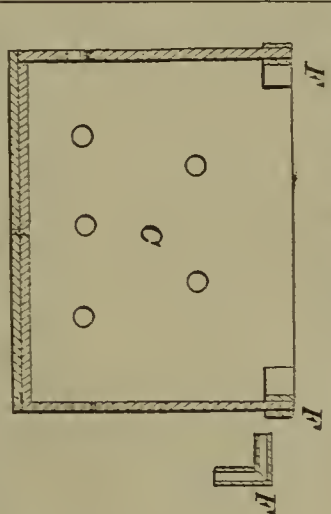

58937—G. W. Briggs—Magazine Fire Arm.

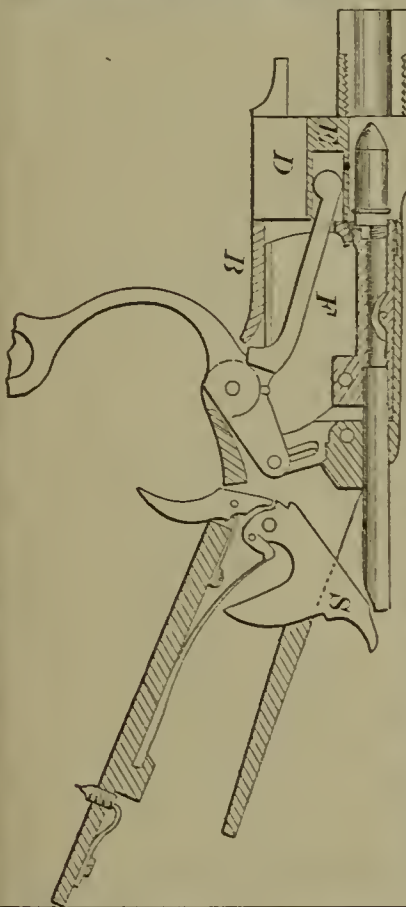

58942—J. O. Harris—Lantern.

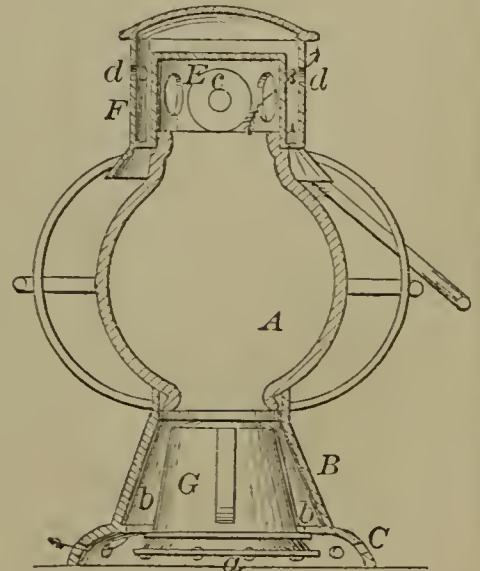

58941—Haueisen, Wagner & Nulsen—Brick Kiln.

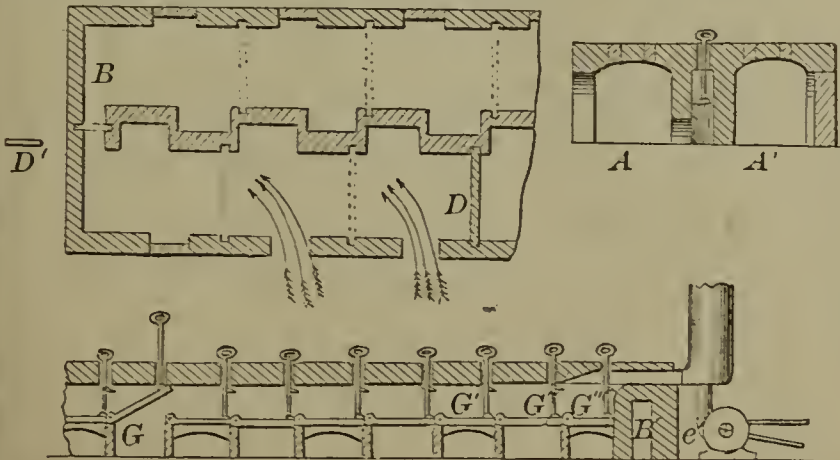

58945—D. Hussey—Brake for Cotton Layers.

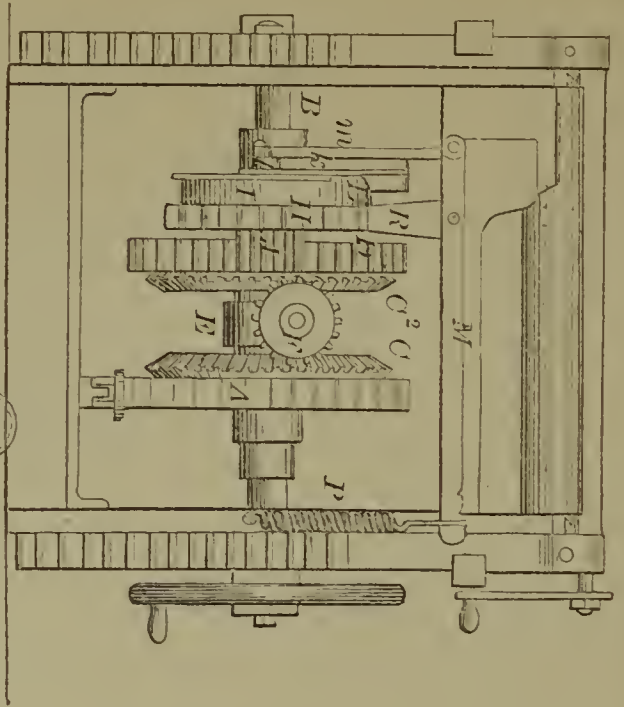

58943—J. A. Heyl—Electric Gas Stop Cock.

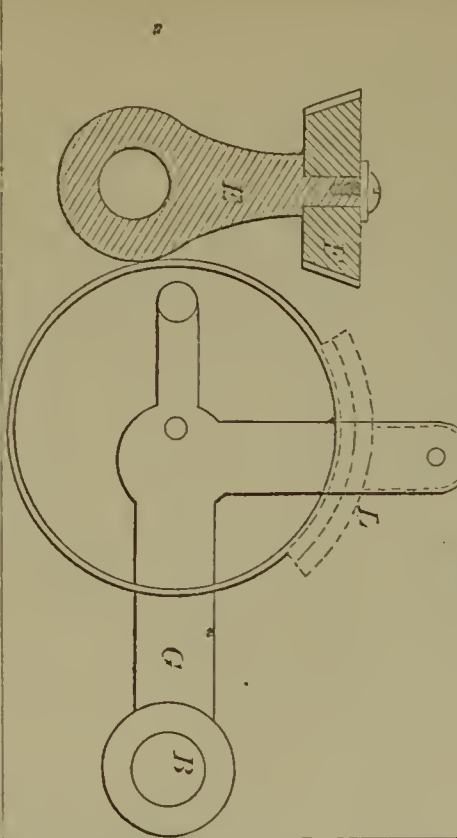
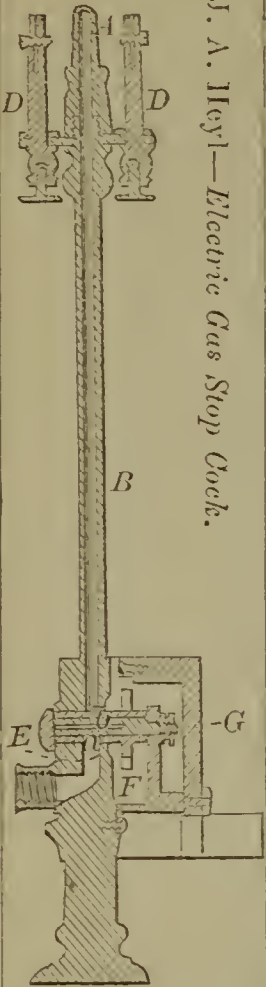

58948—E. C. Little—Hinge for Moulders' Flasks.

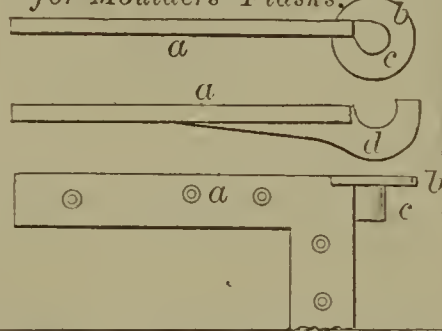

58950—W. H. Mason—Piano Forte.

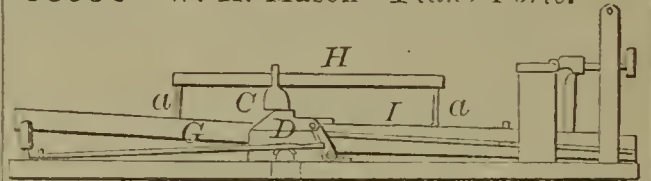

58949—H. S. Loper—Adjustable Frame for Hoop Skirts.

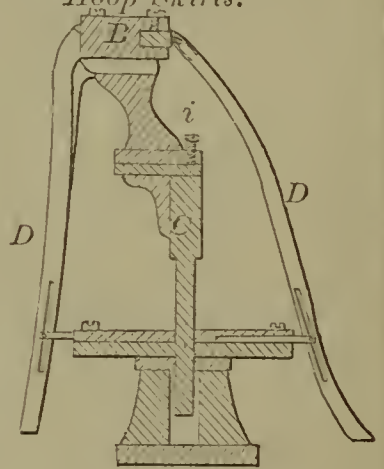

58947—J. E. F. Leland—Wood Turning Lathe.

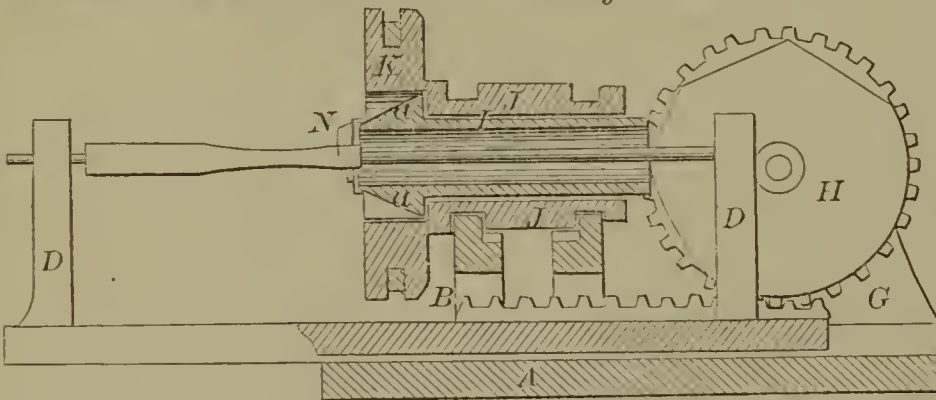

58946—J. G. Lane—Coffee Mill.

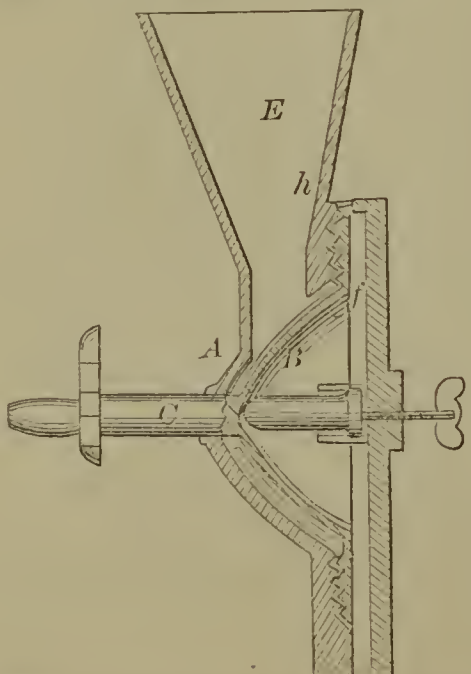

58951—S. A. Moody—Soil Cutter.

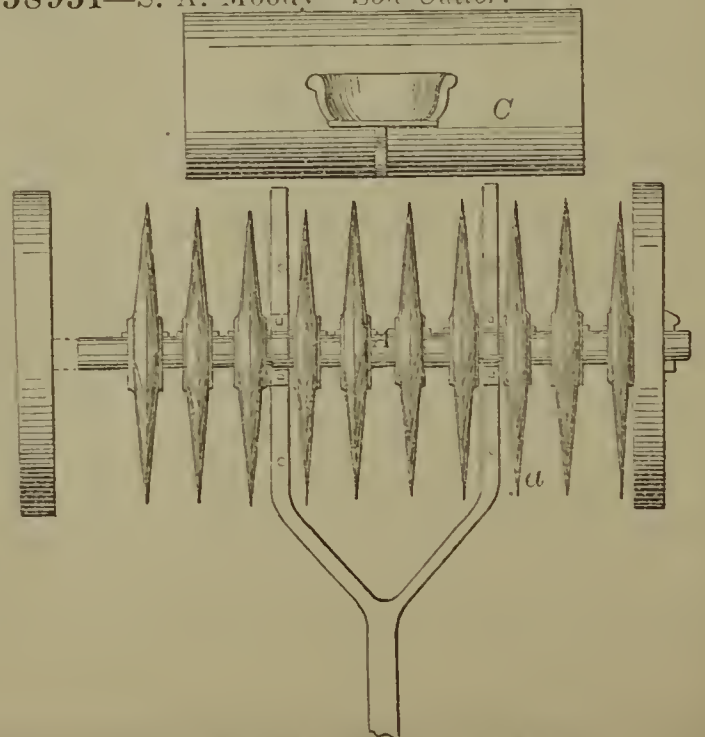

58952—G. Munger—Ink Well Cover.

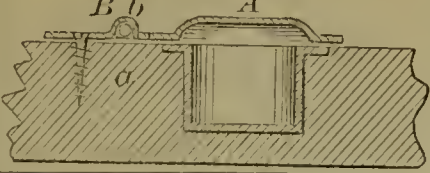

58958—Root & H. & E. Colt—For Dressing Willow for Baskets.

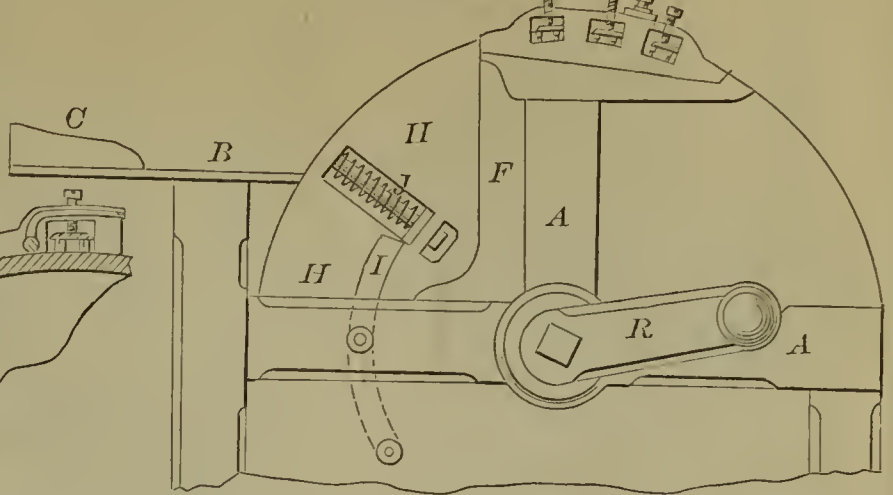

58954—S. J. Shaw—Bicycletal Bruce.

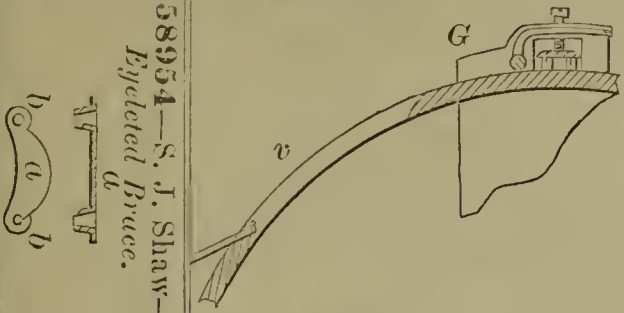

58957—J. Stubbs—Washing Machine.

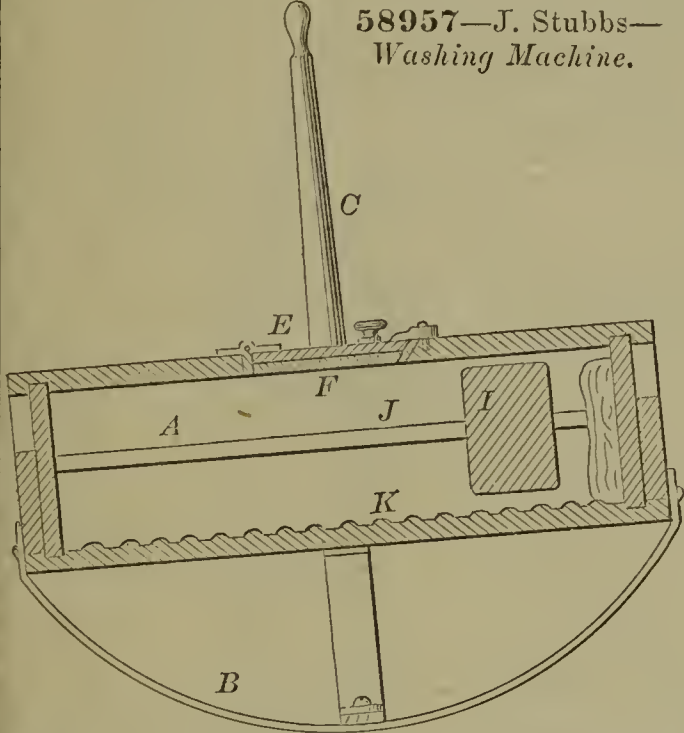

58956—C. W. Singer—Car Brake.

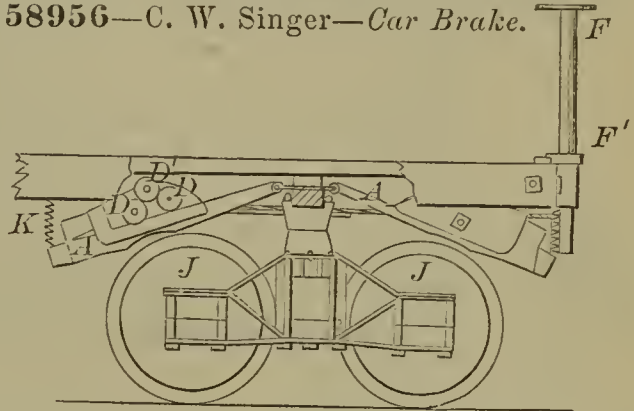

58955—Shaw & Worcester—Brace and Lacing Device.



58953—R. T. Osgood—For Sinking Well Tubing.

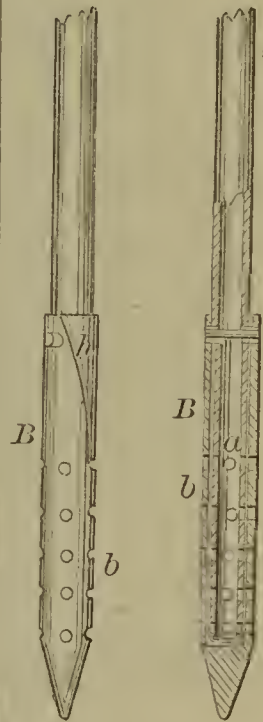

58960—A. P. Berlioz—Electro-Magnetic Engine.

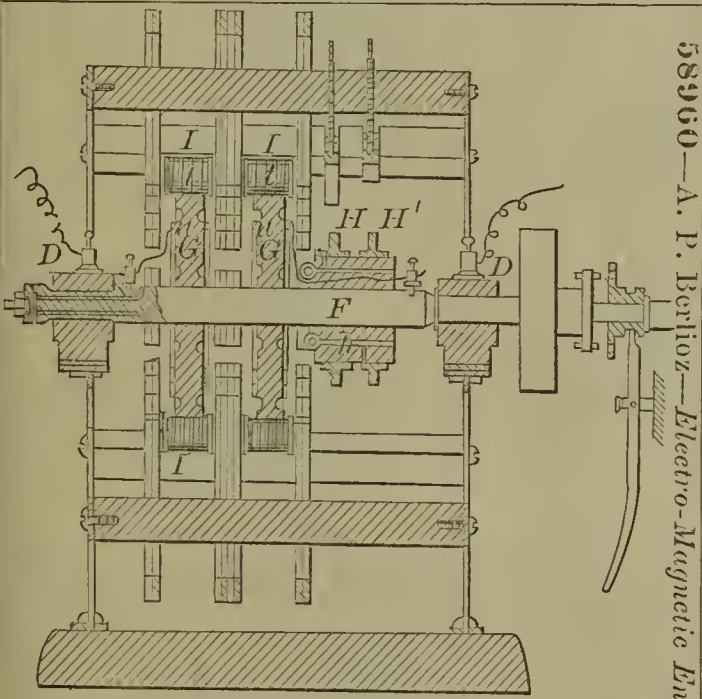

58959—H. C. Baudet—Keyed Musical Instrument.

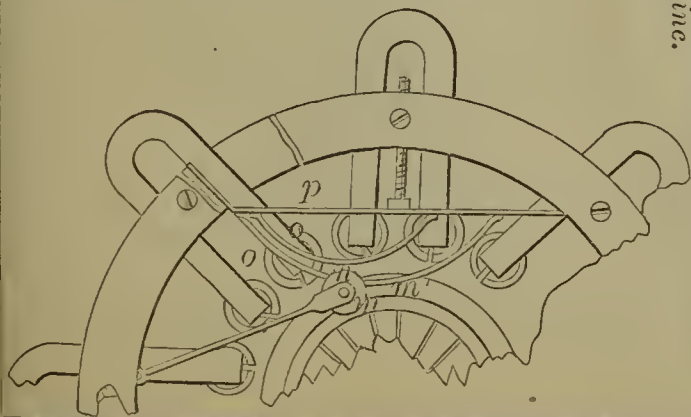
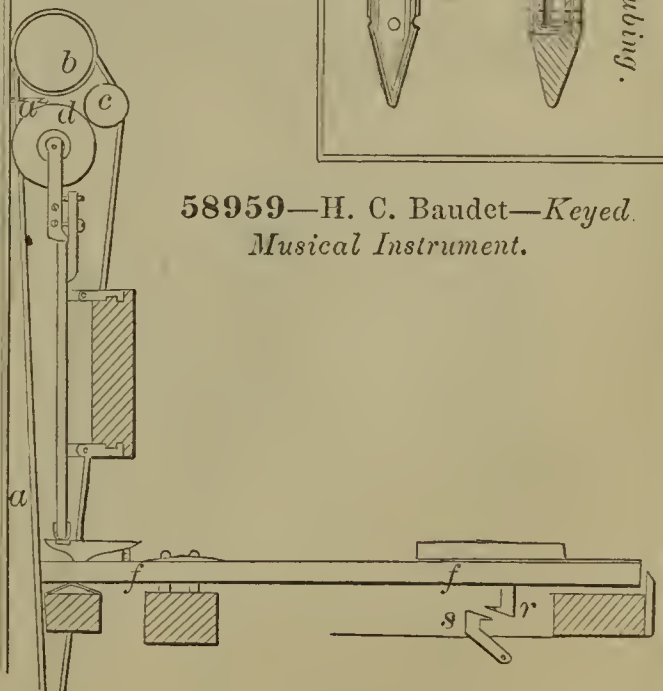

58962—W. Naylor—*Steam Safety Valve.*

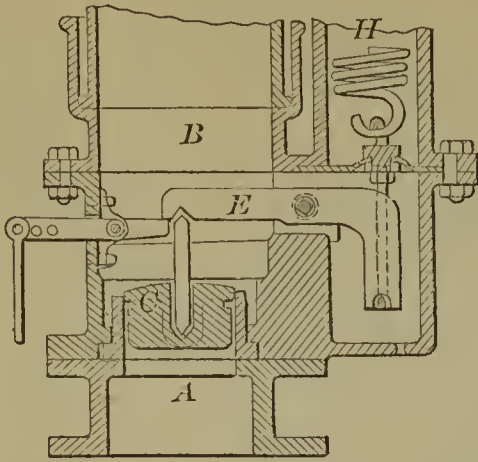

58967—W. F. Altfather—*Feed Cutter.*

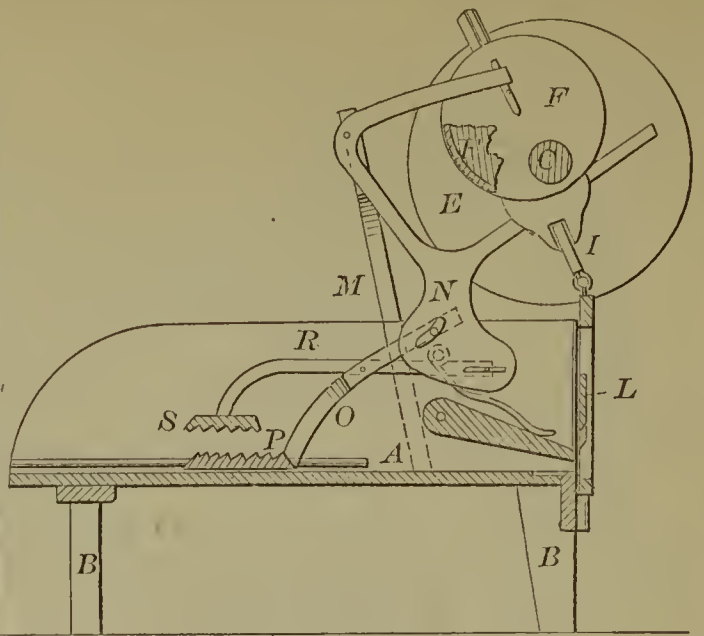

58968—W. R. Andrews—*For Operating the Harness of Looms.*

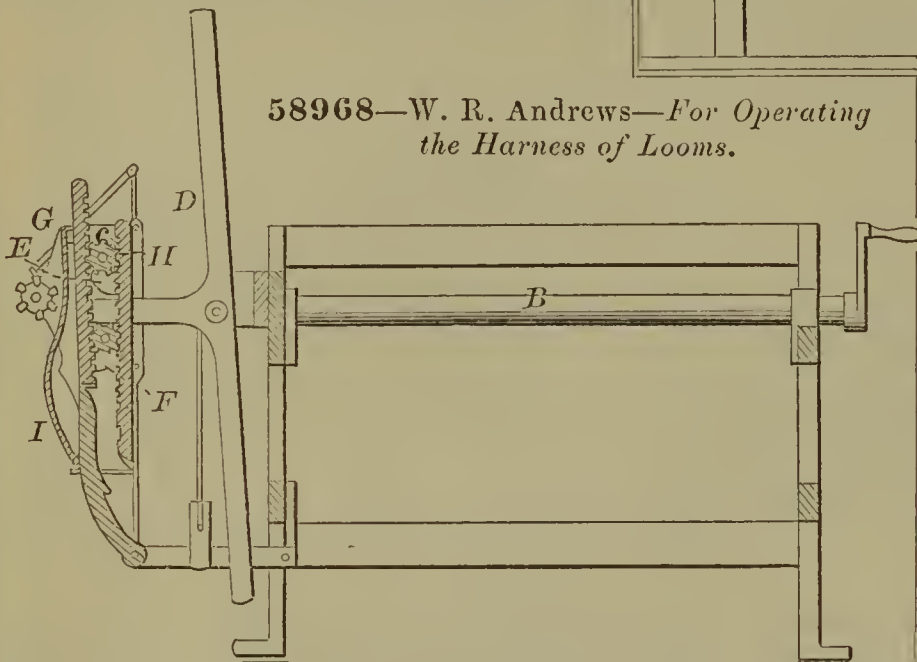

58969—J. T. Ashley—*For Extracting Corks from Bottles.*

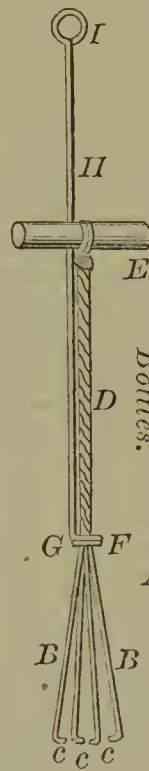

58966—S. W. Adams—*Hoe.*

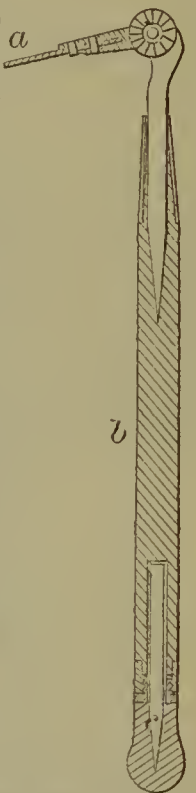

58963—Shipton & Mitchell—*For Forging Pipe Joints.*

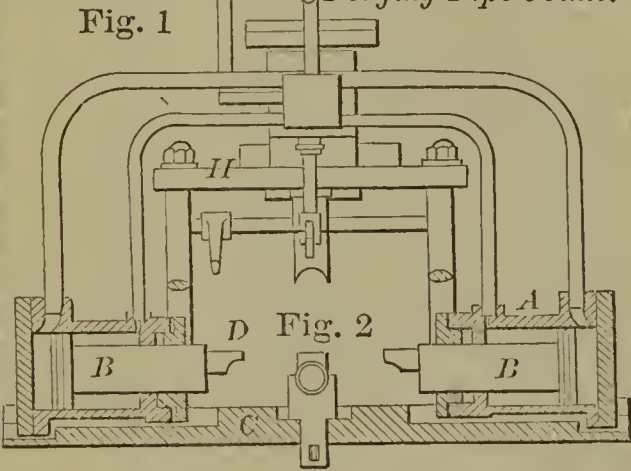

58964—J. Absterdam—*Screw.*



58965—H. Adams—*Gate.*

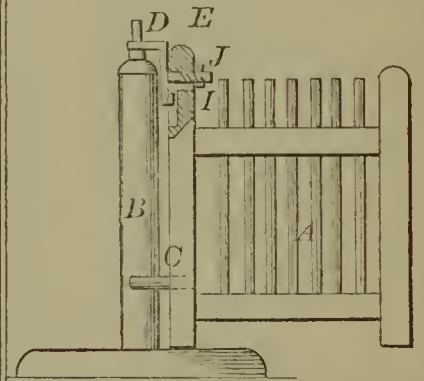
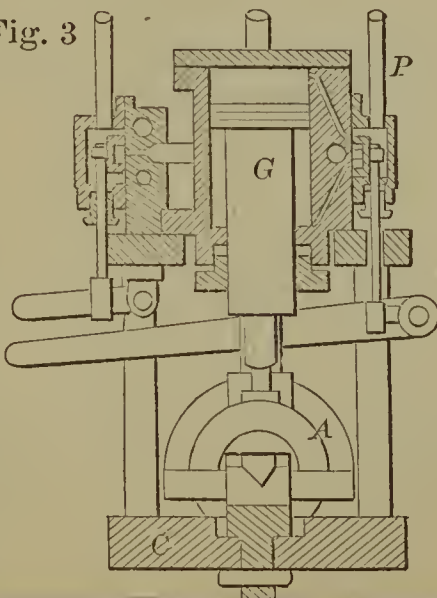
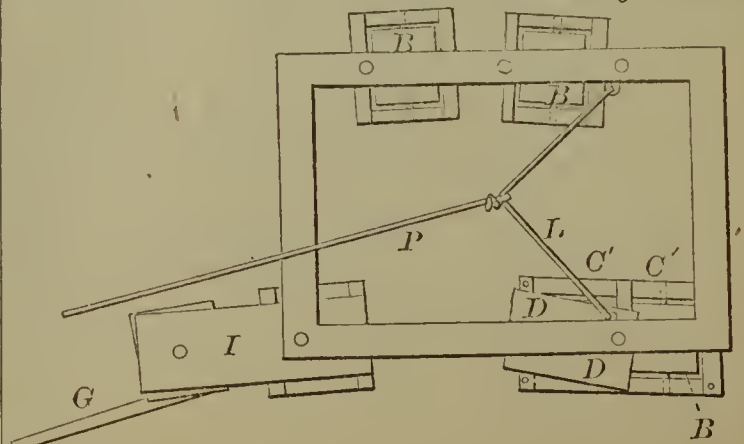

Fig. 3



58970—E. H. Avery—*For Moving Buildings.*



58971—C. F. Barager—*Butter Worker and Packer.*

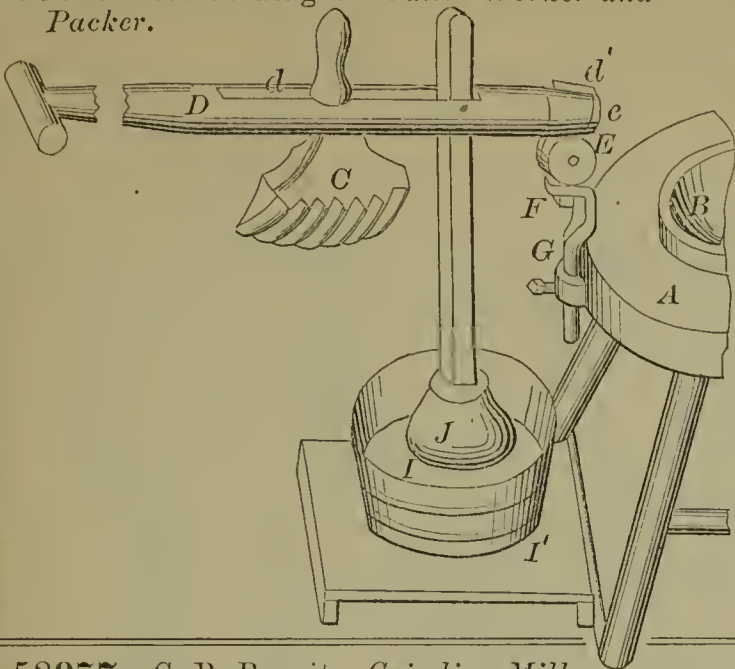

58978—C. C. Bellows—*For Creasing, Slicking and Skiving Leather.*

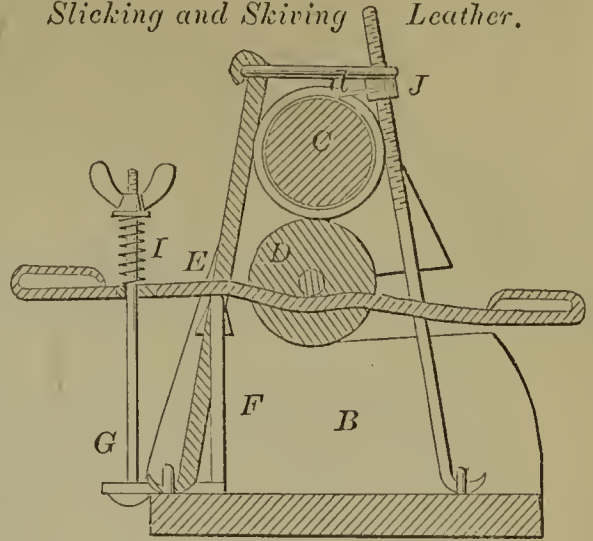

58977—C. P. Benoit—*Grinding Mill.*

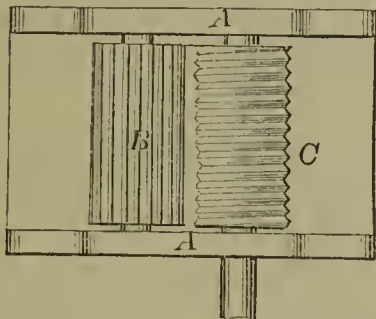

58974—J. W. Bartlett—*Straw Cutter.*

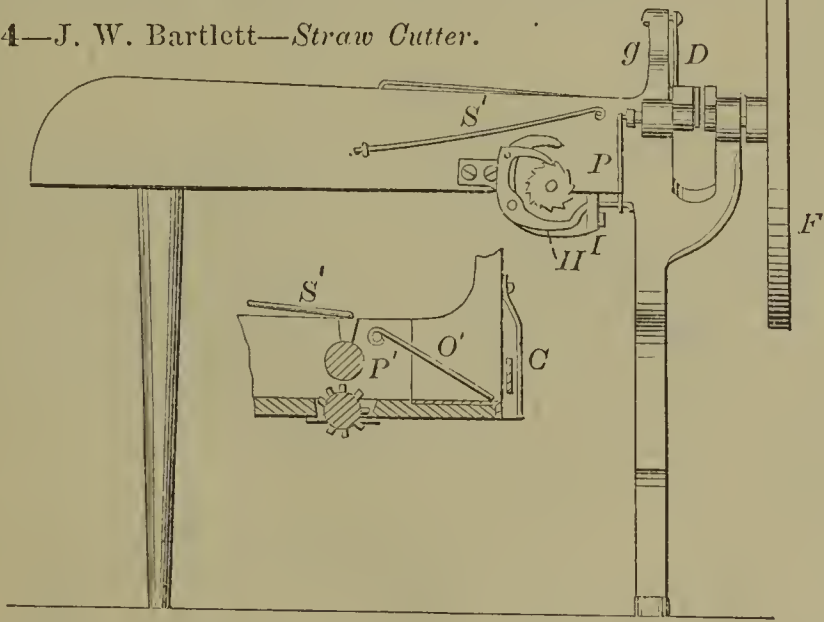

58972—A. B. Barlow—*Pump.*

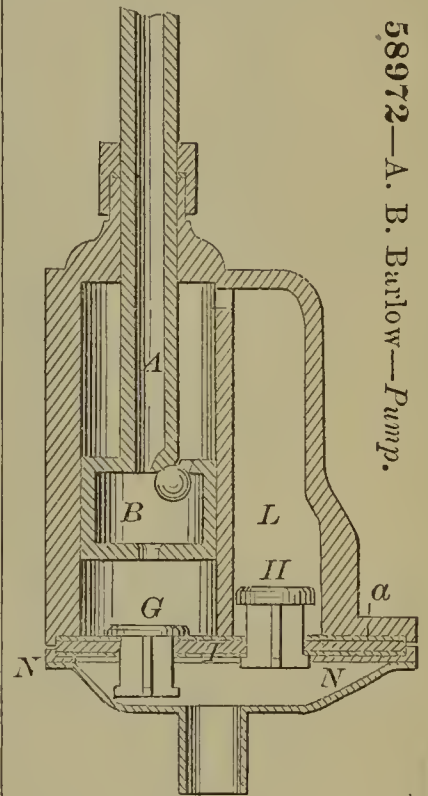

58979—J. Briggs—*Piano Stool.*

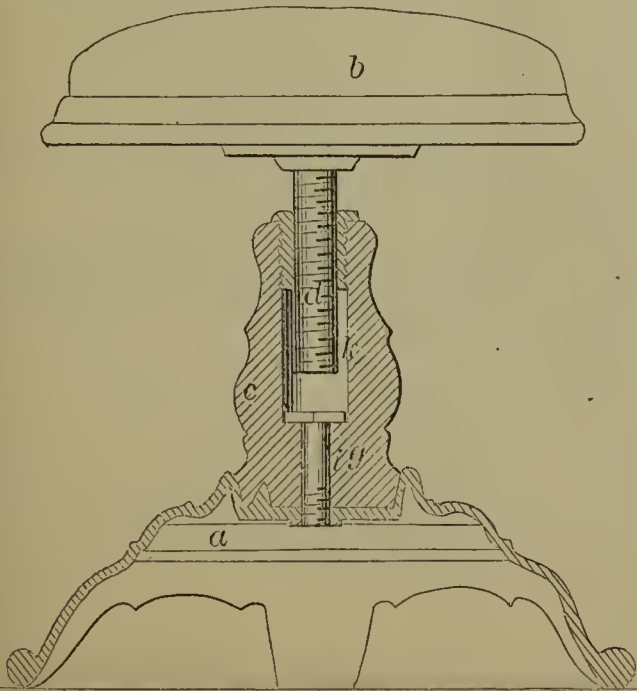

58976—M. Pratt—*Churn.*

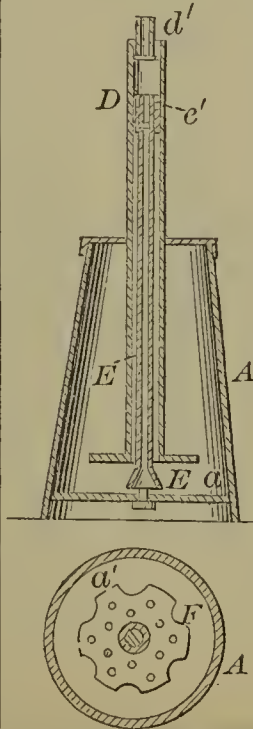

58973—P. Barnhart—*Corn Plow.*

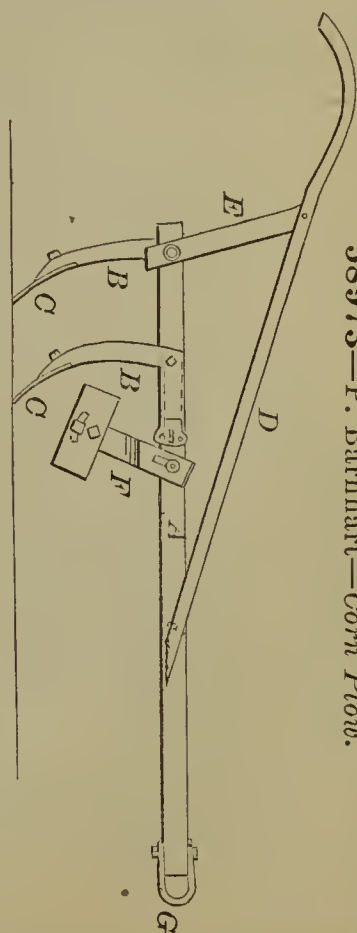

58980—R. C. Bristol—*Steam Engine Slide Valve.*

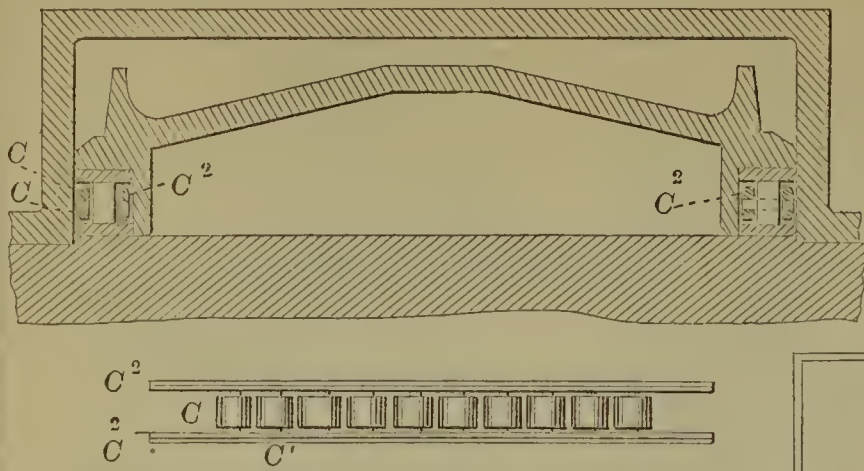

58981—E. Brown—*Amalgamator.*

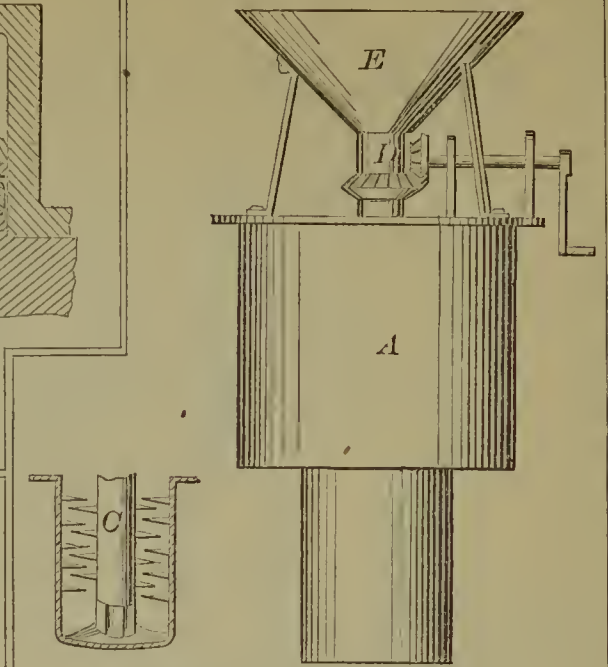

58983—J. A. Cheatham—*Farm Gate.*

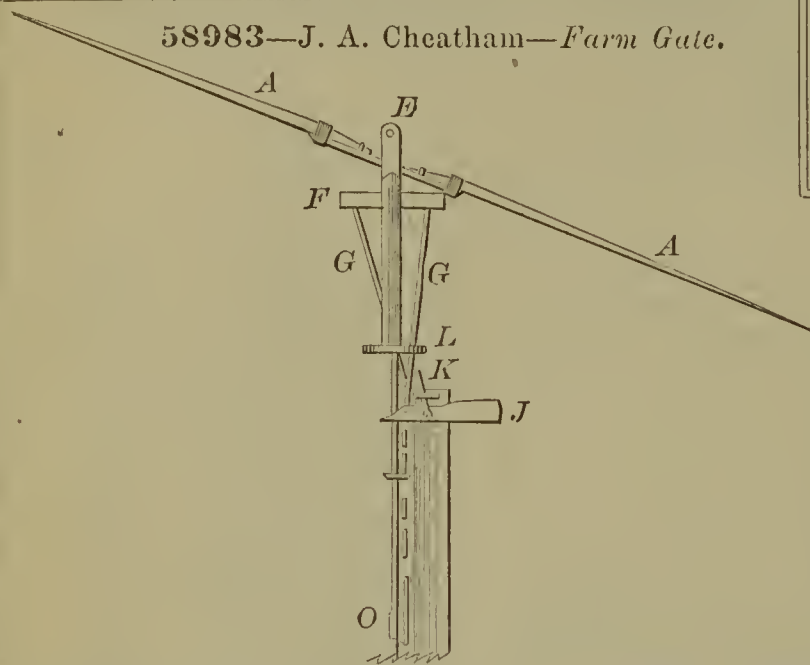

58982—Bucklin & Sutton—*Window Screen.*

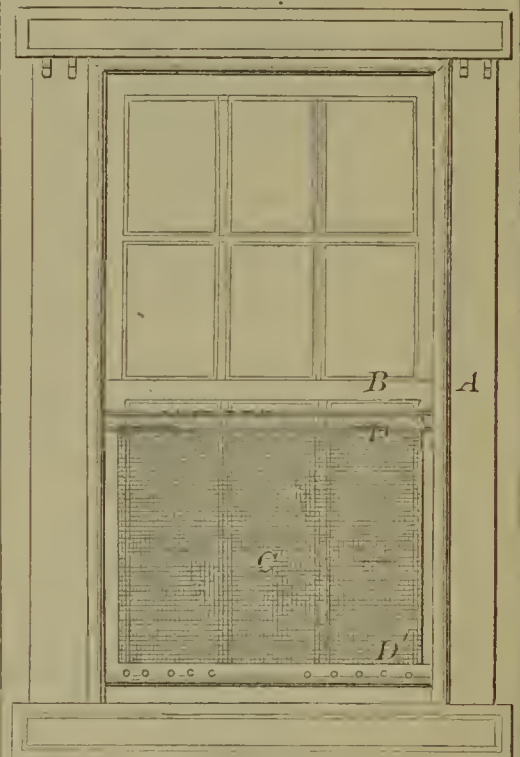

58984—G. Ckertzizza—*Ladder.*

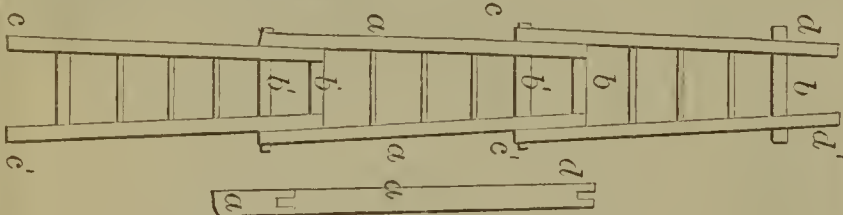

58986—W. Colwell—*Corn Sheller.*

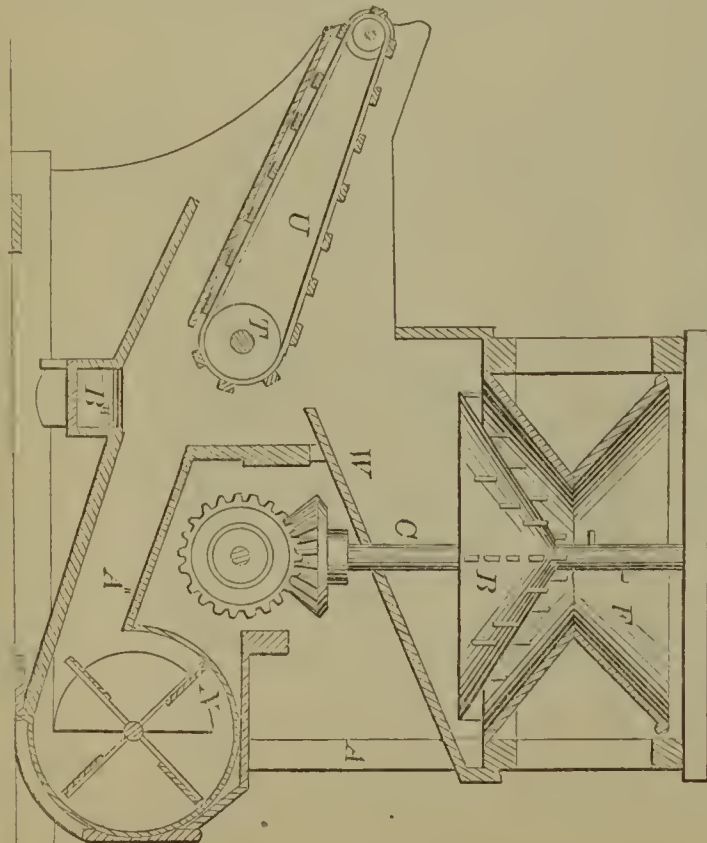

58985—P. Clark—*Fan Blower.*

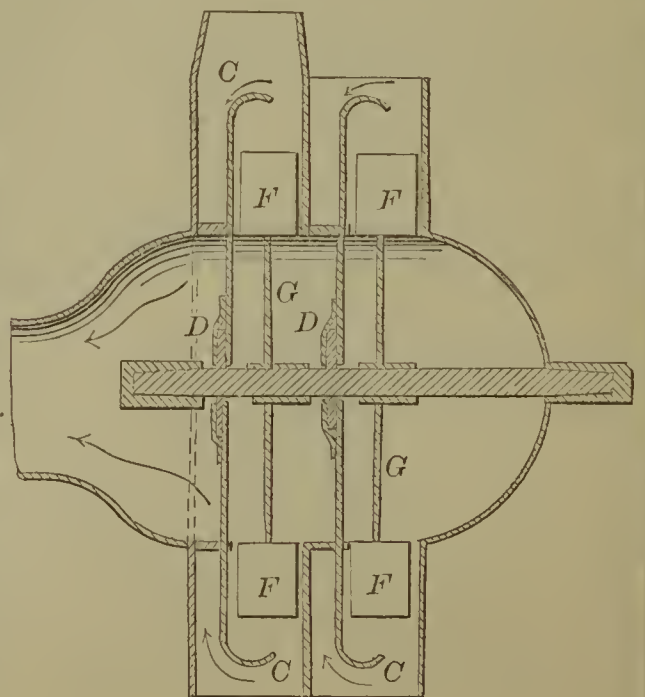

58987—Coppin & Clemens—*Safety Valve.*

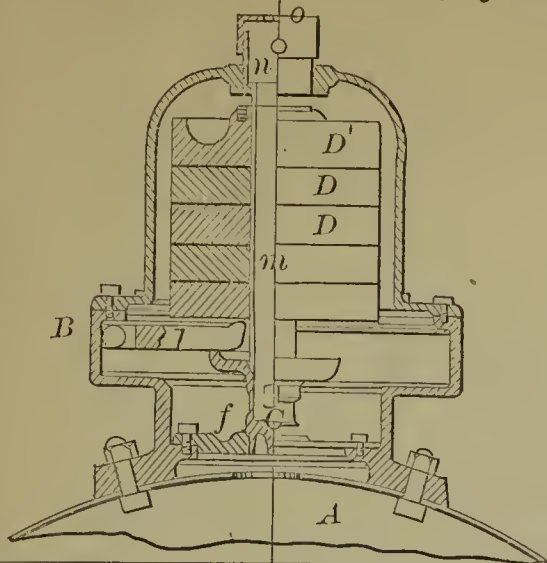

58995—E. Dinter—*Table.*

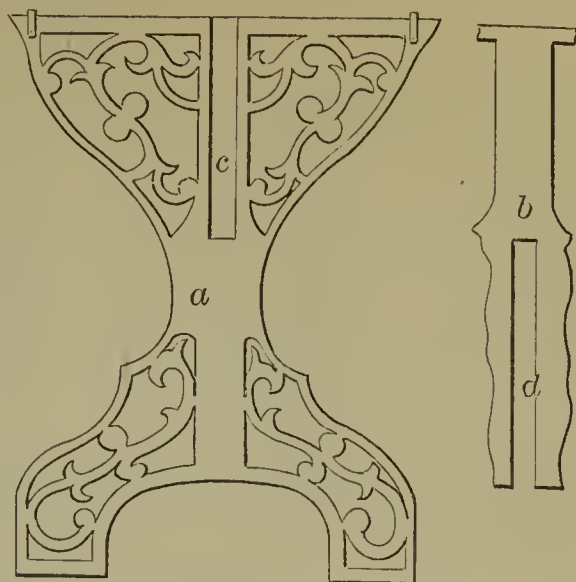

58988—W. H. Cox—*Corn Planter.*

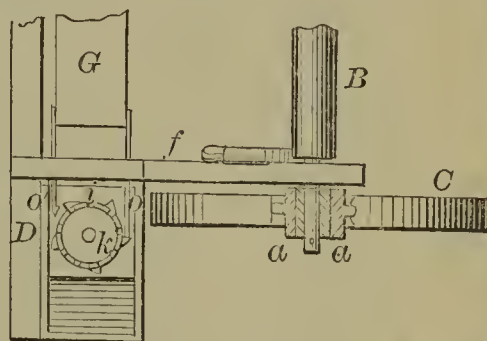
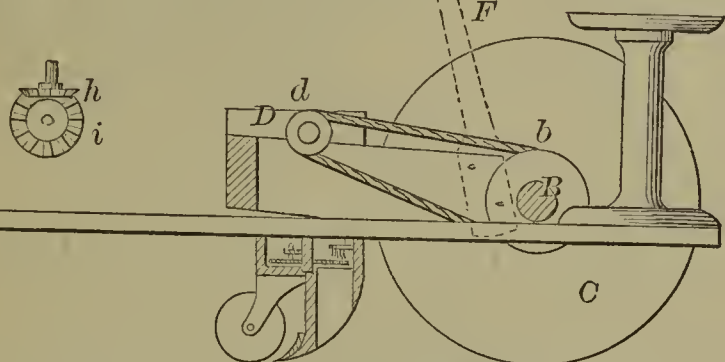

58989—Crockett & Mills—*For Stripping Top Flats of Carding Engines.*

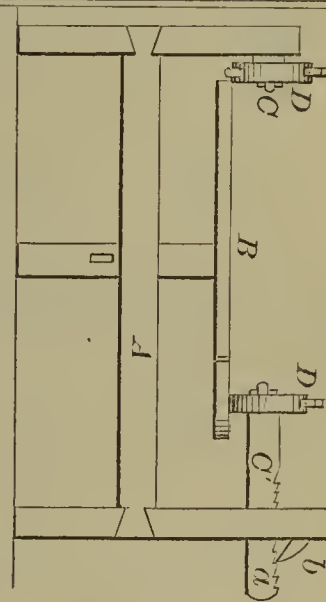
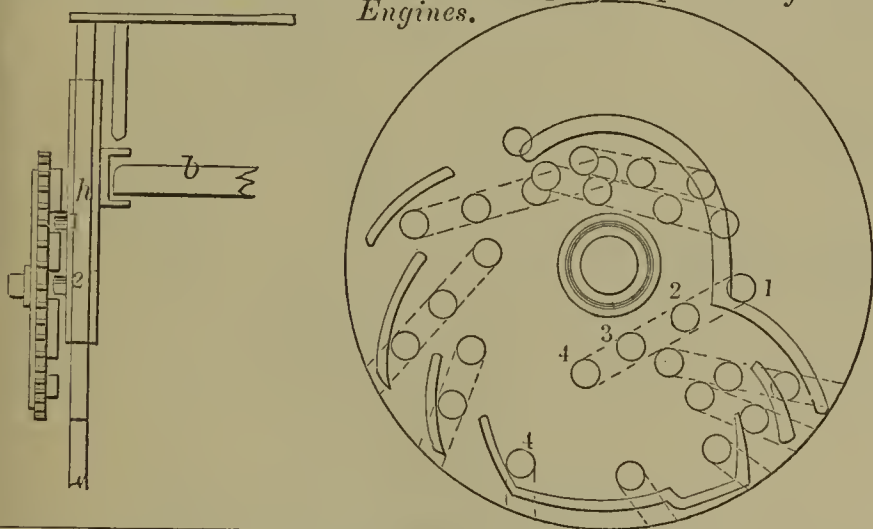

58991—A. M. Culver—*Table and Holder for Shearing Sheep.*

58992—P. E. Cummings—*Knife Carrier.*

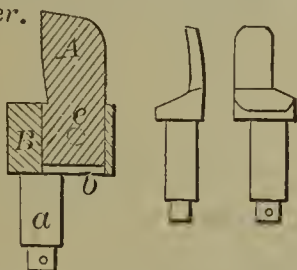

58994—G. B. & C. B. Davis—*Bed Bottom.*

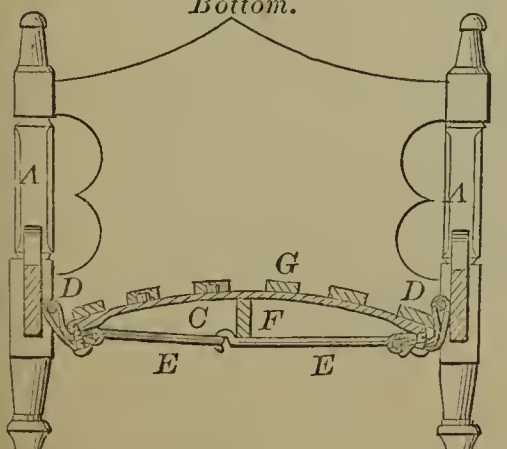

58993—O. Dann—*Hand Seed Sower.*

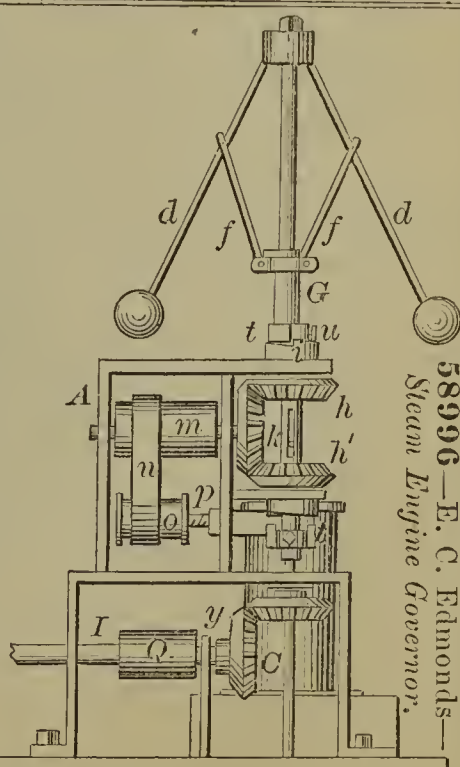
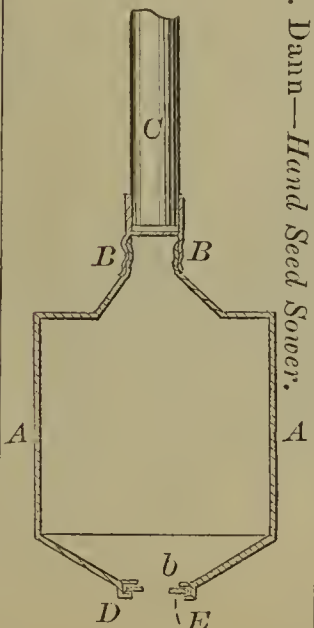

58996—E. C. Edmonds—*Steam Engine Governor.*

58998—H. S. Fisher—*Seal for Cans.*

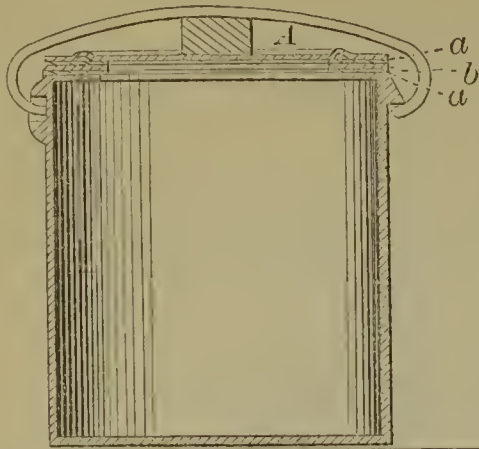

58999—F. G. Ford—*Furniture Caster.*

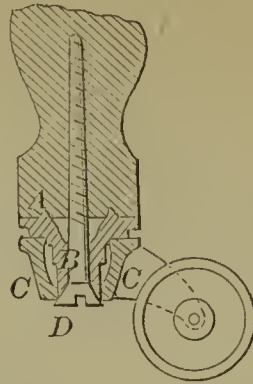

59000—T. F. Frank—*For Inhaling Gas.*

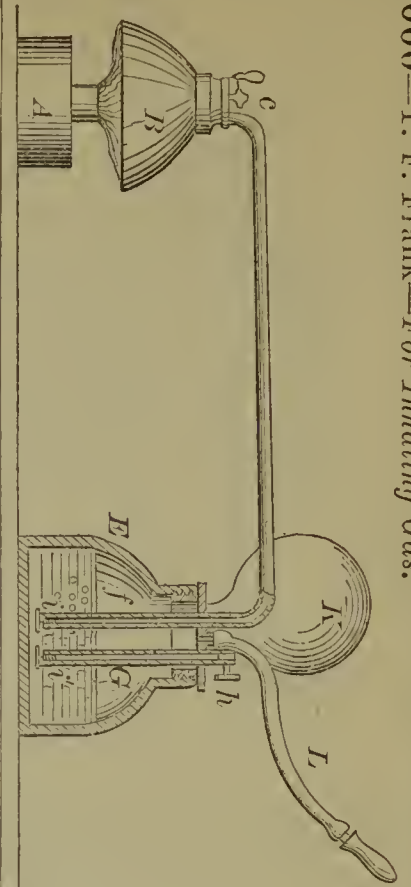

59001—C. R. Frink—*Hay Spreader.*

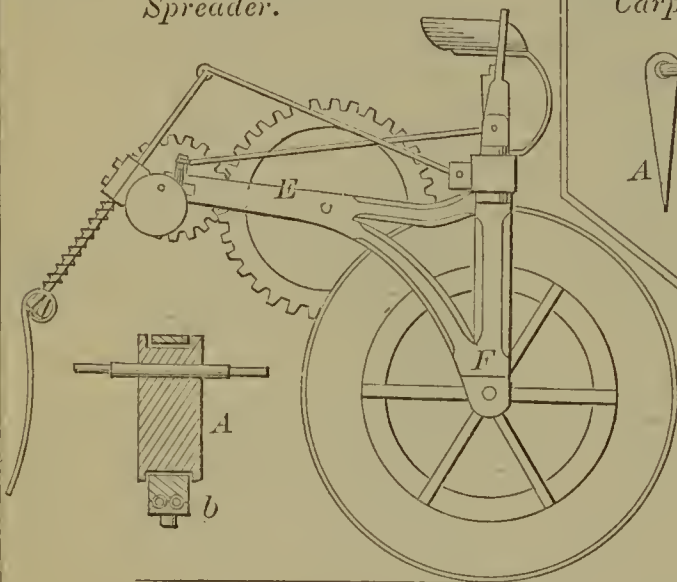

59002—R. A. Gawler—*Carpet Fastener.*

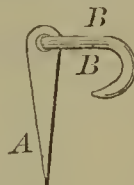

59006—J. B. Gridley—*Brick Machine.*

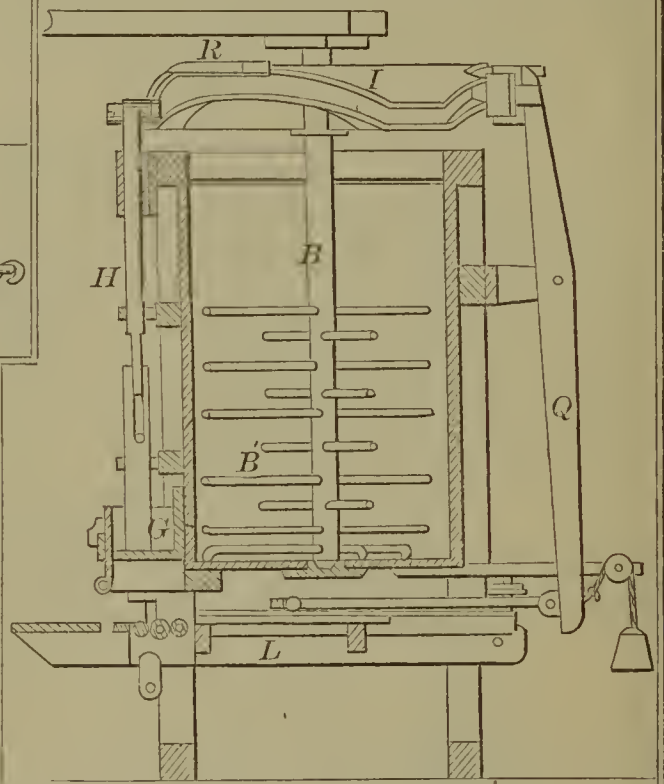

59003—W. O. Gibson—*Cultivator Plow.*

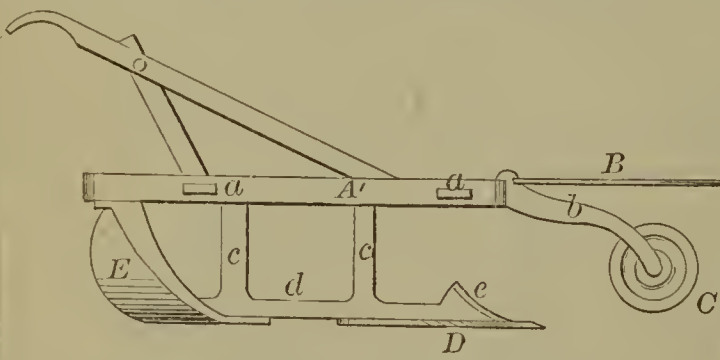

59005—J. J. Green—*Washing Machine.*

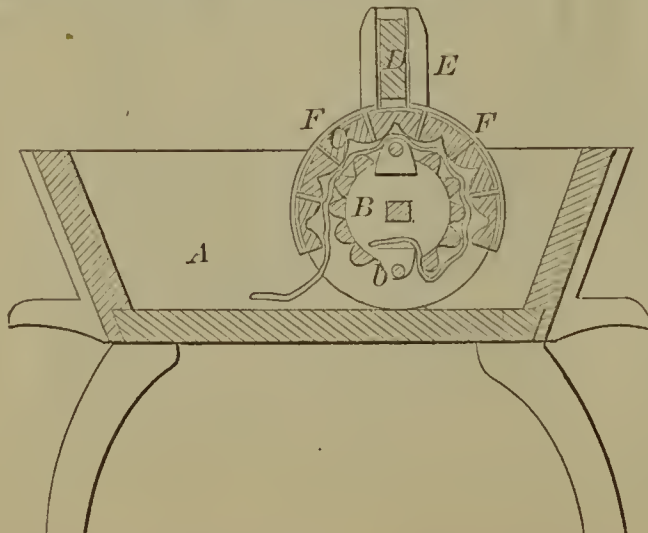

59007—J. H. Gridley—*Cotton Bale Tie.*

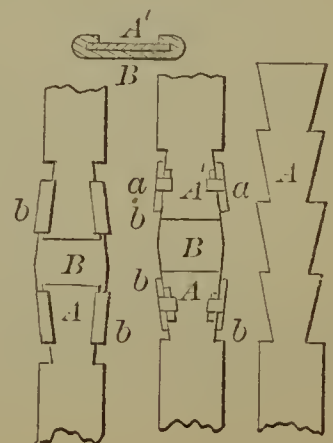



59008—J. F. Hammond—*Carriage Jack.*

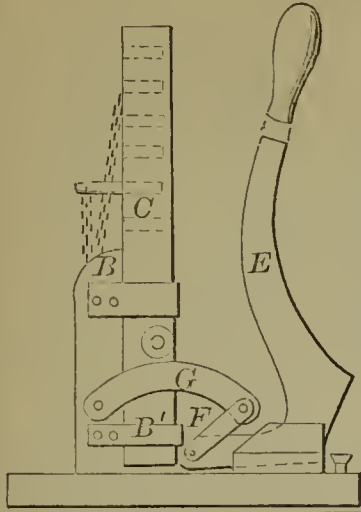

59009—B. Handforth—*Curtain Fixture.*

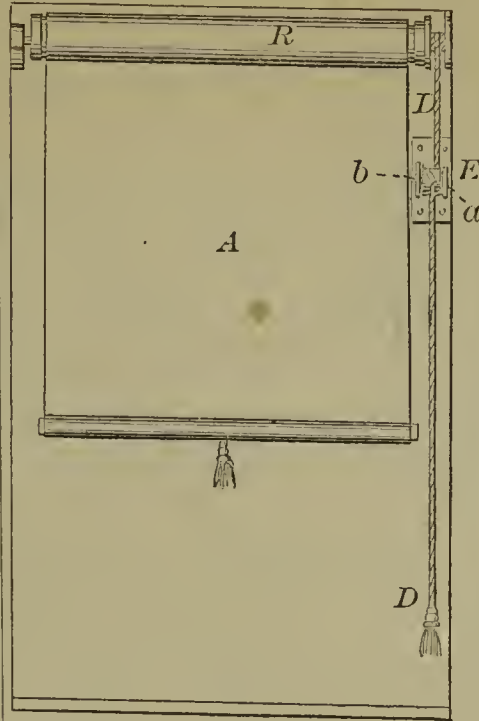

59010—J. Harris—*Plow.*

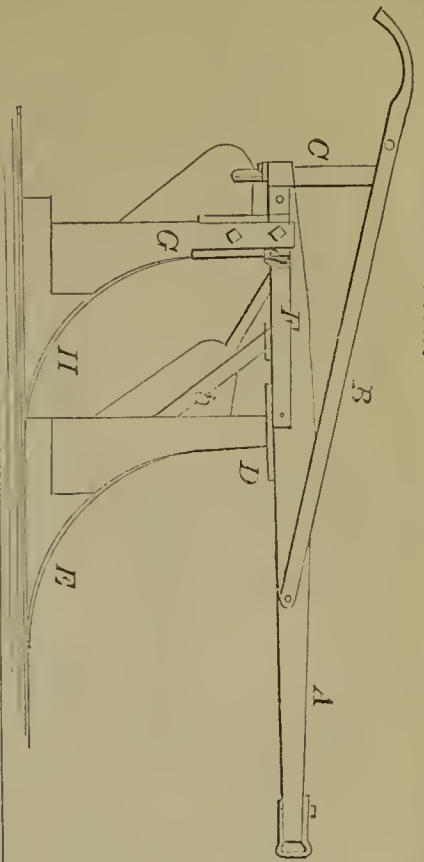

59013—J. B. Herr—*Cultivator.*

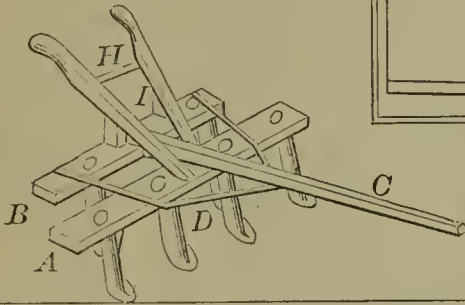

59014—A. V. Heyden—*For Shifting Carriage Tops.*

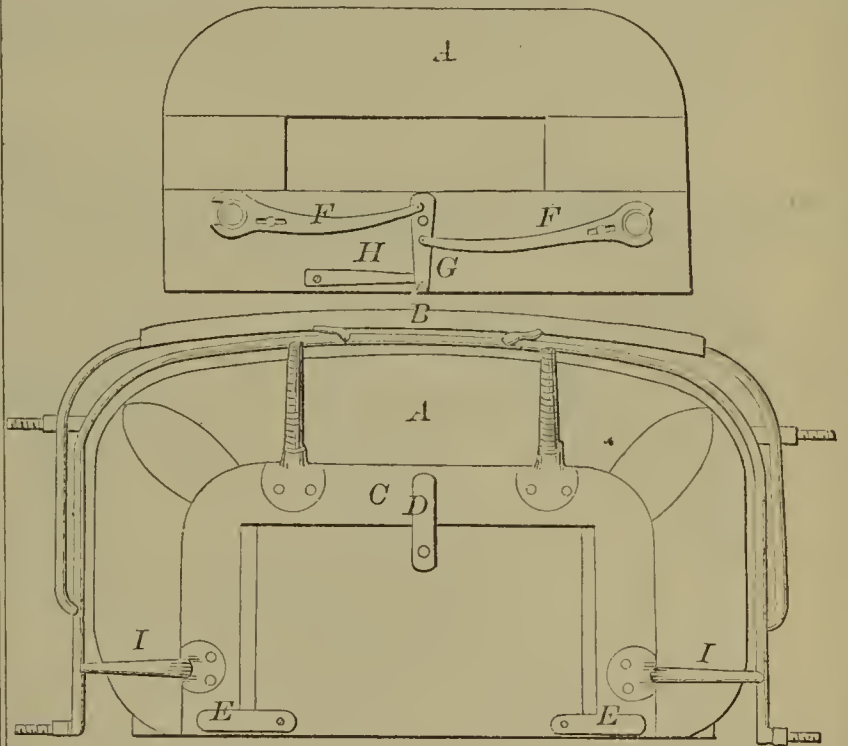

59011—J. Harris—*Broom Head.*

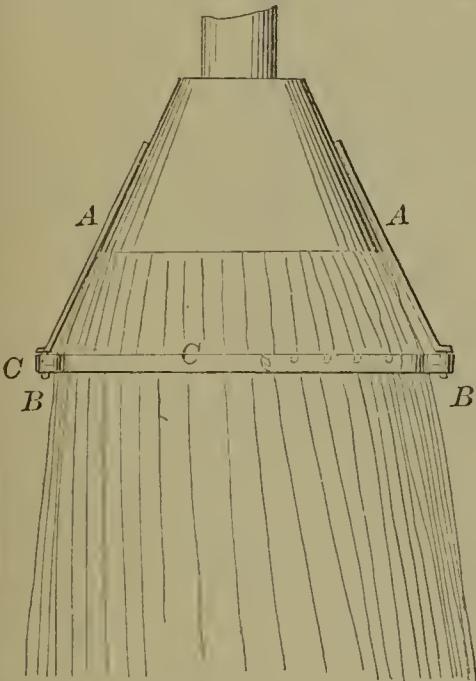

59012—J. B. Herman—*Cultivator.*

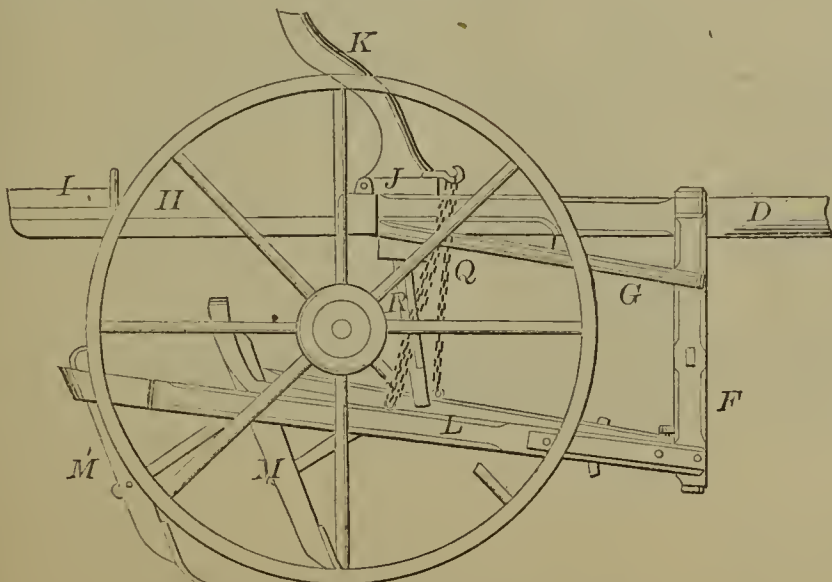

59015—L. F. Hildebrand—*For Cutting Tobacco.*

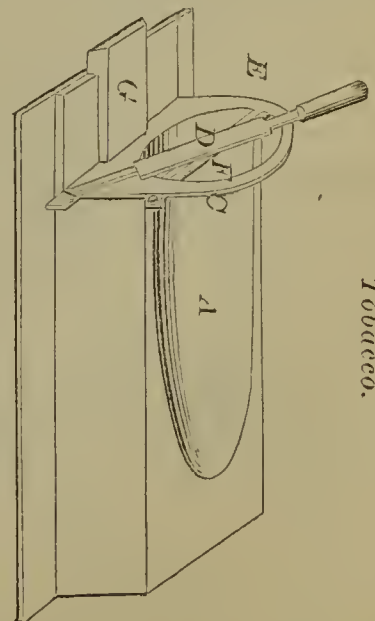

59016—W. Hinds—*Horse Shoe.*

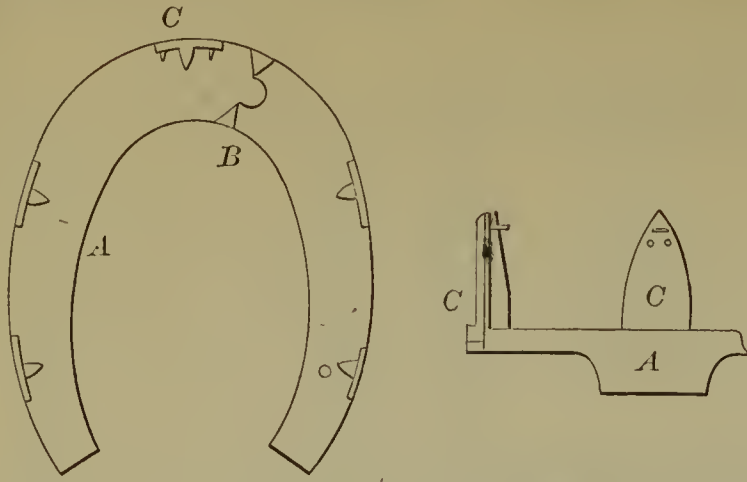

59021—J. S. Howard—*Car Truck.*

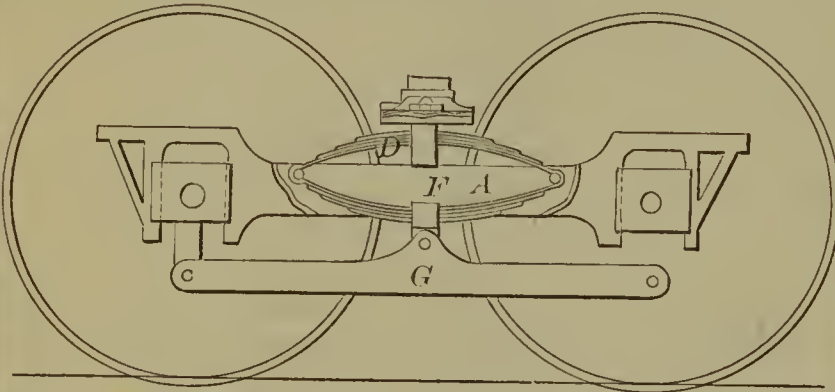

59017—C. Hingher—*Tobacco Pipe Stem.*

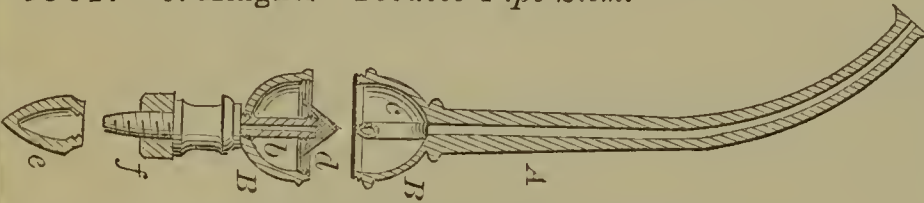

59019—H. Hodgson—*Hat Protector.*

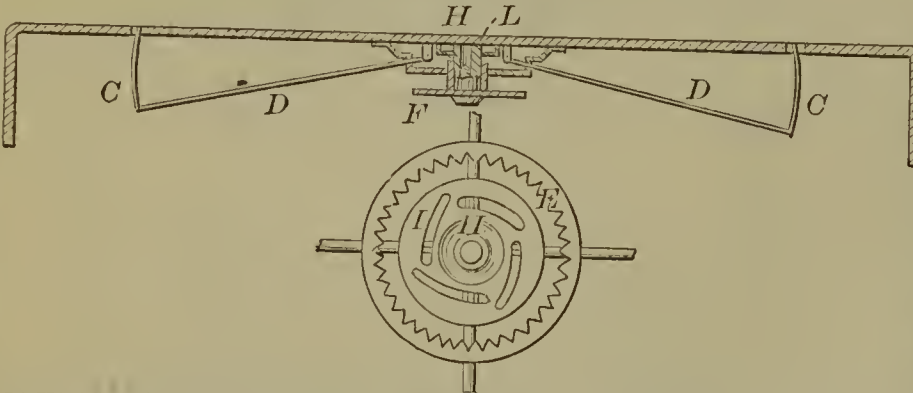

59022—R. C. Howard—*Corn Plow.*

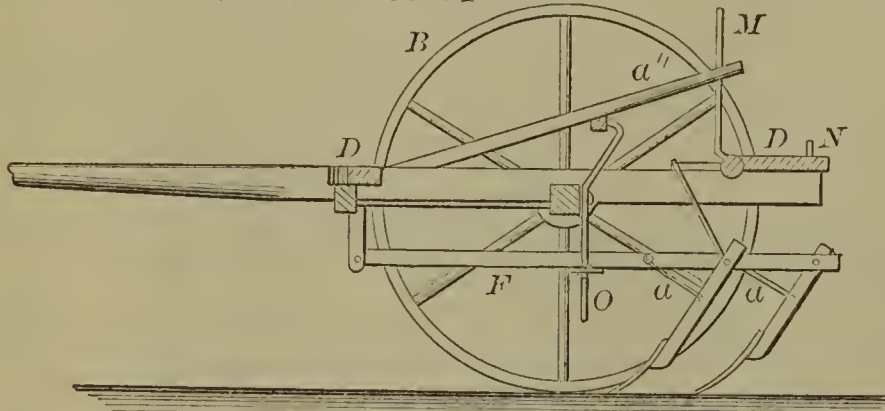

59023—W. Hunter—*Fence Post.*



59018—N. D. Hinman—*Hay Elevator and Conveyor.*

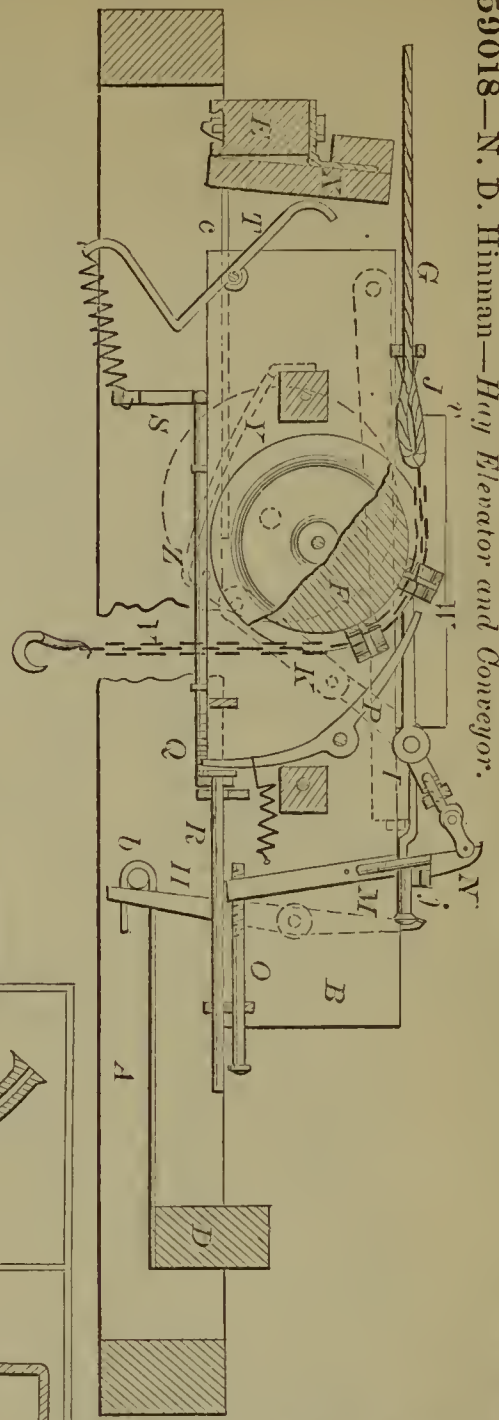

59020—P. Hoelzel—*Steam Generator.*

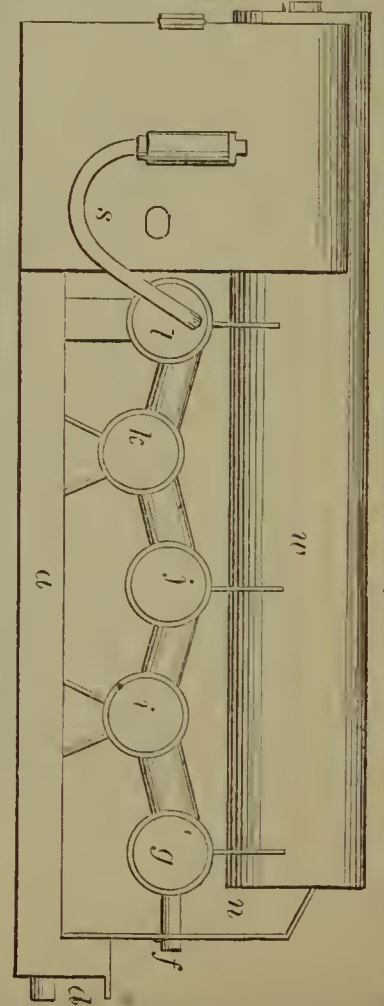

59024—D. Hussey—*Let-off for Looms.*

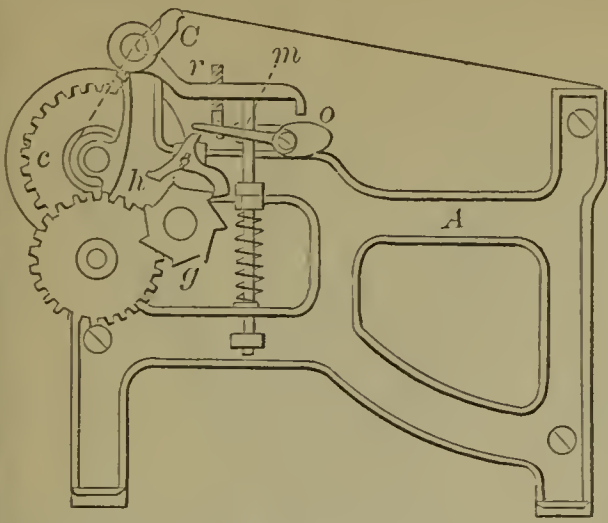

59026—B. S. Hyers—*Sash Fastening.*

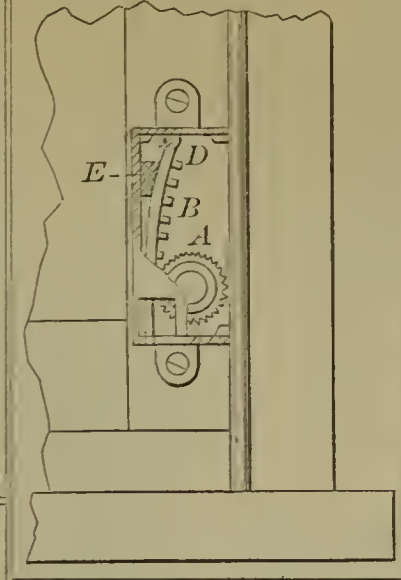

59025—I. Hutchins, Jr.—*Fumigator.*

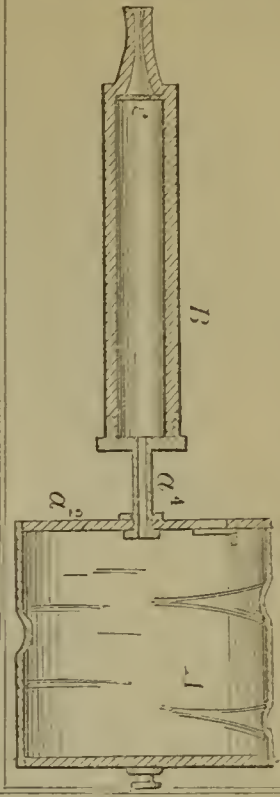

59028—H. C. Ingraham—

*Ditching Machine.*

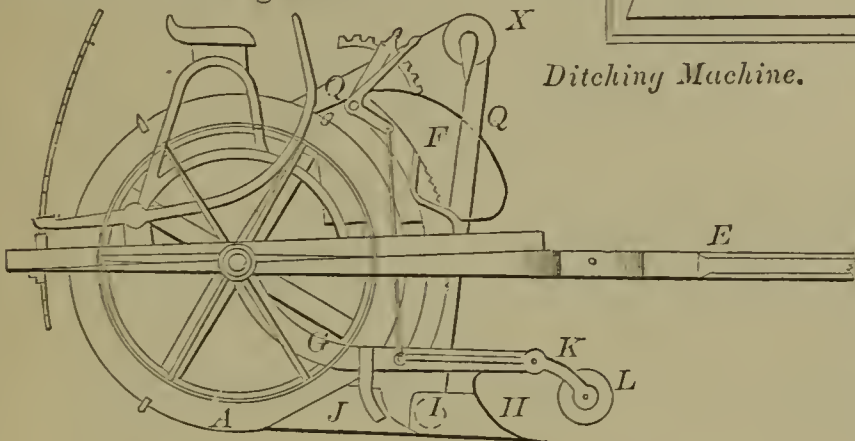

59027—G. W. Ingalls—*Reed Plate for Melodeons, &c.*

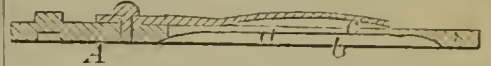

59030—D. L. Jaques—*Pump.*

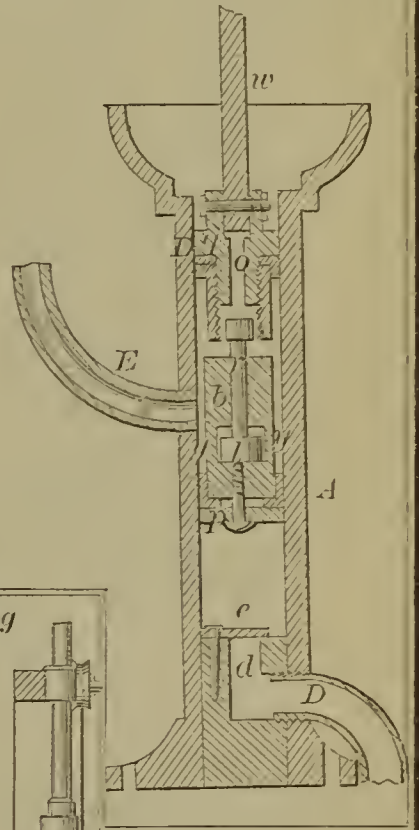

59029—A. Ivers—*Cistern for Water Closets, Urinals, &c.*

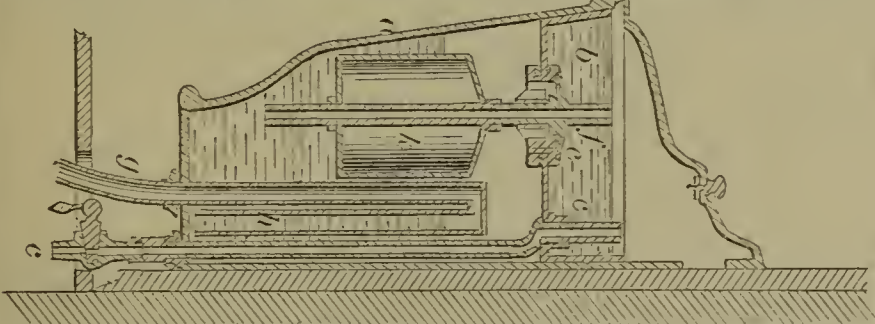

59031—Johnson & Murkland—*For Moulding, Felting and Fulling Hat Bodies.*

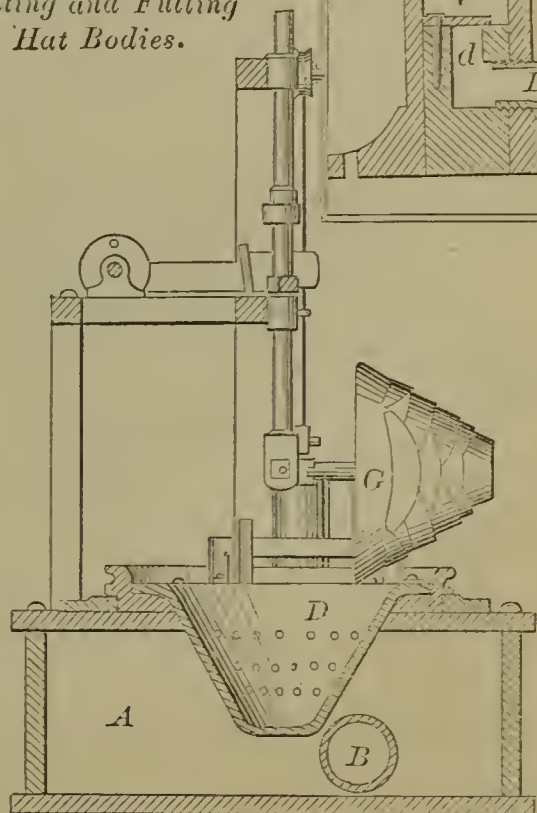
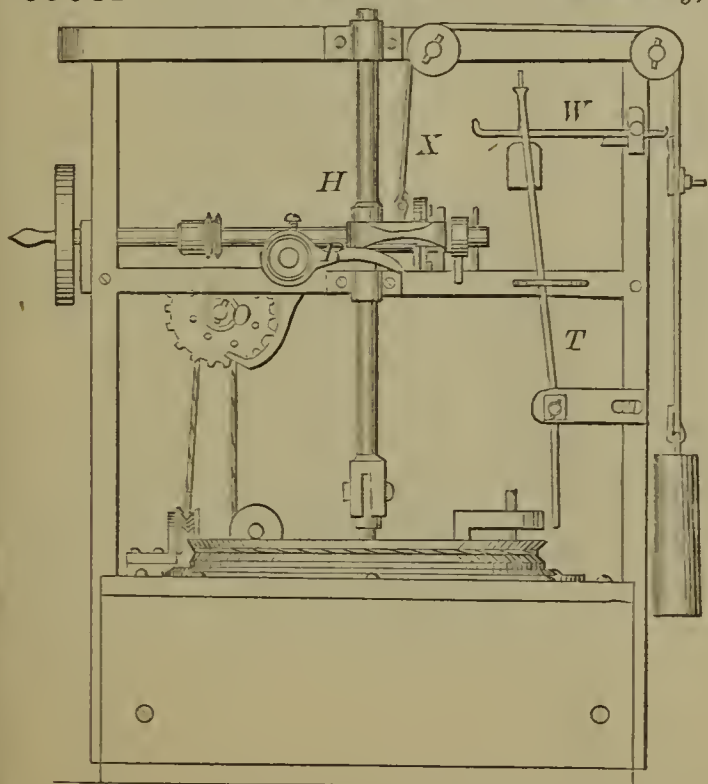

59032—E. B. Jucket—Fly Wheel and Crank Shaft.

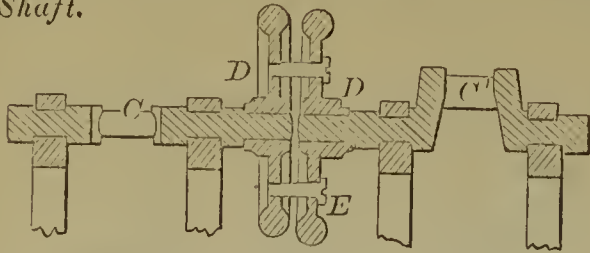

59034—W. E. Keene—Measuring Funnel.

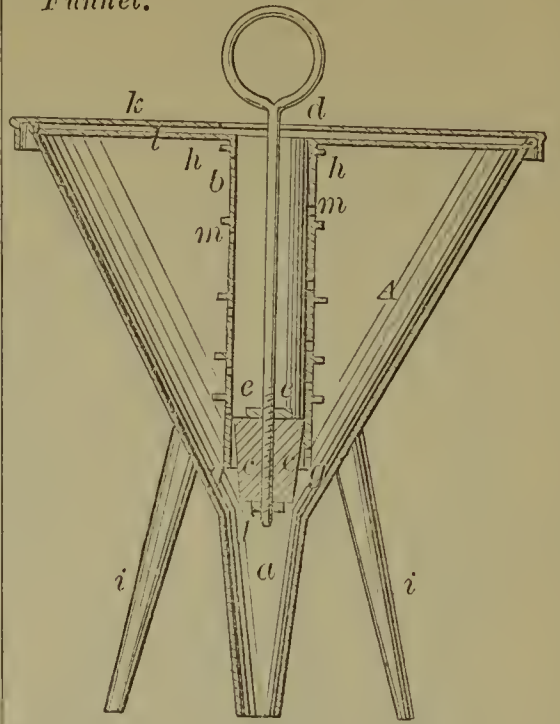

59035—W. Kegg—Cattle Gag.

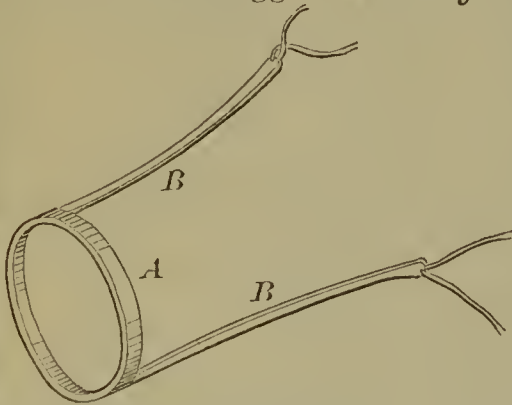

59037—A. P. Kinney—Spindle Step.

59033—H. Kauffman—Horse Hay Fork.

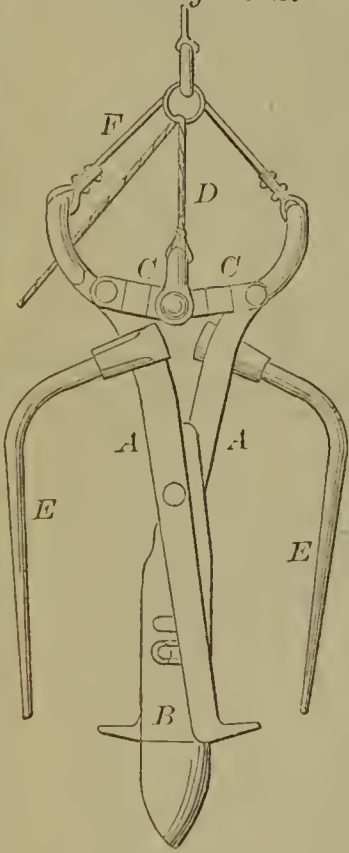

59039—Lanchart & King—For Washing Sand.

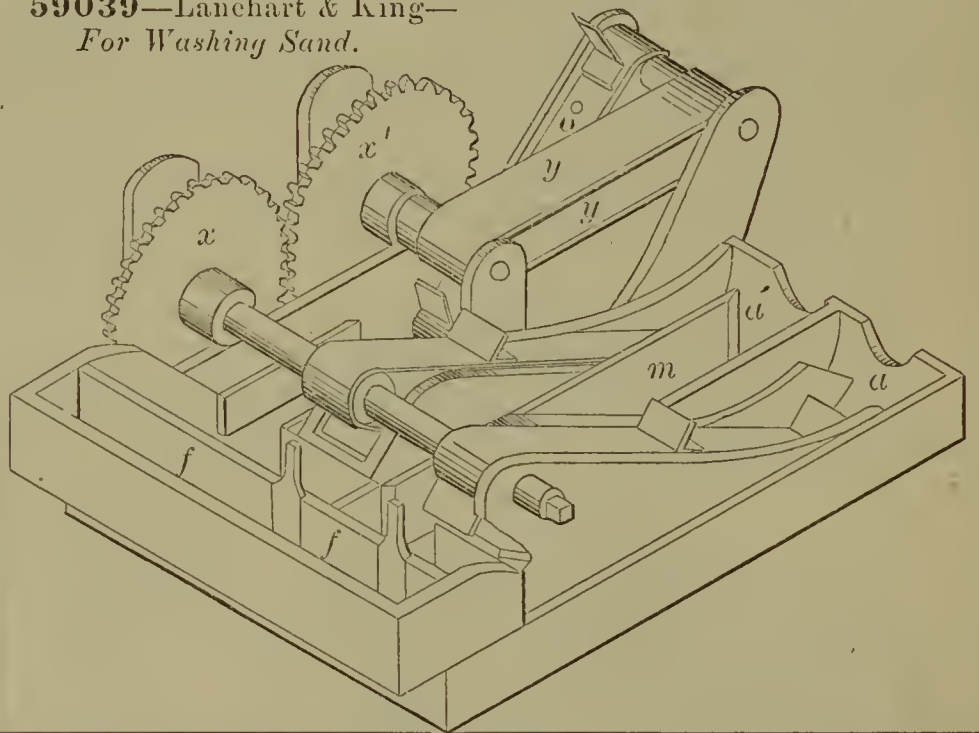

59040—Lindsay & Moses—Hook Pin for Fastening Wearing Apparel.

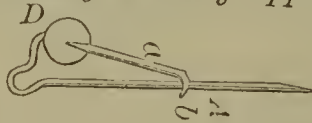

59036—G. E. King—Fluted Puffing for Shirt Bosoms.

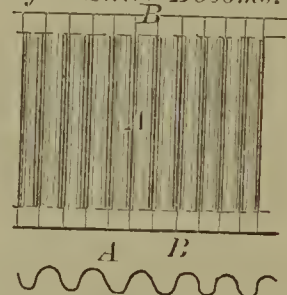

59038—J. Lamb—Washing and Wringing Machine.

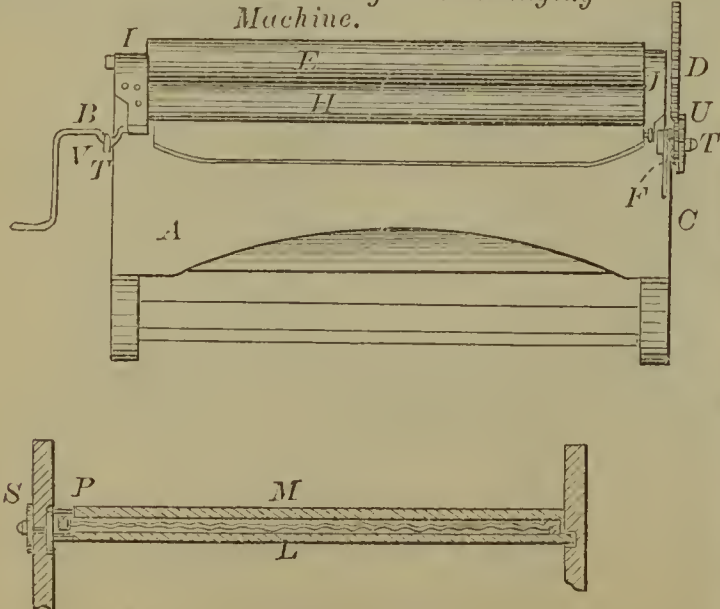

59041—J. S. Lash—Clothes Wringer.

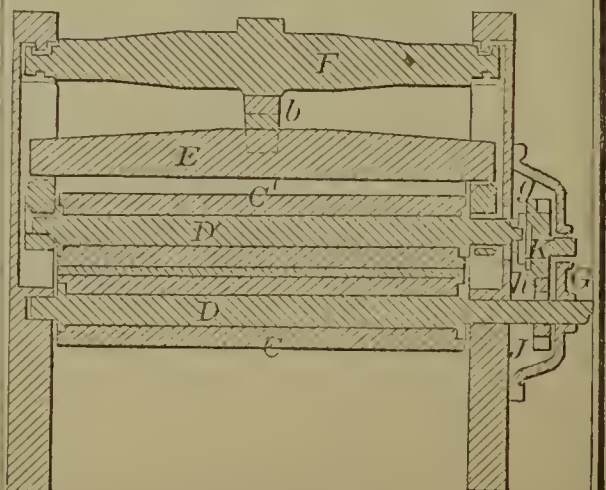

59042—H. & F. Marx—For Making Paper Pulp

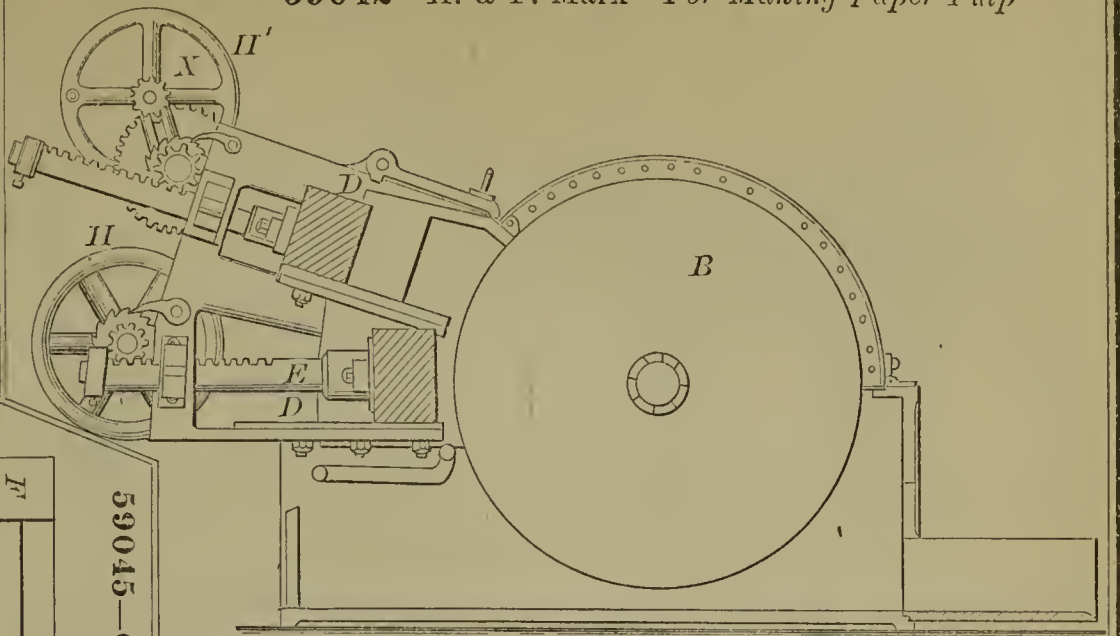

59044—E. Maynard—For Priming Metallic Cartridges.

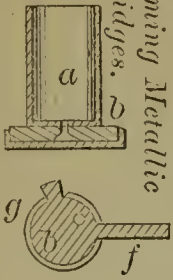

59043—J. Massey—Feed Cutter.

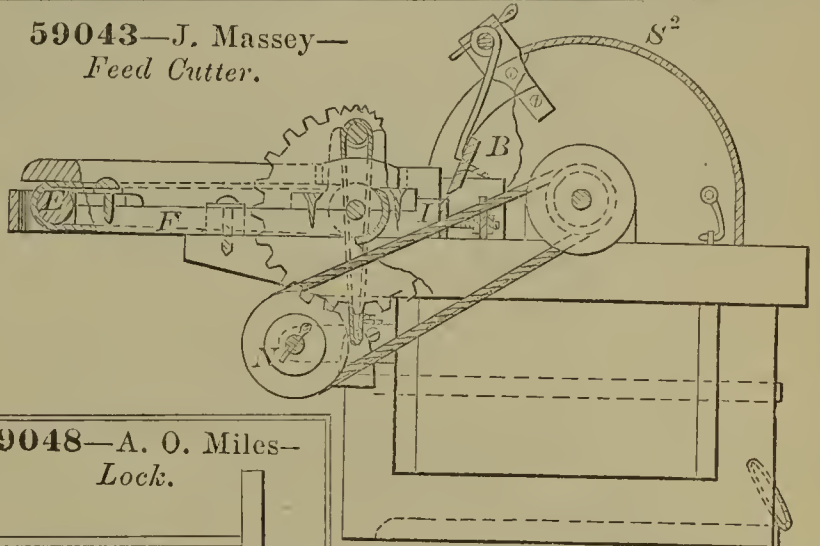

59045—O. C. McCarty—Gate.

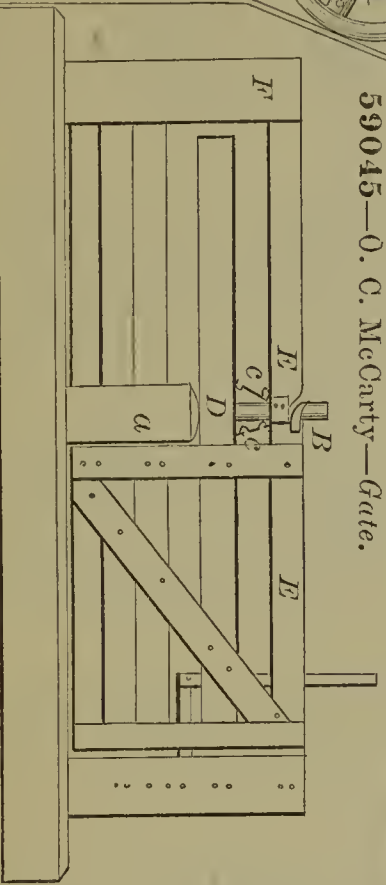

59048—A. O. Miles—Lock.

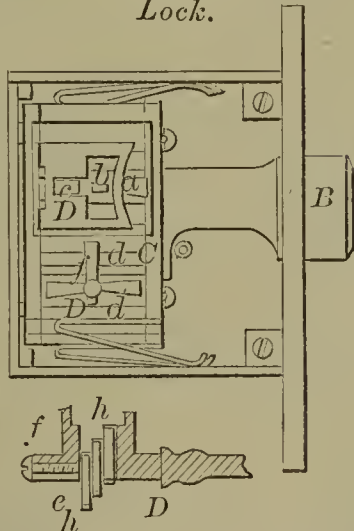

59046—J. A. McKinstry—Miter Box.

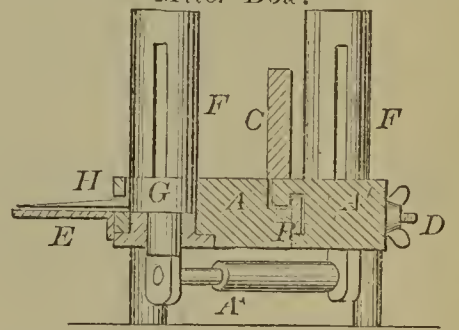

59047—C. H. Merry—For Discharging Grain from Vessels.

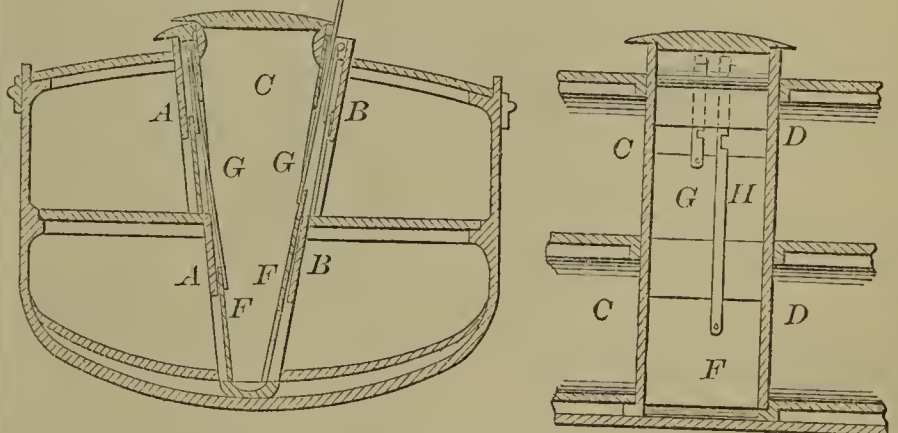

59050—W. H. Miller—Rake and Spade.

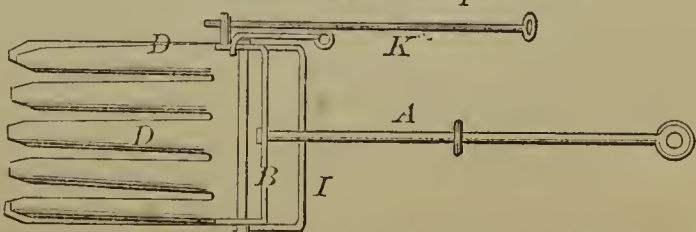

59049—A. Miller—Mole Plow.

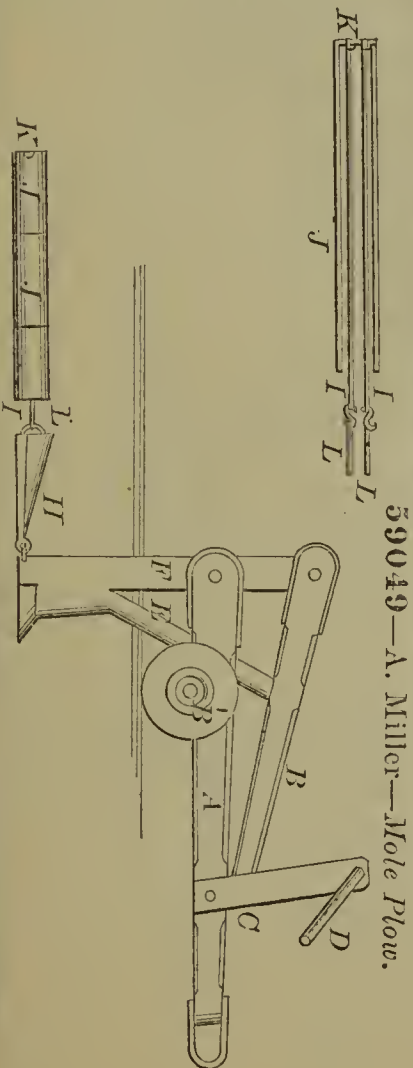

59051—T. Mitchell—Steam Generator.

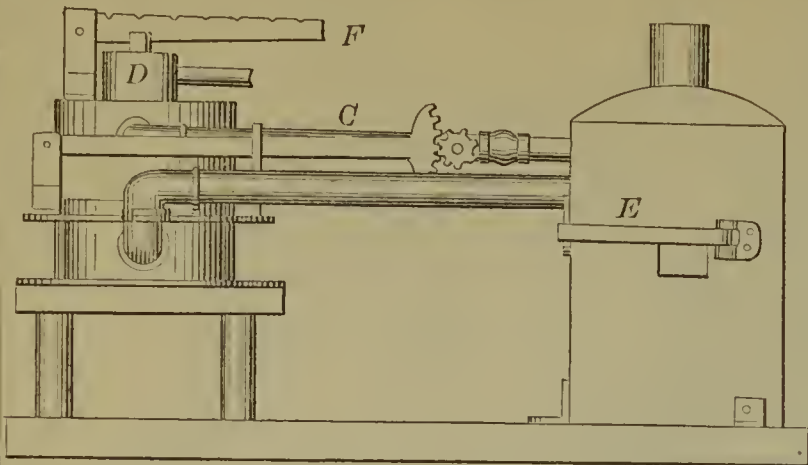

59057—G. Nimms—Stove Grate.

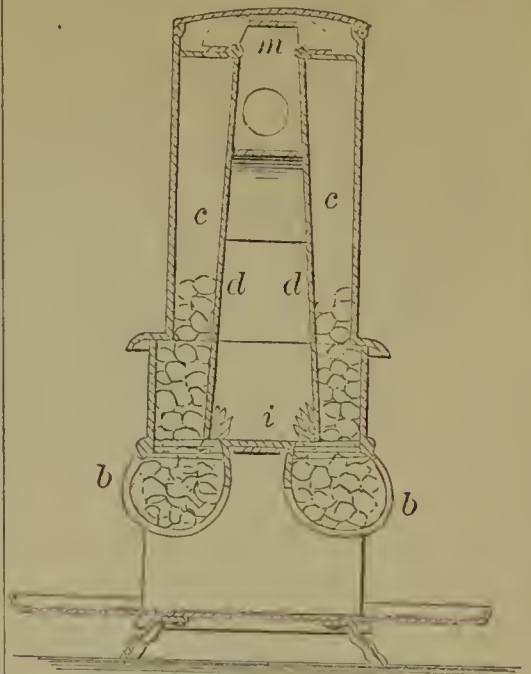

59053—J. B. Morrison—Three Horse Splinter Bar.

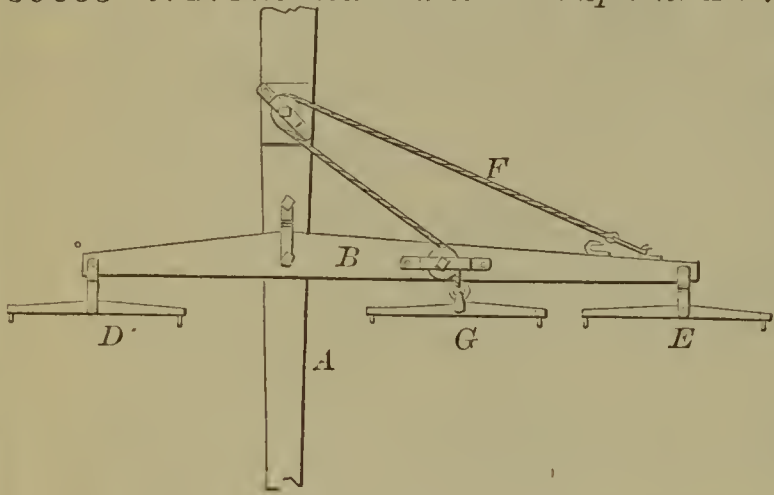

59056—R. Nickson—Carriage Top Protector.



59054—T. W. H. Moseley—Bridge.

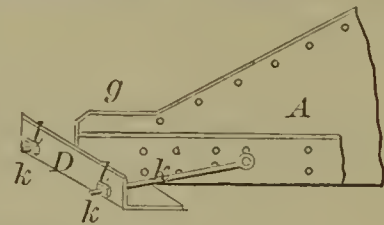
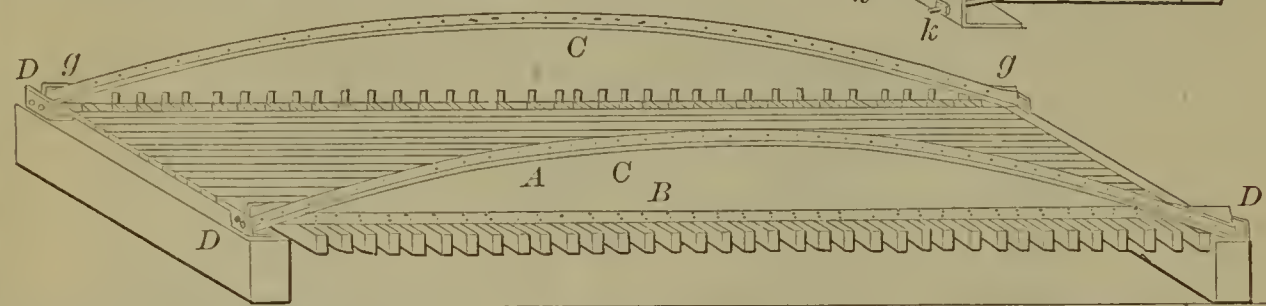

59055—D. M. Nichols—Steam Jet for Steam Generator Furnaces.

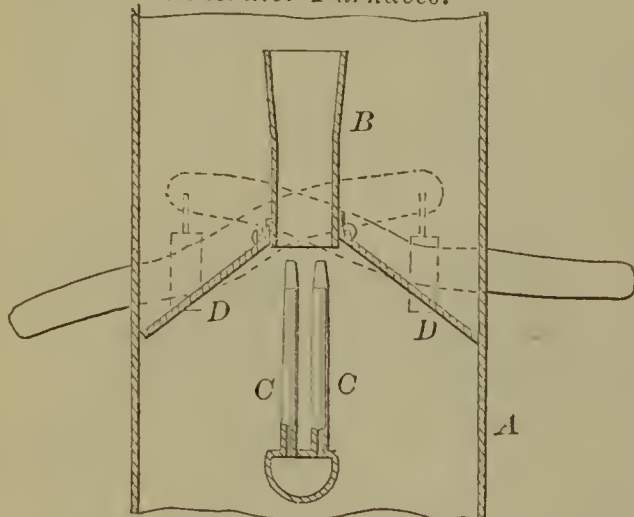

59059—F. M. Osborn—Tack Extractor.



59058—J. B. Oakley—Stove Cover, Pot and Pan Lifter.



59060—M. Packard—Gate.

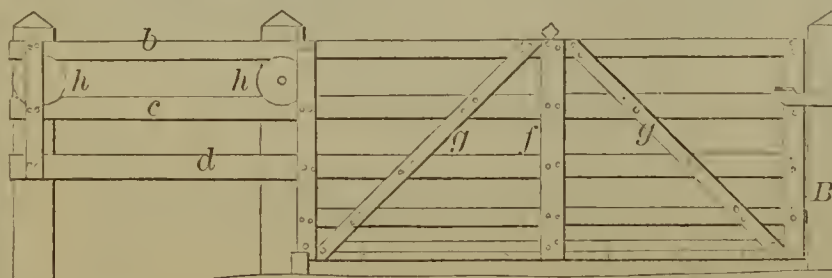

59061—J. S. Patterson—*Potato Fork.*

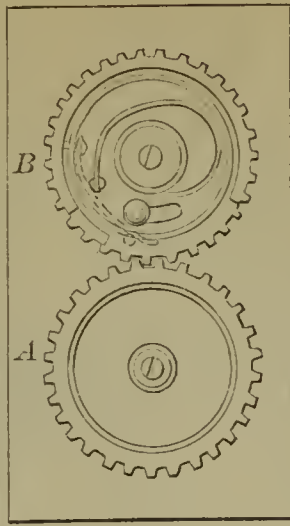
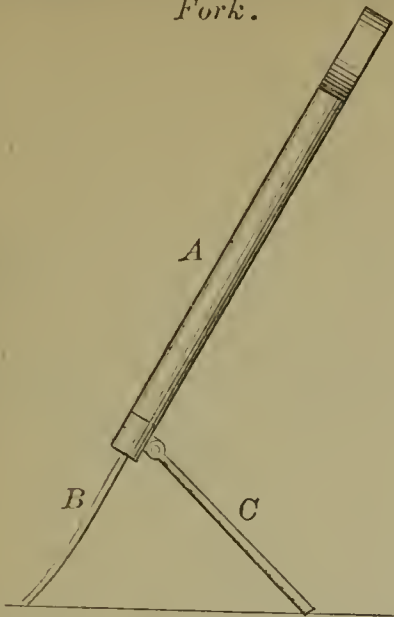

59064—L. B. Potter—*Intermittent and Expansive Gearing.*

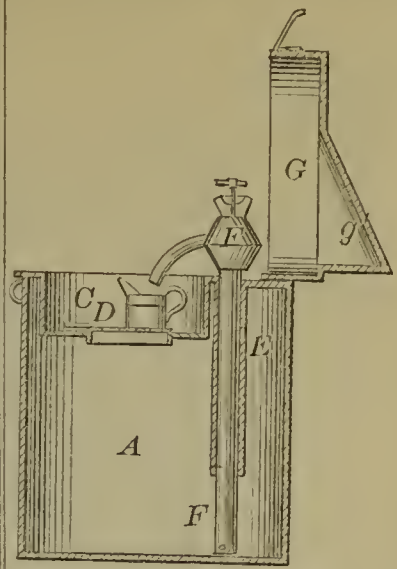

59066—W. J. Prall—*Oil Can.*

59072—T. B. Raymond—*Rafting Pin.*

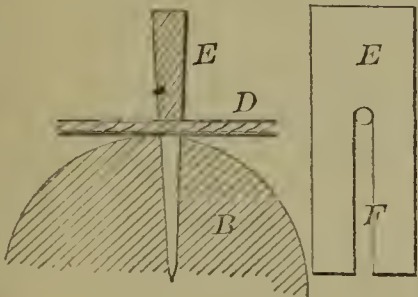

59067—T. Pratt—*Tire Shrinking Machine.*

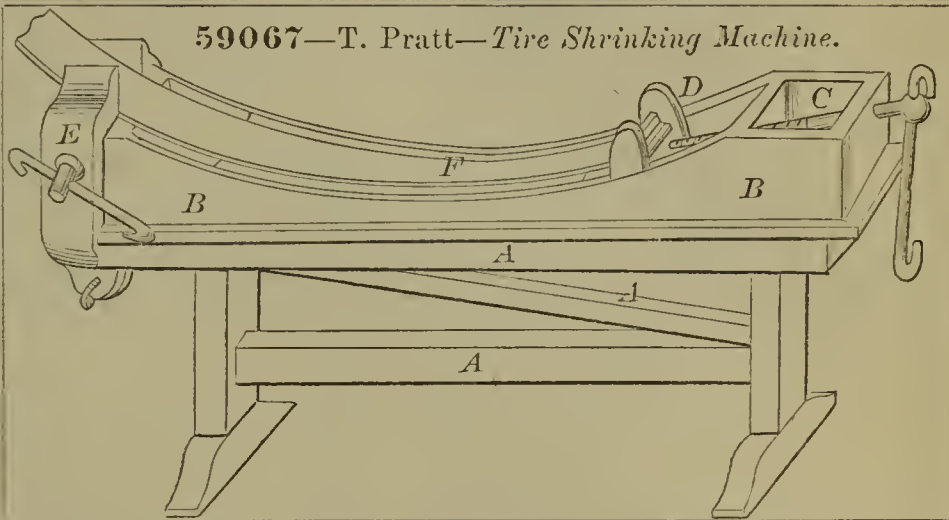

59071—G. Ray—*Planting Machine.*

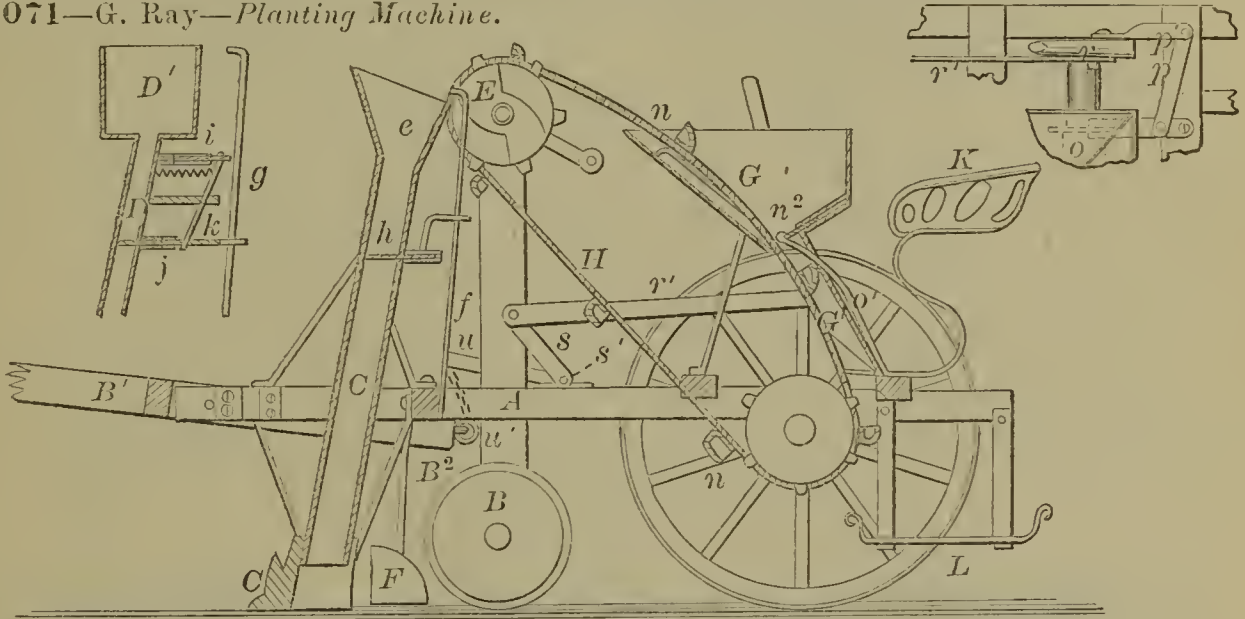

59069—F. E. Ramm—*Piano Sounding Board.*

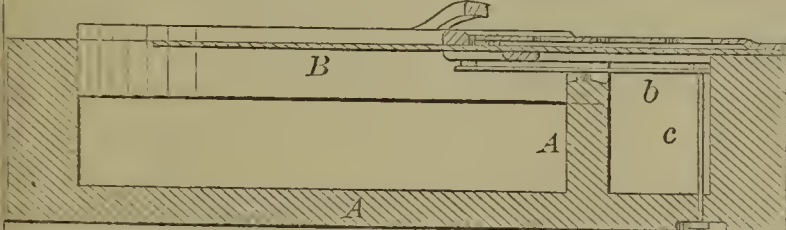

59068—W. H. Pratt—*Washing Machine Heater.*

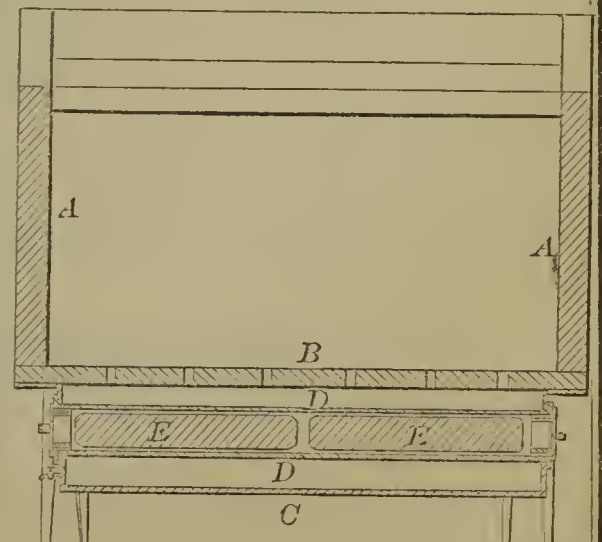

59073—O. Redmond—*Steam Plow.*

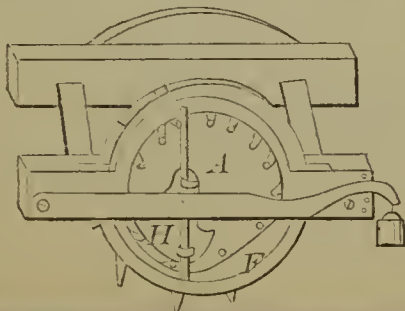

59074—T. Reece—*Portable Propeller and Steerer for Boats.*

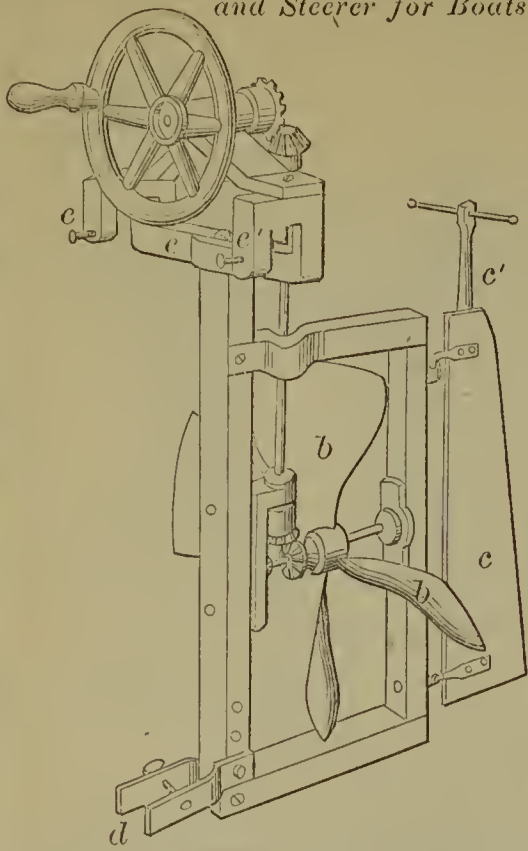

59076—F. A. Richardson—*Stop Mortise Latch.*

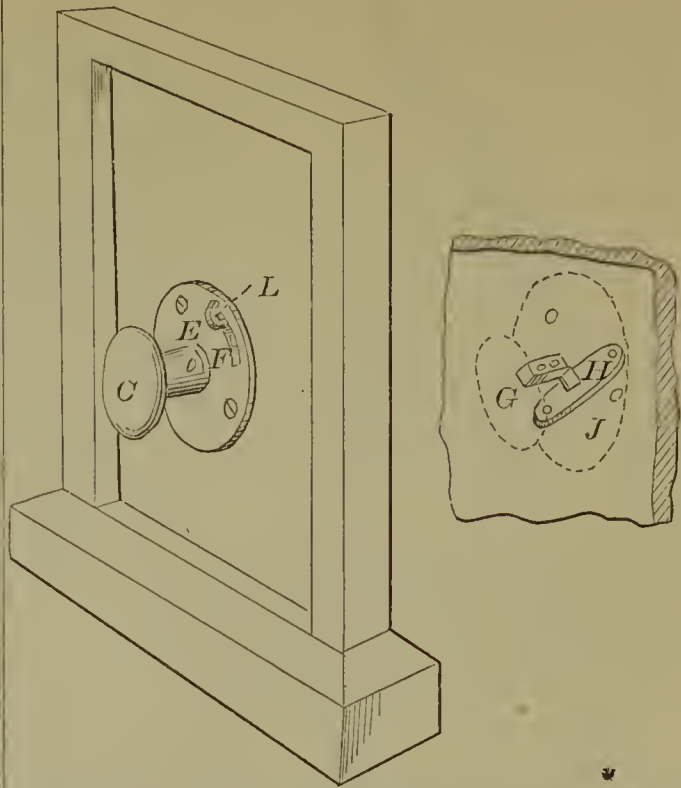

59075—J. Reising—*Counter Supporter.*

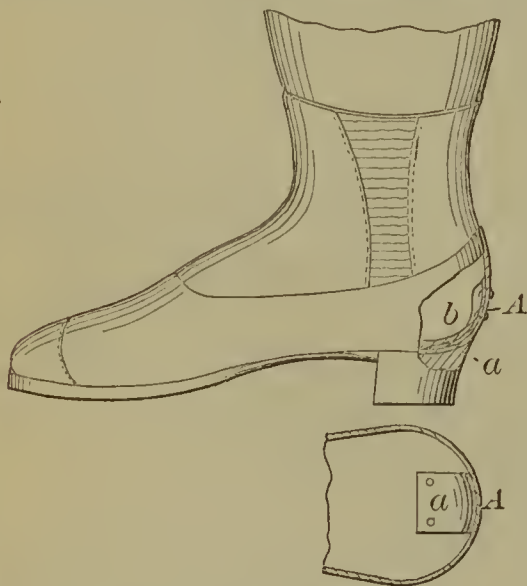

59078—J. L. Roberts—*Plow.*

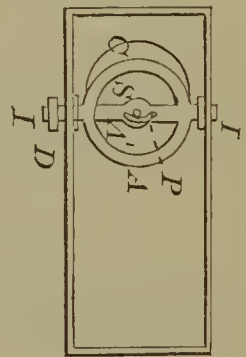
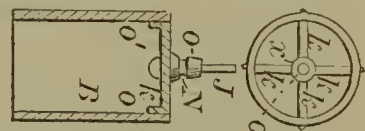
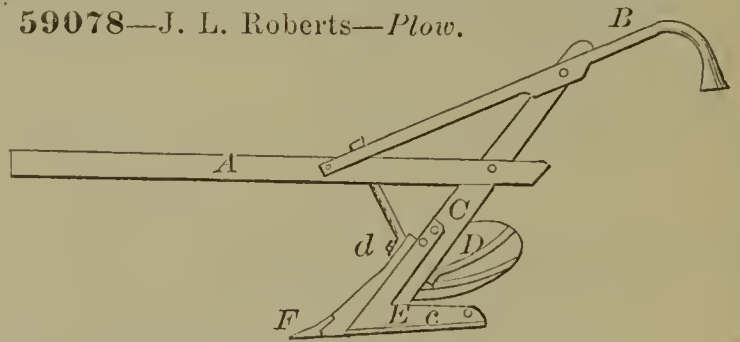

59079—C. W. Saladee—*Water Drawer.*

59077—M. S. & J. S. Rickel—*Wheat Drill.*

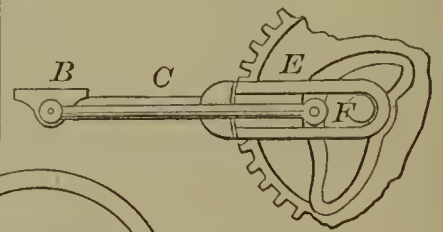
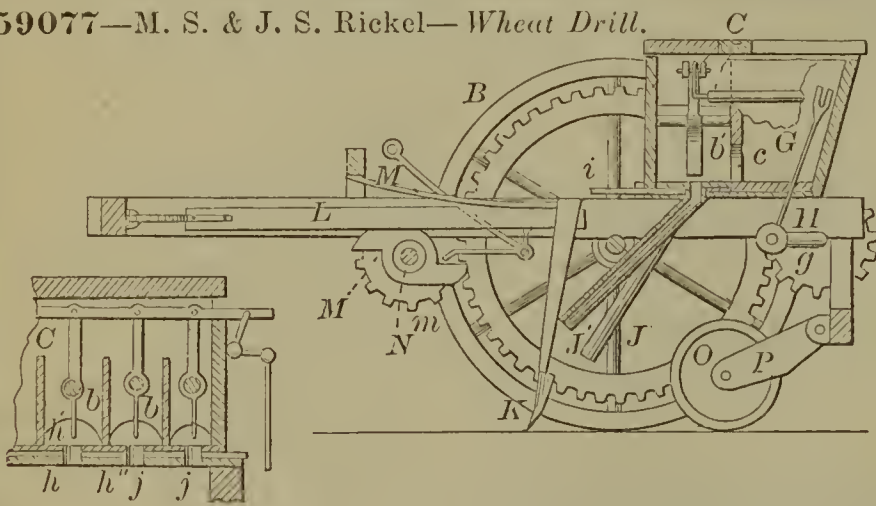

59080—J. Sangster—*Brick Machine.*

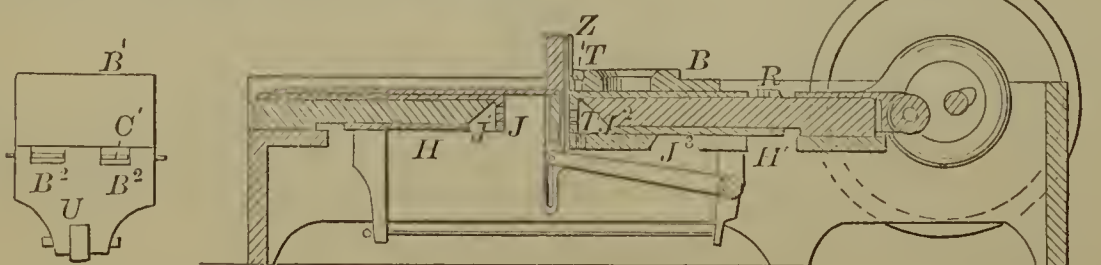



59081—

H. Scharch—*Hanging Carriage Body.*

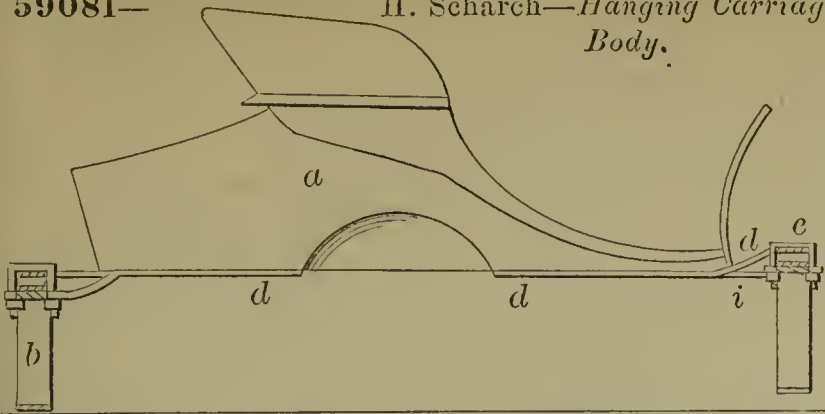

59082—R. Scheidler—*Door Spring.*

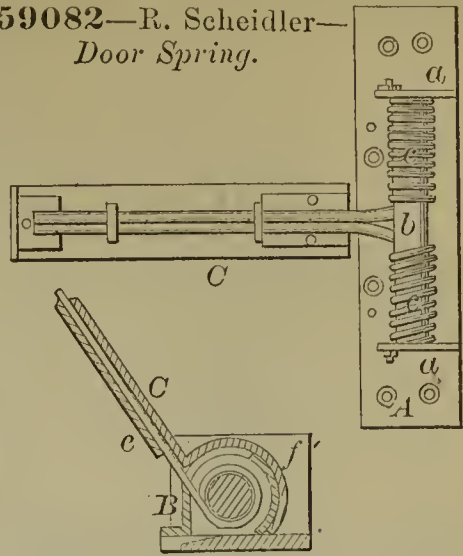

59083—C. W. Schroeder—*For Drying Dishes.*

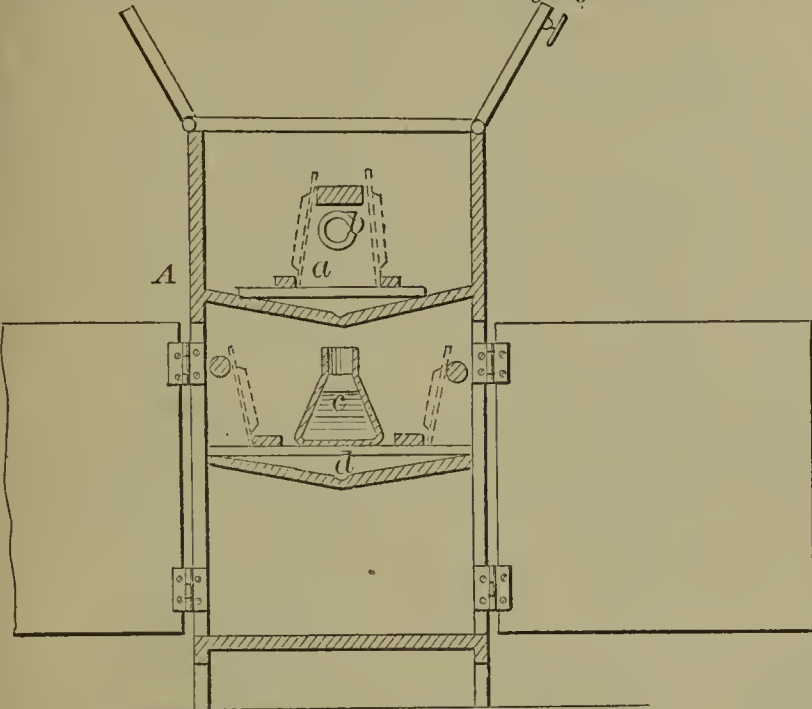

59085—J. P. Sinclair—*Hitching Clamp or Hold Fast.*

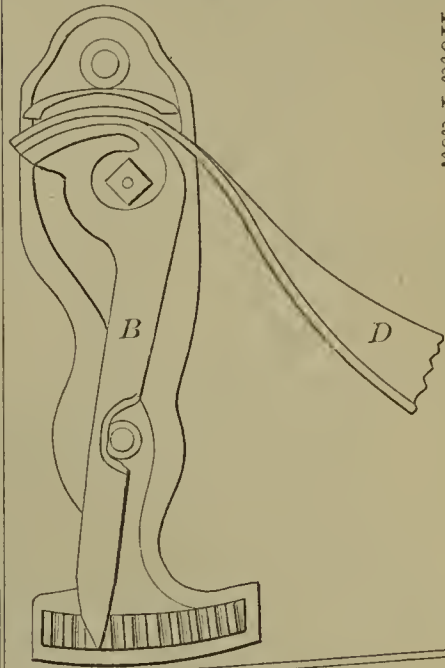

59086—E. M. Skinner—*Medicine Chest.*

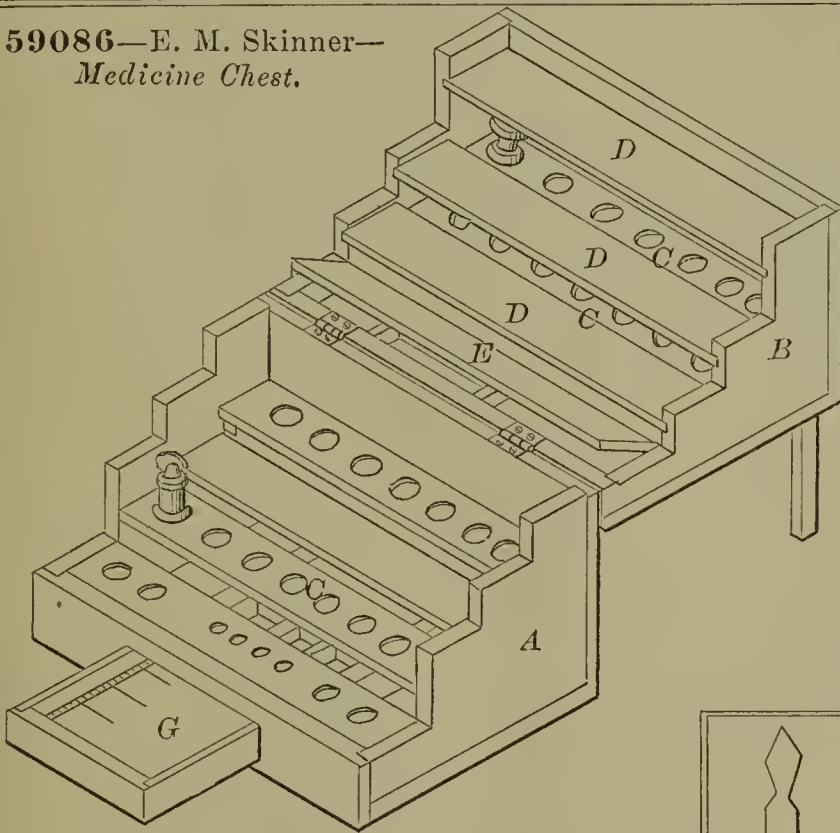

59087—J. E. Small—*Crib and Chair.*

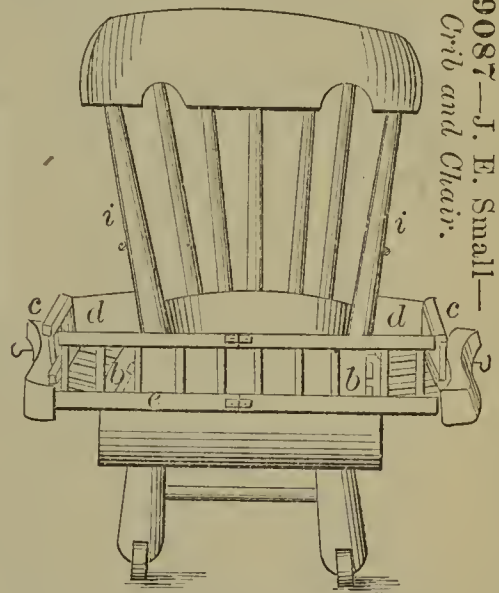

59088—E. H. Smith—*Sewing Machine Shuttle.*

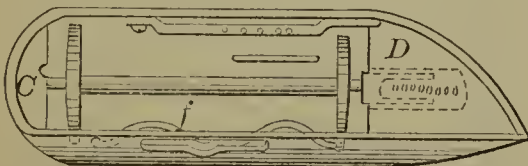

59084—C. Seefeld—*Gate.*

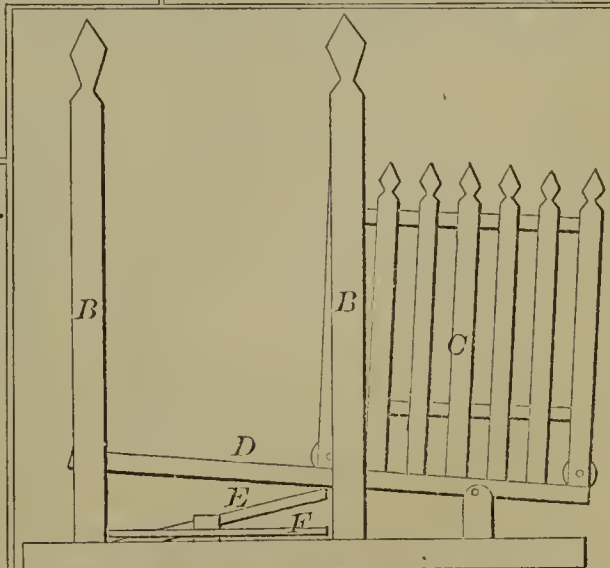

59089—R. T. Smith—*Transmitting Motive Power.*

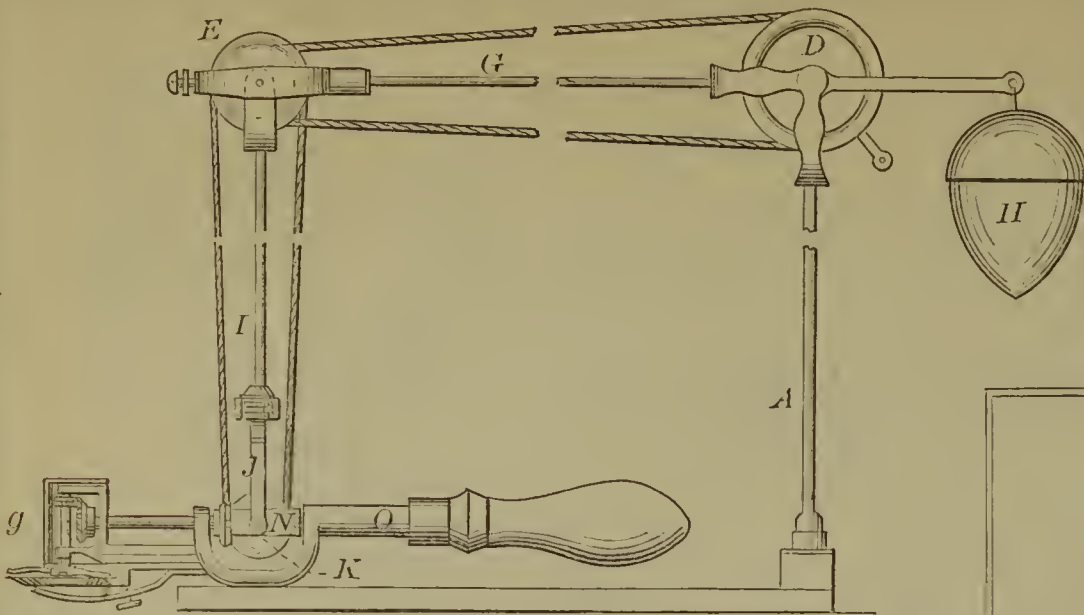

59091—N. H. Spencer—*Churn Dasher.*

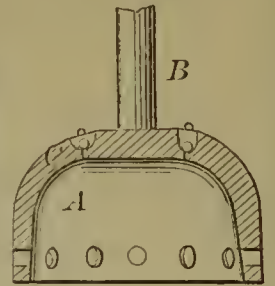

59094—W. W. Taylor—*Stitching Clamp.*

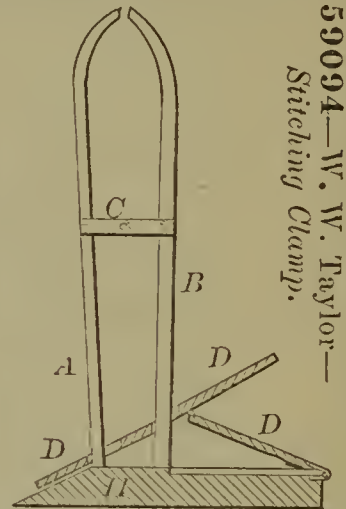

59092—C. & F. Stattmann—*Cap.*

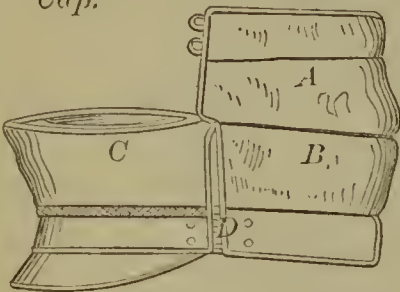

59093—M. Stricker—*Hog Scalding Machine.*

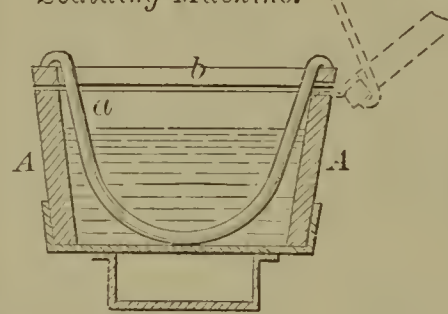

59095—S. E. Totten—*Wrapper for Needles.*

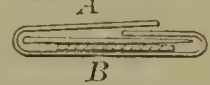

59096—J. Trent—*Balanced Steam Valve.*

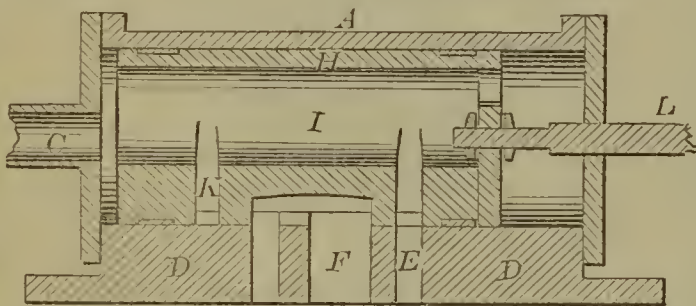

59090—C. F. Spencer—*Button.*

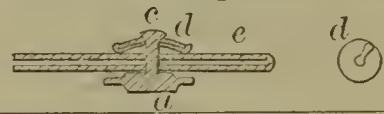

59097—H. W. C. Tweddle—*Barrel Hoop.*

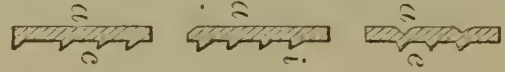

59099—E. W. Vanduzen—*Mode of Hanging Bells.*

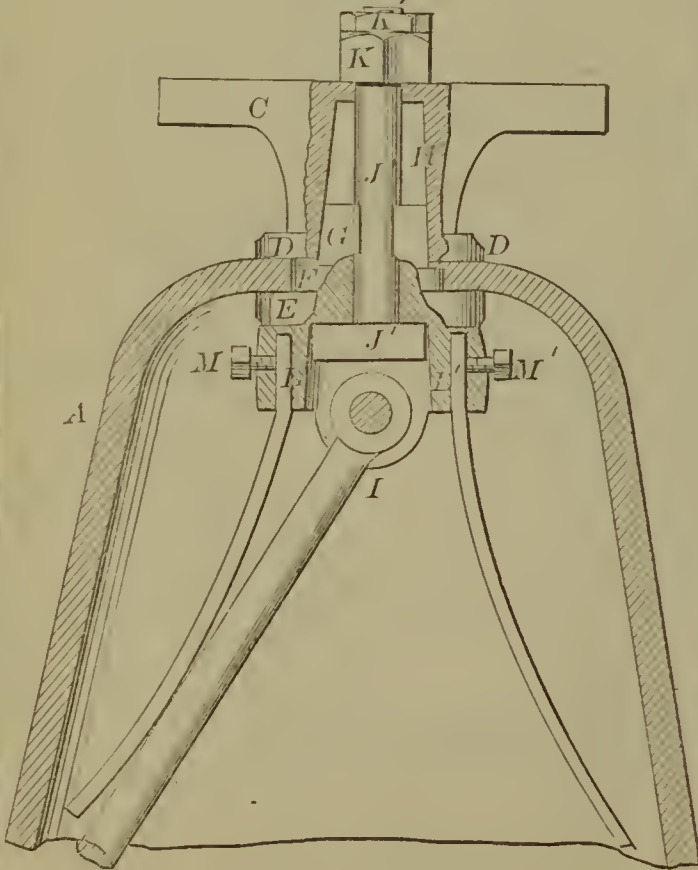

59098—E. W. Vanduzen—*Mode of Hanging Bells.*

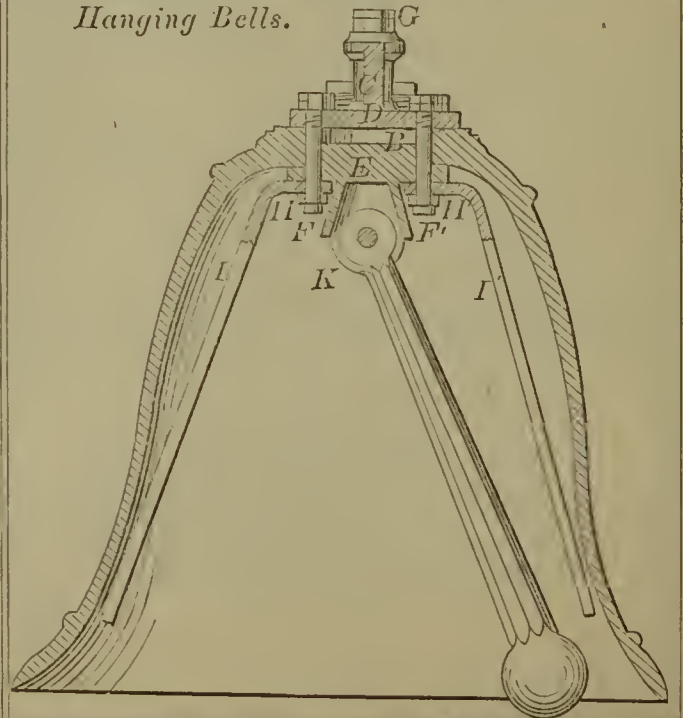

59100—B. Walker—*Bolt Heading Machine.*

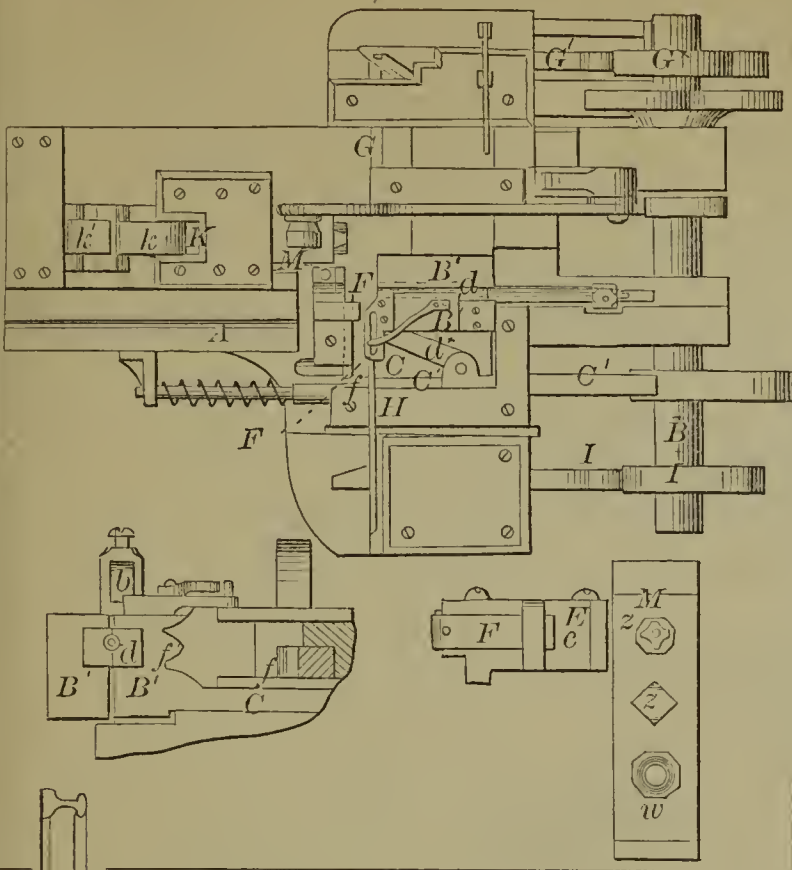

59103—Washburn & Brintnall—*For Shearing Sheep.*

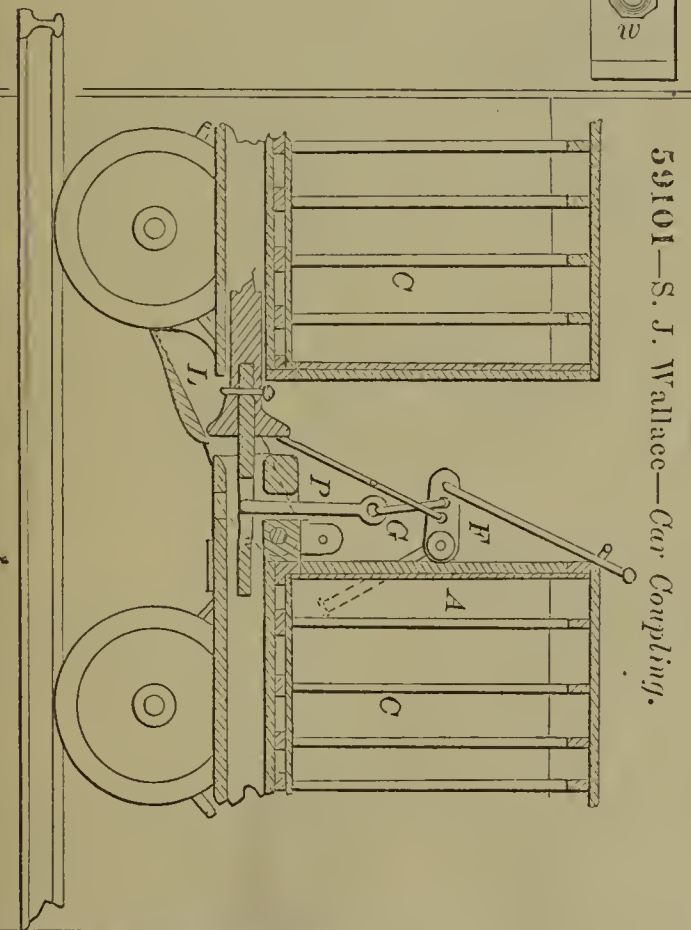
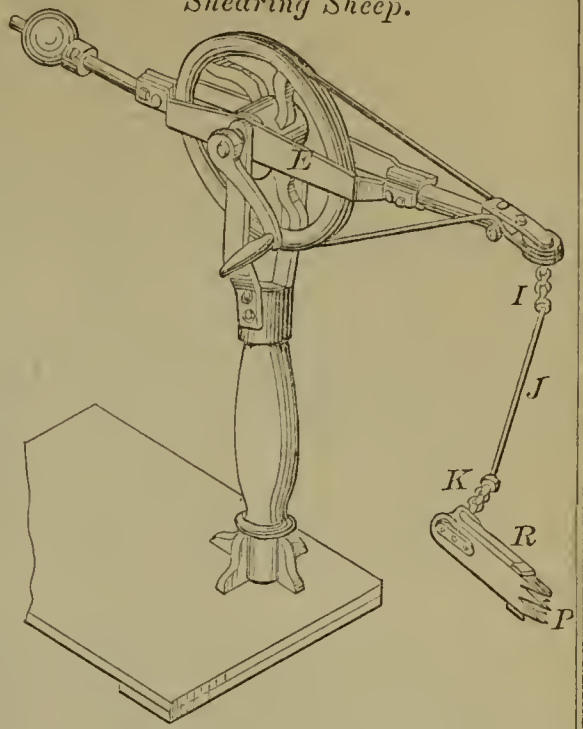

59101—S. J. Wallace—*Car Coupling.*

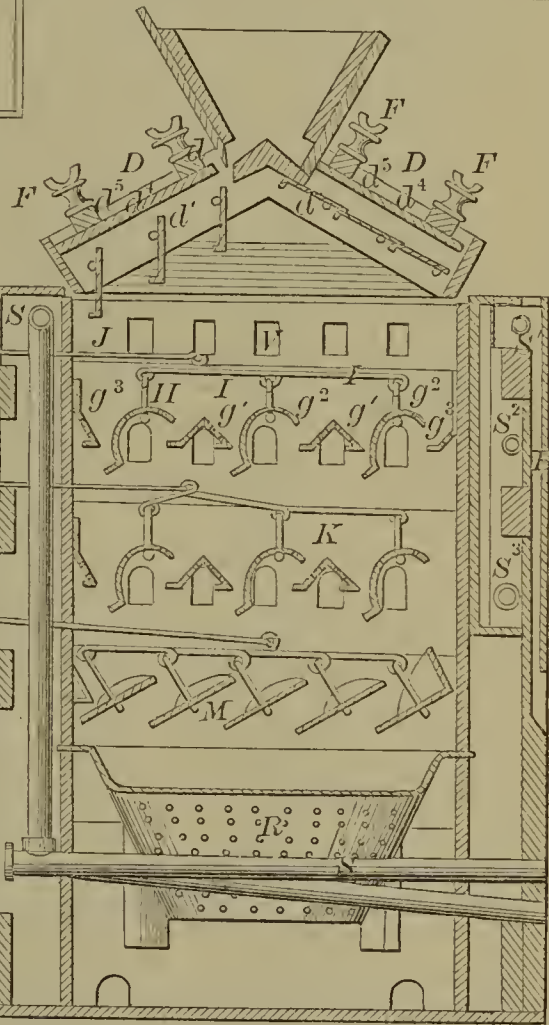

59102—N. Wallaster—*Grain Drying Kiln.*

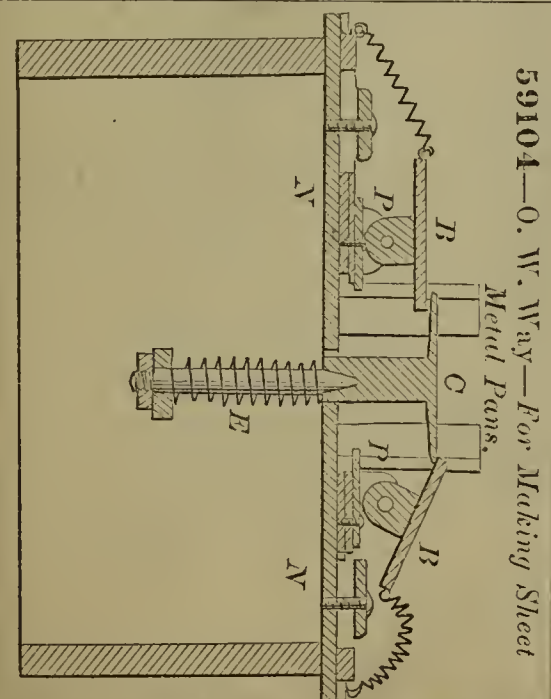

59104—O. W. Way—*For Making Sheet Metal Pans.*

59105—M. Webb—*For Raking and Loading Hay.*

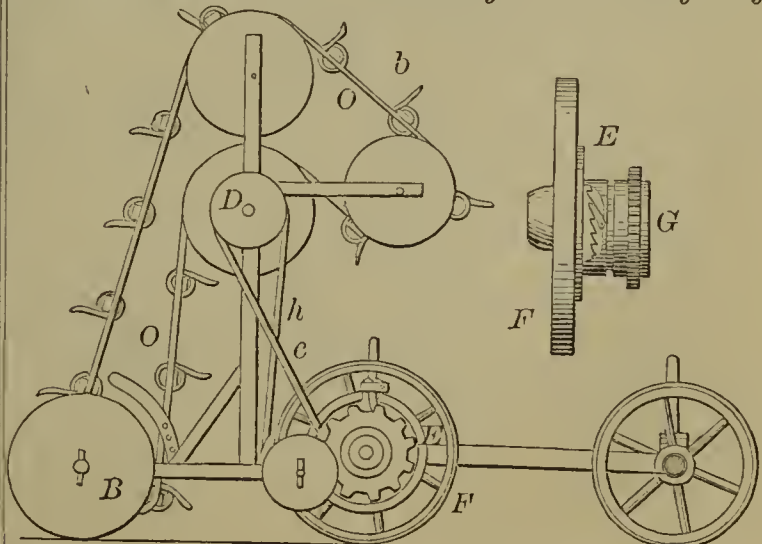

59106—T. Welham—For Spinning direct from the Doffer of Carding Engines.

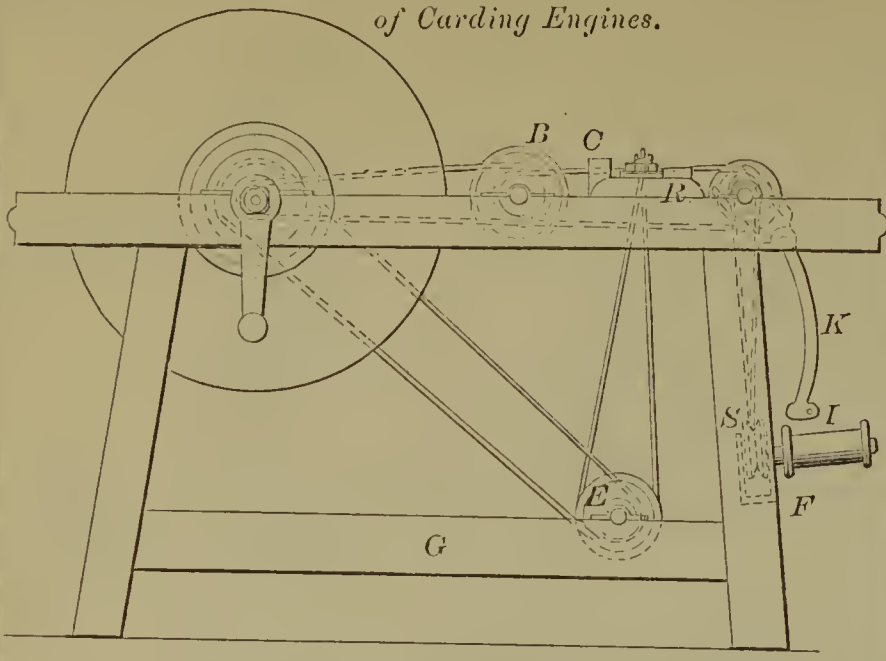

59110—E. Whitney—Double-Barreled Fire Arm.

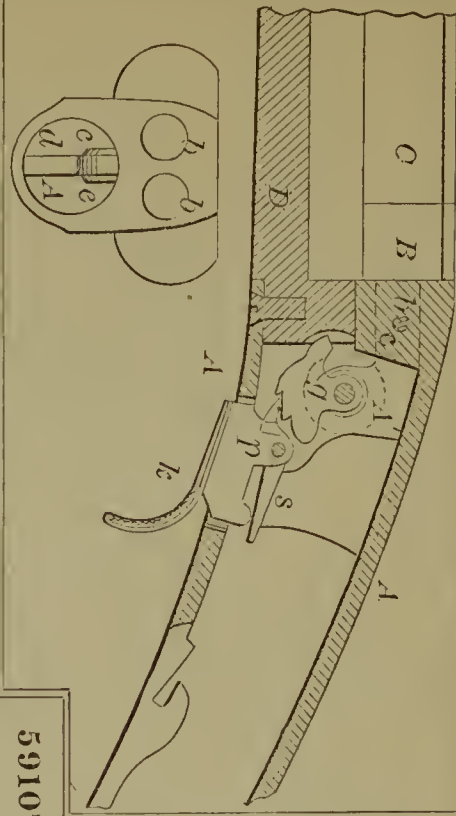

59113—J. Wood—Horse Rake.

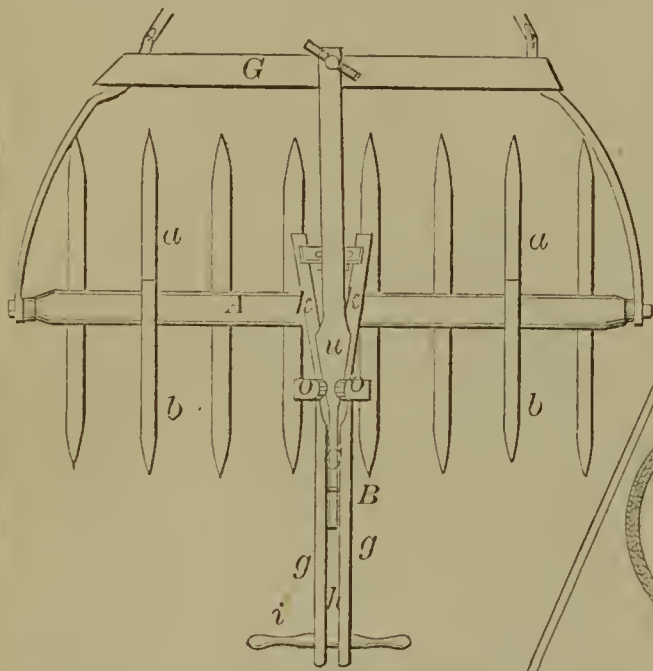

59107—W. T. Wells—Hinge.

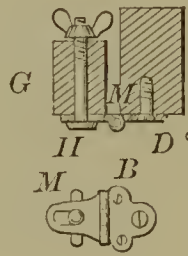

59111—L. J. Wicks—Fruit Can.

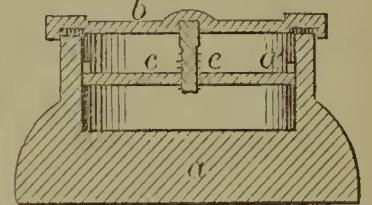

59108—T. S. Wheeler—Truss Pad.

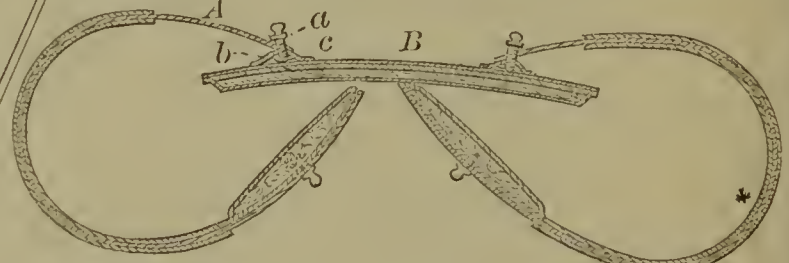

59115—L. R. Wright—Seed Planter.

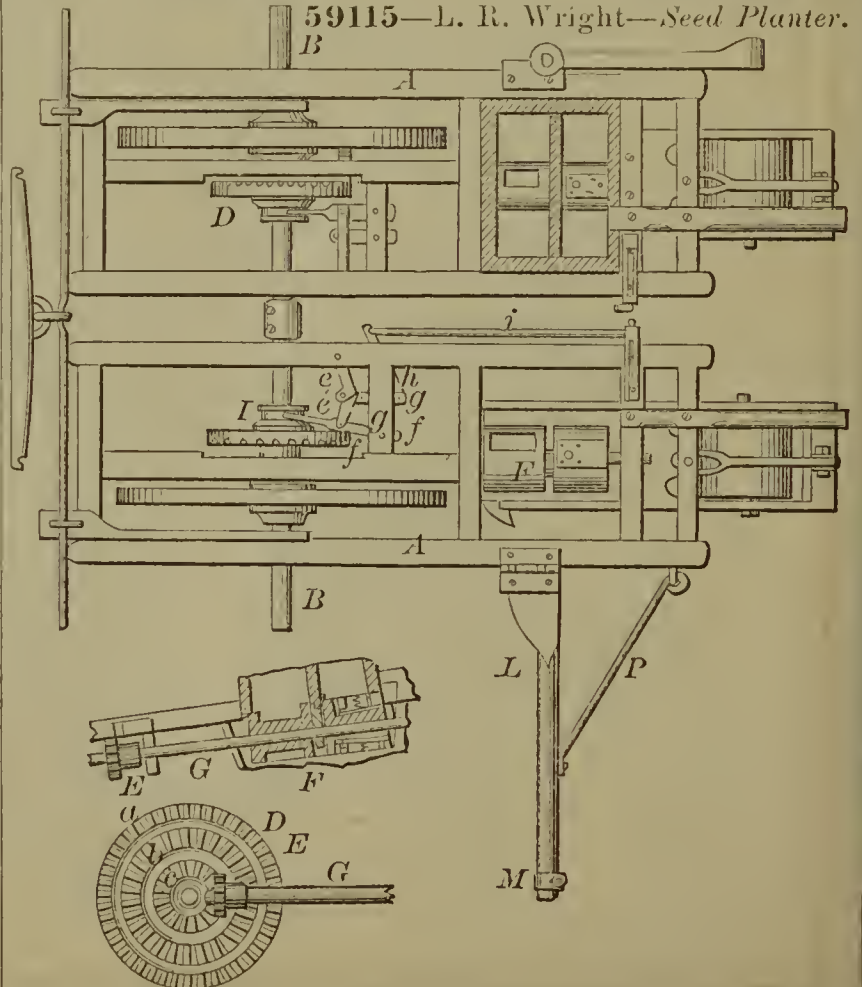

59112—S. Winkley—Railway.



59114—G. C. Wright—Portable Fence.



59116—R. & I. Wright—For Raking and Loading Hay.

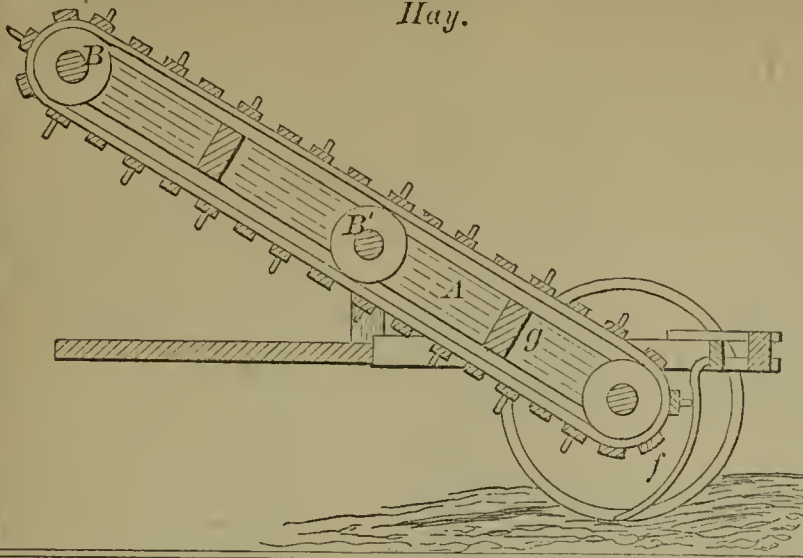

59118—W. F. Arnold—Curry Comb.

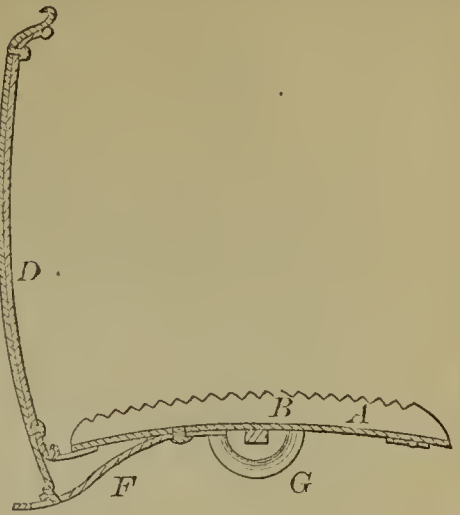

59117—J. H. Yager—Manual Power.

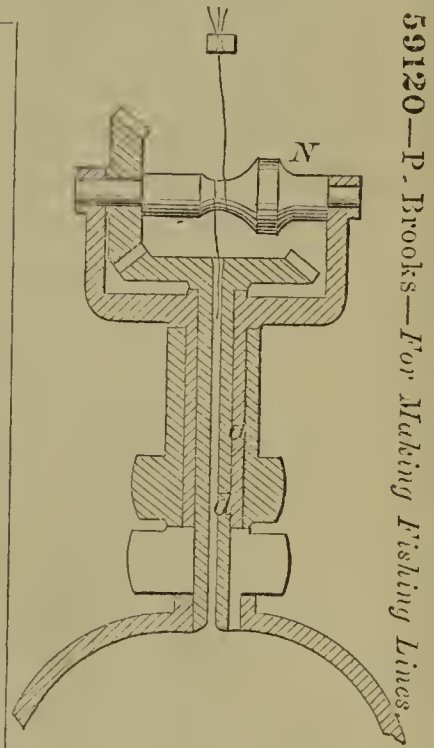
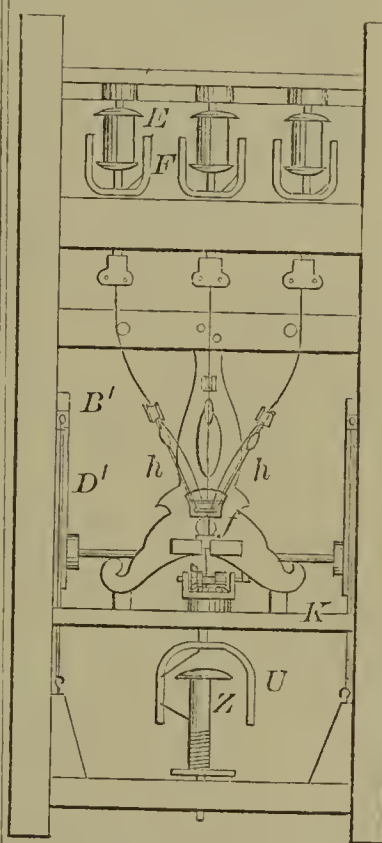
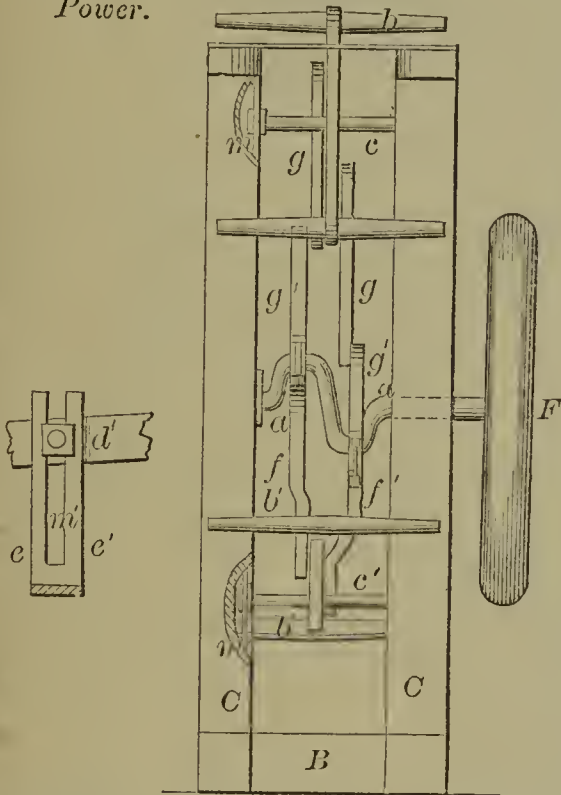

59120—P. Brooks—For Making Fishing Lines.

59121—W. Burnett—Safety Valve.

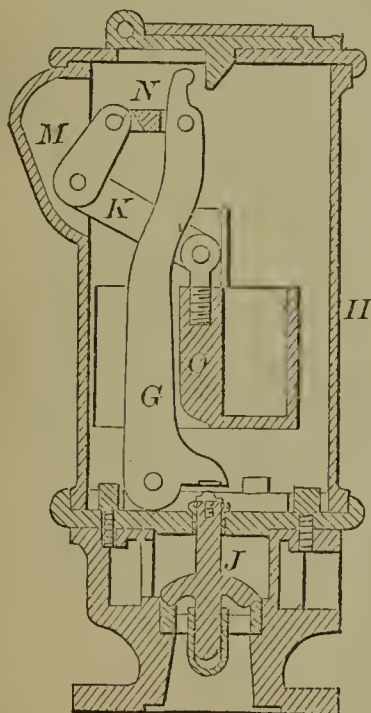

59119—S. C. Batchelor—Stove Door.

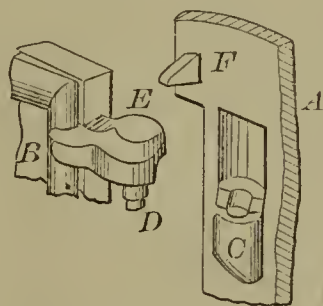

59122—W. S. Cooper—Faucet.

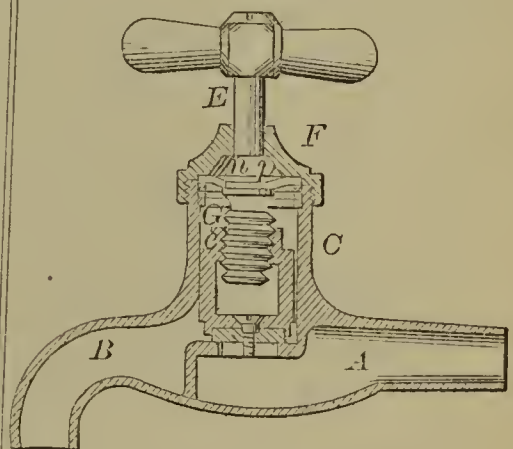

59123—Davis & Peabody—Seed Drill.

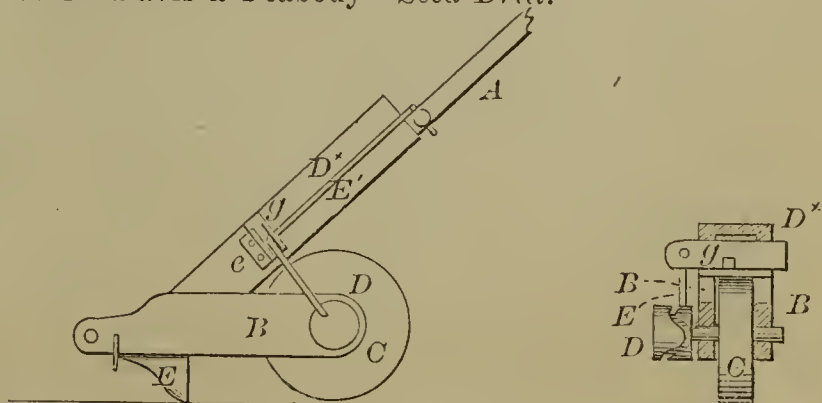

59124—J. N. Dennison—Air Compressing Pump.

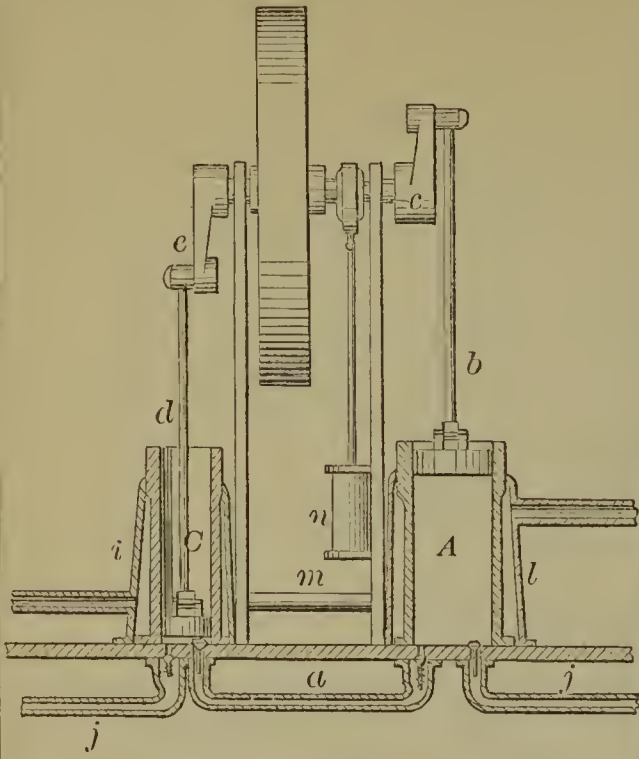

59127—T. J. Halligan—Waxed Thread Sewing Machine.

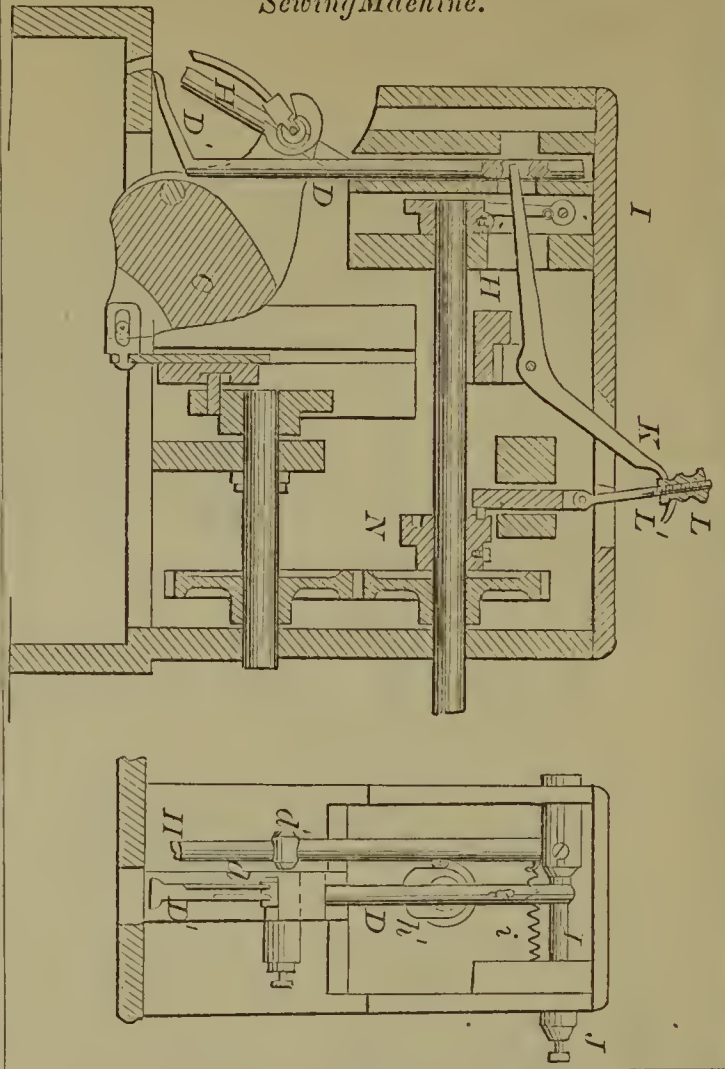

59126—V. Fogarty—Magazine Fire Arm.

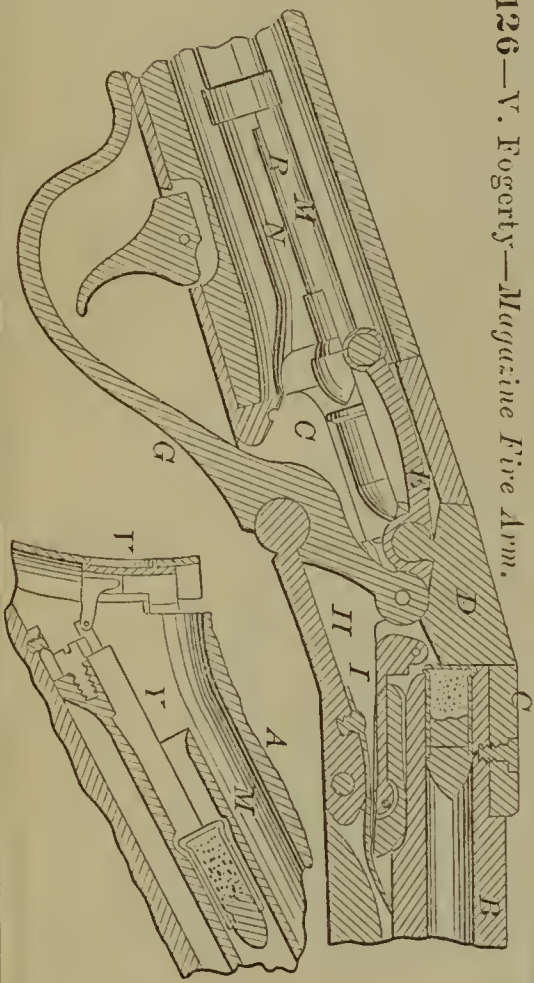

59125—J. N. Dennison—Pump.

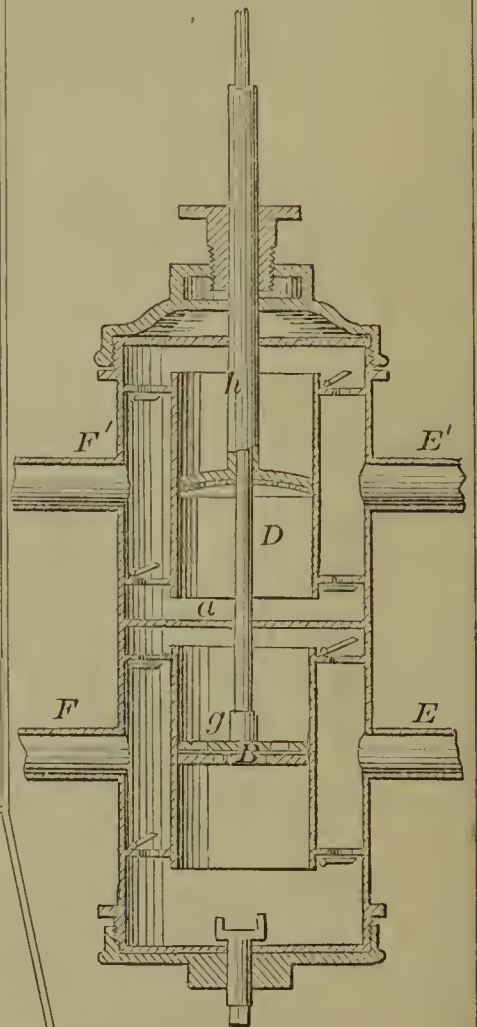

59128—F. Hoddick—Melodeon.

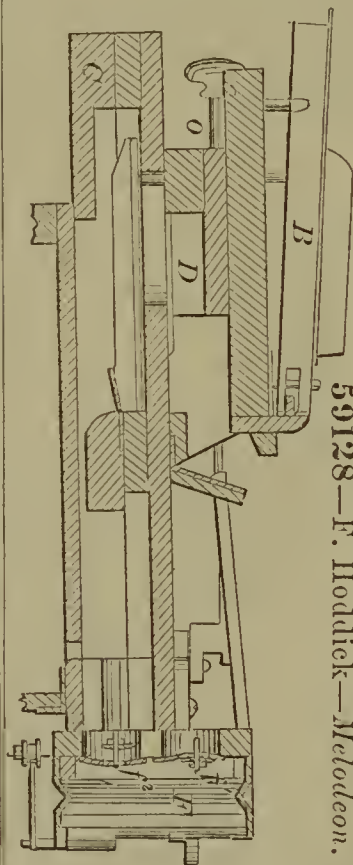

59129—J. Kaily—Carpet Stretcher.

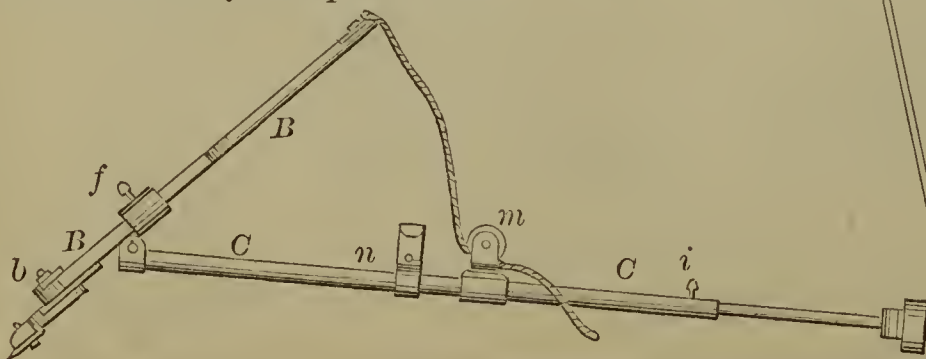

59130—W. A. L. Kirk—Water Grate.

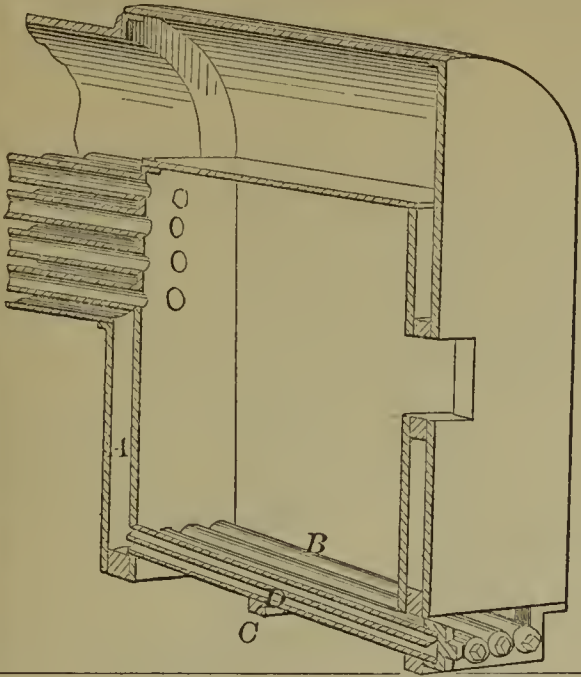

59134—C. E. Moore—For Folding Paper Collars.

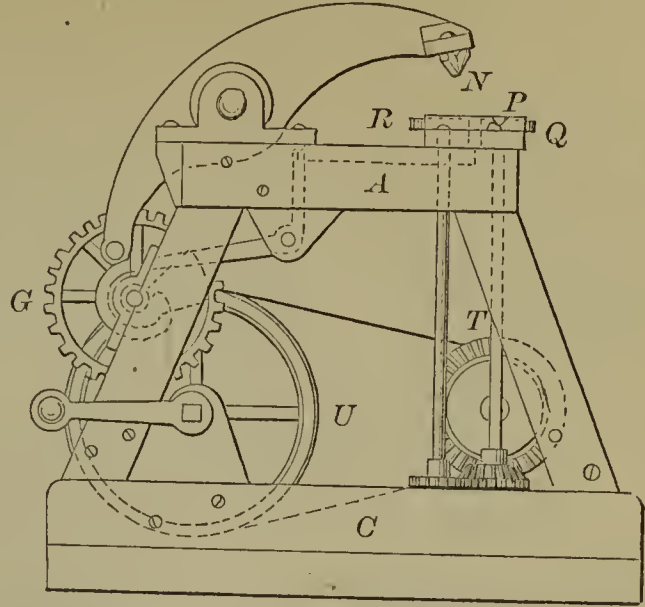

59132—Mendenhall & Sparks—Hand Loom.

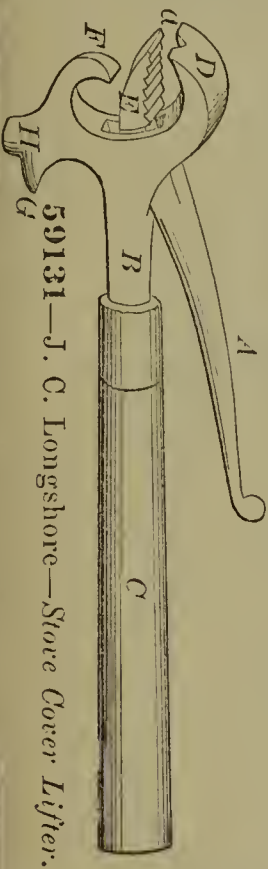
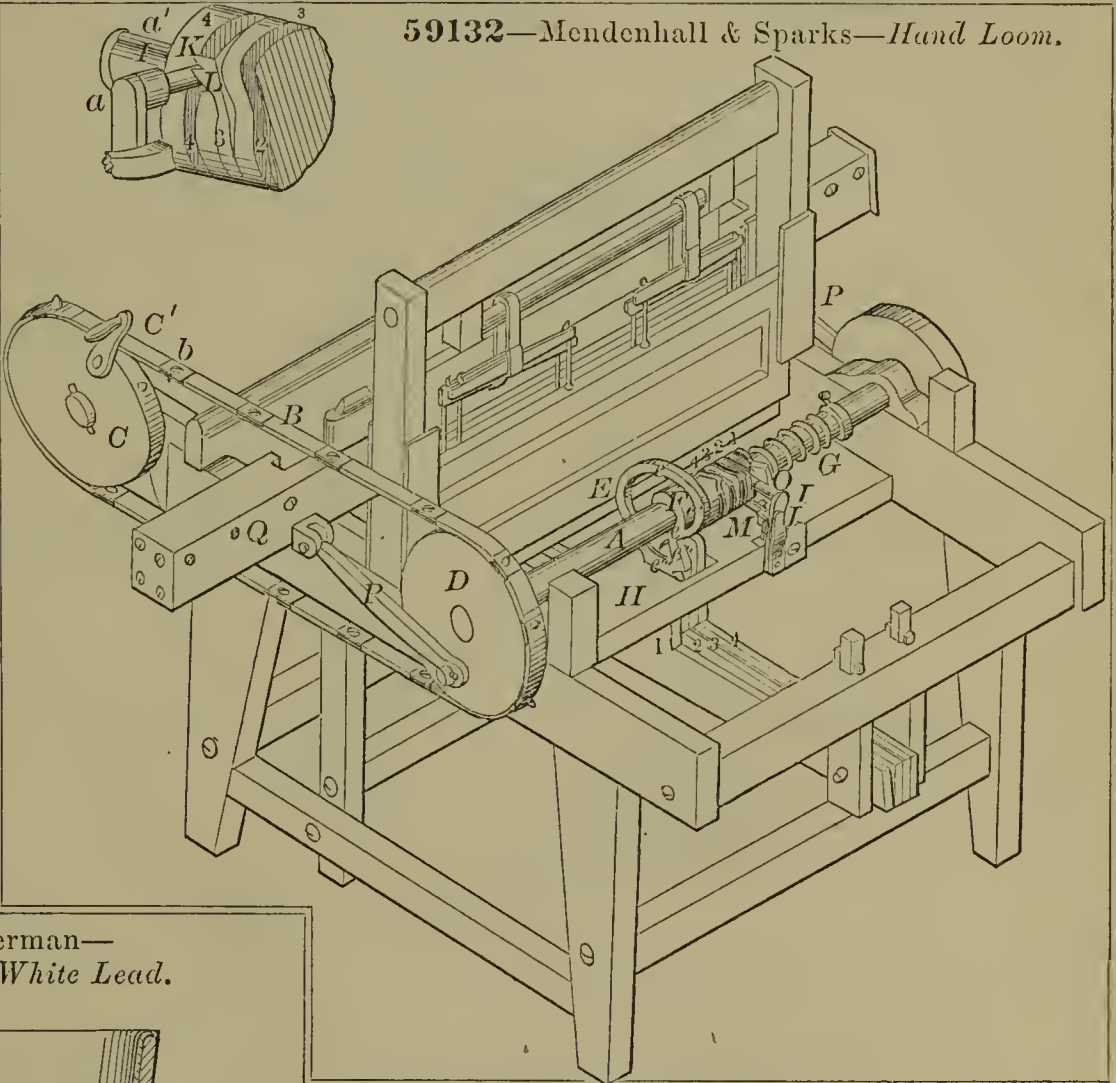

59131—J. C. Longshore—Store Core Lifter.

59135—H. J. Overman—Manufacture of White Lead.

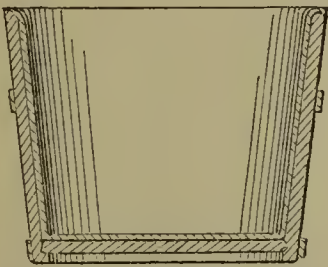

59136—E. B. Quick—Trunk.

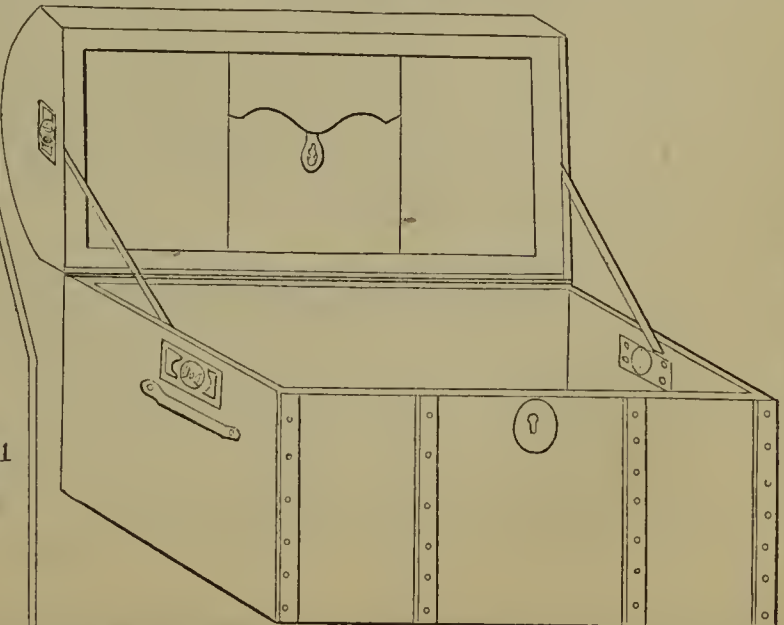

59133—J. O. Montignani—Clothes Rack.

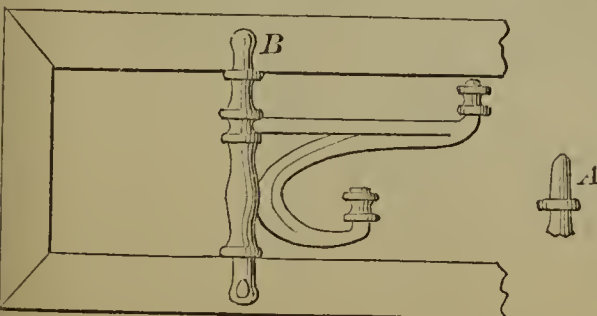

59137—H. J. & J. Reedy—Hoisting Machine.

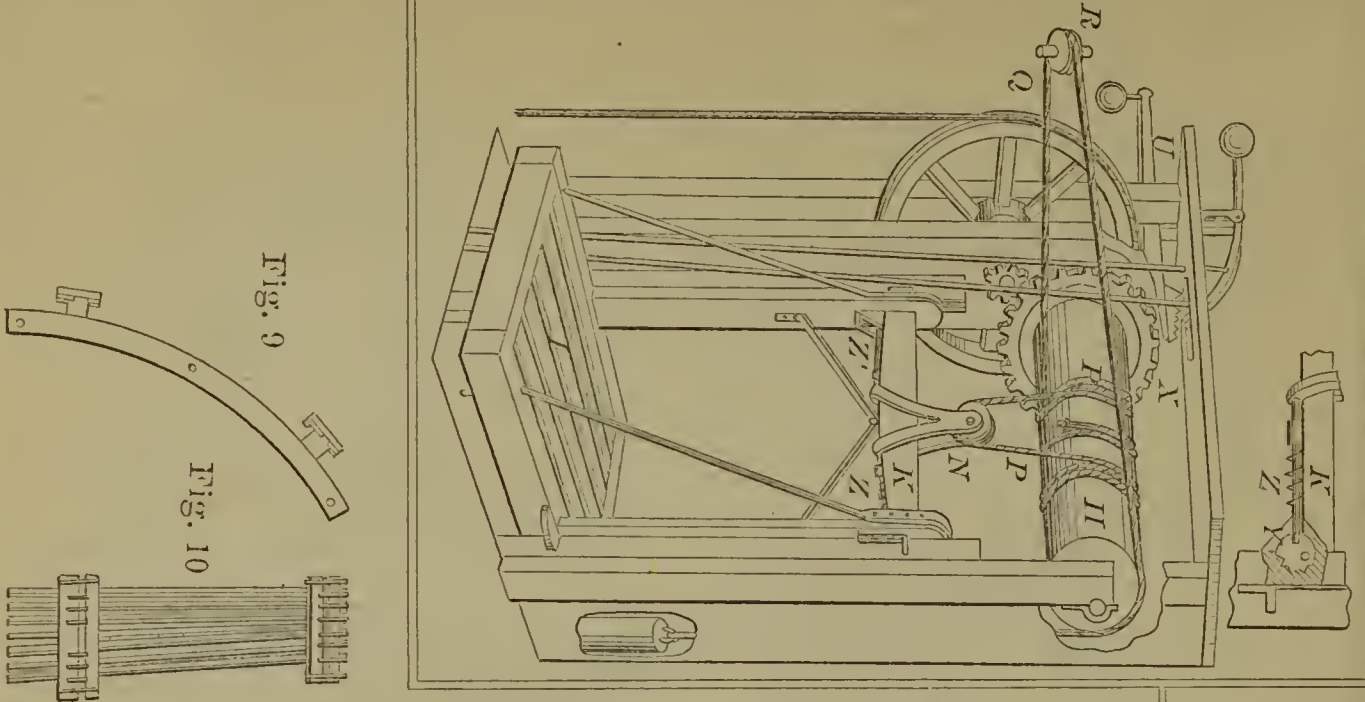

59139—S. Rogers—Horse Hay Fork.

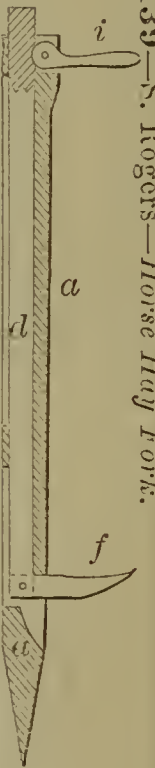

59138—Slayton & Kane—Circular Loom for Weaving Hats.

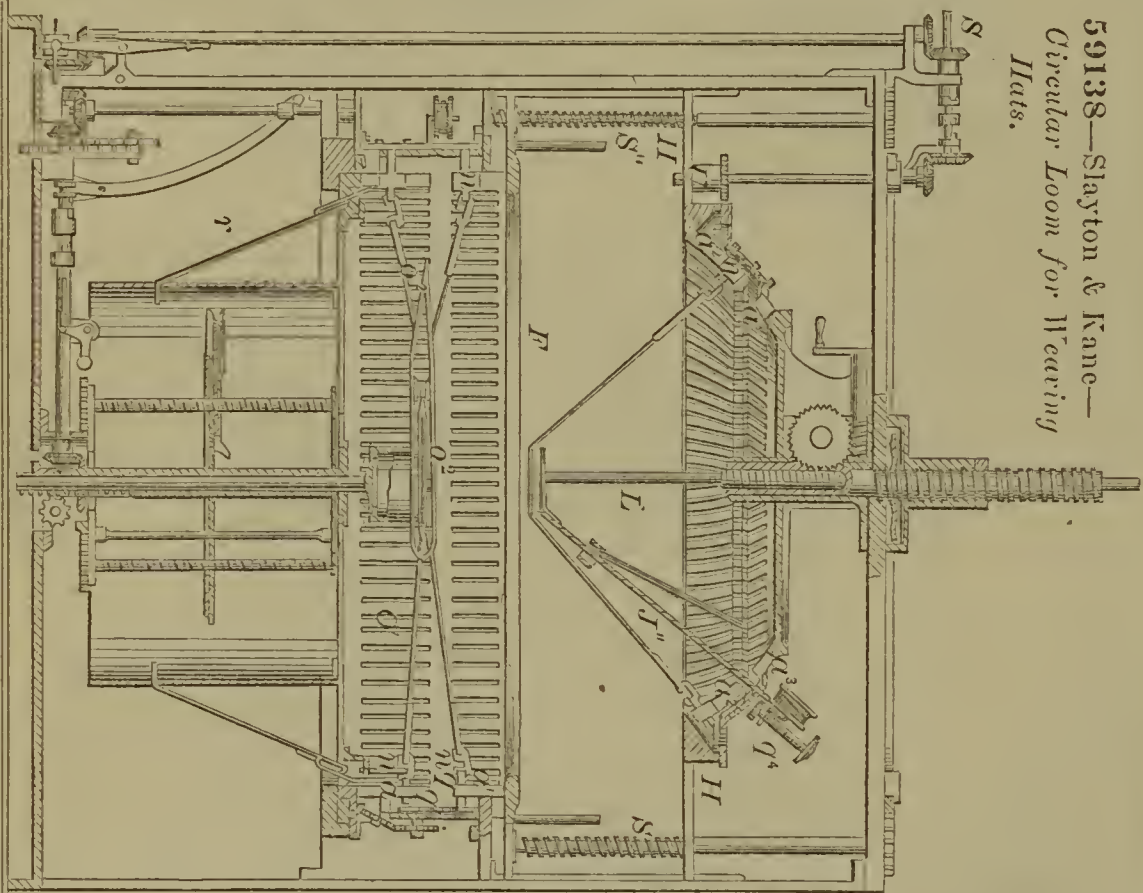

59140—D. Sawyer—Ditching Machine.

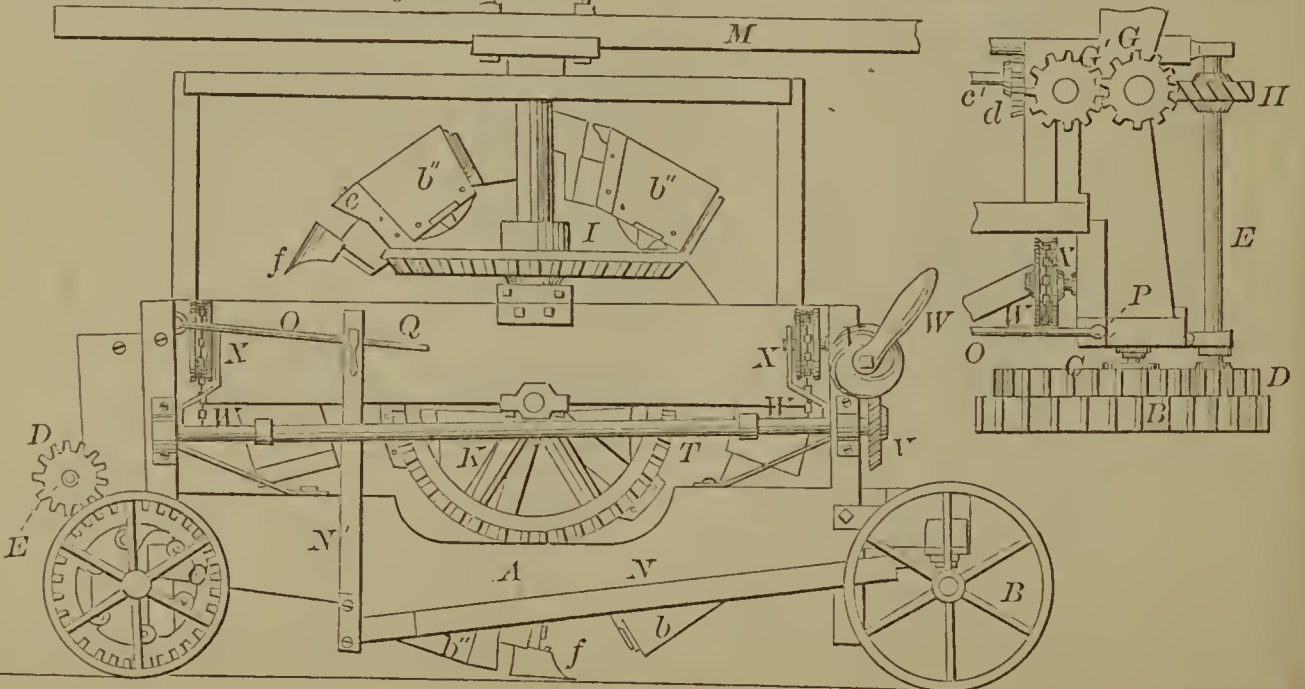



59140—Continued.

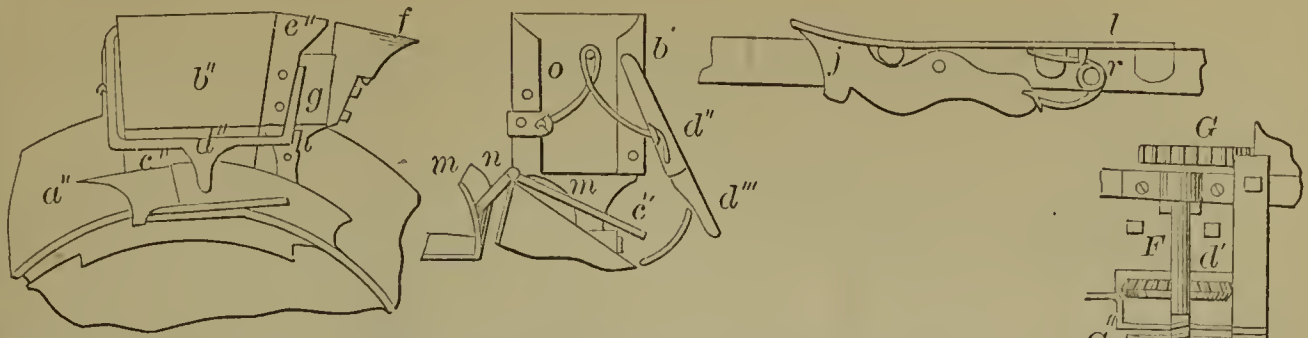

59142—E. M. Smith—Feeder for Carburetors.

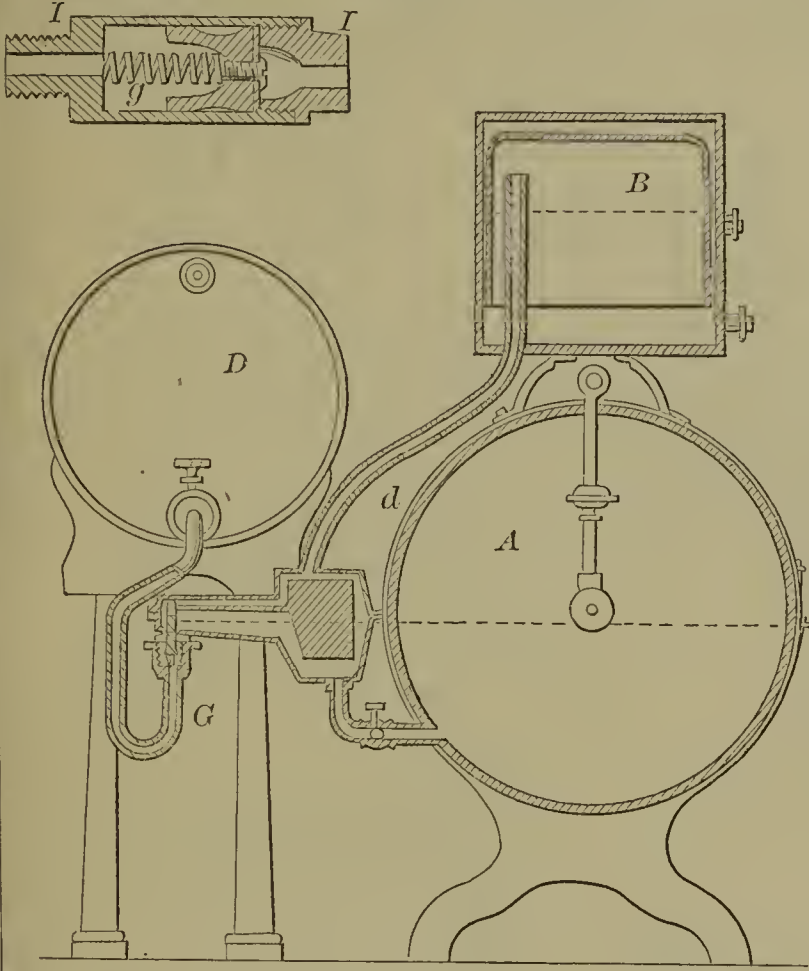

59145—N. B. White—For Forming the Eyes of Bed Springs.

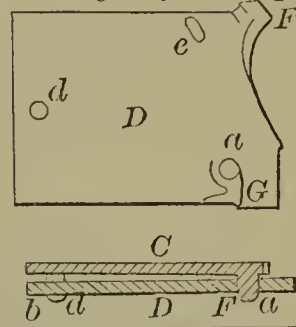

59144—C. Swett—Cotton Bale Tie.

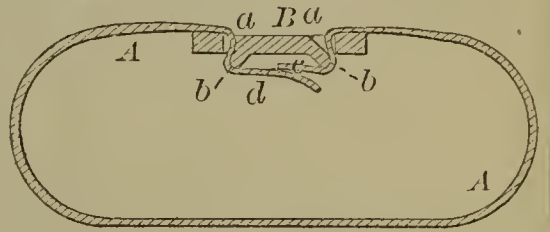

59146—Woodford & Bancroft—Steam Generator.

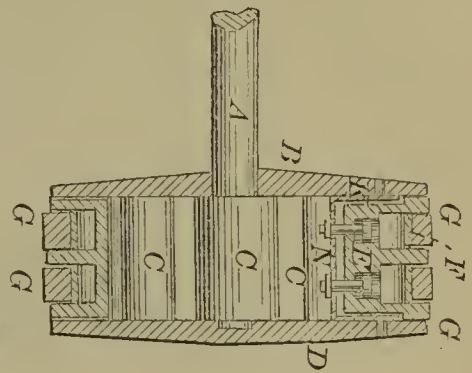
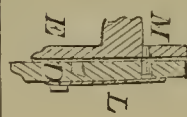
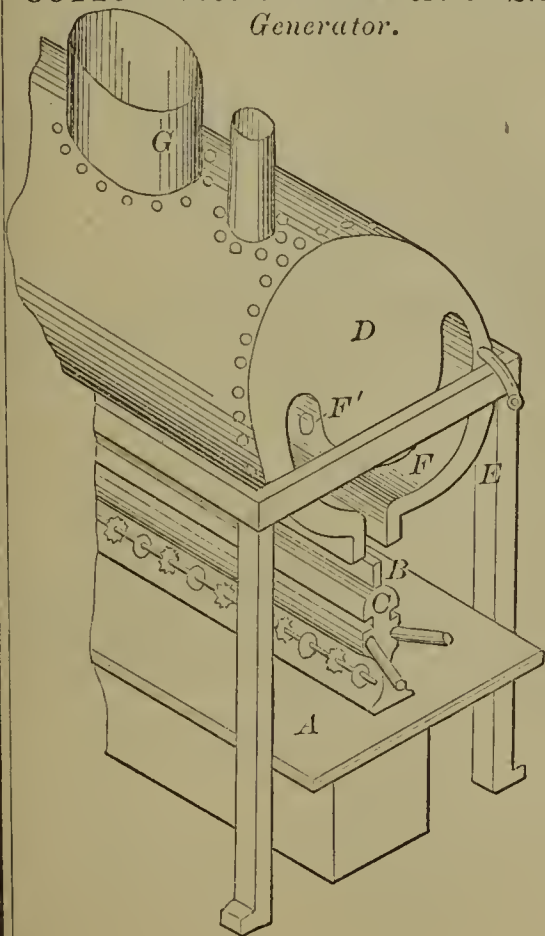

59143—Snook & Patchell—Piston Packing.

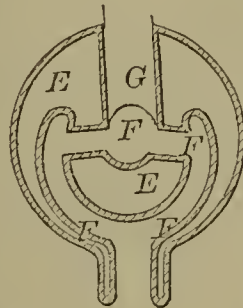

59141—G. A. Scaver—Cotton Bale Tie.

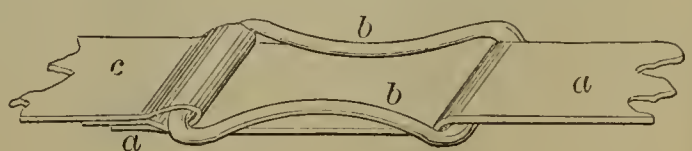

59147—Howard & Tenney—Steam Generator.

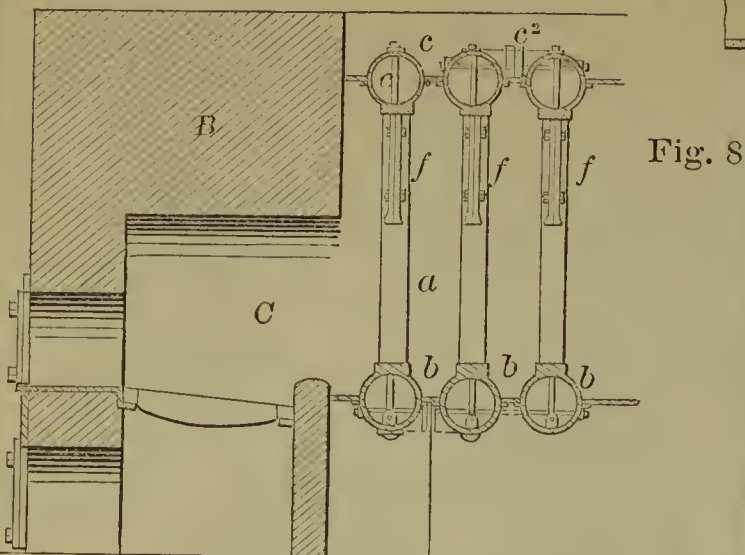

59150—E. Mangeon—Privy Seat.

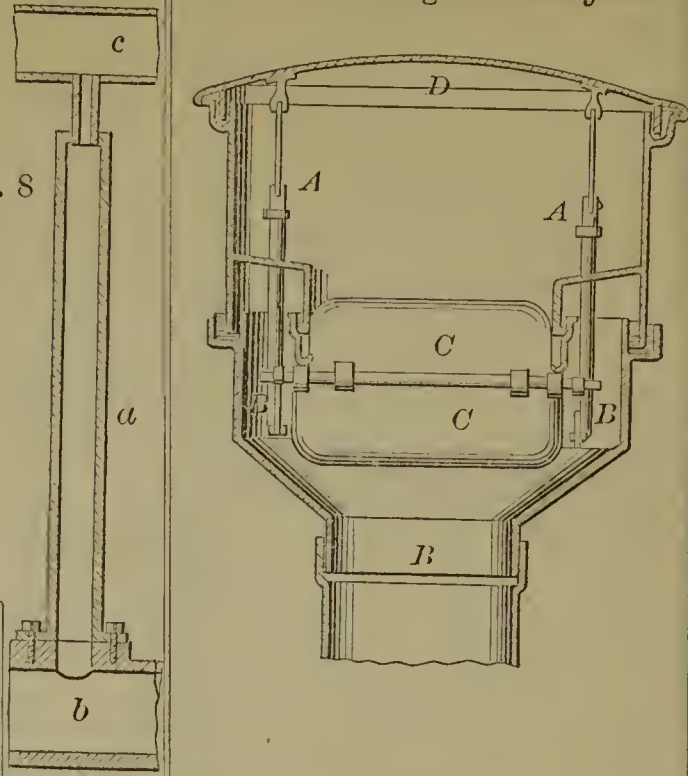

59148—Jones & Hedges—Telegraphic Signal.

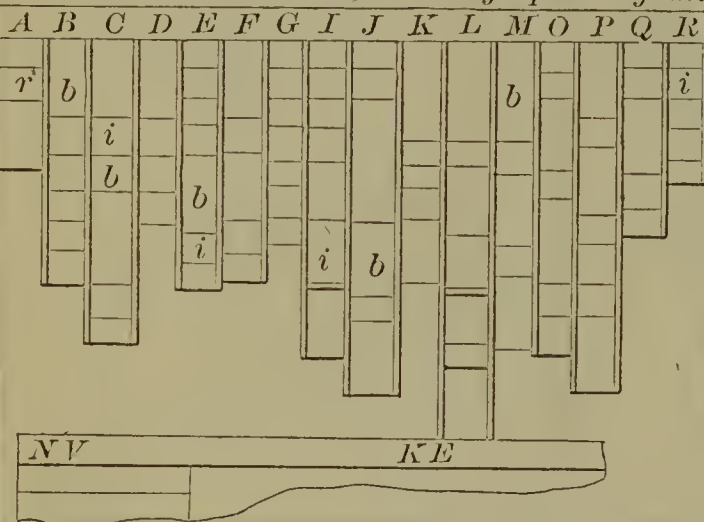

59152—J. J. McComb—Cotton Bale Tie.

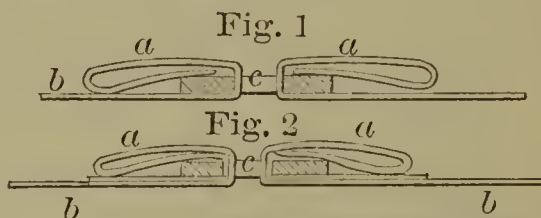

59149 H Lamotte—For Rectifying Alcohol.

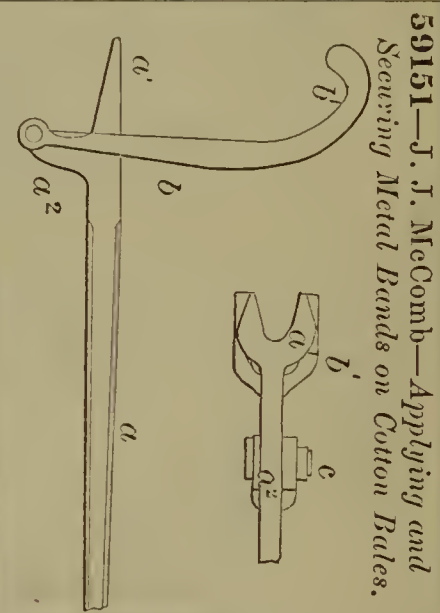
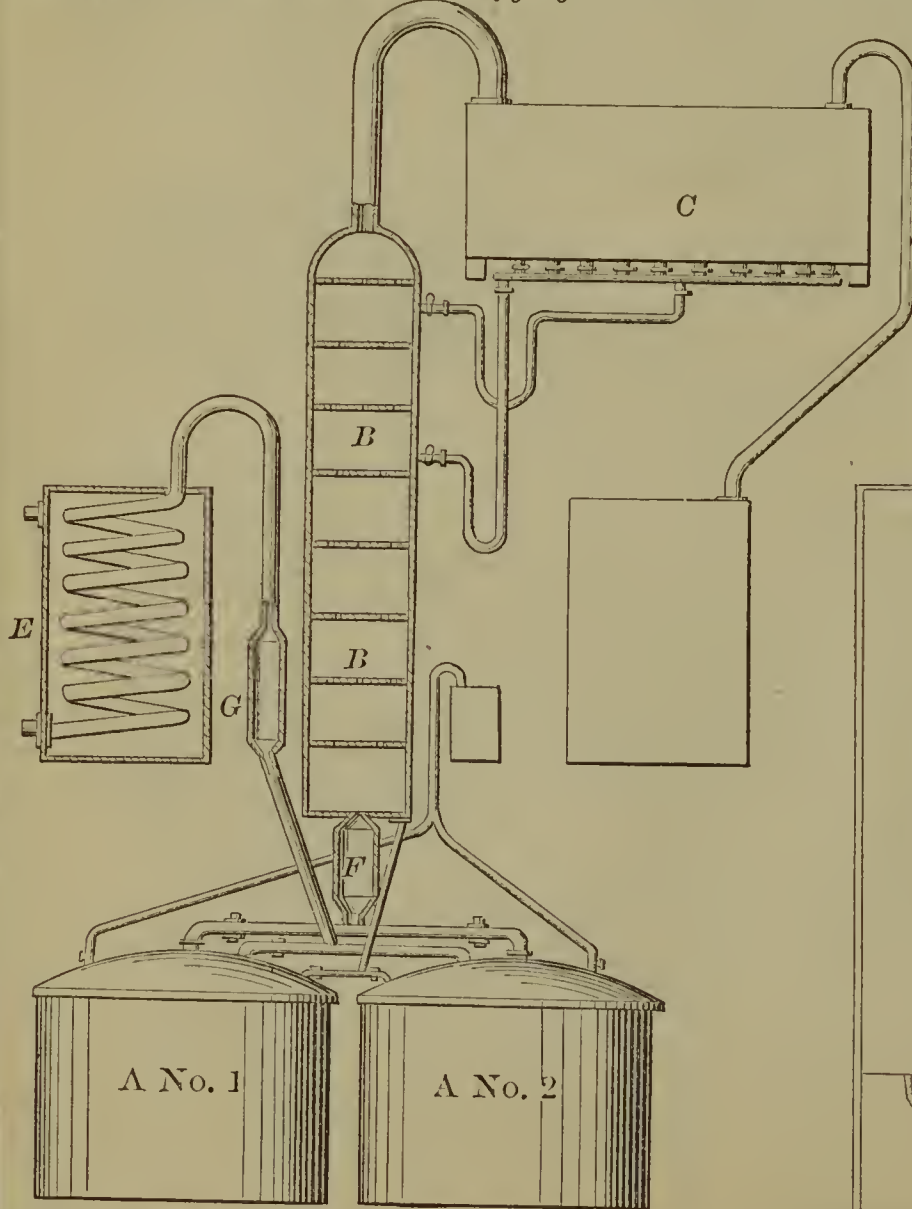

59151—J. J. McComb—Applying and Seaming Metal Bands on Cotton Rules.

59153—C. H. Ramsten—For Lowering and Detaching Boats from Davits.

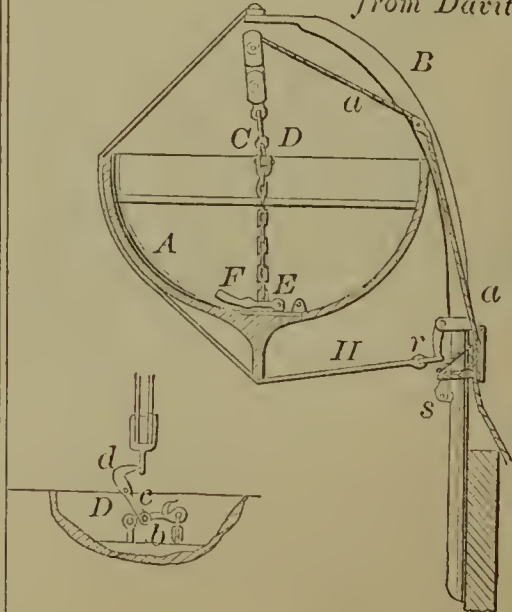

59155—C. L. & A. B. Irving—Piano Forte Action.

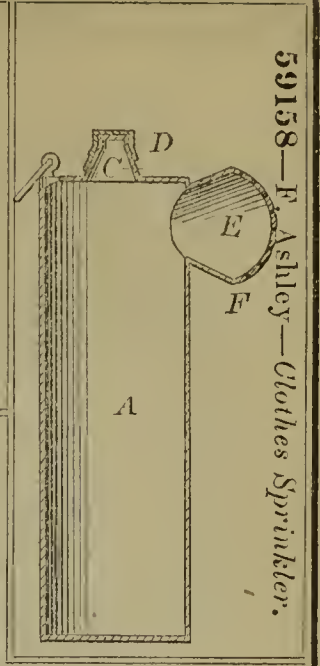
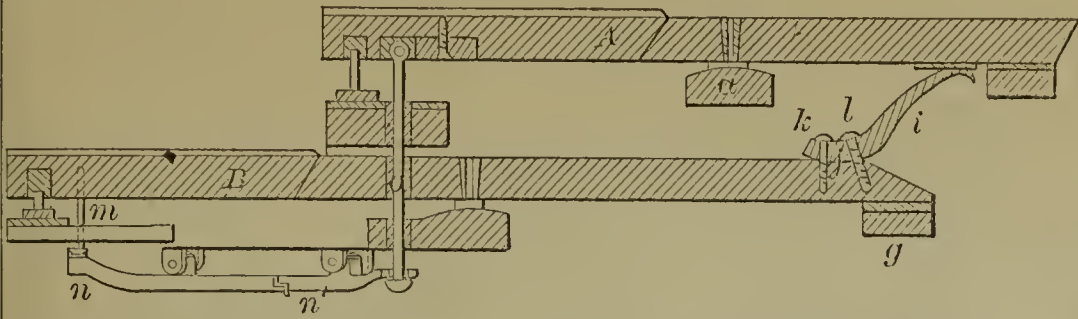

59158—F. Ashley—Clothes Sprinkler.

59156—C. Alden—For Extinguishing Fires.

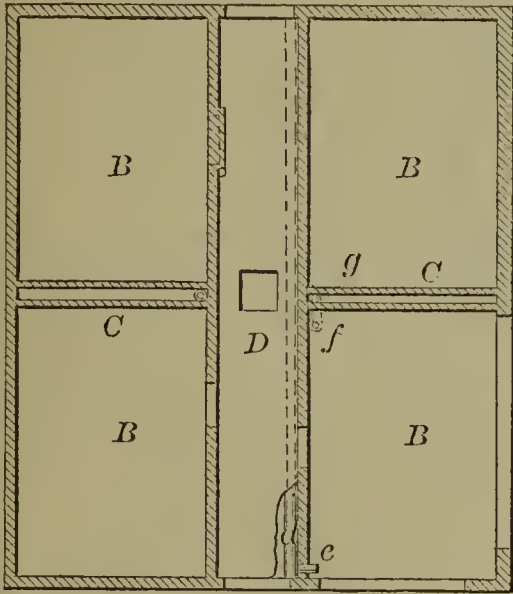

59161—M. F. Bagley—For Discharging Bilge Water from the Holds of Vessels.

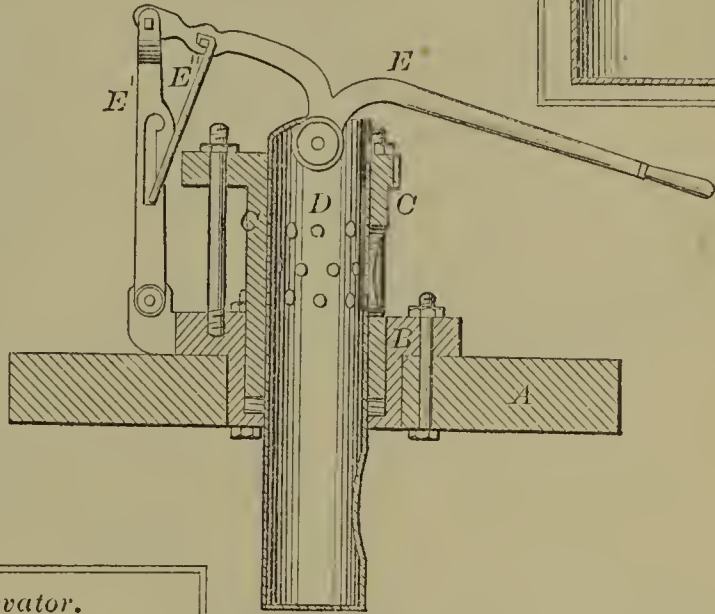

59160—W. E. Babcock—Water Elevator.

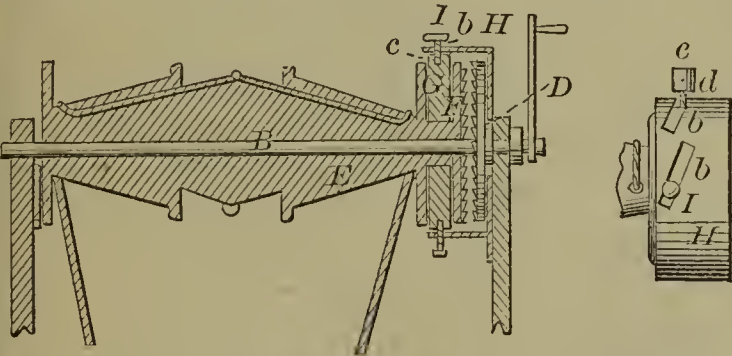

59157—A. Appleby—For Tanning.

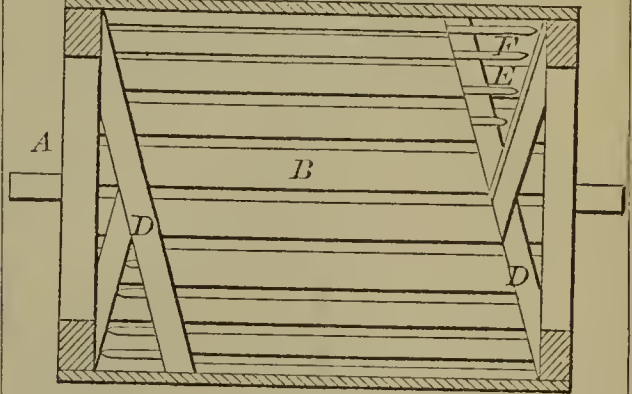

59162—S. Barker—Carriage Axle.

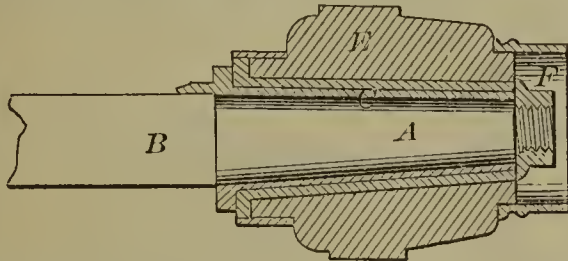

59164—L. Barnes—Whiffletree.

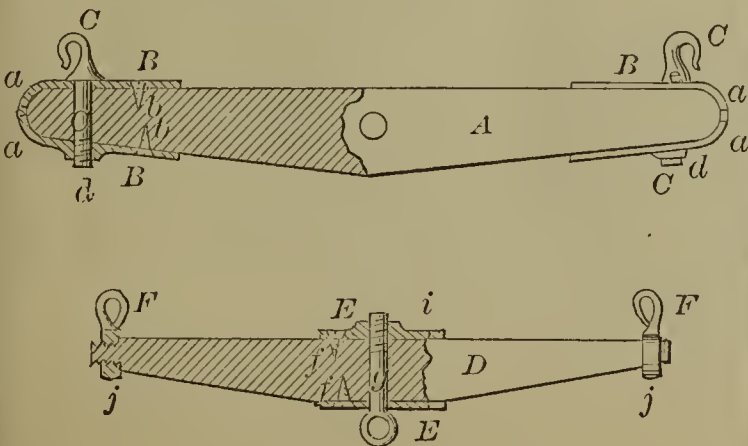

59159—J. S. & T. B. Atterbury—For Making Ring Jaws.

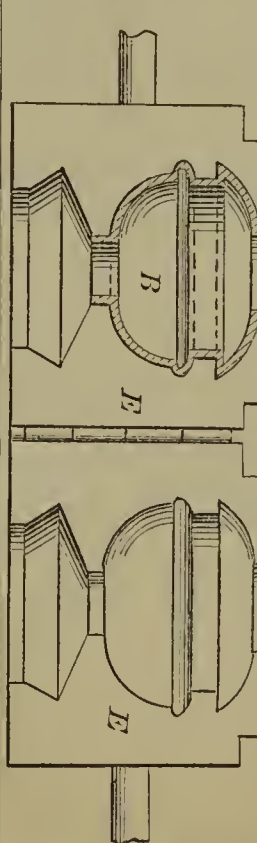

59163—J. T. Barnes—Furniture Caster.

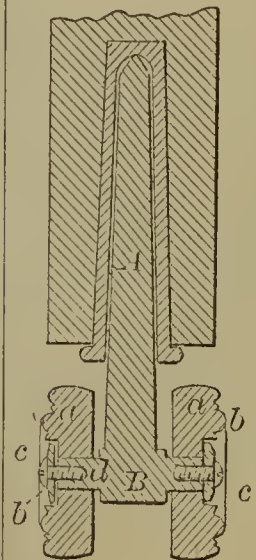

59165—M. L. Battell—Quartz Crusher.

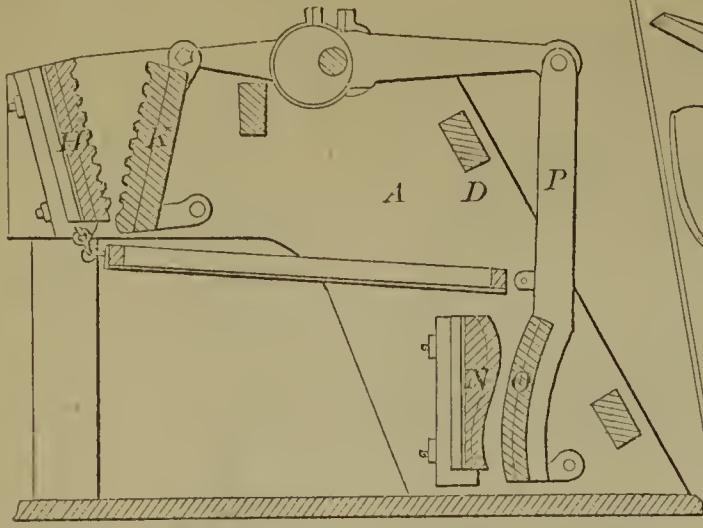

59168—F. Binder—Pruning Shears.

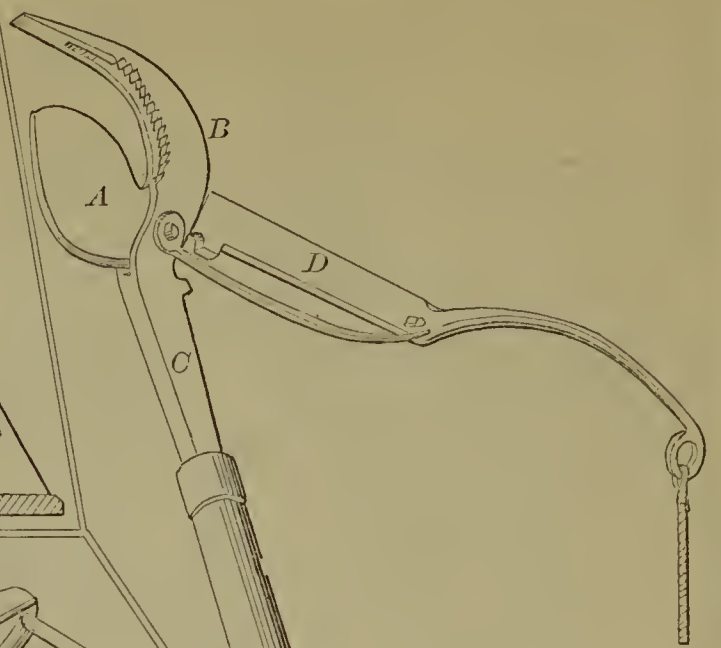

59167—D. J. Bigelow—Sleigh.

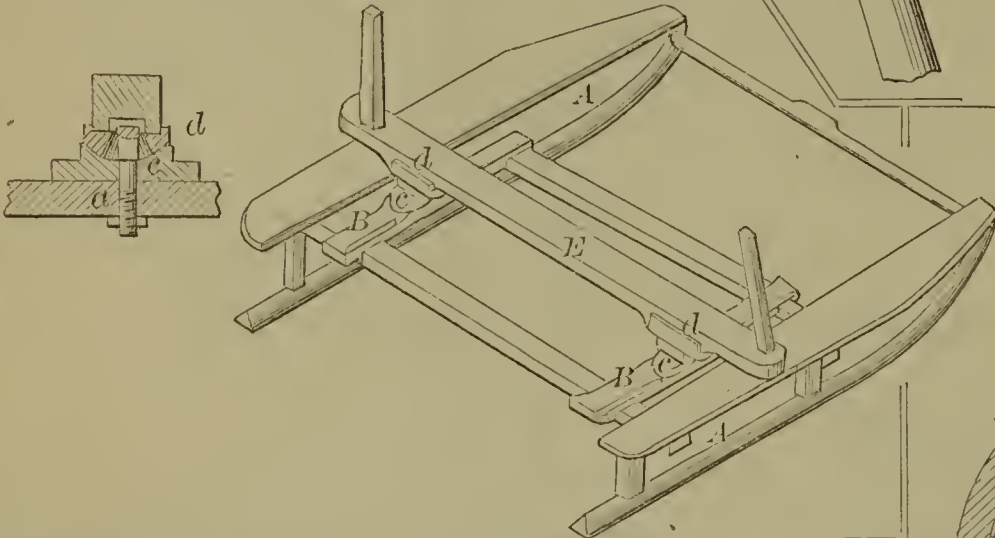

59166—J. B. Bennett—Rotary Steam Engine.

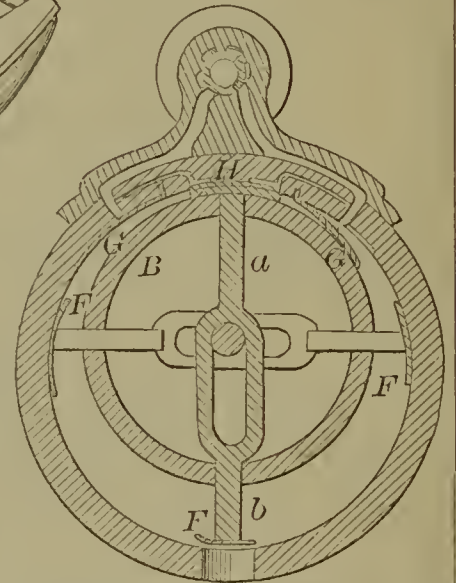

59170—T. F. Bingham—Beehive.

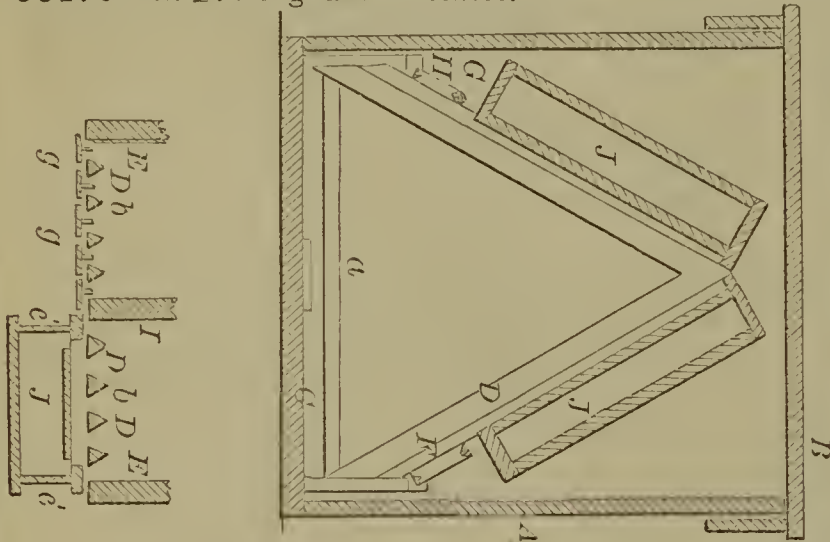

59169—T. F. Bingham—Beehive.

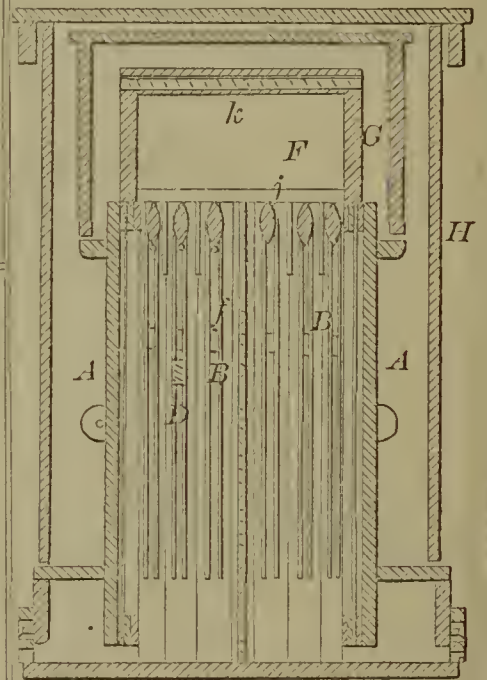

59171—A. A. Bissell—Canal Boat Deck.

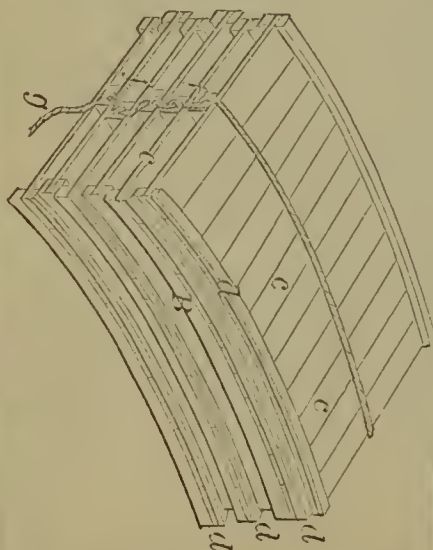

59172—A. S. Blake—Pulley.

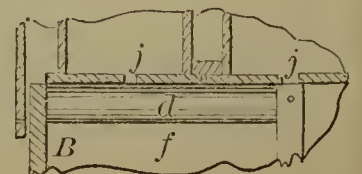
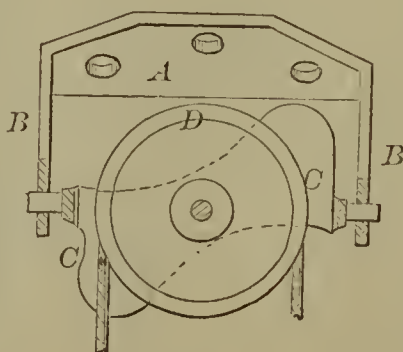

59173—E. S. Blake—*Stove Pipe Drum.*

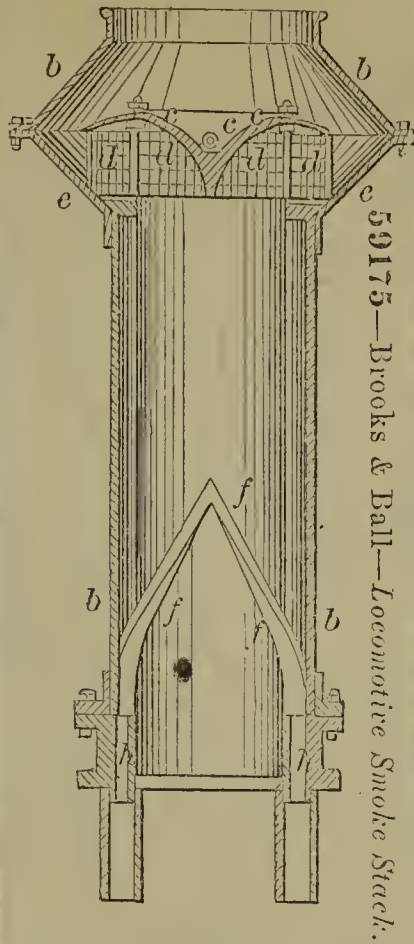
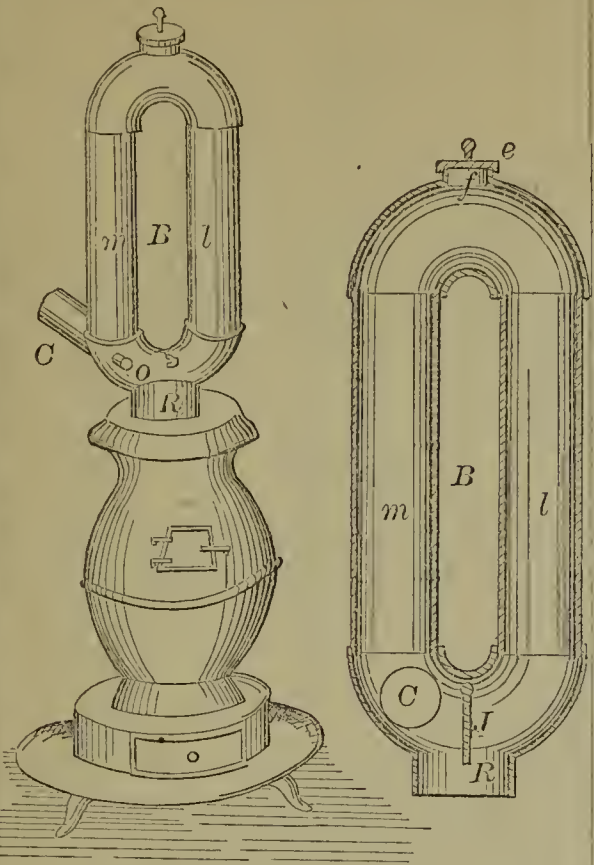

59175—Brooks & Ball—*Locomotive Smoke Stack.*

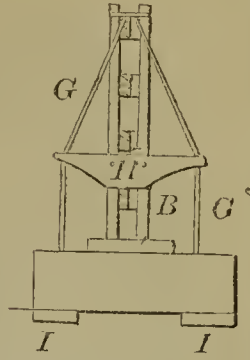

59176—J. Bandy—*Fence.*

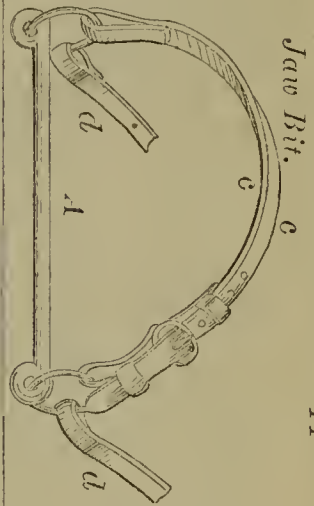

59178—F. B. Carleton—*Upper Jaw Bit.*

59180—H. Carpenter—*Railway Chair.*

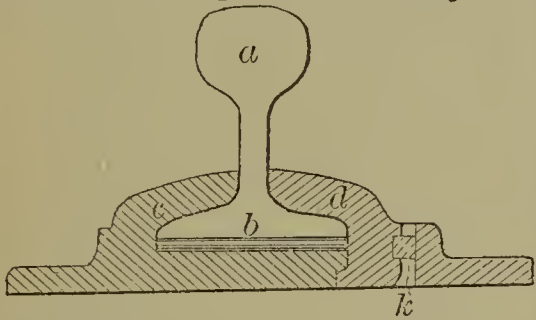

59184—G. H. Chinnoek—*Smoking Pipe.*

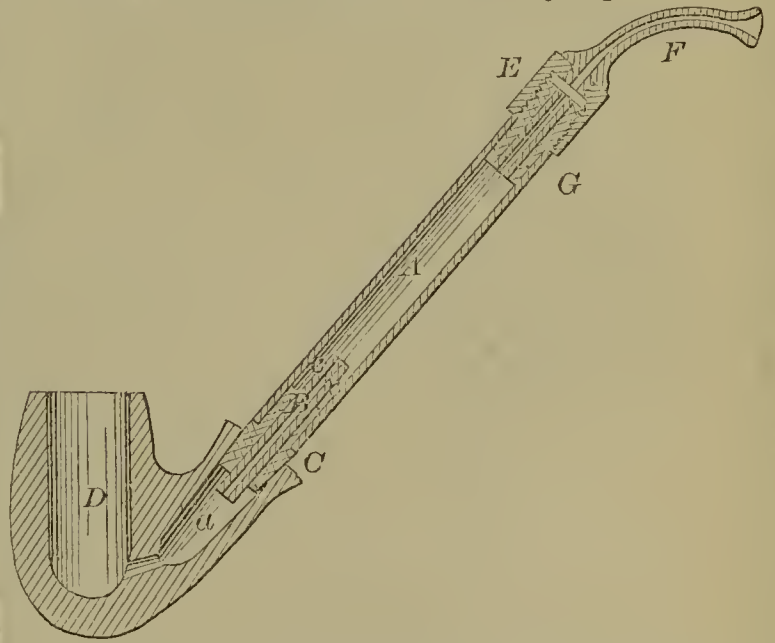

59181—A. L. Carrier—*Tool Supporter.*

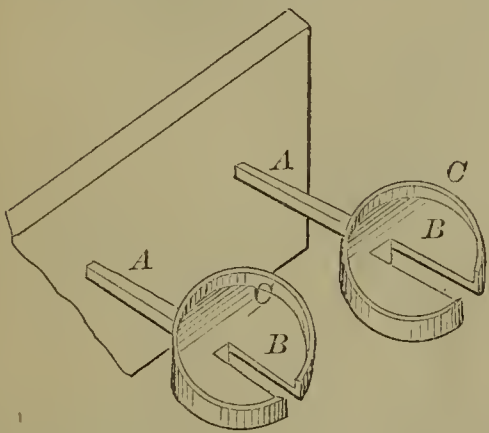

59185—F. C. Class—*Portable Fence.*

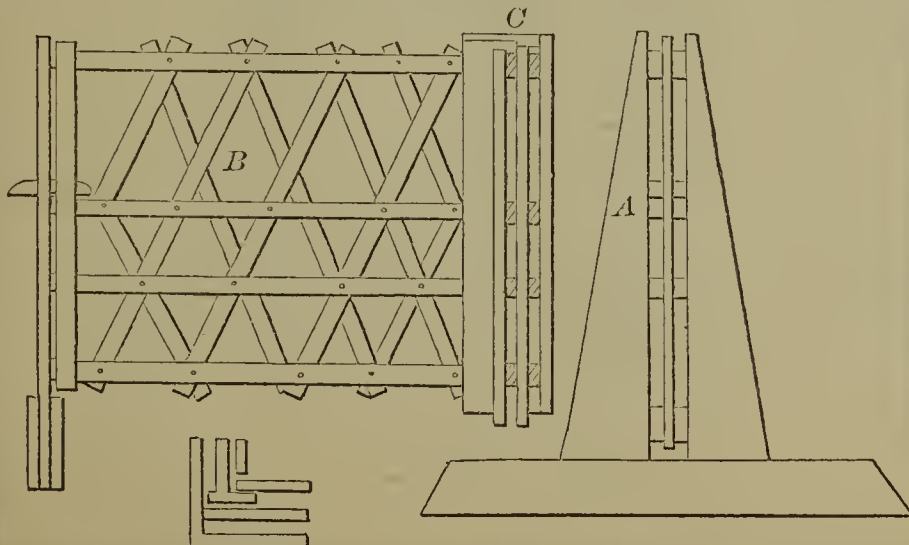

59186—L. Coates—*Variable Measure.*

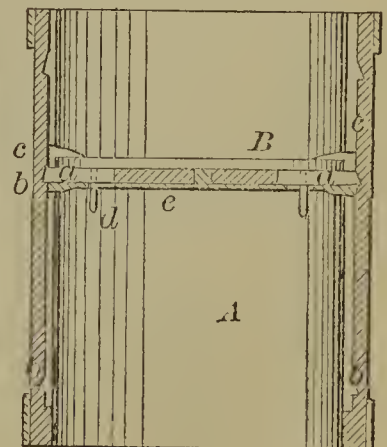

59188—W. Compton—Vessel for Beer, &c.

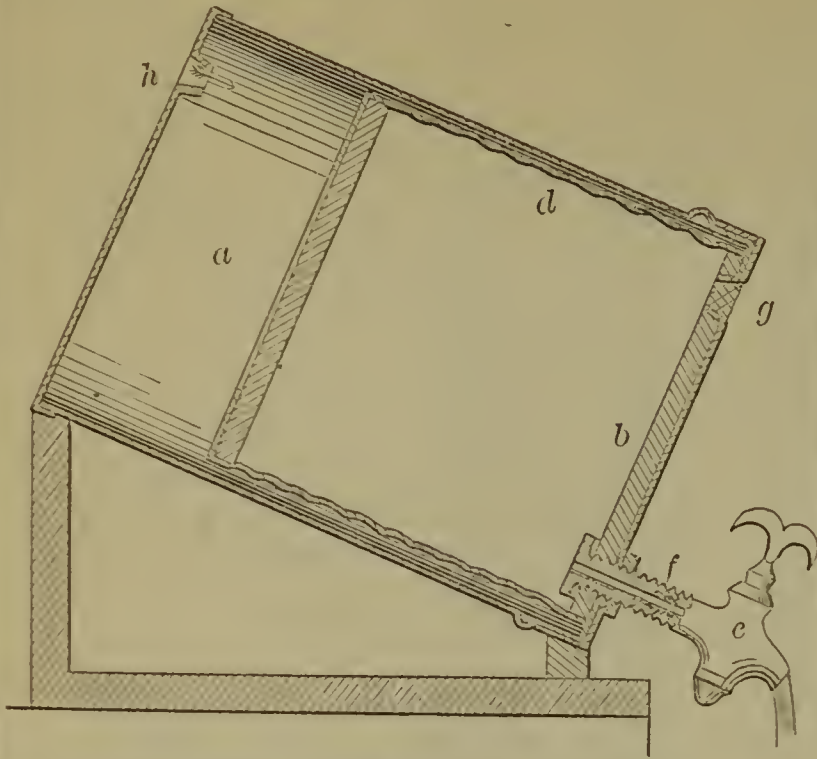

59190—J. B. Crowell—Cattle Stanchion.

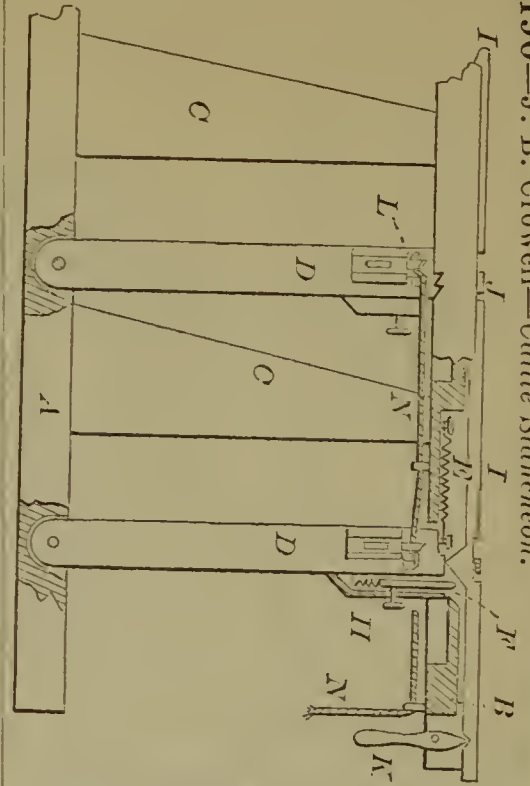

59192—J. W. Doty—Pitman for Harvesters, &c.

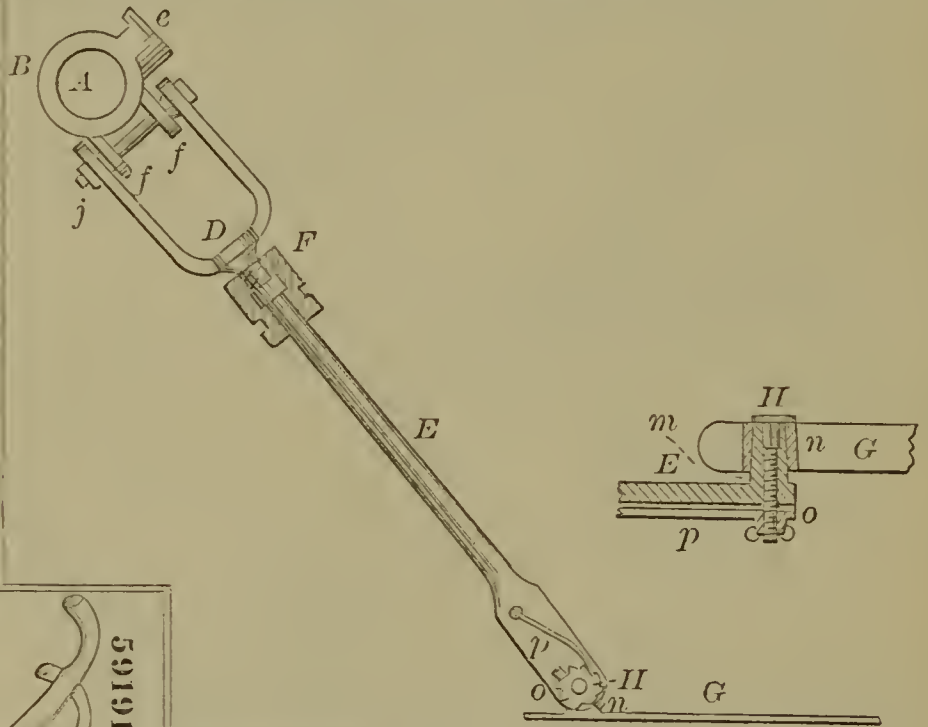

59189—J. B. Cornell—Saw.

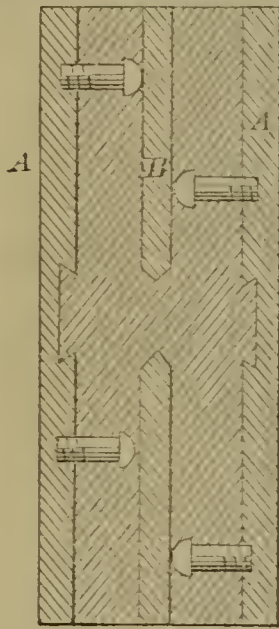

59193—J. W. H. Doubler—Saw Filing Machine.

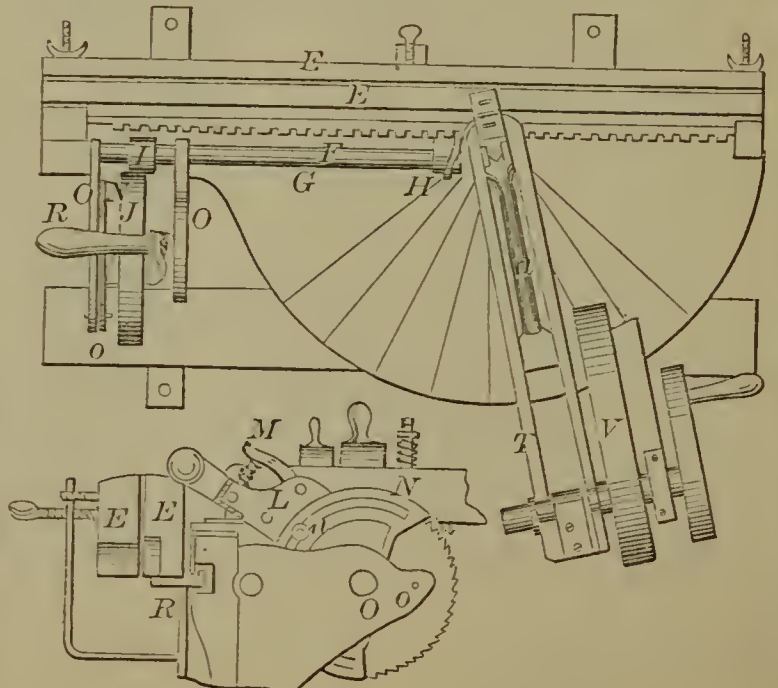

59191—J. C. Daugherty—Shovel Plow.

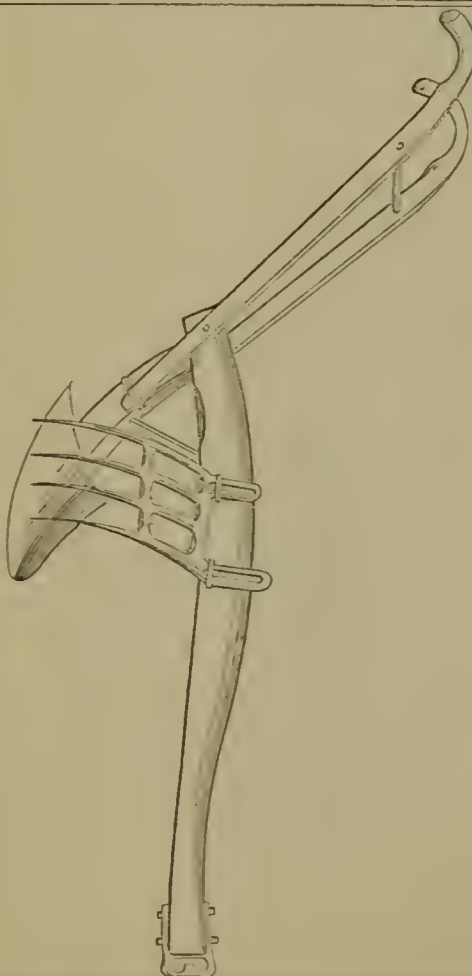

59194—J. W. Drew—Wheel Vehicle.

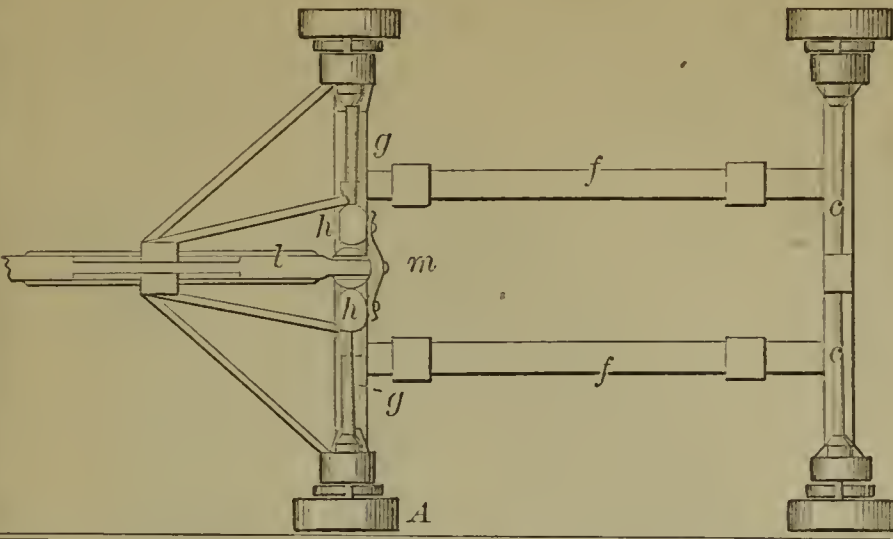

59196—E. Duncan—Gate.

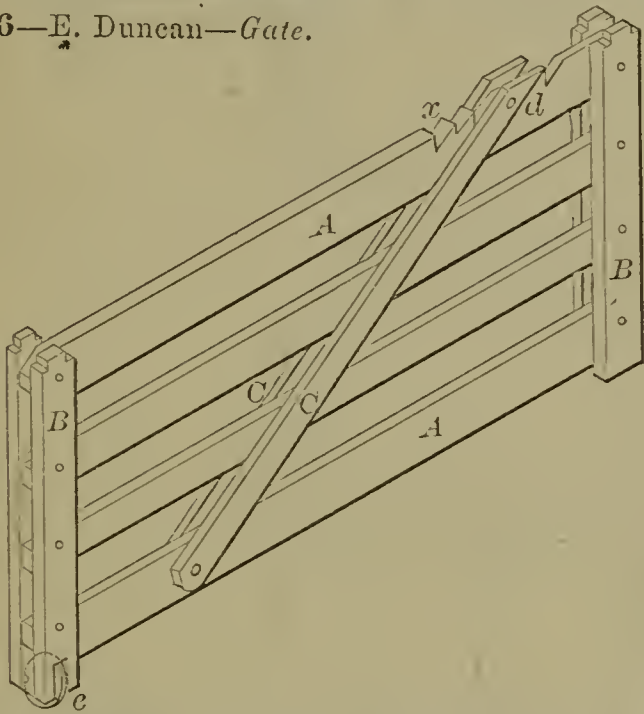

59199—D. S. Evans—Fence.

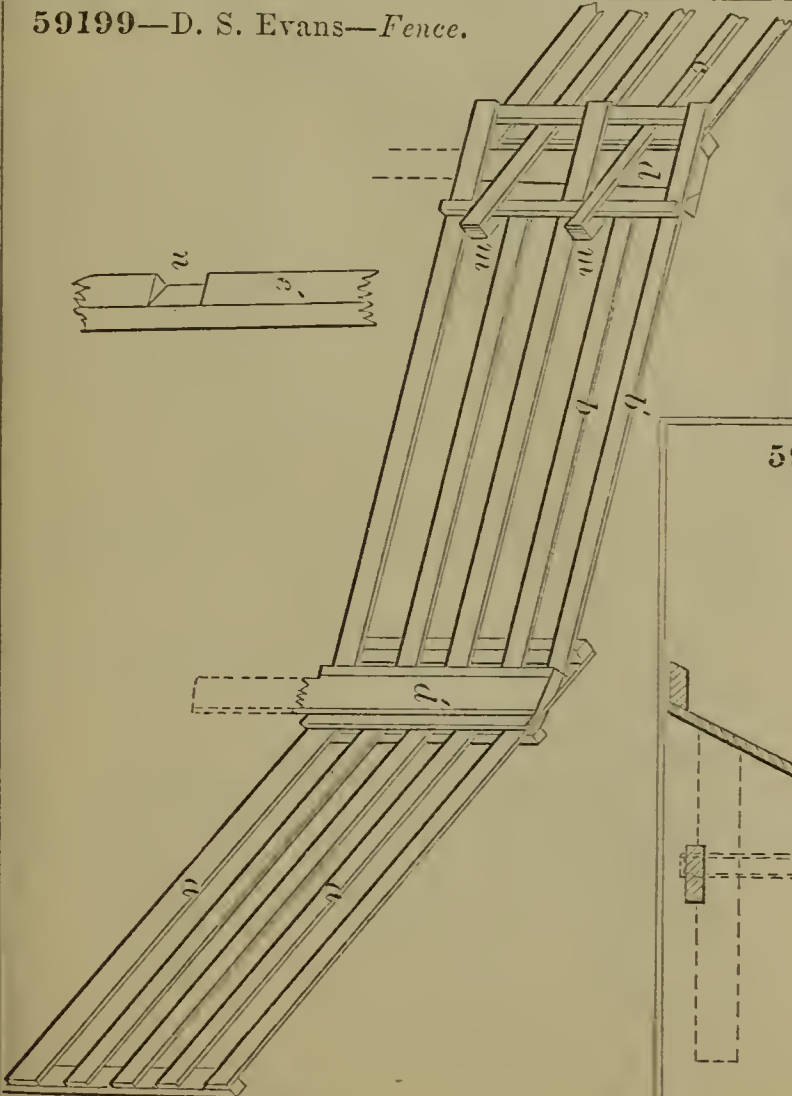

59198—J. Elder, Jr.—Steam Heating Apparatus.

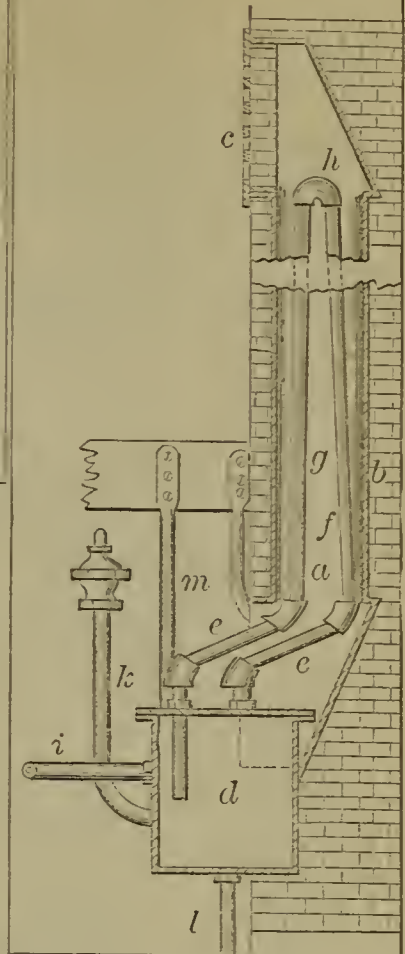

59197—W. C. Dunn—Training Hops.

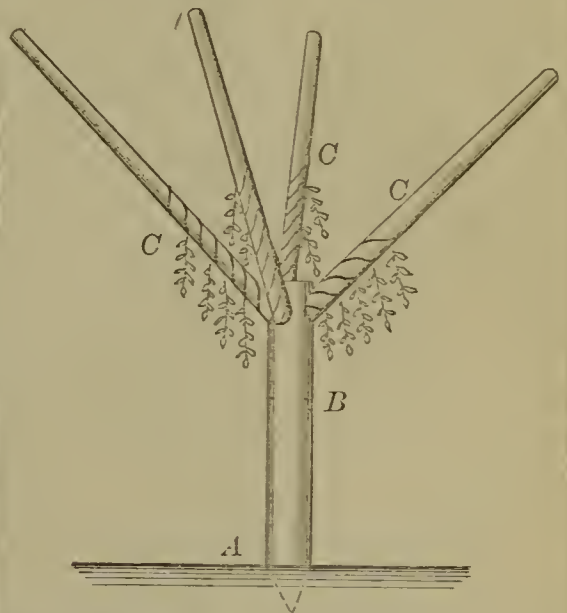

59195—N. Drew—Washing Machine.

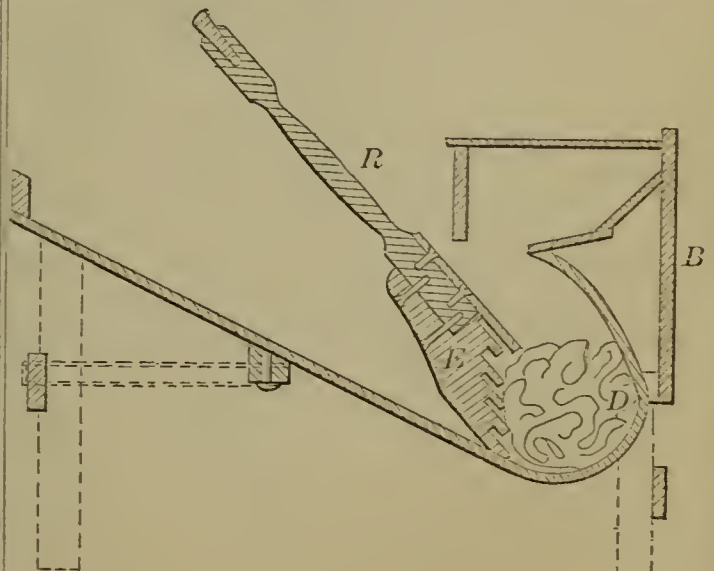

59200—W. W. Ewing—Saw Mill.

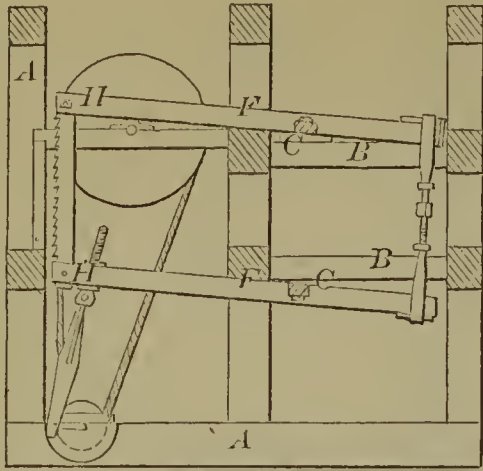

59201—L. Fagin—Hanging Mill Stones.

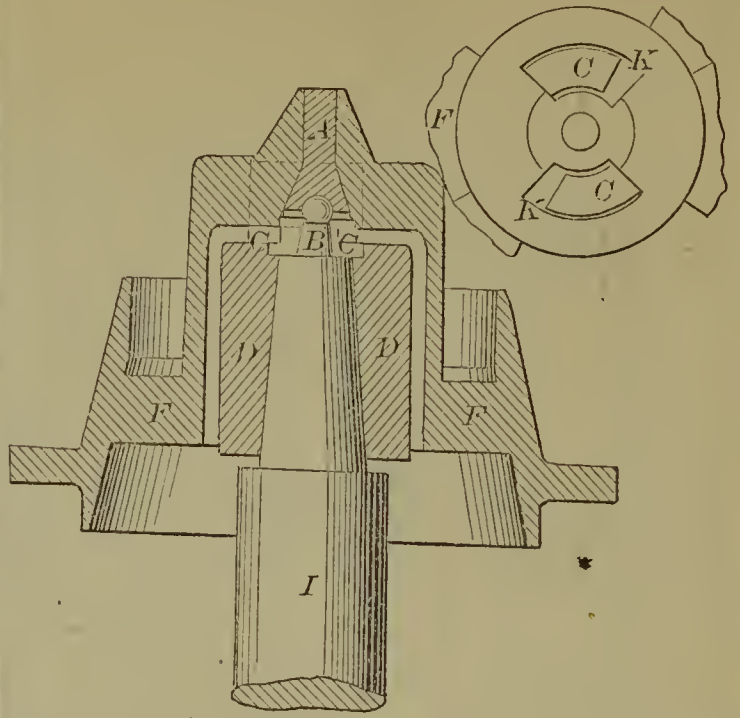

59204—I. Fiske—Cornet and other Wind Instruments.

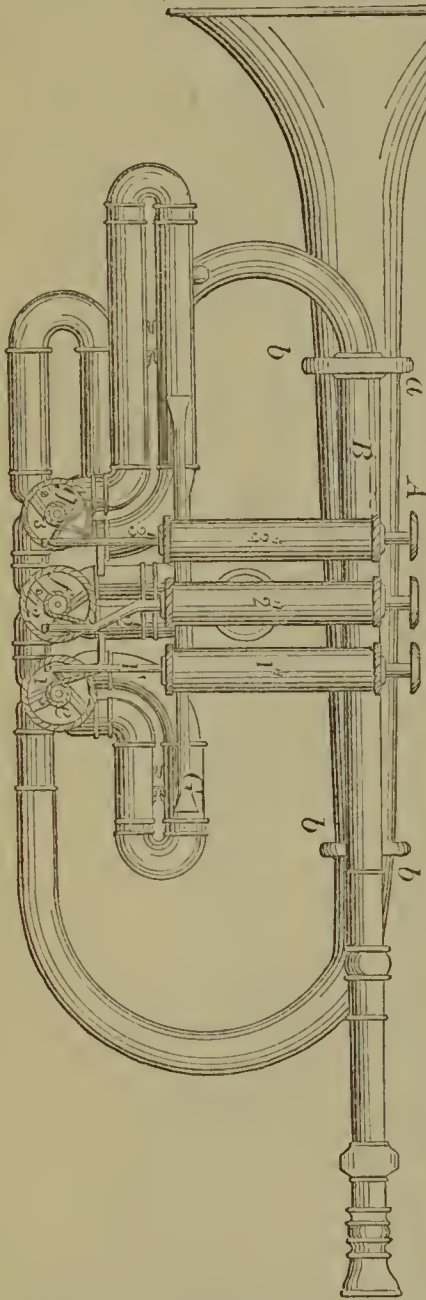

59203—W. H. Field—For Leathering Tucks.

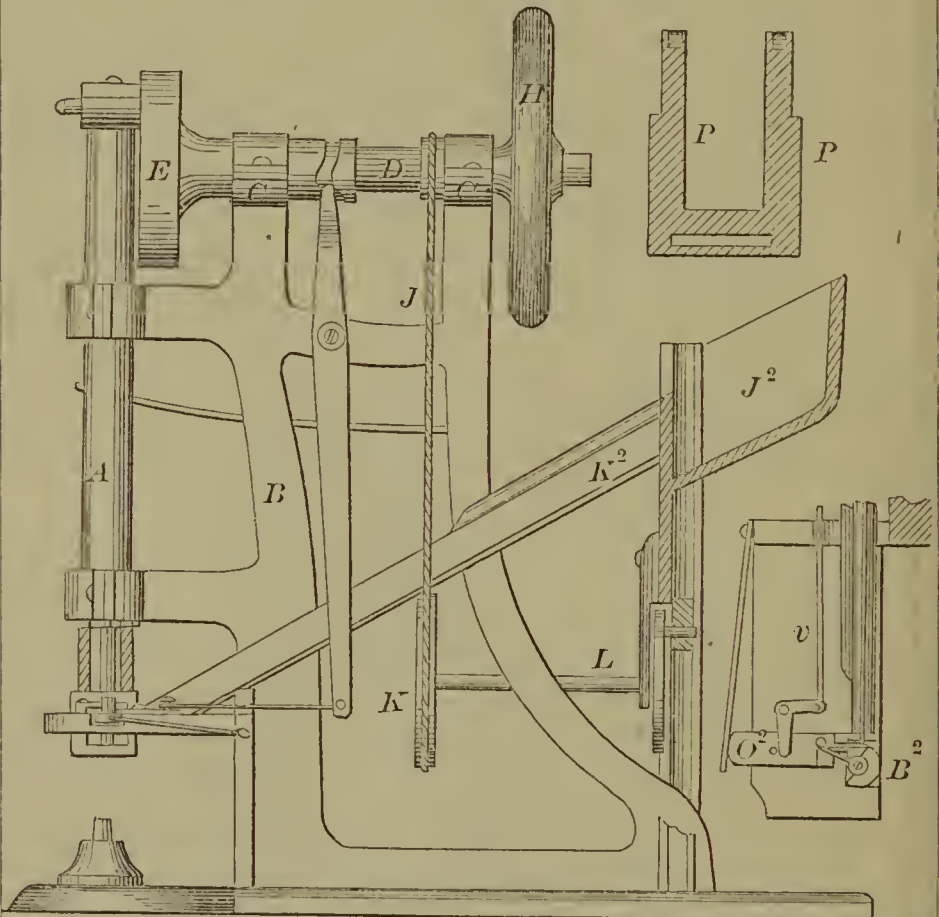

59202—Field & Carruthers—Gate Hinge.

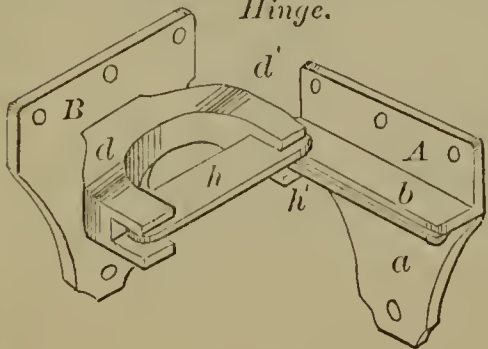

59205—T. Frame—For Raking and Loading Hay.

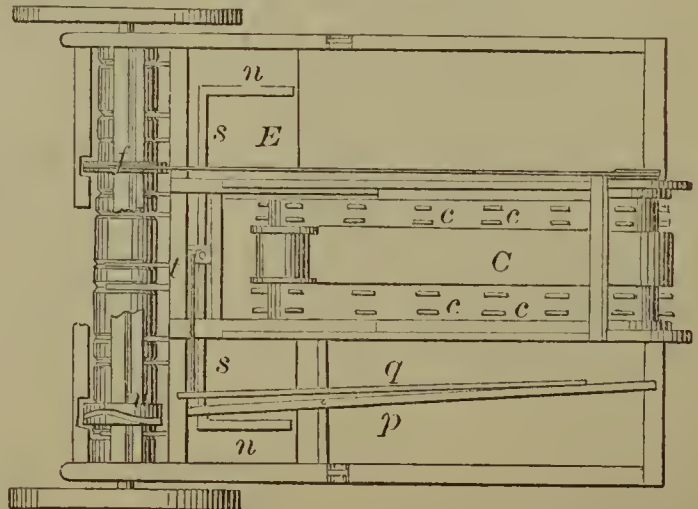



59207—T. T. Furlong—Safe.

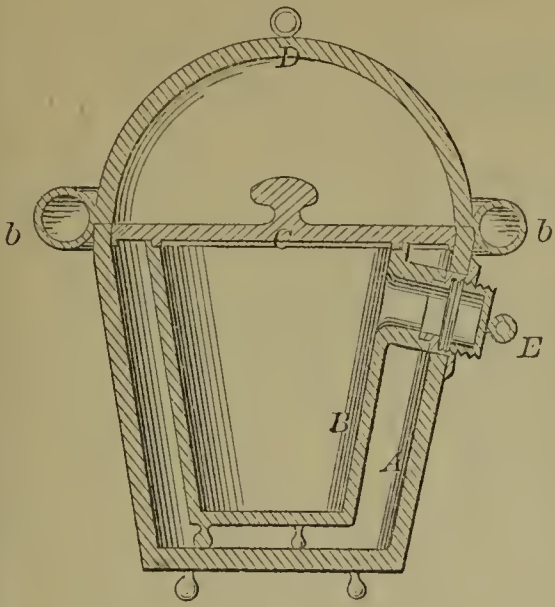

59208—A. C. Gallahue—Clothes Wringer.

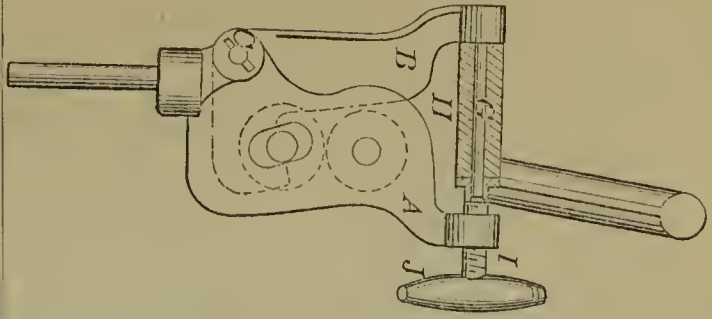

59211—B. Greenside—Gate Hinge.

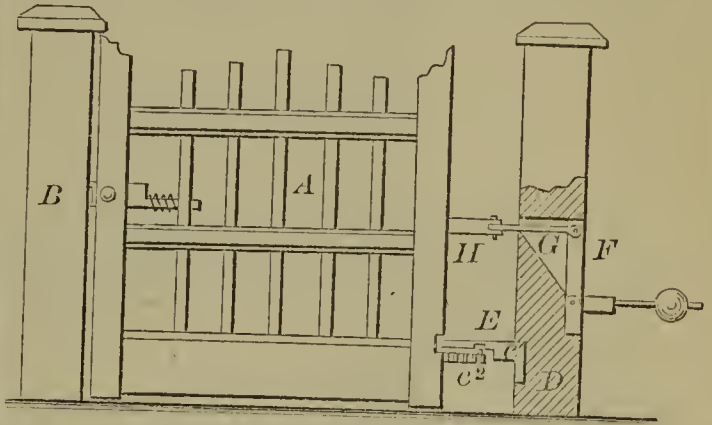

59210—J. Green—Hand Spinning Wheel.

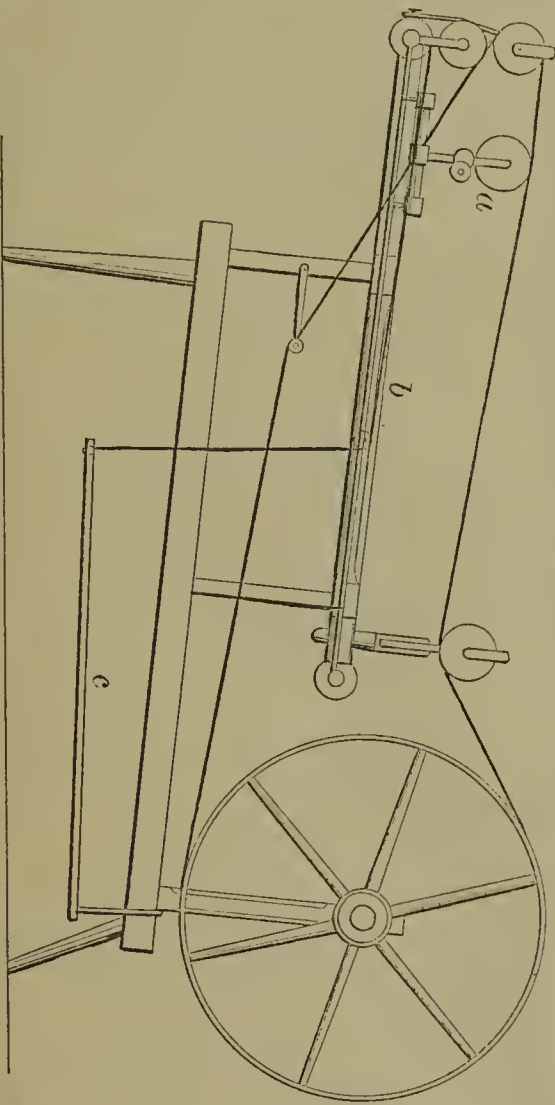

59212—I. Gregg—Brick Machine.

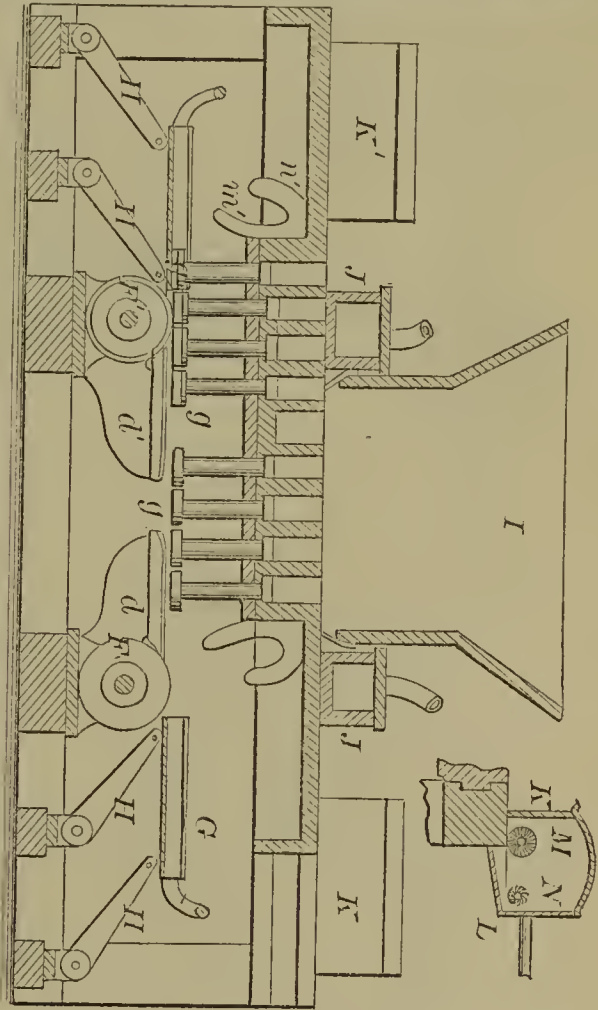

59213—H. Haak—Grain Gauge.

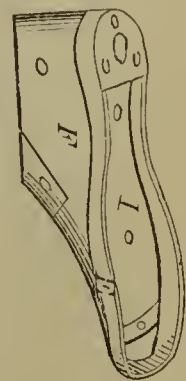
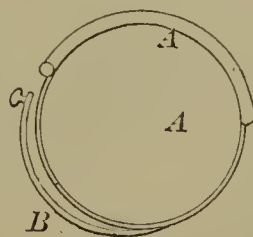
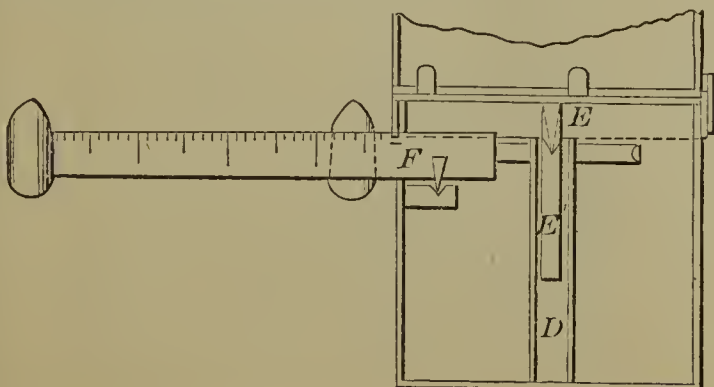

59209—E. T. Green—Last.

59217—A. Harter—Grain Tallying Machine.

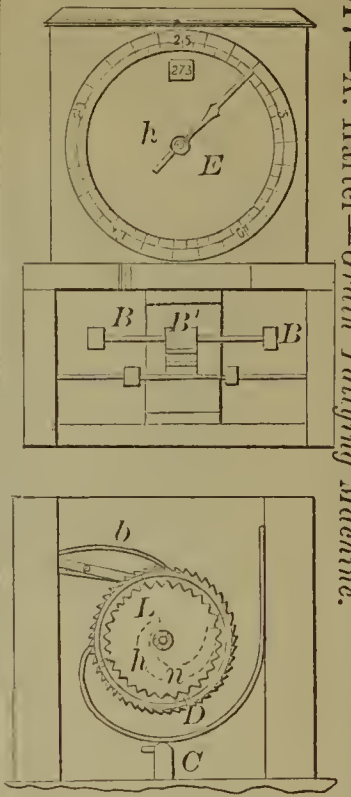

59214—D. & J. Hall—Puddling Furnace.

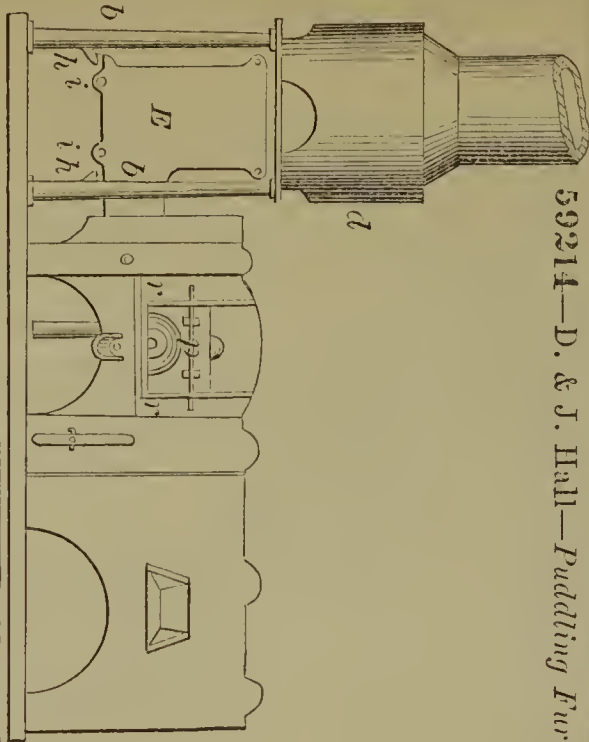

59215—J. A. Hall—Cotton Cultivator.

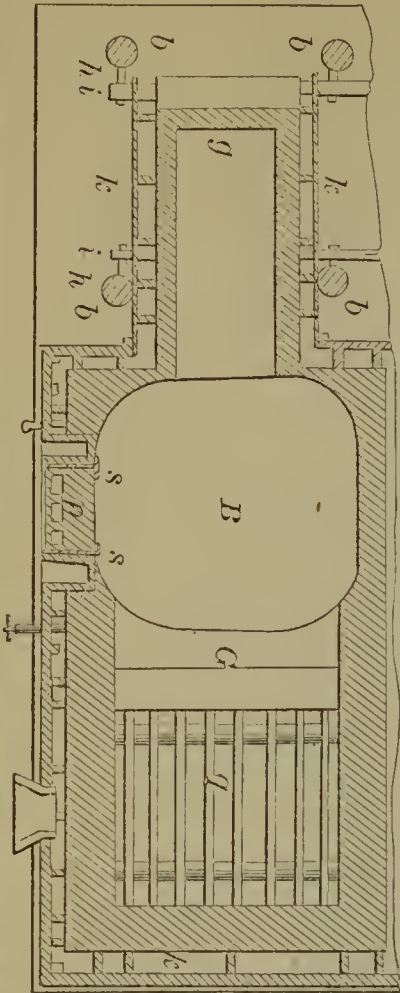
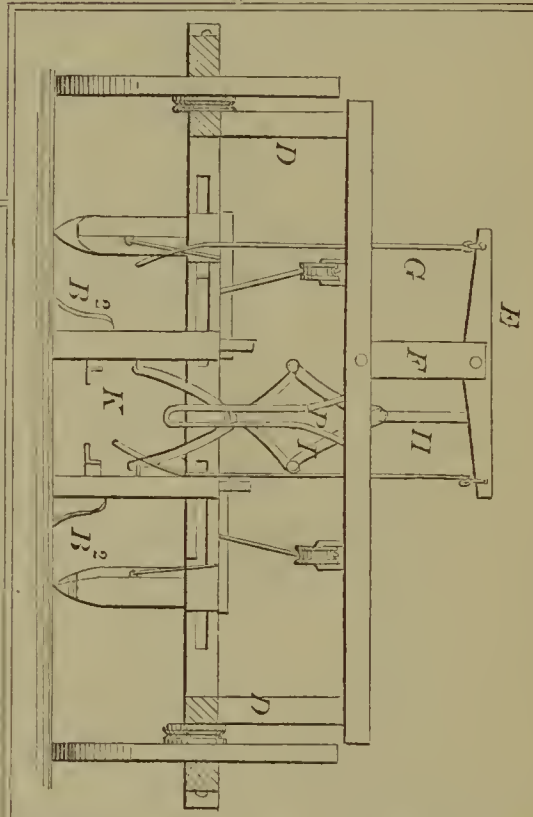

59218—N. Hadington—Railway Chair.

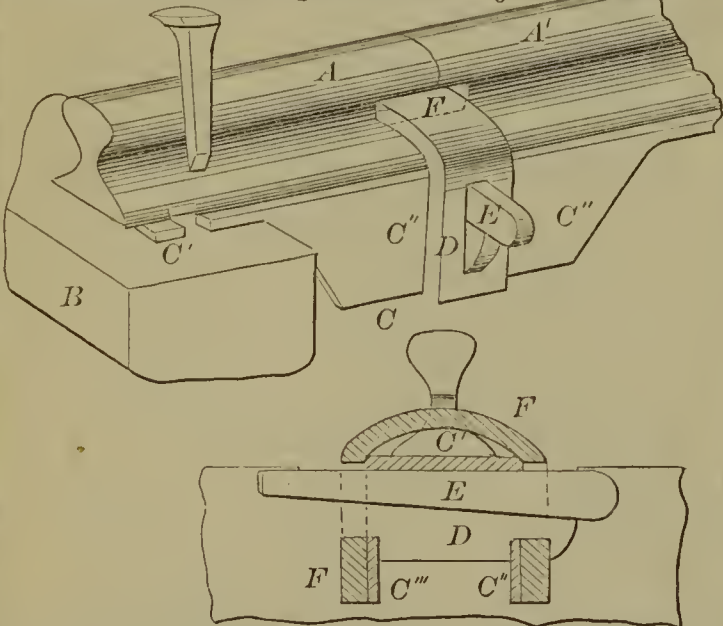

59220—J. D. & I. Hess—Sorghum Stripper.

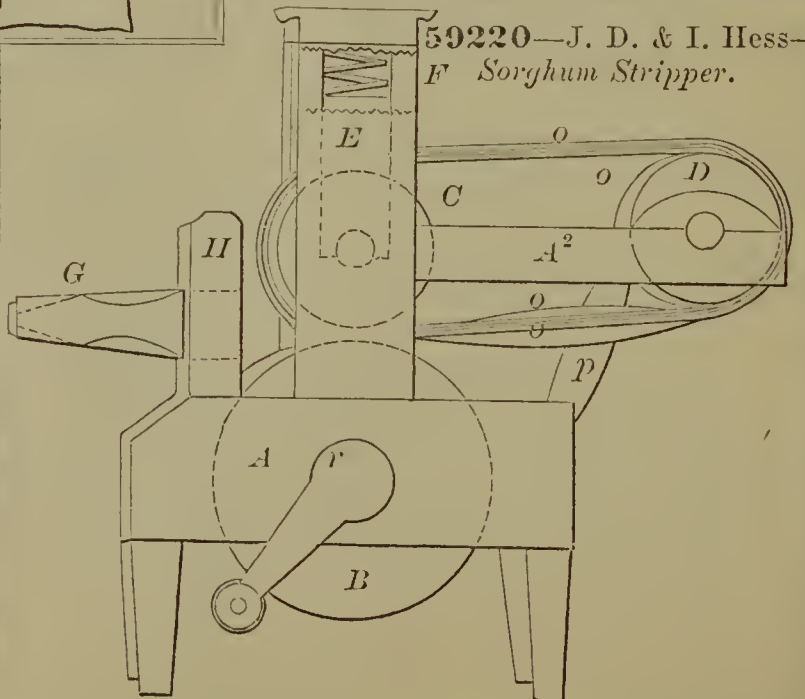

59219—C. Heisterman—For Wrinkling the Insteps of Boots and Shoes.

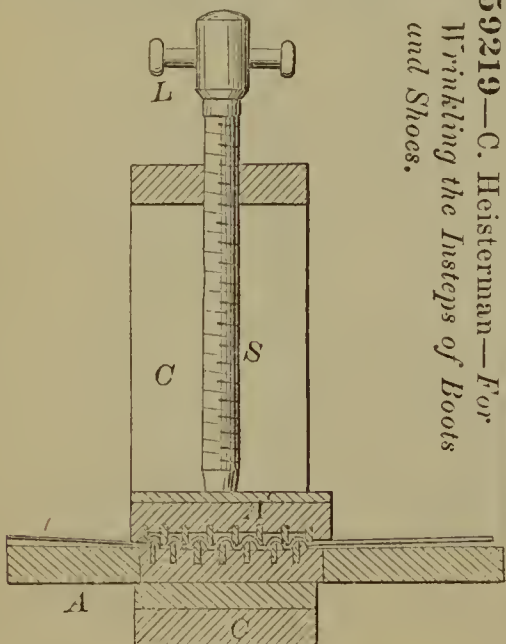

59221—S. E. Hewes—Steam and Air Ejector.

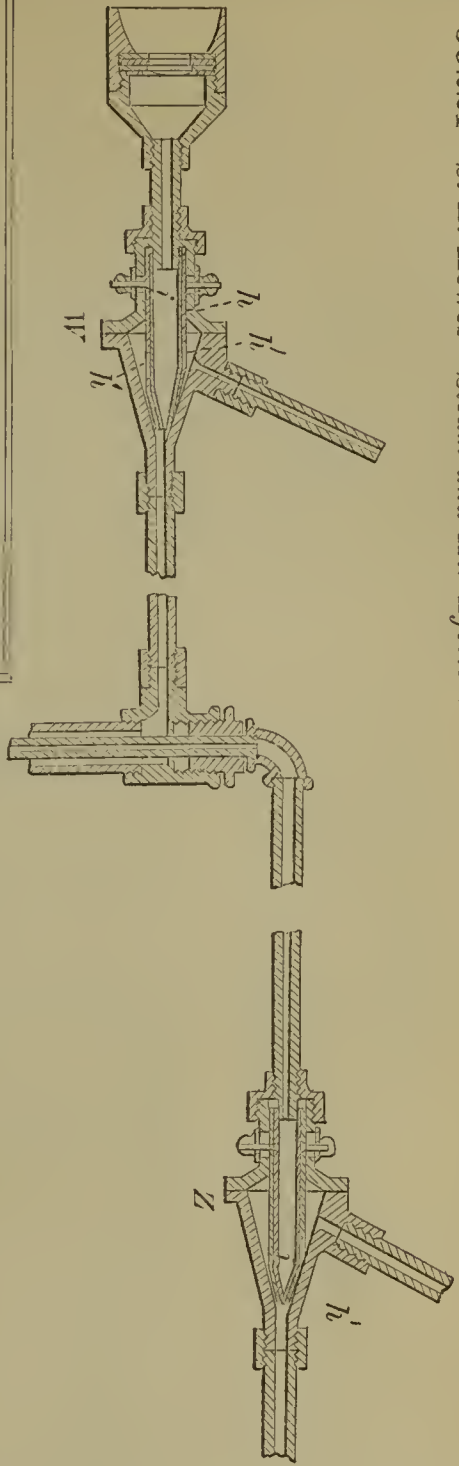

59224—R. Hoover—Washing Machine.

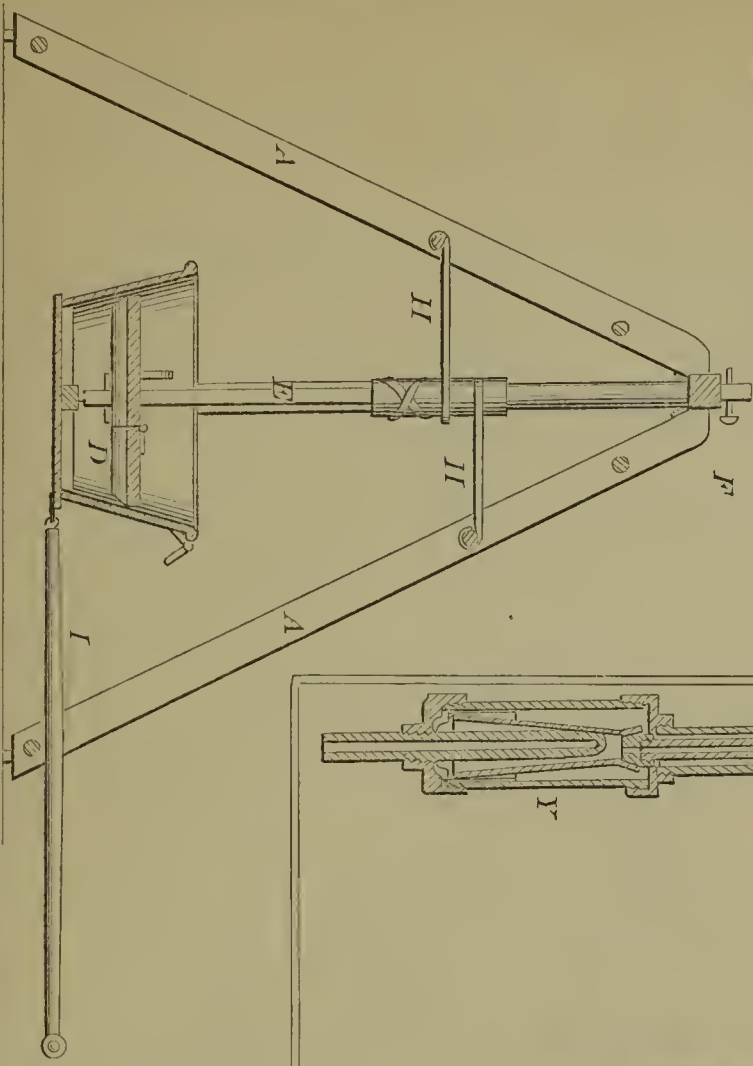

59223—P. K. Holbrook—Ink Cup.

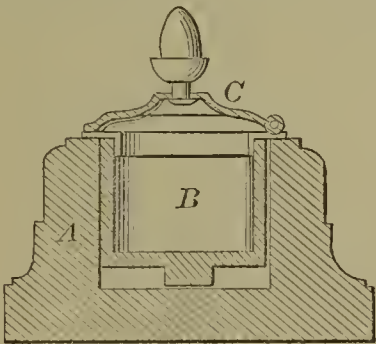

59226—E. S. Hutchinson—Automatic Blast for Carburettors in Railroad Cars, &c.

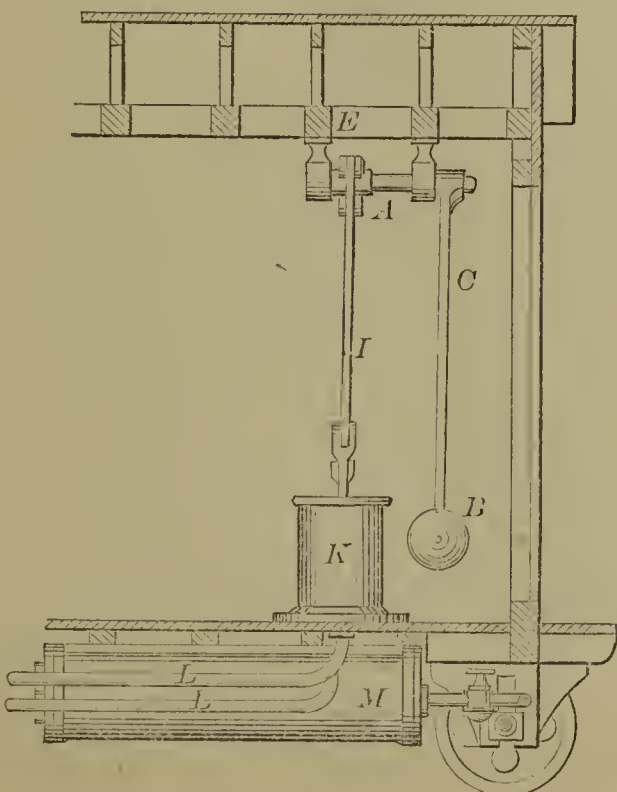

59225—T. S. Hudson—Canceling Apparatus.

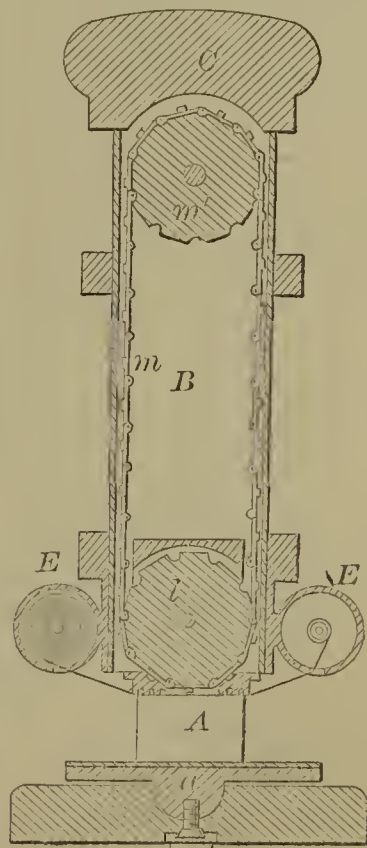

59229—I. Jones—For Cutting the Fronts of Books.

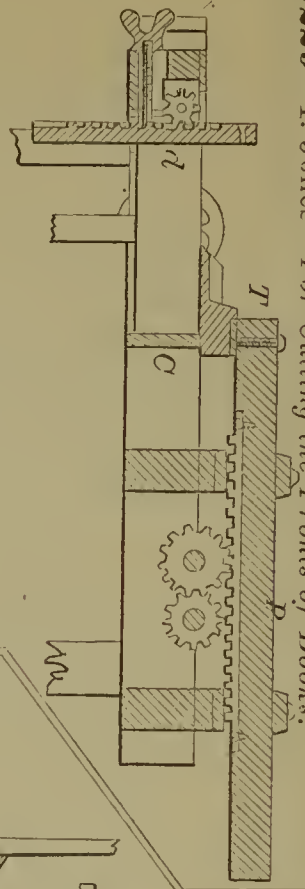

59231—W. Kiddoo—Cultivator.

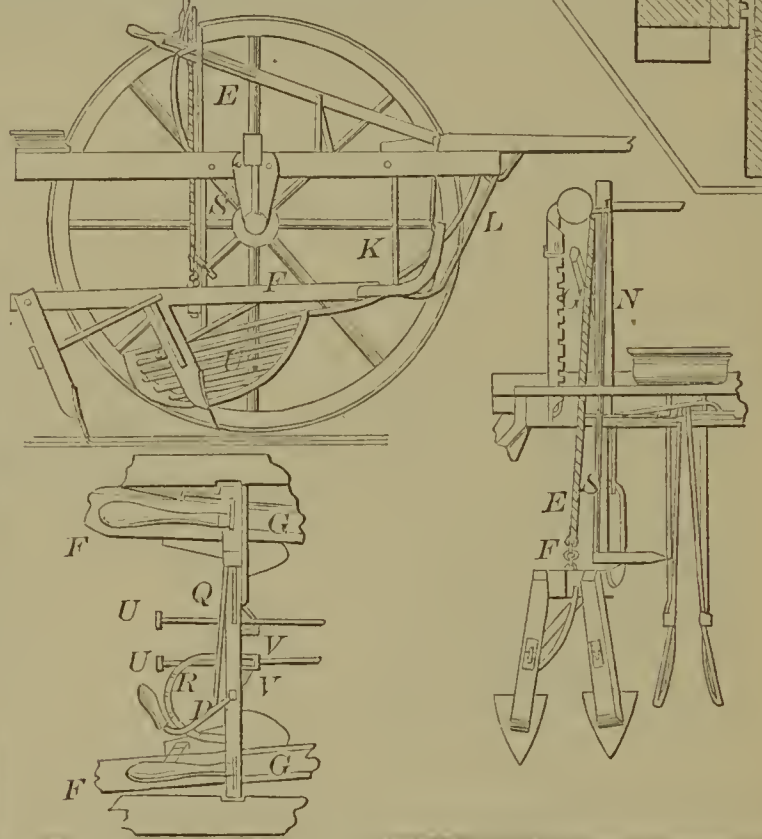

59230—J. Holbrook—Gang Punch.

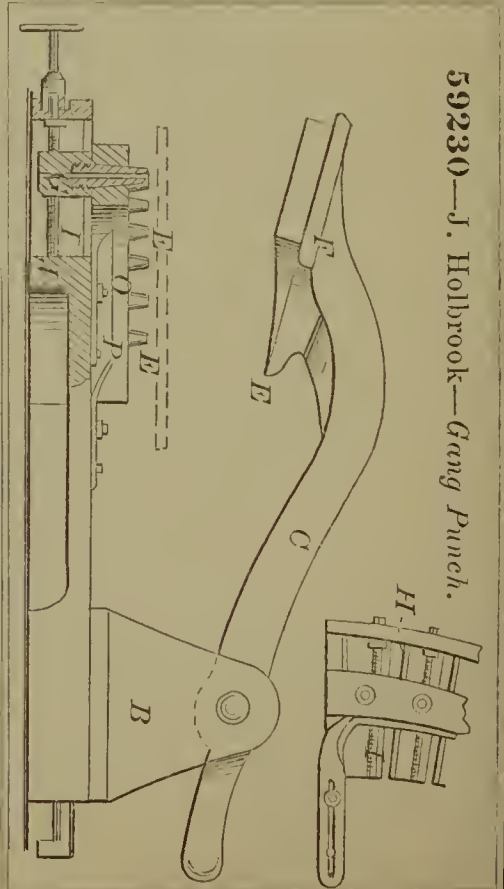

59227—Isaacsohn & Cohn—Victorine, Cape and Cuff.

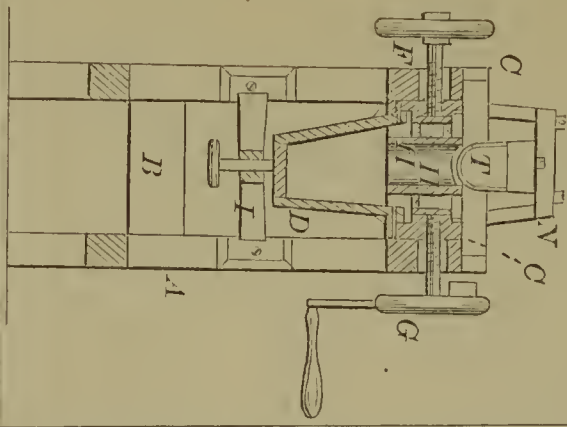

59228—J. M. Jarrett—Waterproof Mail Bag.

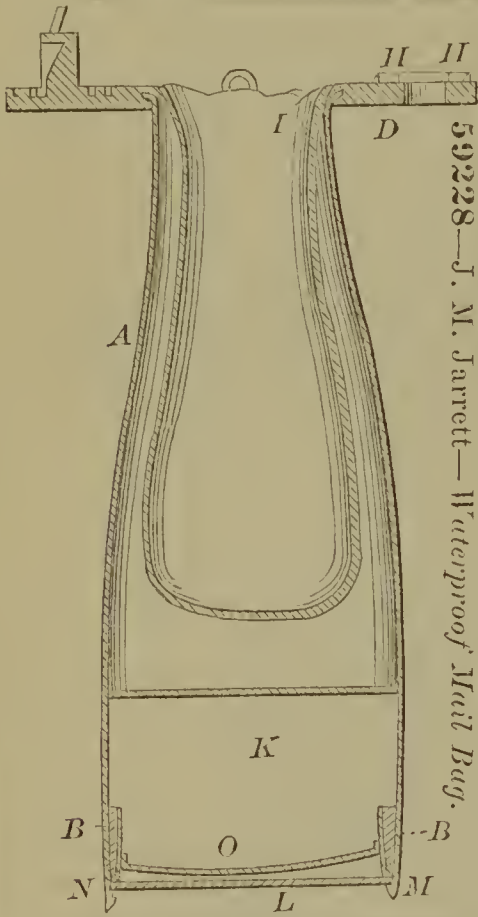

59232—G. Knight—Sulky Plow.

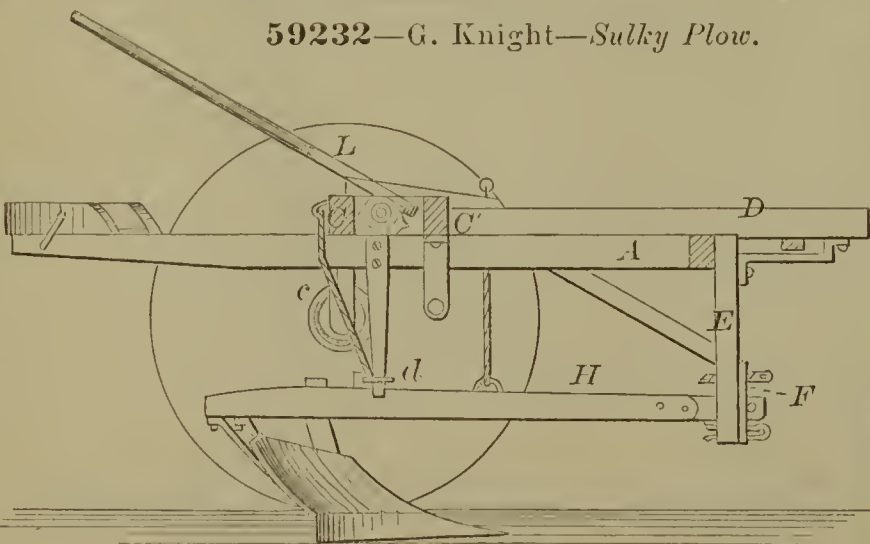

59233—A. J. Knox—Wash Bowl and Water Closet.

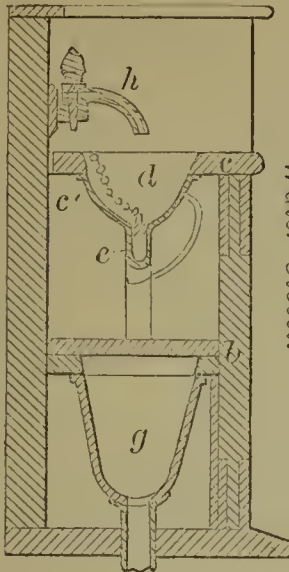

59234—W. Kraemer—For Making Buttons.

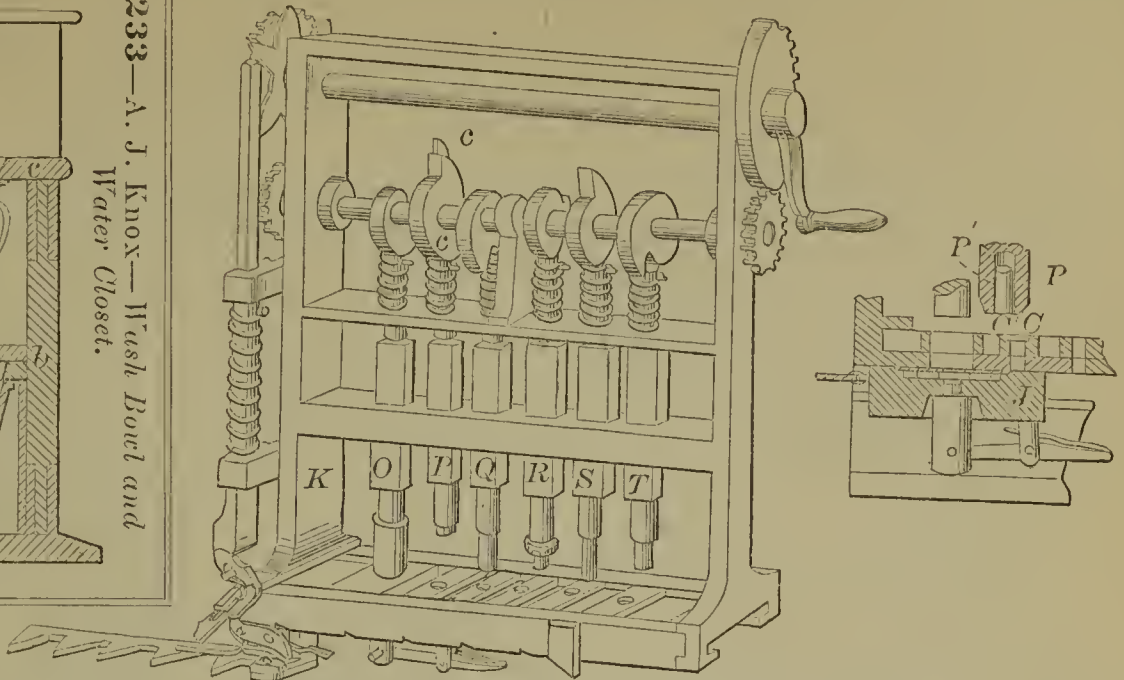

59235—D. Kunkel—Washing Machine.

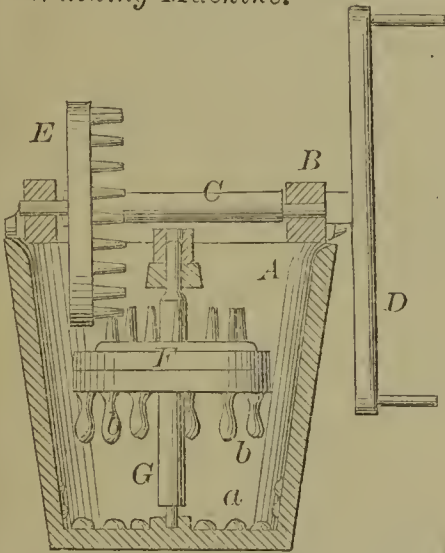

59236—H. H. Ladd—Sheep Rack.

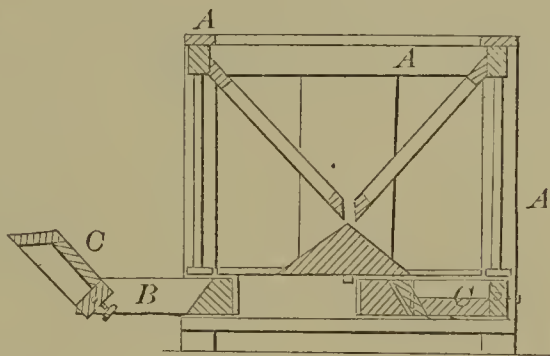

59237

C. W. Le Count—Lamp Wick

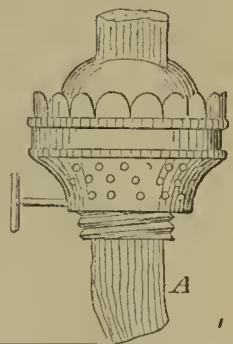

59240—M. T. Lincoln—Bookbinder's Sewing Table.

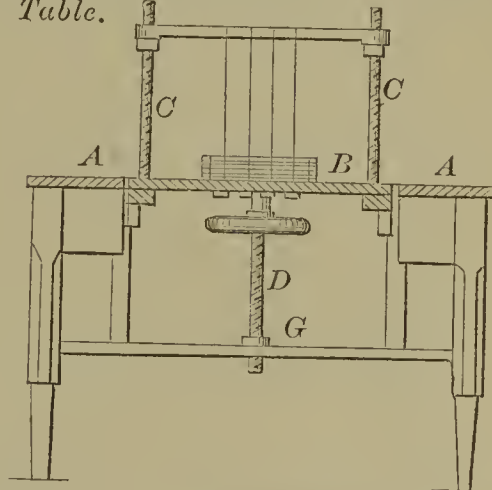

59243—G. Martz—For Hoisting and Dumping Coal.

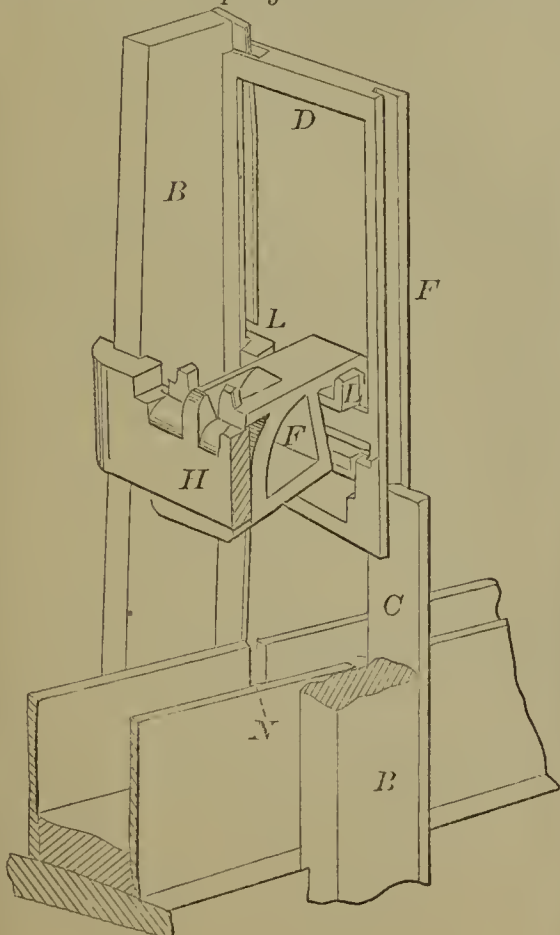

59241—C. Löffler—Cork Pull.

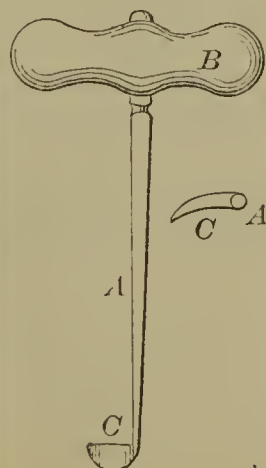

59242—J. J. Love—Double Headed Wrench.

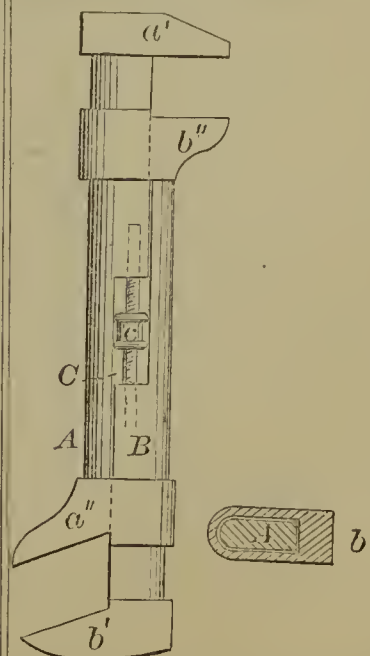

59244—J. R. McAlister—Sleigh Brake.



59245—J. R. McAlister—For Boring Wagon Hubs.

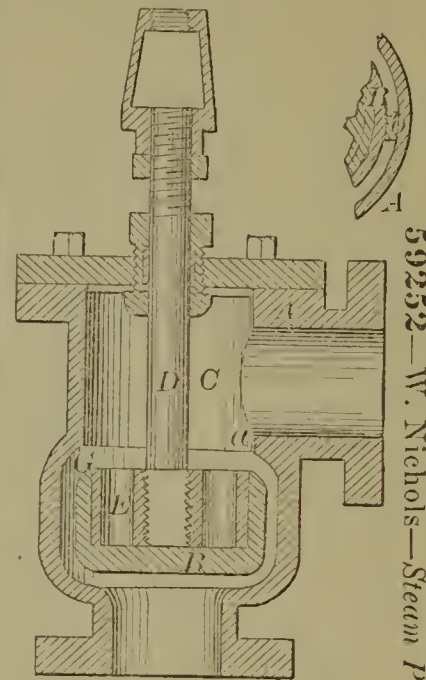
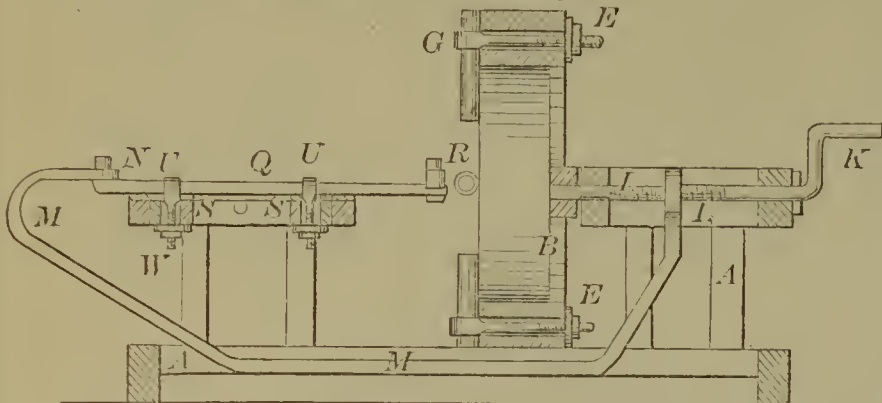

59252—W. Nichols—Steam Piston Valve.

59248—D. N. Minor—Baru Door Fastening.

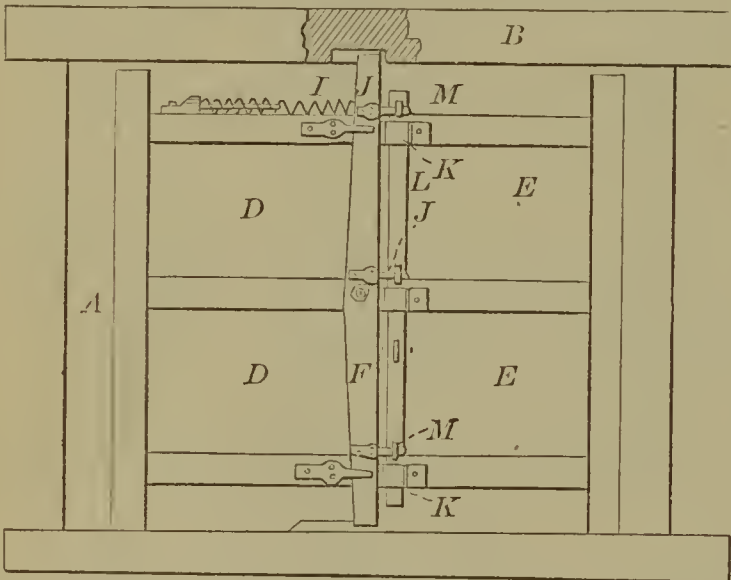

59250—L. B. Myers—Fastening for Furniture Knobs.

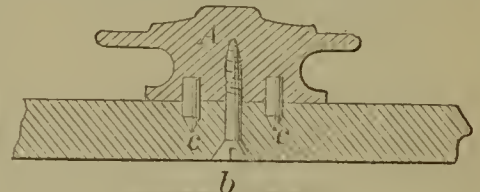

59246—J. McGeary—For Decomposing Steam.

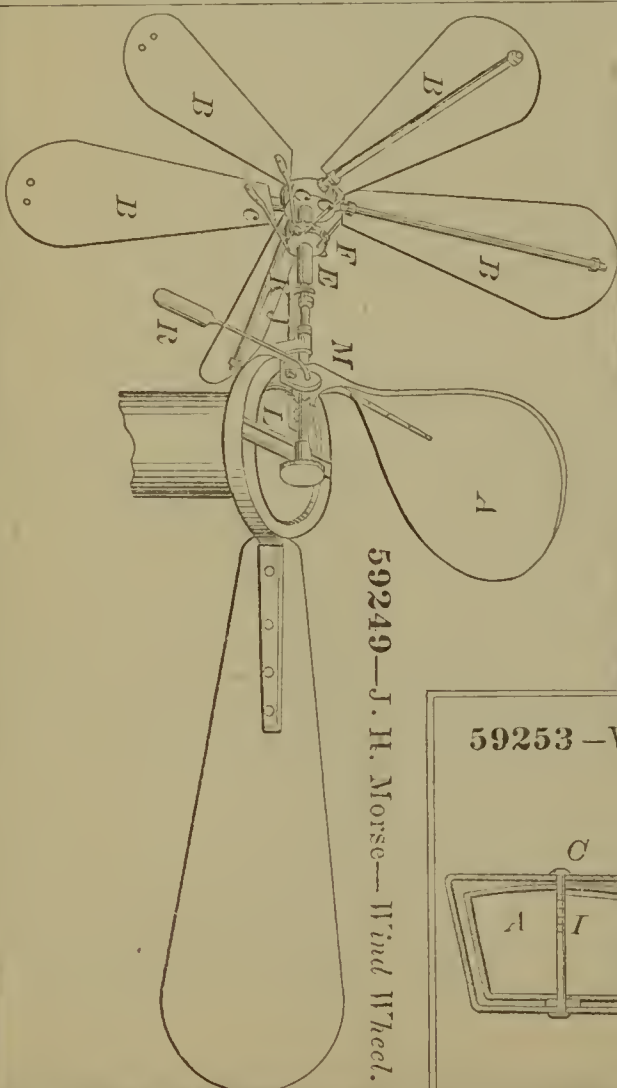
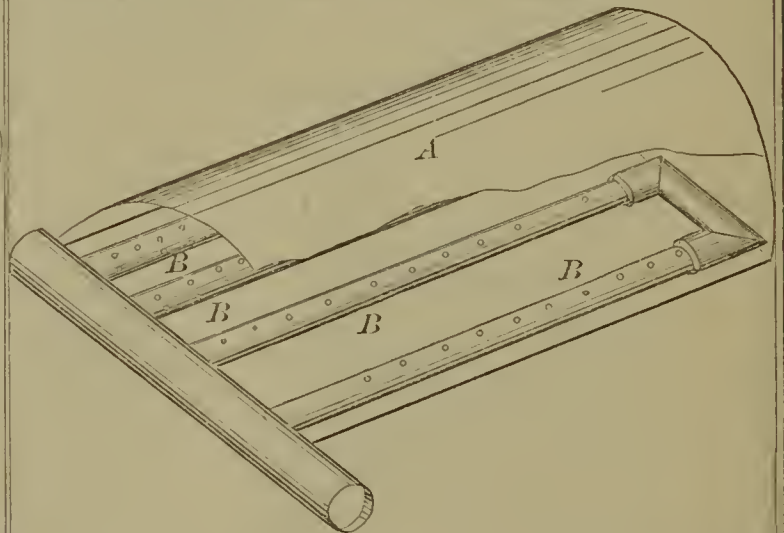

59249—J. H. Morse—Wind Wheel.

59253—W. W. S. Orbeton—Corn Popper.

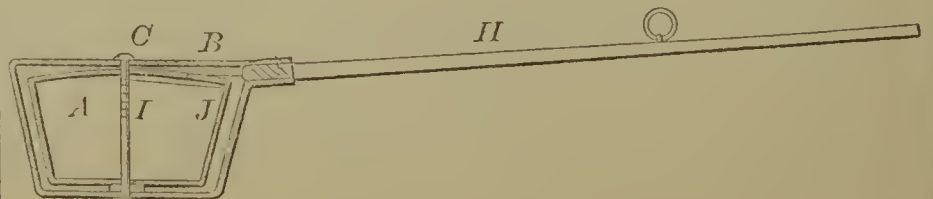

59257—S. Peck—Wash Board Rubber Attachment.

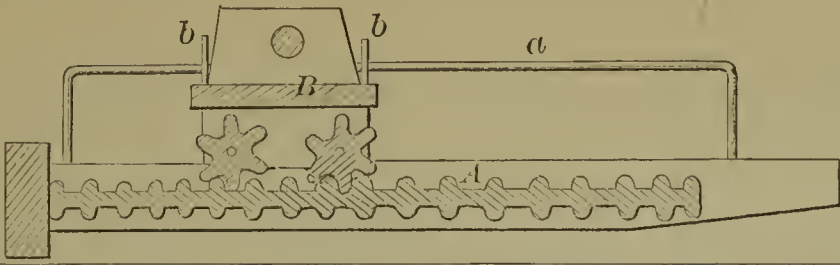

59254—W. W. S. Orbeton—Bit Stock.

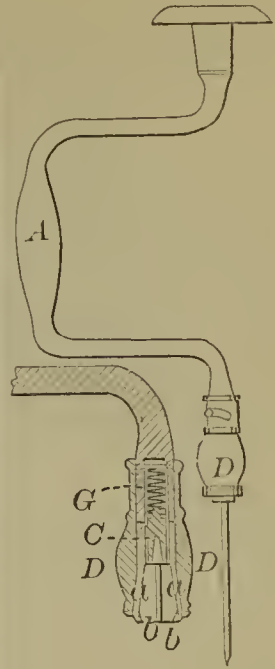

59258—J. E. Peirce—Trace Connection.

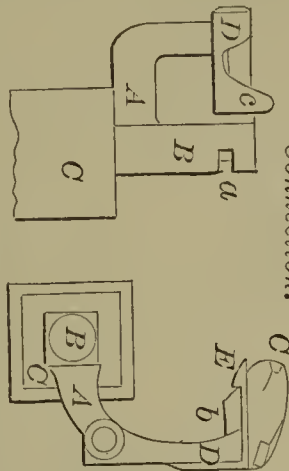

59260—W. H. Pinner—For Preventing the Escape of Gas from Soap Kettles, Rendering Apparatus, &c.

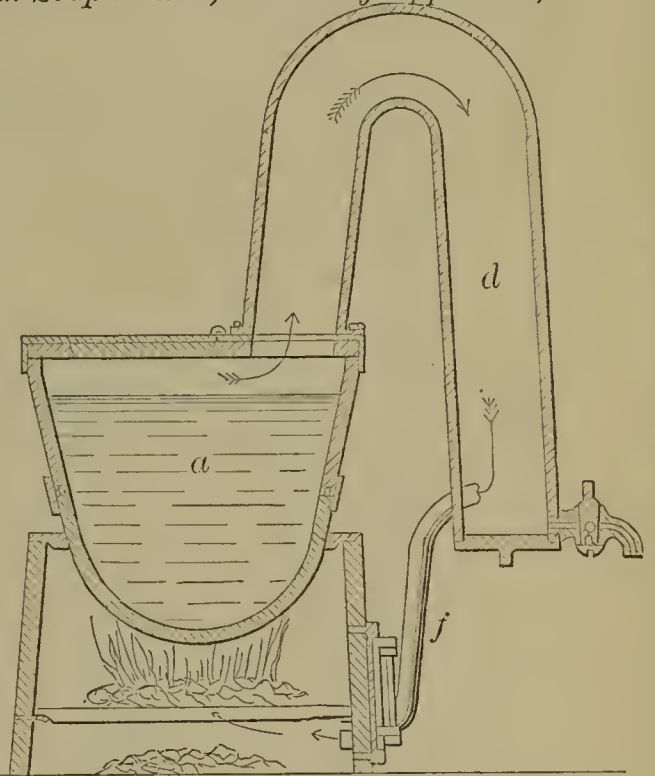

59259—K. Pilson—For Preparing Cotton for Carding Engines.

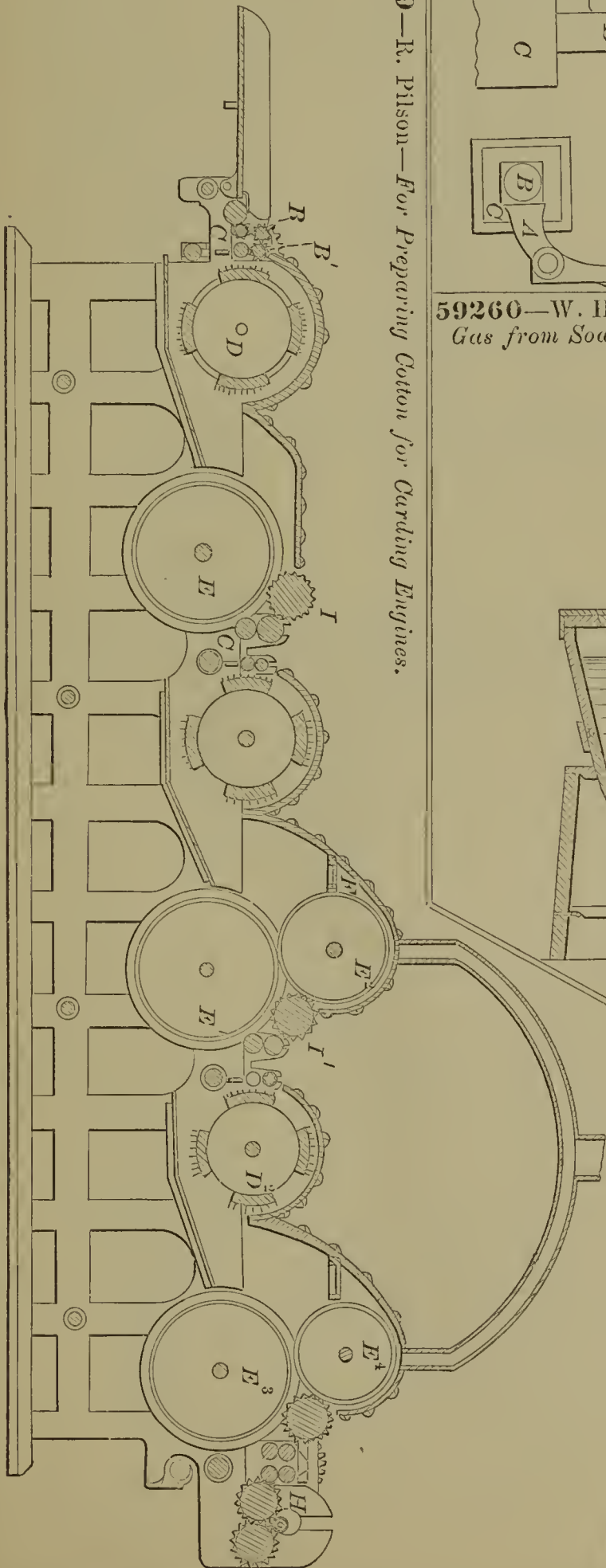

59256—R. W. Parker—Pulley.

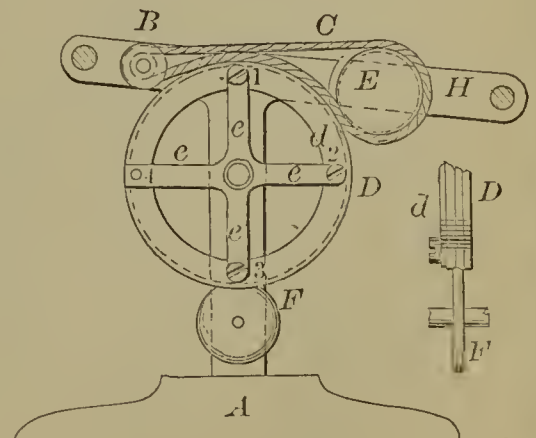

59261—L. Postawka—Piano Seat.

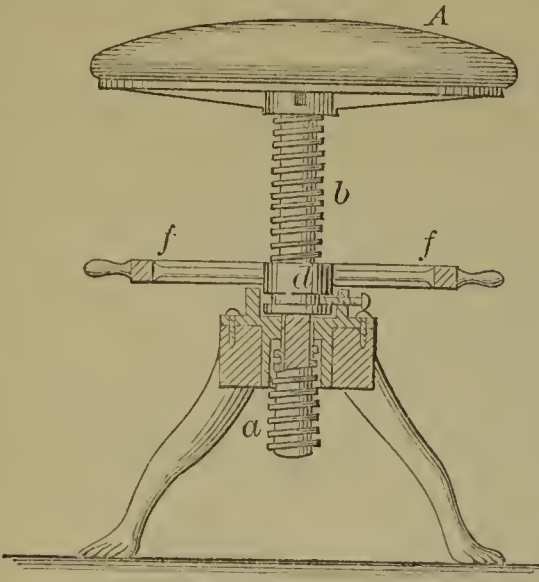

59263—T. D. Price—Seed Drill.

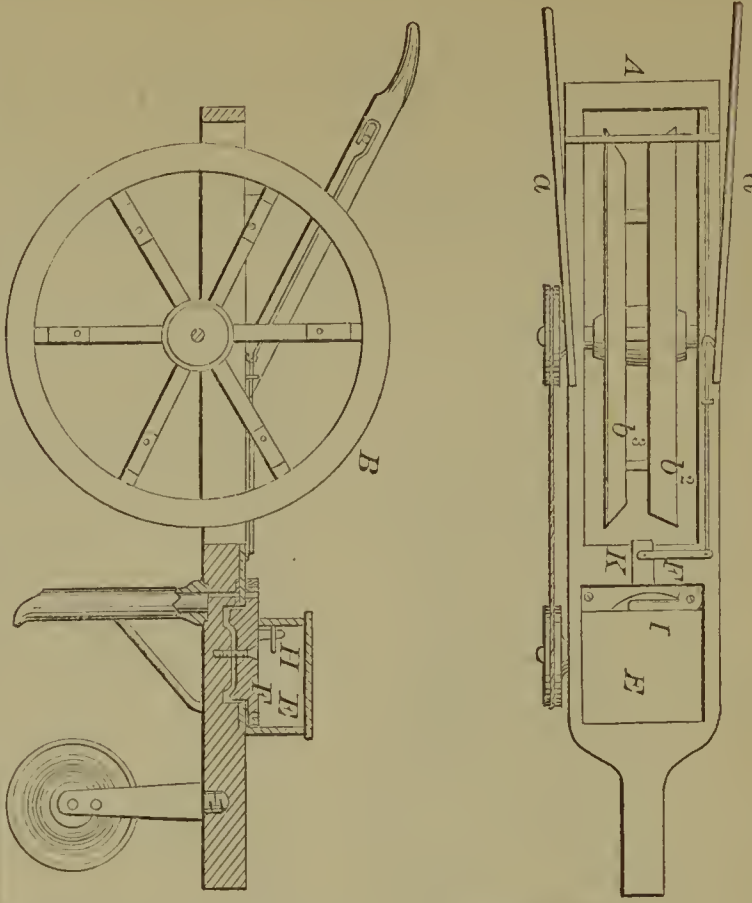

59262—J. Price—Plow.

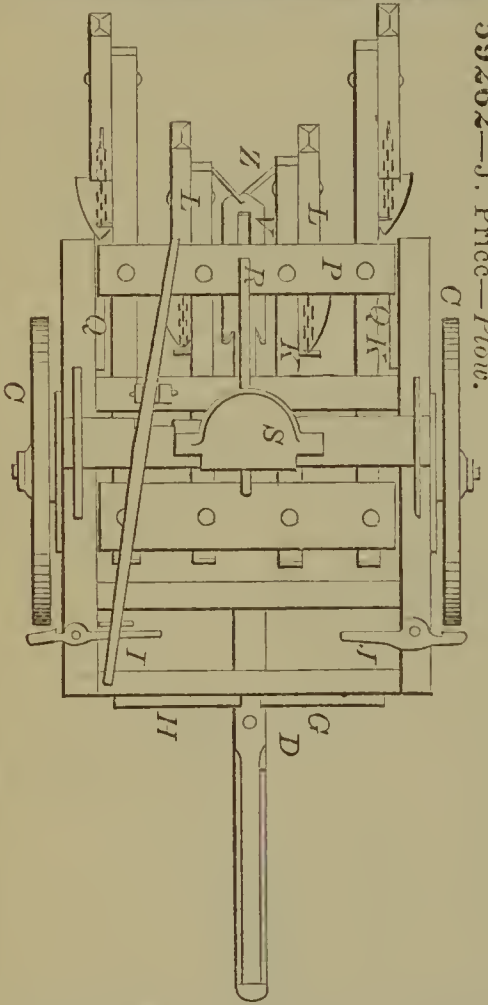

59266—Riddell & Allen—Nutmeg Grater.

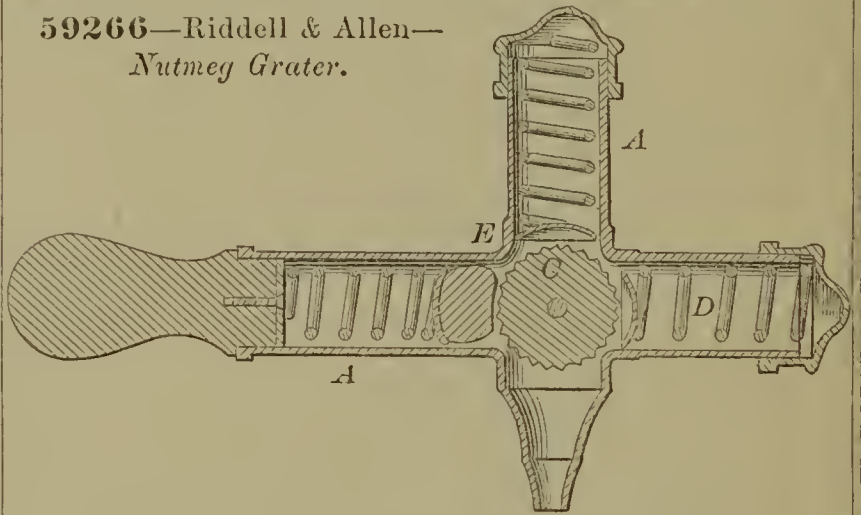

59264—J. C. Raymond—Wind Sail.

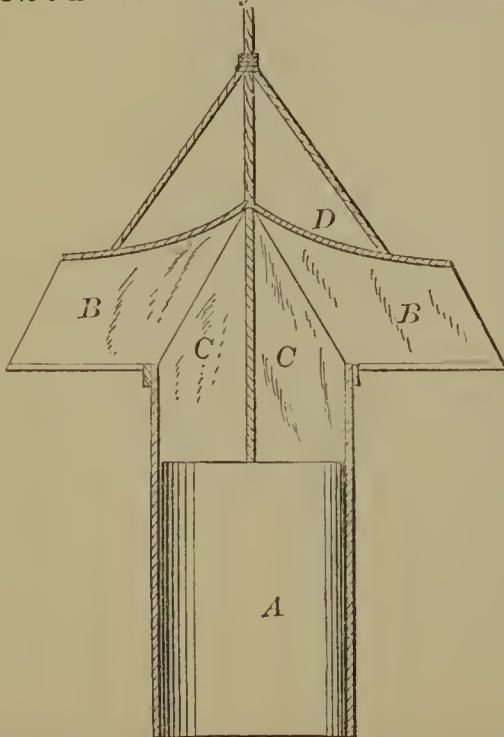

59267—L. P. Rider—Plow Mould Board.



59265—W. P. Richardson—Sewing Machine.

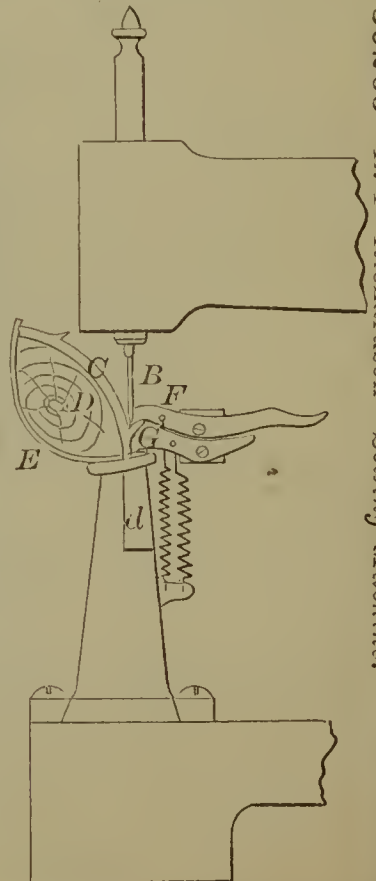



59268—J. H. Rose—*Chalk Line Winder.*

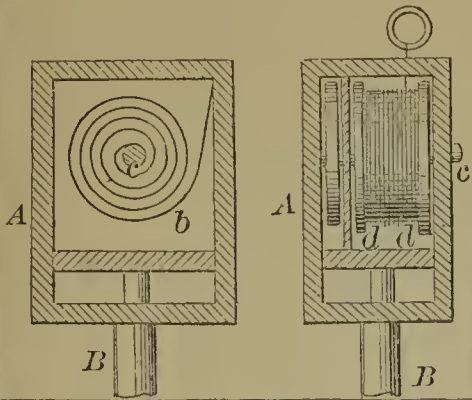

59275—C. W. Sappenfield—*Sawing Machine.*

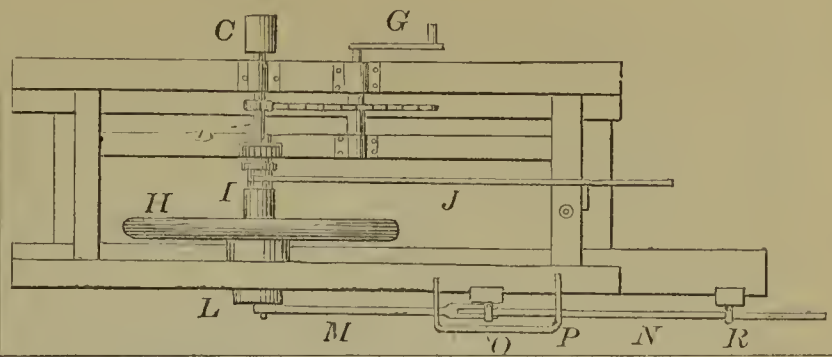

59271—E. A. G. Roulstone—*Traveling Bag.*

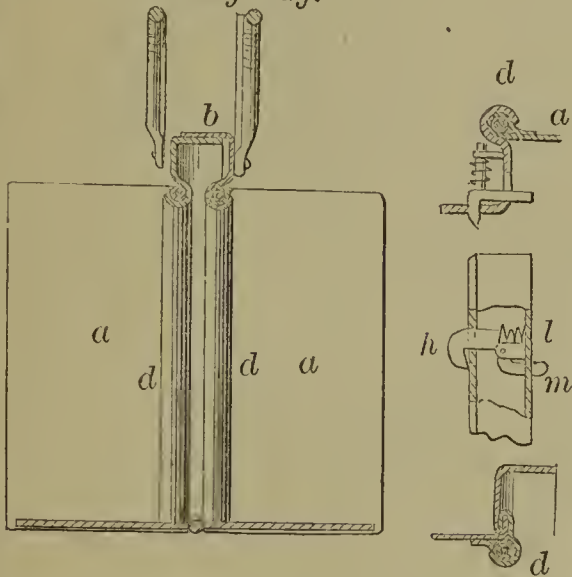

59272—E. A. G. Roulstone—*Trunk.*

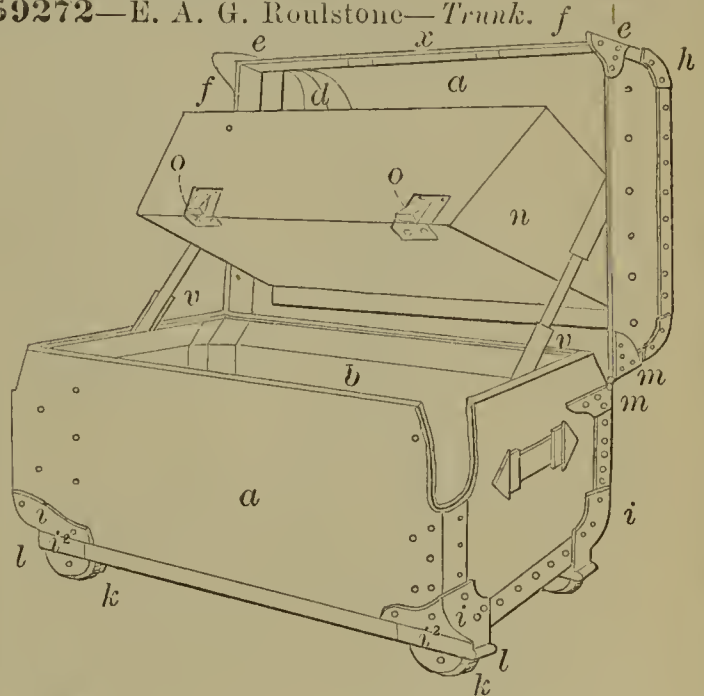

59274—N. M. Sanford—*Washing Machine.*

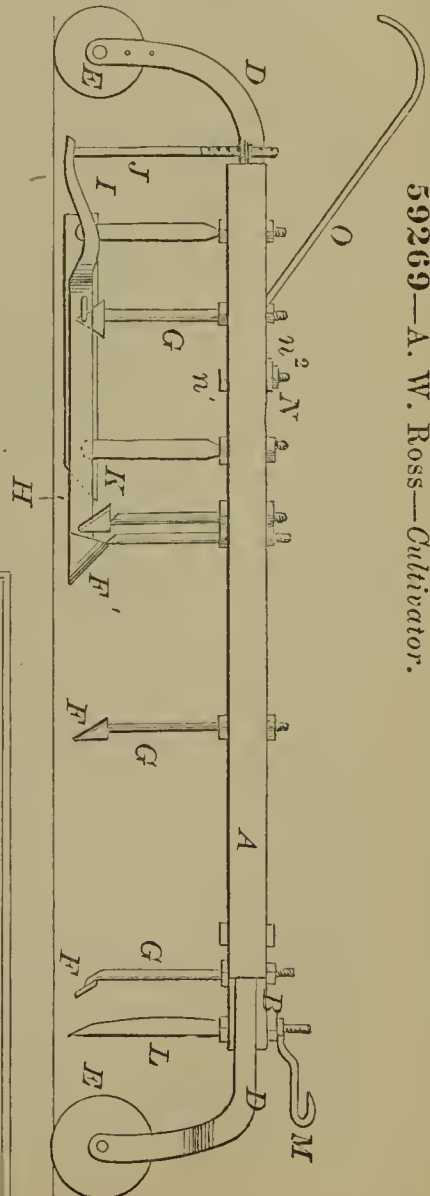
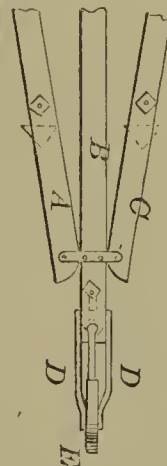
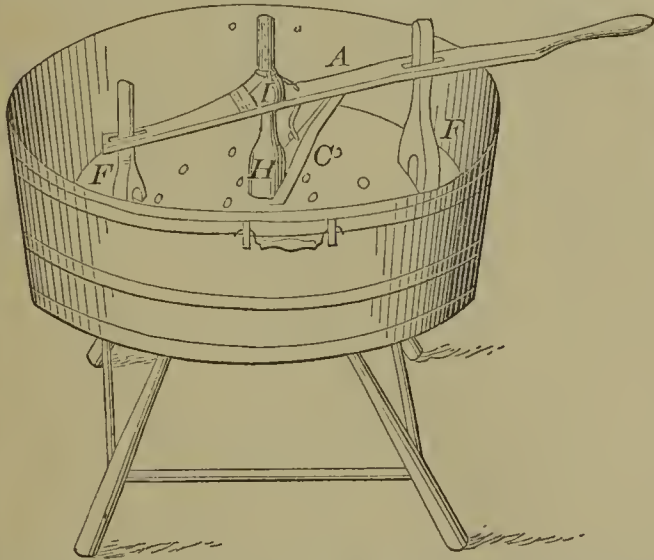

59269—A. W. Ross—*Cultivator.*

59270—E. A. G. Roulstone—*Carpet Bag.*

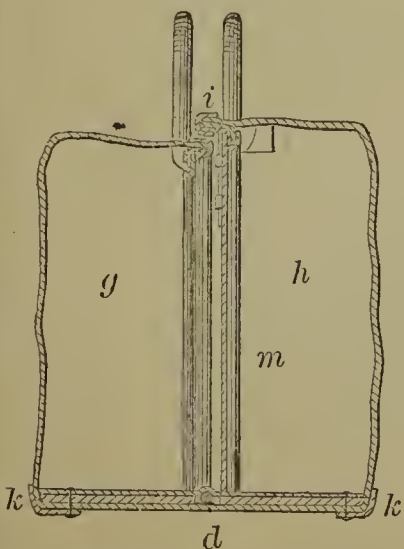

59273—L. D. Rundell—*Car Brake.*

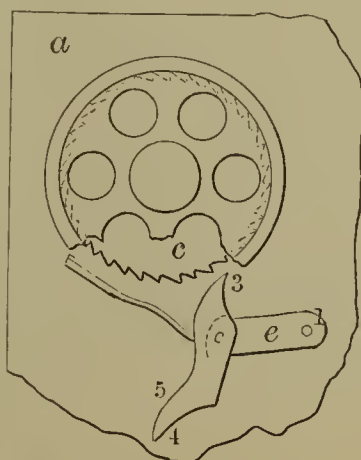

59276—C. H. Sawyer—*Hitching Device.*

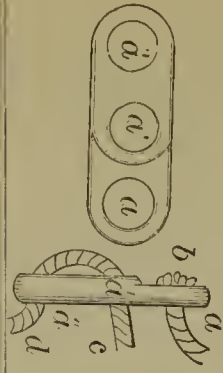
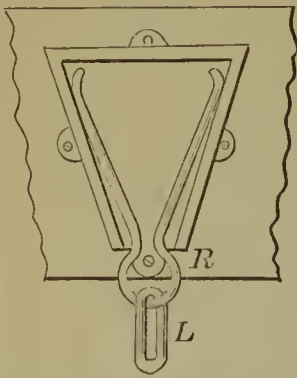

59277—C. H. Sawyer—*Halter.*

59280—J. H. Seymour—*Railroad Car Spittoon.*

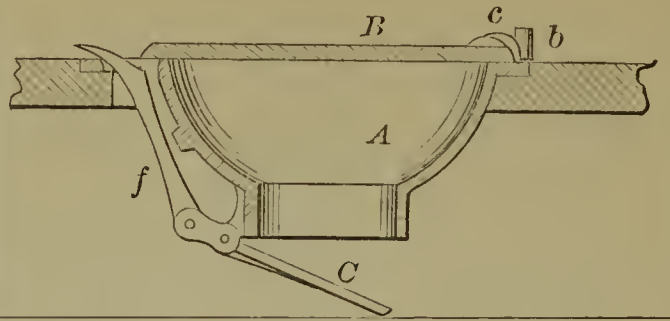

59282—Z. B. Shannon—*Churn.*

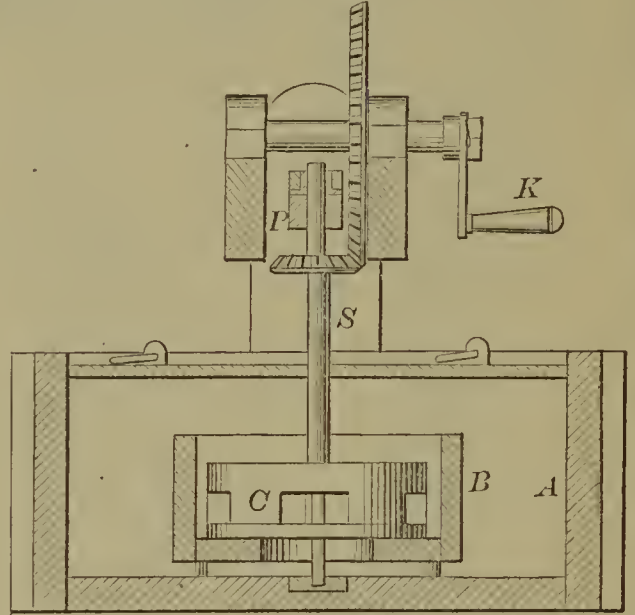

59279—Seeger & Ormiston—*Cultivator.*

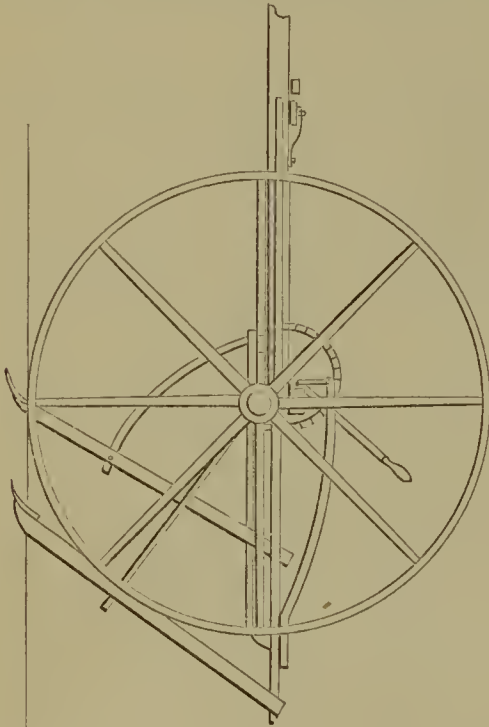

59283—J. D. Smith—*Seeding Machine.*

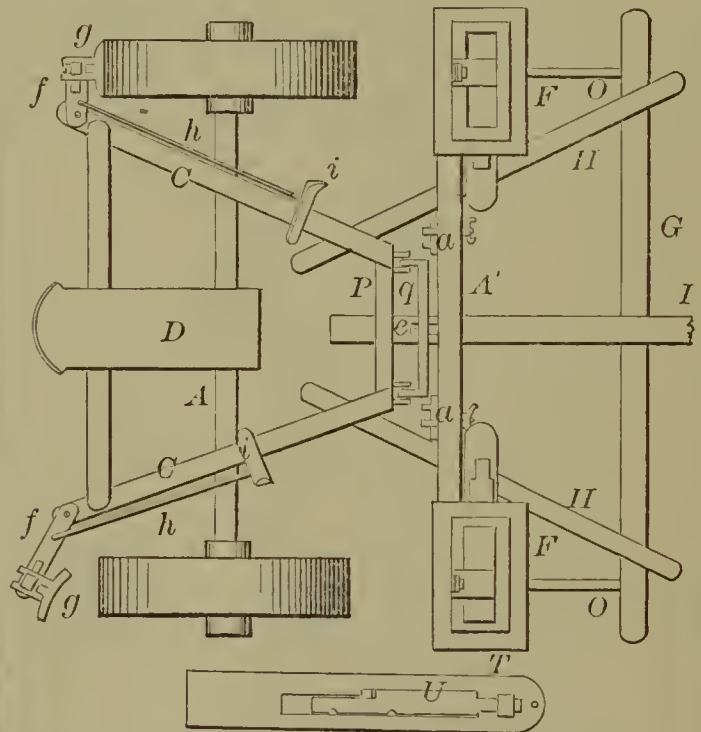

59278—H. Saylor—*Whip Soeket.*

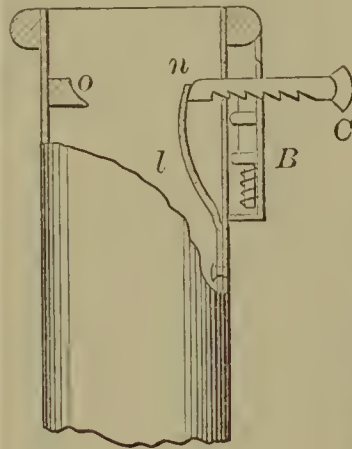

59284—Snow & Lewis—*Dental Plugging Instrument.*

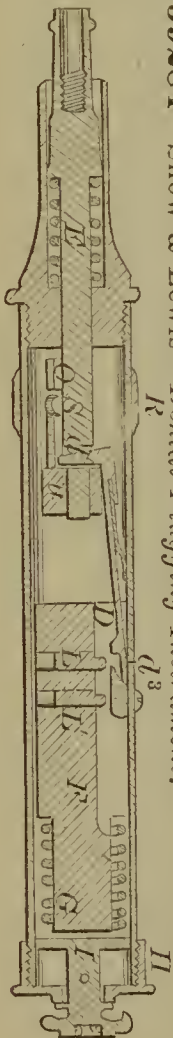

59285—T. G. Springer—*Wagon Brake.*

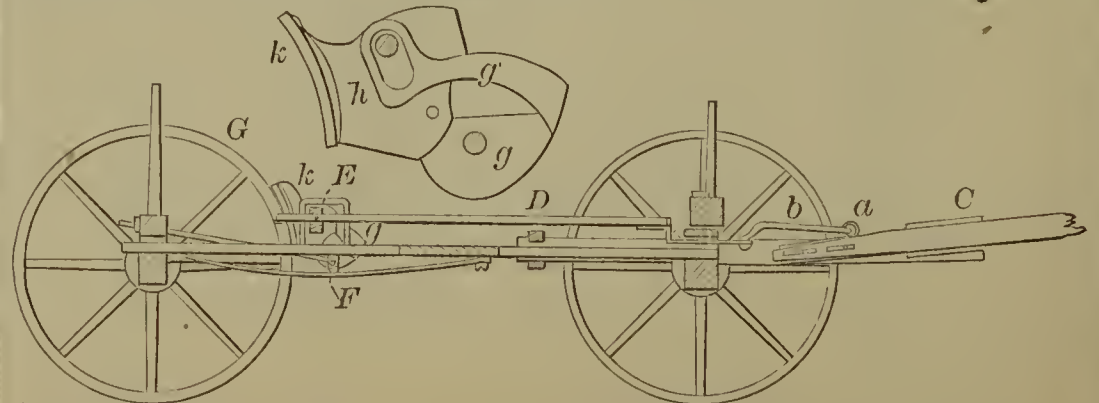

59286—N. H. Spafford—*For Assorting Bristles.*

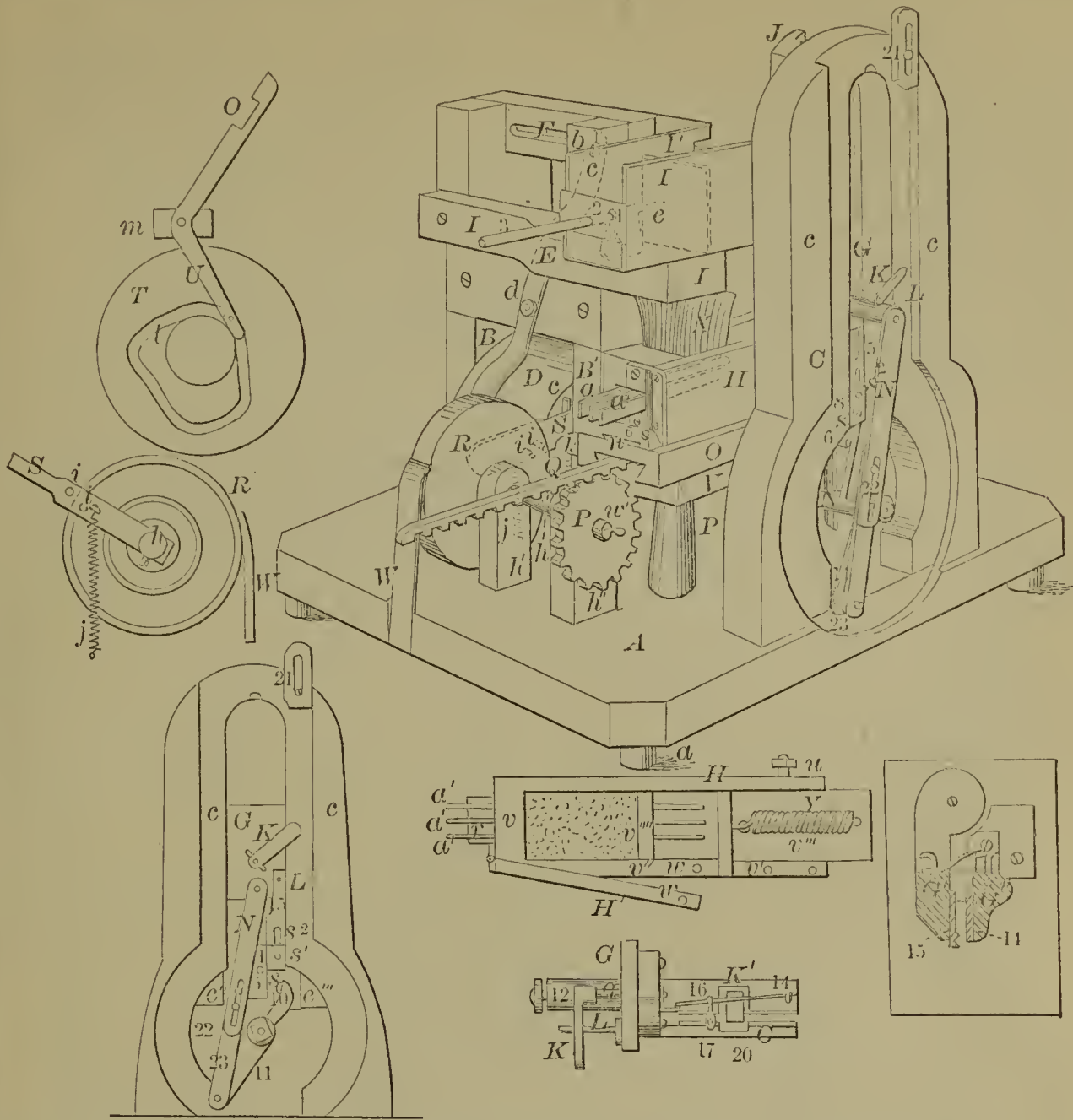

59287—Sterrett & Farrell—*Letter Box File.*

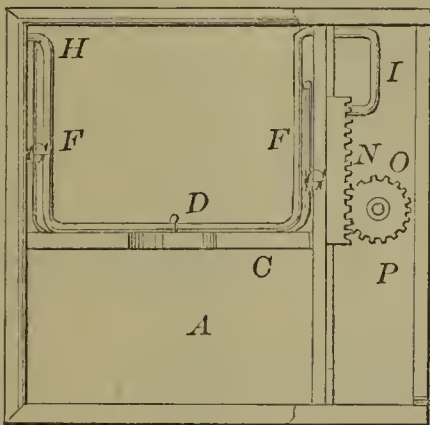

59288—O. Stoddard—*Boots and Shoes.*

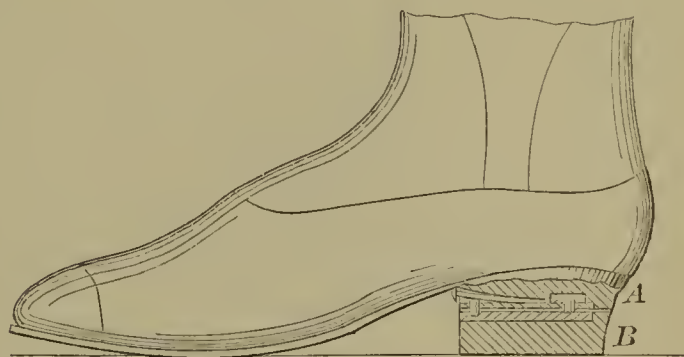

59289—G. Stover—*For Raising and Lowering Carriage Tops.*

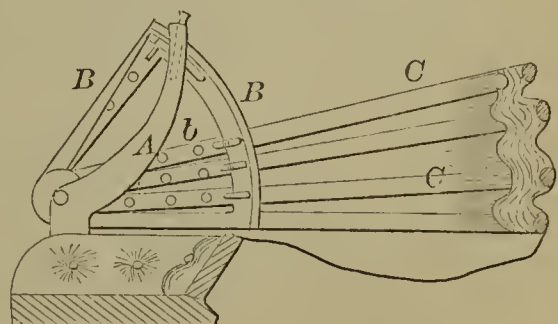
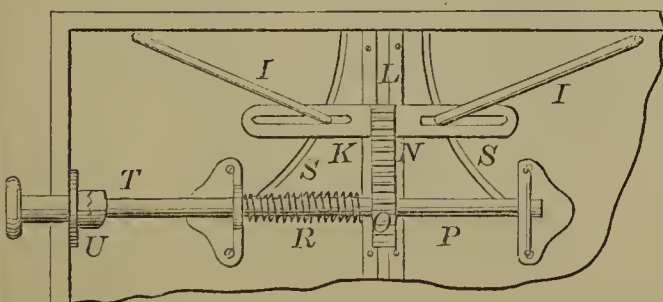

59290—M. L. & O. A. Stray—  
Fruit Basket.

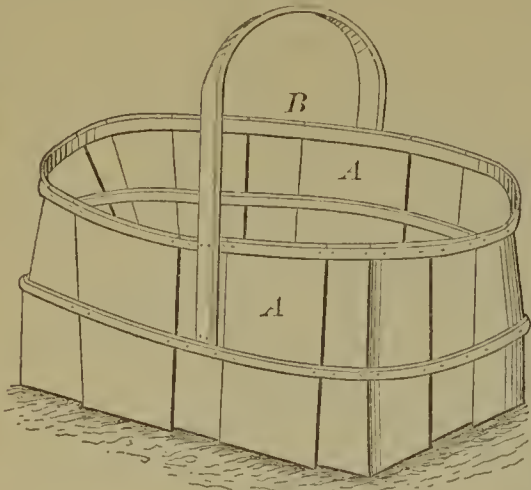

59291—E. D. Street—*Threshing Machine.*

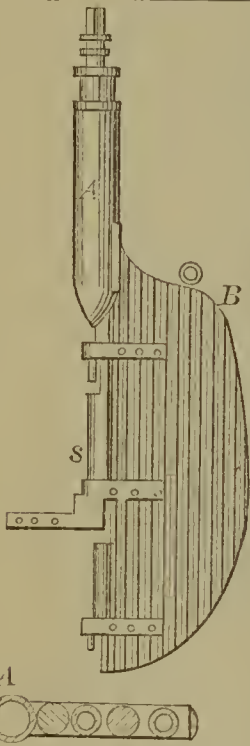
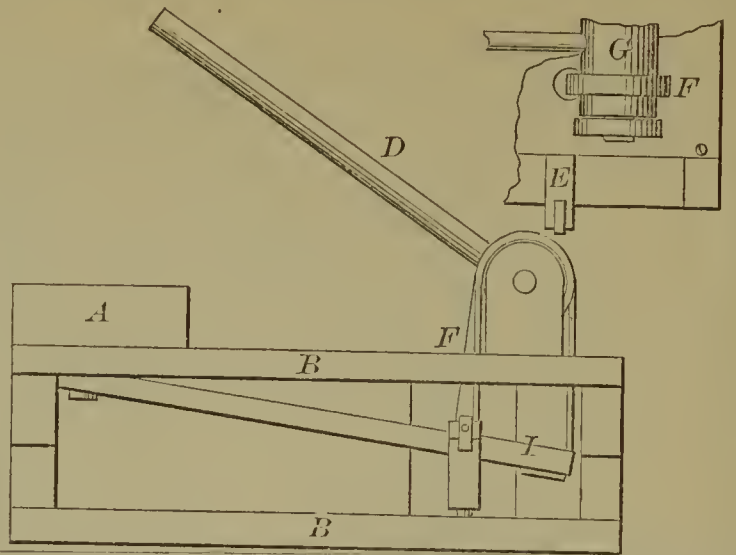

59296—M. Wappich—*Rudder.*

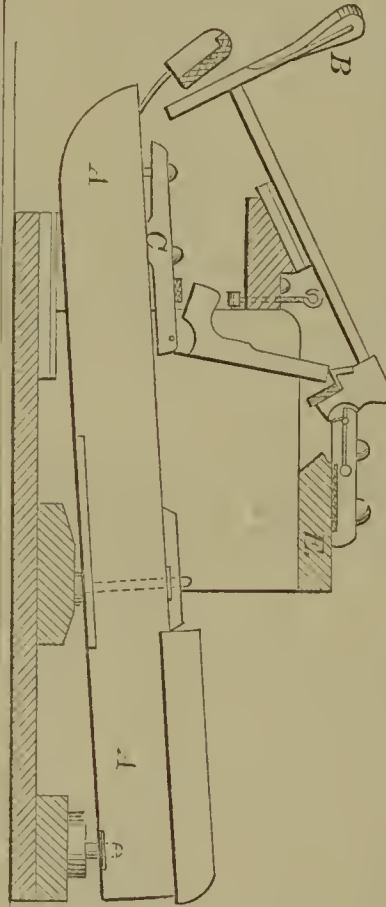

59295—W. V. Wallace—*Pump Forte Action.*

59294—A. H. Tingley—*Heat  
Regulator for Hot Air Furnaces.*

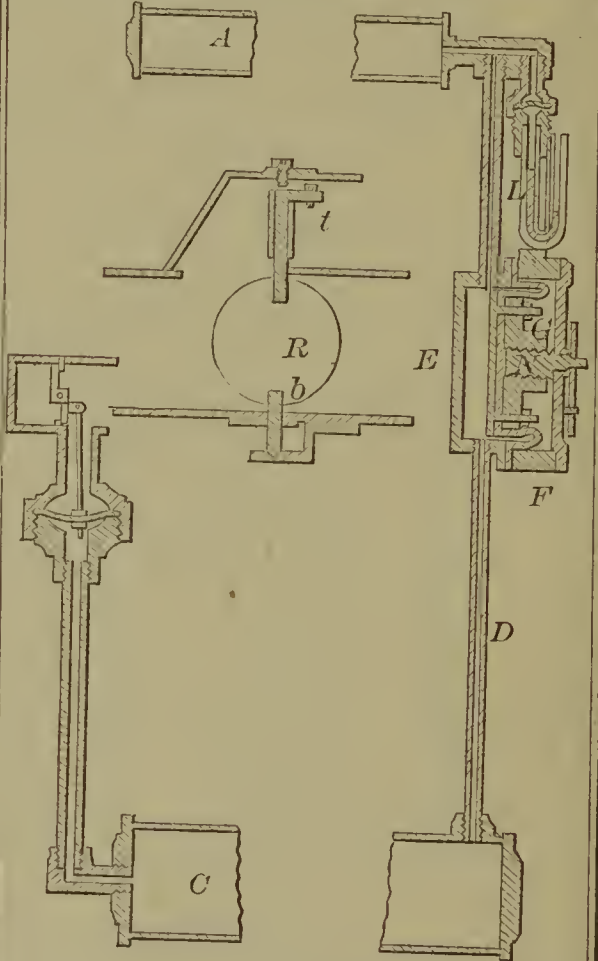

59293—M. A. Turleton—*Cotton Tie.*

59292—W. Strevell—*For Stretching Leather.*

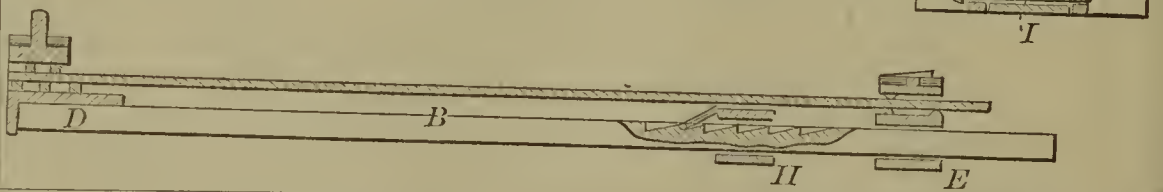

59297—Watson & Perry—*Extension Ladder.*

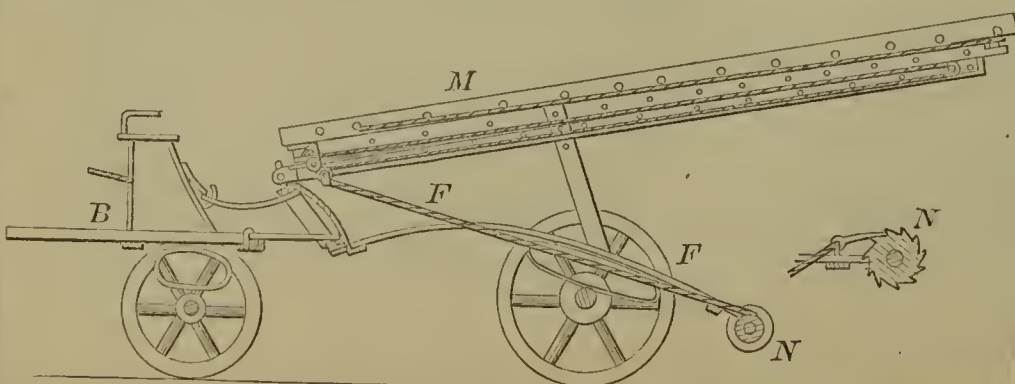

59298—W. Weaver—*Carpet Fastener.*



59299—I. E. Weston—Mop Head.

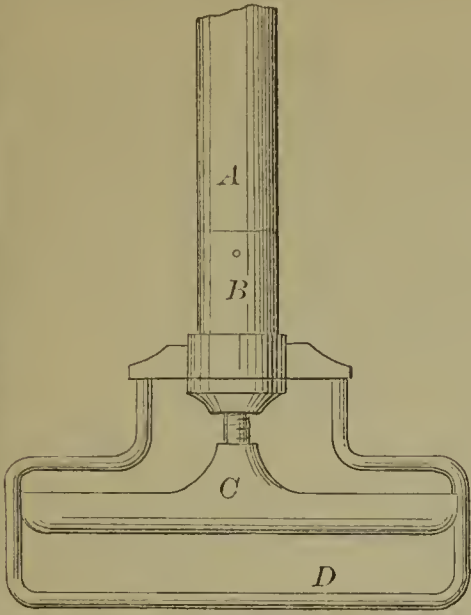

59302—W. N. Whiteley, Jr.—Harvester.

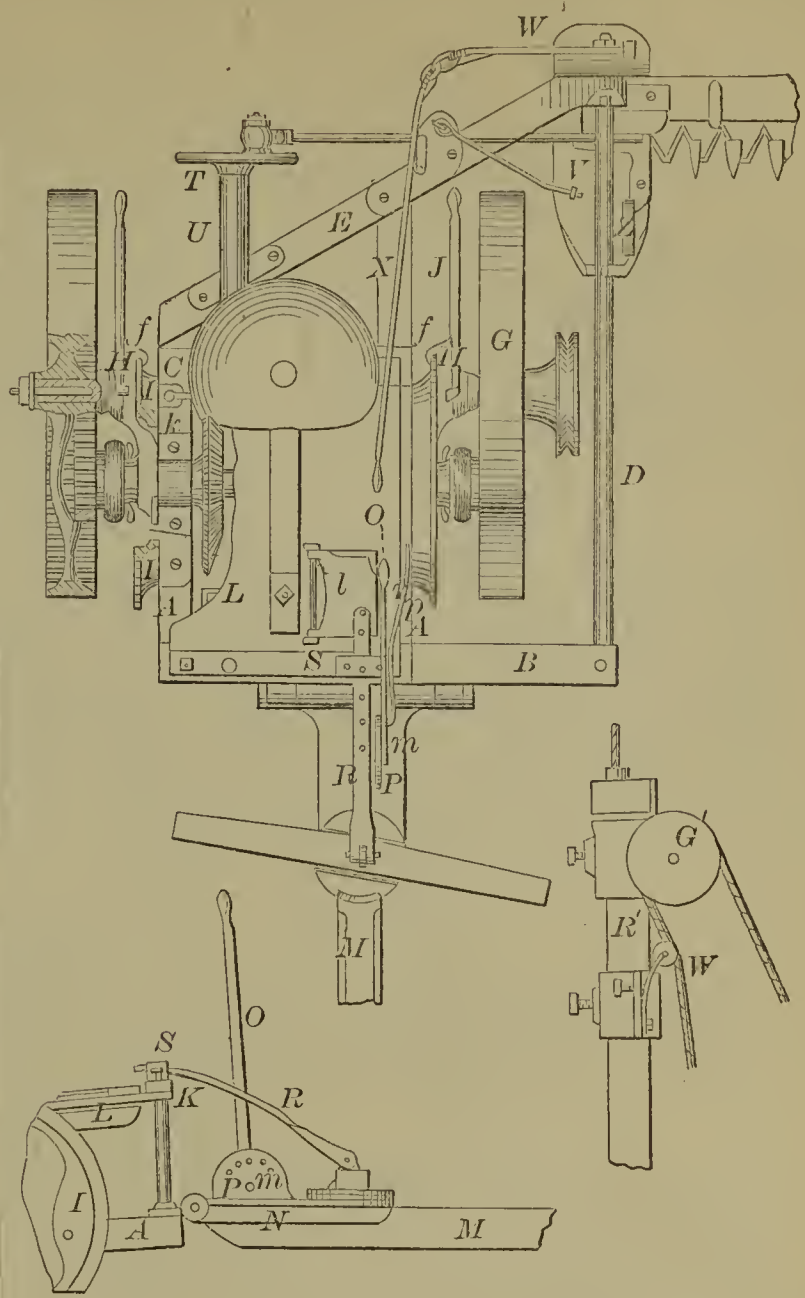

59300—S. Wheelock—For Sowing Plaster, &c.

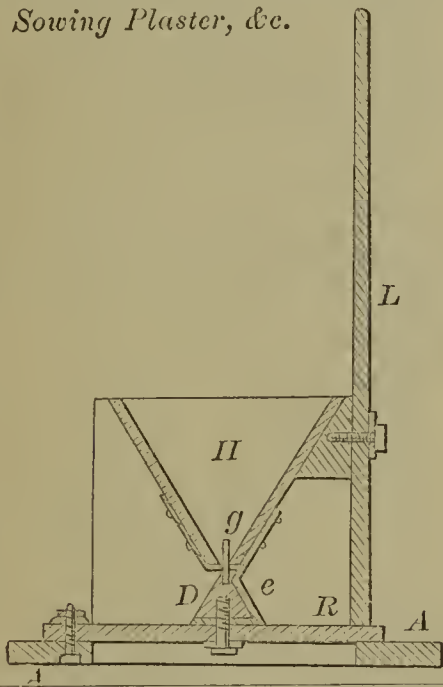

59301—S. H. Whitaker—Decarbonizing Furnace.

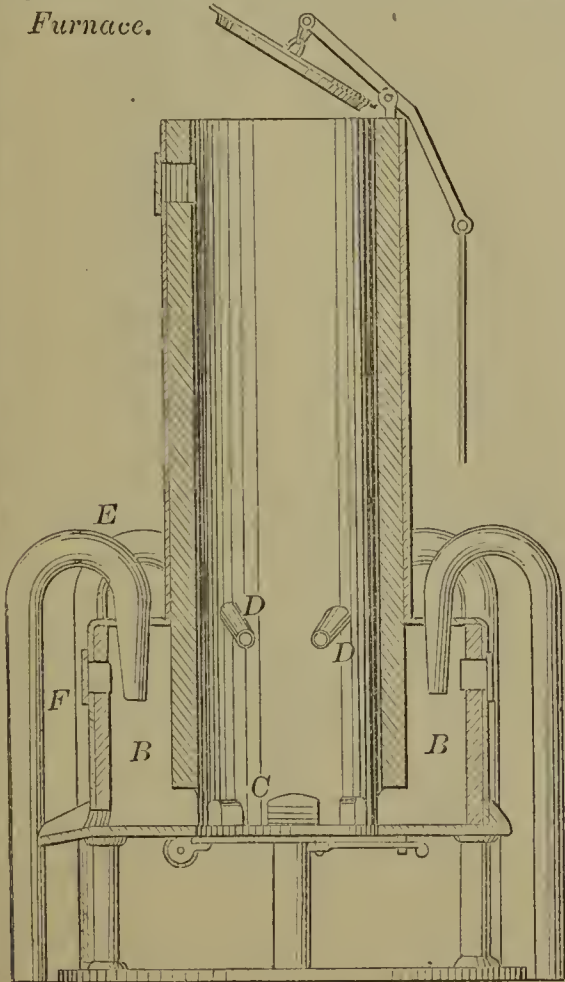

59303—W. N. Whiteley, Jr.—Harvester.

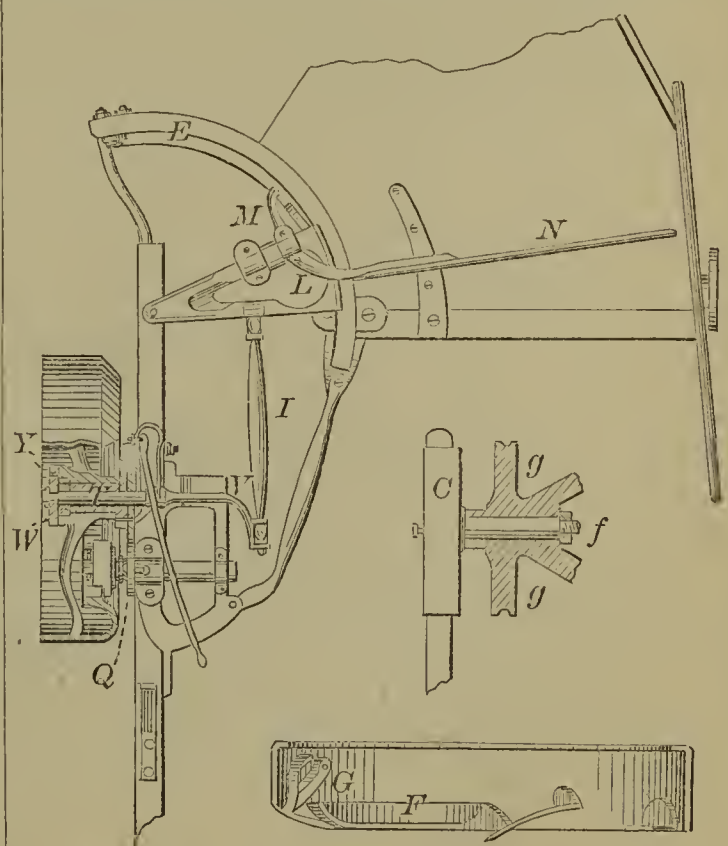

59304—J. M. Williams—Water Wheel.

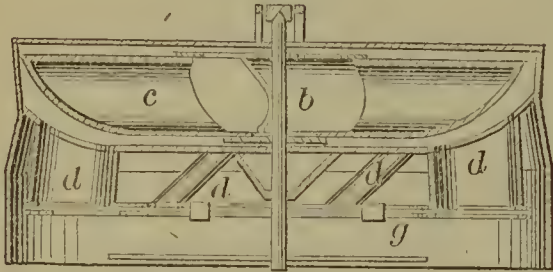
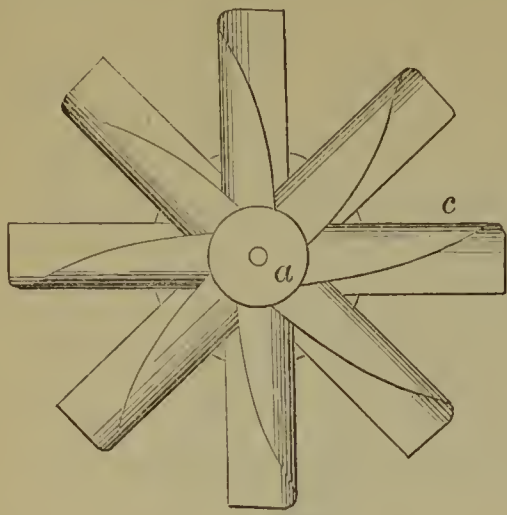

59305—J. D. Winslow—Floor Clamp.

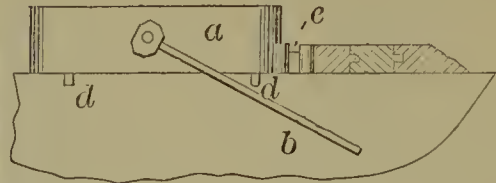
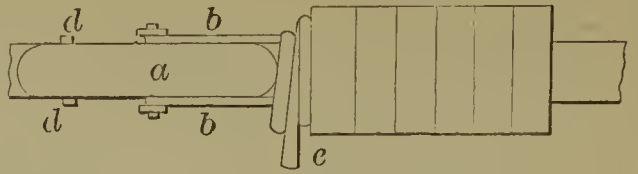

59307—H. Yerty—Burglar Alarm.

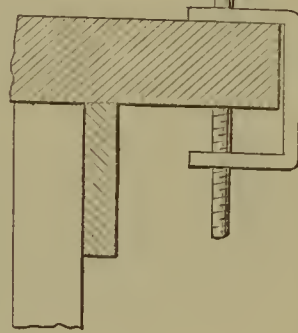
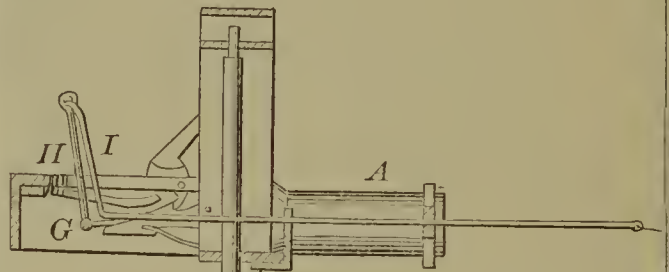

59308—J. H. Aiken—For Oiling Wool for Carding Engines.

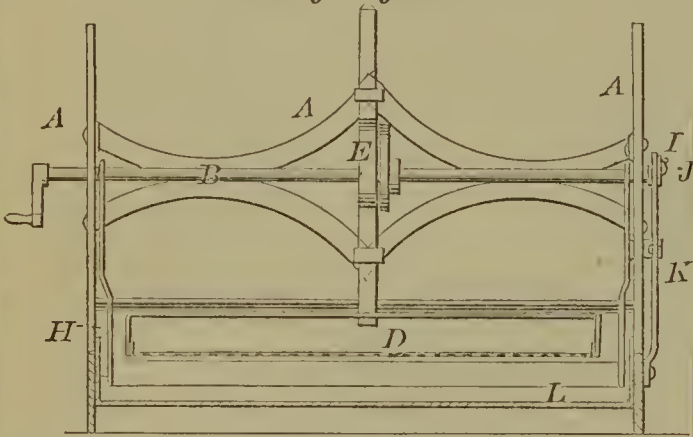

59306—F. Wolff—Artificial Leech.



59309—H. A. Ashley—Baling Press.

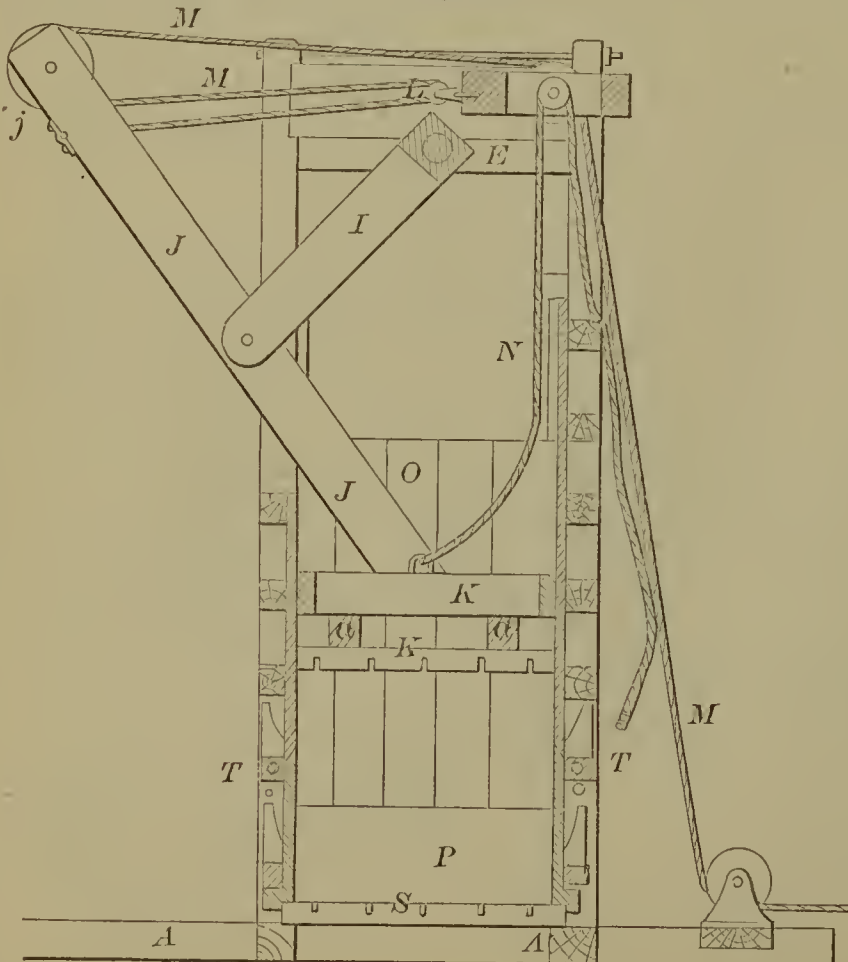

59310—M. L. Ballard—Pitman Connection.

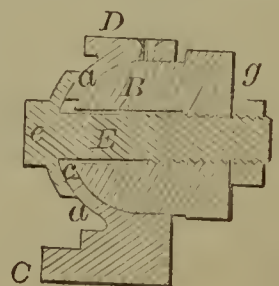

59311—Clarke & Wagenen—Grate Bar.

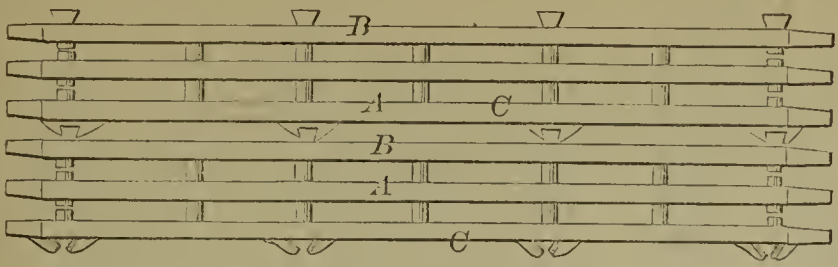

59314—W. A. Horrall—Cotton Seed Planter.

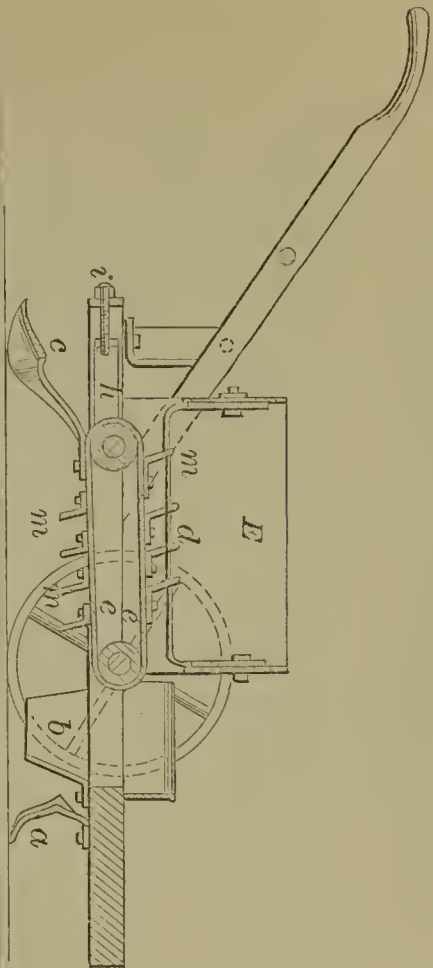
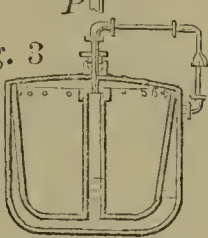

Fig. 3



59313—G. W. Hill—Spring Bar.



59312—C. J. Everett—Rendering Apparatus.

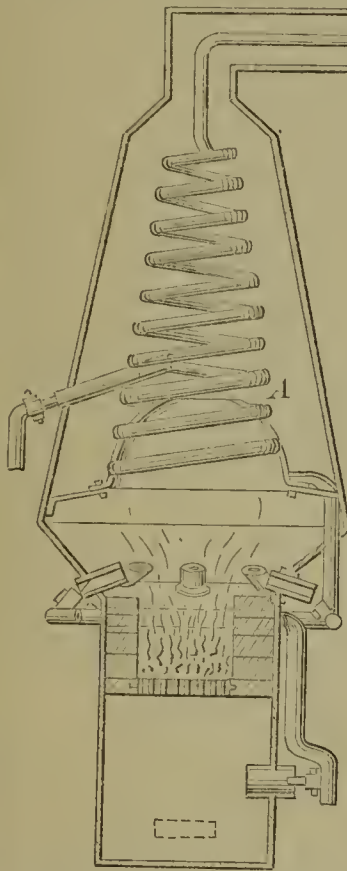

59316—A. D. Kendig—Harness.

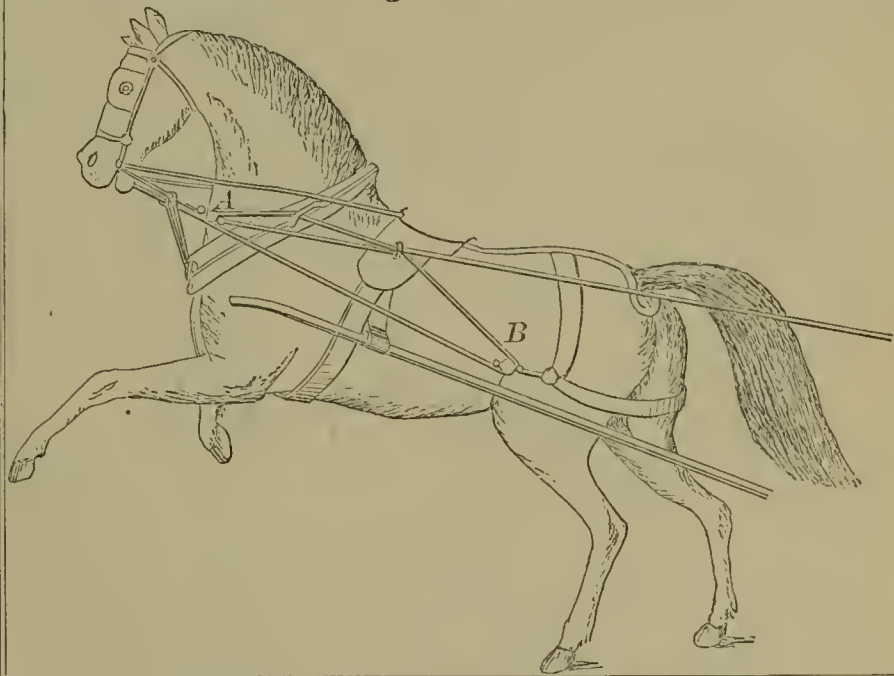

59318—J. N. Phelps—Telegraph Cable.

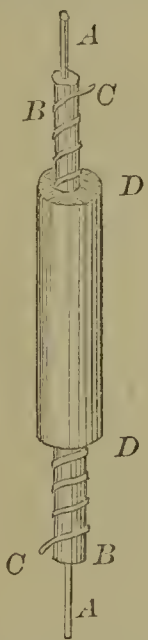

59317—A. Lapham—Petroleum Still.

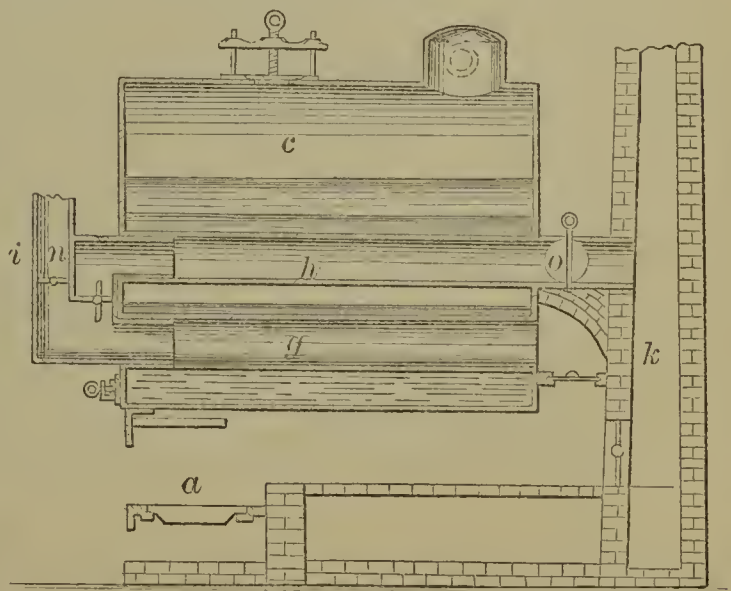

59315—B. Illingworth—Flour Sifter.

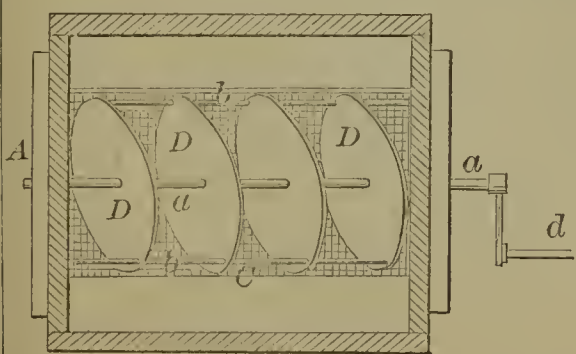

59321—J. W. Tompson—Cherry Stoner.

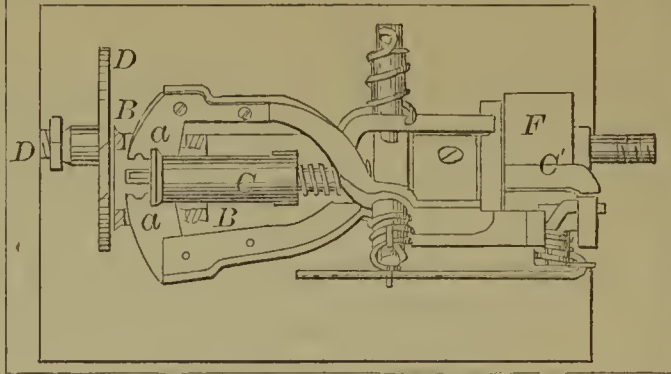

59325—H. Wathew—Confection, Penn.



59319—O. Redmond—Oil Well Packing.

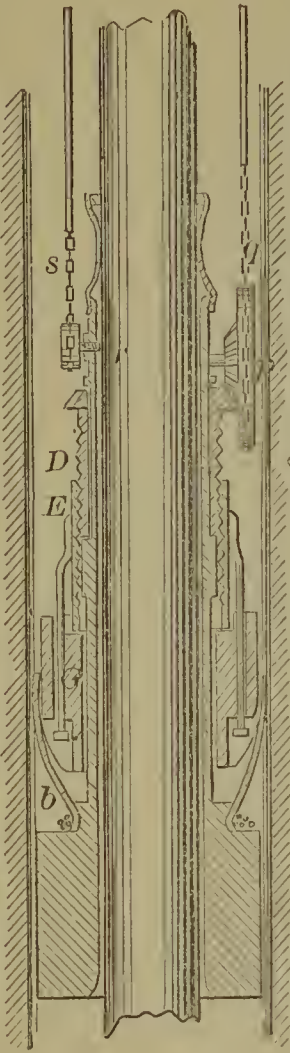

59323—R. Van Velhoven—Album.

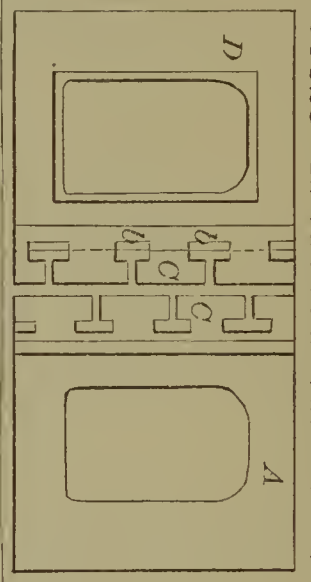

59327—H. E. & C. W. Woodford—Horse Shoe Nail Machine.

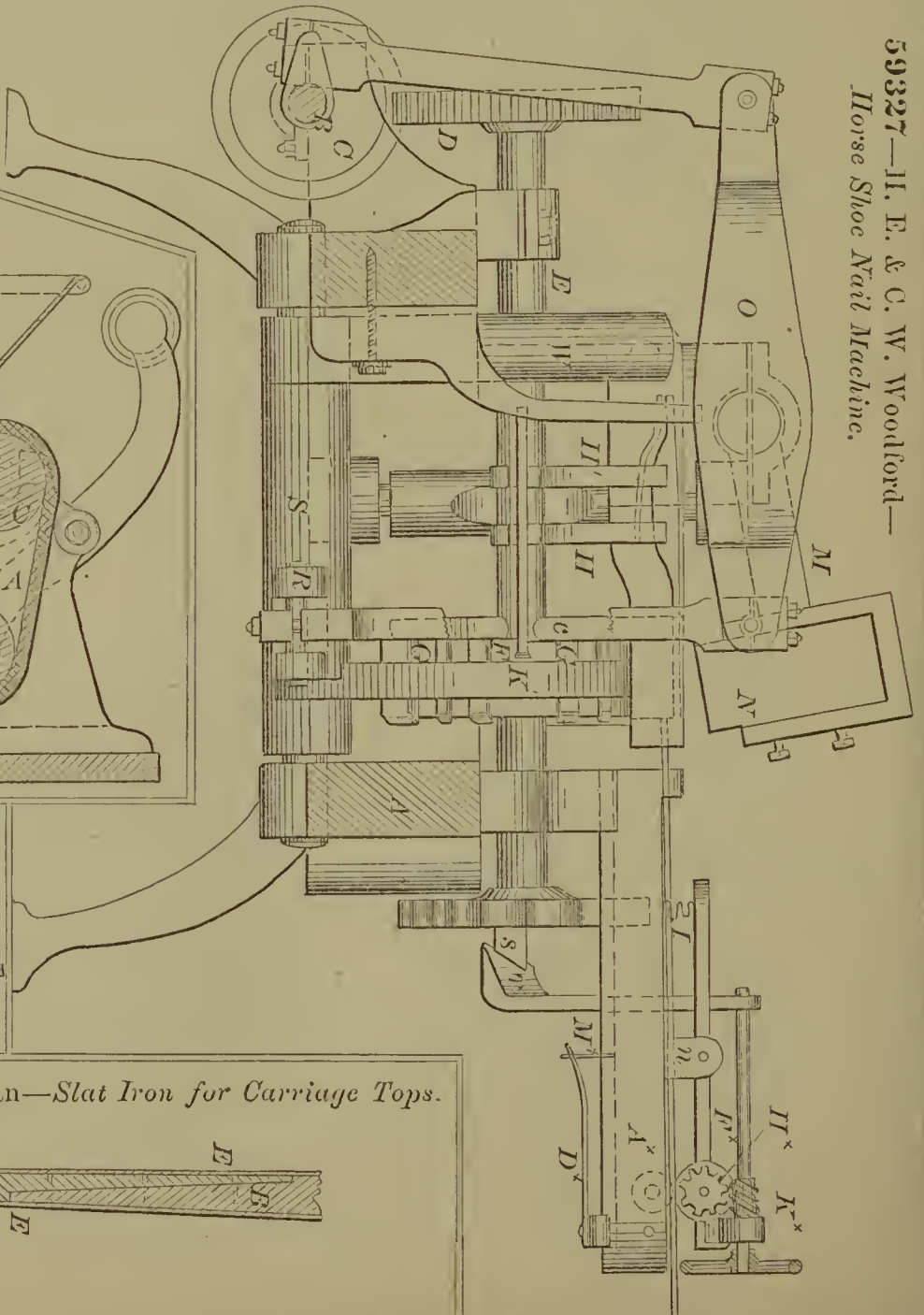

59324—H. Wathew—For Peeling Almonds.

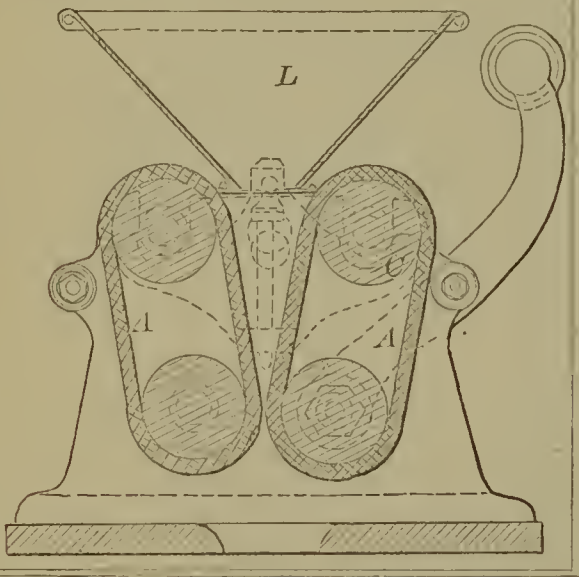

59320—J. Starkey—Curtain Eyelet.



59322—G. W. Traphagan—Slat Iron for Carriage Tops.

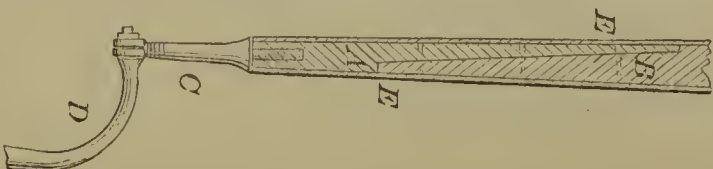



59327—Continued.

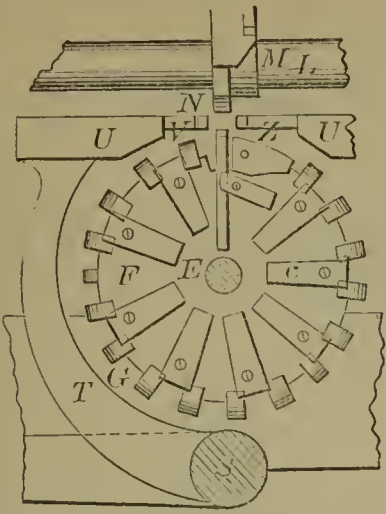

59328—L. A. C. St. Paul—Manufacture of Sulphur.

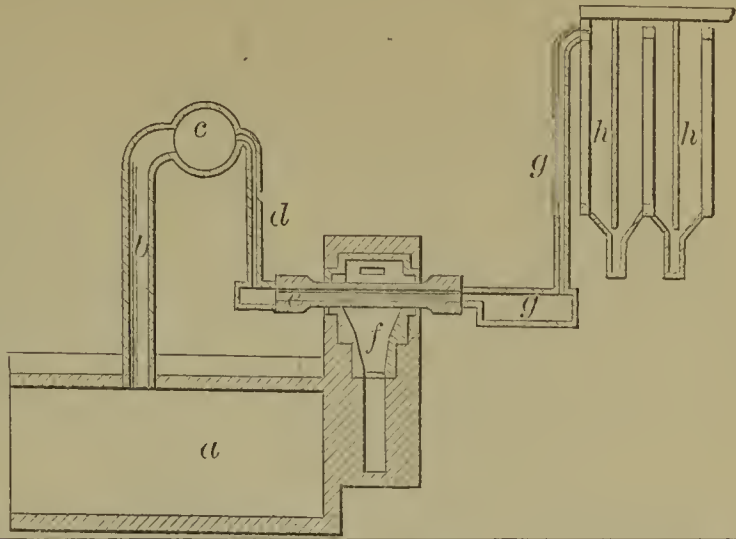

59329—R. Eaton—Locomotive Fire Grate.

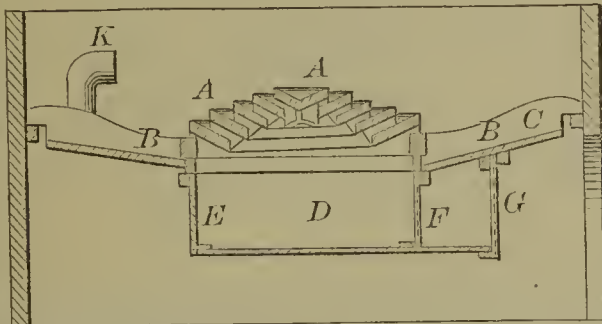

59335—E. A. Adams—Flour Sifter, Mixer, and Kneader.

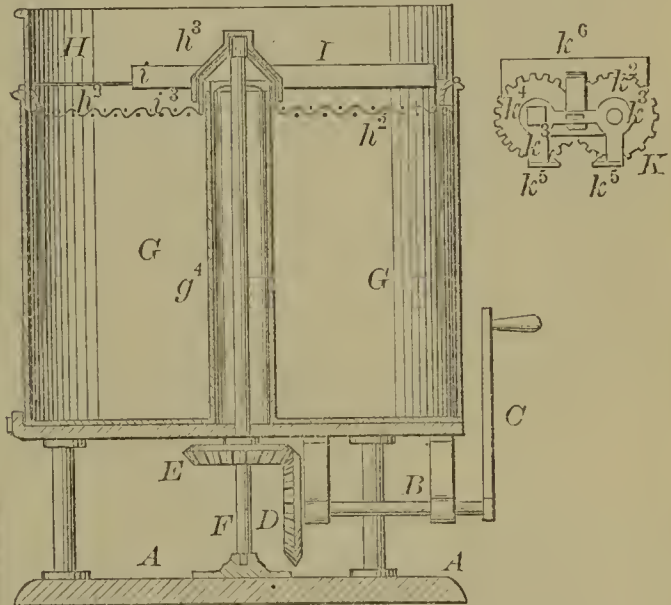

59334—J. F. Collins—For Distilling Petroleum, &c.

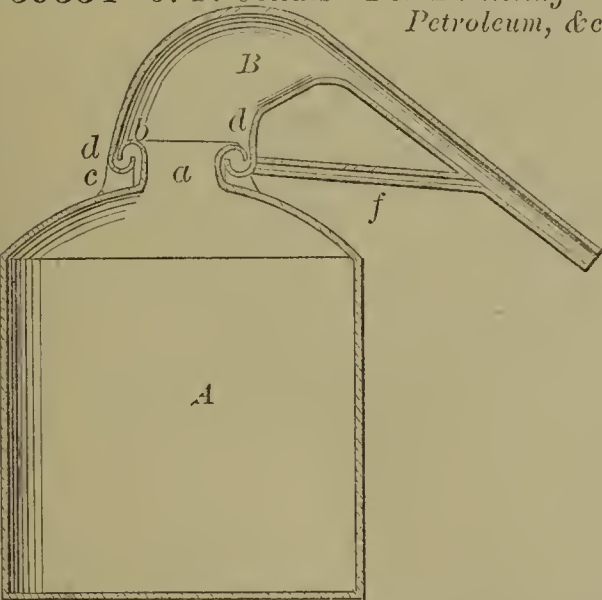

59333—E. N. Bullard—Construction of Glass Bottles.

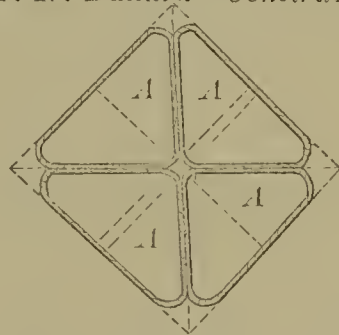

59336—W. Allenderff—For Cooling Malt Liquors.

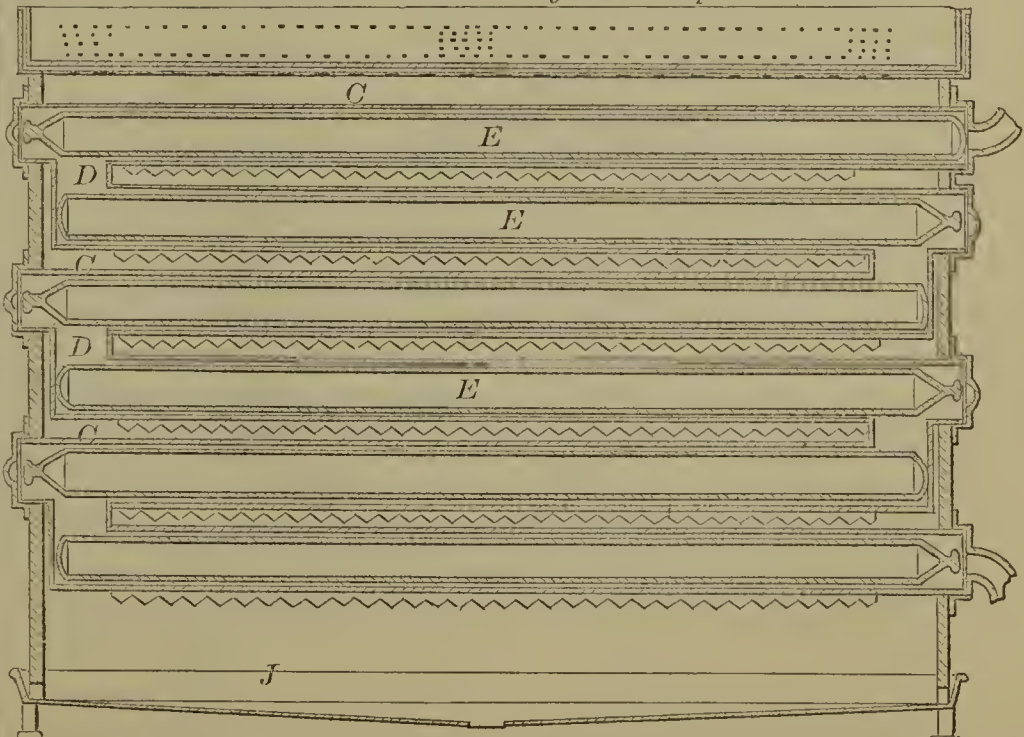

59332—White & Chamberlain—Clasp for Belting, &c.

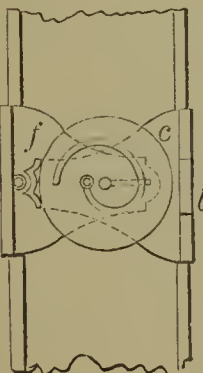

59337—W. T. Altfather—*Car Truck Standard.*

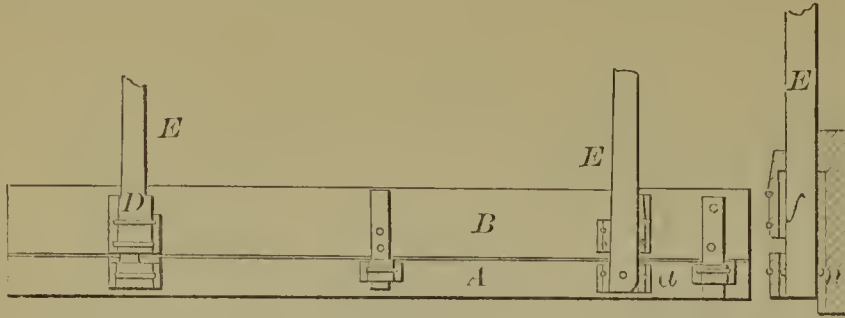

59339—N. E. Badgley—*Cotton Seed Planter.*

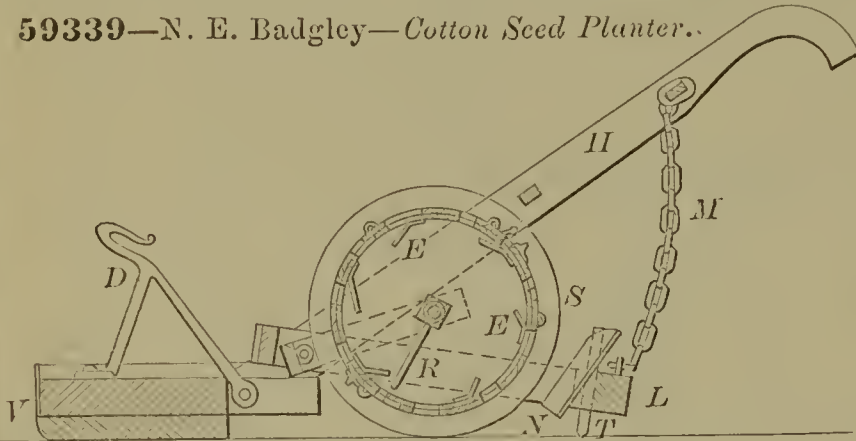

59340—W. S. G. Baker—*Locomotive Engine.*

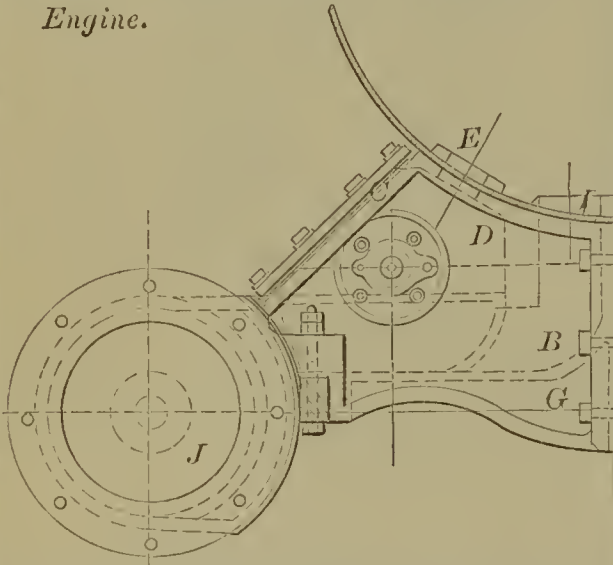

59346—W. Blake—*Diaphragm Faucet.*

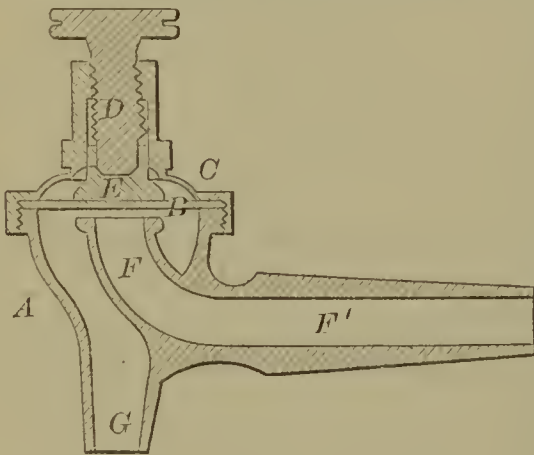

59349—J. F. Boynton—*Vat for Evaporating Salt Water.*

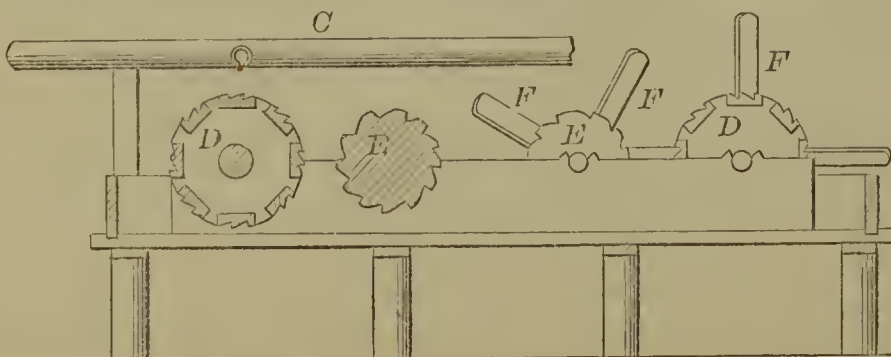

59341—P. Barrett—*Revolving Table.*

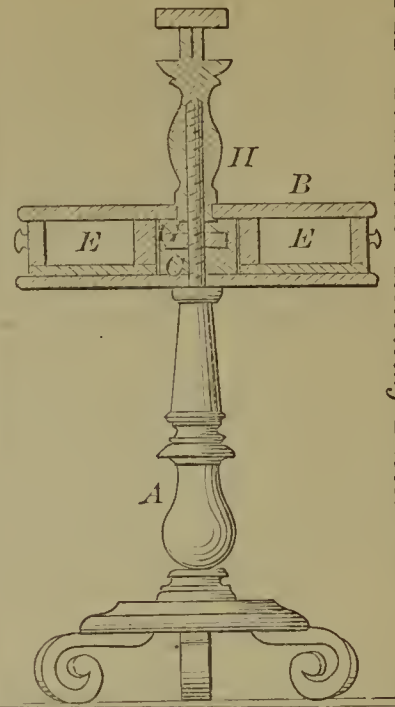

59344—J. W. Bishop—*Capping Screws.*

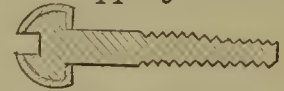

59343—E. M. Bayne—*Broom Head.*

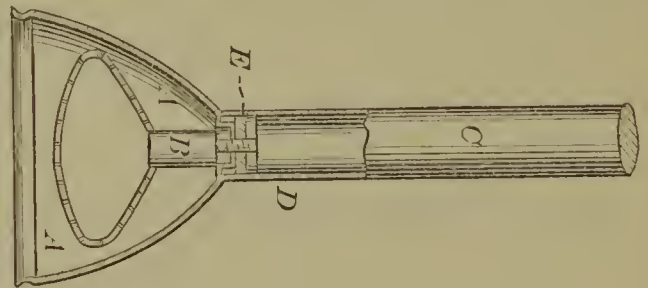

59347—C. Boehmer, Jr.—*Cock Eye.*



59345—D. A. T. Black—*Steigh.*

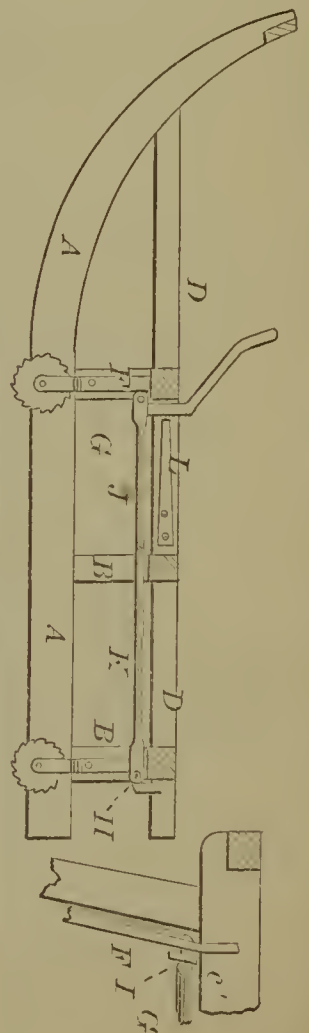

59350—W. Branagan—Lard Boiler.

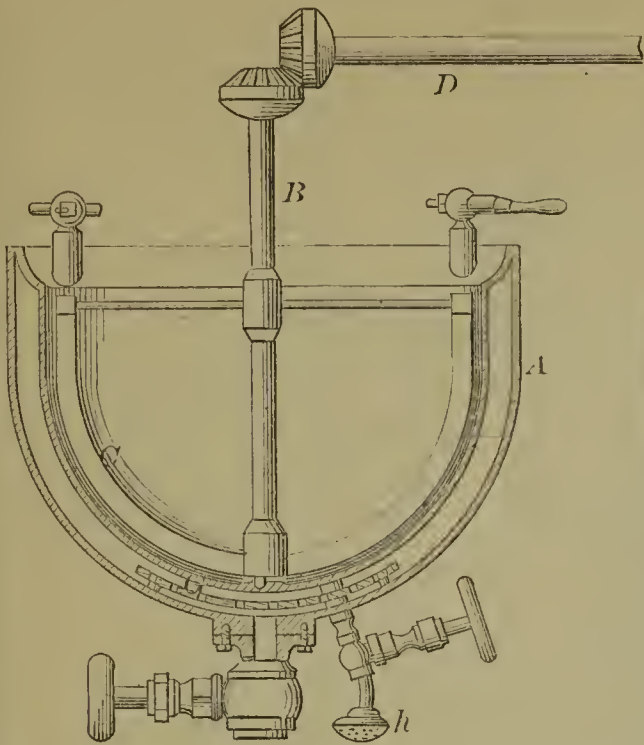

59353—D. H. Brown—Water Wheel.

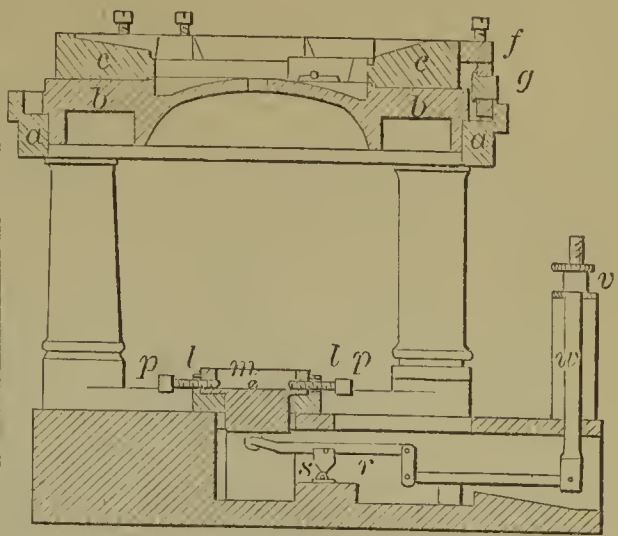

59354—R. Burdett—Reed Musical Instrument.

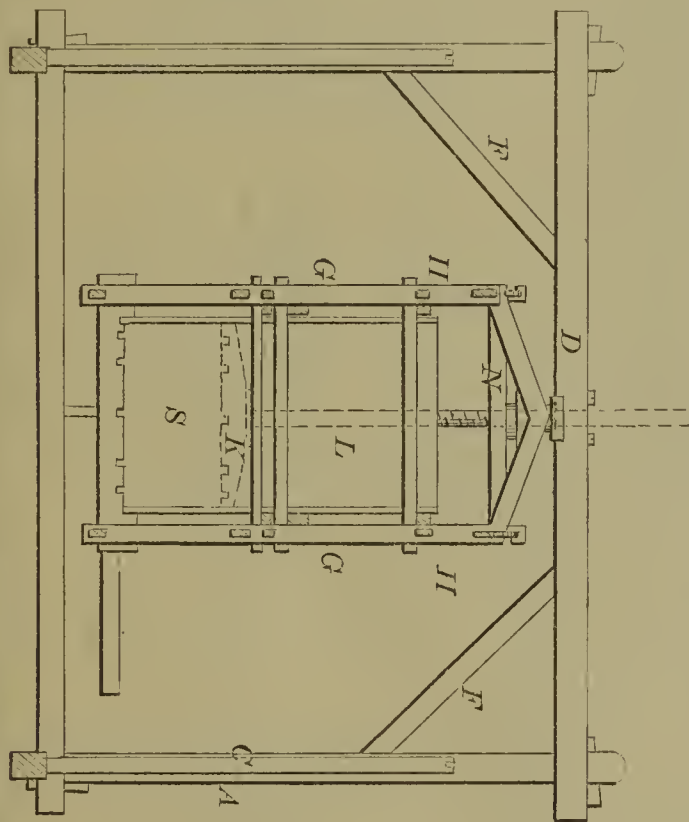

59352—R. M. Brooks—Portable Revolving Screw Press.

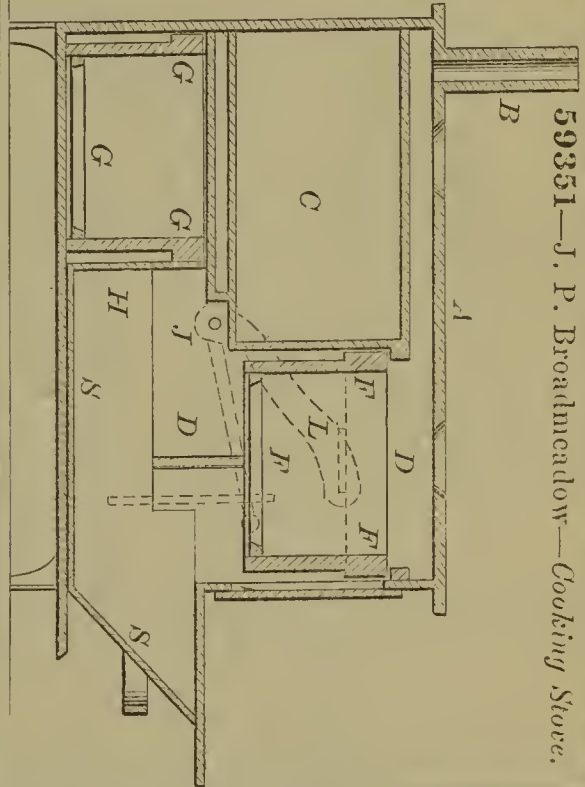
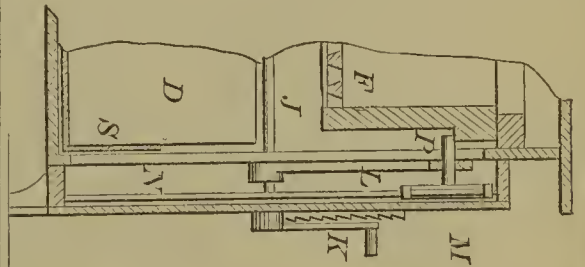

59351—J. P. Broadmadow—Cooking Stove.

59355—G. E. Burt—Car Brake.

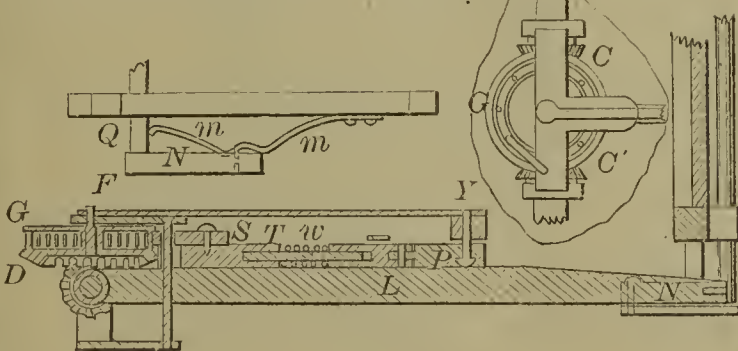

59356—G. R. Cannon—Shelving for Wagons.

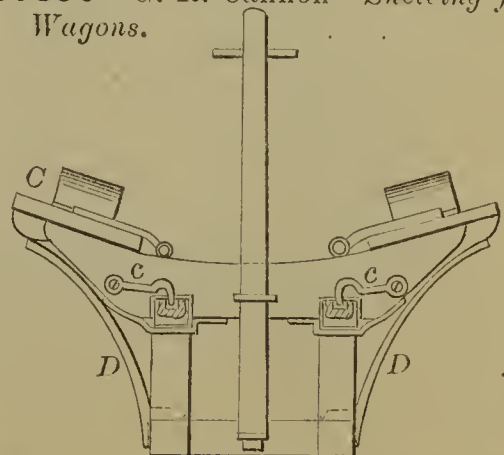

59357—O. F. Case—Water Proof Sole.



59358—L. J. Caswell—Cultivator.

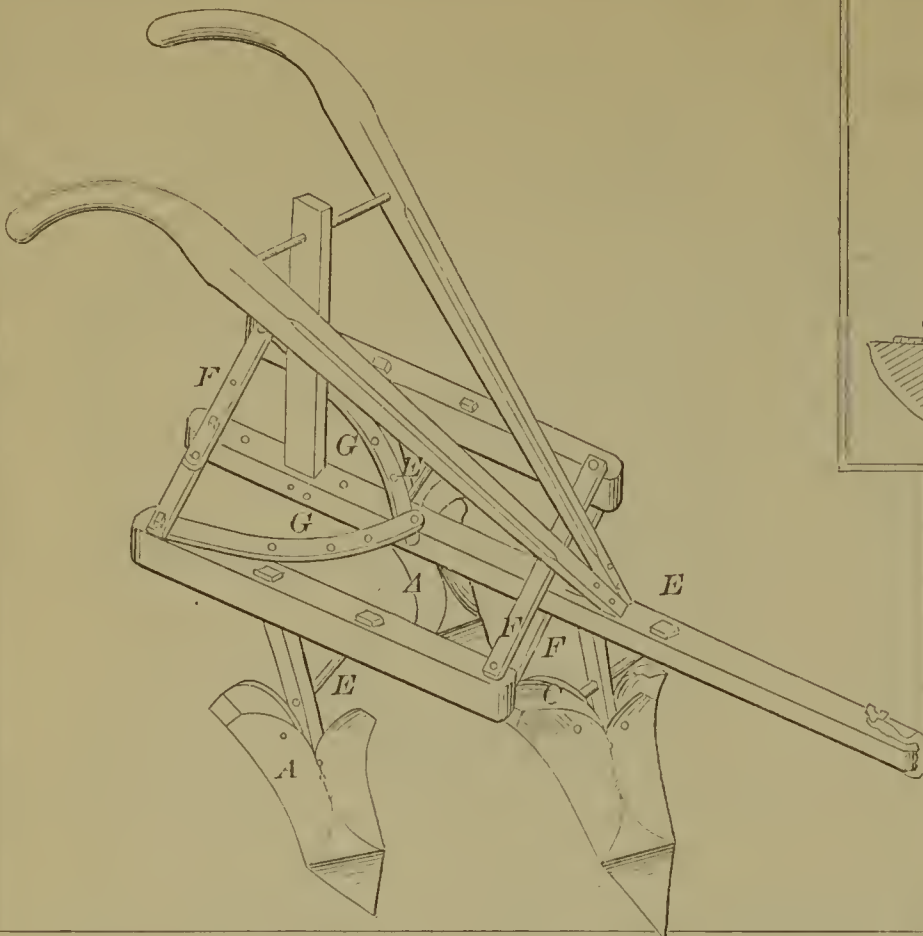

59359—P. C. Clapp—Last.

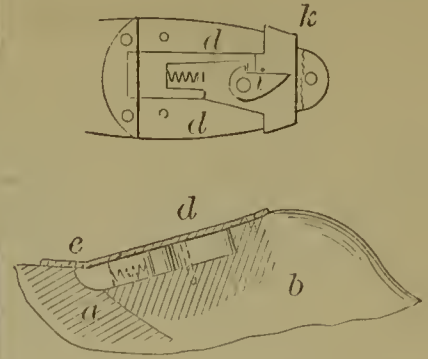

59362—L. R. Comstock—Store Pipe and Damper.

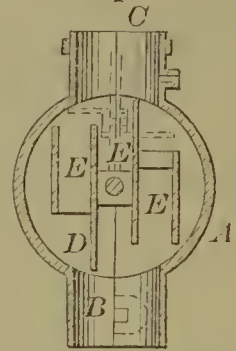

59360—S. A. Clemens—For Threshing Flax.

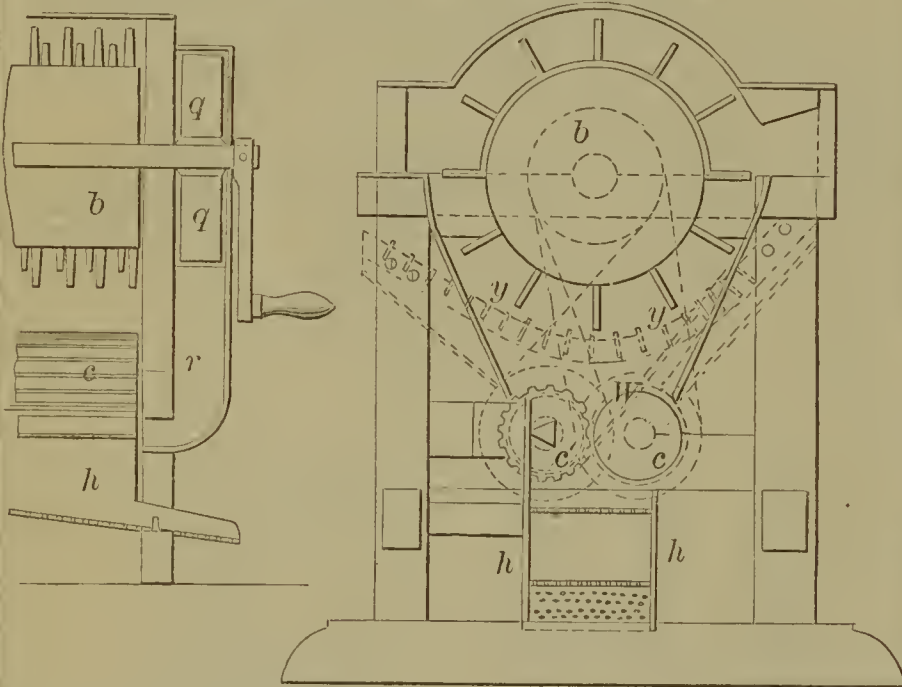

59364—Conant & Brown—Pump.

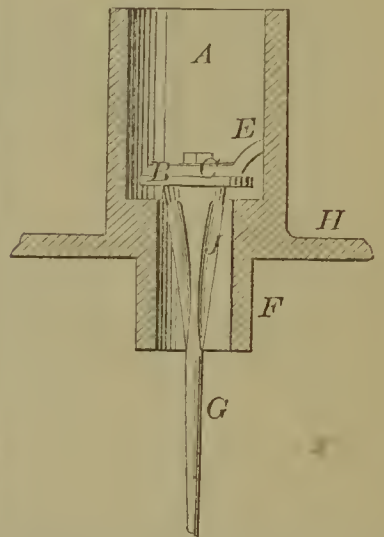

59363—L. R. Comstock—Store Pipe Drum.

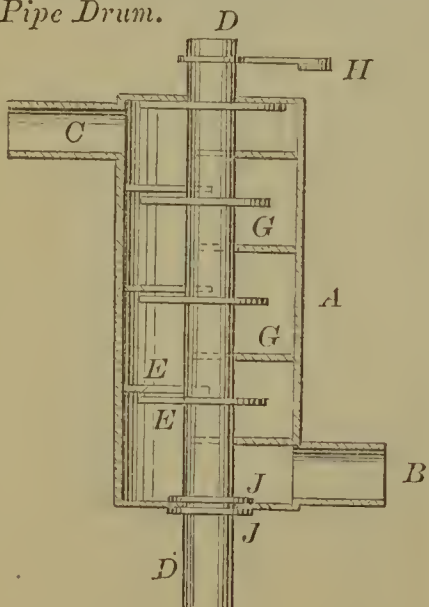

59365—R. Covington—Shutter Hinge.



59366—M. G. Crane—Ice Cream Freezer.

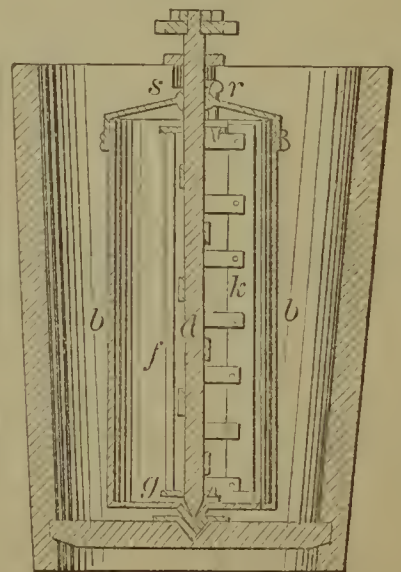

59367—J. B. Curtis—*Extension Table.*

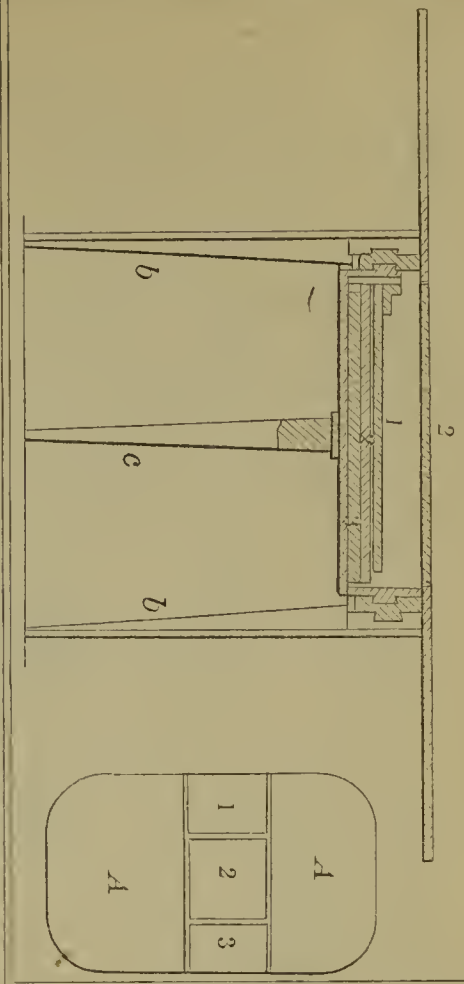

59368—H. A. Daniels—*Sawing Machine.*

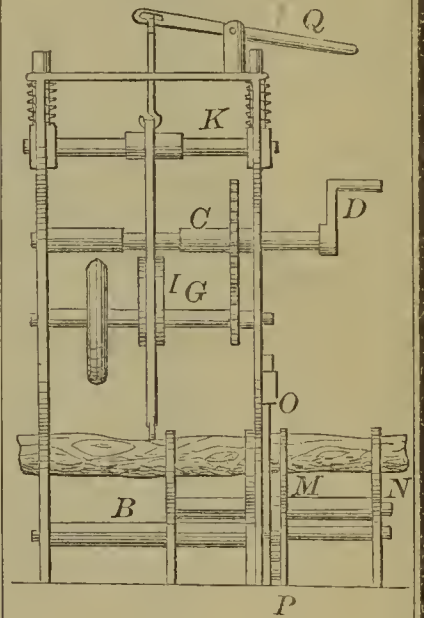

59369—J. Dobbins—*For Bending Wooden Hoops.*

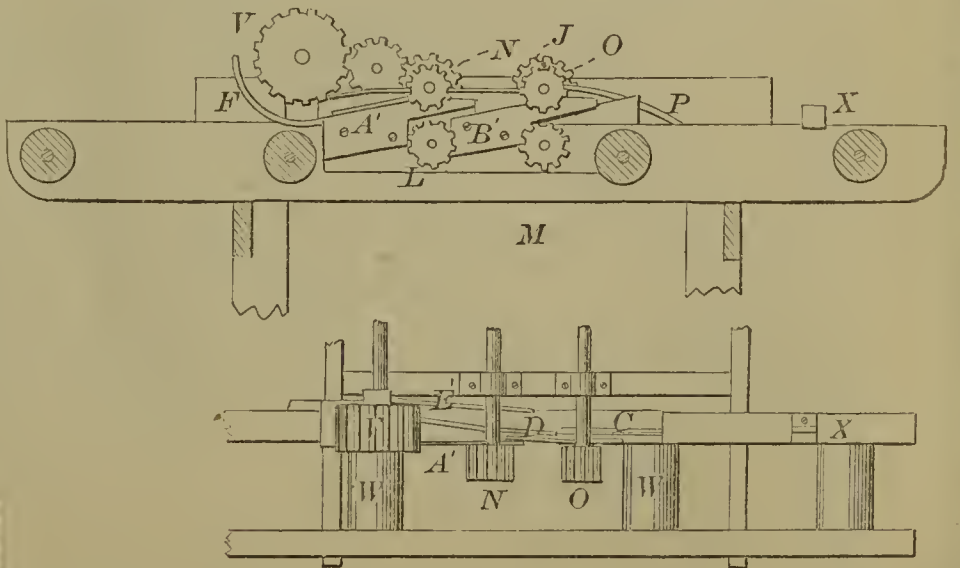

59361—L. H. Colborn—*Steam Generator.*

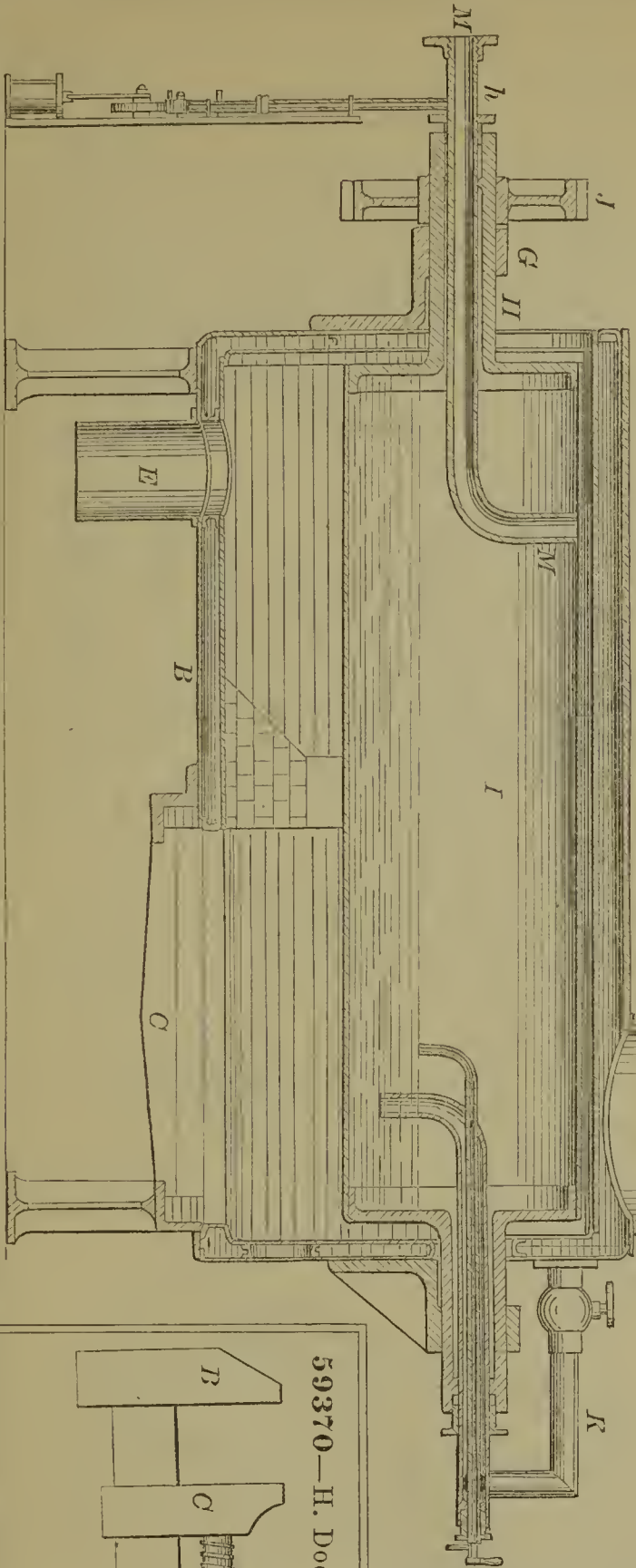

59370—H. Dodge—*Wrench.*

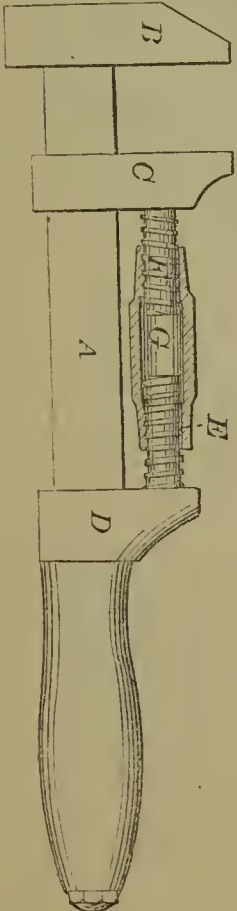

59371—J. E. Earle—  
*Furniture Pad.*

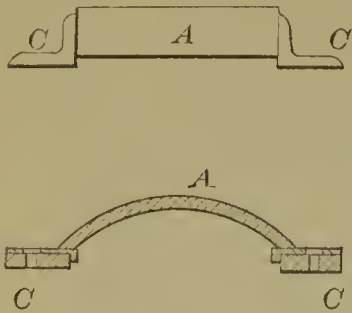

59373—B. Erbe—*Door Latch.*

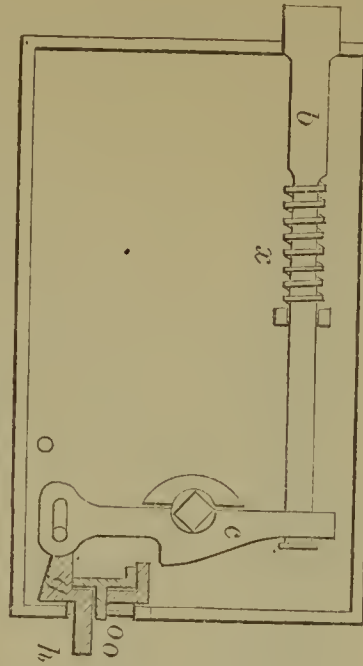

59374—C. R. Myerson—*Foot Warmer.*

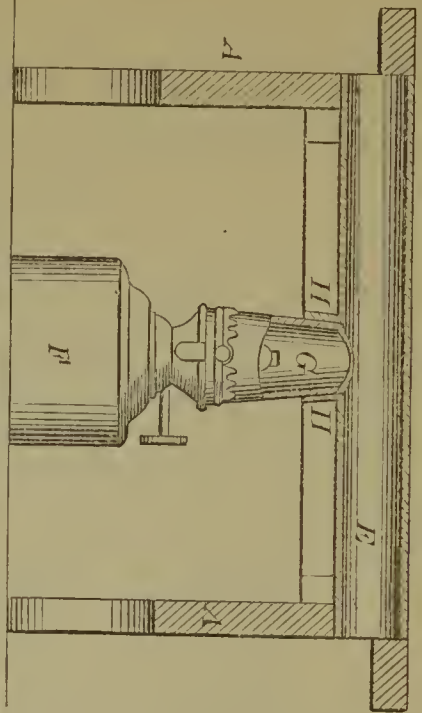

59372—B. F. Early—*Broom Head.*

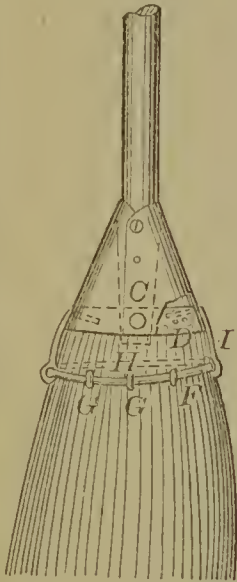

59375—Evroy & Heston—*Boots and Shoes.*

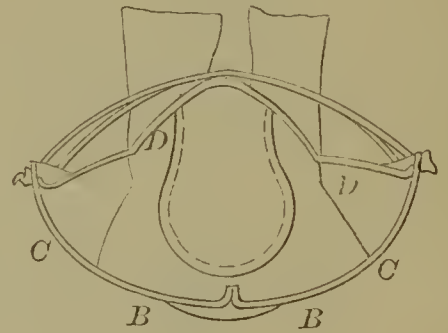

59377—J. E. Finley—*Beehive.*

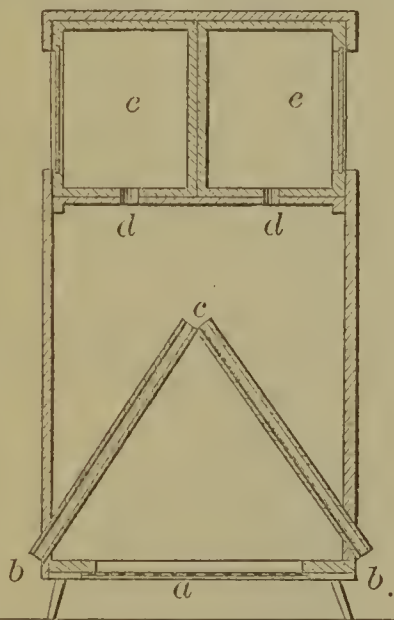

59376—J. Federhen—*Croquet Board.*

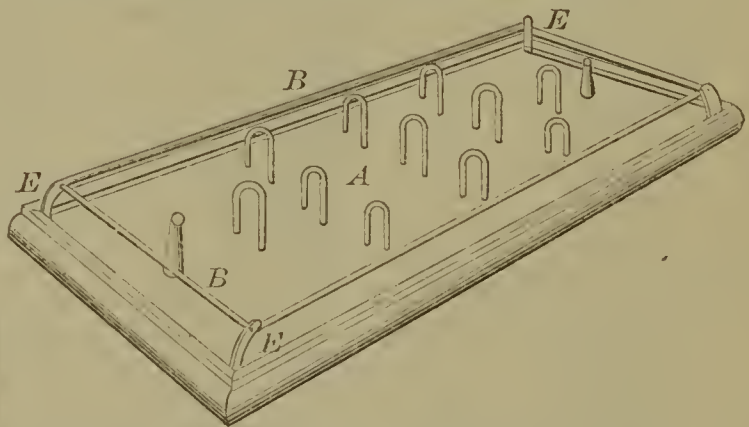

59379—A. Fontaine—*Fire Alarm.*

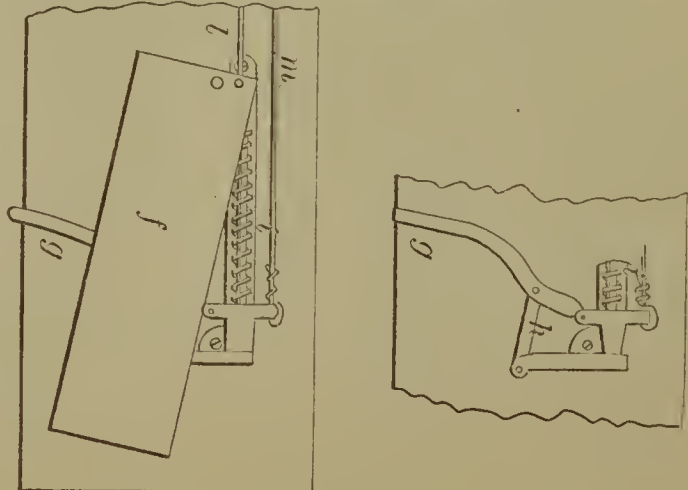

59378—J. E. Fitts—*Gate.*

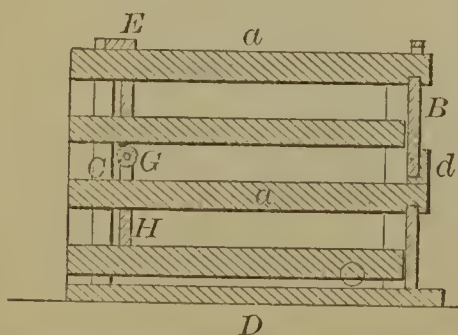

59380—W. H. Fowler—Door Catch.

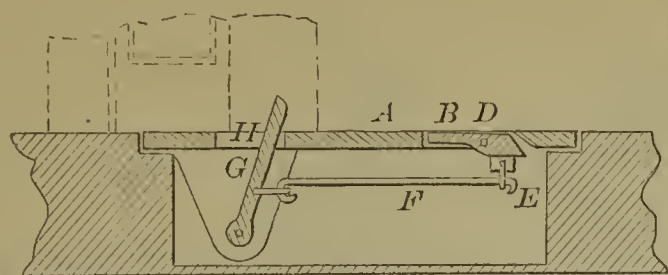

59384—C. Glidden—Car Spring.

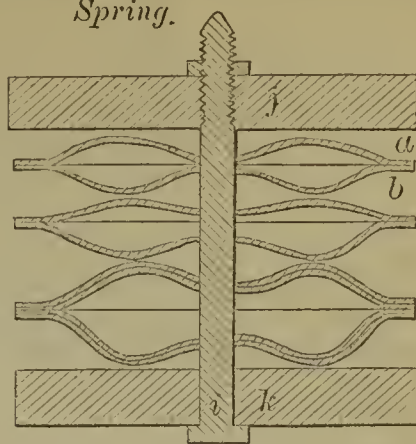

59381—J. C. French—Cultivator.

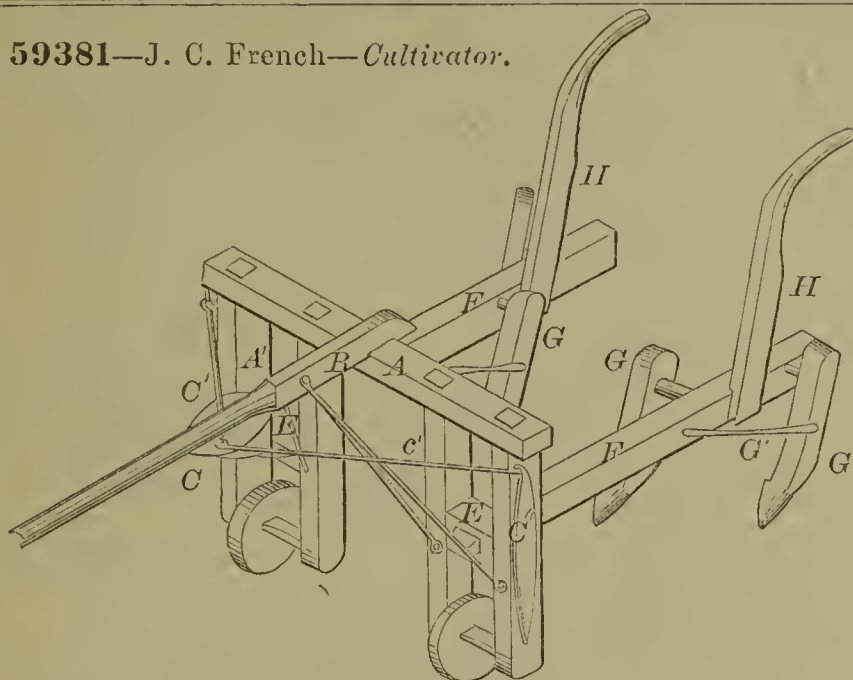

59383—E. P. Furlong—Key Guard.



59382—P. C. Fritz—Cooler for Grinding Mills.

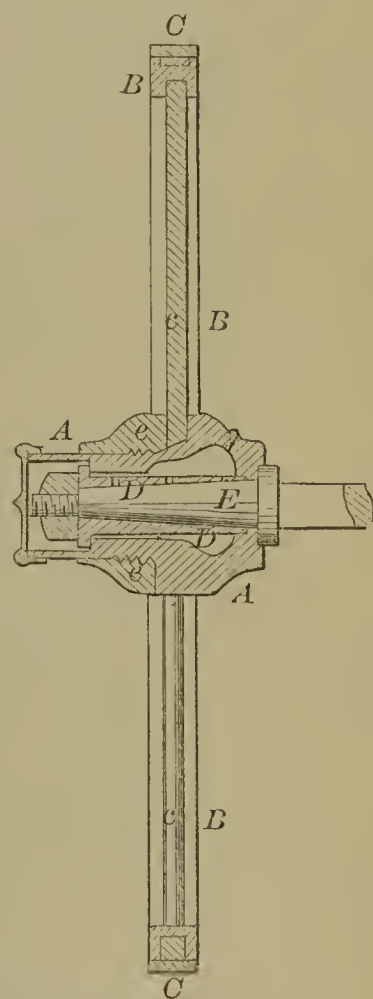
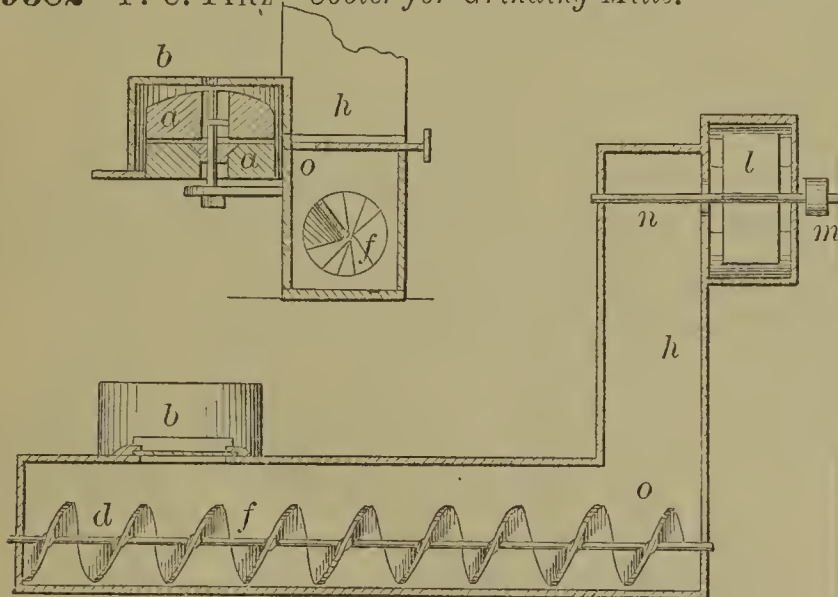

59385—C. Godden—Vehicle Wheel.

59387—J. & C. Gschwind—Car Register.

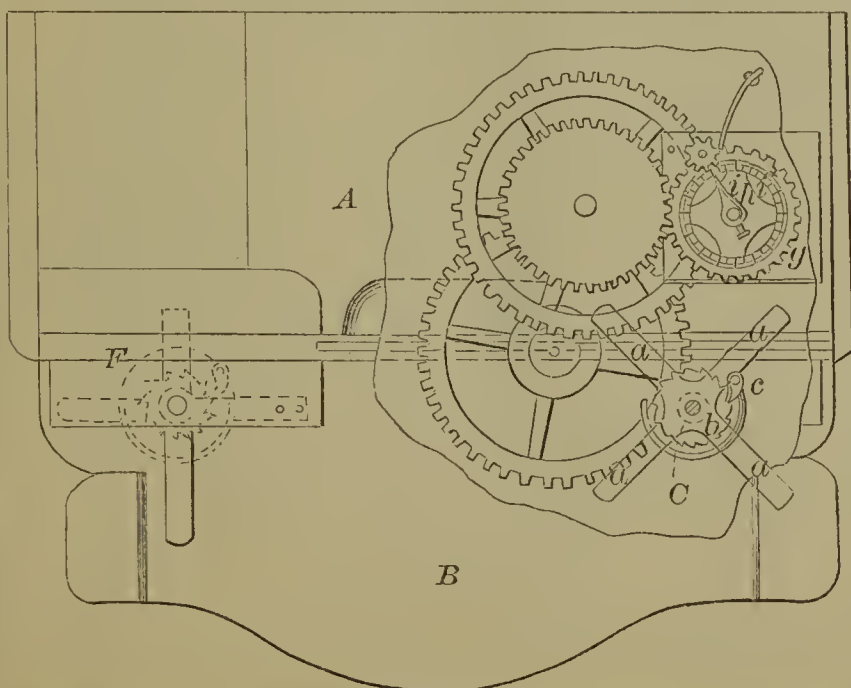

59386—D. H. Goodwillie—Inhaler.

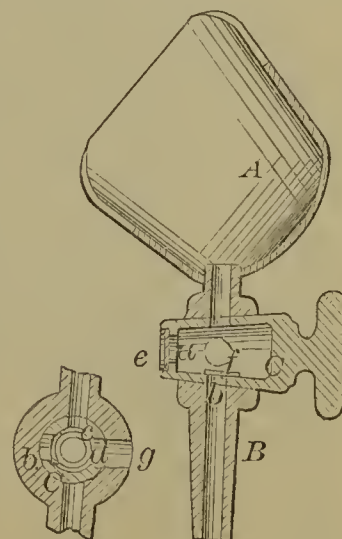

59388—G. Hadfield—Medical Vacuum Chamber.

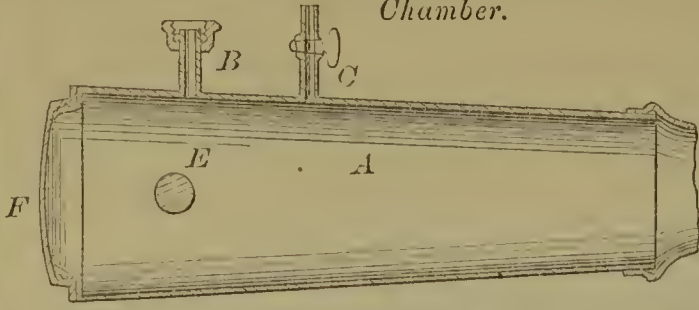

59389—P. Hagan—Lamp Chimney.

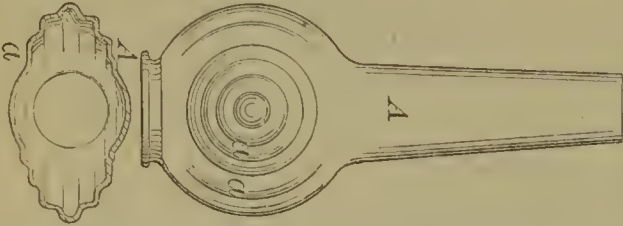

59392—L. S. Hayes—Sawing Machine.

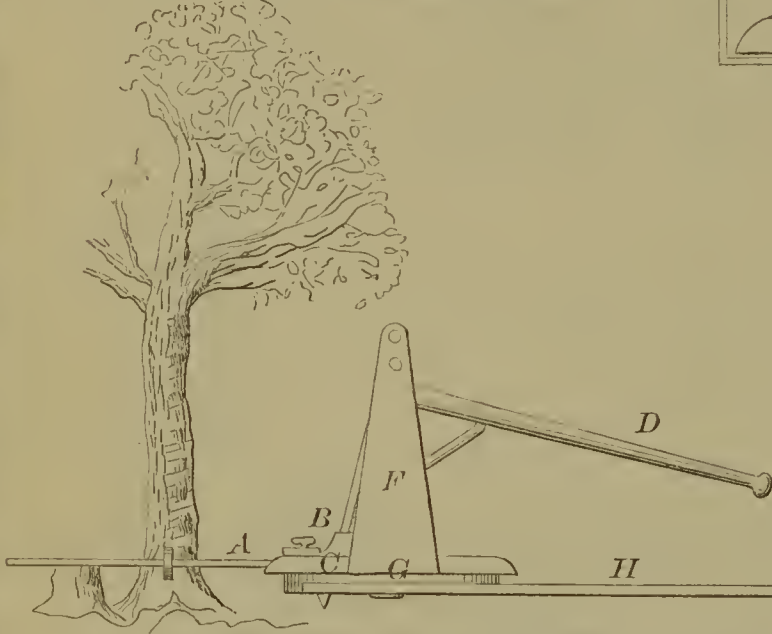

59395—B. B. Hill—Hand Stamp.

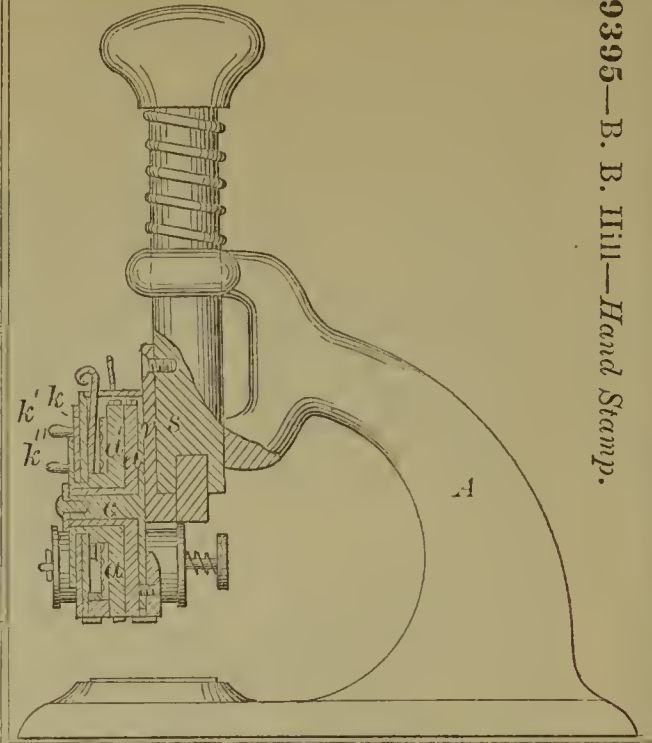

59394—A. Hill—Watch Regulator.

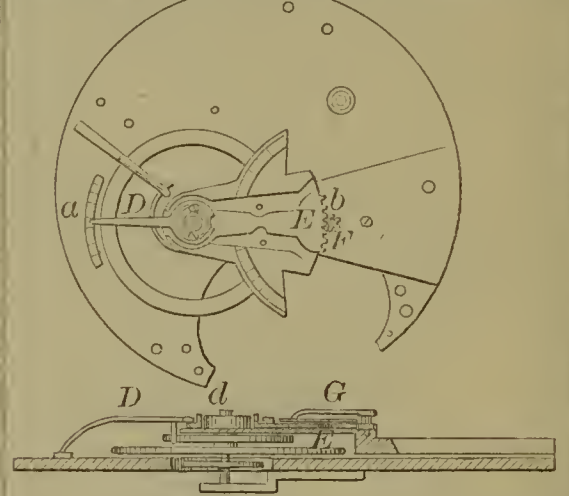

59393—I. Helme—Hydro-Carbon Burner.

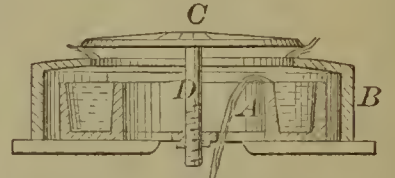

59390—A. Hale—Sulky Plow.

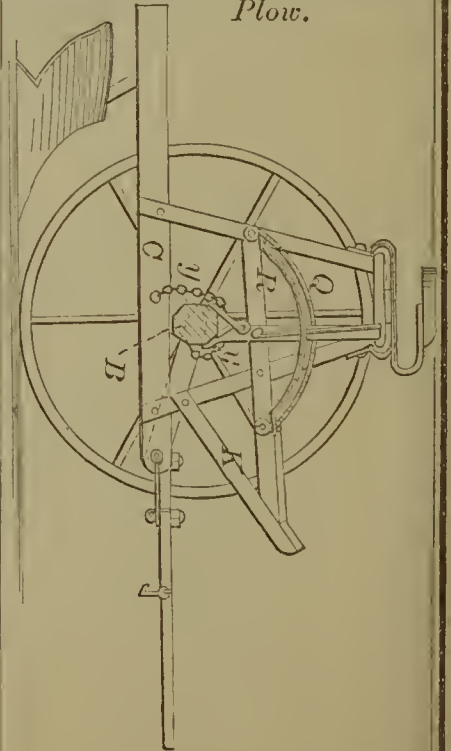

59396—E. G. Holden—For Preserving Fruit.

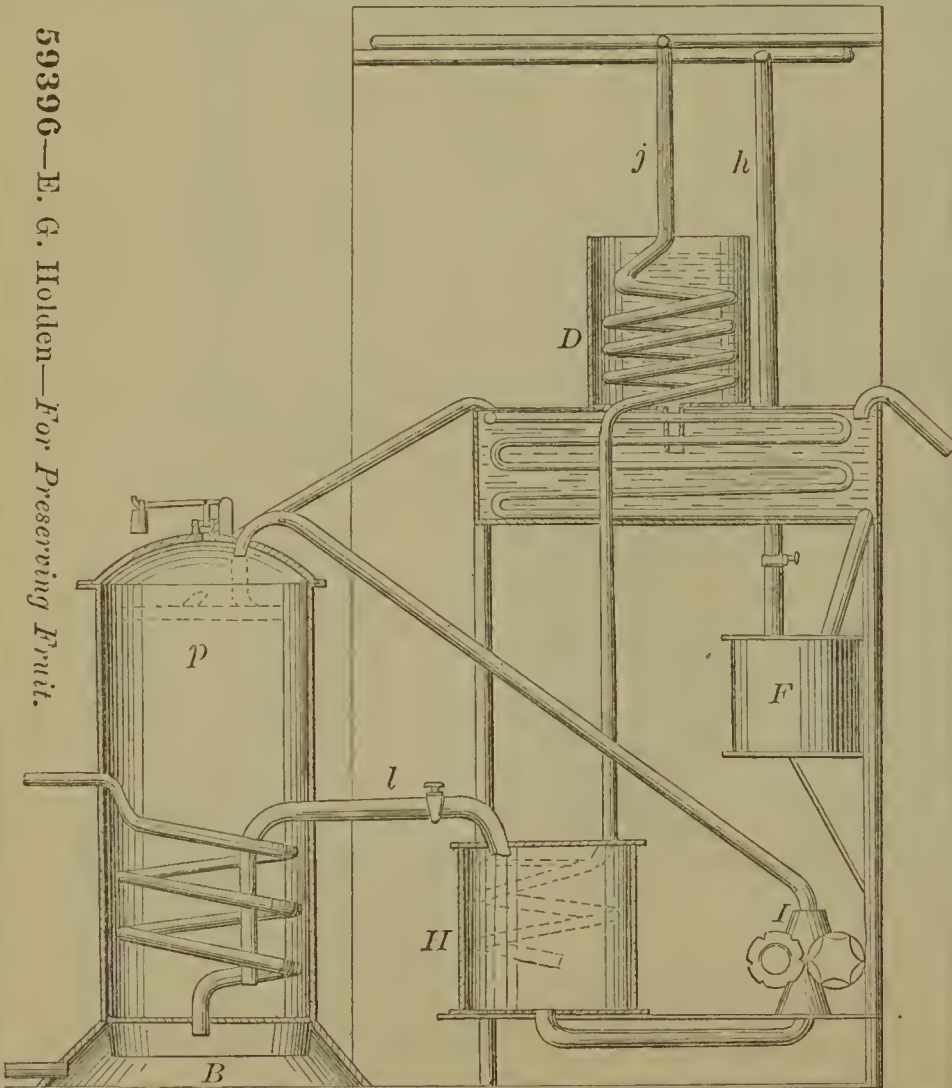



59397—A. T. Hutson—*Portable Heater.*

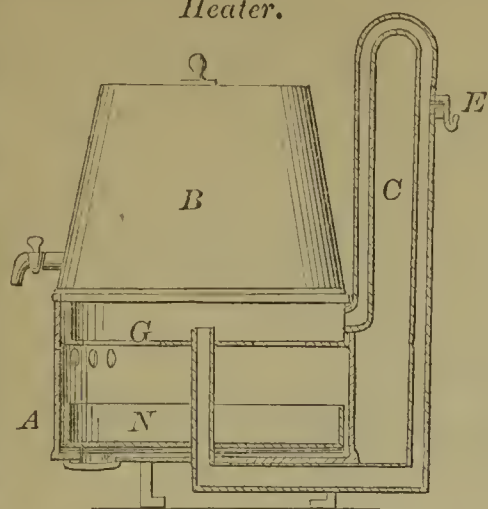

59400—J. Jordan—*Steam Pump.*

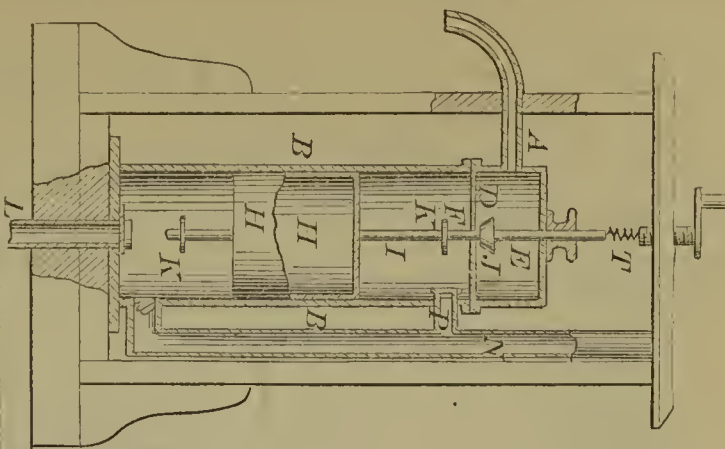

59403—J. E. Jouett—*Chair, Couch and Stretcher.*

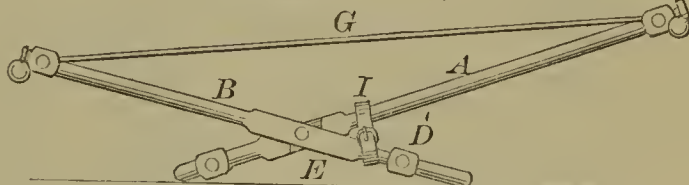

59398—J. Hyde—*Whiffletree Coupling.*

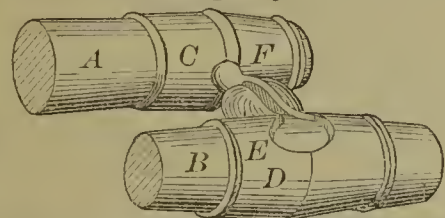

59399—R. B. Jacobs—*Gaiter Boot.*

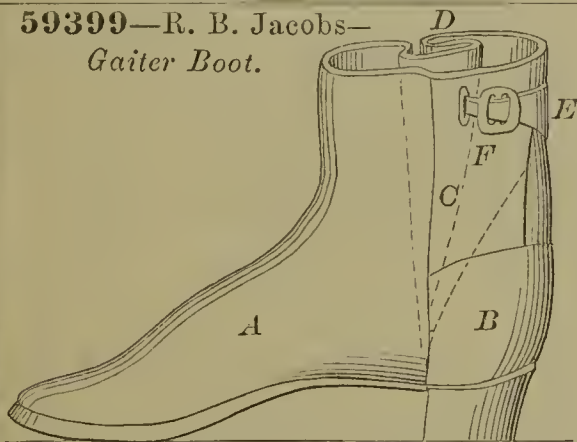

59405—S. S. Kappell—*Gate.*

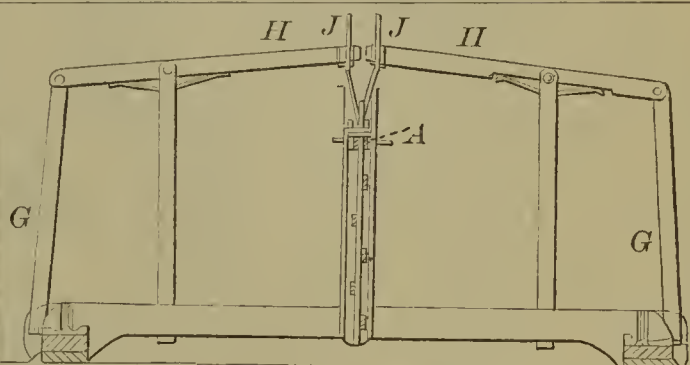

59401—P. F. Jones—*Railroad Rail.*

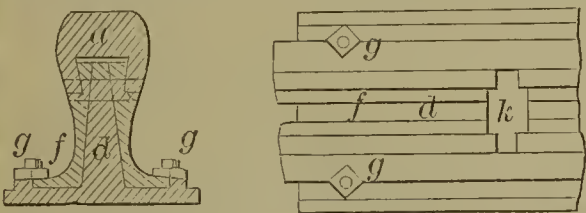

59407—J. Keith—*Lathe for Turning Pen Handles.*

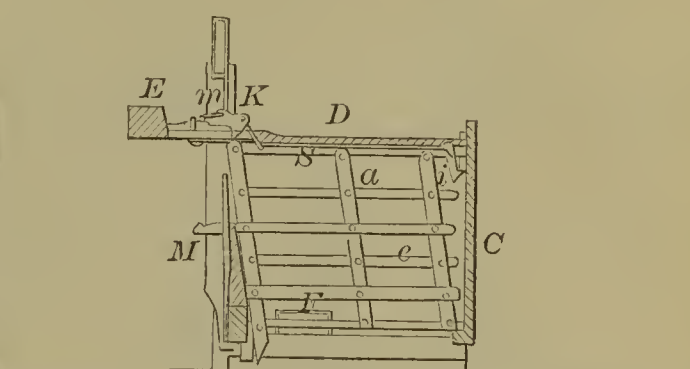

59406—J. M. Keepe—*Sprinkler for Powdered Substances.*

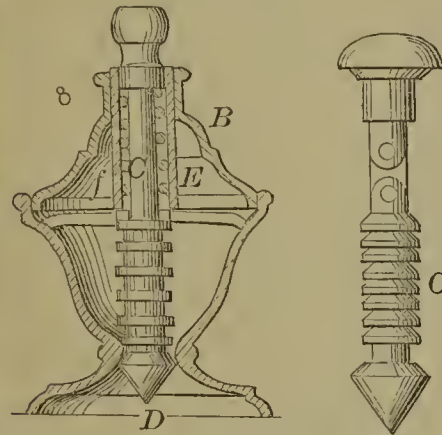

59404—A. D. Judd—*Picture Nail.*

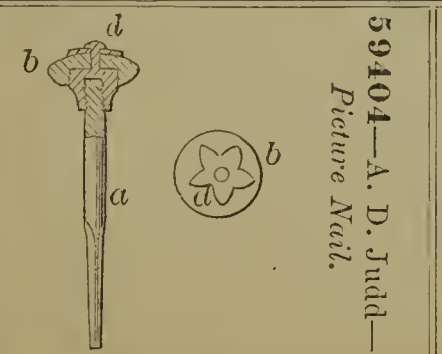

59407—J. Keith—*Lathe for Turning Pen Handles.*

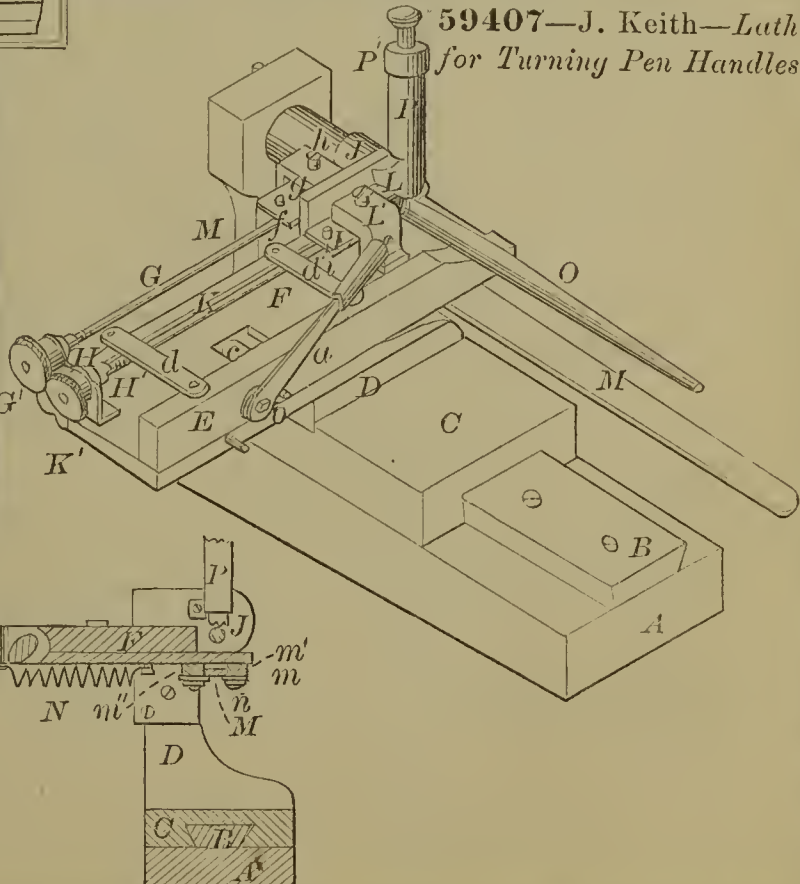

59408—  
A. H. & H. P. Kennedy—  
Cattle Poke.

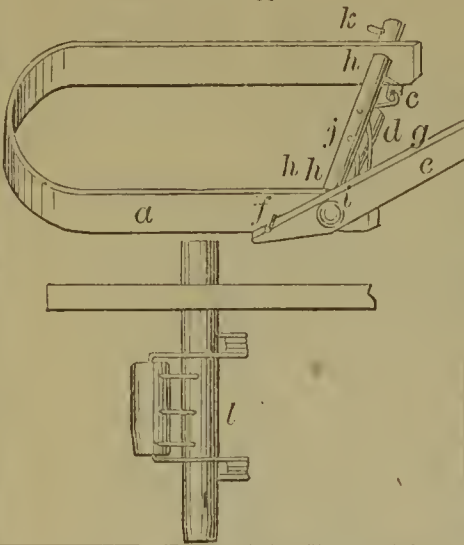

59412—E. H. Knight—Governor.

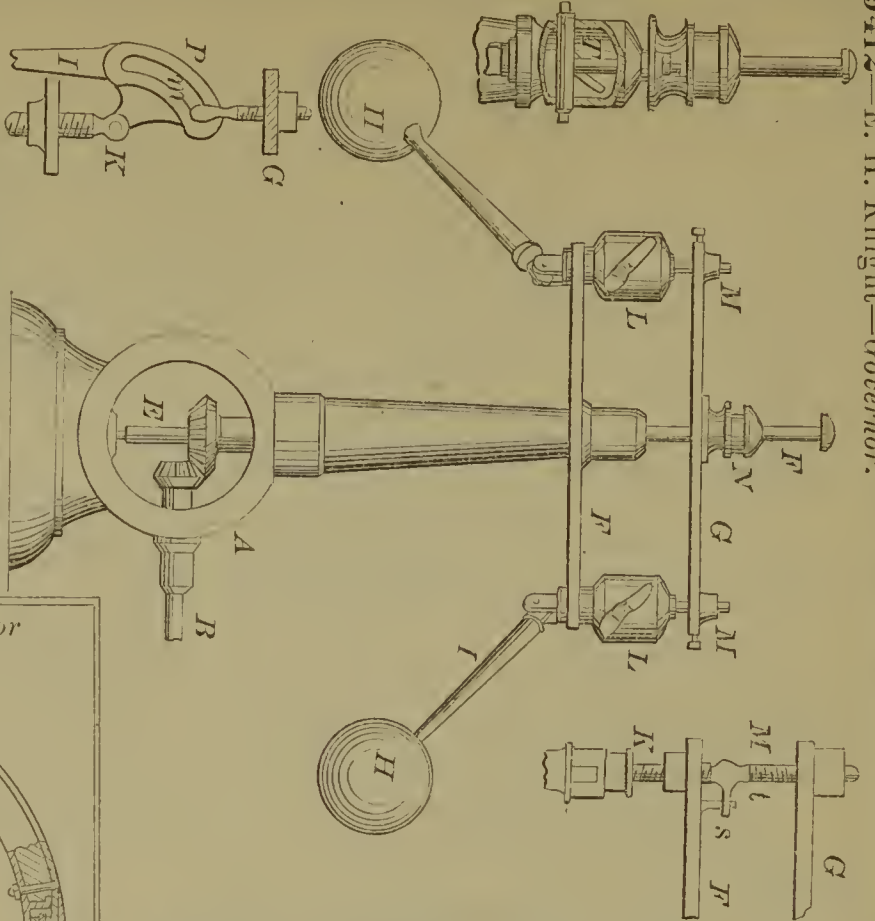

59412—E. H. Knight—Governor.

59409—Kirkman & Gray—For  
Tightening Wheel Tires.



59410—H. F. Knapp—Paper Collar  
Machine. A

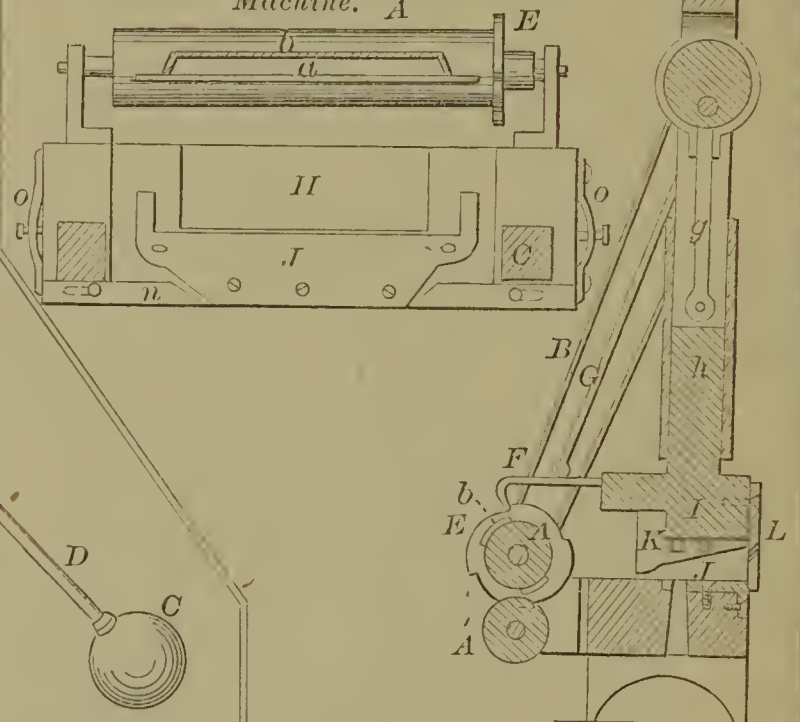

59411—E. H. Knight—Governor.

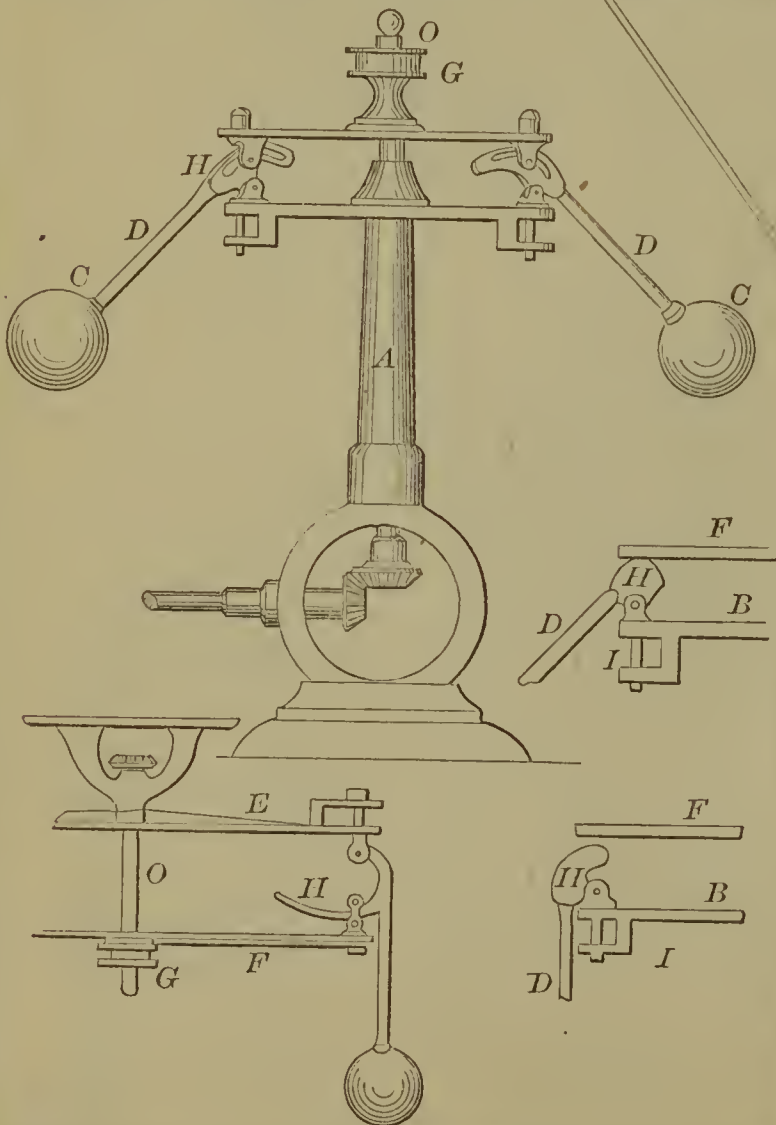

59413—E. H. Knight—Governor.

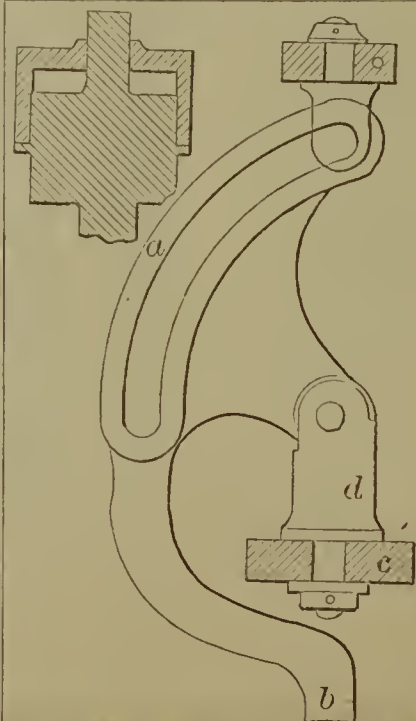

59414—R. T. Knight—*Spring For Closing Doors.*

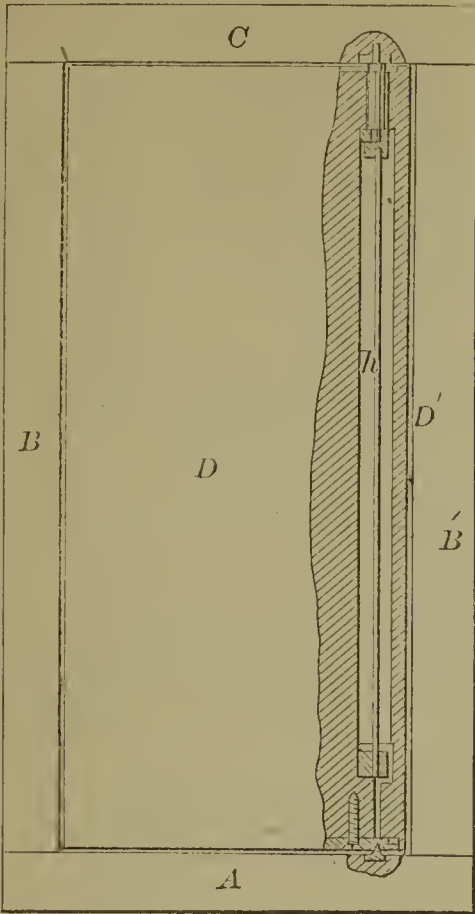

59416—A. Larrowe—*Gate.*

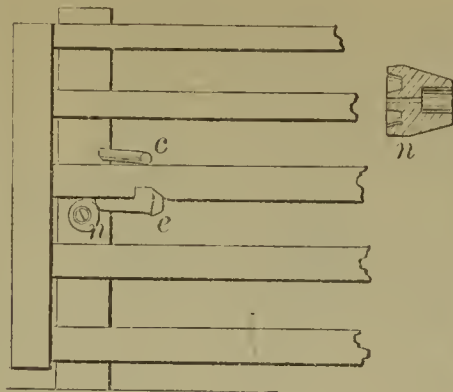

59415—A. T. Large—*Safety Pocket Clasp.*

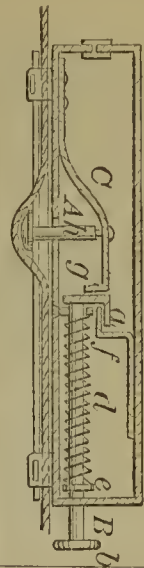

59417—S. Lavenue—*Machine for Boring Wagon Hubs.*

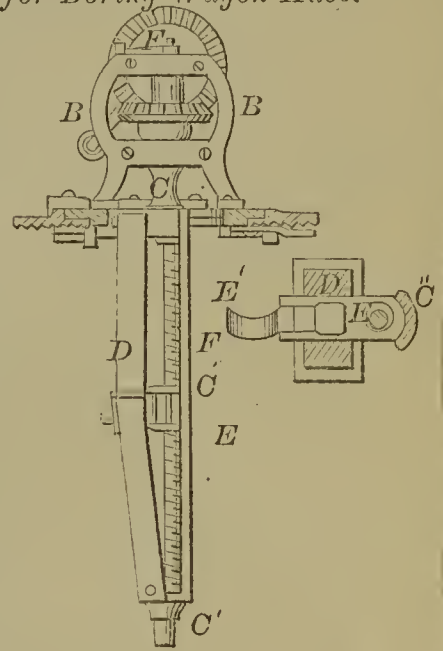

59418—A. R. Lawrence—*For Preventing Sediment in Mineral Waters.*

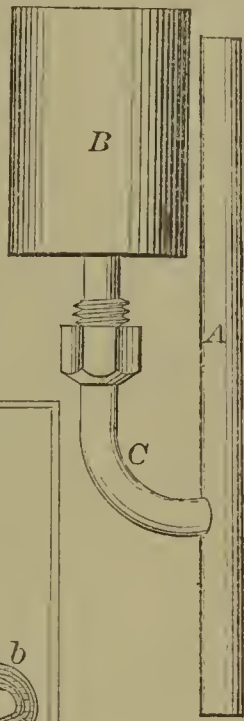

59419—J. Letson—*Waterproof Shoe.*

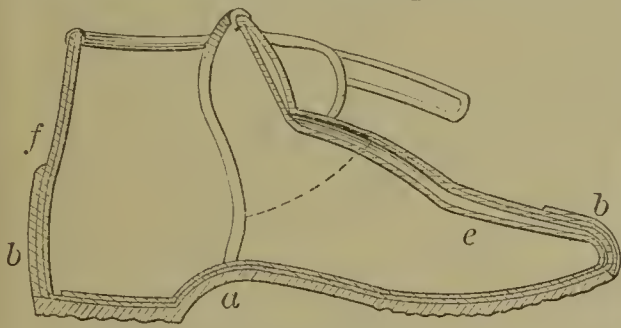

59422—Lighter & Harding—*Grain Drill Tube.*

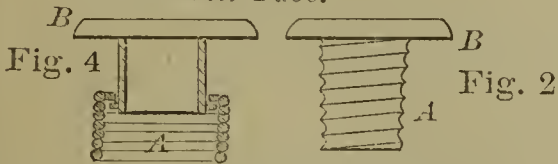

59421—C. Lewis—*Fence Jack.*

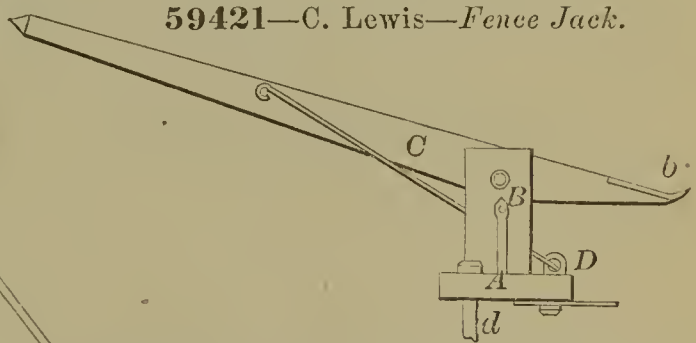

59420—J. Letterel—*For Tenoning Spokes.*

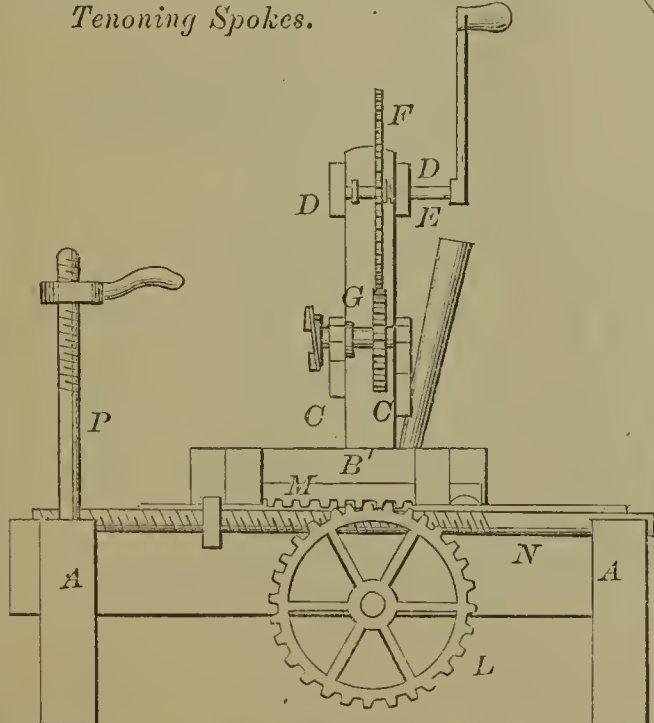

59423—Love & Thornly—*For Operating Wood Splitting Machines.*

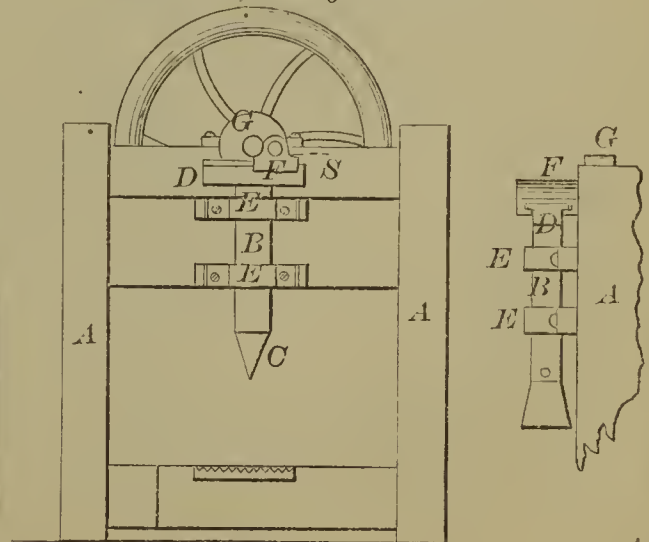

59424—T. Main—*Steam Generator.*

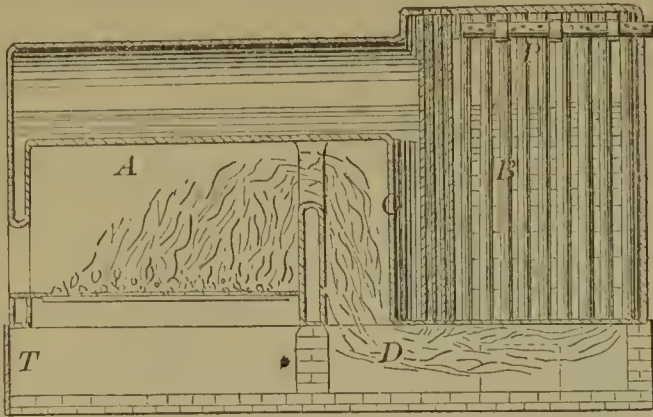

59425—G. B. Manley—*Hammer for Forging Blooms.*

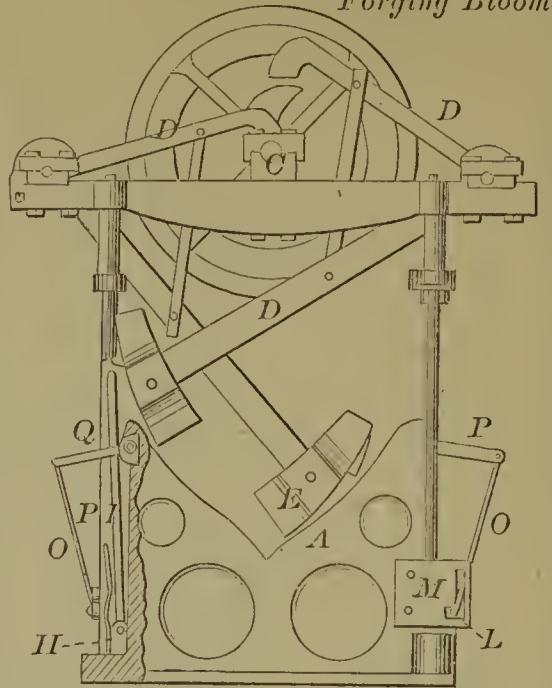

59426—Marchbank & Humphrey—*Faucet.*

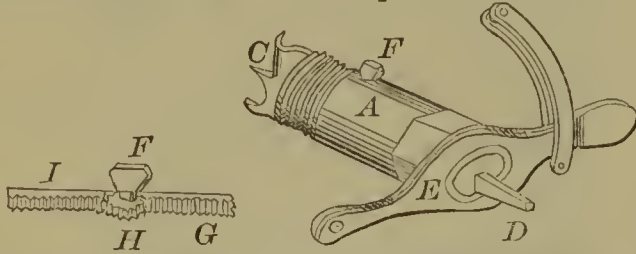

59428—W. D. Matthews—*Churn.*

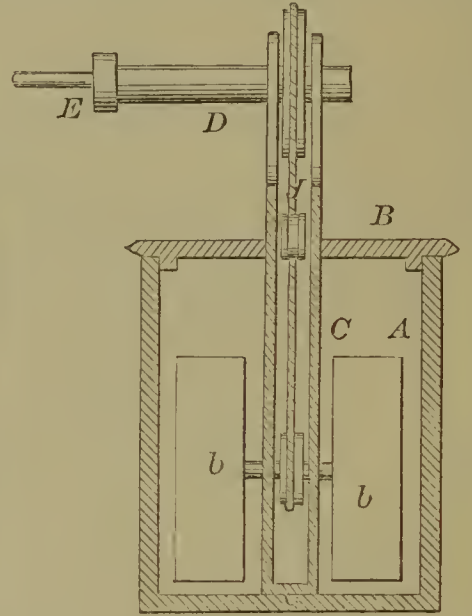

59427—C. C. Mather—*Fence.*

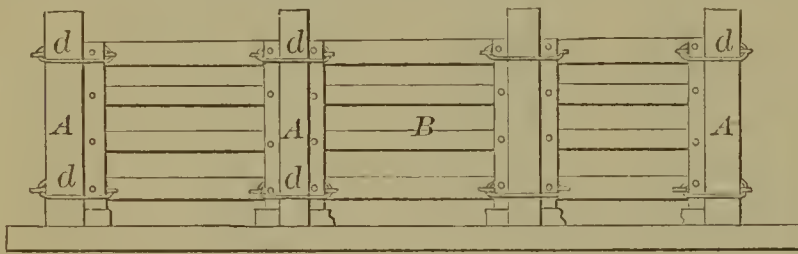

59429—W. Maxwell—*Fishing Net.*

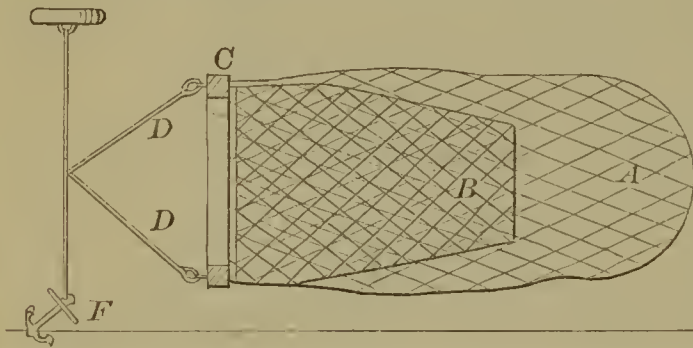

59430—B. McCollum—*Window Shutter.*

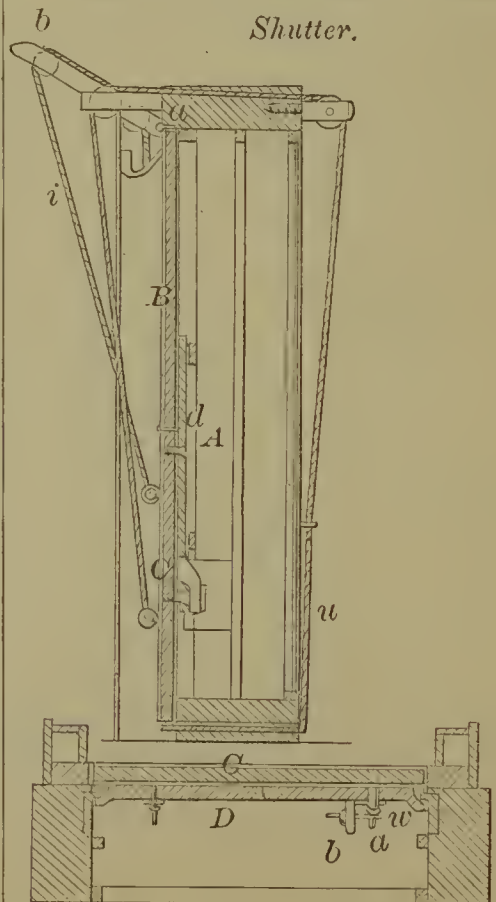

59431—F. McDonough—*Door Fastener.*



59432—P. McKinlay—*For Cleaning Rice.*

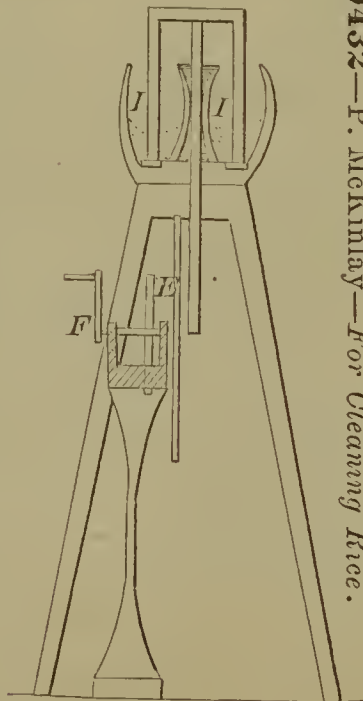

59433—J. McMabel—*Straw Cutter.*

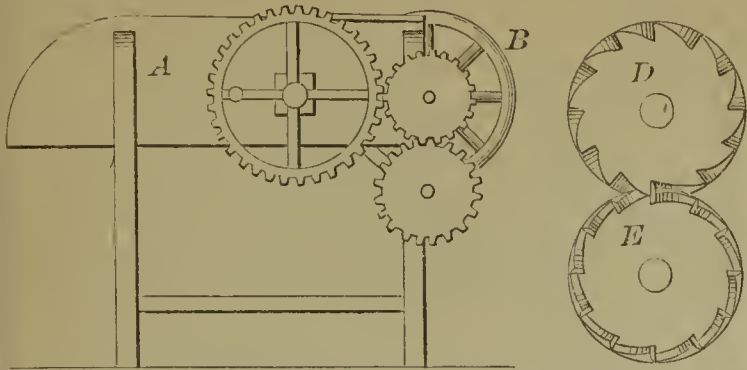

59435—S. M. Miller—*Grinding Mill.*

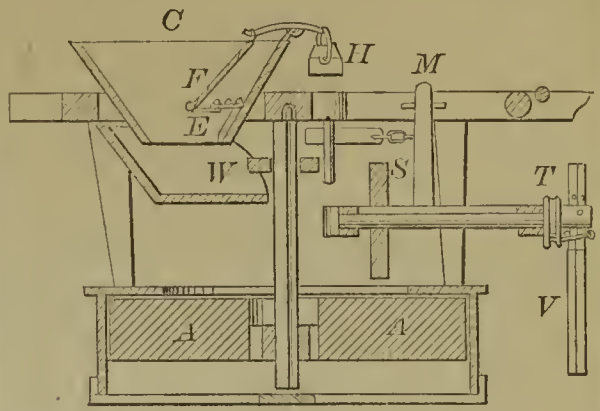

59438—L. F. Morawetz—*Vertical Solar Camera.*

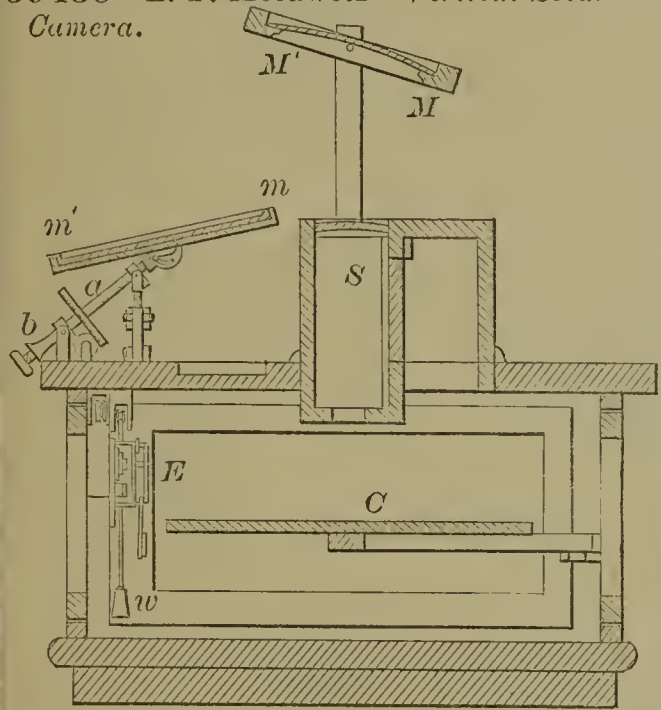

59434—H. Merrill—*Spike.*

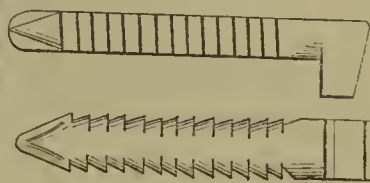

59439—Neill & Myers—*Damper Regulator.*

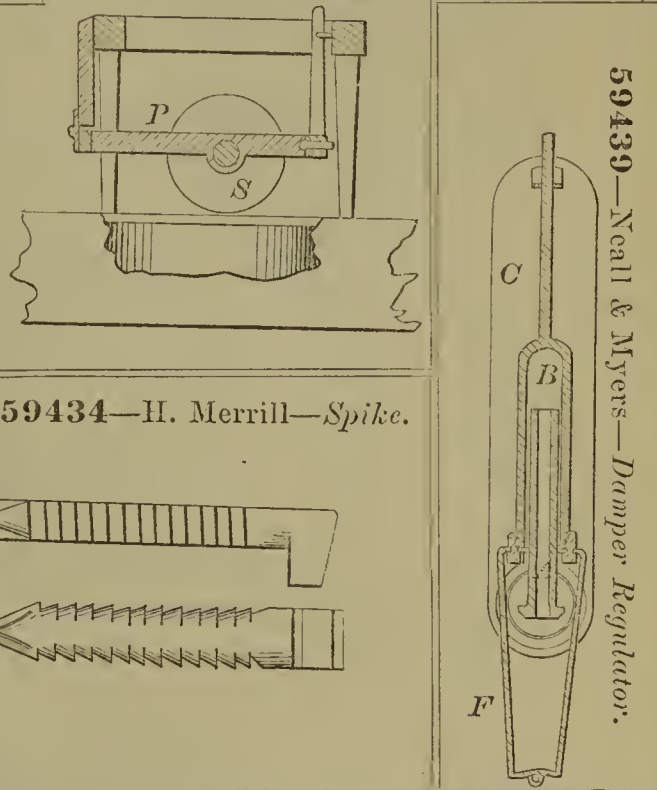

59437—J. A. Moore—*Plow.*

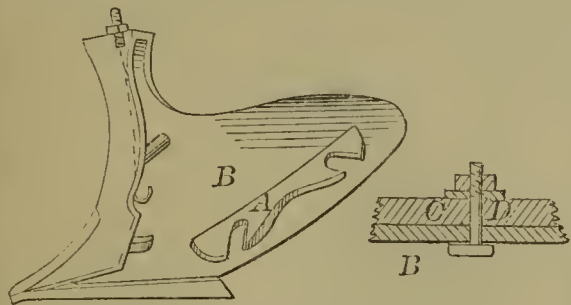

59440—Nichols, Nichols & Shepard—*Threshing Machine.*

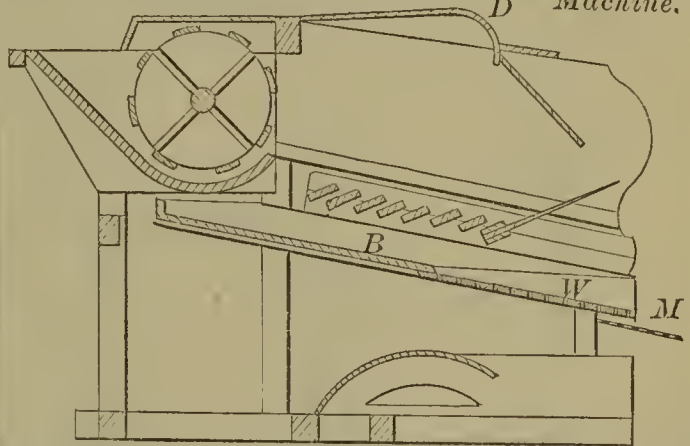

59442—G. E. Noyes—*Steam Governor.*

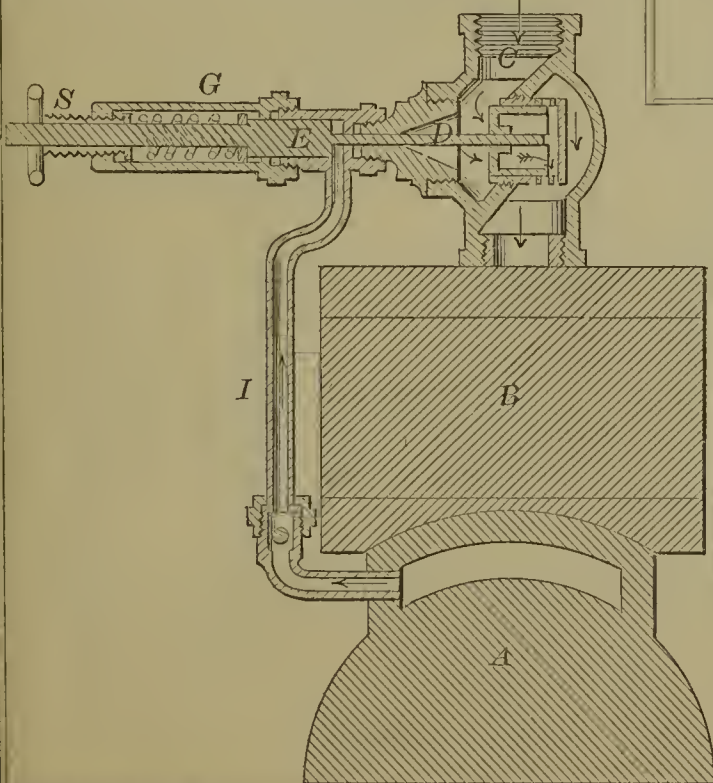

59441—J. & I. Neuburg—*Cooking Apparatus and Refrigerator.*

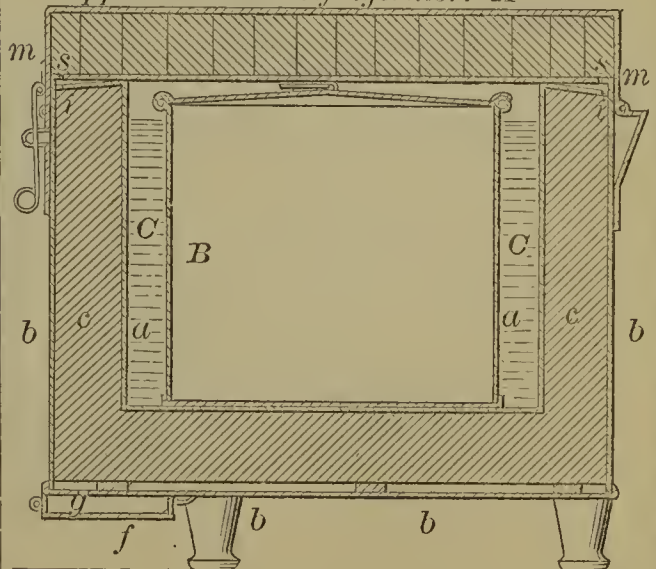

59443—W. Onions—Cotton Bale Tie.

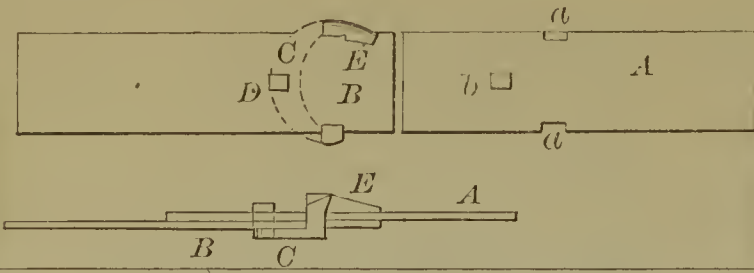

59447—J. M. Peirce—Churn and Washing Machine.

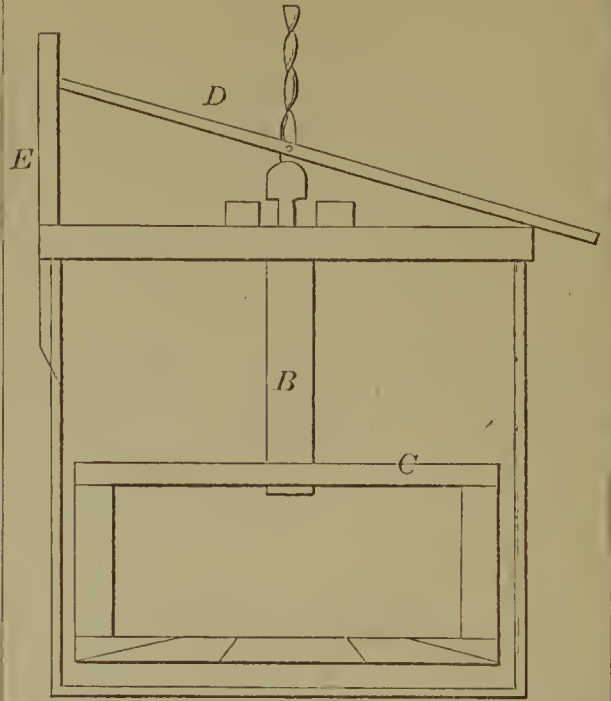

59445—I. Osgood—For Securing Wheel Hubs to Axles.

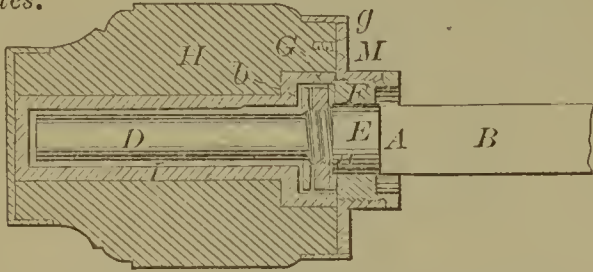

59444—W. Oreutt—Washing Machine and Churn.

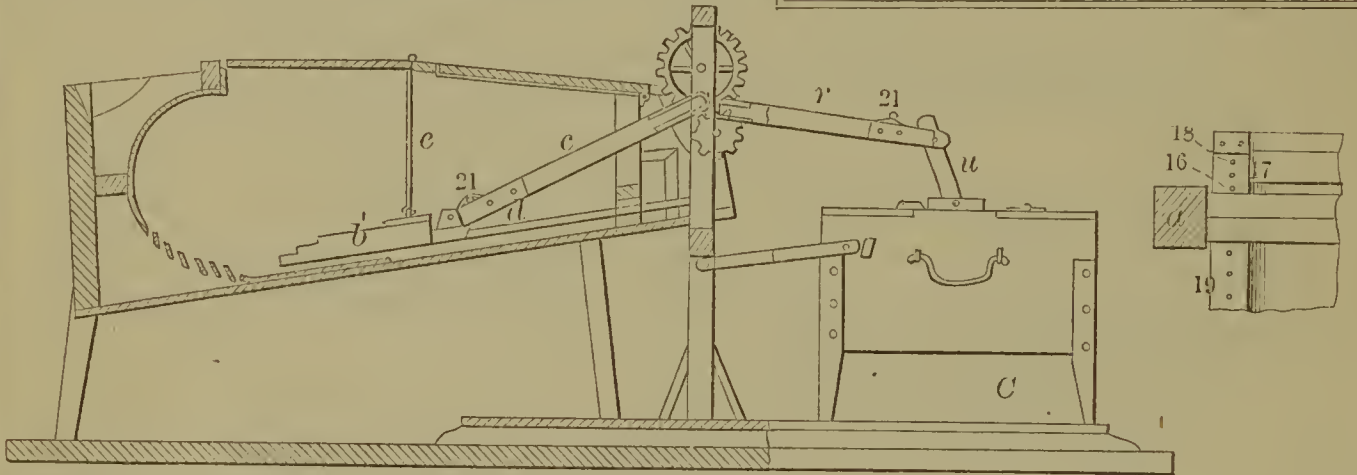

59446—F. S. Pease—Carburettor.

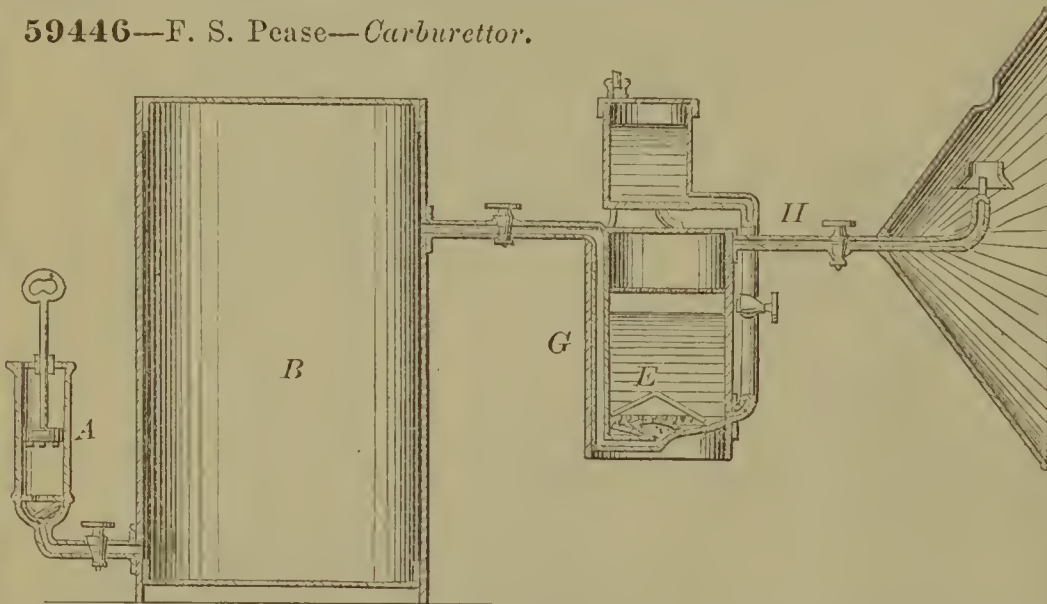

59448—J. H. Pitzel—Sewing Clamp.

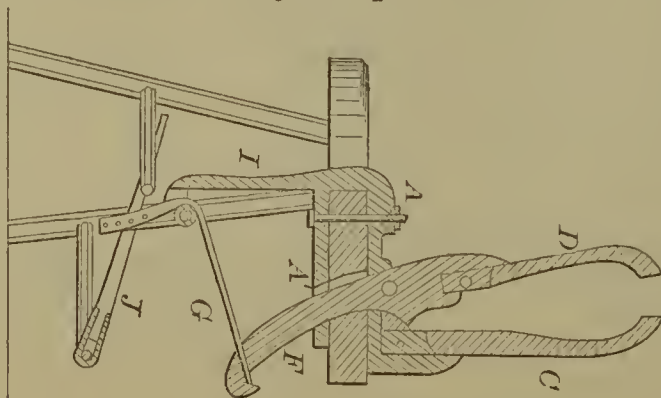

59449—E. L. Pratt—For Aerating and Mixing Substances.

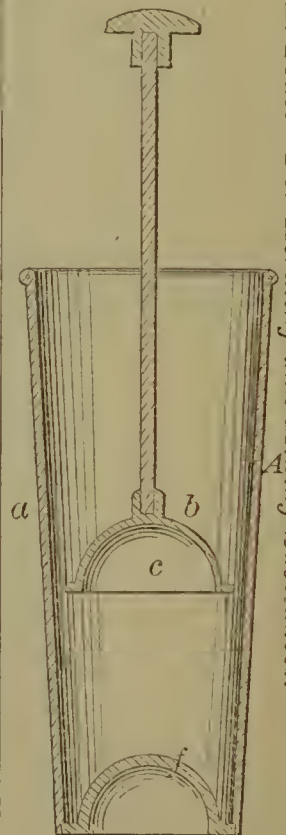

59450—E. L. Pratt—Sieve.



59452—J. G. Reiff—Sulky.

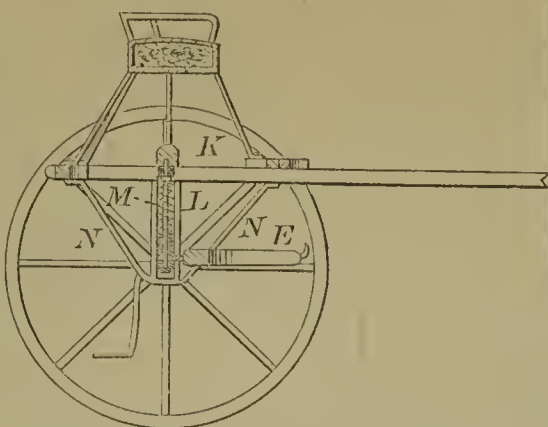

59451—E. Reed—Postal Wrapper.

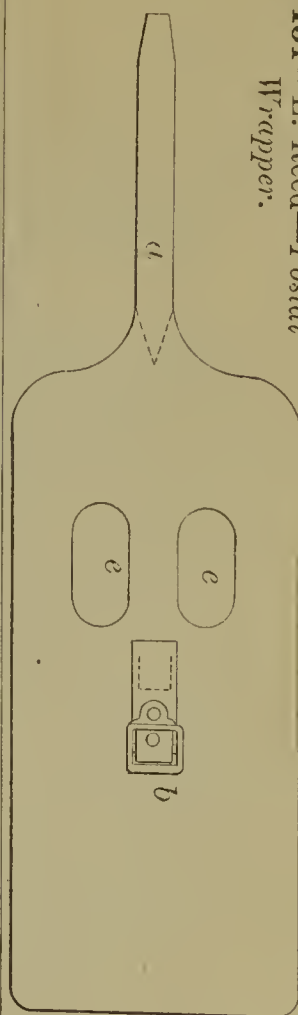

59456—J. Ross—Paper Packing Joint of Steam Engines.

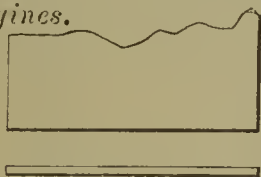

59454—C. S. Roberts—Cultivator.

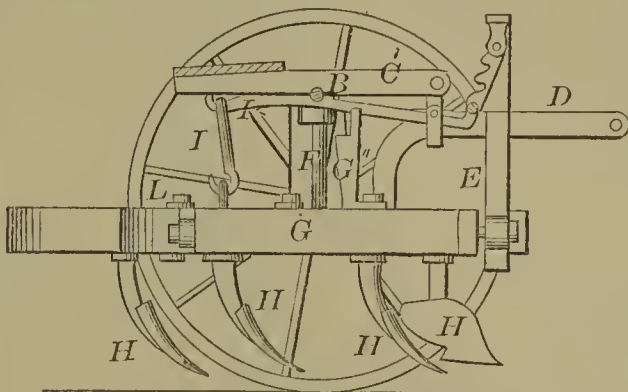

59453—W. A. Rex—Punch.

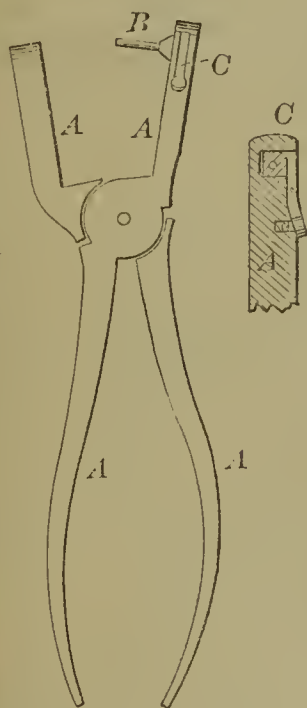

59458—E. A. G. Roulstone—Trunk Moulding.

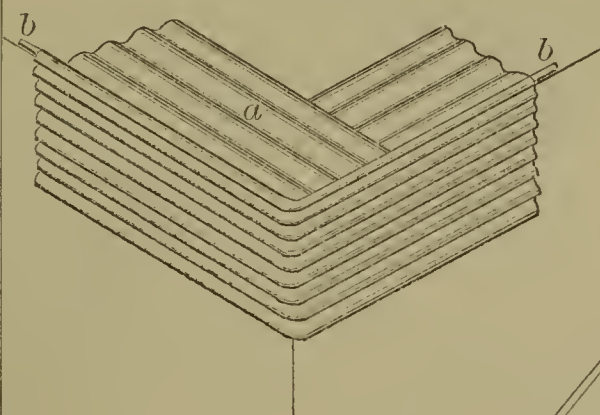

59457—T. J. Ross—Adjustable Back for Stools.

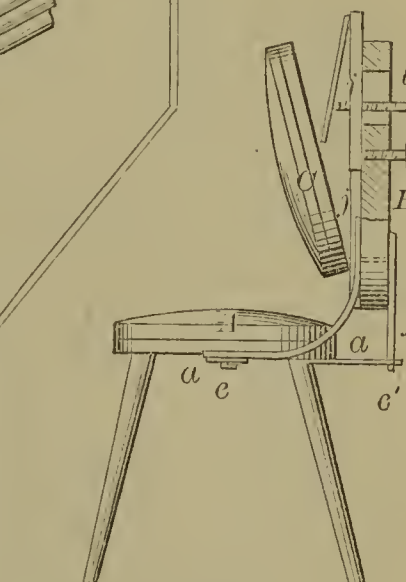

59459—Rucker, Allen & Smith—Ambulance.

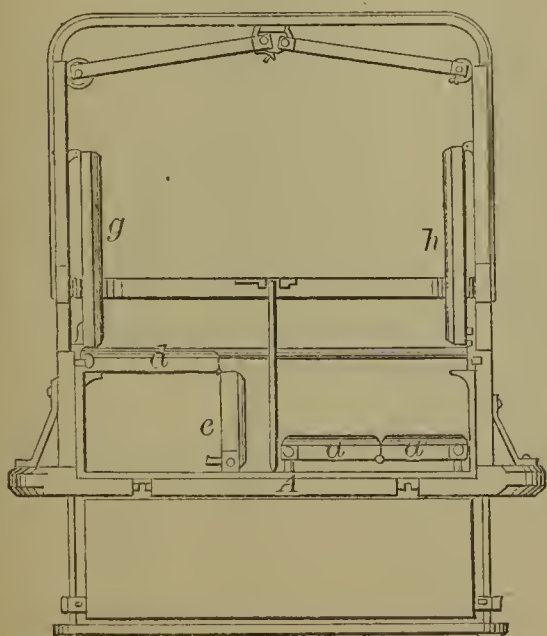

59460—H. Ryder—Tubular Plunger for Candle Moulds.

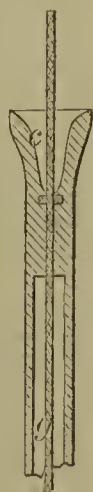

59455—Rood & Hackett—Thill Coupling.

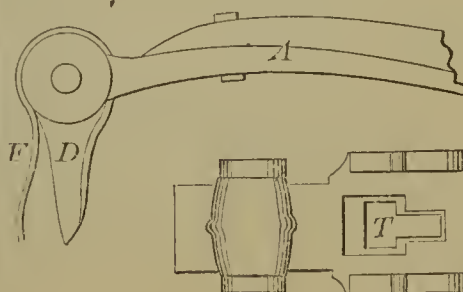

59461—W. H. H. Saunders—  
Blacking Brush and Box.

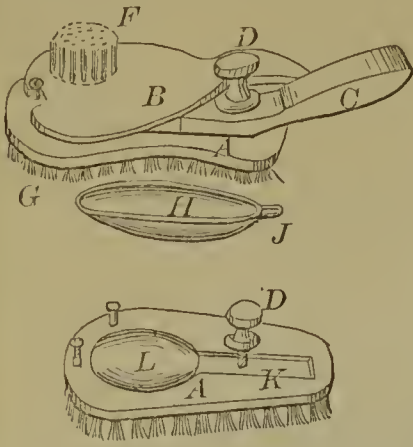

59466—C. W. Sherwood—School Desk and Seat.

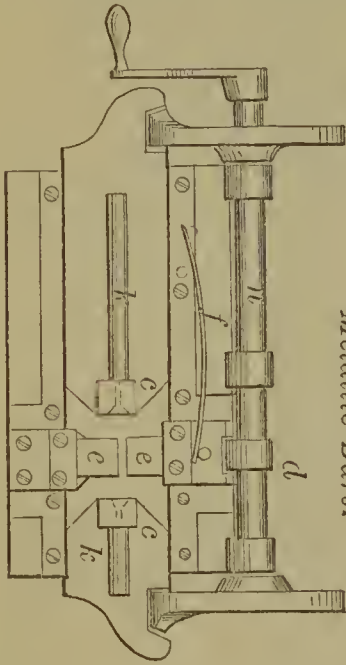
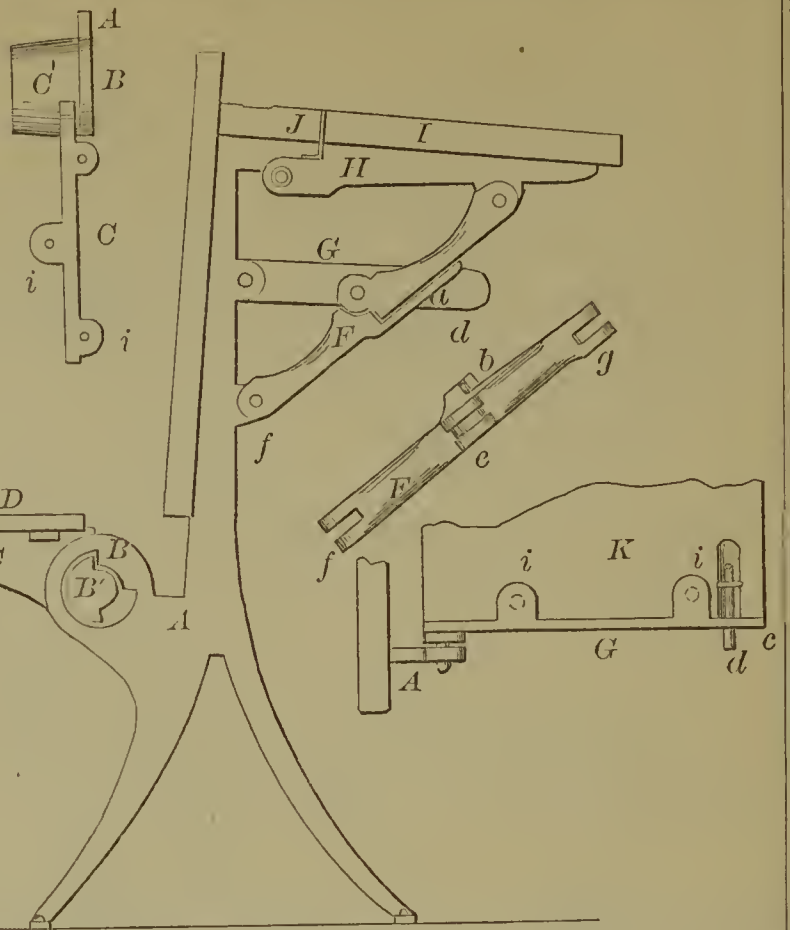

59464—M. Seward—For Upsetting and Forming Articles from  
Metallic Bars.

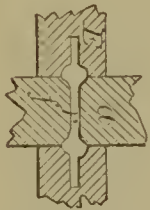

59468—M. T. Smith—Plow.

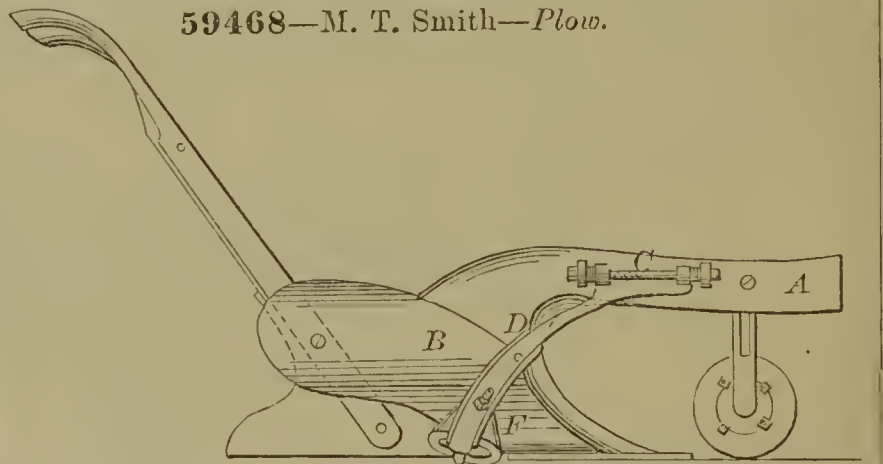

59465—Sharp & Seymour—Suspenders.

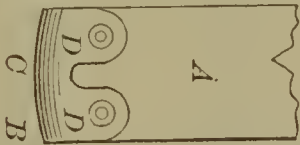

59463—Seoville, Gates & Fraser—Quartz Mill.

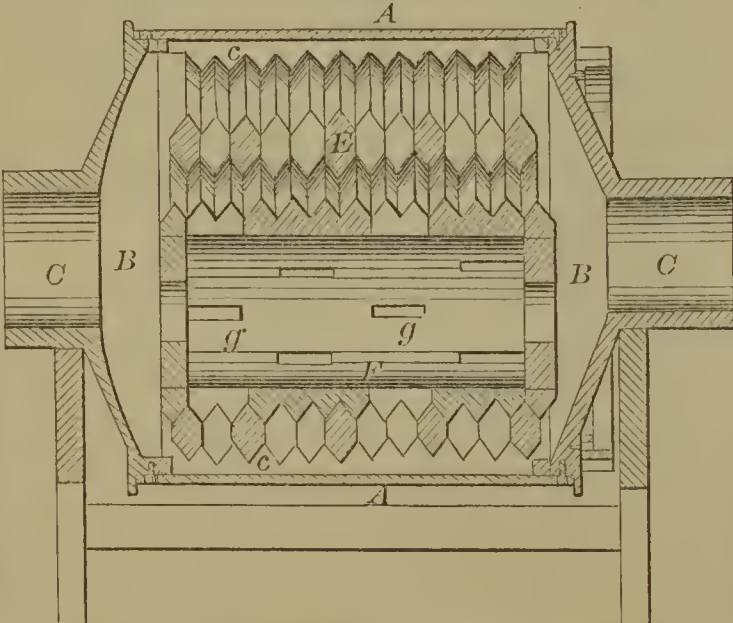

59467—T. Simmons—Filter.

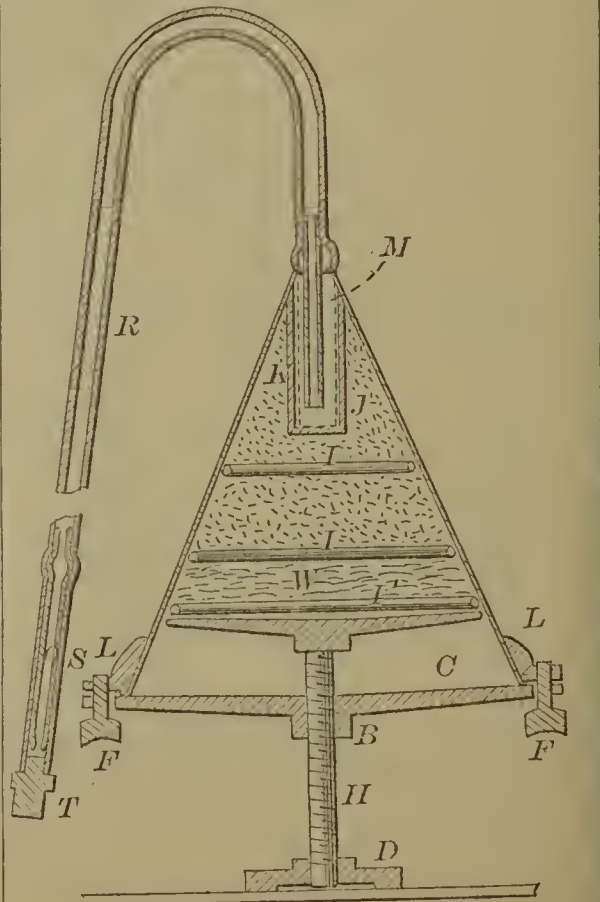



59469—J. Snell, Jr.—For Handling Hides.

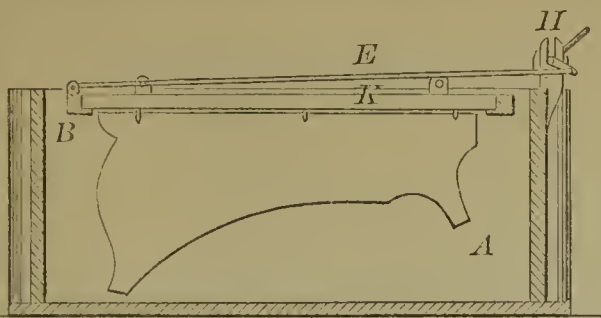

59474—L. Stevens—For Carburetting Air.

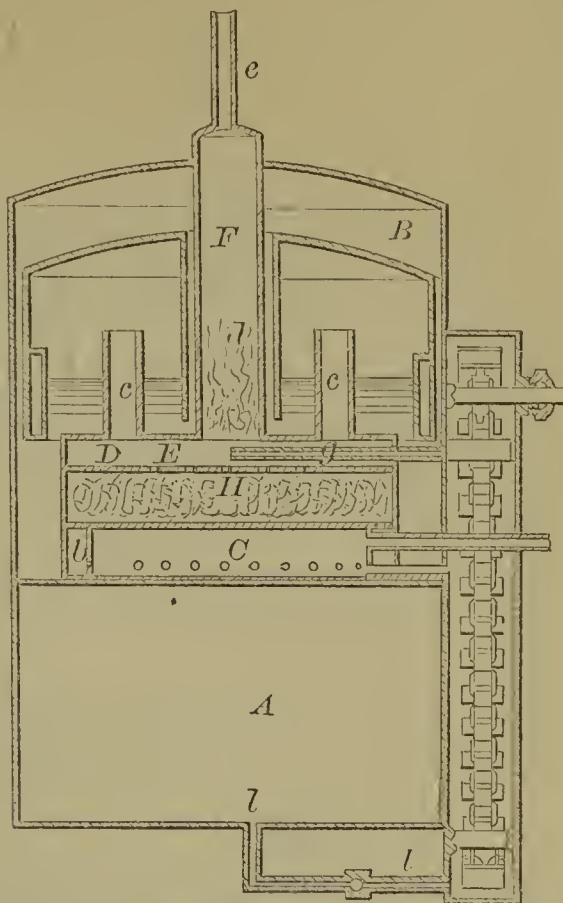

59475—W. H. Stevens—Cheese Press.

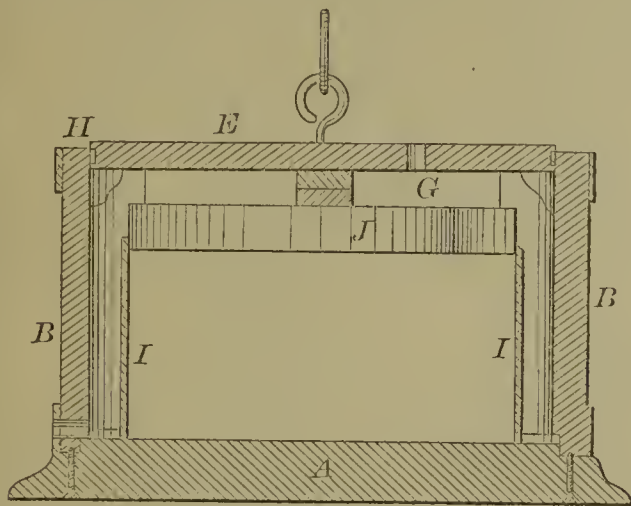

59470—B. Spore—Bed Bottom.



59471—J. H. Starr—Beehive.

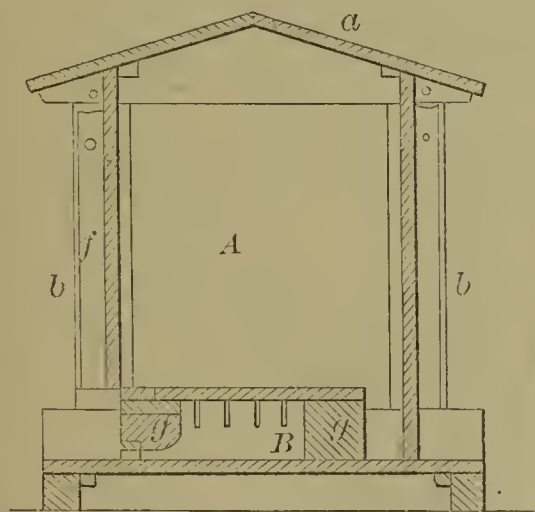

59472—D. H. Stephens—Tool for Making Tenons.

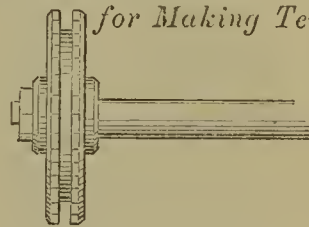

59476—J. J. Studer—Pile Driver.

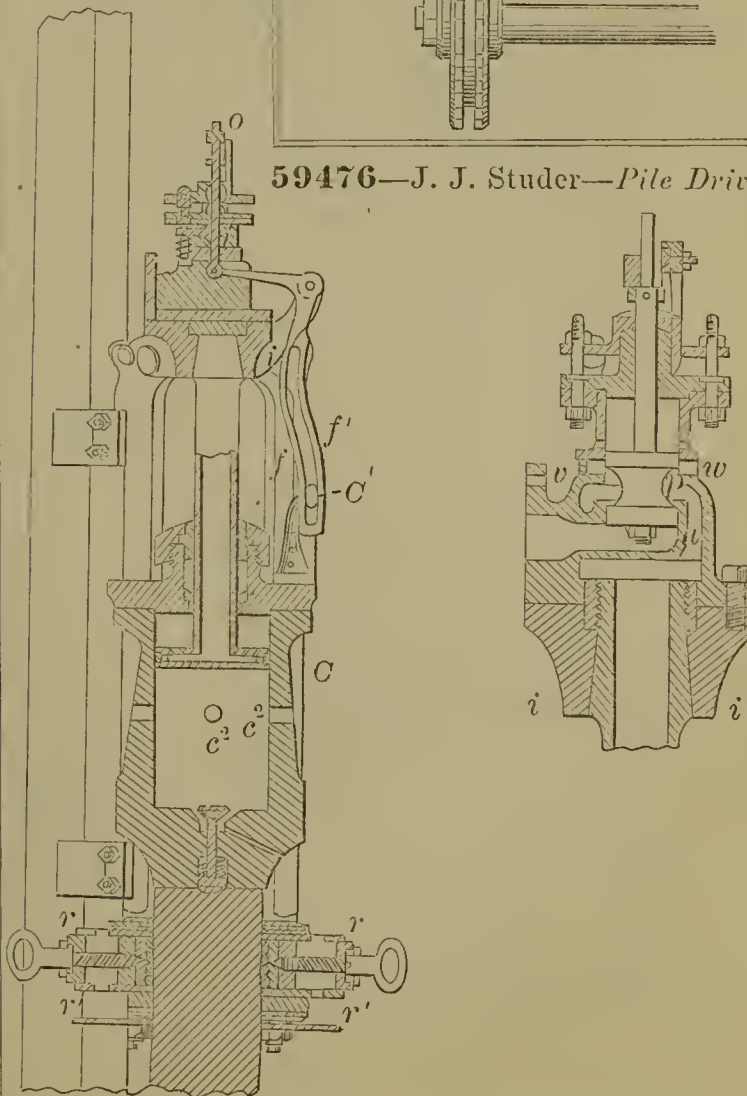

59473—L. Stevens—For Carburetting Air.

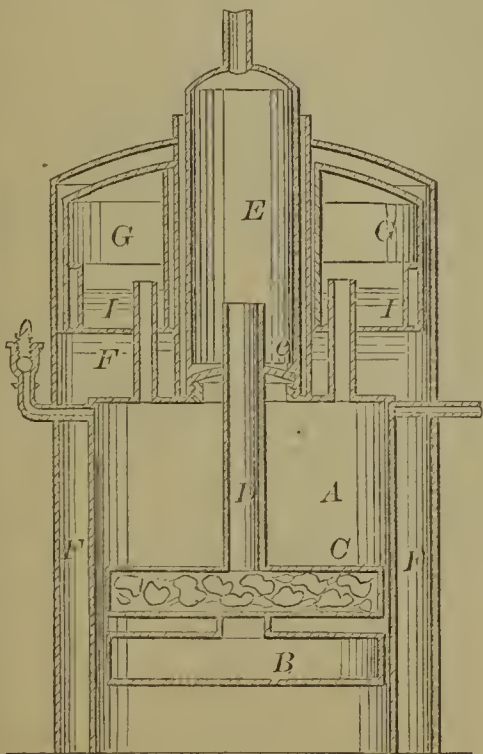

59477—W. C. Taggart—*Washing Machine.*

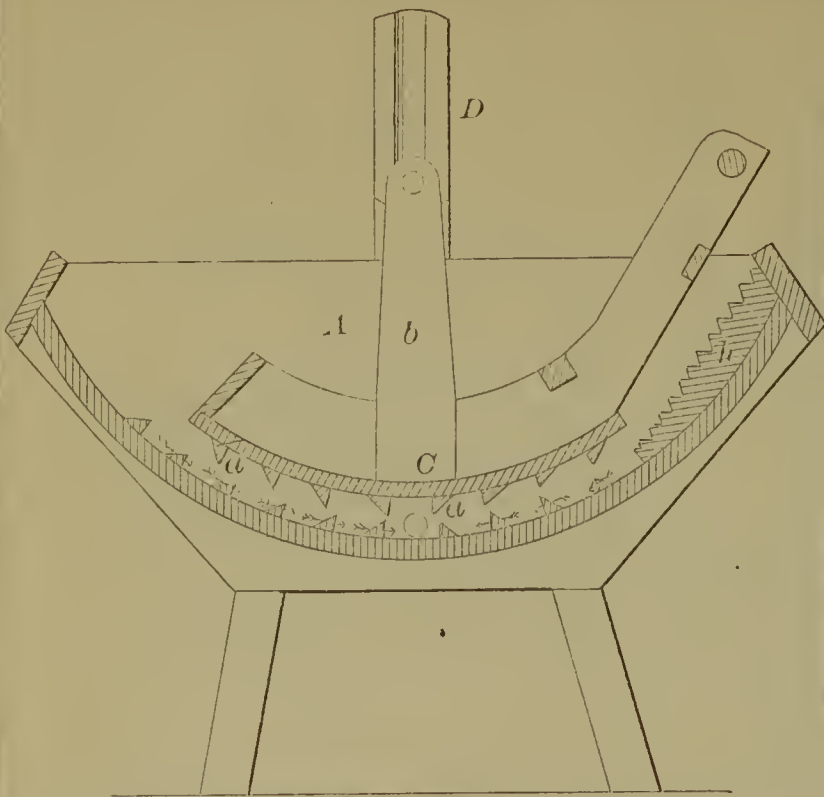

59480—E. D. Taylor—*Steam Engine Slide Valve.*

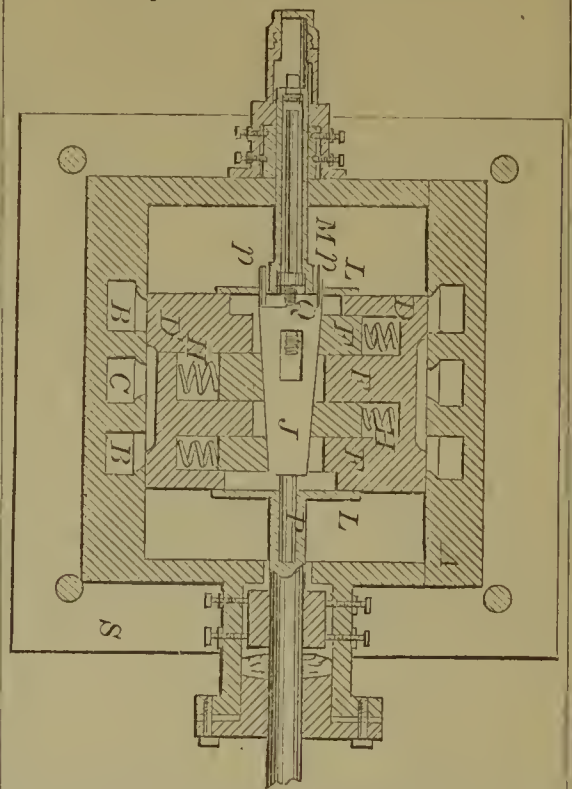

59478—J. M. Talbott—*Tobacco Press.*

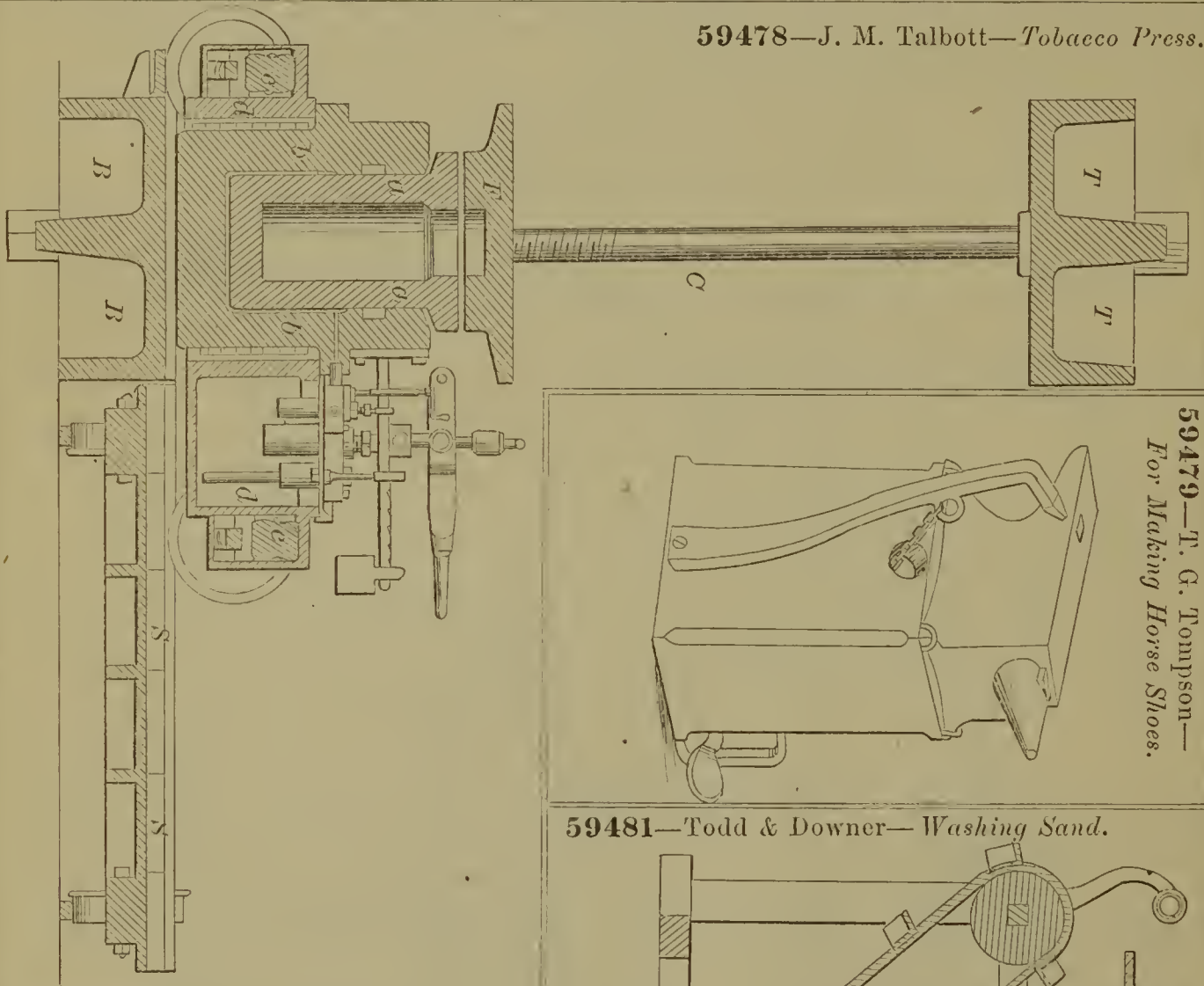

59479—T. G. Tompson—*For Making Horse Shoes.*

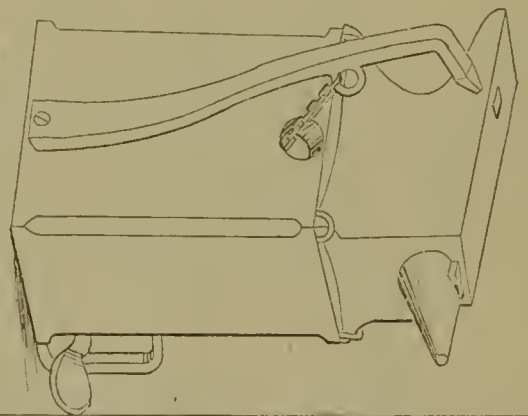

59481—Todd & Downer—*Washing Sand.*

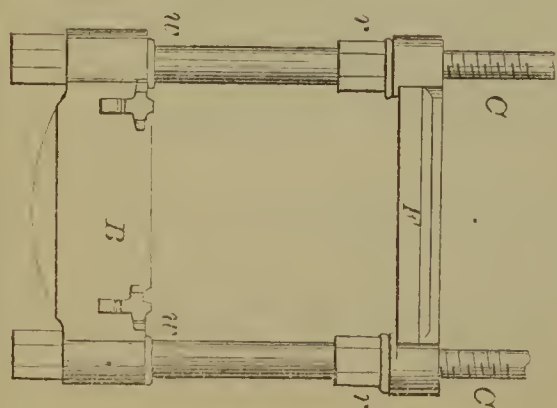
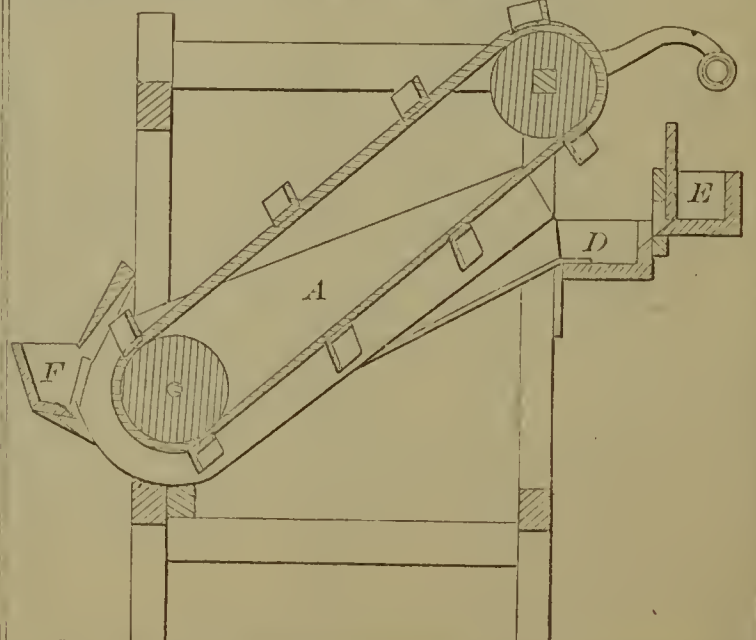

59482—W. B. Trunick—*Boring Tool for Wells.*

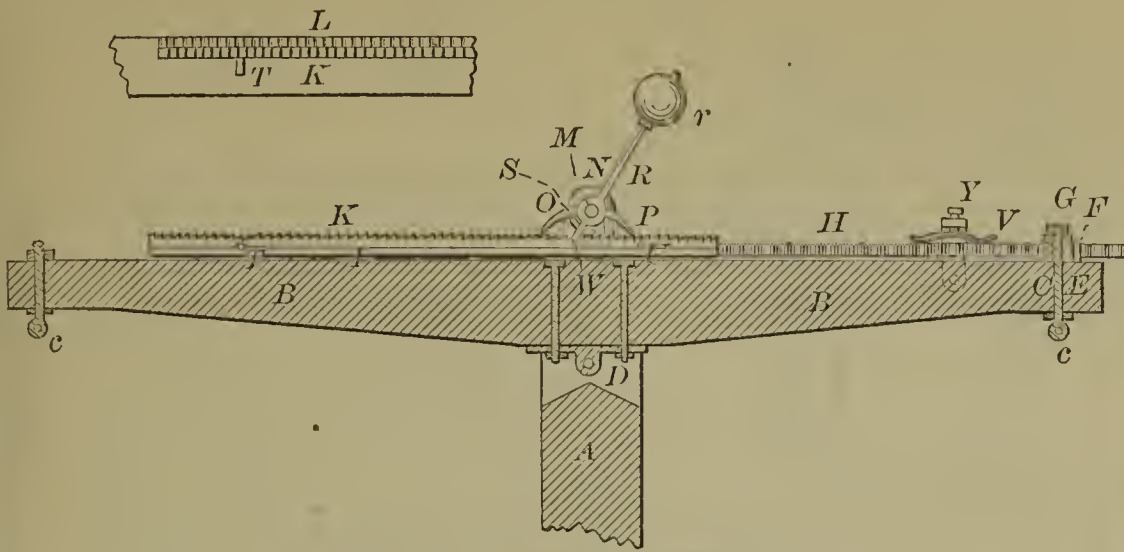

59483—D. Tuttle—*Trace Lock.*

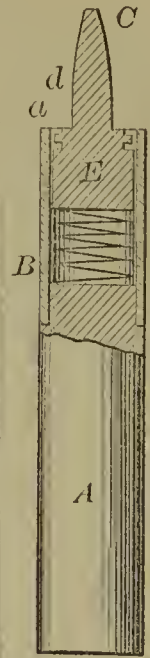

59484—I. H. Upton—*Fire Place.*

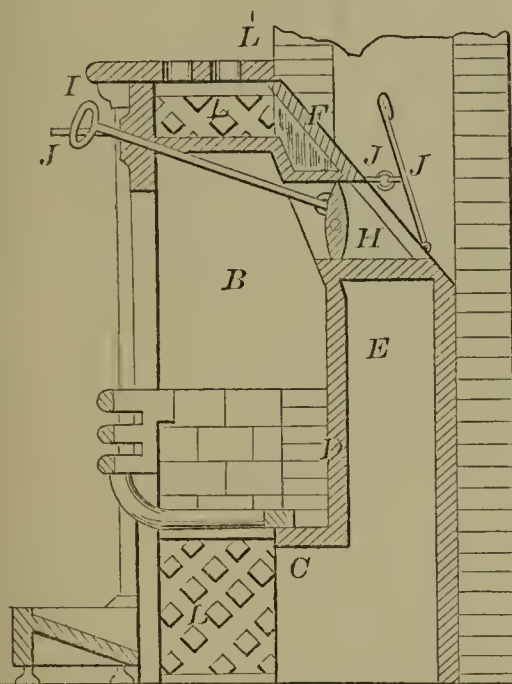

59485—C. Van Dyeck—*Cigar.*



59486—J. A. Vincent—*Weather Strip.*

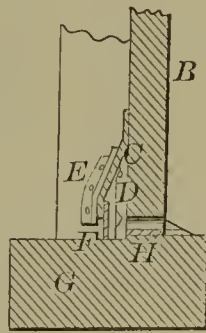

59487—J. J. B. Walbach—*War Rocket.*



59488—H. Waters—*Rolling-Die Apparatus.*

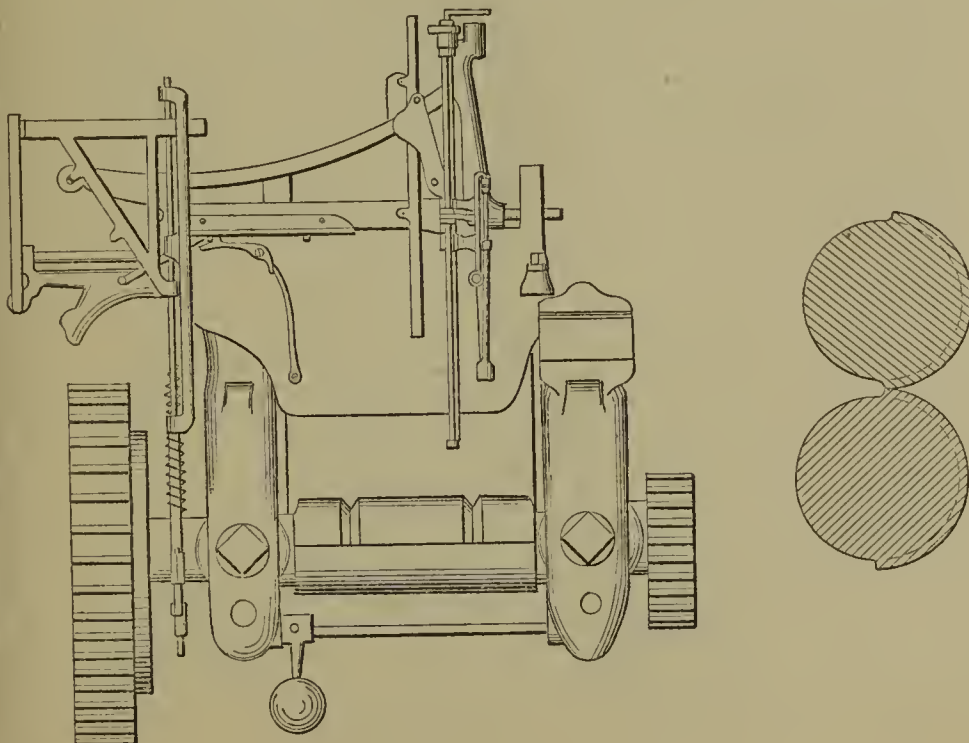

59489—W. H. Watson—For Pressing Tobacco.

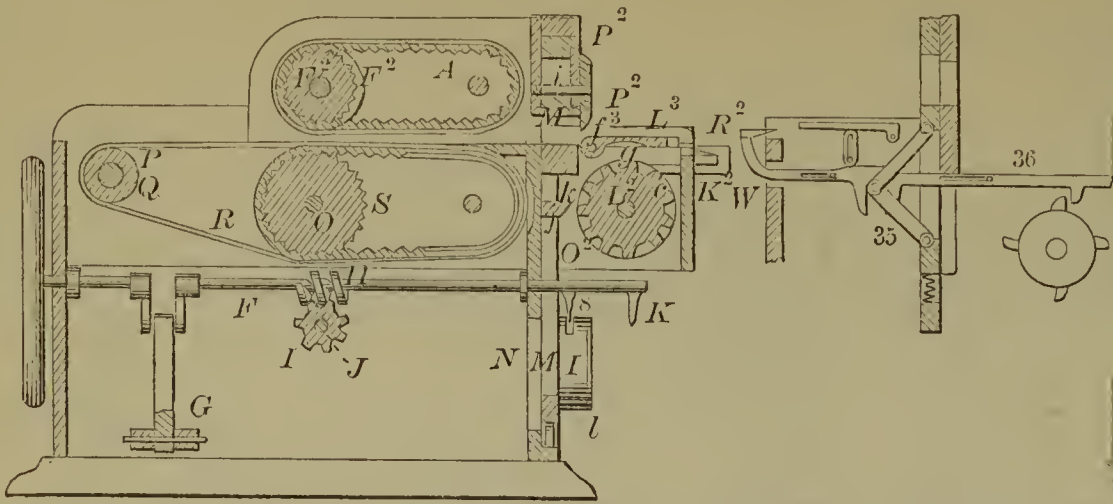

59491—A. Wheeler—Bush Hammer.

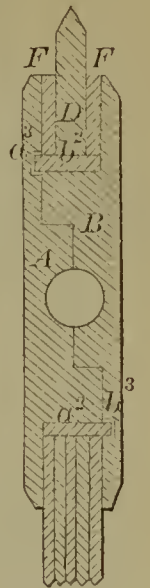

59490—M. D. Wells—Cotton Seed Planter.

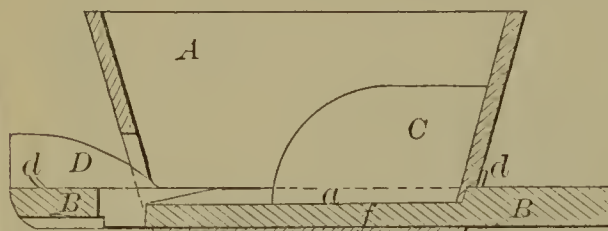

59493—W. G. Wilcox—Smut Machine.

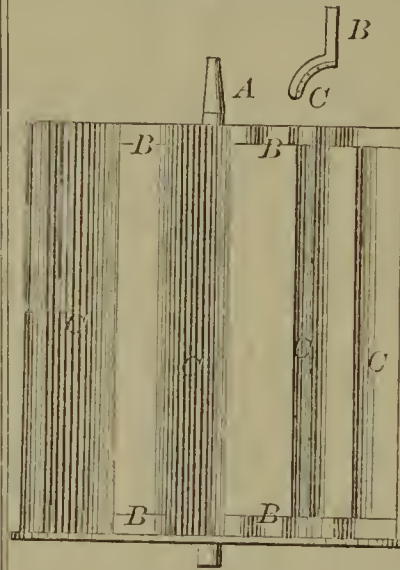

59496—A. G. Wolf—Strapping Block.

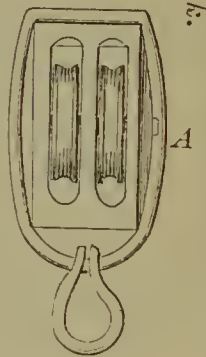

59492—B. J. Wheelock—Fence Gate.

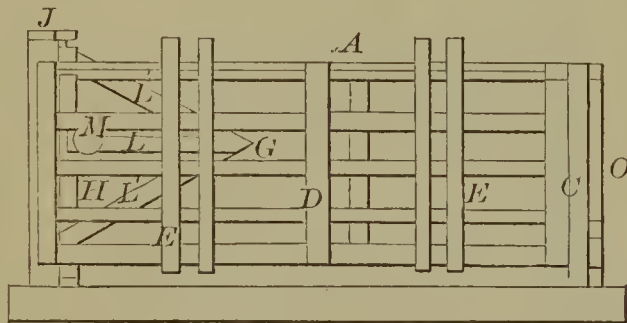

59494—E. Wilson—Hold Back for Carriages.

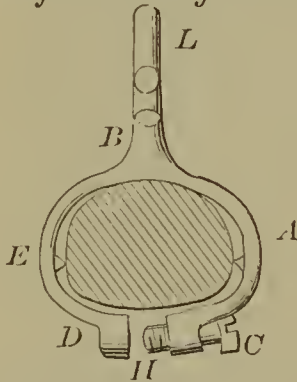

59495—W. Witbeck—Box Setter for Carriage Wheels.

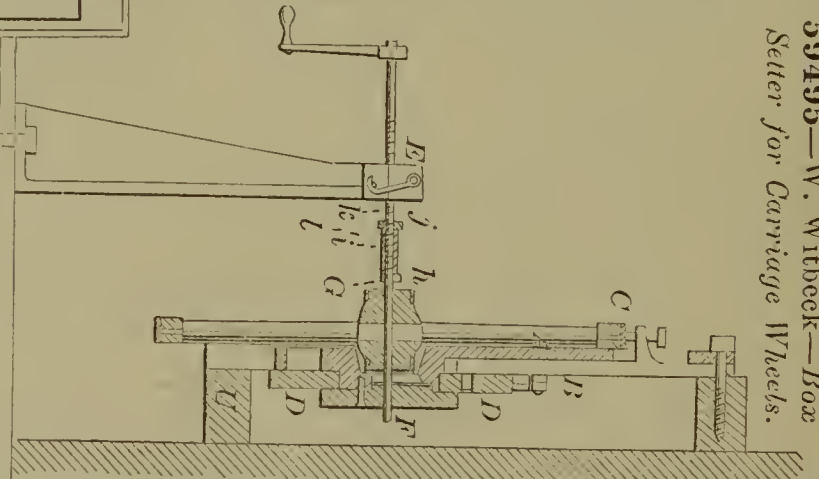

59497—G. E. Woodbury—Hand Stamp.

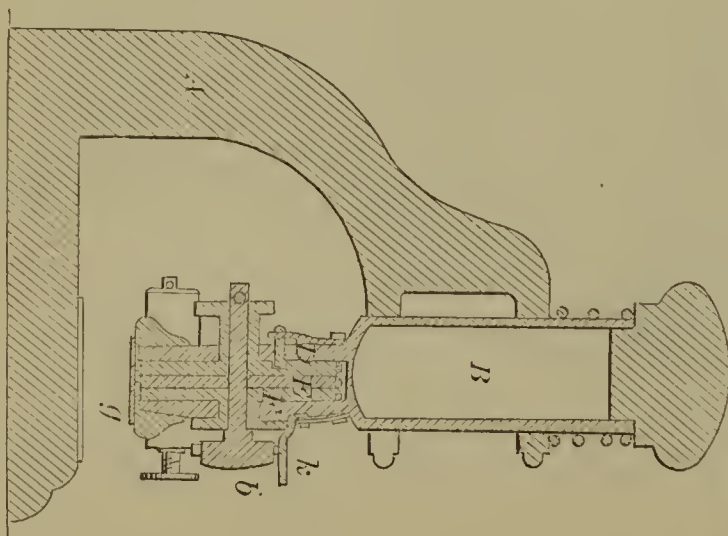

59498—J. Woodville—Carpenter's Plane.

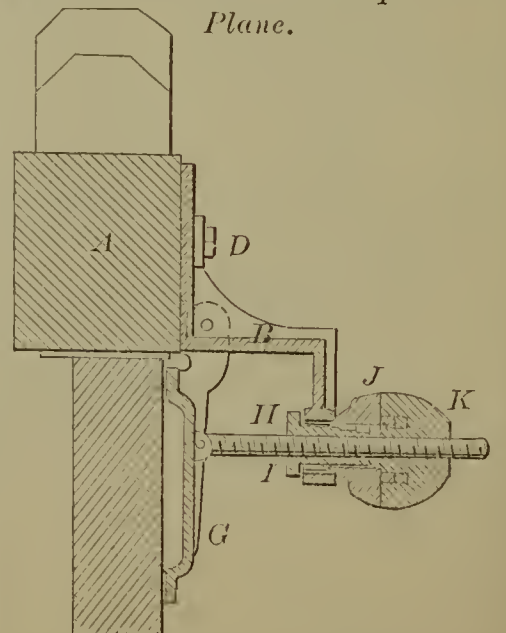

59503—S. A. Clemens—For Breaking and Cleaning Flax.

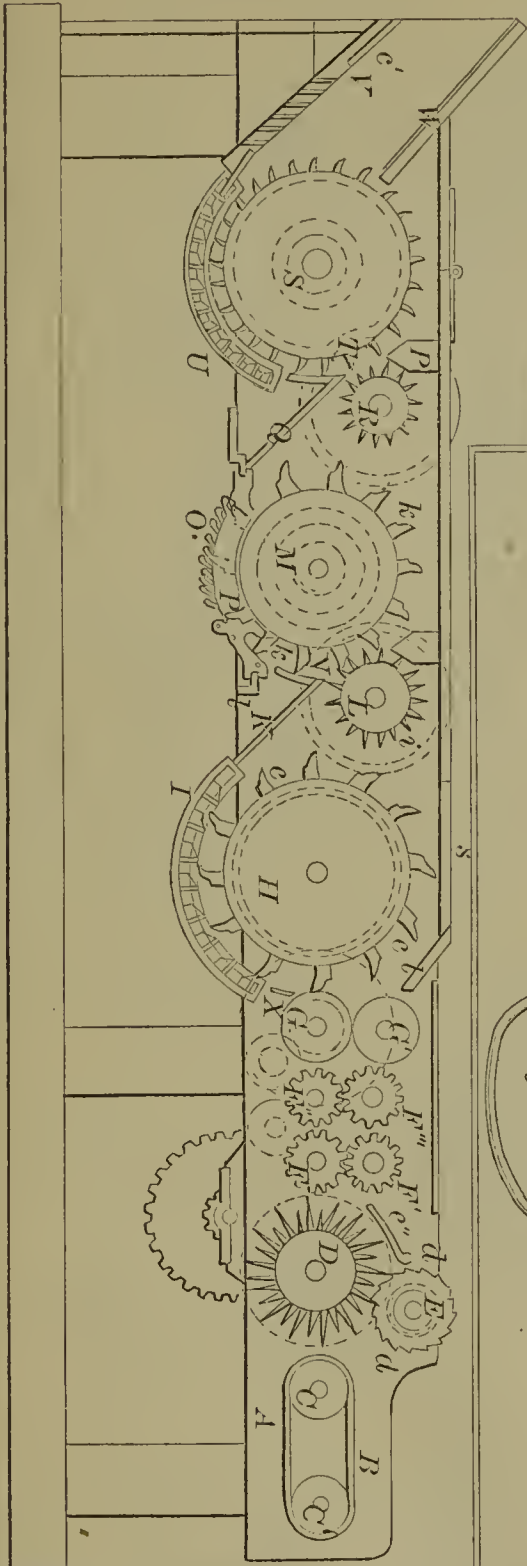

59499—A. Young—Cultivator.

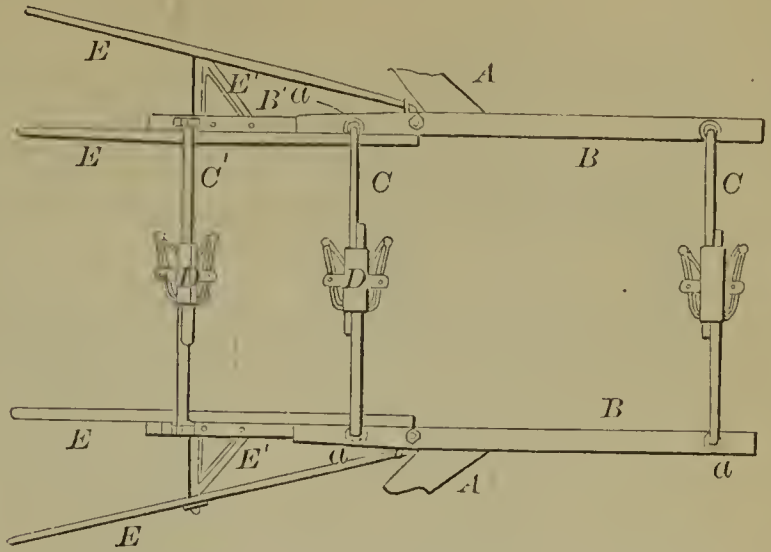

59500—E. B. Stoddard—

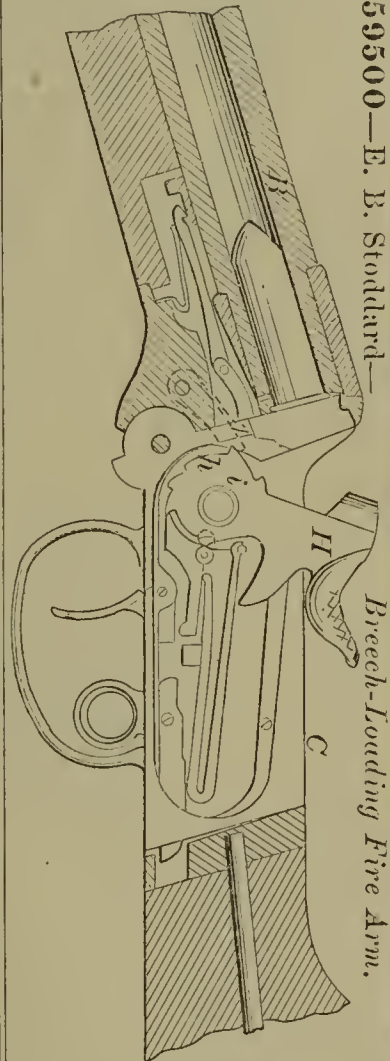

Breech-Loading Fire Arm.

59502—S. A. Clemens—For Straightening and Threshing Tangled Flax.

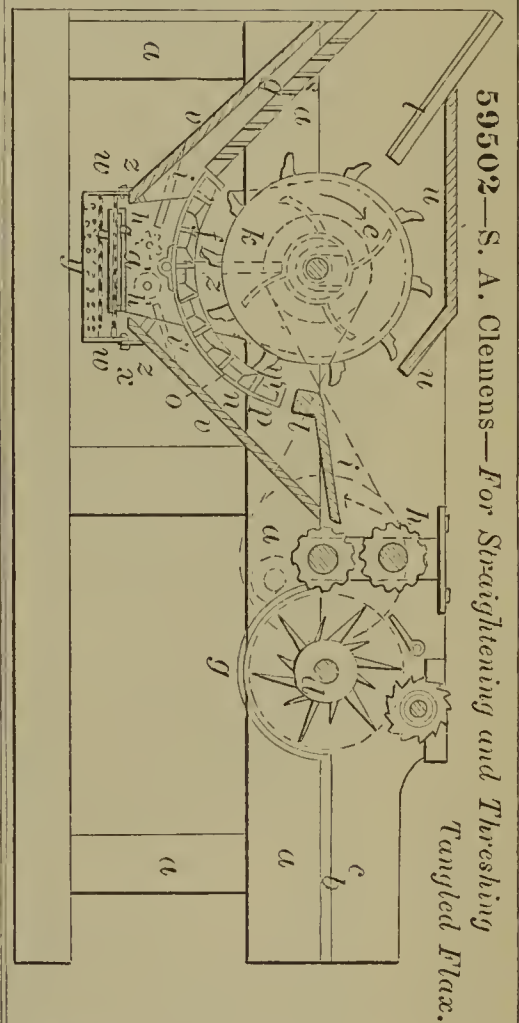

59501—S. A. Clemens—For Straightening, Breaking and Cleaning Flax Straw.

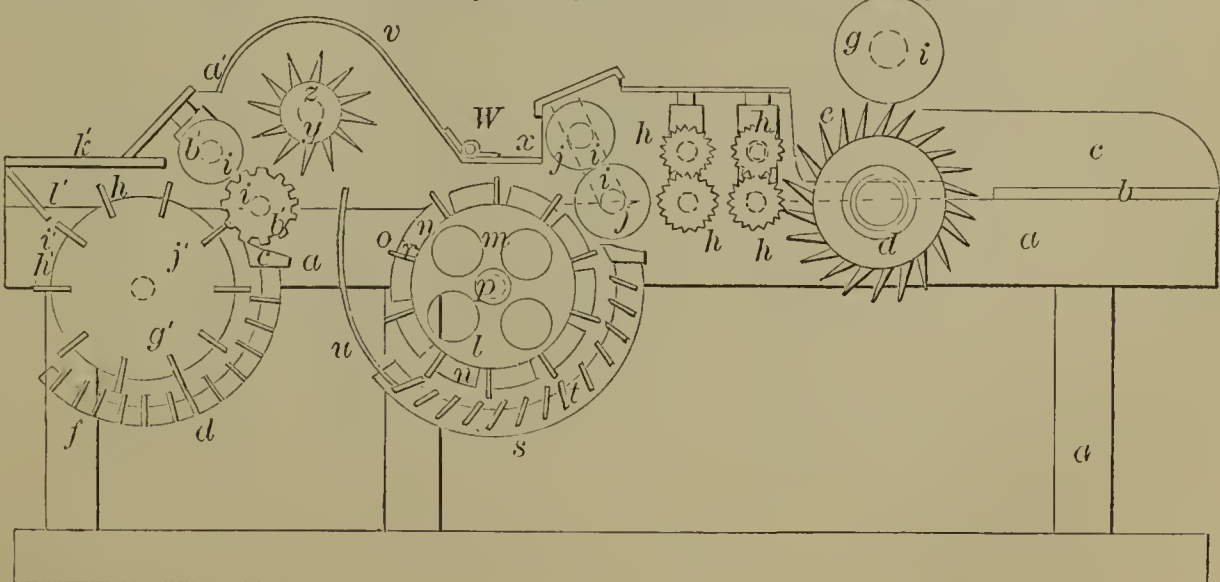

59504—W. P. Corey—*Valve Gear.*

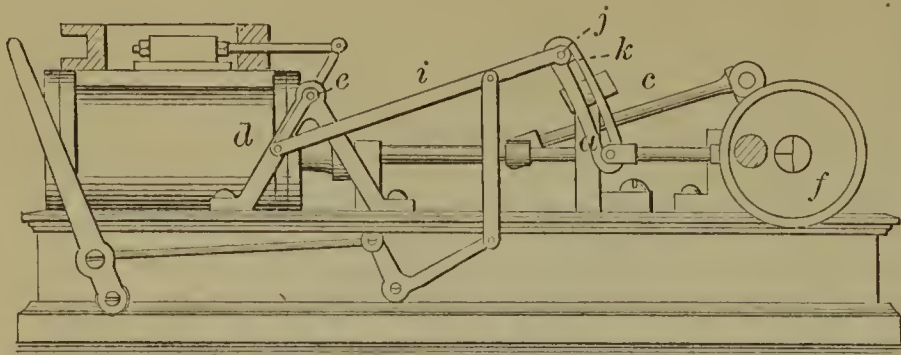

59505—E. L. Ferguson—*Sash Holder or Fastening.*

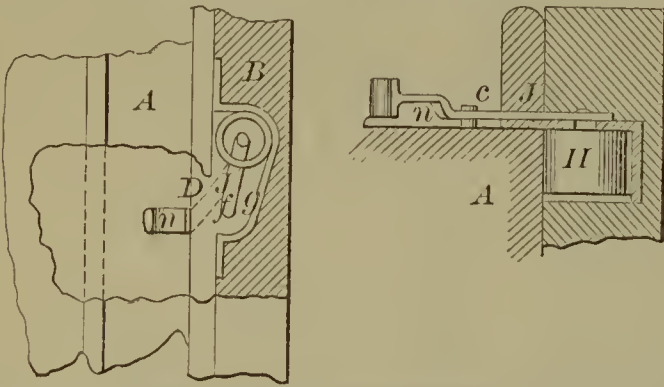

59509—S. R. Krom—*For Separating Metals from Ores.*

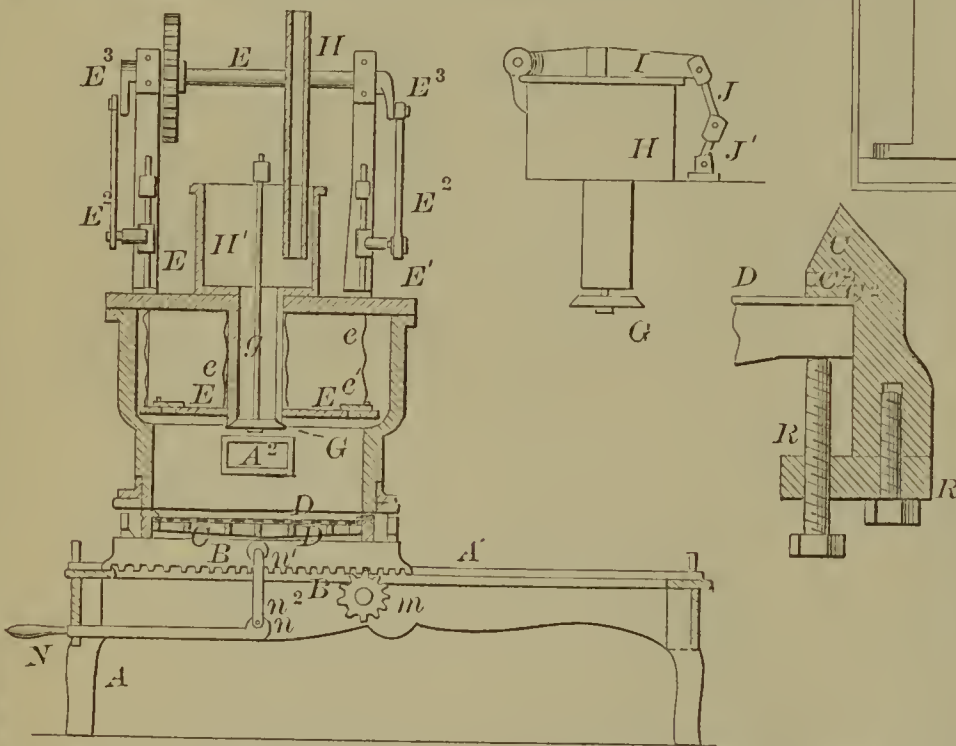

59510—S. R. Krom—*For Separating Metals from Ores.*

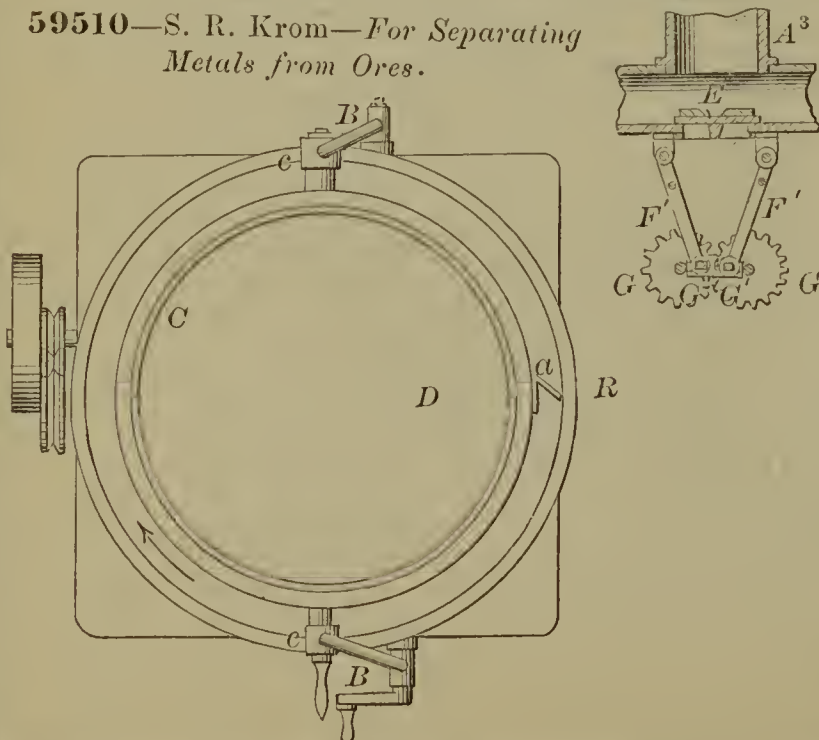

59511—J. Letchworth—*Snap Hook.*

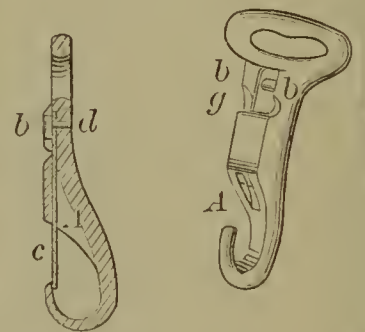

59506—Forbush & Letchworth—*Snap Hook.*

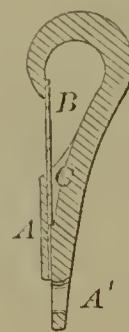

59512—J. F. Milligan—*Cotton Tie.*



59508—B. Harburt—*Carriage Seat.*

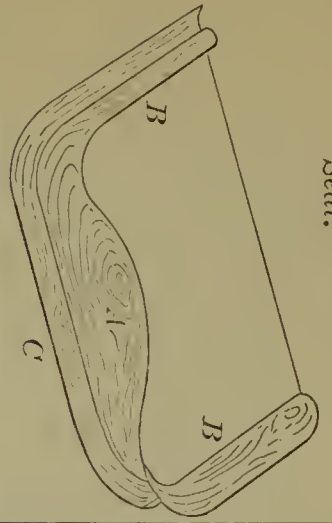

59507—W. J. Gordon *Roller for Finishing Photographs.*

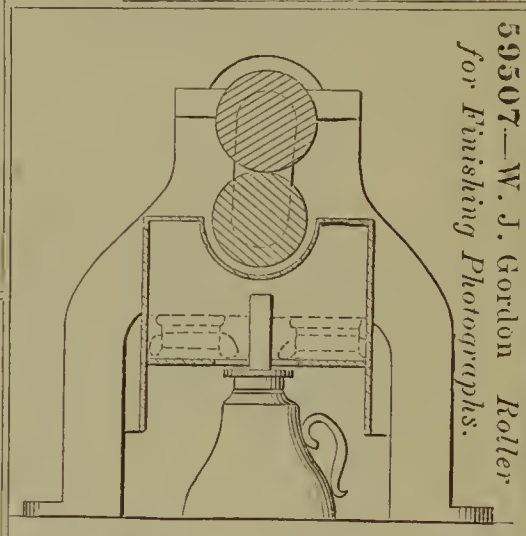

59513—E. T. Orne—Tool for Opening Cans.

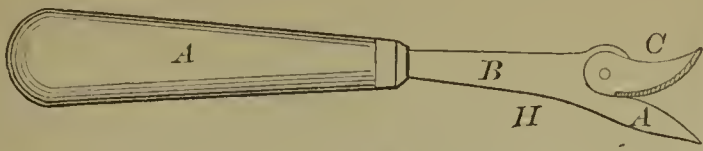

59514—F. J. Plummer—Feed Roller for Planing Machines.

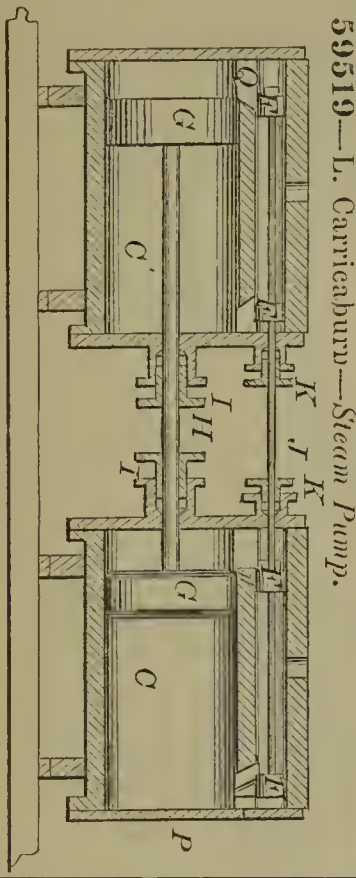
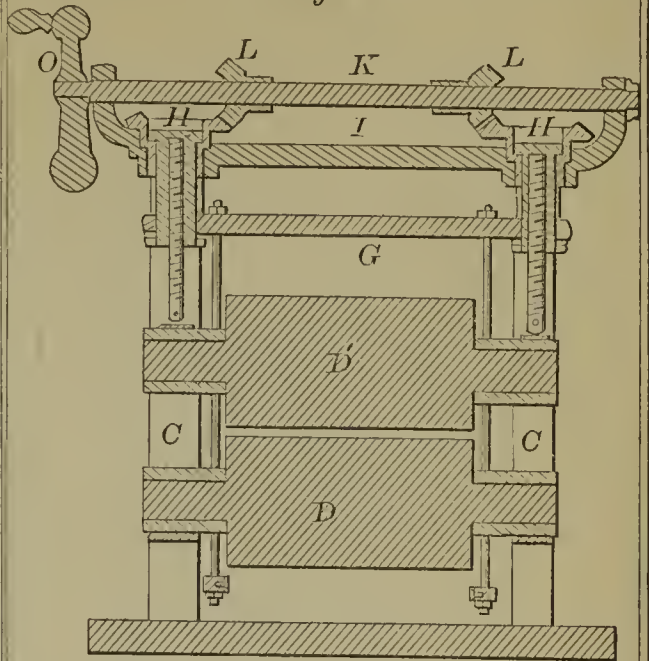

59519—L. Carriaburn—Steam Pump.

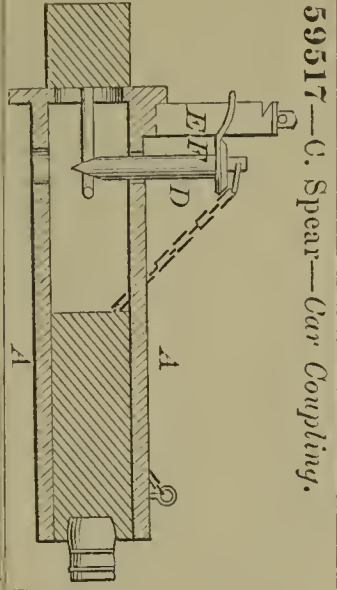

59517—C. Spear—Car Coupling.

59516—J. L. Prescott—Portable Cupboard.

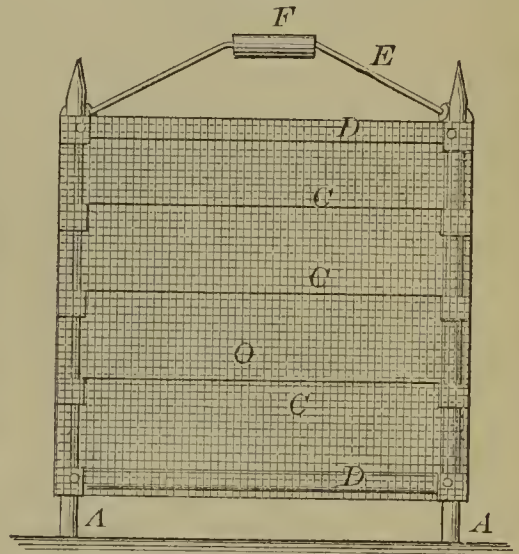

59515—J. N. Pond—Plow.

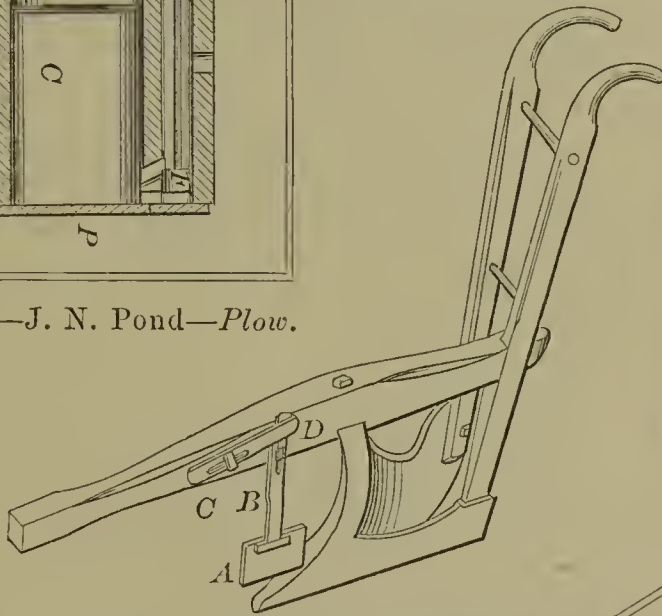

59521—J. K. Farnworth—Sash Fastening.

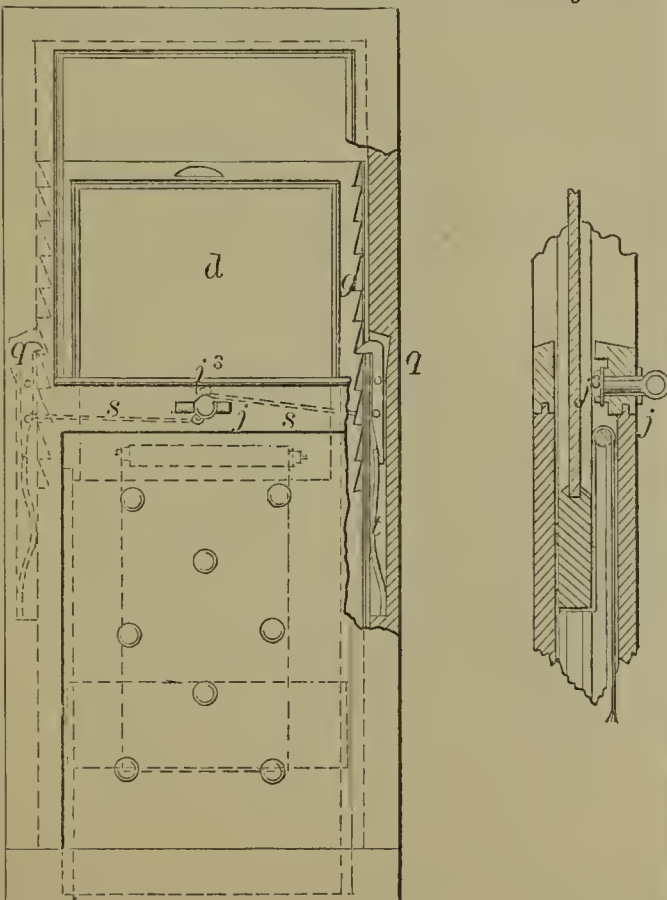

59518—A. C. Vaughan—Lamp Burner.

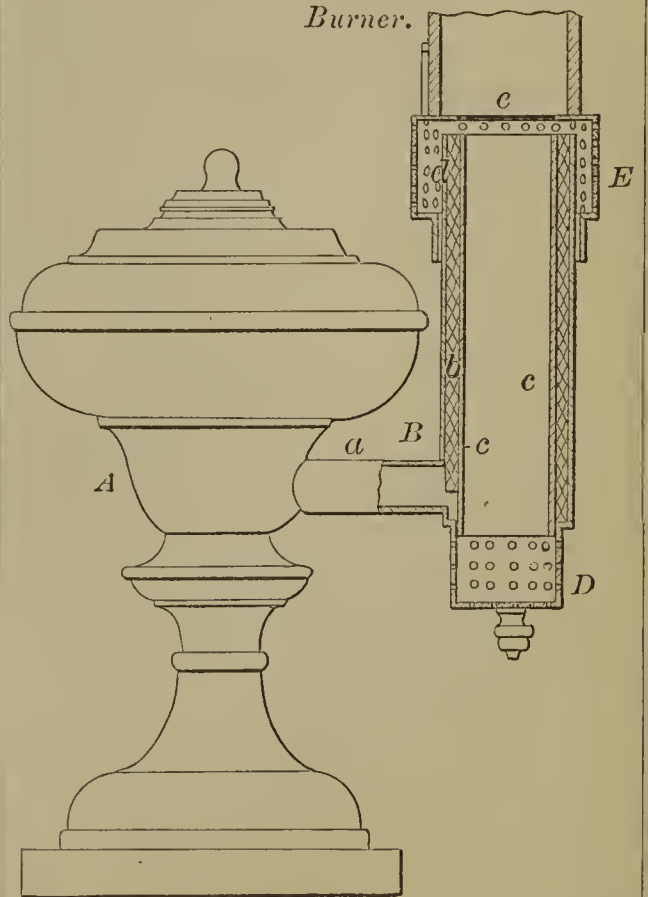

59522—P. Flamm—*Typography.*

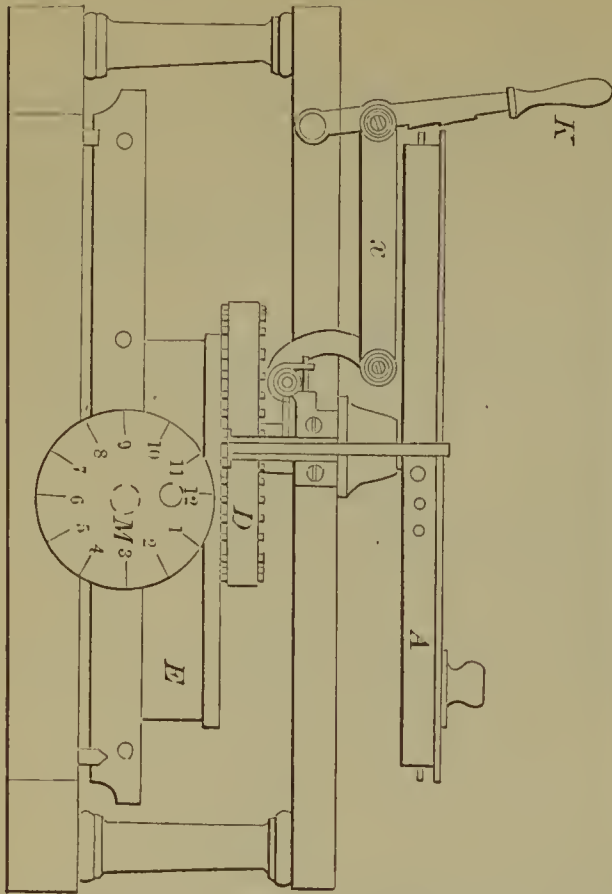

59524—D. Joy—*Valve for Steam Hammers.*

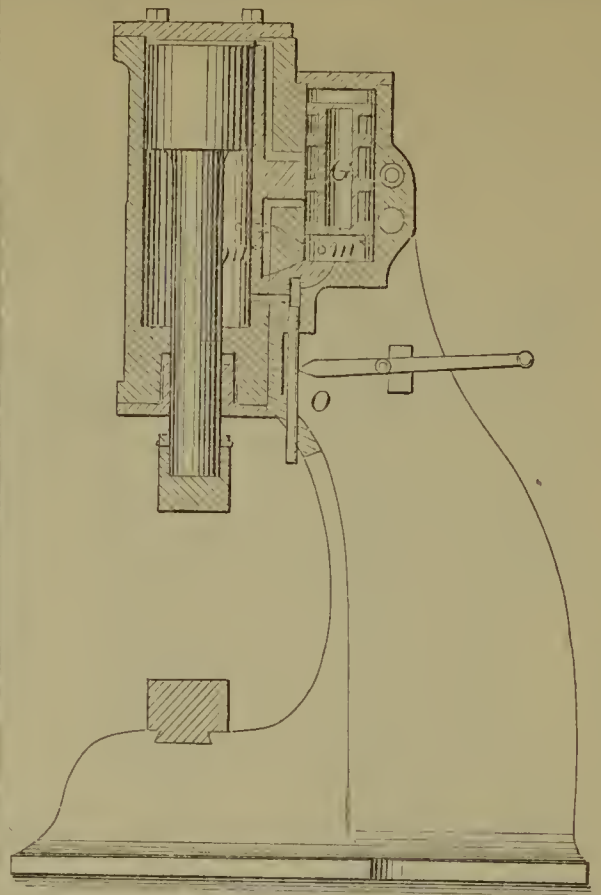

59525—G. H. & E. Morgan—*Carriage.*

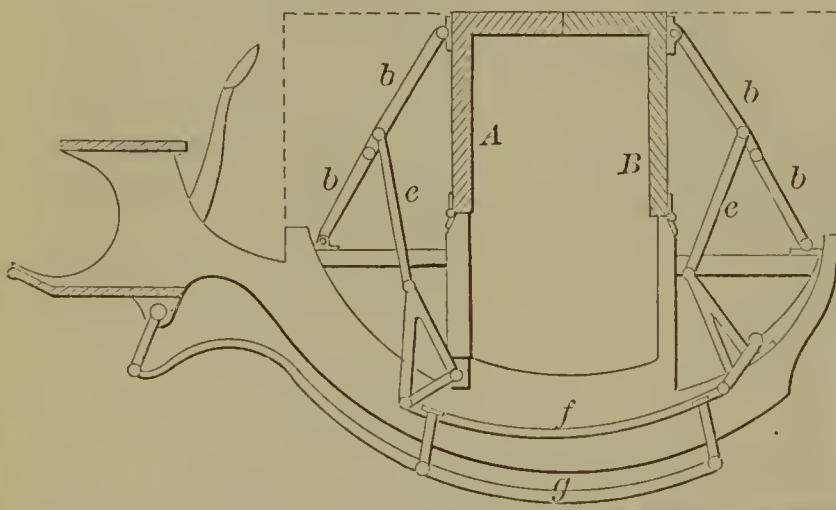

59523—J. Higgins—*Ring for Ring Traveler Spinning Machines.*

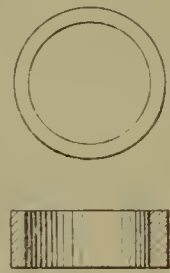

59526—G. H. & E. Morgan—*Carriage.*

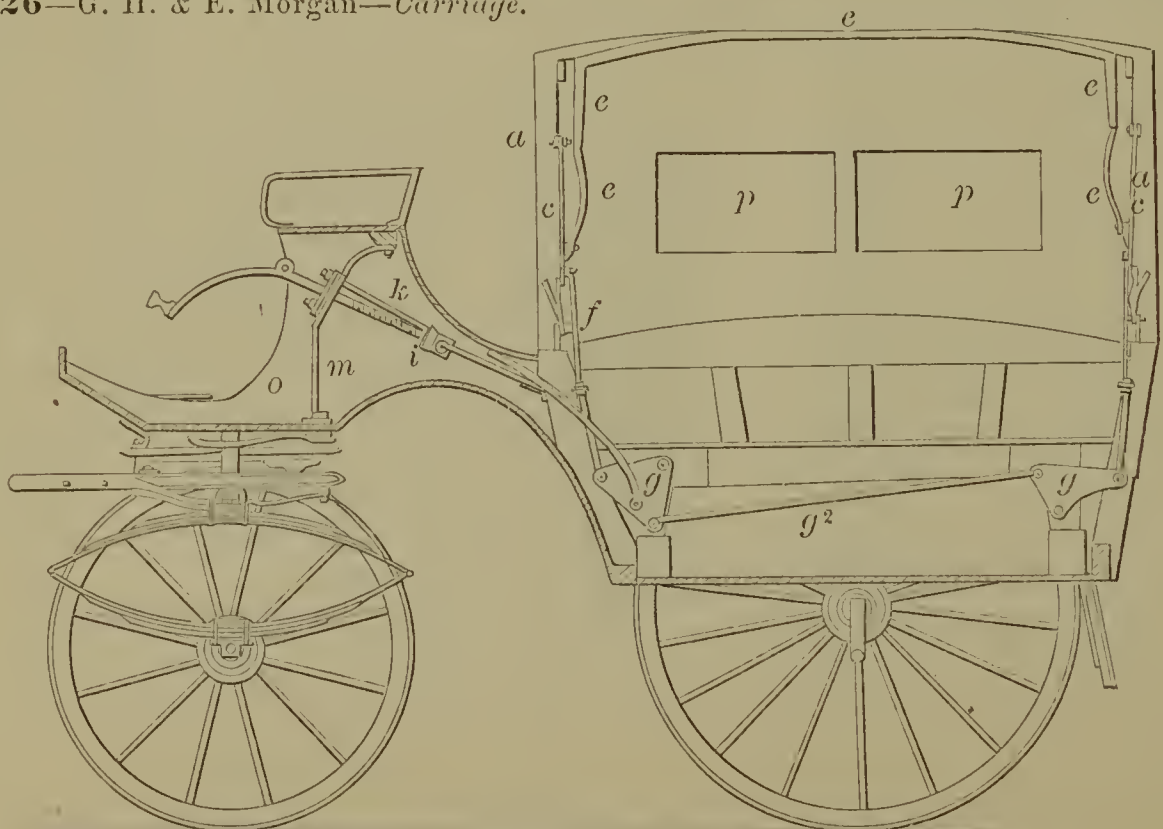



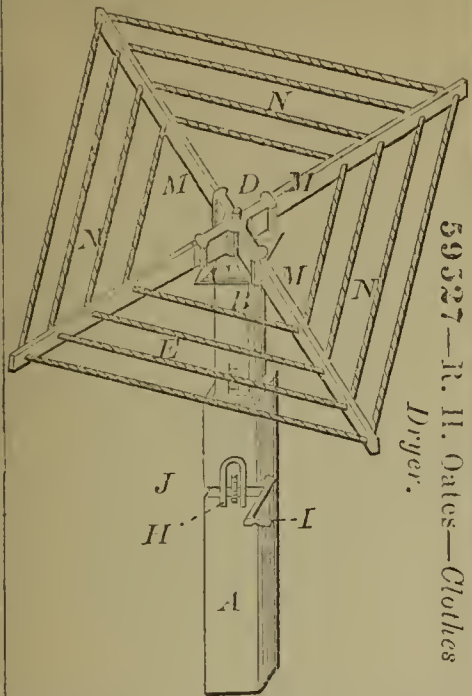

59529—B. Rouquayrol—Regulating the Flow of Gas in Diving Apparatus.

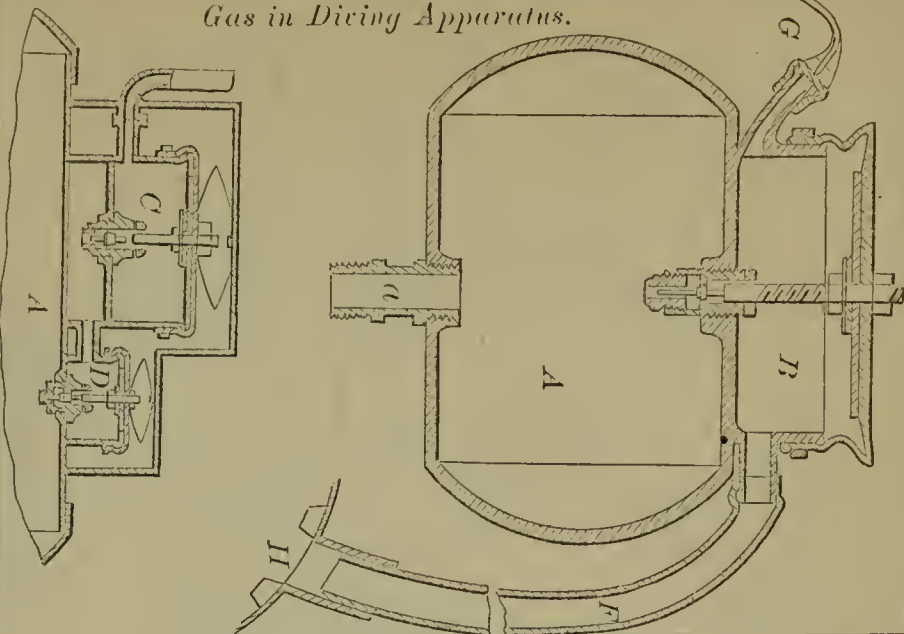

59528—Peugot & Laurent—Grinding Mill.

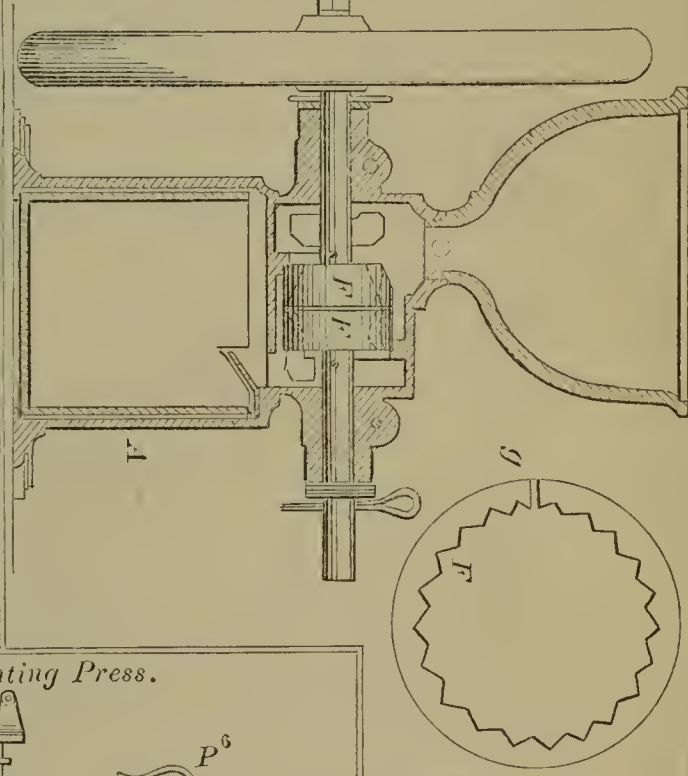

59532—G. L. Witsil—Washing Machine.

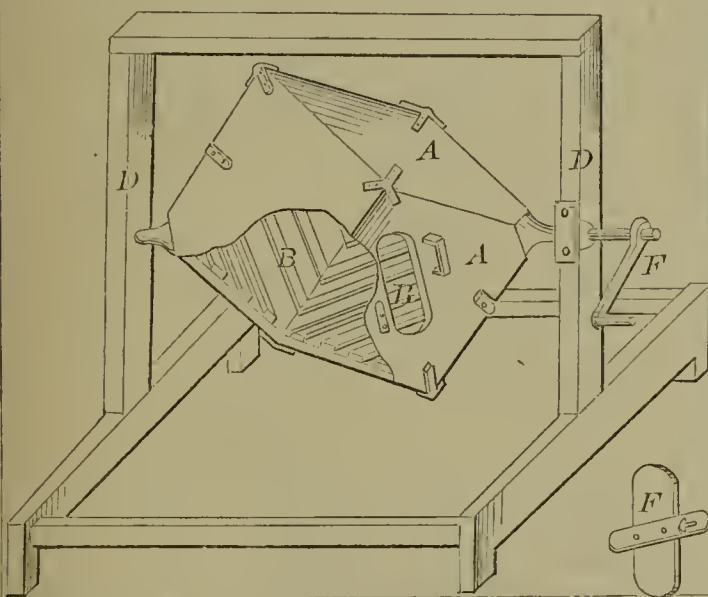

59533—W. H. Forbush—Railroad Ticket Printing Press.

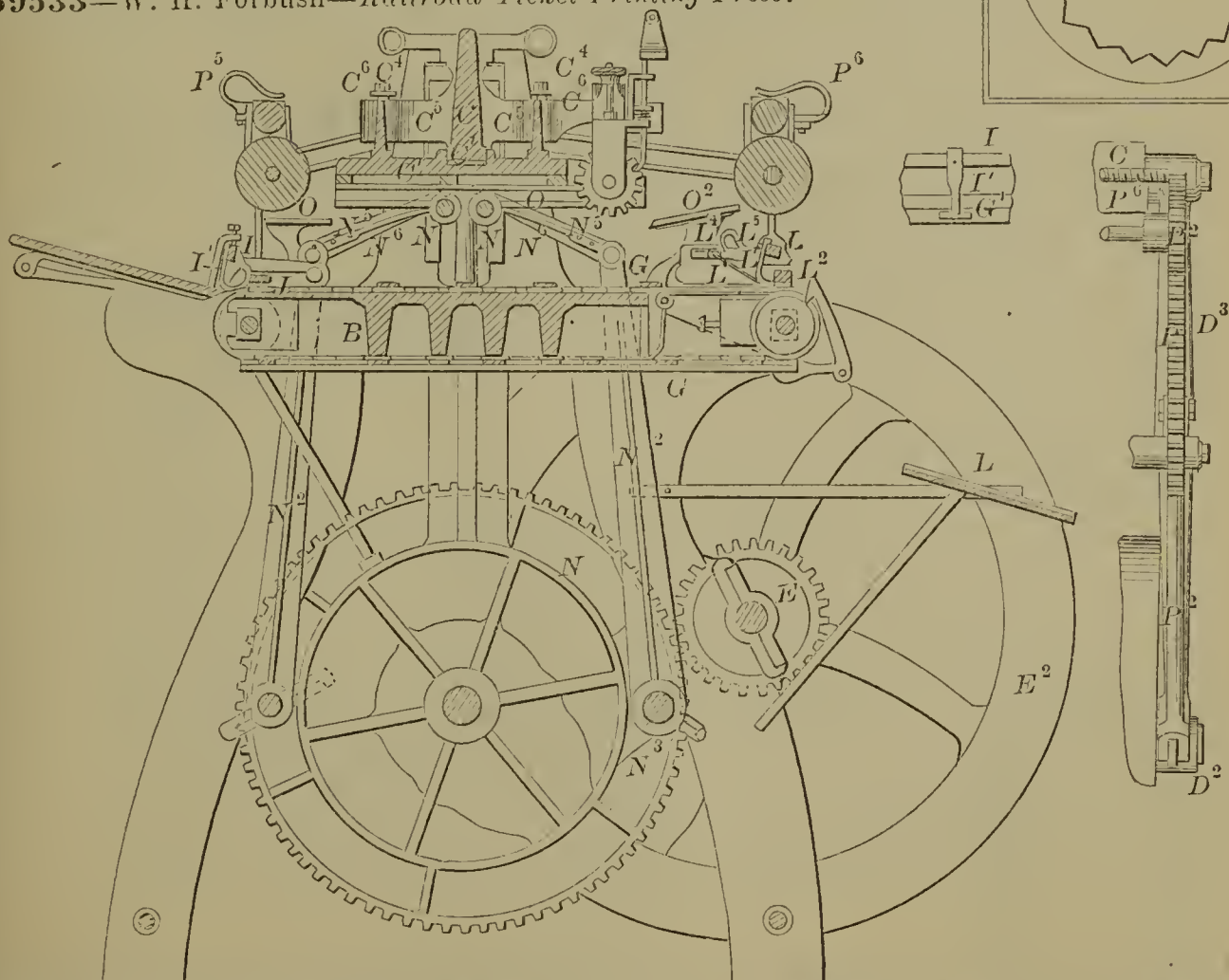

59534—C. E. Abbott—Lamp Extinguisher.

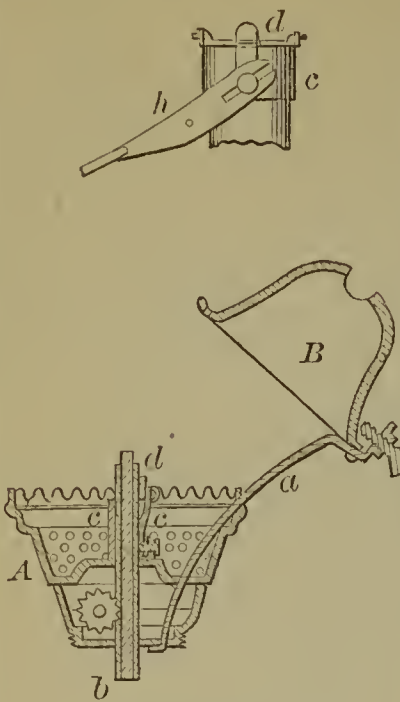

59538—A. Angell—Coffee Huller.

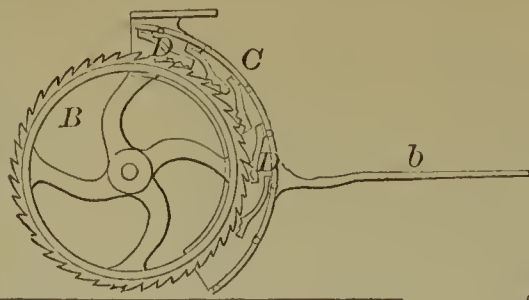

59541—C. Austin—For Stamping Reed Plates.

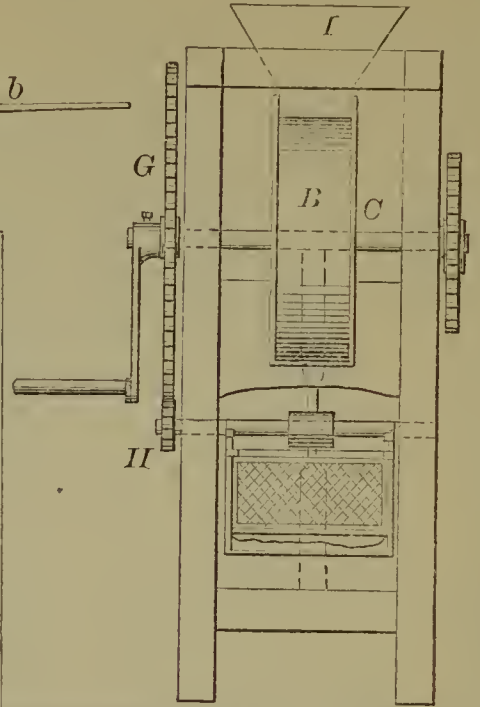
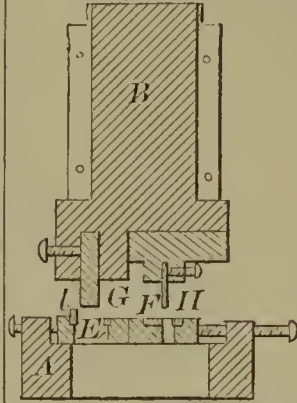

59539—T. H. Arnold—Horse Hay Fork.

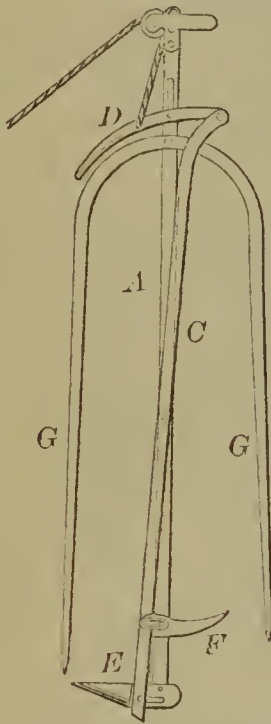

59542—Baker & Miller—Pulley Suspension Hook.

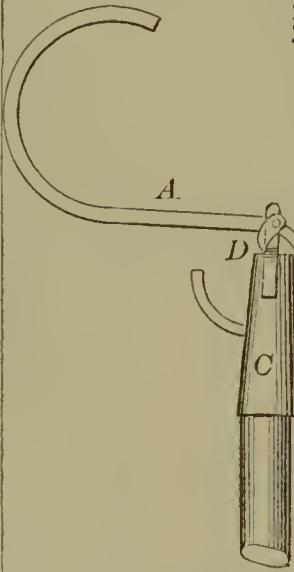

59535—N. Adams—Spike Drawing Machine.

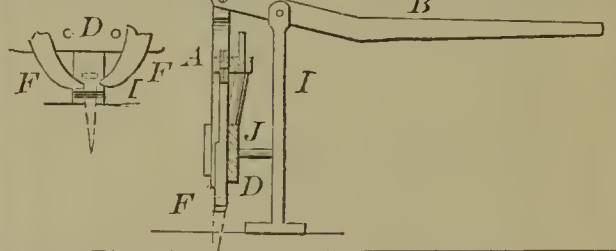

59537—Althouse & Reifsnider—For Attaching Thills to Carriages.

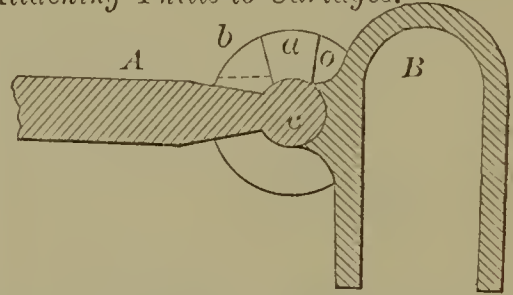

59536—M. J. Althouse—Pump.

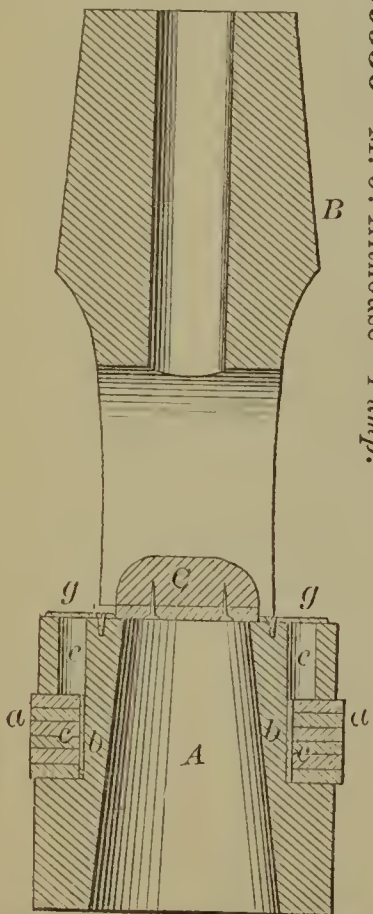

59540—J. N. Aronson—Breech-Loading Fire Arm.

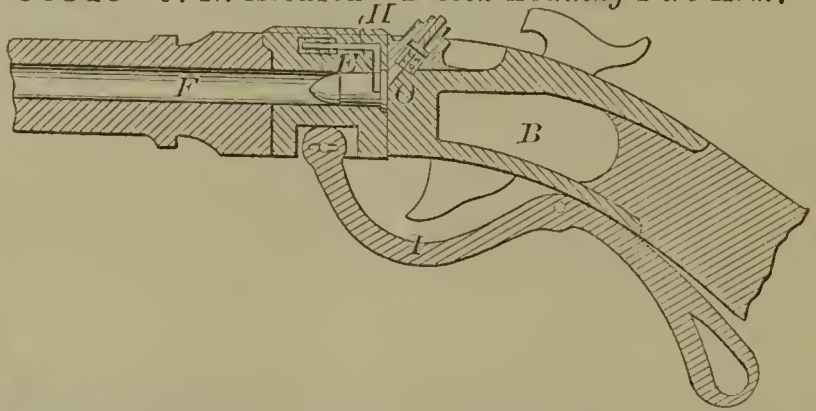

59543—W. R. Baldwin—Corn Planter.

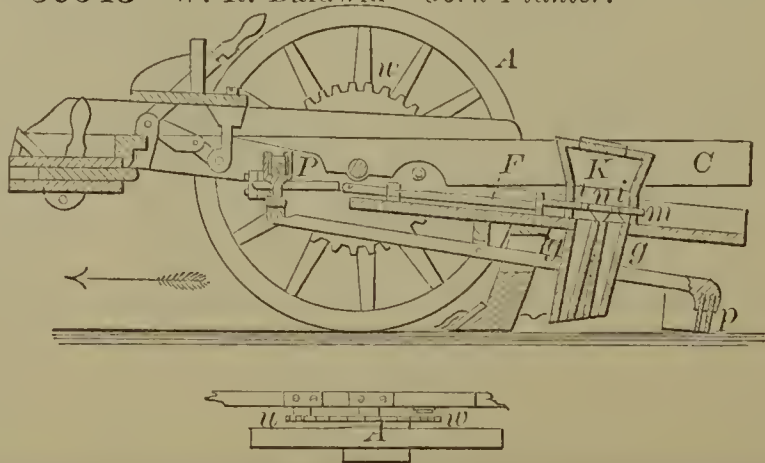

59544—I. S. Barber—*Cigar Mouth Piece.*

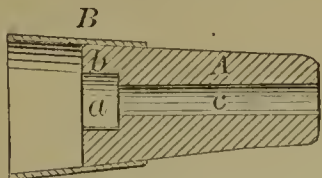

59547—J. Blair—*Poker and Tongs.*

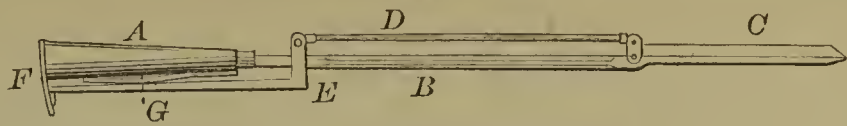

59546—B. F. Bennett—*Spring Bed Bottom.*

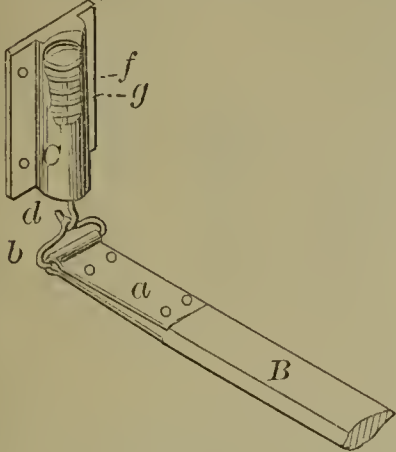

59548—J. C. Bowe—*Awning.*

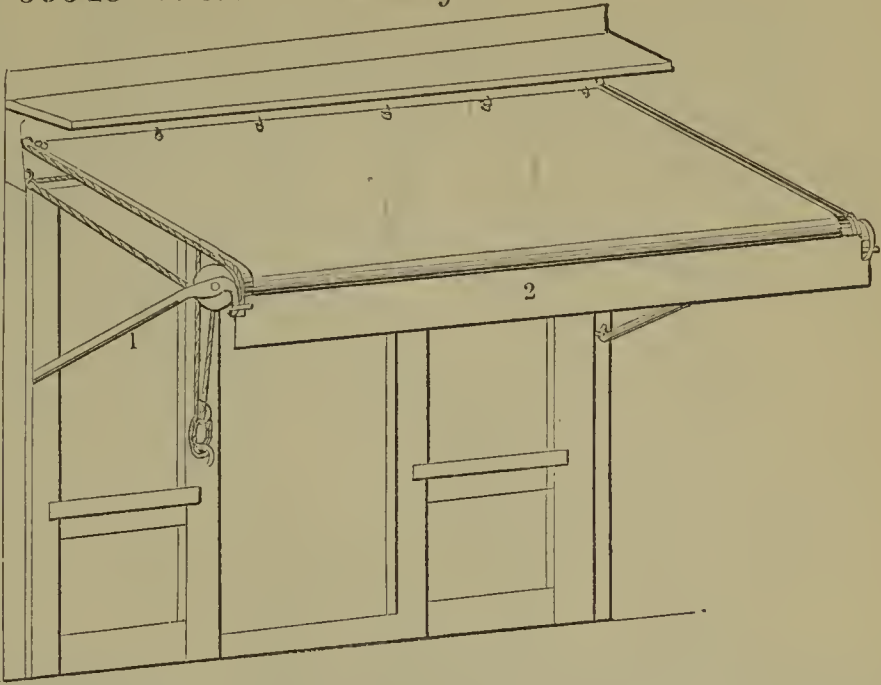

59545—G. F. Barden—*Clothes Pin or Clamp.*

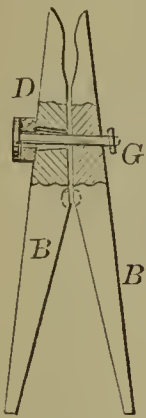

59550—L. Brown—*For Confining Cows while being Milked.*

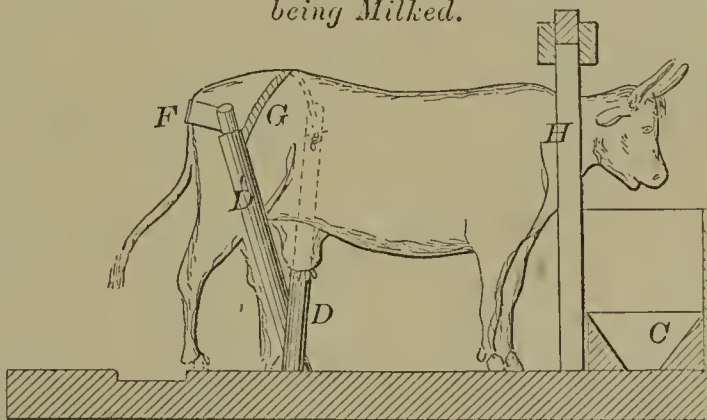

59553—S. G. Cabell—*Door and Shutter.*



59552—J. Burt—*Turning Lathe.*

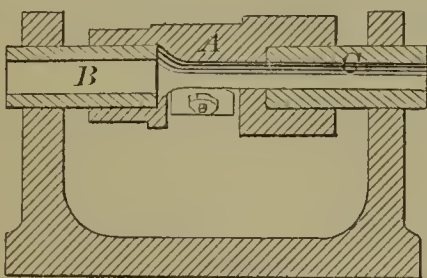

59555—G. W. Carpenter—*Feed Apparatus for Threshing Machines.*

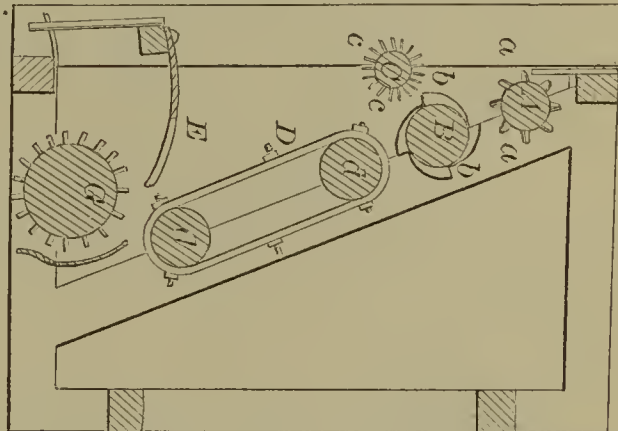

59554—G. J. Capewell—*Lamp Burner.*

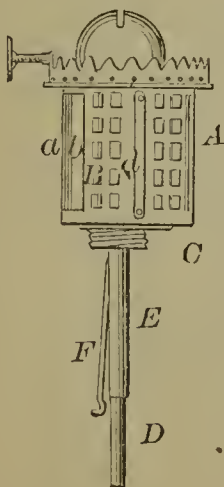

59556—H. H. Christie—*Pessary.*

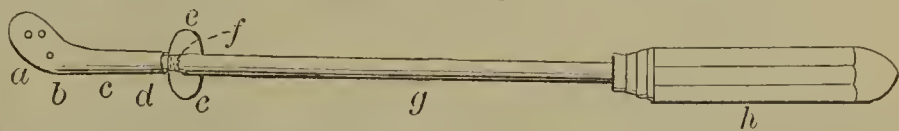

59557—J. Coffey—*Bog Cutting Plow.*

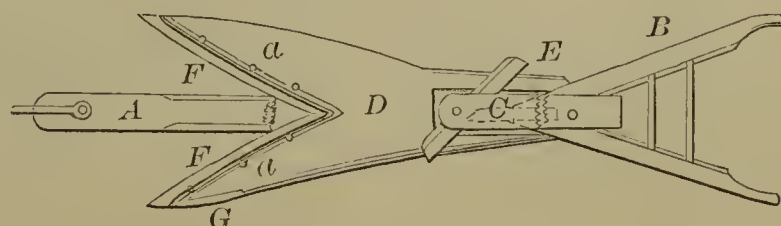

59558—De L. Cole—*Sash Fastener.*

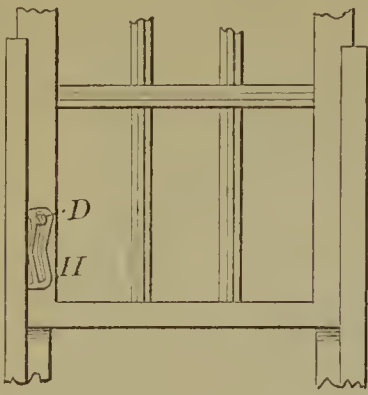

59559—J. Conrad—*Corn Planter.*

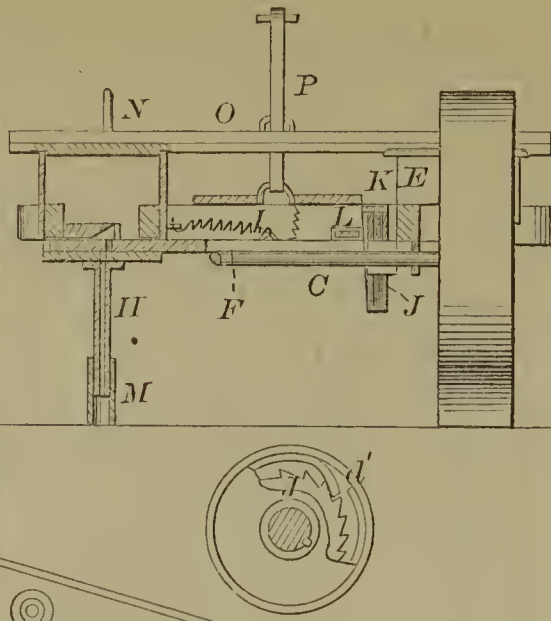

59562—E. Cutter—*Dental Anæsthetic Instrument.*

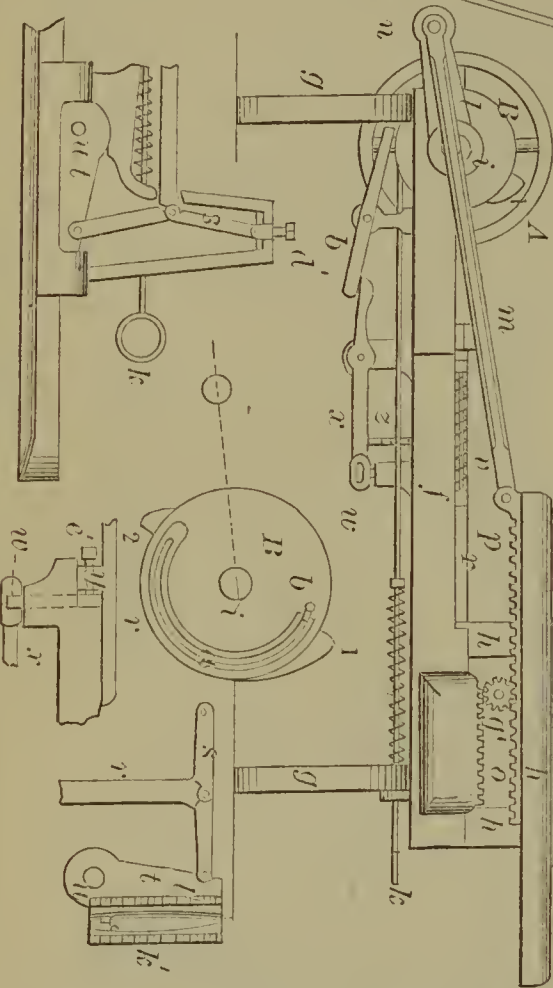
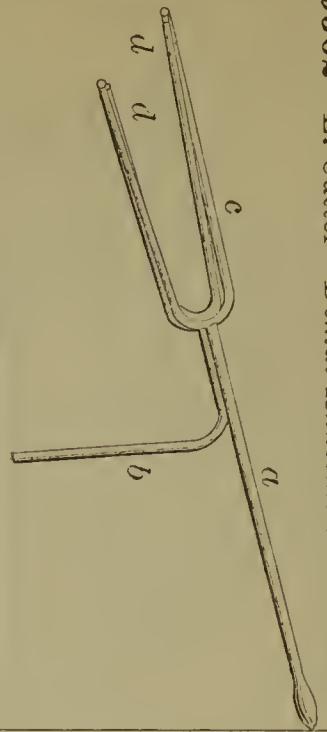

59561—P. D. Cummings—*For Rolling File Blanks.*

59560—W. M. Cook—*Churn.*

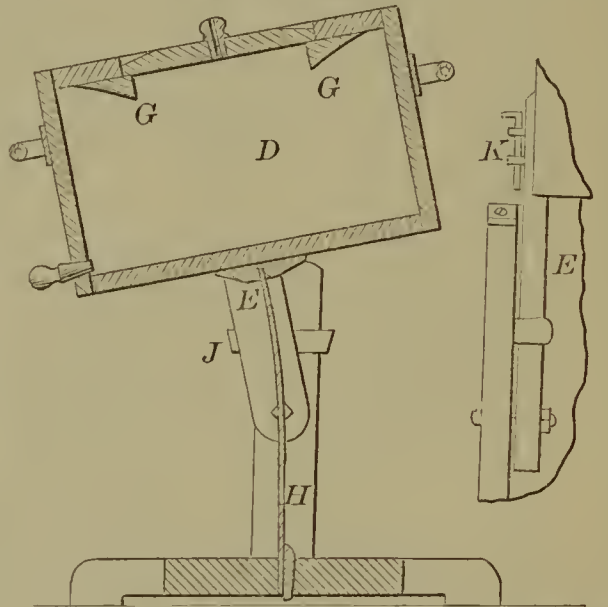

59563—H. G. Dayton—*Coal Stove.*

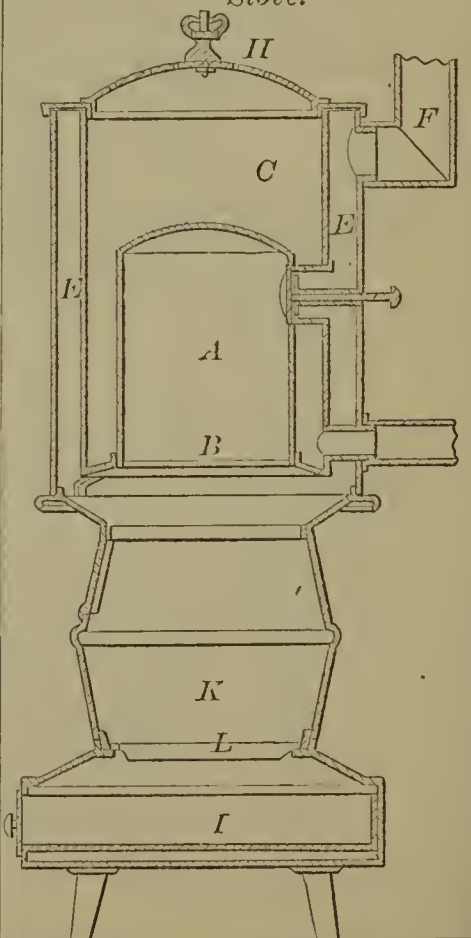

59565—J. L. Dickinson—*Valve Device for Steam Engines.*

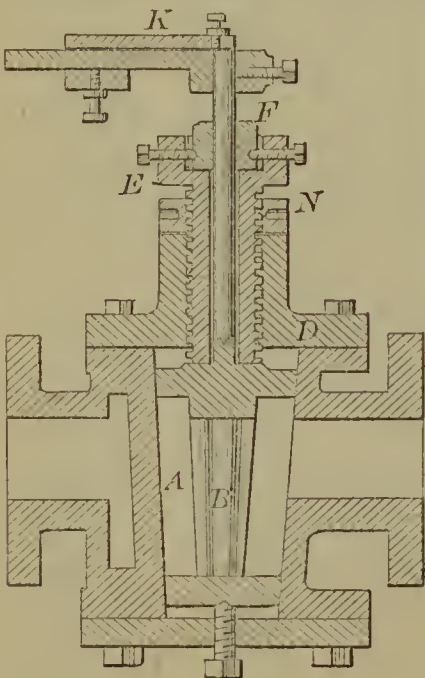

59566—J. V. Dunlap—*Lamp Shade.*

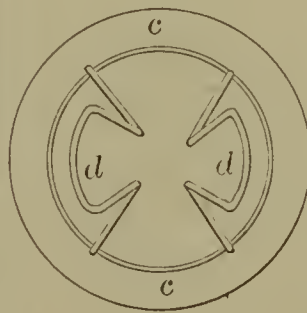

59567—L. H. Dwelley—Machine for Making Barrel Plugs.

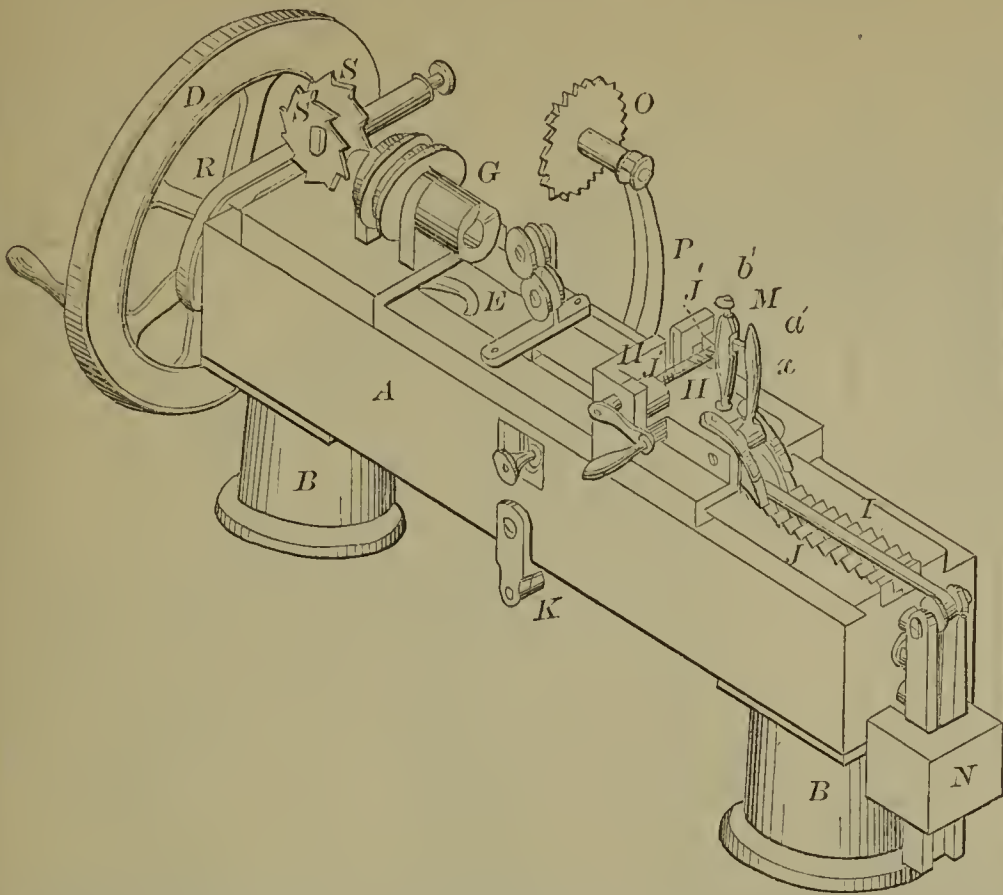

59571—W. Evans—Wrench.

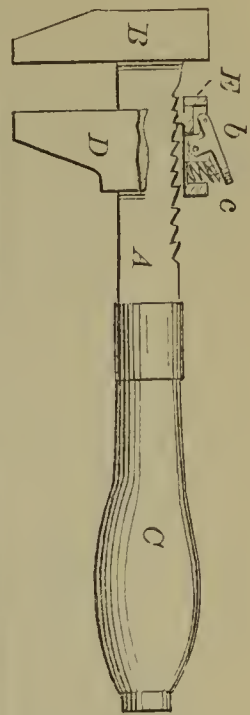

59569—W. T. Eisenhart—Beehive.

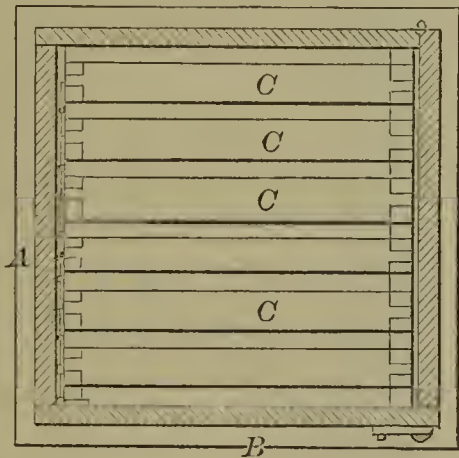

59574—T. Frith—Low Water Detector.

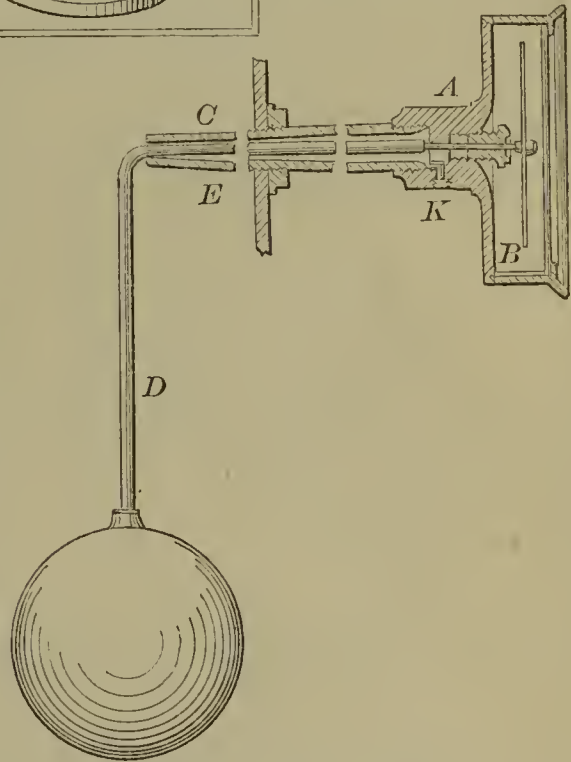

59570—W. H. Elliot—Hay Fork.

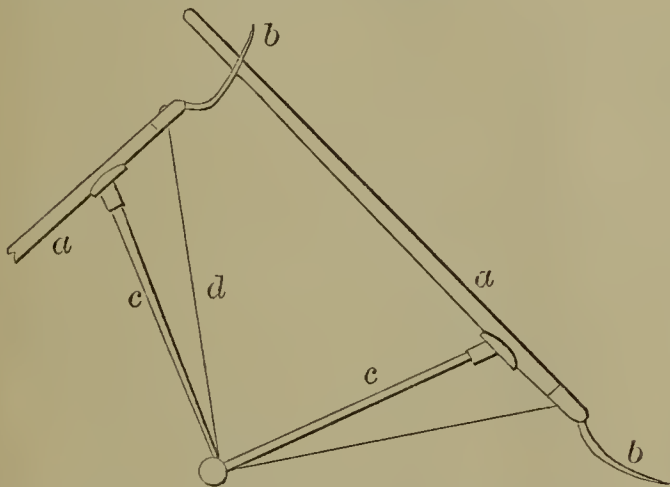

59575—M. Fleisher—Skate Fastening.

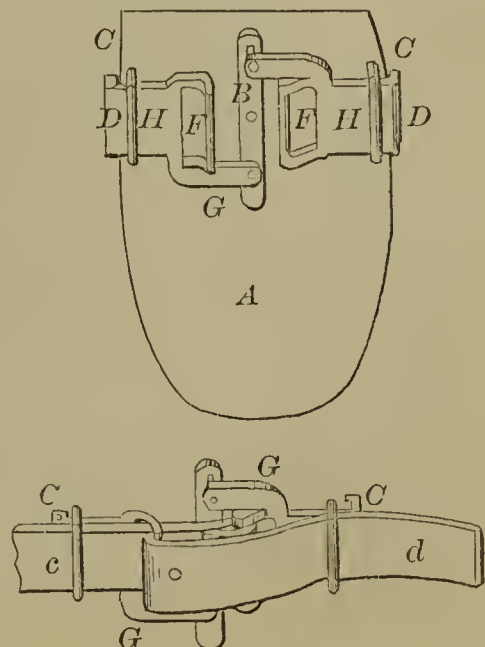

59572—J. Ewing—Wash Basin Clamp.

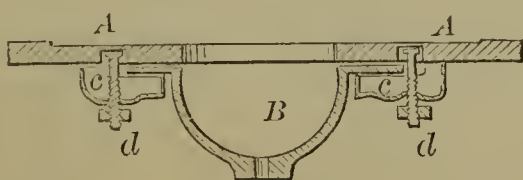

59579—Fontaine & Simons—  
*Fire Alarm.*

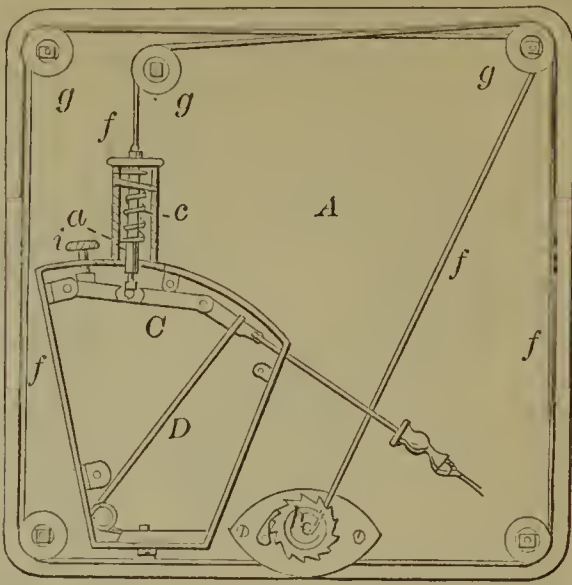

59578—W. S. Follensbee—  
*Grouting Form for Wells.*

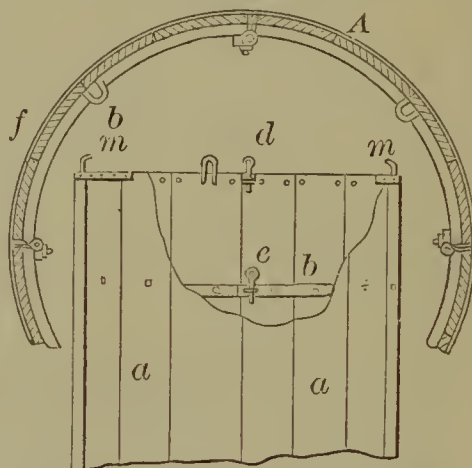

59581—W. H. Foulds—*Window  
Shutter Hinge.*

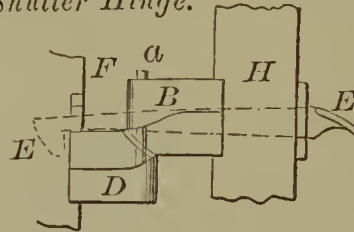

59583—J. Geemen—*Malt Kilm.*

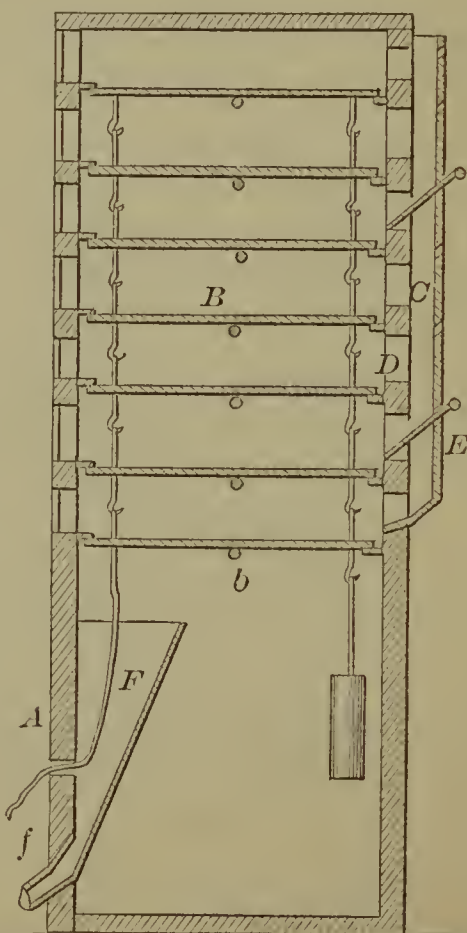

59576—A. L. Fleury—*For Diffusing the  
Vapors of Medical or Aromatic  
Substances.*

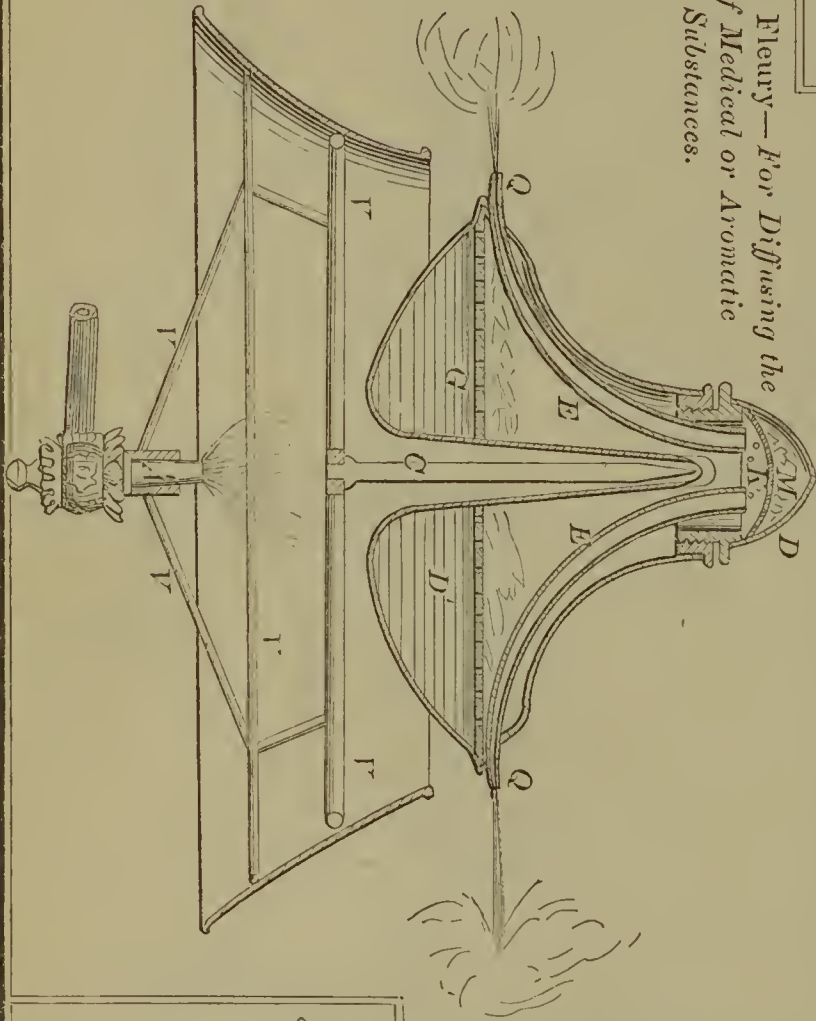
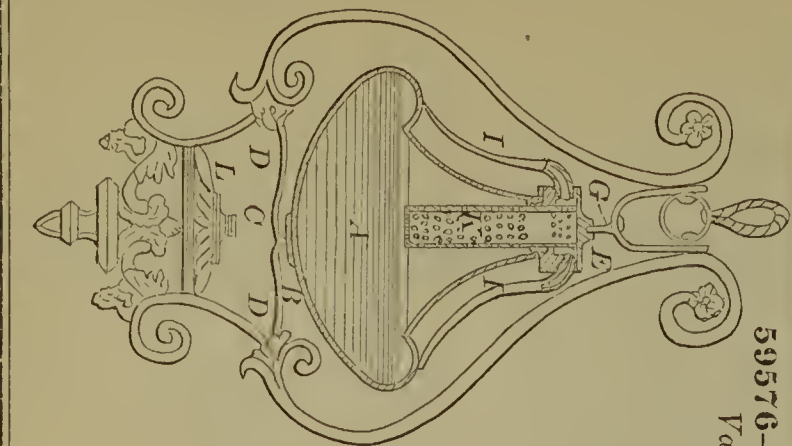

59580—J. B. Forsyth—  
*India Rubber Roller.*

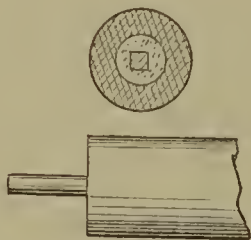

59577—F. Fogelgesang—*Plow.*

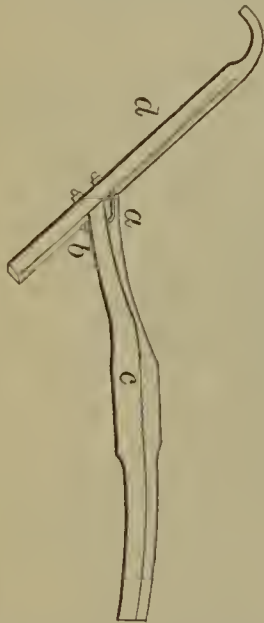

59582—M. H. Freeman—*Pipe Tongs.*

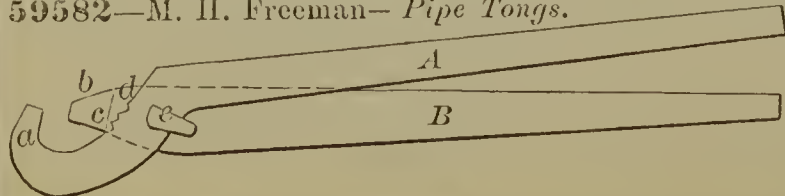

59584—J. Gifford, Jr.—*Horse Hoe.*

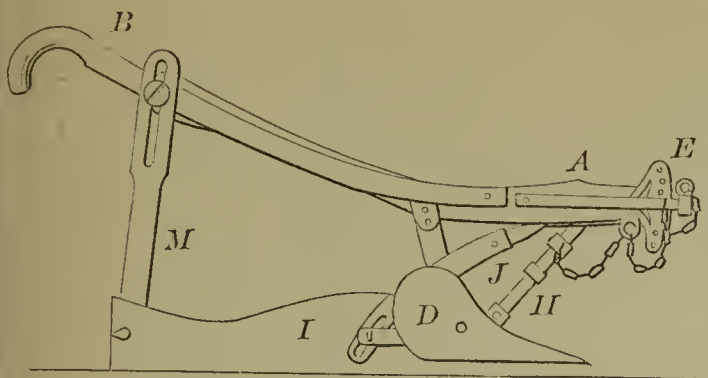

59586—W. & W. S. Gillett—*Mop Wringer.*

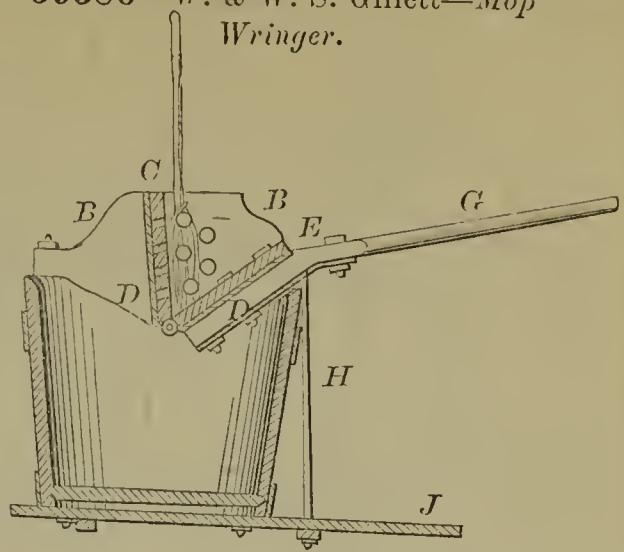

59585—J. Gifford, Jr.—*Hay Elevator.*

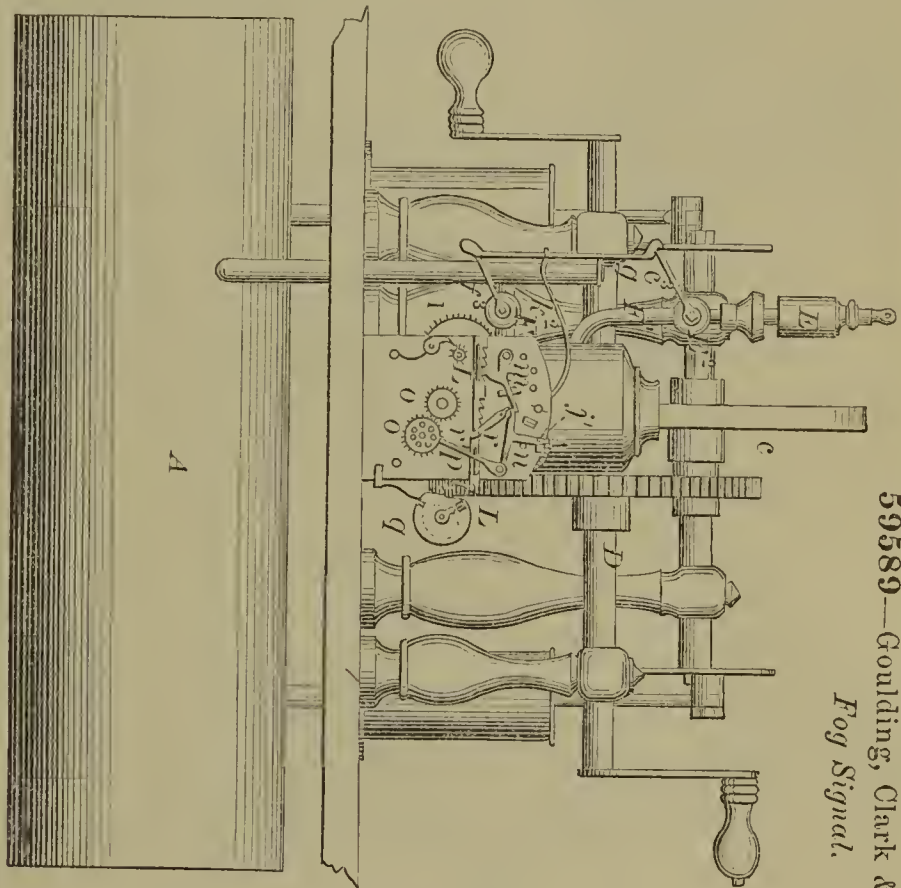
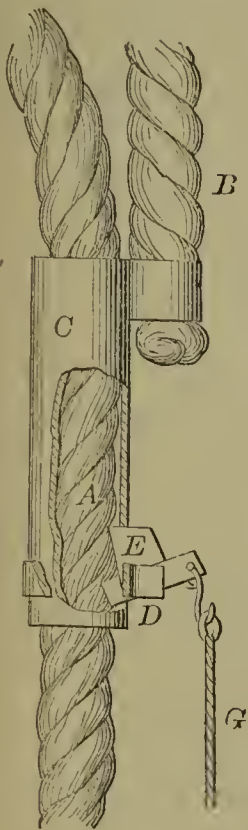

59589—Goulding, Clark & Dickinson—*Fog Signal.*

59588—E. P. Gleason—*Chimney Holder for Gas Burners.*

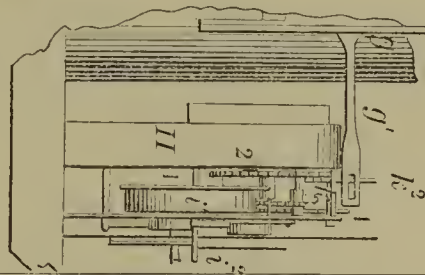
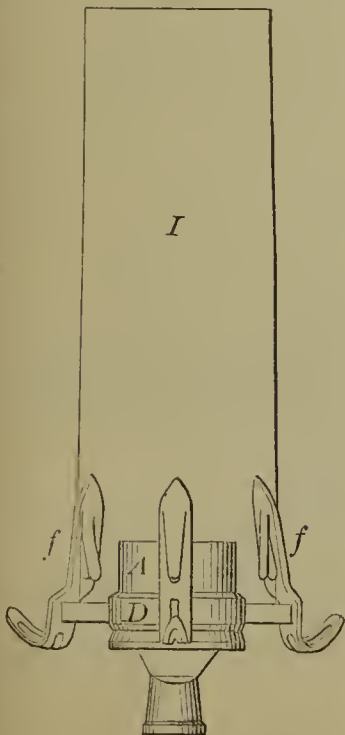

59587—E. P. Gleason—*Cigar Lighter.*

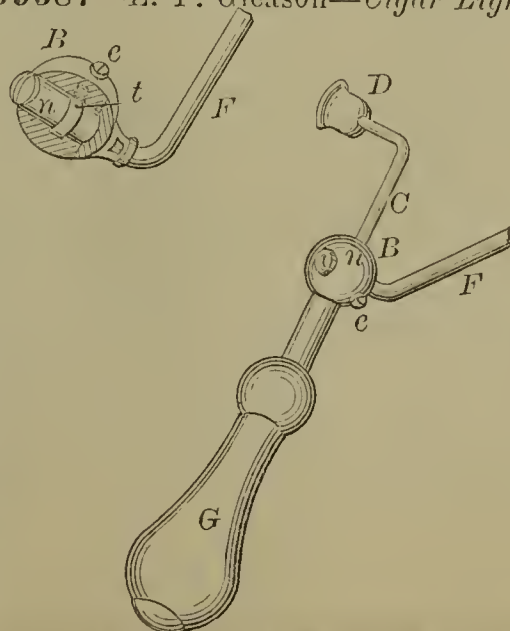

59590—E. Gratern—*Measure and Funnel.*

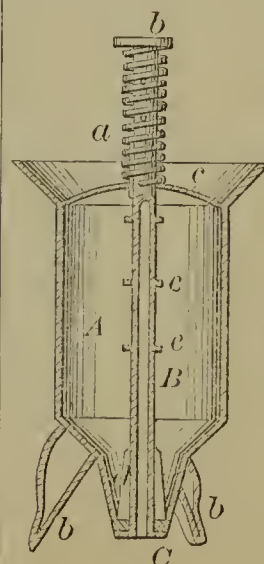

59592—A. F. Grove—Cultivator.

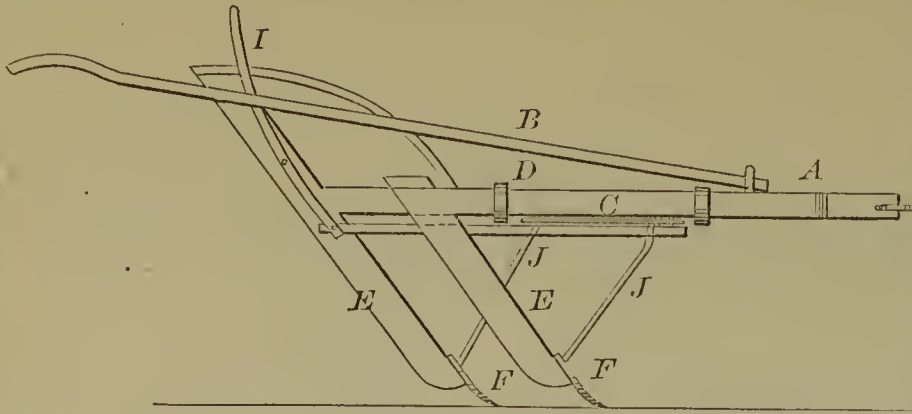

59593—M. Guthrie—Beehive.

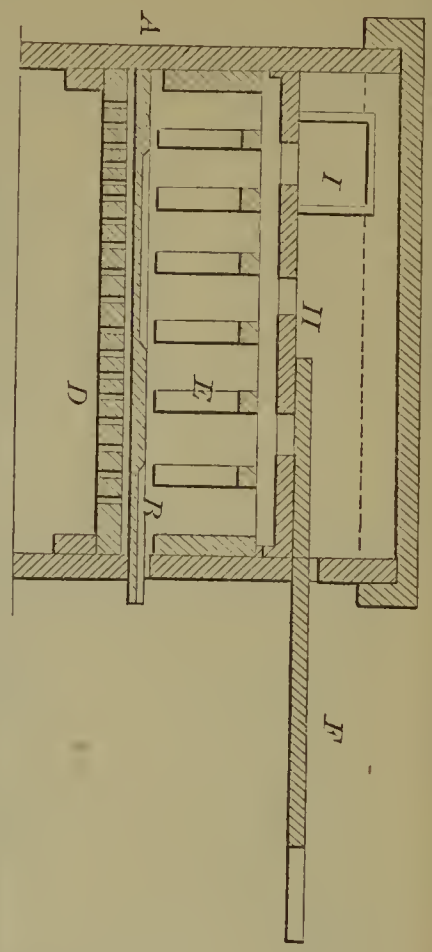

59594—A. G. Hamaker—Step for Upright Shafts.

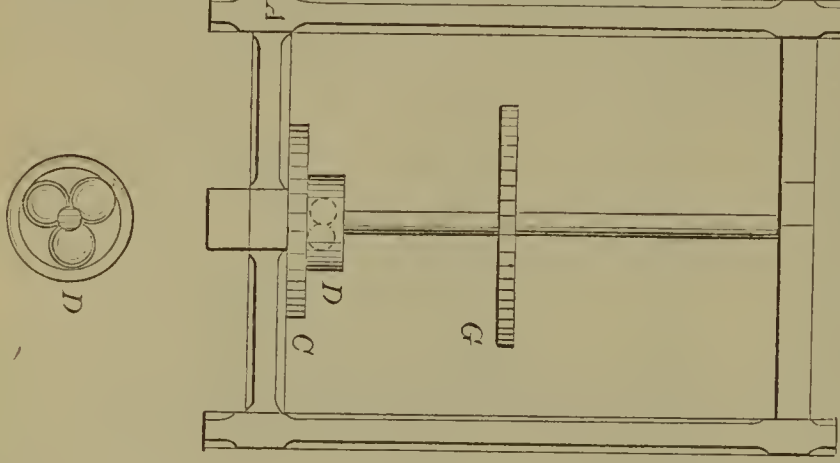

59595—J. F. Harcourt—Wheat Drill.

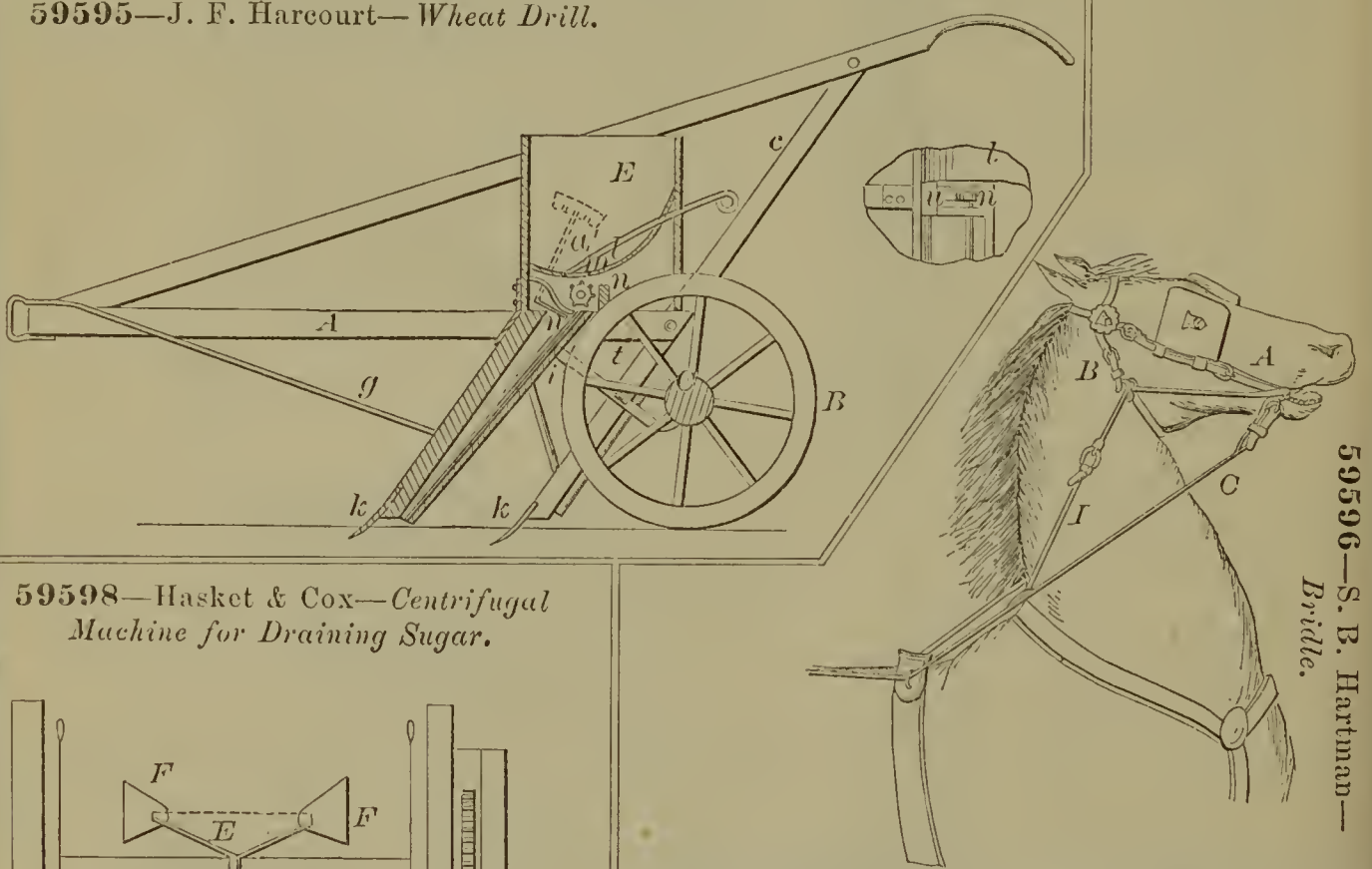

59596—S. B. Hartman—Bridle.

59598—Hasket & Cox—Centrifugal Machine for Draining Sugar.

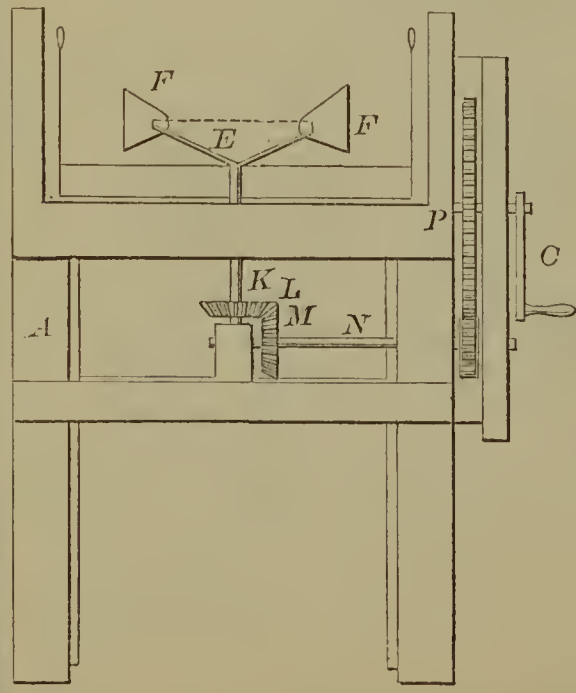

59600—W. Heath—Invalid Bedstead.

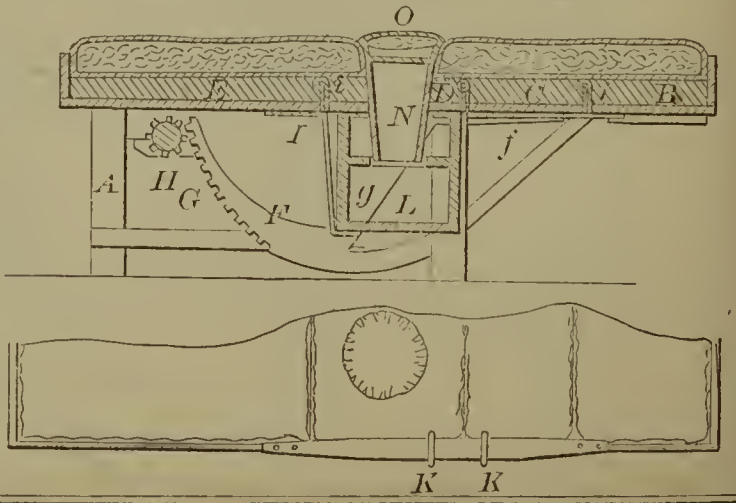



59601—B. Heiderich—*Car Truck.*

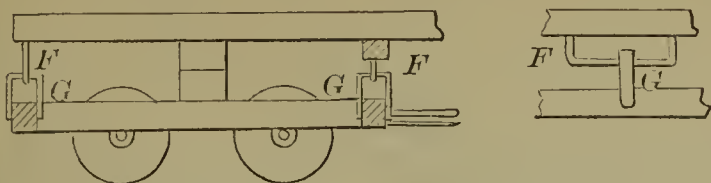

59602—P. C. Heinz—*Injector.*

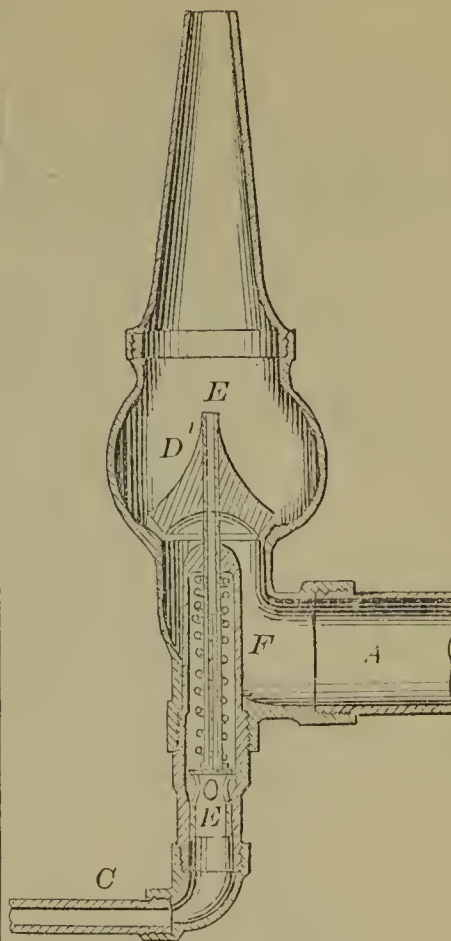

59607—J. N. Howe—*Extinguisher for Lamp.*

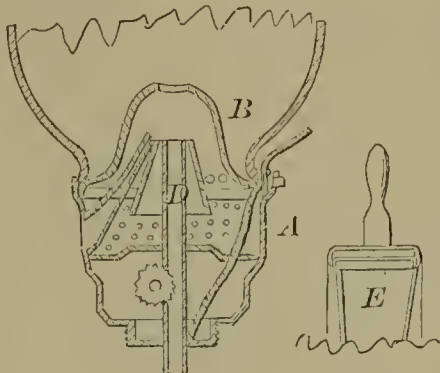

59604—J. Hindman—*Washing Machine.*

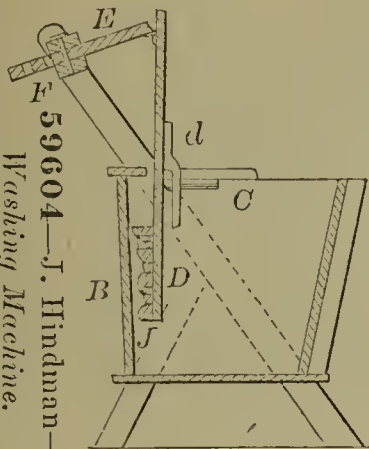

59605—Hochholzer & Denver—*Machine for Tenoning Timber.*

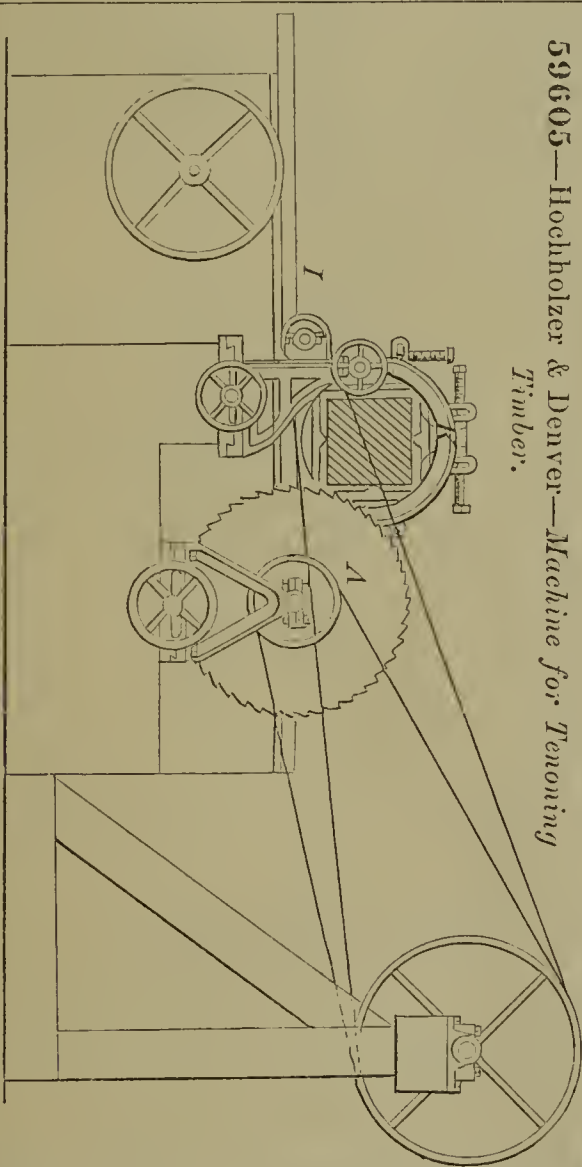

59608—J. Hutchins—*Drill or Well Tube.*



59603—L. Hill—*Alphabet Blocks.*

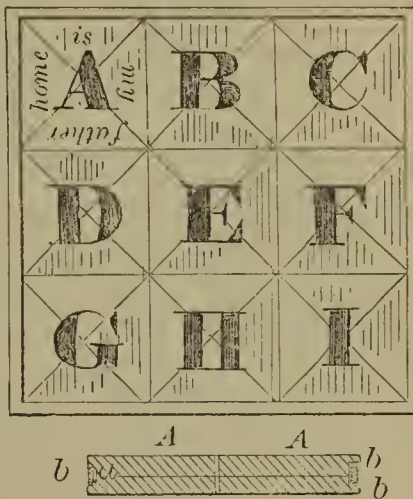

59606—F. W. Hoffmann—*For Cutting off Cigars.*

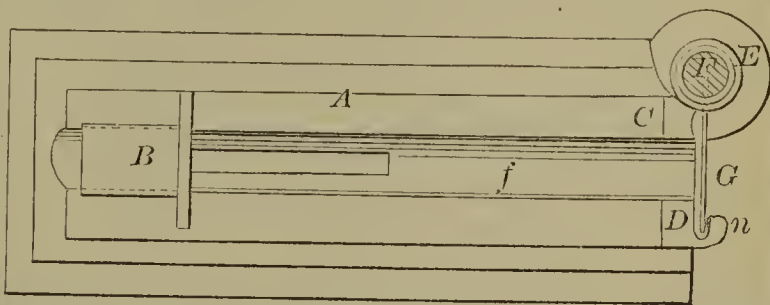

59609—Jones & Mead—*Fastening Door Knobs to Shanks.*

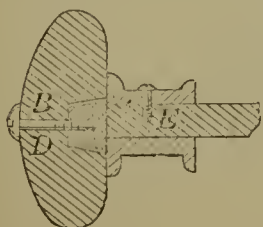

59610—W. A. Jones—*Vehicle.*

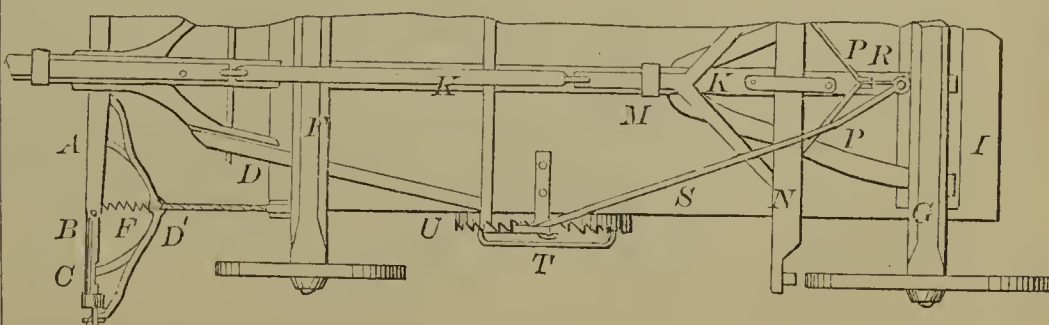

59610—Continued.

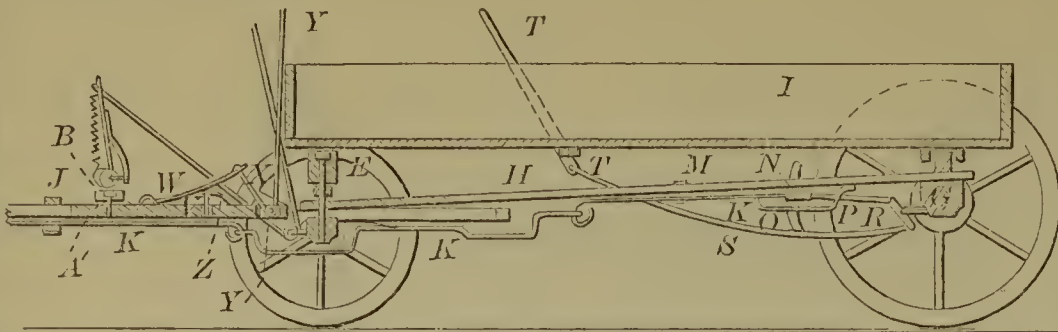

59612—Keith & Bird—Machine for Driving Spokes in Wagon Wheels.

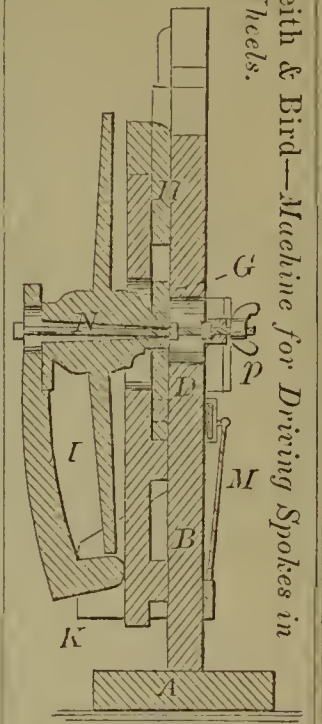

59614—E. Kretchmer—Beehive.

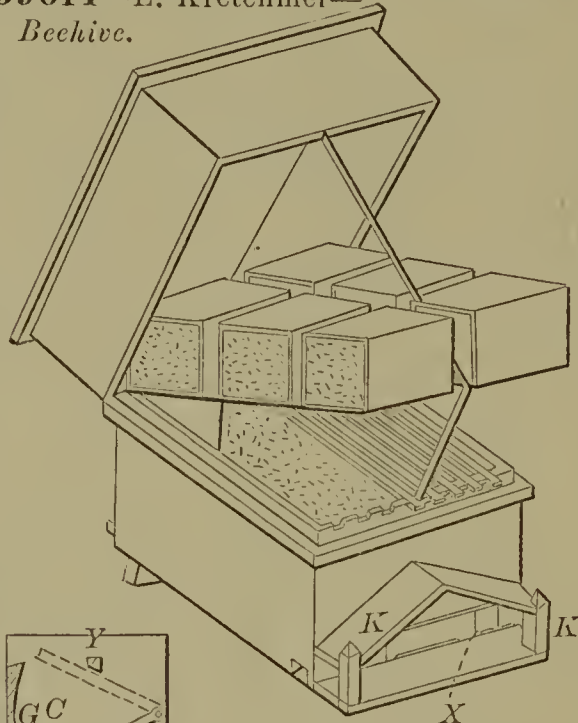

59613—L. J. Knowles—Narrow Ware Loom.

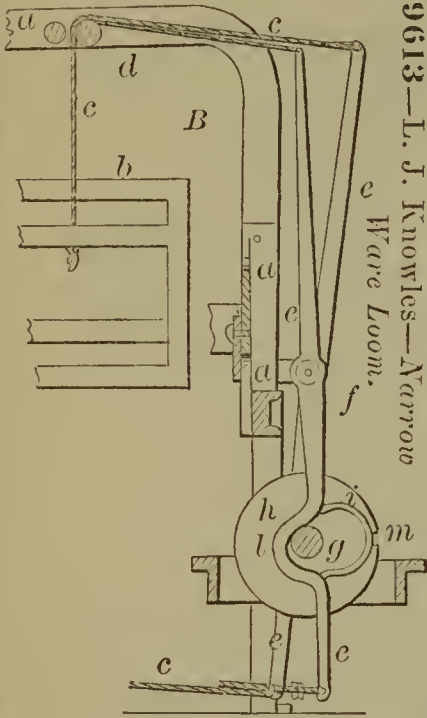

59615—E. Lawshe—Lock.

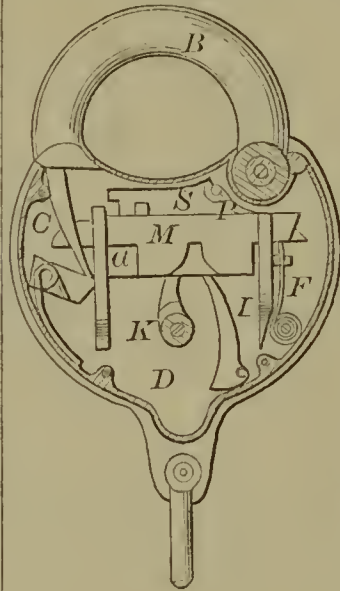

59618—C. Mahon—Ticket Holder.

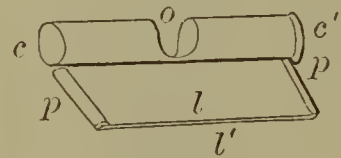

59616—F. Leppens—Axe Box.

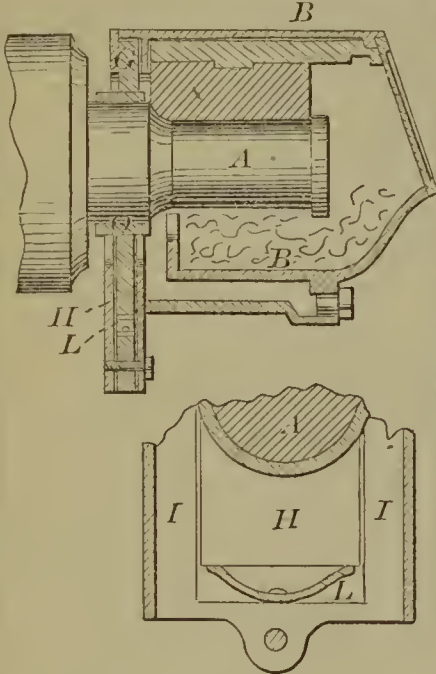

59619—G. C. Manner—Piano Forte.

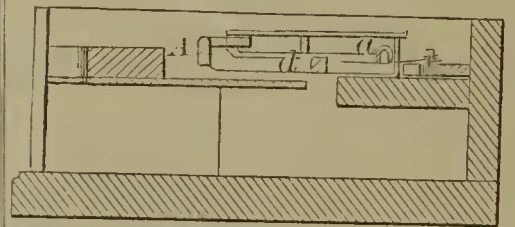

59617—W. C. Lester—Gasalier and Cigar Lighter.

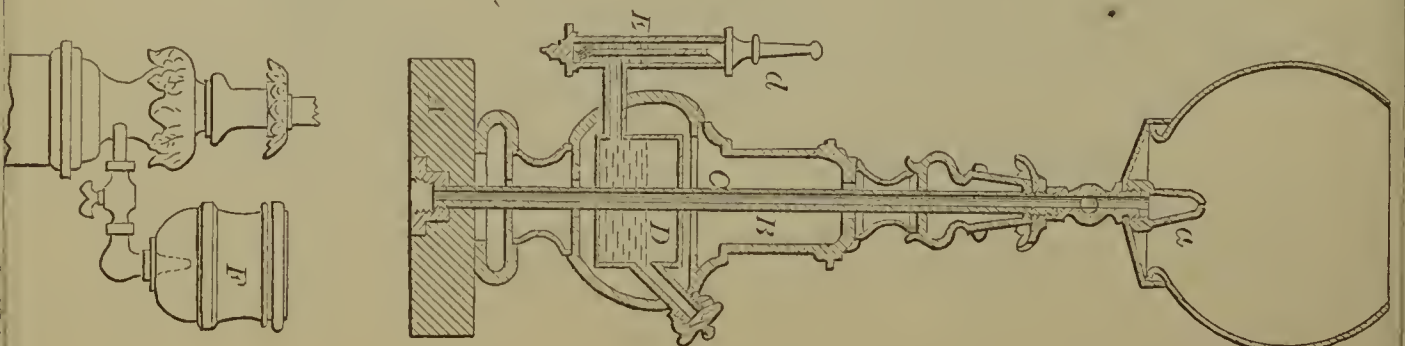

59620—T. McCleary—Fire Place.

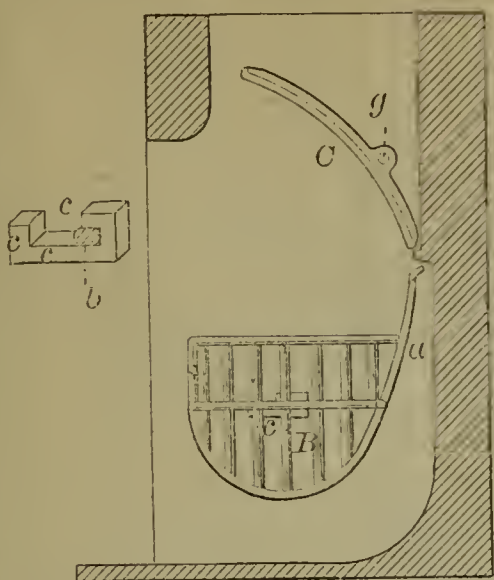

59621—R. W. McFarland—Farm Gate.

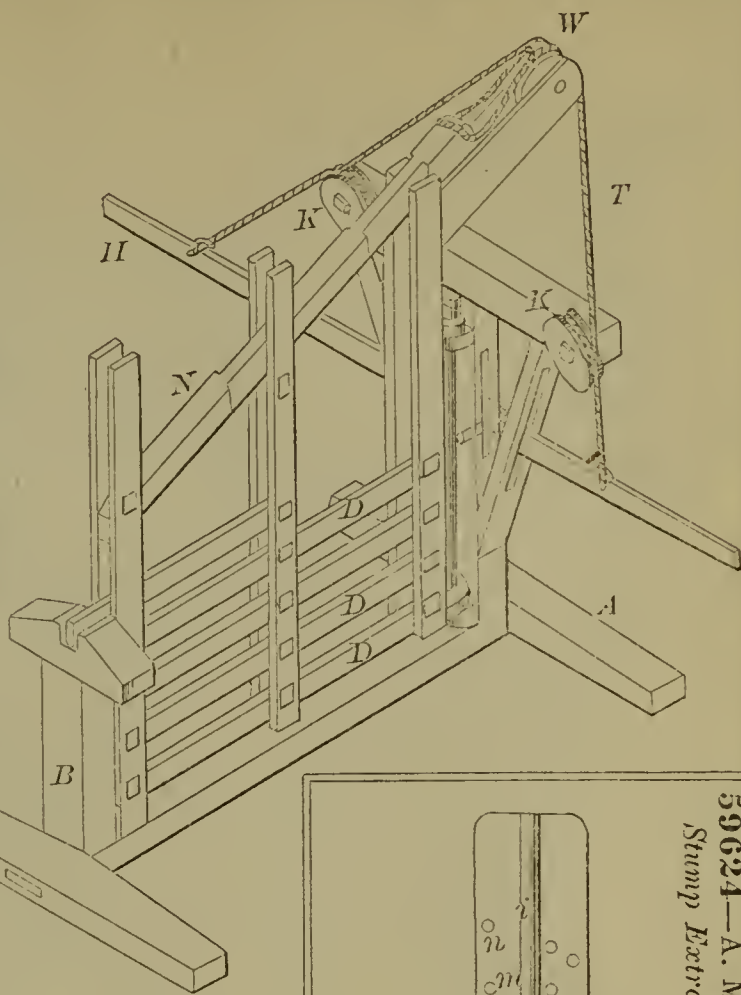

59623—B. Merritt, Jr.—Tree Protector.

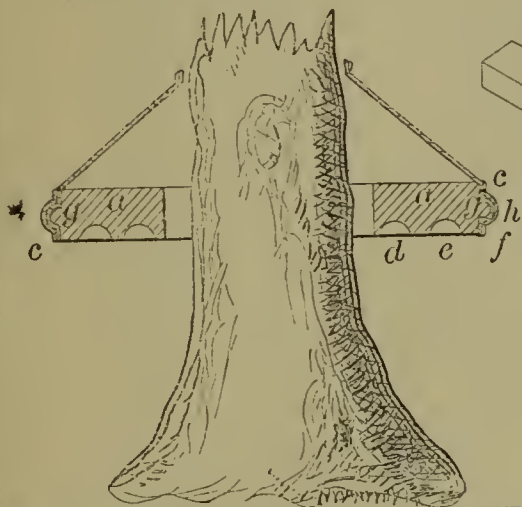

59624—A. Monroe—Stump Extractor.

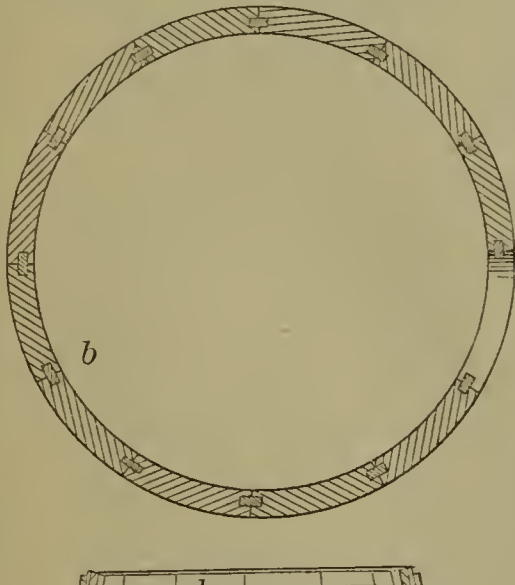
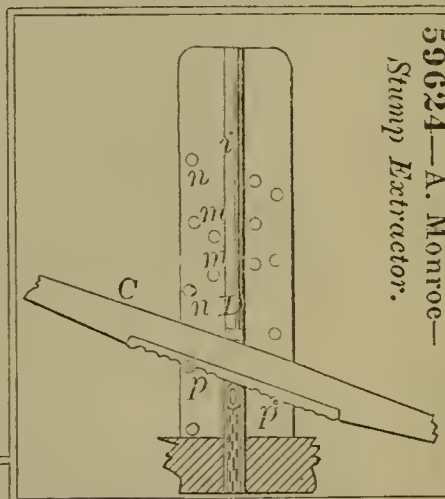

59622—J. Merrill—Cask, Barrel, &c.

59626—D. M. Mourland—Clamp and Gauge for Weather Boarding.

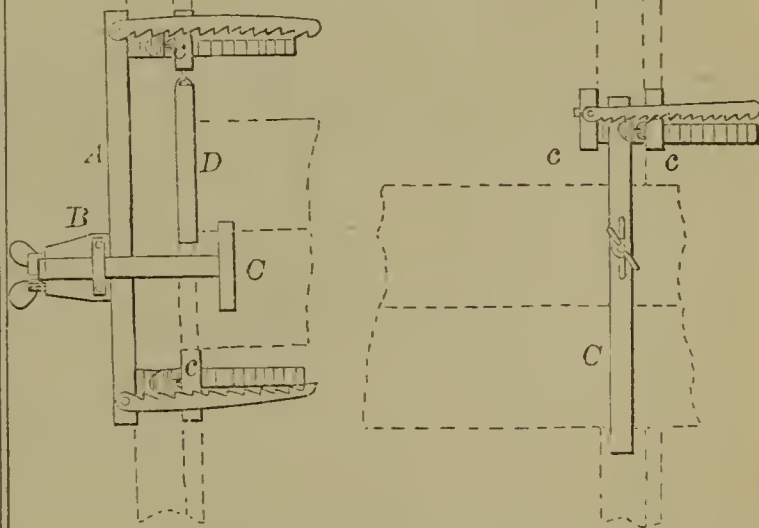

59625—J. Moore—Wood Polishing Machine.

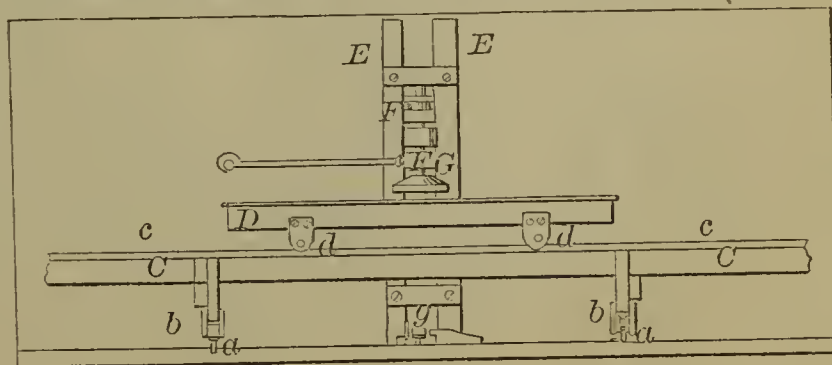

59628—A. B. Mullett—Lock.

Fig. 2

Fig. 4

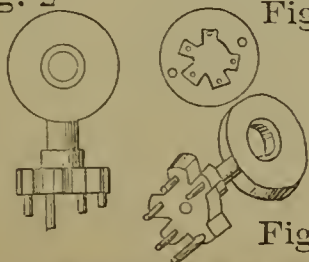
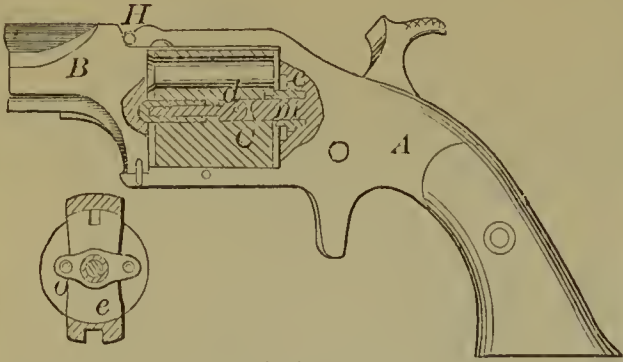
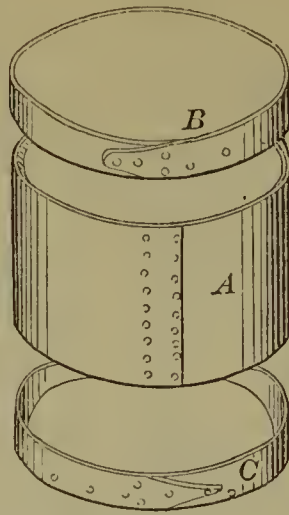

Fig. 8

59629—A. L. Munson—*Revolving Fire Arm.*



59630—W. B. Nickelson—*Cheese Hoop.*



59631—Nottingham & Duncan—*Drill.*

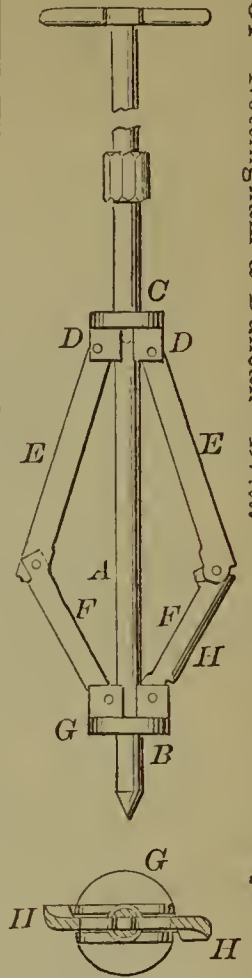

59633—J. K. O'Neil—*Horse Hay Fork.*

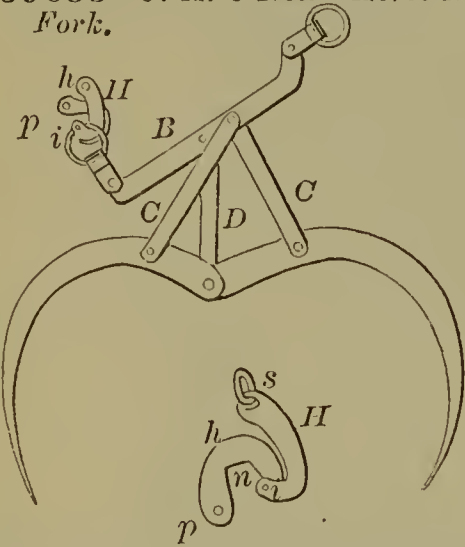

59632—C. M. Oliver—*Axle Box.*

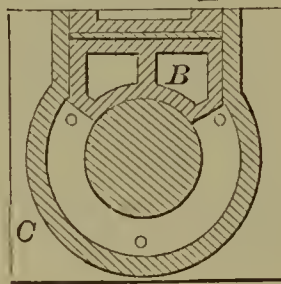

59637—J. D. Parrot—*Churn.*

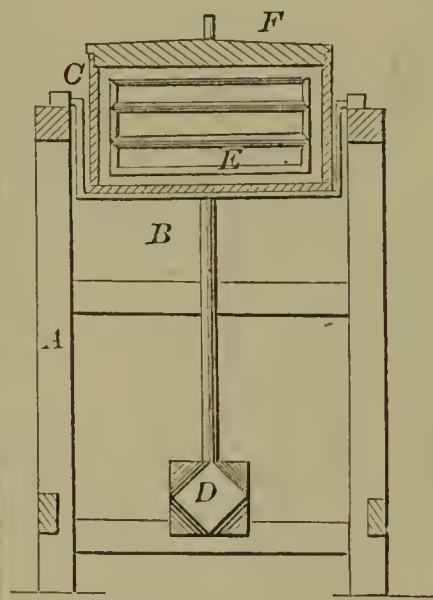

59636—E. A. Palmer—*Cheese Hoop.*

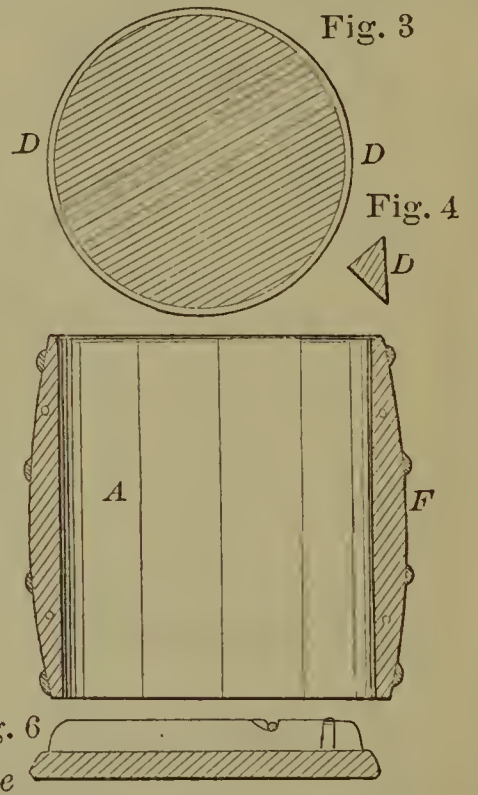

59634—W. M. Owen—*Wrench.*

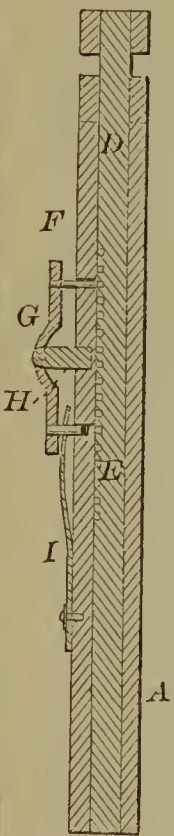

59638—C. W. Patton—*Wheat Drill.*

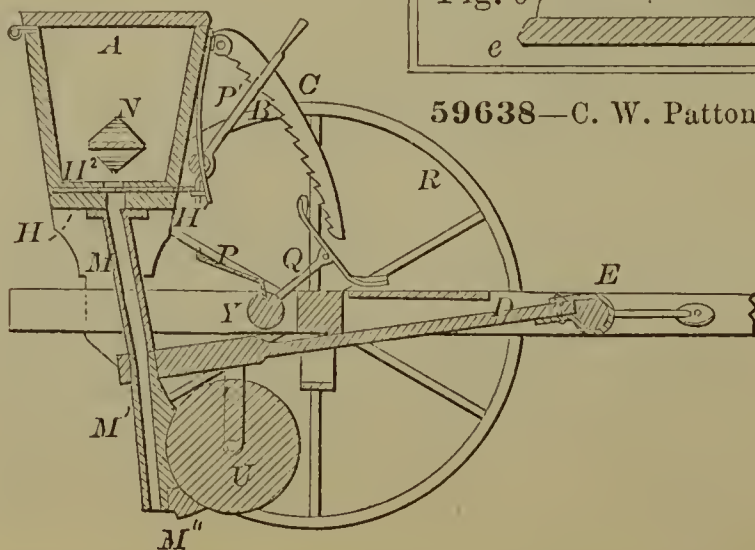

59635—C. Padmore—*Shirt Stud.*



59639—W. P. Penn—Seeding Machine.

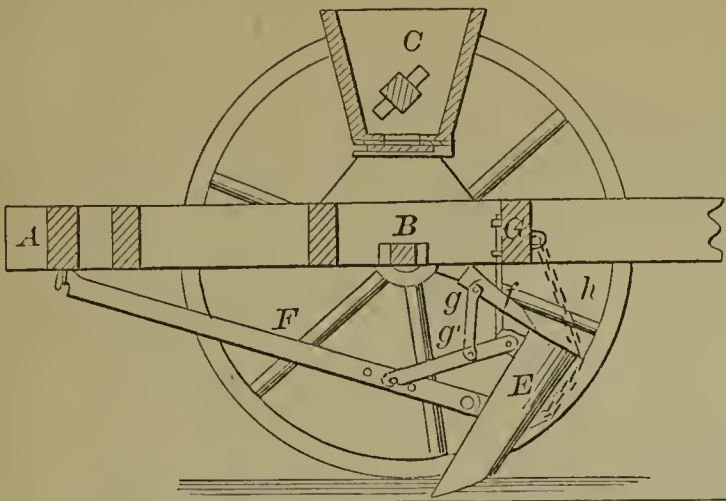

59641—S. Perry—Sawing Machine.

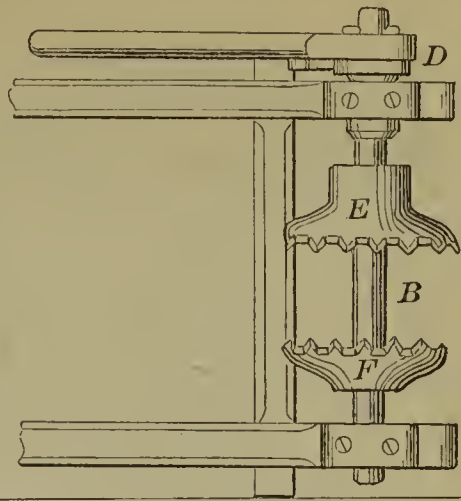

59640—L. C. Pennell—Skirt Lifter for Ladies' Dresses.

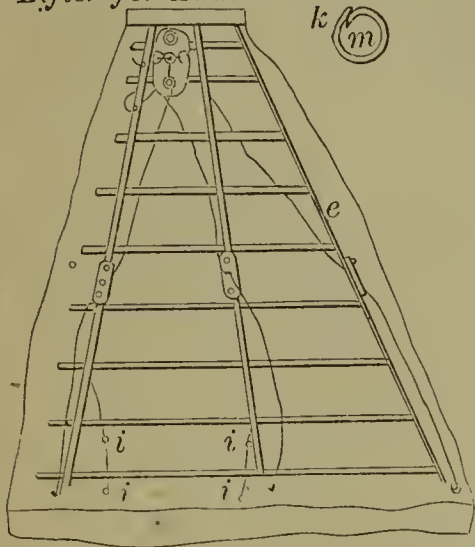

59642—J. Phelps—Carriage King Bolt.

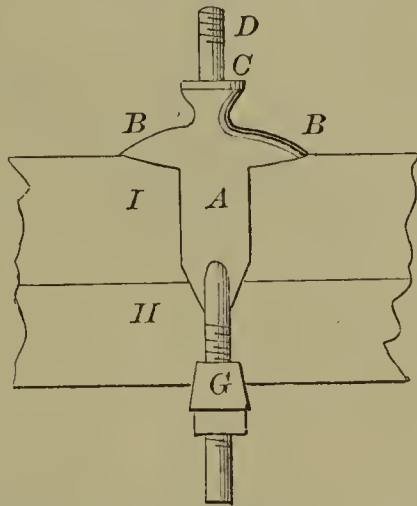

59645—L. Picot—Comb.

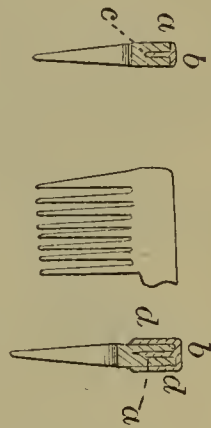

59643—W. W. Philler—Cultivator.

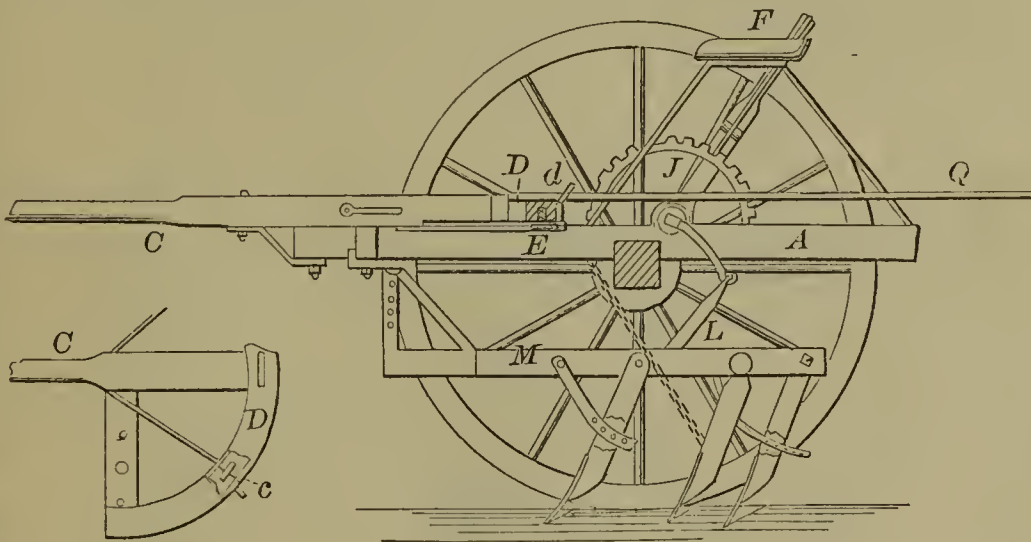

59646—C. W. Powell—Collar and Neck Tie Attachment.

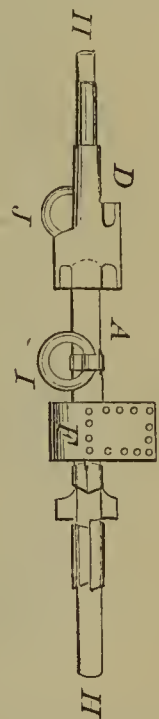

59648—J. Powell—Medallion Case.

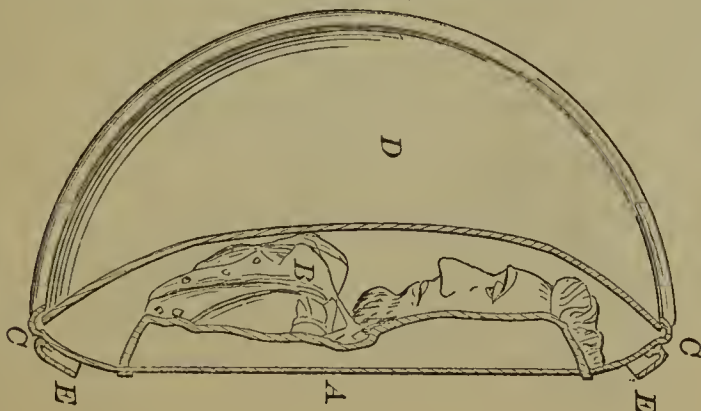

59647—I. A. Powell—Horse Collar.

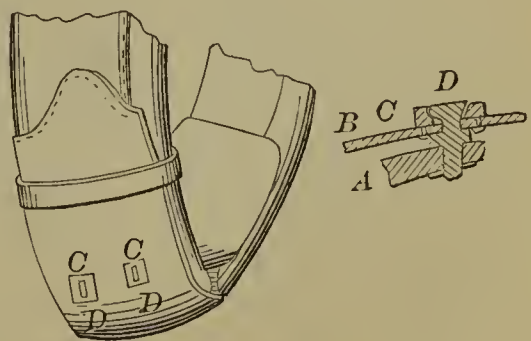

59649—D. Punchies—*Bed Bottom Spring.*

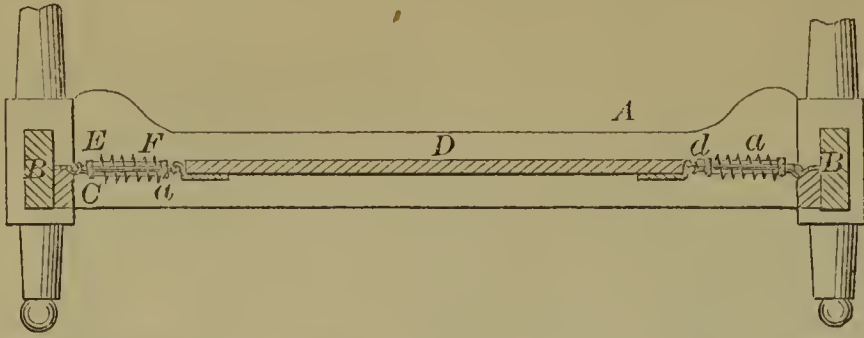

59650—J. Radley—*Locomotive Head Light.*

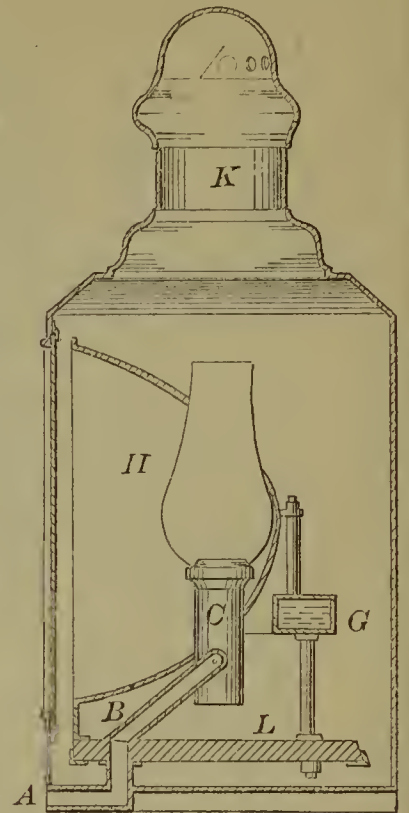

59652—J. R. Reader—*Railroad Car.*

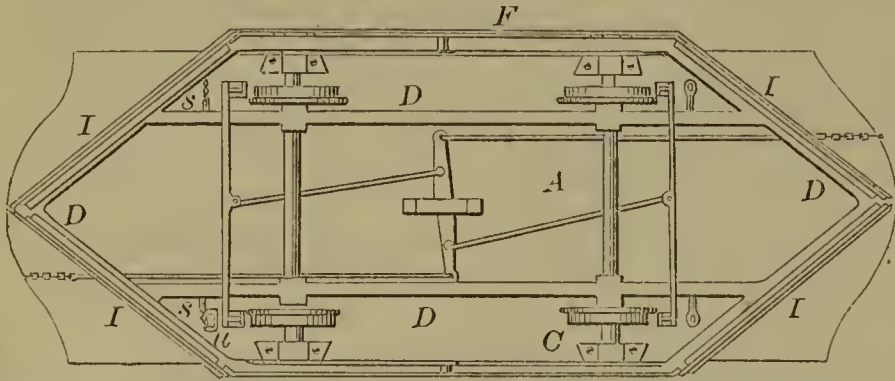

59654—J. J. Reed—*Sulky Plow.*

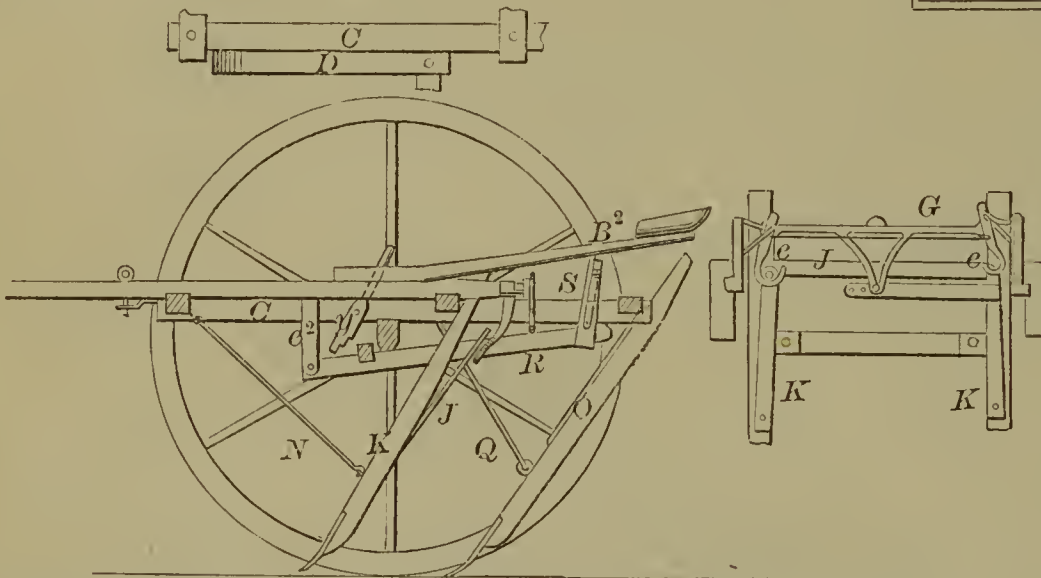

59653—F. Reed—*Door Fastening.*

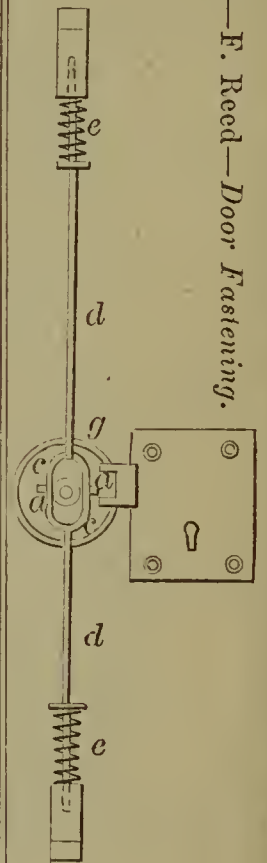

59655—Richards & Lincoln—*Fruit Picker.*

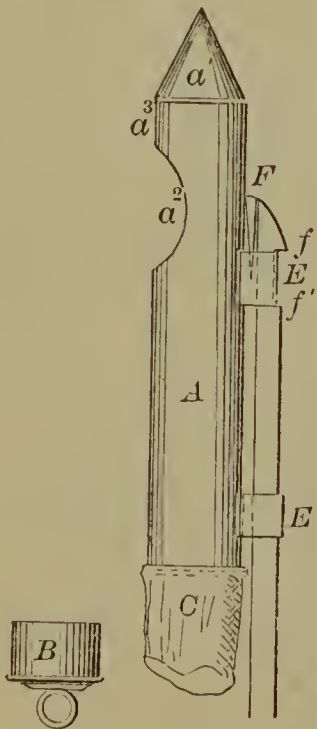

59656—P. Riley—*Securing Shoe Tips.*

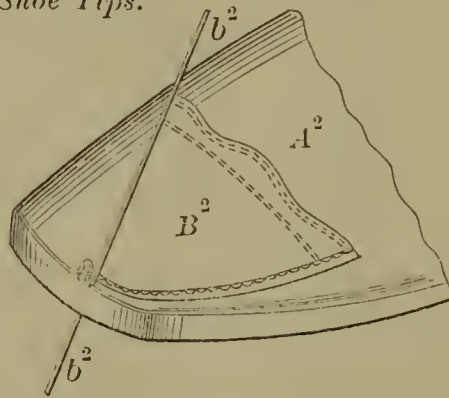

59651—H. A. Rains—*Cart Harness Saddle.*

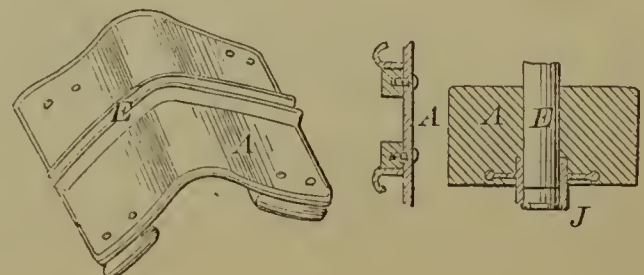

59657—D. T. Robinson—Tool for Drawing Nails.



59654—T. Schreiber—Comb.

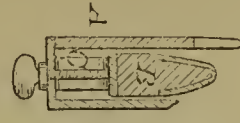

59658—S. W. Robinson—Time Piece Escapement.

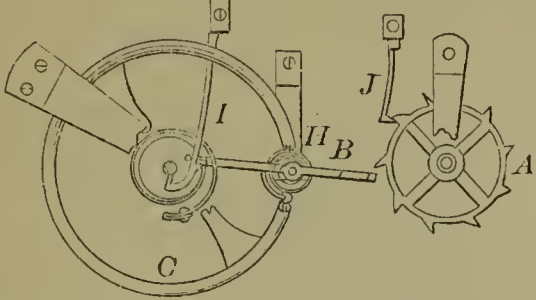

59661—S. G. & G. S. Rogers—Paper Making Machinery.

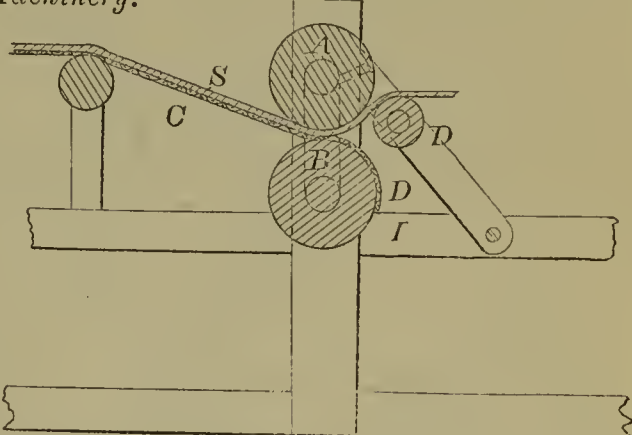

59660—C. Rogers—For Hitching Horses.

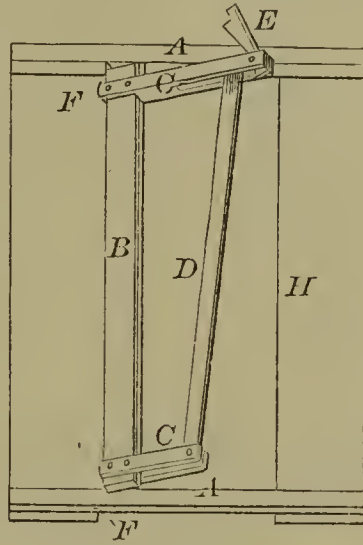
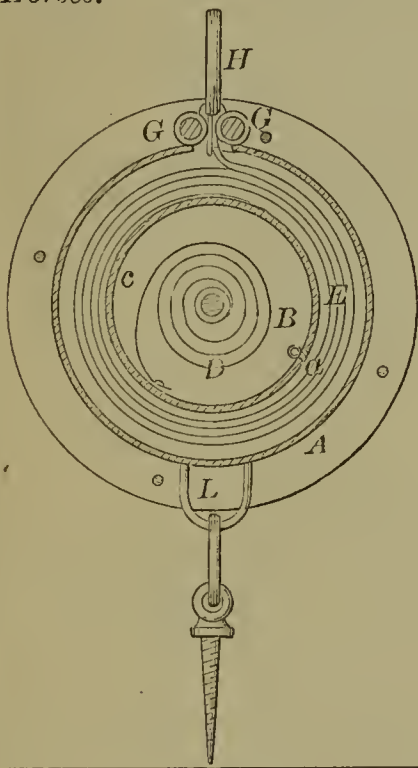

59662—L. S. Safford—Stanchion.

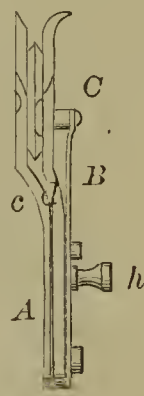

59659—P. Rodier—Loop Check for Sewing Machines.

59663—C. Satterlee—Horse Rake.

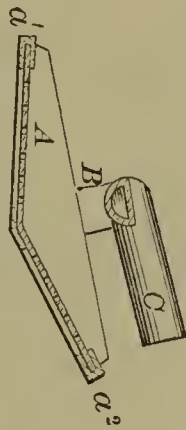
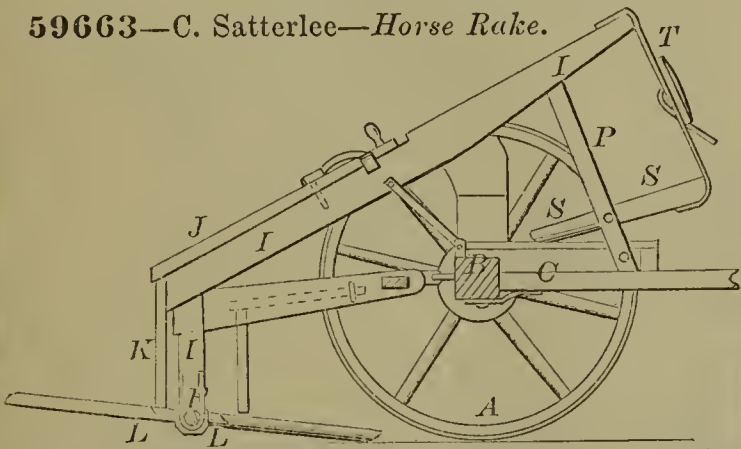

59665—W. B. Seward—Sorghum Stemmer.

59667—G. K. Coates—Mechanism for Closing Doors.

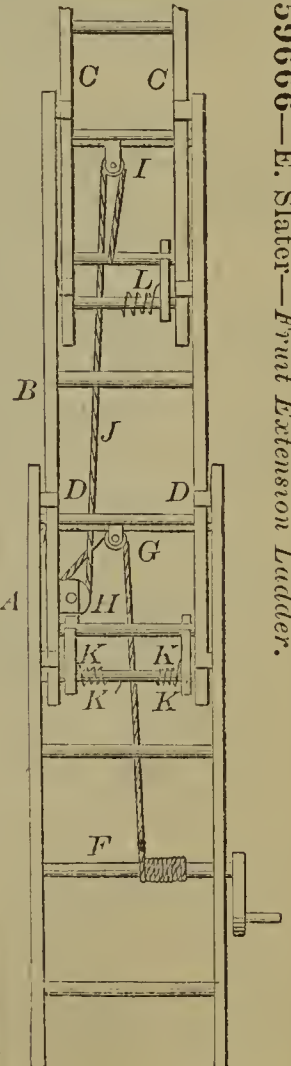
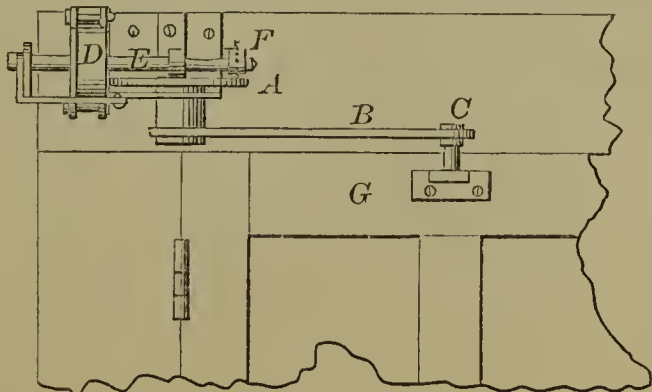

59666—E. Slater—Fruit Extension Ladder.

59668—Equalizing Spring for Clock Movements.

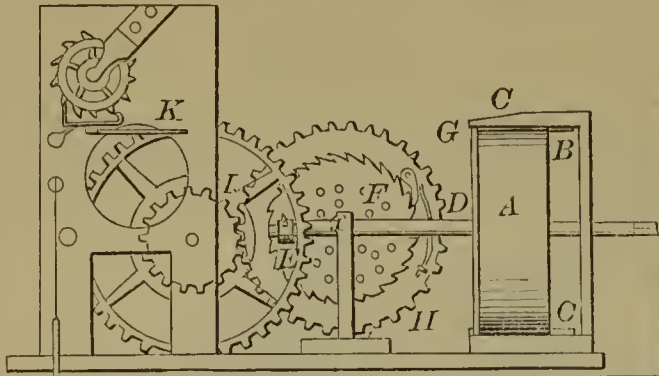

59672—J. N. Smith—Faucet.

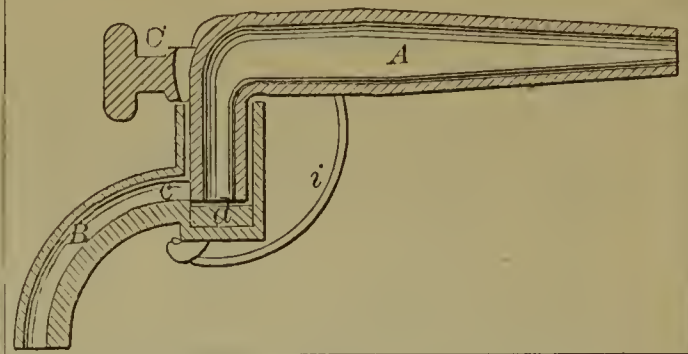

59674—T. F. Smith—Grinding Mill.

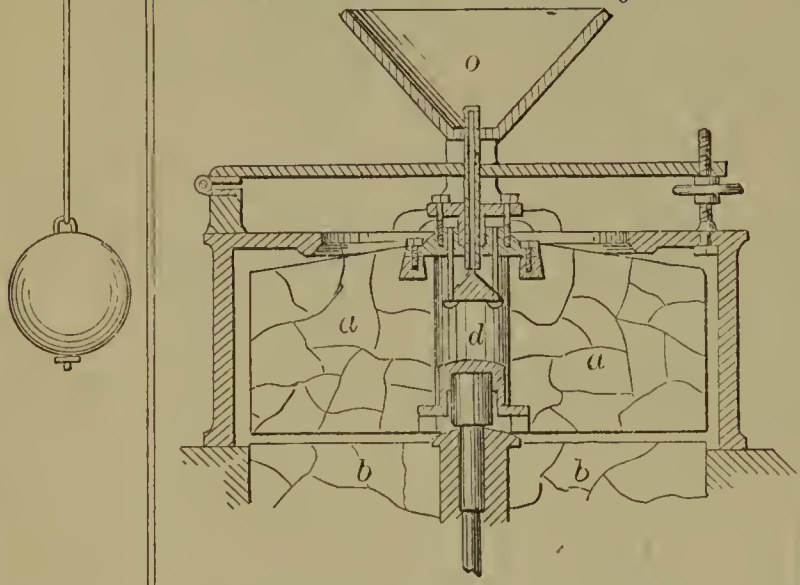

59670—J. N. Smith—Hydrant.

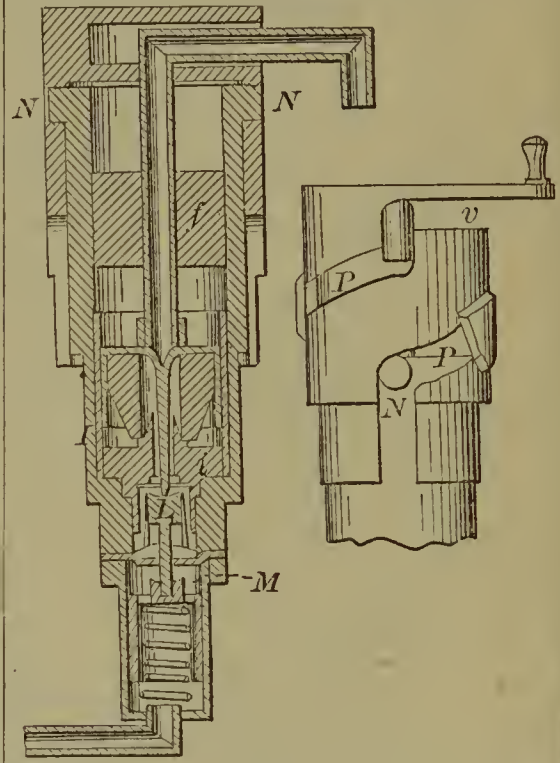

59671—J. N. Smith—Hydrant.

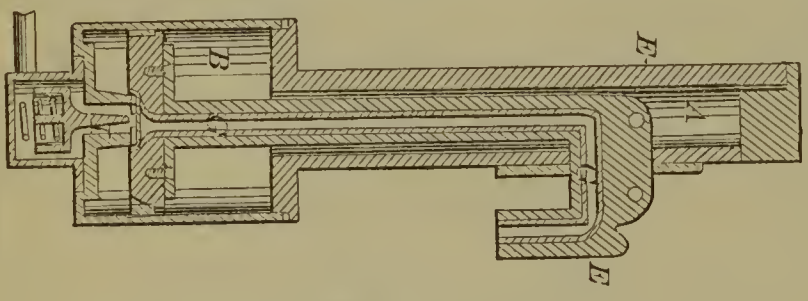

59669—J. N. Smith—Foot Press.

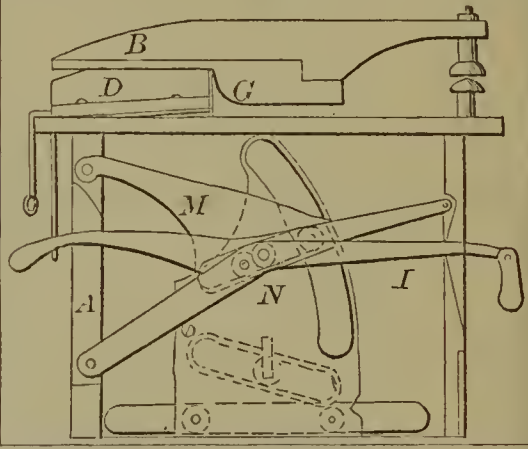

59673—A. J. Smith—Bolt Cutter.

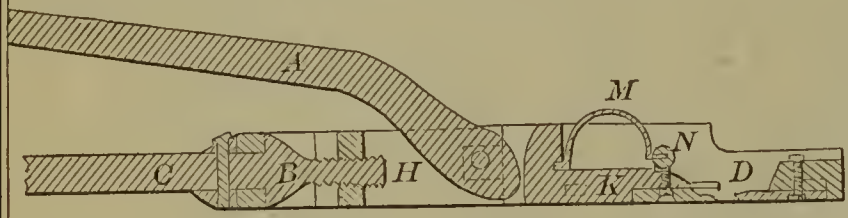

59675—Soule & Sholes—Numbering Machine.

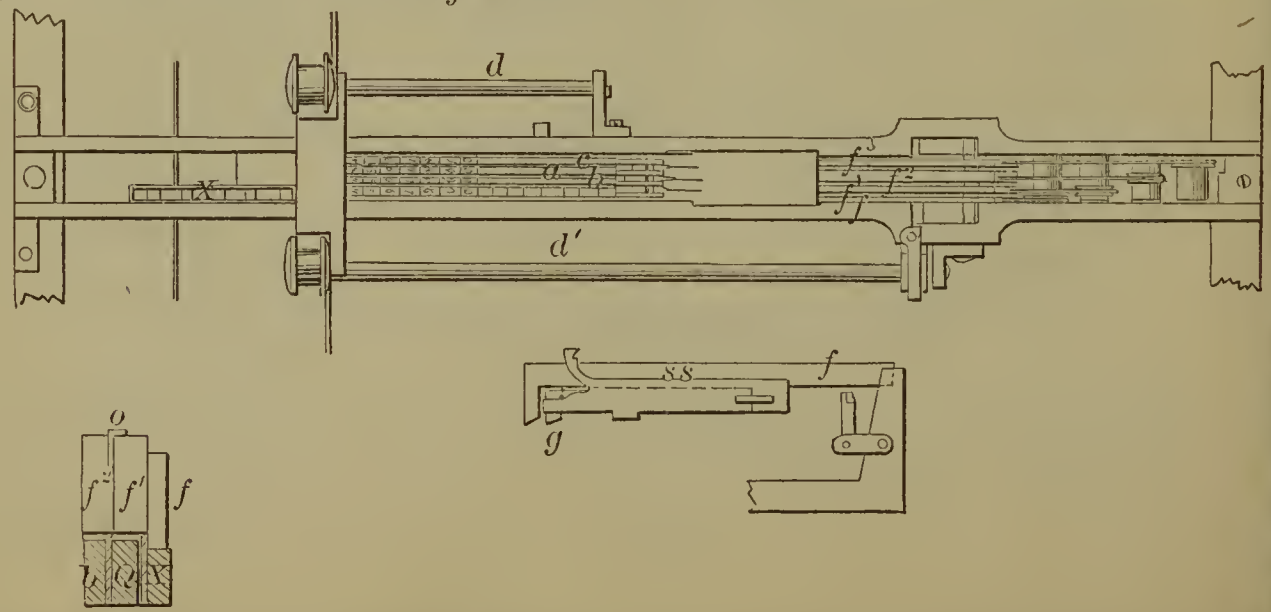



59676—C. W. Stafford—Ore  
Crusher.

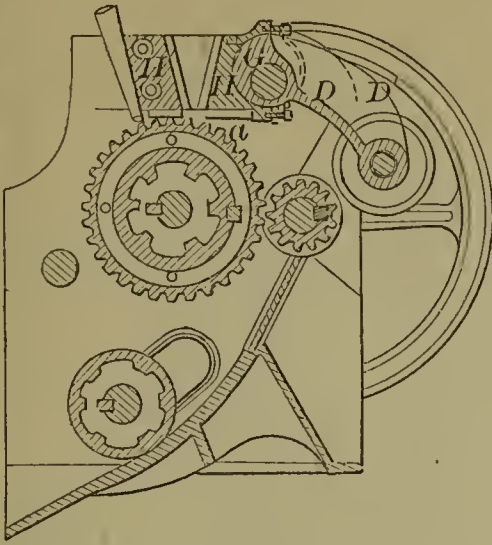

59683—D. S. Trout—  
Wheelwright's Machine.

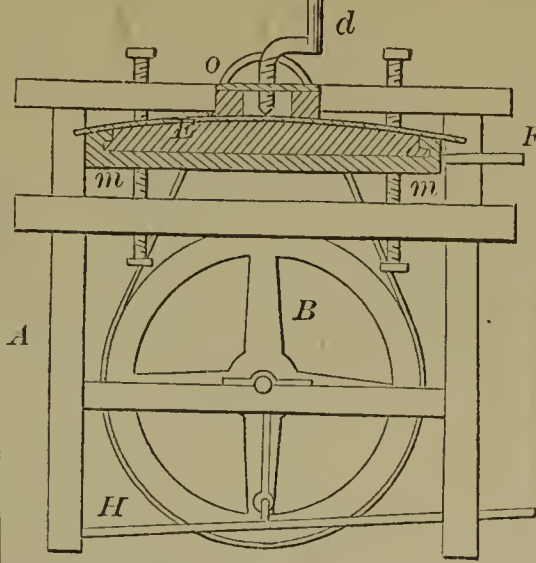

59677—W. H. Stary—Bag Holder.

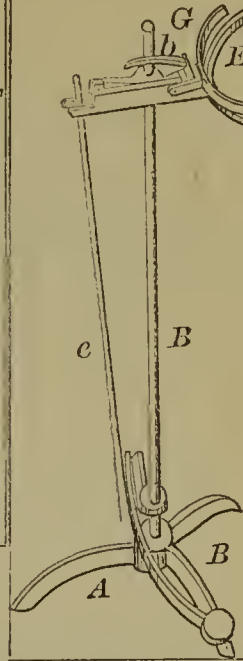

59681—H. Thomason—Seeding  
Machine.

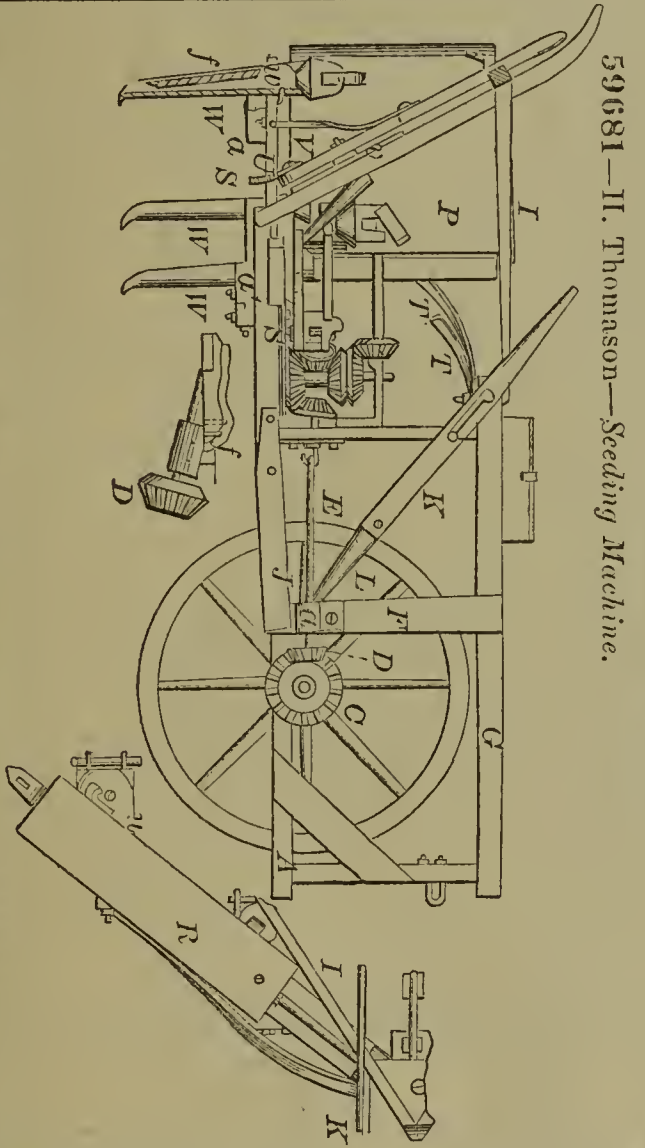

59680—T. Tebbets—For Creasing  
Paper Collars.

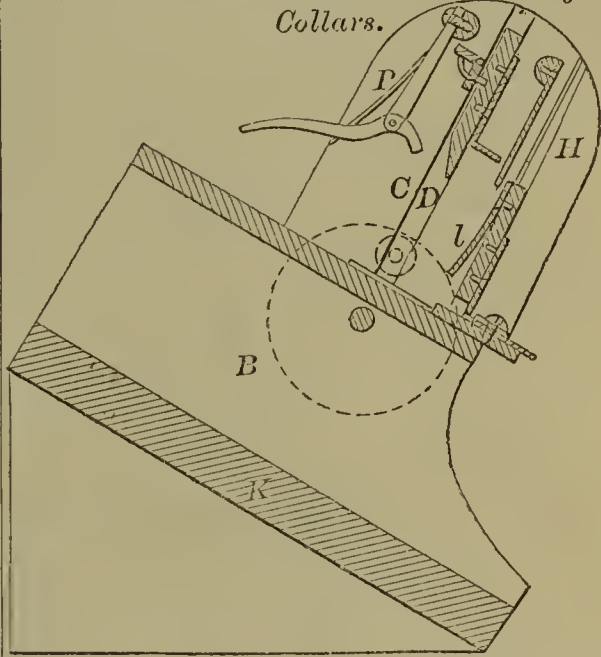

59684—H. Tucker—Venting  
Core for Foundry Purposes.

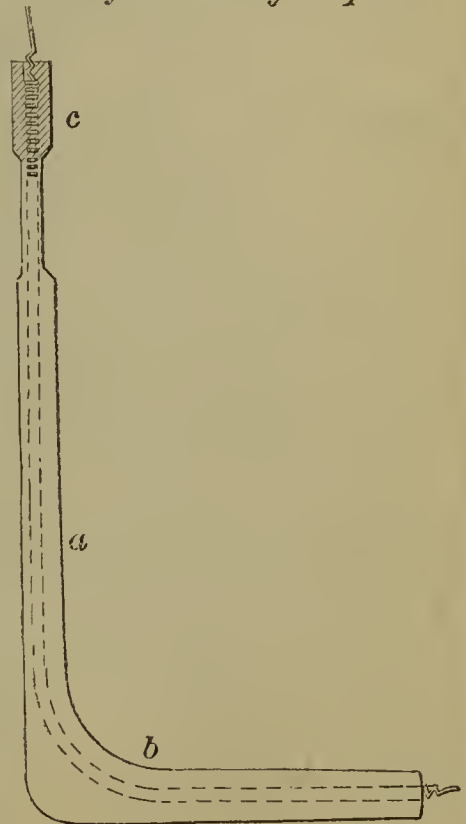

59679—S. C. Talcott—Elastic  
Button Hole for Carriage  
Curtains.

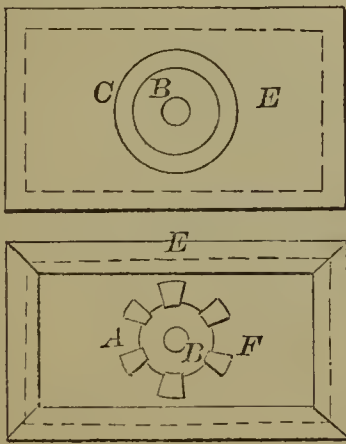

59678—G. W. Storer—Tag or  
Label.

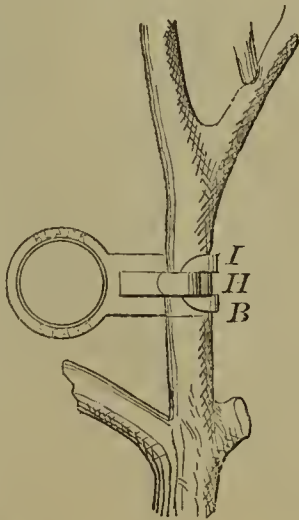

59685—E. B. Van Winkle—Station Indicator for Railways.

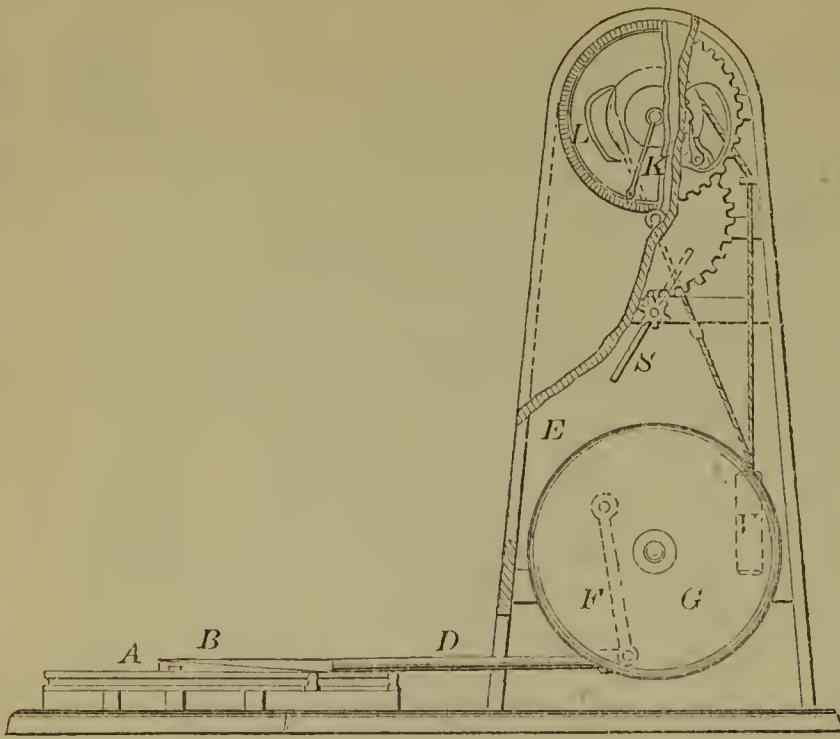

59686—A. W. Von Schmidt—Steam Propeller for Boats.

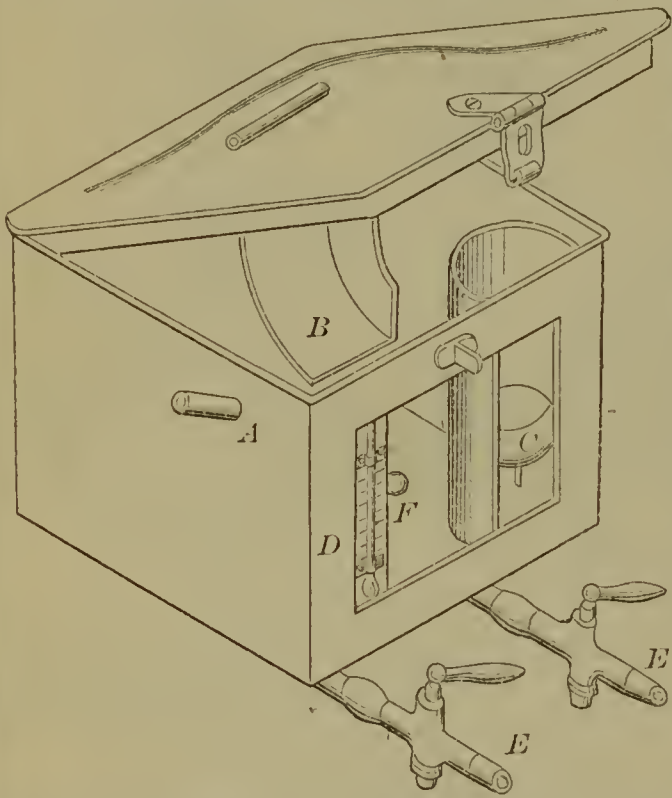
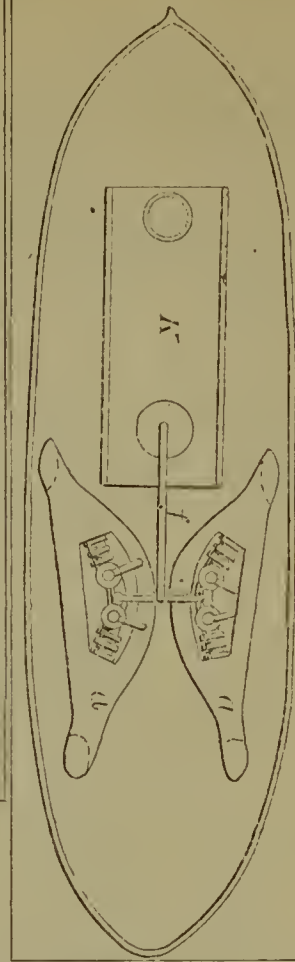

59688—W. J. Walker—Apparatus to be attached to Stills to prevent frauds on the Revenue.

59689—H. Weed—Suspension Device for Lamps, &c.

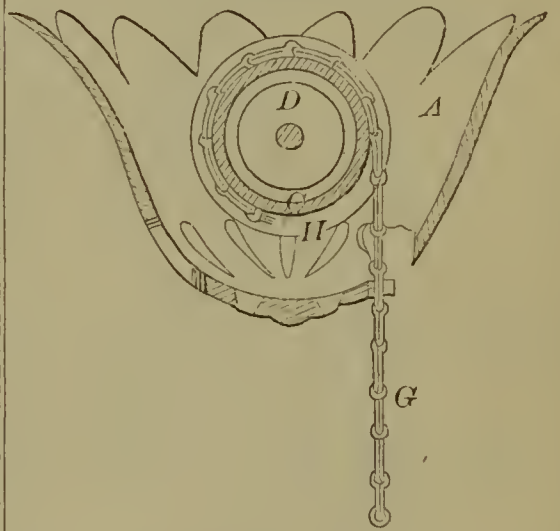

59690—D. Wernz—For Preserving Beer while on Draught.

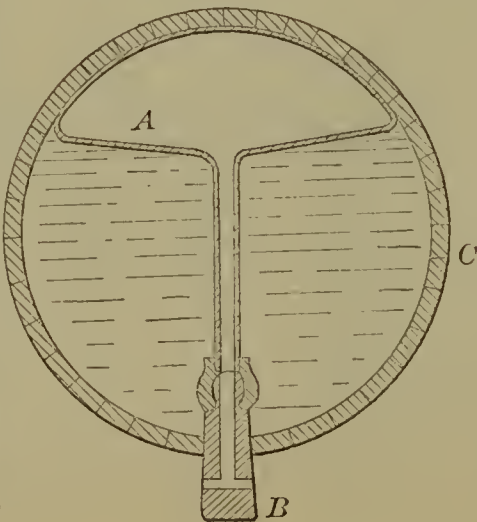

59687—Waldstein & Fausky—Vessel for Cooling Liquids.

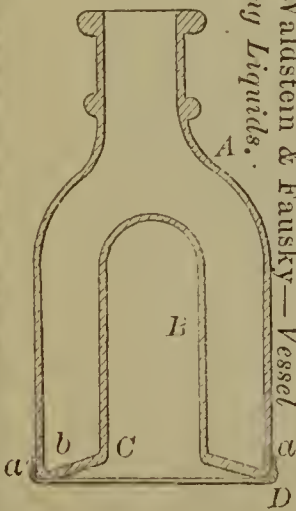

59691—H. P. Westcott—Churn.

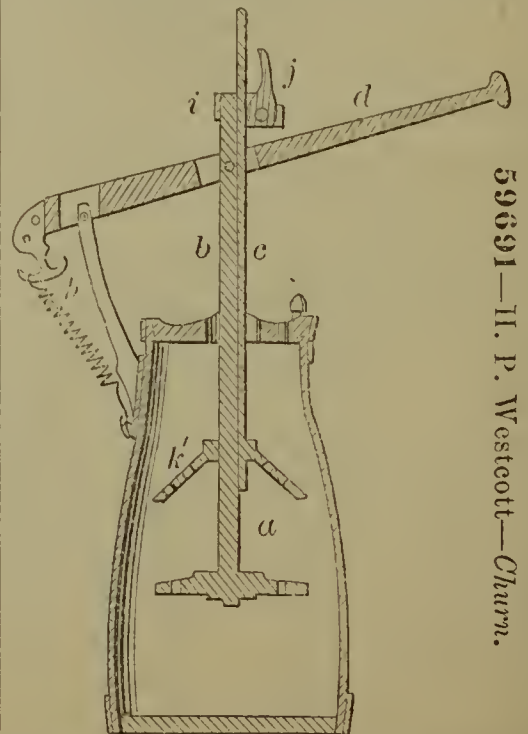

59692—J. S. Wheat—For *Fleshing and Stor' of Hides and Skins.*

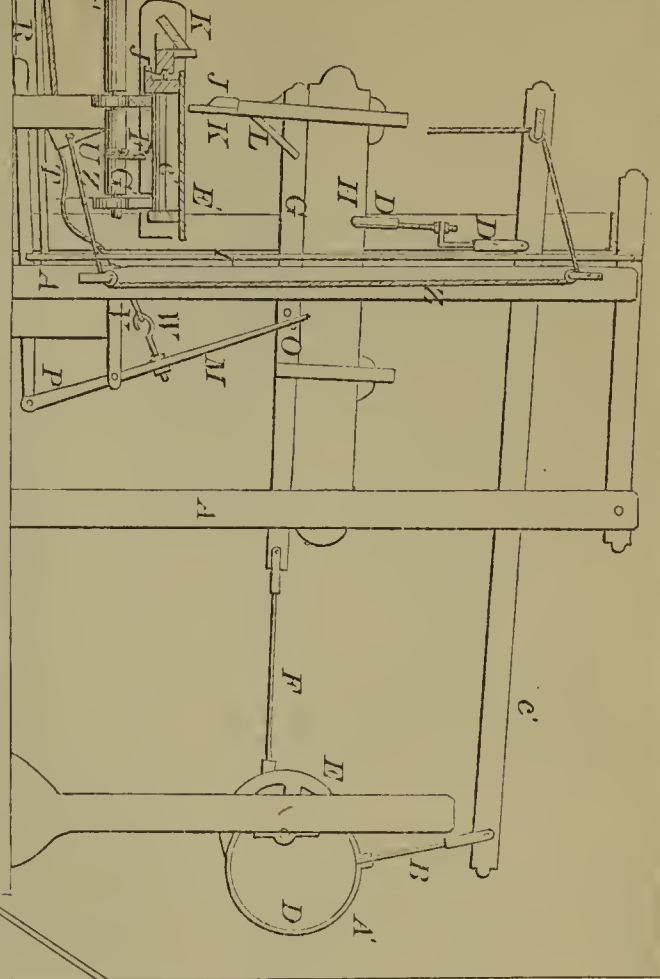

59696—Whepley & Storer—For *Obtaining Metals and other Products from Ores and Minerals.*

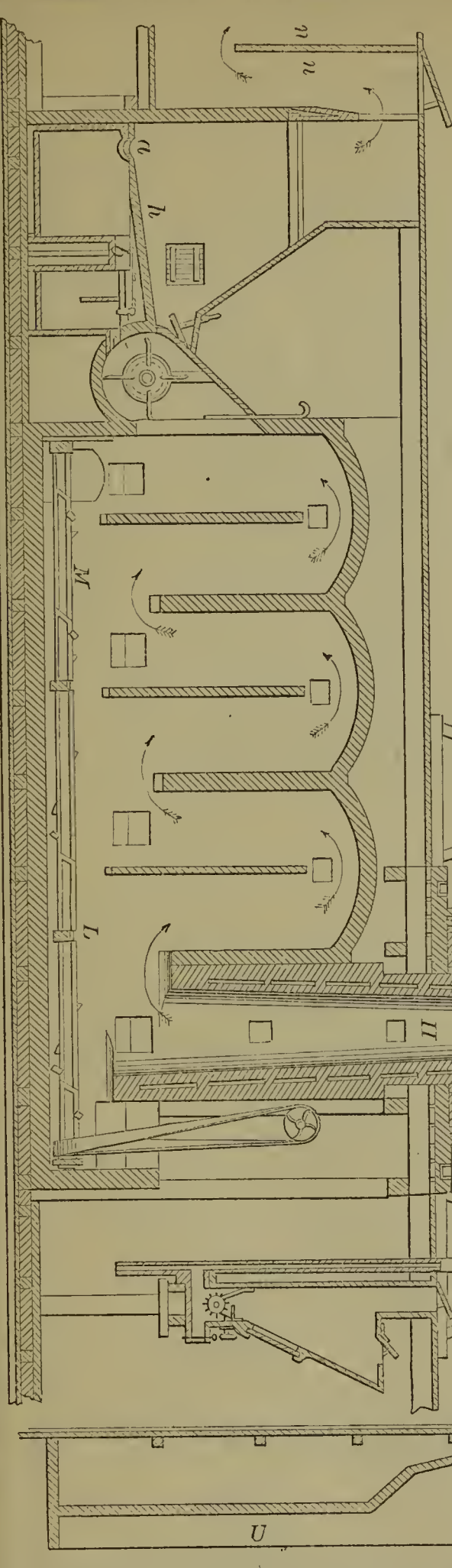

59685—Whepley & Storer—For *Feeding Fuel to Furnaces.*

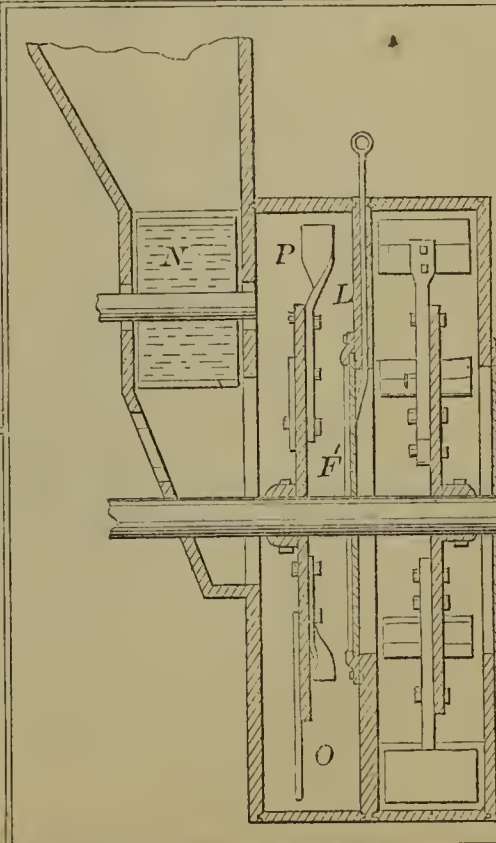

59687—S. B. Whiting—*Rope Driving Machine.*

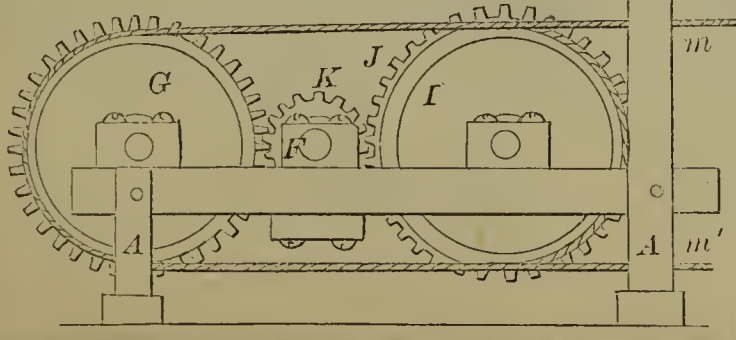

59698—S. M. Whitney—  
Cultivator Coupling.

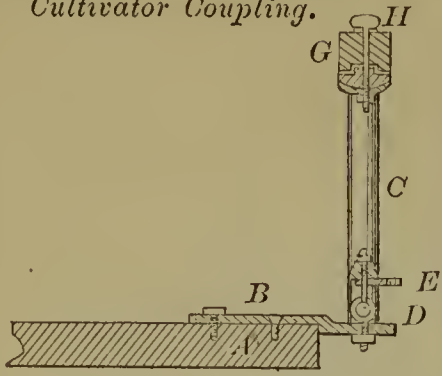

59703—R. M. Yorks—Corn Planter.

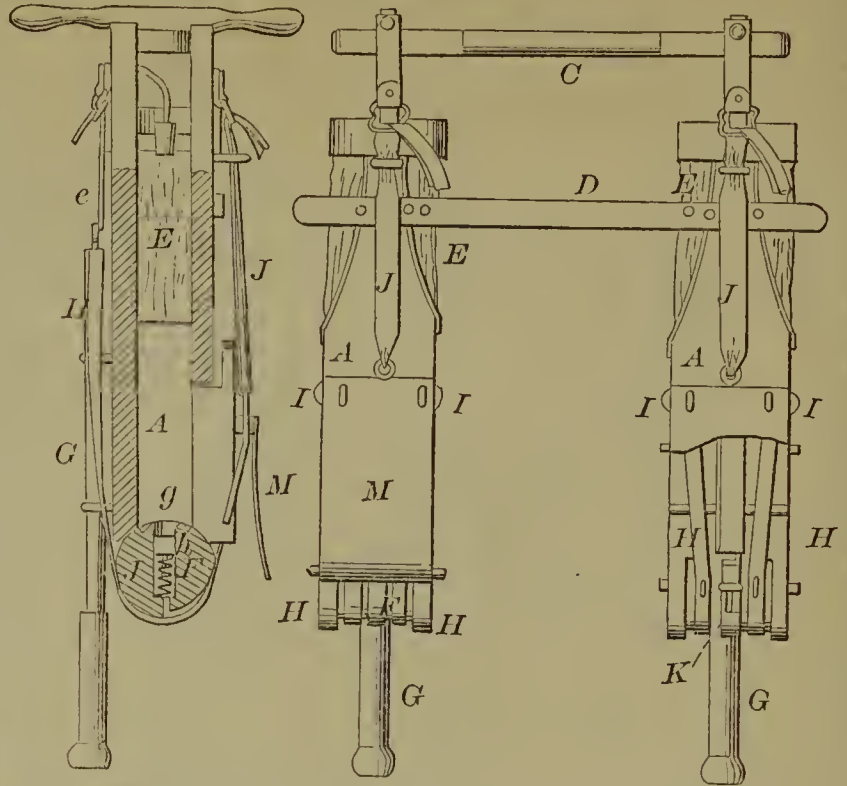

59700—J. H. Williams—  
Cider Mill.

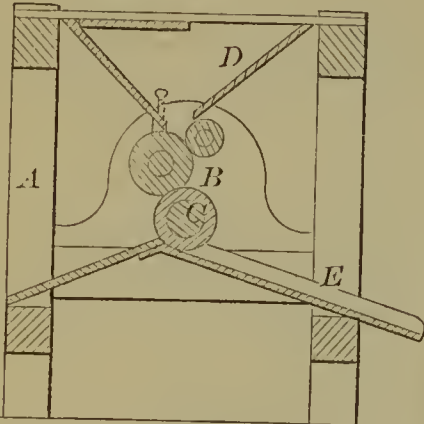

59706—P. Bourdreaux—Breech-Loading Fire Arm.

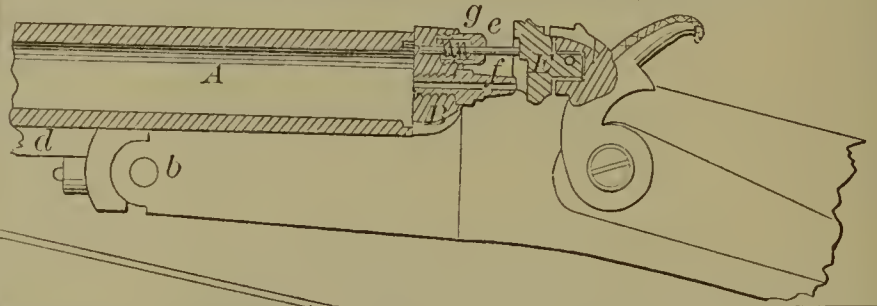

59702—R. Wilson—Gas  
Pipe Joint.

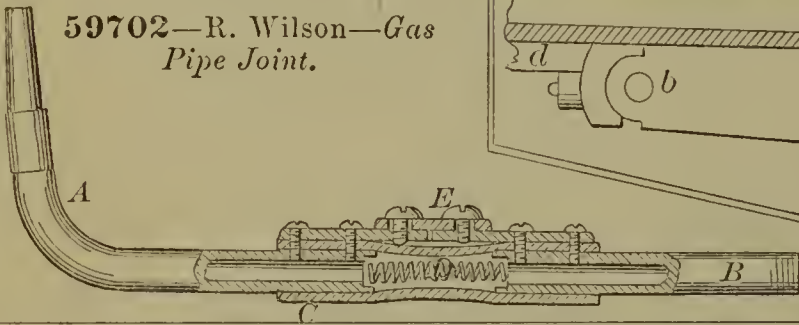

59699—G. Williams—Fruit Jar.

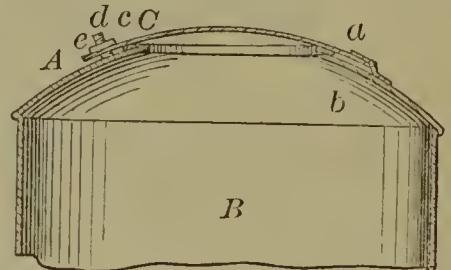

59701—Williamson & Richardson—Rolling Pin, &c.



59705—L. F. Betts—Lantern.

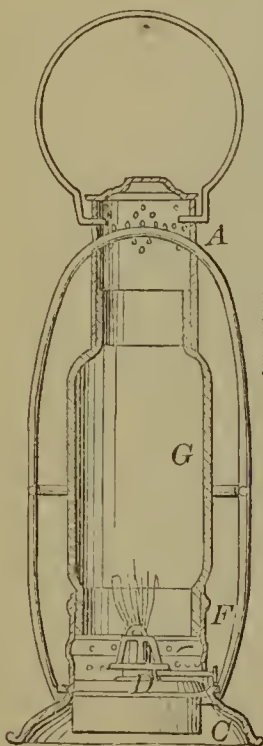

59704—J. K. Andrews—Lamp Burner.

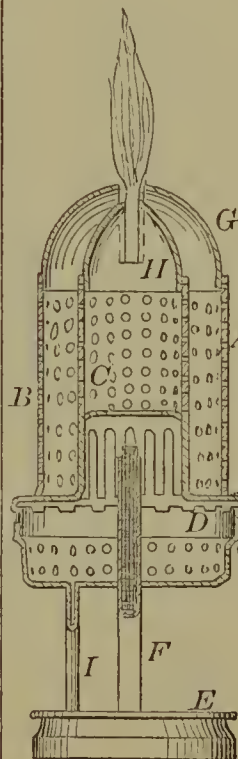

59707—S. Boyden—Hat Blocking Machine.

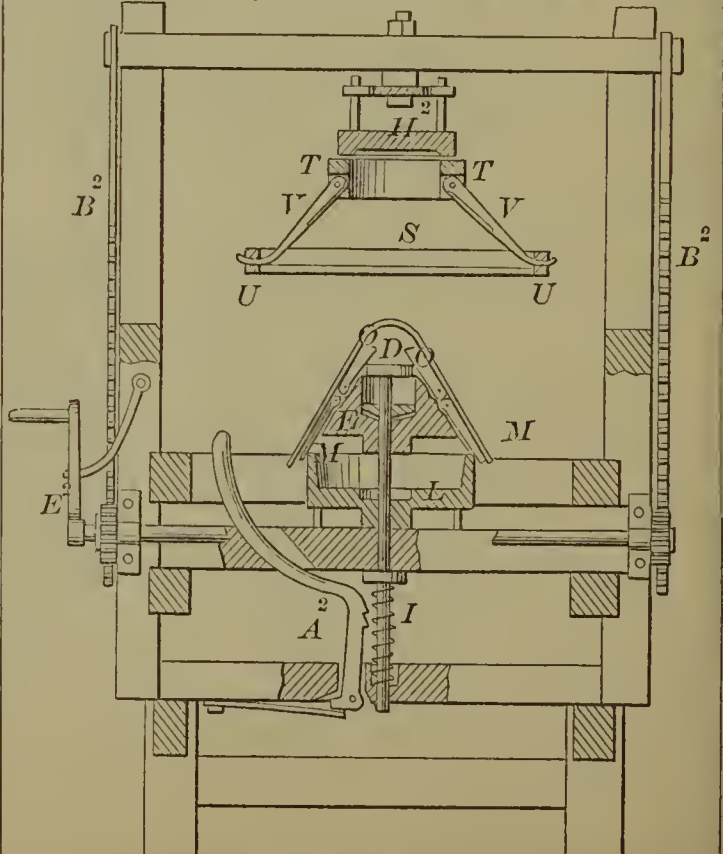

59708—J. W. Cahill—*Pump.*

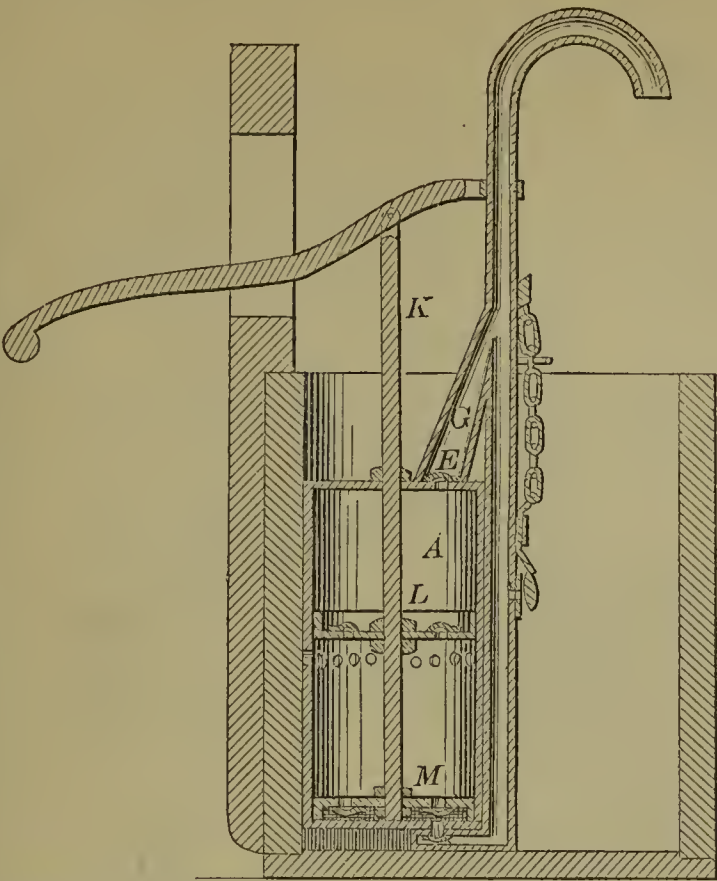

59709—F. M. Carnes—*Shoe and Stove Brush.*

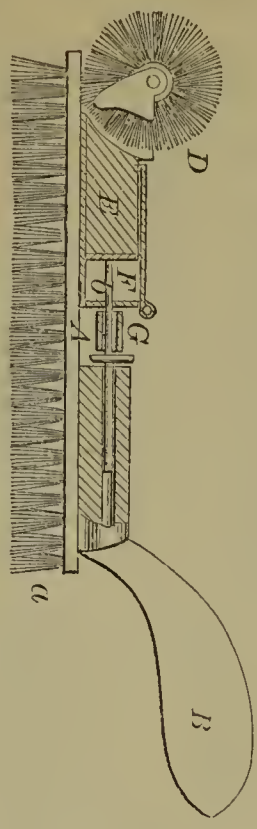

59711—T. B. De Forest—*Hoop Skirt Wire.*



59710—W. B. Chapman—*Horse Holder*

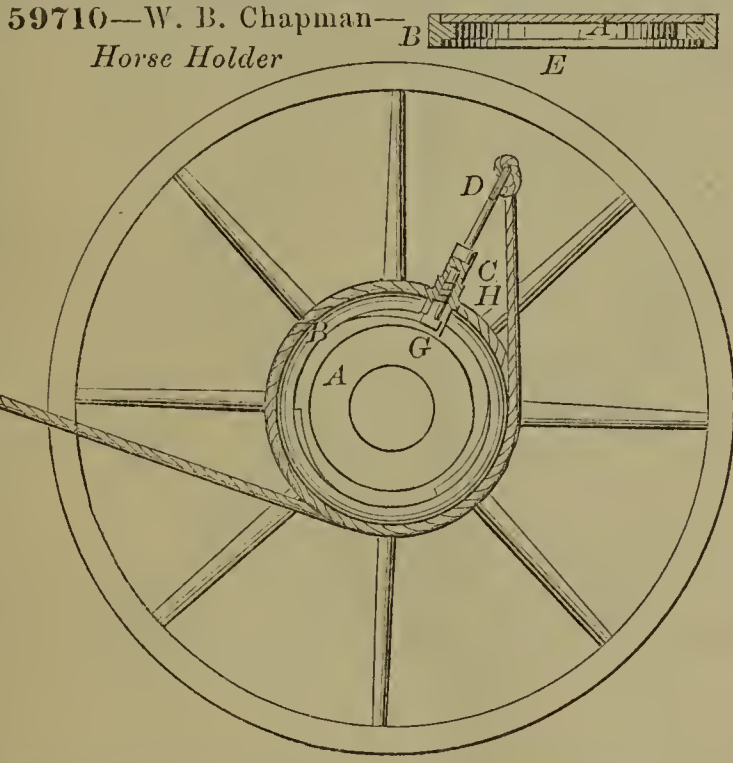

59712—H. N. Degraw—*Boot Jack.*

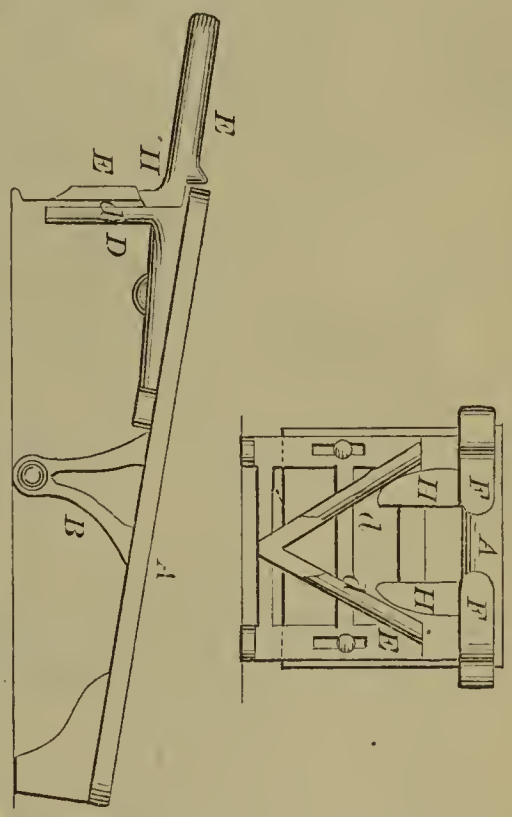

59715—W. Duchemin—*Sewing Machine for Sewing Soles, &c.*

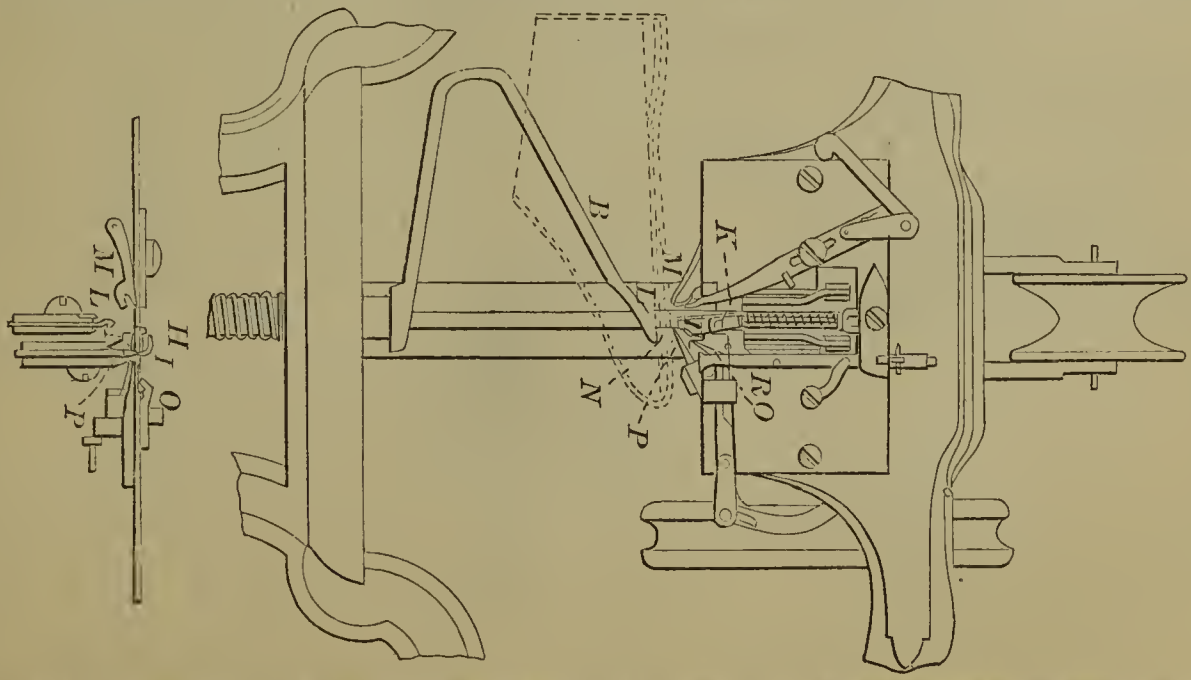

59716—J. B. Fontaine—*Hollow Pressure Plate.*

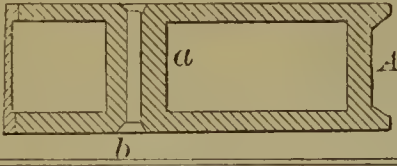

59721—E. C. C. Kellogg—*Gauge for Determining Angles.*

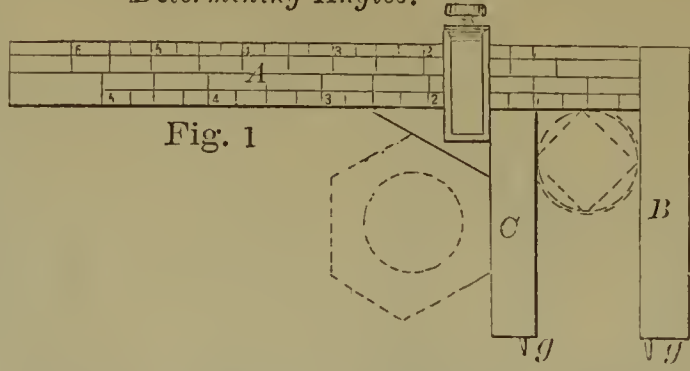
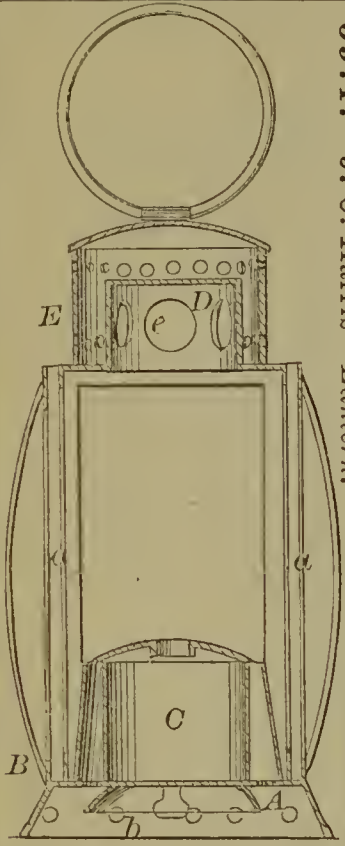

Fig. 1



59718—C. W. Holland—*Knob for Carriage Curtains.*

59717—J. O. Harris—*Lantern.*



59723—W. H. Miller—*Breech-Loading Fire Arm.*

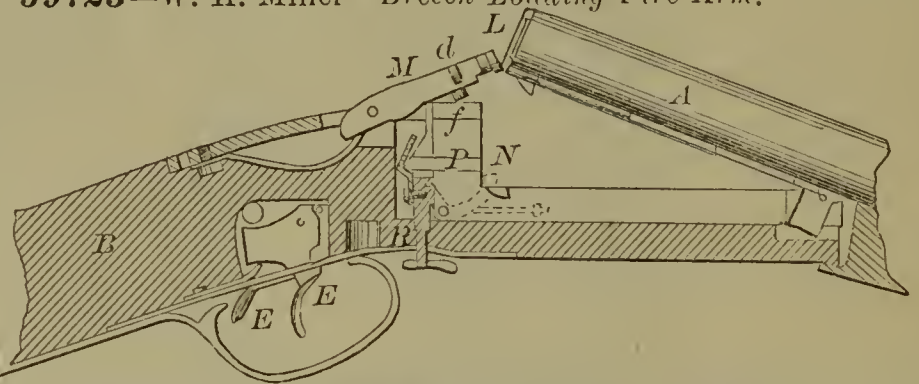

59720—H. C. Hunt—*Cultivator.*

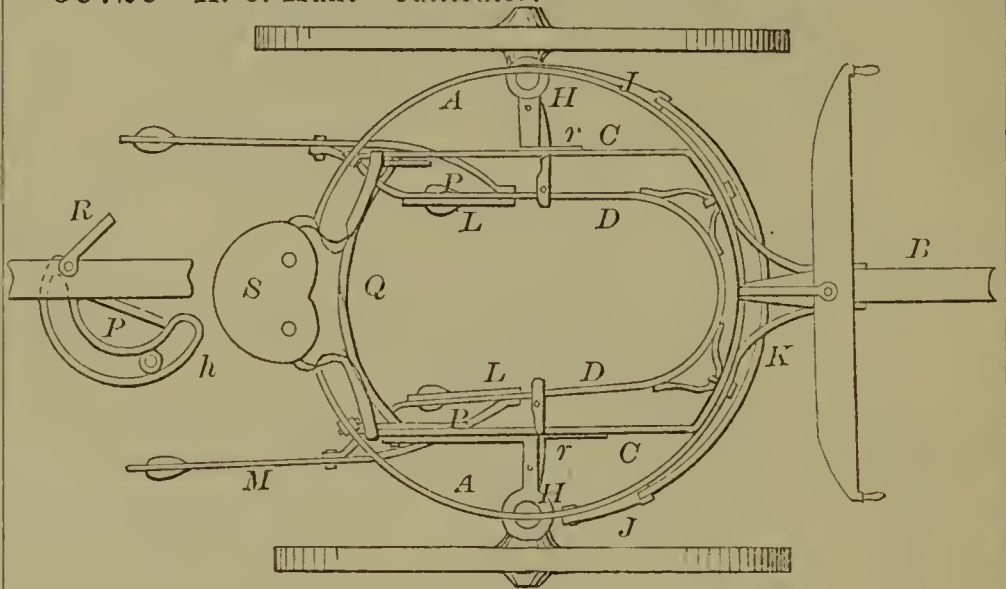

59719—A. J. Holmes—*Picture Frame.*



59726—Schrick & Hildenbrand—*For Filling Horse Collars.*

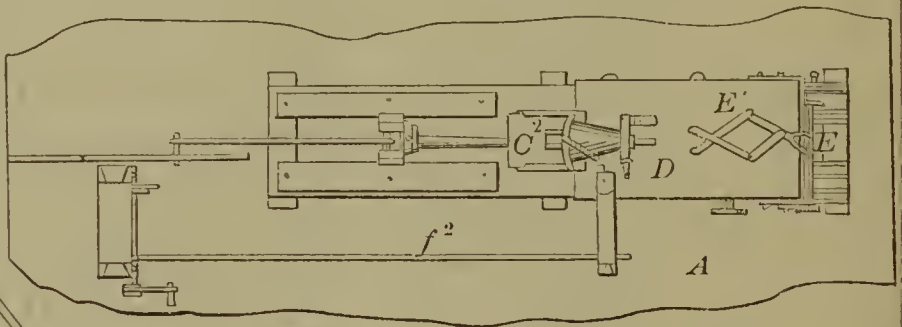

59725—J. I. Peyton—*Horse Shoe.*

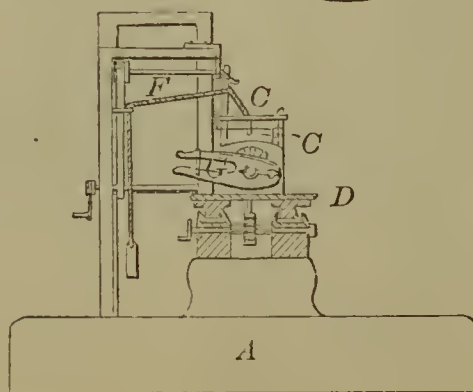
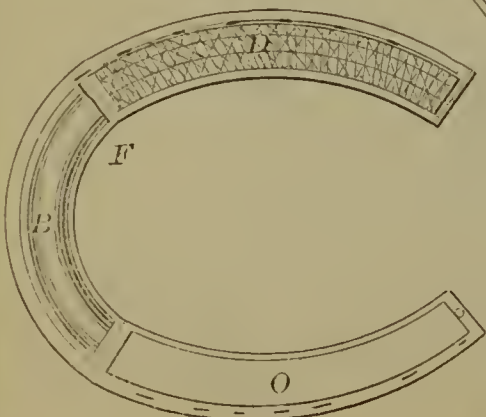

59727—Schrick & Hildenbrand—  
*Stretching Horse Collars.*

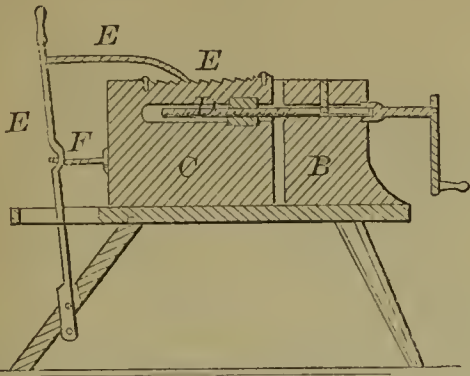

59728—T. S. Smith—  
*Carriage Shackle.*

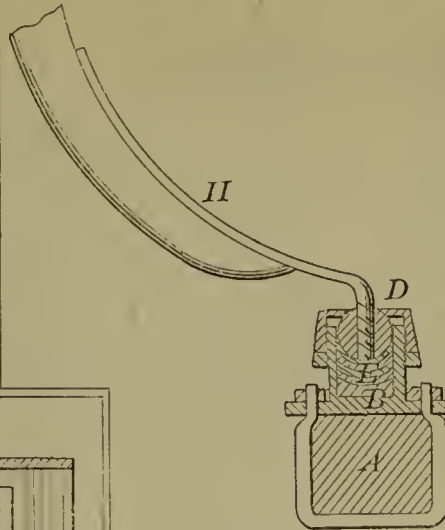

59735—W. Hugo—  
*Umbrella.*



59730—A. Tanner—  
*Constructing Buildings.*

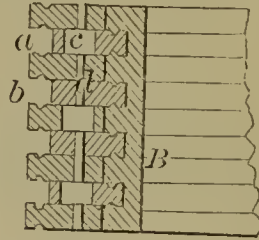

59729—D. Strunk—  
*Wind Mill.*

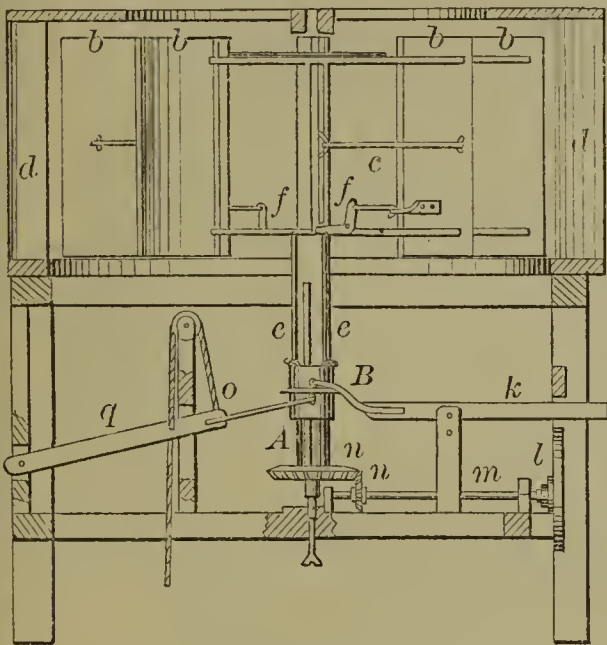

59733—T. Wright—  
*Broom.*

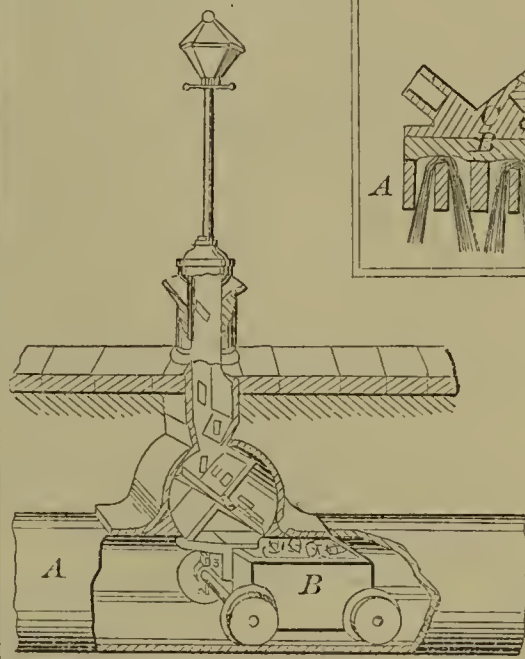
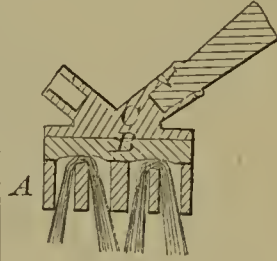

59739—A. E. Beach—  
*Receiving and  
Delivering Letters, Parcels, etc.*

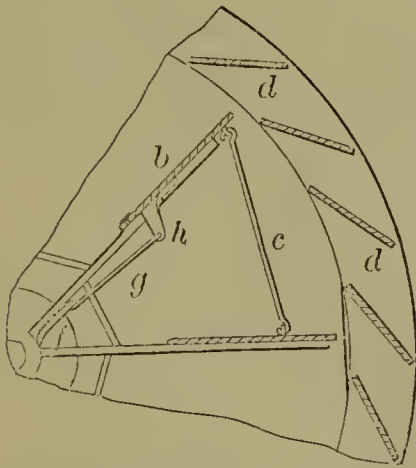

59738—H. Wilde—  
*Magneto-Electric  
Machine.*

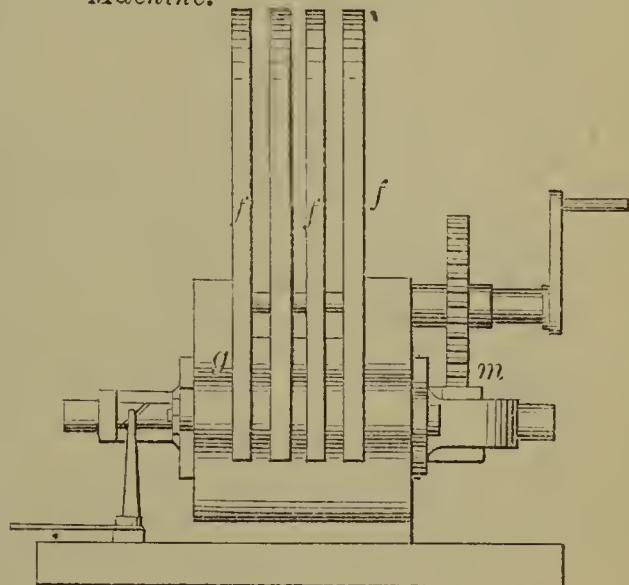

59732—S. West—  
*Baking Pan.*

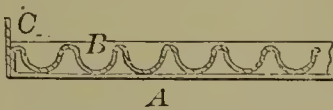

59731—J. Turner—  
*Adjustable  
Nut Box.*

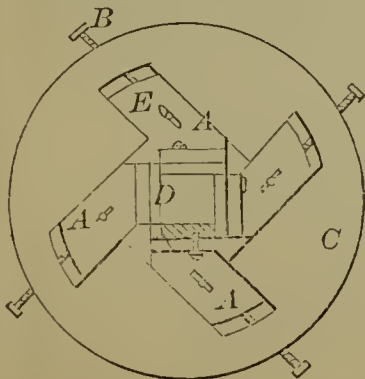

59737—G. L. Turney—  
*Needle  
Case.*

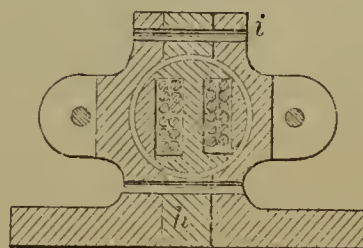

59742—W. R. Butler—Corn Planter.

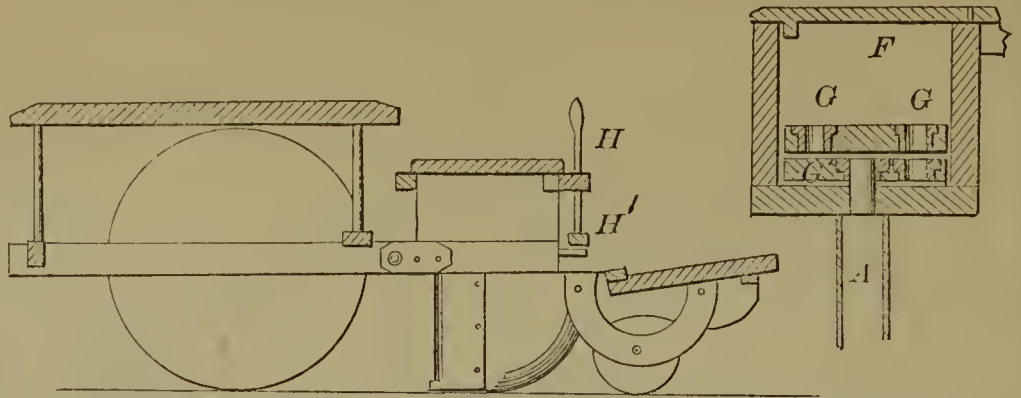

72740—P. Ainsworth—Well Drill.

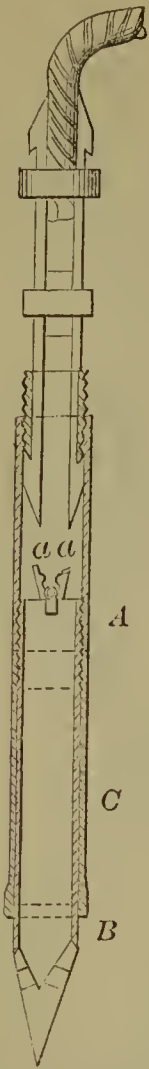

72741—Burton & Covert—Filing Machine.

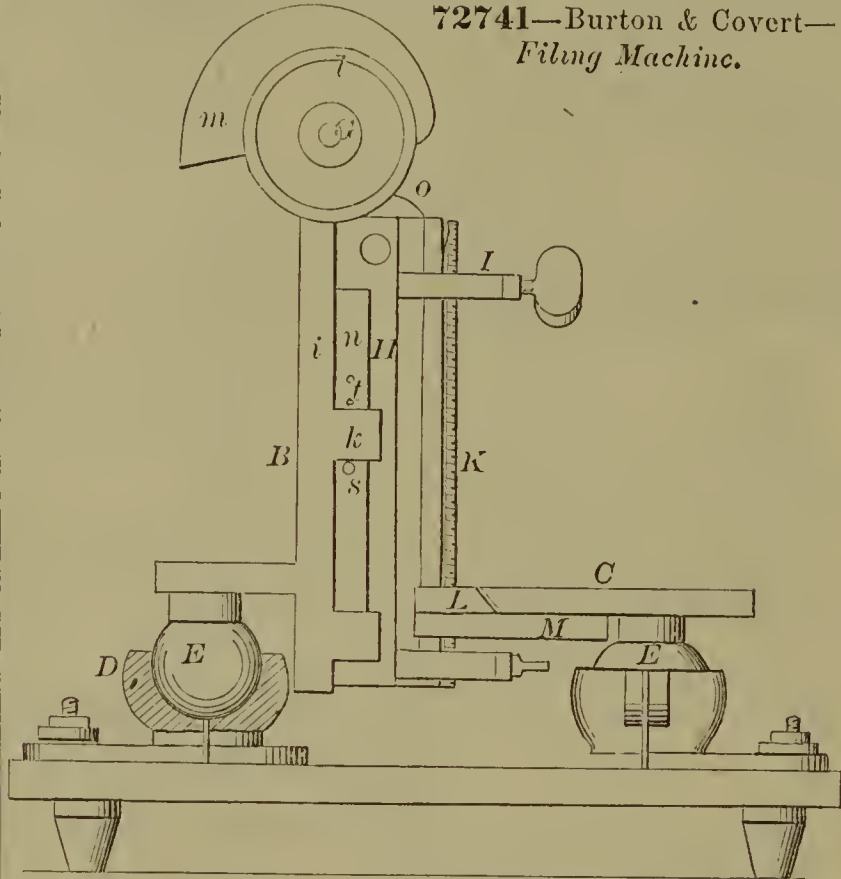

72745—Haven & Hettrick—Bandalore.

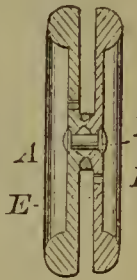

59747—F. S. Packard—Stone Sawing Machine.

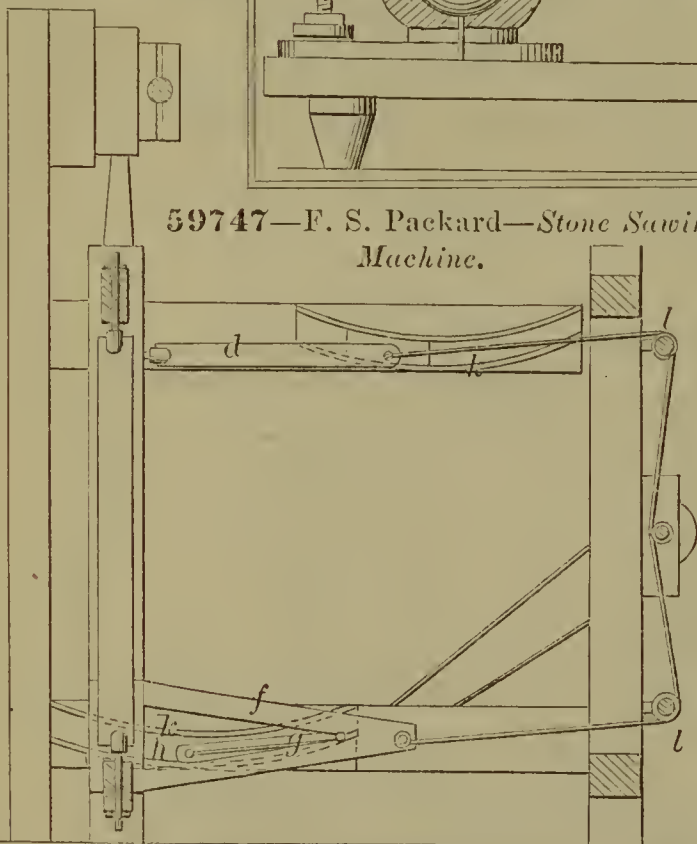

59746—E. E. Kilbourn—For Sewing the Seams of Looped Fabrics.

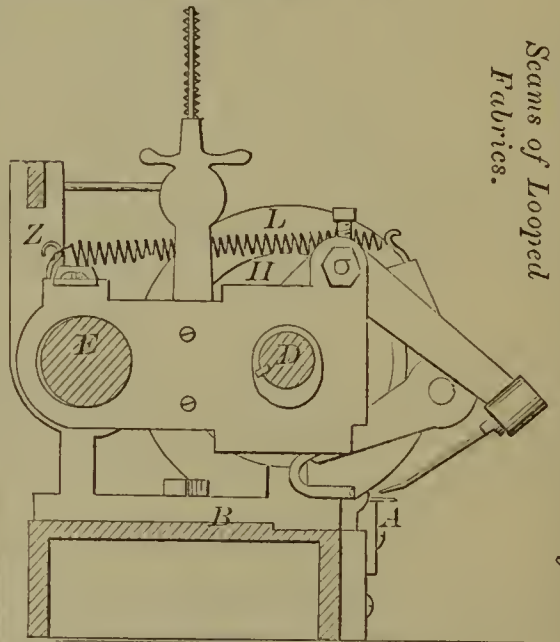

72743—I. J. Gray—Gate.

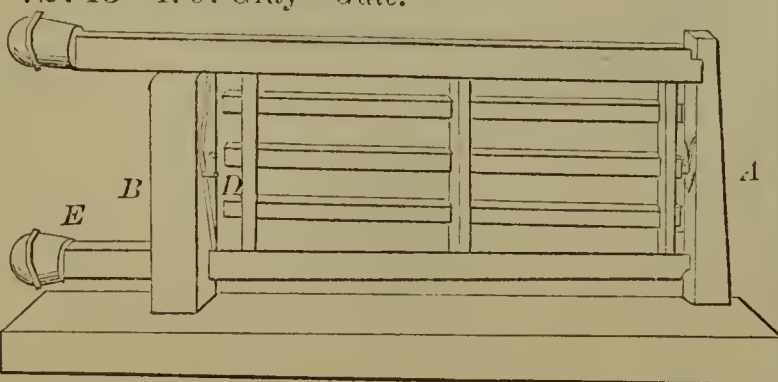

59744—R. Harper—Manufacture of Hoes.

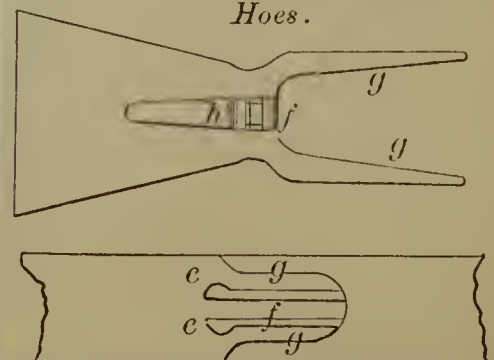



59748—S. G. Rice—Tobacco Press and Cutter.

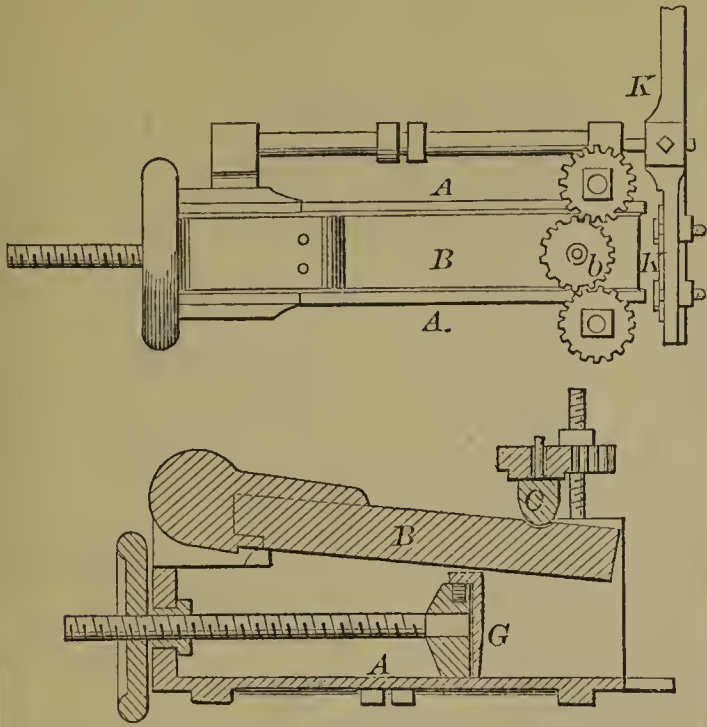

59754—A. Barbarin—Lighting Gas.

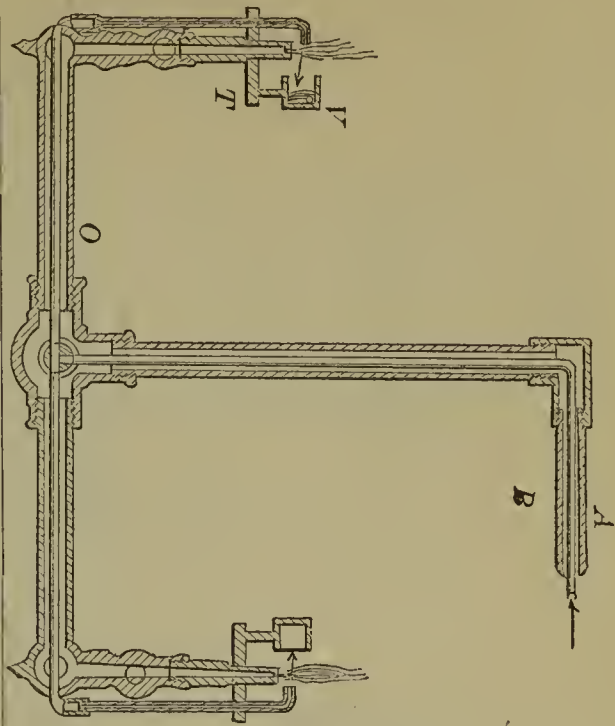

59752—G. E. Whitmore—Stop Valve for Steam Pipes.

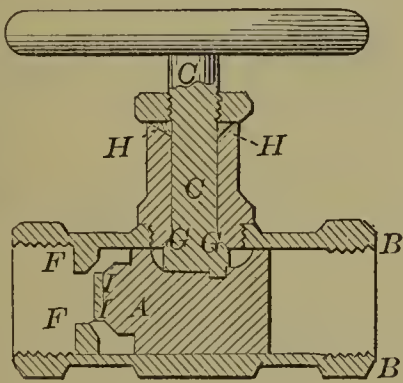

59753—G. W. Balding—Gate and Gate Post.

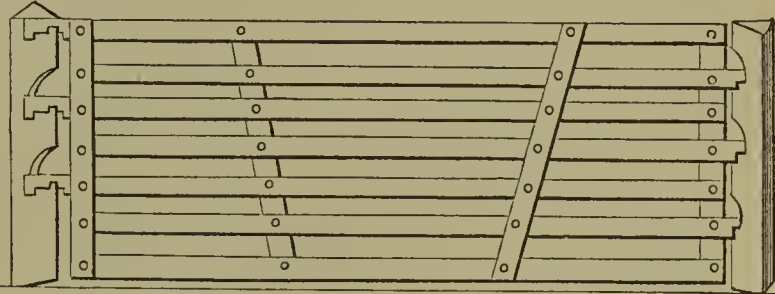

59757—C. W. Bioren—Tool Handle.

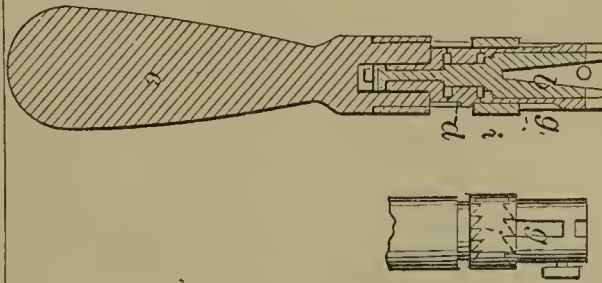

59758—J. W. Blackham—For Felting Hat Bodies.

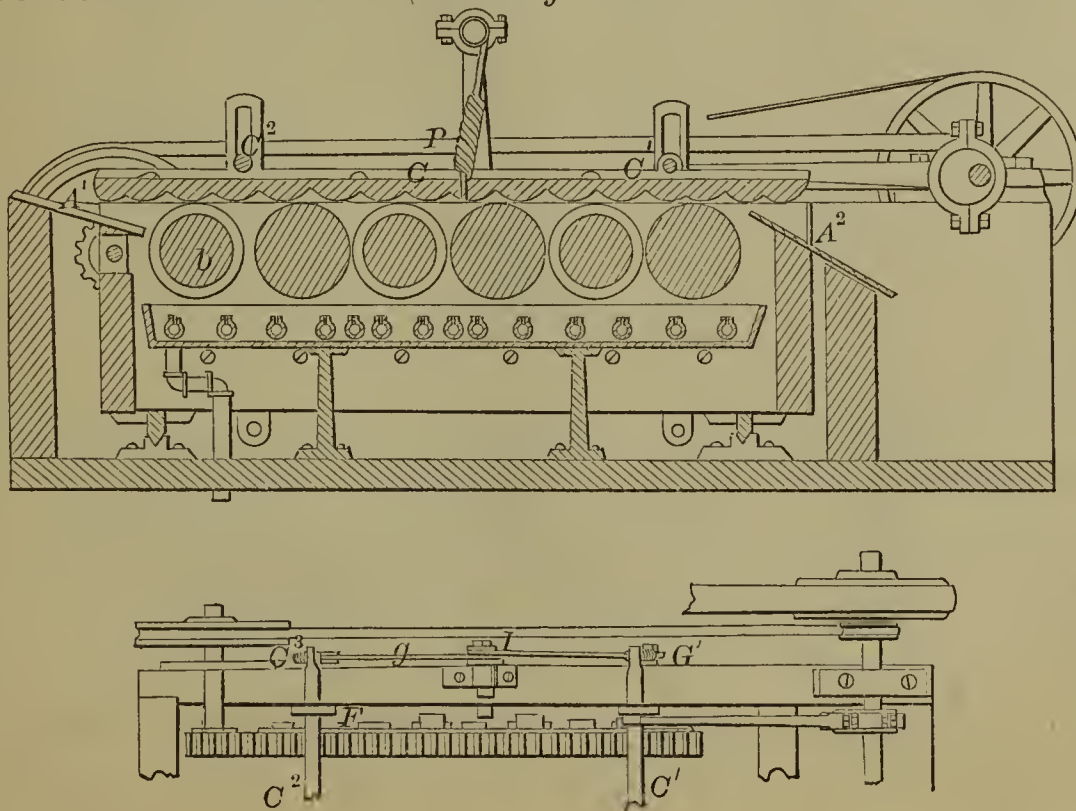

59755—H. J. Batchelder—Horse Shoe Blank.

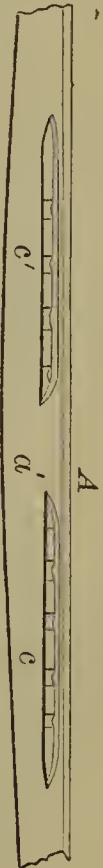

59759—J. C. Bodine—Churn.

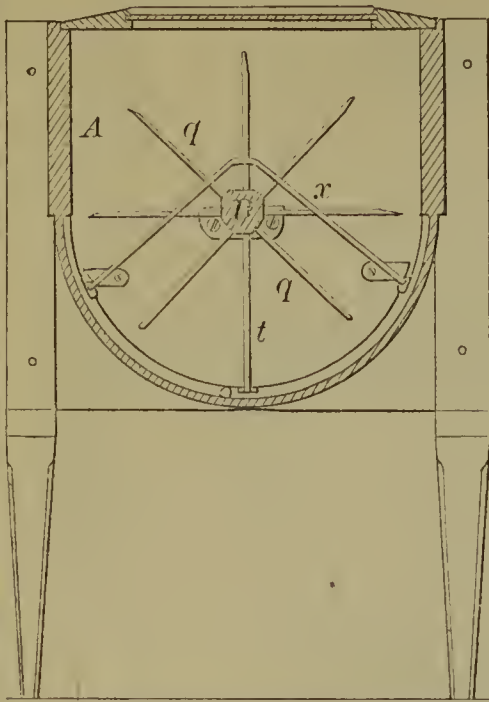

59760—U. Cummings—Lime Kiln.

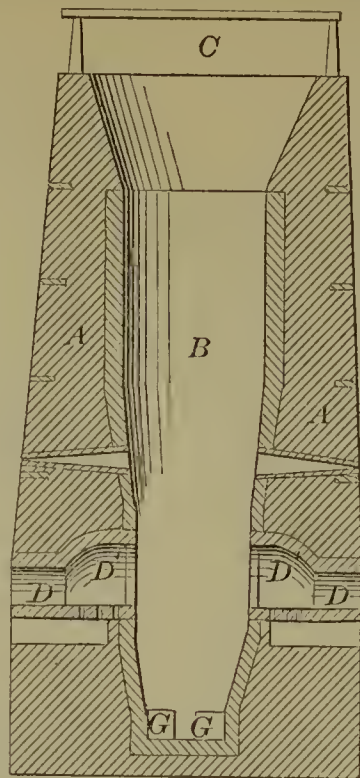

59761—E. K. Dutton—For Measuring Liquids.

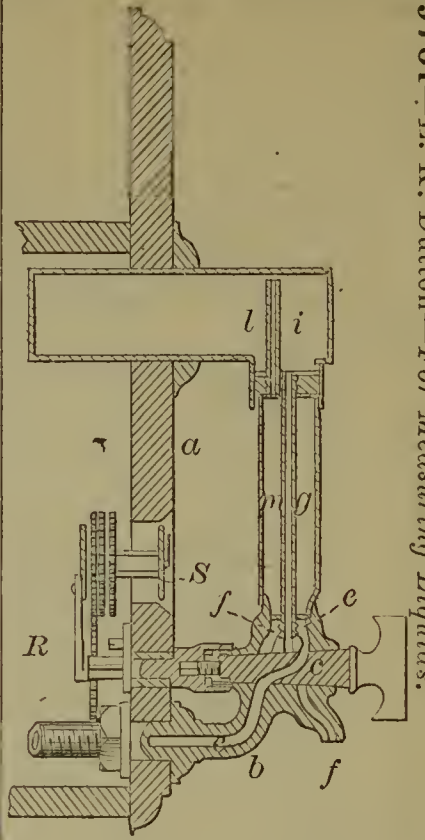

59763—Farmer & Milliken—Telegraph Line Wire.

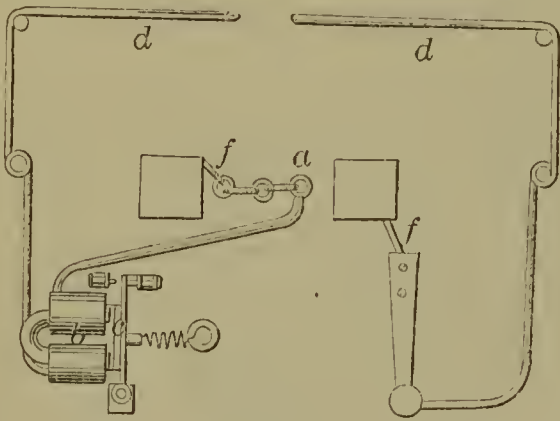

59765—Fell & Phifer—Cotton Seed Planter.

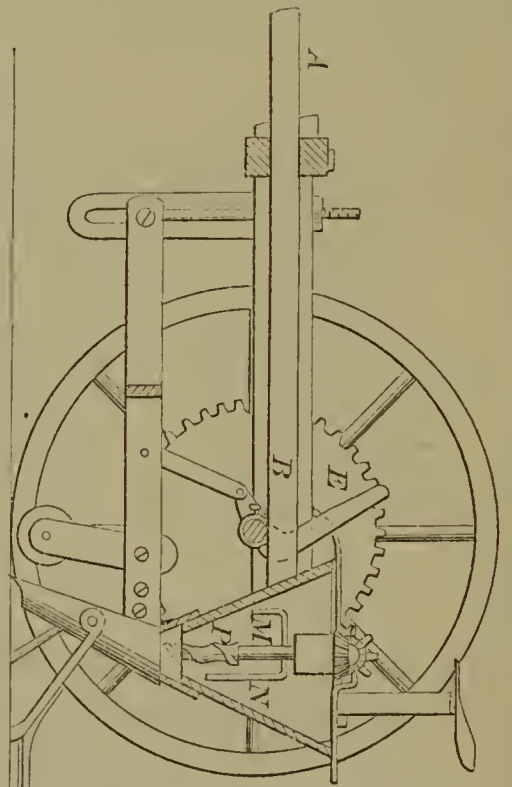

59762—S. F. Estell—Animal Trap.

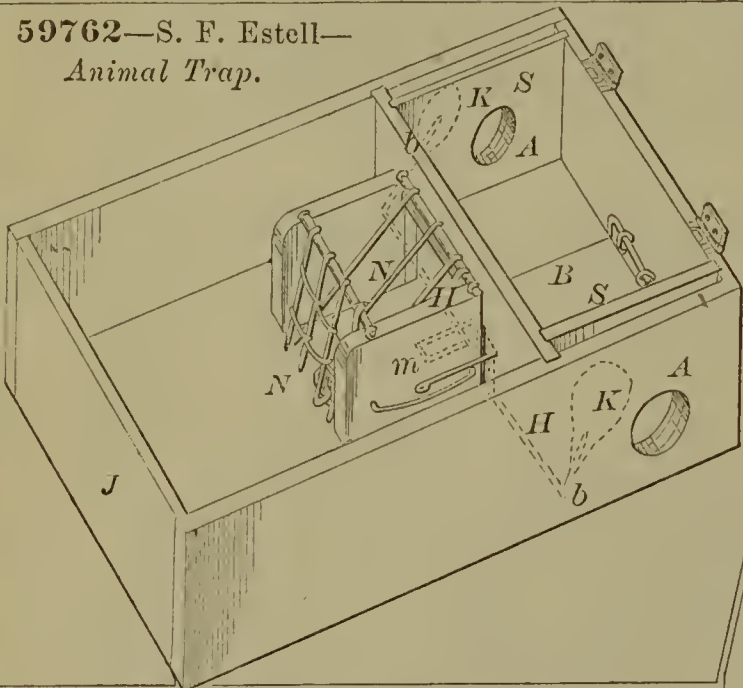

59764—C. M. Farrar—Lock-up Safety Valve.

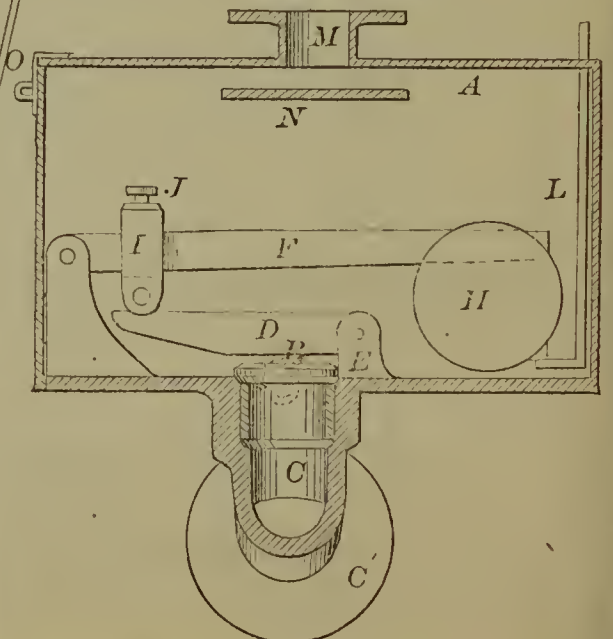

59766—C. A. Harper—Coal Oil Store.

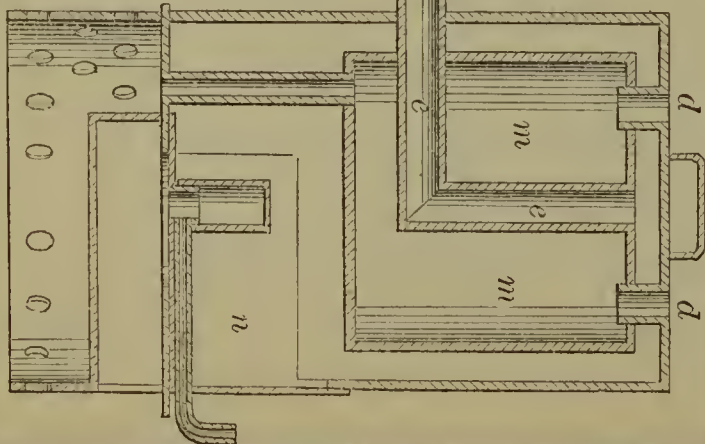

59767—J. J. & E. Harrison—For Operating the Shuttles in Looms.

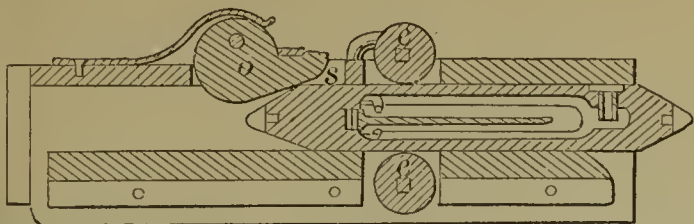

59768—A. T. Hay—For Preventing Incrustation of Steam Boilers.

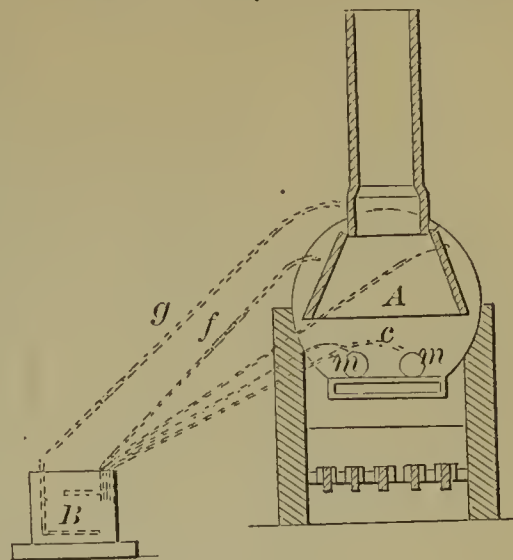

59772—A. Judson—Lamp Burner.

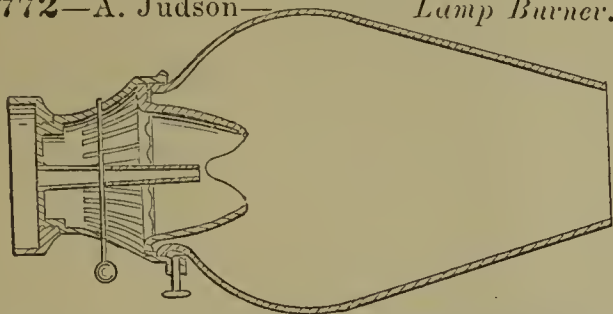

59769—G. P. Hethel—Truss Bridge.

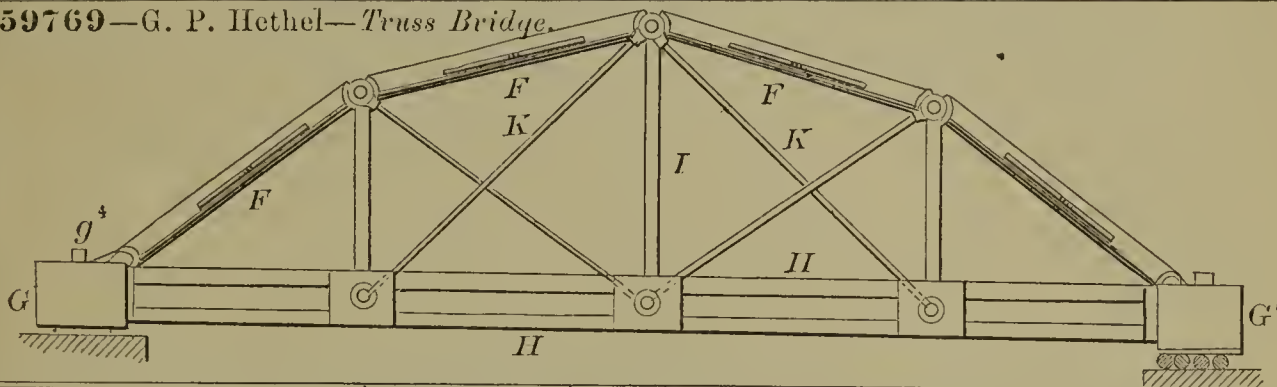

59770—J. Jann—For Sharpening Harvester Sickles.

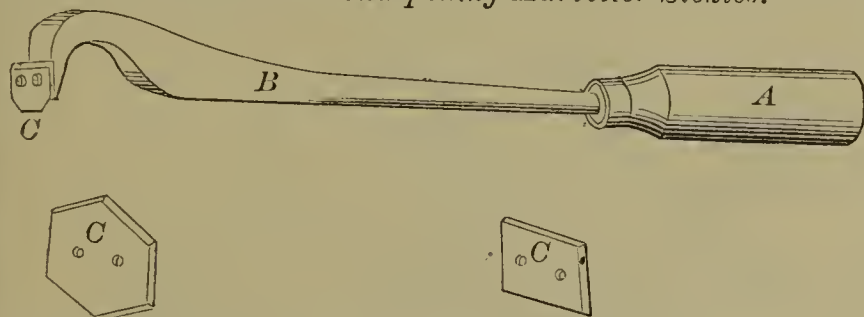

59778—J. C. Plumer—Die for Cutting and Pointing Wire.

Fig. 3

Fig. 4

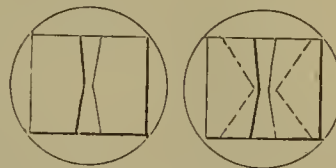

59773—S. R. Krom—For Separating Metals from Ores.

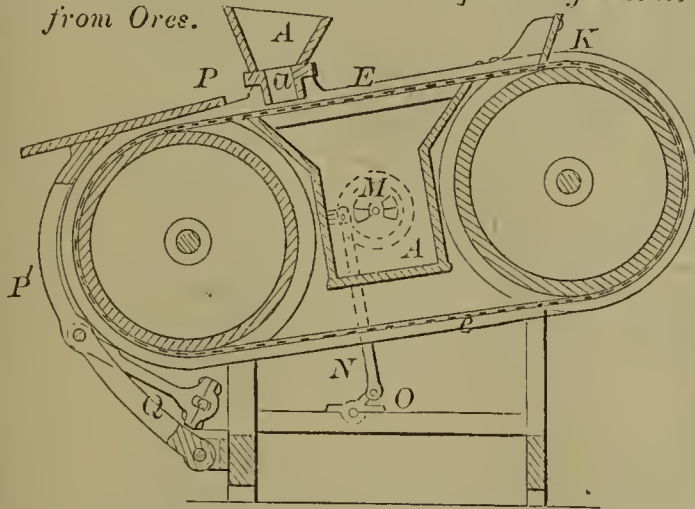

59775—J. S. Marsh—Coal Stove.

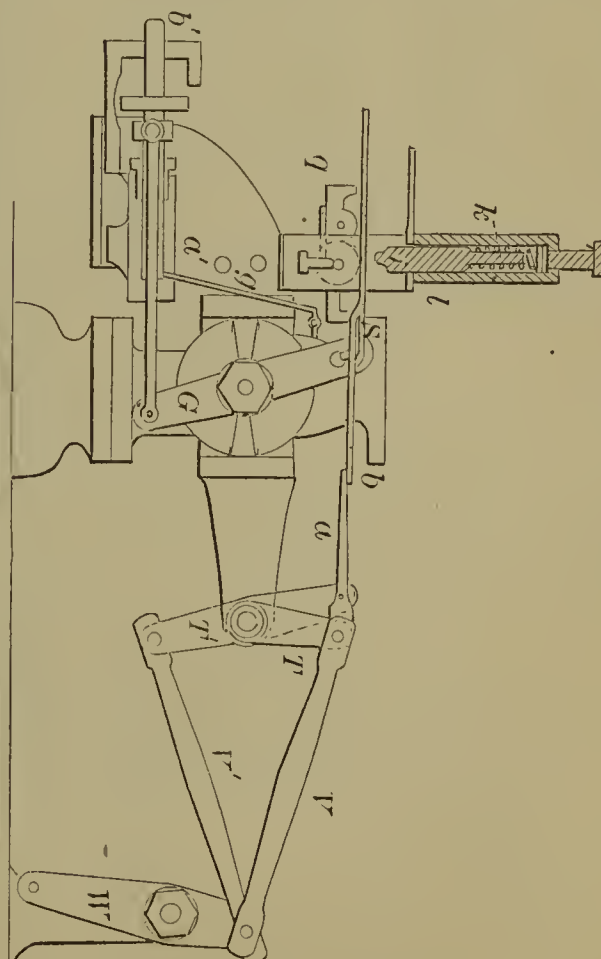
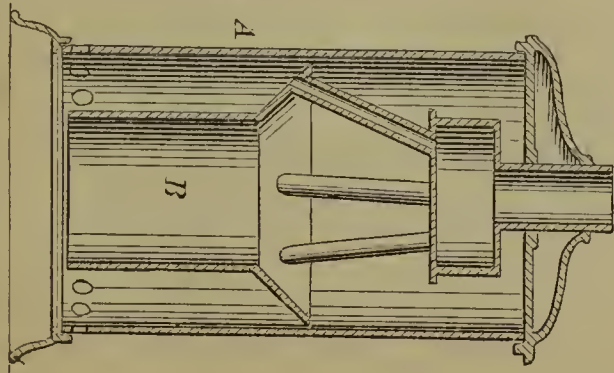

59777—W. G. Pike—Cut-off Valve Gear.

59779—S. S. Putnam—*Self-Lubricating Axle Box for Carriages.*

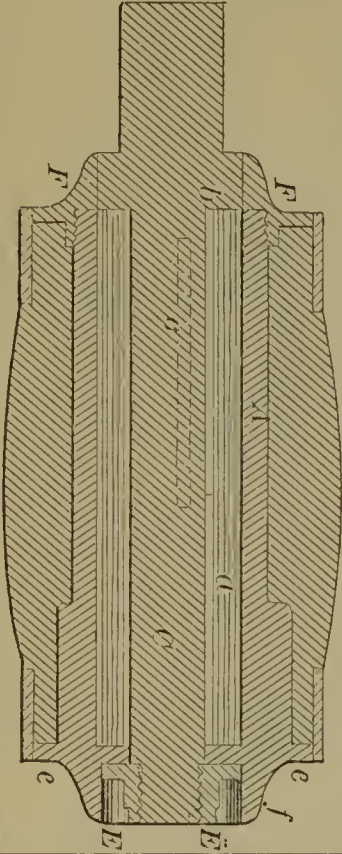

59780—E. Reynolds—*Steam Generator.*

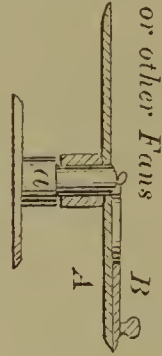
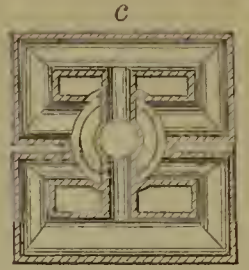
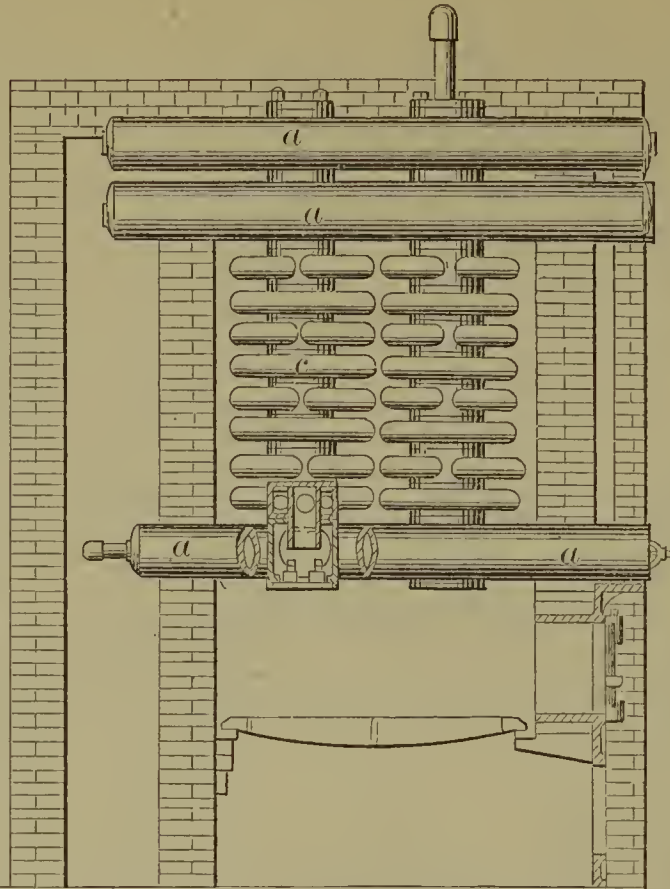

59783—R. T. Smith—*For Binding Circular Paper or other Fans*

59781—J. T. Rittenhouse—*Churn Dasher.*

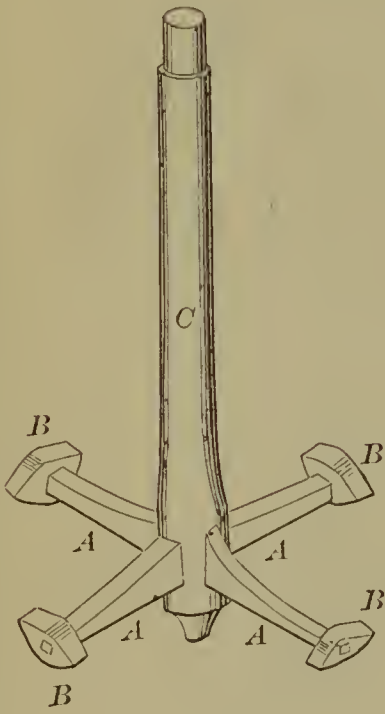

59782—W. Shoupe—*For Obtaining Oil from Wells.*

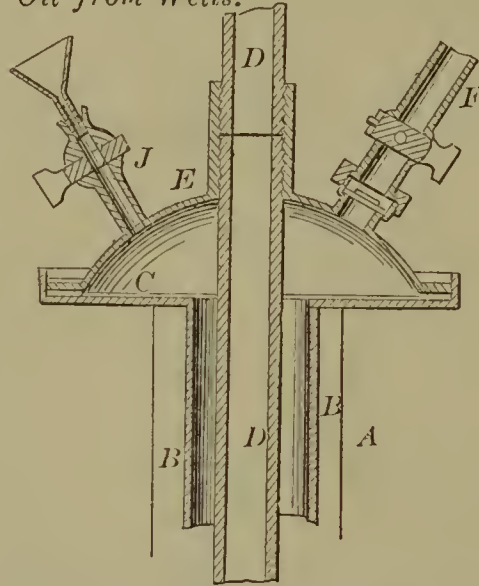

59784—Snow & Lewis—*Dental Plugging Instrument.*

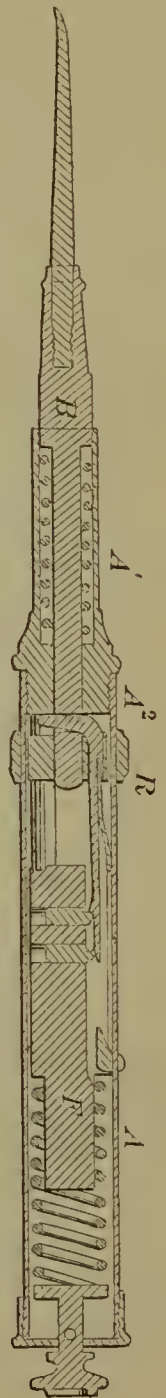

59785—J. J. Tobey—*Scissors Sharpener.*

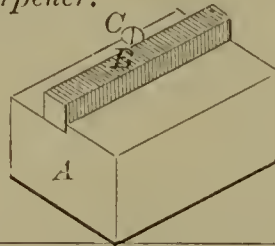

59786—E. Van Gieson—*Type Separator.*

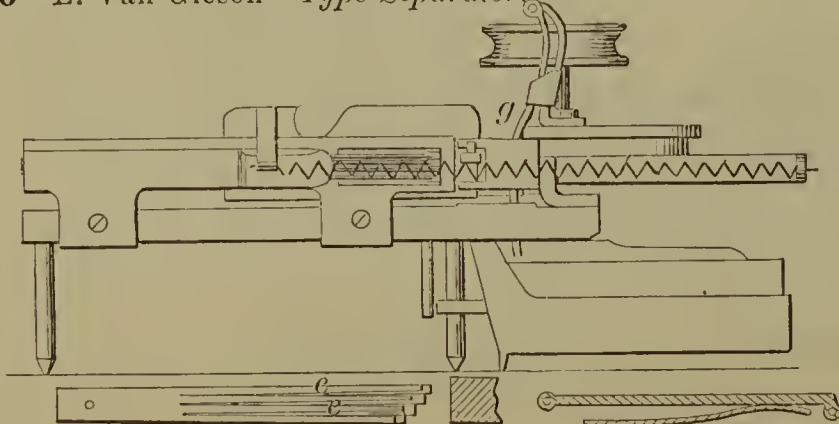

59788—J. & W. Yewdall—For Washing and Drying Wool.

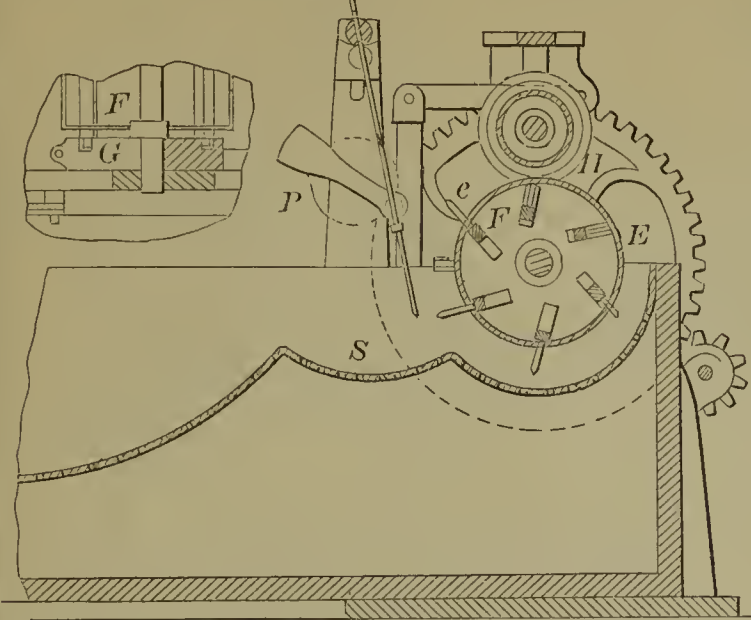

59790—J. Davis, 2d—Churn.

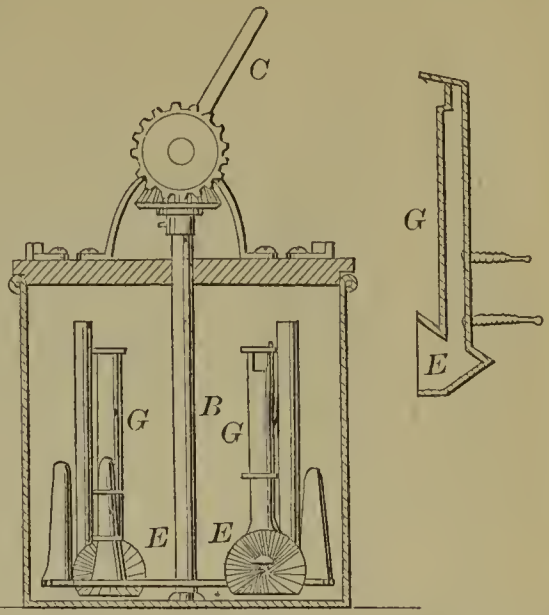

59789—S. Albertson—Adjustable Damper for Fireplaces.

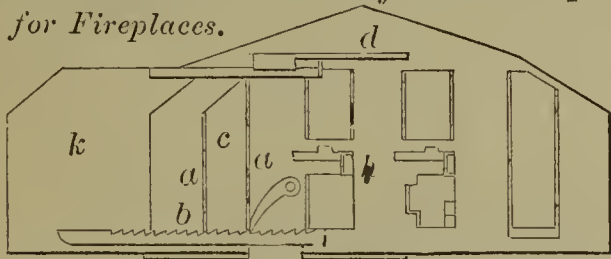

59793—D. Drawbaugh—Faucet.

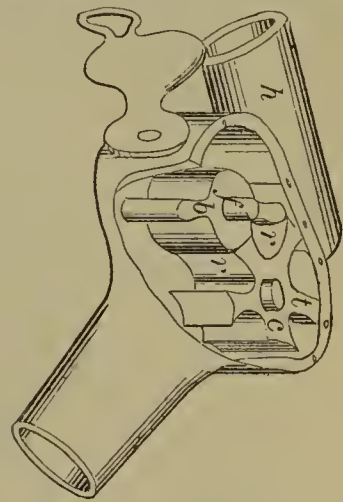
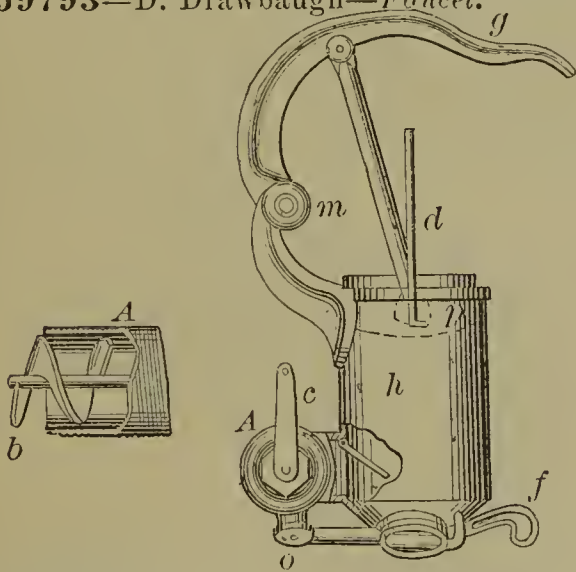

59792—D. Drawbaugh—Faucet.

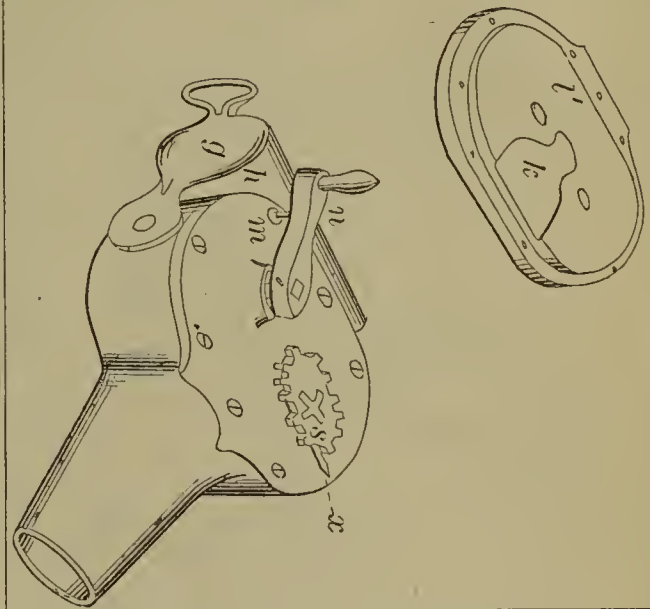

59794—W. H. Elliot—Bedstead Fastening.

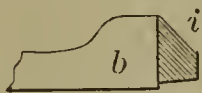
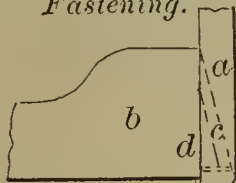

59795—W. H. Elliot—Bedstead Fastening.

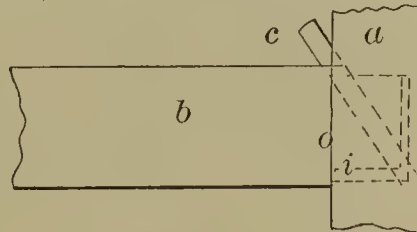

59798—J. B. Forsyth—Clothes Wringer Roller.

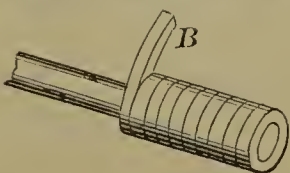
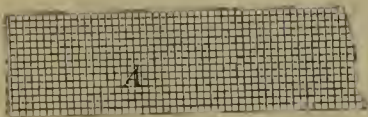

59796—A. W. Elmer—Skate.

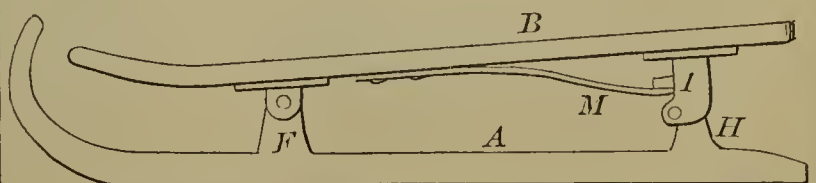

59799—R. Lapham—*Spring Holder for Bed Bottoms.*

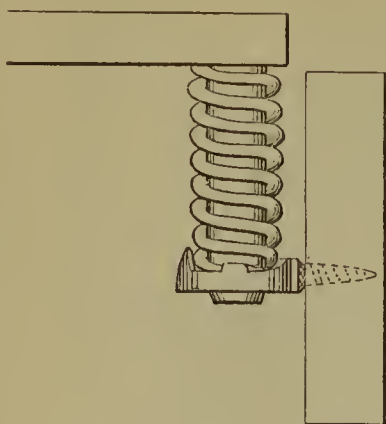

59800—C. L. Lochman—*Photographic Printing Frame.*

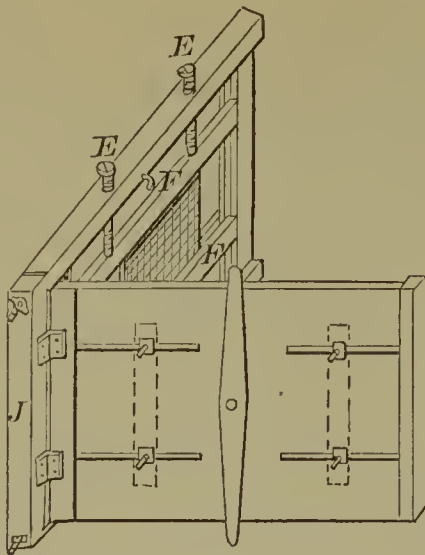

59802—E. McMillan, Jr.—*Churn.*

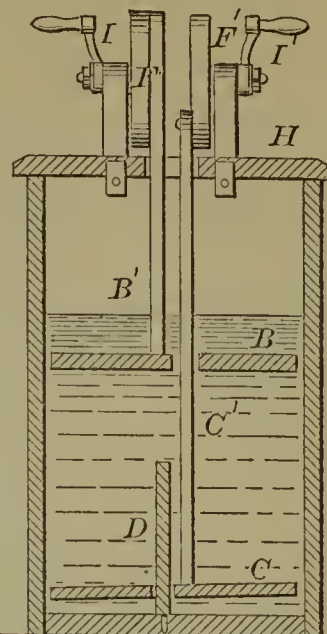

59801—D. H. McLean—*Reel.*

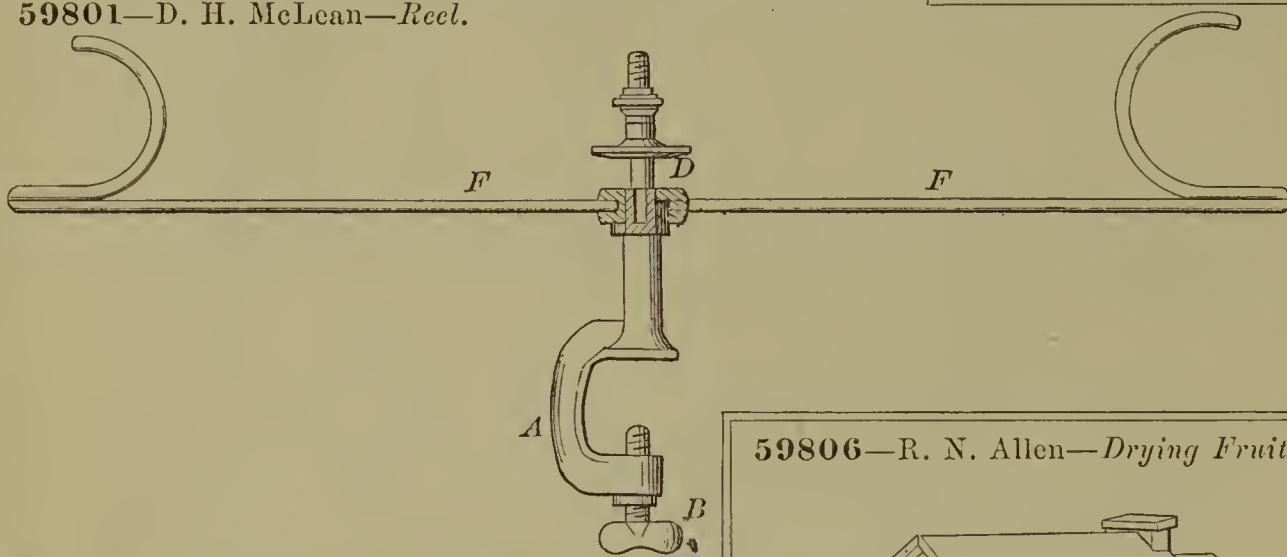

59806—R. N. Allen—*Drying Fruit, &c.*

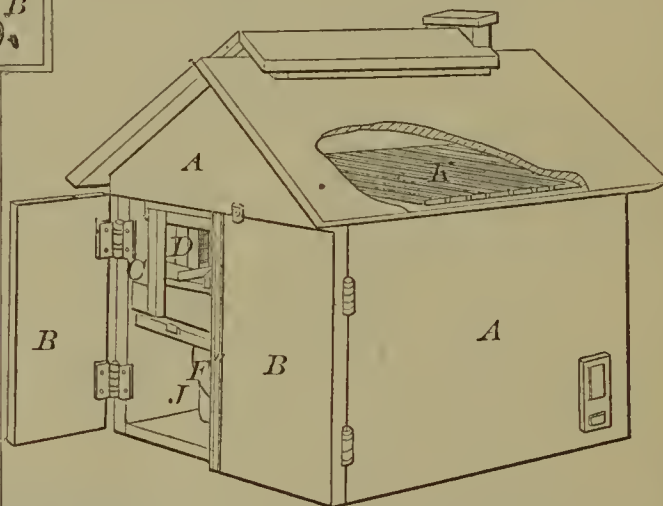

59804—E. Whitehead—*Iron Gutter.*

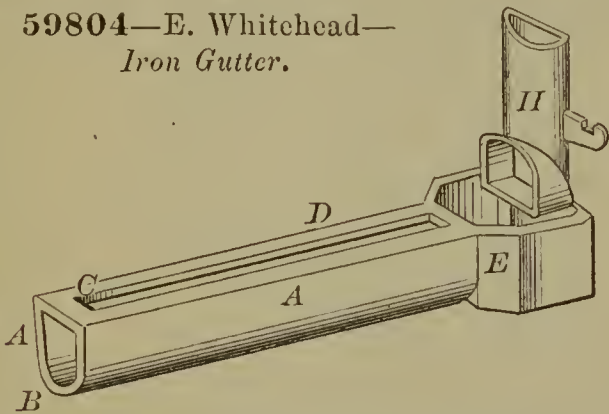

59805—F. F. A. Achard—*Electro-Magnetic Car Brake.*

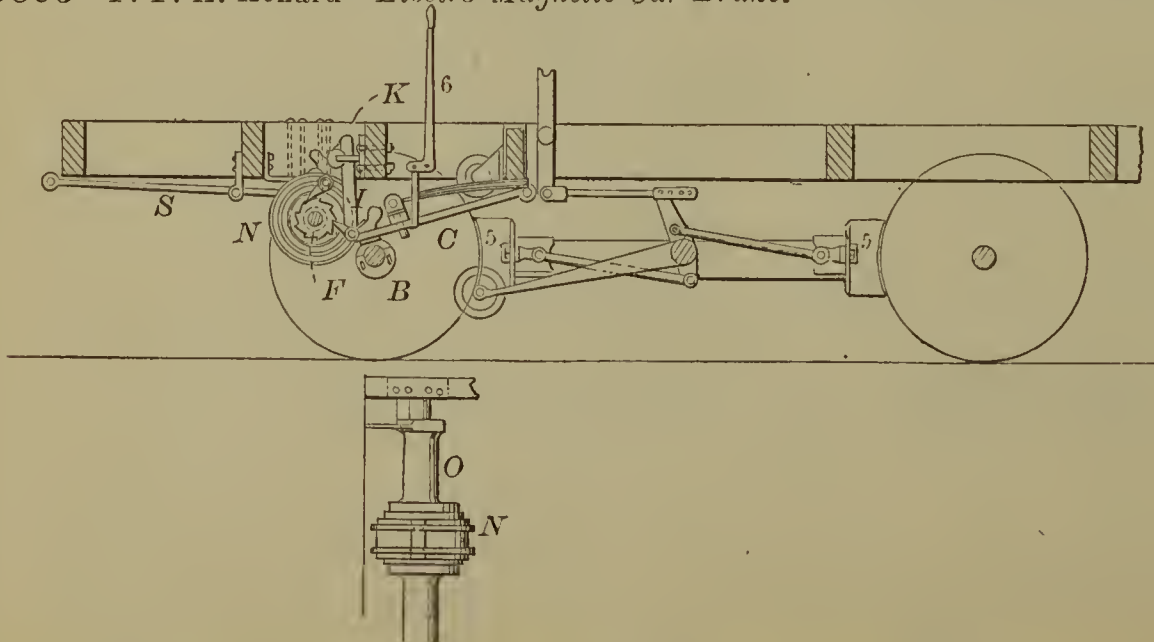

59807—T. Appelget—Cider Mill.

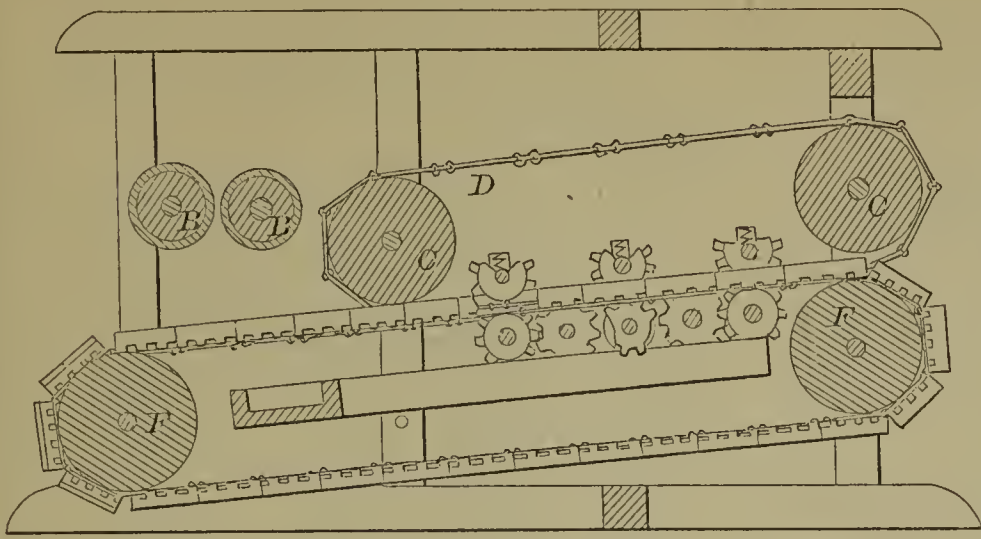

59809—J. I. Baringer—Smoke Furnace for Curing Meat, &c.

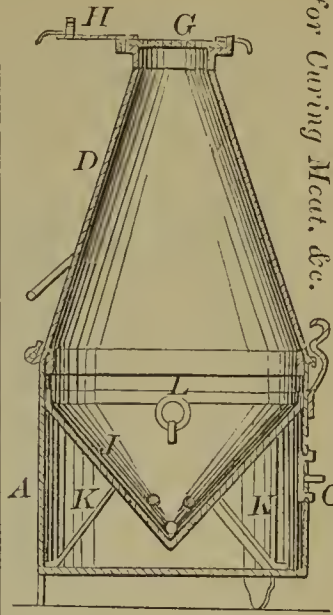

59808—F. Ashley—Lamp Chimney Cleaner.



59812—W. Belbin—Oyster Dredging Apparatus.

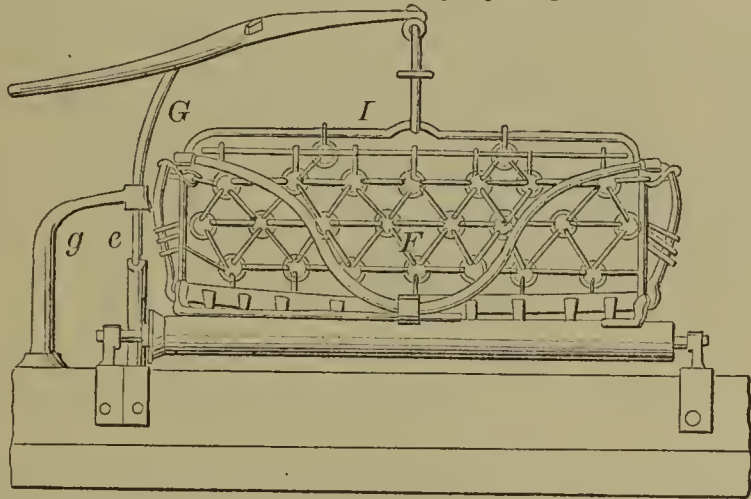

59810—W. F. Bartlett—Lantern and Foot Warmer.

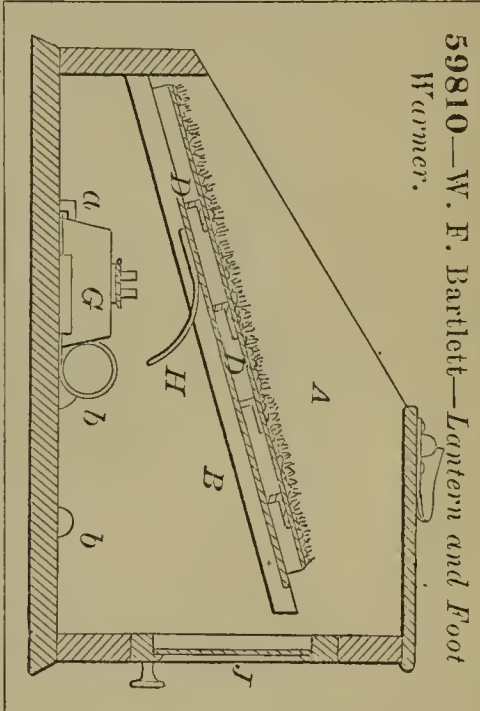

59813—Bequeret & Dumoulin—Gang Plow.

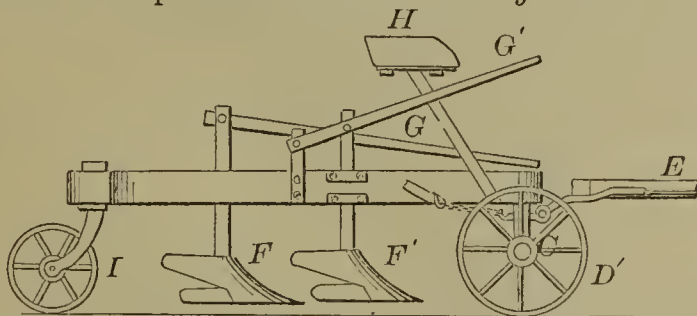

59814—F. Bowman—Stove Criket.

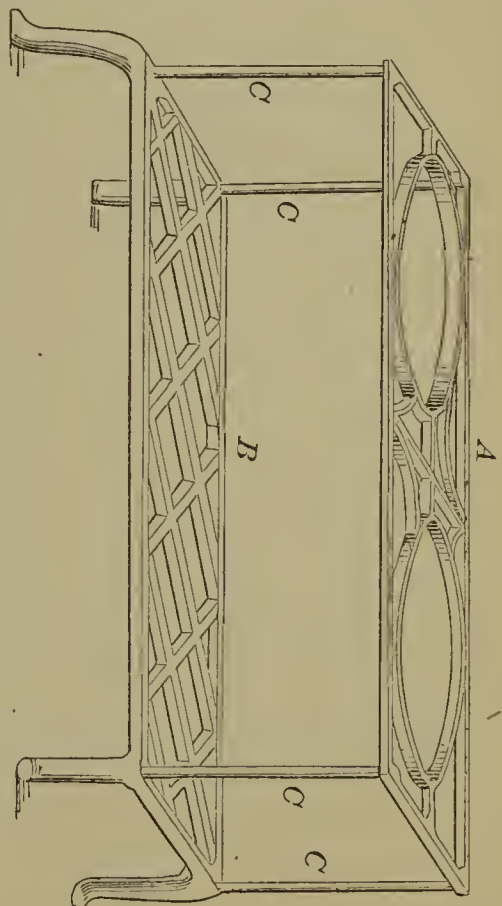

59811—E. H. Beckwith—Churn.

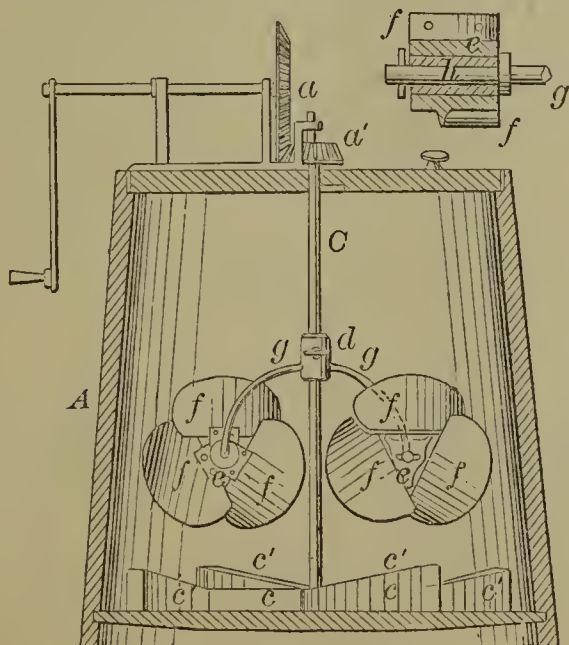

59815—R. Brady—Heater for Soldering Iron.

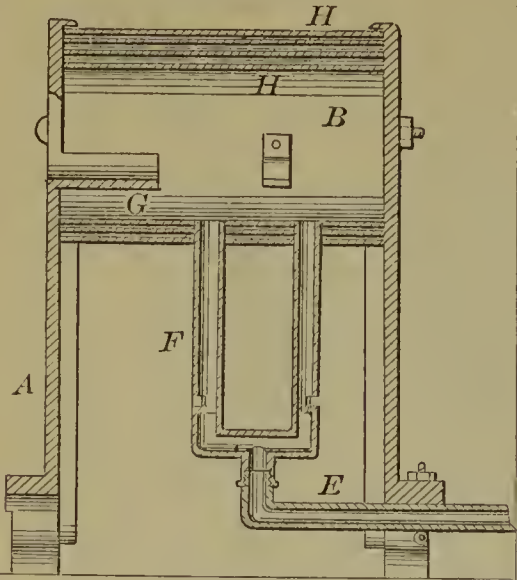

59816—E. K. & J. M. Bruce—For Sealing Fruit Cans.

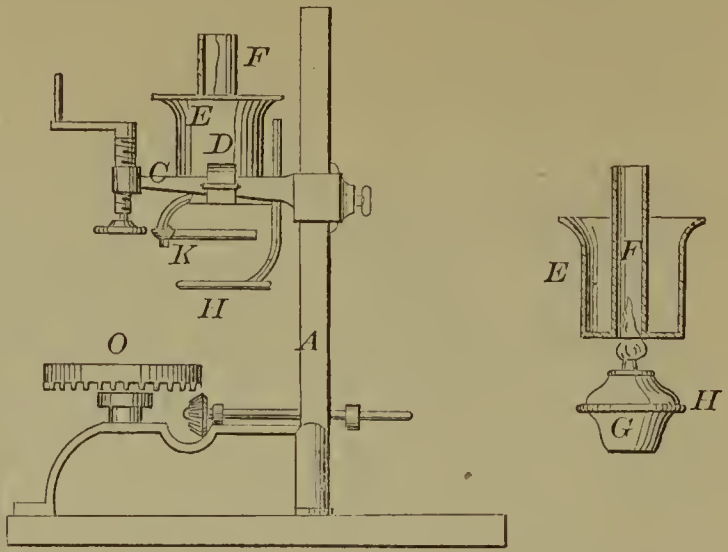

59817—J. W. Campbell—For Ornamenting Mouldings.

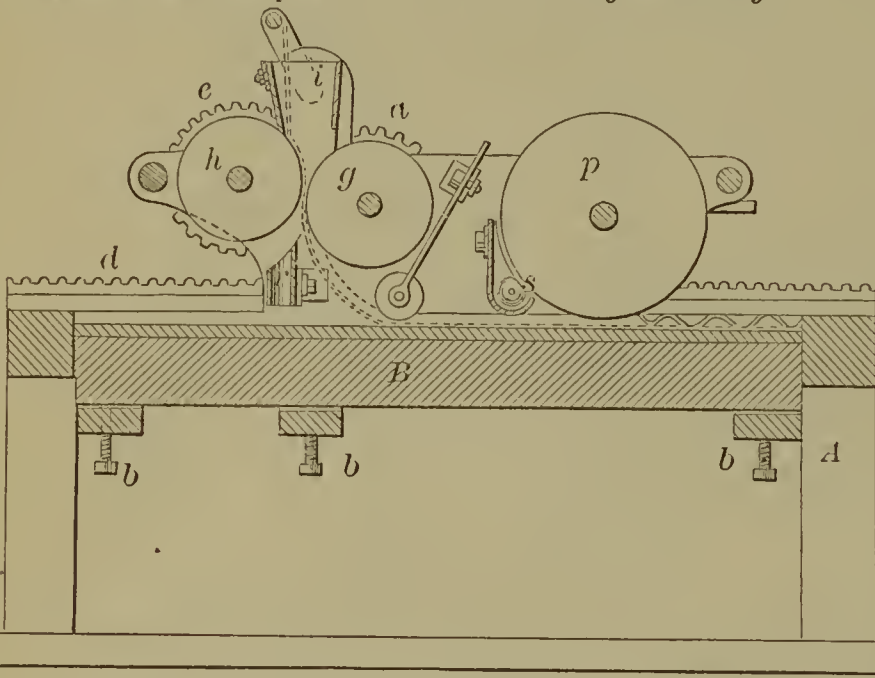

59819—W. Clark—Harness Rein.

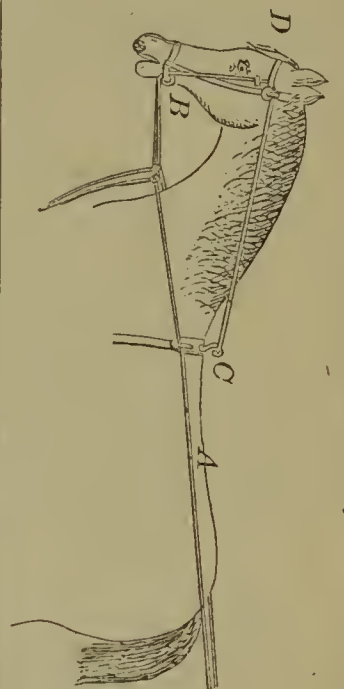

59818—J. B. Cassel—Tread Wheel Hoisting Power.

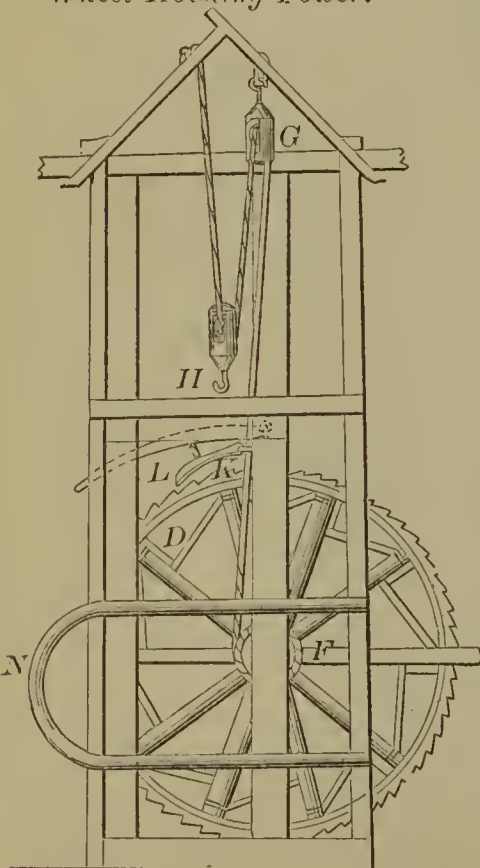

59820—D. L. Collins—Door Bell and Burglar Alarm.

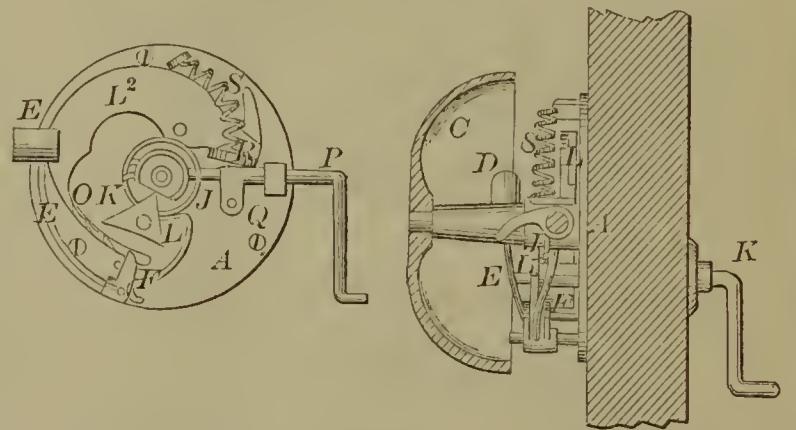

59821—J. C. Cook—Stave Machine.

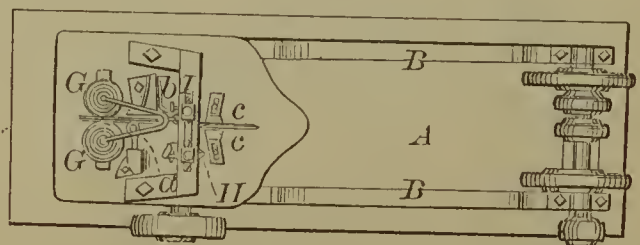



59823—J. V. C. Crate—Rod of Punching Presses.

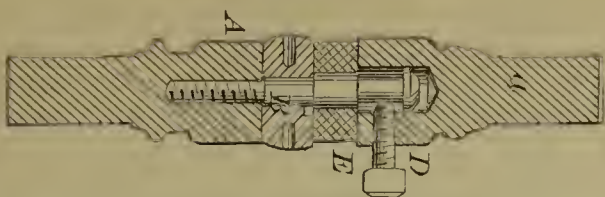

59828—J. C. Fay—Wind Wheel.

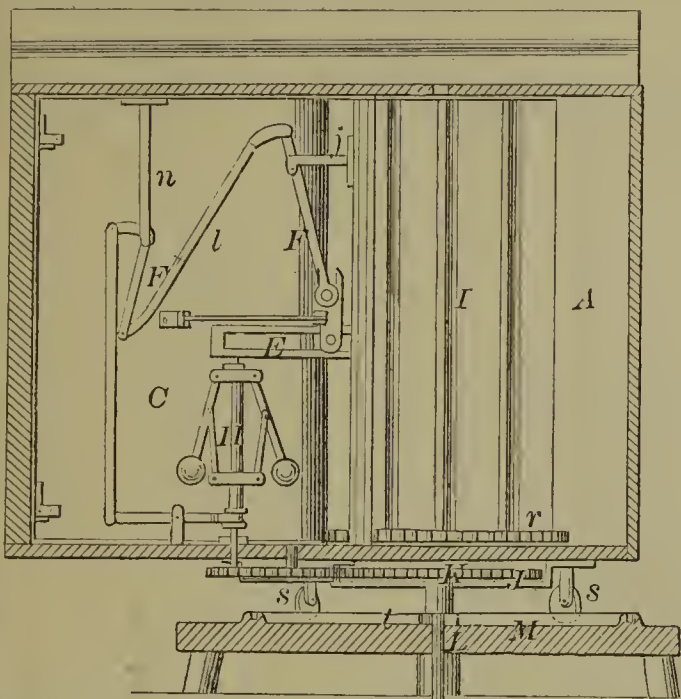

59824—W. A. Devon—For Holding and Adjusting Scaffolds.

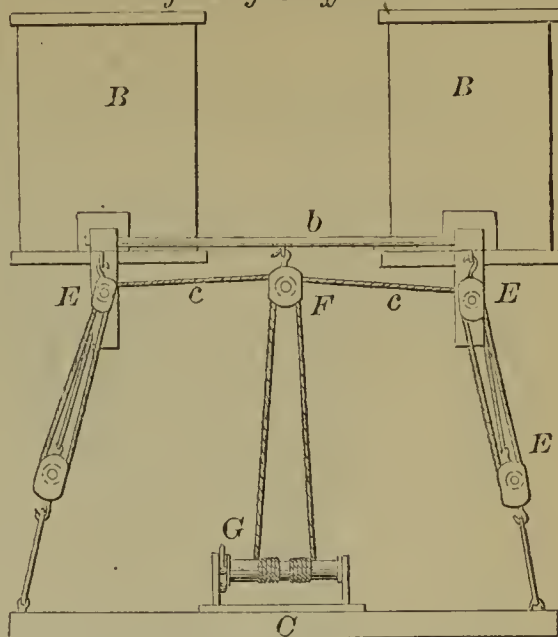

59825—W. H. Elliot—Bedstead Fastening.

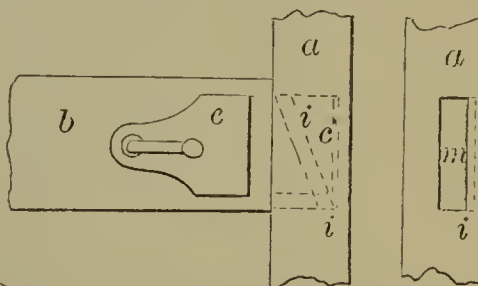

59827—A. Fairchild—Seeder and Harrow.

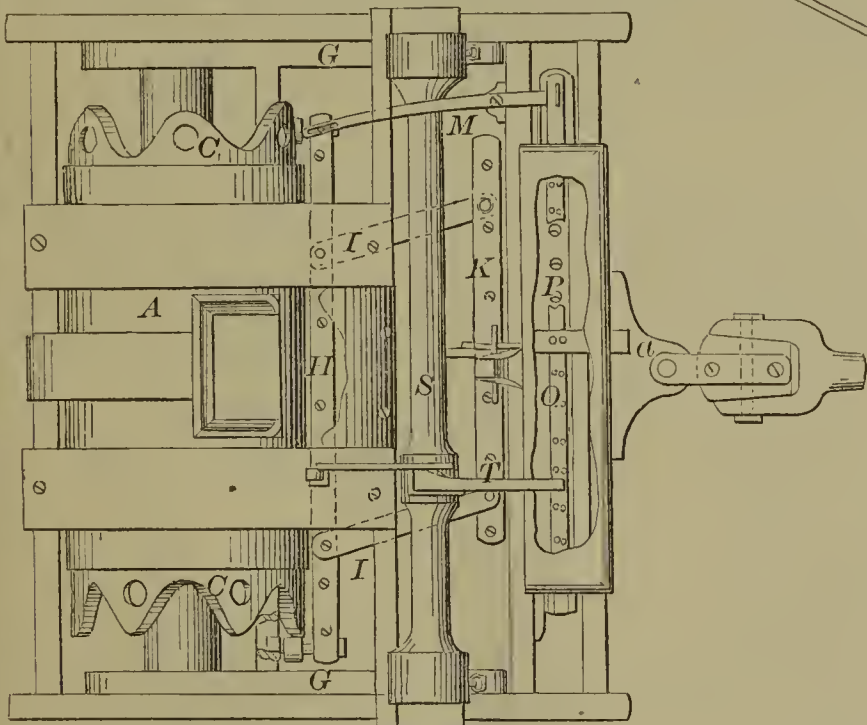

59826—D. Evers—Tenoning Machine.

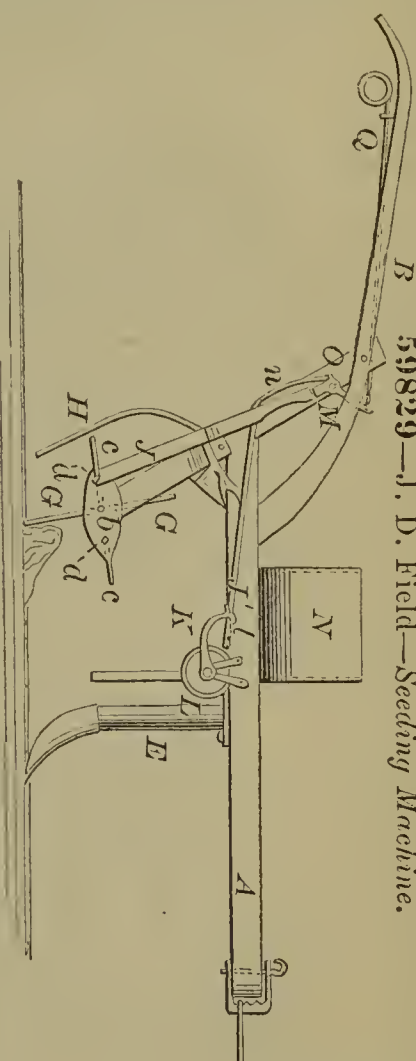
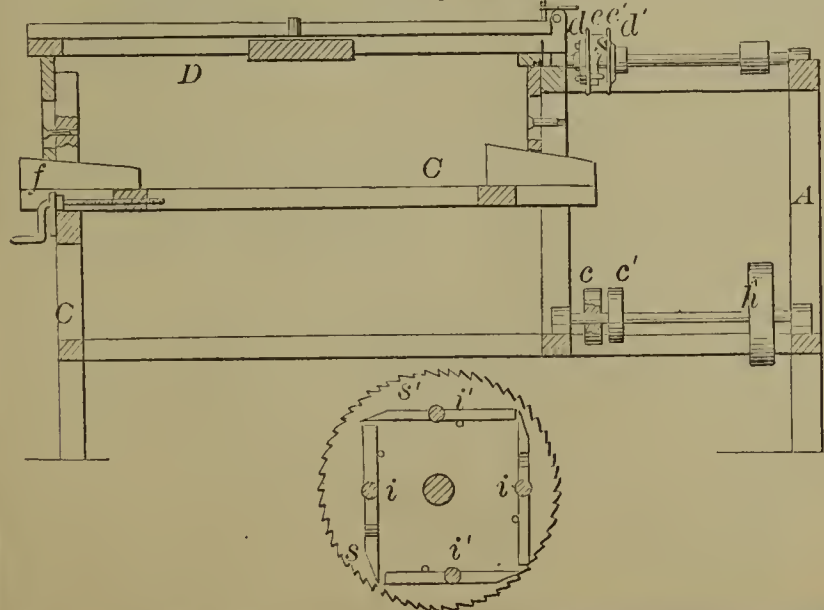

59829—J. D. Field—Seeding Machine.

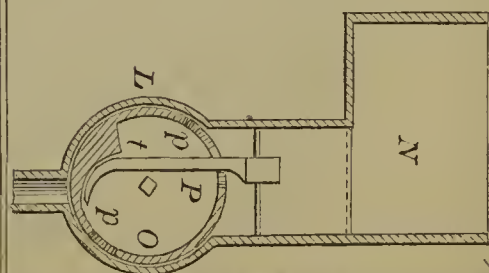

59832—C. W. Gillis—*Baling Press.*

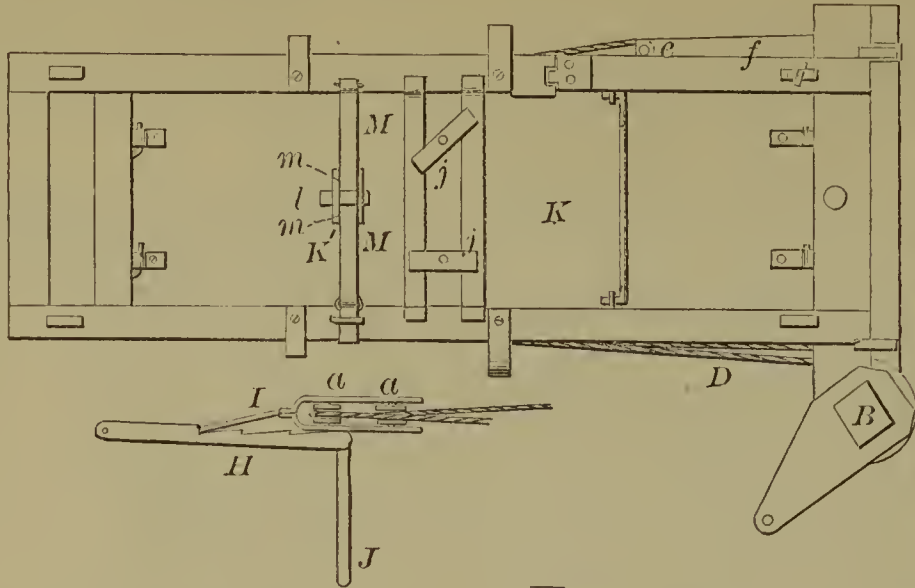

59830—C. L. Fowler—*Pocket Match Safe.*

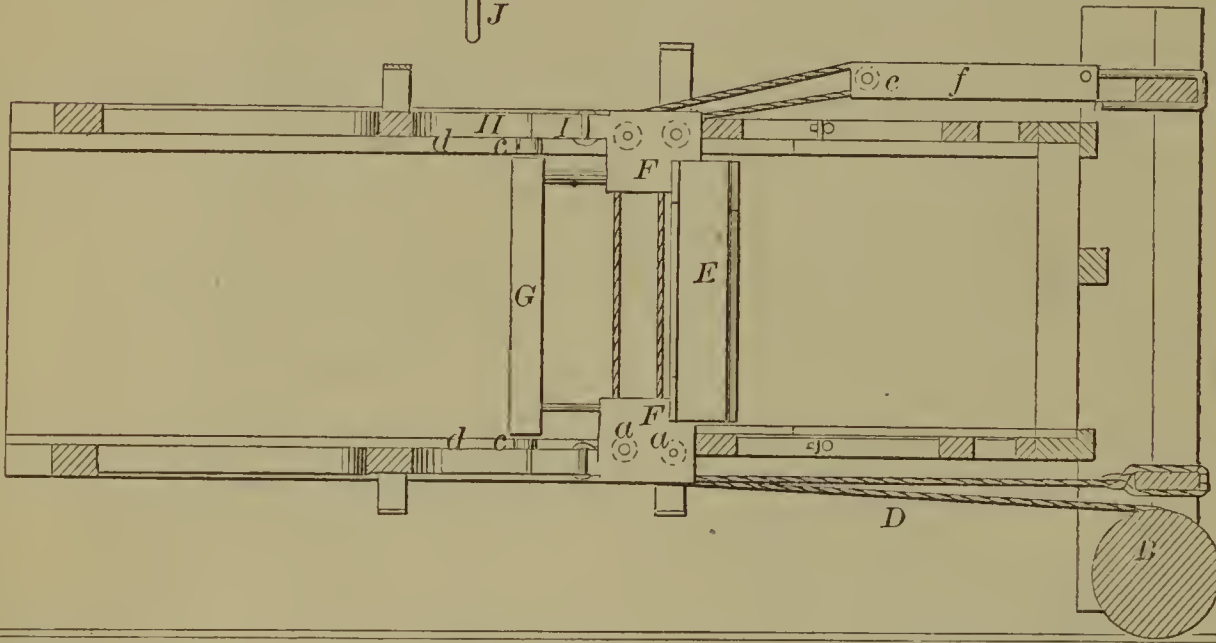
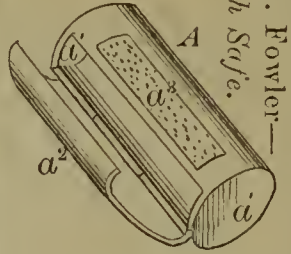

59834—I. & I. M. Gross—*Wagon Brake.*

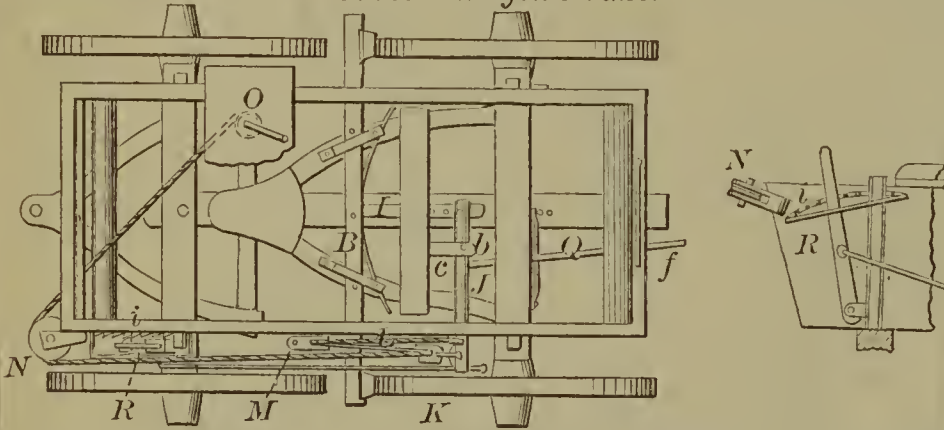

59833—E. T. Gilmore—*For Preserving Oysters.*

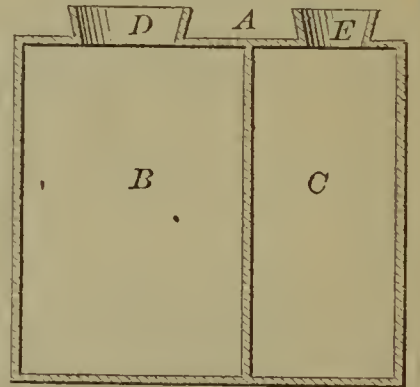

59831—E. R. Gard—*Brick Machine.*

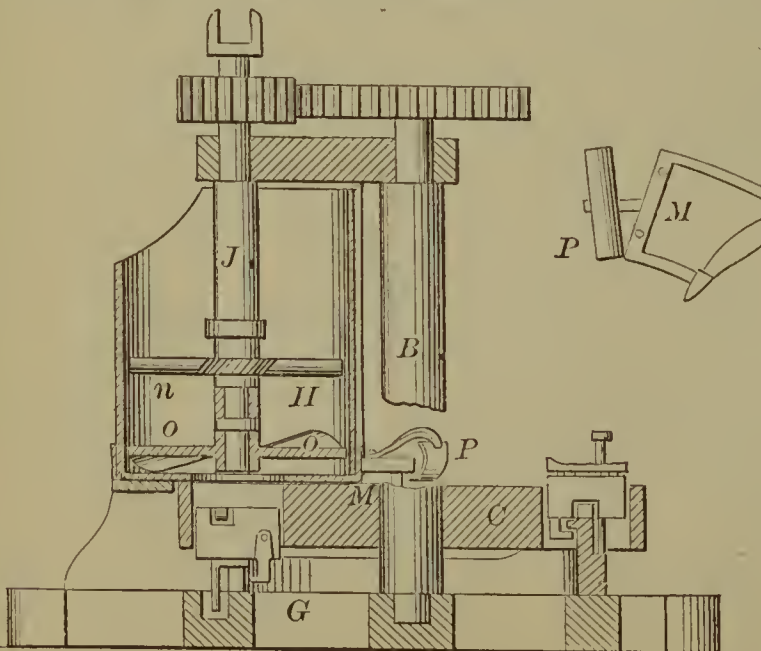

59835—J. Haggert—*Axle Nut for Wagons, &c.*

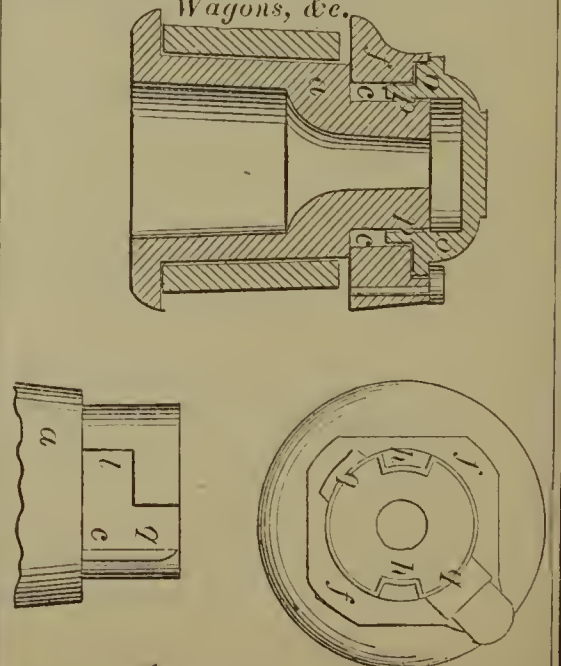

59836—S. W. Hanks—Attaching Pictures to Frames.

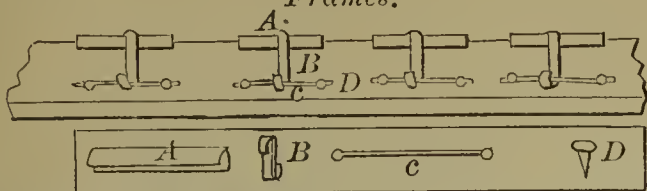

59839—I. L. Hoard—Lamp Wick.



59837—W. Harsen—Stuffing Box.

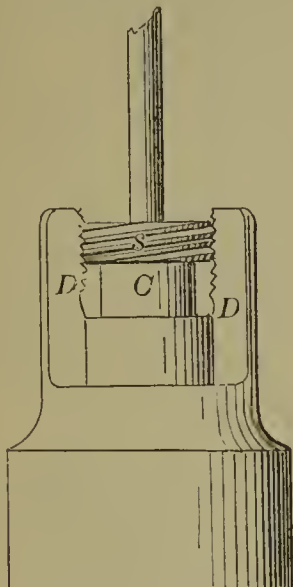

59838—Henckel & Seck—Grain Hulling Machine.

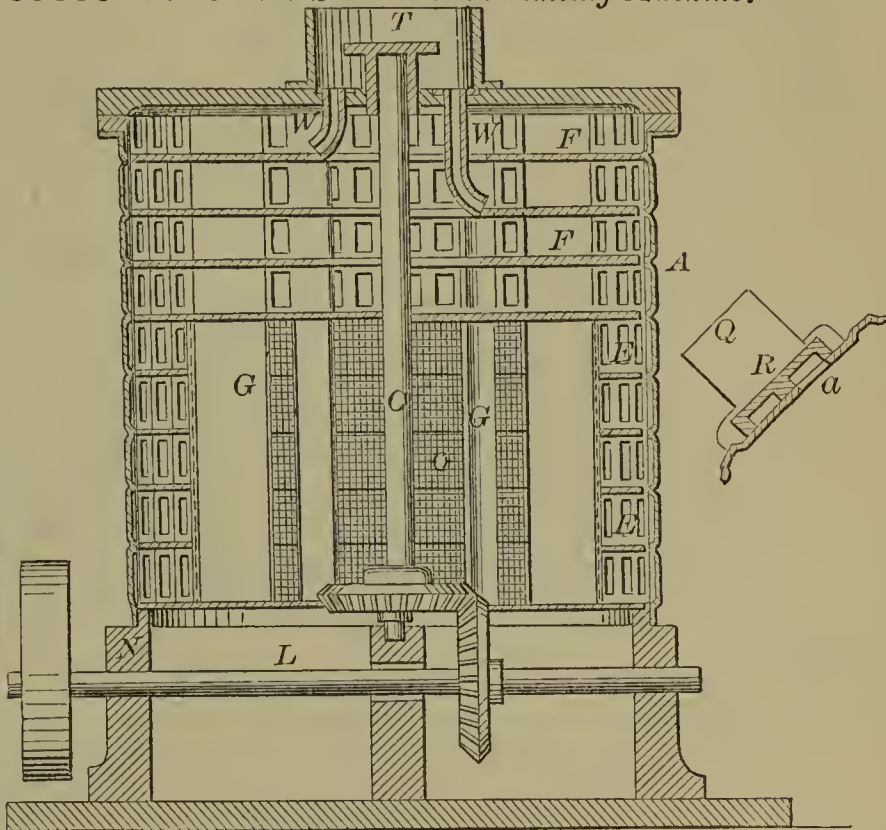

59840—J. G. Holt—Making Sand Cores for Axle Skeins and Hub Boxes.

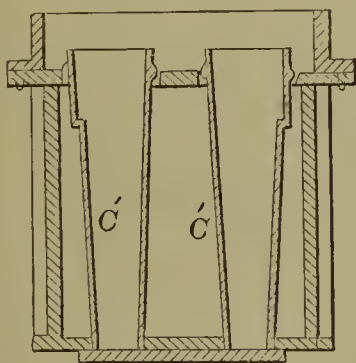

59842—W. & A. G. Kelsey—Boot Tree.

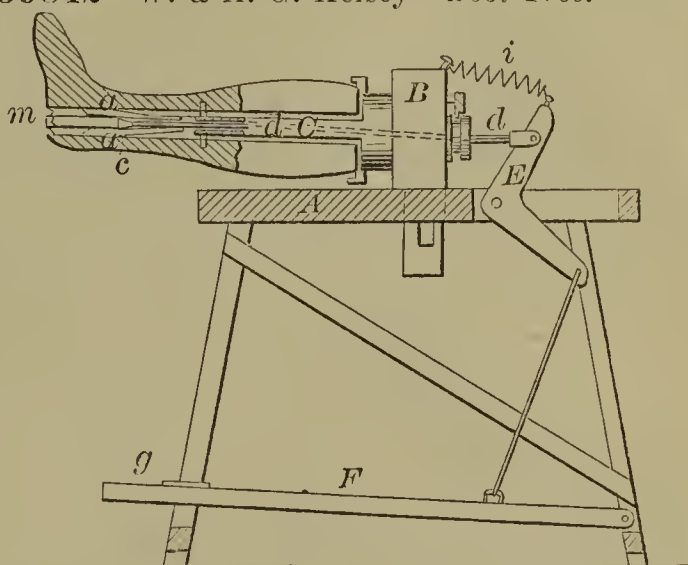

59843—H. Keyes—Apple Parer.

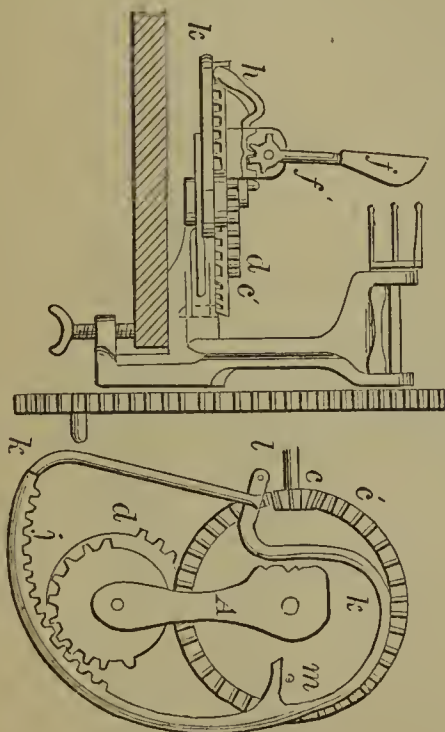

59841—S. Jackson, Jr.—Saw Mill.

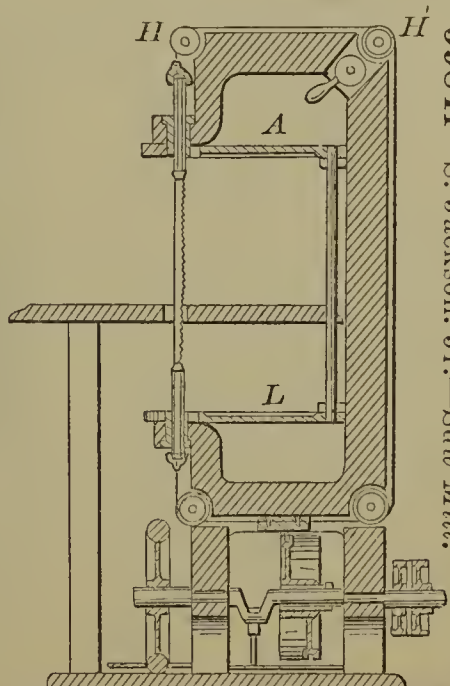

59844—J. King—Spring Fish Hook.

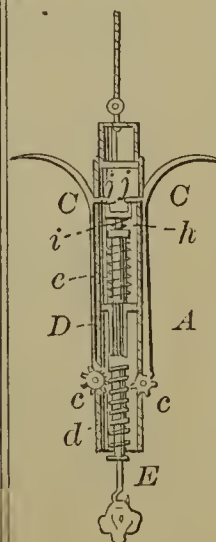

59846—D. Lane—Saw Mill.

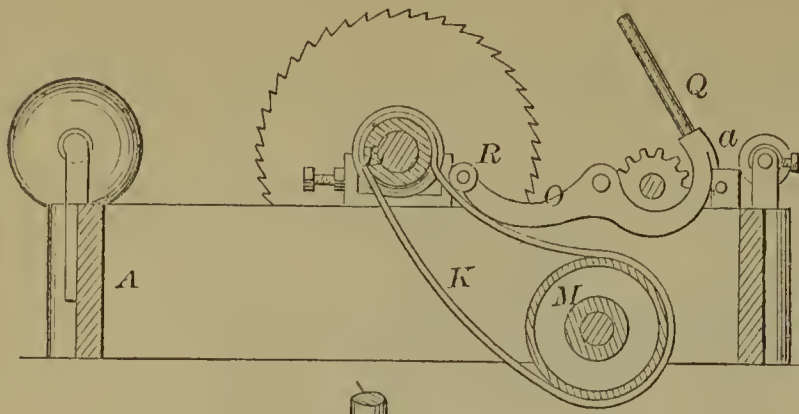

59847—J. R. Laurent—For Extinguishing Fires.

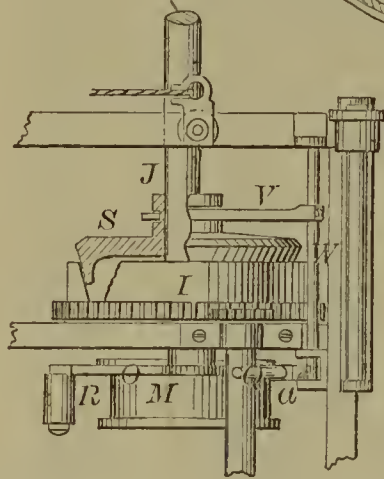
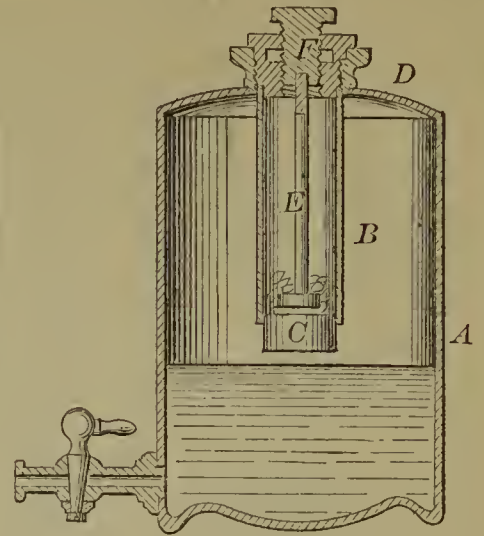

59848—J. Lochhead—Balanced Slide Valve.

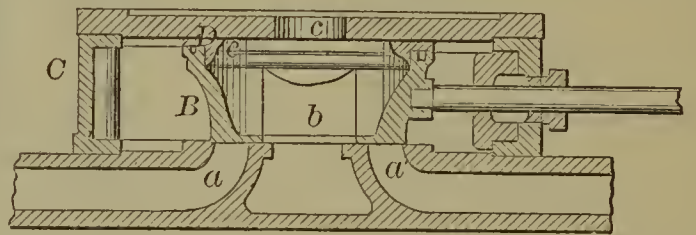

59849—R. Magee—Envelope.

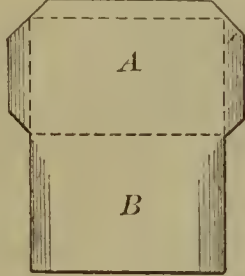

59852—J. McLaren—Wrench.

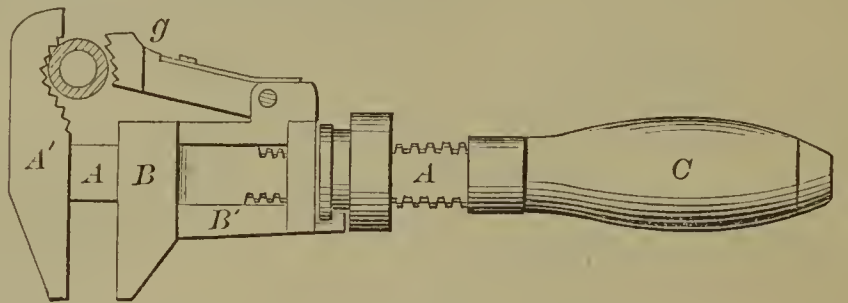

59850—J. Marchbank—Paint Brush.

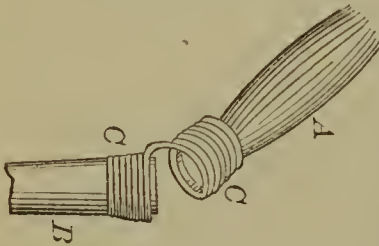

59853—T. E. McNeill—Cotton Press.

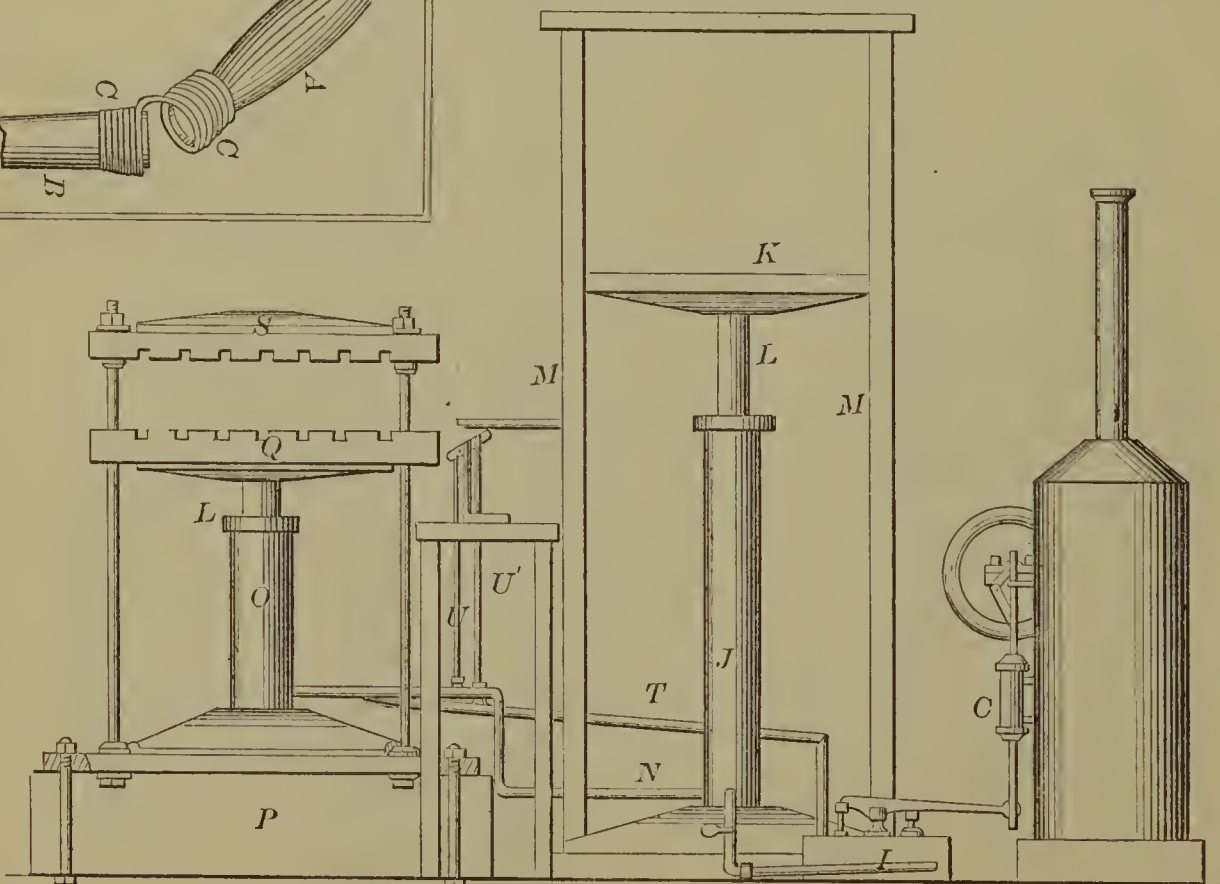

59854—C. V. Mead—For Rolling Rubber.

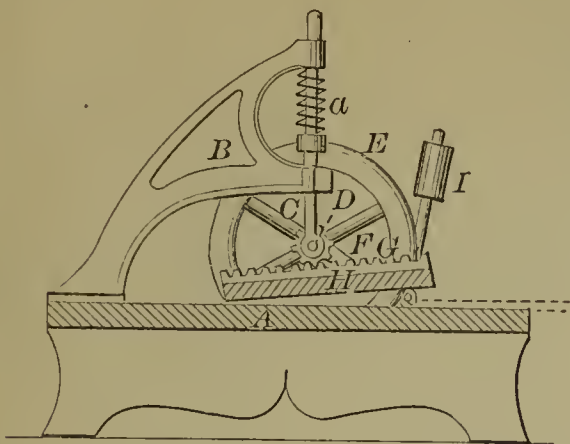

59858—T. S. Minniss—Car Coupling.

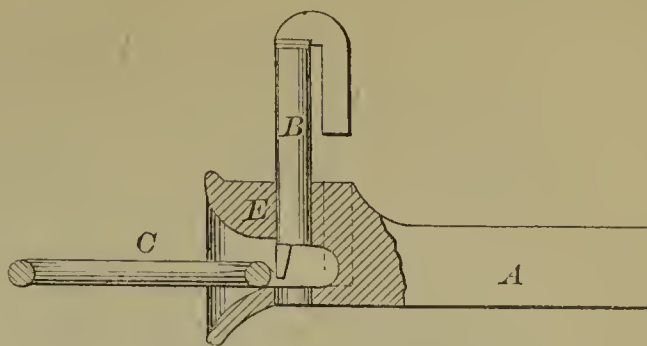

59855—P. Merkel—Gang Plow.

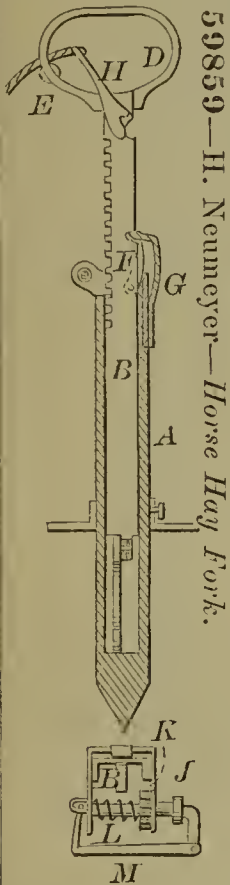
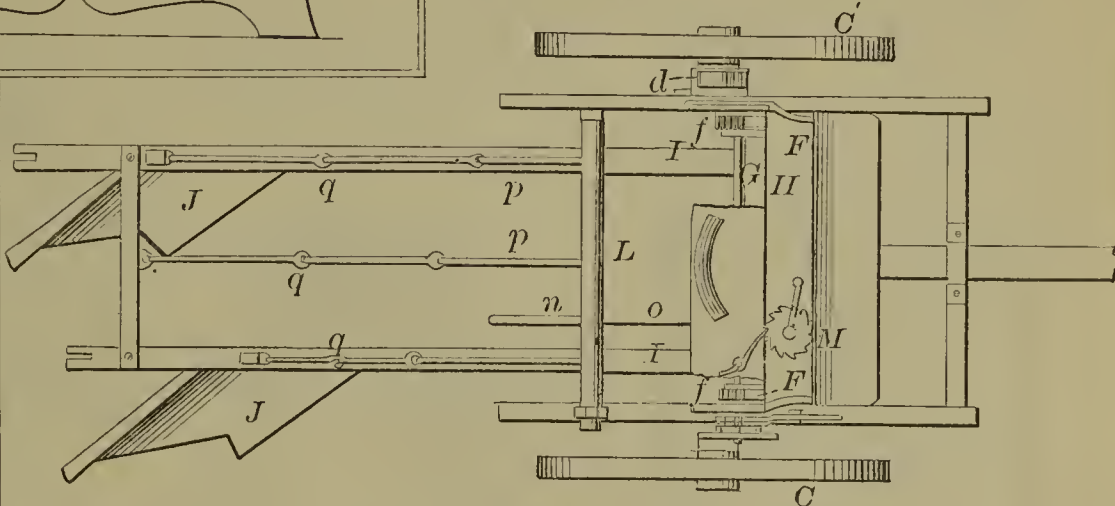

59859—H. Neumeyer—Horse Hay Fork.

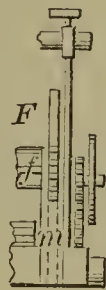
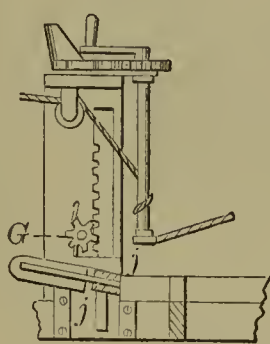

59857—E. D. Miller—Cranberry Gatherer.

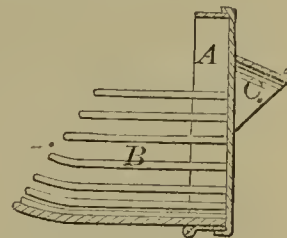

59856—Merriman & Ross—For Channeling Stones.

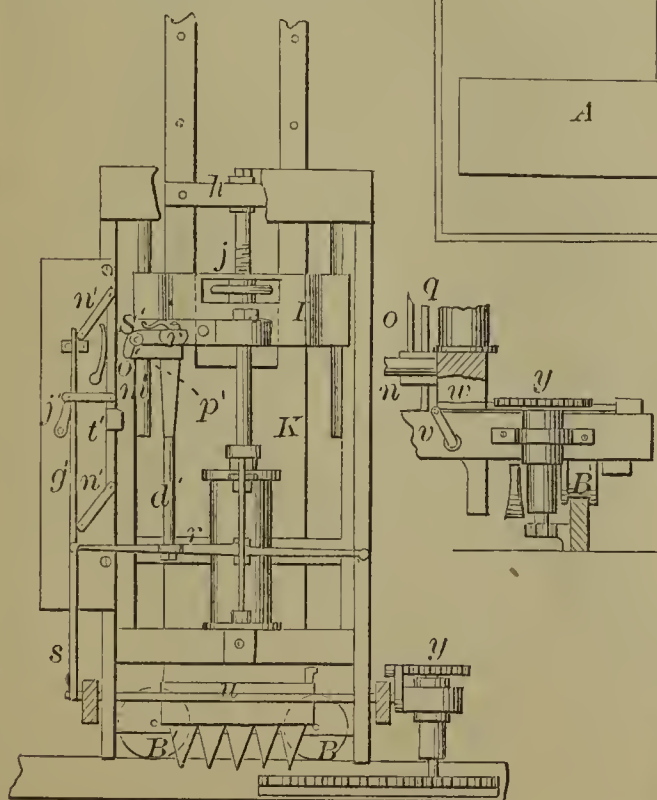

59860—H. L. Ogden—Car Coupling.

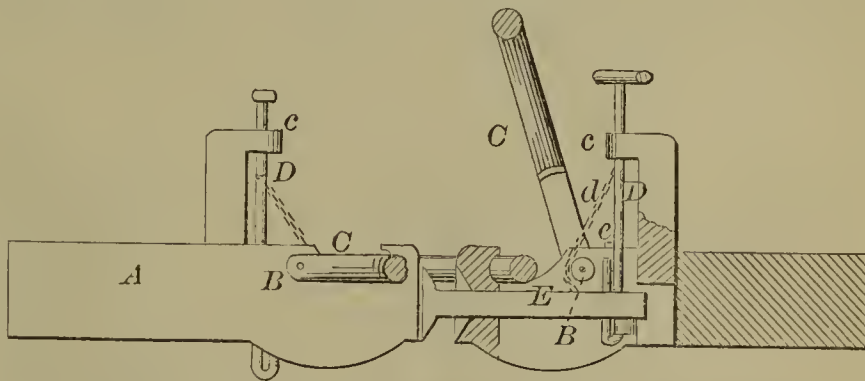

59861—W. Ormesby—Hand Screw Clamp.

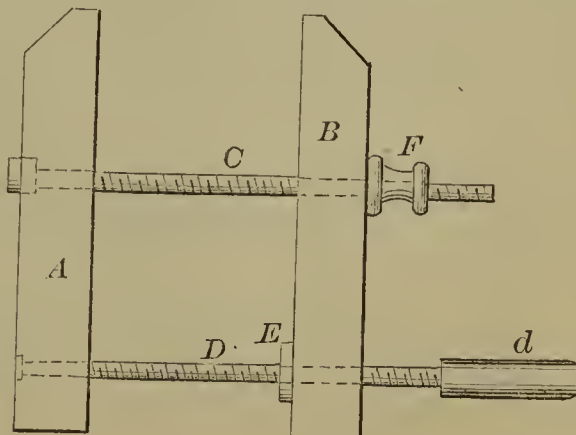

59862—G. H. Reynolds—  
Bran Duster.

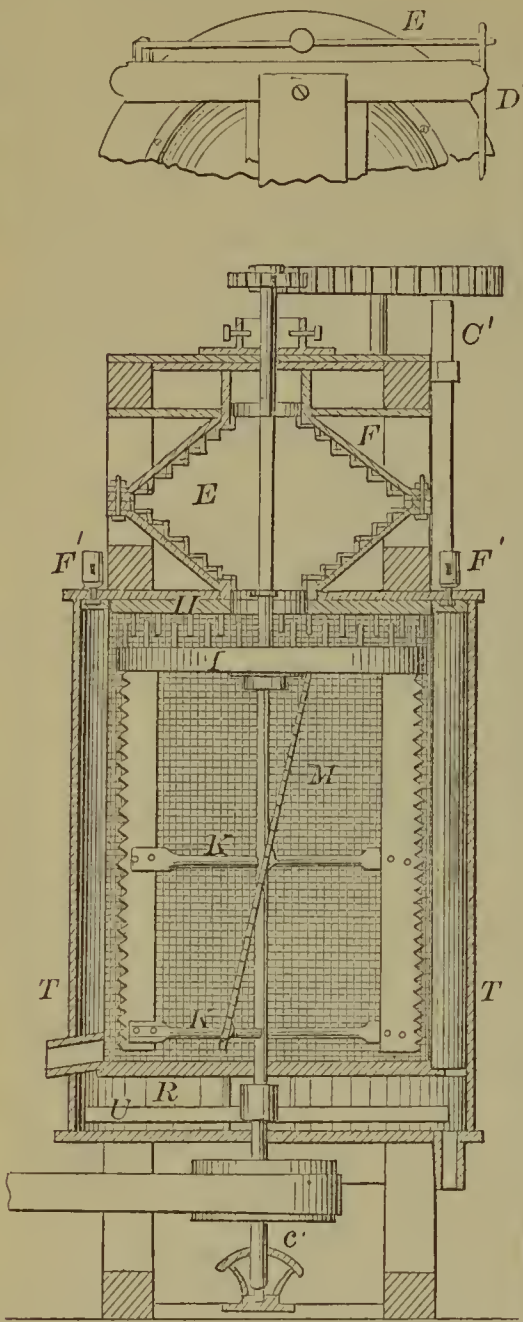

59864—W. Shaw—Cider Mill.

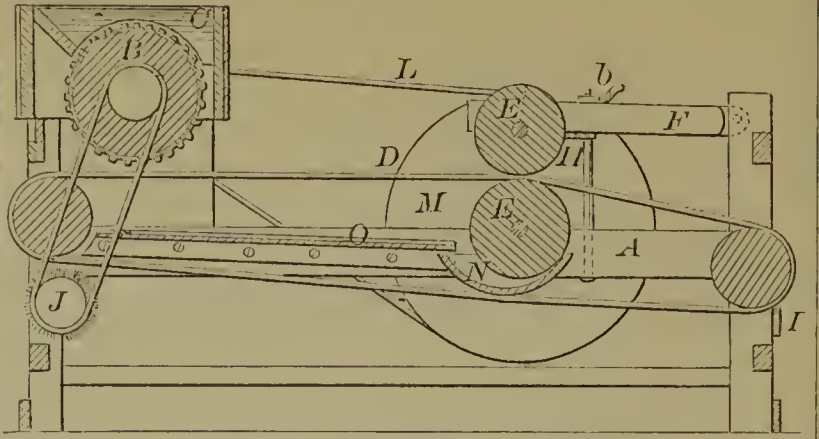

59865—A. G. Smith—  
Lantern.

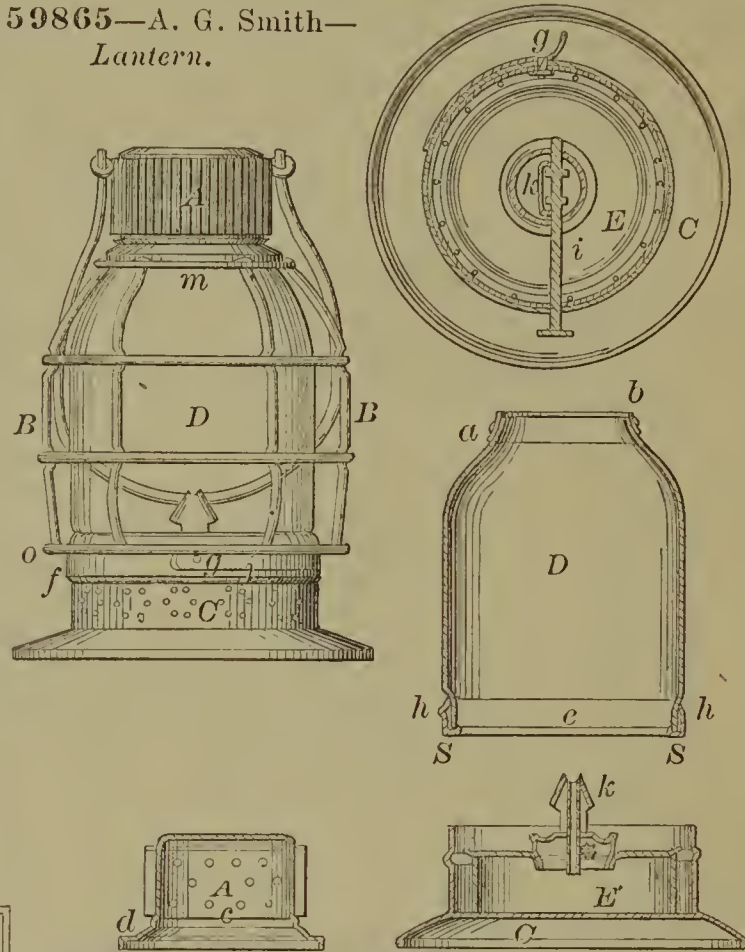

59863—J. L. Rumrill—Water Wheel.

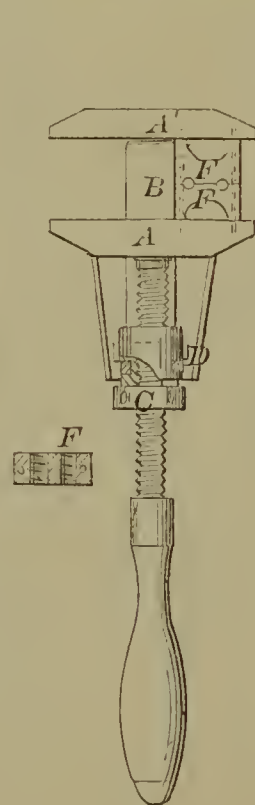
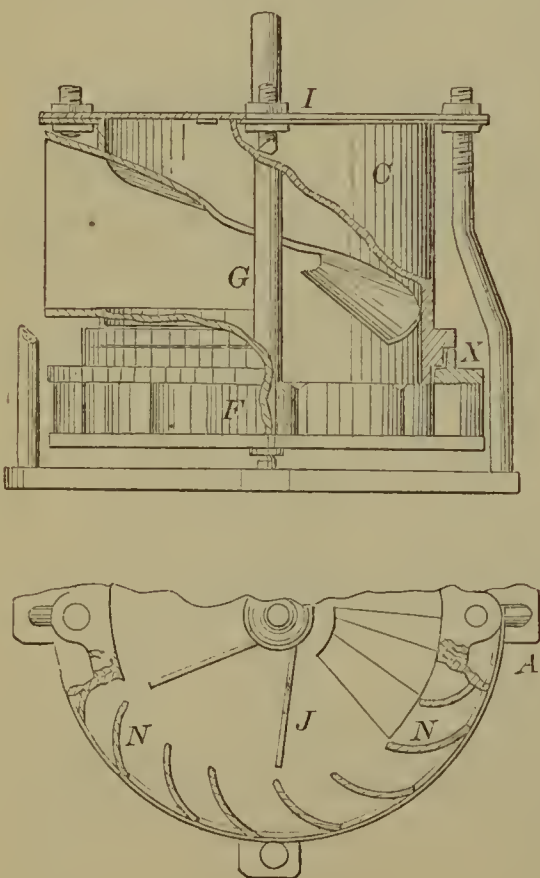

59866—J. A. Smith—Tool.

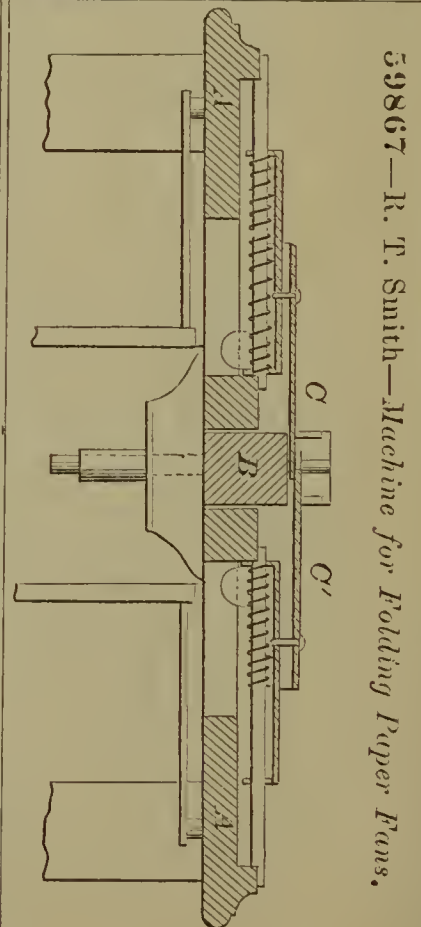

59867—R. T. Smith—Machine for Folding Paper Fans.

59869—W. P. Squire—Pump.

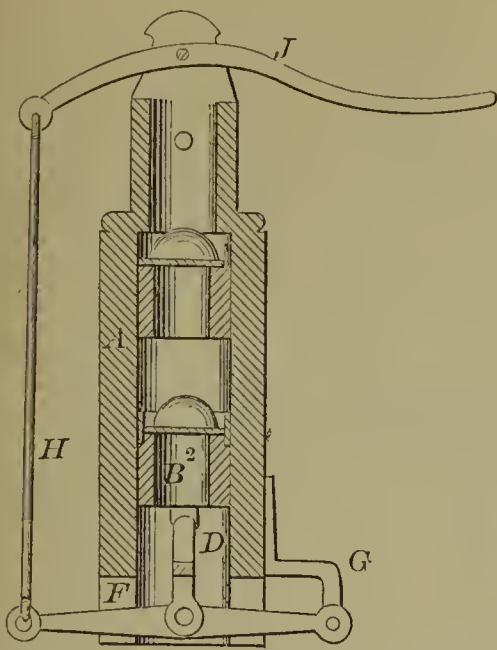

59870—W. P. Squire—Hay Derrick.

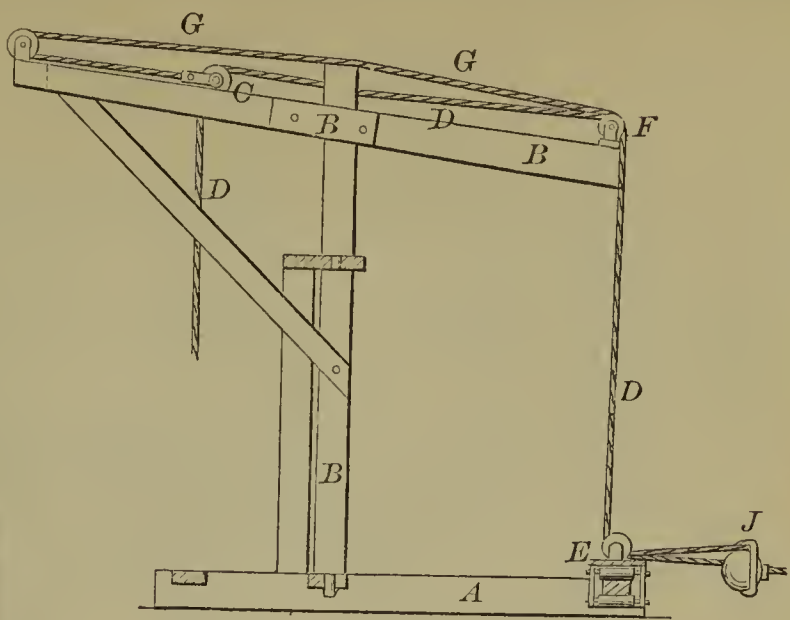

59874—J. S. Tibbets—Pulley.

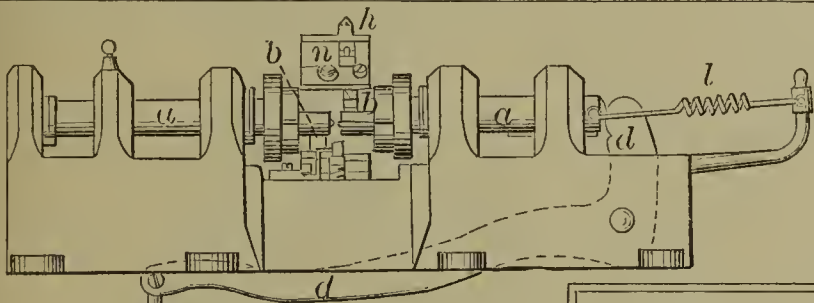
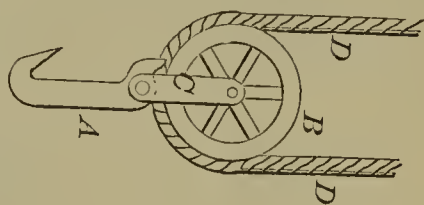

59871—D. H. Stephens—  
For Making Rule Joints.

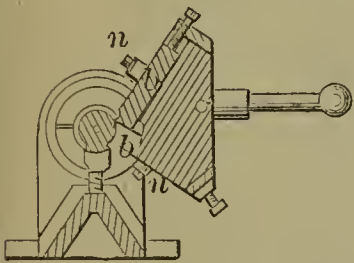

59873—F. F. Terry—Farm Gate.

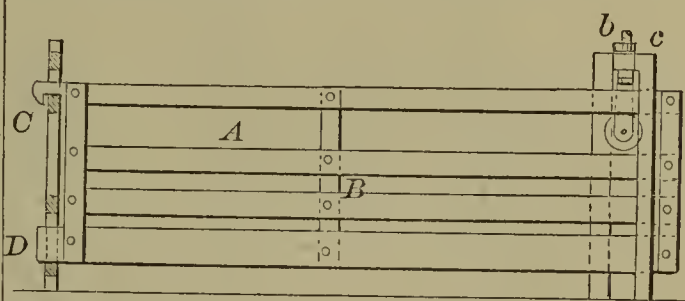

59872—L. W. Feeter—Flour Packer.

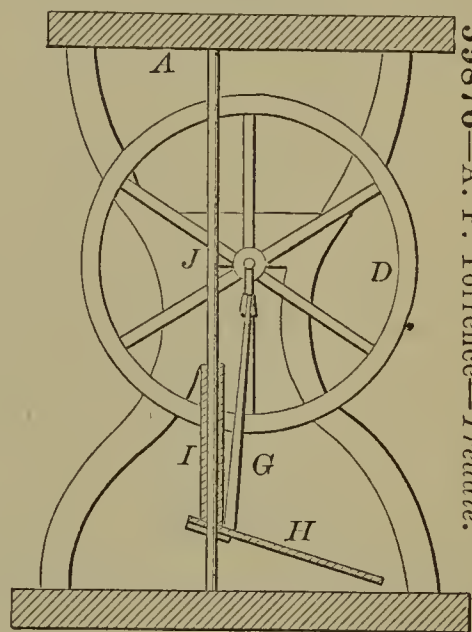
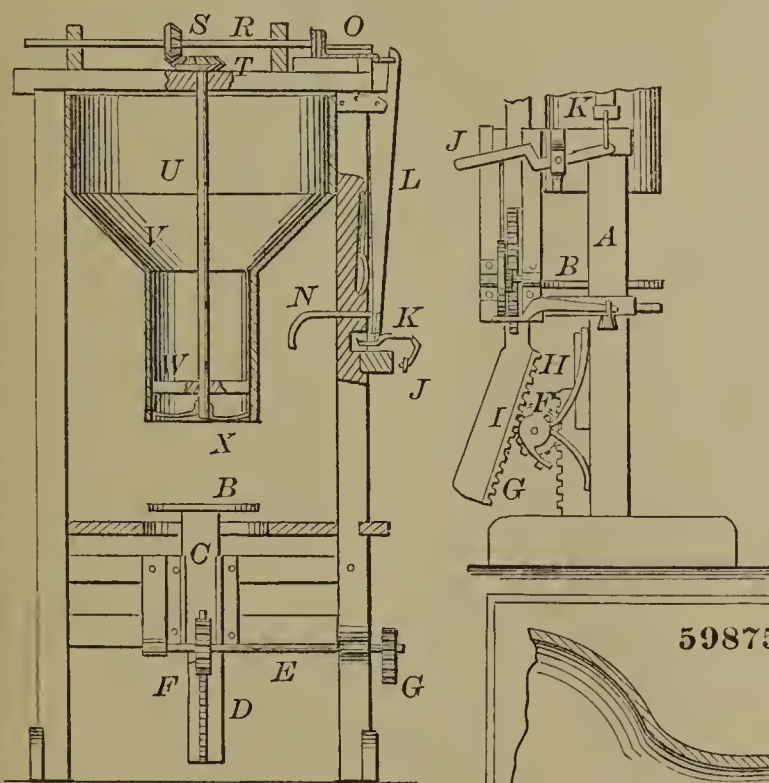

59876—A. P. Torrence—Treacle.

59875—S. H. Timmons—Bottle Stopper and  
Medicine Gauge.

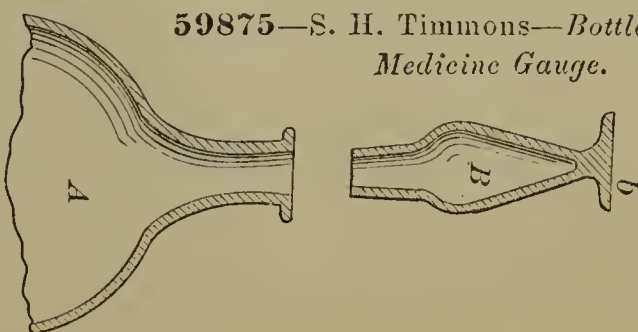

59877—E. Towers—Vibrating Governor.

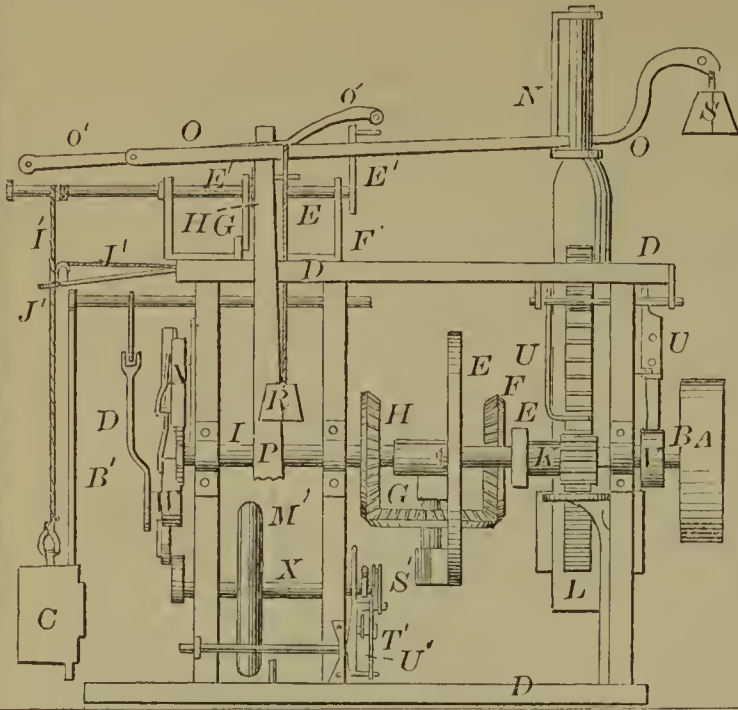

59878—Valentine & Longton—Swing Power.

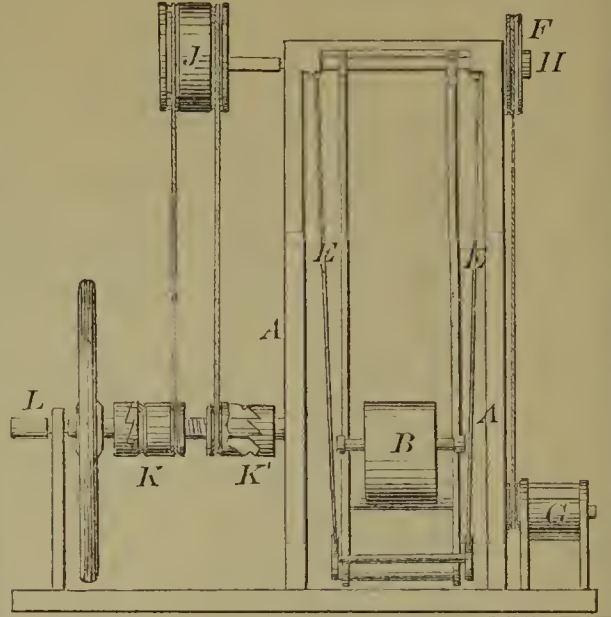

59879—G. Vincent—Sewing Machine Binder.

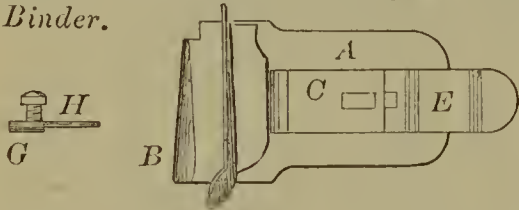

59880—W. S. Watson—Hoisting Apparatus.

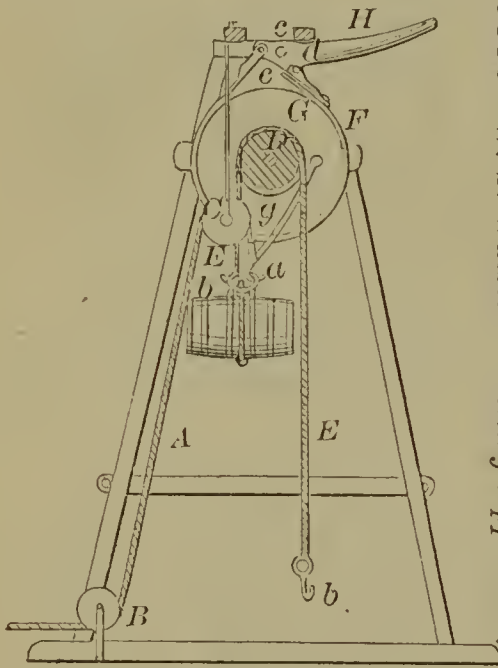

59881—A. H. Wells—Railroad Car Spittoon.

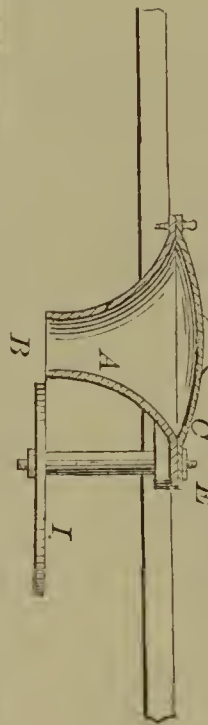

59882—T. J. Wells—Peat Machine.

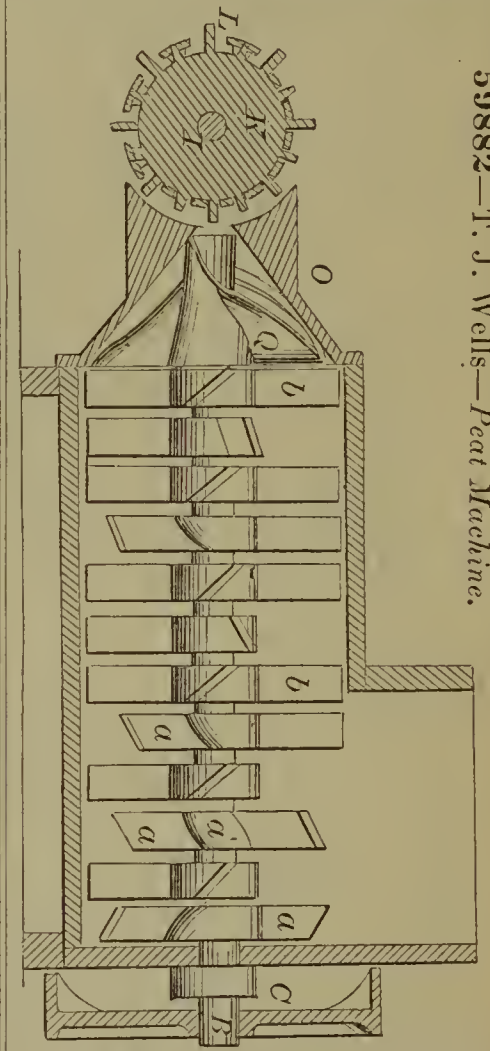

59883—G. Whitaker—Distributing Table.

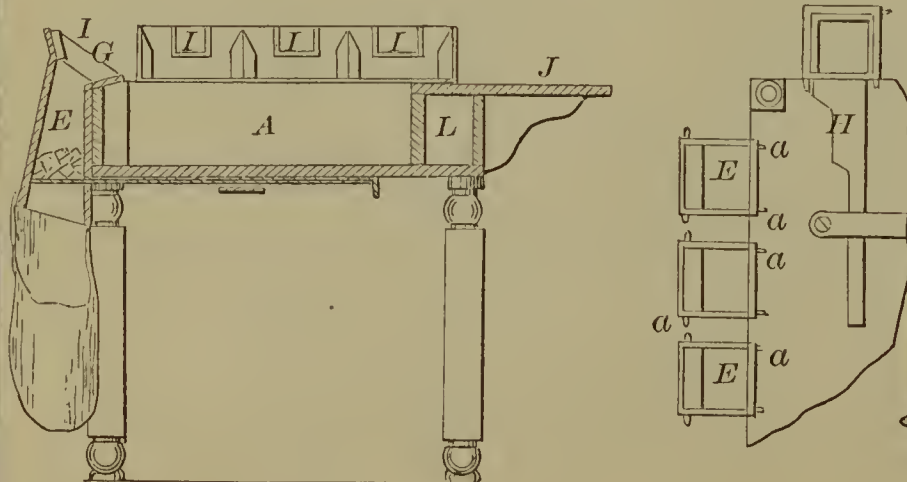

59884—D. H. Whittemore—Apple Parer.

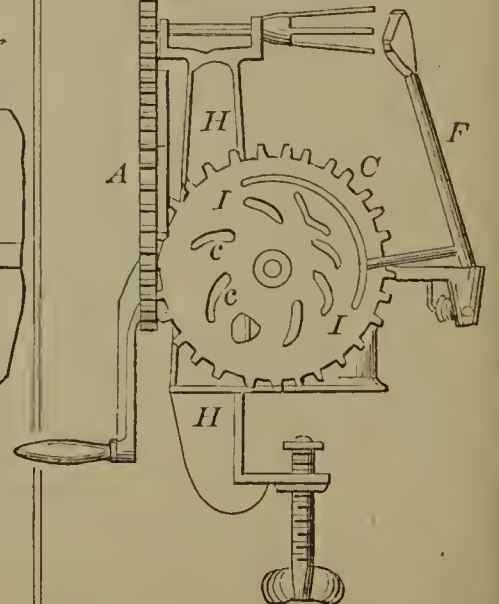



59886—W. Wright—Steam Engine Cut-off Valve Gear.

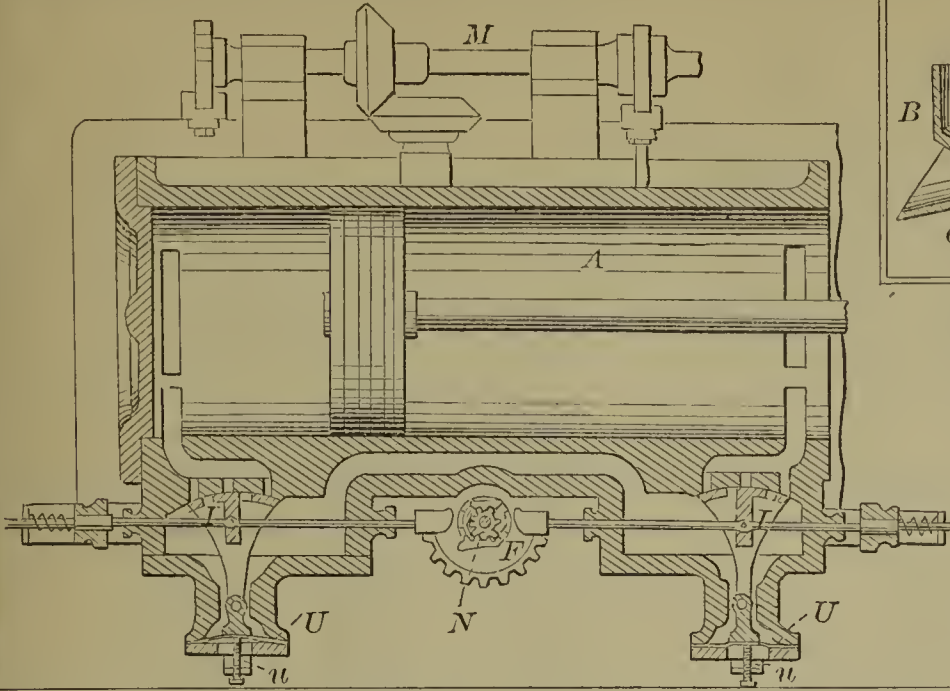

59885—N. A. Wright—Milk Strainer.

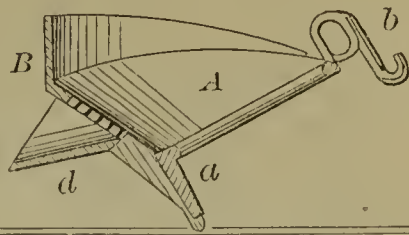

59890—C. B. Bristol—Hook and Fastening for Ropes.

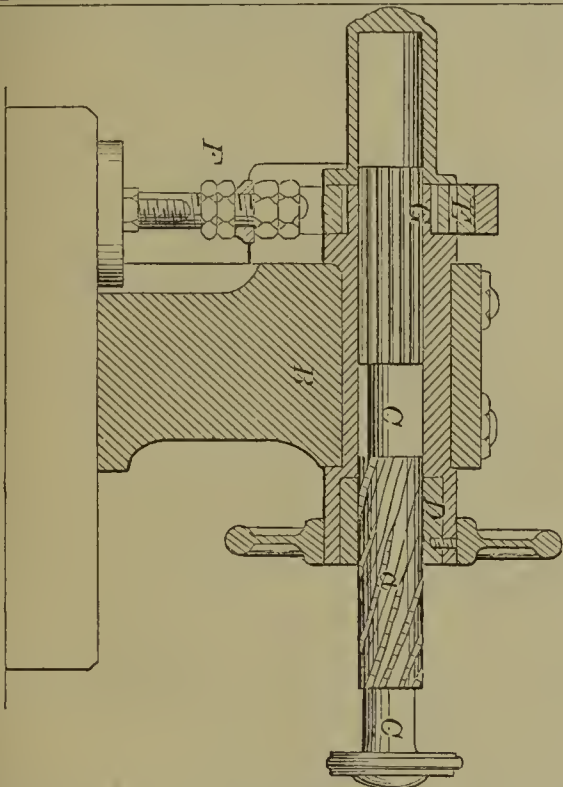
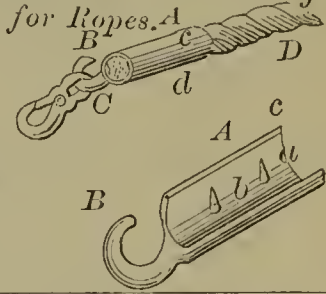

59887—W. Wright—Variable Cut-off Valve Gear.

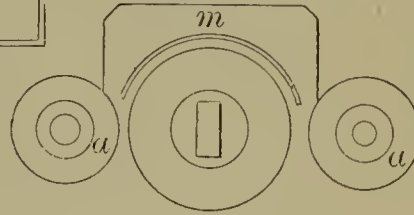

59889—W. Briggs—Cane Mill.

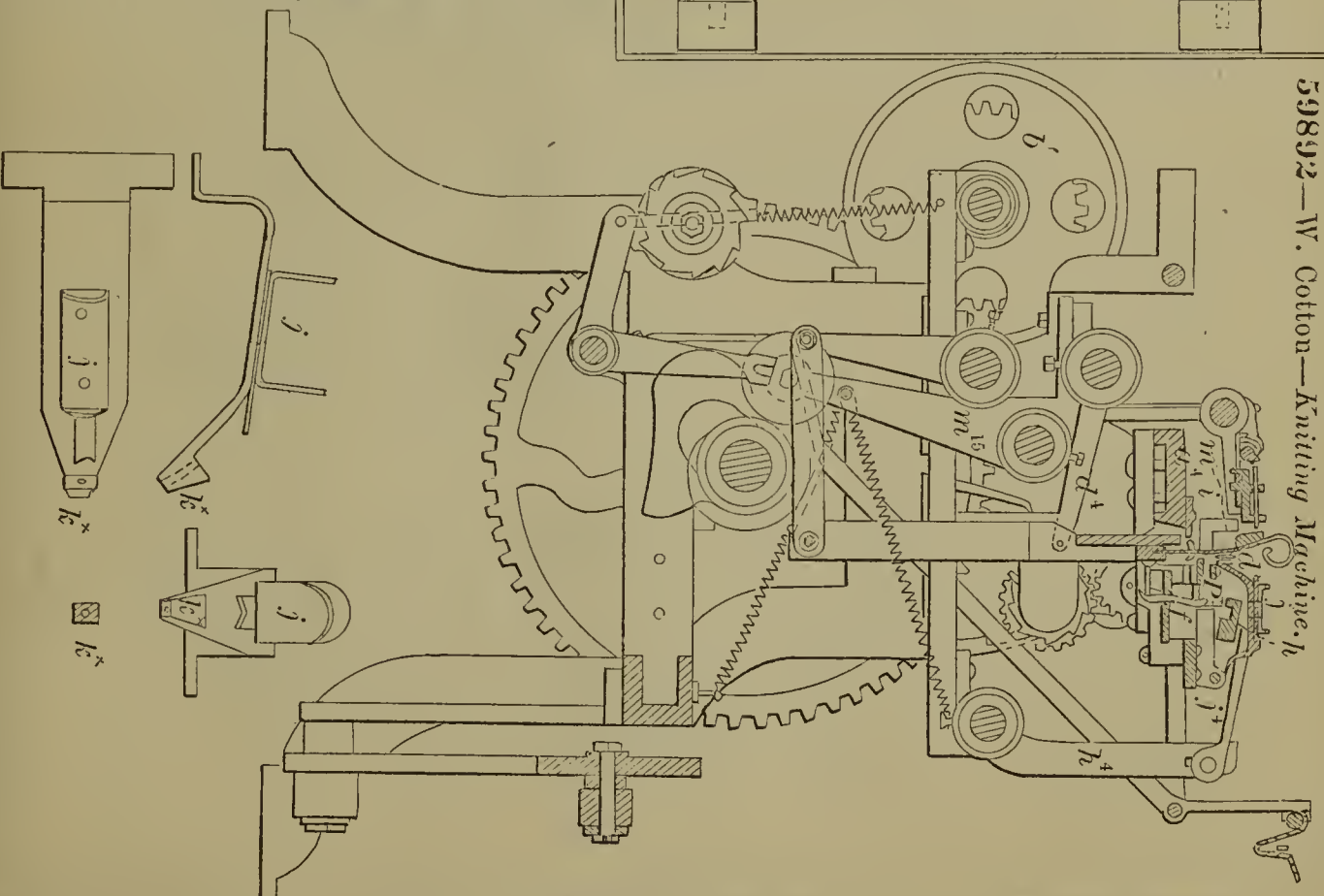
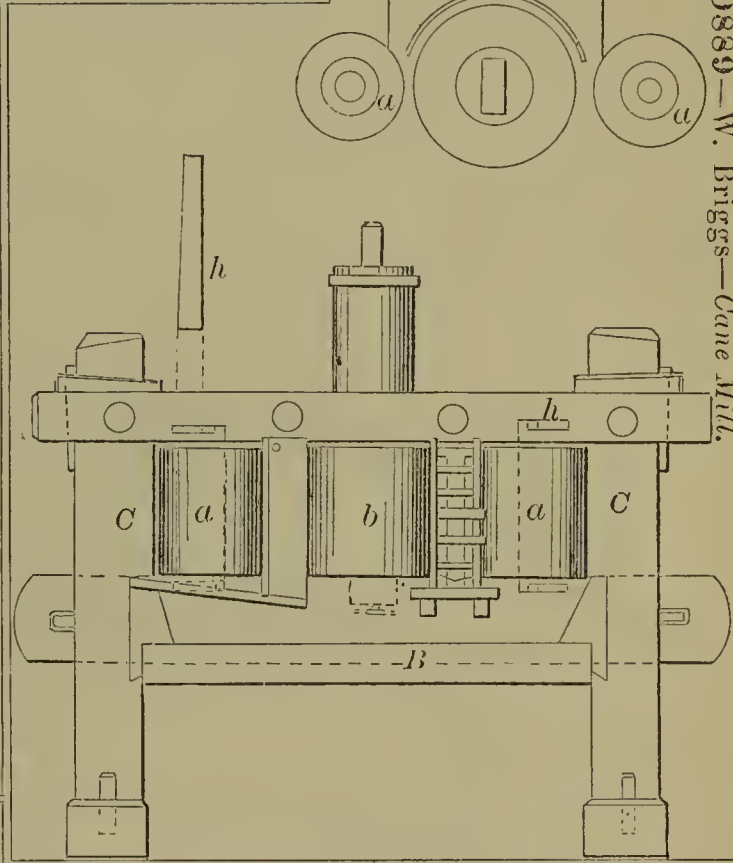

59892—W. Cotton—Knitting Machine.

59893—C. O. Crosby—Fish Hook.

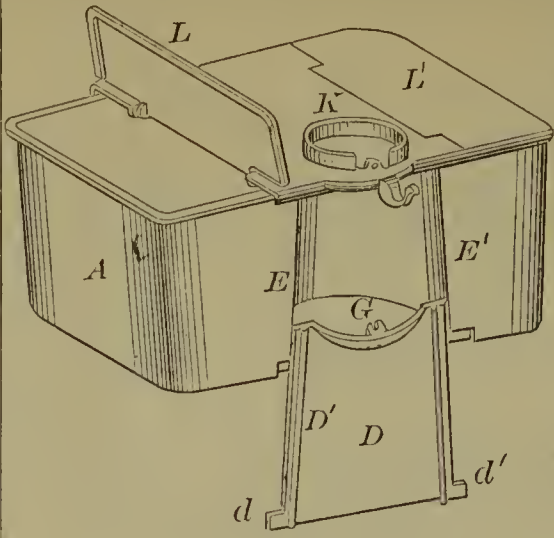

59894—J. B. Crowley—Hot Water Reservoir for Stores.

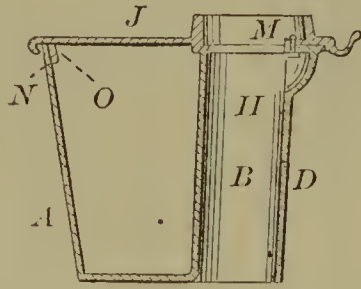

59898—H. W. Dopp—Tubular Wick Burner.

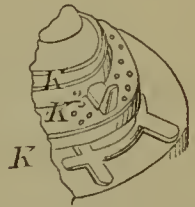
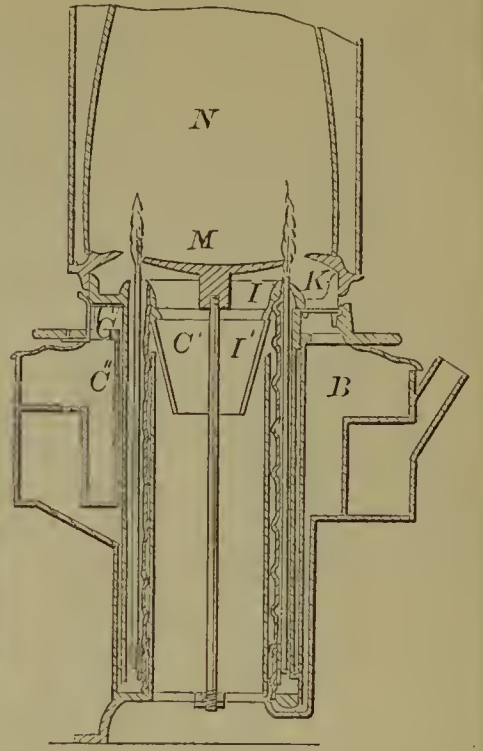

59895—T. B. De Forest—Metallic Binding.

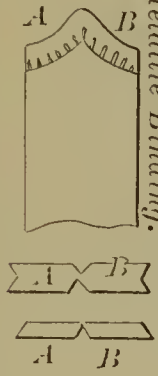

59897—D. Dishart—Washing Machine.

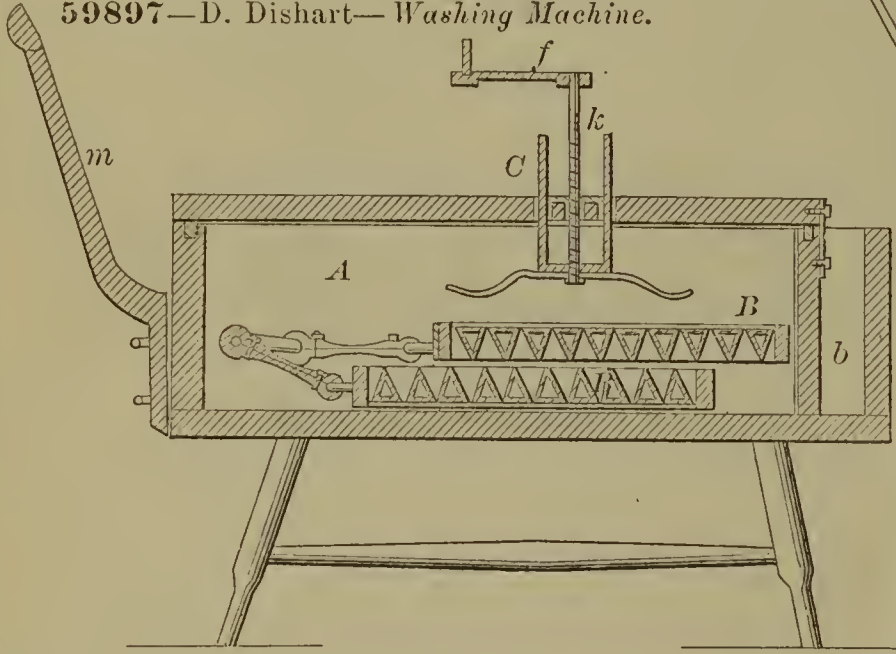

59896—T. B. De Forest—Buckle.

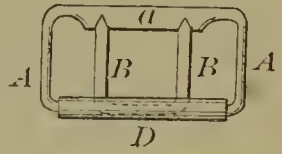

59901—W. Fitzgerald—Pegging Machine.

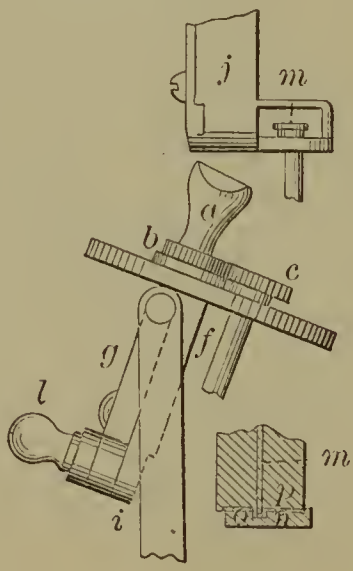

59900—A. Fanckhoner—Field Fence.

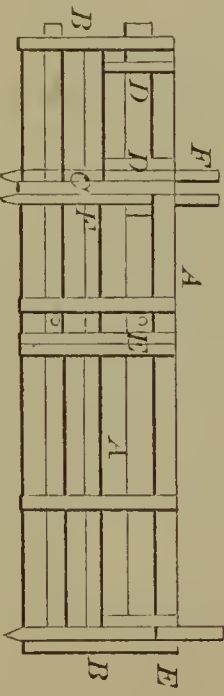

59899—Dopp & Weiss—Skate.

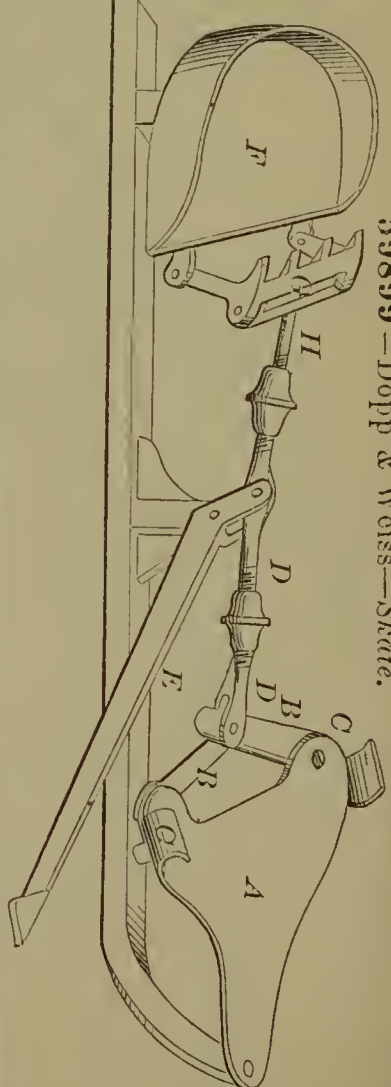

59904—I. Flanders—*Stump Extractor.*

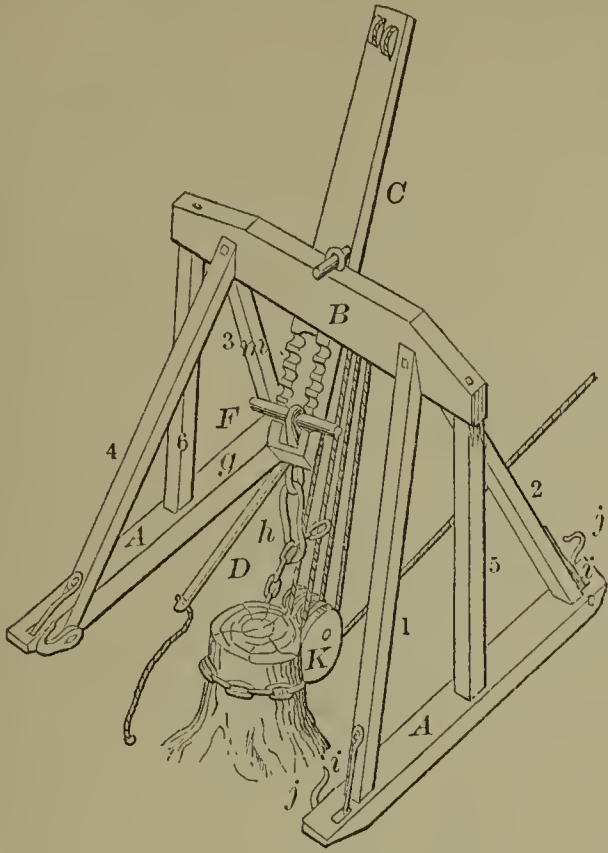

59905—J. S. Foster—*Pastry Roller.*

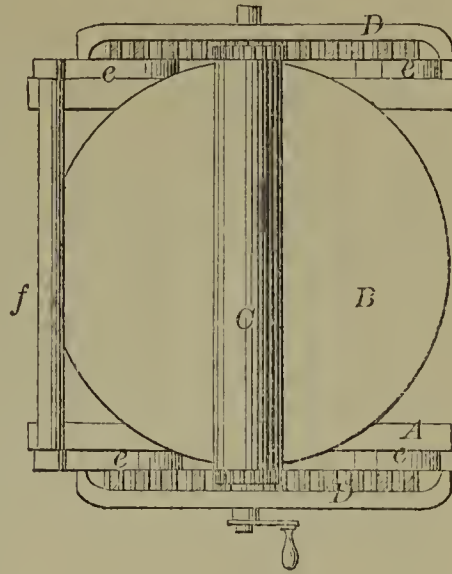

59908—J. H. Greenleaf—*Boot Heel.*

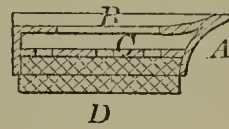

59906—H. P. Gengembre—*Skating Floor.*

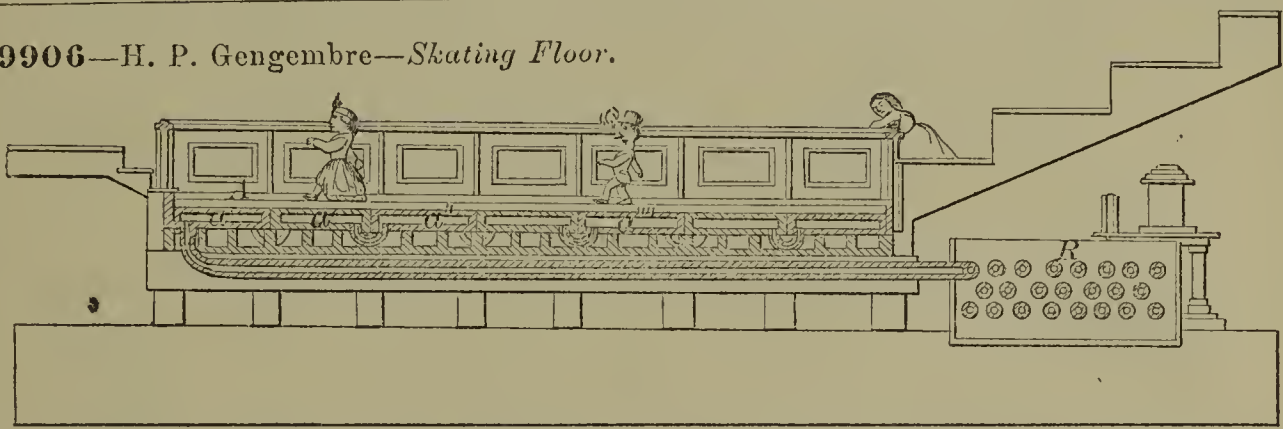

59907—T. R. Grant—*Piston Rod Packing.*

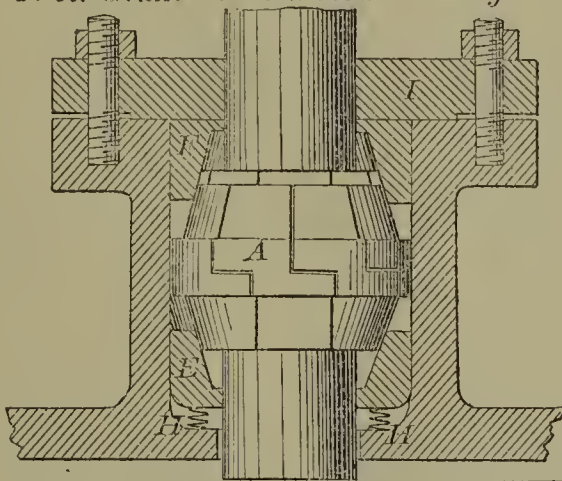

59909—C. H. Griffin—*Boiler Feeder.*

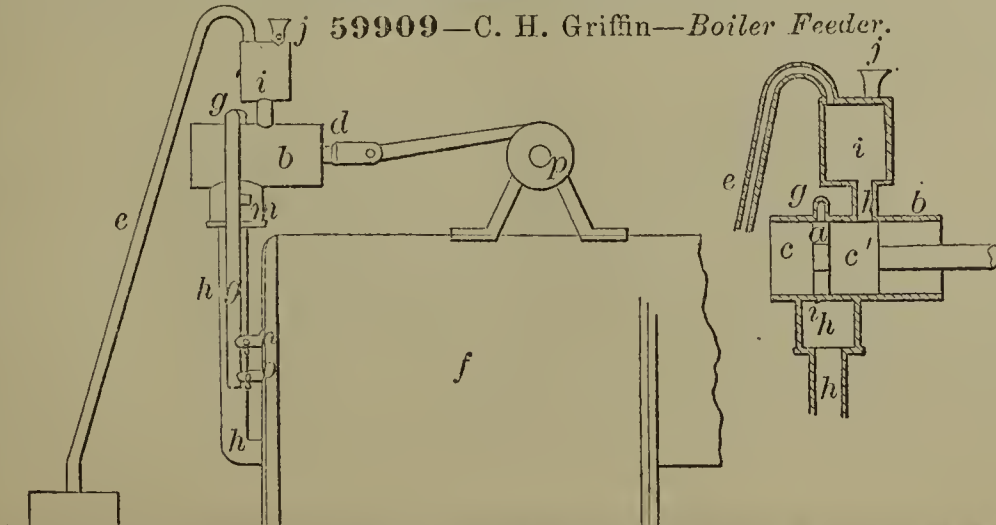

59910—A. T. Hay—*For Preventing Incrustation of Boilers.*

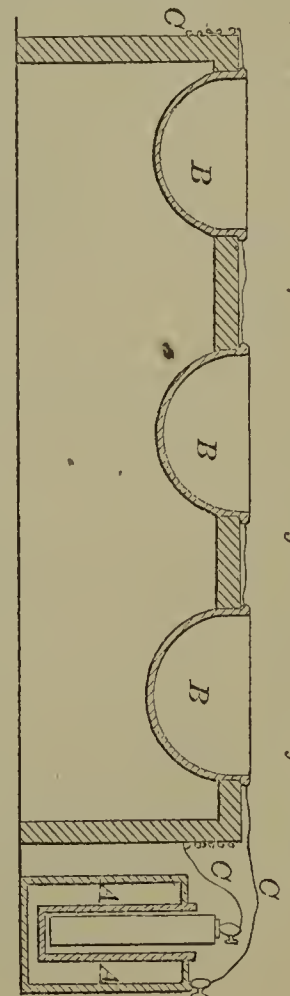

59911—G. Heiss—Cigar Press.

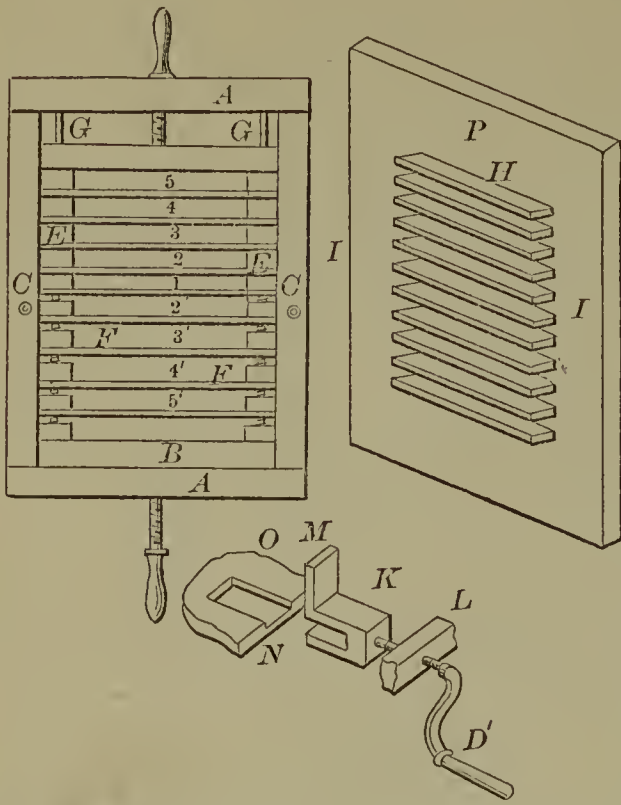

59912—W. Jones—For Stretching Boots and Shoes Lengthways.

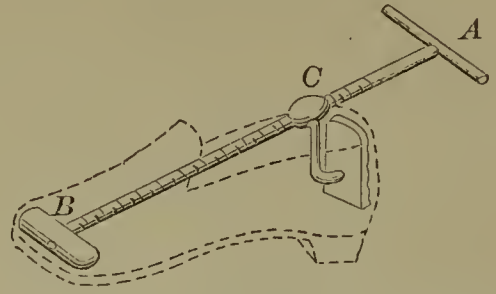

59914—Kromer & Ohlemacher—Belt Clasp.

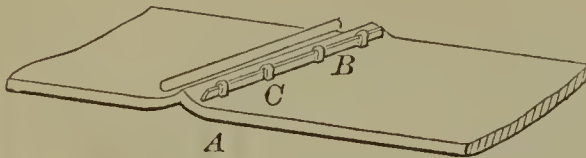

59916—J. W. Maloy—For Polishing Marble.

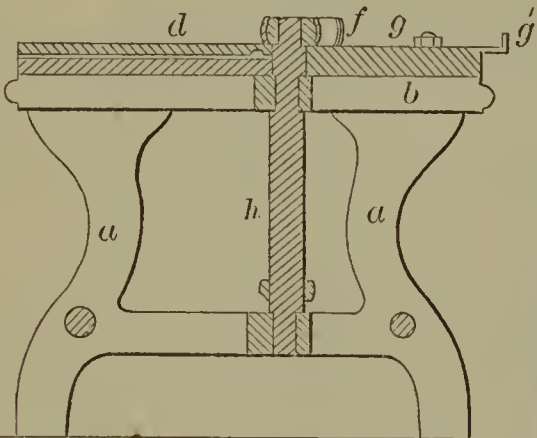

59915—P. Lallement—Velocipede.

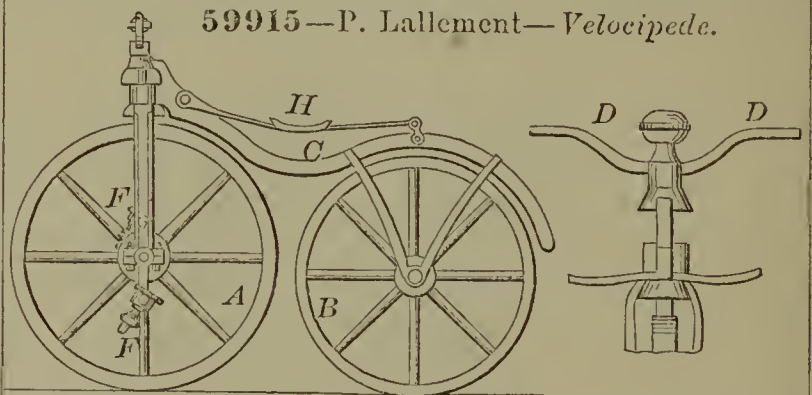

59917—W. H. Masters—Solar Camera.

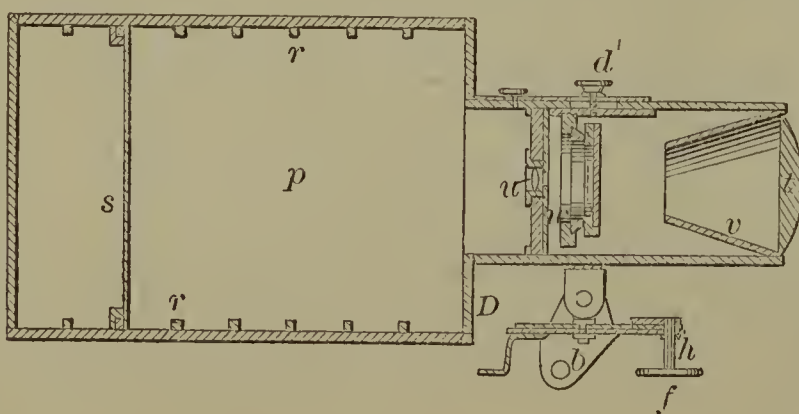

59918—McLean & Vanderear—Piston Rod Packing.

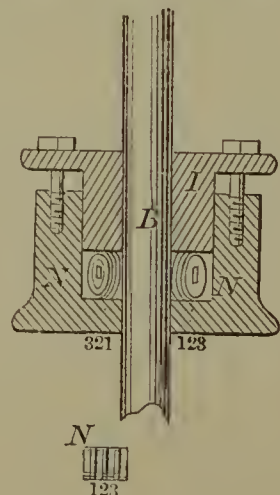

59913—S. R. Knox—Fluting Machine.

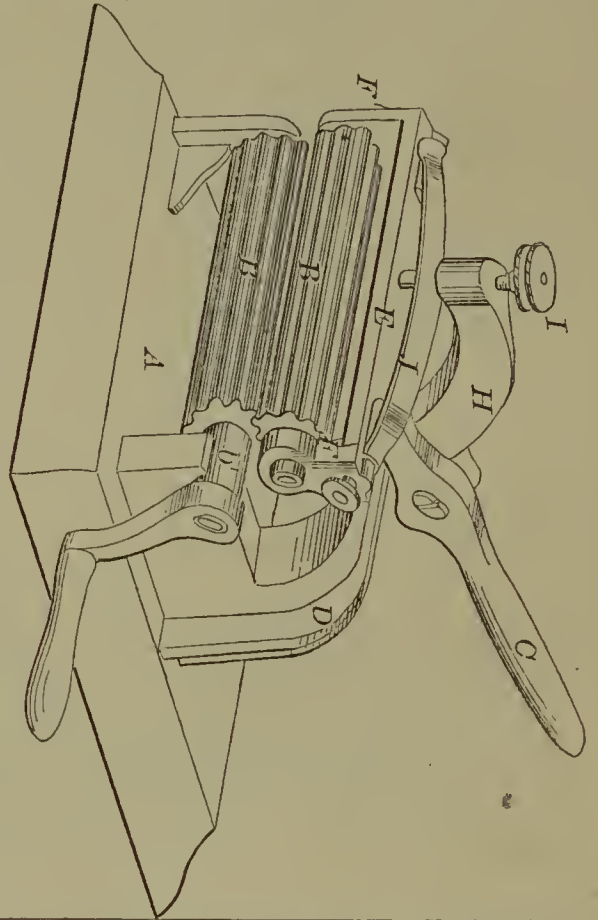

59921—W. T. Mersereau—Stair Rod Fastening.

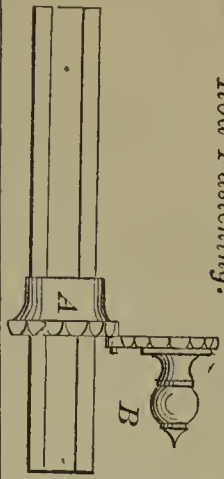

59923—G. L. Morris—Screw.



59920—C. R. Mellinger—Shifting Seat for Carriages.

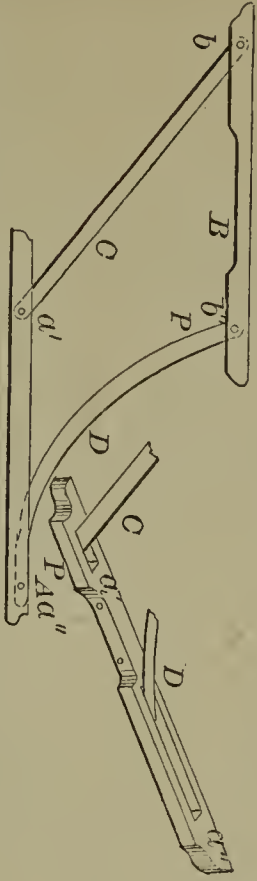

59925—J. H. Pooock—Coal Hod.

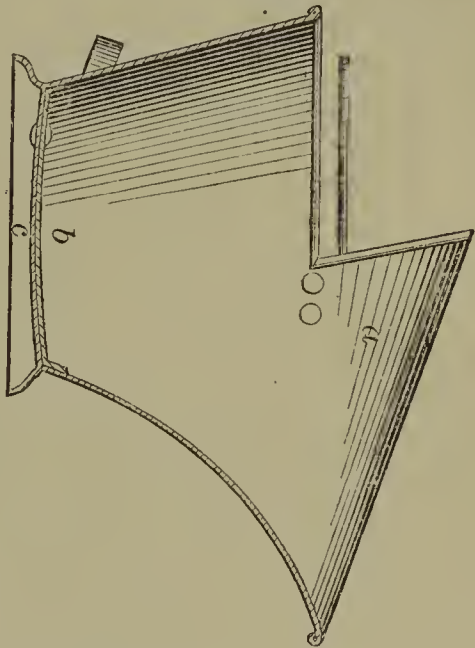

59919—McQuirk & Cole—Carding Engine.

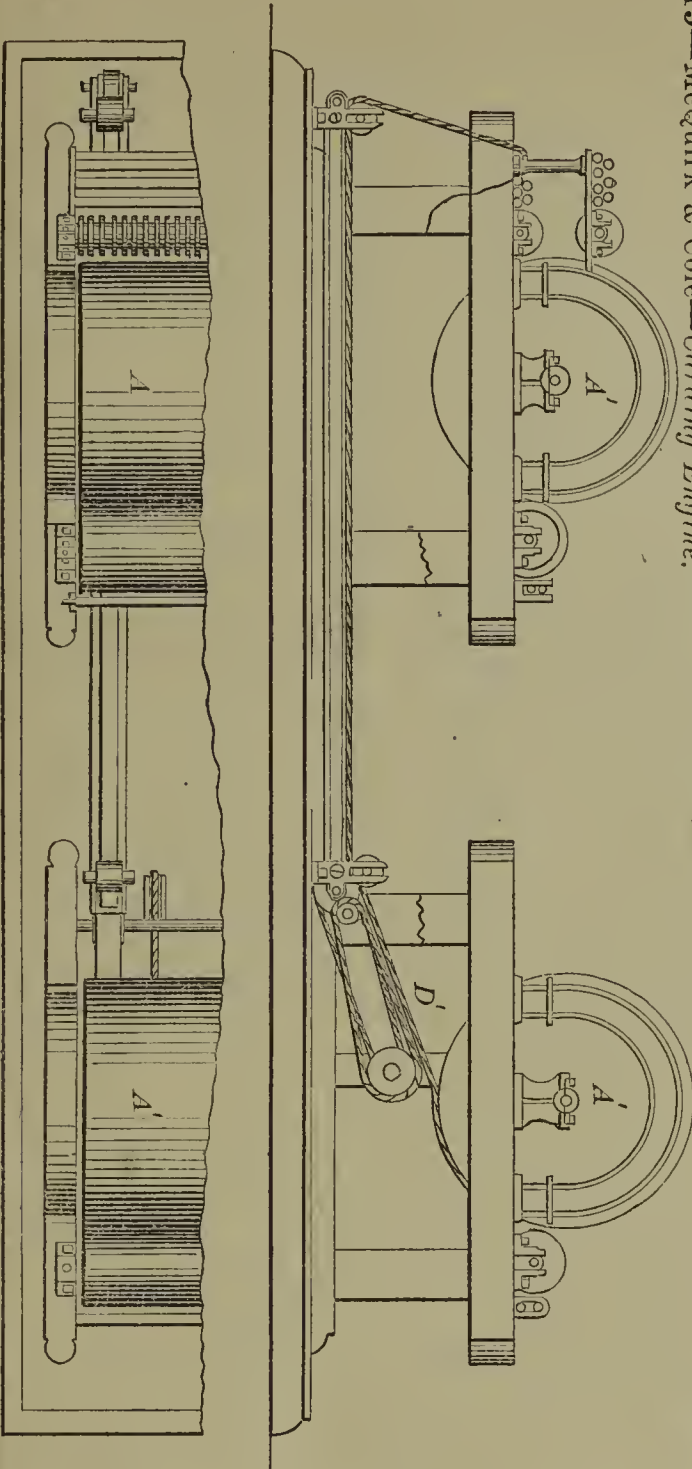

59926—I. Rice—Comb.

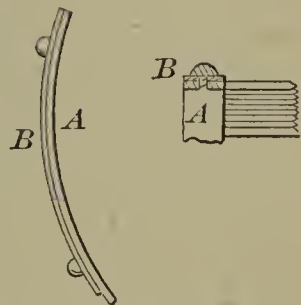

59922—O. E. Miles—Bolster Plate for Wheeled Vehicles.

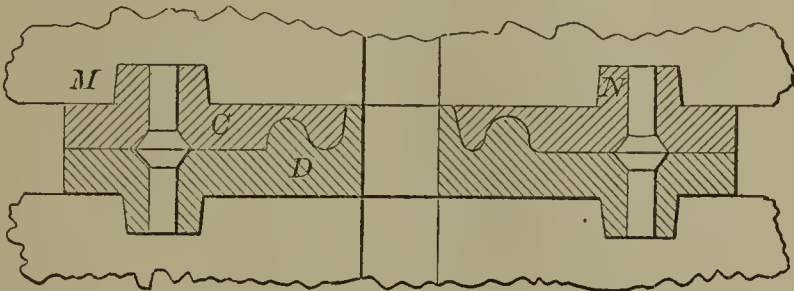

59924—J. S. Morris—Torpedo.

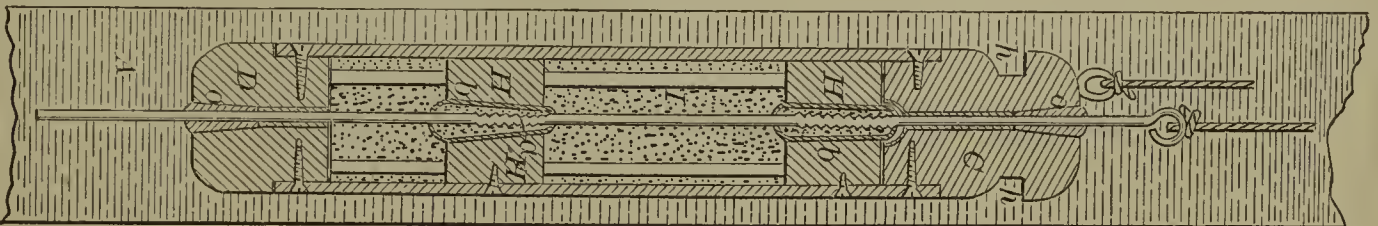

59927—N. L. Robertson—Sifter.

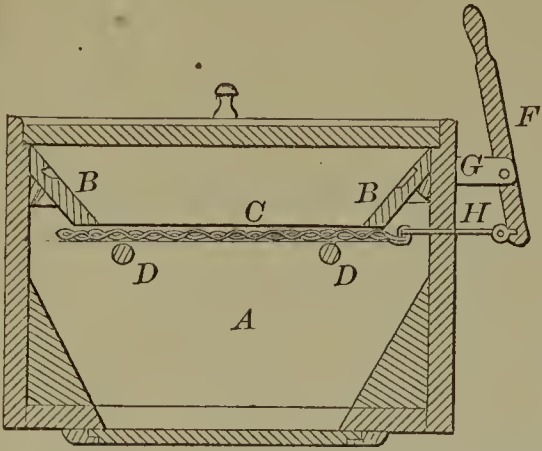

59929—H. Sidle—Construction of Houses.

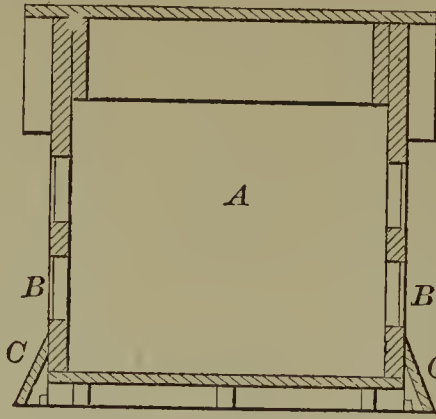

59933—D. Walker—Bolting Pad.

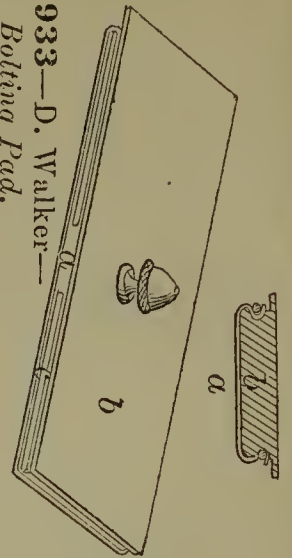

59928—S. J. Seely—Roofing and Clapboarding.

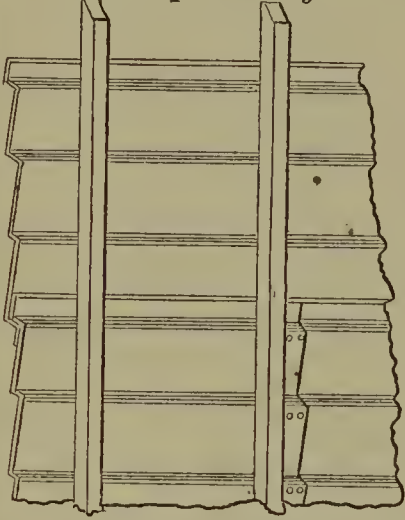

59931—L. S. Stevens—Metallic Smoke House.

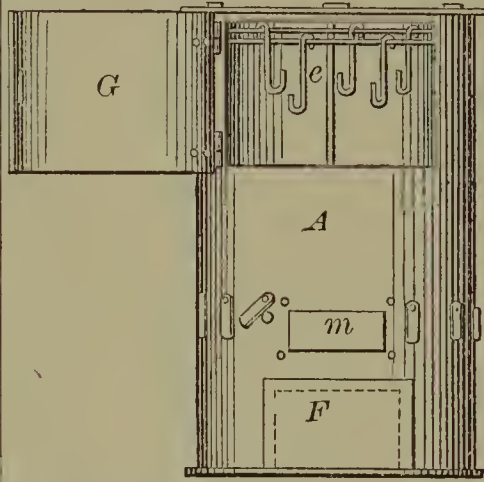

59934—L. Wilkinson—Screw Clamp for Bending Axletrees.

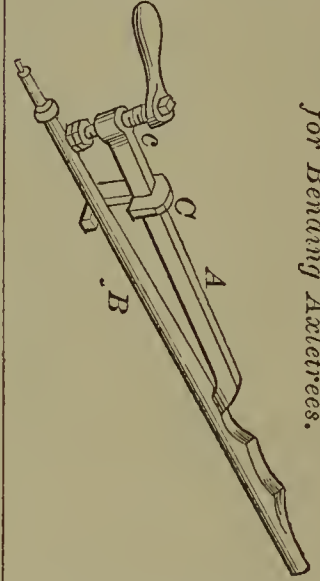

59930—S. Spoor—Gate.

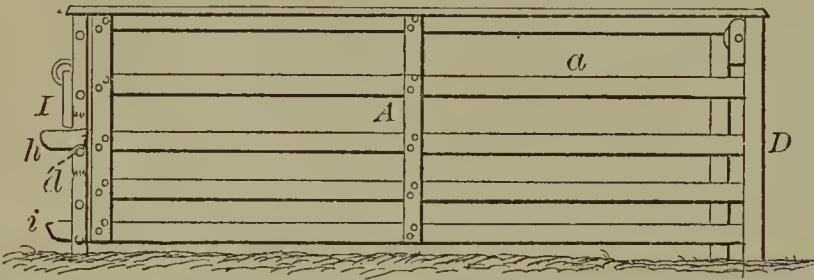

59932—J. Stofer—Window Brush.

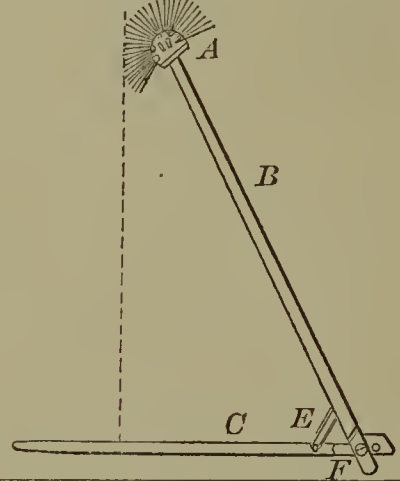

59936—E. A. L. Roberts—For Increasing the Capacity of Oil Wells.

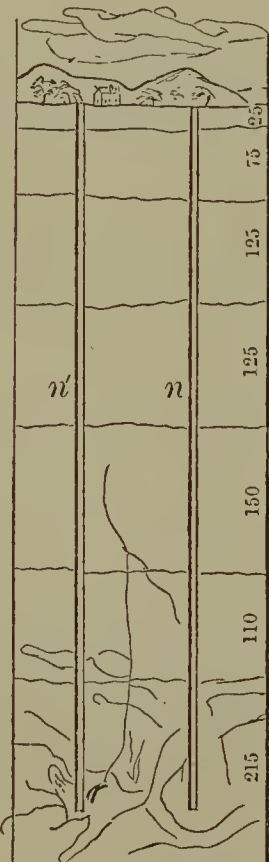

59935—L. C. Wright—Clothes Dryer.

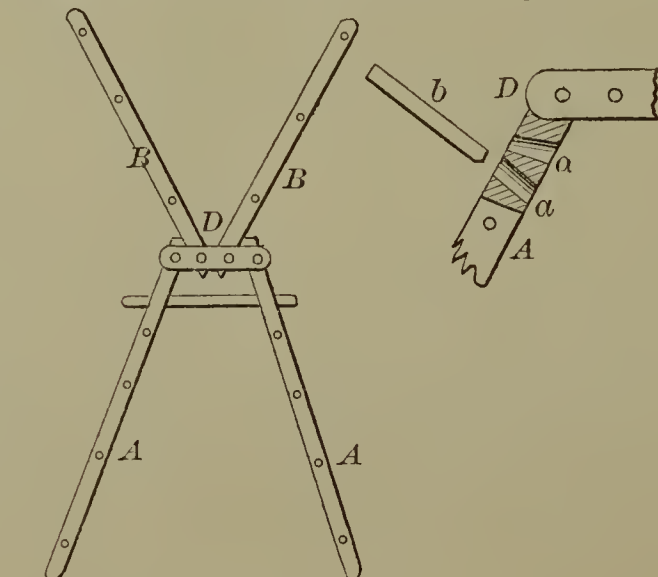

59937—Albright & Burns—Bridle.

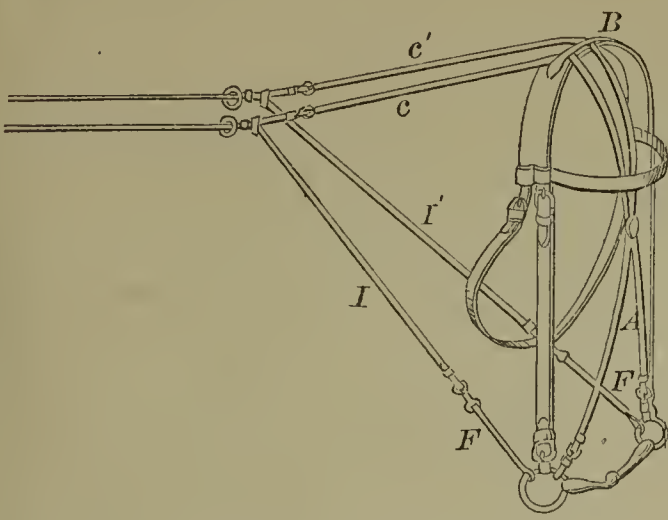

59942—A. Barnes—  
Manufacture of Sheet  
Metal Boxes.

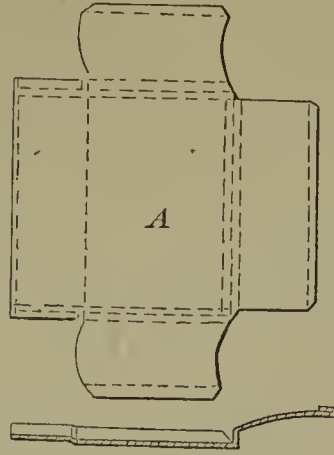

59943—W. Barnes—For Tempering  
Clock Springs.

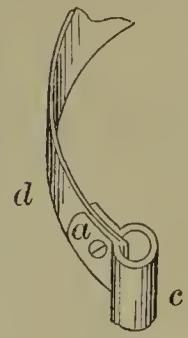

59940—J. G. Newton—Forging Apparatus.

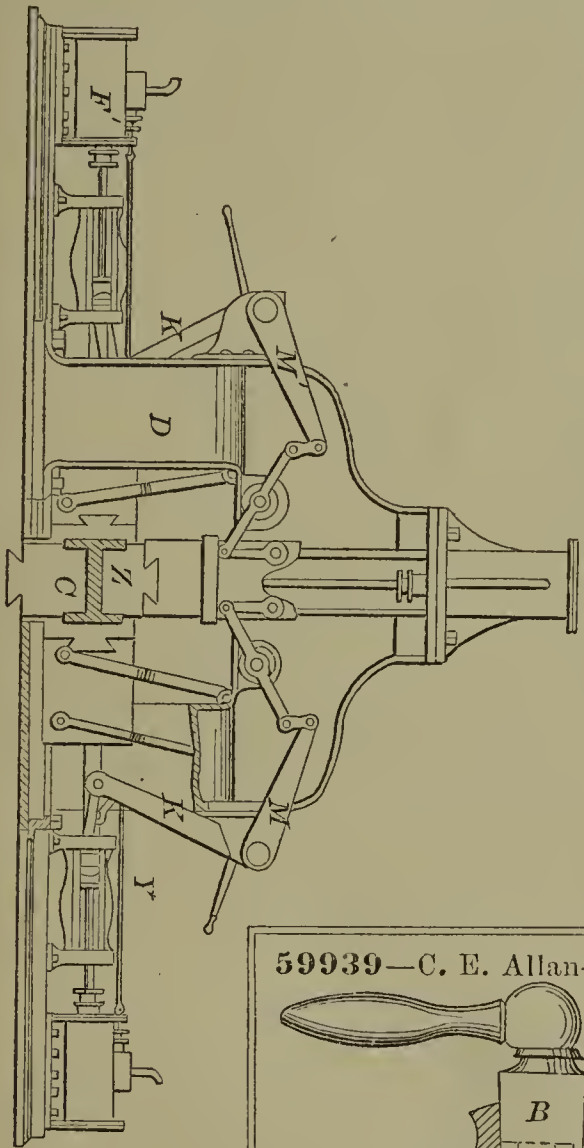

59941—A. G. Bagg—  
Cheese Vat.

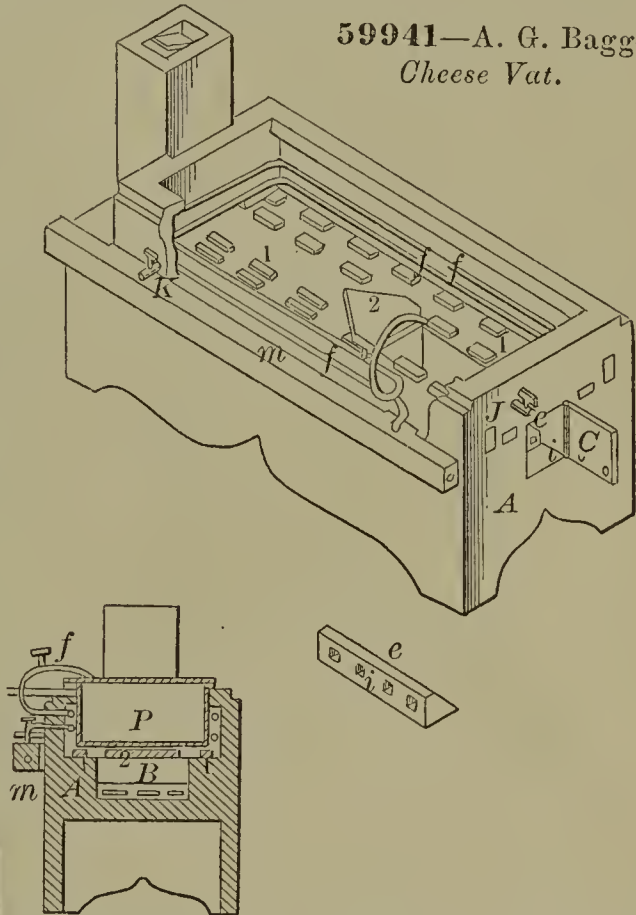

59939—C. E. Allan—Faucet.

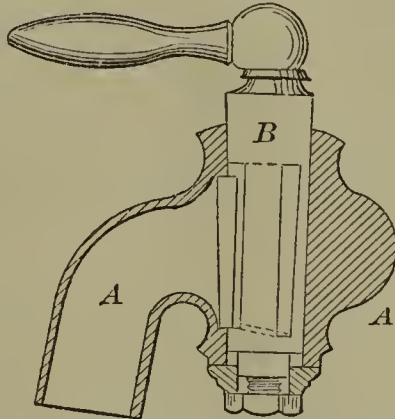

59944—R. T. Barton—For Making  
Paper Boxes.

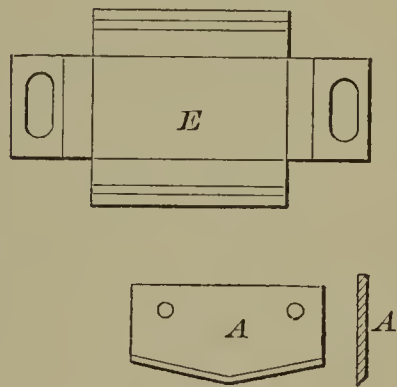

59938—D. A. Alden—Paper Collar and Cuffs.

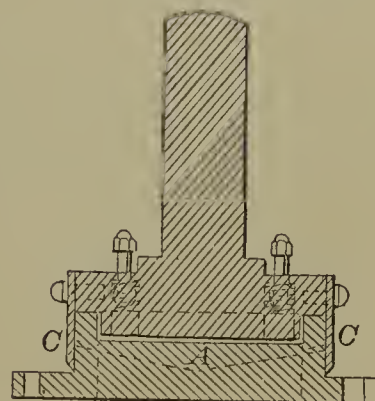
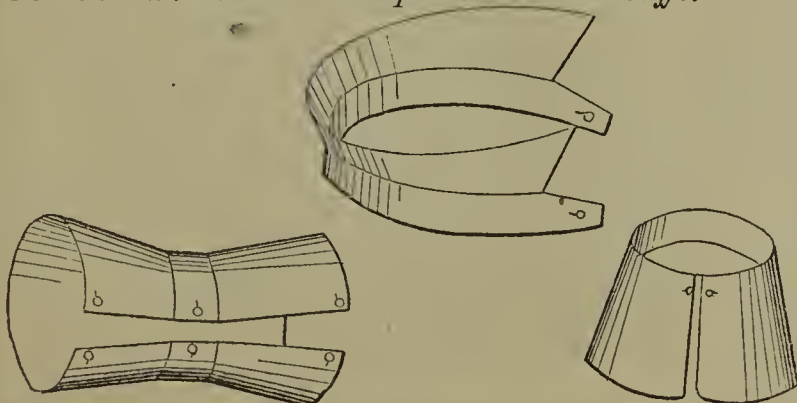

59945—L. Bauhoefer—Cushion or Mattress.

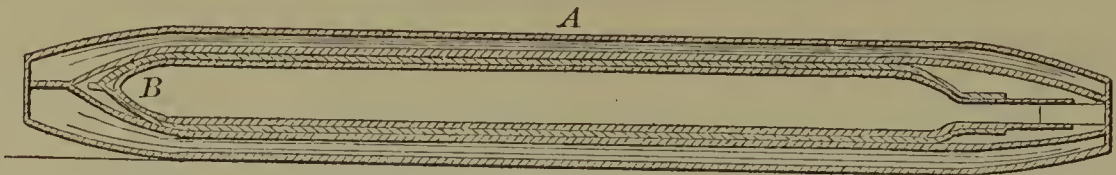

59947—F. Baumann—Steam Generator.

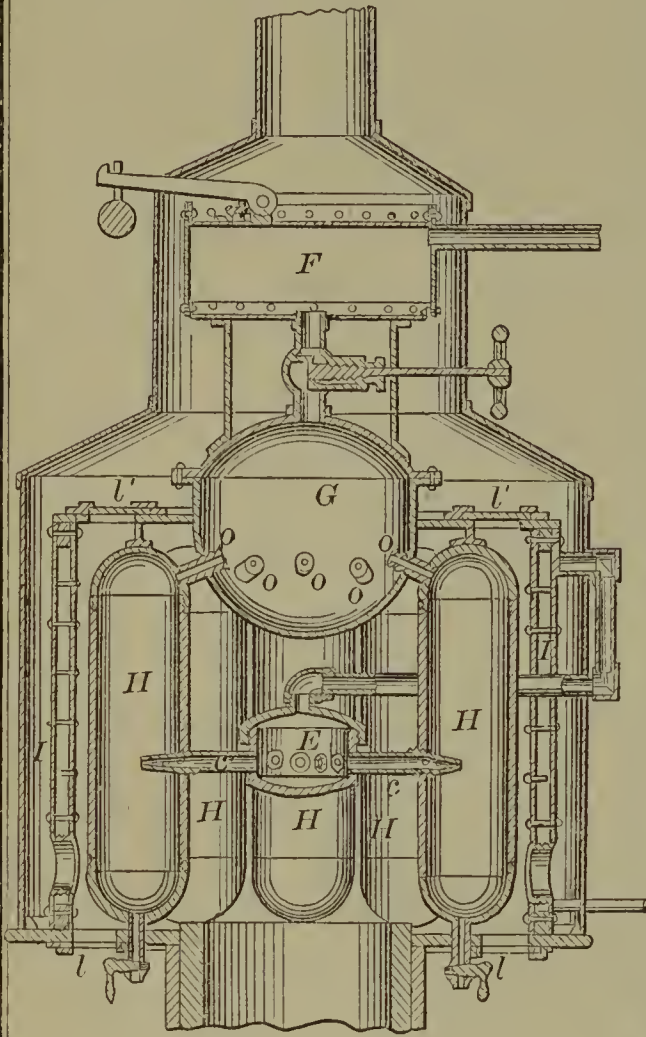

59950—J. Borthwick—For Sharpening Saws.

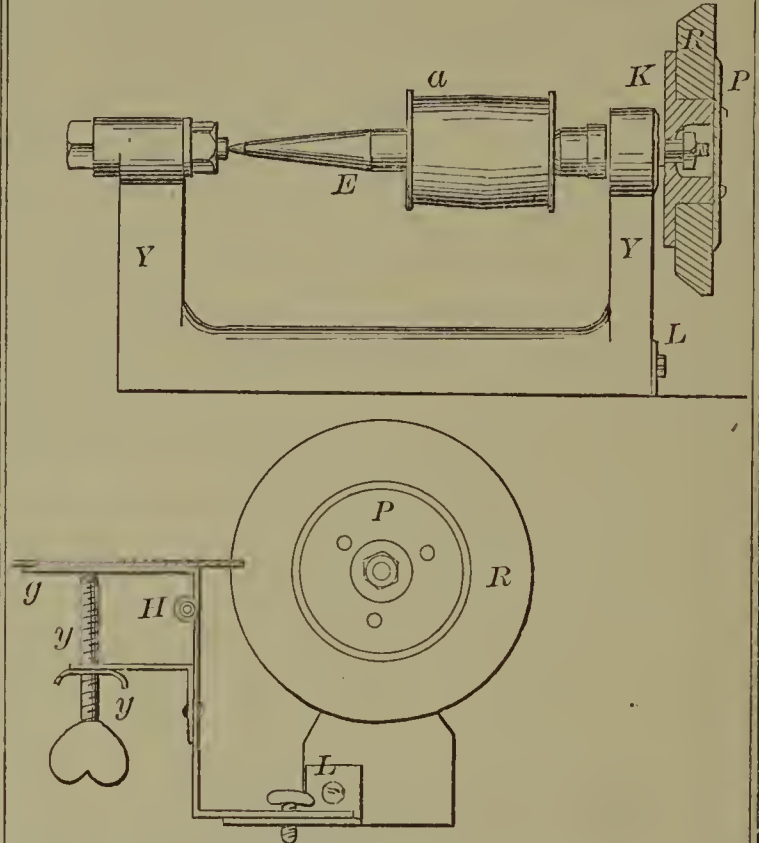

59951—A. Boynton—Saw.

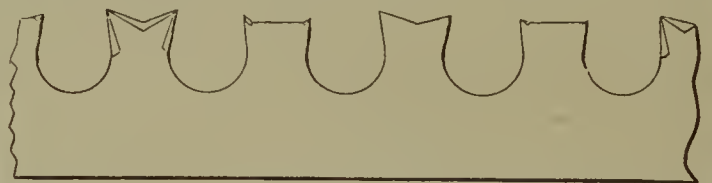

59949—C. A. Blake—Burglar Alarm.

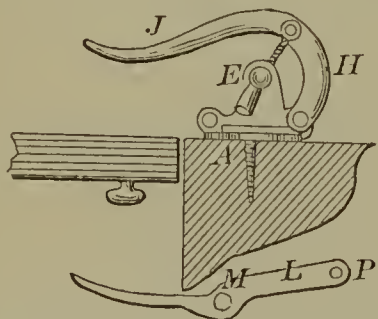

59948—I. Beetison—Expanding Mandrel.

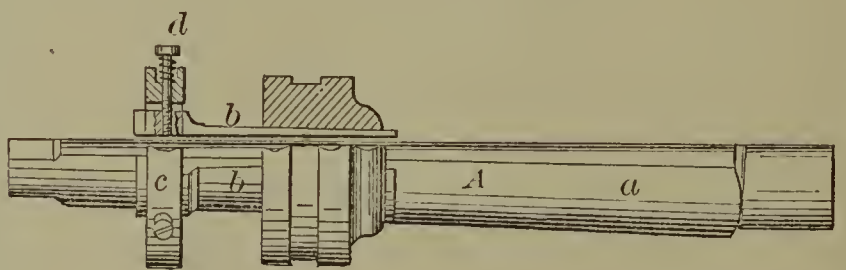

59952—W. Branagan—Steam Generator.

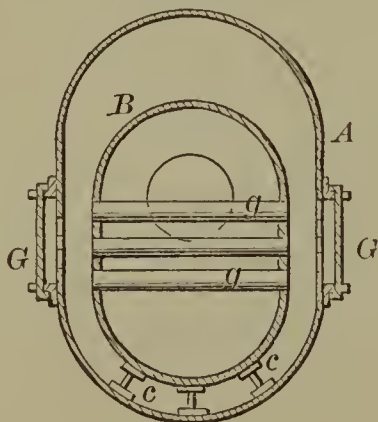

59953—A. Brear—For Trapping Wild Fowl.

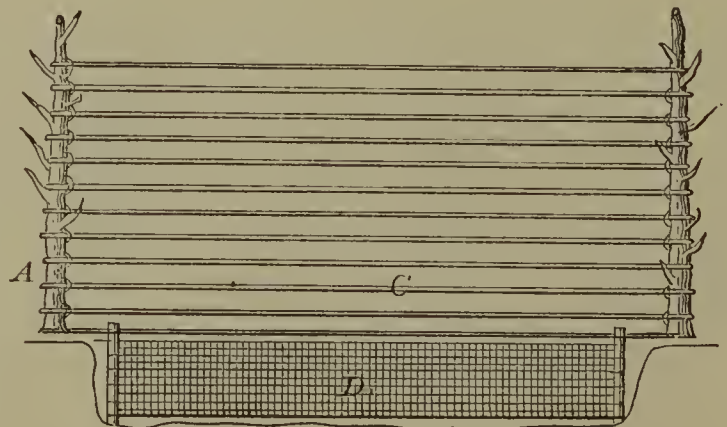



59954—B. F. Brown—Coal Hod and Sifter.

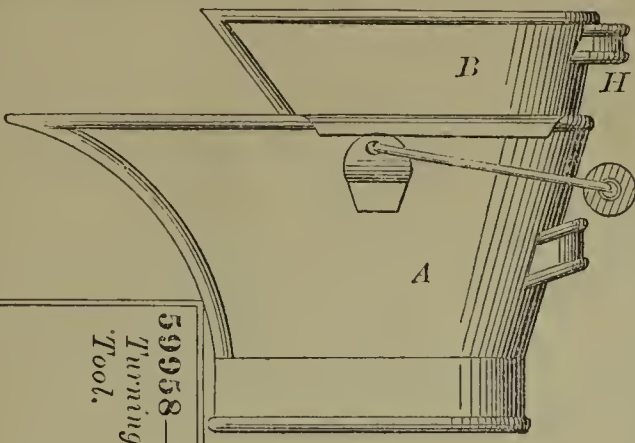

59958—C. W. Burdick—Turning and Planing Tool.

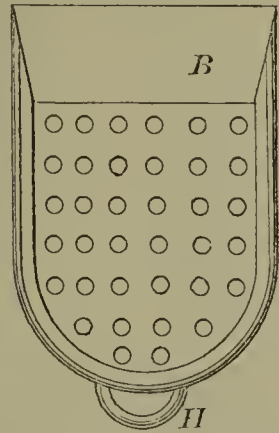
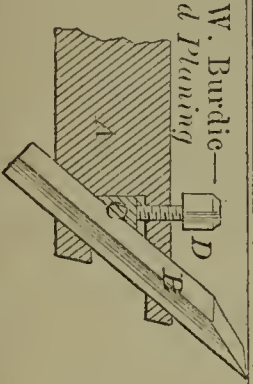

59955—E. Brown—Separating Gold and Silver from Ores.

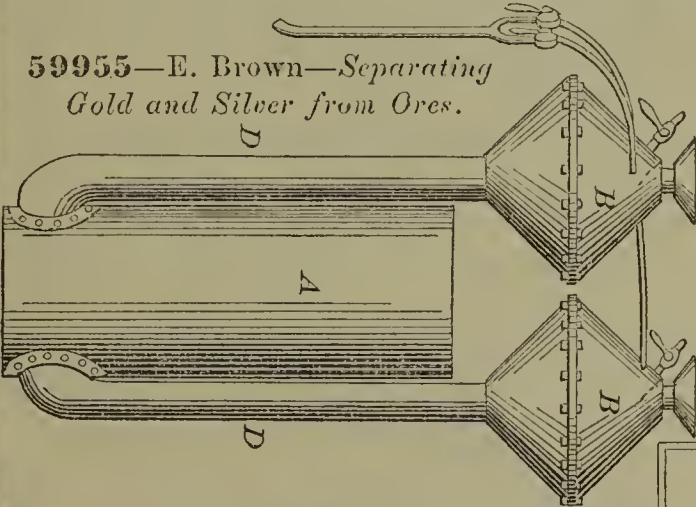

59960—C. Burleigh—Rocks Drilling Machine.

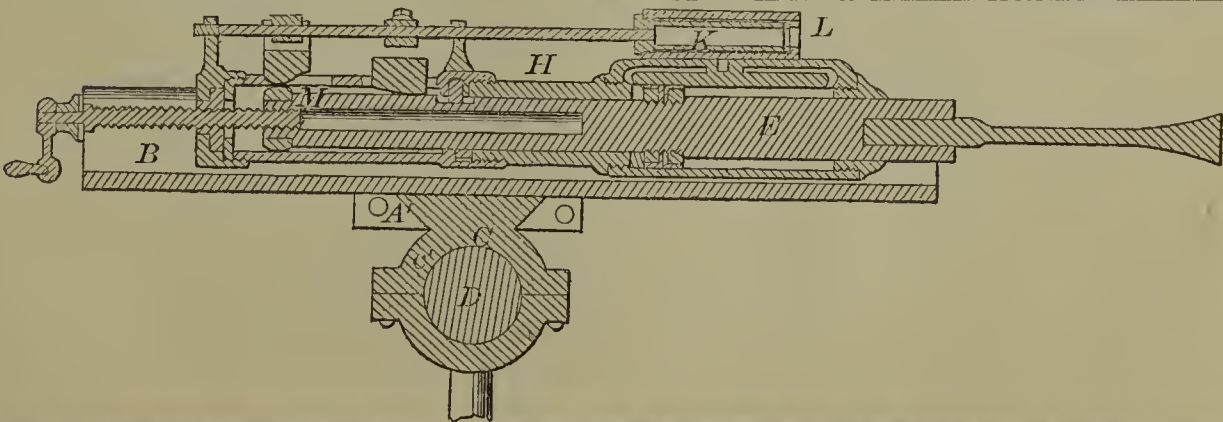
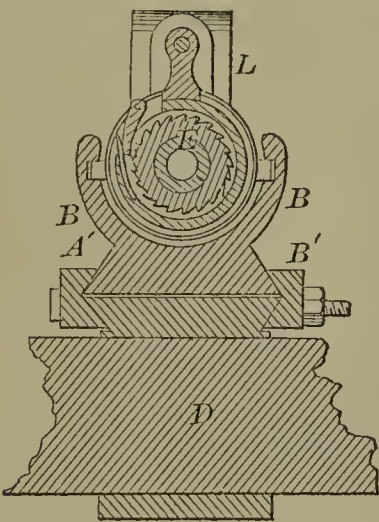

59957—J. T. Bruen—For Cutting and Reenforcing Button Holes.

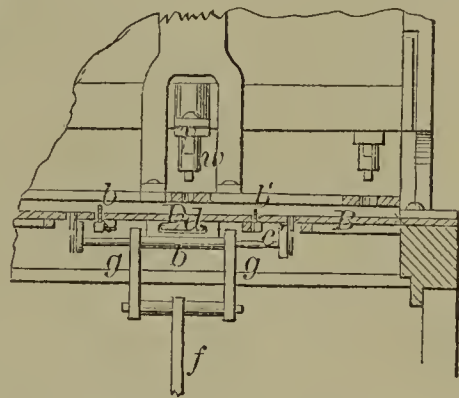
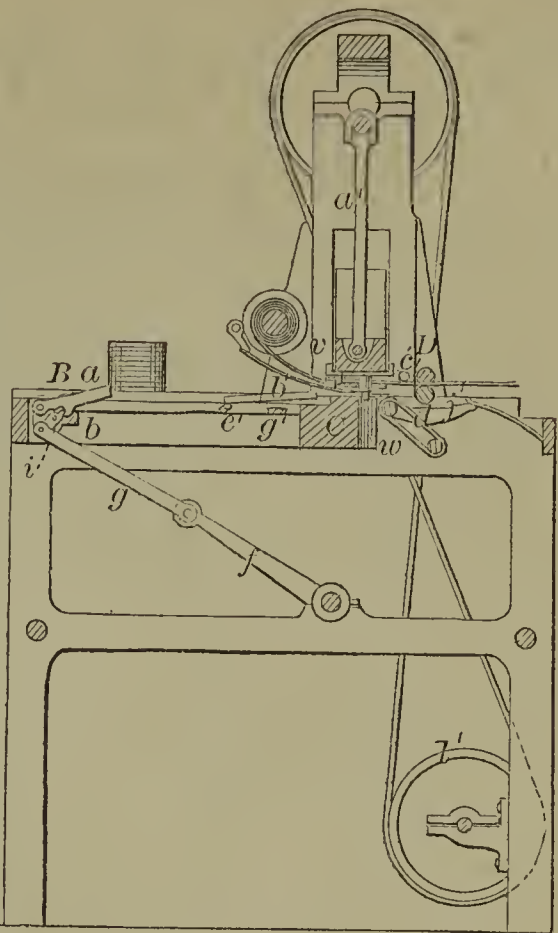

59956—J. R. Brown—For Draining Sugar. G'

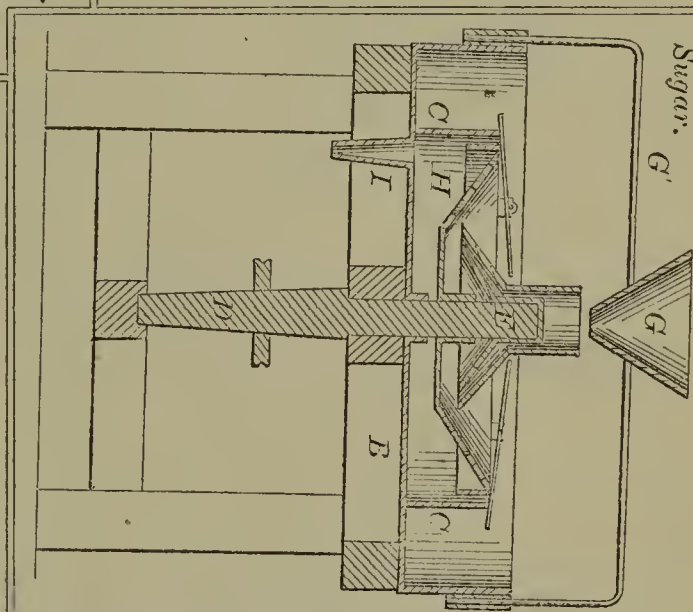

59961—J. N. Byington—Spring Wagon.

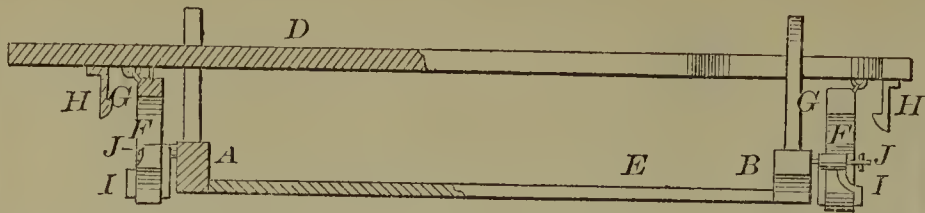

59963—G. F. Case—Feed Motion for Drills.

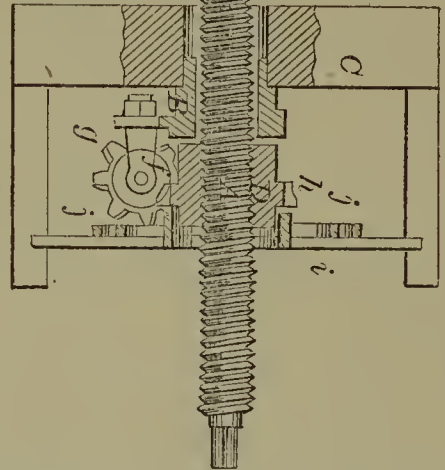

59966—Climer & Riley—Planing Machine.

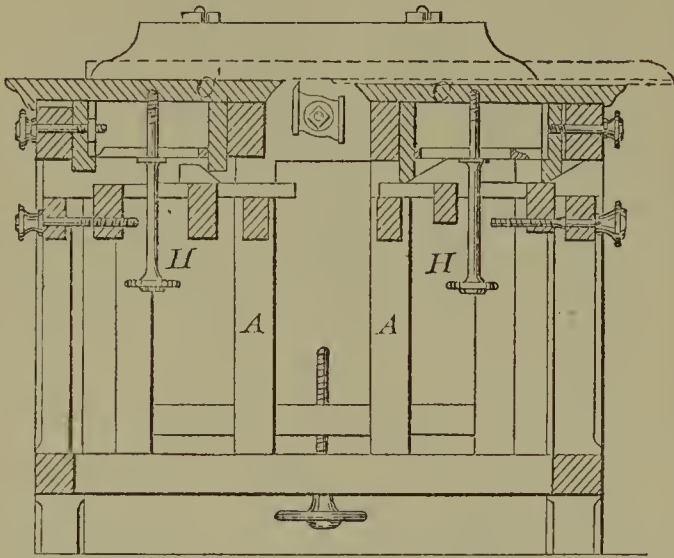

59962—Carmichel & Barney—Stop Motion for Looms.

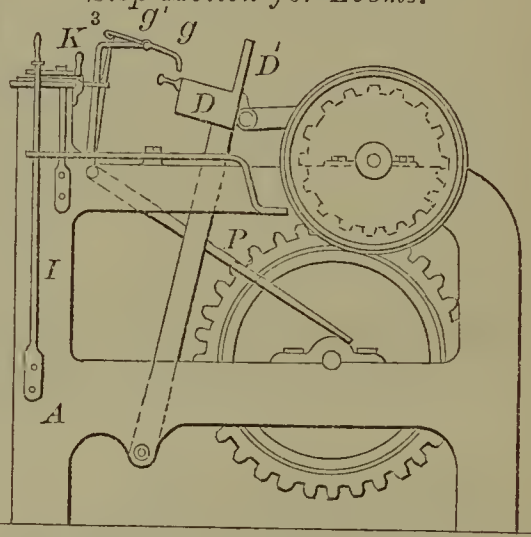

59964—P. Ceredo—Ash Sifter.

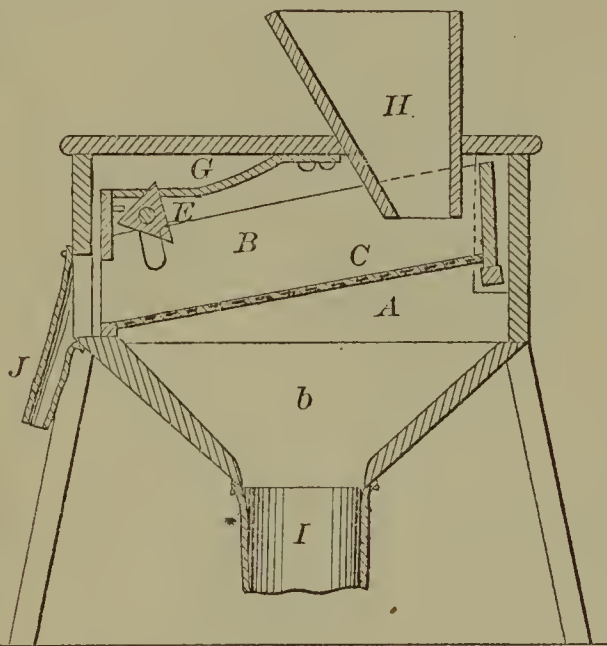

59965—G. T. Chapman—Rein.

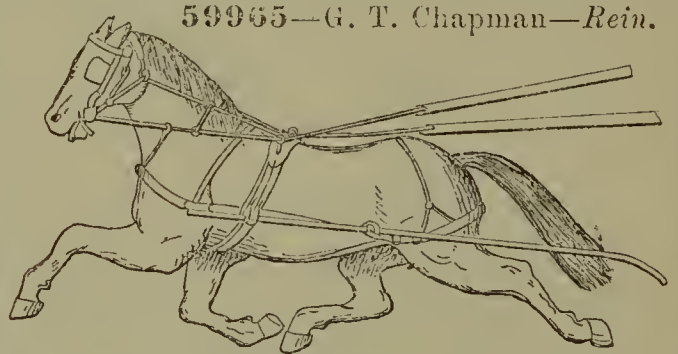

59967—F. Clymer—Tree Protector.

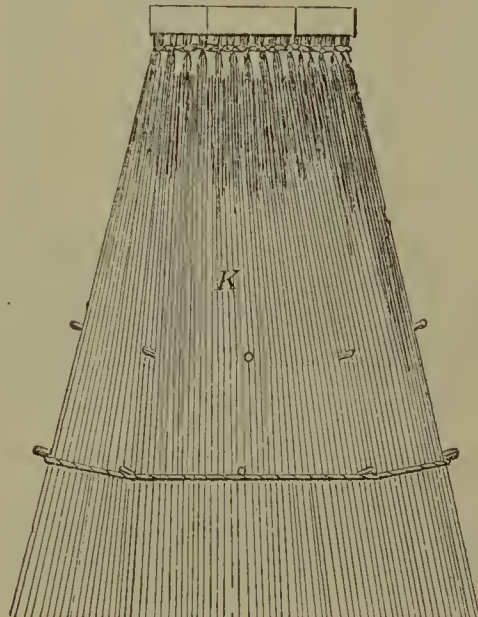
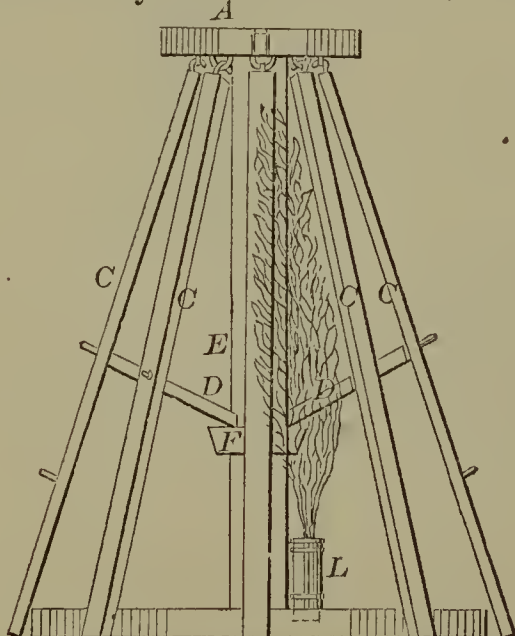

59968—J. H. Coate—Grate and Andiron.

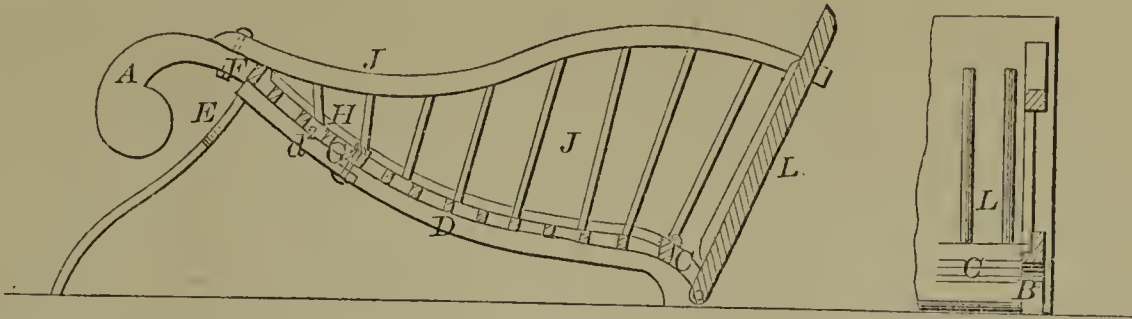

59970—G. Coffin—Attaching Shafts to Sleighs and Carriages.

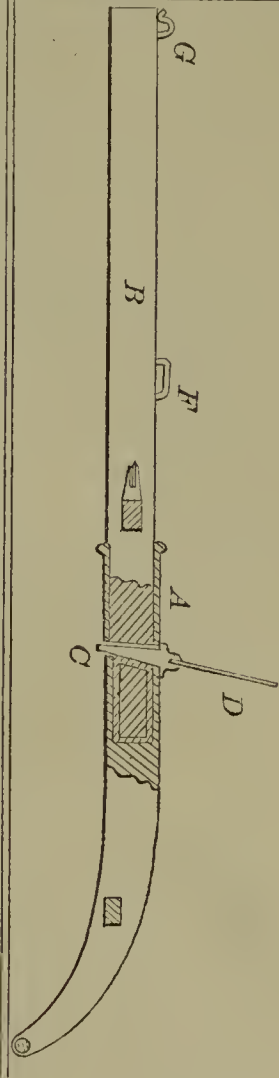

59969—D. N. B. Coffin, Jr.—Capstan and Windlass.

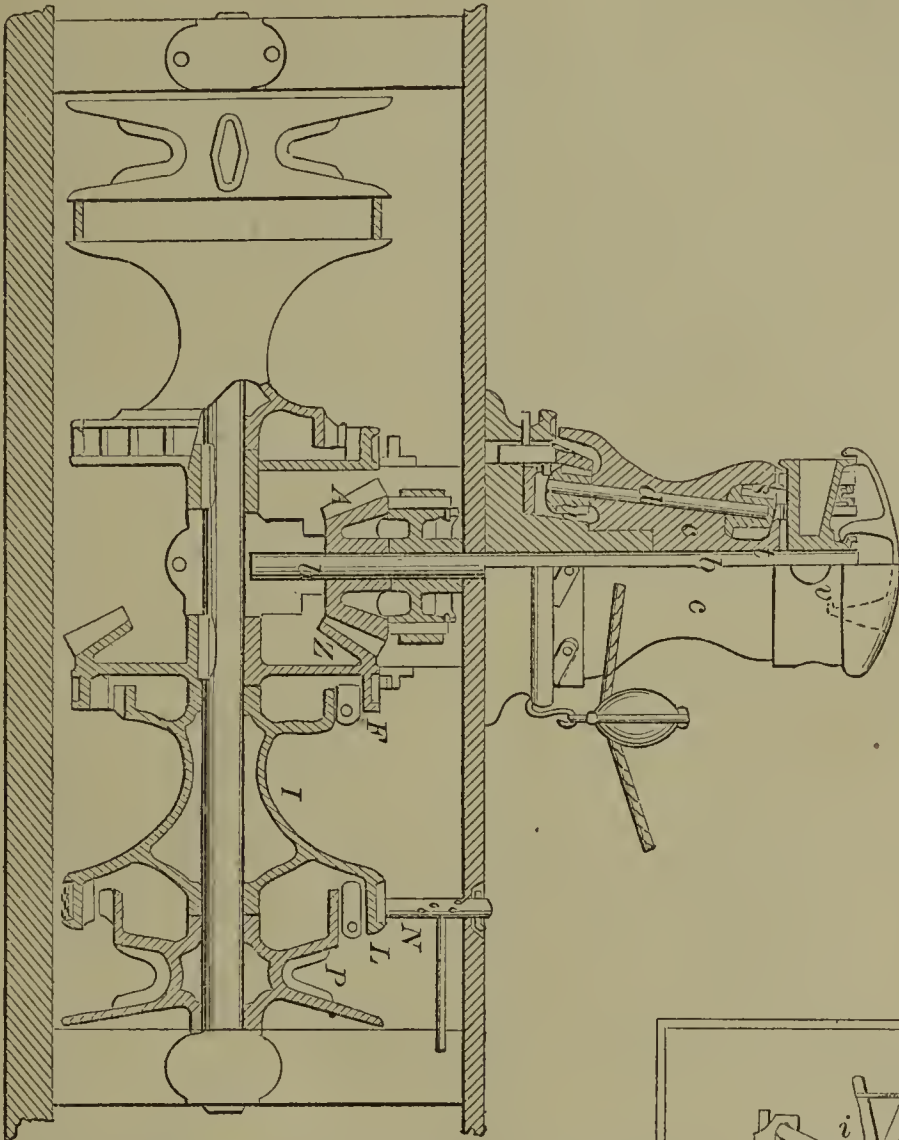

59972—G. Crompton—Harness Motion for Looms.

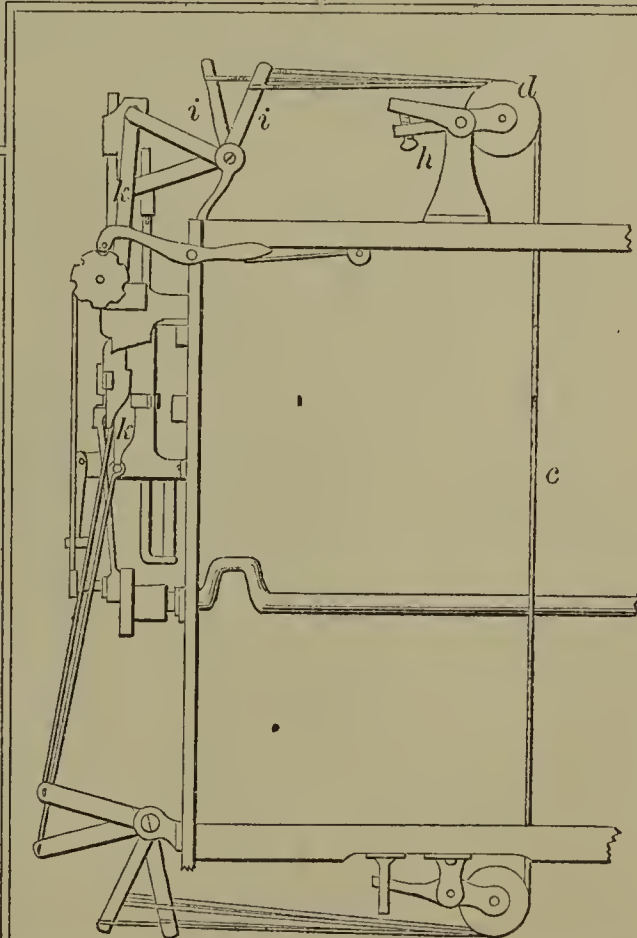

59971—N. E. Cornwall—Stove Pipe Attachment.

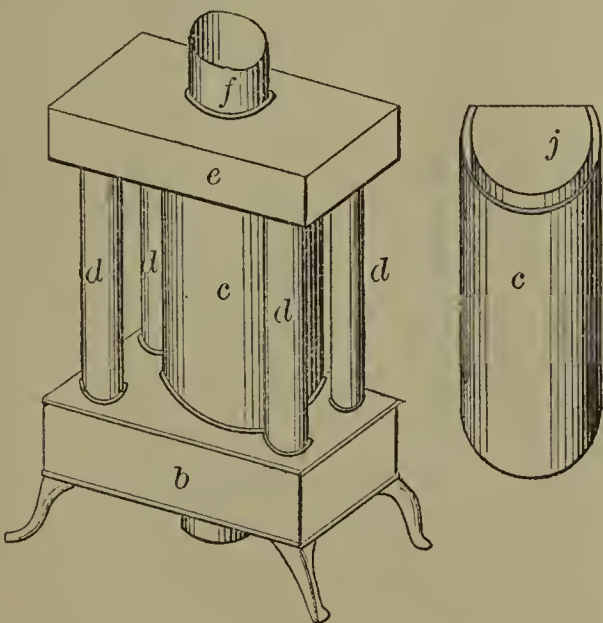

59973—J. Crowfoot—Spinning Machine.

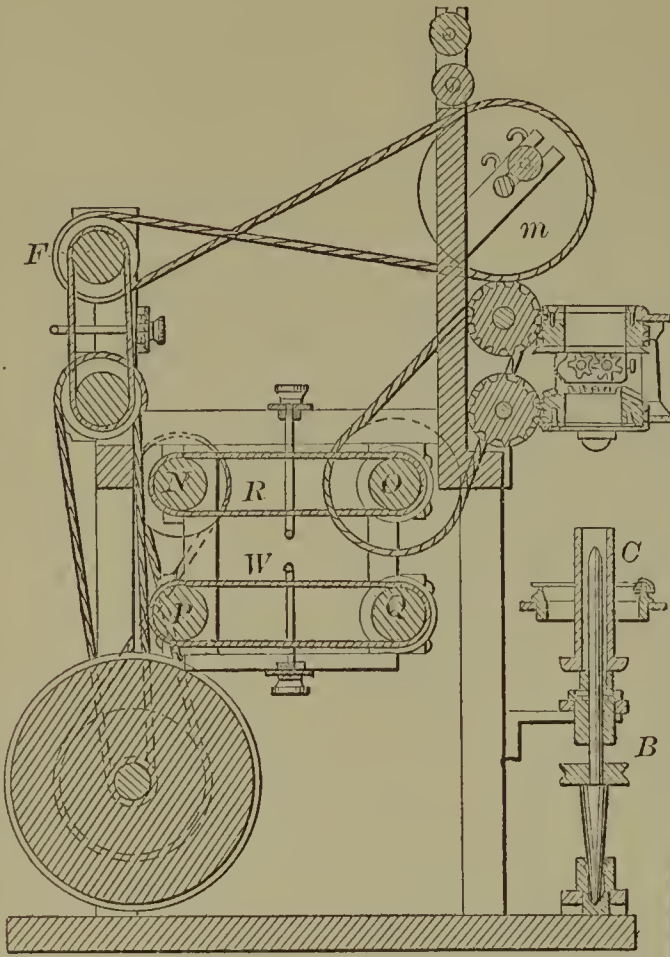

59978—A. de Figanière—Making Super-Phosphate of Lime.

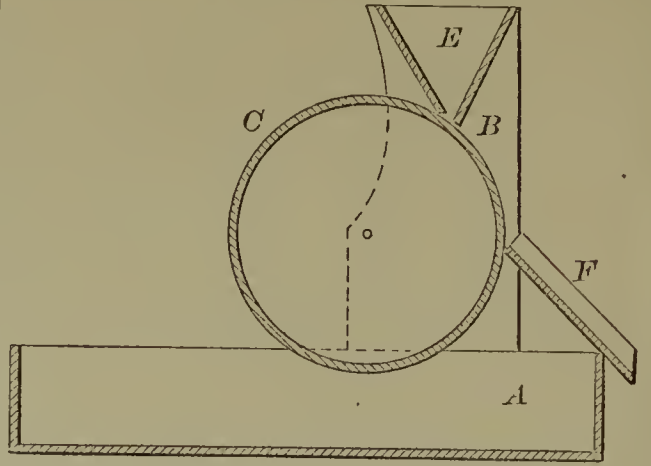

59980—S. F. Dimock—Animal Trap.

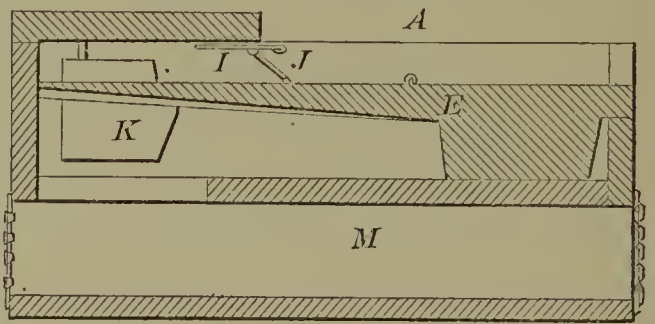

59974—A. Cutler—Table Leaf Support.

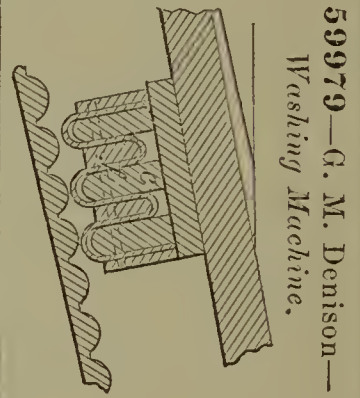
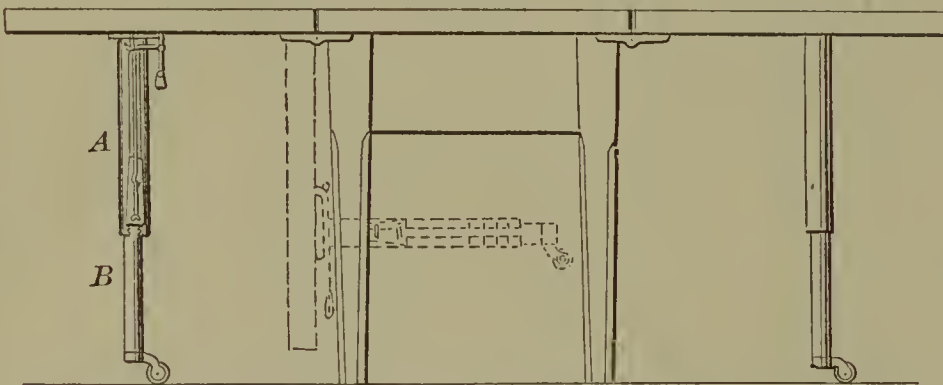

59979—G. M. Denison—Washing Machine.

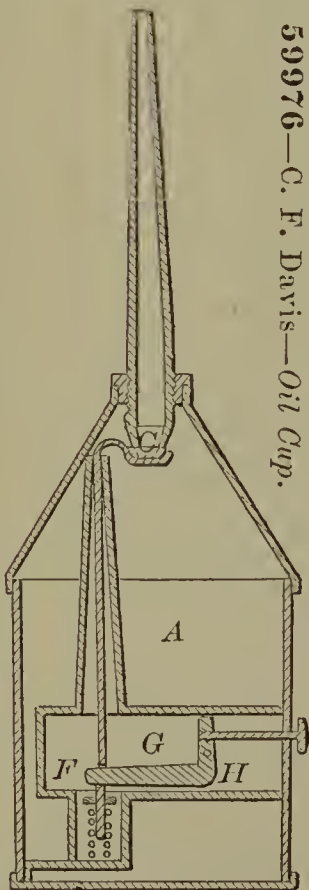

59976—C. F. Davis—Oil Cup.

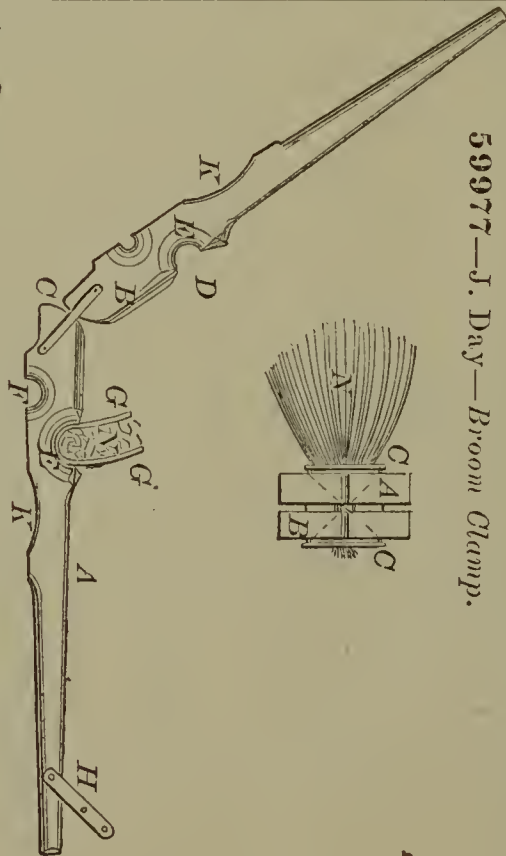

59977—J. Day—Broom Clamp.

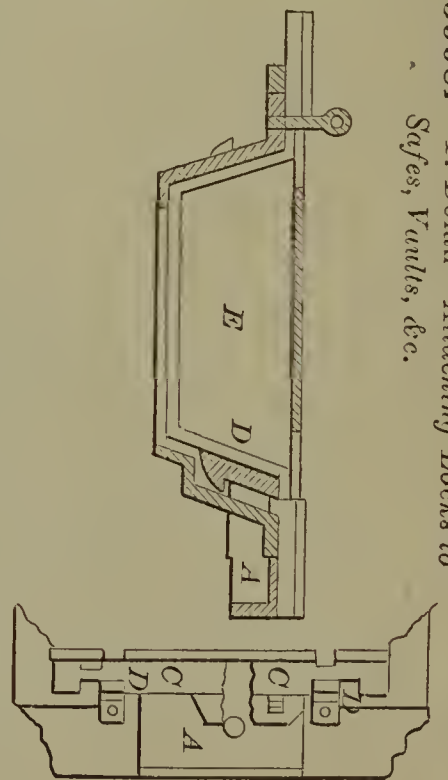

59981—T. Dolan—Attaching Locks to Safes, Vaults, &c.

59982—E. Duffee—Pipe Coupling.

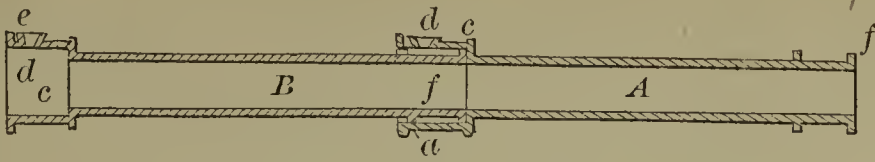

59984—W. W. Dutcher—For Setting Temple Teeth.

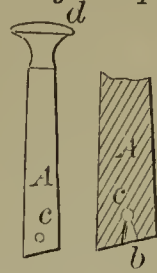

59987—H. A. Ellis—Loom.

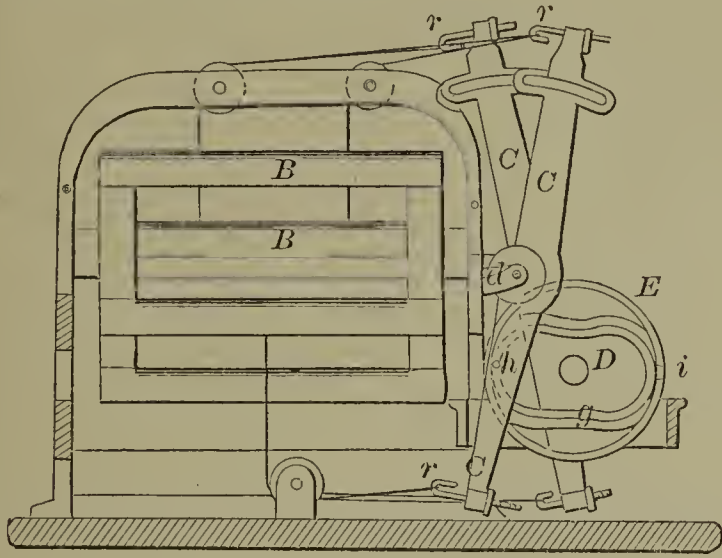

59990—D. D. Foley—Post Driver.

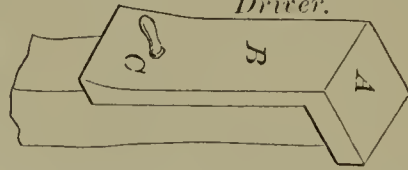

59983—M. A. Duffee—Sewing Machine Gauge.

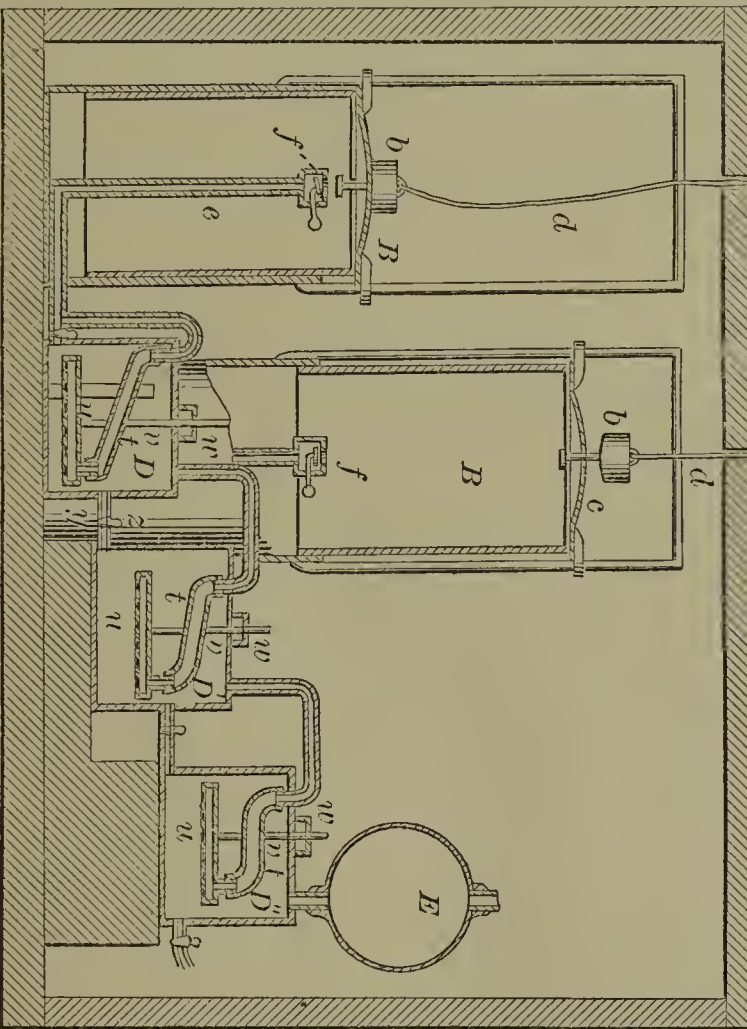
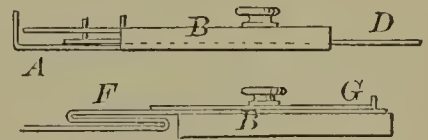
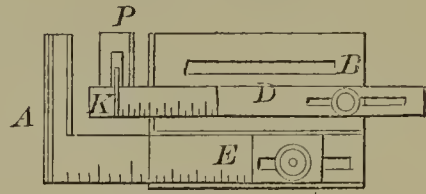

59991—T. F. Frank—For Carbureting Air.

59989—J. R. Evertson—Grain Dryer.

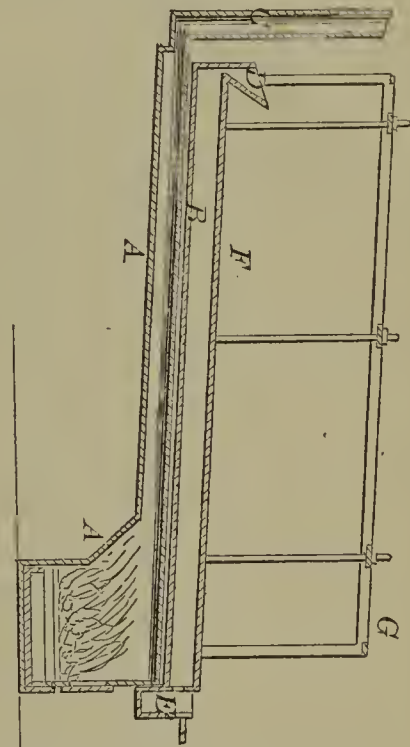

59985—R. R. Eastman—Butter Worker.

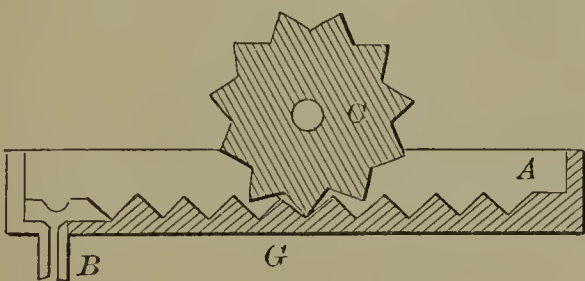

59992—F. N. Frost—Curry Comb.

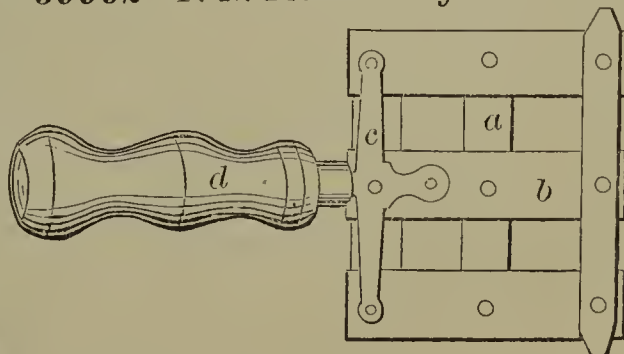

59993—W. Garrard—For Preserving Butter, Milk, and other Articles.

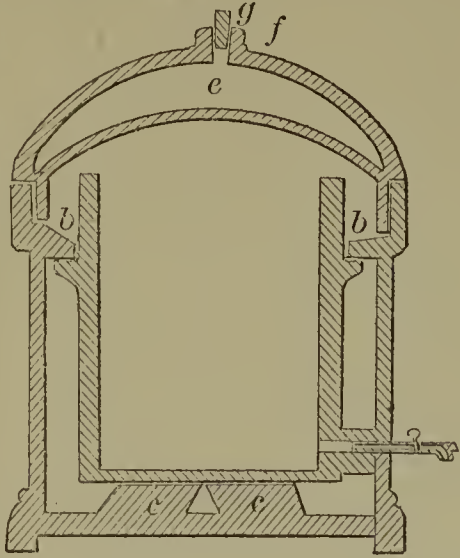

59994—P. A. Gerry—Sawing Machine.

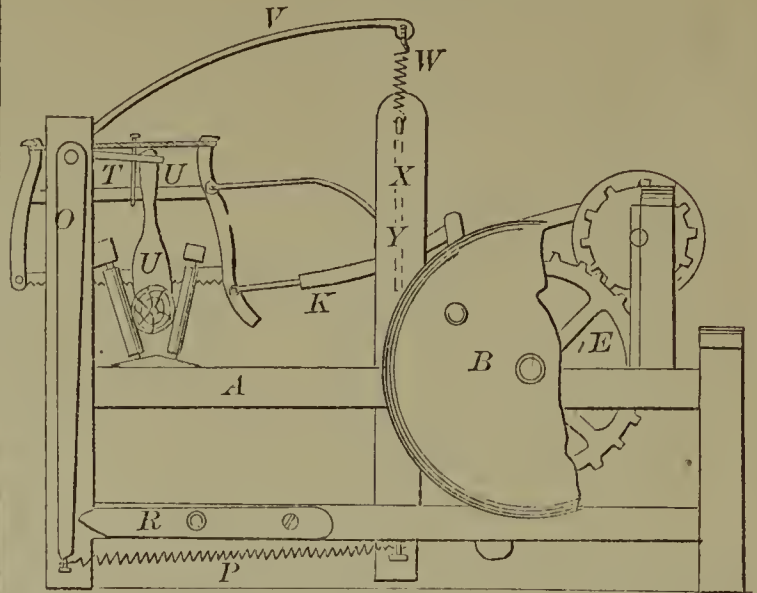

59995—S. Gregg—Spectacles.



59998—J. W. Hanna—For Drying Lumber.

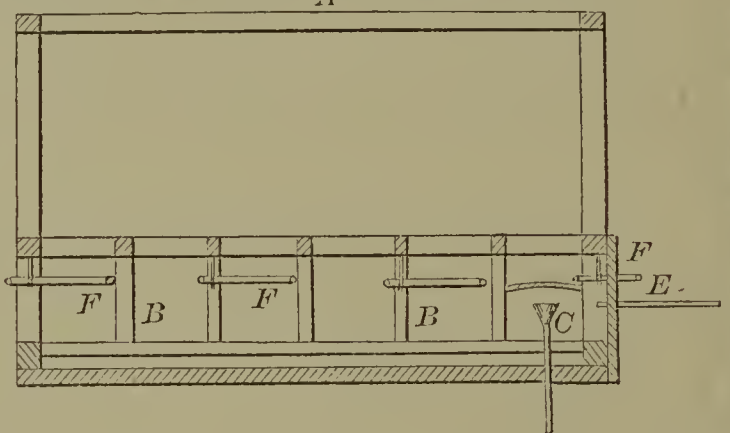

59997—T. Hall—Sewing Machine.

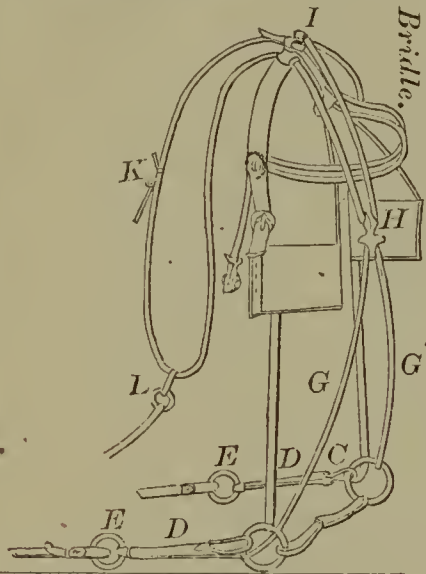
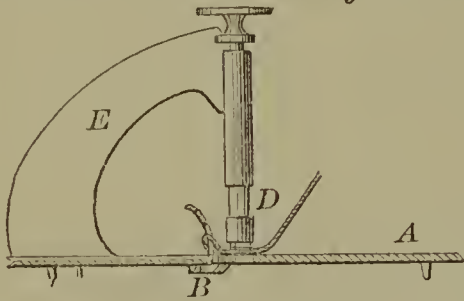

59996—Haberbrush & Kreckel—Bridle.

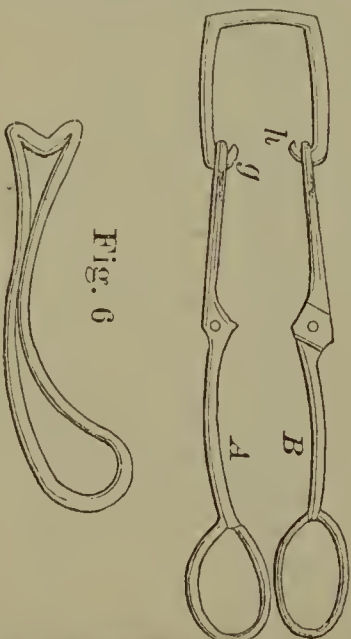

59999—E. B. Harding M. D.—Pessary.

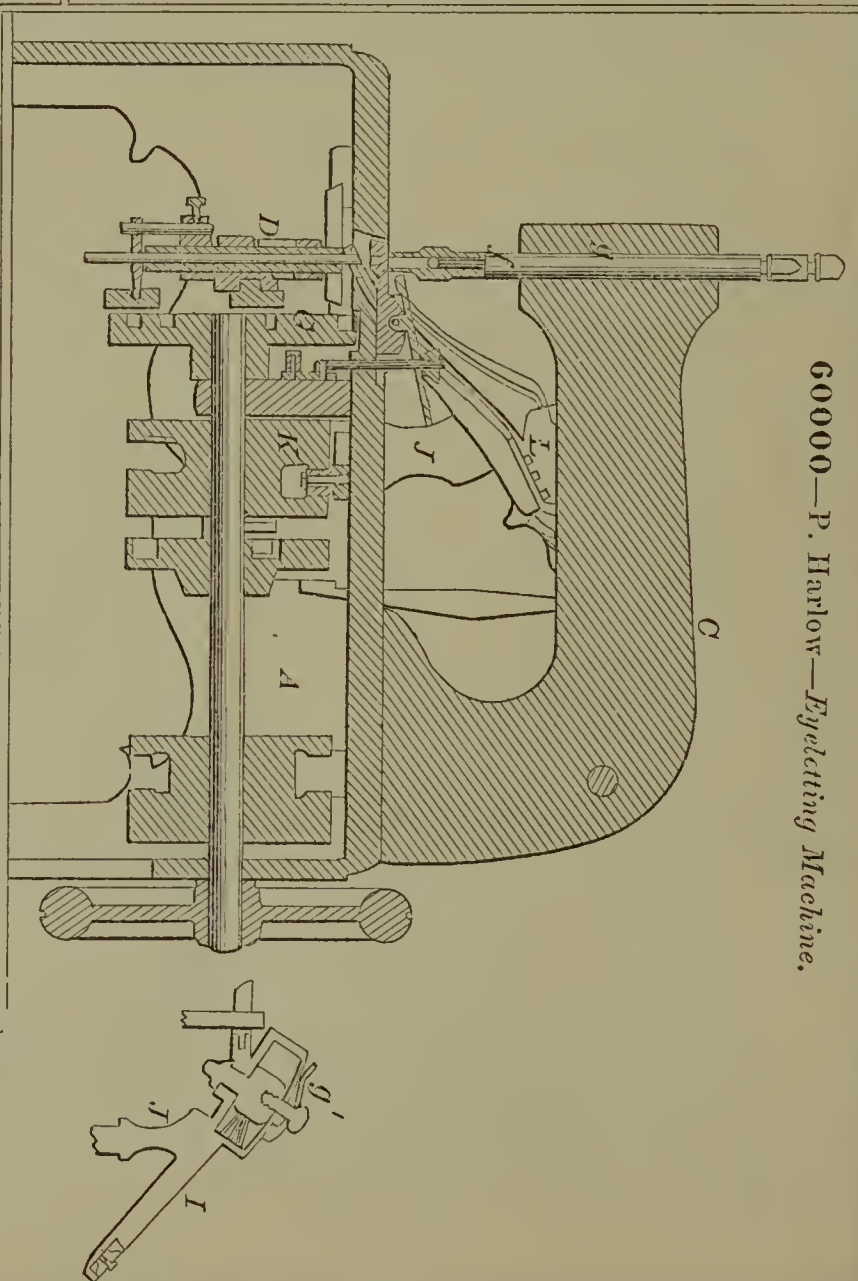

60000—P. Harlow—Flycutting Machine.

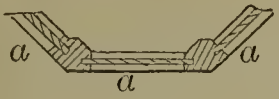

60001—J. P. Haskins—Exhibiting the Gas of Mineral Springs.

60003—C. F. Henis—Coal Scuttle.

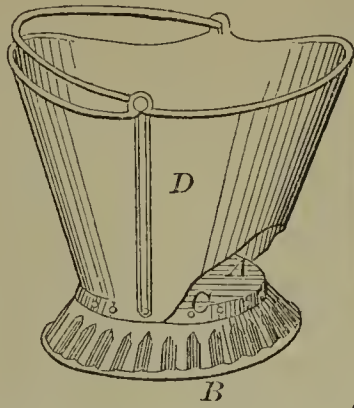

60005—Hicks & Welker—Cut-off for Cistern Leaders.

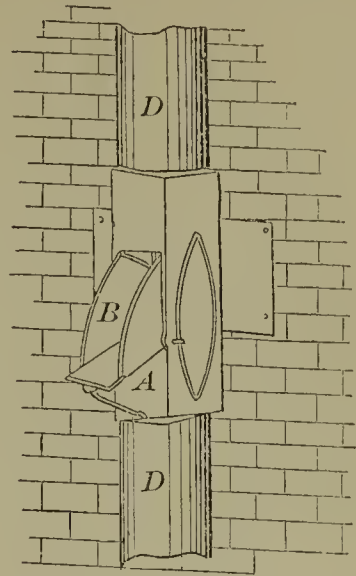

60004—J. H. Hicks—Comb.



60009—A. B. Hoffman—Crumb Remover.

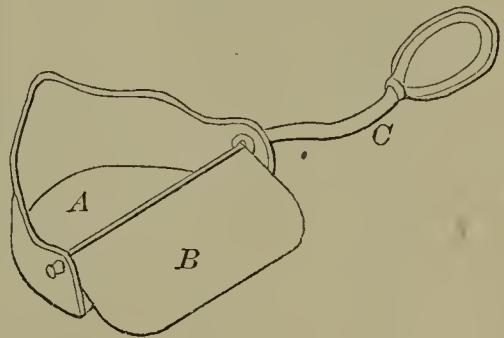

60008—Hill & Tuttle—For Cutting and Raking Corn Stalks.

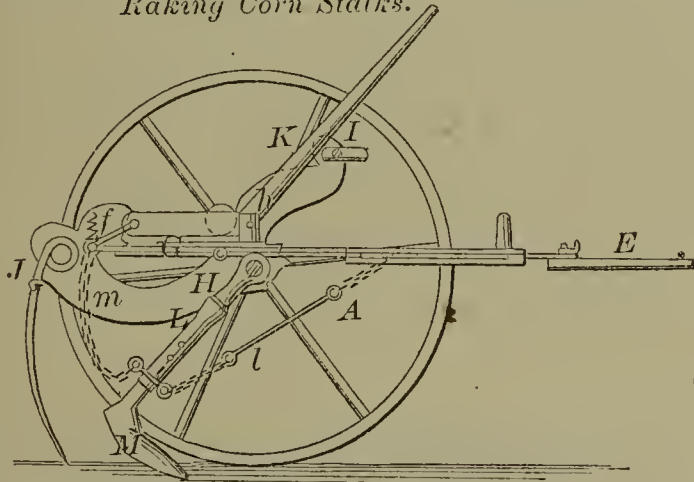

60011—Hufendick & Spangenberg—Bung.

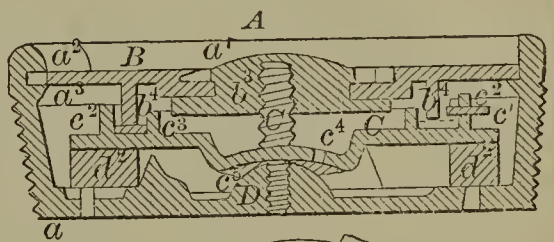

60010—E. R. Hopkins—For Making Hoop Skirts.

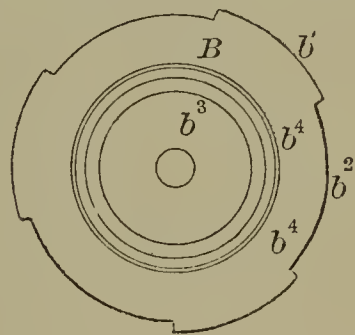
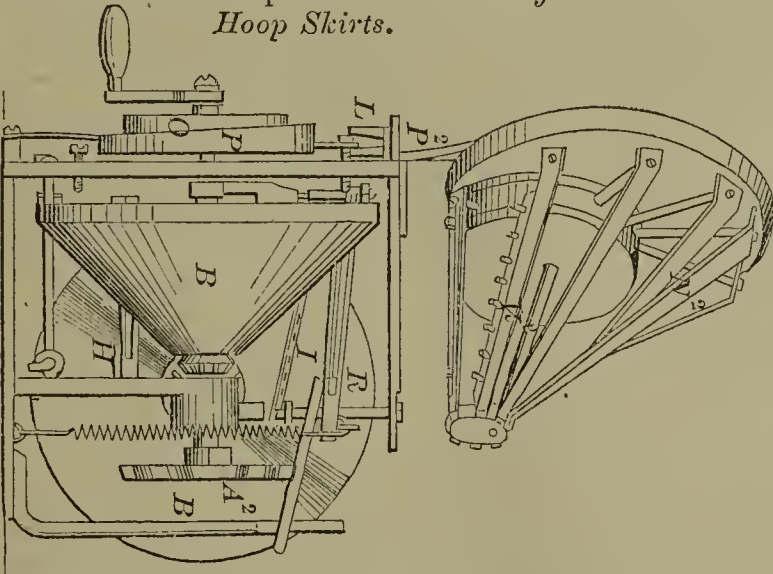

60012—J. H. Kavanagh—Car Coupling.

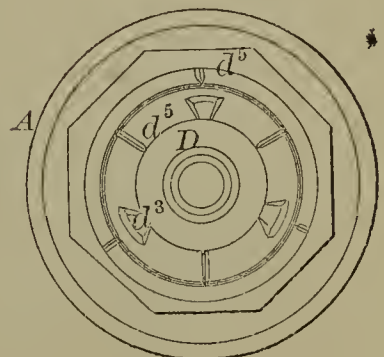
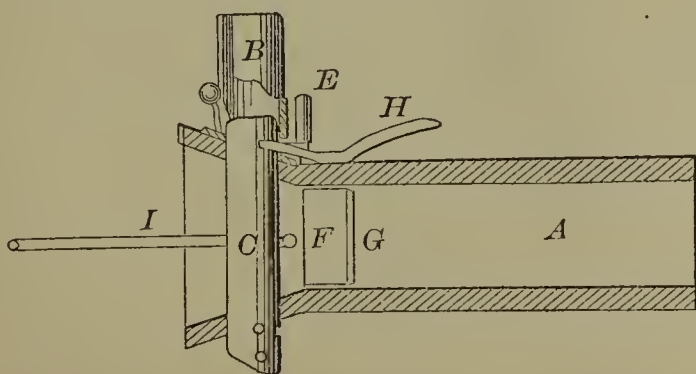

60013—R. King—Boiler Flue Brush.

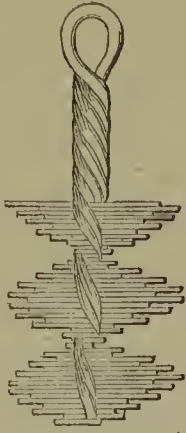

60020—C. G. Lazear—Fence.

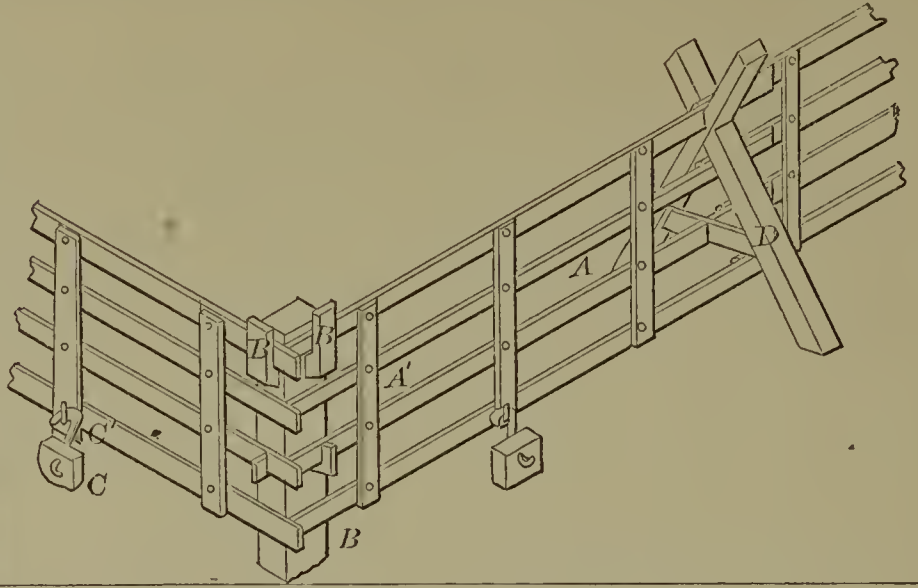

60014—H. Knight—Cement Pipe.

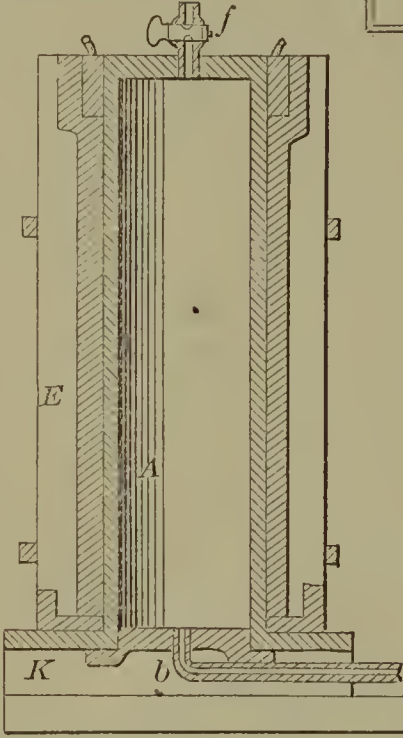

60016—L. Kutscher—Carriage.

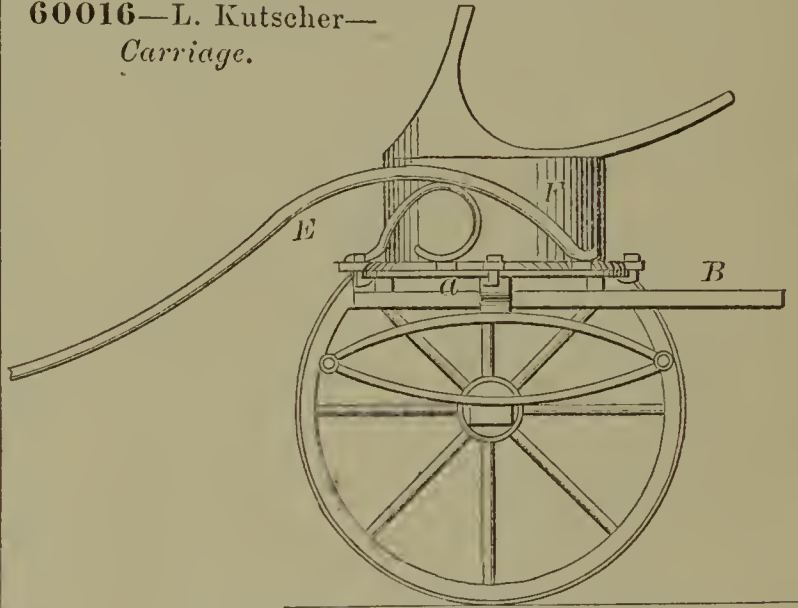

60018—J. Lamphear—Washing Machine.

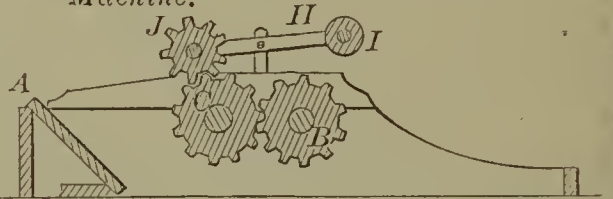

60017—L. Lall—Clasp Lock for Books, &c.

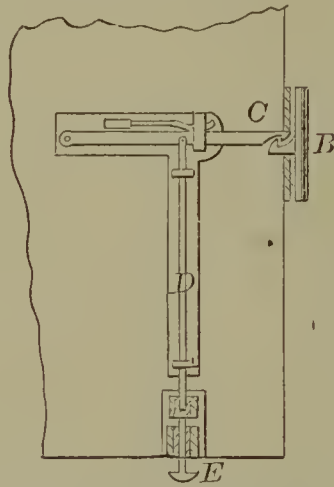

60015—Knapp & Elliott—Sleep Shed.

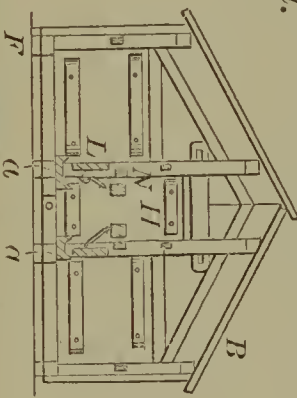

60019—A. T. Large—Hand Seed Planter.

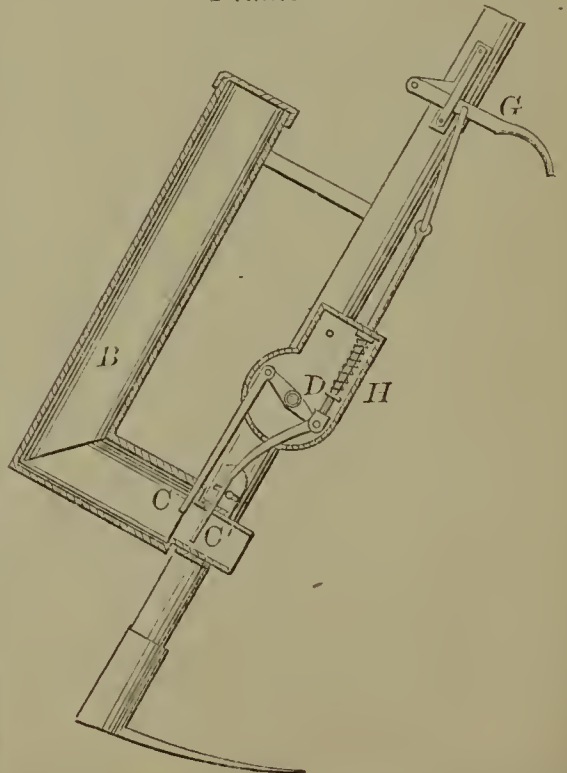

60021—G. H. Lenher—Sewing Machine Shuttle.

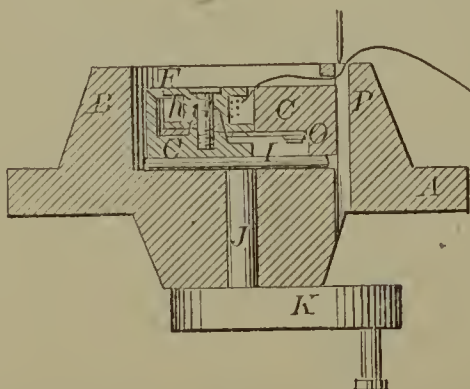



60025—J. H. Marshall—Ditching Machine.

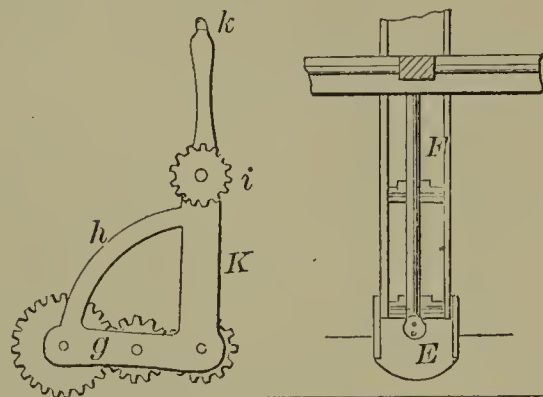
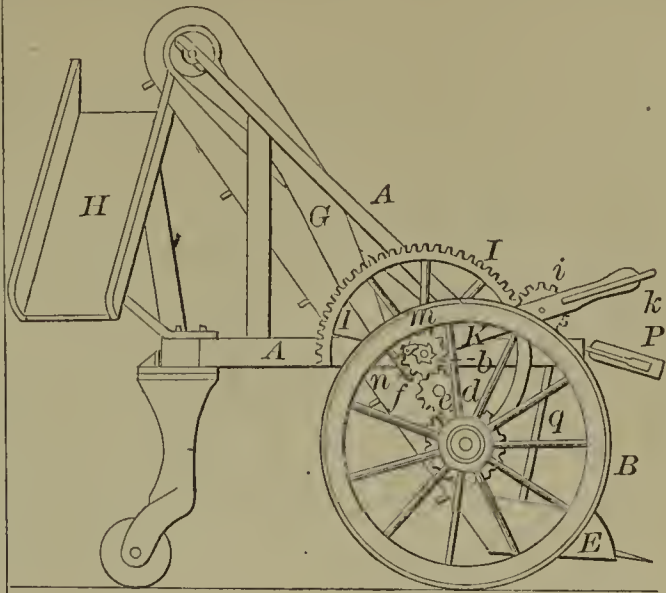

60023—G. H. Lupton—Hanging Windows and Doors.

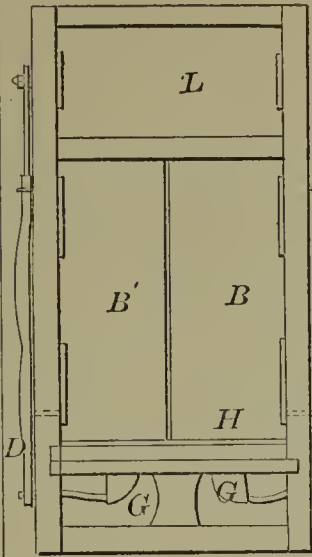

60022—H. L. Lowman—Die for Forming the Eyes of Pick Axes.

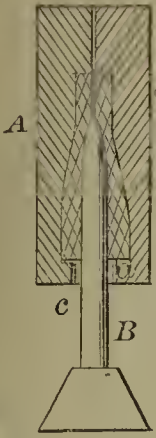

60028—C. E. McDonald—For Obtaining the Measure for Ladies' Dresses.



60026—J. B. Martindale—Hooks and Eyes.

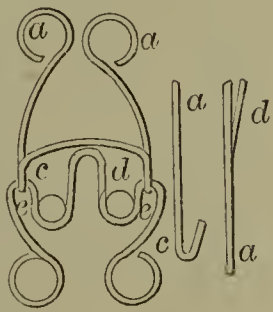

60024—J. C. Mack—Boots and Shoes.

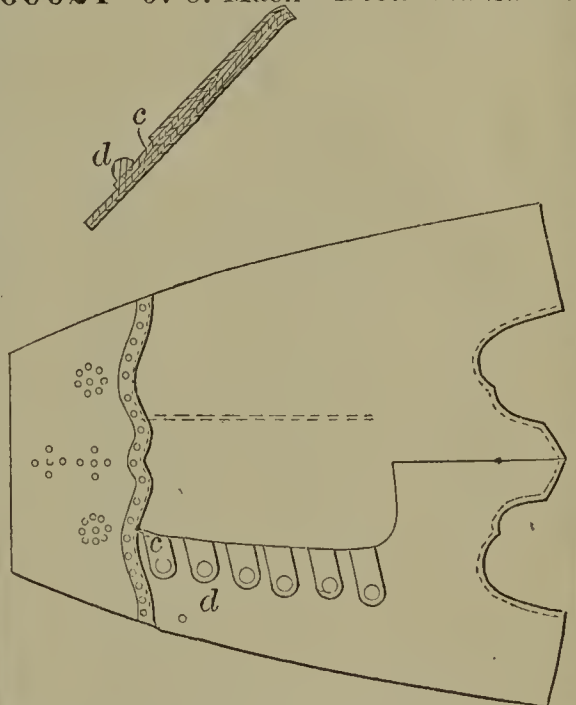

60030—McLelland & Graham—Broom Head.



60031—A. McMullen—Hame Tug and Breast Collar.

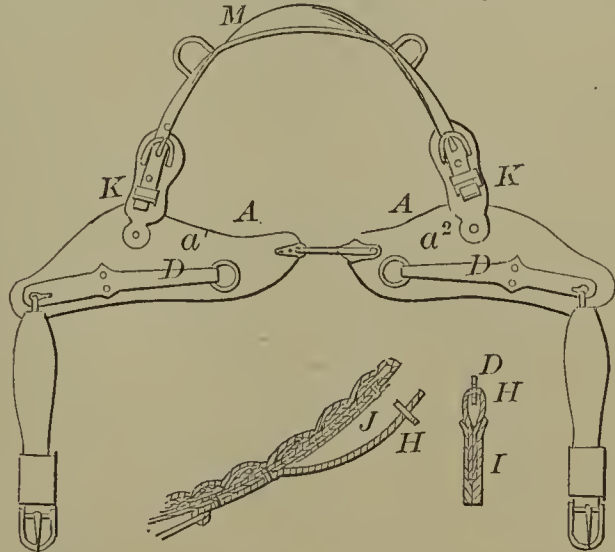

60029—J. McDonald—Brick Kiln.

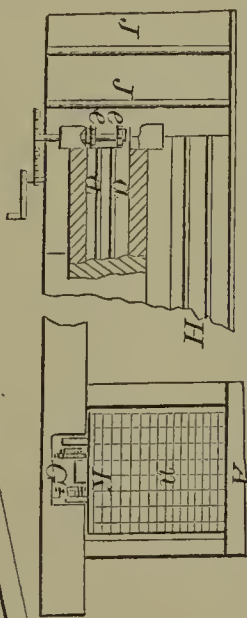

60032—M. Mellinger—Foot Stove.

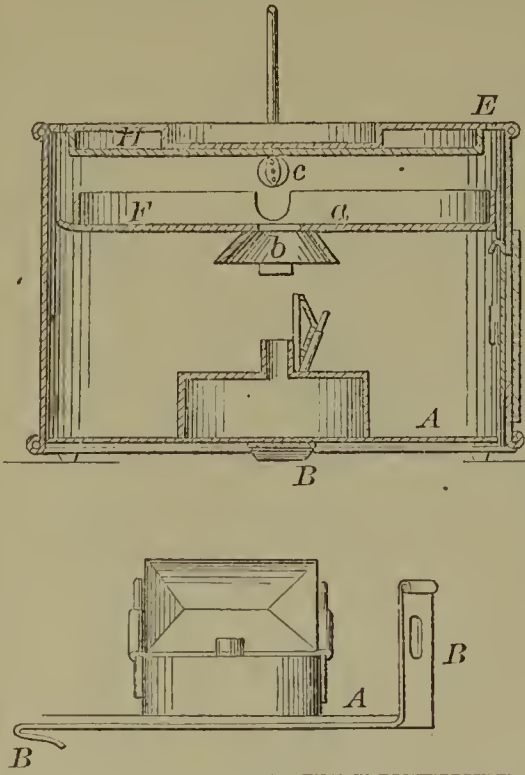

60033—G. W. Miller—Breeching Hook.

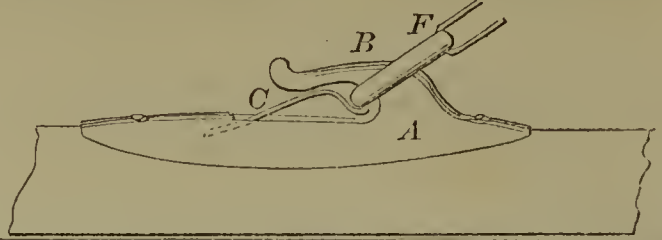

60034—J. K. Mizner—Knapsack.

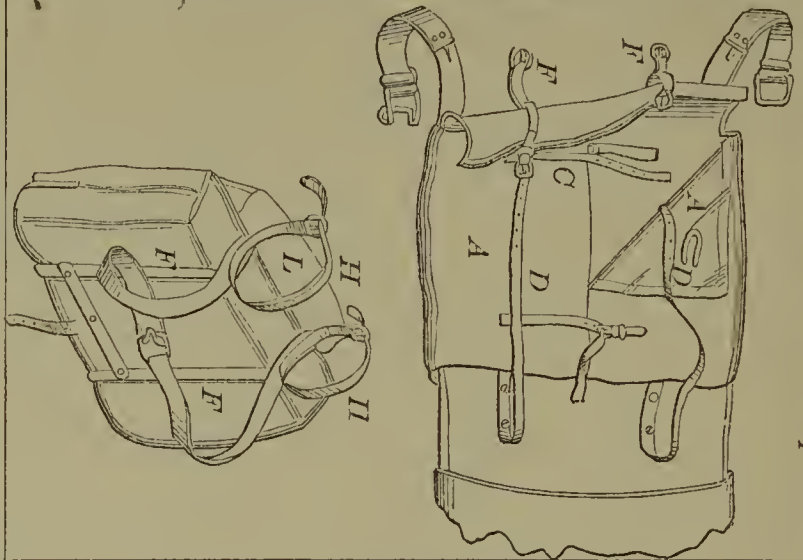

60035—L. Mooney—Churn.

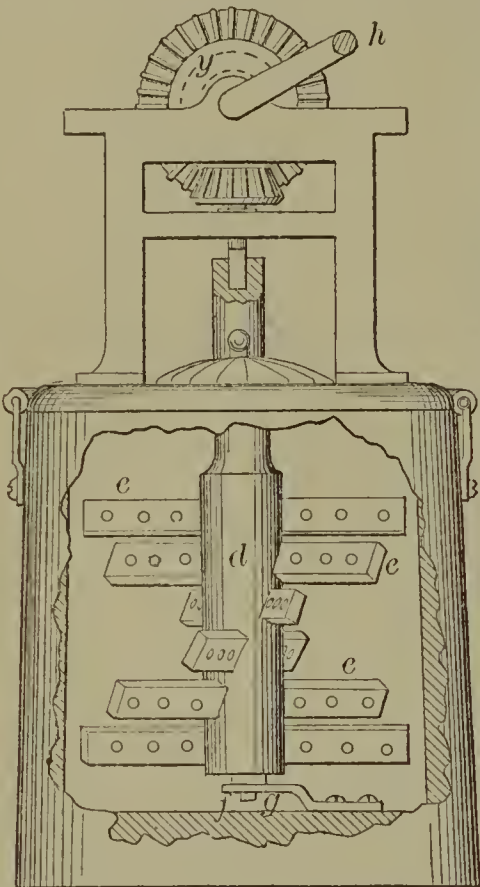

60038—T. Moore—Broom Head.

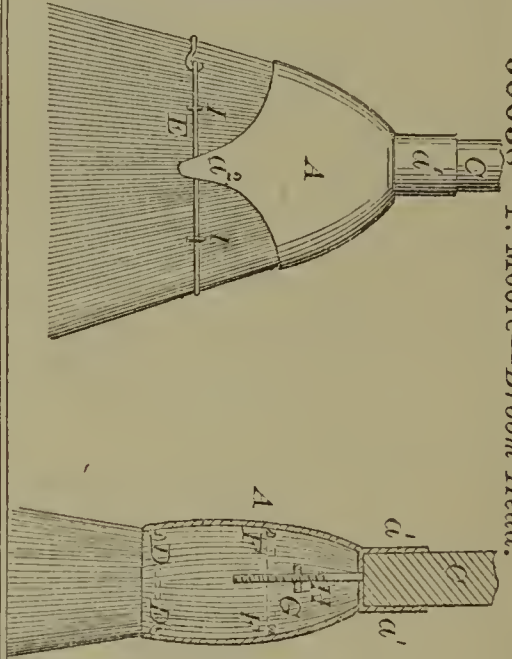

60036—R. F. Moore—Hose Pipe Nozzle.

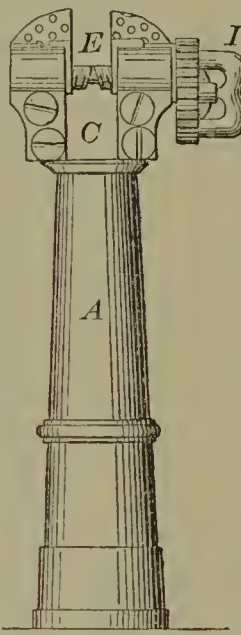

60040—A. P. Odholm—Machine for Dressing Felles.

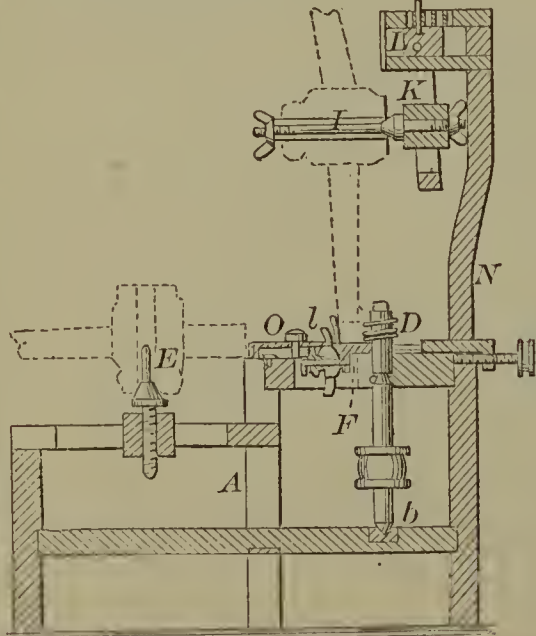

60042—F. Orlich—Surface Condenser.

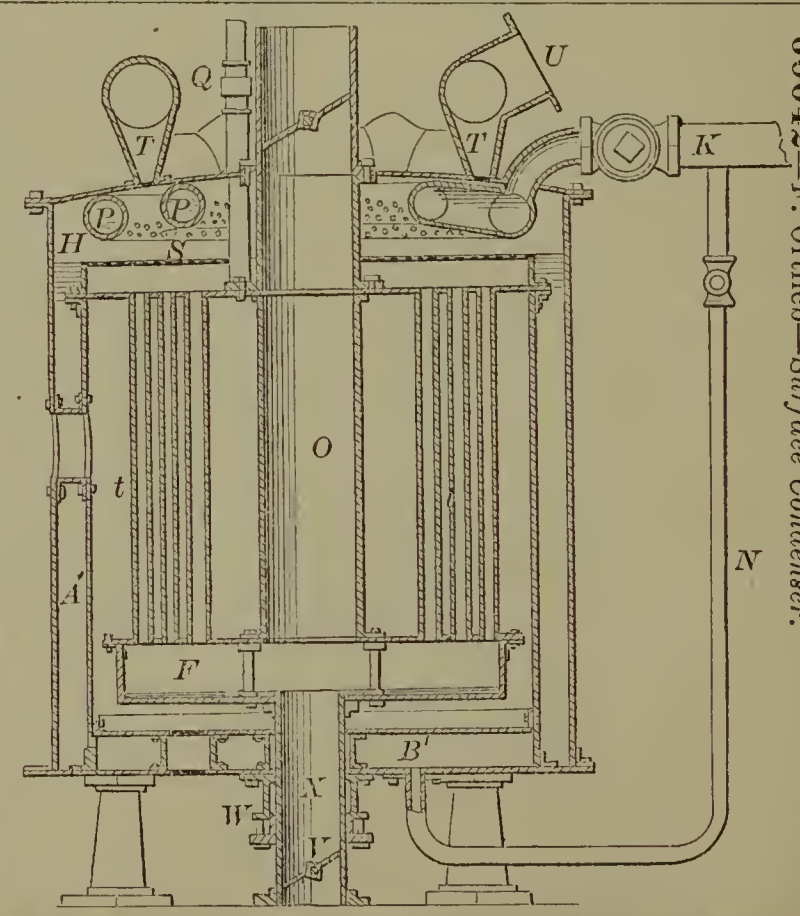

60043—J. H. Osgood, Jr.—For Drying Lumber.

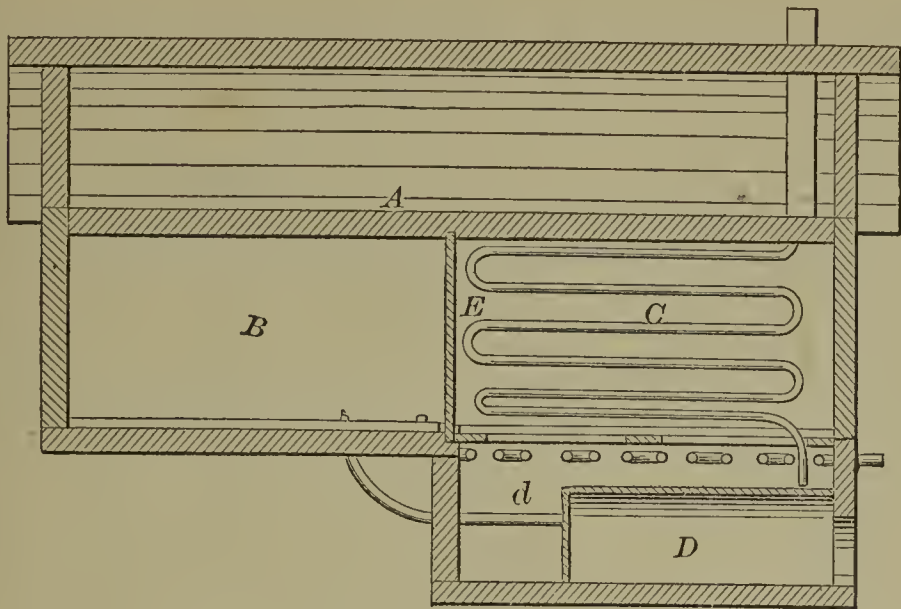

60044—S. A. Otis—Turnout for Railroads.



60046—I. E. Overpeck—Corn Shelter.

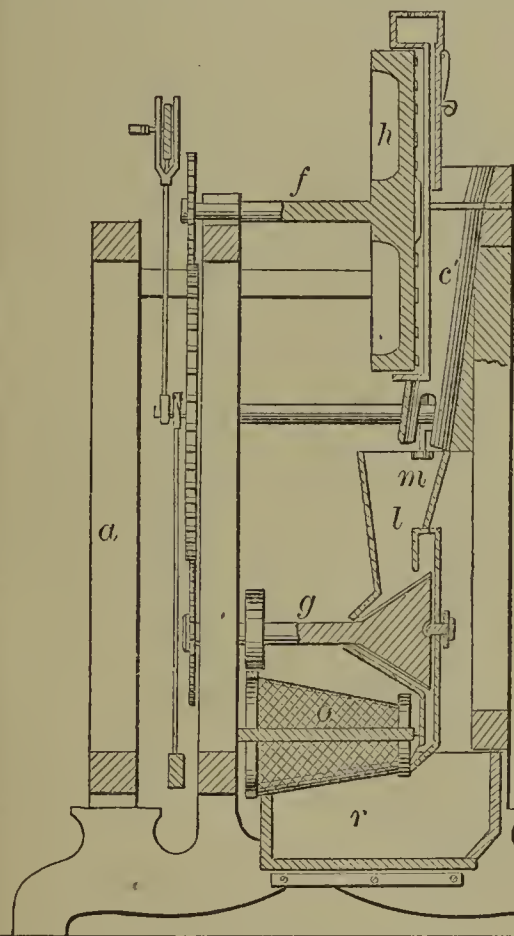

60045—A. W. Overbaugh—Slate Cleaner.

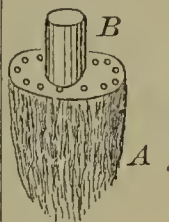

60047—L. E. Page—Back for Vehicles.

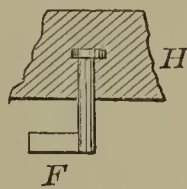

60048—G. Parr—Manufacture of Cutlery.



60049—G. W. Parsons—For Lubricating Axle Journals, &c.

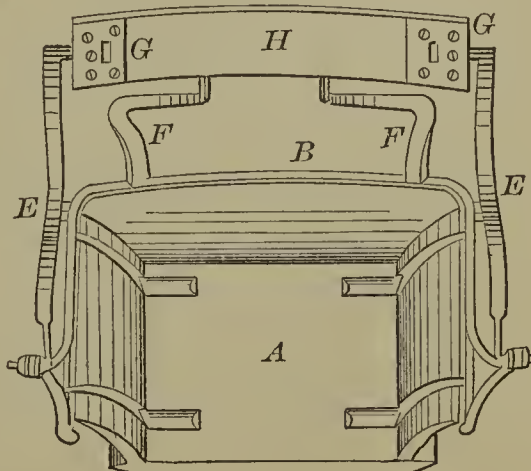
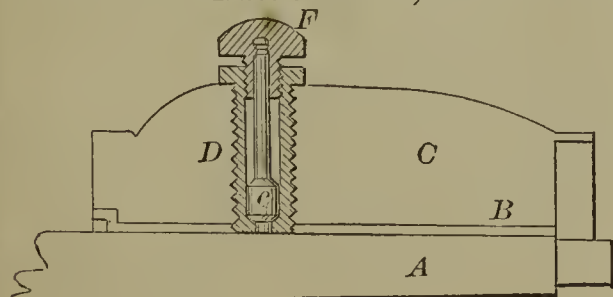

60053—L. D. Phillips—For Making Buttons.

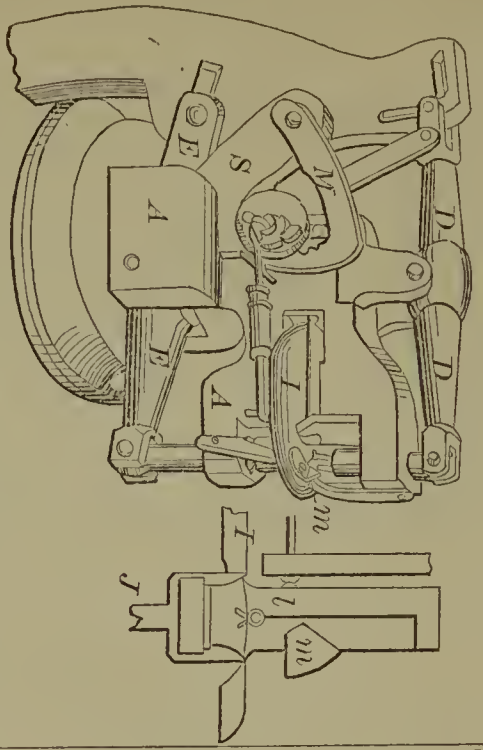

60055—L. B. Pitcher—Mortar Mill.

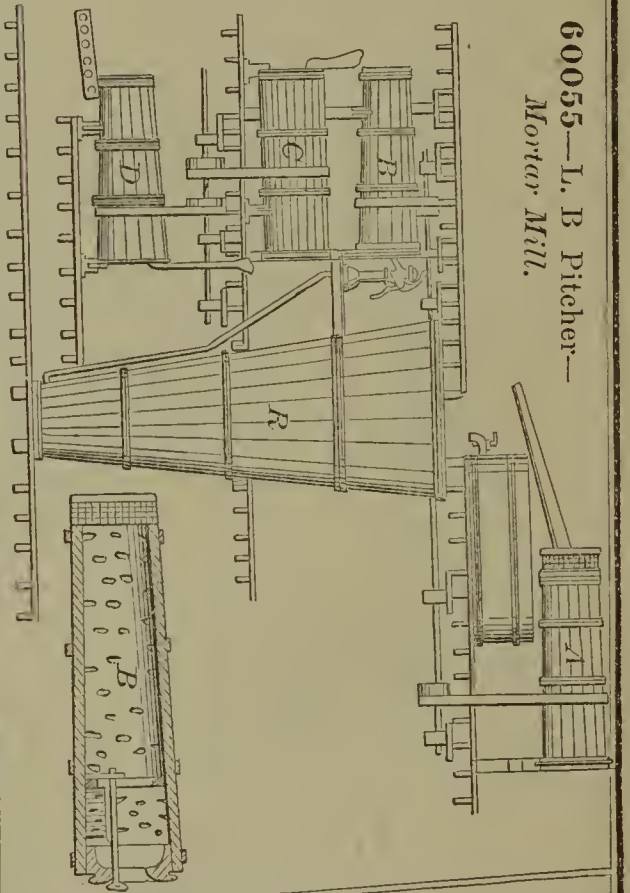

60052—D. Phillips—Regulator for Reaction Water Wheels.

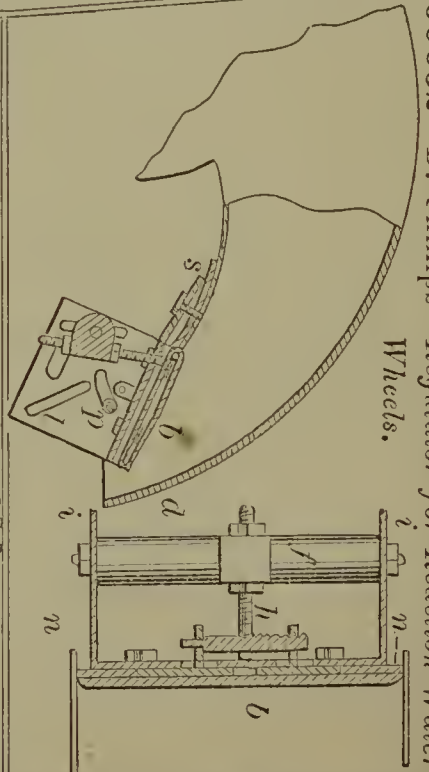

60050—J. W. Pease—Brick Machine.

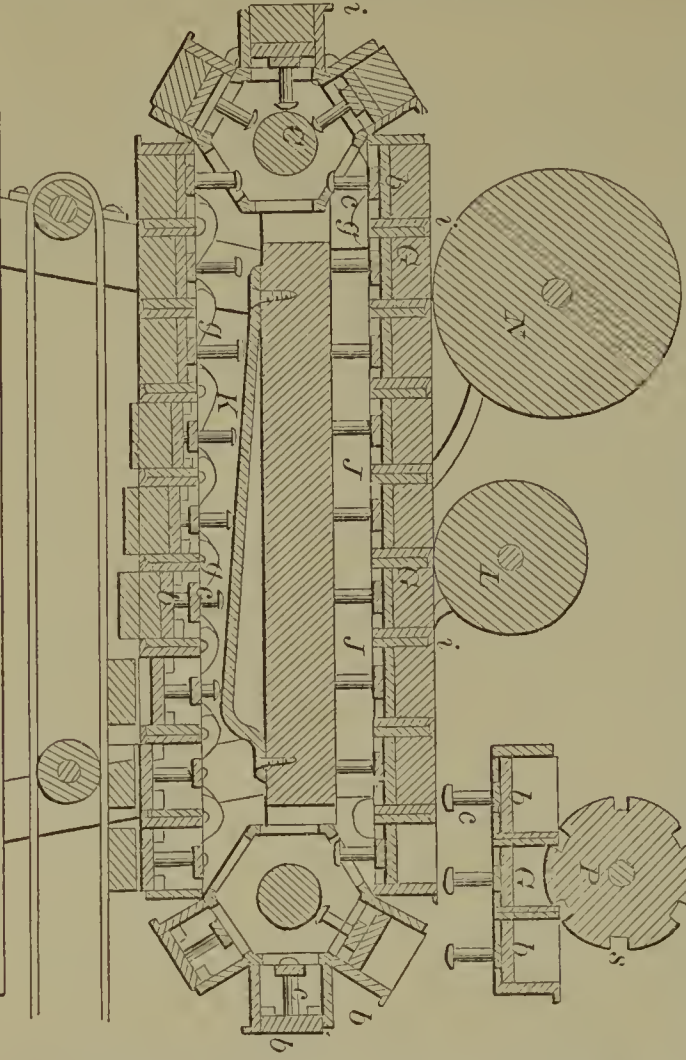

60054—S. G. Piper—Cooking Stone.

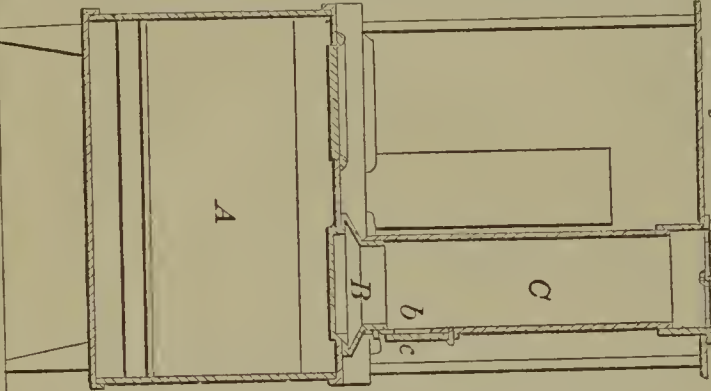

60056—A. M. Polsey—For Making Nails.

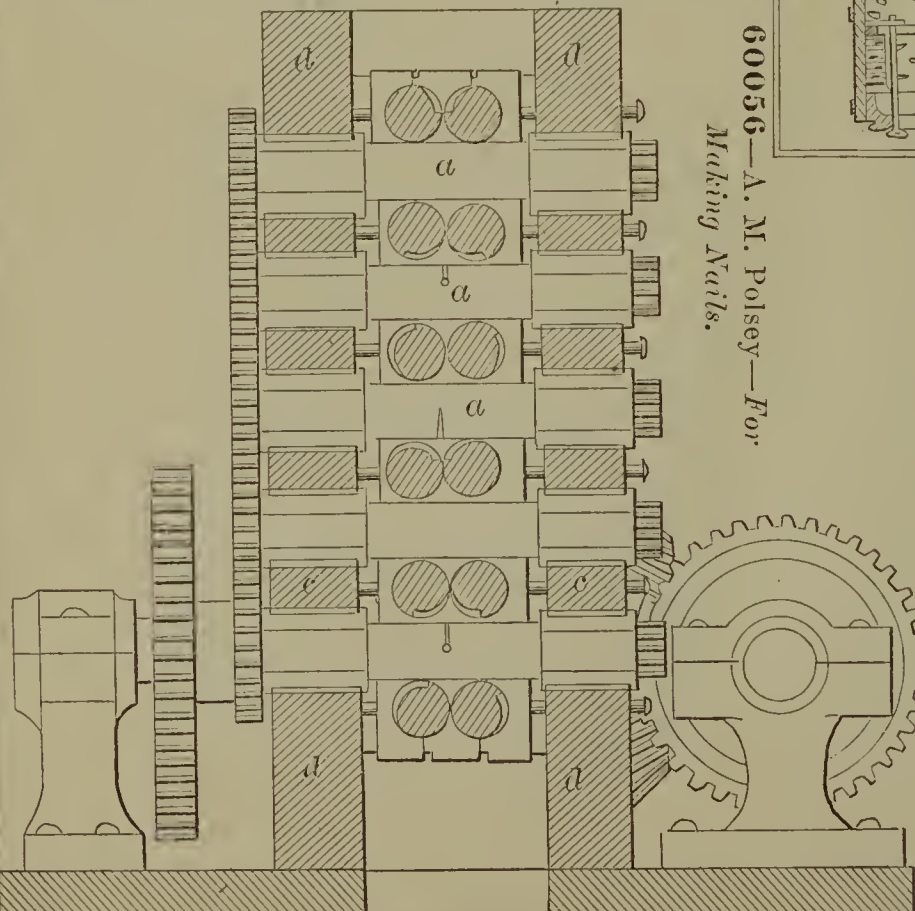

60057—O. Pratt—Sinking Tubular Wells.

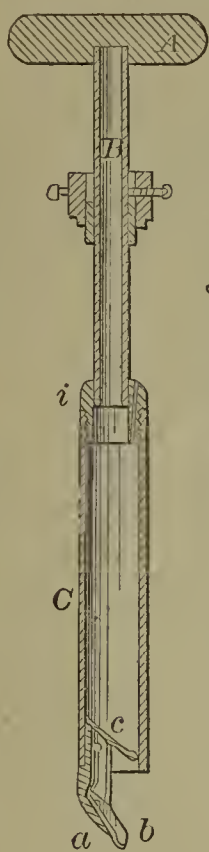

60058—J. K. Reiner—Churn.

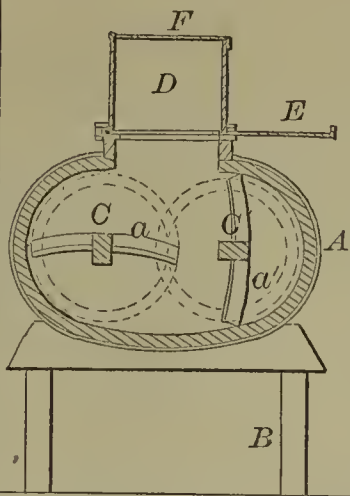

60059—H. Rensch—For Cooling Beer.

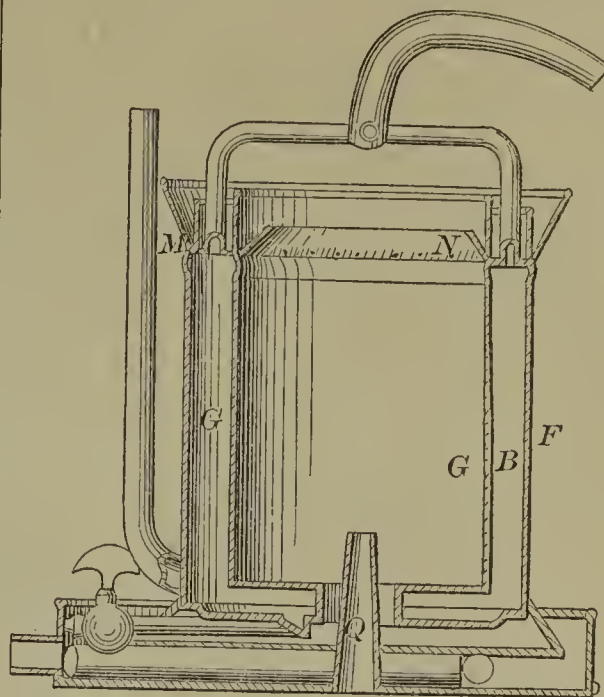

60063—E. A. G. Roulstone—Shoe Brush.

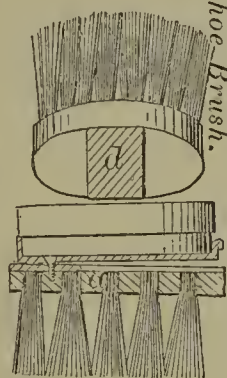

60060—D. T. Robinson—Fruit Press.

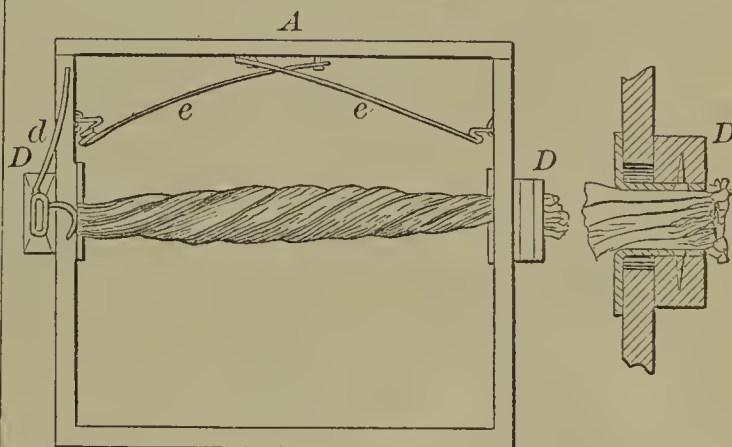

60062—F. J. Roth—Piston Packing.

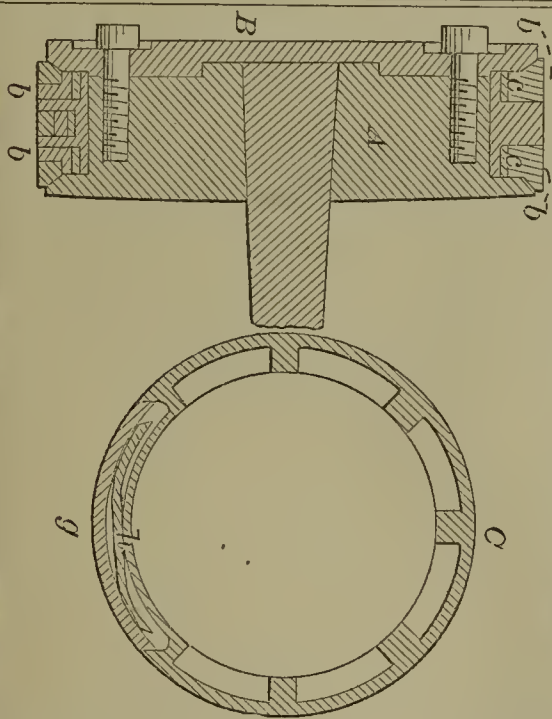

60061—Rohm & Guetlich—Reel.

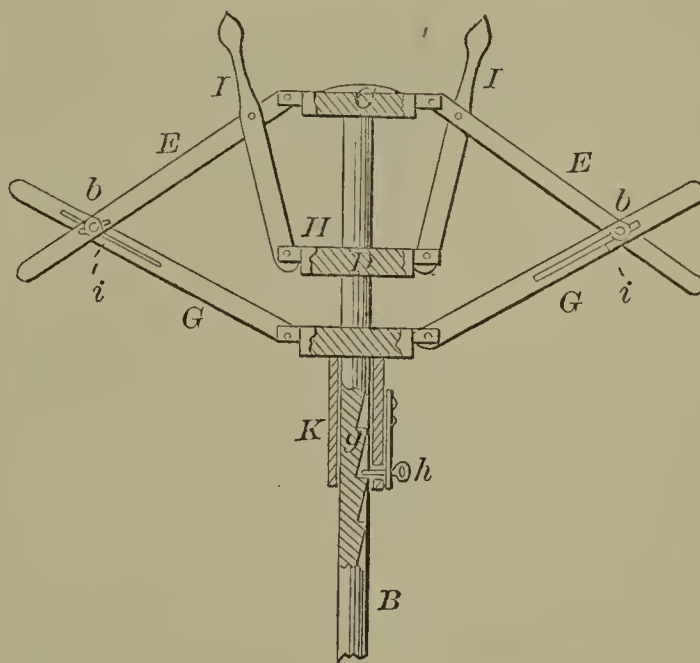

60064—H. B. Rowley—Axle Box.

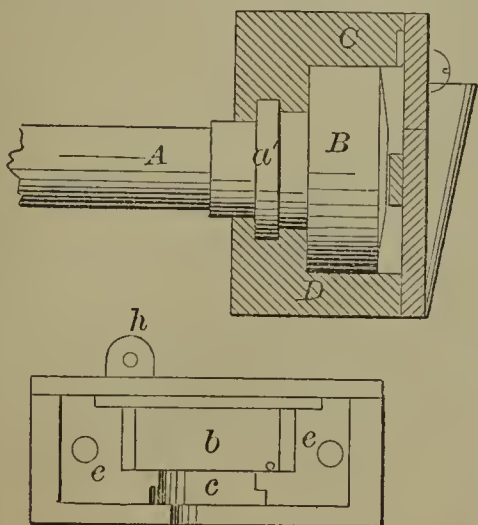

60065—W. F. Rundell—Hay Fork.

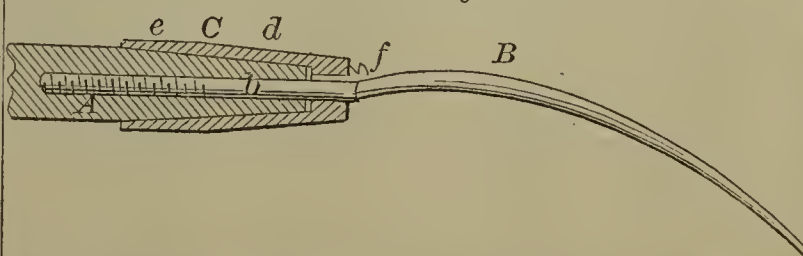

60066—W. F. Rundell—  
*Carriage Top.*

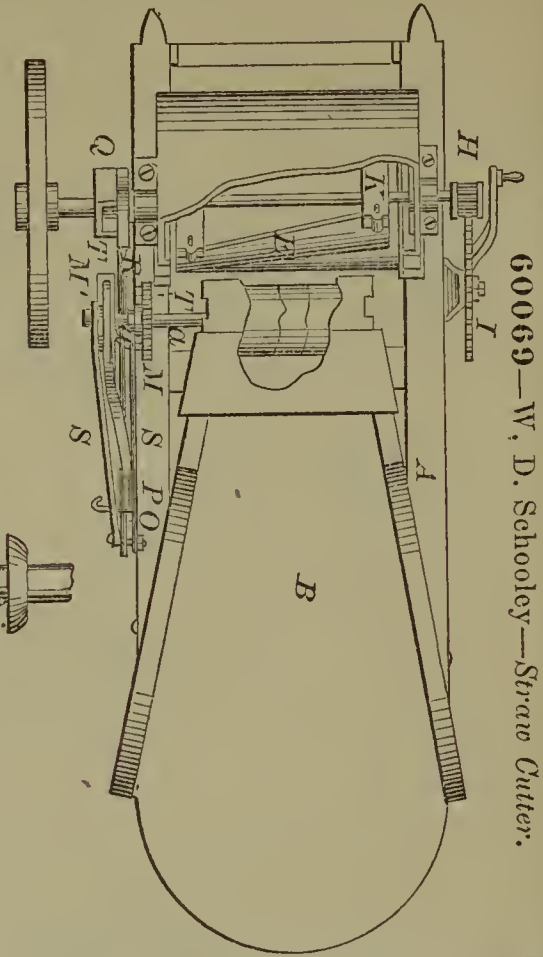
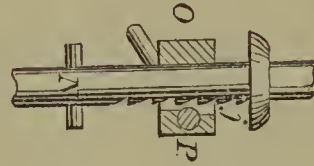
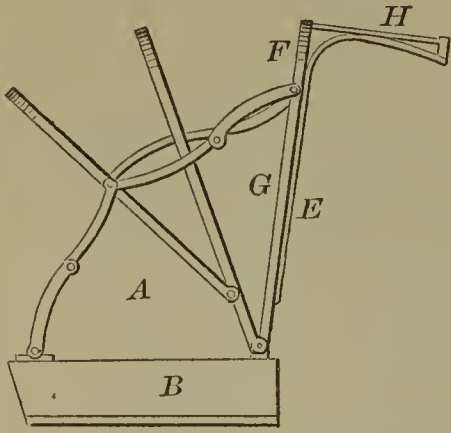

60069—W. D. Schooley—*Straw Cutter.*

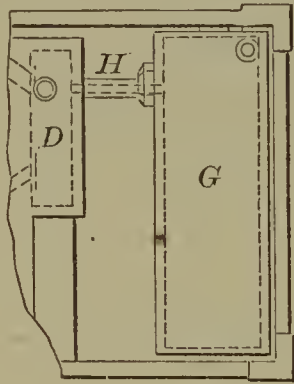

60070—F. Shaller—*Blow Pipe.*

60068—W. H. Sangster—*Lamp.*

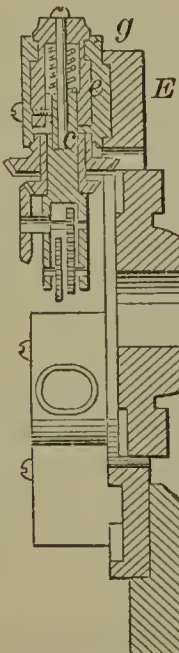
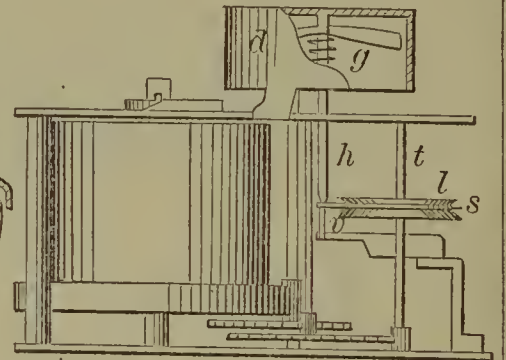
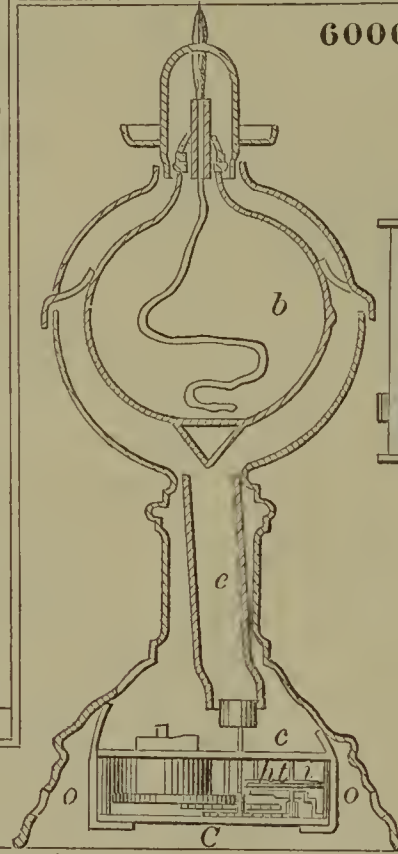
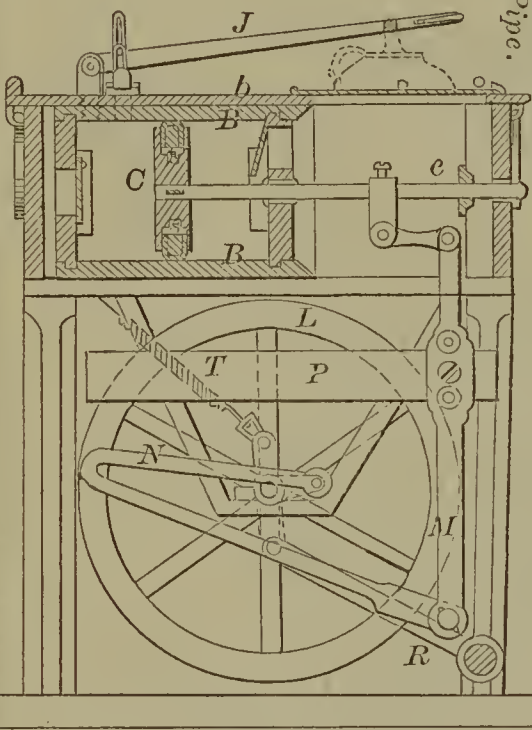

60067—D. T. Sanford—*For  
Embossing Brass Tubes.*

60071—W. C. Sherman—*Attaching  
Carriage Thills.*

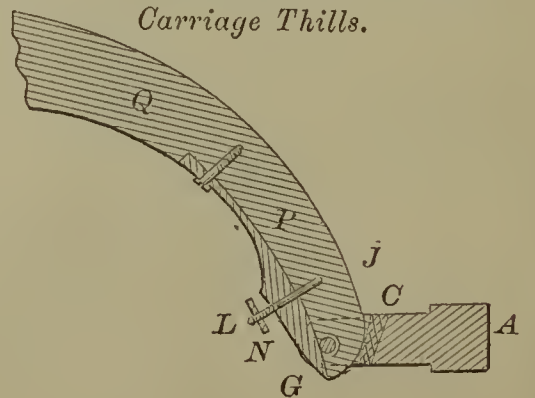

60072—Smiley, Becher & Townsend—*Policeman's Rattle.*

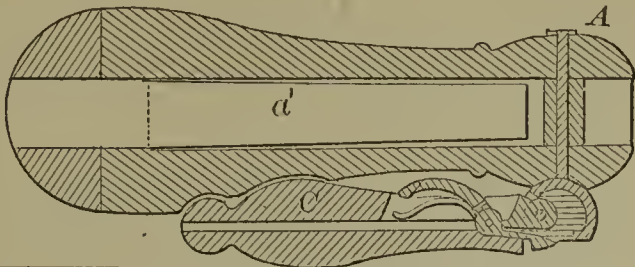

60073—A. R. Smith—*Flour Bolt.*

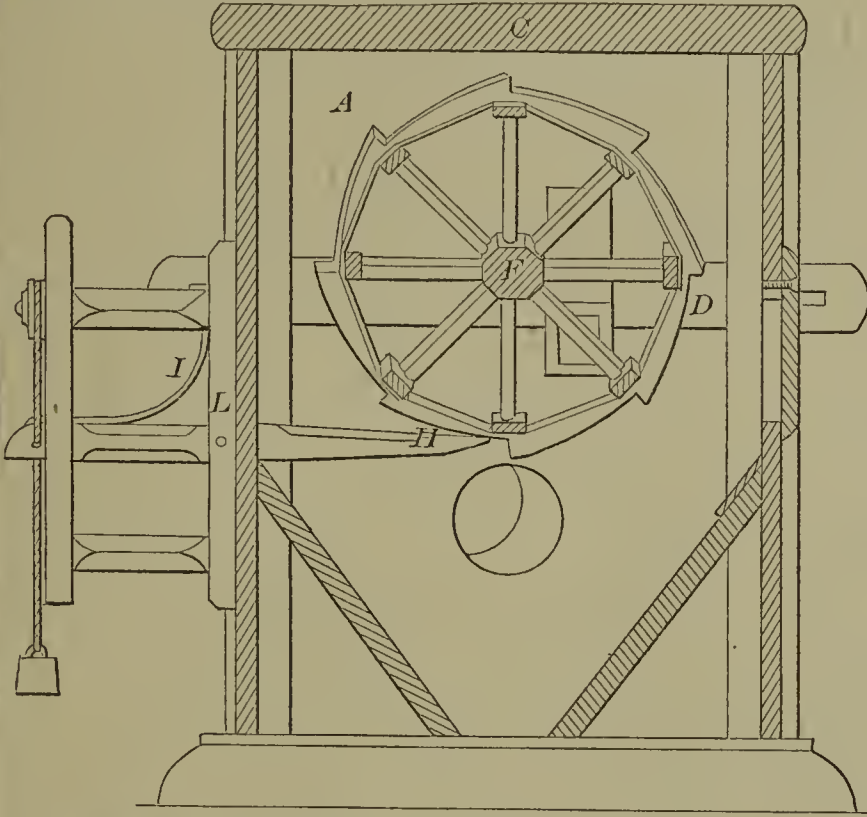

60074—D. Smith—*Cartridge Machine.*

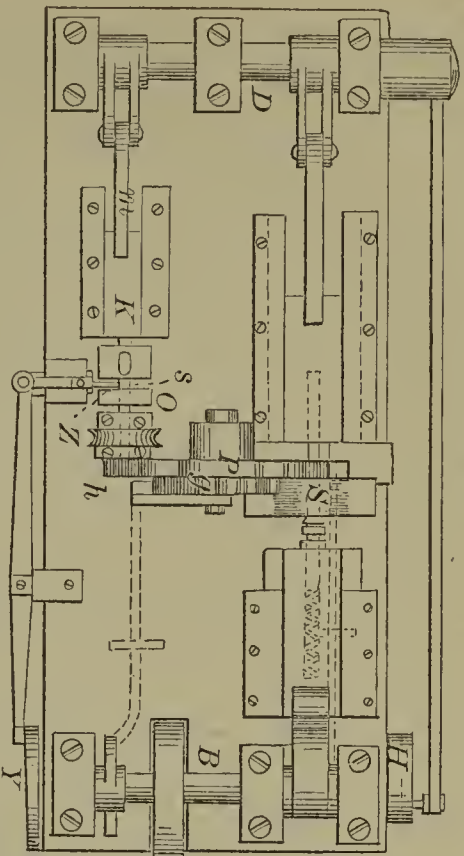

60080—J. W. Steed—*Hoisting Jack.*

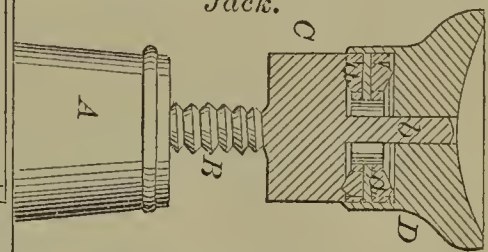

60075—E. C. Smith—*Attaching Draught Poles to Axles.*

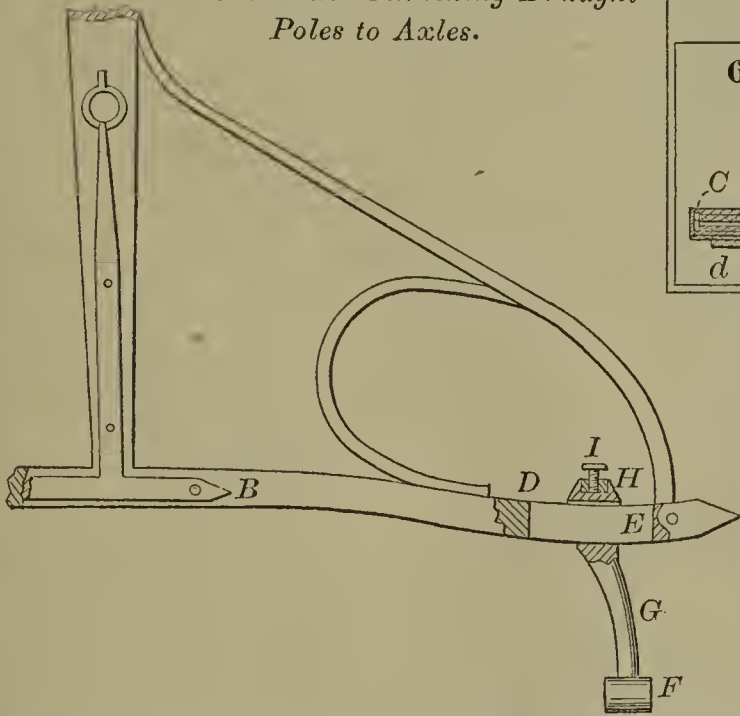

60078—J. Speirs—*Pipe Case.*

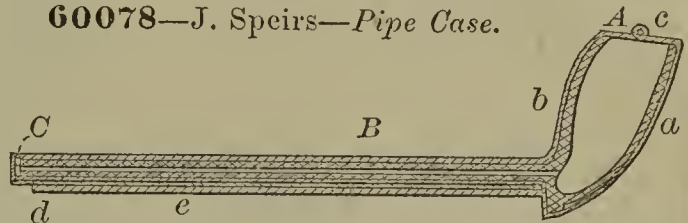

60077—T. K. Smith—*Churn.*

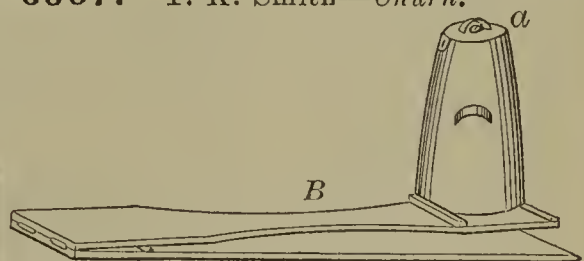

60079—B. P. Stebbins—*Still.*

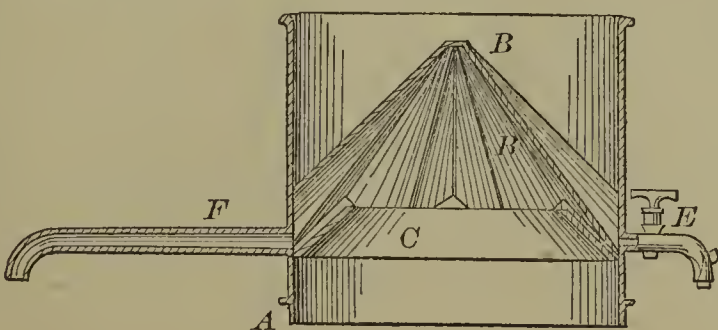

60081—W. J. Stevens—*Slide Valve.*

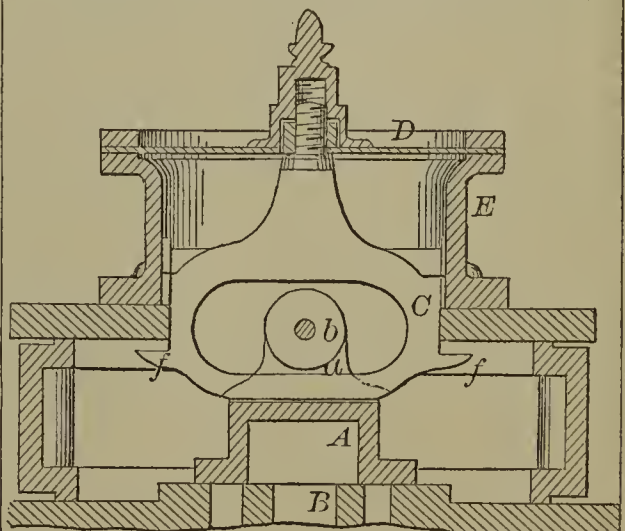

60082—Street & Davis—Faucet.

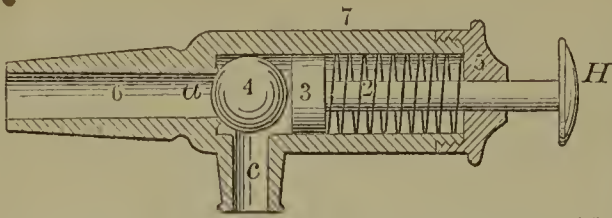

60085—C. M. Tanner—Scaffold.

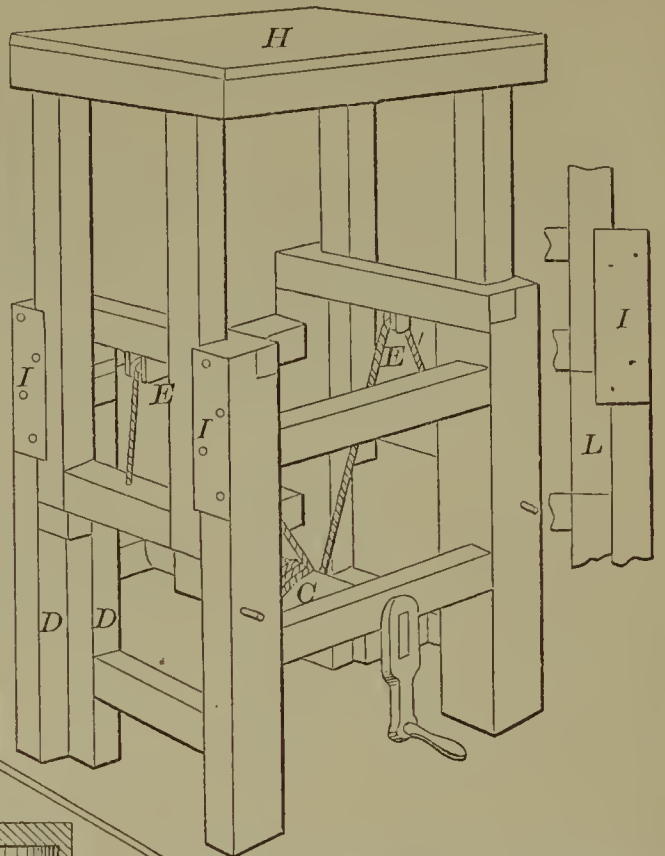

60087—J. W. Taylor, Jr.—Curtain Fixture.

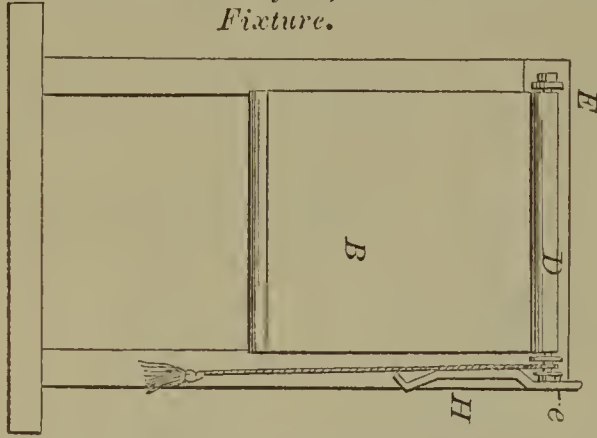

60083—J. Sweeney—Car Bell.

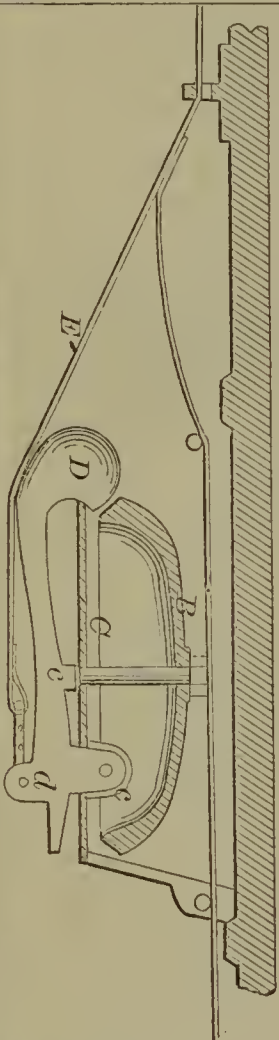

60088—G. L. Thompson—For Pressing Hats.

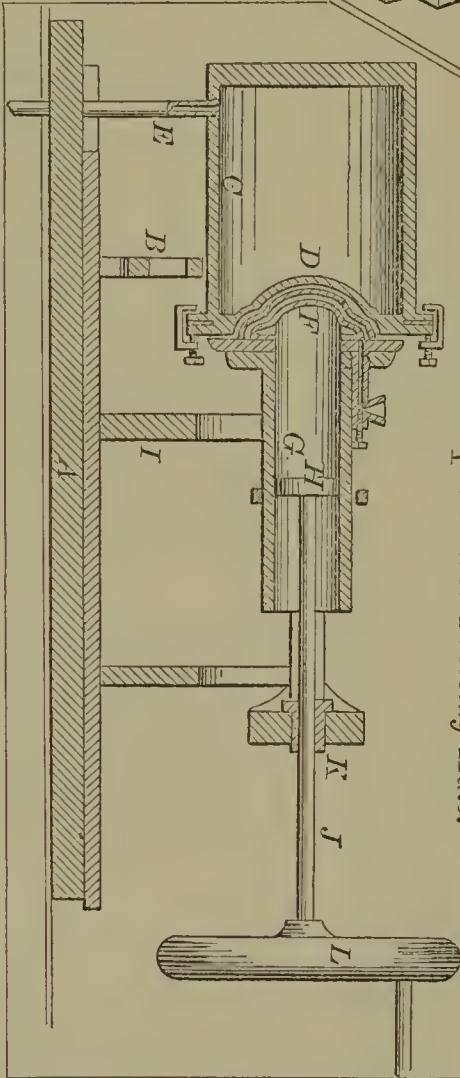

60084—F. Taggart—Steam Engine Governor.

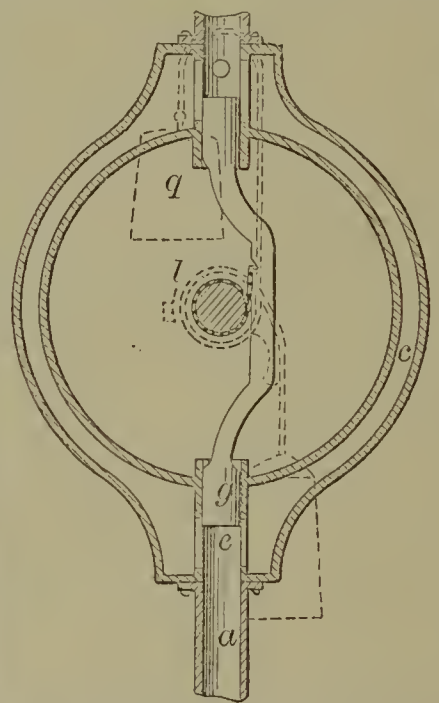

60086—Tay & Fracker—Lamp Bracket.

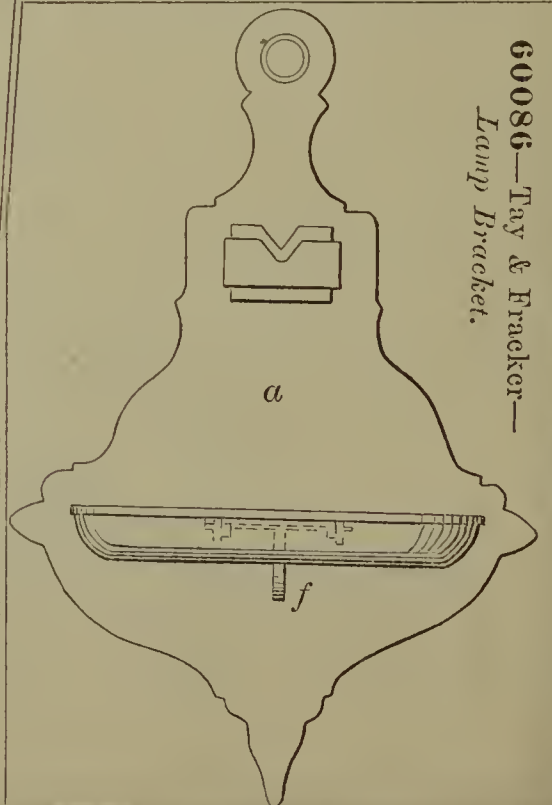

60089—H. A. Thompson—For Concentrating Ores.

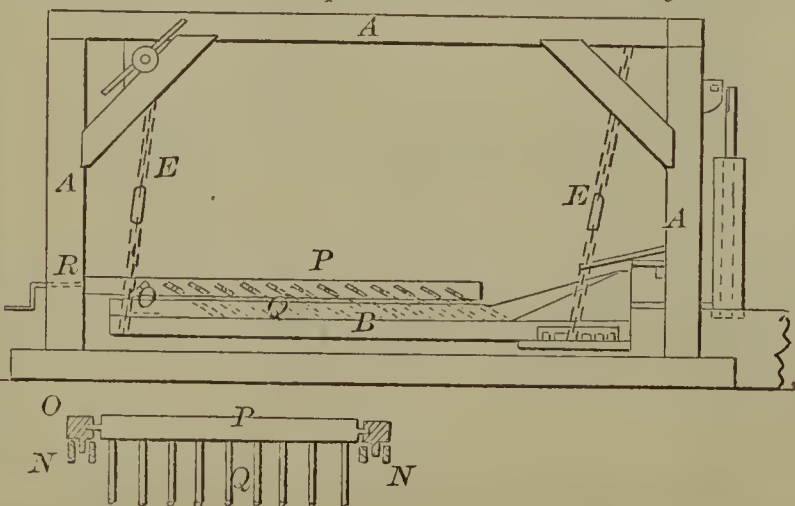



60090—S. R. Thompson—For Making Crucibles.

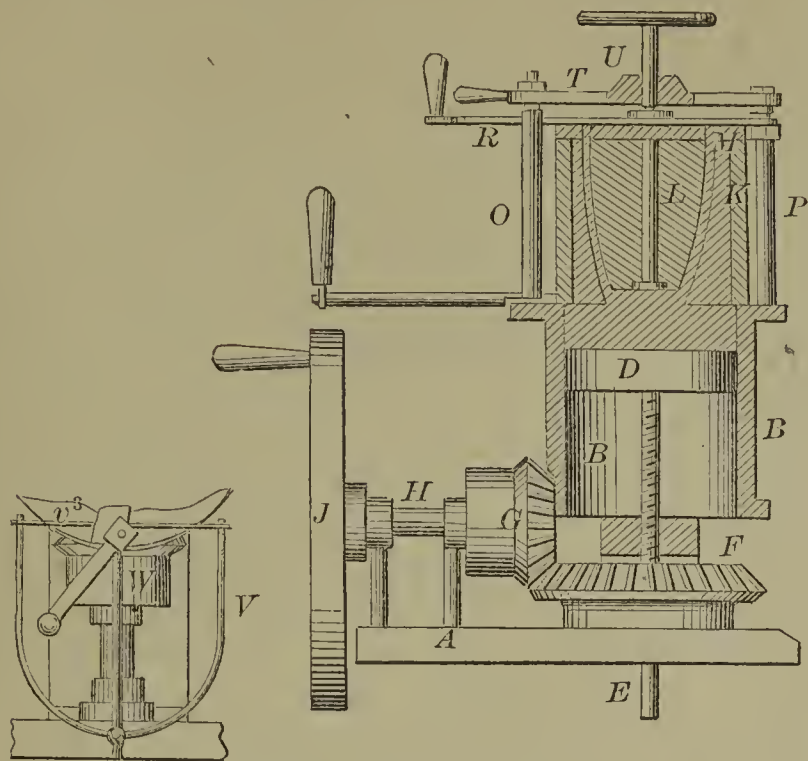

60092—D. J. Tittle—Car Coupling.

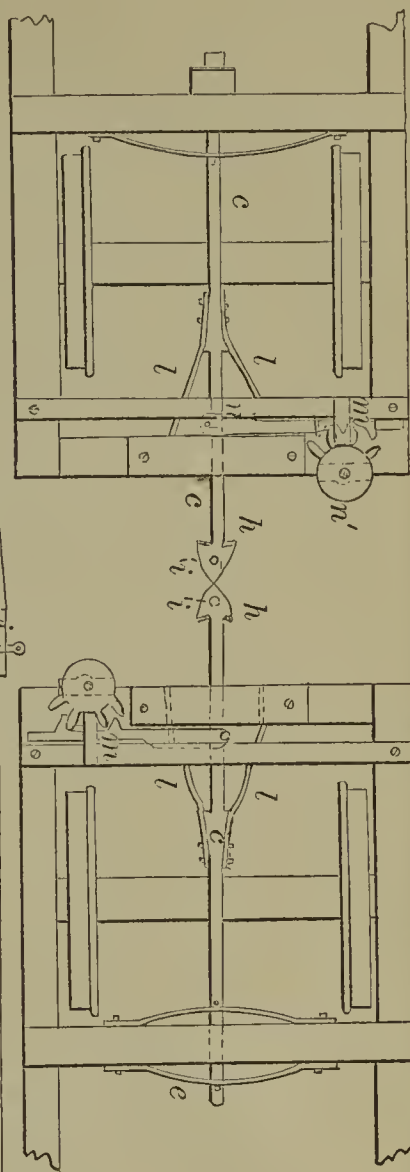

60091—W. W. Tice—Moulder's Clamp.

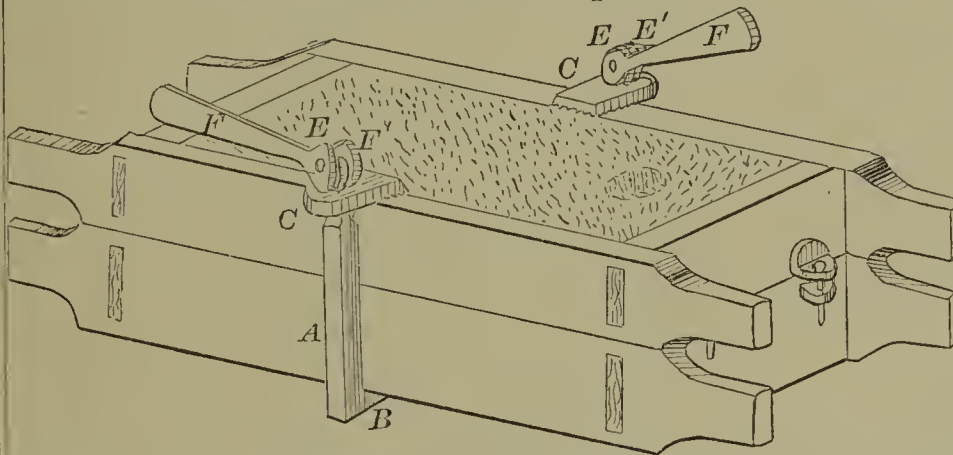

60093—J. D. Van Hoevenbergh—Carriage.

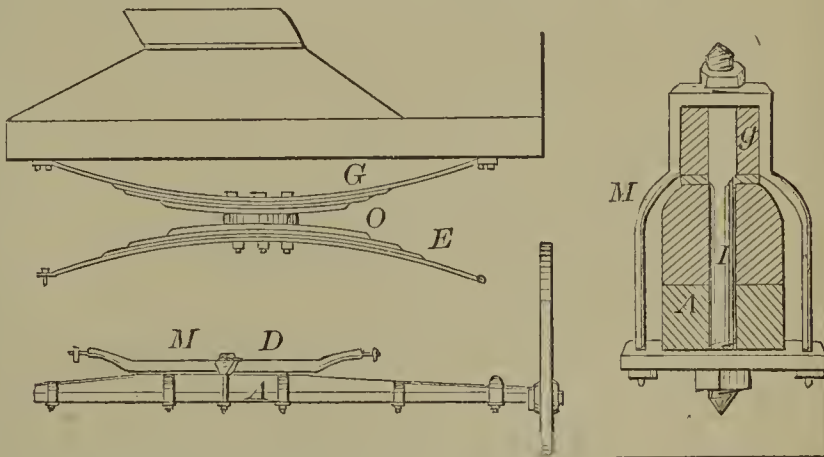

60095—B. Volkmann—Plow.

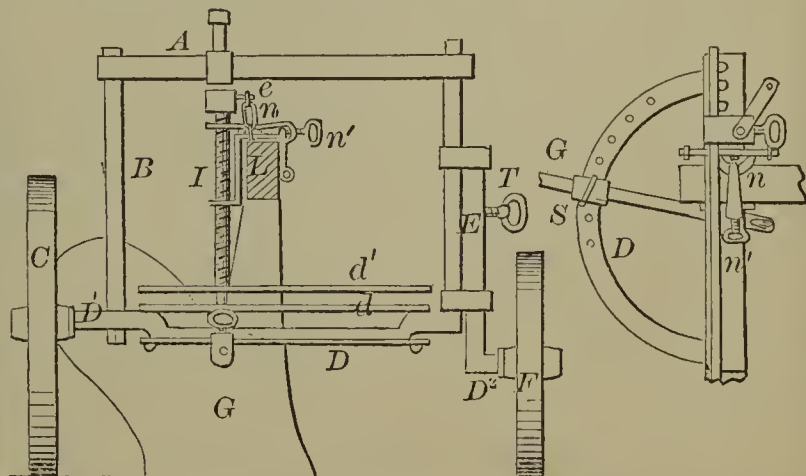

60094—Veln, Fosse & Fosse—Car Brake.

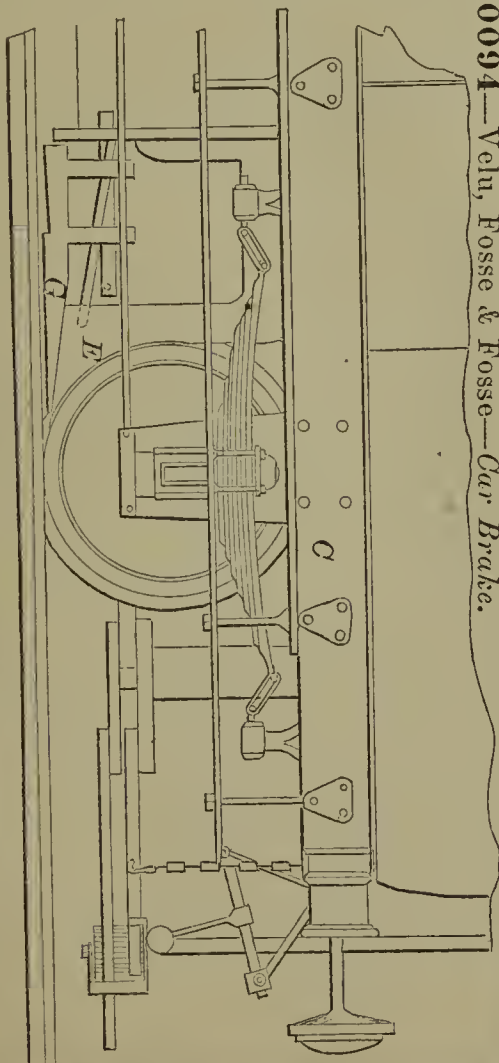

60096—E. Wagoner—*Grain Drill.*

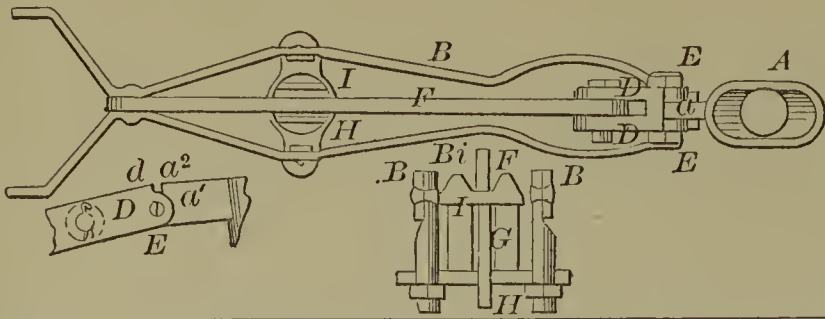

60097—G. B. Waller—*Churn.*

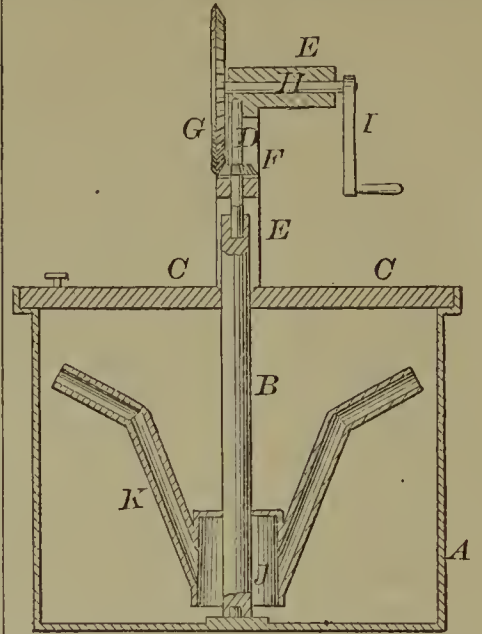

60099—J. Walter—*Grape Vine Protector.*

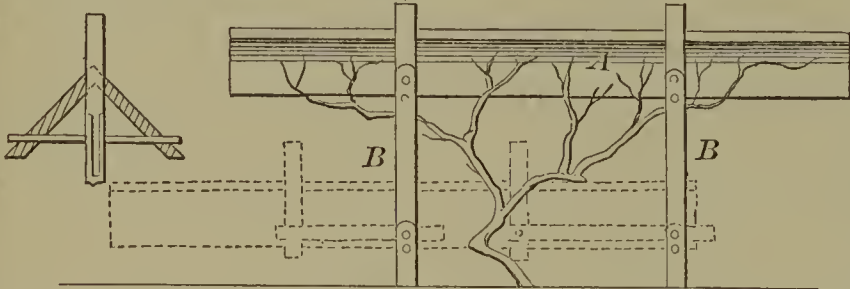

60098—Wallis & Swearingen—*Bellows Pump.*

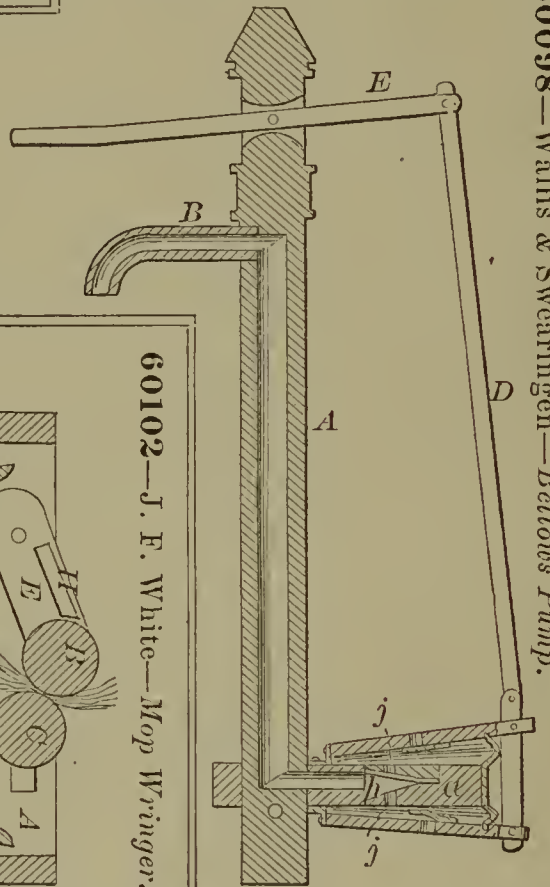

60102—J. F. White—*Mop Wringer.*

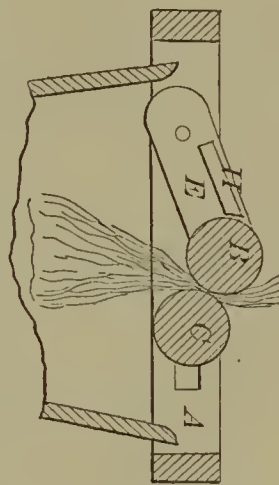

60100—W. H. Watson—*For Pressing Tobacco.*

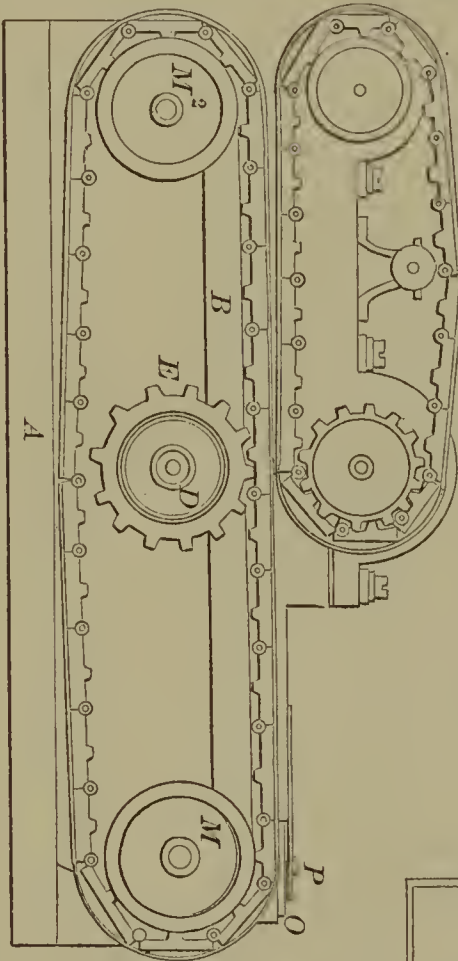

60103—H. Whitehill—*For Drying Yarn.*

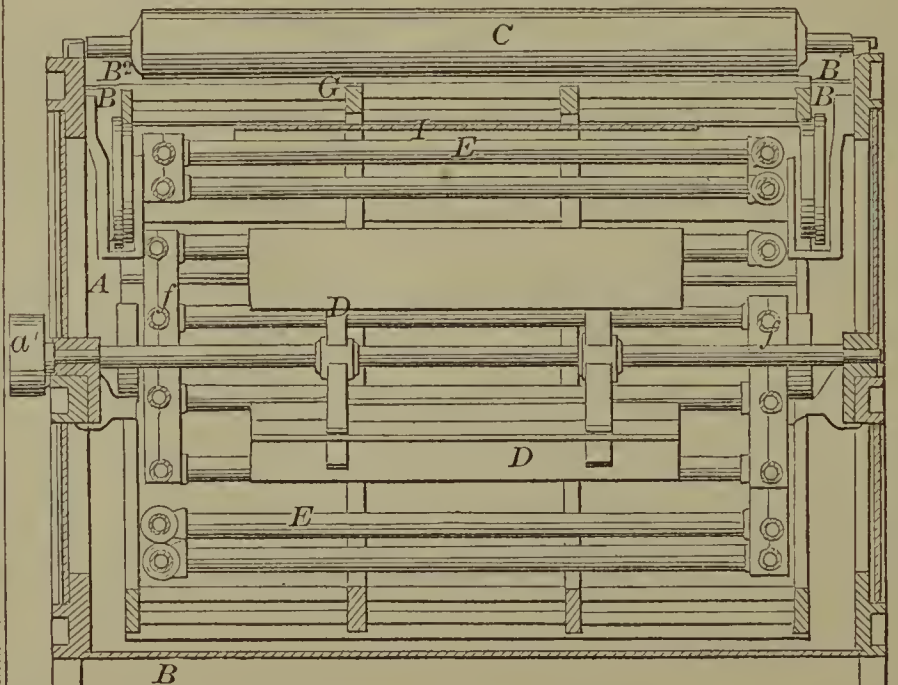

60101—G. L. White—*Loom.*

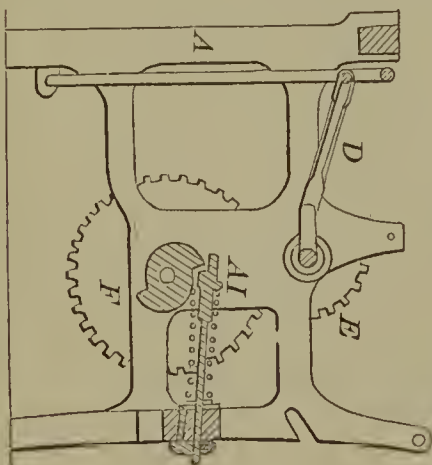

60104—S. S. Wiles—Measuring Faucet.

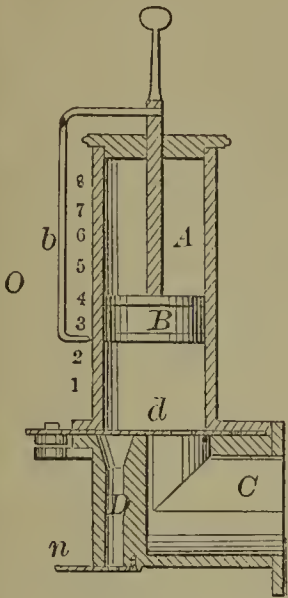

60105—G. L. Witsil—Grinding Mill.

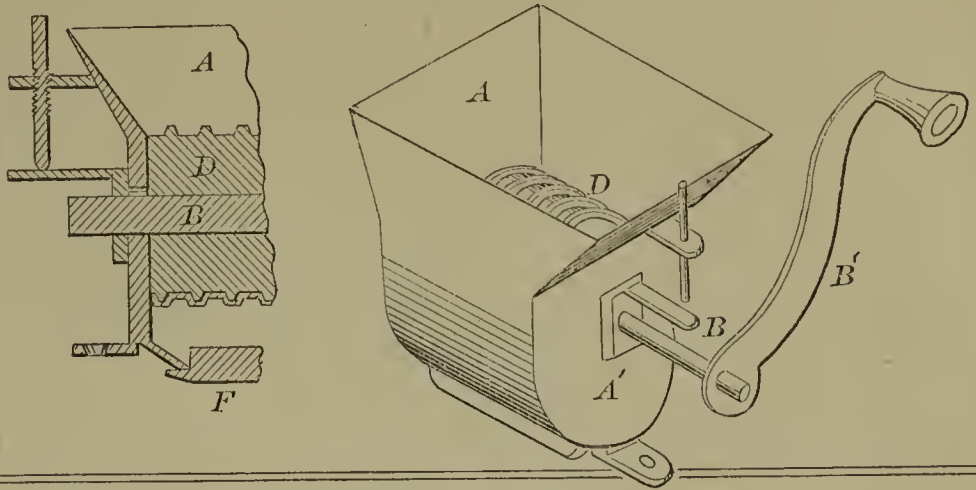

60106—H. H. Wolcott—Fire Arm.

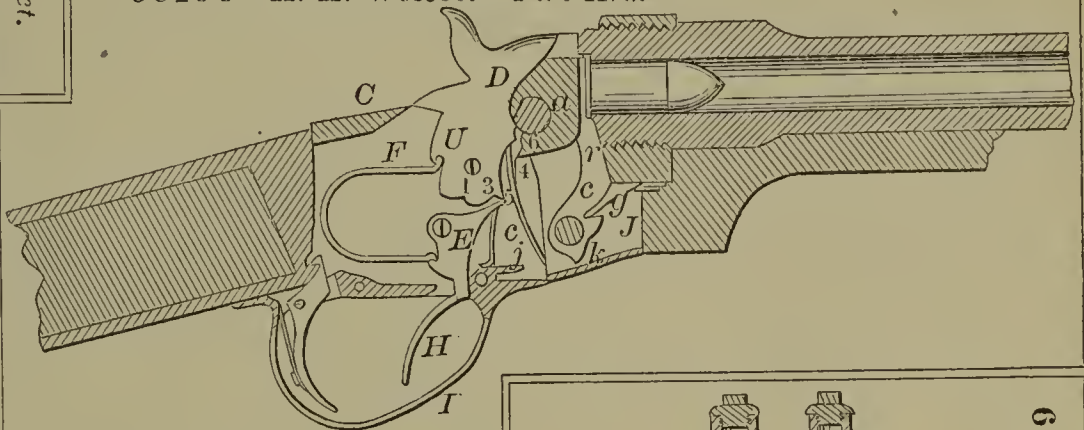

60109—D. A. Woodward—Fluid Lens.

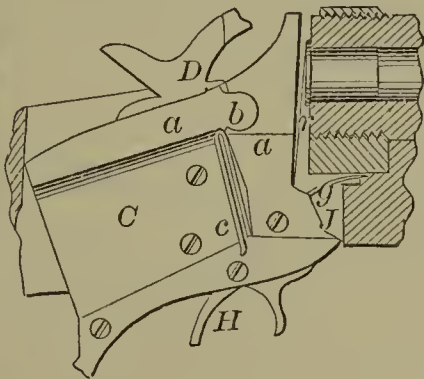
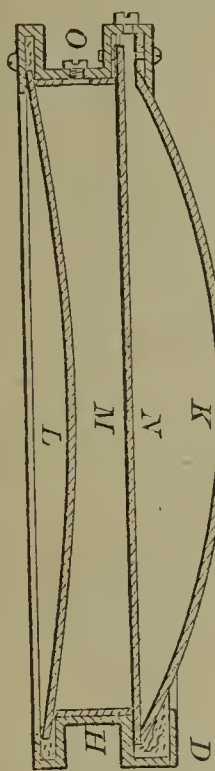

60110—W. Wright—Quartz Mill.

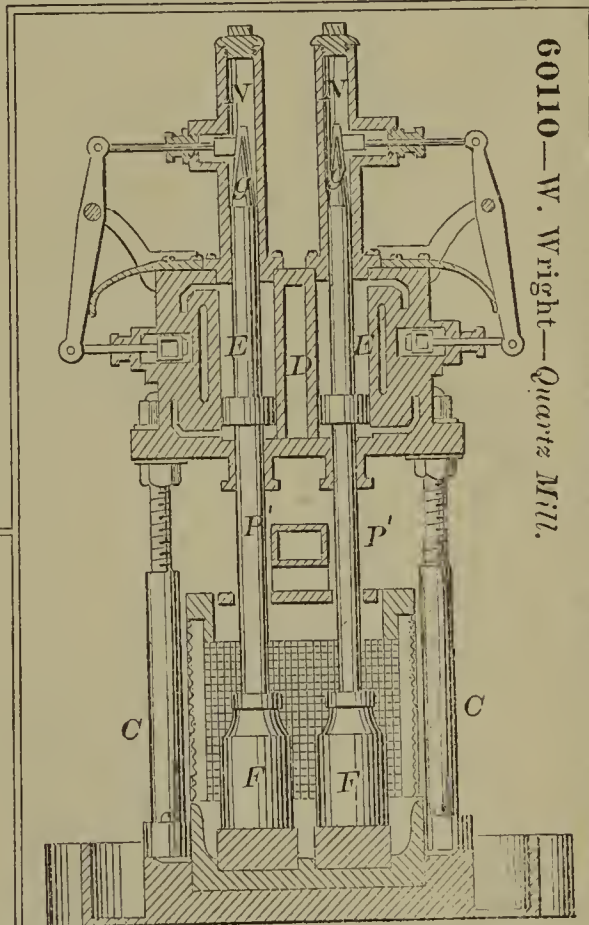

60107—C. Wolf—Horse Collar.

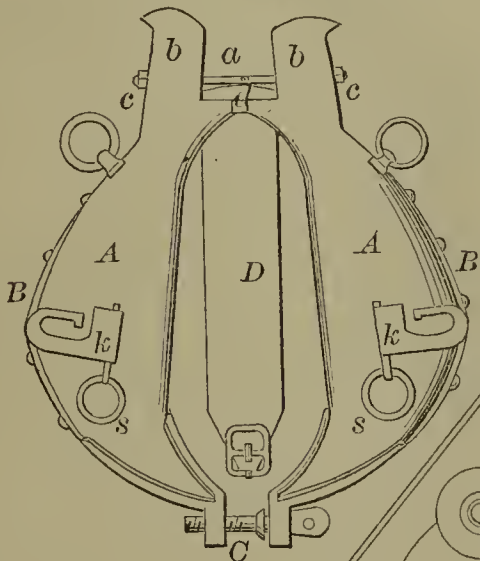

60111—C. O. Yale—Marking Device for Sewing Machines.

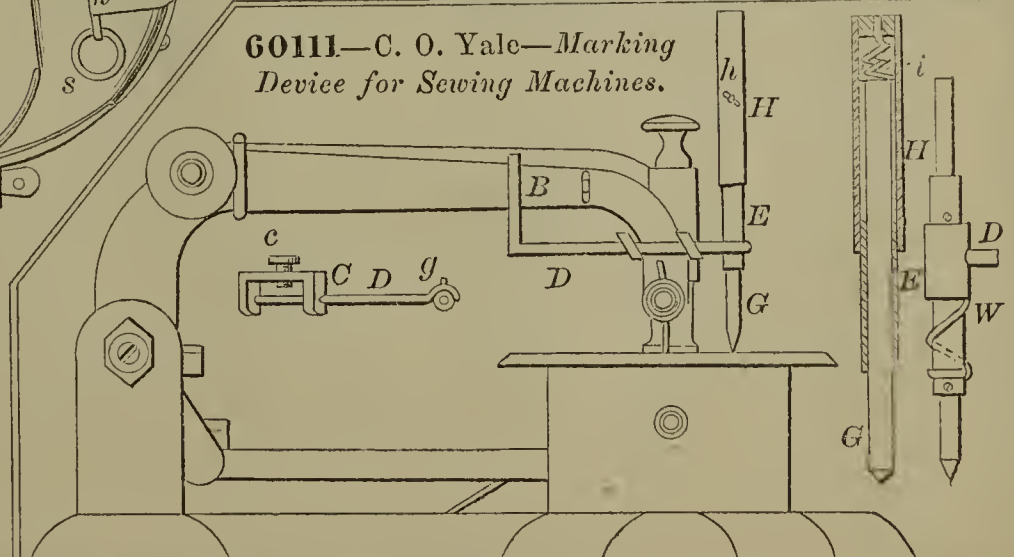

60112—J. Adams—Railroad Rail.

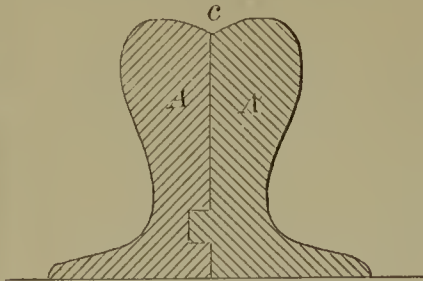

60115—J. C. Arms—Embossing Machine.

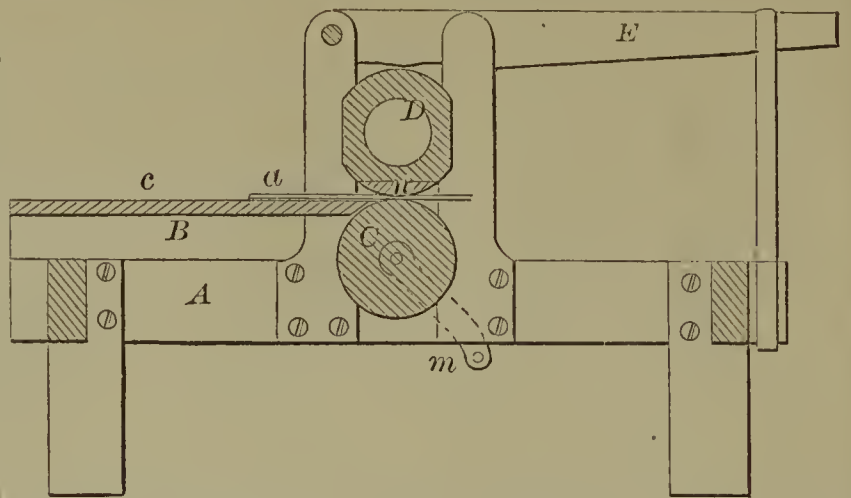

60113—R. Allen—Lathe Clutch.

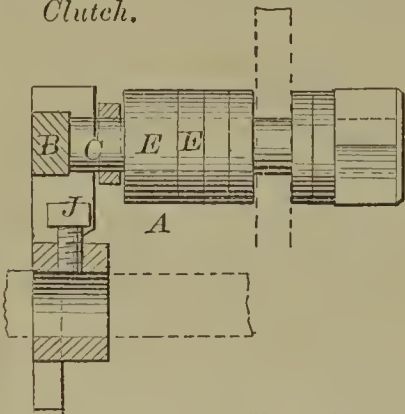

60118—F. M. Baker—Cooking Stove.

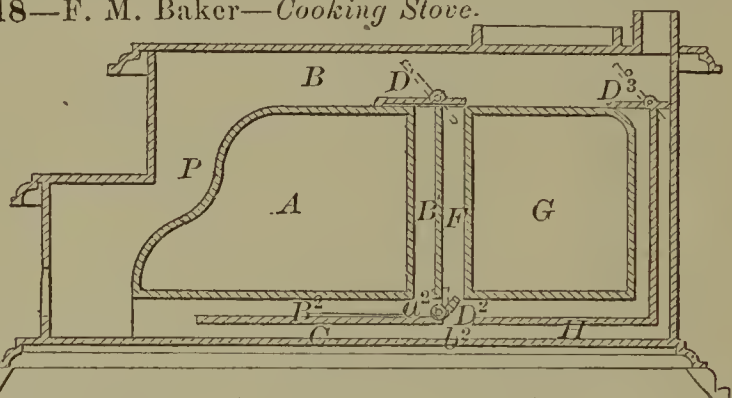

60114—M. M. Ammidown—Drilling Machine.

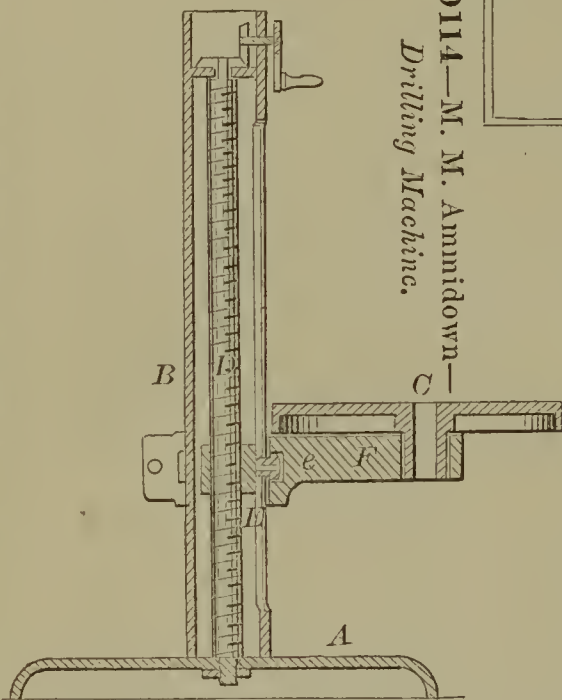

60117—E. Ashcroft—Oil Can and Lamp.

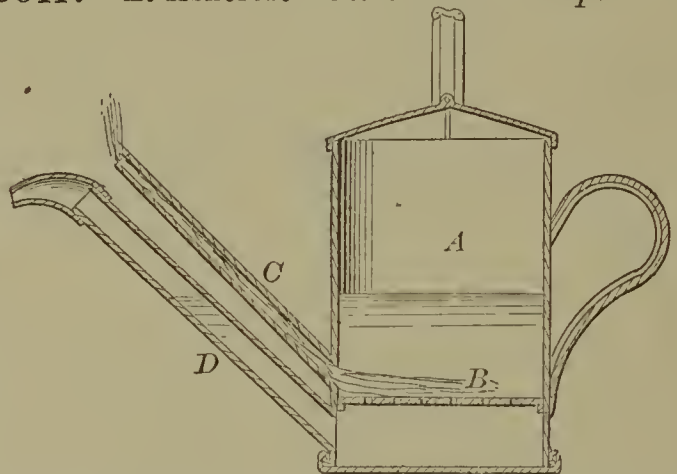

60116—T. G. Arnold—Chuck.

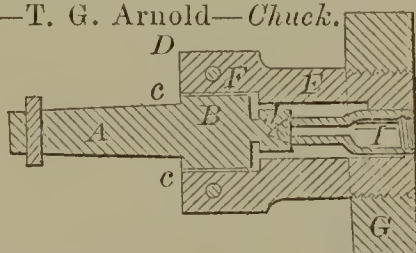

60120—Barnard & Spiller—Manufacture of Salt Block.

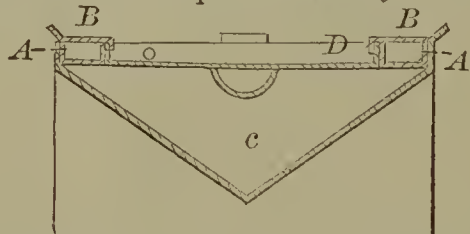

60121—C. J. Barney—Bag Holder.

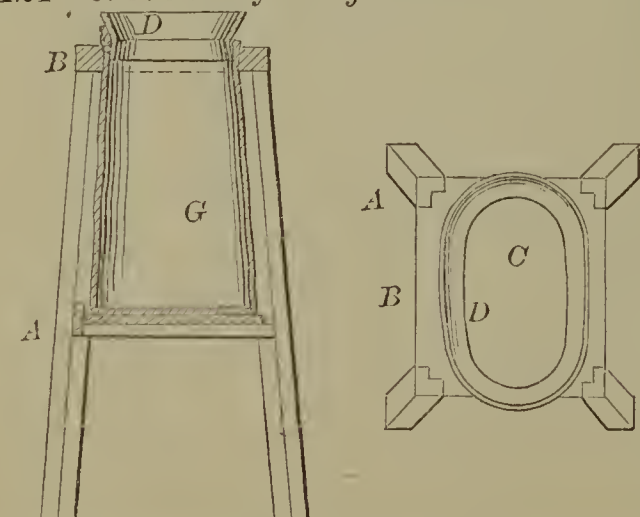

60122—H. Beckwith—Scaffold Bracket.

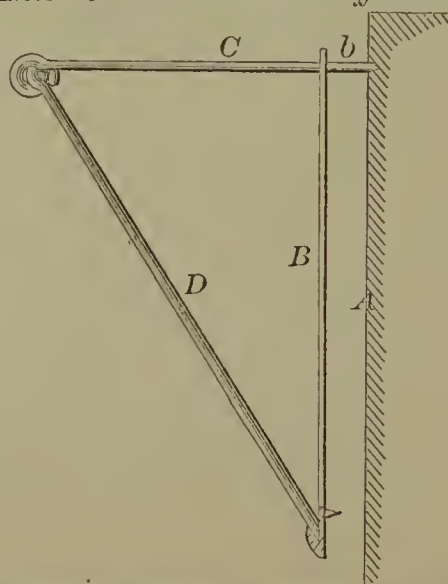

60123—J. Bellerjean—Lantern.

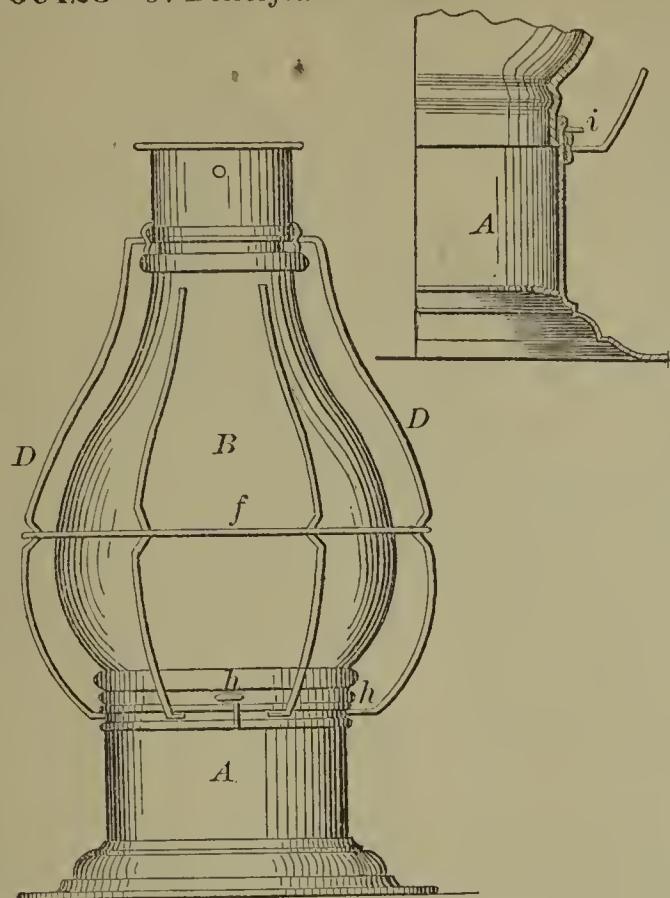

60124—T. E. Belton—Steam Heater.

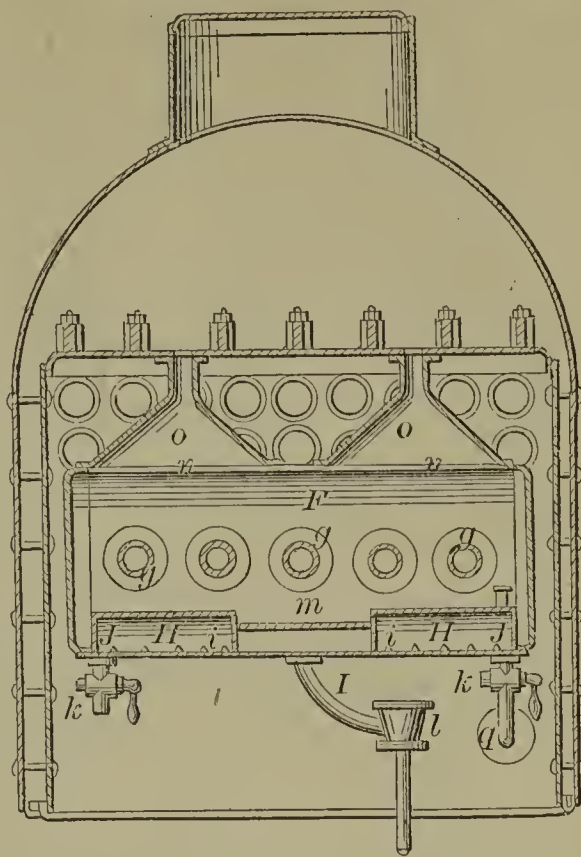

60125—C. C. Bemis—Grate Bar.

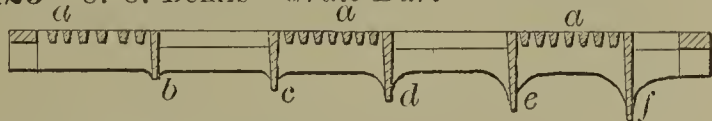

60127—B. Billings—Fence.

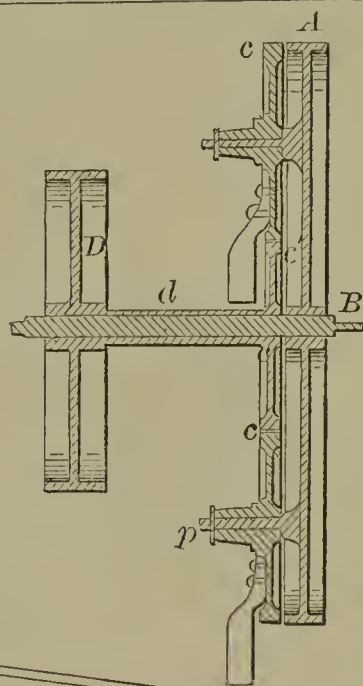
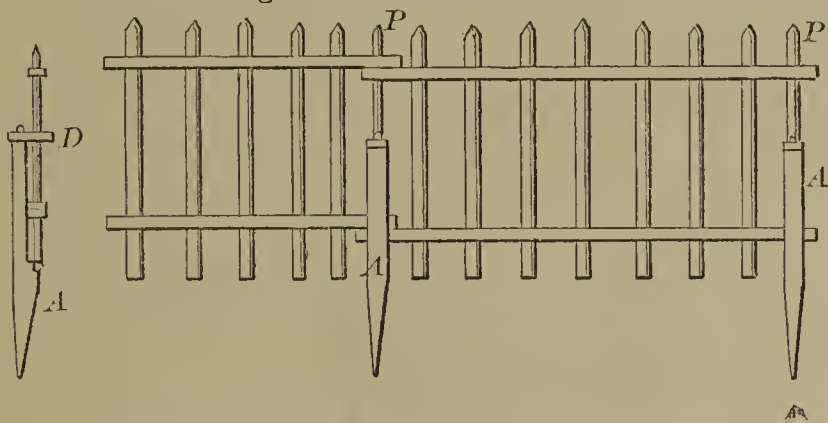

60126—W. Bicknell—Communicating Motion.

60128—G. E. Bingham—Revolving Flue Cleaner.

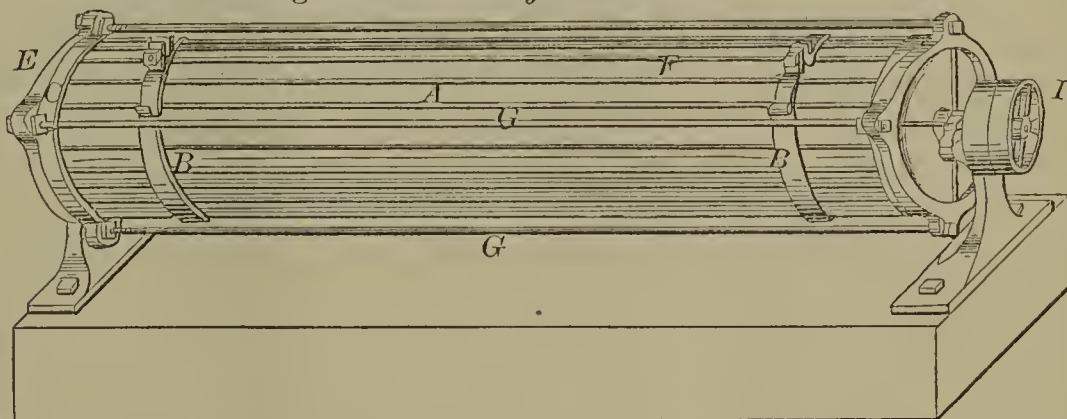

60130—W. Y. A. Boardman—Wick Inserter for Lamps.



60131—J. W. Boughton—Elastic Strap for Garments.

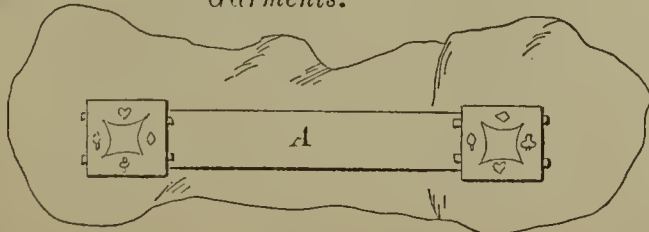

60129—J. B. Blair—Solar Camera.

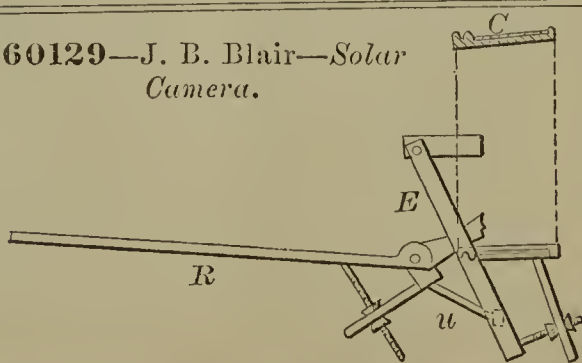

60132—L. Bridge—Heating Stove.

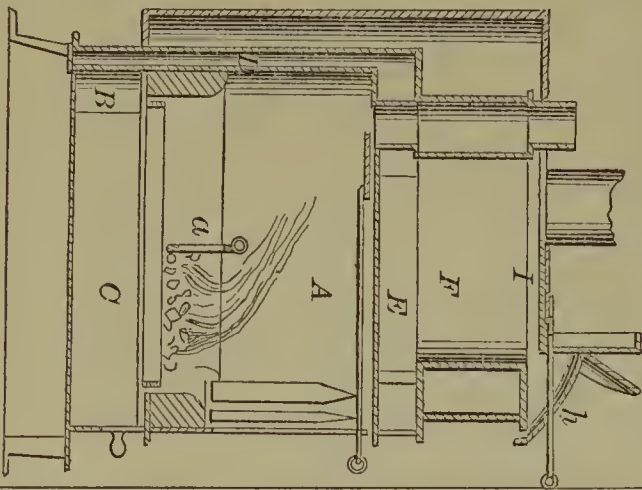

60138—J. C. Chapman—Chuck.

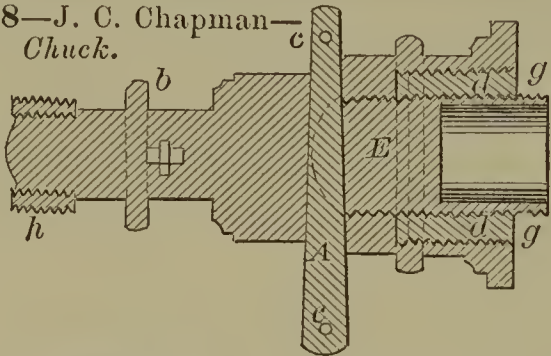

60139—R. Chester—Lantern.

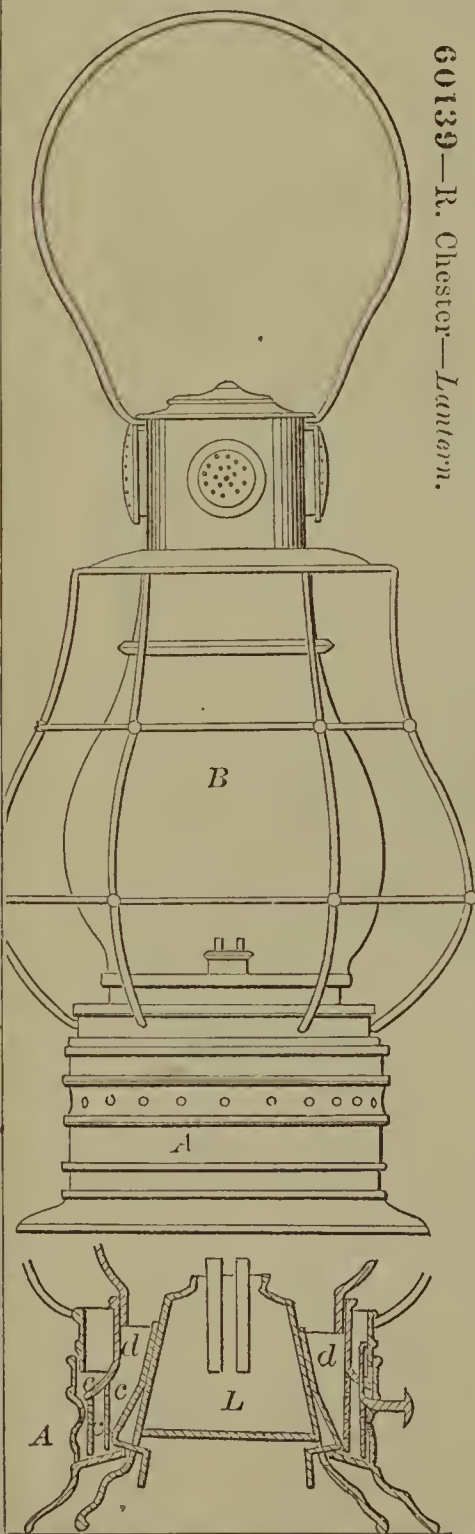

60135—A. Button—Buckle.



60133—Brown & Level—For Detaching Boats.

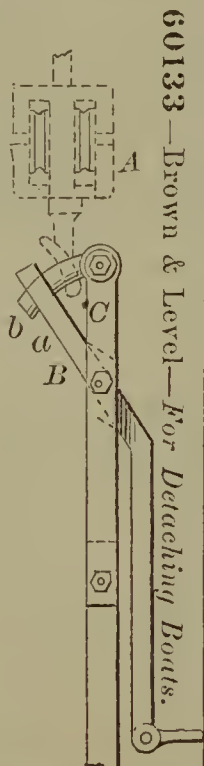

60134—W. Brückner—Furnace for Desulfurizing Ores.

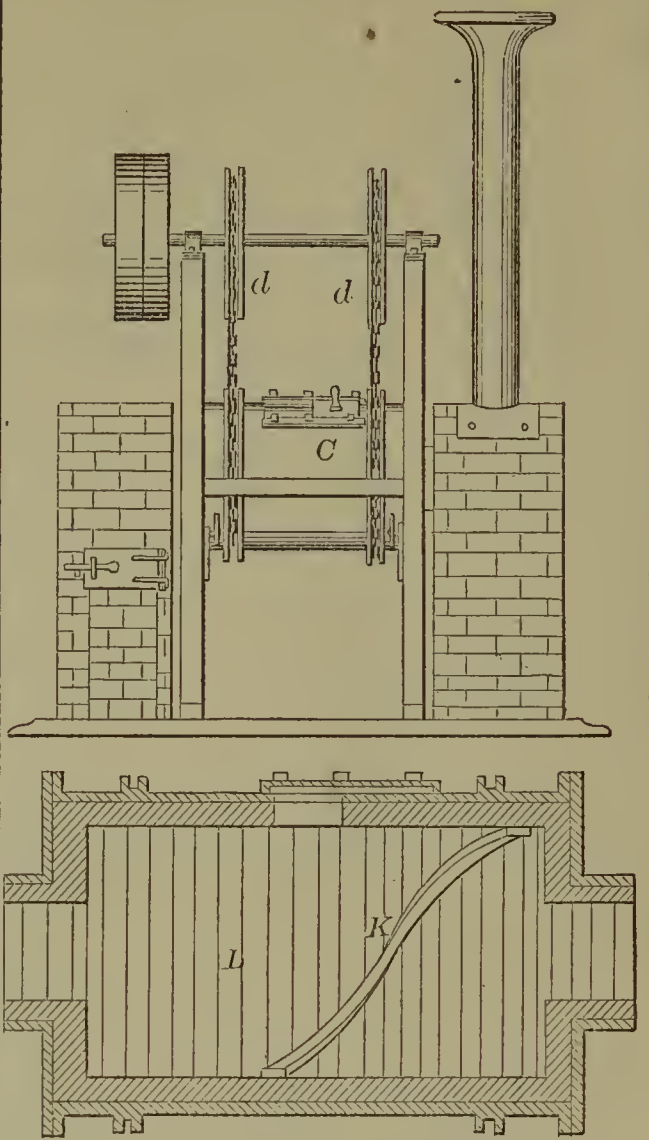

60137—G. Chambers—Car Replacer.

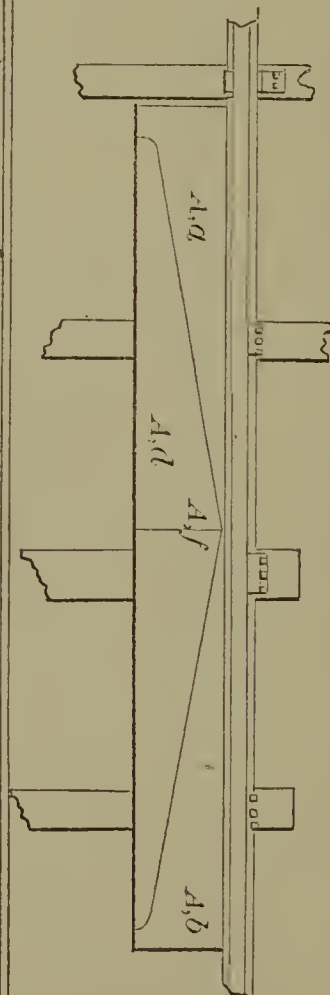

60136—A. Casebeer—For Destroying Embryo Caterpillar.

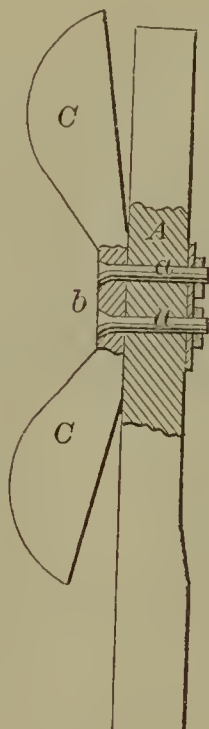

60140—R. Chester—*Lantern.*

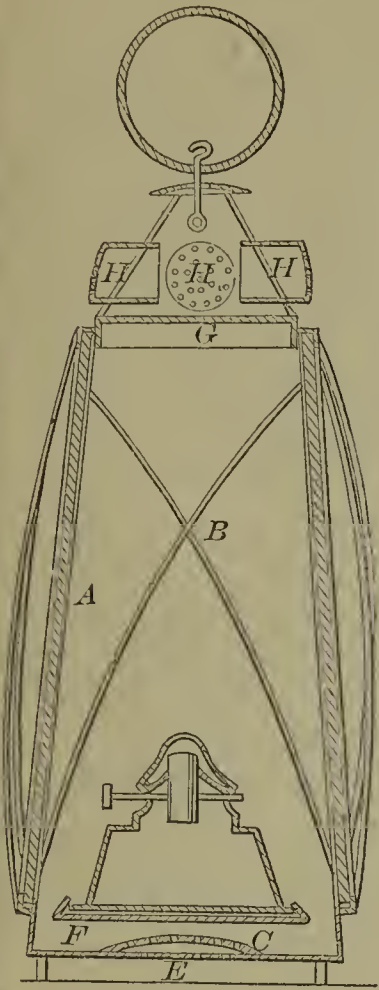

60141—G. H. Chinnoek—*Toy Block.*

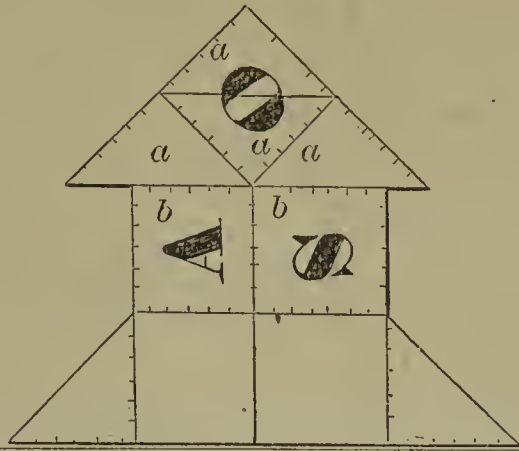

60143—G. E. Clarke—*Animal Trap.*

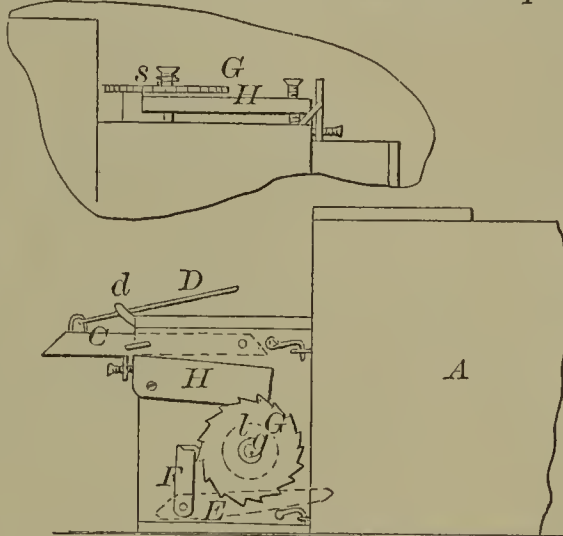

60145—E. H. Covel—*Centrifugal Pump.*

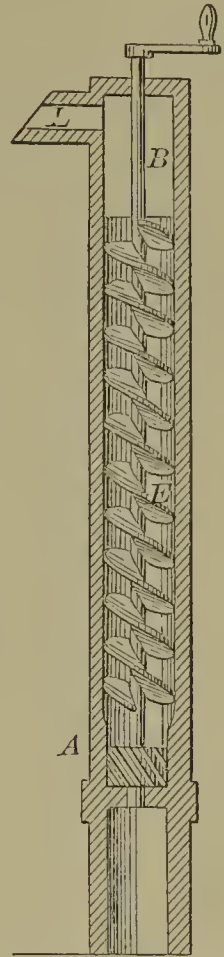

60147—H. D. Dann—*Seeding Machine.*

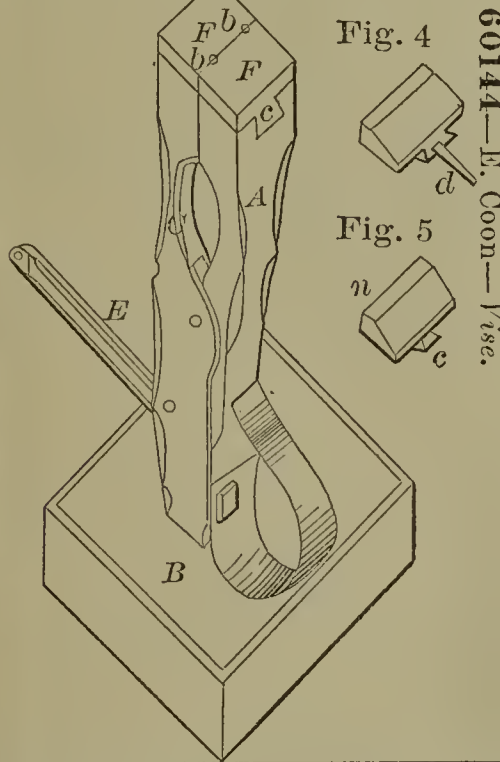
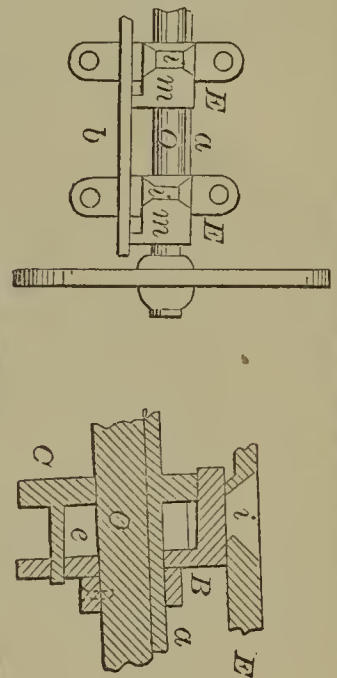

60144—E. Coon—*Yisc.*

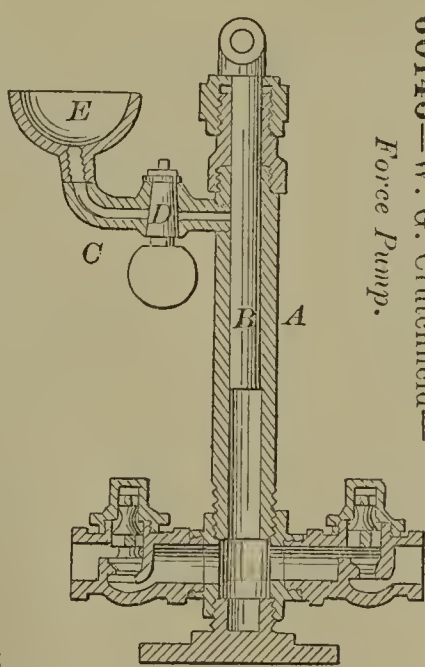

60146—W. G. Crutchfield—*Force Pump.*

60149—F. Davis—*For Scouring Leather.*

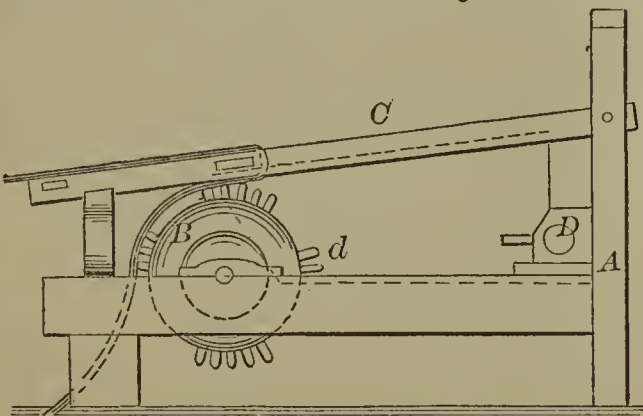

60150—J. S. Dennis—*Sad Iron Heater.*

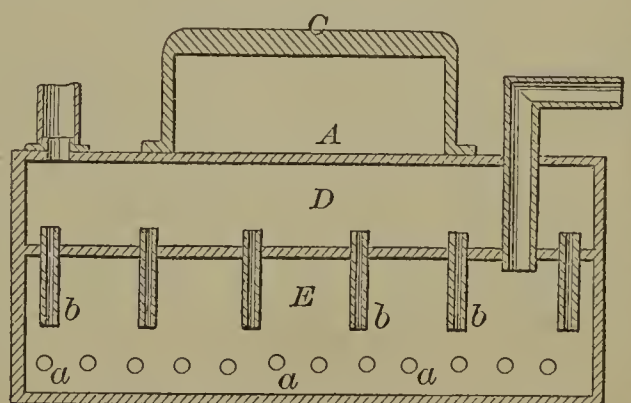

60151—A. T. De Puy—  
*Printer's Galley.*

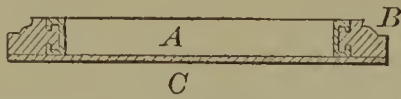

60154—M. B. Dodge—*Ore Crusher.*

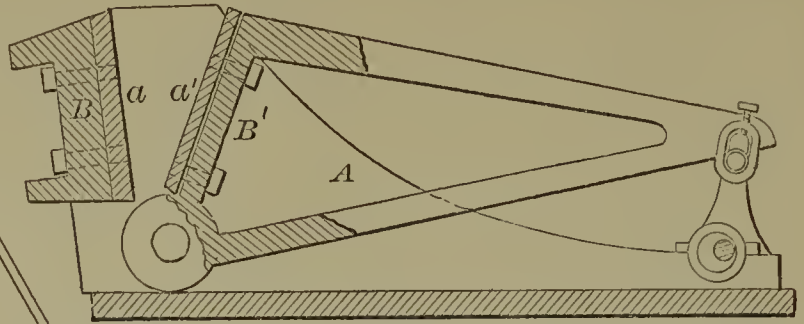

60152—C. Dimmick—  
*Spade Handle.*

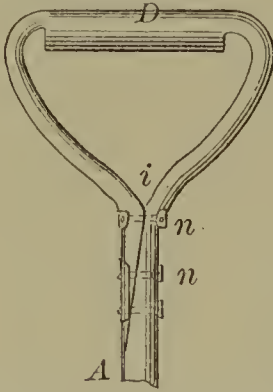

60155—R. W. Drew—*Turning Lathe.*

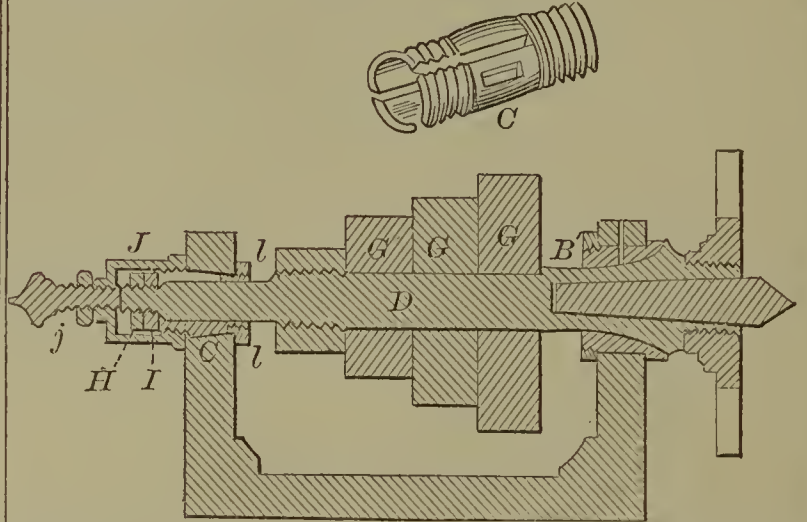

60153—R. Diven—*Privy Bowl.*  
*Flange.*

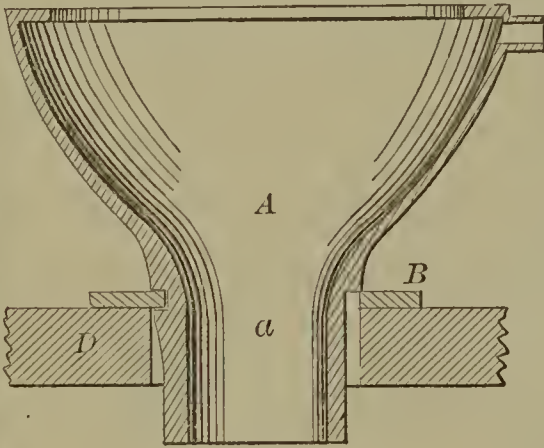

60158—J. C. Dunlevy—  
*For Testing Spirits.*

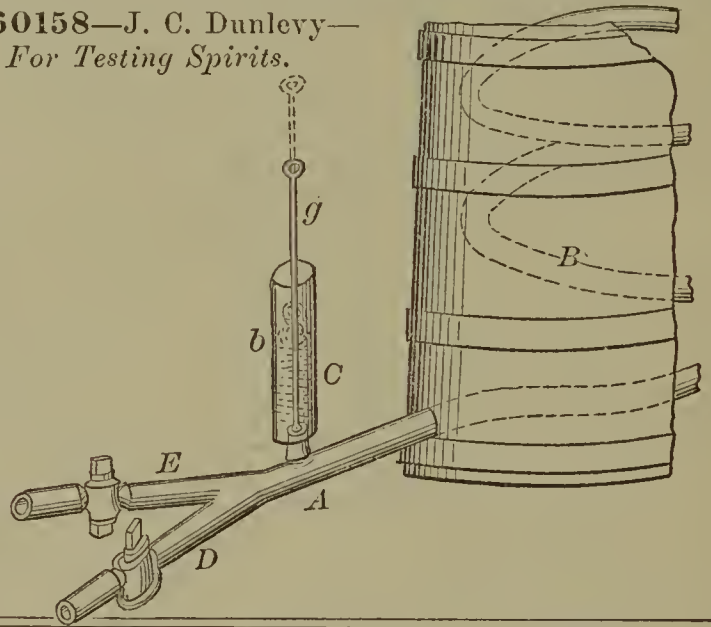

60156—E. F. Driggs—  
*Sash Fastener.*



60159—G. Eichenseer—*Horse Power.*

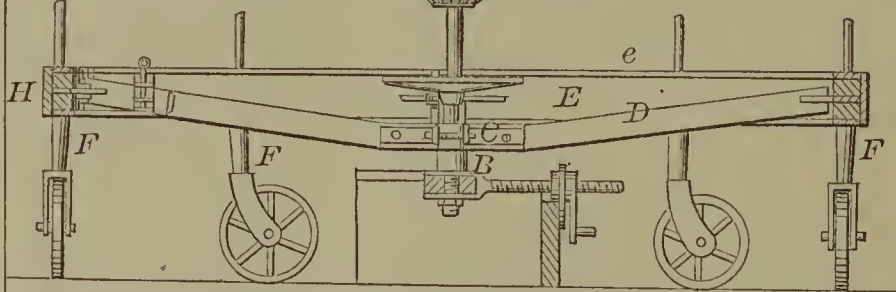

60157—J. F. Dubber—  
*Manufacture of Springs.*

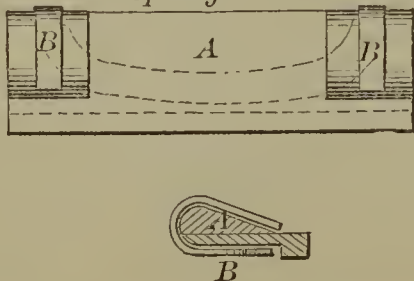

60160—C. R. Everson—  
*Damper.*

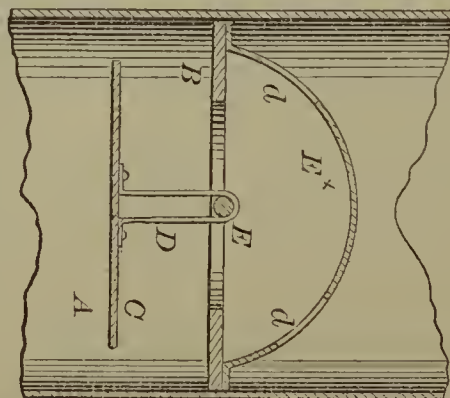



60161—F. M. Eyringham—Wagon Hay Rack.

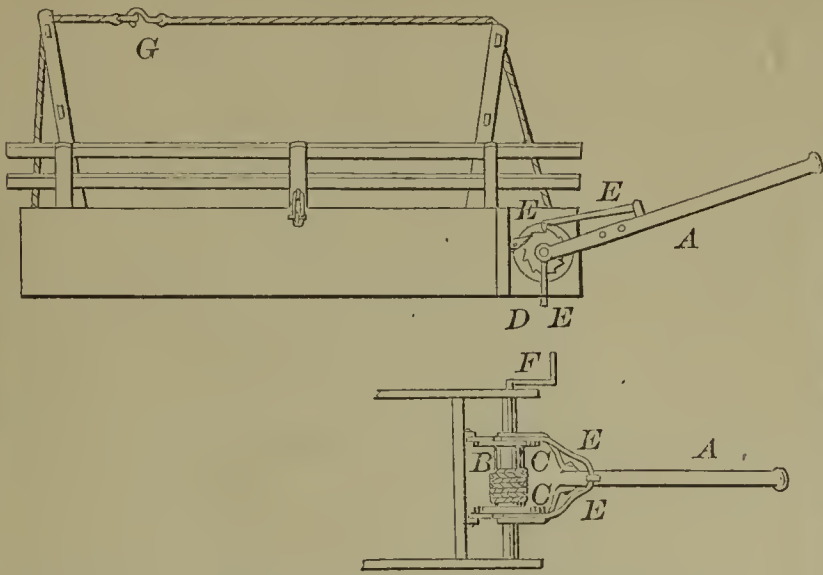

60164—J. C. Fitzgerald—Rotary Cultivator.

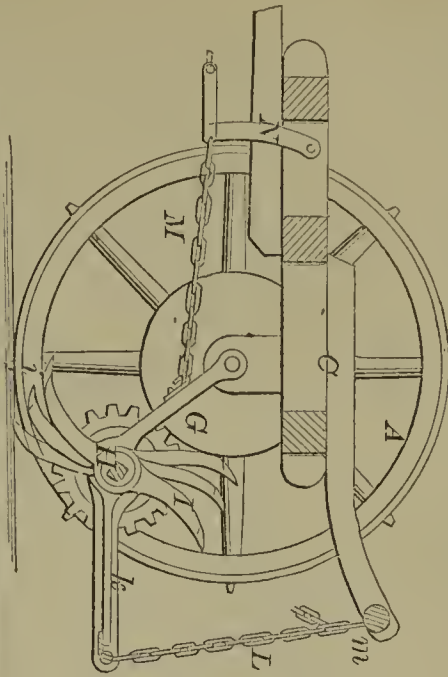

60163—L. R. Faught—Turning Lathe.

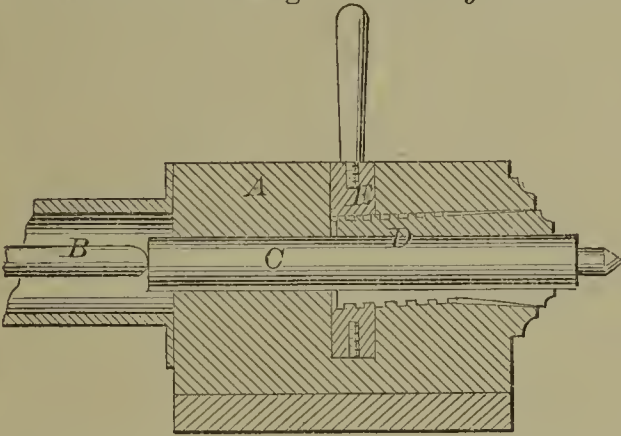

60162—W. Farnham—Burglar Alarm.

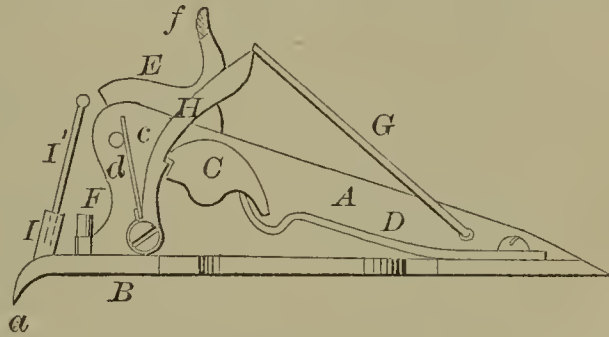

60165—T. M. Foster—Oil Well.

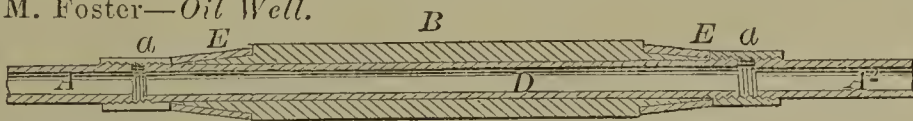

60166—A. Foubert—Distilling and Refining Oils, &c.

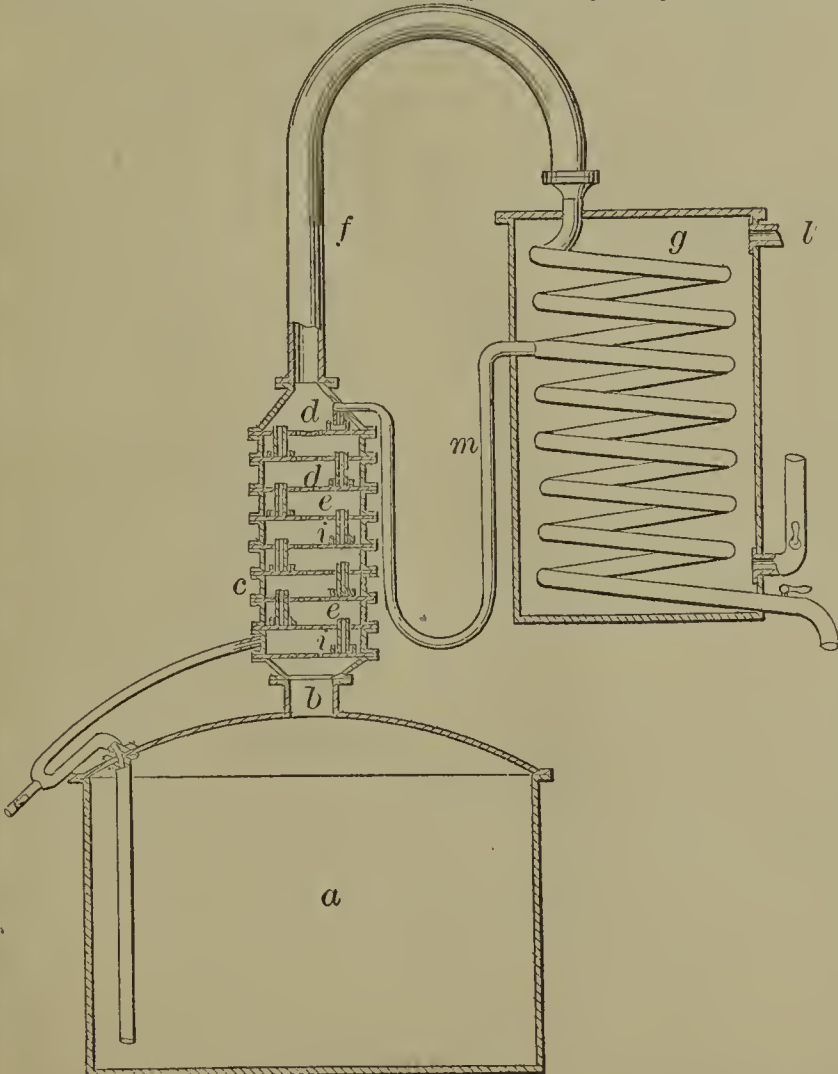

60167—W. Fuzzard—For Striving Fibrous Materials.

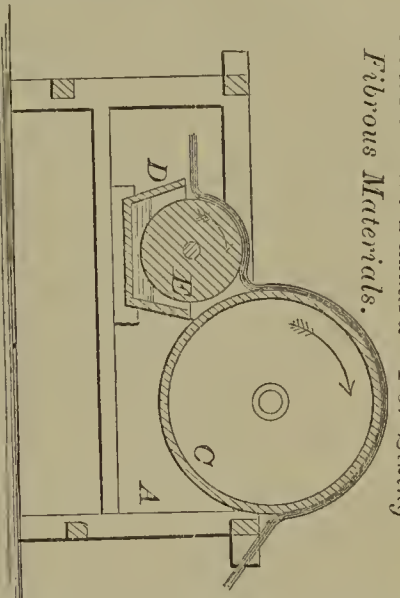

60168—J. Fye—Harness Saddle.

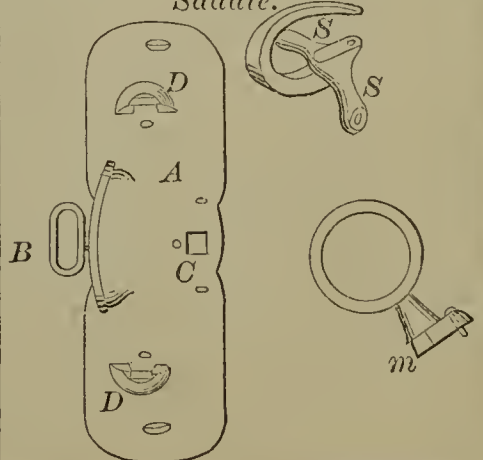

60169—C. O. Gardiner—Centering and Squaring Device.

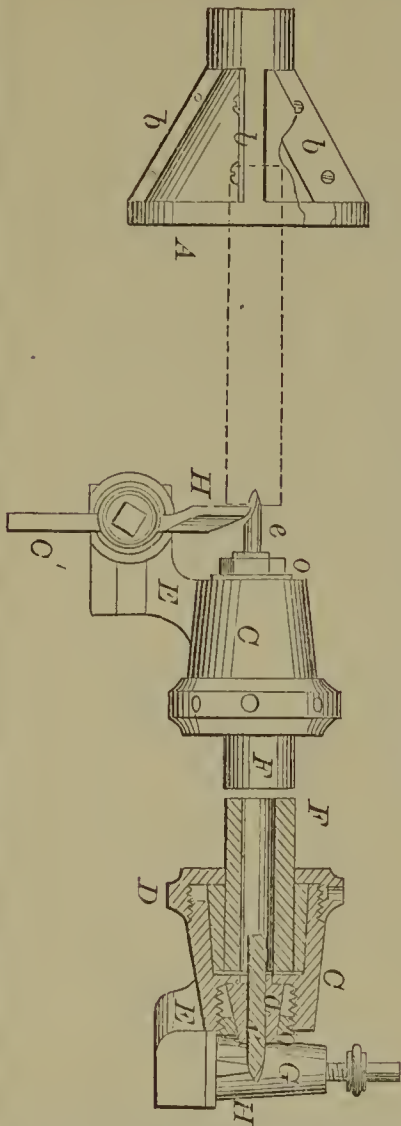

60170—W. L. Gebby—Cotton Planter.

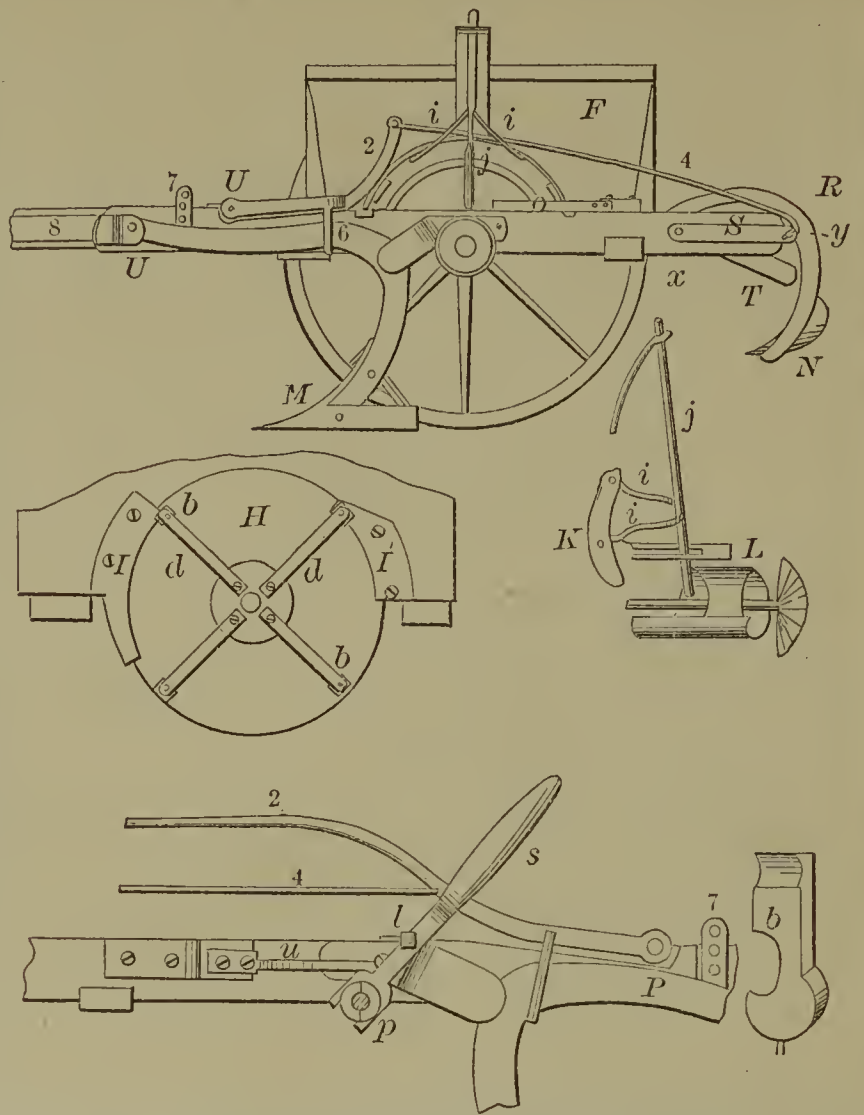

60171—R. J. Gilbert—Gate.

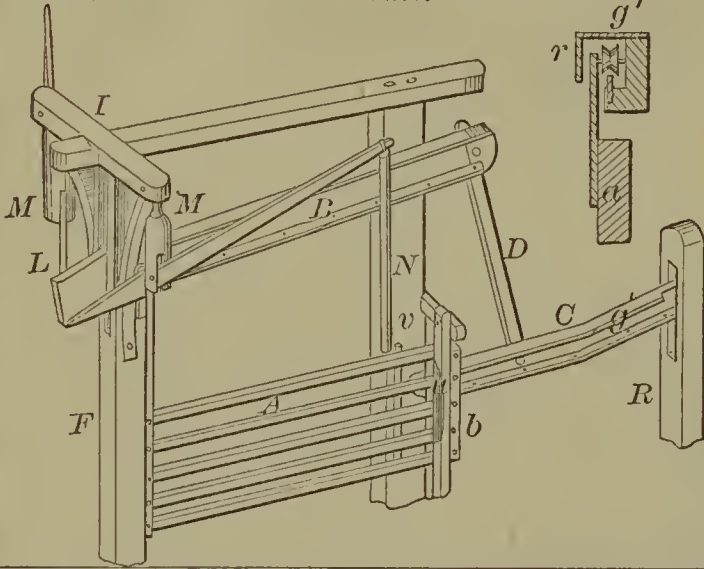

60172—C. Glidden—Plow.

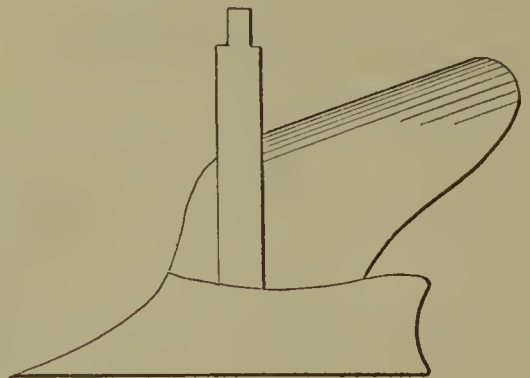

60173—G. F. Goetze—For Ornamenting Mouldings.

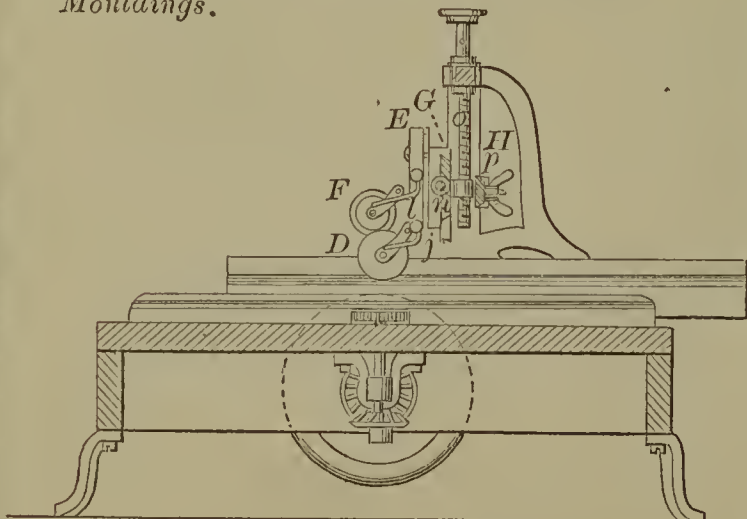

60174—E. C. Gordon—Fence.

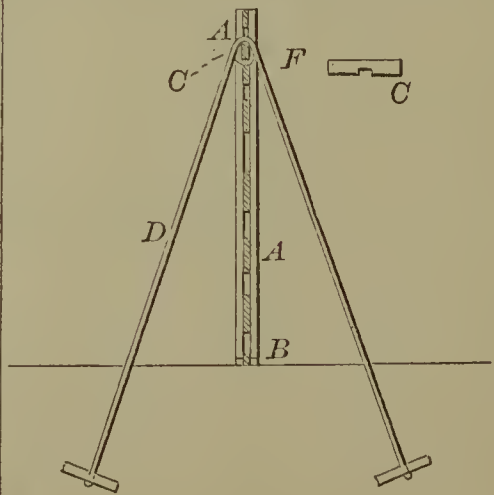

60175—G. Graezle—Brick Machine.

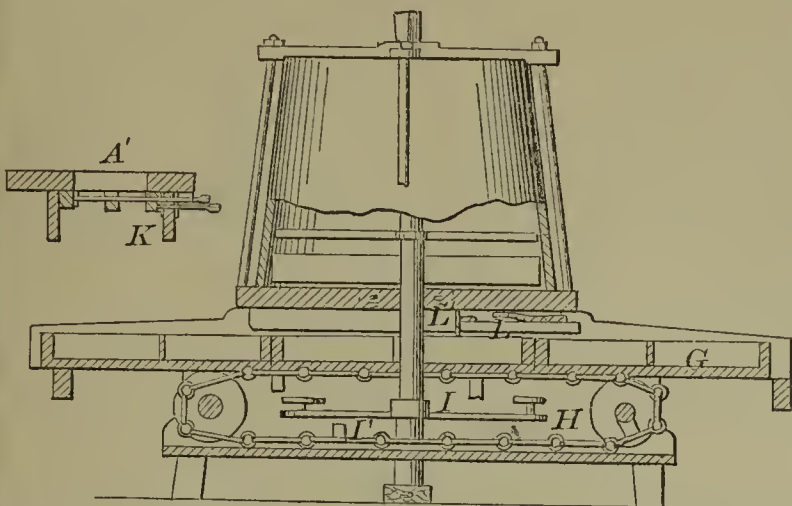

60176—J. H. Gray—For Picking Mill Stones.

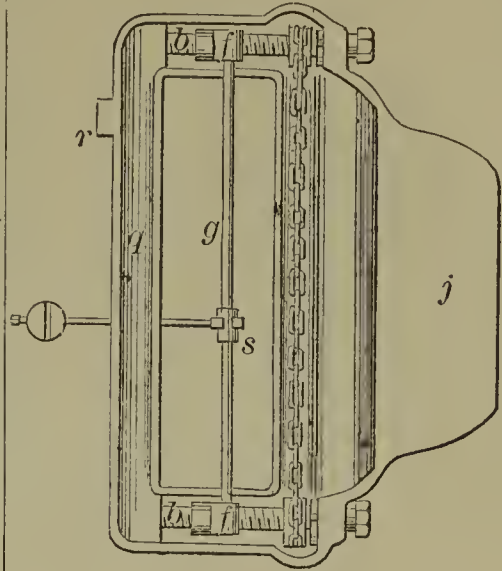

60179—F. Haack—For Imparting Age to Wines.

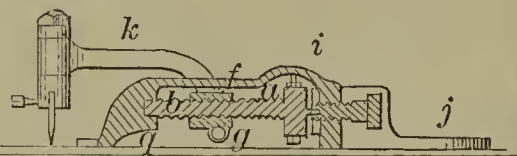
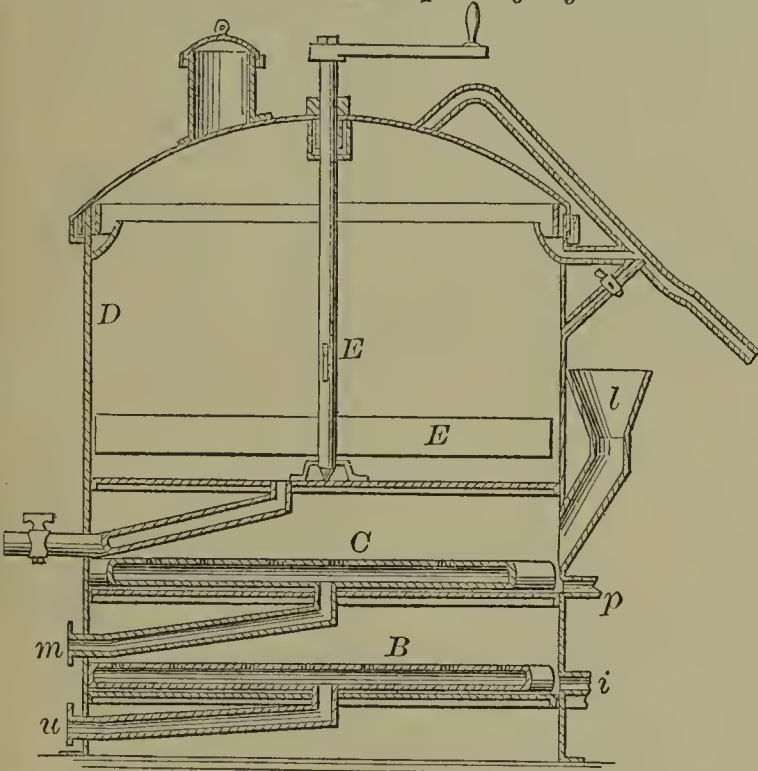

60178—A. Gwynne—Pipe Coupling.

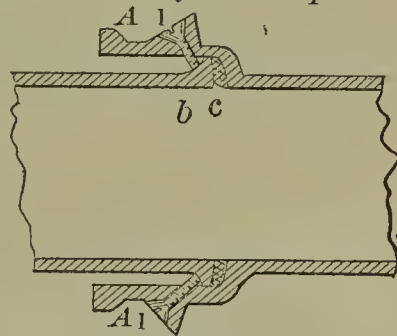

60182—T. Harcourt—Skate Fastener.

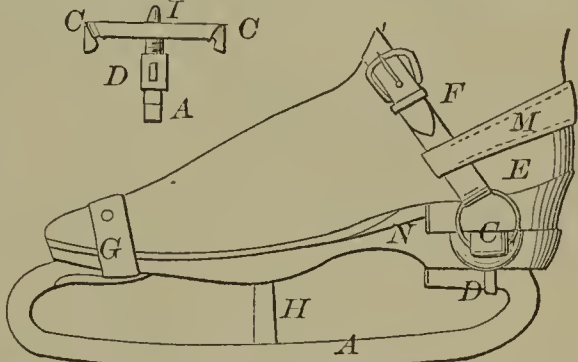

60180—S. C. Hall—For Cutting Sickle Sections.

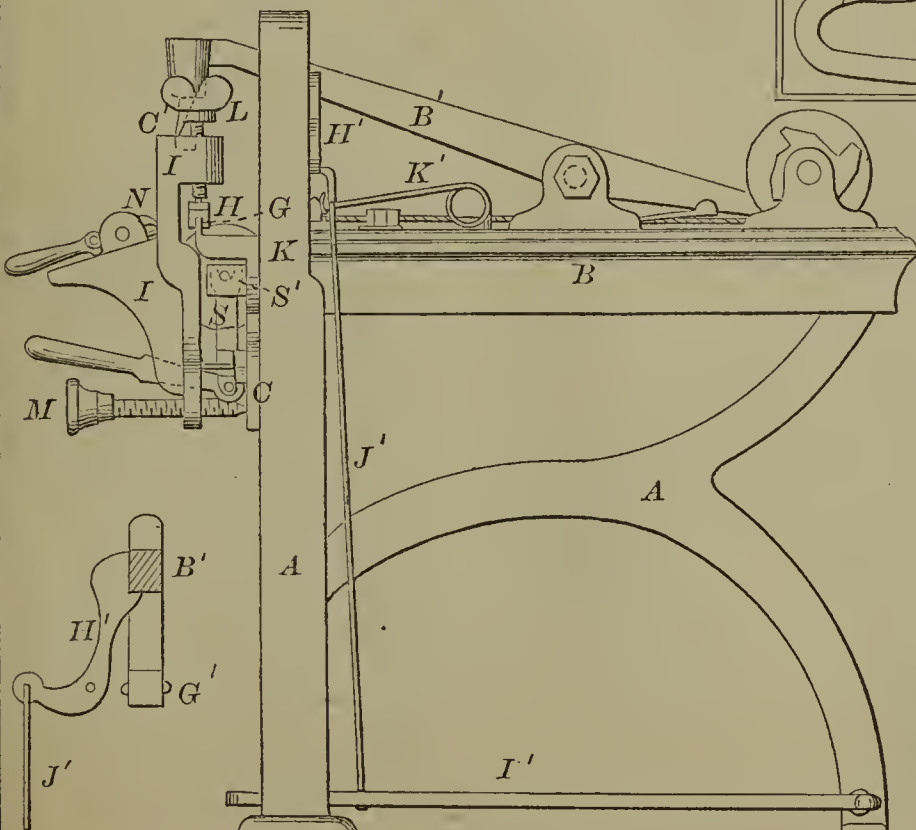

60181—T. Handy—For Grinding Metal Plates.

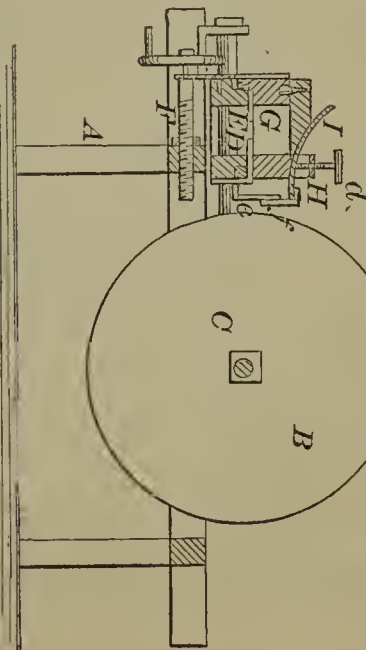

60183—G. W. Harris—*Gas Retort.*



60184—S. Harris—*Balance Weight.*

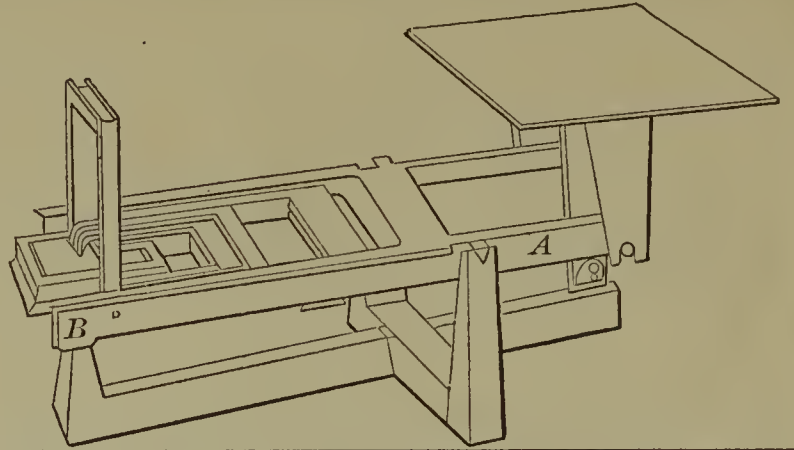

60185—G. W. Hatch—*For Gathering and Loading Flax, &c.*

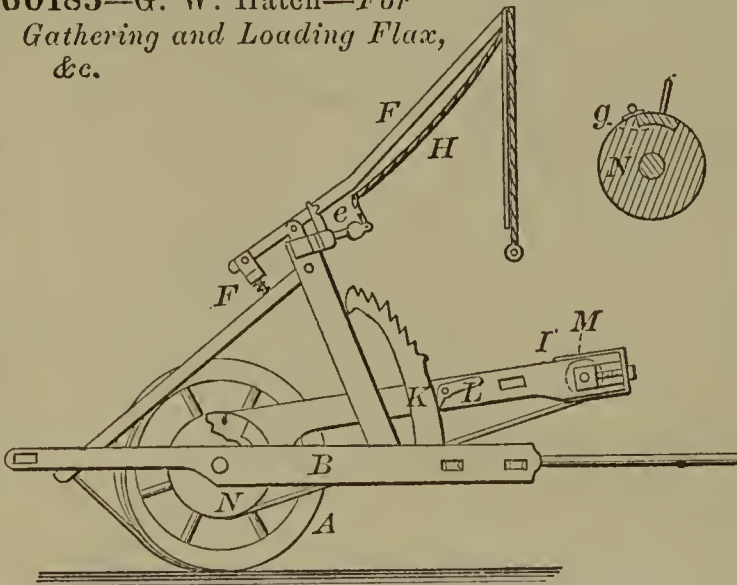

60186—R. Hathaway—*Gauge.*

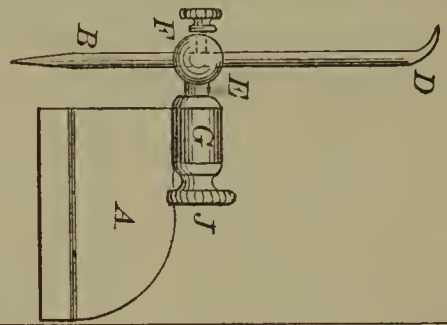

60189—F. A. Hill—*Seeding Machine.*

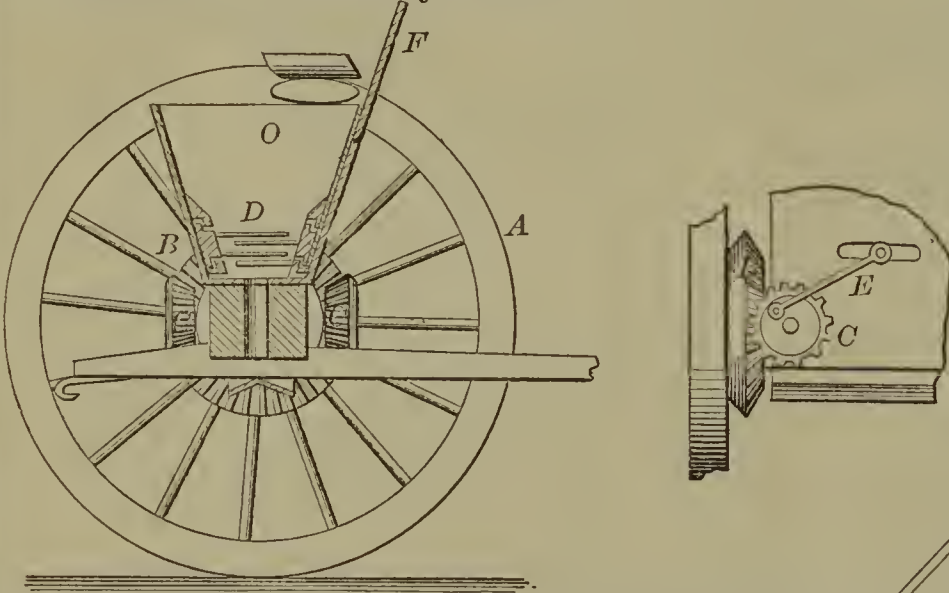

60187—J. W. Hedenberg—*Cotton Tie.*

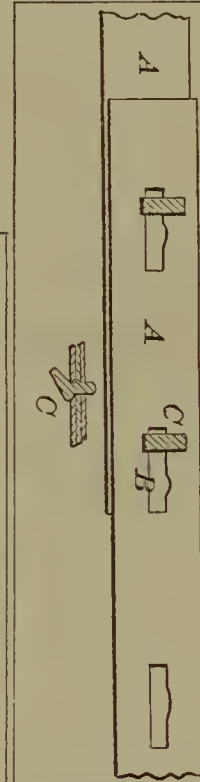

60188—G. Henry—*Fitting Lock Plate to Fire Arm.*

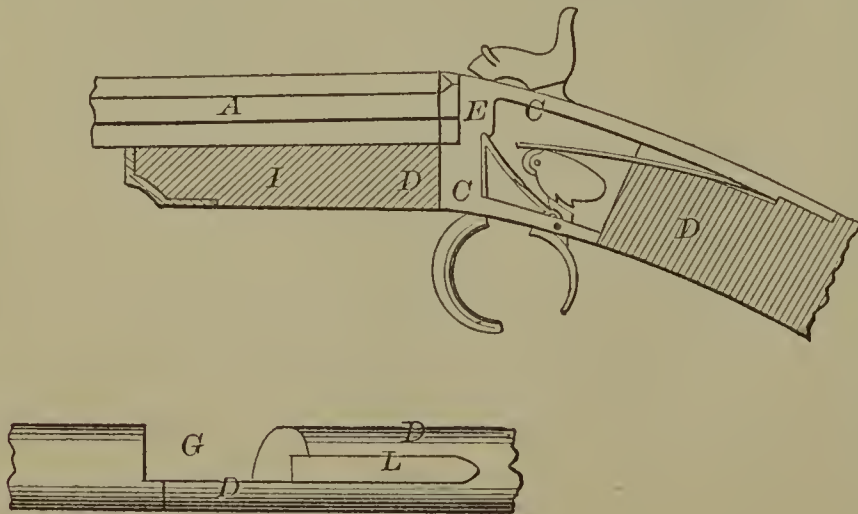

60190—N. P. Holmes—*Milk Preserver.*

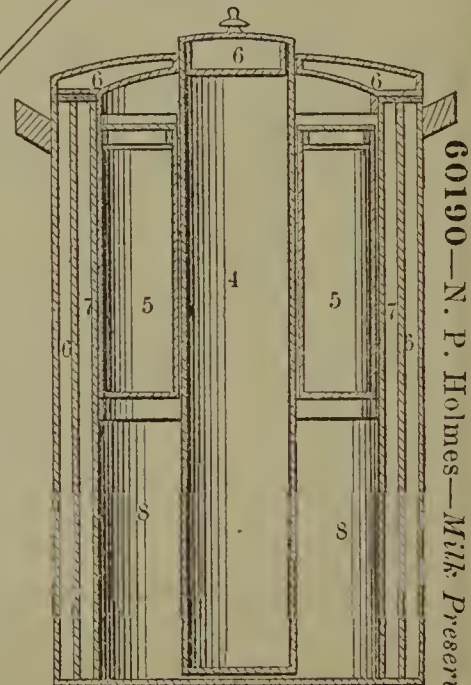

60191—E. B. Horn—*Safe.*

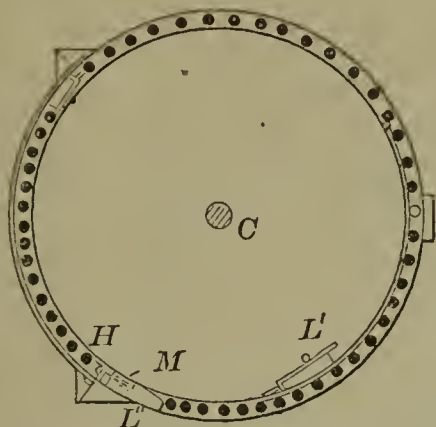

60194—J. M. Johnson—*Fastening for Buttons.*

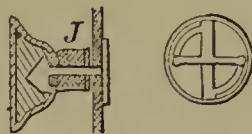

60197—E. H. Knight—*Comb.*

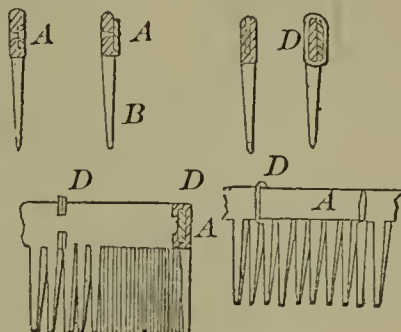

60195—A. C. Kasson—*Hoe.*

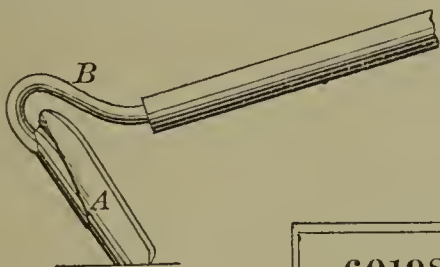

60193—  
R. S. Jennings—*Seal Fastener.*



60198—J. Knox—*Boot and Shoe Iron.*

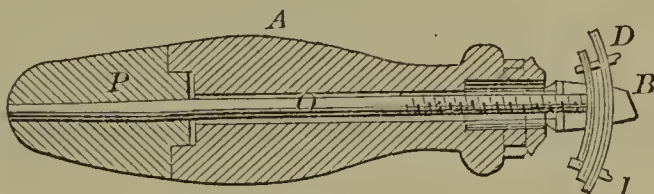

60202—W. & J. Leach—*Hand Spinning Machine.*

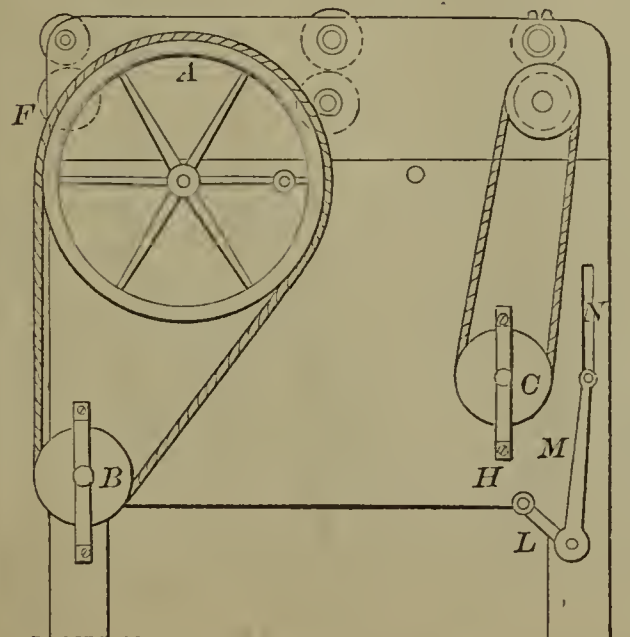
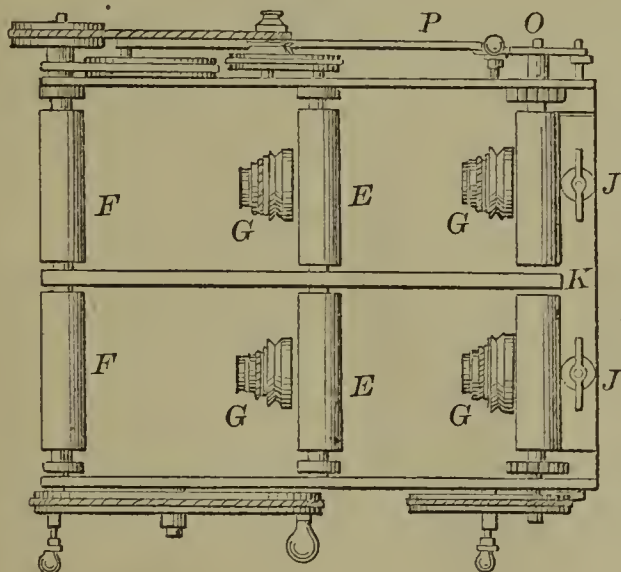

60196—W. R. King—*Baking Press.*

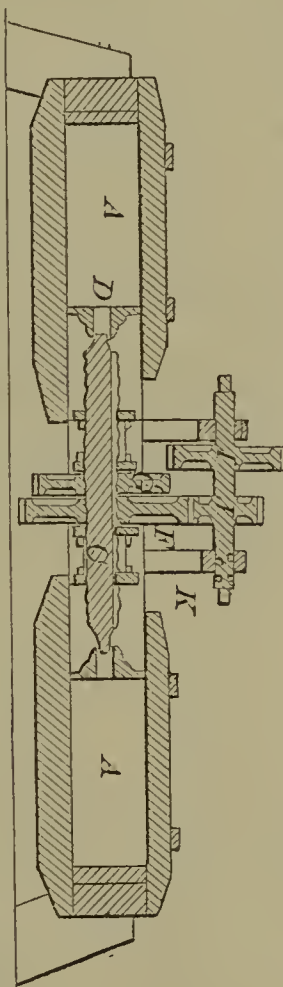

60192—R. K. Hamton—*Steam Engine Governor.*

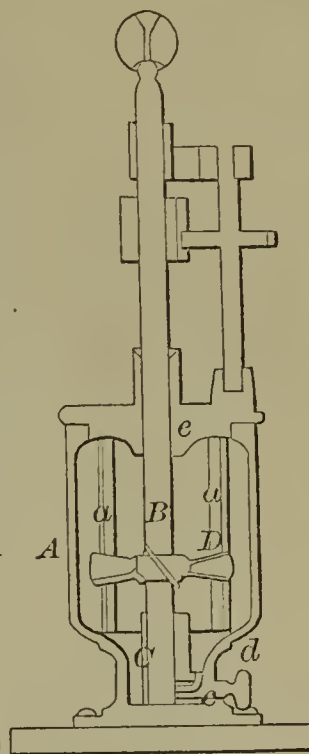

60199—G. T. Lape—*Cast Iron Arch for Bridges, &c.*

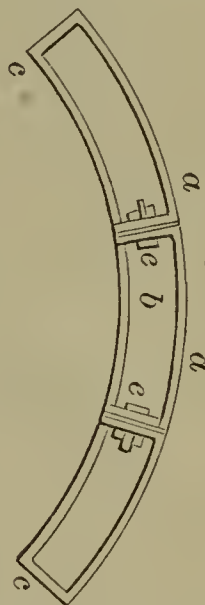

60200—J. H. Latimer—*Hand Seed Planter.*

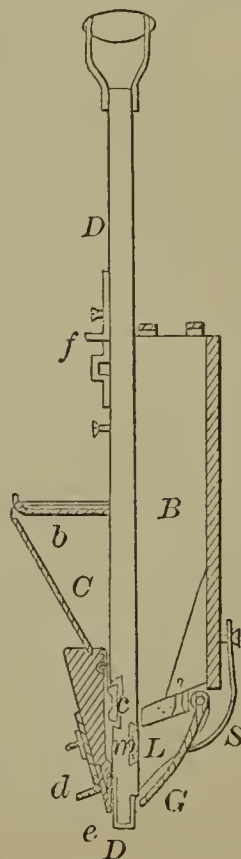

60203—Leasure & Gill—  
Cooling Glass Press.

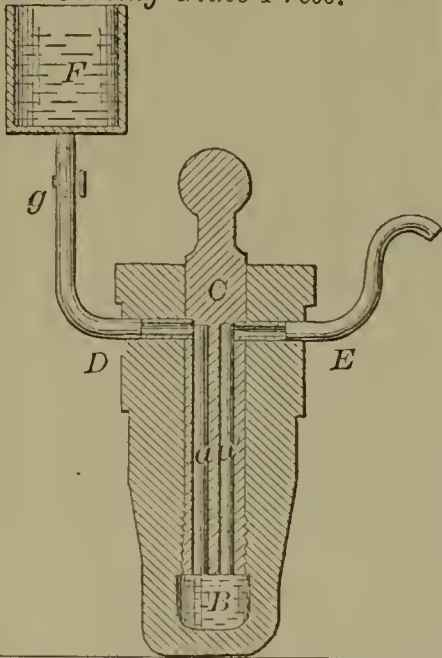

60204—J. H. Lee—Coffee Pot.

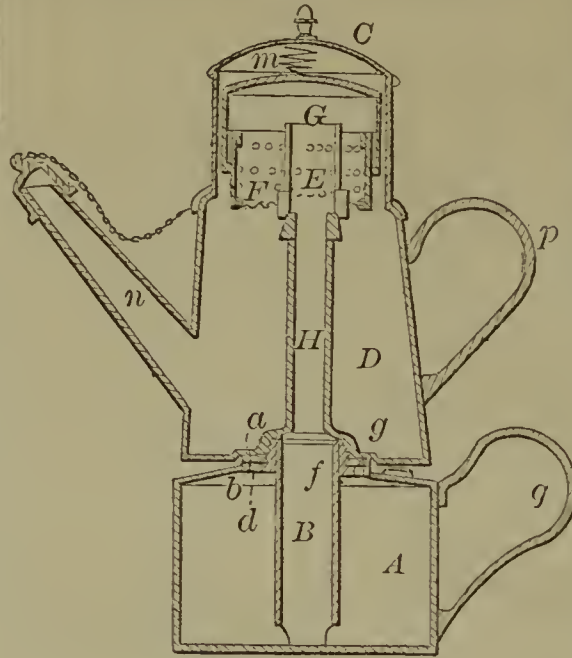

60207—H. C. Lewis—Countersink Bit.

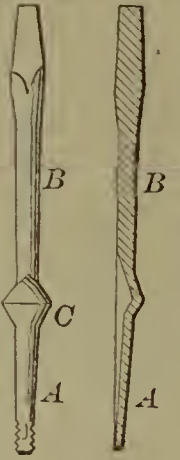

60205—O. G. Leopold—Bridge.

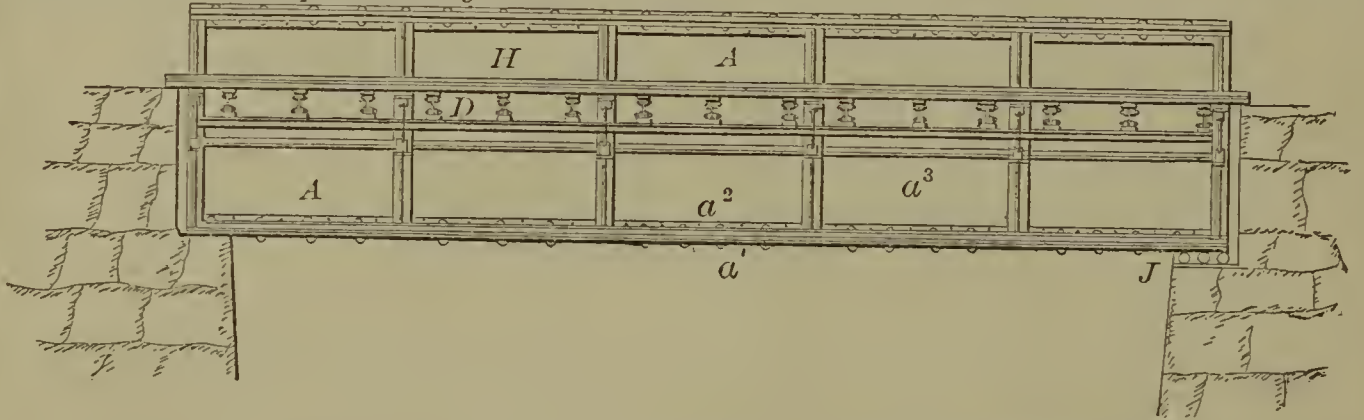

60206—E. W. Lewis—Core Box Plane.

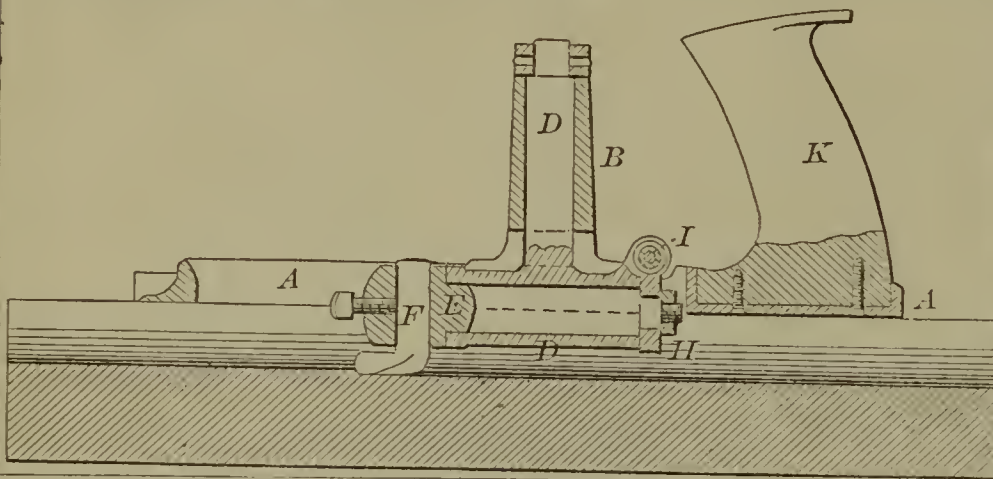

60208—S. D. Locke—  
Grain Binder.

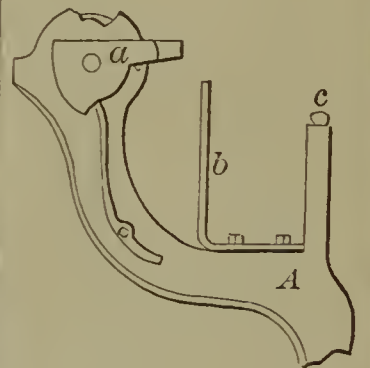

60209—J. J. Look—Wagon Brake.

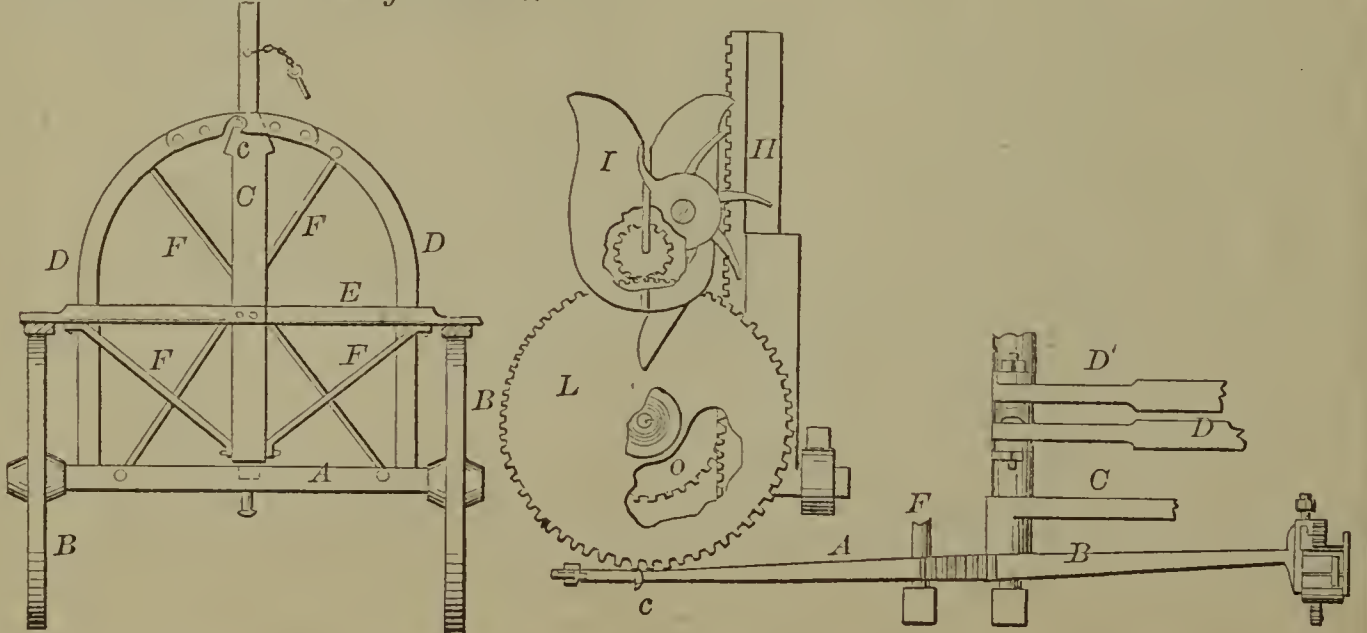

60210—Luther & Marsh—Blind Fastening.

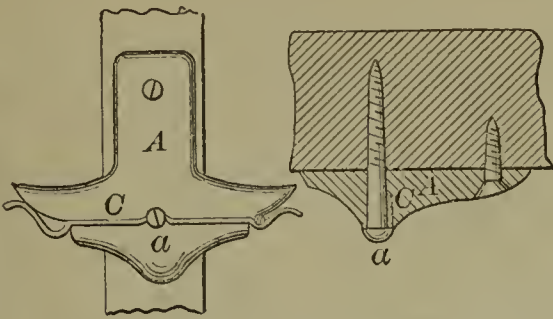

60213—G. Mallory—Spring for Hat Brims.



60211—E. T. C. Lutton—For Shearing Twisted Strands of Wool, &c.

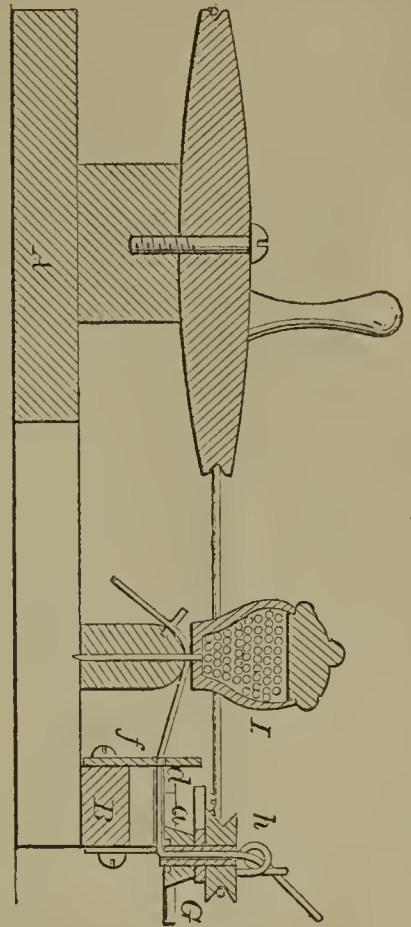

60212—S. C. Maine—For Cooling and Disinfecting.

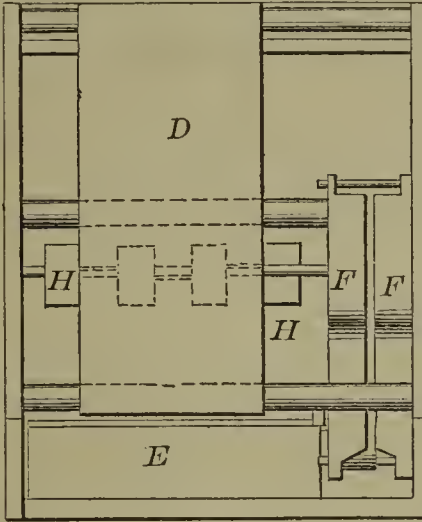

60215—J. J. Marcy—Lamp Burner.

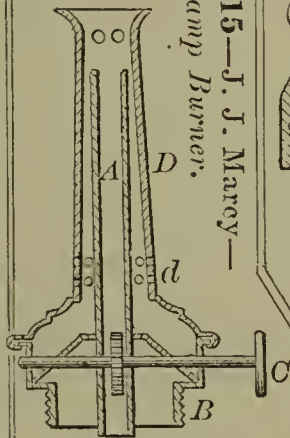

60214—P. Maltby—Expanding Cylinder.

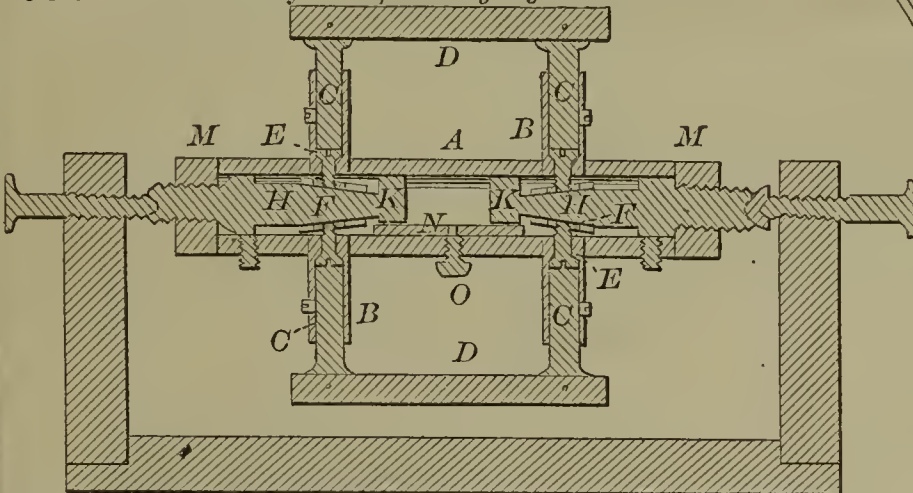

60216—J. B. Martindale—Carpet Stretcher.

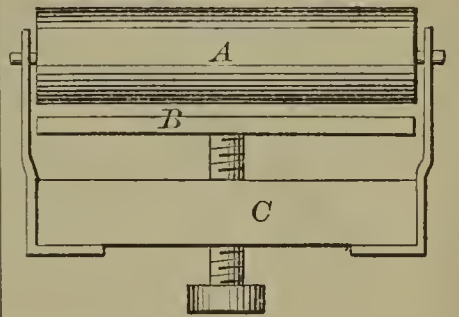

60217—P. F. Mauvas—Button.

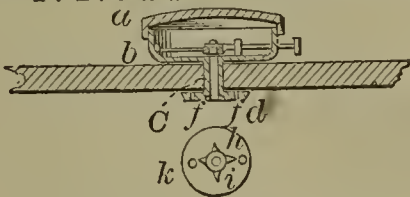

60219—J. T. McDougall—Furnace.

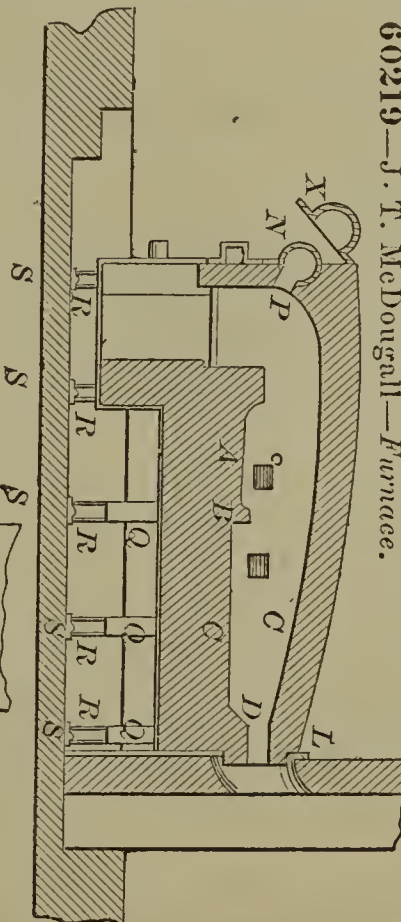

60218—T. B. McConaughy—Corn Planter.

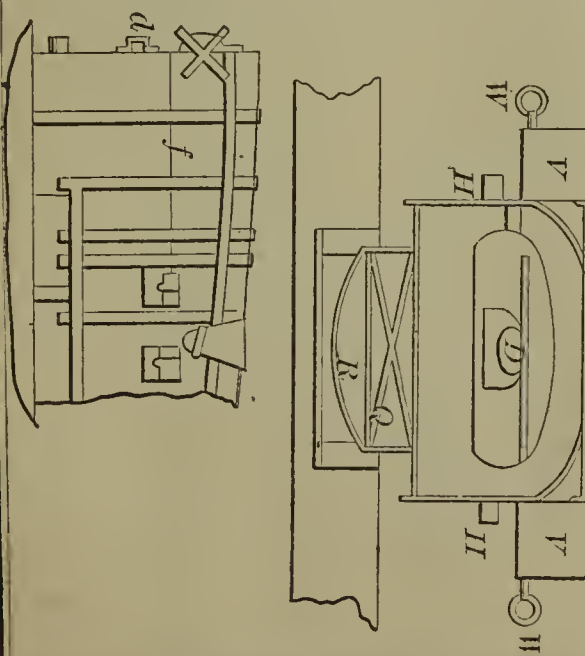
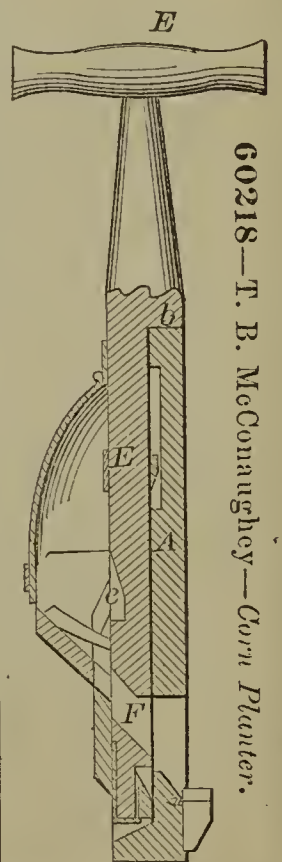

60220—W. T. McMillen—Fire Place.

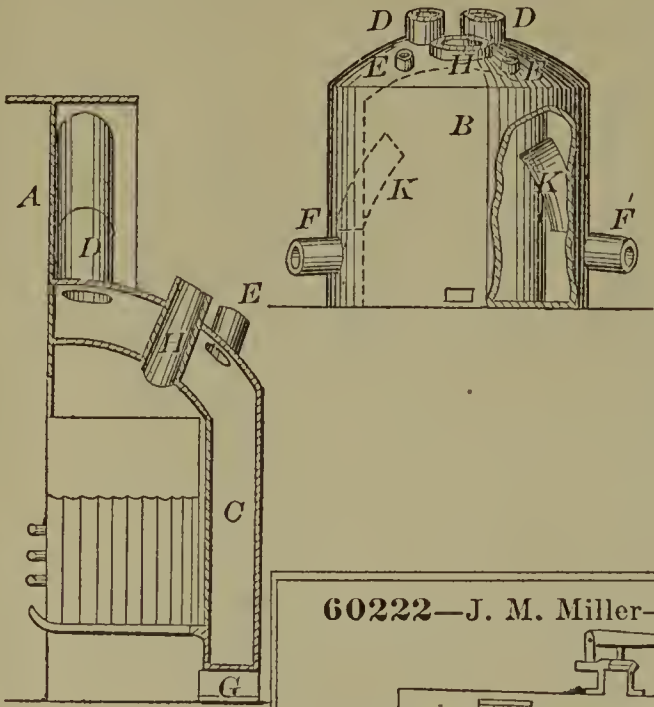

60223—O. F. Morrill—Faucet.

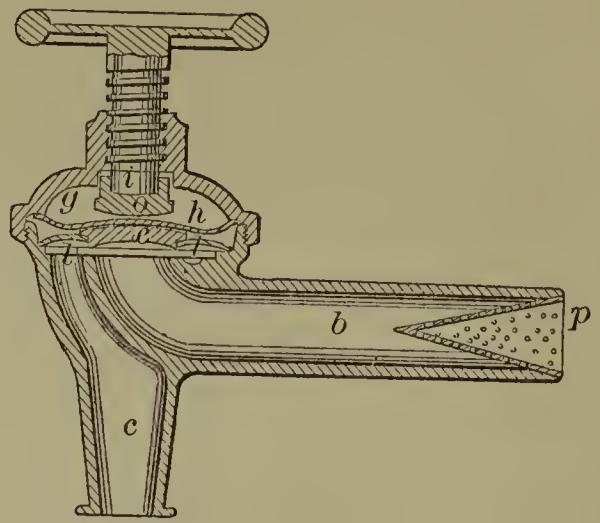

60222—J. M. Miller—Condenser.

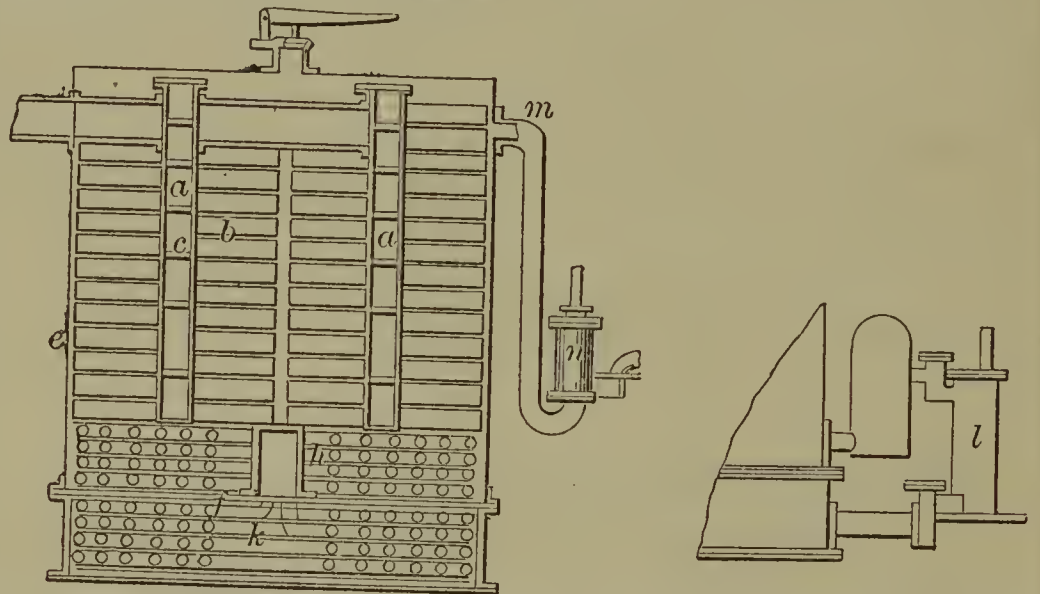

60221—C. Messenger—Broom Head.

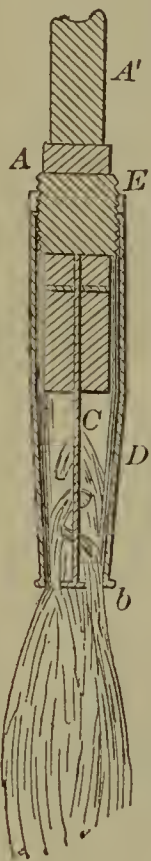

60225—L. B. Morris—Pruning Knife.

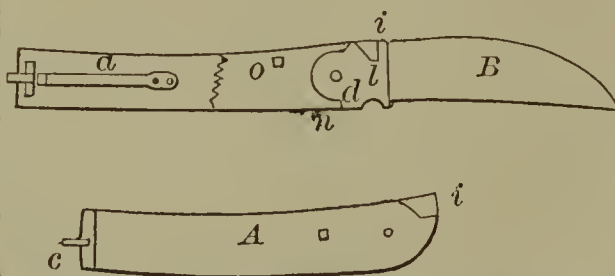

60226—C. Mulchahey—Blacking Brush.

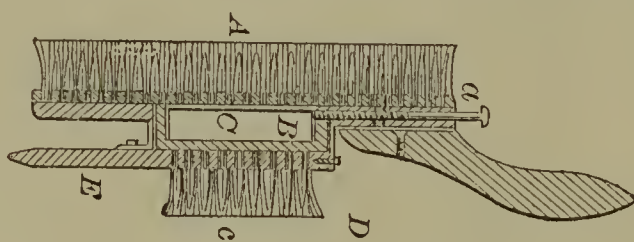

60224—O. F. Morrill—Heating Apparatus.

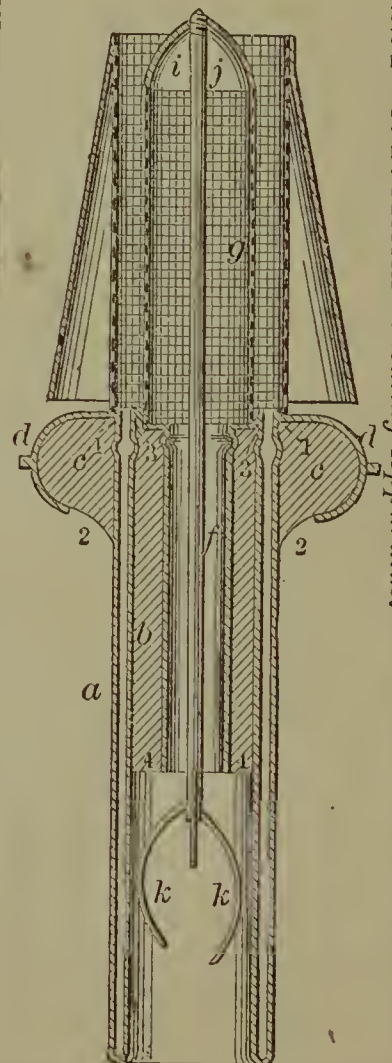

60227—D. Myers—Car Spring.

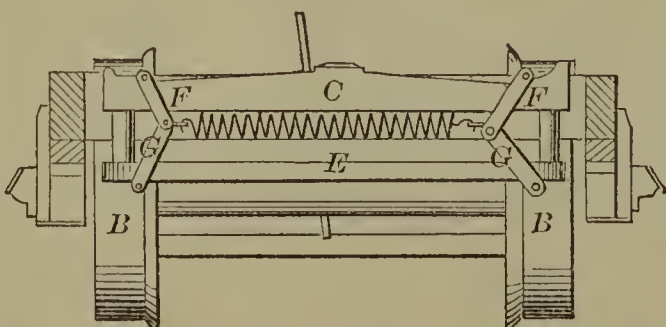



60228—D. Myers—Car Brake.

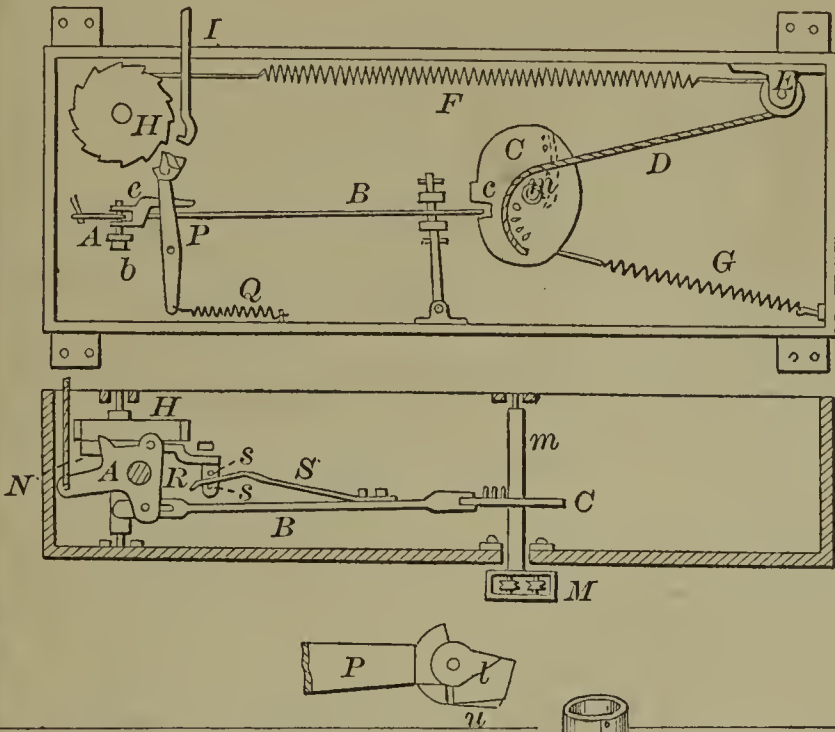

60229—J. F. Myers—Steam Boiler Furnace.

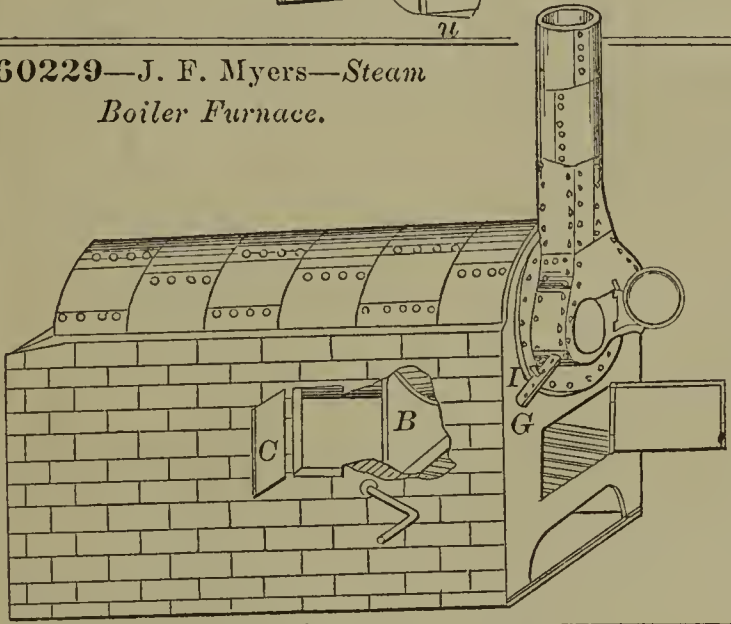

60232—J. P. Nichols—For Operating Churns, &c.

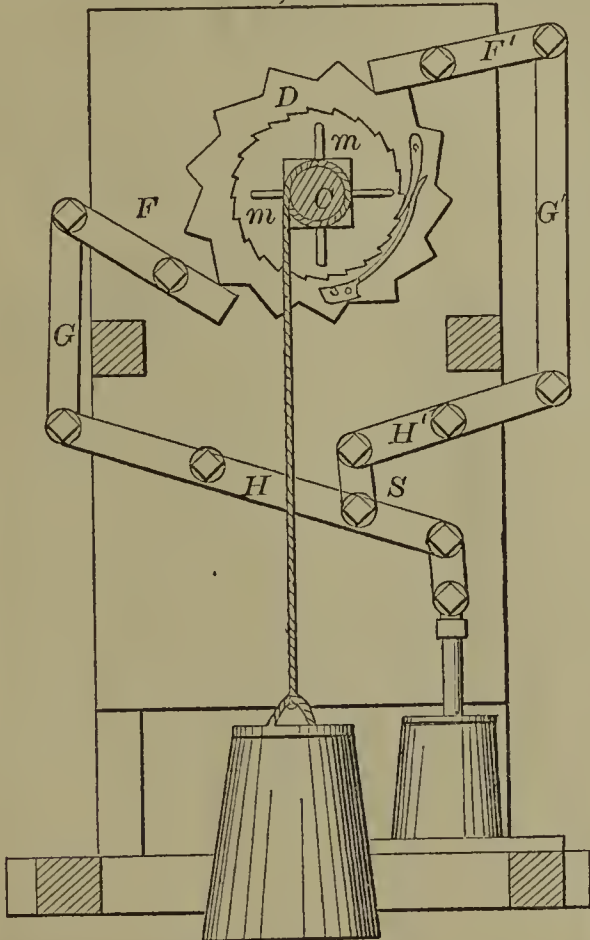

60233—J. V. H. Nott—Bag Holder.

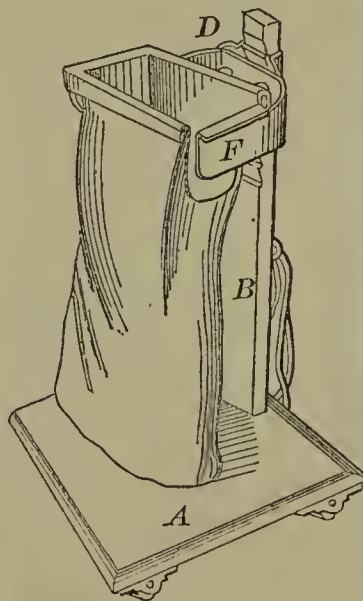

60231—A. N. Newton—Brick Machine.

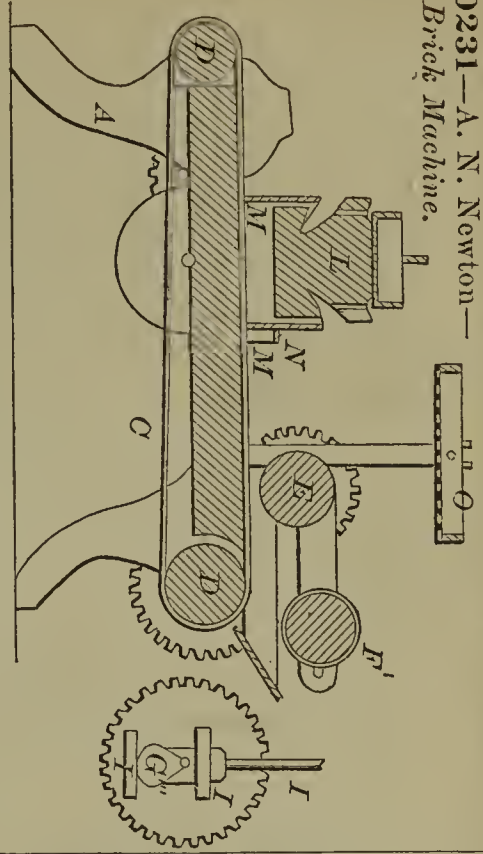

60230—W. P. Newhall—Hydrant.

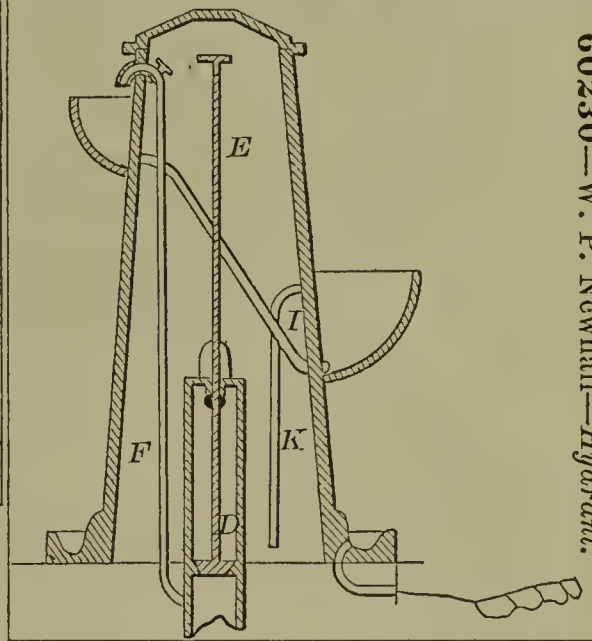

60234—W. D. Osborn—

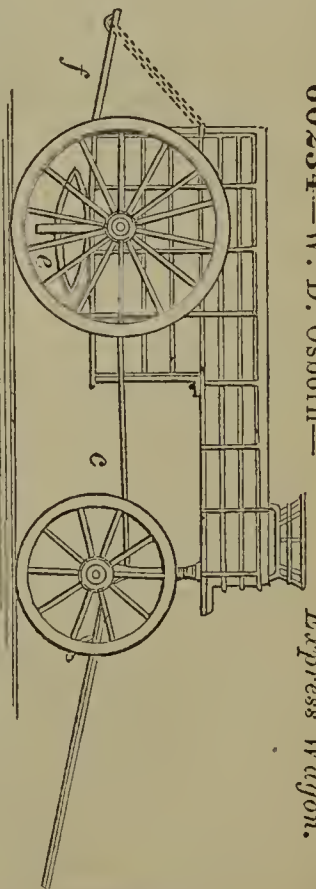

Express Wagon.

60235—J. G. Page—*Canvas Printer.*

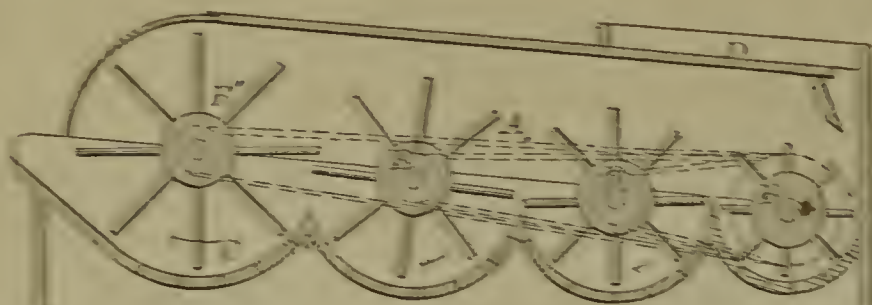

60236—S. Peck—*Spring for Hat Brims.*



60237—M. M. Pennet—*For Filling Saw Teeth.*

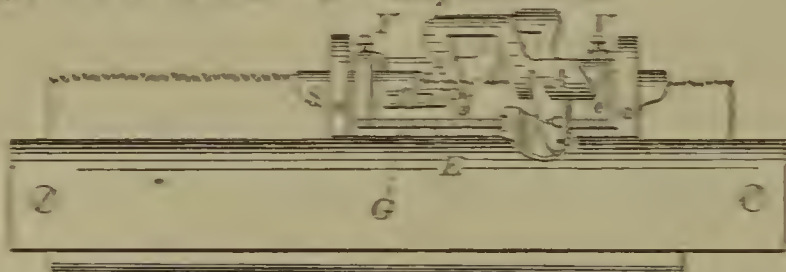

60238—W. Pambell—*Loose Dog.*



60241—T. K. Reed—*Sewing Machine.*

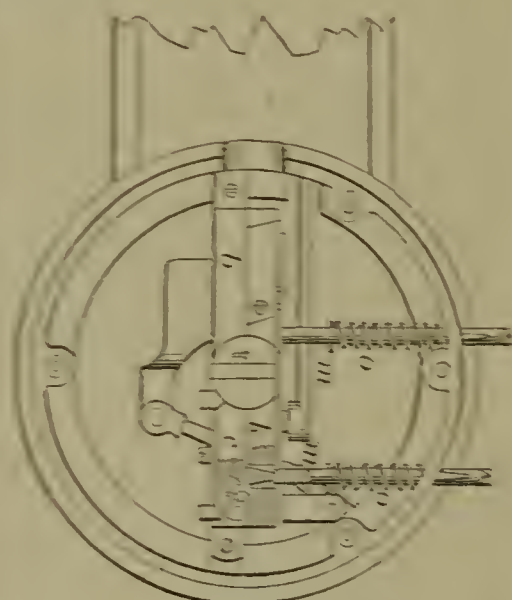

60239—I. A. Pinnell—*Water Elevator.*

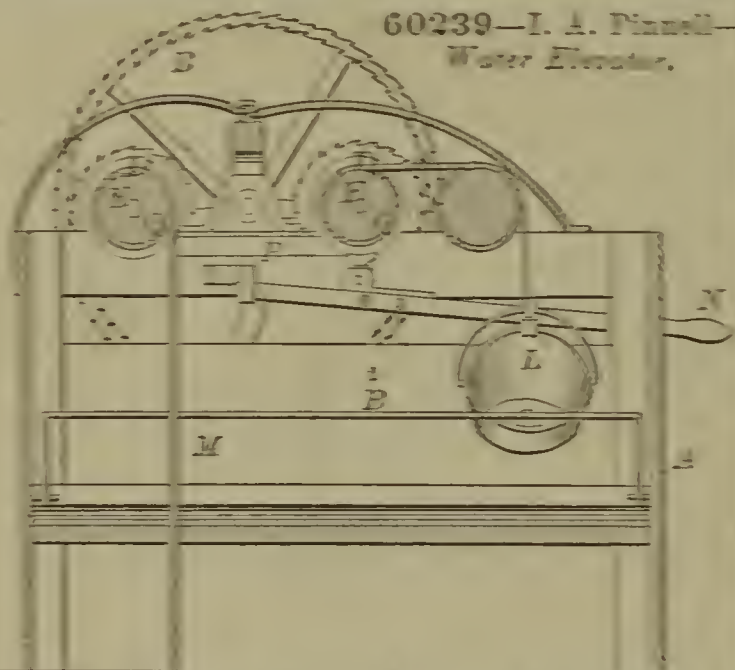

60247—C. Richardson—*Game of Battle War Chess.*

60240—A. J. Pope—*Clamp.*

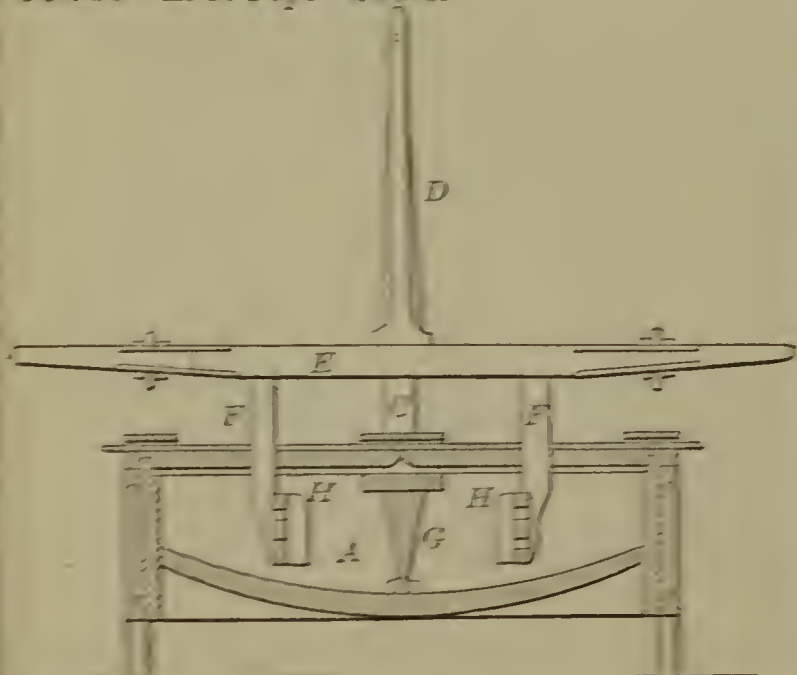

60249—Roberts & Hartzell—Fruit Gatherer.

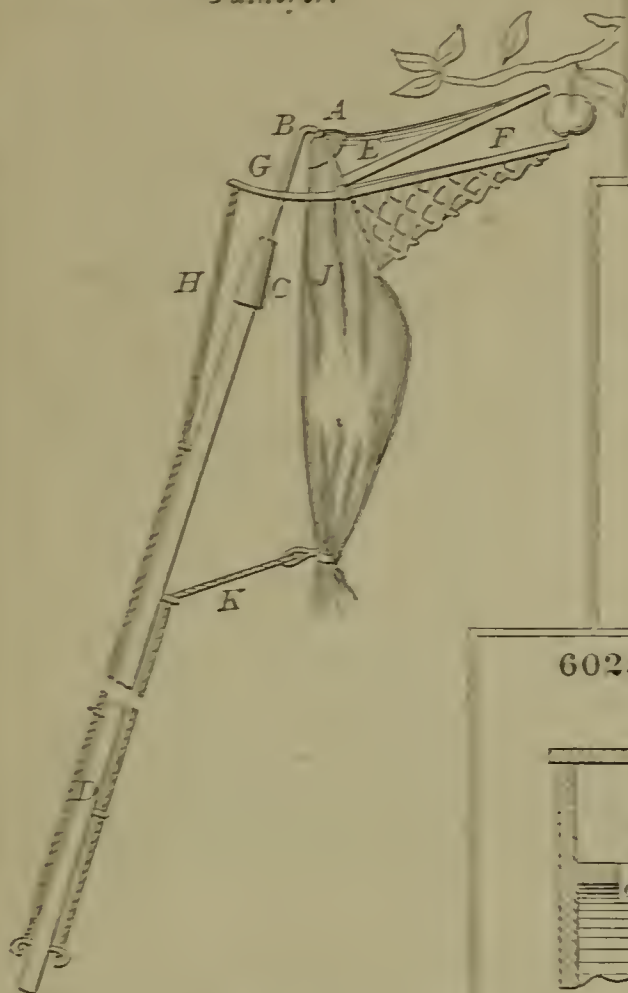

60250—D. T. Robinson—Pole for Horse Care.

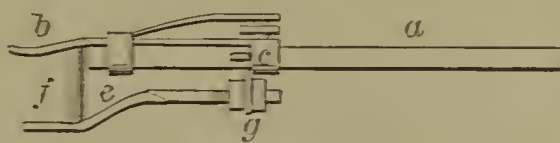

60254—A. H. Rockwell—Bridle.

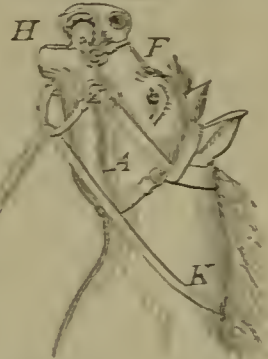

60251—Robinson & Jones—Lubricator.

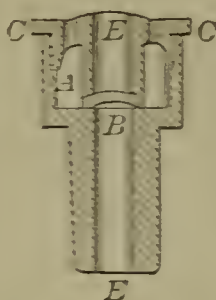

60252—W. B. Robinson—Slide Valve.

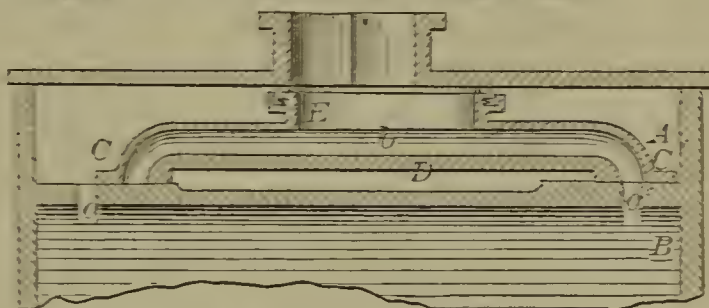

60255—E. A. G. Roulstone—Traveling Bag.

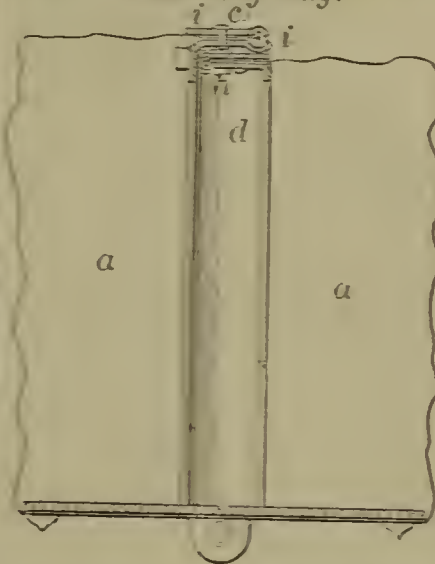

60253—A. H. Rockwell—Safety Line for Harnesses.

60258—E. Russell—Chuck for Holding Buttons.

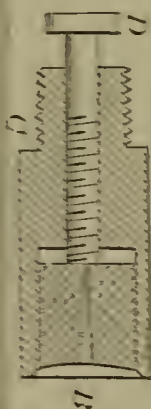

60257—E. A. G. Roulstone—Lock.

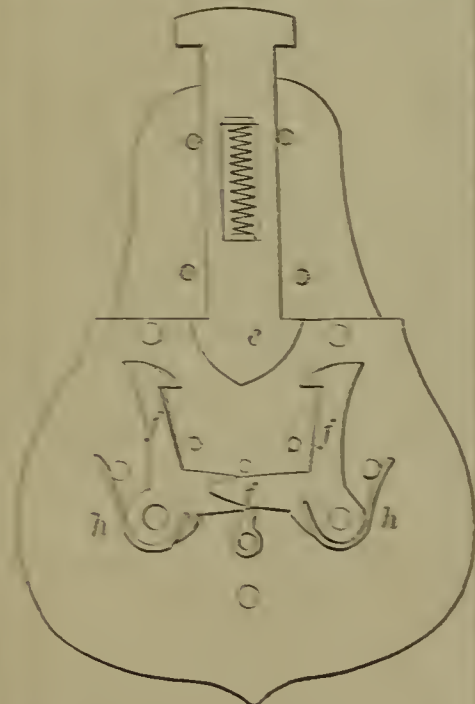

60256—E. A. G. Roulstone—Traveling Bag.

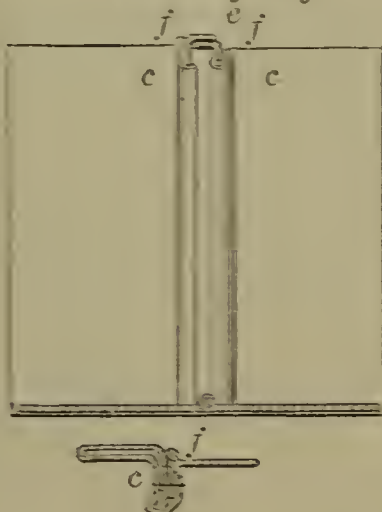

60259—R. Safety—For Pumping Shafting.

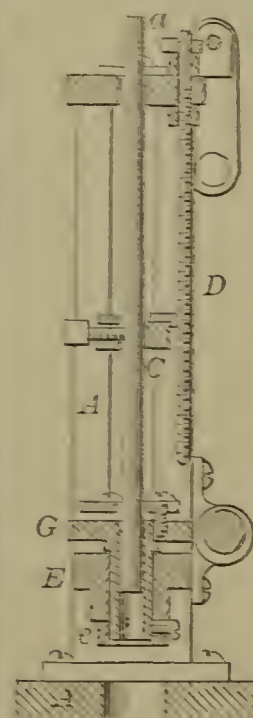

60260—R. Safely—For Straightening Shafting.

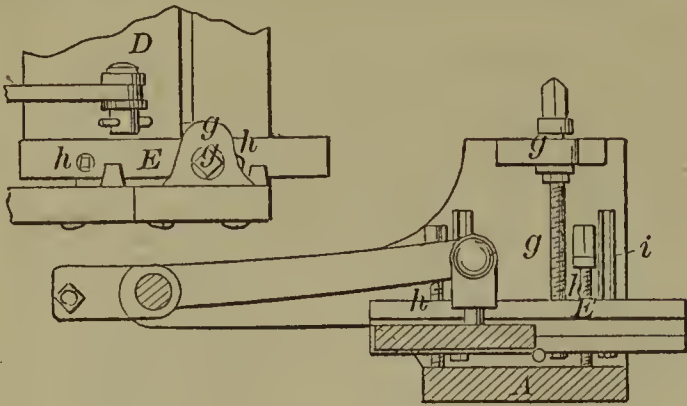

60262—Saladee & Moore—Sheep Chair.

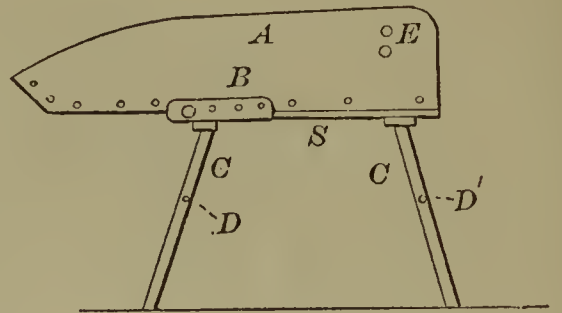

60261—H. W. Safford—Well Drill.

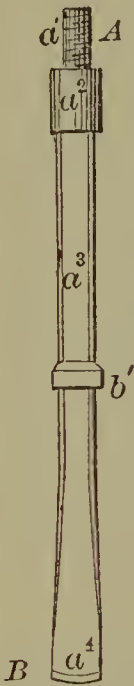

60263—J. F. Sanford—Lamp Burner.

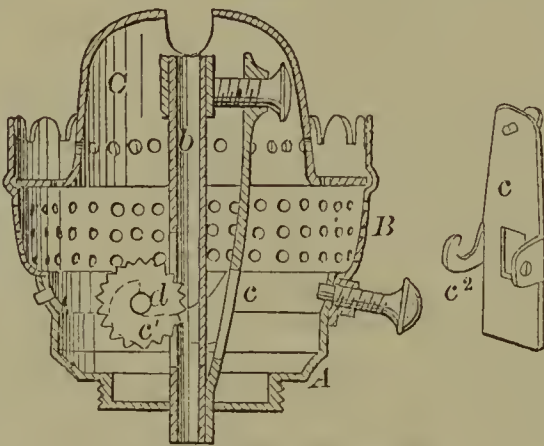

60266—J. Service—Tool Rest for Lathes.

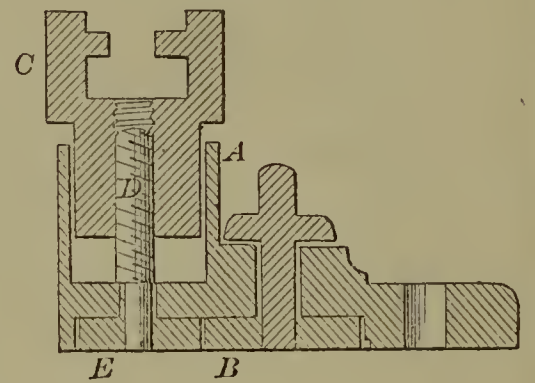

60265—J. Sawyer—Mitre Plane.

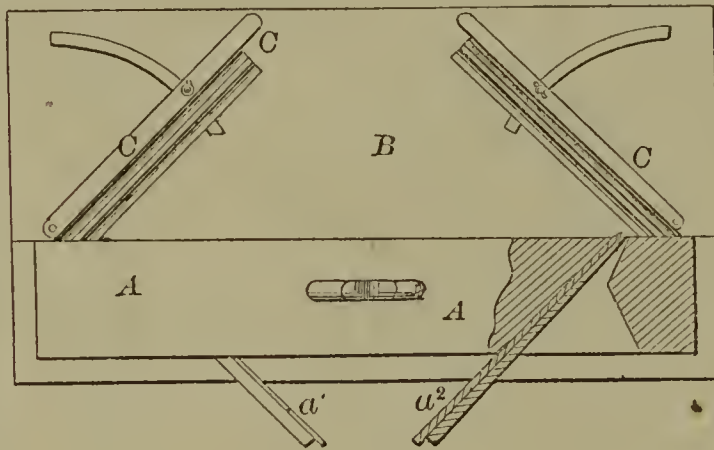

60264—A. M. Sawyer—For Polishing Metals.

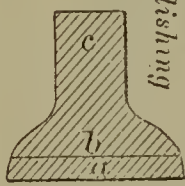

60267—W. Shailer—Window Fastener.

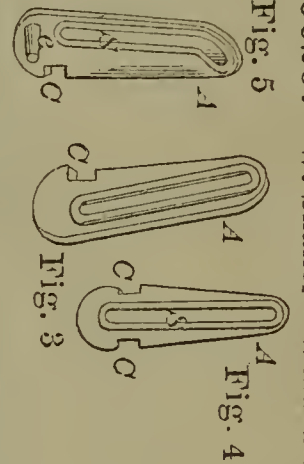

60268—B. Slusser—Excavator.

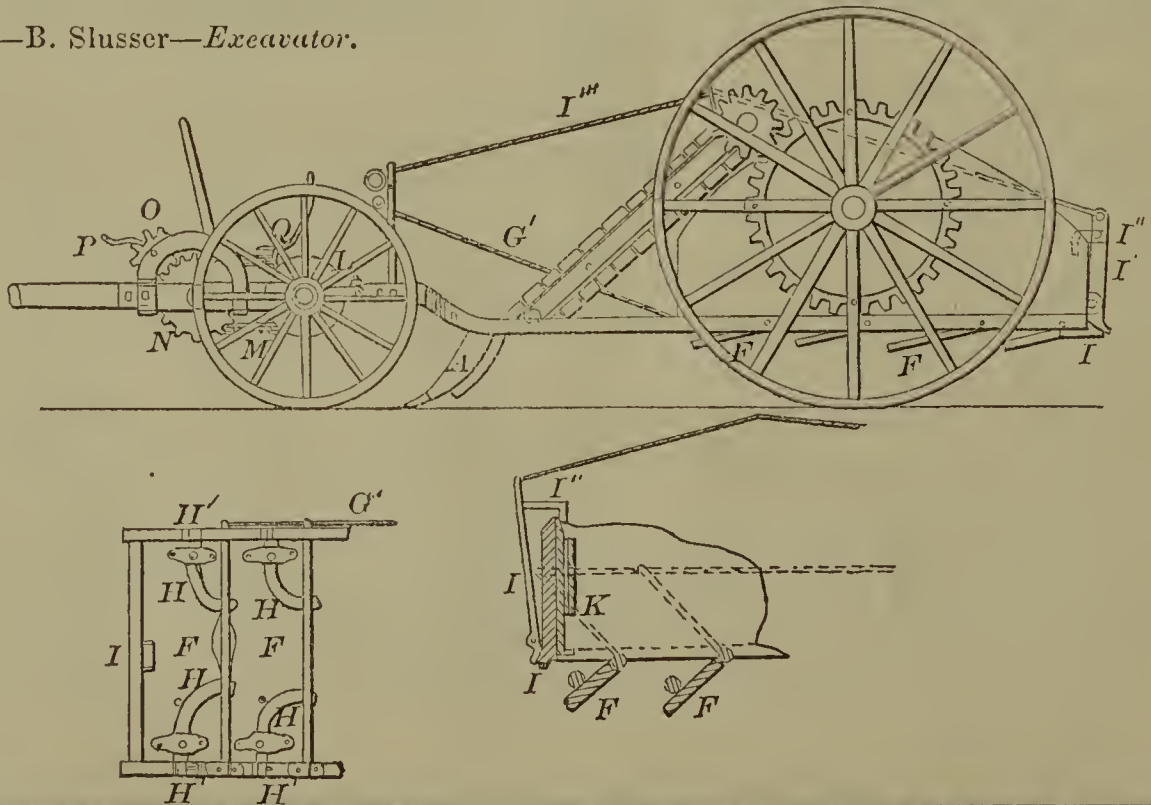

60269—C. B. Smith—Friction Pulley.

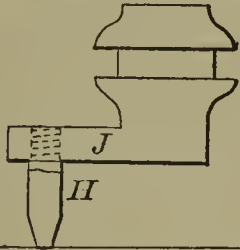
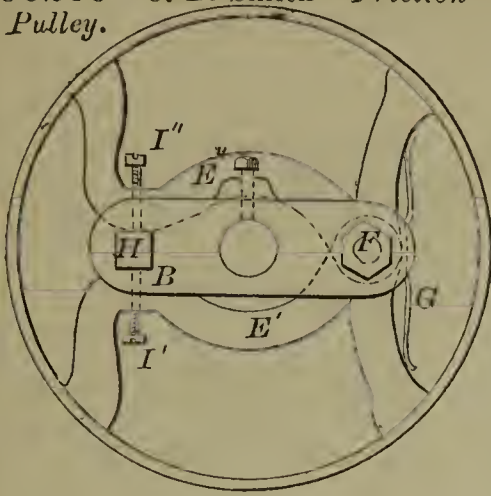

60271—G. Y. Smith—Hay Rack.

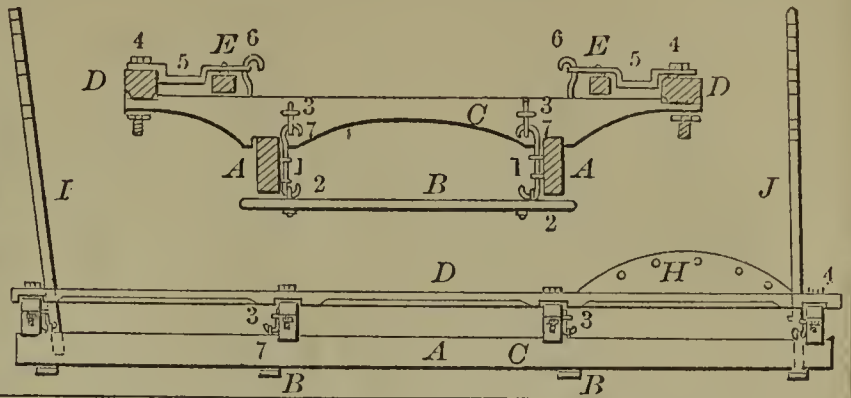

60270—Smith & Brumfield—Horse Rake.

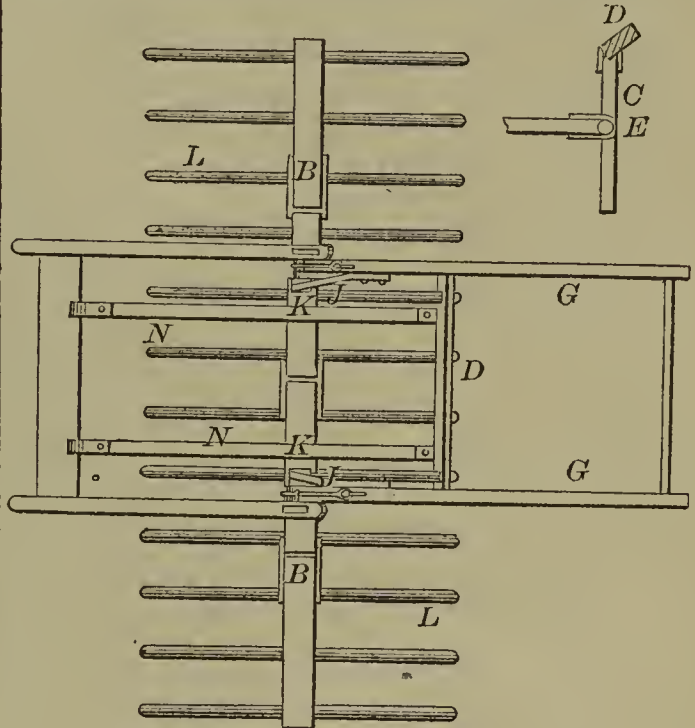

60272—J. E. Smith—For Cutting Bung.

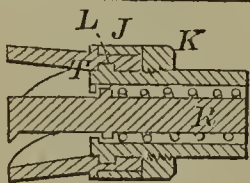
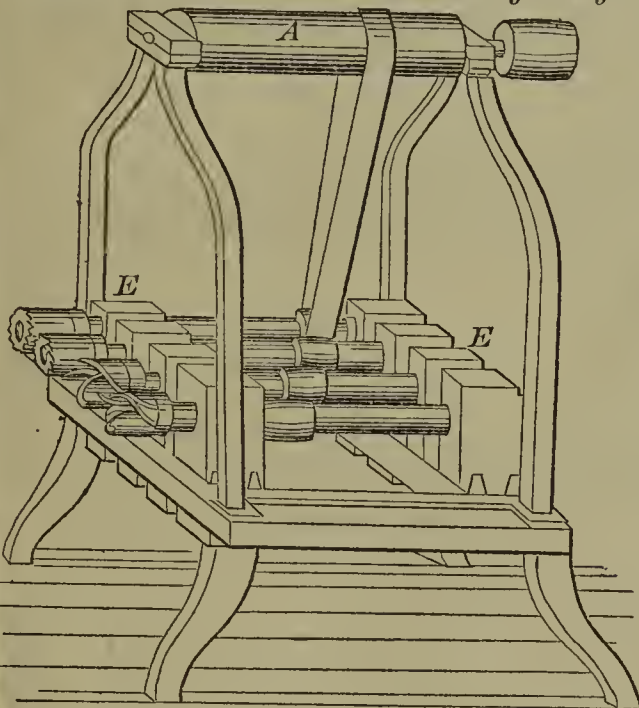

60273—J. V. Smith—Potato Digger.

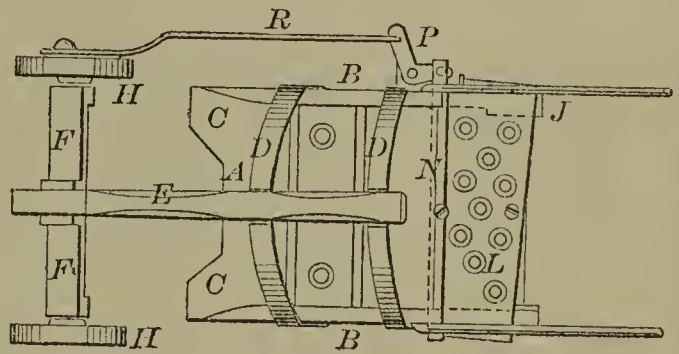

60274—P. W. Somers—For Felting Hat Bodies

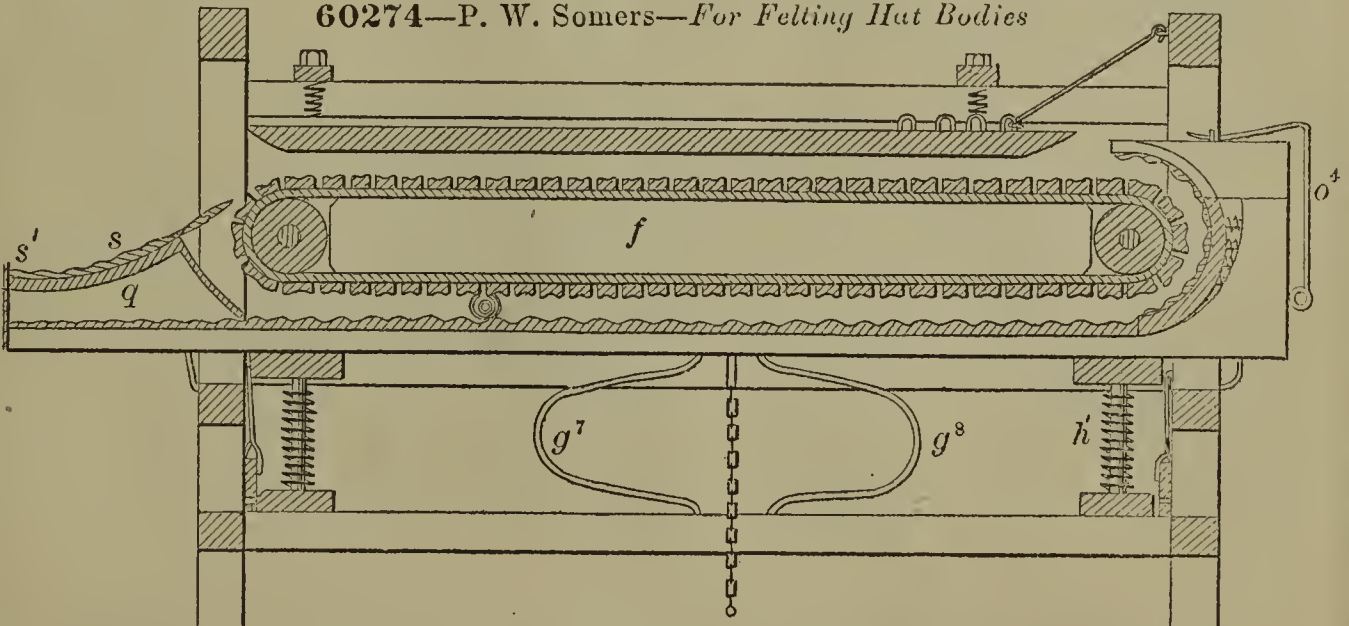

60276—R. Sparks—*Steering Apparatus.*

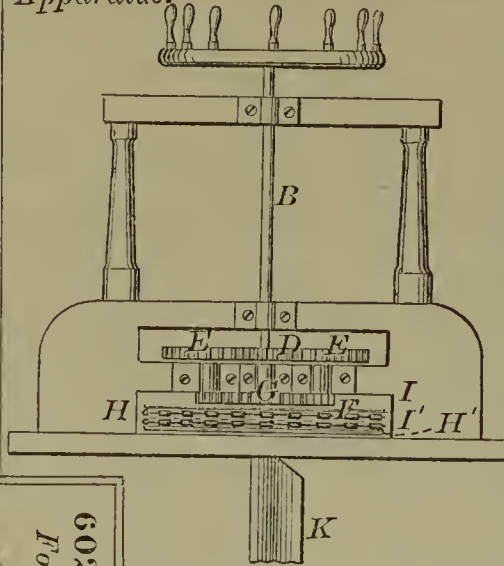

60277—Q. Stoddard—*For Rolling Leather.*

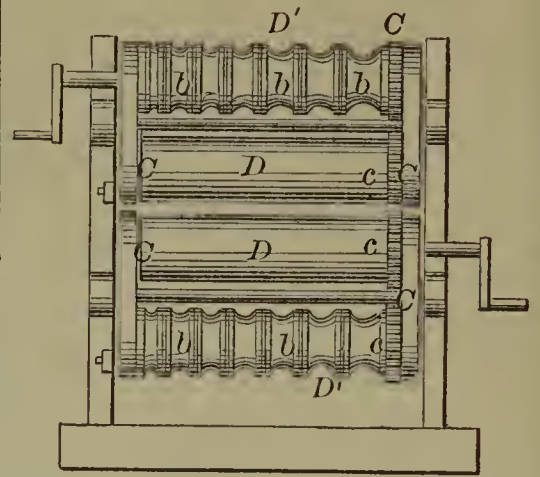

60275—P. W. Somers—*Roll for Felting or Sizing Hat Bodies.*



60278—Stoner & Sigwalt—*For Boxing Paper Collars.*

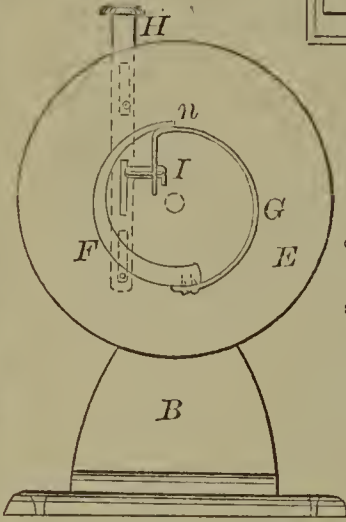

60279—D. B. Tanger—*Steam Generator.*

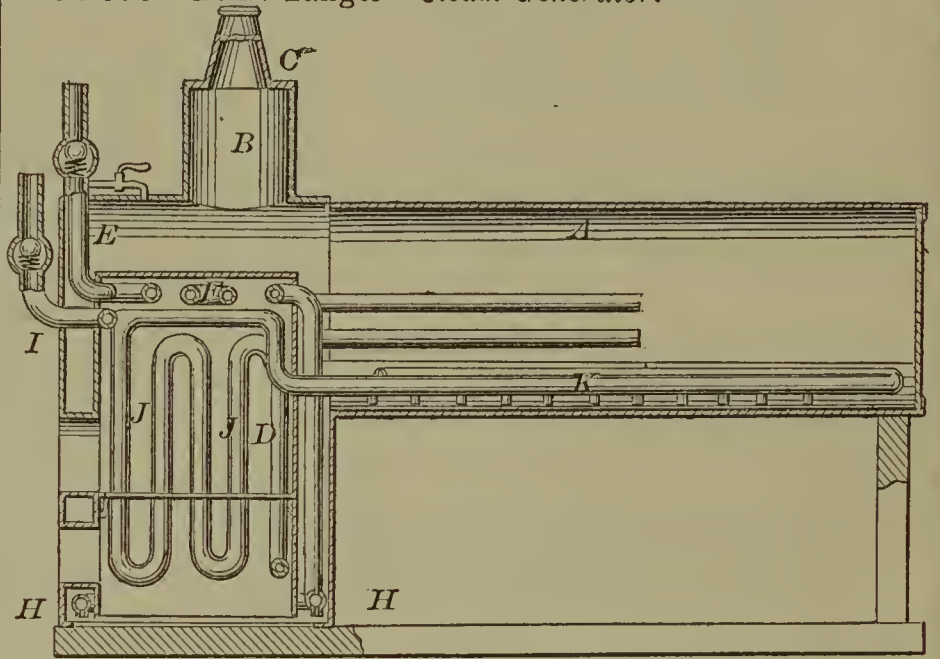

60281—H. R. Taylor—*Refrigerator.*

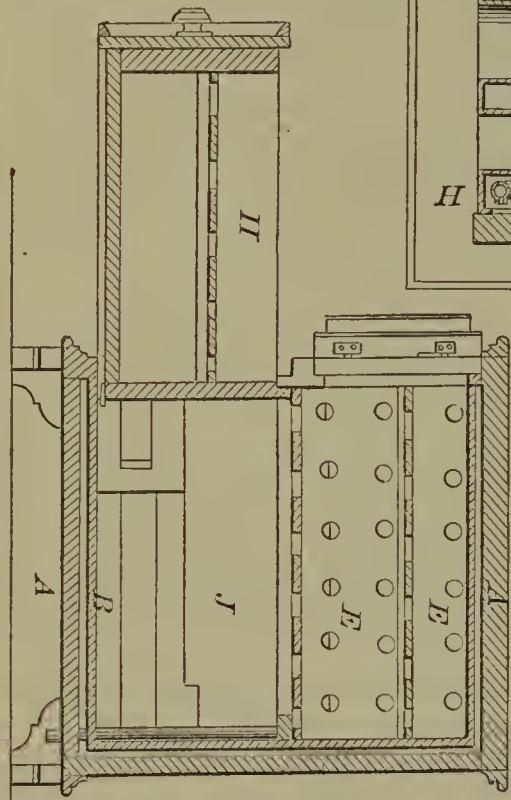

60282—F. Tellmann—*Tobacco Pipe.*

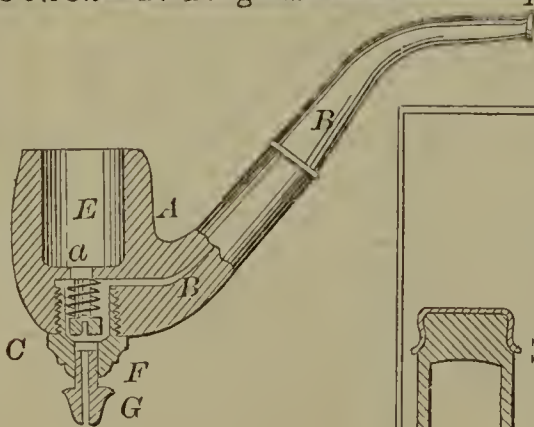

60283—N. Thompson—*Bottle Stopper.*



60280—Taylor, Crandall, Crandall & Tarkin—*For Making Twine.*

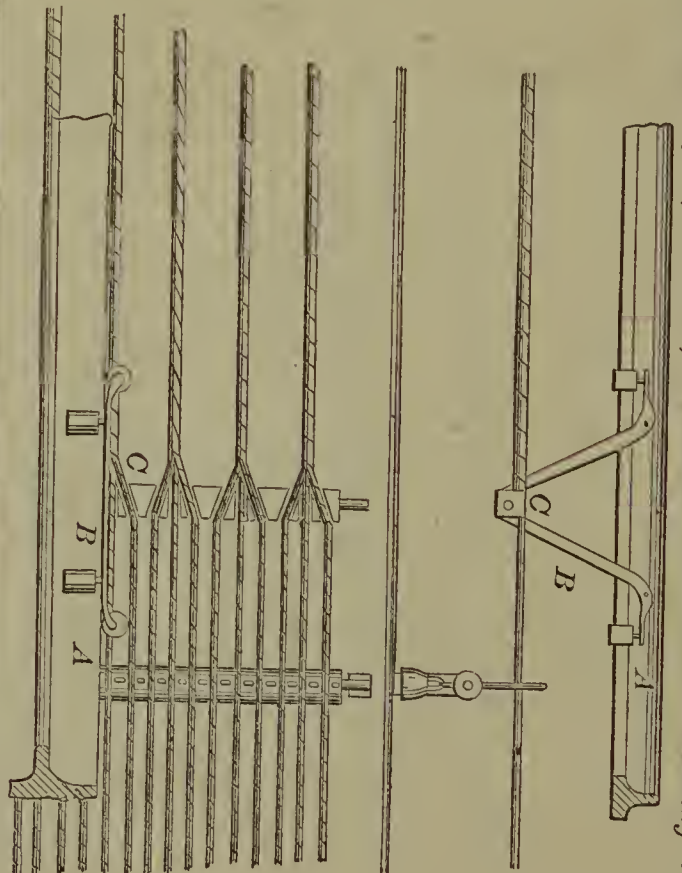

60284—S. H. Timmons—*Car Brake.*

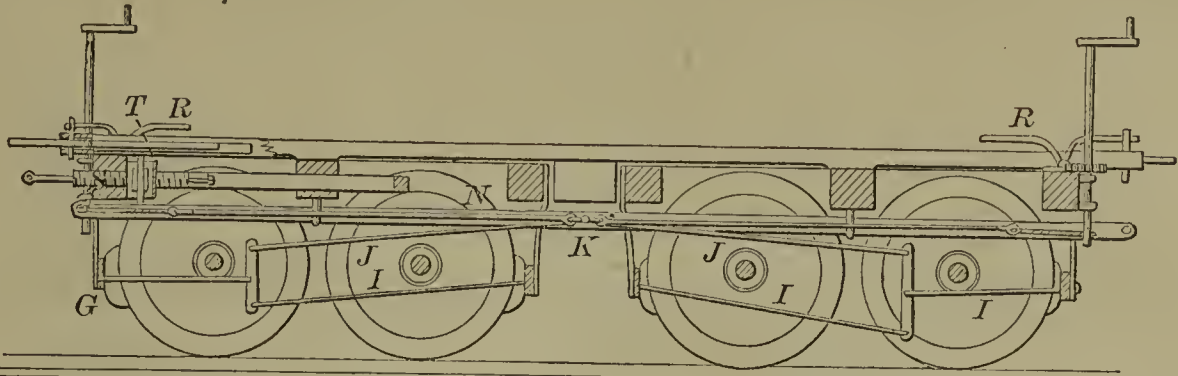

60285—P. Tompert, Jr.—*Book Mark Holder.*

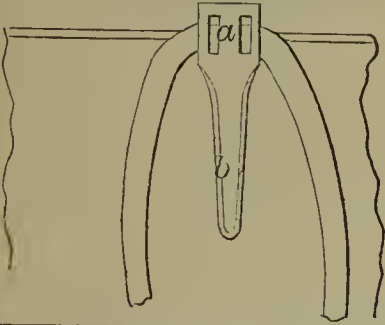

60287—G. L. Upton—*Vessel Drag.*

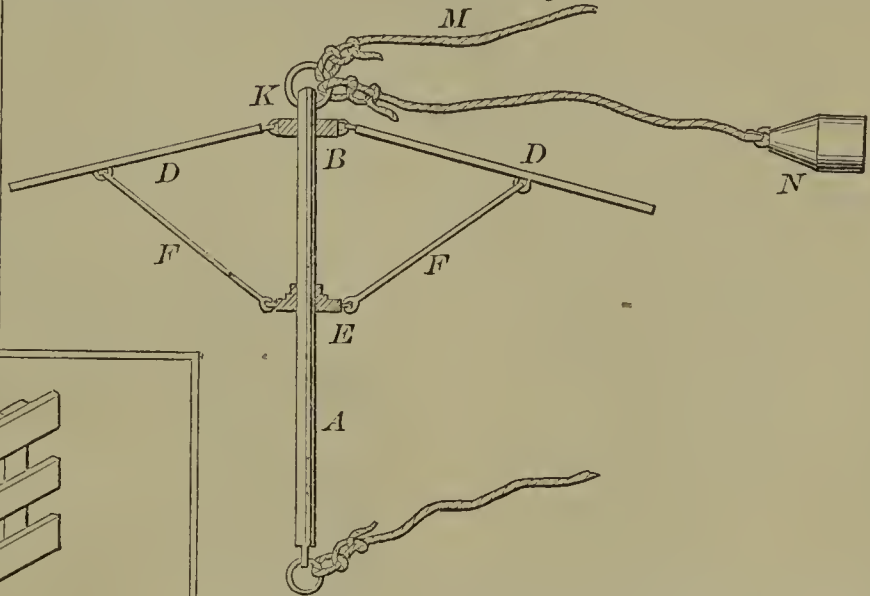

60286—S. P. Tuttle—*Fence.*

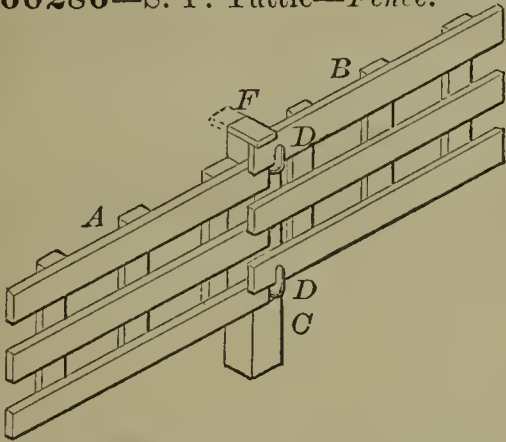

60288—S. W. Valentine—*Trunk.*

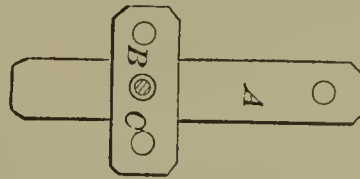

60292—L. Von Gunten—*Lathe Chuck.*

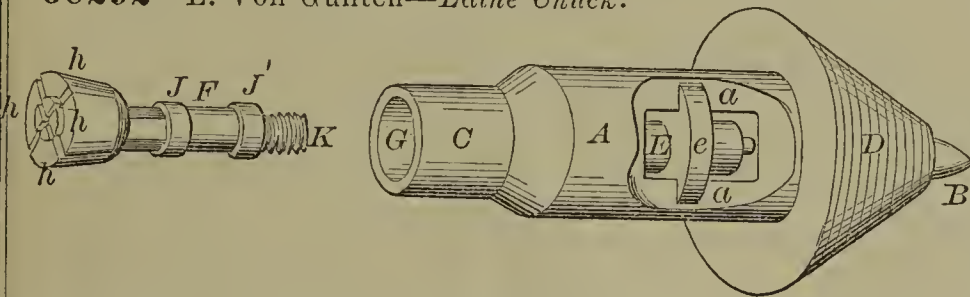

60291—H. H. B. Vincent—*Broom Head.*

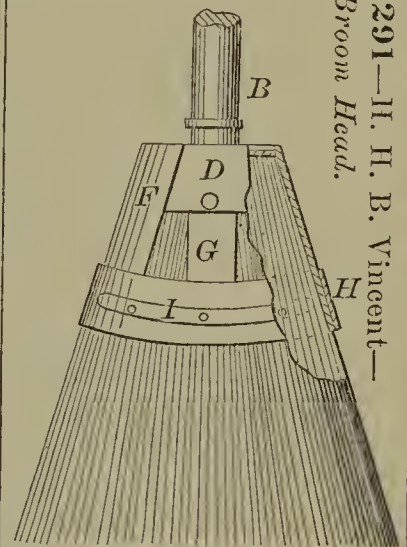

60294—W. J. Walker—*Apparatus to be attached to Stills to prevent Fraud.*

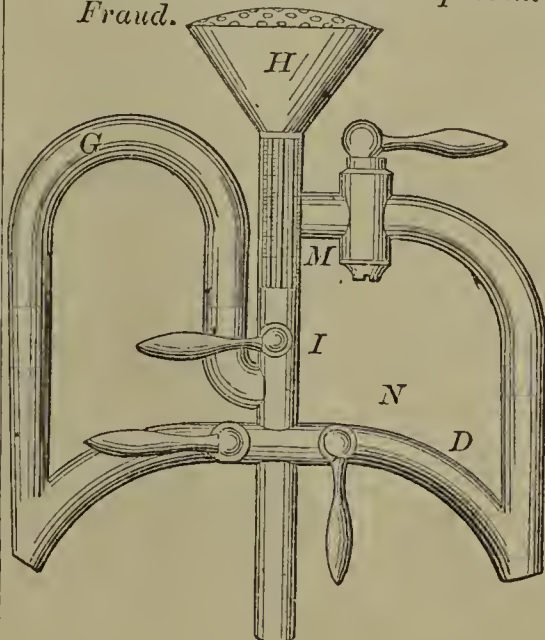

60289—A. J. Vanatta—*Churn.*

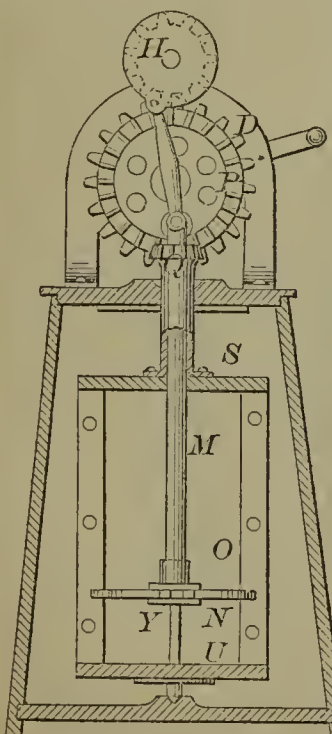

60293—Z. B. Wakeman—*Sash Fastener.*

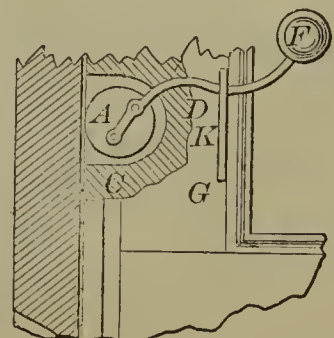

60295—S. L. Walkinshaw—Steering Apparatus.

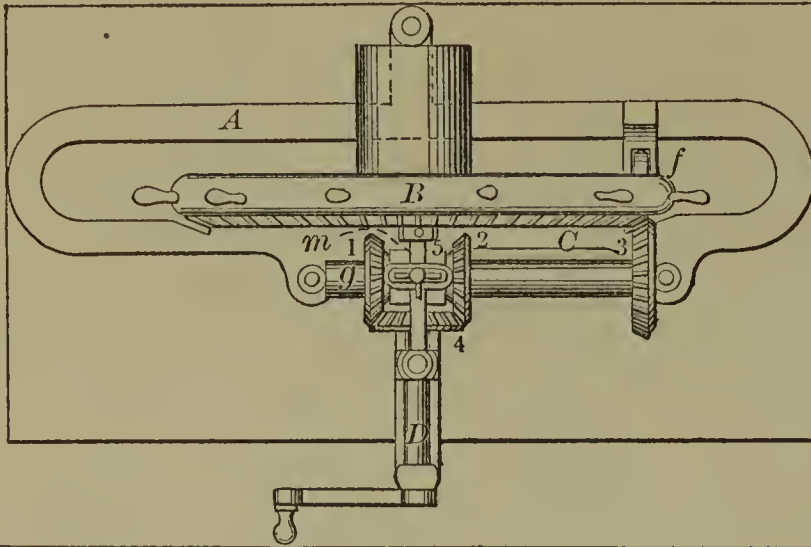

60300—A. Wells—Cotton Seed Cleaner.

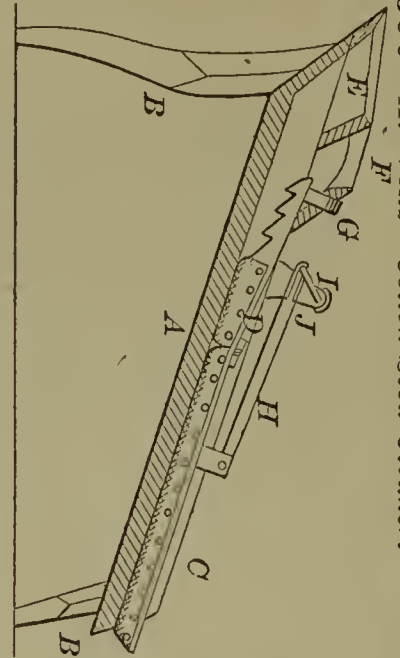

60296—S. H. Ward—Attaching Thills to Carriages.

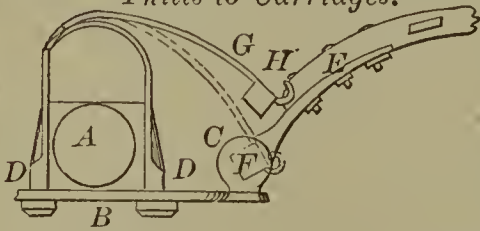

60297—A. E. & J. V. Warner—Sawing Machine.

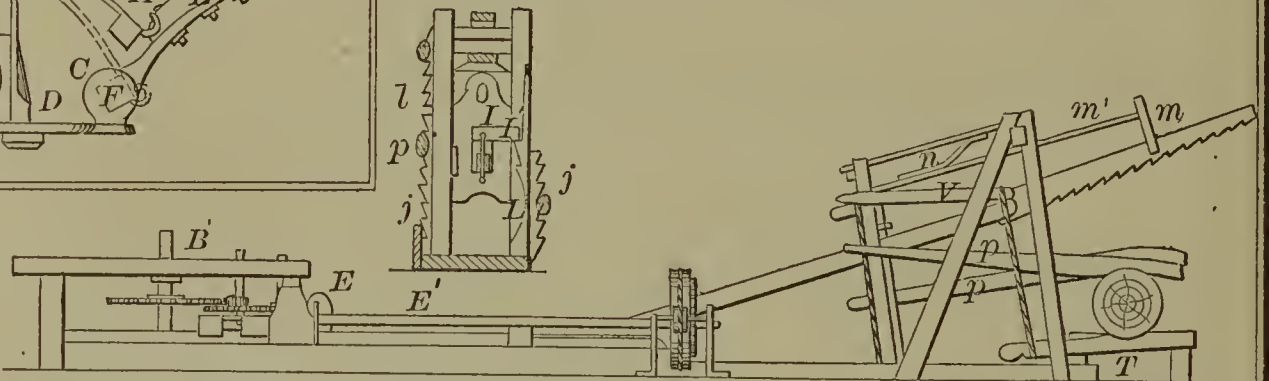

60298—W. T. Watson—Tobacco Press.

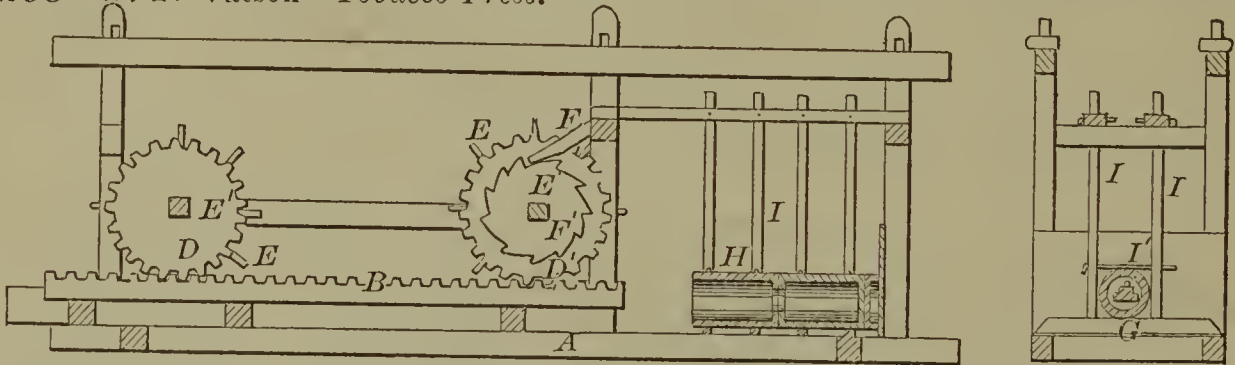

60299—C. Weaver—Car Coupling.

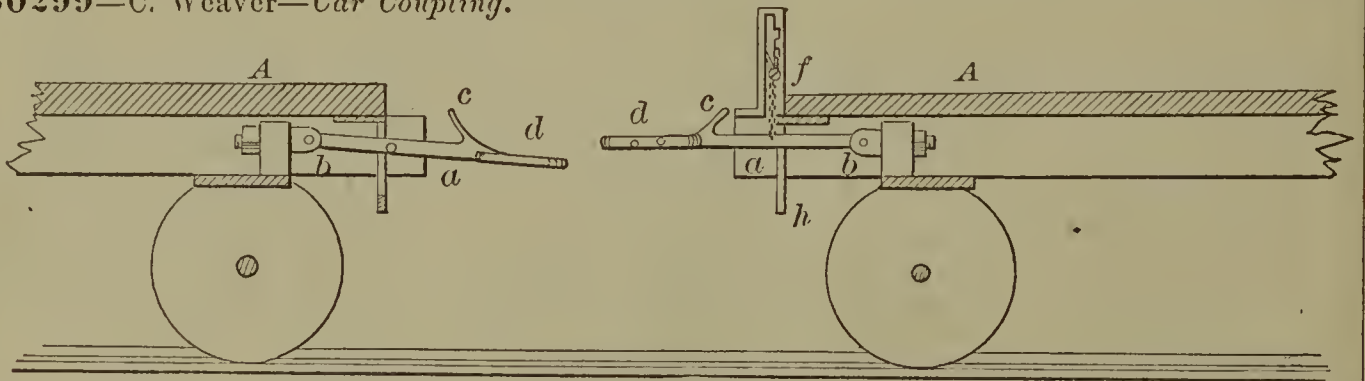

60302—W. Welsh—Buckle.

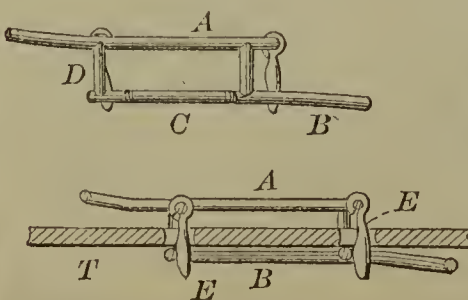

60301—C. Wells—Rack Motion for Hand Presses.

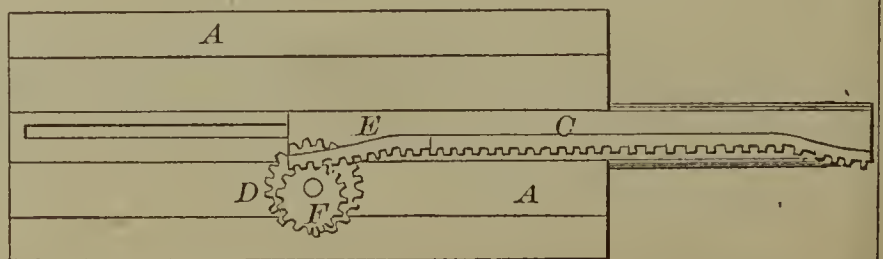



60303—W. D. Whalen—Pendulum.

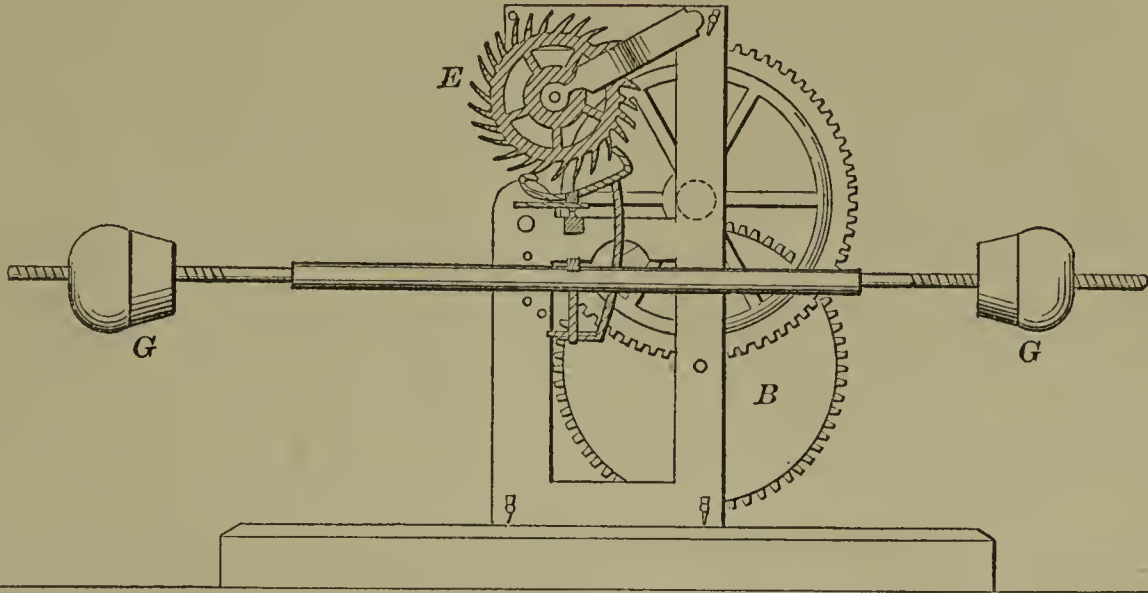

60305—J. Whitehead—Hand Loom.

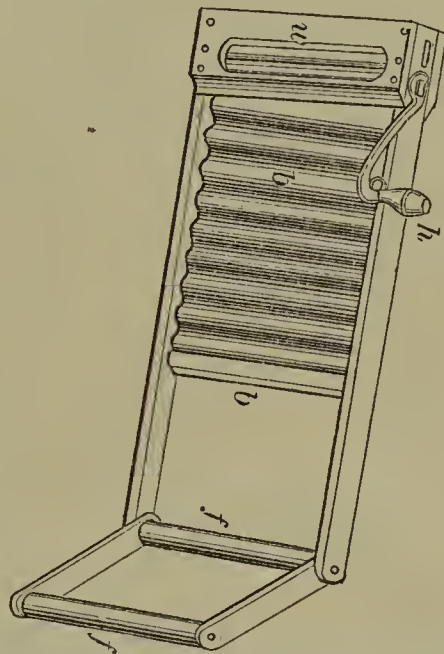
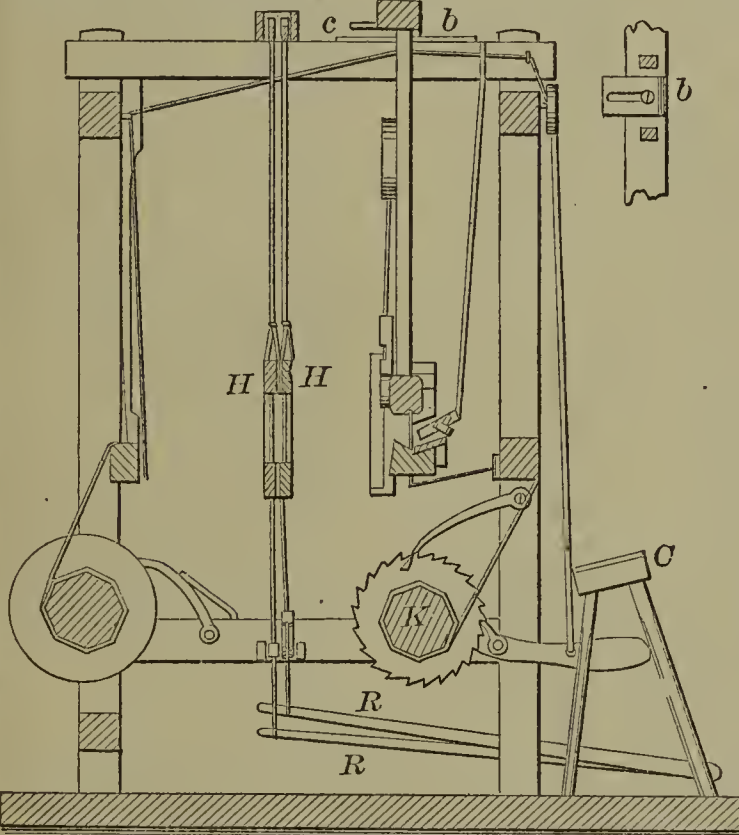

60304—J. Wheeler—Wash Board and Wringer.

60306—L. H. Whitney—For Training Hops.

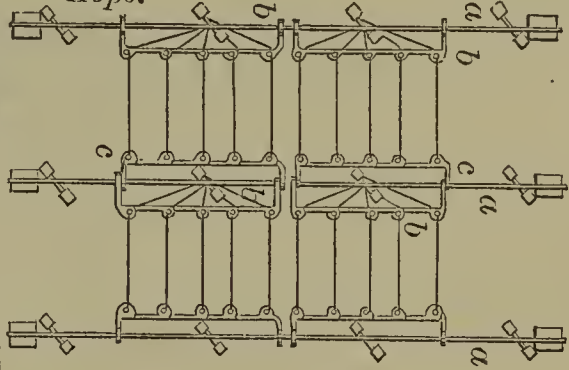

60307—S. A. Whitney—Melting Furnace.

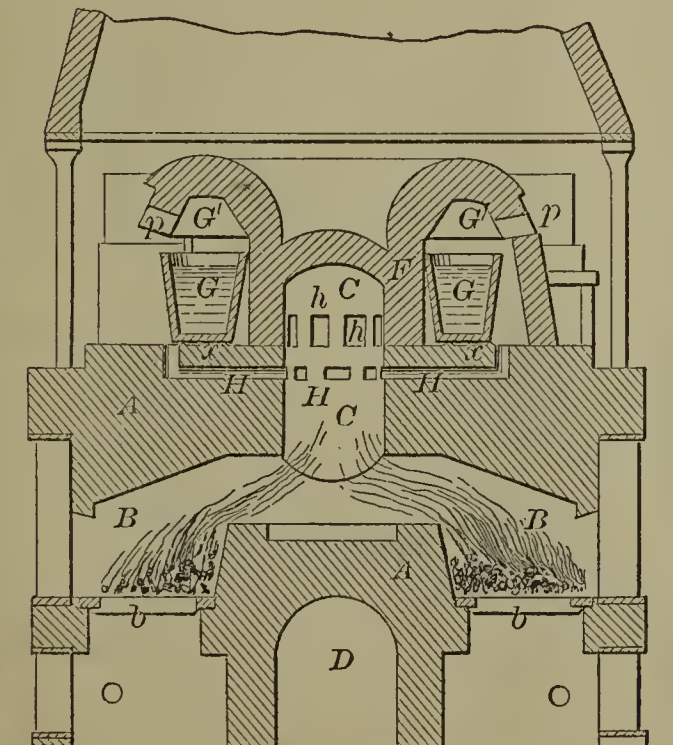

60308—W. M. Whittaker—Butter Dish.

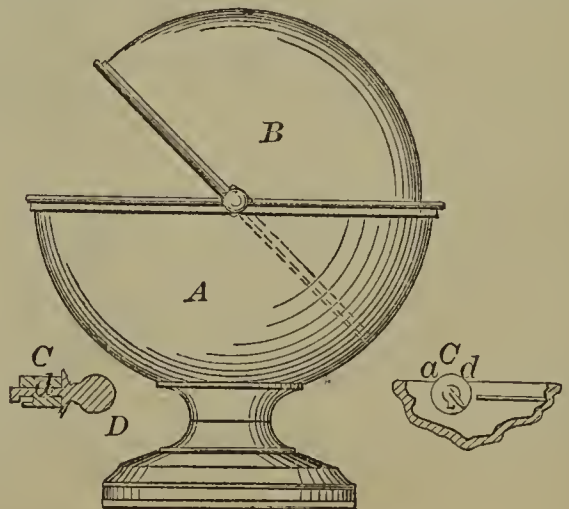

60310—J. J. Wiggin—Mould for Plastic Material.

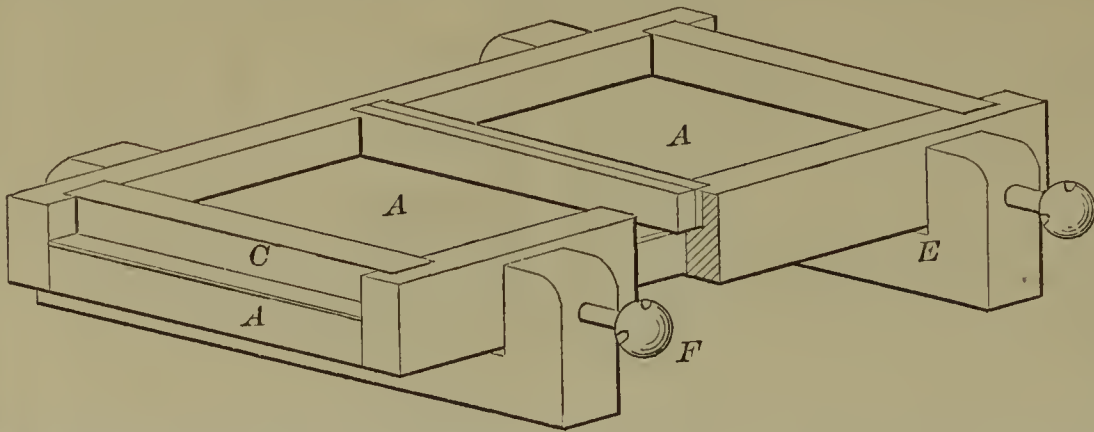

60313—S. W. Wood—For Conveying Grain.

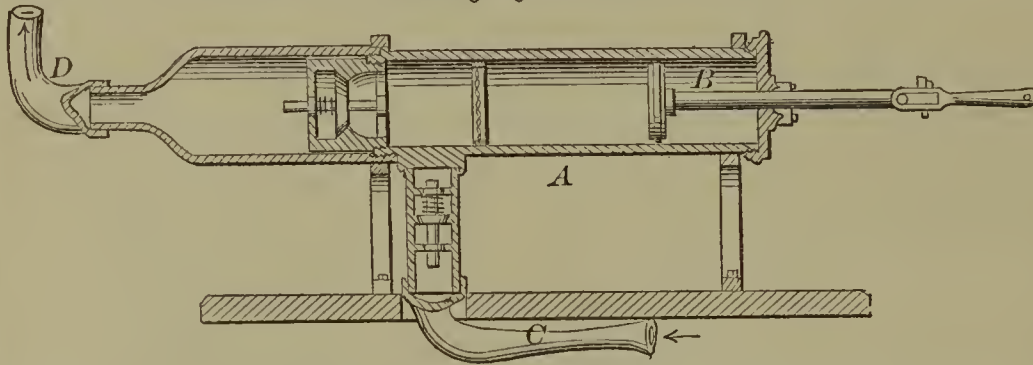

60312—J. P. Wilms—Pessary, B

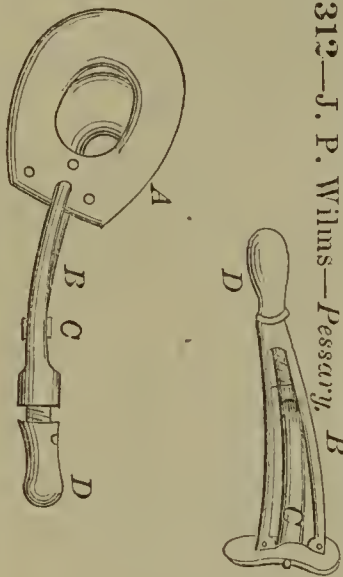

60311—W. H. Wiley—Well and Cistern Filter.

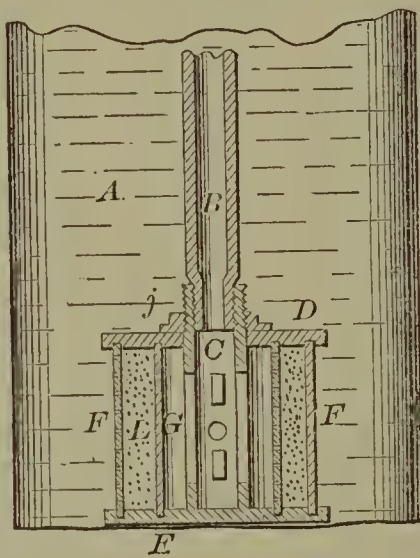

60314—T. Woods—Stone Drill.

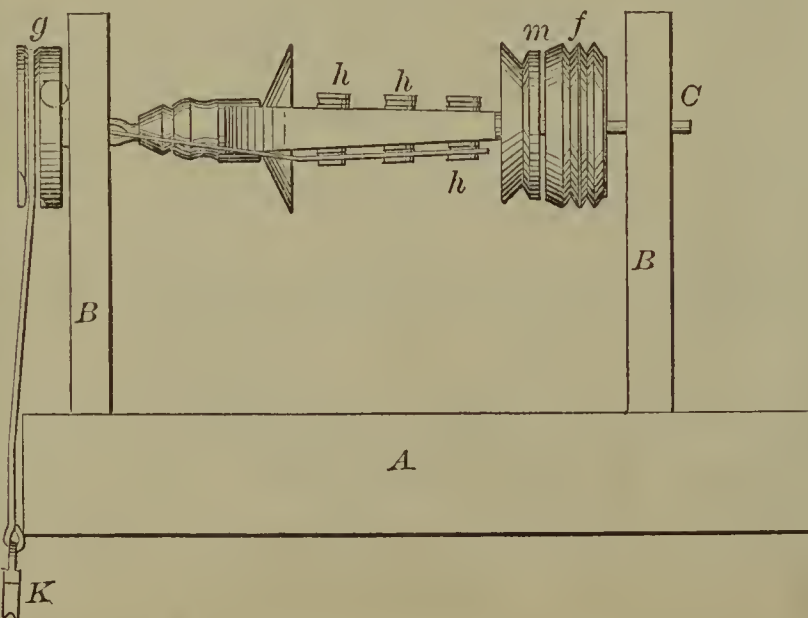

60315—B. Worcester—Scale Pencil.

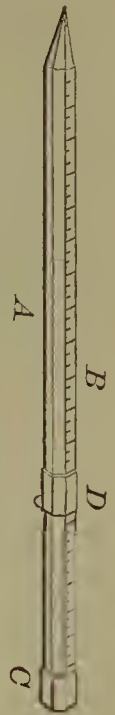

60316—J. M. Worcester—For Tying and Packing Wool.

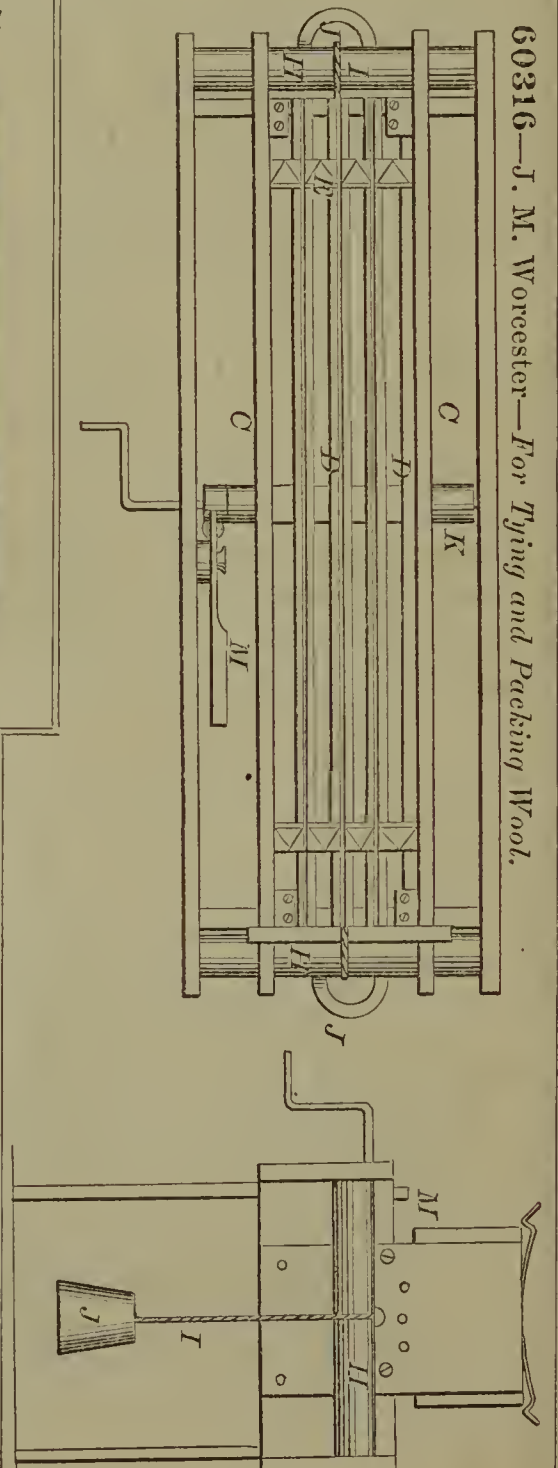

60317—W. H. Wussow—Wood Lathe.

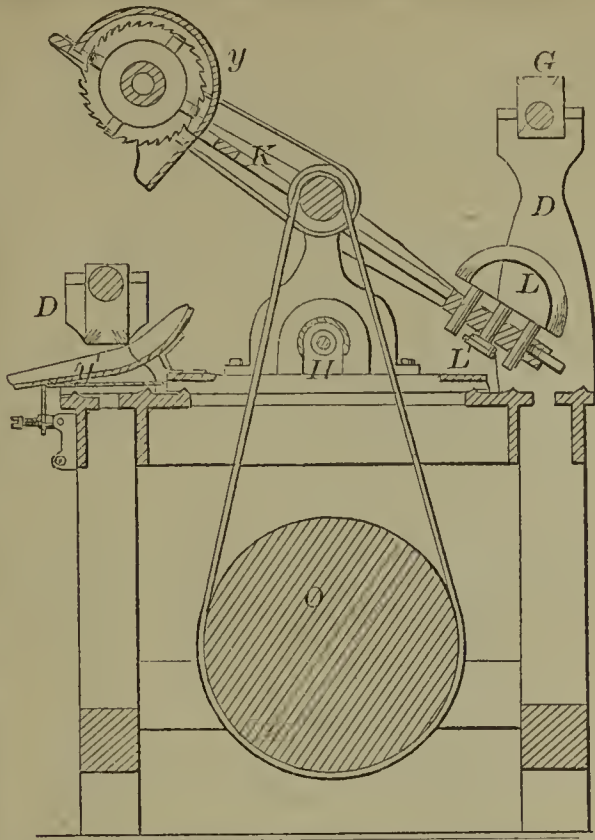

60322—H. Baines—For Rolling Metal.

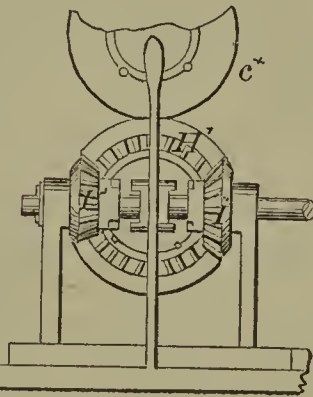
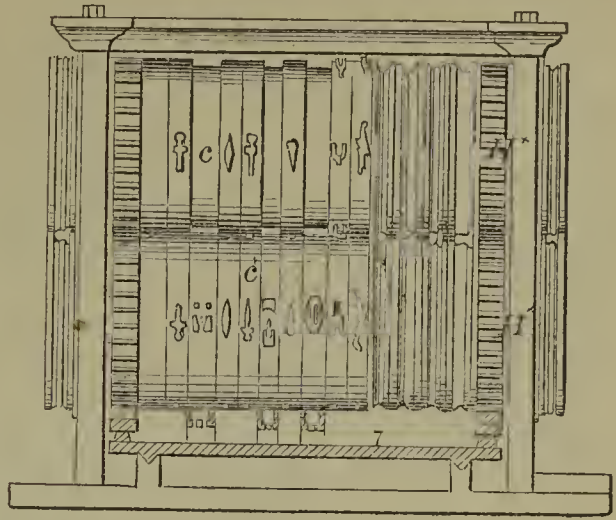

60321—J. E. Atwood—Saw.

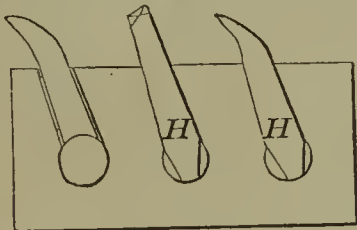

60318—T. Yates—Corn Harvester.

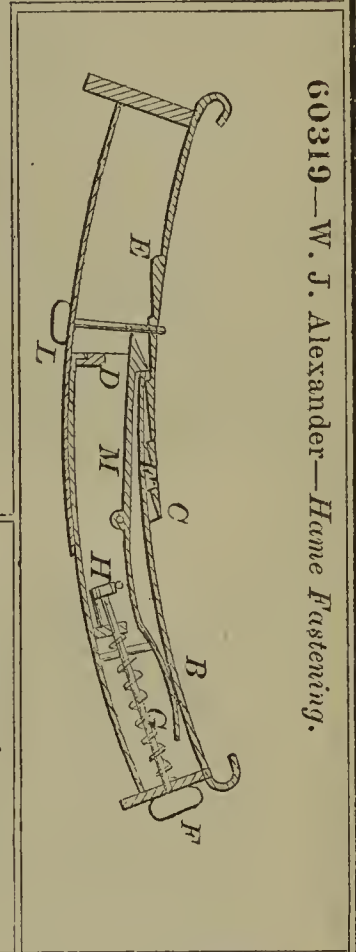
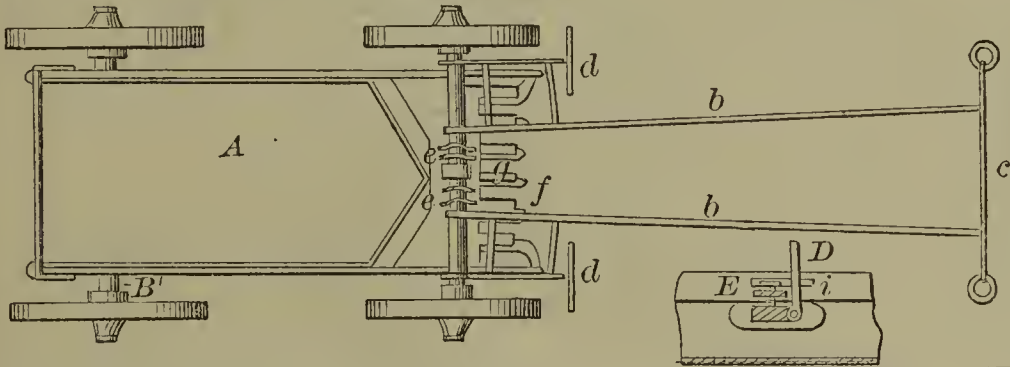

60319—W. J. Alexander—Home Fastening.

60323—W. C. Bartol—Brick Machine.

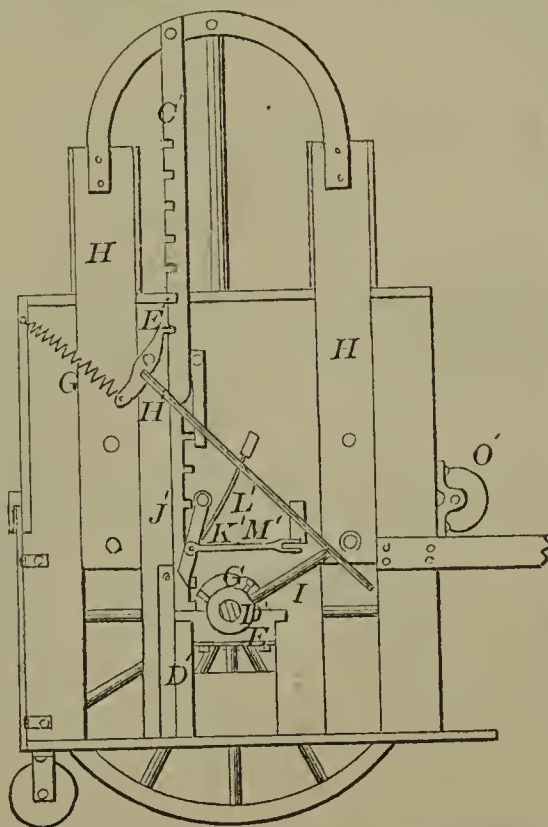
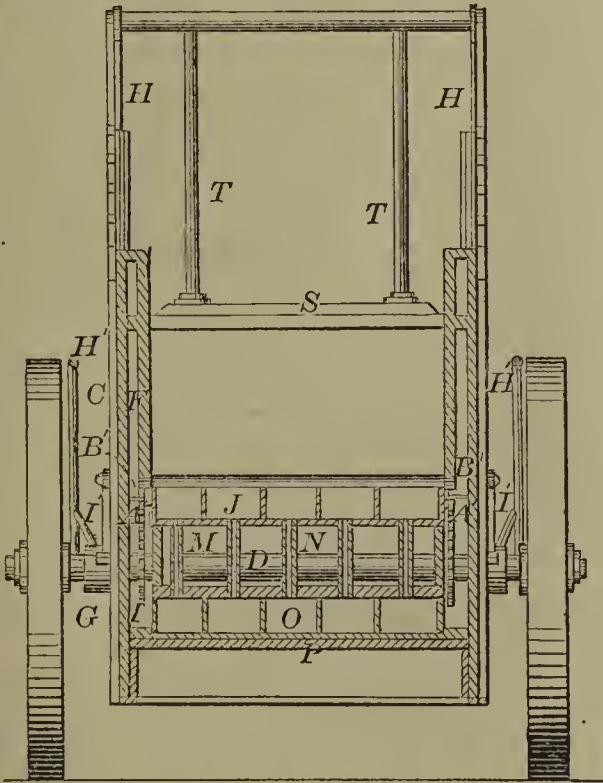

60324—S. Baxendale—Bating and Wadding.

60325—Beall & Grim—Road Scraper.

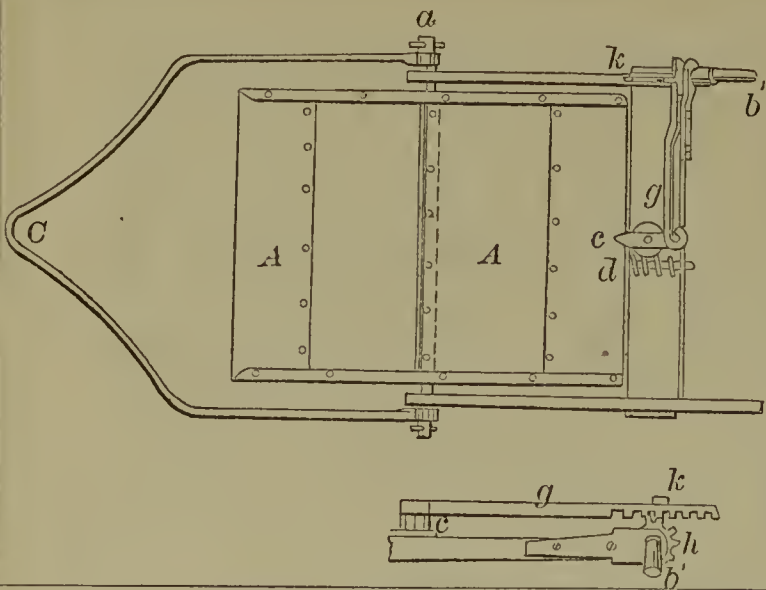

60331—W. W. Bratt—Fence Gate.

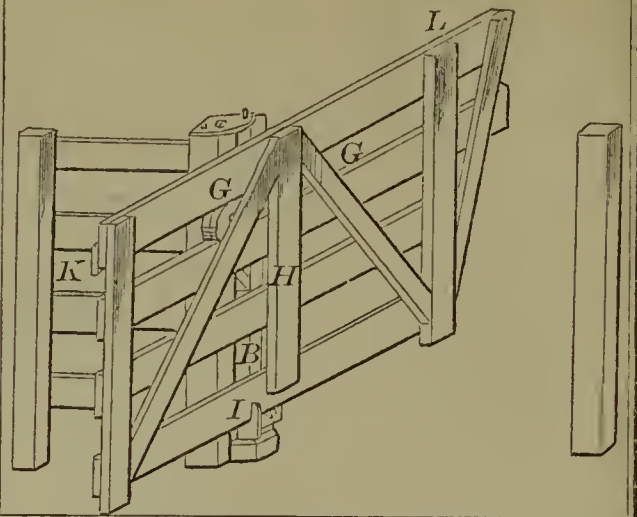

60326—E. Beckwith—Washing Machine.

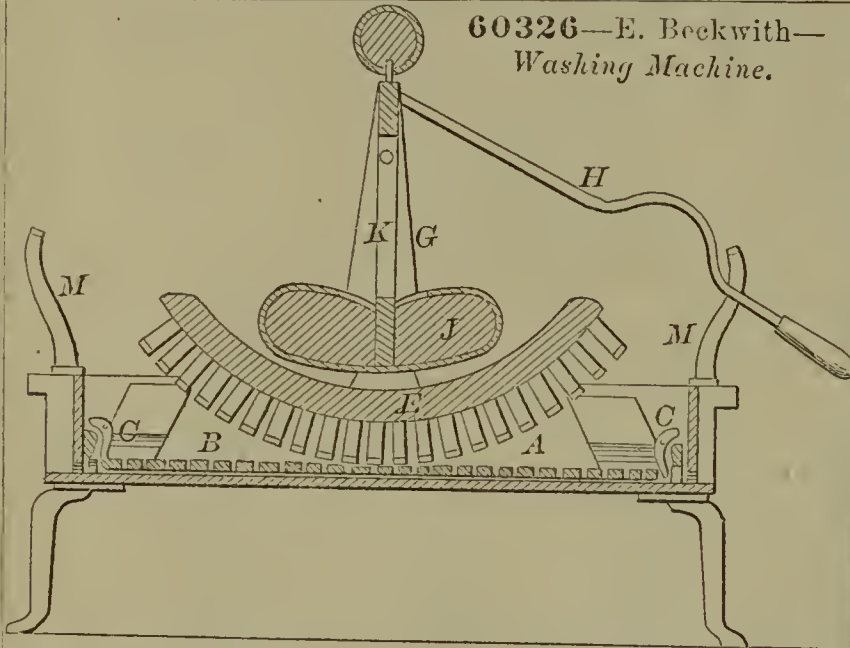

60330—Brand & Hoffmann—Mash Machine.

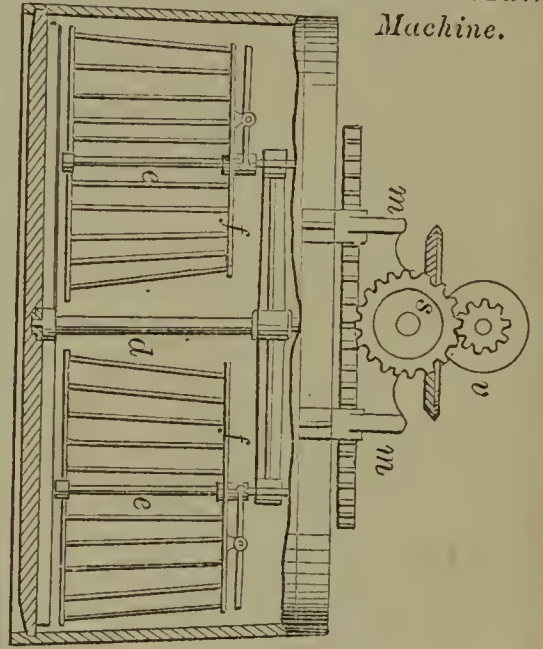

60329—J. Bird—Cast Iron Chain Pulley.

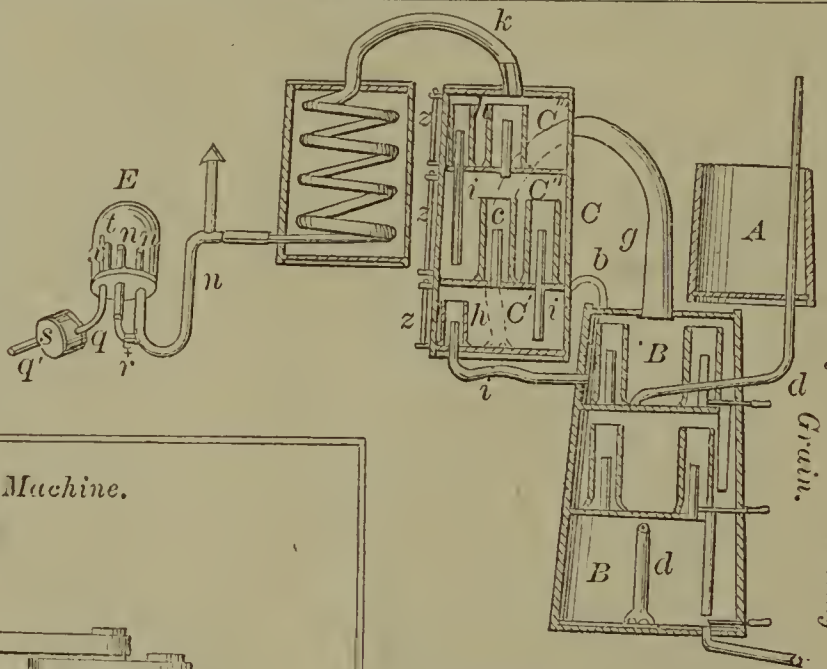

60327—Beebe & Lloyd—For Distilling Grain.

60332—O. Bridgeman—Planing Machine.

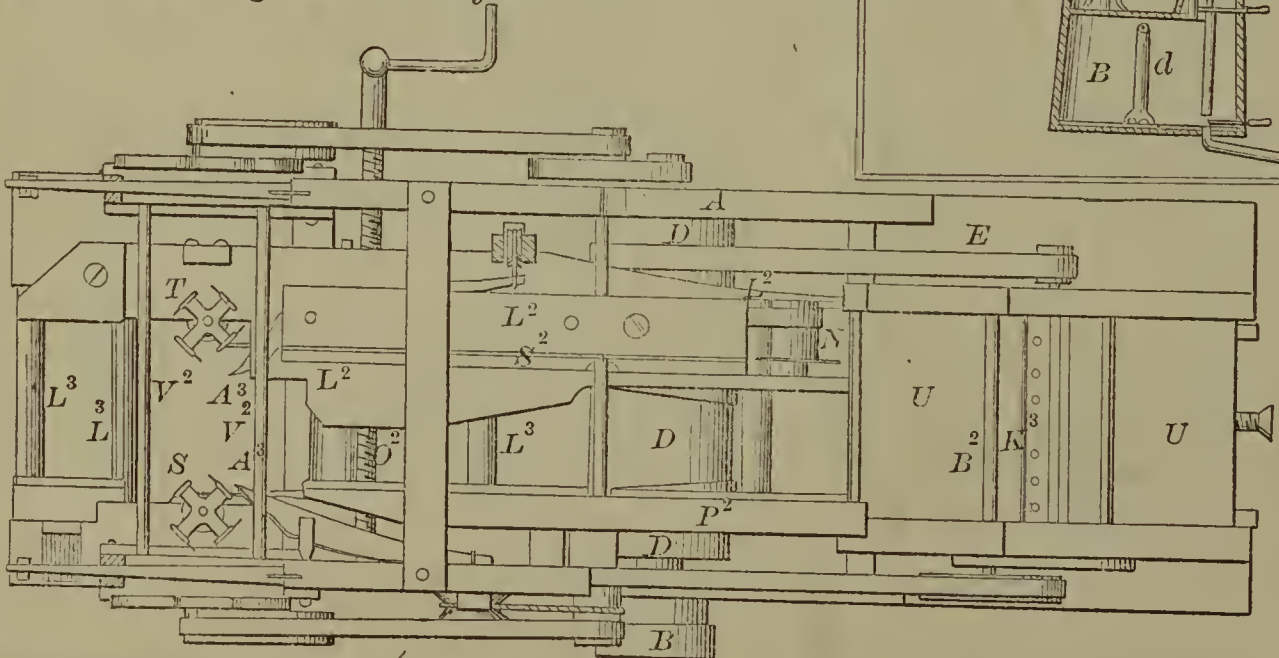

60333—T. E. C. Brinly—*Tuyere.*

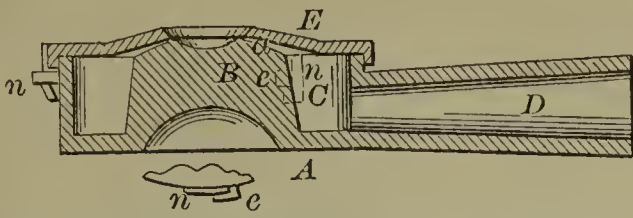

60334—A. Brown—*Stove Grate.*

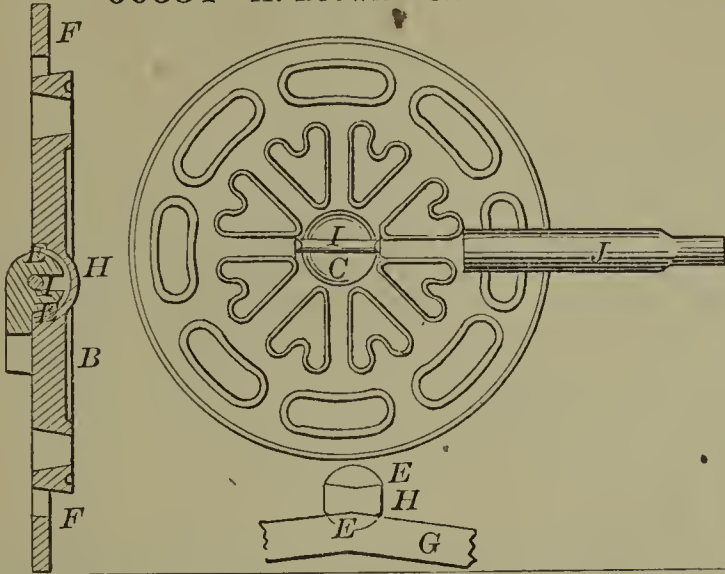

60336—J. H. Brown—*Spring Toy.*

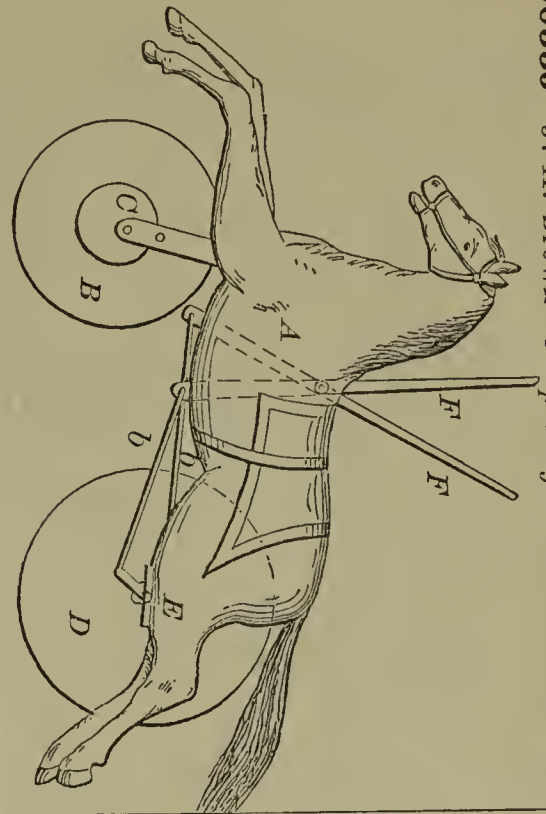

60335—J. H. Brown—*Propelling Horse.*

60337—J. H. Brown—*Attaching Handles to Vessels.*

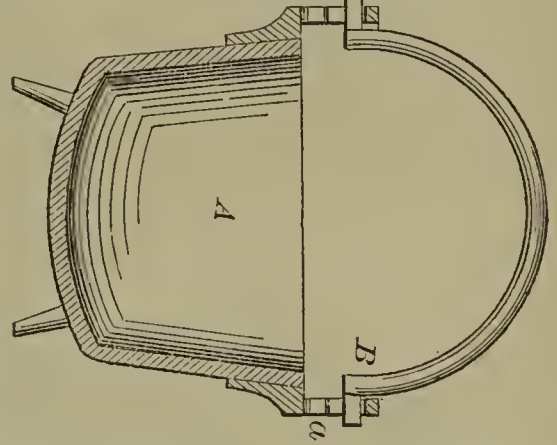

60339—S. S. Burr—*Table and Bedstead.*

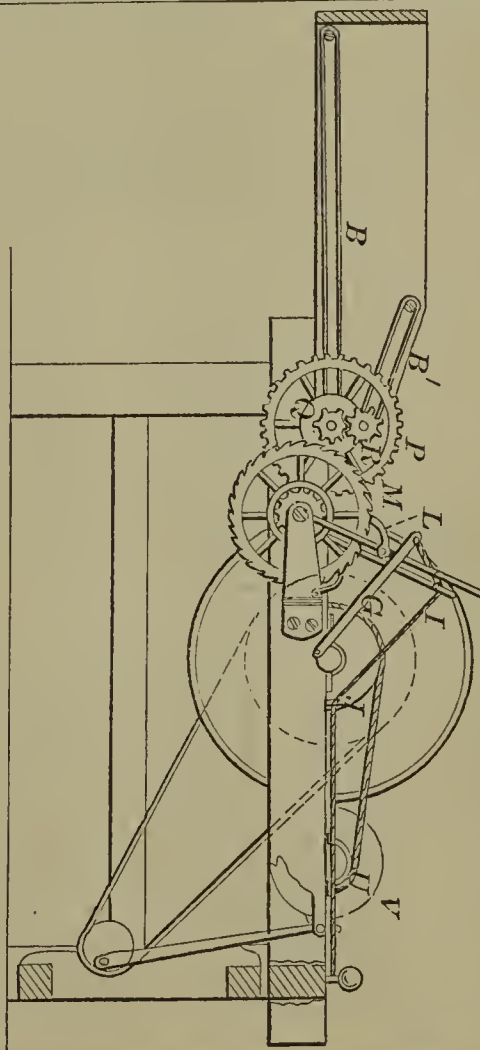
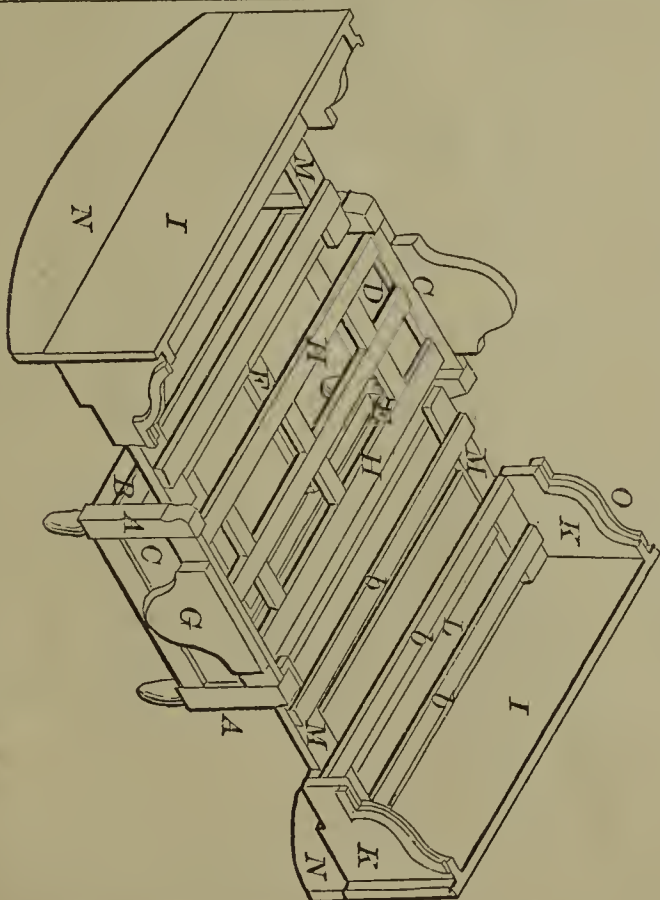

60338—G. Bruce—*Feeding Device for Guarding Engines.*

60340—W. Burt—Fastening Drop Doors in Coal Cars.

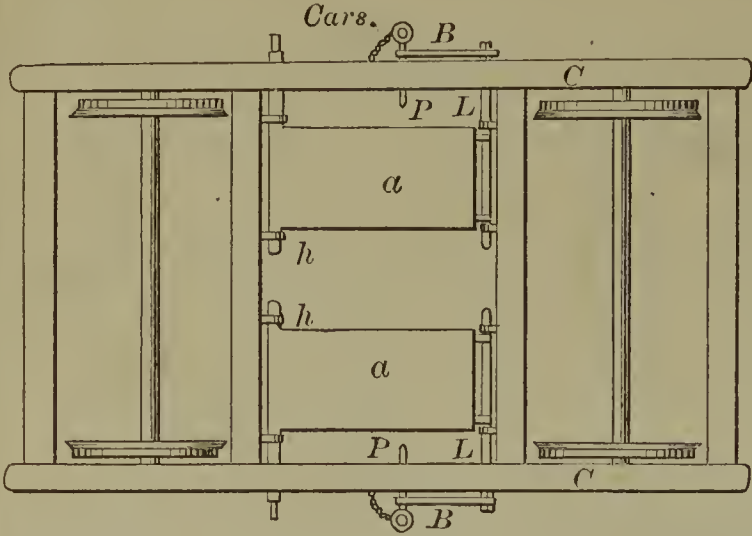

60344—G. W. Devoe—Measuring Liquids.

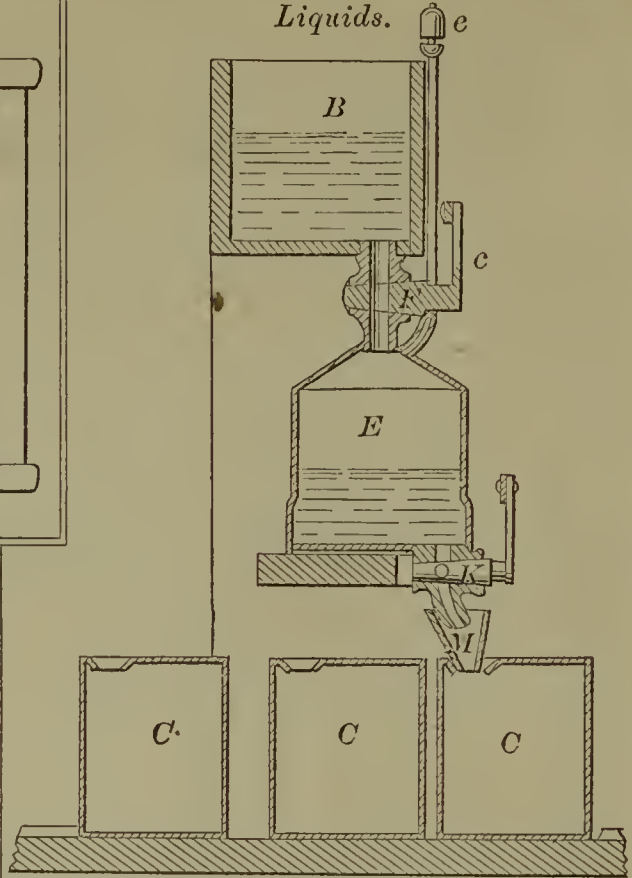

60342—S. S. Crocker—Tap Borer.

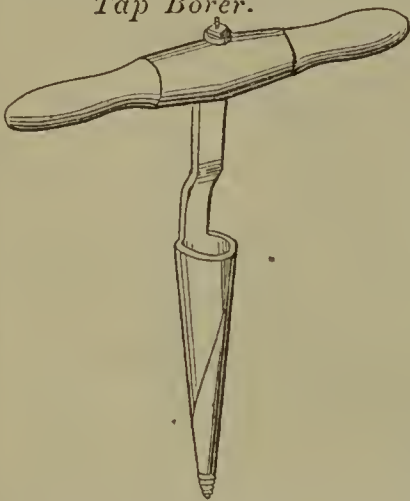

60343—A. C. Crosby—Tool for Setting Jewels in Watches.

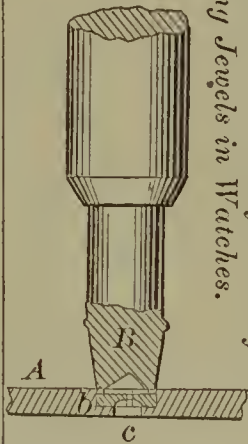

60346—S. L. Donnell—Grading Instrument.

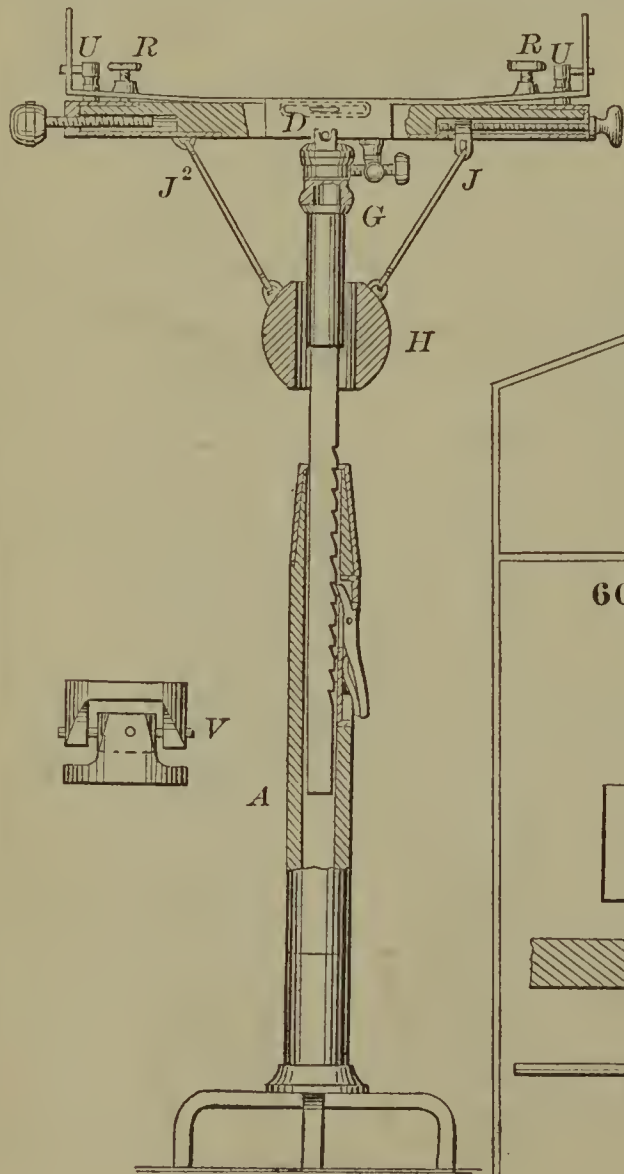

60341—J. J. Butler—Rotary Cutting Machine.

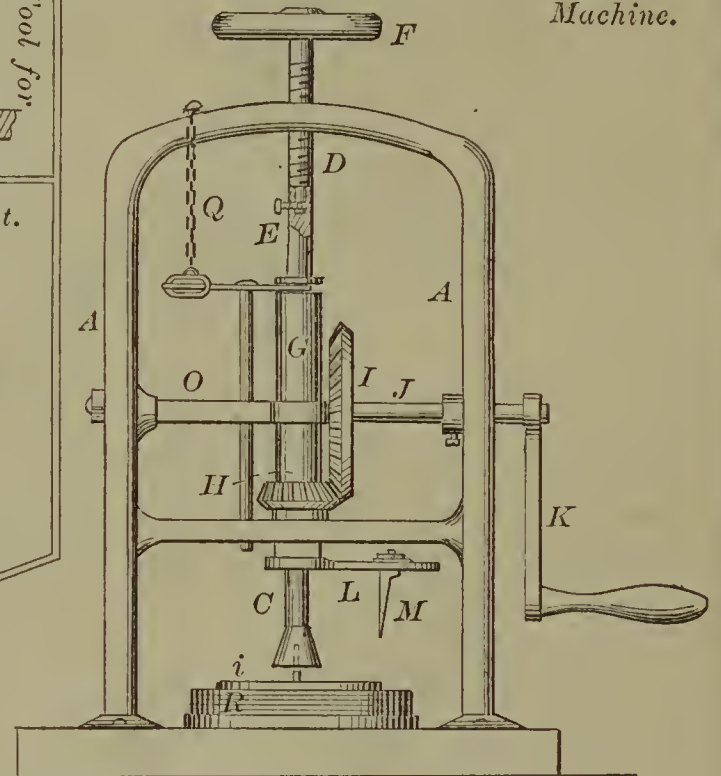

60345—J. V. Dinsmore—Paddle Wheel.

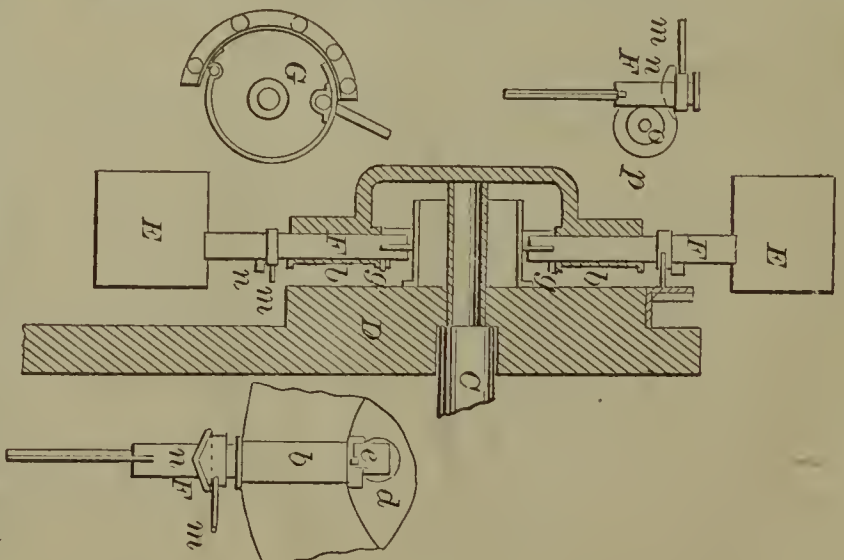

60347—M. T. Drake—Potato Digger.

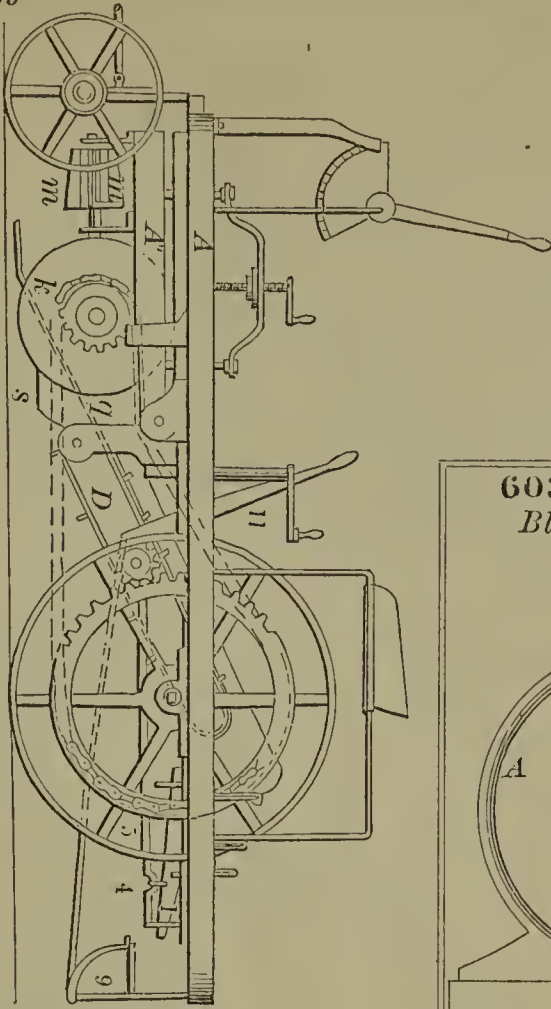
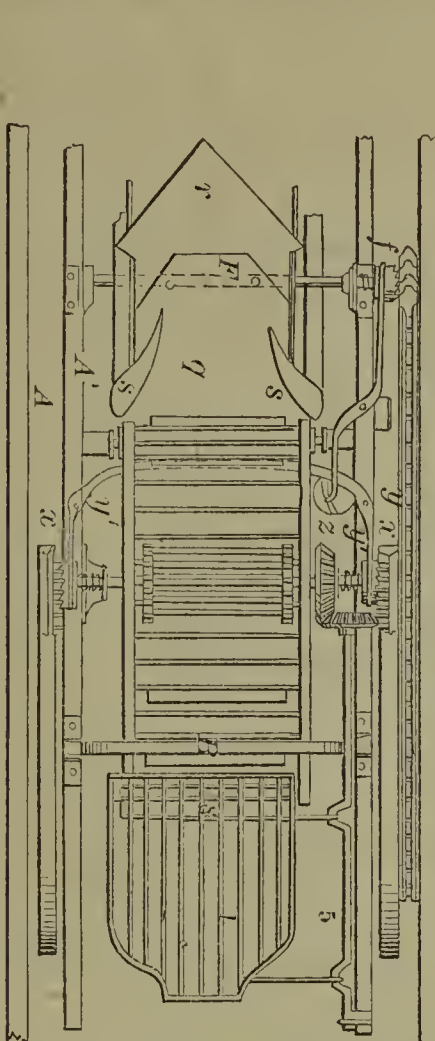

60351—W. Fisher—Bed Clothes Clamp.

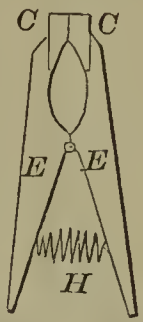

60350—J. A. Evarts—Blower.

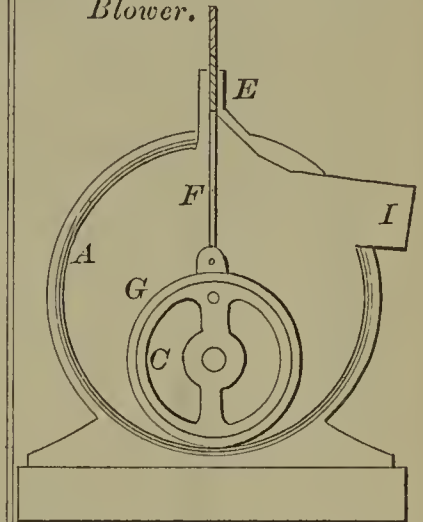

60348—R. B. Dutton—

Sled Brake.

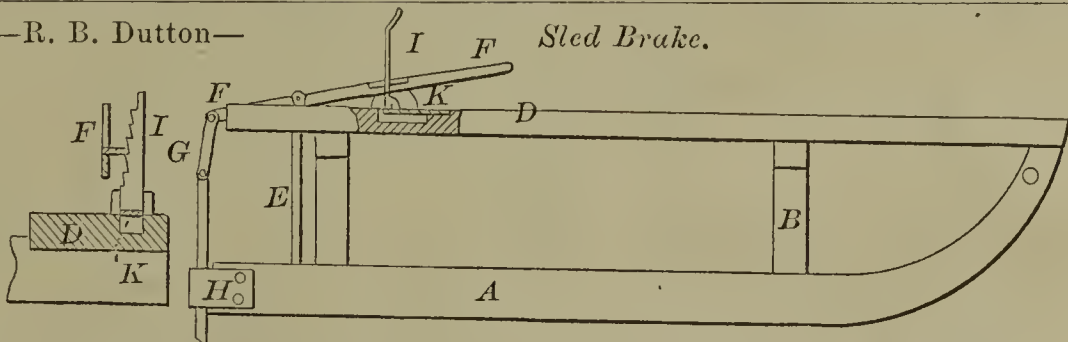

60349—E. Eltinge—Coal Scuttle.

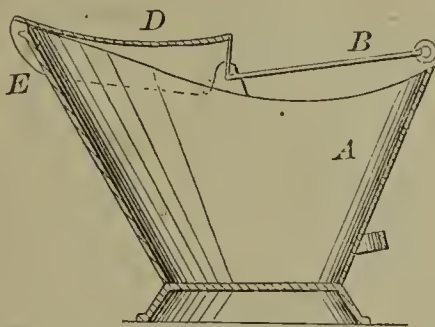

60352—J. W. Foard—Vacuum Ventilator.

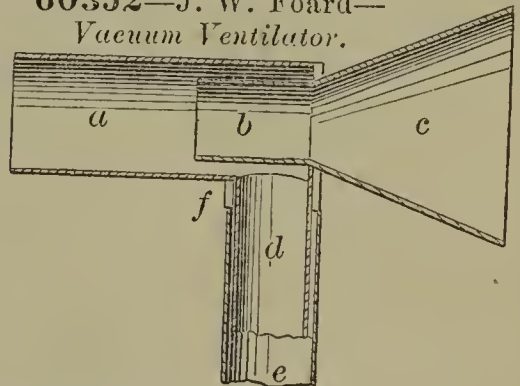

60353—M. B. Foote—Needle Threader for Sewing Machine.

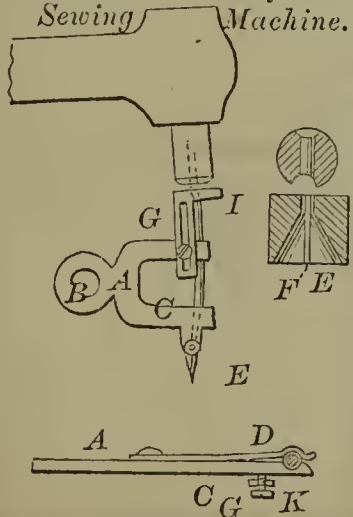

60354—L. Fossee—Sawing Machine.

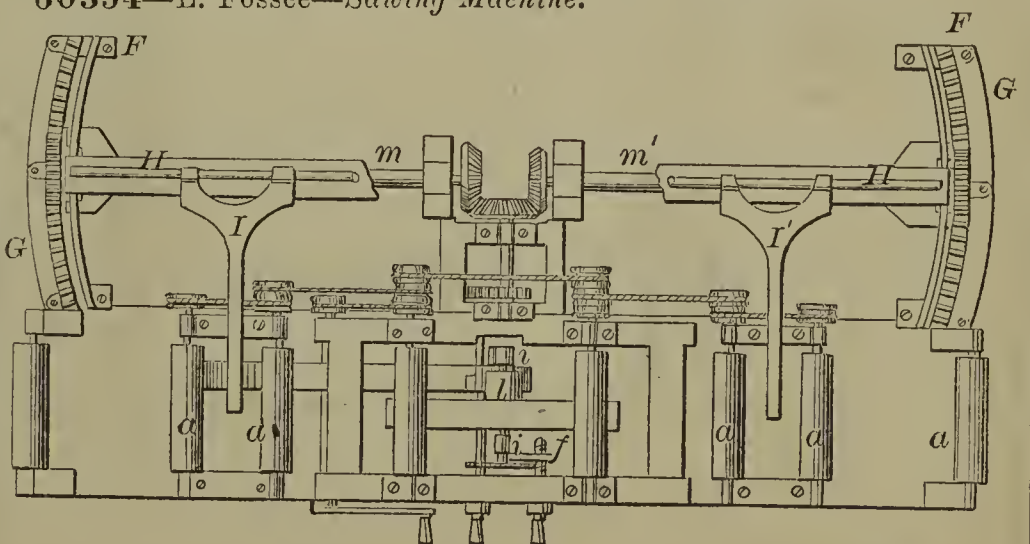

60357—W. L. Gerard—Crib for Children.

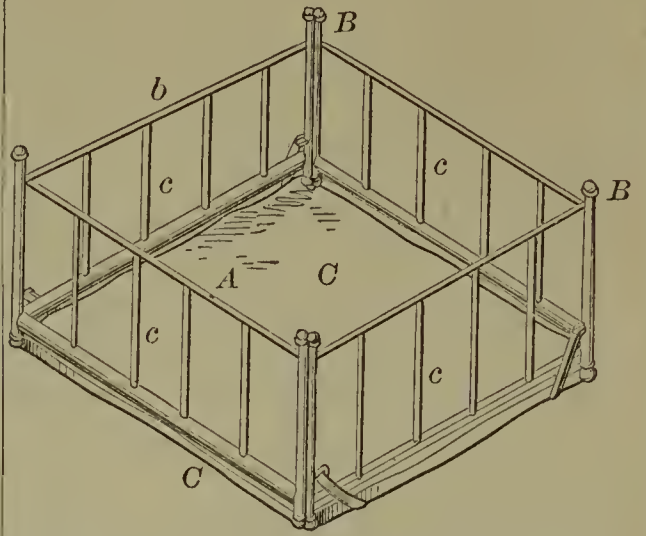

60356—J. H. French—State.

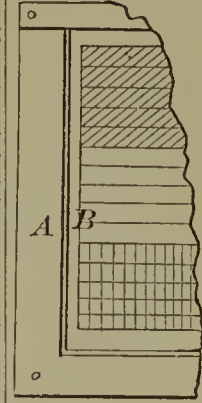

60355—V. Fountain, Jr.—Potato Masher.

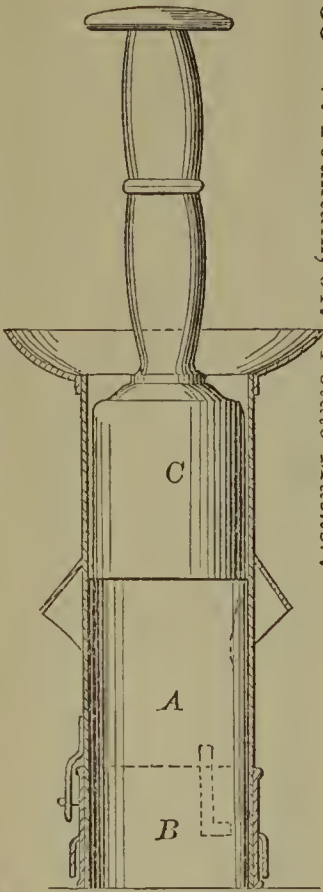

60359—A. W. Goddard—For Pulling Hemp and Cotton Stalks.

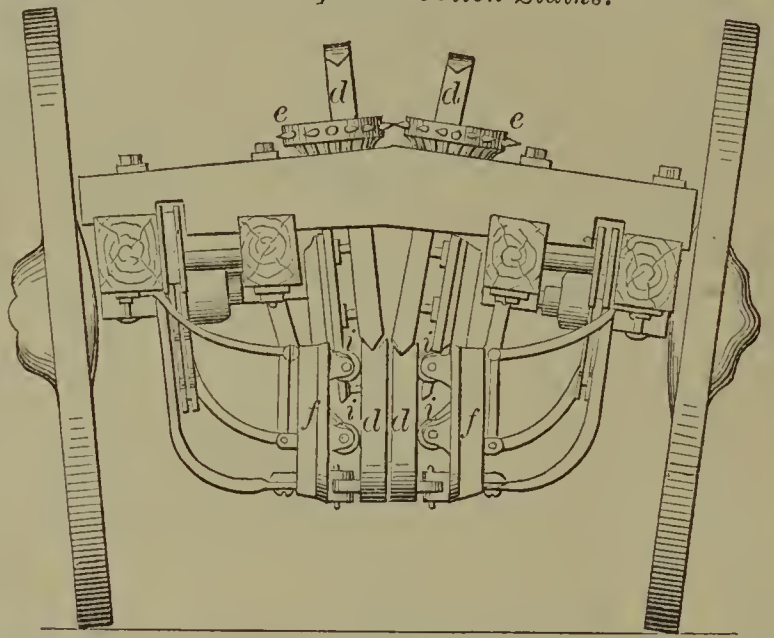

60361—N. W. Green—Grappling Tool.

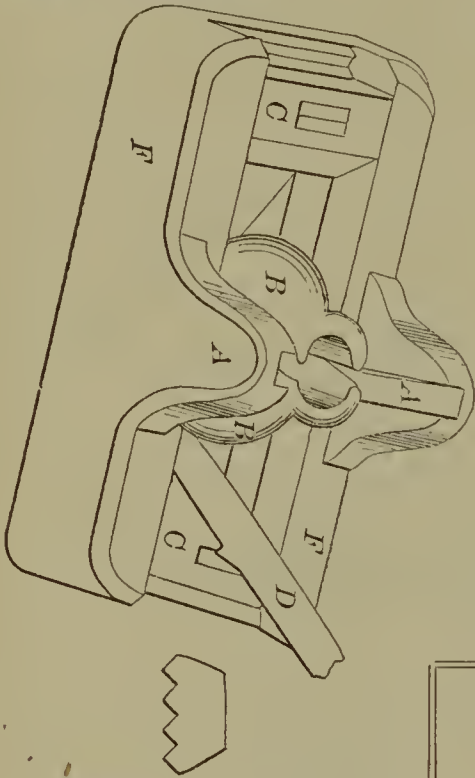

60358—T. Glover—Fence.

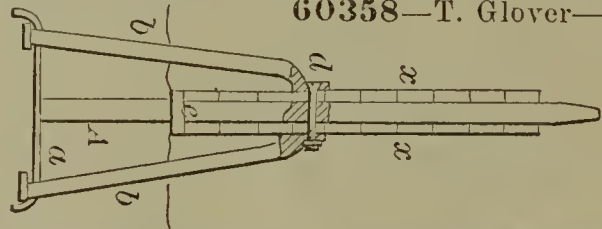

60362—S. B. Guernsey—Wash Stand.

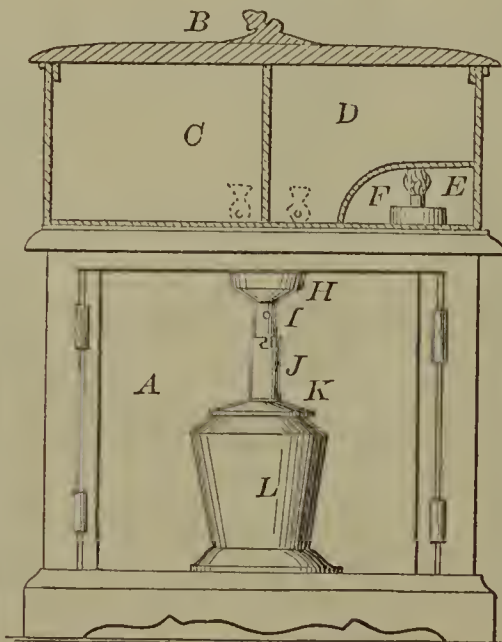

60363—A. W. Hall—Churn Dasher.

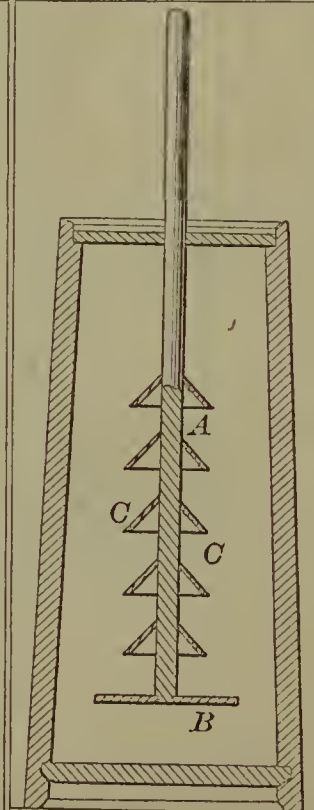

60360—H. C. Goodrich—Sewing Machine Guide.

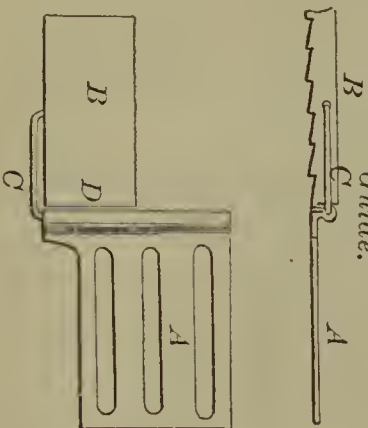



60364—A. S. Hadley—*Dish Mop.*

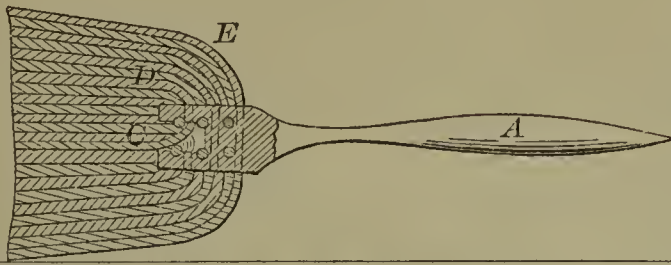

60366—Hardy & Morris—*Rotary Pump and Engine.*

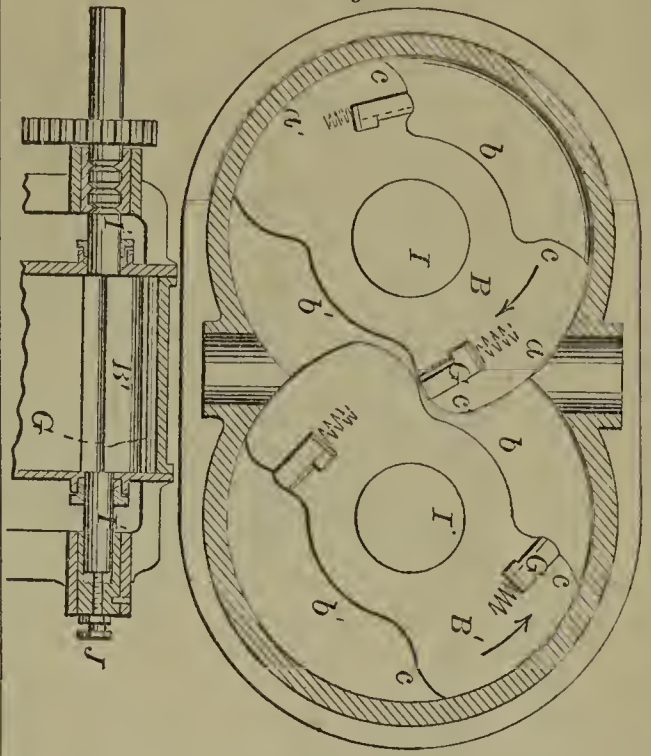

60365—D. D. Hardy—*Rotary Pump and Engine.*

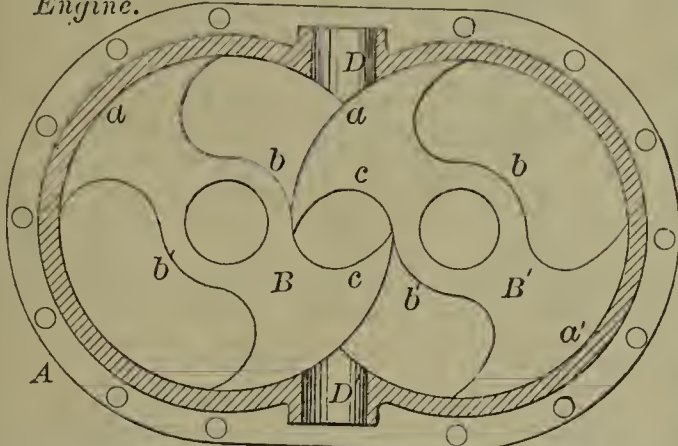

60367—B. T. Harris—*Tool for Inserting Screw Eyes.*

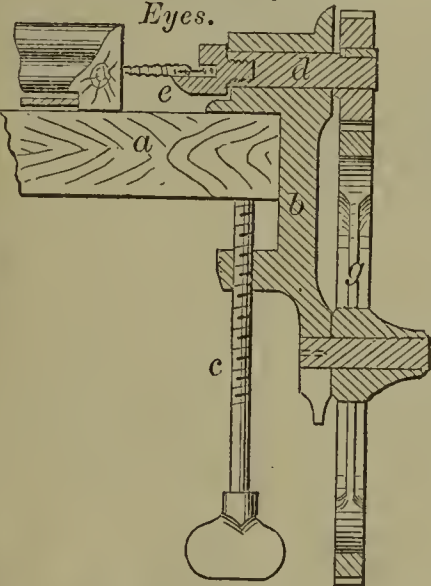

60369—J. Hatch—*Packing Revolving Joints.*

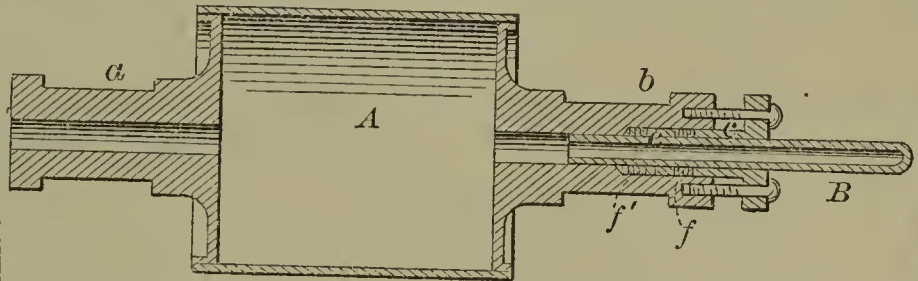

60368—W. J. Haswell—*Bed Bottom.*

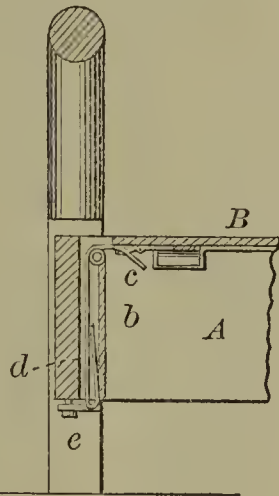

60372—N. M. Healy—*Stump Extractor.*

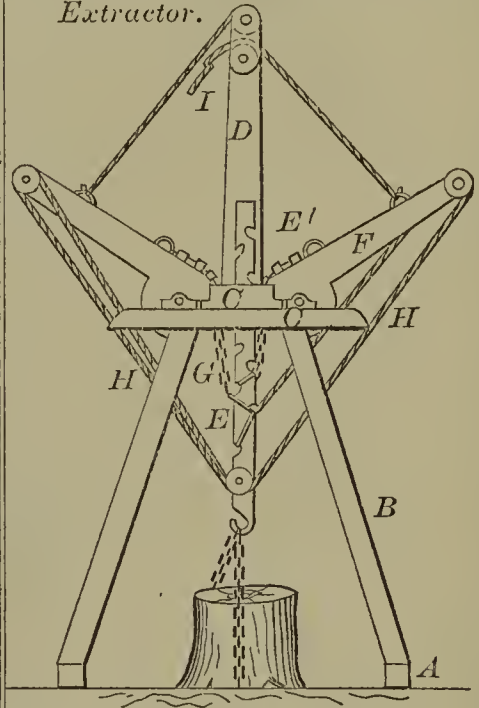

60373—S. Hicks—*Water Wheel.*

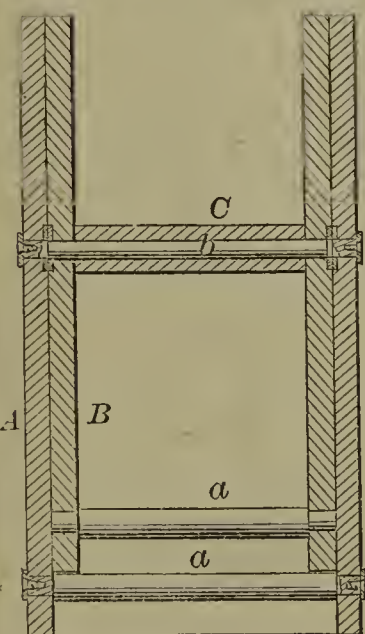
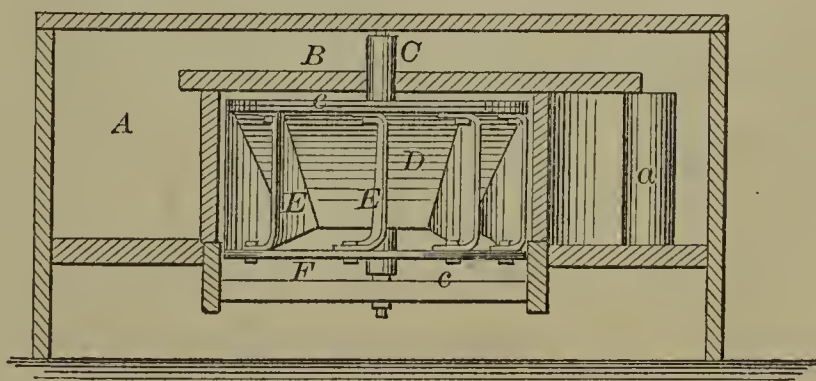

60371—H. M. Hayward—*Saw Horse or Buck.*



60375—M. & S. Housman—*Corn Sheller.*

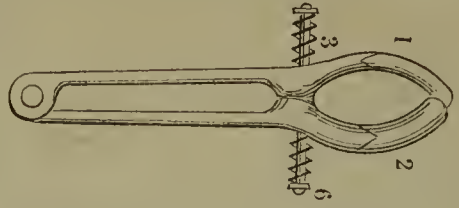

60376—G. D. Howe—*Baling Press.*

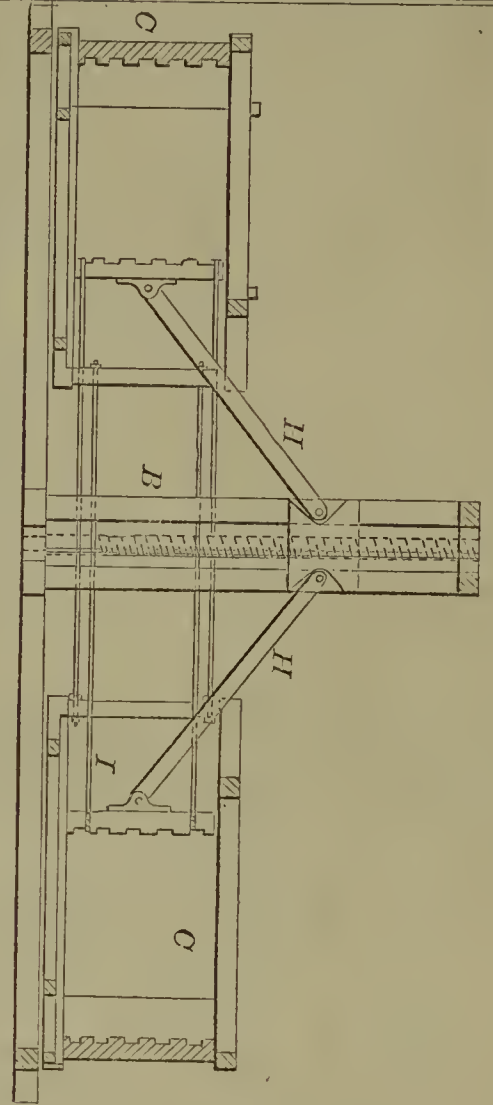

60374—J. A. Holford—*Saw Mill.*

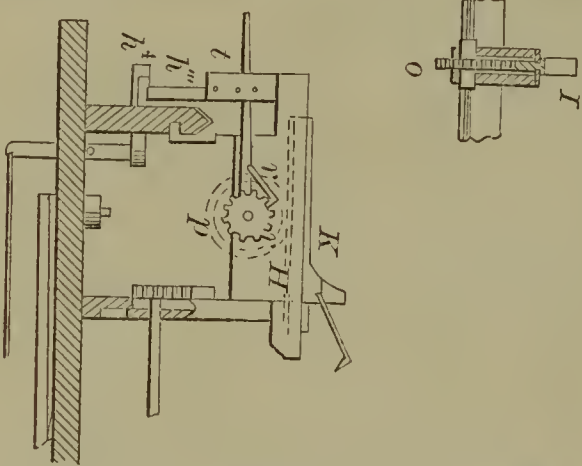
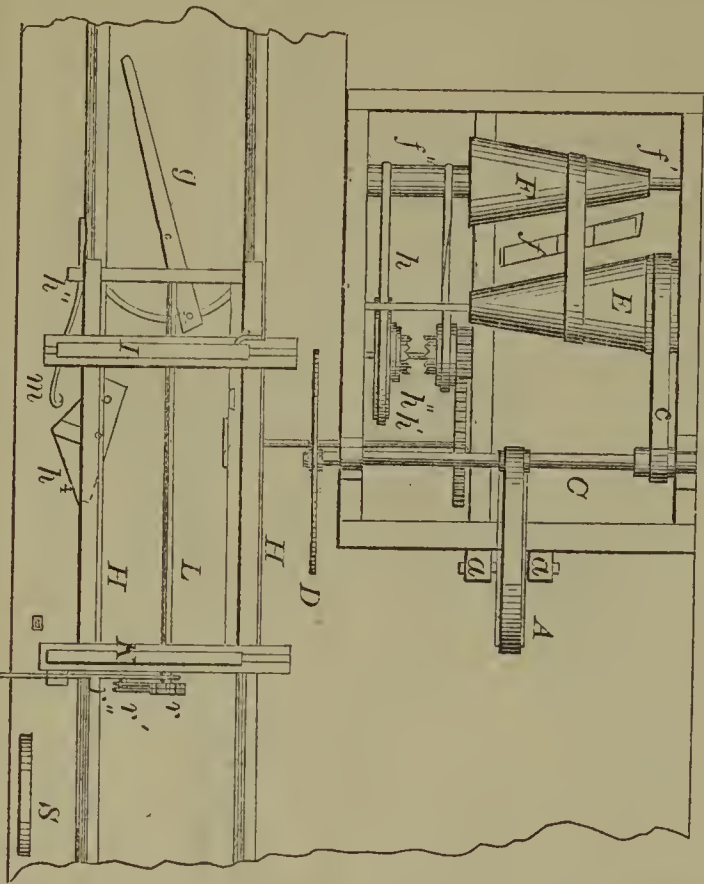

60379—G. A. Jasper—*Steam Pipe.*

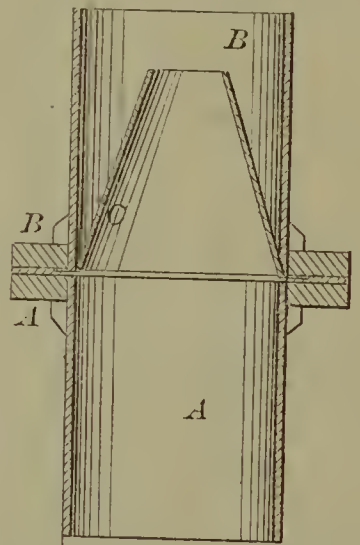

60378—G. G. Hunt—*Steam Valve.*

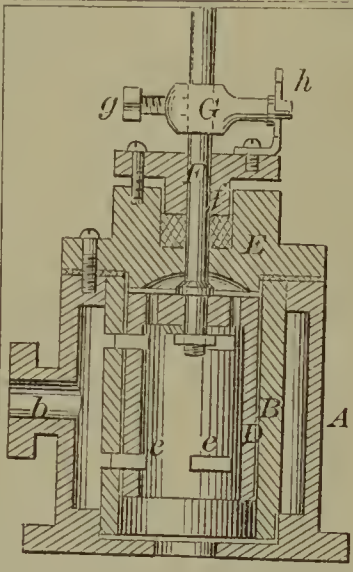

60377—A. R. & E. A. Hunt—*Street Lantern.*

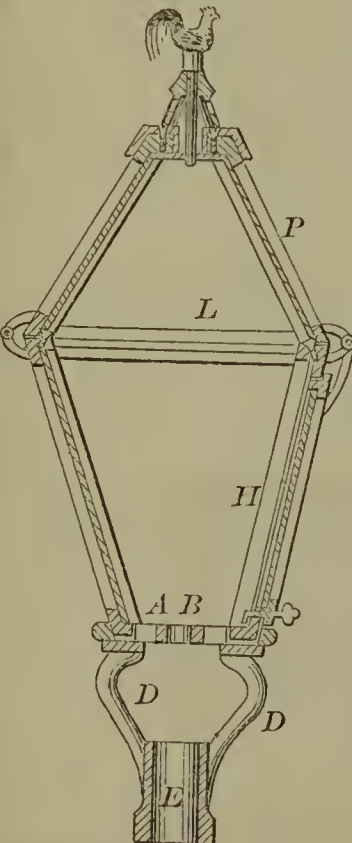

60380—J. V. Jopson—*Tool for Cutting Tubes.*

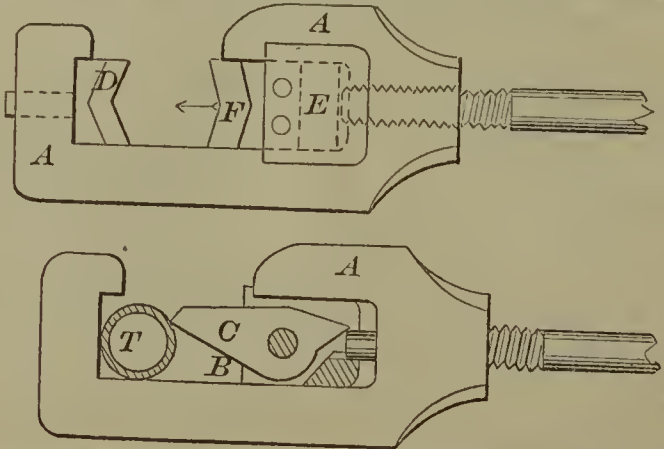

60382—G. D. Jones—For Drying Artists' Materials.

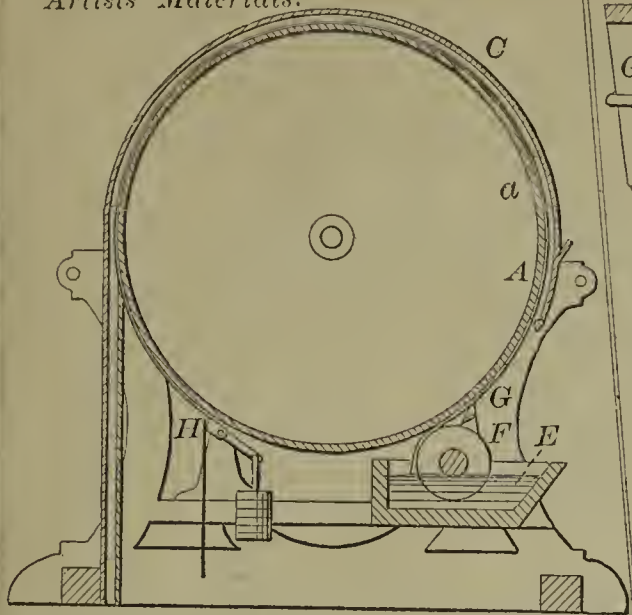

60383—H. C. Jones—Basket.

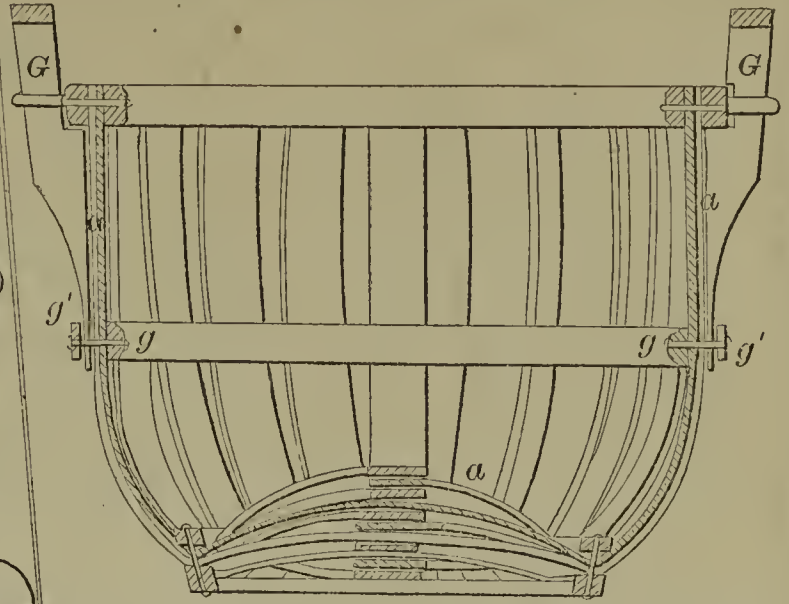

60386—Kirk & Pendergast—Wool Oiling Apparatus.

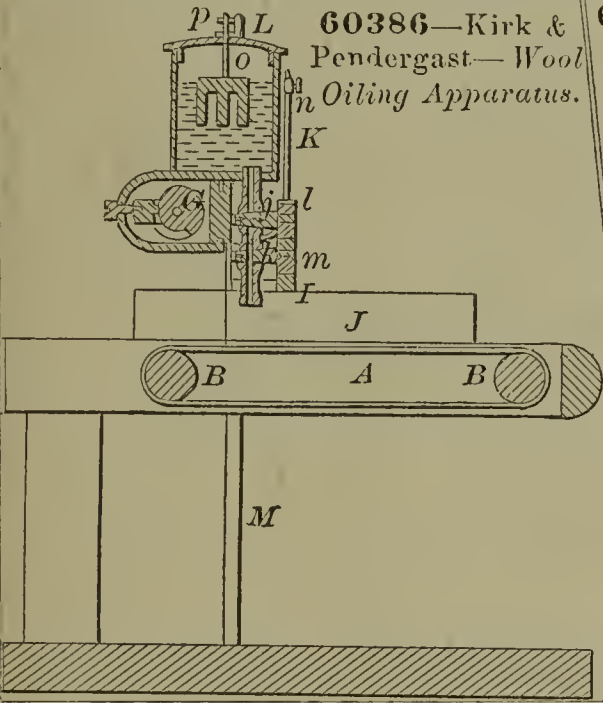

60387—R. Kitson—For Opening and Cleaning Cotton.

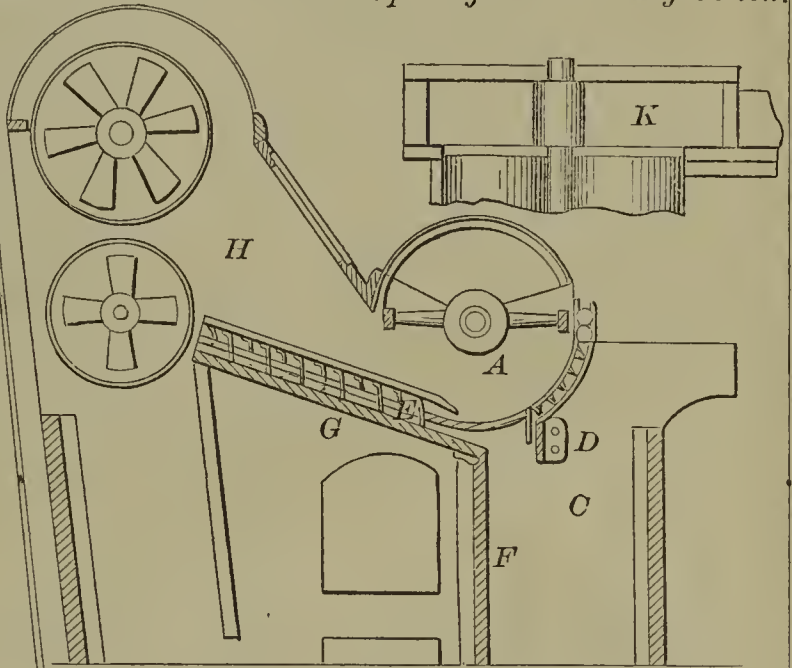

60384—E. H. Keith—Car Coupling.

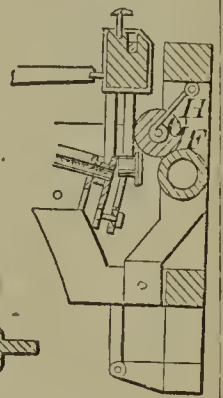
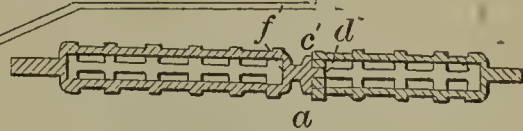
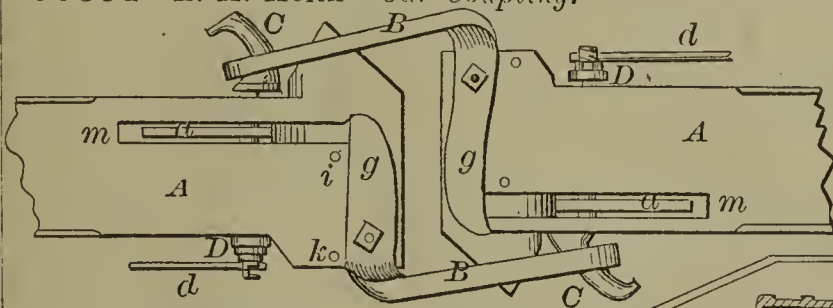

60385—B. Kemp—Homing Mill.

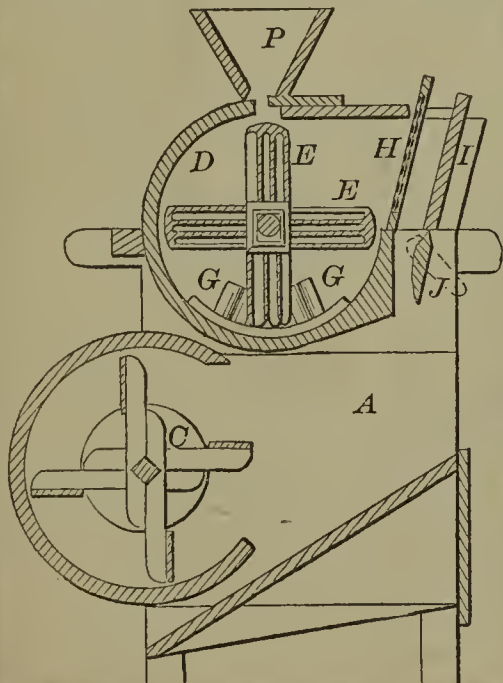

60388—L. J. Knowles—Narrow Ware Loom.

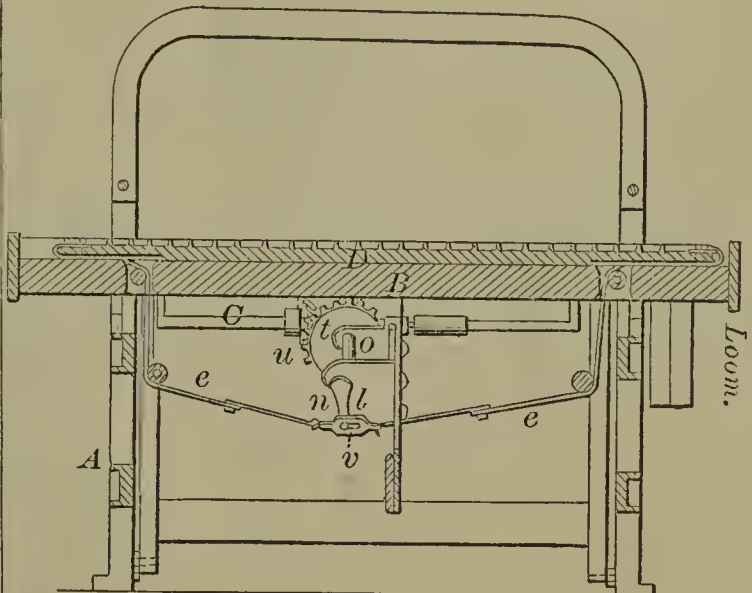

60389—J. Kopp—Baby Chair and Table.

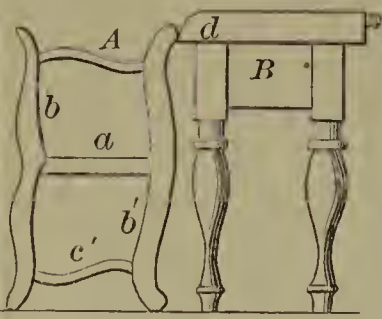

60392—S. K. Lighter—Harvester Rake.

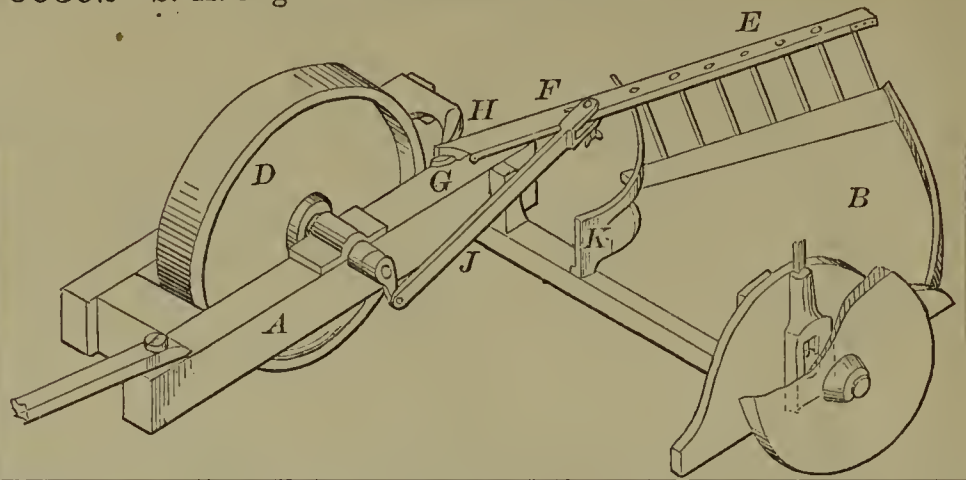

60394—R. B. Lockwood—Disinfecting Rendering Houses, &c.

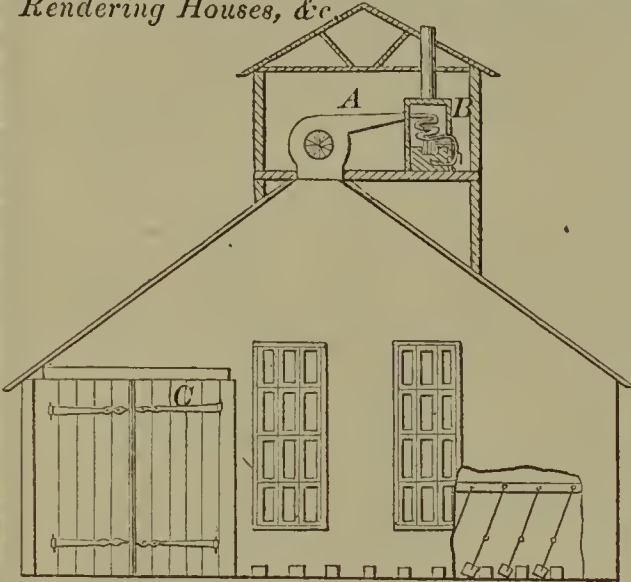

60395—B. Lowe—Piston Packing.

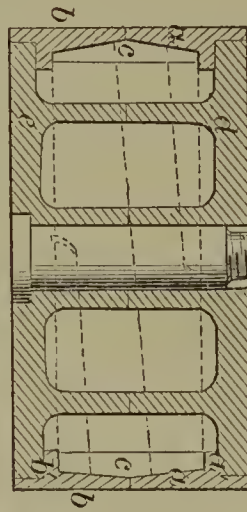

60393—J. H. Lockie—Brace for Wagon Springs.

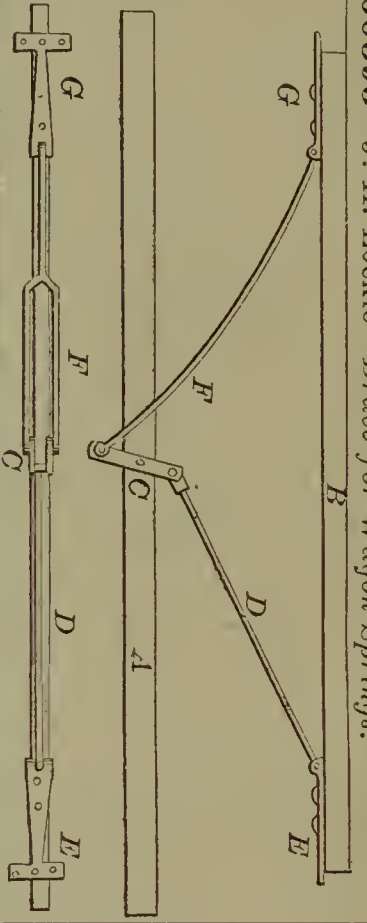

60396—Lugo & Schrader—Distilling Petroleum Oils.

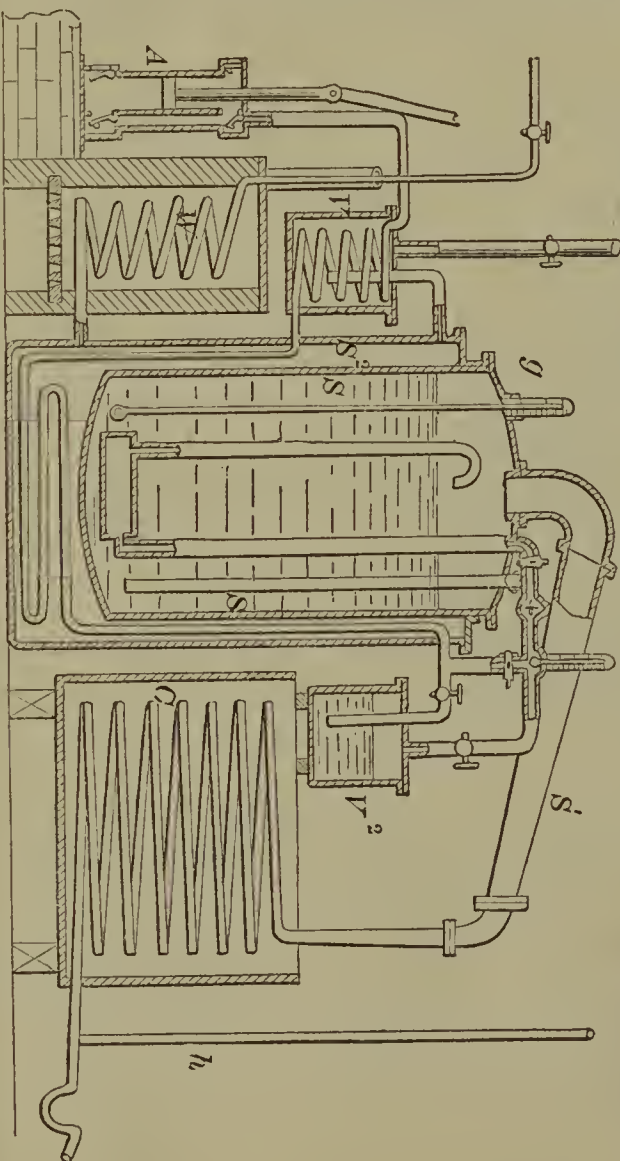

60390—J. Lee—Fire Shield.

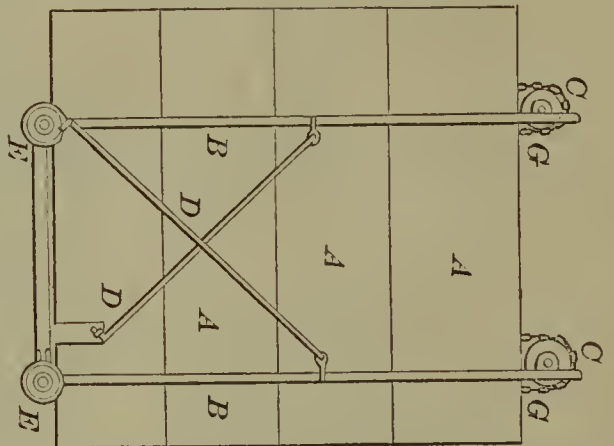

60391—G. H. Lenher—Churn.

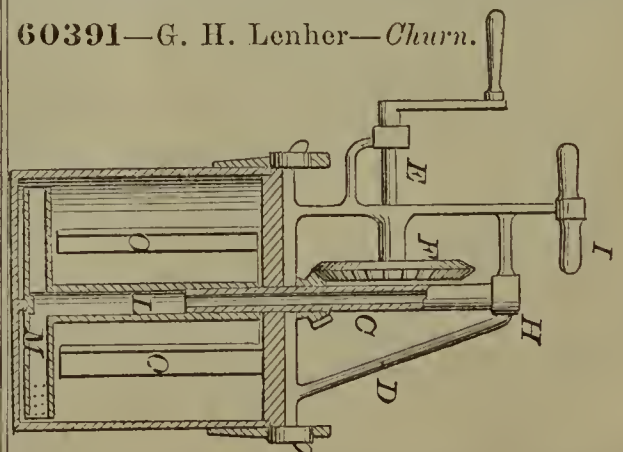

60397—J. B. Lyons—*Peat Machine.*

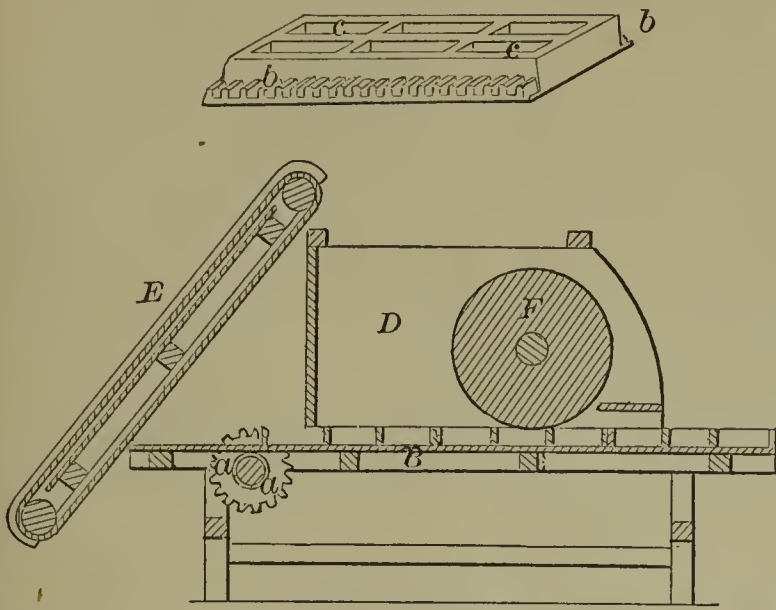

60402—F. M. McMeekin—*Cotton Gin.*

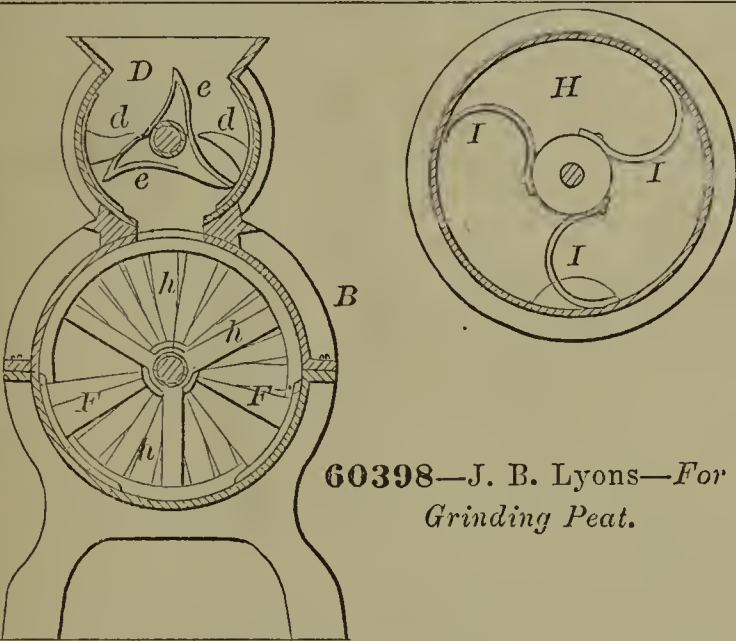
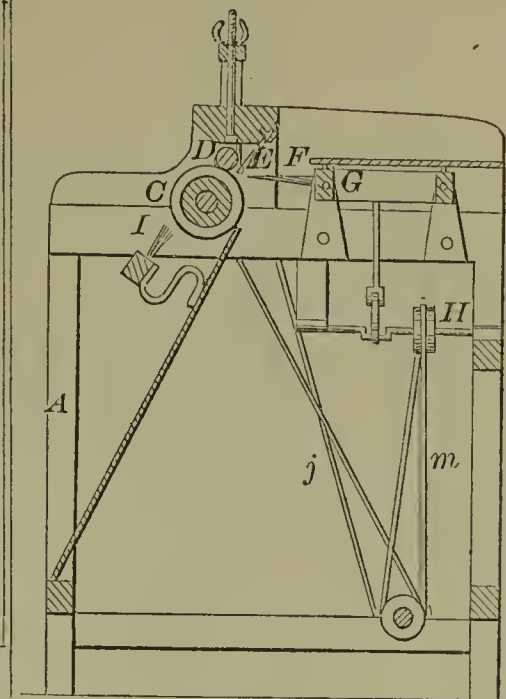

60398—J. B. Lyons—*For Grinding Peat.*

60404—J. M. Miller—*Grinding Mill.*

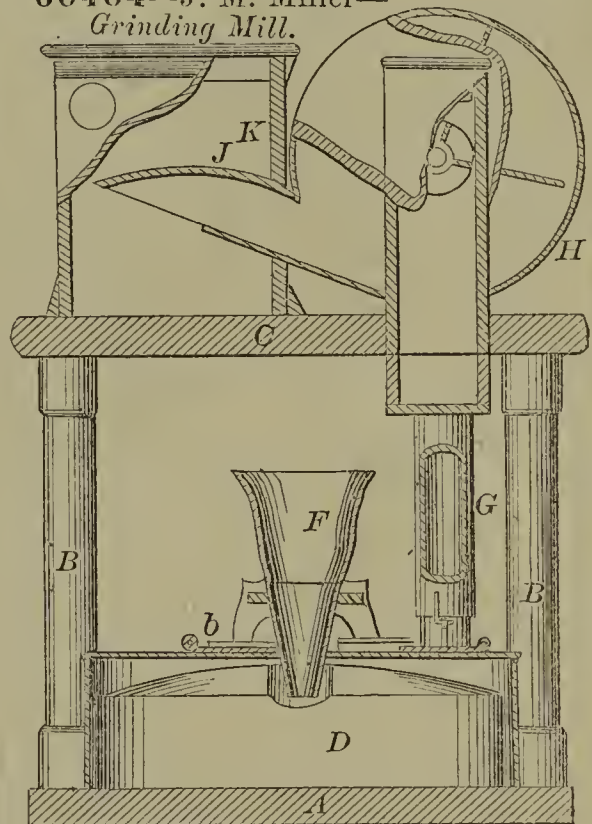

60401—B. F. McKinley—*Head Block for Saw Mills.*

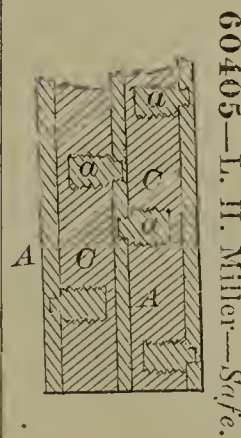
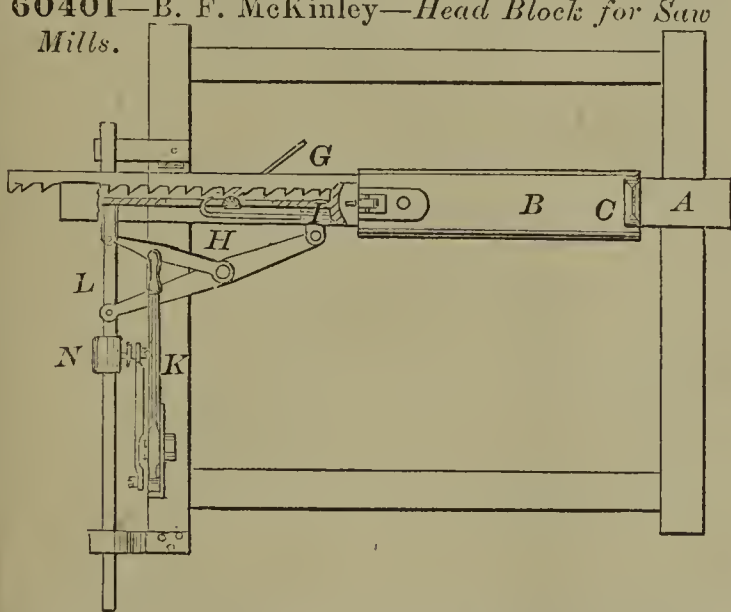

60405—L. H. Miller—*Safe.*

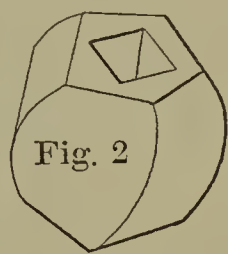

60403—Mears & Yale—*Knuckle Joint.*

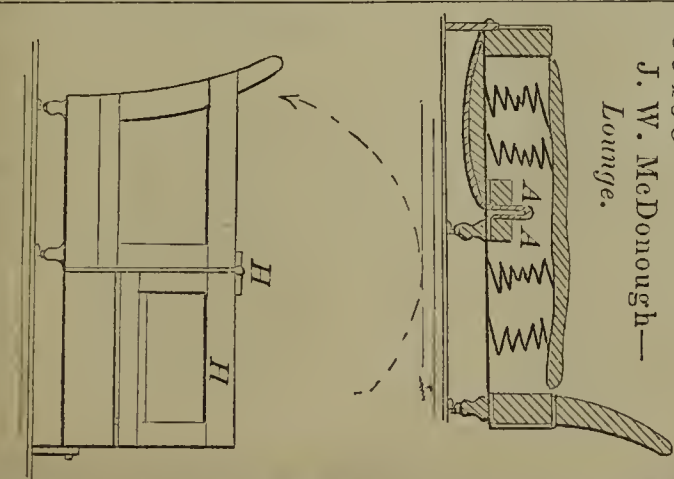

60400—  
J. W. McDonough—  
*Lounge.*

60406—  
C. A. Moore—  
*Tag.*

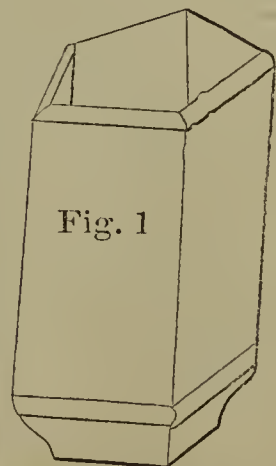

60410—L. L. Newman—Washing Machine.

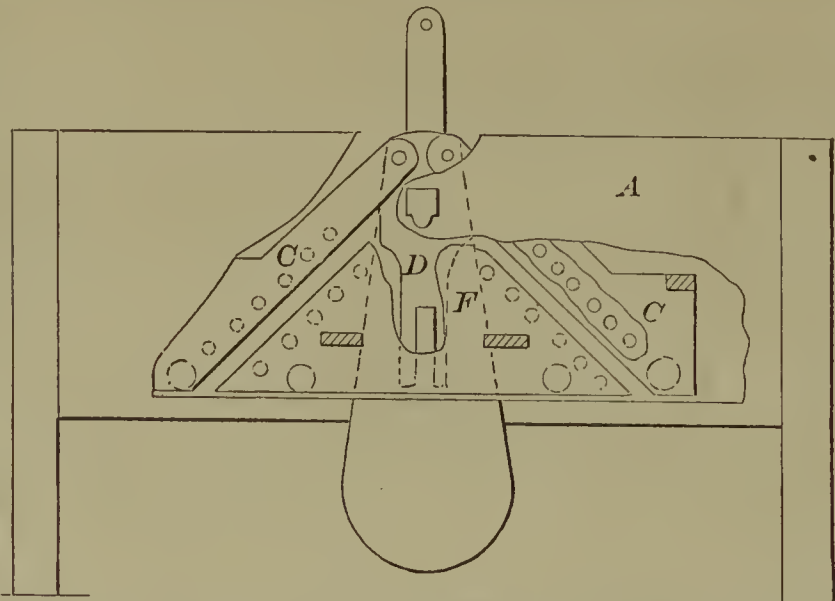

60411—R. J. Nunn—Pin for Weaving Apparel.



60407—J. D. Moore—Tutting Shuttle Winder.

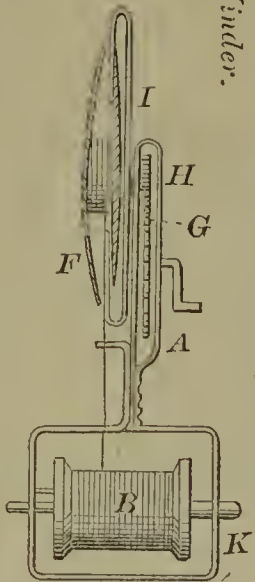

60408—H. G. Nelson—Water Wheel.

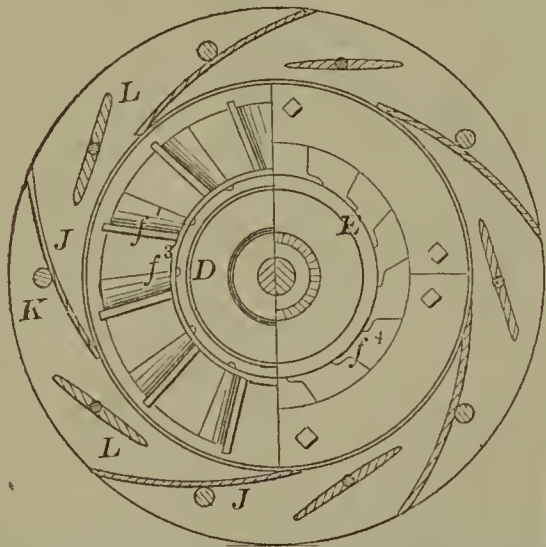
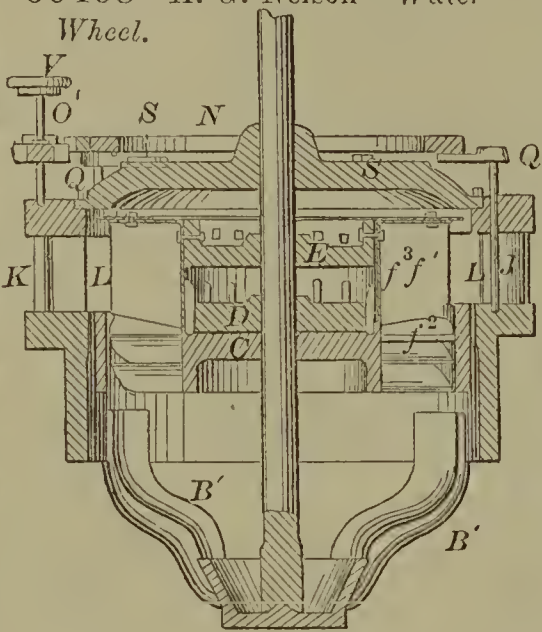

60414—V. Palmer—Churn.

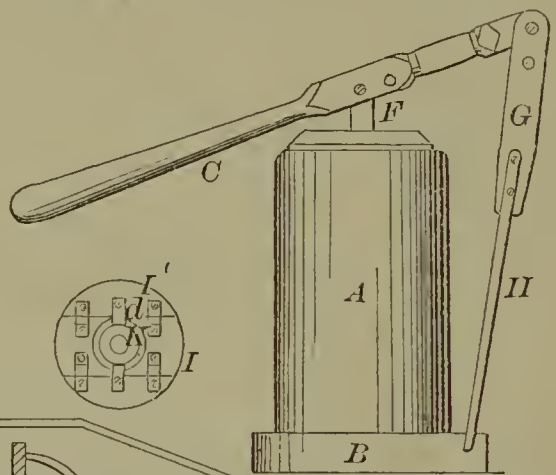

60413—J. L. Ordner—Dumping Wagon.

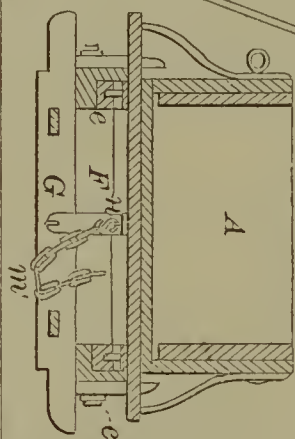

60412—S. Oppenheimer—Draught Regulator for Stoves.

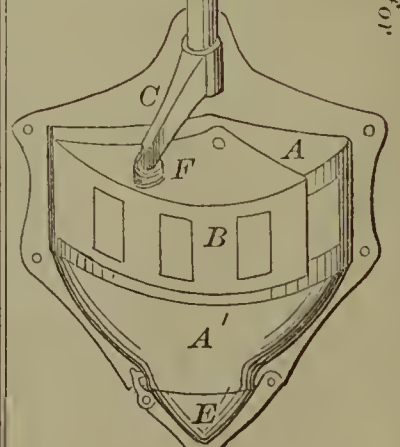
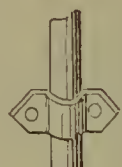
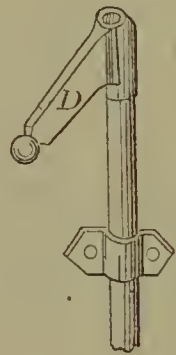

60415—E. H. Peck—Farm Gate.



60409—W. C. Newkirk—Oil Can.

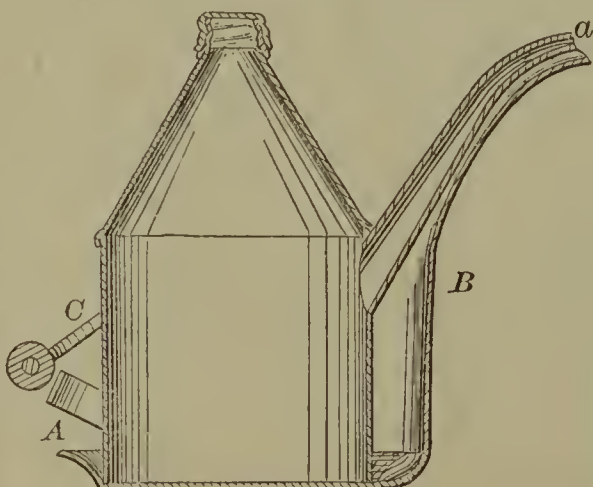

60416—Perkins & House—Lamp

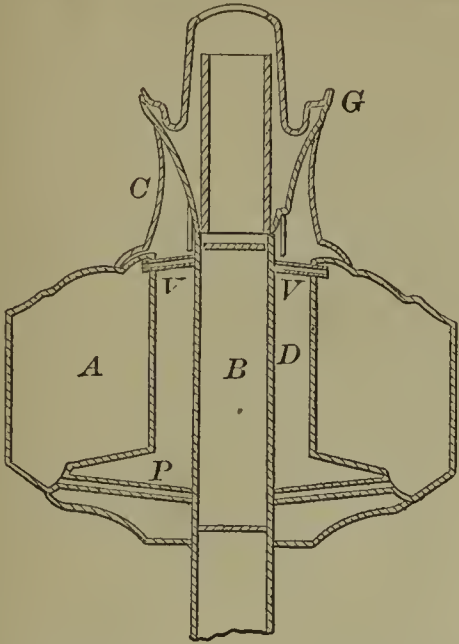

60417—B. Pickering—For Charging Air with Gasoline.

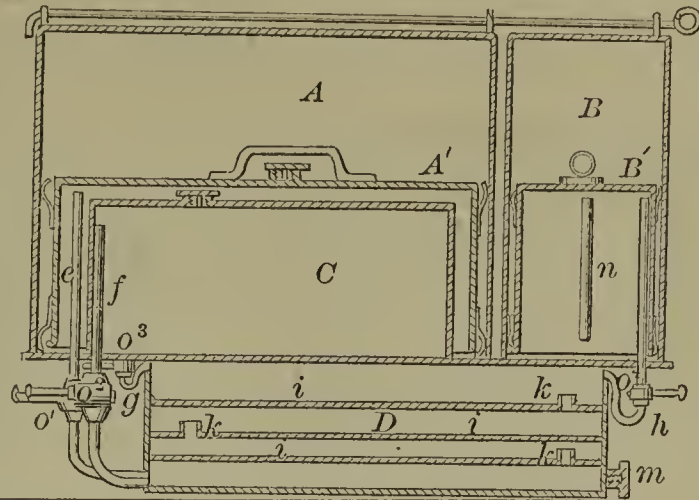

60419—M. Pratt—Stove Boiler.

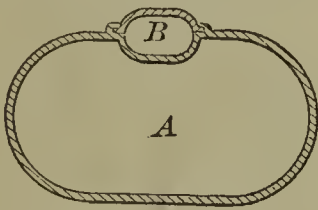

60418—F. A. Pratt—Sewing Machine.

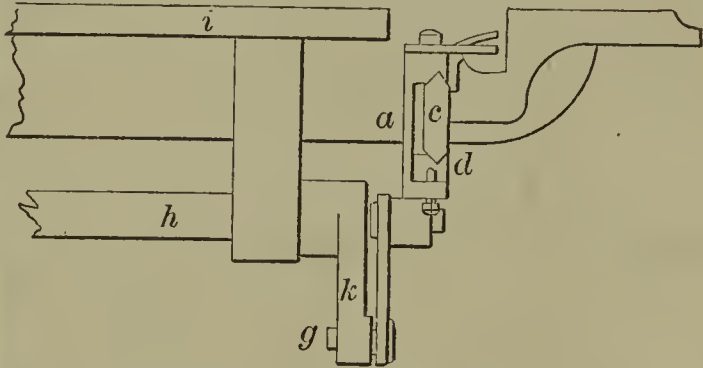

60423—J. P. Riley—Hydrant.

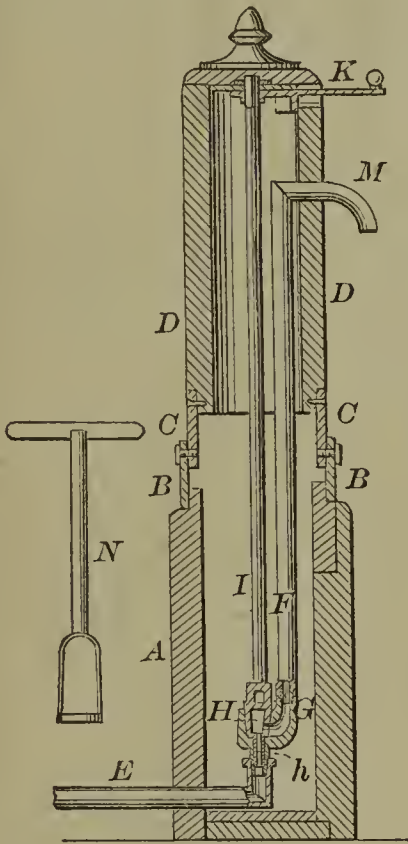

60422—B. S. Rich—Cultivator.

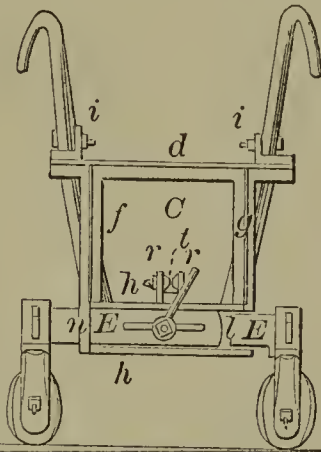
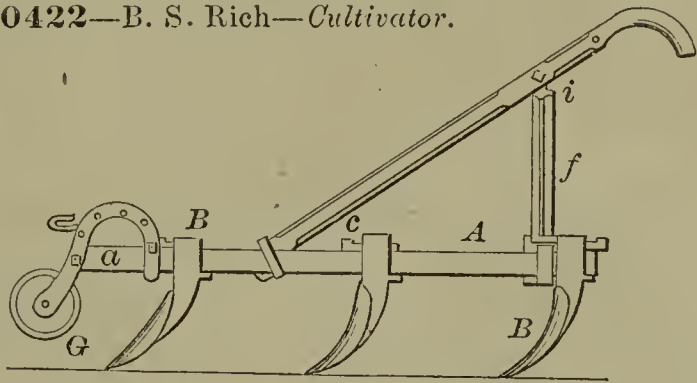

60421—E. W. Quiney—Dice Box.

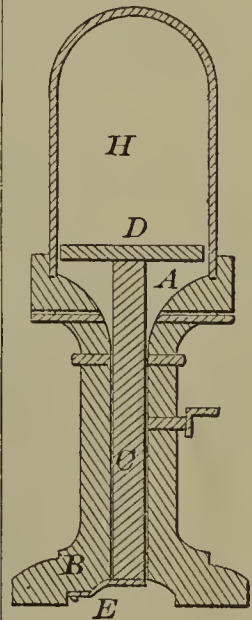

60424—D. T. Robinson—Bottle Stopper.

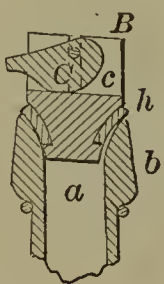

60425—F. O. Rogers—Constructing Buildings.

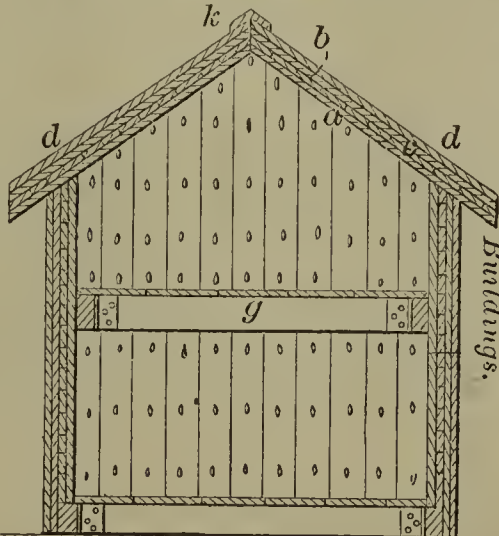

60426—L. Ross—Curtain Fixture.

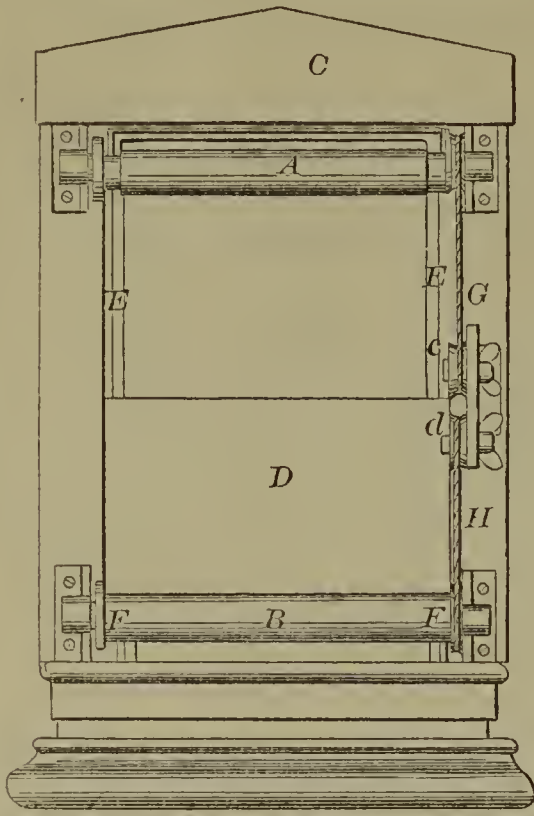

60427—N. Rowe—Harvester.

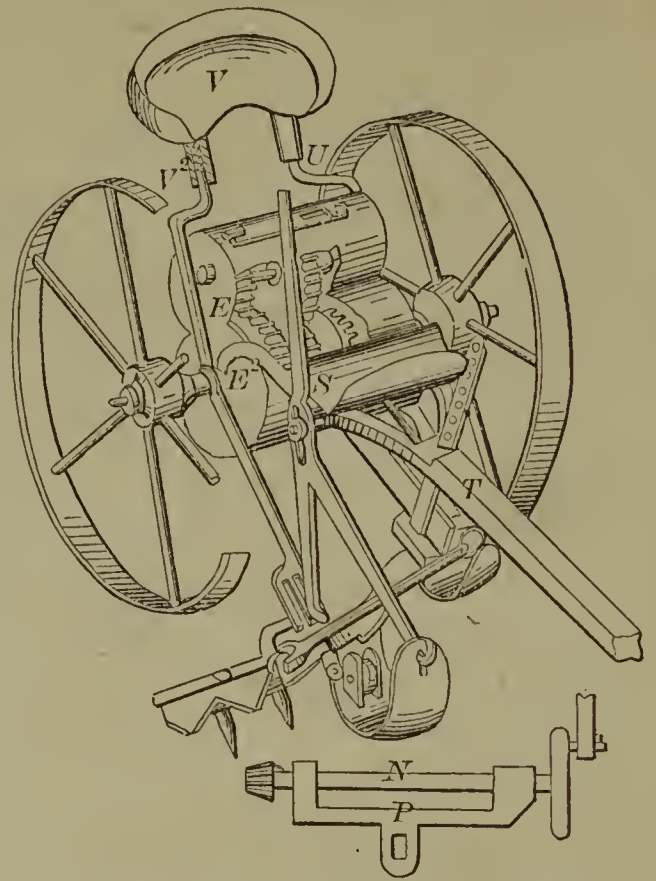

60428—C. D. Rutherford—Corset.

60429—S. Sargent—Oil Can.

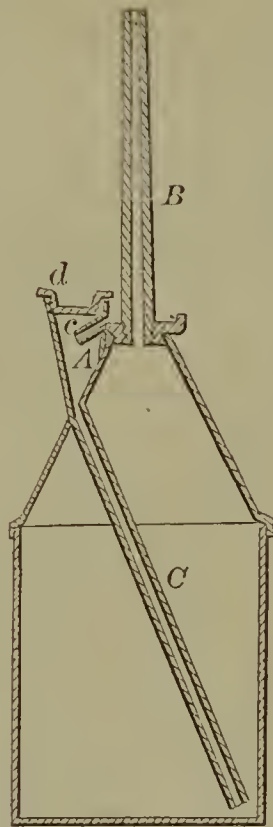

60430—J. G. Schmidt—For Cutting Bungs for Barrels.

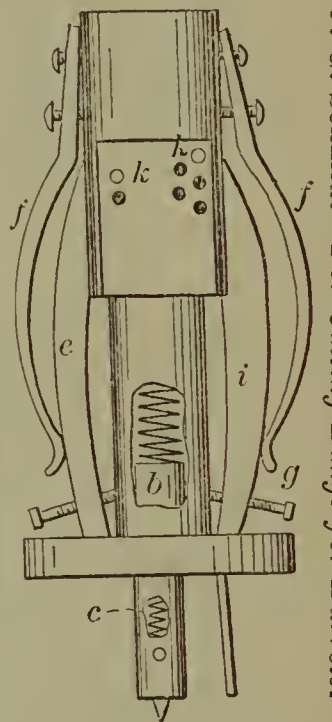

60432—T. P. Shaffner—Magnet for Telegraph.

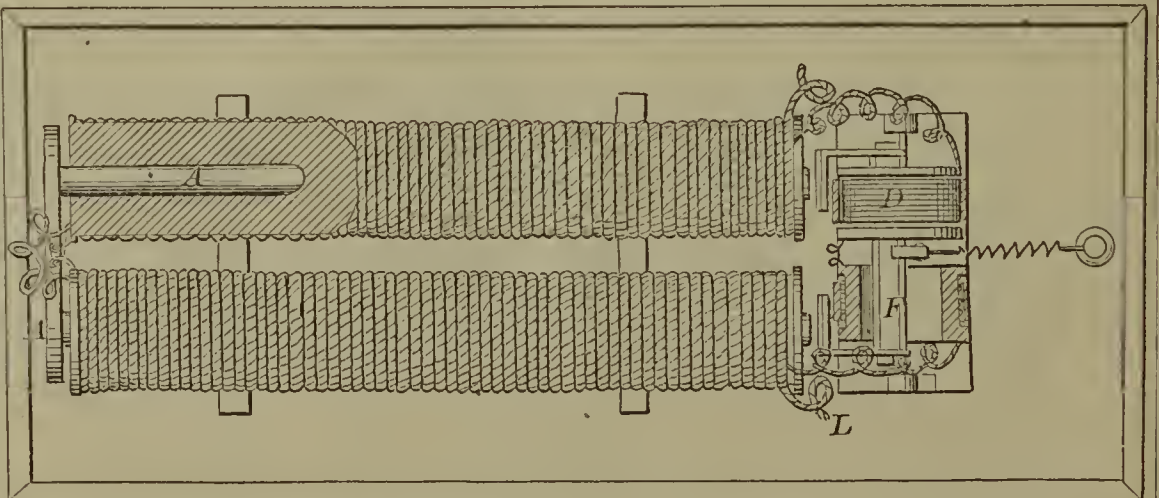

60431—Scott & Smith—Shate.

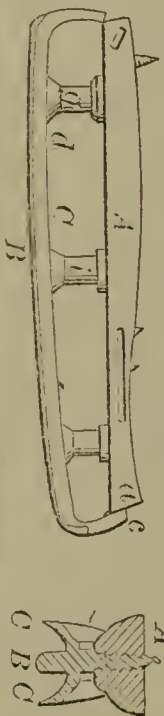



60433—I. M. Singer—Sewing Machine.

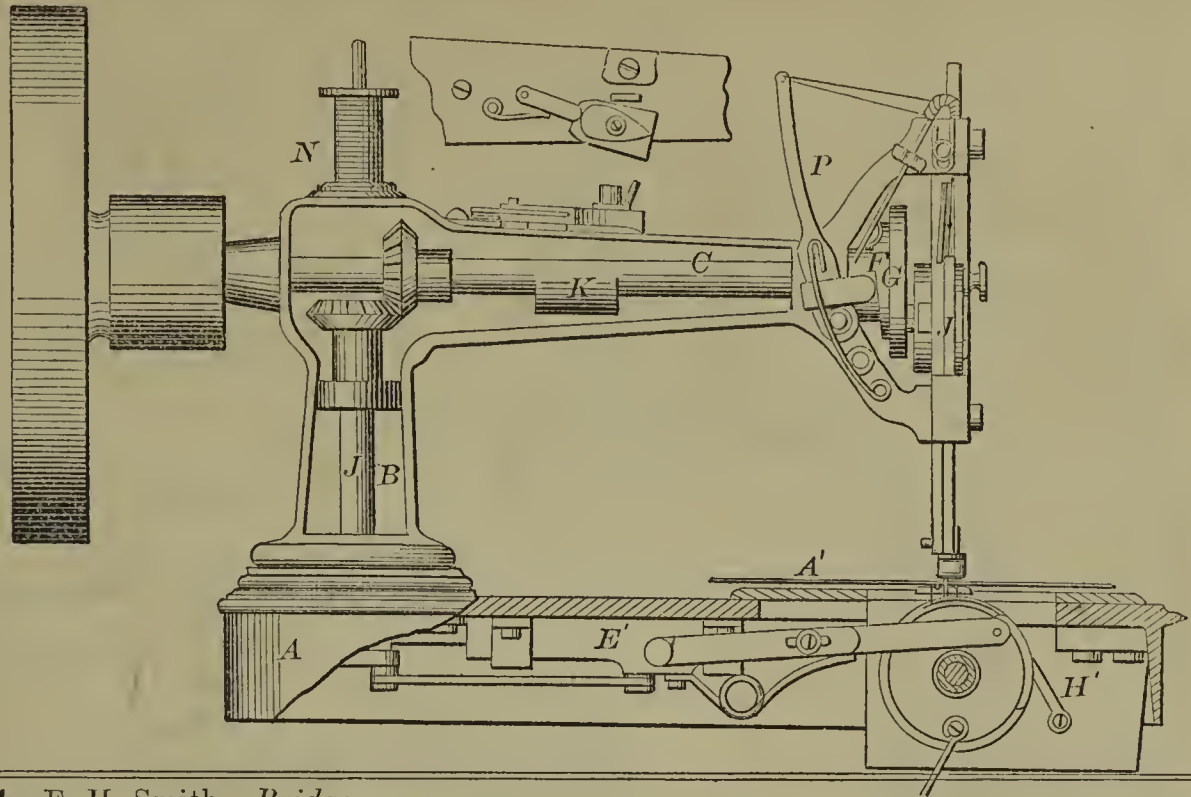

60434—F. H. Smith—Bridge.

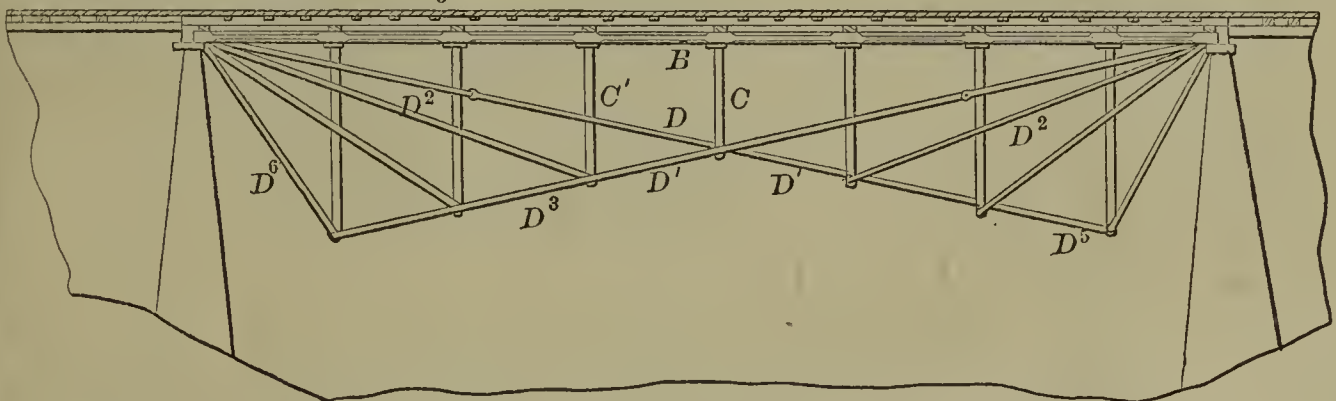

60435—S. Spoor—Gate.

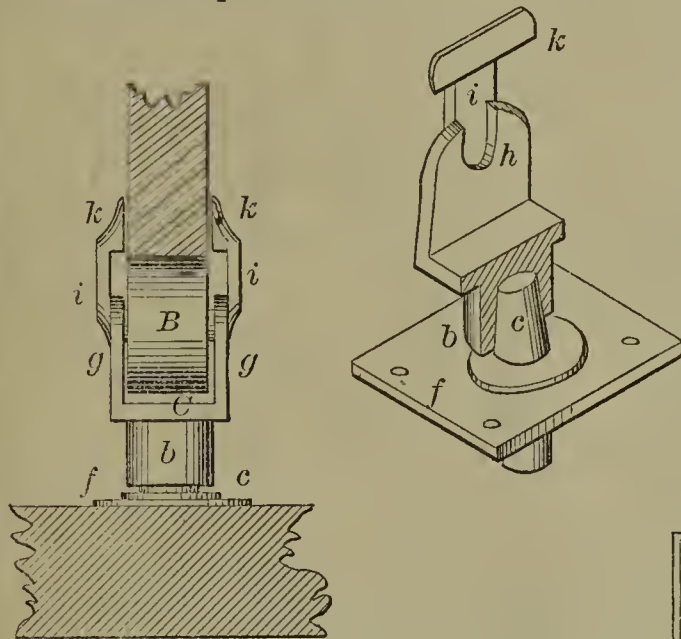

60436—Stadermann & Sauerbier—Breast Protector.

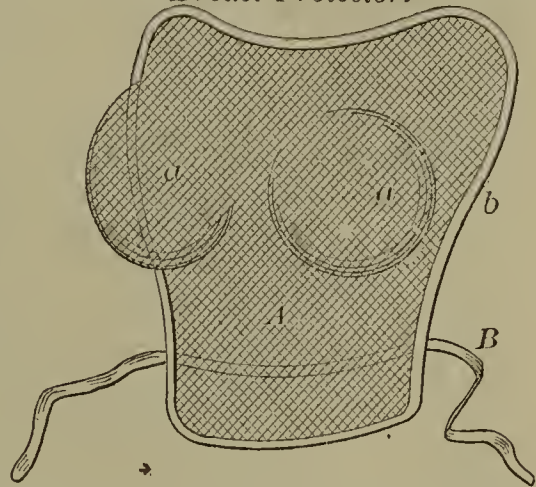

60437—H. H. Stuart—Gas and Liquid Meter.

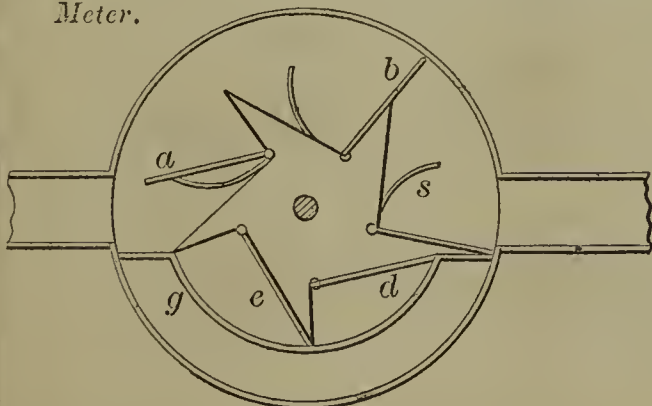

60438—Thomas & Rhoades—Cheese Press.

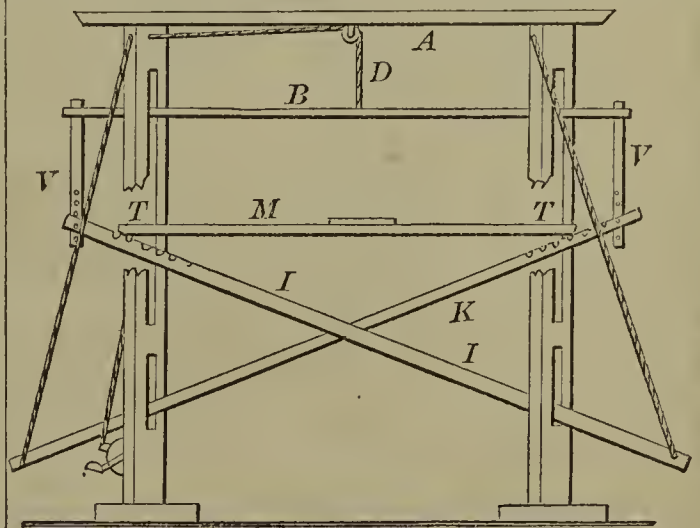



60439—A. Todd, Jr.—Stamp for Marking Sheep.

60441—O. Tufts—Elevator.

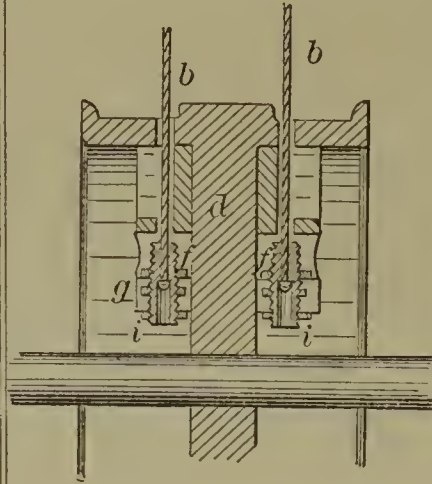

60442—O. Tufts—Elevator.

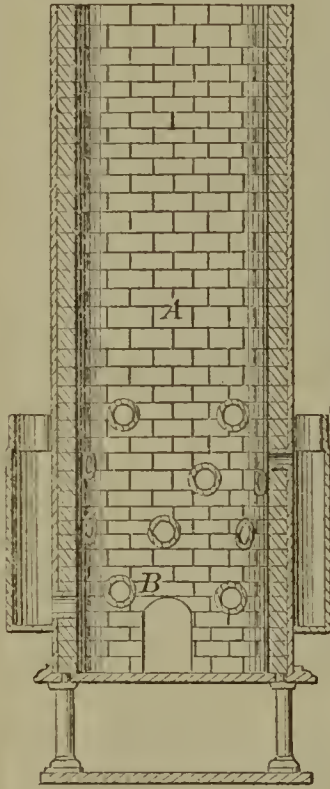
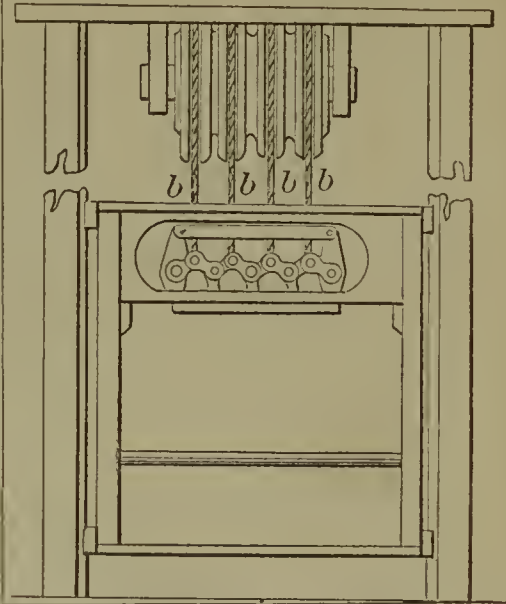

60440—C. Truesdale—Cupola Furnace.

60444—O. Tufts—For Oiling Bodies Rotating around Shafts.

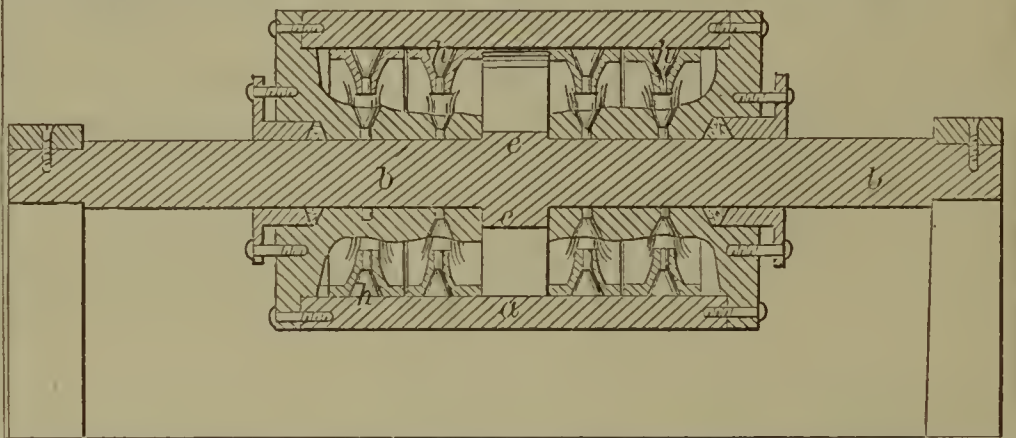

60445—P. H. V. Weyde—Percolator and Filtering Machine.

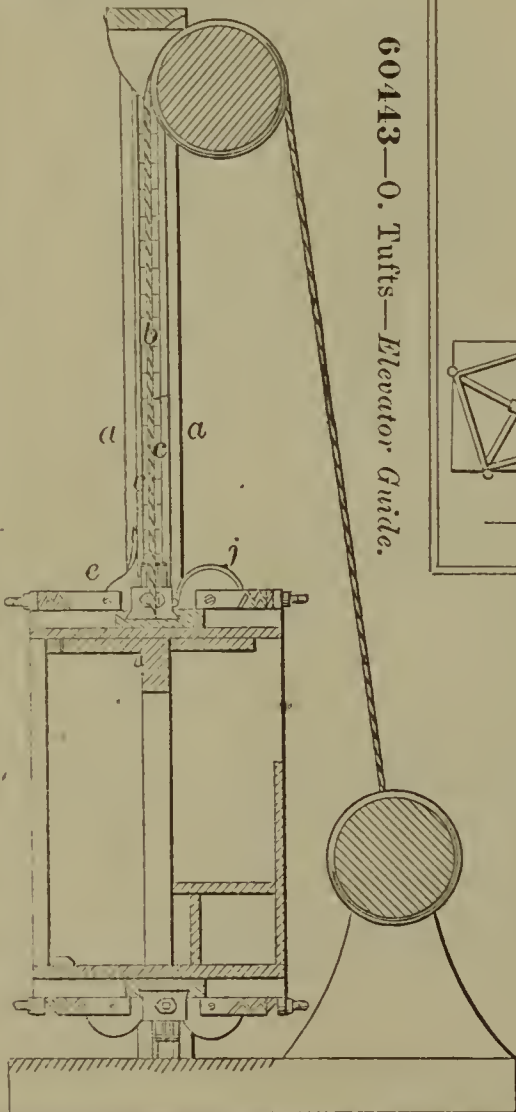
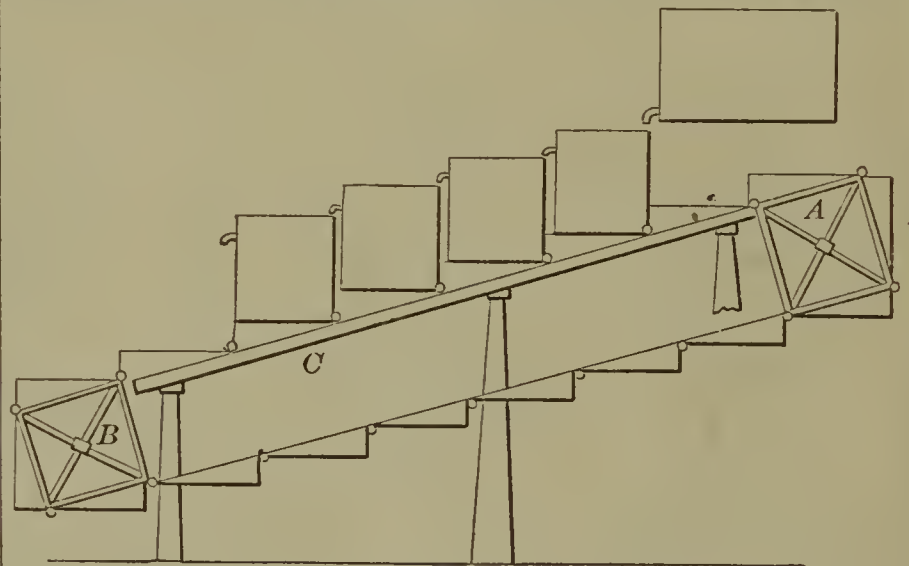

60443—O. Tufts—Elevator Guide.

60446—G. W. Walker—Cooking Stove.

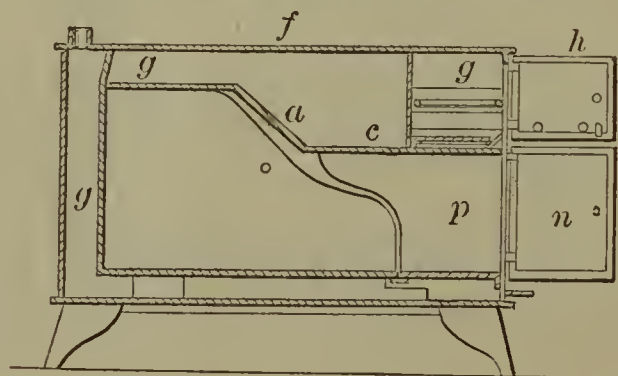

60447—J. C. Walkinshaw—*Corn Planter.*

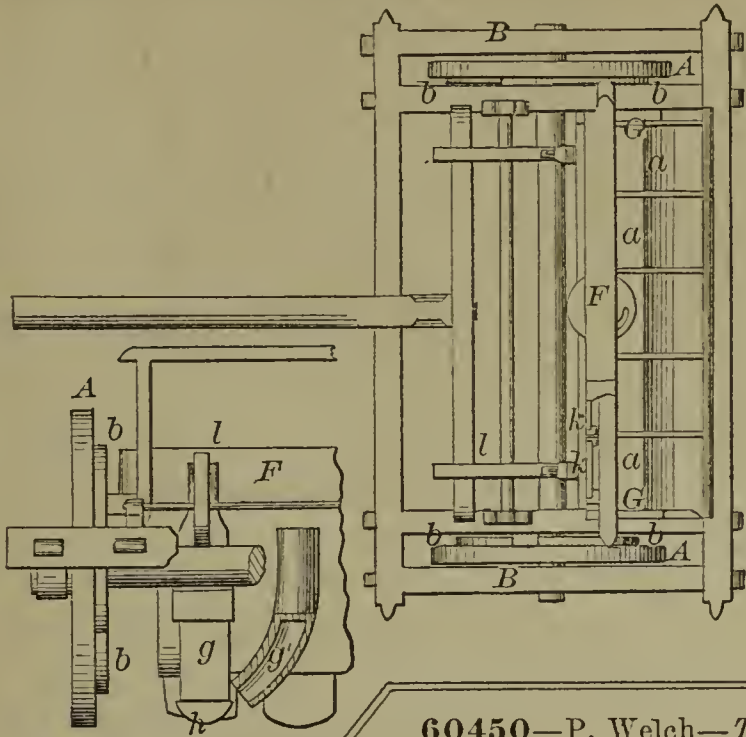

60449—W. T. Watson—*Cultivator.*

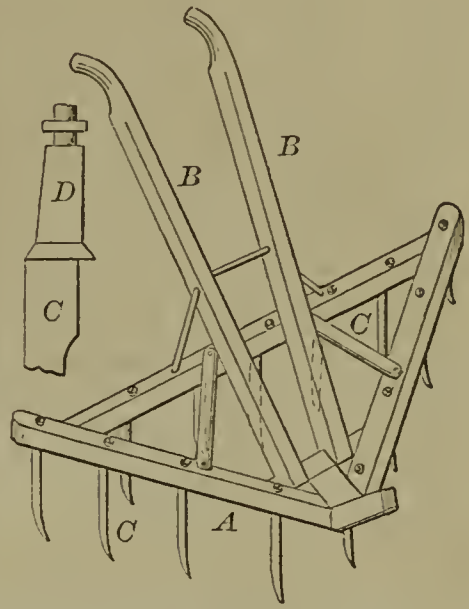

60450—P. Welch—*Type Dressing Machine.*

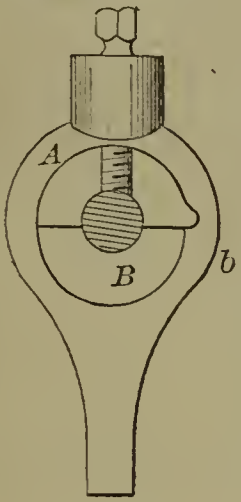
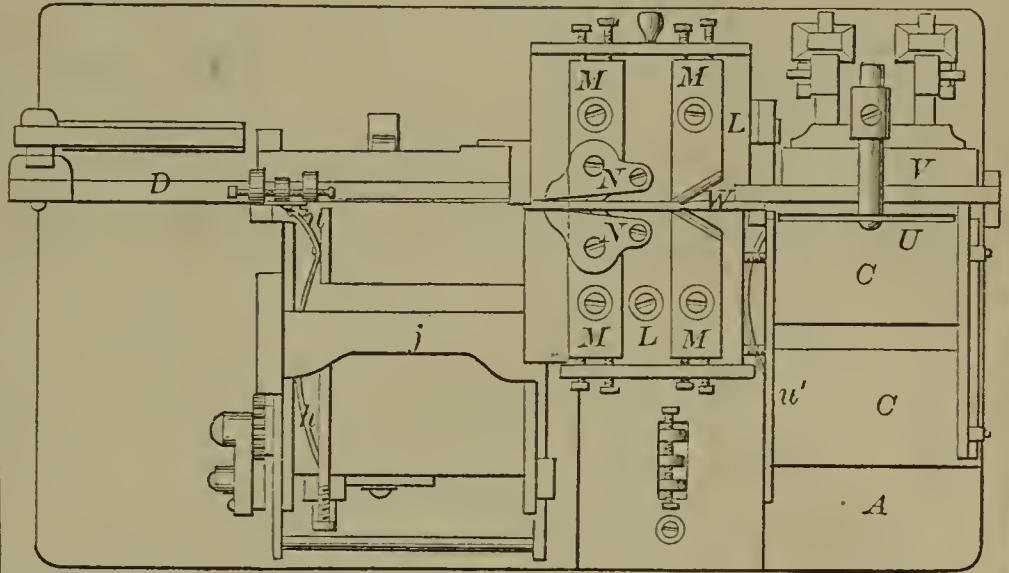

60451—L. P. Wilcox—*Lathe Dog.*

60453—J. Wilson—*Stove Pipe.*

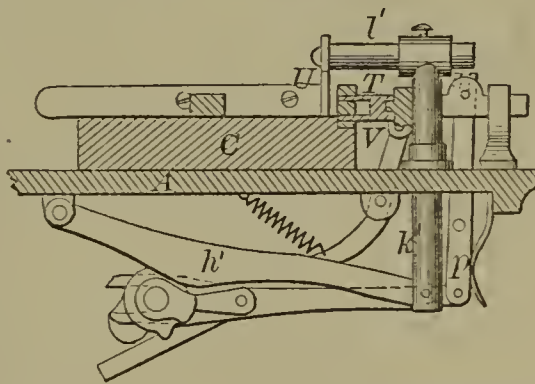
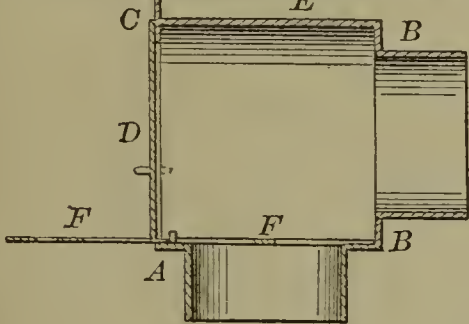

60448—G. & Z. Walsh—*Traveling Bag Frame.*

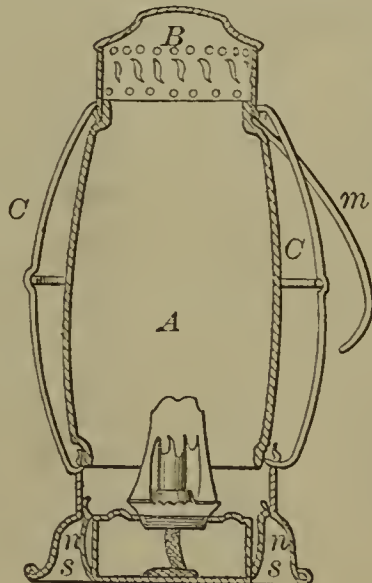

60452—S. R. Wilmot—*Lantern.*

60454—J. E. Wooten—*Padlock.*

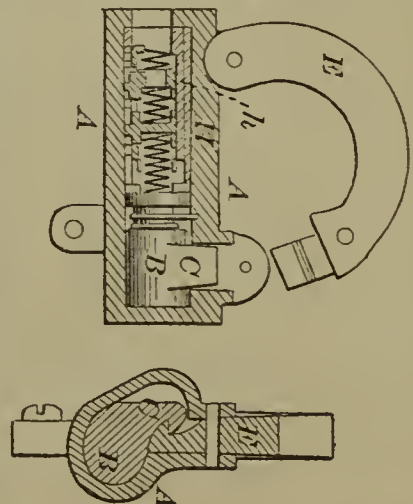

60457—J. S. Allums—Cotton or Hay Press.

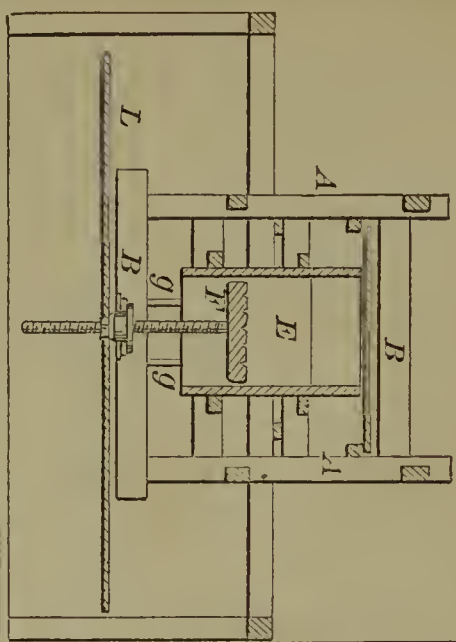

60456—T. Zinek—Tension for Sewing Machines, &c.

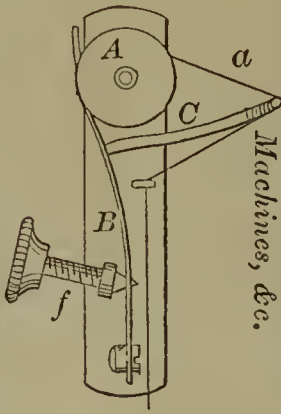

60455—Youmans & Reed—Hydro-Carbon Burner for Heating.

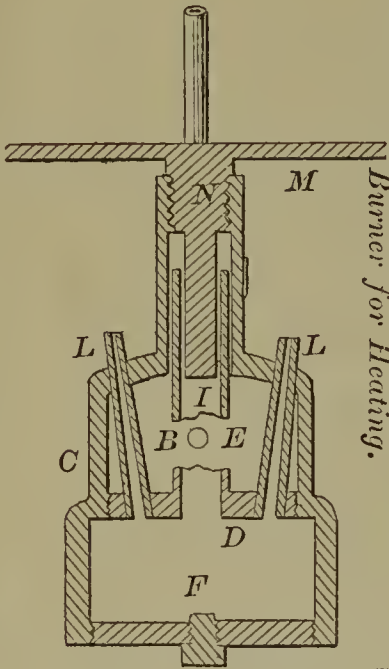

60459—W. C. Baker—Steam Generator.

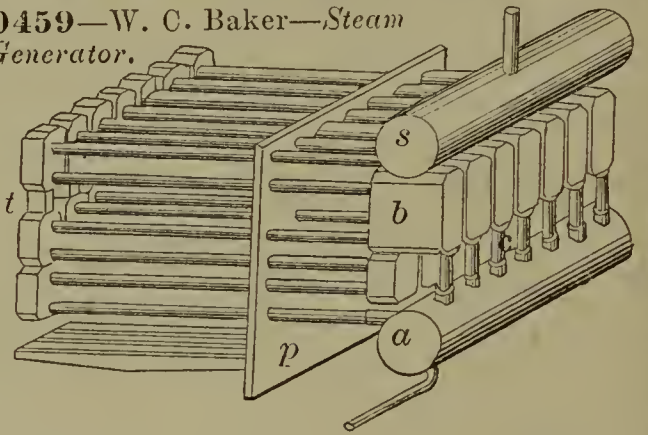

60460—E. P. Barrabi—For Hulling Wheat.

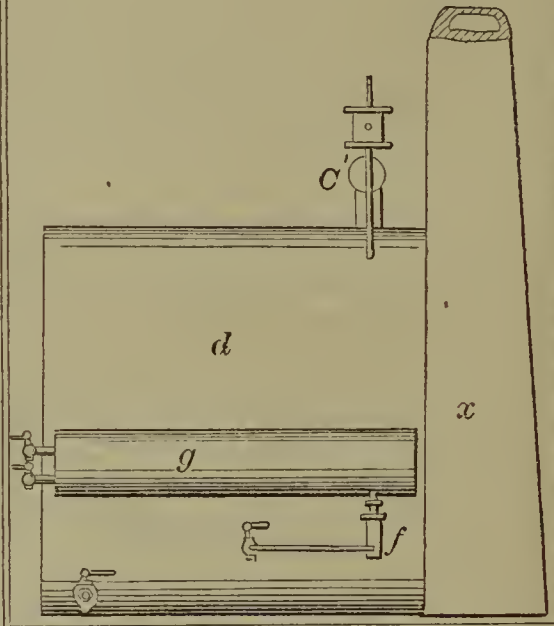
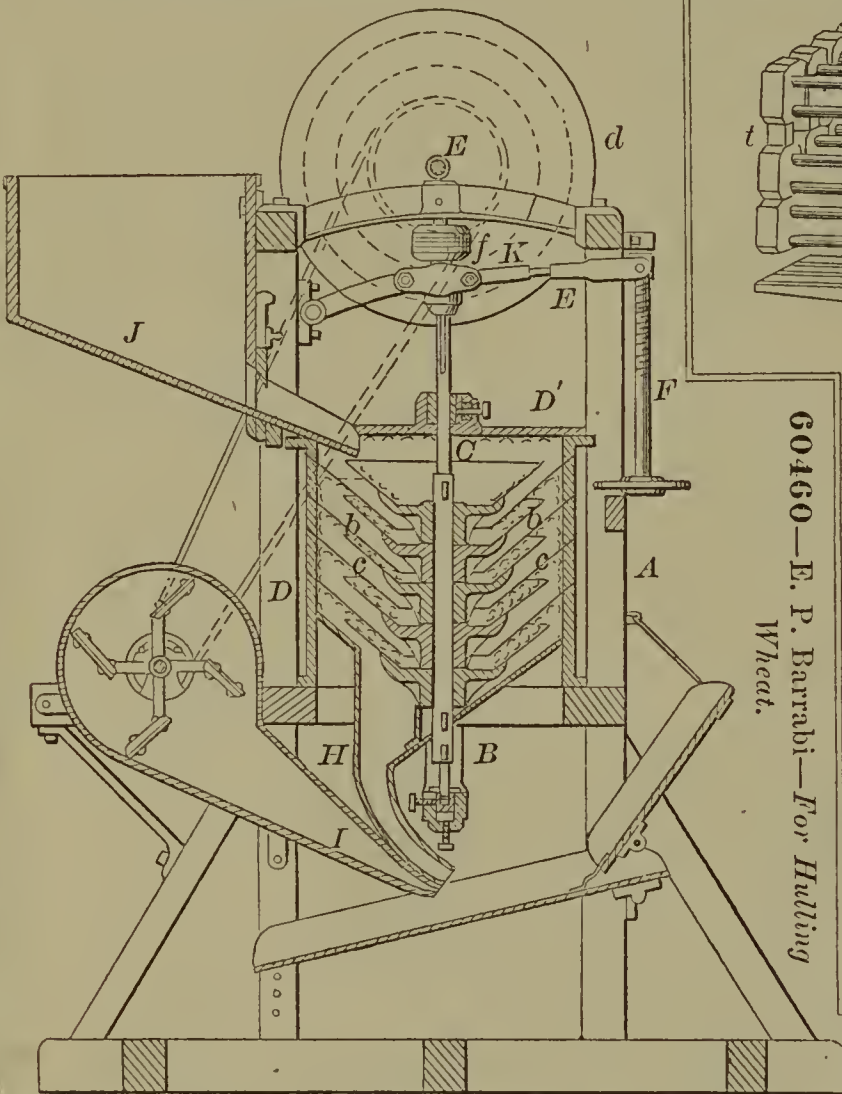

60458—L. & I. Andrews—Blacksmith's Forging Apparatus.

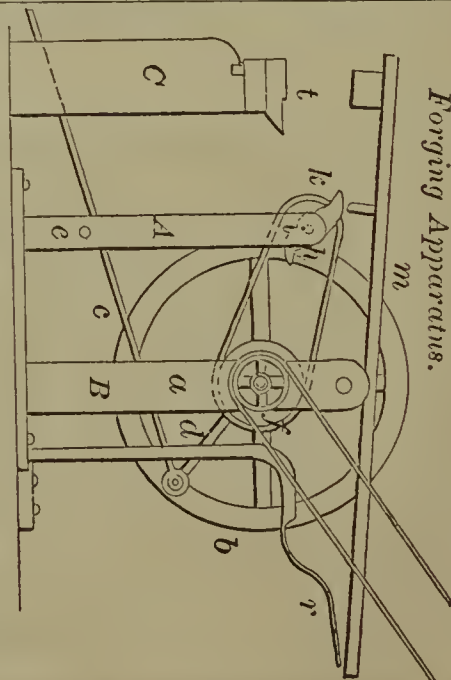

60461—I. W. Bartlett—Plow.

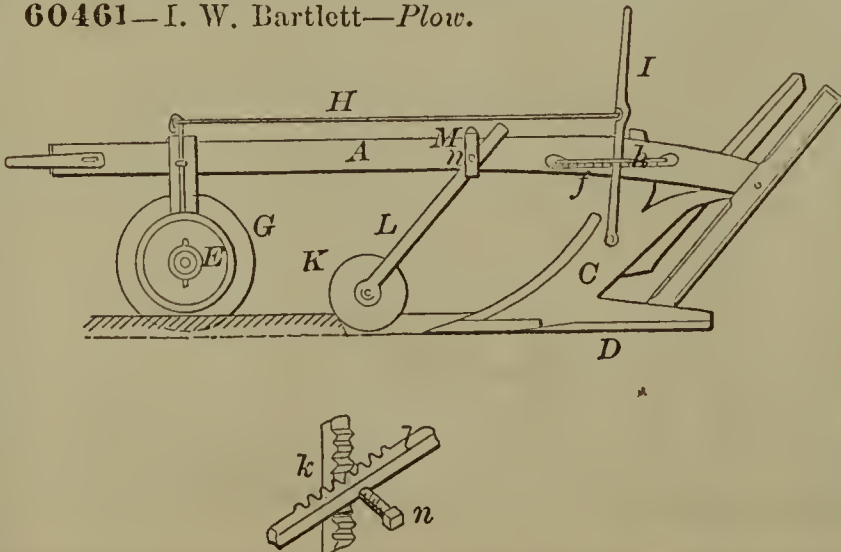

60462—E. S. Bartholomew—  
*Preserving Fruits, Meats, &c.*

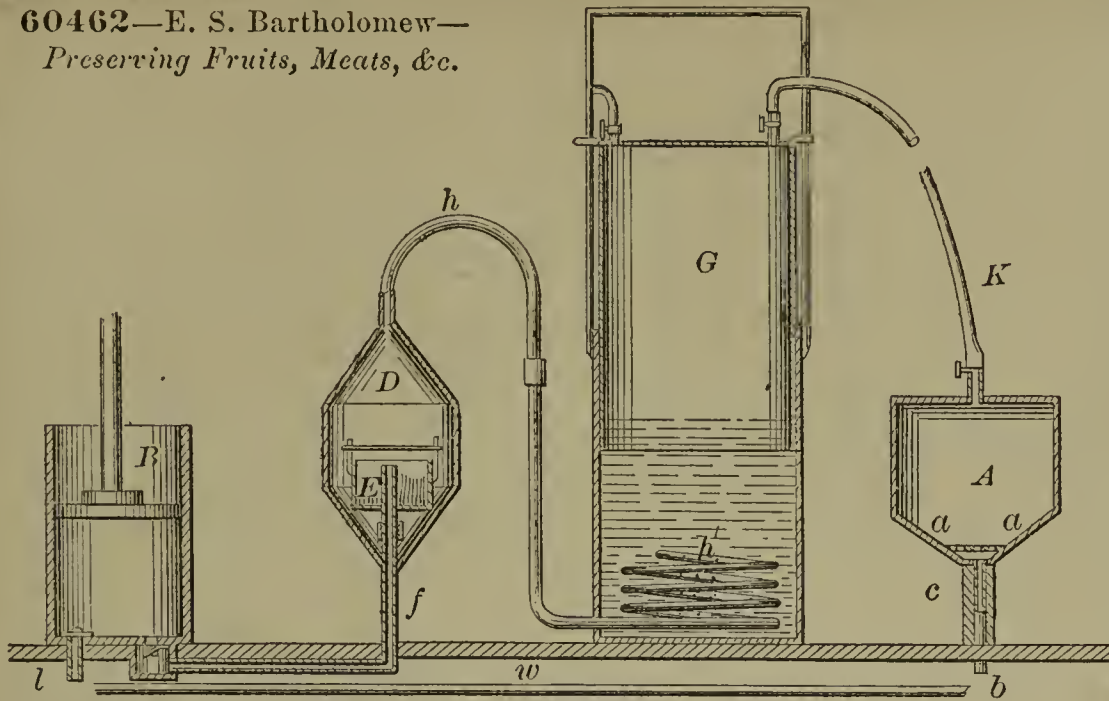

60467—C. O. Blodgett—*Horse Hay Fork.*

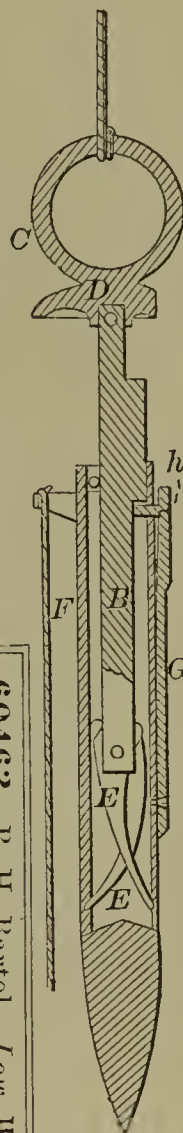

60464—C. L. Bauder—*Invalid Traveling Chair.*

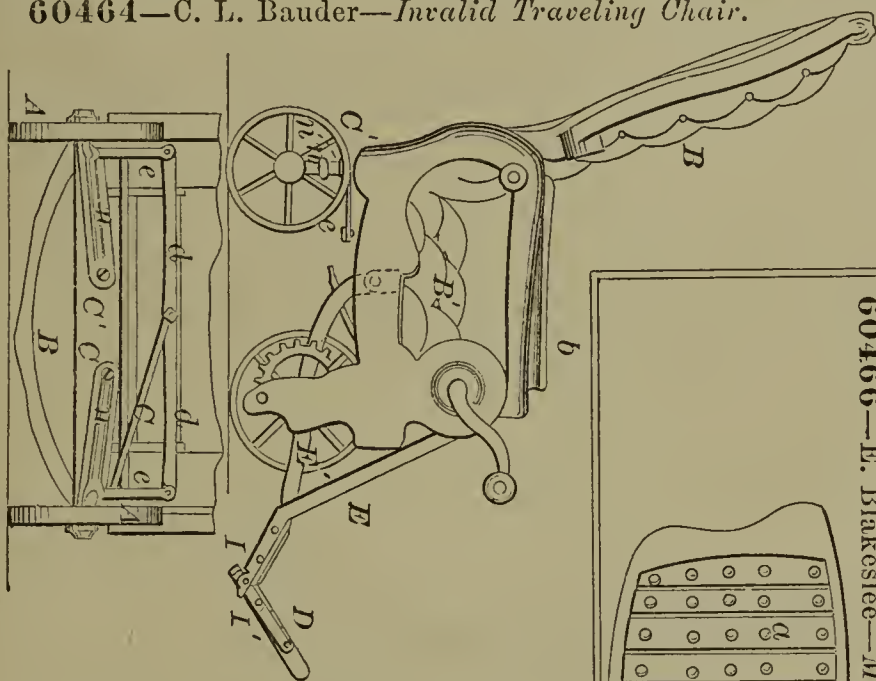

60463—B. H. Bartol—*Low Water Detector.*

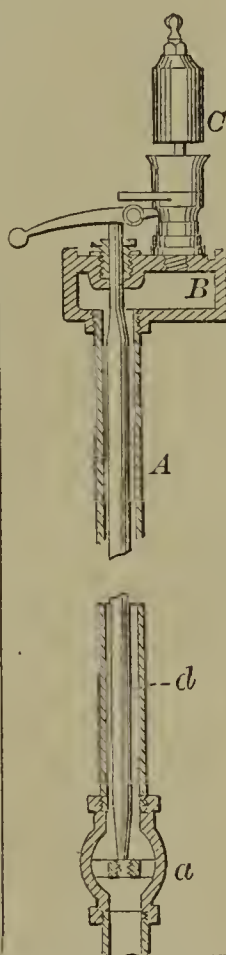

60466—E. Blakeslee—*Metal Plated Sole.*

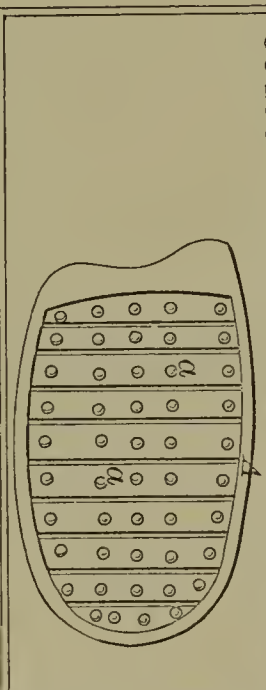

60465—G. & G. T. Benjamin—  
*Railway Car.*

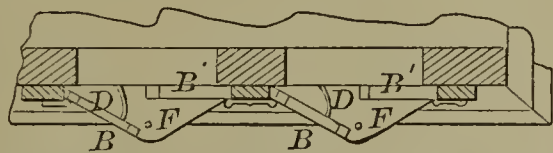

60469—J. H. Bosworth—*Carpet Stretcher.*



60470—R. C. Bristol—*Water and Steam Separator for Steam Generators.*

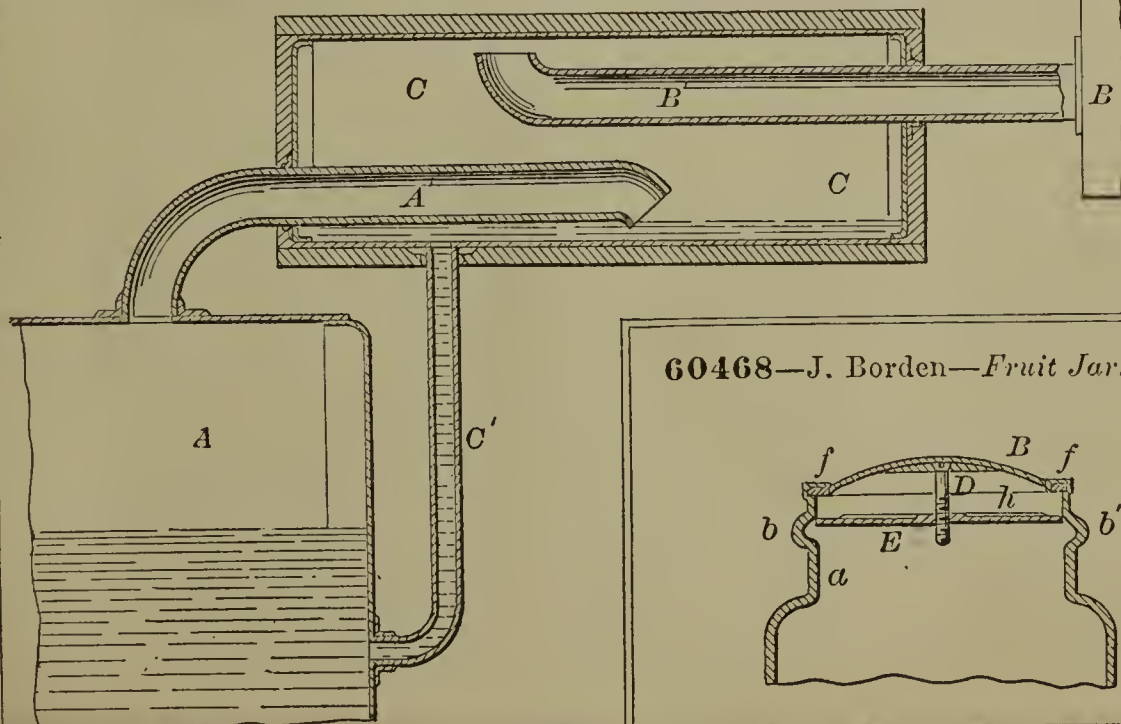

60468—J. Borden—*Fruit Jar.*

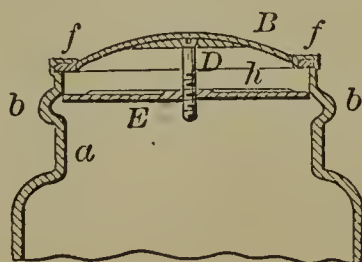

60471—C. W. Cahoon—For Propelling Vessels.

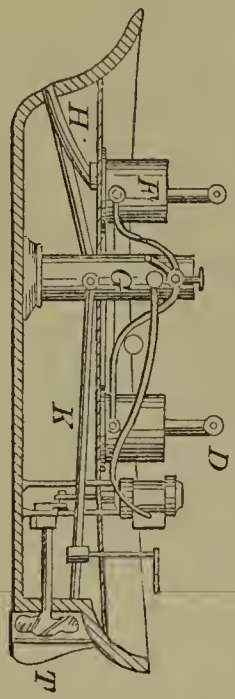

60475—J. H. Chidester—Computing Machine.

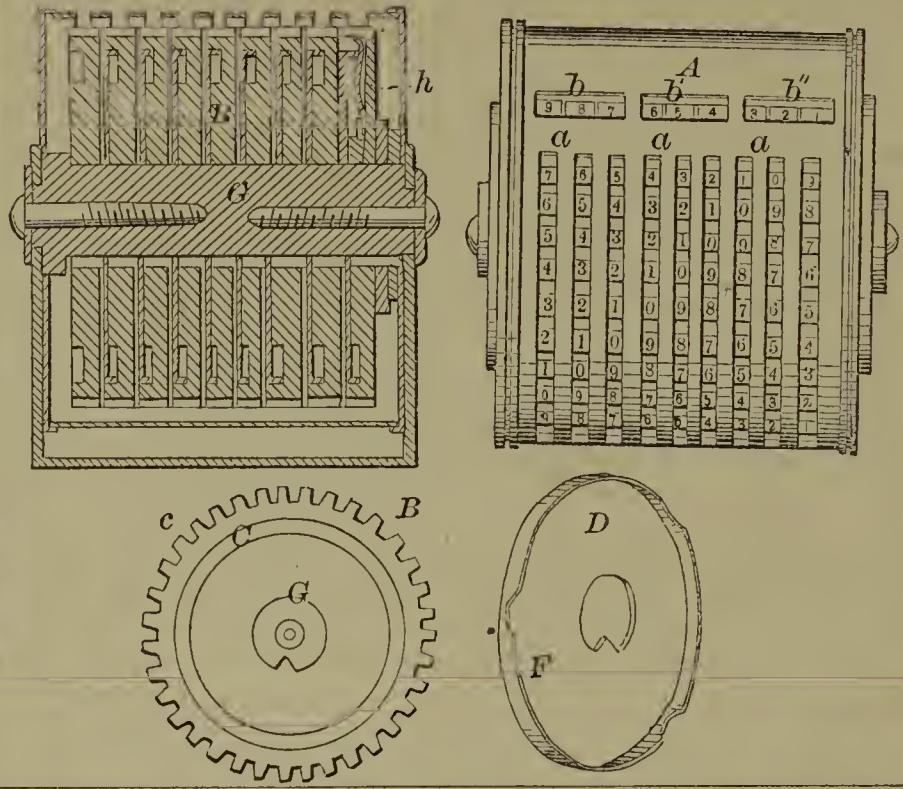

60474—P. Chiek—Air Engine.

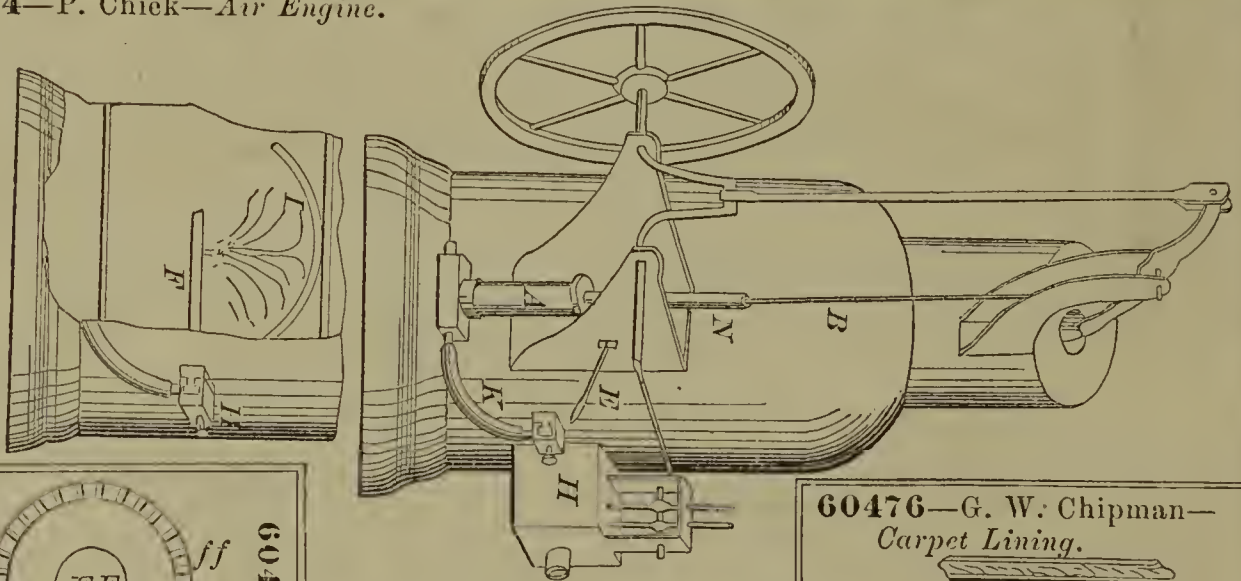

60476—G. W. Chipman—Carpet Lining.

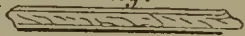

60473—A. Carbow—Churn.

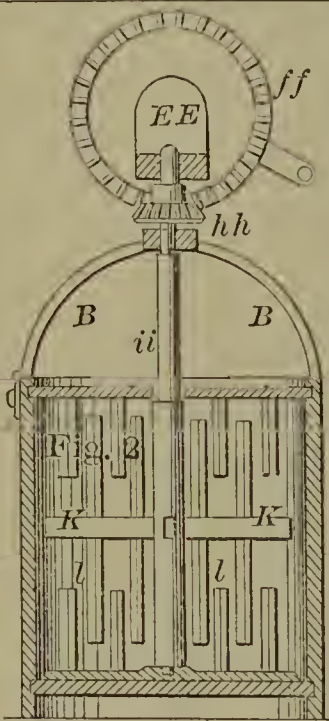

Fig. 4

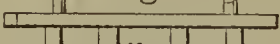
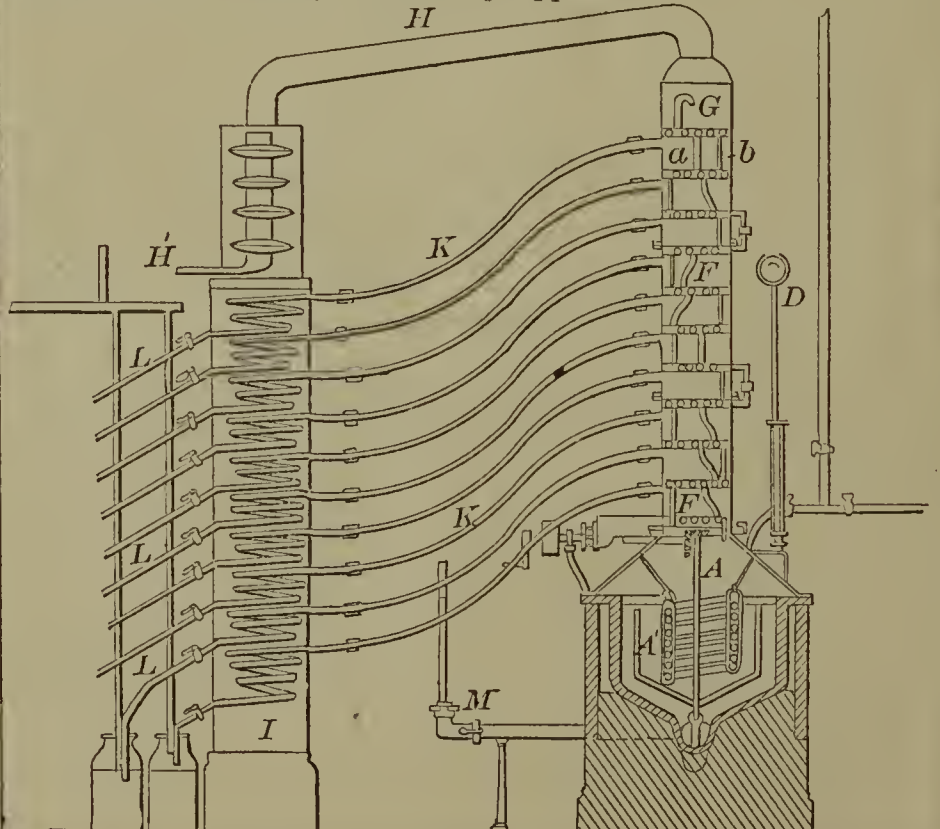

Fig. 3



60477—J. A. Coffey—Distilling Apparatus.



60479—V. & E. Cole—Car Coupling.

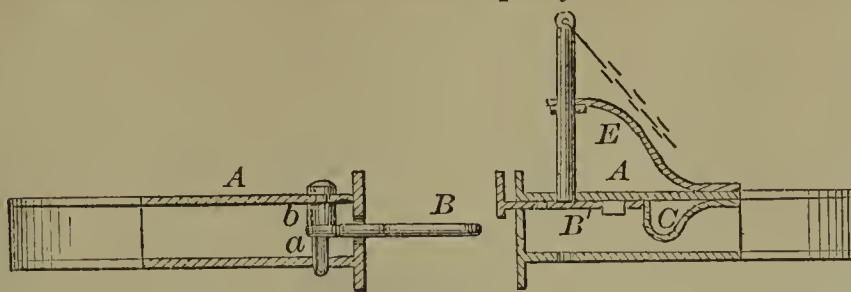

60480—Collins & Grover—Vapor Burning Stove.

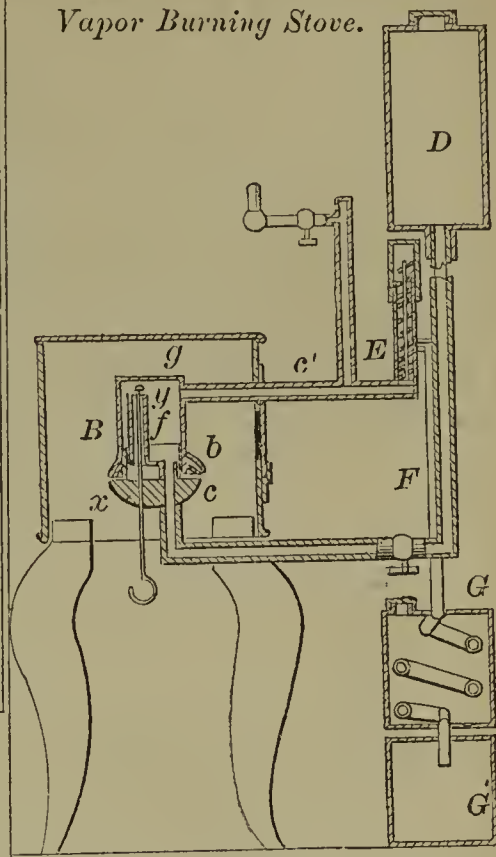

60483—I. Crum—Corn Planter.

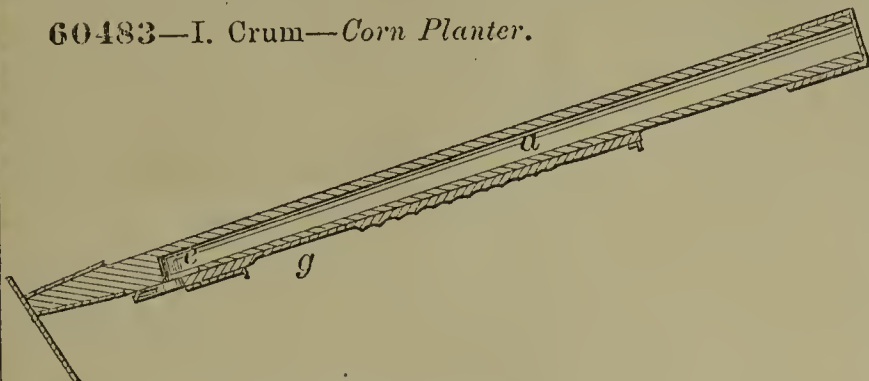

60481—J. M. Connel—Door Spring.

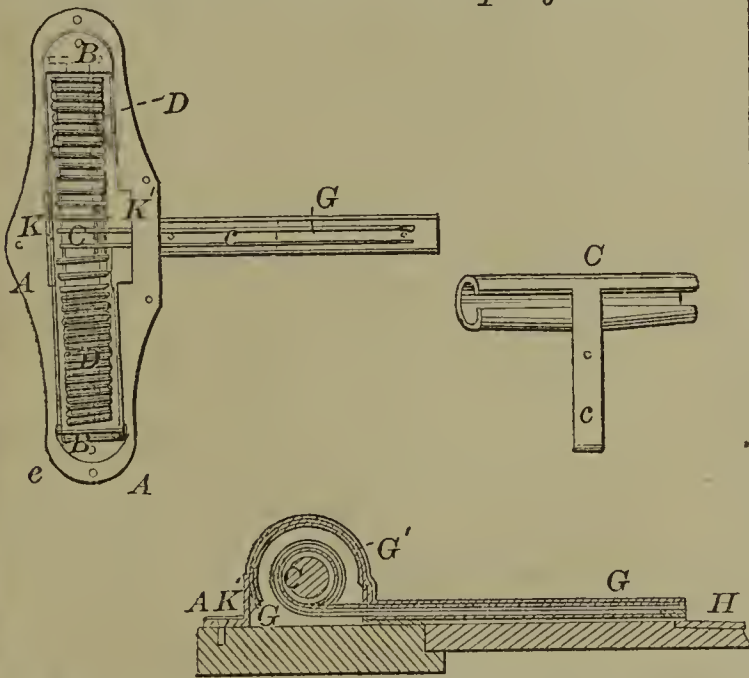

60482—D. T. Crockett—Hammer.

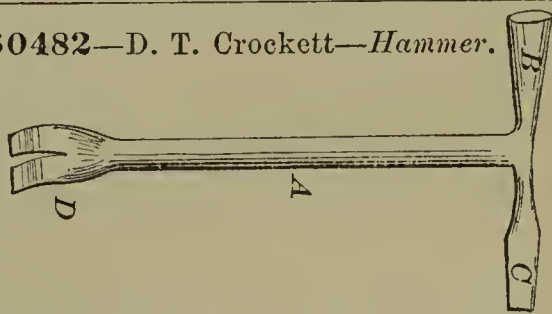

60484—Currier & Wells—For Finishing and Boxing Paper Collars.

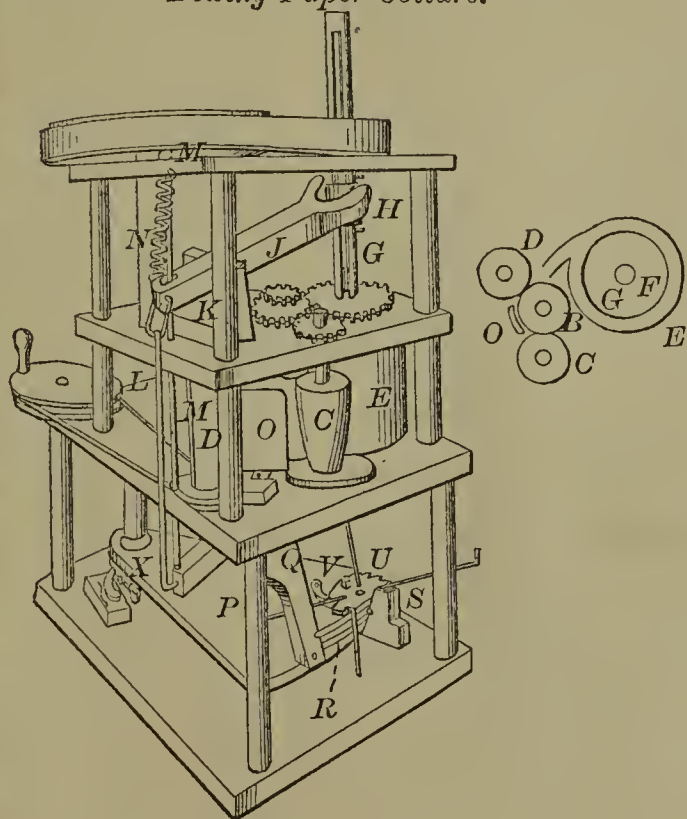

60485—J. Davis—Saw Mill.

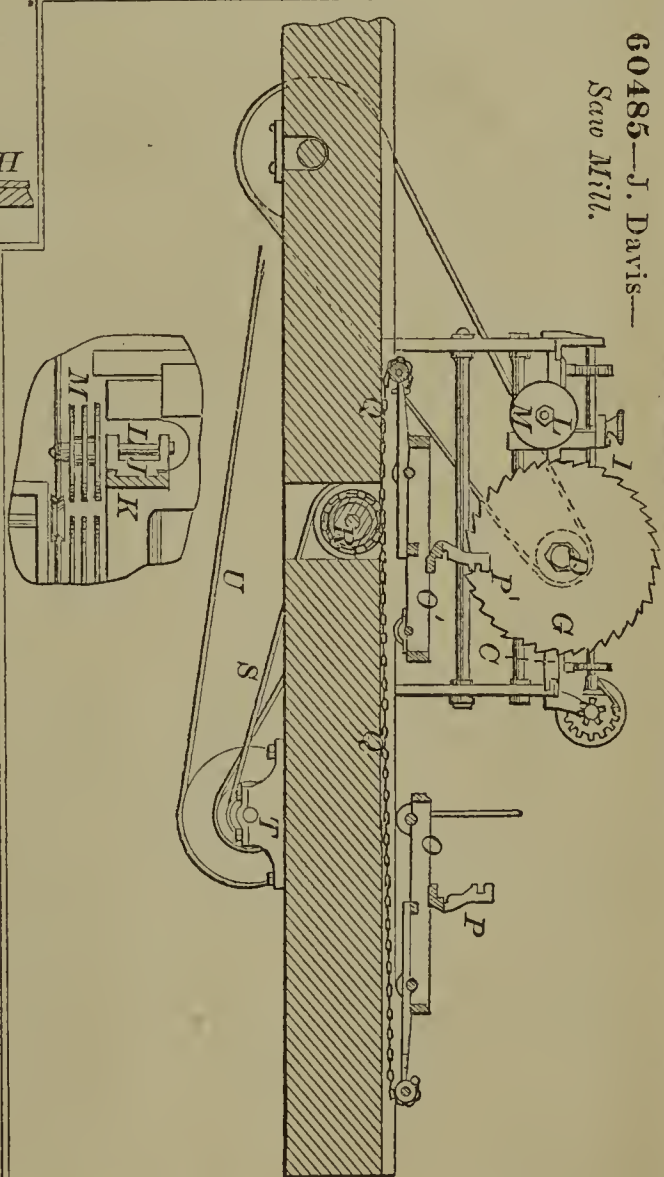

60486—J. Davis—Saw Mill.

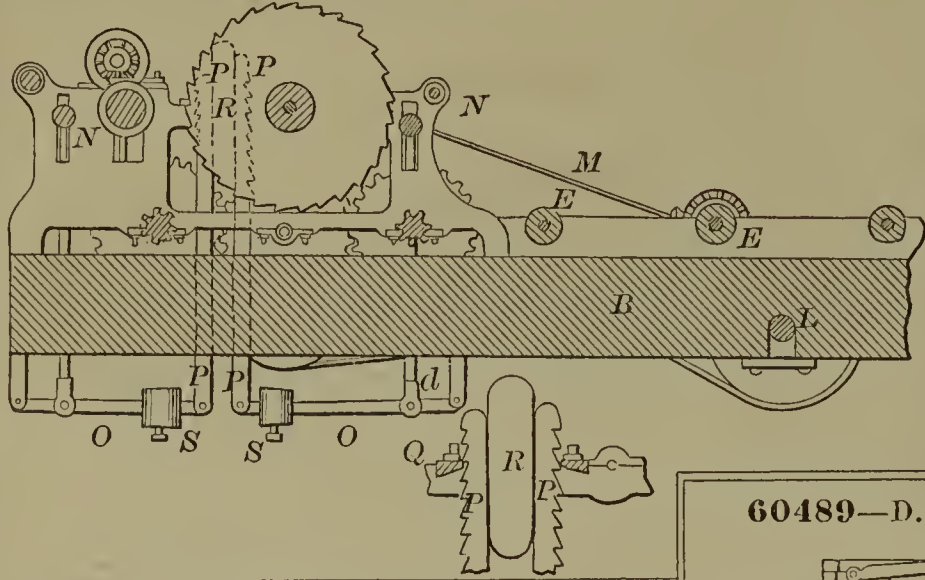

60488—Denison & Furlong—  
Paper Wearing Apparel.



60489—D. Dennett—Dumping Wagon.

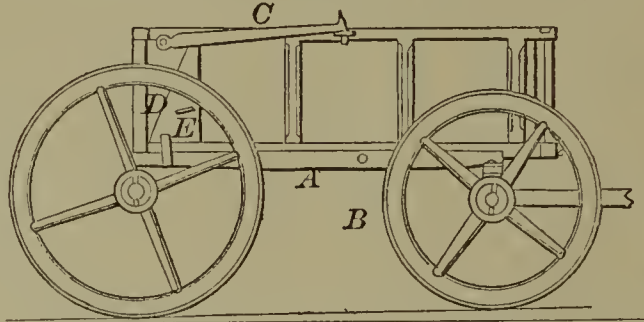

60487—S. T. Denise—Railroad Switch.

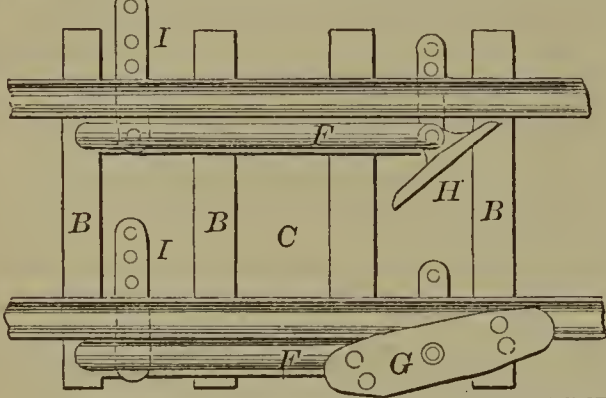

60492—E. P. Eastwick—Bone Black  
Kiln.

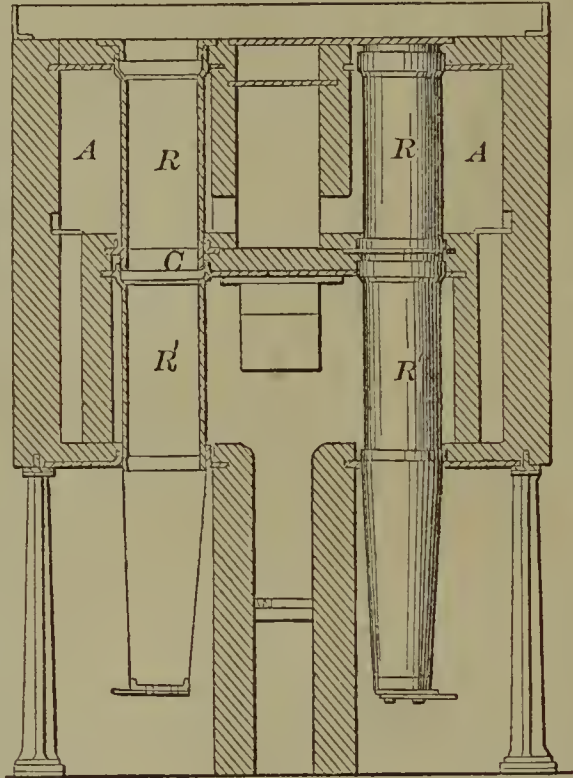

60493—S. S. Elder—Churn, Beer Cooler, &c.

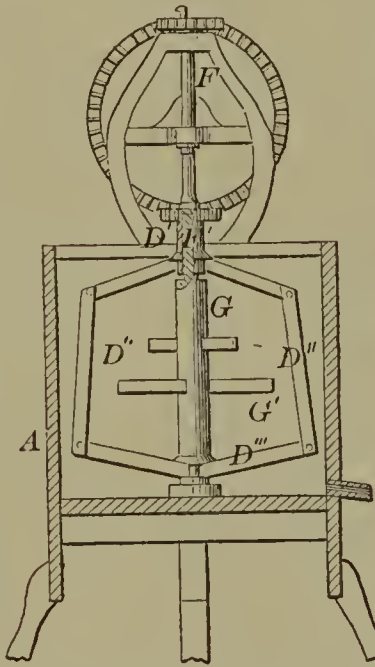

60491—J. J. Detwiler—Igniting Illuminating Signals.

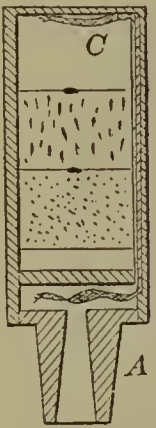
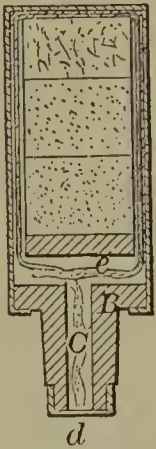
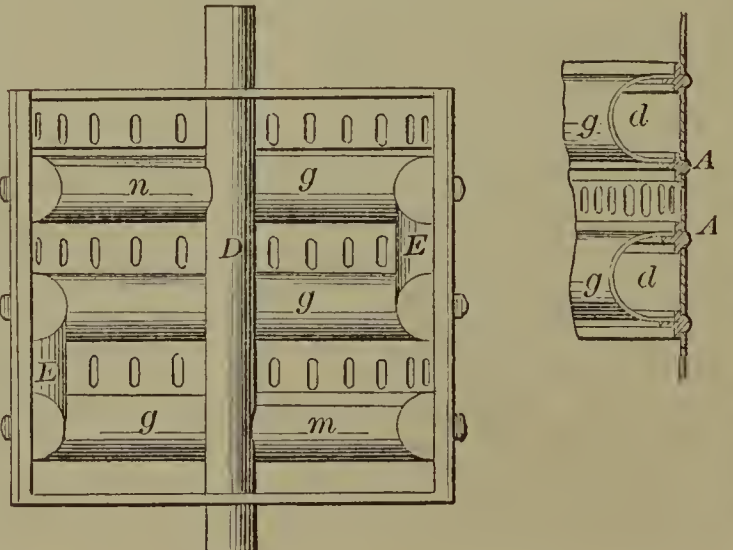

Fig. 12



60490—E. Detwiler—Radiator for Stove Pipes.



60495—B. M. Esterle—  
Wagon Wheel.

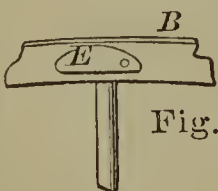
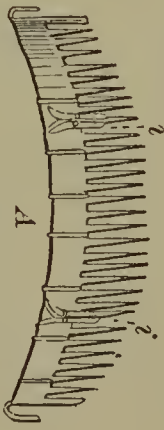

Fig. 3

60494—J. Emerson—Comb.





60496—H. Feyh—*Steam Generator.*

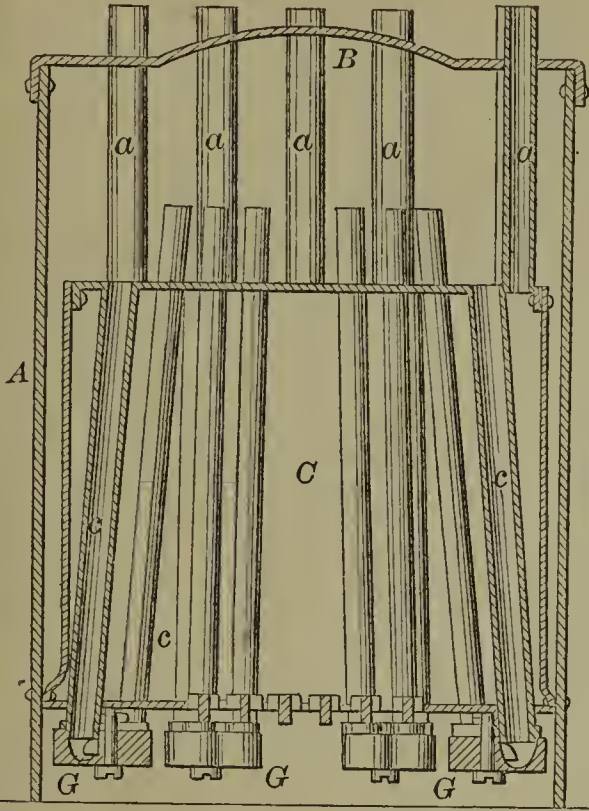

60499—J. A. Frey—*Lamp Burner.*

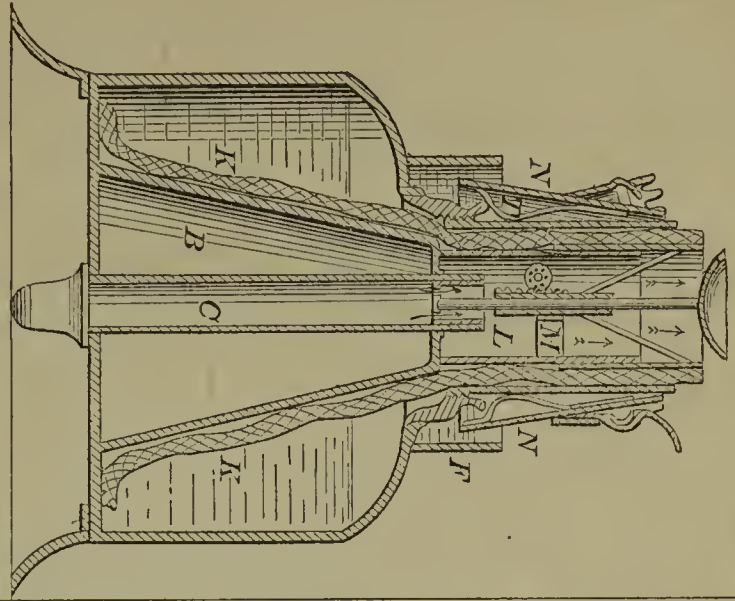

60498—Fraser & Garretson—*Stove Pipe Damper.*

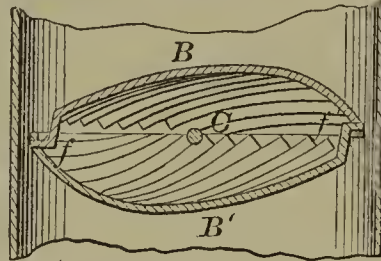

60500—J. Frot—*Engine for the Utilization of Ammonical Gas.*

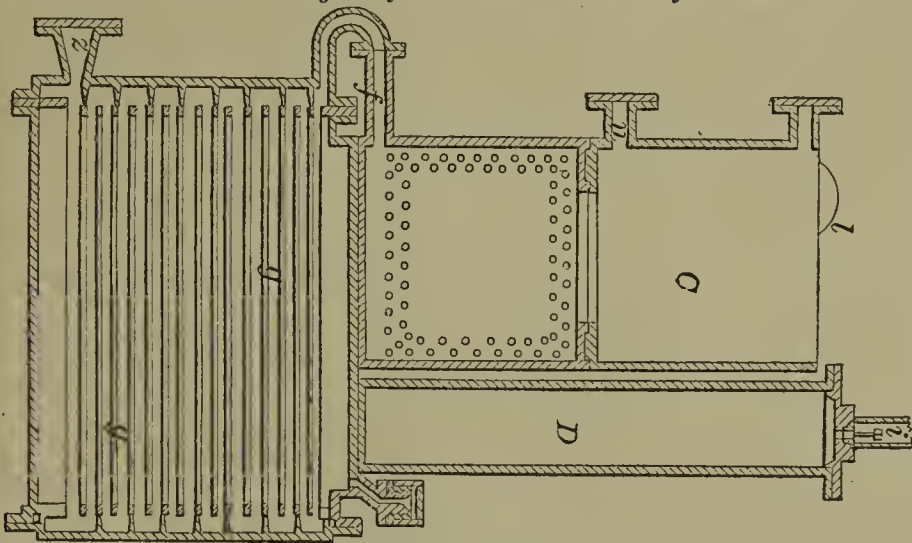

60501—A. Gilmore—*Potato Digger.*

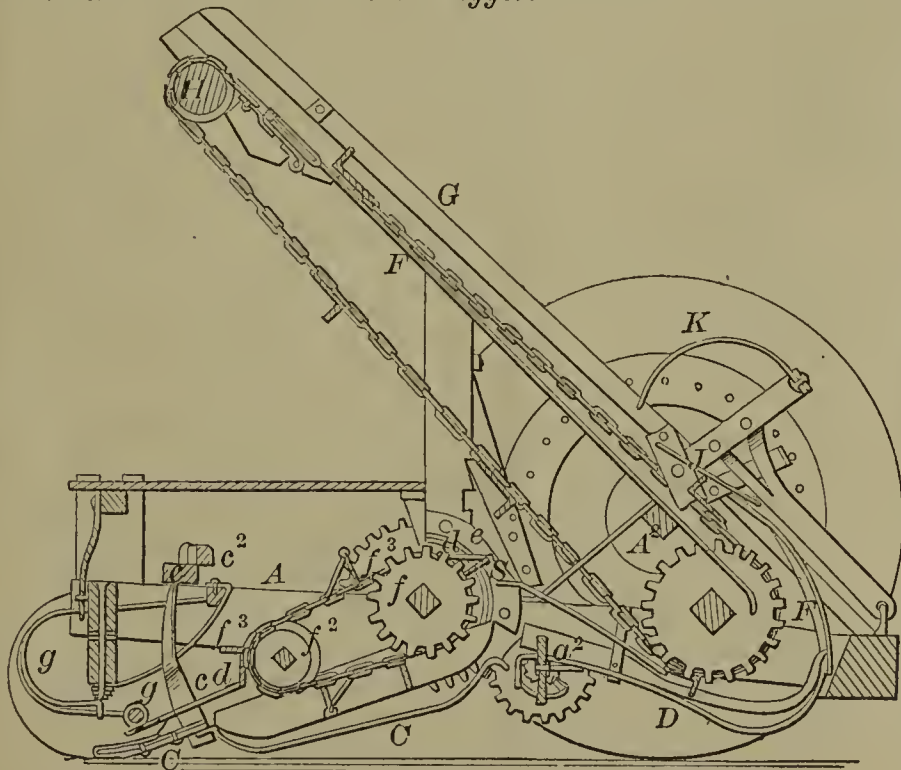

60497—

C. D. Footo—*Rock Drill.*

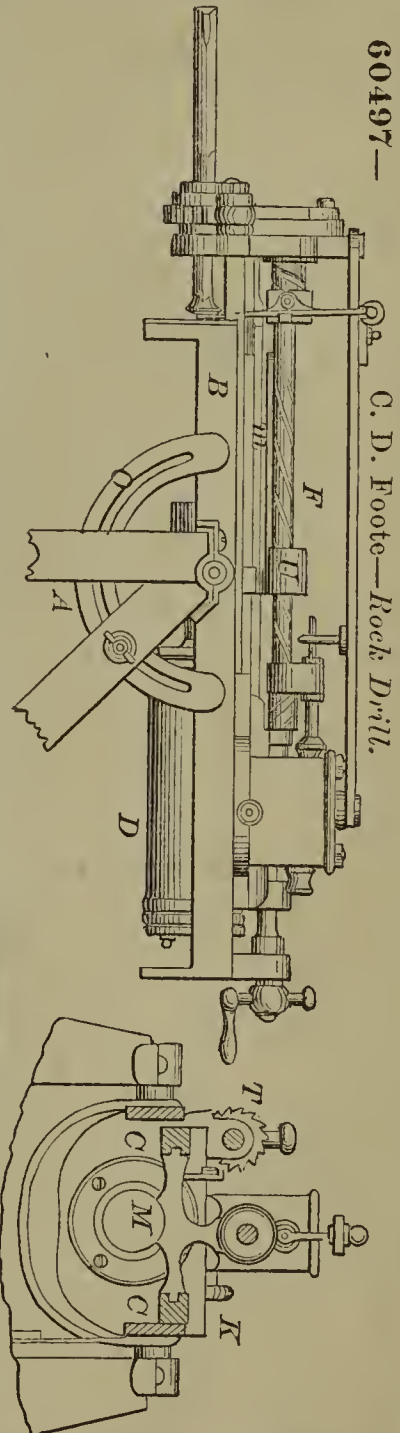

60506—Guerrant & Field—Engraving Machine.

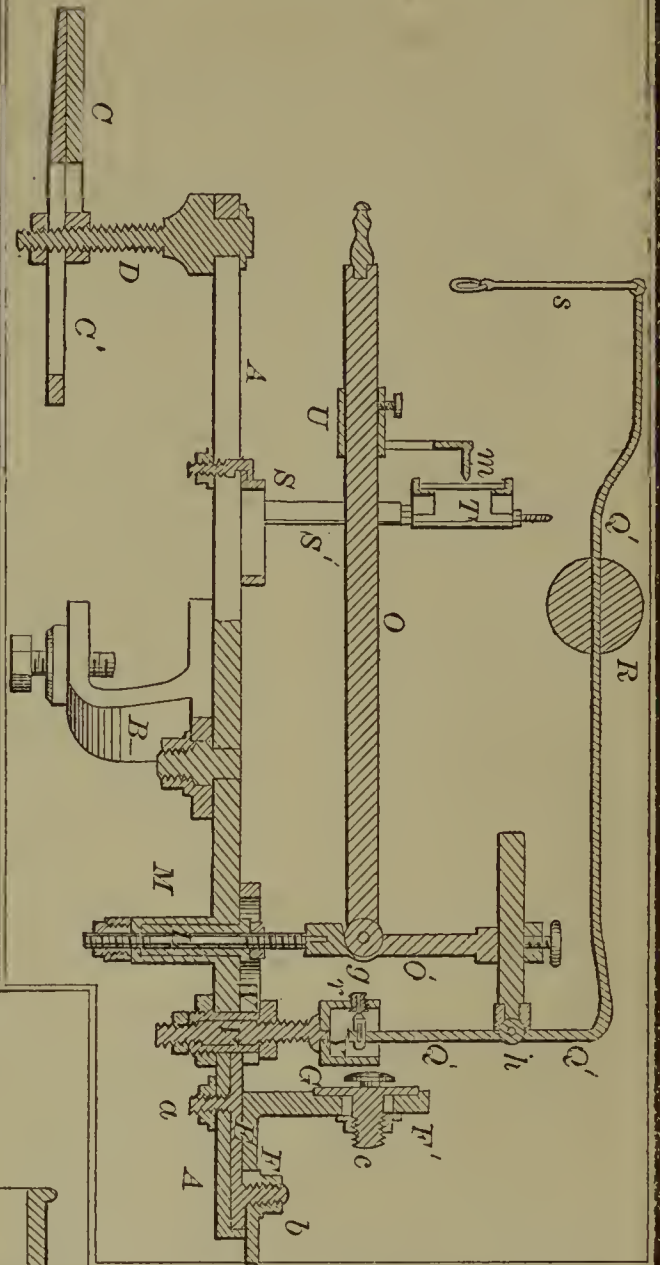

60502—J. S. Gisborne—Signaling Apparatus.

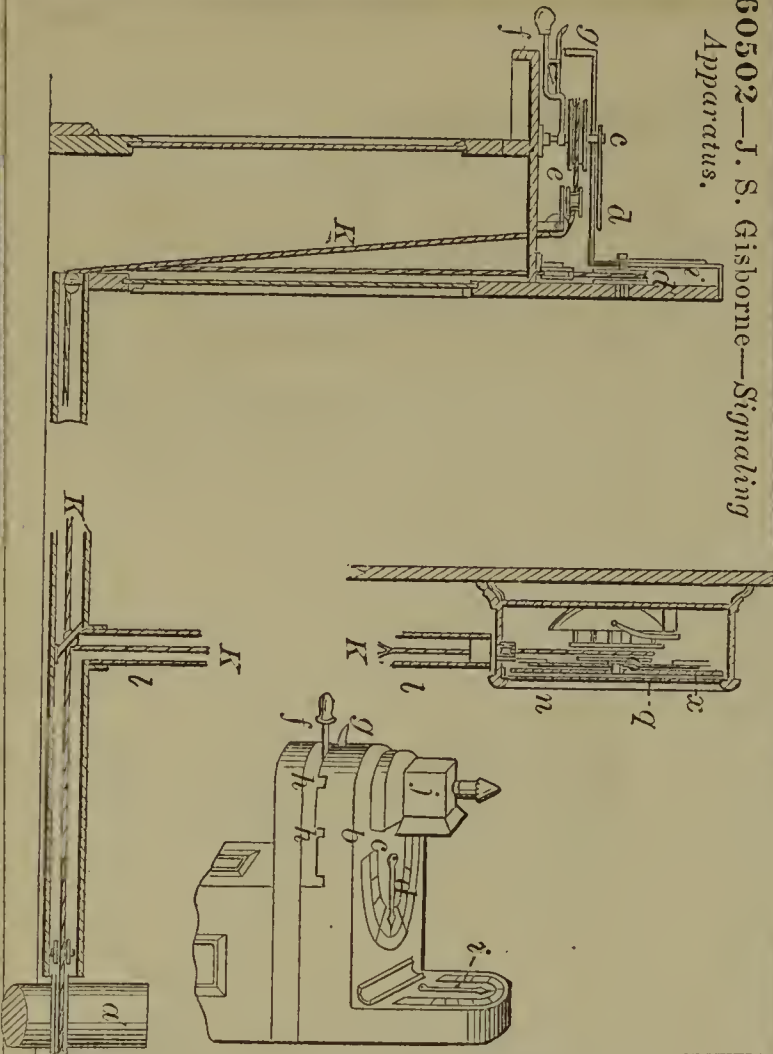

60505—W. D. Grimshaw—Capstan.

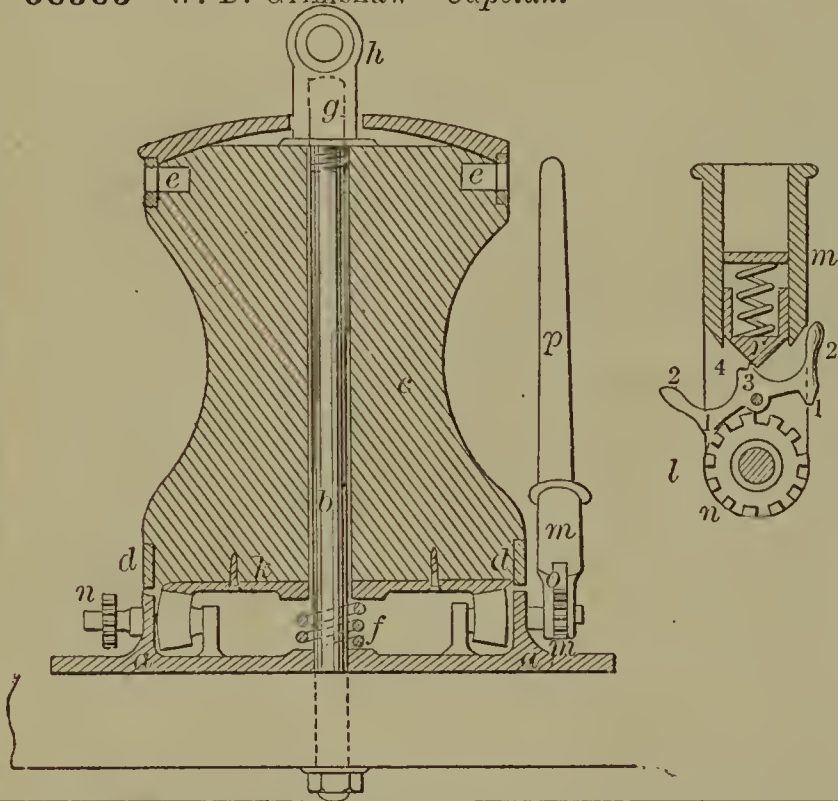

60503—S. Gissinger—Clamp for Gluing the Tips on Billiard Cues.

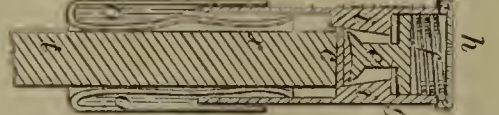

60504—G. P. Gordon—Printing Press.

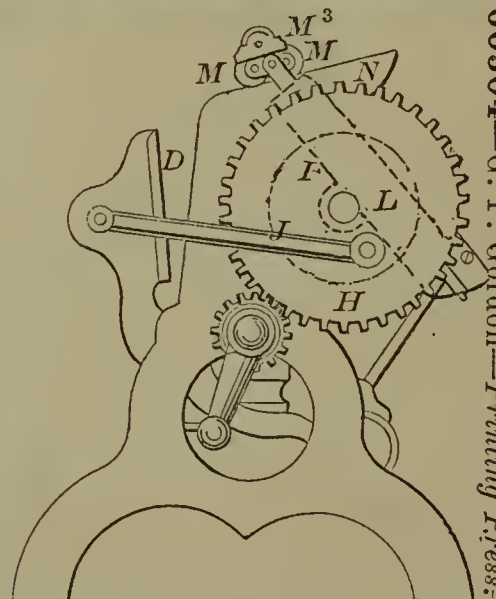

60507—C. M. Gustin—Jack for the Manufacture of Boots and Shoes.

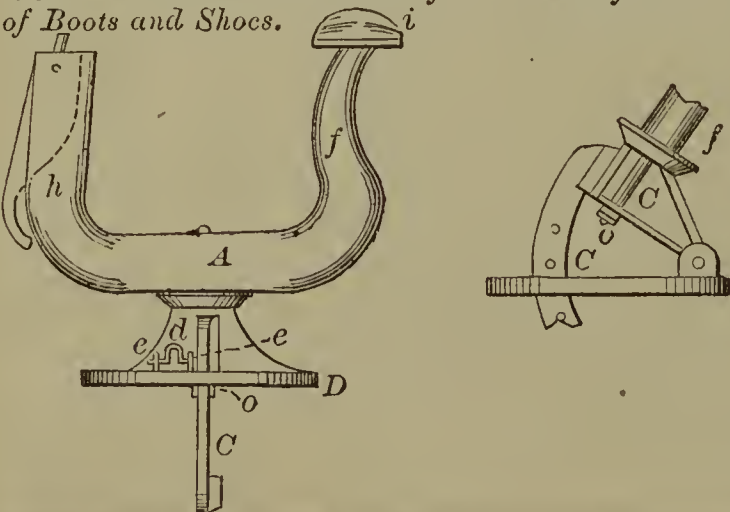

60508—W. Hailes—Attaching Covers to Kettles, &c.

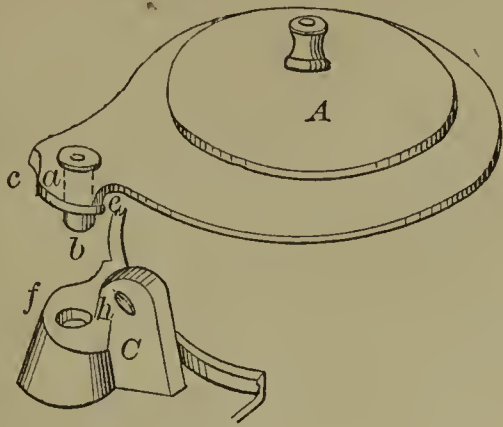

60509—J. Hanley—Spiral Friction Clutch.

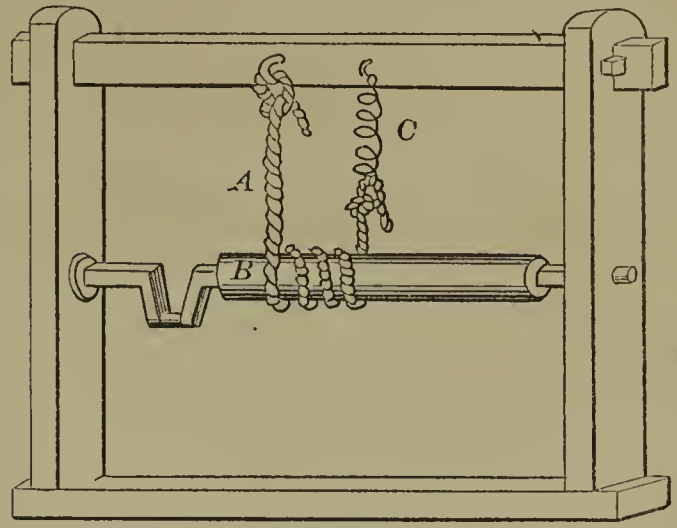

60510—H. Hassenpflug—Sawing Machine.

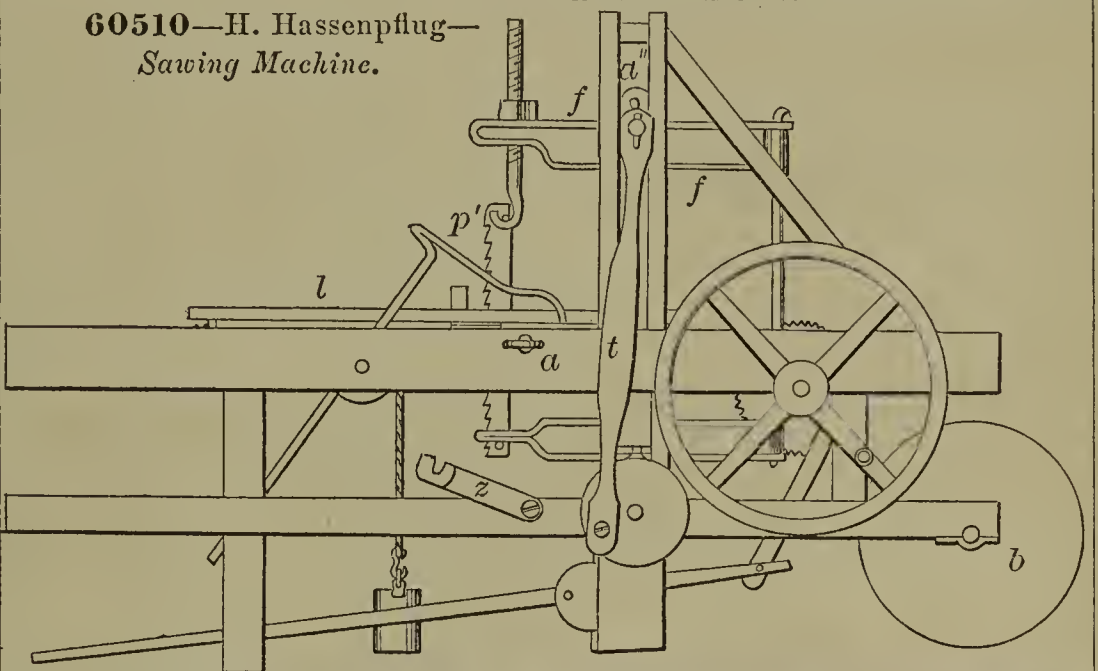

60511—F. Hatch—Blacking Brush and Box.

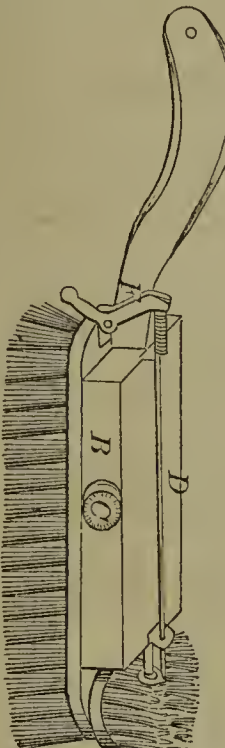

60513—Heflebower & Reed—Separator.

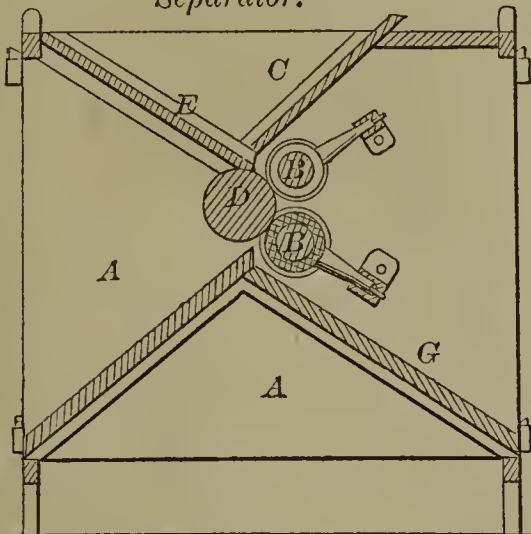

60515—A. Higley—Car Brake.

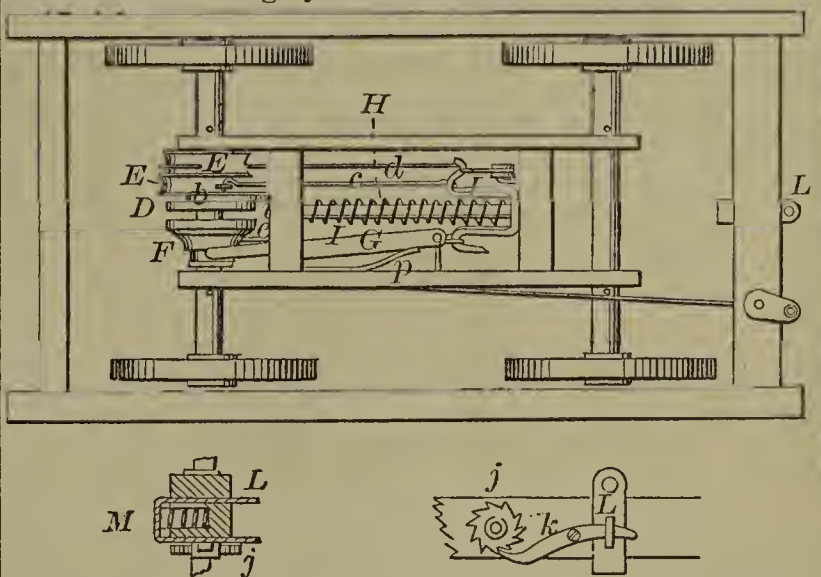

60512—T. Hayes—Filter.

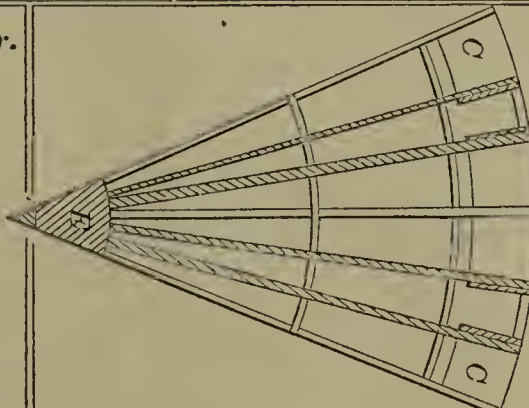
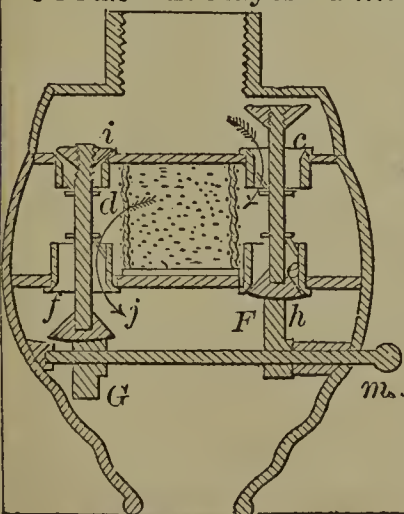

60517—W. H. Holland—Paddle Wheel.

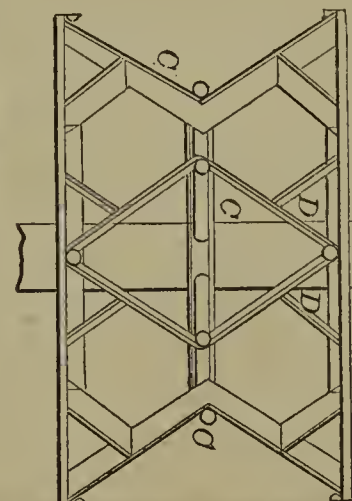

60518—W. H. Holland—  
*Paddle Wheel.*

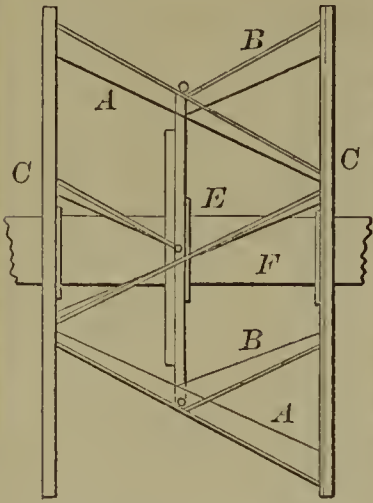

60520—J. Hurd—*Piano Forte.*

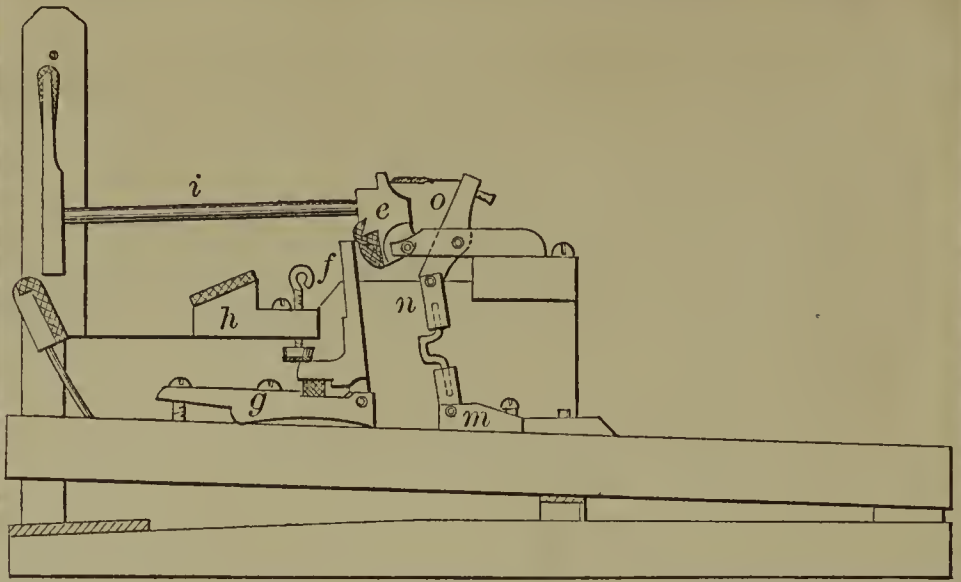

60519—G. H. Hulskamp—*Piano Forte.*

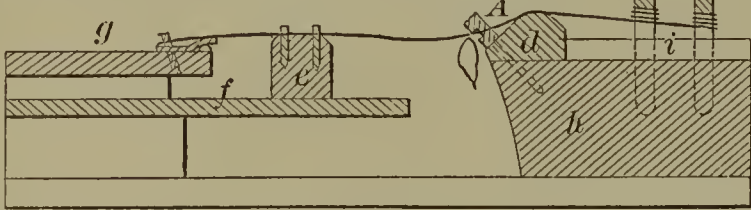

60523—J. C. Jewett—*Bar or Slat for Refrigerators.*

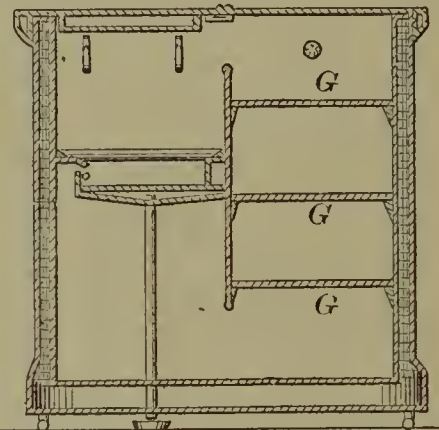

60521—I. A. Isaacs—  
*Foot Bath.*

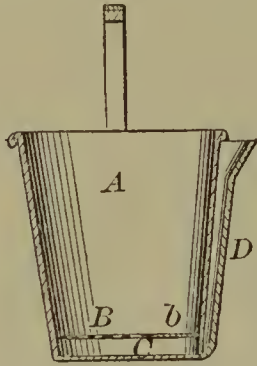

60525—E. Lampman—  
*Centre Table.*

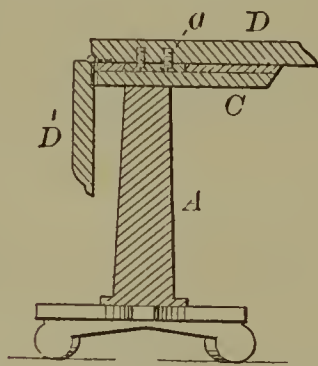

60524—J. J. Johnston—*Tanning.*

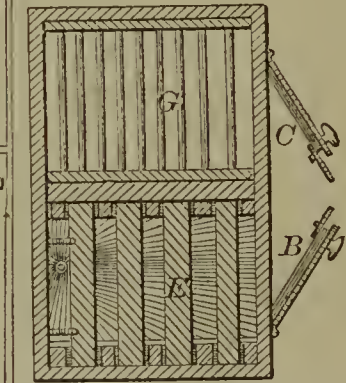
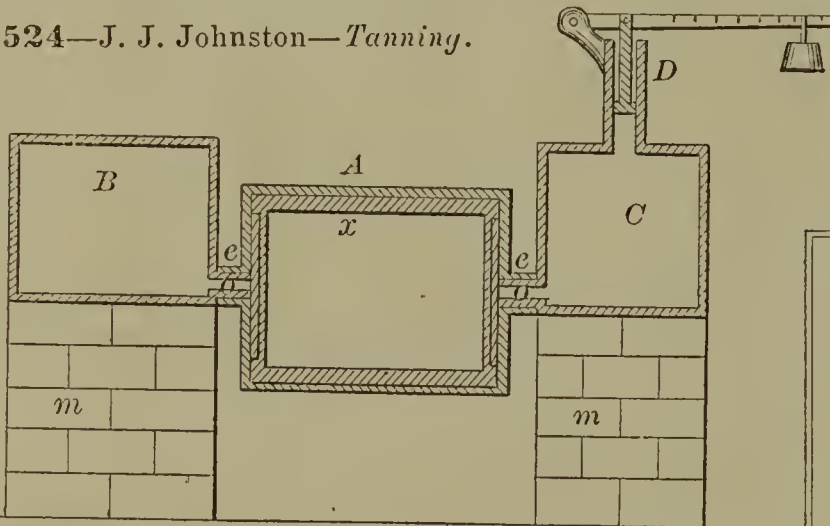

60526—S. M. Landis—*Syringe.*

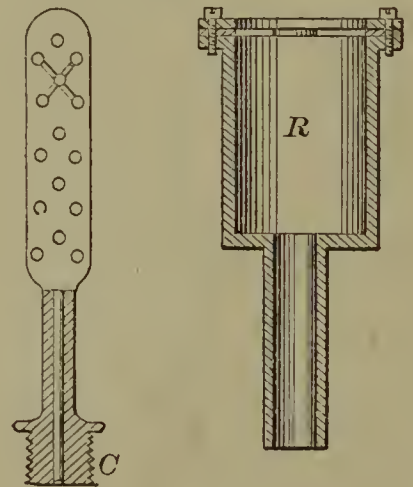

60522—H. Jahne—  
*Watch Chain Fastening.*

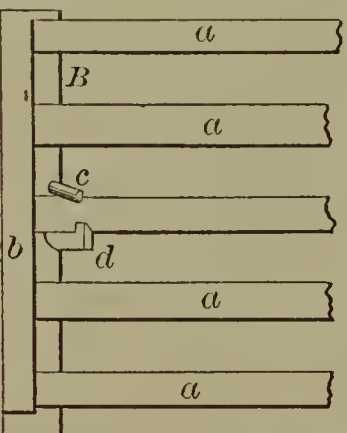
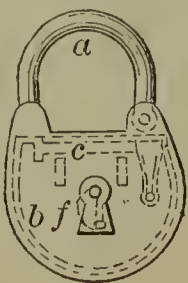

60527—N. Larrowe—  
*Farm Gate.*



60528—R. G. Latting—Cotton Bale Tie.



60529—W. W. Levering—Cabinet.

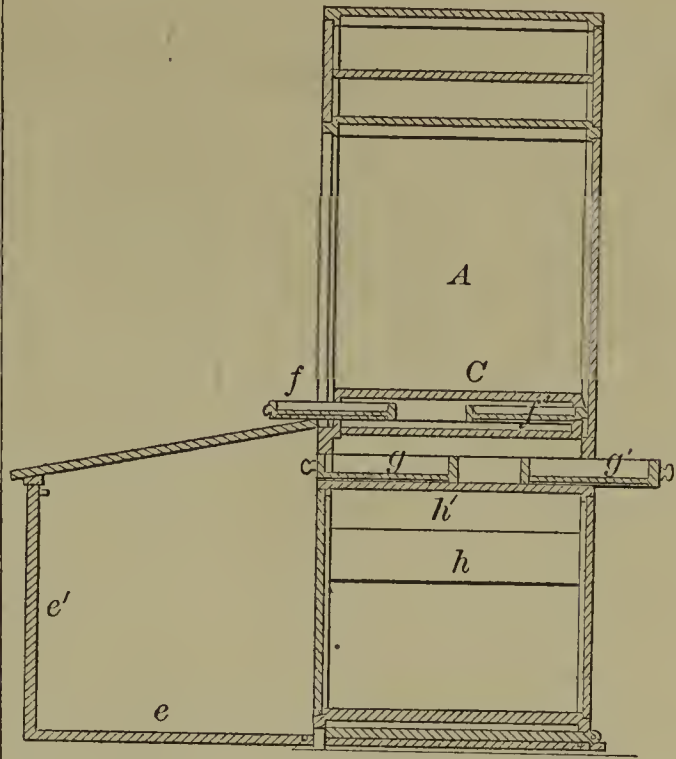

60531—I. Manning—For Forming Bridle Fronts.

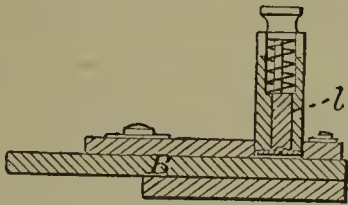
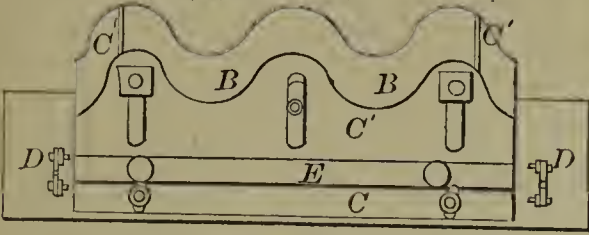

60532—W. B. Mason—For Making Stamps.

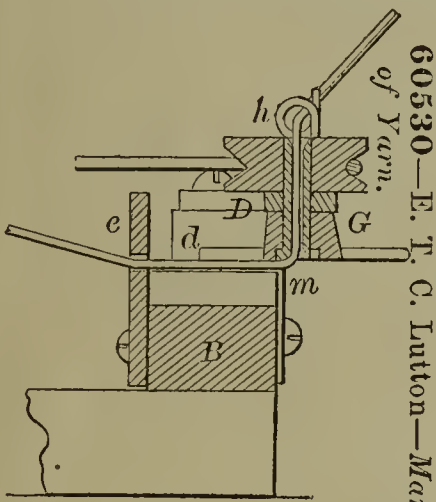
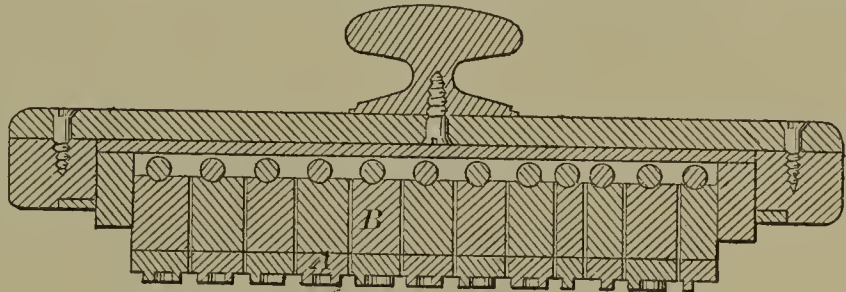

60530—E. T. C. Lutton—Manufacture of Yarn.



60535—O. Miller—Pump.

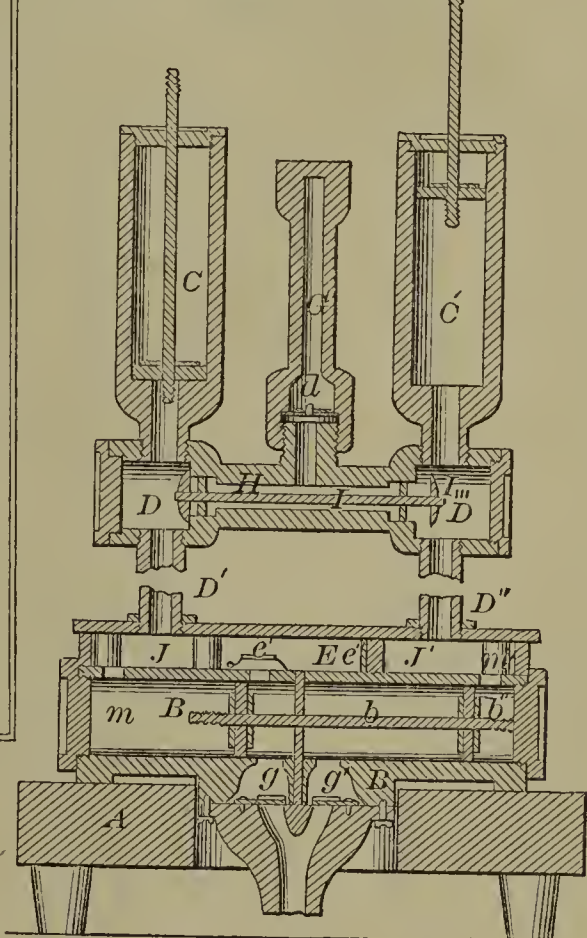

60534—L. H. Miller—Type Case.

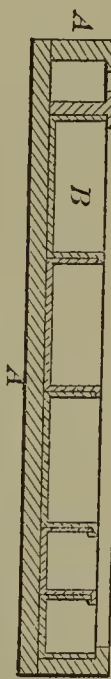

60533—B. A. McConaughy—For Detaching Horses from Vehicles.

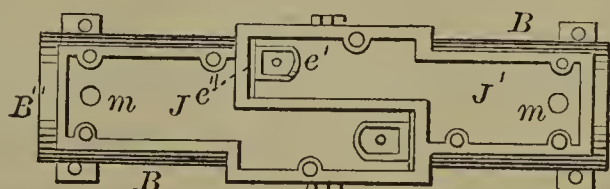
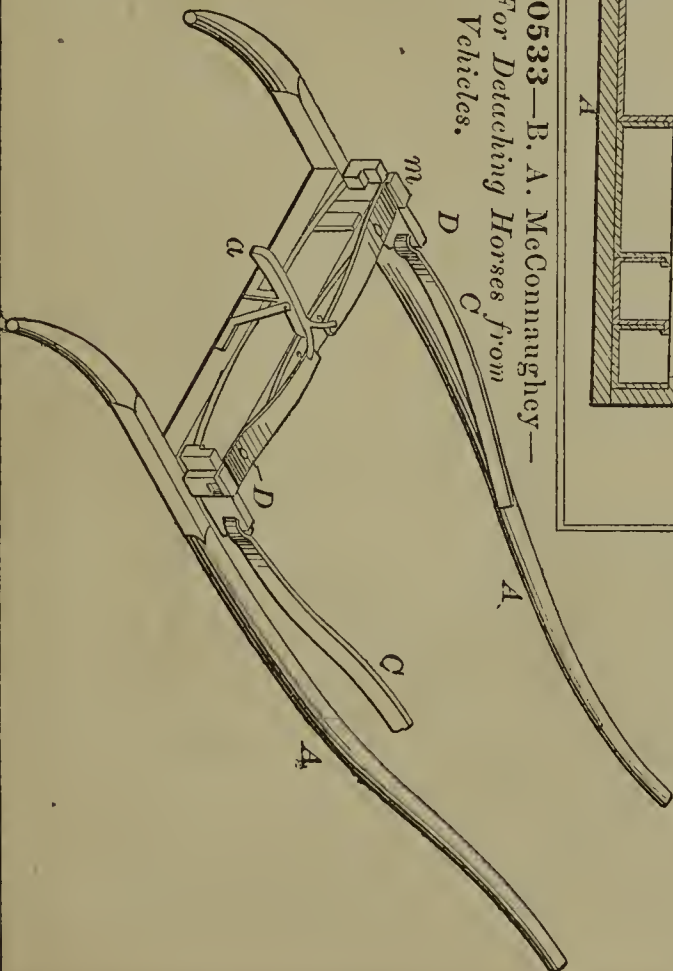

60537—A. Millochau—Illuminating Gas Retort.

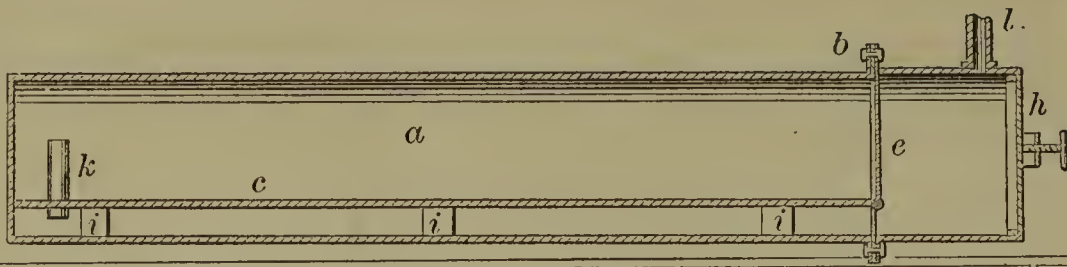

60539—M. F. Morse—Rotary Sifter.

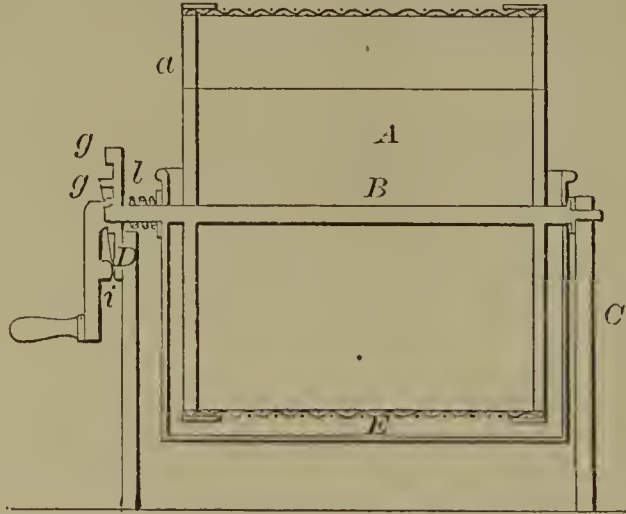

60541—J. Murray—Steam Whistle.

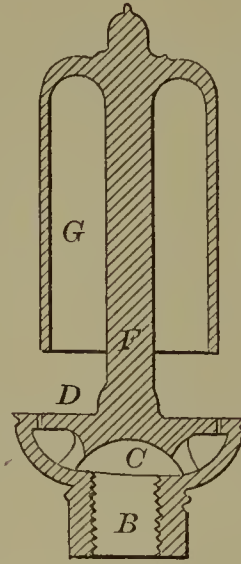

60540—W. J. Murphy—Breech-Loading Ordnance.

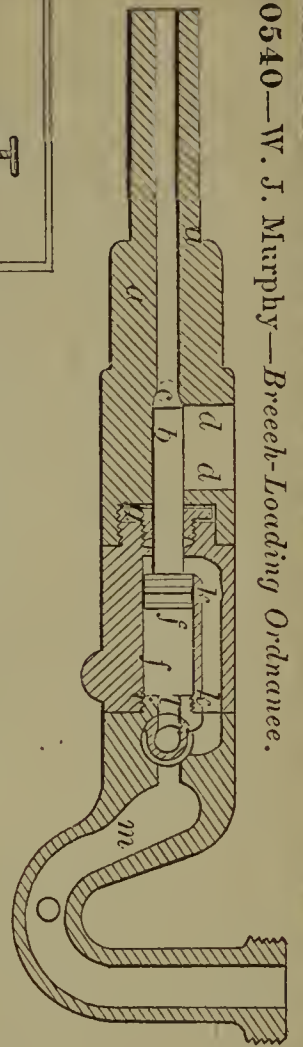

60544—Packer & Daley—Car Coupling.

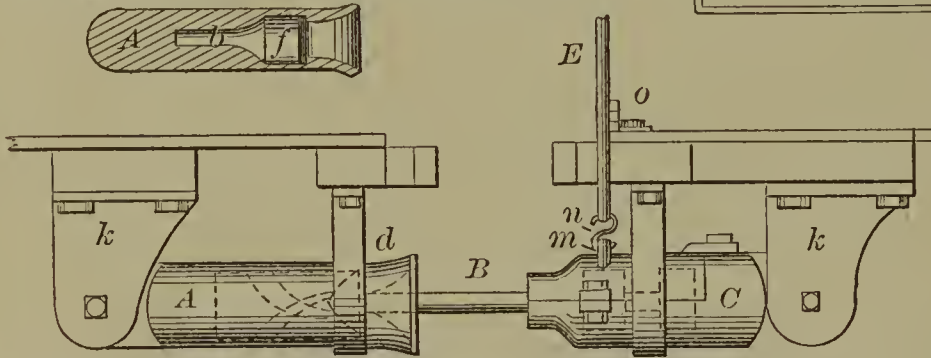

60542—F. B. Northrop—

60543—M. & R. B. Packard—Shoe Binding.

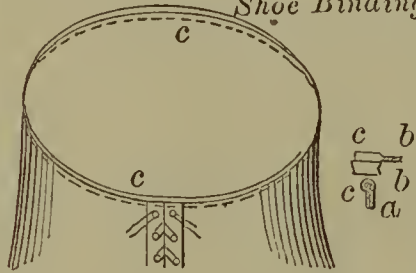

60547—T. Parker—Fruit Can.



Sawing Shingles.

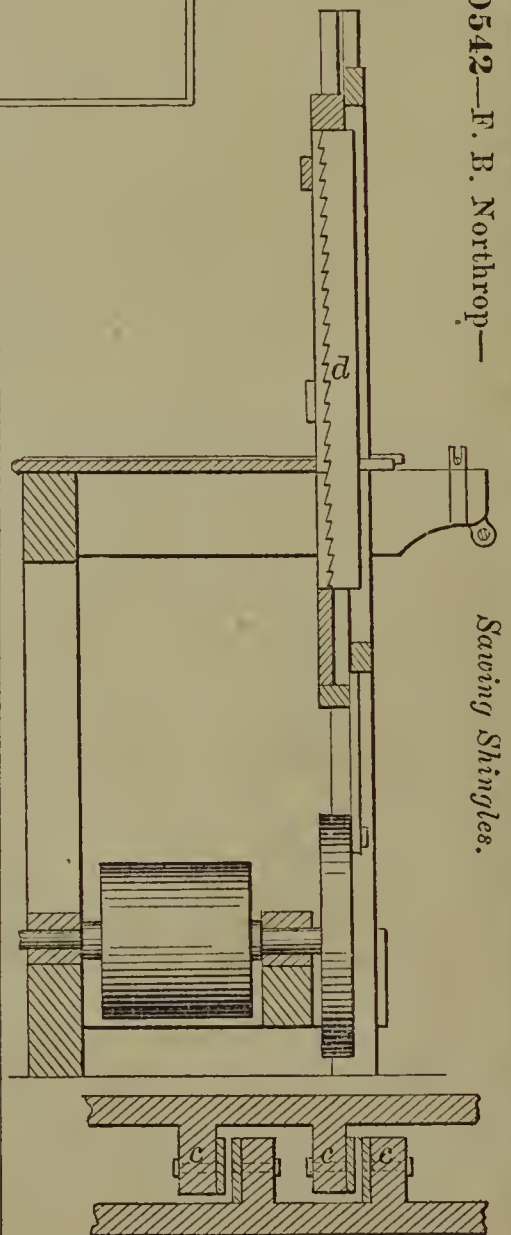

60545—W. Palmer—For Fastening Blind Slats.

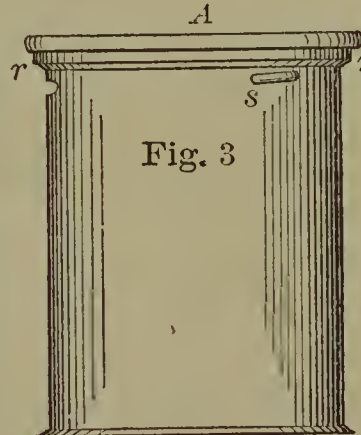
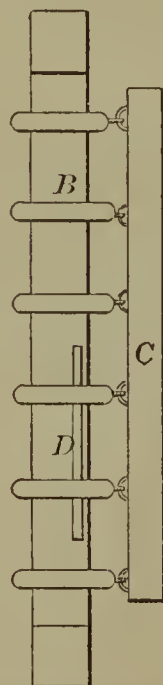
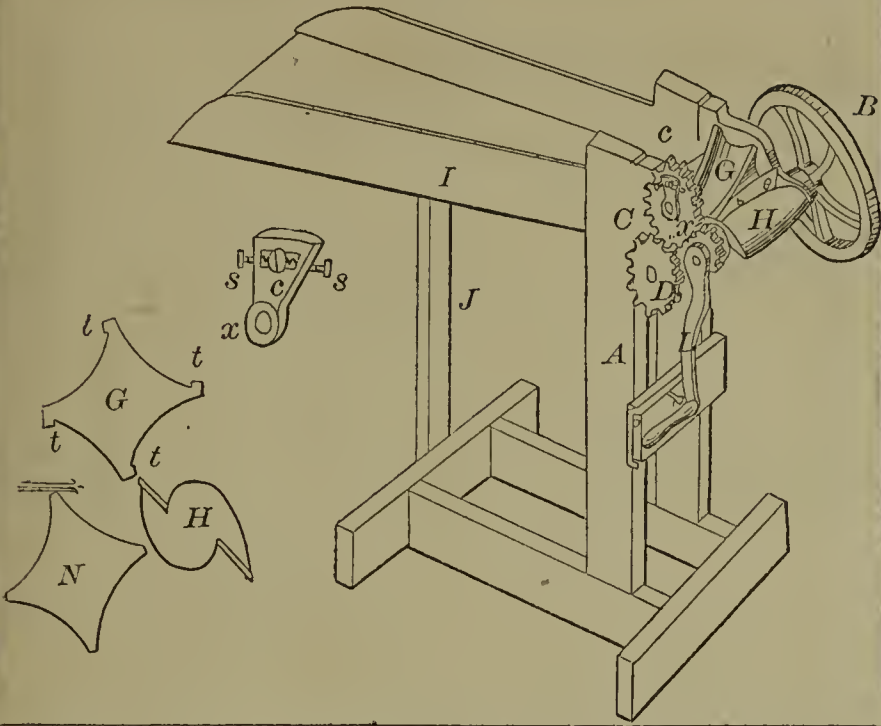
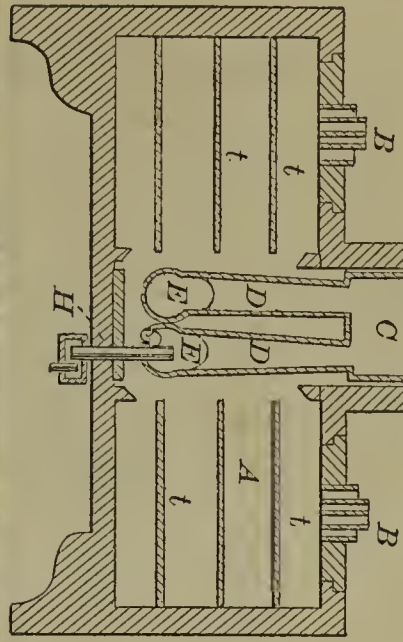

Fig. 3

60550—J. G. Perry—*Straw Cutter.*



60552—C. F. Pike—*For Cooling and Preserving Meats, &c.*



60551—Petveys & Leggett—*Gate.*

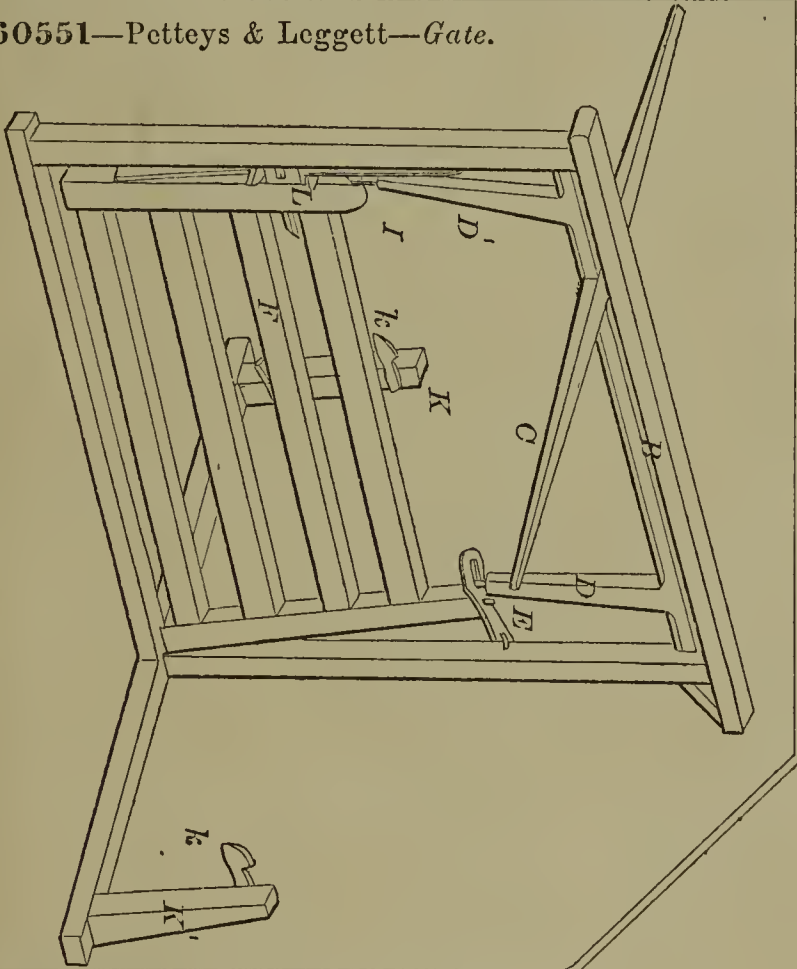

60555—J. & J. A. Punderford—*Leather Hose.*

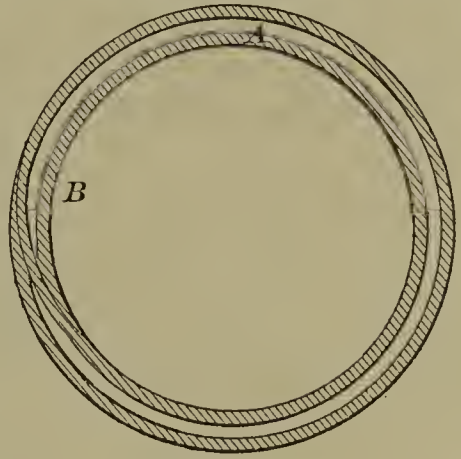

60553—S. M. Pike—*Filter Cooler.*

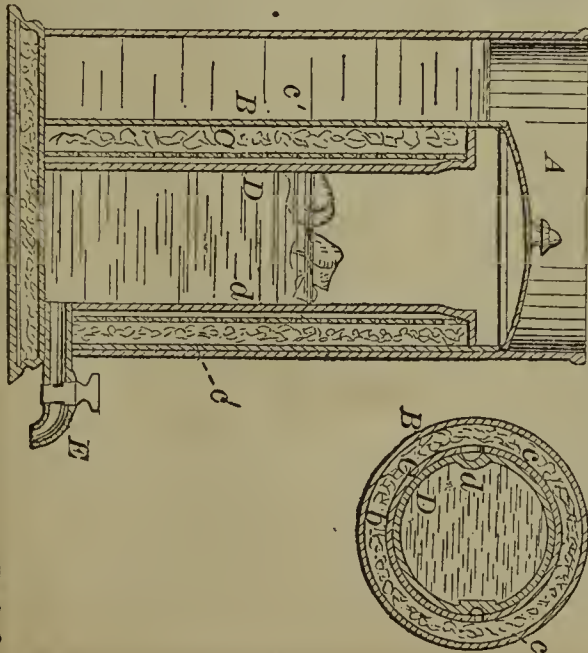

60554—B. Poulson—*Fan, Brush and Rack.*

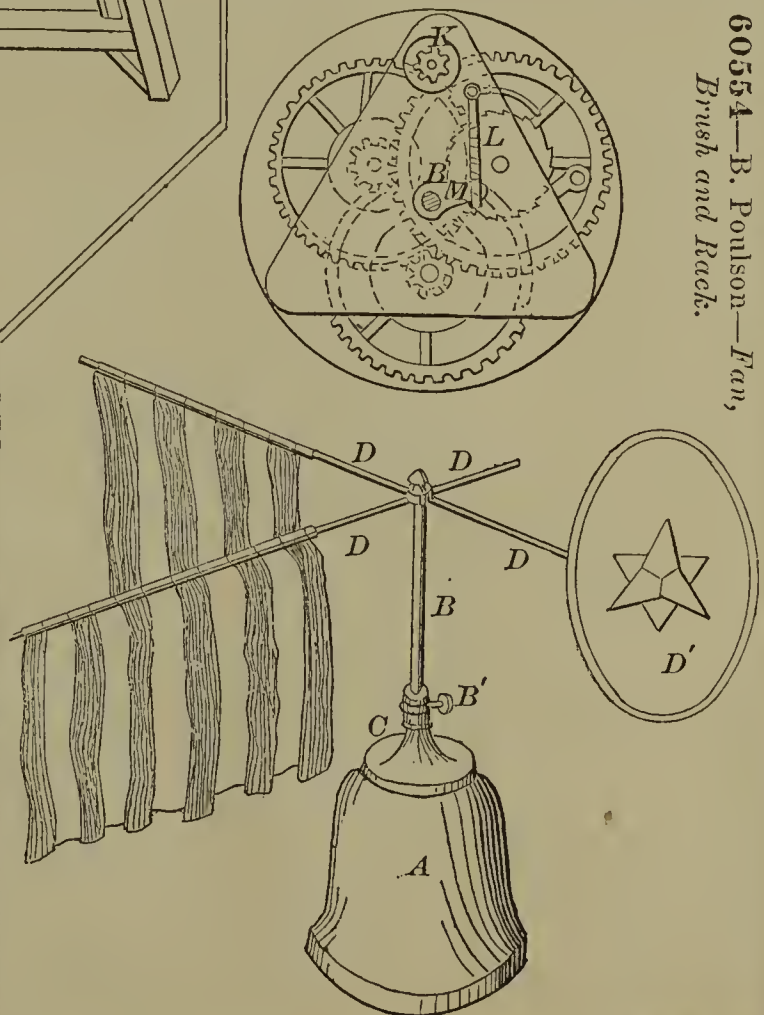

60556—J. Richards—*Poker, Tongs, Wrench, &c.*

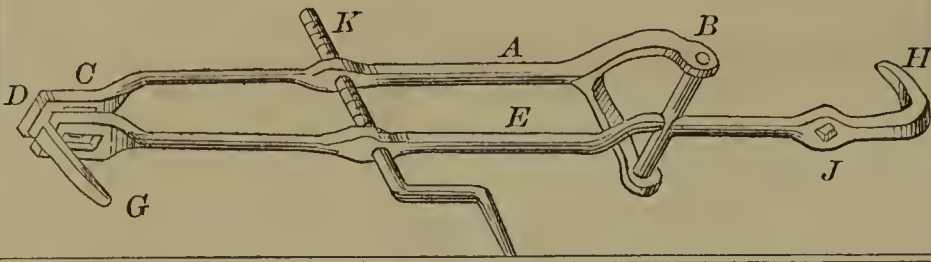

60561—Saiger & Davis—*Fruit Picker.*

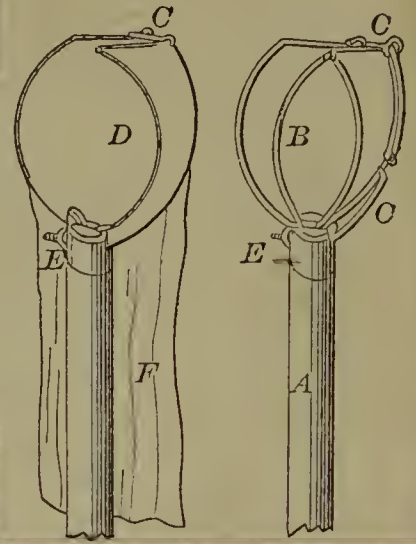

60560—C. & J. Ross—*Steam Generator Flue Brush.*

Fig. 1

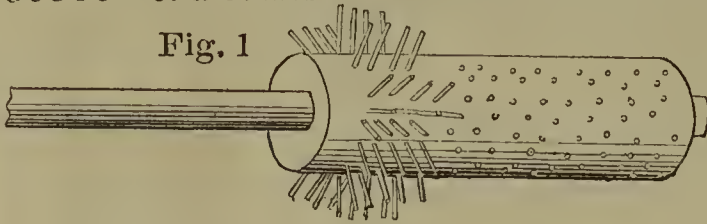

Fig. 3

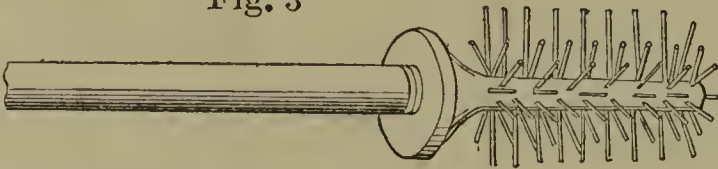
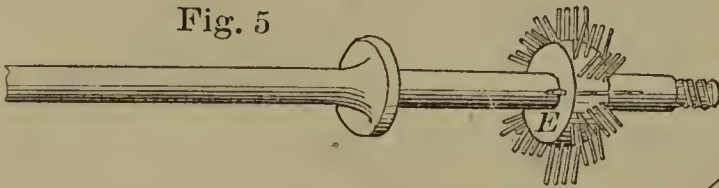

Fig. 6



Fig. 5



60564—H. F. Schroder—*Pan for Evaporating Sugar.*

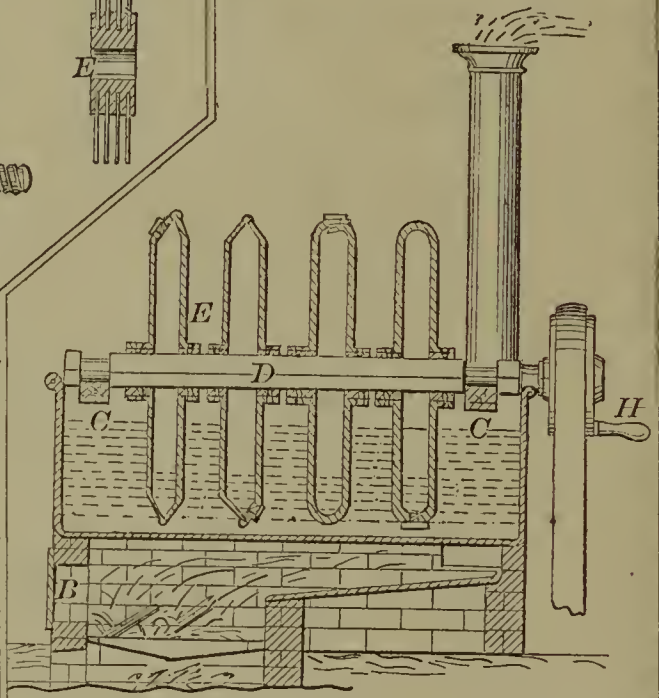

60562—H. S. Saroni—*Steam Generator.*

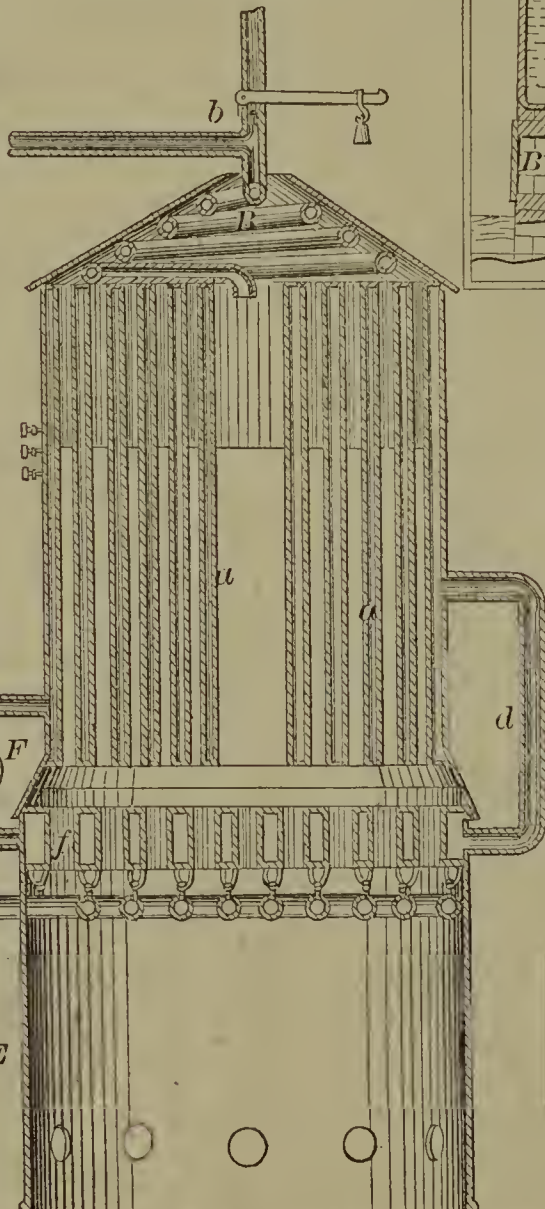

60563—F. M. Schmitt—*Sole Edge Finishing Tool.*

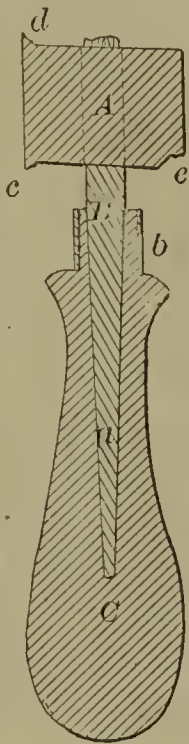

60565—H. L. Scott—*Fruit Gatherer.*

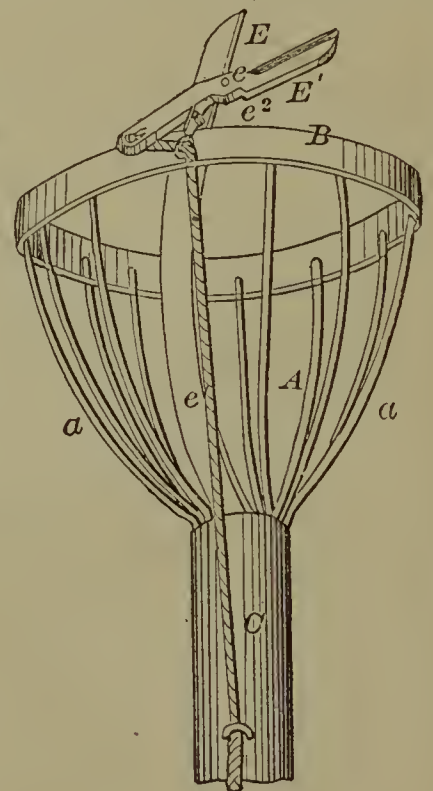



60566—H. Seher—*Fan for Gas Burners.*

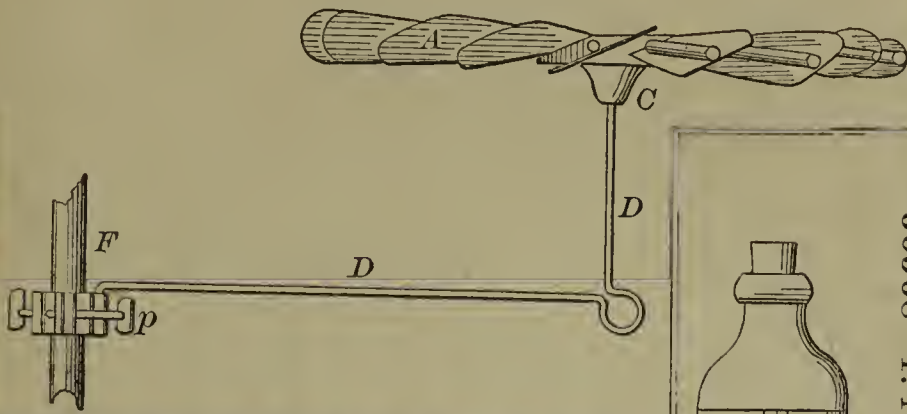

60567—T. P. Shaffner—*For Charging Shells.*

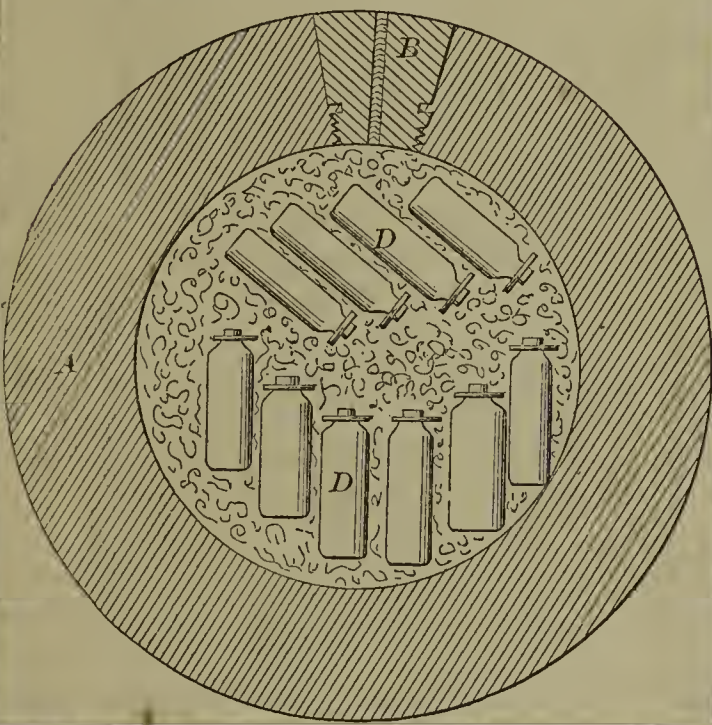
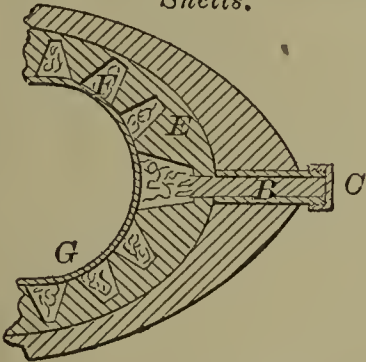

60576—W. B. Shelton—*Fence.*

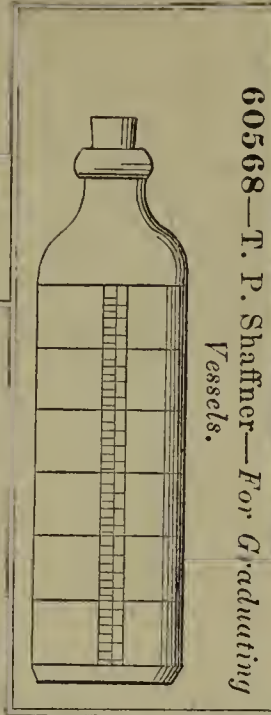
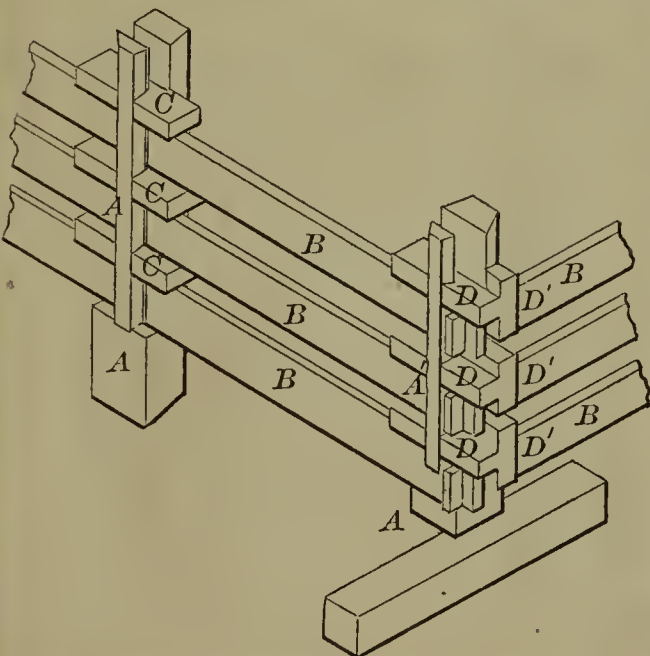

60568—T. P. Shaffner—*For Graduating Vessels.*



60569—T. P. Shaffner—*Electric Fuse.*



60573—T. P. Shaffner—*For Blasting with Nitrobenum.*

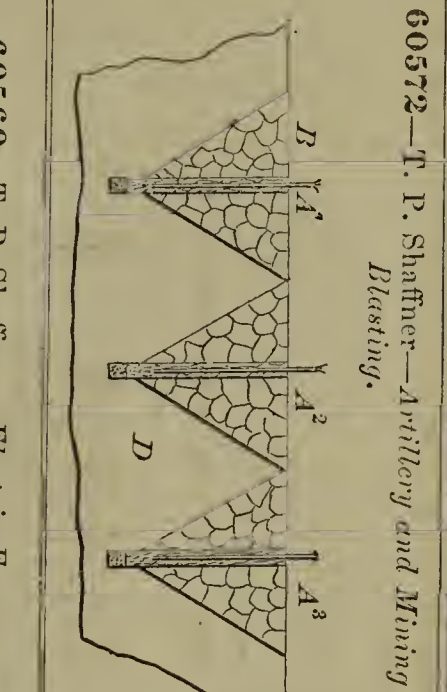
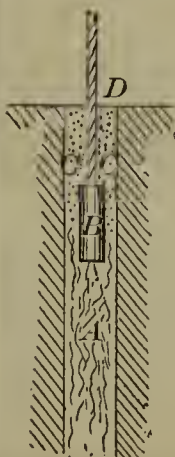

60572—T. P. Shaffner—*Artillery and Mining Blasting.*

60574—Shalters & Catern—*Hame Fastening.*

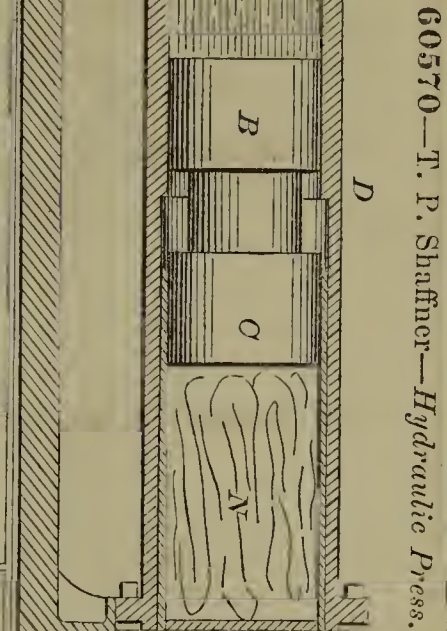
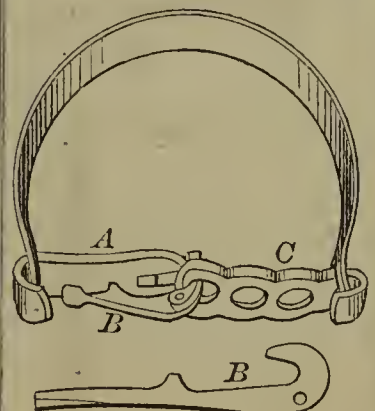

60570—T. P. Shaffner—*Hydraulic Press.*

60577—A. Shepard—Lamp Shade.

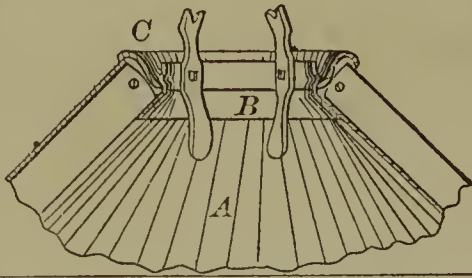

60579—S. J. Sherman—Belt Fastening.

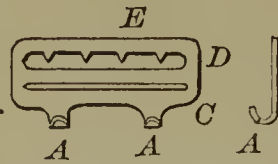

60580—A. M. Shurtleff—Atomizing Tube.

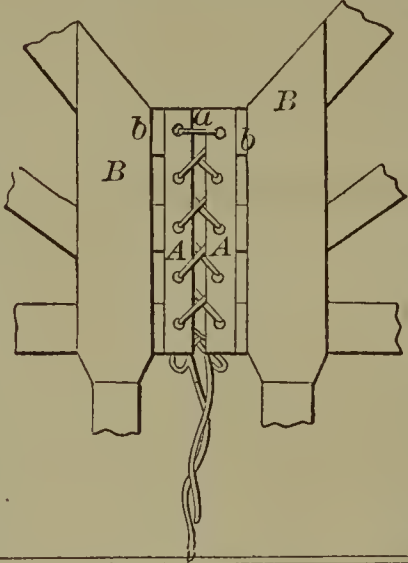
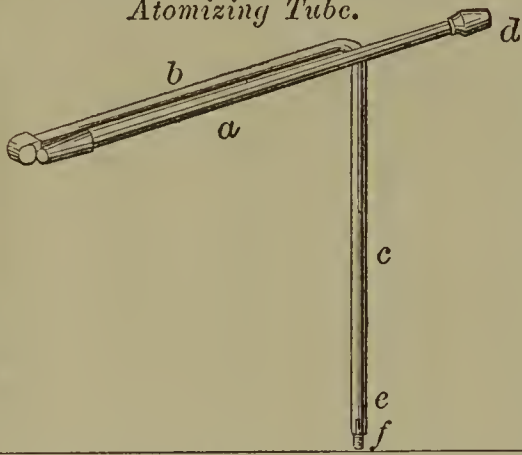

60582—A. N. Smith—Shoulder Brace.

60578—Sherburne & Whipple—Well Tubing.

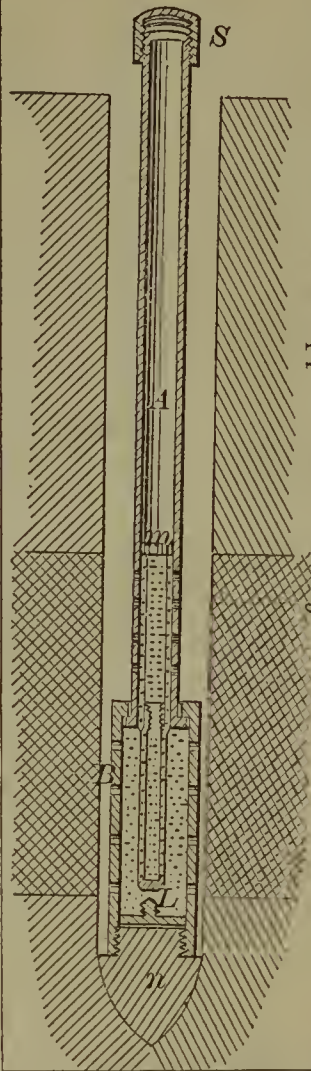

60581—Sigourney, Robinson & Shepard—Hanger for Stove Hooks.

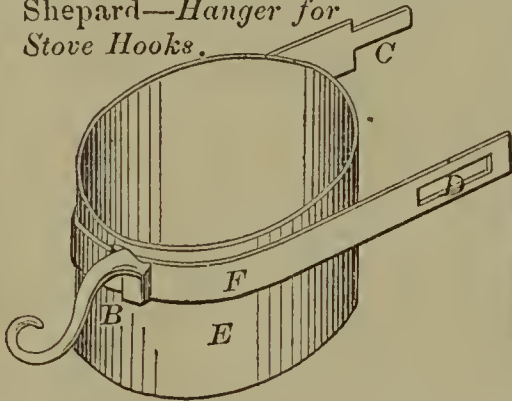

60583—F. W. Smith—Artificial Teeth.

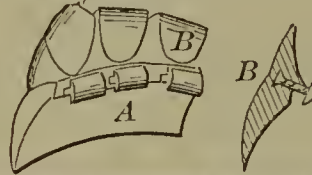

60585—H. L. Smith—Refining Hydro-Carbon.

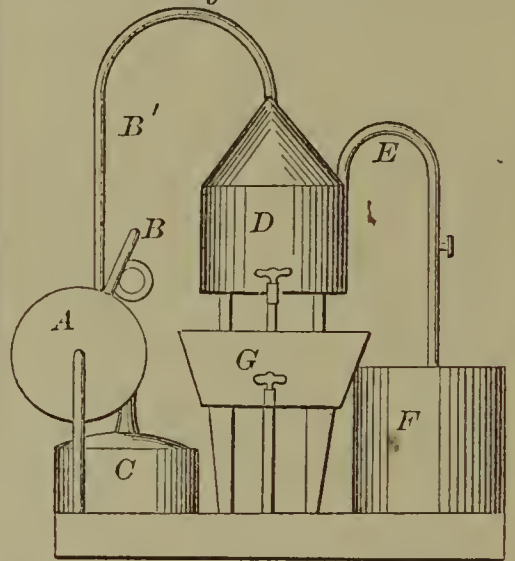

60588—H. P. Stewart—Manufacture of Boots and Shoes.

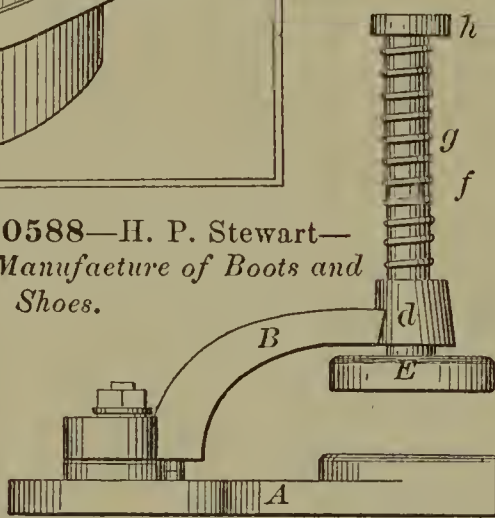

60587—H. P. Stewart—Boots and Shoes.

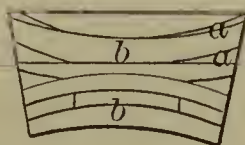

60589—W. W. St. John—Gang Plow and Cultivator.

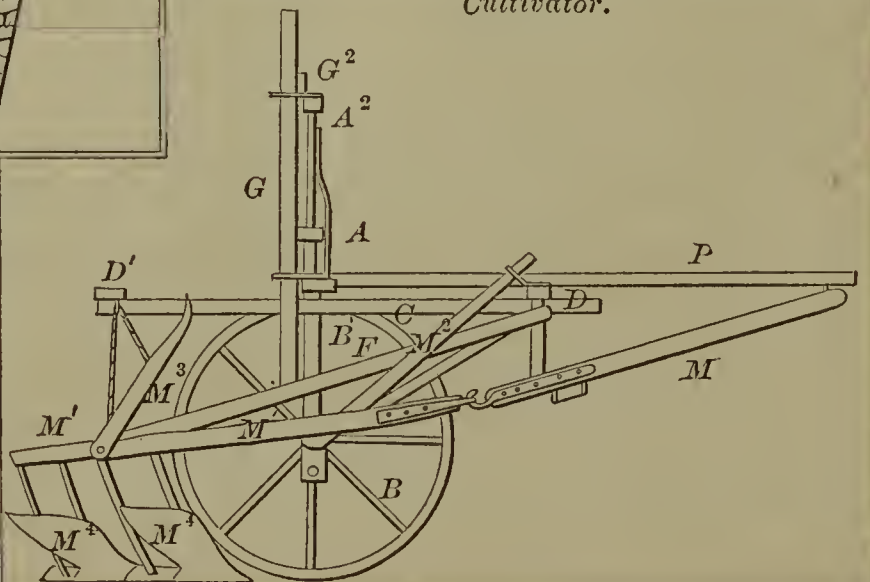

60586—W. B. Snow—Deep Well Pump.

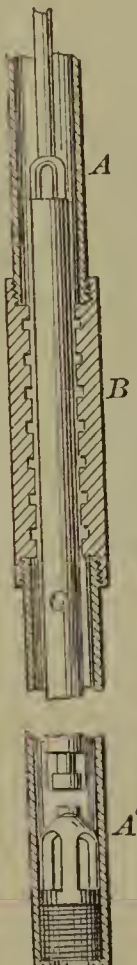

60584—Smith & Sparks—Blind Fastener.

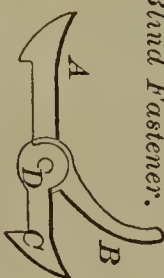

60592—T. L. Sturtevant—Breech-Loading Fire Arm.

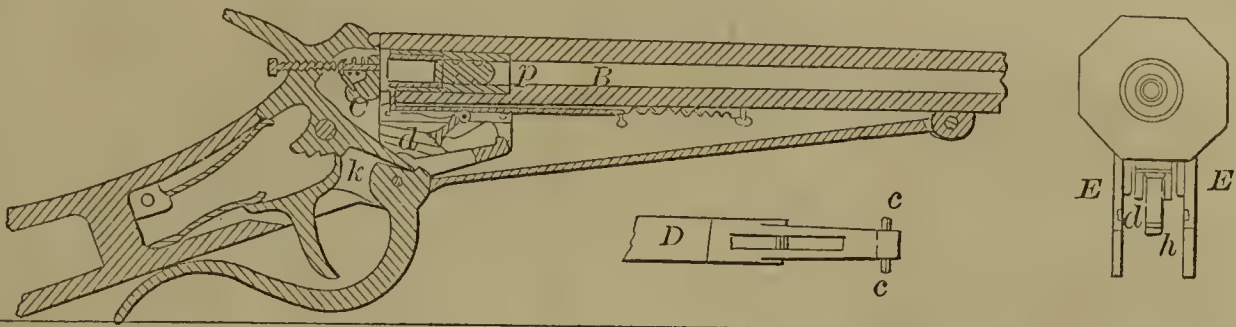

60595—R. S. Torrey—Rock Drill.

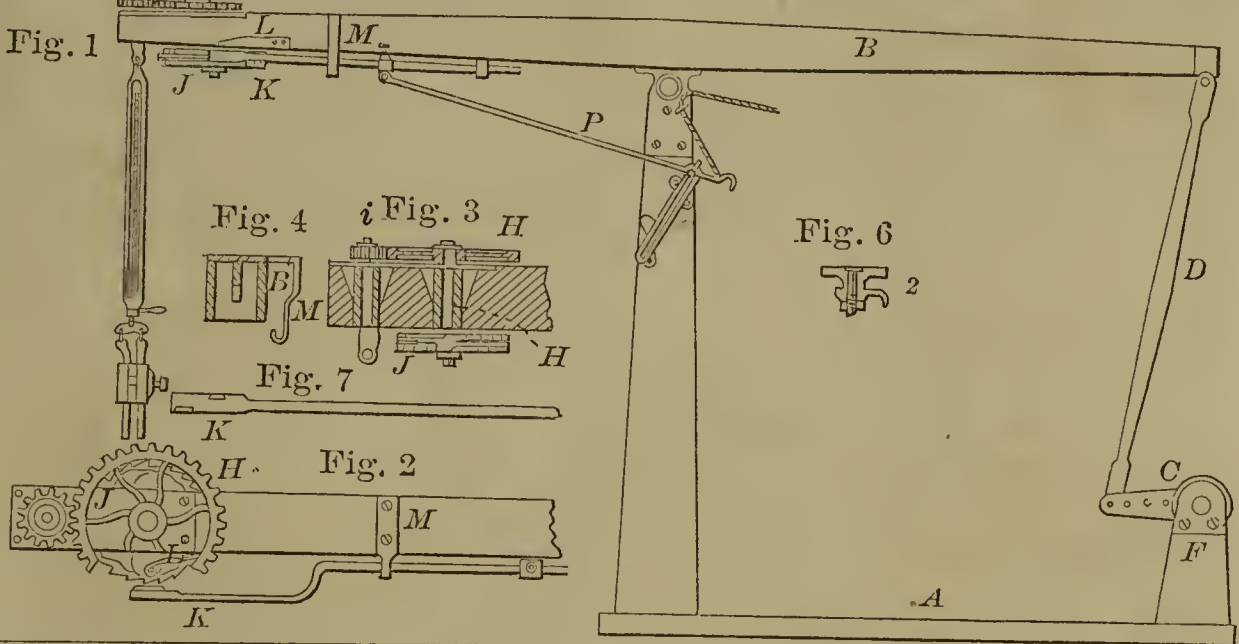

60597—J. H. Walker—Umbrella.

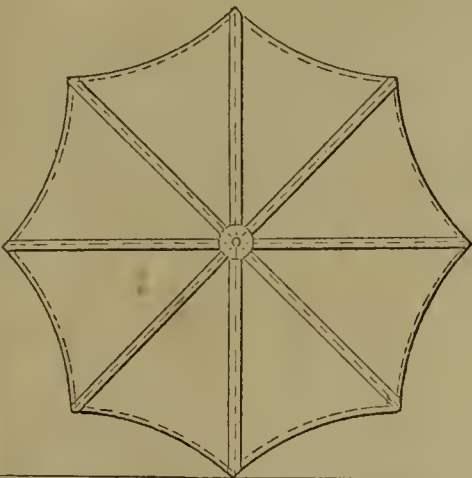

60593—G. W. Sylvester—Petroleum Filter.

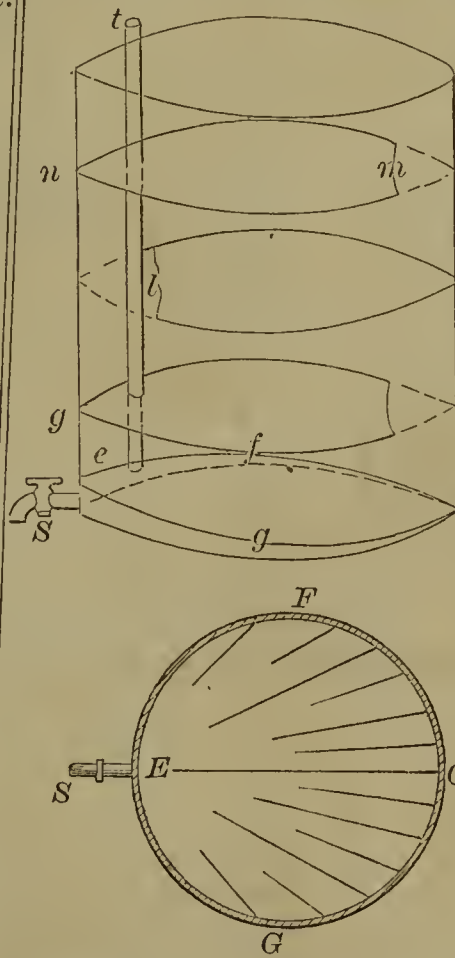

60594—E. H. Tobey—Railroad Signal Light.

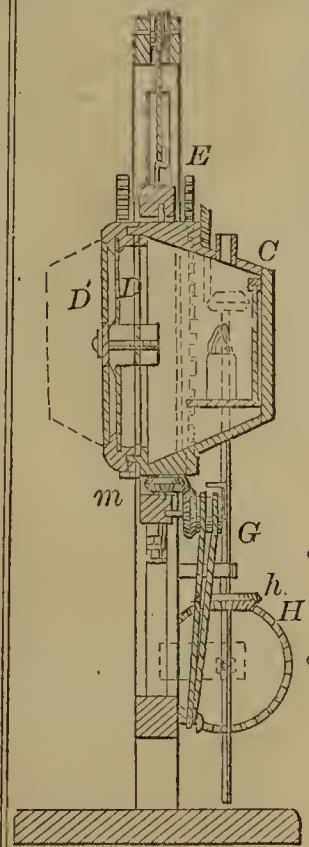

60598—W. S. Walker—Gas Heating Parlor Stove.

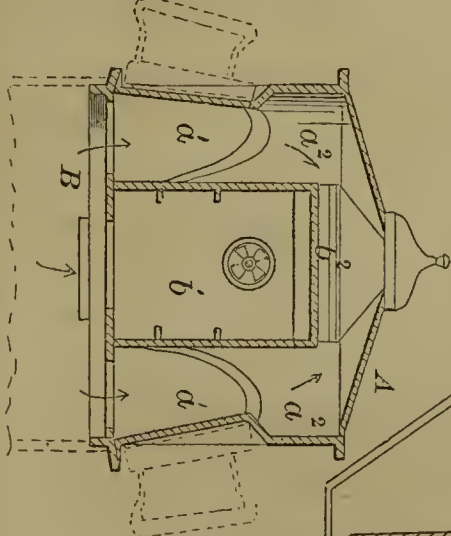

60596—G. G. Townsend—Shoe Peg Float.

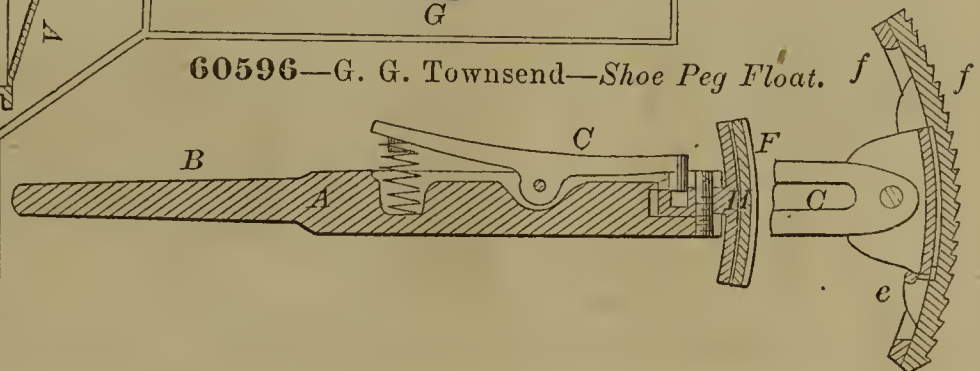

60599—J. R. Watkins—  
*Trace Fastening.*

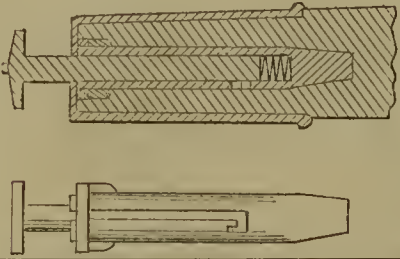

60600—  
I. Weinberg—  
*Hooks and Eyes.*



60601—M. D. Wellman—  
*Open Fire Place.*

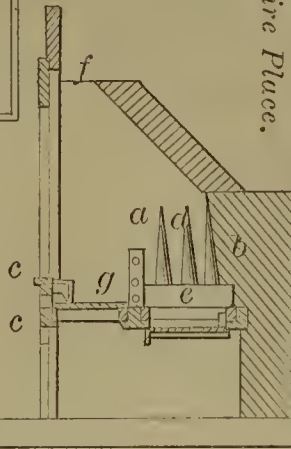

60603—R. C. Wickham—*Milk Can.*



60602—M. D. Wellman—  
*Cooking Stove.*

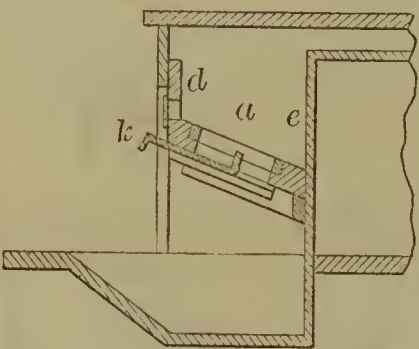
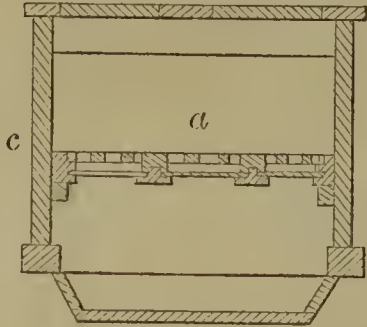

60604—Windeck & Runstetler—*Corn Planter.*

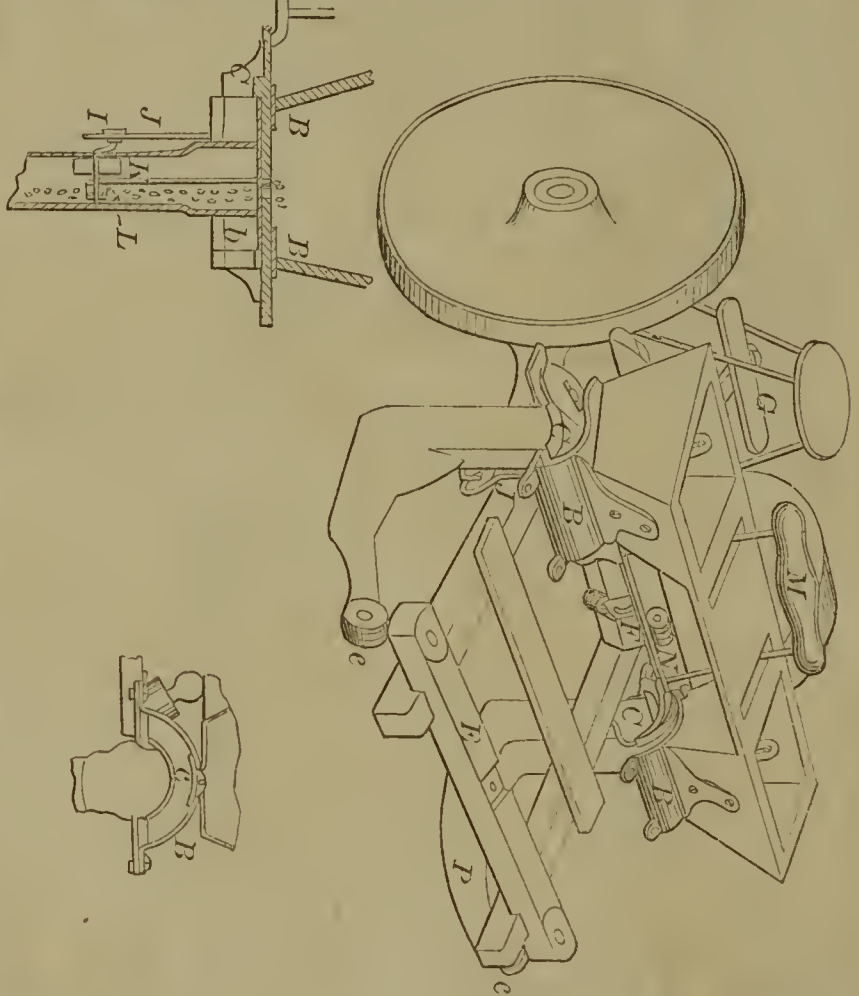

60605—E. B. Winship—  
*Pump.*

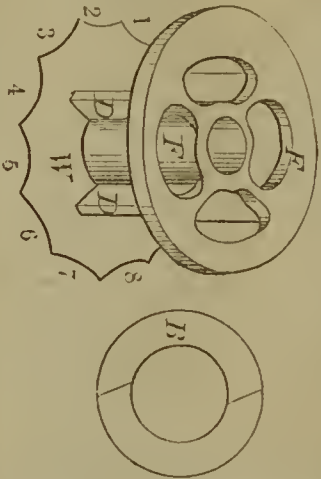

60606—E. F. Woodbury—*Whip.*

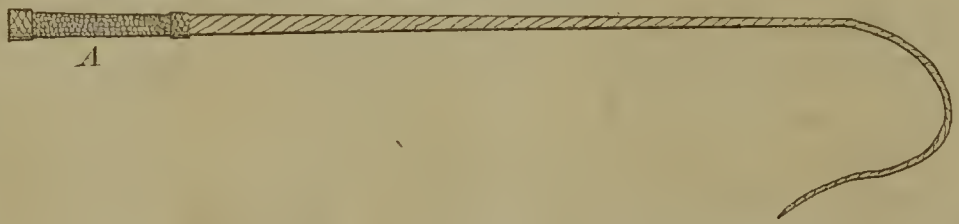

60608—C. W. Acker—*Carriage Curtain Eyelet.*

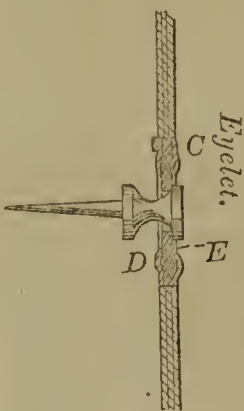

60607—T. Yates—*Breech-Loading Fire Arm.*

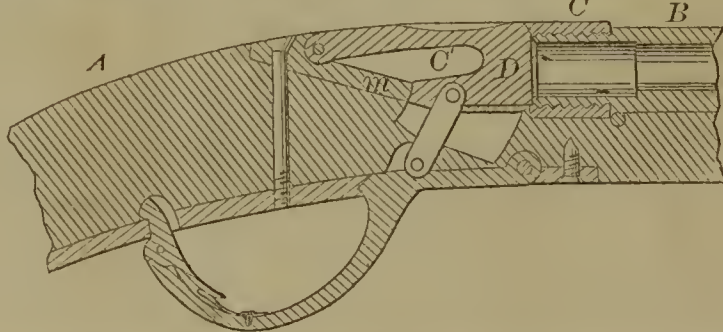

60609—H. M. Albee—*Ellipsograph*.

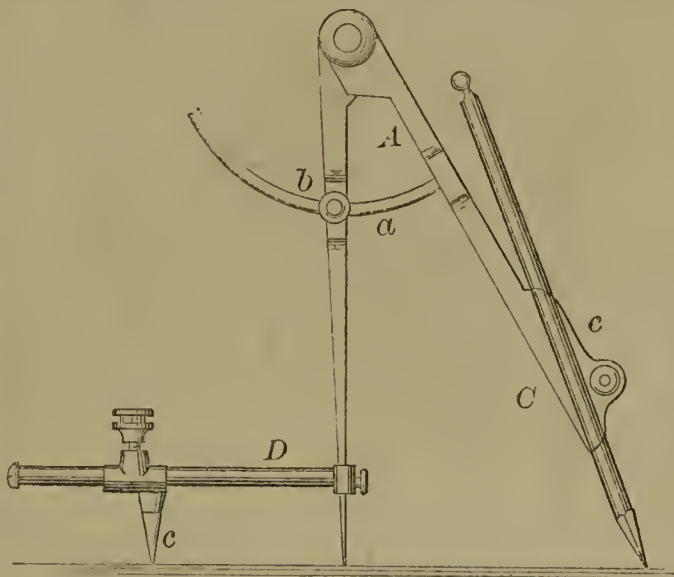

60611—R. Bailey—*Steam Generator*.

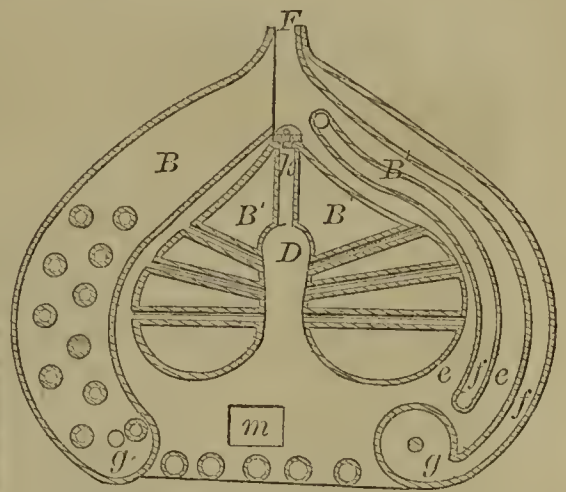

60613—A. G. Bevin—*Sleigh Bells*.

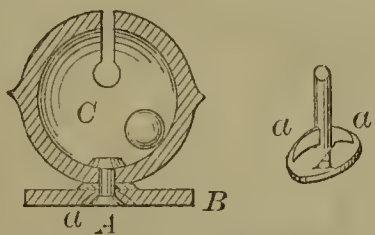

60615—W. P. Brooks—*Broom Head*.

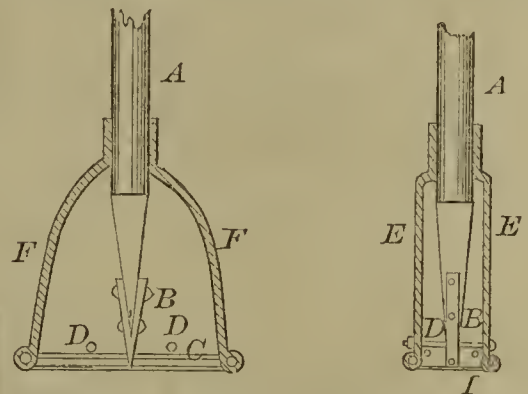

60612—J. Ballard—*Washing Machine*.

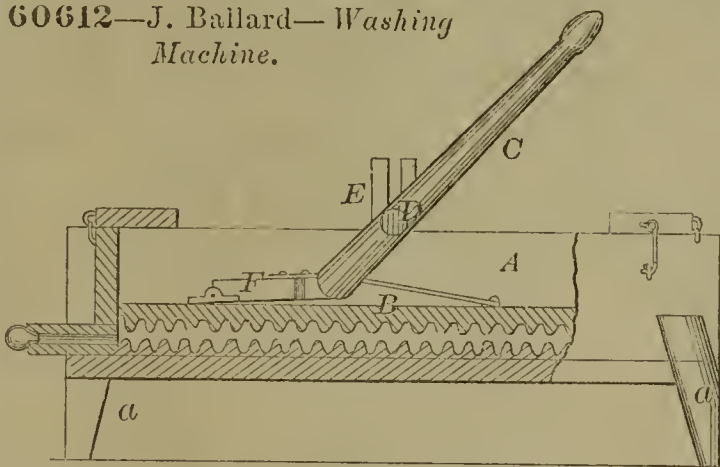

60610—P. Badore—*Anvil for Swaging Culks for Horse Shoes*.

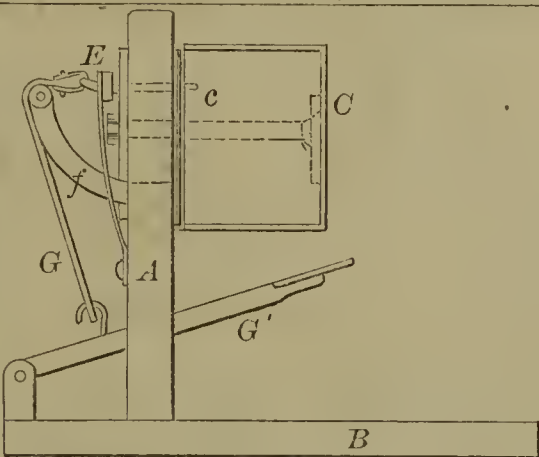
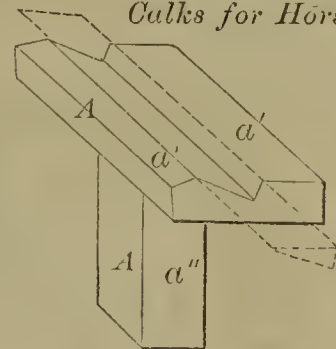

60617—W. D. Burnett—*Anvil to Rivet Trunks*.

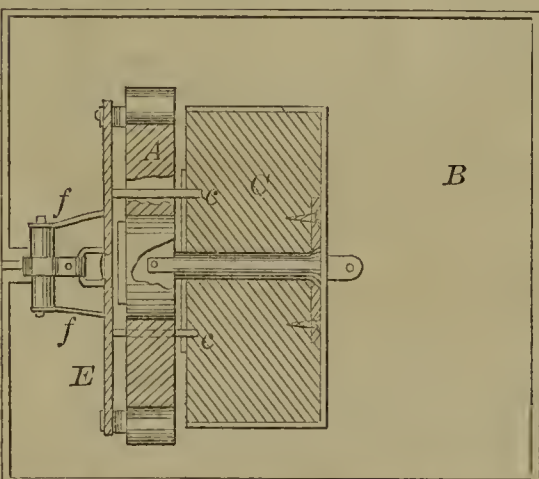

60614—J. Briggs—*Tackle Block*.

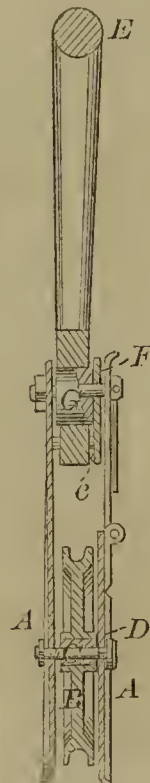

60616—T. S. Brown—*Bearing for Machinery*.

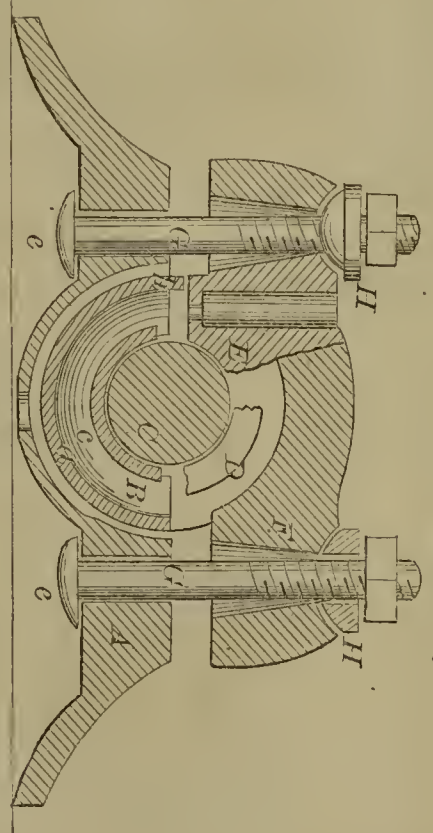

60618—C. B. Cannon—*Potato Digger.*

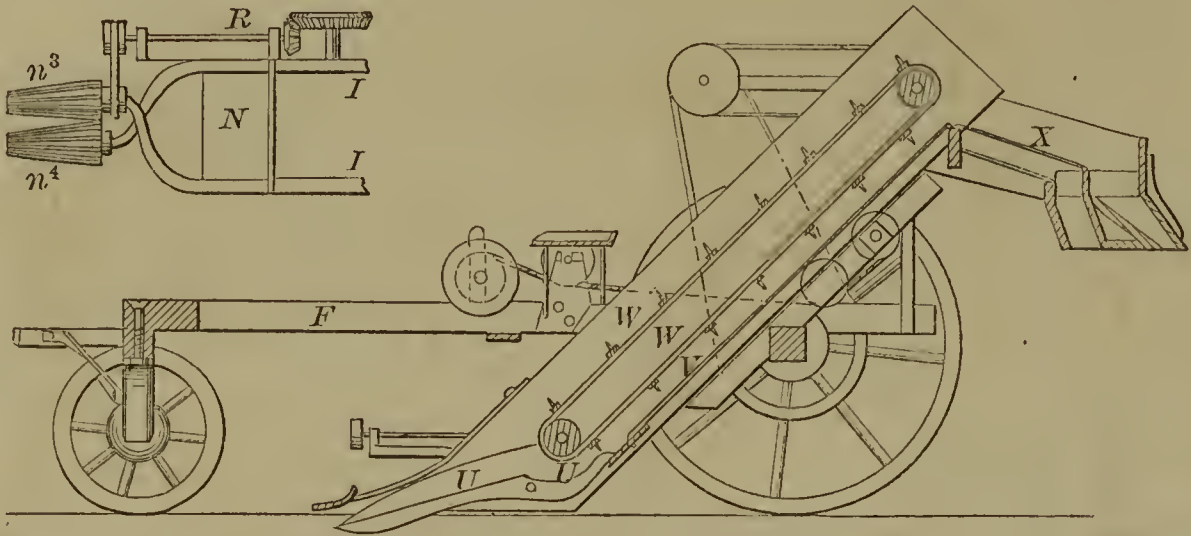

60621—T. H. Cushing—*Sawing Machine.*

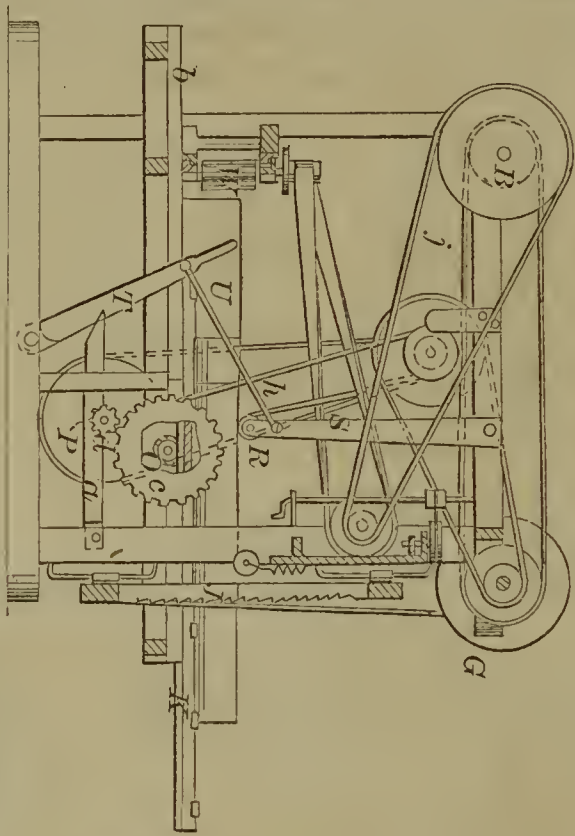

60619—J. Clarridge—*Saw Set.*

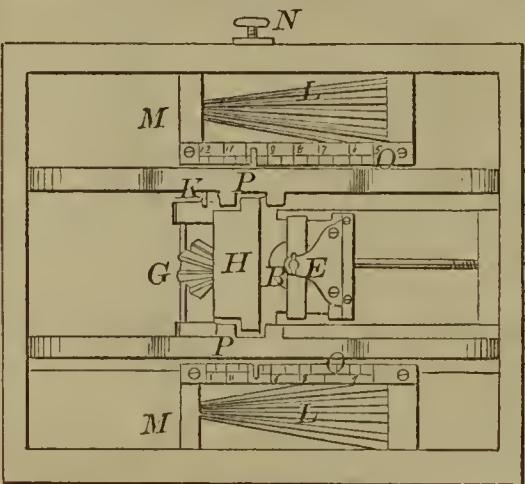

60622—T. N. Davey—*Steam Trap.*

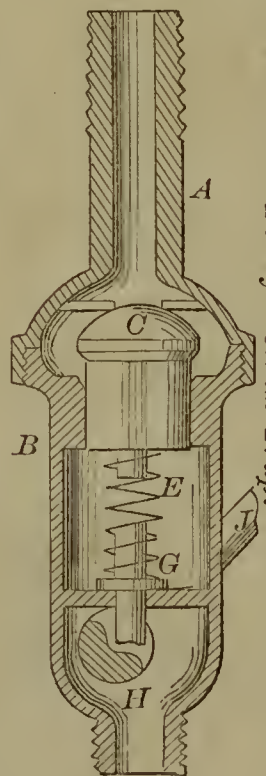

60620—E. Cortés—*Sugar Cane Planter.*

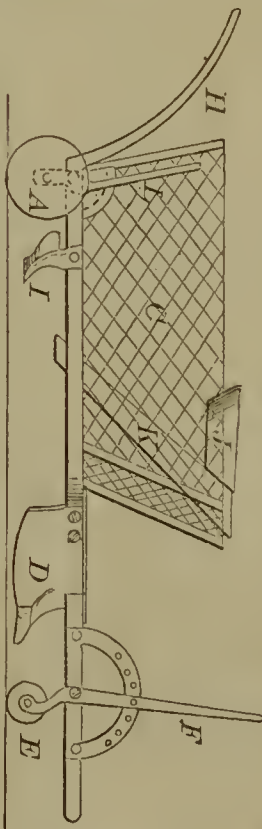

60623—B. F. Elliott—*Grape Vine Trellis.*

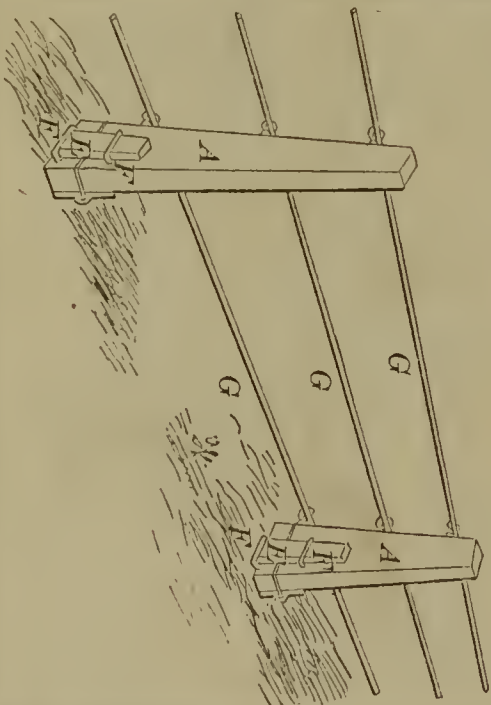

60624—S. B. Fay—*Tag Loop.*

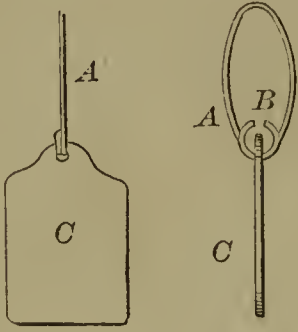

60627—T. L. Goble—*Clothes Pin.*

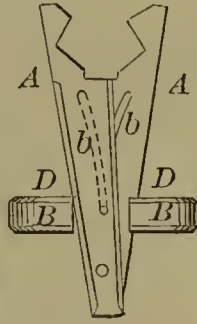

60628—E. Hard—*Sawing Machine.*

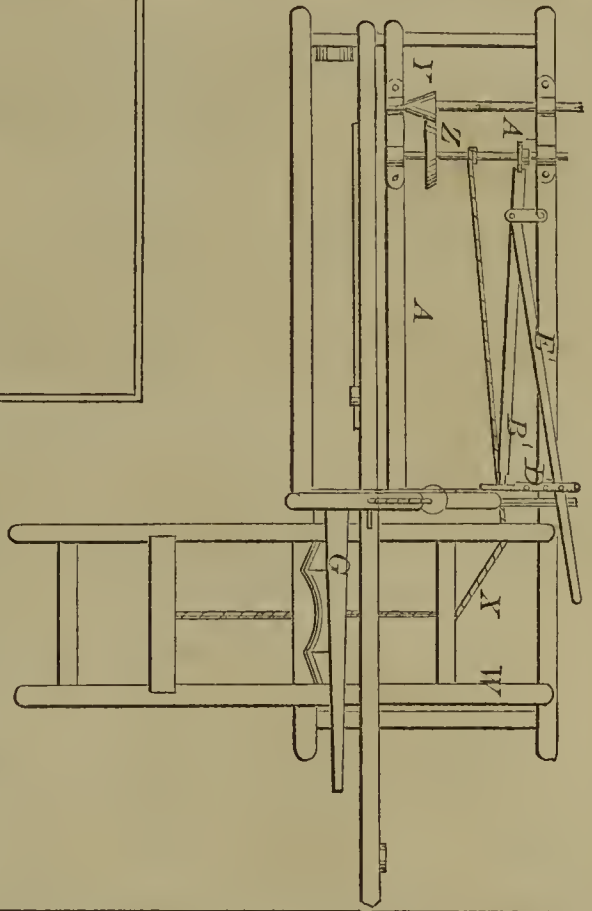

60625—A. K. & B. H. Foster—*Cotton Cultivator.*

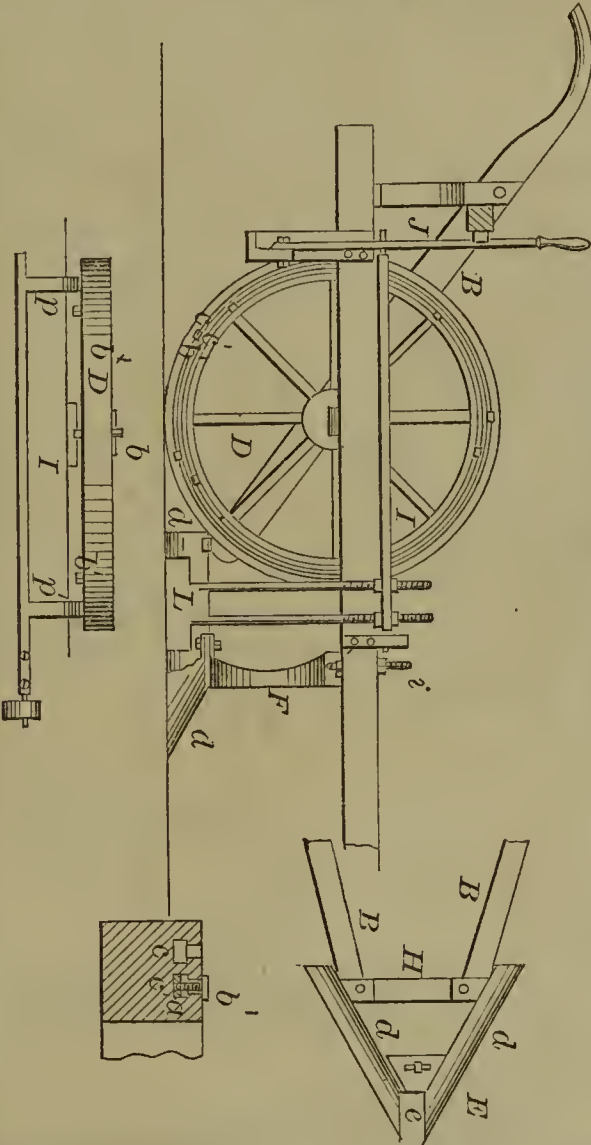

60629—A. A. Henderson—*Steam Engine Governor.*

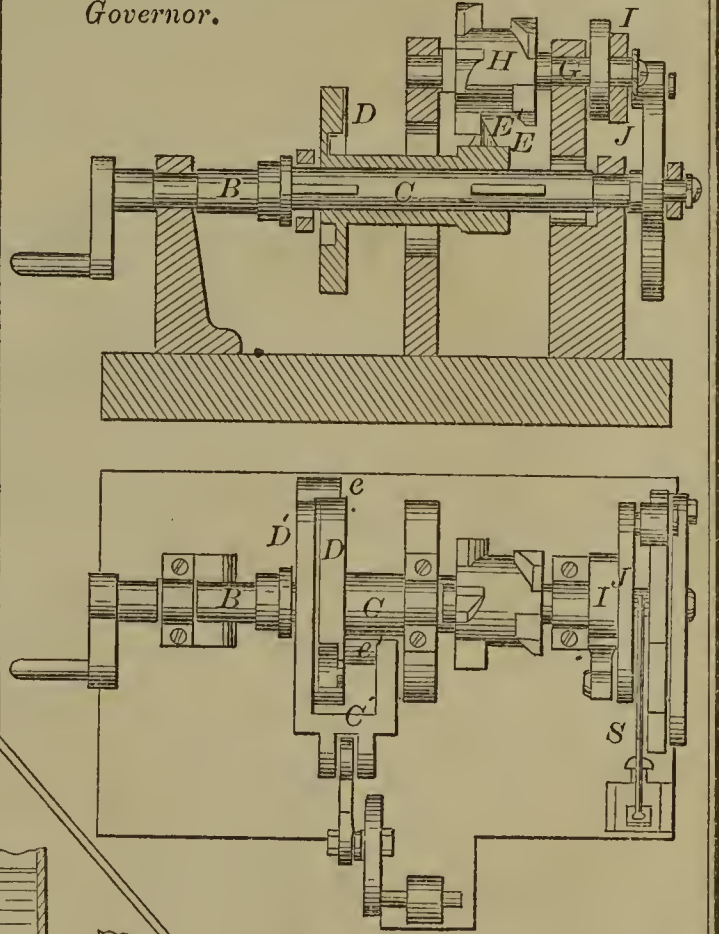

60632—S. M. Hunter—*Hydraulic Governor.*

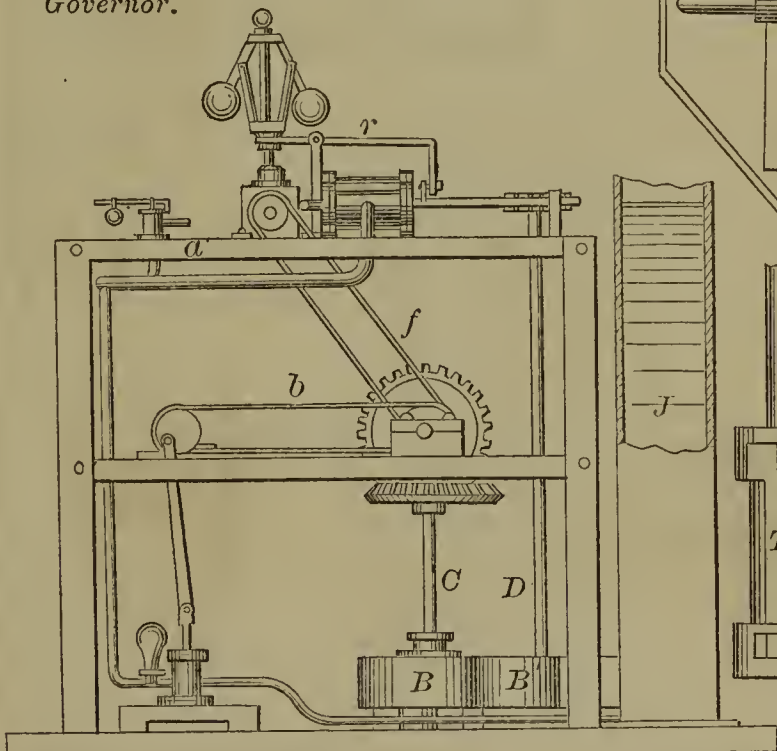

60630—J. Higgins—*Solar Time Indicator.*

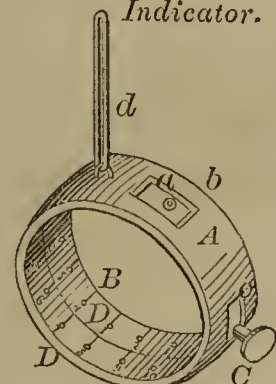

**60633**—B. S. Hyers—*Sash Fastener.*

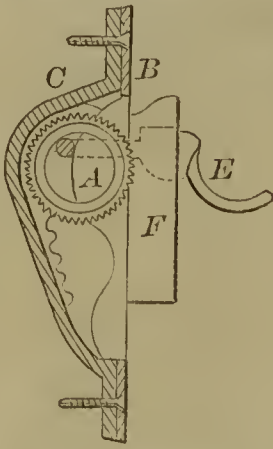

**60634**—J. Irving—*Fifth Wheel.*

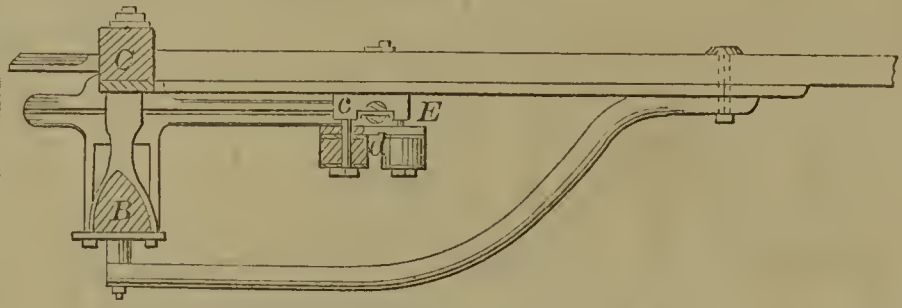

**60637**—P. Louis—*Sprinkling Attachment for Brooms.*

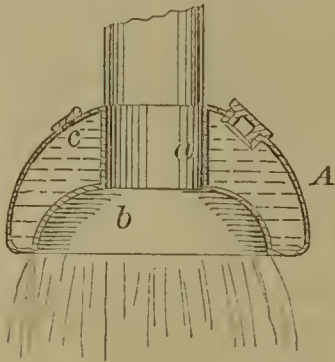

**60636**—H. Lampert—*For Scraping Hides.*

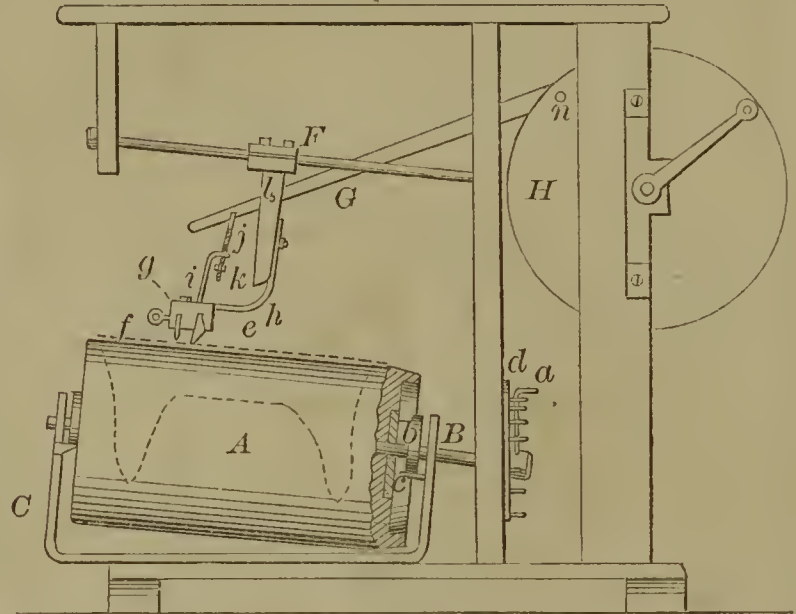

**60638**—J. L. Mackey—*Rotary Steam Valve.*

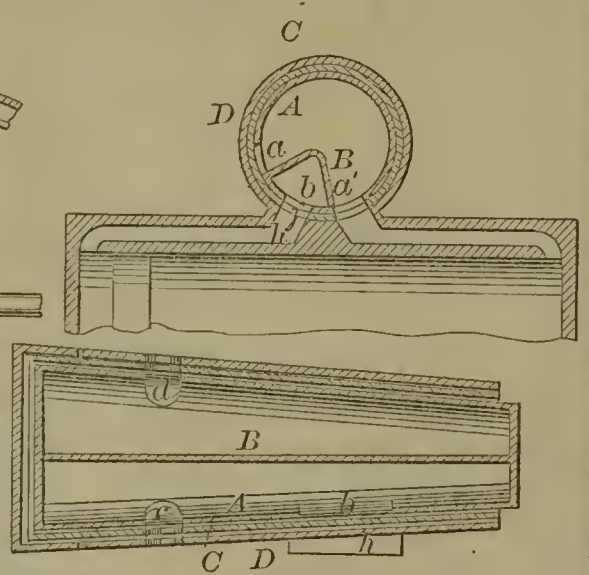
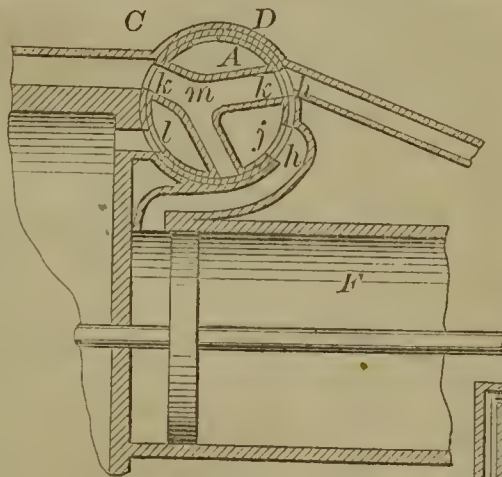

**60639**—F. B. Morse—*For Tightening Wheel Tires.*

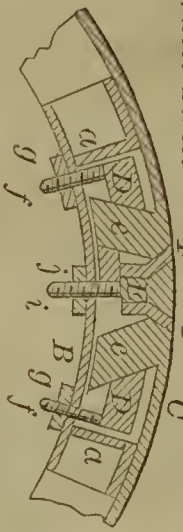

**60640**—J. Murtaugh—*Life Raft.*

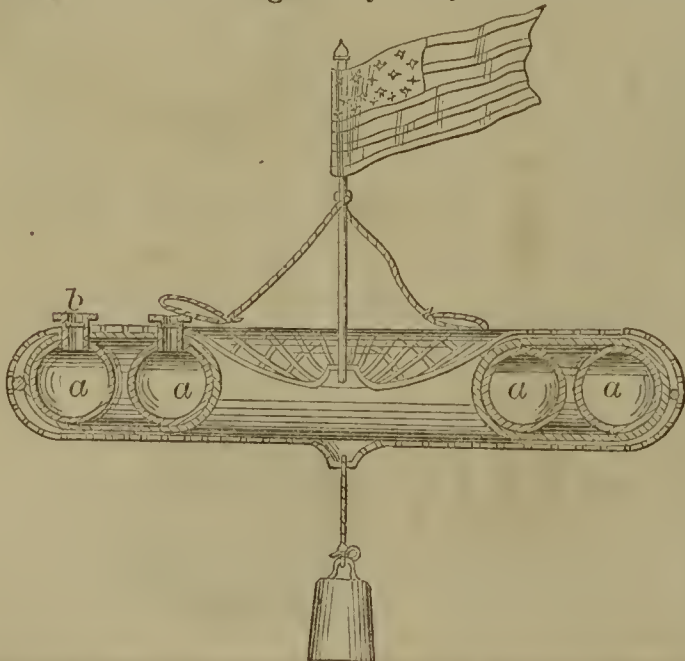

**60641**—M. Renz—*Extension Hoe.*

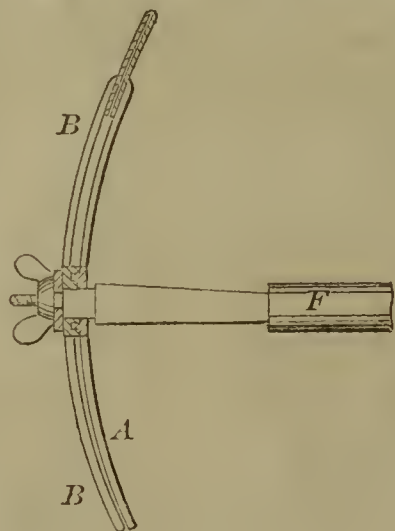



60642—E. Root—Terrasphere.

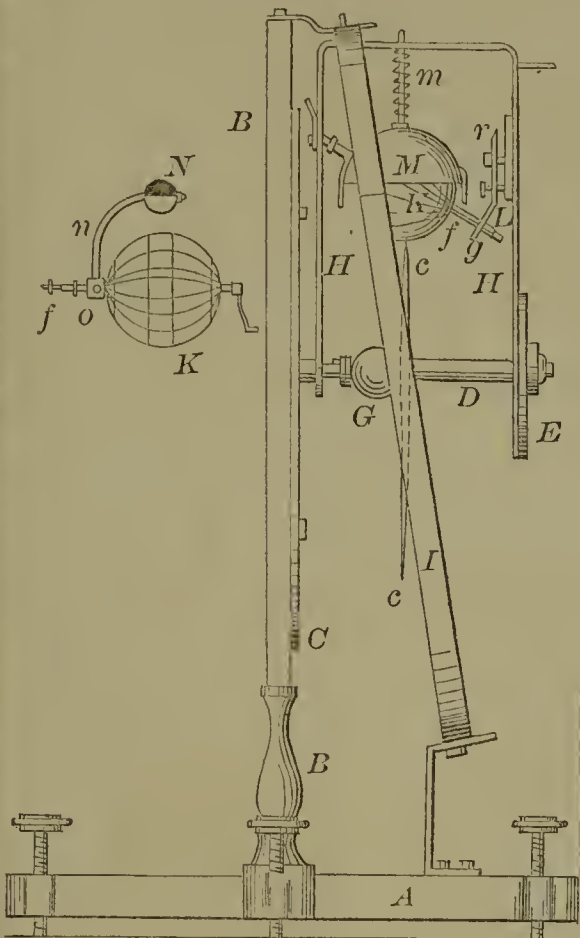

60643—J. Russell—Corn Stalk Cutter and Corn Husker.

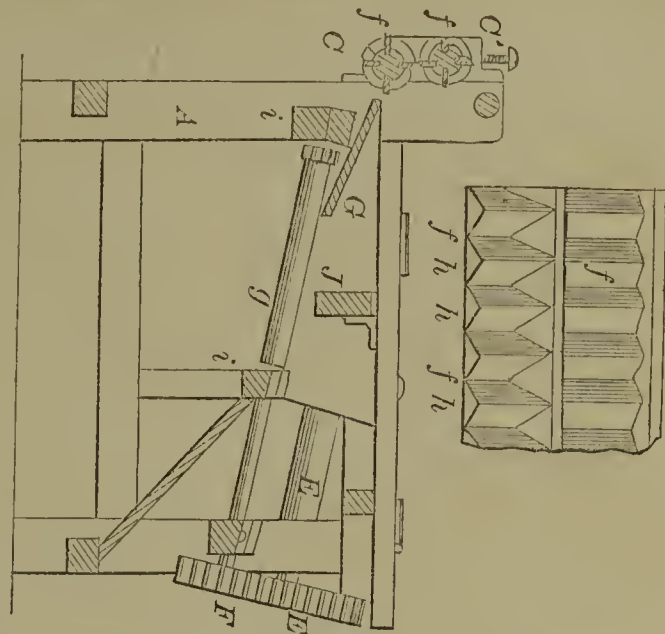

60645—J. M. Shew—Rag Engine.

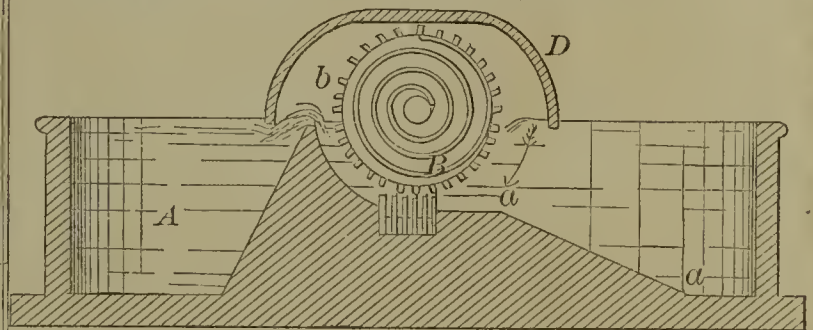

60644—B. D. Shaw—Latch.

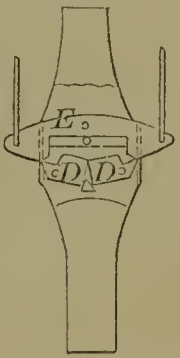

60646—P. A. Snyder—Adjustable Mitre.

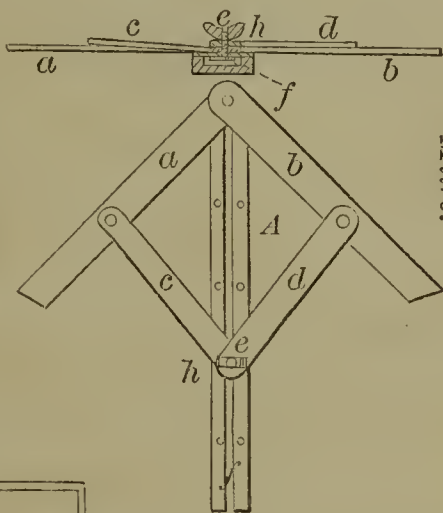

60647—M. Spenle—Lathe.

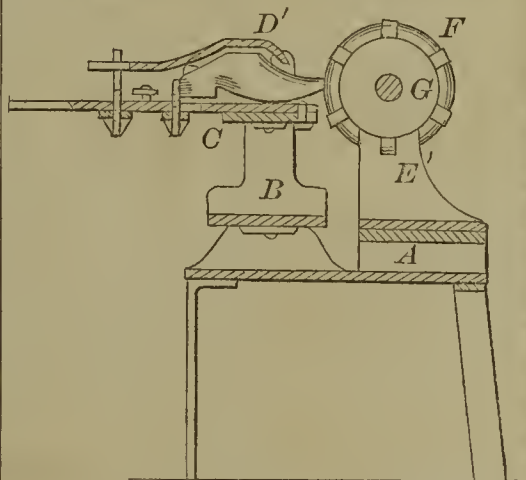

60649—W. H. Stewart—Sawing Machine.

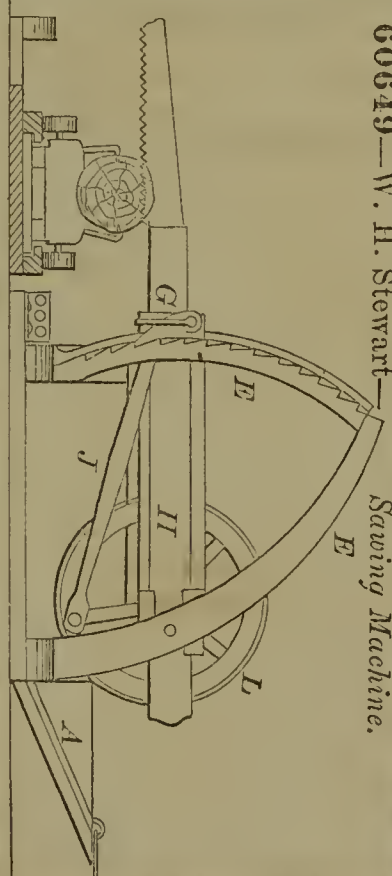

60648—E. H. Stearns—Saw Mill.

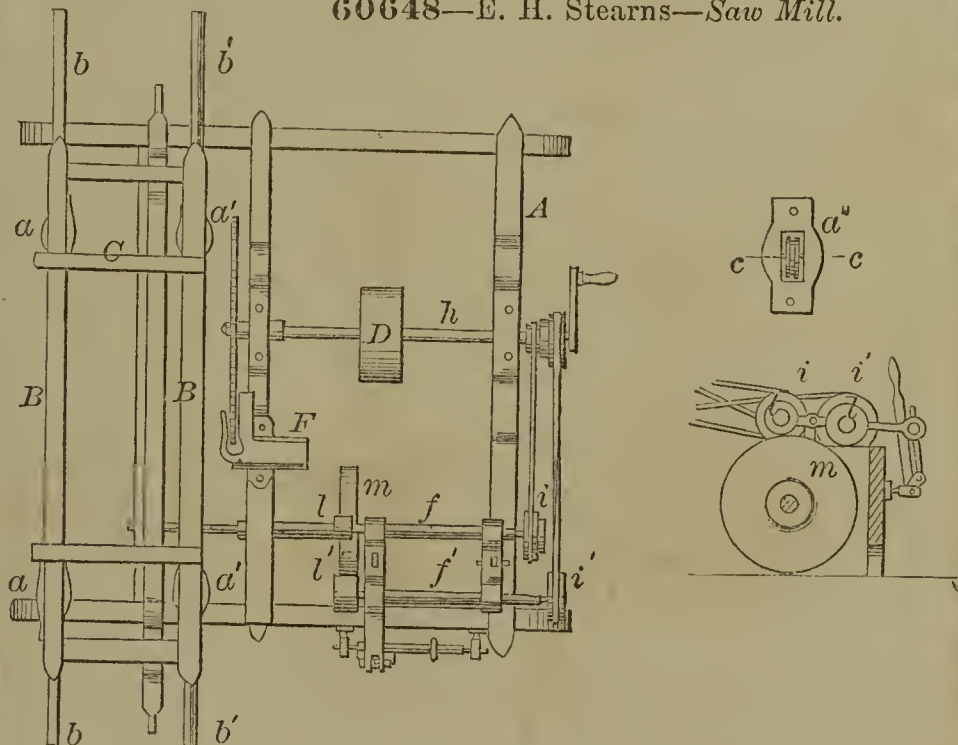

60650—P. L. Suine—Fork and Cake Lifter.

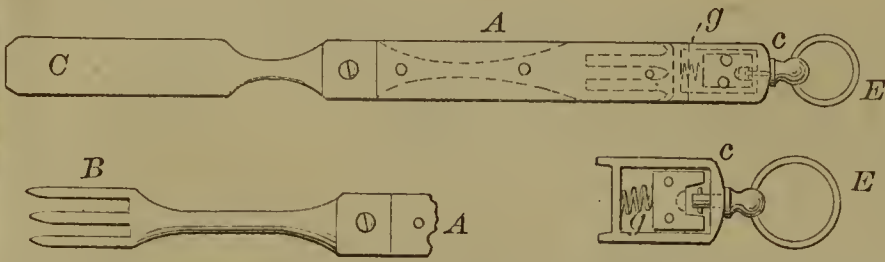

60651—B. D. Tabor—Sheep Rack.

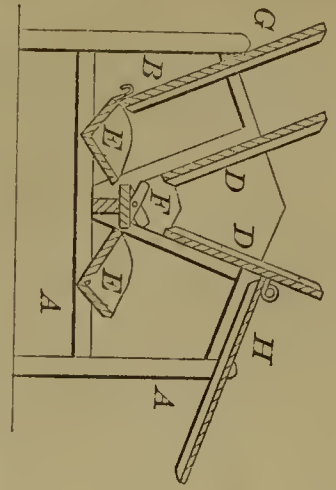

60653—S. Van Auken—For Cleaning Boiler Tubes.

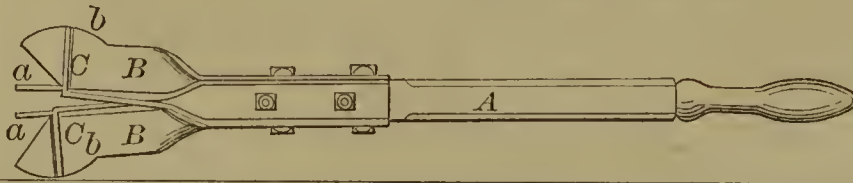

60655—G. H. Woodruff—Roller and Harrow.

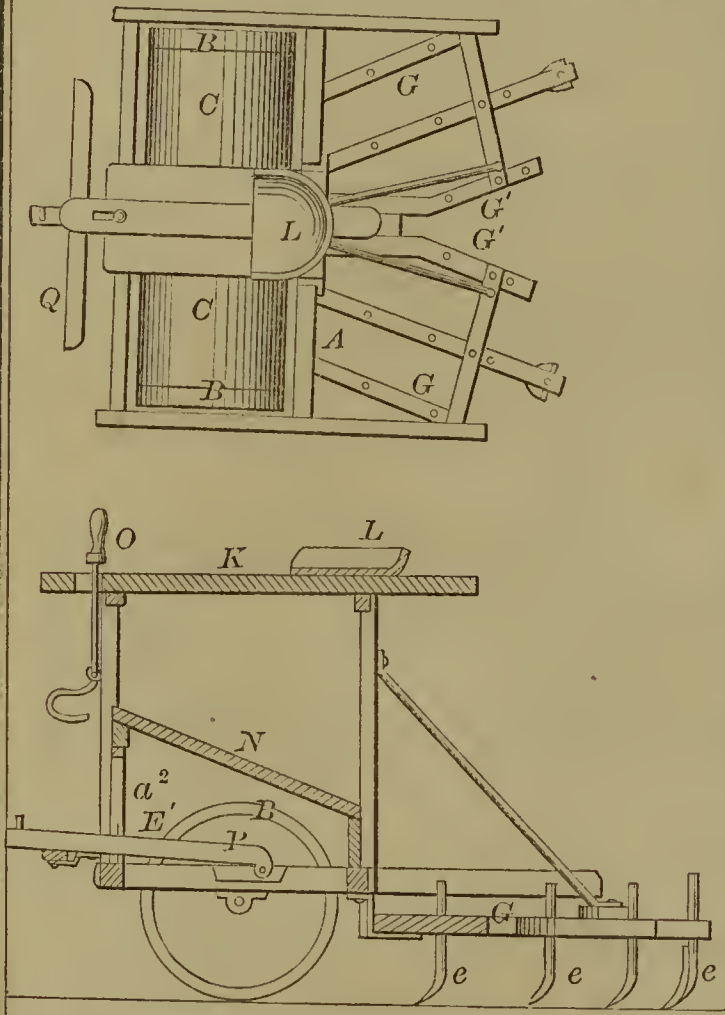

60654—J. M. Whiteside—Reverberatory Furnace.

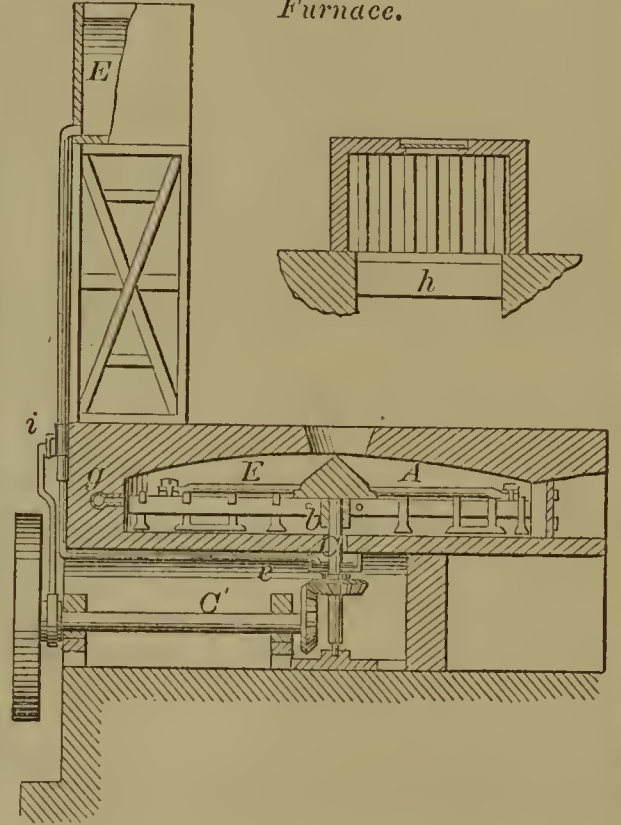

60656—J. Suggett—Manufacture of Butter from Whey.

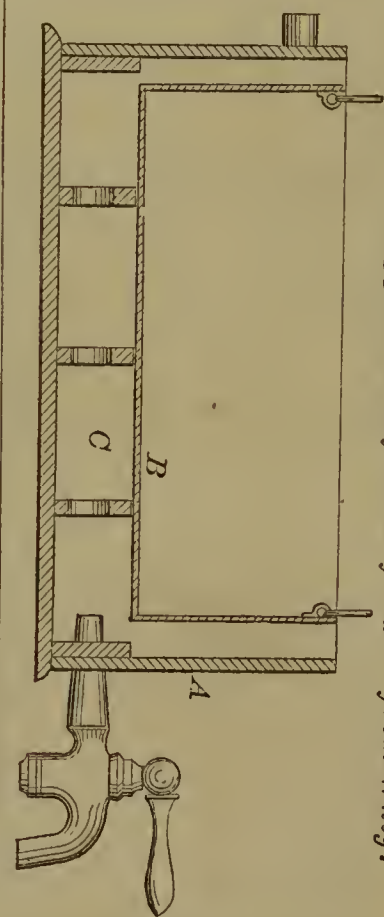

60657—L. Decker—Billiard Table Cushion.

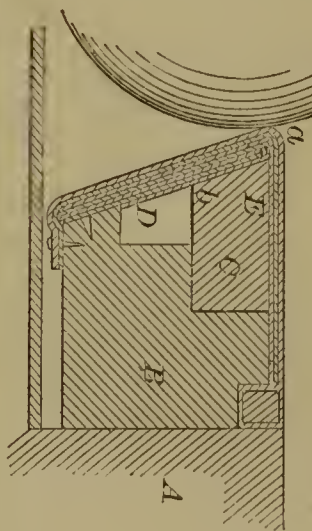

60652—S. J. Talbott—Dough Mixer.

