

Historic, Archive Document

Do not assume content reflects current scientific knowledge, policies, or practices.

Autumn.

SEP 26 1897

BOTANY SEED LABORATORY.



BULBS FOR WINTER FLOWERING

...AND...

GARDEN DECORATION

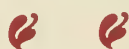

SCHLEGEL & FOTTLER,

GROWERS AND IMPORTERS OF

Seeds, Bulbs, Plants, Shrubs, Etc., Etc.

... WHOLESALE AND RETAIL ...

26 South Market Street, Boston, Mass.



To Our Customers:

GREETING.

In presenting our Autumn Catalogue for 1897, we wish to thank our many friends and customers for their kind recommendations and patronage. Our efforts to please and satisfy those who have dealt with us appear to be well recognized—a fact that brings us much pleasure.

Although we have always chosen to follow a rather conservative course, our record shows constant and steady progress; this encourages us to continue the straightforward, systematic policy in our business affairs that we have from the first adhered to.

Our business success has been largely due to the *superior quality* of the stocks we sell; *we deal in no second grade of anything*. As an illustration of these facts we will state that many of the most prominent seed-houses in this country and Europe often send to us for various special strains of seed to grow their stock from. We do an extensive business with two very critical classes of customers: Market-gardeners and regular Florists. Seeds which satisfy these branches of trade are certainly safe for the general public to use. Our Seed-rooms (the largest in the city) enable us to carry large stocks of seeds, and we are constantly improving our business facilities.

POSTAGE

Is paid by us to all points in the United States on all *Bulbs* at single and dozen prices quoted in this catalogue, except where noted.

OUR BULBS

Are of the very highest quality and at the *Lowest Prices*. Imported direct from the best growers in England, France and Holland. No better are sold in this country.

REMITTANCES

May be made at our risk by draft, money order, American Express Co.'s money order, cash by express or registered letter. Postage stamps may be sent for small amounts.

ADDRESS, Etc.

Purchasers will please be particular in *plainly* signing their *Name, Post-Office, County and State*, and mention mode of conveyance, whether by *Mail, Express or Freight*.

SITUATIONS FOR GARDENERS AND FARMERS.

We have on our books the names of reliable men, experienced in all branches of gardening. Also, men for second places and general work on a gentleman's place. If, at any time, our customers or others are in want of such men, they would do well to call upon or write us. *No fees are ever charged.*

Our Catalogue of Seeds for the coming year will be mailed to all regular customers as soon as issued, to all others upon application.

Hyacinths.



GARDEN CULTURE.—The bulbs may be planted from October to December in any good, well-drained garden soil. They should be set six inches apart, and three to four inches deep. *Before the ground freezes* cover the beds about six inches deep with leaves or other good litter to keep out the frost. The covering can be kept in place by pieces of boards or boughs and should gradually be removed upon approach of warm weather in Spring. The bulbs should be left until the foliage turns yellow, when they may be lifted, dried off and kept in a dry, cool place for replanting.

CULTURE IN POTS.—Select solid, heavy bulbs and plant as early as possible, using a four or five inch pot for a single bulb. Fill the pots with a light, rich potting soil and have the top of the bulb just above the surface, give a good watering and set away in a cool place, covering them with about five inches of sand or coal ashes. This prevents the bulbs from rising while the roots are growing and keeps them quite moist. In about eight weeks they may be taken to the room in which they are to flower. By bringing in a few pots at a time about two weeks apart a succession of bloom may be had.

CULTURE IN GLASSES.—The single varieties are best adapted for glass culture and the best named sorts should be selected. Use soft water in filling the glasses, put in a little charcoal and allow the bottom of the bulb to just come in contact with the water. Keep in a dark, cool place till the roots are about six inches long, when they may be brought into light and warmth to bloom. Add water occasion-

ally as it evaporates, and the nearer they can be kept in a temperature of 60° F. the better will be the results.

CHOICE MIXED HYACINTHS.

IN SEPARATE COLORS.

These are made up of varieties selected for beds and borders, or for forcing for cut flowers, and are of such superior quality as to be entirely satisfactory to florists who use large quantities of them.

If desired by mail add 10 cents per dozen for postage.

SINGLE VARIETIES.

	Each.	Doz.	Hund.
Dark Red sorts, mixed . . .	\$0.05	\$0.60	\$3.75
Rose and Pink sorts, mixed05	.60	3.75
Pure White sorts, mixed05	.60	3.75
Dark Blue sorts, mixed05	.60	3.75
Light Blue sorts, mixed05	.60	3.75
Yellow sorts, mixed05	.60	3.75
Mixed, all the above colors05	.60	3.75

DOUBLE VARIETIES.

	Each.	Doz.	Hund.
Dark Red sorts, mixed . . .	\$0.05	\$0.60	\$3.75
Rose and Pink sorts, mixed05	.60	3.75
Pure White sorts, mixed05	.60	3.75
Dark Blue sorts, mixed05	.60	3.75
Light Blue sorts, mixed05	.60	3.75
Yellow sorts, mixed05	.60	3.75
Mixed, all the above colors05	.60	3.75

NAMED BEDDING OR FORCING HYACINTHS.

Fine solid bulbs specially adapted for planting in beds or forcing in pans, enabling one to secure the exact color effect desired. The large, full spikes will give splendid satisfaction.

Bright Red.
Pink.

Rose.
Blush White.

Pure White.
Porcelain.

Dark Blue.
Light Blue.

8c. each. 75c. per dozen. \$5.00 per hundred.

If desired by mail add 15 cents per dozen for postage.

CHOICE NAMED HYACINTHS.

Selected bulbs of best varieties for house culture in earth or water.

SINGLE RED, ROSE AND PINK.

	Each.		Each.
Amy , bright carmine, large spike	\$0.10	L'Incomparable , dark crimson, fine	\$0.20
Charles Dickens , beautiful rose, fine spike15	Lord Macaulay , fine bright red with pink centre, large compact truss15
Cosmos , dark rose, large12	Lord Wellington , pale pink, fine spike15
Fabiola , pink, carmine striped, extra15	Norma , fine waxy pink, early15
Garibaldi , brilliant deep red, early20	Queen of Hyacinths , crimson carmine12
Gen'l Pelissier , deep crimson, early15	Robert Steiger , bright, deep crimson10
Gertrude , rosy pink, large spike12	Von Schiller , deep pink, large truss20
Giant of Roses , fine rose, large truss20		

SINGLE PURE WHITE AND BLUSH.

	Each.		Each.
Alba Maxima , pure white, very early	\$0.20	La Grandesse , the purest white, extra	\$0.20
Alba Superbissima , pure white, fine truss12	L'Innocence , snow white, large truss15
Baroness Van Tuyll , pure white, extra truss12	Mme. Van der Hoop , splendid white, early15
Grand Vainqueur , pure white, very early15	Paix de l'Europe , pure white, fine truss15
Grand Vedette , pure white, large bells12	Snowball , pure white, large bells25
Grandeur a Merville , blush white, large15	Voltaire , creamy white, fine12

SINGLE LIGHT AND DARK BLUE.

	Each.		Each.
Argus , dark blue, white centre	\$0.12	L'Amie du Coeur , fine violet blue	\$0.12
Baron Van Tuyll , bright blue, fine truss12	Marie , rich dark blue, fine spike12
Charles Dickens , light blue, large truss10	Pieneman , dark porcelain, large bells15
Czar Peter , porcelain blue, extra fine15	Regulus , clear blue with darker stripes15
Grand Maitre , deep porcelain, extra fine15	Sir John Lawrence , fine deep blue15
King of the Blues , rich dark blue, large truss15	Uncle Tom , blackish purple15

SINGLE YELLOW.

	Each.		Each.
Adonia , buff, fine spike	\$0.15	Ida , the best pure yellow	\$0.25
Alida Jacoba , bright yellow20	La Pluie d'Or , pale yellow12
Duc de Malakoff , orange yellow15	L'Or d'Australle , pure yellow, fine25
Herman , fine orange yellow12	Obelisque , dark yellow, good truss25

DOUBLE RED, ROSE AND PINK.

	Each.		Each.
Bouquet Tendre (Waterloo), carmine rose	\$0.12	Noble Par Merite , deep rose, large truss	\$0.15
Bouquet Royal , rosy salmon, large truss15	Princess Louise , deep crimson, fine25
Dibbitz Sabalkansky , deep red, fine15	Regina Victoria , pink, fine truss15
Grootvorst , pink, good truss12	Sans Souci , dark red, magnificent20

DOUBLE PURE WHITE AND BLUSH.

	Each.		Each.
Anna Maria , blush, purple centre	\$0.15	La Virginite , blush, large truss	\$0.12
Bouquet Royal , pure white, good truss20	La tour d'Auvergne , pure white, early15
Duchess of Bedford , pure white, fine15	Prince of Waterloo , pure white, large truss15
Grand Vainqueur , pure white, extra25	Sceptre d'Or , pure white, fine15

DOUBLE LIGHT AND DARK BLUE.

	Each.		Each.
Bloksberg , bright porcelain, large truss	\$0.12	Gen'l Anthink , fine blue, good truss	\$0.15
Charles Dickens , clear blue, early15	Lord Wellington , dark blue, fine spike12
Crown Prince , violet blue, fine truss15	Mignon de Dryfhout , light blue, dark eye20
Envoye , light blue, tinged indigo15	Rembrandt , splendid light blue15
Garrick , lilac blue, splendid12	Van Speyk , bright light blue, extra20

CHOICE NAMED HYACINTHS. (Continued.)

DOUBLE YELLOW.

	Each.		Each.
Bouquet d'Orange , orange salmon	\$0.15	Minerva , reddish yellow, fine	\$0.20
Goethe , splendid light yellow15	Ophir d'Or , pure yellow, dark eye20
Jaune Supreme , rich yellow, early25	William III , pinkish yellow, extra fine20

SPECIAL SELECTIONS OF NAMED HYACINTHS.

For the convenience of our customers unacquainted with the different named Hyacinths, we put up the following selections which comprise only sorts of the highest merit, and recommend them as most worthy of cultivation.

If desired by mail, add 20 cents per dozen for postage.

No. 1.— 12 Distinct Varieties for pot culture, including Double and Single	\$1.50
No. 2.— 12 "	2.00
No. 3.— 25 "	2.50
No. 4.— 25 "	3.50
No. 5.— 12 " " for growing in water, all single	1.50
No. 6.— 25 "	2.50
No. 7.— 50 in Ten Distinct Varieties for House or Show-Beds	3.50
No. 8.— 100 "	6.00

MINIATURE OR DUTCH ROMAN HYACINTHS.

These may be planted close together in pots or boxes, also in beds in the open ground with charming effect. We can furnish them in the following colors.

Dark Red, Rose and Pink, Pure White, Dark Blue, Light Blue, All Colors Mixed.

5 cents each, 50 cents per dozen. By mail, 60 cents per dozen.

EARLY ROMAN HYACINTHS.

A charming class specially adapted for forcing and house culture, each bulb producing several graceful spikes of delicately perfumed flowers. They may be had in bloom from November to spring by early and successive plantings and treating as recommended for Hyacinths on page 1. Bulbs may be planted close together, 3 bulbs in a 4-inch pot.

If desired by mail add 10 cents per dozen for postage.

	Each	Doz.	Hund.
Pure White , one of the most valuable plants for cut flowers	\$0.05	\$0.50	\$3.50
Light Blue , a fine contrast to the other colors05	.50	3.00
Light Rose or Pink , beautiful pale rose05	.50	3.00

WHITE ITALIAN OR PARISIAN HYACINTHS.

This variety is largely grown for the flower markets of Paris. They are a little later in flowering than the Roman, and have larger spikes; very fragrant. 5c. each, 50c. per dozen, \$3.00 per hundred. *By mail 10 cents per dozen.*

GRAPE, MUSK AND FEATHERED HYACINTHS.

Very pretty for permanent beds, clumps or edging. They should be planted in groups of a dozen or more, and being perfectly hardy will soon spread. Fine for partially shaded places, and when grown in pots for winter flowering are pretty and interesting.

	Each.	Doz.	Hund.
Blue Grape , small round blue bells resembling grapes	\$0.03	\$0.15	\$1.00
White Grape , like preceding, except in color03	.25	1.50
Musk , purplish color with quite a strong odor of musk15	1.50	
Feathered , feathery plume like spike of violet color03	.25	1.75

VARIOUS TULIPS.

	Each	Doz.
Cornuta (Chinese Parrot), red and yellow flamed, curiously twisted petals	\$0.08	\$0.75
Florentina Odorata , tall, yellow, sweet scented05	.50
Greigii , large, brilliant orange scarlet with a yellow and black center, foliage oddly spotted with deep maroon20	2.00
Oculis Solis (Sun's Eye), dazzling fiery red with black centre06	.06

Tulips.



Universal favorites and always attractive from the beauty, brilliancy and variety of color, which make them one of the most popular flowers for early spring display in the garden, or for winter flowering in house and conservatory. They are extremely hardy and of easy culture in any good garden soil, seldom failing to give the greatest satisfaction. Clumps of double and single sorts planted together among the shrubs and perennials will give a longer season of bloom than if either were planted alone. The bulbs should be set 3 to 4 inches deep and 4 to 6 inches apart. Culture as recommended for Hyacinths, page 1.

SINGLE EARLY FLOWERING NAMED TULIPS.

Selected Bulbs of Best Varieties for Forcing and Bedding.

If desired by mail add 5 cents per dozen for postage.

	Doz.	Hund.		Doz.	Hund.
Artus , fine scarlet	\$0.20	\$1.25	Pottebakker Scarlet , large, bright scarlet	\$0.30	\$2.00
Belle Alliance , (Waterloo) brilliant scarlet	.25	1.75	“ White , finest pure white	.40	3.00
Bizard Pronkert , fine yellow, red stripe	.25	1.75	“ Yellow , large, pure yellow	.50	3.75
Bizard Verdict , brilliant carmine, gold stripe	.20	1.25	“ Yellow Flame , yellow, red flame	.40	3.00
Brutus , orange crimson25	1.75	Prince of Austria , orange scarlet, extra	.50	3.50
Chrysolora , large, pure yellow30	2.25	Proserpine , rich satiny carmine rose50	3.50
Cottage Maid , rosy pink, white striped	.40	2.75	Purple Crown , very dark red, fine25	1.60
Couleur Cardinal , crimson scarlet30	1.75	Queen Victoria , white, pale rose tint20	1.25
Couleur Ponceau , cherry red and white	.25	1.50	Rachel Ruisch , brilliant rose30	2.25
Crimson King , brilliant crimson20	1.00	Rose Grisdelin , fine bright pink35	2.50
Duc d'Orange , orange red and yellow25	1.75	Rosamundi , bright rose and white30	2.00
Duchess of Parma , orange, yellow edge	.25	1.75	Silver Standard , white, crimson striped	.25	1.75
Jagt Van Delft , fine white25	1.65	Standard , scarlet, golden striped40	3.00
Joost Van Vondel , cherry, white feathered	.30	2.00	Thomas Moore , orange, very effective	.30	2.25
Keizerskroon , deep crimson, yellow edge	.30	2.00	Van der Neer , beautiful clear violet25	1.75
Lac Von Rhyn , dark violet, white border	.25	1.75	Vermilion Brilliant , rich vermilion40	3.00
L'Immaculee , pure white, fine30	1.75	Wapen van Leiden , rose, white striped	.30	2.00
Ma Plus Aimable , red and yellow30	2.00	Yellow Prince , large, bright yellow35	2.50

SINGLE EARLY FLOWERING MIXED TULIPS.

If desired by mail add 5 cents per dozen for postage.

	Doz.	Hund.
Fottler's Selected Mixture. For variety of color, size and brilliancy this mixture is unsurpassed, being made up from named sorts which flower together and grow about the same height	\$0.30	\$2.00
Superfine Mixture. A first-class mixture and equal to the best sent out by many25	1.50

DISTINCT COLORS OF SINGLE EARLY FLOWERING TULIPS.

For Beds, Borders and Massing.

Selected bulbs of the best varieties growing about the same height and blooming about the same time.

	Hund.		Hund.		Hund.
Crimson	\$1.25	Scarlet	\$1.75	White	\$1.75
Rose	2.25	Red and Yellow	2.00	Yellow	2.25

DOUBLE TULIPS IN MIXTURE.

If desired by mail add 5 cents per dozen for postage.

	Doz.	Hund.
Fottler's Selected Mixture , made up from named sorts and is unsurpassed	\$0.30	\$2.00
Superfine Mixture , a special mixture of great variety and color25	1.50

DOUBLE TULIPS. CHOICE NAMED VARIETIES.

These are very effective in beds, borders or clumps planted among the shrubbery. The flowers are very large, of brilliant and varied colors, lasting much longer in bloom than the single sorts.

If desired by mail, add 5 cents per dozen for postage.

	Doz.	Hund.		Doz.	Hund.
Duke of York , carmine, white bordered	\$0.25	\$1.75	Queen Victoria , cherry red	\$0.35	\$2.50
Gloria Solis , red, yellow border	.25	1.75	Raphael , superb, delicate rose	1.25	10.00
Imperator Rubrorum , bright scarlet	.40	2.75	Rex Rubrorum , fine scarlet	.35	2.50
La Candeur , pure white	.25	1.50	Rose Crown , carmine red	.30	2.00
La Citadelle , purplish red, yellow edge	.40	2.75	Rosine , splendid rose	.35	2.50
Le Blason , rosy blush, fine	.40	2.75	Tournesol Red , edged with yellow	.35	2.50
Marriage de ma Fille , red, white striped	.50	3.75	Tournesol Yellow , deep yellow	.50	3.75
Murillo , soft pink, extra	.40	3.00	Turban , fine velvet	.40	3.00
Paeony Red , brilliant red	.30	2.00	Velvet Gem , large, dark carmine	.35	2.50
Purple Crown , dark scarlet	.30	2.00	Yellow Rose , golden yellow	.25	1.50

SINGLE DWARF DUC VAN THOLL TULIPS.

Very early and especially valuable for forcing or pot culture.

If desired by mail add 5 cents per dozen for postage.

	Doz.	Hund.		Doz.	Hund.
Crimson , brilliant	\$0.20	\$1.25	Scarlet , rich, dazzling color	\$0.20	\$1.25
Gold Laced	.20	1.50	Vermilion	.25	1.75
Rose	.35	2.50	White	.30	2.25
Red and Yellow	.20	1.25	Yellow	.40	2.75

PARROT OR DRAGON TULIPS.

These are very attractive for the large size of the flowers, singular and picturesque forms, brilliant and varied colors, and the curiously fringed or cut petals. They are extremely showy in flower beds, blooming between the early and late sorts.

If desired by mail add 5 cents per dozen for postage.

	Doz.	Hund.
Admiral of Constantinople , large, red tipped with orange	\$0.30	\$2.00
Lutea Major , large, bright yellow	.30	2.00
Perfecta , large, yellow striped with red	.30	2.00
Superfine Mixture , a splendid mixture of great variety and color	.25	1.50

LATE FLOWERING SINGLE TULIPS.

The following Tulips differ from the early flowering sorts in their taller growth, later bloom, large and beautifully formed flowers of magnificent colors, with delicate markings and featherings. Excellent for bedding purposes, and being at their best late in May, are extensively used for decorating.

If desired by mail add 5 cents per dozen for postage.

	Doz.	Hund.
Bizarres, Finest Mixed , yellow ground color, striped or feathered with crimson, purple, red, etc.	\$0.25	\$1.50
Byblømens, Finest Mixed , white ground color, blotched or striped with blue, purple, maroon, lilac, etc.	.25	1.75
Roses, Finest Mixed , white ground color with stripes and markings of pink, scarlet, rose, etc.	.25	1.75
Darwins, Finest Mixed . A recently introduced race of the self-colored or <i>Breeder</i> type. The flowers are large, very brilliant, and include almost every shade and color, each flower being of a distinct, clear color borne on a long, stout stem. This race has created a sensation at exhibitions, and received a gold medal at the Paris exposition.	.40	2.50
Gesneriana , immense dazzling scarlet with blue, black centre	.25	1.75
Royal White , large, grand, pure white	.60	4.00
Yellow Crown , large, deep yellow, red edged	.25	1.75

GENTLEMEN: — Your Hyacinths, at 60 cents per dozen, were the finest I saw last winter. Most of them produced two spikes of bloom and some had three, all of good size. S. C. BROWN.

Narcissus or Daffodils.

In the front rank of popularity is placed this most beautiful and fragrant of our flowering bulbs, doing well in almost all soils and situations—among the grass, under trees and in shady borders. Once planted they need no further attention, as they multiply and give larger and finer results each year. For house culture they are equally desirable and should be treated as recommended for Hyacinths. They are all perfectly hardy, excepting the Polyanthus varieties, and these, with a good covering to exclude the frost, will give larger and better flowers than when grown inside.

LARGE TRUMPET NARCISSUS.



Trumpet Narcissus.

	Each	Doz.	Hund.
Ard Righ (Irish King), very large and early, rich deep yellow	\$0.15	\$1.50	\$10.00
Bicolor Empress , magnificent large flower, petals pure white, trumpet golden yellow20	2.00	15.00
Bicolor Grandee , extra large yellow trumpet, pure white petals20	2.00	15.00
Bicolor Horsfieldi , very large flowers of pure white with rich yellow trumpet15	1.50	10.00
Bico'or Michael Foster , creamy white petals with large, rich yellow trumpet30	3.00	20.00
Cernuus , silvery white petals and fine white drooping trumpet25	2.50	20.00
Countess of Annesley , large flower with sulphury petals and rich yellow trumpet30	3.00	20.00
Emperor , large, rich yellow trumpet, light yellow petals, one of the best25	2.50	18.00
Golden Spur , extra large, bold, rich yellow flowers, one of the finest15	1.50	10.00
Henry Irving , rich golden yellow with large, beautifully frilled trumpet12	1.25	8.00
Moschatus (White Spanish Daffodil), large, silvery white, one of the best12	1.25	8.00
Obvallaris (Tenby Daffodil), medium size, rich yellow, very early10	1.00	6.00
Pallidus Praecox , clear, sulphury white, medium size, fine06	.60	4.50
Princeps , large flowers with light yellow petals and deep yellow trumpet05	.50	3.00
Rugilobus , grand variety, a fac-simile of Emperor, but a little smaller and earlier05	.50	3.50
Telamonius (Single Von Sion), fine yellow with golden trumpet05	.35	2.50
Trumpet Major , flowers large and of a uniform deep golden color05	.35	2.50
Trumpet Maximus , a grand, deep golden yellow flower10	1.00	7.00

HOOP PETTICOAT NARCISSUS.

Perfectly hardy and exceedingly pretty for pot culture, each bulb giving from six to twelve blossoms.

	Each	Doz.
Bulbocodium , rich golden yellow	\$0.08	\$0.75
Bulbocodium Monophyllum (Clusii), pure snow white, very early08	.75

NARCISSUS JONQUILLA OR JONQUILS.

Very popular for their charming and delightfully fragrant flowers. Desirable for house culture or planting in the open ground for early flowers.

	Each	Doz.	Hund.
Campernelle , very large, rich yellow	\$0.03	\$0.30	\$1.50
Double Sweet Scented , deep golden yellow08	.75	5.00
Single Sweet Scented , rich golden yellow03	.25	1.50
Rugulosus , the largest flowering Jonquil, pure yellow and very fragrant05	.40	2.00
Tenuior (Silver Jonquil), light silvery yellow05	.60	4.00



Hoop Petticoat Narcissus

MEDIUM TRUMPET AND CUPPED NARCISSUS.

	Each	Doz.	Hund.
Barri Conspicua , large, clear yellow, cup richly stained with scarlet	\$0.25	\$2.50	
Biflora , twin flowers on one stalk, pure white with yellow cup03	.25	
Cynosure , large, primrose petals, cup yellow stained with orange scarlet04	.40	
Johnstoni (Queen of Spain), uniform rich cream color, distinct from any other15	1.50	
Leedsi Amabilis , silvery white petals with long, light yellow cup05	.60	
Nelsoni Major , white petals and long, yellow cup20	2.00	
Nobelissimus , white petals and double yellow crown10	1.00	
Poeticus (Pheasant's Eye or Poet's Narcissus), snow white with red edged cup02	.20	\$0.75
Poeticus Ornatus , like the preceding but with much larger flowers and earlier03	.25	1.50
Scoticus (Garland Lily), white petals and fine yellow trumpet05	.50	
Sir Watkin (Giant Chalice Flower), immense flower with rich primrose petals and golden trumpet20	2.00	
Stella , large, pure white, star shaped flowers with yellow cup			
Triandrus Albus (Angel's Tears), a beautiful variety with several white cyclamen-like flowers			



Narcissus Poeticus. Each Doz. \$0.03 \$0.25

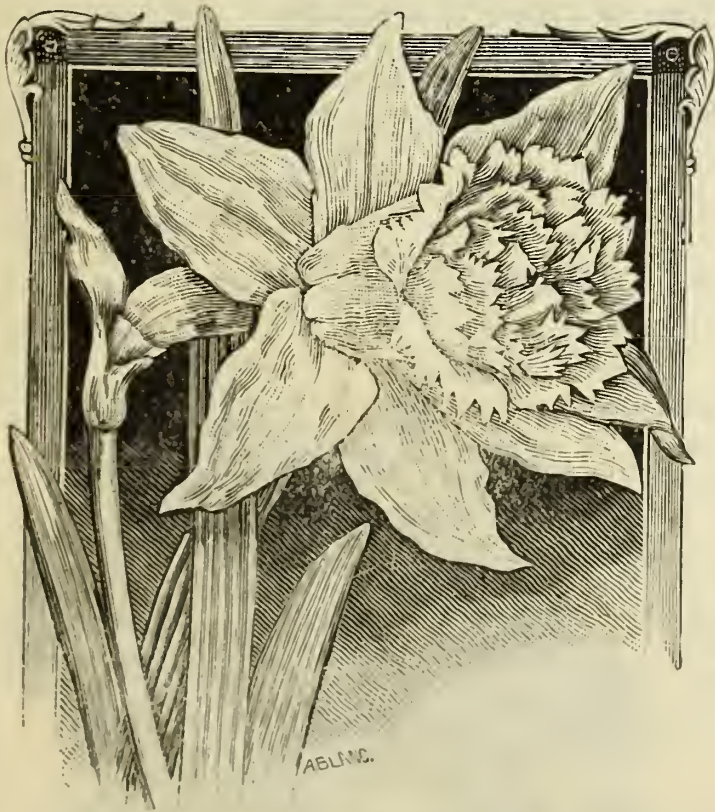

Narcissus Double Von Sion.

DOUBLE NARCISSUS OR DAFFODILS.

	Each.	Doz.	Hund.
Alba Plena Odorata (Double Poeticus), large double, pure white	\$0.03	\$0.25	\$1.25
Incomparable (Butter and Eggs), large double, yellow with orange centre03	.25	1.50
Orange Phoenix (Eggs and Bacon), beautiful double white, orange centre05	.50	3.75
Silver Phoenix (Codlins and Cream), large double creamy white flowers15	1.75	14.00
Von Sion (<i>Telamonius Plenus</i>), the famous "Old Double Yellow Daffodil," rich golden yellow05	.50	3.00

POLYANTHUS NARCISSUS.

If desired by mail add 10 cents per dozen for postage.

Beautiful, free flowering, sweet scented flowers of easiest culture, bearing tall spikes of bloom with from 6 to 20 flowers each. Suitable for house or garden culture.

	Each.	Doz.	Hund.
Paper White Grandiflora. Improved large flowered form, with beautiful, snow white, star-like flowers in large clusters	\$0.05	\$0.35	\$2.25
Yellow Varieties , fine sorts in mixture03	.25	1.75

CHINESE SACRED OR ORIENTAL NARCISSUS.

The Chinese Sacred Lily (*Narcissus Orientalis*) is of easy culture and readily brought into bloom when grown in water. Shallow dishes are used in which the bulbs are placed with enough fancy pebbles to hold them upright when in bloom. The flowers are mostly white with yellow or orange centres and very fragrant.

True Chinese Grown Bulbs,	12c. each, \$1.25 doz., original baskets of thirty bulbs, \$2.25
True Chinese Grown Bulbs, selected	15c. each, \$1.50 per doz.

If desired by mail add 5 cents each for postage.



Crocus.

Crocus.

One of our earliest spring flowers, brilliant and universally admired, occupying a prominent place in every garden. When planted in large groups or lines of distinct colors the effect is striking. Flower beds and borders are made very attractive with a few clumps or rows of the different colors. They thrive in any soil or situation, but to be had in the highest perfection they should be grown in a deep, rich, sandy loam, and in a sunny location. Plant two to three inches apart and three inches deep. Best results are obtained from early planting.

LARGE FLOWERED NAMED CROCUS.

These are large selected bulbs of the best varieties, and are noted for the immense size of their flowers and richness of color. The small, cheap bulbs we do not handle, as they fail to give satisfaction.

	Doz.	Hund.		Doz.	Hund.
Albion, largest, dark violet striped	\$.15	\$1.00	Mammoth Yellow, golden yellow	\$.15	\$1.00
Baron Von Brunow, dark blue	.15	1.00	Mont Blanc, largest, pure white	.15	1.00
David Rizzio, deep blue	.15	1.00	Madame Mina, white, violet feathered	.15	1.00
Caroline Chisholm, fine pure white	.15	1.00	Purpurea Grandiflora, very large, purple	.15	1.00
La Majesteuse, violet striped	.15	1.00	Sir John Franklin, dark purple	.15	1.00
Lilacea, sky blue, white top	.15	1.00	Sir Walter Scott, white, lilac striped	.15	1.00
Mammoth White, very large	.15	1.00	Mixture of Above Named Sorts	.15	1.00

AUTUMN FLOWERING CROCUS. (*Colchicum.*)

Handsome hardy plants, very showy and effective in clumps, producing fine clusters of very large beautiful flowers in September or October, followed by the foliage the next spring.

	Each	Doz.
Colchicum Autumnalis, large, single, rosy purple	\$.05	\$0.60
Colchicum Autumnalis Album, large, single, white	.10	1.00
Colchicum Autumnalis Plenum, large, double, rosy purple	.10	1.00
Colchicum Autumnalis Mixed, large flowers of many shades	.05	.60

ACHIMENES.

One of the finest summer blooming plants for house or conservatory, giving handsome flowers of many charming shades and colors.

Mixed varieties, 10c. each, \$1.00 per dozen.

ADONIS VERNALIS.

One of the brightest and earliest spring flowering perennials, dwarf and compact, with finely cut foliage and large, clear yellow flowers. 20c. each, \$2.00 per dozen. By mail, 30c. each.

AGAPANTHUS. (*African Lily.*)

Splendid ornamental plants for growing in pots or tubs for the lawn or piazza, bearing large clusters of flowers on long stalks, opening in succession for a long period during summer and autumn. They are rapid growers and gross feeders. Plenty water should be given during growth and not allow them to become root-bound.

	Each	By Mail
Umbellatus, bright blue	\$.25	\$0.35
Umbellatus Albus, pure white	.50	.60



Achimenes.

ALLIUM.

Bulbous plants with showy flowers in large clusters, excellent for pot culture and borders.

	Each.	Doz.	Hund.
Azureum , deep azure blue, hardy	\$0.15	\$1.50	
Giant Neapolitanum , a splendid winter flowering or forcing variety, with immense clusters of large snow-white flowers, lasting a long time after being cut03	.25	\$1.50
Moly (<i>Aureum</i>), large clusters of golden yellow flowers, hardy03	.25	1.50
Moly Album , large clusters, pure white flowers, hardy03	.25	1.50

AMARYLLIS.

These are best suited for pot culture, and when established they should bloom every year; after blooming they make their growth and should have occasional waterings with liquid manure till about September, when allow them to rest and give them very little water. A soil composed of loam, leaf mould and sand should be used, and good drainage given.

	Each	Doz.
Belladonna Major , silvery-white flushed with rose, beautiful and fragrant	\$0.25	\$2.50
Johnsoni , fine red, with white stripe through each petal60	
Vallota Purpurea , "Scarborough Lily," rich bright scarlet flower in a cluster, blooming in summer and autumn; this is the variety so much seen growing in tubs on lawns, etc. 35c. each.		
Vittata Hybrids , beautiful large flowered varieties with striped petals. 75c. each.		

ANEMONE (*Wind Flower*).

Very handsome spring flowering plants, with double and single flowers of bright and beautiful colors, they succeed best outside when protected from frost; a rich sandy loam with good drainage is necessary. Roots should be planted three inches deep and five or six inches apart.

Anemones make splendid pot plants, if kept in a cool place and water withheld until they commence their growth, when they may be given more warmth and water enough to keep them moist.

	Each	Doz.	Hund.
Fulgens , rich dazzling scarlet, most brilliant and graceful	\$0.05	\$0.35	\$2.75
Double Mixed , extremely handsome double-flowered varieties25	1.50
Single Mixed , beautiful Poppy-like blossoms in great variety of colors15	1.50



Anemones.

ANEMONE JAPONICA (*Japan Anemones*).

One of the most beautiful garden flowers, giving a profusion of bloom from September to November, and for a mass in the flower garden is unsurpassed for autumn decoration. They attain a height of two to three feet and are covered with bloom. In a well drained, sheltered situation they succeed best.

	Each	Doz.
Alba (Honorine Jobert), large single, pure white, with yellow centres	\$0.25	\$2.50
Rosea , large rosy pink25	2.50
Whirlwind , double, pure white, with yellow centre25	2.50

ANOMATHECA CRUENTA.

Remarkable for the brilliancy and profusion of its flowers, which are crimson scarlet, and produced in succession on slender stems from May to September. Fine for window boxes and pot culture. 5c. each, 50c. per dozen.

ARUM DRACUNCULUS (*Dragon Plant*).

Handsome plant for decorative purposes, with immense blackish purple, calla-like flowers and ornamental foliage. 15c. each; by mail, 20c.

BABIANA.

Cape bulbs, excellent for house culture, growing six to nine inches high, with foliage of the darkest green and showy spikes of flowers of the richest colors.

	Each	Doz.
Mixed Varieties , finest colors	\$0.05	\$0.50



Babianas.

BLEEDING HEART (*Dicentra or Dielytra*).

Spectabilis, well-known hardy spring flowering plant with splendid green foliage and long drooping racemes of pink and white heart-shaped flowers. 20c. each; by mail, 30c.

BULBOCODIUM.

One of the earliest spring flowers, with masses of rich colored blossoms, beautiful for clumps or borders.

	Each	Doz.	Hund.
Vernum , rich rosy purple	\$0.03	\$0.30	\$2.00

CALLA LILIES (*Richardia*).

An old favorite, and too well known to need any description, the only requisite for successful culture are rich soil and plenty of water when growing. By allowing them to rest through the summer an abundance of bloom may be had the following winter.

Black (<i>Arum Sanctum</i>), from the Holy Land, resembling in habit and foliage the White Calla, flowers of a rich blackish purple, and very large	Each	Doz.
	\$0.25	\$2.50
Little Gem , miniature White Calla, nine to twelve inches high, free flowering, and about half the size of the common Calla25	2.50
Spotted Leaf , deep green foliage spotted with white, flowers pure white20	2.00
White or Lily of the Nile , the old well-known favorite20	2.00
Yellow (<i>Hastata</i>), light yellow flowers, otherwise like the White Calla75	



Little Gem Calla.

CALOCHORTUS.

These are the **Butterfly Tulips** or **Mariposa Lilies**, of California. The flowers are of good size and of the richest and most brilliant colors, and are highly recommended for growing in cold frames or planting in the open border in spring.

	Each.	Doz.	Hund.
Finest Varieties, Mixed	\$0.05	\$0.30	\$2.00

CHIONODOXA (*Glory of the Snow*).

One of the most effective spring flowers for clumps or edgings, blooming with the snowdrops and lasting a long time in perfection.

They will succeed well in any good garden soil, and are admirable for pot culture inside.

	Each.	Doz.	Hund.
Gigantea , very large flowers of a soft lavender blue with white centres	\$0.03	\$0.30	\$2.00
Lucillæ , brilliant sky blue, with white centre03	.20	1.50
Sardensis , intense deep gentian blue03	.25	1.75



Calochortus.

CROWN IMPERIALS.

Showy and stately hardy border plants and should be in every collection, growing about three feet high, bearing an umbel of bell shaped flowers on the top, and over them is a crown of green leaves. Bulbs should be planted two or three in a clump and six inches deep.

	Each	Doz.	Each	Doz.			
Large Single Red	\$0.25	\$2.50					
Large Single Yellow30	3.00			Orange Brilliant , fine orange	\$0.30	\$3.00
					Mixed Varieties , fine colors15	1.50

CYCLAMEN PERSICUM.

One of the most beautiful and best adapted plants for winter blooming in the house or greenhouse, grows readily and flowers freely for a long period, the foliage being handsomely mottled is very ornamental. Bulbs should be planted in a coarse, light, rich soil, always bearing in mind that they do best with the bulbs wholly above the soil. After flowering the pots should be plunged in a shady, sheltered place until October, when they should be repotted.

	Each	Doz.
Giganteum Album , large pure white	\$0.25	\$2.50
Giganteum Roseum , large fine bright rose25	2.50
Giganteum Rubrum , large deep red25	2.50

DAY LILIES.

This is one of the most useful families we have for the decoration of the flower border, thoroughly hardy, true perennial, and will succeed in almost any soil or situation; they form handsome tufts of leaves, and clusters of lily-like flowers of great substance, deliciously scented and exceedingly useful for cutting.

If desired by mail add 8 cents each for postage.

	Each
Funkia Grandiflora , large pure white flowers, and broad light green foliage	\$0.25
Funkia Variegated , lilac flowers and handsomely variegated green and white foliage25
Hemerocallis Flava , golden yellow, fine for cutting25
Hemerocallis Thunbergi , bright yellow, quite distinct from <i>Flava</i> , and much later in bloom25

FRITILLARIA MELEAGRIS

(Guinea Hen Flowers).

Beautiful dwarf spring flowering plants for pots or borders with exceedingly pretty bell shaped flowers of various colors.

	Each.	Doz.
Mixed. Finest colors in great variety	\$0 05	\$0.35



Cyclamen Persicum Giganteum.

FREESIA.

One of the most beautiful and popular flowers for pot culture in the house or conservatory. They are very valuable for cutting, being peculiarly graceful and possessed of a sweet, delicate perfume. They force easily and may be had in bloom from Christmas through the winter by planting six or eight bulbs in a 4 or 5 inch pot, keeping in a cool light place, and bringing in at intervals.

	Each.	Doz.	Hund.
Refracta Alba Odorata , pure white, extra large bulbs	\$0.05	\$0.30	\$2.00
Leichtlini Major , large, pure yellow05	.30	2.00

GALTONIA (*Hyacinthus Candicans*).

Hardy ornamental border plants with flower stems 3 to 4 feet high, bearing quantities of large, drooping, bell-shaped flowers.

	Each.	Doz.
Candicans , large, white Hyacinth-like flowers	\$0.10	\$1.00



Freesia.

GLADIOLUS COLVILLI.

Early flowering and fine for pot culture, being largely grown by Florists for cutting, also suitable for cold frames, and the open border, if protected from frost, when they will bloom in May or June. Each Doz. Hund.

Alba (<i>The Bride</i>). Purest white, very beautiful	\$0.03	\$0.25	\$1.50
--	--------	--------	--------

GLOXINIA ERECTA.

Magnificent for house culture, producing in great profusion beautiful flowers of the richest and most beautiful colors. They succeed best in sandy loam and peat, and require a moist heat. After blooming, dry off gradually, let the bulb remain in the pot without water, and keep in a warm place until they show signs of starting again. Each Doz.

Separate Colors , large flowers in distinct colors	\$0.25	\$2.50
Mixed Varieties , finest shades and colors20	2.00

IRIS (*Fleur-de-Lis*).

The Iris is a very extensive and beautiful family for beds, borders and pot culture. They are mostly hardy spring-blooming plants, very free flowering, with large, handsome, rich and varied colored flowers; of easy culture, thriving in any good garden soil Plant three inches deep from September to December. Each Doz

English, Finest Mixed , large, handsome flowers	\$0.05	\$0.50
German, Finest Mixed , very large and showy15	1.50
Peacock (<i>Pavonia</i>), pure white, with bright blue spots, for pots08	.75
Spanish, Baron Von Humbold , rich blue05	.50
“ Blanche Superbe , best pure white05	.50
“ Chrysolora , fine soft yellow05	.50
“ Finest Mixed , early and fragrant03	.25
Susiana (<i>Mourning Lily</i>), immense grayish flowers netted with very dark lines20	2.00



IRIS KAEMPFERI (*Japan Iris*).

One of the most astonishing tribes of plants ever seen, both in its robust, free-blooming habit and in the superb loveliness of its immense flowers. These differ from the other Irises in having the blossoms broad and flat, like a Clematis, growing best in moist, rich soil. If desired by mail, add 5c. each for postage.

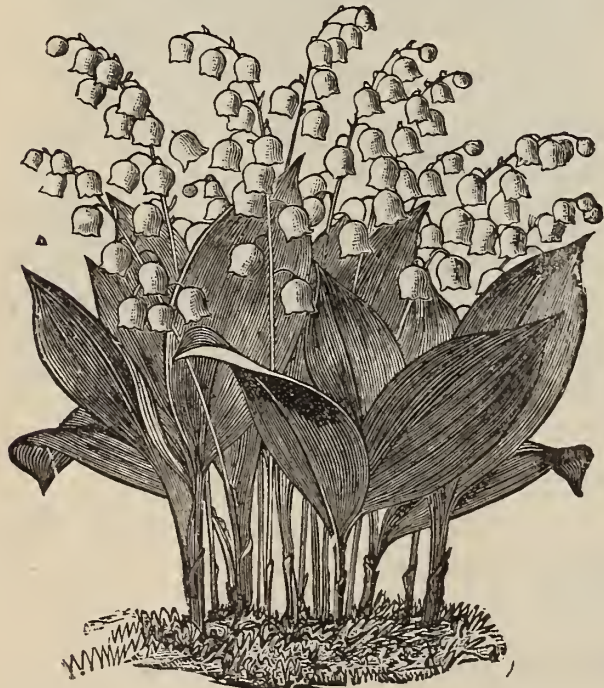

Lily of the Valley.

Hardy bulbs with fragrant white flowers on stems twelve to eighteen inches high. They resemble the snowdrop, but are much larger and about a month later.

Vernum , Spring Snowflake or St. Agnes' flower	\$0.05	\$0.50
---	--------	--------

Double Named Varieties	Iris,	Each	Doz.
Single Named Varieties		\$0.30	\$3.50
Mixed Varieties25	2.25
		.15	1.50

IXIAS.

These are among the most graceful and beautiful winter-flowering bulbs. The colors are rich and varied, the centre differing in color from other parts of the flower. Plant twelve bulbs in a six-inch pot and set in a cool place, water sparingly until some growth is made, then remove to warmer quarters to bloom.

Crateroides , brilliant scarlet, grand for cutting	Each	Doz.
	\$0.03	\$0.30
Mixed Varieties , all colors03	.20

LACHENALIAS.

A family of Cape bulbs of easy culture in the house. They have beautiful pendant flowers and spotted foliage. Pot early in sandy soil, and grow in a cool situation until well rooted, then remove to a warmer situation, and they will bloom through the winter.

Mixed Varieties , finest sorts	Each	Doz.
	\$0.20	\$2.00

LEUCOJUM (*Snowflake*).

LILY OF THE VALLEY (*Convallaria*).

One of the most useful and charming of our spring flowers. The pure white, delicately scented, bell shaped blossoms are very useful for cutting, and a favorite of everyone. A partially shaded situation suits them best.

	Doz.	Hund.
Selected Pips, for forcing or outside growing	\$0.35	\$2.00

LILIUM HARRISII (*Bermuda Easter Lily*).

This splendid lily is undoubtedly one of the best for house culture, as it comes quickly into bloom and flowers freely. The flowers are trumpet shaped, pure waxy white and delightfully fragrant. They will keep ten or twelve days, if cut when partially open. Bulbs should be potted in a rich soil, using a five to eight inch pot, according to the size of bulb, and the pots plunged in a cold frame or kept in a dark, cold place, to get a strong root growth before the top starts; when well rooted they may be brought into gentle heat and forced into bloom. By bringing them in at intervals a succession of bloom may be had throughout the winter.

	Each	Doz.	Hund.
Mammoth Bulbs	\$0.25	\$2.50	\$17.50
Extra Size Bulbs	.15	1.50	8.00
First Size Bulbs	.10	1.00	5.00

LILIUM LONGIFLORUM (*Easter Lily*).

Snow-white, fragrant, trumpet shaped lily, differing from L. Harrisii in being of shorter growth, blooming later and having smaller flowers, but of more substance and lasting longer in bloom. It is more largely grown for Easter than any other variety, and being hardy, is one of the best sorts for garden culture. Treatment same as recommended for L. Harrisii.

	Each	Doz.	Hund.
Mammoth Bulbs	\$0.30	\$3.00	\$20.00
Extra Size Bulbs	.15	1.50	12.00
First Size Bulbs	.10	1.00	6.00



Lilium Harrisii (Bermuda Easter Lily).

LILIES.

In the bulb garden Lilies rank first in importance. They are stately and beautiful, matchless in form and variety of color, while possessing the most agreeable perfume, and for general effect they have no rivals. Bulbs should be planted six inches deep as soon as they can be obtained after ripening, some being ready in August while others are not ready till October or November. They thrive best in a well drained, deep, loamy soil, made rich with thoroughly rotted cow or sheep manure, and an inch of clean sand placed under and over the bulbs when setting; manure should not come in contact with the bulbs as it causes decay. Top dressing is the better way to enrich the soil after the bulbs are once established. The beds should be well covered in the fall with any good litter that will exclude frost.

Postage prepaid at price of single bulbs.

Auratum (Golden Rayed Lily of Japan), large, pure white flowers, with crimson spots and a golden band through the centre of each petal, two to four feet high, blooming in July to October	Each	Doz.
	\$0.20	\$2.00
Batemannia , clear, bright apricot color, one of the best, three to four feet, July and August	.30	3.00
Brownii , trumpet shaped, ivory white inside and purplish brown outside, two to three feet, June and July	.60	6.00



Lilium Auratum.

LILIES — Continued.

Canadense Flavum , bright yellow, spotted with brown, two to four feet, June and July	\$0.10	\$1.00
Canadense Rubrum , bright crimson with dark spots, two to four feet, June and July15	1.50
Candidum (Annunciation Lily), the well-known, snow white, fragrant garden lily, three to four feet, June and July10	1.00
Chalcedonicum , vermilion red, turban shaped flowers, three to four feet, June and July60	6.00
Concolor , crimson, star shaped flowers, slightly spotted, one to two feet, June30	3.00
Elegans Atrosanguineum , rich blood red, spotted, one and a half feet, July15	1.50
Excelsum , fine light yellow, beautiful and fragrant, four to five feet, June and July40	4.00
Hansoni , large, dark yellow, with maroon spots, two to four feet, June75	7.50
Speciosum (Lancifolium), well-known as "Japan Lilies," and one of the most popular garden varieties, also excellent for pot culture, of easy growth, and may be relied upon to give satisfaction, growing two to four feet high, and blooming in August. The varieties are		
— Album , large, fragrant, pure white20	2.00
— Roseum , white, shaded with rose, fragrant15	1.50
— Rubrum , white, heavily spotted with rich crimson, fragrant15	1.50
Superbum , orange red, spotted, four to six feet, July15	1.50
Tenuifolium (Coral Lily), brilliant scarlet, very early, one to two feet, May and June25	2.50
Tigrinum (Tiger Lily), orange red, spotted with black, four feet, August10	1.00
Tigrinum Flore Pleno , double flowering Tiger Lily, four feet, August15	1.50
Umbellatum Mixed , large cup-shaped flowers of brilliant colors, two to three feet, June15	1.50
Wallacei , vermilion orange spotted with maroon, two to three feet, August20	2.00

MADEIRA VINE.

Very handsome climber with waxy light green foliage, fine for window gardening, hanging baskets, etc. Each Doz. \$0.05 \$0.50

MONTBRETIA.

A very desirable plant for the garden, with brilliant flowers, resembling the Gladiolus. It is not hardy and should be planted in cold frames, or kept in dry sand, away from frost, till spring, when they will bloom from July to frost.

Each Doz. \$0.05 \$0.60

Crocsmiflora, brilliant orange scarlet

OXALIS.

Very beautiful winter and spring-flowering bulbs, particularly adapted to pot and window culture. Plant three or four bulbs in a five-inch pot, using a fine, sandy loam. They grow and bloom best in a rather cool, partly shaded situation.

	Each	Doz.
Bowei , large, bright rosy crimson	\$0.05	\$0.50
Cernua (Buttercup), large, bright yellow05	.50
Floribunda , fine rose color, very free flowering05	.50
Virabilis Alba , compact variety with immense pure white flowers on single stems, well above the foliage05	.50
Virabilis Rubra , like preceding, with bright red flowers05	.50



Oxalis.

ORNITHOGALUM (Star of Bethlehem).

Arabicum , handsome variety, with large heads of pure white, star shaped flowers, having a black blotch in the centre. They have a distinct aromatic order, are of easiest culture and largely grown for window decoration	Each	Doz.
	\$0.08	\$0.75
Umbellatum , early flowering, hardy sort, with large clusters of satiny white, star shaped flowers03	.25

PÆONIES.

These have become indispensable in every garden. They are all hardy and admirably adapted to our northern climate, growing in almost all situations, and even flourishing under shade trees.

If desired by mail add 10 cents each for postage.

	Each	Doz.
Double Herbaceous , finest named sorts	\$0.50	\$ 5.00
Tenuifolia, fl. pl. , distinct species, with finely cut foliage, and flowers the color and size of a <i>Jack Rose</i>50	5.00
Tree Pæony (Moutan), beautiful introduction from Japan, distinct from the herbaceous sorts, and have shades of color not found in the latter. They thrive best in a rich soil, warm, sheltered situation and partial shade	1.00 to 1.50	12.00

PANCRATIUM.

Amaryllis-like bulbs, with showy white flowers, suitable for house culture in pots, should be grown in light loam and leaf mould, and allowed a season to rest.

	Each	Doz.
Maritimum , fragrant white flowers in large umbels	\$0.25	\$2.50
Calithinum (Ismene), white flowers, three inches long, expanding in succession, fragrant25	2.50

RANUNCULUS.

Handsome flowers of fine form, very brilliant and attractive colors. They require a little heavier soil and more moisture than Anemones, otherwise treated the same. They are very readily grown.

	Each	Doz.	Hund.
Giant French , large, double flowers, in great variety of colors	\$0.03	\$0.25	\$1.25

SCILLA.

Very early-flowering bulbs, doing well in ordinary soil, producing fine, graceful spikes of bell-shaped flowers. Very showy and attractive as pot plants, and require about the same treatment as Hyacinths.

	Each	Doz.	Hund.
Nutans , long, graceful spikes of <i>white, blue</i> and <i>rose</i> colored flowers, mixed or separate05	.50	2.50
Præcox or Siberica , spikes of intense blue flowers, very early, blooming outside with the Snow-drops and Crocus03	.25	1.25

SNOWDROPS.

The Snowdrop is the first of all flowers to herald the approach of spring. They flourish well in any soil, and bloom best if not transplanted oftener than once every three years. Being dwarf, they should be set near the edge of walks, where in connection with Scilla and Crocus they show to great advantage. They also flourish well in sand or moss, in pots or baskets. They should be planted two inches deep.

	Doz.	Hund.
Double-Flowering	\$0.25	\$1.50
Single-Flowering15	1.00
Giant-Flowering , flowers very large20	1.50



Sparaxis.

SPARAXIS.

One of the most graceful and beautiful half-hardy bulbs, with large, handsome flowers of the brightest colors and shades, and are fine for growing in pots. They are closely allied to the Ixia, and require the same treatment.

	Each	Doz.	Hund.
Mixed Varieties	\$0.03	\$0.25	\$1.50

SPIRÆA (Astilbe).

Splendid plants for forcing in the greenhouse or the conservatory where they produce beautiful sprays of flowers during February and March; they are perfectly hardy and when planted outside, flower in June. The dark green foliage resembles some of our well-known ferns.

If desired by mail add 10 cents each for postage.

	Each	Doz.
Astilboides Floribunda . This new variety is a great improvement over the old sort. It is dwarf, early and very free bloomer, the large feathery plumes are of purest white, and last a long time	\$0.20	\$2.00

Japonica , silvery white flowers, fine for forcing. Strong clumps15	1.50
Japonica Compacta Multiflora (<i>Grandiflora</i>), a dwarf, very compact growing variety. The silvery white flowers are much larger and more freely produced than the preceding20	2.00

TRILLIUM (*Wood Lily or Wake Robin.*)

Grandiflorum, a magnificent plant with fine white flowers changing to rose. It requires a moist situation, doing well among shrubbery, if not too dry Each. Doz.
 \$0.15 \$1.50

TRITELEIA.

A perfect little gem for either pot culture or the open border, it grows well in almost any soil, each bulb producing a number of star-shaped flowers of good substance. Half a dozen bulbs should be planted in a 4 or 5 inch pot. In the garden a good covering with litter is necessary.

	Doz.	Hund.
Uniflora , delicate light blue	\$0.20	\$1.00
Violacea , fine violet blue25	1.50

TRITOMA (*Red-Hot Poker or Flame Flower.*)

Uvaria Grandiflora, admirably adapted for single clumps on the lawn or among shrubbery, its tall spikes of orange red flowers make an effective display from August to frost. If in a dry soil and well protected it will prove hardy Each.
 \$0.25 and \$0.50

TRITONIA.

Mixed Colors, free-blooming bulbs, well suited for pot culture. Plant in a light, rich foam, about six or eight bulbs in a 6-inch pot; give a cool airy situation, and an abundance of bloom will be the result. Each. Doz.
 \$0.05 \$0.40

TROPÆOLUM.

Beautiful and graceful climbing plants for the conservatory or window garden, producing in the early spring months richly-colored flowers. They can be grown in pots and trained over trellises, or as a bracket plant in the window.

	Each.	Doz.
Jarrattii , scarlet, yellow and black	\$0.15	\$1.50

VIOLETS.

We offer strong plants specially grown for winter blooming.

	Each.	Doz.
Marie Louise , the well-known, double, dark-blue variety, with delicious fragrance	\$0.20	\$2.00
Campbell , a little lighter in color than the preceding, but one of the best for winter growing20	2.00

WINTER ACONITE (*Eranthis Hyemalis*).

	Doz.	Hund.
One of the earliest and most hardy of spring flowers, throwing up its pretty yellow flowers before the snow disappears, and continuing in flower several weeks	\$0.20	\$1.25



Winter Aconite.

“*Bulbs and Tuberous-rooted Plants.*” A new book by the well-known Horticultural writer, C. L. Allen; gives full directions for their cultivation. Price, \$2.00 postpaid.

HYACINTH GLASSES.

Hyacinths grown in glasses of water are charming ornaments for parlor windows, and the ease and success in flowering bulbs in this way add greatly to the popularity of not only Hyacinths, but Polyanthus Narcissus, Amaryllis Formosissima and other bulbs, which can be grown in the same manner. Can be used for cut-flower vases when desired.

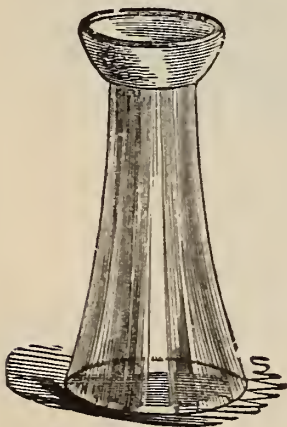

	Each	Doz.
Tall pattern.	\$0.15	\$1.50
Low “15	1.50



Sundries.

FLOWER SCISSORS, PRUNING SHEARS, ETC.

Scissors, Flower. For cutting and holding flowers. 4-in., 75 cts.; 6-in., 90 cts.; 7-in., \$1.15.

Scissors, Grape or Vine. For thinning the bunch. Nickel plated. 6-in., 85 cts.; 7-in., \$1.00.

Scissors, Pruning or Rose Pruners. Nickel plated, without spring. Each, 4-in., 75 cts.; 5-in., 85 cts.; 6-in., \$1.00.

Shears, Grass Border. Long handle, 9-in. blade, each, \$3.00; 10-in., \$3.50. Long handle, wheel, 9-in. blade, each, \$3.50; 10-in., \$4.00.

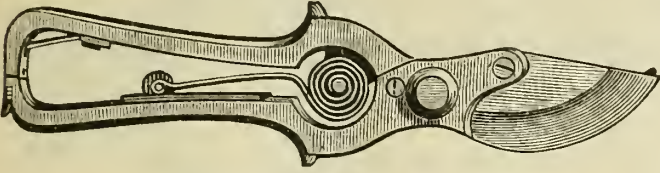

French Pruning Shears.

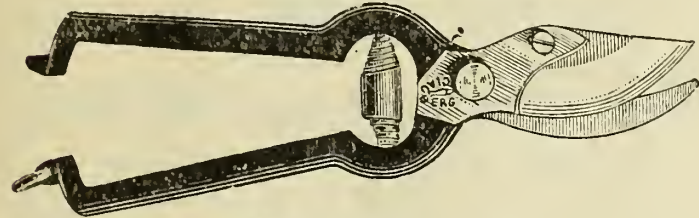

German Pruning Shears.

Shears, Hedge. Pruning notch, 8-in. blade, each, \$1.80; 9-in., \$2.15; 10-in., \$2.50.

Shears, French Pruning. With wheel spring. The best pruner ever offered, polished, each, 8-in., \$1.75; 9-in., \$2.25; 10-in., \$2.75.

Shears, German Pruning. With spiral steel spring. A very superior tool, finely polished, each \$1.75 and \$2.00.

Shears, Trenton Pruning. A fine steel tool, with spiral spring, unpolished, each, 9-in., 60 cts.; 10-in., 75 cts.

Shears, Levin Pruning. The lightest and strongest pruner made. Simple in construction and very useful. Each, 75 cts.

FLOWER POTS AND SAUCERS.

Flower Pots, Standard. Catalogue of fancy pots mailed on application. Measurement from inside to inside. Width and depth equal.

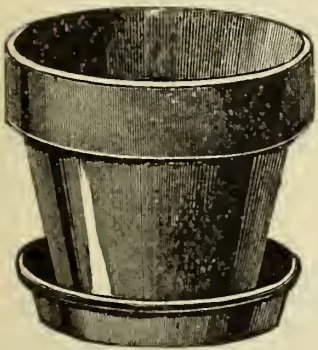

Inches.	Per Doz.	Per Hund.	Inches.	Per Doz.	Per Hund.
2	\$0.12	\$0.75	6	\$0.72	\$4.50
2½	.16	.90	6½	.84	6.00
3	.20	1.15	7	.96	7.50
3½	.24	1.40	8	1.32	9.00
4	.30	2.00	9	1.68	13.50
4½	.36	2.50	10	2.40	17.50
5	.48	3.25	11	3.60	22.00
5½	.60	3.75	12	4.80	32.00

Saucers, Standard.

Inches.	Doz.	Hund.	Inches.	Doz.	Hund.
3½	\$0.18	\$1.25	7	\$0.54	\$3.25
4	.24	1.50	8	.60	4.25
4½	.28	1.75	9	.72	5.25
5	.30	2.00	10	.96	6.50
5½	.36	2.25	11	1.20	8.00
6	.42	2.50	12	15 cents each.	
6½	.48	3.00			

We make no charge for crates, packing or shipping Flower Pots, Bulb Pots, etc.

Bulb Pots.

Inches.	Per Doz.	Per Hund.
3½ x 6	\$0.75	\$5.50
5 x 7	.95	6.50

Bulb or Seed Pans.

Round.			Square.		
Inches.	Each.	Doz.	Inches.	Each.	Doz.
6	\$0.07	\$0.70	6 x 6	\$0.20	\$2.25
8	.10	.95	8 x 8	.25	2.50
10	.15	1.50	10 x 10	.30	3.00
12	.20	2.00	12 x 12	.40	4.00
14	.40	4.00			

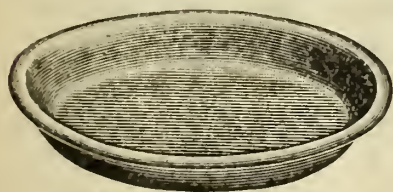

Fibrotta Saucers.

Flower Pot Saucers, Fibrotta. These are made of fibre, and are especially valuable for use when decorative plants are placed on tables, floors or carpets, as no moisture can penetrate them, thus preventing all injury by moisture or stain. 6-in., each, 8c.; per doz., 85c.; 8-in., each, 10c.; per doz., \$1.00; 10-in., each, 13c.; per doz., \$1.25; 12-in., each, 18c.; per doz., \$1.50.

HOT BED MATS.

Straw. These are made to order by hand, from the very best Rye Straw, and in the most thorough manner. Size, 6 x 6 feet. Each, \$1.50. Special prices on large lots, and special sizes made to order.

Singapore Fibre. These are heavier than straw mats, but are said to be more durable. Each, \$2.00.

Protecting Cloth for Hot-Beds. Valuable for forwarding plants and protecting them from frosts; covering hot-beds and frames in spring instead of glass, and for throwing over bedding plants at night in fall; for chrysanthemum houses, etc. Medium grade, per yard, .10; by the piece, about 40 yards, .09 per yard. Heavy grade, per yard, .12; by the piece, about 40 yards, .10 per yard.

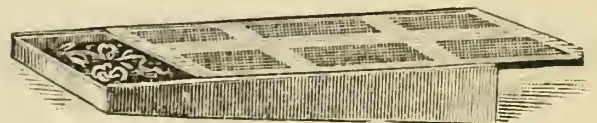

FUMIGATORS.

For Smoking Greenhouses and Conservatories.

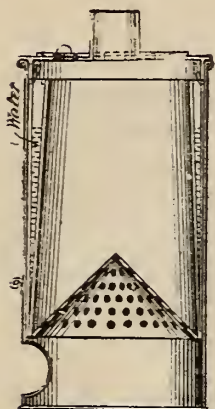

Perfection, (See cut.) The neatest, most durable, and most practicable fumigator ever offered.

By following the directions this fumigator will last for years, it has practically three bodies, the two inside ones forming a water tank, this tank being between the fire and the outside body, prevents the body from burning out.

The tank should be filled with tobacco water, when in operation a vapor arises and mixes with the dry smoke from the stems, producing a dampened smoke more dense and less injurious than from any other fumigator made.

No. 1 holds one peck of stems	Each.	\$3.00
No. 2 holds half bushel of stems		3.75
No. 3 holds three-quarters bushel of stems		4.50
No. 5 holds one bushel of stems		5.50

Boston. Self-acting, and may be left with perfect safety; all the material consumed and gives off a dense smoke; made of extra heavy galvanized iron.

No. 0. 16 in. high, 9 in. diameter, holds 1/4 bush. stems	\$2.00
No. 1. 20 " " 13 " " " 1/2 " "	3.50
No. 2. 24 " " 14 " " " 3/4 " "	4.00
No. 3. 28 " " 16 " " " 1 " "	4.50

Eureka. Simple in construction, and not liable to get out of order.

No. 1. Height, 12 in.; diameter at top, 5 in. For a house 10 x 20 ft. Holds 1/2 peck of stems	\$1.25
No. 2. " 16 " " " " 7 " " " 12 x 40 " " 1 " "	2.00
No. 3. " 20 " " " " 9 " " " 15 x 100 " " 1/2 bush "	2.50
No. 4. " 24 " " " " 12 " " " 20 x 100 " " 3/4 " "	3.50

GLAZIERS' POINTS AND MASTICA.

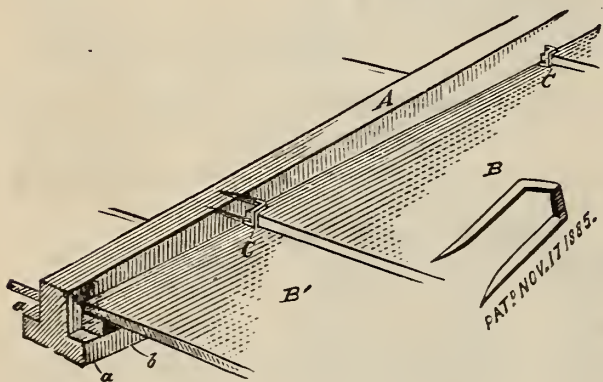

Glaziers' Points, E. J. Van Reyper's. Will stop glass from sliding. The only durable and reliable points, made of steel wire and galvanized. No rights and lefts. Can be used on either side of the bar. Try our pincers for driving these points.

Price, per box of 1,000, .60; by mail, .75; Pincers, .40; by mail, .50.

Mastica. For glazing greenhouses; elastic, adhesive and easy to apply. is not affected by expansion and contraction, and avoids the necessity of repeatedly reglazing, saving time and expense. One gallon will cover about 290 running feet (one side). Per gallon, \$1.00; 1/2 gallon, .60; 1 quart, .35.

Mastica Glazing Machines. Price, \$1.00 each.

PLANT STAKES.

For house, greenhouse, conservatory and *light* garden work, where plants require support. Being painted green, they are exceedingly neat, rather ornamental than otherwise, and in use are not unpleasantly conspicuous.

Light Round Stakes.

Feet	Doz.	Hund.	Feet	Doz.	Hund.
1 1/2	\$0.18	\$1.25	3 1/2	\$0.54	\$3.75
2	.24	1.75	4	.60	4.50
2 1/2	.36	2.25	5	.72	5.50
3	.48	3.00			

Square Stakes.

Feet	Doz.	Hund.	Feet	Doz.	Hund.
1 1/2	\$0.18	\$1.00	4	\$0.60	\$4.00
2	.18	1.35	5	.72	5.00
2 1/2	.24	1.75	6	1.00	6.50
3	.36	2.75	6	1.25	10.00
3 1/2	.48	3.25	(Ex. Heavy),		

Stakes, Square. Unpainted, made of hard wood and neatly finished.

27 inches long, \$0.25 per 100	\$2.00 per 1,000
36 " " .30 " 100	2.50 " 1,000
48 " " .45 " 100	3.75 " 1,000

Heavy Round Stakes.

3	\$0.60	\$4.50	5	\$1.00	\$ 7.00
4	.75	6.00	6	1.25	10.00

Stakes, Cane. Used extensively by plant growers and greenhouse people for tying Roses, Pinks, and all plants where not too heavy a stake is required. They resemble the bamboo, and are very strong and durable, varying in length from eight to twelve feet. \$1.50 per hundred; in bundles of five hundred for \$5.00 per bundle.

HOSE, HOSE NOZZLES AND MENDERS.

Rubber Hose, Seven-ply. An extra quality hose which we can highly recommend. In 50-foot lengths, all coupled, 1/2-inch, 12 cents per foot; 3/4-inch, 14 cents per foot.

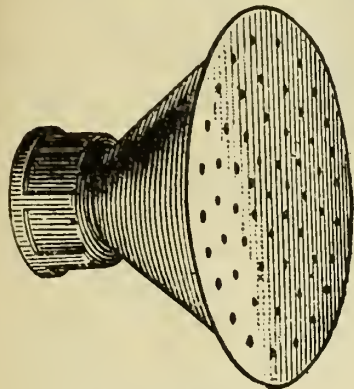

BOSTON SPRAY.

Hose Nozzles, Boston Rose Spray. For the Greenhouse, Flower Garden, Hot-bed, Lawn, etc., it has no equal, as it does not injure the plants, or tear up the ground. It allows the water to flow freely, and does not strain the hose. Having a flat face it throws the water straight ahead and does not spread it too much. It is made of brass, strongly put together, and will last a lifetime. Each, .65.

Hose Nozzle, Cyclone. Makes a fine, mist-like spray, and is of great value in applying insecticides to plants. Each, \$1.00.

Hose Nozzle, Hamblin's Spraying. Made of heavy brass. Each, .50. With shut-off connection, \$1.00.

Hose Nozzle, Gem. Will throw a coarse or fine spray, or a large or small stream, as may be desired. Each, .50

Hose Nozzle, Child's Rain Maker. This is especially recommended for greenhouse use and for spraying shrubs, etc. It is so constructed that the spray will reach the under side of the leaves with perfect ease and with a full force of water. It is also an excellent lawn sprinkler, giving a perfect spray without diminishing the flow of water. Each, .50. By mail, .60.

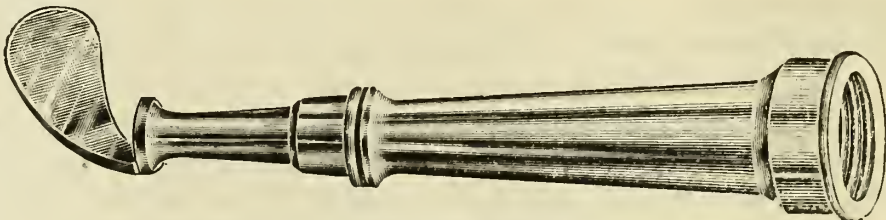

Child's Rain Maker.

Simplex Hose Mender. No bands required and will stand any hydrant pressure; the simplest and best. For 1/2 and 3/4-inch hose, .10 each; .60 per dozen.

SPRINKLERS AND SYRINGES.



Plant Sprinkler, Scollay's Valvular. Made of rubber, with flat bottom, and a detachable brass top, finely perforated. Each, \$1.00; by mail, \$1.10.

Plant Sprinkler, Scollay's Angle. Made of the same material as the preceding, but having an angular neck, thus admitting of sprinkling the under side of the foliage with ease. Each, \$1.00; by mail, \$1.10

Plant Sprinkler, Tyrian The bulb is made of soft rubber, the top of hard rubber with detachable screw cap, and is extremely useful for all purposes to which a sprinkler is put. Three sizes — Large, 75c. each, medium, 60c. each, small, 50c. each. By mail 10c. additional for either size.

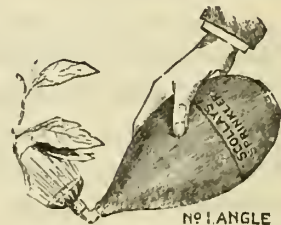

NO. 1 ANGLE

Plant Sprinkler, Tyrian Angle. Like the preceding but with an angular neck. Three sizes — large, \$1.00 each; medium, 75c. each; small, 60c. each.

Brass Syringes for Garden and Greenhouse. We offer a variety of patterns applicable for horticultural purposes.

— No. 0. 12 1/2 in. long, 1 5/16 in. diameter, with one spray rose. Each, \$2.25.

— No. 00. 14 in. long, 1 1/2 in. diameter, with one spray rose. Each, \$3.00.

— No. 2. 13 1/2 in. long, 1 5/16 in. diameter, with one stream and two spray roses. Each, \$4.75.

— No. 3. 18 in. long, 1 1/2 in. diameter; best plate valve springs; large size, with one stream and two spray roses. (Side pieces on barrel.) Each, \$7.00.

— No. 7. 18 in. long, 1 1/2 in. diameter, one stream and two spray roses, with knuckle joint turning in all directions. Each, \$7.50.

— No. H. 18 in. long, 1 1/2 in. diameter; strong, durable, cheap. Each, \$2.00.

— No. G. 16 in. long, 1 1/2 in. diameter; one spray and one stream rose; side attachment and fixed elbow joint. Each, \$4.25.

— L Angle. 16 in. long, 1 7/16 in. diameter; one spray rose. Each, \$2.50.

— Hydro-sprayer. 15 in. long, 1 3/4 in. diameter; fitted with cyclone nozzle. Each, \$6.00.

Zinc Srgyine. Strong, durable, and useful. Each, \$1.25.

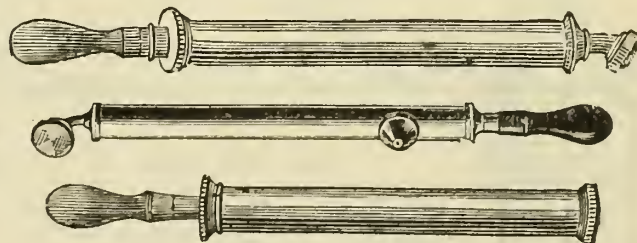

PLANT TUBS.

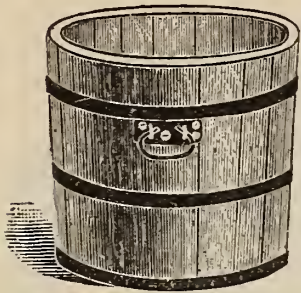

Oak. Made of oak, in natural wood finish, with three strong hoops and good handles. There is no tub on the market that equals this in finish and durability. Measurement from inside to inside.

No. 1.	12 inches in diameter by 12 inches deep,	\$1.25 each.
No. 2.	14 " " " 14 " "	1.50 "
No. 3.	16 " " " 14 " "	1.75 "

Cedar. Painted green. Measurement from outside to outside.

No. 1.	28 inches in diameter, 22 inches deep,	\$5.00 each.	No. 5.	20 inches in diameter, 16 inches deep,	\$2.50 each.
No. 2.	26 " " 20 " "	4.25 "	No. 6.	18½ " " 15 " "	2.00 "
No. 3.	24 " " 18½ " "	3.50 "	No. 7.	16½ " " 14 " "	1.75 "
No. 4.	22 " " 17 " "	3.00 "	No. 8.	15½ " " 13 " "	1.50 "

POTTING MATERIALS.

- Fibrous Peat.** Extensively used in potting Orchids and mixing with other materials. Price, 30c. peck, \$1.00 bushel.
- Rotted Fibrous Peat.** Having constant demands for Peat from our customers who want it to mix with other soils for use in potting plants, we have secured from an old peat bog a quantity which has been thrown out and exposed for years and has become thoroughly rotted, which has made it very fine and light, and for use in potting many plants is invaluable. Price, one half peck, 20c., peck, 30c., bushel, \$1.00, barrel, \$2.00.
- Leaf Mould.** Many valuable plants suffer for the want of Leaf Mould in the soil, and for the benefit of our customers we have collected a large quantity. Price, one-half peck, 20c., peck, 30c., bushel, \$1.00, barrel, \$2.00.
- Prepared Bulb Soil.** Specially prepared with *Peat, Leaf Mould, Loam, Sand,* and a sufficient quantity of *Fertilizer.* Price, half-peck, 20c., peck, 30c., bushel, \$1.00, barrel, \$2.00.
- Sphagnum Moss.** For packing, growing Orchids, etc. Per barrel, \$1.50, per bushel, 75c.

THERMOMETERS.

- Self-Registering.** Registers both heat and cold. No. 1. 8-inch Boxwood scale, \$2.25 each. No. 2. 8-inch Porcelain scale, \$3.00 each. No. 3. 10-inch Porcelain scale, \$4.00 each.
- Plate Glass Window,** with supporters for fastening outside. 9-inch, \$1.50 each; 11-inch, \$2.25
- Hot Bed and Mushroom Bed.** Boxwood, brass tipped, \$2.00 each.
- House.** Various patterns with Porcelain scale, from 75c. to \$2.00 each.
- Walnut Case.** 8 inch, 30c. each; 10-inch, 40c. each.
- Japanned Tin Case.** Enamelled scale; 8-inch, 15c. each.
- Fancy Wood Cases** (Wilder's Thermometer), \$1.25 and \$1.35 each.
- Japanned Tin Case** (Wilder's Thermometer), 8-inch 60c.; 10-inch, 70c.; 12-inch, \$1.00 each.
- " " " " " convex scale. 6-inch, 35c.; 8-inch, 40c.; 10-inch, 50c.; 12-inch, 65c. each.

TRELLISES.

Veranda. This is by far the most ornamental and substantial trellis made. We have eight regular sizes, but can make others to order.

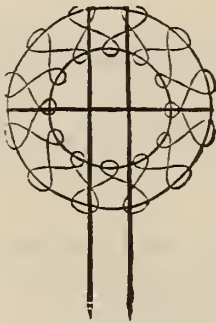

5 ft., 18 in. wide . . .	Each. \$0.70	8 ft., 18 in. wide . . .	Each. \$1.10	11 ft., 24 in. wide. . .	Each. \$1.75
6 " 18 "80	9 " 20 " . . .	1.25	12 " 24 " . . .	2.00
7 " 18. "95	10 " 20 " . . .	1.50		

Round Ivy.		Each.	Oval.		Each.
16 in. diameter . . .		\$0.42	No. 1.	30 in. long, 10 in. wide	\$0.20
20 " "60	" 2.	30 " " 14 " "	.30
24 " "75	" 3.	36 " " 12 " "	.35
			" 3½.	42 " " 14 " "	.40

Small Sizes.		Each.	Doz.
No. 00.	18-in. stick, 3½ in. wide	\$0.05	\$0.50
" 0.	24 " " 5 " "	.08	.75
" 00 wide.	20-in. stick, 8 in. wide	.08	.75
" 0	" 24 " " 8 " "	.10	1.00

Veranda.

Oval.

Round.

FLORISTS' SUPPLIES.

Bouquet Wire. We would call attention to the more convenient form in which we are putting up Nos. 22, 23 and 24 wire. It is straightened, cut in lengths of 9 and 12 inches, and put in boxes of 12 pounds (one stone) each. Price \$1.25 per box, either size; single pounds at 12 cents per pound. We also offer Nos. 22, 23 and 24 Bright Annealed Wire in coils, at \$1.00 per stone, 12 lbs.

Cotton Wadding. Large sheets; 5c. each, 50c. per doz.

Flower Support, Excelsior. The best; made of galvanized wire, strong and durable. Very useful for florists or in private greenhouses. In two sizes: 13 in., \$1.00 per 100, \$4.50 per 500, \$8.00 per 1000; 20 in., \$1.25 per 100, \$5.50 per 500, \$10.00 per 1,000.

Paper, White Tissue. Used in packing flowers; 20c. per lb.

Paper, Waxed. Extensively used in packing small plants and flowers for shipment; size 14 to 18; 30c. per lb. of about 150 sheets.

Roffia. The best tying material, being strong, soft and pliable; 30c. per lb.

Silkline, or Smilax Thread. For tying flowers and stringing smilax; 25c. per spool.

Tarred Marline. In coils, 5 to 8 lbs. each; 18c. per lb.

Twine, Soft. For tying plants, etc.; 25c. per ball.

Tinfoil. For bouquets; 15c. per lb.

Wood Labels. For plants, trees, etc.—

	Plain. 100.	Plain. 1000.	Paint. 1000.		Plain. 100.	Plain. 1000.	Paint. 1000.
4 in. Pot Label	\$0.15	\$0.60	\$0.75	3½ in. Tree Label	\$0.15	\$0.60	\$0.80
4½ " "15	.65	.75	3½ in. Tree Label } (Iron Wired). }	.15	1.00	1.25
5 " "15	.70	.85				
6 " "15	.85	1.00	3½ in. Tree Label } (Copper Wired). }	.20	1.50	1.75
8 " Garden Label40	3.50	4.50				
12 " " "50	4.50	5.50				

Zinc Labels. Medium size; per 100, 75c.

WATERING POTS.

Watering Pots. Made extra strong of double thick tin, carefully braced and painted. Each, 4-qt., 75c.; 6-qt., 87c.; 8-qt., \$1.00; 10-qt., \$1.25; 12-qt., \$1.50

Watering Pots. With long spouts; tin. Each, 2-qt., 50c.; 4-qt., 65c.

Watering Pots, French. Made of galvanized iron; oval in shape, with brass handle and long spout; one fine and one coarse copper-faced rose with each. 6-qt., \$2.25; 8-qt., \$2.50; 10-qt., \$2.75 each.

Watering Pots, Galvanized Iron. The best florists' Watering Pots made for strength, durability and neatness. Made from best quality iron; the top and back handles riveted on; an iron band on the bottom; the spout riveted, and a brace around it riveted to the body, and galvanized after it is made. A coarse and fine copper-faced rose with each pot.

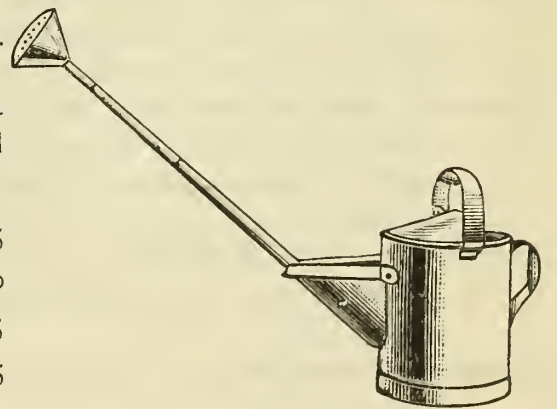

6 Quarts, Spout 21 inches long.	each, \$1.75
8 " " 23 " "	" 2.00
10 " " 25 " "	" 2.25
12 " " 25 " "	" 2.75

Water Pots, Manure. With extra long spouts, to allow a free flow of the thick liquid. Each, \$2.75.

MR. T. D. HATFIELD says:—You want to know how I like your Sheep Manure. I have given it an extended trial, for vegetables as well as plants in pots, and am well pleased with it. I never had better celery, I tried it also on carrots corn and peas with excellent results. For my specimen chrysanthemums I have used scarcely anything else. This I put into a bag to leach the strength out in water. You saw my plants a month ago, and they have gone on doing well. It is more powerful than one would suppose. It does not seem to have lost any strength by being kept dry, in fact I like to have it dry in preference to being wet or moist, as it is lighter and easier to handle. There is a good deal saved in labor, as I estimate it is worth five times its bulk in the best commercial manure. Send me another ton.

Wellesley, October 16, 1896.

Fertilizers.

PURE SHEEP MANURE, El Paso Brand.

A Solid Plant Food. The Best for All Purposes.

We offer an exceptionally pure lot of this excellent fertilizer. It comes direct to us from a large sheep ranch in the west, where it has remained under cover and undisturbed for several years. It is as near absolutely pure as it is possible to have it. We have never sold a fertilizer that has given more general satisfaction.

It is a pure natural manure and the most nutritious food for plants. Its effect is immediate, much more lasting and healthy than guano or any other manure. It is the best of all manures for mixing with the soil for greenhouse plants. It makes the richest, safest and quickest liquid manure, rivaling guano without any deleterious effects. For flower or vegetable gardens, and as a top dressing for lawns, it is unequalled.

DIRECTIONS.—For mixing with soil, take one part manure to six parts soil. For making a liquid, take one pound manure to five gallons of water, which can be used with safety daily if necessary. Price, 4 lb. pkg., .25; 10 lb. pkg., 50; 100-lb. bag \$2.50.

MR. J. H. HEMINGWAY says:—The Sheep Manure bought of you last spring has been a great surprise to us. Never have we used anything to equal it on our lawns, either in chemical fertilizers or in animal or bird manure. Our lawns and bankings are in the best of condition, and have been all summer, by using the Sheep Manure, and with much less water being used. For inside use we apply it to everything. It gives great intensity of color to our tropical house plants, and as a liquid it excels anything tried.

Saxonville, October 15, 1896.

Bowker's Lawn and Garden Dressing. A special fertilizer, prepared from chemicals. Free from weed seeds, odorless, and so clean that any member of the family can apply it.

Trial bags for 1000 sq. ft.,	\$0.50	50 lb. bags for 5,000 sq. ft.,	\$1.75
Trial bags for 2,500 sq. ft.,	1.00	100 lb. bags for 1/4 acre.	3.00

Bowker's Hill and Drill Phosphate. A concentrated general fertilizer. This phosphate is made for the hill or drill, or for broadcast sowing. It may be used in either case to advantage, giving an early and vigorous start. *It is composed principally of bone*, thoroughly dissolved so as to make it active in all stages of plant growth. 50 lb. bags, \$1.00; 100 lb. bags, \$1.80; per ton, \$34.00

Bowker's Fresh Ground Bone. We would call particular attention to this bone, as it is obtained daily from Brighton Abattoir, it contains all the fertilizer properties of raw bone, being dried and ground within twelve hours after the cattle are slaughtered. 5 lbs., .25; 10 lbs., .40; 25 lbs., .75; 100 lb. bags, \$1.75; per ton, \$32.00.

Pure Flour of Bone. Ground very fine. An excellent fertilizer for pot plants or beds where an immediate effect is desired. Excellent for Roses. 5 lbs., .25; 50 lbs., \$1.50; 100 lbs., \$2.50.

Bowker's Greenhouse Dressing. A special fertilizer for use under glass, by professional florists and market gardeners, used and recommended by Prof. S. T. Maynard of the Massachusetts Agricultural College. Sample bag for 100 plants, one year, \$1 00.

Bowker's Ammoniated Food for Flowers. A dressing made expressly for plants grown in the house, garden or conservatory; clean, odorless, and producing early and abundant blossoms of rich and brilliant color, and healthy, luxuriant plants. Prices, No. 1, .15; No 2, .25. If ordered by mail add .10 for No. 1 and .20 for No. 2, for postage.

Stockbridge Special Manure. The following are the leading kinds. For *Potatoes, Corn and Grain, Small Fruits, Vegetables, Root Crops, Asparagus, Top Dressing Grass and Seeding Down Grass.* In 100 lb. bags, \$2.00; per ton, \$38.00.

Dissolved Bone Black. Containing 16 to 18 per cent soluble and available phosphoric acid. Per 100 lbs., \$1.50; per ton, \$25.00.

Muriate of Potash. 80 to 85 per cent. Per 10 lbs., .50; per 100 lbs., \$2.75; per ton, \$44.00.

Nitrate of Soda. 95 to 98 per cent purity. Per 10 lbs., .50; per 100 lbs., \$2.50; per ton \$45.00

Sulphate of Potash. 50 to 55 per cent sulphate of potash, 35 to 40 per cent sulphate of magnesia, and not over 2½ per cent chlorine; an excellent article for potatoes or small fruits. Per 10 lbs., .40; per 100 lbs., \$1.75; per ton, \$32.00.

Sulphate of Ammonia. (Best.) White or Gray. 24¾ to 25¼ per cent ammonia. Per 10 lbs., .60; per 100 lbs., \$2.75.

Unleached Hardwood Ashes. One of the best fertilizers for lawns; also excellent for all kinds of garden or farm crops. They possess the advantage of being clean and sweet, and entirely free from any disagreeable odor. They give to the grass a rich, dark shade of green, and will destroy many of the insects which are so injurious to grass roots and leaves. Per bbl., \$2.50; per ton, \$18.00.

Insect Exterminators.

- Ant Exterminator.** Q. R. S. A most effectual preparation for the destruction of Ants in lawns and pleasure grounds. We guarantee it and will willingly refund the money paid us for it, in case of failure to exterminate or drive away ants. Directions for use on each package. Put up in three sizes, .25, .50 and \$1.00 each, postpaid.
- Flour of Tobacco and Sulphur.** Will prevent and cure mildew on grape vines and rosebushes. It will destroy the Green and Black Fly, Grubs, Cut Worms, Lice, and the Eggs of Insects, Mealy Bug and the Red Spider, Vine Bugs of all kinds and the Tomato Worm, Rose Slugs and Currant Worm, Fleas, Ticks and Scabs, and parasites of all descriptions. It is not poisonous, and has the double advantage of being a Fertilizer as well as an Insecticide. Per lb., .10; 5 lb. pkg., .40; 10 lb. pkg., .75.
- Fir-Tree Oil.** For destroying all insects and parasites that infest fruit-trees, plants and animals, whether on the foliage or at the roots; such as Mealy Bugs, American Blight, Red Spider, Scale, Thrip, Green and Black Fly, Woolly Aphis, Caterpillars, Grubs, Ants, Worms, Lice, Fleas, etc. Fir-Tree Oil does not contain any poisonous properties, being perfectly harmless to the hands and skin. Small bottles, .25; $\frac{1}{2}$ pt. .50; pt. .75; qt. \$1.25; 2 qts. \$2.25.
- Gishurst Compound.** An English preparation for destroying Scale, Mealy Bug, Red Spiders, Thrip, etc. Put up in boxes. Each .60. •
- Hellebore, White Powdered.** For the destruction of Rose Slugs and Currant Worms. Very effectual. $\frac{1}{2}$ lb. pkg. .15; 1 lb. pkg. 30.
- Lemon Oil.** The cheapest, safest and most effectual Insecticide for all purposes. Destroys all insects on the foliage and roots of plants without injury to flowers or leaves. An excellent wash for dogs; cures mange, kills all insects, and gives the coat a fine, glossy appearance. $\frac{1}{2}$ pt., .25; 1 pt., .50; 1 qt., .85; 2 qts., \$1.50; 1 gal., \$2.50.
- Morrill's Tree-Ink.** One of the best and cheapest articles for use in protecting trees from the ravages of the canker worm. Full directions for applying with each package. Two lb. cans each, .30; 3 lb. .45; 5 lb. .60; 10 lb. \$1.10; 20 lb., \$2.00; 28 lb., \$2.80; 125 lb. kegs, per lb., .09.
- Nikoteen.** A liquid to be used in spraying or vaporizing. It contains 40 per cent. nicotine, and one bottle is equivalent to 200 lbs. of tobacco stems or two gallons of tobacco extract. Pint bottles, \$1.50 each. Five for \$7.00.
- Persian Insect Powder.** For destroying all noxious insects. $\frac{1}{2}$ lb., .25; 1 lb., .50.
- Red Wood Extract.** This Extract will not injure plants, foliage or roots and is strongly recommended for killing all kinds of Insects, Slugs, Scale, etc. 1 pt., .30; 1 qt., .50; 2 qts., .85; 1 gal., \$1.50.
- Soap, Sulpho-Tobacco, Rose Brand.** Wherever tried, this soap has given the greatest satisfaction. Two oz. pkg., .10; \$1.00 per doz.; $\frac{1}{2}$ lb. pkg., .25; \$2.50 per doz.
- Soap, Whale Oil.** An effectual remedy for destroying and preventing insects on plants, trees, vines, etc., and for washing the bark of trees. One-pound pkg., .15; 2 lb., .25; 5 lb., .50; 10 lb., .90.
- Soap, Seal Oil.** A cheap and effective all round insecticide, destroys insects of every description on hard or soft-wooded plants without injury to the foliage. 1 lb. box, .25; 5 lb. box, \$1.00.
- Tobacco Extract Compound.** Hammond's. A powerful extract of Tobacco, combined with Sulphur, for destroying Lice, Red Spiders, Mildew and Blight, particularly in the greenhouse, by vaporizing. In pkgs: $\frac{1}{2}$ pt., .30; pt. .50; qt., 75; gal., \$2.00.
- Tobacco Extract, "Rose Leaf."** A concentrated extract of uniform strength, for use in greenhouses. It will not injure the plants if properly used, but will most effectually destroy Green Fly, Scale, Mealy Bug, and can be used by vaporizing or applying on the pipes with a brush. Diluted with water it can also be applied with a syringe. One gal., \$1.50; 2 gal., \$2.75; 5 gal., \$5.00.
- Tobacco Dust.** A sure remedy for the Green Fly, cheaper than snuff, and quite as effectual. Pound, .10; 5 lbs., .20; per hund. lbs., \$2.50.
- Tobacco Stems.** For fumigating. Valuable also when used as a mulch for rose beds. Small quantities, .05 per lb. In bbls. at .03 per lb. Large bales or cases, .02 per lb.

REMEDIES FOR FUNGUS, MILDEW, ETC.

- Ammoniated Solution of Copper.** A concentrated liquid fungicide. Dilute at the rate of 1 quart to 25 gallons of water, and spray lightly. Per qt., \$1.00; per gal. \$2.00; kegs and bbls., \$1.75 and \$1.50 per gal.
- Bordeaux Mixture.** Lion Brand. One gallon *will make 50 gallons* by the addition of 49 gallons of water. A sure cure and prevention for *Black Rot, Mildew, and Rust*. You can use as much or as little of this mixture at a time as is desired; the balance will be good at any future time. One gal. patent cans, \$1.00; 1 qt. patent cans, .40.
- Flowers of Sulphur.** Prevents Mildew on grape vines, rose bushes, etc. Per lb., .08; 5 lbs., .25.
- Grape Dust.** A preparation for destroying Mildew on grape vines. 5 lb. pkg., .35.

MUSHROOM SPAWN.

One pound will spawn about ten square feet. If ordered by mail, add eight cents per pound for postage.

To cultivate mushrooms successfully does not always require extensive experience. Some care is necessary, however, in the selection of the materials, and in forming the beds; but the matter of securing and maintaining the proper temperature in the room and in the beds needs close attention, for success depends very much upon this point. Mushrooms may be grown in a great variety of situations,—a dark room, cellar, stable, or elsewhere. Any place in which an even temperature of about 50° to 60° can be kept, is suitable. For materials for the bed, use fresh horse-manure, free from straw or chips, and good loamy soil. Some growers use the manure unmixed with loam, after first having well fermented it by alternately piling up and mixing for a few weeks; but it is undoubtedly better not to allow the manure to heat much before forming the bed. Use one fourth to one-third loam, the rest manure. Mix very thoroughly and upon a dry, firm bottom, make the bed of this mixture, about four feet wide, and of any desired length. Build it up evenly, pressing it down very firmly, and leave it about a foot high. It will shortly begin to heat. Use a thermometer to thrust into the bed, and note the temperature. When the heat has partially subsided, leaving a temperature of



70° to 80°, put in the spawn. Pieces from the size of walnuts to that of eggs are placed in the bed about a foot apart, deep enough to cover them well, and the manure pressed down. Let it remain thus ten or twelve days: then cover with two inches of fresh loam, and make this moderately firm. The bed is finished by covering all with four or five inches of straw or other litter. Watering is not necessary, unless the surface of the bed gets very dry; in this event, moisten freely with water at a temperature of about 80°. In gathering the crop, do not cut, but twist them off carefully, filling up the holes with loam to keep insects from the roots. In six or eight weeks from spawning the beds, mushrooms should appear. Our space is too limited to present a complete treatise on mushroom culture; and to those wishing to more thoroughly investigate the subject we recommend Robinson's "Mushroom Culture," also "How to Grow Mushrooms," by William Falconer. We will forward a copy of the former upon receipt of \$.50, and the latter upon receipt of \$1.40.

English Spawn. (Bricks) Per lb., \$.15; 8 lbs., \$1.00

BOOKS.

All books sent postpaid, on receipt of price.

BULBS AND TUBEROUS ROOTED PLANTS. By C. L. Allen	\$2.00
FLINT'S GRASSES AND FORAGE PLANTS	2.00
GARDEN AND FARM TOPICS. Henderson	1.00
GARDENING FOR PROFIT. Henderson	1.75
GARDENING FOR PLEASURE. Henderson	1.75
HANDBOOK OF PLANTS. Henderson	3.75
LANDSCAPE GARDENING. Samuel Parsons, Jr., superintendent of Parks, New York City. Notes and suggestions on Lawns and Lawn Planting, laying out and arrangement of country places, large and small parks, etc. Nearly 200 illustrations, pp. xxii + 329	3.50
MUSHROOMS. How to grow them. Falconer	1.40
MUSHROOM CULTURE. Robinson50
MUSHROOMS FOR THE MILLION. Wright50
INSECTS AND INSECTICIDES. A practical manual concerning noxious insects and the methods of preventing their injuries. By Prof. C. M. Weed	1.25
THE LEAF COLLECTOR'S HAND-BOOK AND HERBARIUM. C. A. Newhall. An aid in the preservation and in classification of specimen leaves of trees of North-eastern America. Illustrated	2.00
THE ROSE. By H. B. Ellwanger. A treatise on the cultivation, history, family character, etc., of the various groups of roses, with accurate descriptions of the varieties now generally grown	1.25
THE NEW ONION CULTURE. By T. Greiner50
HORTICULTURIST RULE BOOK. A compendium of useful information for gardeners. L. H. Bailey	1.00

Pot-Grown Strawberry Plants.



Our pot-grown Strawberry Plants are well-rooted, healthy plants, ready for shipment early in August, and by setting them any time during August or September a fine crop of fruit may be had the next season. Price, \$2.50 per 100; \$20.00 per 1,000.

Belmont. Large, crimson, oblong berry, very solid, and of extra flavor and quality. Medium.

Bubach, No. 5. (P). Very large and productive, bright scarlet; a fine market sort. Early to medium.

Brandywine. Large, roundish-conical, bright, glossy, crimson berries, firm and solid, excellent quality and fine flavor. Medium.

Enormous. Large size and good quality. The berries are deep crimson, very glossy, firm and solid. Early to medium.

Gandy. Large, bright crimson berries of uniform size; best of late sorts, ripening two weeks after Sharpless.

Leader. Productive, large size, firm, fine form, and dark crimson color. One of the earliest.

Marshall. Large, rich crimson, and fine flavor.

Rio. A good early sort and large for an early berry, fine flavor, firm and colors evenly. A good keeper and improves like the Belmont. A favorite where large, early berries are wanted for shipping.

Timbrell. (P). A new berry. Solid, dark crimson, of the highest quality, largest size; most productive and one of the latest to ripen.

TABLE OF CONTENTS.

BULBS AND ROOTS.

	PAGE.		PAGE.
Achimenes	8	Ixias	12
Adonis Vernalis	8	Lachenalias	12
Agapanthus	8	Leucojum	12
Allium	9	Lilies	13 and 14
Amaryllis	9	Lily of the Valley	13
Anemone	9	Madeira Vine	14
Anomatheca	9	Montbretia	14
Arum	9	Narcissus	6 and 7
Babiana	9	Oxalis	14
Bleeding Heart	10	Ornithogalum	14
Bulbocodium	10	Pæonies	15
Calla Lilies	10	Pancreatium	15
Calochortus	10	Ranunculus	15
Chionodoxa	10	Scillas	15
Colchicum	8	Snowdrop	15
Crocus	8	Sparaxis	15
Crown Imperials	10	Spirea	15
Cyclamen	11	Trillium	16
Day Lilies	11	Triteleia	16
Freesia	11	Tritoma	16
Frittelarias	11	Tritonia	16
Galtonia	11	Tropaeolum	16
Gladiolus Colvilli	12	Tulips	3 to 5
Gloxinia	12	Violets	16
Hyacinths	1 to 3	Winter Aconite	16
Iris	12		

SUNDRIES.

	PAGE.		PAGE.
Books	24	Mushroom Spawn	24
Fertilizers	22	Mastica	18
Florists' Supplies	21	Plant Stakes	18
Flower Pots and Saucers	17	Plant Tubs	20
Flower Scissors	17	Potting Materials	20
Fumigators	18	Pruning Shears, &c.	17
Glaziers' Points	18	Sprinklers	19
Hose, Hose Nozzles and Menders	19	Syringes	19
Hot Bed Mats	17	Thermometers	20
Hyacinth Glasses	16	Trellises	20
Insect Exterminators	23	Watering Pots	2



Franklin Park Lawn Seed.

OUR SPECIALTY.

TRADE MARK REGISTERED,

Superior Mixture for Lawns, Tennis Courts, Golf Links, etc.

The mixture of grass-seeds we sell under this name is made from the identical formula used by the Park Commissioners of the City of Boston in their work of laying out the beautiful lawns and terraces which add such a charm to our new parks. All the grass seed thus far used on these parks has been supplied by us, which fact should be a strong guarantee of quality. No inferior grade of seed would stand the critical examinations and tests of the Park officials.

The Franklin Park Mixture gives a fine, smooth, velvet sward within a very few weeks after sowing. It is composed of clean seed of the finest and most desirable permanent grasses known, and it contains no chaff nor foul seeds. Weight per bushel about 32 pounds.

The very large demand for this lawn seed has necessitated our having the name "Franklin Park" registered as a trade mark, in order to protect ourselves from imitators.

September and October are most favorable months for sowing.

We put this seed up in packages — all of which bear our name — containing quantities as follows :

64 lbs., sufficient for one acre	Price, \$16.00	16 lbs., sufficient for one-quarter acre	Price, \$4.00
32 " " " one-half acre	" 8.00	Price per pound30

FINEST ENGLISH MIXTURE.

This mixture, made from our own formula, we have sold for many years, and it has given very general satisfaction. Weight per bushel, 16 lbs. Per $\frac{1}{2}$ lb., (1 qt.) 20 cts. ; per lb., (2 qts.,) 35 cts. ; per bushel, (16 lbs.,) \$4.00.

Add eight cents per pound to all grass seed if wanted by mail.