

**EXPERIMENTAL
PHYSIOLOGY**

E. A. SCHÄFER

MBL/WHOI



0 0301 0019473 4

Experimental Physiology

BY THE SAME AUTHOR

Eighth Edition, 1910.

THE ESSENTIALS OF
HISTOLOGY

With 645 Illustrations. 8vo. 10s. 6d. net.

TEXT-BOOK OF
MICROSCOPIC ANATOMY

With 21 Coloured Plates and 1001 Illustrations in the text. Royal 8vo. 25s. net.

This has been published as part of the eleventh edition of Quain's Anatomy, but is a complete work in itself. It contains a full account of the minute structure of all the tissues and organs of the body, illustrated by drawings and photographs.

LIFE: ITS NATURE, ORIGIN
AND MAINTENANCE

Being the Presidential Address delivered before the British Association at Dundee, September 1912.

8vo. Paper Covers. 1s. net.

LONGMANS, GREEN & CO.

39 PATERNOSTER ROW, LONDON, E.C.
NEW YORK, BOMBAY, AND CALCUTTA

2573
1

Experimental Physiology

BY

E. A. SCHÄFER, F.R.S.

PROFESSOR OF PHYSIOLOGY IN EDINBURGH



WITH EIGHTY-THREE ILLUSTRATIONS

LONGMANS, GREEN, AND CO.

39 PATERNOSTER ROW, LONDON

NEW YORK, BOMBAY AND CALCUTTA

1912

All rights reserved

10542

Preface

THE present volume is based upon a small book, entitled *Directions for Class Work in Practical Physiology*, which was published in 1901, and consisted chiefly of an account of the methods employed in the study of muscle and nerve physiology and of the heart, in so far as these could be illustrated in preparations from the frog. To that account have now been added descriptions of such other methods of Experimental Physiology as may be performed by the student either in class or individually, although a few which are given can—at least in this country—only take the form of demonstrations. The additions deal chiefly with the heart and vascular system, respiration, secretion, the central nervous system, and the sense organs; but considerable changes have also been introduced in the description of the methods of studying the physiology of muscle and nerve, and not only have a large number of new illustrations—for the most part in the form of diagrams—been added, but all the original figures have been redrawn, so that the work has taken the character of a new book, which it has been thought proper to furnish with another name.

The descriptions of the methods employed are founded upon twelve years' experience in conducting the classes of Practical Physiology in the University of Edinburgh. These classes are of two kinds, elementary and advanced, and some of the methods described are intended only for advanced students. But no attempt has been made in the work to discriminate between the experiments which are expected to be performed by the one or the other grade. Such selection can be best made by the teacher of the subject, and would be regulated by the requirements of the students and the nature of the examinations for which they are preparing.

UNIVERSITY, EDINBURGH,
September 1912.

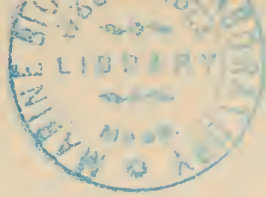

Contents

CHAP.	PAGE
PRELIMINARY	1
I. AMOEBOID AND CILIARY MOVEMENT	2
II. THE ELECTRICAL APPARATUS IN COMMON USE IN PHYSIOLOGICAL WORK	4
III. SIMPLE EXPERIMENTS ILLUSTRATING THE USE OF ELECTRICAL APPARATUS IN PHYSIOLOGY	17
IV. THE NERVE-MUSCLE PREPARATION	20
V. THE RECORDING OF MUSCULAR CONTRACTIONS	26
VI. THE NERVELESS MUSCLE	32
VII. EFFECT OF SUCCESSIVE STIMULI UPON A MUSCLE-NERVE PREPARATION	36
VIII. WORK OF MUSCLE; EXTENSIBILITY OF MUSCLE	39
IX. FATIGUE OF MUSCLE AND NERVE	42
X. CONDUCTION IN NERVE	46
XI. CONDITIONS OF EXCITATION OF NERVE AND MUSCLE BY THE GALVANIC CURRENT	50
XII. POLAR EFFECTS OF A GALVANIC CURRENT; ELECTROTONUS	54
XIII. EXPERIMENTS ON THE ELECTRICAL CONDITIONS OF MUSCLE AND NERVE	57
XIV. INVOLUNTARY MUSCLE	62
XV. THE FROG-HEART	64
XVI. PERFUSION OF HEART	69
XVII. CARDIAC NERVES OF FROG	72
XVIII. STRUCTURE AND ACTION OF THE MAMMALIAN HEART	75
XIX. THE CIRCULATION IN THE BLOOD-VESSELS	77
XX. THE PULSE	83
XXI. PERFUSION OF VESSELS; LYMPH-HEARTS	86
XXII. MECHANISM OF SECRETION	88
XXIII. RESPIRATION	90
XXIV. NERVE-ROOTS	94

CHAP.	PAGE
XXV. REFLEX ACTION AND REACTION TIME. EXCITATION OF CORTEX CEREBRI	95
XXVI. CUTANEOUS SENSATIONS	100
XXVII. EXPERIMENTS ON THE DIOPTRIC MECHANISM	102
XXVIII. STIMULATION OF THE RETINA	106
XXIX. THE PRODUCTION OF VOCAL SOUNDS. ANALYSIS OF SOUNDS AUDITION. THE SEMICIRCULAR CANALS	109
XXX. TASTE AND SMELL	111

EXPERIMENTAL PHYSIOLOGY

PRELIMINARY

As a preliminary to any course of Experimental Physiology, the following dissections should be made :—

Frog. In this the following parts are to be displayed :—

- (a) The brain and spinal cord, with the nerves passing off from them.
- (b) The heart, with the main vessels leading to and from it.
- (c) The lungs.
- (d) The abdominal viscera, including stomach, small intestine, large intestine, liver, spleen, kidneys, bladder, and reproductive glands.
- (e) The nerves and muscles of the leg.

Rabbit.

- (a) The skull to be opened, and the several parts of the brain examined.
- (b) The trachea and the blood-vessels and nerves on either side of it to be displayed, and to be followed as far as possible both upwards towards the head and downwards into the thorax.
- (c) The contents and boundaries of the thorax to be examined. The several parts of the heart to be observed and the vessels which are connected with it. After removing the contents of the thorax, the sympathetic ganglia and the nerves (splanchnic) leading downwards from them towards the abdomen should be noticed.
- (d) The abdominal and pelvic viscera to be displayed.
- (e) The nerves and muscles of one of the hind limbs to be dissected.

Since these dissections form a part of every course of Biology, the student will probably already be familiar with them. If not, they should be made now.

CHAPTER I

AMŒBOID AND CILIARY MOVEMENT

The fresh-water amœba.—Find an amœba in a drop of pond water with the microscope, and study its movements.

Amœboid movements of frog's leucocytes.—Observe in a preparation of frog's blood the amœboid movements of the leucocytes.

Ciliary movement.—(1) Gently scrape some epithelium from the roof of a frog's mouth, and shake the scrapings in a drop of normal salt solution or of Ringer's solution.¹ Observe with the microscope the ciliated cells and the movements of their cilia.

(2) Take a small fragment of the gills of a sea-mussel and examine it under the microscope in a drop of sea water. The cilia are much larger than those of the frog, and their movements more easily watched, especially when they become slow.

Experiments illustrative of amœboid movement.—The following experiments show that movements like those of the amœba can be produced by purely physical means (changes in surface tension).

1. Take on a glass rod a drop of ordinary olive oil which has been coloured with Scharlach R., and place it gently on the surface of a 1 per cent. solution of sodium bicarbonate. Sketch the changes of shape which it undergoes.

2. A globule of mercury is placed in a watch-glass of dilute nitric acid (1 per cent.). Introduce into the fluid near, but not touching, the drop a small crystal of potassium bichromate. Observe the movements of the mercury.

Experiments on ciliary movement.—1. In a model consisting of a thick rubber ball from which a flat, curved rubber tube projects, notice that the tube straightens out or curves over to one side according to the tension of the contents of the ball. This movement, which resembles that of a cilium, is thus produced by variations in tension within the part representing the cell.

2. In a frog which has just been killed, cut through the lower jaw and carry the incision down the œsophagus to the stomach. Cut this organ across, seize the cardiac end with forceps, and dissect out the œsophagus together with the pharynx and a part of the mucous membrane of the mouth. Pin out the œsophagus and pharynx and adjacent parts of the buccal membrane on a flat cork with the inner surface uppermost. Rinse with Ringer's solution. Sprinkle a few grains of charcoal over the buccal end of the preparation, and notice that the charcoal is carried down as far as the stomach by the action of the cilia. In the same way, pieces of cork or wax, or even small flat pieces of heavy materials such as lead, may be passed over the surface.

¹ Normal salt solution is made by dissolving six grams NaCl in a litre of water. *Ringer's solution* is an improved salt solution made by saturating one litre of the above with calcium phosphate and adding ten milligrams of potassium chloride. "Ringer" should always be used in preference to ordinary salt solution. For mammalian tissues it is made similarly but with 7-9 grams NaCl to each litre of water.

3. Effect of temperature on ciliary movement. Fasten with pins two pieces of thread about half an inch apart across the above preparation of œsophagus, and slightly raised above it. Rinse the membrane with *ice-cold* Ringer solution. Drop a grain of charcoal on the buccal end, and with a watch record the number of seconds which the charcoal takes to pass over the half-inch between the threads. Again rinse the membrane, but this time with *warm* Ringer (25° C.), and repeat the experiment. Note the difference in time taken to traverse the space marked off by the threads. Lastly, rinse with Ringer heated to 50° C., and repeat the experiment. The ciliated cells are killed at this temperature, and the charcoal is no longer carried along.



CHAPTER II

THE ELECTRICAL APPARATUS IN COMMON USE IN PHYSIOLOGICAL WORK

Batteries.—A voltaic element or cell usually consists of two metals—*e.g.*, zinc and copper—immersed in a fluid such as dilute sulphuric acid, and the changes (movements of ions) which occur under these

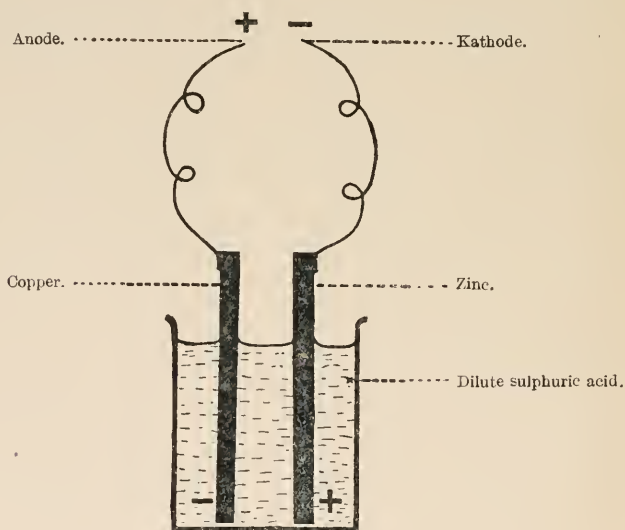

FIG. 1.—VOLTAIC COUPLE.

circumstances in the fluid produce a disturbance of electrical equilibrium in the cell which manifests itself as a difference of electrical potential or pressure at the metals. If wires are connected to these it is found that the end of the wire connected with the copper or electronegative metal is charged with positive electricity, and that connected with the zinc or electropositive metal is charged with

negative electricity ; these ends are called the positive pole, or *anode*, and the negative pole, or *kathode*, respectively. The anode is said to be in a condition of higher potential and the kathode in one of lower potential, and when they are joined electrical equilibrium tends to re-establish itself in the circuit thus closed. It is common to speak of a current as flowing from the anode to the kathode outside the battery and from the zinc to the copper inside.¹ The amount of this current depends upon the difference of potential produced within the cell. This is diminished by any increase of resistance to the flow of electricity, whether occurring within the cell or in the outside circuit. Electromotive force (E.M.F.) is measured in volts ; thus the E.M.F. of a Daniell cell is 1·079 volts. It may be increased by coupling two or more cells together in series, the zinc of one connected with the copper of the next, and so on.

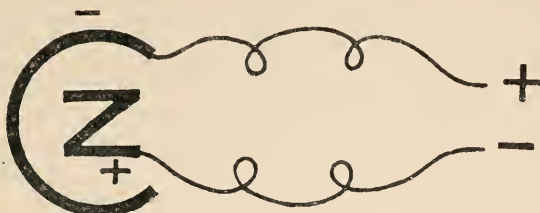

FIG. 2.—DIAGRAM OF A VOLTAIC COUPLE. Z, ZINC ; C, COPPER.

If electricity be generated simply by immersing plates of zinc and copper into acid the chemical action which ensues causes bubbles of hydrogen gas to form on the copper, and this not only introduces a resistance to the flow of current through the cell, but the hydrogen being electropositive tends to set up a current (polarisation current) in the opposite direction in the cell and circuit ; from both these causes the original E.M.F. of the cell becomes rapidly weakened.

To obviate this effect Daniell placed the copper plate in a saturated solution of copper sulphate and introduced a porous pot to separate this from the dilute sulphuric acid in which the zinc is immersed (fig. 3). The zinc then dissolves in the acid, displacing hydrogen ; the hydrogen in its turn displaces copper from the copper sulphate, and the displaced copper is deposited on the copper plate, so that no bubbles of hydrogen are formed upon the metal, and if the copper sulphate solution is kept saturated, the E.M.F. of the cell remains constant. Commercial zinc, which is never pure, must always be “amalgamated”

¹ *Within the battery* the electrical potential is highest at the zinc, which is therefore here the anode, and lowest at the copper, which is here the kathode.

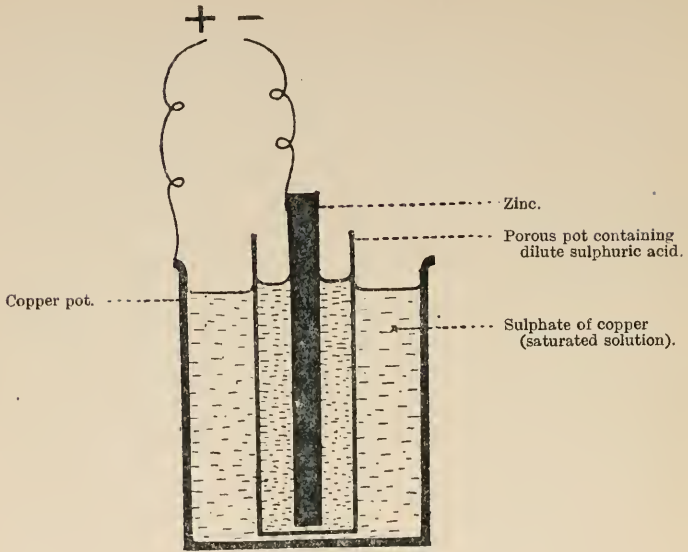

FIG. 3.—DANIELL CELL.

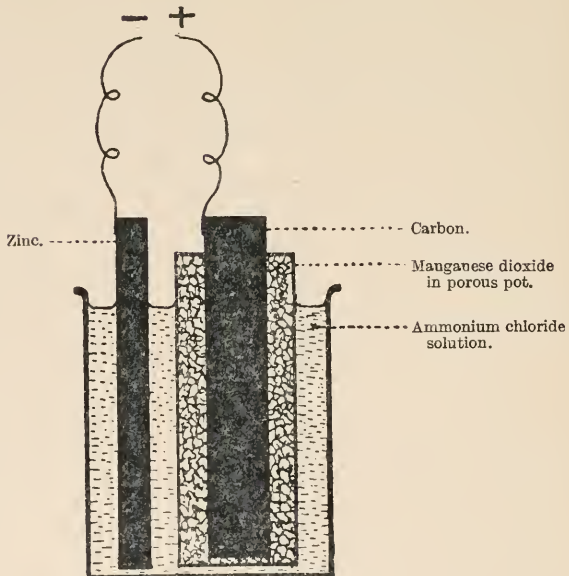

FIG. 4.—LECLANCHÉ CELL.

by rubbing its surface with mercury after it has been cleaned by dipping into dilute sulphuric acid.

Other constant batteries which are frequently used in physiology are that of Grove, where the negative plate is platinum and is plunged into strong nitric acid, separated from the sulphuric acid containing the zinc plate by a porous partition; that of Bunsen, which is similar to Grove's, but with a negative plate of carbon; that of Leclanché (fig. 4), in which the acid is replaced by chloride of ammonium and the place of the negative plate is also taken by carbon, which is surrounded by manganese dioxide; and that of Grenet, where carbon again forms the negative plate, but where a single fluid is used (bichromate of potassium dissolved in dilute sulphuric acid), in which both plates are immersed. The so-called "dry" cells are modified Leclanchés. The positive plate in every one of these cells is amalgamated zinc.

Electrodes.—The wires used in physiological experiments must always be insulated, either with gutta-percha or with silk or cotton; in the latter case the insulation is rendered more effectual by dipping the covered wire into molten paraffin. For experimental purposes it is usual to place the ends of the wires (which must be clean and free from the insulating material) in some sort of holder, so that they can be more readily applied to the tissue which is to be investigated; these ends are usually termed the *electrodes*.¹ They are often made of platinum set in a



FIG. 6.—SIMPLE CORK ELECTRODE-HOLDER.



FIG. 5.—PIN-ELECTRODE.

vulcanite holder; but a pair of pins with fine wires soldered to their heads, which can on occasion be passed through a small cork, with their points projecting for a few millimeters, constitute a readily improvised and efficient pair of electrodes for most class purposes.

To determine which of the two electrodes in any case is the anode and which the kathode, they may be placed in contact with a piece of blotting-paper moistened with starch solution containing iodide of potassium (*pole-testing paper*). Iodine is set free at the anode and turns the starch blue. Feeble differences of electrical potential are determined and estimated by other methods (galvanometer, electrometer), which will be studied later.

Non-polarisable electrodes.—Like the plates of the battery itself, metallic electrodes are capable of becoming polarised when they are in contact with the moist tissues and a current is passed continuously between them in one direction. For some experiments it is necessary to obviate this polarisation of electrodes and to employ electrodes

¹ The term *electrode* means literally the "path" of the electric current, and in this sense the wires throughout are electrodes. But it has come to mean technically the ends of the wires which are used to apply the electric current to a given object (such as an animal tissue).

which are not polarisable. These are usually made by taking two small pieces of glass tubing open at both ends, either straight (fig. 7) or curved (fig. 8), and having plugged one end of such tube with china clay made into a paste with salt solution, the tube is filled with saturated solution of zinc sulphate, and an amalgamated zinc

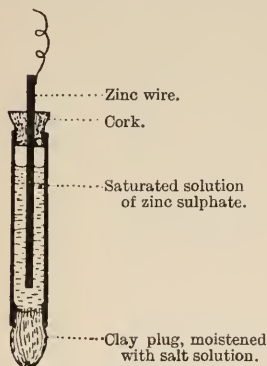

FIG. 7.—NON-POLARISABLE ELECTRODE.

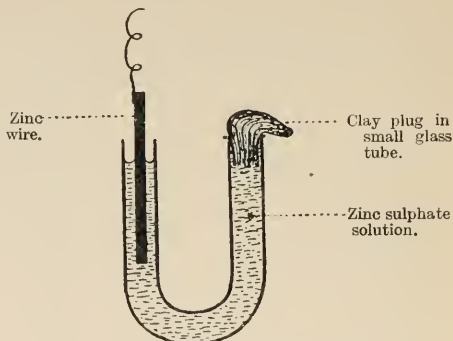

FIG. 8.—SANDERSON'S PATTERN OF NON-POLARISABLE ELECTRODE.

rod (to which one of the wires of the circuit is soldered or otherwise attached) is plunged into the zinc sulphate.

The rod is amalgamated by dipping it for a few seconds into a solution of mercury in nitric acid, washing under a tap, and polishing with cotton-wool.

A convenient form of non-polarisable electrode is that of Porter, who uses a boot-shaped tube of unglazed porcelain which is soaked with normal saline and filled with saturated solution of zinc sulphate; the amalgamated zinc rod is passed into the leg of the boot.

Keys.—Any apparatus which is used for interrupting or diverting the course of a current is called a *key* or *switch*. The keys used in physiological experiments are arranged to close and open a circuit



FIG. 9.—DIAGRAM OF MERCURY KEY.

(make and break the current) by connecting two wires together either through a pool of mercury (*mercury key*—figs. 9 and 10); or by contact between a platinum plate and platinum point (*contact key*—fig. 11),

as in the Morse key; or by friction contact between two brass surfaces (*friction key*), as in that known as du Bois-Reymond's (fig. 12),

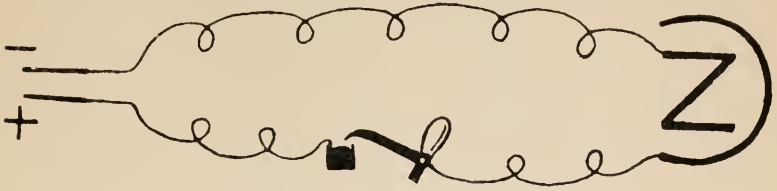

FIG. 10.—MERCURY KEY IN A BATTERY CIRCUIT.

and in the ordinary electric-light switches. They are used in two

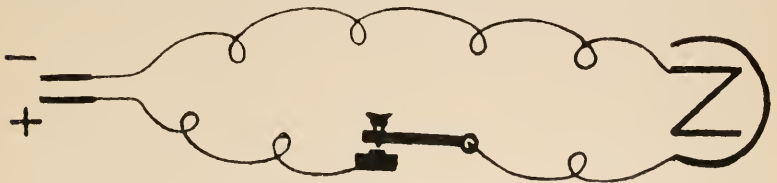

FIG. 11.—CONTACT KEY IN A BATTERY CIRCUIT.

ways, viz. : either to simply close or open the circuit (*direct method*—

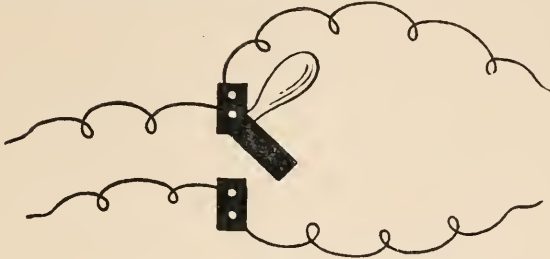

FIG. 12.—DIAGRAM OF SHORT-CIRCUITING KEY OF DU BOIS-REYMOND.

figs. 10, 11, 13) ; or by bridging across a part of the circuit a passage

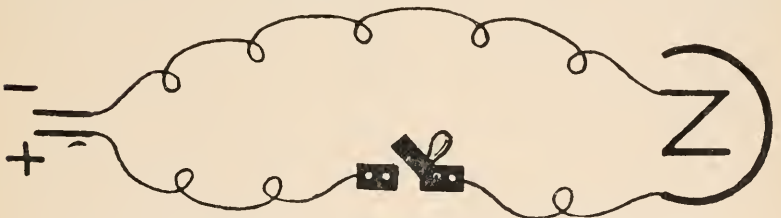

FIG. 13.—FRICTION KEY IN A BATTERY CIRCUIT ; DIRECT METHOD OF USE.

with very little resistance is offered through the key, and the current is thus diverted from the main circuit and from the electrodes (*short-*

circuit method—fig. 14). For this purpose du Bois-Reymond's key is especially well suited.

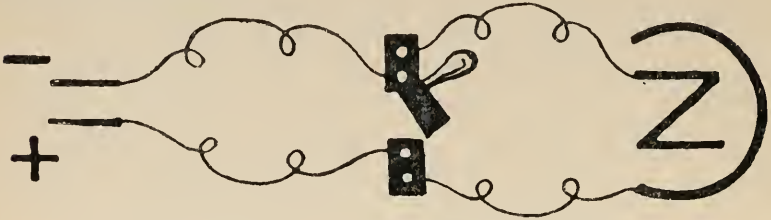

FIG. 14.—FRICTION KEY; SHORT-CIRCUIT METHOD OF USE.

A key which is constructed so as to cause a current to flow either in one direction or in the reverse direction in part of a circuit is called a

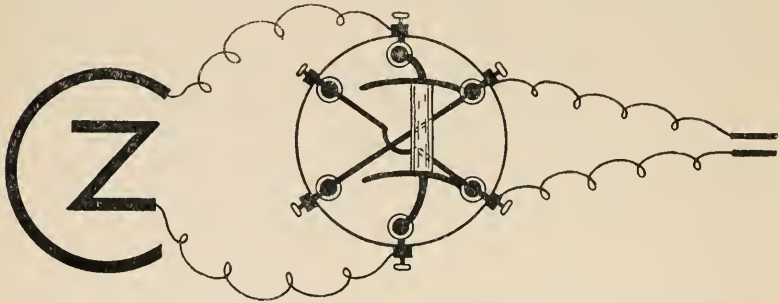

FIG. 15.—DIAGRAM OF POHL'S COMMUTATOR.

reverser or *commutator*. One of the most frequently used is Pohl's commutator (fig. 15), which consists of a plate of vulcanite or

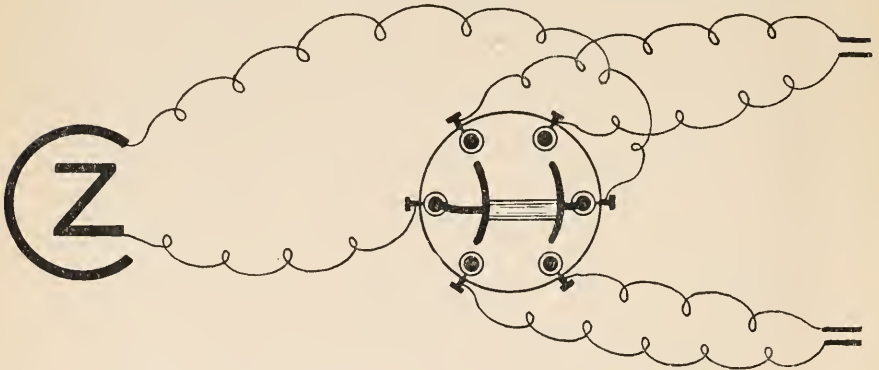

FIG. 16.—POHL'S COMMUTATOR USED AS SWITCH (CROSS WIRES REMOVED).

other non-conducting material in which are six cups of mercury connected with terminals. Four of the cups are joined diagonally, two

and two, by crossed wires. A rocking double bridge of copper

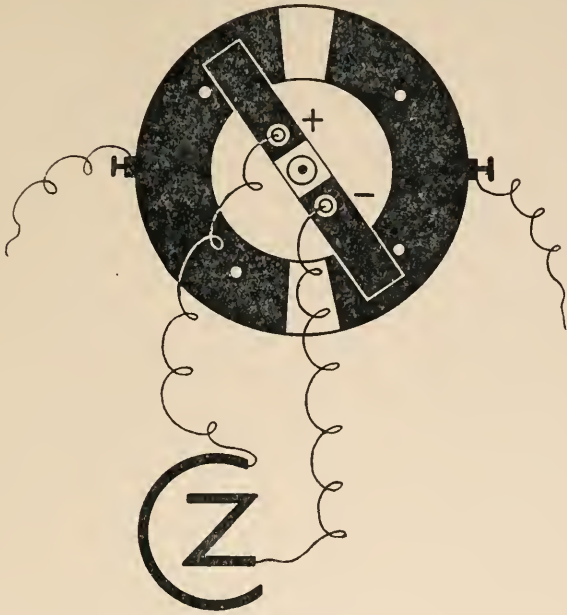

FIG. 17.—WALLER'S COMMUTATOR.

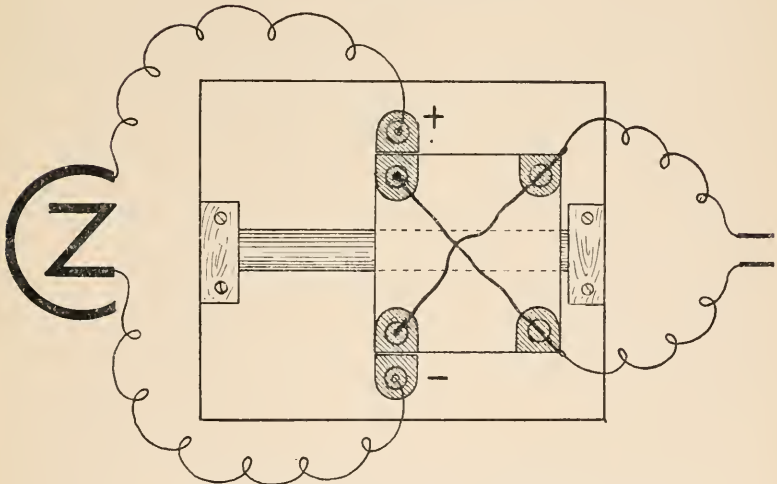

FIG. 18.—DIAGRAM OF MALCOLM'S COMMUTATOR.

serves, on being moved to one side or the other, to effect the reversal.

If the crossed wires are removed the Pohl can be used as a switch for diverting a current into one or other of two circuits (fig. 16).

Other commutators have friction-contacts in place of mercury: of these the simplest are Waller's (fig. 17), which has a rotating action; and Malcolm's (fig. 18), which has a sliding action. The principle is the same as the mercury commutator, and it is often convenient to dispense with mercury.

Rheochords.—A *rheochord* is an apparatus for dividing a constant current by offering a circuit of relatively small resistance which is capable of being varied so that a variable part only of the current shall pass through the experimental circuit. It usually consists of a german-silver or platinum-iridium wire of a certain known resistance

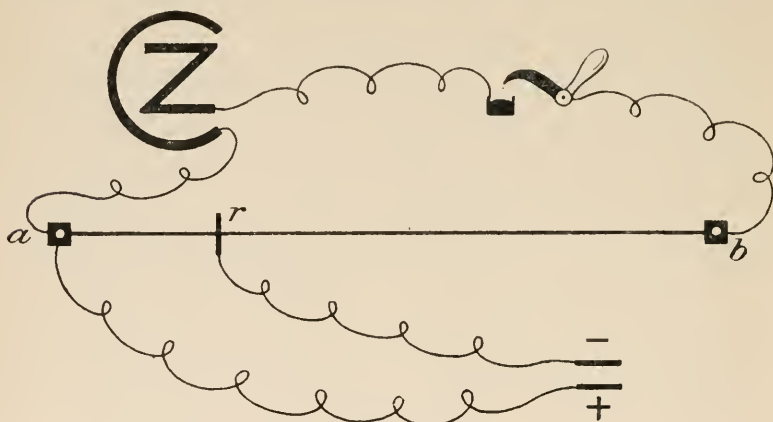

FIG. 19.—DIAGRAM OF RHEOCHORD.

(e.g., 20 ohms), to the ends (fig. 19, *a* and *b*) of which the battery poles are connected; a certain difference of potential is thereby produced at the two ends of the wire. With one of these ends (*b*) another wire is connected; this forms part of the experimental circuit through which a portion of the battery current is to be conducted; this circuit is completed through a wire attached to a rider (*r*) which slides along the rheochord wire.

When *r* is in contact with *b* the whole difference of potential between *a* and *b*—which depends upon the E.M.F. of the battery and the resistance of the rheochord wire relative to that of the experimental circuit—is operative in producing a current through the preparation. When *r* is at the middle of the rheochord wire only one-half of this difference of potential comes into play, and so in proportion to the distance between *a* and *r* as compared with the whole length of the wire. Thus if the wire be 100 centimeters long and *r* be

placed at one centimeter from *a*, only $\frac{1}{100}$ of the total difference of potential will be operative and a proportional current will be diverted into the experimental circuit. If *r* is in contact with *a* no current is led through the preparation.

When this kind of rheochord is used, the resistance of the experimental circuit must always be relatively very great: as is invariably the case in physiological experiments, where an animal tissue forms part of the circuit.

The wire of a rheochord may be stretched straight as in fig. 19, or, to economise space, it may be zig-zagged upon a board (fig. 20), or arranged spirally round a vulcanite cylinder, or circularly round a disc as in du Bois-Reymond's form of instrument.

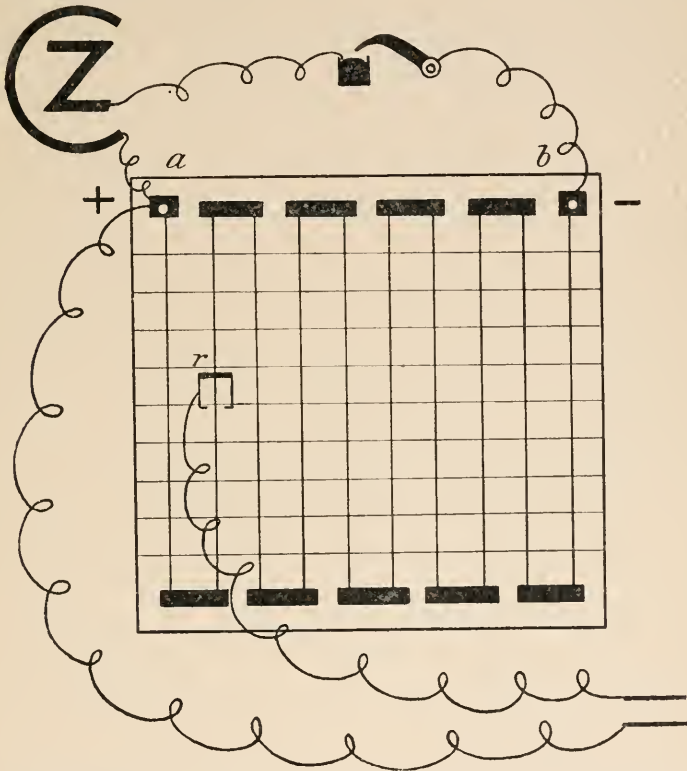

FIG. 20.—DIAGRAM OF THE OXFORD FORM OF RHEOCHORD. *a*, *b*, RHEOCHORD WIRE ZIG-ZAGGED UPON A MAHOGANY BOARD, MARKED BY CROSS LINES INTO HUNDREDETHS; *r*, RIDER.

In another form of rheochord there are two wires, and a broad metal rider (*r*) bridges across and forms a short circuit between the two (fig. 21). The battery circuit and the experimental circuit are both connected with the one end of each wire. When the rider is brought up to these ends the battery current is completely short-circuited, but when the rider is moved away from them a gradually increasing resistance is inserted into the short circuit formed by the

rheochord and its rider, and proportionally more of the battery current passes into the experimental circuit.

Induction coil.—If the wires of two separate circuits are at any point near to and parallel with one another and if, in the first or *primary* circuit, the current of a battery is either made or broken by the closing or opening of a key, an induced current is set up in the other or *secondary* circuit at the instant of such closing or opening, but not during the passage of the primary current. The induced or secondary current is always of very short duration, but has a much higher electromotive force than the primary or inducing current.

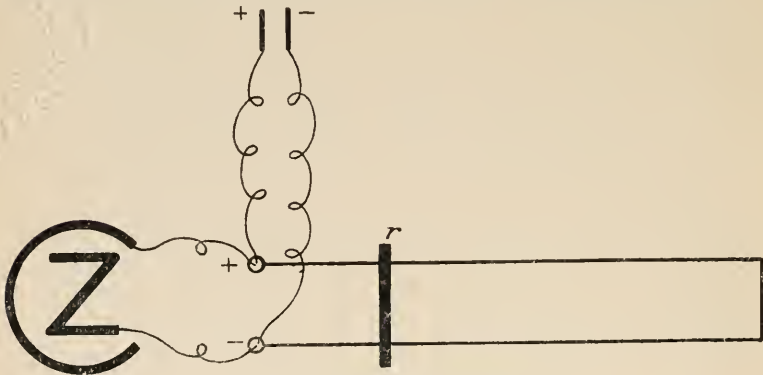

FIG. 21.—DOUBLE-WIRE RHEOCHORD.

In order to multiply the induction effect the two circuits always take the form of closely coiled wires (fig. 22) (that of the secondary circuit being very fine and having very numerous coils), and to still further increase the effect the primary coil is wrapped round a core formed of a bundle of soft iron wires which are magnetized and demagnetized on the closing and opening of the primary circuit, thus enhancing the induction effects.

For physiological purposes the induction coil was arranged by du Bois-Reymond so that the secondary circuit can be made to slide nearer to or farther from the primary circuit; since with the same strength of battery the nearer or further the coils are from one another the greater or less is the strength of the induced current. The variation is not, however, proportional to the distance, but approximately to the square of the distance. For producing single make and break induced shocks the primary circuit is closed and opened with a simple key (fig. 22). For multiple induced shocks most coils are fitted with an apparatus for automatically breaking and making the primary

circuit (Neef's hammer). This will be understood from the diagram shown in fig. 23. The battery current is conveyed from the terminal, t^3 , to a steel spring, sp , having a bar of soft iron at its free end, and

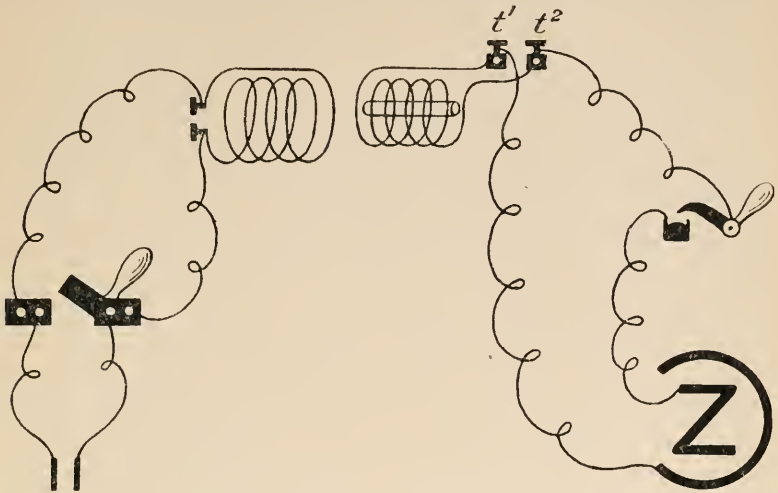

FIG. 22.—INDUCTION COIL ARRANGED FOR SINGLE SHOCKS.

the current passes from the spring, which has a plate of platinum upon it, to the platinum point of a screw, s^1 , and thence through the primary coil. Before passing back to the battery it is conducted

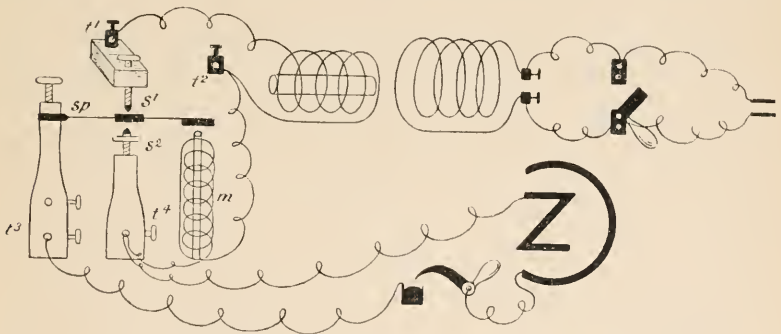

FIG. 23.—DIAGRAM OF DU BOIS COIL ARRANGED FOR FARADISATION.
(FOR DESCRIPTION SEE TEXT.)

through a small electro-magnet, m ; the electro-magnet being thus set in action, draws down the iron bar and with it the spring, which leaves the screw and breaks contact so that a *break* induced current is set up in the secondary coil. But, the current being broken, the

electro-magnet, m , is no longer active, the bar springs up again, and contact is re-established between the spring and screw; this produces a *make* induced current in the secondary coil. Thus the spring vibrates to and fro, and break and make induced currents are set up in the secondary coil many times a second, according to the rate of vibration of the spring.

These make and break shocks are unequal owing to the extra current which is self-induced within the primary coil, and which diminishes the make effect (see Chapter III.). This inequality is, however, overcome by a modification introduced, by Helmholtz. In this arrangement (fig. 24) a wire, w , connects the terminals t^1 , t^3 ; the screw s^1 is raised altogether away from the spring, and does not come into use; the screw s^2 is brought nearly up to the spring. The battery current passes by the wire, w , from the terminal, t^3 , directly to t^1 , thence through the primary coil and through the electro-magnet, m , which draws down

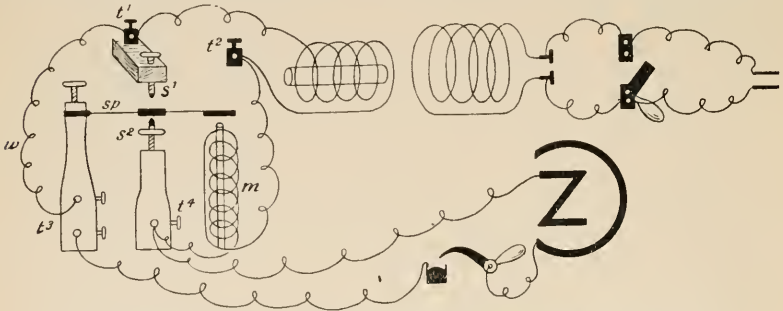

FIG. 24.—DIAGRAM OF THE ARRANGEMENTS EMPLOYED IN THE HELMHOLTZ MODIFICATION OF DU BOIS-REYMOND'S INDUCTION COIL. (FOR DESCRIPTION SEE TEXT.)

the iron bar and brings the spring in contact with the screw, s^2 . A large part of the battery current now goes directly back to the battery through this contact, and is diverted from the primary coil and electro-magnet. This greatly weakens the current through the primary coil, and the equivalent of a *break* induced shock is obtained in the secondary circuit; for any sudden variation in the current of the primary coil is effective in producing an induced current in the secondary coil. But the electro-magnet is also weakened, so that the bar and spring fly up. This breaks the short-circuiting contact which was established between the spring and s^2 , and the whole current again passes through the primary coil, producing the equivalent of a *make* induced shock in the secondary circuit, and so on automatically. It will be observed that the primary circuit is never actually broken, but only short-circuited.

The Helmholtz arrangement should always be employed for tetanic stimulation, unless the nature of the experiment contra-indicates it.

Kronecker's inductorium.—Most du Bois-Reymond coils are furnished with a scale marked in millimeters to indicate the distance of the secondary from the primary coil. But the Kronecker coil is so graduated as to indicate the relative strength of the induced current when a standard battery of constant strength is employed in the primary circuit, and the scale is marked in units as well as millimeters. Moreover, the contacts are between a platinum wire and mercury, the latter being kept clean by passing water or dilute alcohol over its surface. This gives much more constant make and break effects than the contacts between platinum point and platinum plate which are supplied with ordinary coils.

CHAPTER III

SIMPLE EXPERIMENTS ILLUSTRATING THE USE OF ELECTRICAL APPARATUS IN PHYSIOLOGY

1. Connect up a cell with a pair of wires, introducing a simple key into the circuit (fig. 10). Place the free ends of the wires on the tongue, and close and open the key.

2. Repeat this experiment, but use a short-circuiting key (fig. 14). Note that the effect of the current upon the tongue is now only felt when the key is open.

3. Connect a cell with electrodes through a commutator, as shown in figs. 15, 17, and 18. Determine with pole-testing paper which is the anode and which the kathode in the two positions of the bridge of the commutator. Verify this by following out the course of the wires.

4. Connect a cell with the upper terminals, t^1 , t^2 , of the primary coil of the inductorium, introducing a simple key into the circuit. Connect a pair of electrodes through a short-circuiting key with the terminals of the secondary coil, and slide this coil to some distance from the primary (fig. 22). Place the electrodes on the tongue. Alternately close and open the key in the primary circuit. Notice that induction shocks are obtained on making and breaking the primary circuit, but not during the passage of the current. Notice that the break shocks are much sharper than the make.

This is partly due to the fact that as the current of the primary circuit is made and broken, induced currents (*extra currents*) are formed in its own coils; the make extra current of closure, being in the opposite direction to the battery current, diminishes the make induced current in the secondary circuit, while the break extra current is cut off by the opening of the primary circuit, and therefore has no effect on the induced current. The sharpness of the break effect is also partly due to the fact that with the keys generally used the opening of the primary circuit is more sudden than its closure.

5. To show the existence of the "extra" currents, remove the secondary coil altogether and connect up the primary coil

with a battery and keys in the way shown in fig. 25. Place the electrodes on the tongue. Make and break the battery circuit by closing and opening the key, k^1 . If this is done when the primary coil is included in the circuit (*i.e.*, with k^2 open as in the diagram)

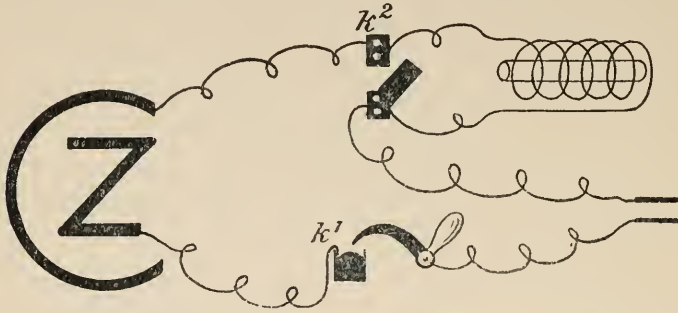

FIG. 25.—EXPERIMENT FOR SHOWING EFFECT OF EXTRA CURRENT.

the stimulus is sharp owing to the “extra” currents, but if the coil is shunted out by closing k^2 the stimulus is hardly perceptible to the tongue.

6. Instead of placing the simple key in the primary circuit place it in a side circuit (fig. 26). On closing and opening the key, shocks are still produced in the secondary circuit, although the current

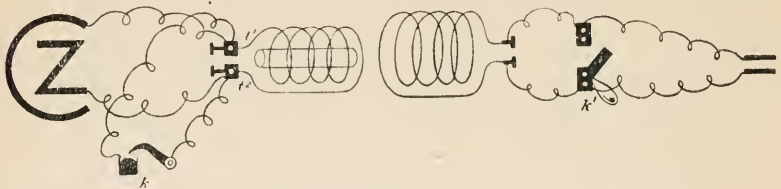

FIG. 26.—DIAGRAM OF EXPERIMENT TO SHOW THE EFFECT OF CLOSING AND OPENING A SIDE CIRCUIT TO PRIMARY COIL. k , KEY IN SIDE CIRCUIT; k' , KEY IN SECONDARY CIRCUIT.

through the primary coil is not made and broken, but only strengthened and weakened. The make and break shocks in the secondary coil are now more uniform, but are both weaker. This is the same effect as is obtained for rapidly interrupted shocks by the use of the Helmholtz wire (see p. 16).

7. Take the secondary coil out and place it across the direction of the primary coil instead of in its usual position. The making and breaking of the primary circuit now produce no effect on the secondary circuit, but induced currents begin to show themselves if the secondary coil is placed obliquely to the primary, and are strongest when the two

coils are again parallel. This principle is embodied in Bowditch's induction coil.

8. Connect up the battery with the terminals, t^3 , t^4 , of the induction coil (as in fig. 23), introducing a simple key into the circuit. Set the Neef's hammer in vibration. The electrodes from the secondary coil are to be applied to the tongue, and the distance of the secondary from the primary coil found at which the induced shocks can just be felt. Determine that these are the break shocks by raising and lowering the hammer by the hand, and thus slowly making and breaking the primary circuit (the mercury key being closed).

9. Detach one of the wires of the electrodes from the secondary coil so that only one electrode is connected with that coil. Slide the coil home. Pass a strong current through the primary coil and set Neef's hammer going as in the last experiment. It will be found that shocks are faintly felt by the tongue, although only the one electrode is in connection with the secondary coil and the secondary circuit is broken (*unipolar induction*).¹ It is on account of this possibility of stimulating through only one pole that a simple key is never used in the secondary circuit, but always a short-circuiting key, which is introduced in the manner shown in fig. 22. No shocks can pass to the electrodes when the key is closed, since the coil is then short-circuited; only when the key is open are the shocks conducted to the electrodes. On the other hand, in the primary or battery circuit a simple key is always used; were a short-circuiting key placed here the battery would rapidly run down.

10. Connect up a battery with the induction coil, using Helmholtz's modification (fig. 24). As in experiment 8, find the distance of the secondary from the primary coil at which the induced shocks can just be felt on the tongue, and determine that the make and break shocks are now nearly equal by raising and lowering the spring by the hand. Both are markedly diminished.

¹ The explanation of this is that the body acts as a condenser which becomes charged and discharged through the electrode applied to the tongue.

CHAPTER IV

THE NERVE-MUSCLE PREPARATION

THE central nervous system of a frog is destroyed by cutting through the spinal cord at the occipito-atlantoid ligament and passing a blanket pin into the skull and down the cord. Notice that the muscles of the trunk and limbs are thrown

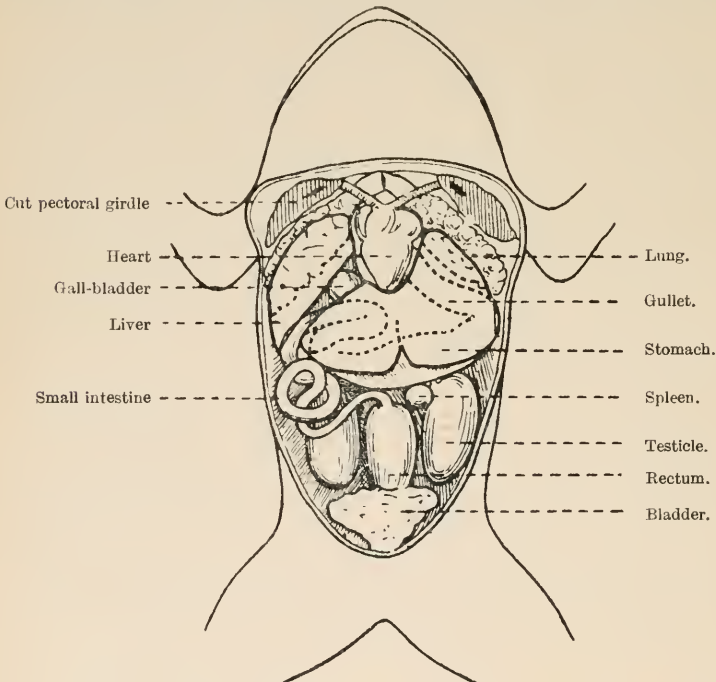

FIG. 27.—VISCERA OF FROG. THE LIVER IS SHOWN IN OUTLINE, AND THE PARTS CONCEALED BY IT ARE INDICATED BY DOTTED LINES.

into contraction when the cord is being destroyed. Make a circular incision round the trunk just below the upper limbs through the skin only, and, seizing the skin covering the lower part, strip it off from both hind limbs. Lay the frog on its back on a glass plate, and open the abdomen and thorax freely but carefully. Notice the viscera (fig. 27)—heart and lungs, liver, stomach, intestines,

ovaries and oviducts or testes, bladder. Cut through the lower end of the rectum and through its attached mesentery. On raising it, two elongated red bodies—the kidneys—are seen at the back of the abdomen, partly covering the nerves which are passing down to the hind limbs. Remove the kidneys without touching the nerves. Now hold the frog up by its legs so that the viscera hang towards the head, and cut through the lower end of the vertebral column with strong scissors so as to separate the fore part of the trunk and the viscera from the pelvis and hind limbs. Lay the latter preparation on a clean glass plate or on a piece of paraffined paper on the frog-cork. Note the several muscles which are seen on the front and back of the lower limbs (figs. 28, 29). The gastrocnemius is generally used for experiments. Tie a thread round its tendon (tendo Achillis), and

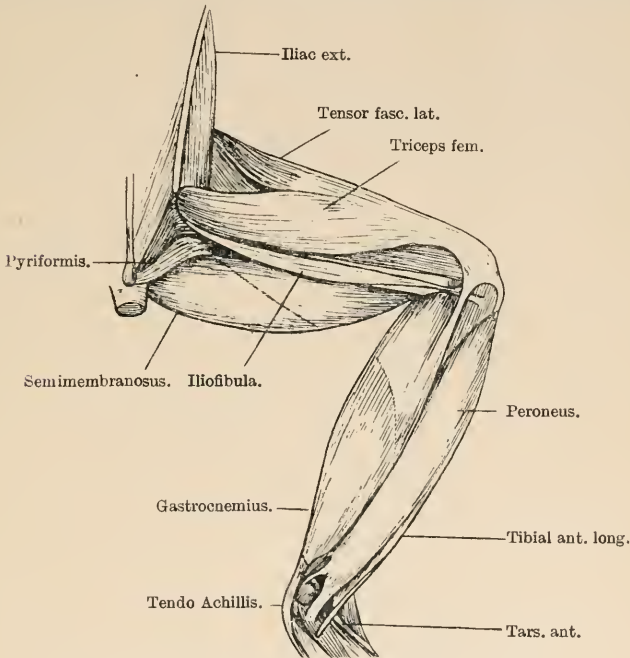

FIG. 28.—MUSCLES OF FROG-LEG: DORSAL ASPECT (GAUPP).

cut this away from the calcaneum. Holding it by the thread, tear the muscle upwards away from the tibia, and sever this bone just below the knee.

Next bring to view the sciatic nerve. Separate the muscles at the back of the thigh by the aid of two pairs of forceps, keeping to the mesial of the two chief intermuscular septa, and the nerve will be seen, accompanied by the femoral vessels. On no account touch the nerve, but separate the muscles from it so as to expose it freely.

If only a short piece of nerve is required, a wet thread may be tied round the uppermost end of the length of nerve displayed, and the nerve may be cut across above the thread. Then, holding it up gently by the thread and passing a pair of straight scissors below and parallel to the nerve, its branches to the thigh muscles are successively severed, and the nerve is separated as far as the back of the knee-joint. Notice that as each branch is snipped the muscles which it supplies contract. Lay the nerve thus isolated upon the gastrocnemius muscle. Then cut through the middle of the femur, and clear the attachments of the thigh muscles away from the lower end of that bone. You now have a prepara-

tion consisting of the knee-joint with portions of the femur and tibia, the gastrocnemius muscle, and the sciatic nerve; this is termed a *muscle-nerve preparation*.

For many experiments a longer nerve is needed. To obtain this the sciatic nerve is to be exposed as before from behind, but not tied or cut; it should indeed not be touched in its course by any instrument. Then seize the urostyle with forceps, and cut it and the muscles attached to it entirely away with scissors. The nerves previously seen behind the kidneys are now exposed from the back; they are continuous on each side with the corresponding sciatic nerve. To isolate the nerve along its whole length, sever the attachment of the ilium to the sacrum. Split the end of the spinal column longitudinally with scissors, and, holding one-half with forceps, lift it up obliquely, but not at too

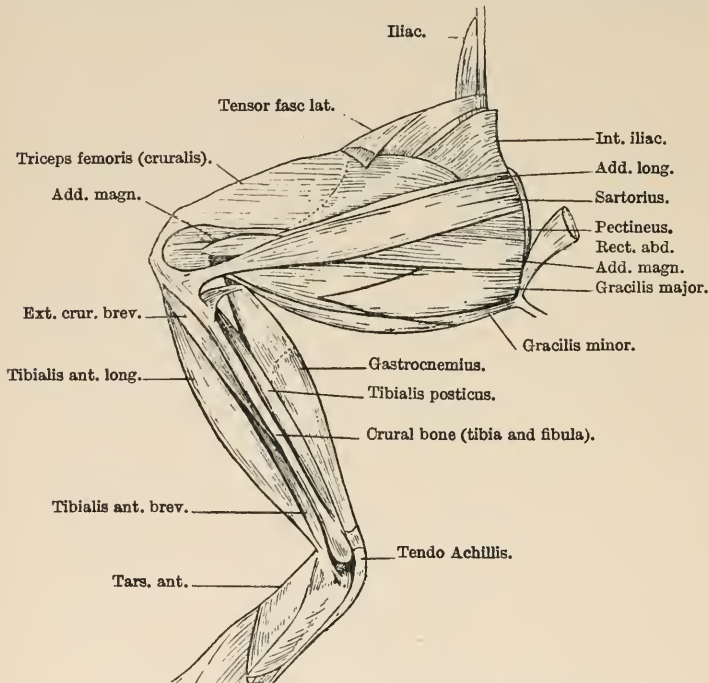

FIG. 29.—MUSCLES OF FROG-LEG : VENTRAL ASPECT (GAUPP).

sharp an angle, along with the nerves issuing from it to form the sciatic. Gradually dissect out the nerve from above down as before described, snipping the lateral branches with scissors (without touching the main nerve) until the back of the knee is reached. Lay the long piece of nerve thus isolated upon the gastrocnemius muscle, and, as before, cut through the middle of the femur after clearing the attachments of the thigh-muscles away from its lower end; you now have a *nerve-muscle preparation with long nerve*. Place a piece of paper impregnated with paraffin on the frog-cork, and lay the nerve out clear of the muscle, fixing a pair of electrodes so that the nerve lies across them. Keep both muscle and nerve—but especially the latter—wet with normal salt solution or Ringer's solution.

With a nerve-muscle preparation thus obtained perform the following experiments, which are, for the most part, similar to those already performed upon the tongue. Note down all your results.

1. Excitation by galvanic current.—Determine that making or breaking the circuit of a battery is a stimulus to the nerve, whereas the passage of the current usually ¹ produces no obvious effect. It is proper to use non-polarisable electrodes wherever the current of a galvanic battery is led through a preparation.

A simple form of battery is furnished by two wires, one of copper, the other of iron or zinc. If these are placed at one end in contact with the moist nerve-muscle preparation, and if the other ends are made to touch one another, the muscle will contract, as in Galvani's original experiment.

Fleischl's rheome is designed to show that not only a change of potential but also the suddenness of the change is an important factor in stimulation by a galvanic current. The rheome consists of a bridge composed of two curved pieces of zinc capable of being rotated about a raised centre. One end of each piece has a terminal attached to it (upper terminals); the other end—which should be amalgamated—dips into saturated solution of zinc sulphate contained in a circular groove in the wooden base of the instrument. Wires

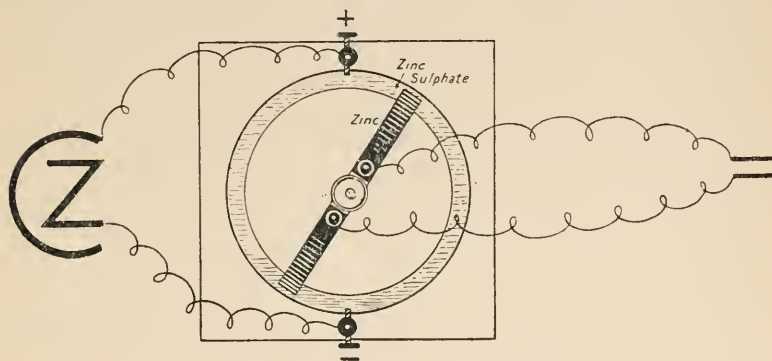

FIG. 30.—DIAGRAM OF FLEISCHL'S RHEOME.

from a battery are brought to opposite sides of the groove and come into connection with the zinc sulphate solution by amalgamated zinc terminals (lower terminals). The upper terminals are brought into relation with a muscle-nerve preparation by other wires, and when the battery circuit is closed part of its current passes to the preparation, part is short-circuited through the zinc sulphate. The amount of short-circuiting depends upon the position of the rotating bridge. Most current passes through the preparation when the ends of the bridge are opposite the lower or battery terminals. On now rotating the bridge this current is diminished, and it vanishes when the rotation has attained 90° of the circle, gradually increasing again as this point is passed. If the rotation is slow, there is no stimulation of the preparation, in spite of the variation in amount of current; but if quick, the muscle-nerve responds to each movement of the bridge.

2. Excitation by induced current; Determination of excitability of a nerve.—An induction shock is a stimulus, and the break induction shock a far stronger stimulus than the make. Get the minimal effect of each by sliding the secondary coil to the necessary

¹ For exceptions see Chapter XI.

distance from the primary, and make a note as to the respective positions of the secondary coil. This gives a measure of the excitability of the nerve. Its excitability to tetanisation (use the Neef's hammer and the Helmholtz wire) is determined in the same way.

3. **Reaction of nerve and muscle to galvanic and faradic excitation.**—If the above experiment be tried with a nerve-muscle preparation and with nerve-less muscle (the nerves within the muscle are paralysed by curari), it will be found that the nerve will react to a weaker stimulus than the muscle when induction shocks are employed; but if the make and break of a galvanic circuit be used as the stimulus, the muscle will respond to the weaker stimulus. Plain muscle shows this even more strikingly.

4. **Gotch's experiment.**—Cooling a nerve causes it to react to galvanic and faradic stimulation in the same way as muscle. The upper end of the nerve of a nerve-muscle preparation is cooled by laying it on a tube through which ice-cold water is passing; the muscle itself must not be allowed to come anywhere near the cold tube. If, now, the cooled part of the nerve be stimulated, it will be found to be less sensitive to faradic and more sensitive to galvanic stimulation than a part nearer the muscle which has not been cooled. Cooling the nerve also diminishes the rate of conduction of nerve impulses along the cooled portion (see p. 48).

5. **Unipolar induction.**—It is possible to stimulate the nerve when it is connected by only one wire with the secondary coil; hence the necessity for using a short-circuit key to prevent *unipolar induction* (see p. 19). It is best for this experiment to place the secondary coil close to the primary and to make use of the automatic interrupter.

6. **Excitation by condenser discharge.**—The discharge of a condenser through a nerve acts as a stimulus. Arrange the apparatus as shown in fig. 31, in which

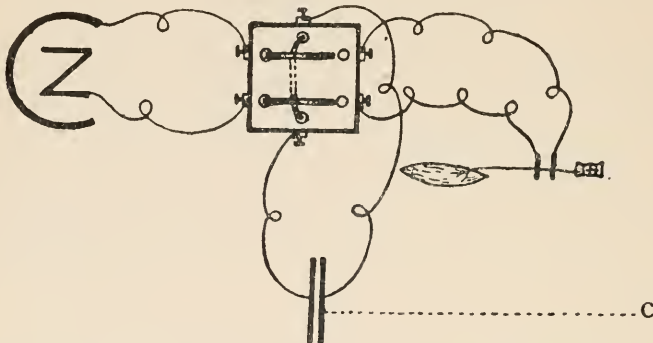

FIG. 31.—STIMULATION OF NERVE BY CONDENSER DISCHARGE.

C is a condenser made by covering a sheet of glass with tinfoil on both sides. The sheets of tinfoil are first connected with the battery for a few seconds, and then, by turning the switch, are connected with the nerve, the battery being cut off by the same movement.

7. Mechanical excitation.—The nerve (or muscle) can be stimulated by mechanical means—*e.g.*, by tapping it gently or by allowing mercury to drop (upon a nerve) from a height of three or four inches. The effect of a mechanical stimulus is seen whenever a nerve is cut or pinched, but any severe injury abolishes its conducting functions.

8. Thermal excitation.—The nerve (or muscle) is stimulated if it be touched with a hot wire.

9. Osmotic excitation.—It can be stimulated by osmosis, as by placing wet salt or pure glycerine upon it. The salt and glycerine act by abstracting water.

10. Excitation by drying.—Drying acts as a stimulus, especially to the nerve. When a nerve begins to dry, its muscle twitches.¹

Addition of water may also act as a stimulus, especially with muscle. If distilled water be injected into the blood-vessels of an animal, all the muscles are thrown into contraction; this is, however, followed by paralysis. These effects are at least in part due to the abstraction of lime salts from the muscle.

¹ This twitching is a frequent source of puzzle to the beginner; it is always a sign that he has not been careful to keep the nerve moist with Ringer's fluid.

CHAPTER V

THE RECORDING OF MUSCULAR CONTRACTIONS

MUSCULAR contractions are recorded by a lever upon a metal drum covered with highly glazed paper, and caused to revolve by clockwork, or some other form of motor, at a regular rate. With a drum of six inches diameter one revolution in a second is a convenient speed. The glazed paper is blackened by holding a gas flame containing benzole vapour against it while the drum is revolving. The paper must fit evenly and tightly, or it will become burnt.

The contraction of the muscle is amplified by the lever (myograph lever), which may be straight (fig. 32), but which may also conveniently take the crank form (fig. 33). In this case the fulcrum of the lever is at the end of a cork plate, to which the muscle is fastened by a pin passed through the knee-joint,¹ the tendon is attached to the short arm of the lever by means of a thread. The cork plate must be covered with paraffined paper. The lever should be weighted with a 20- or 30-gram weight, attached to it close to the fulcrum, and should be so adjusted as to be nearly horizontal, but with the end a little lower than the fulcrum.² The muscle is

¹ In the Keith-Lucas crank myograph the muscle-nerve preparation is enclosed in a vulcanite trough; the muscle is kept immersed in Ringer's fluid; the bony attachment of the muscle is fixed by a pin, and electrodes are introduced through holes in the vulcanite. The whole is covered by a glass plate to prevent evaporation.

² The following points must be attended to in every graphic record in which a lever is employed:—(1) On no account must the lever point be directed obliquely upwards: the result of doing this is to distort the curves which are recorded; (2) the lever must be directed tangentially to the curve of the drum with the point of the lever slightly curved in towards the surface of the drum; (3) the myograph stand, which carries the cork plate and lever upon a vertical rod capable of being turned on its axis, must always be furnished with a *stop*, so that the point of the lever can always be brought against the drum with exactly the same amount of pressure as that with which it is originally adjusted; (4) the myograph stand must always be on the right-hand side of the drum, so that the lever extends from right to left, and the drum itself must always be arranged to move in the direction of the hands of a watch, never in the reverse direction.

kept stretched by the weight, so that the connecting thread is taut. Under these circumstances the muscle is said to be free-weighted.

There should always be a screw near the fulcrum which is intended to support the lever in certain experiments. The screw can be adjusted so that the muscle and thread are not fully stretched, and only become so after the muscle has begun to contract; the muscle is then described as *after-loaded*.

The simple muscle-curve.—Arrange the drum in the primary circuit of the induction coil (in the manner shown in fig. 33), so that, as the drum revolves, a pin (*c*) which projects from it, by just touching a

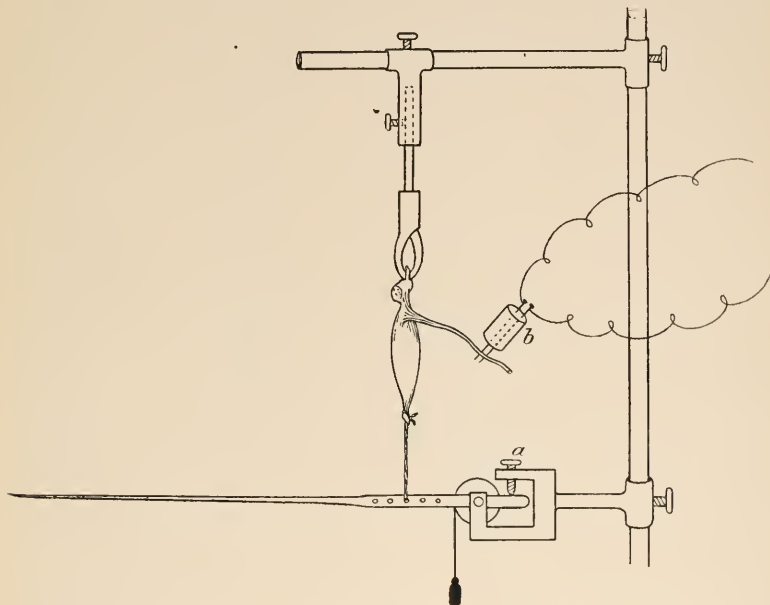

FIG. 32.—MUSCLE-NERVE PREPARATION SUSPENDED AND ATTACHED TO A STRAIGHT MYOGRAPH LEVER. *a*, AFTER-LOADING SCREW; *b*, ELECTRODES.

needle fixed outside, instantaneously makes and breaks the circuit at each revolution. A pair of electrodes is either brought in contact with the muscle itself or the nerve (*n*) is laid upon the electrodes, which are connected through a short-circuit key with the secondary coil. The secondary coil is placed at such a distance from the primary that the "make" shock is insufficiently strong to act; the "break" shock therefore alone furnishes the stimulus.¹ Before the lever is allowed actually to touch the cylinder, determine that the apparatus is all in working order, and at what distance of the secondary from the primary

¹ It is possible to employ a single induction shock as the stimulus by introducing a break key into the primary circuit and making the pin open this key as the drum revolves.

the break shock is effective in causing a full contraction when the drum is made to revolve. Do not allow the muscle to be fatigued by many excitations before recording its contraction.

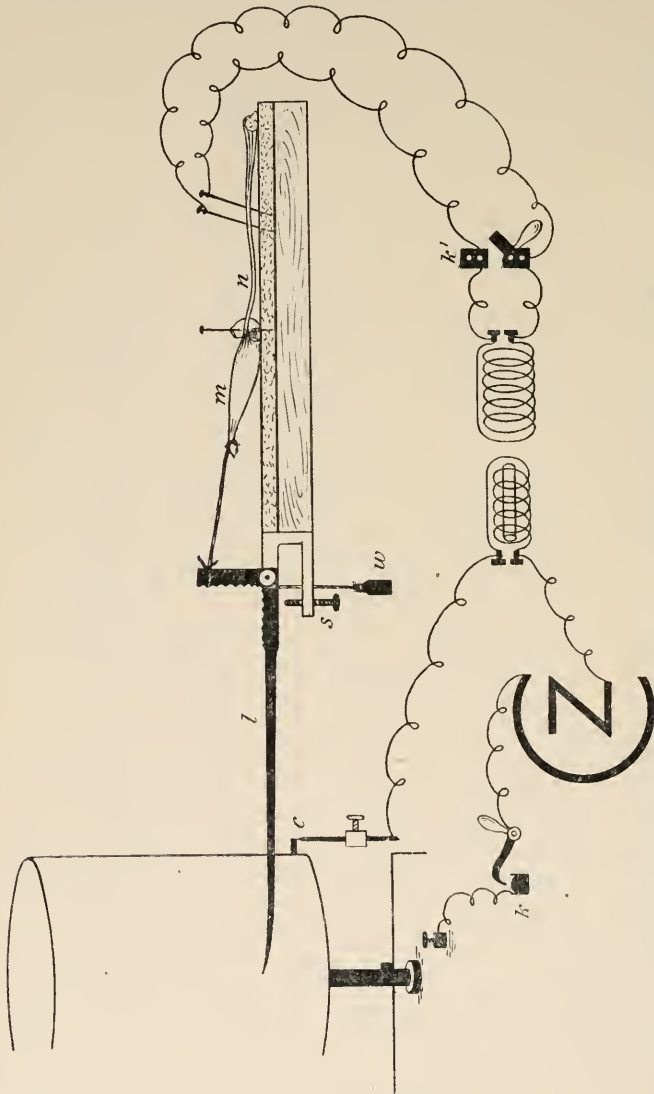

FIG. 33.—ARRANGEMENT OF APPARATUS FOR OBTAINING AN ISOTONIC MUSCLE-CURVE. *c*, DRUM CONTACT IN PRIMARY CIRCUIT; *k*, MERCURY KEY IN DRUM CIRCUIT; *k'*, DU BOIS-REMOND KEY IN SECONDARY CIRCUIT; FROM THIS WIRES PASS TO THE PTN-ELECTRODES ON WHICH THE NERVE, *n*, IS PLACED; *m*, MUSCLE; *4*, CRANK-LEVER; *w*, WEIGHT; *s*, AFTER-LOADING SCREW (NOT BEING USED).

Now bring the lever point so as lightly to touch the blackened paper, using the stop of the myograph stand to prevent the point pressing too hard against the paper. When the stop is used in this

way the lever point can be removed at any time from the paper and brought back again so as to press with exactly the same force as before ; *it is absolutely essential to make use of the stop in all recording experiments in which comparisons of different curves upon the same surface have to be made.*

Start the drum revolving, but keep the short-circuit key (k') closed so that no stimulus reaches the nerve ; the lever point will describe a horizontal line (abscissa). Whilst the drum is still revolving open the short-circuit key, but close it again the instant the muscle has contracted ; immediately afterwards remove the lever point from the drum, before this has had time to perform another revolution. A simple muscle curve will thus be described.

To mark the point of stimulation, move the drum slowly round by hand until the projecting pin just touches the needle where contact is made (as in the diagram, fig. 33) ; bring the lever point against the smoked surface as far as the stop will allow, and raise the lever about half an inch by the finger. The distance between this mark, which indicates the moment when the stimulus was put into the nerve, and the rise of the curve, which indicates the commencement of the contraction of the muscle, gives the *period of latent stimulation*. To measure this period, as well as the duration of the contraction and relaxation of the muscle, remove the lever point from the smoked surface, set the drum revolving at the same rate as before, and allow a tuning-fork of known rate, *e.g.*, one hundred vibrations per second, to record its waves just below the abscissa of the muscle curve, putting the bristle, which is attached to the tuning-fork, during a single revolution only against the drum. Cut through the paper without scoring the surface of the drum. Lay it on the table, and write upon it date and description. Then pass it through the varnishing trough, and hang it up to dry. When dry, cut out the part of the tracing which is required.

Effect of heating and cooling the muscle upon its contraction.—

The same nerve-muscle preparation may be used, the apparatus being arranged exactly as in the last experiment. Mark on a new abscissa the point of stimulation. Then take the following curves on this abscissa :—

1. A simple muscle curve at the room temperature.
2. A simple curve after warming the muscle by dropping Ringer's solution, warmed to about 30° C., upon the muscle.
3. A simple curve after cooling the muscle by dropping upon it ice-cold Ringer.

Finally, take a tuning-fork tracing below the abscissa.

Notice the effect of heat and cold respectively upon the period of latency and upon the amount and duration of the contraction.

Isometric contraction.—If the contracting muscle is prevented from shortening, or allowed only to shorten to so small an extent so that it practically remains of the same length throughout, the contraction is said to be isometric. It is recorded by attaching the muscle very close to the fulcrum of the muscle lever, which is held down by a strong spiral spring (fig. 34) instead of by a weight. All the other arrangements of the experiment are the same as with the ordinary method where the muscle is free to shorten and raise a weight; its tension being constant (isotonic contraction).

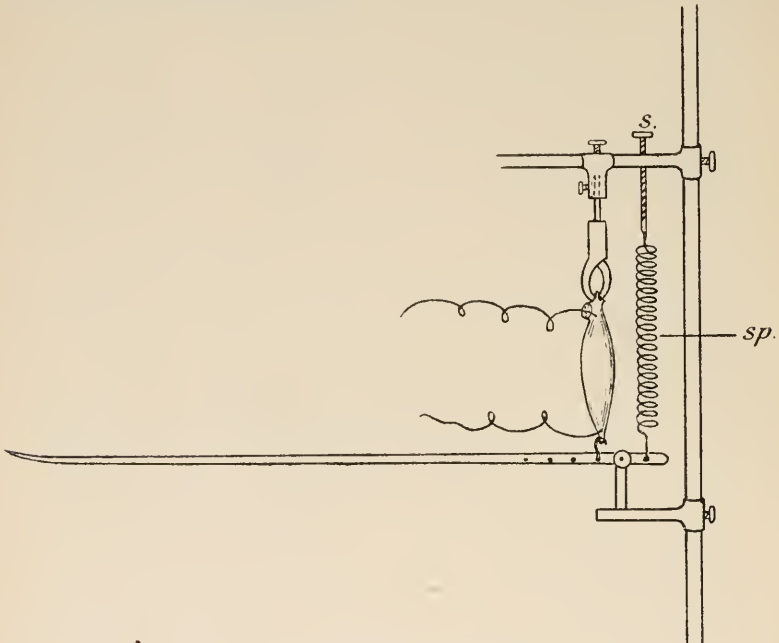

FIG. 34.—METHOD OF STUDYING ISOMETRIC CONTRACTION. *sp.* SPIRAL SPRING; *s.* SCREW FOR REGULATING ITS TENSION.

Action of drugs on muscular contraction.—The hyoglossus muscles may be used. Cut away the whole of the lower jaw, along with the tongue and hyoid bone. Tie a thread to the tongue near its tip and another near its fixed extremity, and cut this away from the hyoid. The tongue thus separated includes the hyoglossus muscles, which run through it from the hyoid bone, and the preparation can be used in the same way as the gastrocnemius muscle, the hyoid end being fixed by a pin to the myograph cork and the tip connected by its thread with the myograph lever. A smaller weight must be used than in the case of the gastrocnemius, since the hyoglossus muscles are far weaker. Probably the weight of the lever alone will be sufficient. Insert pin electrodes on either side near the fixed end so that induction shocks will stimulate all the fibres of both hyoglossus muscles.

Veratrin.—Arrange the apparatus to take a muscle curve in the

usual way. If the speed of the drum is the same as before (one revolution per second), the curve is more prolonged than that of the gastrocnemius, for the contraction of the hyoglossus is slower than that of the gastrocnemius. It is well, however, in investigating the action of veratrin to use a slow rate of cylinder, since this drug enormously delays the relaxation of muscle. The cylinder therefore should be arranged to revolve once in about ten seconds.

A normal muscle curve is first described, the point of stimulation being marked in the usual way. Then inject with a hypodermic syringe a drop or two of veratrin acetate solution (1 in 300) under the mucous membrane of the tongue, so that the drug is brought into contact with the fibres of the hyoglossi. After three minutes take another muscle curve. Describe a tuning-fork tracing below the abscissa. If the preparation is excited repeatedly, it will be found that the contractions lose their prolonged character, which, however, returns after a period of rest.

This method can be used for investigating the action of other drugs upon muscular contraction.

CHAPTER VI

THE NERVELESS MUSCLE

Action of curari.—The brain of a frog is destroyed by passing a sharp splinter of wood through the occipital foramen after cutting through the skin and occipito-atlantoid ligament. The blood-vessels of one leg are ligatured, care being taken to avoid injuring the accompanying sciatic nerve. Or the leg can be tightly tied round with a tape so as to stop the circulation within it. A drop or two of one per cent. solution of curari is now injected under the skin of the back. After a short time the drug will have penetrated to all parts of the body except the ligatured leg.¹ The following observations and experiments may then be made:—

1. Notice that all the muscles are paralysed except those of the ligatured limb.

2. On tapping any of the paralysed parts the foot on the ligatured side is moved—*i.e.*, the conducting power of the nerves both sensory and motor, and the reflex functions of the spinal cord are not abolished.

3. Strip the skin off both legs and isolate both sets of sciatic nerves at the back of the abdomen. Tie their upper ends and cut them away from the vertebral column. Excite both sets of nerves high up, placing them upon the same electrodes and observe the difference of effect. Excitation of the nerve of the limb which has been exposed to the poison produces no contraction of its muscles; excitation of the nerve of the ligatured limb produces the usual effect. Now stimulate the muscles of the two limbs, applying the electrodes directly to them. The muscles of the poisoned limb react like those of the normal limb, but the liminal stimulation² is greater. Deter-

¹ This method is applicable to the study of the action of drugs in general on nerves and muscles.

² The stimulation which is only just effective, *i.e.* the least stimulation which is responded to.

mine at what distance of the secondary coil from the primary a response is obtained in each case.

The conclusion is that neither the nerve fibres, sensory and motor, nor the nerve centres, nor the muscular fibres are affected, but that the poison has produced paralysis by severing the connexion between motor nerve fibres and muscle fibres, probably at the end-plates.

The paralyzing action of curari can also be shown by keeping a muscle-nerve preparation in Ringer's solution to which a little curari solution has been added. It will be found that after a time the muscle will cease to respond to stimulation of its nerve, although it will contract readily if the muscle itself is stimulated. As a control, another preparation may be taken, and its nerve alone placed in the same solution during the same period, the muscle being supported just above the level of the fluid. This preparation will respond to every stimulation of its nerve.

It is best to use a sartorius muscle-nerve preparation for this experiment on account of the length of time necessary for the curari to penetrate the gastrocnemius.

For the mode of preparing the sartorius—the nerve of which must be kept in continuity with the main trunk—see p. 41.

Muscle wave.—Separate from the remaining thigh muscles the adductor muscles (gracilis and semimembranosus; see figs. 28, 29) of a frog which has been poisoned with curari to eliminate the intramuscular nerves. Leave the attachments to the tibia. Cut this bone through just below these attachments, and also sever the tibia from the femur at the knee joint. It is then easy to complete the separation of the muscles up to their iliac attachments; a small fragment of the ilium may be cut away and removed along with them. Tie a thread to the tibial and another to the iliac attachment, stretch the muscular mass lightly between these threads, and fasten to the cork by a couple of pins at one end and a pair of pin electrodes at the other end of the muscle. Allow two long light levers (which can be made of straws, working in simple brass holders capable of being pinned to the cork) to rest upon the muscle near each end close to their fulcra, and let the points of the levers write lightly on the drum, one exactly above the other (fig. 35). When the muscle contracts, its swelling raises first the lever nearer to the electrodes, and later the one at the further end. The movements of the levers are recorded upon the drum, and curves are obtained of the swelling of the muscle during its contraction in the same manner as the curves of shortening of the gastrocnemius were obtained in previous experiments. The drum must move at a fast rate, and the levers should be directed obliquely downwards: much more so than in the ordinary method.

Connect the pair of pin-electrodes with a du Bois-Reymond key

(k') in the secondary circuit. Describe an abscissa, and mark the point of stimulation as in previous experiments by raising the end of each lever by the hand when the projecting pin on the drum just touches the vertical needle (see p. 29), *making use of the stop*. Then take the two tracings of the contraction of the muscle, letting the drum revolve once only, and removing the levers the instant the curves are completed. The difference of latency of the two curves

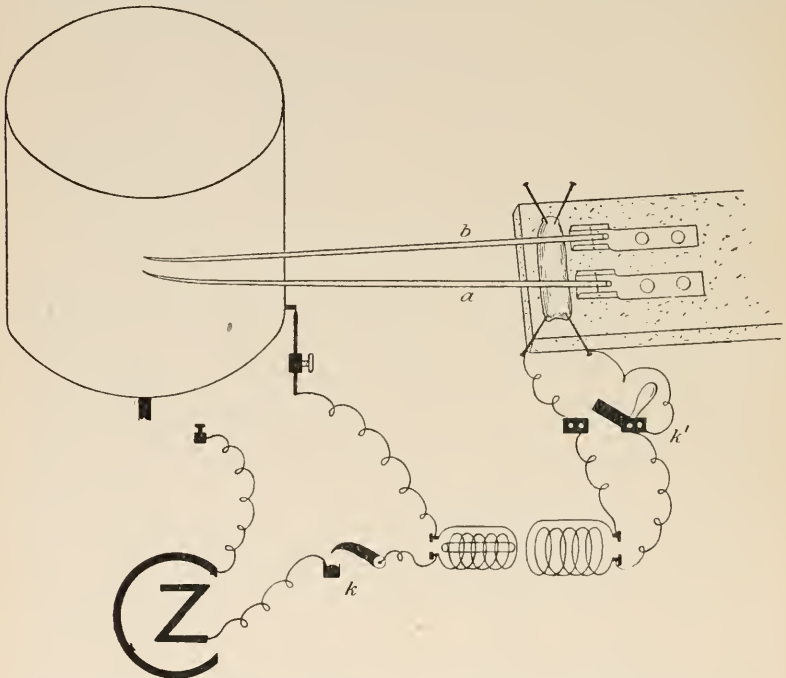

FIG. 35.—DIAGRAM OF AEBV'S EXPERIMENT FOR RECORDING THE MUSCLE WAVE. *a, b*, LIGHT STRAW LEVERS RESTING ON THE MUSCLE, WHICH IS CURARIZED; *k, k'*, KEYS IN PRIMARY AND SECONDARY CIRCUITS.

represents the time which it has taken for the wave of contraction to pass along the length of the fibres which intervene between the two places on which the levers rest. Take a tuning-fork tracing, and measure this time, and from it and the length of muscle traversed by the wave (measure with compasses) calculate the rate of propagation of the muscle wave per second.

It is essential for the success of this experiment that the muscles used should have most of their fibres running longitudinally and parallel with one another. If very large frogs are obtainable the two sartorius muscles may be used with advantage instead of the adductor preparation described.

A method of obtaining the curve of swelling of a contracting muscle which is better adapted for mammalian muscle is to use the *pince myographique* or *myographic forceps* of Marey (fig. 36, F). The muscle is grasped by this, and

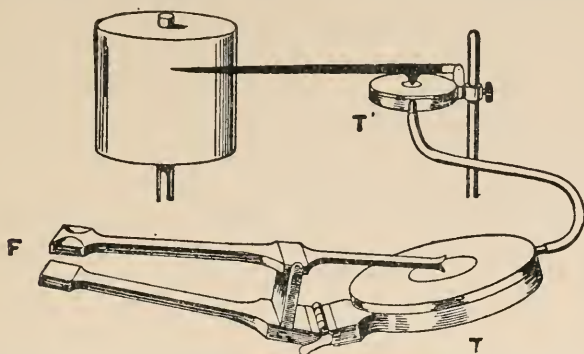

FIG. 36.—MYOGRAPHIC FORCEPS OF MAREY. F, FORCEPS FOR GRASPING THE MUSCLE THE CONTRACTION OF WHICH IS TO BE RECORDED. THE TWO BLADES OF THE FORCEPS ARE DRAWN TOGETHER BY AN INDIA-RUBBER BAND. T, RECEIVING TAMBOUR, THE AIR IN WHICH IS COMPRESSED BY THE SWELLING OF THE MUSCLE, AND FROM WHICH THE PRESSURE IS TRANSMITTED BY AN INDIA-RUBBER TUBE TO T', THE RECORDING TAMBOUR, THE LEVER OF WHICH WRITES ON A REVOLVING DRUM.

its contraction affects a tambour (*T*) which is connected by rubber tubing to another tambour (*T'*), writing upon the drum. The muscle is stimulated (1) at the point of application of the forceps, and (2) at some distance from the forceps. The difference of time between the two resulting curves is measured, and the rate of passage of the muscle wave calculated therefrom.

CHAPTER VII

EFFECT OF SUCCESSIVE STIMULI UPON A MUSCLE-NERVE PREPARATION

Summation.—Make a muscle-nerve preparation and place the nerve upon electrodes connected through a short-circuit key with the secondary coil. Include the Neef hammer in the primary circuit, as in fig. 23. Shift the secondary coil to such a distance from the primary coil that a single-break induction shock, made by moving the Neef hammer by hand, just fails to produce a contraction of the muscle. The stimulation is therefore *subliminal*. Now allow the Neef hammer to vibrate so that a succession of stimuli of the same strength act upon the nerve. The muscle will contract, owing to the summation of the effects of the repeated stimulations of its nerve, although individually these stimulations were ineffective.

Superposition.—Arrange the muscle-nerve preparation on the myograph and connect the drum in the primary circuit in the manner employed to record a simple muscle curve (p. 27 and fig. 33). Place the secondary coil at such a distance from the primary that the excitation produced by a single pin projecting from its circumference and striking the needle in its revolution produces a maximal effect; describe a normal muscle curve in the usual way. Then insert a second pin at varying intervals so that the excitation which it produces will affect the nerve at different intervals after the first excitation; viz., (*a*) during the rise of the first curve, (*b*) near the top of the first curve, (*c*) during the decline of the first curve. Take these double tracings at different levels of the paper, each one on its own abscissa.

Effect of several successive stimuli; tetanus.—For studying the effect on a nerve-muscle preparation of a rapid succession of stimuli a vibrating steel reed is used to make or break the primary circuit of the induction coil by allowing a wire attached to its end to dip into and out of a cup of mercury. The rate of vibration of the reed

depends upon its length, which can be varied by clamping it at different places; it is marked at points for producing vibrations of ten, fifteen, twenty, and thirty per second (fig. 37). The secondary coil should be placed at such a distance from the primary that only the break shock is effective. The drum should revolve at moderate speed (one revolution in ten seconds).

Attach the muscle to the lever of the myograph in the usual way; place the nerve upon the electrodes; set the drum revolving and bring the lever point against it, *using the stop*; set the reed vibrating; open the key in the secondary circuit for about a second; take the

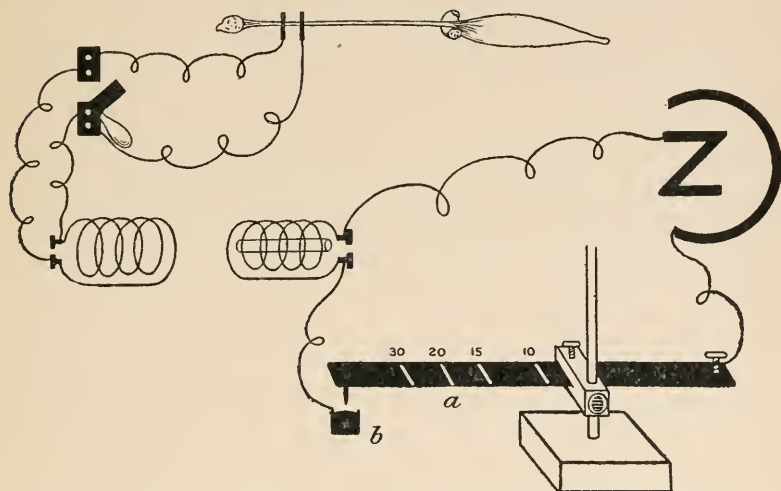

FIG. 37.—EXPERIMENT TO INVESTIGATE THE GENESIS OF TETANUS. *a*, FLAT STEEL SPRING MARKED AT INTERVALS WITH THE NUMBER OF VIBRATIONS CORRESPONDING TO CERTAIN LENGTHS OF THE SPRING; *b*, MERCURY CUP INTO AND OUT OF WHICH A PLATINUM WIRE ATTACHED TO THE SPRING DIPS.

lever point away from the drum. A tracing is to be taken in this way at each of the above rates, each tracing on its own abscissa; add a time marking.

Record of voluntary contraction.—A voluntary muscular contraction of the finger-muscles may be recorded by resting the hand across the myograph plate and tying a thread to the abducted forefinger, the other end of the thread being attached to the short arm of the lever; this is to be held down by a heavy weight or thick elastic band. On adducting the finger the lever is raised, and a curve is described on the moving drum which bears a close resemblance to an incomplete and somewhat irregular tetanus produced by ten or twelve stimulations per second.

It must not be concluded that this represents the rate of the successive individual contractions which fuse to form the voluntary contractions, for it has been shown by photographic records of the capillary electrometer (see p. 49) that in a voluntary contraction there are not less than fifty electrical changes per second, and this probably also represents the number of mechanical changes which succeed one another in a voluntary contraction. The causation of the waves of ten or twelve per second is not fully understood.

Another method of obtaining the curve of a voluntary contraction is by the use of a *transmission myograph*, which consists of two tambours connected by india-rubber tubing. The first or receiving tambour (which may be represented by an ordinary Marey's cardiograph; see fig. 63) is fixed against the masseter muscle; when this muscle is made to contract voluntarily, its movements are communicated to the air within the cardiograph, and the differences of pressure produced are transmitted to the second or recording tambour, which writes against a revolving drum.

Sound of a voluntary contracting muscle.—Place the tips of the middle fingers in the ears, and contract the muscles of the arm strongly. A rumbling sound is heard, which is caused by the vibration of the contracting fibres. The sound actually heard is modified by the resonance of the drum of the ear, and cannot be taken to indicate the rhythm of contraction.

CHAPTER VIII

WORK OF MUSCLE ; EXTENSIBILITY OF MUSCLE

THE experiments to be performed on these subjects are recorded upon a stationary drum which must be moved onwards for about five millimeters by hand after each record.

Make a muscle preparation, preferably the sartorius (see end of chapter), place it on the myograph, and arrange that it shall be stimulated, either directly or through its nerve, by induction shocks. Arrange a mercury key in the primary circuit (which is not to include the drum) and a short-circuit key in the secondary circuit. It is best in these experiments to use tetanic stimuli furnished by the Neef's hammer ; the Helmholtz modification should be employed (fig. 24). The lever should have a light scale pan suspended from it ; such a scale pan can readily be made from the lid of a pill-box. Determine :—

1. The effect upon the lift, the weight being constant (say about thirty grams), of a gradual increase of the strength of the stimulus from minimal to maximal.

Note down on the curve the distances of the secondary coil at which the results recorded are obtained.

2. The amount of work which the muscle performs in lifting different weights, the stimulus being constant and maximal and the muscle free-weighted. Beginning with the weight of the scale pan alone, weights are gradually added, and the muscle being stimulated, an ordinate is described for each additional weight. The work of the muscle is estimated as weight \times height.

Note down the weight which corresponds with each ordinate and the height of the ordinate. The exact height to which the weight is raised is calculated by dividing the height of each ordinate by the magnifying extent of the lever.

Another result is yielded in this experiment ; viz. the effect of the gradually increasing weights in producing extension of muscle in the resting and contracted conditions respectively. For it is obvious that the lowermost point of any ordinate described by the muscle represents the length to which the resting

muscle is extended by the particular weight, and the top of the ordinate the length to which the muscle when contracted is extended by the same weight. If the ordinates are at regular distances apart, a line joining their lowermost ends gives the curve of extension of the resting muscle, and a line joining the tops of the ordinates the curves of extension of the contracting muscle. Further, if the weights are removed in succession and ordinates are again described after each such removal, curves of recovery from extension—*i.e.* of retraction—can be obtained. This experiment can be conveniently performed with the sartorius, large shot serving as the weights.

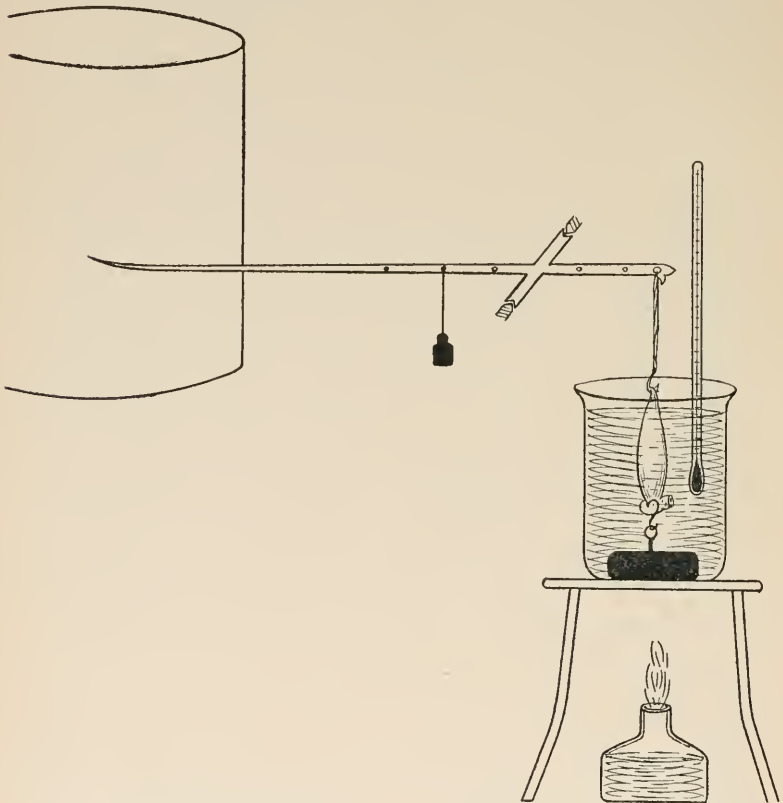

FIG. 38.—EXPERIMENT FOR INVESTIGATING THE EFFECT OF HEAT ON THE EXTENSIBILITY OF MUSCLE.

3. The effect of after-loading (p. 27). Take a series of contraction ordinates, using a maximal stimulus and a constant weight (say about thirty grams). Begin with the muscle free-weighted, and by using the screw stop beneath the lever raise the latter so that the muscle and connecting thread are somewhat slackened. Under these circumstances the muscle will not begin to raise the weight until its contraction has proceeded to a certain extent ; this shows the effect

of after-loading. Describe a series of contraction ordinates with a gradual increase of after-load. Calculate the amount of work done under these conditions, and compare with that performed by the free-weighted muscle.

Effect of heat on the extensibility of muscle.—Take a sartorius muscle and fix one end to a heavy disc of metal provided with a hook: place the disc and muscle in a beaker of Ringer's solution (fig. 38). Attach the other end of the muscle by means of a thread to the short arm of a lightly weighted lever of the first order, so that when the muscle shortens the long arm of the lever is raised. Let the point of the lever write on a very slowly moving drum. Arrange a small gas or spirit flame under the beaker and slowly heat the Ringer's solution, which should be provided with a thermometer. Notice the effect of the gradual rise of temperature upon the length of the muscle as recorded by the lever. Note especially that at certain temperatures—which correspond with the coagulation temperatures of the muscle proteins—there is a marked shortening. (The final contraction corresponds with the coagulation temperature of the collagenous matter, *i.e.* of the connective tissue, and is not muscular.) After no further shortening is produced, remove the flame and allow the Ringer to cool. There is no reversal of the contraction of the muscle, which remains stiff and completely coagulated (heat rigor). If the muscle is cut and tested with litmus paper it will be found to be acid.

During contraction a muscle does not alter in volume.—Take a wide-mouthed bottle with well-fitting paraffined cork (fig. 39). Through the cork are passed (*a*) a glass tube drawn out above the cork to a capillary size; (*b*) two copper wires of unequal length coiled spirally, and each ending below in a sharp hook: above each terminates in a loop close to the cork. Fill the bottle to the rim with Ringer's solution. Attach a fresh muscle by its two ends to the hooks, lower into the bottle, and press the cork in securely: the fluid should completely fill the bottle and capillary to the exclusion of air-bubbles. Draw a little of the fluid out of the capillary by filter paper, and mark the level at which the fluid then stands. Hook wires from the secondary coil to the loops above mentioned, and tetanise the muscle. If there were a diminution of volume the level of the water in the capillary would fall.

Preparation of the sartorius muscle.—The thin, flat sartorius is seen crossing obliquely over the front of the thigh. It is readily isolated by tying a thread round its tendinous attachment to the tibia, cutting this attachment away from the bone, raising the lower end by the aid of the thread, and snipping through the fascia on either side of the muscle, thus separating it right up to its iliac attachment. Notice the twitch which occurs when the nerve, which enters the under surface about its middle, is cut through. The muscle may be left attached to the ilium, or its bony attachment may be cut away with it and the muscle thus completely isolated. Its uppermost part contains no nerve fibres, and can be used to show that, independently of nerve, muscle responds to all forms of stimulation (electrical, mechanical, thermal, and osmotic).

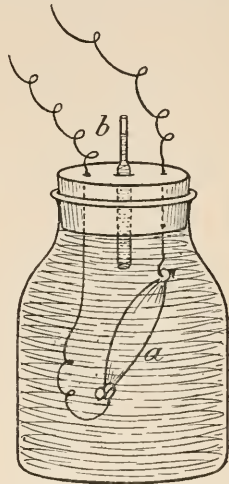

FIG. 39.—EXPERIMENT TO DETERMINE IF A MUSCLE ALTERS IN VOLUME DURING CONTRACTION. *a*, MUSCLE IN RINGER SOLUTION; *b*, CAPILLARY.

CHAPTER IX

FATIGUE OF MUSCLE AND NERVE

Effects of fatigue on muscle : (a) On the form of the muscle curve.—

Take a nerve-muscle preparation and fit it up as for recording the simple muscle curve (p. 27). Make an abscissa, and mark, as usual, upon it the point of stimulation. Take a normal curve with the muscle free-weighted. Remove the writing point from the drum, which is then allowed to revolve continuously and to stimulate the muscle with each revolution. After fifty of such excitations without record, apply the lever point again to the drum (making use, of course, of the stop), and let the muscle describe another curve at the same place as the first. Remove the writing point again for the duration of fifty excitations, and repeat the above procedure, and so on a number of times until the fatigue curves are pronounced. Notice the effects of fatigue upon muscle, in prolonging the latency period, diminishing the amount and slowing the course of its contraction, and greatly delaying, and at length even preventing, its relaxation.

A fatigue curve or series of curves can also be obtained by allowing the lever point to remain in contact with the cylinder during the whole of the experiment, and thus recording every contraction ; but the individual curves in a tracing so obtained are very numerous, and tend to obscure one another.

(b) On the extent of contraction.—The effect of fatigue upon the extent of contraction is best recorded upon a stationary drum, moved by hand about half a millimeter after each excitation, or on a very slowly moving drum ; the extent of the contraction is shown by the ordinates described by the lever. Use the slowest rate of movement of the drum (1 mm. per second or less), and arrange the primary circuit so that it is made and broken about every half-second. This can be done either by closing and opening a key by the hand, or by allowing a metallic bridge, actuated mechanically (*e.g.* by a

metronome), to close and open a gap between two mercury cups in the circuit. Use maximal stimuli. Keep the point of the lever—which must be free-weighted—against the smoked paper, and record every contraction. In this way a continuous *fatigue curve* is obtained, exhibiting the effect of fatigue, not only in the extent of contraction but also on the extensibility of the muscle both in rest and in contraction. Notice the “staircase” (gradual rise of the ordinates) at the beginning of the curve and the “contracture” (permanent contraction remainder) near its termination. Carry the experiment to complete exhaustion—*i.e.*, until the stimuli produce no further perceptible effect. Then allow the preparation to rest, keeping it moist with Ringer’s solution. After 15 or 20 minutes again test the effect of a stimulus. Notice that there is a certain amount of recovery from the fatigue, even in a preparation such as this in which no blood is circulating. In muscle in which the circulation is maintained fatigue comes on more slowly and is more rapidly recovered from, since the circulating blood removes the fatigue products.

Reaction of the fatigued muscle.—Cut across a muscle which is completely fatigued, and apply blue litmus paper to it. Notice that the paper is reddened (production of acid fatigue products). Compare the reaction with that of a piece of fresh, unfatigued muscle. Muscle which has died and passed into rigor—whether natural or the effect of heat (see p. 41)—is also acid.

Onset of the fatigue in a muscle-nerve preparation: Bernstein’s experiment.—Arrange an experiment in the manner shown in the diagram (fig. 40). Dissect out both nerve-muscle preparations of a frog and place both nerves near the spinal cord on a single pair of electrodes connected through a short-circuit key with the secondary coil. Another pair of electrodes—which should be non-polarisable (p. 7)—is connected with one of the nerves in such a manner that the current furnished by three Daniell cells (shown below in the diagram) can be led into the nerve in an ascending direction. When the mercury key of this circuit is closed the constant current from the Daniell cells blocks the nerve, and the nerve impulses generated by the induction shocks fail to pass to the muscle. Stimulate both nerves by induction shocks. The muscle the nerve of which is free to conduct is speedily fatigued: the other one shows no signs of contraction; on removing the block by opening the mercury key it at once responds to the stimuli, and its contractions show no evidence of fatigue even after long faradisation of its nerve.

Fatigue in voluntary contraction.—This is investigated by the

ergograph, the muscles of the fingers being fatigued by causing them to repeatedly raise a heavy weight or repeatedly deflect a strong spring.

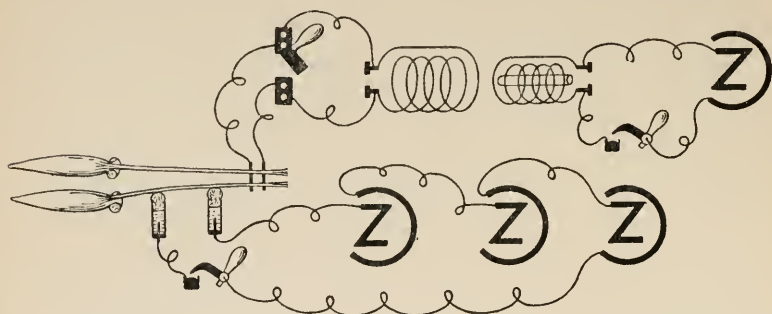

FIG. 40.—DIAGRAM OF BERNSTEIN'S EXPERIMENT TO ILLUSTRATE THE BLOCKING EFFECT OF A CONSTANT CURRENT UPON CONDUCTION OF NERVE-IMPULSES.

The extent of the contractions is recorded upon a very slowly revolving drum, and a fatigue curve or *ergogram*—which shows

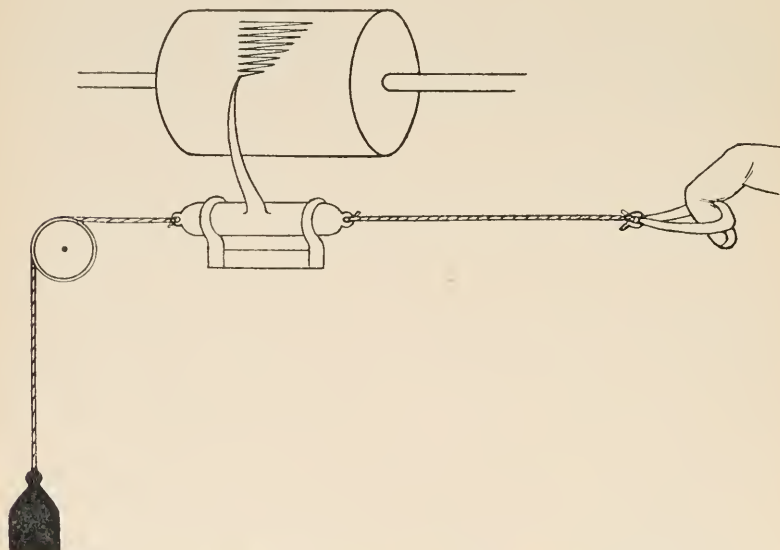

FIG. 41.—DIAGRAM OF MOSSO'S ERGOGRAPH FOR THE INVESTIGATION OF FATIGUE IN THE HUMAN SUBJECT.

individual peculiarities—is thereby produced in the same manner as with the frog muscle-nerve preparation (p. 42, (b)).

In Mosso's ergograph (fig. 41) the record is made upon a horizontal drum ; in Waller's and Porter's modifications the drum is vertical.

In the case of voluntary contractions the result is complicated by the fact that fatigue of nerve-cells in the central nervous system occurs before that either of the muscle itself or of the nerve endings in the muscle. This fact can be shown by direct faradic stimulation of the median nerve (or of the finger muscles) after the fatigue curve is complete. It is found that the muscle can still be made to contract by such peripherally applied stimuli.



CHAPTER X

CONDUCTION IN NERVE

Conduction of nerve-impulses may take place in both directions : Kühne's experiment.—Remove the gracilis with part of its entering nerve ; lay it on a glass plate, with its inner surface uppermost. The nerve is seen to give branches upwards and downwards ; as a matter of fact each nerve fibre divides into two branches, one for the upper and the other for the lower part of the muscle, which has a tendinous intersection obliquely across its middle. The middle part of the muscle can be entirely cut through here without injuring these nerves, and the two parts of the muscle will then only be united by the forked nerves.

If the ends of the nerves in either of the pieces of the muscle are stimulated, whether electrically, osmotically (salt), or mechanically (by snipping with scissors), both pieces contract.

Rate of transmission of nerve impulse.—Make a nerve-muscle preparation in the usual way ; fix it upon the myograph, and lay the nerve out upon two pairs of electrodes, one placed as near the muscle as possible, the other close to the vertebral column. With a large frog nearly two inches will intervene between the two. Place a commutator without cross wires in the secondary circuit, and arrange so that by moving the bridge of the commutator the induction shocks can be switched on to one or other pair of electrodes. The drum is to be included in the primary circuit, and a short-circuit key in the secondary (fig. 42).

Two muscle curves are now successively taken with a fast rate of cylinder and a maximal stimulus. The stimulus is applied to the nerve, first, close to the muscle, and, second, close to the vertebral column. The muscle curves are both taken in exactly the same way, and with exactly the same precautions as to the use of the stop, etc., detailed in Chapter III., and both curves are to be traced upon the one abscissa,

a time tracing being written beneath this. It will be found that the curves are not quite coincident, but that one succeeds the other by a

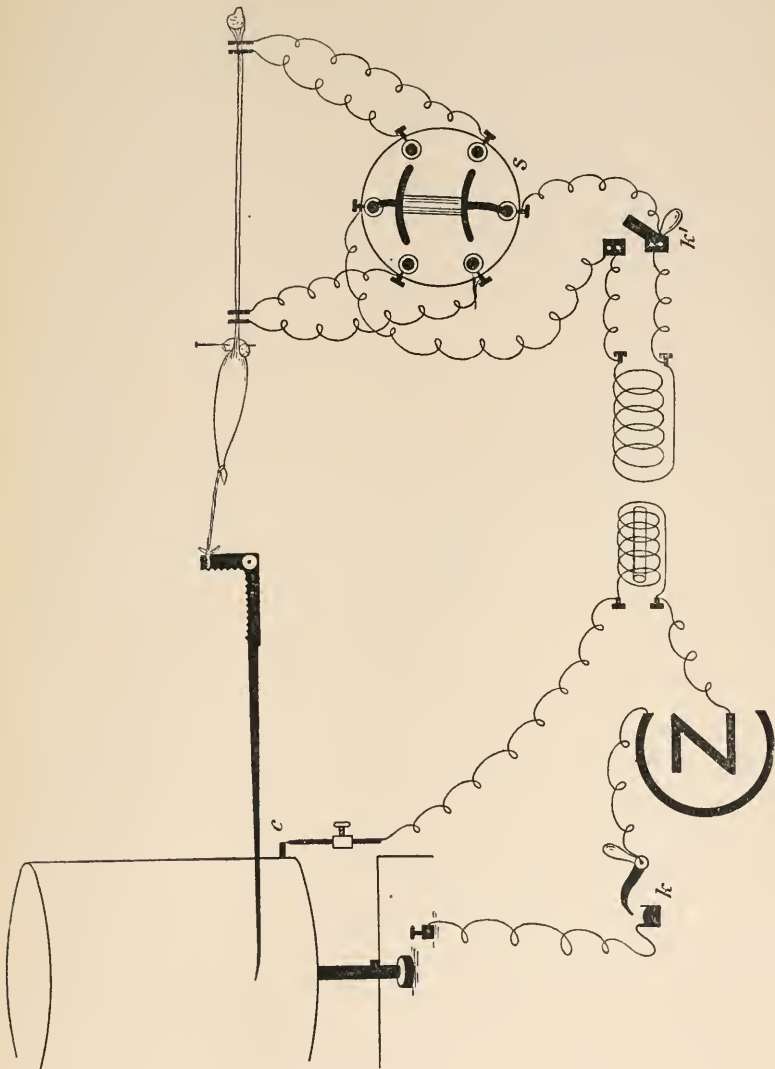

FIG. 42.—EXPERIMENT FOR RECORDING THE DIFFERENCES OF LATENCY OF A NERVE-MUSCLE PREPARATION WHEN THE NERVE IS STIMULATED, (c) NEAR THE VERTEBRAL COLUMN, (b) NEAR THE MUSCLE. *k*, MERCURY KEY IN PRIMARY CIRCUIT; *c*, DRUM-COMMUTATOR IN PRIMARY CIRCUIT; *k'*, KEY IN SECONDARY CIRCUIT; *s*, POHL COMMUTATOR USED AS SWITCH.

very small interval. This interval represents the time occupied by the transmission of the nerve impulse along the length of nerve between the two pairs of electrodes.

The interval is relatively small compared with the total latency period of the muscle-nerve preparation. It can be rendered more evident if the nerve (not the muscle) be cooled (p. 24). To measure it accurately a longer nerve and faster rate of movement must be taken. This is obtained by the use of the *pendulum myograph*, upon which the contraction of the human thumb muscles is recorded. The electrodes used consist of wash-leather pads soaked with strong salt solution. One electrode, large and flat, is fixed against the skin of the upper part of the back, the other smaller one being applied respectively over the median nerve at the elbow and over the brachial plexus above the clavicle; the length of nerve between these points is about 12 inches. The muscle-contraction in this case is recorded by means of two tambours or by the *pince myographique* (p. 35).

Effect of various agencies on nerve-conduction: blocking of nerve by current; carbonic acid; ether vapour; chloroform.—Take a nerve-muscle preparation and lay the nerve across and partly imbedded in a ring of putty or soft modelling clay placed upon a glass slide, to which a tube is cemented so that a current of CO_2 can be

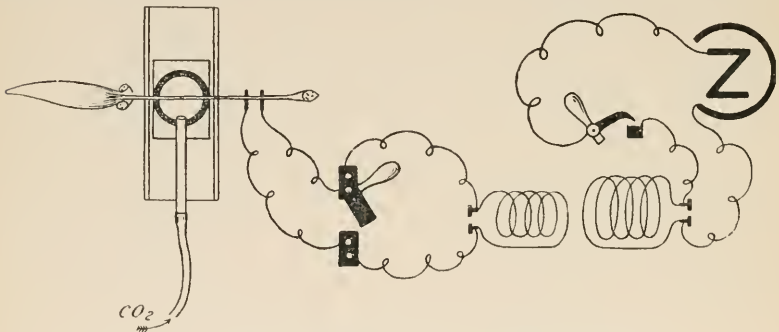

FIG. 43.—EFFECT OF CARBON DIOXIDE ON CONDUCTION IN NERVE.

conducted over the nerve. A cover glass is placed upon the ring; the end of the nerve projects beyond this and rests upon a pair of electrodes (fig. 43).

Find the minimal stimulus which will produce contraction of the muscle; then pass a current of CO_2 over the intervening nerve, and notice its effect in blocking the nerve-impulse. Remove the CO_2 by a current of air, and repeat the observation.

Other experiments may subsequently be made with ether vapour and chloroform vapour instead of CO_2 . It will be found that ether acts like CO_2 , but more powerfully. Chloroform vapour is more powerful than ether; and after a short exposure to it the nerve does not recover its power of conduction on readmitting air; it has, in fact, been killed.

Blocking by a galvanic current.—The blocking effect of a constant current has been made use of in Bernstein's experiment on fatigue (p. 43). To exhibit

it graphically, take a muscle-nerve preparation with long nerve and attach the muscle to the myograph lever in the usual manner, so that its contractions may be recorded upon a slowly moving drum. Apply stimulating electrodes from the secondary coil to the part of the nerve near the vertebral column, using the Neef's hammer (with Helmholtz wire) for tetanisation. Apply a pair of non-polarisable electrodes connected through a mercury key with a 3-cell Daniell battery, arranged so that the current can be passed up the nerve (polarising circuit). Take a tracing of the tetanised muscle, and whilst this is progressing close the polarising circuit. The tetanus at once ceases, to be renewed on again opening that circuit, and so on repeatedly.

CHAPTER XI

CONDITIONS OF EXCITATION OF NERVE AND MUSCLE BY THE GALVANIC CURRENT

THE passage of a galvanic current through a nerve or muscle produces secondary polarisation of these tissues, caused by the accumulation of positive and negative ions at or near the poles of the constant current. This polarisation is accompanied by certain physiological changes, the tissue being more excitable in the neighbourhood of the negative pole or kathode, and less excitable in the neighbourhood of the positive pole or anode. These effects—both physical and physiological—spread for some distance beyond the actual poles. And not only is the tissue rendered more excitable by the kathode, but this itself sets up excitation, which, in the case of a muscle, may cause its contraction not only at the moment of closure, but during the whole time of passage of the current. On breaking the circuit the part of the nerve which was more excitable during the passage of the current becomes instantaneously less so than the rest (physiological rebound). On the other hand, the presence of the anode of a constant current not only renders the tissue less excitable whilst the current is passing, but on breaking the circuit there is again a rebound; the part which

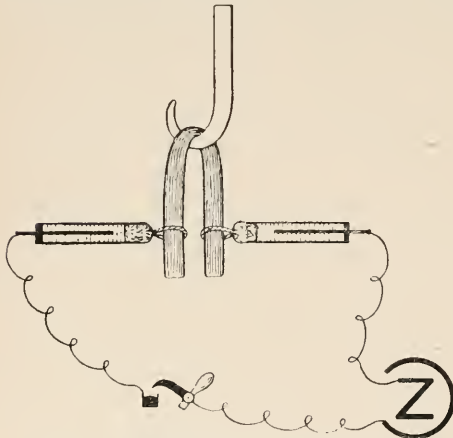

FIG. 44.—POLAR EFFECTS OF CONSTANT CURRENT UPON CURARISED SARTORIUS.

was the less excitable becoming the more excitable; this passage from less to greater excitability again acts as a stimulus. Hence, when a constant current is sent through a nerve or muscle, there is excitation at the kathode on making and at the anode on breaking the circuit. But the latter furnishes a rather weaker excitation than the former.

Polar excitation of muscle.

—1. Engelmann's sartorius experiment.—A curarised sartorius is connected with a pair of non-polarisable electrodes which are joined up through a mercury key with a battery (fig. 44). It will be observed that the twitch begins at the kathode when the current is closed; indeed,

the muscle may remain more or less contracted at that end during the whole time of the passage of a strong current. On the other hand, on opening the circuit the twitch begins near the anode, and may again be followed by a prolonged

contraction. These prolonged contractions show that excitation is produced not only at the make and break but also during the passage and for a short time after the cessation of a strong constant current.

2. An instructive variation of this experiment is to dissect out the rectus abdominis muscles of a curarised frog, and place the non-polarisable electrodes one in contact with the anterior, the other with the posterior end of the flat muscular mass (fig. 45). The muscles are divided into several parts by tendinous

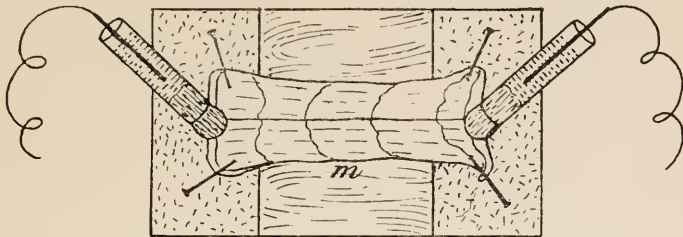

FIG. 45.—POLAR STIMULATION OF RECTUS ABDOMINIS. *m*, MUSCLE CURARISED AND STRETCHED BETWEEN TWO PIECES OF CORK (AFTER VERWORN).

septa, and it will be seen that during the passage of the constant current each of these parts has the part directed towards the kathode in a condition of contraction, and the part directed towards the anode in a condition of relaxation.

3. The effect of the poles of a constant current upon cardiac muscle can be exhibited on the frog's heart. The frog is killed by destroying the brain, and the heart is exposed *in situ*. Using non-polarisable electrodes and the whole current of a Daniell cell with a mercury key and a commutator in the circuit, place one electrode either in the mouth or on any part of the body of the frog, and connect the other, by means of a short piece of cotton-wool wetted with Ringer solution and drawn to a point, with the heart so as to touch it near the base of the ventricle. If this electrode is the anode, on closing the key it will be observed that the part of the ventricle underneath it does not participate in the contractions, but remains quiescent, and, if the heart be filled with blood, even bulges during general systole: on opening the key this part passes into systole—even during general diastole (physiological rebound). If the current be reversed and the cotton-wool be made the kathode, the reversed effects are obtained.

Polar excitation of nerve.—Take a muscle-nerve preparation with as long a nerve as possible and arrange it on the myograph. Non-polarisable electrodes, connected with a constant battery through a mercury key, are placed—the anode in contact with the uppermost end of the nerve, the kathode in contact with the lowermost end, *i.e.* close to the muscle. Insert an electro-magnetic signal into the circuit and cause it to mark on the drum just below the myograph lever. Record two contractions, one produced by closing the mercury key, the other (on a different abscissa) by opening it. Make a tuning-fork tracing below, and measure exactly the period of latency in each case, *i.e.* the time elapsing between the current of the electromagnetic signal and the commencement of rise of the curve. Notice that it is slightly greater as the result of breaking the circuit than on making (by the time taken for the nerve impulse to traverse the length of nerve), since the excitation at *breaking* is at the anode, *i.e.* at a point of the nerve furthest from the muscle, whereas on *making* the excitation was at the kathode, *i.e.* close to the muscle.

If, as represented in fig. 46, an ascending current is used instead of a descending one, the result is complicated by the blocking effect of the constant current on conduction (see pp. 43 and 48). Thus, on *making* such an ascending current, if it were a strong one, the excitation being at the kathode, *i.e.* at the uppermost end of the nerve, and the intermediate part of the nerve being at the same moment traversed by the current, this would block the passage of the nerve-impulse generated at the kathode, and no contraction would result.

Therefore, instead of obtaining a contraction at both make and break, only the break would produce a visible effect under these circumstances. On the other

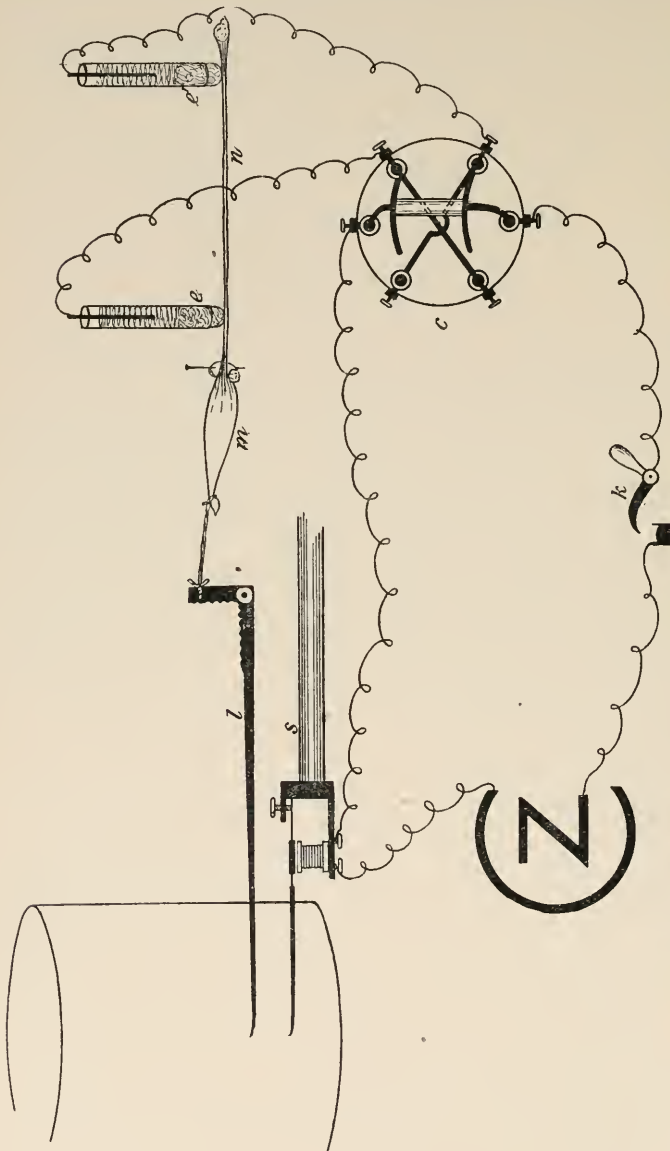

FIG. 46.—EXPERIMENT FOR SHOWING THE POLAR STIMULATION OF NERVE. *m*, MUSCLE; *l*, MYOGRAPH LEVER; *e*, *e'*, NON-POLARISABLE ELECTRODES; *c*, POHL COMMUTATOR; *k*, MERCURY KEY FOR CLOSING OR OPENING BATTERY CIRCUIT; *s*, ELECTROMAGNETIC SIGNAL.

hand, if the constant current is weak, its removal may not be followed by contraction of the muscle, because the breaking of such a current furnishes a smaller excitation than its making.

Pfänger's law.—The above (which has been misnamed "the law of contraction") is illustrated by an experiment devised by Pfänger. The nerve¹ of a nerve-muscle preparation is placed on non-polarisable electrodes, which are connected with a battery of at least three cells through a commutator and rheochord: a mercury key is introduced into the circuit (fig. 47). Beginning with a *very weak current*, the rider of the rheochord being brought near to the end *a* of the rheochord wire (see figs. 19, 20), determine the effect upon the nerve, as indicated by the contraction of the muscle, of making and breaking the current

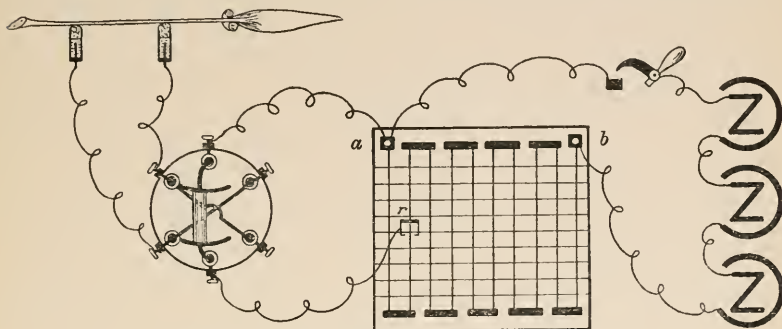

FIG. 47.—TO TEST PFLÜGER'S "LAW OF CONTRACTION."

when it is (1) ascending and (2) descending. Repeat the experiment, using a *moderate strength of polarising current*—i.e. with the rider of the rheochord near the end *b* of the wire. Finally, the effect of a *strong current* is to be studied by eliminating the rheochord altogether. Note down in tabular form all the results obtained. (The contractions of the muscle need not be recorded graphically.)

If the nerve be very excitable¹ the muscle may remain in contraction during the whole time of the passage of a strong descending current (*closing tetanus*), and may also remain contracted for a considerable time after the removal of a strong ascending current (*Ritter's opening tetanus*). If Ritter's tetanus is obtained the nerve may be cut *between* the electrodes. The tetanus instantly ceases because the point where the stimulus occurs (the original anode) is cut off.

¹ The excitability of a muscle-nerve preparation is greater when the latter is made from a frog which has been in a cold place or in contact with ice, and then kept for half an hour at the ordinary room-temperature before being killed.

CHAPTER XII

POLAR EFFECTS OF A GALVANIC CURRENT ; ELECTROTONUS

A POLARISING current produces changes of excitability not only at its poles but also in the adjacent parts of the nerve, and even some distance away from them. This is due to the fact that owing to spread of current in the extra polar regions as well as at and between the poles, changes of potential are manifested in those regions during the passage of the current, these being accompanied by physiological changes, viz. increased excitability near the kathode, and diminished excitability near the anode. Such a condition is known as electrotonus ; that obtaining at and near the kathode being termed katelectrotonus ; that obtaining at and near the anode, anelectrotonus.

The spread of the electrical changes beyond the poles is illustrated by the following experiment.

Paradoxical contraction.—Dissect out the sciatic nerve of a frog, cutting all the branches save that to the calf muscles, but leaving the cut branch to the peronei muscles as long as possible. Place the cut end of this branch upon non-polarisable electrodes connected with a battery and rheochord and have a mercury key in the circuit. On making or breaking the circuit the gastro-

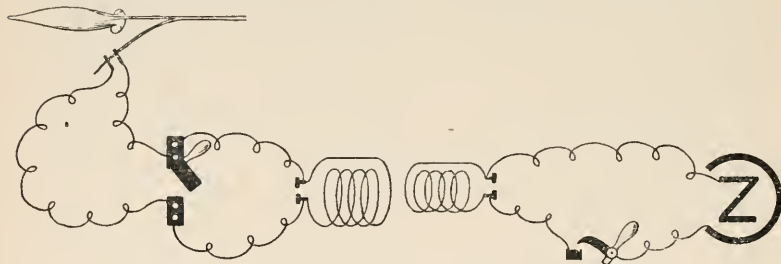

FIG. 48.—PARADOXICAL CONTRACTION SHOWN BY INDUCED CURRENTS.

cnemius will contract. Owing to the electrotonic spread of the current in the fibres of the peroneus nerve the fibres to the gastrocnemius in the trunk of the sciatic become stimulated ; in an excitable preparation this will occur even with very weak currents. The experiment can also be performed with ordinary metallic electrodes connected with the secondary coil of an inductorium (fig. 48). On stimulating the peroneus nerve by closing the mercury key the gastrocnemius is made to contract. If the peroneus branch is tied or crushed near its junction with the sciatic the effect can only be got with strong currents. The experiment should be repeated by placing a thread, wetted with Ringer, along the sciatic nerve, and laying its free end on the electrodes. In this case also the excitation caused by spread of current will only show itself with strong

currents. These experiments show that the spread of current is assisted by the structure of the nerve; even with a weak current it takes place for a considerable distance along an intact nerve, but it is easily blocked if the nerve be tied or crushed.

Electrotonic effects of constant current on excitability.—Take a pair of non-polarisable electrodes and connect with a battery of at least two cells, inserting a rheochord, a commutator, and a mercury key into the circuit (*polarising circuit*). Another circuit is also prepared (*exciting circuit*),¹ including battery, induction coil, and mercury key in the primary circuit; the secondary circuit is to have a short-circuit key, with which a pair of ordinary metallic electrodes are

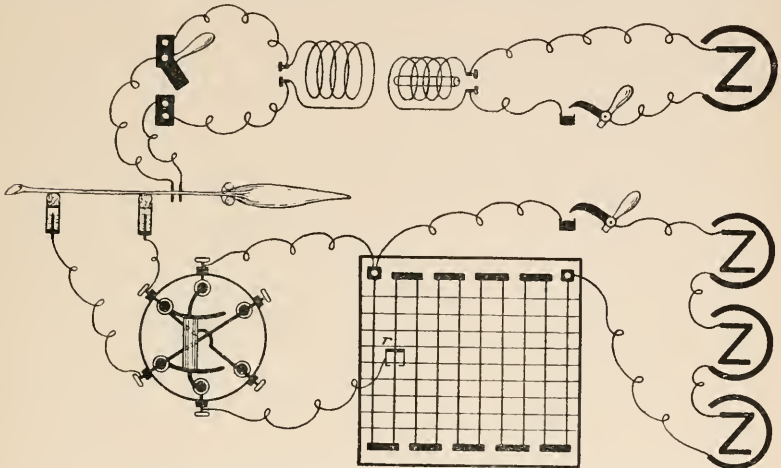

FIG. 49.—TO TEST THE POLAR EFFECTS OF A CONSTANT CURRENT ON NERVE EXCITABILITY.

connected; these electrodes are brought in contact with the nerve of a muscle-nerve preparation *near the muscle*. The non-polarisable electrodes, which may be of the boot pattern, are fixed to the myograph cork, but slightly raised above it; the upper part of the nerve is laid upon them (fig. 49). The record of the muscular contractions obtained is made on a stationary drum. Be careful to keep the nerve moist.

Place the secondary coil at such a distance from the primary coil that faradisation (Helmholtz modification) just produces a small contraction. Now put in the polarising current (1) in an ascend-

¹ A variation of the experiment is to replace the exciting circuit by a few crystals of salt and wait until the penetration of this begins to excite the nerve fibres. The rheochord also may be dispensed with in the polarising circuit, in which case two Daniell cells will suffice.

ing and (2) in a descending direction, and determine the effect of its poles in diminishing or increasing the excitability of the nerve as tested by the height of the ordinates described by the myograph lever.

This experiment can be performed without taking a graphic record by noting at what distance the secondary coil must be placed in order just to produce a contraction. In this way the varying conditions of excitability produced by the polarising current are tested and may be recorded numerically.

CHAPTER XIII

EXPERIMENTS ON THE ELECTRICAL CONDITIONS OF MUSCLE AND NERVE

A galvanometer or electrometer is necessary to study these conditions, but certain facts can be demonstrated without any special apparatus.

Demarcation current of muscle: Contraction without metals.—

By means of a glass rod loop up the nerve of a nerve-muscle preparation, and allow its cut end to come in contact either with an injured part of the surface of its own muscle (fig. 50) or with other muscles. There will be a contraction of its muscle each time that the contact is made or broken. The excitation is caused by the passage through the nerve of part of the demarcation current of the muscle.

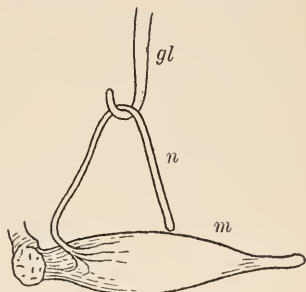

FIG. 50.—EXPERIMENT OF THE CONTRACTION WITHOUT METALS. *gl*, BENT GLASS ROD; *n*, NERVE; *m*, MUSCLE.

The result can sometimes be obtained if the cut end of the nerve be allowed to touch a part of the nerve nearer the muscle: in this case it is the demarcation current of the nerve which stimulates its own fibres.

This experiment is only likely to succeed if a very excitable preparation, such as is obtained from a cooled frog (see footnote, p. 53), is employed.

Action current of muscle; Secondary contraction.—Take a nerve-muscle preparation, and lay its nerve over the muscles of another leg, the nerve of which is placed upon electrodes (fig. 51). Tetanise these muscles; the nerve of the first-named preparation will be stimulated by the electrical variations which accompany the contraction of the tetanised muscles. A nerve-muscle preparation thus used in place of a galvanometer to indicate electrical variations is known as a *rheoscopic frog preparation*.

The result can also be obtained with single contractions.

Secondary contraction from the heart.—Lay the nerve of a muscle-nerve preparation upon the beating heart of the frog. If the preparation is very excitable the muscle will twitch with each beat of the ventricle. If the heart-beat and the twitch are simultaneously recorded on a drum the twitch will be found to slightly precede the beat—*i.e.* the electrical change precedes the mechanical; this is seen best with a cooled heart.

Measurement of demarcation current; Capillary electrometer.—The capillary electrometer consists of a thread of mercury, which is forced by pressure from behind for a certain distance along a glass tube drawn out to a capillary termination; the free end of the capillary is filled with dilute sulphuric acid and dips into a vessel containing the same fluid. The capillary is observed with a microscope. If the mercury and the sulphuric acid be now connected with wires which are charged with electricity, there is produced a movement of the mercury in the direction which the current would take—*i.e.* from positive to negative—the ultimate extent of movement of the meniscus being, for the same electrometer, proportioned to the difference of potential. From the direction and extent of the movement the direction and electromotive force of any constant current can therefore be gauged. The movements of the meniscus can also be photographed, and a graphic record thus obtained.

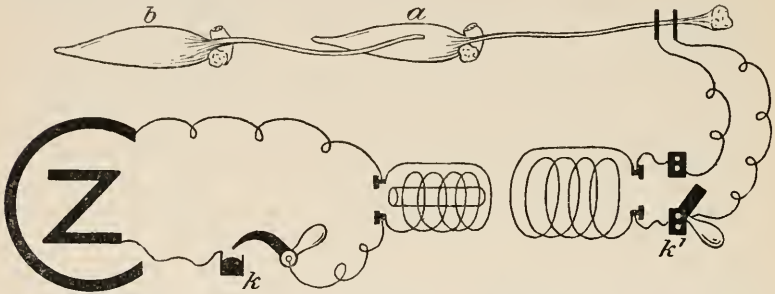

FIG. 51.—EXPERIMENT TO SHOW SECONDARY CONTRACTION. *k*, MERCURY KEY IN PRIMARY CIRCUIT; *k'*, SHORT-CIRCUIT KEY IN SECONDARY CIRCUIT; *a*, FIRST MUSCLE; *b*, SECOND MUSCLE WITH ITS NERVE LAID OVER THE FIRST.

Join a pair of non-polarisable electrodes up in circuit with a capillary electrometer and Daniell cell through a rheochord and commutator in the manner shown in the diagram (fig. 52), but with a piece of blotting-paper moistened with salt solution placed across the electrodes instead of the muscle shown in the figure. Put a short-circuiting key between the electrometer and the electrodes. Have the short-circuiting key (*k'*) shut at first so that the electrometer is short-circuited, and the battery key (*k*) open. Bring the mercury meniscus into the field of the microscope. Now open the short-circuiting key. If the electrodes are themselves without current there will be no effect on the electrometer; but usually there is a slight effect, the direction and the amount of which should be noticed. Next close the battery circuit, leaving the short-circuiting key open. Part of the battery current is now sent through the electrodes and electrometer in a particular direction (which can be reversed by the commutator), and there is a corresponding movement of the mercury. Note the direction of this movement, and by following out the wires from the battery determine with which part of the electrometer the anode and kathode are respectively connected. By means of the rheochord and commutator a definite proportion of the battery current can be sent in either direction through the electrodes and through any preparation with which they may be connected. Open the battery key and close the short-circuiting key; the meniscus should return to its original position.

Lay the muscle of a nerve-muscle preparation, which may have the distal end cut or injured, upon the electrodes in place of the wet blotting-paper. Place it

with one electrode touching the longitudinal surface and the other at or near the injured end. Then open the short-circuiting key to allow the *demarcation current* of the muscle to affect the electrometer. From the direction of movement of the mercury determine the direction of the muscle current through the apparatus—*i.e.* which part of the muscle led off from the electrodes is negative to the other. The electromotive force of the current can be *measured* by closing the battery key, so that the battery current is brought into the circuit, and by aid of the rheochord and commutator sending a current through the circuit in a direction the reverse of the demarcation current and of exactly such a strength (measured by the known electromotive force of the battery employed and the position of the rider on the rheocord) as to bring the mercury back to zero.

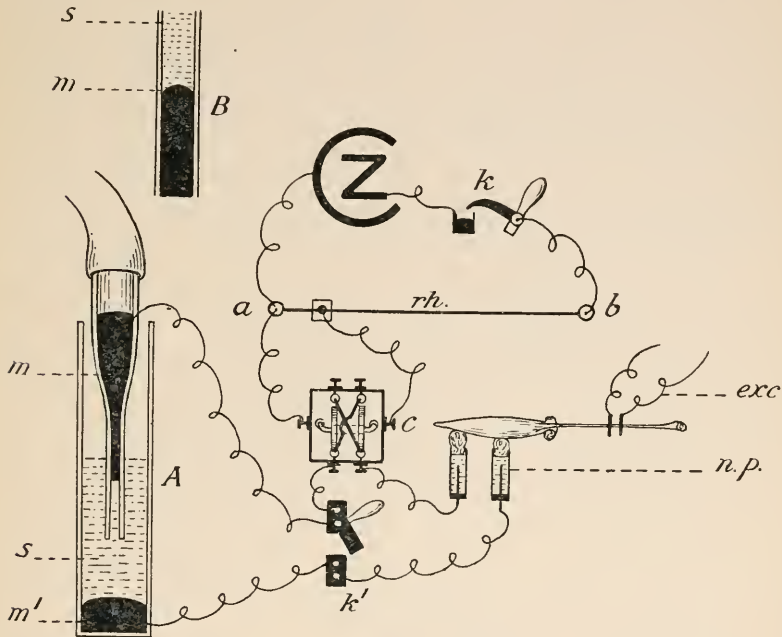

FIG. 52.—DIAGRAM OF CAPILLARY ELECTROMETER. A, RESERVOIR CONTAINING SULPHURIC ACID, s, AND MERCURY, m'; m, MERCURY IN GLASS TUBE DRAWN OUT TO CAPILLARY TERMINATION; B, CAPILLARY AS SEEN UNDER MICROSCOPE; n.p. NON-POLARISABLE ELECTRODES; exc, EXCITING ELECTRODES; k, k', KEYS; c, COMMUTATOR; rh, RHEOCHORD.

Action-current.—Place the upper end of the nerve of the preparation on a pair of exciting electrodes connected with an induction coil arranged for tetanisation. Observe the meniscus with the microscope, and tetanise the muscle, using the weakest possible stimulus. Notice that the meniscus moves in a particular direction. This movement is caused by a change in the electrical condition of the muscle accompanying its contraction. From the direction of movement of the mercury determine which part of the muscle is now negative to the other. The action-current can only be properly studied in photographs of the end of the mercury column, the image of which is thrown on a slit in front of a moving plate.

String galvanometer of Einthoven.—This consists of a microscopically fine thread of silvered quartz stretched between the poles of a powerful electro-magnet (fig. 53). When a galvanic current is passed along it the thread

is deflected to one side or the other to an extent varying with the E.M.F.—the tension of the thread being supposed constant. The movement is observed with a microscope, or the magnified image of the thread is photographed on a moving sensitised surface. The method of conducting the experiment is very similar to that employed for the capillary electrometer. For certain investigations, especially those relating to the electrical conditions accompanying the action of the heart, the string galvanometer is more convenient than either the capillary electrometer or the needle galvanometer. It has been largely adopted by clinicians, since the heart-records obtained by it (electro-cardiograms) furnish valuable indications as to the nature of cardiac affections which might be otherwise difficult to diagnose. When used for the human subject the two hands, or one hand and an opposite foot, are placed in vessels of salt solution, and

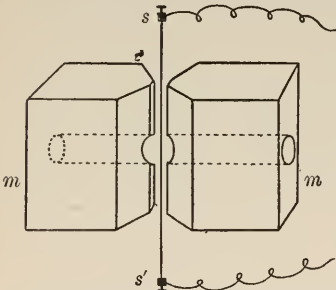

FIG. 53.—DIAGRAM OF EINTHOVEN STRING GALVANOMETER. *s, s'*, SILVERED QUARTZ THREAD, STRETCHED BETWEEN POWERFUL MAGNETS *m, m*, WHICH ARE PERFORATED TO ALLOW A MICROSCOPE TO BEAR UPON THE THREAD.

these are connected, by wires, with the ends of the quartz thread.

Reflecting needle galvanometer.—Reflecting galvanometers of high resistance

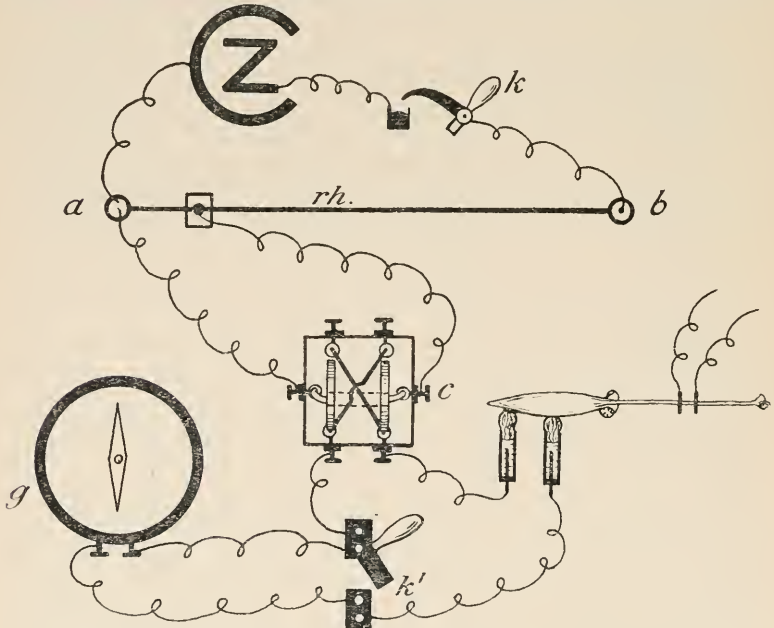

FIG. 54.—DIAGRAM OF ARRANGEMENT OF APPARATUS FOR STUDYING MUSCLE CURRENTS WITH GALVANOMETER. *g*, GALVANOMETER. THE OTHER LETTERS AS IN FIG. 52.

were, until recent years, almost exclusively used for experiments in electro-physiology (fig. 54), but have been largely superseded by the instruments that have just been described.

Demarcation and action currents of nerve.—These are examined and measured in exactly the same way as those of muscle.

Action current of frog-heart.—Non-polarisable electrodes are connected with a beating frog-heart, which may either be removed from the body and laid with the base upon one electrode and the apex on the other, or left *in situ* and the electrodes connected with apex and base by thick threads wetted with salt solution. The electrodes are joined by wires to any of the above instruments. Each contraction of the heart is accompanied by movements of the respective indicators (mercury column, quartz thread, or magnetic needle), the direction of which may be recorded and the alterations in electrical potential of base and apex deduced therefrom.

CHAPTER XIV

INVOLUNTARY MUSCLE

Stomach or bladder of frog.—Take either a transverse strip from the stomach—the frog should have been recently fed—or preferably the whole urinary bladder, fastening a thread to each end. Attach one end to the metal disc used in the experiment on the effect of heat on extensibility (fig. 38); let this lie in a small vessel of Ringer's solution, and, as in that experiment, attach the other end to the short arm of a light lever. Bring fine wires from the induction coil—one in contact with the bottom of the strip, the other with the top. This upper wire must be spirally coiled or otherwise so arranged that the piece of tissue can be stimulated and can contract without interference. Use a very slow drum. Stimulate by making and breaking the primary circuit. With a single make or break there is usually no response owing to the short duration of the induction shock, but by repeating the stimulus the tissue will contract and the lever will describe a simple prolonged muscle curve on the drum. The contraction is best obtained by a rapid succession of stimuli, using the Neef's hammer, but in this case also it is a simple contraction, not a tetanus; it furnishes an example of the effect of summation of stimuli (see p. 36). Involuntary muscle does not show superposition nor tetanus, in this respect resembling the heart. On the other hand, it exhibits great variations in tone—*i.e.* a condition of greater or less continuous contraction.

Intestine of rabbit: Magnus' method.—The same apparatus is used, but the Ringer's solution must be kept warm (35° C. to 40° C.). A longitudinal strip of rabbit intestine (descending colon), which may be divested of its mucous membrane, is attached below to the disc and above to the lever. Rhythmic contractions occur and should be recorded. Add to the Ringer solution of one preparation

a few drops of pituitary extract, and to another a few drops of suprarenal extract, and observe the effect in both cases.

This method is used for investigating the action of drugs upon the muscular tissue of the intestine. For prolonged and exact experiments oxygen is allowed to bubble through the Ringer so as to keep the solution saturated with this gas.

CHAPTER XV

THE FROG-HEART

MAKE a special dissection of the upper part of the body of a large frog to show the situation and connexions of the heart, its several cavities and the blood-vessels leading to and from it. It is advantageous to distend the cavities with gelatin solution and allow this to set. Notice a small nerve entering it on each side along the superior vena cava; this is the cardiac nerve, and is given off from the vagus; it contains also fibres from the sympathetic which reach the vagus near the skull. Cut out a piece of the interauricular septum; place it in dilute methylene blue for five minutes; wash with water, and examine in water under the microscope for nerve fibres and groups of nerve cells. The dissection of the heart may be made beforehand and kept for reference in dilute formalin.

Examine the contracting heart of a frog the brain and spinal cord of which have been destroyed; cut away the sternum and ensiform cartilage and the front of the pericardium. Very gently raise the

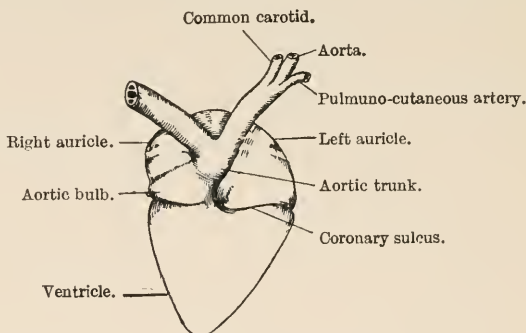

FIG. 55.—HEART OF FROG: VENTRAL ASPECT (GAUPP).

tip of the ventricle with a blunt instrument, and sever the pericardial ligament which binds the ventricle to the back of the pericardium. *Do not grasp the heart with forceps or injure it in any way by manipulation.*

On raising the ventricle the sinus venosus comes into view,

receiving the two venæ cavæ superiores and the vena cava inferior ; above, it is continuous with, but marked off by a whitish line (the sino-auricular junction) from, the auricle, which is double and receives on the left side the pulmonary vein ; the two auricles open into a

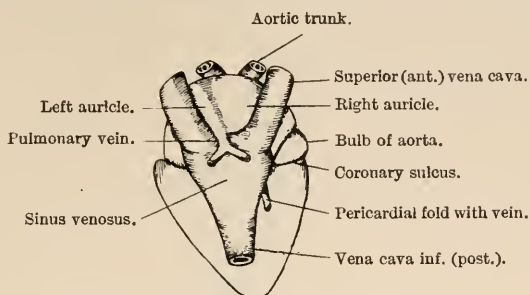

FIG. 56.—HEART OF FROG FROM DORSAL ASPECT (GAUPP). ♀.

single ventricle. On the front the bulbus aortæ is seen leaving the ventricle and dividing into two trunks, the right and left aortæ, each of which again soon divides into three branches.

Notice that with each systole the venous part of the heart (sinus venosus) contracts first ; its contraction is immediately followed by

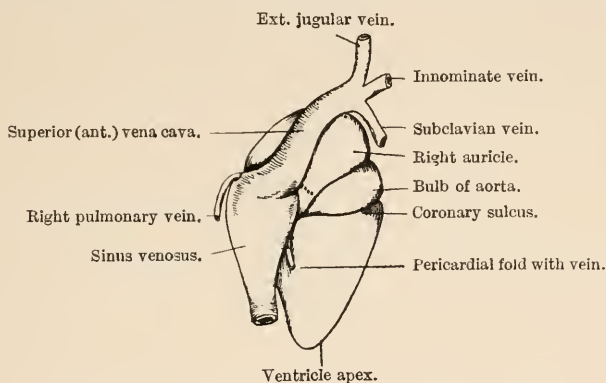

FIG. 57.—HEART OF FROG, SEEN FROM THE RIGHT SIDE (GAUPP). ♀.

that of the auricles, which contract together, and this by that of the ventricle. In a frog the spinal cord of which has been destroyed, there is usually little or no blood passing through the heart. But if blood is being pumped through, notice the sudden distension (diastole) of each cavity which immediately succeeds its contraction (systole). If the finger be very lightly placed on the ventricle the hardening which accompanies systole may be felt.

Using a watch, count the number of beats per minute during several minutes and record the result.

Effect of heat and cold on rate of beat.—Now apply, first, an ice-cold and, second, a warmed thick wire (*a*) to the ventricle, (*b*) to one of the auricles, (*c*) by turning up the heart, to the sinus. Count the rate during each application, and record the results.

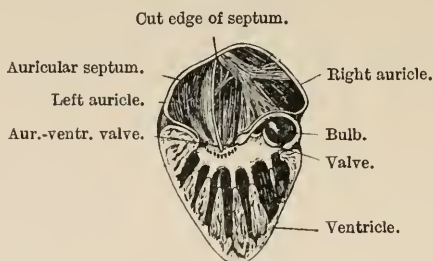

FIG. 58.—SECTION THROUGH HEART OF FROG. FRONT HALF SEEN FROM BEHIND (GAUPP). ♀. THE SPONGY STRUCTURE OF THE VENTRICLE IS WELL SHOWN.

Stannius' experiment.—Raise the ventricle very carefully without pinching or injuring it in any way, and, after cutting a ligament or fold of pericardium which encloses a small vein, pass a thread under the sinus, and tighten it round the sino-auricular junction, which is marked by a whitish line. The sinus continues to beat as before (count the rate), but the auricle and ventricle come to a standstill in diastole. Such a heart is termed a *Stannius heart*.

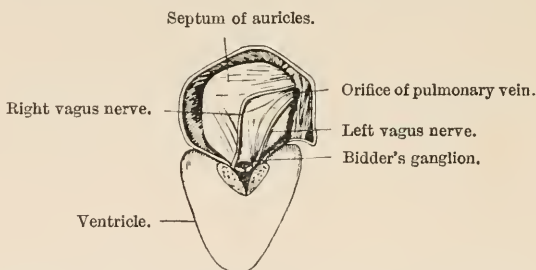

FIG. 59.—HEART OF FROG WITH LEFT AURICLE CUT OPEN TO SHOW THE VAGUS NERVES IN THE AURICULAR SEPTUM (GAUPP). ♀.

Stimulate auricle or ventricle, and notice that each stimulation is followed by a contraction. They are therefore not inhibited, but have ceased to contract owing to their being cut off by the ligature from the sinus (in which the contractions normally begin).

Now tie a second ligature round the auriculo-ventricular junction. The ventricle usually gives a few (three or four) beats, and then both

it and the auricle again come to a standstill. Either can, however, be made to beat by artificial stimulation (prick, electric shock).

After a certain lapse of time (sometimes very soon after the application of the first ligature) the auricle and ventricle may recommence beating regularly and rhythmically, but it will be found on counting the rate that it is never as fast as that of the sinus. If the auricle is cut off from the ventricle, as by the second Stannius ligature, all three parts may ultimately be found beating spontaneously, but it will always be noticed that the rate of the sinus is the fastest, that of the auricles next, and that of the ventricle the slowest. The bulbus aortæ is also spontaneously contractile; even small pieces can be observed to beat rhythmically.

Peculiarities of cardiac contraction.—Apart from its regular rhythm the heart muscle shows certain peculiarities as compared with

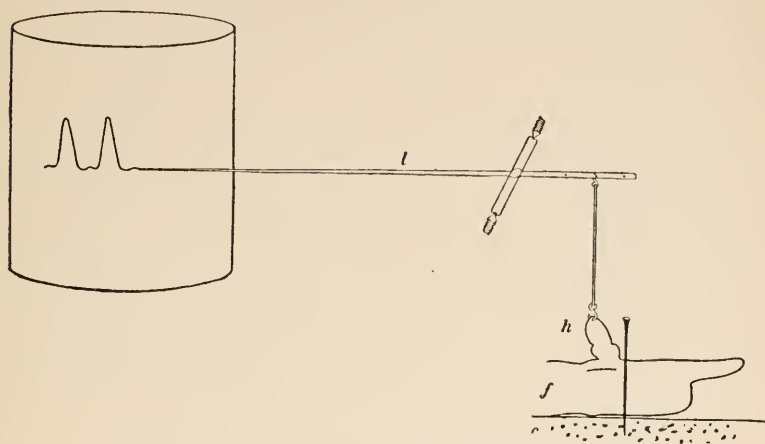

FIG. 60.—FROG CARDIOGRAPH. *f*, FROG; *h*, HEART; *l*, LEVER.

skeletal muscle. To investigate these, apply a ligature at the base of the ventricle; cut out the heart and attach the apex of the ventricle by means of a fine hook or serafin and thread to a muscle lever (such as is shown in fig. 60), the preparation being fixed by a pin passed through the ligatured base. The heart may, if desired, be left *in situ* as shown in the figure. Contractions are recorded by the lever in the same way as those of any other muscle, but on a very slow drum. *Be very careful not to injure the preparation.* As a rule there are no spontaneous contractions, but the ventricle responds to the least stimulus applied to any part of its surface. The following experiments are to be made with this preparation:—

1. “**All or none**” contraction.—Allow a pair of electrodes, connected with an induction coil, to touch the base of the quiescent heart. They must be fixed (this can be done with plasticine), not

held in the hand. Put the secondary coil far from the primary, and break the primary circuit. Determine the excitability of the preparation by ascertaining to what division of the scale the secondary coil must approach the primary before a contraction is produced. This represents the *liminal stimulus*. Now bring the secondary nearer the primary and again stimulate. The contraction is not appreciably larger. Repeat with a still stronger stimulus. In every case the extent of contraction is the same¹ (compare with skeletal muscle, p. 39).

2. Refractory period.—Put in a second stimulus (with the hand) at varying intervals after the first. If put in very soon after so as to reach the heart whilst it is still in process of contraction, no additional effect is produced; there is *no superposition* (compare with skeletal muscle, p. 36). In other words, whilst the contraction produced by the first stimulus is proceeding, cardiac muscle is *refractory* to a second stimulus. This refractory phase is continued to a less extent during the period of relaxation of the muscle. A consequence of the refractory phase and of the lack of superposition is that *cardiac muscle never shows a true tetanus*, although by sending in successive stimuli so that they reach the muscle always at the commencement of the period of relaxation, there is an appearance of fusion of the successive contractions; but they never overtop one another as in tetanus of skeletal muscle. To show this, put in a succession of stimuli by rapidly making and breaking the primary circuit with the hand (compare with tetanus of skeletal muscle, p. 36).

3. Staircase phenomenon.—This is not peculiar to cardiac muscle (see p. 43), but is often well shown by it. Using the Stannius preparation, and after a period of rest, stimulate a number of times in succession at intervals of about two seconds, keeping the strength of the stimulus the same throughout. Notice that there is a slight increase in the extent of the first few successive contractions, the second ordinate being a little higher than the first, the third than the second, and so on.

¹ See, however, what is said as to the staircase phenomenon (paragraph 3).

CHAPTER XVI

PERFUSION OF HEART

Perfusion of frog-heart.—Kill a large frog and expose the heart; remove the pericardium and cut through the pericardial ligament. Very carefully raise the apex of the ventricle with a blunt instrument, remembering that the least injury to the surface of the ventricle will spoil it for this experiment. Make a free cut with scissors into the auricles thus exposed, near to the sino-auricular junction; insert the scissors into the auricles and snip through their septum. Wash all blood away with Ringer's solution. Place a ligature of wet cotton round the auricles near their junction with the ventricles; insert the double perfusion Kronecker cannula (fig. 61, *f'*) through the auricles and into the ventricle, and tie it in firmly by means of the ligature; cut through the sinus, and remove the heart upon the cannula. The inlet tube of the perfusion cannula is connected to a reservoir (Mariotte bottle) containing about 100 c.c. Ringer's solution, and the outlet tube conducts to a receptacle into which the fluid may flow after passing through the heart. Whilst the heart is being fastened over the cannula, let Ringer's fluid flow very slowly (drop by drop) through the cannula so as to expel and keep all air out of the cannula and heart.

Now place the heart in the plethysmograph. The lower part of the plethysmograph contains Ringer's solution: the upper part and the tubes leading horizontally from it contain pure, moderately thin paraffin oil.¹ Both stop-cocks are closed whilst the heart is inserted; then the one belonging to the bent tube is opened. If the reservoir of Ringer's fluid be at a height of three or four inches above the heart, the ventricle will soon begin to beat, and its changes in volume will cause a movement of the oil to and fro in the open tube. If this tube

¹ Not olive oil. Ringer's solution may be substituted for oil in the plethysmograph, but for the piston-tube oil is required.

be now closed and the one containing the piston opened, the piston will move to and fro, and its movements can be recorded on a very slowly rotating horizontal drum.

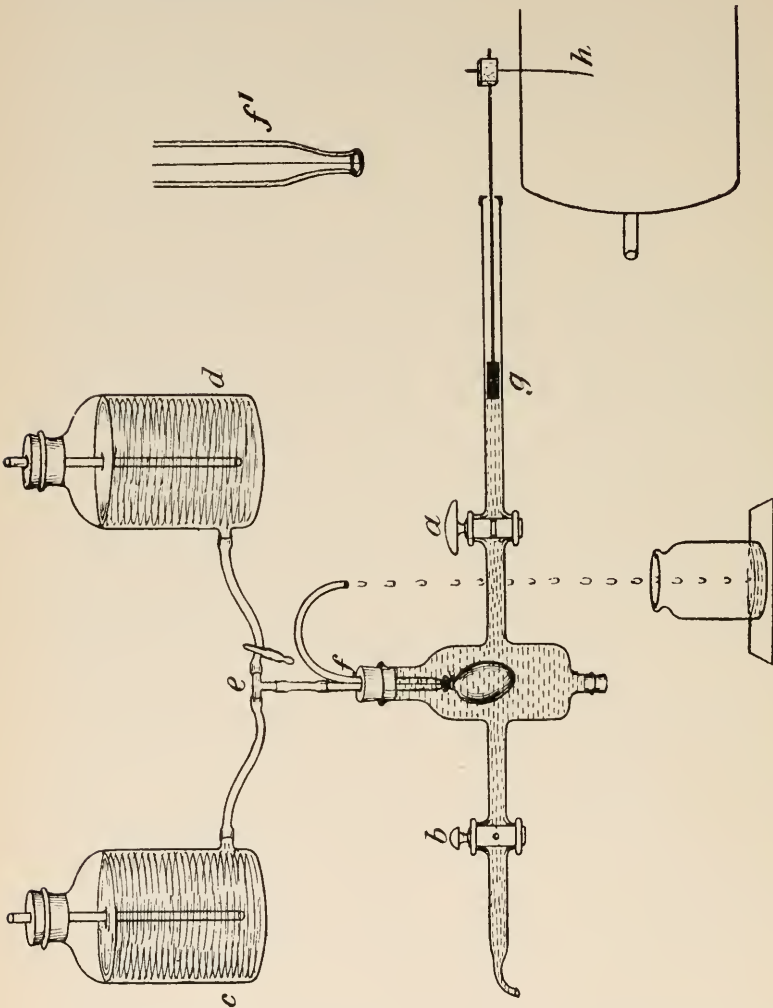

FIG. 61.—FROG-HEART PLETHYSMOGRAPH. *a, b*, TAPS; *c, d*, MARIOTTE BOTTLES; *e*, THREE-WAY TUBE; *f, f'*, KRONECKER CANNULA; *f'*, END OF CANNULA ENLARGED; *g*, ALUMINIUM PISTON; *h*, WRITING POINT.

It may happen that the perfused heart (which is a Stannius heart) does not begin to beat spontaneously, although the salts and the pressure of fluid serve as a slight stimulus. In that event the beats may be started by faradic excitation from an induction coil, one electrode being attached to the metal cannula and the other to a wire which passes up through a cork in the bottom of the plethysmograph, and is brought in contact with the ventricle.

The influence of various salts, such as chloride of calcium and chloride of potassium, of anæsthetic agents such as ether and chloroform, and of drugs such

as digitaline and veratrine, can be studied by adding definite amounts of these to the Ringer's solution used for perfusion. For such purposes it is convenient to have two reservoirs of Ringer's solution (fig. 61), one for addition of the drug to be investigated, and the other to flush out the heart after the action of the drug is complete. Both reservoirs are connected with the inflow of the cannula by a three-way tube (*e*) furnished with a stop-cock or with small clips.

Influence of calcium and potassium on the cardiac contractions: Ringer's experiment.—Place in the second reservoir a solution containing 6 parts of pure NaCl to 1000 of distilled water, and keep it filled with this solution. Flush the heart with it; the organ will soon cease to contract and to respond to excitations. Now mix with the 100 c.c. of fluid in the second reservoir 2 c.c. of a 1 per cent. solution of calcium chloride and flush the heart with the mixture. Contractions will be resumed, but each one will be too prolonged, and the heart will again soon stop: this time in systole. Next add 4 c.c. of a 1 per cent. solution of potassium chloride to the contents of the second reservoir, mix thoroughly, and flush the heart with the mixture. The beats will recommence, either spontaneously or in response to stimulation, the normal character being resumed. If the potassium salt is added in excess, the heart will be arrested in diastole.

Perfusion of the heart *in situ*.—In large frogs the heart can be perfused *in situ* by introducing a very fine glass or metal cannula into the vein which runs along the middle line of the ventral wall of the abdomen. The vein is exposed by making a longitudinal incision through the abdominal wall a little to the right of the middle line, and a transverse incision at the level of the ensiform cartilage starting from the upper end of the longitudinal cut and carried outwards. The triangular flap thus made is turned down, and the vein will be seen passing from the abdominal wall towards the heart. The cannula is connected with a reservoir of Ringer's fluid, which is allowed to drop very slowly from its end during insertion, so that no air-bubbles can enter. It is then tied in, and the heart, previously exposed and attached to a heart lever (as in fig. 60), is flushed with the solution, which is allowed to flow out from a small cut near the apex of the ventricle. Drugs are introduced by means of a second reservoir as before.

Perfusion of the mammalian heart.—The heart is excised from a recently killed cat or rabbit, and the aorta is at once tied on to a cannula through which Ringer's solution, saturated with oxygen, is slowly dropping. The solution is warmed to about 38° C. before reaching the heart—which is itself kept in a warmed chamber. The cannula is directed towards the aortic valves, which are closed on raising the pressure of the perfused fluid; this runs through the coronary vessels and escapes through the right auricle. The amount of fluid perfused can be measured by a tilter (see p. 87). The contractions of the heart can be recorded by one or more light levers, attached to it by threads which are passed over pulleys. The action of drugs is investigated by adding them to the Ringer's solution.



CHAPTER XVII

CARDIAC NERVES

DESTROY by a wire the spinal cord of a frog, and also remove the cerebral hemispheres; this can be done without special dissection by cutting away the upper jaw and anterior part of the skull at the level of the front of the tympana (see fig. 77, p. 95). The posterior part of the brain with the medulla oblongata must not be injured. Fix a pair of pin electrodes connected with an induction coil into this part of the skull and arrange for tetanisation of the medulla oblongata—using the Helmholtz method (p. 16). Lay the frog upon its back on the frog-cork, and fix it securely by strong pins or rubber bands; expose the heart and the chief nerves which are proceeding from the base of the skull to the hyoid region (vagus, glosso-pharyngeal, and hypoglossal; see fig. 62). The vagus gives off a small branch on each side, which runs close along the superior vena cava to the sinus venosus. Place one vagus trunk upon a fine pair of wire electrodes passed through a flat piece of cork (which must itself be fixed by plasticine to the frog-cork, not held in the hand), and connect these electrodes, and also those which are fixed into the skull, to a commutator without cross wires so that the faradising shocks can be sent to one or other pair as may be desired. Place the frog-cork upon the stand of a frog cardiograph (fig. 60), and by means of a thread and fine steel hook attach the apex of the ventricle to the short arm of the light lever. Record the contractions of the heart upon a very slowly moving drum (one revolution in four or five minutes). Use the “stop” for adjusting the lever and for readjusting it after removal from the drum, so that the pressure of the lever point is always exactly the same. Without this precaution the strength of the contractions may be wrongly judged, for if the lever is pressing more at one time than at another, the lever will not be raised so high, even if the force of the heart's contractions is unaltered.

Be careful not to injure the heart more than is absolutely necessary. In order to fix the base securely, pass a strong pin close to the base of the heart and through the vertebral column into the frog-cork.

The following experiments may be performed upon this preparation :—

1. Take a normal tracing of the beats during a short period and record by an electromagnetic signal a time-tracing (seconds) upon the

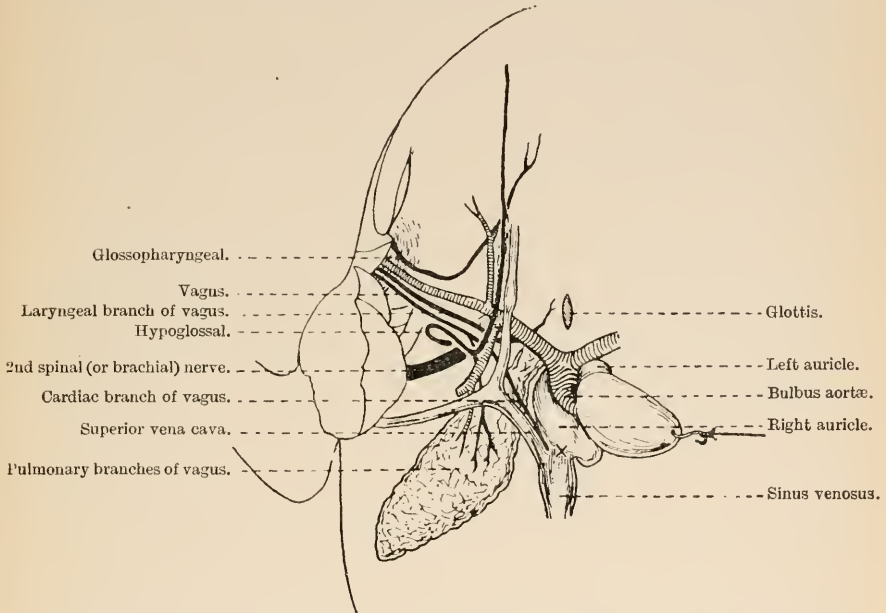

FIG. 62.—RELATIONS OF VAGUS NERVE TO OTHER STRUCTURES IN THE NECK AND THORAX. THE VENTRICLE HAS BEEN DRAWN OVER TO THE LEFT SIDE BY A HOOK AND THE SINUS VENOSUS IS THUS EXPOSED. X, LINE OF JUNCTION BETWEEN SINUS AND AURICLES.

drum. This time-tracing is to serve for determining the exact rate of the heart-beat under the different circumstances of the experiments.

2. Whilst this is proceeding, stimulate, not too strongly, the medulla oblongata, allowing the result to be recorded continuously at the same level of the drum.

3. Cut both vagus nerves near the skull and repeat the above stimulation of the medulla oblongata, recording the result at another level of the drum.

4. Alter the commutator and stimulate the vagus, recording the result at a third level of the drum. With weak stimulation of the vagus in the frog the heart may beat faster and more strongly owing

to excitation of the sympathetic fibres which have joined the vagus near the skull and are running with the cardiac branch to the heart; with stronger stimulation the heart will beat more slowly and less vigorously or may stop altogether.

5. Place one drop of a weak solution (0.2 per cent.) of nicotine upon the sinus; the effect of this is at first to slow the heart, because the nerve cells to which the vagus fibres are distributed are stimulated by the drug; subsequently they are paralysed, and the heart resumes its normal rate. After a short interval stimulate the vagus. No effect should be obtained, since nicotine blocks the junction of its nerve fibres with the distributing nerve cells within the heart. Wash away the nicotine with salt solution; the effect will return after a time.

6. Stimulate the heart at the white line of the sino-auricular junction. (The electrodes must not be held in the hand, but must be fixed in position by a pin through their cork or by plasticine.) The heart comes to a standstill in diastole. Record this effect by a continuous tracing. This standstill is not due to the stimulation of an inhibitory centre, but to the fact that the inhibitory fibres are close to the surface at this place.

Notice that in each case of acceleration or retardation of the pulse-rate there is an after-effect of a nature contrary to the immediate effect.

7. Place a single drop of dilute solution of muscarine upon the sinus, recording the effect produced upon the rate and force of the heart, which will soon come to a standstill in diastole. Now wash away the muscarine with two or three drops of solution of atropine sulphate (1 in 300). Notice the gradual restoration of the rate and force of the beats. Notice further that no inhibition can now be produced on stimulating either the vagus or the sino-auricular junction. There may, however, be *acceleration*, from stimulation of the sympathetic fibres which are running to the heart in the cardiac branch of the vagus.

CHAPTER XVIII

STRUCTURE AND ACTION OF THE MAMMALIAN HEART

THE heart of a sheep or man should have been previously dissected to show its cavities and the blood-vessels connected with them, as well as the arrangement and action of the auriculo-ventricular and semilunar valves.¹ A dissection should also have been made in a rabbit of the nerves accompanying the carotid artery (vagus, sympathetic, depressor).

Action of the heart in man.—Observe the chest wall over the situation of the heart; notice and feel the impulse or apex beat, strongest at one spot; mark this with ink. Apply the ear directly or through a binaural stethoscope over this spot, and also over the second right costo-sternal articulation. Whilst listening to the sounds of the heart feel the carotid pulse of the subject, and determine that the first sound is systolic—*i.e.*, is synchronous with the rise of pressure in the artery due to the contraction of the ventricle.

Cardiographic tracing.—Apply the button of a cardiograph (fig. 63) to the point where the impulse is most distinct, and take a tracing upon a moderately fast drum by the aid of a recording tambour.

The breath should be held whilst the tracing is taken, to eliminate the movements caused by respiration. To obtain a distinct record it is best to select a thin subject, and to place him on a couch in the recumbent position on his left side.

Rate of rhythm of the heart. Effect of position.—Count the rate of the heart's beat by placing the finger either over the apex beat or upon an artery (pulse). Do this with the subject (1) recumbent, (2) sitting up, (3) standing up. Note down any differences you may observe in the rate and also in the character of the beat in these different postures.

Observation of the heart of a mammal in situ.—This observation may be made upon a "Sherrington" preparation. The animal (cat) has been killed under chloroform anæsthesia by decapitation, the carotids having first been ligatured, and the vertebrae occluded by a wire passed immediately in front of the axis vertebra, drawn tightly and securely fastened behind. Another ligature is

¹ The mode of dissecting a sheep's heart is described in Pembrey's *Practical Physiology* and in Stewart's *Physiology*.

made to include all the remaining structures of the neck except the trachea. The head is cut off by an incision in front of these ligatures passing between the occiput and atlas. Oozing of blood is stopped by application of dilute suprarenal extract, and the skin is fastened over the cut end of the neck. Before tying the arteries, a tube has been inserted into the trachea, and artificial respiration kept up by pumping air into the lungs and allowing it to escape by a side tube. This air is warmed, and the body is further kept warm after decapitation by placing it on a warmed plate and covering it with cotton-wool. In such a preparation the circulation is maintained, although the pressure is somewhat low, and the tissues continue to live for several hours. Spinal reflexes can be studied in it (see Chapter XXV.). The heart is exposed by severing four or five ribs or rib-cartilages on each side by bone forceps, and with the same instrument

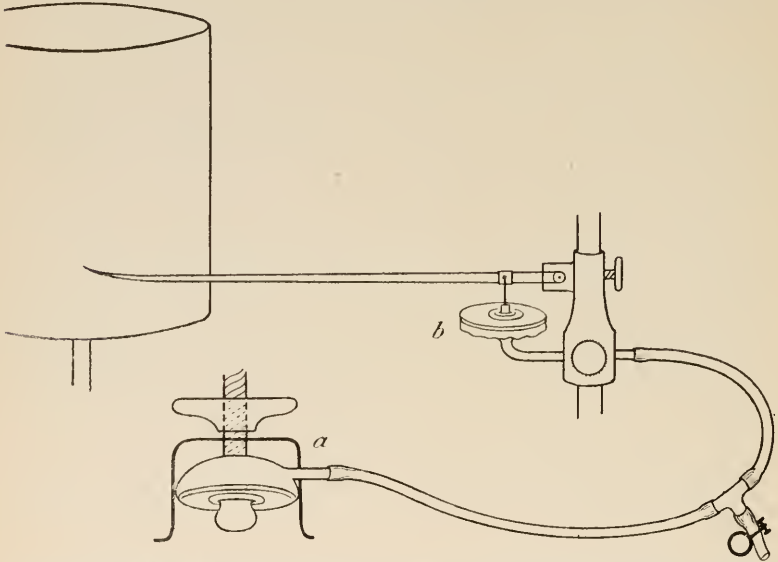

FIG. 63.—DIAGRAM OF MAREY'S CARDIOGRAPH. *a*, RECEIVING TAMBOUR FOR FIXING OVER APEX-BEAT; *b*, RECORDING TAMBOUR CONNECTED WITH *a*, BY RUBBER TUBING, WITH A LATERAL OPENING CLOSED BY A CLIP.

cutting through the sternum near its lower end, and raising the detached part forcibly, along with the cut ends of the ribs. This bony and muscular flap may, if necessary, be removed altogether after tying a string or wire tightly round its anterior end to arrest bleeding from the internal mammary arteries. The window thus opened discloses the heart within the pericardium; the latter may be cut open and the heart fully exposed. The systole, followed by diastole, of auricles and ventricles can be watched, and the hardening of the ventricles during their systole felt by applying the finger to their surface. By attaching one of the ventricles and one of the auricles by fine hooks and threads to light levers suspended by rubber threads, the contractions of these parts can be recorded separately on a drum. The effect of stimulating the vagus in the neck and of atropine in abolishing this effect can be demonstrated; also the effect of stimulating the accelerator fibres which pass from the inferior cervical ganglion of the sympathetic to the cardiac plexuses. The same effect is obtained by stimulating the ganglion itself, which may be found by following the cervical sympathetic downwards. (In the cat the vagus and sympathetic run in the same sheath in the neck, but they separate below and above as the sympathetic passes out of and into its inferior and superior cervical ganglia.)

CHAPTER XIX

METHODS OF INVESTIGATING THE CIRCULATION IN THE BLOOD-VESSELS

THE chief methods used can be practised upon a long india-rubber tube through which water is pumped from a low reservoir by a Higginson syringe actuated by some form of motor. After passing through the system the fluid is again delivered into the reservoir (which represents the capillary and venous systems). A mercury kymograph (fig. 64) and other manometers such as Fick's C-spring (fig. 65), Hürthle's tambour (fig. 66), as well as the stromuhr (fig. 69) and other instruments for measuring or estimating velocity, are connected by means of T-tubes with the main india-rubber tube. The use of each instrument is to be studied separately, the others being temporarily shut off by screw clips. Notice how the movement of any of the recording manometers may be damped by partially closing the tube connecting it with the main system. Observe the effect upon the pressure within the system (1) of increasing either the rate of the pump or the amount delivered at each stroke; (2) of diminishing or enlarging the outflow from the main tube by a screw-clip. This is equivalent to contraction or dilatation of the arterioles. Take a tracing with each form of manometer. Also record the amount of fluid passing through the stromuhr in one minute. Measure the diameter of the artery in whose course the instrument is inserted, and calculate from these data the velocity of flow.

A dog's or lamb's kidney enclosed in a plethysmograph (such as is shown in fig. 68) may also be connected laterally with the main system, and Ringer's fluid allowed to flow in by the renal artery and out by the renal vein; from this it must be conducted straight to the reservoir.

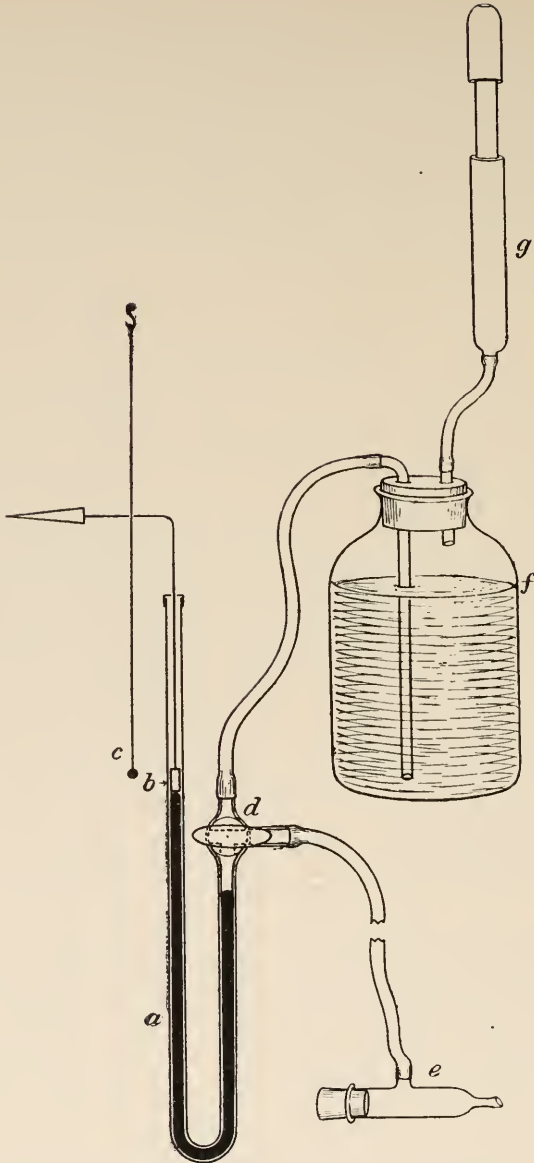

FIG. 64.—DIAGRAM OF MERCURY KYMOGRAPH ARRANGED FOR AN EXPERIMENT. *a*, BENT GLASS TUBE CONTAINING MERCURY FORMING THE MANOMETER; *b*, ALUMINIUM FLOAT WITH ROD, BENT AT RIGHT ANGLES AND ENDING IN A WRITING POINT; *c*, SMALL WEIGHT ATTACHED TO SILK THREAD SUSPENDED ABOVE WRITER AND SERVING TO KEEP IT AGAINST THE SMOKED PAPER; *d*, THREE-WAY STOPCOCK; *e*, ARTERY CANNULA; *f*, BOTTLE OF SODIUM CARBONATE SOLUTION; *g*, BICYCLE PUMP.

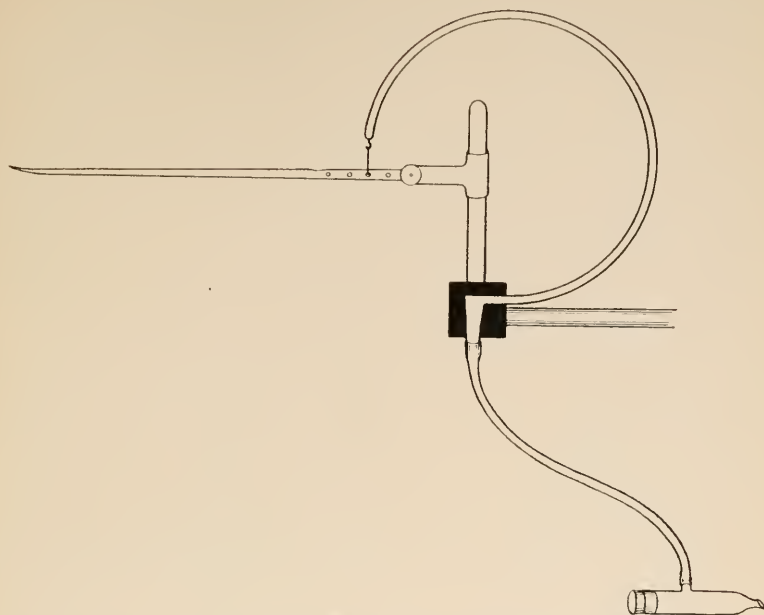

FIG. 65.—DIAGRAM OF FICK'S C-SPRING KYMOGRAPH. ANY INCREASE OF PRESSURE WITHIN THE HOLLOW METAL SPRING (WHICH IS FILLED WITH FLUID) CAUSES THE C TO OPEN; ANY DECREASE OF PRESSURE CAUSES IT TO CLOSE. THESE MOVEMENTS ARE COMMUNICATED TO THE LEVER. THE ADVANTAGE OF EMPLOYING THIS OR THE HÜRTHLE MANOMETER IS THAT THEY HAVE LITTLE INERTIA AS COMPARED WITH THE MERCURY KYMOGRAPH. THEY MUST, HOWEVER, BE GRADUATED BY AID OF A MERCURY MANOMETER.

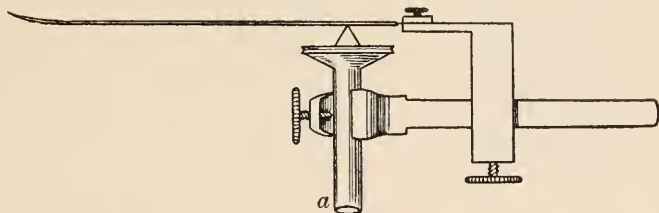

FIG. 66.—DIAGRAM (AFTER SCHENCK) TO SHOW THE PRINCIPLE OF THE HÜRTHLE KYMOGRAPH. *a*, TUBE TERMINATING ABOVE IN A TAMBOUR-LIKE ENLARGEMENT COVERED BY A STOUT RUBBER MEMBRANE UPON WHICH IS A METAL DISK AND A WEDGE ACTUATING A VERY LIGHT LEVER. THE TUBE IS CONNECTED BY RUBBER PRESSURE TUBING WITH AN ARTERY CANNULA LIKE THAT SHOWN IN FIG. 64, AND THE WHOLE IS FILLED WITH SODIUM BICARBONATE SOLUTION.

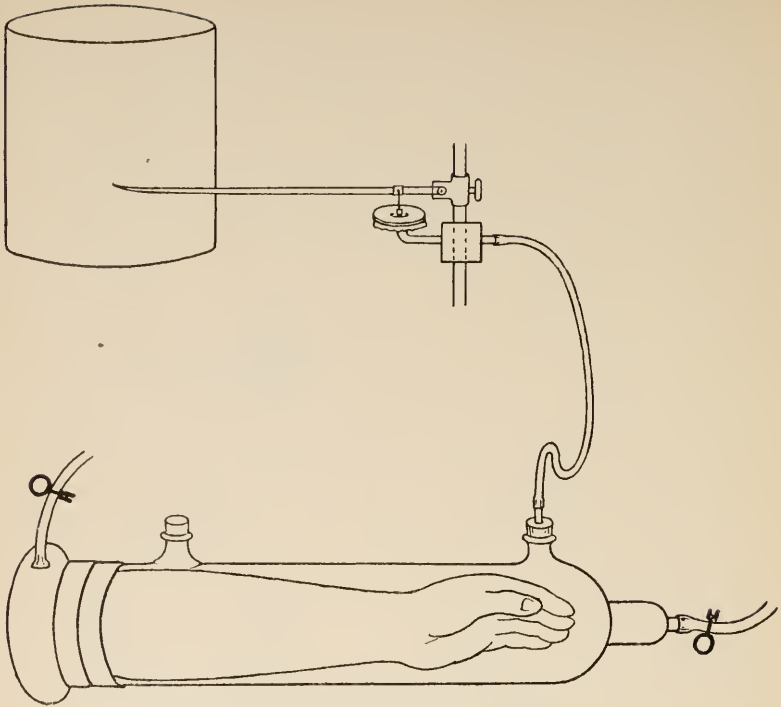
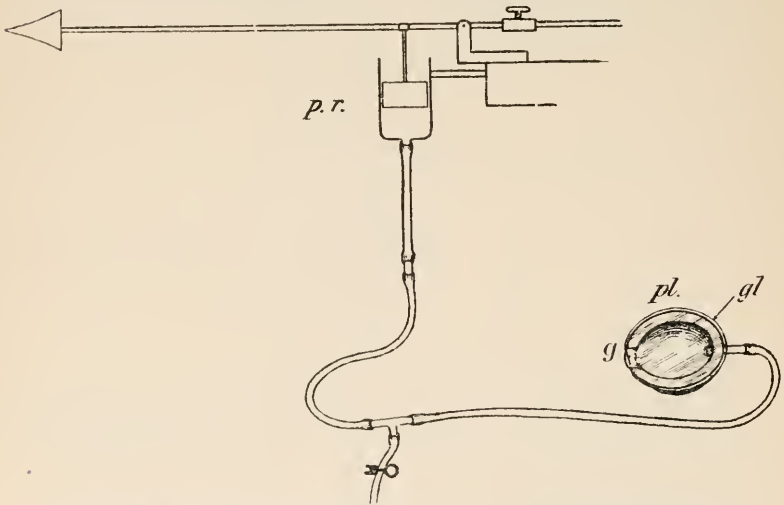

FIG. 67.—MOSSE'S ARM-PLETHYSMOGRAPH.

FIG. 68.—DIAGRAM OF KIDNEY PLETHYSMOGRAPH. *pl.*, PLETHYSMOGRAPH; *gl.*, GLASS COVER; *g*, GAP FOR PASSAGE OF BLOOD-VESSELS AND URETER; *p.r.* PISTON RECORDER.

Plethysmography.—The arm of a subject (who is to be seated comfortably) is placed in a Mosso plethysmograph (fig. 67), and this is allowed to rest on a table or in a sling. The junction with the arm is made by a broad rubber band. The interior of the plethysmograph is connected by rubber tubing with a recording tambour or a bellows- or piston-recorder; the whole is to be airtight. The lever of the recorder registers respiratory and cardiac movements upon the smoked surface, since these movements produce changes in general arterial pressure, and thus in the amount of blood driven into the arm. Compress the brachial vein above the elbow; the swelling of the arm due to retention of blood is at once shown.

Plethysmographs for the kidney (see fig. 68), spleen, and other organs may be also studied. The principle of their action is the same as that used for the arm, but the form is adapted to each particular organ. The gap (*g*) in the instrument through which the vessels and duct pass is made airtight by vaseline.

Study of blood pressure, and the effects of nerves and drugs upon the heart and arteries in animals.—Either an anæsthetised animal may be employed as the subject of a demonstration on blood-pressure, or a "Sherrington" preparation (p. 75) can be used by the student. A cannula (fig. 64, *e*) is inserted into one of the carotids towards the thorax and tied securely in. The artery is previously ligatured above and clamped below the place of insertion. The cannula is connected by a tube containing solution of sodium bicarbonate with the proximal limb of a mercurial manometer; a lateral tube affords communication with a reservoir of the same solution, which is under pressure. By this pressure the mercury is forced up in the distal limb of the manometer, so that the recording style is about 50 mm. above the abscissa or zero line. The clamp on the artery is then removed, and a record of the arterial pressure taken, a time record (in 10-second intervals) being also inscribed. It is useful to record the respiratory movements at the same time: this is conveniently done either by tambours or by attaching a thread by one end to the skin of the epigastric region and causing the other end to activate a lever. A blunt metal cannula, which fits the nozzle of a hypodermic syringe, is tied into one of the jugular veins towards the thorax: this is for the purpose of giving intravenous injections of drugs and extracts. A kidney or the spleen or a loop of intestine,

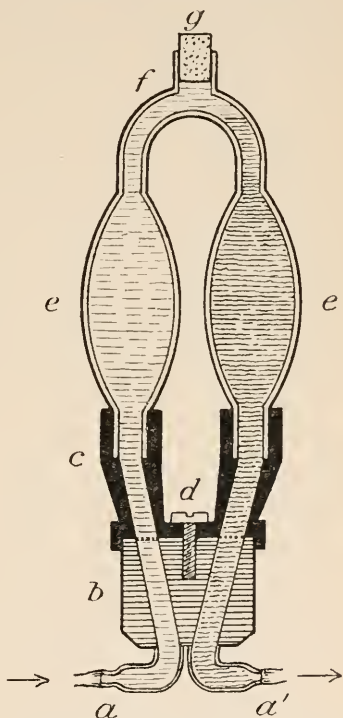

FIG. 69.—LUDWIG'S STROMUHR. *a, a'*, CANNULAS FOR TYING INTO CUT ARTERY; *b*, BLOCK ON WHICH THE PART *c* ROTATES AROUND THE AXIS, *d*; *e*, RESERVOIR CONTAINING OIL; *e'*, RESERVOIR CONTAINING DEFIBRINATED BLOOD; *f*, APERTURE FOR FILLING RESERVOIRS, CLOSED BY CORK, *g*.

or a limb, may be placed in a plethysmograph, and the changes of volume recorded. In the anæsthetised animal the following experiments can be made: for many of them the Sherrington preparation can be used:—

1. Effect of exciting the afferent fibres of a peripheral limb-nerve. Expose any limb nerve, tie a ligature tightly round the distal end of the part exposed. Stimulate the central end. Observe the effects on arterial pressure, on heart rate, and on respiration.

2. Put a drop or two of amyl nitrite on cotton-wool and allow the animal to inhale the vapour. Note the effect on blood-pressure.

3. Effect of exciting the vagus. One of the vagi in the neck having been isolated for a short distance, taking care to avoid injuring it, a thread is tied tightly round it: this serves to hold it, and also severs the continuity of its fibres, and is therefore equivalent to cutting it across. (a) Stimulate the end below the ligature. Observe the effect on blood-pressure caused by cardiac inhibition. (b) Stimulate the upper end. Observe the reflex effects on blood-pressure and on respiration which are produced. (c) Stimulate the superior laryngeal branch, which can be seen passing to the larynx. Observe the effect on respiration and blood-pressure.

4. Effect of cutting both vagi. The ligature of the one vagus—which, as just explained, severs its fibres—produces little or no permanent effect on blood-pressure or respiration. Now tie or cut the other vagus also. Notice the effect (a) on respiration, (b) on blood-pressure. Repeat the excitation experiments.

5. Inject solution of atropine sulphate (about 2 milligrams) into the jugular vein. Notice the effect, if any, upon blood-pressure and respiration. Repeat the excitation of lower and upper ends of vagus as in (1), and note results.

6. If a rabbit is used, two other very fine nerves can be found in the neck accompanying the carotid artery and vagus. One of these is the depressor: it is a branch of the vagus or of the superior laryngeal. The other is the cervical sympathetic: it passes above into the superior ganglion. Both these nerves are to be tied low down. After tying the sympathetic, the pupil of the eye on that side will be more contracted than the other, and the ear of that side will be warmer and redder. (a) Stimulate the upper end of the sympathetic: the pupil dilates, the third eyelid is retracted, some of the hairs on the side of the head may be erected, and the arteries of the ear contract, so that the whole ear becomes pale. (b) Stimulate the upper end of the depressor whilst the blood-pressure is being recorded. After a long period of latency there is a fall of pressure which lasts during stimulation of the nerve and for a short time after its cessation.

7. Inject into the jugular vein a few drops of an extract of the suprarenal capsule of any animal. The extract is made by taking 20 c.c. of Ringer's solution to each gram of suprarenal capsule, boiling and filtering. Record the effect on blood-pressure. Notice the dilatation of the pupils, the retraction of the third eyelid, and the pallor of the ears. If a plethysmograph is being used, the record of the effect on the contained organ indicates contraction of arteries. The experiment can be repeated more than once.

8. Inject into the jugular vein a few drops of an extract of ox-pituitary. The extract is made in the same way as the suprarenal extract. The posterior lobe only should be used. Notice the effect of the extract upon the blood-pressure and upon the plethysmograph record. If the injection is repeated after a short interval, most of the results are not shown, or are much less marked.

9. Kill the animal by asphyxia—which may be effected by occluding the trachea or by allowing carbon monoxide gas (or coal gas) to be respired. A continuous tracing showing the effects of asphyxia, both upon the respiratory movements and upon the blood-pressure and heart-beats, may be recorded.

The capillary circulation.—The flow of blood in the smallest arteries and veins and in the capillaries is observed with the microscope in transparent parts of animals such as the web and mesentery of the frog, the tail of the tadpole, and the mesentery of small mammals.¹

¹ For the methods of displaying these parts, see the author's *Course of Practical Histology*, in which full details are given.

CHAPTER XX

THE PULSE. ARTERIAL PRESSURE IN MAN

The pulse in the arteries.—Feel the pulse in the radial artery and determine and note (1) its rate, (2) its quality, whether hard or soft, bounding, readily compressible, etc. Apply a *sphygmograph*, either

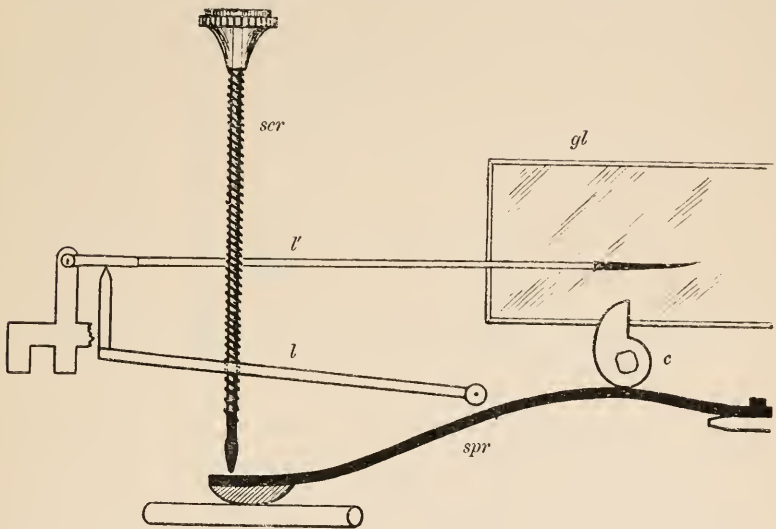

FIG. 70.—DIAGRAM OF MAREY'S SPHYGMOGRAPH. *spr*, SPRING WITH BUTTON FOR RESTING ON RADIAL ARTERY; *c*, CAM, FOR EXERTING PRESSURE ON THE SPRING; *scr*, SCREW CONNECTING SPRING WITH DOUBLE LEVER *l, l'*; *gl*, SMOKED GLASS OR PAPER FOR WRITING THE PULSE.

Marey's original pattern (fig. 70) or the modification devised by Dudgeon (fig. 71). Using the cam, exert such pressure upon the spring of the sphygmograph as will allow the variations in pressure within the artery to be most manifest. The tracings are taken on slips of paper smoked over a candle. Write on each slip the name of the subject of the experiment and the pressure which was employed; varnish and preserve.

The venous pulse.—In a recumbent subject fix a small open receiving tambour (a small thistle funnel will do) at the place in the lower part of the neck where the venous pulse in the jugular is most distinct. The receiving tambour is connected by rubber tubing to a small recording tambour, and the curve is written on paper moved slowly by clockwork. A tracing of the carotid pulse can be obtained on the same paper, another tambour being fixed over the artery. A convenient apparatus for taking such tracings is the *polygraph* of Mackenzie. In this instrument there is a continuous roll of white paper on which the tracings are recorded with ink.

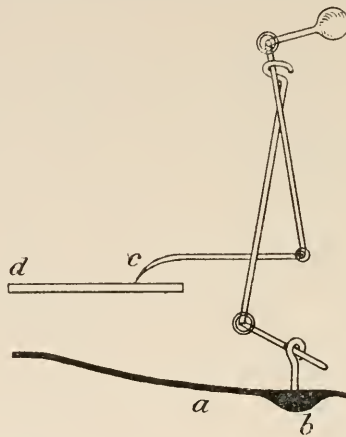

FIG. 71.—DIAGRAM TO SHOW THE LEVER-MECHANISM OF THE DUDGEON SPHYGMOGRAPH. *a*, SPRING; *b*, BUTTON TO BE APPLIED TO THE RADIAL ARTERY; *c*, WRITING POINT OF JOINTED LEVER ATTACHED TO SPRING; *d*, GLASS PLATE OR PAPER ON WHICH THE TRACING IS RECORDED.

Arterial pressure in man.—The pressure of the blood within the human arteries is determined by the *sphygmometer*, of which many forms are available. All have a circular rubber bag (fig. 72, *a*) which is enclosed by leather and is placed round the upper arm. The bag is distended with air by a pump (*c*), the amount of pressure used being recorded either by a mercury manometer (Riva-Rocci) (*b*) or an aneroid (Hill and Barnard) or by compression of air in a closed tube, using a mercury index (G. Oliver). As the distension progresses the manometer shows not only the gradual increase of pressure but also oscillations due to the pulse. These oscillations increase in magnitude up to a certain point. The point around which the oscillations are greatest is the measure of *diastolic* or *average pressure*. On further raising the pressure the oscillations again become smaller, for the brachial artery is now becoming occluded. When it is completely occluded the pulse

ceases to be felt at the wrist ; this point is the measure of *systolic* or *maximal pressure*.

It is not always easy to determine the exact point at which the pulse ceases to be felt. The difficulty is got over by Oliver, who attaches a small tambour

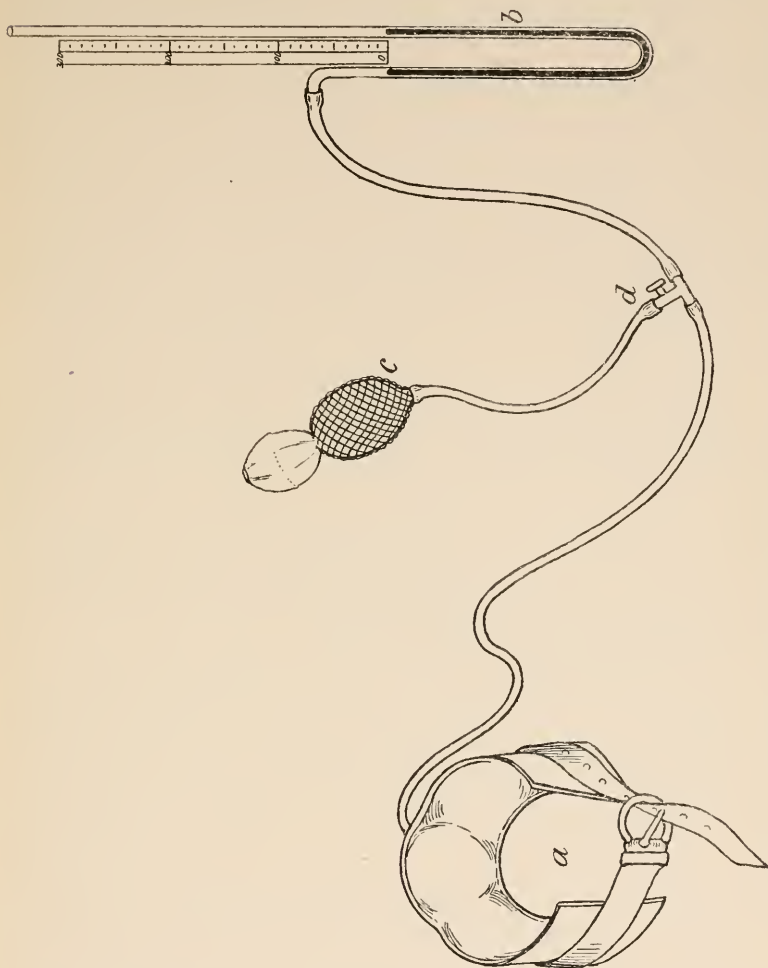

FIG. 72.—RIVA ROCCI APPARATUS FOR DETERMINING ARTERIAL PRESSURE IN MAN. *a*, LEATHER ARM-BAND WITH RUBBER BAG AS LINING ; *c*, PUMP FOR FORCING AIR INTO THE BAG ; *d*, VALVE FOR LETTING AIR OUT OF THE SYSTEM ; *b*, MERCURY MANOMETER.

over the brachial artery at the elbow and connects this with a binaural stethoscope. As the pressure is raised over the upper arm the pulse beats become very distinctly heard in the artery at the elbow, but when the pressure is sufficient to occlude the brachial the beats instantly cease. This observation enables the systolic pressure—which is the point of most value clinically—to be determined with great exactitude.

CHAPTER XXI

PERFUSION OF VESSELS. LYMPH-HEARTS

Estimation of contraction or dilatation of vessels by measurement of perfusion rate.—Tie a small glass cannula, bent round so that its limbs are parallel, into the aorta of a large frog killed by destruction of the nervous system; it can either be passed directly into the cut aorta or more easily through an incision in the ventricle.

In exposing the heart and aorta make as small an opening as possible. First remove a flap of skin, then cut through the upper part of the ensiform cartilage and extend the incision on either side of the sternum: force this up like a flap until the heart is sufficiently exposed.

The cannula must be filled with Ringer's solution, and connected through an india-rubber tube with a reservoir of the same fluid so that the fluid is slowly dropping from it during its introduction; this is for the sake of excluding air bubbles.

Suspend the frog by a pin through the jaw, and fix the reservoir a short distance above the head so that the fluid flows into the vessels by gravitation. Make a cut into the sinus venosus to enable the fluid to flow freely out after it has traversed the blood-vessels of the body; the escaping fluid will drop from the toes, which should be tied together. A cut must also be made through the skin of each foot to prevent any accumulation in the lymph-spaces of the legs. Count the number of drops per minute, and repeat the counting twice; after the blood is completely washed out the flow should be fairly regular.

To test the effect of drugs or reagents upon the muscular tissue of the arterioles the reagent is added in known quantity to the perfused fluid. The Ringer's fluid to which the drug is to be added is placed in a second reservoir as in perfusion of the frog heart (see fig. 61, p. 70). Again count the number of drops per minute (3 estimations), and thus determine whether the arterioles are becoming dilated or contracted as the effect of the reagent. This experiment may be tried

with Ringer's solution containing acid (HCl, 1 in 5000) and alkali (NaOH, 1 in 5000), with a very dilute extract of suprarenal, and with solutions of chloroform and ether in Ringer's solution. Normal Ringer's solution must invariably be substituted afterwards for that containing the drug, and a third determination made in the same way (average of three counts).

The same method is used for perfusion of the organs of mammals. The cannula is tied into the artery of the (excised) organ, which is placed in a jacketed funnel warmed to 40° C.: the perfused fluid, which must also be warmed before entering the organ, escapes by the vein and runs down the funnel into a measuring vessel. In this way perfusion can be conducted through the kidney of the dog or sheep, or through the vessels of a limb. In the case of mammals it is important to allow oxygen to bubble through the Ringer solution used for perfusion.

Methods of recording the outflow of fluid.—1. The sequence of drops can be recorded by aid of an electric drop recorder connected with an electro-magnetic signal, which writes upon the smoked paper of a drum.

2. Another method of graphically registering the rate of flow, especially if the drops follow one another too fast to be recorded individually by a drop-recorder, is furnished by the "tilter" shown diagrammatically in fig. 73. This is a small vulcanite or celluloid trough with open ends with a septum across the middle; the trough is balanced on a vulcanite knife-edge. The drops are led over the middle, and, falling on the side of the septum which happens to be uppermost, they gradually fill that side of the trough.

When full, it overbalances, and the trough tilts over to the other side, when the process is repeated. Each double movement of the tilter is registered, either by an electrical or a pneumatic arrangement, upon the recording paper, on which the time is also written. The capacity of the tilter being known, the amount of fluid flowing in a given time is ascertained. The record will continue automatically for long periods.

The above methods are also used to record the flow of secretions (Chapter XXII.).

Lymph-hearts.—Place a frog the brain of which has been destroyed, or which has been decapitated, in the prone position on the frog-cork, and reflect the skin from either side of the urostyle. Notice the pulsation of the lymph-hearts beneath the fascia on each side: usually they do not synchronize. Destroy the spinal cord completely by a wire. The lymph-hearts now cease to beat: their pulsations are dependent on the spinal cord.



FIG. 73.—DIAGRAM OF TILTER. THE ROCKING MOVEMENTS ARE RECORDED EITHER BY ALLOWING THE ACCUMULATED FLUID TO ACTUATE A TAMBOUR, OR BY AN ELECTRO-MAGNETIC SIGNAL.

CHAPTER XXII

MECHANISM OF SECRETION

THE process of secretion may be studied in the salivary glands, the pancreas, the kidneys, and the mamma. The influence of nerves upon secretion is illustrated by the salivary glands, that of hormones by the pancreas and mamma: the secretion of the kidneys is also dependent partly upon chemical agents, but largely upon the blood-pressure and blood-flow through the organ.

The submaxillary gland.—A dog, having been anæsthetised, is fixed on its back and a vein cannula inserted into a saphenous vein. An incision is then made on one side through the skin and fascia below the mouth extending from the chin backwards for three or four inches nearly parallel with the line of the lower jaw. At the posterior part of the wound the submaxillary gland may be observed. The anterior belly of the digastric, which comes into view and conceals the hilum of the gland, is drawn over laterally by a weighted hook: or it may be cut away. Any oozing from small vessels is controlled by rinsing the wound with dilute extract of suprarenal: larger vessels are tied. A muscle—the geniohyoid—is now exposed: it is composed of transverse fibres. When it is cautiously cut through, the duct of the submaxillary gland (Wharton's duct) is seen passing obliquely forwards towards the floor of the mouth. It is accompanied by a smaller duct, that of the sublingual. Crossing these ducts is a conspicuous nerve—the lingual branch of the 5th. If this is drawn towards the middle line with a blunt hook, it is seen that just before it crosses the ducts it gives off a small nerve—the chorda tympani—which runs sharply backwards and enters the hilum of the submaxillary gland, where the duct is emerging. Tie a thread around the lingual above the place where the chorda leaves it, and, without injuring it, clear a short length of the chorda so that a small pair of flat electrodes can be placed underneath it. Stimulate by induction shocks: the duct will fill with saliva.

Place a wet thread round the duct and slip a pointed piece of paraffined paper under it. Make a snip into it with fine scissors; pass a "finder" into the aperture. Substitute for the "finder" a very fine metal or glass cannula, and tie this in: a piece of small rubber tubing can be used to conduct the secretion beyond the edge of the jaw, where it can be allowed to drop into a beaker.

On the same side of the neck make a longitudinal incision through the skin and fascia, and separate the muscles so as to expose the carotid artery and the common trunk of the vagus and sympathetic nerves. Ligature this combined nerve low down, and place the upper end on a second pair of electrodes. The two pairs of electrodes—for chorda and sympathetic respectively—are connected to a commutator without cross-wires, and this with the secondary coil, so that stimulation can be led into either pair at will.

1. Stimulate the sympathetic. A few drops of thick viscid saliva are secreted.

2. Stimulate the chorda. There is a rapid flow of watery saliva lasting as long as the excitation is continued.

3. Inject a small amount of pilocarpine nitrate (2 or 3 milligrams) into the saphenous vein. This produces an intense secretion.

4. Inject a small amount of atropine sulphate (5 milligrams) into the vein. The flow produced by pilocarpine immediately stops.

5. Stimulate the chorda. The strongest stimulation produces no effect. Atropine has paralysed the nerve endings.

6. Stimulate the sympathetic. A few drops of saliva may be secreted. The dose of atropine is insufficient to abolish the action produced through the sympathetic.

The pancreas.—A dog is anaesthetised and a cannula tied into the saphenous vein. Open the abdomen by an incision in the linea alba. Find the duodenum and bring it up to the surface: the pancreas is seen in the mesentery within its curve. The duct of the gland—canal of Wirsung—may be found without difficulty near the lower end of the part of the gland which is in contact with the duodenum. Isolate a short length of the duct with forceps; pass a wet ligature round it and slip a pointed piece of paraffined paper under it. Make a snip into the duct with fine scissors, introduce a finder, substitute for the finder a fine metal or glass cannula, and tie this in. Attach a short piece of rubber tubing to the cannula, bring the end of this outside the wound, and let the drops of secretion fall into a beaker.

1. Inject into the saphenous vein 5 c.c. of an extract of duodenal mucous membrane of any animal. The extract is made by boiling the clipped mucous membrane with 5 per cent. hydrochloric acid, cooling the decoction, neutralising with dilute alkali, and filtering. It contains *secretin*, which has the effect of producing a rapid flow of pancreatic juice when injected into the circulation.

2. Inject pilocarpine nitrate and compare the effect with that of secretin.

The mamma.—A lactating animal (cat) is anaesthetised and a cannula tied into the external jugular vein. Vaseline the fur over one of the mammae, and arrange the animal so that this gland slightly overhangs the edge of the animal board. Cut away the nipple of that mamma and make a short transverse incision into the substance of the gland. Still any bleeding with cotton-wool or with dilute suprarenal extract. Some milk may ooze out: it will run down the vaselined fur, and can be caught in a beaker.

1. Inject into the vein 1 c.c. of a 10 per cent. decoction of corpus luteum (filtered). Milk will, in a minute or two, exude and drop rapidly from the gland.

2. Inject into the vein 1 c.c. of a 10 per cent. decoction of posterior lobe of pituitary body. The same result will ensue, but the flow will be more rapid.

The kidney.—In an anaesthetised rabbit or cat tie a cannula into the jugular vein and connect the carotid with a manometer for taking blood-pressure. Make an incision through the skin and muscles on the left side of the abdomen near the back over the situation of the kidney, which is easily felt. After exposing the kidney, bring it towards the surface, clear it partly of fat, and allow it to lie in a suitable plethysmograph (fig. 68) the margins of which have been vaselined, and place over it a glass cover also well vaselined: the cover is clipped down on to the plethysmograph. The blood-vessels and ureter pass out at a chink (*g*) left on one side of the plethysmograph; the chink is made airtight with vaseline. A tube leads from the plethysmograph to a piston recorder (*p.r.*) writing on smoked paper. Make another incision in the lower part of the abdomen in the middle line; find the urinary bladder; hold it up with two pairs of clamp forceps; loop a ligature round it just outside these; make an incision into it, and introduce a glass cannula, which must then be tied in. The urine can be led from this cannula over the side of the animal by a rubber tube, and the drops can be registered by a drop-recorder.

1. Inject pituitary extract into the vein, and record the effect on blood-pressure, kidney, volume, and urine.

2. Inject a few milligrams of caffeine citrate into the vein, and record its effect in the same way.

3. Inject atropine sulphate (5 milligrams). This has no effect on the secretion of the kidney (compare with its effect on salivary secretion).

CHAPTER XXIII

RESPIRATION

The respiratory movements in man.—Examine the chest during quiet respiration, and notice the parts in which movement is most evident; the same with forced respiration. Observe the alteration in obliquity

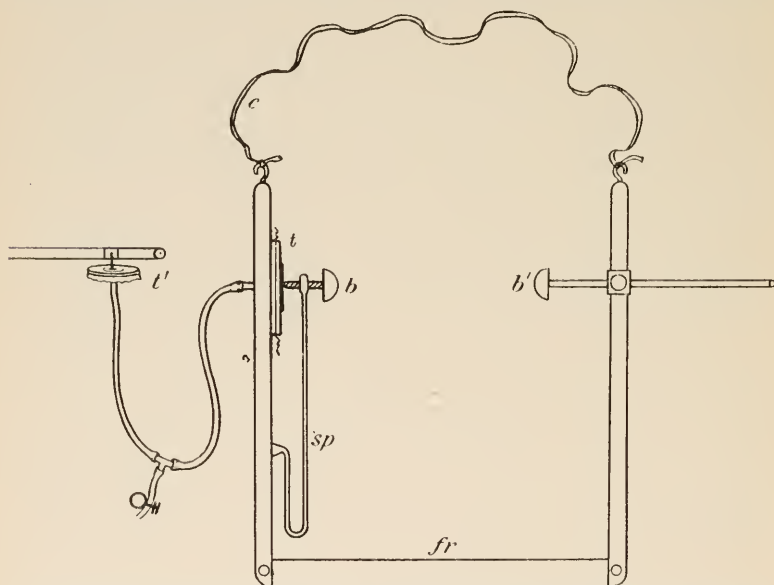

FIG. 74.—BURDON-SANDERSON'S STETHOGRAPH. *fr*, FRAME SUSPENDED OVER THE SHOULDER BY CORD, *c*; *b*, *b'*, BUTTONS APPLIED TO OPPOSITE SIDES OF THE CHEST WALL; *sp*, STEEL SPRING; *t*, RECEIVING TAMBOUR; *t'*, RECORDING TAMBOUR.

and other changes in position of the ribs, rib-cartilages, sternum, and epigastrium. Apply the ear directly or through a stethoscope to the chest wall and listen to the vesicular murmur. Count the rate of respiration and compare it with that of the pulse of the same individual.

For the following experiments the slowest rate of drum is to be used, and the subject must not be allowed to see the tracing which is being taken.

Record of respiratory movements.—Apply a stethograph (Marey's or Sanderson's) (fig. 74) to the chest, and register the movements of respiration by means of a recording tambour.

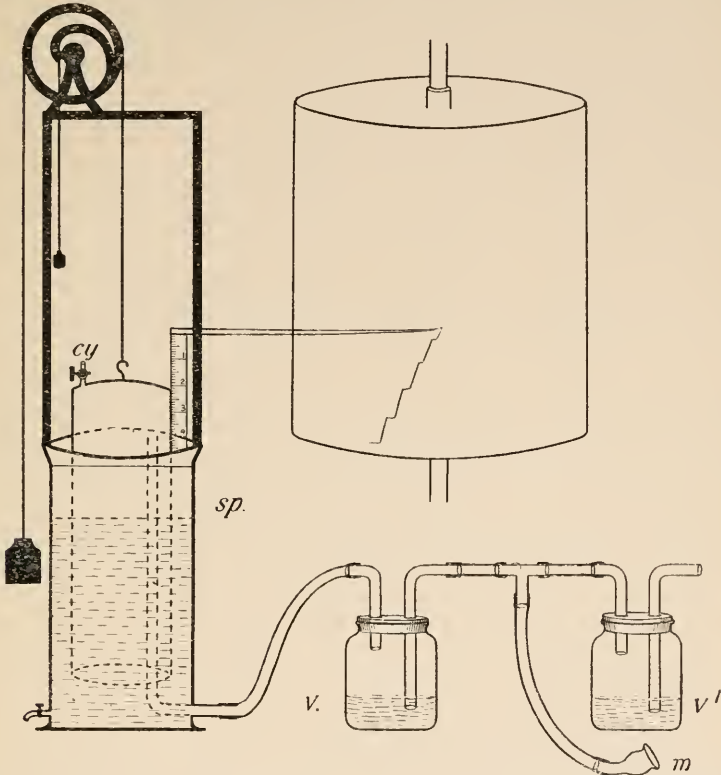

FIG. 75.—SPIROMETER ARRANGED TO REGISTER, UPON A SLOWLY REVOLVING DRUM, THE AMOUNT OF AIR RESPIRED. *sp.*, BODY OF SPIROMETER; *cy*, MEASURING CYLINDER WITH SCALE AND WRITER ATTACHED; *v*, *v'*, WATER VALVES; *m*, MOUTHPIECE.

Apnœa.—Remove the lever of the recording tambour from contact with the drum. Cause the subject to take a number of deep respirations at a rapid rate. Then let him cease these voluntary efforts, and take a record of the ordinary breathing which succeeds to them. There will probably be a pause (apnœa) followed by respirations which are at first shallow but gradually become of the ordinary character.

Measurement of amount of air passing into and out of lungs.—Using either an airtight mask or a mouth-tube (in this case the nostrils

must be closed by a clip) provided with valves (see diagram, fig. 75), allow the subject to breathe during one minute into a carefully balanced spirometer. Count the number of respirations in the given time and note the amount of air which has been breathed in that time. From these results calculate the tidal air passing through the lungs with each respiration. The observation should not be

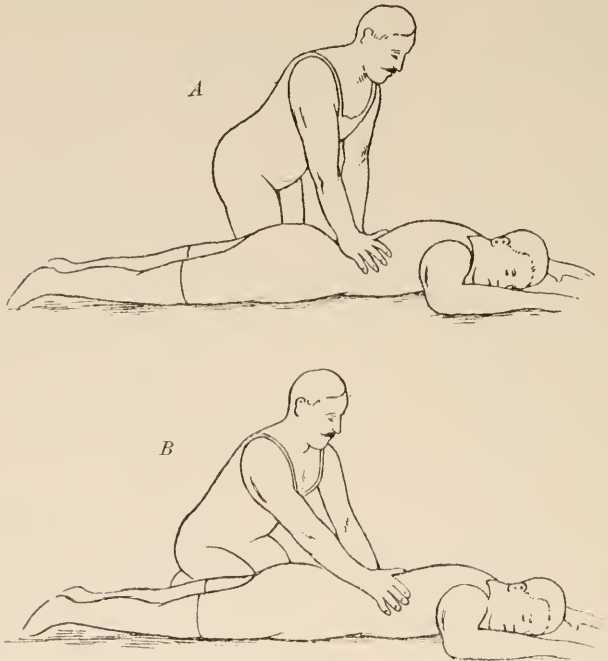

FIG. 76.—PRONE-PRESSURE METHOD OF ARTIFICIAL RESPIRATION. A, PRESSURE BEING APPLIED; B, PRESSURE REMOVED.

begun until the subject is breathing regularly and unconsciously, and he must not be permitted to see the spirometer.

Reserve air, supplemental air, vital capacity.—Determine in your own person with the spirometer the amounts of each of these and note down the results.

Measurements of the chest and abdomen in deepest inspiration and in deepest expiration.—Determine these upon yourself (*a*) at the level of the armpits, (*b*) at the level of the lower end of the sternum, (*c*) at the level of the umbilicus, using a tape measure. Note down the results.

Artificial respiration in man.—Place the subject flat on the ground

in the prone position with the head on one side. Kneel or squat by the side of or across the lower part of the body, facing the head, and place your hands flat on the loins with the thumbs nearly touching at the spine (fig. 75). Throw the weight of your body forwards on the hands, keeping your arms straight (*A*), and count slowly *one, two, three, four, five*. Whilst counting *four, five*, swing backwards (*B*) so as to take the weight off your hands. Then swing forward again, counting, as before, *one, two, three*, and backwards, counting *four, five*; and so on about twelve to fifteen times a minute. The effect of the pressure is to force the abdomen and lower part of the chest against the ground so that the viscera are pressed against the diaphragm. In this way air is driven out of the lungs. On relaxing the pressure the parts resume their former position; the diaphragm descends and air is drawn into the lungs.

The amount of air thus pumped through the lungs in a minute can be measured by the spirometer in the same way as the tidal air measured in natural respiration.

Negative pressure within thorax.—Introduce through an intercostal space into the pleural cavity in the human cadaver or in any dead animal a sharp-pointed cannula or hollow trochar connected by rubber tubing to a water manometer. Notice that as soon as the trochar passes into the pleural space the water in the distal part of the manometer sinks and registers a certain amount of negative pressure within the thorax.

Effects of stimulation of nerves and of asphyxia upon the respiratory movements of animals.—These have been studied in connexion with blood-pressure (see pp. 81, 82).

CHAPTER XXIV

PERIPHERAL NERVES

Nerve-roots ; Magendie's experiment.—Decapitate a large frog and fix it securely in a prone position on the frog-cork. Cut away the skin along the whole length of the spine. With a pair of strong but fine scissors sever the neural arches on each side, working from above down, and removing them so as to expose the spinal cord and the nerve roots. The dorsal roots are distinguished both by their position and by the ganglia through which they pass ; they are especially large and long in the lumbo-sacral region. Cut them here on one side of the body.

1. Tetanise the skin of the corresponding foot. No reflex movement is produced : although if the skin of the opposite foot be stimulated, strong movements are produced in both limbs.

2. Stimulate the distal end of one or more of the cut roots. If care be taken that the current does not spread to a ventral root, no movement results.

3. Stimulate the proximal end. Strong reflex movements are caused. Now cut the ventral roots on the same side in the same region. Notice that on cutting them the leg muscles contract.

4. Stimulate the peripheral end of one or more of the cut ventral roots. There is strong contraction of muscles of the corresponding limb.

5. Stimulate the central end of the same. No effect is observed.

N. B.—The excitation used for the roots may be mechanical, such as a pinch or snip of the scissors near the cut end. In this case errors which with electrical stimulus may arise from spread of current are obviated. But if the Helmholtz arrangement is used and only weak induction shocks employed, the risk of spread is much reduced.



CHAPTER XXV

REFLEX ACTION: REACTION TIME

A FROG the brain of which has been removed¹ is used for the following experiments. Note the position of the animal when placed on the table, and the absence of spontaneous movements. Suspend the preparation by the lower jaw (fig. 78). Have ready a large jar or beaker of water (*a*), a small beaker of 2 per 1000 sulphuric acid (*b*),

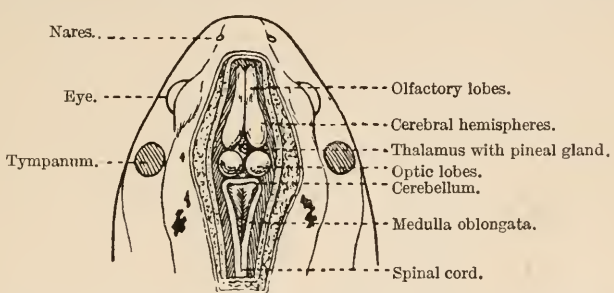

FIG. 77.—BRAIN IN FROG *in situ*, EXPOSED BY REMOVING THE ROOF OF THE CRANIUM.

and some small pieces—about 2 mm. square—of filter paper, moistened with 5 per cent. acetic acid. A watch, with seconds hand, or a metronome is also required.

Effect of strength of stimulus.—Gently pinch the toe of one foot with forceps; the leg is drawn up. When again quiescent pinch the toe more firmly; not only the one, but both legs are drawn up,

¹ For some of the experiments on reflex action the whole contents of the skull are destroyed. This can be done without hæmorrhage by inserting a sharp-pointed plug of wood through the occipital foramen. For other experiments only the cerebrum or brain proper is destroyed, the optic lobes and medulla oblongata being left. This is effected either by crushing the anterior part of the skull with Spencer Wells forceps; or by opening the skull and removing the hemispheres in an anæsthetised animal; or simply by cutting away all the part of the skull in front of the tympanic membranes with stout scissors.

and there may also be a movement of the upper limbs (*spread of excitation*).

Effect of summation of stimuli.—Stimulate the toe (1) with single and (2) with interrupted induced currents. Determine and note down

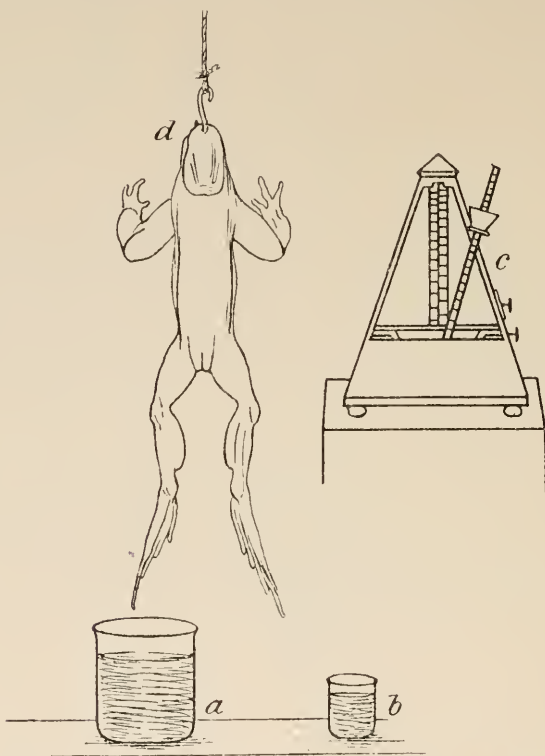

FIG. 78.—TURCK'S METHOD OF DETERMINING TURN OF REFLEX TO ACID-STIMULUS APPLIED TO TOES OF DECAPITATED FROG. *a*, BEAKER OF WATER; *b*, BEAKER OF DILUTE ACID; *c*, METRONOME; *d*, HOOK SUSPENDING FROG BY LOWER JAW.

at what distance of the secondary coil from the primary the reflex response is elicited in each case.

Purposeful reflex action.—Place on one flank a piece of paper moistened with acetic acid; the foot of the same side is raised to rub off the irritant; if that foot is held down, the other foot may be used.

After the observation do not leave the acid in contact with the flank, but wash it off by bringing a large beaker of water up over the legs and lower part of the trunk. The experiment may be repeated upon other places; *e.g.* the inside of one thigh, the upper part of the body, and the abdomen, always washing the acid away after each observation.

Time of reflex response ; Türk's method.—Having allowed the frog to become quiescent, allow the extremity of the toes to dip into a small beaker of dilute sulphuric acid (2 per 1000). Count the time in half-seconds which elapses between the application of the acid and the withdrawal of the toe. Wash the acid off immediately after the withdrawal. Repeat this observation three times at intervals of a few minutes ; calculate and record the average time of response.

Inhibition of reflex by an accompanying excitation ; Setschenow's experiment.—Place a crystal of chloride of sodium upon the optic lobes (or on the upper cut end of the cord if the whole brain have been removed), and again determine the time of response after application of the dilute sulphuric acid to the toes.

Reflex inhibition of heart.—Fix the frog securely on its back upon the frog-cork ; expose the heart sufficiently for its beats to be observed. Tap the abdomen smartly with some small heavy instrument such as a metal rod or the handle of a knife. The effect will be to produce a slowing or complete stoppage of the heart, which will, however, soon recommence beating. The same result is obtained if the abdomen be opened and a loop of intestine strongly stimulated.

For this experiment the medulla oblongata must be left.

Effect of strychnine on reflex action.—Inject a very small dose of strychnine nitrate (1 drop of a 1 per 1000 solution) under the skin of a decerebrate frog, and wait for a few minutes until it is absorbed into and distributed by the circulation. It will be found that pinching the skin eventually produces not simple purposeful reflex actions, but convulsive contractions of all the muscles in the body.

Tendon reflex ; knee jerk.—In a subject seated in a chair with one leg crossed over the other, or seated on a table with the legs dangling, strike the patellar tendon with the handle of a knife or the back of a thin book. Notice the sudden jerk forward of the leg owing to the contraction of the vastus internus. This can be recorded by a transmission myograph (see p. 38).

Reinforcement of tendon reflex.—Just before striking the patellar tendon cause the subject to clench his fist. The movement of the leg will be stronger, or will be elicited with a slighter tap on the tendon.

Reflex action in mammals.—The reflex actions which depend upon the spinal cord can be studied in a Sherrington preparation (see p. 81), reflexes being elicited in various ways, as by pinching or pricking one of the paws or the skin of the flank or side of the thorax. Tendon-reflexes, such as the knee jerk (see above) and the ankle-clonus, obtained by forcibly bending the foot at the ankle, can also be well observed in such a preparation.

Reaction time in man.—The reaction time in man may be determined by an arrangement of electric signals, but is done more simply by Waller's apparatus (fig. 79). This consists of two wooden levers lying across a piece of india-rubber tube, one end of which is closed, the other being connected with a tambour which writes upon a drum, the speed of which should be moderate. A screen hides the movements of the experimenter from the person experimented on, who sits at the table with one finger resting lightly on the extremity of one of the levers. He is to respond by pressing the

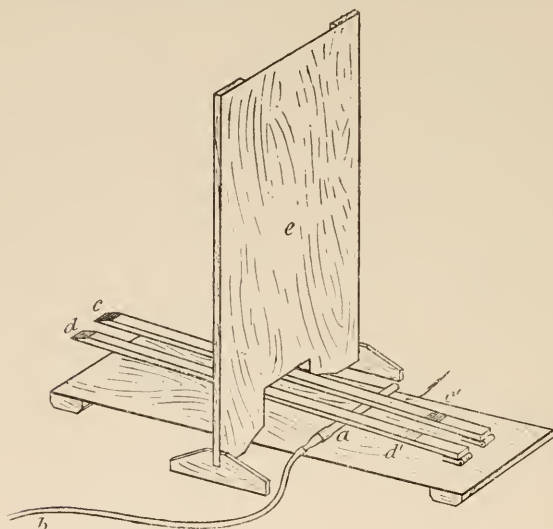

FIG. 79.—WALLER'S APPARATUS FOR REACTION TIME. *a*, RUBBER TUBE CLOSED AT ONE END AND AT THE OTHER CONNECTED BY *b* WITH A TAMBOUR (NOT SHOWN); *c*, *c'*, *d*, *d'*, LEVERS (WITH COLOURED PATCHES) HINGED NEAR *c'*, *d'*, AND RESTING ON THE RUBBER TUBE, *a*; *e*, WOODEN SCREEN.

lever the instant he (1) feels a movement of that lever, his eyes being shut; (2) hears a tap on the second lever; (3) sees a movement which is imparted to the second lever by the experimenter, who presses it down on the other side of the screen. In each case two marks are recorded upon the abscissa: one being that which is made by the experimenter in imparting the stimulus, and the other that made by the observed person in responding. The interval between the two marks, which can be accurately measured by the aid of a time tracing, indicates the time between stimulus and response—*i.e.* the reaction time—in the case of each of the three senses. To record this with any accuracy several observations must be made with each method of stimulation and the average time calculated.

Discrimination time.—For the measurement of this the observed person places one finger over each lever. It is agreed beforehand that he is only to react to a stimulus received on the one side, not on the other. The experimenter may stimulate either. It will be found that the reaction time is lengthened by a certain interval, and this increase of reaction time is termed the *discrimination time*. Determine and record this.

Volitional time.—Similar arrangements are made, but with the understanding that it is only the hand on the side which receives the stimulus which is to be used for the response. The reaction time is now found to be still more lengthened because the observed person has to make a double decision; viz., to determine not only which of the two hands has been stimulated, but also which one he has to use in response to the signal.

Variations of the above experiments can be made with the employment of different sounds and the exhibition of different colours, but the methods for recording the reaction times are essentially the same. For rapid and accurate work it is usual to employ a specially constructed clock which can register the time of a reaction to a fraction of a second.

Excitation of the cortex cerebri.—A monkey, anaesthetised with ether, is used for this demonstration. A considerable portion of the skull cap is removed on one side by trephining the skull and enlarging the aperture by bone-forceps. The dura mater is then cut through below and reflected towards the middle line, thus exposing the cerebral surface. A pair of blunt-pointed platinum electrodes, with their points 1 mm. apart, is connected with a du Bois key in the secondary circuit of an induction-coil (use the Helmholtz modification) and applied to various spots in the excitable region of the frontal lobe, the first temporal gyrus, and the occipital lobe, and the results are noted.

The monopolar method of stimulation may also be employed for these observations. In this case one electrode is a flat pad of wash leather wetted with strong salt solution, and the other [stimulating] electrode is a small spiral platinum wire with blunt point, which is applied to the excitable areas of the cortex.

CHAPTER XXVI

CUTANEOUS SENSATIONS

Cutaneous sensations ; Pain spots.—Explore with an ordinary pin a portion of the skin of the forearm or back of the hand of another person (who should keep his eyes closed), pressing the point firmly here and there, but without penetrating the surface. Notice that whereas at some places the prick is painful, at others no pain is caused, the feeling being either one of touch or pressure or no sensation is produced.

Warmth spots.—Substitute for the pin a steel or copper rod with a smooth blunt point, like a knitting-pin ; the rod may be provided with a wooden handle. Warm the rod by immersing it in water heated to 50° C. Explore the skin by drawing the warm point of the style slowly over it. It will be found that the sensation is only one of warmth at certain points, where it is very distinct ; at others it is merely a sensation of touch.

Cold spots.—Repeat after cooling the rod by immersing it in ice-cold water. In this way spots sensitive to cold alone can be picked out : they are not the same as those which are sensitive to warmth.

The various spots may be mapped out upon a patch of the skin with coloured inks or pencils, and may be tested again later. They are constant in position.

Touch sensations ; Determination of the relative delicacy of different parts to touch.—Take a fine bristle or coarse hair two inches long, and fix it with sealing-wax to a match to serve as a holder (fig. 80). Explore in another person (who is not to see the part which is touched) any part of the skin, determining the spots which are most sensitive to the pressure of the hair. The point of this is to be brought vertically on the skin without lateral movement and pressed down only just enough to bend it slightly. By using a number of bristles of different thickness a certain rough scale of delicacy of touch on different parts of the body

can be made out. Notice that the slightest side-movement greatly increases the sensitiveness of any part to the touch, especially if any hairs are deflected. This can also be shown with a scrap of cotton-wool, the touch of which may be imperceptible until it is moved.

The series of bristles just described form collectively v. Frey's æsthesiometer. In place of these, an instrument is sometimes used consisting of a fine blunt needle set in a handle, within which is a delicate spiral spring furnished with an index to show the amount of pressure required before a sensation is caused. But in general this is found more difficult to apply than the bristles.



FIG. 80.—v. FREY'S HAIR ÆSTHESIOMETER.

Graham Brown's æsthesiometer consists of a convex piece of steel with a polished surface, a part of which can be made to project beyond the rest by turning a truly cut micrometer screw. The surface is passed lightly over the surface of skin to be tested, or *vice versa*. The relative delicacy of touch is gauged by the power of feeling different degrees of projection.

Discrimination of two points.—For this purpose a pair of compasses with blunt points is used; their distance apart is measured upon a scale after each observation. Or the points may be permanently connected with the scale, one being fixed at its zero and the other sliding along it (Sieveking's æsthesiometer). Test in this manner in another person various parts of the integument (back and front of arm, fingers, lips, tip of tongue, etc.) and record the distances at which the two points are discriminated as separate, causing them always to touch simultaneously, and without lateral movement.

Accuracy of localisation.—This is investigated by lightly touching any part of the skin and immediately causing the subject to place his finger upon the part touched.

In all the above experiments the subject should be blindfolded.

CHAPTER XXVII

EXPERIMENTS ON THE DIOPTRIC MECHANISM

AN eye (ox, sheep, or pig) is to be dissected. (1) After cleaning away from the globe all remains of muscles, fat, etc., cut a window out from the back, removing the sclera and choroid and exposing the retina. Notice that when the cornea is turned to the window an inverted image of this is formed upon the retina. (2) Cut away a small portion of the sclera at the edge of the cornea. A grey-looking ring of plain muscular tissue is exposed, the fibres passing from the corneo-sclerotic junction backwards over and into the choroid. This is the ciliary muscle. (3) Cut the eye in two at its equator. Notice, in the posterior half, from which the jelly-like vitreous humour flows away, the retina—usually somewhat opaque and crumpled after death—spreading out from the entrance of the optic nerve; in the anterior half the lens within its capsule, the suspensory ligament around the margin of the lens, the radiating ciliary processes. (4) Snip through the suspensory ligament all round the lens, which can be removed within its capsule; the iris is now seen projecting into the anterior chamber.

Accommodation; Change in shape of the lens.—That the lens bulges forward in accommodation is shown in various ways.

1. Stand at the side of another person and let him fix his vision on a distant object, looking beyond a near object such as a needle or pencil held a few inches from the eye. Notice his iris which can be seen through the edge of the cornea lying against the front of the lens. Now let the subject look at the near object. His iris is seen to advance, being pushed forwards by the bulging lens; the pupil at the same time contracts.

2. *Sanson's images.*—In a dark room hold a candle at one side of the eye of a subject, and, standing on the other side, observe the reflected images—a bright one from the front of the cornea, a less bright one from the front of the lens, and a duller, small, and inverted image—difficult to see—from the back of the lens. The subject as before is to have his vision fixed at first on a distant object, and is then to transfer his gaze to a near object in the same line. The image reflected from the front of the lens becomes smaller and moves nearer to that reflected from the front of the cornea; the other

images remain unaltered. This change of the second image is due to bulging of the anterior surface of the lens.

3. *Phakoscope*.—The same experiment may be performed with a phakoscope (fig. 81) with less trouble, since all the points are fixed. The instrument—a triangular box with truncated angles *a*, *b*, *c*—is used in a darkened room. A lamp is placed in such a position that the light from the two square window prisms at *c* falls upon the observed eye at *a*. The observer looks through the opening at *b* and sees in the observed eye three pairs of images—two bright squares (reflected from the anterior surface of the cornea), two larger but less distinct squares, and two smaller and much dimmer squares. The two last pairs, being reflected from the anterior and posterior surfaces of the lens respectively, can, of course, only be seen within the pupil. The last pair is difficult to

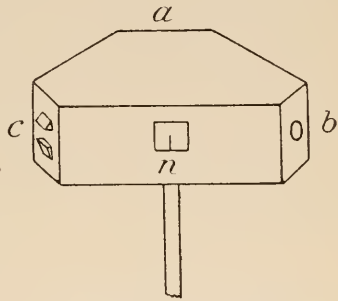

FIG. 81.—PHAKOSCOPE; *a*, SITUATION OF OBSERVED EYE; *b*, DITTO OF OBSERVER'S EYE; *c*, LENSES; *n*, APERTURE WITH NEEDLE.

make out. If the subject be asked, first to look *through* the needle *n* at a distant window and then *at* the needle, the middle pair of images become smaller and slightly brighter; they also approach each other and come nearer to the corneal images during accommodation for the near object; the other two pairs remain unaffected.

Near and far points of distinct vision.—A wooden scale about twelve inches long is marked in inches or centimeters. One end of this is placed close to the eye, and a needle is put in about five inches off. If the eye is normal, it should be seen sharply at this distance and at any point beyond; but if it is brought nearer the eye its image becomes blurred. If the eye is myopic the needle may be brought nearer than five inches without its image being blurred; when this occurs the near point for that eye has been passed.

If the eye is hypermetropic the needle will already appear blurred at five inches, and it may be required to be moved considerably further from the eye before the near point of distinct vision is passed.

Pater Scheiner's experiment.—The observation is rendered easier and more striking by Scheiner's device of observing the needle through two pinholes made close to one another and side by side in a card fixed vertically at one end of the scale (fig. 82). In this

case, when the needle is nearer to or further from the near or far points of distinct vision, its image appears not blurred but double.

That the eye cannot obtain a sharp image simultaneously of a near and a distant object is shown by taking two needles and fixing one at about five inches along the scale and the other some inches further. If now, in Scheiner's experiment, the eye is focused on the near needle the far one looks double, and *vice versa*.

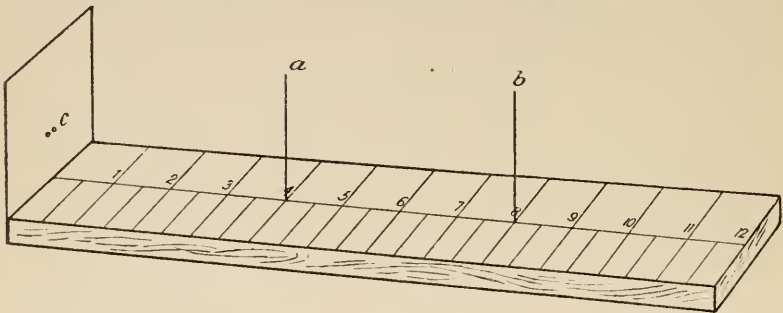

FIG. 82.—BOARD WITH PERFORATED CARD FOR SCHEINER'S EXPERIMENT. *a, b*, NEEDLES; *c*, PERFORATIONS IN CARD.

Changes in the pupil produced by drugs.¹—Carefully enucleate the eyeballs of a frog which has just been killed and place each in a watch glass of Ringer's solution. Measure the diameter of the pupils with compasses and note down the size of each. Add to the contents of one watch glass a drop or two of extract of suprarenal capsule or of dilute solution of eserine or of atropine. After a short time again measure the pupils. Repeat the measurement after an hour or more.

The effects of drugs are also investigated, in man or animals, by dropping them on the conjunctiva, and, in animals, by injecting them into a vein.

The Ophthalmoscope.—This instrument, which is used for examining the interior of the eyeball, consists essentially of a small concave mirror with a hole in the centre. (For the indirect method a biconvex lens is also required.) Practise first on an artificial model of the eye and then on the living subject. It can be practised upon a rabbit: a drop or two of a 1 per cent. solution of atropine should previously be instilled into the eye. Or a frog, with the body wrapped in a cloth, held up near the source of light may be employed.

Direct method.—Only a limited part of the retina is seen at one time, but it is much magnified. The subject is seated in a darkened room with a light, not too bright, near his ear. The observer sits in front of, and on a slightly higher level than, the subject, close to him. The observer holds the mirror in front of and close to his own eye, and, throwing the beam of light into the subject's

¹ The effects upon the pupil of cutting and stimulating the sympathetic have already been studied (see p. 82).

eye, asks him to look upwards and inwards. The observer then moves the mirror, with his eye close behind it, backwards and forwards, looking through the hole in the centre, and when the proper distance is found (two to three inches), the retina comes into view with its vessels running in different directions on a red ground. The mirror is moved about until the optic disk (entrance of optic nerve) is seen as a whitish circular area with the central artery and vein of the retina emerging at its centre. The image of the fundus is virtual (erect), and it is enlarged because the lenses of the subject's eye magnify the parts behind.

Indirect method.—With the subject as before, the observer places himself about eighteen inches in front of the patient and throws the light on the pupil as in the direct method. He then takes a small biconvex lens (two to three inches focus) in his left hand, and, holding it vertically between the thumb and forefinger at a distance of two to three inches from the patient's eye, moves his own eye with the mirror in front of it backwards and forwards and from side to side until the optic disk and other parts of the retina are seen. The image is real (inverted), and is only slightly magnified.

Retinoscopy is difficult in the human subject unless the pupil has been previously dilated by atropine. If the patient or observer has abnormal vision this is corrected by suitable lenses placed behind the aperture in the mirror.

CHAPTER XXVIII

STIMULATION OF THE RETINA

Electrical changes.—That an electrical change results from the action of light upon the retina can be shown in the frog. The eye is enucleated and is placed on non-polarisable electrodes, one of which is in contact with the cut optic nerve, and the other with the front of the eye. The electrodes are connected with a galvanometer, and the preparation is placed in a dark box. On letting light into the box an electric change is produced in the retina, and the galvanometer is deflected. On removing the light there is another deflection in the same direction.

Blind spot; Mariotte's experiment.—Make a mark of any sort (such as a cross) upon a piece of paper, and fix one eye—say the right—upon it, closing the other eye and placing the head about 6 inches from the paper. It will be found that over a considerable area of irregular shape, about 3 or 3½ inches from the cross, the point of a pen or pencil will not be visible because its image falls upon the place where the optic nerve enters the retina. Even a large black dot made in this area upon the white paper is quite invisible as long as the eye is fixed upon the cross. The experiment shows that the optic nerve fibres are insensitive to light. Map out the blind area.

Macula lutea; Maxwell's experiment.—Close the eyes for a minute and on opening them hold a bottle with parallel sides containing a solution of chrome alum—which has a greenish colour—between one eye and a uniform source of light such as a cloud. The middle of the field of vision will be occupied by an oval rose-coloured area; the alteration in colour of this part is due to absorption by the yellowish pigment of the macula of some of the rays transmitted through the chrome-alum, which is dichroic, transmitting greenish-blue and red rays; the former are absorbed.

Purkinje's experiment.—This is to be attempted in a darkened room. Stand about 8 feet from a sheet of white or grey paper fixed to the wall and get an assistant to illuminate the retina through the sclerotic by means of a converging lens and lamp or candle held at

one side of the eye. Look steadily at the paper with one eye, accommodating it for distance. In a minute or two a number of branching figures will be seen like the roots of trees. These are the shadows of the retinal blood-vessels. When the light is moved the shadows are also seen to move. This experiment shows that the visual cells lie behind the blood-vessels of the retina.

Perimetry.—The perimeter is an instrument for testing and recording light perceptions in different parts of the retina. The eye is fixed upon a point in the centre of the concave hemisphere forming the perimeter, and a white disc is brought gradually from the edge of the hemisphere nearer and nearer to the centre until it is perceived. This is repeated along different meridians and the results are marked on a chart at the back of the instrument. By using coloured discs instead of white the area of the retina which is sensitive to each colour can also be ascertained.

The field of vision of a person may be compared roughly with that of the observer in the following manner:—Stand 2 feet in front of the subject, close one eye, ask him to do the same and to look steadily at your eye. Move the fingers of both your hands held in a vertical plane midway between yourself and the subject, drawing the hands apart in the horizontal, vertical, and oblique directions, and note when the moving fingers pass out of his field of vision. If the field is normal in both cases, the observer and the subject should cease to see the fingers at the same time. If it is much restricted in the subject, the fact will easily be detected.

Testing for colour vision. Edridge-Green's lamp and spectroscope. Holmgren's wools.—The best practical method for testing colour vision is by the use of a lamp provided with glasses of different colour, the subject being expected to name the colour which is exhibited. A more accurate method of obtaining spectral colours for testing purposes is the employment of a spectroscope so arranged that only a definite part of the spectrum with a pure spectral colour is visible at one time.

A method which has been considerably used for testing colour vision is to take a box full of skeins of wool dyed with different colours, and, selecting one skein, to ask the person who is being tested to pick out any that match it. If he is colour-blind he is liable to make serious mistakes, matching grey with red, green with grey or red, and so on; but it occasionally happens that persons who fail completely with the lamp test are able, probably by judging from the intensity of the reflected light, to match the Holmgren wools fairly well.

Successive contrast.—Fix the vision upon a white spot on a dark ground. After one minute look at a uniform white surface such as a white ceiling. A dark spot now occupies the centre of the field of vision.

This experiment is varied by employing colours—*e.g.* a yellow spot on a blue ground or *vice versa* ; and a red spot on a green ground or *vice versa*. In each case the vision is transferred to a uniform white surface and the contrast colours are observed.

For the grounds coloured paper is used ; for the spots either disks cut out of the paper, or wafers laid upon it.

Meyer's experiment.—Place a grey disk upon a yellow ground, and cover the whole with thin tissue paper ; the grey disk at once appears blue : the contrast colour of the yellow. If a blue ground be used the disk will appear yellow. The same experiment may be repeated with red and green grounds. On a white ground the grey disk will appear darker ; on a black ground lighter.

Colour mixer.—This usually takes the form of a revolving circular plate on which sectors of different coloured cards can be fastened. Owing to the fact that retinal impressions have an appreciable duration, the colours appear blended during the revolution of the plate, and the mixing of the colours on the retina can thus be studied.

Stereoscope.—The fact that in stereoscopic vision the mind combines the effects produced by slightly dissimilar pictures falling on the two retinæ is illustrated by the ordinary stereoscope.

CHAPTER XXIX

THE PRODUCTION OF VOCAL SOUNDS. ANALYSIS OF SOUNDS. AUDITION. SEMICIRCULAR CANALS

Use of the laryngoscope.—The laryngoscope consists of a small circular plane mirror fixed to a handle at a suitable angle; a large concave mirror with a hole in the centre is strapped to the operator's forehead.

Method of procedure.—Practise first on an artificial model of the larynx and afterwards on the living subject. The latter is placed on a stool with a lamp over his right shoulder, a little above the level of his mouth. The observer sits opposite and close to the subject with the large mirror attached to his forehead. The subject is asked to open his mouth, incline his head slightly backwards, protrude his tongue, and to hold it down with a handkerchief. The observer manoeuvres his head until the back of the subject's throat is brightly illuminated; he then takes the small mirror in his right hand, warms it slightly in a flame to prevent moisture condensing on its surface (the back of the mirror should be just perceptibly warm to the cheek), and, holding the handle as one does a pen, pushes it horizontally backwards until it touches the uvula. First the dorsum of the tongue is seen in the mirror, then, as the handle is depressed, the epiglottis; then the glottis and vocal cords come into view. The image of the larynx thus obtained is an inverted one. In ordinary breathing the glottis is open; if the patient be asked to sound a high note the vocal cords may be seen to come together and to vibrate, and if he be asked to take a deep breath they separate, and the interior of the trachea and even its bifurcation may be seen through the widely open glottis.

Should there be a tendency to retch when the mirror comes in contact with the soft palate, this may be diminished by the application of a solution of cocaine to the mucous membrane.

The movements of the laryngeal cartilages are studied in a model which represents them articulated together. The action of the muscles can be imitated by threads, and the vocal cords by thin flat rubber bands stretched between the thyroid and arytenoids.

The production of vowel sounds.—Notice that the production of the vowel sounds (*ah, eh, ee, o, oo*) is accompanied by changes in the shape and size of the resonating chamber formed by the throat and buccal cavity.

The production of consonants.—Notice that most of the consonants are produced by an interruption, completed and incompleting, of the blast of air which is producing the vibration of the vocal cords, the interruption occurring either at the back of the palate (gutturals) or at the front of the palate (linguals), or at the lips (labials). Notice also that the character of the interruption is a factor in determining the quality of the consonant: thus, with some, such as *k, b,* and *t,* it is sudden or explosive: with others, such as *m* and *n,* the nasal cavities are brought in as resonators: with others, such as *ch, f,* and *s,* the blast is continuous, but is made to traverse a narrowed part of the cavity: whilst with *q* there is an actual vibration of the narrowed part.

The production of sounds by vibration of the vocal cords, and the dependence of the pitch of sounds on the tension of the cords.—Take a sheep's larynx and tie a glass tube into the trachea. Fix the larynx securely on a board, with the dorsal surface downwards, by wires or strong pins through the cricoid cartilage and epiglottis. Pass a string through the lower part of the thyroid cartilage. When this string is pulled vertically upwards, the vocal cords are stretched in proportion to the pull, and become approximated. If air is blown through the tube in the trachea, their edges are set in vibration when thus approximated and a sound is emitted, the pitch of which varies with the tension of the cords (the blast of air should be of about the same strength throughout).

Analysis of sounds of musical instruments and of the voice.—The analysis can be made by applying different Helmholtz resonators to the ear of the observer. König's manometric flames, which are provided with these resonators and are examined with the aid of vertical rotating mirrors, are also employed for this purpose.

Determination of range of pitch for audition.—The highest and lowest notes which can be appreciated are determined by the use of Galton's adjustable whistle.

Conduction of sound by the bones of the skull.—Stop the ears with wool. Set a small tuning-fork in vibration, and hold it with the base touching the top of the skull. The sound is propagated to the cochlea by the bones of the skull.

Inspection of the tympanic membrane.—Using a mirror with a central aperture fixed in front of the eye, throw the reflection of a lamp into the meatus of the subject, whose external ear must be drawn somewhat backwards and upwards.

Propagation of sound to the internal ear.—The mode of transmission may be studied with the aid of a model showing the bones of the middle ear and their attachments to the membrana tympani and the fenestra ovalis. The model shows that when the tympanic membrane—to which the handle of the malleus is attached—is driven in, the base of the stapes, which fits into the fenestra ovalis, follows the movement; but when the tympanic membrane is forced outwards beyond a certain point the stapes is not dragged after it owing to the nature of the articulation between malleus and incus. The model also shows the effect of the tensor tympani in pulling inwards the handle of the malleus and with it the membrana tympani, and the effect of the stapedius in pulling the head of the stapes backwards and causing the base to be tilted within the fenestra ovalis, thus rendering tight the ligament which fixes it in that aperture.

Semicircular canals.—For demonstrating the effects of injury to semicircular canals, a bird (pigeon) is employed. An opening is made in the side of the skull of the anæsthetised animal with a very small trephine, and through the aperture a special instrument is introduced and passed underneath the dura mater until one of the bony semicircular canals (which in the bird project above the surface of the petrous bone) is met with; the canal can then be broken across.

For observing the effects of stimulation of the canals a strong galvanic current is passed from one side of the head to the other; pad electrodes wetted with strong salt solution being applied in the neighbourhood of the ears: the stimulation occurs on the side of the kathode.

CHAPTER XXX

TASTE AND SMELL

Taste.—(a) To test the localisation of taste, direct the subject to close his eyes and put out his tongue. This organ is then dried, and different parts are touched with a small brush or a glass rod moistened with the sapid substance in solution. After each observation the mouth must be rinsed with water. The following solutions may be used for testing the four qualities of taste, viz. : for *bitter*, 1 per cent. solution of quinine sulphate ; for *sweet*, 5 per cent. solution of sugar ;

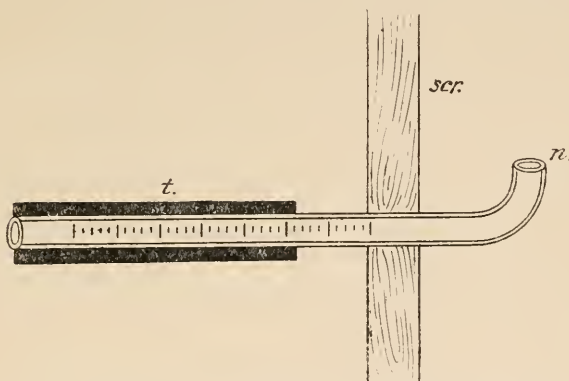

FIG. 83.—ZWAARDEMAKER'S OLFACTOMETER. *n.*, NOSE PIECE ; *scr.*, SCREEN ; *z.*, POROUS TUBE SLIDING OVER GRADUATED GLASS TUBE.

for *acid*, 2 per cent. solution of citric acid ; and for *salt*, 5 per cent. solution of common salt. Notice the time which intervenes between the application of the sapid substance and its effect. Record your results as regards localisation upon an outline plan of the tongue.

(b) Chew a leaf of *Gymnema sylvestris*, or paint with cocaine solution, and determine whether the taste of any of the varieties of sapid substances is affected.

(c) Test different parts of the tongue by applying closely-set electrodes arranged to conduct a weak faradising current.

Smell.—The sense of smell is tested by Zwaardemaker's olfactometer, which consists of a glass tube with one end adapted to the nostril, while over the other end a tube constructed of, or impregnated with, the odoriferous substance, slides ; so that a greater or less amount of its inner surface can be exposed to the air which is passing through the glass tube into the nostril (fig. 83).

PRINTED BY
NEILL AND COMPANY, LIMITED,
EDINBURGH.

