

Mechanics Dept.

Engineering
Library

12

15.



OIL ENGINES



McGraw-Hill Book Co. Inc.

PUBLISHERS OF BOOKS FOR

Coal Age ▽ Electric Railway Journal
Electrical World ▽ Engineering News-Record
American Machinist ▽ Ingeniería Internacional
Engineering & Mining Journal ▽ Power
Chemical & Metallurgical Engineering
Electrical Merchandising

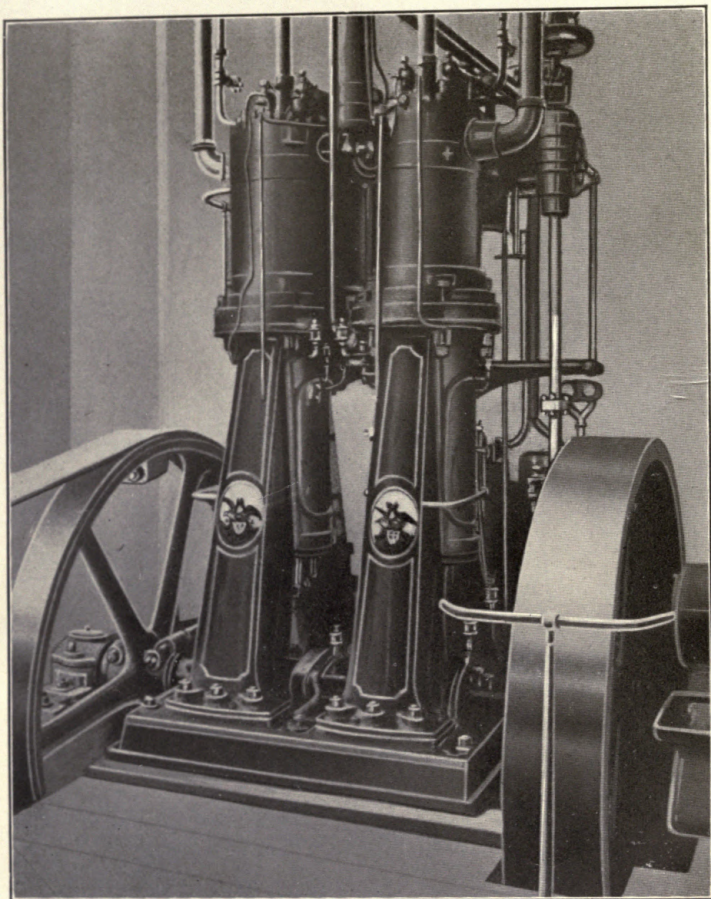

First Diesel built in the United States—1898.

(Frontispiece)

OIL ENGINES

DETAILS AND OPERATION

BY
LACEY H. MORRISON

FIRST EDITION



McGRAW-HILL BOOK COMPANY, INC.
239 WEST 39TH STREET. NEW YORK

LONDON: HILL PUBLISHING CO., LTD.
6 & 8 BOUVERIE ST., E. C.

1919

TJ 785
M6

Engineering
Library

COPYRIGHT, 1919, BY THE
MCGRAW-HILL BOOK COMPANY, INC.

Mechanics Dept,

TO VNU
ASSOCIATION

PREFACE

This volume has been written with the idea of providing oil engine operators with information as to the details of construction and methods of adjustments of the more important oil engines manufactured in the United States.

The author wishes to express his thanks to those manufacturers who kindly supplied drawings and photographs of various engine parts.

L. H. M.

PHILADELPHIA, PENNA.

July, 1919.

CONTENTS

	PAGE
PREFACE	vii
CHAPTER I	
HISTORICAL	1
General—Huyghens—Barber—Lenoir—Otto—Beau De Rochas Otto Silent—Brayton—Hornsby-Ackroyd—Diesel—Diesel Marine Engines.	
CHAPTER II	
THE DIESEL ENGINE.	10
Cycle of Events—Schematic Layout of Diesel Engine—American Diesel—Busch-Sulzer—McIntosh & Seymour—Snow—Allis- Chalmers—National Transit—McEwen—De La Vergne—Two- Stroke-Cycle—Southwark-Harris—Standard Fuel Oil—Nobel Bros. Marine—Werkspoor Marine—McIntosh & Seymour Marine—Fulton Machine Co. Marine—Lyons-Atlas—Nordberg.	
CHAPTER III	
INSTALLATION OF AN OIL ENGINE.	32
General—Excavation—Establishing Engine Center Line— Engine Template—Foundation Material—Foundation Bolts— Insufficient Foundation—Vibration—Installation of Engine Frame—Leveling up Frame—Erecting the Cylinders—Centering the Shaft—Plant Building.	
CHAPTER IV	
MAIN BEARINGS.	44
Adjustable Bearings, Vertical Engines—Adjustable Bearings, Horizontal Engines—National Transit—Snow—Allis-Chalmers —Two Piece Bearings—McIntosh & Seymour—Busch-Sulzer— McEwen—De La Vergne—Aligning Bearings—Hot Bearings— Scored Shafts—Fractured Crankshafts—Hot Bearings, Two- Stroke-Cycle Engine.	
CHAPTER V	
CONNECTING RODS.	57
General—American—Allis-Chalmers—Snow—McEwan— McIntosh & Seymour—National Transit—Busch-Sulzer— De La Vergne—Nelseco—Big End Bearings—Pin Clearance.	

CONTENTS

CHAPTER VI

PISTON AND PISTON PINS.	PAGE 64
General—Trunk Pistons—Piston Clearance—Crosshead Type Piston—American Diesel—Busch-Sulzer Type B—McIntosh & Seymour—Allis-Chalmers—McEwen—Snow—Standard Fuel Oil—Sieved Pistons—Piston Wear—Piston Rings—Fractured Piston Heads—Piston Ring Troubles—Grinding Taper Pin Bosses—Worm Piston Bosses—Emergency Piston Pins.	

CHAPTER VII

CYLINDERS AND CYLINDER HEADS.	79
General—American Diesel—Standard Fuel Oil—Busch-Sulzer— A Frame Cylinders—Horizontal Diesel—Snow—De La Vergne— McEwen—Allis-Chalmers—National Transit—Fractured Cyl- inders—Scored Cylinders—Liner Replacement—Cylinder and Head Joint—Cylinder Stud Bolts—Fractured Heads.	

CHAPTER VIII

DIESEL ADMISSION AND EXHAUST VALVES.	93
General—Valve Mechanism—American Diesel—Adjustments— Timing—Busch-Sulzer Type B—Adjustments—Cam Levers— Cam Clearance—Valve Timing—Cam Shaft Layout—McIn- tosh & Seymour—Camshaft—Cam Clearance—Valve Timing —Snow—Camshaft—Cam Clearance—McEwan—Camshaft— Cam Clearance—Valve Timing—National Transit—Valve Cam Mechanism—National Transit 1918 Design—Camshaft— Timing—Allis-Chalmers—Camshaft—Standard Fuel Oil— General—Timing—McIntosh & Seymour Marine Diesel— Rockers—Reverse Control—Nelseco Marine Diesel Rockers— General—Valve Cages—Water-cooled Valves—Corrosion— Cleaning Valves—Grinding Valve—Valve Grinding—Valve Timing—Leaky Valves.	

CHAPTER IX

DIESEL FUEL INJECTION VALVES	127
Dr. Diesel's Original Injection Valve—Injection Action—Open- Nozzle Valves—Closed-Nozzle Valves—American Diesel— Adjustments—Busch-Sulzer—Adjustments—Rocker Mechan- ism—Servomotor—McIntosh & Seymour—Action—Adjustments —Starting Fuel—McIntosh & Seymour Marine Diesel—Snow —Adjustments—Körting—McEwen—Adjustments—Allis- Chalmers—Adjustments—National Transit—Adjustments— Standard Fuel Oil—Adjustments—Fulton Marine—Nelseco Marine—General—Tar Oil Fuel Valves—Regrinding Valves— Needle Valves—Leaky Valves—Valve Timing—Injection Air Pressure—Adjustable Timing—Timing—Back Lash.	

CHAPTER X

	PAGE
DIESEL FUEL PUMP.	159
General—American Diesel—Adjustments—Pump Valves— Busch-Sulzer Type B Diesel—Adjustments—Timing—McIntosh & Seymour—Original Fuel Pump—Present Fuel Pump— McIntosh & Seymour Marine Diesel—Adjustments—McEwen— Adjustments—Snow—Adjustments—Allis-Chalmers—De La Vergne Type F D—Nelseco Marine—Adjustments—National Transit—Adjustments—National Transit 1918 Fuel Pump— Standard Fuel Oil—Adjustments—General—Pump Valve Grinding.	

CHAPTER XI

GOVERNORS, DIESEL.	181
General—American Diesel—Adjustments—System Jahns Governors—Regulator—Busch-Sulzer Type B—Snow—National Transit—McEwen—Allis-Chalmers—Standard Fuel Oil— McIntosh & Seymour—Eccentric Positions—General Adjust- ments—Governor Springs—Governor Drive Shafts—Gear Lubrication.	

CHAPTER XII

AIR COMPRESSOR SYSTEMS, DIESEL	195
General—Compressor Stages—Air Systems—Independent Compressor—Built-in Compressor—Busch-Sulzer—Air Regula- tion—McIntosh & Seymour Marine Diesel—Stationary Diesel Compressor—Snow—McEwen—National Transit—Standard Fuel Oil—Allis-Chalmers—General—Valves—Lubrication—Air Piping—Air Bottles—Air Pressure.	

CHAPTER XIII

COOLING SYSTEMS, DIESEL	209
Distribution of Heat Losses—Cooling Water Required—Types of Cooling Systems—Closed System—Open System—Water Piping —Water Tanks and Towers—Regulating Float—Cooling Towers —Circulating Pumps—Bad Water—Water Purification—Sediment —Salts—Exhaust Distiller—Cooling Water Temperature.	

CHAPTER XIV

LUBRICATION, DIESEL.	224
General—Lubricator System—Mechanical Lubricators—Stream Lubrication—Pressure Feed—Busch-Sulzer System—Water Separator—Splash Oiling System—Lubrication Oil Require- ments—Lubrication Oil Specifications—Amount of Lubrication.	

CHAPTER XV

	PAGE
DIESEL FUEL OILS.	232
Combustion—Fuel Classification—Stove Oil—Solar Oil—Fuel Oil—Gas Oil—Diesel Oil—Desulphurized Oil—Distillate Oil—Tops—Crude Oil—Specifications—Heat Value of Oils—Gravity—Residue—Flashpoint—Burning Point—Sulphur—Water—Ash—Viscosity—Acid—Engine Oil Tanks—Oil Storage Tanks—Coal Tar Oils—Method of Burning Tar Oils.	

CHAPTER XVI

FUEL CONSUMPTION, DIESEL	251
Guarantees—Tests—Snow—McEwen—Standard Fuel Oil—Körting—Busch-Sulzer—McIntosh & Seymour—Sulzer Bros—Actual Operating Results—Production Costs—Gas Engine Plants—Producer Engine—Comparative Costs—Steam vs. Diesel—Plant Logs—Heat Balance—Indicator Cards—McEwen Indicator Cards—Allis-Chalmers Indicator Cards—National Transit Indicator Cards—Standard Fuel Oil—Faulty Cards—Distorted Cards—Indicator Rigging.	

CHAPTER XVII

THE SEMI-DIESEL OIL ENGINE	280
General—Comparative Indicator Cards—Ignition Devices—Hvid or Brons—St. Mary's—Operation—Modified Hvid—Lyons-Atlas—Burn Oil—Nordberg—Müller—De La Vergne Type F H—Fuel Consumption—Fuel—Price Ignition System—Indicator Cards—Test.	

CHAPTER XVIII

LOW-COMPRESSION OIL ENGINE	306
General—Two-Stroke-Cycle, Operation—Theory of Combustion—Ignition Devices: Hot-Bulb—Hot-Bolt—Hot-Plate—Separate Combustion Chamber—Operation—De La Vergne.	

CHAPTER XIX

LOW-COMPRESSION ENGINE CYLINDERS.	324
Cylinder Design—Two-Cycle—Crank Case Compression Cylinder—Cylinder Using Front End For Compressor—Cylinder With Removable Liner—Vertical Engine Cylinder—Cylinder Wall Thickness—Reboring Cylinder—Cylinder Wear—Fractured Cylinders—Cylinder Head Packing.	

CONTENTS

xiii

CHAPTER XX

	PAGE
PISTONS, PISTON PINS AND CONNECTING-RODS, LOW COMPRESSION ENGINE.	333
Pistons, Types—Clearances—Turning New Pistons—Distorted Pistons—Piston Rings—Distorted Exhaust Bridges—Fractured Piston Heads—Piston Pins—Connecting Rods—Adjustments—Babbitting Crank Bearings—Crank Pin Clearances—Pin Lubrication.	

CHAPTER XXI

FRAMES, BEARINGS, SHAFTS AND FLYWHEELS; LOW COMPRESSION OIL ENGINE.	347
Engine Frames—Inclosed Frames, Open Frames—Air-Suction Valves; Automatic—Piston Air Valve—Corliss Air Valve—Adjustments—Crankshaft Air Seals—Main Bearings—Adjustments—Crankshaft—Flywheels.	

CHAPTER XXII

GOVERNORS, FUEL INJECTION PUMP, LOW COMPRESSION ENGINE. . .	365
Governors; General—Hit and Miss Governing—Classes of Governors—Muncie Governor—Muncie Fuel Injection Pump—Adjustments—Fairbanks-Morse Horizontal Engine; Governor—Fuel Pump—Fairbanks-Morse Vertical Type Y; Governor—Fuel Pump—Adjustments—Mietz & Weiss Horizontal Engine; Governor—Fuel Pump—Mietz & Weiss Vertical Engine; Governor—Fuel Pump—Fuel Distributor—Adjustments—Fuel Timing Control—Little Giant; Governor—Fuel Pump—Governors Giving Constant Injection Angle—Bessemer Oil Engine; Governor—Fuel Pump—Adjustments—Primm Oil Engine; Governor—Fuel Pump—De La Vergne; Governor—Fuel Pump—Buckeye-Barrett Oil Engine; Governor—Fuel Pump.	

CHAPTER XXIII

FUEL NOZZLES; WATER INJECTION; LOW COMPRESSION ENGINE . . .	403
Fuel Nozzles—Little Giant Fuel Nozzle—Muncie Fuel Nozzle—Fairbanks-Morse Fuel Nozzle—Buckeye-Barrett Fuel Nozzle—Primm Fuel Nozzle—Bessemer Fuel Nozzle—Mietz & Weiss Fuel Nozzle—Care of Fuel Nozzle—Water Injection—Cylinder Wear Due to Water Injection—Faulty Lubrication Caused by Water Injection—Method of Injection—Bleeder Valve—Muncie System—Mietz & Weiss System—Primm System—Little Giant System—Bessemer System—Engines Without Water Injection—General—Manipulation of the Water Injection.	

CHAPTER XXIV

	PAGE
EXHAUST PIPE AND PIT WATER COOLING SYSTEMS, LOW-COMPRESSION ENGINE.	420
Exhaust Pipes—Exhaust Pits—Circulating Water Systems—Thermo-Syphon System—Fresh Water System—Tank and Tower System—Closed System.	

CHAPTER XXV

AIR STARTING SYSTEMS, OPERATING TROUBLES, LOW-COMPRESSION ENGINE.	432
Air-Starting Systems—Fairbanks-Morse Air Starting Valve—Primm Air-Starters—Mietz & Weiss Air Starters—Starting an Engine—Temperature of Cooling Water—Lubrication—Engine Smokes—Preignition—Engine Pounds—Indicator Cards—General.	

CHAPTER XXVI

FUEL, FUEL CONSUMPTION, LOW-COMPRESSION ENGINE	447
Fuel—Fuel Specifications—Engine Behavior On Various Oils—Fuel Storage—Fuel Consumption—Tests—Operation Costs—Conclusion.	
INDEX	461

OIL ENGINES

CHAPTER I

HISTORICAL

Although for decades the internal combustion engine was neglected while the attention of the engineer was centered on the steam engine, still the former had been built and actually used long before Watts constructed his atmospheric steam engine. Because of defects of operation in the internal combustion engine that seemed impossible of solution, the steam engine took precedence, and it was only during the latter part of the nineteenth century that the gas engine began to come into commercial favor.

Huyghens.—While several scientists had suggested the use of gunpowder in a closed vessel as a source of power, Huyghens appears to have been the first who actually built an internal combustion engine (1680). His design embodied an open-ended cylinder with a piston. The powder was exploded when the piston was at the bottom of the cylinder: the explosion forced the piston upward. The gases were expelled through leather valves, and the cooling of the gases that remained in the cylinder created a vacuum. The atmospheric pressure, acting on the piston, forced it downward into the cylinder, doing work by its movement. Many structural defects caused the abandonment of this design.

Barber's Producer Gas Engine.—The internal combustion engine was practically ignored until 1791 when an Englishman, John Barber, built an engine which made use of gas distilled from coal. The essential features of Barber's engine were the use of a mixing chamber wherein the air and producer gas were mixed and ignited, and the employment of a paddle-wheel against the blades of which the gases, issuing from the chamber, impinged. This machine was in reality a gas turbine rather than a gas engine, and several modern engineers have worked on the

design of a gas turbine along the same lines. Barber patented this engine in 1791.

Lenoir.—Although a number of experimenters interested themselves in the problem of building an internal combustion engine, Lenoir was the first to manufacture a marketable engine in 1860.

The Lenoir engine, Fig. 1, was double acting; the valves were of the flat-ported type, somewhat along steam engine practice, being operated by eccentrics. The gas and air were mixed in the inlet valve and passed into the cylinder under the suction effect of the retreating piston. When the piston was almost

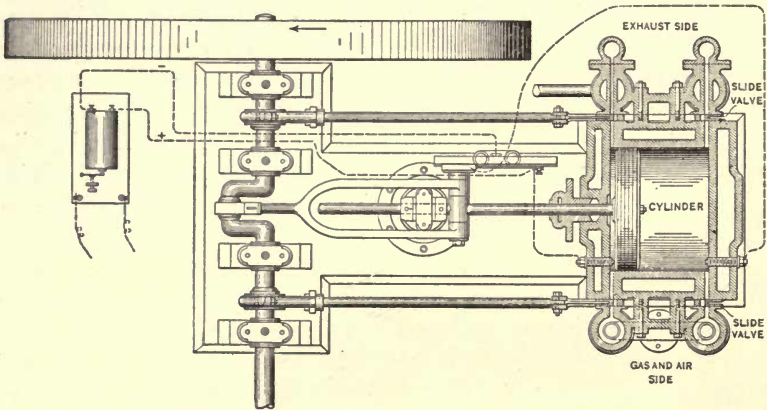

FIG. 1.—Lenoir's gas engine.

halfway in its stroke, the charge was ignited. The pressure then rose to the vicinity of 75 pounds. The piston continued to the end of its stroke, being acted upon by the gas pressure. The exhaust valve then opened, and the burnt products were pushed out by the piston on the return stroke. Hundreds of these engines were placed in commercial use, but the gas consumption was high, the efficiency being but little above 4 per cent.

Otto's Engine.—About this time, 1866, Otto, in Germany, designed an engine with a free piston. In this engine, which was built vertically with the cylinder below the crankshaft, the piston was forced upward by the explosion. The weight of the piston then caused it to descend into the cylinder, assisted by the vacuum formed by the cooling of the gases. In descending, the piston engaged a rack which turned the crankshaft through a clutch. The inertia of the flywheel started the piston on the

upward stroke, and the vacuum formed drew in a gas charge. This charge was exploded when the piston was partly advanced on the upstroke. It is apparent that this embodied the same principles as did Lenoir's engine.

Beau de Rochas.—In 1862 Beau de Rochas, a Frenchman, proposed the cycle that is at present used by the majority of gas engines. His proposal, although he never actually built an engine, was as follows:

The essential factors in obtaining high efficiency are: first, the highest possible compression pressure at the moment of ignition; second, the greatest possible expansion of the gases after combustion.

To achieve the desired efficiency in an engine, de Rochas proposed that an engine should operate on the four-stroke-cycle principle, having the following events:

Stroke 1. Draw in the air and gas charge.

Stroke 2. Compression of the charge.

Stroke 3. Ignition and expansion of the charge.

Stroke 4. Discharge of the burnt gases.

It is to be observed that these events are those occurring in all present-day four-stroke-cycle gas or gasoline engines.

Otto's Silent Engine.—As stated heretofore, Otto had obtained a patent on a free piston engine in 1866. In company with Langen, Otto formed an engine-building organization—the Gas-Motorem Fabrik Deutz—which is still in existence. Objectionable features of the Otto and Langen engine caused them to adopt the design proposed by Beau de Rochas. This engine, which was known as the "Otto Silent," created a furor at the Paris Exhibition in 1878. Figure 2 shows a view of one of these early Otto engines, while Fig. 3 is a section through the intake valve. This valve has two passages in it. The port *M* is the air passage, which, on the suction stroke of the engine, is in line with *m*, the air-suction pipe; *Q* is, at this time, in contact with *a*; and *n* communicates with *L*, the gas passage. This allows the air and gas to enter the cylinder through *a*. As the valve continues to move to the left on the compression stroke of the piston, *N* receives a small charge of gas from the gas line *d*. As the valve moves to the right on its return stroke, the cavity *N* moves past *B*, which carries an open flame, and the gas in *N* ignites. When this passage moves past the passage *a*, the flame in *N* ignites the gas in the cylinder. The exhaust valve, not shown, was of the

poppet type. The disadvantage lay in the flat admission valve. To keep it against its seat, a strong spring pressure was necessary; this occasioned rapid wear. However, the engine was so superior to its competitors that thousands were sold all over

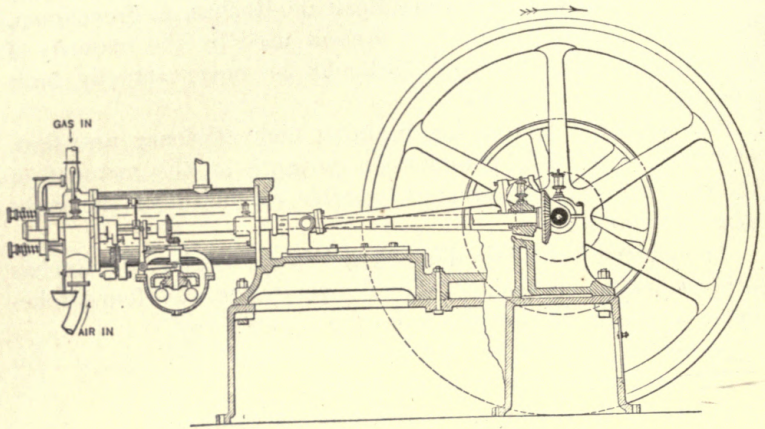

FIG. 2.—Otto's silent engine.

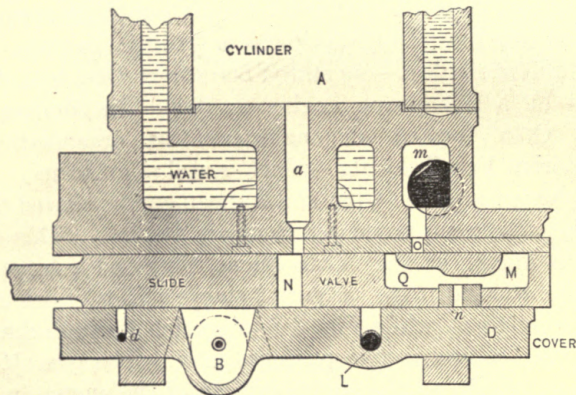

FIG. 3.—Cross-section of Otto's silent engine valve.

Europe. It is to be noticed that the cycle used should have been termed the "Beau de Rochas cycle" instead of the Otto, by which latter name this cycle is now universally designated.

This engine, modified to better meet existing conditions, is in daily use all over the world; thousands are sold each year; one American firm in 1917 marketed 30,000 Otto cycle engines in sizes from $1\frac{1}{2}$ to 10 h.p., and there are scores of manufacturers who produce from 1000 to 10,000 engines yearly.

Brayton's Constant Pressure Engine.—A few years previous to the design of the Otto silent engine, Geo. Brayton, a Philadelphian, secured patents on an engine that differed from all other internal combustion engines in that, instead of the charge burning at constant volume or instantaneously as in the Otto cycle, the fuel, either gas or liquid, was introduced into the cylinder in such a manner as to cause it to burn at constant pressure. The design of this engine embodied the use of an engine cylinder and of a separate charging or compressing cylinder. The gas and air were introduced into this charging cylinder and compressed. At the beginning of the power stroke in the engine cylinder the mixture passed into the cylinder through the intake device, which was in the form of a gauze screen. A pilot light ignited the charge as it blew into the cylinder until cut-off took place at about 10 per cent. of the engine stroke. The flow of the mixture was such that the pressure in the power cylinder did not increase during combustion. After the flow of fuel ceased, the burnt gases expanded as in any engine. This Brayton cycle had much to commend it. It was the most efficient of all cycles operating between the same temperature limits. Its drawback was that, for equal power, it required a much larger cylinder volume than did the Otto cycle. The serious objection, both from a manufacturing and operating standpoint, was the excessive size and weight of the engine as well as the complicated mechanisms. This cycle was early abandoned in favor of the more simple Otto cycle.

Clerk's Two-cycle Engine.—This engine was the design of Dugan Clerk, and, in place of being four-stroke-cycle, the engine was of the two-stroke-cycle type. The design embodied the use of a charging cylinder into which the air and gas was introduced and compressed. The engine cylinder used no exhaust valves but, instead, made use of ports about the cylinder. After the power stroke was almost completed, the piston uncovered these ports, allowing the exhaust gases to blow out. At the same time the charging cylinder forced a charge of air and gas into the engine cylinder. This charge assisted in freeing the cylinder of the remaining consumed gases and was compressed by the piston on its return stroke. At the proper time a gas flame, and in some engines a hot bolt on the piston, ignited the charge. This cycle was not so favorably received since it was not as simple as the Otto engine. Sub-

sequently, many engines were built using this two-cycle principle but compressing the gas and air in the crankcase in preference to the separate charging cylinder. The Clerk engine was the forerunner of the modern two-cycle engine.

Hornsby-Ackroyd Engine.—This engine, which was the pioneer of all the Hot-Bulb or "Surface Ignition" engines, was an English product. It is still being manufactured in England and in the United States, though the design has been considerably improved.

This engine was of the four-stroke-cycle principle, the valves being placed in a valve chamber at one side of the cylinder. The cylinder head included a vaporizer or uncooled bulb. The oil was injected into the bulb and, owing to the intense heat contained in the walls of the bulb, was vaporized. At the end of the compression stroke the heat of the bulb, increased by the heat caused by the compression in the cylinder, was high enough to ignite the fuel. The engine was an explosive or constant-volume engine and followed the Otto cycle in its action.

Since the engine used the four-stroke-cycle, the air charge was compressed in the engine cylinder. The compression pressure seldom exceeded 60 lbs. per sq. inch. While this was as high a pressure as the first engine could use due to preignition troubles, later modifications of this engine have the compression as high as 140 lbs. per sq. inch. The variation in compression depends on the time of depositing the fuel charge in the vaporizer. In the early models the oil entered the cylinder very early in the compression stroke, while the later designs have the oil injection occurring during the last 45 degrees before dead-center.

The hot-bulb or vaporizer engine came into general favor based on its ability to successfully burn kerosene (termed paraffine in England) and on the simplicity of design, which made it far superior to the ordinary four-stroke-cycle gasoline or carburetor engine.

The trend during the past fifteen years is toward a two-stroke-cycle engine using the crankcase or front of the cylinder as a scavenging air compressor. This present-day engine is, in respect to the method of fuel ignition and combustion, the original Hornsby-Ackroyd; the chief departure from this original design is the change from four-stroke-cycle to two-stroke-cycle. This change lowers the manufacturing costs and in

some respects simplifies the operating details. In the number of builders and in the total horsepower capacity of these two-cycle hot-bulb engines the United States easily ranks first. In England and on the Continent more attention was given the vaporizer engine, and it was as late as 1910 before the hot-bulb came into favor in England. At the present time they are finding a field of usefulness in stationary work and in small vessels, such as fishing boats, tugs and cruising yachts.

The Diesel Engine.—The practice has always been for the inventor or engine builder to construct his engine and then from its operation deduce the thermodynamic principles under which it operated. Dr. Diesel, a German engineer, designed an engine to operate on the constant temperature cycle. In this engine the air charge on the compression stroke was to be compressed to a pressure such that the resulting temperature was above the ignition temperature of the fuel. The fuel was to be introduced into the cylinder at a rate such as to cause the heat released by the combustion to exactly equal the work performed on the moving piston. This would cause the cylinder temperature to remain constant during the period of fuel introduction extending over some 10 per cent. of the piston stroke. After "cutoff" the gases were to expand adiabatically without absorbing or losing any heat save that consumed in doing work; the exhaust was to be at constant pressure. The engine was originally designed without water-jacket cooling since there was to be no heat loss.

The original patent, dated 1892, outlined an engine wherein the fuel used was to be pulverized coal or coal dust. This coal was to be stored in a hopper immediately above the engine-cylinder head. Between the hopper and the cylinder was interposed a rotary valve having a cavity or pocket. The valve received a charge of coal dust and in rotating in its seat came in communication with the cylinder. The coal dust then dropped into the combustion space as the piston reached the end of the compression stroke. The fuel charge was varied to suit load conditions through the governor control of the valve movement.

Another interesting feature was the proposed introduction of a water charge at the beginning of the compression stroke for the purpose of keeping the compression pressure under control.

A second claim embodied in the same patent covered the use

of liquid fuels with the employment of a spraying valve but without the air injection feature. The engine was to be started by some explosive agent in the cylinder for the initial stroke. The expansion was to be carried to such a point that the exhaust gases were to be cold enough to be used as the cooling medium in the cylinder jacket.

An engine was constructed along these lines but never turned over beyond the initial stroke, during which it was completely wrecked. At this late date no information seems available as to the cause of this wreck, but it is to be presumed that the starting charge of explosives was the destructive agent.

This disappointment caused the builders of this engine to partially abandon Dr. Diesel's ideas, and a water-cooled engine was built in which the admission of heat was at constant pressure instead of at constant temperature as originally contemplated by Dr. Diesel. The first of these later engines actually ran but never was able to carry any load. The development of the Diesel proceeded slowly for a few years, and it was not until 1897-1898 that a commercial engine was produced, this being a single-cylinder 25 h.p. engine of vertical design and using a crosshead.

From this modest-powered engine it was but a question of a relatively few years before engines of a thousand horsepower per cylinder were in commercial use. The engine was patented in practically every country, and for a few years all European manufacturers operated under a license; this, however, was discontinued around 1904, and but few manufacturers paid royalties. The popularity of the Diesel engine in Europe has been due, to a large extent, to the type of manufacturer building these engines. In Germany a number of the strongest steam engine builders, having the facilities to do the extensive experimenting necessary, early took up this engine. In Switzerland and the Scandinavian countries the engine found early favor. The British Diesel Engine Co., even when the engine temporarily fell into disrepute in Germany, continued their labors, and much credit for the successful outcome of the Diesel, usually attributed to German firms, actually is due to the activities of the British manufacturers.

The Diesel was introduced into the United States by Adolphus Busch of St. Louis. The first American Diesel engine was completed in 1898, being of the two-cylinder vertical A-frame design,

and developed 60 h.p. The early history of the Diesel engine in America was one of disappointment; part of the adverse criticism of the engine that is encountered even now is the result of the policies of the early firms. During the past five years a number of American engine builders have taken up the manufacture of the engine; the designs, in the main, follow European practice, though in the tendency toward horizontal frames can be detected the objection which the American engineer has toward the vertical type engine.

Diesel Marine Engine.—It is for marine work that the Diesel possesses many favorable characteristics, and the past two years have found the majority of builders engaging their shop facilities in the manufacture of this type of Diesel. The first marine Diesel was constructed in 1903 by French engineers for use on a canal boat. This particular engine was single cylindered with opposed pistons and worked on the four-stroke-cycle. While French firms produced a considerable horsepower of the marine engines, the greatest development occurred in Russia where the demand for river boat engines stimulated the activities of the Diesel builders. Credit must also be given to Nobel Bros. of Petrograd for the production of the first Diesel for submarine service in 1908. This phase of Diesel manufacture has received great attention since 1914, and undoubtedly the greatest improvements in design have occurred on the submarine engine.

While of late years engines have been built having a capacity of 2000 h.p. per cylinder, the American operator is actually concerned in engines ranging below 1200 h.p. per unit.

CHAPTER II

THE DIESEL ENGINE

Cycle of Events.—The readers who are familiar with the operation of a gasolene engine should easily grasp the cycle of events occurring in the cylinder of the Diesel engine. In Fig. 4, *a* to *d*, are shown four conditions existing in the engine cylinder at

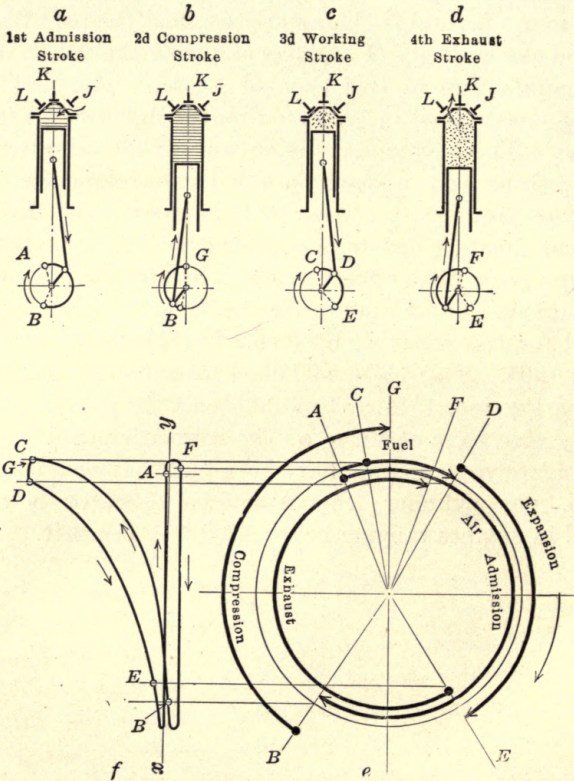

FIG. 4.—Working diagram of four-stroke-cycle Diesel engine.

various points of the piston's stroke, while Fig. 4e indicates the portion of the stroke as covered by each event.

In Fig. 4, drawing *a* covers the suction or admission stroke of the piston. The admission valve *J* has opened at the point *A*

just before dead-center. The valve *J* remains open from the point *A* to the point *B*. This admission stroke is shown in Fig. 4*e* and Fig. 4*f*; in the latter the indicator card shows this line as being below the atmospheric pressure line *xy*. The air actually enters the cylinder under suction pressure. In drawing *b*, Fig. 4, the admission valve *J* has closed at *B*, and the pure air charge is compressed by the piston up to the point *G*, which is top dead-center. This process is covered by the compression line *BC* on the indicator card in Fig. 4*f*. The clearance volume is very small, and the maximum or final compression pressure rises to some 500 to 550 lbs. per sq. inch. The work done on the air charge in compression causes the temperature to ascend to about 1100° Fahrenheit.

At the point *C* in drawing *c*, Fig. 4, the injection valve opens, and a charge of fuel is blown into the cylinder by means of a blast of high-pressure air. The injection valve is designed to cause the rate of flow through the valve to be "braked" so that the injection is not instantaneous but takes place while the engine crank turns through a considerable angle. In drawing *c*, Fig. 4, the injection of fuel starts when the crank is at *C* and ends when the crank is at *D*. In Fig. 4*f* the line *CD* represents the admission period, and the desired condition is attained when the line *CD* is practically horizontal, showing that the rate of heat addition is such that there is no increase in the cylinder pressure.

The injection and the combustion of the fuel ceasing at the point *D*, the piston continues to the end of its stroke under the influence of the expanding gases. Before the completion of the stroke, the exhaust valve *L* opens when the crank is at *E*. This allows the gases to rush out through the exhaust passage. The exhaust valve continues to remain open until the piston again ascends to the top of the cylinder, expelling all the exhaust gases. This part of the cycle is shown in drawings *d* and *e* as continuing from *E* to *F*; in Fig. 4*f* this forms the exhaust line *EF*. Before the exhaust valve *L* closes, the admission valve opens at *A*, allowing a fresh air charge to be inducted into the cylinder during the stroke shown in drawing *a*.

These events complete the cycle of the four-stroke-cycle Diesel. From a practical viewpoint the differences between the Diesel and the gas engine are that in the Diesel nothing but pure air is compressed in the cylinder and that the fuel is forced into the cylinder slowly, causing the combustion to be gradual; in the

gas engine both the gaseous fuel and the air are compressed, and the combustion takes the form of an explosion.

Schematic Layout of the Diesel Engine.—Figure 5 embodies the schematic arrangement of the essential mechanism of a Diesel engine. In this particular instance the engine is of the horizontal type operating on the four-stroke-cycle principle. The engine crank is represented with its center at *O*, and the crank revolves clockwise. To the crankshaft is geared a layshaft *A* which revolves at half-engine speed. On this layshaft

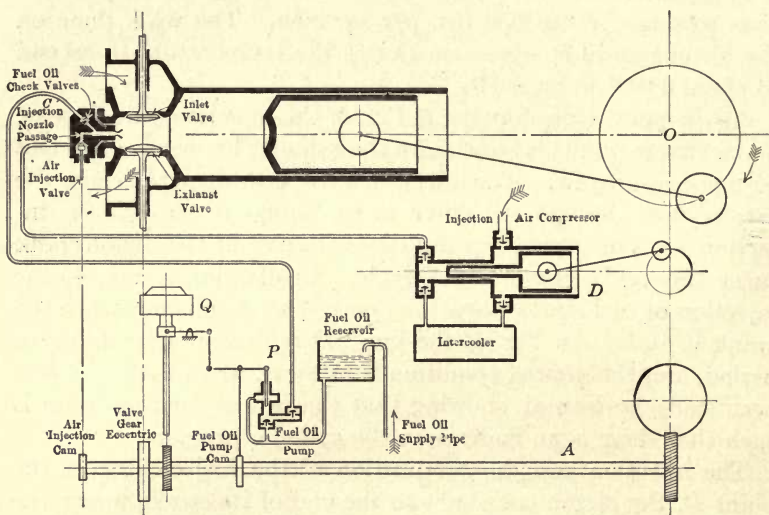

FIG. 5.—Schematic arrangement of Diesel engine mechanism.

are mounted the cams used to actuate the exhaust, admission and fuel injection valves, which are operated in the sequence outlined in Fig. 4. The fuel pump *P* is driven off the layshaft, the fuel charge being under control of the governor *Q*. The fuel is deposited in the injection valve *C*, out of which it is forced by the air charge at the proper moment. The air blast is supplied by the air compressor *D*, which is driven by a crank on the end of the engine shaft. In this diagram the air line is not supplied with a receiver or air bottle, and the air is delivered directly from the compressor to the fuel valve.

The parts enumerated above are the essential parts of the Diesel engine. However the arrangements may differ, it is necessary that the unit include an air compressor, fuel pump,

governor, camshaft and injection or fuel valve in addition to those parts generally found on an internal combustion engine.

Figure 6 represents the working diagram of a two-stroke-cycle. In Fig. 6*b* the air charge is compressed; in Fig. 6*c* the fuel is injected and the piston forced downward on the working stroke; in *d* the piston uncovers passages or ports in the side of the cylinder through which the exhaust gases pass. As the piston moves downward to the point *A*, a valve in the cylinder head opens, and a charge of pure air which has been compressed to

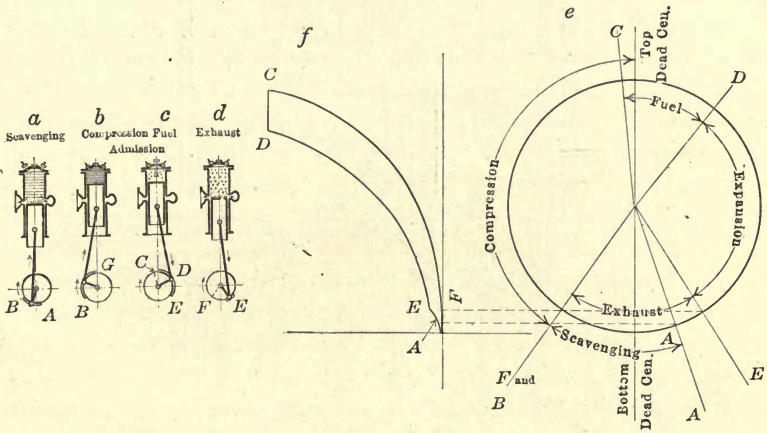

FIG. 6.—Working diagram of two-stroke-cycle Diesel engine.

about 10 lbs. blows into the cylinder, clearing it of all exhaust gases. At *B*, or before this point, the scavenging valve closes, and, as the piston moves upward, it seals the exhaust ports at the point *B*. Continued upward motion compresses the air charge until upper dead-center is reached whereupon the cycle is repeated.

American Diesel Engine Company.—This company was the pioneer Diesel engine company in the United States. At the present time there are many installations of the American Diesels which have been in operation for ten to fifteen years, though they have largely been replaced by units of modern design. For this reason the engine is mainly of historical interest although there is more demand for experts to adjust and repair these engines than any other. This, of course, is because the engines have been in service for such lengths of time that extensive overhauls and rebuildings are necessary.

Figure 7 is the cross-section of the American engine. Even to the inexperienced it is evident that the builders largely followed accepted gas engine designs in the general construction of this

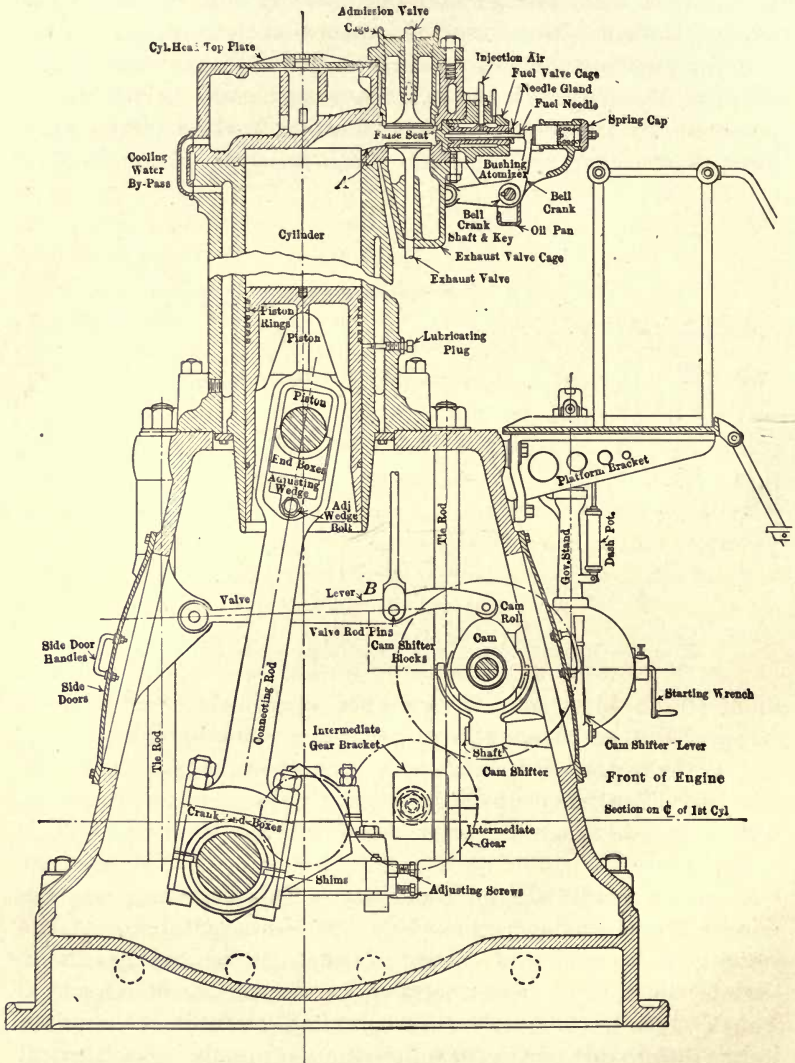

FIG. 7.—Cross section of American Diesel engine.

unit. The frame was of the box type and was reinforced by tension rods to absorb the working stress. The cylinders, of which there were three per engine, were cast integral with the

jacket walls. The valves were located at the side of the cylinders quite like the gas engine practice of ten years ago. The box frame was entirely enclosed, though provided with side doors, and splash lubrication was used. The camshaft was carried inside of the frame in bushed bearings bolted to the interior of the frame; the gear reduction was 2 to 1, with an idler pinion between the camshaft and the crankshaft gears. The various parts will be discussed in succeeding chapters as will also the parts of other engines.

The engine, when first introduced, was of a type unknown to the American engineer and, like all new machines, suffered at the hands of ignorant and unskilled laborers. Probably no prime mover ever experienced the manhandling accorded this oil engine. Scores of cylinder-head stud bolts were twisted off under the efforts of a brawny laborer using a 5-foot pipe wrench. As faulty as the engine was, it is highly probable that it would have been fairly successful under the attention of more skilled operators. It, however, served the useful purpose of giving many Diesel engineers experience. Later-day manufacturers should, for this reason, have a grateful feeling toward this pioneer.

Busch-Sulzer Bros. Diesel Engine.—This company represents a reorganization of the American Diesel Engine Co. In the design of the Type B stationary engine the experience of their Swiss associates, Sulzer Bros., has been drawn upon. The engine, a view of which appears in Fig. 8, has four working cylinders, while the air compressor is mounted on the engine frame and has much the appearance of a fifth cylinder. The frame is of two-piece construction, the base carrying the shaft bearings. The upper portion of the frame rests on the base and is tied to it both by base stud-bolts and tension bolts or tie rods.

The camshaft is mounted close to the top of the cylinder and is driven by a vertical drive shaft, which also carries the governor. This is shown in Fig. 8. The camshaft is entirely enclosed, the cams working in an oil bath. Doors provide access to the various parts. The valve mechanism has incorporated with it a servomotor, which controls the injection point and the air-injection pressure. The cam housing also includes the support for the fuel pumps which are driven from off the vertical cam drive shaft.

McIntosh & Seymour Diesel Engine.—This engine, of the A-frame design, is practically identical with the product of the

Aktiebolaget Diesels Motorer (Swedish Diesel Engine Co.) of Sweden. As outlined in Fig. 9, the engine frame or base is a low box section casting some 12 inches in height. This frame rests directly on the foundation. To the base are bolted

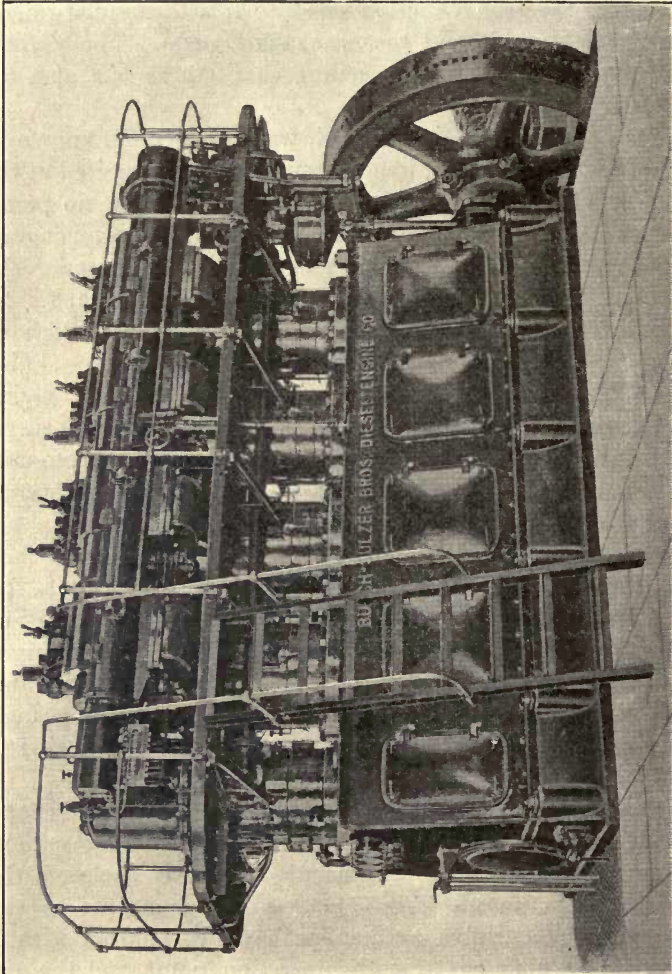

Fig. 8.—520 H.P. Busch Sulzer Bros. Diesel.

the A-frame castings, which are of cylindrical form at the top to receive the cylinder liner, in this way acting as the cooling jacket outer walls. In the 500 h.p. unit there are four cylinders and A-frames, while the air compressor is mounted in

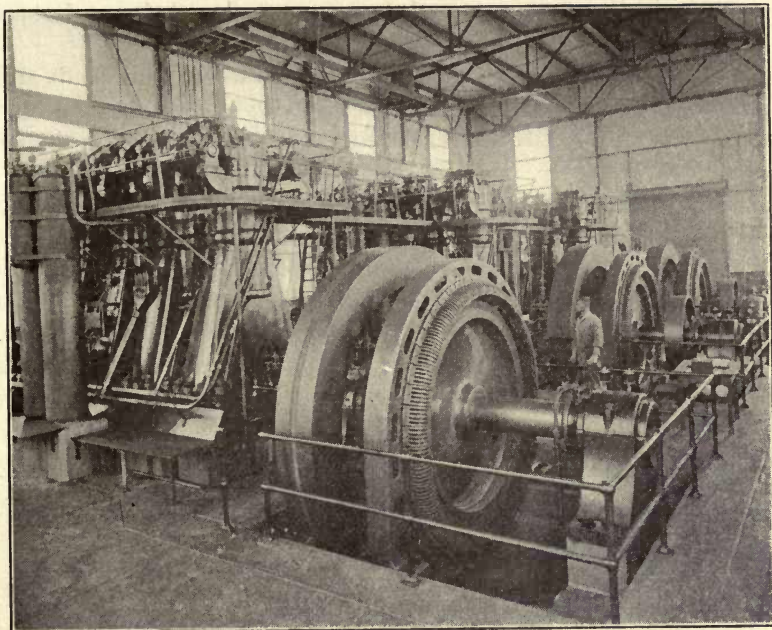

FIG. 9.—McIntosh and Seymour Diesels, Texas Light and Power Co., Paris, Texas.

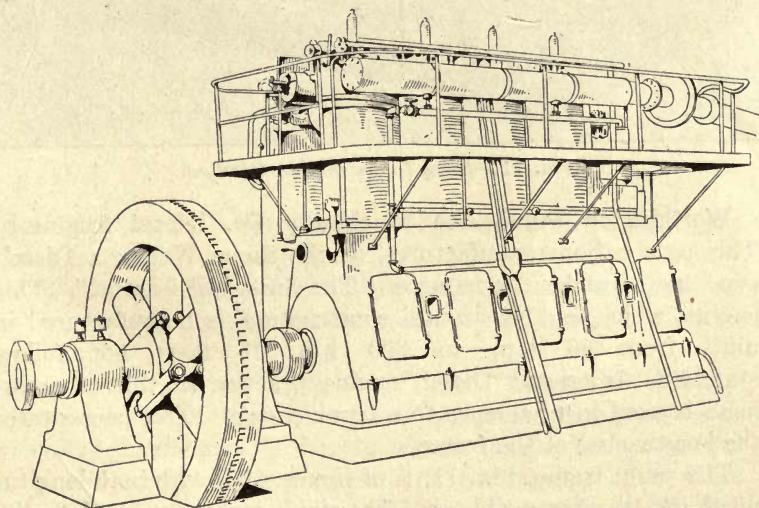

FIG. 10.—McIntosh and Seymour box frame Diesel.

line with the power cylinders on a similar A-frame but of much lower height.

The camshaft is carried at a level with the cylinder heads and is driven by a vertical shaft and bevel gears; the shaft carries the governor while the fuel pump is supported on one of the cylinder castings.

The McIntosh & Seymour Corporation has now virtually abandoned the A-frame engine for stationary work and are centering their manufacturing facilities on the box-frame engine. Beyond the frame itself, the engine has been modified in no way, the details of valves, governors, etc., remaining as before. Figure 10 is a view of the box-frame engine. These engines range in size up to 1000 B.h.p., which unit is of six-cylinder construction.

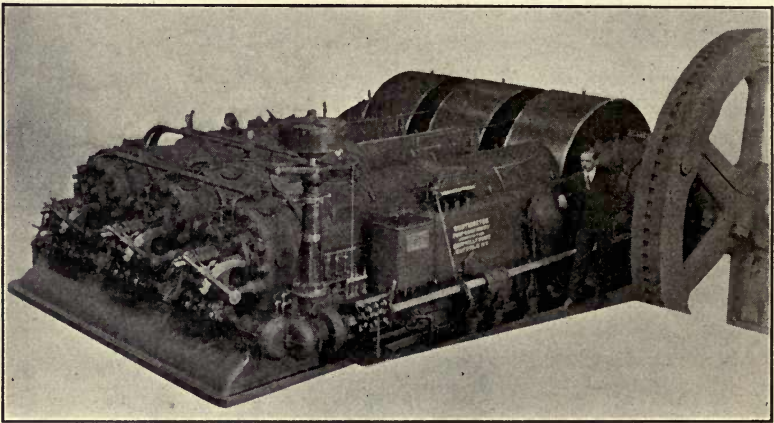

FIG. 11.—Snow four-stroke-cycle Diesel.

Worthington Pump and Machinery Co. Diesel Engine.—

This corporation manufactures, at the Snow Works, a Diesel-type engine under the name of "The Snow Oil Engine." This engine, which is of horizontal construction, is manufactured in units from 65 h.p. to 800 h.p. It does not follow standard American Diesel engine practice in that a cross-head is used in preference to a trunk piston. This necessitates the lengthening of the frame.

The main frame, Fig. 11, is of box section with both longitudinal and transverse ribbing. The single and twin cylinder units have a one-piece frame, while the frame of the three-cylinder

engine is of two-part construction to facilitate shipping and erection. As seen by Fig. 11, the frame is extended to form the cylinder cooling jacket; the liner is separate and is forced into the jacket cavity. The air charge for the engine cylinder enters the frame at one side of the crankcase and flows along the frame before passing through the admission valve. The air compressor is mounted on the engine frame and is driven by a crank keyed to the engine shaft. The valves are controlled by a camshaft placed transversely in front of the cylinder head; this shaft is driven through bevel gears by a layshaft at one side of the engine. This latter shaft also drives the governor and fuel pumps.

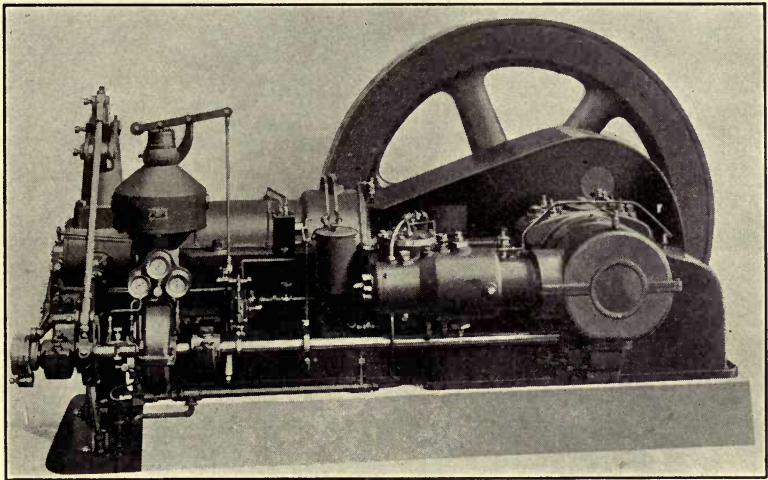

FIG. 12.—Allis-Chalmers Diesel, single cylinder.

Allis-Chalmers Diesel Engine.—The frame is of the box type, Fig. 12, and is so designed as to allow the engine shaft to rest deep in the bearings. This gives the engine a low center of gravity, making it rigid and fairly free from vibration while in operation.

As with all modern Diesels the frame forms the cylinder jacket, while the liner is held in place by a flange at the head end. The valve mechanism is driven off the longitudinal layshaft, which also handles the governor and fuel pump. The Allis-Chalmers engines are manufactured in single, twin, triple and quadruple cylinder units. The single and twin engines are both

built with a one-piece frame. The triple-cylinder unit consists of a single and a twin engine with the flywheel between the two engines, the two-piece shaft being flanged and bolted to the wheel hub. The quadruple-cylinder engine is obtained by using two twins with the flywheel between the two frames.

National Transit Pump and Machine Co. Diesel Engine.—The engine manufactured by this company is of horizontal design, as outlined in Fig. 13, which brings out the massive lines, particularly those of the bearing housing footings. The engine is

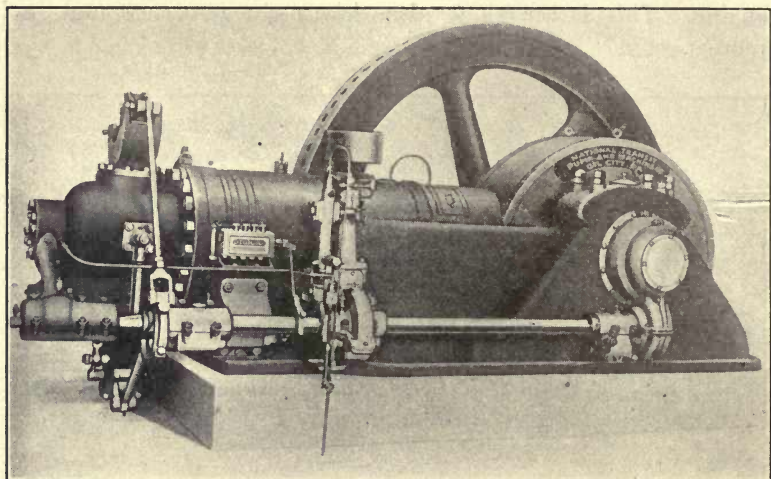

FIG. 13.—National Transit Diesel.

built in one and two cylinder units. As usual with the horizontal design, a layshaft is employed to control the valve mechanism, as well as to drive the pump and governor.

McEwen Bros. Diesel Engine.—This company is one of the later firms to embark upon Diesel engine manufacture. The engine closely resembles other American units, being of the horizontal design, Fig. 14; the cylinder liner is pressed into the jacket, which is a part of the frame. The piston is of the standard trunk design. The valves are vertical, and both admission and exhaust valves are provided with cages. The valves are controlled by separate eccentrics while the injection valve is actuated by a cam. The air compressor, which is two-stage, is driven by a crank extension of the engine shaft. No air storage is employed,

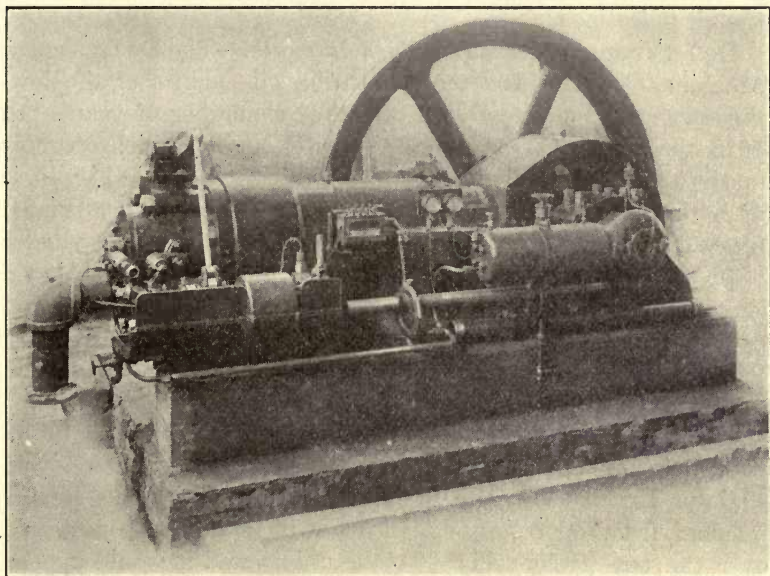

FIG. 14.—McEwen Bros. Diesel.

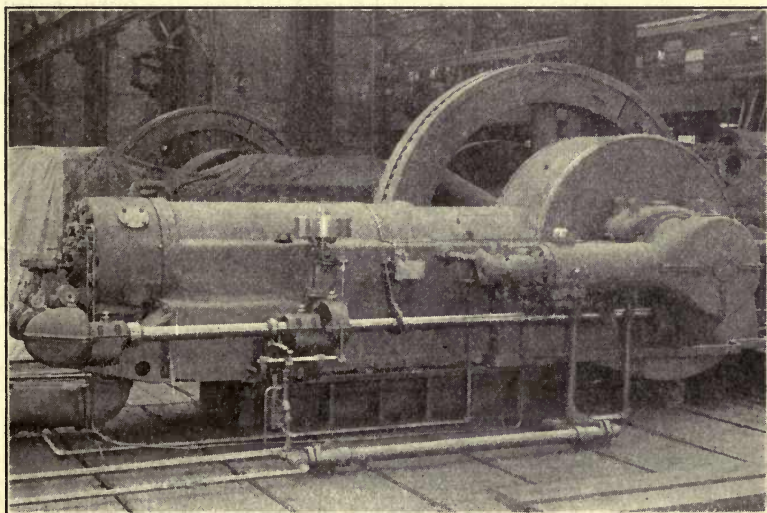

FIG. 15.—De La Vergne Type F. D. four-stroke-cycle Diesel.

a small bottle being placed in the air discharge line to absorb the air pulsations.

De La Vergne Machine Co. Diesel Engine.—The De La Vergne Machine Co. has been manufacturing oil engines of the low-pressure and the semi-Diesel types for a number of years. In 1918 they brought out their Type FD engine, which operates on the true Diesel cycle. The engine, which appears in Fig. 15, is of horizontal design, and embodies the use of a very rugged frame. The camshaft is borne in bearings in front of the cylinder head and is driven by the longitudinal layshaft through bevel gears. The valves lie horizontally and are actuated by short cam levers. The fuel pump and governor, which are driven by the layshaft, are similar to those used on the De La Vergne FH engine and are the result of a number of years of experience.

Two-stroke-cycle Diesel.—The American manufacturers, with but few exceptions, have adopted the four-stroke-cycle engine. In this they were undoubtedly influenced by the greater freedom from operating difficulties which this type possesses over the two-stroke-cycle. To the uninitiated it would appear that the two-stroke-cycle engine was simpler, due to the elimination of the admission and exhaust valves. However, the design calls for the incorporation of some form of scavenging air compressor since an air charge must be used to force the burnt gases out the exhaust ports when the ports are uncovered by the piston. If the fuel consumption is to approach that of the four-stroke-cycle, the scavenging air charge must enter the cylinder at the cylinder head in order that the scavenging be successful. If air ports are used, the eddy currents set up by the air as it enters the cylinder somewhat destroy its scavenging effect.

The two-stroke-cycle, chiefly on account of the lighter weight per horsepower, has been in favor in marine work. It has not won complete possession of this field, and at present the swing is strongly toward the four-cycle. For the small-powered boat under 200 h.p. rating and for the large motorships calling for engines of 2000 h.p. or greater, the two-stroke-cycle engine is better adapted than is the four-stroke-cycle. This applies especially to submarine boats, even though the latter engine is more popular in this field at the present time.

The Southwark-Harris Diesel Engine.—The Southwark Foundry and Machine Co. is manufacturing a two-stroke-cycle engine that is applicable both for stationary and marine work.

This engine, a cross-section of which is shown in Fig. 16, is of vertical design and has cylinders ranging in number from four to eight, dependent on the horsepower rating.

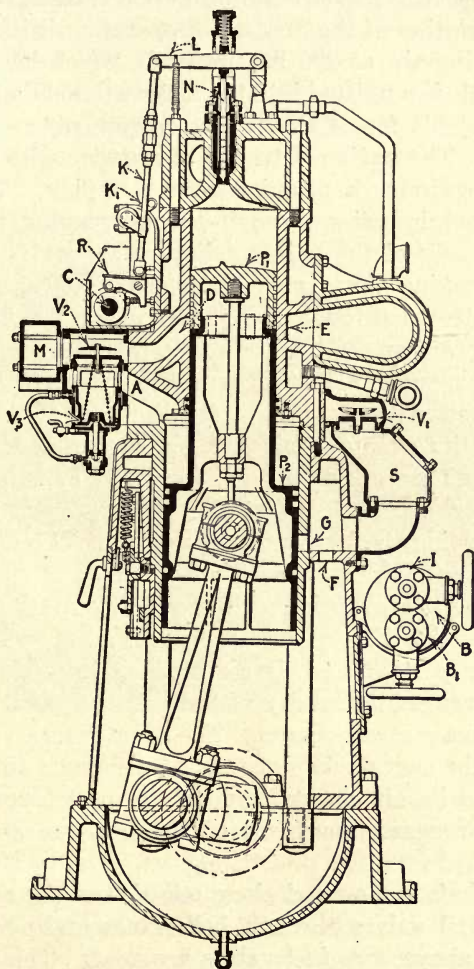

FIG. 16.—Southwark-Harris two-stroke-cycle Diesel.

The engine is provided with a base or crankcase, to which is bolted the vertical support for the cylinder. This cast-iron support is at one side only, the other side being supported by tension rods. This makes the engine frame very open when the steel guards are removed. The cylinder and water jacket are

cast in one piece; this is not objectionable on cylinders 12 inches in diameter. Use is made of a stepped piston, the differential cavity being used for the scavenging air compressor and for air starting as well. Since this engine is quite different from standard designs, a brief description of the method of operation is included.

The starting air, at 200 lbs. pressure, which has been stored in an air tank, is admitted into the differential cylinder above the piston P_2 . This forces the piston downward, and the engine turns over. The engine is turned over twice with the air, and the fuel-injection mechanism is thrown into play. The cylinders are connected in pairs through the scavenging manifold M , while the cranks of the paired cylinders are set at 180 degrees. With the working piston of cylinder No. 1 at top-center a fuel charge is injected through the needle valve N . The piston is forced downward on the power stroke while the piston in cylinder No. 2 is moving upward on the compression stroke. The scavenging or stepped piston P_2 of No. 2 cylinder is at the same time compressing its charge of air to a pressure of around 7 pounds gage. When the working piston P_1 in No. 1 cylinder has moved over 80 per cent. of its stroke, it uncovers the exhaust ports E , allowing the burnt gases to escape. At the same time the scavenging air ports D are uncovered, and the scavenging air from No. 2 scavenging cylinder flows up the passage A , through the valve V_2 , and into the manifold M , which connects with the air ports D . This air blowing into No. 1 working cylinder scavenges the cavity of the exhaust gases and fills the cylinder with a pure air charge. The same events occur in No. 2 cylinder on the next stroke since the scavenging cylinder of No. 1 has drawn in its air charge through the port G and muffler S when the downward movement of No. 1 piston uncovered the port G .

The camshaft is mounted along one side of the cylinders and drives the fuel valves through bell-cranks and push-rods. As pointed out above, two fuel valves are used. This necessitates the use of two fuel cams per cylinder, the cam noses being slightly less than 180 degrees apart for each cylinder. One feature of this engine that has merit is the variable lift of the fuel valves. The push-rod K rests on the upper surface of the rocker or bell-crank R . A movement of the crank K_1 slides the push-rod roller along the rocker R , thereby producing a change in the valve lift. The engine then has two fuel controls—variable valve lift

and variable fuel charges. The variation in valve lift is under manual control only, unlike those engines using a servomotor which automatically secures the same advantages. This represents the method of operation. The action of the fuel pump will be discussed in the chapter devoted to fuel-pumping mechanisms.

Standard Fuel Oil Engine Co. Two-stroke-cycle Diesel Engine.—The Diesel engine manufactured by this firm is of the two-cycle type, Fig. 16A. The piston is stepped, and the scavenging air is compressed by the enlarged section of the piston.

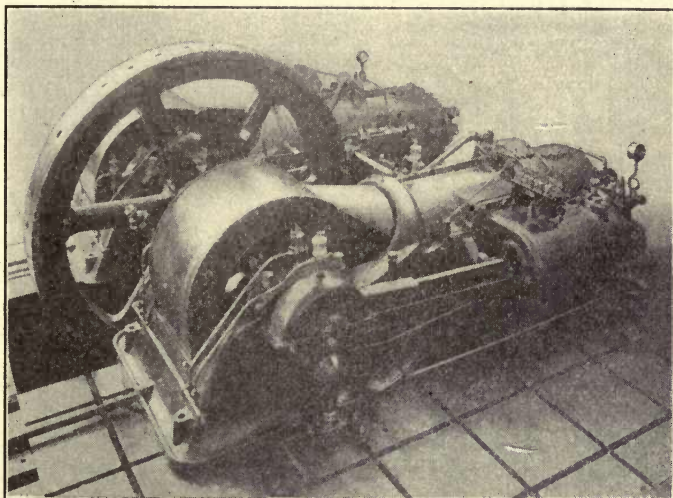

FIG. 16A.—Standard Fuel Oil twin cylinder two-stroke-cycle Diesel.

The frame casting is massive in design. The cylinder casting fits into the bored frame cavity, which design gives a rigid support to the working cylinder. The method of fuel injection and air scavenging will be discussed in a later chapter.

Nobel Bros. Marine Diesel.—The honor of building the first commercial line of marine Diesels belongs to this Russian firm. Since the demand was for Diesels to engine the river and ferry boats, the units Nobel Bros. produced were all of small powers—ranging from 50 to 200 h.p. The same firm was the first to adopt the Diesel engine to submarine boats. The Russian government leaned to the small-dimensioned sub-boats, consequently the development of the Nobel Bros. submarine Diesel has been along the smaller units below 200 h.p., although they

produced a 900 horsepower submarine Diesel prior to 1914. Like all new apparatus the Nobel Diesel has undergone various changes in design.

Werkspoor Marine Diesel.—The first ocean-going motorship of any size equipped with a Diesel engine was the *Vulcanus*. This

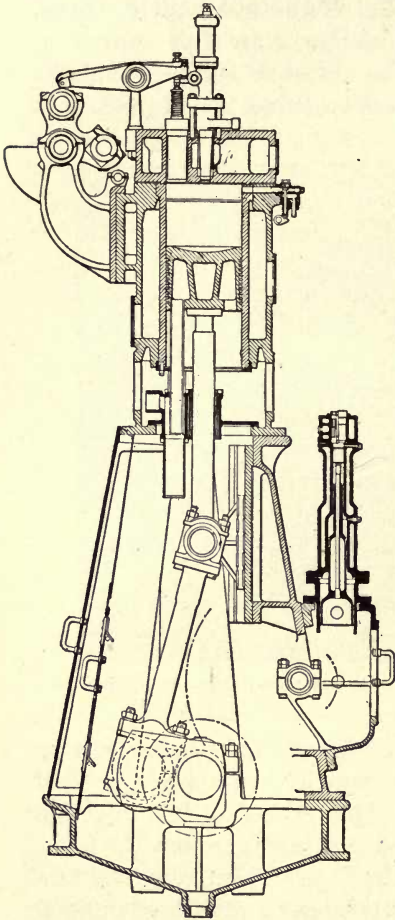

FIG. 17.—Cross-section of Werkspoor Diesel on the motor-ship "*Vulcanus*."

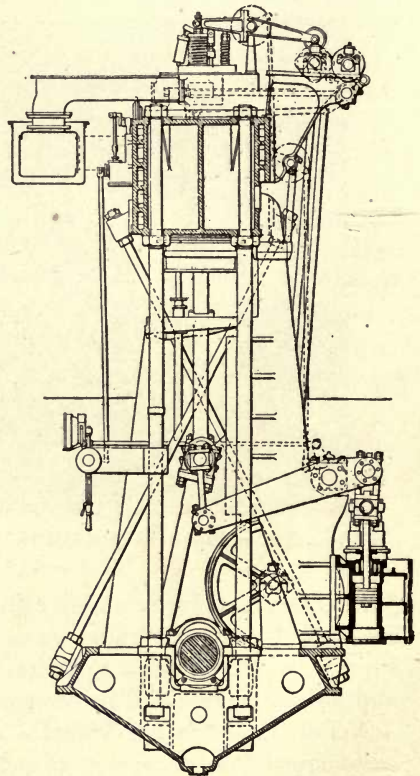

FIG. 18.—Werkspoor open frame marine Diesel.

boat was a 1000-ton tank ship fitted with a 450 h.p. Werkspoor engine having cylinders 15.7 inches diameter by 31.5 inches stroke, operating at 180 r.p.m. This engine is shown in Fig. 17. Although the design necessitated an increased height, the cross-

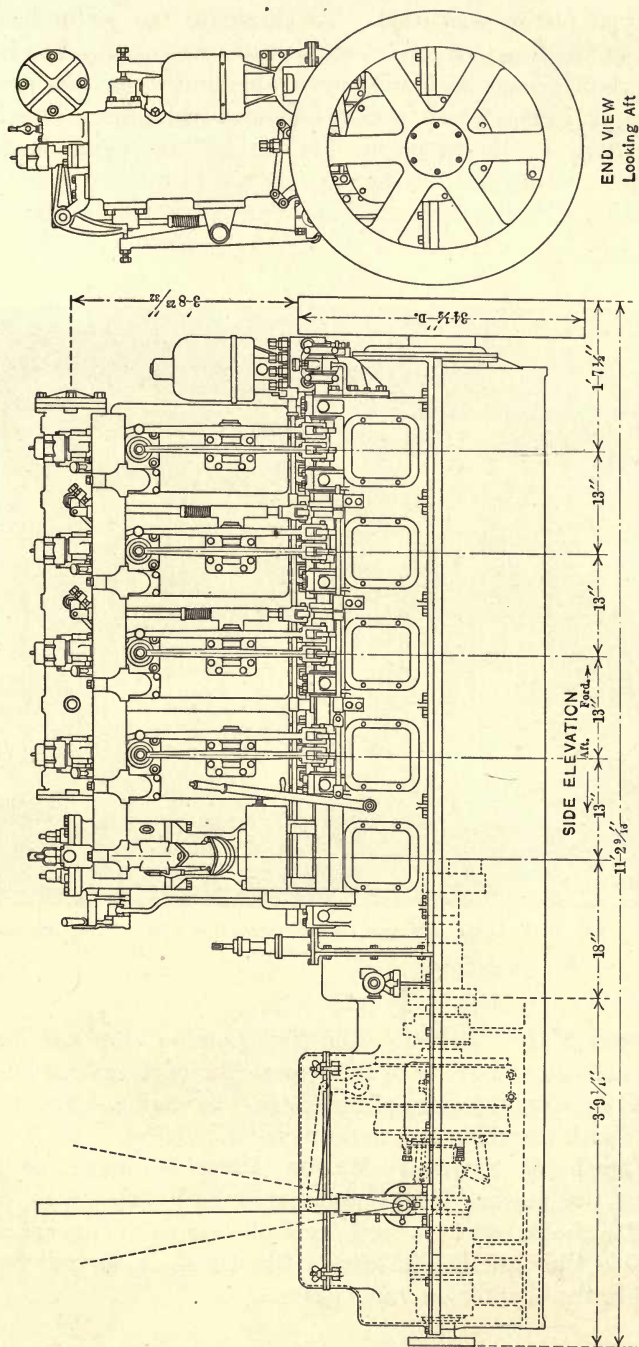

FIG. 19.—Nelseco four-stroke-cycle marine Diesel.

head type piston was used. To eliminate the piston-heating risk, water-cooling through telescopic tubes was used. The frame was of box design and was early abandoned for the present Werkspoor frame which consists of steel columns. This later construction is illustrated in Fig. 18. This engine is being manufactured in the United States by the Midwest Engine Co., the Pacific Skandia Co. and the New York Shipbuilding and Engine Co.

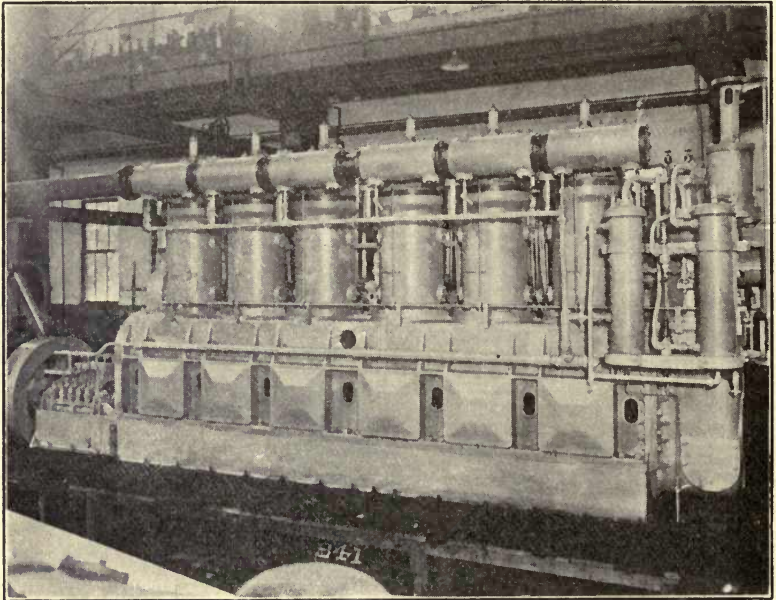

FIG. 20.—600 H.P. McIntosh and Seymour marine Diesel four-stroke-cycle reversible type.

Nelseco Marine Diesel.—The New London Ship and Engine Co. manufactures both two- and four-stroke-cycle marine Diesels. Figure 19 is a cross-section of the latter type engine. This engine is built both reversing and non-reversing.

McIntosh & Seymour Marine Diesel.—Figure 20 is a view of the marine Diesel manufactured by this firm, while Fig. 21 shows section and end elevations. The engine is reversible through the shifting of the camshaft, as will be discussed in the chapter on valve gears.

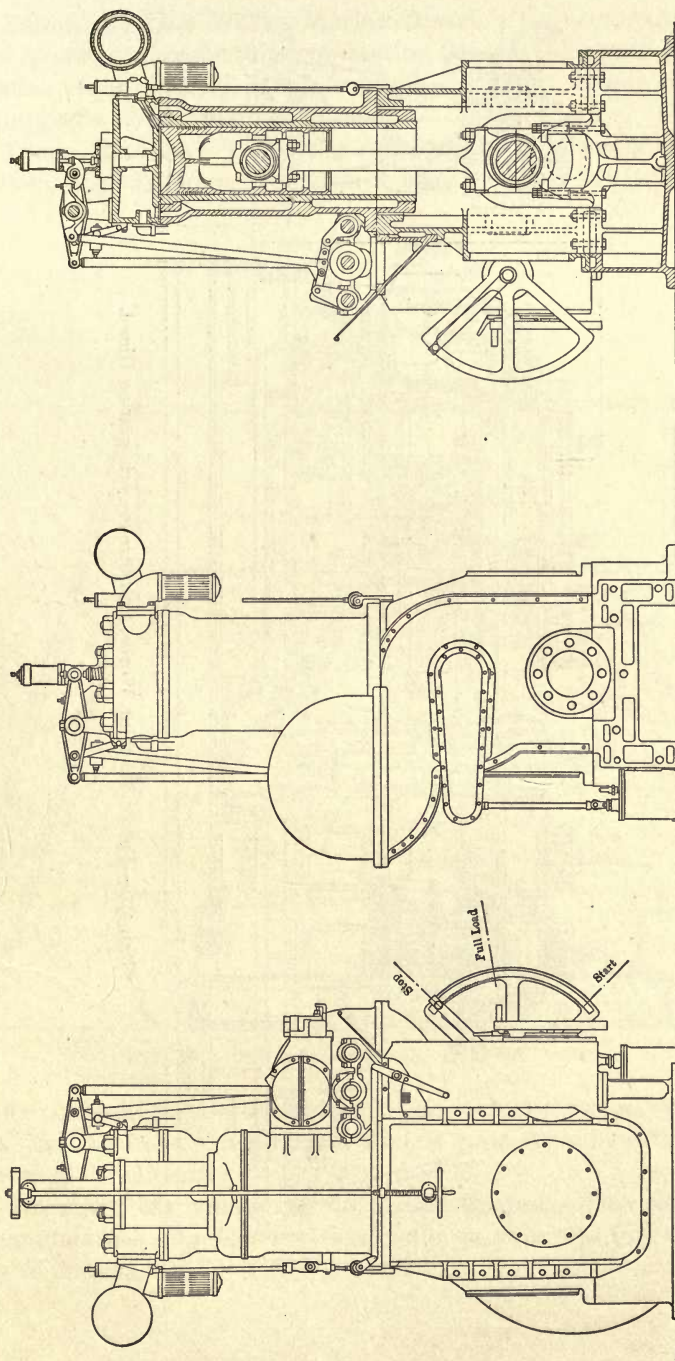

Fig. 21.—McIntosh and Seymour marine Diesel.

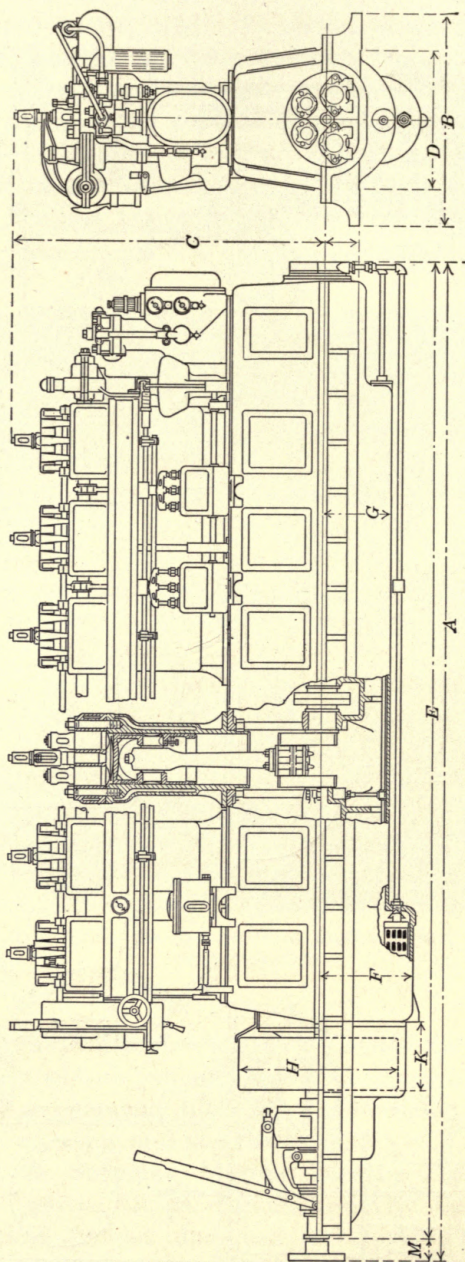

FIG. 22.—Fulton Machine Works, four-stroke-cycle marine Diesel.

Fulton Machine Works Marine Diesel.—This company was the pioneer manufacturer of marine Diesels of small power. These units, Fig. 22, range from 32 to 100 h.p. in size and are equipped with a reversing clutch.

Lyons-Atlas Co.—The Lyons-Atlas Co. brought out a vertical Diesel, Fig. 23, from their own designs. There are several of

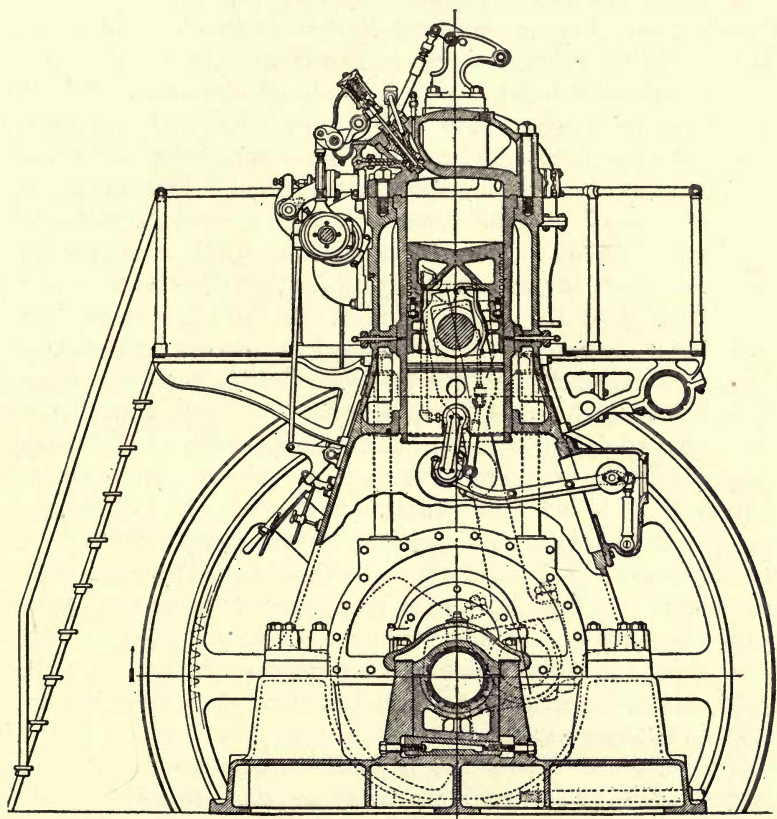

FIG. 23.—Lyons-Atlas Diesel. Original Design.

these units in the United States. The company was reorganized as the Midwest Engine Co. and is now manufacturing the Werkspoor Diesel.

Nordberg Manufacturing Co. Diesel Engine.—This company manufactures the Carels Diesel in both two- and four-stroke-cycle designs.

CHAPTER III

INSTALLATION OF AN OIL ENGINE

General.—The average engineer takes up the problem of installing an oil engine with a feeling of foreboding and dread. This is due to his inexperience in this character of work. It is not an impossible task; indeed, it can hardly be termed difficult if the matter is approached with composure. Under ordinary conditions the engine builder insists on supplying an erector as a safeguard that his interests are protected. Certain details, such as excavation, foundation work, etc., are delegated to the purchaser. Even in the actual work of assembly many factory engineers place the responsibility of setting the frame on the foundation onto the plant engineer. If the latter is capable, he will speedily find that he must direct the erection of the entire engine with the exception of a few important parts. Since there are many second-hand oil engines offered for sale, it behooves the engineer to place himself in possession of sufficient knowledge to enable him to erect any of these that might be purchased.

Excavation.—The first problem that presents itself is the matter of foundation excavation. With small belted units the easiest and the best procedure is to make the foundation pit rectangular, of the size shown on the manufacturer's setting plan. Use can then be made of the earth sides of the pit as the form walls. If the foundation is desired with sloping sides, the earth can be undercut, and, unless it be sandy, the sides will not crumble to any great extent.

With engines above 200 h.p. the expense of a wooden form is low enough to justify its use since it will simplify the work of excavation. In making the excavation it is a good policy to remove enough earth around the foundation proper to accommodate a pipe trench or chase. The use of a chase enables the erector to place all the water and oil piping out of sight yet accessible. This method of pipe disposal is far superior to that, followed by many erectors, of installing the pipe in the floor, permanently covering it with concrete.

After removing the earth, wooden forms are next installed, outlining the shape of the engine foundation. A form often

employed is made up of 1-inch rough lumber nailed to 2×4 in. studding. Frequently the manufacturer's draftsman indulges his fancy in giving the foundation a multitude of steps and angles. It is advisable to boldly depart from all unnecessary shapes and make the foundation as nearly rectangular as possible. Some designers claim that the earth pressure on the foundation steps eliminates the vibration that is common to many engines. The total earth pressure is so slight that the results secured are insignificant. The proper method of preventing vibration is the use of generous dimensions in the footing and in the foundation proper. Frequently the eradication of the many irregular shapes entails the employment of more concrete than otherwise, but it will prove cheaper in the end. Concrete is lower in cost than the carpenter work of making forms.

In locations where "made ground" is encountered it becomes absolutely necessary to provide piling under the foundation. A very common practice is to drive two rows of piles 10 to 20 feet long, the piles being some 8 feet apart. A 3-foot diameter excavation is made about each pile-head 2 or 3 feet deep. These round holes are filled with concrete as the foundation is poured. Such a plan provides a secure footing that will prevent any displacement of the foundation.

Establishing Engine Center Line.—Before pouring the concrete, it is necessary to set the template. In the majority of installations it is usual to have the engine align with some shaft already installed. The proper way to establish the engine shaft center line is by the use of an engineer's transit. This is set under the existing shaft and sighted along the shaft. Dropping two plumb lines from the shaft makes the locating of the line an easy problem. After the line of sight is established, and the datum mark made, the transit is turned 90 degrees and a stake set along the desired engine shaft line. Moving the transit to this latter stake, it is sighted on the datum stake or mark. This establishes a line of sight at right angles to the line shaft. Turning the transit 90 degrees and driving a stake along the new line of sight gives two points in a line parallel to the datum shaft. After these two points are located, a strong piano wire run through them will indicate the desired engine shaft center line. The anchorage for the wire ends should be substantial since workmen in moving material quite often strike it.

Engine Template.—Almost all manufacturers furnish the wooden template with shaft and cylinder center lines marked and with all the bolt-holes bored in their correct positions. When the template arrives in several sections, the engineer must unite the parts. Extreme care must be used in this assembling. It is advisable to lay the parts on a level floor, and, after squaring up the center lines, the sections can be fastened together with screws.

In setting the template above the foundation excavation, engineers use devious methods. Some block up the wooden form at a number of points. This is indicative of shiftlessness and lack of appreciation of the work's importance. The one method that is free from criticism is the use of two heavy timbers, about 12×12 in., to which are bolted cross stringers of 6×6 in. The template is suspended from this framing by bolts, and, if the ends of the 12×12 's rest on solid footings, the entire framing is rigid. If the engine is of medium size, 8×8 in. will serve for the bearing timbers. Such a structure will not move in event a barrow of concrete is thrown against it.

Foundation Material.—The proportioning of the concrete ingredients varies over a wide range. It depends to a considerable extent upon the character of the sand and gravel used. It is obvious that, if the gravel is not washed, the proportion of sand would be less than where a clean gravel was obtainable. For heavy foundations, such as the one under discussion, a ratio of one part cement, two parts sand and four parts gravel, or crushed rock, is advisable. This mixture possesses ample binding strength and is free from the danger of cracking which develops when a leaner mixture is adopted. In order to lessen the foundation expense, many replace the gravel or crushed stone by broken brick. The objection to the brickbat lies in the danger of serious fractures; furthermore, unless they are clean, a good bond with the cement cannot be secured. Upon pouring the conglomerate into the excavation it should be thoroughly rammed, especially at the corners. Enough water should be added to make the mixture "quaky."

In most installations the process of pouring the foundation extends over a period of several days. Each night the surface should be given a thorough wetting down to prevent any premature setting during the night. If the weather is cold, an old carpet or other covering can be placed over the foundation to pre-

vent freezing. It is seldom necessary to place a foundation in freezing weather, but when such conditions do exist the water used should be warm, and a liberal covering of straw and old carpets placed over it each night. After bringing the foundation to the desired level, the surface should be left in an unfinished condition and dampened each night. This keeps the surface concrete green and allows a good finish coating to be applied after the erection is complete.

Often the foundation print shows no reinforcing steel. With any oil engine there is need of tie bars inserted in the concrete. It is not necessary that special bars be purchased. Old steel rails, discard I-beams and the like are just as serviceable. A row of rods or bars laid longitudinally with crossbars at frequent intervals for a reinforcing matting will bind the entire structure. The steel should be laid about halfway from the base.

Foundation Bolts.—The best of authorities recommend a foundation bolt tunnel under the foundation in order that the bolts may be placed in the holes after the frame is set on the foundation. This is undoubtedly an excellent plan with engines above a thousand horsepower capacity. With units under this size the results obtained do not justify the heavy expense of forming the tunnel. The same objection applies to the design wherein recesses are formed in the concrete at the base of the bolt cavities.

For all ordinary installations the best method embodies the employment of bolt tubes: 3-inch black pipe is quite satisfactory. When such an arrangement is decided upon, the pipes should be cut to a length equal to the length of the bolt from bottom washer to wooden template. After the pipes are placed upon the bolts and the latter suspended from the wooden template, it is advisable to wrap the pipes with a strong manila paper. This paper prevents the pipes from being gripped by the concrete, allowing the pipes to be withdrawn after the concrete has set. After the engine base has been set, the space between bolt and concrete should be filled with neat concrete.

Insufficient Foundation.—In foundations installed for some years parts that are exposed to oil drippings become rotten. These portions should be cut away and renewed with neat concrete. Frequently the foundation proves to be too small to adequately support the engine. It then becomes necessary to devise ways and means of increasing the foundation footings.

Some engineers merely trench around the old footing and add a few feet of concrete. Unfortunately the new and old concrete always fail to unite with any measure of bonding. The only satisfactory correction of this foundation trouble is "rafting." A trench should be dug completely around the engine foundation; the bottom of the trench should be at least 4 feet below the foundation base. Three or more tunnels about 4 feet high and 6 feet wide should be driven transversely under the foundation. These tunnels connect with the trench and are filled with concrete as is also the trench. If the vibrations have been excessive, it is advisable to fill the tunnels with concrete and remove the earth from between the tunnels, filling these voids with concrete. This increases the entire foundation depth by the height of the tunnels. The footings can be extended to any desired width. Many instances of warm bearings on engines using outboard bearings are directly traceable to a shifting or settling of the foundation.

Vibration.—One of the objections voiced against the installation of a Diesel engine in an office building is the vibration so often present in the internal combustion engine. There is no adequate defense against this charge, for, as customarily installed, an oil engine sets up vibrations that can be felt even in large buildings.

In preparing the foundation for these installations a layer of felt at least 10 inches thick should be placed over the entire bottom of the foundation excavation. A concrete retaining wall 6 inches thick should be built about the foundation. This wall serves to keep the earth from touching the foundation. A wooden form for the foundation is then placed within this retaining wall. The form can be made of 2×4 in. studding and 1×12 in. rough boards. The 2×4's should not touch the retaining walls but should be supported by wedges. After the concrete is in the wedges can be removed; this will allow the wooden forms to be dismantled. The distance between foundation and retaining wall ought not to be less than 8 inches. With this construction the foundation is not bound in any way to the building and the layer of felt will absorb all the shocks incident to the engine's operation.

With any concrete foundation, after the engine is erected, a heavy coating of waterproofing cement mixture makes an ideal finish. This coating will serve to keep any oil from seeping into the concrete.

Installation of Engine Frame or Bed.—The frame is generally mounted on skids when shipped from the factory. To unload this heavy section entails considerable mental and physical effort. The easiest method involves the building of a crib against the end of the flat car with a runway of heavy timbers, such as 12×12 in., laid from the level of the car to the edge of the engine foundation. After the frame has been jacked up and rollers inserted under the skids, it can be easily pinched to the incline. A rope hitch should be run to the end of the car and about the car axle for

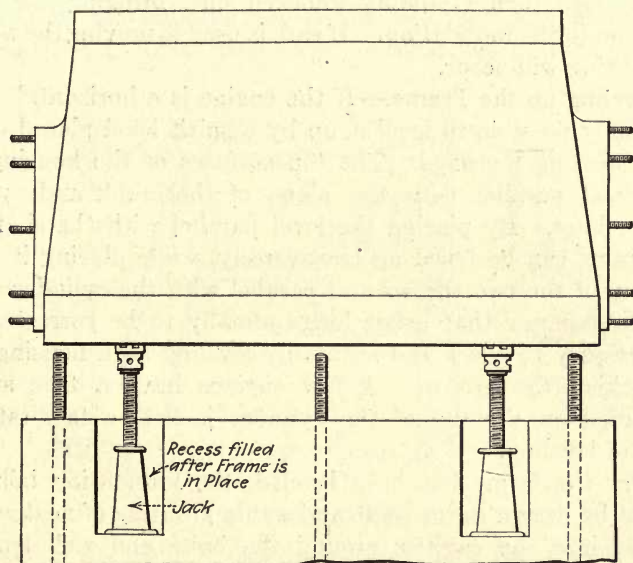

FIG. 24.—Setting engine on foundation.

the purpose of restraining the motion down the incline. Since the "runway" has been carried up over the foundation, clearing the foundation bolts, the frame is moved without difficulty into approximate position on the concrete. In many instances a winch is available, which reduces the labor of moving the heavy bed. It usually is necessary to employ a "dead man," or post, and a tackle block. The next step is the placement of the frame directly on to the concrete. This involves the use of at least four heavy jacks, one at each corner. These jacks can be located in recesses to be filled after the engine is set. The frame is raised a slight amount and the skids are removed, Fig. 24, after a number of iron wedges with a butt thickness of about $\frac{3}{4}$

inch have been prepared and placed on the foundation along the line of the frame. The frame is now lowered and rests on these wedges, whereupon the jacks are removed. The wedges are used to line up the frame.

As the frame rests on wedges, the center lines of the engine should be established. Since the stakes used in locating the center line of the template are still in place, the piano wire is run between the two stakes and through the bearing housings. The bed can be shifted until the wire is exactly center. The wedges are then gradually knocked out, bringing the frame down on to the foundation. If care is used in moving the wedges, no shifting will occur.

Leveling up the Frame.—If the engine is a horizontal one, it is usually possible to level it up by a spirit level placed on the main bearing housings. The top surfaces of the housings are machined parallel with the plane of the crank and cylinder center lines. By placing the level parallel with the shaft line the frame can be trued up transversely, while placing it across the top of the two throws and parallel with the cylinder allows the discrepancy that exists longitudinally to be corrected. It is necessary to check the results by leveling both housings and rechecking the process. A few engines have a true surface machined on the top of the cylinder jacket to facilitate the work of leveling.

After the frame has been leveled, the foundation bolt-nuts should be drawn down tight and a thin grouting of neat cement poured into the cavities around the bolts and well troweled under the frame. If this coating is brought up above the bottom of the engine frame an inch or so and sloped toward the edge of the foundation, the appearance of the installation is much improved. The iron wedges should be left in place. In event the engine settles out of line, these wedges facilitate correcting the trouble.

With a vertical box-frame engine a sub-base is usually provided. This is first set on the foundation and aligned by the same procedure. However, while the bolts should be drawn up snug, the grouting in is best deferred until the main frame is set. Where the sub-base is used, the bottom of the frame is usually planed, and the frame should set level if the sub-base has been properly aligned.

Erecting the Cylinders.—All horizontal engines are shipped with the cylinder liner in place; it follows that correct alignment of the cylinder is secured when the frame is properly set. With the vertical box-frame engine the placing of the cylinders is a ticklish proceeding and calls for much ingenuity in plants where facilities are meager.

Every plant should be equipped with an I-beam trolley and differential hoist. This hoist should be of at least 5-ton capacity. The I-beams can rest on brick pediments that are incorporated in the building walls. In case such equipment is not available, it becomes necessary to construct a wooden frame

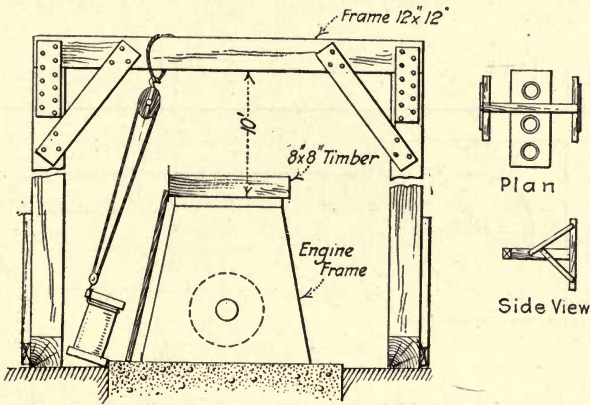

FIG. 24A.—Scaffolding.

similar to Fig. 24A. The top beam should clear the frame by at least 10 feet to give ample room for the blocks. If timbers of sufficient length are not obtainable, the frame can be made of built-up timbers constructed of six planks, 2×12 in. in size, lag-screwed together. Stout planking should be placed along the side of the engine to prevent the cylinder damaging the frame as it is hoisted to the top; 6×6 in. cross timbers can be laid across the top of the frame to act as a landing for the cylinder. These timbers guard the studs against damage. The tackle blocks, or chain hoists, are fastened to the cylinder top, and it is raised until it can be lowered on to the 6×6 in. platform. It is always advisable to use two blocks. This is a safety measure in case one breaks. After the cylinder is placed on the platform, it should be pinched into place over the studs. All the timbers save two outside the bolt circle can be removed. By

lifting the cylinder with the blocks, which have been centered above the cylinder, the two timbers are withdrawn and the cylinder lowered on to the frame.

After the cylinder is in place, a plumb bob is dropped through it. To do this a metal or wood strip, similar to Fig. 25, is fastened to one of the cylinder-head studs. A washer is attached to the bob line after the line has been passed through the slot in the strap. The strap is placed over the approximate cylinder center. The slot allows the bob line to be moved until it is exactly center. To center the plumb line at the top of the cylinder, a pair of inside calipers are used. This centering calls for the greatest patience on the part of the erector. After centering

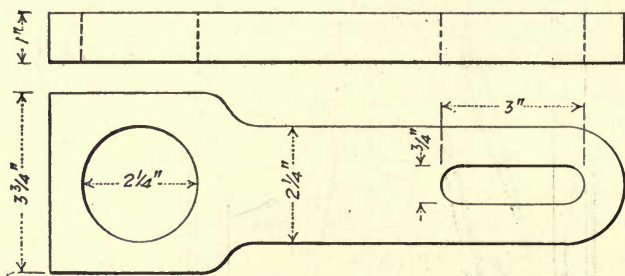

FIG. 25.—Centering strip.

the line at the top, measurements must be taken at the bottom of the cylinder to ascertain if the bob line is central at this place. Since both the cylinder flange and frame top are machined true, it is seldom that the cylinder does prove out of plumb, providing the frame has been properly set. If this should occur, the frame must be wedged up until the cylinder center line is plumb. If the engine is multi-cylindere, a plumb is dropped through each cylinder and kept in place until the engine shaft is lined up, Fig. 26. The bob lines must square with shaft center line. Practically the same method can be followed with the A-frame engine.

Centering the Shaft.—It is necessary to check the crankshaft bearings to insure that the shaft will be square with the cylinder center lines. Two metal or wood strips, Fig. 25, should be fastened to the ends of the engine frame, as in Fig. 26, with a piano wire stretched between. The disks should be moved until the horizontal wire just touches the three cylinder plumb lines; the

wire should be leveled at the same time with the spirit level. The bearings, which have been placed in their housings, should be calipered to see if the line is central with each bearing. If a bearing is out, then it must be shifted until it registers central. With the wedge-type bearing this alteration can be secured by proper movement of the wedges. If the bearings are of the non-adjustable shell type, it becomes necessary to scrape the high bearing and shim up the low ones.

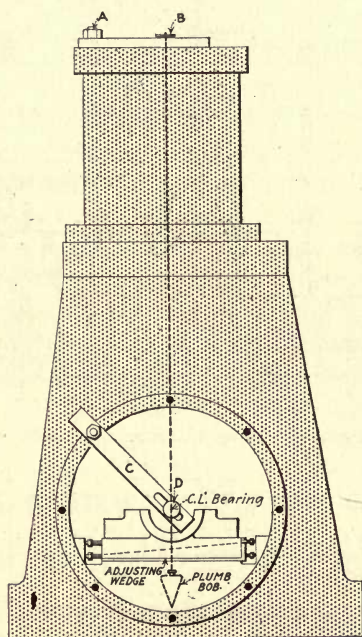

FIG. 26.—Aligning cylinders and shaft.

Before the shaft is lowered on to the bottom bearing shells, small lead wires, about $\frac{1}{32}$ inch in diameter, should be placed along the bottom of each bearing. When the shaft is placed in position, these wires flatten out. By raising the shaft, these wires can be removed and their thickness measured by a micrometer. If the lead is of the same thickness throughout its length, the shaft evidently bears evenly in a longitudinal direction. If any unevenness is present, the shell must be scraped to a fit. To check the area of the shell which is supporting the shaft, the shaft can be coated with Prussian blue and rotated.

Upon lifting the shaft the bearing will show which points are high or low. Scraping the babbitt will bring the surface to a perfect contact.

Many erectors have the habit of using a chain sling on the shaft. This is absolutely out of place with a Diesel engine.

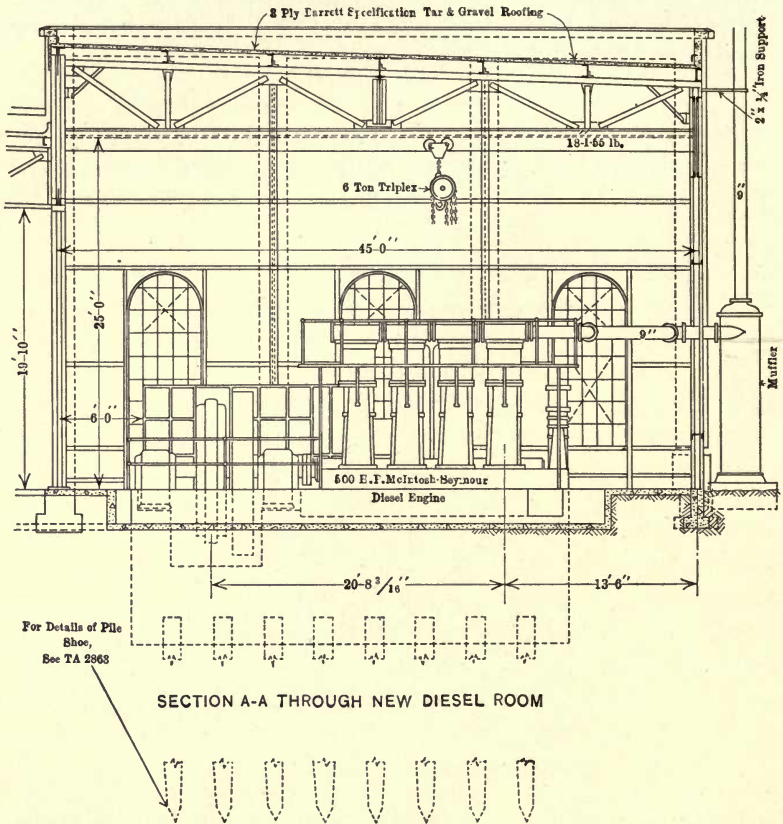

FIG. 27.—Diesel engine room.

Sacking wrapped about the shaft and the use of rope slings will eliminate all danger of scoring the shaft. It requires only a small dent or cut on the journal to ruin a bearing. In handling the shaft it is advisable to suspend it by slings from each end; if possible, the slings should be tied on the shaft at other than journal points. If no traveling crane is at hand, two wooden forms, such as indicated in Fig. 24, can be constructed.

In checking up the alignment of an engine shaft already installed, an approximate solution is by placing one of the cranks in a horizontal position, which can be done by using a spirit level: placing the level across the two webs will prove if the shaft is out of line. This should be rechecked by reversing the level. This, of course, is only possible where the crank throws are milled on all sides.

With an engine employing an outboard bearing the alignment of the extension shaft merely necessitates the continuation of the shaft center line. In erection the main point that demands the exercise of extreme care is the bolting of the extension shaft to the main shaft, or to the flywheel, as the design may be. The flange bolts should be drawn up uniformly, a part turn of each nut in succession. Some erectors are in the habit of bolting the two parts together with the outer end unsupported by the outboard bearing. They then turn the engine over and adjust the outer bearing against the shaft end. The danger here lies in the liability of the unsupported shaft weight throwing it out of level. Many hot outer bearings can be attributed to this carelessness.

Plant Building.—The design of plant building is largely determined by instrumentalities beyond the sphere of the engineer's influence, though the layout of the machinery is essentially a matter where the operator should be considered. Figure 27 is a section through a plant containing two 500 h.p. units. The figure shows the method of piling the foundation.

CHAPTER IV

MAIN BEARINGS. CRANKSHAFTS

TYPES, ADJUSTMENTS AND REPAIRS

Main Bearings.—Diesel engine bearings may broadly be divided into two classes; namely, adjustable and non-adjustable. The former, of course, embodies the addition of a wedge and, as applied to the vertical type engine, is outlined in Figs. 7 and 23.

Adjustable Bearings for Vertical Engines.—This bearing design is found mainly on the older engines, such as the American Diesel. It follows gas engine practice of fifteen years ago. At that time the rapid wear of the main bearings seemed to demand some form of adjustment. It is now apparent that the trouble lay in excessive bearing pressures. With more liberal bearing area this difficulty of rapid wear has largely disappeared.

In the hands of an experienced operator the adjustable feature has its attractions. It is well-nigh impossible to have three or four bearings with babbitt liners of uniform characteristics. The babbitt first run out of the ladle is of a density considerably higher than the bearing that is poured last. The natural result of this non-uniform density is the variation in the bearing wear. To the engineer who is versed in the finer adjustments of a Diesel engine the realignment of the bearings is not a difficult task. In readjusting the bearings the first step is to remove the bearing tops, then thoroughly wipe off the shaft and bearings after the shaft has been raised by a jack set at each end of the frame. After the shaft is lowered on to the bottom bearing, it should be aligned by using a spirit level. The two end bearings are adjusted until the shaft is level. The inside bearings are then brought up snug against the shaft by means of the wedges. The connecting rod big-ends are next made fast and the clearance of each cylinder measured. Often, when the engine has been badly out of alignment, the readjustment of the bearings alters the clearance of one of the end cylinders. This, of course, must be taken care of by varying the thickness of the shims between the connecting rod and its big-end.

In making corrections for misaligned bearings, it is highly important that the bearing bolt nuts be tightened up very snugly and a lock nut provided. The same applies to the side set-screws of both the wedge and the bearing where they are used, as in Fig. 7. If either the bolt or set-screw works loose, the bearing will shift sidewise, allowing the shaft to bend at each impulse. Many shafts have been fractured because of this unrestrained flexure. Each time the crankcase is opened the bearings should be examined and the bolts tightened.

Adjustable Bearings on Horizontal Engines.—The direction of the bearing pressure, due to the explosion in the cylinder, makes the adjustable bearing well-nigh imperative on horizontal engines. The cylinder pressure against the piston head may be said to act in three directions. Part acts in a vertical direction against the cylinder walls; the remainder has its direction along the connecting rod. This latter force is separated into two components, one acting tangentially to the crank-pin, producing rotation, while the second component acts against the lower bearing in a direction dependent on the crank position; but at all points on the outward or power stroke its direction falls between the horizontal and vertical plane of the lower half of the bearing. If the bearing be of two-piece construction, the wear resulting from this bearing pressure cannot be taken up. The bearing wears oblong, and the engine soon pounds.

Means must be provided for compensation for this wear, and the quarter-box designs of bearing are the natural selection. The adjustable or quarter-box design may follow either of two types; namely, a three or four-piece bearing. In actual operation the three-piece is as satisfactory as is the four-piece bearing. The pressure is against the bottom and the front quarter, consequently there is practically no wear on the rear or cylinder side of the bearing. The wear on the bottom is usually insignificant since it receives but little pressure other than that due to the weight of the flywheel and shaft. The front quarter experiences the greatest wear and must be given constant attention. Ordinarily it will be found that the two main bearings do not wear at a uniform rate. While the wear on each bearing should be taken up as it develops, it should not be forgotten that the lower shell and the rear quarter also require attention. Periodically the shaft should be realigned and, if it is proven out of line, the lower and rear shells shimmed or wedged up the proper amount. Since

the clearance space between the cylinder head and the piston is small in the Diesel engine, there is a danger of excessive compression pressures if the wear on both front and back quarters is taken up by the front quarter only, for this tends to throw the shaft toward the cylinder. Usually the horizontal engine employs an extension shaft and outboard bearing. This outer bearing along with the main bearing adjacent to the flywheel carries the weight of the wheel. The flywheel weight on this main bearing causes more rapid wear on the bottom quarter than on the other main bearing. Realizing this the operator should see that the bearing does not become low.

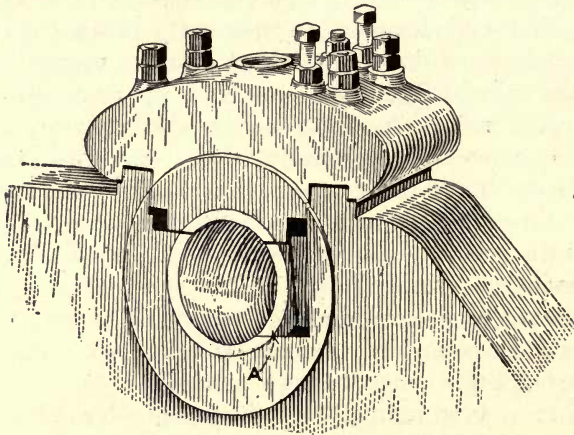

FIG. 28.—National Transit Diesel main bearing.

National Transit Diesel Main Bearing.—Figure 28 is the three-piece bearing used on the National Transit Diesel. As will be noted, the upper part of the bearing is babbitted directly on to the bearing cap. The bottom and rear quarter consists of a single babbitted shell while the front quarter is provided with a wedge. To avoid the danger of wedge-bolt breakage, the bolt-head fits into a circular opening in the wedge. The bolt can, then, accommodate itself to any displacement of the wedge. The lubrication is effected by two chain oilers which dip into the oil cellar east in the housing.

The Snow Oil Engine Main Bearing.—This engine employs a bearing as illustrated in Fig. 29. The lower shell, as well as the two quarter-boxes, is equipped with a wedge. The top quarter is a separate shell and is not cast directly on to the cap, as is usual.

The engineer will find that the bottom bearing wears most at the edge adjacent to the front quarter. The front quarter also wears at this edge.

It should be a rigid rule in every plant where oil engines are installed that no adjustment of the bearings shall be made while

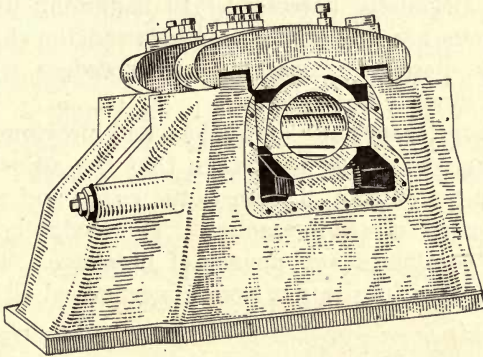

FIG. 29.—Snow-Diesel main bearing.

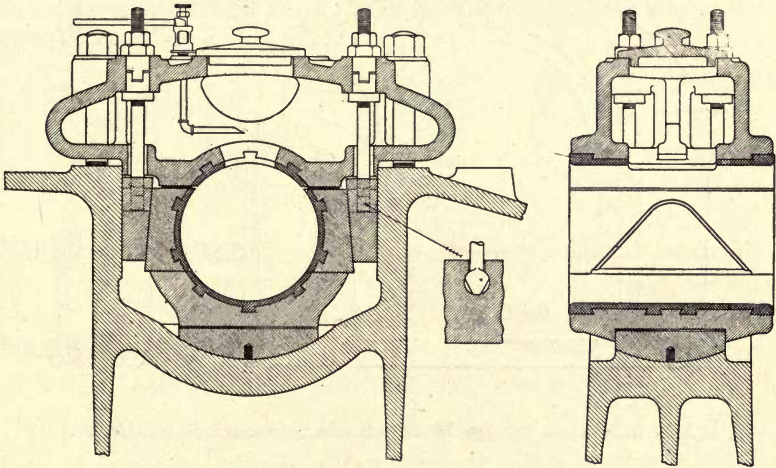

FIG. 30.—Allis-Chalmers Diesel main bearing.

the engine is running. The revolving shaft allows the bearings to be drawn up tighter than when idle; the careless operator will likely tighten up the wedges enough to occasion a hot bearing. The oiling of the bearing is accomplished by means of a mechanical lubricator furnishing stream lubrication.

Allis-Chalmers Diesel Main Bearing.—A four-piece bearing has been adopted by the Allis-Chalmers Co. and appears in Fig. 30. The lower shell rests on a spherical-bottomed pad with the idea of allowing the bearing to shift to conform with the position of the shaft. Since the shaft has but one true position, which must be maintained if the operation be smooth, the spherical seat is not absolutely necessary. In shimming up the lower shell, the liners are properly placed between the shell and pad. The two side quarters are equipped with wedges, while the top is babbitted directly onto the cap.

The operator, especially if he has had previous experience on steam engines, should remember that the adjustment must be made almost entirely by the front wedge and not by both quarter-boxes as in steam practice. The wedge bolts are of a design that eliminates any danger of breakage. The oiling is secured by stream lubrication from a mechanical oil pump.

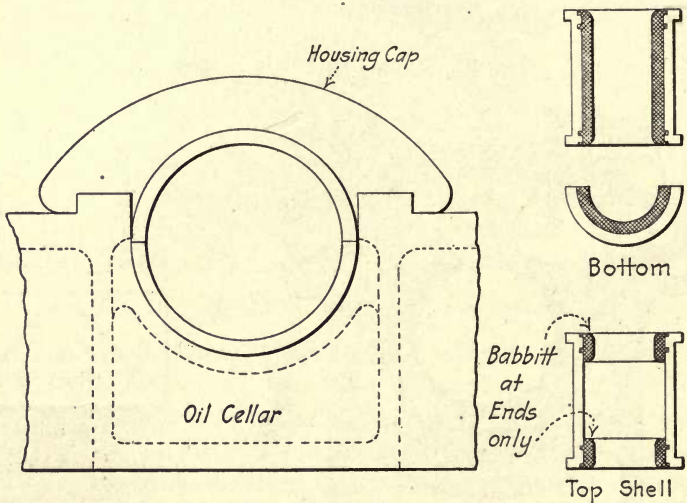

FIG. 31.—Main bearing McIntosh and Seymour vertical Diesel.

Two-piece Main Bearings.—In vertical engines the wedgeless bearing, built along the lines of Fig. 31, is a common practice. The bearing is provided with a ring oiling system; generally two rings are used, and the lubricating oil is carried in a cellar in the bearing housing. Much depends on the rings working freely. Ruined bearings frequently occur where the rings cease rotating, leaving the bearing without oil. With this

bearing it is absolutely imperative that the oil in the cellar be maintained at a high level. To insure copious lubrication the distance between oil level and point of contact of ring and shaft should be as small as possible. It is self-evident that the greater this distance is made the smaller will be the amount of oil which will reach the shaft since there is a longer time interval to allow the oil to flow back down the ring. The same reasoning applies to the grade of oil used. If it is fairly free-flowing, the shaft will receive a meager supply. The same type of bearing is adaptable to the use of a chain instead of a ring for oiling purpose. The chain should always be of brass in order to eliminate any grooving of the shaft. It is to be remembered that this brass chain will wear and break. If the bearings are not inspected occasionally, a broken chain may cause the babbitt to be ruined. It is an easy matter, when the engine is stopped, to pull a loop of the chain up through the bearing cap and run the entire length through one's fingers. Any links that are worn thin are easily detected, and, if many links are in a bad condition, the entire chain should be renewed. The advantage of the chain oiler lies in the greater amount of oil the links will carry to the shaft over that supplied by a ring oiler.

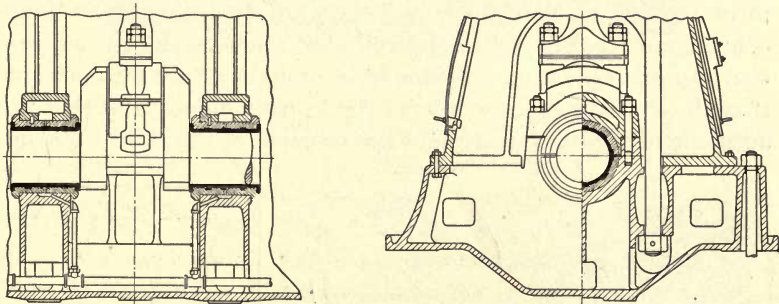

FIG. 32.—Busch-Sulzer Bros. Diesel main bearing.

Busch-Sulzer Diesel Main Bearing.—The same general type of bearing, Fig. 32, with a pressure oiling system is found on the Busch-Sulzer Engine. With this design the top and bottom shells are identical and in emergencies, when the lower shell wears, the bearing may be reversed, using the top for the bottom. There is no wear on the top shell, and a worn bearing can be used here for a time. This practice should not be maintained continually since a loose fit at the top shell may cause the shaft to whip and lift upward.

With the pressure system it is essential that there be a good seal between the shell and the housing. If not, the oil will escape at the ends, and the shaft will fail to receive proper lubrication. Ordinarily, if the oil passage to one bearing becomes clogged, the gage on the oil-pressure line will show an increased pressure. If another bearing is worn, thus allowing a freer passage than usual, it is possible for one line to be completely clogged without any pressure change being evidenced.

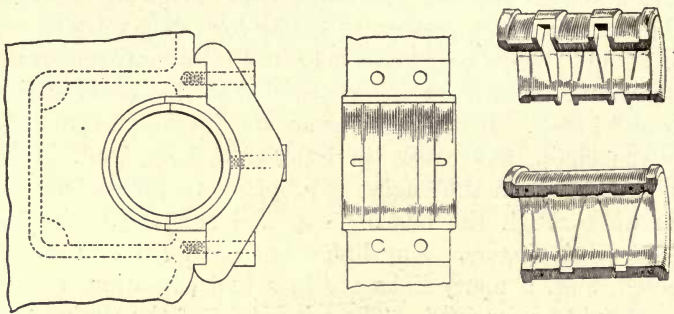

FIG. 33.—McEwen Diesel main bearing.

McEwen Diesel Main Bearing.—Figure 33 shows the two-piece bearing of the McEwen Horizontal Engine. Since these engines are small-powered per cylinder, the two-piece construction offers no objection. It should be understood by the operator that the shaft pressure will wear the bearing oblong and that no adjustment is practical beyond the removal of the shims. After

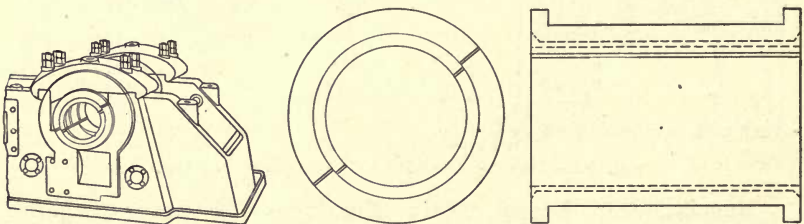

FIG. 34.—De La Vergne Diesel main bearing.

the wear becomes pronounced, the only remedy is replacement of the worn part. The oiling is effected by two rings which dip into the oil cellar below the bearing.

De La Vergne Diesel Main Bearing.—The De La Vergne Engines use a two-piece bearing, as appears in Fig. 34. The bottom and top halves are set at a 45-degree angle which allows

the pressure to bear on the center of the bottom shell. By removing shims from between the two shells the necessary adjustment can be made.

Aligning of Bearings.—In lining up shaft bearings the first step is to establish the shaft center line, using a fine piano wire. Next, the bottom shells are placed in the housings. If the shaft is 9 inches in diameter, the shell is adjusted until the radii from all points on the shell surface to the center line are $4\frac{1}{2}$ inches. Where the bearing is of the bottom-wedge type, it is easy to make the adjustment. If the engine is a horizontal one, or a vertical engine with a wedgeless bearing, the only way to raise the shell is

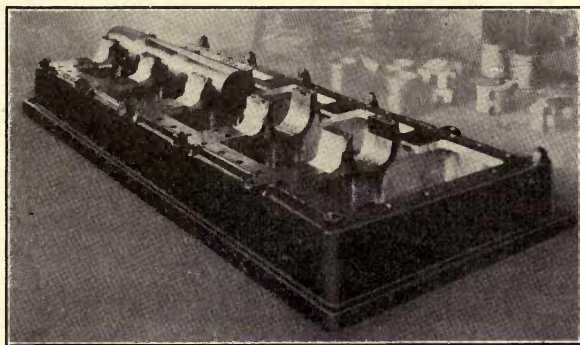

FIG. 35.—Fitting main bearings shells to seats in baseplate.

by the insertion of shims between the housing and the shell. Practically all manufacturers bore the housings true to a test bar. Figure 35 is self-explanatory as to the method of truing the housing. It should never be necessary to shim up the bearings of a new engine. When an engine is installed, among other records the engineer should make note of the thickness of the bearings, including the cast-iron shell and the babbitt lining. Then, in case of wear, the engineer knows exactly how much he should shim up to bring the distance back to the original value. The variation in the bearing levels should not exceed .003 inch. If more than this, the shaft will likely spring in operation. On engines with the flywheel mounted on an extension shaft the wear is more rapid on the main bearing adjacent to the flywheel. The thoroughly versed erector always sets this bearing from .003 to .004 inch higher than the other bearings. This allows a wear of .006 to .008 inch before the bearing becomes too low.

Because of the initial misalignment this particular main bearing always runs warmer than the other bearings. Many operators experience a great deal of worry over the temperature condition of this bearing when, in fact, the higher temperature actually indicates that the bearing is in proper shape. When the temperature becomes lower than with the other bearings, it can be taken as evidence that this bearing has worn low and must be raised.

Babbitting a Bearing.—There are many instances where a bearing becomes hot, causing the babbitt to drag and cut; yet

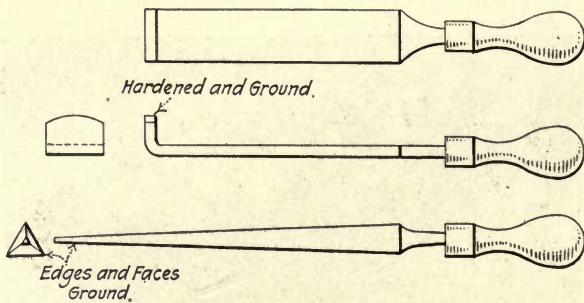

FIG. 36.—Bearing scrapers.

in the majority of cases it is not necessary to rebabbit this bearing. The proper procedure is to use scrapers made of old files along the lines of Fig. 36. The babbitt should be smoothed down and all loose and damaged metal cut out. This may cause part of the liner to be so low that it fails to contact with the shaft. This is not objectionable since the ordinary shell has an excess of bearing surface. Where the damage is considerable, a new babbitt liner is the only solution. Under these circumstances it is first necessary to melt out all the old metal by placing the shell in an iron pot over a fire until all the babbitt becomes soft enough to flow off of the cast iron.

A good many engineers think that tinning the cast-iron shell is uncalled-for labor, but it does guarantee that the babbitt will hold. To cast the new liner it is advisable to secure a cast-iron or sheet-steel plate. The two halves are then clamped together, with a paper separator where the two halves meet, heated and placed in an upright position on this plate, inserting an asbestos sheet between the shells and plate to prevent the babbitt from

adhering to the plate, Fig. 38. The mandril may be either of cold rolled steel or a piece of pipe about an inch smaller in diameter than is the engine shaft. The shell base is dammed with fire-clay to avoid any leakage of the molten babbitt. The babbitt, which should be of new metal, is now heated in a ladle or cast-iron pot until it will char a pine splinter. The dross that floats on the surface of the hot metal is best skimmed off before the bearing is poured. The pot should contain enough metal to fill the entire cavity. It is impossible to use two pourings on a bearing for the two will not unite. Most bearings have a solid

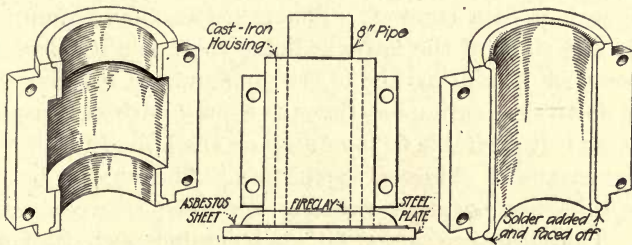

FIG. 37.

FIG. 38.

FIG. 39.

Babbitting a bearing.

babbitt liner for the top of the bearing. Since there is practically no upward thrust, all that is required is sufficient surface to prevent the shaft from lifting. To save babbitt, it is a good plan to fill in the top shell with fire-clay with the exception of the ends, where space must be left for about 2 inches of bearing metal, similar to Fig. 37.

The bearing is now cast with the bore an inch smaller in diameter than the shaft. The halves, still clamped together, are now removed from the plate and cleaned of fire-clay. They should be placed on a lathe and bored out to exact shaft diameter. After being separated, a bevel should be cut along the parting edges so that these edges do not tend to scrape off the oil as the shaft revolves. It is of no benefit to peen the surface of the babbitt. This practice is likely to loosen the bond between the babbitt and cast-iron shell. After boring the shell, the two halves should be lightly coated with Prussian blue and placed one at a time on the shaft. By rotating the half of the liner, the engineer can note the high spots and scrape the bearing to a perfect contact. This scraping is a tedious affair, but the resultant long

life of the bearing justifies the labor. Oil grooves of ample length should be cut in the babbitt. In cutting the oil grooves none of them should be carried to the edges of the shells. If this is not observed, the open ends of the grooves offer too free a passage to the oil; consequently but little oil flows over the babbitt surface.

Frequently the housings are not bored exactly true, and the bearings are a trifle cramped, touching the shaft on only a part of their length. To guard against this, a new liner should be examined after the engine has been run an hour or so on light load. If the shaft bears only partially, scraping the high end will bring all the surface to a contact. This is better than shimming up the low end since, if the latter is done, there is a liability of the cast-iron shell fracturing due to the poor support it receives. In bolting down the bearing cap the nuts should be drawn up snugly. In no case is it desirable to loosen up on the bolts from the lower shell by means of shims or separators. These must be of the proper thickness to allow running clearance between cap and shaft. This clearance can be .001 inch per inch of shaft diameter. By placing lead wire or fuse wire between the cap and shaft, the cap can be drawn up as tight as possible by the bolts. Removing and measuring the thickness of the wire enables the engineer to determine the proper amount of shimming that is necessary between the two bearing halves to obtain this running clearance.

Hot Bearings.—A hot bearing is a trouble that every engineer some day will experience. Generally this occurs when the load is heavy and when a shut-down is an impossibility. The engineer must maintain his presence of mind even though the bearing smokes. It is an all too common practice for the operator to excitedly *douche* the bearing with a bucket of water. This is of no avail. Water is at best a poor lubricant, and it will merely make matters worse by washing off the little oil that does cling to the shaft. The water strikes the shell and the shaft; this results in the contraction of the shell, thereby loosening the babbitt. Another bad practice is the use of an air hose in a vain endeavor to cool the bearing. The only correct procedure is to run an oil pipe or hose to the bearing and feed a heavy stream of cool oil through the inspection hole in the cap directly on to the shaft. If the bearing is provided with an oil cellar, the drain cock to this should be opened and the oil allowed to flow out after passing over the shaft. It is best to run the engine

light until the bearing cools off. If the engine is arranged to allow a cylinder to be cut out, the two cylinders adjacent to the hot bearing should be operated idle, with the exhaust valves blocked open. This relieves the damaged bearing of part of the pressure due to the cylinder explosion. After shutting down, the bearing liners should be examined and any necessary repairs made.

Clearance Between Bearing and Crank-cheek.—Many engines develop considerable side-play in the crankshaft after being in service a few years. This is attributable to excessive clearance between the end of the main bearings and the crank-cheeks or

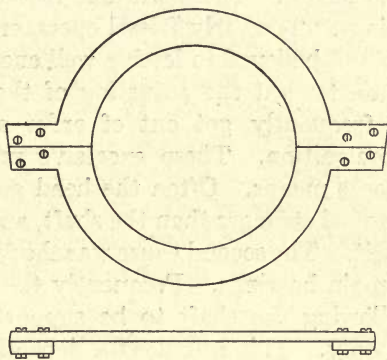

FIG. 40.—Steel ring to eliminate shaft side play.

throws. Engines of different makes vary as to the allowable clearance, but .007 inch is a representative value. If the clearance is too great, the remedy is to tin the ends of the bearing and run a ridge of babbitt around these ends, Fig. 39. Using a file and scraper, all surplus metal can be removed and this ring of babbitt reduced to the desired thickness. This will prevent the side-play and should last for at least a year before requiring renewal. Still another method is the employment of a sheet-steel ring. This may be made along the lines of Fig. 40. The wings at the side provide space for the fasteners.

Scored Shafts.—There are occasions when an engine crankshaft becomes scored to a serious extent or worn unevenly at the journals. The average engineer is prone to think that a shaft in either of these conditions is worthless and should be removed at once. When the damage is severe, of course this is necessary. More often a little work will allow the engine to

still pull its load. In cases of scored shafts an emery stone will serve to smooth up the shafts, finishing with a scraper and a final polish by lapping. The scores do not cause trouble providing the edges of the cuts are smoothed off, preventing the babbitt from being picked up. When the wear is uneven, the bearing shell should be scraped to a fit, even though the diameters at the two ends vary to a marked degree.

Fractured Crankshafts.—The bogie of the Diesels when first introduced in this country was broken crankshafts. Undoubtedly the one thing that proved an obstacle to the introduction of the oil engine was this question. There were a few isolated cases of fractured shafts. These without reservation were due to one of two things. The early Diesel operator knew but little about the engine and believed in letting well enough alone. No attempt was made toward the adjusting of the various parts. The fuel valve frequently got out of order and opened too early, causing preignition. These excessive pressures had to be relieved by some means. Often the head gave way, but at times the head proved stronger than the shaft, and so a fractured shaft was the result. The second cause was the failure to take up the wear in the main bearings. Frequently the inside bearings became worn, allowing the shaft to be supported by the two outside bearings only. This produced a deflection in the shaft which was repeated and reversed each revolution. Ultimately the shaft gave way. As a rule the break occurred between the pin and the web or throw. More liberal fillets at this point along with more knowledge acquired by the engineer has eliminated this danger. Several score of Diesel plants, to whose records access is had, report no trouble with fractured shafts.

Hot Bearings—Two-cycle Engines.—The horizontal two-stroke-cycle Diesels are as free from bearing trouble as are the four-stroke cycle engines. At the reversal of the stroke the bearing pressure is somewhat relieved, thereby allowing the oil to form a film. With vertical two-cycle engines the constant downward pressure results in faulty lubrication. This is the cause of the many instances of hot main bearings. The operator must maintain vigilance, seeing that the oil supply is ample, and at the first sign of a hot bearing the engine should be shut down.

CHAPTER V

CONNECTING-RODS

TYPES AND ADJUSTMENTS

The Diesel connecting-rod shares with the main bearings the questionable honor of giving the operator hours of worry. To the engineer who is versed in steam engine practice it remains a source of wonderment why even the smallest amount of connecting-rod brass wear can cause such heavy pounding. The cylinder pressure of the Diesel at the moment of initial combustion mounts into the hundreds of pounds: many times, on starting, the pressure runs as high as 750 lbs. per sq. inch in those engines not equipped with relief valves. The pressure is in the nature of a hammer blow, even where the fuel valve adjustment is correct. It is to be expected that, because of this constant hammering, the wear on the brasses will be far more than that which occurs in the steam engine where the steam enters the cylinder in a less violent manner. Furthermore, a condition of brass clearance that would be perfectly acceptable with the steam unit cannot be tolerated with the Diesel. This explains the continual brass adjustment that, to the uninitiated, seems to indicate that the engine builder had failed to properly manufacture these parts.

American Diesel Engine Co.'s Connecting-rod.—The first Diesel manufactured in America was fitted with a connecting-rod similar to Fig. 41. This gave place to the type illustrated in Fig. 42. The wedge design was quite prevalent in gas engine work, and the Diesel builders evidently obtained it from that source.

In adjusting the piston-pin bearing, it is necessary to remove the rod from the piston. To reduce the clearance resulting from the wearing of the brass, the cap is unbolted and the required amount of shims removed. The wedge must then be brought up snug against the pin. Some operators, under a mistaken idea, use no shims or separators, depending solely upon the wedge. It must be conceded that many engines have operated fairly successfully under this condition. However,

the shims serve to keep the two bearing halves rigid, and, in the event wear occurs, the play of the two halves will not hammer the wedge. The objection to this form of wedge is based on the frequency of fracture of the wedge bolt. The wedge has a steep angle, and the end thrust against the bolt is of considerable proportion. The break usually occurs in the thread, allowing the wedge to shift. A remedy for this can be obtained by reduc-

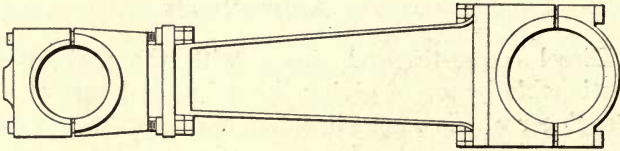

FIG. 41.—American Diesel Co. connecting-rod.

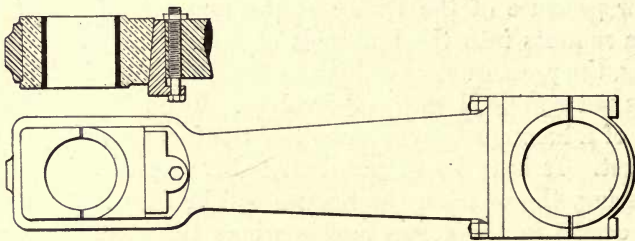

FIG. 42.—American Diesel Co. connecting-rod.

ing the wedge angle. This, of course, lessens the total adjustment obtainable, but shims can be interposed between the wedge and brass, giving a further lift. .

The crank or big end follows conventional Diesel lines in being of the marine design. The housing is cast steel and has the babbitt run directly on its inner surface.

Allis-Chalmers Diesel Connecting-rod.—An improved form of the wedge-type rod is found on the Allis-Chalmers Diesel. This rod has a marine crank end and a wedge-adjustable piston-pin bearing, Fig. 43. The improvement consists, mainly, in the employment of adjusting or separating set-screws in conjunction with the wedge. In taking up the bearing wear the set-screws are slackened off and the wedge brought up hard against the brass. The wedge bolt is then backed off an eighth of a turn and the set-screws tightened. These set-screws serve to separate the two bearing shells enough to provide running clearance between the pin and the bearing. This design enables the oper-

ator to correct any piston-pin bearing wear without removing the rod from the engine. After the clearance assumes proportions beyond the capacity of the wedge, shims can be inserted between the shell and the wedge block. The big-end bearing follows the usual marine design; the babbitt is cast directly onto the housing halves. Separators of $\frac{1}{8}$ -inch thickness are placed between the housings when the bearing is bolted together for boring. The adjustment is secured by the addition or removal of separators.

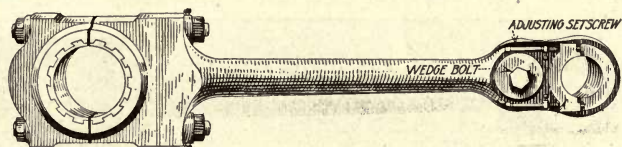

FIG. 43.—Allis-Chalmers connecting-rod.

Snow Oil Engine Connecting-rod.—This rod, Fig. 44, is quite dissimilar to the rods used on other American engines. The piston-pin end is of the marine type while the big end is provided with a wedge-adjustable open-end bearing. The engine has a crosshead design piston. Consequently it is not necessary

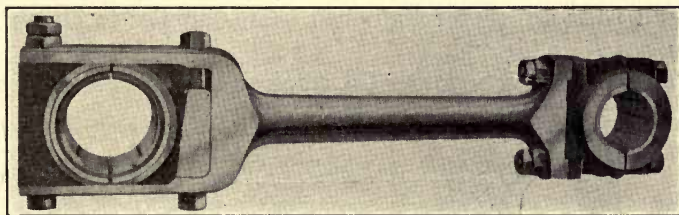

FIG. 44.—Snow Diesel connecting-rod.

to remove the pin for the purpose of taking up the wear in the bearing. The bearing bolts can be slackened off and the proper amount of shims or separators removed. Since the crosshead pin is large, but little adjustment need be made on this end. Adjustment at the piston-pin end reduces the connecting-rod length, and thereby increases the compression clearance in the cylinder.

In compensating for the wear at the big end, the wedge is taken up. Since the entire pressure acts on the wedge, the bolts must be kept snug; also there must be no binding of the bolt if fracture at the thread is to be avoided.

McEwen Diesel Connecting-rod.—This rod, Fig. 45, has both ends of the marine type. The adjustment follows standard practice. On the big end the bolts are provided with set-screws to prevent turning. These set-screws must be tightened after each adjustment. It should be understood that the taking up of the wear by removal of shims shortens the connecting-rod. This affects the compression pressure by increasing the clearance between the piston and cylinder head. A record should be kept showing the distance between the piston head and cylinder

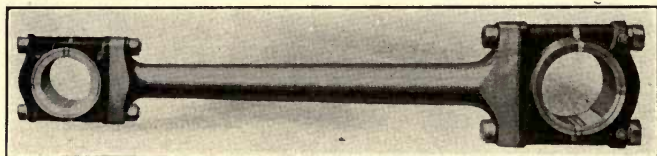

FIG. 45.—McEwen Diesel connecting rod.

flange when the piston is at top dead-center. After taking up the wear in the pin bearings, the engine should be put on top dead-center and the clearance measured again. The increase is noted, and separators of the same thickness as the clearance increase are inserted between the rod and the big-end box. The big-end bolts are then retightened. This applies to all engines using a marine big end.

The McIntosh & Seymour Co. employs a rod of similar design.

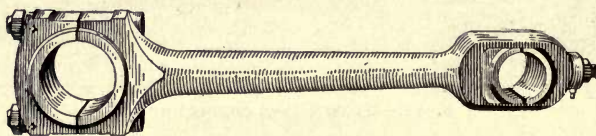

FIG. 46.—National Transit Diesel connecting rod.

National- Transit Diesel Connecting-rod.—The National Transit Pump and Machinery Co. has adopted the form of rod appearing in Fig. 46. The big end is of the standard marine type while the piston-pin end is solid and fitted with bronze bearing shells. The wear on these shells is compensated by the adjusting screw in the rod end.

In correcting this pin wear, the rod is removed from the piston as is also the piston pin. The pin is then replaced in the bearing and the required amount of shims inserted between the two

halves, whereupon the adjusting screw is tightened. The pin is then driven out of the rod, and the piston, pin and rod are reassembled. If the pin is too tight in the brass, after being tried out by swinging the rod, the process must be repeated. Some engineers neglect the matter of the shims, but it is not advisable.

With this particular rod, since the big end does not admit of the use of separators to bring the rod length back to normal, this correction must be made by the insertion of strips or shims between the piston-pin lower bearing shell and the rod.

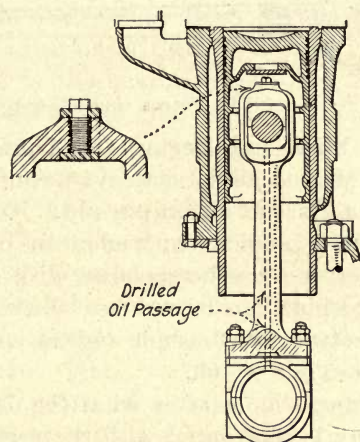

FIG. 47.—Busch-Sulzer Diesel connecting-rod.

Busch-Sulzer Bros. Diesel Connecting-rod.—The rod design of this engine has the big end of the marine type, separate from the rod itself. The piston-pin end is solid, having phosphor bronze bearing shells and an adjusting screw, as outlined in Fig. 47.

The method of taking up the piston-pin bearing is the same as with the National Transit engine. Since the big end is separate, the rod length is corrected by the insertion of separators between the rod and the big end. The crank pin is lubricated by a drilled passage in the shaft, as indicated in Fig. 186. The rod is drilled its entire length and the piston pin receives its lubrication through this passage. The passage in the rod registers with the oil line in the crankshaft once per revolution, thus obtaining the proper amount of lubricant.

De La Vergne Diesel Connecting-rod.—On the F.D. Diesel engine manufactured by the De La Vergne Machine Co. the rod follows the lines of Fig. 48. This is quite like the two rods last mentioned. The unique feature is the drilled passage in the center of the rod for the purpose of oiling the piston pin. The oil is picked up from the big-end bearing, and the ports here must be kept open. It is possible for a hot big-end bearing to close the ports with flowing babbitt. This, of course, results in a ruined piston-pin bearing.

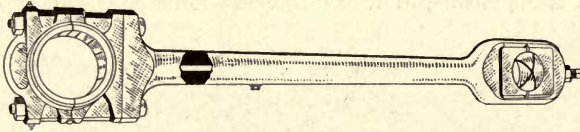

FIG. 48.—De La Vergne connecting-rod.

New London Ship and Engine Co. Connecting-rod.—The Nelseco Vertical Marine Diesel employs a connecting-rod with a marine big end and a solid piston-pin end. The latter end has a bronze bushing but is provided with no means of adjustment. If the bushing wears, it must be replaced with a new one; in an emergency the bushing can be reduced at the split and a thin shim interposed between the bushing and the walls of the rod end. This rod can be seen in Fig. 103.

Big-end Bearings.—No matter what the design may be, the operator some day is confronted with the problem of a big end that insists on running hot. The first move is to determine whether the lubrication has been faulty. In the majority of cases this proves the origin of the trouble. Generally the oil pipe or passage has become clogged with dirt or a bit of waste. The remedy is obvious. There is, for some unknown reason, a tendency for the big-end bearing to wear more rapidly at one end than at the other; or, at times, both ends wear while the center remains in its original condition. This “bellng” of the bearing permits the pin pressure to be distributed over a rather small area of the brass. This produces a local heating that forces the babbitt to drag, filling the oil passages and grooves. An additional result of this unequal bearing wear is the scoring of the cylinder on one side. When this bearing wear has occurred, it is imperative that the babbitt be rebored to the pin diameter and the oil grooves cut. Even if the wear seems excessive, it is, as a rule, possible to avoid rebabbiting. Part of the shims

between the bearing halves can be removed, and the halves clamped together and rebored to size.

It sometimes happens that part of the babbitt cracks and drags around the pin. This results in heating and a badly scored bearing. If the trouble is local, the rough spots can be smoothed with a scraper, and the bearing can then be placed in service again. In all instances where big-end bearings become so hot that the babbitt is thrown, the engine should not be stopped immediately; rather, the load should be taken off and the engine turned over very slowly, with the particular cylinder cut out. In re-babbiting rod bearings the same method as described for main bearings can be followed. The babbitt should always be cut on a bevel at the junction of the two halves. The oil grooves should not extend to the bearing edges, and, when a pressure-oiling system is used, the oil grooves should be eliminated since they allow the oil to escape too rapidly.

Side-play is of frequent occurrence in Diesel operation. The best method is to tin the bearing sides and run a collar of babbitt around the bore. This collar must be turned square with the pin. It is not necessary to cover the entire side; consequently, the collar can be machined parallel with the side of the big end. Another method is the employment of sheet-steel washers between the web and the big-end sides. Inspection of the connecting-rod bearings should be performed at least every three months.

Along with the wear of the big-end bearing occurs the wear of the pin. In old engines, which have seen several years of service, the pins may become flattened on one side. This can be corrected by filing and lapping, but it is a task requiring great care and patience. It is, ordinarily, not difficult to detect a worn rod bearing. The engine will emit a thump or pound both on the in and out strokes.

Pin Clearance.—To estimate the amount of clearance necessary between bearing and pin, an excellent scheme is to “jump” the rod with a bar. If a slight movement can be felt, the big end has ample clearance. “Jumping” the piston allows one to judge the piston-pin clearance. Another and better method is to tighten up the piston-pin bearing until the connecting-rod can be barely swung back and forth when the piston is suspended by a chain hoist. If the movement is free, there is too much clearance. If a man cannot swing the rod without tilting or moving the piston, the bearing is too tight.

CHAPTER VI

PISTONS AND PISTON PINS

General.—The pistons of all engines properly fall into two general classes—Crosshead and Trunk Pistons. The crosshead piston is usually shorter than the trunk piston and is provided with a crosshead which receives the side thrust due to the an-

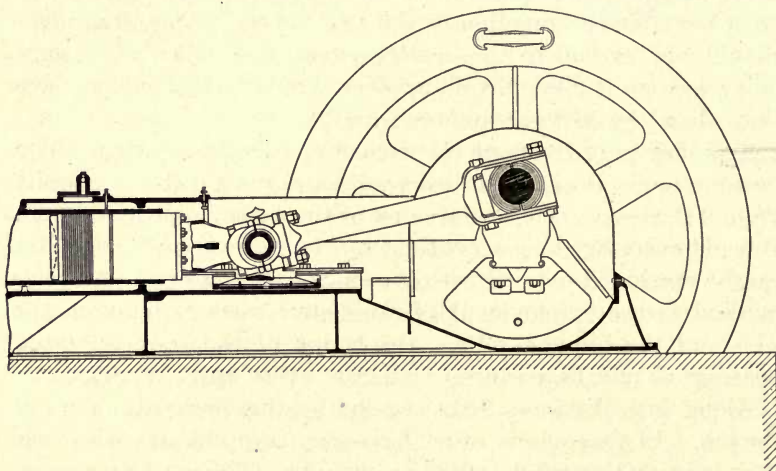

FIG. 49.—Cross-section of Snow oil engine employing a cross-head type of piston.

gularity of the connecting-rod. Figure 49 illustrates this type. With the trunk piston the upper end of the connecting-rod is supported by the piston pin, which is fastened in the piston. Consequently the piston receives the side thrust which is taken up by the crosshead in the former type. The engine shown in Fig. 7 employs the trunk design of piston.

The American manufacturers of small and medium powered engines, up to 200 h.p. per cylinder, have with few exceptions designed their engines with trunk pistons. Owing to the high cylinder pressures of the Diesel engine, the side thrust of the piston is of serious consequence, although in a 200 h.p. cylinder the piston can be constructed of a length sufficient to bring the side pressure within reasonable limits.

Trunk Pistons.—On units with a rating beyond 200 h.p. per cylinder practically all builders use a crosshead design of piston; in fact, the first Diesel built, even though of 25 h.p., employed a crosshead, and the present-day trunk piston is actually an adaptation of gas engine practice. The trunk piston possesses certain features that make it attractive to the average operator. Since the side pressure is taken by the piston, there is no crosshead shoe to adjust. This adjustment, on a Diesel, must be made with a degree of knowledge possessed by none save experienced engineers. A guide clearance that would be quite satisfactory on a high-grade steam engine will prove entirely too liberal with the oil engine. This nicety of running fit necessitates constant adjusting of the crosshead shoes. The operator should understand that, beyond the pound that it occasions, a loose crosshead will allow the piston to bind in the cylinder, producing heavy scoring.

The trunk piston presents a problem in lubrication that does not exist with the crosshead type. The side thrust is borne by the trunk piston along its entire length, but this bearing surface extends over only a portion of the circumference. This rubbing area must be positively and copiously lubricated. The problem of lubricating a surface periodically exposed to hot cylinder gases is difficult. If the cylinder and piston are not oiled, either the piston or cylinder liner will cut.

Piston Clearance.—Since the transverse pressure throws the piston against the bearing side of the cylinder, the clearance between the piston and cylinder must be less on the trunk than on the crosshead design. This is evident since, with the trunk piston, the entire clearance exists on the piston opposite to the wearing side. On the crosshead type the clearance is fairly well distributed around the piston; consequently a clearance between piston and cylinder of .007 inch is actually a clearance of .015 when the engine is firing. The crosshead piston can, then, be allowed a greater clearance than can the trunk type. This obviates danger of piston seizing when the engine is stopped after a run.

Crosshead Piston.—The crosshead design eliminates the heat difficulties of the piston-pin brass which are so often present with the trunk piston. Opportunity is also afforded for a heavier reinforced piston head. There is also less likelihood of the piston fracturing since it is not confined at the pin bosses. The cross-

head and rod design admits of an oil guard at the front end of the cylinder thereby preventing the throwing of lubricating oil into the cylinder with the consequent carbonization. The dripping of dirty cylinder oil or unconsumed fuel oil into the crank case, where it renders unusable the bearing oil that is held there, is also eliminated by this design. To this can be ascribed the lower lubricating oil consumption of the crosshead design of engine. These manifest advantages are, it is the feeling of the majority of engine builders, offset by its greater complication of parts and the greater necessity for intelligent adjustments.

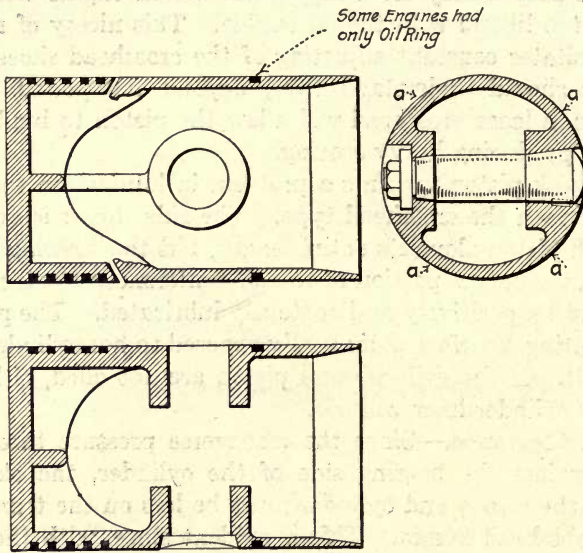

FIG. 50.—American Diesel Engine Co. piston.

American Diesel Piston and Pin.—This engine is, of course, no longer manufactured. However, many of these older engines are still in service, and the operator should be as interested in it as in more modern designs. The piston has a flat crown or top that is strengthened by ribs which extend down along the sides to the pin bosses, as shown in Fig. 50. The bosses are bored taper and offer support for both ends of the pin which are of different diameters. The pin is fastened into the piston by a washer and lock-nut; a dowel or short key at the large end prevents any turning of the pin. Since the latter is ground to a seat in the bosses, the contact is highly satisfactory.

The chief difficulty experienced with this design of piston is the distortion at the pin bosses, with a resultant oval shape. This distortion produces severe cutting on the piston sides along lines about 30 degrees from the pin axis. It is at once apparent that the pin holds the two bosses at a fixed distance; when the piston heats, the expansion will occur along the weakest section. Figure 51 outlines the points *a.a.* of distortion. The pin bearing is oiled by the splash from the crank-case; consequently no oil passages are needed in the pin.

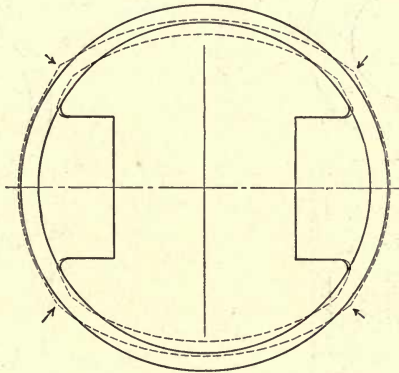

FIG. 51.—Piston distortion from elongation of the piston pin.

The number of rings used with this piston varies, ranging from four to seven. Frequently one of these pistons is found equipped with two rings per groove. In such event, the first step toward the elimination of ring trouble is the substitution of one broad ring in each groove.

Busch-Sulzer Type B Piston and Pin.—The type B piston represents the modern development of the Diesel piston design. The head is thick to better resist the cylinder pressure and is concave. The clearance is small, and it has been necessary to cut away the edge of this concave to afford a clear passage for the gases as they enter or depart around the valves. To avoid distortion of the walls it is strongly reinforced by girth ribs. Seven rings are used about the upper part for sealing; a single ring is placed at the bottom as an oil wiper.

The chief variation from the usual American design is the water-cooling of the head. This feature is clearly shown in Fig. 52, although the water piping is not included in the drawing.

The pipes are rigid and run parallel to the piston axis at each side of the connecting-rod. The lower ends slide in the stuffing-boxes which are connected to the engine's water-piping system. This telescopic method of feeding the water is superior to the pantagraph or knuckle form. There is no inertia effect of swinging parts as with the latter type. The stuffing-box is much easier to maintain water-tight than is the knuckle. Even

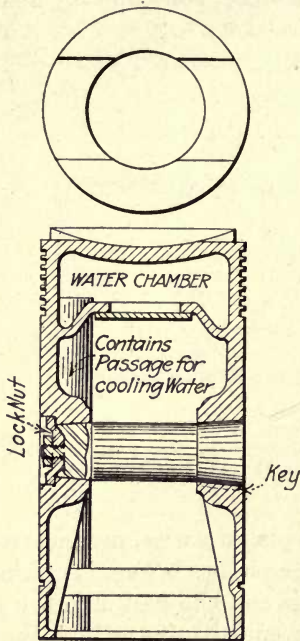

FIG. 52.—Busch-Sulzer type B piston.

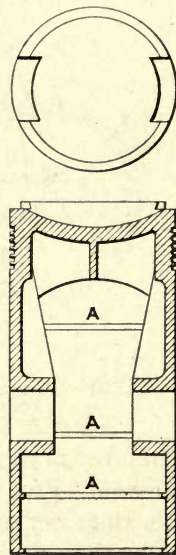

FIG. 53.—McIntosh and Seymour Diesel piston.

the telescopic arrangement will in time give trouble from weeping. In the Busch-Sulzer the crank-case receives all the return lubricating oil. For this reason leaks at the stuffing-boxes allow water to mix with the oil returns, practically destroying the lubricating qualities of the latter. On each occasion that the engine is stopped, the crank-case doors should be opened and the water connections examined.

The piston pin is tapered at both ends and is held by a washer and nut as outlined. When the engine has been in careless hands, the pin may deform the bosses to such an extent that the pin has a poor bearing at the ends. It then becomes necessary to

grind the pin to new seats. To accomplish this the dowel key at the big end must be removed to allow rotation of the pin.

McIntosh & Seymour Piston and Pin.—This company followed the designs of their Swedish associates in building the piston appearing in Fig. 53. The head is concave and is strongly reinforced on the lower side with a series of ribs. These ribs do not extend down along the piston walls, which are supported by a set of girth ribs. The piston pin is straight and is held in the bosses by set-screws.

Allis-Chalmers Piston and Pin.—The first Diesel engines manufactured by the Allis-Chalmers Co. had pistons of the standard one-piece construction. The small clearance maintained between the piston and cylinder liner made this design impractical, and it was early replaced by the piston outlined in Fig. 54. The piston body is formed of high-grade cast

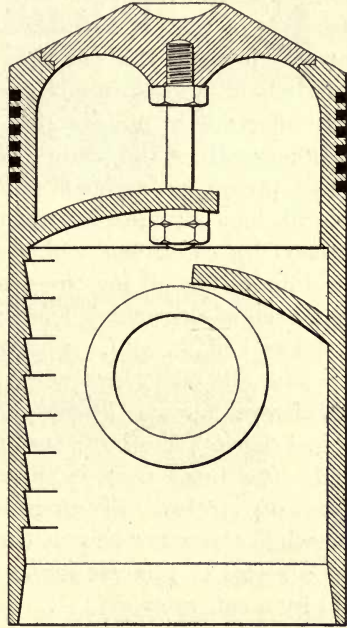

FIG. 54.—Allis-Chalmers Diesel section of piston.

iron and is provided with a false or removable head. This head is of nickel-steel, which develops fractures at a much slower rate than does cast iron, and is held in a machined recess by the stud

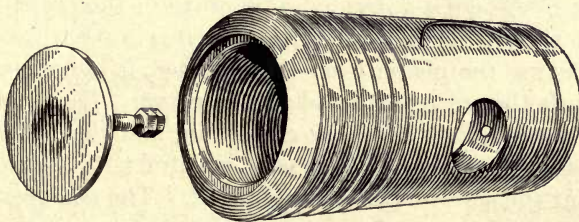

FIG. 54a.—Allis-Chalmers Diesel piston.

shown. The piston head is conical in shape, and the impingement of the fuel charge is localized at the center of the nickel-steel head. This construction enables the builder to give a

very small clearance between the piston and cylinder without danger of piston seizing due to head expansion. The compression is sealed by six rings while an oil-wiper ring is used at the base. To avoid the trouble of lubricating oil depositing on the inner side of the piston head and forming a hard scale, a baffle plate is incorporated in the casting. This plate is in two parts which allows a circulation of air. While this plate is fairly effectual in maintaining a clean head, oil will deposit on the inner walls of the piston, as in all horizontal engines.

The piston or gudgeon pin is hardened and ground. The ends fit into straight bearings in the bosses, the piston being fastened by set-screws which are locked by smaller set-screws. The lubricating oil for the pin is deposited in a trough at the front edge of the piston, from whence it flows through a passage to the end of the pin. The pin is drilled on its upper surface to permit the oil to issue onto the bearing surface.

McEwen Diesel Piston and Pin.—McEwen Bros. use a conical head piston of one-piece construction, Fig. 55. The head, after being cast, is annealed for the purpose of removing all casting strains. Six rings are employed to hold the compression while the wiper ring at the bottom has been dispensed with and a series of grooves made to replace this ring. The pin is held by a set-screw.

Snow Diesel Engine Piston.—The Snow Engine has a piston that is a radical departure from the usual design with four-stroke-cycle engines. The piston, as seen in Fig. 56, is a single barrel casting with a separate steel head which is concave on its surface. The front end is bolted to the crosshead yoke. The crosshead is provided with a single shoe and has a wrist pin of extra large dimensions. There is a decided advantage in the crosshead design since the pin size is not restricted as it is in the trunk piston.

In removing the piston from the cylinder, it is not necessary to dismantle the entire head and valve rigging. The connecting-rod can be unbolted from the crank pin, and the piston withdrawn through the frame. It is very essential with the crosshead piston that the shoe be properly adjusted. The engineer should measure the thickness of the shoe when first installed and endeavor to maintain this dimension by the insertion of shims.

The Standard Fuel Oil Engine Piston.—The Standard Fuel Oil Engine is of the two-cycle design and has a stepped piston, outlined in Fig. 63. The main or power piston, Fig. 57, is a two-piece barrel casting. The head is conical and extends

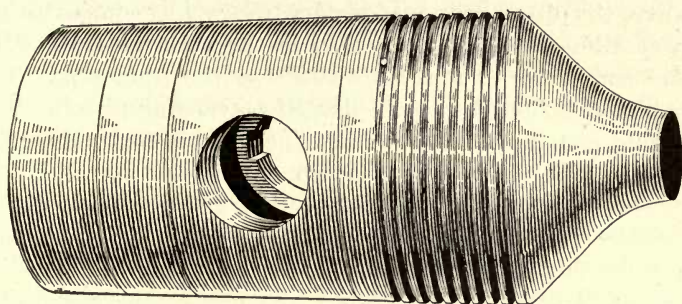

FIG. 55.—McEwen Diesel piston.

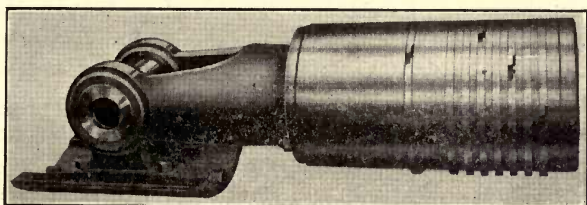

FIG. 56.—Snow Diesel piston cross-head type.

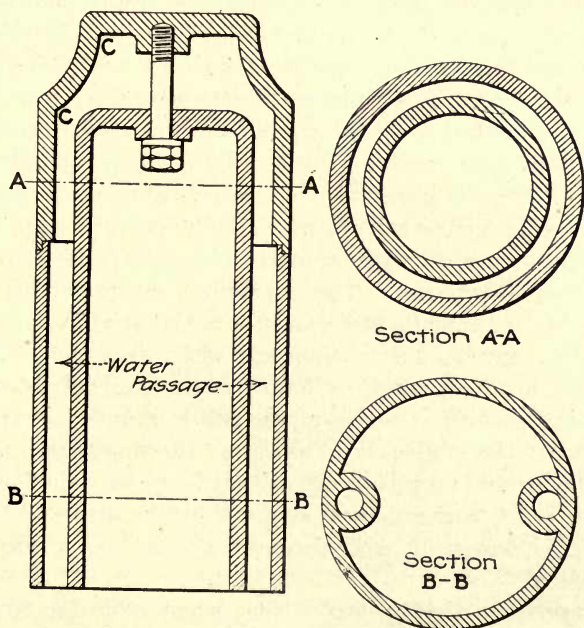

FIG. 57.—Standard Fuel Oil Diesel. Power piston.

down over the piston body forming a water-cooling compartment. The water lines are passages cored in the main piston casting and are connected to telescopic tubes at the front end. The power piston is bolted to the enlarged scavenging piston. The scavenging piston, in the 60 h.p. engine, is 30 inches in diameter and is strongly ribbed. The piston or gudgeon pin is bolted to this piston, consequently the latter acts as the cross-head and receives the transverse thrust of the piston.

Since the crank-case does not act as the return lubricating oil receiver, leaks in the water tubes are not so serious as with the vertical engines. The water stuffing-box glands must be kept tight or the seeping water will destroy the lubrication on the walls of the scavenging piston. The cooling water discharge must be kept below 120°, and the line should be vented to avoid steam pocketing at the lower edge of the piston head, which receives a great amount of heat as the exhaust gases pass out through the ports.

Seized Pistons.—Even with the modern types of pistons now in use, many plants have experienced trouble with seized pistons. This difficulty is directly traceable to either of two conditions. One of these is insufficient clearance between the piston and liner. This applies especially to the clearance around the piston immediately below the head. The temperature of the piston head must run very high to establish a heat balance wherein the heat thrown off equals the heat absorbed by the piston. This heat condition causes the head to expand diametrically. If there is insufficient clearance between the head and cylinder walls, seizing will occur. To obviate this the piston can be slightly tapered, with a decreasing clearance downward toward the piston pin. The maximum clearance can be as great as $\frac{1}{16}$ inch, while the clearance in the neighborhood of the first piston ring should be approximately .007 inch. Another solution of head expansion is found in the conical piston head. This conical surface possesses ample side clearance for expansion. Incidentally, the conical head assists in the thorough intermingling of the air and atomized fuel as they leave the injection valve. The same relief from seizing is attained by the dished or concave head. This design of head also serves as an aid in mixing the air and fuel.

It is apparent that piston seizing when it is due to lack of clearance can be eliminated by taking a small taper cut off the

piston immediately below the head. The taper may well start between the top pair of rings. Certain cast irons continue to grow even after the clearance has been increased by such a cut. It then becomes necessary to watch this piston and repeat the tapering process as required.

The second and more common cause of seizing or freezing of the piston is lack of cooling water. This may occur both while the engine is in operation and after it is shut down. The former is evidenced by the loss of power and decrease in the engine speed and usually happens on a change from light to heavy load. The average operator understands that on full load the quantity of cooling water required is greater than on the lower loads. As the load comes on, the usual practice is to increase the flow of the cooling water. This chills the cylinder liner and causes it to contract before the hot piston experiences any effect from this additional cooling medium. This contraction lessens the working clearance; the piston becomes hotter and ultimately grips the liner walls. The remedy is to decrease the amount of cooling water as the heavy load comes on; then, after the cylinder liner warms up, the flow of water can be gradually increased while the discharge temperature is kept fairly constant.

There are, also, occasions when the seizing can be attributed to a hot piston pin, and ordinarily this is noticeable on starting the engine. After an engine has been in operation for some minutes, the heat absorbed by the piston is equaled by the heat given off by the piston to the cylinder walls, etc. The heat contained in the piston when the engine is shut down is large. If the flow of cooling water is discontinued at once, this heat is slowly radiated and a great part is absorbed by the piston pin. The pin elongates as a result of this heat absorption. The end thrust of the pin produces a change in the shape of the piston walls; especially is this true when the walls are not strongly ribbed. The deformation of the piston occurs along the thinnest sections, which commonly are at the junction of the pin bosses with the piston walls. These ridges or deformations produce severe cutting of the cylinder walls. Many liners are ruined by this action. When this misfortune is experienced, the sole relief other than piston replacement is the filing of the high spots until the piston is again cylindrical. The surface can then be dressed by emery cloth. Filing will also smoothen the scored cylinder walls. A quick and efficacious repair can be accom-

plished by first dressing down the rough places with a fine emery wheel, say 80J grade, held in the hand, finishing with a file and emery cloth. To some this probably seems a radical treatment, but extensive experience on many scored pistons and cylinders tends to prove that this is an effective way to rectify the damage. If the engineer is careful in using the emery cloth, the cylinder and piston can be made as smooth as when new.

Piston seizing is at times in evidence when turning the engine over at the beginning of a run. If, at the close of the last run, the cooling water was shut off too early, the heat in the piston head may evaporate all the lubricant on the piston pin. As the dry bronze bearing absorbs the heat, it cannot expand outward because of the greater mass of the connecting-rod end. The bearing closes in on the pin, which is also expanding; this action results in a gripping of the pin that is not completely loosened even after the parts have cooled. On starting, this wedged bearing restrains the motion of the connecting-rod, and the engineer calls it a seized piston, though it actually is a case of a seized piston pin.

Piston Wear.—The wear of the piston is due to lack of lubrication, deformation and the natural abrasive action that results when two surfaces rub together. The lack of lubrication can be attributed to the carelessness of the operator. No matter what manner of oiling system is used, the engineer is never blameless when it fails so far as to wear or cut the piston.

The natural abrasive action requires years before the wear assumes such proportions as to necessitate a replacement. A piston should last from four to eight years dependent on the hours of service and on the degree of intelligent care it receives. It is impossible to set a hard and fast rule as to the clearance that can exist before replacement is imperative. A vertical trunk or horizontal crosshead type piston should have a clearance of around .007 inch, while the horizontal trunk piston should have still less. In operation, if the rings are in good shape, a piston will hold the compression quite satisfactorily if these values are doubled. With the clearance question, as with many Diesel problems, the engineer must allow the engine's performance to guide his actions.

Piston Rings.—The customary designs of rings have lapped ends and are constrained from shifting in the groove by dowels.

Some builders fasten the ring ends together with a pin. It is doubtful whether this serves any useful purpose. In turning up new rings, the casting should be made from gray cast iron free from scrap. The outside of the ring is machined to size. Then the casting is chucked $\frac{1}{32}$ inch out of center and the inside turned, the ring next being cut off. This produces a ring of a

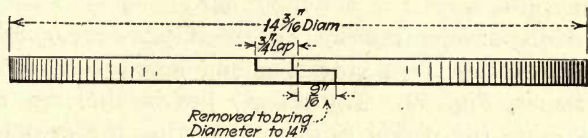

FIG. 58.—Piston ring lap.

varying thickness and gives an almost uniform pressure entirely around its circumference. The outside diameter of the ring should be $\frac{3}{16}$ inch greater than the cylinder bore of the engine. In cutting the lap, the clearance is best made about $\frac{3}{16}$ inch, while the lap may be as much as 1 inch. The lap can be drilled and then cut out with a hack-saw, as shown in Fig. 58. The edges of the ring are left square and should never be rounded as is practiced by many engineers.

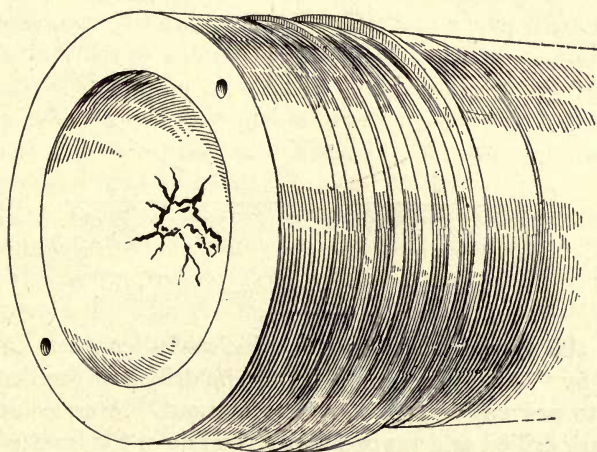

FIG. 59.—Fractured piston head.

Fractured Piston Heads.—The cracks that develop in the piston head can be placed in two classes; namely, those which take a circular form and appear around the base of the concave portion of the head, and those fractures which are radial in

direction. The former are caused by heat strains with a consequent breathing action at the base of the cone. These fractures seldom prove serious, and it is possible to continue to operate the engine without piston replacement. At times these fractures appear in conjunction with cracks on the interior side of the piston head, across the reinforcing ribs. In such cases the entire head may give way.

The really serious fractures are those that develop radially in the head. Often these cracks extend across the head some 6 to 10 inches, Fig. 59. The danger lies in the now non-rigid head allowing the piston to distort, scoring the cylinder walls.

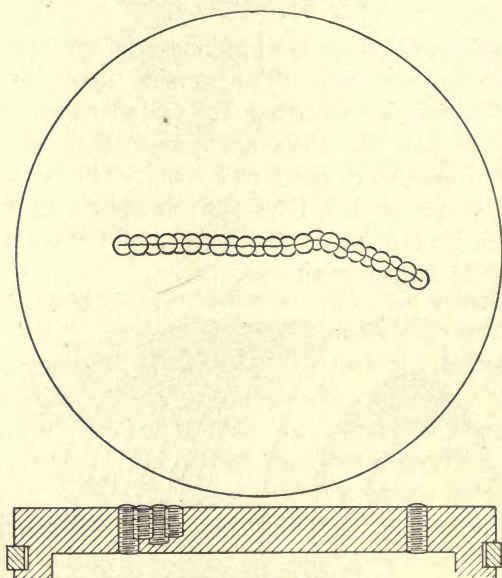

FIG. 60.—Sewing fractured piston head.

When the fracture is only a few inches in length it can be repaired by "sewing." A hole should be drilled at each end of the crack to prevent any further development. A series of $\frac{3}{8}$ -inch holes are drilled and tapped along the line of the fracture. Into these holes threaded brass plugs should be inserted and cut smooth with the surface. Between these plugs a second row is inserted, lapping over the first plugs. This entire line of plugs is then hammered smooth; see Fig. 60. This "sewing" has been practised with success on pistons as large as 18 inches in diameter.

Piston Ring Troubles.—Beyond an occasional broken ring the only difficulty that the operator will experience is the gumming of the rings in the grooves. The gumming may be produced either by an excessive amount of fuel oil which remains in the cylinder in an unconsumed condition or by an overabundance of lubricating oil. The solution of the latter trouble is simple; all that need be done is the reduction of the quantity supplied. If the oiling is accomplished by a mechanical pump, the control can be readjusted. If the engine has splash lubrication, the oil level can be lowered, thereby preventing undue throwing of the oil emulsion on to the cylinder walls. Where the trouble is traceable to excessive fuel oil, the problem is not as simple of solution. It is apparent that, in such cases, the difficulty lies in the fuel valve. The timing may be incorrect, or the air pressure too low or too high, or the atomizer disks or cones may be out of order. It becomes necessary to try various experiments until the proper remedy is obtained.

The rings can be loosened by soaking the entire piston in kerosene or lye water, after which the rings can be pried off. In removing the gum and carbon a copper or brass scraper should be used. It is not advisable to clean with emery paper as long as the piston is perfectly smooth. Each time the engine is laid up for a few hours a small quantity of kerosene should be injected into the cylinder through the air admission valve. This kerosene will remove any carbon on the piston and rings that is in the process of formation. The exhaust valve, in such event, is best blocked open to allow the vapor to escape.

Grinding Taper Piston Pins.—A number of engines have piston pins with taper ends. The tapered ends fit into ground seats in the piston bosses. The ground seats gradually pounds out of round, forcing the engineer to regrind the pin to new bearings. To accomplish this with the minimum of trouble the piston can be placed on two 8×8 in. timbers, as shown in Fig. 61. A discarded valve spring, if set under the piston immediately below the pin, will keep the pin raised from the seats in the bosses unless the pin is pressed downward. Emery paste is coated over the two pin ends, and while the pin is forced into the bosses it is rotated by a pin wrench, as outlined in the sketch. Removal of the downward pressure allows the spring to raise the pin. This action serves to distribute the grinding paste over the entire seat, preventing the seat from

being ground hollow. The pin grinding is fully as important as valve grinding although it is done very carelessly in many plants.

In reassembling the piston, pin and rod it is not enough to simply push the pin into the bosses and tighten up on the lock-nut. The pin must be driven in with a sledge and copper mallet with as great a blow as an able-bodied man can deliver. The timorous feeling many engineers have about this driving process is entirely without foundation; there is no danger of fracturing the piston.

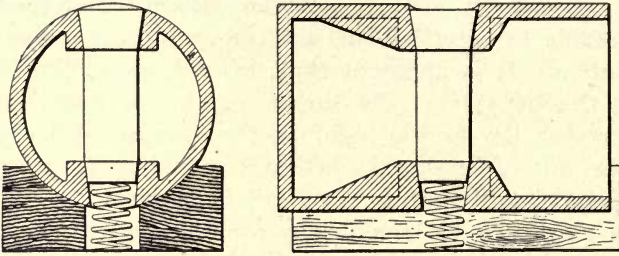

FIG. 61.—Grinding piston pin in taper bosses.

Worn Piston Bosses.—On old engines the bosses sometimes wear so oval as to allow the pin to fit loosely. It is impossible to secure a good seat if this wear is great. A partial remedy for this condition is effected by peening the bosses on the outside, followed up by regrinding.

Emergency Piston Pin.—When a pin has scored badly or developed a fracture, it occasionally becomes necessary to make an emergency pin. Without question the manufacturer is the proper party to furnish this new part. But where the engine is urgently required, the engineer cannot wait on the slow delivery that is so prevalent. A makeshift pin can be turned from cold rolled shafting. It should be machined to size and then case-hardened with bone-black or cyanide of potassium. After remaining in the fire for twelve hours, the pin should be cooled off. As a rule, the pin expands but slightly in the hardening process. The exact dimensions can be secured by lapping with emery paste, although it is a laborious procedure.

CHAPTER VII

CYLINDERS AND CYLINDER HEADS

Since the first Diesel engines followed gas engine practice as much as was possible, it is not surprising that the one-piece cylinder was incorporated in the first designs. At the present time no Diesel of any size is fitted with a cylinder having the liner cast integral with the jacket, though a few small units do use it on account of the smaller initial cost and the consequent lower replacement expense. For cylinders of 10 inches or less in bore the one-piece cylinder casting has no objectionable features. In fact, from the operator's viewpoint the one-piece cylinder is fully as serviceable as is the separate liner design. The cylinder walls are always amply thick for rebor-ing.

American Diesel Engine.—This pioneer company employed a one-piece cylinder, as may be seen in Fig. 7. The bottom of the liner is not united with the jacket but is free to elongate without strain. This open end of the jacket cavity is closed with a cover ring. The top is not provided with cored water passages to the cylinder head, the water being passed into the head by outside gooseneck connections.

The lubrication of the cylinder is largely dependent on the splashing of oil from the enclosed crank-case. To make the oiling more certain, an oil line leads from a mechanical oil pump to the cylinder about midway down the cylinder.

American Cylinder Head.—This head, a cross-section of which appears in Figs. 7 and 62, is of irregular shape, one side carrying the cavity for the air admission valve. The exhaust-valve cage is bolted to the lower side of this projection. The hot exhaust gases pass across the bridge or separator *A*, as does also the cold air charge. The alternate heating and chilling of this bridge produce shrinkage cracks that speedily extend entirely through the cast-iron wall. This allows the exhaust valve to leak. Many heads have been scrapped solely because of this bridge fracture. This is totally an uncalled-for extravagance since in all instances the fracture can be repaired by welding.

The head is fitted with a relief valve. Unfortunately few operators test this valve; consequently it fails to function when an excessively high preignition pressure is experienced in the

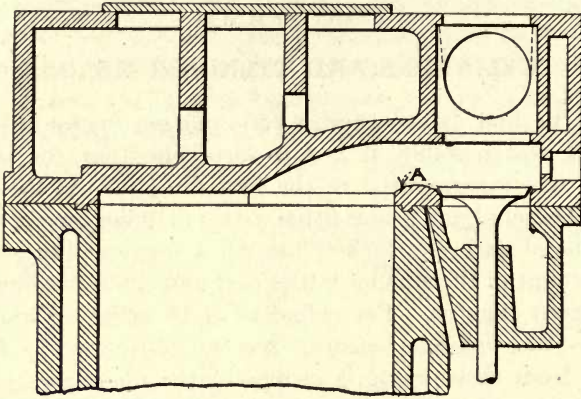

FIG. 62.—American Diesel cylinder head.

cylinder. The valve carbonizes and freezes to its seat unless relieved by being lifted at least once a week.

Standard Fuel Oil Engine.—The cylinder of the engine manufactured by the Standard Fuel Oil Engine Co. is of one-piece

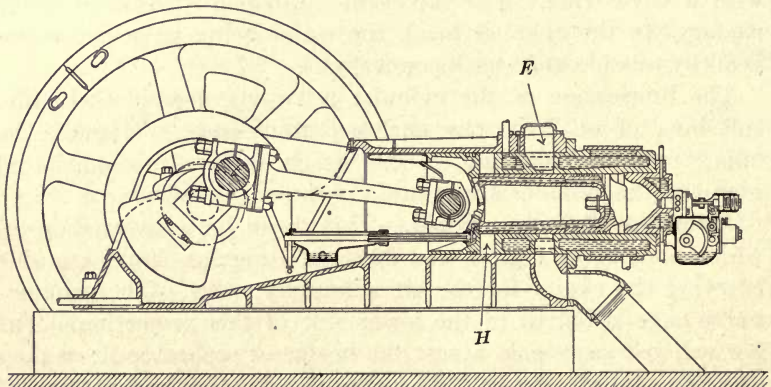

FIG. 63.—Longitudinal section through working cylinder. Standard Fuel Oil engine.

construction, when the power cylinder alone is considered. As outlined in Fig. 63, the liner and jacket are in one piece, the front end of which fits into the frame casting. The scavenging piston works in a bored cavity of the frame which is not provided

with any means of cooling. The power cylinder, as mentioned above, is fitted into this cavity and is held by a flange. The cylinder casting is provided with ports, both for the exhaust gases and for the scavenging air. The air ports, at the top of the cylinder, are arranged to give to the air charge a whirling motion which materially assists in the scavenging of the exhaust gases; see Fig. 64. The water spaces in the bridges are small and tend to scale

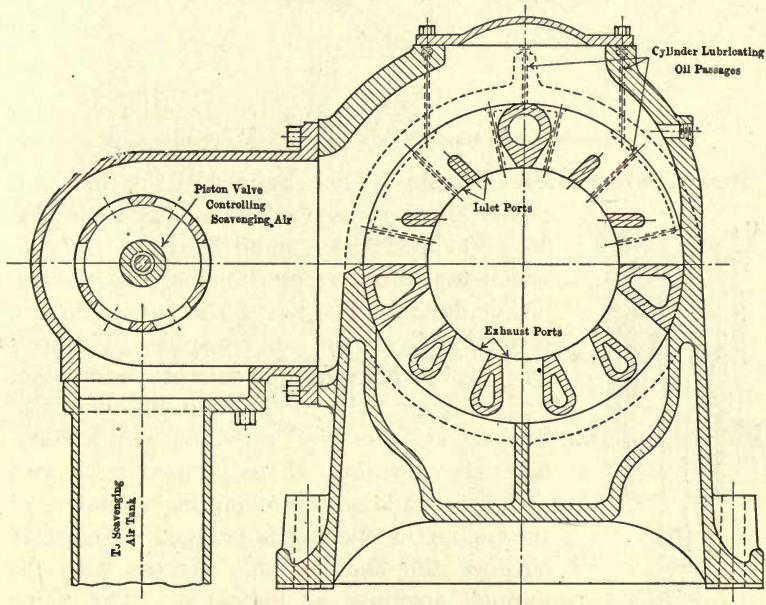

FIG. 64.—Standard Fuel Oil Diesel section through air and exhaust ports.

if the water is bad since this is the place of greatest temperature. If the spaces once fill with scale, the bridges are subject to fracture. Periodical cleaning of the water jacket is imperative.

Cylinder Head.—The cylinder head, Fig. 65, is water-cooled and contains but one opening—that for the fuel valve. Since the water line to the head is separate from the jacket cooling system, some engineers attempt to operate the engine on low loads with the head water line cut out. Since the head becomes hot, this does improve the combustion on low loads. However, there is danger in the liability of the head showing a fracture on cooling. The joint between the cylinder and the head should be metal to metal. In replacing the head the surfaces require

a thorough cleaning to avoid the risk of small particles injuring the gas-tight joint.

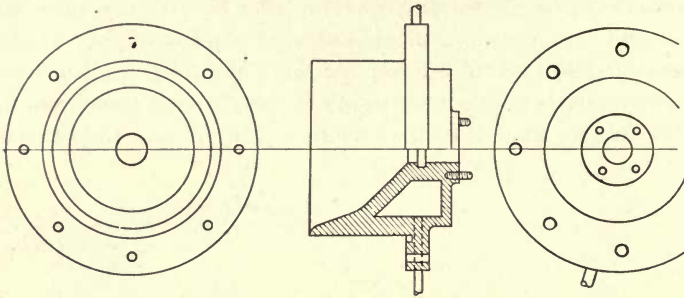

FIG. 65.—Standard Fuel Oil two cycle Diesel cylinder head.

Busch-Sulzer Diesel Engine.—This engine has the liner cast separately from the jacket, as appears in Fig. 66. The liner has a small flange at the top, which fits into a recess machined in the top jacket flange. The bottom is not anchored, being free to expand and contract. The head has four openings, for the exhaust, admission, fuel, and air valves. The Busch-Sulzer Co. has each cylinder head provided with a starting valve opening. This is used with two cylinders while on the remaining cylinders of the engine the opening is plugged. Figure 67 outlines the head of this engine, with the various openings as indicated. The same general lines are followed on practically all

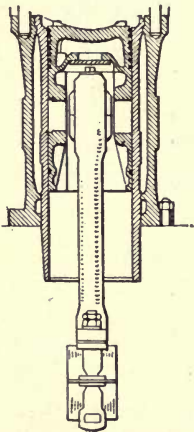

FIG. 66.—Busch-Sulzer Diesel cylinder.

Cylinders of A-frame Engines.—The Fulton Iron Works, and the McIntosh & Seymour Co. in their A-frame en-

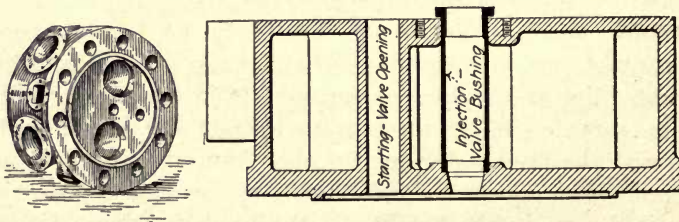

FIG. 67.—Busch-Sulzer type B Diesel cylinder head.

gines, extend the frame to act as the cylinder jacket. The liner in

many respects is the same as is found on a box-frame engine. This frame and cylinder construction is very popular with European manufacturers but is losing favor in the United States. It offers the serious objection of high replacement cost in event the cylinder-jacket wall fractures. This has happened on a few occasions in this country and led to its abandonment by at least one manufacturer. Figure 68 illustrates the McIntosh & Seymour A-frame cylinder. Their marine Diesel cylinder appears in Fig. 21.

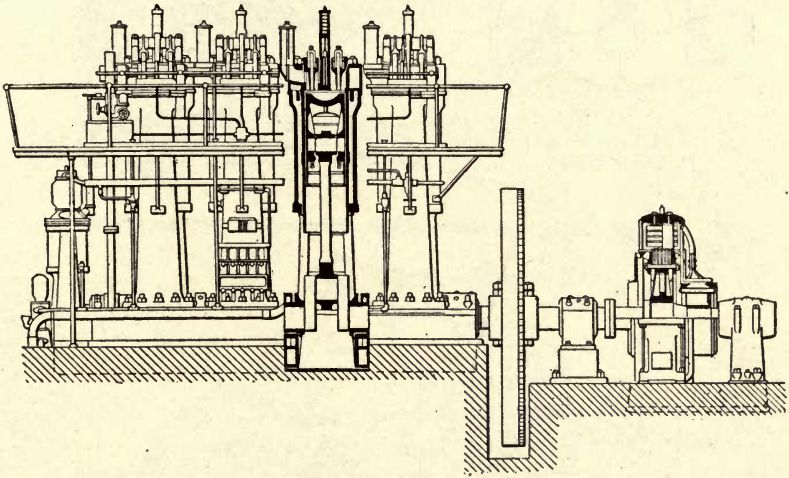

FIG. 68.—McIntosh & Seymour A frame Diesel.

Horizontal Diesel Cylinders.—Without exception all manufacturers of the horizontal four-stroke-cycle engine extend the frame casting to enclose the cylinder liner, thereby forming the water jacket without an additional casting.

Horizontal Diesel Cylinder Heads.—The manufacturers of the horizontal engine have two head designs from which to choose. If the head be of a symmetrical design, such as is found on the vertical Diesel engine, the valves must be placed horizontally. Figure 67 shows a very symmetrical casting that is closely followed on the Snow Oil Engine and on the De La Vergne F.D. Engine. This design entails increased wear on the valve stems, and the seating of the valve is difficult. To obviate this condition many manufacturers have had recourse to a head with the valves placed vertically. This head, in order to keep

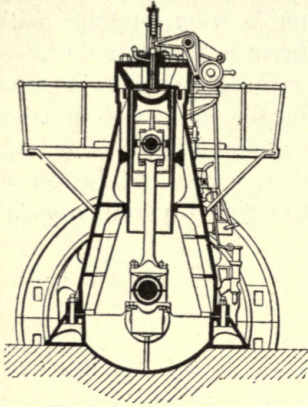

FIG. 68a.—McIntosh & Seymour
A frame Diesel.

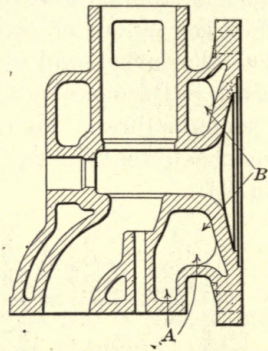

FIG. 69.—Cylinder head design with
vertical valves.

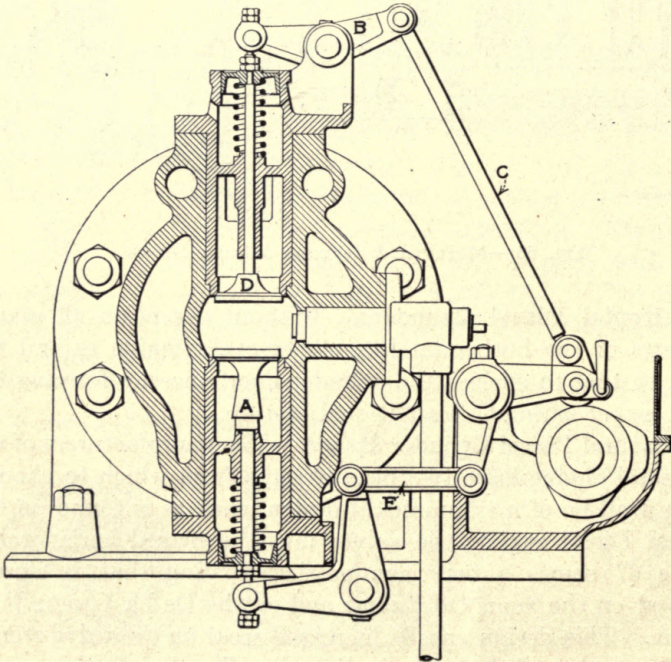

FIG. 70.—McEwen Diesel cylinder head.

down the compression volume, must be built somewhat along the lines of Fig. 69. It is apparent that this form of head will experience certain casting strains which will develop into fractures if they are not removed by the annealing of the entire head. If this procedure is followed, no great danger of fracture exists.

McEwen Diesel Cylinder Head.—Figure 70 is a view of the cylinder head of the McEwen Diesel.

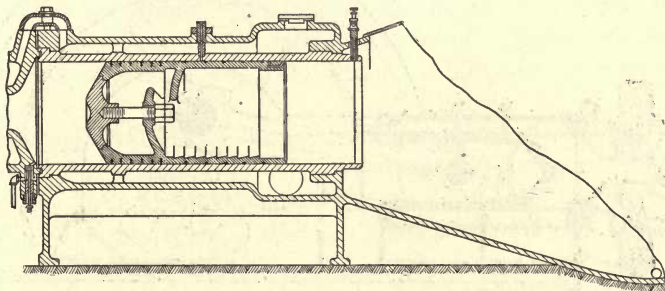

FIG. 71.—Allis-Chalmers Diesel cylinder.

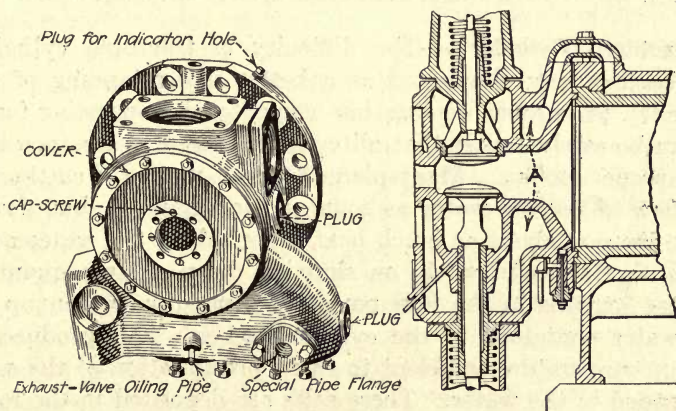

FIG. 72.—Allis-Chalmers Diesel cylinder head.

Allis-Chalmers Diesel Cylinder.—Figure 71 gives a view of the cylinder of this engine.

Allis-Chalmers Cylinder Head.—The Allis-Chalmers Diesel employs the head shown in Fig. 72. The valves are set vertically while the fuel nozzle rests horizontally in the center of the head cover.

National Transit Diesel Cylinder.—Figure 73 shows the cylinder and head of the first Diesels manufactured by this firm. Figure 96A is a view of the head adopted for the 1918 Diesels. The valves are in a horizontal position while the head casting is simple, thereby removing practically all danger of fracture.

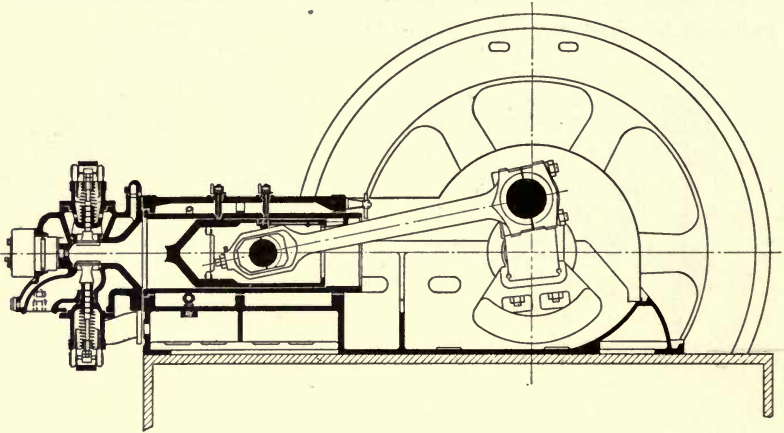

FIG. 73.—National Transit Diesel engine cylinder and cylinder head.

Fractured Cylinders.—The difficulty of fractured cylinders has been largely eliminated as a better understanding of the necessity for proper cooling has come to the operating force. It can be safely stated that all cylinder fractures are traceable to improper cooling. Many plants follow a custom of cutting off the flow of cooling water as soon as the engine is shut down. Since there is about as much heat absorbed by the water as is given up in useful work, on shutting down a large quantity of heat remains in the iron parts—this must be taken up by the water contained in the cylinder jacket. This produces a rise in temperature sufficient to cause precipitation of the salts suspended in the water. These salts are deposited in the form of scale on the jacket walls. The action continues until the scale becomes so thick as to preclude the possibility of proper cooling. The cylinder walls attain a high temperature and develop fractures because of the inability of the red-hot walls to withstand the high cylinder pressure. Due attention to the cooling water will prevent any fracture in the cylinder liner.

Scored Cylinders.—In the chapter on pistons, several defects that would cause piston scoring were pointed out, and the discus-

sion applies to cylinders. Where the scoring is purely local in character, the surface can be placed in working condition by rubbing with an emery stone, finishing up with a patient application of a scraper. Ordinarily, since the scoring is due to piston distortion, the defective surfaces are not in the plane of the crank and piston; consequently the reduction of the scored surface below the cylinder wall circle is not of any moment. Another type of scoring is at times encountered: this has the character of grooves and ridges. As long as the depth of the grooves is .005 inch or less no serious damage will occur. But when secondary ridges appear between the original ridges, the liner must be rebored.

Reboring Cylinders.—The natural course of wear in the liner increases the clearances to such an extent as to require reboring. The liner, as an average, will need replacement or reboring every three to five years, dependent on the hours of service and the attention it has received.

When the engineer is confronted with the problem of cylinder reboring, it is well for him to shift the work to the shoulders of some machine shop that makes a specialty of such work. The actual reboring is not hard, neither is the setting up of the boring machine; however, it requires a boring bar that will cost around \$800, and few shops are willing to place their machine on a rental basis. A shop that does much of this work charges \$15 per inch of cylinder diameter—a 16×24 in. cylinder would cost \$240 to be rebored and fitted with a new piston. This represents a fair charge and is far less costly than the entire replacement of the liner.

Liner Replacement.—All cylinders are of a thickness that will allow at least one reboring. If the liner becomes worn, after it has had one reboring, or if it is fractured, the withdrawal of the damaged liner is easily effected by the use of the draw-bolt, as outlined in Fig. 74. The spider may be made with either two or three fingers; the two fingers are as serviceable as the three fingers. The bolt is of $1\frac{9}{16}$ -inch cold rolled shafting, the thread having a $1\frac{1}{2}$ -inch diameter. The spiders are placed over the cylinder flange and the front end of the liner as indicated. A part turn of the nut will bring the rod under tension; a few sharp blows on the inner surface of the liner at the head end will, in most cases, loosen it so that the bolt can pull it out with ease. If

the liner resists, additional bolt tension, followed with hammer blows along the liner supports, will expedite the removal.

In inserting a new liner the oil passages must check, as also must the dowels. After the casting has been driven into place by the use of a sledge and hardwood block, the bolt and spiders used in removing the discarded part can be reversed to press the liner into the recess.

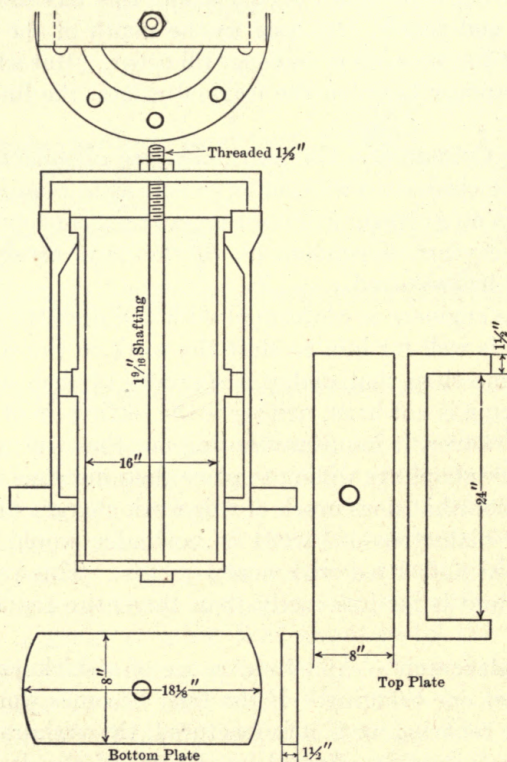

FIG. 74.—Removing cylinder liner screw jack.

Cylinder and Head Joints.—While a few engineers depend on a metal-to-metal joint at the head to withstand the cylinder pressures, some form of gasketing is now well-nigh universal. The gasket may be either a flat copper ring, a copper wire, or a round rubber ring.

The flat copper ring is very successful as a gas check and is not difficult to make. Its objectionable feature is the large amount of sheet copper that is wasted in cutting the ring. Ex-

perience proves that the thinner copper sheet makes the best gaskets; $\frac{1}{32}$ -inch thickness of metal is ample and enables the gasket to conform to the flange face. The gasket is best cut scant so that it fits easily into the gasket recess. If it is so wide as to require driving, the edges will bend and the gasket will not prove gas-tight. If a gasket cutter is not at hand, a pair of tinner's shears will be very satisfactory. A wooden mallet is handy to hammer the gasket to a flat surface.

In case sheet copper cannot be procured, an equally serviceable ring can be made of No. 10 gage soft copper wire; when the bare copper is not available, water-proofed electrical wire of No. 10 gage may have its insulation burned off and the bare wire used. The wire is formed into a circle of the proper diameter and the ends soldered together. If the cylinder flange is not provided with a recess to receive the ring, the latter should be placed inside the bolt circle, touching each stud. This allows the leverage to be a minimum. The wire must be free from kinks or bends.

Round rubber gaskets are often used on vertical engines, particularly on the McIntosh & Seymour engines. The rubber tubing is shaped into a ring of the proper diameter and the ends united by rubber glue. In engines where the cooling compartment of the head communicates with the cylinder jacket by cored openings at the flange the openings are surrounded with like tubes. These gaskets of rubber tubing can always be obtained from the engine builder, but any mill supply house will furnish the tubing in coils at a far less cost.

Drawing Up Cylinder Stud Nuts.—In tightening up the cylinder-head nuts, many engineers draw up one nut as snugly as possible before drawing up any of the other nuts. Such handiwork is evidence of a lack of mechanical knowledge and is to be shunned. If the top of the studs are numbered in pairs, similar to Fig. 75, and tightened in rotation, the head can be

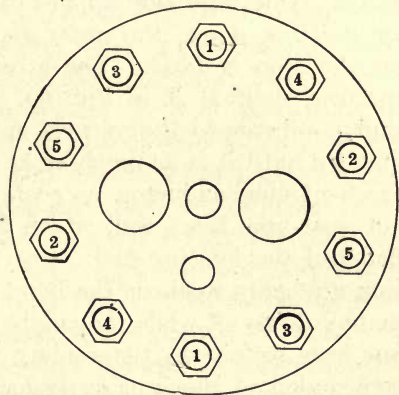

FIG. 75.—Method of drawing up head nuts.

drawn down quite evenly. As example, all the nuts are run down against the head, then the No. 1 nuts are given an eighth turn, followed by a similar performance on No. 2 nuts, etc. Returning to the No. 1 nuts, they are given another eighth turn, etc. When giving the nuts the final movement, a workman can strike the wrench handle several sharp blows with a sledge.

Fractured Heads.—Fracture of a cylinder head is a malady which appears to afflict all makes of Diesels, no matter what the design may be. There is no doubt that the more complicated heads fracture often, but even the simplest of head castings do give way, usually on heavier loads. Bad water, without question, occasions the greater number of the fractured cylinder heads. This especially applies to the horizontal engine. Here, on shutting down, the water gives up its salts, which deposit on the iron surfaces. The greater part settles on the lower surfaces, marked *A* in Fig. 69. However, a part of the soft sludge adheres to the vertical surfaces *B*. This coating accumulates until it is as much as an inch thick. Since scale is an excellent non-conductor, no cooling effect is experienced on the hot cast-iron head wall which is in contact with the intense flame of the burning fuel. On cooling, the contraction of the iron gradually weakens the bond of the scale. This scale ultimately drops off while the engine is under load, exposing a red-hot iron surface to the cooling water. The sudden localized contraction of the iron on being chilled results in a fractured head. Evidently the horizontal head is more likely to shed the scale than is the vertical head. It becomes necessary for an engineer to inspect the cylinder head at stated intervals; if scale is present, it can be removed by scraping. If a solution of muriatic acid and water in the proportion of one to ten is allowed to remain in the jacket a few hours, all the scale can be washed out with a hose.

Heat stresses due to faulty design of the head also contribute to these fractures. This, however, is beyond the sphere of the operating force, although every engineer should endeavor to persuade the management, when new units are to be installed, to purchase only those engines whose design offers comparative freedom from operating difficulties.

Cylinder heads frequently crack through the bridge between the exhaust and fuel valve cavities. These fractures are due to improper cooling rather than to faulty design, although there

are doubtless instances where casting fractures develop at these places as soon as the head is machined. To safeguard the engine head from such fractures that may develop in service, the flow of cooling water to the head must be positive and the temperature kept at a constant reading, the value of which can only be determined by experiment on the particular engine.

On marine Diesels the fracturing of cylinder heads is directly traceable to excessive overloads. In a heavy sea the propeller is at times exposed and immediately thereafter completely buried. This leads to engine hunting, and neither governor nor manual control can cope with the situation. The fuel pumps deliver excessive charges to the cylinder, creating pressures beyond the capacity of the heads to withstand.

Furthermore the marine engine, to reduce the weight per horsepower, is speeded far higher than the stationary Diesel. This applies especially to the submarine and light cruising engines. The heat absorbed per sq. inch of surface by the heads of a 500 h.p. engine at 400 r.p.m. is double the amount absorbed by the heads of a 500 h.p. at 200 r.p.m., since the cylinder bore is practically one-half that of the latter engine and the total amount of heat absorbed is approximately the same. The cooling system, then, must be absolutely correct in design if fractures are to be avoided. The tendency of the salt water to scale is, of course, more pronounced where the temperatures are as high as exist in the marine Diesel heads.

Repair of Fractured Cylinder Heads.—Oxyacetylene welding has not been a marked success in the repairing of cracked cylinder heads. The cylinder head contains a great weight of iron, and, in welding, the flame is localized. The consequence is that the metal immediately about the fracture is highly heated and expands. After the molten metal is added, closing the fracture, the head is allowed to cool. The mass of the head has not been heated, and so shows no contraction. The obvious result is the shrinkage of the metal at the edges of the fracture, reestablishing the fault.

To successfully weld a cylinder head, a furnace similar to Fig. 76 can be constructed of fire brick. The floor should also be made of fire brick supported by old grate bars or iron rods. After a coke fire has been burning about the head for twenty-four hours, the entire casting becomes red-hot. The oxyacetylene flame is then applied; the fracture is enlarged to a

trough shape, thus allowing the added metal to reach the bottom of the fracture. The new metal is deposited in small quantities and thoroughly welded to the cast iron before more is added. The head should then be left in the furnace to cool for forty-eight hours. Since the entire furnace has been at a high tem-

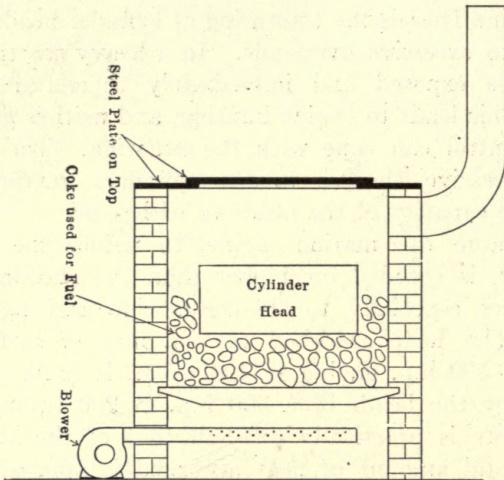

FIG. 76.—Repair of fractured cylinder head.

perature, the cooling will be very gradual, thereby avoiding all shrinkage strains. If the fracture has been across a valve seat, the part must be machined and the valve refitted. The process of welding here outlined has been followed with complete success, saving hundreds of dollars in a plant where five Diesels were installed.

CHAPTER VIII

ADMISSION AND EXHAUST VALVES

TYPES. ADJUSTMENTS. REPAIRS

Valves.—The four-stroke-cycle Diesel engines are provided with air admission and exhaust valves as are all four-stroke-cycle gas engines. In fact, a number of Diesels are built with cylinder heads and valve mechanisms that are but slight devia-

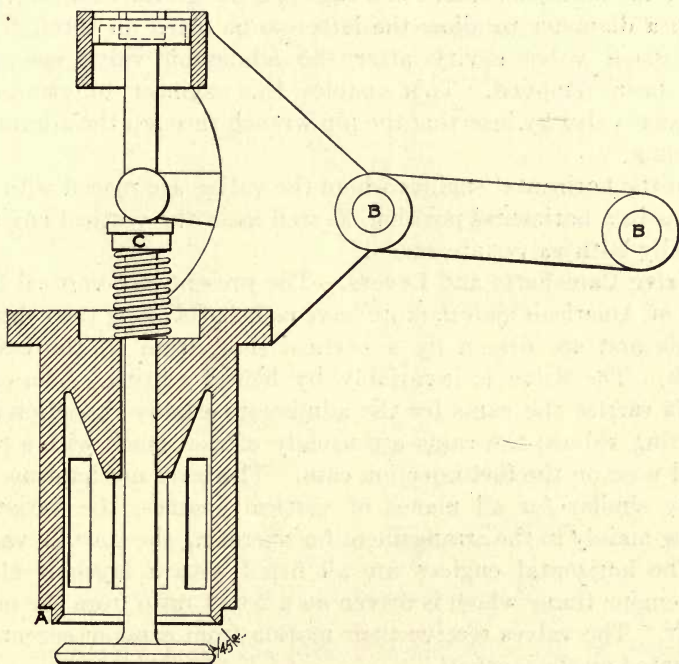

FIG. 77.—Admission valve cage. American Diesel.

tions from the similar parts of a gas engine. This applies particularly to the horizontal Diesel of which a number possess what might well be termed "gas engine heads." In the vertical engines the entire valve equipment is distinctly a Diesel feature, differing in many respects from any of the gas engine designs.

In all Diesels the admission valves seat in valve cages along the lines of Fig. 77; the builders are not so unanimous as to the exhaust valve. This latter valve, in some engines, is provided

with a cage; in other makes the valve seats directly on the cylinder casting; in others a removable seat which is fastened to the head casting is supplied. Strictly speaking, the exhaust rather than the admission valve should be fitted into a cage. The hot exhaust gases, in passing through the valve opening, wear the ground seats very rapidly, while the admission valve is not subject to such an erosive action. From the operator's viewpoint the exhaust valve should be caged, as well as the admission valve. Engine builders, in a desire to eliminate the difficulty of lowering the exhaust cage under the cylinder head, place the admission valve in a cage and design the exhaust valve with a diameter to allow the latter to be lifted up through the admission valve cavity after the admission valve assembly has been removed. This enables the engineer to grind the exhaust valve by inserting the pin wrench through the admission opening.

In the horizontal engines where the valves are placed with the stems in a horizontal position, as well as in the vertical engines, usually both valves are caged.

Valve Camshafts and Levers.—The present-day vertical Diesels of American manufacture have camshafts along the cylinder heads and are driven by a vertical shaft from off the crankshaft. The drive is invariably by helical gearing. The camshaft carries the cams for the admission, exhaust, injection and starting valves; the cams are usually of cast steel, with a tool-steel nose on the fuel-injection cam. The lever mechanisms are quite similar for all makes of vertical engines, the variation being mainly in the arrangement for operating the starting valve.

The horizontal engines are all fitted with a layshaft along the engine frame which is driven on a 2 to 1 ratio from the main shaft. The valves receive their motion from cams or eccentrics mounted on the layshaft.

American Diesel or Busch-Sulzer Type A.—The former engine, which was the forerunner of the Busch Type A engine, is of interest since many are still in operation. The positions of the admission and exhaust valves are shown in Fig. 7. The camshaft is mounted within the enclosed crank-case and is driven from the main shaft, through an idle or intermediate gear, and operates at half engine speed. The exhaust valve seats vertically in the lower face of the head and is driven directly by a vertical push-rod pinned to the valve lever *B*. The lever is closed

by a spring which is held in place by a washer and lock-nuts as shown in Fig. 78. This valve has two tapped holes in the top which allow a wrench to be used, but the size of the cap screws are such that it is impossible to hold the valve with the wrench when disassembling. The most satisfactory procedure to follow is outlined in the sketch to the left of Fig. 78. The spring is compressed by a pinch-bar, allowing the engineer to grasp the valve stem with a pipe wrench. By placing an

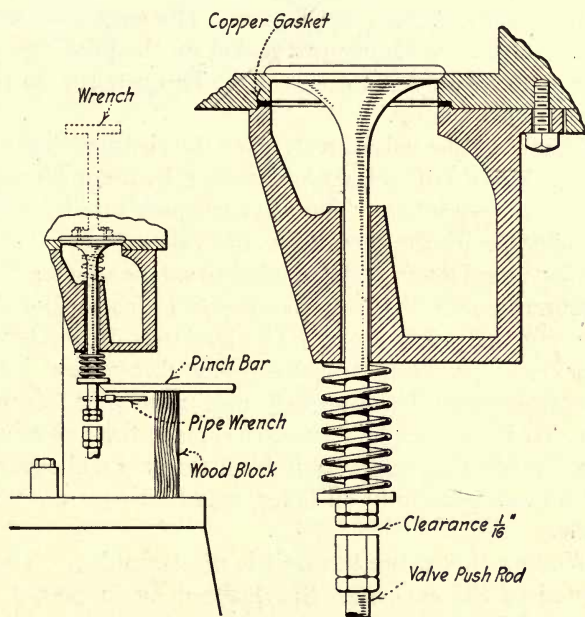

FIG. 78.—American Diesel exhaust valve.

open-end wrench on the lock-nuts the nuts can be removed, whereupon the spring is released and the valve withdrawn. The valve has a 45-degree angle to its face, seating directly on the cast-iron base of the cylinder head. If the engineer desires to regrind, the valve is reinserted on the stem housing and a light spring set below the valve as indicated by the dotted outline.

The valve stem housing is not bushed and in time wears enough to emit part of the exhaust gases. This can be eliminated by the reaming of the housing and the insertion of a brass tube of the correct diameter and bore. The exhaust pot has a

water drip connection for the purpose of maintaining the temperature at a reasonably low value. A drip cock is also a useful adjunct to the pot since it will free the chamber of tarry deposits. The junction of the pot and cylinder head is sealed by a copper gasket. It is absolutely necessary that the stud-bolts have clean threads for they are rather inaccessible, and if the stud nuts are not tight the gasket will blow.

Admission Valve.—The admission valve is contained in a cage, Fig. 77, and is actuated by a cam, similar to the exhaust cam, through the lever and push-rod shown. The cage has a gasketed joint at *a*. In placing the copper gasket on the joint and setting the valve cage into position, care is to be exercised to prevent the gasket from wedging.

Adjustments.—The valve lever, since the clearance between its end and the valve nut is large, delivers a hammer blow to this nut and the fibre washer. The washer wears rapidly while the nut gradually shears the threads on the valve stem. The valve stem can be turned down and threaded to take a smaller diameter nut; a second remedy is the employment of a cotter pin through the worn nut and valve stem. The bushings on the lever pins also wear rapidly; these can be replaced by new bushings. The pins frequently become flat, and new pins of machine steel, case-hardened, can be turned to replace the defective ones. If the pins are oiled, as they should be, little wear will occur; while the pin bearings have only oil holes, small oil cups are far more serviceable.

In regrinding this valve the unit is disassembled. The valve is reinserted in the cage and the dashpot again placed on the valve stem. This constrains the valve stem to remain in its proper position while the valve face is ground to the correct angle.

Adjusting Valve Levers.—The long nut on the upper end of the exhaust valve push-rod is screwed on until it clears the valve stem nuts by $\frac{1}{16}$ inch when the valve is at rest and the push-rod is in its lowest position. The lock-nuts on both push-rod and valve stem must be jammed tight to prevent any change in this clearance when the engine is running. The upper end of the admission valve push-rod is adjusted to allow the valve end of the rocker to clear the fibre washer by $\frac{1}{32}$ inch when the valve is seated.

A layout of the valve mechanism is shown in Fig. 7. This

also includes the fuel valve rocker arm and rod. The cams are of cast steel keyed to the camshaft. Change in the timing of the cam assembly can be effected by shifting the cam gear a tooth or two. This is made possible by sliding the idle gear until it is out of mesh with the cam gear. Alteration of an individual cam is obtained by the employment of an offset key which will move the cam the required amount.

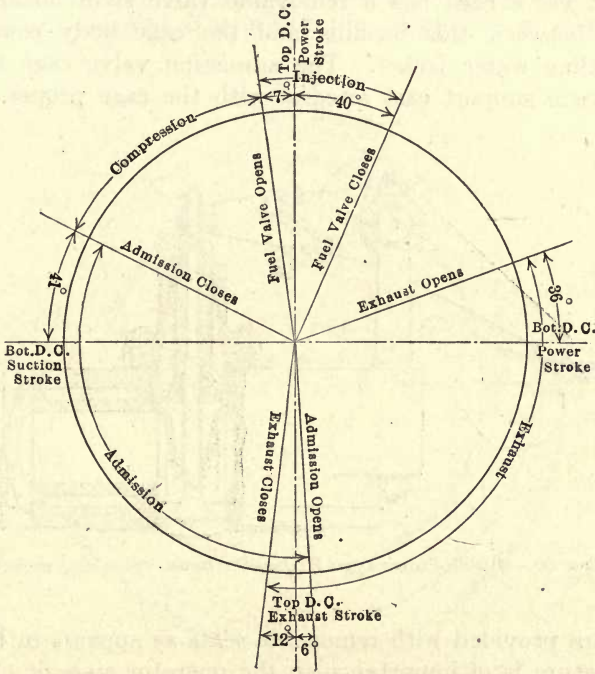

FIG. 79.—Valve timing of American Diesel engines.

Valve Timing.—Figure 79 gives the timing of admission, exhaust and fuel valves on the 225 h.p. American-Diesel engine. These timings represent standard practices and are equally applicable to 120 and 170 h.p. engines of this make. In this diagram each quarter circle represents 180 degrees and not 90 degrees, being equal to one complete stroke of the engine piston. The degrees indicated are to be laid off on the fly-wheel rim and are not percentages of the piston travel. To translate these degrees to inches on the periphery of the flywheel is a matter of simple mathematics. For example, if the wheel be 8 feet in diameter, the circumference is then 302 inches.

One degree is in this case $30\frac{2}{360}$ - inch or $.83 +$ inch. If the operator uses a value of $.8$ inch per degree, he will be working amply close.

Busch-Sulzer Type B Diesel Valves.—In exterior form the admission and exhaust valves and cages are quite similar. Both are placed vertical in the cylinder. The interior arrangement of the cages, however, are by no means identical. The exhaust valve cage has a removable valve stem bushing; the cavity between this bushing and the cage body constitutes the cooling water jacket. The admission valve cage has the valve stem support cast integral with the cage proper. Both

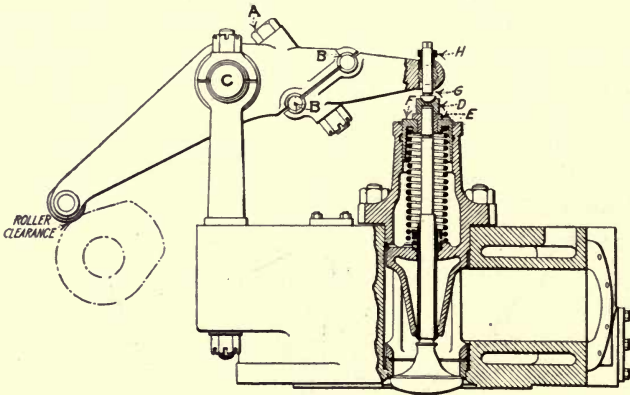

FIG. 80.—Busch-Sulzer type B Diesel exhaust valve and rocker.

cages are provided with removable seats as appears in Fig. 80. This feature is of importance to the operator since it obviates the necessity of replacement of the complete cage when the valve seat has been worn excessively.

The valves, both admission and exhaust, have cast-iron bodies with steel stems. In disassembling the valve, the lock-nuts *D* and *E* are unscrewed, the valve being held by a pin wrench inserted in the two pin holes in the valve body. The removal of the spring cap *F* allows the valve to be withdrawn. The exhaust valve seat, of course, experiences the greatest wear; consequently frequent refacing of the cage seat becomes necessary. After a number of refacings with a reamer the cage seat lies too deep in the cage; when this occurs, a new removable seat ring can be obtained.

Cam Levers.—The valves are actuated by levers which receive their motion from a camshaft that lies along the cylinder head. This camshaft is driven by the engine shaft through the intermediation of the vertical governor shaft and two sets of helical gears.

To allow the valves and cages to be lifted without the removal of the entire rocker arm and shaft, the rockers are in two parts. These two parts are held together by one bolt *A* while two dowel pins *B* preclude the possibility of the parts

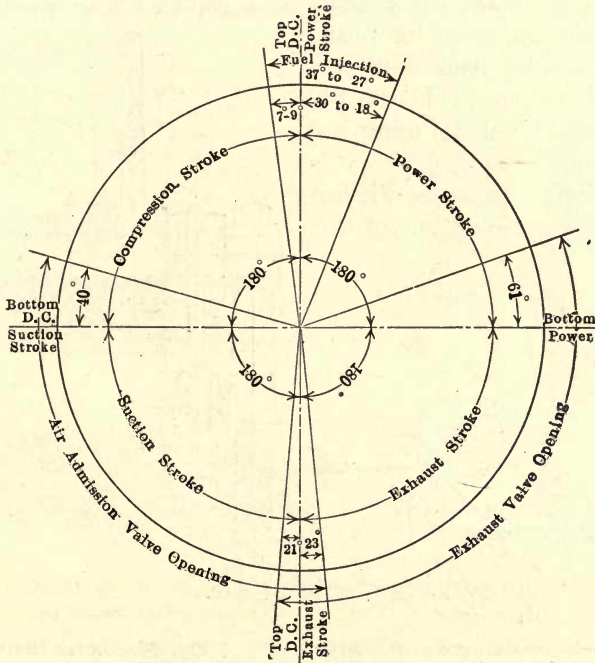

FIG. 81.—Busch-Sulzer 500 H.P. type B 4 cylinder, 200 R.P.M. Diesel valve timing diagram.

being improperly aligned on reassembly. One end of the rocker carries a hardened steel roller while the other end is fitted with the adjusting screw *G*, which screws into a steel pin and is locked by the nut *H*.

Valve Lever Clearances.—The adjusting screw enables the operator to obtain the required clearance between the roller and the cam when the valve is closed. The rocker arm is held against the valve stem, and the clearance is measured between

roller and cam by ordinary thickness gages. The clearance values that are correct for all sizes of the Busch-Sulzer Type B engines are as follows:

Admission valve cam clearance.....	0.012 inch
Exhaust valve cam clearance.....	0.018 inch
Fuel valve cam clearance.....	0.004 inch
Starting valve cam clearance.....	0.012 inch

Since the clearances are established when the engine is cold, it becomes necessary to note whether the valves close after the engine has become warmed. If not, the adjusting or push screws can be backed off to give these values. Figure 81 is the usual valve timing on this engine.

Camshaft Layout.—Figure 82 is a schematic outline of the

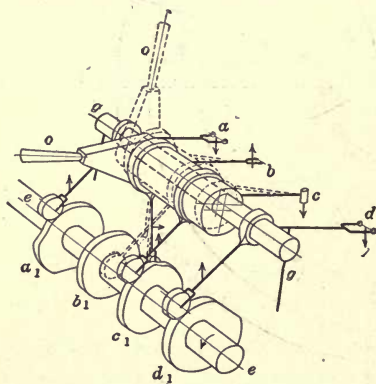

FIG. 82.—Busch-Sulzer Diesel rocker layout.

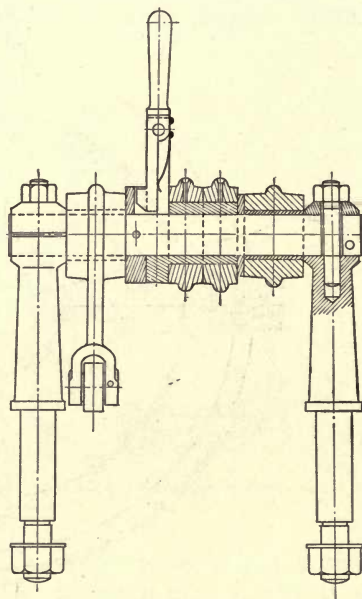

FIG. 83.—Lever shaft.

actuating valve levers of the Busch-Sulzer engine. The lever shaft *g* is supported by the pedestal bearings, better shown in Fig. 83. The lever *d* controls the exhaust valve, while *a* actuates the air admission valve, and the lever *b* governs the fuel valve, the lever *c* opening the air starting valve in starting the engine. The levers *b* and *c* are mounted on an eccentric bushing which is supported by the shaft *g*. In starting, the lever *o* moves the eccentric bushing to the “starting” position where the fuel lever *b* does not engage its cam *b*; this movement brings the starting lever *c* into contact with its cam *c*. This action is

To disassemble the valve, the pin *b*, Fig. 86, is driven out of the valve stem, and the bushing *a* is removed. The spring cap *d* is pushed downward, allowing the slotted ring *c* to be slipped from around the valve stem. This being done, the spring cap and the spring are withdrawn from the top of the cage while the valve can be removed through the bottom end of the cage.

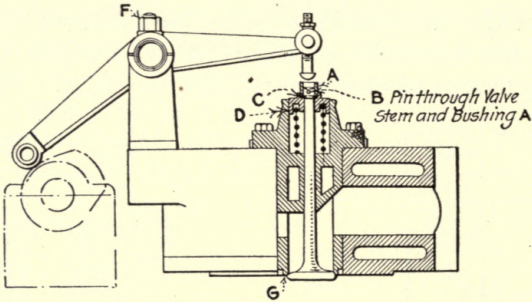

FIG. 86.—McIntosh and Seymour valve layout.

Camshaft.—The camshaft lies along the cylinder heads, resting in bearing pedestals mounted on extensions from the cylinder castings. The camshaft is driven, through helical gears and a vertical governor shaft, by the main engine shaft.

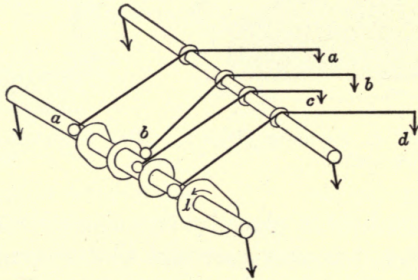

FIG. 87.—McIntosh & Seymour valve rocker layout.

Figure 87 shows the valve rocker arrangement where *d* is the exhaust rocker, *a* is the admission rocker, *b* the fuel rocker, and *c* the air starting rocker. The cams for *b* and *c* are in one piece; the engine is started by shifting the starting roller *c* until it contacts with the starting cam; a small lever is provided on the rocker for this purpose. After the engine fires, the roller *c* is moved out of contact with its cam.

In removing the valve cages, the caps of the pedestal bearings *f*, Fig. 86, are first unbolted and a rope sling passed around the ends of this rocker shaft. Since the shaft is lifted, the entire valve rocker mechanism for this particular cylinder is removed. While this appears to be a more difficult task than the removal of part of a rocker arm as in Fig. 80, actually it consumes no more time and, if the plant possesses a traveling crane hoist, is no more difficult.

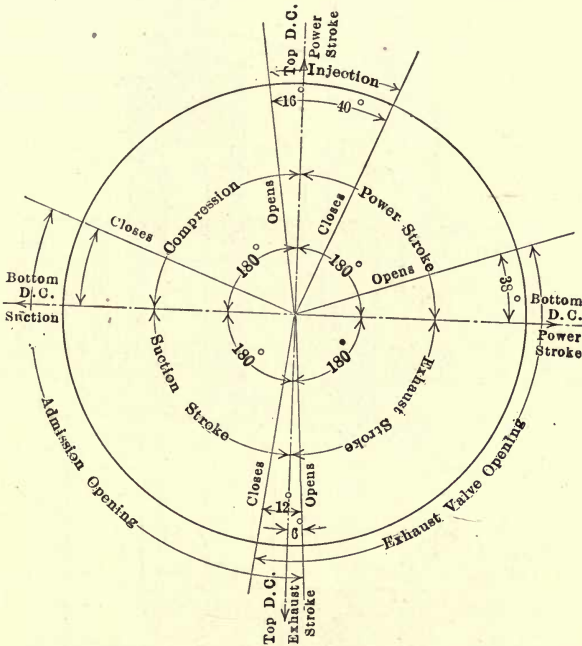

FIG. 88.—Valve timing McIntosh & Seymour 500 H.P. Diesel engine 164 R.P.M. 4 cylinders 18 $\frac{7}{8}$ dia. \times 28 $\frac{3}{4}$ stroke.

Valve Cam Clearances.—The roller clearances to be maintained are as follows:

Admission valve cam clearance.....	0.039 inch
Exhaust valve cam clearance.....	0.036 inch
Fuel valve cam clearance.....	0.002 inch
Starting valve cam clearance.....	0.036 inch

Figure 88 gives the valve timing which is correct for the 500 h.p. engine at 164 r.p.m., and this equally applies to all sizes of the slow-speed engine. The manufacturers set the admission and exhaust valves on the erecting floor and do not

recommend any change. The helical gears are marked to enable the erector to assemble the valve mechanism. Nevertheless, after a few years of service the gear teeth and the cams wear to such an extent that the valves do not function as originally

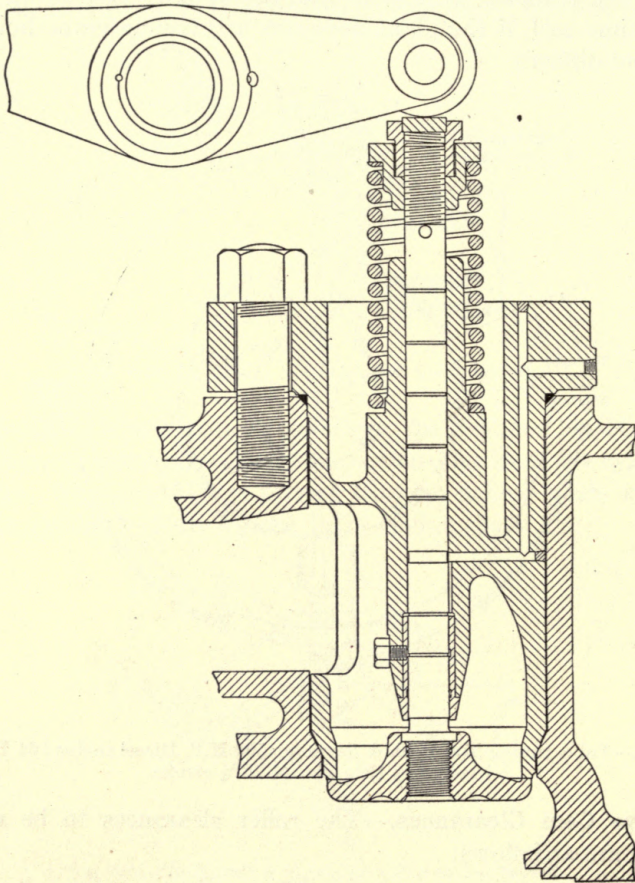

FIG. 89.—Snow Diesel admission valve.

set. It then becomes necessary to retine the valves along the settings indicated above.

The rocker shaft is provided with small grease cups. Usually the lubrication so obtained is insufficient, and the cups should be replaced by sight-feed oil cups.

Snow Diesel Engine Valves.—Figure 89 outlines the admission valve while Fig. 90 is the exhaust valve assembly of the Snow engine. The valve stems are identical, while the valve bodies differ in that the exhaust valve body is extended along the stem,

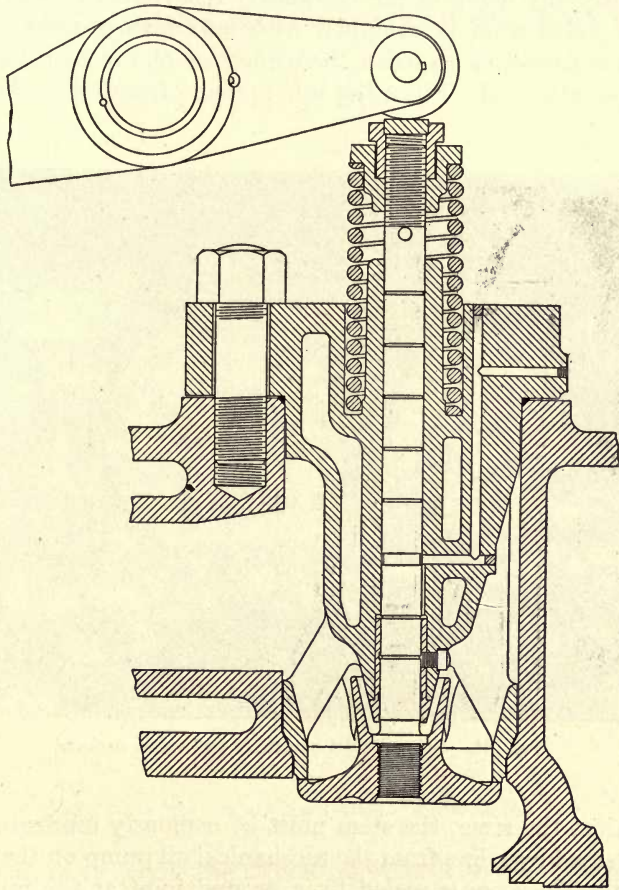

FIG. 90.—Snow Diesel exhaust valve.

forming a gas deflector to avoid the burning of the stem. The valves have one feature that makes them rather peculiar—the valve seats are flat surfaces. The advantage of the flat valve lies in its freedom from any wedging action, with the consequent grooving which, at times, occurs with the bevel seat, and in the

increased valve opening over the bevel seated valve for any given lift. There is, however, an objection to the flat valve which an occasional engineer voices. It is much more difficult to keep gas-tight, largely due to the accumulation of small carbon particles on the face. The valves are easier to regrind, and consequently any deposits can be quickly removed.

The valve stem is equipped with labyrinth grooves, and it becomes necessary to clean these recesses of tar each time the valve is inspected. Since the side pressure from the rocker arm

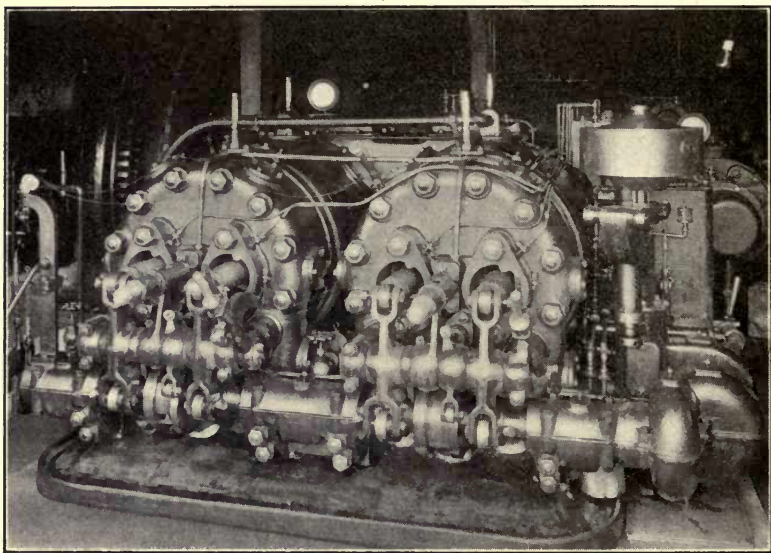

FIG. 91.—Snow Diesel camshaft and valve rockers.

is against the stem, the stem must be copiously lubricated; this is obtained by a line from the mechanical oil pump on the engine frame. The cage is sealed by a ground joint at the inner end as well as by a gasket at the outside flange.

Camshaft.—The camshaft, as will be noted in Fig. 91, is driven by bevel gears from the engine layshaft. The rockers are fulcrumed on a short shaft which is supported by the cylinder head. To remove a valve cage, the entire rocker assembly must be unbolted. This fulcrum shaft is provided with an eccentric bushing upon which are fitted the starting and fuel valve rockers.

Cam Clearances.—The proper roller clearances are as follows:

Admission valve cam clearance.....	0.01 inch
Exhaust valve cam clearance.....	0.01 inch
Fuel valve cam clearance.....	0.004 inch
Air starting valve cam clearance.....	0.036 inch

The proper valve timing appears in Fig. 92. Any change of the entire cam timing can be obtained by shifting the gears one

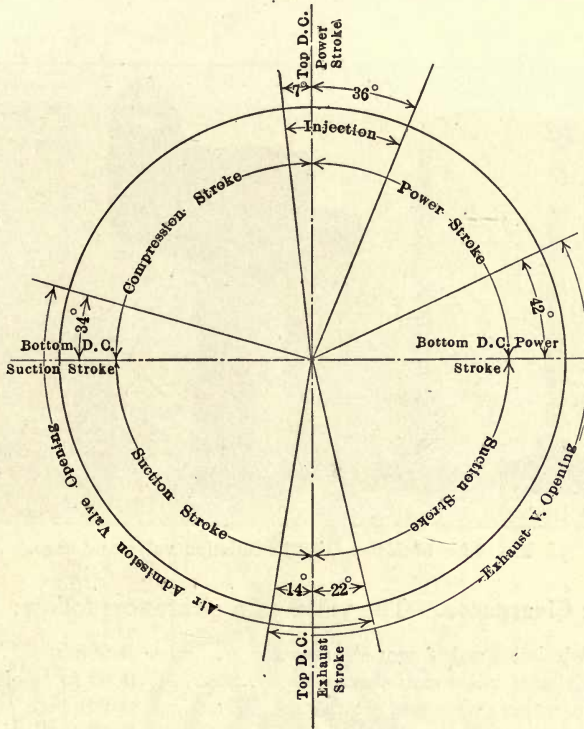

FIG. 92.—Snow Diesel. Valve timing.

or two teeth, while the alteration of an individual valve cam can be secured by the use of a properly offsetted key.

McEwen Diesel Valves.—One excellent feature of this horizontal engine is the provision of cages for both the exhaust and the admission valves. These cages and valves are mounted in the cylinder head in vertical positions, as appears in Fig. 70. Both valves are of cast iron with steel stems; the exhaust valve body is extended to form a hood about the lower part of the stem.

The two valves and the admission valve cage are shown in Fig. 93; both valves have 45-degree seats. To remove either cage, it is only necessary to unship the reach-rod pin and lift out the cage with the rocker attached.

The camshaft is driven by a helical gear from the engine shaft. The valve rocker arrangement is outlined in Fig. 70. Each valve has its individual cam, the exhaust cam roller being provided with a shifting pin which relieves the compression on starting the engine.

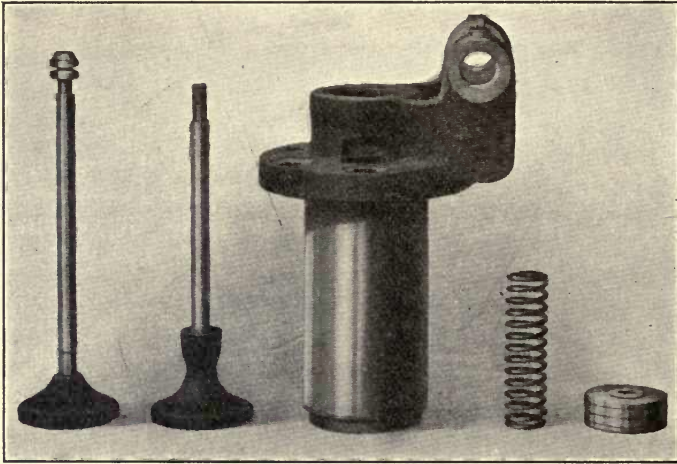

FIG. 93.—McEwen Diesel admission valve and cage.

Cam Clearances.—The valve cam clearances follow:

Admission valve cam clearance.....	0.005 inch
Exhaust valve cam clearance.....	0.03 to $\frac{1}{32}$ inch
Injection valve cam clearance.....	0.001 inch
Starting valve cam clearance.....	0.03 to $\frac{1}{32}$ inch

Valve Timing.—The timing diagram applicable to the engine appears in Fig. 94. These values can be followed by the operator with a feeling that they are correct.

National Transit Diesel Valves.—This engine has the admission valve provided with a cage while the exhaust valve has a half-cage, which carries the valve spring and stem housing. The latter valve does not seat on the cage but instead a removable seat is set into the cylinder casting and held in place by machine screws, Fig. 95.

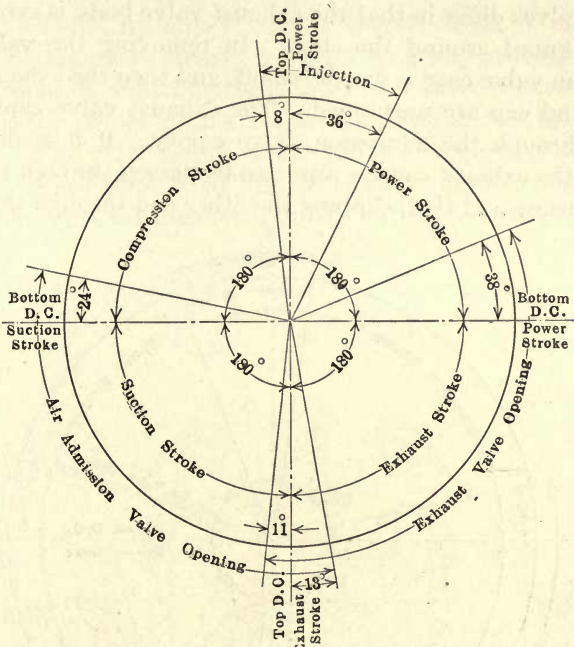

FIG. 94.—McEwen Diesel. Valve timing.

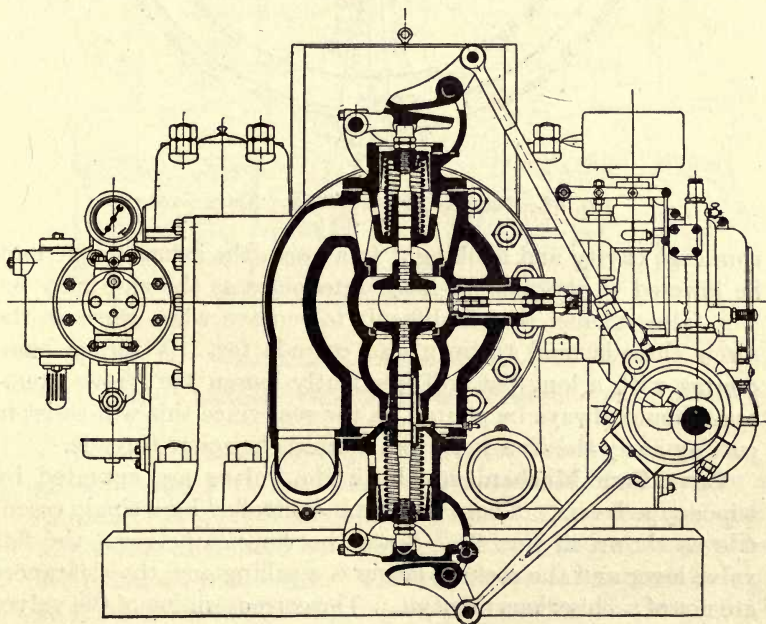

FIG. 95.—National Transit Diesel valves and rockers.

The valves differ in that the exhaust valve body is extended to form a guard around the stem. In removing the valves, the admission valve cage is first lifted off, and then the exhaust valve spring and cap are unshipped. The exhaust valve can then be raised through the admission valve cavity. If it is desired to remove the exhaust cage, a rope can be passed through the valve stem housing and tied; slipping the other end through the admis-

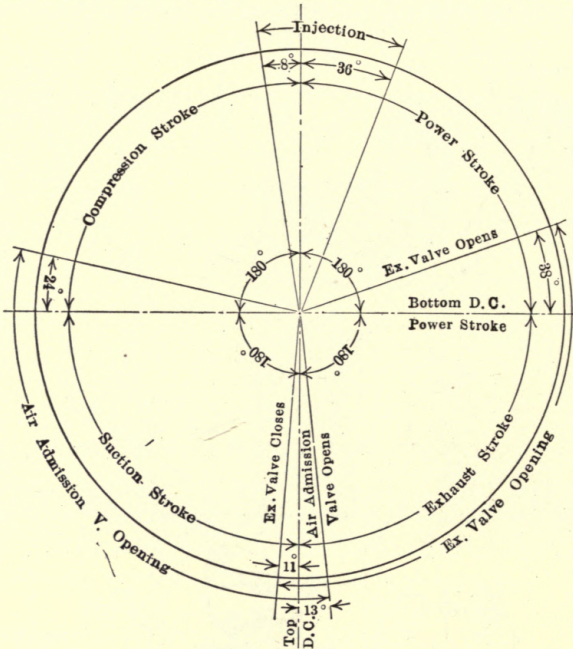

FIG. 96.—National Transit Diesel. Valve timing.

sion cage cavity and hooking it to a hoist, the exhaust cage may be lowered to the floor or lifted into place as the case may be. The false exhaust seat is difficult to remove when worn as the screw threads tend to burn and corrode fast. Vigorous hammering with a long bar will frequently loosen the screws; kerosene should always be poured on the seat since this will assist in cutting away the iron rust from around the screw threads.

Valve Cam Mechanism.—Both the valves are actuated by wiper type levers. These levers are controlled by a single eccentric as shown in Fig. 95. Since the contact between the flat valve lever and the rocking levers is a rolling one, the clearances are not of such serious moment. The correct timing of the valves

can be secured by either shifting the eccentric, or altering the length of the valve stems through the agency of the valve lock-nut caps, or by adjusting the length of the valve reach-rods. The latter is the proper method for securing any minor timing adjustments. The valve timing of this make of engine appears in Fig. 96. It is apparent from Fig. 13 that the air starting and fuel-injection cams are distinct from the valve eccentric.

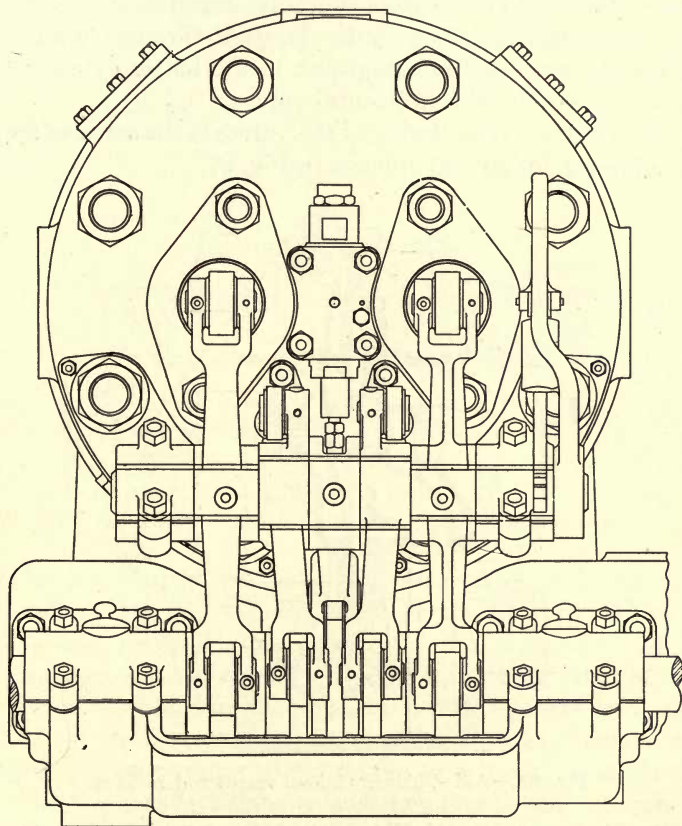

FIG. 96A.—National Transit 1918 design Diesel valve rocker assembly.

National Transit Diesel, 1918 Model Valves.—The later engines produced by the National Transit Co. have a valve and camshaft design radically different from the one discussed above. The valves are placed horizontally in the cylinder head, and both are provided with cages. This entire assembly appears in Fig. 96A. The end of the valve stem has an adjustable head which is

in contact with the valve rocker, and a collar against which the valve spring rests. No spring cap or other bearing is provided for the support of the outer end of the stem. However, the cage sleeve is long and gives ample support.

Camshaft Layout.—The rocker arms fulcrum on a short shaft which is carried on bearings bolted to the head; this shaft is loose in the bearings and is held by the starting lever shown. The rocker rollers rest on the cams which are keyed to the short camshaft; this shaft is driven by the layshaft through bevel gears.

The advantage of this design lies in the better cylinder head that is permissible with horizontal valves.

Valve Timing.—The timing of the valves is the same as applies to the former design and appears in Fig. 96.

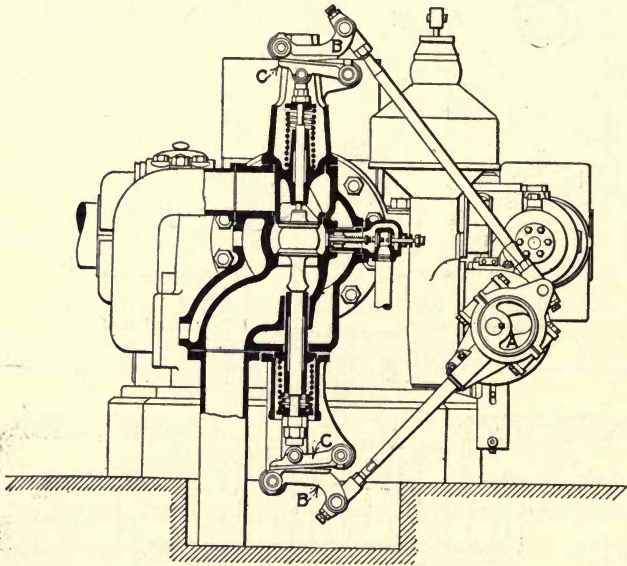

FIG. 97.—Allis-Chalmers Diesel valves and rockers.

Allis-Chalmers Diesel Valves and Rockers.—The valve arrangement of this engine, Fig. 97, is quite similar to the one just discussed in Fig. 95. The exhaust valve, however, has no removable seat since it rests directly on the cylinder-head casting. Use is made of a single eccentric for both valve actuating rods. In the two-cylinder engines a system of links allows the one camshaft to control the exhaust and admission valves of both cylinders. The valve rockers have a wiping action and conse-

quently open and close the valve, while the rocker is moving at a maximum speed, without shock or noise. The noiseless valve action is especially noticeable to one accustomed to the slamming noise of the usual cam-controlled Diesel valves. Since this form of valve actuating levers is used, no clearance is required between the lever and valve cap when the eccentric is in its extreme low position, beyond that necessary for the oil film, which need not be more than .001 inch.

Standard Fuel Oil Engine.—This engine, being of the two-stroke-cycle type, possesses no air admission or exhaust valves.

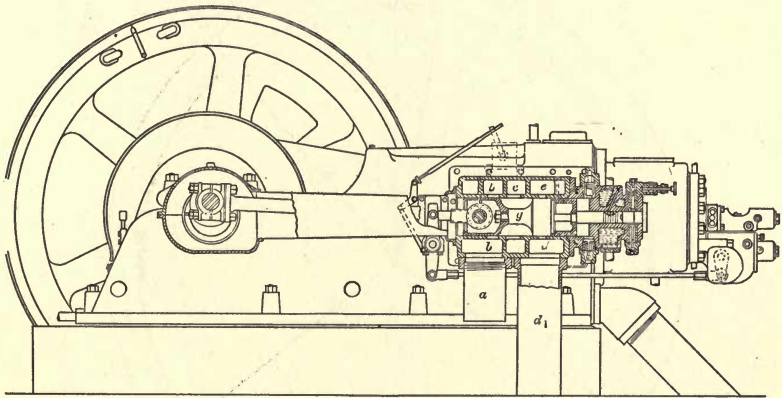

FIG. 98.—Standard Fuel Oil Diesel compressor and section.

The piston performs the duty of both valves, uncovering air scavenging ports and exhaust ports at the forward end of its stroke. The piston action, along with the functioning of the scavenging air valve, should properly fall within the scope of this discussion of engine valves. In Chapter VI a few words were devoted to the scavenging piston which acts as a compressor to supply the scavenging air to the power cylinder, although the means of this accomplishment were not mentioned. Figure 63 represents the engine cross-section, showing both the power piston and the scavenging piston, which is bolted to the former. Figure 98 is a view of the injection air compressor. The low-pressure air piston is of an hour-glass shape and acts as a valve in directing the proper flow of the scavenging air. The pipe *a* is the air suction line open to the atmosphere. The air, flowing in along the pipe *a*, passes through the port *l*, allowing this air to enter the scavenging air cylinder *H*, shown in Fig. 63. As

the engine turns over this air is compressed, and the continued movement of the plug piston *g*, Fig. 98, uncovers the port *d*, which permits the air to flow out through the pipe *d*₁ into a low-pressure air receiver, not shown. This air is at a pressure of 8 to 10 lbs. gage. After the fuel charge in the power cylinder fires and the piston moves outward, the exhaust ports *K* are uncovered. At the same time the scavenging air ports *e* are also

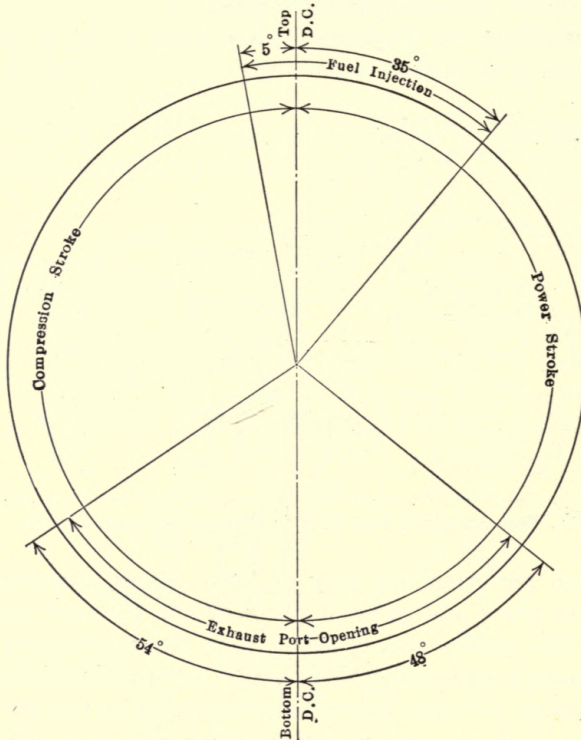

Fig. 99.—Standard Fuel Oil engine two-stroke-cycle Diesel fuel valve and exhaust port timing.

opened. During this interval the plug piston *g* has moved, shutting off the connection between the scavenging cylinder and the air-receiver line *d*, and has placed *d* in communication with the scavenging air ports *e*. The air, stored in the receiver, rushes through the ports *e*, scavenging the power cylinder of the exhaust gases. It is apparent that the successful functioning of the entire air scavenging system depends on the condition of the air-compressor piston or plug valve *g*.

Valve Timing.—The timing of the fuel valve, as well as the points of opening and closure of the exhaust ports, is indicated in Fig. 99.

De La Vergne Type FD Diesel Valves.—This horizontal Diesel has the valves located horizontally in the head. They are driven by rockers which are actuated by a camshaft bolted to the front of the cylinder head, as appears in Fig. 15.

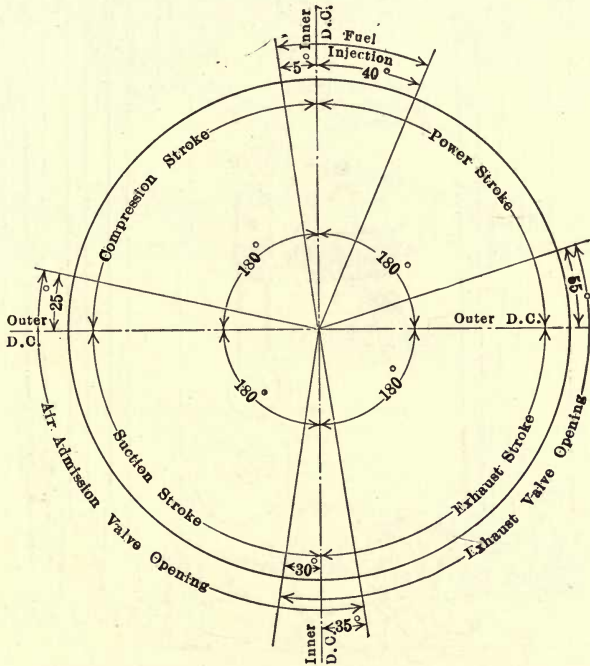

FIG. 100.—De La Vergne FD Diesel. Valve timing.

Valve Timing.—Figure 100 gives the valve timing of this Diesel. Individual units may vary slightly from these values.

McIntosh & Seymour Marine Diesel Valves and Valve Cages.—The admission and exhaust valve cages are made of cast iron and do not have separate valve seats. The valves proper are also of cast iron with steel stems cast in, and are guided in the lower part of the valve cage and do not have an upper guide as is used in the stationary Diesel for the guiding of the valve.

Rocker Arms.—The various rocker arms are operated from the cams by means of vertical push-rods, including the air starter and fuel valve rockers, Fig. 101.

Camshaft.—The camshaft is driven by a set of spur gears from the crankshaft at the after end and runs at half the engine speed. A double set of cams is arranged side by side in the following order: exhaust, fuel, starting, and admission. They are keyed to the shaft and bolted together. Cams and rollers are made of cast iron and are chilled at the running edges.

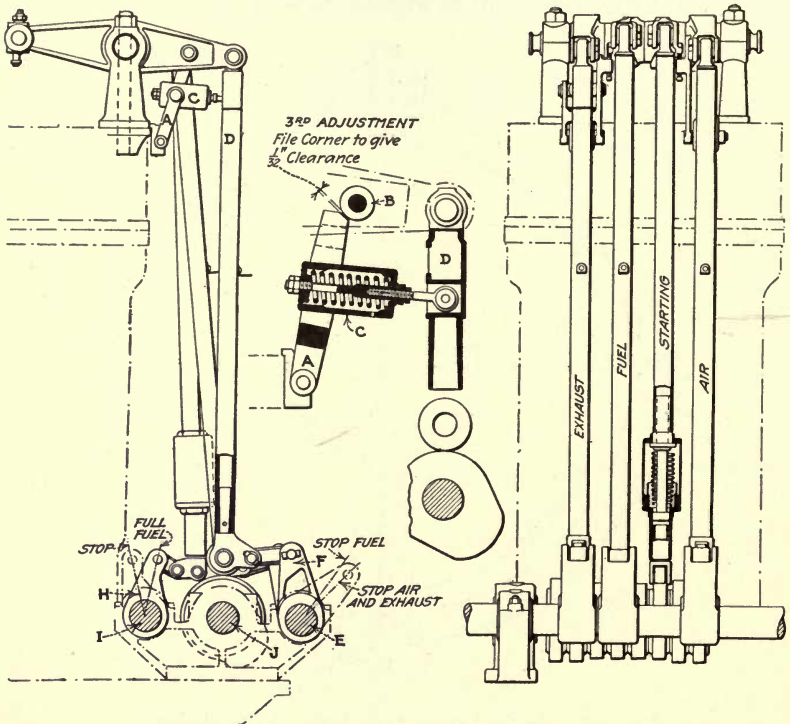

FIG. 101.—McIntosh & Seymour marine Diesel. Valve arrangement.

Reversing and Operating Gear.—This gear is located on the forward end of the engine. Two turns of the reversing wheel shift the camshaft in a horizontal direction for either ahead or astern rotation. This mechanism is designed as follows: The handwheel turns a shaft to which a bevel gear is keyed, Fig. 102, which in turn rotates a large bevel gear *D* mounted on another shaft, at right angles to the first one, carrying a pinion which operates a rack *L* up and down. This rack has an extension which is provided with a slot in which a roller moves, which roller is fastened to a rocker arm *M* pivoted around a fixed point.

The other end of the lever is forked and its arms fit in a groove in a sleeve fastened to the camshaft, thus moving this shaft in

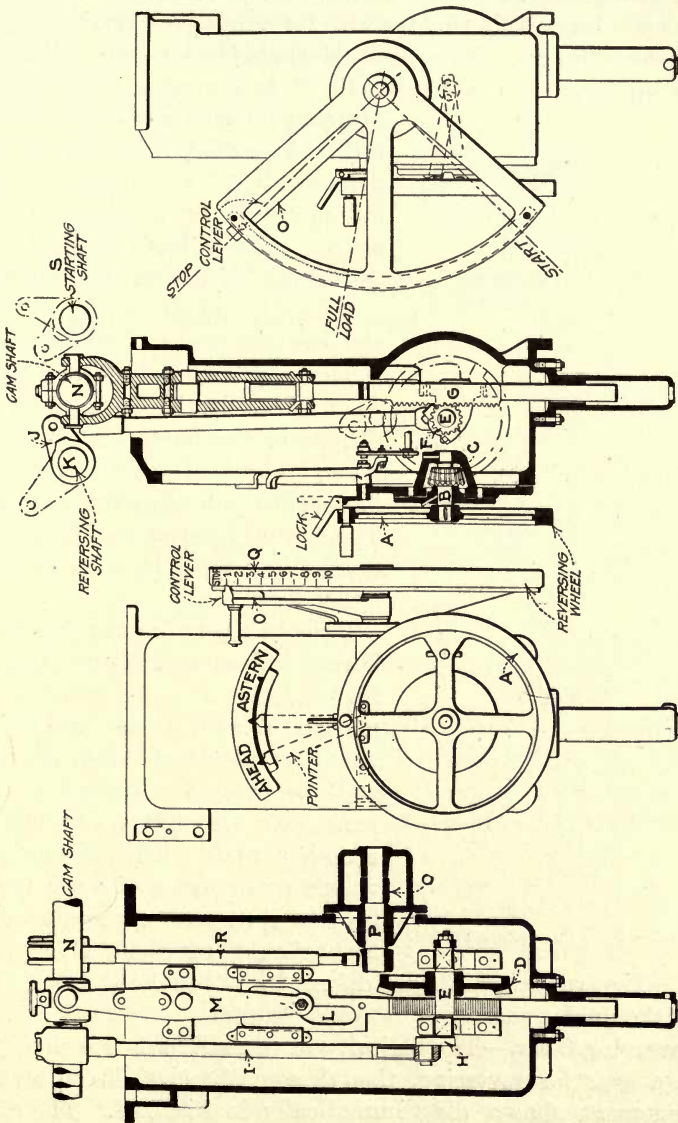
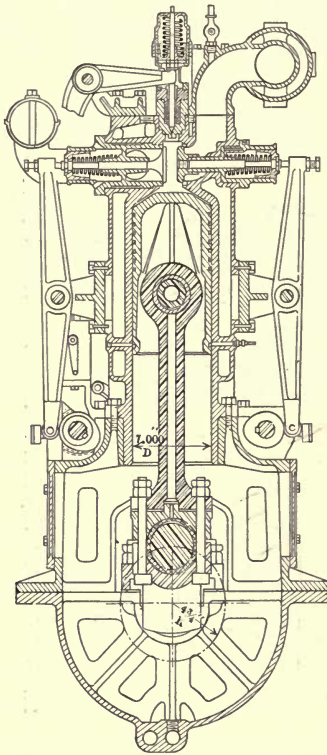

Fig. 102.—McIntosh & Seymour marine Diesel reversing apparatus.

either direction at will. The rollers for exhaust, fuel, and admission are moved away from the respective cams by the rods

I and *R* at the same time the camshaft is shifted longitudinally. Starting is performed by moving the lever *O*, which controls fuel and starting, all the way downward, in which event the starting air roller is brought in contact with its respective cam, admitting air to the cylinders. As soon as the engine has turned over a few times on air, the control handle *O* is moved upward again,



SECTION C CYL. No. 4

FIG. 103.—Nelseco marine Diesel.

bringing the fuel admission at the full-load position. It will be understood that the starting air was automatically cut off again as soon as the control lever reached the "full-load" mark on the segment.

When the engine is run on fuel, the reversing gear and the fuel regulations are interlocked, and only when the control lever is on stop does it become possible to turn the reversing wheel as the notch is disengaged from the bevel gear rim. The control lever cannot be moved unless the engine is fully reversed either way.

Nelseco Four-cycle Marine Diesel Valves and Valve Gear.—Figure 103 is a cross-section of this marine Diesel. The admission valve is provided with a cage, and the exhaust valve seats on a removable seat in the combustion chamber walls. The air and fuel valves are actuated through levers by the starboard camshaft while the exhaust camshaft is on port side.

The two camshafts are driven by a 2 to 1 reduction gear from the engine shaft.

Reversing Gear.—The majority of these Diesels are equipped with a gear for reversing, though some have a direct reverse arrangement shown diagrammatically in Fig. 104. The camshafts, of which there are three, have spiral keyways cut in them. Each shaft has a collar with a spiral key which is shifted by a pneumatic reversing cylinder. A movement of the rocker *A*

throws the collars to one side, thus turning the camshafts through an angle that will set the valve cams correct for reverse running. Due to the varying angle through which the three sets of cams must move, the spiral keyways do not have the same pitch, thus securing proper shifting of the cams.

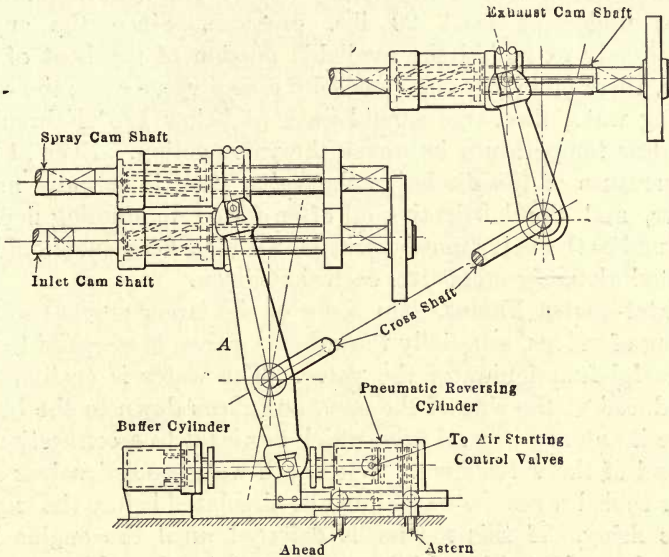

FIG. 104.—Nelseco four-cycle-engine reversing mechanism.

Valve Cages.—As would appear from the foregoing discussion, all the manufacturers use cages on the admission valves while the practice is not universal as regards the exhaust valves. There can be no doubt that the cage design is superior and is of advantage to the operator. When a valve seat leaks, a spare valve and cage can be used to replace the defective parts. No matter how thrifty the operator must be as to the capital invested in replacement parts, it is the height of economy to carry one extra admission and one extra exhaust valve with their cages.

Water-cooled Cages and Valves.—Due to the severe temperatures of the exhaust gases as they pass through the exhaust valve cage, water-cooling of the valve stem housing is well-nigh imperative in engines above 12-inch cylinder bore. All manufacturers provide for this stem cooling even though a valve cage is not included in the valve design. It is clear that the circulation of water must be positive if the sticking of the stem is to be

avoided. Where the water carries any considerable percentage of mineral salts, there is a decided tendency toward the scaling-up of the cooling space, which is, at best, of small volume. Consequently, each time the exhaust cage is removed the water-cooling cavity should be filled with a 10 per cent. muriatic acid solution and afterward thoroughly flushed out with a stream of water under at least 20 lbs. pressure. Since the engine has already extracted the available portion of the heat of the gases, there is no loss occasioned by a cool valve cage; the cage-cooling water discharge should be kept below 120° Fahrenheit as a low temperature improves the valve action. Even at this temperature of the discharge the valve stem is actually much hotter, and the lubricating oil often forms a gumming deposit that makes the valve motion erratic. A little kerosene should be injected along the stem after each shut-down.

Water-cooled Valves.—On some of the larger engines water-cooling of valves, especially the exhaust valve, is essential to the successful functioning of the valve. The water is customarily introduced at the side of the stem and flows down to the body, where it enters a central tube which carries it to a connection at the end of the valve stem. With both water-cooled valves and water-cooled cages the water must be circulated before the engine starts firing. If this matter is deferred until the engine has warmed up, the sudden chilling of the parts by the cold water will invariably produce a fracture.

Pitting and Corrosion of Valve Seats.—Both chemical and mechanical reactions cause pitting and corrosion of the valve seats, particularly of the exhaust valve. The pounding of the valves, as they close rapidly, produces a series of minute surface fractures that, in time, allow small portions of the metal to flake off, giving the effect of pits. A more prevalent result of the valve hammering is the formation of grooves around the seat. These serve as recesses to hold carbon deposits, which soon cause the valve to leak.

The chemical action of the exhaust gases, especially when any considerable amount of sulphur is contained in the fuel oil, rapidly forms pits that enlarge to some magnitude. This manner of pitting is responsible for the majority of leaking valves. It can be largely offset by more rigid fuel specifications, which exclude all oils having a sulphur content above 1 per cent. and all oils possessing even a trace of acid.

Cleaning Valves.—Once a month each valve and cage should be removed for inspection and cleaning. A regular schedule can be followed whereby the valves of one cylinder are removed each week; in a four-cylinder engine this gives a monthly inspection, while in a three-cylinder engine an inspection every three weeks is secured. When the engine is a single- or double-cylinder unit, the schedule should be arranged so that the monthly examination is obtained. At these inspections the valve and cage should be completely disassembled and thoroughly cleaned with kerosene, washing off with gasolene. If a valve and cage is kept on hand, the old one can be cleaned at leisure. This spare set is very essential where an engine operates almost continuously. The time required for removal and replacement of cage and valve should not exceed thirty minutes when the engine room force is well organized.

Grinding Valves.—If the valve seat becomes rough, allowing the compression to escape, it must be re-ground. Where the valve seats in a cage the unit is disassembled. The valve and dashpot or spring cap, as it is more popularly termed, is replaced in the cage with a light spring resting between the valve body and the stem housing, along the lines of Fig. 105. The cage is inverted, placed on some form of support, and the valve pin wrench is then set in position. The spring raises the valve off the cage seat until a slight downward pressure is exerted by the man doing the regrinding. A mixture of emery flour and oil or emery flour and vaseline should be coated over the valve face and the valve rotated back and forth. The valve should, in no case, be completely revolved; the rotation or movement should cover a trifle more than a quarter circle. After rotating a few minutes, the valve should be moved another 90 degrees and the rotation renewed. This grinds every portion of the valve face to conform to the entire seat of the cage. As the operator grinds the valve, he should release the down-

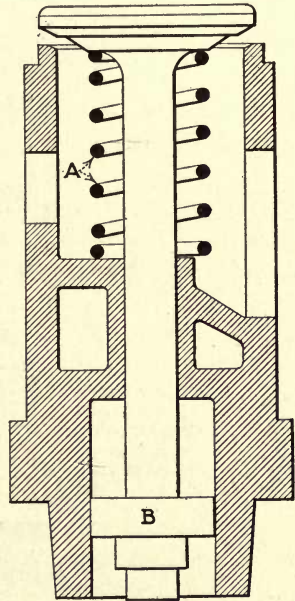

FIG. 105.—Regrinding valves.

ward pressure on the valve, allowing it to rise from the seat. This serves to distribute the emery paste over the entire face. If this is not observed, the paste forms at the edges only, causing the valve seat to be ground concave.

The operator need not secure a ground seat over the entire valve face. A narrow contact $\frac{1}{16}$ -inch wide is ample; in fact, a line contact of $\frac{1}{32}$ -inch width is as serviceable a gas seal as is a wider space. After the seat is sufficiently ground, the emery

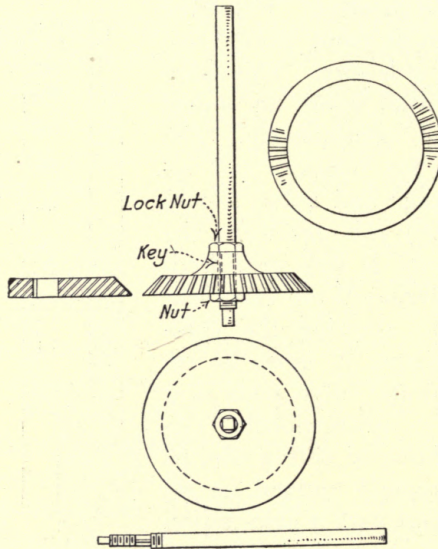

FIG. 106.—Valve seat reamer.

paste can be removed. The valve should then be rotated without any paste between the two surfaces; this metal to metal grinding or rubbing will make the area of contact as smooth as a mirror and prolongs the tightness of the valve.

When the valve becomes so pitted or grooved that grinding will not be of any avail, the cage and valve faces must have a light cut taken off their surfaces. The valve can be centered in a lathe and a finishing tool used, making the cut as light as possible. To reface the cage a refacing machine, similar to a rose reamer, is necessary. This reamer must have a stem resting in the valve-stem housing to hold the reamer square with the valve stem. Most manufacturers are in a position

to supply this machine, although any machine shop can build one like the sketch in Fig. 106. The cutting head should be of tool steel while the stem can be either of tool steel or machine steel. The latter is preferable since the cutting head can be hardened and the machine-steel stem turned to bring the cutter concentric.

Few plants possess any stand to hold the cage other than a wooden box. The box is a poor accessory since it is almost impossible to seat the irregular-formed cage on it with any feeling of security. A wooden grinding stand, similar to Fig. 107,

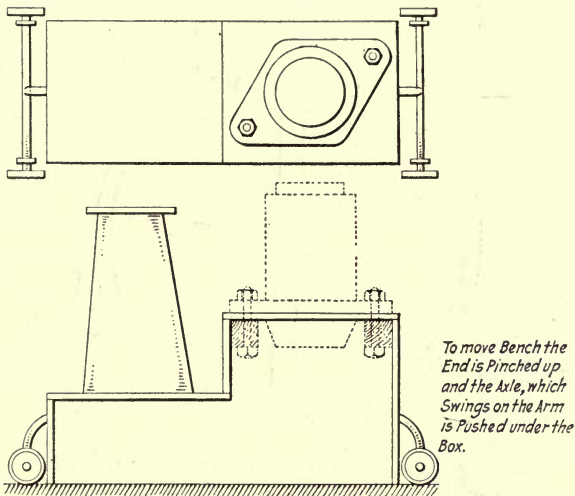

FIG. 107.—Bench for grinding and reaming valve cages.

can be made during odd hours and certainly repays all labor spent on it. The opening in the top should conform to the shape of the cage while the two stud-bolts should fit into the regular stud-bolt holes in the cage. With such an apparatus an engineer can sit down while grinding, thus lessening as much as possible the labor involved in this operation.

Valve Timing.—In timing valves the first step is the establishment on the flywheel of the points of dead-center of the cranks. The simplest method of marking the dead-centers is to use a steel trammel having both ends pointed. A steel block, with a counter punch mark on the surface, can be inset into the founda-

tion, being held by lead or cement grouting, Fig. 108. To establish the flywheel position, when the crank is on upper dead-center, one of the valve cages can be removed and the distance from the surface of the cylinder head to the piston, when the piston is approximately at upper dead-center, can be measured and a trammel mark made on the flywheel rim. The wheel is then turned on over past dead-center until the piston is again the same distance from the cylinder head. A second mark is placed on the flywheel rim; the bisection of the distance be-

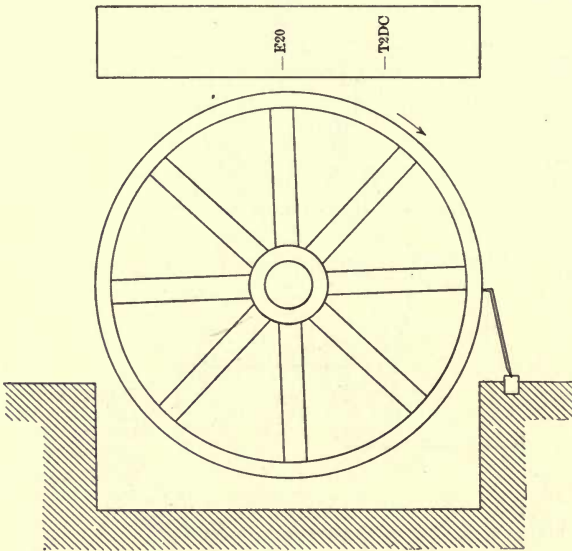

FIG. 108.—Locating crank positions on the flywheel.

tween the two trammel marks gives the exact dead-center for the piston in question. A second but not so exact a method is the use of a spirit level on the crank throws; this, of course, is impossible if the throws are not machined accurately on all four sides. The center mark should be placed on the flywheel rim and stamped with the cylinder number, as example 2TC, indicating top dead-center of No. 2 cylinder. The same procedure is followed on all the cylinders for both top and bottom dead-centers. These center positions being determined, the next step is the checking of the exhaust valves. The engine should be turned over until the piston of the cylinder in question is about 50 degrees from

bottom dead-center. A steel tape line can be used to measure the distance on the flywheel rim from the bottom dead-center line to the point of correct exhaust valve opening. Since the timing given is in degrees, the value must be transformed into inches on the flywheel circle. Presuming the wheel is 8 feet in diameter, the circumference being 302 inches, each degree represents, very closely, $\frac{5}{16}$ -inch. If the proper opening of the exhaust is 42 degrees ahead of bottom dead-center, a distance of 35 inches is set off ahead of the dead-center mark. This is spotted and stamped E20; that is, exhaust opening for No. 2 cylinder. The flywheel should then be turned slowly until the trammel cuts this E20 mark. The exhaust cam rocker should be firmly in contact both with the cam and with the valve stem. To be doubly certain, the adjusting screw on the rocker should be backed off and brought up again until the operator can feel the resistance of the valve spring against the screw. In case, while revolving the wheel, the mark E20 is passed, the valve should not be checked by bringing the wheel back to the mark. Instead, the wheel should be brought back past the mark at least 12 inches and then again turned until the trammel cuts the mark. This removes all effect of any back lash that might exist in the cam gears. The same process is followed in checking the exhaust closing position. After this is accomplished, the exhaust valve settings of the other cylinders are checked, the flywheel being properly marked for each position. The admission valves should next be gone over in proper sequence, and all points should be indicated on the wheel for future reference.

In event any of the valves fail to check up correctly, the operator is confronted with the question as to the method of changing the setting. If the discrepancy is only a few inches, the clearance between the cam and the valve rocker can be changed, bringing the setting back to the stated values. If the valve opens vastly early, or late, the only recourse is the shifting of the cams by the use of an offset key. This condition is encountered in old engines only. In these engines quite often the entire valve layout is timed late. This is attributable to the wear in the cam gear teeth and can be partially corrected by advancing the cam gear one or two teeth.

The average operator, until he is very familiar with engine timing, does well to time the exhaust and admission valves of one cylinder before proceeding to any of the valves of the other

cylinders. There is, in this way, little danger of becoming confused as to the proper stroke upon which the valve should function. The trained operator customarily checks the valves as they come in sequence. For example, the exhaust opening of one cylinder will be set, then the admission closing of a second cylinder will be checked. This reduces the time occupied in going over the valves by at least 75 per cent. The checking and setting of the fuel valves will be taken up in the chapter on fuel valves.

Leaky Valves.—A leaky admission valve is readily detected by placing one's ear close to the intake nipple or screen. If the leak is from a scored seat, a whistling noise will be heard; this whistling increases in volume as the scoring becomes more pronounced.

A leaky exhaust valve is more difficult to detect. The best method is to place the engine in that position where both the admission and exhaust valves are closed; that is, at the beginning of the power stroke. The injection air line valve should be "cracked," allowing a small amount of air to blow into the cylinder through the fuel injection valve. If the exhaust leaks, the air can be heard flowing through the valve. This same procedure will also locate admission valve leaks. While the engine is running, a smoky exhaust and a decrease in power are often due to a leaky exhaust valve.

CHAPTER IX

FUEL INJECTION VALVES

TYPES. ACTION. ADJUSTMENT. REPAIRS

Injection Design of the Original Diesel Engine.—Dr. Diesel in his first patent application, made no mention of any mechanism for the forcible injection of the fuel. The fuel contemplated was coal dust, and this was to be deposited in a pocket of the rotary valve *V*, which, in revolving, dropped the charge into the cylinder. A schematic outline of this fuel-conveying apparatus is shown in Fig. 109.

This design was never followed in an actual engine since it was early seen that it would not properly deliver the fuel charge. Furthermore, the plan of using coal dust was abandoned in favor of oil. Dr. Diesel, in conjunction with the M. A. N. Co. of Germany, adopted the idea of employing a blast of air to break up the oil charge and deliver it into the cylinder.

Injection Action.—For the benefit of those unacquainted with the functioning of the fuel injection valve the following brief explanation is given. The charge of fuel oil is pumped into a receptacle called the fuel valve by some form of pump. An air compressor delivers a charge of pure air at about 900 lbs. gage to this injection device. At the proper moment in the engine's cycle the needle valve of the injection device, or fuel valve, is opened, connecting the cylinder with the fuel supply. The high-pressure air then rushes into the cylinder, carrying the oil charge with it. This fuel, as it is forced through a device

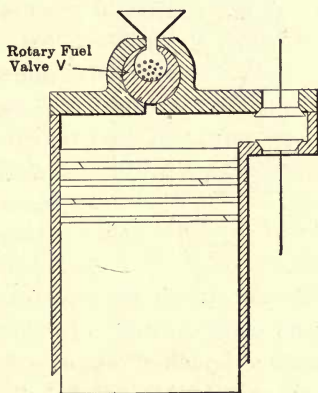

FIG. 109.—Fuel feeding arrangement, Dr. Diesel's original patent.

called the atomizer, which is located in the valve housing or cage, is broken up into fine fog-like particles that will ignite when intermingled with the cylinder charge of air, which is at a high temperature. Figure 110 shows such an elementary form of fuel valve where *D* is the valve stem; *A*, the oil line; *C*, the air line; *B*, the atomizer; and *E*, the opening into the cylinder.

It is evident that the fuel valve has two main functions. First, it must allow the oil charge to be introduced into the engine cylinder or combustion chamber at the proper time. Second,

it atomizes or breaks up the stream of oil in such a thorough manner as to occasion ignition. The cylinder temperature is high; the value corresponding to 550 lbs. compression pressure should be at least 1000° Fahrenheit, when the engine is cold; after warming up, the temperature would be well above 1400° Fahrenheit. If the oil charge was injected in a solid mass into this highly heated air, the oil would vaporize and burn but at a very slow rate. The air would not be thoroughly mixed with the oil, and the combustion would occur only on the

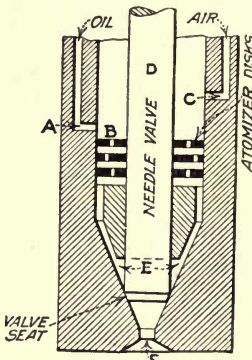

FIG. 110.—Fuel valve, closed type.

surface of the oil mass, in exactly the same manner as a pool of oil burns when ignited. In this is seen an example of the so-called "surface ignition" employed in hot-bulb engines. The objection to this method lies in the slow rate of combustion and in the loss of fuel which escapes as unburned gas vapors. If the oil charge is separated into many minute particles, more surface area is presented to the air. If this oil separation process is to be successful, the fuel valve must be provided with some means whereby the oil is broken into particles and mixed with the injection air before the oil enters the engine cylinder.

The theory of the present-day Diesel contemplates the introduction of the fuel at a rate which will allow the combustion to be carried on at constant pressure. If the oil charge was injected at a high rate, the combustion would partake of the nature of an explosion; the indicator card would then resemble an Otto-cycle engine, and the combustion line would be in the form

of a sharp peak, somewhat like Fig. 215. If the combustion is to be at a constant pressure rate, the flow of oil through the fuel valve must be gradual. The two main offices the valve performs are that of "braking," or offering a resistance to the oil flow, and that of thoroughly atomizing the charge. The latter would not be difficult of achievement if there were no other considerations entering into the problem. The same conditions prevail as to the "braking" action. If this "braking" effect is obtained by the imposition of a series of improperly designed baffle plates or disks, the air pressure required to force the oil through these resistances may become so great as to make the method impractical. The desirable fuel valve is one that thoroughly atomizes the fuel and exercises a control, or a "braking" action, over the fuel charge without any great loss of air pressure through the valve. Many designs have been used, all of which fail to completely fulfill the above conditions.

Classes of Atomizers or Fuel Valves.—The many fuel valves employed on the various makes of Diesel engines fall into two classes—the closed-nozzle and the open-nozzle valves. The former is the one adopted on the pioneer Diesels and is found on all vertical engines of the present day; in fact, this is necessary for structural reasons. The open nozzle, known in Europe as the Lietzenmayer nozzle, is largely used on the horizontal engines, both of the domestic and foreign manufacture.

Open-nozzle Fuel Valve.—In the design of this nozzle, or fuel valve, the needle valve controls the flow of air to the atomizer tip, this needle valve being opened at the proper time by a cam-actuated rocker. Between the valve and the cylinder is interposed a small cavity, or enlargement of the passage to the cylinder; into this cavity is deposited the fuel charge. Since the fuel is pumped during the suction or exhaust stroke of the piston, the fuel pump works against only a few pounds pipe-resistance pressure. This enables the governor to be very sensitive in action since the reaction of the pump is at a minimum. At the proper time the needle valve is opened, and the air from the compressor, as it sweeps along the passage to the cylinder, picks up the oil charge and carries it into the cylinder. The swirling of the air serves to thoroughly break up the mass of the fuel; this is further increased by perforated disks or other devices at the nozzle tip. Figure 111 outlines this class of injection valve. It would appear that the duration of the fuel injection would be

in exact ratio to the amount of oil deposited in the atomizer and that the first particles of oil entering the cylinder should be as completely nebulized as are the last few oil droplets. In actual practice the air, when it strikes the fuel charge, produces slugs of oil that enter the cylinder in an unatomized condition. Where

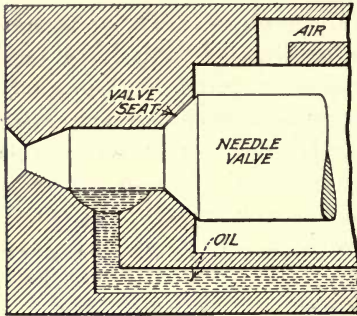

FIG. 111.—Open nozzle fuel valve, elementary form.

perforated disks intercept the slugs, as in some designs, the entire charge is satisfactorily broken up. The only real objection the operator can well offer is the rapid carbonization of the fuel passage and atomizer disks; this can be attributed to the absorption of heat from the combustion chamber since the temperature in the nozzle tip fairly approaches that existing in the cylinder on the compression stroke. This neces-

sitates a more frequent cleaning of the atomizer than is required by a closed type of nozzle.

The open-type valve is of advantage where dirty oil is burned. Since nothing but pure air passes the needle valve, the scoring of the valve seat, so prevalent with the closed-nozzle fuel valve, is entirely absent. Consequently, this valve requires less than half as much regrinding as does the closed type.

Closed-nozzle Fuel Valve.—The earlier Diesels employed the closed nozzle, and it was exclusively used on all Diesels until five or so years ago. Figure 110 outlines the basic principle of this type of nozzle. The fuel valve has a body in which a cavity is formed, enclosing the atomization device. The fuel needle valve is seated below this device and is actuated by a cam-controlled lever. The interior of the fuel valve is in connection with the air line through the passage and is at all times under an air pressure of 900 or more lbs. per sq. inch. The fuel pump forces the oil charge through the line *A*, the oil settling around the valve stem at *E* above the valve seat. When the needle valve opens, the compression pressure of the engine is around 500–550 lbs., while the air pressure in the valve body is about 900 lbs. This pressure difference results in a rapid flow of the air into the cylinder. The air charge forces the oil along with

it, and, in passing through the tortuous passages of the atomizer disks, the oil is completely nebulized.

This form of fuel valve has the advantage of depositing the oil in a receptacle entirely isolated from the influence of the hot compressed air in the cylinder. Furthermore part of the oil, being immediately around the valve tip, enters the cylinder ahead of the air and ignites, even though it is not thoroughly atomized. This primary ignition provides a flame to fire the remainder of the oil, which enters the cylinder at a somewhat low temperature due to the expansion of the air charge at the valve tip. Unfortunately, with many closed-nozzle designs, an entirely too great a percentage of the fuel enters the cylinder ahead of the air; in some it appears that all the oil is forced ahead of the air. If the disks are designed with perforations of small diameter to enable the air to mix with the oil, the "braking" or resistance of the atomizer is increased since the disks are entirely filled with oil at full load. This compels the employment of a higher injection pressure, or the time interval of fuel injection is prolonged. On low loads, with small perforations, the fuel charge is of small weight and does not flow down around the valve seat. The consequence is that the first part of the injection consists of air only, which, in expanding, chills the nozzle tip and housing. This delays the combustion, producing a smoky exhaust.

Hardly any two Diesel manufacturers follow the same design in the fuel valve, although there is some degree of similarity in a few designs, especially of the open-nozzle type.

American Diesel Co.—One of the pioneer fuel valves was that of the American Diesel engine. This injection device was contained in a cast-iron housing, which was bolted to the side of the cylinder head, as shown in Fig. 112.

The needle valve is opened by the bracket lever shown, which, in turn, receives its motion from a reach-rod and cam, the latter being mounted on the engine camshaft. The closure of the needle valve is accomplished, as is the universal practice, by a spring, which has been compressed by the opening of the valve. The housing of the fuel valve carries the needle valve, which is surrounded by the atomizer body. This atomizer is similar to Fig. 113. The fuel enters the fuel valve housing or cage through the passage *A* and flows along the recess between the atomizer and the valve body until it reaches the front or valve end of the atomizer.

The recess is enlarged, at this point, to include the entire circumference of the atomizer. From this recess or ring a series of minute passages lead to the needle valve immediately above the valve seat. The injection air enters the housing at *D* and flows

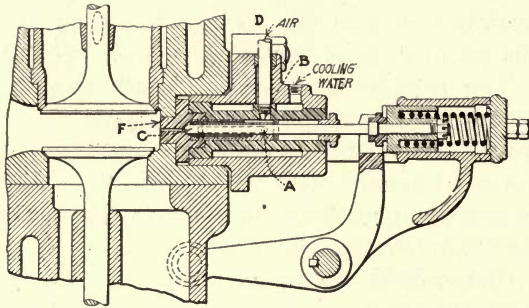

FIG. 112.—American Diesel fuel valve assembly.

around the atomizer, behind the oil; it also fills the space about the needle valve stem. When the valve *C* opens, the flow of air around the stem results in a drop in pressure from the back of the valve toward the valve tip. The air pressure behind the oil charge, on account of the larger volume, remains practi-

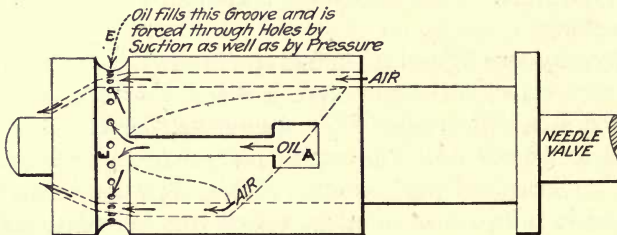

FIG. 113.—American Diesel atomizer.

cally constant and at a higher value than the pressure around the valve seat. This pressure difference forces the oil through the small ports *E* into the stream of high-velocity air rushing through the needle valve opening. The air thoroughly separates the oil into minute particles; this breaking-up process is further intensified by the flow of the oil and air through the openings in the nozzle-tip plate *F* between the valve seat and the cylinder. The disadvantage of the valve lies in the chilling effect of the air charge. The design allows a considerable part of the air

to enter the cylinder ahead of the oil; since there is no resistance from an oil body present, this air attains a high velocity and, in expanding, lowers the temperature of the nozzle tip as well as exerts a similar effect upon the air which has been compressed in the cylinder.

The fuel valve is equipped with a by-pass valve of the screw-needle type; this valve is for the purpose of draining the valve cage of any oil. In stopping the engine, the by-pass valve is opened and the oil flows through the valve back to the storage tank. The lack of fuel then causes the engine to stop. In starting the engine, the fuel pump is operated, by a hand crank, until oil appears at the by-pass overflow, indicating the fuel line is free from air. The by-pass valve is then closed.

Timing of Fuel Valve.—The fuel valve of the American Diesel engine should be timed as outlined in Fig. 79. The fuel valve cam has an adjustable tool-steel nose, the position of which can be varied to secure proper valve opening.

Adjustment and Repair. By-pass Valve.—The American Diesels in service have been operating a number of years, and consequently frequent repairs are to be expected. One defect that will early develop is the leaking of the by-pass valve. The valve is of the needle type, and the corrosion of the point allows oil to seep at all times. This can be eliminated by redressing the point of the valve, followed by a regrinding.

Needle Valve.—The needle valve has a rounded end which seats on a bevel surface of the atomizer shell. Ordinarily the valve is made of toben bronze and wears rather rapidly. To regrind the valve, the end should be rounded and all rough spots removed. The valve can then be inserted into the atomizer, being coated with extra fine emery paste and ground to a proper contact with the seat. After a number of regrindings the valve stem becomes too short to afford any initial compression of the valve spring. If a washer is placed between the spring and cap, the spring will be compressed on assembling, and the valve made serviceable again. Since the bronze stems are rather expensive many plants use a cold rolled steel valve stem with the lower part of bronze screwed into the steel stem. In case wear shortens the stem beyond the ability of washers to cope with the spring compression, the bronze tip only need be replaced.

Valve Stem Stuffing-box.—The gland of the valve stem stuffing-box is rather weak, while the stuffing-box is very shallow.

The air will blow out along the stem, and in tightening the gland stud-nuts the ears of the gland will invariably bend. If the stuffing-box were deeper, enough packing could be inserted to withstand the air pressure. The only available remedy is the substitution of heavier glands, enabling more pressure to be exerted on the nuts. The packing used is vulcanbestos and wears away rapidly. In renewing the packing, the rings should be soaked in oil for at least twenty-four hours. When in use, the valve stem must be lubricated frequently to maintain the packing in a pliable condition. The fuel valve disk, which lies between the valve seat and the cylinder, carbonizes very heavily when a low gravity fuel is burned. A lye solution will loosen this deposit.

Busch-Sulzer Type B Diesel.—The fuel valve of this Diesel, with its rocker mechanism, appears in Fig. 114, while Fig. 115

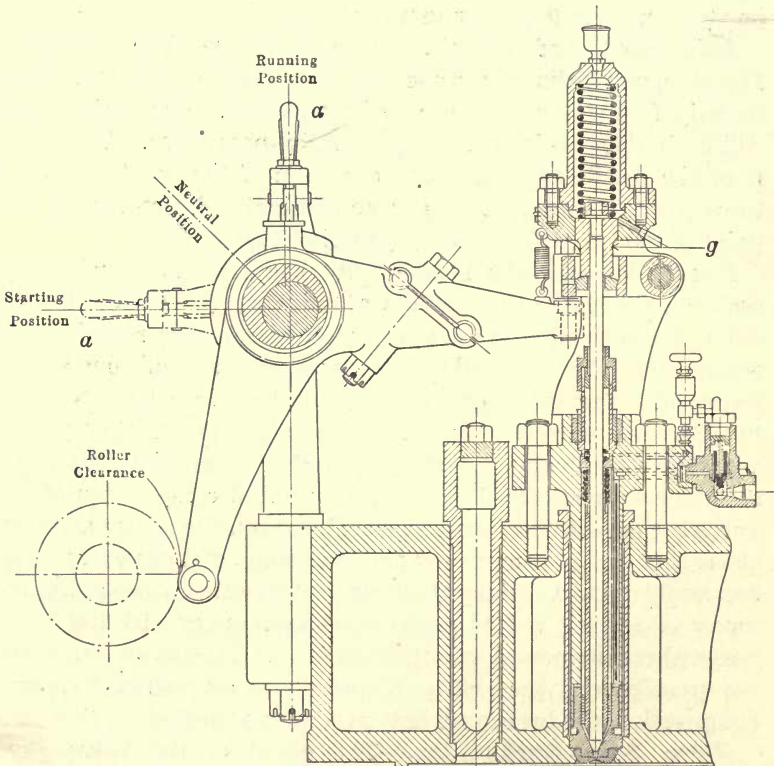

FIG. 114.—Fuel valve arrangement Busch-Sulzer type B Diesel.

gives a view of the lower part of the same valve. The valve consists of a cast-iron body with an extension which carries the spring, a needle valve and an atomization device. The body or cage rests in a bushing, which is pressed into the cylinder head, and is held by two studs. The needle valve *a* is enclosed along the lower part, which is in the cage, by a bushing or barrel *b*.

This bushing rests, at its base, on the atomizer cone and is prevented from lifting by a coil spring at the top. As is seen in Fig. 115 there is a space, between this bushing and the cage wall, which serves as the air and fuel cavity. The fuel charge flows down the passage *A* and enters the fuel cavity above the atomizer disks. The disks are several plates containing small perforations and are so placed as to stagger these holes. The oil, by its own weight, is forced to pass through these openings and fills the intricacies between the plates as well as the space around the needle valve seat.

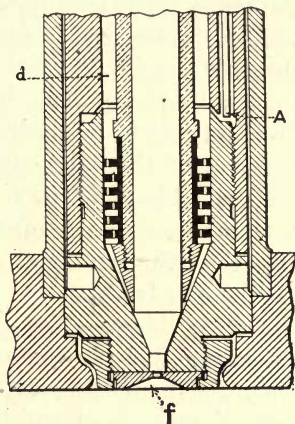

Fig. 115.—Bush-Sulzer type B fuel valve.

The air enters the cavity *d* above the oil level. When the needle valve is opened by the valve rocker, the air, which is at a pressure much higher than that existing in the engine cylinder, forces the oil charge into the combustion space. The oil, as it is broken up, passes from disk to disk, and is mixed with the air which is flowing toward the cylinder. The emulsion is further increased as the air and oil issues through the single small opening in the atomizer tip *f*. This continues as long as the needle valve is open; this valve is closed at the proper time by the fuel cam, and the small amount of fuel still left in the atomizer flows down around the needle valve seat. This insures a small charge of oil which will enter the cylinder at the next valve opening ahead of the air and produce ignition. With the usual fuel oil the fuel charge is able to pass through the disks under the influence of its own weight. When the valve opens, the oil is forced into the cylinder in front of the air. Since this oil is fairly light, it ignites even though poorly broken up. A heavy oil behaves quite differently. Its viscosity is such that the fuel does not readily flow through the disks but rests above

them. The air must force the oil through the atomizer and, in so doing, thoroughly nebulize the charge. This type, then, has the advantage of offering a mixing and atomizing effect in inverse ratio to the gravity of the fuel; the actual degree of combustion in the cylinder is fairly constant, regardless of the nature of the oil.

Adjustments—Fuel Passage.—The fuel passage in the body of the valve cage is equipped with an aluminum rod which stands vertically; the rod moves with the vibration of the engine, thereby keeping the fuel line free from stoppage due to dirty or thick oil. Even with this precaution, the fuel line does collect dirt and should be flushed out with kerosene on the occasion of removal of the valve and cage.

Nozzle Tip and Disks.—The fuel cage tip has a single central perforation which gradually fills up with tarry deposits, as do also the atomizer rings or disks. These can be cleaned with kerosene or lye water.

Needle Valve.—The needle valve is of steel and will corrode when the fuel oil contains any acid or sulphur. If the corrosion is slight, the valve should be polished with emery paste and, if possible, burnished with a cloth buffing wheel. The buffing of the stem seems to retard the rate of corrosion. The buffing of the stem seems to retard the rate of corrosion. The valve seat is at an angle of 30 degrees with the axis of the needle valve. This angle, which gives an angle of 60 degrees to the valve end, is such that there is a wedging action each time the valve seats. This serves to effectually seal the valve but causes scores on the bearing surface in event any grit has settled on the valve.

Stuffing-box.—The stuffing-box has a screw gland and is best packed with lead or babbitt shavings or strings. This packing conforms to the valve sufficiently to prevent the loss of air and does not become hard as does all composition packing.

Valve Spring.—The valve spring is of a length that allows the needle valve to be reground before the initial compression of the spring is lost. An iron washer placed above the spring will give the effect of a lengthened stem. However, the valve cannot be used after it is worn short enough to cause the spring plunger *g* to drop below its housing.

Fuel Line Check Valve.—The fuel line has a ball check valve immediately at the valve cage. This ball, in time, wears, allowing the high-pressure air to back through the oil line to the pump. This causes the line to become air bound.

Fuel Valve Rocker Arm.—The rocker arm is of two-piece construction and fulcrums on an eccentric bushing, which carries the air-starting rocker. The valve end of the rocker has an adjusting screw that can be manipulated to provide the required clearance between the roller and the fuel cam.

Fuel Cam.—The fuel cam is fitted with an adjustable steel nose. The nose is slotted and is held by two countersunk screws. This allows a considerable shifting of the nose. After the nose is set in position, it is locked by end shims. These shims are best made of wrought iron and should be hammered until the entire recess is filled; the surface should then be smoothed with a file to conform to the curvature of the cam.

Eccentric Rocker Bushing.—As has been mentioned, the fuel rocker arm is fulcrumed on an eccentric bushing, which also carries the starting rocker. On a four-cylinder engine the two inside cylinders are fitted with starting valves. When the engine is to be started, the eccentric lever *o* of these two cylinders is thrown into the starting position, Fig. 82. This revolves the eccentric bushing until the fuel rocker fails to engage its cam while the starting rocker comes into contact with its cam. The levers of the outside cylinders (1 and 4) are set to "neutral," which disengages the fuel rocker and cam. As soon as the air line valve is opened, the two starting cylinders turn the engine over. After one or two revolutions of the flywheel, the levers of 1 and 4 are moved to the running position, admitting fuel to the fuel valves. When these cylinders start firing, the levers on No. 2 and No. 3 cylinders are moved from the starting to the running position, cutting out the air-valve mechanism and engaging the fuel rockers.

Servomotor.—On the larger Busch-Sulzer engines the timing of the fuel injection is altered at load changes. This is accomplished through the agency of a cylinder placed in front of the engine, containing a spring and piston. This cylinder is in communication with the low-pressure cylinder of the air compressor. The air-compressor suction is provided with a damper arrangement actuated by the engine governor. On low loads the air to the compressor is throttled. This results in a lower discharge pressure in the low-pressure cylinder; this, in turn, lowers the pressure existing in the servomotor. The spring then forces the piston downward. The piston rod moves a system of levers that actuates an auxiliary roller which is linked to the fuel valve

rocker. This layout appears in Fig. 116. It will be noted that as the air pressure in the servomotor becomes lower, due to a lighter load, the auxiliary roller *a* moves upward, thereby allowing the cam nose to strike it slightly earlier in the engine cycle. The auxiliary roller is in contact with the fuel rocker roller *b* at all times, being held by the links *c*. The auxiliary roller is set in such a position that if the injection opening is early, as on low load, this roller remains in contact with the cam nose for a smaller

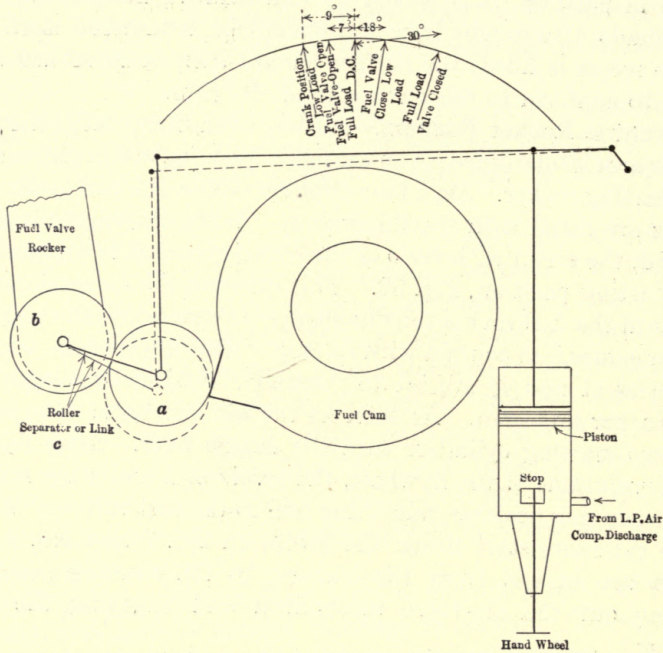

FIG. 116.—Method of altering full injections by servomotor.

interval. Consequently, on full load the period of injection begins later and extends over a greater crank angle than it does on low loads. This is shown in Fig. 116 where the dotted lines indicate the roller positions on low load and the full lines are the full-load positions.

On starting the engine, the handwheel of the servomotor is raised to the half-load position while the air from the air compressor to the servomotor is cut off. This latter action is for the purpose of preventing the servomotor from moving the injection roller to the full-load position. Frequently, when the engine is

using heavy oil, it is necessary to adjust the servomotor hand-wheel to provide for earlier admission than the air pressure would give, or vice versa with heavy oil on light loads.

Fuel Valve By-pass.—Each fuel line has a by-pass, or relief valve, mounted on a block at the camshaft cover. Before the engine is turned over under air pressure, these valves should be opened and left in this position until a solid stream of oil issues from each valve, thus indicating that all air in the pump or oil lines has escaped. When running, frequently one or more cylinders skip in firing, or fail to fire at all; this, in most cases, is due to an air-bound fuel line.

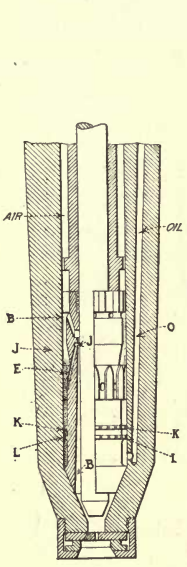

FIG. 117.—McIntosh & Seymour fuel valve.

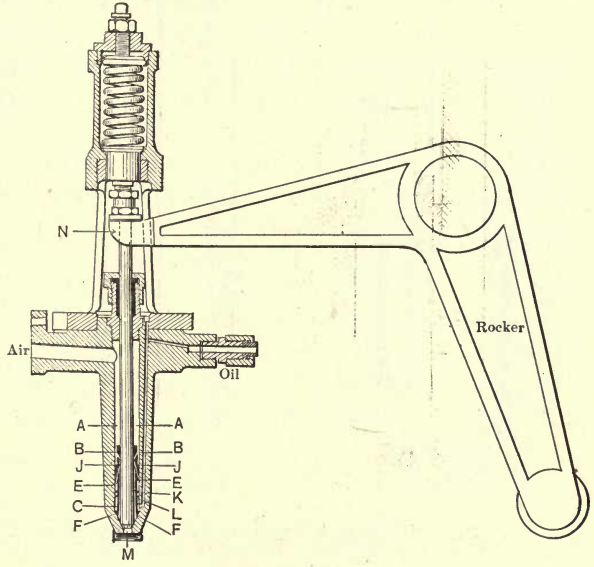

FIG. 118.—McIntosh & Seymour stationary Diesel fuel valve assembly.

McIntosh & Seymour Diesel.—The fuel valve of this engine, appearing in Figs. 117 and 118, is contained in a cast-iron housing or cage. The valve, the needle end of which has a 60-degree included angle, seats on the cage itself. The upper end of the cage carries the spring housing. This end of the valve stem is screwed and locked into a dashpot, against which the spring bears. The valve is opened by the movement of the rocker arm shown. The atomizer is the detail of the valve that differentiates it from other American fuel valves. This is a gun metal

barrel, the diameters of which are of irregular dimensions. The interior is bored taper, fitting the valve stem at the upper end, while a number of passages connect this taper bore with the outside surface. In operation the charge of oil is forced, by the fuel pump, through the passage *O* and surrounds the atomizer at the space *J*, issuing through the serrated fins at *K* and *L* until the fuel reaches the level *P*, Fig. 119. The injection air fills the cavity above the atomizer, and, when the needle valve opens, this air flows through the ports *B* and along the valve stem into

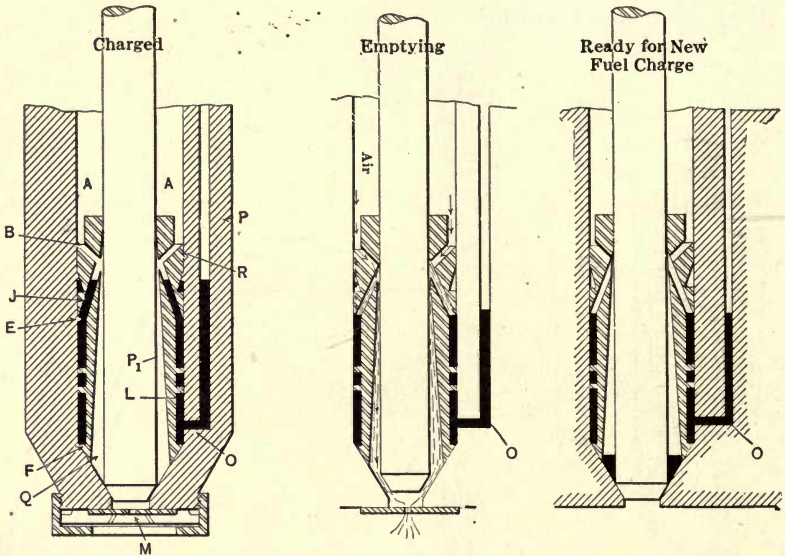

FIG. 119.—McIntosh & Seymour Diesel Hesselmann fuel valve action.

the cylinder. The air pressure on the surface of the oil at *J* remains constant while the velocity of the air current along the valve stem reduces the pressure at the inner end of the oil ports *E*. The consequence is a flow of oil through the oil ports *E* under the influence of the unbalanced air pressure. This oil, as it enters the stream of high-velocity air, is broken up and thoroughly atomized by the time it reaches the cylinder through the atomizer cap *M*. The flow of oil continues until the oil level falls below the ports *E*. If the fuel valve is properly timed, the valve should then close, preventing an excessive amount of air blowing into the cylinder. Although this excess air may actually increase the m.e.p. of the engine as figured from an indicator

card, it represents a loss of power since it has been compressed to 900 lbs. per sq. inch and is allowed to expand through the nozzle to 500 lbs. per sq. inch without doing any work.

On full load the closure of the needle valve should trap a small amount of oil immediately above the valve seat. This oil, on the next valve opening, is blown in ahead of the air charge, providing an initial ignition to balance the chilling action of the expanding air charge. It is variously claimed that an injector effect is set up by the air current. In reality, the action is merely that of unbalanced forces, and the oil below the ports *E* remains in the atomizer. The oil, if it contains dirt or a tarry base, gums badly until the fuel chamber is filled, forcing the oil to deposit around the valve stem. When this occurs, the oil enters the cylinder in a slug. This is indicated by loss of power and a smoky exhaust. The remedy is, of course, the cleansing of the atomizer.

It is claimed that this valve design permits operation with a lower injection air pressure than with other types of atomizers. In practice it would appear that this advantage does not exist as at full load a pressure of about 900 lbs. gage is necessary.

Adjustments—Valve Stem.—The valve stem, which is steel, corrodes with a sulphurized oil and must be burnished at each removal. The stuffing-box is best packed with shredded babbitt, although vulcanbestos is very serviceable. After the valve has been ground, it becomes necessary to bring the distance from the valve tip to the rocker lock washer back to the original length. This is accomplished by running both the washer and lock-nut up until there is the proper clearance between the fuel cam and rocker roller. The spring tension can be made normal by the insertion of a washer between the spring and the dashpot, or spring cap. The valve can be reground until the lock-nut is against the dashpot at which time a new valve must be secured.

Valve Cage.—The valve cage is held by two studs and rests on a taper seat in the cylinder head casting. This taper joint should be cleaned of soot before the cage is replaced or the joint will leak.

In removing the valve cage the entire rocker assembly of all the valves must be lifted. When only the valve stem is removed, it is merely necessary to unbolt the upper part of the cage or housing which contains the spring. The valve stem will slip through the fingers of the rocker.

Fuel Line.—The fuel line, as on all engines, fills with dirt and must be flushed with kerosene. There is no by-pass or relief valve on the fuel line. If the oil line becomes air-bound, the union at the valve cage must be unscrewed to allow the fuel line to clear. To avoid a messy appearance after a line has been emptied, a shallow pan can be constructed to receive the oil.

Starting Fuels.—For starting purposes, it is customary for the manufacturer to furnish a two-compartment fuel tank, one compartment containing the fuel oil which is used, while kerosene is placed in the other part. This kerosene is supplied to the engine in starting since it will ignite at a lower temperature.

McIntosh & Seymour Marine Diesel Fuel Valve.—The fuel valve of the McIntosh & Seymour Marine Engine, while using a Hesselman atomizer, has a cage and actuating rocker quite different from that described above. The cage rests in a bushed opening in the cylinder head. The rocker arrangement is shown in Fig. 120. The rocker arm, at one end, is pinned to the vertical push-rod while the other end carries a hardened steel button in contact with a dog which, in turn, raises the valve by its adjusting nut. The fuel cam, etc., have already been discussed in the preceding chapter.

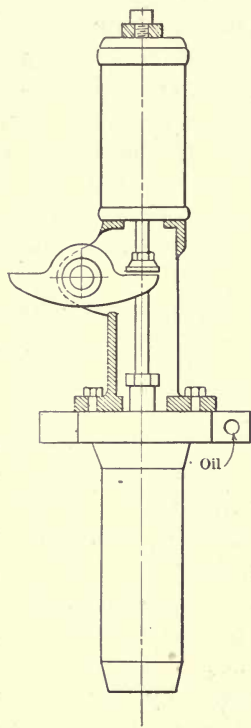

FIG. 120.—McIntosh & Seymour marine Diesel fuel injection valve.

The Snow Diesel Fuel Valve.—The Snow Diesel fuel valve is of the open type and is shown in Fig. 121. The valve is enclosed in a cast-iron cage which is held to the cylinder head by two studs. The cage extension carries the valve spring, which seats on a cast-iron bushing about the valve stem. This cage has a gasket at the cylinder head surface while a ground joint between the atomizer and head casting prevents water leakage into the cylinder. This arrangement provides an effective water-cooling of the valve cage without the necessity of a water cavity in the cage body.

The oil charge enters the valve cage at *c*, flowing along the check valve *D*, and comes to rest in the small cup or reservoir *E*. The air from the compressor enters at *B* and fills the recess at *A*. At the proper time the needle valve *H* is opened; the air rushes out the valve opening, through the passage *F* and into the cylinder at *I*. In sweeping over the surface of the fuel charge at *E*, the oil is picked up and, as it is forced along through the atomizer disks *C*, is broken up.

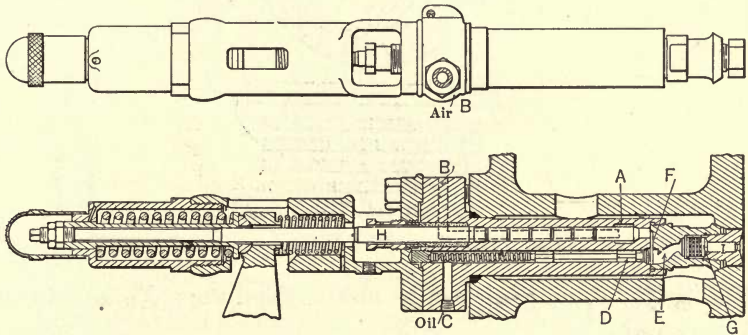

Fig. 121.—Snow Diesel fuel valve, open type.

Valve Stem.—The valve stem can be removed, without disturbing the rocker arm, by unscrewing it from the spring bushing. In making adjustment for cam roller clearance, the stem is screwed in or out of this spring bushing as required. This allows a considerable shortening of the valve stem, from regrinding, before replacement is necessary. The lower part of the stem is grooved, and these grooves collect dirt and consequently should be cleaned occasionally.

Fuel Check Valve.—While cutting of the fuel valve seat due to dirty oil is avoided, the scoring is merely transferred to the check valve *D*. The oil is at all times in contact with this valve, and there is a strong tendency for the dirt to settle on the inner edges of the seat. This will cause the valve to leak, although the scoring action is much less than with the closed nozzle since there is no high-velocity air stream present.

Atomizer Disks.—The atomizer is provided with a series of fins about the peripheries of which are a number of notches, Fig. 122. These notches will fill with a tarry deposit when a heavy asphaltum base fuel is burned. The presence of these deposits is usually indicated by the engine requiring a high air

injection pressure to maintain the correct speed. The atomizer disks should be cleaned at least once a month—more often if the

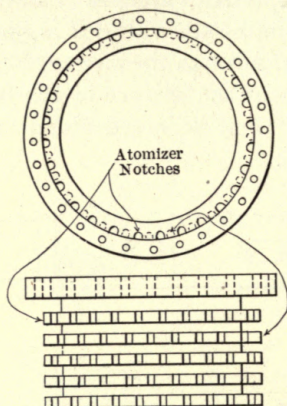

FIG. 122.—Snow Diesel atomizer disc.

oil is dirty. A spare set can be inserted and the old ones soaked in lye water.

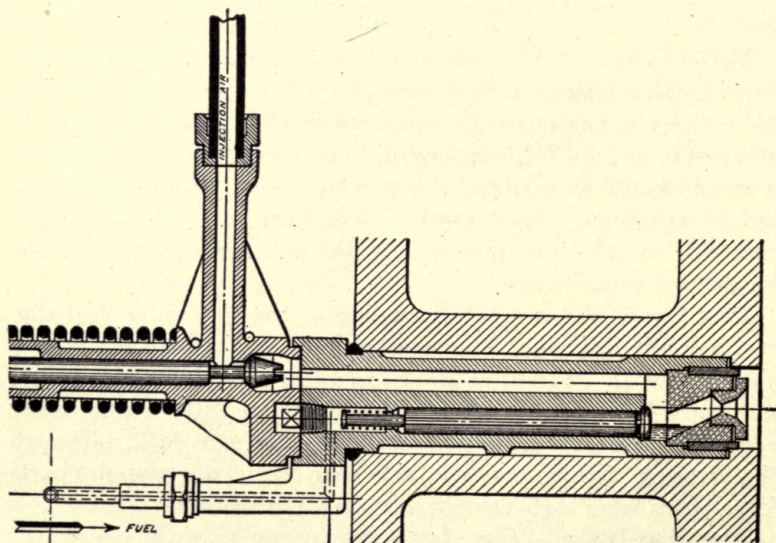

FIG. 123.—Körting Diesel fuel valve, open type.

Körting Diesel Fuel Valve.—A fuel valve along the same lines has been manufactured by the Korting Co. for some years. This valve, however, has no atomizer disks. The oil is swept

into the cylinder by the passage of the air over the surface of the oil pool. This valve appears in Fig. 123.

The McEwen Diesel Fuel Valve.—Another design of open-type fuel valve is found on the McEwen Diesel. As outlined in Fig. 124, this valve consists of a cast-iron housing, or cage, which is bolted to the cylinder head with the axis of the fuel nozzle coincident with the axis of the cylinder, and of the necessary atomizer and needle valve.

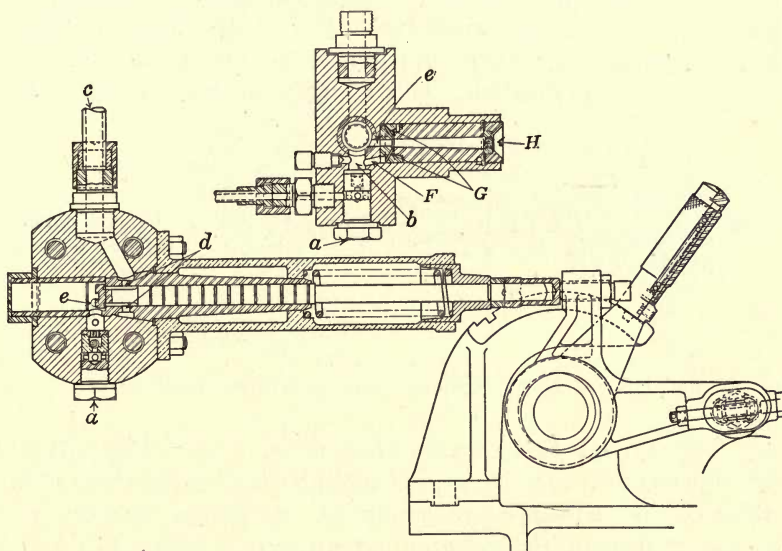

FIG. 124.—Fuel injection valve, McEwen Diesel.

The fuel oil enters the valve at *a* and, passing around the ball check, deposits in the fuel chamber *b*; part of the charge also flows into the fuel valve plug. The air charge enters at *c* and surrounds the base of the valve stem at *d*. When the needle valve opens, the air passes through the valve opening and into the air port *e*; a part also completely fills the fuel valve nut cavity where it exerts a pressure on the oil contained in the reservoir *b*. The air flowing through the port *e* toward the cylinder attains a high velocity with a decrease in pressure. The air above the oil, having a fairly large volume, maintains its original pressure. This unbalanced pressure produces a flow of oil in the port *F*. This oil, after passing through the small channels *G*, encounters the stream of high-velocity air and is swept

into the cylinder. The oil issues from the channels *G* in very fine streams, which are quickly mixed with the air. The atomization is further increased by the action of the atomizing plate *H*. This valve is one of the best yet designed. The air does not "slug" the oil, causing a poor atomizing effect. On the contrary, the channels *G* are of such cross-section that the oil issues from them in streams of a size that will allow a thorough breaking-up by the air. Regardless of the engine load and the volume of the fuel charge, the rate of fuel injection into the cylinder is fairly constant with any given fuel. Even a decrease of 100 lbs. in the injection air pressure apparently has but minor effect on the degree of atomization. Oils of different characteristics do

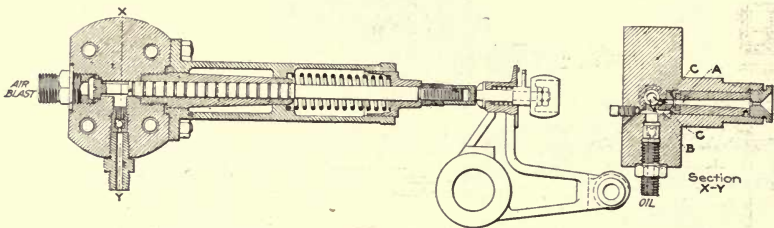

FIG. 125.—McEwen Diesel fuel valve, open type. Early model.

not flow through the passages at identical rates. The natural consequence is a variable rate of fuel injection unless disks with different size passages are employed. A partial remedy lies in the control of the injection air pressure. Figure 125 is an early model used on the McEwen engine. It differs but slightly from Fig. 124.

Adjustments.—The ball check valve requires some attention; especially is this true with dirty oils. In case the seat is worn, a new contact can be formed by using a hardwood stick or soft copper pin; lightly striking the pin will cause the ball to renew the curvature of the valve cage seat.

The roller, actuating the valve, is mounted on an eccentric. A lever moves the roller into and out of contact with the fuel cam. In changing the valve timing, the rocker roller can be moved by means of the adjusting pin. The adjusting pin passes through the roller pin or bearing and moves the bearing along the slots shown. The fuel valve rocker set-screw, resting on the end of the valve stem, controls the clearance between stem and rocker.

Allis-Chalmers Diesel Fuel Valve.—The fuel valve of this engine is of the open type, Fig. 126. The body is a steel block, the nozzle extension of which fits into the cylinder head. The oil enters the valve body at the bottom, the line having two poppet check valves. The air enters the block at the top and fills a recess behind the fuel valve. As the lever or rocker arm lifts the valve, the air rushes through the valve opening and flows into the oil cavity at the point *a*. As it passes over the body of

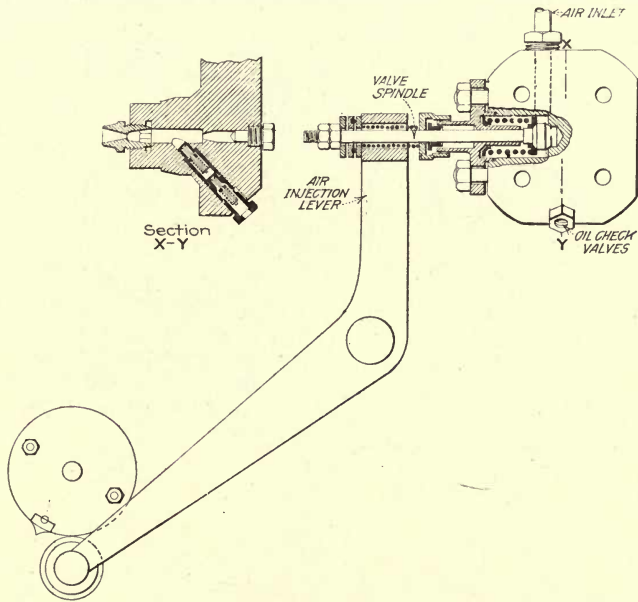

FIG. 126.—Allis-Chalmers Diesel fuel valve.

fuel, the air picks up the oil and blows it into the cylinder. The velocity of the air stream, together with the action of the atomizer, breaks up the charge into particles. The nozzle tip is flaring in contour, causing the mixture of air and oil to assume a cone shape.

Adjustments. Check Valves.—The oil check valves require regrinding at intervals, especially with dirty oils. The check valve cage is quite easily removed for valve repairs by unshipping the oil pipe line and unscrewing the cage from the fuel valve body.

Needle Valve.—The valve is of generous dimensions, and consequently very little regrinding is necessary.

The Atomizer Tip.—The atomizer, since it is exposed to the cylinder temperature, carbonizes or gums from the small amount of oil that adheres to the atomizer after the air blast ceases. A spare tip should be on hand at all times. The presence of deposits will ordinarily be indicated by the engine laboring until the injection air pressure is raised.

Fuel Cam.—The layshaft is provided with a hub disk which is held by a nose-key. This hub is fitted with an extension upon

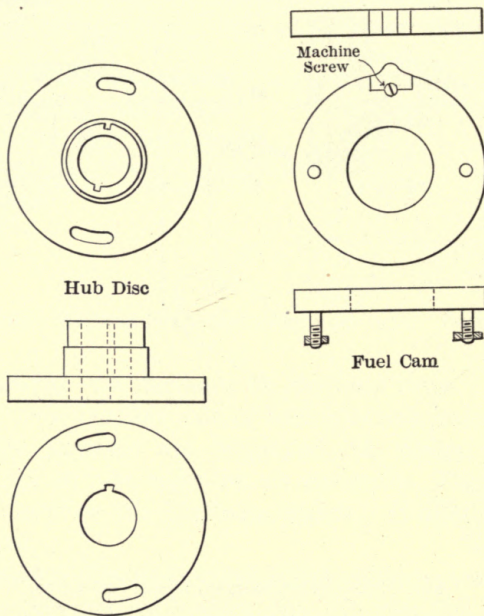

FIG. 127.—Allis-Chalmers Diesel fuel cam.

which is keyed the air-starting cam. The hub flange, as will be observed in Fig. 127, is slotted. Into these slots are placed the fuel cam bolts. The fuel cam also appears in Fig. 126, where it can be seen that it has an adjustable nose. In setting the fuel valve timing, the fuel cam can be moved several degrees around the hub disks and held in place by the bolts. This provides the easiest method of adjusting the fuel valve timing.

The National Transit Diesel Fuel Valve.—The National Transit Co. equip their Diesels with an open-nozzle fuel valve, Fig. 128. The needle valve is placed vertically in the valve block and has the closing spring located in the top of the valve body. This spring is enclosed in a sleeve which is in

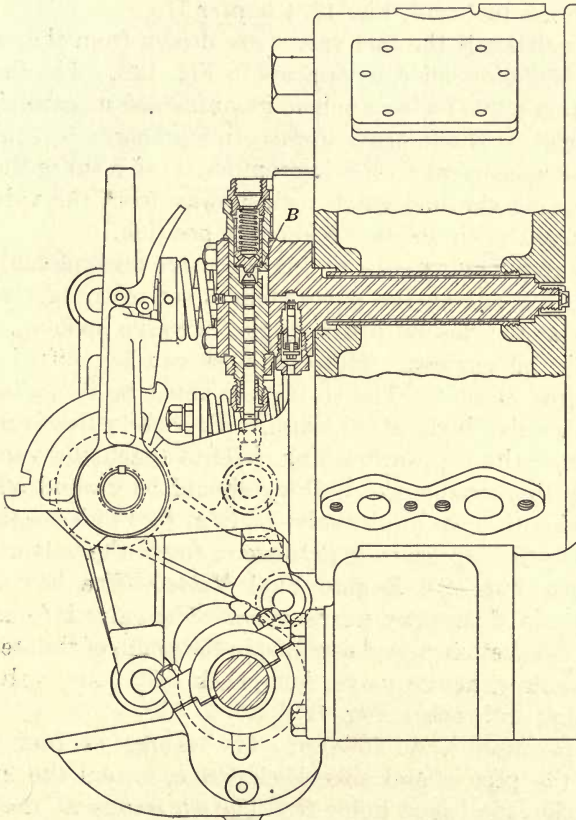

FIG. 128.—National Transit 1918 design Diesel fuel valve and cam assembly.

contact with the needle valve and is moved vertically, compressing the spring, as the valve is opened by the rocker. The oil enters the valve passage of the atomizer through the check valve *a*. The oil reservoir extends the depth of the cylinder head. This causes the oil charge to spread out in a thin sheet; consequently, the air does not pick up the oil in slugs. Owing to this passage length, no atomizer disks are necessary.

The valve body has no cooling water passages since it rests in a thin bushing pressed into the cylinder head; the cooling effect through the bushing is quite satisfactory.

The fuel valve of the National Transit Diesel manufactured prior to 1918 was opened by a push-rod carried in the hollow housing of the camshaft end bearing. This push-rod is in contact with the fuel cam, Fig. 13, Chapter II.

On later Diesels the fuel valves are driven from the camshaft in front of the cylinder, as appears in Fig. 128. The fuel valve and starting valve rocker are here mounted on an eccentric which is machined on the fulcrum shaft. In starting, a lever gives an angular displacement to the fulcrum shaft; this shifts the eccentric, throwing the fuel valve rocker away from the valve stem and moving the air starter rocker into position.

Fuel Valve Timing.—In timing the valve opening and closure the adjusting nut on the valve stem is set to contact with the fuel cam at the desired piston angle for valve opening, as with practically all engines. The cam nose can be shifted to give the required closure. The spring cap must be in contact with the needle valve body at all times. After the valve is reground a few times the cap, or bushing, fails to touch the valve. To overcome this trouble the bushing should be ground off at the surface where it seats on the valve body at *B*. This has the effect of lowering the cap, causing it to again touch the valve.

Standard Fuel Oil Engine Fuel Valve.—The fuel valve of this engine is of the open-nozzle type. The valve is housed in a cast-iron bracket block and consists, in the main, of the steel valve body, atomizer, needle valve, fuel check valve, and valve actuating spring and rocker, Fig. 129.

The operation is as follows: The charge of fuel, flowing through the pipe *a* and the check valve, enters the atomizer through the small port holes *B*. The air enters at the side of the valve block, passing around the valve stem above the seat at *C*. As the needle valve is raised, this air enters the atomizer passage *D*; to do this, the air must pass through the atomizer cone shown in the section *B-B*. This effectually breaks up the air stream, preventing the air from "slugging" the oil into the cylinder. As the high-velocity air passes over the oil, the latter is picked up and swept into the cylinder. As a means of giving sensitive control of the fuel supply on low loads and of eliminating "hunting" by the governor, a by-pass fuel valve is placed in the

fuel line. When low loads are carried, the governor, which is of the Rites Interia type, is at the extreme limit of its travel.

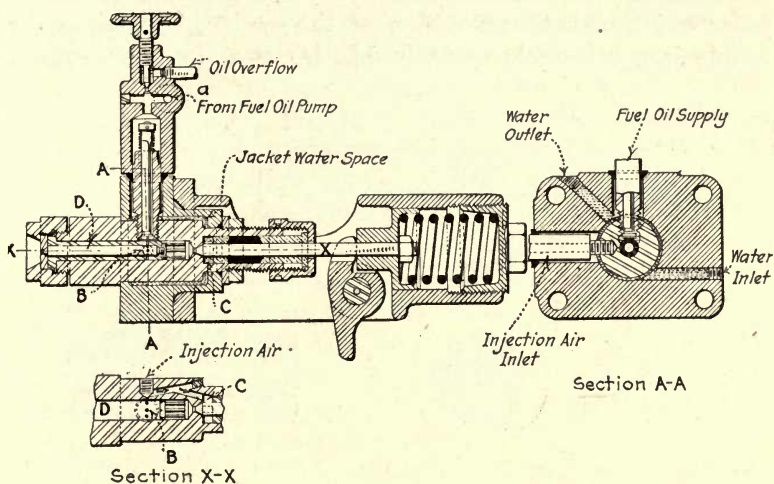

FIG. 129.—Standard Fuel Oil two-cycle Diesel fuel valve.

In this condition this type of governor is unstable and will hunt excessively. By cracking the overflow valve to allow part of the fuel pumped to by-pass back to the tank, the governor is compelled to handle more than the engine's requirements. The governor then moves outward to a more stable position, giving a closer regulation to the engine speed.

Fuel Valve Actuating Mechanism.—The fuel valve is operated by a unique cam arrangement radically different from that used on all other Diesels. The device appears in Fig. 130 where *a*, the fuel valve, is moved by the dog *b*; this dog, in turn, receives its motion from the cam lever *d*. On the lower end of this lever is mounted a roller which is in contact with the cam *e*. It will be observed that, as the engine turns over, the drag crank, being connected to the

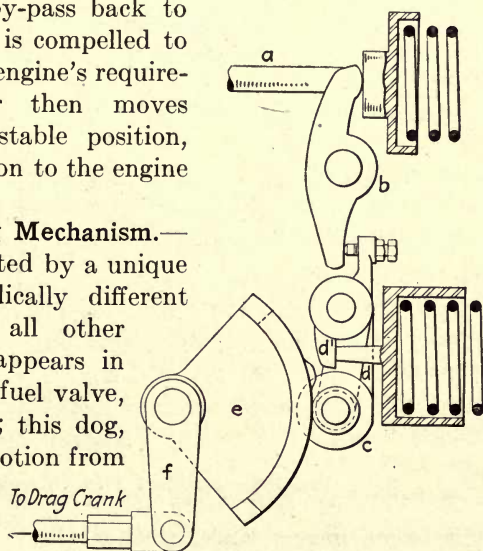

FIG. 130.

reach-rod and crank *f*, will raise the needle valve through this system of levers. The cam nose comes under the roller twice in each revolution of the engine, and, since the engine is a two-stroke-cycle, it then becomes necessary to pro-

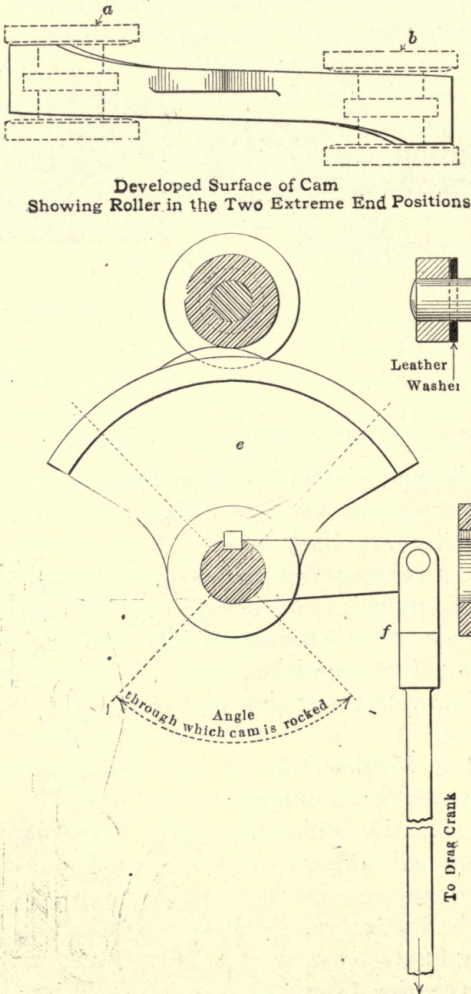

FIG. 131.—Standard Fuel Oil engine fuel cam.

vide some means whereby the roller is raised only once per revolution of the engine shaft. This is accomplished by equipping the cam roller with two flanges, as more fully illustrated in Fig. 131. The cam is milled with curved sides, and the nose

extends over only one-half of the cam width. As the reach-rod moves to the left, Fig. 131, the right-hand roller flange bears against the cam edge; the cam nose then passes between the flange and the roller. At the extreme travel of the reach-rod, the curved side of the cam throws the roller to the left, pulling it into the position *a*, Fig. 131. When the drag crank reverses the travel of the reach-rod *f*, the cam nose strikes the roller, raising the needle valve; the cam at the end of its travel then shifts the roller to the right to the position *b*, which allows the roller on the return stroke to slide over the cam, untouched by the nose.

Adjustments. Timing of Fuel Valve.—The point of beginning of fuel injection can be altered by adjusting the reach-rod length. The clearance between the valve spring cap and dog is controlled by the adjusting set-screw on the roller lever *d*; this need not be more than $\frac{1}{32}$ -inch.

Fuel Valve.—The valve body is water-cooled, and it is necessary to use this cooling system when high-gravity fuel oil is burned. With heavy oils, around 24° Baumé, the water tends to chill the valve and lower its atomizing efficiency; the result is a decidedly smoky exhaust. It is advisable, with such oils, to discontinue the flow of water around the valve.

Needle Valve.—The valve seat requires the same attention as do all open-type valves. The shortening of the valve, due to regrinding, can be compensated for by screwing the valve out of the spring cap or dash-pot.

Fuel Check Valve.—Especial attention should be given to the fuel check valve while the plant is burning dirty oil. If the fuel be sulphurized to any extent, this valve will corrode and of course demand regrinding. Since the fuel is deposited in the atomizer during the compression stroke, the check works against a considerable pressure—from 250 to 400 lbs.; the sudden opening and closing of the valve in time hammer the seat. The check valve stem must be kept clean from corrosion since the spring is light and will not close the valve against any decided binding of the stem.

Injection Air.—The injection air pressure is controlled by a governor-controlled valve, interposed between the low- and high-pressure air compressor cylinders. This is illustrated in Fig. 161.

Fulton Machine Co. Marine Diesel Fuel Valve.—Figure 132 illustrates the fuel valve of the Fulton Marine Diesel. It is along standard practice in closed-nozzle valves and is controlled by a rocker from the camshaft.

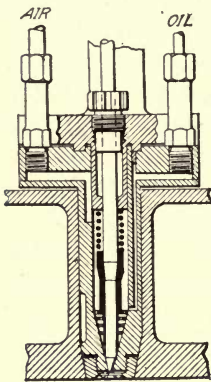

FIG. 132.—Fulton Machine Co. Diesel fuel valve.

Nelseco Marine Diesel Fuel Valve.—This Diesel employs a closed-nozzle valve. The valve is located vertically in the cylinder head and is actuated by a rocker arrangement shown in Figs. 19 and 103.

Fuel Valves for Tar Oil.—Figures 133 and 134 illustrate fuel valves designed to use tar oil as the main charge and light oil for primary ignition.

Regrinding Fuel Valves.—Regardless of the type of fuel valve, each, sooner or later, requires regrinding. In performing this process, an engineer should be very miserly with the amount of grinding paste used. The best compound is one of powdered glass and vaseline, or emery flour and vaseline. Only a very small amount should be placed on the needle, being spread out evenly over the entire seating surface. The entire valve, with the exception of the spring, should be assembled when grinding. This is to insure that the

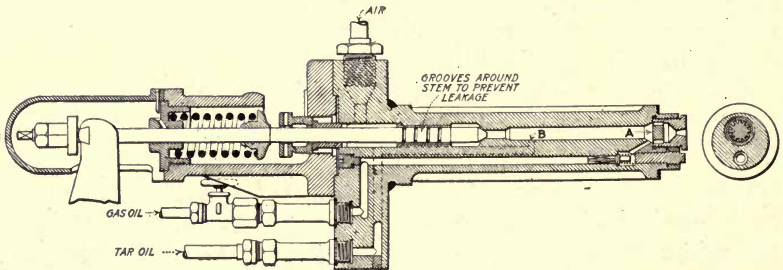

FIG. 133.—Körting tar oil fuel valve.

valve is aligned properly. It is unnecessary to secure more than a thin line contact at the seat— $\frac{1}{64}$ inch in width is ample. After grinding, it is advisable to disassemble the entire valve and cage and wash very thoroughly with kerosene. This is to remove all emery particles.

New Needle Valves.—Undoubtedly the average plant can profitably purchase new needle valves from the engine builder.

Where a plant contains several engines, this valve cost is of some moment. Perfectly good valves can be made of drill rod or cold rolled steel with either a tool-steel or phosphor-bronze tip.

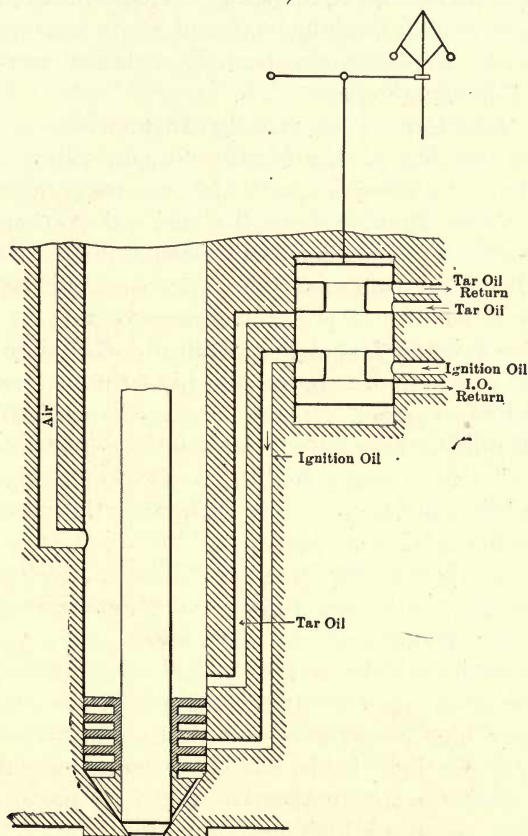

FIG. 134.—Tar oil fuel valve.

Lubrication of Valve Stem.—The valve stem gradually becomes coated with a thin layer of oil residue, this being more noticeable in non-cooled valves. To prevent binding of the stem, it should be constantly lubricated. A small amount of kerosene injected around the valve at least once every twenty-four hours will remove any residue.

Leaky Fuel Valves.—A leaky injection valve usually betrays its presence by causing the engine exhaust to be smoky. Leaky

valves also allow the fuel charge to seep into the cylinder during the compression stroke and so produce violent preignition.

Incorrect Fuel Valve Timing.—If the valve opens too early, a sharp metallic click or pound will be heard in the cylinder. This is evidence of premature combustion. If the valve opens late, a dull thump or pound, quite like a pound due to loose pin bearing, can be heard. Furthermore, a smoky exhaust ordinarily accompanies this pounding.

Clogged Atomizer or Nozzle-tip Disk.—When either the atomizer or the disk at the end of the fuel valve, sometimes called the burner plate, is clogged, the exhaust is smoky.

Sticking Valve Stem.—When the fuel valve stem sticks in the open position, the exhaust will be smoky and the injection air gage will show a drop—with the open nozzle, the gage needle will show as much as a 75 per cent. pressure drop.

Fuel Valve Cooling Jacket Temperature.—The desirable temperature, at which the discharge line from the fuel valve water jacket should be carried, depends on the characteristics of the fuels. If the oil is heavy and viscous, the discharge should be around 160° Fahrenheit. With fuel oil of 28° Baumé. and higher, 120° Fahrenheit is amply high since the valve must be cool to prevent gassing of the light oil.

Adjustable Injection Air Pressure.—The engineer can appreciate the necessity of having a higher injection air pressure when the engine is carrying full load than when under a light load. When the fuel charge delivered to the fuel valve is large, as on full load, the resistance or “braking” action of the atomizer is high and requires a high pressure to force the entire charge of oil into the cylinder. On light loads, the oil occupies only part of the atomizing space, and consequently a light air pressure is sufficient. If the pressure is high on light loads, the oil is blown into the cylinder at an increased rate. The passage of the fuel would then require only part of the time during which the needle valve is opened. The remainder of the period of valve opening would be devoted to the passage of pure air. The high velocity of the free air as it left the nozzle tip would chill the tip and lower the entire cylinder temperature, causing a decreased cylinder efficiency as well as a direct loss of air that has been compressed at a considerable expense of power. Furthermore, if the air pressure is high on low loads, a sharp knock is produced in the cylinder which results from the inrush of air at a pressure far

above cylinder pressure. Conversely, if the air pressure is too low the engine will smoke since the fuel has not been sufficiently atomized.

It is necessary for the successful operation of any Diesel that the injection air pressure be altered to conform to load change. This adjustment can be under manual control of the engineer, as is the general practice. The manual control can be obtained in several ways. The McIntosh & Seymour Marine Engine is provided with a clearance chamber on the low-pressure cylinder, whose volume can be altered, changing the air discharge pressure. Other builders arrange for the operator to adjust the low-pressure suction, obtaining the required air-pressure control. However, on fluctuating loads, this entails constant attention and is more suitably handled by some automatic arrangement. There are several designs of automatic injection control. The Busch-Sulzer Diesel throttles the compressor suction through a linkage from the engine governor. The Standard Fuel Oil Engines, as has been outlined, use a governor-controlled air by-pass valve. These varied control arrangements will be taken up in the discussion on air compressors.

Adjustable Fuel Valve Timing.—The usual Diesel engine fuel valve is designed with a constant period of valve opening, regardless of load conditions. In the Otto-type explosive engine the efficiency of the engine depends on the maximum explosive pressure. With the Diesel engine the efficiency depends both on the combustion pressure, which should be identical with the maximum compression pressure, and on the duration of the fuel injection. It is very clear that with load changes the time during which the fuel is injected should also vary. Since the rate of combustion should be constant, the period of injection must vary if the greatest possible efficiency is to be secured. Furthermore, a factor of operation also enters into the problem. On low loads the amount of oil is small and will be entirely blown into the cylinder long before the valve closes. The balance of the valve opening period is taken up with the injection of high-pressure injection air. This air assists in no way toward the combustion. For these reasons several European builders, as well as the Busch-Sulzer Co., have adopted a form of injection timing control along the lines of the servomotor in Fig. 116.

Timing of Fuel Valves.—In timing a fuel valve the engine is pinched over until it is several degrees ahead of the desired point of fuel valve opening. The air line valve is "cracked," giving about 75 lbs. air pressure on the fuel valve. The indicator plug is removed, and the engine is slowly barred over until the trammel cuts the opening mark on the flywheel. The injection valve should now start to open, as evidenced by the sound of injection air blowing into the cylinder. If the valve opens before the mark is reached, the rocker clearance can be increased, producing a later opening. If the valve opens late, the clearance can be reduced. The engine should be barred on to the closing mark, and the sound of the escaping air should cease as the mark is reached. Since the roller clearance has been altered to make the opening earlier, the closing point will probably be late. It then becomes necessary to turn the engine back ahead of the valve opening mark and shift the cam nose. The nose should be shifted to produce the required opening with the roller clearance correct. Then, on checking the closing point, it should either be correct or early. If the latter, the nose must be shifted back a trifle and the roller clearance made less. This should produce the required opening and closure. If the nose is excessively worn, it is impossible to obtain a correct timing, and a new nose must be secured.

Back Lash.—The camshaft gears are not immune to wear, and in the course of five to seven years of constant service the back lash between the gears becomes noticeable. The clearance between the gear teeth has a very detrimental effect on the injection cam. As the cam nose contacts with the valve rocker roller, the pressure that the spring offers against the rocker movement is considerable. As the roller travels over the surface of the cam nose and starts down along the back slope, this spring pressure forces the camshaft forward, causing the valve to close early. Since the wear is between the teeth, the camshaft is already behind its exact timing with the engine shaft, and consequently the opening of the fuel valve is late and the closure is early. A new cam nose of greater length will partially overcome the defect, but new gears should be ordered to replace the worn ones.

CHAPTER X

FUEL PUMPS

TYPES. ADJUSTMENTS

Fuel Pumps.—While adjustments of a Diesel fuel pump are not of frequent occurrence, nevertheless, this particular part of the engine is of vital importance. The successful operation of a Diesel depends, in a great measure, upon the accuracy and reliability of the pumping mechanism. When it is considered that on a 100 h.p. cylinder, operating at 200 r.p.m. or 100 power strokes per minute, the volume of a single full-load fuel charge is less than .3 cubic inch, the necessity of accurate pumping is apparent. Since the usual speed regulation requirement is 2 per cent. on each side of normal, the extreme variation that is permissible in the volume of a single injection at a given speed is .006 cubic inch. The pump, then, must be not only correct in design but also absolutely high-grade in the workmanship involved in its actual manufacture.

As has been previously outlined, two types of fuel injection are in use: the open- and the enclosed-nozzle type. The fuel pumps follow the same classification. First, the pumps on engines employing the closed-nozzle fuel valve must be constructed to resist a pumping head equivalent of more than 1000 lbs. per sq. inch. This demands rugged construction and absolutely leak-proof pump valves. The governor control, where the control is through the pump plunger, is called upon to withstand severe stresses. The open-nozzle fuel valve offers no pressure resistance to the pump discharge; consequently the pumping head consists of merely the pipe and check valve resistances, which are negligible. This fact enables the fuel pump to be designed with direct control of the pump plunger, with but slight reactions on the governor.

American Diesel.—The numerous American engines that are still in service are equipped with the Bagtrup governor and fuel pump, appearing in Fig. 135. The mechanism consists of a pump body in which reciprocates the plunger, one plunger for

each engine cylinder, the plunger being driven by an eccentric mounted on the pump shaft. This shaft carries a gear which is actuated by a train of gears from the engine crankshaft. The

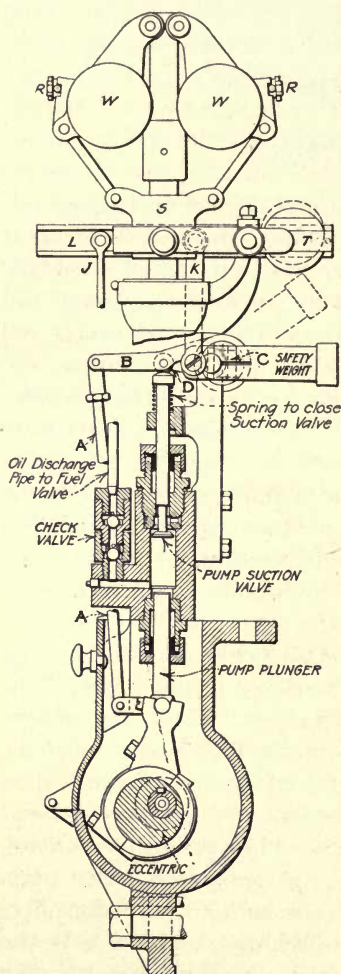

FIG. 135.—American Diesel fuel pump.

suction valve is mechanically operated, by means of a bell-crank *B* and reach-rod *A*, from the plunger eccentric strap. The bell-crank fulcrums on an eccentric shaft *C* controlled by the governor sleeve. The suction valve is opened during the suction stroke and part of the discharge stroke. If the load is heavy the fulcrum pivot is raised, allowing the suction valve to close early; the fuel then is forced out through the discharge valve into the fuel injection valve. On light loads the governor lowers the fulcrum, causing the suction valve to remain open for a greater part of the plunger stroke; the oil then passes back through the suction valve.

The reaction of the governor sleeve is heavy, and the speed regulation is not as close as is demanded in electric plants. In starting the engine a hand crank is provided, which allows the fuel line and injection valve to be charged before the engine is turned over.

Adjustments. Setting Suction Valve.—In setting the suction valve the governor should be blocked to the mid-position and

the particular pump plunger placed on the upper dead-center. The suction valve lever should then clear the suction valve stem by $\frac{1}{32}$ inch. This clearance can be secured by altering the length of the lever reach-rod *A*, which has turnbuckle ends.

Leaky Valves.—The suction valve, being of the poppet type, frequently leaks. The proper method of regrinding is to remove the valve and cage. Disassembling, the spring is removed and the valve coated with emery flour and vaseline and again placed in the cage. A nail thrust through the cotter opening makes a convenient handle with which to turn the valve.

Discharge Valves.—The discharge line has two ball valves. When the oil is clean and free from dirt, little trouble is experienced. The chief attention is given to the valve seats. These seats tend to wear rounded, making a poor seal. When the seat is in this condition, it should be reamed to the correct 45-degree angle; in this work the reamer must not chatter, or the seat will not be oil-tight. The lift of the valve should not exceed $\frac{1}{16}$ inch. If it is greater, the ball valve will be slow in seating and will allow part of the oil to flow back through the valve opening. With heavy oils the seating is so slow that a small helical spring becomes necessary.

Levers and Pins.—On these old engines the pump levers and pins are generally badly worn. An engineer, when this condition exists, should promptly ream the pin bearings to a larger diameter and turn up new pins to conform. For this work an expansion reamer is desirable in order to handle all the various size pin bearings.

Busch-Sulzer Type B Diesel Fuel Pump.—While the mechanical details differ, the Busch-Sulzer Type B Diesel's fuel pump follows the same principle as does the American engine just discussed. Figure 136 is a cross-section of the Type B pump, showing one plunger. This is along designs adopted by the majority of European and English Diesel builders. In this construction the plunger *A* is driven by an eccentric *B* keyed to the vertical governor shaft *C*. The suction valve is mechanically operated by a dog *F*, which swings on an eccentric *G*. This eccentric is mounted on a small shaft controlled by the governor *K* through a linkage *J* and bell-crank *I* shown. The suction valve plunger *D* is also driven by a fixed eccentric *E* on the vertical governor shaft, being 180 degrees behind the pump plunger eccentric. In Fig. 136 the pump plunger is at the end of the delivery stroke while the suction valve plunger is at the extreme inner position. As the governor shaft revolves, at one-half engine speed, the pump plunger moves to the end of its suction stroke; the suction plunger moves outward, lifting the suction valve off its seat; this

allows the fuel to enter the pump cavity. As the pump plunger reverses and moves on its delivery stroke, the suction valve remains open, the oil flowing back into the suction line. At a stated point in the pump plunger travel, the suction plunger moves out of contact with the dog *F*; the valve now closes and the oil is forced out through the discharge valve. If the load decreases, the rising governor sleeve shifts the center of the eccentric dog bearing. This allows the valve plunger to remain in

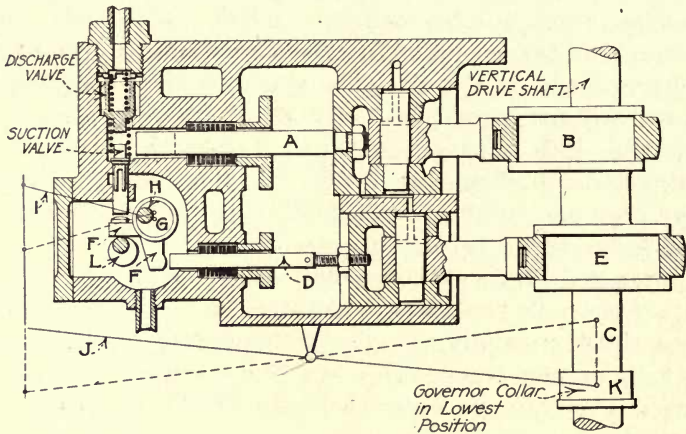

FIG. 136.—Busch-Sulzer type B Diesel fuel pump.

contact with the suction valve for a longer interval, which permits more of the fuel charge to flow back into the suction line.

On these engines there is a pump plunger and suction valve plunger for each engine cylinder. It is possible to use only one suction valve plunger, but this individual suction valve mechanism offers opportunity for a closer adjustment of the functioning of each pump. On some of the four-cylinder engines the four plungers are arranged in a single row, while on others there are two sets of two plunger cavities each, placed end to end with the valve block in the center.

This fuel pump gives the closest possible speed regulation while the reaction on the governor is at a minimum. The resistance offered to the movement of the governor sleeve consists of the suction valve spring compression.

Filling the Fuel Pump.—To facilitate charging the pump and discharge line with oil, an eccentric shaft *L* is provided. This

shaft is rotated by means of a hand lever, and, by so doing, the dog *F* is raised to its maximum lift. This lifts both the suction and discharge valves.

Stopping the Engine.—A less angular travel of the eccentric shaft *L* lifts only the suction valve. This relieves the pumps of the oil charge, and the engine stops from the lack of fuel.

Setting Pump Valves.—The four plunger pumps deliver the fuel to the four cylinders on all four cycles, *i.e.*, suction, compression, expansion and exhaust strokes. In timing the pump and the suction valve opening, the engine is slowly turned over, and the inner and outer dead-centers of the pump plunger eccentric are marked on the plunger. The engine is then turned over until the pump plunger is $\frac{7}{16}$ inch from its discharge dead-center. The suction valve plunger, or regulating plunger, has at this point moved away from the dog or bell-crank, which leaves its contact with the suction valve stem. The suction valve plunger should be adjusted to give a clearance of .002 inch between the dog and valve stem when the pump plunger is in the position mentioned. In setting the valve, the governor collar must be central. In a two-plunger pump this means that the collar must be in the mid-point of its travel, while with a four-plunger pump the collar must be on its bottom position; to obtain the latter the governor springs must be removed.

Pump Valves.—The engineer need give but slight attention to the pump other than to the valves. Both the suction and discharge valves wear rapidly, as may be expected of any type of pump valve when dirty oil is handled. In regrinding, emery flour should be used, placing a very small quantity on the valve face. In some engines the discharge valve spring continually breaks. It is hard to determine the cause; at times a lighter spring relieves the trouble while on other pumps a heavier spring is required.

McIntosh & Seymour Diesel Fuel Pump.—The first Diesels manufactured by the McIntosh & Seymour Corporation were equipped with fuel pumps somewhat after the design appearing in Fig. 136. The engines were four-cylinder units, and the fuel pumps had two pumping plungers, one plunger for each pair of cylinders. The fuel from one plunger cavity passed through the discharge valve and pipe line into a block, called the Distributor. This block contains two passages connected to the fuel lines leading to the two fuel injection valves. The cross-

sections of these passages are controlled by needle valves. The fuel, entering the distributor, divides into two streams; the needle valves allow the operator to properly proportion the two oil streams.

The operating difficulty of this pumping system lies in the inability of the engineer to regulate the distribution of the fuel on varying loads. A setting of the needles that is correct for full load will not give the proper regulation at low loads since the resistances of the passages vary, due to a smaller quantity of oil entering the distributor. Another factor that prevents proper proportioning of the fuel is the partial clogging of one line; this throws almost all the oil into one cylinder.

With this form of pumping mechanism it is imperative that the oil is filtered to prevent the clogging of a distributor. Furthermore, the fuel valves must be kept in perfect condition since the smallest leak in a fuel injection valve lowers the resistance of this particular fuel line, allowing this cylinder to receive too large a proportion of the fuel from the pump.

The fuel pump, mentioned above, gave way to a design which is shown in Figs. 137 and 138. Unlike the distributor type pump which followed Sulzer Bros. patents, Fig. 137 is of exclusive American design. This pumping apparatus consists of two pumps, set at right angles, each being an outside packed double-plunger pump. The eccentric strap *E* driving the two plungers is mounted on an eccentric *D*, and the governor acts directly on the pump plungers, in this way regulating the amount of fuel pumped by varying the plunger stroke. The reaction on the governor of direct plunger controlled pumps is considerable. McIntosh & Seymour partially avoid this by using two eccentrics; the eccentric *D*, controlled by the governor, drives the pump and is mounted on a second eccentric *B* that is keyed to the vertical governor shaft *C*. It is apparent that this offers a more accurate regulation of the pump stroke and a greater reduction in the reaction on the governor than can be secured by a single eccentric.

The pump suction valves are located below the discharge valves, being removed through the discharge valve opening. The latter valves are accessible by the removal of the valve cap or plug *G*. Below the suction valves of the two pumps is placed a shaft *H*, which has two milled cams, as shown in the cross-section. During the functioning of the pump the suction valve

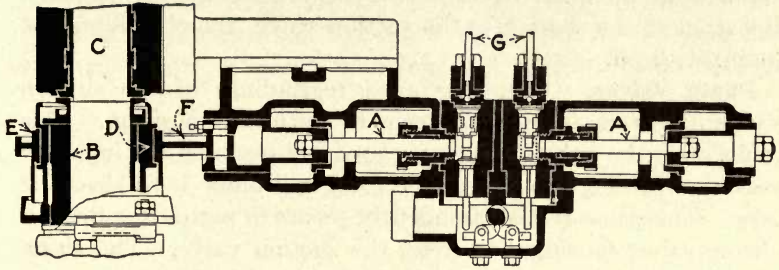

FIG. 137.

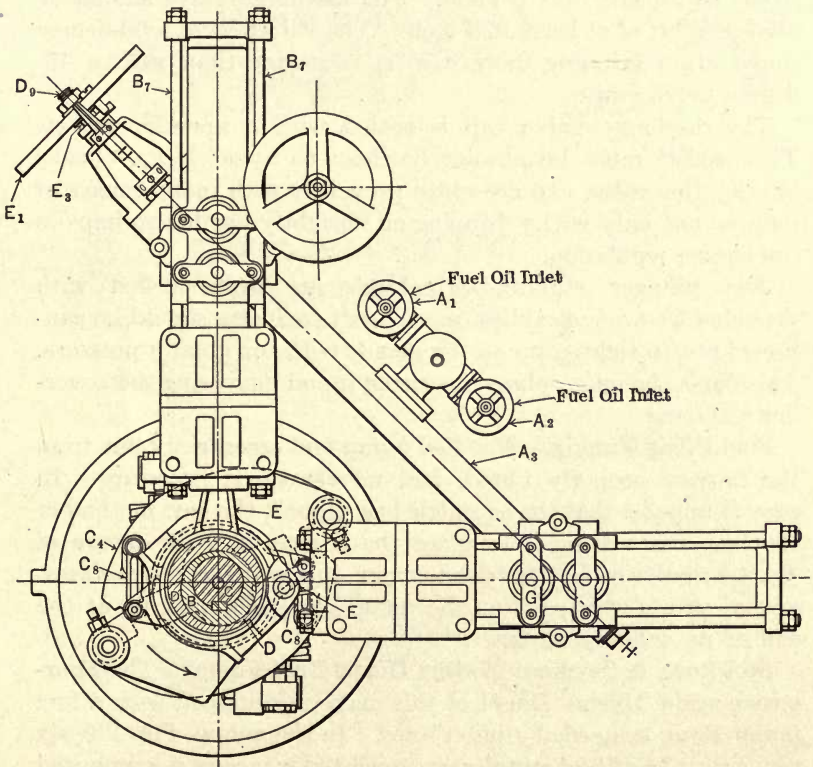

FIG. 138.—Governor and fuel pump, top view.

stems clear the shaft by means of the depressions in the shaft. Rotation of the shaft lifts the suction valve, thereby filling the pump with oil.

Pump Valves.—After continued regrindings of the suction valve, the stem touches the cam at its lowest position. This cocks open the valve, preventing any fuel reaching the injection valve. Grinding the end of the stem will allow it to clear the cam. This same trouble frequently occurs in regrinding the discharge valve, causing it to strike the suction valve. The clearance between the two should be approximately $\frac{5}{16}$ inch.

The valve springs at times break. This is probably due to fatigue; replacement by a spring of smaller wire in most cases seems to remedy this trouble. The discharge valve should be allowed a lift of at least .025 inch. The valves have a 60-degree slope. In regrinding more care is necessary than with a 45-degree valve seat.

The discharge valve cap is sealed with a metallic gasket. This gasket must be absolutely clean to avoid leaks. Leaks around the valve cap are quite prevalent with many makes of pumps; not only is the dripping oil unsightly but it also impairs the engine regulation.

The plunger stuffing-box glands are best packed with shredded lead or vulcanbestos. Watch engineers should be cautioned not to tighten up on the glands with too great a pressure. This binds the pump plunger, scoring it and increasing the governor reactions.

Fuel Pump Timing.—The fuel pump and eccentrics come from the factory properly timed, and no change is necessary. In case it appears that the eccentric has slipped, the best method of checking the setting is to place the engine with the piston of No. 1 cylinder on bottom dead-center, just starting the compression stroke; in this position the pump plunger should be at the end of its delivery stroke.

McIntosh & Seymour Marine Diesel Fuel Pump.—The Four-stroke-cycle Marine Diesel of this make is equipped with a fuel pump along somewhat similar lines. In this pump, Fig. 139, six plungers, placed horizontally, are operated by eccentrics mounted on eccentrics. This second set of eccentrics is keyed to the pump shaft, which is moved lengthwise by means of the manual control lever. These eccentrics are made with their axes at angles with the eccentric shaft center line. Shifting the shaft lengthwise

increases or decreases the travel of the pump plungers; the travel of the plungers can be completely cut out by reducing the eccentric throw to zero. The longitudinal movement of this

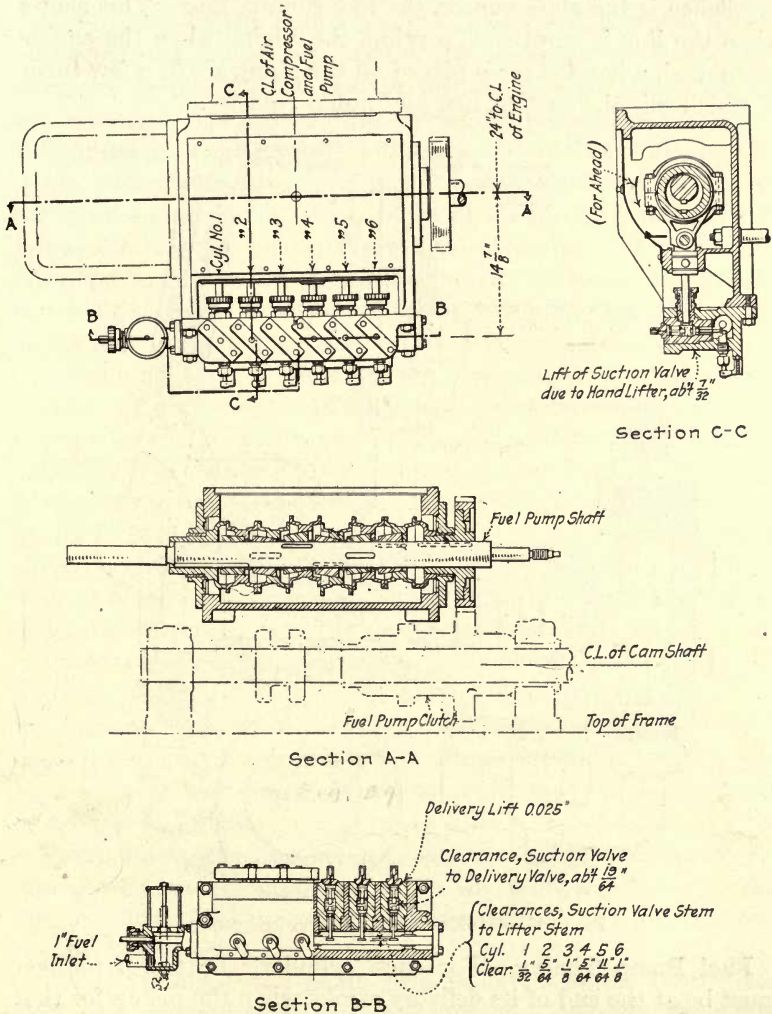

FIG. 139.—McIntosh & Seymour marine four-stroke-cycle Diesel.

pump shaft is accomplished by the control lever through the air-starting control shaft, as has been discussed in Chapter VIII.

As a precaution against overspeeding, a governor is mounted on the pump shaft in the extension case of the pump and operates,

through a linkage, a small shaft *A*, which raises the suction valves. In order to allow a single cylinder to be cut out at will, a hand-lifter is provided for each suction valve. Another feature of excellence is the glass cup on the fuel suction line. This shows when the line is empty. To prime the engine when the engine is stopped, a handwheel is placed on the pump shaft, a few turns of which fills the suction line and pump cavities.

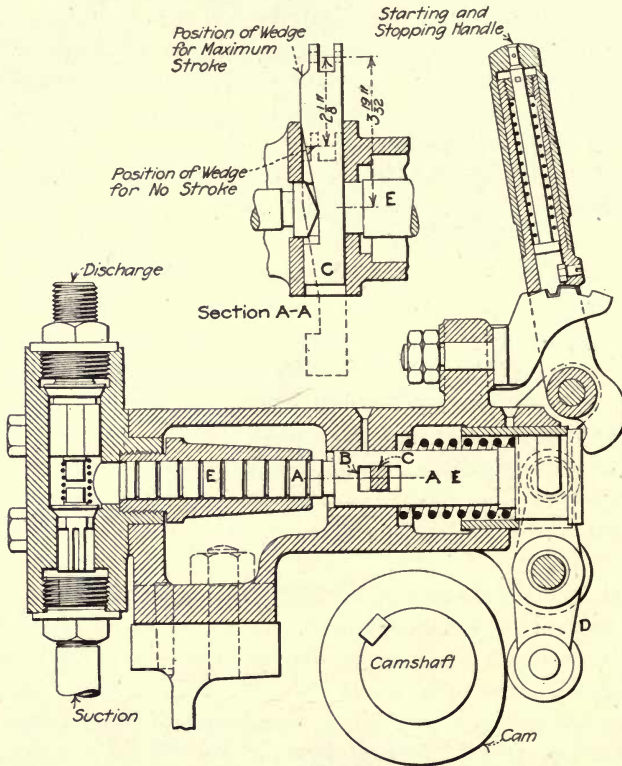

FIG. 140.—McEwen Bros. Diesel fuel pump.

Fuel Pump Timing.—For each cylinder, the pump plunger must be at the end of its delivery stroke when the piston for that particular cylinder is at bottom dead-center, just beginning the compression stroke. The linkage to the control lever must be adjusted to give the pump plungers zero travel when the control lever is at both the start and stop positions.

McEwen Diesel Fuel Pump.—The McEwen Diesel has an open-nozzle fuel valve; consequently the pump is a departure

from the designs already discussed. As will be noted in Fig. 140, the pump, for a single-cylinder engine, consists of a plunger housing, to which is bolted the valve body, and the pump plunger with actuating mechanism. In action the cam, through the rocker *D*, moves the pump plunger *E* to the left, which action forces the fuel charge out through the discharge line to the fuel injection valve. As the cam in turning releases the thrust on the rocker, the plunger spring forces the plunger to the right; this draws in a charge of oil through the suction valve. The pump plunger on this stroke moves to the right until it strikes the governor wedge *C*. The length of the plunger stroke determines the amount of oil entering the cylinder. The governor is linked to the wedge *C* and, as the engine speeds up, shoves the wedge farther in, decreasing the distance from the wedge to the face of the plunger slot. This reduces the plunger stroke.

This pump is one of the simplest in use and has the advantage, as have all wedge-governored pumps, of offering but slight resistance to any governor movement. The reaction on the wedge is merely that due to the plunger spring tension when the wedge is in contact with the plunger. This is slight and occurs only at the point of extreme suction travel of the plunger. As a consequence, the governor can be light and extremely sensitive. This is of distinct advantage in alternating-current work, or in any other work necessitating close regulation.

Pump Valves.—Both suction and discharge valves are of the poppet wing type with seats having a 60-degree slope. In regrinding these valves, the discharge valve must not be lowered enough to prevent a proper lift of the suction valve; this should be at least .03 inch, while the discharge lift works best with a lift of around $\frac{5}{64}$ inch.

Pump Plunger.—The plunger has no stuffing-box, being provided with sealing grooves. Since the pumping head is very low, but little leakage will occur even though the pump sleeve is considerably worn.

Pump Timing.—The pump cam is keyed to the engine layshaft and requires no alteration in timing. However, the pump plunger should be at the end of its discharge stroke when the engine piston is on out dead-center, just starting the compression stroke.

In setting the governor wedge for no-load conditions, after the weights are thrown out to their greatest travel, the wedge should

be moved in until the slot is in contact with the thickest part of the wedge. Then after throwing the pump plunger to the end of its discharge by turning the engine over, there should be not more than .01-inch play between the wedge and the inner edge of the slot. This is the position of the wedge when no fuel is pumped. For full-load condition, at which event the weight arms are at their maximum position, the wedge should have moved in the slot so that the slot edge just strikes the wedge at the point where the wedge slope begins. This point should be $2\frac{1}{8}$ inches from this first or no-load position.

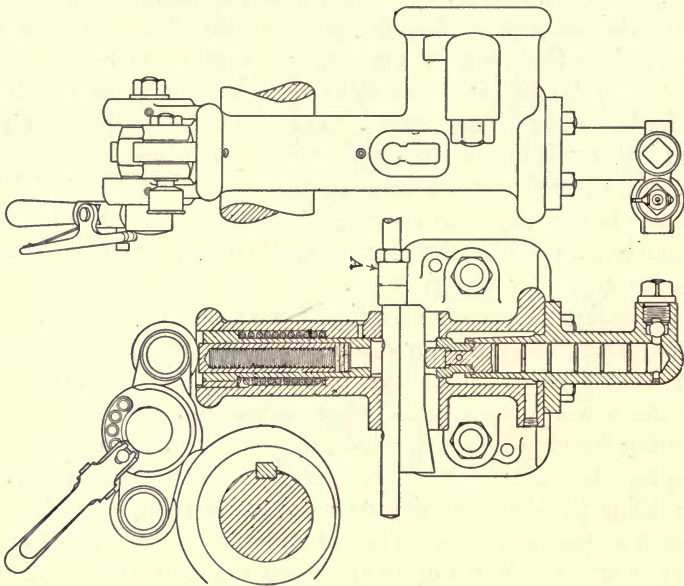

FIG. 141.—Snow Diesel fuel pump.

Snow Diesel Fuel Pump.—The Snow Diesel engine has a fuel pump designed with wedge control. This pump, which appears in Fig. 141, has the plunger in two sections. The driving end of this plunger is hollow and carries the slot for the wedge. It is also provided with a pin which bears against the cam lever roller at all times, being held by a compressed spring. With this design, on short plunger strokes, as on low load, the roller does not strike the plunger end when traveling at maximum speed. Instead the plunger pin moves in, being resisted by the spring, until the spring compression overcomes the pump plunger resist-

ance. At this point the pump plunger starts on the delivery stroke. The result is a quiet pump with a minimum of wear and shocks on the mechanism. The plunger wedge is fastened to the reach-rod *A*, which is under control of the governor.

Pump Valves.—The pump valves are of the ball type. In case leaks develop, a hardwood stick can be placed on the ball and struck a light blow with a hammer. This will give the ball a new seat on the housing. In event the ball is scored or rough, the only remedy is replacement with a new ball; even here the ball must be given a new seat in the housing. The ball valve, if it has any great amount of lift, is sluggish in closing. A lift for a pump ball valve ought never to exceed $\frac{1}{16}$ inch. If more than this, a light coil spring should be inserted above the ball to quicken its action.

Timing the Pump.—In adjusting the pump plunger for no-load and full-load strokes, the reach-rod *A* should be adjusted to allow the plunger to touch the wedge at the beginning of the wedge slope, when the governor is at its lowest position, which is the full-load condition. For no load, when the governor is blocked open, the wedge should have moved to a position where the plunger has a slight clearance between the slot edge and the wedge, on the inner position of the pump plunger.

Allis-Chalmers Diesel Fuel Pump.—The fuel pump used on the Allis-Chalmers engine is shown in Fig. 142. The pump plunger is actuated, through a rock-shaft *D* and the connection rod *C*, by the fuel cam below the pump. The plunger rock-shaft *D* is fulcrumed at *E* on the lever *F*, which is under control of the governor through the reach-rod *G*. As the engine speeds up, the reach-rod moves downward; this raises the fulcrum pivot *E*. This motion of the fulcrum raises the pump plunger *A* until its end is above the by-pass slot *H* at the end of the suction stroke since the plunger spring holds the rod *C* in contact with the cam *B*. As the cam rotates, the plunger receives a constant stroke, but, since part of the stroke occurs before the by-pass slot is covered by the plunger, the first portion of the oil displaced by the plunger flows through the slots *H*. As soon as the plunger passes the slots, the oil below the plunger is forced through the discharge valve to the atomizer. Since an open-nozzle fuel valve is employed in connection with the pump, the latter has but the pipe resistance to overcome. The

governor, then, is called upon to oppose only a slight reaction and consequently can be sensitive without danger of hunting.

The cam connection rod *C* is provided with a special head having adjusting set-screws. Proper manipulation of these set-screws will alter the effective stroke of the pump plunger.

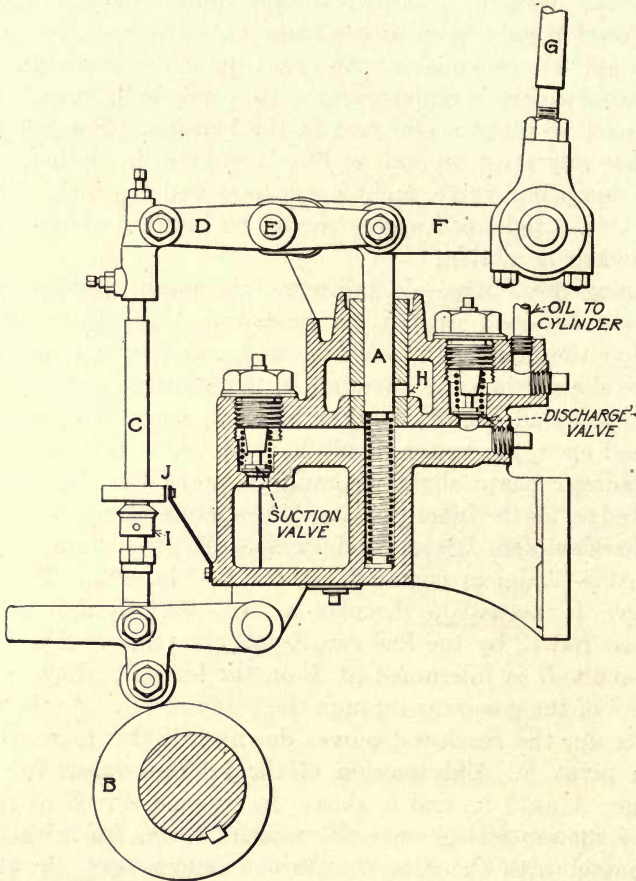

FIG. 142.—Allis-Chalmers Diesel fuel pump.

In stopping the engine the hand lever is raised, allowing the release band *J* to grip the lock *I* on the rod *C*. This prevents the rod from dropping into contact with the cam. In starting, the handle is used to prime the pump.

The pump is fitted with a plunger and rocker mechanism for each cylinder of engine, with individual cams on the layshaft.

De La Vergne FD Diesel Fuel Pump.—Figure 143 is an external view of the fuel pump used on the FD engine. The governor acts upon a by-pass valve *a* through a system of levers. The fuel charges are controlled by the movement of this by-pass valve.

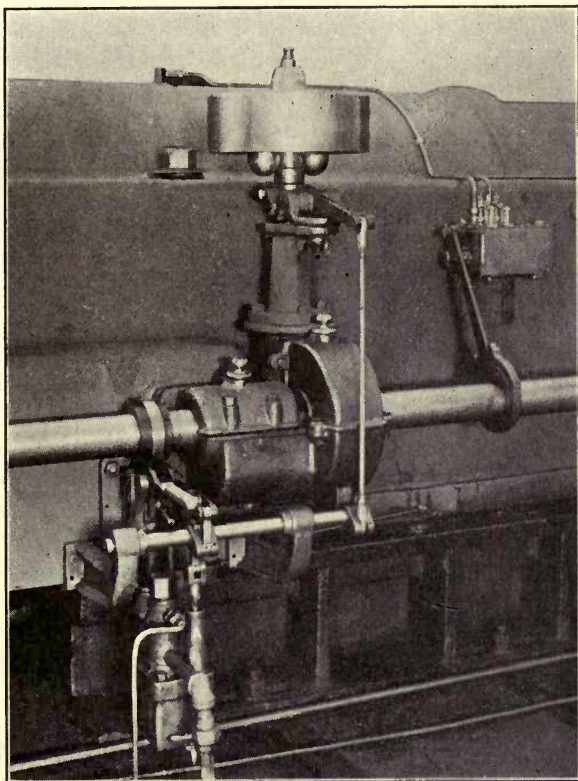

FIG. 143.—De La Vergne type FD Diesel fuel pump.

Nelseco Marine Diesel Fuel Pump.—The fuel pump fitted to the Nelseco Marine Diesel appears in Fig. 144. The engine speed can be altered by the control lever shown, through a linkage which alters the position of the governor lever fulcrum. The governor then maintains this desired speed by changing the period of suction valve opening. The fuel pump consists of the working plunger driven by an eccentric, and the suction and discharge valves. The suction valve is held open through

part of the delivery stroke of the pump, the length of this period being under governor control.

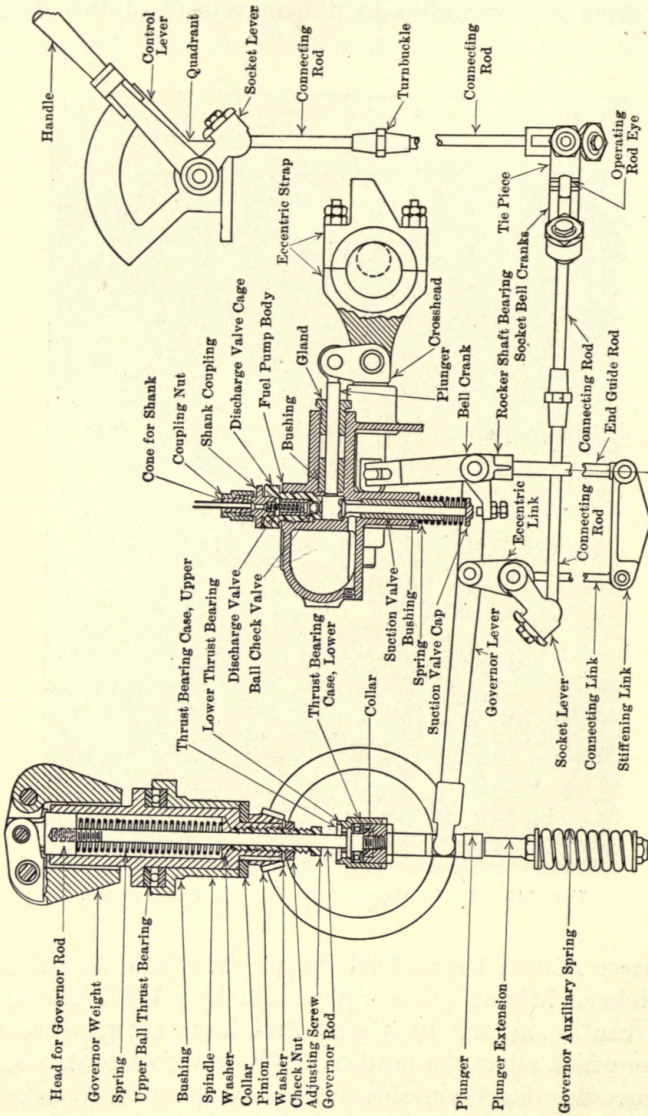

FIG. 144.—Nelseco marine Diesel fuel pump.

Timing Fuel Pump.—To adjust the pump proceed as follows: Set the fuel control lever at division No. 1 and lock. Bar the engine

over until some two plungers are at the inner end of their stroke. Then adjust the adjusting screw on the corresponding suction valves until a piece of paper placed between the adjusting screw point and the fuel suction valve end is just barely held. Adjust all the other suction valves in the same way, still keeping the fuel control handle locked in the same place.

National Transit Diesel Fuel Pump.—The fuel pump on the first National Transit engines has a differential plunger, the upper end being hollow and provided with a cut-off valve, Fig.

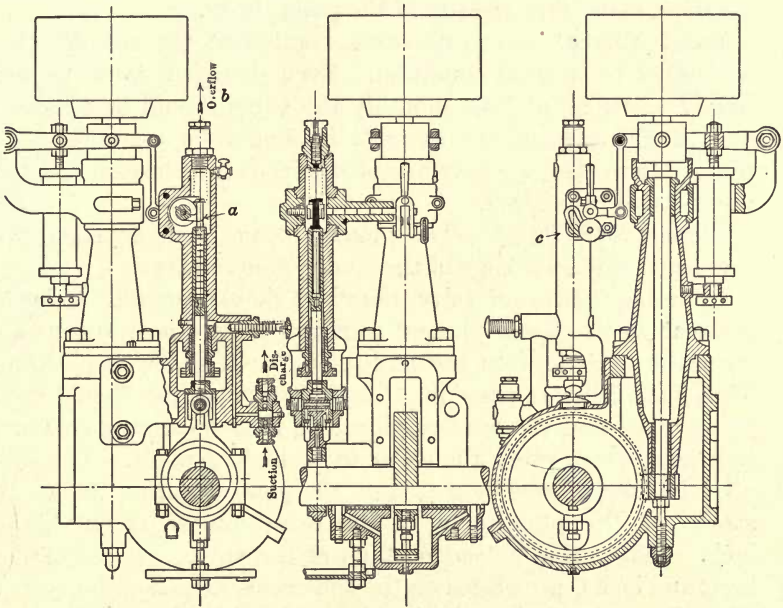

FIG. 145.—National Transit Diesel fuel pump, old model.

145. This differential plunger is driven by an eccentric keyed to the camshaft. The cut-off valve is under control of the governor through a link and bell-crank. The pump functions as follows: On full load the governor sleeve is as shown in the figure; this position is such that the cut-off valve leaves its seat on the plunger as soon as the latter starts on the downward or suction stroke. The oil is then drawn through the suction valve and fills the passage in the plunger and the chamber *A* above the differential plunger. On the upward or discharge stroke, the cut-off valve being open, the large end of the plunger

displaces the oil in this chamber and forces it down through the plunger and out the discharge valve. On low loads the governor bell-crank moves downward; this allows the valve to remain seated on the plunger during part of the downward stroke. As soon as the plunger moves below this point, the valve rests on the bell-crank fingers and leaves its seat. The chamber fills with oil, and on the upward stroke the fuel is forced out the discharge valve until the plunger comes in contact with the cut-off valve. The cut-off valve then seats, and all the oil displaced by the further movement of the plunger passes out through the overflow valve *B* at the top of the pump body.

Pump Valves.—To insure close regulation, the cut-off valve seat must be in good condition. Even though it is rather unhandy to reach, at least monthly the valve should be removed and, if the seat is not smooth, it should be reground. To remove the valve, the overflow-pipe joint can be broken and the check-valve cage lifted.

Timing Fuel Pump.—The plunger eccentric is keyed to the camshaft, and no change of the timing is necessary.

In timing the cut-off valve, the valve should just start to leave the seat as the pump plunger commences its downward stroke when the governor is at rest and the collar in its lowest position. This is the full-load position. The governor springs should then be removed and the weights moved to their maximum outward positions, which raises the collar to its highest point. The cut-off valve should now be seated on the plunger during the entire stroke of the plunger, with the exception of about $\frac{5}{1000}$ inch. This is the no-load position of the valve. An adjusting lever and lock *C* are placed on the bell-crank outside of the casing. This allows the timing of the valve to be altered to conform to the desired setting. To stop the engine this lever is moved to lower the cut-off valve.

National Transit 1918 Diesel.—The later National Transit Diesels are supplied with a fuel pump that, in form, resembles the pump discussed above but which functions on an entirely different principle. This pump appears in Fig. 146. In this design the pump plunger is actuated by a rocker and cam in place of the former's eccentric and strap. The plunger *P* is hollow and carries at its top the cut-off valve *V*. This valve has a triangular shank which extends down into the hollow plunger, and the valve is controlled by the fingered or forked lever *E*. This

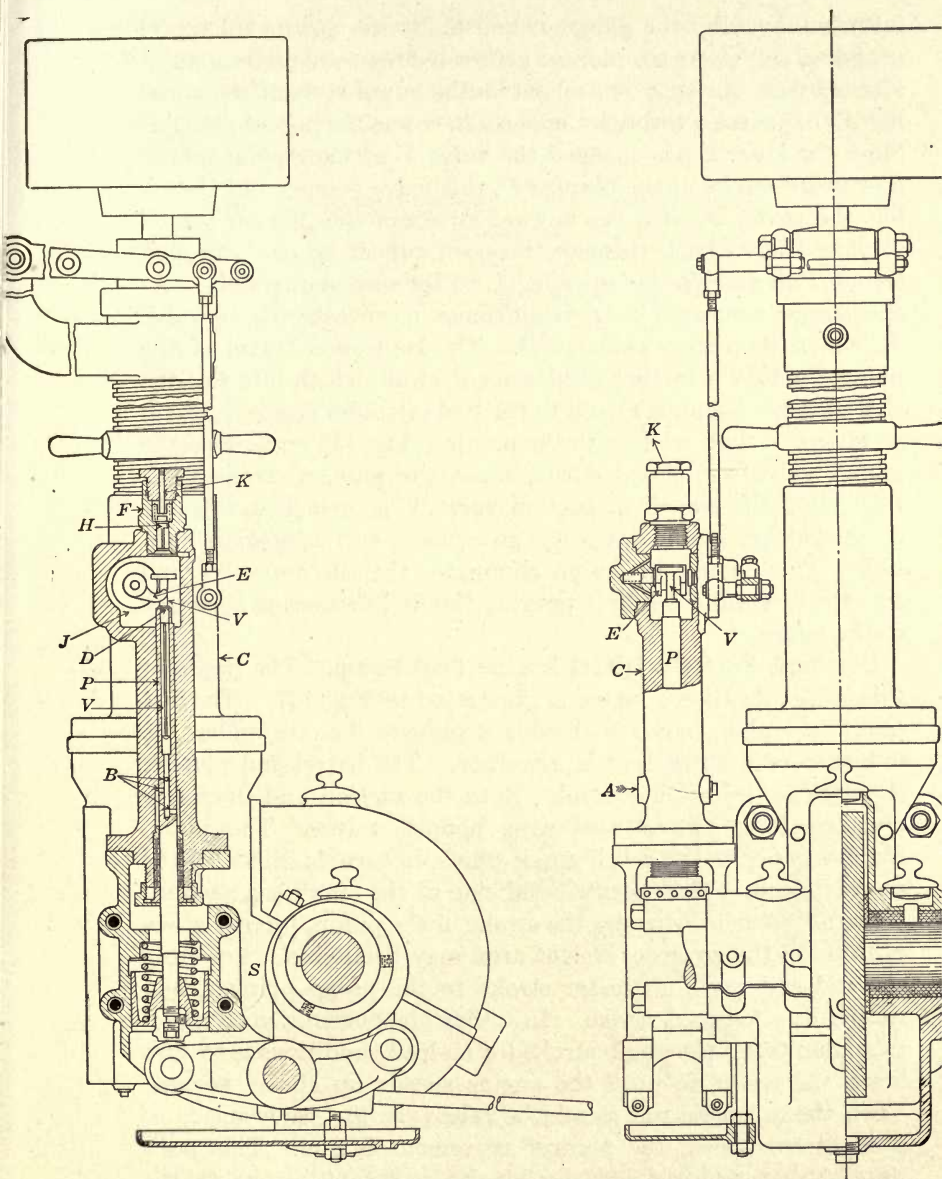

FIG. 146.—Fuel pump and governor, type D-3. National Transit Diesel.

lever is moved by the governor and limits the downward travel of the valve *V*. As the plunger is forced downward on its suction stroke by the spring *S*, the oil enters the pump body at the opening *A* and, passing through the ports *B*, enters the hollow plunger. Since the lever *E* has engaged the valve *V* at some point on the downward stroke of the plunger *P*, this valve is open and the oil fills the cavity *J*. On the upward stroke of the plunger the oil displaced flows back through the open cut-off valve *V*, through the ports *B* and suction opening *A*, to the source of supply. As the plunger continues its travel, it comes in contact with the valve *V*, which thereupon seats at *D*. The continued travel of the plunger entails a further displacement of oil, which lifts the discharge valve *H* and is forced to the fuel injection nozzle. It will be observed that, while with the pump in Fig. 145 on no load the cut-off valve was closed during the entire plunger stroke, with this pump the cut-off or suction valve *V* is opened during the entire plunger stroke when the governor is in the no-load position. This change in design eliminates the suction valve and the overflow valve while improving the fuel-measuring accuracy of the pump.

Standard Fuel Oil Diesel Engine Fuel Pump.—The pump of this two-cycle Diesel engine is illustrated in Fig. 147. The fuel pump is a plain barrel *B*, having a plunger directly under the influence of a Rites Inertia governor. The barrel and plunger *A* is the air injection control. Both the suction and discharge openings have two sets of wing poppet valves. The pump plunger is pivoted to a bell-crank which, in turn, is driven by the eccentric rod. The eccentric-rod side of the crank has a worm-screw adjustment whereby the stroke of the pump, for any given position of the governor weight arm, may be altered. Lowering the rod end gives a greater stroke to the pump plunger, and raising it, a lessened stroke. In timing the engine a good practical plan to set the pump stroke for no-load conditions is to first lower the eccentric until the engine speeds up above normal. Then the eccentric rod should be raised by the screw until, at a slight overspeed, the plunger movement is zero. This position of the eccentric end should give sufficient stroke to the plunger at the full-load position of the governor.

In stopping the engine the lock screw *C* is loosened, cutting out the pump. Since the engine is two-cycle, the pump works against a much greater pressure than exists with a four-stroke-

cycle engine, even though an open nozzle is employed on both engines. For this reason the wear on the pump valves is greater, and regrinding is more frequent. The engineer must give special attention to the plunger stuffing-box, as a small leakage effects the engine's regulation.

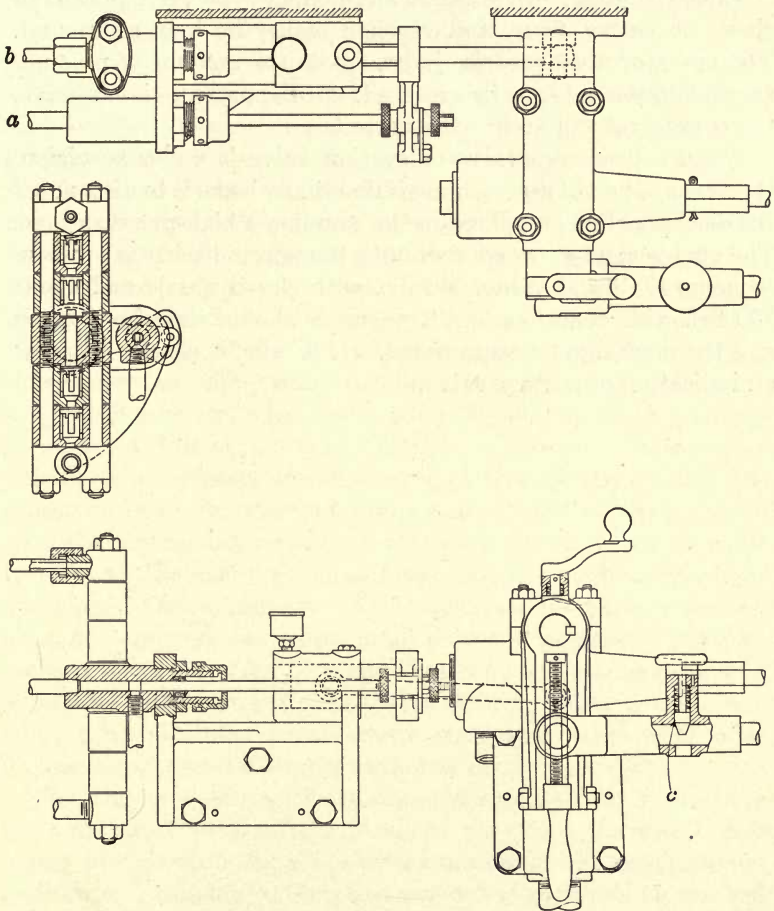

FIG. 147.—Standard fuel oil Diesel fuel pump.

General.—After the valves of any design of fuel pump have been replaced, after grinding, etc., the discharge line should be disconnected from the injection valve, if no by-pass valve is attached. The pump should then be primed. This will effect the escape of any air that might be trapped in the pump cylinder.

In case the engine, on starting, fails to fire on any particular cylinder, the pump is probably air-bound, and the lines must be freed before oil will enter the fuel valve. At times the fuel-line check valve leaks, allowing air to flow down the pipe to the fuel pump. This will prevent the pump from delivering any oil.

Valve Grinding.—In grinding any poppet-type valve powdered glass, or emery flour, and vaseline make the best compound. The operator must exercise judgment in the amount of pressure exerted on the valve as it is rotated. If the pressure is excessive, the compound will groove the valve faces.

When a discharge valve or suction valve is under suspicion, the best method of ascertaining if it actually leaks is to disconnect the discharge line and place on the coupling a high-pressure gage. The engine can be turned over until the pump discharge pressure registers the usual value, 900 lbs. with closed nozzle and about 200 lbs. with open nozzle. The engine should then be stopped and the discharge pressure noted. If it falls, it can be taken as an indication of a leaky valve.

CHAPTER XI

GOVERNORS

TYPES. ADJUSTMENTS

Governors.—When an engine is carrying a constant load, the fuel pump delivers to the engine cylinders just enough fuel to enable the engine to overcome the resistance at the flywheel and the frictional resistance of the engine itself. This condition never exists in a power plant. The load may decrease, with the result that the fuel injected into the engine cylinder is greater than is necessary to overcome the lessened load. The engine would then speed up and wreck itself. If the load increased, the fuel charge would be insufficient and the engine would slow down and finally cease turning. Some form of fuel control is then imperative. On the marine Diesel, when the engineer is in constant attention upon the unit, a manual control is provided. This consists of some form of leverage that alters the pump stroke or the period of pump suction valve opening. Even with the marine engine an automatic overspeed device is usual to prevent disaster in event of non-attention on the part of the operator. The stationary engine receives no such attention since the engineer has many other duties to perform. Furthermore, a speed variation permissible on a marine engine cannot be allowed in an engine pulling either a central station or an industrial load. To obtain the speed regulation that such loads impose the device called a governor is used.

The close regulation of an engine's speed requires that the governor must be sensitive to speed changes. To attain this object the governor should possess a minimum internal frictional resistance, or otherwise too great a speed change will be reached before the governor overcomes its resistance and moves the control lever. It is clear that, without any internal resistance, the governor would respond to an infinitesimal change in engine speed with the result that the speed would be constant, within the power of observation. This internal resistance produces a sluggishness in the governor action which can be given a numerical value by defining it as the proportion which the change in

speed necessary to produce the required governor movement bears to the total speed. That is, if N_1 is the speed at which the engine has been turning and N_2 is the speed the engine attains, at a change in load, before the governor acts upon the fuel pump, then

$$\frac{N_1 - N_2}{N_1}$$

can be termed the sluggishness of the governor. For many kinds of work this value must be as small as possible; a value of $\frac{1}{100}$ is satisfactory in service. To secure this value the governor must be free from excessive friction; in other words, it must be sensitive. This, in many forms of governors, produces a "hunting" effect wherein the governor is constantly changing the position of the weights in order to meet the engine speed changes. Since the governor movement always follows the change in speed, if the governor is sensitive it may over-travel in meeting a speed increase; this over-travel will cause the engine's revolutions to decrease below normal; the latter then produces a governor movement which results in another increase in speed above normal. It is necessary that the governor sleeve has the same lifting force in every position for a given change of speed. Furthermore, the engine flywheel must be of ample size to absorb the speed fluctuations occurring during one cycle of the engine.

To avoid the "hunting" effect mentioned above, some governors are fitted with one of many designs of dashpots. Some of these dashpots consist of oil cylinders containing a piston connected to the governor-sleeve lever, having a passage between the two ends of the cylinder through which the oil can pass. This provides a resistance to prevent a governor movement due to any sudden speed change. The oil flows through the opening, thus allowing the governor to cope with any permanent change in engine speed. This, of course, makes the engine slow in action.

While the desirable governor must not be sluggish, it does not follow that a sensitive governor holds the engine speed within narrow limits on a change from no load to full load unless a correct design of pump is chosen. Much depends upon the effort which must be exerted on the fuel pump mechanism to bring it from its minimum pumping position to its maximum

position. Since a large change in engine speed gives the governor a maximum force to exert on the pump, it follows that the greatest permissible fluctuation in engine speed should be adopted to give the governor a high work capacity. A 6 per cent. fluctuation or 3 per cent. variation above or below normal speed is quite satisfactory for oil-engine governing. It does not follow that this variation occurs on any save extreme load changes. In the load changes that ordinarily take place, the fluctuations would not exceed 1 per cent. since the governor-sleeve travel is small on small load changes.

American Diesel Governor.—The governor of the American Diesel and the Busch-Sulzer Type A engines is of the fly-ball type. The two weight arms *W*, which are held by a spring at *RR*, Fig. 135, act upon a sleeve *S*, which in turn raises or lowers a lever *L*. This lever is connected by the link *K* to the fuel pump suction valve rocker shaft *C* and alters the period of valve opening, as described in the preceding chapter. To absorb small speed variations an oil dashpot, not shown, is linked to the governor-sleeve lever at *J*; a speed regulator is also included, this being in the form of a weighted arm as appears in the illustration at *T*. As a protection in event the governor breaks, a safety weight arm is fitted to the fulcrum shaft. This weight will pull the shaft into the inoperative position if the governor links break. This governor is not of a type that allows any great permanent change in the engine speed; 20 per cent. is as much as can be obtained while maintaining the governor's stability.

Adjustments.—The governor shows a decided tendency to wear at the links and pins. About every two years it is necessary to reream the link-pin bearings and turn up new pins. These pins are best made of brass to allow the wear to occur on the pins rather than on the links. It is much easier to turn up new pins than it is to re-ream the links. For the latter purpose an expansion rereamer is more serviceable than is the ordinary kind. The blades can be extended, giving a greater capacity for reaming.

Jahns System.—The Jahns governor has been adopted by the builders of the Busch-Sulzer Type B Diesel, the Snow Diesel, and the National Transit Diesel.

The construction of the Jahns governor may be readily seen from Figs. 148 and 149. The two weights *AA* are guided in a radial straight line perpendicular to the spindle by three rolls

C on the lower surface sustaining the weights, and two rolls, not shown, on the sides resisting the force of inertia which would tend to keep the weights revolving at the same rate while the engine—and, therefore, the governor casing—increases or decreases its speed by an infinitesimal amount. The centrifugal force of each weight acts directly upon its spring so that all lever joints are entirely free from any centrifugal or spring force.

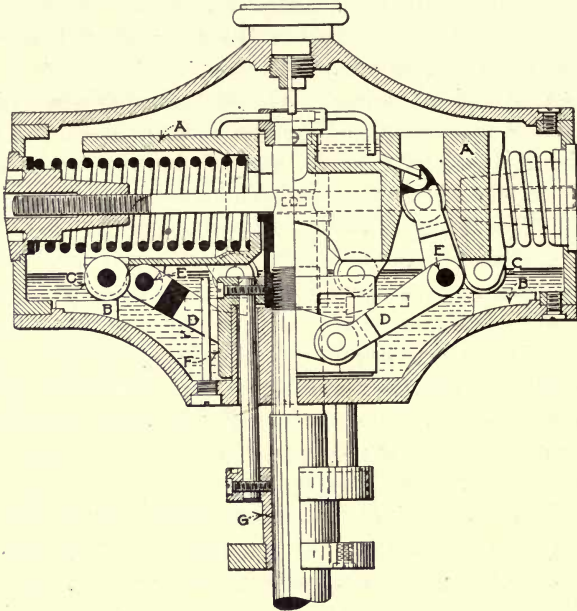

FIG. 148.—System Jahns governor.

The transmission of the motion of the weights to the sliding sleeve on the spindle is effected by the bell-cranks *D* fulcrumed on the lower casing, the upper arms engaging, by means of rolls, the vertical straight slots in the weights, while the lower arms engage sloping slots in the spindle sleeve *F*. The angle of this slope is fixed in such a manner that the centrifugal force of the weights, as transmitted to the sleeve, is a practically constant force, being the same for each position of the sleeve throughout its stroke. The collar *G* to which is connected the pump-control lever receives its motion from the spindle collar.

The Jahns governor casing is entirely enclosed, and all of the lower pins and slides are in a bath of oil. The oiling of the upper pins and slides is effected through the oil cup on the top of the

governor. This oiling can be effected while the governor is in motion. When the oil has attained a certain height any additional amount will cause overflow. This surplus is conducted to the rubbing surfaces of the sliding spool located below and outside of the casing. In this manner every point of possible friction is automatically oiled.

The Jahns governor possesses great sensitiveness owing to its extremely small internal friction and the fact that none of the working parts may become rusted or clogged with dust.

Owing to its low internal resistance, the Jahns governor has great capacity, the percentage of available energy for regulation as compared with the total energy developed by the weights being 99.8 per cent.

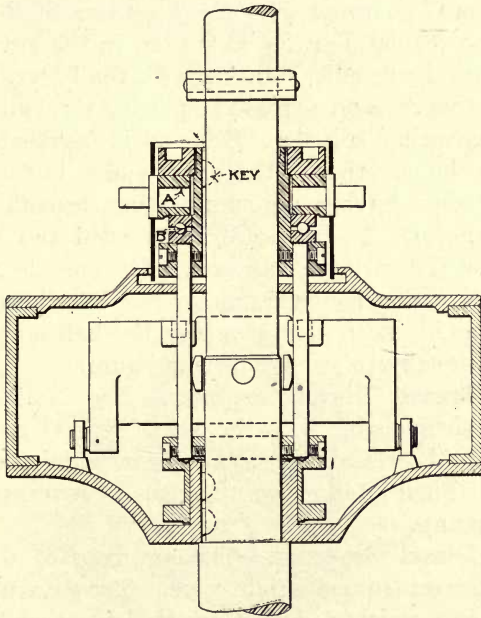

FIG. 149.—Busch-Sulzer type B Diesel Jahns governor.

The Jahns' governor, as supplied on the oil engine, always has a speed regulator attached. This regulator is usually made to give a variation of plus and minus 5 per cent. of the standard speed. The arrangement of the governor and regulator varies slightly in each engine.

Busch-Sulzer Diesel Governor.—The Jahns governor fitted to the Busch-Sulzer engine appears in Fig. 149. The governor

sleeve is placed above the governor case rather than below as is the standard practice. This brings the sleeve within range of the fuel pump. The governor acts on the suction valve, as shown in Fig. 136.

An overspeed governor is also placed on the Busch-Sulzer engine. This is of the ordinary centrifugal weight design. If the engine overspeeds, the weight strikes a lever which releases a catch on a relief valve. This allows the oil to by-pass back to the supply.

Snow Diesel Governor.—The Snow engine is equipped with the Jahns governor with the regulator as appears in Fig. 91. On some of the engines, where a great speed range is required, the class D Jahns governor is used. This governor is identical with the class C governor with the exception of the regulator, Fig. 11. The regulator spring is located in the governor stand and surrounds the spindle, rotating with the latter. The lower end of the spring rests on a cross-key passing through a rod inside the hollow governor spindle. This rod is fastened to the roll sleeve inside the governor. The upper end is in contact with a ball-bearing collar having two ears passing through slots in the governor pedestal. The pedestal is threaded and has a hand-wheel holding the spring collar ears. Turning the wheel gives the necessary spring compression for any speed within 50 per cent. of normal. With this governor the ball-races should be cleaned occasionally to remove dirt and gum.

National Transit Diesel Governor.—The National Transit Co. provide their engine with the Jahns type C governor, Fig. 145, although the class D is used to meet wide speed range requirements. Figure 146 shows the class D governor connected to the fuel pump.

McEwen Diesel Governor.—The governor of the McEwen Diesel is of the centrifugal weight type. The governor, Fig. 150, consists of two weights *A* that are held together by a spring-loaded rod *B* which passes through the engine layshaft. Two sets of bell-cranks connect the governor weights with the governor sleeve *D* and are fulcrumed on the spider *H*. The sleeve *D* extends along the shaft between the two weights and has a yoke and lever connected to the fuel pump wedge. Any change of engine speed causes the weights to take new positions; this shifts the sleeve along the shaft, causing the fuel pump wedge to shorten or lengthen the pump plunger stroke.

Adjustments.—With this type of governor about the only attention required is the cleaning of all the parts. If the pins and rollers are allowed to become foul with grit and grime, the wear will result in considerable lost motion. This causes the engine to be erratic in speed regulation.

Allis-Chalmers Diesel Governor.—The governor of the Allis-Chalmers Diesel appears in Fig. 151. The governor spindle carries a yoke-shaped frame which revolves with the spindle. To the frame is hung two weights which are held together by two spring bolts and one spring. The spring is in tension, rather than compression as is the usual governor practice. At an increase in the engine speed, which is communicated to the weights through the layshaft and the spindle, the weights move outward. The motion is translated to the regulator connection by the yoke levers. The regulator connection raises and shifts the pump lever as described in Chapter XI.

This governor has the advantage that lies in the employment of but one weight spring. It is practically impossible to secure two springs possessing the same characteristics. Where two springs are used the outward travel of the two weights will not be equal, throwing a side thrust on the spindle.

Adjustments.—Speed regulation is secured by the spring bolt, while shifting the weight on the outside lever will give a small speed change.

A disk step bearing is fitted to the base of the governor spindle. This consists of two steel disks and one bronze disk. The bronze disk wears from the weight of the governor and the thrust of the helical gear. As soon as the gear emits a grinding sound, the operator should examine the step bearing since, when it wears, it causes the gears to mesh improperly.

Standard Fuel Oil Diesel Governor.—The Rites Inertia governor is used on this engine. The governor eccentric gives a variable throw to the fuel pump plunger. The governor is fitted with a dashpot to eliminate the super-sensitiveness that is inherent in this form of shaft governor. The governor has the advantage of being extremely simple and devoid of wear with the exception of the governor pin bushing. This must be well lubricated. A change of speed can be secured by altering the spring tension. The regulation can be varied by shifting the location of the spring bolt in the governor slot—moving the bolt in toward the center makes the governor more sensitive.

McIntosh and Seymour
 Fig. 90
 Diesel Governor which

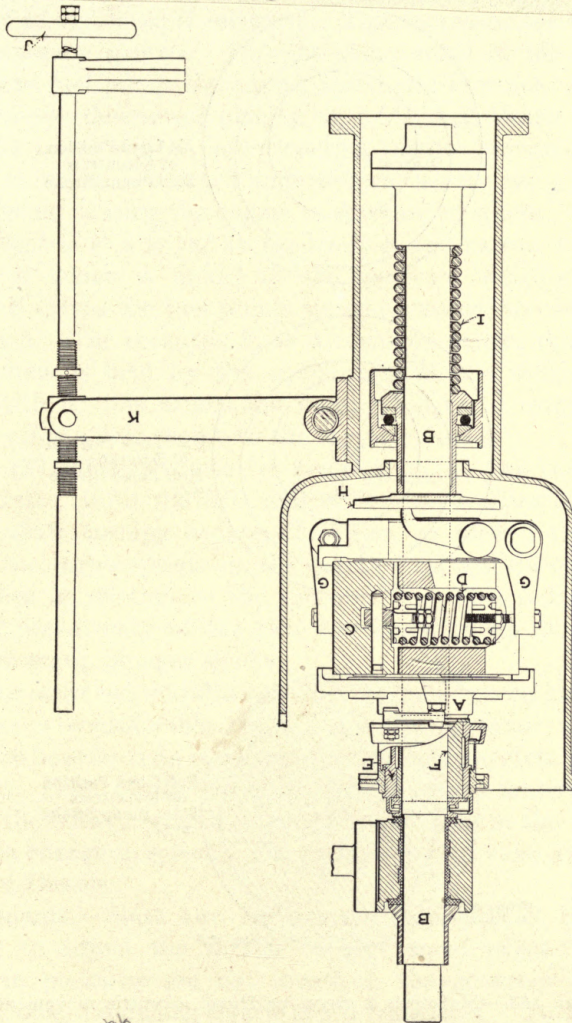

Fig. 152. — McIntosh & Seymour Diesel governor.

a spider *A* which is keyed to the vertical shaft *B* and carries two pins to which are fastened the two weight arms *C*. As the shaft rotates, the weights tend to swing outward, being

In
 to go inside

restrained by the tension of the two springs. One end of the spring is pinned to the weight arm while the other end is held by the spring collar *D* and the bolt to the regulator lever *G*.

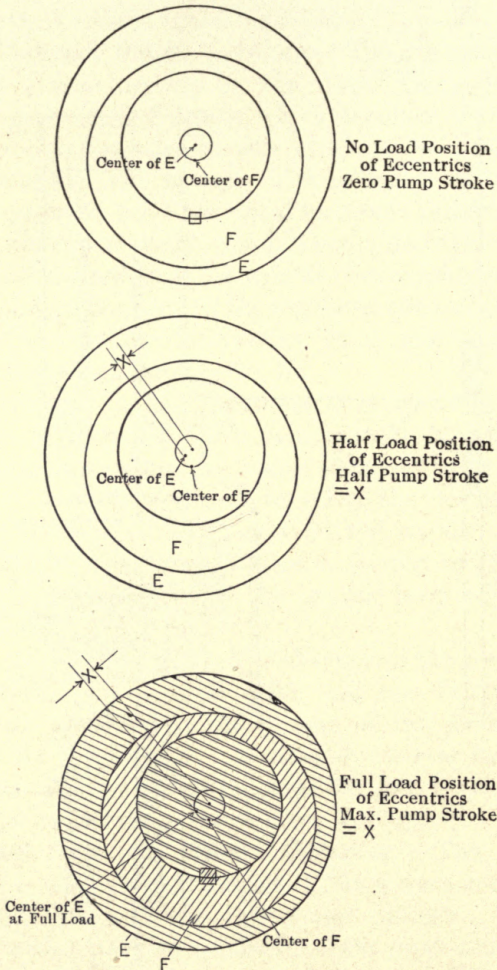

FIG. 153.—McIntosh & Seymour Diesel eccentric movements.

The lower end of this lever rests on the flat collar *H*, which also rotates with the shaft. The thrust of the collar *H*, due to the reaction of the lever *G*, is absorbed by the spring *I*. A regulator shaft and wheel *J* is provided, a movement of which alters

the position of the lever *K*. It is apparent from the drawing that, if the wheel *J* is turned to lift the bearing end of the lever *K*, the thrust of the spring, through the ball-bearing collar, will be less; consequently the collar *H* is raised, throwing the upper end of the lever *G* outward. This increases the tension on the governor springs. Through the control of the weight arms on the fuel pump the engine speed will increase. If this lever *K* moves downward placing an additional thrust on the spring, the latter will be compressed a further amount. This allows *H* to move downward and, in turn, lessens the governor spring tension, causing the engine to decrease in speed.

The eccentric *F* is keyed to the shaft *B* and carries a second eccentric *E* which is linked to the governor weights. This eccentric *E* drives the fuel pump plunger through the eccentric strap shown. The eccentric *F*, as it revolves, carries the eccentric *E*, which is held by the equilibrium of the weights and springs, with it; this causes the pump plunger to reciprocate, thus delivering a fuel charge to the engine cylinder.

Figure 153 shows the relative position of the two eccentrics when at rest. Both the left- and right-hand engines have the governor shaft turning counter-clockwise, as viewed from the top. As the engine speeds up, the weight arms pull the eccentric *E* clockwise in relation to the eccentric *F*. This reduces the combined eccentricity of the two eccentrics, which action decreases the pump plunger stroke.

It will be observed that this acts directly on the pump governor; this places a considerable reaction on the governor and the weights are heavier than is required on a spilling system governing device. The double eccentric design assists materially in reducing the effort required to produce a change in the pump's stroke at a change in speed. The regulation is as close as occurs with other Diesels.

Adjustments.—Since two springs are employed, it becomes necessary to adjust the springs to give equal effect. If the weight-arm positions are not identical, the governor will be out of balance, producing erratic speed regulation. To equalize the two spring tensions, the spring collar *D* can be screwed into one of the springs a fractional part of a turn, thereby increasing the tension on this particular spring.

The eccentrics must be well lubricated to reduce the wear occasioned by the pump reaction.

The weight of the entire governor assembly is supported by the ball bearing *A*, which is shown in Fig. 154. This bearing

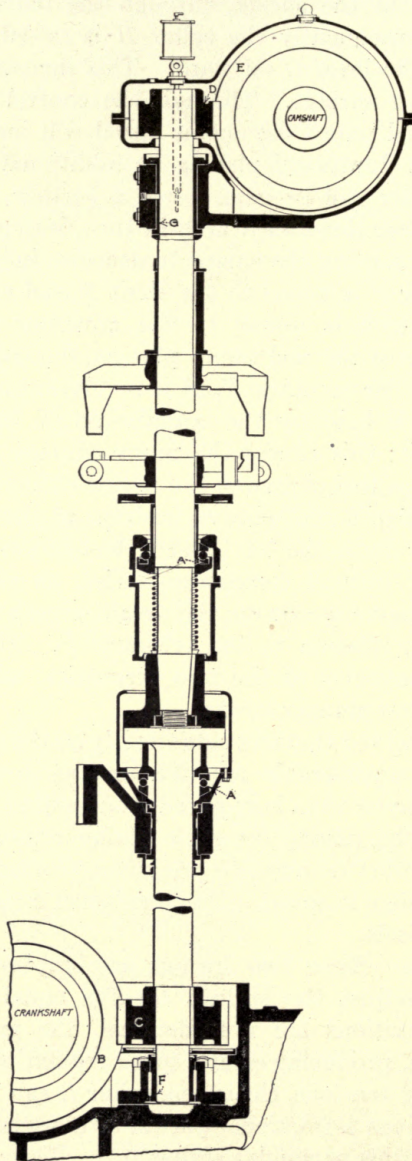

FIG. 154.—Governor shaft drive, McIntosh & Seymour Diesel.

also receives the downward thrust of the upper set of helical

gears *D* and *E*. Precaution must be taken to replace any broken balls, and all wear of the ball-race must be taken up by shimming under the case which is supported by the bracket. If the bearing lowers, the upper gear train will not mesh properly. This produces severe cutting of the gear teeth and increases the side pressure on the upper bearing *G*. If this bearing wears, the shaft is thrown out of plumb, placing a side pressure on the lower bearing *F*. Since this bearing *F* is rather inaccessible, the average operator neglects to inspect it for wear.

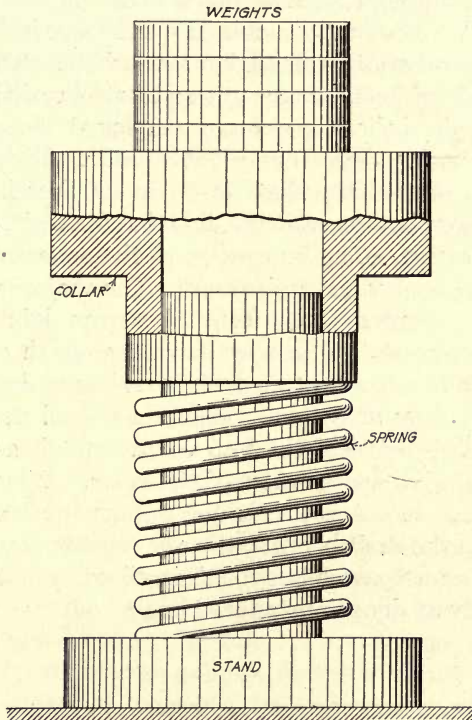

FIG. 155.—Device for testing governor springs.

General Adjustments. Governor Springs.—It is impossible to secure satisfactory functioning of a governor employing two springs unless these springs are of the same diameter wire and have the same number of coils and diameter of helix. Even with these features identical in two springs, the spring action may vary as a result of a difference in the heat treatment. In replacing governor springs the spring should be checked. A

small stand and weight collar, such as is illustrated in Fig. 155, enables the engineer to observe the spring action under compression. Placing the spring on the stand, weights are added to the collar, and the spring compression in inches noted at each increment of weight. Comparison of springs then becomes a simple matter. The weights can be made of lead rather than of iron, thereby reducing the size.

Governor Shaft Gears.—Practically all the Diesels have the governor either mounted on a shaft geared to the engine shaft or are driven through such a shaft. On the vertical engine the governor is customarily mounted on the vertical shaft connecting the camshaft to the engine crankshaft. This involves the use of a set of gears at the top and bottom of this vertical shaft; ordinarily helical gears are employed since the gear diameters can be kept within reasonable limits. Figure 154 outlines the gear of the McIntosh & Seymour Diesel. With all helical gears there is a thrust in the direction of the driven shaft.

Gear Lubrication.—The lubrication of the governor-shaft and layshaft gears is of vital importance. The majority of engine builders have adopted some form of stream lubrication. If this is to be successful in keeping down gear-teeth cutting, the oil must be fed in a heavy stream—it is useless to deposit the oil on the teeth a drop at a time. Much of the oil never reaches the pressure line between the two contact teeth as the teeth squeeze the oil film out the sides of the gears. When the gears show a tendency to cut, which is due to poor lubrication rather than to play in the shaft bearing, the sole remedy is the adoption of an oil having a heavier body. This oil will not flow off the teeth as readily as does the standard engine oil.

CHAPTER XII

AIR COMPRESSION SYSTEMS

TYPES. ADJUSTMENTS

Air Compression Systems.—The air that is employed in injecting or blowing the fuel charge into the engine cylinder must necessarily be at a high pressure. Since the force that produces the flow of air into the cylinder against the resistance of the fuel valve atomizing disks is the difference in the injection air pressure and the engine compression pressure, it is evident that the air pressure must be above the compression pressure of approximately 500 lbs. To insure a thorough nebulization of the oil and a rapid rate of injection, the air pressure must exceed the value by several hundred pounds. The design of fuel atomizer governs the required air pressure; this pressure will range from 1050 lbs. to 850 lbs. per sq. inch at full load.

The production of this extremely high air pressure becomes one of the serious problems of Diesel engine construction and operation. The ordinary commercial air compressor is of too light a design to guarantee continuous service; consequently all Diesels are equipped with compressors that have been developed especially for this service. While a few of the first Diesels used a single-stage compressor, all modern engines have either a three- or two-stage compressor. The air temperature due to a final pressure of 900 lbs. is high enough to ignite the lubricating oil if any is trapped in the pipe line. To overcome this as well as the objection of having a large diameter compressor cylinder exposed to this high pressure, the compression is divided into stages with inter-coolers placed between these stages. This design places but a small pressure on the low-pressure cylinder and allows the temperature of the air, after leaving each stage, to be reduced to approximately the temperature of the outside air. The high-pressure discharge temperature is then around 150° Fahrenheit rather than 1500° or more which would exist without inter- or after-coolers. Some engineers consider that this between-stage cooling reduces the power consumption of the air compressor. Considering the same volume of air compressed

with and without inter-cooling, there is a saving from inter-cooling. However, since without inter-cooling either the discharge pressure or discharge volume will be greater than with cooling, a smaller volume of air could be compressed under non-cooling conditions to perform the same degree of atomization. The practical advantages of inter-cooling are the lessened danger of cylinder fracture, the freedom from explosions of lubricating oil that might collect in the discharge piping, and the better service obtained from the compressor valves while working under a fairly small temperature range.

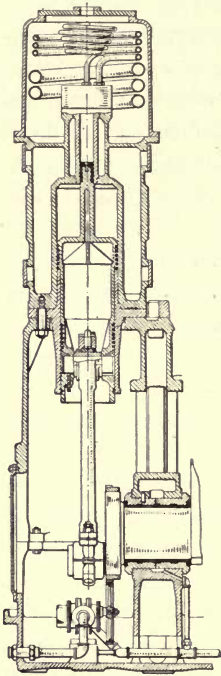

FIG. 156.—Three-stage compressor.

Compressor Stages.—In engines ranging over 150 h.p. capacity it is customary to employ a three-stage compressor. With the smaller units a two-stage compressor is more generally used. The volume of air required for these smaller-powered engines is such that the cooling effect of two stages and one inter-cooler is ample to remove the objectionable temperature conditions. The three-stage compressor customarily has the cylinders placed in-steeple or escalon, wherein the high-pressure cylinder is mounted above the low-pressure cylinder while the intermediate compression space is between the bottom of the low-pressure cylinder and the top of the low-pressure piston, the latter being turned with a barrel smaller than the head, as is outlined in Fig. 156.

Independent Air Compressors.—The first Diesels manufactured in the United States were equipped with belt-driven three-stage straight-line air compressors. The difficulties experienced with the breaking and slipping of belts resulted in the adoption of compressors directly connected to the engine crankshaft. The independent compressor has certain features that are of advantage in Diesel practice. If two compressor units are installed with independent motor drive, either belted or geared, there is no danger of plant shut-down owing to compressor trouble. Since at least 50 per cent. of the breaks in Diesel operation con-

tinuity are attributable to trouble with the air compressor valve, it must be conceded that any system that will enable the engine to continue functioning in the face of a broken air compressor valve ought to be welcomed. In a number of plants where a modern Diesel with direct-connected compressor is installed by the side of an old Diesel with an independent motor-driven compressor, it is quite common to see the engineer start up the independent compressor to relieve the engine compressor because of a faulty valve. Without the independent compressor such a plant would be helpless in case of accident, if, as is usual, the plant load is so large that it cannot be handled with one engine disabled. For these reasons, each plant should possess one motor-driven compressor of a capacity sufficient to handle the largest engine installed in the plant even though the engines have built-in compressors.

Built-in Compressors.—As has been heretofore mentioned, all the modern Diesels have the air compressor built onto the engine frame, being driven by a crank on the end of the crankshaft. As previously outlined, this has the objection of entailing an engine shut-down in case of compressor failure. On the other hand, the direct-connected unit simplifies the plant installation and brings this important auxiliary under the eyes of the engine operator. This insures a better lubrication treatment and places the compressor in a light, dustless location. Moreover, this design entails the employment of a minimum amount of pipe. Engines having the closed-nozzle fuel injection valve are ordinarily provided with air bottles in which is stored an excess supply of air. These engines can be satisfactorily charged from a separate compressor unit. The engines employing the open-nozzle valve seldom have air bottles; the air enters the atomizer direct from the compressor. With these engines, before an independent compressor can be used, some manner of air bottle must be added to the equipment since the independent compressor never runs at engine speed.

Beyond these, there are no other advantages in the direct-connected compressor for stationary engines. With engines of variable speed, such as marine engines, the built-in compressor is essential if maximum economy is to be secured. On slow speed the amount of air needed at the injection valve is less than on full speed, the ratio being approximately identical with the ratio in speed change. If an independent compressor

charged the engine, at slow speed an excess amount of air would be compressed and ultimately lost through the relief valve. Since the direct-connected compressor operates at engine speed, the rate of compression output is the same as the rate of demand.

Busch-Sulzer Diesel Air Compressor.—A three-stage air compressor is incorporated in the design of the Busch-Sulzer Class B engine. The compressor cylinder assembly is bolted

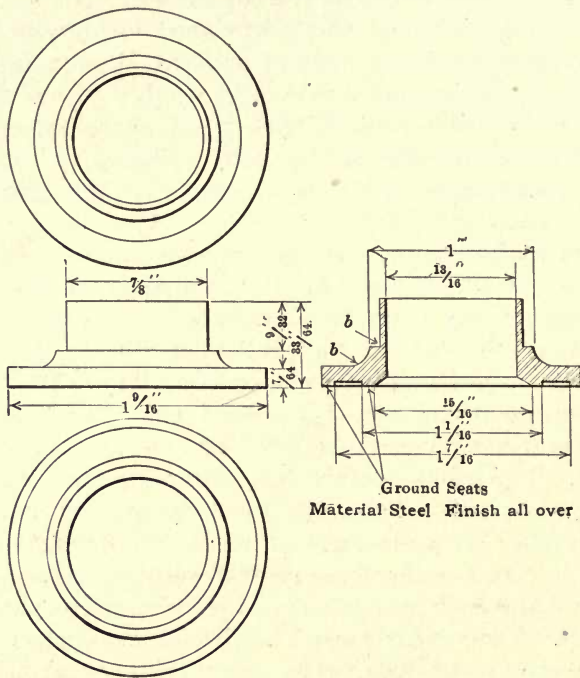

FIG. 157.—Busch-Sulzer Diesel air compressor valve.

to the engine frame, giving the appearance of a fifth cylinder. The low-pressure cylinder casting is bolted to the frame with the high-pressure cylinder above it while the intermediate cylinder is formed by the stepped piston, being between the piston barrel and the low-pressure cylinder walls. All the valves are similar to the high-pressure suction valve shown in Fig. 157. These valves are of the flat-seated poppet type and are made of alloy steel. The operator of this engine should keep on hand a complete set of spare valves since they frequently break at the point *b*, Fig. 157. There is serious question as to the under-

lying cause of this valve fracture; it is probably due to too great a valve lift, resulting in hammer blows as the valve falls back on its seat.

With this air compressor is furnished three air bottles—two for storage and one for the starting air. The air is cooled both between stages and after passing the high-pressure discharge valve. The cooling is effected by copper coils placed in the top of the compressor jacket and surrounding the high-pressure cylinder.

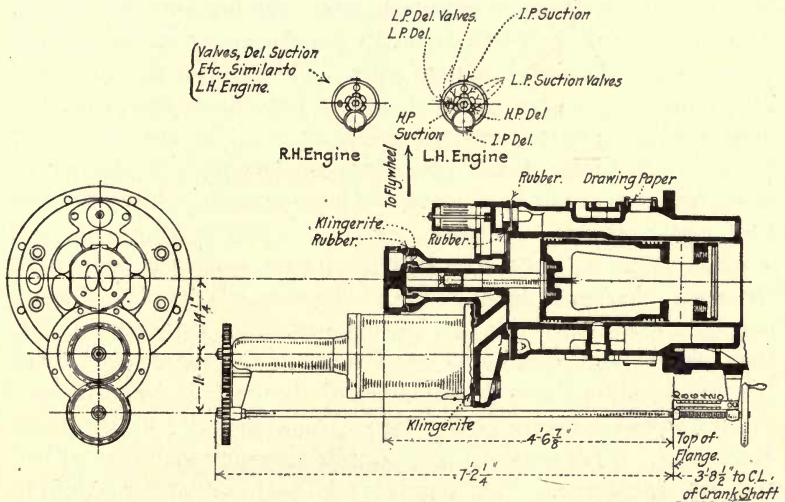

FIG. 158.—McIntosh & Seymour marine Diesel air compressor.

Air Pressure Regulation.—To give a variable air discharge pressure dependent on the engine load, the suction of the low-pressure cylinder has a damper under control of the engine governor. On low loads the movement of the governor sleeve partially closes the suction opening. This results in a low air discharge pressure. To the discharge of the low-pressure cylinder is connected the servomotor which controls the fuel valve opening and closing points. As the air suction is throttled, lowering the low-pressure cylinder terminal pressure, the servomotor piston moves under the influence of a spring which overcomes the lessened air pressure on the opposite side of the servomotor piston making the fuel valve open late and close early.

McIntosh & Seymour Marine Diesel Air Compressor.—Figure 158 outlines the compressor of the McIntosh & Seymour

Marine Diesel. The compressor is three stage and is placed at the front end of the engine, being driven by an overhung crank on the engine shaft. The low-pressure and intermediate cylinders are cast together as shown in Fig. 158, while the high-pressure cylinder is in one piece with the low-pressure cylinder head. The low-pressure suction and discharge valves are all in the low-pressure cylinder head; the intermediate-pressure valves are arranged around the cylinder barrel and the high-pressure valves are in the high-pressure cylinder head. The air, after leaving the low-pressure cylinder, enters the low-pressure cooler. This is a steel tank in which the air circulates, while the cooling water flows through copper coils. This allows the moisture in the air to condense and rest at the bottom of the tank; the plan is superior to that one where the air is in the coils since with the latter there is a decided tendency on the part of the air to hold the moisture in suspension. The intermediate-pressure and the high-pressure discharge air lines enter a common tank where the air currents circulate in separate coils of copper while the cooling water is flowing around the coils. This plan of using a common cooling tank has the advantage of reducing weight, but, even though it is quite usual to so design the coolers, there is some question about the efficiency of the cooling system.

The air compressor is supplied with a pressure and volume Regulator. This appears in Fig. 158 together with the control rod and indicator. This regulator is a cylinder connected to the low-pressure air cylinder and contains a piston that is raised and lowered by the control rod acting through the gears at the top of the regulator. By the proper displacement of this piston the low-pressure cylinder volume is altered to give any desired high-pressure discharge pressure. The indicator scale on the handwheel shaft is marked with the same load points as is the fuel control lever. The operator, then, on throwing the fuel injection control to full load moves the air indicator to the corresponding point. This gives maximum air pressure for a maximum fuel charge.

The compressor valves closely follow the design appearing Fig. 157. The material is a nickel-steel alloy heat-treated and toughened. A valve lift of .03 inch is about the most advisable value to use.

McIntosh & Seymour Stationary Diesel Air Compressor.—The stationary engine's compressor is practically the same as the

compressor of the marine engine, though the regulator is not included.

The chief points of attention are the valves and the connecting-rod boxes. The former frequently break at the junction of the "brim and crown." This is usually attributed to an excessive lift of the valve and can only be avoided by valve replacement when the lift becomes more than .05 inch. To avoid air leakage the valve seats must be well-nigh perfect. To regrind a valve only a small amount of powdered glass and vaseline should be used. The slightest scratch on the seat surface will destroy the valve's usefulness.

The connecting-rod brasses require attention more than do the main engine rods. The current of air passing through the compressor frame deposits dirt and grit on the bearings that soon reveal their presence by overheating.

The control of the air pressure is attained by the regulation of the valve leading to the starting tank; opening this allows part of the air compressed to enter this tank, lowering the pressure in the line to the fuel pump. Two running air tanks and one starting tank are supplied for each engine.

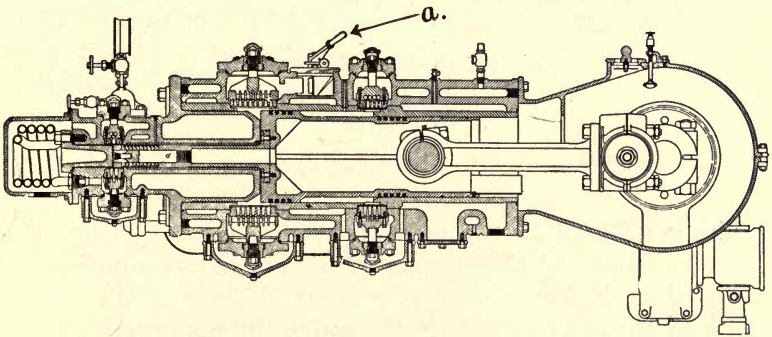

FIG. 159.—Snow Diesel three-stage air-compressor.

Snow Diesel Air Compressor.—The Snow Diesel is equipped with a three-stage compressor, the piston being of the stepped type, although the smaller units are fitted with two-stage compressors. The three-stage unit cross-section appears in Fig. 159. The valves are of the flat feather type, which are of light steel strips restrained at the ends and free to lift from the seat to allow the air to pass. This valve design permits the valve to seat fairly gently without danger of fracture due to hammering; the frac-

tures that do appear are caused by "fatigue," resulting from continual bending of the steel fibres.

The compressor is arranged with inter-coolers between the stages. These are formed in the cylinder jackets. The high-pressure discharge passes through a cooling coil placed in the high-pressure cylinder cover.

Pressure control is obtained by altering the low-pressure suction area through the hand lever *a*.

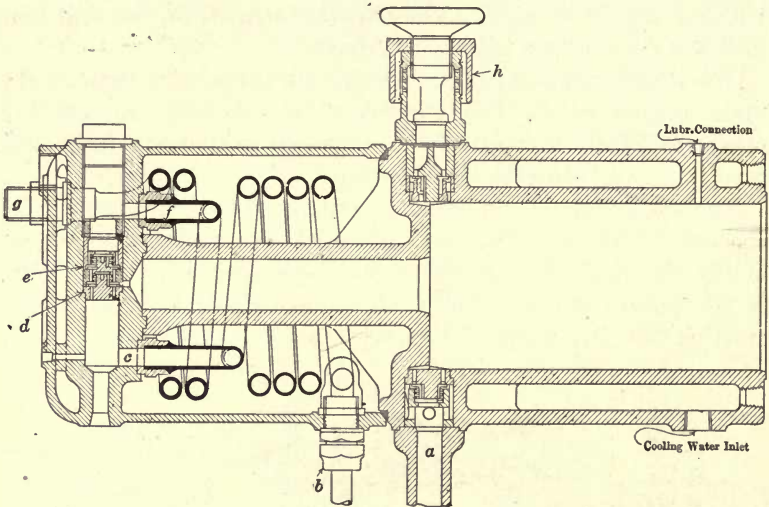

• FIG. 160.—McEwen Diesel air compressor.

McEwen Diesel Air Compressor.—On the small- and medium-powered McEwen Diesel engines a two-stage compressor is mounted on the side of the engine frame, Fig. 160. This stepped piston is driven by a crank on the end of the engine shaft. The valves are of the standard "plug hat" form. The two cylinders are water-jacketed, and the inter-cooler and after-cooler coils, of copper tubing, are placed in the high-pressure cylinder jacket. The air, after leaving the low-pressure discharge at *a*, passes through an oil separator before entering the inter-cooler coils at *b*. After being cooled, the air issues from the coil at *c* and enters the high-pressure cylinder through the high-pressure suction valve *d*. After being compressed, it is forced out the discharge valve at *e* into the after-cooler coils at *f*. It leaves these coils at *g* and flows to the fuel valve.

Pressure control is achieved by regulating the suction opening at *h*. The valve lifts should be between .03 and .04 inch.

No air tank is interposed between the compressor and the fuel valve; consequently the air charge for both compression strokes of the air compressor enters the fuel nozzle on the power stroke of the engine. The air line is of some volume; therefore the drop in the discharge air-line pressure at the point of injection valve opening is but slight.

National Transit Diesel Air Compressor.—The National Transit Diesel has a two-stage compressor bolted to the engine frame, the piston being stepped, and driven by a crank on the end of the engine-shaft. The two cylinders and the valve-cavity covers are water-cooled; an inter-receiver between the two cylinders serves as an inter-cooler as well. Regulation is obtained by hand control of the suction opening.

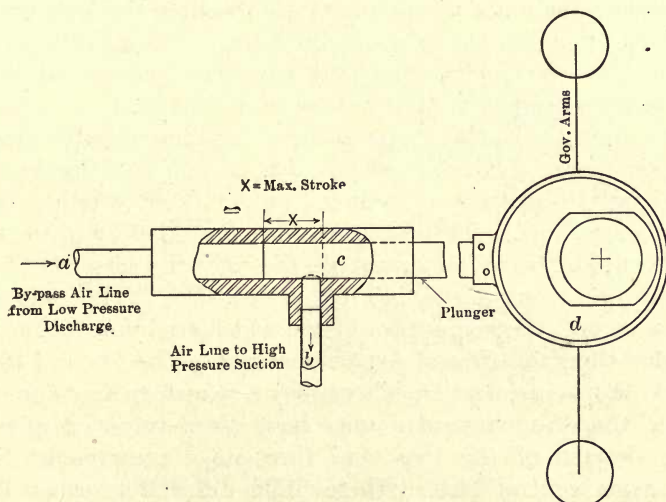

FIG. 161.—Standard Fuel Oil engine injection air pressure control.

Standard Fuel Oil Diesel Air Compressor.—A two-stage compressor is driven by a crank off the engine crankshaft, Fig. 98. While the compressor is only two-stage, it has a three-stage effect. The air is compressed in the scavenging cylinder of the engine to from 7 to 11 pounds gage. It then passes into a receiver from where it is blown into the engine working cylinder during the exhaust portion of the cycle. The suction of the low-pressure air-compressor cylinder is connected to this scaveng-

ing air receiver; consequently the low-pressure cylinder is in effect an intermediate cylinder.

The discharge from the low-pressure cylinder is piped to the starting air tanks. A connection on this line leads to the pressure control, Fig. 161. The air enters the control body at *a*. The plunger is under the control of the engine governor, altering its stroke according to the load carried. As the plunger moves to the right, the port *b* is uncovered, and the air flows through the port *b* back to the suction of the high-pressure cylinder of the air compressor where it is further compressed to about 900 pounds. From the high-pressure discharge the air is forced into the fuel valve.

It is apparent that, with the larger volume to be compressed, the final pressure at the fuel valve is high, as is desirable, at full load. On lower loads the plunger uncovers less of *b*, allowing a corresponding smaller amount of air to enter the high-pressure cylinder, reducing the injection pressure. This injection control is very close in regulation; a hand adjustment allows any desired pressure to be secured at any set governor position.

At first glance, this seems to involve a considerable air-compression loss. However, all air that is not used in the high-pressure air-compressor cylinder enters these starting tanks. A relief valve permits the excess above the capacity of the tanks to pass into the scavenging tank, the valve being set to lift at a pressure of from 100 to 140 lbs. per sq. inch. This reduces, to some extent, the compressor losses, which are by no means high.

Allis-Chalmers Diesel Air Compressor.—The 14- and 16-inch stroke Allis-Chalmers Diesels employ a two-stage air compressor, while the 18-inch stroke units have three-stage compressors. The designs of the two- and three-stage compressors follow the same general lines. These units differ from most Diesel compressors in that the inter-coolers are not placed in the high-pressure cylinder head jacket. Each cooling coil is placed in a cavity in the base of the compressor casting, which is in the form of a cast-iron drum. The air from the low-pressure discharge enters an air pot or receiver; a copper pipe is coiled about the pot and is connected to it. Both coil and pot fit into the cooling drum. In Fig. 12 the compressor is shown in position on the engine frame. On the two-stage compressor the air, after passing through the inter-cooler coil and pot, is compressed in the high-pressure cylinder; the air is then discharged into the after-cooler

air coils which are placed in the after-cooler water pot. On the three-stage compressors two inter-coolers are used. The valve and cage appear in Fig. 162.

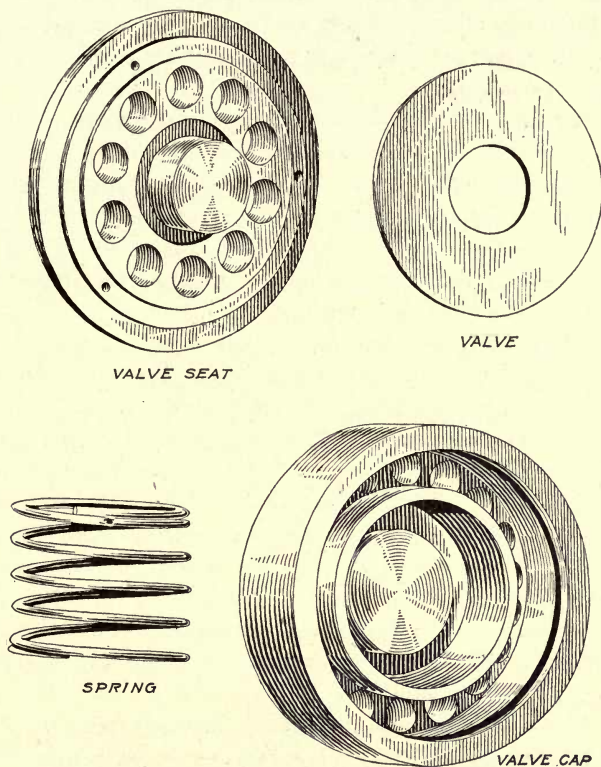

FIG. 162.—Allis-Chalmers Diesel air-compressor valve.

Compressor Valves.—The engineer should early recognize the serious part the air compressor and its valves play in the successful operation of the engine. The compressor must function continuously and perfectly. To attain this, the air valves must be kept in first-class condition. The least amount of wear destroys their usefulness. The lift of the valve should be as small as is possible while maintaining a full air opening. If an excessive lift is allowed, the valve will hammer on its seat, damaging both valve and seat. Often compressors are discovered emitting a sharp click as the valves seat, with the operator perfectly satisfied with the engine's performance. Usually

a week of continuous operation ruins such valves. In regrinding all types of poppet valves, a very meager amount of powdered glass and vaseline is used. The valve should be rotated very lightly, with no pressure exerted on it and the valve cage. After grinding, all parts must be thoroughly washed with kerosene or gasolene. A defective valve reveals itself in the change in the air pressure.

Air Suction.—If the plant is at all dusty, an air pipe with the free end covered by a fine mesh screen should be run from outside of the building. If this is not possible, the suction connection at the compressor should be screened with a fine-mesh netting, covered with muslin. The dust will collect on the screen, and the engineer need not be informed that he must clean this screen at least once a week.

Air-compressor Lubrication.—This will be more fully discussed in the chapter on Lubrication. The engineer is quite safe in following factory instructions as to the amount of cylinder lubrication he should use. It is not advisable to increase the amount recommended, since any oil that is not destroyed in the cylinder will collect in the air piping. This oil deposit will quite likely explode, especially if the air temperature is not maintained below 150°. As a safeguard, the discharge line should be equipped with an oil separator and relief valve. The latter is absolutely necessary. A precaution that can well be observed in every plant is the daily purging of the air line and bottles of all collected oil and moisture.

Air Pipe.—All manufacturers supply air piping of ample strength. Occasionally on second-hand, or rearranged, installations new lines are erected. It is never advisable to use steel pipe less than double extra heavy, though copper pipe is far better. The fittings should be of ground-joint, gasketless design; not only should the pipe be screwed into the fitting flanges, but the latter should have set-screws locking them to the pipe. Some plants use a Van-Stone joint or a welded connection. These are excellent but are ordinarily impossible to obtain for a small line. The pipe line is best run with the smallest possible number of fittings since each is a potential source of trouble.

Air Bottles.—The typical air receiver or bottle is made of steel with all joints welded. It is always advisable to have a drip cock or plug at the base of each bottle to draw off the moisture occasionally. It is usual to carry the air pressure at approxi-

mately 1000 pounds, though this varies with the load conditions. In operating, one bottle should be used for starting purposes only, and, after charging to about 1000 lbs. per sq. inch, this bottle is cut off from the air line by closing its needle valve. Of the other two, if only three are supplied with the engine, it is good practice to carry one fully charged while allowing the other to float on the air line. With this arrangement, in case of a failure of the air line, a starting and a running bottle are on hand fully charged.

The open-nozzle engines are not equipped with air bottles, since the air passes directly to the injection valve. For starting purposes one or more steel tanks are employed, the air being around 200 to 250 lbs. per sq. inch. To charge, the excess air from the compressor is piped to the tanks. An engineer should always charge these tanks promptly after starting the engine. Many Diesels have been condemned as unsatisfactory in operation when the fault was attributable to the engineer's carelessness in failing to have the air tanks fully charged.

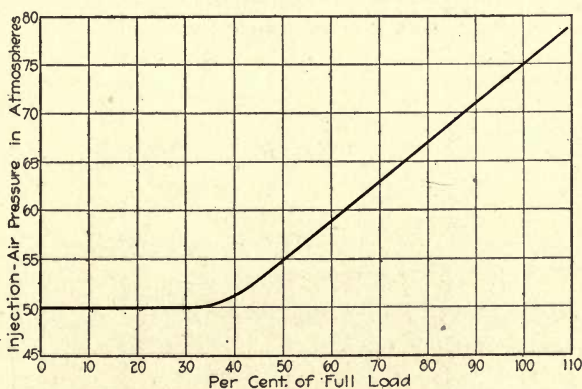

FIG. 163.—Injection-air pressure.

Injection-air Pressure.—Each design of fuel atomizer requires a certain air pressure to properly inject the oil. This pressure will vary with the resistance or “braking” action of the atomizer disks. It follows that no set pressure values can be given which will apply to all engines. However, the curve in Fig. 163 gives the relation between engine load and injection pressure that is correct for practically all closed-nozzle engines. For open-nozzle units the pressure will run some 50 to 100 pounds lower than is given in the table.

The engineer should recognize that on light loads the injection pressure must be lower than is required on full load. If the pressure is not reduced, the air will "slug" the oil into the cylinder since there is practically no atomizer resistance. The engine will then smoke badly. Conversely, with full-load fuel charges a low air pressure will not be sufficient to force the large oil charge through the disks. Still another condition necessitates higher pressure on full load. When the engine is carrying a heavy load, the cylinder heats up, causing the fresh charge of air in the engine cylinder to have a higher terminal pressure resulting from the increased absorption of heat. To obtain a given pressure drop in the atomizer, the air injection pressure must be increased.

CHAPTER XIII

COOLING SYSTEMS

TYPES OF SYSTEMS. PUMPS. WATER PURIFICATION

Distribution of Heat Losses.—Various experiments on the subject of Diesel heat losses check very closely as to final results. The consensus of opinion is that the total heat evolved in the combustion of a charge of oil in the engine cylinder is absorbed in doing work and in various losses in the engine at the following percentages:

Heat generated in the cylinder.....	100
Heat converted into work.....	30
Heat lost in engine friction.....	6
Heat lost in the exhaust gases.....	28
Heat absorbed by the cooling water.....	34
Heat lost by radiation, etc.....	2

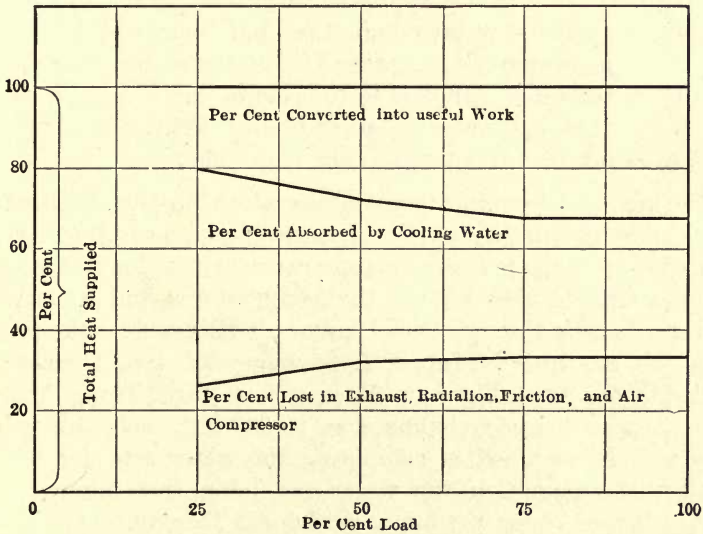

FIG. 164.—Heat distribution in Diesel engines.

Figure 164 covers the losses at various loads. These values are the result of a number of experiments on various engines. If the work done is 30 per cent. of the heat generated, then the engine will consume 8470 B.t.u. per b.h.p. The cooling water must be of a quantity sufficient to absorb 34 per cent. of the amount or 2879 B.t.u., in round numbers 3000 B.t.u. per hour.

Cooling Water Required.—The calculations necessary to employ in determining the amount of cooling water required for a Diesel are quite simple. As an example of the maximum amount that could be used, the intake water temperature at the jacket entrance can be taken as 90°. This is at least 10° higher than normal, even with a cooling pond. The engine discharge water temperature can be taken as 140° Fahrenheit, which is 20° below the value most successfully used. Then the rise in temperature will be 50°; consequently each pound of water will absorb 50 B.t.u. The water per h.p. hour will be

$$\frac{3000}{50} = 60 \text{ lbs.}$$

This expressed in the form of an equation appears as

$$W = \frac{XH}{100(t_1 - t_2)}$$

where

W = weight of water required per h.p. hour.

X = percentage of heat absorbed by the water.

H = total heat supplied to the engine.

t_1 = discharge water temperature deg. Fahr.

t_2 = intake water temperature deg. Fahr.

The inlet and discharge temperatures given may not check with those observed in any particular installation, nevertheless the temperature range is approximately correct; it is this factor that is important. Table I gives the temperatures and quantities of water passing through Diesel engines. This table is the result of a test on three McIntosh & Seymour 500 h.p. Diesels installed by the Texas Light and Power Co. at Paris, Texas. Since these engines were developing close to 500 h.p. each, this value may well be assumed in computing the water rate per b.h.p. With this assumption the water per b.h.p. per minute was $1\frac{25}{100}$ lbs. or 75 lbs. per b.h.p. per hour. This considerably exceeded the value computed above, which can be explained on the grounds that both the exhaust head and air compressor were maintained at a very low temperature. In ordinary operation these engines tested do not carry the exhaust header temperature lower than 130 to 135° Fahrenheit.

The cooling system should then be based on a pumping and cooling tower capacity of at least 60 lbs. per b.h.p. per hour of installed engine rating.

TABLE I.—TYPICAL JACKET-COOLING WATER DATA FOR DIESEL ENGINES
3-500 h.p. McIntosh & Seymour Diesels, 164 r.p.m.

Unit No. 3	Pounds per minute				Temperature (deg. Fahr.)				B.t.u. absorbed per minute			
	Full	¾	½	¼	Full	¾	½	¼	Full	¾	½	¼
Engine pump intake.....	83	83	83	77
Air-compressor discharge.....	48	33	...	44	110	110	101	104	1,796	891	1,188
Inter-cooler discharge.....	None in use	36	106	120	136	110	713	1,221	1,188
After-cooler discharge.....	31	33	...	176	120	118	102	100	4,327	4,865	4,048
Exhaust-header discharge.....	171	139	141	32	138	132	131	132	2,860	2,352	1,760
Cylinder No. 1: Jacket.....	52	48	42	10	102	100	96	92	209	136	150
Exhaust valve.....	11	8	9	10	140	132	130	126	3,192	2,352	1,764
Cylinder No. 2: Jacket.....	56	48	40	36	103	104	98	94	253	168	170
Exhaust valve.....	11	8	9	10	140	132	127	126	3,135	2,352	1,666
Cylinder No. 3: Jacket.....	55	48	43	34	90	104	96	92	84	168	165
Exhaust valve.....	12	8	10	11	144	122	128	122	4,270	2,964	2,205
Cylinder No. 4: Jacket.....	70	76	49	49	105	104	98	96	253	189	190
Exhaust valve.....	11	9	9	10
Total: Unit No. 3.....	528	458	352 ¹	522	21,092	17,658	14,494
Total: Unit No. 2.....	698.5	488	482	23,115	16,921	14,180
Total: Unit No. 1.....	647	499	485	22,975	18,424	13,255

¹ Except for air compressors.

Types of Cooling Systems. Closed System.—Two designs of cooling systems are in quite general use. Figure 165 outlines the closed system often found in small installations. With this design the water from the engine jacket is discharged through a distributing pipe *D* on a cooling tower *C*. The water drips down through the tower and is stored in the sump *A*, from which point it is drawn by the circulating pump *B* and forced through the engine jacket and out the discharge again. When this system is adapted to a horizontal engine, the discharge line should rise

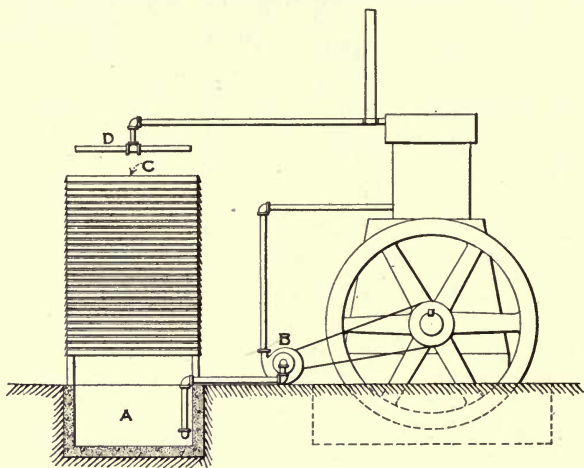

FIG. 165.—“Closed” cooling water system.

vertically from the engine until it is above the cooling tower distributing pipe. With such a layout it is necessary to place a vent pipe in the discharge line, immediately above the engine. This prevents the formation of steam or air pockets in the jacket with consequent overheating of the cylinder.

While the figure embodies a centrifugal circulating sump, this design of pump is one that should never be employed with a closed system. The objection to this pump is based on the liability of losing the suction. This is of frequent occurrence when the drive belt becomes dirty or oily, and in the best-kept plants a belt at times breaks.

There is a serious objection to the closed system that makes its use inadvisable under any condition with a Diesel engine. The discharge, being closed, is not under the observation of the operator. The circulation can be broken without the knowledge of

the operating force; this has resulted in broken cylinder heads and jackets in a number of cases. As a safeguard, a check valve with an outside lever connected to a bell-ringer is recommended.

Open Cooling System.—Figure 166 is the schematic layout of the open cooling system with a storage tank. With this system, the water is stored in the overhead tank and enters the cylinder jacket at *A*; after cooling the engine, the water discharges into the open funnel at *B*, flowing into the sump *C*. A centrifugal pump *D* lifts the water from this sump and discharges it in the

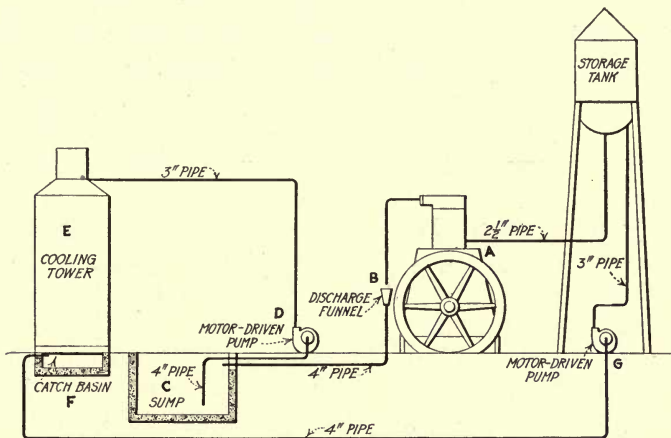

FIG. 166.—Open cooling system with overhead tank.

top of the cooling tower *E*. In dripping down this tower the water is cooled and, collecting in the catch basin *F*, is lifted by the pump *G* and forced into the overhead tower. This system is frequently used without the overhead tank. With this plan the pump *G* forces the water through the engine jacket. It is at once apparent that this latter plan is objectionable since it is dependent on the pump *G* for the steady flow of water. If the suction is destroyed, the system at once becomes dangerous. Low-pressure engines are often installed with this system, but the cost of a Diesel plant is entirely too great to ignore the overhead tank. A 30,000-gallon tank with a 30-foot steel tower can be installed at a pre-war cost of approximately \$3000. The interest on the investment (\$180) is a low premium on the insurance of protection against engine damage due to lack of cooling water.

With a few engines the cooling water, after passing through the engine, is used to cool the exhaust header. With others the water

is first passed around the air compressor and inter- and after-cooler before entering the engine jackets. Results from these cooling methods are fairly satisfactory. The proper cooling pipe layout embodies individual lines to the air compressor and coolers, to each engine cylinder jacket, to the valve cages and to the exhaust headers. All these lines should have brass cocks in the intake side, and the discharges should all lead to a common discharge funnel. Each discharge line may well be fitted with thermometers, while a single thermometer on the intake line before the lines branch to the various parts is sufficient.

Water Pipe.—All the water lines in the engine room are best laid in pipe chases. This places the piping out of sight and provides more room in the plant. The pipe should be extra heavy galvanized pipe; though the pressure is small, this thickness of pipe prolongs the life of the system. The threads in all fittings must be clean and sharp, while the pipe ends should be fully threaded. Red lead or other dope must be avoided, while the unions should have either ground joints or copper gaskets; rubber gaskets are at best of short life, and a pipe line should be made up in such a way that it will never give trouble. In those engines where water is admitted direct into the exhaust pipe, the drip line from the exhaust should not discharge into the cooling-water discharge; due to the carbon in suspension, it is advisable to run this drip to the sewer. Frequently the fuel contains enough sulphur to eat iron pipe if employed in the drip line; consequently brass drips can be more profitably used.

Cooling Towers and Tanks.—As has been already explained, an overhead tank is advisable in every Diesel installation. A steel tower and tank of from 25,000 to 30,000 gallons capacity is sufficient for any installation under 3000 h.p. since in this maximum case a 30,000-gallon tank would provide, in the event of pump failure, cooling water for one and one-half hours. Plants of 300 h.p. or less will find a wooden tank on a wood tower quite satisfactory, Fig. 167. A 12×12 ft. tank of 2-inch cypress staves will hold close to 12,000 gallons and can be erected on a 30-foot tower at a cost of \$1200. A tower made of 8×8 in. yellow pine with the joints reinforced by steel plates and braced by diagonal steel rods is amply strong for this tank.

Regulating Floats.—Every overhead tank should be fitted with some form of high- and low-water alarm. Such a device

appears in Fig. 168. When, due to faulty circulation, the water level in the tank becomes dangerously low, the float strikes the lower collar on the shaft A. Its weight overcomes the resistance of the spring E, and the point F contacts with H, causing a bell

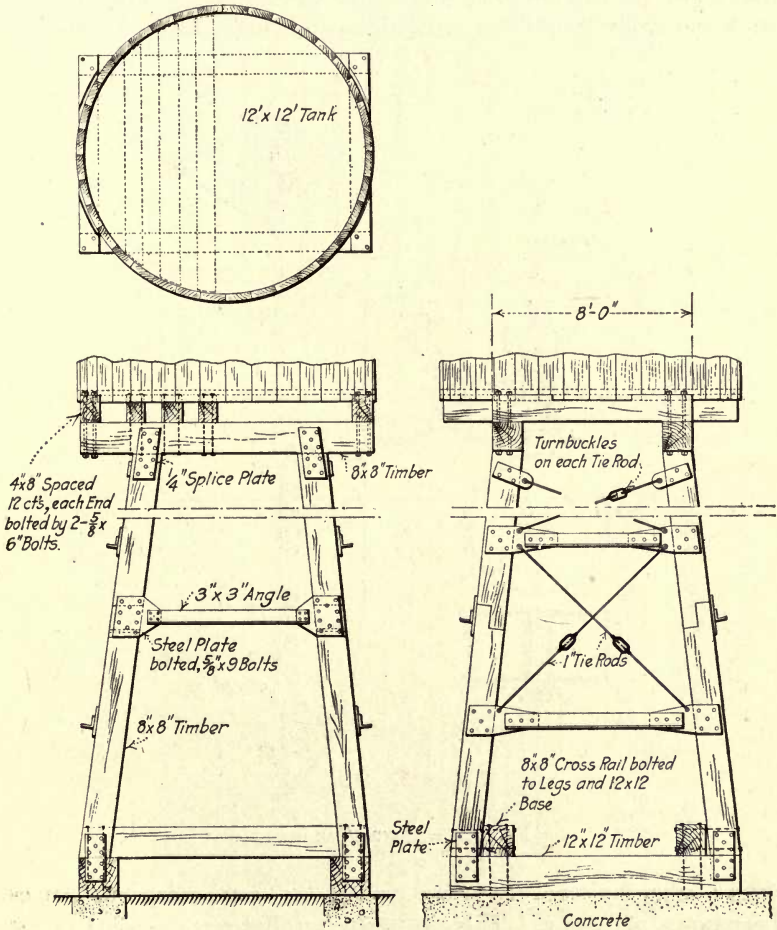

FIG. 167.—Wooden tank and tower.

to ring and lighting up the red globes. If the level becomes high, the green lamps light and the bell rings. In either event the engineer has ample warning that the water tank demands attention. This is a positive safeguard against damage due to a pump failure.

A somewhat similar system can be arranged to operate the starting box of the pump motor as well as to ring an alarm bell.

Cooling Towers.—If a supply of cooling water can be secured from a shallow well, the best plan is to install a power well pump and allow the discharge to waste into the sewer. Unfortunately such a supply is seldom available, and some form of cooling

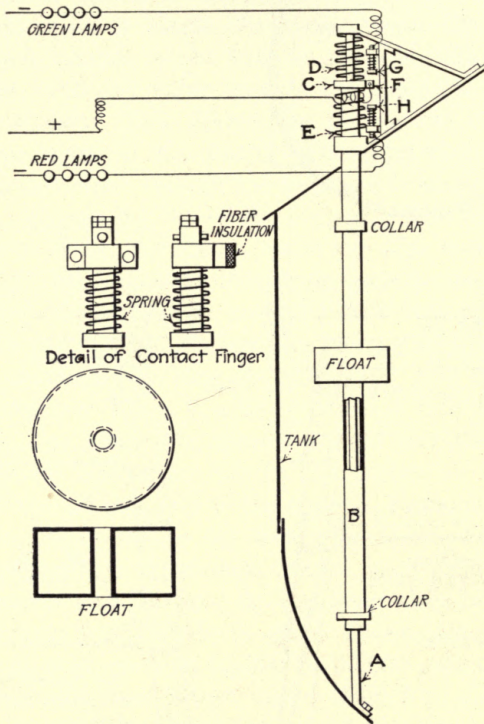

FIG. 168.—Regulating float.

tower whereby the discharge water can be cooled for reuse becomes a necessity. This, in most installations, consists of an upright wooden tower filled with slats down which the water trickles and is cooled by the upward current of air. Like all structures, the tower may be constructed at an expense ranging from a few hundred to several thousand dollars. The former cost covers a simple tower for a small plant, while a large installation demands the more expensive construction.

Plants of 300 h.p. will find the tower in Fig. 169 fairly

economical in first cost and amply large for the required cooling. This tower can be erected at a total material and labor charge of \$300. The sump under the tower is made 24

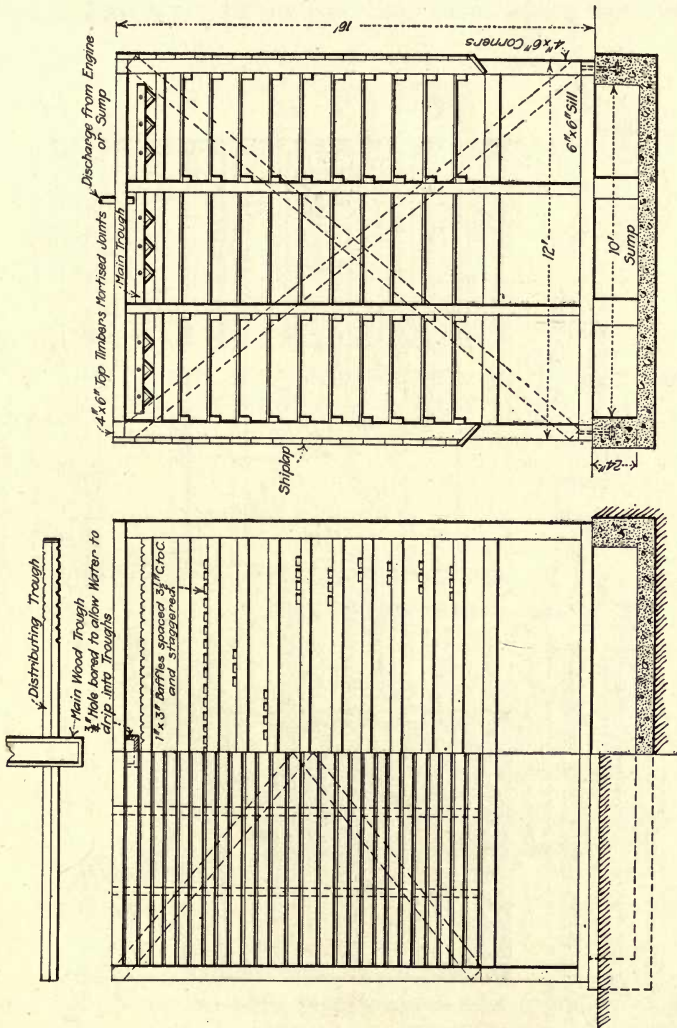

FIG. 169.—Cooling tower for 300 H.P. plant.

inches deep but can easily be deepened at slight expense. The $\frac{3}{4} \times 16$ in. foundation bolts should be inserted at the time the concrete is poured. The frame of 4x6 in. timbers, resting on 6x6 in. sills, is large enough, especially since the ship-lap sides

was not carried down below the bottom baffles. On windy days the water was blown out the open sides at the bottom, causing a washing of the bank and a settling of the tower sills. In erecting a tower, the sides should always be carried well down below the bottom baffles.

For plants having a capacity of 1500 to 2000 h.p. the more elaborate tower design in Fig. 171 will prove more suitable. This tower has the sides covered with louvres while the top is carried above the trough, forming a chimney. This construction provides an increased volume of air passing through the sides while the chimney gives the necessary draft.

Circulating Pumps.—In the small one-engine plants where a single operator cares for the machinery, the most approved type of circulating pump is either an outside packed triplex pump or a horizontal plunger pump. A large percentage of plants have centrifugal pumps, but this type is dangerous in the small plant. If an overhead tank is a part of the installation, the centrifugal pump offers no objectionable feature. In those plants not possessing the protection of the overhead tank, the loss of the pump suction, as often occurs with this pump, is dangerous. The pump, in small plants, should, if possible, be chain-driven from the engine shaft since a broken belt is to be avoided at all costs.

Large installations usually employ motor-driven centrifugal pumps. With the overhead storage as a plant protection, this pump is by far the best for large plants.

In placing the pump, the suction line should be made as short as possible and the lift kept at a low value. In discharging into the overhead tank the pipe should run to the top of the tank rather than enter the tank bottom. This places a constant head on the pump, and, in case the pump suction valve leaks the entire tank will not empty. A by-pass line from the tank bottom can be run into the pump discharge for priming purposes.

Both the tank and the cooling-tower pumps should be installed in accessible places in the plant. The common practice of putting the pumps in out-of-the-way corners has nothing to commend it. The various water lines can be painted in different colors; this enables the operator to trace out a line with a minimum of difficulty.

Effects of Bad Water.—In many Western and Southwestern states bad water is one of the serious problems confronting the Diesel operator. The organic matter in suspension as well as

certain mineral salts tend to deposit in the cylinder jacket and cylinder head. These deposits must be removed if the required cooling effect is to be maintained. Many oil engines have had the cylinders badly distorted as a result of heavy scale formations. Deposits are especially dangerous when formed on the heads of horizontal engines. The expansion and contraction of the metal causes the scale to flake off, exposing a red-hot iron surface to the cooling water. Local fractures result, later developing into cracks across the cylinder head.

When the water scales, a periodic inspection of the jackets is necessary. It is impossible to reach all the scale with a scraper; consequently a muriatic acid solution should be left in the jacket for a few hours, followed up by a thorough flushing with water. If the deposits are heavy, a 50-50 solution of acid and water may be used, though ordinarily a 10 per cent. solution is amply strong.

Practically all mineral salts will not settle at a temperature lower than 150°. If the discharge temperature of the cooling water is maintained below this point but little scale will occur. This low temperature affects the engine's efficiency, but not to any marked extent.

Purification of Water Supply.—If a plant is of considerable size, it is of advantage to install a water purification plant. The type of purification system to be used depends on the results desired.

Sediment. Mud. Sand.—If the water is taken from a stream holding much mud or sand in suspension, a large settling basin with a filter on the cooling-water suction line is all that is necessary to secure a satisfactory cooling medium.

Bicarbonates of Lime and Magnesia.—The removal of these salts requires a purification system involving the employment of chemical reagents. The character of the supply water must be analyzed and the correct system installed. The proper course is to purchase a system from one of a number of well-known manufacturers. This guarantees a certain performance of the apparatus installed. A fair estimate of the cost of a purifier is approximately \$7.50 per horsepower of station engine capacity. The majority of purifiers are based on the lime and soda process where either lime or soda is used as the reagent, at times in combination with other chemicals.

Exhaust Distiller.—The logical method of water purification is the employment of an exhaust distiller. This heater is placed in the engine exhaust line and absorbs part of the heat contained

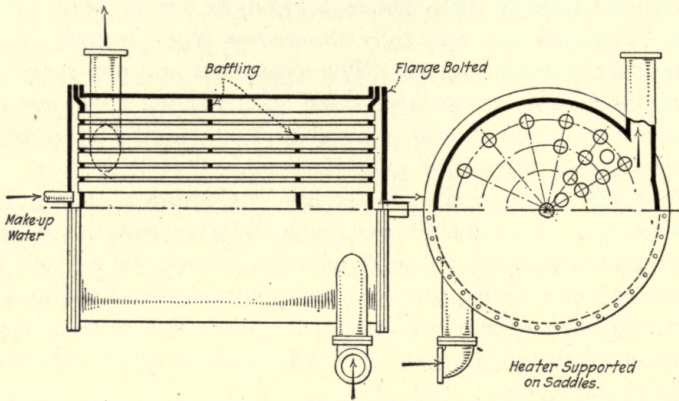

FIG. 172.—Make-up water distillery.

in the exhaust gases. The engine cooling water ordinarily loses 3 per cent. of its volume in being cooled. The make-up water necessary to balance this loss is first circulated through the

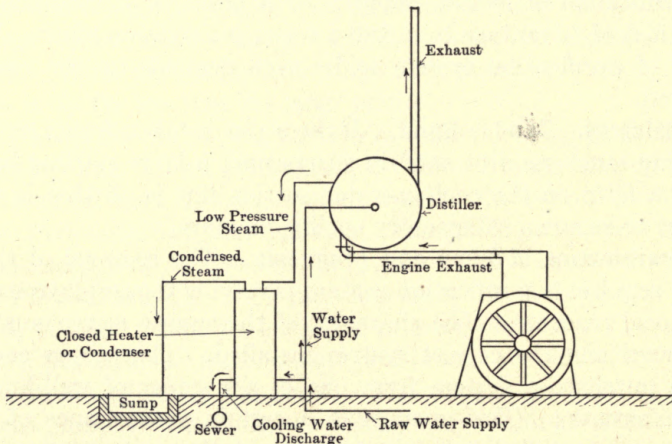

FIG. 173.—Schematic layout of make-up distiller system.

heater and is converted into steam at atmospheric pressure. This steam is then led to a closed heater where it is condensed by cooling water from the source of supply. The heater is, in form, nothing but a steel tank filled with 2-inch tubes through

which the water circulates. The heater in Fig. 172 has both heads flanged, which feature allows the tubes to be bored out with a hydraulic turbine tube cleaner.

To raise the temperature of the feed water before it enters the tank, the feed line can easily be passed through the engine exhaust pot. This will raise the temperature to about 150°. In computing the size of heater required for any given plant, 1 sq. foot of heater surface per horsepower will be amply large to absorb all available exhaust heat. The heat wasted by the engine will average 3000 B.t.u. per horsepower, and the heater will abstract 2000 B.t.u. This will give roughly 2 pounds of make-up water per horsepower. Since the cooling loss will not exceed 3 per cent., this amount of make-up water is sufficient even when the quantity of water used exceeds the usual 60 pounds per brake horsepower. Figure 173 is a schematic layout of a make-up water system. The advantage of this method of water supply lies in the absolute purity of the engine cooling water.

A distiller should be made of cast iron rather than steel plate to better resist the corrosive action of the exhaust gases. No foundry can build such an article at an attractive price if the pattern cost is assessed against one distiller. To date no manufacturer has attempted to standardize this accessory. A very serviceable one can be obtained by adapting the S. and K. Oil Cooler to distilling purposes. This is of cast iron throughout with the exception of the tubes and baffle plates.

Temperature of Cooling Lines.—Each engine possesses individual characteristics that preclude any set rules as to the temperatures that should exist in the discharge cooling lines from the various parts. Table II is the schedule that is followed in a plant containing three 500 h.p. vertical Diesels. These values give the best possible operating results as applied to these particular units.

TABLE II.—COOLING WATER DISCHARGE TEMPERATURES

Air-compressor discharge.....	105° F.
Inter- and after-cooler discharge.....	105° F.
Exhaust-header discharge.....	130° F.
Cylinder-jacket discharge.....	150–160° F.
Exhaust-valve discharge.....	120° F.

CHAPTER XIV

LUBRICATION

LUBRICATION SYSTEMS. LUBRICATION SPECIFICATIONS.

OPERATING DIFFICULTIES

General.—The problem of lubrication is one of the most important that confronts the Diesel engineer. Many individual engines have achieved a sorry reputation due to poor lubrication facilities or to mediocre grades of lubricating oils. The engineer does well to insist on a high quality of oil, and he should see that the oiling devices function properly. If the lubrication method is incorrect, a proper device should be installed.

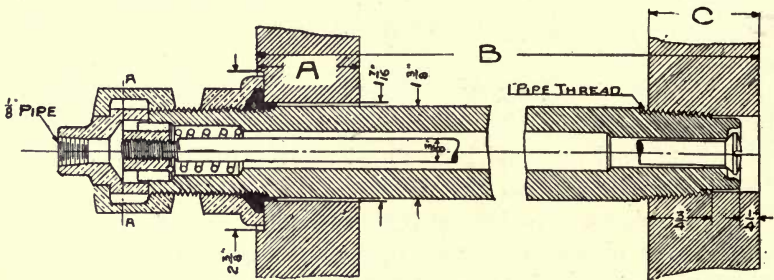
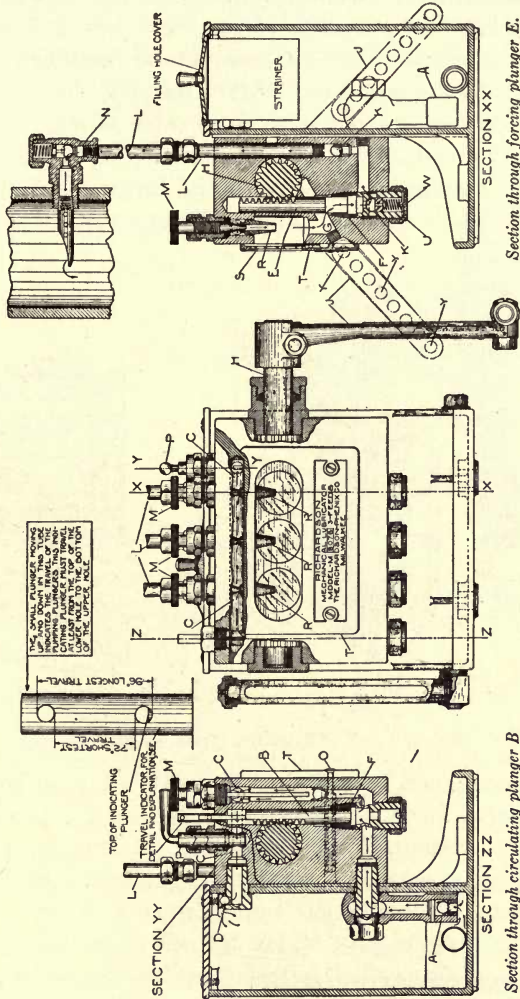

FIG. 174.—Cylinder lubrication check valve.

Lubrication Systems.—Two lubricating systems are at present in general use. The most popular one is the force-feed design where one or more positive-driven mechanical oil pumps force the lubricant to all moving parts with the exception of the crank bearings. These parts are generally oiled by gravity stream lubrication. A design of cylinder oiling that is coming into use employs a spray check valve quite similar to the fuel injection nozzle of a low-pressure engine. This valve, Fig. 174, passes through the cylinder jacket and cylinder wall. The mechanical oil pump is timed to cause the lubricating oil to be injected through this nozzle as the piston is below the central point of its travel. The oil sprays on to the piston, covering a considerable area even though the clearance between the piston and cylinder walls is small. The piston, as it moves upward, swabs

this oil over the cylinder walls. This principle of cylinder lubrication is most satisfactory in operation. The oil is deposited when the cylinder temperature is fairly low; con-



Section through forcing plunger E.

Section through circulating plunger B

Fig. 175.—Mechanical lubrication pump used on Diesel engines.

sequently a decided lubricating effect will be experienced before the flame of combustion burns the lubricating oil.

Even when such an injection device is not employed, the oil is always forced into the cylinder by a mechanical oil pump. Although several makes of oil pumps are in use, the majority

of domestic Diesels are equipped with the Richardson-Phenix Model M mechanical oil pump. This pump is shown in Fig. 175, where the course of the oil is indicated by arrows.

An engineer should bear in mind that the mechanical oil pump is subjected to stoppage of one or more oil lines due to the presence of bits of waste. Consequently, as much attention must be given to the pump as to other parts of the engine.

Stream Lubrication.—As has been mentioned, an engine having a mechanical oiler for the cylinders, as a rule, employs either drop or stream lubrication for the bearings. The stream system is preferable since a sufficient amount of oil is assured.

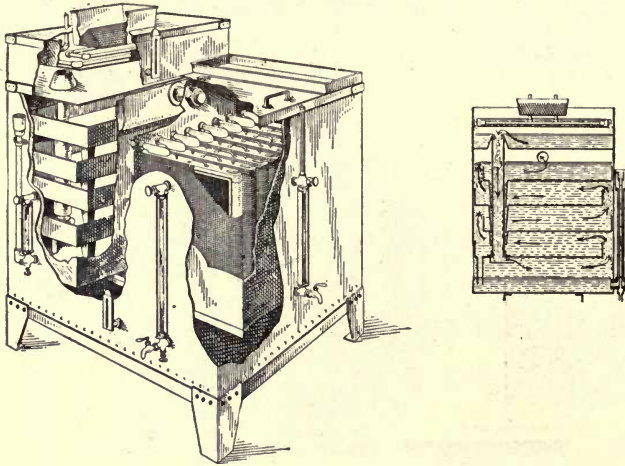

FIG. 176.—R-P filter for Diesel engines.

The lubricating oil can be stored in an overhead tank from which piping with sight feeds leads to all the bearings. The oil, after performing its mission, flows down into the engine crankcase. Collecting in the case, it is generally led out into a receiver tank or into a filter. Probably the best plan is to have a receiver tank below the engine into which the oil drips can discharge. After the tank contains a half barrel or so, this oil can be pumped, either by motor or by hand, into a filter. After filtering, it can then be pumped back into the overhead tank. If a good filter is purchased, the oil can be reused almost indefinitely. With a filter having ample filtering area, it has been found that the renewal of oil does not exceed $\frac{2}{10}$ of 1 per cent. of the oil circulated. Figure 176 illustrates a well-known filter that is in general use in Diesel plants.

Pressure-feed Lubrication System.—A pressure-feed system for crankshaft and connecting-rod bearings is employed on the Busch-Sulzer Type B and on the New London Ship and Engine Co. Diesels. This system, as used on the Busch-Sulzer, is outlined in Fig. 177, showing the drilled crankshaft and connecting-rods, as well as the pump and filtering mechanism. The oil is forced by the pump, which is a rotary geared to the air-compressor crank disk, into the lower half of the main bearings as indicated. The oil flows around the journal, lubricating the

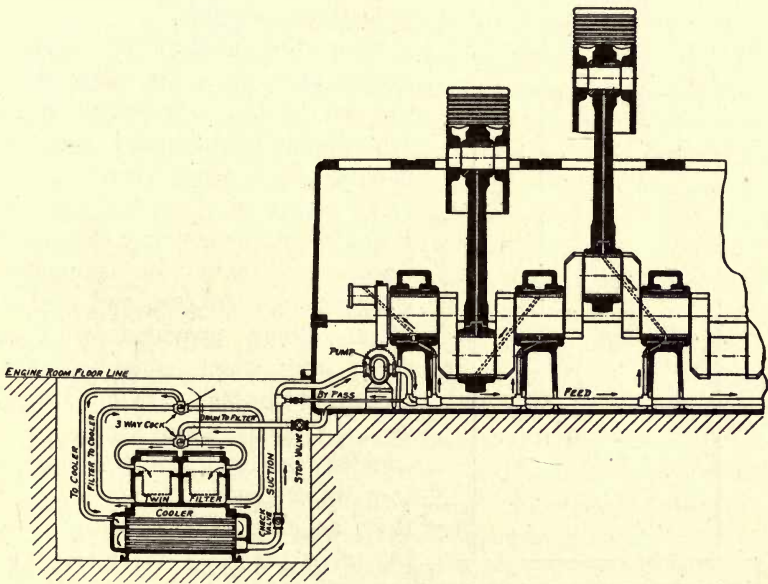

FIG. 177.—Busch-Sulzer lubrication system.

entire surface. The diagonal-drilled passages to the crank pins once each revolution register with the oil inlet opening in the lower bearing shell. This allows a stream of oil to enter the passage and to flow to the crank-pin box. The connecting-rod also is drilled, and each revolution this passage aligns with the crank end of the diagonal passage, which causes a supply of oil to pass up the rod to the wrist-pin bearing. The drip from the various parts is caught in the crankcase and from there flows through the filter into the cooler. The pump then draws the oil from the cooler to be reused. In order to seal the various

parts of the system, the oil level in the crankcase should be around 3 inches before the engine is started and should always be carried at least 1 inch in depth while the engine is running. The pump discharge has a pressure gage attached; the pressure should average around 25 pounds. The gage pressure is a fair indication of the condition of the system. If the pressure shows a decided increase, it is evident that part of the discharge lines are clogged

with dirt or waste. If the pressure drops, usually one or more bearings are worn, allowing the oil to leak out the ends.

Since the pistons are water-cooled, at times water mixes with the oil in the crankcase. If in any considerable amount, there is danger of bearing trouble. A water separator along the lines of Fig. 178 will remove any entrained water. It should be connected between the crankcase and the oil filter. Being provided with a drain, any water caught in the separator can be drained off each day. A sight glass at the side enables the operator to observe the water level. It is evident that, as long as the velocity of the oil is low, any water entering the separator will settle at the bottom due to its greater weight.

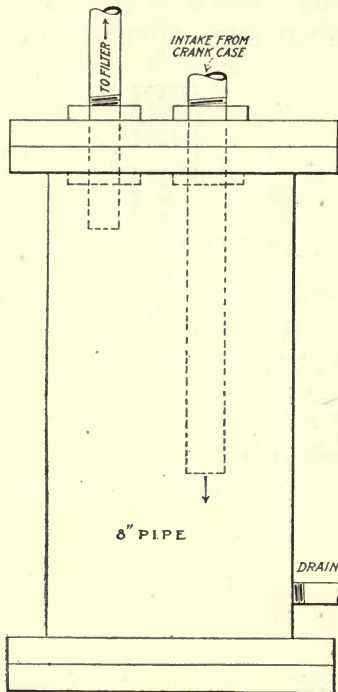

Fig. 178.—Water separator for lubrication system.

Splash Oiling Systems.—The splash oiling system is almost abandoned in Diesel engine practice. It was, however, the method employed on the first American Diesels for lubricating the bearings and connecting-rod brasses as well as the piston. The American Diesel Co. used a mechanical oil pump for the purpose of lubricating the cylinder walls but, in fact, depended on the splash from the crankcase to meet most of the cylinder lubrication demands.

The great objection to the splash system is the difficulty of preventing excessive oil deposits forming on the cylinder walls;

the oil burns and gums the piston rings. Since the shaft bearings are covered with oil emulsion, it is impossible to detect loose bearing shells. It is generally conceded that, due to the air-tight crankcase, the heat passing down the cylinders vaporizes a considerable portion of the oil. Experience proves that the lubrication demands are high with the splash system. On many old engines the splash has been abandoned in favor of a stream lubrication system.

Lubricant Oil Requirements.—The qualities which a lubricant must possess to enable it to be used successfully in the cylinder of a Diesel are few in number. First, it must possess lubricating qualities; in other words, it must be able to form a film over the rubbing surfaces that will prevent the piston and cylinder from touching. Furthermore, it must possess a low coefficient of friction. The oil must possess sufficient body to enable it to seal the clearances between piston rings and grooves, thereby preventing loss of compression. Finally, the lubricant must have a fire test high enough so that it will not be burned at the temperature in the cylinder during the suction and exhaust strokes and during the final part of the power stroke. In burning, during the period of high cylinder temperatures, the oil should leave no carbon or tarry deposits. Many engineers are of the opinion that the lubricating oil should not be burned. In this they are in error since the temperature of the flame produced by the combustion of the fuel oil is far above the burning point of any lubricating oil. If too great an amount of lubricant is fed into the cylinder, only the top surface is consumed; the part next to the cylinder wall does not burn but merely breaks up into its several constituents, thus leaving a residue of heavy carbon on the walls. The best oil will show these deposits when fed in excessive amounts.

Much of the trouble of carbon deposits on the cylinder and piston is primarily traceable to poor filtering facilities. If the oil circulating through the bearings and other parts is filtered and used in the engine, including the piston, this filtered oil will contain fine particles of carbon held in suspension. This free carbon settles on the cylinder walls in a hard flint-like coat. The remedy is the purchase of a filter that will remove all but the very finest of these particles. Probably the most advisable method of operation is to use only new oil in the cylinder lubricating oil pumps and to place the refiltered oil in the bearing oiling system.

The ordinary plant has no equipment for analyzing the oil purchased. A rough method of ascertaining if the lubricant is free from a gummy residue is to place a smear of the oil on a clean pane of glass. After the glass has been placed in the sun for some time, the oil, with the exception of the gummy remainder, will evaporate. The amount remaining indicates, in a fair manner, the gumming characteristics of the oil.

It has been frequently claimed that a lubricant from an asphaltum base oil is more desirable in the Diesel than paraffine base oil. The experience of many operators indicates that this is a matter dependent on the particular engine tested. Frequently an oil is purchased with the understanding that it has a paraffine base. If a small amount is placed on a piece of paper, the paper will become translucent. Upon evaporating, if the oil is of a paraffine base, the paper returns to its former color; if the oil has an asphaltum base, the paper will have a darker shade.

The most important detail in the manufacture of lubricating oils is the process of filtering. All Diesel oils should be filtered through fuller's earth. However, the cheapest oils have been treated with sulphuric acid in place of the fuller's earth process. The acid-treated oils may be detected by suspending a polished brass strip in the oil. If left for several days, the acid-treated oil will cause the surface of the strip to become somewhat mottled in appearance due to the formation of minute pits.

Lubrication Oil Specifications.—While oils of widely varying characteristics give excellent service in many plants, the following specifications, if adhered to, will guarantee the procurement of an oil that will give satisfactory results. Practically all refineries have a lubricant that will meet these requirements.

LUBRICATING OIL SPECIFICATIONS

Boiling point.....	600-700° F.
Flash point.....	325-500° F.
Fire point.....	400-600° F.
Viscosity at 100° F., Sayboldt.....	550-800
Specific gravity, Baumé.....	18-24
Carbon content per cent.....	0.05-0.2
Sulphur.....	None

If the lubricating oil is to be used on the compressor cylinders, the flash point must be above 450°.

Amount of Lubrication.—The lubrication consumption varies over wide limits in various makes of engines. Table III gives values that follow very closely the amounts necessary on engines from 200 to 600 h.p. capacity.

TABLE III.—DIESEL LUBRICATION REQUIREMENTS

	Drops per minute
Air compressor cylinder.....	3-4
Engine cylinder.....	25-30
Wrist pin.....	10-15
Crank pin.....	15-25
Helical gears.....	5-10
Governor.....	4-8
Exhaust valve stem.....	2-5
Admission.....	2-5

CHAPTER XV

DIESEL FUEL OILS

COMBUSTION. CLASSIFICATION OF FUELS. ACTION OF FUELS.
FUEL SPECIFICATIONS. FILTERS. TANKS

Combustion.—The process of combustion which takes place in the cylinder of an internal combustion engine is simply a chemical reaction. In actuality the cylinder is merely a chemist's retort wherein the atoms of hydrogen and carbon, which make up the body of the fuel charge, unite with the oxygen contained in the air charge, forming oxides. The carbon in its union with oxygen forms either carbon monoxide (CO) or carbon dioxide (CO₂). In this latter chemical reaction an atom of carbon unites with two atoms of oxygen forming one molecule of carbon dioxide; this combustion releases 14,600 B.t.u. per pound of carbon and raises the remaining unburnt carbon to the incandescent point. Unless there is sufficient oxygen present to unite with this incandescent carbon, the latter unites with one of the oxygen atoms of the carbon dioxide (CO₂), causing the entire carbon oxide to assume the form of carbon monoxide (CO). Since the reaction is incomplete, the heat released by the formation of carbon monoxide from carbon and oxygen is less than that produced by the complete reaction, CO₂. The value is approximately 4380 B.t.u., making evident the heat loss when the combustion is not complete. All Diesel cylinders are of ample volume to give sufficient oxygen for complete combustion. If the chemical reaction is not fully carried out, it is due to causes other than an insufficient supply of oxygen. In most instances the defect is traceable to poor atomization wherein the oil charge is not separated into particles of such minute dimensions that each carbon atom contacts with the required oxygen atoms. If the oil droplets entering the cylinder are of fairly large diameter, the oxygen is in direct contact with only the carbon at the surface of the droplet. The carbon atoms within the droplet must receive their oxygen from the carbon dioxide formed at the surface. For this reason the engine's efficiency

depends on the degree of atomization of the fuel charge. The chemical reactions taking place probably follow this order:

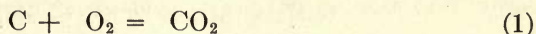

The hydrogen atom of the oil molecule also unites with the oxygen, forming water (H_2O) or rather water vapor commonly called steam, the reaction being as follows:



This reaction generates 62,100 B.t.u. per pound of hydrogen. The equations do not refer to the actual weight of the carbon, oxygen and hydrogen but merely indicate the relation of the atoms. Since the atomic weights of the various substances differ, it follows that the weight of each substance entering into the reaction depends on its atomic weight wherein a hydrogen atom has unity weight, carbon 12 and oxygen 16. Furthermore, where oxygen and hydrogen are not in combination with other gases, both oxygen and hydrogen have their atoms, or most minute particles, in groups of two or more. Equation (1) can then be written

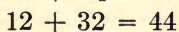
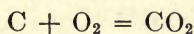

indicating that 12 parts by weight of carbon combining with 32 parts of oxygen form 44 parts of carbon dioxide; then, 1 pound of carbon requires $3\frac{2}{12}$ or 2.67 pounds of oxygen to be converted into 3.67 pounds of CO_2 . Since a pound of air contains $2\frac{3}{100}$ pound of oxygen, there are 11.6 pounds of air required in the combustion of 1 pound of carbon. Air at 62° Fahrenheit has a volume of 13.14 cubic feet per pound; the 11.6 pounds then have a volume of 152.4 cubic feet. The hydrogen reaction (4) can be written as follows:

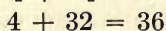
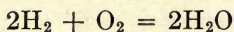

where 1 pound of hydrogen requires 8 pounds of oxygen or 34.78 pounds of air.

While the petroleum oils contain hydrocarbons of a varied structure, the equation below, covering the ethylene series of

hydrocarbons, outlines the process of equating the reactions taking place.

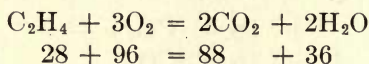

where 28 pounds of ethylene require 96 pounds of oxygen to form 88 pounds of carbon dioxide and 36 pounds of water or steam. Since 23 per cent. of the air is oxygen, 417 pounds of air are required to consume the 28 pounds of C_2H_4 , of which 77 per cent., or 321 pounds, is nitrogen, which experiences no chemical reaction. Then, for perfect combustion, the percentage by weight of the exhaust products would be

CO_2	H_2O	N
Carbon dioxide	Water	Nitrogen
20	8	72

These are the theoretical percentages and are quite different from those obtained on an actual Diesel engine test where the percentages obtained were as follows:

CO_2	CO	N	O
Carbon dioxide	Carbon monoxide	Nitrogen	Oxygen
7.2	.2	81.6	11

The H_2O percentage was not obtained in the test. This analysis would apparently indicate that an excessive amount of air was employed due to large cylinders or to an over-supply of injection air. The oxygen percentage could be reduced by shortening the period of injection valve opening. From these results, which were obtained under full-load conditions, the conclusion could be drawn that the engine was able to carry a considerable overload.

Fuel Classification.—Liquid fuels that are available for use in the Diesel engines fall into three groups. The first includes those hydrocarbons of the paraffine, olefiant and acetylene series, such as are familiarly known as the petroleum oils, the principal family being the paraffine series $\text{C}_n\text{H}_{2n+2}$. The second group covers the liquids known as benzol derivatives, such as coal tars. The third group is composed of the many vegetable oils containing hydrocarbons, such as peanut oil, palm oil, cocoanut oil and oils from other tropical and sub-tropical vegetation. The last group, up to the present time, has not been used commercially since their cost has been far above that of the petroleums. The coal tars are employed to a considerable degree in Europe; Germany, especially, has given much attention to the adaptation of the Diesel to these oils. The increasing

favor of the tar oils has been largely induced by the low cost of these oils and by the import duty laid on the petroleum oils; in Germany the import duty is equal to the cost of the fuel delivered at the wharf.

TABLE IV.—FUEL-OIL PRODUCTION BY DISTRICTS IN 1916 AND 1917

Field	1916 Barrels	1917 Barrels
Appalachian.....	23,009,455	24,600,000
Lima-Indiana.....	3,905,003	3,500,000
Illinois.....	17,714,235	15,900,000
Oklahoma-Kansas.....	115,809,792	147,000,000
Central and Northern Texas.....	9,303,005	11,000,000
North Louisiana.....	11,821,642	8,700,000
Gulf Coast.....	21,768,096	24,900,000
Rocky Mountain.....	6,476,289	9,200,000
California.....	90,951,936	97,000,000
Other fields.....	7,705
	300,767,158	341,800,000

In the United States no fuel other than the petroleum oils has found favor; this is attributable to the low price and convenience of these oils. Some speculation has been indulged in as to the advisability of using the American tar oils. However, this will be unnecessary for many years to come. Table IV gives the production of crude petroleum for the years 1916 and 1917. Approximately 40 per cent., or 150,000,000 barrels, of this oil remains after the gasolene, kerosene and light distillates have been distilled off. These heavy residual oils are marketable as road surfacers, boiler fuel and Diesel fuel oils. Since the Diesel plant can offer a higher price than is justified by the boiler plant, all this oil may be regarded as a potential Diesel supply. The total of 150,000,000 barrels would furnish fuel for more than 10,000,000 h.p. on a 24-hour service. This is many times the total Diesel installation in America.

Furthermore, the Mexican oil fields are of vast productive possibilities. The many internal disturbances in Mexico have served to limit the output; this will be overcome in the near future, and vast quantities of Mexican crudes will be on the market. These oils offer but small inducements to the refiner since they carry very low percentages of the lighter distillates. The Mexican oils are marketable only as boiler fuels and Diesel

oils. Their employment in a Diesel entails more attention from the engine operator than do the higher gravity oils of the United States. There is no constructional grounds for ignoring the Mexican fuels when the supply of the American oils is depleted.

Of the petroleum oils of the United States those of the Eastern and Midcontinental fields prove the most satisfactory in Diesel operation. This is a generality, however, and oils from wells in the Southern Texas fields, where the fuel is somewhat similar to Mexican crudes, give excellent results. The Diesel plant can purchase oils covered by rigid specifications, but the only positive way to determine the suitability of an oil is to run a test. It is of no advantage to test a single barrel since no engine will reveal the objectionable features of a fuel on a one-barrel test. The lowest quantity to experiment with is at least ten barrels.

The petroleum oils on the market as Diesel fuels range from South Texas and Mexican crudes, which contain too small a percentage of gasolene to justify distillation, up to 40° distillate, which is actually a low-grade kerosene. Most Diesels are burning fuel oil from 20 to 30° Baumé, which is a residue left after the gasolene and kerosene constituents have been distilled out of the crude and which has been filtered to remove the dirt. This oil ordinarily is desulphurized, which process eliminates practically all the sulphuric acid which was introduced in the distillation. This fuel oil has a varied color, ranging from light yellow to a deep black. The color is no criterion of the gravity of the oil, the crudes of various fields differing widely in color.

The Diesel fuels fall under the following grades: Stove Oil, Solar Oil, Gas Oil, Distillate, Fuel Oil, Diesel Oil, Desulphurized Fuel Oil, Crude Oil, Tops.

Stove Oil.—This a trade name attached to a low-grade kerosene from 39 to 44° Baumé gravity. The oil is ordinarily of a yellow-white color having a dirty appearance. It is quite serviceable for a low-compression engine but cannot be termed a desirable Diesel oil since it flows very readily and will pass the injection atomizer disks without being broken up. Blowing into the cylinder ahead of the air, it produces severe preignitions. It is of advantage only as a starting oil that can be used in cold weather for the purpose of warming the engine before the heavier fuel oil is introduced. It constitutes a serious fire hazard if any large quantity is kept on hand. Its price, which averages 2 to 4 cents above fuel oil, would make its adoption inadvisable even if it were an otherwise desirable fuel.

Solar Oil.—This is a trade name covering some of the lighter grade distillates and may vary over a wide range in gravity from 36 to 42° Baumé. Like stove oil, it cannot be classed among the desirable fuels and should be used only where frequent starting and stopping are usual, such as in a Diesel-engined tug. Serious preignitions are of frequent occurrence with this fuel. Its price is usually some 2 cents per gallon above fuel-oil quotations.

Fuel Oil.—This term covers all oil residue that remains after distillation has removed the gasolene, kerosene and light distillates. Dependent on the particular crude, the fuel oil may vary in gravity from 20 to 32° Baumé. In practically all cases it is black in color, though some of the Eastern oils have a light color, as also have certain North Texas fuel oils. When properly filtered, etc., it is the most desirable fuel that can be purchased. Since all the light volatile gases have been removed, there is no preignition danger. It is low in price in comparison with either crude or the light oils.

Gas Oil.—After the kerosene, gasolene, etc., have been removed, if the distillation temperature is sufficiently increased, all the remainder of the crude will distil over, with the exception of a heavy tarry portion which is sold for road surfacing. These heavy distillations are called gas oils and are sold for Diesel consumption. They are superior to the fuel oils, being free from asphaltum residue, but their price, which is above that of fuel oil, somewhat limits their application.

Diesel Oil.—This is a refinery trade name for a filtered fuel oil. It is sold at a slight advance over the unfiltered fuel and has a ready market in the Midwest. For small plants where no filtering apparatus is installed it is the fuel that should be purchased.

Desulphurized Oil.—The oil is, as its name indicates, a fuel oil which has been desulphurized. As customarily sold, the fuel contains a considerable percentage of distillates. Its use, in preference to fuel oil, cannot well be recommended since it is sold at a considerable advance in price.

Distillate Oil.—The distillate oils range in gravity from 30 to 39° Baumé. They have a yellow-green tinge and are the products of a distillation, being vaporized at a higher temperature than is kerosene or stove oil. They are ideal fuels for hot-bulb engines, but the price is entirely too high to be attractive for Diesel use.

Tops.—Topped oil is the residue after the gasoline has been removed. It is not commercially offered in any but limited quantities and can be ignored in making a test of Diesel fuels.

Crude Oil.—Within this class fall all crude oils which have undergone no process of distillation and which are marketed as they come from the well. With the exception of some South Texas and Mexican crudes which do not justify distillation, no crude can be obtained save in limited quantities. In some localities the owners of small wells sell the raw crude to the local plants. Since the range in the character of oils forming the crude is great, it is not a desirable oil. The gasoline content becomes a fire hazard that cannot be ignored. The functioning of the engine on the crude is by no means perfect. The Mexican crudes do not carry such a range in hydrocarbons and perform fairly satisfactorily if the engine's fuel nozzle and combustion chamber are designed to atomize and mix the air and fuel in an efficient manner. It is essential that the heavy crudes be heated; a temperature of 150° can exist in the fuel line without a fire hazard, being present. The pump, however, must have its suction under a pressure head to avoid the creation of oil vapors during the pump suction stroke.

Specifications.—The following specifications are quite broad and cover all oils that can be successfully burned in the Diesel engine. A few plants may be using oils of a heavier character, but investigation ordinarily will prove that the operation is not entirely satisfactory.

FUEL OIL SPECIFICATIONS

Heat Value.—Not less than 18,500 B.t.u. per pound. Contractor must give low heating value of the fuel supplied.

Gravity at 60° F.—With engines having closed fuel nozzles the oil shall not be heavier than 20° Baumé. For engines having open nozzles the oil should not be heavier than 16° Baumé. The oil should not be lighter than 36° Baumé.

Residue.—Not more than 10 per cent. The residue is that portion of the fuel remaining in the cup after being subjected to a temperature of 300° C. (572° F.) for 120 hours.

Flash Point.—From 125° to 250° F.—dependent on the engine.

Burning Point.—From 160° to 300° F.

Sulphur.—Not over 2.0 per cent.

Water.—Not over .3 per cent.

Ash.—Not over .05 per cent.

Heat Value of Fuel Oils.—It is self-evident that the oils having a higher heat value are more valuable than those oils with a low heating value. All other qualities being equal, the comparative values of two oils are in direct proportion with the ratio of their heating values. If oil of 36° Baumé gravity having 18,000 B.t.u. per pound is quoted at \$3.60 per 100 gallons or \$5.12 per 1000 pounds, an oil containing 20,000 B.t.u. is equally attractive at \$4.00 per 100 gallons or \$5.69 per 1000 pounds. The policy of purchasing oil by the gallon is not to be recommended, although it is the custom to quote in this manner. Orders for oil should be placed on the pound basis since the heating value of oil is so computed. Since the pounds per gallon of fuel oil of 30° and 20° Baumé are respectively 7.294 pounds and 7.777 pounds, it is apparent why the heavier oil is worth more per gallon.

Gravity.—The usual method of indicating the weight of crude or fuel oil is by the Baumé scale. The numbers of this scale are given by the formula:

$$\text{Degrees Baumé} = \left\{ \frac{140}{\text{s.g.}} \right\} - 130$$

where s.g. is the specific gravity, water being $-1-$. The specific gravity can be determined by a hydrometer. The gravity of a fuel, in itself, is of no vital importance; however, it can be generally employed as an indication of the oil's freedom from a large residue content and from a heavy percentage of the

TABLE V.—THE BAUMÉ SCALE

Degrees Baumé	Pounds per U. S. gallon	Specific gravity	Degrees Baumé	Pounds per U. S. gallon	Specific gravity
10	8.336	1.000	26	7.477	0.897
11	8.277	0.993	27	7.435	0.892
12	8.219	0.986	28	7.385	0.886
13	8.161	0.979	29	7.344	0.881
14	8.102	0.972	30	7.294	0.875
15	8.052	0.966	31	7.252	0.870
16	7.994	0.959	32	7.202	0.864
17	7.935	0.952	33	7.160	0.859
18	7.885	0.946	34	7.119	0.854
19	7.835	0.940	35	7.069	0.848
20	7.777	0.933	36	7.027	0.843
21	7.727	0.927	37	6.985	0.838
22	7.677	0.921	38	6.944	0.833
23	7.627	0.915	39	6.902	0.828
24	7.577	0.909	40	6.869	0.824
25	7.527	0.903			

more complex hydrocarbons that are difficult to burn in a Diesel engine. Table V is a table of the relation of Baumé gravity to pounds per gallon.

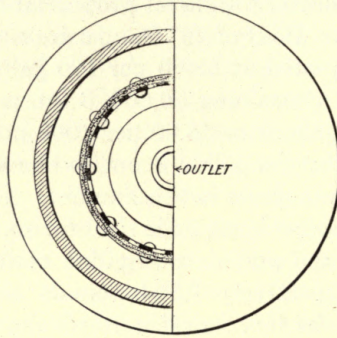

Section A-B

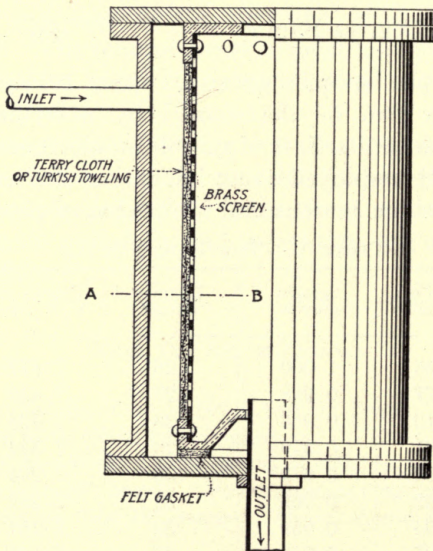

FIG. 179.—Fuel oil filter.

Residue.—The residue that remains after an oil has been subjected to a temperature of 572° Fahrenheit (300° Centigrade) consists of coke and dirt. The most serviceable oil is that oil which has the minimum percentage of residue. The coke will not burn at any temperature occurring in the cylinder. Pos-

sessing some of the characteristics of tar, it settles on the fuel and exhaust valve seats, resulting in leaks, and fouls the piston rings, freezing them in the grooves and thereby destroying the engine compression. Frequently the coke deposits on the cylinder walls, especially if there be any rough spots on the walls, with a scored piston as an immediate result.

The dirt also has a deleterious effect on the valves and piston. There is no excuse for any oil being dirty as filtering will remove all the dirt in suspension. While the upper limit of the dirt and coke is set at 10 per cent., a value of half this amount can well be adopted as the upper limit of the residue carried by the oil. For the purpose of removing any dirt, a filter such as is illustrated in Fig. 179 is quite satisfactory. This consists of a flanged tank carrying a brass cylindrical screen which is provided with a felt gasket at the base; the upper flange holds the screen against this gasket. Terry cloth is wrapped around this screen as indicated. The filter is fitted with a by-pass not shown. The large area of the terry cloth enables the filtering to be carried on at a slow rate. A 1000 h.p. filter, 12×24 in. outside diameter, is required to filter $\frac{1}{10}$ gallon per hour per sq. inch of screen area; this gives a velocity of .4 inch per minute. The terry cloth screen may be of as many thicknesses as desired. Three folds ordinarily give ample filtering effect. To clean, the top flange is removed, the screen lifted out and new cloth wound on the screen while the dirty cloth is washed.

Flash Point.—The flash point of oil is merely that temperature at which the oil gives off a vapor that will ignite in the presence of an open flame. This point should not be below 125° Centigrade for two reasons. First, if the oil has a lower flash point than that given above, there is a fire risk due to oil vapors forming under atmospheric conditions. Second, if the flash point is low, the oil, as it rests in the engine fuel valve, may vaporize and ignite on account of the absorption of heat from the injection air and the cylinder head. If the flash point is exceedingly high, the ability of the oil to burn in the short time allowed during the admission period is lessened. In this the flash point is merely an indication of the vaporizing characteristics of the oil.

It should be added, at this point, that no person should be allowed to approach an oil storage tank with an open light. Neither should an unprotected electric lamp be dropped into the tank. In cleaning out an empty tank, the cover should be re-

moved and the tank left open for at least forty-eight hours before a man is allowed to enter the tank. The oil vapors dispel very slowly; more than one death is traceable to carelessness in this matter.

Burning Point.—The burning point of an oil is that temperature at which the oil ignites and burns in an open cup. By some it is claimed that the burning point in no way indicates an oil's usefulness as a Diesel fuel.

Nevertheless, if the burning point is high, with a corresponding high flash point, the oil will cause the engine exhaust to be smoky. This is attributable to the sluggish rate of combustion. If the burning point is fairly low, the fuel charge need not be so thoroughly atomized to obtain perfect combustion. As a matter of practical operation, a fuel oil should not have its burning point exceed 300° Fahrenheit or 150° Centigrade.

Sulphur.—The sulphur content should under no circumstance exceed 2 per cent. With this low value the action of the sulphur dioxide on the cast-iron parts is negligible. Even this small amount of sulphur will attack the exhaust pipe line if a water line runs into the exhaust header for cooling purposes. In the presence of the water a formation of sulphuric or sulphurous acid occurs with a consequent eating of the header. On certain early Diesels where water was introduced into the exhaust valve pots, the corrosion from the sulphur was very evident. If the cooling of the cylinder head and exhaust header is carried at a temperature low enough to condense the H_2O resulting from the process of combustion, sulphuric acid may form in the exhaust. This is especially true on low loads when the operator neglects to reduce the flow of cooling water.

The American Diesels had splash lubrication employing an emulsion of oil and water. The sulphur dioxide gas, blowing past the piston, came in contact with the emulsion, forming sulphuric acid. The acid attacked all the iron and steel parts of the crankcase and cylinder. The same effect may be observed in engines having a water-cooled piston. If the water connections leak, small portions of the joints will show the effects of acid. A corrosive action is at times observed in the cylinder immediately below the head joint. This is undoubtedly the result of water seeping past the flange gasket and uniting with the sulphur in the fuel.

Water.—The presence of water in Diesel fuel oils is objectionable from the viewpoint of both the purchasing agent and the plant operator. It requires no argument to prove that it is of no advantage to buy the water content of the oil. The water increases the net cost of the fuel while likewise increasing the freight charges. Ordinarily this is not of great moment since the percentage of water is never large.

The engineer is justified in protesting against an excessive amount of water since it increases his operating difficulties. In certain fields where the oil comes from flowing wells, instead of from "pumpers," the water and oil exist in an emulsion. It is practically impossible to separate the water and oil. The emul-

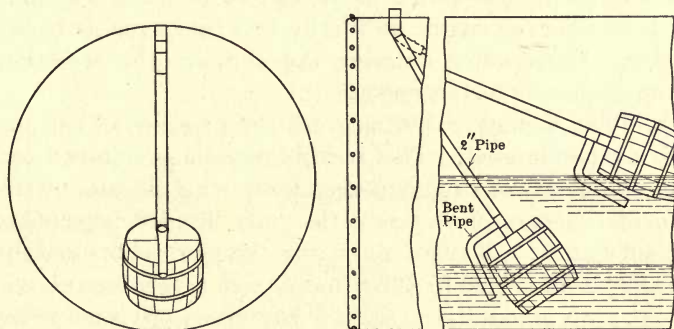

FIG. 180.—Tank suction line float.

sion also entrains a large quantity of air globules. As this combination of oil, water and air enters the fuel pump the air often breaks away from the oil and, collecting in the pump, disturbs the functioning of the valves. The air, water and oil mixture has a greater volume than a pure oil charge of equal heating value. This increased fuel volume demands an increased air-injection pressure to force it into the cylinder.

If the water is in a free state, it will settle at the bottom of the oil storage tank. If this is not drained at frequent intervals, the water level will reach the end of the fuel suction line, with the result that the fuel valve injects nothing but a water charge into the engine cylinder. The engine then drops its load and slows down. This constitutes one of the most serious nuisances that occur in a plant. When it does happen, the entire fuel line must be purged of the water and the storage tank drained. It is practically impossible to secure oil that is entirely free from water.

The storage tank can be arranged with a float which will permit the oil suction line to be below the fluid level at all times and yet never touch the bottom where the water rests. This may be in the form of a barrel float, Fig. 180, where the oil line, at the point where it enters the tank, has a short rubber connection. The other end is plugged and is fastened to a keg while a tee and nipple above the keg allows the oil to enter the line. The keg floats on the surface and, even if the tank is almost empty, the angle at which the keg rests prevents the suction nipple from touching the bottom. The only attention required is the occasional renewal of the rubber hose.

When an engine ceases functioning in all the cylinders, it is usually an indication either of no fuel or of water-logging. If there is no fuel, the engine ordinarily first runs irregularly before stopping. With water entering the cylinder the cessation of ignition is almost instantaneous.

Ash.—The damage resulting from the presence of ash in the fuel is over-estimated. This residue remaining unburnt in the engine cylinder is of a mineral character, being silicate, quartz or iron oxide. There is no doubt that any decided percentage of these substances will score an engine cylinder. Fortunately no oil is offered for Diesel fuel that has an ash percentage above .05 per cent.; this amount is so slight that its presence is not revealed through any engine trouble.

Viscosity.—The viscosity of an oil has no bearing on its adaptability as a Diesel fuel. The thickest, most sluggish oil can be made quite free flowing through the application of heat. In the Northern states every oil storage tank should have heating coils for use in the winter months. If these coils are connected with the discharge cooling water before it enters the cooling tower, the heat abstracted is ample to make the oil free flowing. In the cold climates it is always advisable to have a tank inside the building of at least one barrel capacity. If shut-downs are of more than a few hours duration, the engine should be run on kerosene or stove oil until the heavy oil becomes fluid. It is necessary to drain the fuel pump and lines on a shut-down to prevent clogging of the lines with congealed oil.

Acid.—To avoid corrosion in the pumping and cylinder parts the oil should be devoid of any trace of acid.

Engine Oil Tanks.—Each engine should be supplied with an individual oil tank. This tank is best elevated with its base

at least 5 feet above the engine fuel pump. This places a pressure head on the pump suction that does much to eliminate air leakage into the pump. The tanks are often of two compartments, one of which holds kerosene for starting purposes.

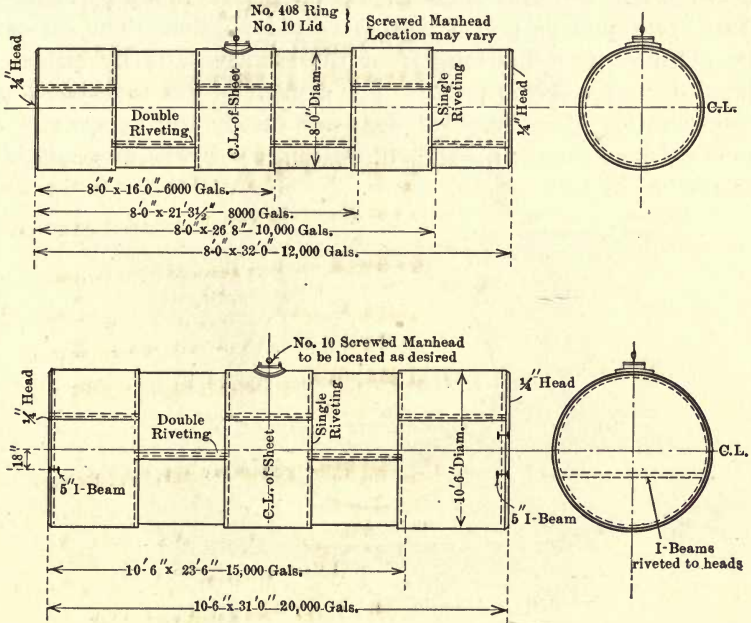

Size	Capacity	Heads	Shell	Riveted with	Weight
8' X 16'	6,000 Gals.	1/4"	3/16"	1/2" Rivets	5,000 lbs.
8' X 21'-3 1/2"	8,000 Gals.	1/4"	3/16"	1/2" Rivets	6,100 lbs.
8' X 26'-8 1/2"	10,000 Gals.	1/4"	3/16"	1/2" Rivets	7,200 lbs.
8' X 32'	12,000 Gals.	1/4"	3/16"	1/2" Rivets	8,400 lbs.
10'-6" X 23'-6"	15,000 Gals.	1/4"	3/16"	1/2" Rivets	9,000 lbs.
10'-6" X 31'	20,000 Gals.	1/4"	3/16"	1/2" Rivets	11,000 lbs.
8' X 16'	6,000 Gals.	1/4"	1/2"	1/2" Rivets	6,100 lbs.
8' X 21'-3 1/2"	8,000 Gals.	1/4"	1/2"	1/2" Rivets	7,600 lbs.
8' X 26'-8 1/2"	10,000 Gals.	1/4"	1/2"	1/2" Rivets	9,100 lbs.
8' X 32'	12,000 Gals.	1/4"	1/2"	1/2" Rivets	10,600 lbs.
10'-6" X 23'-6"	15,000 Gals.	1/4"	1/2"	1/2" Rivets	11,000 lbs.
10'-6" X 31'	20,000 Gals.	1/4"	1/2"	1/2" Rivets	14,000 lbs.

A 2" Duplex Oil Tank Vacuum Valve should be furnished with each tank.

FIG. 181.—Steel oil storage tank.

The employment of kerosene for starting is advisable in all plants. It reduces the liability of the engine refusing to fire and eliminates the tarry deposits that frequently occur when the heavy fuel oil is injected into a cold engine. The kerosene

should be fed for ten or fifteen minutes on starting and for four or five minutes before stopping. At the latter time, the kerosene cuts the carbon deposits and prevents freezing of the piston rings.

The tank, in every instance, ought to have a level indicator fitted to it. A simple indicator can be made out of a galvanized float, two pulleys and a light-weighted pointer. The oil can be pumped into this tank from the storage tank by either a hand or motor-driven pump. For a plant of less than 300 h.p. the quantity of oil handled does not justify the expense of a motor-driven pump; a hand rotary pump proves quite suitable and is low in cost.

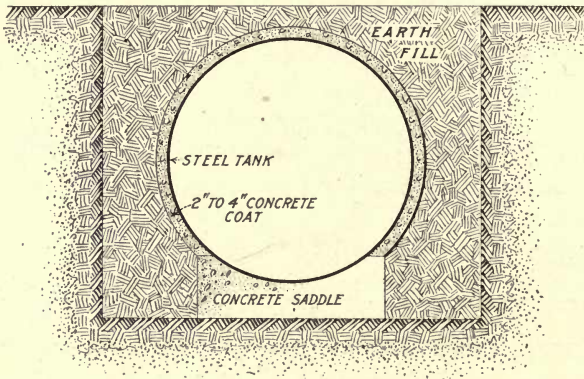

FIG. 182.—Steel tank setting.

Oil Storage Tanks.—The capacity of the plant together with its location largely determines the type of oil storage tank. If the plant consumes less than 12,000 gallons per year, two steel tanks of 6000 gallons each are probably the most advisable size to install. The employment of two tanks provides means whereby a damaged tank can be repaired without a plant shut-down. It allows a thorough cleaning of the tank after each emptying. Figure 181 covers the steel tanks that are of commercial sizes.

If steel tanks are installed, they should be set in a pit and covered to eliminate any fire risk. Figure 182 illustrates a convenient method of placing the tanks. Concrete saddles are placed in the pit; the tanks rest on these saddles. The earth is filled in and a 2- to 4-inch layer of concrete is formed around the tank, completely encasing it. This concrete layer prevents any corrosion of the steel plate by excluding all air and moisture.

Where the ground is inclined to be marshy or water-logged at periods of wet weather, an empty steel tank has sufficient buoyancy to float on this water and, rising up above the ground, will break the pipe connections. To avoid this danger, in ground of this character, a heavy concrete slab can be run about

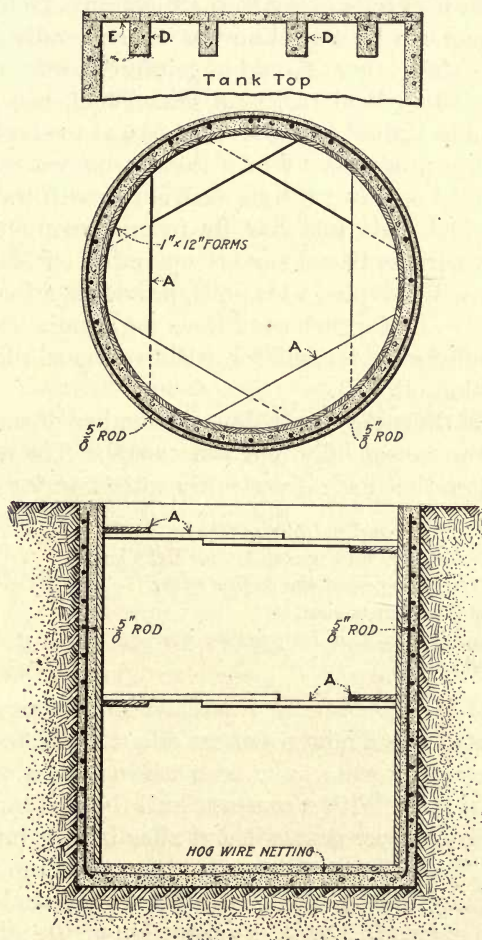

FIG. 183.—Concrete oil storage tank.

the upper half of the tank or concrete beams laid across the top of the tanks and tied to the saddles with long rods. The weight of the concrete then overcomes the buoyancy of the tank.

Concrete Storage Tanks.—From every viewpoint the concrete storage tank is the most advisable to install. It is cheaper than

a steel tank of a corresponding capacity and has an indefinite life with no danger of leakage if the concrete is well reinforced.

Figure 183 sketches a circular concrete tank that can be made of any desired capacity. The bottom must be well reinforced with steel rods or hog wire fencing. The vertical walls should have $\frac{5}{8}$ - to $\frac{3}{4}$ -inch iron rods every 8 to 12 inches. To form the top, concrete beams can be placed on the vertical walls and covered with concrete slabs; these should be reinforced with wire fencing.

Coal Tar Oils.—Coal tar, as a Diesel fuel, has received no attention in the United States. This is due to the low price of the petroleum products. While it will be years before the American Diesel operator will be confronted with the problem of coal tar as fuel, this fuel has its future possibilities. There are several American Diesel engines operating on Mexican crude that can be easily adapted to tar oils, providing a fairly constant load is carried. Under such conditions the atomizer will nebulize the tar oil sufficiently for ignition without the employment of a primary ignition oil.

Methods of Burning Tar Oils.—A number of methods have been devised to successfully burn the tar oil. The following list comprises those that have given fairly satisfactory results.

1. Mixture of tar oil and petroleum oil.
2. Tar oil for full load and petroleum for light loads.
3. Raising thermal range of the engine cycle.
4. Increasing the compression.
5. Application of a light oil for primary ignition.
6. Catalytical action.

1. *Mixture of Tar Oil and Petroleum Oil.*—Among the first plans advocated was a mixture of tar oil and a lighter petroleum oil. Various experiments have been made with a varying proportion of coal tar. With a constant load the coal tar percentage can be as high as 75 per cent. without affecting the functioning of the engine. The problem that so far has not been solved is the thorough mixing of the two oils. If a mechanical agitator is placed in the engine fuel tank, a separation of the oils will occur in their passage to the fuel valve. The consequence is an irregularity in the ignition of the charges. This method can hardly be termed successful at the present time.

2. *Tar Oil for Full Load and Petroleum Oil for Light Loads.*—There is no condition existing within the engine cylinder that would prevent this method from being successful. However,

the design of the fuel injection system presents many mechanical difficulties. The injection valve as well as the fuel pump must be under governor control. Figure 134 illustrates an injection nozzle having a piston valve under control of the governor. A tar-oil line and an ignition-oil line lead to this piston valve. If the load is light, the governor shifts the valve, causing the full charge of ignition oil to enter the fuel nozzle; the tar-oil line is placed in connection with the tar-oil return line. If the engine is carrying full load, the movement of the piston valve uncovers the tar-oil line, allowing the tar oil to enter the fuel nozzle while the ignition oil flows back through its return line. The ignition-oil line to the nozzle enters the nozzle body below the tar-oil entrance. On partial loads when both tar oil and ignition oil enter the fuel nozzle, the ignition oil enters below the tar oil, thereby being blown into the cylinder and igniting before the tar oil enters.

3. *Raising Thermal Range of the Engine Cycle.*—This method includes the raising of the temperature of the injection air, the fuel charge and the cylinder air charge; in fact, it contemplates the increase of the temperature of the entire working parts. Starting with a higher temperature of the cylinder charge of air, the combustion of the injected fuel takes place at an increased temperature. This insures a positive ignition of the tar oil. The thermal efficiency of the engine depends on the temperature range $t_1 - t_2$. Although the actual temperatures t_1 and t_2 are higher than usual, the range $t_1 - t_2$ is identical with the normal Diesel temperature range. Consequently the efficiency would not be changed. The objection lies in the increased stresses occurring in the engine, and the method has never met with commercial success.

4. *Increasing the Compression.*—The plan of increasing the compression has received considerable attention but is not commercially attractive. The Diesel engine under present designs works with as great a pressure as is advisable. The increase of compression pressure would augment the operating difficulties and is dangerous. Furthermore, many tests of engines with varying compressions appear to bear out the belief of practical engineers that a compression of 500 to 550 lbs. per sq. inch gives the engine the greatest possible efficiency and is as high as is practical. The injection-air pressure would necessarily be increased a corresponding amount, thus increasing the engine

losses. In these tests referred to, the engine smoked badly at loads below half rating.

5. *Application of a Light Oil for Primary Ignition.*—This plan is the only one offered that possesses merit and has been employed to a large extent in Germany and in a few English installations. The fuel-injection valve, which, in most cases, is of the open type, is equipped with two oil lines. Figure 133 illustrates the Körting tar-oil valve. All of the tar-oil valves are designed to allow the light ignition oil to be blown into the cylinder ahead of the tar-oil charge. Being lighter, this primary charge immediately ignites and supplies the additional heat required to ignite the heavy tar oil. The time interval for this action is short even in a slow-speed engine. Consequently, it cannot be expected that an engine above 200 r.p.m. will successfully handle tar oils even under this system. The fuel valve becomes foul in a short time. A thorough cleaning is necessary at least once a week. The tar coats the piston and combustion-chamber walls with a thick hard scale that requires constant attention.

6. *Catalytical Action.*—No commercial engine has been operated under this method of tar-oil ignition. A catalytic agent is required that will produce combustion even when the tar is in fairly large particles. The cost of the agent and its life are matters of importance. It is highly improbable that it will ever be commercially successful.

CHAPTER XVI

FUEL CONSUMPTION

GUARANTEES. TEST RESULTS. OPERATING RESULTS. GAS
ENGINE, DIESEL AND STEAM TURBINE EFFICIENCIES.

DIESEL INDICATOR CARDS. INDICATOR RIGGINGS.

METHOD OF CONDUCTING DIESEL TESTS

Guarantees.—The manufacturers of Diesel engines have been very conservative in the guarantees of fuel consumption of their engines. Table VI gives the standard guarantees of various builders, although all are lowered in tests. All of these guarantees, with the exception of the McIntosh & Seymour and the Busch-Sulzer engines, exceed the usual European Diesel guarantees by a marked amount. However, the actual fuel consumption, by test, of American Diesels is not much greater than those of the European engines. The difference is attributable to the superior workmanship of the latter along with the more developed fuel-injection devices.

TABLE VI.—MANUFACTURERS' FUEL GUARANTEES

Make	Type	Size	Full load, lb.	¾	½	¼
National Transit.....	H. A.	65-300	0.48	0.50	0.58	
De La Vergne.....	H. A.	100-300	0.42	0.435	0.52	
Körting.....	H. A.	300	0.42	0.43	0.52	
Snow.....	H. A.	65-600	0.50	0.52	0.60	
McEwen.....	H. A.	65-300	0.48	0.50	0.58	
Nelseco.....	V. M. A.	120-240	0.50			
Fulton.....	V. M. A.	50-100	0.50			
Busch & Sulzer.....	V. A.	500	0.425	0.44	0.52	
McIntosh & Seymour..	V. A.	500-1000	0.42	0.43	0.52	
McIntosh & Seymour..	V. M. A.	600	0.404			
Standard Fuel Oil Engine.....	H. B.	60-300	0.50	0.50	0.56	0.84

H = horizontal engines.

V = vertical engines.

M = marine engines.

A = four-cycle.

B = two-cycle.

Snow Diesel Fuel Consumption.—Figure 184 is the result of a test on a 300 h.p. Snow Diesel. It will be noted that the test

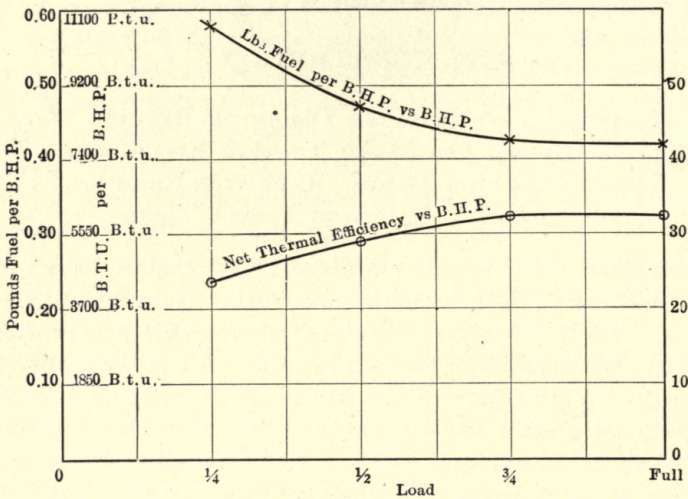

FIG. 184.—Test results of a Snow Diesel.

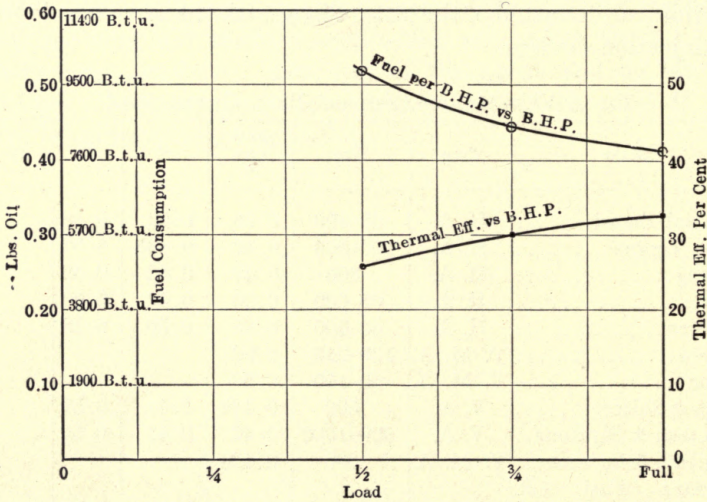

FIG. 185.—Test—Oct. 12, 1916—65 H.P. McEwen Diesel.

gives fuel consumptions that are 20 per cent. lower than this company's standard guarantees.

McEwen Diesel Fuel Consumption.—Figure 185 shows a test on a 65 h.p. McEwen Diesel. The fuel consumption at full

load is remarkably low. The increase at three-quarters and half-load over the full-load consumption is quite marked. From this it would appear that the engine's rating was not as high as it should be. In other words, the rating should be raised, making the engine a 75 h.p. unit.

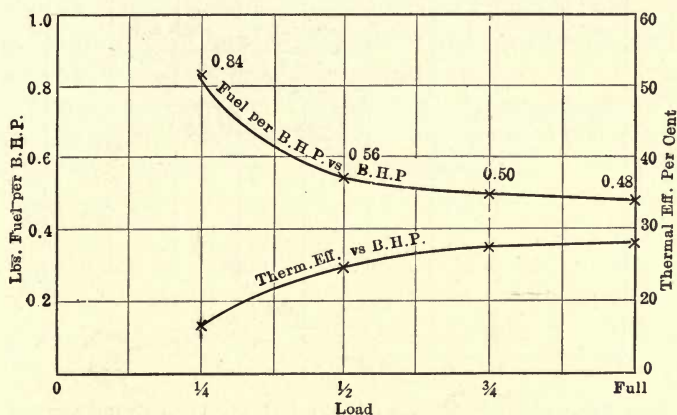

FIG. 186.—Test Standard Fuel Oil two-stroke-cycle Diesel.

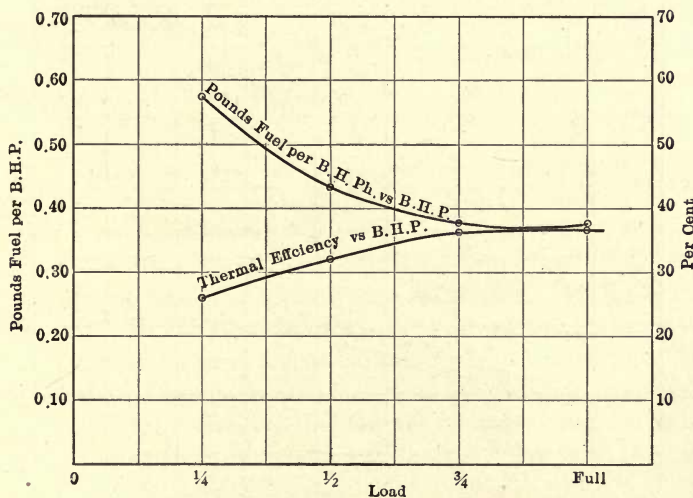

FIG. 187.—Test of 300 H.P. Körting Diesel.

Standard Fuel Oil Engine Fuel Consumption.—Figure 186 is the result of a test on a 120 h.p. Standard Fuel Oil two-stroke-cycle Diesel. This test is fairly representative of two-stroke-cycle Diesel engines of small powers.

Körting Diesel Fuel Consumption.—Figure 187 shows the results of a test on a 300 h.p. Körting four-cylinder horizontal Diesel.

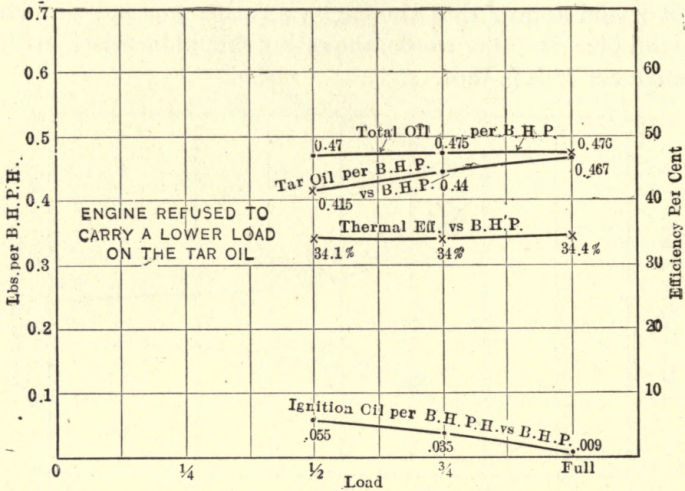

FIG. 188.—100 H.P. Körting Diesel using tar oil and an ignition oil.

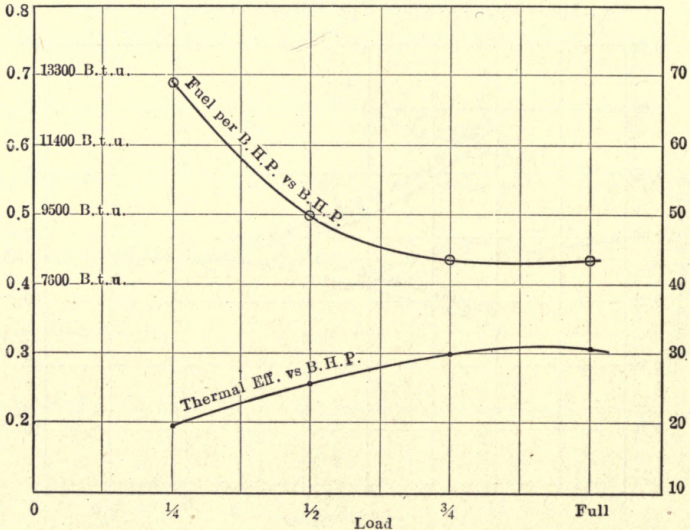

FIG. 189.—500 H.P. type 4B Busch-Sulzer Bros. Diesel, cylinders 16 × 24, speed 200 R.P.M.

The fuel consumptions and thermal efficiencies are extremely attractive.

A 100 h.p. Körting Diesel employing tar oil as a fuel was tested with the results appearing in Fig. 188. A light distillate was

used as an ignition oil, being injected ahead of the main tar-oil charge. This test is not of great interest to the operator since the results are plainly inaccurate. The thermal efficiency at half load would appear to approach the full-load efficiency.

Busch-Sulzer Diesel Fuel Consumption.—Figure 189 shows the results of a test on a 500 h.p. Busch-Sulzer Type B Diesel. This test was run without any preparation in the way of engine adjustments and represents actual operating results.

McIntosh & Seymour Diesel Fuel Consumption.—Figure 190 is the result of a test on a 500 h.p. McIntosh & Seymour Diesel. This engine was one of three installed in a Texas

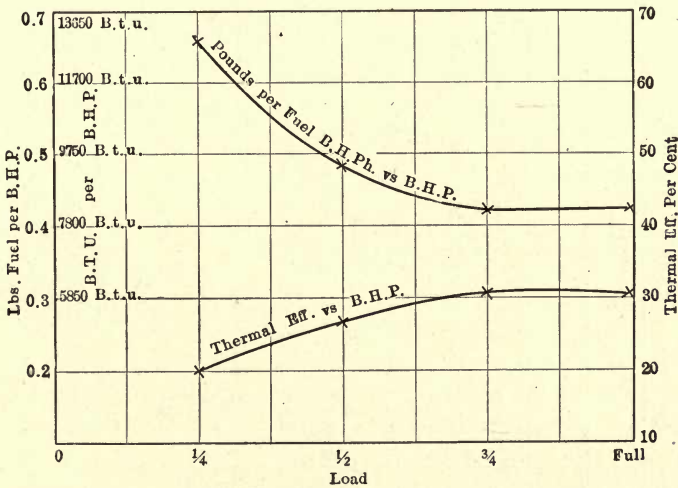

FIG. 190.—500 H.P. McIntosh & Seymour Diesel engine, 164 R.P.M., Paris, Texas.

electric plant and was direct connected to a 437 kv.-a. G.E. alternator. In running this test, the fuel consumption per kilowatt hour was obtained at the various loads. Using the builder's guarantee of the generator efficiency, the fuel per brake horsepower was computed from the fuel per kilowatt hour. The units were delivering their output to a high-tension line, and the results represent operating conditions.

Table VII outlines complete tests on three 500 h.p. McIntosh & Seymour Diesels direct connected to G.E. alternators. These tests were carried out while the engines were in actual service, delivering current into a 100 kv. high-tension line. The efficiencies of the three units were practically uniform and represent values that are about as high as can be expected in units of this size.

TABLE VII.—SUMMARY OF TESTS ON PARIS (TEX.) DIESEL ENGINES

	Unit No. 1				Unit No. 2				Unit No. 3			
	1	3	2	4	5	6	7	8	9	10	11	12
Approximate load.....	Full	Three-fourths	Half	Quarter	Full	Three-fourths	Half	Quarter	Full	Three-fourths	Half	Quarter
Kw. (average).....	340.6	253.3	168.9	86.1	333.4	250.5	153.4	82.4	340.0	249.7	162.9	79.6
Load factor (kw.), per cent.....	97.5	72.5	48.2	24.6	95.2	71.6	44.2	23.5	97.2	71.3	46.5	22.7
Kv.-a. (average).....	400.7	301.5	211.1	117.9	396.2	316.5	199.1	112.8	409.5	320.1	211.5	109.0
Load factor (kv.-a.), per cent.....	91.7	69.0	48.2	27.0	90.8	72.5	45.6	28.0	93.7	73.3	48.4	25.0
B.h.p. (average).....	481.3	359.8	240.2	127.1	472.6	355.6	222.0	117.3	482.0	356.9	234.3	117.2
Kw.-hr. generated (total)	1299.3	891.1	577.0	101.9	1103	784	413.1	49.45	1008.5	919.7	450.9	55.7
Time start, P.M. and A.M....	2:29	7:13	2:53	11:37	6:00	2:21	10:01	1:16	5:55	2:02	9:41	12:54
Time stop, P.M. and A.M....	6:18	10:49	6:18	12:48	9:18½	5:28½	12:42½	1:52	8:53	5:43	12:27	1:36
Duration of test, hours.....	3.816	3.517	3.417	1.183	0.84	3.125	2.692	0.6	2.966	3.683	2.767	0.7
Power factor (average).....	0.85	0.84	0.80	0.73	3.308	0.79	0.77	0.73	0.84	0.78	0.77	0.73
Kw. for excitation (average).....	8.1	6.91	7.64	7.42	7.25	7.90	6.50	7.17	7.4	7.0	7.1	7.3
Fuel oil consumed (gal.)....	111	77	56	14	96	68	41.5	6.7	84	77½	44	7
Fuel oil consumed (lbs.)....	783	543	396	98½	673	481½	290½	47	582½	542½	310	49
Fuel oil consumed (B.t.u.)...	15,321,744	10,621,080	7,789,616	1,923,803	13,145,036	9,396,954	5,657,778	918,615	11,590,485	10,625,948	6,064,220	955,500
Fuel oil per kw.-hr. (lb.)...	0.603	0.609	0.686	0.966	0.610	0.614	0.703	0.950	0.590	0.590	0.688	0.880
B.t.u. per kw.-hr. (lb.)...	11,792	11,930	13,500	18,879	11,917	11,984	13,720	18,576	11,492	11,553	13,448	17,154
B.t.u. per b.h.p. hr.....	8,342	8,396	9,491	12,795	8,407	8,450	9,467	13,052	8,037	8,083	9,354	11,646

Generator efficiency, per cent.....	92.6	91.8	89.5	83.0	92.5	91.4	88.7	86.0	92.6	91.3	89.2	82.8
Thermal efficiency, per cent.....	28.9	28.6	25.3	18.0	28.7	28.5	25.0	18.4	29.7	29.4	25.4	19.9
Water for cooling (total gal.).....	14,653	11,606	4,436	15,382	11,250	9,388	14,949	13,038	9,629
Water per minute (gal.)...	64	55	62½	77.5	60.0	58	84	59	58
Number units in operation	3	3	3	2	3	3	3	2	3	3	3 & 2
Station load (average kw.)	635	697	660	370	703	688	478	385	666.6	520	483
Station factor (average)...	60.5	64.2	62.8	35.2	67	65.5	45.5	35.6	63.5	49.5	46.0

Actual Operating Results.—The preceding figures represent test values at certain stated loads. It is impossible to secure a given load factor at all times. Consequently the fuel consumption of a Diesel in actual operation will not check with test results. In a few instances, such as with the plant containing the three 500 h.p. engines appearing in Table VII, the plant can operate at practically full load at all times. The fuel consumption should then check with test results. In the Paris, Texas, plant the test gave a fuel consumption at full load of .603 lb. per kw.-hr. The actual operating consumption in this plant is .672 lb. per kw.-hr. while the load ranges from three-quarters to full load. This is but 10 per cent. above the test results.

Unfortunately, such ideal loads seldom are encountered. The usual Diesel engine carries a load from one-quarter to full load, and the fuel consumption is vastly different from full-load test results.

Table VIII is a compilation of the hourly loads in a plant containing three old 225 h.p. Diesels and a 500 h.p. Busch-Sulzer Type B Diesel. The 500 h.p. engine has an individual fuel tank while all three of the older engines obtain their supply from a common tank. Hourly readings of the fuel consumed, actual kilowatts delivered to the switchboard and the indicated kilowatt load are entered in a station log. It will be noted that the 500 h.p. unit operated sixteen hours daily and carried a load

TABLE VIII.—DAILY LOG, DIESEL PLANT A

Time	500 h.p.		225 h.p.		225 h.p.		225 h.p.		500 h.p. fuel		Fuel, other engines	
	Ind. kw.	Kw.-hr.	Ind. kw.	Kw.-hr.	Ind. kw.	Kw.-hr.	Ind. kw.	Kw.-hr.	Total, gals.	Lb. per kw.-hr.	Total, gals.	Lb. per kw.-hr.
12 P.M.												
1 A.M.												
2					80	70	80	70	100	80	25	0.87
3					80	75	80	70	80	80	28	0.97
4					65	85	80	80	80	80	28	0.85
5					75	70	80	70	80	80	26	0.90
6					70	80	80	70	80	80	27	0.91
7					75	80	70	80	70	80	34	1.18
8					130	75	130	75	130	130	28	0.97
9					130	120	130	120	130	130	24	0.73
10					...	75	...	65	...	9	18	0.965
11					...	240	...	240	...	18	21	0.55
12 Noon					...	230	...	230	...	21	20	0.73
1 P.M.					...	210	...	210	...	20	21	0.70
2					...	210	...	210	...	21	21	0.73
3					...	200	...	180	...	18	21	0.73
4					...	200	...	210	...	21	20	0.70
5					...	230	...	215	...	21	20	0.71
6					...	250	...	210	...	20	20	0.70
7					...	200	...	170	...	20	20	0.86
8					...	200	...	180	...	20	20	0.81
9					...	260	...	240	...	22	22	0.67
10					...	300	...	260	...	23	23	0.65
11					...	240	...	260	...	23	22	0.65
12 P.M.					...	220	...	210	...	22	22	0.76
Total kw.-hr.....					...	3285	...	725	...	485	700	...
Fuel per kw.-hr.,				
average.....					0.71	238	0.909

Operation record—Plant A.
 Units: 500 h.p. Busch-Sulzer Type B.
 225 h.p. Busch-Sulzer Type A (old Apolphus Busch engines).

ranging from one-third to one-half load. One hour's fuel consumption (from 9 A.M. to 10 A.M.) is evidently erroneous, but this was rectified in the subsequent hourly readings. The average consumption of .71 lb. per kw.-hr. at half load is exceptionally good and is evidence of the high-class attendance employed in the plant. The interesting figures in this log are the fuel consumptions of the obsolete 225 h.p. Diesels. These engines are from ten to fifteen years old and have had hard service. Nevertheless, the fuel consumption of these engines at less than half load averages .909 lb. per kw.-hr. Although the design and workmanship of these early American Diesels are often ridiculed, it is questionable if the more modern engines will show any better results after the same length of service.

Table IX is the summary of a daily log of a plant having two 225 h.p. and one 170 h.p. old Diesels and one 500 h.p. McIntosh & Seymour Diesel. The average fuel consumption was .972 lb. per kw.-hr. This high value is due to the condition of the old engines and to the engineer's unwillingness to have the 500 h.p. engine carry the night load even though it was less than the engine rating. Frequently the engineer is blameable for a high fuel consumption since he is unwilling to work the engines at their economical load factors.

Production Costs.—While the Diesel is superior to any other form of prime mover in thermal efficiency, the actual commercial efficiency of the engine may be even less than a steam turbine at low loads. It is obvious that the Diesel plant investment is high with consequent high interest and depreciation (fixed) charges. If the plant is operated at a low load factor, the fixed charges and the labor charge will cause the total cost per kw.-hr. to be excessive. Figure 191 is a chart which shows the total cost per kw.-hr. in a graphic manner. This plant had a total installed capacity of 500 kw. The entire plant cost \$81,600. Table X gives the various charges used in developing the curves in Fig. 191. It is apparent that the two factors that determine the total cost per kw.-hr. are the labor and fixed charges. These two items, divided into hourly charges, are assessed against the hourly load and cause the total cost per kw.-hr. to mount very rapidly on low loads. The solution of economical Diesel operation is a high load factor which would tend to reduce the overhead and labor charges. This particular plant employs seven men, and the capacity could be doubled without any increase in the

labor cost, although the fixed charge would increase in ratio with the engine capacity. These curves prove that Diesel plants

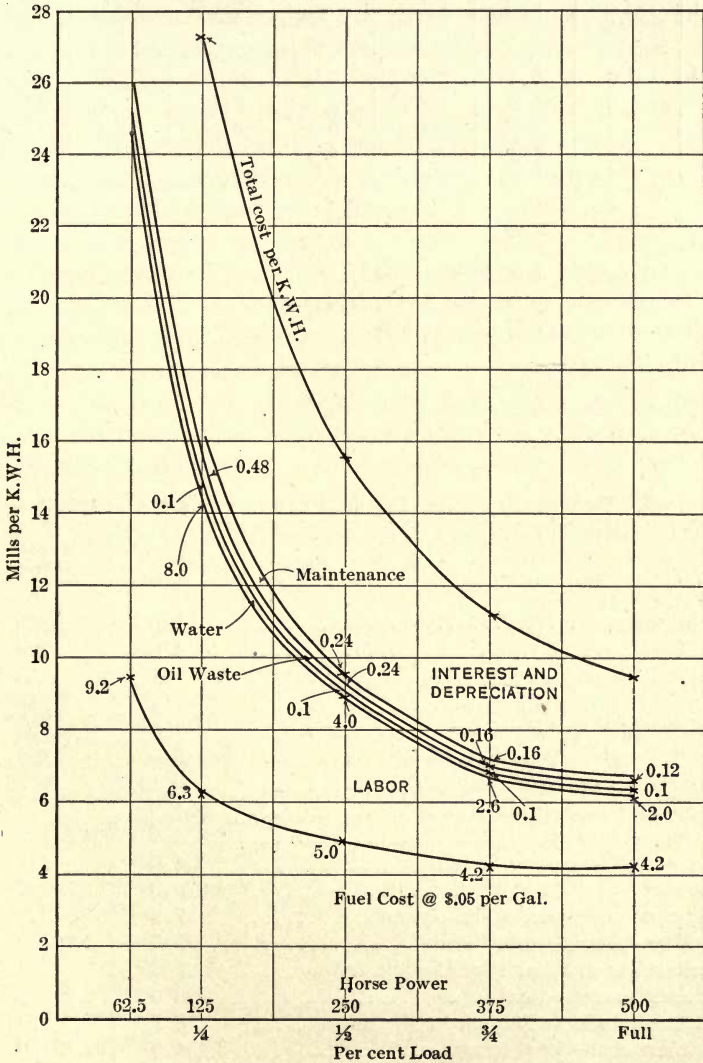

FIG. 191.—Influence of load on total cost per kw.-hr.

must be fairly well loaded to be economical. For this reason it frequently pays a plant to give a very low power rate in order to increase the load factor.

TABLE X.—PRODUCTION COSTS, 500 H.P. DIESEL PLANT IN MILLS
PER KW.-HR.

Load	Interest and depreciation	Fuel	Labor	Water	Oil and waste	Maintenance	Total
Full	3.0	4.2	2.0	0.1	0.12	0.12	9.54
$\frac{3}{4}$	4.0	4.2	2.66	0.1	0.16	0.16	11.28
$\frac{1}{2}$	6.0	5.0	4.0	0.1	0.24	0.24	15.58
$\frac{1}{4}$	12.0	6.3	8.0	0.1	0.48	0.48	27.36

Fuel at 5 cents per gal.

Labor:

Chief engineer at \$150 per month.

Three watch engineers at \$100 per month.

Three helpers at \$70 per month.

Overhead:

7 per cent. interest

8 per cent. depreciation

15 per cent. total.

TABLE XI.—PRODUCTION COST, DIESEL PLANT AT PLANT C, SEPT. 2, 1917

Daily plant operation reportCo.	To-day	Month to date
Kw.-hr. output.....	1,930	4,810
Peak load kw. at 9 P.M.....	150	200
Peak load factor per cent.....	57	50
Station load factor per cent.....	11	14
Generator load factor per cent.....	38	29
Fuel used (gals. oil) Diesel fuel oil.....	340	762
Fuel used per kw.-hr. output, gals. oil.....	0.18	0.16
B.t.u. per kw.-hr. output.....	22,420
Fuel cost—total (cents).....	884.0	1,981.0
Fuel cost (mills) per kw.-hr. output.....	4.6	4.1
Labor cost—total (cents).....	1,370.0	2,740.0
Labor cost (mills) per kw.-hr. output.....	7.2	5.7
Miscellaneous cost—total (cents).....	500.0	1,000.0
Miscellaneous cost (mills) per kw.-hr. output....	2.6	2.1
Maintenance cost—total (cents).....	700.0	1,400.0
Maintenance cost (mills) per kw.-hr. output....	3.7	3.0
Production cost—total (cents).....	3,454.0	7,121.0
Production cost (mills) per kw.-hr. output.....	18.0	15.0
Time generators in service—gen. hr.....	32	67
Temperature (deg. F.) circulating water.....	76	76
Signed.....		

Table XI is the daily report of a Diesel plant having a 350 kw., two 125 kw. and one 100 kw. Diesel units. The smaller units are very old and have a high fuel consumption. The load factor is very low which results in an excessive fuel charge even on the modern 500 h.p. unit. The old units required much overhauling,—this shows up in the maintenance charge. The total production cost was 18 mills per kw.-hr. while the fixed charges are about 10 mills per kw.-hr., based on the daily output. However, this total cost of 28 mills per kw.-hr. compares very favorably with steam plants having similar load conditions.

Table XII covers the results of three months' operation of two Diesel plants of the Texas Light and Power Co. The Paris plant possesses three modern 500 h.p. Diesels, while the Tyler plant has two double-engine units. These latter were second-hand units that were originally installed in an Eastern industrial plant. The condition of these units is revealed in the maintenance charge of 4.48 mills per kw.-hr. The fuel cost of the Tyler plant is 30 per cent. greater than in the Paris plant.

TABLE XII.—ACTUAL UNIT PRODUCTION COSTS, PARIS AND TYLER DIESEL STATIONS, SEPT. 1 TO DEC. 31, 1915

Article	Paris	Tyler
Data:		
Station output (m. kw.-hr.)	1,565	499
Rating of plant (kw.).....	1,050	600
Station factor, per cent.....	51	28½
Total fuel oil (gals.).....	149,072	78,455
Pounds oil per kw.-hr. output.....	0.672	1.100
B.t.u. per kw.-hr. output	13,100	21,400
Production costs (mills per kw.-hr.):		
All labor.....	1.44	2.24
Fuel oil.....	3.07	5.18
Water.....	0.09	0.19
Lubricants and waste.....	0.04	0.56
Miscellaneous supplies and expense.....	0.10	0.29
Maintenance of engines.....	0.04	4.48
Maintenance of buildings.....	0.05	0.05
All other maintenance.....	0.15	0.61
Total production cost, mills.....	4.98	13.60

Oil at 3 cents per gal.

This cannot be attributed entirely to the mechanical condition of the engines but to the load factor as well. The fuel consumption of these old American Diesels is less than 10 per cent. over the fuel consumption of the modern Paris engines on the same load. From this the reader can rightly conclude that the efficiency of the Diesel is fairly constant, regardless of the mechanical condition of the units, as long as the engine will function.

Gas Engine Plant.—The potential competitor of the Diesel engine where natural gas is available is the natural-gas engine. Table XIII is a published report on the gas engine plant of the Willard Storage Battery Co.; this report, as it appears herein, has been amended by the elimination of the depreciation

TABLE XIII.—OPERATING DATA, WILLARD STORAGE PLANT, MONTH OF JANUARY, 1912

Rent of space occupied.....	\$25.00
Water at \$0.40 per 1000 cu. ft.....	20.77
Gas at \$0.30 per 1000 cu. ft.....	511.80
Repairs.....	70.54
Oil.....	101.88
Labor.....	396.00
	<hr/>
	\$1,125.99
Credit—old oil barrels.....	9.05
	<hr/>
Net—with no credit for heating from cooling water....	\$1,116.94
Kw.-hr. generated.....	122.428
Cost per kw.-hr. (mills).....	9.14
B.t.u. per kw.-hr.....	13,935.00

and insurance charges. The production cost totals 9.14 mills per kw.-hr. at a load factor of 41.8 per cent. This is in striking contrast with the Paris Diesel Plant in Table XII where the production cost was 4.98 mills per kw.-hr. and is only slightly better than the results secured with the Tyler second-hand units. The heat units per kw.-hr. in these gas engines do not differ materially from the B.t.u. per kw.-hr. at half load in the Diesels of Table XII. The advantage the Diesel possesses is principally in the lower cost per B.t.u. of its fuel over the natural gas. This can be placed in the form of an equation.

If c = cost of fuel oil per gallon (19,000 B.t.u. per lb.)

a = cost of gas per 1000 cu. ft.

y = B.t.u. per cu. ft. of gas

then

$$\frac{a}{y} = \frac{c}{133}$$

if the cost per B.t.u. is to be the same in fuel oil and gas. As example, if fuel oil can be obtained for 3 cents per gallon and the natural gas contains 600 B.t.u. per cubic foot, the gas must be obtained at a cost of 13½ cents per 1000 cubic feet to equal the fuel oil as a fuel.

At the same net cost per B.t.u. the natural-gas engine would possess a lower total cost per kw.-hr. because of its lower fixed charges. Each installation must necessarily depend on the varying considerations that enter into the problem.

Producer-gas Engines vs. Diesel Engines.—From the viewpoint of fuel cost alone, the producer-gas engine is usually more economical than is the Diesel. Table XIV is a summary of a test on a 200 h.p. producer-gas engine conducted by the Lehigh University. The dry coal per brake horsepower was 1.04 lbs. Based on usual generator efficiency, the coal per kw.-hr. would approximate 1½ lbs. or 20,000 B.t.u. The coal must then be purchased at \$4 per ton to allow the fuel cost to equal the Diesel fuel cost in Table XII. In normal times anthracite pea coal can be purchased at a decidedly lower price in the vicinity of the mines.

TABLE XIV.—PRODUCER-GAS ENGINE TEST

Duration of test.....	24 hr.
Make of engine.....	Fairbanks Morse
Type.....	Four-stroke-cycle
Size.....	Four-cylinder 14½ × 18-in.
Method of ignition.....	Battery during test, ordinarily magneto
Rated capacity.....	200 h.p. at 250 r.p.m.
Kind of gas.....	Mixed producer gas
Average Pressures and Temperatures	
Pressure of gas near meter, in. of water.....	0.985
Temperature of cooling water.....	Deg. F.
(a) Inlet to cylinders and valves.....	53.74
(b) Outlet from cylinders.....	114.56
(c) Outlet from valves.....	104.95
Temperature of gas near meter.....	62.3
Temperature of exhaust gases.....	1019.23
Gas consumed per hour at 62° and 30 in.....	15,520 cu. ft.
Cooling water supplied per hour:	
(a) To jackets.....	9,000 lb.
(b) To valves.....	475 lb.

TABLE XIV.—PRODUCER-GAS ENGINE TEST.—(Continued.)

Analysis of Exhaust Gases by Volume		Per cent.
Carbon dioxide (CO ₂).....		16.99
Oxygen (O ₂).....		1.84
Carbon monoxide (CO).....		0.50
Nitrogen (by difference) N ₂		80.67
Indicator Diagrams		
Pressure in lbs. per sq. in. above atmosphere:		
(a) Maximum pressure.....		300
(b) Pressure at end of expansion.....		25
(c) Exhaust pressure at lowest point.....		2
Average mean effective pressure in lbs. per sq. in.....		59
Speed and Explosions		
Revolutions per minute.....		239
Average number of explosions per minute.....		478.5
Indicated horsepower.....		211.8
Brake horsepower.....		199.2
Friction horsepower by difference.....		12.6
Percentage lost in friction.....		5.8
Economy Results		
Heat units consumed by engine per hour:		
Per indicated horsepower.....		10,034 B.t.u.
Per brake horsepower.....		10,674 B.t.u.
Gas consumed per hour:		
Per indicated horsepower.....		73.3 cu. ft.
Per brake horsepower.....		78 cu. ft.
Dry coal consumed per i.h.p.-hr.....		0.98 lb.
Dry coal consumed per b.h.p.-hr.....		1.04 lb.
Efficiency		
Thermal efficiency ratio:		Per cent.
Based on i.h.p.-hr.....		25.3
Based on brake horsepower.....		23.8
Heat Balance Based on B.t.u. per i.h.p.		
	B.t.u.	Per cent.
Heat converted into work.....	2,545	25.4
Heat rejected in cooling water.....	2,700	26.9
Heat rejected in exhaust gases.....	2,582	25.8
Heat lost due to moisture formed by the burning of hydrogen.....	228	2.2
Heat lost by incomplete combustion.....	205	2.0
Heat unaccounted for, including radiation.....	1,774	17.7
Total heat consumed per i.h.p.-hr.....	10,034	100.0

TABLE XV.—COMPARATIVE ESTIMATES FOR 1000-KW. POWER PLANT

Type.....	Diesels 3—500 h.p. engines 1050 kw. \$18,000 150,000	Natural-gas engines 3—500 h.p. engines 1050 kw. \$18,000 90,000	Producer-gas engines 3—500 h.p. engines 1050 kw. \$22,000 120,000	Steam turbine 2—turbo units 1100 kw. \$18,000 30,000 40,000 30,000 15,000 30,000 163,000
Building.....				
Engine.....				
Boilers.....				
Turbine set.....				
Generators.....				
Incidentals.....				
Overhead expense.....				
Total cost.....	253,000	193,000	227,000	163,000
Station factor, per cent.....	50	50	50	50
Yearly output, m.kw.-hr.....	4600	4600	4600	4600
Interest, per cent.....	7	7	7	7
Depreciation, per cent.....	8	8	8	5
Total fixed charges, per cent....	15 or \$37,950	15 or \$28,950	15 or \$34,050	12 or \$19,560
Fixed charges per kw.-hr., mills	8.25	6.29	7.40	4.21
Labor per kw.-hr., mills.....	1.50	1.50	1.50	1.50
Fuel per kw.-hr., mills.....	5.00	7.43	6.00	6.00
Lubricating oil per kw.-hr., mills	0.05	0.06	0.10	0.03
Incidentals per kw.-hr., mills...	0.10	0.10	0.10	0.10
Maintenance per kw.-hr., mills..	0.30	0.30	0.50	0.70
Total cost per kw.-hr., mills....	15.20	15.68	15.60	16.54
Saving of Diesel per year.....	\$2028	\$1840	\$6164
	Fuel oil at \$0.05 per gal.	Gas at \$0.40 per 1000 cu. ft.	Anthracite at \$8.00 per ton	Coal at \$4.00 per ton

Comparative Estimates for Diesel, Steam Turbine, Natural-gas and Producer-gas Engine Plants.—Table XV covers estimates on various types of prime movers. It will be observed that the Diesel engine is the most economical unit under these conditions. The estimates are based on war prices and should be revised to prevailing quotations as should also be the fuel costs. The producer units approach the Diesels in total efficiency; in fact, in most cases the producer unit will prove more efficient. The serious drawback to the installation of a producer engine is the unreliability of the producer. This apparatus requires skilled attendants not easily procured; producer breakdowns are of common occurrence in such plants.

Steam vs. Diesel.—In large units, above 5000 kw. the steam turbine will probably prove more economical than the Diesel. Plants of less capacity will find that the Diesel gives a lower total cost per kw.-hr. Under 1000 kw., the turbine is not as attractive as the reciprocating steam engine and cannot compete with the oil engine. If a manufacturing establishment or office building creates a demand for exhaust steam, the Corliss or the Uniflow steam engine may be the type to install. For all other plants, where no demand exists for exhaust steam, the Diesel is superior.

Plant Logs.—Every power plant should have a daily log in which are entered the hourly load, fuel consumption and other details. Figure 192 is a log employed in a number of Diesel plants and is quite complete. Along with this daily log, a summary sheet, such as appears in Table XI, should be maintained. This sheet, being made up daily, gives the management a check on daily efficiencies.

Comparative Heat Balances.—Figures 193 to 195 show graphically the heat balances of various prime movers. It is apparent from these comparative charts that the Diesel engine is approached in heat-absorption efficiency only by the natural-gas engine. The actual efficiency of the producer engine is identical with that of the natural-gas engine, but the loss occasioned in the producer or gas generator must be charged against the engine.

Indicator Cards.—Many Diesel operators, being inexperienced in handling an indicator, do not understand the significance of an indicator card. For these, a few words of explanation will not be amiss.

It is obvious that, in any engine cylinder, we are confronted

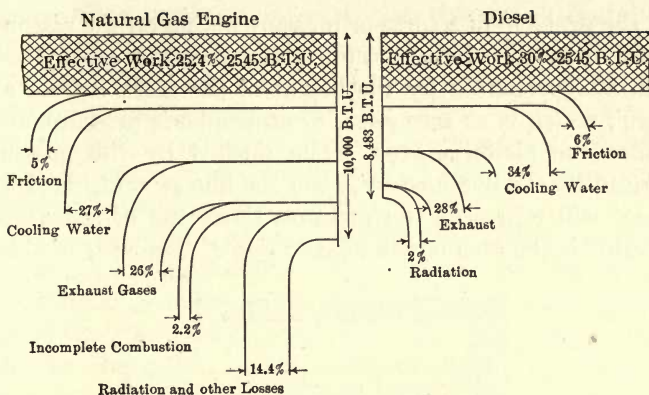

FIG. 193.—Heat balances.

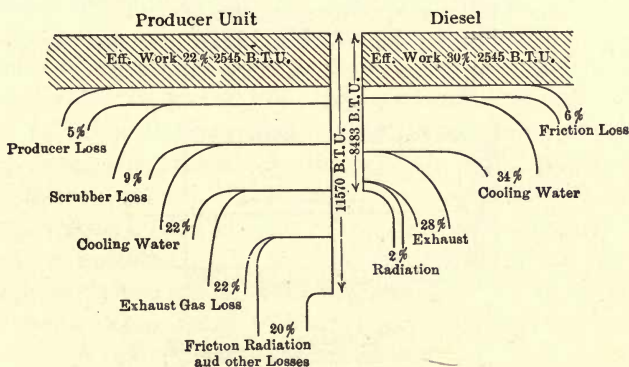

FIG. 194.—Heat balances.

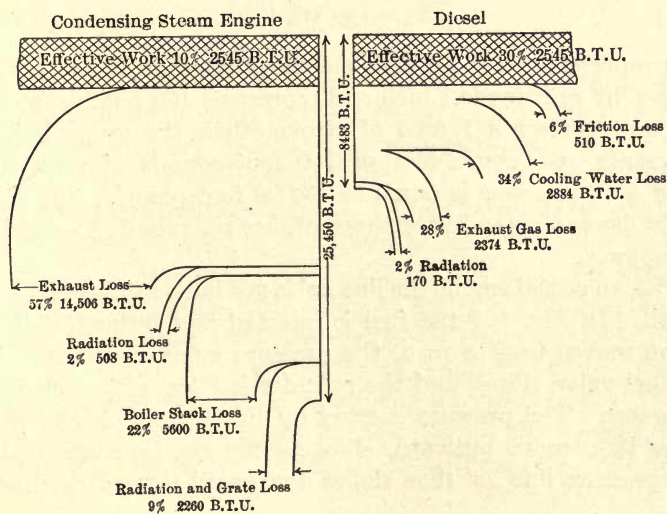
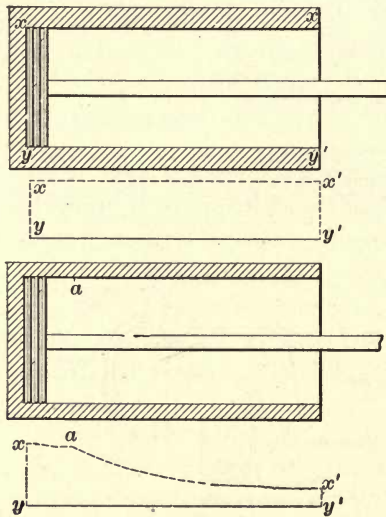

FIG. 195.—Heat balances.

with the problem of a force or pressure acting on the piston for a certain distance. In Fig. 196, if the pressure exerted on the piston is represented by the height of the mark x from a base line yy' , which is at zero gage, or atmospheric pressure, and the distance the piston moves, while pushed by the pressure x , indicated by the distance xx' , then the line xy multiplied by the line xx' will represent the pressure times the distance moved; this value is the area of the figure $xx'yy'$. The area of this card



FIGS. 196, 197, 198.

then represents to some scale the work done on the piston. If the height xy is made 1 inch and represents 100 pounds, and the line xx' represents 1 foot of stroke, then the area obviously represents 100 pound-feet or 100 foot-pounds of work done. Since a horsepower is equal to 33,000 foot-pounds, this engine would have to make 330 of these strokes per minute to equal one horsepower.

With an actual engine the line xx' is not horizontal for its entire length. In Fig. 197 the fuel is injected and burned while the piston moves from x to a , the pressure being constant. At a the fuel valve closes, and the cylinder is filled with a charge of hot gases. The pressure exerted by these gases on the piston forces it to move outward, allowing the gas pressure to drop. The pressure line xx' then slopes downward toward the base or

atmospheric line until the piston reaches the end of its stroke at x' . It will be noted that the gas pressure has dropped as the piston receded. The area of the figure still represents the work performed on the piston. Since the line xx' is not horizontal, the area is no longer xx' times yy' but the average height of the line xx' times the actual stroke, which is yy' . This area can be determined by an instrument called a planimeter.

In an actual engine at the end of the stroke the exhaust valve opens, allowing the gas to blow out, and the line xx' drops sharply from x' to b , Fig. 198. The piston then moves forward, forcing all the gas out of the cylinder. This gas exerts a counter pressure on the piston which, while small, is indicated by the line bc . As the piston then reverses its travel, a partial vacuum is formed in the cylinder, and the pressure drops below the atmospheric line; this causes the outside air to rush in. Since the pressure is below atmospheric in the cylinder during this stroke, the pressure on the piston has a negative value as indicated by the line cd below the base line. At d the suction valve closes, and the piston compresses the charge of air. The pressure rises as the piston advances. This pressure works against the piston and is indicated by the line dx . At x the fuel valve opens, and the cycle is repeated. The area of the figure formed by these lines represents the actual work performed in the cylinder.

The cards taken from various Diesels all have a marked similarity. A few typical cards are shown.

McEwen Diesel Indicator Cards.—Figure 199 shows cards from a 14×22 McEwen Diesel. All show a slight drop in the admission line, indicating that the resistance in the nozzle was too great for the injection-air pressure carried. Raising the air-blast pressure would tend to bring the admission line to a horizontal position. For the sake of clearness the exhaust and suction strokes are not indicated.

Allis-Chalmers Indicator Cards.—Figure 200 shows typical cards from the Allis-Chalmers open-nozzle Diesel. The rising slope of the admission or combustion line indicates that the fuel, although injection began early, did not ignite readily; at the beginning of injection only the lighter portions ignited. This raised the temperature sufficiently to ignite the entire charge. The effect was accumulative, producing the rising line.

National Transit Indicator Cards.—Figure 201 depicts cards from a $15\frac{1}{2} \times 24$ National Transit Diesel engine at 180 r.p.m.

The notable feature of these cards is the horizontal combustion line, produced, evidently, by a happy combination of efficient atomization and proper air-blast pressure. The quarter-load card shows a sharp peak at the end of the compression. Some attribute this to inertia in the indicator. It is very probable that this peak is a result of the inability of the air blast to pick up the fuel at the instant of valve opening. The air had to attain a high velocity before the oil was swept into the cylinder.

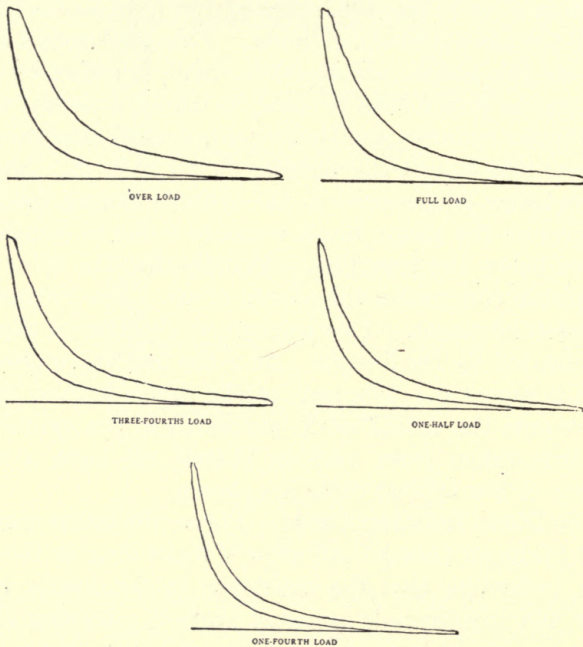

FIG. 199.—Indicator cards. McEwen Diesel.

The piston, in the meantime, had retreated; the combustion of the fuel was insufficient to keep the pressure constant.

Standard Fuel Oil Indicator Cards.—Figure 202 shows cards for the Standard Fuel Oil two-stroke-cycle Diesel engine, and they are typical cards from an engine working under this cycle.

Faulty Indicator Cards.—Figure 203 is a card from a two-stroke-cycle Diesel. The compression was carried to the end of the stroke at *c*. On the power stroke the combustion did not occur until the pressure had dropped to the point *a*. Since the oil

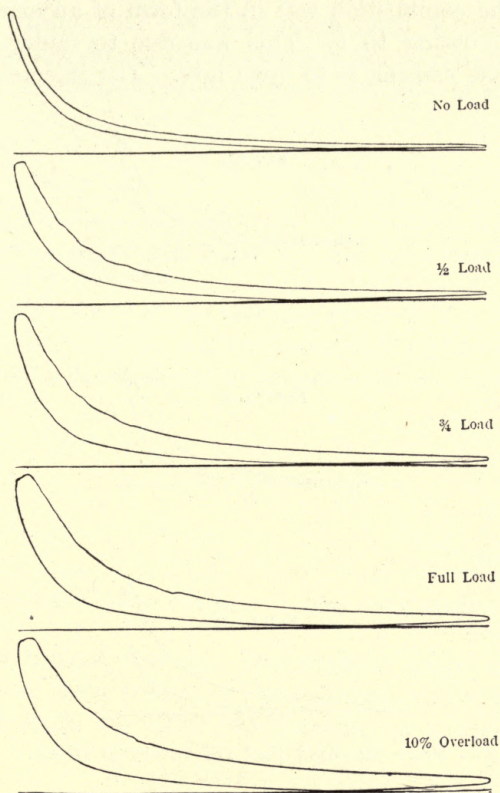

FIG. 200.—Indicator cards. Allis-Chalmers Diesel.

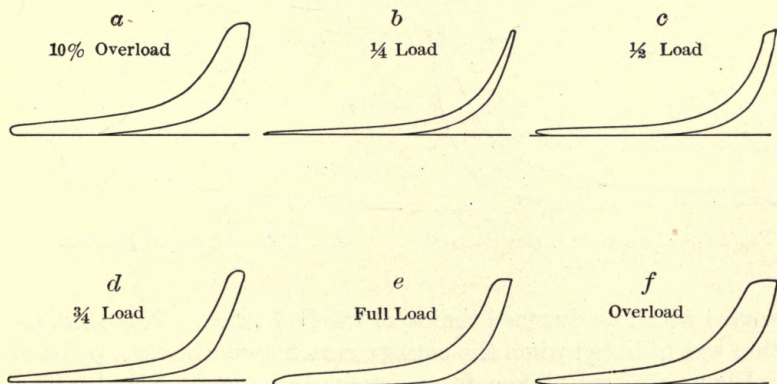

FIG. 201.—Indicator cards, National Transit Diesel.

was light, the combustion was in the form of an explosion, the pressure line rising to *b*. This was due to faulty setting of the fuel valve, causing it to open late. The injection pressure

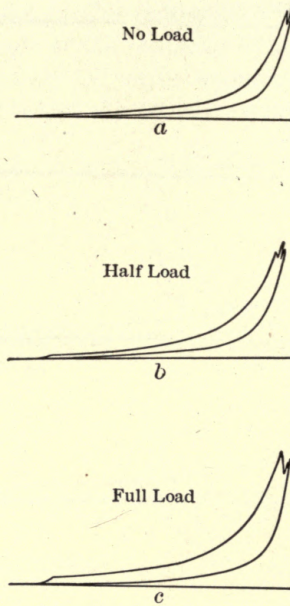

FIG. 202.—Standard Fuel Oil two-cycle Diesel.

was high, and this forced the entire fuel charge into the cylinder as soon as the valve opened. Figure 204 is a card from the same

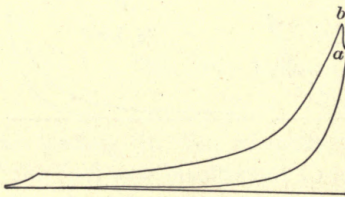

FIG. 203.—Two cycle engine delayed ignition.

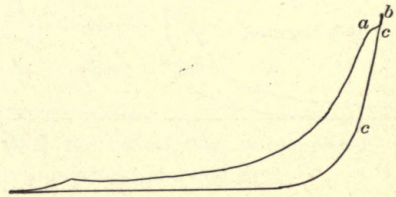

FIG. 204.—Advanced ignition.

engine with an advanced timing of the fuel valve. The combustion was initiated when the compression line reached the point *c*.

Figure 205 was taken from a four-stroke-cycle Diesel. The compression was carried to *a*. Due to the heavy character of

the oil, ignition did not take place until *b*, where the entire charge ignited, raising the combustion line to the point *c*. Figure 206 may be considered a perfect card and is from the same

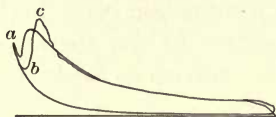

FIG. 205.—Four stroke cycle engine delayed combustion.



FIG. 206.—Perfect combustion.

engine. The shape of the combustion *ab* in Fig. 207 discloses a high injection velocity, with a consequent rapid rate of combustion. With a lower injection pressure the combustion would be

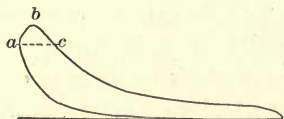

FIG. 207.—High injection velocity.

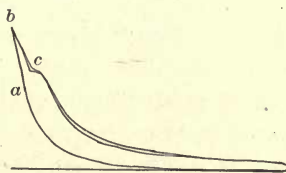

FIG. 208.—Early injection using a crude oil.

along the broken line *ac*. The peculiar shape of Fig. 208 is traceable to early timing of the injection valve when using an untapped crude oil. The valve opened at *a*; the gasolene and

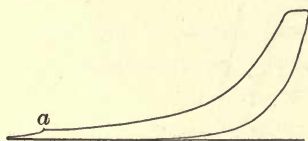

FIG. 209.—Four stroke cycle Diesel early exhaust opening.

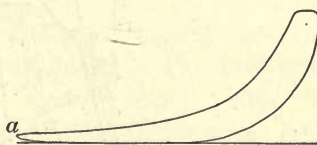

FIG. 210.—Late exhaust opening.

kerosene content ignited, raising the pressure from *a* to *b*. The heavier particles did not ignite until the piston started on the return stroke, as evidenced by the point *c*.

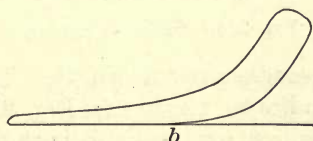

FIG. 211.—Late suction valve closure.

Figure 209 shows an early opening of the exhaust valve. Figure 210 betrays a late exhaust opening. The piston reaches

the end of the stroke before the exhaust valve opens. Figure 211 reveals a late closure of the suction valve; this valve closed at *b*, producing a low terminal compression.

Distorted Cards.—The process of combustion occurring in the engine cylinder is of more vital interest to the operator than anything else. The timing of the valves is easily checked

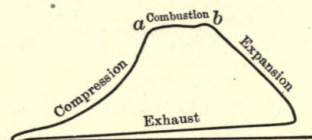

FIG. 212.—Distorted indicator card.

while the actual events within the cylinder must be deduced from the indicator card. With the usual card the combustion line is of small length, making impossible any determination of the combustion processes. If the indicator is connected in such a way as to have it set 90 degrees ahead of the engine crank, the

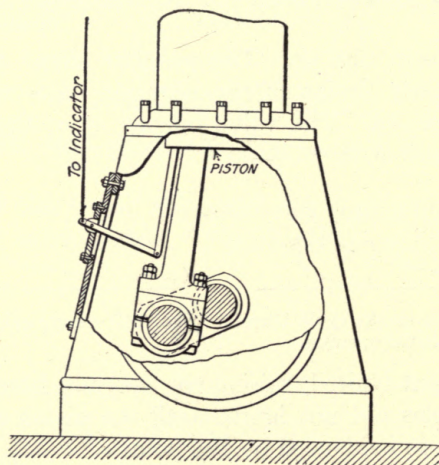

FIG. 213.—Indicator rigging.

combustion line is exaggerated in length. This can be accomplished with the indicator rigging in Fig. 214 by shifting the eccentric 90 degrees. A card secured with this setting appears in Fig. 212. It is apparent that the lengthened line *ab* gives an increased insight into the cylinder pressure change during combustion.

CHAPTER XVII

THE SEMI-DIESEL OIL ENGINE

The mechanism of the Diesel engine is rather complicated, and the manufacturing cost is too high for the small-powered units. To be economical in total expense, a Diesel must be at least of 100 h.p. capacity. Even in this size the working hours should extend over the major portion of the day. The chief objection to Diesels below 150 h.p. lies in the high attendance charge per horsepower-hour. Regardless of the size of the unit, the operator must not only be intelligent but skilled as well. It is necessary to pay fairly high wages to secure the services of an experienced Diesel engineer.

To meet the demand for an engine that would be economical to the use of fuel and at the same time simple enough in design in permit an intelligent workman to operate it, the semi-Diesel engine was brought out.

As has been explained in a previous chapter, the basic principle of the present-day Diesel is the reception of the heat at constant pressure. While the term "semi-Diesel" has been applied to certain engines because their compression pressure was approximately half that occurring in a true Diesel, it so happens that all these true semi-Diesel designs embody the principle of receiving a part of the heat of combustion at constant pressure and a part at constant volume. A great many low-pressure engines are marketed under the trade name of "semi-Diesel." To establish the right of an engine to this name an indicator card from the engine should be studied, and the proper classification can be determined by the shape of the combustion line.

Indicator Cards of Semi-Diesel and Low-pressure Engines.—An indicator card taken from a two-stroke-cycle low-compression engine is shown in Fig. 215. The compression reaches a value of approximately 100 lbs. per sq. inch at the end *A* of the stroke. At this point the fuel charge, which was gasified during the latter part of the compression stroke, is exploded instantaneously. The maximum explosion pressure reaches 400 lbs. per sq. inch at *B*.

In this type of engine all the heat is added along the vertical line *AB*, at constant volume.

Figure 216 is a card from a four-stroke-cycle semi-Diesel engine. In this engine a charge of fresh air is drawn into the cylinder from *A* to *B* and compressed from *B* to *C*. At the point *C* the atomizer explodes a primary charge, raising the pressure to about 600 lbs. per sq. inch at *D*, which causes the injection of the

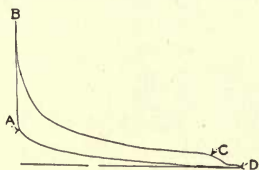

FIG. 215.—Card from two-stroke low compression engine.

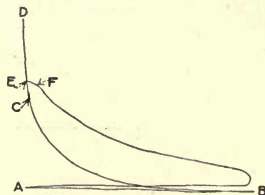

FIG. 216.—Four-stroke-cycle semi-Diesel engine.

secondary or main fuel charge from *E* to *F*. This main charge is injected and burned at practically a constant pressure of 300 to 400 lbs. per sq. inch. The primary charge adds but a slight amount of power and may be ignored entirely when figuring the indicated horsepower. If the sharp peak from *E* to *D* is eliminated, the card will have a form which to all appearances is a typical Diesel engine card.

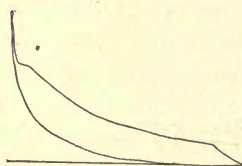

FIG. 217.—Two-stroke-cycle semi-Diesel engine.

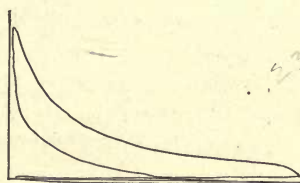

FIG. 218.—De La Vergne F.H. semi-Diesel engine, 200 spring.

The card shown in Fig. 217 was taken from a two-stroke-cycle semi-Diesel engine and displays the same effects of the primary and secondary charges. Figure 218 is a card from a De La Vergne Type F.H., a semi-Diesel engine using a vaporizer and air injection but without a primary charge. This is quite similar to the true Diesel card, the chief differences being in the maximum compression pressure developed, which is lower than in the Diesel, and the slight increase in pressure during combustion.

Comparing these semi-Diesel cards with Fig. 215, taken from a low-pressure or hot-bulb engine, it is evident that the compress-

sion in the former is carried much higher and that the addition of heat is accomplished in a vastly different manner from that followed in the low-compression constant-volume engine.

Ignition Devices. Hvid or Brons Principle.—Several makes of semi-Diesel engines use the "cup" form of injection and atomization of the fuel. With this device the combustion of the atomized fuel is accomplished by means of the heat of compression, exactly as in the true Diesel engine. The sectional view in Fig.

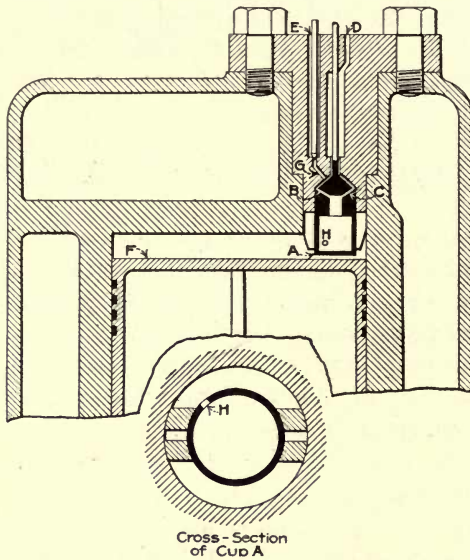

FIG. 219.—One form of Hvid ignition device.

219 shows a cup employed to produce the injection of the main fuel charge. The operation of this device is based on the fact that every oil, no matter how heavy it may be, contains some light hydrocarbons that will vaporize or distil at a fairly low temperature. The explosion of these lighter parts of the fuel provides the propellant whereby the remainder of the fuel is injected in a finely atomized condition. It is a further matter of common knowledge that the temperature of ignition of an oil is dependent upon the degree of atomization.

In Fig. 219 the cup or primary cylinder *A* has ports *B* and *C* that communicate with the outside air at *D* and with the fuel supply at *E*. As the piston *F* starts on its suction stroke, the pressure inside the cup *A* decreases, as the joint between the cup

and the cylinder casting is not tight. The reduced pressure in the cup causes a small charge of air and oil to be drawn into the cup. The oil port *G* is closed by the action of the governor, thereby regulating the amount of the fuel charge. At the proper point, at the end of the suction stroke, the cup moves upward and closes the fuel and air ports *B* and *C*, and at the same time covers the communicating port *H* in the side of the cup. As the piston returns on its compression stroke, the air leaking past the joint between the cup and the cylinder raises the pressure in the cup to from 350 to 400 lbs. per sq. inch. The resulting temperature is sufficient to vaporize and ignite some of the light hydrocarbons, causing a maximum ignition pressure inside the cup of about 700 lbs. per sq. inch. Just before the crank reaches dead-center, the cup is rotated a slight amount, uncovering the port *H*. The extremely high pressure in the cup immediately forces the heavy oil charge out through the port *H* into the cylinder space. In passing through the port into the low pressure existing in the cylinder, the oil is atomized sufficiently to unite with the air charge in the cylinder. It will be observed that the character of the oil determines in a great measure the time of ignition and the shape of the combustion line on the indicator card. If the oil is extremely heavy, with the lightest hydrocarbons of fairly low gravity, then the light portion will not ignite in the cup until practically dead-center is reached. The pressure in the cup, due to this primary combustion, will not reach a high value before the port *H* is opened. The pressure difference existing between the cup and the cylinder will not be great, and consequently the injection through the port *H* will be slower, and the combustion line on the card will be practically horizontal.

In the card shown in Fig. 242 the oil used was around 26° Baumé and contained a considerable percentage of light oils. The explosion in the cup was, consequently, intense, causing a high pressure. This high pressure combined with the explosion of the remainder of the lighter percentage of oil as it entered the cylinder was sufficient to cause the peak on the card at dead-center. The heavy particles of oil burned more slowly, as indicated by the sloping combustion line.

Operation.—In operation much depends on the adjustment of the cup-valve stem. If the movement of the cup uncovers the port *H* too early, preignition will occur. Since the pressure

carried is much higher than in the low-compression engine, pre-ignition has a greater detrimental effect. Ordinarily, the bearings show great wear, and they, as well as the shaft, should be made heavier than is customary.

The cup has a tendency to become fouled with carbon and should be inspected regularly. Attention should be paid to the beveled seat between the cup and the engine casting, as the slight-

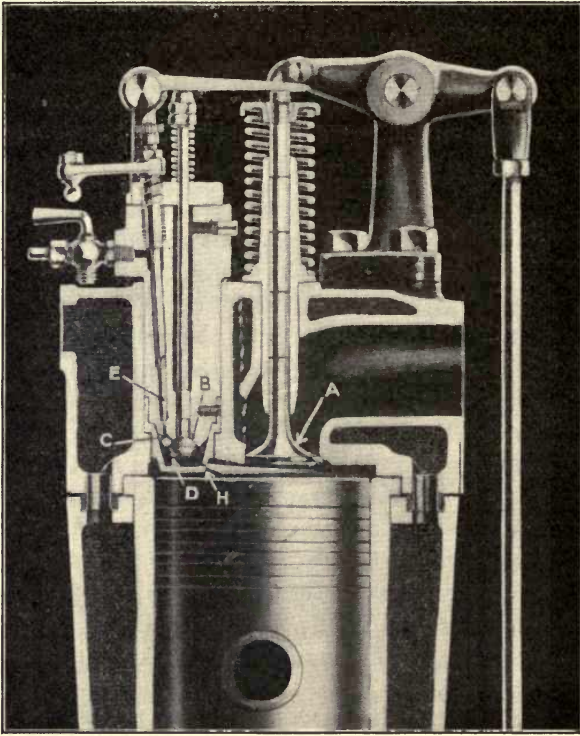

FIG. 220.—Hvid principle of ignition, Lyons-Atlas design.

est leakage at this point will prevent the engine from operating satisfactorily. The seat may be ground with coarse emery compound, finishing with a mixture of pumice flour and oil. Cylinder oil such as is used on ammonia compressors makes the best paste.

This ignition device was employed on the St. Mary's oil engine of the vertical type.

A cup device on the same lines is shown in Fig. 220. This embodies the same principle of primary ignition, but the cup does

not possess the angular movement for the purpose of opening the port *H*. This cup is equipped with a fuel valve which is mechanically operated from the camshaft. In operation a charge is drawn into this cup by atmospheric pressure when the engine is on the suction stroke. The fuel valve controls the timing of the period of fuel admission. To regulate the amount of fuel admitted, the needle valve *E* is connected to the governor. The movement of the governor, through a suitable linkage not shown in Fig. 220, rotates the needle valve stem; this, in turn, alters the area of the fuel port or passage *C*. It is to be observed that the fuel charge enters the cup on the suction stroke of the engine.

It remains here during the entire compression stroke. If the oil varies in character, it will ignite earlier or later as the case may be. There is, then, a danger of pre-ignition. Figure 221 is an indicator card taken from an engine equipped with this device. The primary explosion occurred when the piston was approximately 20 degrees ahead of dead-center. The

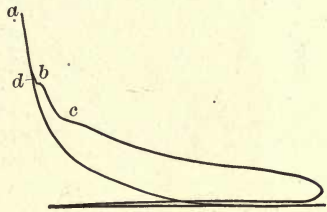

FIG. 221.—Indicator card from engine employing the Hvid or Brons principle.

injection of the oil from the cup into the cylinder and the ignition of this charge took place some 15 degrees after dead-center had been passed. The burning of this main charge is shown in the horizontal line. Apparently the combustion of part of the heavy particles was somewhat delayed, the burning taking place at the point *C*.

It is to be expected that this cup will require the same care as the one previously described. Since the injection is not positively controlled, the openings *H* must be altered in size to regulate the flow of oil through them. On a light oil, if the openings are large, the injection will be early, causing preignition. The compression carried, averaging 450 pounds, requires a sturdiness of construction approaching the Diesel. The cup and fuel valve must be maintained in the best of shape. The smallest leak will lower the cup compression. Since the explosive pressure approximates 600 pounds, it is evident that the valve must be ground often and with the utmost intelligence. As there is no water-cooling of this valve and seat, it will corrode and pit if it does not receive attention. This device is found on the horizontal Atlas-

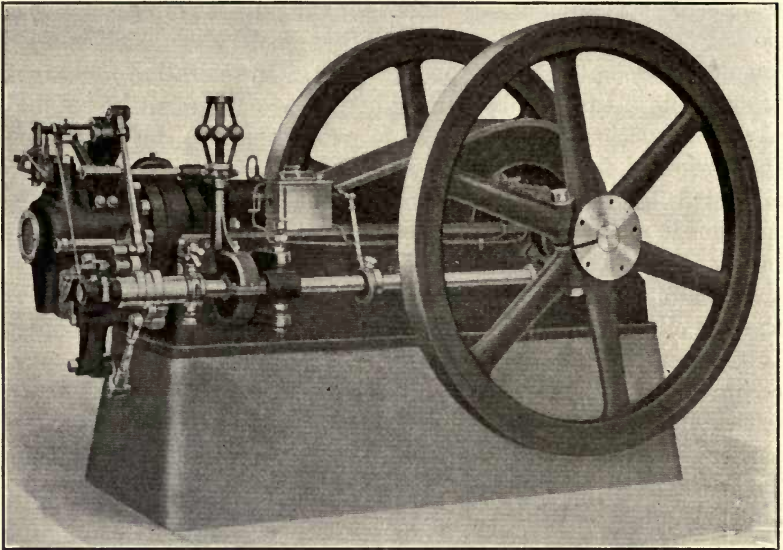

FIG. 222.—Midwest-type V.D.H. horizontal four-stroke-cycle semi-Diesel engine.

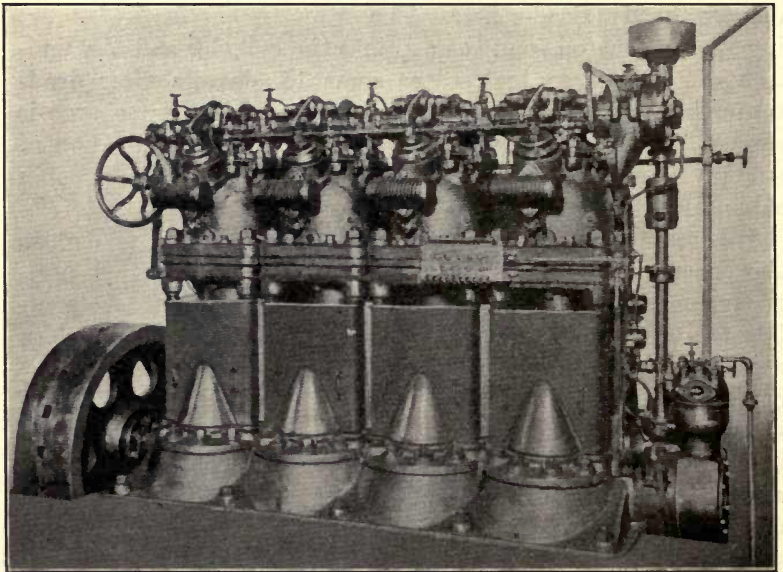

FIG. 223.—Midwest type V.D.H. vertical semi-Diesel oil engine.

Lyons (now Midwest) V.D.H. engines, as well as on the Burnoil engine. An illustration of the V.D.H. engine appears in Fig. 222. The governor, which is of the spring-loaded type, is driven off the layshaft and controls the fuel needle valve *E* in Fig. 220.

Lyons-Atlas Vertical V.D.H. Engines.—On their vertical V.D.H. engine the Lyons-Atlas Co. has eliminated the governor-controlled needle valve and uses a fuel pump for each engine cylinder, the fuel pump being under governor control.

The vertical engine is illustrated in Fig. 223. The cylinders, which are 9-inch bore by 13-inch stroke, are mounted on A-frames. On one side the frames are open, being supported by tension rods. The openings are covered by steel oil guards that are removable. The cylinder construction is quite unusual. Each cylinder is provided with a removable skirt. This skirt can be unbolted, allowing the piston to be swung out to the side without unshipping the connecting-rod from the crank. The engine is built for both stationary and marine service.

Fuel Consumption. Hvid Engines.—The fuel consumptions of the various engines employing the Hvid principle are practically the same. Table XVI covers tests on a three-cylinder vertical engine, 9½-inch bore by 10½-inch stroke, and is quite representative of this type.

TABLE XVI.—TEST ON SEMI-DIESEL ENGINE EMPLOYING HVID PRINCIPLE

Test No.	I	II	III	IV
Bore of cylinder, in.....	9½	9½	9½	9½
Stroke, in.....	10½	10½	10½	10½
Fuel.....	Kerosene	Mexican fuel oil	Standard Oil Co. fuel oil	Lansing fuel
Weight per gallon, lbs.....	6.9375	7.1875	7.375	6.9375
Weight per pint, lbs.....	0.8672	0.8984	0.922	0.8672
Gravity, deg. Baumé.....	42	33	29	39
Flash open flame, deg. F.....	160	200	196	210
R.p.m.....	315	330	345	340
Pounds pull net.....	191	191	191	191
Brake-arm circle circum., ft.....	33	33	33	33
Torque, lb.-ft.....	1003.3	1003.3	1003.3	1003.5
Horsepower.....	60.165	63.03	65.895	64.94
Fuel, lbs. per b.h.p.-hr.....	0.586	0.500	0.481	0.466
Operation of engine.....	Smooth	Very smooth	Smooth	Smooth
Exhaust.....	Clear	Trace of smoke	Almost clear	Trace
Engine troubles.....	None	None	None	None
Maximum b.h.p. with slight smoke.....	60.16	85.00	84.15	86.70

Nordberg Ignition Device.—Another form of ignition cup, adopted by the Nordberg Manufacturing Co. for their two-stroke-cycle semi-Diesel (or high-compression, as the manufacturers call it) engine, appears in Fig. 224. The fuel oil is injected into the cup *A* through the atomizing nozzle *B*, by the action of the fuel pump, a few degrees before mid-point in the compression stroke. This fuel, as it leaves the injection nozzle, mixes with the air which has been forced into the cup by the advancing engine piston. As with the devices already discussed, the lighter con-

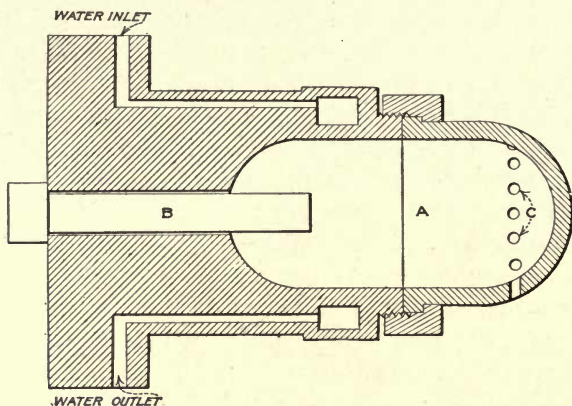

FIG. 224.—Nordberg semi-Diesel ignitor.

stituents ignite as soon as the oil enters the hot cup and mingles with the air. The combustion of this part of the oil charge creates, within the cup, an extremely high pressure, which is much greater than the engine compression pressure. This difference in the two pressures causes the remainder of the fuel charge to be forced out through the ports marked *C*. The high velocity of the fuel passing through the ports *C* atomizes it sufficiently to produce ignition when mixed with the air charge in the cylinder.

In this engine the point of injection of the fuel into the cup is about mid-stroke of the piston. Since the timing of the injection of the main charge from the cup into the cylinder is not under positive control, with certain oils preignition may occur. If the oil is of light gravity, the high compression pressure carried will cause it to ignite very early. This primary explosion forces the main charge into the cylinder before dead-center, causing

preignition and bearing pounding. To avoid premature combustion, the cup is designed with a water-cooled space; this assists in keeping down the temperature of the cup and delays combustion.

Figure 225 is a later design of cup. In this the water-cooling is discarded. The injection nozzle is provided with a spring-

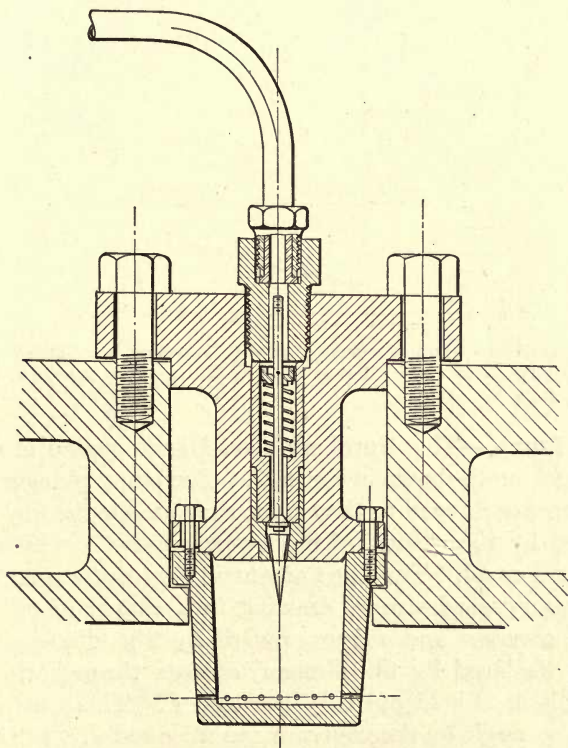

FIG. 225.—Nordberg ignition device on semi-Diesel engine, late design.

loaded check valve and is held in position by a screwed lock bushing instead of a locking bar as was used on the former design. The bowl of the cup is bolted to the body of the igniter; this eliminates the difficulty experienced with the screwed ring collar of the previous cup.

Figure 226 shows an indicator card from this engine. The card reveals combustion conditions that are not along the true Hvid plan. It would appear that the primary charge did not explode

until dead-center and that the piston retreated some distance before the pressure difference caused the injection of the main charge and its consequent combustion. Under such injection conditions a dull thump would be heard, produced by the burning gases striking the receding piston. If the injection had been early, as is usual, a sharp sound would have been emitted as the primary charge impinged on the advancing piston.

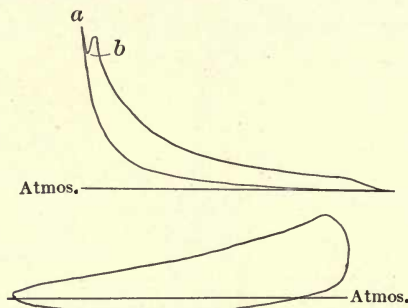

FIG. 226.—Power and scavenging cards, Nordberg semi-Diesel oil engine. Cards reproduced to scale. Power card is 300 pounds per inch, scavenging card 10 pounds per inch.

Fuel Pump.—The Nordberg semi-Diesel engine is equipped with a fuel pump shown in Fig. 227. The pump plunger is driven by an eccentric keyed to the engine shaft, while the fuel charge is regulated by the closure of the by-pass valve *V* which is under governor control. The fixed eccentric moves the pump plunger *P* on the outward stroke, drawing in a charge of oil. As the plunger reverses and moves inward on the discharge stroke, the oil, displaced by the plunger, escapes through the by-pass valve, which is held open by the cam *F*. This cam is rocked through an angle by the governor eccentric rod *G*. At the proper time the cam is moved to its mid-position, as shown in Fig. 228. The by-pass valve closes, and the oil displaced by the further movement of the pump plunger passes through the discharge valve *H* and enters the fuel atomizer.

Governor.—Figure 228 outlines the relative positions of the governor and pump at the beginning of the fuel-injection period. The governor is of the inertia type and carries a pin *B* to which is fastened the by-pass valve rod *G*. The governor is fulcrumed at *J* on the flywheel; the position of the governor pin *B* is such that the by-pass valve is just closed when the engine crank is at

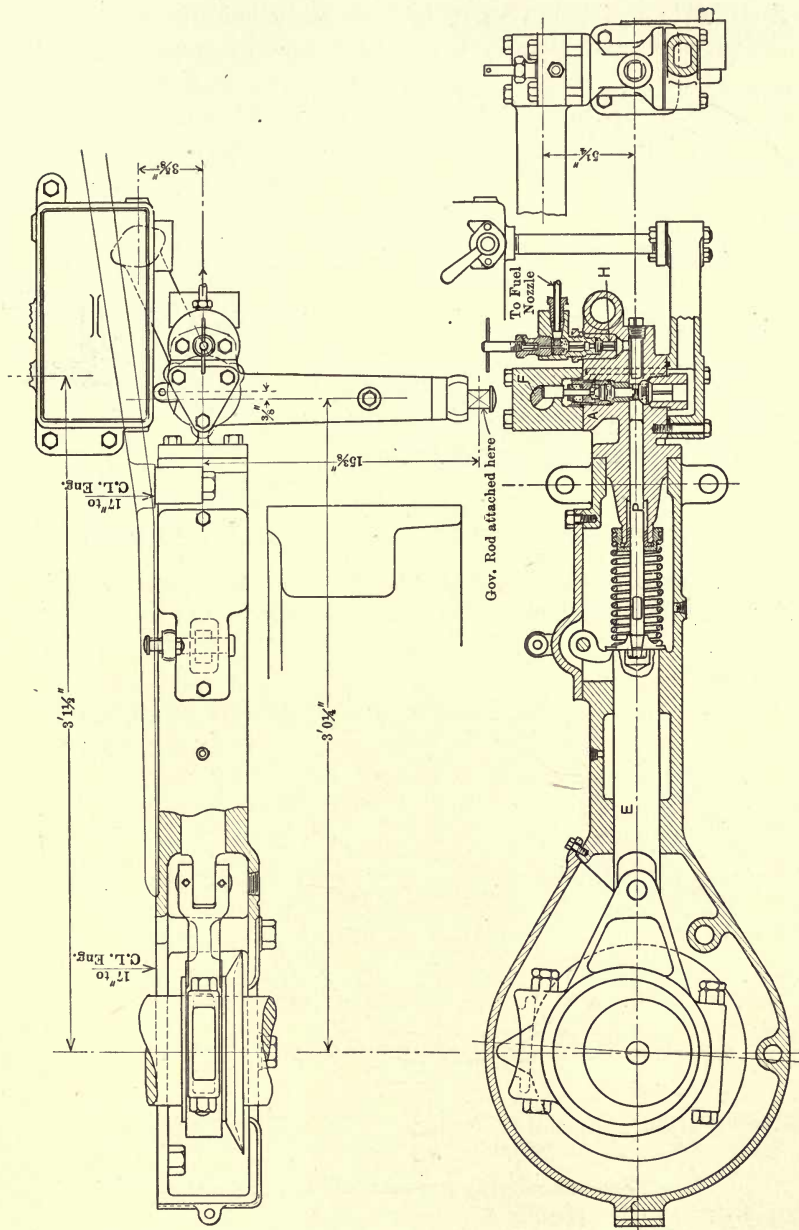

FIG. 227.—Nordberg semi-Diesel engine fuel pump.

of 5 degrees. From the figure it is evident that the oil is injected before mid-stroke of the engine piston.

Valve Timing.—The timing diagram of the Nordberg semi-Diesel appears in Fig. 229. Since this engine is two-cycle, the piston acts as the exhaust and air-admission valves; the exhaust and admission periods are dependent on the location of the ports in the cylinder and are fixed.

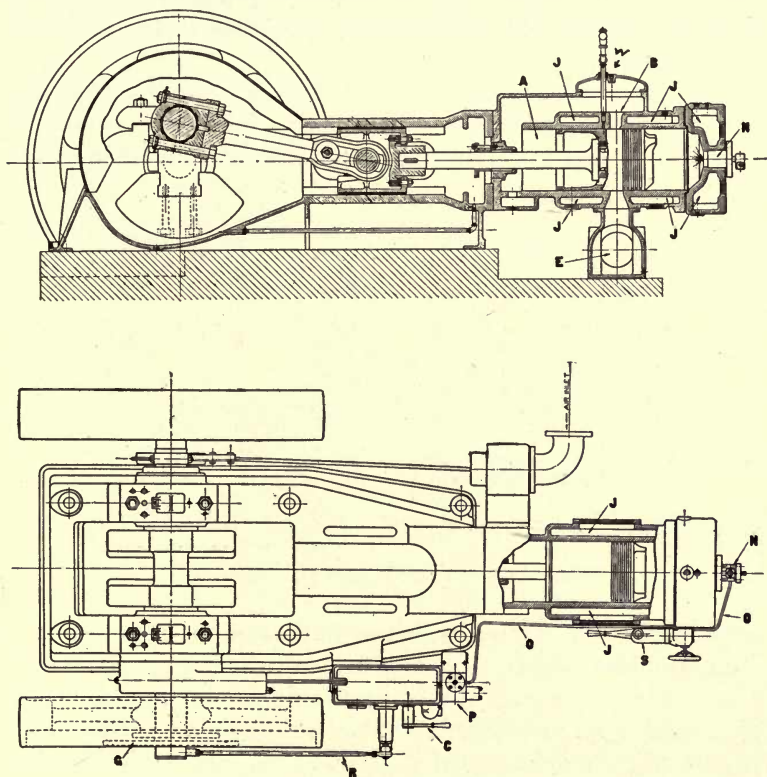

FIG. 230.—Nordberg semi-Diesel two-stroke-cycle oil engine.

Nordberg Engine Frame.—Figure 230 illustrates the engine section and plan. The frame is of heavy construction and has two main bearings. The piston is provided with a piston rod and crosshead. The front end of the cylinder *A* is closed and acts as the air compressor to furnish the scavenging air charge to the power cylinder. The air enters the compressor through the piston valve *V*.

This engine employs water injection to control the cylinder temperature, thus preventing preignition. The operator should examine the cylinder at frequent intervals as the water often scores the piston and cylinder. The question of water injection is fully discussed in the chapter on Water Injection.

Müller Ignition.—While no American firm has adopted this design, it is, nevertheless, of interest. This is especially true since some claim that the American engines using the Hvid principle are actually operating along the lines covered by the Müller patent.

This ignition or injection method has simplicity to recommend it since it does not require either an air compressor, as does the Diesel, or a fuel injection pump, as found on the majority of

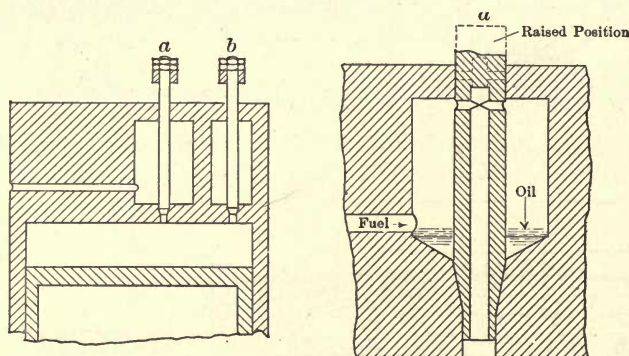

FIG. 231.—Muller super compression ignition device.

semi-Diesels. The plan which is illustrated in Fig. 231 is as follows: The cylinder head is provided with two compartments. Into one of these runs the fuel line from the measuring device controlled by the governor. This cavity is connected to the engine cylinder by means of a needle valve. The valve is better shown in the drawing to the right. It has a drilled passage and is actuated from the engine camshaft, the timing of which allows the cylinder to be in communication with the fuel chamber during the engine suction and compression stroke. During the early part of the compression stroke the fuel is deposited in the space around the hollow valve stem. At the end of the compression stroke this valve is raised and, in so doing, cuts off the communication of the cylinder with the portion of the fuel chamber above the surface of the fuel charge. The drawing

illustrates the manner by which the valve stem, in raising, brings the cross passages up into the casting.

At the moment the valve *a* is raised the valve *b*, which connects the second cavity with the cylinder, opens. The movement of this valve allows part of the cylinder air charge to rush into the cavity, reducing the cylinder pressure. The pressure now existing within the cylinder is lower than the pressure of the air which is trapped in the fuel chamber. This pressure difference forces the oil charge through the valve opening into the

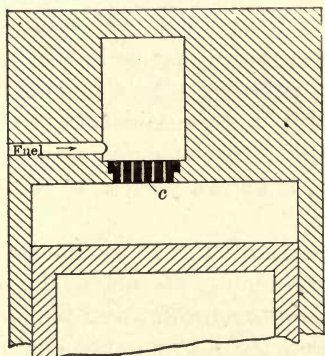

FIG. 232.—Muller modified ignition device.

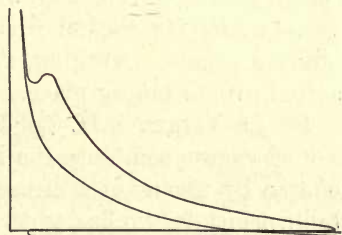

FIG. 233.—Constructed card of Muller modified engine.

cylinder. The velocity of the oil through the passage atomizes it sufficiently for ignition purposes.

A modification of this idea is seen in Fig. 232. In this design the valves are dispensed with and only one chamber is needed. In operation the fuel charge is deposited during the compression stroke in the fuel compartment. Between this and the cylinder is interposed a disk with a number of very small openings. The fuel rests upon the disk and is prevented from flowing into the cylinder both by the minuteness of the openings and the surface tension of the oil.

When the piston reaches dead-center, the existing pressures in the cylinder and the fuel chamber are of equal value while the oil rests in a layer between these two air charges. As the piston moves past dead-center on the outward stroke, the increase in the engine clearance volume causes the compression in the cylinder to drop rapidly. The original pressure in the fuel chamber then injects the fuel through the atomizer holes into

the cylinder where the temperature is high enough to ignite the charge when finely divided. A card from an engine with this ignition would probably appear as shown in Fig. 233.

Neither of these designs has been commercially successful. Attention is called to the similarity of the card from the Nordberg engine, Fig. 226, and the "constructed" card of the Müller engine. They follow the same general outline at the ignition point. It is probable, with heavy oils, that there is no ignition in the cup, the compression pressure running up to the peak *d*. The piston in starting outward no doubt causes the air charge in the cylinder to drop in pressure to the point *b*. Due to the absorption of heat from the hot piston head, the air in the cup then naturally experiences a rise in pressure. At the point *b* the air pressure in the cup, which would have remained above the value *d*, injects the oil from the cup into the cylinder where ignition occurs. Nothing, of course, is known positively of the actual events taking place.

De La Vergne F.H. Oil Engine.—Another type of the semi-Diesel engine combines the Diesel principle of atomizing the oil charge by means of a stream of high-pressure air, and the hot-bulb principle, similar to that used on the low-pressure engine. A cross-section of the De La Vergne type F.H. engine with this combination ignition is shown in Fig. 234. In general outline and in many details it closely conforms to standard horizontal Diesel practice. It has a two-stage air compressor *A* for the supply of the injection and starting air. The fuel valve of the multi-cylinder engines closely follows standard Diesel-engine design; the single-cylinder engine valve is somewhat different in action.

In operation the bulb *B* is first heated by a torch until fairly hot. The fuel pump is then operated by hand until the line to the injection valve is filled. The engine, which has already been placed in the starting position, is turned over by the manipulation of the air-starting valve. After two air charges the engine will begin firing. The fuel from the pump enters the body of the injection valve or atomizer where it comes in contact with the charge of high-pressure air from the air compressor, which is mounted on the engine frame. At the proper moment the needle valve is opened, and the combined charge of air and fuel is blown into the cylinder in a highly nebulized condition. The fuel charge is injected slightly before dead-center. The charge,

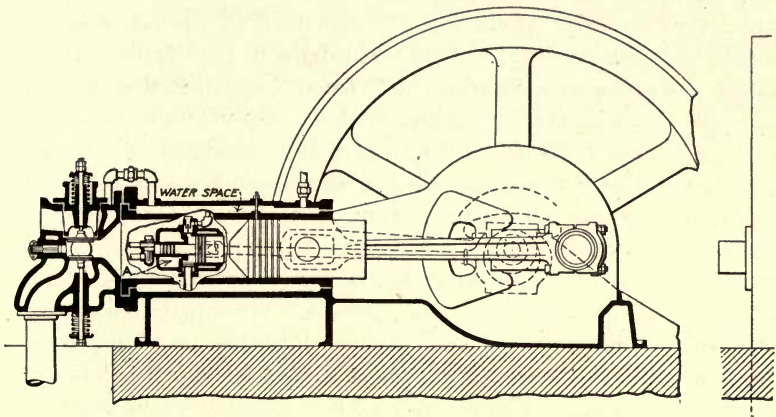

FIG. 234a.—De La Vergne type F.H. semi-Diesel engine.

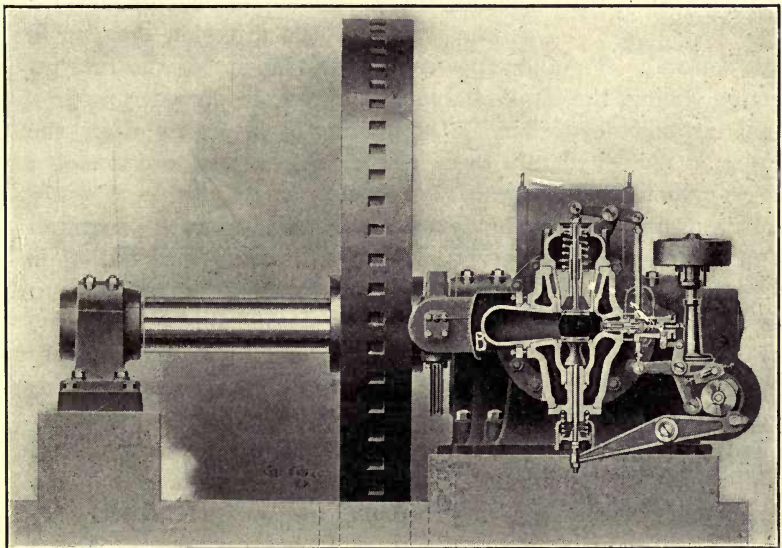

FIG. 234b.—De La Vergne type F.H. semi-Diesel engine.

as it blows across the combustion chamber into the vaporizer, burns very rapidly, producing a sharp peak in the combustion line on the indicator card. If the oil is light in gravity, the entire charge is consumed instantaneously since it is injected at a high velocity, the injection occupying only an infinitesimal period of time. On the indicator card, this action produces a decided sharp combustion peak; the card closely resembles a card from a low-compression or constant-volume engine. If the fuel is heavy, 24° Baumé crude oil for example, the heavier parts are not ignited immediately and strike the hot vaporizer walls. The hot surfaces vaporize these more complex hydrocarbons with a resultant combustion. It then follows that the heavier the oil the nearer the F.H. card approaches a card from a true Diesel.



FIG. 235.—Indicator card type F.H. semi-Diesel engine.

Figure 235 shows a card where such a heavy oil was used. The compression reached 275 pounds while the maximum cylinder pressure approximated 600 pounds. Since with light oils the combustion is in the nature of an explosion, preignitions will be present if the injection opening is not delayed. To allow necessary adjustments of the fuel injection timing, the needle valve rocker arm is provided with a screw arrangement whereby the moving of the roller alters the timing. This is plainly seen in Fig. 234, a cross-section of a single-cylinder F.H. engine.

It is problematical whether the vaporizer is actually required after the engine is in operation and has become warmed. The compression pressure of 280 to 300 pounds should be sufficient to vaporize and ignite all save the heaviest of crude oils. That none of the light fuel oils ever reach the vaporizer is conclusively proven by the absence of soot or carbon. When heavy crude is burned, there is some carbon deposit, but not more than is usually found on the piston heads of Diesel engines when supplied with similar oils. Furthermore, true Diesel engines have been observed operating with a compression as low as 300 to 350 lbs. per sq. inch, in cases where piston rings leaked or where the engine was turning over very slowly. Under such conditions the Diesel would ignite every charge although the exhaust was somewhat cloudy. After an engine is warmed up, a compression of 275 to 300 lbs. per sq. inch will ignite any fuel above 28° Baumé gravity.

Fuel Consumption. F.H. Oil Engine.—In fuel consumption this engine approaches the Diesel engine. Figure 236 shows the results of a test on one of these engines. It must be understood that such low fuel consumptions are not usually secured in operation. If a full-load consumption of .55 lb. per brake horsepower is obtained, the engine can be considered in excellent condition.

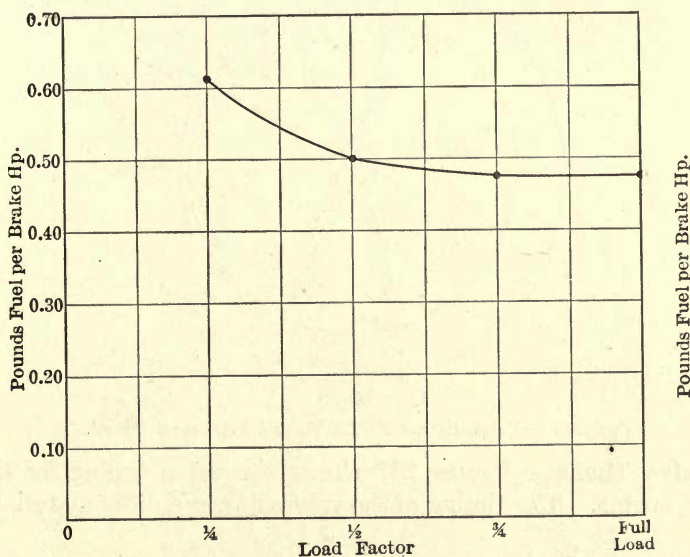

FIG. 236.—Teston 200 H.P. De La Vergne type F.H. semi-Diesel engine.

The indicator card, Fig. 235, is somewhat like a Diesel card, though the combustion line is not a constant-pressure one. The major part of the fuel charge explodes almost instantaneously, the slow combustion occurring with the heavier parts only.

Fuel Specifications. F.H. Engines.—Due to the use of the vaporizer, practically all fuels above 16° Baumé can be consumed with success. If the cylinder temperature is inadequate for the combustion of the heavy oils, the hot surface of the vaporizer will “crack” the oils and complete the ignition. With the asphaltum-base heavy crude oils, a deposit of carbon will usually be found in the vaporizer. This deposit is not as serious nor as extensive as in the low-pressure engine, and the cleaning need be performed only every month or so.

De La Vergne Fuel Pump.—On the multi-cylinder F.H. engines the De La Vergne Co. employs the same fuel pump and

governor as shown in Fig. 143. On the single-cylinder units the governor is the same while the operation of the pump is slightly different.

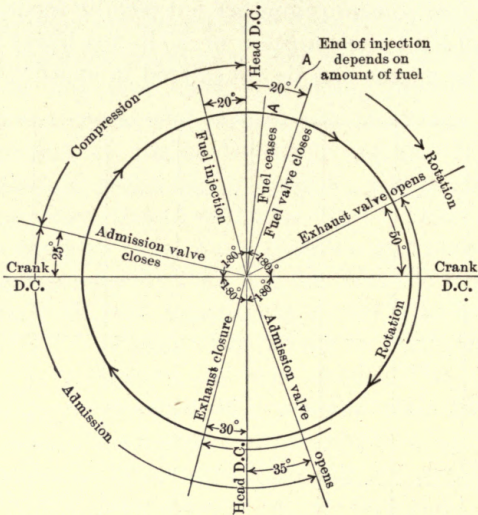
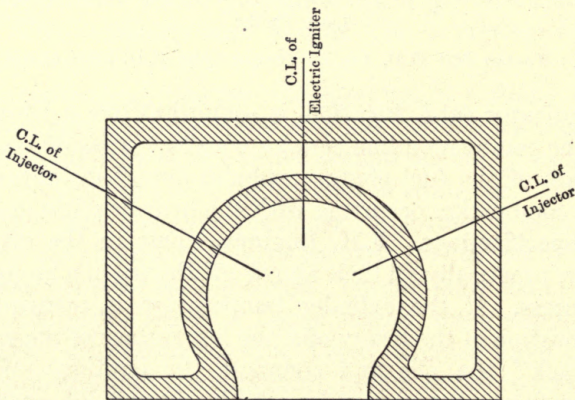

FIG. 237.—Valve timing De La Vergne F.H. semi-Diesel.

Valve Timing.—Figure 237 shows the valve timing for the F.H. engine. The timing of the valves does not differ materially



(Suction and discharge valves not shown.)

FIG. 238.—Price combustion chamber.

from standard Diesel practice. The period of fuel injection varies with the fuel charge, although the period of fuel valve opening is constant.

Price Ignition System.—During the past year several American engine builders have begun the manufacture of semi-Diesel engines with the Price ignition system or principle. The theory

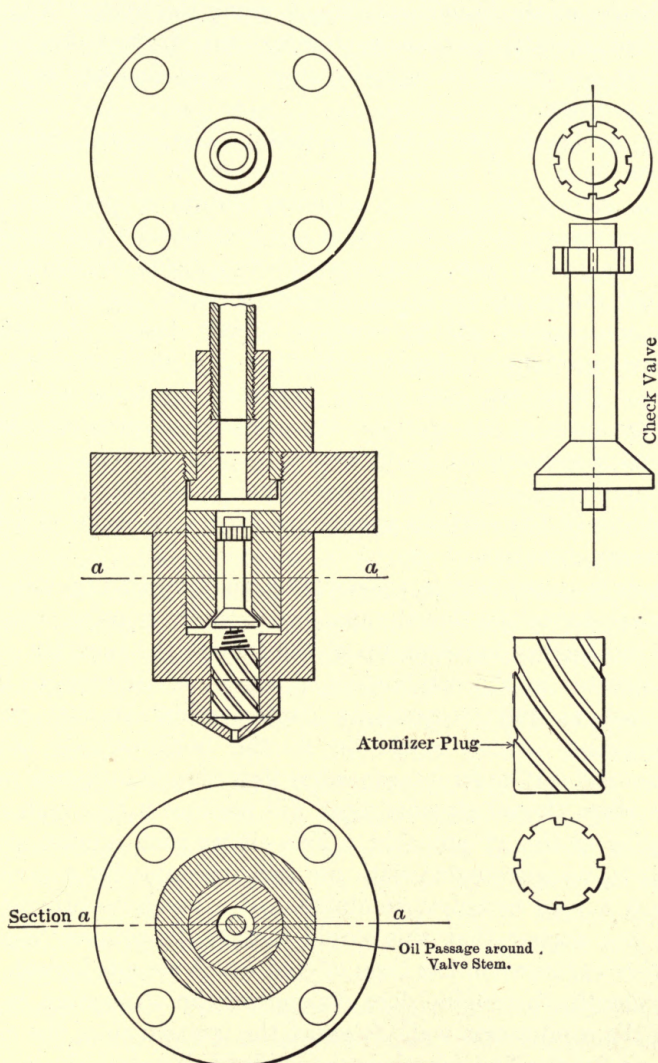

FIG. 239.—Price engine nozzle.

of operation contemplates the use of a compression pressure of 200 lbs. per sq. inch. Into this combustion chamber two streams of oil are injected. These two streams meet and com-

bustion ensues due to the thorough breaking up of the oil charges.

The combustion chamber, which is located in the head or separately, as the builder chooses, is along the lines of Fig. 238. The two injection nozzles, a cross-section of which appears in Fig. 239, are placed in opposite sides of the chamber in an inclined position.

The cycle of events is as follows: The engine, which so far has been built on the four-stroke-cycle plan, during the suction stroke draws in a cylinder charge of pure air. On the compression stroke this air is compressed to a final pressure of 200 lbs. per sq. inch. Six degrees before dead-center is reached the fuel pump injects an oil stream through the two nozzles. As a consequence of the excellent nozzle design, the two oil streams enter the combustion chamber in a highly divided condition. These two jets of oil particles, traveling at a high velocity, meet at the center of the combustion space and ignite. The entire combustion is instantaneous, and the engine may be said to operate on the "constant-volume" or Otto cycle. The remainder of the engine's events are such as is usual in a four-stroke-cycle engine.

There is some question as to what actually occurs on injection. The patentees claim that the atomization at the nozzles, combined with the further breaking up of the fuel at the junction of the two streams in the combustion chamber, is sufficient to ignite the fuel at the temperature corresponding to 200 pounds compression, which would be in the neighborhood of 265° Fahrenheit. It must be conceded that the disturbance taking place when the oil streams meet will produce a thorough intermingling of the air and fuel. This allows each minute globule of oil to be surrounded with air and undoubtedly contributes toward a very complete combustion if a flame be present. It does not appear that this would initiate the primary ignition. Another explanation has been offered which sounds logical.

Evidently the engine does depend on the absorption of heat from the combustion walls to assist the ignition since the engine will not fire the first few charges unaided. To start the engine a nickel-covered anode or resistance coil is used. A small dynamo supplies the current necessary to bring this coil to a red heat. On starting the engine, the electric current is thrown on to the element, and the oil charge is ignited exactly as in a hot-bulb

low-compression engine. When the combustion chamber is thoroughly warmed the current flowing through the coil is discontinued, although the coil still remains in the combustion chamber. Quite likely the heat of combustion maintains it in a red-hot condition, although at a much lower temperature than when the electric current was flowing. It would appear that some heat other than that of compression is required. There also seems to be a second source of heat that might assist the process.

The opening in the nozzle tip is about $\frac{1}{64}$ -inch in diameter. If, in service, a fuel consumption of $16\frac{1}{2}$ h.p. per gallon is secured, and the engine operates at 200 r.p.m., then with a 100 h.p. engine the fuel consumed per minute would be $\frac{1}{10}$ -gallon or 23.1 cubic inches. At 200 r.p.m., operating on the four-stroke-cycle, the fuel per stroke would be .23 cubic inch per effective stroke. The injection does not cover more than 6 degrees; the injection of oil through the two atomizers is then at the rate of .02 cubic inch per degree of revolution or 1440 cubic inches per minute. The orifice at the nozzle tip is approximately $\frac{1}{64}$ -inch, and the actual injection rate through the nozzle opening is at a linear velocity of 60,000 feet per minute. The weight of the injection charge is .0036 pound. When the two oil streams, issuing from the atomizers at this rate of speed, meet, it may be considered that all their velocity is destroyed and the energy developed by this impact appears as heat. The work done would be $\frac{1}{2} MV^2$ or 560 foot-pounds. The heat equivalent of 200 foot-pounds is 0.70 B.t.u. This heat is absorbed by the oil charge, which weighs .0036 pound, and is sufficient to raise the temperature of the oil charge some 400° . This temperature increase added to that resulting from the compression is high enough to ignite the lighter hydrocarbons, which, in turn, ignite the heavy particles. The rate of flame propagation would be rapid since the oil stream is atomized in a very thorough manner.

Indicator Card. Price Engine.—Figure 240 is a card from this engine while Fig. 241 is a distorted card. The injection begins at 6 degrees ahead of dead-center and ceases at about $1\frac{1}{2}$ -degrees before dead-center.

One decidedly attractive feature of this engine is the high mechanical efficiency. This, in comparison with the efficiency of the Diesel engine, can be attributed mainly to the elimination

of the air compressor, which usually absorbs from 7 to 10 per cent. of the engine's output.

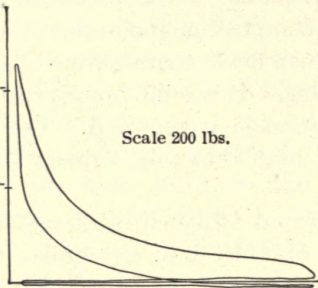

FIG. 240.—Full load indicator card Price engine.

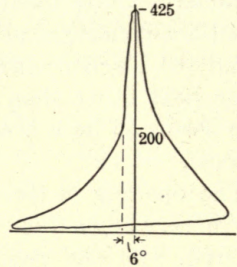

FIG. 241.—Distorted card Price engine.

Test on Price Engine.—Based on a series of tests conducted at the De La Vergne Machine Co. plant, before a committee of

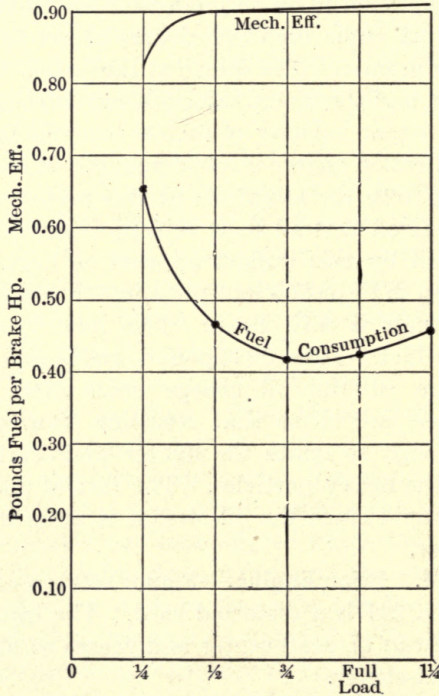

FIG. 242.—Test on 19×24 Price engine.

naval officials, on a 19×24 engine using the Price injection system, the following report was submitted.

1. The fuel economy under favorable conditions was .395 pound per brake horsepower.
2. Fuel economies of .42 pound at full load could be maintained indefinitely.
3. The engine could be put in operation from a cold condition to full load at full speed in ten seconds.
4. Any fuel from 15-degree Mexican crude to light fuel oil could be used.
5. At all loads up to 20 per cent. overload the exhaust was invisible, and up to 30 per cent. overload the exhaust was tolerable.
6. A twenty-four-hour test, running full load ten minutes then stopping five minutes, proved the engine to be safe against heat stresses, etc.
7. The engine could be stopped twenty minutes and started again without the assistance of the electrical igniter.
8. A mean pressure of 87 lbs. per sq. inch with respect to brake horsepower, which corresponds to approximately 100 lbs. per sq. inch mean effective pressure, was attained with clean exhaust.
9. The mechanical efficiency when operating above three-quarters load approximated 90 per cent.

Figure 242 presents the results of the test, showing the mechanical efficiency and the fuel per brake horsepower. The fuel consumption compares favorably with the economies obtained from Diesels manufactured in the United States.

CHAPTER XVIII

LOW-COMPRESSION OIL ENGINES

TYPES OF ENGINES. DESIGN OF IGNITION DEVICES

General.—Although the crude oil engines should properly be divided into the three classes: Diesel, or high-compression; semi-Diesel, or medium-compression; and low-compression, or vaporizer engines, there is a strong tendency on the part of many builders of the low-pressure engines to call their product semi-Diesel engines. As discussed in previous chapters, the word "semi-Diesel" does convey a distinction as regards the limits of compression carried on the engine. Any engine whose compression pressure does not reach at least 250 lbs. per sq. inch and which depends on some manner of hot surface for the vaporization of the fuel before ignition, quite properly falls within the third class that is covered by the term "low-compression engines." It is quite possible to use another distinguishing mark whereby an engine may be correctly labeled. If the heat is received at constant volume, the engine falls in the third class. There is no theoretical reason why a high-compression engine should not be built to receive the heat at constant volume. It is impossible, practically, since the pressure of explosion would run so high as to wreck the engine.

Probably the greatest volume of crude oil engine business, both in number of units and in horsepower, is in the low-pressure type. Various designs of this class of engines have been built in this country for fifteen years or more, and the total number of installations is large. In the year of 1916, one company sold more than 50,000 h.p. in sizes ranging from 10 h.p. to 200 h.p. The majority of these units are installed in small mills, factories and light plants where the attendants are usually unskilled. It speaks volumes for the simplicity of the low-pressure engines that they can run day in and day out under such conditions. It is this simplicity of design that causes the low-compression engine to prove actually more economical than the Diesel in total operating costs in a great many plants.

The low-compression engines are all modifications of the original Hornsby-Akroyd engine. While this engine was of the four-cycle principle, only one manufacturer, the De La Vergne Machine Co., still adheres to the four-stroke-cycle; all the other manufacturers adopted the two-stroke-cycle as being simpler and less costly to build. This design is quite similar to the well-known two-cycle gasolene engine wherein the crankcase is enclosed and acts as a compressor to furnish the necessary air to scavenge the cylinder of the burnt charge, although in the oil engine nothing but air is compressed in the crankcase.

Two-stroke-cycle Engine. Method of Operation.—Figures 243 to 246 show this type of engine with the crank at different angles and the probable process of mixing and firing of the fuel charge. It is impossible to ascertain the exact state of affairs transpiring in the cylinder, and these figures are at best but an attempt to give the most probable course of events. In Fig. 243, after the bulb on the cylinder has been heated by a torch, not shown, the fuel is sprayed upon the red-hot lip of the bulb, which projects into the cylinder space. This fuel, on igniting, drives the piston forward. At a point in the stroke of the piston, as indicated in Fig. 244, the exhaust port is uncovered by the piston, and the burnt gases, which still have considerable pressure, rush out through the exhaust pipe. Figure 245 shows the air port uncovered by the piston and the pure compressed air from the crankcase displacing the exhaust gases and filling the cylinder with a fresh air charge. In Fig. 246 the piston has compressed this air charge to from 70 to 120 pounds, and the fuel is beginning to spray into the combustion space. The above sequence of action is followed in all two-stroke-cycle surface ignition oil engines, although each builder has certain modifications of the cylinder and the hot-bulb design.

Theory of Combustion.—The operation of the low-compression engine is based on the fact that the heavier oils will not self-ignite in the presence of air having a temperature corresponding to 90 to 150 pounds compression pressure, but if this oil strikes a hot surface it will break up into hydrocarbons of a less complex series; in other words, it will "crack." These light oils will vaporize readily and will ignite at a temperature much lower than is required to ignite the heavy original oil. Since the combustion of the fuel involves a process of distillation of the oil into oils of lighter gravity before burning, the time necessary for

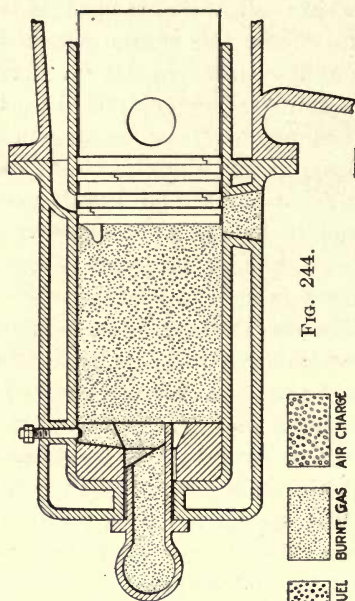

FIG. 244.

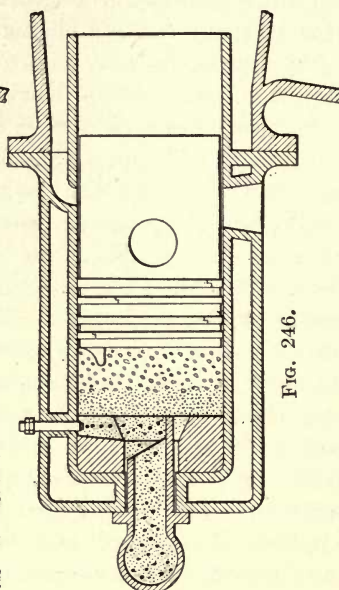

FIG. 246.

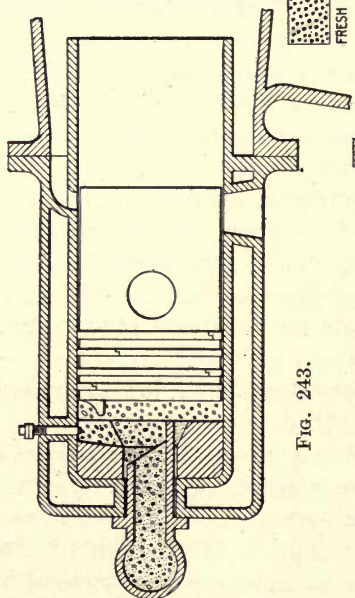

FIG. 243.

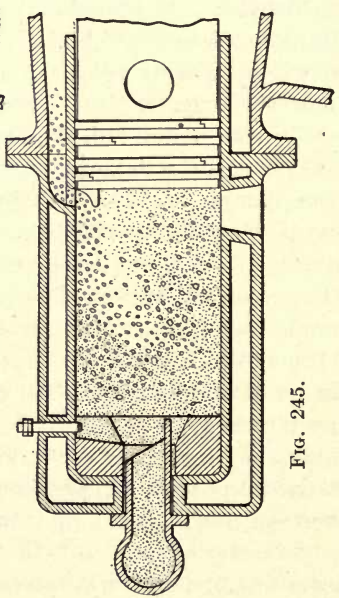

FIG. 245.



Probable events occurring in cylinder of low-compression oil engine.

complete combustion is somewhat longer than in the gasoline engine, where the distillation process has been completed at the refinery, or in the Diesel engine, where the atomization of the heavy oil breaks it up into particles small enough to be ignited by the high temperature of the compressed air charge. Consequently, if the engine speed is kept above 200 r.p.m., the oil must be injected at such a point before dead-center as to allow it sufficient time to "crack," vaporize and burn. At 200 r.p.m., or 400 strokes, the time consumed in making a power stroke is but .15 second; if the combustion or explosion takes place while the piston covers one-fifth of its stroke, the time interval is only .03 second. To allow the oil time to undergo the process of distillation and ignition by the time the piston reaches dead-center, the current practice is to begin the injection when the crank is 30 degrees or more ahead of rear dead-center, allowing the injection to cease before the piston completes this compression stroke. Since practically all the oils used contain a percentage of lighter constituents that will vaporize without going through the process of "cracking," and burn at a low temperature, there is a tendency of this part of the oil to ignite before the piston reaches dead-center and while the compression pressure is still low. To avoid this, builders depend upon one of two factors—they either design the combustion chamber in such a manner as to allow the fresh oil vapors to remain unmixed with the fresh air until the piston is approximately 10 degrees from dead-center, or they provide for the injection of a small amount of water at each cycle; this water tends to keep down the temperature in the cylinder during compression, thereby precluding the preignition of the lighter portions of the oil. Stratification of the gases and air as aimed at in the first method does occur in some designs, although it is far from successful in all.

Ignition Devices. Hot-ball Igniters.—Figure 247 shows a cross-section of the ignition device used on one engine long on the market. In this the cylinder head is a plain water-cooled casting of a design free from danger of heat fracture. To this head is bolted the bulb *A* projecting outward, and against this bulb is placed a "spoon," or lip, *B*, which passes through an opening in the head and projects into the cylinder cavity (in a somewhat similar design the spoon is integral with the bulb). There is also a heavy block or combustion chamber *C* fitting into the cylinder space. In starting, the bulb is first heated to a high temperature

(not red-hot) by a torch. As soon as the engine is started, either by cranking or by using an air starter, the fuel pump, actuated by a cam, injects a charge of oil through the nozzle *D* immediately above the hot spoon. This oil, on striking the spoon, is "cracked" and vaporized and, mixing with the air charge, is ignited by the temperature of the compressed air charge.

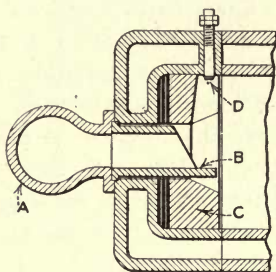

FIG. 247.

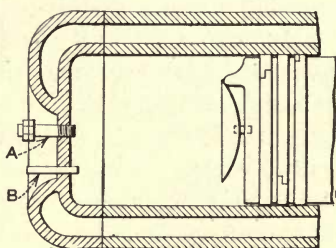

FIG. 249.

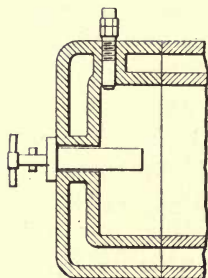

FIG. 248.

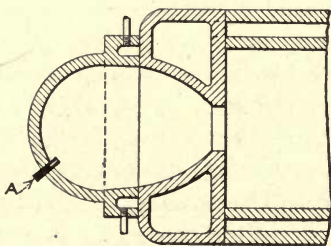

FIG. 250.

Ignition devices of low-compression oil engines.

Since this engine operates on the two-stroke-cycle, using crankcase compression, the air charge, as it blows through the air ports, is unable to completely scavenge the cylinder of all the burnt gases. This is traceable to two defects that are inherent in all two-stroke-cycle engines. One of these defects is the volumetric efficiency of the crankcase air compressor. Due to the volume of the enclosed crankcase in respect to the displacement of the piston, the air actually passing into the cylinder through the air ports is not equal to the cylinder volume by any means; 60 per cent. is as much as can be expected. The second defect lies in the inability of the air to force the exhaust gases out through the exhaust ports without mingling with these

gases and partially escaping into the exhaust pipe. Complete scavenging of the cylinder is highly desirable in order that sufficient oxygen be supplied to unite with the oil. On the other hand, scavenging of the hot bulb is far from being desirable; in fact, the entire scheme of operation is based on the bulb being charged with burnt and inert gases at the moment the fuel charge is injected onto the "spoon." Consequently, when the fuel is vaporized by the hot spoon, the movement of the air charge in front of the advancing piston pushes this vapor into the bulb where it mixes with the inert gases. As there is no free oxygen present in the bulb, there can be no explosion, although the temperature, due to the hot bulb and to the compression pressure, is much above the ignition point.

As the piston advances toward the head, the air is forced into the bulb, where it mixes with the oil vapors and burns. This stratification of the oil vapors, the burnt gases and air is fairly successful at loads up to about three-quarters of the engine's rating. At values approaching full load, the beginning of the injection of oil is much advanced, and the amount of fuel injected is increased to such a value that the bulb does not accommodate all the vapors. As a result part of the fuel charge mixes with the pure air in the cylinder. As the temperature existing in the cylinder, due to the hot bulb and to the compression, is above the ignition point of the "cracked" light oils, preignition of the charge frequently takes place, resulting in piston pounding and loss of power. In order to avoid the preignition, this engine, as do most others, makes use of water injection, whereby at each cycle a small quantity of water is injected into the cylinder, reducing the compression pressure and the temperature existing in the cylinder. Because of the successful stratification of the gases on loads below three-quarters rating, it is not necessary to use water at lower load values.

The combustion block *C* merely serves as a reservoir of heat to assist in the vaporizing of the fuel. When using kerosene or the lighter distillates, this block gives off enough heat to vaporize the oil before it strikes the spoon; with heavy fuels, below 30° Baumé test, most of the charge actually strikes the spoon before "cracking" and vaporizing.

Oils of different gravities will ignite at different temperatures and at different pressures. In order to make the time of ignition constant, it is necessary to vary the compression pressure

according to the character of fuel oil used. To do this, the Muncie Engine Co. has adopted the plan of inserting steel compression plates behind the combustion block. By varying the number and thickness of the plates used, it is possible to vary the compression from 90 to 140 pounds; the former suitable for kerosene, the latter for the heavy fuel oils.

The hot bulb has a number of advantages. Among these is the fact that, being made with fairly thin walls, the bulb will break in case of any dangerous increase of pressure in the cylin-

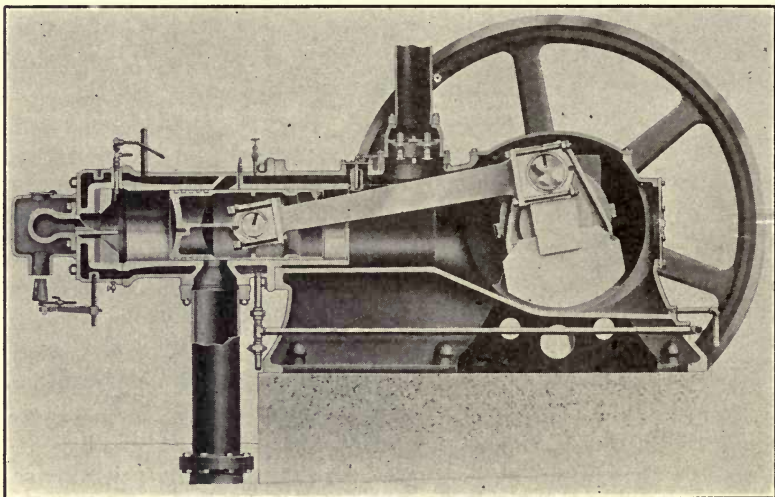

Fig. 251.—Muncie two-cycle oil engine low compression type.

der, thereby protecting the more expensive parts, such as the cylinder and the cylinder head. It is inexpensive in replacement cost, quite unlike several of the more complicated devices. It has another advantage that is of material assistance in operation. The bulb is of sufficient size to contain in its walls a great amount of heat. The heavier the load the greater is the amount of heat absorbed by the bulb. This increased heat serves to raise the compression temperature to a higher degree than usual. The oil burns earlier in the cycle, and by suitable adjustment of the water injection the engine can be made to fire just before dead-center, giving the maximum of power. The bulb is open to objection because of its tendency to fill with unburnt carbon in cases of leaky fuel injection nozzles or heavy overloads. The same deposits will occur where leaky piston rings allow the compression

to escape or where the bulb is too low in temperature. This latter may be due to cold air currents striking the bulb or to the cooling water in the cylinder head having too low a discharge temperature. Carbon deposits in the bulb are invariably accompanied by decrease of power. The carbon frequently is the cause of preignitions. Carbon is not as good a conductor of heat as are the iron walls of the bulb; consequently the carbon will become red-hot. This, of course, raises the cylinder temperature sufficiently to ignite the oil practically at the instant of its injection. In cases where the engine preignites even with the normal supply of injection water, the engineer is practically safe in assuming that the bulb is full of carbon. When the bulb is badly carbonized, the easiest way to cleanse it is by soaking it for several days in a bucket of lye, following up with a thorough washing in kerosene. It pays to keep at least two extra bulbs on hand.

Figure 251 shows a view of the Muncie Oil Engine, which makes use of the hot-bulb igniter device.

Hot-tube Ignition.—A second ignition device is that shown in Fig. 248. Here the head is completely water-cooled and has an ignition tube projecting into the cylinder space. This tube may be either fixed or removable. If fixed in place, a part extends beyond the outside wall of the head and is heated by some manner of torch. In the drawing shown, the tube is removable and is first heated by the operator at some convenient flame and is then placed in its recess and clamped into place. The engine is started, and the fuel is then injected in a manner similar to that of the hot-bulb engine. The oil, on leaving the nozzle, strikes the red-hot tube and of course "cracks" and vaporizes. This oil vapor mixes with the air charge, and, as soon as the advancing piston has raised the compression temperature high enough, the charge is fired and burns.

In a hot-tube design the scavenging air frees the cylinder from almost all of the burnt gases since there is no pocket or bulb. Therefore the opportunity for stratification of the vaporized oil and fresh air is not so good since there is no intervening stratum of inert gases to separate the two; as a result, they doubtless mix immediately. The only way, then, to prevent preignition of the charge is to keep the temperature down until the piston is practically on dead-center. Since the hot tube contains but a small amount of heat, the compression temperature and pressure do not increase as rapidly on the heavy loads as they do in an

engine having a large heating element, such as the bulb. Nevertheless, to keep down preignition recourse is had to water injection even at fairly low loads.

It is the general experience that all engines using the hot-tube arrangement will operate better on lighter oils than on the heavier fuel oils—quite the opposite of the hot-bulb design in this respect. The hot-tube engine scavenges better than the hot-ball engine and consequently shows a slightly superior economy at the heavy loads since the cylinder is charged with virtually pure air, insuring a better combustion. The tube is simple, easy to replace if defective, and the design allows the head to be symmetrical and free from casting strains. On the other hand, it does not present a large surface to the injected oils and often does not give off enough heat to vaporize all the charge when using heavy fuel oils.

The operator should be cautious about keeping in service a tube after it shows any considerable amount of corrosion. The tube will burn in two eventually. If part drops into the cylinder, it is liable to cut the walls. Some engineers have a practice of heating the tube at a fire placed some distance from the engine. They often wonder why the engine fails to fire after they hurriedly put the tube into place. It should be remembered that the radiation of heat from a red-hot bolt is very rapid, and the tube quite likely is fairly cold by the time it is locked into place. It is best to use a kerosene or gasolene blow-torch placed not more than 3 feet from the engine. The Primm Engine makes use of a device along these lines. See Fig. 330.

Hot-plate Ignition.—Some builders have adopted modifications of the hot-plate design, as in Fig. 249. In this design a bell-shaped iron casting is bolted to the piston head. To start the engine, the cylinder head is provided with a small hot tube, which is heated externally by a torch. The fuel is injected through the nozzle *A*, which is located in the center of the cylinder head. On starting, this oil will drip onto the starting tube *B* and ignite. After a few revolutions, the bell casting or hot plate attains a sufficient temperature to allow the torch to be removed.

In this design the cylinder is practically free from obstructions, and the scavenging effect of the air charge is good. On the compression stroke the air charge is compressed to 90 to 120 lb., and at approximately 20 degrees from dead-center the fuel is in-

jected through the nozzle. The hot plate remains at a high temperature, due to the heat absorbed from the burning fuel. Using light distillates, the temperature existing in the cylinder is sufficient to vaporize it before any strikes the plate. There is no attempt at stratification since the fuel charge is intermixed with the air immediately upon vaporizing. Where the oil used carries much lighter portions there is a considerable tendency toward preignition at all loads above one-half engine rating. This preignition is especially noticeable on heavy loads where the fuel injection begins very early in the stroke. Consequently, water injection is used at any load above $\frac{1}{2}$ or $\frac{5}{8}$ rating.

The hot-plate design is good in many respects. It is better than the hot tube when using heavy fuel oil since it provides more vaporizing surface. It is not liable to become overheated or burned since it loses part of its heat to the exhaust. Further-

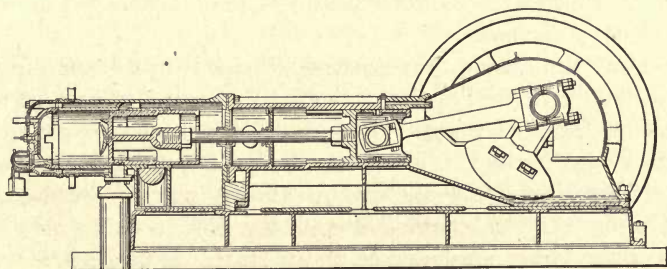

Fig. 252.—Little Giant oil engine employing hot-bolt ignition.

more, as the air enters the ports it blows across the plate, cooling it to a considerable extent. This is an advantage at full loads, but on lighter loads this cooling effect quite often results in the plate not igniting the fuel charge. It is doubtful if the hot plate helps the lubrication of the cylinder; certainly, many engineers are in constant fear of faulty lubrication due to the high temperature of the plate burning the lubricating oil off the cylinder walls on the compression stroke. There is another little trouble that must be guarded against. The plate may fracture, and the broken parts, becoming wedged in the exhaust ports, will ruin the piston. This probably happens but seldom; nevertheless, it is worth the attention of the careful engineer. If a battering sound is heard in the cylinder, it is advisable to stop the engine and see if the plate is intact.

Figure 252 shows a cross-section of the Chicago Pneumatic

Tool Co.'s "Little Giant," an engine making use of a modification of this principle.

Separate Combustion Chamber.—To attain fair stratification or separation of the oil vapor and air charges, the ignition device shown in Fig. 250 has been brought out. This combustion chamber, in some respects, is a reversion to the original Hornsby-Akroyd design. With this construction a cavity is cast in the head with the open end outward, while a small opening acts as a port of communication between the cavity and the engine cylinder. To complete the combustion chamber a semi-spherical casting is held against the combustion chamber by means of a retaining collar, not shown. The cylinder head is completely water-cooled, consequently the half of the combustion chamber formed in the head is also water-cooled; the combustion chamber cap is partially water-cooled by means of a cored passage around its juncture with the cylinder head. The oil is sprayed in at the side of the chamber.

To start the engine, the starting tube *A* is first heated until it is red-hot. The fuel is then injected by means of a hand lever operating the fuel pump. It is usually necessary to give the pump several strokes. Then the engine is pulled back against the compression until the piston almost reaches dead-center, whereupon the fuel explodes and the engine turns over. In cases of the larger size engines an air starter is used; it is necessary to turn the engine over two or three times with the air starter before the fuel will ignite. After the engine has run a few minutes, the vaporizer or combustion chamber absorbs enough heat to fire the fuel without the assistance of the torch.

The scavenging air frees the cylinder of at least 75 per cent. of the exhaust gases. Owing to the restricted opening into the combustion chamber, it remains filled with inert gases during the compression stroke. The fuel is injected directly into the combustion chamber, when the piston is from 20 to 40 degrees from dead-center and the temperature of the uncooled chamber cap is sufficient to vaporize it. When the piston approaches the head, the air is forced into the chamber and, uniting with the oil vapor, causes combustion. The piston leaves but a slight clearance in the cylinder, and all the combustion occurs in the chamber; the hot gases, passing through the narrow opening, act on the piston face. This design is one of the best used. The fuel being burnt outside the cylinder, there is but little danger of

unburnt carbon deposits cutting the cylinder walls. As a result, the amount of lubrication necessary is considerably less than in the case of a hot-tube or hot-plate engine. Since the combustion chamber is filled with burnt gases when the fresh oil charge is injected, there can be no ignition until the piston forces the pure air charge into the combustion chamber. Having the advantage of being partly water-cooled, the combustion chamber seldom becomes overheated. However, on full loads, the amount of heat absorbed by the walls is so considerable as to cause the cap to get cherry red. To reduce this temperature the cap, as already mentioned, has a small cooling space, and the operator must open the cooling-water connection. This sudden chilling quite often causes the cap to break; in fact, this is the one serious drawback to this design of combustion chamber. Where fuel oil of 30° Baumé or lower is used, it is absolutely necessary that this cap be allowed to become cherry red in order that all this heavy oil be vaporized. With the light distillates the oil will preignite if the cap gets too hot. If it is cherry red, the oil vapors will absorb so much heat that their volume will exceed that of the chamber, and some of the vapor will enter the cylinder and, uniting with the air, explode. Each engine has certain characteristics of its own; the engineer must experiment and ascertain under what temperature condition his engine best handles the fuel used.

In the water connections to the cooling ring it is imperative to have an atmospheric vent. If this is not provided, steam will be trapped in the water space and all cooling effect prevented. The cap continues to become more heated and ultimately will give way.

As there is good stratification, the builders have eliminated the water injection feature. Without water injection the engine operates, on the partial loads, up to about 80 per cent. of normal rating, without preignition; at full load the oil charge is great enough to allow some of it to escape into the cylinder, resulting in preignition. This, of course, applies to engines where the fuel used is of high gravity, since with such oil the compression pressure is sufficient to cause ignition, being about 160 pounds. This type of engine operates best on distillates above 32° Baumé. The temperature of the combustion chamber is not sufficient to completely vaporize the heavy oils, such as 24° fuel oil. Consequently, using this latter fuel, there is always a heavy

deposit of carbon in the combustion chamber, requiring frequent cleaning. The fuel economy, compared with other low-pressure engines, is good. This is due, in part, to the fact that there is not the thermal loss which occurs with water injection. It might be well to call attention to the fact that an engine with a given cylinder volume will not develop as great a horsepower without water injection as it will with water injection. This is based solely on the fact that water injection will prevent preignition, which occurs in any engine pulling a heavy load. It is customary to find an engine given a lower rating when the water feature is abandoned. An English firm reduced the ratings of their engines 25 per cent. when they gave up the water injection. An American engine builder, when first going into the crude-oil engine business, used the water feature. This was abandoned as a result of a conclusion that it possessed certain objectionable characteristics. On changing the design to eliminate the water, the ratings were changed approximately 20 per cent. The engine then developed only the normal rated output without preignition, while the first design easily developed 30 to 40 per cent. overload with the same size cylinder and the same speed.

This design is used on several English engines, notably the Petter, as well as on American engines. Figure 253 is a view of the Fairbanks-Morse vertical engine, which makes use of this device. The Bolinder engine also uses a device along the same lines.

As mentioned previously, these engines, using the combustion chamber, employ a nickel starting tube. This tube heats more than the cast-iron head. The oil charge is so directed as to strike the tube and vaporize readily. A second nickel tube is sometimes used in order to positively vaporize and fire the heavy crude oils. This tube has a cavity opening into the chamber, and the oil enters this opening and is vaporized by the hot walls of the tube. This tube has a tendency to coke up and will soon lose its usefulness. Each time the cap is removed, the tube should be cleaned out. In case of a burned tube, it can be removed by unscrewing it from the inside of the cap, using a chisel driven into the tube cavity. If an extra tube is not available, an iron bolt about 2 inches long will be about as serviceable since it will project into the chamber and the fuel will strike it, or at least in its close vicinity.

A modification of this design is used on the Fairbanks-Morse

vertical engines. In this construction the entire combustion chamber is water-cooled with the exception of a flat cover-plate. By this means there is no overheating at full load, as the water-cooling keeps the temperature within reasonable limits; in fact, on partial loads, the cooling is too successful, resulting in some of the fuel charges not igniting at all. This is especially noticeable when using heavy oils. As a result, if the engine runs on

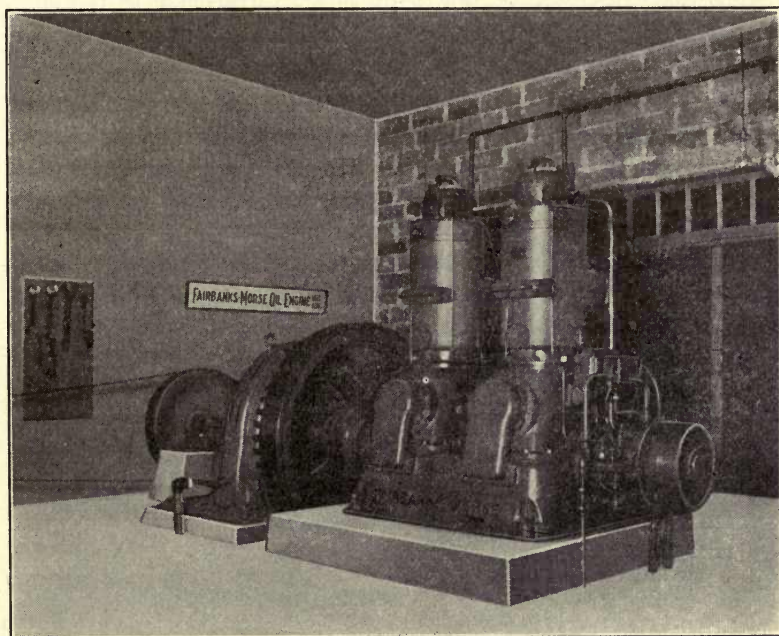

FIG. 253.—Fairbanks-Morse type "Y" oil engine.

partial loads very much of the time there is a decided tendency toward heavy carbon deposits both on the combustion chamber walls and on the flat cover-plate. If this carbon is not cleaned out, the engine will run very hot on heavy loads and will pre-ignite very pronouncedly, and the exhaust will show very smoky. The carbon will work loose and drop into the cylinder cavity. When it is recalled that this deposit becomes as hard as iron, it is easy to see how quickly a little carbon will ruin the cylinder walls.

Since the combustion chamber is cooled by the same water that flows around the cylinder walls, there is no way of varying

the cooling effect on the head in accordance with the load carried. In a few installations engineers have made the combustion chamber cooling system separate from the jacket, with very desirable results.

The casting is rather complicated, and, as a result, there are severe shrinkage stresses existing in the head; these strains, augmented by the explosion stresses, frequently cause fractures. Some cases of fractured heads are directly traceable to the engineer's negligence; he starts his engine without first having the cooling water running. Afterward, when this neglect is noticed, the sudden impinging of the cold water on the hot sides of the head breaks it.

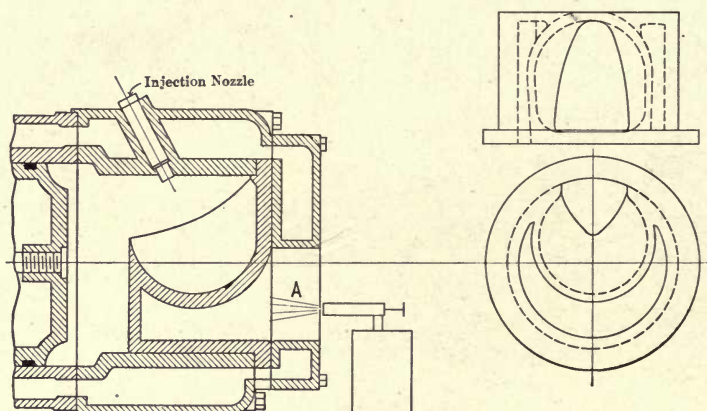

FIG. 254.—Buckeye Barrett oil engine combustion chamber.

Figure 254 outlines an ignition bowl employed on the Buckeye-Barrett engine that is in principle the same as Fig. 250. In this case the interior of the bowl is spherical shaped, with the upper part cut away, affording an entrance to the cylinder. This casting is cylindrical in outer form and fits into the cylinder head, which is entirely water-cooled as is also the cylinder head-cap. The bowl is heated by a starting torch, blowing through the passage A. Since it has no starting tube, more time is required to start as the bowl heats slowly. The design contemplates the isolation of the vaporized fuel charge in the bowl until dead-center has been reached, when the air charge entering the bowl furnishes the necessary oxygen for combustion.

Operation.—In starting an engine using any of these devices, the operator should not pump too much oil in by hand before

starting. There are two objections to this all too common practice. First, the amount of oil vaporized will be so great as to fill part of the cylinder volume, and the extra quantity of gas to be compressed will raise the compression pressure high enough to explode the charge early in the compression stroke. The engine will then run backward until stopped by the explosion on the next stroke. This is not advisable, especially when pulling a direct-current dynamo. The second objection lies in the heavy carbon deposits that this excess fuel charge causes. Experiment will soon reveal just how much of an initial oil charge must be injected.

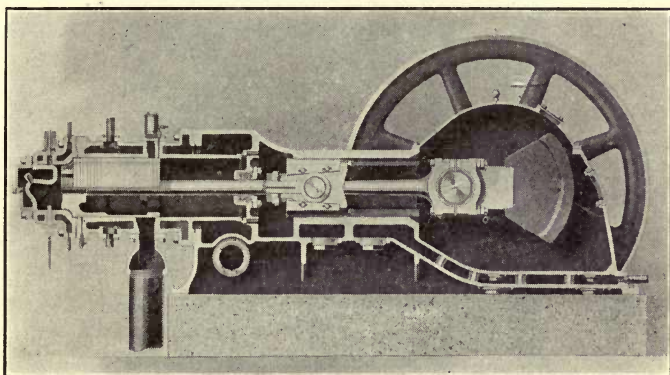

FIG. 255.—Bessemer oil engine.

Figure 255, cross-section of the Bessemer oil engine, illustrates an ignition bowl that operates on the same general principles as does the above. In this case, however, a starting tube, which is cast on the bowl, is used.

Four-stroke-cycle Engine Ignition Device.—Very few builders have adopted the four-stroke-cycle in their low-pressure engine. The only prominent American firm doing so has adopted the ignition device illustrated in Fig. 256. In this design the cylinder head is water-cooled and has embodied in it the engine combustion chamber. As the drawing shows, the admission and exhaust valves are in the top of this combustion chamber. The lower part of the chamber is formed by a separate uncooled cup. This cup or cover is heated by a torch, and the vaporization and ignition of the fuel proceed in a manner quite like that in the design of the two-cycle engine, Fig. 250.

The four-cycle design insures a cylinder charge of pure air as the exhaust stroke of the piston dispels all the burnt gases. The scavenging is usually more than is desired. In many cases the inertia of the moving gases tends to clear the combustion chamber of the burnt charge. This fills with fresh air on the suction stroke, and the oil, then, is injected into a mass of pure air. The proneness toward preignition is present even on loads below engine rating. The intense heat radiated from the hot cup is partially absorbed by the overhead valves. The engineer should

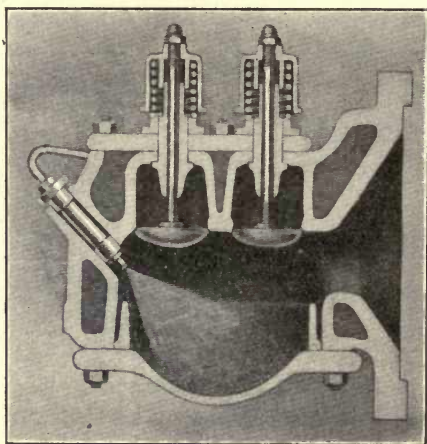

FIG. 256.—De La Vergne D.H. engine vaporizer or ignitor.

examine the valves periodically and regrind as often as necessary. In case of loss of power it is usually safe to figure that the valves are leaking. If the water contains much mineral matter, a solution of muriatic acid should be used occasionally. Due to the form of the cooling space, the sediment is liable to deposit around the port into the cylinder. This is a dangerous condition, for fire cracks will develop, resulting in leakage.

General.—From the foregoing it is apparent that there are a number of different cylinder head designs, although all these ignition devices are based on the process of vaporization and ignition, by temperature, of the fuel charge.

The first and all-important factor in successful operation of any of these hot-igniter engines is to keep the ignition device clean. The operator should have an extra part on hand and, when cleaning

one, should use the spare part. Soaking the carbonized igniter in lye for a few days and ending up with a thorough washing in kerosene will clean it very satisfactorily. If the engine tends to preignite on ordinary loads, inserting copper gaskets between the head and bulb, or the head and cylinder casting, thereby increasing the clearance volume, will probably relieve this. If the engine, on starting, blows through the joint between the head and bulb, too much pressure should not be used in tightening up the studs. The engineer should bear in mind that, as soon as the engine warms up, this leakage will cease.

CHAPTER XIX

LOW-PRESSURE ENGINE CYLINDERS

Cylinder Designs.—The cylinders used on two-cycle low-pressure engines may well be separated into two classes—those having the crankcase enclosed to act as a scavenging air compressor, and those which make use of the front end of the cylinder for the same purpose. However, the general designs of these two are quite similar, the chief difference being in the extra length of cylinder employed in the second class.

Figure 251 is a typical horizontal cylinder where crankcase compression is used. It consists of a simple casting with the necessary cored passages for the exhaust ports, air-intake, etc. This design is closely followed by a number of builders. The details in which they vary are usually the shape and extent of the air ports and the position of the exhaust ports.

To attain a good scavenging effect with the air charge, it is necessary to have the air passages enter the cylinder at an angle so as to direct the air toward the cylinder head, and then it is not necessary to rely exclusively on the deflection plate on the piston. It is about as harmful to have too much air-port area as too little. Some builders attempt to place the ports as far around the cylinder girth as the exhaust passage permits—planning, in this way, to obtain a better scavenging effect. However, as the air enters the many ports it tends to focus on the center of the cylinder head, causing eddy currents that do but little good. Furthermore, with a decreased port area the air velocity is higher with a consequent better cleansing of the cylinder.

The majority of engines are arranged to have the piston uncover the exhaust ports before the air ports are opened; in this way a greater part of the gases pass out of the cylinder before the air enters. This decreases the amount of air required, or the case is better stated by saying that the available air supply is used to better advantage. At the same time, it allows the air pressure to be less since the gases in the cylinder would be at practically atmospheric pressure when the air starts to blow

through. In many installations the exhaust falls below atmospheric pressure, owing to the inertia of the column of exhaust gases forming a vacuum at the engine. To obtain this the exhaust pipe must be of a length that allows the gases to leave the open end at the moment the piston uncovers the exhaust port for the discharge of the succeeding charge.

Cylinder with Front-end Compression.—Figure 255 is a cross-section of a cylinder wherein the front end is enclosed and acts as the scavenging air compressor, in place of the enclosed crankcase. The layouts of the air and exhaust ports are quite like the cylinder shown in Fig. 251.

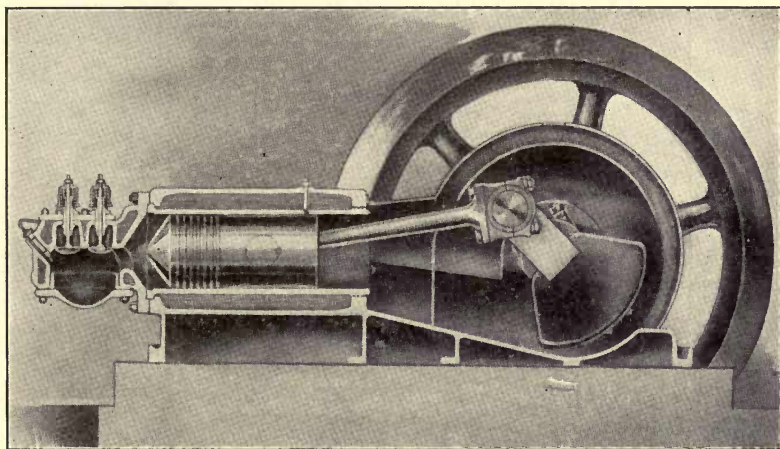

FIG. 257.—Cylinder with removable liners De La Vergne D.H. low compression oil engine.

Cylinder with Removable Liner.—Figure 257 shows a design of cylinder that follows accepted gas and high-compression oil engine practices. The cylinder jacket is cast integral with the engine frame while the cylinder itself is a removable cast-iron liner pressed into the jacket. At the rear or cylinder-head end a flange rests in a recess in the jacket, while the other end is sealed against water leakage by packing rings. The liner, by this method of anchorage, is free to expand lengthwise. The design has much to commend itself. It makes cylinder replacements lower than in the case of the combined jacket and cylinder; and there is but little danger of leakage, even though many engineers are prejudiced because of this remote possibility.

Vertical Engine Cylinder.—Figure 258 is that of the cylinder used on several makes of vertical engines. It is a one-piece casting of simple design, having the air passage formed in the casting. An attractive feature is the hand plate at the side. Opening this allows the piston pin and brass to be inspected, through a like opening in the piston. It is also handy to see if the piston rings are fast in their grooves. This cylinder design is employed on the Fairbanks-Morse engines and is similar to that of the Bolinder and of the Mietz and Weiss engines.

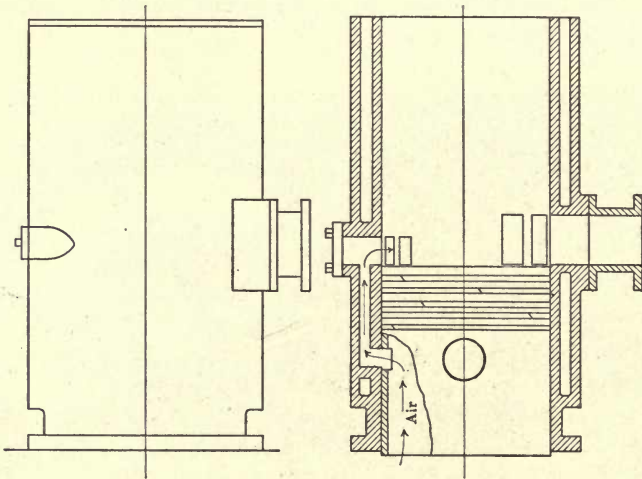

FIG. 258.—Vertical engine cylinder.

Thickness of Cylinder Walls.—The design of cylinders, as well as of all other parts, is strictly a matter that pertains to engine manufacturing, and not to engine operation. Even so, an operator should see that certain precautions have been observed in order that he may be assured a satisfactory machine. In all these designs it is well for the operator or purchaser to note if the cylinder walls are thick enough to allow for at least one re-boring. The walls should be calculated from the formula for a cylinder with thin walls.

$$t = \frac{pD}{2S} + k$$

where

t = thickness of cylinder wall.

p = maximum explosion pressure.

D = diameter of cylinder.

S = allowable fibre stress.

k = constant to allow for reboring,

its value depending on cylinder diameter.

Diameter of cylinder	6 to 11 in.	12 to 20 in.
Value of k	$\frac{7}{16}$ -in.	$\frac{1}{2}$ -in.

It is common practice with low-pressure engines to cast the cylinder liners with the jacket. It is undoubtedly the most satisfactory method in engines of moderate size. It is very easy to provide material for reboring and at the same time keep the thickness down to a value where the cooling effect of the water is sufficient. It is seldom that the cylinder liner develops a fracture, and so the replacement cost may be forgotten. As regards the reboring feature a few builders are following the practice of selling a new piston, oversize, and a rebored cylinder, taking as part payment the worn cylinder; this cylinder is then rebored at the factory and sold to the next customer.

Reboring a Cylinder.—Frequently the cost of a new cylinder is so excessive that the cheapest procedure is to rebores the worn cylinder. If the engine cylinder be under 10 inches in diameter, the job of reboring can be done by almost any machine shop. It is not necessary that the shop have a horizontal boring mill. The cylinder can be clamped onto the carriage of a large lathe, and a boring bar made of a piece of shafting with a boring tool clamped in a slot cut in the shafting. This can be placed between centers on the lathe and be driven by a lathe dog. No matter whether the job be done on a boring mill or lathe, a roughing cut should be first taken, followed up by a light finishing cut; the feed should be fine enough to allow the surface to be free from any undesirable tool marks. To complete the reboring job a block of brass or cast iron should have one side turned to the cylinder radius; wrapping fine emery cloth about this block, a vigorous rubbing will make the cylinder smooth as glass and preserve the curvature. In reboring a worn cylinder, extreme care should be used in getting the center line. The average cylinder has the flange, where it is bolted to the frame, turned square with the original cylinder center line. This flange should be used as a guidance in lining up. On large engines the cylinder cannot be handled on a lathe. The best procedure is to have the cylinder rebored by some firm that makes a specialty of

reboring cylinders. This can be done by means of a portable boring mill without removing the cylinder from the engine.

Causes of Cylinder Wear.—The question of cylinder wear on the low-pressure oil engine is very vital. Probably this is raised more than any other where the purchase of such an engine is being considered. Looking back into the history of the development of this type, one must concede that cut and scored cylinders figure quite prominently. A number of things were contributory causes. Water injection was blamed by many; lack of lubrication, poor grade of cast iron used in making the cylinder, and lack of cooling effect by others. Water injection may have some effect where kerosene is used or where the fuel oil is high in sulphur, but for the fuel or distillate oils ordinarily used it is open to dispute as to whether the water does cause cutting. A great number of engines have run from five to seven years without any decided cylinder cutting. In discussing water injection in semi-Diesel engines the statement was made that the nascent oxygen combined with the iron, forming a ferric oxide, and that this caused cylinder cutting. It must be borne in mind that the temperature attained in the semi-Diesel is much higher than in the low-pressure engine using fuel oil. On the other hand, where kerosene is used, the combustion is in the form of a rapid explosion, and the temperature does run much higher than when using fuel oil. So it is probable that water injection with kerosene does cause ferric oxide deposits. However, the chief cause of this cutting is the lack of proper lubrication of the piston and cylinder. It is a common occurrence to discover an operator using a light gas-engine or automobile oil, and these oils do not have sufficient body to lubricate an oil engine properly. Regardless of statements that the temperature of the cylinder does not exceed 250° Fahrenheit, an engineer knows that the temperature of the flame in the cylinder runs up into the three thousand degrees Fahrenheit, and that this heat will burn a light body, low-fire test oil. A successful cylinder lubricant must have enough body to stay on the walls, a fairly high fire test, and must burn without leaving any deposit of ash or carbon. Many engineers, especially in small plants, use oils that have not been filtered properly; these oils will always leave a deposit of carbon.

Many instances of scored cylinders can be attributed to the faulty design of cylinder and piston. The temperature of the

exhaust gases is high, and, as they pass through the exhaust ports, they raise the temperature of the exhaust port bridges to at least 800°. There is, at best, but a poor cooling effect around the ports, and often this high temperature causes the bridges to elongate. Since the ends of the bridges are held from movement by the rest of the cylinder casting, the bridge must bend and warp to accommodate this growth of the iron. This will, of course, score the piston on the underside. The rough piston then continues the damage by cutting the cylinder surface. When the cylinder and piston are inspected, and the piston has a bright streak on the bottom, it is safe to assume that the bridges have warped. This distortion must be corrected by bringing the bridge back to its original position. To smooth up the bridge, a file should have its end ground square with the edges sharp. This scraper can then be used to remove the excess metal. If the damage be severe, a roughing cut can be made with a flat file or a block of emery stone.

In some engines the piston is made very light; the walls and head are not able to resist the high pressures. The piston walls tend to bend into an elliptical shape. Once the piston gets out of true, it is only a question of time until the cylinder is badly scored. The only remedy in this event is the purchase of a piston with heavier walls and top.

There exists on some cylinders, especially those on vertical engines, a grooving or cutting of the wall surface into ridges and valleys, these ridges extending about the girth of the cylinder. Just what causes this manner of cutting is unknown, though it occurs more often where the piston has considerable play. Smoothing with a scraper provides the only relief, which unfortunately is but temporary, as secondary grooves soon begin to appear between the old cuts.

Fractured Cylinders.—Fractured cylinders, due to a poor cooling effect of the circulating water, is often encountered. It might be stated as an axiom that a fractured cylinder is indicative of a lack of attention on the part of the engineer. The jackets of practically all engines provide enough water storage space to absorb sufficient heat to prevent the engine from fracturing due to heat stresses. The great trouble that must be overcome is the lack of that careful attention that the engineer should give the machinery under his care. It is absolutely imperative that the flow of cooling water should be uninterrupted. It should

not be necessary to state that the water must begin to flow as soon as the engine starts firing. If an engineer lets the entire jacket run dry when starting, he should not blame the manufacturer if a fracture develops in the cylinder.

When the water is bad, carrying much sediment, the deposits, which will always occur on the cylinder walls, must be removed. It is far better to remove the mineral or vegetable matter before the water enters the jacket. Unfortunately this demands an expensive purification system which is out of question in the average plant. It follows that the jackets must be cleaned periodically. If the scale is bad, an acid solution will allow it to be washed out. Graphite, pumped into the circulating water pipe at frequent intervals, will cause the scale to break loose from the iron walls and prevent new scale from forming. Care should be observed in using graphite. The scale will drop off the hot cylinder walls, allowing water to strike the fresh portion of the wall while it is at a very high temperature. The best plan is to cut the scale with acid and use the graphite to prevent any further scaling. Due to the low temperature of the cooling water, commercial boiler compounds do not prove successful as a scale solvent.

In journeying among oil engine plants, one is struck by the great number of fractured cylinders laying around. It would appear that practically no effort is ever made to repair a cylinder where a crack extends through the wall to the interior. Oil engine cylinders are always high priced (in fact, entirely out of proportion to the factory cost) and more study should be spent on the question of welding the fracture. On engines of less than 10-inch diameter, the expense of welding, with the risk of it being unsatisfactory, is too high for such a procedure to be recommended. On the larger cylinders, if the services of an experienced oxyacetylene welder can be secured, the saving is well worth the trouble of welding. In welding ordinary cast-iron parts, the usual method is to cut out a V of the metal, this cut extending through the entire fracture. This allows the welding iron or steel to be deposited in layers, building up from the bottom of the fracture. If this is done in a cylinder, there is a strong tendency for the cylinder to warp out of shape. A small V, to open up the top of the fracture, should be cut, and the welding iron should be kept almost to the burning point to allow it, when deposited, to flow as deep as possible into the fracture.

The blow-pipe should not be played over the cylinder walls around the fracture any more than sufficient to bring the edges up to a welding heat. The welding material should not be piled up above the surface as is the usual practice. After cooling, the weld should be smoothed down with a file and scraper. It is best to use soft steel rod for the welding material.

This method has been used in a few cases and was satisfactory in a low-pressure engine. It would not be a success in Diesel engines as the weld usually makes either a low or high spot on the cylinder wall, which would not hold a very high compression, while it would hold quite well with the low-pressure engine.

In the case of cylinders, the two important items that demand attention are the condition of the water jacket and the lubrication of the cylinder walls. If the jacket be maintained free from scale, and the cylinder be lubricated to the correct amount, the cylinder will take care of itself.

Cylinder Head Packing.—Even though it is a seeming paradox, it is true that the best cylinder packing is no packing at all. It seems to be the idea of the average engineer that he must use a thick packing in order to seal the joint securely. Even though it may be demonstrated that, theoretically, the more compressible the packing is the greater the elongation of the studs before "blowing" will occur, in actual practice a thick resilient packing should be avoided. In designs where the head and cylinder flanges are faced straight across, the best possible packing is a thin sheet of copper. This sheet should be annealed and made perfectly smooth and straight. The flange surfaces should be cleaned and, if necessary, smoothed up with emery cloth. The copper gasket, which should also encircle the studs to keep it in place, will maintain a tight seal. A slight blowing on starting is not harmful on a copper gasket and serves to relieve any excessive cylinder pressure. Some engines have this joint grooved for a copper ring gasket. In replacements the copper wire should be cut, and the ends scarfed and soldered. The wire should also be annealed before using so that it will compress easily. The copper wire gasket, undoubtedly, makes the best seal that can be secured. Some of the better grade engines use a ground joint between the head and the cylinder. If the head was never removed, this kind of seal is most superior. Unfortunately, it often becomes necessary to inspect the cylinder or remove the piston. It is almost impossible to tighten up enough to reseal

this ground joint. Small particles, almost invisible to the eye, will prevent a perfect contact. In replacing this type of head, it is a good procedure to insert a copper sheet gasket. The use of vulcanized rubber or asbestos gaskets, even with wire insertion, is poor practice. The gasket seldom holds against the pressure, and the blowing of the joint at starting will cause the gasket to tear and be rendered worthless.

A word might be added about the "blowing" of this joint. While it serves to relieve excessive cylinder pressure, the engineer should recognize it as an indication that he has pumped too much fuel into the combustion chamber on starting. He should give the pump fewer initial strokes on the next starting. If the engine "blows," the operator should retard the fuel pump stroke so that the oil injected is less. On starting an engine, the usual governor, since it is not in a state of perfect equilibrium, will give the fuel pump its greatest possible stroke, even more than full-load stroke, and the fuel injected exceeds the capacity of the engine. The pump handle should always be used to hold the pump stroke to a low value, until the engine has come up to speed.

CHAPTER XX

PISTONS, PISTON PINS AND CONNECTING-RODS

Types of Pistons.—While the majority of the two-stroke-cycle engines of the low-pressure type use pistons having deflector lips, similar to Fig. 259, there are several other designs coming into vogue. Quite a number adopt the double piston, Fig. 260. This piston, as shown, has part of the head cut away to form a deflector for the air; and, to allow the exhaust to uncover at the proper time, a similar portion is removed from the bottom side



FIG. 259.—Low-pressure engine piston with deflector.

of the piston. This simplifies the casting of the piston, but it is likely to prevent free exhaust as the curve will set up eddy currents, and the scavenging will not be perfect by any means. Still another design is Fig. 261, which is used on the De La Vergne four-stroke-cycle type D.H. engine. The conical head will allow expansion without seizing. Another design which is coming

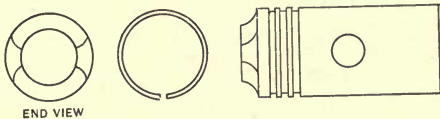

FIG. 260.

into favor, especially for vertical engines, is the one adopted by the Muncie Co. and outlined in Fig. 262. This has a straight face head, and, if the air ports enter the cylinder at an angle, the elimination of the deflection lip will not prove objectionable. In those engine designs where the scavenging air is compressed in the front end of the cylinder, the common practice is to use a crosshead and piston rod. This necessitates a considerable departure in the piston design. Figure 275, showing the Buckeye

Machine Co.'s design, is along the lines of this type piston as ordinarily built. This piston, as regards strength, is of excellent design. The head is strongly ribbed—which prevents distortion of both the head and piston body. See, also, Fig. 255.

Piston Clearance.—There is much difference in the practice of engine builders in regard to the clearance between cylinder walls and piston. On new engines it seems to range anywhere from $\frac{1}{32}$ inch to .005 or .006 inch. The variation is not dependent upon size; the largest clearance encountered has been on pistons below 10 inches in diameter. Apparently the values chosen have

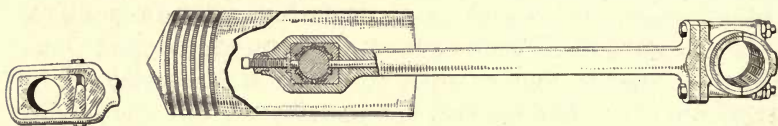

FIG. 261.—De La Vergne piston and rod.

depended upon the builder's viewpoint. If he desired absolute freedom from piston seizing, he chose a large value; if good compression was attractive, a small clearance was used at the risk of piston seizing. In operation, the engineer should see that the clearance does not exceed .008 inch; that is, the difference in cylinder and piston diameter should not exceed .0016 inch, nor be less than .005 inch. This clearance value is considerably greater

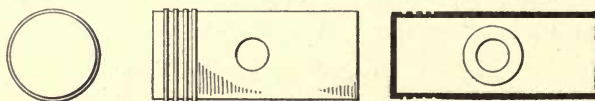

FIG. 262.—Low-pressure engine piston without deflector.

than in either the gasolene or Diesel engine. However, owing to the heat conditions in the cylinder of the two-stroke-cycle type of engine, the piston expansion is rather extensive. Operating at a fairly high rate of speed, the cooling of the piston is difficult, especially in view of the fact that either the frame or the front end of the cylinder is enclosed, preventing any cooling by air currents which assist materially in the gasolene engine. Since the two-stroke-cycle receives twice as many fuel charges as does the gasolene or Diesel for the same number of revolutions per minute, the amount of heat that the cylinder jacket absorbs

is approximately twice as great. The piston receives more heat than it can radiate at ordinary temperatures. The result is that it must reach a higher temperature limit before the heat balance is attained. Being at a higher temperature, it is natural to expect the piston to expand more than does a gasolene engine piston. There must be more clearance to accommodate this expansion. While there must be clearance ample for this, the maximum allowable clearance is limited as well. It seems to be the impression of most engineers that, as long as the rings fit snugly and hold compression, the actual piston clearance does not matter. On the contrary, it is highly important that there be no excessive play. The air ports and exhaust passages are practically in line. If the piston is loose in the cylinder, the air charge will flow around the piston into the exhaust ports, even though the rings are snug enough to prevent the cylinder compression from being lost. A great many instances of poor scavenging are traceable to excessive piston clearance. Another common practice is the dependence engineers place on the piston rings. These should not be expected to hold the cylinder compression with the piston badly worn. Probably nine out of ten operators, as soon as the piston shows signs of wear, order a new set of rings and feel that these are a cure-all. When the piston wear exceeds the above-mentioned clearances, and the engine shows signs of loss of power or excessive fuel consumption, it becomes necessary to install a new piston and rebore the cylinder. Most builders furnish replacement pistons from $\frac{1}{8}$ to $\frac{1}{16}$ inch oversize.

Turning a New Piston.—Viewed from all aspects, it is advisable to purchase the new piston from the engine builder. Frequently, due to high repair prices or delay in delivery, it becomes advantageous to have the piston cast at a local foundry. The old piston can be used for the pattern. A core box can be cheaply made since the piston bosses and ribs can be cut in the core itself. The success of the entire process depends on getting the core central in the mold, having the risers of considerable height, and in using iron that has but a small amount of scrap, using no stove or agricultural scrap at all.

In many instances the cylinder is not scored nor worn out of round, and so it does not demand reboring. If the piston be purchased oversize from the manufacturer or be cast at the local foundry, it is necessary for the engineer to have the piston turned

to the correct size. It is usually best to have this job completed at a machine shop. In those installations where the engineer is expected to do his own machine work, this undertaking need not be dreaded. The main thing is to exercise great care in centering it in the lathe. The best method is to first place the piston on the lathe, chucking the head. A light cut should be taken off the inside of the bottom end, as well as on the edge, to square up this end of the piston, using the steady rest to support the weight of the piston. The next process is to reverse the piston, chucking from the inside surface that has just been finished. Still using the steady rest, the head of the piston is finished up. A drill is inserted in the tail stock, and the center is counter-bored to receive the center of the tail stock. The steady rest is then removed, and the piston tested for trueness. If it is a little out, this should be corrected. A roughing cut is next taken over the body of the piston, ending with a finishing cut. If the piston-pin bosses must be bored, the best procedure, on an ordinary lathe, is to block the piston up on the carriage and bolt the boring tool to the lathe face-plate. A very light cut should be first taken, to check the lining up of the piston. If it is not blocked up true, this reveals the error. The ring grooves can be made while the piston is chucked on the lathe.

After taking the finishing cut on the piston, a file should be used to give the surface a good finish; the use of emery cloth to follow up the work of the file is also a good plan. It is the practice of most builders to give a slight taper to the piston from the first ring to the edge of the head. In turning a new piston, the engineer should taper it at this point, making the variation in diameter about $\frac{1}{32}$ inch.

Distorted Pistons.—One encounters a great many instances where the cylinder is badly scored and where the operator cannot account for this damage, he being insistent that the piston has been supplied with plenty of lubrication. Usually investigation reveals that the piston walls are not strengthened by supporting ribs, and the piston pin is locked at both bosses by set-screws or similar devices. If the piston pin becomes heated, it will tend to lengthen. When there are no ribs to resist this force and the pin is held at both ends, the thin piston walls assume an elliptical shape. This always results in the cylinder cutting along the sides in line with the pin bosses. If the engineer finds that the piston is built on similar lines, it is well to file a

flat surface on the piston around the bosses. Then, in case of elongation, this clearance will allow the piston to change its shape without damage to the cylinder.

Where the damage already exists, it is not always necessary to rebores the cylinder, even though the scoring be deep. If the scoring or cutting is limited in area and does not extend along the entire stroke, the damage can be remedied by using an emery stone, file and scraper. In such instances good results are obtained by first using an emery wheel held in the hand. By rubbing the scored spots in this way the rough ridges are removed, and a file and emery stone, finishing up with the scraper, will smooth the work. This process has been used on many occasions where the cylinder looked hopeless.

Piston Rings.—In cases of worn piston rings, the best plan is to replace them since their continued use means loss of power. There is a prevailing habit of engineers to let the

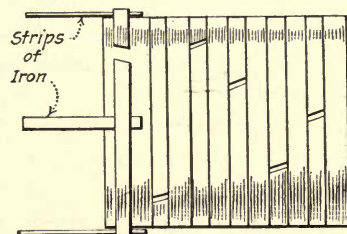

FIG. 263.

rings stay in, no matter how badly worn, if the engine continues to pull its load. Usually the engine is underloaded, and its ability to take care of the plant's demand is no criterion as to the suitability of the piston rings. In most plants the best way to decide the problem of ring renewal is to depend on the fuel consumption. If this shows an increase, and the rings are worn, then it is time to replace them.

Frequently, these new rings must be made at a local shop. In such cases it is good practice to have the rings rough-turned to an outside diameter about $\frac{1}{16}$ inch larger than the cylinder. The ring should then be cut and, after being clamped to the desired diameter, finished inside and out. This method insures a ring that will hug the cylinder walls at all times. Moreover, the ring should be made almost as wide as the groove; the difference should not exceed .01 inch. The ring should equal in thickness the depth of the groove less .02 inch. If made thinner, the clearance will simply fill up with coked oil.

In removing piston rings, the best method is to start on the one nearest the piston end and remove each one successively. The easiest way is to use a file to spring one end of the ring so

that an iron strip, such as a barrel hoop, can be inserted between ring and piston. The strip is worked around the piston, others being added as the process continues. The ring is now raised above the piston surface by the four strips, similar to Fig. 263. It is now easy to slip it off. The strips also prevent the ring from dropping into a groove as it is slipped off. In replacing rings, the same method can be followed.

Distorted Exhaust Bridges.—Another common cause of a worn piston is the distortion of the exhaust port bridges. The cylinder should be inspected at least every sixty days, and if the port bridges seem bright the piston will probably be found to be cut to some extent. The remedy is to file and scrape these bright spots until the piston clears them. At these inspections the piston should be pulled and the rings examined. If badly

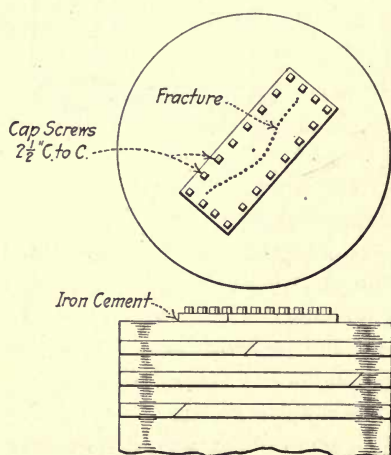

FIG. 264.

gummed, kerosene will usually loosen them. If this is not successful, placing the piston in strong lye will free the rings.

Fractured Piston Heads.—The expansion of the piston head often causes minute fire cracks to appear; this occurs but seldom in conical head pistons. Frequently, one of these fire cracks will develop into a well-defined fracture several inches in length. Usually this extends entirely through the head and allows the gases to blow through, resulting in poor compression and decreased power. The tendency of the inexperienced engineer is to replace the piston at a heavy cost. This replacement is entirely unnecessary in the majority of cases. If the piston is 12 inches or over in diameter, the method described in Chapter VI is the most acceptable. In small engines this entails too much time and skill. A cheaper repair is shown in Fig. 264. Here a steel plate $\frac{1}{4}$ inch thick is fastened over the crack by means of a series of machine screws. Iron cement, such as smooth-on, should be coated over the piston face before the plate is drawn

into place. This patch will hold the compression and will strengthen the head. To prevent the crack from developing in length, a $\frac{1}{8}$ -inch hole should be drilled in the head at the ends of the crack. The machine screw heads should be sawed off short so that they do not project into the cylinder space any great amount; if they do, they might cause preignition.

Piston Pins.—The usual type of piston pin consists of a straight cylindrical piece of steel, hardened and ground. In most designs it is held in both bosses by means of two set-screws, the pin being countersunk to receive the conical ends of the set-screws. In some engines the pin is prevented from turning by the use of a key. The use of a set-screw in each boss constrains the pin from having any opportunity to expand lengthwise without distorting the piston. As a safeguard, the engineer need have no hesitancy about removing one of these set-screws. He can then be a little more at ease as to the danger of the piston getting out of round. Due to the frequent preignition in the cylinder, the piston pin is subjected to extreme hammer blows. If it is not properly heat-treated, a flat place will develop where it comes in contact with the bronze bearing. Where the wear becomes considerable, the pin should be rotated either a quarter or half turn, thereby presenting a true surface to the bearing. When the pin has been so rotated, and flat places have been worn on all four sides, a new pin is necessary. On engines above 30 or 40 h.p. it is inadvisable to turn the pin since turning it results in considerable play in the brasses. Where the pins are not a snug fit in the bosses, the latter tends to pound out of shape. In renewing pins, the bosses should be examined for wear. If the bosses are out of round, the cavities must be rebored, and the new pin must be made large enough to fit the new bore. Since the increase in diameter will be slight, the pin need not be reduced in diameter at the brasses. These can be enlarged to accommodate the new pin. Piston pins should, if at all possible, be procured from the builder. He is in a position to furnish a pin heat-treated and ground. When this is impossible, a pin can be made up from cold-rolled shafting. If facilities are at hand, it should be case-hardened and ground. Where the engineer is satisfied with a less expensive method, a lathe-turned pin, smoothed up with emery and with the two ends ground into bearing at the bosses, will suffice for a long time, though its wear will be much more than that of a hardened pin.

Connecting-rods.—Figures 265 to 269 show the types of connecting-rods generally used on the low-pressure engine. Figure 265, Bessemer Oil Engine, has a marine-type crank end and a round

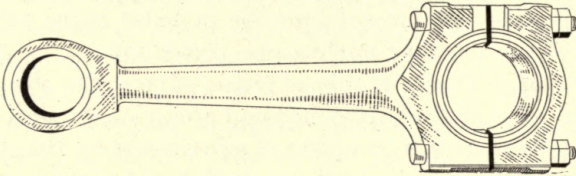

FIG. 265.

non-adjustable piston pin end. As the latter has no means of taking up wear, the engineer should not allow this solid end bearing to become too worn; prompt replacement by a new bushing will

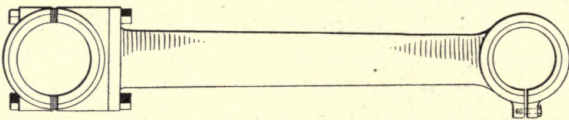

FIG. 266.—Buckeye-Barrett connecting rod.

help maintain a smooth-running engine. Figure 266, Buckeye Oil Engine, shows a rod along somewhat similar lines. The principal difference is in the split wrist-pin bearing. In taking up

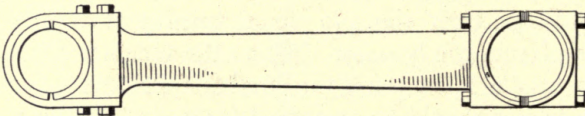

FIG. 267.—Primm connecting rod.

the wear, this split bearing will not maintain a perfect bore. It will tend to go out of round. When making adjustment, the brass should be slipped over the pin, which is removed from the engine

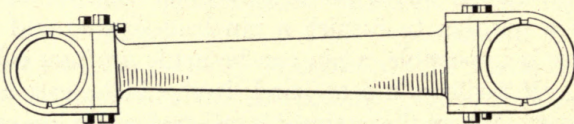

FIG. 268.—Muncie connecting rod.

and coated with Prussian blue. Rotating the bushing reveals where it bears hard on the pin. The operator can bring the bushing true by judicious scraping. Too many engineers feel

that such attention to details is unnecessary; nevertheless, the life of any engine can be doubled by the exercise of due vigilance by the operator. Figure 267, Primm Oil Engine, shows a rod having a wedge adjustment at both ends. Figure 268, Muncie Oil Engine, shows a rod used on some engines with both ends of the marine type. Figure 261, De La Vergne D.H. Engine, shows a rod that closely follows Diesel practice, with the additional feature of oiling the piston pin by a passage in the rod itself.

The connecting-rod used in the Fairbanks-Morse Vertical Engine is shown in Fig. 269. The crank bearing has a renewable

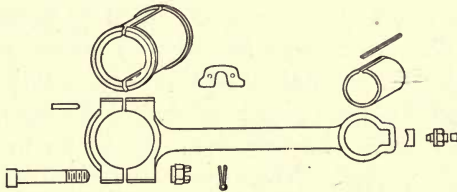

FIG. 269.—Fairbanks-Morse vertical engine connecting rod.

liner, and any slight wear can be taken up by removal of a shim. The piston-pin bearing is a bronze bushing, split on one side. This bushing fits into the rod and is held by the adjusting, or take-up, block set-screw. When the bearing has worn, it is necessary to remove the rod and piston pin from the piston. The brass shim or strip, which fills the space between the two edges of the bushing, is taken out and filed until the bushing will fit the pin. This must be done gradually in order not to reduce the shim too much. The bushing and shim are placed in the rod and the pin inserted; the take-up block is then forced down to a solid contact by the screw. Nothing should be taken for granted. The pin should be rotated, being coated with Prussian blue, and any high spots in the bushing scraped away. The engineer must remember that the bushing must come into contact with the shim. If the high spots are not scraped, the bushing will not bear true since its design is such that it becomes elliptical when adjusted.

Adjustments.—In operation, the engine should never be allowed to run with any play in the brasses. Wear is easily detected by the thumping sound as the piston reverses at the end of the explosion stroke. At the moment of explosion the

impetus given the crank and flywheel is sufficient to cause it to run ahead of the piston toward the end of the stroke. The pin, then, might be said to be out of contact with the pressure side of the brass. Upon reversal of the crank, the connecting-rod brass comes into contact with the piston pin, producing a blow or thump. If the brasses are snug, the pin is never out of contact. If the wrist end has a wedge adjustment, it is an easy matter to take up the lost motion without pulling the piston. The same applies to the crank end, regardless of the particular type of bearing. However, if the wrist end be a marine-type or screw-adjusting box, it will be necessary to pull the piston in order to make the proper adjustment. The brass should be drawn up tight, and then the bolts should be backed off a sixth of a turn. Some engineers attempt to adjust without using shims between the two halves of the brass. It is advisable to insert shims so that the pressure of the bolts is on the shims and not on the pin itself. In tightening the brass, the pin is withdrawn from the piston. When the correct fit is secured, the pin is driven out of the rod, and the piston, connecting-rod and pin are reassembled. No connecting rod will run without heating if there is no provision made for a small amount of clearance between pin and brass. The fit should be snug, yet not tight. A good way to determine whether the adjustment is correct is to "jump" the piston. If a 5-foot pinch bar will just cause the piston to move, it is safe to assume that the brasses are snug enough.

Connecting-rod Brasses.—The piston-pin bearing, or box, is usually made of phosphor bronze—a babbitt bearing will not stand up very well on account of the heat conditions within the piston. It is well to remember that it is not necessary to have the bearing completely surround the pin. The pressure actually falls on a very small portion of the bearing, and the lubrication is better with part of the brass cut away, as shown in Fig. 270. Frequently, the engine manufacturer does not do this, and the engineer will make no mistake if he removes the surplus portion before using the bearing.

The crank-pin bearing used on this type of engine up to 35 h.p. is usually a split babbitt bushing enclosed in the bearing housing or box. Ordinarily, the manufacturer die-casts these bearings and reams or broaches them to exact size. If the die-casting is not so finished, the surface is not perfect, and the

metal has a tendency to "drag." With the die-cast bearing, in case of renewal the cheapest way is to buy a new one from the engine builder, since the plants using these small engines are not equipped, as a rule, to make a bushing. In case of urgency, where it is impossible to wait for a new bushing from the factory, it is easy to have a local machine shop cast a babbitt bushing, around a mandrel placed in a piece of pipe. The engineer should see that the machinist who fits the bushing to the engine pin uses extreme care in bringing it to a perfect contact with the pin.

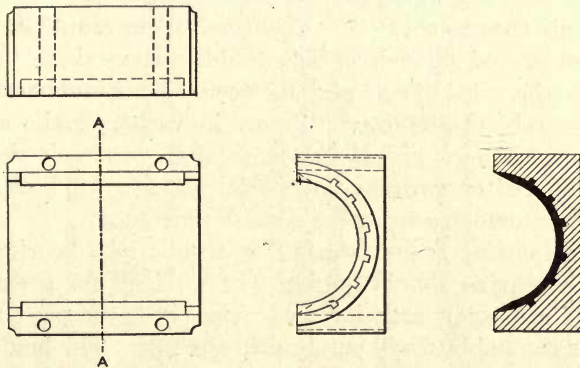

FIG. 270.—Big-end rod bearing.

On larger engines the removable bushing is seldom used. The crank-pin bearing housing is usually made of steel or cast iron, though a few housings have been made of bronze; the cast-steel housing is by far the best. The box is lined with babbitt, and the best babbitt is always the cheapest in the long run.

Quite often one sees a crank box that will not retain the babbitt. The fault generally proves to be a lack of sufficient anchorage in the bearing. If the box is merely drilled in a number of places for babbitt anchors, it will be well to put it on a planer, or shaper, and cut dovetail slots in the surface of the housing. These slots will hold the babbitt under unusually severe conditions.

Babbitting a Crank Bearing.—In rebabbitting a box, it is never advisable to run it with the box cold. If this is done, the babbitt will seldom unite with the box. Where the engine is small, as good a method as any is to secure a mandrel the same diameter as the crank pin and, after placing this in the housing (which has been heated), run the bearing around the mandrel. Any bad spots in the babbitt can be smoothed up, and the entire

bearing scraped into a good fit to the pin. On large engines the same method as is used on a Diesel engine should be followed. In running a new bearing, a liberal amount of shims should be used between the two housing halves in order that the babbitt can wear considerable and still leave room between the two housing parts for "take-up." Extreme care should be exercised to see that the babbitt is not overheated in melting. Regardless of the question of economy, it does not pay to use the old scrap babbitt in the ladle. It carries too much abrasives; it is best reserved for ordinary work, such as line-shaft boxes.

Crank-pin Clearances.—The clearance for the crank pin, which should not exceed .02 inch, is indicated by a very slight "jump." As regards the value of side play between the big-end bearing and the crank web, this of course differs in various make engines. Some demand more liberal clearance than others if the brass does not bind after warming up. A fair value is $\frac{1}{64}$ inch, or just enough to be detected by using a small pinch bar.

When an engine is first started or after a new bearing is installed, the engine should be run without load for a couple of hours. If a bearing runs hot in service, it never pays to shut down, for the babbitt will surely grip the pin. The load should be thrown off and the engine run at a slow speed, with the lubrication increased, until the bearing cools off.

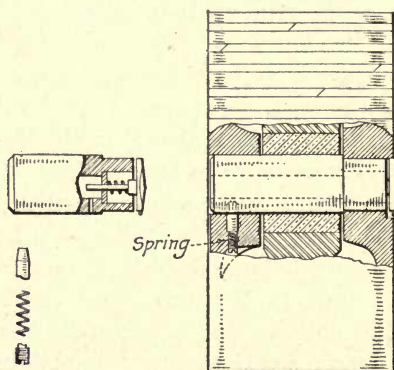

FIG. 271.—Piston pin oiling. (Fairbanks Morse Co.)

Crank-pin and Piston-pin Lubrication.—Probably the oiling of the wrist-pin box has caused more trouble and worry to the engineer than the oiling of all the rest of the engine. Some builders depend on picking up enough oil from the cylinder walls to

lubricate the pin, the pin being drilled lengthwise and provided with a scoop at one end, Fig. 271. The great objection to such a method of oiling is the likelihood of the scoop picking up carbon particles and thereby clogging the oil passage, causing a troublesome pin. A second arrangement is to have a pipe passing

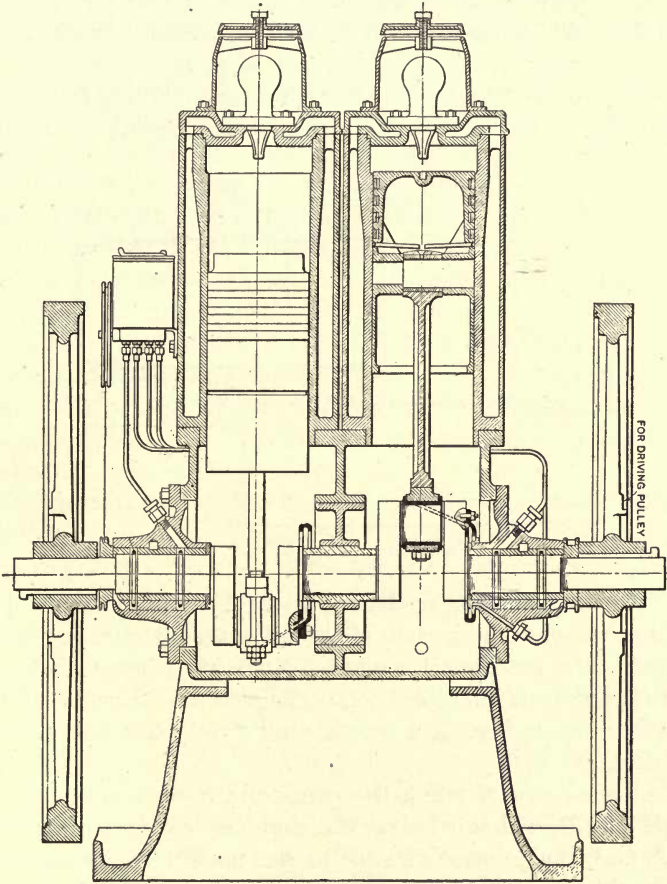

FIG. 272.—Mietz and Weiss low-pressure oil engine, showing lubrication system.

through the cylinder walls, allowing the oil issuing from the end of the pipe to be picked up by a groove on the piston and then conveyed to the pin, Fig. 272. Still another plan is to supply the pin by means of a drilled hole extending through the connecting-rod from the crank end, Fig. 261. Probably the best way to oil the pin of a horizontal engine is to use a device such as a

wick or wiper oiler in connection with a mechanical oil pump, Fig. 251.

A contrivance that has been used on an inclosed-frame engine is outlined in Fig. 273. A $1\frac{1}{4}$ -inch brass pipe is slotted on one side and the ends capped. This pipe is fastened to the inner wall of the piston by two clamping bands and extends out 16 inches beyond the end of the piston. A $\frac{1}{4}$ -inch connection is run to the pin boss connecting with the oil passage already in the pin. The $1\frac{1}{4}$ -inch pipe receives the oil through a tube running from the oil pump, which is mounted on the engine frame back of the cylinder.

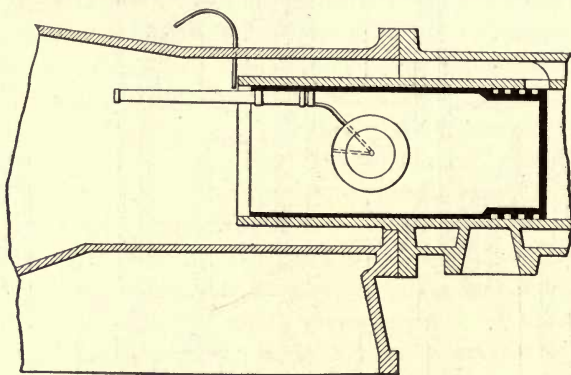

FIG. 273.—Piston pin oiler.

Since the slot is as long as the engine stroke, the oil supply to the pin is positive. The inertia of the oil as the piston moves assists in insuring a steady oil stream. No matter what system be used, it must be given attention. The piston pin is in a high temperature zone and needs a constant oil supply to keep in normal condition.

The usual way of oiling the crank pin is by a centrifugal oil ring, Fig. 272, which is by far the simplest and most reliable device. Only one precaution need be exercised. The big-end bearing should have liberal oil grooves cut in the babbitt in order to distribute the oil as it emerges from the drilled passage in the pin. Whenever the bearing gets warm, the babbitt may be forced into the oil passage, closing it. The oil passage, then, should always be cleaned out after the hot box has been cooled.

CHAPTER XXI

ENGINE FRAMES. BEARINGS. SHAFTS. FLYWHEELS.

Engine Frames.—In the matter of frame design, each engine builder has followed his own ideas. Unlike steam engine manufacturers, hardly any two low-pressure-engine builders use the same design of frame. However, all may be separated into two types—the open frame, where the scavenging air is compressed in the front end of the cylinder; and the inclosed frame, where the air-tight frame itself serves as the air compressor. Figure 256 is a view of an open-frame while Fig. 251 is a cross-section of an inclosed-frame engine. While both show a horizontal engine, it is in the vertical type engine that the inclosed frame is used exclusively. This is for the reason that an open frame with cylinder air compression would make the engine much higher than is desirable.

Inclosed Frame.—The inclosed frame is immensely attractive both from a manufacturing and an operating viewpoint. Since all parts are bound together the frame can weigh less for the same strength. Being inclosed, the matter of keeping the bearings and cylinder free from grit is very much simplified. However, of late, a number of open-frame engines are being equipped with dust-proof steel covers. Many engines of the horizontal two-stroke-cycle type have frames that are entirely inclosed, access to the interior parts being had only by a small opening at the front of the frame. This opening is taken up by the air-check valve, and inspection of the parts involves removal of the valve and the suction piping. In an engine of this design the engineer should not fall into the lamentable habit of neglecting to inspect the connecting-rod brasses. It is not easy to do this, but even though it does involve considerable effort the air valve should be removed at least monthly, and the crank box inspected for wear. There is a tendency at all times for this bearing to wear unevenly, allowing the rod to get out of line, and it is more likely to happen in the inclosed engine if the engineer is lax in his inspection.

Another detail of importance, especially in the horizontal engine, is the necessity of keeping the crankcase free from excess lubricating oil. In many plants the engineer is careless in this matter and allows the oil to accumulate until the crank strikes the oil surface. This causes the oil to splash into the piston and also causes the air to be charged with a fog of lubricating oil particles. This fog of lubricating oil is blown along with the air into the cylinder at the moment the air port is opened. These particles blow on out through the exhaust, giving it a decidedly smoky appearance. The oil which splashes into the piston may strike the hot piston head, carbonize and adhere in a thick coat or scale. Means of removing the heat from the piston head are meager at the best, and scale is a poor conductor of heat. Therefore, this splashing oil will likely contribute to a fractured piston head. In the vertical cylinder this carbonized scale on the interior of the piston has a habit of dropping down on the crankpin and piston-pin brasses. Small particles working in between the pin and brass cause a good many hot boxes. The splashing lubricating oil, in a horizontal engine, strikes the cylinder walls in excessive amounts. This oil will invariably gum up the piston rings and frequently cut the piston. Figure 272 is a cross-section of the Mietz and Weiss engine which uses the inclosed frame; the Fairbanks-Morse inclosed frame appears in Fig. 253.

Engines using the front end of the cylinder as the air compressor are free from those troubles due to the oil in the crankcase. The crankcase, in such designs, is entirely separated from the air chamber. As a result of this separation, quite a number of these engines use a splash-oiling system for the lubrication of the crank pin and main bearings. This gives a copious supply of oil to these parts. The oil, however, should be removed occasionally for refiltering. When the runs are long, the oil should be drawn off and cool oil substituted. It does not require many days of operation to raise the oil temperature up to a point where the lubrication of the pin becomes unsatisfactory. Figure 255 is a cross-section of the Bessemer engine, which uses the splash-oiling system.

Open Frames.—Figure 274 illustrates the frame of the De La Vergne four-stroke-cycle low-pressure engine. Since no scavenging air is used, the frame does not embody the compressor feature. This frame in many respects follows closely the design of horizontal Diesel engines, though of much lighter weight. The

cylinder jacket is part of the frame, and support is given the cylinder over its entire length. This extensive foundation bearing surface makes this frame very rigid.

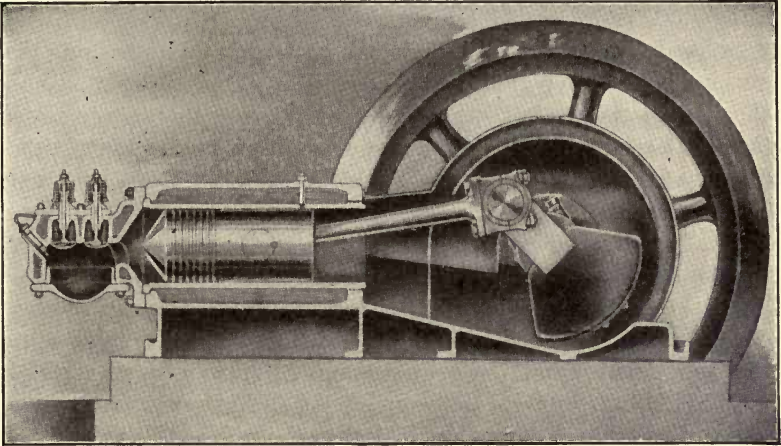

FIG. 274.—Cylinder with removable liners De La Vergne D.H. low compression oil engine.

Figure 275, Buckeye-Barrett engine, is a typical design of the two-stroke-cycle engine using cylinder air-compression. Since this type of air compression necessitates the use of a piston rod,

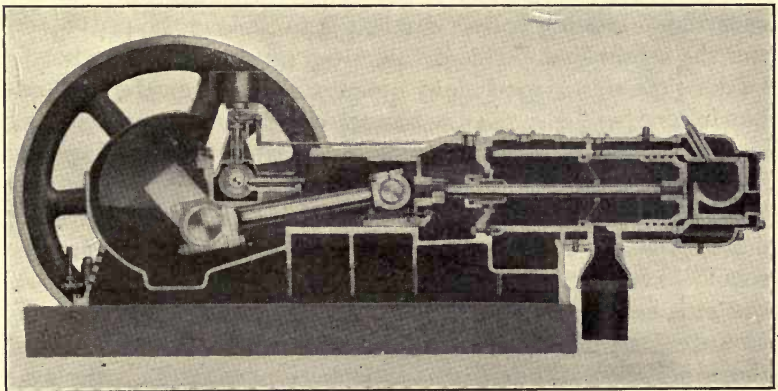

FIG. 275.—Buckeye-Barrett oil engine.

a crosshead is used. The adjustments of the crosshead are identical with those occurring in steam engine practice. Since most oil engine operators are familiar only with the trunk piston type

engine, frequently the crosshead is ignored, and the wear on the lower shoe is not taken up at the proper time. It is apparent that, if the lower crosshead shoe wears, the piston rod will ride on the bottom part of the stuffing-box. The piston is usually about 40 per cent. as long as the piston rod. Then if the crosshead shoe wears $\frac{1}{16}$ inch, the rod will rest on the stuffing-box, the piston rod fulcruming at this point. When the fuel charge explodes, the piston, in forcing the crosshead to the front end, will tend to tilt an amount corresponding to the crosshead shoe wear. Being of considerable length, cylinder scoring may be caused by either the front or rear end of the piston. This has happened in a number of instances where the engineer was careless about taking up crosshead shoe wear. While the lower shoe wears more rapidly, due to the higher pressure exerted on the piston during the explosion stroke, there is some wear on the top shoe. Unlike the steam engine, there is a reversal of direction of the pressure on the crosshead; during the compression stroke the flywheel forces the piston to the rear, and the vertical component of this pressure on the crosshead is upward. Since the pressure is fairly low, the wear is slight, and usually no adjusting wedge is incorporated in the design. Even though this be true, it is advisable for the engineer to examine the upper shoe for wear. It is extremely difficult, after the engine is once in operation, for the engineer to detect on which shoe the wear has occurred. The one correct method is to remove the piston and run the center line. This involves too much time and labor to be done often. A good many operators depend on the stuffing-box to serve as a gage in adjusting the crosshead, raising the lower shoe until the piston rod apparently centers the stuffing-box. The objection to this lies in the wear in the stuffing-box, destroying its usefulness as an indicator. In the data book, covering dimensions and adjustments of the engine, which every engineer should have in his possession, when the engine is first installed, the crosshead measurements should be entered. Using a micrometer, the distances between outside surface of the shoes and the inside edges of the crosshead should be noted. The crosshead can be turned enough to cause the shoes to be horizontal and clear of the guides. In taking up any wear, the wedges should be moved to bring the shoes back to the original measurements. Where the upper shoe is babbitted directly onto the crosshead, the wear can only be taken up by rebabbiting. Consequently,

it is necessary to allow the wear to go awhile before this rebabbiting is done. Special care should be used in keeping the oil grooves on the shoes clean of grit.

Another detail that should not escape the engineer's attention is the piston-rod lock-nut. This lock-nut serves to jamb the rod into the crosshead. If the nut works loose, the rod will likely unscrew a thread or so. This will raise the compression in the cylinder by reducing the clearance. In cases where the rod has worked entirely free from the crosshead, the cylinder head has been broken by the piston striking it. If the nut is jambed up hard, and the locking set-screw or cotter key properly adjusted, there should be but little danger. Nevertheless, the rod should be examined each time the crankcase door is opened.

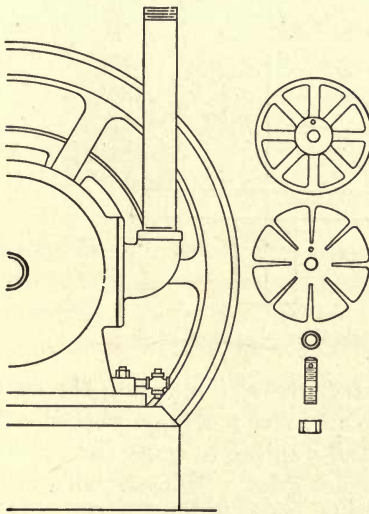

FIG. 276.—Air suction valve, F. M. & Co. horizontal oil engine.

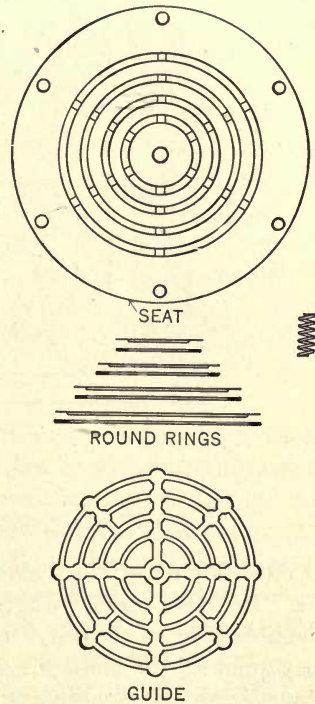

FIG. 277.—Air valve, F. M. & Co. vertical oil engine.

Air Suction Valves.—The air suction valve is a frequent source of trouble. This valve, when made of leather and after being in use for some time, will have a tendency to cup and partly pull through the valve seat. In the inclosed frame, when the crankcase is not kept drained of oil, the breathing action of the valve causes the leather to become saturated with oil, rapidly destroy-

ing the valve. The best leather to use in replacing the worn valves is an acid- and oil-proof leather-belted stock; oak-tanned leather will not stand up very long. Figure 276 illustrates the leather valve used on the Fairbanks-Morse horizontal engine, while Fig. 277 is the valve used on their vertical engine.

In many engines the air valve is noisy in action. This, ordinarily, is due to its having too great a lift. The remedy is

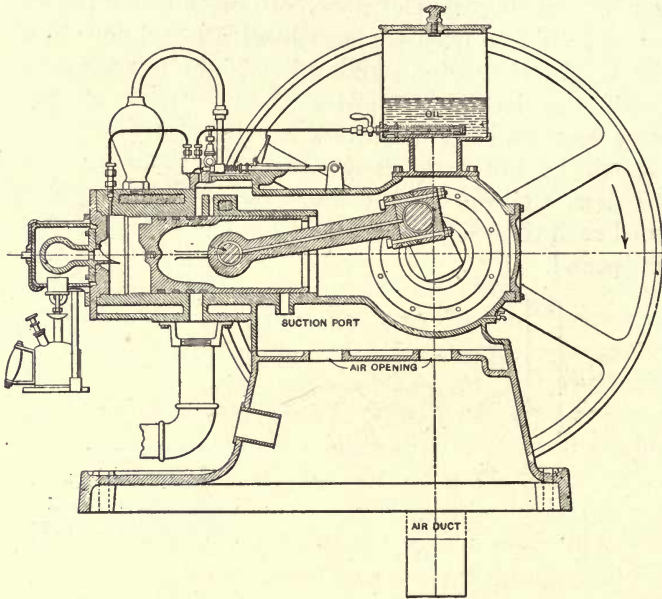

FIG. 278.—Mietz and Weiss three ported oil engine.

to cut off part of the valve guard, thereby reducing the valve lift. In those engines where the air valve is a brass poppet with a rubber ring on the valve seat and a spring to cause the valve to seat quickly, the noise is usually not great. In cases where it is objectionable, it is better to increase the thickness of the rubber ring, thus decreasing the valve lift, rather than to change the spring tension. If the springs are weakened, the time interval of closing is increased, thus reducing the compression efficiency by allowing the air column to reverse and flow back out the suction. Muncie Oil Engine Co. makes use of a valve of this design.

Some of the inclosed engines are three-ported instead of two-ported. This design eliminates the air suction valve, and the piston, by uncovering a port, allows the air to flow into the crank-

case. The one objection that has been advanced against the three-ported engine is the lower volumetric efficiency of the compressor. The piston must move a considerable distance on the return stroke before the suction air port is closed, lowering the volumetric efficiency by the percentage of the total stroke the piston moves before covering the port. Figure 278 is a cross-section of the Mietz and Weiss engine which uses the three-ported design.

It is well to remember that it is impossible to make the air suction noiseless as long as there is no muffler on the air suction line. Some engine designs include a muffling effect by drawing

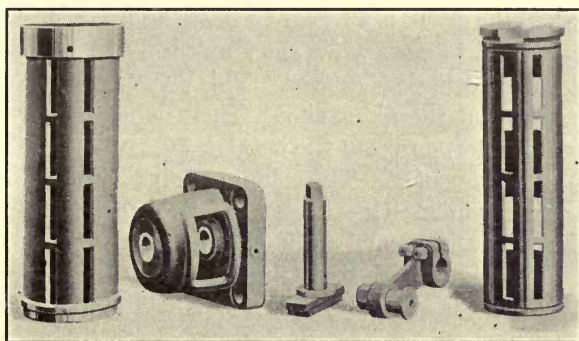

FIG. 279.—Bessemer Corliss air valve.

the air through the hollow engine sub-base. In most of these cases the air passes across the top of the foundation and below the oil pan. There is a tendency in such a construction for the current of air to pick up any particles of cement that are on the surface of the concrete foundation. To safeguard this, on erection of an engine a couple of gallons of linseed oil should be poured on the foundation surface beneath the engine. This makes a dust-proof seal that will eliminate all cement, dust or grit.

Some engines make use of a piston air valve, while others have adopted a rotating valve of the so-called "Corliss" type. These valves usually last for a number of years before replacement. The objectionable feature is the wear on the valve cage or cavity. When the valve is replaced, it is imperative that the valve cavity be rebored if it is not of the renewable type. These two designs of valves require lubrication, or they cut quickly. They eliminate all breathing noise, and this is an attractive feature in an engine that is located in a congested district.

Figure 255 shows the location of the Corliss air valve on the Bessemer Oil Engine under the cylinder casting; the valve is driven by an eccentric from the crankshaft. Figure 279 shows the details of the same valve. This is made of a valve bushing; this reduces replacement cost in case of wear. In order to secure the proper amount of air the eccentric must not be allowed to slip. In one plant the engine refused to run, despite the effort of the engineer and an engine expert. By accident, after both had given up in disgust, it was discovered that the eccentric had shifted, preventing the air valve from opening until late in the air compression stroke. Various adjustments of the timing of this air valve have been tried out. The builders recommend that the valve be set to open when the crank is 40 degrees past the front, or outstroke, dead-center, and to close when the crank is 30 degrees past rear, or the cylinder head, dead-center. This gives ample time for the complete filling of the air cavity. There is no reason why the valve should not open when the crank is 30 degrees instead of 40 degrees past dead-center. The column of air rushing into the cylinder has sufficient inertia to prevent any backward flow when the suction valve is opened while the discharge port is still uncovered. This will allow the valve to close earlier, preventing air loss through the suction valve. This will increase the volumetric efficiency.

Adjustments.—Air valves, of all types, require replacement when the wear allows the air to leak through. This air leakage reduces the amount of scavenging air and its pressure, which is seldom over 4 pounds gage. If the pressure is lowered but slightly below its normal value, the air will be insufficient to completely scavenge the cylinder of exhaust gases. This air valve leakage invariably causes loss of power, increased fuel consumption and a smoky exhaust.

Crankshaft Air Seal.—Any inclosed crankcase engine must have some means of preventing the air from blowing out along the shaft. Some builders make use of a stuffing-box arrangement at the outer end of the main bearings, Fig. 280. With this design the bearing cap must make an air-tight joint with the lower part of the bearing or housing. It is better, in case of renewing the shims, to use either a paper or a thin rubber gasket. It is well-nigh impossible to secure air-tightness when using copper or tin shims.

In replacing the stuffing-box packing, square duck packing or braided hemp, well soaked in oil and graphite, is excellent. In drawing up the gland, it is not necessary to exert much pressure; the 2 or 3 pounds air pressure does not require much gland pressure. If the gland is drawn up tight, a groove will gradually develop on the shaft.

A few engines are equipped with an air-sealing device at the inner face of the main bearing. This is usually in the form of a brass plate placed between the crank web and the main bearing

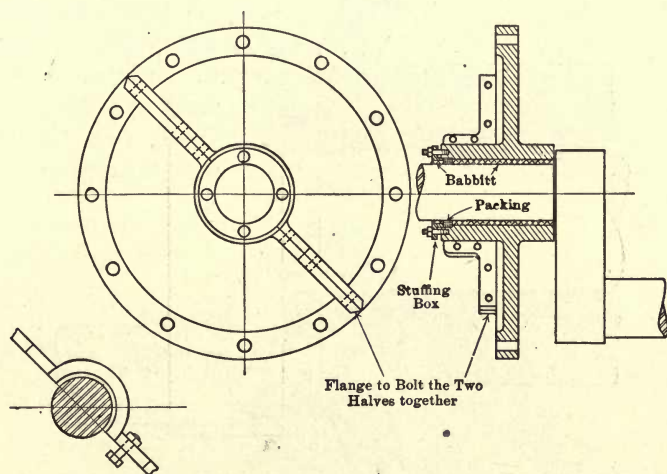

FIG. 280.—Stuffing box air seal.

face. It has a close fit with the shaft and, if provided with springs to keep it against the bearing, will prove effective. The objection to this device is that it is hard to replace when made in one piece, as is usually done. This requires the removal of flywheel and bearing; but it should be renewed as soon as the leaking air causes the oil to blow out of the bearing. It is possible to replace this without the removal of the flywheel by making the ring in two pieces. The Fairbanks-Morse Co. now furnishes a two-piece ring for replacement. Where the one-piece replacement ring is supplied by any particular manufacturer, the ring can be split. By removing the bearing liners, the two ring halves can be brazed together. Another method of emergency replacement is the use of a ring of V-shaped leather, Fig. 281. This circle can be cut in two to place it on the shaft and the ends secured

by fine wire. A coiled steel spring can then be arranged around the shaft, resting in the V. The spring forces the leather against the web and the air-sealing ring, preventing any air leaks. The leather wears rather rapidly but has solved the difficulty in more than one plant where the brass sealing ring began to leak. This sealing ring takes the side thrust of the cranks, and, because of this, the leather cannot be recommended for a permanent replacement. Even with the standard sealing rings the wear, due

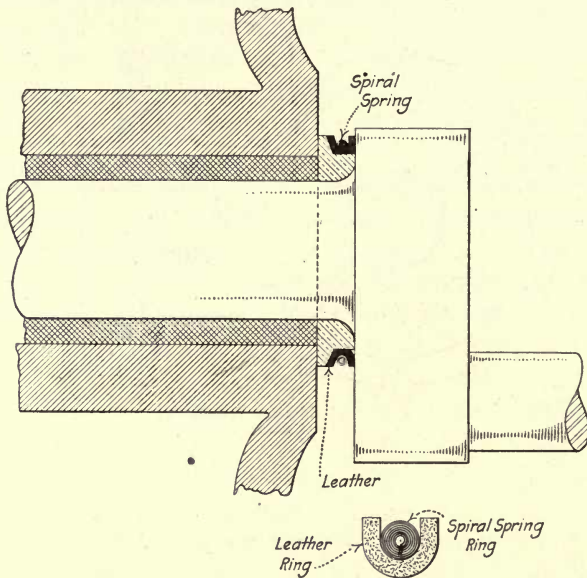

FIG. 281.—Leather air seal.

to the side thrust of the shaft, is rather heavy. In time this causes excessive clearance, which must be corrected by inserting thin brass or steel shims between the sealing ring and the crank web. The ring springs will hold the shims into place. These shims wear rapidly, and the sheet-steel ones last much longer than the brass.

The important thing to remember is that the air seal must be effective, otherwise the oil film will be blown off the shaft. This is more likely to happen on a ring-oiling bearing than on a force-feed type and will invariably result in a hot bearing.

Air Seal in Open-frame Engines.—In engines with an open frame, and using the front of the cylinder for the air compressor, the

troubles of the inclosed frame are largely eliminated. The points requiring attention are the air valve and the piston rod stuffing-box. The latter has a marked habit of wearing, due to the pressure of the rod when the crosshead is not in alignment. In such cases it is practically impossible to keep the packing in condition. A good way to tell when the stuffing-box needs re-packing is the presence of air bubbles mixed with the oil on the piston rod. If the leak is bad, the air, jetting out around the rod, will blow the oil entirely off the rod. Metallic packing rings have been used on the rod with some slight success; taken all in all, nothing can eclipse the old diagonal duck and rubber square packing. In inserting the packing, the rings should be cut diagonally and the joints staggered. An oil pipe should be located over the rod immediately in front of the stuffing-box; it is imperative that the rod receive positive lubrication.

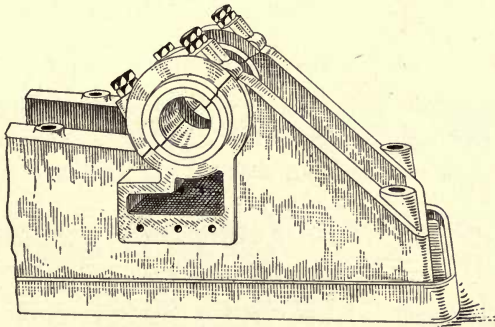

FIG. 282.—Two piece main bearing.

Main Bearings.—In the low-pressure engine three classes of bearings are commonly employed, as shown in Figs. 282 to 285. Figure 282 is a type best adapted to engines below 50 or 60 h.p. per cylinder. It allows the wear to occur at the center of the bottom shell, which is placed at a 45-degree angle. Consequently, to take up a slight wear, it is only necessary to remove a shim or two from between the two shells. This, of course, applies to the smaller size engines. Much bearing wear causes the piston to increase the cylinder clearance, lowering the compression. To partly remedy this, thin shims should be inserted under and back of the lower shell, bringing the shaft center back to its original position. This particular bearing is lubricated by a mechanical oil pump, the oil flowing down into the interior of the

engine frame. Figure 283 is the same type of bearing, with the addition of an oil cellar and an oiler chain.

Figure 284 is a bearing quite generally used on both vertical and horizontal engines. In the horizontal engine the direction of

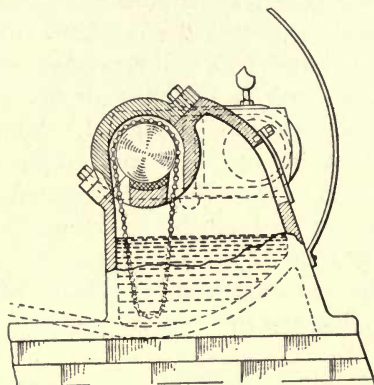

FIG. 283.—Main bearing with chain oiler.

pressure is against the front side of the bearing. Both the upper and the lower halves wear oblong; consequently only a small amount of wear can be compensated for by means of shims. If

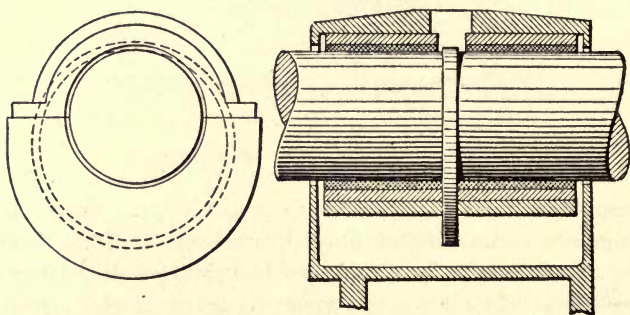

FIG. 284.—Main bearing.

the engineer desires to eliminate all play in the bearings, it will be necessary to replace these bearing shells quite often. Due to this, the bearing is suitable for the smaller sizes of horizontal engines only.

For vertical engines this is the most acceptable bearing. The pressure is always downward, and the wear occurs uniformly on the lower shell. It is then an easy matter to shim this shell back

to its original position. On a single-cylinder vertical engine, to shim up the shell it is necessary to jack-up the shaft from the outside. The jacks should be placed under the flywheels, or, if it is impossible to do this, wood blocks with a V cut into their upper side should be placed under the shaft where it extends beyond the wheels. By setting the jacks under the blocks, the shaft

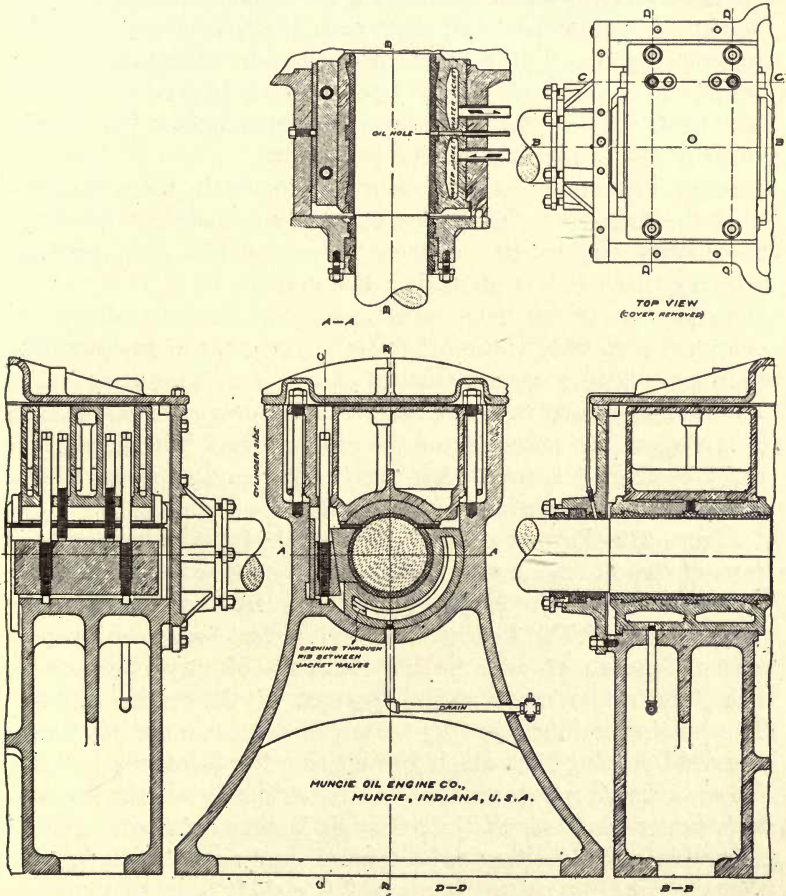

FIG. 285.—Muncie oil engine main bearing, quarter-box type.

may be raised with ease. Before jacking-up the shaft, if the engine is a belted unit, the belt should be removed so that there will be no outside force acting on the engine. In a three- or four-cylinder engine, a jack should be placed under the center crank-pin box to assist in raising the shaft.

The quarter-box bearing, Fig. 285, when used on horizontal engines, is very attractive from the operator's viewpoint. It is customary to have the wedge on the front side only. This takes care of all adjustments since the direction of pressure is invariably toward the front side of the bearing. This being true, it is not essential to have the rear quarter-box adjustable. Ordinarily, the front and bottom of the bearing are made in one piece. The weight of the flywheel and shaft wear the bottom only a slight amount, and usually this wear will not require attention for some years. It is very easy to keep the bearing snug since all that need be done is to take up on the front wedge bolts. This should never be done when the engine is running.

Some engine builders reverse the position of the wedge, placing it at the rear side. This does not allow adjustment for wear, but merely enables the engineer to reduce the shaft play by bringing this side box up against the shaft.

Various attempts have been made to water-cool the main bearings, Fig. 285. Since there is no reversal of pressure, the bearings will run warmer than in case of a steam engine. The water-cooling involves complicated pipe lines and valves, and it is difficult to take care of the piping. If a bearing requires water-cooling, it is proof that the bearing surface is not liberal enough and the pressure per sq. inch is too high.

Figure 272 shows a bearing that was the favorite in the earlier days of the oil engine and is still used by a few builders. This bearing housing is in the form of a flange which is bolted to the engine frame. The bearing is a cylindrical one-piece bushing without means of adjustment. In case of any considerable wear, the sole remedy is replacement of the entire bushing. The bearing is lubricated by means of a mechanical oil pump, assisted by a ring oiler which dips into a cellar below the bushing. Since the bearing wear must be of some extent before the engineer feels that replacement is justified, air leaking along the shaft is a trouble often encountered. The air-seal ring should prevent the air leaks, but the "jump" of the shaft, due to the worn bearing, will wear the ring until it is valueless.

Adjustments.—In making bearing adjustments the operator should keep in mind the fact that the shaft must be leveled up true in respect to the housing. To line them up with the cylinder, a good plan is to place the engine on both dead-centers and see if the connecting-rod is in the center of the crank throw. In case of general repairs center lines should be established.

The question is frequently asked as to what amount of play should be allowed between the shaft and upper bearing cap. If the bearing be one where the cap does not carry any of the pressure, a good plan is to loosen the cap, or tighten it, until the shaft can be "jumped" about one or two hundredths of an inch. Side play between bearing face and crank web can be from $\frac{1}{100}$ to $\frac{1}{64}$ inch without danger, though the first value is one that conforms more closely to good engineering.

The real difficulty in main bearings is the question of lubrication. The suggestions outlined in the care of Diesel bearings apply with equal force to the low-pressure engine. Even with an oil-cellar design stream lubrication is highly desirable. The practice many engineers have of using the same oil for months without refiltering is open to severe criticism. No engine bearing will stand up long if dirty oil be used. For a small plant, where first cost of accessories is of serious moment, a 5-gallon can with a false bottom and with the upper part filled with waste makes a good filter. A high-grade filter, purchased from a filter manufacturer, will pay for itself in a short time, in oil saving alone.

Another matter of doubt is how hot an engine bearing may become before the engineer should consider it dangerous. In all two-stroke-cycle engines the bearings will run warmer than on a four-stroke-cycle engine, since the direction of pressure is not reversed; and, as a result, the lubrication is not so good. In case the bearing becomes too hot to touch with the fingers, the load should be thrown off and the engine run slowly while the bearing cools off. It is usually noticeable that on a single-flywheel engine the bearing next to the flywheel runs warmer than the other bearings. Many new engines have this bearing slightly higher than the other one, to compensate for the wear. On engines already in service the hot bearing is probably due to increased wear caused by the extra weight of the flywheel.

Crankshafts.—Investigation of crankshaft failures, in most instances, reveals that the fracture occurred at the junction of the shaft and crank throw, or at the junction of the crank throw, or web, and crank pin. This liability of fracture can be largely reduced by more liberal fillets at these points. The danger of fractures will never be totally eliminated as long as engineers, on starting, allow too much oil to be injected into the cylinder. Not all of this oil burns on the first stroke. Some is trapped in the cylinder and, mixing with the air on the com-

pression stroke, preignites long before the piston reaches dead-center. To better protect the engine against the operator's carelessness it is good practice to attach a safety valve to the cylinder. A great many engines are so equipped, and all engines have a pet-cock or indicator opening that can be used to connect the safety or relief valve to the cylinder.

There seems to be a deep-rooted belief, held by many engineers, that a crankshaft must be scrapped at the least sign of grooving or cutting at the bearings. Since a crankshaft represents a considerable per cent. of an engine's total cost, effort should always be exerted to repair the old shaft. If the grooving is slight, the bearing cap should be removed as should also the entire bearing shell. Wooden blocks should be inserted to prevent the shaft from shifting. A file, used while the shaft is turned slowly by hand, will smooth up cuts that are rather deep. When the defect is too far developed to be cured by this method, the shaft should be shipped to a good machine shop and a cut taken off of it at the journals. Where this is done, it becomes necessary to rebabbitt the bearing shells to the now smaller diameter of the shaft.

Flywheels.—Small oil engines up to about 100 h.p. make use of a solid rim flywheel, the hub being either split at one side or at both sides, according to the tastes of the builder. In placing a flywheel onto the shaft, iron wedges should be driven into the splits at the hub; a wedge should be used both on the outside and on the frame side of the hub in order to open the split evenly. The shaft should be carefully cleaned with gasoline, and, if any rust is present, this should be removed by emery cloth. The shaft should be well oiled and the flywheel, after being blocked up level with the shaft, slipped on. The iron wedges usually open up the hub enough to allow the wheel to slip on easily. After the wheel is on far enough to prevent it tilting, rotation of the wheel will cause it to slip along the shaft much more freely. In tightening the hub bolts after the wheel is in place, the same tension should be given each bolt; the nuts should be tightened slowly, working them down uniformly. If one bolt is drawn up before the others have been touched, the wheel may cock a little.

A close observer, in visiting oil engine plants, will notice the practically universal habit of the flywheel's running out of true. In some cases it is because the builder fails to true the wheel up

properly. Usually, though, it is caused by the erector cocking the wheel when pulling it on the shaft. While a wheel in this shape is not dangerous, still it detracts from the appearance of an otherwise attractive power plant. Many suggestions have been offered in regard to the best way to correct this. Some engineers loosen up the hub and insert a thin shim around the shaft on the "out" side. It is seldom that this does any good, and it is not safe since the shims always work loose. Others shim up under the key on one side of the hub and attempt to throw the

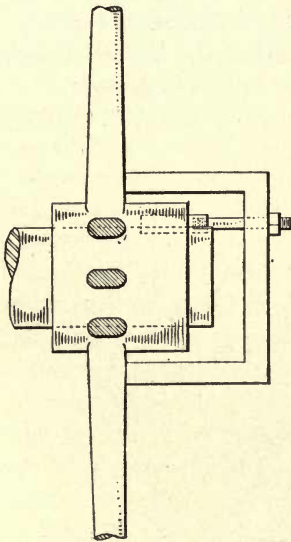

FIG. 286.—Key puller.

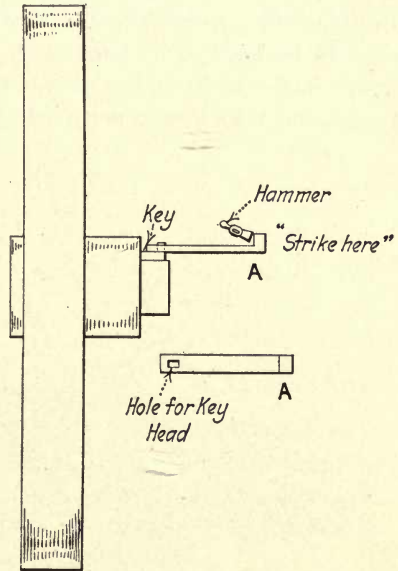

FIG. 287.—Key puller.

wheel straight. Even if successful, the flywheel is left in an insecure position since now only the key holds it. The most approved way is to peen the rim until the wheel runs true. The engineer should mark the part of the rim that runs out with chalk. This will indicate the particular section of the wheel that must be peened. The engine should be slowed down to about 30 to 50 r.p.m. and a 5-pound hammer used against the rim at the chalked place. The rim should not be struck with much force. Preseverance with the hammer will bring the wheel back into line, and the engine will run without the slightest variation in the rim travel.

Withdrawing a wheel key is probably the hardest undertaking around an engine. This is simply due to the lack of proper facilities. The average engineer drives a chisel between the key-head and the wheel hub, mars up the shaft and gets disgusted with the job. A key on an oil engine should be drilled and tapped for a "pull-out" bolt. If this is not already done, the operator should do it, for it is not difficult. Then a piece of iron can be made U-shaped and tapped for the bolt. Placing this U bracket over the shaft, Fig. 286, the bolt can be drawn taut, and a sharp blow on the key will start it. A device like Fig. 287 can be used on the smaller engines with success. A $\frac{1}{2} \times 2$ in. flat strip of iron some 16 inches long is bent at the end *A*. The other end has a square hole which is placed over the head of the key as shown. By striking with a hammer at *A* the key can be loosened.

CHAPTER XXII

GOVERNORS, FUEL PUMPS AND INJECTION NOZZLES, TYPES, ADJUSTMENTS AND REPAIRS

Governors.—If a smooth-running, efficient engine is to be produced, the designs of the governor and the fuel pump must be co-ordinated. Indeed, many engine builders have united these two mechanisms into one design. For this reason it is advisable that any discussion of a particular fuel pump should be incorporated into the discussion of its respective governor.

Hit-and-miss Governing.—The hit-and-miss method of governing has been tried out on the low-pressure oil engine, but it has never proved successful. With this arrangement, the scavenging air charge blows into the cylinder on the idle as well as on the power cycles. This results in the removal of a great amount of heat from the hot head, the head generally becoming so cold as to be very irregular in the ignition of the fuel charge. When the fuel charge does ignite, the low temperature of the bulb results in a large heat transfer from the hot gases to the cold bulb. This, of course, lowers the engine's efficiency. There is a still more serious defect. The irregularity of the explosions, and the miss-firing when the governor does inject a fuel charge, produces marked "hunting." This destroys the engine's usefulness in any situation where close regulation is demanded.

With the price of gasoline advancing, as it has been doing the past few years, there will be a large field for cheap low-pressure engines of small powers capable of handling distillates. The kerosene or modified gasoline engine will not burn even kerosene in a satisfactory manner where the load is variable. It would seem that the hot-bulb engine must be the type adopted. Since it must be low in cost, the present-day forms of governors cannot be used. The hit-and-miss principle is the logical choice. To accomplish this, probably the hot tube, formerly used on the gasoline engine, will be the ignition device adopted. This resembles the present day hot-bulb with the exception that the torch is always maintained lighted. The use of a permanent flame would eliminate all the objections mentioned above. On

engines above 10 h.p. the advantages of the quantitative governor over the hit-and-miss type make its use advisable even though more costly.

Classes of Governors.—The vast majority of low-pressure oil engines use a quantitative governor, wherein the amount of fuel injected each cycle is regulated to conform to the power demands.

This may be accomplished by either of two means. By the first method the stroke of the pump plunger is regulated, thereby delivering a varying quantity of oil to the nozzle. The second method consists of some arrangement whereby the opening of the pump suction valve, or of a by-pass valve, limits the fuel entering the cylinder to the amount actually required to carry the load. Both in effect might be compared to the automatic cut-off governor so popular with high-speed steam engine builders.

While a few builders employ fly-ball governors similar to those used on throttling steam engines, the majority have adopted shaft governors of either the centrifugal or inertia type. The use of the shaft governor allows the eccentric to act directly on the pump mechanism, and this type is more favorably received by operating engineers.

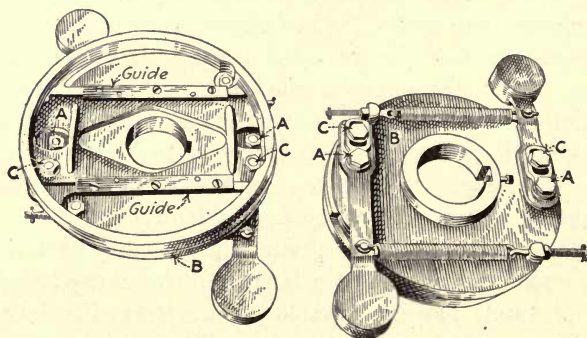

FIG. 288.—Muncie oil engine governor.

Muncie Oil Engine Co.'s Governor.—The form of governor shown in Fig. 288 is used extensively with certain modifications. This particular governor is that used on the Muncie oil engine. It consists of two weighted arms pivoted at *A* to a disk *B* that is keyed to the crankshaft. The extensions of these arms are pivoted at the points *C* to the eccentric plate which is held in guides that are a part of the disk *B*. The disk *B* has

slots in it to allow the lever pivots at *C* to project through into the eccentric plate. As the engine comes up to speed, the arms tend to move outward, this movement being resisted by the tension springs. If the load on the engine is decreased, the engine speeds up and the weights overcome the spring tension and move outward, due to the increased centrifugal effect. This movement of the arms continues until the increased spring tension equalizes the centrifugal force due to the increased speed. The movement of the arms causes the eccentric to slide in the guides and, consequently, alters the stroke of the fuel pump. If the speed decreases, the movement of the arms and eccentric is, of course, the reversal of the above, resulting in the pump stroke lengthening.

In operation, this governor is practically trouble-proof. A point to be remembered is the necessity of keeping the pivots and the guides well oiled. The guides will quite likely collect dirt and grit. This will hinder the movement of the eccentric, and the engine will tend to race. The governor should be wiped with a rag or wiping cloth each time the engine is stopped. Every few months the governor should be dismantled and every part thoroughly cleaned and oiled. If the guides seem rough, they should be smoothed with a scraper. An engine must be in service a number of years before much play develops in the guides. When this does occur, the guides should be removed and the base filed down. If there is side play, a copper strip can be placed between the guide and the disk and flanged up so that it fills the space between the guide and the eccentric. It is also a good plan to keep on hand a spare set of governor springs. Some operators have the idea that any spring will meet the requirements. In governor construction, the spring must be of a length and the wire of a cross-section such as will allow the governor weights to be in equilibrium in any position. If the spring has too many coils, even though of the correct size wire, the governor may "hunt," and the engine may even have a higher speed at full load than at no load. This is true where there is any inertia effect from the arms. There are few shaft governors that do not display some inertia effect in operation.

While it is possible to move the disk on the shaft, it is not advisable for the inexperienced engineer to attempt to alter the setting. The builders always set the eccentric at the point where the oil injection should best begin when the average

gravity fuel oil is used. Even though a different oil be used, the operator can seldom better the conditions; none but an expert should make this adjustment. However, when an engineer is meeting with preignition trouble due to light oils, there is no reason why he should not experiment with the setting, using an off-set key to secure any alteration in the position of the disk.

This governor belongs to that class wherein the point of beginning of oil injection, as well as the amount of oil injected, which depends on the length of pump stroke, is altered as the load changes. In other words, speaking in steam engine nomenclature, both the angular advance and the eccentricity change.

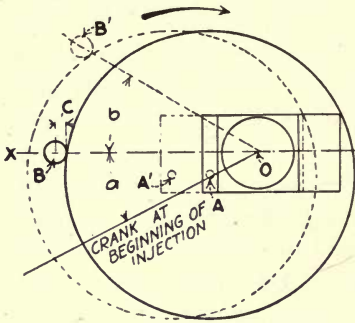

FIG. 289.

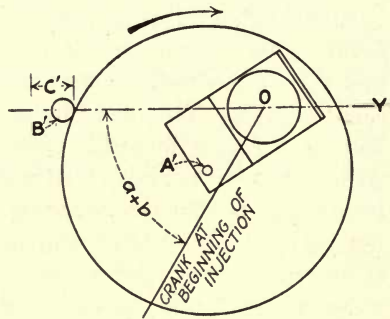

FIG. 290.

Action of Muncie governor.

The action of this governor may be understood from Figs. 289 and 290. In Fig. 289 the full lines show the eccentric position at low load. The crankshaft center is at O and the center of the eccentric at A . The crank is at an angle α from the center line XY . In this position fuel injection is just commencing, as indicated by the contact of the eccentrics with the push-rod B of the fuel pump. Under full load the eccentric is moved to the position shown in Fig. 290, the eccentric center being then at A' and contact with the push-rod being made at B' . These same positions are shown dotted in Fig. 289.

In the first position of the eccentric the injection of oil begins when the crank is α degrees from rear dead-center, and the total movement of the plunger is C . In the new position of the eccentric, the crank is $\alpha + \beta$ degrees from dead-center when the injection begins, while the total plunger movement is C' . It

is apparent that the eccentricity or throw of the eccentric in Fig. 289 is greater than C , but the difference represents the movement of the eccentric before it strikes the push-rod or the pump plunger and might well be called the "lap" of the pump.

In operation, on low loads, the angle of advance of the eccentric is such that the fuel is injected somewhat later in the compression stroke than on full load, the crank being about 15 degrees ahead of the rear dead-center and the change in crank position being about 15 degrees. This results in poor combustion and a smoky exhaust since the oil charge has insufficient time to vaporize and burn. With the use of kerosene or light distillates this objection cannot be raised since the rate of vaporization is very rapid even at a low temperature. On full load the point of injection advances to practically 30 degrees ahead of rear dead-center. With heavy fuel oil or "tops" this point of admission is not objectionable; in fact, it is an advantage since there is a greater time interval before dead-center is reached for the heavy oil to completely vaporize and ignite. But with light oils, such as distillates or a crude containing a considerable percentage of light hydrocarbons, this early injection causes preignition. Such preignition often becomes so heavy that it is impossible to eliminate the knock by using water injection; for, if enough water is used to prevent preignition, the cylinder will be flooded and the hot bulb cooled to an extent that combustion is entirely suppressed. This early injection of the fuel charge is not required, and in actual operation the skilled engineer makes the admission occur later by manipulation of the fuel pump regulator which will be mentioned on succeeding pages.

Muncie Fuel Injection Pump.—The fuel pump used on all the Muncie engines, with the exception of a few of the larger sizes, is shown in Fig. 291. The stroke of the pump plunger is controlled by the eccentric push-rod, as outlined in Fig. 289. The spring A is seated against a collar B on the pump plunger and serves to move the plunger on the outward, or suction, stroke. The eccentric push-rod, of course, actuates the plunger on the discharge stroke; any change of the shaft governor, by altering the throw of the eccentric, causes an alteration in the plunger movement.

This pump is provided with a hand-controlled speed-changing device mounted on the body of the pump. It consists of a link C which is threaded at one end to receive a wing-nut D and which is

slotted at the other end to engage a pin *E* on the pump plunger. If it is desired to lower the speed, the wing-nut is screwed up,

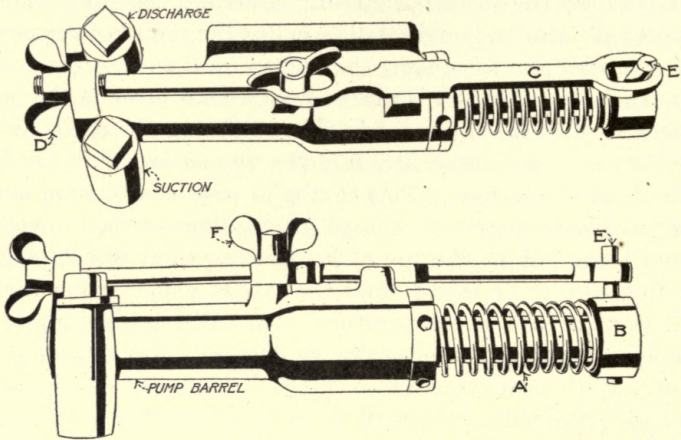

FIG. 291.—Muncie fuel pump.

shortening the link and lessening the outward movement of the plunger. The link is provided with a lock-nut *F* that serves

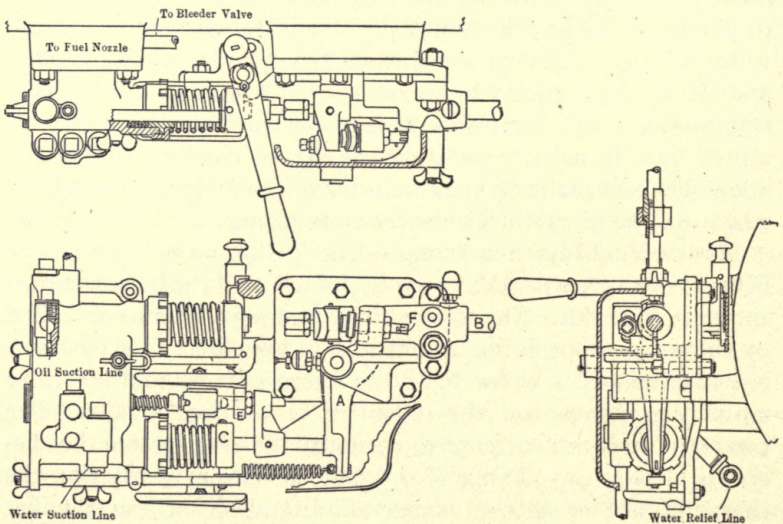

FIG. 292.—Muncie oil engine, fuel and water injection pump.

to hold the link in the desired position. By using this adjustment the plunger travel can be reduced until practically no oil

is injected into the engine so that an excellent speed control is obtained. It has another important advantage that is of more benefit than is its speed-regulating ability. This is its use in changing the point of injection, which principle will be discussed later in the chapter.

The pump is simple in design and requires but little attention, but probably some degree of fuel control has been sacrificed in obtaining this simplicity. The valves are steel balls; to reseal these, a sharp blow with a hardwood stick and a mallet will usually be all that is needed. The lift of the ball valves should be limited to $\frac{1}{32}$ inch by dressing off the plug seat until this value is attained. The packing around the plunger, as in all pumps, in time wears out. In replacing the worn rings, they should be well soaped before being inserted into the stuffing-box. It is never advisable to screw down very hard on the gland as the side pressure of the rings will cause the pump plunger to stick, or at least to score.

On the larger Muncie engines the company has brought out a combined fuel and water injection pump, Fig. 292. This unit consists of a heavy bracket pump casting with two cavities for the fuel and water plungers. The pump plunger *b* is actuated directly by the eccentric push-rod *a*. The push-rod has an adjustable end which allows the clearance between rod and plunger to be adjusted. Due to the pounding of the rod end, the clearance increases and should be checked at least every two months. To make the adjustment the engineer should proceed as follows: Set the fuel pump plunger out to its extreme forward or suction position by unloosening the adjusting or regulator rod. Loosen the governor springs and block the governor weights to their maximum outward position so that, as the crankshaft is turned, no motion is given to the push-rod—the eccentric is now concentric with the shaft. The adjusting stud should now be set to allow the clearance between stud and pump plunger to be $\frac{1}{32}$ inch. The lock-nut should be screwed up and the governor springs tightened into place. The engine should be started and brought up to maximum speed by manipulating the pump handle. At this speed, with the governor weights at their greatest throw, the plunger clearance should be $\frac{1}{32}$ inch. If the governor weights do not throw out enough to cut down the throw of the eccentric, the springs are too tight and should be loosened a slight amount.

Fairbanks-Morse Horizontal Engine Governor.—Figure 293 is a sketch of the shaft governor used on the Fairbanks-Morse horizontal oil engines of 25 h.p. and under. It is of the well-known Rites inertia type which has been adopted by many builders of high-speed steam engines. This governor, at first glance, appears to be the simplest and most reliable of all; however, there are certain features to be borne in mind. Since the

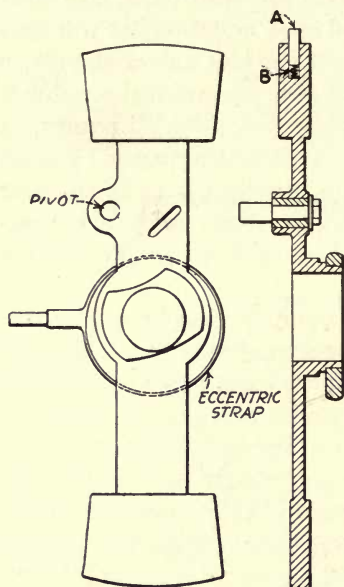

FIG. 293.—Governor of Fairbanks-Morse horizontal type Y engine.

If the compression grease cup is not watched, the friction will make the governor very sluggish in action. In those engines where the design does not embody a hardened bushing, the pin should be given a quarter turn each thirty days. This will distribute the wear evenly about the entire periphery of the pin. If a soft bushing is used, this, rather than the pin, should be turned.

The weights are held in equilibrium by a tension spring, and the speed of the engine is increased by tightening the spring. The engine will regulate more closely if the end of the spring, held in the slot in the weight arm, is moved outward. Moving it inward decreases the sensitiveness of the governor, allowing

the governor arm is supported at one point and all the weight is concentrated on a line falling outside of this pivot point, the governor is out of balance. All the thrust of the weights is against one side of the pivot or fulcrum pin, and the natural result is wear of this pin on that one side, causing the governor to bind. The engine, in consequence of this binding, shows marked racing or "hunting," especially on low or varying loads. In the Fairbanks-Morse governor, to eliminate this defect, the pin is hardened and ground, and the governor carries a hardened bushing into which this pin fits. This serves to reduce the wear, but the friction between pin and bushing, produced by the side thrust of the weights, is considerable.

the engine to have quite a range in speed variation; but this is the proper way to have the engine govern if it is pulling an industrial load, such as a cereal mill.

To dampen the action of the governor, which is inherently very sensitive, some kind of drag is used. In the Fairbanks-Morse engine the drag is introduced by the action of a small plunger *A*, Fig. 293, placed in a recess in one of the weights. The outer end of the plunger bears against a wrought-iron angle bolted to the inner face of the flywheel rim. The plunger is kept in contact with the angle iron by the coil spring *B*. It is necessary

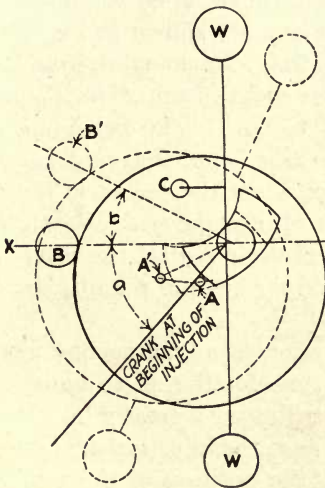

FIG. 294.

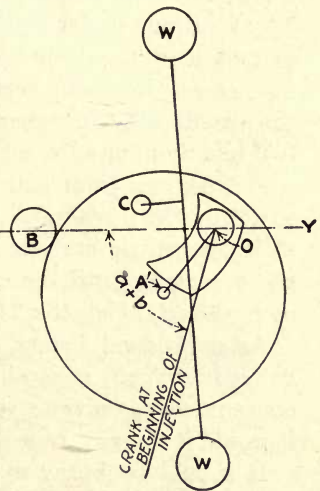

FIG. 295.

Action of Fairbanks-Morse Rites governor.

to give this plunger considerable side clearance to allow it to move freely. The drag of the governor tends to cause the plunger to bind on one side of the cavity at the top and on the other side at the bottom of the plunger. This wears the cavity out of true and causes the plunger to wedge, resulting in the governor hunting. If the wear becomes pronounced, the proper method of adjustment is to drill the recess to a larger bore and turn up a new plunger to fit it. Since it is easier to make a new plunger than to enlarge the recess, the plunger should be made of mild steel; it will then receive all the wear while the recess will keep its true shape.

The Rites governor, also, advances the point of injection, or

“admission,” and increases the eccentricity, or the pump plunger travel, as the load increases; see Figs. 294 and 295. The full lines in Fig. 294 show the positions of the crank, eccentric and weight arm at low load. The eccentricity is OA , and the crank is α degrees from dead-center when the eccentric begins to move the push-plunger B . It should be understood that an eccentric strap is used on this governor, and the pump plunger receives its motion from the action of the eccentric strap and push-rod. The point B , which represents the end of the pump plunger, is for clearness and simplicity shown as being in contact with the eccentric. The weight arm and eccentric swing on the pivot C . The positions under full-load conditions are shown in Fig. 295, as well as by the dotted lines in Fig. 294. In changing from low load to full load, the eccentric center moves from A to A' , and the eccentricity increases from OA to OA' . The beginning of fuel injection, or admission, is made earlier since the crank is now $\alpha + \delta$ degrees from rear dead-center when the eccentric begins to act on the push-rod. As with the Muncie governor, the throw of the eccentric exceeds the pump plunger stroke, the travel of the eccentric, until the operating rod strikes the pump plunger or push-rod, being the “lap.”

As mentioned before, early injection is advantageous when using heavy oil, as it allows more time for the oil to vaporize; consequently, a given size of engine will carry a greater load than it would if the governor did not advance the injection admission.

It should be borne in mind that the position of the weight-arm pivot, relative to the position of the crank and the center of the eccentric, largely determines the actual action of the governor. While the governor should be designed to allow the speed at no load to be above the full-load speed, it is possible, by proper distribution of the weights and the spring tension, to cause the engine to speed up on full load.

The relative positions shown in Figs. 294 and 295 closely approximate those on the governors in use. The eccentric is made in one piece with the weight arm, and no means are present to change the angle of advance. The pump, however, has a stop whereby some adjustment can be made as outlined in the discussion on page 387.

Fairbanks-Morse Fuel Pump.—The fuel pump used with this governor is shown in Fig. 296. It consists of a bracket pump body into which are fitted the valves and plunger. The plunger

is hardened and ground, and no packing is used. The plunger is forced to the rear on the suction stroke by the spring shown. Its suction travel is limited by the plunger stop "99." This is provided with a fibre tip, which wears and must be renewed at intervals. The plunger stop is bored out, allowing the eccentric push-rod to work through it against the end of the pump plunger. The stop can be screwed in or out, thereby adjusting the suction

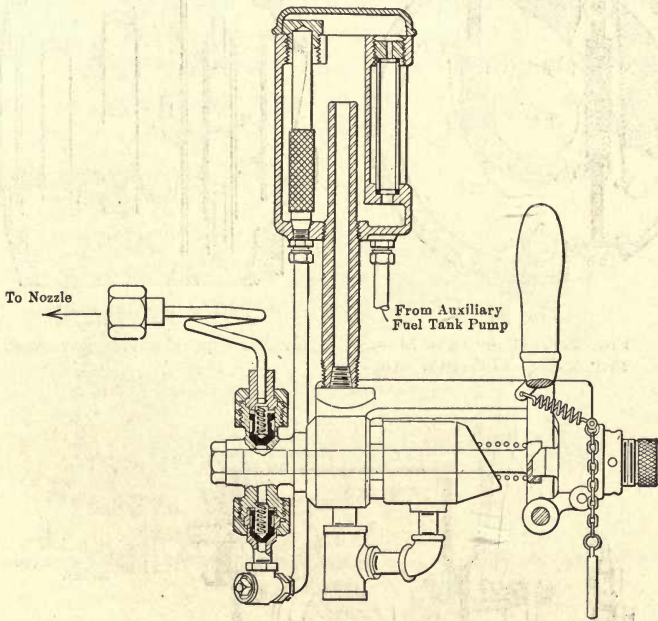

FIG. 296.—Fairbanks-Morse type "Y" horizontal engine fuel pump.

travel. This alters the speed and provides a means of manipulating the injection timing, as will be discussed later in the chapter. Since the Fairbanks-Morse engine does not use water injection, the adjusting of this stop allows the engineer to deaden preignition pounds. If the engine pounds, the screwing-in of the stop will cause the preignition to cease. If the engine slows down due to overload or slow-burning oil, the screwing-out of the stop will cause the oil to be injected earlier and in slightly greater amounts.

The suction and discharge valves are of steel and are of the spring-loaded poppet type. The seats are at an angle of 45 degrees, while the lift should not exceed $\frac{1}{32}$ inch. In regrinding

these valves nothing but the finest of emery flour or rotten stone mixed with vaseline should be used. Care should be taken that all the parts are thoroughly clean on reassembling. In tightening up the cap lock-nuts, if the operator is not cautious, the brazed joint between the sleeve and the oil pipe will break.

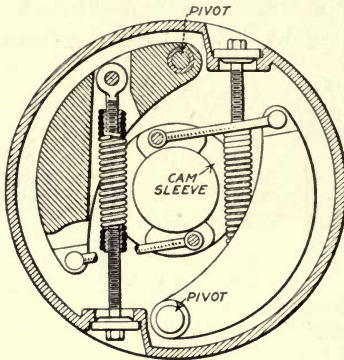

FIG. 297.

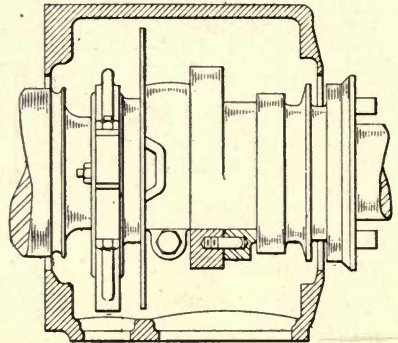

FIG. 297a.

FIG. 297.—Fairbanks Morse Co. vertical type Y engine governor.
FIG. 297a.—Governor cam case.

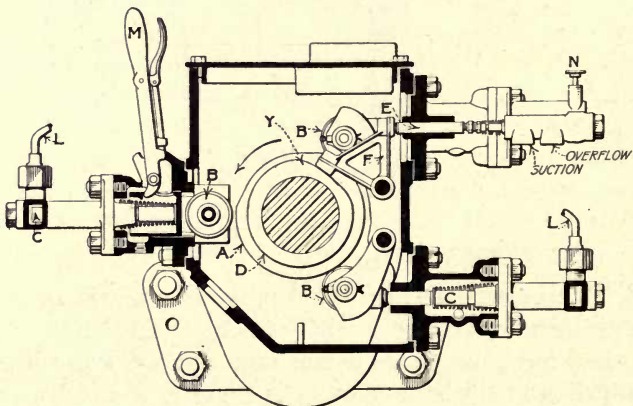

FIG. 298.—Fairbanks-Morse vertical type Y engine fuel pump for three cylinder engine.

The fuel is pumped into the pump tank by a plunger pump driven off the eccentric rocker shaft. The tank is fitted with a sight glass and a small gauze filter. This filter must be cleaned at least twice each day since the mesh is very fine and the collection of dirt soon stops the flow of oil.

Fairbanks-Morse Vertical Engine Governor.—The governor shown in Figs. 297 and 298 is the one used by the Fairbanks-Morse Co. on their vertical type “Y,” both single- and multi-cylinder engines. It consists of a small wheel, which is mounted on the engine shaft opposite the flywheel, and two weight arms whose centrifugal effort is resisted by the tension springs shown. Through the agency of two links the arms are connected to the cam sleeve. This sleeve is mounted on the engine shaft, about which it is free to move under control of the weights. The cam, which is a part of the sleeve, controls the opening and closure of the injection pump suction valve. The governor, as shown, is for an engine running anti-clockwise, as seen when facing the governor side of the engine.

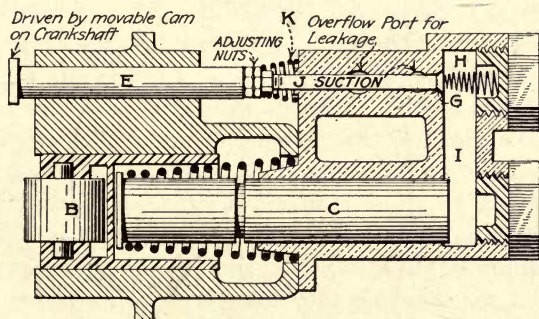

FIG. 299.—Fairbanks-Morse fuel pump. Section through plunger and suction valve.

To obtain a clear understanding of the action of the governor, it must be considered in conjunction with the action of the fuel pump. Figures 298 and 299 show views of the pump for a three-cylinder engine.

The fuel pump plunger *C* is driven by the cam *A*. This cam is clamped to the engine shaft as outlined in Fig. 297A. This cam, which has its nose or lifting surface extending over about 15 degrees, strikes the roller *B*, which is mounted on the end of the pump plunger. This movement, extending over 15 degrees, injects the fuel charge into the cylinder. The exact point of injection is shown in Fig. 300. Just before the pump plunger begins its outward or discharge stroke, the governor cam, which has been holding the pump suction valve open, presents a low surface *Y* and the suction valve closes. After the engine shaft

has revolved sufficiently to allow the pump to complete its injection stroke, the governor cam, which is rotating with the shaft, presents its high surface to the suction valve plunger. This again opens the valve, enabling the pump to take in another fuel charge. The positions of both governor and pump cams are shown in Fig. 298. This view shows the relative position of the cams at the beginning of injection.

The governor action is as follows: If the engine speeds up, the weight arms, due to the increased centrifugal force, move outward to a new position. This movement of the governor arms causes the governor cam to shift clockwise, or opposite to

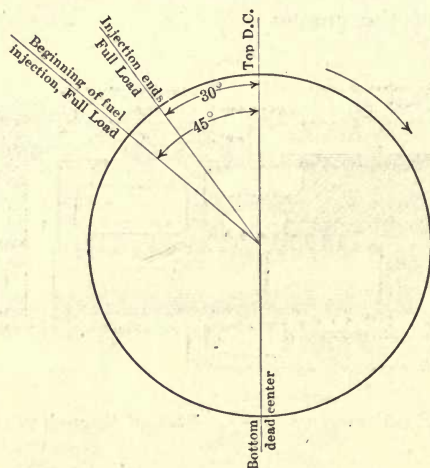

FIG. 300.—Fairbanks-Morse vertical oil engine fuel injection timing.

the direction of rotation. The consequence of this shifting of the governor cam is to cause the low surface on the cam to move under the suction valve push-rod *E* at a later position of the engine crank, that is, the suction valve is held open during the first part of plunger's discharge stroke. The pump plunger then actually forces a part of the fuel charge back through the open suction valve before it is closed. When the low surface on the governor cam comes under the suction valve plunger, the valve closes, and the remainder of the fuel charge is forced through the discharge valve into the cylinder.

It follows that the injection point of the engine varies with the load. The change from no load to full load is not great, and

no objectionable results occur when oils below 38° Baumé are used. It is always advisable to have the pump injection cam timing, and the governor cam timing as well, adjusted to suit the particular fuel used. Where heavy crude under 24° is used, the injection angle of 45 degrees is not sufficiently early to insure complete combustion. It then becomes good engineering for the operator to set the injection at an earlier point. This is by no means beyond the powers of the intelligent engineer, and this adjustment should be made when the combustion is not good. This is especially true where the engine is operated constantly, for a 10 to 15 per cent. fuel saving, which may result, is attractive.

When the engine is tested out at the factory, the cam and shaft are marked. This marking represents the proper timing for usual conditions. If it is desired to have the injection occur earlier, the pump cam should be unclamped and shifted, in the direction of the engine's rotation, the desired number of degrees. The governor should now be shifted a corresponding amount. Since the governor, when the engine is at rest, holds the governor cam in a position slightly more advanced than when under operating conditions, to reset the governor to conform to the new pump cam timing, it should be shifted until the leading high cam point is 35 degrees ahead of the high cam point of the pump cam. To shift the governor, it is necessary to unclamp the bolts and use a wedge to open the split in the hub. If the adjustment of the pump cam is to be but slight, the engineer is not justified in altering the governor setting. Loosening up the governor spring tension will cause the governor to shift its cam enough to bring the two cams into proper relationship. These springs can be adjusted until the correct speed is obtained. If kerosene or very light distillate is to be used, the timing should be made later. In fact, with kerosene 20 degrees ahead of dead-center is ample for the injection point. This allows all the fuel to enter the cylinder before dead-center is reached.

In event the pump refuses to deliver oil to the cylinder, the pump cam should be inspected. It is split, being held by a clamp bolt, and is liable to slip. The hammer blow due to the sudden movement of the pump plunger causes the plunger roller to chatter against the cam face, leaving a series of ridges. To eliminate this, the builders have tried an inlay of tool steel at the nose or high point; and have used an all tool-steel cam. It would

appear that, in cam construction, the cam nose only should be of oil-treated, high-carbon steel, while the body of the cam should be of cast steel or machinery steel to absorb the shocks.

Adjustments of the Fuel Pump.—Attention is called to the starting lever *M*, Fig. 298, which is fulcrumed on the pump housing and, in starting, is used to pump the fuel by hand to one cylinder. A few strokes usually fill the discharge pipe. When this is accomplished, the handle is set to the neutral position until the air starter is cut out. In stopping a multi-cylinder engine the by-passes on all except this one cylinder is opened, preventing any explosions in these cylinders. The pump handle is then slowly drawn back so that the fuel to this one cylinder is gradually reduced. If the fuel is shut off instantaneously, the engine will pound very violently.

Another important detail is the by-pass valve *N*. Usually, in starting, the engine has a tendency to take too heavy fuel charges because the governor arms are at their innermost position and the movable cam at its most advanced point so that all the fuel entering the pump chamber must pass through the discharge valve into the cylinder. To overcome this objection, the by-pass valve *N* is provided. In starting, the operator opens the valve a slight amount, thus allowing part of the charge to flow back into the suction line. Under ordinary conditions, when the engine runs only partially loaded, it is advisable to "crack" the valve and by-pass part of the fuel. This causes the governor to advance the suction valve cam so that the charge is forced into the cylinder earlier than when the by-pass is not used on low loads. The result is a greater time interval for the fuel to vaporize and burn, and better combustion is obtained. Where the engine is a multi-cylinder one, adjusting the by-pass valve serves to equalize the fuel charges to the different cylinders. It is impossible to secure exact distribution by adjustment of the suction valve tappet rods.

The suction valve and discharge valve are of the spring-loaded, poppet type, and in regrinding the utmost care must be exercised. It is unnecessary to grind the valve so that the entire seat is in perfect contact. A line contact $\frac{1}{64}$ inch in width is very satisfactory and will usually be better than a poor job of grinding the entire seat into contact. While the erecting engineer may instruct the operator to use powdered glass as the grinding medium, a fine grade of emery flour and oil has made an excellent job on numerous occasions.

When heavy fuel or boiler oil is used unfiltered, the grit carried with the oil will cut the pump valves rather rapidly, even though the engine, at all times, employs a small oil filter, which is located immediately above the pump. Ordinarily, such oil is thick enough to be sluggish about leaking past the valves. However, if a change is made to an oil of lighter gravity, such as distillate oil, the valves will leak badly, since this oil will seep by a valve showing the slightest ridge or rough spot on its face. If, after making a change in the oil, the engine seems to lose power, the new oil should not be the subject of censure, but the condition of the pump valves should be investigated. This, of course, applies to any and all makes of fuel pumps.

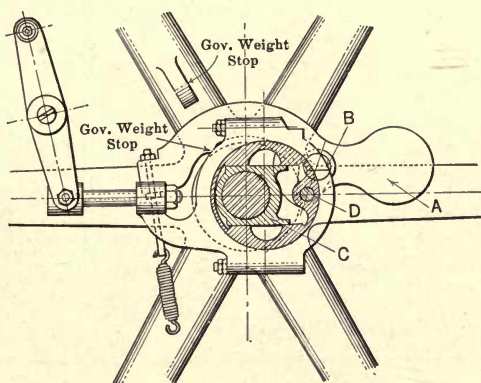

FIG. 301.—Governor of the Mietz and Weiss oil engine.

If the engine is of fair size—above 100 h.p.—and the lower cost of the unfiltered fuel oil is attractive, the operator should prepare to meet these valve leaks. It is a good plan to procure a valve-seat reamer so that the seat may be brought back to its proper shape when badly scored. Since the valve seat is of brass, a reamer of ordinary tool steel, hardened, will do good work. The reamer should be in the shape of a cone with a number of cutting edges or notches, and the sides of the cone should have a 45-degree slope to conform to the angle of the valve seat.

After regrinding or reaming a valve seat, it is imperative that the outer end of the valve plunger or tappet rod be adjusted to give the proper clearance between valve stem and tappet rod.

Mietz and Weiss Governor.—Figure 301 outlines the governor of the single- and two-cylinder horizontal Mietz and Weiss oil engines. The governor consists of a weight arm A, which is pivoted to the

flywheel by the pin *B*. This arm, by means of a pin connection *D*, moves the eccentric along the governor slide, which is fastened to the crankshaft. As the engine speeds up, the weight arm tends to fly outward, moving the eccentric along the governor block. This shortens the throw of the eccentric, which in turn reduces the pump plunger stroke. In order to secure stability of the arm, the centrifugal force is opposed by the tension in the governor spring. This method of changing the eccentricity by means of the sliding governor block is somewhat similar to the

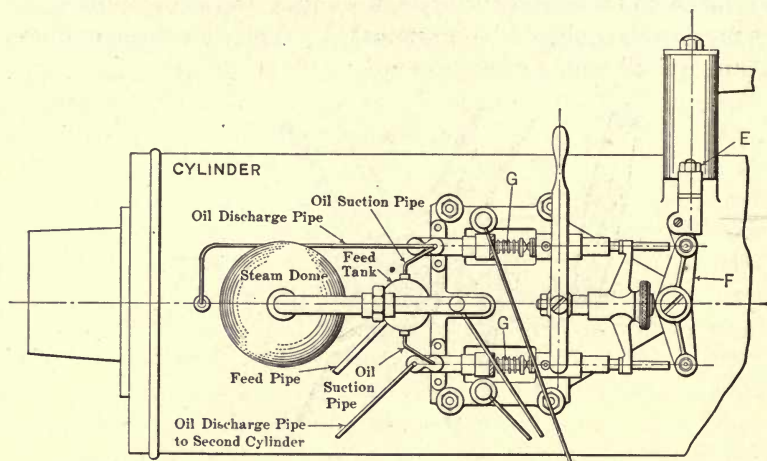

FIG. 302.—Horizontal twin-cylinder oil engines.

Muncie governor, and the same results are achieved—variations in both pump stroke and injection angle, or angle of advance.

The principal points requiring attention are the condition of the slide block *C* and the weight pivot pin *D*. This pin is fitted into the weight arm bushing, and the side pressure will eventually wear the hole oblong. The only remedy is a new bushing. The operator should in no event neglect the pivot oiler. If this clogs up, the pin wear will be excessive and the governor will be sluggish in action. As in all governors, the pins will in time wear out and should be renewed when there is any excessive side play in the parts.

Mietz and Weiss Fuel Pump.—The fuel pump used with the governor just outlined is shown in Fig. 302. This particular pump is for a two-cylinder engine; the single-cylinder engine's pump consists, in all respects, of one-half of the pump shown.

The governor eccentric strap, through its connection with the rocker arm *E*, controls the pump actuator lever *F*. This lever in turn gives the two fuel pump plungers *G* a travel sufficient to inject the required amount of fuel into the cylinder.

The actuator used on the horizontal twin engine is pivoted in its center. The pump plungers are then in opposition. The engine cranks are 180 degrees apart, and the actuator causes the pump to inject the oil charges into the two cylinders the corresponding degrees apart. The pump is provided with a stroke regulator which allows the stroke of the pump to be altered and the speed to be controlled by this means, however, only to a minor extent.

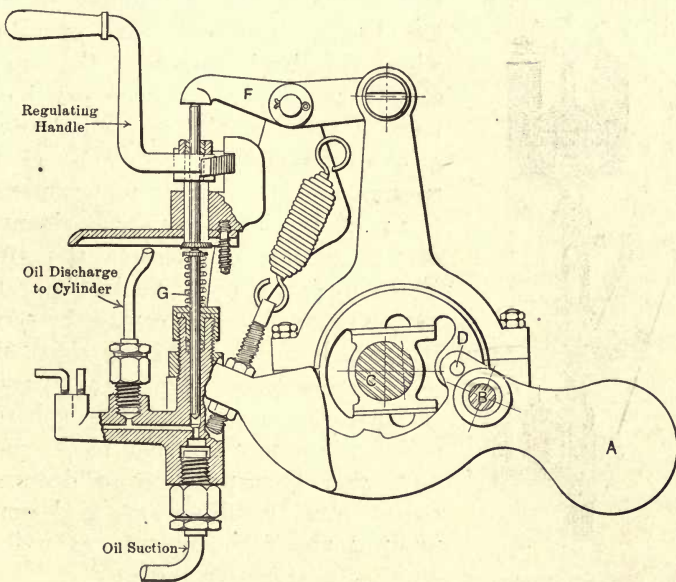

FIG. 303.—Governor of the single cylinder Mietz-Weiss vertical engine.

Mietz and Weiss Vertical Engine Governor.—Figure 303 is a cross-section of the governor and pump used on the single-cylinder vertical Mietz and Weiss engine. The governor is of the flywheel type, closely following the lines of the horizontal engine governor, while the pump is quite similar to the horizontal engine fuel pump.

Figure 304 is a cross-section of the governor and pump used on the Mietz and Weiss vertical multi-cylinder engines. The governor is mounted on a shaft which is driven by a chain belt

from a sprocket wheel on the crankshaft, the gear ratio depending on the number of cylinders—as example, a four-cylinder unit has a ratio of 1 to 4, and a three-cylinder engine has a ratio of 1 to 3. The governor consists of an eccentric *C* fitted with two weight arms *A* that are in a plane at a slight angle with the plane of the

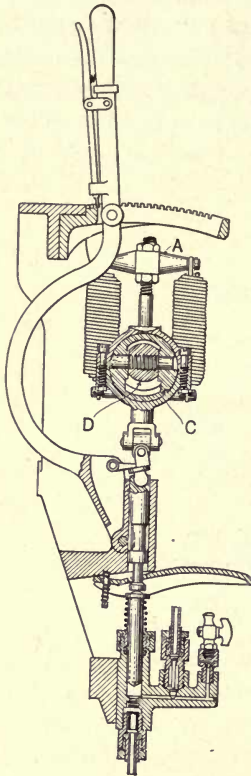

FIG. 304.—Governor of the M. & W. vertical multiple cylinder engines.

horizontal governor shaft *D*. These arms are fitted with tension springs. The governor shaft passes through the eccentric which bears on a milled surface on the shaft to which the eccentric is pinned as shown. The eccentric strap fits the spherical surface of the eccentric and drives the pump plunger through the linkage outlined. In operation, when the load decreases the engine speeds up slightly. The increased centrifugal force of the revolving weight arms overcomes the resistance of the springs, and the weights move outward to a position where the additional tension of the springs counteracts the effect of the increased centrifugal force. The movement of the arms causes the eccentric, which is pinned to the shaft at a point outside of the plane passing through the center of the spherical eccentric and perpendicular to the shaft, to shift. This produces a decreased eccentricity, resulting in a lessened pump plunger movement, as well as altering the injection angle.

To change the engine speed, it is only necessary to adjust the spring tension. The timing of the oil injection can be changed by removing the drive chain and advancing or retarding the governor sprocket wheel the desired amount.

Fuel Pump for the Mietz and Weiss Vertical Engines.—The fuel pump for the multi-cylinder engines is incorporated in the governor assembly. It consists of a single pump block with the necessary suction and discharge valves and is equipped with one plunger. The pump is further provided with a regulator

lever. This lever, through a wedge, regulates the stroke of the pump, in addition to the regulation effected by the governor. On starting the engine, the regulator should be adjusted to limit the plunger travel to a low value. The stroke can be gradually increased as the engine comes up to speed. The hand regulation is especially desirable when the engine is in marine service. The regulator is also of use in advancing or retarding the injection angle in case of preignition or delayed combustion.

The suction and discharge valves are of the spring-loaded poppet type. For regrinding, pumice flour and vaseline make an ideal mixture. The valve spring should be removed and the valve lightly held against its seat, and the amount of grinding material applied should be very meager. If a thick coat of the compound is placed on the valve, the seat will be cut to a rounded form.

The Mietz and Weiss Fuel Pump Distributor.—Since the fuel pump for the multi-cylinder engines is of the single-plunger type, it becomes necessary to employ some mechanism to direct the flow of oil to the particular cylinder whose crank is at the injection angle. This purpose is achieved by the distributor, as shown in Fig. 305. This consists of a body *G*, gears *H*, and distributing disk *I*. The disk is driven by bevel gears from the governor-shaft and has an oil passage through it. The coverplate *J* of the distributor is further provided with openings from which the oil lines run to each of the cylinder nozzles.

The oil from the injection pump is forced into the cavity *K* below the disk. From this chamber it flows through the hole in the disk and enters the oil line whose opening registers with the disk opening. It is to be observed that, as the disk rotates in synchronism with the engine, its port successively registers with the pipe line to the various cylinders. In this manner the oil is injected into the proper cylinder. The disk must have an oil-tight seat on the distributor cover. If a leak develops here, the oil will be forced into the cylinders at all points in the stroke. To correct any cutting or uneven wear, the cover should be removed and the plate and cover ground together, using emery paste. It requires a great deal of care to prevent the plate from being ground to a concave surface. Figure 306 shows a diagrammatical layout of the oil distribution.

The Mietz and Weiss engine operates at a low compression pressure, about 90 pounds, and the fuel is injected very early in

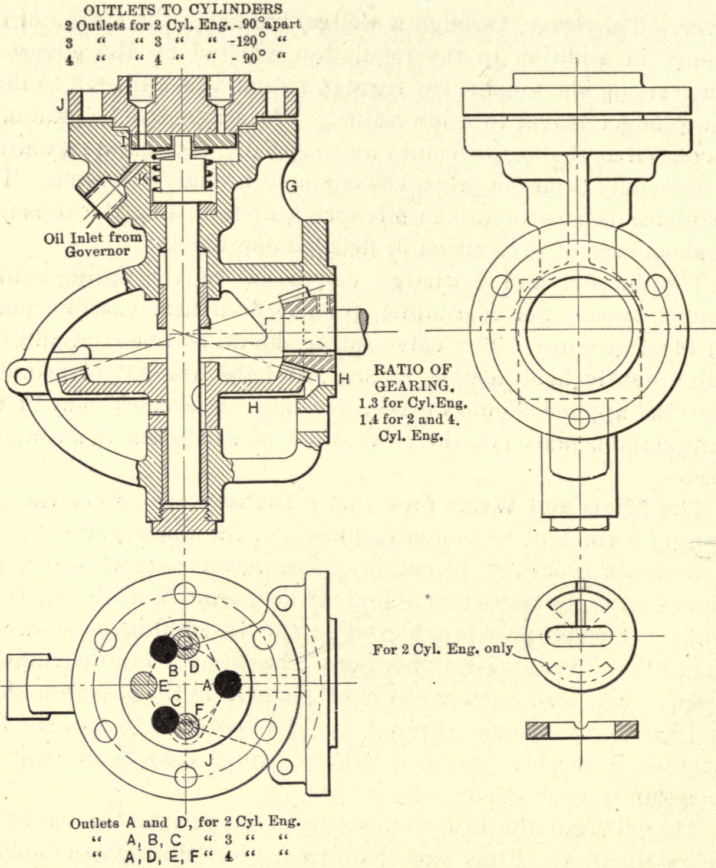

FIG. 305.—Fuel distributor M. & W. vertical engines.

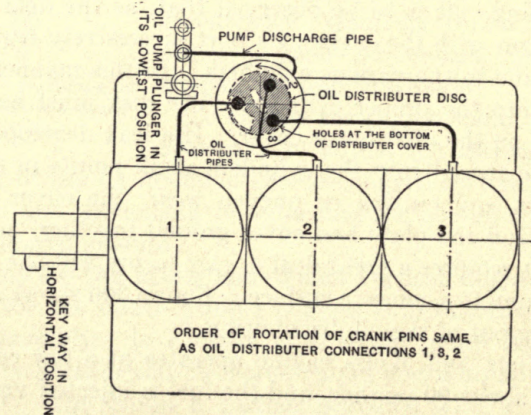

FIG. 306.—Mietz and Weiss oil engine. Diagrammatical layout of the fuel distribution.

the compression stroke. Using kerosene, the injection can begin as late as 45 degrees ahead of rear dead-center. This allows the cut-off at full load to occur a little before dead-center. With heavier oils the injection, as the governor is usually set, begins when the piston is in mid-position, or 90 degrees ahead of dead-center, and cut-off occurs at approximately 45 degrees before dead-center. This engine, by means of the steam and water injection, which absorbs much heat with little increase in temperature, carries a low compression temperature. Due to this peculiar arrangement, the fuel can be vaporized very early in the compression stroke. Even though the oil be completely vaporized and mixed with the air charge, the temperature does not reach the ignition point until the piston is virtually at the end of the stroke.

Pump Regulators.—It will be noted that all the pumps discussed have some type of hand regulator. This is in the form of a lever or a threaded nut. By adjusting the regulator the pump plunger's stroke is lengthened or shortened, as the case may be. The regulation of the pump stroke affects the injection angle; in this way, by proper manipulation, the injection angle can be altered over quite a range. It is not clear to many engineers why this is true. While it is generally stated that the regulator shortens the pump stroke, in actual operation it merely acts as a stop to limit the return or suction stroke of the pump. The pump, on the power stroke, can be moved as far as the throw of the eccentric will allow. Thus the stroke of the plunger is limited to that percentage of the eccentric's throw which lies between its point of contact with the plunger at the beginning of the power and its extreme point of throw. The argument is often advanced, when due thought has not been given to the subject, that, if the return travel of the pump is shortened, then the eccentric, in order to maintain speed, will increase its throw. This increased throw, so it is claimed, will increase the pump plunger travel sufficiently to enable the correct amount of oil to enter the cylinder. Then, the argument continues, the events are back to the original state, and no change is made in pump stroke or angle of injection admission.

To correct this erroneous belief, attention is invited to Fig. 307. The circle *E* with its center at *A* represents the engine eccentric. The crank is represented by the line *OF*, which shows the position of the crank when the eccentric rod strikes the pump

speed, and, while the pump stroke is now the same as before, the injection is later. This will assist in reducing the preignition. The reversal of this action may be used if the oil is very heavy, requiring a longer time for vaporization. This manual adjustment cannot well be used to prevent preignitions which occur with varying load conditions, since it would require constant attention from the operator.

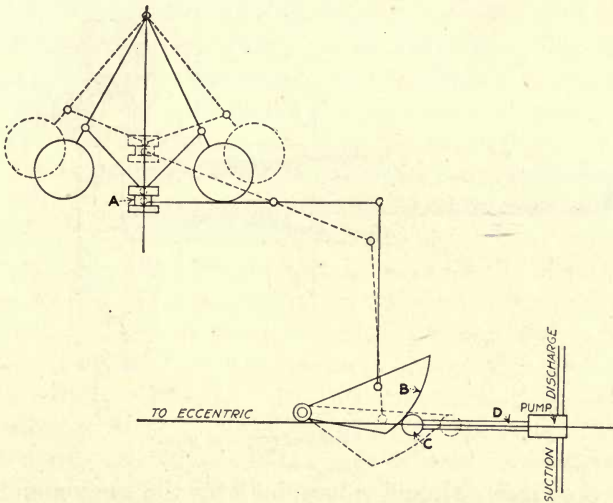

FIG. 308.—Schematic layout of the Little Giant governor and fuel pump.

Little Giant Engine Governor.—Figure 308 outlines schematically the governor used on the Little Giant engine. The governor sleeve *A* is connected by a system of links to a cam *B* that bears against a collar *C* on the pump plunger *D*. The eccentric is keyed to the engine shaft and moves the pump plunger through a reach-rod, not shown. Any movement of the cam will allow the plunger to take a longer or shorter suction stroke, as the case may be, and thus will regulate the amount of oil injected into the cylinder.

The spring-loaded governor is belted to the crankshaft, and any movement of the balls is communicated to the cam. It is apparent that each variation in the return stroke of the pump plunger through a movement of the cam causes the injection angle to change. Since the eccentric is keyed to the shaft, the crank turns until the eccentric push-rod strikes the pump plunger. If the plunger has had a short return stroke, then the crank must

turn through a greater angle before the eccentric rod comes into contact. Unlike the pumps previously discussed, there is no way to change the injection angle other than by a permanent shifting of the fixed eccentric. All preignitions must be controlled by means of the water injection.

Little Giant Fuel Pump.—Figure 309 shows the pump used in conjunction with the above governor. It is a very simple casting

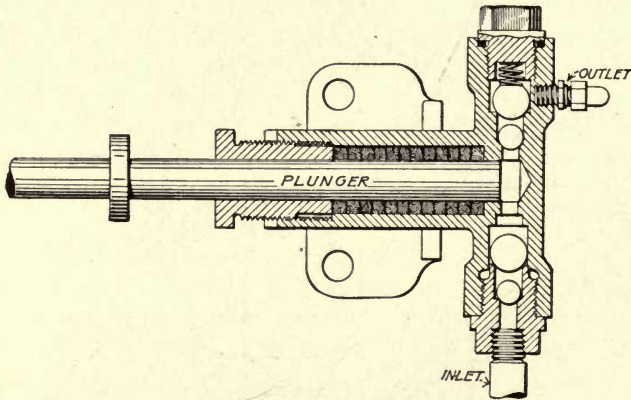

FIG. 309.—Little Giant fuel pump.

and is provided with ball valves, both for the suction and for the discharge line. It will be noticed that each line is fitted with two ball valves. This is unnecessary since leakage is evident only when both balls fail; consequently one may leak without detection, bringing conditions back to the use of a single ball. If the operator runs out of spare valves, the pump will operate quite successfully with one set. A ball-bearing ball, which can be procured at any garage, makes a very satisfactory valve. The governor is set to inject the oil at approximately 90 degrees ahead of dead-center.

Governors with Constant Injection Angle.—A governor of a design that will maintain a constant fuel injection point, regardless of the load carried, is without question the most advantageous. Such a governor will relieve the engine of preignition shocks, when these are due to too early injection and not to poor gas stratification. In an engine where the oil is vaporized directly in the cylinder, preignition may occur practically regardless of the injection point. The vaporized fuel and the air are fairly well mixed as soon as the oil is sprayed into the cylinder. If

the temperature existent in the cylinder, resulting from the heat absorbed from the previous charge as well as from the compression, is high enough, the charge will burn considerably before the crank reaches dead-center; in fact, preignition has occurred when the piston is at mid-stroke. On the other hand, if the fuel is introduced at a point but little ahead of dead-center, there can be no preignition.

With governors that vary the angle of advance with the load, there is no danger of preignition at low loads. The angle of advance, or the injection angle, at low loads is small, and the fuel is injected but little ahead of dead-center. On heavy loads, due to the early injection, the danger of preignition is considerable. The contrary is true of the governor with a fixed injection point. If the injection point be such as to preclude preignition at light loads, there is but little danger of full-load prematures; however, if the eccentric is so set as to cause the engine to pre-mature on heavy loads, preignition will probably occur even at light loads. The statement that the governor with a fixed injection point is the better in operation applies only where a combustion chamber is used. In this construction the injection point selected must be a favorable one for full-load conditions.

One source of criticism is the thermal loss occasioned in this type of engine at low load factors. Using the class of governors just referred to, the injection point must be placed early enough in the cycle to enable all the fuel required at full load to be injected before dead-center is reached. Indeed, the entire fuel charge must be injected sufficiently early to allow it to be completely vaporized by the time the piston reaches dead-center. It follows, then, that even at low loads the fuel is introduced early in the stroke. This oil, on vaporizing, adds to the existing pressure in the cylinder against which the advancing piston must do work to overcome this resistance. This work is not given back during the expansion stroke since the cooling water has partially or totally absorbed the heat produced by the work performed during the compression stroke. With the variable governor, on light loads, since the admission is later, this loss is not so great. Under full-load conditions, the losses with each type are equal.

Another disadvantage lies in the inability of the engine to carry as great an overload as is possible with the variable injection engine. The reason for this is that the builders arrange the

injection point to allow the full-load charge to be injected and vaporized before dead-center. The beginning of the injection is made as late as it is possible, while giving a sufficient time interval for vaporization before dead-center. The result is that when an overload is experienced, the engine cannot obtain enough vaporized fuel before dead-center to enable it to carry this additional load. If such an engine does display an ability to handle a large overload, it naturally follows that the normal injection point is too early for economical operation at partial loads. Another element that must be taken into consideration is the liability of preignition with early injection, but this can be controlled by the use of water injection.

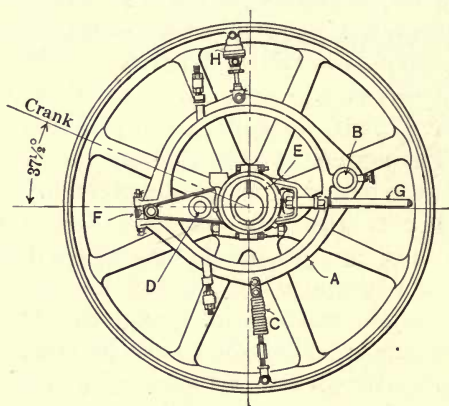

FIG. 310.—Bessemer oil engine governor.

Bessemer Oil Engine Governor.—The governor used on this engine is decidedly novel in design. The governor proper, as shown in Fig. 310, is of the inertia type, the governor weight being in the form of a ring *A*. This ring is pivoted on one of the wheel arms *B*, and its movement following a change in speed is opposed by a tension spring *C*. The eccentric *E* is carried on an arm which is pivoted on the wheel at *D* and which has one end engaged in a slide *F* on the weight circle. The eccentric drives the fuel pump through an eccentric strap and reach-rod *G*. It is evident that the governor circle will move outward when the engine speed increases. This shifts the eccentric *E* toward the shaft center, shortening the pump stroke; the reverse occurs on an increased load when the speed drops.

In order to limit the movement of the weight, an inner and outer stop is employed. The inner stop, which is the one adjacent to the tension spring, limits the movement of the ring toward the spring. This stop, then, controls the maximum stroke which the pump plunger can take. On starting the engine, the inertia of the ring causes it to move more slowly than the wheel, and if there were no stop the pump stroke would be excessive.

To prevent the eccentric, at an increase of the engine speed, from moving across the shaft center, an outer stop is provided. This is adjusted to allow the eccentric sheave to throw central with the shaft at no load. This, then, is the minimum position of the eccentric, and, being central, no stroke of the plunger occurs. With this arrangement, if the spring breaks, there can be no run-away since the eccentric throw would be reduced to zero. To steady the governor and prevent hunting, a dashpot *H* is supplied. The eccentric rod is adjustable but, when shipped, is usually regulated to give the proper maximum pump stroke.

Bessemer Fuel Pump.—This governor is used in conjunction with the fuel pump in Fig. 312. The eccentric, through the agency of the eccentric rod, actuates the pump plunger *a*. The oil enters the pump body through the suction opening *b* and the suction valve *F*. The discharge valve is spring-loaded while the suction valve *F* is mechanically operated by means of a bell-crank *N* and rod driven by the cam *M*, Fig. 311, which is keyed to the engine shaft. During the suction stroke of the pump the suction valve is held open by the bell-crank *N* and cam *M*. When the governor reaches its dead-center and begins its return or delivery stroke, the suction valve *F* is still held open. The oil then merely passes back through the suction passage. At the proper moment the flat spot *O* on the cam comes under the cam roller *P*. This allows the valve plunger spring, Fig. 312, to force the suction valve closed. The oil raises the discharge valve and enters the cylinder through the injection nozzle. After the crank turns 12 to 15 degrees, the roller leaves the flat surface of the cam, Fig. 311, and the suction valve is reopened. In actual operation the suction valve is not open longer than 3 degrees. This, of course, is due to the fact that the tappet does not completely close the valve until the roller has traveled several degrees on the flat spot. This valve-opening action prevents any further injection into the

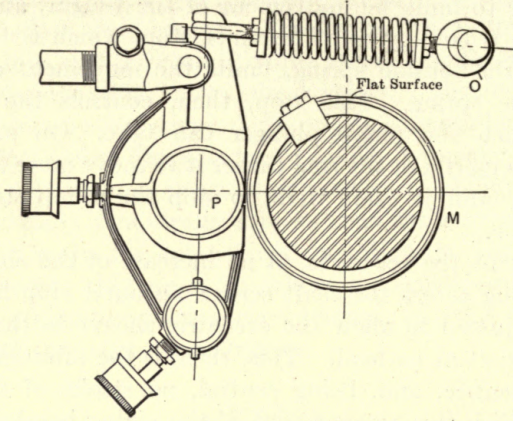

FIG. 311.—Fuel pump suction valve control cam.

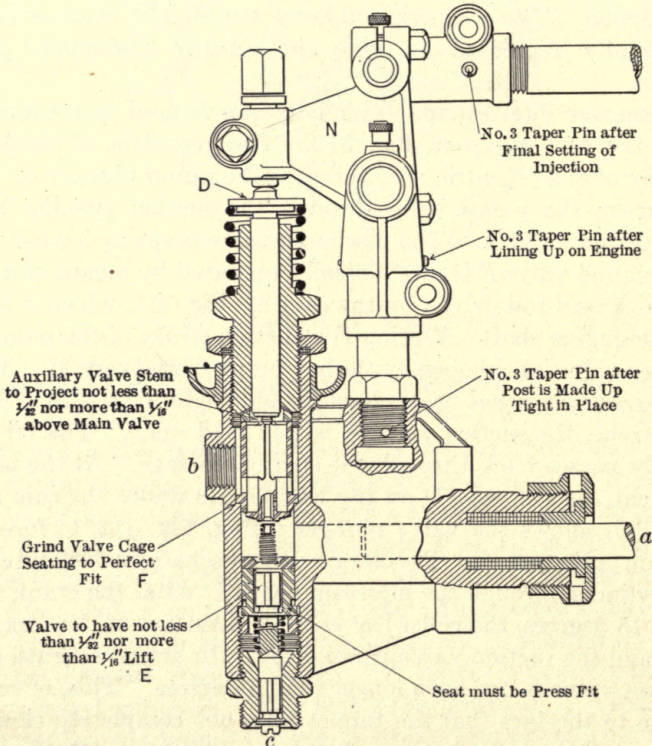

FIG. 312.—Bessemer oil engine fuel pump.

degree of revolution of the engine varies with the eccentricity. Consequently, taking any small segment, such as the length of the flat on the cam, *de*, the amount of fuel that is pumped while the angle is being covered depends on the throw of the governor eccentric. The eccentric is so placed that the speed of the pump is at its maximum value when the cam flat *O* closes the suction valve *F*. It is apparent that, with this design of governor and fuel pump, the commencement and completion of the fuel injection into the cylinder are constant at all loads. The only variables are the rate of travel of the fuel pump plunger per degree of engine revolution and the consequent rate of oil flow per degree of revolution.

From this discussion it is obvious that the velocity of the oil jet issuing from the injection nozzle varies with the load. This probably accounts for the better full-load combustion, since the oil atomization is nearer perfect at a high jet velocity. The operator is seldom called upon to alter the setting of the cam. While it is keyed to the engine shaft, if an adjustment is decided upon, an offset key can be used to hold the cam in its new position. A slight alteration in the timing of the suction valve may be obtained by adjustment of the tappet *f*. This is a rather delicate procedure as a matter of two turns of the screw will cause the valve to remain open during the entire cycle. If the tappet is adjusted very closely to the plunger, the suction valve opens early and closes late, resulting in an excessive fuel charge, which will be indicated by a smoky exhaust and, at times, by blowing of the relief valve. When the roller is in the center of the flat surface on the cam, the clearance between the valve plunger *f* and the tappet should equal the thickness of a piece of writing paper. Having this clearance, at its maximum upward travel, the suction valve opens considerably before the end of the flat has been reached by the roller and closes some degrees after the roller strikes the flat. As already stated, the actual valve closure covers from 2 to 3 degrees although the cam flat is from 12 to 15 degrees in extent.

Reverting to the pump, the suction valve demands a certain amount of attention. The valve is closed by the action of a strong spring, and a heavy blow is occasioned to the flat valve seat. This in time will wear. To correct this a light cut should be taken from the valve and the valve seat. The adjustment should be finished up by regrinding with emery flour and vaseline.

In later built Bessemer engines the suction valve is equipped with a small auxiliary valve. This is opened a trifle ahead of the main valve, thus relieving the pressure and making it easy to open the main suction valve. In the closing action this small valve seats first, avoiding any wire-drawing effect.

With double-cylinder engines two of these pumps are used, both suction valves being driven by the one cam rod while the two plungers are controlled by the single eccentric rod. To give the proper timing to the two suction valves, the fixed or suction cam has two flat spots. Both valves are opened and closed twice during each revolution. With each valve, one of the closures occurs when the pump plunger is on the suction stroke, and so no oil is injected during this particular valve closure.

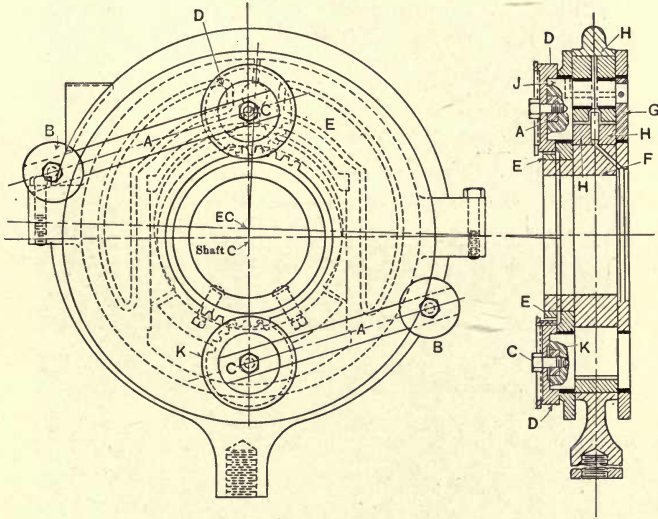

FIG. 314.—Primm oil engine governor.

Primm Oil Engine Governor.—This governor is of the constant injection-angle type and is possessed of certain unique details. The assembly is shown in Fig. 314. The governor consists of a governor hub *F*, which has a flange *G* forming the back side plate. About this hub is fitted the eccentric bushing *H*. The eccentric *I* has guides milled on its inner surface as a support for this bushing. To the eccentric is fitted a pin *J* which acts as a crank in moving the eccentric. The enlarged end of this crank

pin, which is recessed into the front coverplate, is provided with a governor weight arm *A*. An additional weight arm is pivoted to a dummy pin *K*, which does not come into action. The second weight merely balances the active weight. The crank pin *D* is equipped with a small pinion which engages a gear mounted on the governor hub.

In operation, the action is as follows: Any increase of speed causes both the weight arms to move outward. Since one weight arm is fastened to the pinion *D* which is part of the eccentric crank, already mentioned, the weight arm and crank may be regarded as one lever fulcrumed at the pinion tooth which is in mesh. Then the outward motion of the weight causes the crank to move inward, carrying the eccentric with it, thereby reducing

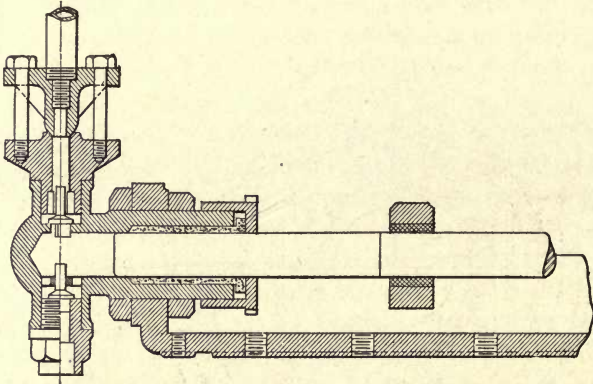

FIG. 315.—Primm oil engine fuel pump.

the eccentricity. This change in eccentric throw reduces the fuel pump stroke. With the usual governor, the change in eccentricity would alter the injection point. To maintain this injection point at a fixed value, the governor crank is set so that the eccentric receives an angular motion as well as a movement across the shaft. The angular motion corrects the defect of changing injection point, keeping it at a fixed value. The movement of the crank produces a rolling or angular motion at the fulcrum tooth. This is taken care of by the pinion. The pinion teeth remain in mesh at all points of the governor crank's displacement.

The governor is bronze-bushed throughout, and all parts are oiled by the single sight oiler. Beyond renewing the bushings when worn and seeing that the governor is lubricated, the oper-

ator has little trouble with it. The teeth in gear and pinion will wear slightly after some length of service. This has but little effect since the change in the admission angle, due to back lash at the pinion, is very slight.

Primm Injection Pump.—This pump is outlined in Fig. 315. The body of the pump is a bronze casting mounted in a cast-iron housing or support. This pump is fibrous packed, being provided with a gland and a screwed stuffing-box nut. The plunger is

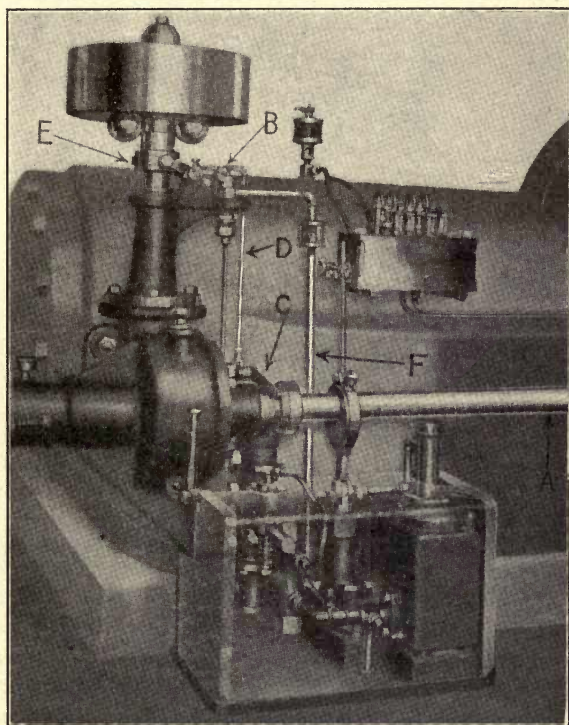

FIG. 316.—De La Vergne type D.H. oil engine governor and fuel pump.

positively driven by the eccentric rod and is equipped with a return spring. The valves are rather different from accepted oil engine designs. It is claimed that the flat seats facilitate re-grinding. Since the fuel used is ordinarily filtered, the danger of grit getting under the valves is remote. The operator should give these valves attention, for it requires less cutting to injure flat valves than ball or bevel-seated poppet valves. The stuffing-box should be repacked every few months. A good many

operators have the habit of pulling a new ring behind the old packing when a leak develops. The only correct method of stopping seeping around the plunger is the renewal of the entire packing.

De La Vergne Governor and Fuel Pump.—The governor, Fig. 316, used on the D.H. engine is the De La Vergne standard fly-ball type and is driven by bevel gears from the cam or layshaft *A*. The governor controls the engine speed by regulation of the amount of oil entering the combustion chamber. This is

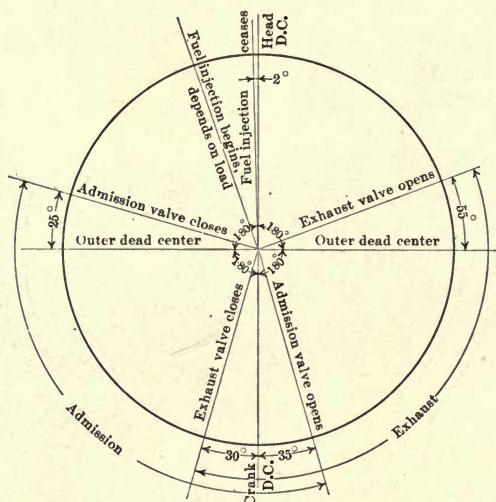

FIG. 317.—De La Vergne type D.H. engine valve timing.

achieved by means of a by-pass valve *B*. The fuel pump is driven by a cam *C* on the layshaft. The pump stroke is constant, handling a fixed quantity of oil. Connected with the discharge line is the by-pass valve *B*. This valve is opened and closed by means of a push-rod *D* actuated by a cam on the layshaft. The lever which opens the poppet by-pass valve is fulcrumed on a pin which is linked to the governor collar *E*. It is evident that, if the governor balls rise and lift the collar, the fulcrum pin will move to a lower position. This allows the reach-rod lever to touch the valve stem *B* earlier in the cycle. Early valve opening causes most of the fuel charge to by-pass back into the return line *F*. On heavy loads the action is the reverse of the above.

This governor, then, is of the constant injection type. The timing of the injection period depends on the load on the engine;

Fig. 317 gives the valve timing. The velocity of injection is constant at all loads; the atomization is as successful at low loads

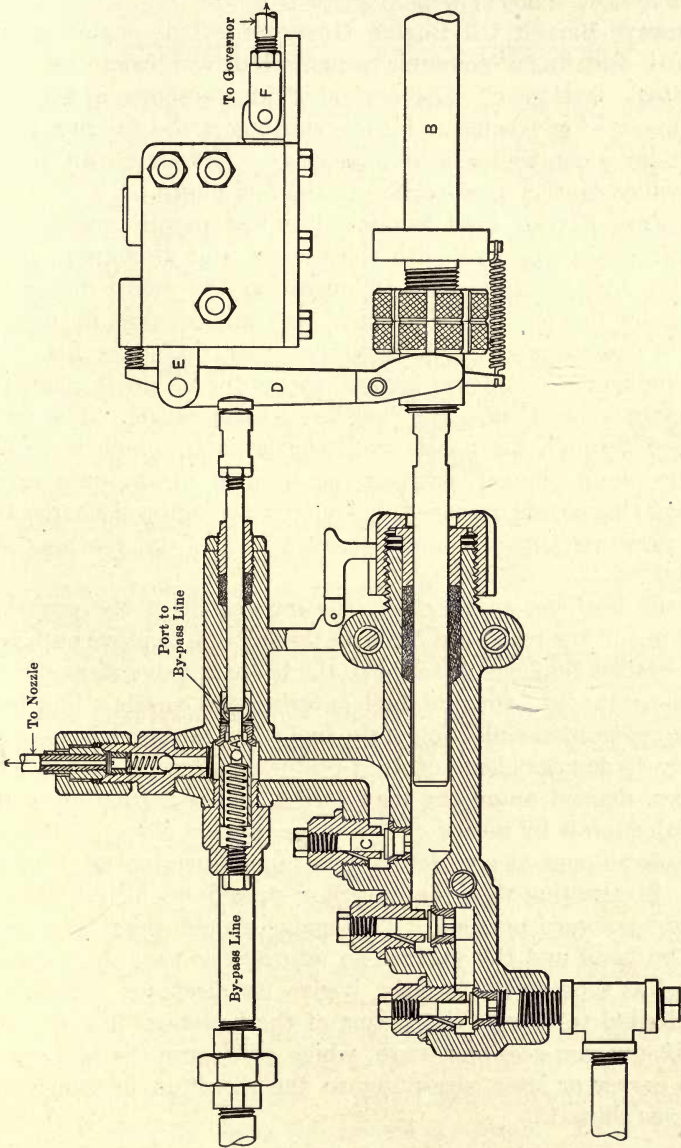

FIG. 318. — Buckeye-Barrett engine fuel pump.

as at the heavy loads. To this may be attributed the excellent fuel economy at all loads. Since the slightest movement of the

fulcrum pin affects the valve opening, a small amount of wear will alter the fuel consumption. The links and pins must be replaced at the first evidence of wear.

Buckeye-Barrett Oil Engine Governor.—This engine uses a vertical centrifugal governor which is driven from the camshaft by a bevel gear. The method of drive is shown in Fig. 275. The mode of governing is by the shifting of the fulcrum point of the lever controlling a by-pass valve. This is shown in Fig. 318, which gives a cross-section of the fuel pump.

Buckeye-Barrett Fuel Pump.—The fuel pump consists of a plunger cavity together with the suction and discharge valves, and the by-pass valve *A*. In operation the pump plunger is driven by the push-rod *B*, which, in turn, receives its motion from a cam formed on the governor gear shaft; see Fig. 275. This plunger, as it moves inward, forces the oil up through the discharge valve *C* into the fuel line to the nozzle. The oil is injected through the nozzle until the lever *D*, which is moved by the pump plunger, engages the stem of the by-pass valve. The opening of this by-pass valve relieves the pump discharge and thus prevents any additional amount of oil from reaching the nozzle.

If the load becomes lighter, the movement of the governor weights and the reach-rod *F* causes the fulcrum to move outward. This enables the lever *D* to strike the by-pass valve stem earlier, reducing the quantity of fuel entering the nozzle. The fuel plunger begins the injection of the fuel when the crank is approximately 40 degrees ahead of dead-center, continuing for some 20 degrees, dependent on the load carried. The regulation of the fuel injection is by means of the by-pass valve alone. This can be made to open at any desired point by adjustment of the stem end. In resetting this, the governor should be blocked in its greatest outward position. The engine should then be turned over by hand and the valve stem adjusted so that the valve is opened as soon as the plunger begins its discharge stroke. If it is desired to change the timing of the injection, it is possible to shift the cam gear one tooth, which will cause the plunger to move earlier or later, according to the direction in which the gear was shifted.

CHAPTER XXIII

FUEL NOZZLES. WATER INJECTION

Fuel Nozzles.—All fuel nozzles used on low-compression engines show much similarity of design. Unlike the Diesel nozzle, there is but little attempt to thoroughly atomize the fuel charge as it leaves the nozzle tip. The chief use, apparently, for the nozzle is its service as a check valve to cut off the fuel supply as soon as the pump ceases to inject the charge. Since all low-pressure engines actually vaporize the fuel before it is consumed, it is not absolutely necessary that the oil be atomized, but there is no doubt that the vaporization and combustion are more or less dependent on the degree of atomization.

In the nozzle, as in the fuel pump, a quick-closing and absolutely tight valve is necessary. Many of the poor economy records of this type of oil engine are due to the inefficient nozzle valves. Closing, as it does, during an infinitesimal fraction of a second, it requires a tight valve to prevent some drops of oil from leaking past the seat.

Little Giant Oil Engine Nozzle.

Figure 319 is a cross-section of the nozzle used by the Chicago Pneumatic Tool Co. In this nozzle a single ball valve, spring-loaded, serves as the

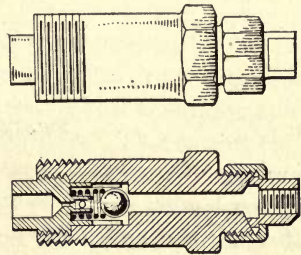

FIG. 319.—Little giant engine nozzle. (Chicago Pneumatic Tool Co.)

check and assists in giving a snappy cut-off to the fuel charge at the moment the pump reverses its stroke. The oil, in issuing around the ball valve, enters the nozzle-tip passage through the small opening in the spring guard. No effort is made to secure a breaking up of the fuel in the nozzle, and consequently the charge strikes the hot plate on the piston in a fairly solid stream.

A ball valve, after the seat is but slightly cut, will leak more rapidly than a poppet valve. With this fact in mind the engineer should frequently check the valve's condition. To do this, the nozzle can be unscrewed from the head. It should then be screwed onto the oil line and the pump given a few sharp strokes.

If the valve leaks, the oil leaves the nozzle without any decided pressure behind it, and the cut-off of the pump is not evidenced by an instantaneous cessation of the oil flow. It is necessary that the nozzle be held horizontal to enable the ball valve to rest on its seat.

Muncie Oil Engine Fuel Nozzle.—This nozzle, Fig. 320, also makes use of a ball valve. The ball in this instance is provided with a spring-loaded cage. The nozzle is screwed into the top of the cylinder-head casting in a vertical position. In operation, the fuel pump injects a charge of oil into the nozzle. The oil

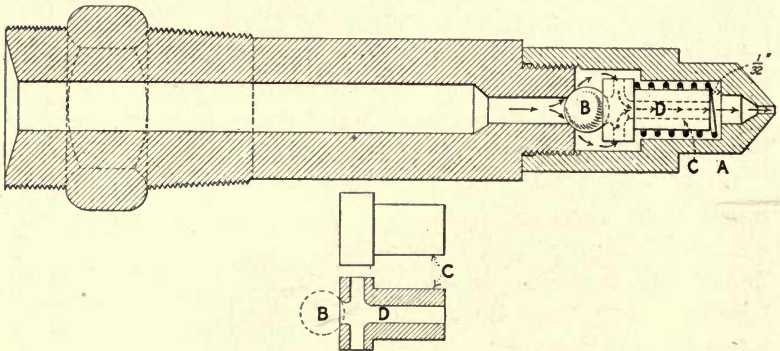

FIG. 320.—Muncie fuel nozzle.

pressure forces the ball *B* downward against the resistance of the spring-loaded cage *C*. The oil flows around the ball and then through the side ports into the cage which has a central cavity *D*. The oil, as it leaves the cage, is forced out through the small nozzle opening. This opening is approximately $\frac{1}{32}$ inch in diameter. As soon as the pump reverses its stroke, the spring snaps the ball against its seat. While the entire nozzle is filled with oil during the period of combustion in the cylinder, there is but a small amount below the ball valve. This small quantity usually drips out into the cylinder.

When the oil used is of an asphaltum base, the spring and cage are prone to carbonize, destroying their effectiveness. When the cage is free and in proper working condition, it emits a sharp click at each pump injection. This "clicking" can be heard by placing the ear against the nozzle's outer end. If no rhythmic click is heard, the nozzle should be taken off and the carbon deposits removed by soaking in strong lye. The nozzle tip opening often cakes up. This can be removed with a sharpened

darning needle. Care should be exercised that the opening is not enlarged during the process of cleaning.

If the ball valve leaks, a small hardwood stick should be placed squarely against the ball and given a sharp blow with a light hammer. After long use, the cage wears until its clearance is more than the $\frac{1}{32}$ inch which is standard. In such event a thin sheet-steel washer can be cut and placed between the cage and nozzle tips.

Fairbanks-Morse Type "Y" Fuel Nozzle.—In this nozzle, a cross-section of which appears in Fig. 321, an attempt has been

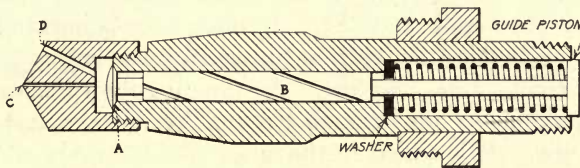

FIG. 321.—Fairbanks-Morse oil engine fuel atomizer nozzle.

made to partially atomize the fuel before it passes the check valve *A*. The valve stem *B* has a series of spiral grooves milled in its surface. The stem fits the nozzle cavity rather snugly, and the oil is forced to flow along the spiral grooves. This causes the oil particles to separate, and, after passing the valve, the nozzle-tip opening completes the breaking-up of the oil into minute globules. The valve is closed by the reaction of the spring. This spring should be compressed about $\frac{3}{4}$ inch when being assembled. This will give the proper tension to the spring. While this nozzle does break up the oil fairly well, the operator must keep the spiral grooves clean. With heavy oil, a deposit of coke will settle on the grooves, choking up the action of the nozzle. In regrinding the valve seat, emery flour, or pumice flour, and vaseline make an ideal grinding compound. The nozzle should be held in one hand, while the fingers of the other hand are used in rotating the valve. The tension of the spring should be partially relieved by pressing inward with the finger. It is not necessary to grind the entire valve face into contact. A light line contact is just as serviceable and much easier to obtain. With this nozzle, as with all others, a spare one should be on hand so that the used nozzle can be removed and soaked in lye or kerosene to thoroughly clean all the parts.

If there is any suspicion that the valve is leaking, the cap of the combustion chamber should be removed. The engineer can then have his helper operate the fuel pump by hand. The oil should jet out of the nozzle tip in a fine stream that breaks up before it reaches the combustion chamber walls. If the stream of oil is not fine, the nozzle-tip opening is too large and should be replaced with one having a smaller opening. If the valve leaks, the stream of oil does not cut off quickly. The nozzle tip has two openings. The main opening *C* is along the axis of the nozzle, while a smaller passage *D* is at an angle. In operation, when a heavy oil is used, the temperature of the combustion chamber is not sufficient to ignite the fuel. An alloy tube is inserted in the chamber wall; this tube retains the heat much better than the cast-iron combustion chamber. As the oil enters the tip, part of the charge flows out through the angular passage and strikes the hot tube. This assists in the ignition of the main oil charge which has flowed through the axial passage. If the fuel be of light gravity, all of it will flow through the axial passage *C* due to its low resistance and to the high resistance of the angular passage. With light oils little, if any, strikes the hot tube. The nozzle tip has a groove on one side which fits a dowel pin in the combustion chamber. It is imperative that this dowel rests in this groove to enable the oil jet to strike the hot tube. The nozzle itself is turned on its outer surface and fits very snugly into the engine casting. It is a good plan to clean out the cavity, into which it is secured, to remove any carbon that might prevent a good bearing.

Buckeye-Barrett Oil Engine Fuel Nozzle.—This nozzle, Fig. 322, employs two spring-loaded check valves. The lower one *A*, which is immediately behind the atomizer tip *B*, performs the office of cutting off the oil flow and breaking up the oil stream; this "breaking-up" is assisted by the spring washers which are perforated with a series of small openings. The upper check *C* merely assists the lower check valve in sealing the oil line against any danger of back-firing from the cylinder. With any type of nozzle where the check leaks, there is danger of explosions in the fuel line caused by the gas flame in the engine cylinder traveling up through the nozzle. The use of two check valves serves to confine any combustion to the nozzle.

To regrind the valves the nozzle is disassembled at the joint D. The nozzle tip is also removed. Taking up the lower half, the valve spring guard *E* should be removed. This frees the spring and allows the valve to drop down. The valve face can then be lightly coated with the grinding compound. In grinding the valve, a small screw-driver can be inserted in the slot in the end of the valve. No pressure should be exerted against the valve, or the seat will score.

In regrinding the upper check, the spring guard must be unscrewed from the nozzle body and the spring removed. A pair of tweezers can be used to grasp the valve stem for the purpose of rotating the valve.

The nozzle end fits against a ground shoulder that effectually prevents any hot gas from surrounding the nozzle body. As a consequence of this sealing, there should be no coking in the nozzle.

Primm Oil Engine Fuel Nozzle.

—This nozzle, Fig. 323, is built along standard and accepted principles as regards tip and check valve. The method of connecting the fuel line to the nozzle is somewhat different from the general practice. The Primm makes use of a yoke connection which admits the fuel into the nozzle at one side, the junction being a ball and socket joint.

In removing the nozzle, which is screwed into the cylinder-head casting, if care is not used there is a liability of twisting the nozzle—especially so if a long-handle wrench is used. The

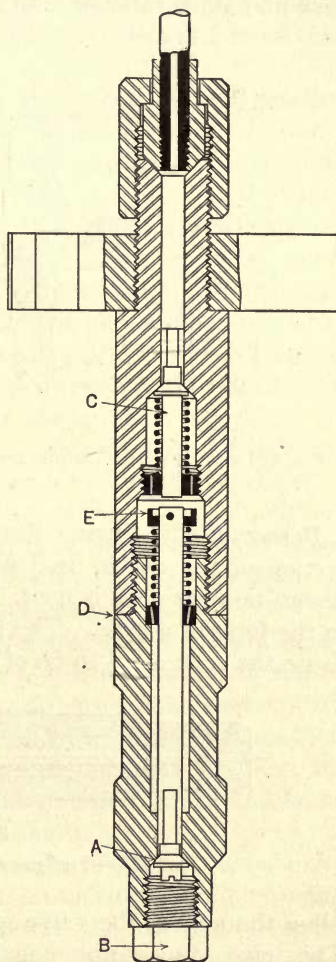

FIG. 322.—Fuel nozzle, Buckeye-Barrett oil engine.

best method of removal is to run kerosene around the nozzle to cut away the rust. Then the nozzle should be given a few sharp blows with a copper mallet. This will effectually "break" the joint and allow the nozzle to be unscrewed with a small wrench.

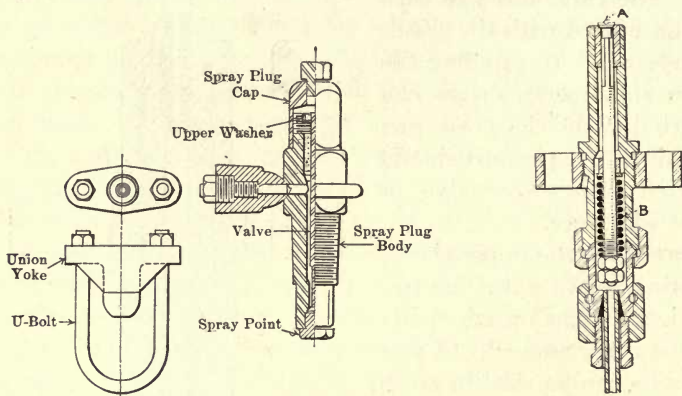

FIG. 323.—Fuel nozzle, Primm oil engine.

FIG. 324.—Bessemer oil engine fuel nozzle.

Bessemer Oil Engine Fuel Nozzle.—Figure 324 is a cross-section of the nozzle used with the Bessemer engine. In this design no nozzle tip is used. The oil, as it leaves the nozzle, is in the form of a cone. The lift of the valve *A* is so slight as to cause the cone of oil to be of infinitesimal thickness. In assem-

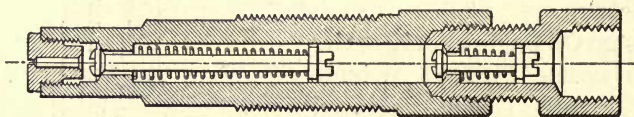

FIG. 325.—Fuel nozzle for Mietz & Weiss oil engines.

bling the nozzle, the valve spring should be compressed $\frac{3}{4}$ inch. This gives the spring enough tension to cause the valve to have a very snappy action. After repeated regrindings the valve may seat so deeply as to cause a shoulder at the nozzle end. This shoulder prevents the oil from issuing in a cone and must be removed. To do this the nozzle should be ground on an emery wheel until the shoulder disappears.

Mietz and Weiss Oil Engine Fuel Nozzle.—This nozzle, a cross-section of which appears in Fig. 325, makes use of two check

valves and a nozzle tip. The method of regrinding the valves is the same as used on any similar nozzle.

Care of Fuel Nozzles.—The successful operation of a low-pressure oil engine depends, to a great extent, on the action of the fuel nozzle. The check valves must not leak and must close and open rapidly.

At least once every thirty days, if the engine is in constant service, the nozzle should be removed and cleaned. Kerosene or strong lye water is by far the best cleansing agent to use. The interior of the nozzle should be inspected and all coke or carbon deposits completely removed.

After cleaning the nozzle, it should be connected to the pump line, although not inserted into the cylinder, with the tip removed. Kerosene should be supplied to the pump, and a pint or so should be forced through the discharge line and the nozzle. This will cleanse the line and nozzle of any small particles of grit or dust. The tip should then be screwed into the nozzle.

To check the nozzle valve action, the pump should be given several vigorous strokes to remove all air. As soon as the pressure builds up in the line, which is evidenced by the "pull" of the pump handle, the pump should be given a few short quick strokes. If the nozzle valve does not shut off the oil, or if the tip drips oil, it is proof that the valve is leaking.

In regrinding the valve, as already mentioned, a paste of emery flour and vaseline should be used. A sparing amount should be placed on the valve, spreading it over the entire valve seat. Turn the valve, while grinding, with the fingers only, or with a light screw-driver. To avoid forming grooves on the valve face, the valve should be lifted frequently and given a forward and backward motion, never completely rotating it.

In operation, after replacing the nozzle, the engine occasionally refuses to fire. This, in most cases, is due to the fuel pump and nozzle being air-bound. To relieve this, the line should be disconnected at the nozzle and the pump worked by hand until a solid stream of oil appears. The nozzle should be filled with kerosene, which should be poured in slowly to allow the air to be displaced.

As to the efficiency of the nozzle, much depends on its location in the cylinder or combustion-chamber walls. If the nozzle is in a vertical position, opening upward into the cylinder, practically no drops of oil will enter the cylinder after the valve cuts

off. On the other hand, the oil remaining in the nozzle tip, above the valve, will tend to vaporize, and, if it is a heavy oil, it will leave a tarry residue which will choke up the tip. If the nozzle opens downward into the cylinder, it will clear itself of all excess oil, resulting in a fairly open nozzle tip. But this position allows the excess oil to drip into the cylinder. If the pump and nozzle valves leak, oil will drip during the entire stroke. When placed horizontally in the head or combustion-chamber walls, the nozzle seems to give the best results.

Water Injection.—Originally, water was injected into the cylinder for the purpose of preventing preignition, and it undoubtedly accomplishes this object. In those engines in which the fuel is injected early in the compression stroke, the use of water is absolutely imperative to keep the compression pressure below the preignition temperature. In the early days of low-pressure engines, if the compression pressure rose above 60 pounds the engine would wreck itself if the supply of water was cut off.

With more modern designs of this engine the injection of fuel occurs much later; in some engines the injection is almost at dead-center. In these engines the elimination of preignition is but a secondary result of the use of water. The principal use of water injection is the control of the temperature of the hot bulb or combustion chamber.

It is very apparent that with a given size bulb the total amount of heat that the bulb will absorb is dependent on the amount of heat it will radiate. If it receives more heat than it can give up to the cooling jacket and the outside air, then it will show an increase in temperature. The result is that on low loads, if the bulb is of a size suitable for full load, the temperature of the bulb becomes so low as to preclude successful ignition of each fuel charge. If the bulb be designed for half-load conditions, at full load the temperature of the bulb becomes so great as to cause preignition even though the fuel be injected as late as 20 degrees ahead of dead-center. The size of the bulb cannot profitably be altered at each load change, and water injection does serve to control the temperature of the bulb. By designing the bulb to be of ample size to vaporize the fuel at low loads the water can absorb the excess heat developed under full-load conditions.

Figure 326 shows an indicator card where the water injection was cut out. This reveals a very marked preignition considerably

before dead-center. Figure 327 is a card from an engine using water injection. Even at full load there was no premature combustion; in fact, the explosion occurred slightly after dead-center was reached.

Another use of water injection is in the control of the varying ignition temperature of different oils. Oils show marked differences in the temperature at which auto-ignition occurs. If the compression pressure is one suitable for a heavy oil, a change to a lighter gravity oil necessitates a lowering of the compression temperature. If the change be a permanent one, the clearance volume of the engine could be altered, but the most successful method is the use of water injection to lower the temperature of the cylinder during the compression stroke.

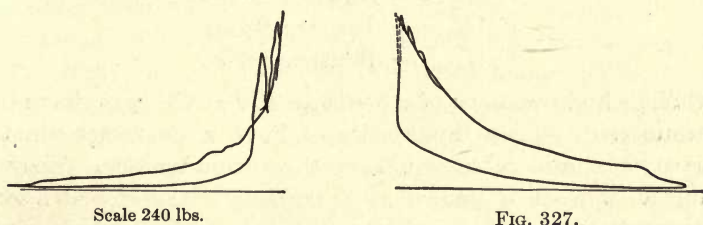

FIG. 326.—Low-compression engine,
no water injection.

FIG. 327.

A few low-pressure oil engines do not use water injection, thus proving that it is not absolutely necessary for the prevention of premature explosions. If water is not used, it follows that the oil must not be injected early in the compression stroke; 35 degrees ahead of dead-center is as early as is feasible, and even at this late injection point the stratification in the cylinder must be good or preignitions will occur on full load. From considerable experience with these, so-called, "dry" engines it can be stated that they will display a tendency to preignite if operated at full load for a number of hours and, if operated at a low load factor, will likely possess the fault of missing explosions.

Of late years, due to certain objectionable features of water injection and a hesitancy of acknowledging that it is used to correct defects of design, other claims of the virtues of water injection have been set up. Among the uses of water injection, it is now considered to assist in better combustion and to keep down carbon deposits.

It is practically impossible to establish exactly what occurs in the engine cylinder. All that it is possible to prove is that,

under conditions such as are presumed to exist in the engine cylinder, certain events will take place, and from this basis deduce that these same events do occur in the engine.

Crude oil or petroleum is made up of an extremely complex mixture of carbon and hydrogen, known as hydrocarbon. The chemical composition of the crude oil in each field shows different characteristics. In fact, even in a single field the oil from different wells may belong to an entirely different hydrocarbon series. There are five of these hydrocarbon series that are usually met with. They are

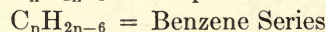
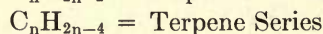
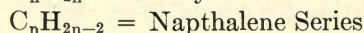
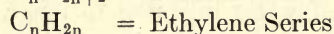
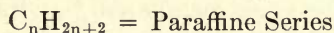

although hydrocarbons of a series as low as C_nH_{2n-24} have been encountered. These hydrocarbons have a characteristic that has given considerable trouble to the engine builder. They are subject to what is known as "cracking," whereby at a given temperature the hydrocarbon will break up into a more simple compound. As example, at a certain temperature the paraffine series $C_{15}H_{32}$ breaks up as follows:

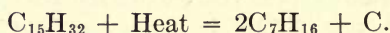

This "cracking" temperature is considerably lower than the temperature of auto-ignition.

It was found that, when such an oil was "cracked" and then burned in the presence of water vapor, the free carbon C disappeared, evidently consumed in connection with the water vapor.

The explanation of this phenomenon is as follows: The free carbon atom will not unite with the oxygen of the air except at a temperature much higher than that existing in the engine. On the other hand, the cylinder temperature, during combustion, is sufficient to disassociate the hydrogen and oxygen of the water. This nascent oxygen will unite with the carbon at the cylinder temperature. We have then the following reactions:

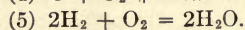
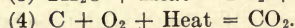
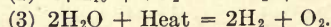
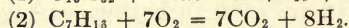
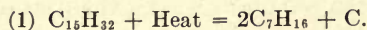

Reaction No. 1 occurs as soon as the oil is injected and before ignition occurs, and is the "cracking" process. When the cylinder temperature, assisted by the hot bulb, ignites the vaporized oil, reaction No. 2 takes place. The temperature which now exists in the cylinder is around 3000° Fahrenheit, sufficient to separate the water into its hydrogen and oxygen atoms. Consequently the hydrogen released by No. 2 reaction does not unite with the oxygen of the air. As already stated, this water oxygen will unite with the carbon and reaction No. 4 occurs. As the piston moves outward, the temperature falls below the disassociation point of water, and the hydrogen set free by No. 2 reaction unites with the oxygen freed by No. 3 reaction.

This would seem to explain the reason a "dry" engine operates at a higher temperature than does a water injection engine. The reactions absorb considerable heat, which is of course given up by reaction No. 5. However, this last reaction occurs when the piston is fairly well advanced on the power stroke and the cylinder temperature at this point is low enough to receive an increment without overheating the engine.

To offset this claim many "dry" engines are operating at practically full load with no carbon deposits. Even water-injection engines usually operate below half load without the use of any water, and no carbon deposits appear. There is no doubt that water injection does prevent preignitions at full load and assists in clearing the cylinder of exhaust gases. This, however, is better obtained by proper design of the air ports.

Cylinder Wear Due to Water Injection.—It has frequently been observed that engines using water injection are subject to serious cylinder wear. This is more prevalent in the Southwest where the oil carries considerable sulphur. This sulphur undoubtedly does unite, to some extent, with the water introduced into the cylinder, forming sulphurous acid. This acid cuts the cylinder and piston walls. From reports of a number of engines using Eastern oils that contain little or no sulphur it appears that cylinder wear occurs without the presence of sulphur. This could be explained on the grounds that the oxygen of the water unites with the iron of the walls, forming ferric oxide. This oxide is very abrasive and cuts the walls, presenting a fresh iron surface to the action of the water.

Faulty Lubrication Caused by Water Injection.—The opponents of the use of water injection claim, with some degree of truth,

that it tends to wash the lubrication off the piston and that faulty lubrication is the chief cause of the rapid cylinder wear. From reports obtained it would appear that rapid cylinder wear takes place in those cases where the operator has followed shop instructions as to the amount of lubricating oil to use. Since the engine builder usually states the minimum amount advisable to use under the best conditions, it follows that the operator, in limiting the quantity of oil to this figure, did not use enough. The piston and cylinder wear rapidly because the water washes away the oil that is supplied. All reports on cylinder wear make mention of the dry condition of the piston, showing the absence of any lubricant.

The Method of Water Injection.—This has much influence on the degree of cylinder wear. Figure 251 shows a cross-section of an engine using a simple bleeder valve. As shown, the water connection enters the cylinder, although the majority of engines using water have the water line leading into the air passage. The water is injected solely by the difference between the pressure existing in the engine cooling jacket and the pressure in the cylinder or air passage. The intention of the designer is to cause the water to be injected at the moment the piston uncovers the exhaust port, the cylinder pressure dropping to zero at this point. If the water entered at this time, the heat in the cylinder would transform it into steam and probably no cylinder cutting would occur. It happens that on the compression stroke the air pressure in the crankcase, or front end of the cylinder, drops below the atmospheric pressure. The pressure difference will cause the water to drip into the cylinder, or air passage, and run down onto the piston. This will evidently wash away any oil film. With an automatic pump arrangement the water is injected at a fixed point when the piston has uncovered the exhaust and air ports. The existing cylinder temperature is sufficiently high to vaporize the water into steam. Under these conditions there should be but little effect shown on the piston lubrication.

Mietz and Weiss Water Injection System.—The Mietz and Weiss horizontal oil engines make use of a unique design of water injection. The cylinder water jacket is provided with a float box *A*, Fig. 328. The water line to the cylinder jacket is connected through the float box, the float of which maintains the water in the jacket at a level about two-thirds from the top.

The heat in the cylinder evaporates this water, forming it into steam at atmospheric pressure, or a few pounds gage. This steam is led into the air passage through the steam dome B. When the pressure in the air passage drops below the pressure in the jacket, there is a flow of steam into the air passage and the

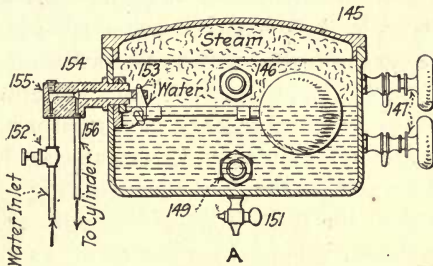

FIG. 328.

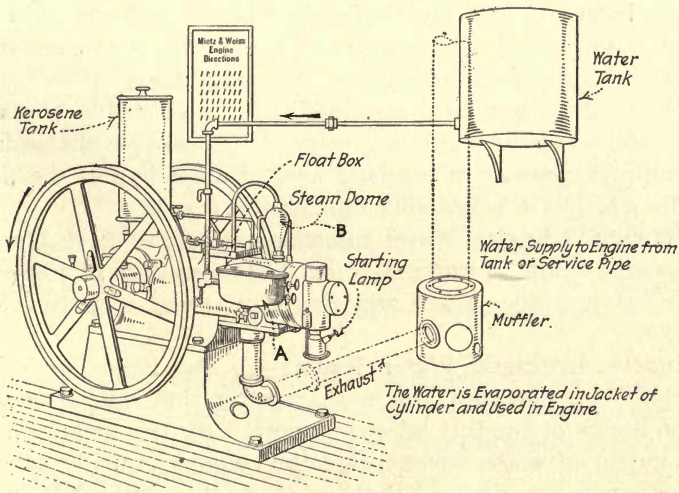

FIG. 328a.

engine cylinder. At the time the exhaust port opens the cylinder pressure drops to atmospheric, and a supply of steam rushes in with the air charge. This assists in cleansing the cylinder of the exhaust gases and also serves to lower the compression temperature, due to the absorption of heat by the steam, which has a greater specific heat capacity than has air.

To provide an additional cooling agent a water bleeder valve is also used. The water drips, as is customary, into the air pas-

sage and, being blown into the cylinder, assists in reducing the temperature.

The one objection to the use of steam is the tendency for it to pass into the crankcase when a suction pressure exists there, thus partially destroying the compressor efficiency.

The arrangement for the vertical engines is somewhat different. The float box is so located that the water level in the jacket is several inches below the top of the cylinder head. The consequence is that on full load the head runs abnormally hot. In many installations of vertical engines the operator has abandoned the boiler idea and used a standard circulating water system, depending on the water jet for internal cooling in preference to the steam. To do this, the float box and steam dome are removed. The entrance to the air passage from the dome, as well as the connection into the jacket for the water line from the float box, is plugged up. The water is put into the jacket through passages at the bottom which are ordinarily plugged and are used for cleaning purposes. The water discharge line is connected to the opening that previously ran to the steam dome.

With water carrying mineral salts the float valve tends to scale, destroying its regulating powers. To remove the scale is absolutely necessary; a muriatic acid solution left in the float box for a couple of hours will eliminate this deposit.

Muncie Oil Engine Water Injection.—In all sizes of Muncie engines the standard water injection system consists of a bleeder valve between the jacket and the air passage, as outlined in Fig. 251.

Muncie Automatic Water Pump.—In the larger sizes the Muncie Co. is now supplying a water pump that is incorporated in the design of the fuel injection pump. By this arrangement the amount of water injected into the cylinder is under control of the governor. Figure 329 shows their latest automatic water pump, the lower pump being that used for the water. The eccentric rod *B* on the return stroke of the fuel pump strikes the lever *A*, which in turn gives a stroke to the water pump plunger *C*. As the lever *A* forces the water plunger inward, injecting a charge of water into the engine cylinder, it engages the by-pass valve stem *D*. The opening of this by-pass valve relieves the water discharge line, the flow of water to the injection valve then ceasing. The lug *E* allows an adjustment of the timing of the by-pass valve, in this way regulating the amount of water which

enters the cylinder for a given movement of the governor eccentric rod. When heavy oil is used but little water is necessary, consequently the adjusting nut is screwed inward on the valve stem. This causes the valve to open practically as soon as the water plunger moves. If the oil is light, more water is necessary so the by-pass valve is allowed to remain closed until the water plunger has completed the major portion of its stroke. It will be observed that the adjustment of the by-pass valve allows the

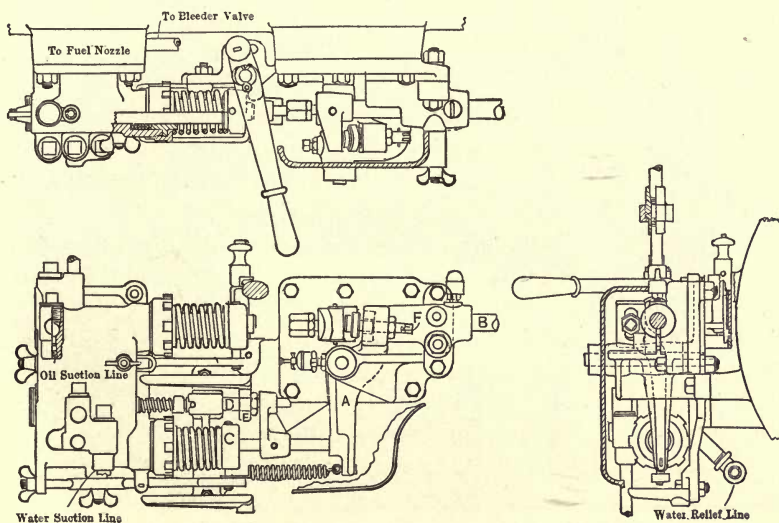

FIG. 329.—Muncie oil engine, fuel and water injection pump.

necessary water to be used for any certain oil, while the governor itself regulates the quantity admitted on the various load charges. It is of frequent occurrence that the engine operates better when the water is injected at some fixed point. The lug screw *F* can be adjusted so that the water will enter the cylinder at any point between the point of exhaust port opening and exhaust port closure. When heavy oil is used, early water injection produces a good scavenging effect. With light oil, inclined to preignition, early water admission allows most of the water vapor to blow out the exhaust, consequently the cooling effect on the cylinder is slight. With such oils late water injection serves to keep most of the water in the cylinder, thereby providing an effective cooling medium.

Primm Oil Engine Water Injection.—The Power Manufacturing Co. makes use of a valve *A*, Fig. 330, which is controlled by the governor. The valve, itself, consists of a disk with a series of holes registering with like openings in the valve body. The valve stem is linked to the fuel pump plunger *B*, and the degree of valve opening is dependent on the length of the pump plunger stroke. The actual quantity of water passing through the valve at maxi-

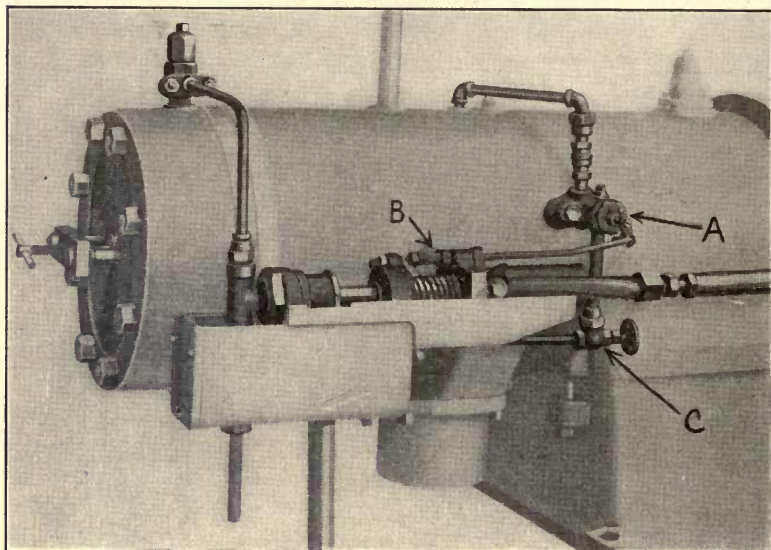

FIG. 330.—Primm oil engine, water regulating valve.

imum valve opening can be regulated by means of the globe valve shown. In later models the Primm water valve is supplied with a regulating needle valve in place of the globe valve *C*.

Little Giant Oil Engine Water Injection.—The Chicago Pneumatic Tool Co., on their Little Giant engine, use a governor-controlled bleeder valve. This valve is connected to the Pickering governor by a link, and the movement of the governor on load changes alters the valve opening. The action of the valve itself is subject to the influences that act on a manual-controlled bleeder valve, as the timing of the water injection is not positive. A globe valve is used to give the proportion of water to fuel charge at any given load value.

Bessemer Oil Engine Water Injection System.—The Bessemer water injection is controlled by a water pump embodied in the

fuel pump casting. The stroke of the water pump is under direct control of the engine governor through a floating fulcrumed lever. This lever is adjustable, enabling the operator to regulate the amount of water used on any given load. The governor then automatically controls the water for any other given load, proportioning the water injection in accordance with the quantity of fuel injected.

Engines Without Water Injection.—As has been mentioned heretofore, a number of engines, such as the Fairbanks-Morse and the De La Vergne, operate “dry,” making no use of water injection as a temperature control but depending on the water cooling of the combustion chamber to keep the temperature of the combustion chamber within the desirable range. Others use a simple bleeder valve.

General.—If an engine using water injection is to be purchased, automatic control of the water should be insisted upon. All manufacturers are in a position to supply the automatic control if the purchaser makes it one of the conditions of the sale. If an engine already installed has a manual-controlled bleeder valve, the operator should early decide that it will be impossible to alter the valve setting at each change of load. The proper method is to adjust the valve to suit average load conditions. If the engine, momentarily, has a heavier load to handle, the operator should allow the engine to pound a little; as long as the preignitions are not violent, the water valve should not be touched. If the load becomes less than normal, the water will be excessive and the engine will probably miss an occasional explosion. This miss-firing should be allowed to occur as long as the engine does not begin to “hunt.” The operator cannot afford to spend his time in adjusting the bleeder valve to conform to every load change.

Manipulations of the Water Injection.—On starting the engine, the water valve should be shut off entirely. If it be a pump feed, the pump should have its stroke reduced to the minimum. After the engine has been started and the load thrown on, the water should be increased until all premature explosions have been subdued. The amount of water supplied should never be so plentiful as to unduly chill the combustion chamber or bulb. Usually a cold bulb is evidenced by missed explosions, “hunting” of the engine and occasional violent preignitions as well as a liquid exhaust.

CHAPTER XXIV

EXHAUST PIPE AND PIT. WATER COOLING SYSTEMS

Exhaust Pipe.—In planning the installation of a low-pressure oil engine, the exhaust piping should be made as short and direct as possible. All elbows that are not absolutely necessary should be eliminated. In a horizontal engine plant the best pipe layout has the exhaust pipe running straight down from the engine to the exhaust elbow which rests in a pipe conduit. The exhaust pipe should run from the elbow, through the conduit, into the exhaust pit, located outside the building. The pit should be at least 3 feet from the building wall to avoid fire risk. Good

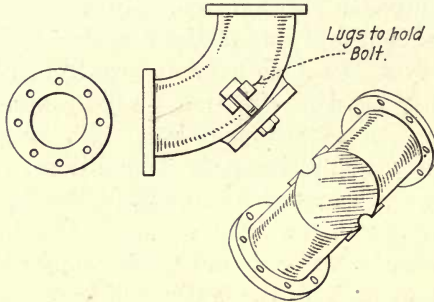

FIG. 331.—Exhaust elbow with clean out door.

engineering specifies that the pipe conduit must have concrete walls and bottom and be provided with a cast-iron cover, although a wooden cover will do in an emergency. The exhaust elbow should, if possible, be of special design with a clean-out door at the back; see Fig. 331. A tee instead of an elbow can be used with one outlet closed by a plug or blind flange. This admits of cleaning out the vertical pipe. Figure 332 shows a well-planned pipe layout. If the conduit be extended along one side of the engine foundation, the oil and water piping can also be run in it, out of the way.

The majority of engine builders have the exhaust pipe sizes suitable for short lines only. If the building plan necessitates a longer run, the pipe should be increased at least one size. In

laying the pipe, it should be sloped to drain away from the engine. A plugged opening should be drilled in each exhaust pipe immedi-

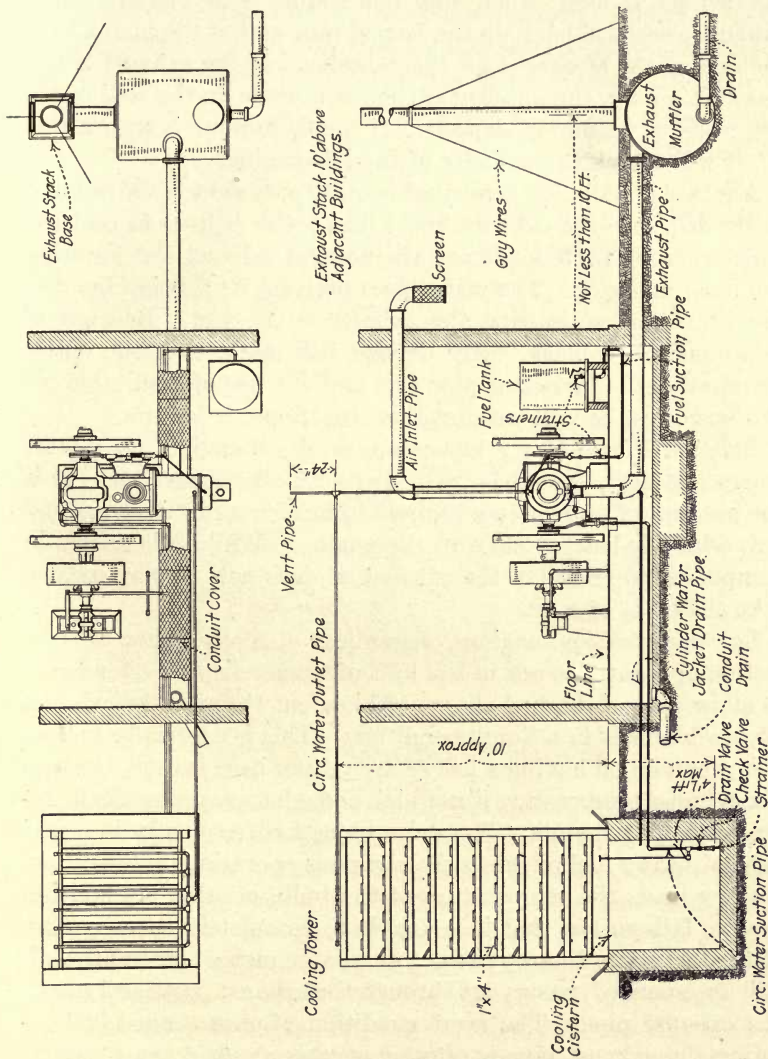

Fig. 332.

ately below the cylinder. By removing the plug, the operator can tell exactly how the engine is firing and the condition of the exhaust gases.

A common practice is the connection of two engines to a single exhaust pit. Each engine should have its individual exhaust pit or pot. With two-stroke-cycle engines, where a common exhaust pit is used, when only one engine is in operation the exhaust gases will back up the second pipe and, if the piston is at the end of the stroke, enter the cylinder. If the exhaust is the least bit smoky, the unburnt carbon will settle on the cold cylinder walls in a gummy deposit. If much sulphur is in the fuel oil, it will attack the cylinder of the idle engine.

Another installation error that is quite prevalent is the use of a water drip into the exhaust line. The water is used to cool the gases, thereby both deadening the noise of exhaust and lowering the back pressure. The water does perform its mission but has the objection of causing the exhaust to be wet. Because of this moisture a black, tarry deposit will settle over the entire surroundings. Increased pipe size and the use of a suitable pit will serve just as well without this objectionable feature.

Exhaust Pits.—Every low-compression oil engine, no matter where installed, should be provided with an exhaust pit. It is the practice of some manufacturers to furnish a cast-iron exhaust pot, which is located close to the engine. While this assists in dampening the noise of the exhaust, it does not, by any means, take the place of a pit.

Low-compression engines, regardless of make, when the injection apparatus is not in the best of shape, display a tendency to allow part of the fuel charge to blow out through the exhaust ports while it is in a liquid condition. This is especially noticeable when an oil having a heavy asphaltum base is used, because the cylinder temperature is not high enough to vaporize the heavier portion of the oil. The same objection frequently is raised against heavy fuel oil when the engine is operating on low loads. On low loads the temperature of the bulb, or other hot ignition device, falls so low that it is unable to completely vaporize any of the fuel oils ordinarily used. As a consequence some of the oil, still unvaporized, passes out through the exhaust ports and enters the exhaust pipe. The same condition of unconsumed fuel entering the exhaust pipe is often encountered when the governor or the injection nozzle fails to cut off the oil supply at the proper point.

If the discharge oil is trapped in the pipe or in an exhaust pot located close to the engine, it will accumulate until it is set afire.

The exhaust is always at a high temperature, around 800° Fahrenheit, and frequently a flame blows through the exhaust ports and ignites this residue. Many fires, some of them serious, have resulted from the use of an exhaust pot or muffler. If the employment of a pot is decided upon, then a thimble should by all means be placed around the pipe where it passes through the roof.

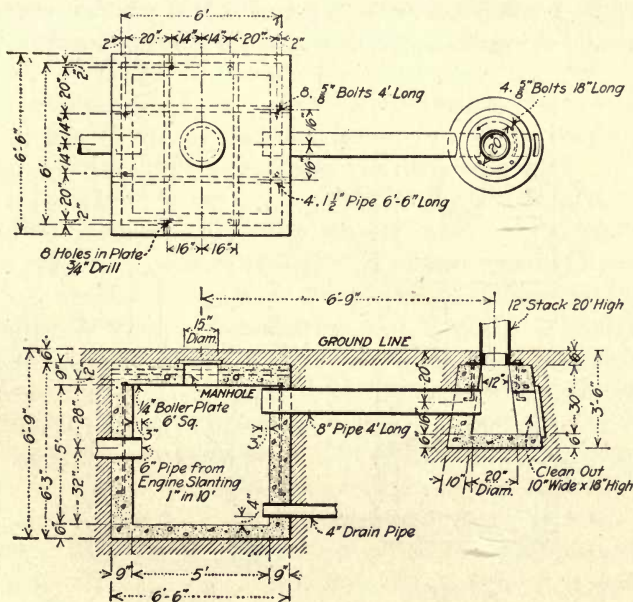

FIG. 333.—Modern design of exhaust pit.

In preference to the pot, a concrete exhaust pit should be constructed outside the building. It is a good plan to place the pit at least 3 feet from the building wall, although 5 feet is better. Means must be provided for draining away the residue that accumulates in the pit. If the contour of the land permits, the drain should have an open end. If not, it can be run to a smaller pit and a bucket placed in this pit below the drain. In this way the residue will collect in the bucket and can be removed.

Figure 333 shows a form of exhaust pit very generally adopted. It is provided with an extra exhaust-stack pit leading from the pit proper. While this is of assistance in deadening the noise, it is a refinement not actually required. The concrete walls should be 9 inches thick as a minimum, and reinforcing rods should

be used. These rods will resist the ordinary strains to which the walls are subjected. The top can be made either of a boiler plate covered with earth, or of old iron rails with a concrete slab as a cover. A manhole should be constructed in the top, both for access to the pit and for safety in case a violent explosion occurs.

Another good form of pit is shown in Fig. 334. Here the exhaust pipe *A* enters below the layer of rock *B* which is supported by old rails or iron bars and serves to deaden the sound of the ex-

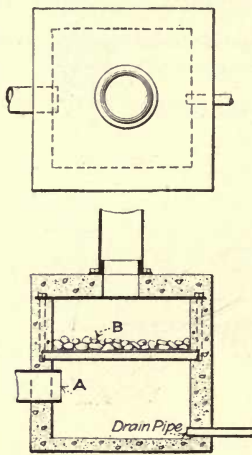

FIG. 334.

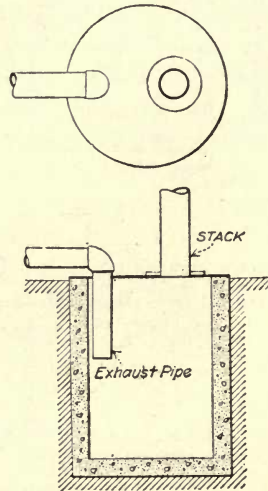

FIG. 335.

Exhaust pits.

plosion. Such a pit is well-nigh noiseless and is as cheap to build as a less efficient one. It should be provided with a manhole in the side, below the layer of rock. This manhole should be fitted with a thin cover held in place by two small studs so that, if a heavy explosion does occur, the cover will blow off and prevent damage to the pit.

Frequently a cylindrical exhaust pit like that shown in Fig. 335 is used. This, however, is not as good a design as Figs. 333 and 334 since it does not even deaden the noise of the exhaust. Furthermore, as it has no drain, the residue cannot be removed readily. Figure 332, showing pipe conduit, also outlines a type of exhaust pit, or pot, that is used in some installations. It is essentially a boiler plate tank with inlet and discharge openings.

It has the disadvantage of high initial cost and no advantage other than that it can be moved in case the power plant is ever transferred to another location.

In a two-engine installation the two engine exhausts can be run into one exhaust pit that is partitioned into two parts, each of which has a manhole and a stack. This reduces the cost of excavation.

There is a large variation in the plans of different engine builders as to the necessary exhaust pit volume. Some call for entirely too great an outlay of concrete while others are equally as thrifty in the dimensions given. If the pit is designed on the basis of 1 cubic foot of volume for each horsepower of the engine rating, the pit will be ample in size and the cost reasonable.

The pit should be so located that its top will be a few inches below the ground level. The exhaust stack is best held to the pit by means of a cast-iron flange. If a flange cannot be procured, four lugs riveted on the stack will serve. The stack should have a reinforcing ring both at the top and bottom. It is advisable to have the stack considerably larger than the exhaust piping; for instance, if an exhaust pipe 8 inches in diameter is used, the stack should be at least 12 inches in diameter. Owing to initial cost it is customary to use a sheet-steel stack of from No. 8 to No. 16 gage. Corrosion in the stack is generally severe, and a light gage steel will not last long. The stack ought never be made of less than No. 10, and $\frac{1}{4}$ -inch plate will prove the cheapest in the end. It is good practice to paint the stack each year with an asphaltum stack paint. This will keep down the corrosion and increase the good appearance of the plant. The question as to the length of stack is one that is governed by the location of the plant. A good rule is to always have its top at least 10 feet above any building close by. This serves to carry away all fumes and eliminates the effect of the air waves that so often cause windows, for blocks around, to rattle.

Water Circulating Systems.—Every oil engine demands some form of water circulating system. The particular system most applicable to any plant depends upon many factors. The systems most used may be classified as: Thermo-syphon, Fresh Water, Closed Cooling Tower, and Tank and Tower Systems.

Thermo-syphon System.—The thermo-syphon principle of circulating water is generally adopted on small oil engines of 25 h.p. or less. It consists of one or more galvanized steel

tanks that are connected to the engine water jacket by an inlet and discharge pipe. The water in the cylinder jacket becomes warm, and the weight of the heavier cold water causes it to raise up the pipe *A* and to flow into the cooling tank where its temperature is lowered by radiation and convection; see Fig. 336. The cold water in the bottom of the cooling tank flows through the inlet pipe *B* to displace the warm water. The discharge pipe *A* must be provided with a riser, as shown, in order

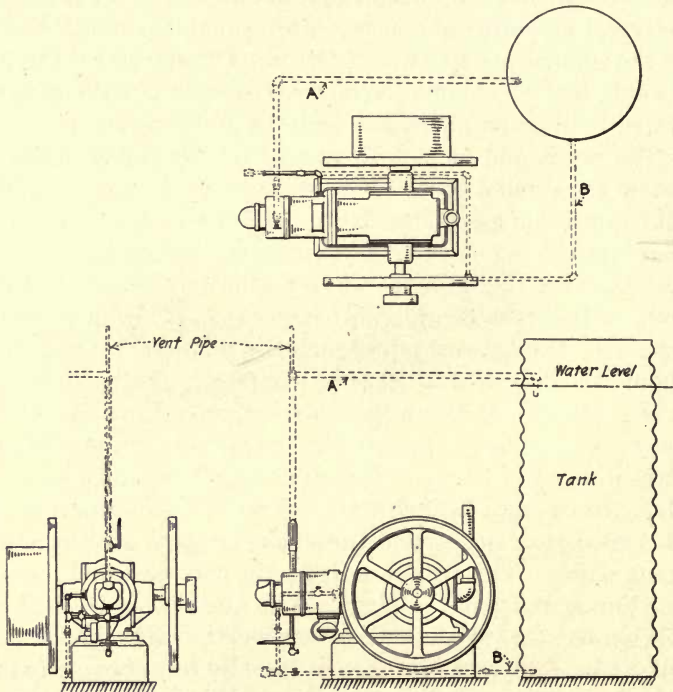

FIG. 336.—Thermosyphon cooling system.

to prevent any air pockets and to allow all accumulations of steam or water vapor to escape. The advantage of this system lies in its simplicity and freedom from trouble. Two precautions must be observed. First, the water level in the cooling tanks should be maintained at least 4 inches above the outlet of the discharge or hot-water pipe. If it falls below this outlet, the circulation will cease. Second, if the locality is subject to cold weather, the jacket should be drained. This calls for a three-way cock in the cold-water connection.

The average purchaser, since he has paid so much for his oil engine, is usually loathe to invest any great amount of money in his steel cooling tanks. The result is a cooling system much too small for the engine's requirements. It is customary to find tanks with a total capacity of around 20 gallons of water per engine horsepower, while the smallest value that should be considered is 50 gallons per engine horse-power. The warm water loses its heat by surface radiation and evaporation; little heat is lost through the tank walls. It then follows that the larger the diameter of the cooling tank the smaller need be the volume of water. This factor often dictates the use of a cypress tank with a 3-foot stave. A tank of this kind costs less than the steel tanks of equal cooling capacity and will last much longer. The cypress tank can be mounted on a platform to bring its top above the engine's water discharge pipe. It can safely be from 5 to 10 feet above the ground level.

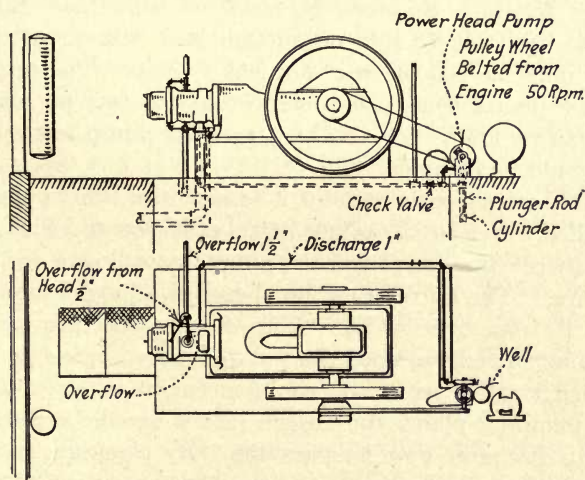

FIG. 337.—Fresh water system.

Fresh-water System.—When water can be secured within 30 or 40 feet of the ground surface, the most economical way to cool the engine is by the fresh-water system. A two-stroke-cycle low-pressure engine loses more heat to the jacket than does the Diesel, and so a greater amount of water must be used. A fair value upon which to estimate the water requirements is 70 lbs. of water per b.h.p. per hour or 1 lb. per b.h.p. per minute. The power required to handle this water from a depth of 30 feet

and through the jacket will not exceed one-half of 1 per cent. of the engine's rating.

If the water is over 16 feet from the surface, some form of power pumping head with an extended pump cylinder should be installed. The pump cylinder is best placed below the surface of the water. This arrangement keeps the pump primed at all times and also prevents the plunger rings from drying out when the engine is idle. The best cylinder is one fitted with brass poppet valves and with the pump plunger of brass with at least four leather rings, while the cylinder itself should be brass, or brass-lined. The working head can be belted and of almost any design. The well is best placed close to the engine in order to allow the pump to be belted direct from the engine shaft. The head need have no idle pulley, for frequently the belt will run on to this pulley and the pump will stop, Fig. 337.

If the water is within 16 feet, a belted horizontal force pump is by far the best that can be used. A centrifugal pump for this work is liable to lose its suction and, when starting, frequently must be primed due to a leaky valve. The centrifugal pump for plants using low-pressure engines has no attraction other than its low price. No matter what pump is used a foot valve should be included.

With this fresh-water system it is essential that a riser pipe be installed with a small tank or barrel at its top and with a check valve between the barrel and the pump, as well as a cock in the engine line. The barrel must be placed at a height sufficient to prevent it from overflowing. This storage will provide water for running the engine until the pump begins to pick up its suction when started up at the commencement of the day's run.

In a pumping plant, the engine jacket can be connected to the pump discharge by a by-pass line. By placing a gate valve in the main pump discharge, between the engine jacket connections, the flow of water through the engine can be adjusted to suit conditions. The amount of water that flows through the jacket is a small percentage of the pump's capacity; consequently the rise in temperature of the water discharge is not noticeable and forms no objection to the use of the water for drinking or general waterworks purposes. If the discharge head on the pump exceeds 75 feet, this method of handling the cooling water is open to objection since too great a pressure is placed on the thin jacket walls with a likelihood of fracturing the jacket. In in-

stallations where the pumping head is great, the proper method is to tap the engine line off the pump discharge with a regulating valve in this line and to allow the water flowing through the jacket to run into the sewer or drainage ditch, or back into the well if water be scarce.

Tank and Tower System.—The ideal method of coping with the circulating water problem, where the water is not heavy with mineral, is by means of the tank and tower plan. In low-pressure engines, since they are usually but moderate in size, the storage tank need not be as large as with a Diesel engine. A tank 6 feet in diameter with a 5 foot stave is ample for a 50 h.p. engine while a 100 h.p. engine should be supplied with an 8×8 ft. tank. The tank should be mounted on a wooden tower at least 20 feet high; the height depends on the surrounding buildings. On top of the tank are placed the cooling screens. The cooling apparatus may be made of wooden slats in the form of a pyramid. Any ordinary mechanic can build this, and it is as efficient as the more expensive designs. Conical sheet pans superimposed on each other, quite like in steam condenser practice, are used in many plants. The objection to this cooling tower is the rapid corrosion of the galvanized sheet-steel pans.

The tank and tower system includes a sump to which the engine discharge water flows. Since a positive supply of water is obtained by the overhead storage, the use of a centrifugal pump to lift the water from the sump to the tower is permissible. This pump can be placed close to the engine and belted direct from the shaft. If the sump can be located so that the water level is within 2 feet of the engine room floor, the pump can be placed in a small pit by the engine and the intake line will then be under a slight head at all times. This eliminates the trouble of losing the pump suction. The pressure line from the tower to the engine should be equipped with a regulating cock, while the tank should have a float with a bell-ringing attachment to guard against the danger of the supply giving out without warning to the operator. In this system the discharge line from the cylinder jacket is usually provided with a funnel so that the flow of water can be in plain view at all times.

The Closed Circulating System.—In this design the water is forced, by a pump, through the engine jacket and out over a cooling tower. From the cooling tower it drops into a sump underneath, from which the pump draws it again. When the

engine is 50 h.p. or less, a tower such as that outlined in Fig. 338 is cheap to build, satisfactory in operation and has a fair life. The cooling water is brought from the engine and discharged at a height sufficient to allow it to flow over the top of the tower. The tower supports a number of $1\frac{1}{2}$ -inch pipes branching from the main 3-inch discharge header, and each branch has a series of $\frac{1}{8}$ -inch holes drilled along its top surface. A rectangular

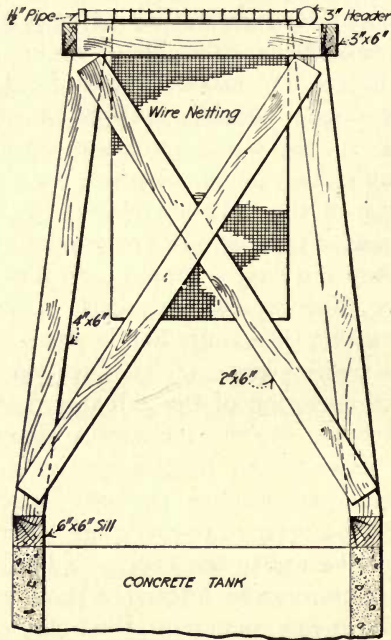

FIG. 338.—Cooling tower for engines under 50 H.P.

sheet of 5-mesh wire netting is suspended from each pipe. The water issues from the holes in the pipes and runs down the vertical netting, being cooled to the temperature of the surrounding air before it strikes the sump. This sump, or storage tank, may be either a concrete pit or a cypress tank above ground. The use of a pit allows the tower to be lower and the engine jacket pressure head less.

Figure 332 outlines a very excellent cooling system. In this design the circulating water pump is of the plunger type and is an integral part of the engine. One very important detail is included—a drain valve on the suction line. In localities where

there is danger of frost, the lines should be drained every cold night. One of the greatest items of expense in engine operation in the Northern climates is the replacement of fractured parts due to freezing. This type of tower is quite suitable for installations of 150 h.p. or less. In the event a plant possesses more than this capacity, the cooling systems discussed in Chapter XIII will be found adaptable for low-pressure engines as well.

Because of the danger resulting from pump failure the overhead tank system is by far the best. In case the first cost is considered too high to permit of its use, and the closed system is adopted, the circulating pump should be driven direct from the engine either by a silent chain or a linkage. In no case is a belted pump good practice where the closed system is used. The plunger type pump is more suitable for a circulating system than is a centrifugal pump even though hundreds of the latter are in such service. The centrifugal pump must be primed on starting. Frequently the suction is temporarily stopped by leaves or the like. If extra care is not exercised, the pump may lose its suction and fail to maintain the flow of cooling water.

In operation it is quite often a question as to the temperature the discharge water should have. It is self-evident that the engine's efficiency will improve with an increase in cooling water temperature. With heavy oils 160° Fahrenheit is not too hot, while with high-gravity distillate or kerosene 125° is as high as can be used successfully.

CHAPTER XXV

AIR STARTING SYSTEMS. OPERATING TROUBLES

Air Starting Systems.—In engines up to 30 h.p. an air starter is not required. It is not difficult to turn these small engines back against the compression in order to start. In the larger engines some form of starter is imperative.

An air starting system consists of an air storage tank, small air compressor, piping and the engine starter-valve mechanism. The capacity of the tank depends on the engine size: a 24×72 in. tank is ample for engines of 60 h.p. or less. For

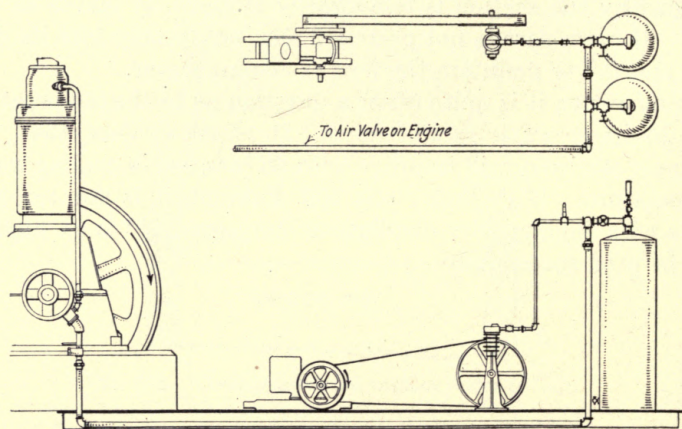

FIG. 339.—Air piping arrangement.

engines from 60 h.p. to 150 h.p. two tanks 24×60 in. should be used. These tanks should be built for 200 pounds working pressure, and the seams are preferably welded. The air piping should be constructed of extra heavy pipe and malleable fittings. The pipe lines should be provided with a drip or drips at the low points, while the tanks should have drip cocks and safety valves.

The types of air compressors used are quite varied as to size and design. Since the air is used but a few minutes daily, the

air compressor can be quite small. A $2 \times 2\frac{1}{2}$ in. compressor is much used in installations below 100 h.p. capacity. For larger installations a 3×3 in. or $3\frac{1}{2} \times 3$ in. compressor is more suitable. If the compressor is air-cooled, the plant piping is greatly simplified, and the compressor operation is just as satisfactory. A motor-driven machine is very attractive, although in the small plants, as a matter of cost, the compressor is best belt-driven from the engine shaft. Where this plan is adopted, a small gasolene engine should be installed to operate the compressor in case the air tanks lose their charge, similar to Fig. 339. In all installations the discharge from the pump should enter the top of the air tank, as should also the line to the engine starting valve. This eliminates the danger of water settling or condensing in the pipe line.

A number of arrangements for starting the engine are employed. The majority of builders furnish some form of quick-opening valve. This valve is manipulated by the operator. The greatest objection to the hand-controlled valve is the difficulty of opening it when the piston is in the proper position. Usually it is necessary to give the engine several air charges as the fuel charge is slow in igniting. The only way to distinguish the proper point for starting the air injection is by means of a mark on the wheel. As the wheel turns over, it is no easy task to jerk open the valve at the precise moment.

Fairbanks-Morse Air Valve.

—The drift of present-day air starting design is to provide some form of mechanical-controlled valve. Figure 340 is the starter used on the Fairbanks-Morse vertical engines. When the engine is in

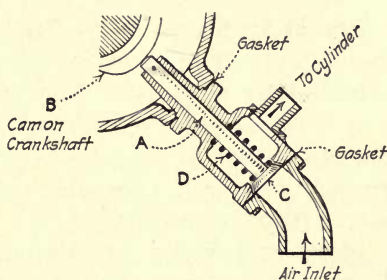

FIG. 340.—Fairbanks-Morse Co. vertical air starting valve.

operation, a globe valve in the air line, not shown, is closed, cutting off the air. This removal of air pressure from the starting valve disk allows the spring to move the valve stem *A* from engagement with the starting cam *B*. In starting the engine the flywheel is barred over until the piston is about 4 inches past top dead-center. The globe valve is opened and the air, blowing past the starting valve *C*, enters the cylinder, causing the piston to move. The

air pressure on the valve disk *C* holds the stem *A* in contact with the cam *B*, and, as soon as the cam nose is passed, the air pressure against the valve disk *C* closes the starting valve. As the engine turns over, the nose again opens the air valve, allowing another charge to blow into the cylinder. This action is repeated until the operator closes the globe valve. Since the starting arrangement is connected to only one cylinder in the multi-cylinder engines, the other cylinder can begin to fire while the starter is still in operation. In the single-cylinder engines, it is always advisable to give the engine at least three charges of air before closing the globe valve. This will give sufficient impetus to the flywheel to enable it to turn over in case the first fuel charge fails to ignite. To prevent the products of combustion from blowing back into the air lines, a check valve is mounted on the cylinder.

Two minor precautions should be observed. The check valve seat must be cleaned and ground occasionally to eliminate all danger of any blowing into the air line. The air-starter spring *D* must have sufficient tension to pull the stem out of contact with the cam. If the spring breaks or if the stem becomes dry and dirty, the end of the stem will continue to touch the cam nose while the engine is running. This will speedily mushroom the ends of the stem.

Primm Air Starter.—The Primm engine employs a very simple mechanism. This consists of a double-seated valve which is actuated by a push-rod. This push-rod is moved, through a bell-crank arrangement, by a cam mounted on the flywheel hub. The operator follows practically the same procedure as with the starter already discussed. The only attention demanded is the grinding of the starter valve.

Mietz and Weiss Air Starter.—On some of the Mietz and Weiss vertical engines the form of starter shown in Fig. 341 is used. The rocking or corliss type of starting valve *A* is actuated by an eccentric on the engine shaft. As indicated in the drawing, it is equipped with a check valve *B*, as well as a disk valve *C*, immediately at the cylinder to shut off the air after the engine is in operation. In starting it is only necessary to bar the engine a few degrees past upper dead-center and open the hand-controlled valve. The starter eccentric will then open and close the rocking air valve at the proper times until the air supply is cut off, and the engine begins firing.

Starting an Engine.—All engines have minor differences in the method of starting. The following is the procedure that applies to practically all of the low-pressure engines.

The engine should first be barred over to its starting position. Usually the flywheel carries a mark to indicate when this position is reached. If not, the engineer can locate the position of the crank by means of the split in the flywheel hub, if it be of this design. After locating the crank position, the wheel should be turned until the crank is about 30 degrees past the rear dead-center.

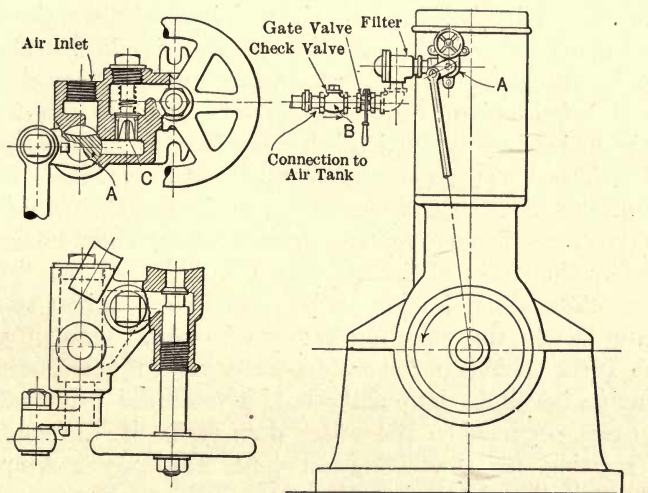

FIG. 341.—Meitz & Weiss air starter.

The indicator or test cock on the engine should be opened. In fact, it is better to open it before turning the engine over since it will relieve the compression. The starting torch is next ignited and the flame directed against the ignition device, whatever design be used—hot ball, hot tube or hot head. While the torch is heating the igniter, the operator should fill up the oil and grease cups.

The fuel should next be admitted into the pump. After the torch has been burning for some minutes, the fuel pump should be operated by hand until the plunger works hard. This shows that the discharge oil line to the nozzle is filled. The pump handle should now be given about three strokes, injecting some of the fuel into the cylinder. If this results in a blue vapor issuing from the test cock, it can be assumed that the igniter is

hot enough. The test cock is now closed, and a final stroke is given to the pump.

The air-starter mechanism is next operated, and the engine is turned over. Ordinarily the engine will not explode on the second revolution, and it is generally advisable to allow at least three air charges to enter the cylinder. The engine should now ignite the fuel. If it fails to do so, the operator should discontinue his efforts to start the engine with the air and should proceed to heat the igniter to a higher temperature. A cold igniter is almost always the cause of a starting failure.

When the engine begins to fire the fuel, in most cases, there is a decided pound or preignition. The operator should restrain the motion of the pump plunger, preventing any great amount of fuel from being ignited. Since the governor is in its lowest position, the fuel charge at starting is heavier than when fully loaded. A few strokes of the piston will allow all the fuel in the cylinder to burn, and the stroke of the pump can be lengthened a little. Until the engine is up to full speed, the engineer should continue to restrain the stroke of the fuel pump.

The cooling water should now be turned on; it is best to open the valve slowly, thus allowing the cylinder head to cool off gradually. If the opening of the cooling-water valve is neglected until the engine becomes thoroughly hot, a fractured head will, in most cases, occur when the water does strike it. Frequently, when starting, the connecting-rod emits a snappy or whip-like sound, while the piston slams if worn at all. This merely indicates that the engine is coming up to speed too rapidly, and the operator should lessen the amount of fuel injected by control of the pump plunger stroke.

As soon as the engine is at normal speed the water injection should be started, provided the engine is of a design using water in the cylinder.

If the engine is belted to its load through a friction clutch or clutch pulley, the clutch should now be thrown in. If the engine is belted or direct-connected to a generator, the line switch should be closed and the voltage on the machine gradually built up. In two-unit plants, where the generators operate in parallel, special care should be exercised in order that the two generator voltages be identical before they are thrown together; this applies to direct-current machines. If the machines are alternating current, it is imperative that they be in phase before

being paralleled. The most feasible arrangement whereby the paralleling can be easily accomplished is the use of a synchronoscope. A plant with a total capacity of 50 kw. should be equipped with this instrument. In the small plants, or in larger ones where it is impossible to purchase the synchronoscope, the pilot lamp device should be used. In no plant should an engineer depend on chance in the matter of paralleling alternators.

Temperature of Cooling Water.—The proper temperature of the jacket-cooling water is a matter that must be determined by experiment on the particular engine used. Engines, even of the same horsepower and same manufacture, show a decided variation in the water temperature most favorable for efficient operation. The characteristics of the fuel oil used have considerable effect. As a general rule, it may be stated that with oils under 32° Baumé gravity the temperature of the discharge cooling water should be maintained around 150° to 160° Fahrenheit. For lighter oils, such as distillates up to 42° Baumé, the temperature should not exceed 140° Fahrenheit, and usually 125° Fahrenheit will prove satisfactory. With the heavier oils it is necessary that the cylinder and head be kept fairly warm in order to thoroughly vaporize the fuel charge.

Lubrication.—As with the cooling-water temperature, the amount of lubricating oil that is required on any engine cannot be stated with any degree of certainty. Much depends on the fuel used, the condition of the engine and the particular design of the unit. Where either splash lubrication or oil cellars are used for the lubrication of the bearings and crank pin, if 600 h.p.-hr. are produced per gallon of lubricating oil the operator can feel that he is securing efficiency in his oiling. It should be understood that usually an engine will require as much lubrication on half as on full load. Consequently, if the engine be at half load, the horsepower per gallon of lubricating oil will be one-half of the above. If kerosene or high-gravity distillate, usually termed "stove oil," be used, the amount of lubrication required for the cylinder is practically doubled.

The following table represents a fair average for an engine of above 40 h.p. per cylinder.

Piston pin	10 drops per min.
Crank pin	30 drops per min.
Cylinder, exhaust side	40 drops per min.
Cylinder, air-port side	50 drops per min.

In engines where the cylinder is oiled at three points, the amount of oil for the three should approximate the total for the two values above. If the piston pin is lubricated by scooping up oil from the cylinder walls, of course the oil to the cylinder must be increased.

Each oil company has a particular oil that usually is suitable for low-pressure engines. It is hardly profitable for an engineer to experiment with the various oils offered, and the most satisfactory oil to purchase is the one recommended by the builder of the engine. All engine builders are much interested in the lubrication problem and are in a position to conduct extensive tests on all the lubricants on the market. They seldom are prejudiced in this matter, and their recommendations can be followed with confidence.

Operation Troubles. Engine Smokes.—At least 50 per cent. of the engines in use show a decided inclination toward a smoky exhaust. Since this symptom of imperfect operation is so apparent, the most inexperienced engineer cannot overlook it. Any one of a number of misadjustments may be the cause of this dark-colored exhaust.

The hot bulb or other ignition device may be too cold, thus failing to vaporize all the oil, which then exhausts while in a liquid or at least a saturated condition. The cold bulb may be due to two causes—the bulb may be too large, thereby exposing too great an exterior surface to the cooling action of the air; or carbon deposits may cause the interior to be closed, shutting off the absorption of heat. If the device be water-cooled, the jacket may be absorbing too much of the heat from the combustion chamber. In those engines using a hot bolt, the bolt may be burned or oxidized to such an extent that there is only a small amount of metal left in the bolt to absorb the heat of combustion. The proper adjustments to relieve these various defects are apparent.

Frequently an over-abundant supply of injection water lowers the temperature of the entire cylinder and ignition device, preventing proper vaporization. The heavier oil particles, even though partially gasified, will then blow out, giving a decidedly dark hue to the exhaust, unless an unusually good exhaust pit is used to trap the free oil particles. This condition is always accompanied by the loss of power in the engine. The water should always be reduced in quantity until the engine begins to

preignite; the water supply should then be increased a slight amount—sufficient to destroy the preignition sound.

On the other hand, too little injection water may produce a smoky exhaust. This applies where a heavy fuel is used. The water injected in the cylinder seems to assist the heavier particles in burning, even though these heavier parts do not vaporize. If the water supply is insufficient, these heavier particles of oil blow out in a liquid state.

If a dirty fuel oil be used, the injection nozzle check valve will probably cut, thereby imperfectly sealing the nozzle. The oil which drips into the cylinder during the latter part of the power stroke does not burn. This, of course, will cause a dark exhaust.

Another very frequent cause of a smoky exhaust lies in the use of entirely too much lubricating oil in the cylinder. If more of this oil is supplied to the cylinder walls than the gas flame will completely burn, the unburned part will settle in the exhaust ports and pipe. The exhaust gases, as they pass through the exhaust line, pick up this oil and blow it out the discharge.

Low-compression pressure is largely responsible for an objectionable color to the exhaust. If the compression leaks past the piston, the pressure and temperature in the cylinder and bulb will not be sufficient to vaporize and ignite the fuel. It follows that at least the heavier fuel particles will blow out the exhaust in an unconsumed state.

Preignitions.—If the ignition device is at too high a temperature, the vaporized fuel will mix with the air charge early in the compression stroke. The natural result of the mixing, already discussed in a previous chapter, is premature combustion before the piston reaches dead-center. Much depends on the character of the oil. If it vaporizes rapidly, the preignitions will continue. If water injection is not used, or if the bulb is not equipped with some form of a cooling jacket, which may be provided with a valve to control the bulb temperature, it is necessary to alter the size of the hot ball. If the bulb be made larger, it will radiate heat faster, thus maintaining itself at a lower temperature. It is a wise precaution for the engineer to keep two or three bulbs or tubes of different sizes on hand so that this change can be made without any delay. Another remedy is the adjustment of the fuel injection timing, making it occur later in the compression stroke.

If the load be around the engine's full rating, and a light fuel

is used, the vaporized charge has too large a volume to be contained in the combustion chamber. Expanding into the cylinder proper, it mixes with the air and ignites. If the fuel is of light gravity, of course it will ignite earlier in the compression stroke. This tendency to preignite at full load is more evident in "dry" engines than in those making use of water injection.

Where the injection nozzle leaks, this oil drip, which does not blow out the exhaust, is trapped in the cylinder. Even though the cylinder temperature is fairly low, the interval of time, during which the piston is compressing the air charge, is ample to allow this fuel to vaporize and ignite very early in the stroke.

If the fuel used possesses a low flash point, as in case of kerosene, the tendency of the oil to ignite prematurely is always present. A more liberal supply of injection water will cool the hot device and cylinder, thereby reducing the preignition.

Strange as it may seem, a cold hot bulb or other ignition device will occasion preignitions as will also a bulb when too hot. If the bulb is cold, the fuel charge will not burn completely. The unconsumed portion blows out the exhaust. Due to imperfect scavenging, some of the fuel remains in the cylinder where it gradually vaporizes and ignites on the succeeding compression stroke. This oil more frequently collects in the exhaust passages where a blast of hot exhaust gases ignites it, producing what is mistakenly termed preignitions, although it is more in the nature of a back-fire.

Excessive use of water injection cools the hot device, causing the same trouble just mentioned.

An incorrect governor adjustment will produce preignitions by injecting too great an amount of oil or by allowing the normal injection to commence too early in the compression stroke. This is more evident when using light fuels.

The major part of the troubles discussed are of interest only to the operator. The plant owner does not display a great amount of concern until the engine begins to lose power and the factory machinery lags in its work. To satisfactorily operate the power plant the engineer must understand those things which cause the engine to lose its power capacity. The causes can be listed briefly as loss of compression; cold hot bulb; too heavy fuel oil; water in the fuel oil; governor or pump out of adjustment; leaky injection nozzle; too much water injection; preignitions; leaking air compressor, whether it be crankcase or rear of cylinder

compression; clogged oil line; and in a four-stroke-cycle engine leaky valves or incorrect valve timing. The engineer can easily understand the particular adjustment necessary in each event. The items that cause the most trouble are loss of compression, water in the oil, leaky injection nozzle and defective pump valves.

Engine Pounds.—To the inexperienced engineer a pound in the engine is a source of worry and bewilderment. Most of the pounding can be attributed to four things—loose crank-pin or piston-pin brasses; worn main bearings; worn pistons; and pre-ignitions.

A worn piston pin or crank pin gives out a dull pound as the piston starts back on the compression stroke, although frequently it shows up as the piston passes the rear dead-center. This sound is different from a preignition and is seldom found on a new engine. The proper remedy is the adjusting of the particular brass that is worn. "Jumping" the piston and connecting-rod will reveal which bearing is at fault.

The wear in the main bearings will sometimes cause a pound as the piston passes dead-center. The shaft always "jumps," and the engineer can readily detect the bearing that is worn.

If the piston is badly worn, it will emit a slapping sound that is quite different from the bearing pounds. As discussed in the chapter on pistons, a new piston, or in all events replacement of the worn rings, is the remedy for this slapping.

The sound of preignitions in the cylinder can hardly be mistaken for anything else. It is usually sharp and clearly defined. Any of a variety of misadjustments will cause preignitions, as already discussed.

The elimination of any of the troubles enumerated, which might be present, along with liberal lubrication of all the engine parts, will result in a smooth-running machine.

Stopping the Engine.—If the engine is a single-cylinder unit, the stroke of the fuel pump should be gradually reduced by means of the handle. If the pump is stopped immediately without this preliminary restraint, the engine will pound badly. If the unit be a multi-cylinder engine, the fuel to all but the starting cylinder should be cut off and the starting engine used to gradually bring the engine to a state of rest.

When the engine has almost come to a standstill, the lubricating oil pump should be given several strokes by hand in order to supply a liberal amount of oil to all the parts. The fuel line

to the pump should be drained, and the engine indicator or test cock opened. If the engine is to be idle for more than a day or two, the oil from the crankcase and main-bearing cellars should be drawn off. The crankcase cover should be opened to allow the engine to cool unless the unit be in a dusty location. The cooling water should be allowed to circulate for at least thirty minutes after the engine is stopped. If there is any danger of frost, the cylinder jacket and water line should be drained.

The operator should carefully examine all the engine bearings, paying particular attention to the crank-pin brasses. Using a small pinch-bar, this brass should be tested for clearance as well as side play. If the brass seems unusually warm, it should be disassembled and the oil grooves cleaned out. Any rough spots in the babbitt should be scraped smooth. If the crankcase is enclosed, it should be drained and the slimy deposit at the bottom mopped out with a handful of waste.

These are the points that should be observed each time the engine is stopped for inspection or for a shut-down. If the shut-down is only for a few hours and is a matter of frequent occurrence, this inspection of the bearings is not necessary. No matter how short is the period of shut-down, the engine should be thoroughly wiped with waste or rags. Nothing is so conducive to a long-lived engine as thorough cleanliness. All the small moving parts, such as make up the fuel pump and governor assembly, must be kept clean.

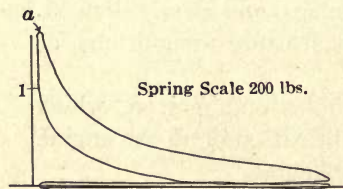

FIG. 342.—De Lavergne type DH 24° crude oil.

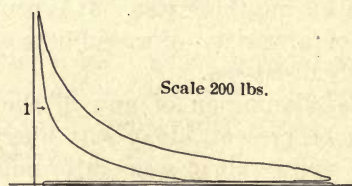

FIG. 343.—De Lavergne type DH 32° Bé fuel oil.

Low-pressure Indicator Cards.—The use of the indicator is not general, even where the units are Diesels. The operator of small low-pressure engines usually does not feel justified in investing in an indicator; where the engine is above 50 h p., this accessory is almost indispensable if economy in operation is to be achieved. By the intelligent use of the indicator an engineer is in the position to know when his engine is not working efficiently.

Frequently, a preignition sound is mistaken for a pound produced by a worn bearing. An indicator card would reveal at once if the fuel was exploding prematurely. Again, the engine may labor and the engineer think the load is excessive, whereas the trouble may be due to late injection or delayed combustion.

The different fuels have marked differences in behavior, as revealed on the card. Figure 342 is a card from a De La Vergne Type D.H. engine using 24° Baumé crude oil. The ignition is a trifle late since the vertical line slopes to the right, showing that the piston had passed dead-center before the fuel ignited. The horizontal hook "a" indicates that, after most of the fuel exploded, there was a percentage of heavier particles that continued the combustion. The compression pressure at the point "1" reached 200 lbs. per sq. inch while the maximum explosive pressure ran above 360 pounds. The fact that the fuel did not ignite just before dead-center can probably be attributed to a cold combustion chamber. With this engine the fuel injection occurs considerably ahead of dead-center, and evidently then the trouble was not delayed injection.

Figure 343 is a card from the same engine while using 32° Baumé fuel oil. The charge exploded about 6 degrees ahead of dead-center, where the compression was around 175 lbs. per sq. inch. The maximum explosive pressure reached 380 pounds. This card is well-nigh ideal for a low-pressure engine. The explosion had better occur a trifle before dead-center than after the piston commences its return stroke.

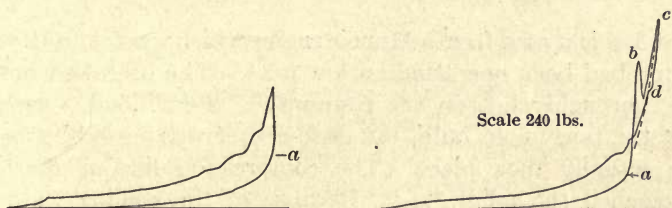

FIG. 344.—Fairbanks-Morse type Y indicator card. FIG. 345.—Fairbanks-Morse oil engine kerosene fuel.

Figure 344 is a card from a 50 h.p. Fairbanks-Morse Type Y engine running at 257 r.p.m. The compression at "a" reaches 160 pounds while the maximum cylinder pressure exceeds 375 pounds. The fuel used was 27° fuel oil, which resulted in a flattening of the explosion peak. The waves in the expansion line are not due to delayed explosion but are caused by the inertia of the indicator

piston and other parts. The combustion was a trifle late, which produced a slight pound in the piston-pin bearing. On investigation the piston-pin bearing was found to be somewhat worn. For an engine operating at a speed of 257 r.p.m. the card is exceedingly satisfactory.

Figure 345 is an example of the freak cards occasionally taken with the indicator. The engine was the same from which Fig. 344 was secured but at a later date. The fuel used was kerosene. The compression reached approximately 100 pounds when the kerosene charge in the combustion chamber fired. Due to the inertia of the indicator piston and levers the pencil point jumped to "b," far beyond the actual cylinder pressure at this position of the piston. The pencil then moved downward toward its true position, but the inertia of the spring forced the pencil to "d," whereupon, being stable now, the point moved up approximately along its true course to the maximum point "c." This erratic behavior of the indicator mechanism completely distorted the card, and the events as outlined on this card are by no means representative of the actual occurrences in the cylinder. The dotted line from "a" to "c" probably is the path the pencil should have taken. Regardless of the action of the indicator, this card shows that if kerosene is to be used in an engine without water injection, either the fuel must be injected practically at dead-center or the compression must be reduced. Due to the design of connecting-rod on this engine, no great alteration in the compression is possible, making it necessary to delay the injection pump action.

Figure 346 is a card from a Muncie engine which was taken after the engine had been operating on low load. The bulb had not become thoroughly hot on the resumption of full load. As a result of the fairly cold bulb, the dead-center was passed before ignition actually took place. The compression line at dead-center reached the point "a." Because of the cooling water absorbing part of the heat of compression, as well as because of leaky piston rings, the compression dropped to "c," practically at dead-center or a few degrees beyond center. The explosion occurred at this point "c," reaching to the point "b" where the piston was fairly well advanced in the power stroke. This condition is very likely to exist in any engine that has been operating at a low load and has a heavy load suddenly thrown onto it.

Figure 347 shows a card from a Mietz and Weiss engine. This

engine carries a much lower compression pressure, about 90 pounds, and the card here shown is a fairly representative one when such pressures are used. The fact that an oil engine does operate satisfactorily with such a low compression pressure proves that the time element, as well as the temperature range, influences the ignition of the fuel charge. In the Mietz and Weiss engine the fuel is injected very early in the compression stroke; this allows ample time for the oil to distil or vaporize at a compar-

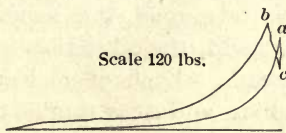

FIG. 346.—Muncie oil engine.

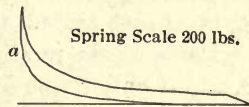

FIG. 347.—M. and W. oil engines.

tively low temperature. The objection to this low pressure is the liability of the fuel not igniting in case there is any leak around the piston, which would produce a reduction of the already low compression pressure.

Figures 348 and 349 are cards taken from the air compressor of the Primm oil engine. The rear of the cylinder was used as the air compressor. Figure 348 was taken from the engine when it was of the three-ported design. In this construction the piston

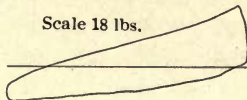

FIG. 348.

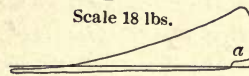

FIG. 349.

uncovered the air-intake port. This card shows that the piston on the power stroke created a suction in the air compartment until about 25 degrees from dead-center. The suction pressure was around 8 pounds absolute or 7 pounds below atmospheric, while the maximum compression reached 8 pounds gage. Figure 349 is from the engine after being equipped with an automatic air-intake valve. It is apparent that the suction pressure is slightly below atmospheric save at the point "a." The cause of this portion of the suction line being above the atmospheric line is doubtless the blowing back of the engine exhaust gases through the air discharge ports. From these cards it would appear that the power requirements of the air compressor on a three-ported engine are

practically twice that demanded by an engine using an automatic air-intake valve.

General.—In the operation of a low-compression oil engine the operator must put aside any and all prejudices he may entertain as to the suitability of an internal-combustion engine. He must bear in mind that thousands are daily producing power at a total overhead cost that makes the oil engine a successful competitor of the Central Station Service. If he is possessed with the belief that he is a “natural-born” engineer and that the oil engine is an open book to him for his own good, this belief had best be thrust aside. On the other hand, the oil engine is not an unanswerable puzzle by any means. Each effect has its cause, and it only requires level-headedness and clear thinking to enable the operator to understand the machine intrusted to him.

CHAPTER XXVI

FUEL. FUEL CONSUMPTION. OPERATION COSTS INSTALLATIONS

Fuel.—A considerable misapprehension exists among operating engineers as to the oils that are suitable as fuel in a low-pressure oil engine. It is unfortunate that many extravagant statements have been made concerning the results obtained with low-gravity oils. An operator should understand that an engine's adaptability to burn the heavy oils is a matter that must be determined by a test on the particular engine in which he is interested. It may be safely stated that an expert can secure satisfactory operation regardless of the character of the fuel, providing the load be maintained at a constant value. The average operator, however, will find that the oils having a gravity lower than 24° Baumé will give trouble. In the oil districts of the Southwest the low-pressure engine is handling pumping plants and is burning the heavy crude oil to the entire satisfaction of all concerned. These engines are operating on a constant load, and the smoky exhaust, that invariably accompanies the use of this heavy oil, is not objectionable in such isolated plants. In most installations, such as a light or an industrial plant, the load is far from being constant. On a varying load the ignition device will not maintain a temperature sufficiently high to burn all the heavy "uncracked" particles of oil. The speed will be erratic, and the performance entirely unsatisfactory. Furthermore, such plants are usually wedged in among other factories or mercantile establishments where the disagreeable features of a smoky exhaust will not be tolerated.

Though the above statements concerning the operation on low-gravity fuels may be accepted as facts, it is not actually the oil's gravity that makes it objectionable, but rather it is its characteristics that determine its usefulness. Regardless of its gravity, an oil must not contain much coke or dirt; neither must it hold any large degree of sulphur or water. Since practically all low-gravity oils do contain a considerable percentage of coke and dirt, the gravity is usually taken as an indication of an oil's suitability. As can be readily seen, the dirt and coke gives off no heat and is

useless in an engine cylinder. Both settle on the combustion chamber walls in a hard, thick scale, which is commonly called carbon. Filling up the hot bulb, it reduces the capacity of the bulb and cuts down the engine's output. Since it absorbs a large amount of heat, it remains incandescent and causes pre-ignition by igniting the fuel charge early in the compression stroke. Frequently, settling on the cylinder walls, it reveals itself in piston cutting and cylinder scoring. The sulphur unites with the water, and the resultant acid corrodes the cylinder. The water must be evaporated and raised to the temperature of the burning fuel charge. This requires heat; thus not only is the temperature of combustion lowered, but heat is abstracted. This results in an impaired efficiency. The water enters the combustion chamber along with the fuel particles; intermingling with the particles of oil, it chills the fuel charge with a consequent delay in the process of vaporization and combustion.

Since these objectionable characteristics are possessed by practically all oils lower than 24° Baumé having an asphaltum base, the average plant will do well to avoid the use of oils heavier than this gravity. As a guide to purchasers of fuel oil for low-pressure engines, the following specifications are worthy of attention.

Specifications. Fuel Oil for Low-pressure Oil Engines.—The oil purchased is to be either crude oil, fuel oil or distillate oil, with a gravity not lower than 24° Baumé, gravity to be tested at a temperature of 60° Fahrenheit. The oil shall not contain more than one-half of one (.5) per cent. of sulphur; not more than eight-tenths of one (.8) per cent. of water; and not to exceed six (6) per cent. of coke or dirt. Flash point below 275° Fahrenheit, open cup, and not lower than 160° Fahrenheit. When subjected to fractional distillation, at least fifty (50) per cent. shall distil over at a temperature below 680° Fahrenheit. The lower heat value shall not be less than 18,000 B.t.u. per pound. For engines above 50 h.p. these specifications will secure a suitable fuel. For smaller powered engines operating less than twelve hours daily, the best fuel is a distillate from 32° Baumé to 38° Baumé. Fuels of this gravity are commonly marketed under refinery trade names, such as, Staroil; B. Solar Oil; Oriental Distillate, etc. These oils usually have a yellow-greenish color, though some approach the color of kerosene. It is the best for medium-powered plants as it is heavy enough to

be used without a great amount of preignition, and yet of high enough gravity to vaporize and ignite at a fairly low bulb temperature.

The very small units, ranging from 10 to 20 h.p., work best on kerosene, around 44° Baumé gravity. These engines are seldom loaded up to full capacity, and so there is little likelihood of serious preignition, which will occur on full load with kerosene. The kerosene vaporizes very readily, and the bulb can run at a low temperature. This is an advantage as the small engines usually are started and stopped several times each day. It might be well to call attention to the trouble that is experienced in large engines pulling heavy loads while using kerosene. Investigations covering over one hundred installations where kerosene had been burned revealed that in every instance severe cylinder cutting occurred. It is impossible to definitely determine why this condition should exist. In a number of engines 36° Baumé distillate had been used with entire satisfaction, but on changing to 44° Baumé kerosene cylinder cutting immediately became apparent.

The various make engines show quite different operating characteristics with oils of practically the same gravity. Table XVI is the result of a series of tests on a 25 h.p. Fairbanks-Morse Type Y engine. This engine has a hot combustion chamber and operates without water injection.

TABLE XVI.—BEHAVIOR OF A LOW-PRESSURE ENGINE ON VARIOUS FUELS
Make of Engine.—Fairbanks-Morse Type Y, 25 H.p.

Fuel	Characteristics	Engine behavior
Texas Crude.....	Asphaltum base; 24° Baumé; .5 per cent. sulphur	Speed slightly below normal. Exhaust smoky.
Texas Fuel Oil...	32° Baumé.....	Speed normal. Exhaust almost clear.
Okla. Distillate...	36° Baumé.....	Speed normal. Exhaust clear. Slight preignition at Full Load.
Kerosene.....	44° Baumé.....	Speed normal. Exhaust clear. Preignition at Full Load.
½ kerosene; ½ gasolene		Speed above normal. Preignition at all loads Above Half Rating; very violent at Full Load. Engine had a tendency to "hunt."

Table XVII covers the behavior of a 50 h.p. Bessemer oil engine using water injection.

TABLE XVII.—BEHAVIOR OF A LOW-PRESSURE OIL ENGINE ON VARIOUS FUELS

Make of Engine.—Bessemer, 50 H.p.

Fuel	Characteristics	Engine behavior
Texas Crude.....	Asphaltum base; 24° Baumé	Speed normal. Exhaust smoky. Water injection reduced from normal.
Texas Fuel Oil...	32° Baumé.....	Speed normal. Exhaust slightly dark.
Kerosene.....	46° Baumé.....	Speed normal. Water injection was increased. Slight preignitions at Full Load. Exhaust clear.
Gasolene.....	62° Baumé.....	Speed a trifle above normal. Water injection increased which killed the preignitions. Exhaust clear.

These tests, while not entirely conclusive, indicate that an oil with a higher gravity can be burned without preignition in a water-injection engine than in a "dry" engine. Due to this comparative absence of preignition in the water-injection engine, there is also less tendency to "hunt." On the heavier oils both engines displayed a smoky exhaust. The exhaust of the water-injection engine always has a dark color accompanied by an oily or tar-like fog, which is, of course, a result of a combination of the steam and heavy hydrocarbons. So objectionable is this oily exhalation that it is never advisable to run a stream of water into the exhaust line, even though this does serve to deaden the noise.

Fuel Storage.—It is seldom profitable to purchase oil in barrel lots when the yearly consumption exceeds 8000 gallons. With an annual demand beyond this figure the difference in the carload and barrel prices will pay for a storage tank. When the yearly requirements are less than two tank cars, the best storage is the vertical corrugated steel tank made of No. 16 gage galvanized sheets. These tanks are not costly and serve their purpose admirably. If leaks develop at the rivets, a little soap will seal the openings until the seam can be soldered when the tank is emptied. There is no danger of an explosion when soldering, for, unlike a gasolene tank, the small amount of vapor fumes

speedily dispel after the tank cover is removed. Red lead is useless as a temporary seal since the oil causes the lead to thin and flow. In the Northern states a cypress storage tank can be employed with success. The cypress tank is lower in price than is the steel one; in the Southern states the oil evaporation from a wood tank is too excessive to justify its utilization. With the larger units, ranging from 50 h.p. upward, the choice of storage lies between the horizontal steel tank, constructed of boiler plate, and the vertical concrete tank. In the majority of installations the steel tank is more advisable since it is difficult to secure the services of a concrete contractor who is able to construct a leak-proof concrete tank.

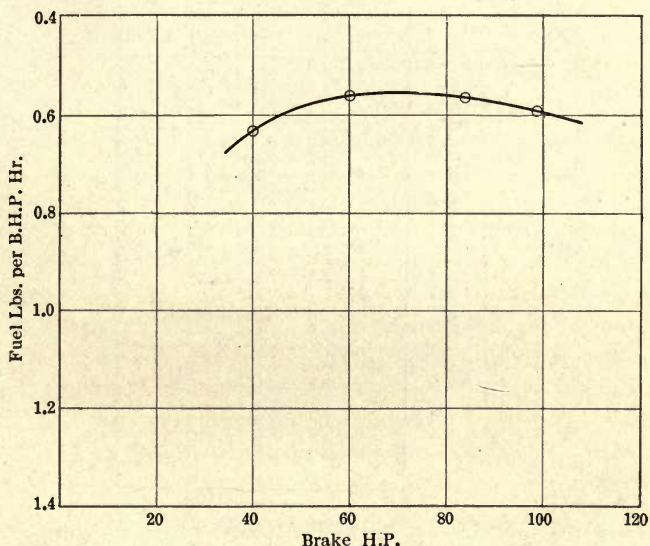

FIG. 350.—Test 16 × 20 — 85 H.P. Bessemer oil engine.

Fuel Consumption.—An average of the guarantees of various builders of low-pressure oil engines gives the following values for fuel consumption:

Full load	Three-quarters load	One-half load
.65 lb.	.68 lb.	1.00 lb.

These figures are based on the use of fuels from 32° to 44° Baumé. On factory tests or on tests conducted by an engineer who is thoroughly conversant with the peculiarities of the engine tested, these values can usually be more than equaled. However,

in actual operation, the engineer cannot hope to better the builder's guarantee; indeed, he is fortunate if he equals it.

Figure 350 is the result of a factory test run on a Bessemer oil engine No. 16668 of 85 h.p. rating. The standard guarantee of this concern is $\frac{7}{10}$ pint or from .6 pound to .7 pound, dependent on the weight of the oil per gallon. The test curve shows the full-load fuel consumption to have been .57 pound, while the half-load value was .63 pound. This half-load fuel consumption is rather remarkable. Ordinarily, the net mechanical efficiency

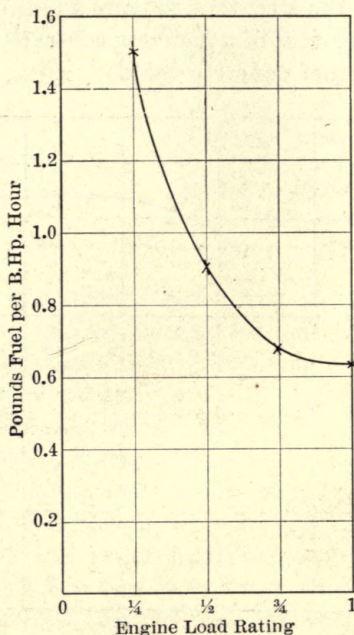

FIG. 351.—Test on 85 H.P. Bessemer oil engine.

of a two-cycle low-pressure engine is around 85 per cent. at full load and approximately 70 per cent. at half load. Naturally it would seem that at half load the fuel consumption must be at least $\frac{85}{70}$ of the full-load result. The half-load efficiency would be still less, due to the lower cylinder temperature. That the fuel consumptions, in this case, are practically identical can evidently be attributed to the higher thermal efficiency at half load; the oil vapor and air mixture was leaner than at full load—it has been proved many times that with a lean mixture the thermal efficiency is higher than with a rich mixture.

Figure 351 shows the results of a test on an 85 h.p. Bessemer engine, installed in a cotton gin and using Texas distillate of 36° Baumé. The full-load value closely approximated the factory test in Fig. 350; the increased fuel consumption at the lower loads is due, no doubt, to misadjustments in the fuel pump and injector nozzle, since the engine had been operated one season by an inexperienced engineer. Even with this handicap the results are surprisingly good.

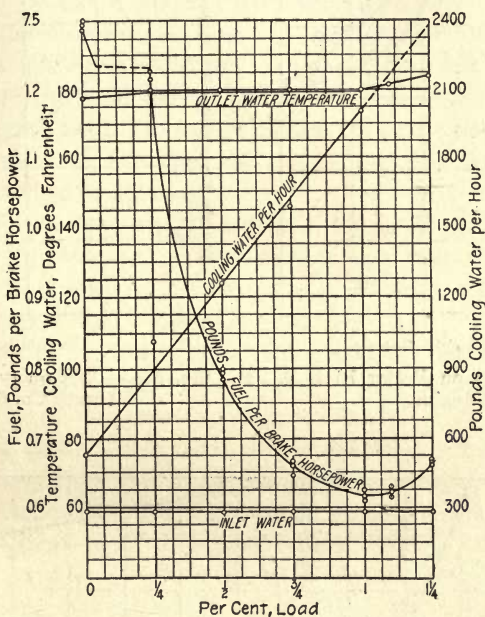

FIG. 352.—Test on 50 H.P. Fairbanks-Morse vertical type Y oil engine.

Figure 352 is a test on a 50 h.p. Fairbanks-Morse vertical Type Y engine. The engine was of the single-cylinder design and was installed in a combination electric light and flour mill plant. After the engine had been in service for some time, the question as to its fuel consumption in actual operation was raised. A test, consisting of three one-hour runs at the various loads, was conducted. The fuel was carefully weighed, while the temperature of the cooling water was maintained as constant as possible by operating the inlet valve; the actual amount of cooling water used was measured by two tanks of known value. The engine carried a 10 per cent. overload with ease, but at 25 per cent. overload

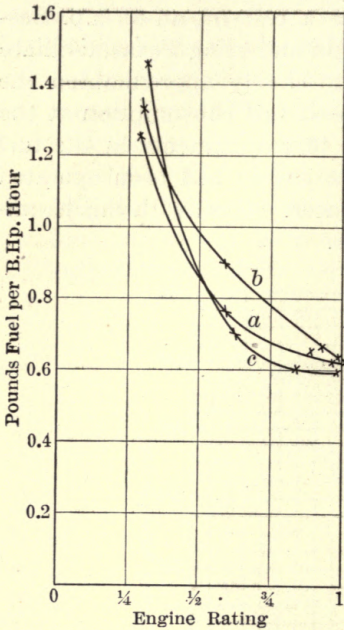

FIG. 353.—Test on Petter 16 H.P. oil engine.

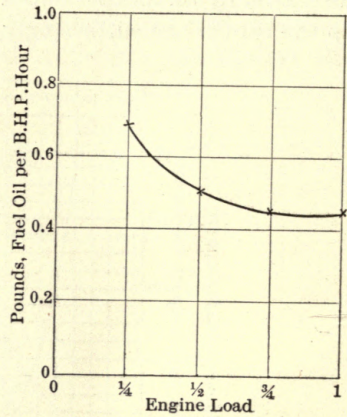

FIG. 354.—Test on type DH De La Vergne Co. 60 HP.

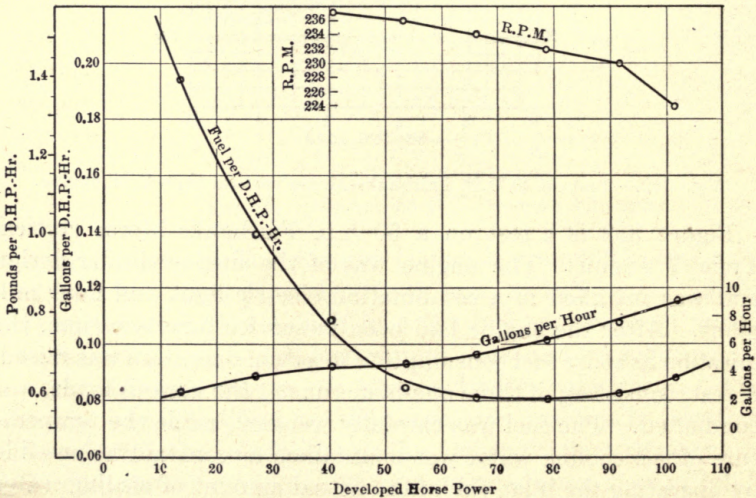

FIG. 355.—Fuel consumption curve Buckeye-Barrett 75 H.P. oil engine.

the exhaust became very smoky, showing that part of the fuel was not being consumed. The engine labored considerably and lost speed slightly. Since no oil engine should be expected to carry more than a 10 per cent. overload, the behavior on the 25 per cent. overload is not open to criticism.

The fuel was a 38° Baumé distillate weighing 6.94 pounds per gallon. The builder's guarantee of fuel consumption at full load was .694 pound. This guarantee was more than fulfilled. The efficiencies at the lower loads were also good.

Figure 353 covers tests on a 16 h.p. Petter oil engine. This engine was built at Yoevil, England, and was imported for experimental purposes by a firm which was entering the low-pressure engine field. Curve *a* covers the test using 26° Baumé Peruvian crude oil; *b* covers 28° fuel oil, while *c* covers the use of 42.5° distillate or stove oil.

Figure 354 covers tests on a 60 h.p. De La Vergne Type D.H. low-pressure oil engine. These were factory tests and are much lower than the company's guarantee. In fact, they approach the performance of the Diesel engine.

Figure 355 is the result of a test on a 75 h.p. Buckeye-Barrett oil engine using Lima Ohio crude. These results are quite representative of low-pressure engine practice.

Operation Costs.—The fuel consumption in actual operation is much greater than the values obtained on a test. In the latter case all conditions are well-nigh perfect, whereas in ordinary operation many things serve to preclude ideal results. The engineer should be guided by his judgment in determining whether he is obtaining fair efficiency, rather than by comparison with factory tests. Even though the efficiency be considerably lower than that reported by the testing engineers, the operator should not feel that the engine is not giving satisfactory service. This, of course, applies only to plants where a reasonable amount of attention is given the various engine parts and necessary adjustments made.

Table XVIII covers a monthly report on a small combined water and light plant. In this plant a 50 h.p. low-pressure oil engine was belted to an alternator and a waterworks pump. Even though the engine was not carrying its rated load, the fuel cost was reasonable. The lubricating oil consumption was somewhat high, but this was evidently due to the lack of a filter. It is in such plants as this one that the low-pressure engine finds

TABLE XVIII.—OPERATION COSTS OF COMBINED WATER AND ELECTRIC LIGHT PLANT

Engine.....	.50 h.p., vertical low-pressure	
Generator.....	30 kv.a. alternator	
Pump.....	6×10 in. duplex power pump	
Total kw.-hr. during month.....		2920
Total hours in operation.....		182
Average kilowatts per hour.....		16.15
Water pumper per month, gallons.....		1,820,000
Pumping head, feet.....		140
Electrical h.p., figuring 90 per cent. generator efficiency.....		4350
Water h.p., assuming 50 per cent. pump efficiency.....		1786
Total brake horsepower.....		6136
Distillate oil used, gallons.....		840
Cost of fuel at 4½ cents per gal.....		\$37.80
Cost of lubricating oil (20 gal. at 35 cents).....		5.00
Waste and incidentals.....		3.55
Engineer's wages per month (one man used).....		70.00
Total operating cost.....		116.35
Total operating cost per h.p.....		0.0189
Gallons of fuel oil per h.p.-hr.....		0.135

its greatest field. Such a plant could not exist if a steam engine were used since the operating expenses would exceed the gross income. In this plant the engineer's wage was not high, but the matter of wages is largely determined by the cost of living in the particular locality. This plant was situated in a small Texas town where living expenses were low; the engineer's salary of \$70 probably was as high as was paid to any workman in the town.

While it is in the smallwater works and electric light plants that these engines are in greatest demand, industrially they are meeting the requirements of low fuel and maintenance charges.

In those larger centers where electric power can be purchased for 3 cents per kw.-hr., it is problematical whether the low-pressure oil engine can be used successfully. In communities where electric power rates range from 5 cents upward and where the power demand is under 100 h.p., the owner of a small manufacturing plant should install some make of the low-pressure oil engine and thereby reduce his factory costs. For example, a small 100-barrel flour mill, if running twenty-four hours daily and producing the rated capacity, will use between 600 and 700 kw.-hr. per day. At the low rate of 5 cents per kw.-hr. the power charges would run from \$30 to \$35

daily. Since it requires approximately 10 h.p.-hr. to produce a barrel of flour, a 50 h.p. oil engine would handle the plant with ease, being able to operate the elevator machinery as well. Such a unit on a load of 40 h.p. would not consume in excess of 100 gallons of distillate oil per day. The fuel would cost less than \$5 per day. On the basis of three hundred working days the net saving, including fuel, lubricating oil, etc., as well

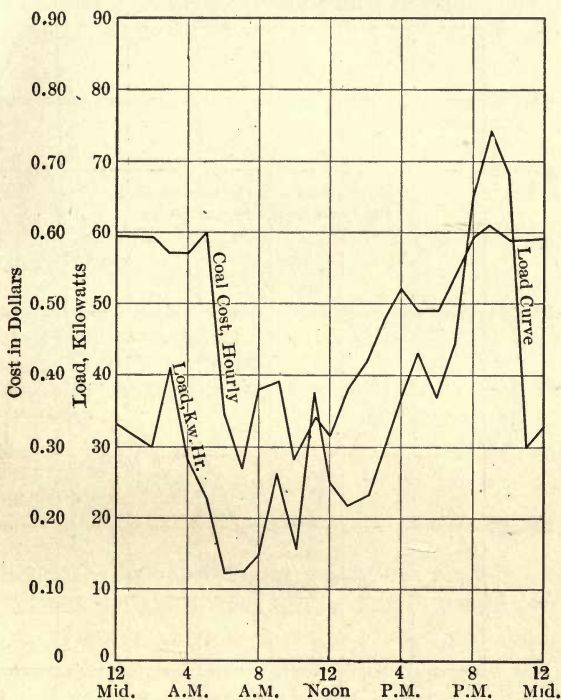

FIG. 356.—Hourly load and fuel cost, steam power.

as the wages of an operator, is more than \$6000 yearly. The only argument against the use of an oil engine in such installations is the poor results obtained from engines erected several years ago. During the last few years the improvements in design have converted this type of engine into a very reliable mechanism. Records of one hundred to one and fifty days of twenty-four hours' service without a single stop are not extraordinary.

The field for this oil engine is not limited to new installations. Indeed, its greatest opportunity lies in those steam power plants where the load is light during the major part of the day. Often

it is possible to install an oil engine to care for the light loads, relying on the steam unit to meet the demands of the peak load which are beyond the capacity of the oil engine. An example of such a combined steam-oil engine plant is the Municipal Power Plant at Pala Alto, California.

The records of a somewhat similar plant, although much smaller, are given below. This plant originally contained a small

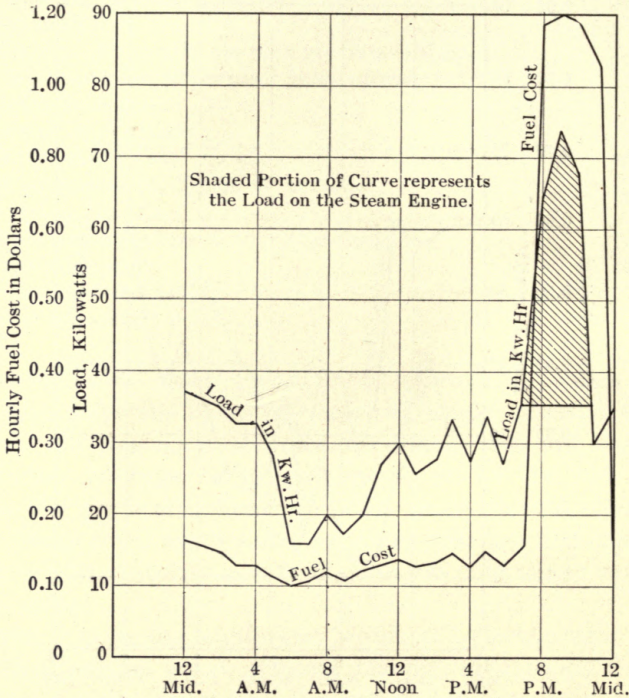

FIG. 357.—Hourly load and fuel costs, using combined oil and steam engine units.

Corliss and a high-speed engine, and two tubular boilers. The output of the plant was used in lighting the municipality and in pumping water.

Figure 356 shows the hourly load carried as well as the fuel costs. This excessive fuel expense was instrumental in the installing of a 60 h.p. low-pressure oil engine which, with the boiler alterations, cost \$4200. In order to even up the load, the hours of pumping were slightly changed.

The plan of operation is to have the oil engine handle the load

from midnight until 7 P. M. the next morning. At that hour the steam boilers, which have partially maintained their pressure all day, are fired up, using fuel oil. The corliss engine then carries that part of the evening peak load which exceeds the capacity of the oil engine. Figure 357 gives the hourly load and hourly fuel costs while operating under this arrangement. The fuel expense during the peak load is high since fuel oil is burned under the boilers. The daily expenditure under the old and the new plan is as follows:

TABLE XIX

	Old steam plant	Steam and oil
Fuel:		
Coal at \$1.80 per ton.....	\$11.60
Oil at \$.03 per gal.....	\$7.25
Labor:		
2 engineers at \$72.00 per month.....	8.80
2 firemen at \$60.00 per month.....		
2 engineers at \$80.00 per month.....	7.33
1 fireman at \$60.00 per month.....		
Total.....	\$20.40	\$14.58
Net saving per day.....	5.82
Net saving per year.....	\$2124.30

Conclusion.—The low-compression oil engine does possess merit. It has a field of usefulness that is gradually increasing in extent. Its competitors are the Diesel and semi-Diesel engines, although the fields of these three types do not overlap to any marked extent. The operating costs just discussed, when taken in conjunction with the Diesel costs in Chapter XVI, afford a means of comparing the values of the two types of oil engines in respect to their efficiency as heat-converters. It must be remembered that operating costs are by no means total costs; consequently in many plants where the Diesel oil engines of low powers are installed, low-compression engines would prove far more economical in respect to total costs per horsepower hour.

INDEX

Diesel Engine Index.....	Pages 461 to 468
Semi-Diesel Engine Index.....	Pages 468 to 469
Low-Compression Engine Index.....	Pages 469 to 472

Diesel Engine Index

A

- Adjustable injection air pressure, 156-157
 - main bearings, 44-45
- Admission valves (see *Valves*), 93-123
- Air,
 - bottles, 206-207
 - compression systems (see *Compressors*), 195-208
 - pipe, 206
 - pressure for injection valves, 207-208
 - regulation, 156-157, 207, 208
- Aligning of bearings, 51
- Allis-Chalmers Diesel, 19
 - admission valves, 112
 - air compressor, 204-205
 - bearings, 48
 - connecting-rod, 58-59
 - cylinder, 85
 - head, 85
 - exhaust valve, 112
 - fuel pump, 171-172
 - governor, 188
 - indicator cards, 273, 274, 275
 - injection valve, 145-147
 - main bearing, 48
 - piston, 69-70
 - valves, admission and exhaust, 112
 - fuel injection, 145-147
- American Diesel, 13-15
 - admission valves, 94
 - bearings, 44
 - connecting-rod, 57-58
 - cylinder, 79
 - head, 79-80
 - exhaust valve, 95
 - fuel consumption, 258-260
 - pump, 159-161
 - governor, 183
 - injection valve, 131-134
 - main bearings, 44
 - piston, 66-67
 - production costs, 263
 - valves, admission and exhaust, 94-96
 - adjustments, 96-97
 - timing, 97-98
 - injection, 131-134

B

- Babbitting a bearing, 52-54
- Barber producer-gas engine, 1
- Bearings, main, 44
 - adjustable, for vertical engine, 44
 - for horizontal engines, 45
 - aligning of, 51
- Allis-Chalmers, 48
- American Diesel, 44
- babbitting of, 52-54
- Busch-Sulzer, 49-50
- clearances of, 55
- De La Vergne, 50
- hot, 54-55
- McEwen, 50
- National Transit, 46
- Snow, 46-47
- two-cycle engine, of, 56
- two-piece, 48-49
- Brayton's constant pressure engine, 5
- Busch-Sulzer Diesel, 15
 - admission valves, 98
 - air compressor, 198-199
 - bearings, main, 49-50
 - connecting-rod, 61
 - cylinder, 82
 - head, 82
 - exhaust valve, 98
 - fuel consumption, 251, 254, 257, 258
 - pump, 161-163
 - governor, 185-186
 - guarantee of fuel consumption, 251
 - injection valve, 134-139
 - adjustments, 136-137
 - servomotor, 137-138
 - piston, 67-68
 - valves, admission and exhaust, 98-101
 - cam levers, 99-137
 - camshaft layout, 100
 - lever roller clearances, 100
 - timing, 99
 - injection, 134-139

C

- Camshafts, 94
- Allis-Chalmers, 112

- Camshafts, American Diesel, Fig. 7, 94
 Busch-Sulzer, 99-100
 De La Vergne, 115
 McEwen, 108
 McIntosh & Seymour, 102
 McIntosh & Seymour Marine, 116
 National Transit, 110-111
 National Transit 1918 Model, 28, 112
 Nelseco Marine, 118-119
 Snow, 28, 106
- Center-line, establishing engine, 33
- Centering engine shaft, 40-41
- Circulating pumps, 57
 water (see *Cooling systems*).
- Clearances, bearing, 55
 crank-pin, 63
 piston, 65
 valve cam, of
 American Diesel, 96
 Busch-Sulzer, 99
 McEwen, 108
 McIntosh & Seymour, 103
 National Transit, 29
 Snow Diesel, 107
- Clerk's two-cycle engine, 5
- Combustion, 232-234
- Compressors, air, 195-208
 built-in, 197-205
 Allis-Chalmers, 204-205
 Busch-Sulzer, 198-199
 McEwen, 202-203
 McIntosh & Seymour, 200-201
 McIntosh & Seymour Marine, 199-200
 National Transit, 203
 Snow, 201-202
 Standard Fuel Oil, 203-204
- independent, 190
 lubrication of, 206
 pressure, 54
 stages, 196
 suction, 206
 valves, 205-206
- Connecting-rods, big-end bearing of, 62-63
 designs, 57
 Allis-Chalmers, 58-59
 American Diesel, 57-58
 Busch-Sulzer, 61
 De La Vergne, 62
 McEwen, 60
 McIntosh & Seymour, 60
 National Transit, 60-61
 Nelseco, 62
 Snow, 59
 pin clearances of, 63
- Constant pressure engine, Brayton's, 5
- Cooling water (see *Cooling systems*), 209-223
 temperature of, 211, 223
- Cooling water systems, 209-223
 bad water in, 220-221
- Cooling water systems, circulating pumps, 220
 sediment in, 221
 tanks and towers for, 214
 towers, cooling, for, 216-220
 types of, 212-214
 closed system, 212
 open system, 213-214
 water pipe for, 214
 required in, 210
- Costs, production,
 Diesel, 260-264
 gas engine, 72
 producer gas, 72
 steam, 74
 turbine, 73
- Crank-pin bearings, 63
 clearances, 63
- Crankshafts, fractured, 56
- Crosshead piston, 65
- Cycle of events, Diesel, 10
 two-cycle Diesel, 13
- Cylinders, 79
 designs of,
 Allis-Chalmers, 85
 American Diesel, 79
 Busch-Sulzer, 82
 De La Vergne, Fig. 15, 83
 Fulton Iron Works, 82-83
 horizontal, 83
 McEwen, Fig. 14
 McIntosh & Seymour, 82-83
 National Transit, 86
 Snow, Fig. 11, 83
 Standard Fuel Oil, 80-81
 erecting of, 39-40
 fractured, 86
 liner replacement, 87-88
 reboring of, 87
 scored, 86-87
- Cylinder head, fractured, 90-91
 joints, 88-89
 repair of, 91-92
 studs, 89-90
- Cylinder heads, designs of,
 Allis-Chalmers, 85
 American Diesel, 79-80
 Busch-Sulzer, 82
 De La Vergne, 83
 horizontal engines, 83
 McEwen, 85
 McIntosh & Seymour, 82-83
 National Transit, 86
 Snow, 83
 Standard Fuel Oil, 81-82

D

- De La Vergne Diesel, 22
 bearings, 50
 connecting-rod, 62

- De La Vergne Diesel, cylinder, Fig. 15, 83
 head, 86
 fuel consumption, 251
 pump, 173
 governor, 46
 guarantees, fuel, 251
 main bearing, 50
 valves, admission and exhaust, 115
 valve timing, 115
- Diesel engine, The, 7-280
- American Manufacturers of,
 Allis-Chalmers Co., 19
 American Diesel Engine Co. (Am.),
 13-15
 Busch-Sulzer Bros. D. E. Co. (type
 B), 15
 De La Vergne Machine Co. (F.D.),
 22
 Fulton Iron Works, 82
 Fulton Machine Co., 31
 Lyons-Atlas Co. (Atlas), 31
 McEwen Bros., 20-21
 McIntosh & Seymour Co., 15-18, 28
 Midwest Engine Co. (Werkspoor), 27
 National Transit P. & M. Co., 20
 New London Ship & Eng. Co.
 (Nelseco), 28
 New York Shipbuilding & Eng. Co.,
 (Werkspoor), 27
 Nobel Bros., 25
 Nordberg Co. (Corels), 31
 Pacific Skandia Co. (Werkspoor), 27
 Snow Pump Works, 18
 Southwark Foundry & Machine Co.,
 22-25
 Standard Fuel Oil Engine Co., 25
 Worthington Pump & Machine Corp.
 (Snow), 18
- cycle of events of, 10
 marine, 9
 McIntosh & Seymour, 28
 Nelseco, 28
 New York Shipbuilding & Eng. Co.,
 28
 Nobel Bros., 25
 Pacific Skandia, 28
 Southwark-Harris, 22-25
 Werkspoor, 26
 schematic layout of, 10
 two-stroke-cycle, 22
 schematic layout of, 13
 Southwark-Harris, 22-24
 Standard Fuel Oil, 25
- Distiller, exhaust, 222-223
- E
- Efficiency of the Diesel (see *Fuel consumption*).
- Engine center line, 33
 cylinder, erection of, 39-40
- Engine erection, 32-43
 establishing center-line of, 33, 40
 foundation, bolts, 35
 excavation for, 32-33
 insufficient, 33-34
 material for, 34-35
- Engine frame, installation of, 37
 leveling of, 38
 template, 34
- Engines, oil,
 Brayton's, 5
 Diesel (see *Diesel engine*).
 Hornsby-Ackroyd, 6
 Low-compression (see *Low-compression section of index*).
 Semi-Diesel (see *Semi-Diesel section of index*).
- Erection of engine, 32-34
- Exhaust distiller, 222-223
 valves (see *Valves*), 93-123
- F
- Foundation, bolts, 35
 excavation for, 32-33
 insufficient, 33-34
 material for, 34-35
 vibration of, 36-37
- Fractured crankshaft, 56
 cylinders, 86
- Frame, installation of engine, 37-38
 leveling of, 38
- Fuel consumption, guarantees,
 Busch-Sulzer, 251
 De La Vergne, 251
 Fulton Machine Co., 251
 Körting, 251
 McEwen, 251
 McIntosh & Seymour, 251
 McIntosh & Seymour Marine, 251
 National Transit, 251
 Nelseco, 251
 Snow, 251
 Standard Fuel Oil, 251
- operating results, 257-260
 American Diesel, 258, 259-260
 Busch-Sulzer, 258
- tests,
 American Diesel, 263
 Busch-Sulzer, 255
 Körting, 254
 McEwen, 252
 McIntosh & Seymour, 255-257, 259-260
 Snow, 252
 Standard Fuel Oil, 253
- Fuel injection valves (see *Injection valves*.)
- Fuel oil, 234-250
 acid in, 244
 ash, percentage in, 244
 burning point of, 242

Fuel oil, classification of, 234-238
 flash point of, 241
 gravity of, 239
 heat value, 239
 production of, 235, Table IV
 specification, 238
 sulphur per cent. in, 242
 tanks for, 246-248
 viscosity of, 244
 water in, 243-244

Fuel pumps, 159-180
 Allis-Chalmers, 171-172
 American Diesel, 159-161
 Busch-Sulzer, 161-163
 De La Vergne, 173
 McEwen, 168-170
 McIntosh & Seymour, 164-166
 McIntosh & Seymour Marine, 166-168
 National Transit, 175-176
 National Transit 1918 Model, 176-178
 Nelseco, 173-175
 Snow, 170-171
 Standard Fuel Oil, 178-179
 Fulton Iron Works Diesel, 83
 Fulton Machine Co. Diesel, 28, 154, 251

G

Gas engines, early,
 Barber, 1
 Beau de Rochas, 1
 Brayton's, 5
 Clerk's, 5
 Huyghens, 1
 Lenoir, 2
 Otto, 2
 Otto Silent, 3
 production costs, 264
 Gear lubrication, 194
 Gears, governor shaft (see *Governors*).
 Governor shaft gears, 192, 194
 springs, 193-194
 Governors, 181-194
 Allis-Chalmers, 188
 American Diesel, 183
 Busch-Sulzer, 185-186
 Jahns System, 183-186
 McEwen, 186-188
 McIntosh & Seymour, 189-193
 National Transit, 186
 Nelseco, 173
 Snow, 186
 Standard Fuel Oil, 188
 Gravity of fuel oil, 65
 Guarantees of fuel consumption, 251
 (see *Fuel consumption, guarantees*).

H

Heads, cylinder, designs of,
 Allis-Chalmers, 85

Heads, cylinder, American Diesel, 79
 Busch-Sulzer, 82
 De La Vergne, 83
 horizontal Diesel, 83
 McEwen, 84, 85
 McIntosh & Seymour, 83
 National Transit, 86
 Snow, 83
 Standard Fuel Oil, 81
 fractured, 90
 joints, 88-89
 repair of, 91-92
 studs, 89-90
 Heat balances, comparative, 270, 271
 losses, distribution of, 209
 Hornsby-Ackroyd Oil engine, 6
 Huyghens engine, 1

I

Indicator cards, 270-278
 distorted, 278
 faulty, 274-278
 rigging, 279
 typical,
 Allis-Chalmers, 273, 274, 275
 McEwen, 273
 National Transit, 273, 275
 Standard Fuel Oil, 274, 276
 Injection action, 127
 Injection fuel valves,
 adjustments,
 adjustable air pressure, 156, 199
 air pressure, 207
 clogged nozzle tips, 156
 leaky valves, 155-156
 lubrication, 155
 needle valve, 154-155
 regrinding, 154
 timing, 156, 158
 adjustable, 157
 incorrect, 158
 classification, 129
 closed nozzle, 130-131
 open nozzle, 129
 designs of, 127
 Allis-Chalmers, 145-149
 American Diesel, 131-134
 Busch-Sulzer, 134-139
 Fulton Machine Co., 154
 Körting, 144-145
 McEwen, 145-146
 McIntosh & Seymour, 139-142
 McIntosh & Seymour Marine, 142
 National Transit, 149-150
 Nelseco, 154
 Snow, 142-144
 Standard Fuel Oil, 150-153
 Injection fuel valve of original Diesel, 127
 Injection fuel valves for tar oil, 154
 Installation, 32-48
 aligning of bearings, 40

- Installation, cylinder erection, 39-40
 engine frame, 37-38
 engine template, 34
 establishing center line, 33
 excavation, 32-33
 foundation, 34-35
 foundation bolts, 35
 leveling of frame, 38
 plant building, 43
 shaft, centering of, 40-43
 vibration, 36
- J
- Jahns governors, 183-186
 Joints, cylinder and head, 88
- K
- Körting Diesel fuel consumption, 251, 254
 Körting fuel injection valve, 144
- L
- Lenoir gas engine, 2
 Liner replacement cylinder, 87-88
 Logs, plant, 268-269, 270
 Lubrication, 224-231
 amount of, 231
 of compressor, 206
 of gears, 194
 oil requirements, 229
 oil specifications, 230
 Lubrication systems, 224-229
 pressure feed, 227-228
 splash, 228-229
 stream, 226
 Lyons-Atlas (Midwest) Diesel, 31
- M
- Marine Diesels,
 Fulton Machine Co., 31
 McIntosh & Seymour, 28
 Midwest Engine Co., 27 (see *Diesels, Werkspoor*).
 Nelseco, 28 (see *Diesels, New London Ship. & Eng. Co.*).
 New York Shipbuilding Co., 27 (see *Diesels, Werkspoor*).
 Nobel Bros., 25
 Pacific Skandia, 27
 Southwark-Harris, 22-25
 Werkspoor, 26-27
 Material, foundation, 34-35
 McEwen Diesel, 20-21
 admission valves, 107-108
 air compressor, 202-203
 bearings, main, 50
 connecting-rod, 60
 cylinder, Fig. 4
 head, 85
 ,McEwen Diesel, exhaust valves, 107-108
 fuel consumption, 251, 253, 259-260
 pump, 168-170
 guarantees, 251
 governor, 186-188
 indicator cards, 273
 injection valve, 145-146
 piston, 70
 valves, admission and exhaust, 107-108
 camshaft, 108
 cam clearances, 108
 timing, 109
 injection, 145-146
 timing, 109
 McIntosh & Seymour Diesel, 15-18
 admission valves, 101
 air compressor, 200-201
 connecting-rod, 60
 cylinder, 82-83
 head, 83
 exhaust valve, 101
 efficiency, 255-256
 fuel consumption, 251
 pump, 164-166
 governor, 189-193
 guarantee, fuel, 251
 injection valve, 139-142
 piston, 68-69
 production costs, 263
 valves, admission and exhaust, 101-104
 cam clearance, 103
 camshaft, 102
 timing, 103
 injection, 139-142
 timing, 103
 McIntosh & Seymour Marine Diesel, 28-29
 admission valves, 115
 air compressor, 199-200
 exhaust valve, 115
 efficiency, 251
 fuel consumption, 251
 pump, 166-168
 guarantee, fuel, 251
 injection valve, 139-142
 valves, admission and exhaust, 115-118
 camshaft, 116
 operating gear, 116-118
 reversing gear, 116-118
 rocker arms, 115
 injection, 139-142
 Midwest Diesel, 27
- N
- National Transit Diesel, 20
 admission valves, 108-110, 112
 air compressor, 203
 bearings, 46
 connecting-rod, 60
 cylinder, 86
 head, 86

- National Transit Diesel, exhaust valve,
108-112
efficiency, 251
fuel consumption, 251
pump, 175-176
pump, 1918 Model, 176-178
guarantee, fuel, 251
governor, 186
indicator cards, 273, 275
injection valve, 149-150
valves, admission and exhaust, 108-112
camshaft, 110, 112
cam clearance, 110
timing, 110
injection, 149-150
timing, 110
- Nelseco (New London Ship. & Eng. Co.), 28
admission valves, 118
connecting-rod, 62
exhaust valve, 118
fuel consumption, 251
pump, 173-175
guarantee, fuel, 251
reversing gear, 118-119
valves, admission and exhaust, 118-119
gear for reversing, 118-119
- Nordberg Diesel (Carels), 8
- Nobel Bros. Diesel, Marine, 25
- O
- Oil engines,
Brayton's, 2
Diesel (see *Diesel*), 7-280
Hornsby-Ackroyd, 3
(see also *Low-compression engine*).
Low-compression, 306-459
(see *Low-compression index*).
Semi-Diesel (see *Semi-Diesel index*),
281-305
Surface Ignition, 306-459
(see *Low-compression index*).
- Oil, fuel, 234-250
acid in, 244
ash percentage, 244
burning point of, 242
classification of, 234-238
flash point of, 241
gravity of, 235
heat value, 239
production of, 235, Table IV
residue in, 240
specification, 238
sulphur, percentage of, 242
viscosity of, 244
water in, 243-244
- Oil tanks, 244-248
engine, 244-246
storage, 246-248
- Oil, tar, 248
injection valves for, 154, 155, 249
- Oil, method of burning, 248-250
Otto gas engine, 2
Otto's Silent engine, 3
- P
- Pipe, air, 206
water, 214
- Piston clearances, 65
head fracture, 75-76
pin bosses, worn, 78
pins, emergency, 78
grinding, 77-78
rings, 74-75, 77
- Pistons, designs of, 64-72
Allis-Chalmers, 69-70
American Diesel, 66-67
Busch-Sulzer, 67-68
Fulton Machine Co., Fig. 22
Lyons-Atlas, Fig. 23
McEwen, 70
McIntosh & Seymour, 68-69
National Transit, Fig. 73
Nelseco, Fig. 103
Snow, 70
Southwark-Harris, Fig. 16
Standard Fuel Oil, 70-72
distorted, 67
seized, 72-74
types,
crosshead, 65-66
trunk, 65
water-cooled, 68
wear of, 74
- Plant buildings, 43
logs, 268-269, 270
- Producer gas engine,
Barber's, 1
fuel consumption, 265-266
production costs, 265
- Production costs, Diesel, 260-264, 265
gas engine, 264
producer gas engine, 264-266
steam vs. Diesel, 267
turbine, 267
- Pumps, fuel (see *Fuel pumps*).
circulating, 220
- R
- Rigging, indicator, 279
- Rings, piston, 74-75, 77
- S
- Schematic layout of Diesel, 10
- Scored shafts, 55-56
- Servomotor, 137-138
- Shafts, centering of, 40-43
fractured, 56
scored, 55-56

- Snow Diesel, 18-19
 admission valves, 105-107
 air compressor, 201-202
 bearings, main, 46-47
 connecting-rod, 59
 cylinder, Fig. 11, 83
 head, 83
 exhaust valve, 105-107
 fuel consumption, 251
 injection valve, 142-144
 pump, 170-171
 guarantees, fuel, 251
 governor, 185-186
 injection valve, 142-144
 piston, 70
 valves, admission and exhaust, 105-107
 camshaft, 106
 cam clearances, 107
 timing, 107
 injection, 142-144
 timing, 107
- Southwark-Harris two-cycle Diesel, 22-25
 Standard Fuel Oil two-cycle Diesel, 25
 air compressor, 203-204
 ports, 113-114
 connecting-rod, Fig. 63
 cylinder, 80-81
 head, 81-82
 exhaust ports, 113-114
 fuel consumption, 251, 252
 pump, 178-179
 guarantee, fuel, 251
 governor, 188
 indicator cards, 274, 276
 injection valve, 150-153
 piston, power, 70-72
 scavenging, 72, Fig. 63
 ports, air, 113-114
 exhaust, 113-114
 valves, injection, 150-153
 timing, 114
- Stud nuts, cylinder, drawing up, 89
 System, Jahns, governor, 183-186
 lubrication (see *Lubricating system*),
 224-229
- Systems, cooling water (see *Cooling water systems*), 209-223
- T
- Tanks, oil, 244-248
 water, 214
- Tar oils, 154, 248-250
 injection valves for, 154, 249
 method of burning, 248-250
- Temperature of cooling water, 211
 Template, foundation, 34
 Timing valve, Diesel,
 American Diesel, 97
 Busch-Sulzer, 99
- Timing valve, De La Vergne, 115
 McEwen, 109
 McIntosh & Seymour, 103
 National Transit, 110
 Snow, 107
 Standard Fuel Oil, 114
 method of, 123-124
- Towers, cooling, 216-220
- Two-stroke-cycle Diesel, 22
 bearings, 56
 cycle of events, 13
 diagram of, 13
 engine, Clerk's, 5
 indicator cards from, 276
 Southwark-Harris, 22-25
 Standard Fuel Oil, 25
- V
- Valve cages, 119
 Valve, fuel pump (see *Fuel pumps*), 159-180
- Valve reamer, 121
 Valve seats, corrosion of, 120-121
- Valves, adjustments,
 cleaning of, 121
 corrosion, 121
 grinding of, 121-122
 leaks, 126
 timing, 123-124
- Valves, admission and exhaust, 93-123
 Allis-Chalmers, 112
 American Diesel, 94
 Busch-Sulzer, 98
 De La Vergne, 115
 Fulton Machine Co., Fig. 22
 Lyons-Atlas, Fig. 23
 McEwen, 107-108
 McIntosh & Seymour, 101-104
 McIntosh & Seymour Marine, 116-118
 National Transit, 108-112
 National Transit 1918 Model, 111-112
 Nelseco, 118-119
 Snow, 105-107
 Standard Fuel Oil, 113-114
- Valves, compressor, 205-206
- Valves, fuel injection, classification,
 closed type, 130-131
 open type, 129
- Valves, fuel injection, designs,
 Allis-Chalmers, 147-148
 American Diesel, 131-134
 Busch-Sulzer, 134-139
 Fulton Machine Co., 154
 Körting, 412-414
 McEwen, 145-146
 McIntosh & Seymour, 139-142
 McIntosh & Seymour, Marine, 142
 National Transit, 149-150

- Valves, fuel injection, designs, Nelseco, 154
 Original Diesel, 127
 Snow, 142-144
 Standard Fuel Oil, 150-153
- Valves, water-cooled, 119-120
- Vibration of foundation, 36
- W
- Water, bad, 58
 cooling, amount required, 55
- Water-cooled valves, 119-120
- Water cooling systems (see *Cooling water systems*), 209-223
- Water, temperature of cooling, 211,
 Table I
- Werkspoor Marine Diesel, 26-28
- Working cycle diagram of Diesel, 10-11
- Worthington Pump & Mach. Corp. (see *Snow Diesel*), 18-19

Semi-Diesel Engine Index

- | A | F |
|----------------------------------------------------------------------------------------------------------------------------------------------------------------------------------------------------------------------------------------------------------------------------------------------------------------------------------------------------------------------------------------------------------------------------------------------------------------------------------------------------------------------------------------------------------------------------------------------------------------------------------------------------------------------------------------------------------------------------------------------------------------------------------------------------------------------------------------------------------------------------------------------------------------------------------------------------------------------------------------------------------------------------------------------------------------------------------------------------------------------------------------------------------------------------------------------------------------------------------------------------------------------------------------------|------------------------------------------------------------------------------------------------------------------------------------------------------------------------------------------------------------------------------------------------------------------------------------------------------------------------------------------------------------------------------------------------------------------------------------------------------------------------------------------------------------------------------------------------------------------------------------------------------------------------------------------------------------------------------------------------------------------------------------------------------------------------------------------------------------------------------------------------------------------------------------------------------------------------------------------------------------------------------------------------------------------------------------------------------------------------------------------------------------------------------------------------------------------------------------------------------------------------------|
| <p>Air compressor,
 De La Vergne Type F. D., 296
 Nordberg, 293</p> <p style="text-align: center;">B</p> <p>Brons (or Hvid) ignition, 282-288
 Burnoil engine, 287
 Lyons-Atlas V. D. H., 284-288
 Midwest V. D. H., 284-288
 St. Mary's engine, 282-284</p> <p style="text-align: center;">C</p> <p>Compression pressure of Semi-Diesel engine,
 280, 283, 298, 301</p> <p>Cup ignition (also Hvid),
 Burnoil Semi-Diesel, 287
 Midwest V. D. H., 284-288
 Müller, 294-296
 Nordberg, 284-293</p> <p style="text-align: center;">D</p> <p>De La Vergne Type F. D. Semi-Diesel
 engine, 296-300
 fuel consumption, 299
 fuel pump, 299
 fuel specification, 299
 ignition device, 296-298
 indicator cards, 281, 298
 valve timing, 300</p> <p style="text-align: center;">E</p> <p>Engines, Semi-Diesel,
 Burnoil, 287
 De La Vergne Type F. H., 296-300
 Midwest V. D. H., 287
 Nordberg, 288-294
 Price, 301-305
 St. Mary's, 282-284</p> | <p>Fuel consumption,
 De La Vergne Type F. H., 299
 Midwest V. D. H., 287
 Price, 304</p> <p>Fuel pumps,
 De La Vergne Type F. H., 299
 Lyons-Atlas, 287
 Midwest V. D. H., 287
 Nordberg, 290</p> <p style="text-align: center;">G</p> <p>Governors,
 De La Vergne Type F. H., 300
 Midwest V. D. H., 286-287
 Nordberg, 290-293</p> <p style="text-align: center;">H</p> <p>Hvid ignition device,
 Burnoil engine, 287
 Midwest V. D. H., engine, 284-288
 St. Mary's engine, 282-284</p> <p style="text-align: center;">I</p> <p>Ignition devices,
 Brons (or Hvid), 282-288
 Burnoil, 287
 De La Vergne Type F. H., 296-298
 Midwest, 284-288
 Müller, 294-296
 Nordberg, 288-290
 Price, 301-305</p> <p style="text-align: center;">L</p> <p>Lyons-Atlas (Midwest) Semi-Diesel, 284-288</p> <p style="text-align: center;">M</p> <p>Mean effective pressure,
 Midwest V. D. H., 287
 Price, 305</p> |

- Midwest V. D. H. Semi-Diesel engine, 284-288
- Müller ignition device, 294-296
- N
- Nordberg Semi-Diesel, 288-293
 frame, 293
 fuel pump, 290
 governor, 290-293
 ignition device, 288-290
 injection timing, 293
- P
- Price ignition system, 301-305
 atomizer, 301
 fuel consumption, 304
 indicator card, 304
 test by U. S. Navy, 305
- S
- Semi-Diesel engine, 281-305
 Burnoil, 287
- Semi-Diesel engine, De La Vergne, 296-300
 Midwest, 284-287
 Nordberg, 288-294
 Price, 301-305
 St. Mary's, 282-284
- T
- Two-stroke-cycle Semi-Diesel engines,
 indicator card of, 281
 Nordberg engine, 288-294
- V
- Valve timing,
 De La Vergne Type F. H., 300
 Nordberg, 293
- W
- Water injection,
 Nordberg engine, 294

Low-Compression Engine Index

- A
- Air seal for crankshaft, 354-357
 emergency, 355-356
 Fairbanks-Morse, 355
 Mietz & Weiss, 355, Fig. 280
 open frame engines, on, 356-357
- Air starting systems, 432-434
 Fairbanks-Morse, 433-434
 Mietz & Weiss, 434
 Primm, 434
- Air-suction valves, 351-354
 Bessemer, 353-354
 Fairbanks-Morse, 351-352
 Mietz & Weiss, 352-353
 Muncie, 352
- B
- Babbitting crank-pin bearing, 343-344
- Bearings, main, 357-361, Figs. 282-285
- Bessemer oil engine,
 air-suction valve, 353-354
 behavior on various fuels, 450
 connecting-rod, 340, Fig. 265
 frame, 348
 fuel consumption, 452-453
 injection nozzle, 408
 pump, 393-397
 fuel injection pump, 393-397
 governor, 392-397
 ignition device, 321
 piston, Fig. 340.
 water injection system, 418-419
- Bolinder oil engine,
 cylinder, 326
 ignition device, 318
- Brasses, connecting-rod, 342
- Bridges, exhaust, 338
- Buckeye-Barrett oil engine,
 fuel consumption, 454
 fuel injection nozzle, 406-407
 fuel injection pump, 402
 governor, 402
 ignition device, 320-321
 piston, 333
- C
- Chicago Pneumatic Tool Co., Giant oil
 engine,
 frame, Fig. 252
 fuel injection pump, 390
 governor, 389-390
 ignition device, 314-316
 injection nozzle, 403-404
 water injection system, 418
- Clearances, crank-pin, 344
 piston, 334-335
 pins, 339
- Combustion, theory of, 307-309
- Compression pressure of low-compression
 engines, 306-307
- Connecting-rod, adjustments, 341-342
 babbitting brass, 343-344
 brasses, 342-343

- Connecting-rods, designs,
 Bessemer, 340, Fig. 265
 Buckeye-Barrett, 340, Fig. 266
 De La Vergne, 341, Fig. 261
 Fairbanks-Morse, Type Y, 341, Fig. 269
 Muncie, 340-341, Fig. 268
 Primm, 340
- Constant injection angle governors, 390-392
- Costs, operation, 455-459
- Crank-pin clearances, 344
 lubrication, 344-346
 babbitting bearing of, 343-344
- Crankshaft, 361-362
- Crosshead piston design, 349-350
- Cylinder design, 324-332
 four-stroke-cycle engine, 325
 thickness of walls, 326
 two-stroke-cycle engine, 324-327
- Cylinder, fractured, 329-331
 reboring of, 327-328
 wear of, 328-329, 413
- Cylinder-head packing, 331
- D
- De La Vergne D.H. low-pressure oil engine, 307
 bearings, main, Fig. 282
 connecting-rod, 341, Fig. 261
 cylinder, 325
 fuel consumption, 454
 injection pump, 400-401
 governor, 400-401
 ignition device, 321-322
 piston, 333, Fig. 261
 -pin lubrication, 345, Fig. 261
- Design of ignition device, 306-323
- Distributor for Mietz & Weiss fuel pump, 385-387
- E
- Engine pounds, 441
 smokes, 438-439
- Exhaust bridges, distorted, 338
 pipe, 420-422
 pits, 422-425
- F
- Fairbanks-Morse Horizontal Type Y engine,
 air seal for crankshaft, 355
 -suction valve, 351-352
 behavior on various fuels, 449
 frame, 348
 fuel injection nozzles, 405-406
 pump, 374-376
 governor, 372-374
 ignition device, 316-318
 piston, 333, Fig. 260
 pin lubrication, 344-345
- Fairbanks-Morse Vertical Type Y oil engine,
 air seal for crankshaft, 355
 -starting system, 432-434
 -suction valve, 351-352
 connecting-rod, 341, Fig. 269
 cylinder, 326
 fuel consumption, 454
 injection pump, 377-381
 governor, 377-380
 ignition device, 318-320
- Flywheels, 362-364
 puller, 363-364, Figs. 286-287
- Fractured cylinders, 329-331
- Frames, 347-351
 inclosed type, 347-348
 Bessemer, 348
 Fairbanks-Morse, 348, Fig. 253
 Mietz & Weiss, 348
 Muncie, Fig. 251
 open type, 348-351
 Buckeye-Barrett, 349
 De La Vergne, 348
 Giant, Fig. 252
- Fuel, 447-455
 behavior of engines on various fuels, 449-450
 specifications, 448
 storage of, 450-451
- Fuel consumption, 451-455
 Bessemer, 452-453
 Buckeye-Barrett, 454
 De La Vergne, 454
 Fairbanks-Morse, 453
 Petter, 454
 usual guarantees, 451
- Fuel injection nozzles, 403-410
 care of, 409-410
 designs,
 Bessemer, 408
 Buckeye-Barrett, 406-407
 Fairbanks-Morse, 405-406
 Giant (Chicago Pneumatic Tool Co.), 403-405
 Mietz & Weiss, 408-409
 Muncie, 404-405
 Primm, 407-408
- Fuel injection pumps,
 Bessemer, 393-397
 Buckeye-Barrett, 402
 De La Vergne, 400-401
 Fairbanks-Morse [Horizontal Type Y, 374-376
 Fairbanks-Morse [Vertical [Type Y, 377-381
 Giant (Chicago Pneumatic Tool Co.), 390
 Mietz & Weiss Horizontal, 381-382
 Mietz & Weiss Vertical, 384-385
 distributor for, 385-387
 Muncie, 369-371
 Muncie large engines, 371
- Fuel injection pump regulators, 387-389

G

- Governors, 365-402
 constant injection angle, 390-392
 designs of,
 Bessemer, 392-397
 Buckeye-Barrett, 402
 De La Vergne, 400-401
 Fairbanks-Morse Horizontal Type Y, 372-374
 Fairbanks-Morse Vertical Type Y, 377-380
 Giant (Chicago Pneumatic Tool Co.), 389-390
 Mietz & Weiss Horizontal, 381-382
 Mietz & Weiss Vertical, 383-384
 Muncie, 366-369
 Governors, "Hit & Miss," 365-366
 Governors, Quantitative, 366

H

- Head, cylinder, packing, 331-332
 Head, piston, 338-339
 Hornsby-Ackroyd oil engine, 6, 307

I

- Ignition devices, 309-323
 hot-ball, Muncie, 309-313
 hot-plate, Giant (Chicago Pneu. Tool Co.), 314-316
 hot-tube, Primm, 313-314
 separate combustion, 316
 Bessemer, 321
 Bolinder, 318
 Buckeye-Barrett, 320
 De La Vergne, 321-322
 Fairbanks-Morse, 316-320
 Petter, 318
 Indicator cards, 442-446
 De La Vergne, 442
 Fairbanks-Morse, 443
 Mietz & Weiss, 444-445
 Muncie, 444
 Primm, 445
 Injection, water, 410-413

L

- Low-compression oil engines, 306-459
 Lubrication, amount of, 437-438
 crank pin, 344-346
 piston pin, 344-346

M

- Method of operation, low-compression oil engine, 307
 Mietz & Weiss,
 air suction, 352-353
 crank-pin lubrication, 344-346

- Mietz & Weiss, crankshaft air seal, 354
 cylinder, 326
 frame, 348
 fuel injection nozzle, 408-409
 pump, 382-383, 384-385
 distributor, 385, 387
 governor for small engines, 381-382
 piston-pin lubrication, 344-346
 water injection system, 414-416
 Muncie oil engine,
 air-starting system, 434
 air-suction valve, 352
 bearing, main, 360, Fig. 285
 connecting-rod, 341, Fig. 285
 crankshaft air seal, Fig. 285
 fuel injection nozzle, 404-405
 pump, 369-371
 for large engines, 371
 governor, 366-369
 ignition device, 309-313
 piston, 333
 water injection system, 416-417

N

- Nozzles, fuel injection, 403-410
 Bessemer, 408
 Buckeye-Barrett, 406-407
 Fairbanks-Morse, 405-406
 Giant (Chicago Pneumatic Tool Co.), 403-404
 Mietz & Weiss, 408, 409
 Muncie, 404-405
 Primm, 407-408

O

- Operation, costs, 455-459
 engine pounds, 441
 indicator cards, 442-446
 De La Vergne, 442
 Fairbanks-Morse, 443
 Mietz & Weiss, 444-445
 Muncie, 444
 Primm, 445
 lubrication, 437
 method of, in low-compression engines, 307
 preignition, 439-441
 smoking engine, 438
 starting an engine, 435-437
 stopping engine, 441-442
 temperature of cooling water, 437

P

- Packing, cylinder head, 331-332
 Piston clearances, 334-335
 Piston heads, fractured, 338-339
 Piston-pin lubrication, 344-345
 Piston pins, 339

Piston rings, 337
 Pistons, crosshead design, 349-351
 distorted, 336-337
 turning of new, 335-336
 Pistons, types of, 333-335
 Buckeye-Barrett, 333-334
 De La Vergne, 333
 Muncie, 333
 with deflector lips, 333
 Preignitions, 439-441
 Primm oil engine,
 air-starting system, 434
 bearings, main, Fig. 283
 connecting-rod, 341, Fig. 267
 fuel injection nozzle, 407-408
 pump, 399-400
 governor, 397-399
 ignition device, 313-314
 water injection system, 418

R

Reboring of cylinder, 327-328
 Regulators, fuel pump, 387-389
 Rings, piston, 337

S

Smoky engine, 438-439
 Specifications of fuel oil, 448-449
 Starters, air, 432-434
 Starting an engine, 435-437
 Stopping the engine, 441-442

T

Temperature of cooling water, 437
 Theory of combustion, low-compression
 engine, 307-309
 Two-stroke-cycle low-compression engine,
 307
 ignition devices, 309
 hot-ball, 309-313
 hot-plate, 314-316
 hot-tube, 313-314
 separate combustion chamber, 316-
 321
 method of operation, 307
 theory of combustion, 307-309

W

Water circulating systems, 425-431
 fresh water system, 427-429
 tank and tower system, 429-431
 thermo-syphon system, 425-427
 Water injection, 410-413
 cylinder wear due to, 413
 faulty lubrication due to, 413-414
 method of, 414-419
 Bessemer, 418-419
 bleeder valve, 414
 Giant (Chicago Pneumatic Tool Co.),
 418
 Mietz & Weiss, 414-146
 Muncie automatic pump, 416-417
 Muncie Standard, 416
 Wear in cylinder walls, 328-329

THIS BOOK IS DUE ON THE LAST DATE
STAMPED BELOW

AN INITIAL FINE OF 25 CENTS

WILL BE ASSESSED FOR FAILURE TO RETURN
THIS BOOK ON THE DATE DUE. THE PENALTY
WILL INCREASE TO 50 CENTS ON THE FOURTH
DAY AND TO \$1.00 ON THE SEVENTH DAY
OVERDUE.

ENGINEERING LIBRARY

JUN 4 1947

MAR 29 1949

APR 12 1949

72

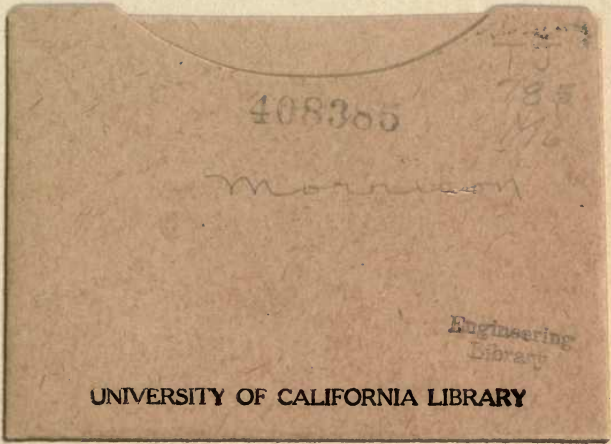

408305

Morrison

Engineering
Library

UNIVERSITY OF CALIFORNIA LIBRARY

