

NPS ARCHIVE  
1963  
GONZALEZ, J.

A 10 KC KERR CELL MODULATOR FOR  
THE PRODUCTION OF REPETITIVE  
GIANT LASER PULSES

JOHN C. GONZALEZ

LIBRARY  
U.S. NAVAL POSTGRADUATE SCHOOL  
MONTEREY, CALIFORNIA









A 10 KC KERR CELL MODULATOR FOR THE  
PRODUCTION OF REPETITIVE GIANT LASER PULSES

\*\*\*\*

John C. Gonzalez





A 10 KC KERR CELL MODULATOR FOR THE  
PRODUCTION OF REPETITIVE GIANT LASER PULSES

BY

JOHN C. GONZALEZ  
Captain, United States Marine Corps

Submitted in partial fulfillment of  
the requirements for the degree of

MASTER OF SCIENCE  
IN  
ENGINEERING ELECTRONICS

United States Naval Postgraduate School

1963

1963

Gonzalez, J.

X

A 10 KC KERR CELL MODULATOR FOR THE  
PRODUCTION OF REPETITIVE GIANT LASER PULSES

BY

JOHN C. GONZALEZ

This work is accepted as fulfilling  
the thesis requirements for the degree of

MASTER OF SCIENCE  
IN  
ENGINEERING ELECTRONICS

from the

United States Naval Postgraduate School



## ABSTRACT

The output from a conventional laser is a spontaneous burst of radiation which lasts about one microsecond. If now the reflectivity of one of the two "mirrors" in the system is controllable, it is possible to develop laser system conditions which permit the generation of high peak-power pulses with a pulse width of about 30 nanoseconds. Such a system utilizes the principle of regeneration modulation and has been successfully applied to the production of single high peak-power pulses. A natural step then is to utilize this method to generate a series of repetitive "giant" pulses.

This report describes the electronics equipment developed to assist in producing such pulses at a 10 kc pulse repetition frequency. The approach used represents a first attempt towards an effective means of obtaining controlled high-powered laser pulses.

The author extends appreciation to all the members of the Hughes Aircraft Company Laser Research group who offered their advice and knowledge.

The final successful days of the experiment were under the guidance of Dr. E. Woodbury. The author was also directly and ably assisted during the final stages of the experiment by engineer-physicist Mr. B. E. Dobratz. Also, gratitude and appreciation is offered to Mr. E. D. Stephans for his special kind of guidance and good humor.

... ..

... ..

... ..

... ..

... ..

... ..

... ..

... ..

... ..

... ..

... ..

... ..

... ..

... ..

... ..

... ..

... ..

... ..

... ..

... ..

... ..

... ..

## TABLE OF CONTENTS

		Page
	CERTIFICATE OF APPROVAL	i
	ABSTRACT	ii
	TABLE OF CONTENTS	iii
	LIST OF ILLUSTRATIONS	iv
	TABLE OF SYMBOLS AND ABBREVIATIONS	v i
SECTION		
1	INTRODUCTION	1
2	DESIGN OF THE KERR CELL MODULATOR	9
3	TESTS AND RESULTS	28
4	CONCLUSIONS	49
Appendicies		
A	Characteristic Impedance Calculations	52
B	Pertinent Data About Equipment Used	53
	Bibliography	57

MEMORANDUM

TO : [Illegible]

FROM : [Illegible]

SUBJECT : [Illegible]

[Illegible text follows, consisting of several paragraphs of faint, mostly illegible text.]



## LIST OF ILLUSTRATIONS

Figure		Page
1.	Conventional vs Giant Pulse Laser Output	2
2.	Giant Pulse Laser Configuration	4
3.	Ruby Energy Levels	5
4.	Complete Optical System of Giant Pulse Laser	7
5.	Output Waveforms of First Modulator Circuit	15
6.	Static Transfer Characteristics	17
7.	Schematic of 10 kc Kerr Cell Modulator	19
8.	Kerr Cell Modulator Driver Stage	22
9.	Pulses Appearing Within Circuitry of Modulator	24
10.	Kerr Cell Modulator Output Stage	26
11.	Kerr Cell and Holder	29
12.	Ruby and Flashlamp	30
13.	Schematic of Planned Circuit Arrangement	35
14.	Equipment Arrangement to Measure Laser Output	36
15.	Actual System	37
16.	Integrated Output of Giant Pulse Laser (Modulated at 10 kc Rate)	40
17.	Integrated Output of Giant Pulse Laser (Modulated at 4 kc Rate)	41



Figure		Page
18.	Output Pulse; 10 kc vs 25 kc Modulator Operation	43
19.	Multiple-Pulsing of Modulator and Laser	45
20.	Integrated Laser Output; Maximum Input Energy to Flashlamp	48
21.	Actual Giant Pulse (Kerr Cell Pulsed at 10 kc Rate)	48
B-1.	Cavity and Flashlamp	55
B-2.	Flashlamp	56

		Page
1	Introduction	1
2	1.1. The Problem	2
3	1.2. The Method	3
4	1.3. The Results	4
5	1.4. The Discussion	5
6	2. Theoretical Framework	6
7	2.1. Theoretical Model	7
8	2.2. Hypotheses	8
9	3. Method	9
10	3.1. Participants	10
11	3.2. Procedure	11
12	3.3. Measures	12
13	4. Results	13
14	4.1. Descriptive Statistics	14
15	4.2. Hypothesis Testing	15
16	5. Discussion	16
17	5.1. Summary	17
18	5.2. Implications	18
19	5.3. Limitations	19
20	5.4. Future Research	20
21	6. Conclusion	21
22	References	22
23	Appendix A	23
24	Appendix B	24
25	Appendix C	25
26	Appendix D	26
27	Appendix E	27
28	Appendix F	28
29	Appendix G	29
30	Appendix H	30
31	Appendix I	31
32	Appendix J	32
33	Appendix K	33
34	Appendix L	34
35	Appendix M	35
36	Appendix N	36
37	Appendix O	37
38	Appendix P	38
39	Appendix Q	39
40	Appendix R	40
41	Appendix S	41
42	Appendix T	42
43	Appendix U	43
44	Appendix V	44
45	Appendix W	45
46	Appendix X	46
47	Appendix Y	47
48	Appendix Z	48
49	Appendix AA	49
50	Appendix AB	50
51	Appendix AC	51
52	Appendix AD	52
53	Appendix AE	53
54	Appendix AF	54
55	Appendix AG	55
56	Appendix AH	56
57	Appendix AI	57
58	Appendix AJ	58
59	Appendix AK	59
60	Appendix AL	60
61	Appendix AM	61
62	Appendix AN	62
63	Appendix AO	63
64	Appendix AP	64
65	Appendix AQ	65
66	Appendix AR	66
67	Appendix AS	67
68	Appendix AT	68
69	Appendix AU	69
70	Appendix AV	70
71	Appendix AW	71
72	Appendix AX	72
73	Appendix AY	73
74	Appendix AZ	74
75	Appendix BA	75
76	Appendix BB	76
77	Appendix BC	77
78	Appendix BD	78
79	Appendix BE	79
80	Appendix BF	80
81	Appendix BG	81
82	Appendix BH	82
83	Appendix BI	83
84	Appendix BJ	84
85	Appendix BK	85
86	Appendix BL	86
87	Appendix BM	87
88	Appendix BN	88
89	Appendix BO	89
90	Appendix BP	90
91	Appendix BQ	91
92	Appendix BR	92
93	Appendix BS	93
94	Appendix BT	94
95	Appendix BU	95
96	Appendix BV	96
97	Appendix BW	97
98	Appendix BX	98
99	Appendix BY	99
100	Appendix BZ	100

## TABLE OF SYMBOLS AND ABBREVIATIONS

<u>SYMBOL</u>	<u>DEFINITION</u>
kc	kilocycles
kv	kilovolts
nsec	nanoseconds
"Q"	cavity quality factor
Cr <sup>+3</sup>	chromium ions
Å	angstrom units (1Å = 10 <sup>-4</sup> microns)
τ	pulse width in seconds
Z <sub>o</sub>	characteristic impedance
sw	switch
I <sub>b</sub>	D.C. plate current in milliamperes
E <sub>b</sub>	D.C. plate voltage in volts
E <sub>g</sub>	D.C. grid bias in volts
E <sub>bb</sub>	D.C. plate supply voltage in volts
mh	millihenries
L	inductance
C	capacitance
λ	wavelength in a medium
ν	frequency
O.D.	outside diameter
r.f.	radio frequency
cm	centimeter

THE HISTORY OF THE

CHAPTER	PAGES
I	1
II	10
III	20
IV	30
V	40
VI	50
VII	60
VIII	70
IX	80
X	90
XI	100
XII	110
XIII	120
XIV	130
XV	140
XVI	150
XVII	160
XVIII	170
XIX	180
XX	190
XXI	200
XXII	210
XXIII	220
XXIV	230
XXV	240
XXVI	250
XXVII	260
XXVIII	270
XXIX	280
XXX	290
XXXI	300
XXXII	310
XXXIII	320
XXXIV	330
XXXV	340
XXXVI	350
XXXVII	360
XXXVIII	370
XXXIX	380
XL	390
XL I	400
XL II	410
XL III	420
XL IV	430
XL V	440
XL VI	450
XL VII	460
XL VIII	470
XL IX	480
L	490
L I	500
L II	510
L III	520
L IV	530
L V	540
L VI	550
L VII	560
L VIII	570
L IX	580
LI	590
LI I	600
LI II	610
LI III	620
LI IV	630
LI V	640
LI VI	650
LI VII	660
LI VIII	670
LI IX	680
LII	690
LII I	700
LII II	710
LII III	720
LII IV	730
LII V	740
LII VI	750
LII VII	760
LII VIII	770
LII IX	780
LIII	790
LIII I	800
LIII II	810
LIII III	820
LIII IV	830
LIII V	840
LIII VI	850
LIII VII	860
LIII VIII	870
LIII IX	880
LIV	890
LIV I	900
LIV II	910
LIV III	920
LIV IV	930
LIV V	940
LIV VI	950
LIV VII	960
LIV VIII	970
LIV IX	980
LV	990
LV I	1000
LV II	1010
LV III	1020
LV IV	1030
LV V	1040
LV VI	1050
LV VII	1060
LV VIII	1070
LV IX	1080
LVI	1090
LVI I	1100
LVI II	1110
LVI III	1120
LVI IV	1130
LVI V	1140
LVI VI	1150
LVI VII	1160
LVI VIII	1170
LVI IX	1180
LVII	1190
LVII I	1200
LVII II	1210
LVII III	1220
LVII IV	1230
LVII V	1240
LVII VI	1250
LVII VII	1260
LVII VIII	1270
LVII IX	1280
LVIII	1290
LVIII I	1300
LVIII II	1310
LVIII III	1320
LVIII IV	1330
LVIII V	1340
LVIII VI	1350
LVIII VII	1360
LVIII VIII	1370
LVIII IX	1380
LIX	1390
LIX I	1400
LIX II	1410
LIX III	1420
LIX IV	1430
LIX V	1440
LIX VI	1450
LIX VII	1460
LIX VIII	1470
LIX IX	1480
LX	1490
LX I	1500
LX II	1510
LX III	1520
LX IV	1530
LX V	1540
LX VI	1550
LX VII	1560
LX VIII	1570
LX IX	1580
LXI	1590
LXI I	1600
LXI II	1610
LXI III	1620
LXI IV	1630
LXI V	1640
LXI VI	1650
LXI VII	1660
LXI VIII	1670
LXI IX	1680
LXII	1690
LXII I	1700
LXII II	1710
LXII III	1720
LXII IV	1730
LXII V	1740
LXII VI	1750
LXII VII	1760
LXII VIII	1770
LXII IX	1780
LXIII	1790
LXIII I	1800
LXIII II	1810
LXIII III	1820
LXIII IV	1830
LXIII V	1840
LXIII VI	1850
LXIII VII	1860
LXIII VIII	1870
LXIII IX	1880
LXIV	1890
LXIV I	1900
LXIV II	1910
LXIV III	1920
LXIV IV	1930
LXIV V	1940
LXIV VI	1950
LXIV VII	1960
LXIV VIII	1970
LXIV IX	1980
LXV	1990
LXV I	2000
LXV II	2010
LXV III	2020
LXV IV	2030
LXV V	2040
LXV VI	2050
LXV VII	2060
LXV VIII	2070
LXV IX	2080
LXVI	2090
LXVI I	2100
LXVI II	2110
LXVI III	2120
LXVI IV	2130
LXVI V	2140
LXVI VI	2150
LXVI VII	2160
LXVI VIII	2170
LXVI IX	2180
LXVII	2190
LXVII I	2200
LXVII II	2210
LXVII III	2220
LXVII IV	2230
LXVII V	2240
LXVII VI	2250
LXVII VII	2260
LXVII VIII	2270
LXVII IX	2280
LXVIII	2290
LXVIII I	2300
LXVIII II	2310
LXVIII III	2320
LXVIII IV	2330
LXVIII V	2340
LXVIII VI	2350
LXVIII VII	2360
LXVIII VIII	2370
LXVIII IX	2380
LXIX	2390
LXIX I	2400
LXIX II	2410
LXIX III	2420
LXIX IV	2430
LXIX V	2440
LXIX VI	2450
LXIX VII	2460
LXIX VIII	2470
LXIX IX	2480
LXX	2490
LXX I	2500
LXX II	2510
LXX III	2520
LXX IV	2530
LXX V	2540
LXX VI	2550
LXX VII	2560
LXX VIII	2570
LXX IX	2580
LXXI	2590
LXXI I	2600
LXXI II	2610
LXXI III	2620
LXXI IV	2630
LXXI V	2640
LXXI VI	2650
LXXI VII	2660
LXXI VIII	2670
LXXI IX	2680
LXXII	2690
LXXII I	2700
LXXII II	2710
LXXII III	2720
LXXII IV	2730
LXXII V	2740
LXXII VI	2750
LXXII VII	2760
LXXII VIII	2770
LXXII IX	2780
LXXIII	2790
LXXIII I	2800
LXXIII II	2810
LXXIII III	2820
LXXIII IV	2830
LXXIII V	2840
LXXIII VI	2850
LXXIII VII	2860
LXXIII VIII	2870
LXXIII IX	2880
LXXIV	2890
LXXIV I	2900
LXXIV II	2910
LXXIV III	2920
LXXIV IV	2930
LXXIV V	2940
LXXIV VI	2950
LXXIV VII	2960
LXXIV VIII	2970
LXXIV IX	2980
LXXV	2990
LXXV I	3000
LXXV II	3010
LXXV III	3020
LXXV IV	3030
LXXV V	3040
LXXV VI	3050
LXXV VII	3060
LXXV VIII	3070
LXXV IX	3080
LXXVI	3090
LXXVI I	3100
LXXVI II	3110
LXXVI III	3120
LXXVI IV	3130
LXXVI V	3140
LXXVI VI	3150
LXXVI VII	3160
LXXVI VIII	3170
LXXVI IX	3180
LXXVII	3190
LXXVII I	3200
LXXVII II	3210
LXXVII III	3220
LXXVII IV	3230
LXXVII V	3240
LXXVII VI	3250
LXXVII VII	3260
LXXVII VIII	3270
LXXVII IX	3280
LXXVIII	3290
LXXVIII I	3300
LXXVIII II	3310
LXXVIII III	3320
LXXVIII IV	3330
LXXVIII V	3340
LXXVIII VI	3350
LXXVIII VII	3360
LXXVIII VIII	3370
LXXVIII IX	3380
LXXIX	3390
LXXIX I	3400
LXXIX II	3410
LXXIX III	3420
LXXIX IV	3430
LXXIX V	3440
LXXIX VI	3450
LXXIX VII	3460
LXXIX VIII	3470
LXXIX IX	3480
LXXX	3490
LXXX I	3500
LXXX II	3510
LXXX III	3520
LXXX IV	3530
LXXX V	3540
LXXX VI	3550
LXXX VII	3560
LXXX VIII	3570
LXXX IX	3580
LXXXI	3590
LXXXI I	3600
LXXXI II	3610
LXXXI III	3620
LXXXI IV	3630
LXXXI V	3640
LXXXI VI	3650
LXXXI VII	3660
LXXXI VIII	3670
LXXXI IX	3680
LXXXII	3690
LXXXII I	3700
LXXXII II	3710
LXXXII III	3720
LXXXII IV	3730
LXXXII V	3740
LXXXII VI	3750
LXXXII VII	3760
LXXXII VIII	3770
LXXXII IX	3780
LXXXIII	3790
LXXXIII I	3800
LXXXIII II	3810
LXXXIII III	3820
LXXXIII IV	3830
LXXXIII V	3840
LXXXIII VI	3850
LXXXIII VII	3860
LXXXIII VIII	3870
LXXXIII IX	3880
LXXXIV	3890
LXXXIV I	3900
LXXXIV II	3910
LXXXIV III	3920
LXXXIV IV	3930
LXXXIV V	3940
LXXXIV VI	3950
LXXXIV VII	3960
LXXXIV VIII	3970
LXXXIV IX	3980
LXXXV	3990
LXXXV I	4000
LXXXV II	4010
LXXXV III	4020
LXXXV IV	4030
LXXXV V	4040
LXXXV VI	4050
LXXXV VII	4060
LXXXV VIII	4070
LXXXV IX	4080
LXXXVI	4090
LXXXVI I	4100
LXXXVI II	4110
LXXXVI III	4120
LXXXVI IV	4130
LXXXVI V	4140
LXXXVI VI	4150
LXXXVI VII	4160
LXXXVI VIII	4170
LXXXVI IX	4180
LXXXVII	4190
LXXXVII I	4200
LXXXVII II	4210
LXXXVII III	4220
LXXXVII IV	4230
LXXXVII V	4240
LXXXVII VI	4250
LXXXVII VII	4260
LXXXVII VIII	4270
LXXXVII IX	4280
LXXXVIII	4290
LXXXVIII I	4300
LXXXVIII II	4310
LXXXVIII III	4320
LXXXVIII IV	4330
LXXXVIII V	4340
LXXXVIII VI	4350
LXXXVIII VII	4360
LXXXVIII VIII	4370
LXXXVIII IX	4380
LXXXIX	4390
LXXXIX I	4400
LXXXIX II	4410
LXXXIX III	4420
LXXXIX IV	4430
LXXXIX V	4440
LXXXIX VI	4450
LXXXIX VII	4460
LXXXIX VIII	4470
LXXXIX IX	4480
LXXXX	4490
LXXXX I	4500
LXXXX II	4510
LXXXX III	4520
LXXXX IV	4530
LXXXX V	4540
LXXXX VI	4550
LXXXX VII	4560
LXXXX VIII	4570
LXXXX IX	4580
LXXXXI	4590
LXXXXI I	4600
LXXXXI II	4610
LXXXXI III	4620
LXXXXI IV	4630
LXXXXI V	4640
LXXXXI VI	4650
LXXXXI VII	4660
LXXXXI VIII	4670
LXXXXI IX	4680
LXXXXII	4690
LXXXXII I	4700
LXXXXII II	4710
LXXXXII III	4720
LXXXXII IV	4730
LXXXXII V	4740
LXXXXII VI	4750
LXXXXII VII	4760
LXXXXII VIII	4770
LXXXXII IX	4780
LXXXXIII	4790
LXXXXIII I	4800
LXXXXIII II	4810
LXXXXIII III	4820
LXXXXIII IV	4830
LXXXXIII V	4840
LXXXXIII VI	4850
LXXXXIII VII	4860
LXXXXIII VIII	4870
LXXXXIII IX	4880
LXXXXIV	4890
LXXXXIV I	4900
LXXXXIV II	4910
LXXXXIV III	4920
LXXXXIV IV	4930
LXXXXIV V	4940
LXXXXIV VI	4950
LXXXXIV VII	4960
LXXXXIV VIII	4970
LXXXXIV IX	4980
LXXXXV	4990
LXXXXV I	5000
LXXXXV II	5010
LXXXXV III	5020
LXXXXV IV	5030
LXXXXV V	5040
LXXXXV VI	5050
LXXXXV VII	5060
LXXXXV VIII	5070
LXXXXV IX	5080
LXXXXVI	5090
LXXXXVI I	5100
LXXXXVI II	5110
LXXXXVI III	5120
LXXXXVI IV	5130
LXXXXVI V	5140
LXXXXVI VI	5150
LXXXXVI VII	5160
LXXXXVI VIII	5170
LXXXXVI IX	5180
LXXXXVII	5190
LXXXXVII I	5200
LXXXXVII II	5210
LXXXXVII III	5220
LXXXXVII IV	5230
LXXXXVII V	5240
LXXXXVII VI	5250
LXXXXVII VII	5260
LXXXXVII VIII	5270
LXXXXVII IX	5280
LXXXXVIII	5290
LXXXXVIII I	5300
LXXXXVIII II	5310
LXXXXVIII III	5320
LXXXXVIII IV	5330
LXXXXVIII V	5340
LXXXXVIII VI	5350
LXXXXVIII VII	5360
LXXXXVIII VIII	5370
LXXXXVIII IX	5380
LXXXXIX	5390
LXXXXIX I	5400
LXXXXIX II	5410
LXXXXIX III	5420
LXXXXIX IV	5430
LXXXXIX V	5440
LXXXXIX VI	5450
LXXXXIX VII	5460
LXXXXIX VIII	5470
LXXXXIX IX	5480
LXXXXX	5490
LXXXXX I	5500
LXXXXX II	5510
LXXXXX III	5520
LXXXXX IV	5530
LXXXXX V	5540
LXXXXX VI	5550
LXXXXX VII	5560
LXXXXX VIII	5570
LXXXXX IX	5580
LXXXXXI	5590
LXXXXXI I	5600
LXXXXXI II	5610
LXXXXXI III	5620
LXXXXXI IV	5630
LXXXXXI V	5640
LXXXXXI VI	5650
LXXXXXI VII	5660
LXXXXXI VIII	5670
LXXXXXI IX	5680
LXXXXXII	5690
LXXXXXII I	5700
LXXXXXII II	5710
LXXXXXII III	5720
LXXXXXII IV	5730
LXXXXXII V	5740
LXXXXXII VI	5750
LXXXXXII VII	5760
LXXXXXII VIII	5770
LXXXXXII IX	5780
LXXXXXIII	5790
LXXXXXIII I	5800
LXXXXXIII II	5810
LXXXXXIII III	5820
LXXXXXIII IV	5830
LXXXXXIII V	5840
LXXXXXIII VI	5850
LXXXXXIII VII	5860
LXXXXXIII VIII	5870
LXXXXXIII IX	5880
LXXXXXIV	5890
LXXXXXIV I	5900
LXXXXXIV II	5910
LXXXXXIV III	5920
LXXXXXIV IV	5930
LXXXXXIV V	5940
LXXXXXIV VI	5950
LXXXXXIV VII	5960
LXXXXXIV VIII	5970
LXXXXXIV IX	5980
LXXXXXV	5990
LXXXXXV I	6000
LXXXXXV II	6010
LXXXXXV III	60

## 1. Introduction

Since the first operating laser was introduced by T. H. Maiman in 1960 /5,6/ a great deal of effort has been directed by physicists and engineers toward understanding and improving the characteristics of this device. In the past few years it has become readily apparent that the harnessing of the tremendous potential that the laser unquestionably possesses will prove to be a great asset to both science and industry. Already the laser has made an impact comparable to that made by electron tubes and semiconductor devices, even with its true versatility not yet fully exploited, and perhaps not completely known. However, in the strides that have been made, a technique for improving the utility of the laser beam output has resulted. Less than two years ago an optical switching technique was proposed by McClung and Hellwarth /1/ of Hughes Aircraft Company, which "compressed" a great deal of the total energy inherent in a conventional laser pulse into one "giant" pulse. In this fashion, the characteristic low-energy sporadic output of uncontrolled "spikes" of the conventional laser, as shown in Figure 1-a, was modified so that intense and very narrow pulses of radiation were emitted by the same material. (See Figure 1-b) To date these giant pulses have been generated by the sudden change of the regeneration characteristics of a laser cavity whose active medium is chromium-doped sapphire (ruby). The system which gen-

The first part of the document discusses the importance of maintaining accurate records of all transactions. It emphasizes that every entry should be supported by a valid receipt or invoice, and that these documents should be stored in a secure and accessible location. The text also mentions the need to regularly reconcile the accounts to ensure that the books are balanced and that there are no discrepancies.

In the second part, the author provides a detailed explanation of the accounting cycle, which consists of eight steps: identifying the accounting cycle, analyzing the source documents, journalizing the transactions, posting to the ledger, preparing a trial balance, adjusting the accounts, preparing financial statements, and closing the books. Each step is described in detail, with examples and explanations of the underlying principles.

The third part of the document focuses on the preparation of financial statements. It discusses the different types of statements, including the balance sheet, income statement, and statement of cash flows, and explains how they are prepared and used to evaluate the financial performance of a business. The author also provides a checklist of items to be included in each statement and offers tips for ensuring accuracy and clarity.

Finally, the document concludes with a summary of the key points and a reminder of the importance of ethical behavior in accounting. The author stresses that accountants have a responsibility to provide accurate and reliable information to their clients and the public, and that they should always act with integrity and honesty.





FIGURE 1a  
 CONVENTIONAL LASER ACTION  
 HORIZ.: 200 micrseconds/cm

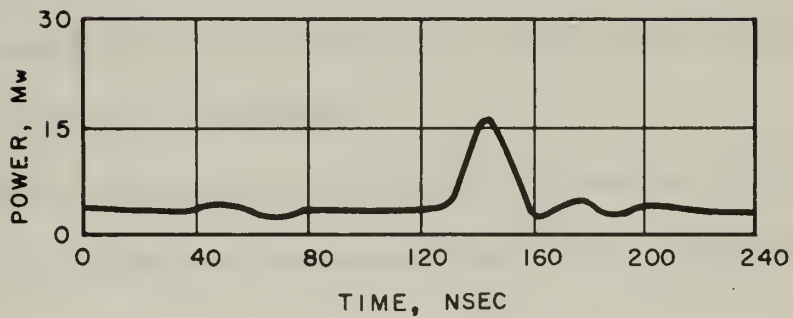
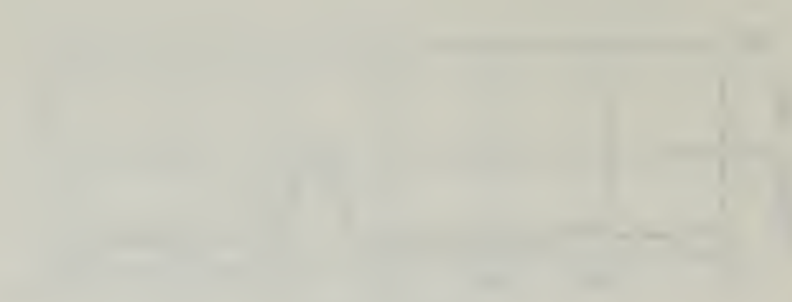

FIGURE 1b  
 GIANT PULSE LASER OUTPUT; ACHIEVED  
 BY REGENERATION MODULATION OF  
 RUBY LASER /7/

FIGURE 1



1900  
1901  
1902



1903  
1904  
1905

erates these high peak-power pulses has been called the Giant Pulse Laser or Pulsed Reflector Laser<sup>1</sup> and the principle of operation is based on the fact that materials which laser in the conventional configuration can be caused to emit fast, intense pulses. Figure 2 shows the arrangement used by McClung and Hellwarth in their first experiments. It was similar to the usual laser configuration except that a voltage-controlled Kerr cell /15/ was physically introduced between one end reflector and the ruby. The flash lamp was first fired in order to bathe the ruby in white light. Inversion commenced to a higher energy level (see Figure 3) and when the voltage applied to the Kerr cell was quickly pulsed off, the back reflector was effectively introduced into the optical path thereby permitting the "Q" of the laser cavity to be enhanced and allowing regeneration of the red light beam. Instantly, a single high peak-power pulse was emitted. Characteristically this pulse was about 30 nanoseconds wide and had a peak of about 14 megawatts.

The optical configuration of Giant Pulse Lasers has since been improved by the addition of a Wollaston prism<sup>2</sup> /15/. Figure 4 dis-

<sup>1</sup>There exists another technique for generation of high peak-power pulses. It is called the Hair Trigger Mode. See References /2,7/.

<sup>2</sup>The Wollaston prism is not essential but improves the system operation in that regeneration can be achieved on all passes through the ruby and not on just alternate passes as when no prism is in the system.

The first part of the document discusses the importance of maintaining accurate records of all transactions. It emphasizes that proper record-keeping is essential for the success of any business and for the protection of the interests of all parties involved. The document then outlines the various methods and procedures for recording transactions, including the use of journals, ledgers, and other accounting systems. It also discusses the importance of regular audits and the role of the auditor in ensuring the accuracy and integrity of the financial records. The document concludes by stating that the proper management of financial records is a key factor in the long-term success and stability of any organization.

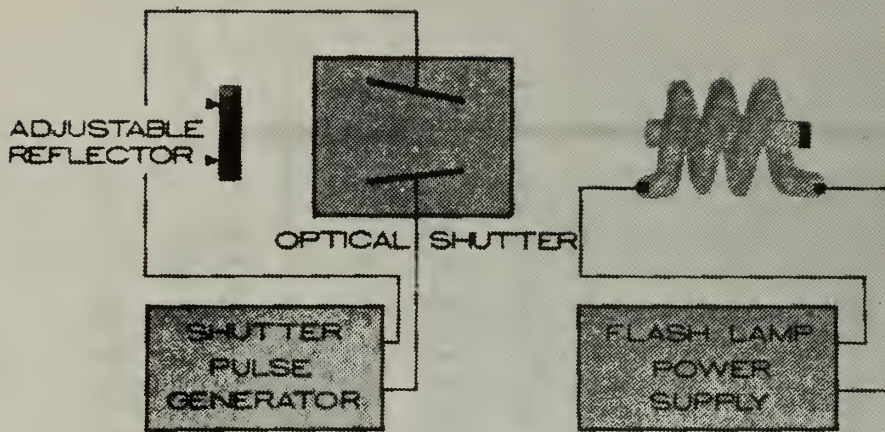

FIGURE 2

GIANT PULSE LASER CONFIGURATION;  
FOR OBTAINING HIGH-POWER PULSE  
FROM A RUBY LASER /1/

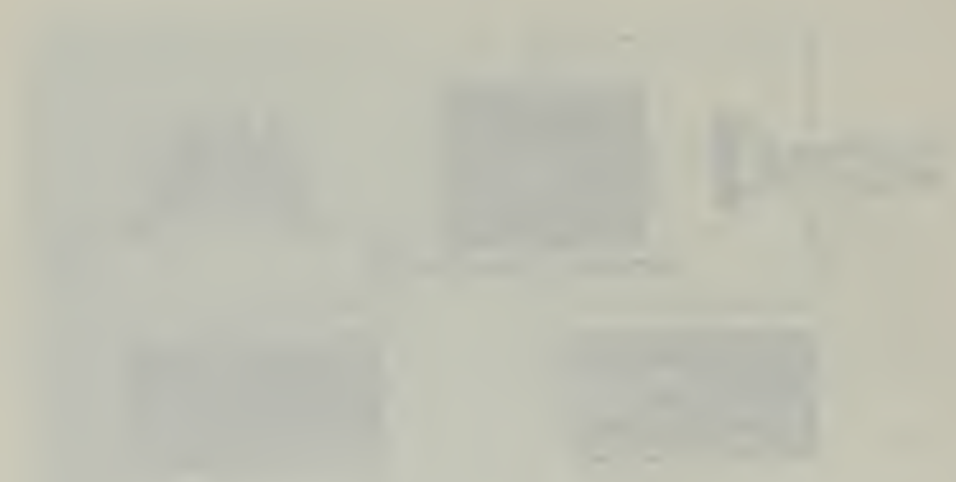

Figure 1

Figure 1 shows the schematic diagram of the mechanical assembly. The diagram illustrates the arrangement of various components, including a central square part, a triangular part, and two rectangular parts, all interconnected as shown.





The first part of the document discusses the importance of maintaining accurate records of all transactions. It emphasizes that every entry should be supported by a valid receipt or invoice. This ensures transparency and allows for easy auditing of the accounts.

Additionally, it is noted that regular reconciliation of the books is essential to identify any discrepancies early on. This process involves comparing the internal records with bank statements and other external sources to ensure they match.

The second part of the document provides a detailed breakdown of the company's financial performance over the last quarter. It includes a summary of revenue, expenses, and net profit, along with a comparison to the same period in the previous year.



Category	Amount
Revenue	10000
Expenses	7500
Net Profit	2500



plays the arrangement of all the essential optical pieces. Each is supported firmly in its specially built holder and mounted on a firm base. After the flash lamp is fired, the Kerr cell is held "on"<sup>3</sup> to permit the ground-level ions to be "pumped" until a high inversion ratio is first achieved. Thus, stimulated emission is restrained until the Kerr cell voltage is removed electronically permitting the Cr<sup>+3</sup> ions to be then triggered to "fall" together to the ground state. The released energy is emitted as a single narrow pulse of intense radiation of very short duration. The result is known as a "giant" pulse.

A simple calculation can be made of power out which is indicative of the future utility of this system. Assume an output pulse containing one joule of energy--a realistic choice. If this amount of energy is emitted in about 33 nanoseconds, as usually occurs, the power out is 30 megawatts. The state of the art as of the period of the writing of this paper, has exceeded this output. It then becomes apparent that the high peak-power feature offered by the Giant Pulse Laser has a realistic and practical application. The technique described--which is also called regeneration modulation--has an

<sup>3</sup>"On" implies that the quarter-wave voltage is applied to the plates and the polarization characteristics of the entire system is such as to prevent lasering.





WOLLASTON PRISM

KERR CELL

CAVITY WITH RUBY

FRONT FLAT

BACK FLAT

COMPLETE OPTICAL SYSTEM OF GIANT PULSE LASER

FIGURE 4



obvious extension. With proper electronics circuitry so designed to pulse the Kerr cell off repetitively it should be possible to develop a series of such pulses at equally spaced intervals--contingent, of course, upon how long the flash lamp can continue to bathe the ruby in white light.

It was proposed that the author attempt to design a pulser (or modulator) that could force the Kerr cell on and off at a controllable repetition frequency. The objective of this paper, therefore, is to present an explanation of the design of the modulator which was finally used to generate repetitive giant pulses and to disclose the overall results obtained from both the designed pulser and the ruby output.

♦

Faint, illegible text, possibly bleed-through from the reverse side of the page. The text is arranged in several paragraphs, but the characters are too light and blurry to be transcribed accurately.



## 2. Design Of The Kerr Cell Modulator /8,9,11,12,13,14/

As described previously, generation of giant pulses is based upon an important factor, that of suitably switching the Kerr cell from a condition of high voltage to one of essentially less than 1/10 of this level--or, equivalently, a condition of incomplete transmission to one of complete transmission. A 10 kilovolt Kerr cell was used as the criterion in the design of the high voltage modulator. Thus the circuitry required, had to reduce the Kerr cell voltage instantaneously from 10,000 volts to less than 1,000 volts.<sup>4</sup>

The following criteria were used as a basis for the design. They were somewhat arbitrary in that the full requirements and the effect such a design would have on a Giant Pulse Laser had not previously been ascertained.

- (1) 10 kc or higher repetition rate
- (2)  $\approx$  10 kilovolt pulse height
- (3) Less than 50 nanosecond rise time
- (4) Fall time not critical
- (5) Pulse width from 200- to 400- nanoseconds
- (6) Variable pulse width, if possible

The following pulser waveshape was offered as a suggested goal:

<sup>4</sup>It was found experimentally that the Kerr cell was completely "on" when anything less than 5,000 volts was applied to its plates.





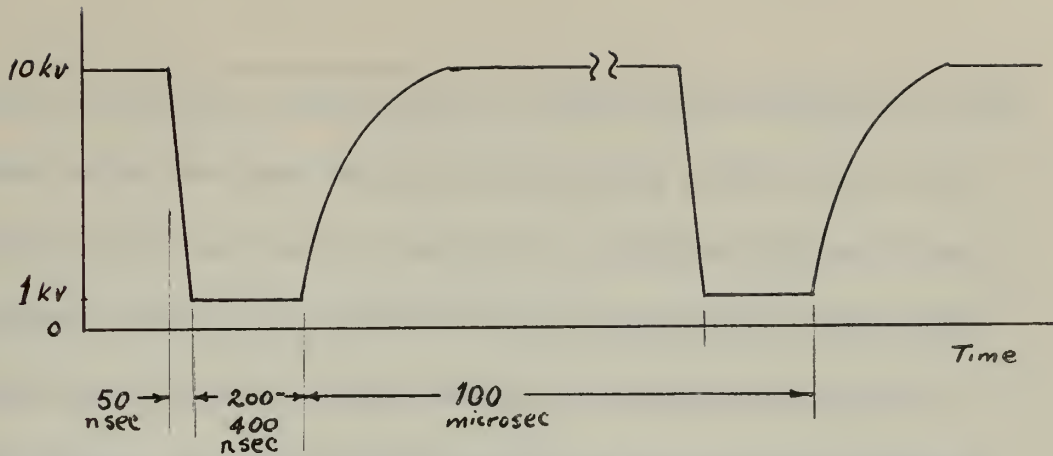

The charge-time back to 10 kilovolts was not critical as long as the 10 kilovolt level was reached within the stated 100 microseconds.

When the initial specifications were proposed one important feature was brought to the attention of the author. It was known that an initial pumping-time interval of about 200- to 500- microseconds was required during which the chromium ion population was raised to a high energy level. /3/ It would be necessary to restrain the pulser from pulsing the Kerr cell during this period. After satisfactory inversion resulted, lasering could occur. If the Kerr cell was then triggered "off" the first single giant pulse should result. Preparation to repeat the cycle would then be a matter of turning the Kerr cell back "on" while the flash lamp was still emitting light. As long as the flash lamp was on, any controlled repetitive pulsing of the Kerr cell should permit well-spaced laser emissions. It became apparent that, to be really effective in controlling the giant pulse laser output, the modulator had to commence pulsing only after this relatively long initial inversion time had passed. This and one other important

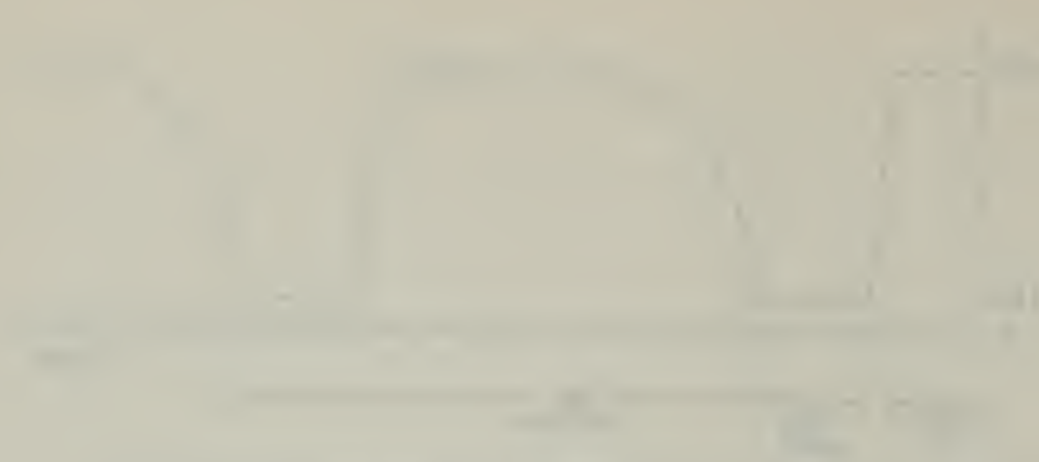

The following text is extremely faint and illegible. It appears to be a series of paragraphs or a list of items, but the content cannot be discerned. The text is centered on the page and occupies most of the lower two-thirds of the document.

feature was kept in mind during the design of the modulator. Other experiments disclosed that immediately after a giant pulse was emitted much less time was required to pump the ruby back above threshold since only a portion of all the excited ions (about 25%) gave up their energy as laser radiation during each successive giant pulse. It was necessary then to excite only this portion of the ions again. (Along with any that gave up their energy in normal fluorescence.) The process is depicted below.

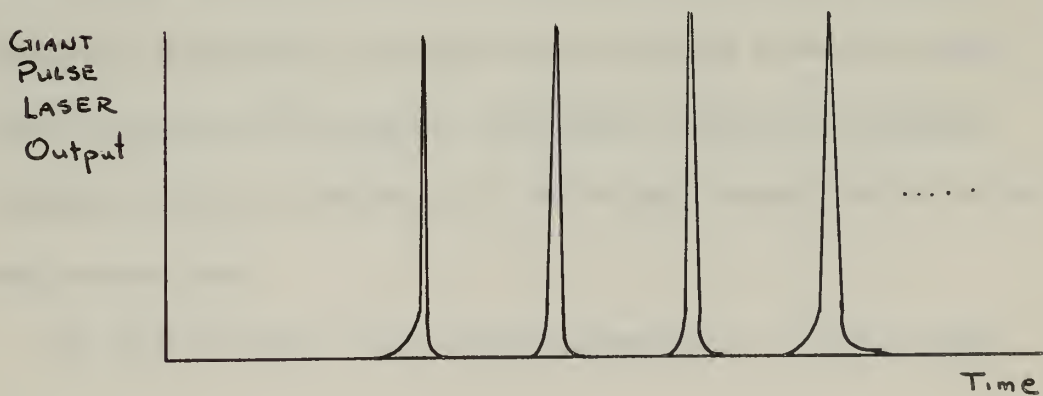
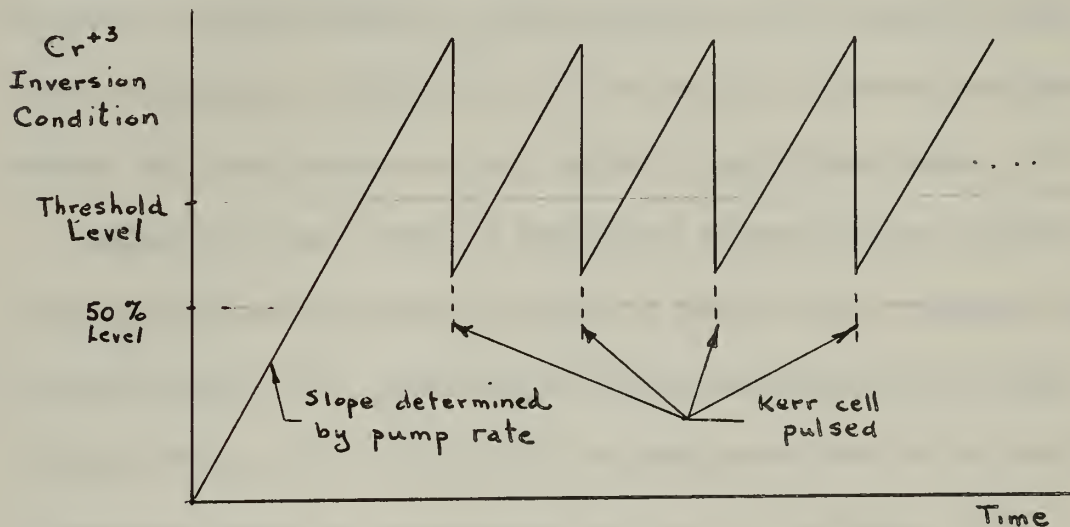

1. The first part of the document discusses the importance of maintaining accurate records of all transactions. This is essential for ensuring the integrity of the financial statements and for providing a clear audit trail. The records should be kept up-to-date and should be easily accessible to all relevant parties.

2. The second part of the document outlines the various methods used to collect and analyze data. These methods include direct observation, interviews, and the use of specialized software. Each method has its own strengths and weaknesses, and it is important to choose the most appropriate one for the specific situation.

3. The third part of the document describes the process of data analysis. This involves identifying patterns, trends, and anomalies in the data. It is important to use statistical techniques to help with this process and to ensure that the results are reliable and valid.

4. The fourth part of the document discusses the importance of communication in the data analysis process. This involves sharing the results of the analysis with all relevant parties and ensuring that they understand the findings and the implications of the data.

5. The fifth part of the document outlines the various ways in which the results of the data analysis can be used. This includes identifying areas for improvement, making strategic decisions, and providing feedback to the relevant parties.

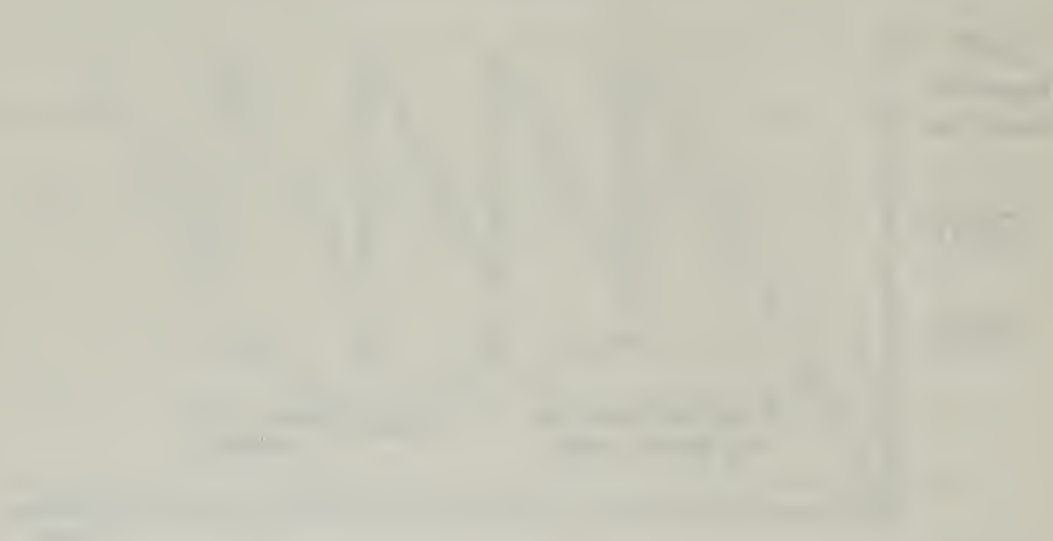

A power supply was available which was able to keep the flash lamp "on" a maximum of 1344 microseconds. Therefore, it was hoped that after allowing  $\cong$  350 microseconds initial inversion time, about 1000 microseconds of additional flash lamp on-time would remain. Thereafter, if the modulator could pulse the Kerr cell every 100 microseconds, a maximum of 10 giant pulses might be obtained when proper synchronization was used.

The basic problem faced, then, involved the development of a modulator or pulser similar in characteristics to that utilized to pulse a radar magnetron. Consequently, it was natural to investigate radar circuits that could produce a fast, narrow, high-voltage pulse. /16/

Normally two main types of modulators categorize most all electronic circuits that are used to develop or generate high voltage pulses as used in radar. /10/ These are the line-type pulser and the hard-tube type pulser. /17/ Generally such modulators involve the storage of electrical energy by some means and then the discharge of this energy through some load (all or a fraction of it) during a pulse. Usually, the line-type discharges a pulse forming network's stored energy into the load through a "soft-tube" (mercury or hydrogen thyatron) switch. However, in a "hard-tube" pulser the switch is a high-vacuum tube.

Up until the time of the author's experiment, all giant pulse

Faint, illegible text, possibly bleed-through from the reverse side of the page. The text is arranged in several paragraphs and appears to be a formal document or report.



work involved the production of only single pulses. The modulators used to develop these pulses are composed of a charged line whose characteristic impedance almost match the "on" impedance of the flash-lamp. The line's stored energy is then discharged through a soft-tube switch with the flash lamp as a load. The hydrogen thyatron soft-tube permits developing pulses with exceedingly short rise times--on the order of 30 nanoseconds. Such rise times make it ideal for fast switching use. However, the greatest problem faced in its use results from the very same effect that permits the fast rise time--the ionized hydrogen. After the gas is ionized and the tube fired, it is very difficult to extinguish the discharge. Only after the plate voltage is reduced and the gas is deionized is the tube extinguished. The deionization time is of the order of 10 microseconds or more, and is dependent upon the tube used, the degree of ionization and the plate voltage. The hard-tube pulser was therefore, considered as more appropriate for the use intended since it offered better control features, though the rise-time might not equal that of a soft-tube pulser.

A simplified schematic of the approach considered to solve the modulator problem using hard tube switches follows:





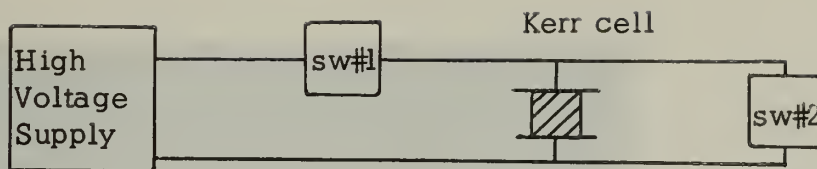

Ideally one switch is instantaneously opened as the other is closed. Thus, when sw#1 is closed and sw#2 is opened, the Kerr cell can be charged to the full value of the supply voltage. After a fixed increment of time, sw#1 is opened and sw#2 is closed, thereby discharging the Kerr cell. (At first it was hoped to use high-vacuum tubes for both switches. A simpler arrangement was finally evolved by replacing sw#1 with a suitable resistor.)

Many circuits were tried on paper incorporating the above approach and three were actually breadboarded. The first circuit attempted, used an interstage coupling pulse transformer. It gave a satisfactory output pulse (see Figure 5) but the output stage had to be operated beyond the rated values of the tubes. It was therefore abandoned. The second circuit contained a bootstrap driver but was also unsatisfactory because of input isolation problems. The third and last breadboarded circuit was the most suitable, and although the rise time of the final output pulse was not that originally



The first part of the document discusses the importance of maintaining accurate records of all transactions. It emphasizes that proper bookkeeping is essential for the success of any business. The text then proceeds to describe various methods for recording and organizing financial data, including the use of ledgers and journals. It also touches upon the significance of regular audits and the role of accountants in ensuring the integrity of the financial statements. The document concludes by highlighting the long-term benefits of diligent financial management and the importance of staying up-to-date with the latest accounting practices.

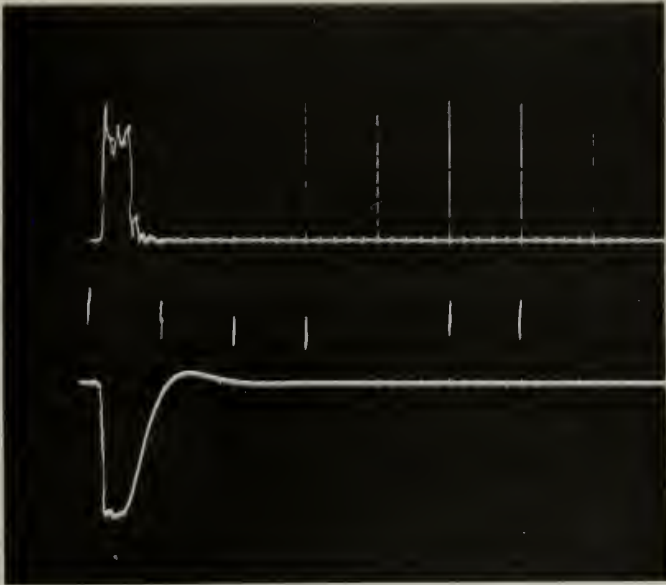

HORIZ.: 200 nsec/cm

UPPER: Input pulse;  
50 volts/cm

LOWER: Modulator  
output pulse;  
5 kilovolts/cm

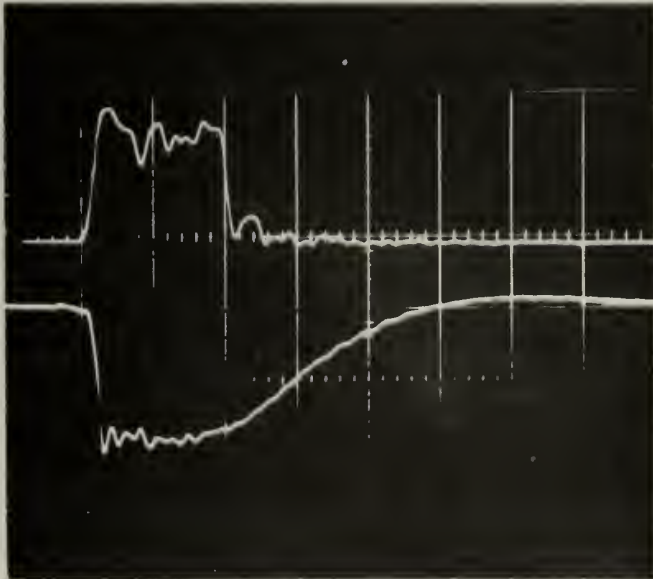

HORIZ.: 100 nsec/cm

Upper: Input pulse;  
50 volts/cm

LOWER: Modulator  
output pulse;  
5 kilovolts/cm

FIGURE 5

OUTPUT WAVEFORMS OF  
FIRST MODULATOR CIRCUIT

1. *Chlorophyll a* (Chl a)  
2. *Chlorophyll b* (Chl b)  
3. *Carotenoids* (Car)  
4. *Xanthophylls* (Xan)  
5. *Lutein* (Lut)



6. *Phycocyanin* (Pcy)  
7. *Algae* (Alg)  
8. *Plankton* (Plk)



arbitrarily stipulated, the results obtained proved useful. It was stated previously that the specifications originally offered required a pulse rise time of 30- to 50-nanoseconds. The pulser that was finally assembled developed a pulse with a 90 nanosecond rise time (10% to 90%). While actual testing was being performed on each circuit, it was determined that the final pulse rise time was a function of two principle factors: the pulse transformer used (with its inherent stray capacitance and leakage inductance), and the grid characteristics of the power tetrodes (4PR60B) which were used in the final stage. The last factor proved to be the most difficult to contend with in that the tubes, though listed as possessing sharp cutoff features did not actually function in this fashion. A plot of the change in plate current ( $\Delta I_p$ ) versus change in grid voltage ( $\Delta E_g$ ) was made to verify this point. From Figure 6, which was drawn for a plate voltage of 1,000 volts, it can be seen that unless the grids of these power tubes were driven into the positive region, the operation was essentially in the non-linear region of the curve. Consequently, the  $g_m$  was a changing number and relatively low. Thus, the tubes turned on too slowly to obtain the rise time desired, which, perhaps in part, accounts for the slower rise time pulse finally obtained. In the first breadboarded circuit, the last stage tubes were biased off at -500 volts. They were then raised to





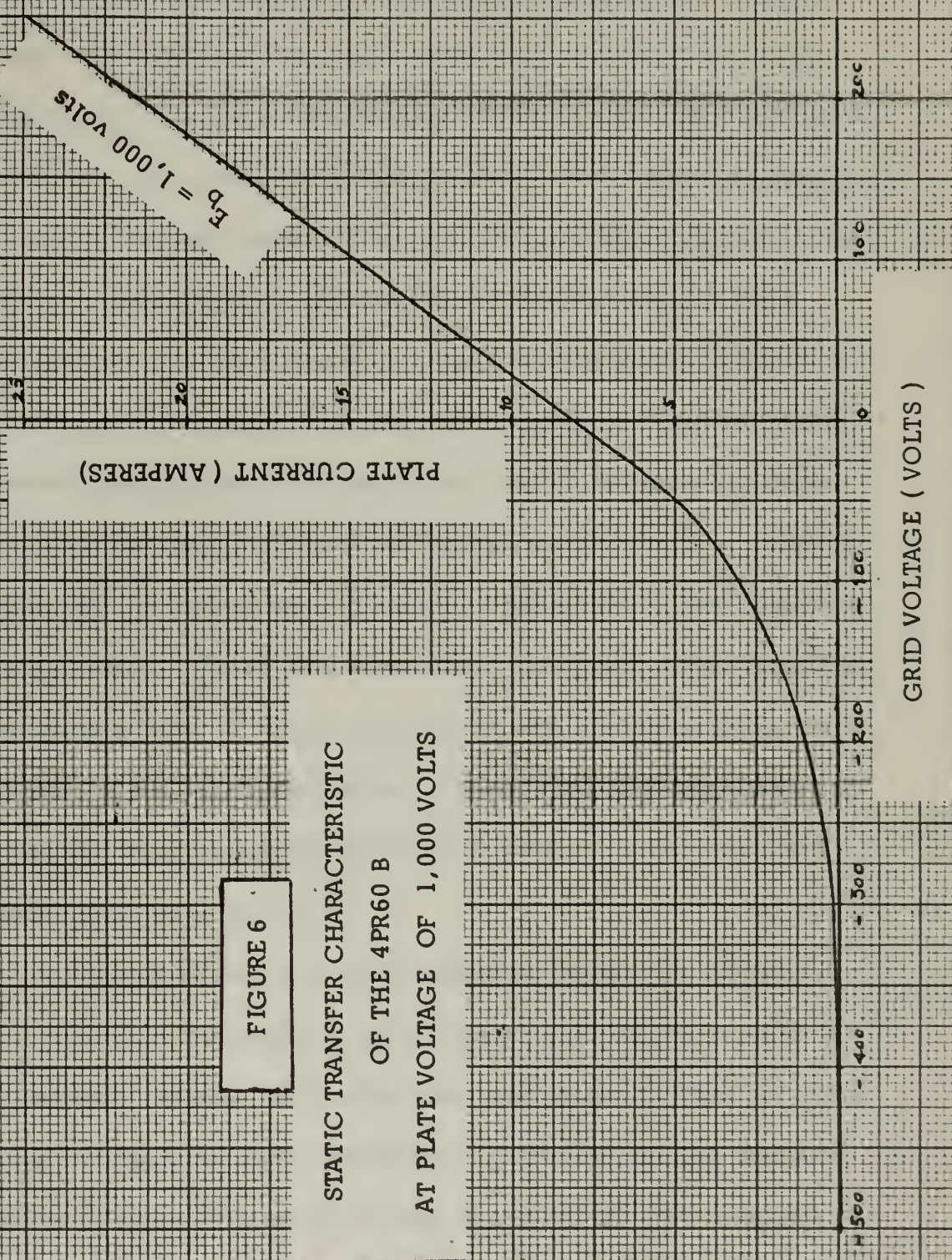

FIGURE 6

STATIC TRANSFER CHARACTERISTIC  
 OF THE 4PR60 B  
 AT PLATE VOLTAGE OF 1,000 VOLTS

PLATE CURRENT ( AMPERES )

GRID VOLTAGE ( VOLTS )





0 volts with a +500 volt pulse from the preceding stage. A glance at Figure 6 will disclose that in the range of from -500 volts to zero volts the  $g_m$  is varying continuously. Thus, the driving pulse never drove the output power tubes into the truly linear region of operation.

In the approach used for the final design it was considered that one of the better ways of pulsing the output stage was to use a circuit in the preceding stage that was not appreciably loaded when the large output tubes were in the "on" condition. This would then pre-empt loading that might be caused by grid current being drawn. It was decided that either of two alternatives was in order, a pulse transformer for impedance matching or a different and more suitable driving circuit. The second alternative was chosen since parts were readily available. A regenerative driver was assembled to act as the heart of the entire modulator. A pulse amplifier stage preceded a triggered blocking oscillator which drove the final high-voltage output stage (see Figure 7).

An Electro-Pulse, Inc. pulse generator (Model 190215) was used to provide the negative input trigger pulse which initiated the entire pulser action. This pulse when more negative than -10 volts turned-off the normally-on first tube, the 6S4-A, causing its plate voltage to swing from about 40 volts to 300 volts. The resultant positive going pulse was coupled into the next stage, the blocking



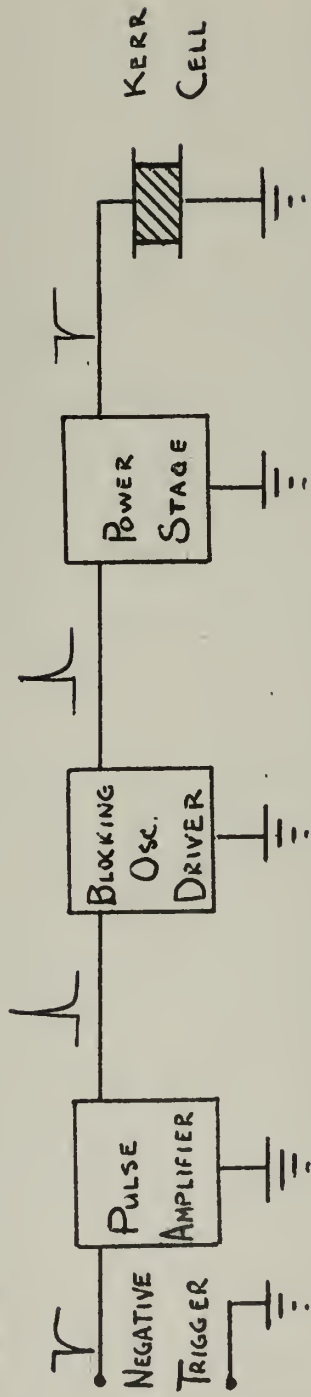

SCHEMATIC OF 10 KC KERR CELL MODULATOR

FIGURE 7



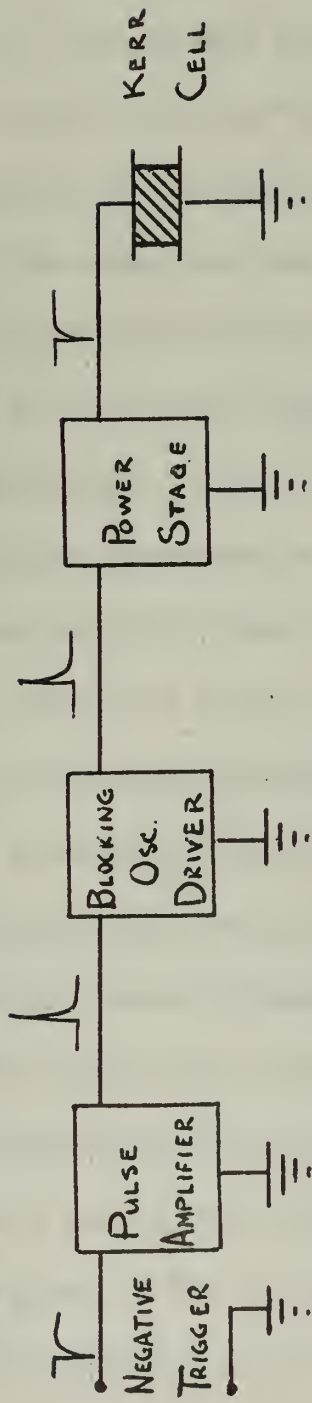

SCHEMATIC OF 10 KC KERR CELL MODULATOR

FIGURE 7



oscillator. The 260-volt pulse out of the first stage triggered the blocking oscillator and started the usual blocking oscillator regenerative action. The resulting plate current developed a positive voltage of 500 volts across an unbypassed 330-ohm cathode resistor. This voltage was then used to pulse "on" two parallel-connected 4PR60B's which made up the last stage. The output of this stage was fed directly to the capacitive energy storage device, the Kerr cell. The 6S4-A (triode) was chosen for the first stage since it could be operated up to 500 volts thereby permitting a large amplitude pulse to be developed in order to trigger the blocking oscillator. It was later determined experimentally that good blocking oscillator action occurred with the 6S4-A plate supply voltage reduced to as low as 300 volts. Below 300 volts, however, the rise time of the pulse triggering the blocking oscillator was increased causing irregular triggering to result and pulse-to-pulse jitter to appear in the output. When triggered hard, the blocking oscillator went into and out of conduction more strongly thereby reducing jitter appreciably, and allowing better control of the last stage output.

The blocking oscillator circuit used was of a standard configuration built around a power triode (the 811-A) capable of developing a large amplitude pulse. A 2:1 (2-winding) pulse transformer (PCA 102-1) was used in the plate and grid circuits. The plate voltage





was 1,000 volts and the tube was biased off at -22 volts. Depending on the amplitude of the trigger pulse into this stage, any variation of the bias from -20 volts to -30 volts caused a change in the slope of the leading edge of the output pulse. A bias more positive than -20 volts caused free-running operation of the blocking oscillator. A diagram of the first two stages is shown in Figure 8.

The final-stage positive driving-pulse was obtained from the unbypassed 330-ohm resistor in the cathode of the 811-A. The output impedance of this cathode follower was determined to be about 90 ohms. Thus, a 93-ohm line (RG62A/U) was used to couple this pulse to the two 4PR60B tubes used in the last stage. The plate supply voltage of these tubes was 10 kilovolts and the screen supply was 1250 volts. The grids were biased in the off-condition at -500 volts. A clamping circuit was also used to assure that the bottom of the input pulse was held at -500 volts. The chokes used in the grids of the second and last stages aided in blocking out of the bias circuits the r.f. components in the pulse. The choice of the particular tube, the 4PR60B, was based on the following features: it had (1) low interelectrode capacitance, (2) a plate voltage capability of 10 kv or greater, (3) the ability to withstand large current pulses for short lengths of time (a plate dissipation of 60 watts) and (4) a high emission capability. Since relatively large



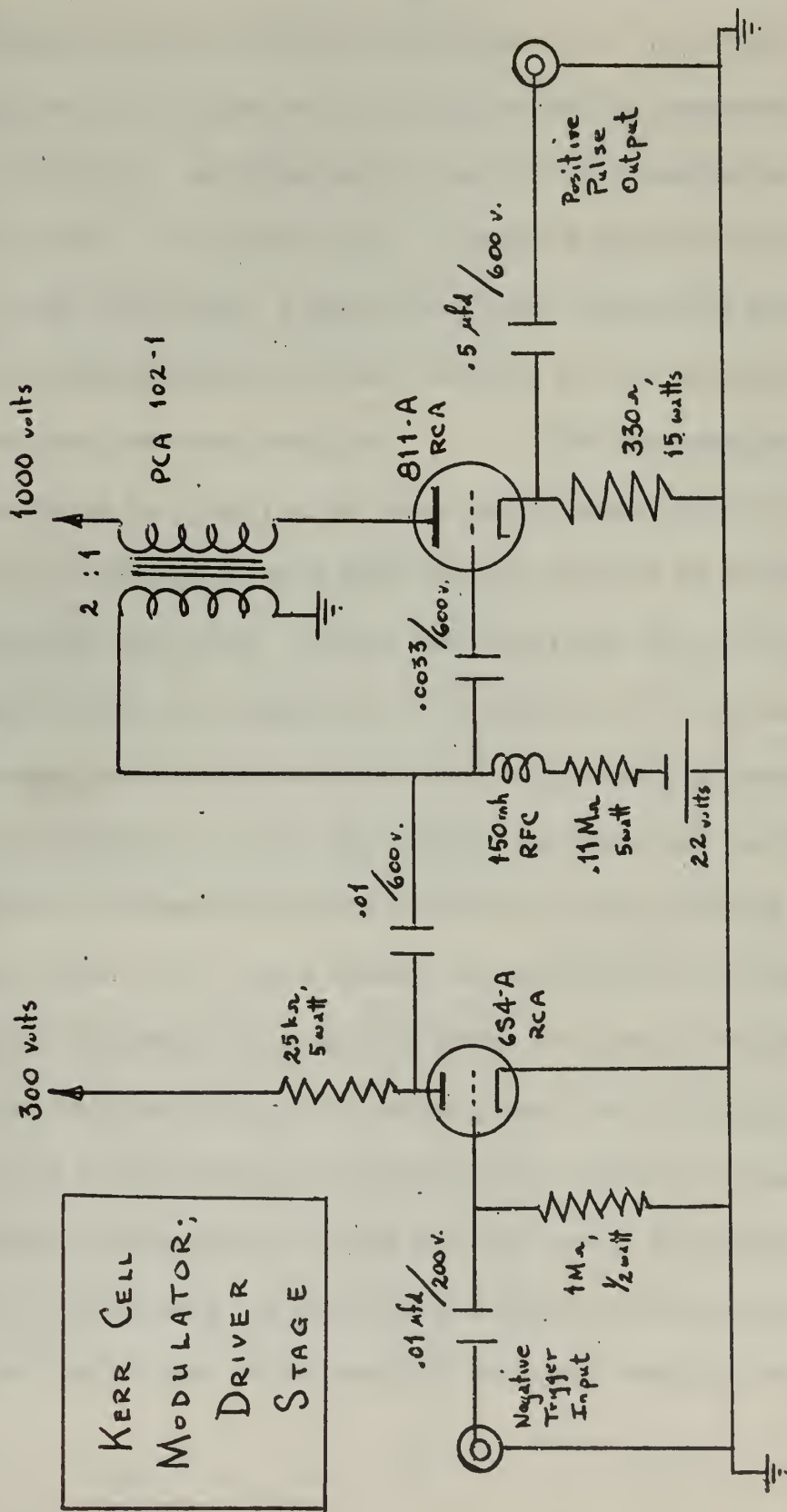

FIGURE 8



pulses of current of short duration were handled in the last stage, it was decided to use two of these tubes in parallel. In addition, small resistors were used in the screen and plate leads to suppress parasitic oscillations. An added feature was also incorporated to assure a fast fall time on the output pulse; inductors were tried in the plate circuit of the last stage. First attempts were unsuccessful since at the high voltage involved, corona and arcing occurred in the "pancake"-type inductors that were available. The most satisfactory solution during the course of the experiment resulted from the use of inductive wire-wound Sprague high-wattage resistors for the load resistor of the last stage. Though this gave little control over the inductance value, the output pulse was improved. A 2000-ohm wire-wound resistor was used which had a characteristic inductance of 110 mh (bridged at 1 kc). The improved waveform can be seen in Figure 9b, as compared to that of Figure 9c which displays the resulting pulse of the circuit without any inductance in the plate. Care was exercised in the amount of series inductance used since excessive overshoot could have turned the Kerr cell off again at 14 kv. (This is the 140%-of-maximum-voltage point in the sine-squared transmission characteristics of the Kerr cell used. See References /11,12/.) Note that a low value of load resistor was necessary to assure that the Kerr cell charge path (when the 4PR60B's were off)





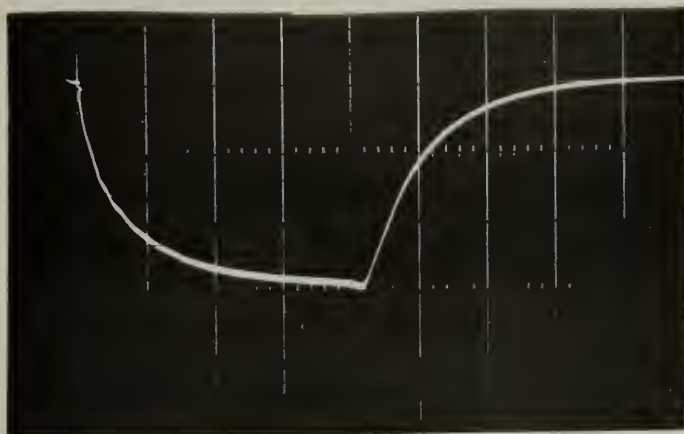

FIGURE 9 a  
 Negative-trigger input  
 pulse to first stage.  
 Time Scale: 100 nanosec./cm  
 Vertical Scale: 10 volts / cm

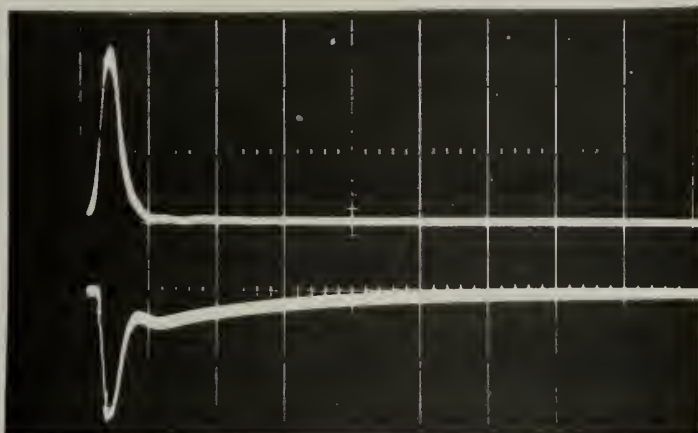

FIGURE 9 b  
 Output pulse from cathode  
 resistor of blocking oscillator  
 circuitry.  
 Vertical Scale: 200 volts/cm  
 Output pulse to Kerr cell  
 ( series inductance in output  
 stage plate circuit ).  
 Vertical Scale: 5,000 volts/cm  
 Time Scale: 1 microsecond/cm

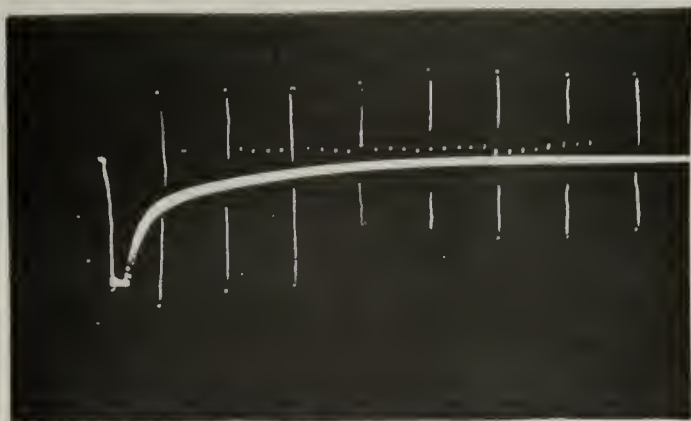

FIGURE 9 c  
 Output pulse to Kerr cell  
 ( no series inductance in output  
 stage plate circuit ).  
 Vertical Scale: 5,000 volts/cm  
 Time Scale: 1 microsecond/cm

PULSES APPEARING WITHIN CIRCUITRY OF MODULATOR





had as low an RC time constant as was practicable in order to give a fast pulse fall time (the time involved in charging the Kerr cell back to 10 kv). A diagram of the output stage is shown in Figure 10.

With no applied pulse and the output tubes "off" the Kerr cell capacitance and stray capacitance ( $\approx 50$  picofarads) was charged by the last stage plate supply through the 2000--ohm load. This gave an R-C charge time constant of 100 nanoseconds which seemed satisfactory for the conditions under which the Kerr cell was to be operated. When the last stage was then turned on the total output capacitance expended its stored energy through the low resistance of the two tubes.

Because of the high cost of Kerr cells it was necessary during the breadboard stage to use a substitute which simulated as closely as possible the Kerr cell's actual characteristics. This required that the author construct a capacitor which presented a capacitive load of about 50 picofarads (includes output, stray, and Kerr cell capacitance) and did not break down with 10,000 volts across its plates. Two plates cut from thin sheet copper were separated by several thin layers of Teflon insulator. Plexiglass outer plates were cut to hold the "sandwich" compactly. It was found that the capacitance was variable from 17 picofarads to 50 picofarads by simply tightening down on the four corner support nuts. The



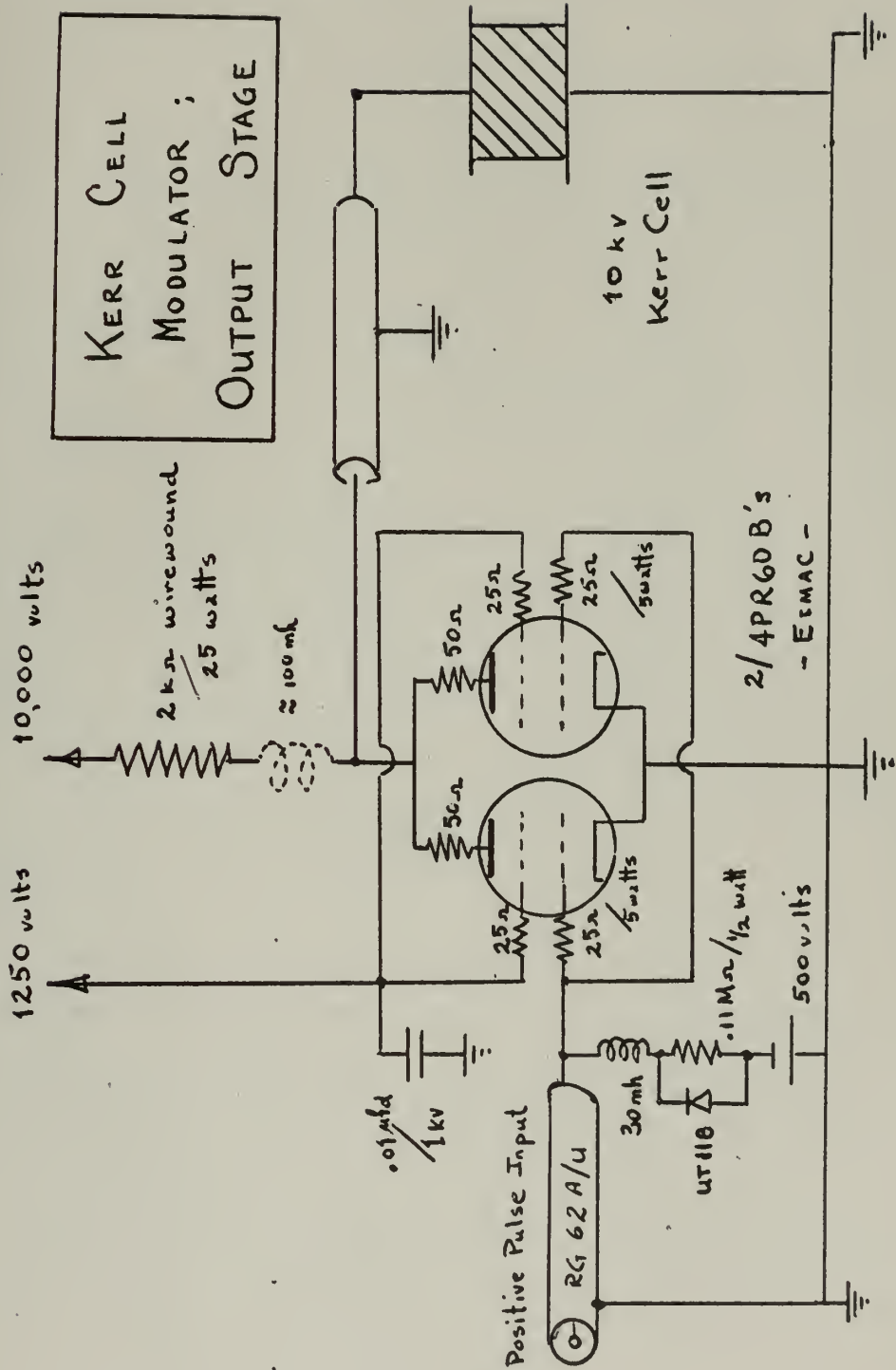

FIGURE 10



arrangement proved quite satisfactory, since results obtained on the breadboard were not too different from those obtained when the actual Kerr cell was used.

116



### 3. Tests And Results

After it was determined that the circuitry would be capable of pulsing the Kerr cell, a complete laser system was assembled. An optical bench 160 cm long was selected as the foundation piece. A heavy metal base mounting bar was then erected on the optical bench. Upon this accurately machined bar was mounted the entire laser cavity with associated optical pieces in their respective special precision-made holders (see Figure 11). At each end of the bar (about 15 1/2 " apart) was placed a dielectrically coated "flat" of high grade glass. The back flat had a 98% reflection characteristic while the front flat had 53%. Adjacent to the back flat and mounted on the bar was the 10 kv Kerr cell. Next in line toward the front flat was the Wollaston prism. Between the prism and the front flat was mounted the ruby's metallic cylindrical cavity containing the special spiral flash lamp, the trigger lead and the 3" ruby. (See Figure 12)

In addition to the optical pieces two magnesium oxide diffuse reflectors were placed on the optical bench--one immediately behind the back flat as protection from back scatter and the other about 4 feet forward of the front flat.

The power supply used to operate the flash lamp was specially designed for Laser operation. It consisted essentially of two





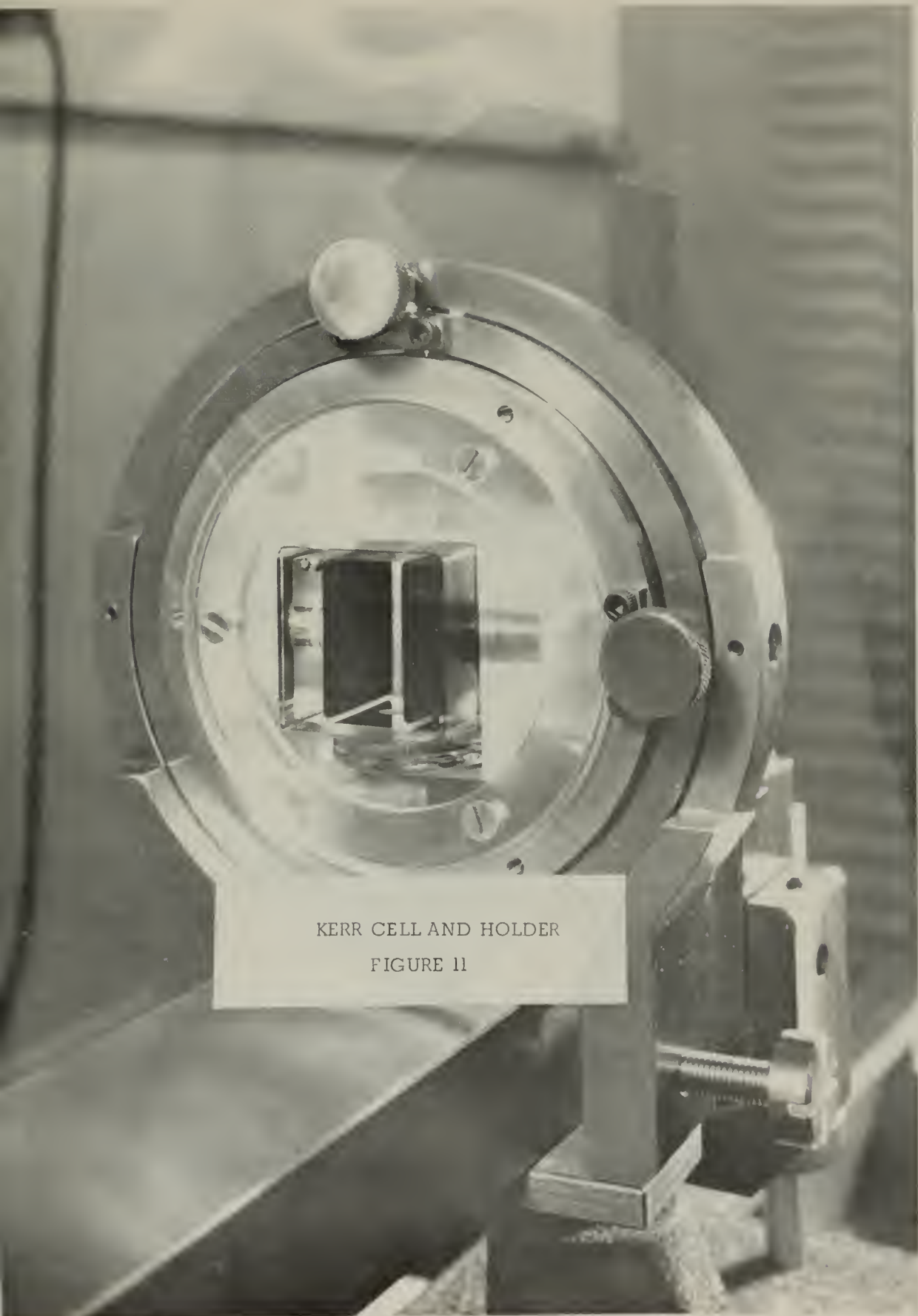

KERR CELL AND HOLDER  
FIGURE 11







separate circuits. One was used to charge a pulse-forming network, the other was used to develop triggers to fire the ignitron switch and to ionize the xenon gas in the spiral flash lamp.

To the output of the charged pulse forming network was attached, in series, the flash lamp and the open ignitron switch. After the line was charged, the main switch was depressed. This introduced one trigger to ionize the flash lamp xenon gas and another to ionize the ignitron pool. Upon this action the energy stored on the pulse forming network was released into the series load represented by the "on"-condition low impedances offered by the flash lamp and ignitron.

The light pulse width, (or the "on"-time of the flash lamp) and the rate at which energy could be injected into the flash lamp were controllable. By suitable choice of up to eight independent "L" sections, light pulse widths of from 168 microseconds to 1344 microseconds in eight equal increments could be chosen by inserting capacitance (13.2 microfarad/section) and inductance (530 microhenries/section) to make up the line.<sup>5</sup> The energy stored on the line was also controllable by varying the charging voltage. Except for the distinct upper limit of the light-pulse width resulting from the

<sup>5</sup> $Z_0$  of this line was 6.3 ohms (see Appendix A).





physical limitation of the power supply, all other parameters could be readily controlled.

The first arrangement used for monitoring the ruby light output utilized an RCA 6217 phototube as a photodiode.<sup>6</sup> This tube was housed in a flat-back coated oblong container. A 270-volt battery was used as its power supply and the tube output was fed through a 50-ohm cable (RG 58 C/U) to a capacitive load which totaled .0014 microfarads (20 picofarad, scope; 187 picofarad, line; and .00120 microfarad, fixed) and shunted the input of the Tektronix-555 oscilloscope. The purpose of this capacitive load was to produce integration of the output pulses. During the test the pulse periods used were in the hundreds of microseconds, and since the output giant laser pulse was on the order of 30 nanoseconds, integration would assure that if a pulse existed its amplitude could be detected by the polaroid ASA 3000 film used when the oscilloscope was set on the 100 microsecond/cm time scale.

During this portion of the experiment no major synchronization circuitry was used. The pulser was started and kept on. The flash lamp was then fired while the polaroid camera shutter was kept open. For the initial period of time from about 200 microseconds to

<sup>6</sup>A later arrangement used a more sensitive photomultiplier with Kodak Wratten (gelatin) neutral density filters.





600 microseconds (depending on the pump rate in joules/sec) the ruby was pumped. When the inversion level went above threshold the ruby was ready to laser. If after this point any pulse from the designed modulator opened the Kerr cell optical shutter, the back reflector was switched instantaneously into the optical path thereby increasing the "Q" of the laser cavity to a point which permitted regeneration. A giant pulse resulted as the energy was released. This was accompanied by a reduction in the upper level inverted  $\text{Cr}^{+3}$  ion population. The Kerr cell was then quickly turned "off" but the flash lamp remained on. Consequently, there was sufficient time for the ruby to be re-pumped. A situation prevailed which was similar to that described on page 11. It appeared possible to continue this process of pumping the ruby, switching the Kerr cell and obtaining a single laser pulse as long as the flash lamp was on and the ruby temperature was not raised excessively. Any rise in temperature was accompanied by an upward shift of the threshold level /4/ and made it more difficult to obtain lasering. As was hoped, when the modulator was operated at 10 kc, about 6 to 8 giant pulses were obtained. (Pictures of the resulting integrated output of laser pulses are shown later in this section.) Since synchronization was not at first attempted only pure chance permitted a large number of laser giant pulses to be emitted. When this occurred,



the pulse sequence of the modulator was such as to allow sufficient time for a large initial inversion above the threshold level to be reached before the Kerr cell was triggered. It was hoped to eventually implement a method of synchronizing all the circuitry in order to assure that the largest number of pulses were emitted during a firing. A schematic of the planned synchronization system is shown in Figure 13. The complete system used to obtain the described experimental results is schematically depicted (without power supplies) in Figure 14, and photographs of the actual equipment are shown in Figure 15. Appendix B also provides pertinent data describing each piece that was used in the system.

During the actual tests of the system the pulser was first started, and the polaroid camera shutter was then held open until the flash lamp was fired. A train of giant pulses, at a controlled repetition rate, was emitted from the air-cooled ruby. The output was monitored by the photodiode whose output was fed to the integrating circuit which paralleled the input of the Tektronix dual-beam (555) oscilloscope. When the flash lamp extinguished, lasering ceased. The camera shutter was then closed. From the photograph taken it was then possible to make a calculation of the energy output in each of the integrated pulses. The energy in these pulses was determined without too much difficulty, since



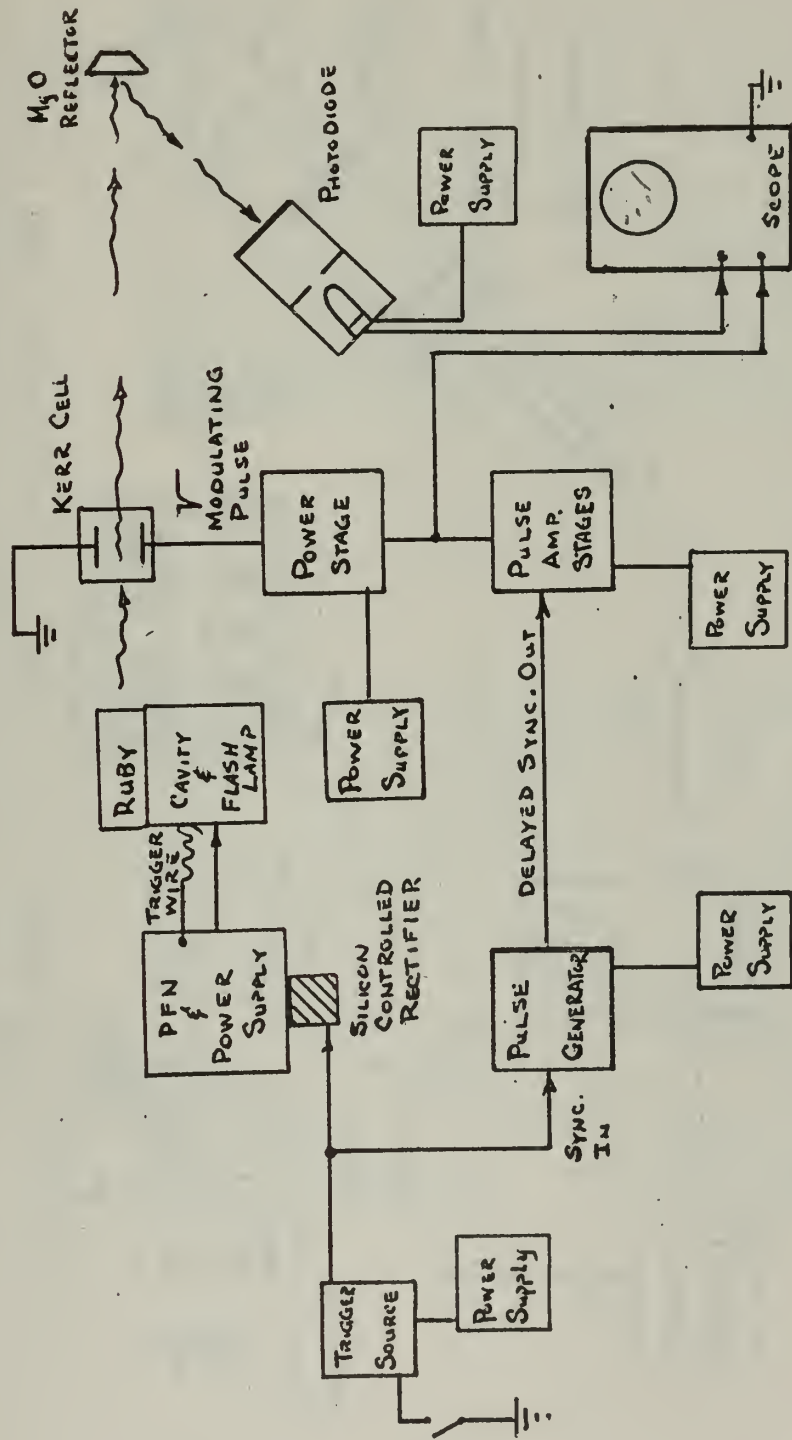

Schematic Of Planned Circuit Arrangement

FIGURE 13



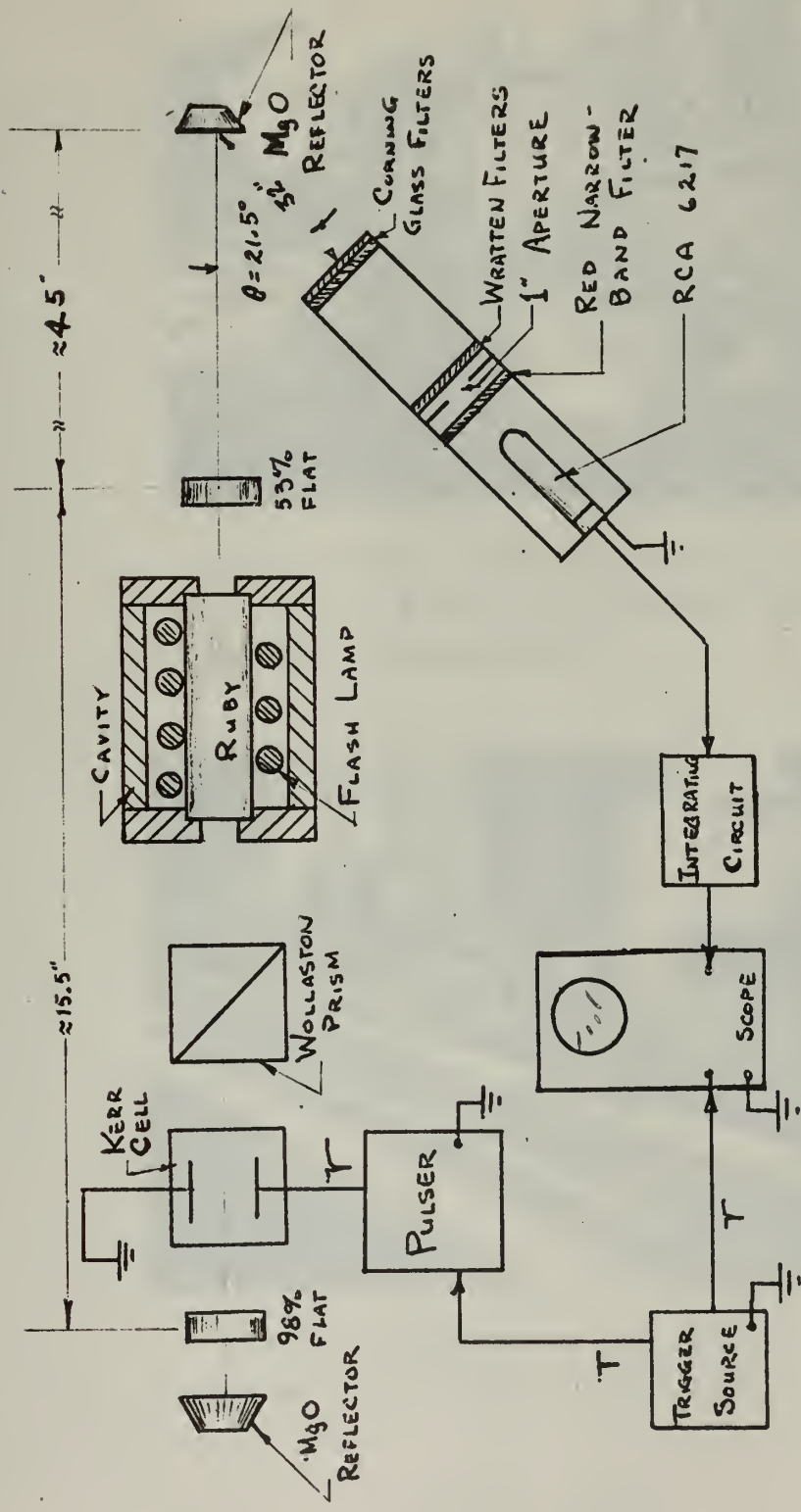

EQUIPMENT ARRANGEMENT TO MEASURE LASER OUTPUT  
 FIGURE 14







LEFT: Output stage supplying pulse  
to Kerr cell in background.  
RIGHT: Driver stage.

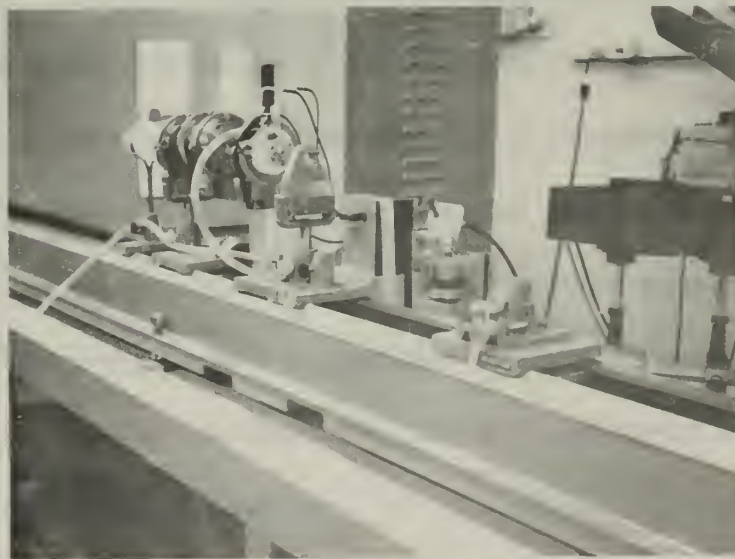

Optical arrangement including  
cavity with forced air cooling.

ACTUAL SYSTEM

FIGURE 15



it was a function of the photodiode sensitivity, the total integration capacitance in the output of the photodiode and into the oscilloscope, the voltage amplitude appearing across the integration capacitance, as read from the photograph, the filters and attenuators used in the optical path, and the general geometry of the readout system. The energy input to the flash lamp was simply a function of the total capacitance in the number of sections of line used and the amount of voltage to which this capacitance was charged. Figure 16 is a group of photographs of the integrated laser output. Time increases from left to right and the leading edge of each step represents a giant laser pulse which resulted when the Kerr cell was pulsed. The giant pulses were so fast that the film responded only to the interpulse decay of the stored energy on the integration capacitance. However, the magnitude of the step-change was a direct representation of the energy that was emitted in each giant pulse. In the following chart, the energy in each pulse is compared as a function of the number of sections used in the pulse forming network that fired the flash lamp. The modulator was operated at a 10 kc rate for these results.



Sections	Energy (mj) in Pulse Number							Total Energy (Joules)	
	1	2	3	4	5	6	7	Output	Input
5	153	204	150	201	153			.86	1200
6	223	121	93	197	147	≈15*		.80	1200
7	115	248	93	188	102	80		.83	1200
8	178	71	233	≈15*	≈16*	259	80	.85	1200

\*See photo of Figure 19.

Energy per pulse at a 10 kc pulse repetition frequency.

Similar results were obtained when the modulator was adjusted to pulse at other repetition frequencies. Photographs taken when the modulator pulsed the Kerr cell at a 4 kc rate are shown in Figure 17. All these photographs disclose that for any fixed input energy, an increase in the number of pulse-forming-network sections used (i.e. an increase in the width of the flash lamp light pulse) generally gave an increased number of output pulses emitted from the laser. Also, an increase in the energy input resulted in laser pulses of larger magnitude. It is felt that the pump rate was a significant factor in determining how large the individual pulses were. Time did not permit a thorough investigation of this aspect





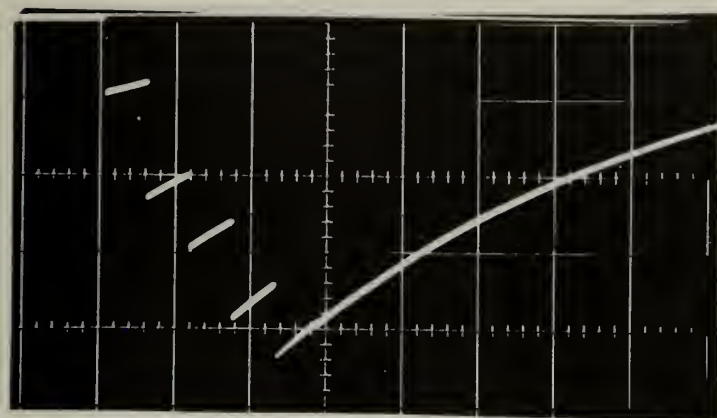

FIVE sections of line  
Total output: 0.86 joules

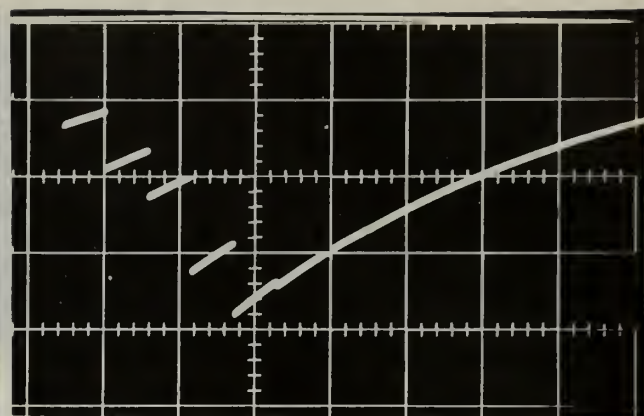

SIX sections of line  
Total output: 0.80 joules

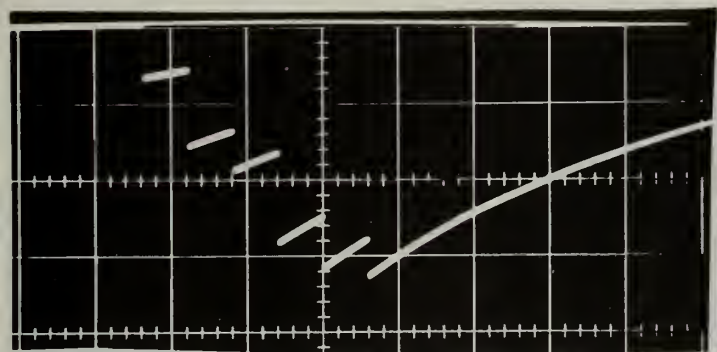

SEVEN sections of line  
Total output: 0.83 joules

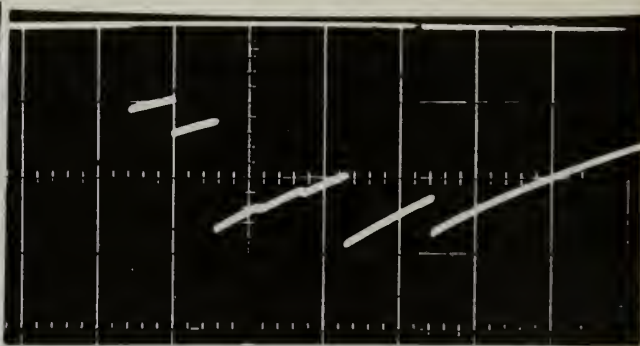

EIGHT sections of line  
Total output: 0.85 joules

Time Scale: 200 microseconds/cm  
Pulse Repetition Frequency: 10 kc  
Input Energy: 1200 joules

INTEGRATED OUTPUT OF GIANT PULSE LASER (10 kc RATE)

FIGURE 16



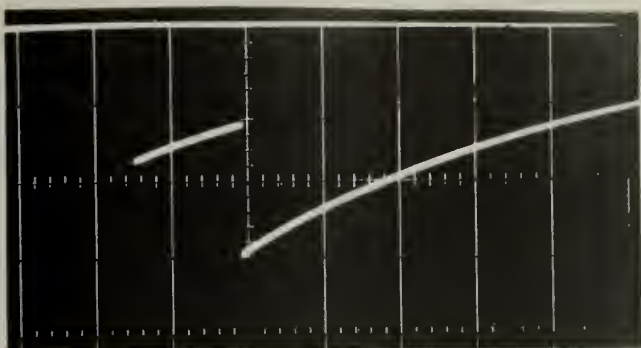

SIX sections of line  
 Total input: 1010 joules  
 Total output:  $\approx 0.54$  joules

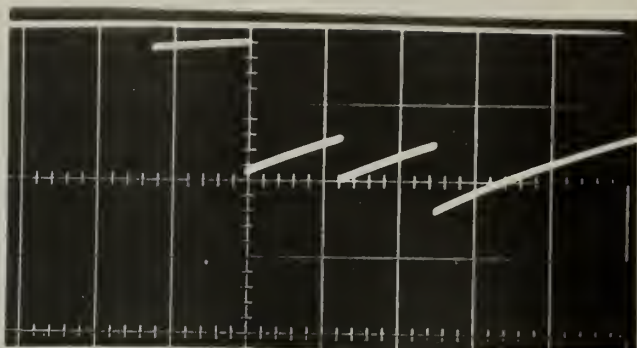

EIGHT sections of line  
 Total input: 1013 joules  
 Total output:  $\approx 0.53$  joules

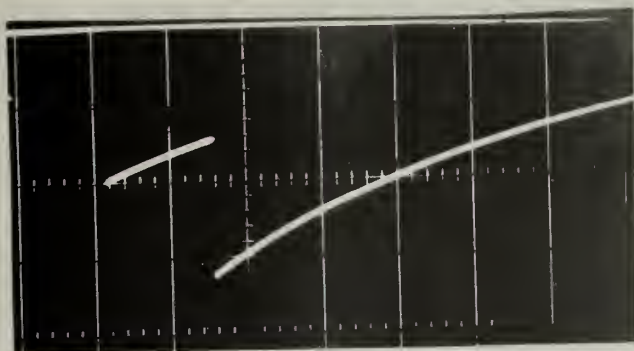

SIX sections of line  
 Total input: 1200 joules  
 Total output:  $\approx 0.60$  joules



EIGHT sections of line  
 Total input: 1200 joules  
 Total output:  $\approx 0.77$  joules

Time Scale: 200 microseconds/cm  
 Pulse Repetition Frequency: 4 kc

INTEGRATED OUTPUT OF GIANT PULSE LASER ( 4 kc RATE)

FIGURE 17



of the system. Though not conclusive, it is noticed that the photographs disclose a trend toward larger giant pulses when the pump rate is higher. Eight sections gave a flash lamp light pulse of about 1340 microseconds whereas five sections gave a light pulse of 840 microseconds. Thus, when a fixed energy of 1200 joules was stored on the pulse forming network the pump rates were respectively  $\approx .9$  joules per microsecond and  $\approx 1.4$  joules per microsecond for the light pulses described above. The shorter light pulse injected more joules per microsecond permitting a large inversion condition to result more quickly. This should give larger amplitude laser pulses. It is noted, however, that the wider pulse of white light obtained from the 8-section line gave the ruby a greater opportunity to have its  $\text{Cr}^{+3}$  ion population inverted more often; consequently, a greater number of pulses resulted even though they were of lower magnitude.

Though the pulser was designed to be operated at a 10 kc rate it was decided to determine if it could be operated at a higher pulse repetition frequency. Figure 18 is a photograph of the pulser output when being operated at a 25 kc rate in comparison with the output when operating at a 10 kc rate. Beyond 25 kc the output tubes began to draw excessive currents to a point where they were operating beyond their ratings. Typical values of voltages and





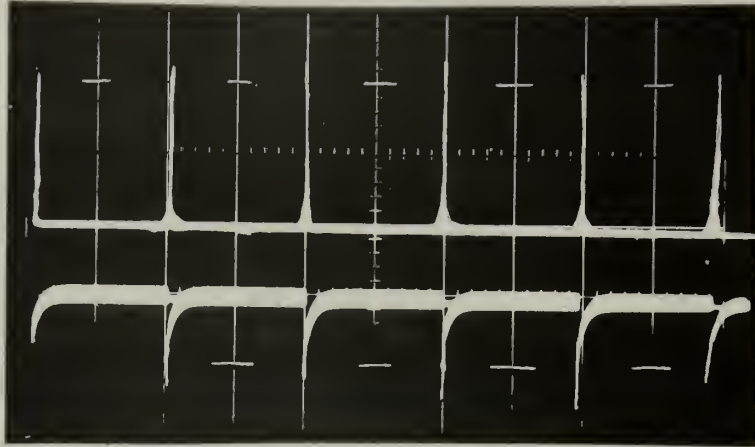

PULSE REPETITION FREQUENCY: 25 kc

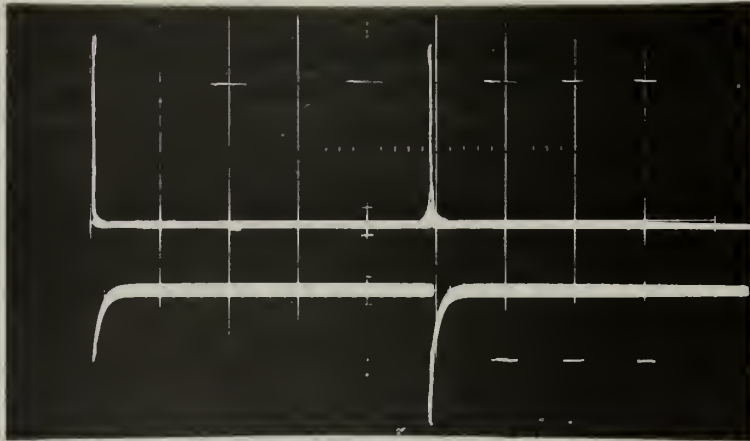

PULSE REPETITION FREQUENCY: 10 kc

Time Scale: 20 microseconds/cm

OUTPUT PULSE; 10 kc vs. 25 kc  
MODULATOR OPERATION

FIGURE 18





currents resulting during operation of the final modulator constructed are shown below for two arbitrary pulse repetition frequencies:

	PULSE REPETITION RATE	
	3.3 kc	10 kc
FIRST STAGE		
$E_{bb}$ (volts)	350	350
$I_b$ (ma)	13.5	13.5
SECOND STAGE		
$E_{bb}$	1200	1200
$I_b$	2.5	6
LAST STAGE		
$E_{bb}$	10,000	10,000
$I_b$	5	15
$E_{sc}$	1200	1200
$I_{sc}$	4	7

Toward the end of the experimental period interesting results were obtained by increasing the width of the input trigger emanating from the laboratory pulse generator. It seems that when the trigger pulse was made much greater than 500 nanoseconds wide the blocking oscillator was able to recycle itself two and even three times (depending on the width of the input trigger pulse). This resulted in double- and triple-pulsing of the Kerr cell with subsequent emission of double and triple giant laser pulses spaced approximately 2.2 microseconds apart. (See Figure 19). The first laser pulse



currents resulting during operation of the final modulator constructed are shown below for two arbitrary pulse repetition frequencies:

	PULSE REPETITION RATE	
	3.3 kc	10 kc
FIRST STAGE		
$E_{bb}$ (volts)	350	350
$I_b$ (ma)	13.5	13.5
SECOND STAGE		
$E_{bb}$	1200	1200
$I_b$	2.5	6
LAST STAGE		
$E_{bb}$	10,000	10,000
$I_b$	5	15
$E_{sc}$	1200	1200
$I_{sc}$	4	7

Toward the end of the experimental period interesting results were obtained by increasing the width of the input trigger emanating from the laboratory pulse generator. It seems that when the trigger pulse was made much greater than 500 nanoseconds wide the blocking oscillator was able to recycle itself two and even three times (depending on the width of the input trigger pulse). This resulted in double- and triple-pulsing of the Kerr cell with subsequent emission of double and triple giant laser pulses spaced approximately 2.2 microseconds apart. (See Figure 19). The first laser pulse



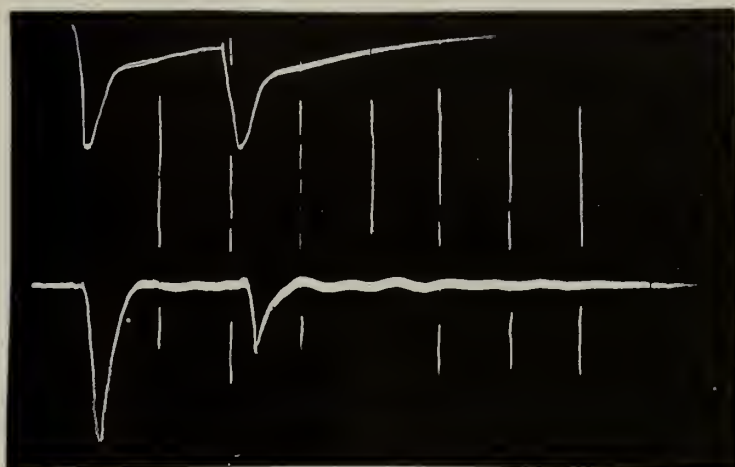

Double-pulsing of  
Kerr cell

Double-pulsing of  
laser output

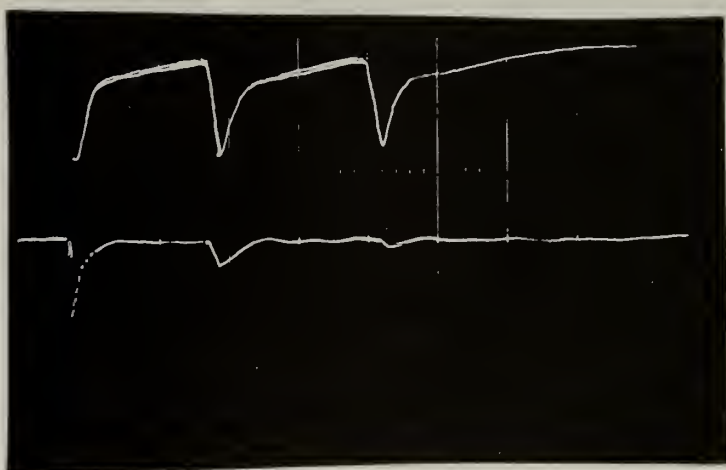

Triple-pulsing of  
Kerr cell

Triple-pulsing of  
laser output

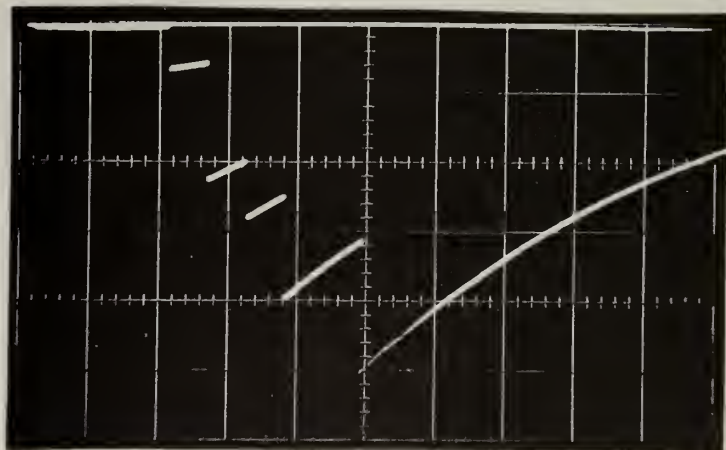

Multiple-pulsing  
of integrated  
output

Time Scale: 200  
microseconds/cm

MULTIPLE - PULSING OF MODULATOR AND LASER

FIGURE 19





was usually quite large; the second and third were much smaller. The short 2.2 microsecond interpulse period did not permit the ruby chromium ions to be inverted sufficiently to provide a significant laser output from the additional pulses. From these results it became apparent then, that a closer investigation was in order, of the integrated output photographs taken during the series of tests where the input trigger pulse had been widened. In the integrated output photograph of Figure 19 what was overlooked before was now obvious. Though barely discernible double-pulsing is apparent in the region of the third and fourth distinct giant pulse step.

A test was carried out to determine what the result would be if the flash lamp was fired with an input energy near its rated maximum of 1500 joules. All 8 sections of the pulse forming network were used in this test in order to obtain the longest light pulse possible with the available equipment. The resulting output is shown in the photograph of Figure 20. This represented the largest total energy output that was obtained in any of the tests performed at a 10 kc repetition frequency.

In order to be sure that each of the laser pulses emitted was truly a giant pulse, a separate test was performed. It was decided to attempt to isolate, at random, one of the pulses that appeared in the train. A slight modification of trigger circuitry was used



and the oscilloscope time scale was set to 100 nanoseconds per centimeter. The first pulse out of the laser was used to trigger the Tektronix. By varying the delay time in the oscilloscope any pulse after the first could then be selected for photographing. Figure 21 shows a photograph of a typical giant pulse. Note the very fast rise time (much less than 10 nanoseconds). Another interesting aspect is the pulse width, which is no more than 40 nanoseconds even at the widest portion of the base. For an idea of the power available in such a pulse an average pulse magnitude of 120 millijoules can be selected from the chart shown previously and divided by the pulse width of 40 nanoseconds. The result is 3 megawatts of average power. (From the pulse shape the peak power can be estimated at about 12 megawatts.) Even with the relatively low energy involved, the pulse power is significant and quite comparable to that in some present-day radar pulses. Yet at the time of this writing no radar can give the narrow beam width, spatial directivity, and coherence which is characteristic of the laser output.



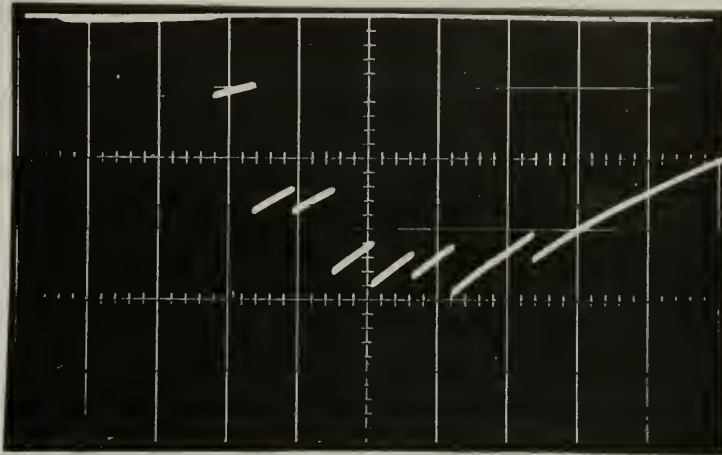

FIGURE 20

INTEGRATED OUTPUT; MAXIMUM INPUT ENERGY  
TO FLASHLAMP

Eight sections of line

Total input: 1513 joules

Total output: 0.98 joules

Pulse Repetition Frequency: 10 kc

Time Scale: 200 microseconds/cm

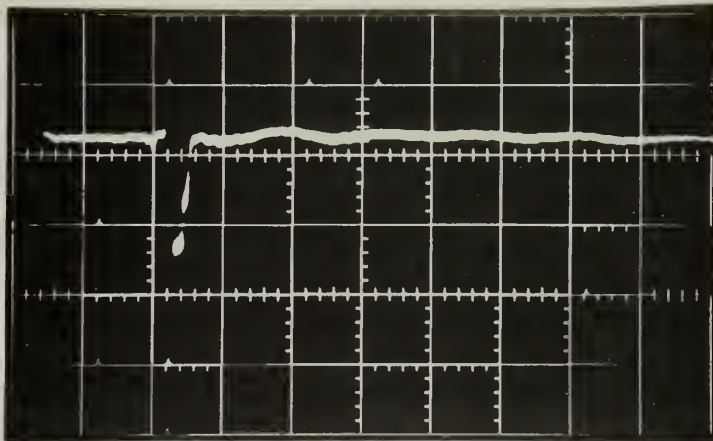

FIGURE 21

ACTUAL GIANT PULSE

Time Scale: 100 nanoseconds/cm



#### 4. Conclusions

The major problem faced in attempting to generate a series of repetitive giant laser pulses was that of electronically modulating the Kerr cell. The circuitry used was successful in that it was capable of producing as many as eight successive laser pulses. Except for the rise time of the pulse driving the Kerr cell the more important specifications of those originally stipulated were met satisfactorily. Those specifications that were not actually met in the final circuitry were mainly refinements necessary to assist in controlling the output more effectively. Their omission did not detract from proving the feasibility of the concept. The experimental results proved the possibility of controlling the Giant Pulse Laser output in applications requiring high peak-power pulses.

The following suggestions are offered to assist in improving the entire modulator system that was used in this experiment:

(a) Remove the coupling capacitor that exists between the first stage and the blocking oscillator. In its place insert a variable, or tapped delay line. This will add a means of controlling the output pulse width.

(b) Select an optimum inductance for insertion into the plate circuit of the last stage to improve the pulse fall time.





(c) Introduce external synchronization circuitry so that the modulator pulse can be forced to commence at a desired time after the ruby has had its ion population pumped high above the threshold level.

(d) Use different tubes in the last stage with sharper cutoff features; or drive the tubes used, into the linear region of operation.

(e) Parallel more than two tubes in the last stage so that the Kerr cell discharges through a lower impedance switch, thereby, improving the pulse rise time. More tubes in parallel will also provide the added capability of operating at higher repetition frequencies than 25 kc without the danger of exceeding the individual tube ratings.

(f) Consider using a different modulator design one which takes advantage of the sine-squared transmission characteristic of the Kerr cell. Normally the Kerr cell is operated in a condition of full voltage or zero voltage; however, the sine-squared feature provides another zero of transmission at the 140% full-voltage point. In the Kerr cell used in this experiment it would mean designing the modulator to instantaneously modify the voltage from 10,000 volts to 14,000 volts. This obviously represents a voltage swing of only 4,000 volts in comparison to the  $\approx 9,000$  volt swing used in this experiment.



(g) If it is desired to use higher pulse repetition rates without revising the circuit entirely, the last stage plate resistance can be increased in order to reduce the average plate current inherent when using larger duty factors. An increase in plate load resistance, however, will necessarily also increase the Kerr cell charge time.

(h) Finally, a more comprehensive testing program should be carried out in which one system parameter at a time is varied through a wide range of values. Such a program would result in a better understanding of the ultimate capabilities of the modulator.



## APPENDIX A

Calculation of the pulse width from, and the characteristic impedance of, the pulse forming network used in the large power supply to pulse the flash lamp.

$$\tau/\text{section} = 2\sqrt{LC} = 2\sqrt{(530 \text{ microhenries})(132 \text{ microfarads})}$$

$$\cong 168 \text{ microseconds/section}$$

Maximum light pulse width:

$$8 \text{ sections } (168) \cong 1344 \text{ microseconds}$$

$$Z_o = \sqrt{\frac{L}{C}} = \sqrt{\frac{530}{13.2}} = 6.32 \text{ ohms}$$





## APPENDIX B

Pertinent data for some of the other equipment and optical pieces used in the 10 kc modulator system:

- (1) Reflecting Flats: Perkin and Elmer. They were dielectrically coated having a 53% and 98% reflectivity at  $6943\text{\AA}$ .
- (2) Laser Cavity: (see Figure B-1) 9.5 cm long by 4.3 cm O.D.
- (3) Flash Lamp: Kemlite (specially made) (see Figure B-2).
- (4) Ruby: Linde and Company  
.05% doping of  $\text{Cr}^{+3}$ ;  $1/4'' \times 2.5''$ .  
 $90^\circ$  optic axis unpolished; end faces flat to  $1/15$  of a wavelength and parallel to within 2.5 seconds.
- (5) Oscilloscope: Tektronix dual-beam (with power supply and associated fast rise time pre-amplifiers); 20 picofarad, 1 megohm input. Photographs of repetitive pulses were taken with a sensitivity setting of 10 millivolts/cm.



- (6) Phototube: RCA 6217 in a photodiode configuration  
Sensitivity  $.75 (10^{-3})$  microamps/  
microwatt (calibrated against an Eppley  
thermopile ).
- (7) Filters:
- (a) Corning glass plate neutral density  
filters placed on front of photodiode  
housing. Attenuation factor of 4 each.
  - (b) Interference filter (red)  
48.8% transmission (measured at  $6943\text{\AA}$   
on Cary photo spectrometer)  
 $100\text{\AA}$  bandwidth; attenuation factor of 2.
  - (c) Wratten filters (Kodak)  
Various N.D. numbers used.
- (8) Kerr Cell: Electro-Optic Company. Rated at 10  
kilovolts. Plates were 4.0 cm x 1.2 cm  
with a .6 cm spacing between. Plates  
immersed in Nitrobenzene and packaged  
in a pyrex container.



- (6) Phototube: RCA 6217 in a photodiode configuration  
Sensitivity  $.75 (10^{-3})$  microamps/  
microwatt (calibrated against an Eppley  
thermopile ).
- (7) Filters: (a) Corning glass plate neutral density  
filters placed on front of photodiode  
housing. Attenuation factor of 4 each.  
(b) Interference filter (red)  
48.8% transmission (measured at  $6943\text{\AA}$   
on Cary photo spectrometer)  
 $100\text{\AA}$  bandwidth; attenuation factor of 2.  
(c) Wratten filters (Kodak)  
Various N.D. numbers used.
- (8) Kerr Cell: Electro-Optic Company. Rated at 10  
kilovolts. Plates were 4.0 cm x 1.2 cm  
with a .6 cm spacing between. Plates  
immersed in Nitrobenzene and packaged  
in a pyrex container.



- (6) Phototube: RCA 6217 in a photodiode configuration  
Sensitivity  $.75 (10^{-3})$  microamps/  
microwatt (calibrated against an Eppley  
thermopile ).
- (7) Filters:
- (a) Corning glass plate neutral density  
filters placed on front of photodiode  
housing. Attenuation factor of 4 each.
  - (b) Interference filter (red)  
48.8% transmission (measured at  $6943\text{\AA}$   
on Cary photo spectrometer)  
 $100\text{\AA}$  bandwidth; attenuation factor of 2.
  - (c) Wratten filters (Kodak)  
Various N. D. numbers used.
- (8) Kerr Cell: Electro-Optic Company. Rated at 10  
kilovolts. Plates were 4.0 cm x 1.2 cm  
with a .6 cm spacing between. Plates  
immersed in Nitrobenzene and packaged  
in a pyrex container.





- (6) Phototube: RCA 6217 in a photodiode configuration  
Sensitivity  $.75 (10^{-3})$  microamps/  
microwatt (calibrated against an Eppley  
thermopile ).
- (7) Filters:
- (a) Corning glass plate neutral density  
filters placed on front of photodiode  
housing. Attenuation factor of 4 each.
  - (b) Interference filter (red)  
48.8% transmission (measured at  $6943\text{\AA}$   
on Cary photo spectrometer)  
 $100\text{\AA}$  bandwidth; attenuation factor of 2.
  - (c) Wratten filters (Kodak)  
Various N.D. numbers used.
- (8) Kerr Cell: Electro-Optic Company. Rated at 10  
kilovolts. Plates were 4.0 cm x 1.2 cm  
with a .6 cm spacing between. Plates  
immersed in Nitrobenzene and packaged  
in a pyrex container.



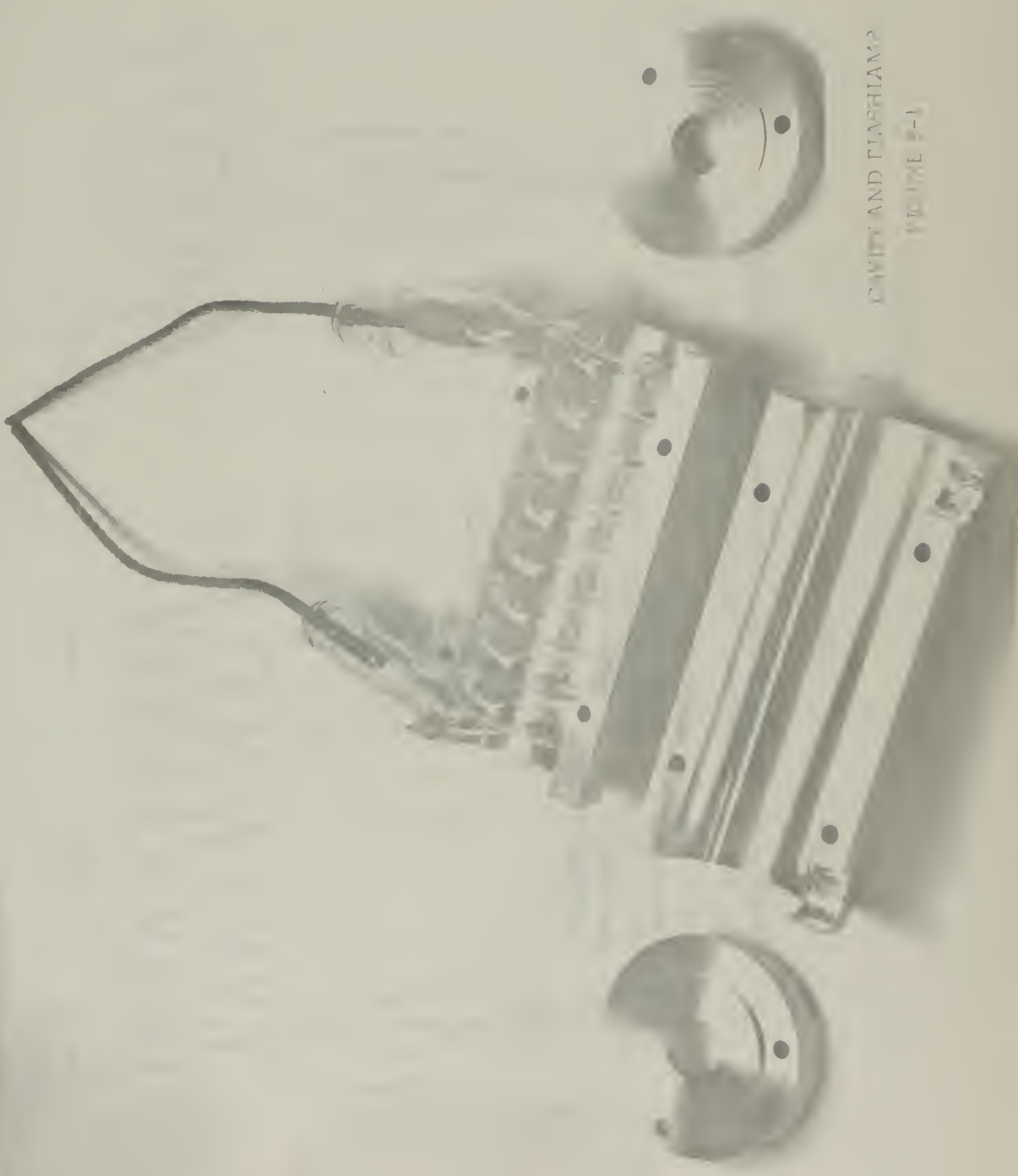

CAVITY AND FLASHLAMP  
FIGURE 8-1



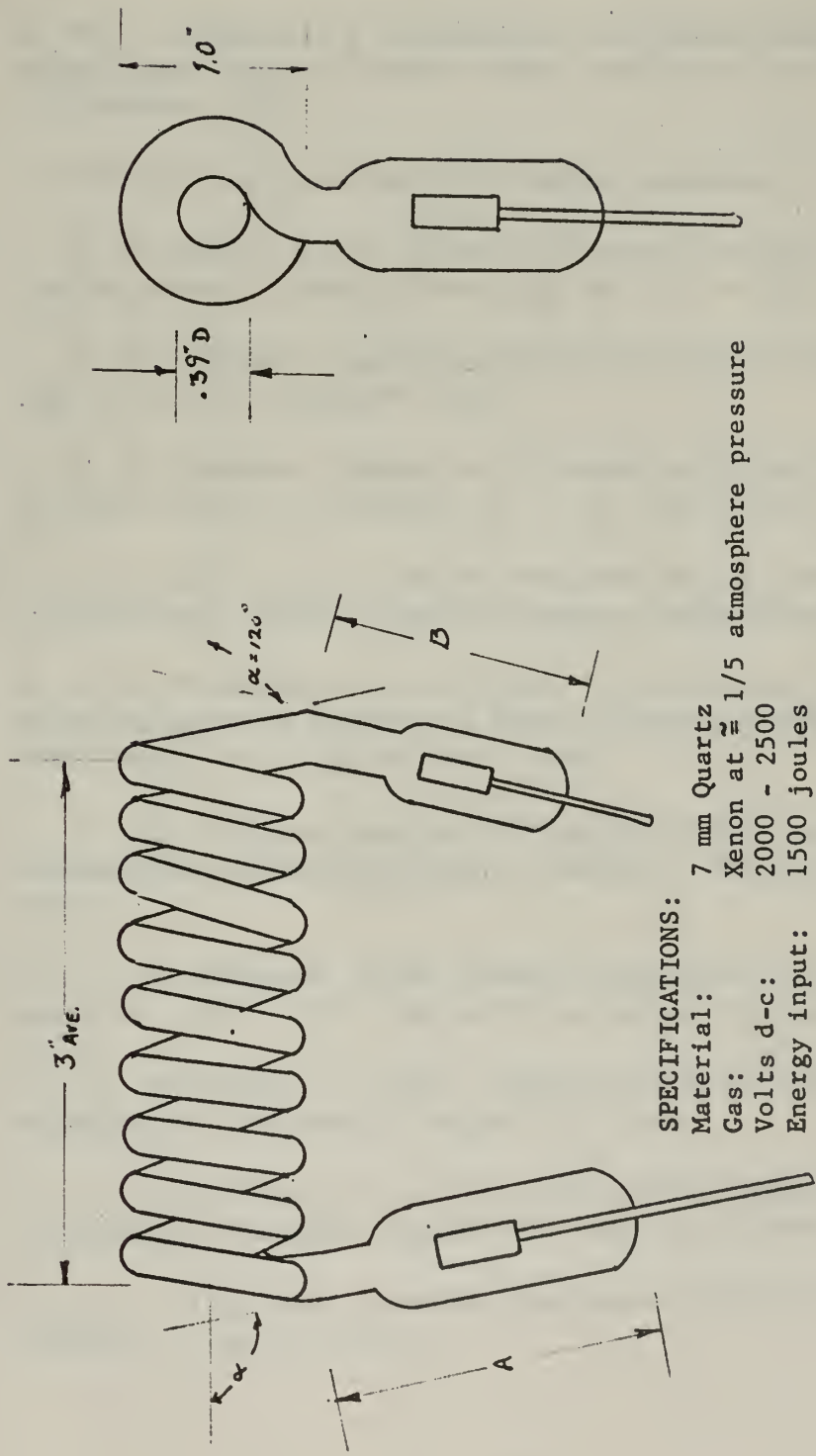

**SPECIFICATIONS:**

- Material: 7 mm Quartz
- Gas: Xenon at  $\approx 1/5$  atmosphere pressure
- Volts d-c: 2000 - 2500
- Energy input: 1500 joules

"A" and "B" dimensions: 1 1/2" to 2" nominal.  
 Cylindrical tube 3" X 3/8" fits inside helical winding.

FLASH LAMP

FIGURE B-2





## BIBLIOGRAPHY

1. F. J. McClung, R. W. Hellwarth, Giant Optical Pulsations from Ruby, *J. Appl. Phys.*, 33, pp. 828-829, March, 1962.
2. M. L. Stitch, E. J. Woodbury, J. H. Morse, Repetitive Hair-Trigger Mode of Optical Maser Radiation, *Proc. IRE*, 49, 10, October, 1961.
3. Private communication with Hughes personnel.
4. I. D. Abella, H. Z. Cummins, Thermal Tuning of Ruby Optical Maser, *J. Appl. Phys.*, 32, pp. 1177-1178, June, 1961.
5. T. H. Maiman, Stimulated Optical Radiation in Ruby, *Nature*, 187, 6, p. 493, August 6, 1960.
6. T. H. Maiman, Optical and Microwave-Optical Experiments In Ruby, *Phys. Rev. Letters*, 4, 11, p. 564, June 1, 1960.
7. C. V. Smith, M. L. Stitch, Applications of Lasers to Ranging and Tracking, Hughes Aircraft Company Memorandum, March, 1962.
8. A. E. J. Holtham, H. A. Prime, The Operation and Photographic Characteristics of a Kerr-cell Type of Electro-optical Shutter, *Proc. Phys. Soc.*, 63, Pt. 8-B, 1950.
9. J. Kerr, On a New Relation Between Electricity and Light, *Philosophical Magazine (London, England)*, 4th Series, 1, p. 337, 1875.
10. L. N. Ridenour, *Radar Systems Engineering*, 1, McGraw-Hill Book Co., Inc., 1947, (Radiation Laboratory Series).
11. S. M. Hauser, H. Quan, Applying the Kerr Cell to Nanosecond Photography, *Electronics*, August 25, 1961.
12. A. M. Marshall, F. L. Poole, An Electro-Optical Shutter for Photographic Purposes, *Trans. Am. Inst. Elect. Engr.*, 68, 1, 1949.
13. E. F. Kingsbury, The Kerr Electrostatic Effect, *Rev. Sci. Instrum.*, 1, p. 22, 1930.



14. F. G. Dunnington, The Electro-optical Shutter - Its Theory and Technique, Phys. Rev., 38, pp. 1506-1534, October 15, 1931.
15. B. Rossi, Optics, Addison-Wesley Publishing Co., Inc., 1959.
16. J. F. Reintjes, G. T. Coate, Principles of Radar, 3rd edition, McGraw-Hill Book Co., Inc., 1952.
17. G. N. Glasoe, J. V. Lebacqz, Pulse Generators, 5, McGraw-Hill Book Co., Inc., 1959, (Radiation Laboratory Series).















thesG548

A 10kc Kerr cell modulator for the produ



3 2768 002 13095 7

DUDLEY KNOX LIBRARY